

U.S. Department
of Transportation

Publication No. FHWA-RD-99-085
March 1999

**Federal Highway
Administration - Final Approval Pending**

U.S. Department
of the Interior

U.S. Geological Survey - Approved February 1999

**Portable Instrumentation for Real-Time
Measurement of Scour at Bridges**

Research, Development, and Technology
Turner-Fairbank Highway Research Center
6300 Georgetown Pike
McLean, Virginia 22101-2296

NOTICE

This document is disseminated under the sponsorship of the U.S. Department of Transportation in the interest of information exchange. The U.S. Government assumes no liability for the contents or the use thereof.

This report does not constitute a standard, specification, or regulation. The U.S. Government does not endorse products or manufacturers. Trade or manufacturers' names appear herein only because they are considered essential to the objective of this document.

1. Report No. FHWA-RD-99-085		2. Government Accession No.		3. Recipient's Catalog No.	
4. Title and Subtitle PORTABLE INSTRUMENTATION FOR REAL-TIME MEASUREMENT OF SCOUR AT BRIDGES				5. Report Date March 1999	
				6. Performing Organization Code	
7. Author (s) David S. Mueller and Mark N. Landers				8. Performing Organization Report No.	
9. Performing Organization Name and Address U.S. Geological Survey Water Resources Division 9818 Bluegrass Parkway Louisville, KY 40299				10. Work Unit No. (TRAIS)	
				11. Contract or Grant No. DTFH61-91-Y-30036	
12. Sponsoring Agency Name and Address Office of Engineering R&D Federal Highway Administration 6300 Georgetown Pike McLean, VA 22101-2296				13. Type of Report and Period Covered Final Report: 1991-1998	
				14. Sponsoring Agency Code	
15. Supplementary Notes Contracting Officer's Technical Representative (COTR): J. Sterling Jones, HNR-10					
16. Abstract Portable scour-measuring systems were developed to meet the requirements of three different applications: bridge inspections, limited-detail data collection, and detailed data collection. A portable scour-measuring system consists of four components: (1) the instrument(s) for making the measurement, (2) a system for deploying the instrument(s), (3) a method to identify and record the horizontal position of the data collected, and (4) a data-storage device. Commercially available instruments were evaluated for use in measuring scour at bridges during floods. The systems developed consist primarily of commercially available instruments, which were modified and interfaced to achieve the required functionality. The bridge-inspection system is intended for use by bridge inspectors to measure the streambed elevation around piers and abutments to ensure the stability of bridge foundations. The system developed and described here uses a low-cost echo sounder to measure the water depth and a tethered float to deploy the transducer around the bridge piers and abutments. Data are recorded on a chart-recording echo sounder or in a notebook if the echo sounder has only a graphical or numerical display. The U.S. Geological Survey has collected limited-detail data on scour at bridges for several years. The only additional development for limited-detail data collection was to use a float to deploy the transducer of an echo sounder, which allows data to be collected beneath the bridge and along the sides of the piers. The detailed data collection system allows collection of detailed channel bathymetry and hydraulic data at the bridge and in the approach and exit reaches. Channel geometry is measured using a digital echo sounder; three-dimensional velocity profiles are collected using a broadband acoustic Doppler current profiler (BB-ADCP); and the position of the data collected is measured using either a range-azimuth positioning system or a differential global positioning system. All data are transmitted to shore where they are stored on a field computer. Because of the spatial coverage required of detailed data, the instruments must be deployed from a boat. Although manned boats are frequently used on some streams, safety and access considerations, particularly on small streams, led to the development of a remote-control boat. The remote-control boat consists of a flat-bottom jon boat powered by an outboard engine with servos and switches mounted directly on the engine to allow control of the engine by use of standard recreational remote controls. All systems developed have been used successfully during major floods and allow data to be collected more efficiently and in more detail than was previously possible.					
17. Key Words Bridge scour, instrumentation, data collection			18. Distribution Statement		
19. Security Classif. (of this report) Unclassified		20. Security Classif. (of this report) Unclassified		21. No. of Pages 79	22. Price

TABLE OF CONTENTS

<u>Section</u>	<u>Page</u>
CHAPTER 1: INTRODUCTION	1
GENERAL	1
PURPOSE AND SCOPE	1
OVERVIEW OF SCOUR-MEASUREMENT SYSTEMS	1
Bridge-Inspection System	2
Limited-Detail Data-Collection System	3
Detailed Data-Collection System	4
CHAPTER 2: EVALUATION OF INSTRUMENTATION	7
GENERAL	7
STREAMBED-ELEVATION MEASUREMENT	7
Sounding Weights	7
Echo Sounders	8
Theoretical Considerations.....	8
Non-Recording Echo Sounders.....	14
Analog-Recording Echo Sounders	16
Digital-Output Echo Sounders.....	16
Multibeam and Scanning Sonar.....	17
VELOCITY-MEASUREMENT INSTRUMENTATION	19
HORIZONTAL POSITIONING SYSTEMS	22
Visual and Physical Measurement Systems	22
Range-Range Systems	23
Global Positioning Systems	25
Range-Azimuth Systems	26
VESSEL-MOTION COMPENSATION	29
Theoretical Considerations	30
Fluid Systems	33
Pendulum Systems	33
Gyroscope Systems	33
Range-Range Systems	34
Accelerometer Systems	34
Combination Systems	35
DATA RECORDING AND STORAGE	35
CHAPTER 3: EVALUATION OF DEPLOYMENT SYSTEMS	37
GENERAL	37
DEPLOYMENT FROM THE BRIDGE DECK	37
Non-Floating Deployment Systems	37

Floating Deployment Systems	41
DEPLOYMENT FROM THE WATER SURFACE	42
Manned vessels	42
Unmanned vessels	43
SUMMARY	45
CHAPTER 4: EQUIPMENT DEVELOPMENT	47
GENERAL	47
INSPECTION-LEVEL DATA COLLECTION	47
LIMITED-DETAIL DATA COLLECTION	53
DETAILED DATA COLLECTION	54
Development of Instrumentation	54
Development of Deployment System	59
CHAPTER 5: PERFORMANCE OF PORTABLE SCOUR-MEASURING SYSTEMS	69
GENERAL	69
INSPECTION-LEVEL DATA COLLECTION	69
LIMITED-DETAIL DATA COLLECTION	70
DETAILED DATA COLLECTION	70
CHAPTER 6: SUMMARY AND CONCLUSIONS	75
REFERENCES	77

LIST OF FIGURES

<u>Figure</u>	<u>Page</u>
1. Illustration of transducer beamwidth	9
2. Effect of beamwidth on diameter of acoustic footprint	9
3. Effect of beamwidth on measured depth.....	10
4. Example of side echoes from bridge pier	11
5. Potential vertical and horizontal errors in acoustic measurements caused by instability of the deployment platform	13
6. Illustration of undulating streambed with tilted transducer.....	14
7. Coverage of scanning sonar system.....	18
8. Illustration of swath hydrographic-survey system	18
9. Beam pattern and velocity homogeneity for broadband acoustic Doppler current profiler.....	20
10. Position location using a range-range positioning system.....	24
11. Range-azimuth positioning systems.....	27
12. Illustration of vessel motion	29
13. Definition sketch for pitch-and-roll compensation equations.....	31
14. Vertical- and horizontal-measurement errors resulting from inaccurate measurements of pitch and roll (shown for a pitch and roll of 10°).....	32
15. Truck-mounted hydrologic-equipment crane deploying transducer mounted on the bottom of a Columbus weight	38
16. Four-wheel base with standard stream-gaging equipment	38
17. Two-wheel base modified for bridge-scour data collection	39

18.	Bridge board with standard stream-gaging equipment	39
19.	Closeup of transducer mounted to the bottom of a Columbus weight	40
20.	Deployment using rubber balls for flotation.....	42
21.	Soft carrying cases and battery belt for echo sounders.....	49
22.	Chart-recording echo sounder being used with carrying case and battery belt	49
23.	Numerical-display echo sounder mounted in box with batteries and area for notepad.....	50
24.	Knee board modified to deploy a transducer.....	51
25.	PVC-pontoon float for deploying a transducer	52
26.	Water skis modified to deploy a transducer	52
27.	Two-piece range-azimuth system used for detailed data collection	55
28.	Waterproof case with electronics for shore station	58
29.	Waterproof case with electronics for transmitting data to the shore station.....	58
30.	Waterproof case with digital echo sounder used for detailed data collection	58
31.	Typical shore station.....	59
32.	Illustration of swath boat design.....	60
33.	Swath boat being tested	62
34.	Front view of engine with radio controls installed.....	63
35.	Side view of engine showing throttle servo and shutoff relay	63
36.	Instability of swath boat during testing	63
37.	Steering servo and linkage	65
38.	Rear view of engine showing dual steering servos	65
39.	Polyethylene twin-hull boat tested for use as a remote-control boat.....	66

40.	Flat-bottom jon boat modified for use as a remote-control boat.....	66
41.	Instrument well used in jon boat.....	66
42.	Remote-control boat being tested near a pier	67
43.	Modified knee board showing cable attachment for use directly below the upstream edge of a bridge	69
44.	Three-dimensional mesh of channel bathymetry near pier 8 on Interstate 255 over the Mississippi River near St. Louis, Missouri, July 17, 1993.....	71
45.	Velocity profile downstream from U.S. Highway 32 over the Sacramento River near Hamilton City, California	72
46.	Depth-integrated velocity vectors collected using the remote-control boat and a 1,200-kHz BB-ADCP at U.S. Route 45 over Skillet Fork River near Mill Shoals, Illinois	73
47.	Real-time display of velocity magnitudes at the upstream edge of U.S. Route 45 over the Skillet Fork River near Mill Shoals, Illinois.....	73

LIST OF TABLES

<u>Table</u>	<u>Page</u>
1. Design goals and actual specifications for the remote-control boat	61

CHAPTER 1: INTRODUCTION

GENERAL

Bridge scour is a longstanding transportation-engineering problem. Scour of the streambed at bridge piers and abutments has resulted in more bridge failures than all other causes in recent history.⁽¹⁾ Methods to estimate the magnitude of scour at bridges are commonly based only on laboratory studies; however, laboratory studies are limited in their applicability and reliability for field conditions if they do not adequately reproduce the effects of turbulence, flow instability, heterogeneous bed material, and other factors present in natural rivers. Until the 1980s, little emphasis was placed on the collection of field data to study scour processes at bridges or to verify the applicability of published equations and methods.

Field data are needed to improve design and evaluation techniques. Bridges may need to be inspected during floods to ensure public safety. Analysis of the maximum scour and associated hydraulic parameters requires real-time measurements. However, development of integrated systems for measuring scour and (or) the associated hydraulic parameters during major floods received little research before 1991. Development of portable scour-measurement systems requires design, testing, and evaluation of instruments for application to bridge inspections and data collection for scientific investigations.

PURPOSE AND SCOPE

This report describes the advantages and disadvantages of selected instruments and deployment systems for making real-time scour measurements at bridges during floods. The development and performance of systems that meet three specific objectives—bridge inspection, limited-detail data collection, and detailed data collection—are described.

OVERVIEW OF SCOUR-MEASUREMENT SYSTEMS

The instrumentation for a scour-measurement system depends on the measurement objective, which can be categorized into one of three categories—bridge inspection, limited-detail data collection, and detailed data collection. Bridge-inspection measurements help inspectors determine bridge safety during routine and emergency inspections. Limited-detail data are used primarily for evaluating published scour equations and exploring relations between scour and explanatory variables. Detailed data are used primarily to develop a better understanding of the processes causing scour and to evaluate and develop improved predictive models of these processes. The type of data, scope, and detail required for each measurement objective define criteria needed to evaluate, design, and develop appropriate scour-measurement systems.

Bridge-Inspection System

Inspecting bridges and monitoring scour during high flow can improve public transportation safety by providing early identification of scour and stream stability problems; these inspections may require only a few measurements to determine the streambed elevation near the bridge foundations. Measurement of complete cross sections is a better alternative because these data can be used to evaluate local scour, general scour, and long-term changes to the streambed.

To establish design criteria for the bridge-inspection system, questionnaires regarding scour-data collection were mailed to the Department of Transportation (DOT) and the Federal Highway Administration (FHWA) offices in each state. The responses to the questionnaires indicated that DOT personnel use a variety of techniques and equipment to measure scour at bridges, including sounding weights and echo sounders with chart recorders, graphical displays, or numerical displays. Most responses cited simplicity-of-operation as the most important functional characteristic of a new scour-data collection system. Other important features noted were portability and size, durability, cost, and the ability of the instrument to furnish permanent records of the data. An important operational criterion was the need to limit personnel requirements and supporting equipment. The typical price most respondents considered reasonable was \$1,000 per unit. On the basis of this and other information contained in the responses to the questionnaire, the bridge-inspection system should do the following:

1. Measure streambed elevation.
2. Be easily transportable and durable.
3. Operate in water velocities of at least 4 m/s.
4. Be hand deployable.
5. Be operable by one or two persons (preferably one).
6. Be able to measure under the bridge and along the sides of piers and abutments.
7. Provide a graphical or numerical display (permanent record is optional).
8. Provide depth measurement accuracy of about 0.3 m.
9. Be powered by small portable batteries.

The system developed uses a low-cost echo sounder to measure the water depth and a tethered knee board to deploy the transducer around the bridge piers and abutments. A chart-recording echo sounder is the preferred instrument because it produces a permanent record and notes can be written on the chart. Graphical- or numerical-display echo sounders are also acceptable but the data must be recorded in a notebook.

Limited-Detail Data-Collection System

Limited-detail data are collected primarily to evaluate published equations and to investigate the relations between local scour and explanatory variables. Limited-detail data sets should include the following data: ⁽³⁾

1. Water discharge.
2. Water-surface elevation at the bridge.
3. Cross-section data along the upstream and downstream edges of the bridge.
4. Cross sections, approximately one bridge-width upstream and downstream of the bridge (it is desirable to measure this during the flood, but low-water approach and exit sections are usually acceptable).
5. Approach flow velocity for each pier location.
6. Bed-material samples (it is desirable to collect these during the flood but low-water samples are usually acceptable).
7. Notes on debris accumulations, surface currents, roughness, and vegetation.
8. Photographs of the bridge and stream reaches upstream and downstream.
9. Water temperature.
10. Bridge and pier geometry.
11. Soil boring logs for the bridge crossing.

Rantz and others⁽⁴⁾ and Landers and Mueller⁽³⁾ describe equipment and procedures for discharge and approach velocity measurements. Bed-material samples can be collected using the equipment and procedures described in Landers and Mueller⁽³⁾, Edwards and Glysson⁽⁵⁾, Ashmore and others⁽⁶⁾, Yuzyk⁽⁷⁾, and International Organization for Standardization⁽⁸⁾. Therefore, evaluation and development activities focused on instrumentation for collecting bathymetric data sufficient to identify and delineate maximum local scour. Instrumentation to measure channel bathymetry should meet the following criteria:

1. Be portable in field vehicles.
2. Be functional in velocities of at least 4 m/s.
3. Be deployable by hand or by use of either a manual boom or power winch.
4. Be durable and reliable in adverse-weather conditions.
5. Provide a graphical display (permanent record or digital output recommended).
6. Allow horizontal positions to be measured or estimated easily.
7. Provide depth-measurement accuracy of at least 0.15 m.
8. Be powered by a field vehicle or portable battery.
9. Allow collection of data along the bridge, under the bridge, and along the sides of piers and abutments.

The U.S. Geological Survey (USGS) has collected limited-detail data for several years and the only additional development was to use a tethered knee board to deploy the transducer of an echo sounder. Collecting channel-geometry data with the knee board is efficient. The scaling of the data to bridge plans is not difficult, provided that adequate notes were recorded in the field and that the paper chart is clearly annotated. This technique allows measurement of scour along the sides of piers and under the bridge. Hydrologic-equipment cranes are necessary to collect velocity and sediment data, but the hand-deployed knee board provides a more flexible and efficient method for measuring channel geometry.

Detailed Data-Collection System

Detailed data sets are similar to limited-detail data except the density of the data is greater and the spatial extent of the data collected is significantly broader. Ideally, detailed data sets include real-time measurements of hydraulic and channel-geometry data at several times during the flood hydrograph. Data are collected both upstream and downstream in an area that extends to just beyond the hydraulic influence of the bridge. Detailed data sets allow distinction between local, contraction, and general scour occurring at the highway crossing and are needed to advance the understanding of complex bridge-scour processes. Detailed data sets should include the following data:

1. Water-discharge hydrograph.
2. Water-surface elevation hydrograph.
3. Water-surface slope.
4. Detailed channel-geometry data at and near the bridge.
5. Channel geometry in the river reach upstream and downstream of the bridge.
6. Flow velocities (magnitude and direction) in the entire study reach.
7. Bed-material samples.
8. Suspended-load and bed-load measurements (if possible).
9. Notes on surface currents, channel roughness, and vegetation.
10. Approximate measurements of debris piles present.
11. Photographs of the bridge and stream reaches upstream and downstream.
12. Water temperature.
13. Bridge and pier geometry.
14. Soil boring logs for the bridge crossing.

The procedures and equipment for making discharge measurements and collecting suspended-load and bed-material samples are the same as those used for the limited-detail measurements. (See references 3, 4, 5, 6, 7, 8) The spatial extent of the bathymetric and velocity data is much greater for detailed data sets than for limited-detail data sets; therefore, instruments must be deployed from the water surface rather than from the bridge deck. It is also highly desirable to collect directional velocities rather than only velocity magnitude. The detailed-data collection system should meet the following criteria:

1. Be operational in water velocities of least 5 m/s.
2. Have a deployment platform that is stable in very turbulent water.
3. Provide a depth measurement accuracy of about 0.15 m, and preferably better.
4. Provide a horizontal position accuracy of better than 1 m, and preferably about 0.1 m.
5. Be transportable with a standard field vehicle.
6. Be shippable by use of overnight express service.
7. Have an unmanned deployment platform.
8. Store all data digitally on field computer.
9. Require only two or three persons to deploy and operate.
10. Provide adequate spatial range.
11. Be durable and reliable.
12. Provide directional velocity data, preferably three-dimensional components.
13. Provide a backup paper chart for depth data.

At the outset of this investigation, more stringent criteria for position accuracy, depth accuracy, size, and operational features of the deployment platform were proposed; however, the more stringent criteria were neither feasible nor cost effective during the early phases of development. The system developed meets the criteria presented and can collect scour data more accurately and in more detail than in the past. Technology continues to change and improve rapidly, and it is likely that improved system accuracy at a lower cost will be achievable in the future.

The instrumentation for the detailed data-collection system includes a digital-output echo sounder, a BB-ADCP, a range-azimuth positioning system, a differential global positioning system (DGPS), data radios, field computer, and data-collection and processing software. Channel geometry is measured using a digital echo sounder; three-dimensional velocity profiles are collected using a BB-ADCP; and the position of the data collected is measured using either a range-azimuth positioning system or DGPS. Because of the spatial coverage required of detailed data, the instruments must be deployed from a boat. Although manned boats are frequently used on some streams, safety and access considerations, particularly on small streams, led to the development of a remote-control boat. The remote-control boat consists of a flat-bottom jon boat powered by an outboard engine with servos and switches to allow control of the engine by use of standard recreational remote controls. Data collected by instruments deployed on a manned or unmanned boat can be radio linked to the shore by use of data radios. The position and depth or velocity data are recorded simultaneously on a field computer.

CHAPTER 2: EVALUATION OF INSTRUMENTATION

GENERAL

A portable scour-measuring system consists of four components: (1) the instrument(s) for making the measurement, (2) a deployment system, (3) a method to identify and record the horizontal position of the data collected, and (4) a data-storage device. The requirements for each component may be satisfied using different methods, instruments, and manufacturers. Instruments and methods to measure streambed elevation, flow velocity, spatial location, and to store the measured data were evaluated for functionality and performance with respect to system requirements. Initially, instruments were evaluated using information compiled from published literature, researchers and consultants, and manufacturer's product literature; subsequently, selected instruments were evaluated in laboratory and field tests. Finally, integrated scour-measurement systems for each measurement objective were field tested and evaluated in flood conditions.

STREAMBED-ELEVATION MEASUREMENT

Channel geometry is a fundamental component of a bridge-scour data set and requires concurrent measurements of streambed elevation and horizontal position. The streambed elevation is determined by measuring the distance from a known datum to the streambed. The most common instruments for measuring the streambed elevation during floods are sounding weights and echo sounders.

Sounding Weights

Most USGS bridge-scour data-collection projects initially used a sounding weight to measure cross sections along the upstream and downstream edges of the bridge.⁽⁹⁾ With proper equipment, the sounding-weight method can collect data where extreme turbulence and air entrainment prevent echo sounders from collecting accurate data. For example, the May 1990 flooding on the Red River at I-30 resulted in flow velocities of 4.5 m/s. In this environment, an echo sounder failed to collect accurate data because of excessive turbulence and entrained air. However, a 91-kg weight was allowed to free-fall and sound depths between 2.4 and 2.8 m.⁽⁹⁾ (did what? The previous sentence is incomplete or the first 'and' should be 'at'.)

In more commonly occurring conditions, the sounding-weight method has several limitations. The sounding-weight method is slow; during high flow, 45- to 136-kg weights are required to minimize downstream drift of the weight. A bridge crane or truck-mounted boom is required to raise and lower these heavy weights. Even these heavy weights can be swept downstream before reaching bottom in deep streams with high velocities. Although, vertical-angle corrections can be used to correct the measured depth; the streambed elevation at the location of the weight after it has been swept downstream, may be significantly different from the streambed elevation where the measurement is needed, such as near a bridge pier. In streams with depths greater than 10 m and velocities greater than about 3 m/s, a weight may not be usable to sound the depth.

Furthermore, debris near the bottom, especially around piers, can snag suspension lines and cause loss of the sounding weight, breakage of the suspension cable, and safety hazards to field personnel.⁽⁹⁾ The sounding weight method only measures the depth at discrete points, making complete documentation of important features such as the shape, maximum depth, and width of the scour holes difficult.⁽²⁾ Although sounding weights have advantages as described, their disadvantages are significant. For most conditions, a good echo sounder is easier to deploy and collects more comprehensive data.

Echo Sounders

Echo sounders measure the distance from the transducer to the streambed using the speed of sound in water and the time required for an acoustic pulse to reflect off the streambed and return to the transducer. The streambed elevation is calculated by subtracting the distance measured by the echo sounder from the elevation of the transducer, which is usually the water-surface elevation less the draft of the transducer. Echo sounders work well in streams with depths of at least 3 m and velocities less than 4 m/s, but, in shallow streams, with depths of 2 m or less and velocities exceeding 3 m/s, problems have been encountered.⁽²⁾ Very high levels of turbulence, air entrainment, and heavy suspended-sediment loads all adversely affect the operation of echo sounders; however, echo sounders operating at 200 kHz worked well in conditions encountered during six floods on both small and large streams.

Echo sounders are grouped into three general classes based on the type of output they provide: non-recording, analog recording, and digital recording. Non-recording echo sounders display a graph or numeric value of the depth measured and are not typically used to collect limited-detail or detailed data. Recording echo sounders provide a continuous record of the cross section, thus eliminating gaps in the data, except where obstructions prohibit an instrument from being lowered into the water. Analog-recording echo sounders record an analog representation of the returned echo on a paper chart. Digital-recording echo sounders process the signal and provide a single digital value through a computer communications port.

Theoretical Considerations

The typical echo sounder consists of two basic parts—a transducer and a processing unit. A device designed specifically for reception of sound is a hydrophone; one designed for transmission is a projector. The transducer is reversible and is used for both transmission and reception. The processing unit generates the electrical pulse causing the transducer to emit acoustic energy, processes the returned signal, and displays or outputs the results.

The accuracy of a streambed-elevation measurement made using an echo sounder is dependent upon several factors including the transducer beamwidth, digitization technique, acoustic frequency, water temperature, and platform stability. The transducer beamwidth is the degree of directivity or the ability of a transducer to concentrate the acoustic energy.⁽¹⁰⁾ The emitted sound propagates away from the center of the transducer in a direction perpendicular to the primary direction of the sound waves, forming a conical-shaped beam. The beamwidth is the angle between the points at which the acoustic energy has fallen to half that along the centerline of the

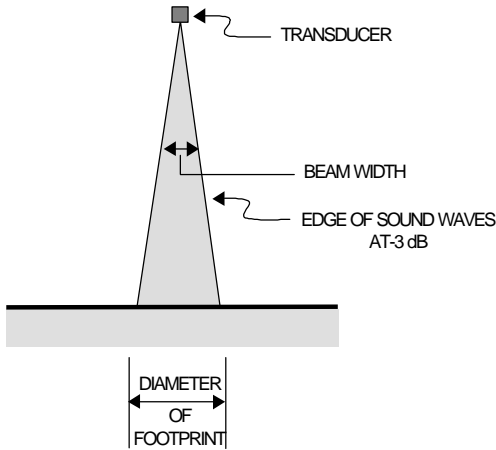

Figure 1. Illustration of transducer beamwidth.

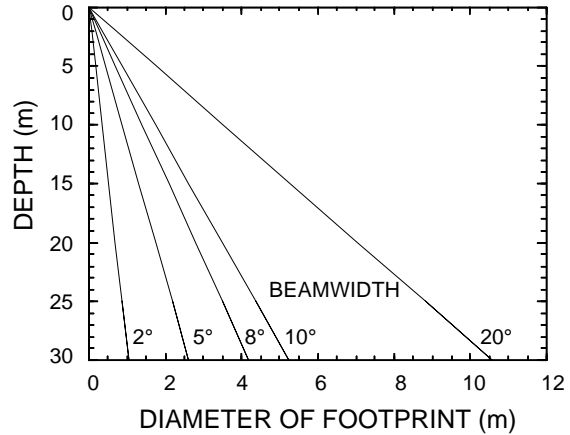

Figure 2. Effect of beamwidth on diameter of acoustic footprint.

beam (figure 1). The beamwidth and the depth of water determine the footprint size of the acoustic wave when it strikes a level streambed (figure 2). A smaller acoustic footprint is desirable to measure inside scour holes and close to piers and abutments (figure 3).

A narrower beamwidth is achieved in hardware by increasing the frequency or enlarging the transducer. The relation between transducer size, frequency, and beamwidth for a circular transducer is approximated by the following equation,

$$\beta = \frac{65\lambda}{d} \quad (1)$$

where

- β is the beamwidth in degrees,
- λ is the wave length in the same units as d , and
- d is the diameter of the transducer.⁽¹⁰⁾

For a frequency of 200 kHz, a 1° beamwidth requires a transducer with a diameter of approximately 0.5 m. Achieving small beamwidths through hardware can result in large, heavy transducers. The digitization technique employed in the echo sounder can be used to reduce the effective acoustic footprint.

Many graphical- or numerical-display echo sounders determine the depth when the reflected acoustic energy first exceeds a predetermined threshold. This digitization technique is called threshold detection. When measuring depressions or holes the reflected acoustic energy that exceeds the threshold will likely come from the edges of the acoustic footprint. If the footprint is large and the width of the hole is small (figure 3A) or if the bed is sloping significantly (figure 3B), the depth measured by the echo sounder may not be accurate.

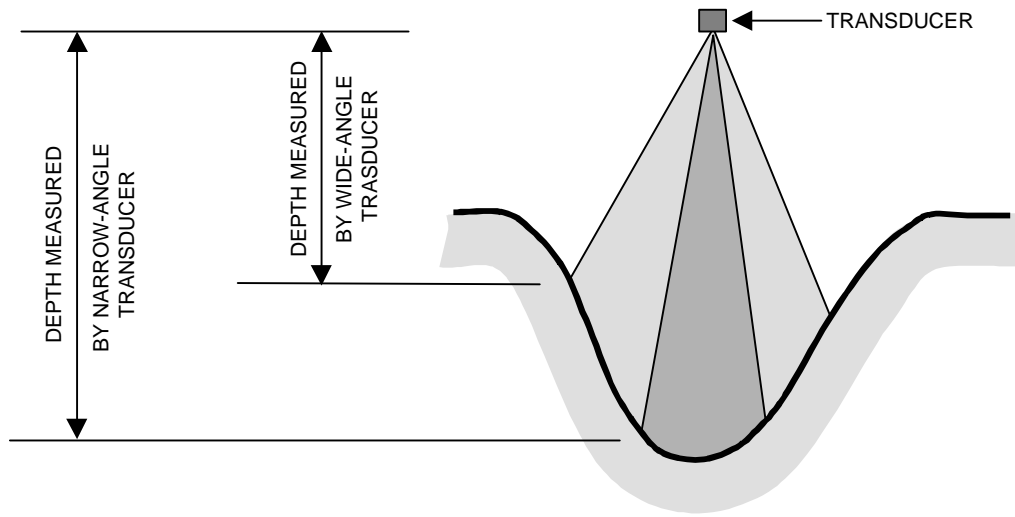

(A) NARROW SCOUR HOLE

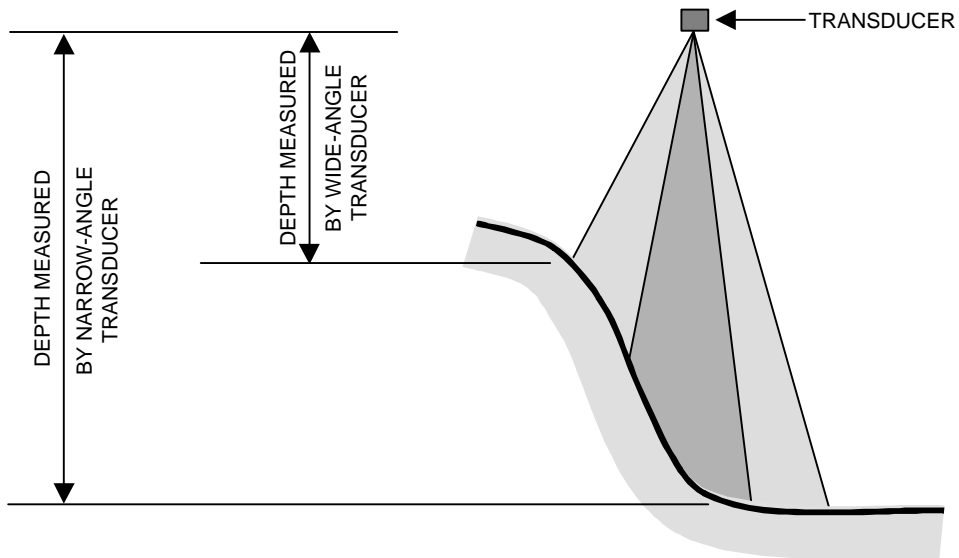

(B) SLOPING BED

Figure 3. Effect of beamwidth on measured depth.

An alternative to physically reducing the beamwidth is to use peak detection rather than threshold detection. The peak-detection technique analyzes the return echo and computes the distance associated with the peak amplitude of the return signal rather than a predetermined threshold value; therefore, the peak-detection method measures the depth at the approximate center of the footprint and the beamwidth is effectively reduced.⁽¹¹⁾ The peak-detection method is also less sensitive to acoustic reflectors in the water column (sediment, debris, etc.) than threshold detection. Although adequate data can be achieved with an echo sounder using threshold detection, peak detection may be more accurate and reliable during floods that may be transporting high sediment loads and debris or for streambeds with a highly irregular surface.

No digitization technique is infallible and none provide all of the information included on an analog chart. For example, surveying near bridge foundations or debris accumulations can cause reflection of acoustic energy off objects other than the streambed. These side echoes are often strong enough to trigger the digitization technique causing incorrect depths to be digitized and even incorrect interpretation of chart records. Figure 4 illustrates a chart record collected near a pier with a stepped design.⁽¹²⁾ The chart record includes side echoes off the pier and the streambed. The chart reveals that the streambed has scoured below the top of the seal; however, even using an echo sounder with peak detection, the digital record indicated an elevation of about 112 m. The side echo had sufficient intensity to be the peak return signal and the actual streambed elevation could have been missed. Fortunately, this echo sounder had both digital output and analog chart recording features so that the digital data could be compared with the chart record and appropriate corrections made to the digital data.

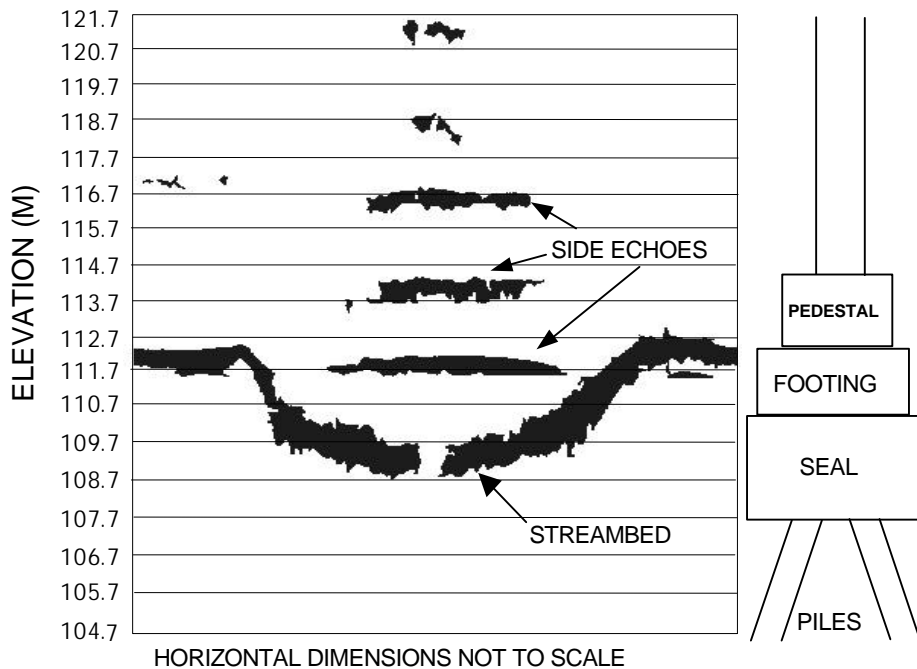

Figure 4. Example of side echoes from bridge pier.

The next major factor effecting the accuracy of echo-sounder depth measurements is the acoustic frequency. The acoustic frequency of the echo sounder not only effects the accuracy of the echo sounder through the size of the beamwidth and footprint, but also effects the measurement resolution of the echo sounder. A gated acoustic pulse has a finite length determined by the acoustic frequency, the speed of sound, and the duration of the pulse. The resolution is normally taken to be half the pulse length.⁽¹⁰⁾ The speed of sound varies with the temperature and density of the water. For a given water condition and pulse duration, the resolution of the echo sounder becomes directly dependent upon the acoustic frequency. A higher frequency system will have a shorter wavelength than a lower frequency system and can resolve smaller objects. However, higher frequency acoustic waves may be attenuated by acoustic reflectors in the water column (suspended sediment and debris) before they can be reflected off the streambed and return to the transducer. A balance between resolution and water depth must be achieved to collect high-quality data. Most standard commercial echo sounders operate at about 200 kHz. Instruments that operate at both higher and lower frequencies are available for high-resolution applications (high frequency) or subbottom profiling (low frequency).

The accuracy of echo-sounder measurements is also dependent upon the speed of sound through the water column, which depends on the temperature and density of the water. Most echo sounders provide a means to correct the speed of sound for temperature and density due to salinity. This correction is typically made using one of two methods. Many echo sounders provide a chart in the user's manual that allows the correction to be determined based on the salinity and temperature of the water; the salinity and temperature values used should reflect the average value of the water column through which the acoustic energy is traveling. The most accurate and most commonly used technique is a bar check. A bar or disc is set horizontally beneath the transducer at known depths, and the draft and speed of sound correction on echo sounder is adjusted until the measured depths agree with the depths of the disc or bar. Care is necessary to ensure the bar or disc is level to obtain accurate adjustments. If water temperatures or salinity values change during a survey, the echo sounder should be readjusted as necessary to maintain accurate depth measurements. A detailed description of the bar-check procedure and instructions on how to construct a bar-check device is provided in the U.S. Army Corps of Engineers hydrographic surveying manual.⁽¹³⁾

The accuracy of an echo-sounder depth measurement is dependent upon the vertical and angular stability of the transducer. A transducer fixed mounted on a survey vessel is subject to the vertical and horizontal motions of the vessel. Vertical displacement of the transducer (heave), such as by wave action, changes the distance between the transducer and the measurement datum. Lack of compensation for this variation in distance between the transducer and the measurement datum will result in errors in streambed elevations equal to the vertical displacement of the survey vessel.

Angular displacement of the transducer from the vertical will cause the transducer to measure a distance to the streambed that is not vertical. For a situation where the streambed is perfectly flat, a correction for pitch and roll of the transducer can be applied to obtain the correct vertical depth. This correction is simply the cosine of the angle by which the transducer is offset from vertical. Assuming the echo sounder measures to the center of the footprint, figure 5 illustrates

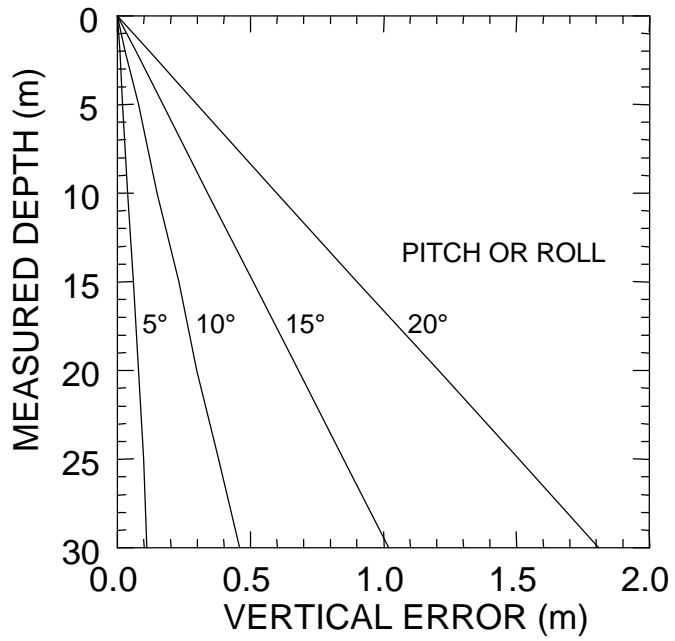

(A) VERTICAL ERROR

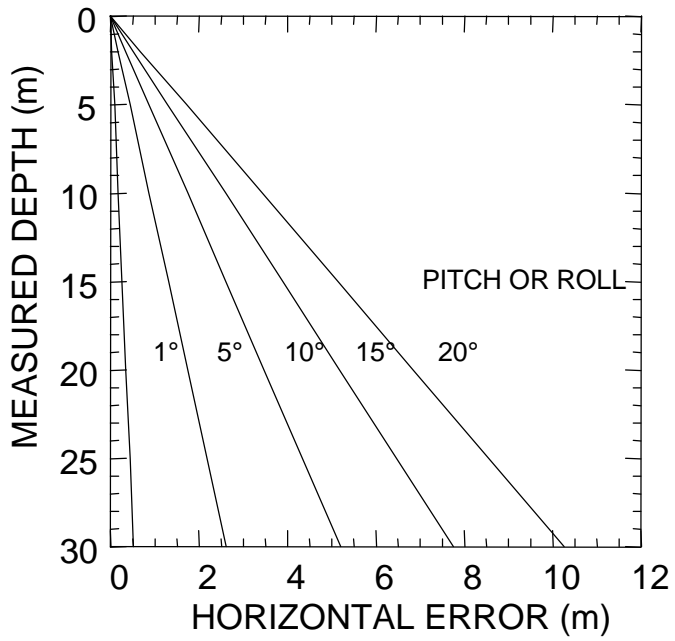

(B) HORIZONTAL ERROR

Figure 5. Potential vertical and horizontal errors in acoustic measurements caused by instability of the deployment platform.

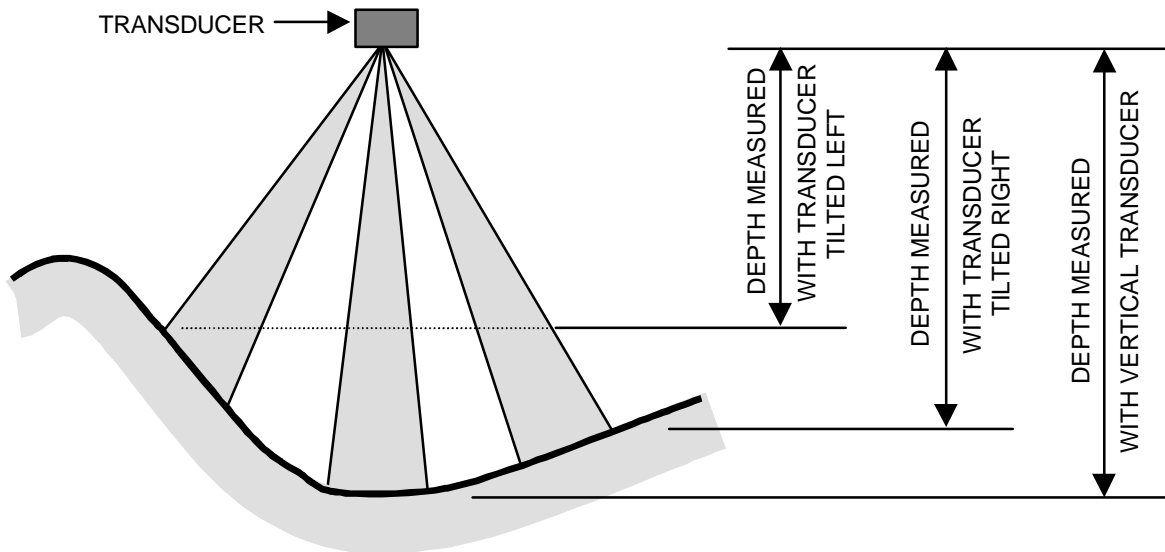

Figure 6. Illustration of undulating streambed with titled transducer.

the potential errors; however, for an undulating streambed (figure 6) both the depth and horizontal location of the measurement must be adjusted (see Vessel Motion Compensation, Theoretical Considerations).

Non-Recording Echo Sounders

Non-recording echo sounders display the depth numerically, graphically, or both. Echo sounders with only numerical displays are often the least-expensive echo sounders. They are manufactured primarily for installation on recreational boats. Graphical-display echo sounders have increased in accuracy and popularity with recent advances in liquid crystal display (LCD) technology. These devices display a scrolling graph of the streambed and may display the numerical value of the depth. The transducers for these echo sounders may include a temperature probe and a paddle wheel for measuring velocity. Fisherman commonly uses these echo sounders, often called fishfinders, because they show reflections off fish. These units are available in sporting-goods and marine-supply stores. Fishfinders normally operate at a frequency of about 200 kHz and often employ a transducer with a wide beamwidth (20° or greater). The wide beamwidth is advantageous for looking for fish; however, it is a major disadvantage for accurately measuring the depth of scour around bridge foundations. Narrow beamwidth transducers (5° to 8°) are sometimes available for these echo sounders both with and without the temperature and velocity sensors. Experience gained through use of low-cost echo sounders in various USGS projects have shown that a beamwidth less than or equal to 8° will normally produce reliable scour measurements. Many of these low-cost echo sounders do not allow compensation for water temperature and salinity. Even the units with a temperature probe often do not use the temperature to adjust the speed of sound, but simply report the water temperature for reference by the user.

Although most of the non-recording echo sounders use an LCD display, there are some units that use a cathode ray tube (CRT). The CRT units are commonly used on larger commercial vessels. The CRT displays often display the intensity of the reflected acoustic energy in different colors. If a sufficiently low-frequency transducer is used, penetration of the streambed may occur and information about the subbottom may also be displayed. A skilled operator may be able to distinguish between hard bottoms and soft bottoms and also interpret depositional patterns below the surface. These units are available in single-frequency and dual-frequency models that often support transducers with frequencies of 200 kHz and 50 kHz, although other frequencies are available. The lower-frequency transducers typically have very wide beamwidths (> 40°).

Most transducers come standard with less than 7 m of cable. Extension of the transducer cable is often necessary to allow deployment of the transducer from the bridge deck. Tests with several different low-cost echo sounders using 33 m of transducer cable caused some units to report incorrect depths. If a transducer cable longer than the one supplied with the transducer is installed, the measurement accuracy of the echo sounder should be verified with the longer cable and adjusted as required. Many echo-sounder repair shops can tune the echo sounder to a long cable.

The depth reported by some echo sounders is dependent upon the user setting the gain adjustment. The gain adjustment sets a magnification factor for the returned acoustic signal to allow it to exceed the digitizer's threshold. During tests, one model failed to measure consistent and accurate depths in water less than 2-m deep with the gain set to automatic. Manually adjusting the gain on this unit caused the depth reported by the unit to vary by more than 20 percent of the depth.

Many echo sounders will not consistently and accurately measure water depths less than about 1 m. The maximum measurable depth depends on the power output of the echo sounder, the gain, and the frequency of the transducer. Accuracy of these low-cost fishfinders is typically 0.3 m, although some units display depths to the tenth of a foot or the tenth of a meter.

Most of the non-recording echo sounders with an LCD display cost between \$100 and \$500. Multiple-frequency color CRT display units may cost between \$600 and \$1,000. Many of these low-cost echo sounders have National Marine Electronics Association (NMEA)-0183 standard input and output capabilities. (For more information on this, see Digital-Output Echo Sounders.) The NMEA-0183 allows recording of the digitized depths by an external device, such as a field computer. Generally, non-recording echo sounders are a cost-effective instrument for measuring streambed elevation, but care must be taken to use the appropriate transducer and to calibrate the instrument properly.

Recent additions to the fishfinder market include very wide beamwidth or multiple-transducer echo sounders. These units sound a very wide area and display it as a three-dimensional wire mesh on the LCD display. These units were not evaluated but could be very useful for making scour inspections if they accurately measure the depths in scour holes.

Analog-Recording Echo Sounders

Analog-recording echo sounders are the oldest type of echo sounder. Analog recording echo sounders do not digitize or report numerical depth values. These devices record all return echoes above a user-selectable threshold on a paper chart. The user-selectable threshold is often called the sensitivity adjustment on the echo sounder. A stylus is often used to record the data on the chart. The speed of the stylus must be calibrated to the speed the acoustic pulse travels through the water column.⁽¹⁰⁾ Older analog recording echo sounders used paper with preprinted scales. Currently, most chart recording systems print both the scale and the trace of reflected acoustic echoes on plain thermal paper. Many analog-recording echo sounders now use a fixed thermal recording head that eliminates errors associated with synchronization of the stylus with the speed of the acoustic pulse. Although, these are effective low-cost instruments for collecting channel bathymetry, the LCD technology has virtually eliminated this class of instrument from use by recreational fishermen. Consequently, manufacturers have stopped making low-cost analog recording echo sounders. Most of the echo sounders manufactured for use by commercial surveyors have both an analog chart and a digital output but typically cost more than \$7,000. Fewer calibration problems were experienced when adding 33 m of transducer cable to the transducer of analog-recording echo sounders; however, all instruments should be verified for accuracy before collecting data.

Digital-Output Echo Sounders

Digital output echo sounders typically provide both a numerical display of the depth and an analog chart to help with interpreting the digital data. The primary purpose of these instruments is for commercial hydrographic surveys. These instruments employ digitization techniques and data filters to help eliminate false data from side echoes and acoustic reflectors in the water column. The filters often require the digitized depth to be within a specified distance of the previous depth, although some manufacturers use more complex algorithms.

Three types of digital interfaces are common on digital-output echo sounders: (a) RS-232 with NMEA-0183 communications protocol, (b) RS-232 with proprietary protocol, and (c) parallel. RS-232 interfaces are common for both commercial and low-cost systems, including the non-recording echo sounders. The NMEA-0183 is a standard communication protocol for marine electronic instruments. This standard is capable of transmitting different types of ASCII information including navigation, meteorological, geophysical, time, and depth information on a single RS-232 compatible communications line operating at 4800 baud, with 8 data bits, 1 stop bit, and no parity. Many low-cost systems use NMEA-0183 for digital output, allowing them to be combined with compatible long-range navigation systems (LORAN) or Global Positioning Systems (GPS). Some commercial hydrographic surveying echo sounders provide RS-232 output that does not follow the NMEA-0183 standard. These proprietary communication protocols are often more efficient because they operate at a higher baud rate and do not require the extra control and identification characters specified in the NMEA-0183 standard; however, they require recording software customized for the protocol of each instrument. The fastest and most efficient interface is the parallel interface, which is found only on the more expensive commercial

hydrographic surveying instruments. The parallel interface significantly reduces the time for data transmission and improves the correction of depth for the heave, pitch, and roll of the vessel because of its low latency time.

Digital-output echo sounders can generate large amounts of data. The frequency of depth measurements varies with the echo sounder being used. Low-cost systems typically provide a depth every 1 to 2 seconds, while hydrographic surveying systems may provide multiple readings per second. This update rate is also a function of the averaging or filtering techniques employed by the echo sounder.

Coordinates defining the channel bathymetry are collected by simultaneously recording the transducer location and the water depth. Before developing a digital terrain model or a bathymetric map, it is important to check the quality of the recorded data. Some quality checks can be automated and commercial packages are available to assist in the data processing; however, manual comparison of the digital data to the analog chart is also important and can prevent important features from being missed or misrepresented.

Many different digital-output echo sounders are available. Operating frequencies range from less than 20 kHz (for subbottom profiling) to greater than 1,000 kHz. The transducer beamwidths vary with frequency; however, a much broader choice of transducers is available for commercial hydrographic-surveying instruments than for those instruments used primarily by recreational boaters. A low-cost digital-output echo sounder with an 8° beamwidth, RS-232 NMEA-0183 standard output, and no analog chart costs less than \$600. Commercial hydrographic-surveying instruments with transducer beamwidths of 3° or less, an analog chart, and RS-232 output cost between \$5,000 and \$15,000; instruments with a parallel interface cost between \$10,000 and \$30,000. Unless external instruments are used for correcting the depth for vessel motion and attitude, it is not likely that a parallel interface is needed for data-collection activities related to scour of the streambed at bridges.

Multibeam and Scanning Sonar

Recent developments of multibeam and sector-scanning sonar systems permit accurate bathymetric data to be collected rapidly over a large area. These systems are typically expensive (< \$100,000 for a complete system), and a complete evaluation was beyond the scope of this report. However, a brief description of these systems is provided based on published literature and from information provided by private contractors that have used such systems for collecting data on scour at bridges.⁽¹⁴⁾

Sector-scanning sonar has been used to locate well heads for drilling operations and as an aid to obstacle avoidance.⁽¹⁰⁾ The technology is similar to a fixed-transducer echo sounder, except the transducer is mounted on a mechanism that rotates and tilts the transducer. The measurement location and depth of the streambed are determined from the slope distance measured by the acoustic system and the tilt and rotation of the transducer. Complete data coverage of a circular area can be obtained from a single location (figure 7).⁽¹⁴⁾ If the system is mounted on a moving

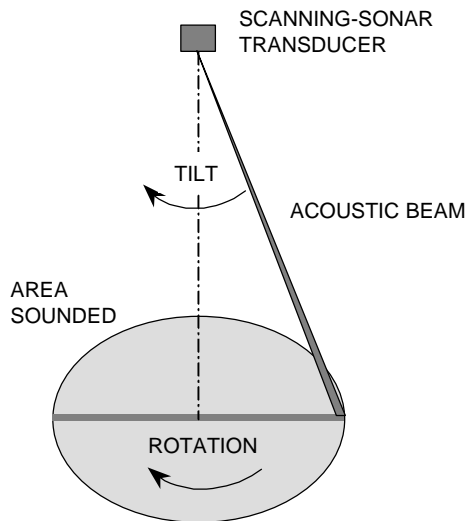

Figure 7. Coverage of scanning sonar system.

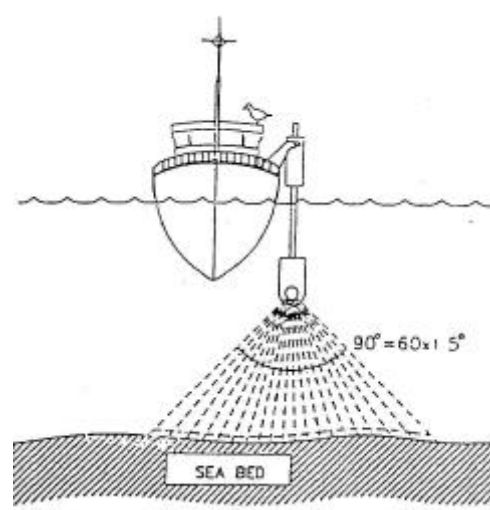

Figure 8. Illustration of swath hydrographic-survey system.

survey vessel, the system can effectively collect a swath of data as the vessel is maneuvered in the stream (figure 8).

A multibeam system is similar in capability to the sector-scanning sonar. The multibeam system eliminates the time lag of a transducer rotating from one position to another (i.e., from bank to bank on a longitudinal survey line). The multibeam systems do not actually use multiple beams but emit a fan of sound and receive segments of the reflected sound by electronically phasing an array of transducers.^(10, 13) The transducers are arranged in an arc and are typically in configurations of 60 transducers in a 90° arc. Thus, a swath of streambed is measured almost instantaneously (figure 8).

The accuracy of the sector-scanning and multibeam systems is highly dependent upon accurate measurements of the position of the transducer or transducer array at the time data are collected. When the transducer is at acute angles with the streambed (figure 5) small errors in the measured angle of the transducer can cause substantial errors in the depth measurement. Therefore, very stable deployment platforms or use of external instruments to accurately measure and compensate for vessel attitude are required to collect accurate data with these systems. The effective range depends upon the frequency of the acoustics and the characteristics of the water. Sector scanning sonar has been used to measure depths at ranges in excess of 100 m.⁽¹⁴⁾

Sector scanning and multibeam systems collect an enormous amount of data and require fast computation and storage routines running on high-speed computers to process and store the data. These systems collect more detailed data than can be accomplished with a single transducer system. Measurements made at acute angles to the streambed can be used to measure scour under ice and debris jams, which is not possible with a single transducer. Therefore, use of this

technology for measuring scour at bridges is very promising and may provide measurements in conditions and locations that have not been possible using previously available technology.

VELOCITY-MEASUREMENT INSTRUMENTATION

Water velocity is an important parameter for assessing the energy available to scour the streambed. Flow-velocity measurements are usually made with horizontal or vertical axis current meters according to methods described by Rantz and others.^(4, 15) This technique measures only the magnitude of the velocity. The horizontal direction of the velocity can be measured by a flux-gate compass mounted in the weight deployed with the meter. The meter measures the velocity at a single point; therefore, the meter must be raised and lowered to specific depths to obtain a velocity profile or to obtain an acceptable estimate of the depth-averaged velocity. Like streambed-elevation measurements made using sounding weights, this requires the use of a bridge crane or truck-mounted boom to raise and lower the weight needed to stabilize the meter in flood flows. Flood flows often transport a significant amount of debris that may snag suspension lines, damage or destroy the equipment, and present a safety hazard to field personnel. Although this technique has limitations, it is a standard technique and is frequently used to collect velocity data for limited-detail measurements.

Electromagnetic current meters are commonly used to collect two-dimensional current direction and velocities both in the laboratory and in the field. These instruments are based on the Faraday principle of electromagnetic induction. This principle states that a conductor (the water) moving in a magnetic field (generated from within the instrument) produces a voltage that is proportional to the velocity of the water.⁽¹⁶⁾ Several researchers have reported varying degrees of success with these instruments.^(17, 18, 19) Use of the instrument in highly turbulent flows, characteristic of floods, could result in errors in the velocity measurements.⁽¹⁹⁾ The primary advantage of the electromagnetic meters is the ability to collect two-dimensional velocities and potentially measure turbulent fluctuations. Deployment of these instruments requires similar equipment as the horizontal and vertical axis meters (bridge cranes or truck-mounted booms to raise and lower heavy weights) and would experience similar problems with debris. Electromagnetic current meters have only minor advantages over the horizontal and vertical axis meters and because of the potential problems in using electromagnetic meters, they were not considered for further evaluation in this study. For specific field applications, however, the electromagnetic meters may be a valuable instrument for collecting two-dimensional velocities.

Detailed data should include velocity profiles and, if possible, measured current directions. Standard mechanical and electromagnetic meters require discrete measurements at different depths to measure a velocity profile; however, acoustic technology allows near-instantaneous measurement of a three-dimensional velocity profile. Acoustic Doppler current profilers (ADCP) were originally used to study ocean currents and estuaries. The development of the BB-ADCP allows three-dimensional velocity profiles and discharge to be measured in rivers and canals with an acceptable accuracy from a moving boat.⁽¹⁹⁾

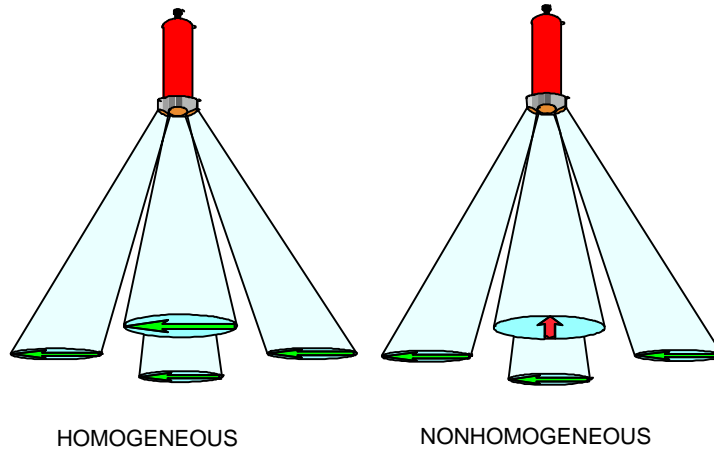

Figure 9. Beam pattern and velocity homogeneity for broadband acoustic Doppler current profiler.

The BB-ADCP measures velocity magnitude and direction by use of the Doppler shift associated with the reflection of acoustic waves off particles moving with the water (acoustic reflectors). The BB-ADCP transmits pairs of short, phase-encoded acoustic pulses along four narrow beams (figure 9) at a known, fixed frequency (from 300 to 1,200 kHz for rivers). The reflected signal is discretized by time differences into individual segments representing specific depth cells within the water column. The time-lag change and difference in frequency (shift) between successive echoes are proportional to the relative velocity of the acoustic reflectors referenced to the BB-ADCP. This frequency shift is known as the Doppler effect. The BB-ADCP uses this technique to compute a water-velocity component along each beam. The beams are positioned 90° apart horizontally and at a known angle (typically 20 or 30°) from the vertical. Three-dimensional velocity vectors are computed for each depth cell by use of trigonometric relations and the geometric arrangement of the beams. For the trigonometric relations to be valid, water velocities must be horizontally homogeneous in all four beams (figure 9). Although theoretically, only three beams are needed to resolve a three-dimensional velocity, the fourth beam provides a quality check of the measurement.^(20, 21)

The BB-ADCP cannot measure water velocities near the water surface and near the streambed. Water velocities near the surface cannot be measured for two reasons: (a) the BB-ADCP must be deployed so that transducers remain under water during a measurement, and (b) the physical characteristics of the transducers are such that accurate velocity measurements cannot be made within a frequency-dependent distance from the transducer.⁽²⁰⁾ Water velocities cannot be measured near the streambed because of side-lobe interference. Acoustic transmissions generate a main beam of energy, and parasitic side lobes of energy. Acoustic energy from the side lobes reflects off the streambed and interferes with the acoustic energy from the main beam reflecting off acoustic reflectors near the streambed. This interference prevents measurement of velocities in the lower 6 percent of the water column for BB-ADCPs commonly used in streams.^(22, 23, 24)

The velocity measured by the BB-ADCP is relative to the instrument itself; therefore, the speed and direction of the instrument must be measured when deploying the instrument from a moving survey

vessel. Under most conditions, the BB-ADCP measures the boat velocity by a technique called bottom tracking. The BB-ADCP transmits bottom-track acoustic pulses and analyzes the Doppler shift of the backscattered energy reflected from the streambed. If the streambed is a stationary reference, this technique measures the velocity and course of the boat accurately. If the streambed is actively transporting sediment, however, the streambed may not be a good stationary reference. Sediment transport along the streambed during floods can cause the reference to be moving downstream and the measured velocities to be biased low. During floods the accuracy of the bottom tracking should be verified by one of two methods: (1) by anchoring the boat in the main flow and collecting data for 5 to 10 minutes or (2) by traversing across the stream from a known point and then returning to that known point. In both methods the distance made good (distance from first position to last position) is divided by the time required to complete the test to obtain an average bottom velocity, which should be very close to zero.

In some instances, the use of a lower-frequency BB-ADCP (using a 300-kHz instrument instead of a 1,200-kHz instrument) will allow penetration of the acoustic signal through the mobile sediment and result in a stable bottom reference, where a higher frequency instrument would indicate a moving bottom.⁽²⁰⁾ For example, problems were encountered with a 1,200-kHz instrument on the Mississippi River during the 1993 flood. Water conditions were characterized by depths greater than 19 m, high suspended-sediment concentrations, and 2-m dunes. The survey vessel was tied to a barge anchored near the main navigation channel. A 1,200-kHz and a 300-kHz BB-ADCP were deployed, in turn, at this fixed location. The 300-kHz instrument correctly showed that the survey vessel was not moving, however, the 1,200-kHz instrument indicated that the vessel was moving at rate of approximately 0.6 m/s.⁽²⁰⁾ These tests confirmed that the 1,200-kHz instrument did not penetrate the heavy sediment load near the streambed and was bottom tracking off of the mobile bed. The 300-kHz instrument penetrated the mobile bed layer, provided acceptable bottom track, and allowed three-dimensional velocities to be collected under extreme conditions. These results seem to indicate that the 300-kHz instrument is the preferred instrument; however, other factors must be considered in selecting a BB-ADCP for data collection. The blanking distance, the distance from the face of the transducer to the first location where data can be collected, and the minimum length of the depth cells is a direct function of the acoustic frequency. The lower the frequency the longer the blanking distance and minimum length of depth cells. For a 300-kHz instrument, the minimum blanking distance and depth cell length is about 1 m. If the 300-kHz instrument is deployed approximately 0.5 m into the water, the first velocity measurement is at a depth of about 3 m and additional measurements can be made for depth cells every 1 m. For the 1,200-kHz instrument the blanking distance is 0.5 m and the minimum depth cell length is 0.25 m. Again, if the instrument is deployed approximately 0.5 m into the water, the first velocity measurement is at a depth of approximately 1.4 m and additional measurements can be made for depth cells every 0.25 m. Therefore, the 300-kHz unit is more suitable for deep water, and the 1,200-kHz unit is more suitable for shallow-water applications. Recent developments in the processing software appear to make a 600-kHz instrument the most versatile instrument for both shallow- and deep-water applications.

An alternative to bottom tracking for measuring the boat speed and course is to use real-time kinematic differential global positioning systems (DGPS). The software used with the BB-ADCP supports DGPS as an external navigation reference. The BB-ADCP measurements are referenced

to magnetic north by a fluxgate compass and the DGPS navigation reference is referenced to true north; thus, the effect of the magnetic declination and any errors in the compass must be accounted for. The accuracy of using DGPS as the velocity reference has not been completely defined and is dependent upon the timing of the position readings, the accuracy of the those readings, and the accuracy of the BB-ADCP fluxgate compass.

The BB-ADCP allows very detailed velocity data to be collected in the approach- and exit-reaches and near the bridge. However, collecting velocity data in the turbulence and vortices caused by bridge piers and abutments with a BB-ADCP requires extreme care. The trigonometric relations used to compute the three-dimensional velocity components are only valid if the water velocity is uniform along a horizontal plane passing through the four beams. The size of the vortices is often smaller than the area bounded by the four beams, so flow measured by one beam may not be continuous with flow measured by another beam. Additional research and signal processing will be required before three-dimensional velocity-profile measurements in the vortices adjacent to piers and abutments can be made with a BB-ADCP.

Development of an acoustic correlation current profiler (ACCP) for riverine applications may allow these vortices to be measured in the field without the limitations imposed by the BB-ADCP. Currently, the ACCP is operational for oceanographic work but its minimum depth and cell size limitations prevent its use in the riverine environment. The ACCP differs from the BB-ADCP in that it has only one transmitter that emits a coded pulse. The reflected acoustic energy is monitored in time at differing spatial locations. Complex signal processing routines described by Bradley and Kuo⁽²⁵⁾ are used to compute the three-dimensional velocities at various depths. With additional research, the ACCP could be developed with higher frequency acoustics and a 10° beam pattern that would allow three-dimensional velocity measurements in the field near bridge piers and abutments.

HORIZONTAL POSITIONING SYSTEMS

The horizontal location of streambed elevation and velocity data is required for bridge-scour studies. A horizontal positioning system consists of the instrumentation and techniques used to measure the position at which data are collected. The instrumentation and techniques used depend upon the accuracy required and spatial distribution of the data.

Visual and Physical Measurement Systems

Visual and physical measurement systems are systems that do not track the deployment platform, but require personnel to directly make the position measurement. These systems can be divided into general location descriptions, approximate visual measurements, and physical measurements. General location descriptions are recorded in the field notes and describe the approximate location of the measurement or observation referenced to a feature of the bridge or study reach. For example, the position description may read, 'west side of the upstream end of the third pier from the north abutment on the downstream (southbound) bridge.' Approximate visual-position measurements are numerical distances to the location of the measurement or observation,

referenced to a feature of the bridge or study reach. For example, the visual measurement may be, '5 m left of pier five and 3 m downstream from the upstream edge of the bridge.' Physical measurements may be made by the use of a tagline, tape, presurveyed stationing, or other instrument to determine the location of the data. An example of a physical measurement may be, 'station 103 on the downstream side of the bridge.'

General-location descriptions are sufficient for some bridge-inspection data and for describing the location of qualitative observations. Visual and physical measurements usually include a general-location description. Although general-location descriptions and visual estimates may be sufficient for some data, measuring channel cross sections requires physical measurements.

Bridge cross-section measurements include a specific description of the cross-section location and the stationing and streambed elevations along the cross section. For limited-detail measurements, the cross section is referenced to the upstream or downstream side of the bridge (i.e., 3 m downstream from the upstream edge of the bridge). For cross sections collected at the bridge, stationing is measured across the bridge deck from stations marked on the bridge or from a tape or tag line stretched along the bridge handrail. Marked stations are easiest to use during a measurement, but require extra time to set and maintain. Stationing can be measured using a tape or a measuring wheel. Tapes have the advantage that a weight can be attached to the end so that they can also be used to measure the water-surface elevation. Tapes also are more accurate than a measuring wheel. However, measuring wheels have continuous numerical counters for distances of up to 330 m (or more) and are a more efficient means of measuring stations on a long bridge than repeated use of a 30- or 60-m tape. Tag lines may also be used and are available in lengths over 100 m, but often are only marked in 2-m intervals for lengths greater than 20 m.

Range-Range Systems

Range-range systems locate a position by making distance measurements from two or more known locations (figure 10). If the approximate location of the target is known, only two stations are required (figure 10A). However, to uniquely determine the position without supplemental information, at least three stations are required (figure 10B). Range-range systems operate in one of two modes: (1) fixed transponder stations with mobile transmitter or (2) fixed transmitting stations with mobile receiver. In the first mode, the mobile transmitter interrogates the fixed-station transponders and interprets the return signal. In the second mode, the fixed stations continually transmit a signal that can be received by a mobile receiver located on the survey vessel. Range-range systems can be designed to operate in various frequency bands including infrared, microwave, and acoustic underwater systems. Typical accuracies of such systems are 1 to 10 m depending on the type of system and distance from the fixed stations.⁽¹⁰⁾ The maximum range varies from a few hundred meters to several hundred kilometers depending on the technology and system selected.

Setting up a range-range system during a flood can be a problem. Two or more known locations must be established for the fixed stations. The fixed stations must be located in a pattern that allows positioning over the desired study area. If acoustics are used these stations must be

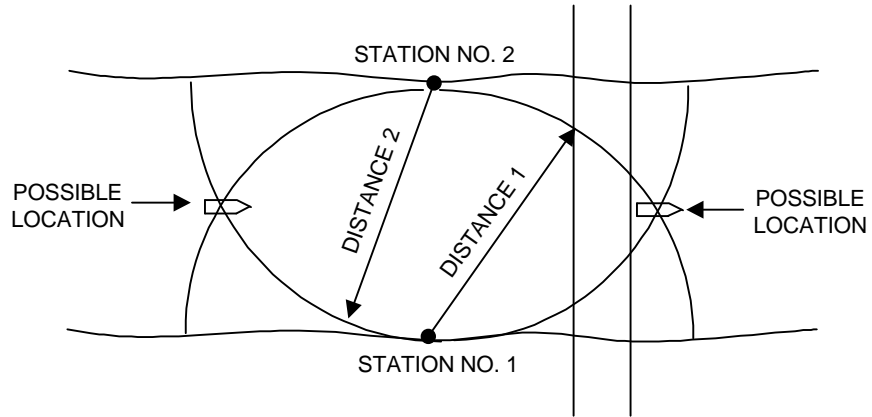

(A) TWO STATION RANGE-RANGE

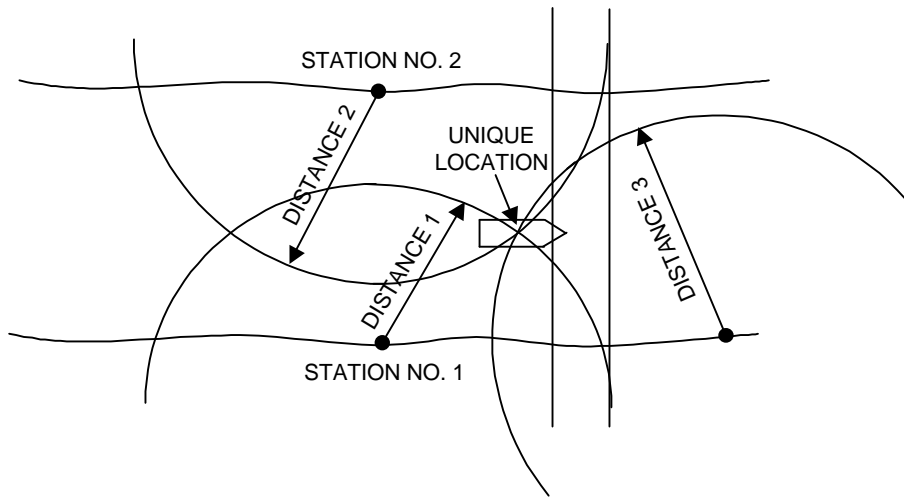

(B) THREE STATION RANGE-RANGE

Figure 10. Position location using a range-range positioning system.

located in water of sufficient depth to deploy the acoustic transponders. During extreme floods, flood plains may be inundated and adequate locations for the infrared or microwave fixed stations may be difficult to establish. Considerable time may also be required to survey the locations of fixed stations that cannot be established at previously known locations. However, range-range systems are passive and once established, the positions of the survey vessel are determined by the electronics without manual intervention. These systems are available from several manufacturers and have been extensively used in hydrographic surveying.

Global Positioning Systems

Global positioning systems are actually a type of range-range system that use satellites in known orbits instead of fixed land-based stations. GPS is a continuous, all-weather, worldwide, satellite-based electronic positioning and navigation system, which was developed by the U.S. Department of Defense. Development of GPS began in 1973 and the system became fully operational in 1993 with 21 satellites and 3 operational spare satellites. For national defense concerns, the accuracy for civilian applications is randomly degraded (selective availability). Development of improved electronics and differential corrections to GPS positions has resulted in a rapid increase in civilian applications in recent years.

The accuracy of a GPS location is determined by the sum of several sources of error. Sources of error are as follows: (1) satellite clock error, (2) ephemeris error, (3) receiver errors, (4) atmospheric/ionospheric errors, (5) position dilution of precision, and (6) selective availability.⁽²⁶⁾ The accuracy of a location determined with a single GPS receiver will vary from 15 to 100 m depending on the quality of the receiver and the selective availability; however, making differential corrections to the data can significantly increase the accuracy of GPS positions.

DGPS uses a GPS receiver on the ground in a known location (base station) to determine the errors associated with the satellites currently in use. Because the location of the GPS receiver is known, the difference between the true location and the GPS-determined location can be determined. If a second GPS receiver (rover) is collecting data during the same time period using the same array of satellites, its data can be corrected based on the information from the receiver at the base station. This correction can be accomplished through post processing or in real time by transmitting the corrections by use of a radio or satellite link to the roaming GPS receiver. DGPS can provide position accuracies ranging from 0.01 to 5 m depending on the instruments used and the distance of the rover from the base station.

During initial evaluations of positioning systems, real-time, kinematic, DGPS with submeter accuracy was not readily available. In addition, this accuracy required the signals from four satellites to be locked in at all times; if failure occurred, it could take several minutes to reacquire signal lock and be ready to survey again. These limitations were not reasonable for surveying around bridges where satellite view is frequently blocked. However, the capabilities of DGPS have evolved rapidly and at the writing of this report, real-time, kinematic, DGPS can achieve centimeter accuracy and can reacquire satellite lock and be ready to begin surveying in a few seconds. These enhancements make DGPS a viable positioning system for collection of scour data upstream and downstream of bridges; however, a second positioning system may be required for measurements underneath the bridge deck, where satellite visibility is blocked.

The establishment of a base station with suitable radio telemetry to the study site is essential to real-time, kinematic, DGPS. At many locations, suitable base stations may already be established by the U.S. Army Corps of Engineers, U.S. Coast Guard, other state or federal agencies, or

commercial companies. With the appropriate radio receiver these existing base stations may be used for the differential corrections.

Commercially available differential corrections are also common. These commercial corrections are typically transmitted through FM radio stations with a special decoder or through satellite downlinks. The radio stations have limited coverage, like regular radio stations; however, the satellite downlinks can be used anywhere in the contiguous U.S. The costs of these services are reasonable (< \$1,000 per year) when compared to the cost of establishing temporary base stations. The accuracy of kinematic DGPS positions using commercial corrections ranges from 0.5 to 1 m.

If existing base stations are not available or if accuracies better than 0.5 m are required, a base station must be established. To achieve centimeter accuracy, the base station should be located within 10 km of the study area. Adequate radio telemetry of the data to the study site is an important consideration in selecting a location of a base station. A temporary base station often requires a person to remain at the base station to prevent vandalism or theft and to correct problems that may occur at the base station.

Use of DGPS for navigation reference and positioning allows rapid collection of velocity and bathymetric data in the approach and exit reaches of a stream. Because DGPS requires no setups on shore and no personnel to track the boat, data can be collected very rapidly and over a much longer reach of river than would be feasible with the land-based range-range or range-azimuth systems. However, data collection near tree lines and bridges is hampered by loss of adequate satellite coverage caused by blockage of the sky by trees and by the bridge structure. It is possible to survey under the bridge by maintaining a constant course until DGPS is reacquired on the other side of the bridge, but some loss of accuracy is inherent in this process. Therefore, the optimum positioning system for collecting real-time scour data at bridges allows both detailed positioning data to be collected under the bridge, as well as, in the approach and exit reaches. Using available technology, the optimum system is a combination of DGPS and range-azimuth tracking systems. The DGPS provides accurate positions in areas where adequate satellite coverage can be maintained. The range-azimuth system provides accurate positions under the bridge, around the piers, and on small streams where DGPS may not be usable because of lack of adequate satellite visibility.

Range-Azimuth Systems

Range-azimuth systems operate like engineering survey total stations, which combine an electronic distance meter (EDM) with an electronic theodolite (figure 11). The position of the target is determined by measuring the range using a laser and the corresponding azimuth and vertical angle with an integrated electronic theodolite. Tracking systems have broad-beam lasers to readily provide target acquisition. The system will measure and record the position of the center of the beam when the prism (or reflector) is anywhere within the beam area. For a beam four milliradians in the vertical by seven milliradians in the horizontal, the beam area is 0.4 by 0.7 m at 100 m. If the instrument is not pointed directly at the target, the measured position will be incorrect. Although the lasers are eye-safe, they are more powerful than the lasers typically



Figure 11. Range-azimuth positioning system.

used in total stations and are capable of reflecting from objects up to 300 m away and from prisms up to 10,000 m away. Positions are typically measured 2-10 times per second. Some systems provide data filters to eliminate erroneous positions. Erroneous positions are collected when the instrument is pointed away from the target or when an object between the instrument and the target (such as tree limbs) reflects the laser. The accuracy of the data depends on the accuracy of the instrument and on the proximity of the crosshairs to the center of the target. The instruments have distance accuracies ranging from 0.1 to 0.5 m and horizontal and vertical angle accuracies ranging from 0.01 to 0.001°; tracking errors are often greater than the instrument errors. Tracking of the target is accomplished manually or automatically depending on the system used.

Manual systems require an operator to sight the target with the instrument. When tracking a moving target the operator must continually adjust the horizontal and vertical orientation of the scope to maintain the crosshairs of the instrument on the target. To facilitate continuous tracking, the systems provide a continuous tangent for the horizontal angle and either a continuous- or limited-tangent knob for the vertical angle. During hands-on evaluations of manual range-azimuth systems, it was noted that tracking was improved by the addition of a handle on the continuous tangent. When only a knob was present the tracking became difficult because the operator had to frequently shift his hand to keep turning the knob. This resulted in tracking that often lagged behind the target. Much smoother tracking was achieved with a handle attached to the continuous horizontal tangent, allowing it to be used like a crank. A continuous vertical tangent also improved the vertical adjustment. A limited tangent, similar to that found on land-surveying equipment, created problems when the vertical angle needed to be adjusted beyond the limits of the tangent screw. A continuous vertical-tangent knob is sufficient because the adjustments are much slower and smaller than are those in the horizontal direction. Tracking errors were found to be significant and accuracies better than 0.15 m were not achievable during normal-flow conditions. Horizontal accuracies were estimated to be about 0.7 m when tracking a boat on the Mississippi River during the 1993 flood. Accuracies in the vertical direction were larger than the

typical movement of the boat in the water. Therefore, the water surface may be a more accurate vertical-reference plane than the vertical coordinate computed by the tracking system. However, the vertical angle must be adjusted to the vertical proximity of the target to maintain a strong laser reflection and to properly account for the vertical slope of the distance measured.

Automatic tracking systems require little or no operator control after initial setup, provide single point setups, and can provide positions with accuracies of about 0.2 m in the horizontal and vertical directions. The automatic systems have limitations on the radial speed the instrument can turn or adjust the vertical angle; however, the radial speed of the instruments is adequate for most surveying applications. The primary advantage of this system is that like the range-range and GPS systems it determines the position automatically without the need for an operator. The disadvantage of the system is the initial cost, which was from 3 to 5 times the cost of a manual system in 1993.

Total stations have also been used to track a moving survey vessel by use of larger targets on the vessel or by only collecting occasional locations. Most total stations do not have the continuous tangents; a wide, powerful laser; or the data filters present in range-azimuth tracking systems and, therefore, are not well suited to tracking moving targets. However, new robotic total stations have been introduced that provide automatic-tracking features comparable to the hydrographic-survey systems. These robotic total stations still have a less powerful laser but using larger reflectors on the survey vessel can compensate for this loss of range. The accuracy of the robotic total station is similar to traditional total stations and the cost is comparable to a manual tracking range-azimuth system (\$30,000-\$40,000). The robotic total stations were not tested with a moving survey vessel, but an initial evaluation indicated that these instruments have potential for use as a positioning system for collecting scour data, particularly on smaller streams.

The number of setup locations for a range-azimuth system depends on the site and bridge configuration. If the bridge has solid wall piers, two setup locations (one on each bank) are typically required to allow surveying along both sides of the piers. Other conditions and bridge configurations may require more or fewer setup locations. During extreme floods, locations for instrument setup that provide an adequate view of the bridge, approach, or exit sections are often difficult to find, especially at sites with very wide inundated flood plains. Vegetation on the banks can also restrict use of range-azimuth systems.

The power of the laser on most range-azimuth systems allows setup points to be referenced to the bridge quickly and often without the need of a prism. At many sites, the powerful laser allows the setup location to be referenced to the centerlines of several piers by pointing the instrument at the centerline of each pier and reflecting the laser directly off the concrete pier. This capability provides for fast and efficient setups; it reduces the time required for surveying control points and increases the time spent collecting data. Plotting of the pier and setup-point locations for several sites showed that an accuracy of about 0.3 m was achieved when using the instrument to survey setup points in the manner described.

VESSEL-MOTION COMPENSATION

Highly turbulent water may cause a boat to tilt side to side (roll), (or) tilt front to back (pitch), and move vertically (heave) (figure 12). Changes in vessel attitude will cause the acoustic beam of a fixed-mounted echo sounder to be directed to portions of the seabed not directly beneath the boat, and the depth and position data may need to be corrected for vessel attitude (heading, roll, pitch, and heave).

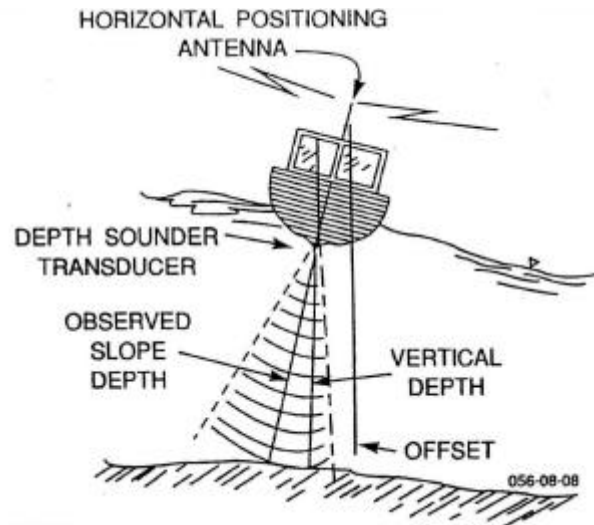

(A) ILLUSTRATION OF ROLL

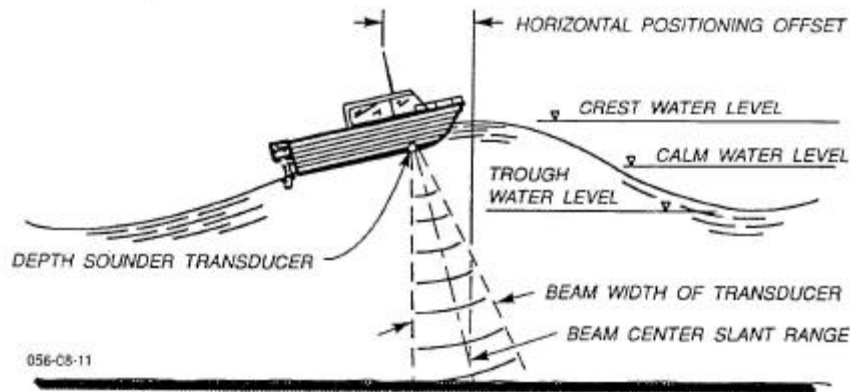

(B) ILLUSTRATION OF PITCH AND HEAVE

Figure 12. Illustration of vessel motion⁽¹³⁾.

Theoretical Considerations

Corrections for vessel attitude could be applied only to the depth measurement if the streambed bottom is flat; however, the streambed is seldom flat, particularly where scour is occurring. Therefore, the measured depth and the measured position of that depth must be corrected for the vessel attitude (figure 12). Figure 13 defines the X, Y, and Z axes and shows the measured location (X_o , Y_o) and actual location of the measured depth (X_a , Y_a). The corrections (X_c , Y_c) to the measured location (X_o , Y_o) and the measured vertical distance (Z_c) can be computed from the following equations:

$$X_c = D \frac{\cos(\theta_p) \sin(\theta_R)}{\sqrt{1 - \sin^2(\theta_R) \sin^2(\theta_p)}} \quad (2)$$

$$Y_c = D \frac{\cos(\theta_R) \sin(\theta_p)}{\sqrt{1 - \sin^2(\theta_R) \sin^2(\theta_p)}} \quad (3)$$

$$Z_c = D \frac{1}{\sqrt{1 + \tan^2(\theta_R) + \tan^2(\theta_p)}} \quad (4)$$

where

θ_R is the angle of roll referenced to vertical,

θ_p is the angle of pitch referenced to vertical, and

D is the sloped distance from the known location (X_o , Y_o , Z_o)

The corrections given in equations 2 and 3 are relative to the axes of the boat as defined in figures 12 and 13. The heading of the boat must be used to rotate the corrections on to the coordinate system being used in the survey. The elevation correction in equation 4 must also be corrected for the heave of the boat; therefore, the final coordinates are computed as follows:

$$X = X_c \cos(\theta_H) - Y_c \sin(\theta_H) + X_o \quad (5)$$

$$Y = X_c \sin(\theta_H) + Y_c \cos(\theta_H) + Y_o \quad (6)$$

$$Z = Z_c + H_z + Z_o \quad (7)$$

where

θ_H is the heading of the boat referenced to the desired coordinate system, and

H_z is the heave of the boat.

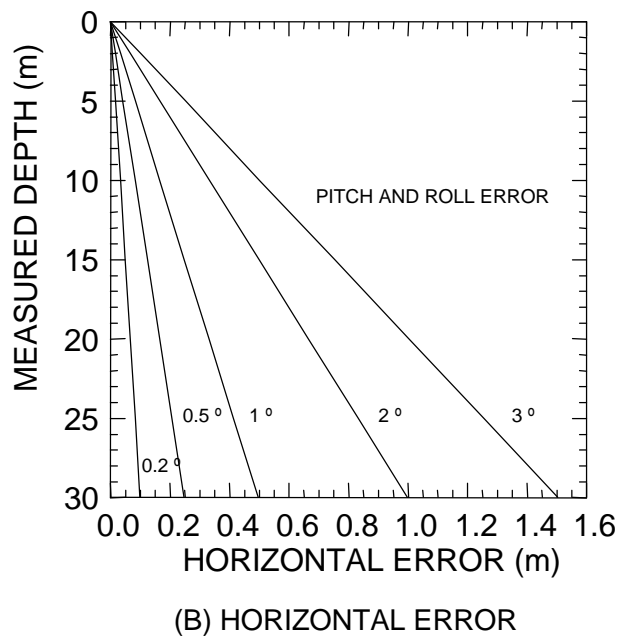
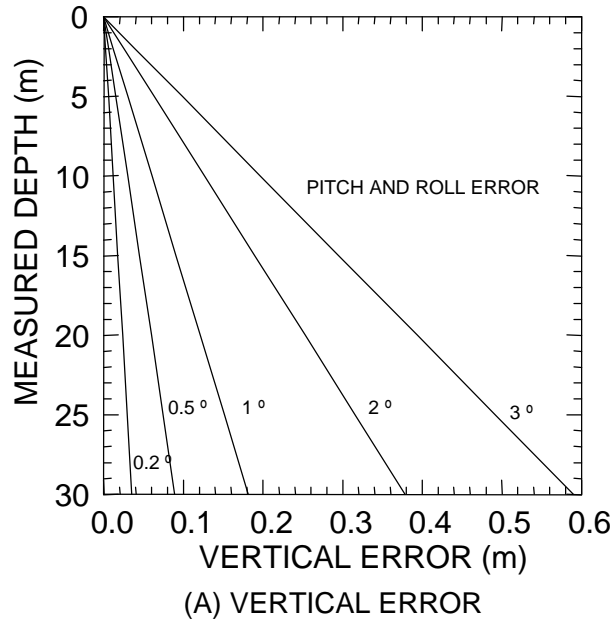

Figure 14. Vertical- and horizontal-measurement errors resulting from inaccurate measurements of pitch and roll. (shown for a pitch and roll of 10°)

survey and the equations presented. The accuracy of the survey can be approximated from estimates of the maximum pitch and roll of the boat.

Measurements of depth, position, and vessel attitude must be synchronized to avoid additional errors. In very dynamic systems, even the small amount of time required for data transmission can

be significant; thus, the latency time of each instrument should be determined. Consideration should be given to the use of a parallel interface to increase the data transmission speed. For single-transducer systems, the vessel attitude is seldom measured, unless the survey is in a coastal environment with significant wave action or a very accurate survey is required. Correction for vessel attitude is required for scanning-sonar systems.

Vessel attitude can be measured using several types of instruments but very accurate instruments can be very expensive. Vessel-attitude measurement systems can be grouped into the following general categories: (1) fluid systems, (2) pendulum systems, (3) range-range systems, (4) gyroscope systems, and (5) combination systems.

Fluid Systems

Fluid-based systems determine the tilt angle using the change in capacitance from movement of electrolytic liquid over electrodes caused by the tilt of the instrument. The two most common configurations are the dome system and the vial system. These fluid-based systems work well for slow moving equipment such as cranes. However, a boat deployed in flood conditions is subject to horizontal and vertical accelerations caused by surface turbulence and maneuvering of the boat. These accelerations cause the liquid in a fluid sensor to tilt although the instrument is not tilted. For example, if a glass of water setting on a table is quickly slid across the table the water surface will become tilted although the glass remained level. Using a fluid with a high viscosity can reduce this problem. The tradeoff is that the higher the viscosity of the fluid, the slower the fluid responds to motion. Because the timing of vessel motion with depth and position measurements is critical, the response time of the tilt sensor is also critical. Several companies reported success using fluid-based sensors on boats, aircraft, land vehicles, and remotely operated vessels; however, these instruments are not commonly used by the hydrographic surveying industry for high accuracy surveys. The BB-ADCP discussed in "Velocity Measurements" uses a fluid-based sensor. No field evaluation or comparison of these instruments was conducted against a known standard. Theoretical static accuracy of these systems is typically $\pm 0.01^\circ$ to $\pm 0.5^\circ$ with response times of 0.5 to 5 Hz depending on the instrument.

Pendulum Systems

Pendulum-based systems utilize gravity to maintain a pendulum in a vertical orientation so that as the instrument is tilted, the tilt is referenced to the vertical pendulum. The pendulum motion is often dampened by placing the pendulum in a fluid. Like the fluid-based system, the pendulum-based system is subject to errors associated with horizontal accelerations. Again, there is a tradeoff between stability and response time based on the viscosity of the fluid used to dampen the pendulum motion. Accuracy of these instruments is about $\pm 1^\circ$ with a response time of about 20 Hz.

Gyroscope Systems

Vertical gyroscopes were developed to overcome the shortcomings of static inclinometer systems. Vertical gyroscopes employ a disc revolving on an axis. When the instrument is at rest there are

no lateral forces, but as the instrument is rotated gyroscopic forces change and the angular rate can be determined. Gyroscopes can be expensive and often require an alternating-current power source. The power requirements, while readily available on a large manned vessel, are significant for a small manned or unmanned vessel. The time for gyroscopes to spin until they reach operational speed, drift over time, and sensitivity to shock are further disadvantages of gyroscopes for this application. Typical accuracy of these instruments is in the range of $\pm 1^\circ$ to $\pm 3^\circ$.

Range-Range Systems

The range-range based systems utilize multiple antennas or targets on the survey vessel, and the position and orientation of the boat can be determined by measuring the position of each antenna. The antenna or target configuration can be adjusted to allow use of these systems on many different types of vessels. Two implementations of this technique are currently available. A short-range (less than 100 m) laser-based system has been developed for use on construction sites and should be readily adaptable to use from a bridge for scour surveys. The laser-based systems can achieve an accuracy at each target of ± 25 mm with an update rate of about 4 Hz. The actual accuracy of the pitch and roll angles will depend on the distance between the individual targets mounted on the vessel.

A GPS based three-dimensional position and attitude determination system is currently marketed as an alternative to traditional accelerometer-based systems. The vessel-attitude accuracy can be as good as $\pm 0.057^\circ$ but depends on the antenna configuration. For a 1-m square antenna configuration the accuracy would be better than 0.5° . This GPS system has an update rate of about 2 Hz.

The GPS system does not have a range limit and unlike the laser-based system, it does not require multiple base stations to be established. However, the laser-based system supports surveying under bridges where the GPS based systems could not be used. In addition to tilt (pitch and roll), these systems also measure the vertical position (heave) and heading of the vessel. These systems can be used in dynamic environments with little or no effects from horizontal accelerations.

Accelerometer Systems

Marine- and hydrographic-survey operations requiring compensation for vessel attitude commonly use accelerometer-based systems. Accelerometer-based systems have no moving parts and can measure heave, pitch, and roll. These systems typically employ three high-grade linear accelerometers. In addition to the triax of linear accelerometers, two angular accelerometers are often used to compensate for the horizontal accelerations. These instruments can achieve an accuracy of ± 5 cm for heave and $\pm 0.15^\circ$ for pitch and roll and provide data rates of about 20 Hz. These systems are frequently used with scanning and multibeam sonar systems for detailed mapping in inland and offshore environments.

Combination Systems

There are several systems available that combine one or more of the technologies already presented. Fluid-based systems have been combined with low-power gyroscopes to smooth the short-term inaccuracies of a fluid-based inclinometer caused by lateral accelerations. Others have proposed fluid systems using multiple sensors with different viscosity fluids and digital filters to smooth short-term inaccuracies of fluid-based inclinometers. Some gyroscope systems use GPS to correct for drift or accelerometers to correct for lateral accelerations. These combination systems complement the strength and weaknesses of the various technologies and provide a system with better characteristics than is available with a single technology.

DATA RECORDING AND STORAGE

Efficient and reliable data storage is essential to any data-collection system. Inspection and limited-detail data are typically recorded in field notebooks or written on the chart of a recording echo sounder. Bridge-scour data are often collected during wet conditions; therefore, waterproof notebooks and (or) pens are highly recommended to prevent loss of data. When annotating echo-sounder charts, it is important to indicate the beginning and ending of all transects, to identify known positions of reference features (such as piers), and to indicate portions of the chart made where the transducer was not moving at a reasonably constant speed. Pictures and video help document water-surface elevations, debris accumulations, surface currents, and general site characteristics. Clear and detailed notes are required to ensure proper interpretation of the data at a later time.

Inspection and limited-detail cross-section data could be collected using a portable computer to record digital data from a low-cost echo sounder with digital output; however, a portable computer is not required and the computer is often cumbersome to carry across the bridge. Long data cables or radio telemetry could be used to allow the computer to remain in the field truck or at a fixed location; however, this would require a minimum of two persons (one to deploy the transducer and one to operate the computer) and would significantly increase the cost of the system.

Detailed data sets contain large amounts of digital data that must be collected and stored using a computer. The computer used to collect data in the field should be designed to operate in an outdoor environment. Many notebook computers are designed for the temperature-controlled office environment and will not operate well in an outdoor environment. The computer screen is also critical in an outdoor environment. Color screens, both passive display and active matrix, may be difficult to see on a sunny day, even in the shade. Monochrome screens are a good alternative for field-data collection. A computer with at least two RS-232 serial ports is required, if both position and either depth or velocity data are to be collected simultaneously. Most notebook computers come standard with only one serial port. A PCMCIA serial card can be used for the second serial port if the computer has PCMCIA capabilities. Although more expensive than business-oriented notebook computers, ruggedized portable computers are better suited for field-data collection. These ruggedized computers have broader temperature specifications, have screens that are visible in direct sunlight, can operate from an external 12-VDC power source, and

often have a stronger case than business computers. Computers used in the field can be fitted with a keyboard cover to prevent moisture and dirt from entering the keyboard.

The data collected may need to be transmitted to the computer by use of radio telemetry depending on the type of boat used to deploy the instruments and the type of positioning system. A range-azimuth tracking system would be located on the shore while the digital echo sounder is on the boat. Telemetry of the data from one instrument to the computer may be required to record the position and depth simultaneously. Most commercial hydrographic-surveying instruments and positioning systems have telemetry systems available. However, some of these systems are designed for larger boats and the data link only transmits data from the shore station to the survey vessel. For small-boat and remote-control boat surveys it is advantageous to maintain the computer on the shore and transmit data from the boat to the shore. Once properly configured, a radio data link operates like a hardwired cable. Depending on the radio frequency selected for the telemetry system, federal licensing of the radio frequency may be required.

Recording the data from the various instruments used in a detailed-measurement system requires special software. The output strings from many of the instruments are simple and a user familiar with programming can develop software to record the data. However, proper data timing to ensure that near simultaneous data is recorded, real-time display of the data, compatibility with various instruments, corrections for vessel attitude, and post-survey editing of the data are problems that require a significant programming effort. Commercial software, commonly used by professional hydrographic surveyors, interfaces to most standard hydrographic-surveying instruments. The software developers are often willing to develop interfaces to support particular instruments, if they are not already supported. Commercial software provides advantages such as compatibility with commonly used instruments, verified timing routines, real-time data display, tools for pre-survey planning, post-survey data editing routines, and geodesy and data transformations. Because commercial software supports a variety of users with different requirements, it often contains features that are not required for scour surveys. These additional features can make learning and use of the software somewhat cumbersome; however, instrument compatibility and the data collection and editing features make the commercial software a valuable tool for collecting detailed hydrographic data. Use of commercial or proprietary software (sold with the instrument) is required if multibeam or scanning sonar are used. Proprietary software is provided with some instruments; however, interfacing this proprietary software with other unsupported instruments is often difficult.

CHAPTER 3: EVALUATION OF DEPLOYMENT SYSTEMS

GENERAL

The overall functionality and many of the design criteria for a scour-measurement system are dependent upon the method used to deploy instruments in the river. The best instrument is useless if it cannot be deployed to where data need to be collected. Often, the deployment mechanism becomes the component that limits the success of a scour-measurement system. The spatial extent of the study reach, the detail required for the measurement, and the geometric configuration of the bridge determine the requirements of an instrument-deployment system for collecting bridge-scour data. Deployment systems were evaluated for use from the bridge deck and from the water surface. Deployment mechanisms developed outside of this investigation are described in Chapter 3. Deployment mechanisms developed in this investigation are described in Chapter 4, as part of equipment development.

DEPLOYMENT FROM THE BRIDGE DECK

Deploying instruments from the bridge deck is adequate for most limited-detail and inspection measurements. The spatial coverage of these measurements extends from the upstream edge of the bridge deck to the downstream edge of the bridge deck. A boat may be required to collect the data at bridges that have decks more than 25 m above the water surface. Systems used to deploy instruments from the bridge deck can be classified into two general categories: non-floating systems and floating systems.

Non-Floating Deployment Systems

Systems without flotation include manually and electrically powered hydrologic-equipment cranes mounted on a truck (figure 15), a 4-wheel base (figure 16), a 3-wheel base, a 2-wheel base (figure 17), a bridge board (figure 18), and hand-held systems. The truck-mounted cranes are typically easier to use and are recommended when stream velocities and depths require use of weights heavier than 68 kg. Bridge boards can be used to make measurements when weights of 34 kg or less are required. Hand lines can be used when weights of 14 kg or less are required. The electric-powered crane mounted on a truck or a 4-wheel base is commonly used by the USGS. These systems can deploy weights for direct soundings, echo sounders, velocity meters, or sediment samplers.

A 4-wheel base configured with the appropriate Columbus weight and velocity meter is shown in figure 16. The equipment is moved to discrete locations across the bridge and the instruments lowered to obtain a water-surface elevation, a depth measurement, and a velocity measurement. Sediment-concentration or bed-material samples can be collected in the same manner, by attaching the appropriate sampler to the end of the cable.



Figure 15. Truck-mounted hydrologic-equipment crane deploying transducer mounted on the boom of a Columbus weight.



Figure 16. Four-wheel base with standard stream-gaging equipment.

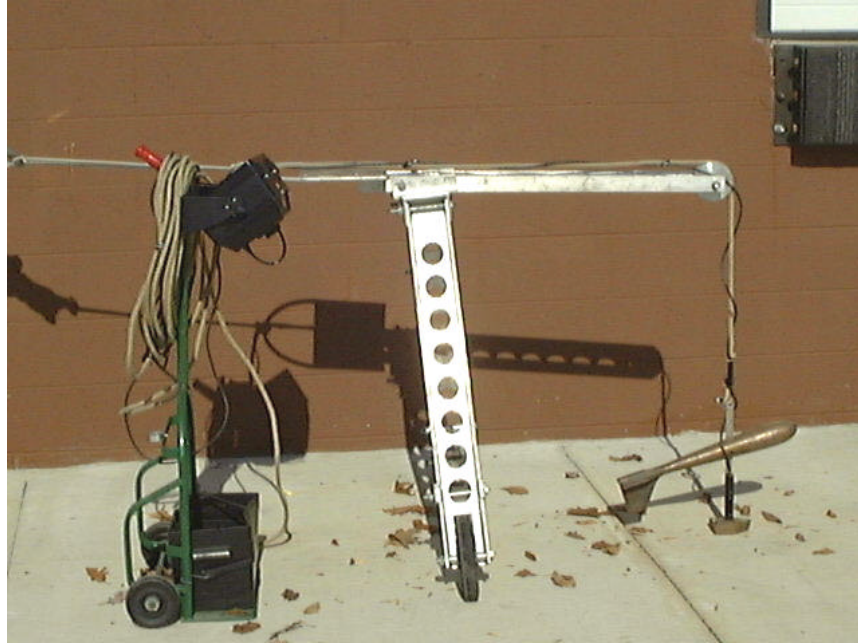

Figure 17. Two-wheel base modified for bridge-scour data collection.



Figure 18. Bridge board with standard stream-gaging equipment.



Figure 19. Closeup of transducer mounted to the bottom of a Columbus weight.

Channel geometry can be measured with an echo sounder, by mounting the transducer on the bottom of a Columbus weight (figure 19). The weight is lowered into the water so that the transducer is submerged about 0.5 m. The echo sounder is slowly moved across the bridge at a constant speed and the chart of an analog-recording echo sounder is annotated with stationing, location of the piers, and other important features. The depth of the transducer below the water surface must be measured often to provide an accurate record of the streambed elevation. Where the piers are inset from the edge of the bridge, the sounding weight may be lowered further to increase the drag and allow the current to carry the sounding weight closer to the pier.⁽⁹⁾ A typical truck-mounted hydrologic-equipment crane being used to deploy an echo sounder on a Columbus-type weight is shown in figure 15.

These mechanical deployment systems work very well and are required to deploy velocity meters and sediment samplers; however, data can only be collected along the upstream and downstream edges of the bridge. Continuous cross sections with an echo sounder cannot be obtained on bridges with superstructure or obstructions (signs, lampposts, etc.).

Traffic control must be handled in a manner consistent with State laws when collecting data from bridges with narrow shoulders or on most bridges when using truck-mounted equipment. Often, local law enforcement or State DOT personnel are willing to assist with traffic control.

Floating Deployment Systems

Floats are used to reduce the weight required to deploy a transducer and to allow the transducer to be maneuvered beneath the bridge and along the sides of the piers. Floating platforms are often hand deployable; however, a hand-deployable floating platform cannot be used to collect standard velocities, sediment concentrations, or bed-material samples. These types of data collection require a mechanical-deployment system. The floating platform allows channel-geometry data to be collected quickly and extends the spatial coverage from the upstream edge of the bridge, to areas under the bridge, and to as far downstream of the bridge as the tether will allow.

Researchers and field personnel have tested several different floating deployment systems with varying levels of success. The floating platforms can be classified by their basic designs: rafts, spherical floats, and skis.⁽²⁾ Several different raft-type floats have been designed using PVC pipe. One design used in California consists of 10.2-cm (4-in) Schedule 40 PVC pipe constructed in a horseshoe (raft) shape.⁽²⁷⁾ A 1-m by 1-m piece of plywood was attached to the top of each pipe and a mast was installed to mount a target for a range-azimuth positioning system. Another 10.2-cm (4-in) piece of pipe was attached to the raft as a rudder and the transducer was mounted on the bottom of this pipe. Another similar design uses two pipes to form two pontoons. Either 90° or 45° elbows, a short piece of pipe, and a cap are used to form the bow of each pontoon. The pontoons are attached to a deck made from Plexiglas or marine-grade plywood. The transducer is mounted to a bracket on the underside of the deck and a tether is attached to the front of the deck with an eye-bolt. These rafts are inexpensive and are good deployment platforms at low to moderate flows. Their viability in flood conditions, with high levels of turbulence and average velocities of 3 m/s, has not been verified, although they are expected to be usable in these conditions.

The Arkansas District of the USGS developed a spherical float deployment platform using a 61-cm (24-in) fiberglass sphere filled with polyurethane foam. The fiberglass sphere is an aircraft-warning marker for power lines. This design requires that a 2.54-cm (1-in) diameter pipe be installed through the center of the sphere. A short hanger bar and a 22.7 kg weight, with the transducer attached, are mounted to the bottom of the pipe. The steel cable from a mechanical deployment system was attached to the top of the pipe and used to lower the float to the water surface.⁽²⁷⁾ The National Scour Project also attempted to use spherical floats for data collection under the bridge and along the sides of the piers. The transducer was attached to the bottom of a Columbus weight and rubber balls were attached above the weight to provide flotation (figure 20).⁽⁹⁾ These attempts to use spherical floats were only partially successful. Spherical floats have substantial drag at high velocities when partly submerged. The resulting instability caused the transducer to be raised and tilted out of the vertical position. In addition, the weights used to hold the spheres in a vertical position generally required a mechanical-deployment system.



Figure 20. Deployment using rubber balls for flotation.

The Texas and Arkansas DOTs had success using a water ski to deploy a transducer during high-flow conditions. The transducer was mounted on the bottom of the water ski and a rope was attached to the front of the water ski to maneuver it without putting stress on the transducer cable. Air entrainment beneath the transducer and instability of the platform at high flows are the primary problems associated with the water-ski deployment platform.⁽²⁸⁾

DEPLOYMENT FROM THE WATER SURFACE

Inspection and limited-detail data collection around the foundations of high bridges and the spatial coverage for detailed-data collection requires that instruments be deployed from a boat. Manned boats are the most common means of collecting these types of data; however, safety considerations have led researchers to evaluate the use of unmanned boats.

Manned vessels

Manned boats are commonly used to collect data around bridges at low to moderate flows and, when necessary, during floods. Bridge-scour data collection on the Red River in 1990 and on the Mississippi River in 1993 using manned boats revealed many important considerations for collecting data from a manned boat during floods. The use of a manned boat requires sufficient clearance beneath the bridge to avoid safety hazards and to collect data under the bridge. This limits data collection on small rivers where clearance under bridges is often less than 1.5 m during floods. Reliability and handling of the boat and adequate launch facilities are also important. Use of manned boats during floods requires a highly skilled operator to collect data very close to the

piers, particularly when debris is present. During extreme floods, boat ramps are flooded and water velocities can be high even near the shore. Flooded local streets with sufficient slope and the river side of levees are often the only options for launching boats. The support and cooperation of local citizens and government agencies are valuable in locating adequate launch facilities. A small boat is easy to launch, but safety and proper handling of the boat in high velocities may require a boat larger than typical flat-bottom boats commonly used during low- and moderate-flow data collection. Small inflatable boats, with custom frames that stiffen the boat and allow deployment of instruments, are commonly used for data collection in the Grand Canyon. This configuration may provide an alternative to boats commonly used for data collection around bridges during high flows.

Manned boats offer some advantages over other deployment platforms. Manned boats are capable of carrying several hundred kilograms of equipment and two or three persons. Having personnel on the water and at the areas being studied improves assessment of flow conditions and debris accumulations and helps in determining the required extent of the study area, what data should be collected, and how the data should be collected. If visual estimates of location are sufficient, such as for inspection surveys, the boat becomes an autonomous platform with no support required from the bridge or banks. Using GPS on a manned boat allows the study reach to be extended far beyond what is possible using most other deployment platforms.

Unmanned vessels

The safety, launching, and clearance limitations of a manned boat may be negated with a properly designed unmanned or remote-control boat. The only reported investigation of remote-control boats for bridge-scour data collection was reported by Skinner.⁽²⁹⁾ Unmanned vessels have been developed for other applications, but most of the effort has been on remotely operated vessels (ROVs) for oceanographic research. Two commercially available remote-control boats were evaluated.

Skinner's research on a remote controlled boat had the following design objectives:

1. The boat must be portable so that it can be quickly moved to the site of a flood.
2. The hull must be narrow so that it can be safely moved along the bridge walkways.
3. The boat must be lightweight so that it can be lifted and lowered by hand or with a portable crane.
4. The boat, its propulsive system, and its cargo of instruments must be inexpensive.
5. The boat must be maneuverable and stable in flow velocities of about 5 m/s.
6. The boat must support a cargo of about 70 kg.
7. The boat hull and the propulsive system must operate in debris-laden flow.⁽²⁹⁾

On the basis of these objectives, Skinner evaluated a variety of platforms including a boat hull made from automobile inner tubes, a catamaran-style boat, and a flat-bottom planing-hull boat. The inner-tube boat had several attractive features; it was rugged, portable, and inexpensive. However, the boat's small size and blunt shape produced a large amount of drag.⁽²⁹⁾ Most boat designers agree that a catamaran-style boat is ideal for high-speed travel. A 4.6-m catamaran with

15.2-cm diameter pontoons and a 1.6-m wide deck was proposed on the basis of computations of drag and buoyancy requirements; however, this size vessel did not meet the criteria for moving the vessel along the narrow walkway of a bridge. Skinner suggested that a 1.8-m flat-bottom boat with a beam of 0.6-m and a draft of 7.6 cm would probably satisfy the design requirements and could transport a total weight of 86 kg.

Skinner also evaluated propulsion systems, power systems, control systems, data links, and positioning systems. The two primary propulsion systems evaluated were fan propulsion, commonly used on swamp boats and traditional propeller propulsion. Skinner determined that the propeller system is the preferred system. Skinner's evaluation of power systems showed that gasoline powered engines had a weight advantage but that electric powered systems provided higher reliability and were easier to control. No untethered control systems for the boat were discussed. Radio linking the data from the transducer was feasible but initial tests using a photographic-light system as a data link were not successful. The positioning system proposed was a visual triangulation system requiring two shore stations with an operator at each station. Skinner concluded that designing an unmanned boat for mapping scour holes was feasible provided the system was tethered or the design speed reduced significantly.⁽²⁹⁾

A commercial remote-control boat designed for conducting surveys in shallow, confined, or hazardous-waste areas was investigated.⁽³⁰⁾ The vessel is 185-cm long, 70-cm wide, and 45-cm high. It is powered by twin 95-watt, 12-VDC motors and can achieve a maximum speed of 3.1 m/s. The vessel can operate about 4 hours from a 60-ampere-hour battery. Remote controls are standard recreational-boat controls. The boat can be purchased as a package with echo sounder, data telemetry, and positioning system. This vessel is very close to the requirements needed for a remotely operated boat to collect scour data; however, the maximum speed of 3.1 m/s is below what can be expected around piers during floods. The manufacturer indicated that it was designed for surveys in lakes and ponds, particularly in hazardous areas where manned vessels were not recommended or allowed, not open-river conditions.

A commercial remote-control boat designed for military operations in the coastal and open-sea environment was also investigated. The design objectives of this system were very different than the vessels previously evaluated. The boat is 295-cm long, 165-cm wide, 61-cm high, drafts 10 cm, and weighs 204 kg. It can carry a 204-kg payload, achieve speeds up to 18 m/s, and carry up to 132 L of fuel, which allows the boat to operate at maximum speed for 7.5 hrs.⁽³¹⁾ The data telemetry and control system will operate at distances up to 10 nautical miles. The vessel is controlled from a console that can show live video from cameras located on the boat, display real-time locations on digital maps by use of GPS deployed on the vessel, be programmed to automatically navigate the boat along a preselected path, and collect and record data from instruments deployed on the vessel. The performance characteristics of this vessel exceed all design parameters necessary to collect scour data during floods; however, the size, weight, and cost of the system are significant disadvantages.

SUMMARY

Different equipment and techniques have been used to deploy instruments to collect data around bridges during floods. All of the deployment systems evaluated have advantages and disadvantages. Deployment using equipment cranes is a standard USGS technique and no further development is needed. Deployment using flotation promises to provide a lightweight and efficient method for collecting channel geometry with an echo sounder. Additional development of a floating deployment system is likely to lead to a good system for inspection measurements that will allow the spatial extent of limited-detail data to be extended beyond what is feasible using only a hydrologic-equipment crane.

Although manned boats have advantages, safety and portability make use of a remote-control boat very attractive for collection of data around bridges on small streams during floods. The technological advancements since Skinner's report⁽²⁹⁾ should make development of an untethered remote-control boat feasible. This type of deployment system would greatly increase the ability of researchers to safely collect detailed data on scour at bridges.

CHAPTER 4: EQUIPMENT DEVELOPMENT

GENERAL

Equipment packages to make scour measurements for three different objectives (inspections, limited-detail data collection, and detailed data collection) were developed. Although commercially available equipment satisfied many of the design criteria, it was necessary to integrate, modify, and repackage some of the equipment. Except for the detailed measurement system, someone with minimal experience with this type of equipment can make the modifications to the equipment.

INSPECTION-LEVEL DATA COLLECTION

Several instrumentation packages were developed in this investigation for bridge inspectors to measure streambed elevations around bridge foundations. Cost, portability, reliability, and simplicity of operation were primary considerations during the development. Commercially available and custom-designed equipment was considered for each component (measuring instrument, deployment method, positioning system, and data-storage device). Commercially available components were given preference because of their immediate availability and potentially lower cost.

Selection of depth-sounding equipment and deployment methods is interdependent. Deploying the transducer of an echo sounder using a lightweight, hand-held floatation system is less expensive and more portable than using sounding weights and mechanical deployment systems. Simultaneous use of both systems has shown both to have approximately the same accuracy at discrete points. The echo sounder provides continuous measurements as the transducer is moved around the bridge substructure. Continuous measurements reduce the chance that important data could be missed by the discrete points collected when using sounding weights. Therefore, an echo sounder with the transducer deployed by a hand-held floatation system was selected for the inspection-level data-collection system.

The final selection of an echo sounder depends on the personal preferences of the operator and the availability of low-cost chart-recording instruments. Project personnel found the chart-recording echo sounder to be the preferred instrument. The chart is a permanent record of the depth measurements and is a convenient place to record notes and horizontal positions of the data. Responses to the questionnaire sent to the DOTs indicated that many of them did not want a permanent record. If no permanent record is needed, a graphical or numerical-display echo sounder could be used. A graphical display helps the operator interpret the scour patterns. Most graphical-display echo sounders also display the depth numerically. The graphical displays often will not display a complete cross section and some echo sounders provide only a numerical display of the depth. Side echoes and echoes off of exposed footings are easier to identify with a graphical display than with only a numerical display. If adequate notes are taken, the numerical- and graphical-display echo sounders are satisfactory and less expensive than the chart-recording models. Some graphical- and numerical-display echo sounders provide RS-232 output, which

could be interfaced with a field computer or data logger. Use of a field computer on the bridge deck, while maneuvering the transducer around the bridge substructure, can be cumbersome and unless specific requirements dictate collection of digital data, this configuration is not recommended for inspection-level data collection. The chart-recording echo sounder is perhaps the best instrument for collecting inspection data. Currently, low-cost chart-recording echo sounders are not being manufactured, but used and rebuilt units are often available from marine-equipment dealers and repair shops. The graphical-display echo sounders are a good alternative, provided adequate notes are taken.

Some graphical- and numerical-display echo sounders use transducers that contain sensors to measure the water temperature and velocity. If this multifunction transducer is deployed on a float and is held in a single location, the near-surface water velocity can be measured. This surface velocity measurement can be used to help characterize the hydraulic conditions at the time of the measurement.

Transducer beamwidth and cable lengths are important considerations for any of the echo sounders. A transducer with a beamwidth of 8° or less should be used to obtain good measurements in narrow holes, on steep slopes, and near bridge piers and abutments. Deployment of the transducer from the bridge deck may require a long cable (approximately 30 m). Tests, conducted as part of this project, showed incorrect depths reported by some instruments when measured using long cables. Therefore, if a cable longer than the standard cable supplied with the transducer is used, the accuracy of the echo-sounder depth measurements should be checked to verify proper operation. In addition, the accuracy of the echo sounder should be checked regularly over the range of expected depths.

Custom cases were ordered from a commercial company to provide easy transportation of the echo sounder and batteries. The configuration of the case depends upon the size and style of the echo sounder. Three different configurations were developed: one for a chart-recording echo sounder, one for a graphical-display echo sounder, and one for a numerical-display echo sounder.

The carrying cases for the chart-recording and graphical-display echo sounders are soft-sided and padded (figure 21). When the strap is placed across the back of the user's neck, the echo sounder is positioned in front of the user where the display can be easily viewed and the controls adjusted (figure 22). Additional straps and belts were tested, but a one-strap system was simple and convenient to use. Pockets are provided on the side of the cases for a notebook and cables. The chart-recording echo sounder must have the front opened to record notes directly onto the chart. This can be accomplished with the case designed. However, an alternative would be to modify the cover of the echo sounder to allow removal of the window covering the paper chart. The echo sounders are powered from a separate battery belt made from a military pistol belt (figures 21 and 22). The battery belt can carry up to 8 ampere-hours of 12-VDC power using sealed gel-cell batteries. This is sufficient power to run a chart-recording echo sounder for at least 4 hours.



Figure 21. Soft carrying cases and battery belt for echo sounders.



Figure 22. Chart-recording echo sounder being used with carrying case and battery belt.



Figure 23. Numerical-display echo sounder mounted in box with batteries and area for notepad.

The numerical-display echo sounder evaluated was small (11 cm x 9 cm x 5 cm) and requires less than 100 mA at 12 VDC during normal operation. The aluminum carrying case was designed to contain the echo sounder, 2.5 ampere-hours of 12-VDC power using sealed gel-cell batteries, and a space to record field notes (figure 23). This design has a strap that is placed behind the user's neck and a belt that is placed around the user's waist. With the straps properly adjusted the box is level, the numerical display can be easily read, and part of the top of the box provides a surface for recording notes in a notebook.

Evaluation of flotation systems showed the water-ski design to be the most promising and the PVC-pontoon design to be the least expensive. The hydrodynamic design of the water ski makes it ideally suited for floating a transducer in water velocities exceeding 3 m/s; however, the ski was reported to be unstable in turbulent water.⁽²⁸⁾ To improve the instability problem while maintaining the hydrodynamic design and commercial availability, a knee board was tested.

The knee board is about 1.4-m long and 0.5-m wide, giving it more lateral stability than a single water ski. An eye bolt was mounted in the front of the knee board for attaching a tether to steer and maneuver the board (figure 24). The transducer cable may be strong enough to maneuver the board in most conditions, provided it is properly secured to the board and not pulling on the connection to the transducer. However, during deployment in water velocities greater than 3 m/s, a transducer cable was broken and the board would have been lost if a nylon rope had not been attached. The rope-cable combination was cumbersome and the rope wore quickly when rubbed along the sides of concrete bridges. The rope-cable combination was replaced with a single cable having a nylon-covered Kevlar braid with a 544-kg tensile strength wrapped around a transducer cable. The Kevlar braid is attached to the eye bolt, thus eliminating any stress on the inner transducer cable (figure 24); this cable worked well. The only disadvantage is the cost of the Kevlar cable, which is about five times the cost of regular transducer cable.

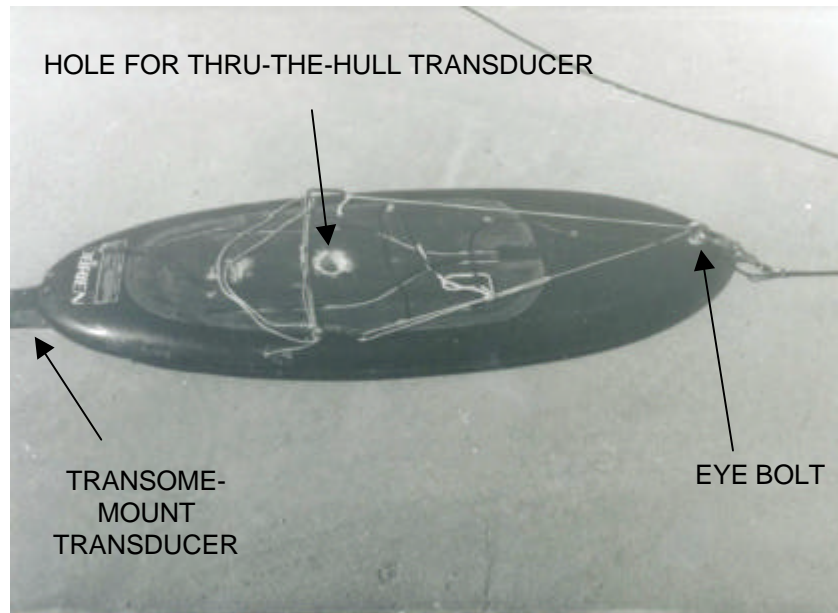

Figure 24. Knee board modified to deploy a transducer.

Transducers were mounted to the board in different ways depending upon the style of the transducer. A transom-mount transducer can be mounted off the back of the board as indicated in figure 24. This worked well, provided the sloping edge of the transducer was pointed upstream to allow the flow to draw the back of the board down. A transom-mount transducer could also be mounted on the bottom of the board by attaching the bracket to the bottom or to a special mount that would fit through the board. Through-the-hull transducers were mounted through the board. The board is filled with closed-cell foam and when mounting a transducer through the board an oversized hole was drilled and an appropriately sized section of PVC pipe and silicon were used to seal the board while providing a hole for mounting transducers (figure 24).

The knee board, used in this project, had retractable fins near the back of the board. The board was tested in high-flow conditions with and without the fins extended. Although the board handled satisfactorily for both configurations, it was more stable with the fins extended.

Two other flotation platforms were built: one from PVC pipe and one from a pair of training water skis. The PVC-pipe platform is similar to the one described previously in Chapter 3. Each pontoon is made of 10-cm diameter PVC pipe and has a total length of about 1-m with 45° elbows on the front (figure 25). The pontoons are attached to a plywood deck with an eye bolt installed at the front. The transducer is mounted below the plywood deck. Depending upon the transducer style, a bracket to extend the transducer into the water may be required. The design is lightweight, inexpensive, and constructed of commonly available materials. This design worked well in limited testing during flood conditions.



Figure 25. PVC-pontoon float for deploying a transducer.



Figure 26. Water skis modified to deploy a transducer

Another design to overcome the stability problems of the single water ski was to use two training water skis. The skis were connected by two aluminum braces making the float about 1.2-m long and 0.3-m wide (figure 26). An eye bolt was mounted in the front brace, and a through-the-hull transducer was mounted through one ski. This design was not tested in high flows because low-flow tests indicated that it did not have sufficient flotation.

LIMITED-DETAIL DATA COLLECTION

A limited-detail data set is more extensive than that required for bridge inspections. Velocity should be measured using standard USGS procedures. Surface velocities should be collected only when no other method is safe or practical. Bed-material samples must also be collected at the site. Therefore, limited-detail equipment must include mechanical-deployment systems suitable for the flow conditions and data being collected. The USGS uses these mechanical-deployment systems routinely for stream gaging. Some USGS personnel have modified standard equipment for more efficient collection of bridge-scour data (figure 17). Most of these modifications have been to facilitate use of an echo sounder to measure channel geometry at the bridge, with a transducer mounted on the bottom of a sounding weight. The mechanical-deployment systems used by the USGS are adequate for making velocity and sediment measurements and no further development is needed.

As previously discussed, the locations of depth measurements made with a sounding weight or with a transducer mounted on a sounding weight are limited to the upstream and downstream edges of the bridge. If the approach flow is skewed to the alignment of the pier or if debris is present, the maximum scour may not occur at the nose of the pier. Measurements along the edges of the bridge may fail to measure the maximum scour. The floating-deployment systems discussed in inspection-level data collection are suitable for collection of limited-detail channel geometry and allow collection of data beneath the bridge and along the sides of piers and abutments. Boats can be used, where appropriate, to ensure that the maximum scour is measured and to measure concurrent approach cross-section geometry. The concurrent approach cross-section geometry is needed to isolate contraction scour from scour caused by other processes.

The positions of limited-detail data are determined by a combination of physical and visual measurements. Marks along the bridge rails make measuring the position of the transducer, velocity meter, or sampler more efficient than on an unmarked bridge. Measuring tapes or wheels and a lumber crayon or chalk can be used to temporarily mark stations on a bridge. Marking the pier numbers on the railing helps prevent confusion during a measurement. Although more accurate measurement technology is available (GPS, range-range, and range-azimuth systems), the cost and effort required to use the equipment is significant and is probably not warranted for limited-detail measurements.

A permanent record of the channel geometry is required for limited-detail data; therefore, the use of a chart-recording echo sounder is appropriate. However, the limited availability of these instruments may require use of nonrecording or digital-output echo sounders. Digital-output echo sounders and field computers are more appropriate for limited-detail data collection than for bridge inspections; however, the use of a field computer on a bridge is still cumbersome. Although hand-held computers were not evaluated, a hand-held computer could be programmed to record, display, and annotate the digital data.

DETAILED DATA COLLECTION

Detailed data include channel geometry and hydraulic measurements in an area extending from the upstream extent to the downstream extent of the hydraulic influence of the bridge. This spatial extent of the data requires instruments to be deployed by boat. Velocity and channel-geometry data are collected in more detail than for a limited-detail data set and require more complex and accurate instruments. Because of safety and mobility considerations, the goal was to develop an instrumentation package and remote-control boat suitable for measuring channel bathymetry and three-dimensional velocities in real time during flood conditions. Although hydrographic surveyors routinely use much of the proposed equipment, bridge-scour data collection is sufficiently different from common hydrographic surveying to require modification of some equipment. Measurement of bed-material transport, particularly bed load, is important, but development of such a system was determined to be beyond the scope of this report.

Development of Instrumentation

An instrument package to collect detailed data includes a positioning system, digital echo sounder, BB-ADCP, radio telemetry, field computer, software, and standard surveying equipment. Because of the volume of data collected during a detailed survey, it is desirable to have all data recorded digitally on a field computer. The development included selecting, interfacing, and packaging the instruments for use in a harsh environment. Weight and power consumption were essential elements in selecting particular instruments. The goal was to have battery-powered equipment. Because access to streambanks and flood plains can be difficult during floods, the weight, ruggedness, and portability of the equipment was important. The type of boat required for deployment was also considered. Although the goal of the project was to develop a remote-control boat, a manned boat may be more appropriate for large rivers. Therefore, the instrumentation package was not developed for specific boats but is deployable and operational on a variety of boats.

Many different positioning systems and technologies were evaluated. DGPS is attractive because it is passive and through use of existing base stations requires no setups on site. Several different DGPS configurations can be used, including use of U.S. Army Corps of Engineers and U.S. Coast Guard differential correction beacons. The preferred method for obtaining DGPS positioning is through commercial services that operate a network of ground stations linked through a communications satellite. The differential correction is received through a small satellite receiver and is valid anywhere in the contiguous United States. Although accuracy of the position is dependent upon the differential network, the biggest variation in accuracy is from the quality of the local GPS receiver. With low-quality receivers submeter accuracy is achieved at one standard deviation, but with a high-quality receiver the range of submeter accuracy is extended two standard deviations. DGPS is the preferred method of positioning the data collected; however, DGPS does not work under the bridge where the bridge blocks the view of the satellites. Range-range systems were expensive and require a significant amount of setup time to establish three or more stations at a site. Therefore, the optimum system is a combination of DGPS and range-azimuth tracking systems. The DGPS provides accurate positions in areas where adequate

satellite coverage can be maintained. The range-azimuth system provides accurate positions under the bridge, around the piers, and on small streams where DGPS may not be usable because of lack of adequate satellite visibility.

The range-azimuth system selected uses a standard theodolite as its base with a high-power laser for distance measurement (figure 27). The hydrographic-surveying laser can be easily replaced with a land-surveying electronic-distance-measurement (EDM) laser for more accurate measurements. The system has RS-232 interfaces for the laser and for the theodolite. The update rate is approximately 2 Hz. The theodolite has a continuous tangent for tracking a moving target. The vertical adjustment is not continuous. Although the two-piece design is cumbersome to setup, it has advantages. Failure of one component only requires repair or placement of that component. The ability to use an EDM allows the instrument to be used to survey high-water marks and other geometric features at the site.

The requirements for an echo sounder include both digital RS-232 output and a paper chart. Although the depths are recorded on a field computer, a paper chart for backup and verification of the digital data is recommended.⁽¹³⁾ Nearly all of the survey-grade digital echo sounders provided both a paper chart and an RS-232 compatible output. The primary criteria for selecting an echo sounder were the digitization algorithm, price, size, and weight. Although the echo sounder selected did not have all the annotation features available on other models, many of the other models are made for use on large vessels. The instrument selected was one of the least expensive and was the smallest and lightest echo sounder available. The selected instrument provides a thermal-recording paper chart, proprietary format RS-232 output, adjustable blanking distance, adjustable speed of sound compensation, peak-detection digitization, and selectable internal averaging of measured depths.

Measuring the velocity field throughout a study reach extending upstream and downstream of the hydraulic influence of the bridge would require many hours using cup meters. The BB-ADCP measures three-dimensional velocity profiles from a moving deployment platform



Figure 27. Two-piece range-azimuth system used for detailed data collection.

and can measure the velocity field much faster and in greater detail than cup meters; therefore, a BB-ADCP is an important part of the instrument package for collecting detailed scour data. During the development phase of the project the BB-ADCP was still somewhat experimental for collecting data in rivers. However, the use of the BB-ADCP for discharge and velocity measurements has been verified and these instruments are used regularly by the USGS, other government agencies, and consultants.^(20,32)

Most hydrographic-surveying systems provide compatible data radios. Many of these radios are instrument specific, operate at low baud rates (4,800 or less) and only provide transmission in one direction, usually from the shore to the boat. A remote-control deployment system requires data to be transmitted from the boat to the shore. In addition, the BB-ADCP requires three-wire bi-directional communication and standard data radios used for hydrographic surveying were not suitable for this application. Two different 9,600-baud radio systems were tested. The first system transmitted in the UHF band and required one radio to be set to transmit mode, which consumed a significant amount of power and frequently caused the radio to overheat. The second 9,600-baud radio system evaluated consisted of spread-spectrum radios that transmit in a license-free band at about 900 MHz. The radios were capable of three-wire bi-directional communication, which significantly reduced power consumption, because the radio only transmitted when data were output by the instrument rather than continuously, as did the other radios. Communication with the BB-ADCP requires a 'break' to be transmitted. This break is not a standard ASCII character, and the manufacturer had to modify the radio's firmware to allow a variable length 'break' to be transmitted. With this modification the radio link provides communication between the field computer and all the selected instruments. The limitation with this particular radio is that to remain license free it transmits at about 0.5 watt, which limits its distance to less than 1.6 km.

Heave, pitch, and roll of the boat can degrade the quality of depth measurements. The gyroscope and accelerometer-based instruments for measuring heave, pitch, and roll are expensive (\$10,000-\$30,000). Fluid-based sensors are much less expensive (<\$500) but could provide incorrect data if horizontal accelerations of the boat are significant. The accuracy of the data being collected is about 0.6 m in the horizontal and about 0.15 m in the vertical; therefore, heave, pitch, and roll compensation was not cost effective for the increase in accuracy it could provide. Thus, the detailed data-collection system developed does not include compensation for heave, pitch, or roll. However, heave, pitch, and roll compensation may be necessary in a coastal environment and is required if a multibeam or scanning sonar is used.

The position and depth or velocity measurements are recorded simultaneously on a field computer. The computer must have at least two serial ports and be able to operate in harsh conditions. Portable computers with more than two serial ports are rare but PCMCIA technology allows some computers to be configured with up to three serial ports. The positioning system, as configured, requires two ports and the instrument on the boat (echo sounder or BB-ADCP) requires one port for the data radios for a total of three ports. To eliminate the need for one of the ports, a small programmable communications processor with four ports was programmed to read data from the theodolite and laser, combine the data into a single string, and output the combined string through a single port. This allowed the field computer to obtain continuous-

position data through a single port. If pitch and roll compensation were used, a similar dedicated computer could be used to allow communication with multiple instruments through a single set of data radios. Currently, only one instrument is used at a time, either the echo sounder or the BB-ADCP.

Instrumentation cases are used to protect the instruments, data radios, and interfaces from the harsh environment and during transportation. The positioning system and field computer must be removed from their shipping cases to be used; however, all instruments located on the boat are in waterproof cases. In addition to shipping containers for all the instruments, three waterproof instrument boxes were constructed for the data radios and echo sounder. The shore box (figure 28) contains batteries, a data radio, and communications processor for the range-azimuth positioning system. The box provides data and power connections to the theodolite, laser, and field computer. The boat communications box (figure 29) contains batteries and a data radio. This box provides connections to the instrument (echo sounder or BB-ADCP) and an external-power source. In each box, all internal wires are individually fused and a main breaker is installed to protect the equipment from a short circuit. Each box has an LCD display of the battery voltage and an external power light for the data radios. A second boat box (figure 30) contains the digital echo sounder and provides connections to the transducer, power, and the boat-communications box.

Software to record and display the data collected is an important part of the equipment package. The software must be able to display, in real time, the data being collected so field personnel can verify that the instruments are working properly and can make decisions on where additional data need to be collected. Software developed by project personnel was used initially. Although commercial hydrographic-surveying software is expensive, the advantages outweigh the cost. Commercial software provides many features: compatibility with a variety of instruments, including GPS; real-time display of ship tracks and depths; ability to display predefined site features or planned survey lines; coordinate transformation tools; and editing and postprocessing routines. The commercial software often provides a much more flexible data-collection system than software designed only for a particular configuration of instruments; however, none of the commercial software is compatible with the BB-ADCP.

The BB-ADCP has proprietary software, which is not directly compatible with any positioning instruments, except GPS. The software will record in a separate file any information that is transmitted to a second serial port. The instrument can be connected to one serial port, and the range-azimuth positioning system to a second serial port. Although the software cannot interpret the positions, it will record and tag them in a separate file simultaneously with the velocity profile data. The data files can be postprocessed with a user-developed program to assign a position to each velocity profile.

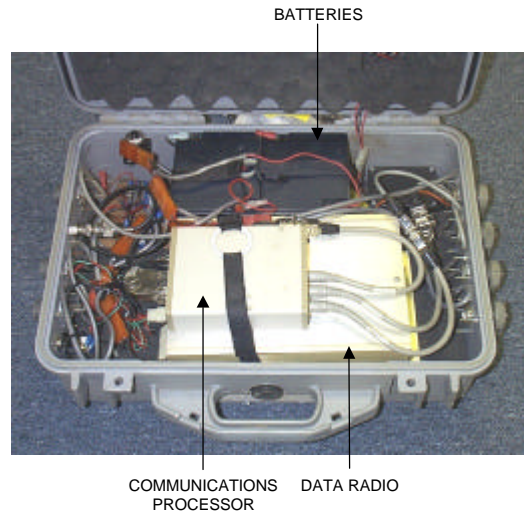

Figure 28. Waterproof case with electronics for shore station.



Figure 29. Waterproof case with electronics for transmitting data to the shore station.



Figure 30. Waterproof case with digital echo sounder used for detailed data collection.

The detailed data-collection-instrument package is efficient, cost effective, rugged, easily transported, and quick to setup. It is adaptable to both large and small boats. Data transmission can be from the boat to the shore or from the shore to the boat depending upon the system configuration. The system is readily adaptable to other instruments that are RS-232 compatible. A typical shore setup is shown in figure 31. The shore-communications box collects data from the positioning system, and data from instruments on the boat are collected by use of the radio link. The data are transmitted through two RS-232 lines to the computer, which displays the data in real time and stores the data in a file for postprocessing. Two persons are required to operate the system: one to operate the positioning system and one to operate the computer. The equipment on the boat does not require manual operation; however, if a manned boat is used, annotations on the paper chart are very helpful when comparing the paper chart with the digital data. If the remote-control boat is used, one person should be dedicated to operating the boat. Two people are always required onboard a manned boat; one should be an excellent boat operator with experience operating a boat in flood conditions.

Development of Deployment System

A boat is necessary to obtain the spatial coverage required for a detailed data set. Manned boats have been used successfully in the past but safety and launching considerations often prevent the use of manned boats on small streams where contraction- and abutment-scour processes are common. The instrumentation package previously discussed has been used on manned boats and is easily adapted for use on boats ranging in size from a small jon boat to a 10-m vessel. This effort concentrated on the development of a small, unmanned vessel that could be easily transported and deployed in conditions that would prevent use of a manned boat.



Figure 31. Typical shore station.

The design goals for the remote-control boat were to minimize size and weight while maintaining viability, stability, and operability in a flood environment. Heave, pitch, and roll of small boats can be significant in flood conditions and can degrade the quality of the data. Stability of ships in high seas is critical for high-speed ferries, anti-submarine warfare, and other applications. In 1969, the U.S. Navy began development of a Small Waterplane Area, Twin-Hull (SWATH) ship concept to provide increased platform stability in high seas. The SWATH concept is derived from the conventional catamaran hull and ocean oil-drilling platforms. A SWATH boat consists of two submerged pontoons that are attached to an above-water structural box by thin struts (figure 32). A typical SWATH design has only 20 percent of the waterplane area of a conventional monohull. The reduced waterplane area and redistribution of buoyant volume into submerged hulls reduce wave excitation forces and wave period to which the boat would normally respond.⁽³³⁾ Consultants familiar with full-scale SWATH boats were used to design the remote-control boat. Models of full-scale designs are sometimes in the size range of the remote-control boat needed for this application, but this may be the first time the SWATH concept has been applied to a remote-control boat for use in the river environment. The design requirements of the SWATH are shown in table 1.

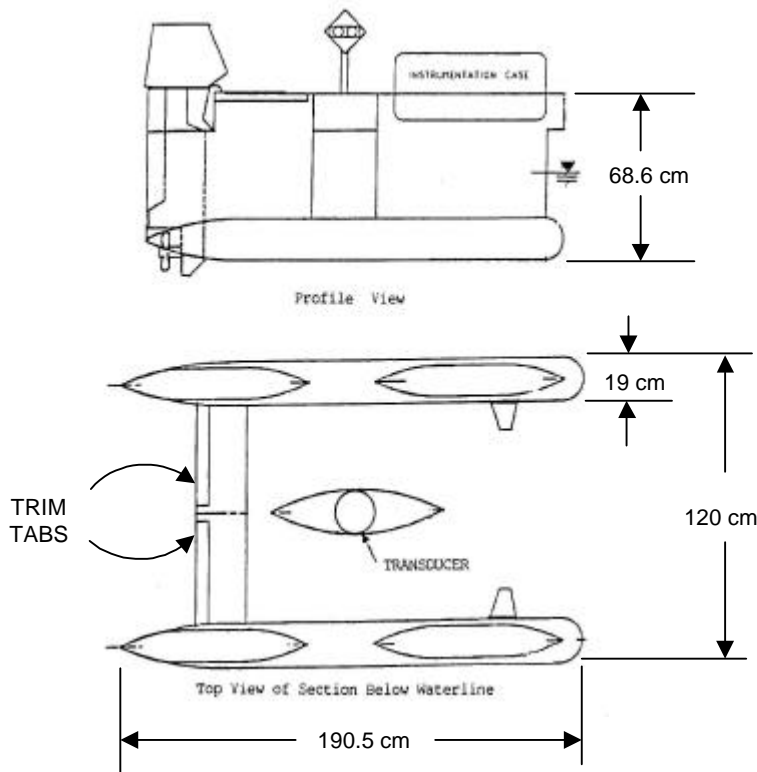

Figure 32. Illustration of swath boat design.

Table 1. Design goals and actual specifications for the remote-control boat.

Description	Goal	SWATH	Twin-hull	Jon
length (m)	2	2	2.6	2.8
beam (m)	1.2	1.2	1.2	1.2
draft (m)	0.6 - 0.9	0.46	0.3	0.2
weight ¹ (kg)	100	130	110 ²	104
payload (kg)	35	32	>50 kg	>50 kg
max speed (m/s)	5.2	5.2	>5.2	>5.2
viability	unsinkable	unsinkable	unsinkable	unsinkable
reliability	excellent	excellent	very good	excellent
operation (persons)	1	1	1	1
stability	very good	poor	very good	very good
maneuverability	good	very good	very good	excellent
deployability (persons)	2	2	2	2

¹ Weight includes weight of boat, motor, fuel, and mounting brackets, but not instrumentation and batteries.

² Weight is estimated because brackets to deploy instruments were not built.

The payload is critical for a SWATH boat. Small changes in the weight of the payload result in significant changes in the draft of the boat. The centroid of the payload is also very important to prevent continuous pitch or roll of the boat. The BB-ADCP or echo-sounder transducer is deployed in a fairing near the middle of the boat to offset the weight of the engine (figure 32). The instrumentation and radio telemetry are housed in a waterproof box at the front of the boat.

Hull cavities were filled with foam to make the boat virtually unsinkable. The SWATH designed for this project differed from full-scale SWATH boats in that the full-scale SWATH boats have active stabilization. Trim tabs located between the pontoons at the rear of the boat and fins on the inside of each pontoon near the front were installed to improve stability (figure 32). During initial testing, the trim tabs were controlled with small servos but this proved to be difficult for the boat operator, so the tabs are adjusted prior to deployment and fixed in the desired position.

Electric motors, although preferred for their greater reliability, were not selected because they could not sustain the speeds needed to operate in floods without exceeding overall weight constraints. The boat was powered by an 8-horsepower gasoline outboard motor with a remote-control electric start (figure 33). The motor has about 25 percent more power than was necessary to propel the boat but it was the lightest electric-start outboard motor available. Modifications to the motor were minimized and consisted of removing the tiller and throttle assembly, the rope-start, and associated brackets.



Figure 33. Swath boat being tested.

Radio control was achieved using recreational remote-control radios and accessories. Pulse-coded modulation (PCM) and frequency-modulated (FM) systems were evaluated. PCM controls are much less susceptible to interference from other radio communications than FM systems for the same frequency band. However, when interference occurs, PCM radios go into a fail-safe mode and require three clear signals before control to the operator is restored. The fail-safe mode is attractive; however, users of PCM radios reported problems with this feature. FM systems work on higher-frequency channels that are not as susceptible to interference as the lower channels used by PCM systems. Interference in an FM system usually does not affect the entire system and does not last for an extended period of time. The FM receiver locks onto the first clear signal and control is restored to the operator much faster than with PCM systems. Therefore, the FM system was selected for initial development; however, new technology may provide more-reliable controls in the future.

The radio receiver and voltage regulator were mounted on the engine and fit beneath the engine cover (figure 34). The antenna for the receiver was mounted on the engine cover. The throttle and shift servos (12 kg-cm torque) were mounted on the engine using custom brackets that fit the existing mounting holes (figures 34 and 35). A waterproof servo capable of generating a starting torque of 125 kg-cm with a holding torque of 20 kg-cm was initially used to steer the engine. The servo was mounted to the transom mount of the engine so that the engine was fixed and could not be trimmed or tilted out of the water. The spark plug was replaced with a resistor spark plug and the spark-plug wire was shielded with a copper-braided wire covering to reduce radio interference.

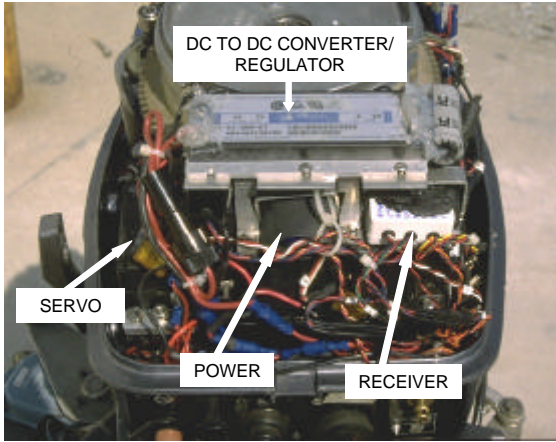

Figure 34. Front view of engine with radio controls installed.

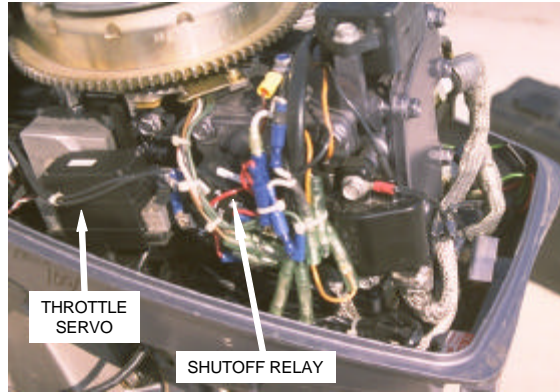

Figure 35. Side view of engine showing throttle servo and shutoff relay.

Initial testing by the contractor indicated several potential problems. Spray from the opening between the struts was excessive, and cavitation on the propeller was frequent. The opening between the struts was closed so that the submerged pontoons were connected to the deck by solid walls. Radio interference was intermittent.

Field tests of the SWATH boat by project personnel indicated the boat had less stability than the design goals (figure 36). The following problems were identified during field tests:



Figure 36. Instability of swath boat during testing.

1. Cavitation at the propeller caused acceleration and deceleration of the boat. The cavitation was probably caused by the location of the instrument pod immediately in front of the lower unit of the outboard motor.
2. Pitch of the boat caused by accelerations and decelerations caused by cavitation was excessive. The trim tabs were very sensitive to adjustments and caused the boat to travel either higher or lower in the water.
3. At speeds near the top of the design range, the boat listed because of the torque generated by the propeller and the boat's lack of resistance to vertical forces. A trim-tab adjustment corrected this problem for high speeds, but caused a list in the opposite direction at low speeds.
4. The boat rolled during sharp turns at speeds near the top of the design criteria and capsized during one turn in field testing. Although wind is believed to have been a factor in the capsize, this was less stability than required by the design criteria.
5. The steering servo was not waterproof, as claimed, and malfunctioned after being submerged.
6. The steering servo was undersized, causing it to work continuously, resulting in frequent failure. Servos are not designed for 100-percent duty cycle, so for the system to work without overheating, approximately 20 percent of the starting torque must be sufficient to hold the motor after it has reached the desired position.
7. The throttle control was too sensitive, and the engine was significantly overpowered for the boat. The trim knobs on the radio control had to be used to control the throttle.
8. The connecting rod for the shifting servo was weak and bent frequently.

Field tests showed that remotely controlling the outboard engine was achievable but the initial design required modifications. The performance of the SWATH boat was significantly less than the design goals. Stability problems experienced at the top of the speed range in a lake would probably be magnified by the current in a river. The performance of the solid struts in a strong cross current was of particular concern.

The engine was modified so that it can be used on any boat that can be powered by an 8-horsepower outboard engine. The stainless-steel connecting rods for the steering and throttle controls were replaced with titanium rods. The radio controls were reprogrammed to reduce the sensitivity of the throttle servo. Placing electronic chokes and filters on the wiring harnesses reduced radio interference. The transmission power of the radio controls was increased, without exceeding Federal Communications Commission regulations, by powering it directly from an external 12-VDC battery.

Several options to correct the steering problem were considered including a single larger servo, a dual servo system, and a hydraulic steering system. The power requirements of a new steering system were a significant consideration. It was decided that both a dual-servo steering system and a hydraulic steering system would be investigated. Each servo selected for the dual servo system can generate a starting torque of 380 kg-cm and have a holding torque of 100 kg-cm. This system has more than 5 times the starting torque and about 10 times the holding torque as the previous steering system. Power requirements are high, because each servo requires a no-load current of 290 mA, and an average running current of 650 mA, with a stall current of 9 A. A mounting bracket and linkage were designed to allow the engine to be trimmed and tilted out of the water (figures 37 and 38). Tests on the dual-servo steering system were successful and no servo failure occurred. The servos may get hot if overworked but no overheating occurred during extensive field tests.

A hydraulic steering system for the outboard engine is available. Modifications to the system are required to provide feedback through the radio controls necessary to have the steering system self-centering, like the servos. Because of the success of the dual servo system testing, the modifications to the hydraulic system were not pursued.

Three commercially available boats were tested using the remote-control engine. Limited testing of a 3.7-m V-bottom boat showed that it rolled excessively in sharp turns. Testing of a polyethylene twin-hull boat, 2.6-m long by 1.2-m wide (figure 39, table 1), and a flat-bottom jon boat, 2.8-m long by 1.2-m wide (figure 40, table 1), showed both boats to be more stable than the SWATH or V-bottom boats. Both boats were stable in sharp turns at 6.1 m/s, which is beyond the design goals. Overall, the jon boat performed better and was selected for further development. The jon boat used is an old design that is about 10 cm wider than small jon boats currently available. The stability of the narrower design should be verified, but no stability problems are anticipated because the instrumentation and batteries are below the top of the gunnels resulting in a center of gravity near the water surface.



Figure 37. Steering servo and linkage.

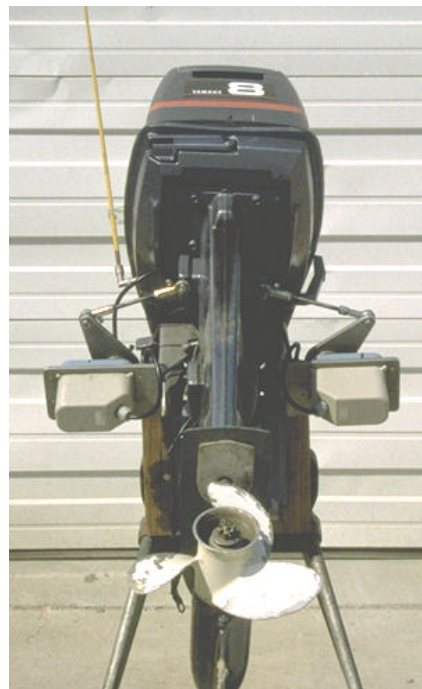

Figure 38. Rear view of engine showing dual steering servos.



Figure 39. Polyethylene twin-hull boat tested for use as a remote-control boat.



Figure 40. Flat-bottom jon boat modified for use as a remote-control boat.

The jon boat was modified for deploying instruments to collect detailed scour data. A wet-well for instrument deployment was fabricated in the jon boat to balance the boat and to protect the instruments from damage by impact. Mounts were fabricated for the BB-ADCP and the echosounder transducer that can be quickly and easily secured in the instrument well (figure 41). A cover for the instrument well was designed to mount prisms or a GPS antenna directly over the center of the well (figure 40). A bracket was also designed to mount the transducer along the side of the boat. The transom of the boat was reinforced, and the center seat was replaced with a cross brace to allow installation of the instrument well. Flotation was added to compensate for the flotation removed with the center seat.

Loss of radio contact and boat control is potentially a serious problem. Field testing showed that the control servos were unpredictable when loss of radio signal occurred. Error switches that turn the motor off when the radio signal is lost were installed. Other fail-safe options are available such as circling at a predetermined speed and dropping an anchor. Causing the boat to circle could result in the boat colliding with a bridge pier or debris pile. Automatically dropping an anchor could result in the boat being anchored in a location that was inaccessible or unsafe; however, anchoring the boat is a better alternative to losing it downstream. An anchor system was developed that will deploy an anchor if radio control is lost for a specified period of time (typically about 60 seconds). The winch can also be controlled by the radio, so if communications are reestablished the anchor can be pulled up and the boat driven to shore.

Field tests of the remote-control jon boat with a complete instrumentation package installed were very promising. The boat is stable, easy to maneuver, and easy to deploy. One of the potential

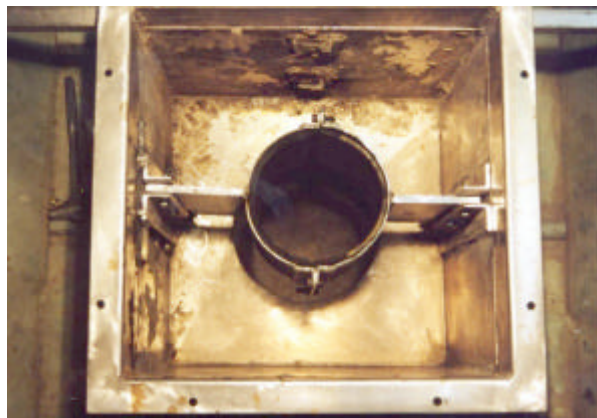

Figure 41. Instrument well used in jon boat.

problems identified during field tests near a bridge pier (figure 42) was depth perception. Proximity of the boat to a bridge pier was difficult to determine when the operator was more than 50 m from the boat. This developmental effort was successful in developing a working prototype of a remote-control data-collection platform. Additional development should focus on reducing the size and weight of the boat and motor and improving the reliability of the radio controls.



Figure 42. Remote-control boat being tested near a pier.

CHAPTER 5: PERFORMANCE OF PORTABLE SCOUR-MEASURING SYSTEMS

GENERAL

The portable scour-measuring systems discussed in this report have been used to collect data during six major floods: the 1993 Upper Mississippi River Basin flood, the 1994 Brazos River flood, the January 1995 floods in California, the May 1995 flooding in Missouri, the flooding in Illinois and Indiana in 1996, and the flood in Minnesota in 1997. The instruments worked well during these floods. Minor deficiencies that were identified have been corrected and the equipment has allowed detailed data to be collected at many sites.

INSPECTION-LEVEL DATA COLLECTION

The portable equipment developed for inspection-level data collection, consisting of a knee-board deployment system and either a chart-recording or a graphical-display echo sounder, worked well during the floods. The equipment was easy to deploy and maneuver by hand. No failure or damage to the equipment occurred during shipping, transportation, or data collection. The knee-board system is usually the first equipment used at a site because it allows a quick evaluation of the scour present at the site. Decisions for more detailed data collection are based on this preliminary information. The chart-recording echo sounder worked well throughout the floods; however, problems with the gain adjustment on a graphical-display echo sounder (discussed in Chapter 2) were again observed when a 30-m cable was used.

Data collection at the upstream edge of the bridge using the knee board required a modification of the attachment point for the tether. When the tether is attached to the front of the board, the board floats several meters downstream of the upstream edge of the bridge before it floats flat on the water surface at high velocities (3 m/s). With the attachment point moved to the center of the board, the board floated flat directly beneath the upstream edge of the bridge. This center attachment can be a problem if the board gets flipped in the flow or if it catches debris. The tether should always be attached at the front of the board, but when upstream sections are needed the cable should be weakly tied to the center of the board (figure 43) so that the center attachment will break and allow the board to be pulled out from the front, rather than the center, should it get caught in a vortex or by debris. This is particularly important where standing

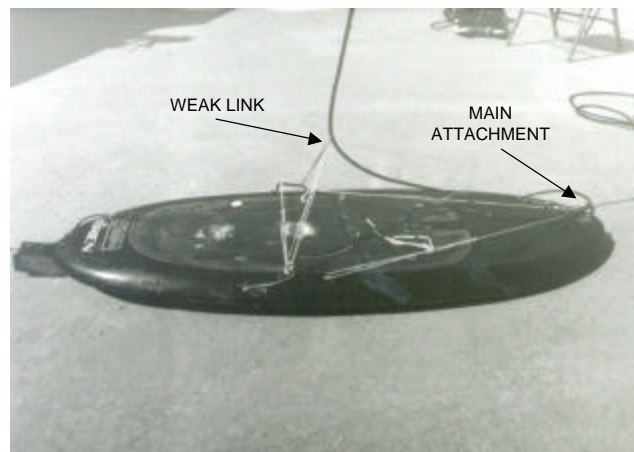

Figure 43. Modified knee board showing cable attachment for use directly below the upstream edge of a bridge.

waves or large vortices are present, which could cause the board to be submerged. The board became submerged in a large vortex on the Mississippi River and in a standing wave in California. In both situations the board was pulled to the surface and continued to function properly. At the site with standing waves, air entrainment prevented the acoustic waves from penetrating to the streambed; however, at other sites with velocities over 3 m/s and high levels of turbulence, very few problems were encountered.

LIMITED-DETAIL DATA COLLECTION

The equipment and techniques used to collect velocity and sediment data from the bridge deck have been proven through years of use by the USGS. The use of an echo sounder mounted to the bottom of a sounding weight to measure continuous cross sections has also worked well in State-funded scour projects and in the national bridge-scour project. The use of the knee board to deploy a transducer for the collection of limited-detail data was the only new technique requiring demonstration. Collecting channel-geometry data with the knee board was efficient. The scaling of the data to bridge plans was not difficult, provided that adequate notes were recorded in the field and that the paper chart was clearly annotated. This technique allowed measurement of scour along the sides of piers and under the bridge. Hydrologic-equipment cranes are necessary to collect velocity and sediment data, but a hand-deployed knee board provides a more flexible and efficient method for measuring channel geometry.

DETAILED DATA COLLECTION

The instrument and deployment package developed to make detailed scour measurements meets all of the design goals and has been used to collect scour data at a level of detail and accuracy that was previously unattainable. This equipment was used with a manned boat on the Mississippi River in 1993; on the Brazos River near Lake Jackson, Texas in 1994; on the Sacramento River near Hamilton City, California in 1995; and on several rivers in Minnesota and North Dakota in 1997. The data were collected using a manned boat to deploy the instruments on large rivers. The equipment is rugged and proved adaptable to whatever deployment platform was available including two boats borrowed from local agencies. The equipment was air shipped to Texas and California and appropriate mounts were fabricated in less than 4 hours to allow deployment on the boat available. The only component that requires any fabrication of mountings is the BB-ADCP, which weighs approximately 17 kg.

The first detailed data sets were collected in 1993 at Interstate 255 over the Mississippi River near St. Louis and at State Route 51/150 over the Mississippi River at Chester, Illinois. The bathymetry-mapping equipment worked well and allowed detailed mapping of scour holes (figure 5). Collection of detailed bathymetric data to delineate the maximum depth and shape of local scour holes requires many cross sections and longitudinal sections to be measured. A highly skilled boat operator is required to collect these data near the pier. Problems were encountered with the 1,200-kHz BB-ADCP because of sediment movement along the streambed. A 300-kHz BB-ADCP was successful at penetrating the moving sediment and was used to collect velocity data several times during the flood.

The range-azimuth positioning system was a very useful and flexible tool. The instrument could be setup in less than 30 minutes. The powerful laser allowed the setup position to be referenced to the bridge by surveying the centerline of the piers, often without the need for a prism at the piers. Positions located in this manner were accurate to about 0.3 m, which is better than the accuracy of the dynamic tracking of the boat. The theodolite portion of the instrument failed during the Mississippi River flood and was easily replaced with a standard theodolite from a local equipment-rental company. The rented theodolite did not have the continuous tangent, which made tracking difficult, but it did permit data to be collected, despite equipment failure. The most-frequent problem encountered with the positioning system was locating dry land with a suitable view of the study area. DGPS was also used on the Mississippi River and allowed the approach and exit reaches to be extended far beyond what would have been feasible with only the range-azimuth positioning system.

The value of the paper chart to verify the digital data was realized during the first data-collection trip on the Mississippi River. The bridge had piers with a stepped design (figure 4). The side echoes off the features of the pier were strong enough to trigger the digitization algorithm and the digital data did not contain the deep scour holes that were present; however, the deep scour holes were readily apparent on the paper chart. The paper chart was then used to correct the digital data, and an accurate representation of the scour holes were achieved (figure 44).

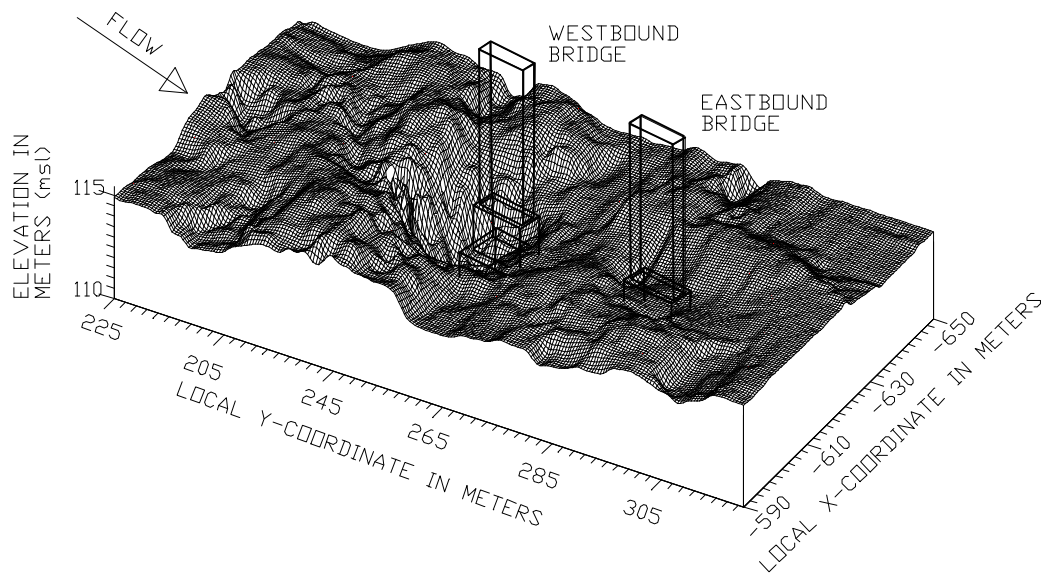

Figure 44. Three-dimensional mesh of channel bathymetry near pier 8 on Interstate 255 over the Mississippi River near St. Louis, Missouri, July 17, 1993.

A detailed data set around a significant debris accumulation on a pier in the main flow was collected at Farm-Market 2004 over the Brazos River near Lake Jackson, Texas. A 300-kHz BB-ADCP and a digital echo sounder were used successfully to collect detailed-velocity and channel-bathymetry data.⁽³⁴⁾ All data were positioned using a range-azimuth tracking system.

The echo sounder worked well at all sites although electronic problems were encountered at U.S. Highway 32 over the Sacramento River near Hamilton City, Calif. The low-powered spread-spectrum data radios also did not work well under power lines and were limited to less than a 1.5-km range. However, these electronic problems highlighted the versatility of the equipment package. The BB-ADCP was used to survey the entire reach including the scour holes at the piers. The data had to be postprocessed but the equipment allowed digital data to be collected although an instrument failed to operate properly. The digital channel-geometry data around the piers were supplemented with data collected by use of a chart-recording echo sounder with the transducer deployed from the boat using the knee board. Figure 45 shows a velocity profile collected downstream from the bridge near the center of the channel.

The remote-control boat was first used to collect scour data during flooding in Missouri in May 1995. The remote-control boat allowed data to be collected on small streams with low bridges where use of a manned boat was not feasible. Use of the remote-control boat near piers was difficult because of the inability of the operator to visually resolve distances of less than 1 m from a distance of about 50-m. Data collection on small streams is more difficult than on larger streams because of the proximity of vegetation and the shallow depths in the flood plains. Although minor problems with the remote-control boat were identified, it proved to be an efficient and viable tool for data collection on small streams.

The remote-control boat was again used in Illinois and Indiana during flooding in the spring of 1996. Deployment of a 1,200-kHz BB-ADCP on a small stream with less than 0.7 m of clearance under the bridge was successful through the use of the remote-control boat. Three people deployed the boat and instruments from the roadway embankment in about 45 minutes. Because of the configuration of the site, the range-azimuth tracking system could not be used to position the data; however, the remote-control boat allowed detailed velocities to be measured at a highly contracted bridge opening. The flow curvature and distribution is shown in plan view using depth-integrated velocity

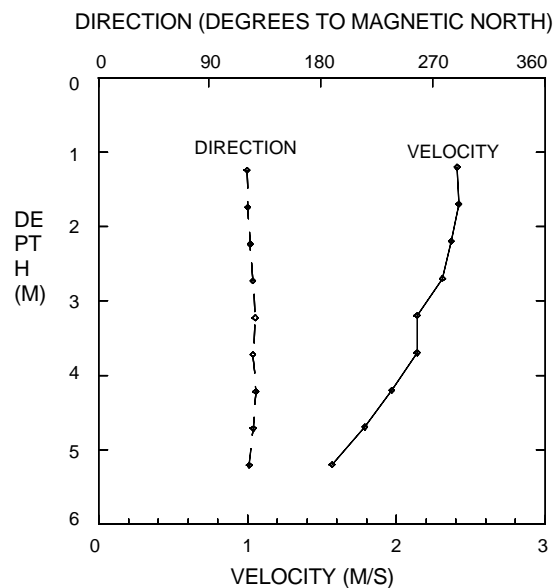

Figure 45. Velocity profile downstream from U.S. Highway 32 over the Sacramento River near Hamilton City, California.

vectors in figure 46. The circulation zones near the abutment are clearly shown in the data. The BB-ADCP collects three-dimensional data; the vertical and cross-sectional distribution of the velocity at the upstream edge of the bridge is shown in figure 47. It is evident from figure 47 that the highest velocity is located just past the toe of the abutment spill slope.

The instrument and deployment package developed to make detailed scour measurements has proven to meet all of the design goals and has been used to collect scour data at a level of detail and accuracy that was previously unattainable.

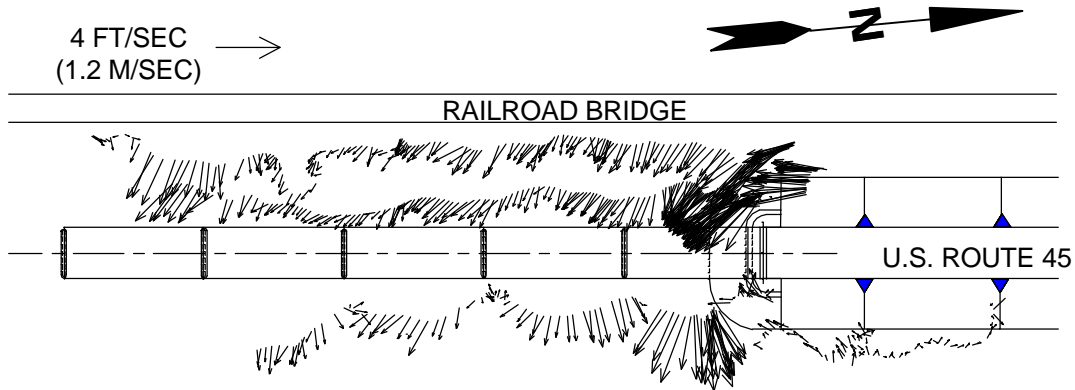

Figure 46. Depth-integrated velocity vectors collected using the remote-control boat and a 1,200-kHz BB-ADCP at U.S. Route 45 over Skillet Fork River near Mill Shoals, Illinois.

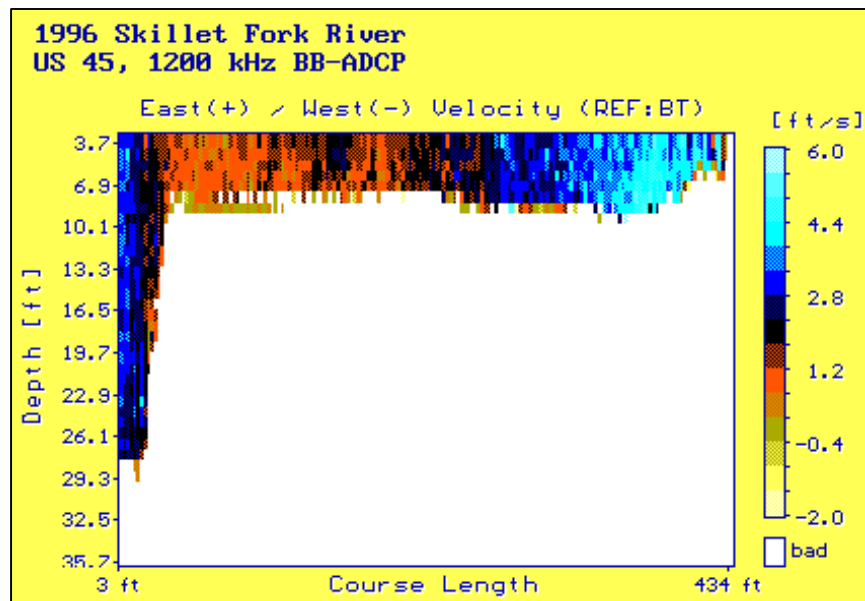

Figure 47. Real-time display of velocity magnitudes at the upstream edge of U.S. Route 45 over the Skillet Fork River near Mill Shoals, Illinois.

CHAPTER 6: SUMMARY AND CONCLUSIONS

Portable scour-measuring systems consist of four components: (1) the instrument(s) for making the measurement, (2) a deployment system, (3) a method to identify and record the horizontal position of the data collected, and (4) a data-storage device. Many different types of instruments and equipment were evaluated for their potential use as components of a portable scour-measuring system. Three systems were designed on the basis of requirements for bridge inspections, limited-detail data collection, and detailed-data collection. Preference was given to commercially available products that could be integrated or modified to achieve the required function.

The bridge-inspection system is designed to be a low-cost system, simple to operate, and easy to transport and deploy. The system developed consists of a chart-recording or graphical-display echo sounder deployed on a floating platform. The performance of some echo sounders is sensitive to the length of cable. Use of cables other than the cable supplied with the transducer may require recalibration of the instrument. The chart-recording echo sounder is the preferred instrument because it produces a permanent graphic record of the streambed, which can be annotated with on-site observations and positional descriptions of the depth-measurement locations.

A knee board worked well for deploying a transducer during three major floods. The knee board is hand deployable; creates only a small amount of drag; is stable in all but the most turbulent water; and allows data collection both along the edges of the bridge and under the bridge, along the sides of the piers and abutments. Air entrainment was a problem only in very turbulent water. Overall, the knee-board-deployment system is a valuable tool for making quick measurements of the streambed from the bridge deck.

The limited-detail data collection system is designed to allow collection of velocity, sediment, and channel-geometry data from the bridge deck. The mechanical-deployment systems, velocity meters, and sediment samplers have all been used extensively by the USGS. A knee board and chart-recording echo sounder are valuable additions to existing scour-measuring equipment. This floating deployment platform allows data to be collected under the bridge and along the sides of piers and abutments, which was not attainable using a sounding weight.

The detailed-data collection system is designed to allow collection of velocity and channel-geometry data throughout a study reach, extending from upstream of to downstream of the hydraulic influence of the bridge. This expanded spatial extent of the study area requires the instruments to be deployed from the water surface. Because safety considerations and launching requirements often limit the use of a manned boat on small streams where contraction and abutment scour are common scour processes, an unmanned remote-control boat was developed. Several boat designs were tested, and a 3-m flat-bottom jon boat was selected. A wet well was installed in the boat to allow deployment of instruments through the hull. The boat is powered by an 8-hp outboard motor, which could be used on any suitable boat because all controls are attached directly to the motor. Recreational remote-control radios and heavy-duty waterproof

servos are used to control the motor. The boat has been used in several floods and has allowed the collection of data that could not have been safely or efficiently collected with a manned boat.

The instrumentation for the detailed data-collection system includes a digital-output echo sounder, a broadband acoustic Doppler current profiler, a range-azimuth positioning system, a real-time kinematic differential global positioning system, data radios, a field computer, and data-collection and processing software. The digital-output echo sounder has a paper chart, which is used to verify the digital data. The BB-ADCP measures three-dimensional velocities acoustically from a moving boat allowing the flow field to be characterized in more detail than was previously possible. Near the bridge, the position of the depth and velocity measurements is measured with a range-azimuth positioning system designed for hydrographic surveying. Away from the bridge, in the approach and exit reaches, DGPS is more efficient and allows the boundaries of the study reach to be extended beyond what is practical with only the range-azimuth system. Data collected by instruments deployed on a manned or unmanned boat are radio linked to the shore using UHF or spread-spectrum RS-232-compatible data radios. The position and depth or velocity data are recorded simultaneously on a field computer. Commercial hydrographic-surveying software is used to display the ship track and channel cross sections in real time. This software logs the data and provides editing and postprocessing routines. Velocity data are collected using proprietary software available with the BB-ADCP. The positions of the BB-ADCP data are logged by the software in a separate file and postprocessing is necessary to assign a position to each velocity profile.

The scour-data-collection equipment described herein was used successfully in six major floods. This equipment can be deployed using almost any available boat from the small 3-m remote-control boat to a larger 8-m manned boat. This equipment has been used to measure scour and the associated hydraulic parameters in more detail than was previously possible. The study of scour processes is no longer restricted to the laboratory but have been extended to the field through the use of the instruments and techniques presented in this report. New technology will inevitably provide instruments that allow more accurate and more detailed field data on scour processes to be collected in the future. Continued evaluation and development of instrumentation to measure and study scour processes will help improve the understanding of scour processes and ultimately result in safer and more economical bridge designs.

REFERENCES

1. Murillo, J.A., "The Scourge of Scour," *Civil Engineering*, American Society of Civil Engineers, Vol. 57, No. 7, 1987, pp. 66-69.
2. Mueller, D.S., and Landers, M.N., "Development of Bridge-Scour Instrumentation for Inspection and Maintenance Personnel," *Hydraulic Engineering '93 -- Proceedings of the 1993 Conference*, Shen, H.W., Su, S.T., and Wen, Feng, eds., American Society of Civil Engineers, New York, N.Y., August 1993, pp. 2045-2050.
3. Landers, M.N., and Mueller, D.S., "*Channel Scour at Bridges in the United States*," Federal Highway Administration Report FHWA-RD-95-184, 1996, 140 p.
4. Rantz, S.E. and others, "*Measurement and Computation of Streamflow*," U.S. Geological Survey Water-Supply Paper 2175, 1982, 631 p.
5. Edwards, T.K., and Glysson, G.D., "*Field Methods for Measurement of Fluvial Sediment*," U.S. Geological Survey Open-File Report 86-531, 1988, 118 p.
6. Ashmore, P.E., Yuzyk, T.R., and Herrington, R., "*Bed-Material Sampling in Sand-Bed Streams*," Environment Canada, Report No. IWD-HQ-WRB-SS-88-4, Ottawa, Canada, 1988, 87 p.
7. Yuzyk, T.R., "*Bed-Material Sampling in Gravel-Bed Streams*," Environment Canada, Report No. IWQ-HQ-WRB-SS-86-8, Ottawa, Canada, 1986, 74 p.
8. International Organization for Standardization (ISO), "*Liquid Flow Measurement in Open Channels -- Sampling and Analysis of Gravel-Bed Material*," ISO Reference No. ISO 9195:1992(E), 1992, 9 p.
9. Trent, R.E., and Landers, M.N., "Chasing Floods and Measuring Scour," Transportation Research Board, *Transportation Research Record 1290*, Third Bridge Engineering Conference, Vol. 2, 1991, pp. 235-244.
10. Ingham, A.E., "*Hydrography for the surveyor and engineer*," 3rd edition, revised by Abbott, V.J., Blackwell Scientific Publications, Cambridge, Mass., 1992, 132 p.
11. Ocean Data Equipment Corporation, "*Thermal Digital Sounder TDS-1000 Instruction Manual*," Ocean Data Equipment Corporation, Fall River, Mass., 1993, 20 p.
12. Mueller, D.S., and Landers, M.N., "Real-Time Data Collection of Scour at Bridges," *Fundamentals and Advancements in Hydraulic Measurements and Experimentation*, Pugh, C.A., ed., American Society of Civil Engineers, New York, N.Y., August 1994, pp. 104-113.

13. U.S. Army Corps of Engineers, *Hydrographic Surveying*, Engineering Manual EM1110-2-1003, October 1994, 340 p.
14. Barksdale, G.G., "Bridge Scour During the 1993 Floods in the Upper Mississippi River Basin," *Hydraulic Engineering '94*, Cotroneo, G.V., and Rumer, R.R., eds., American Society of Civil Engineers, New York, N.Y., August 1994, pp. 21-25.
15. Fulford, J.M., Thibodeaux, K.G., and Kaehrle, W.R., "Comparison of Current Meters Used for Stream Gaging," *Fundamentals and Advancements in Hydraulic Measurements and Experimentation*, Pugh, C.A., ed., American Society of Civil Engineers, New York, N. Y., August 1994, pp. 376-385.
16. Marsh-McBirney, Inc., "*Instruction Manual, Model 511, Electromagnetic Water Current Meter*," Marsh-McBirney, Inc., Gaithersburg, Md., 16 p.
17. Parola, A.C., Ruhl, K.J., Brown, B.M., Ford, D., and Korves, A.A., "*Boundary Stresses and Flow Around Bridge Piers*," U.S. Geological Survey Water-Resources Investigations Report 96-4142, 128 p.
18. Derecki, J.A., and Quinn, F.H., "Use of Current Meters for Continuous Measurement of Flows in Large Rivers," *Water Resources Research*, Vol. 23, No. 9, 1987, pp. 1751-1756.
19. Aubrey, D.G., Spencer, W.D., and Trowbridge, J.H., "*Dynamic Response of Electromagnetic Current Meters*," Woods Hole Oceanographic Institution, Report WHOI-84-20, 1984, 150 p.
20. Oberg, K.A., and Mueller, D.S., "Recent Applications of Acoustic Doppler Current Profilers," *Fundamentals and Advancements in Hydraulic Measurements and Experimentation*, Pugh, C.A., ed., American Society of Civil Engineers, New York, N. Y., August 1994, pp. 341-350.
21. RD Instruments, "*Acoustic Doppler Current Profilers, Principles of Operation: A Practical Primer*," RD Instruments, San Diego, Calif., 1989, 36 p.
22. RD Instruments, "*Direct-Reading Broadband Acoustic Doppler Current Profiler Technical Manual*," RD Instruments, San Diego, Calif., 1993, 224 p.
23. Gordon, R.L., "Acoustic Measurement of River Discharge," *Journal of Hydraulic Engineering*, American Society of Civil Engineers, Vol. 115, No. 7, 1989, pp. 925-936.
24. Simpson, M.R., and Oltman, R.N., "*Discharge-Measurement System Using an Acoustic Doppler Current Profiler With Applications to Large Rivers and Estuaries*," U.S. Geological Survey Water-Supply Paper 2395, 32 p.

25. Bradley, S.E., and Kuo, S.Y., "Long Range Acoustic Correlation Current Profiler," *Oceans '92 - Proceedings of Mastering the Oceans Through Technology*, Newport, R.I., October 26-29, 1992, pp. 648-653.
26. Hurn, Jeff, "*GPS C A Guide to the Next Utility*," Trimble Navigation Ltd., Part Number 18239, Sunnyvale, Calif., 1989, 76 p.
27. Carlson, G.H., written communication, 1991.
28. Land, Garland, Arkansas DOT, oral communication, 1992.
29. Skinner, J.V., "*Measurement of Scour-Depths Near Bridge Piers*," U.S. Geological Survey Water-Resources Investigations Report 85-4106, 1986, 33 p.
30. Measurement Devices Limited, Product Literature, 1993.
31. International Robotic Systems, Inc., Product Literature, 1994.
32. Morlock, S.E., *Evaluation of Acoustic Doppler Current Profiler Measurements of River Discharge*, U.S. Geological Survey Water-Resources Investigations Report 95-4218, 1996, 37 p.
33. Landers, M.N., Mueller, D.S., and Trent, R.E., Instrumentation for Detailed Bridge-Scour
Hydraulic Engineering '93 -- Proceedings of the 1993 Conference, Shen, H.W., Su, S.T., and Wen, Feng, eds., American Society of Civil Engineers, New York, N.Y., August 1993, pp. 2063-2068
34. Mueller, D.S., and Parola, A.C., Detailed Scour Measurements Around a Debris
Water Resources Engineering 98, Abt, S.R., Young-Pezeshk, J., and Watson, C.C., eds., American Society of Civil Engineers, Reston, Va., 1998, pp.234-239.