

United States
Department of
Agriculture

Animal and
Plant Health
Inspection
Service

Plant Protection
and Quarantine

Cooperating State
Departments of
Agriculture

September 1984

ACTION PLAN

EUROPEAN CHERRY FRUIT FLY
Rhagoletis cerasi (Linnaeus)

7

This PPQ Action Plan or New Pest Response Guideline has not been updated since its publication date. The actions or guidelines recommended may not be appropriate now, new survey tools may be available, and chemical pesticides named may no longer be registered. This documents is posted until updated versions can be drafted and as such are only guidelines that represent the state of knowledge at the time they were written. Please consult PPQ and/or your State Plant Regulatory Official prior to implementing any recommendations listed herein.

INDEX

	<u>Page</u>
Index.....	i
Authorization.....	iii
Notice.....	iv
I. General Information.....	I-1
A. Action Statement.....	I-1
B. Background Information.....	I-1
C. Post Diapause Development.....	I-1
II. Survey Procedures.....	II-1
A. Delimiting Survey.....	II-1
B. Monitoring/Evaluation Survey.....	II-1
C. Host Cutting Survey.....	II-2
D. Host Collection and Holding.....	II-2
E. Soil Screening.....	II-2
F. Detection Survey.....	II-2
G. Orientation of Survey Personnel.....	II-2
H. Survey Records.....	II-3
III. Regulatory Procedures.....	III-1
A. Instructions to Officers.....	III-1
B. Regulated Articles.....	III-1
C. Regulatory Actions.....	III-2
D. Regulatory Establishments Inspection.....	III-3
E. Use of Authorized Chemicals.....	III-3
F. Approved Regulatory Treatments.....	III-4
G. Principal Activities.....	III-4
H. Orientation of Regulatory Personnel.....	III-5
I. Regulatory Records.....	III-5
IV. Eradication Procedures.....	IV-1
A. Recommended Pesticides.....	IV-1
B. Approved Eradication Treatments.....	IV-1
C. Eradication/Control Method Selection.....	IV-3
D. Orientation of Eradication/Control Procedures.....	IV-3
E. Eradication/Control Records.....	IV-3
F. Monitoring.....	IV-3
V. Contacts.....	V

VI.	Addenda.....	VI-A1
	Addendum A--Definitions.....	VI-A1
	Addendum B--Safety.....	VI-B1
	Addendum C--Hosts.....	VI-C1
	Addendum D--Life History.....	VI-D1
	Addendum E--Identification of Specimen(s).....	VI-E1
	Addendum F--Technical Survey Information.....	VI-F1
	Addendum G--Technical Application Data.....	VI-G1
	Addendum H--Forms.....	VI-H1
	Addendum I--Contributors.....	VI-I1
	Addendum J--References.....	VI-J1

AUTHORIZATION

This Action Plan provides guidelines and actions for the eradication of a European cherry fruit fly infestation. This Action Plan supplements information contained in the Plant Protection and Quarantine (PPQ) Treatment Manual and Emergency Program and Administrative Cadre Manuals.

It is to be used in conjunction with other manuals when conducting emergency program activities. The information and instructions contained in this Action Plan were developed with and approved by representatives of cooperating States, the U.S. Department of Agriculture's Agricultural Research and Cooperative State Research Services, and affected industry.

All program technology and methodology employed is determined through discussion, consultation, or agreement with the cooperating State officials.

NOTICE

Recommendations in this Action Plan which involve the use of pesticides concern products which are registered or exempted under the Federal Insecticide, Fungicide, and Rodenticide Act (FIFRA), as amended. Precautions on the pesticide label and all instructions in this Action Plan must be carefully followed.

Federal and/or State personnel may not make any warranty or representations, expressed or implied, concerning the use of these products and shall not be responsible for any loss, damage, or injury sustained as a result of the use of any product as specified in this Action Plan.

The use of trade names in this Action Plan does not imply an endorsement of those products or of the manufacturers thereof by Federal-State pest control programs.

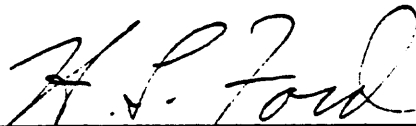

Deputy Administrator
Plant Protection and Quarantine

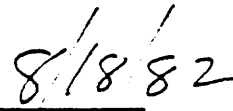

Date

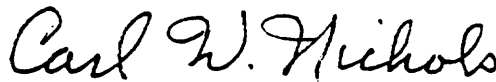

Chairman
National Plant Board

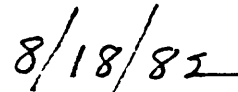

Date

I. GENERAL INFORMATION

- A. Action Statement
The information contained in this document is intended for use only when a European cherry fruit fly infestation is known to exist. This Action Plan is to be used for guidance in implementing eradication procedures and in preventing spread to other locations. This Action Plan provides all available technical and general information needed to implement any phase of a European cherry fruit fly eradication program. Specific emergency program action is to be based on information available at that time.
- B. Background Information
The European cherry fruit fly, Diptera, Tephritidae, Rhagoletis cerasi (Linnaeus), occurs in all countries in Europe, Russia, Iran, and Turkey.

Under ideal conditions, the preoviposition period is 3 to 10 days and temperature dependent. Adult populations may be present for several months and the females lay 50 to 60 eggs, usually one per fruit. The female normally lays its eggs in fruit just beginning to turn color. The eggs hatch in 5 to 12 days. Larval development lasts 2 to 4 weeks depending on temperature. The larvae leave the fruit when mature to pupate in the soil. The European cherry fruit fly in the pupal stage has an obligatory diapause.
- C. Post Diapause Development
Insect development is temperature dependent. The egg, larval, and adult reproductive development is influenced by air temperatures. The pupal development is influenced by soil temperatures. In both environments, a minimum temperature is established, below which no measurable development takes place. These thresholds for European cherry fruit fly are 41° F. (5° C.) in soil and 17.4° F. (3° C.) in air. Only post diapause development need be given, since this species has only one generation a year and it is normally sufficient to start summing temperatures from some arbitrary date such as January 1 or February 1. A temperature model that is designed to use soil temperature data can be used to predict emergence. A number of degrees accumulated above the developmental threshold for a life stage are called day degrees. For the model depicted in the table, 430 day degrees (post diapause development) must be accumulated before emergence. One complete life cycle, with day degrees accumulated via air temperatures added, is 550 day degrees.

Formula:

<u>Minimum</u> <u>Daily</u>	<u>Maximum</u> <u>Daily</u>	<u>Total</u>	<u>Average</u> <u>Daily</u>	<u>Threshold</u>	<u>Day</u> <u>Degrees</u>
Temp° F.	+ Temp° F.	= $\frac{\text{Temp° F.}}{2}$	= Temp° F.	- Temp° F.	= Temp° F.

Example: (Soil Model 41° F. Threshold)

<u>Minimum</u> <u>Daily</u>	<u>Maximum</u> <u>Daily</u>	<u>Total</u>	<u>Average</u> <u>Daily</u>	<u>Threshold</u>	<u>Day</u> <u>Degrees</u>
54° F.	+ 74° F.	= $\frac{128° F.}{2}$	= 64° F.	- 41° F.	= 23° F.

Program actions are guided in part by insect life cycle data. Duration and timing of eradication treatments, length of trapping activities, and regulatory functions are affected primarily by the length of time it takes to complete each phase of the life cycle. Temperature data are available from the National Oceanic and Atmospheric Administration, U.S. Department of Commerce, private, State, university, or industry sources, or can be generated by strategically placing thermometers on the soil surface.

II. SURVEY PROCEDURES

A. Delimiting Survey:

When one or more European cherry fruit flies are collected in an area, a delimiting survey will be implemented immediately to determine population distribution. To maximize the survey effort, traps should be deployed April (or date of first emergence) through October of any given year. Using the site of the detection as the epicenter (focal point), Rebell traps, using carbonate compound as an attractant, are to be set out in a minimum of 32-16-8-8-4-4-2 trapping array sequence. This sequence is approximately equivalent to a U.S. standard system of 81 square miles (sq mi), with a core area of 1 sq mi and a similar trap system. The traps must be serviced weekly. Place traps in or near major hosts--cherries and honeysuckle. Traps will be relocated to available preferred hosts within each square mile after each servicing.

Traps Set Per Square Kilometer

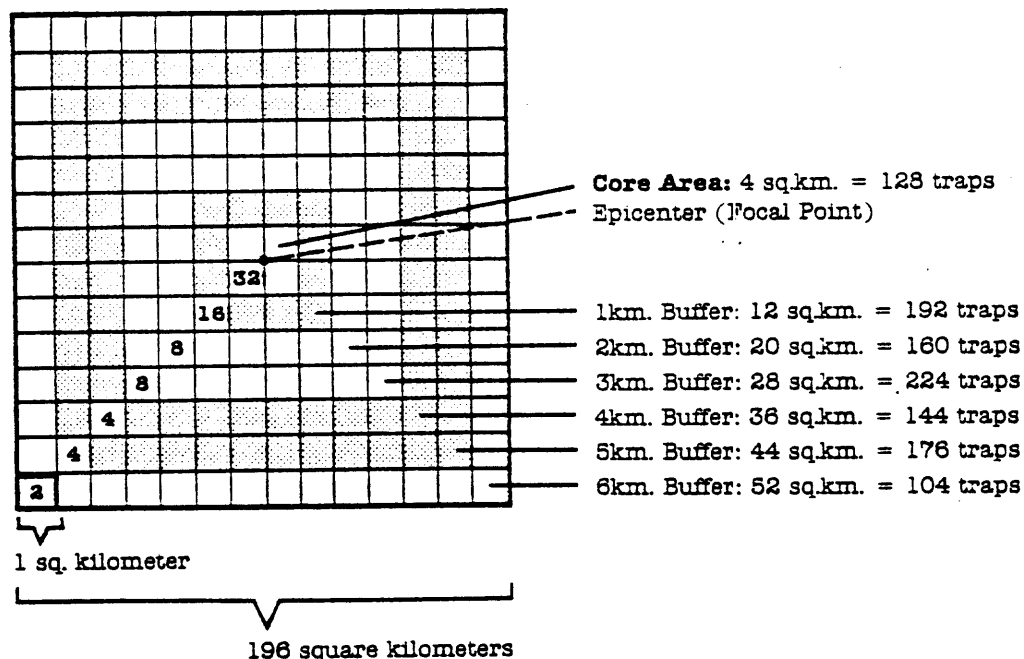

B. Monitoring/Evaluation Survey

A monitoring/evaluation survey will be conducted in that area where eradication treatments are applied. The Rebell traps, baited with the carbonate compound, are used at the delimiting rate. Traps are to be placed in or near host material. The traps are used to monitor the effectiveness of the treatment program.

Fruit cutting/larval separation, fruit collection/holding, and/or soil screening can also be used to supplement monitoring/evaluation survey.

- C. Host Cutting Survey Preferred host fruit from the core area and buffer areas can be surveyed, depending on host availability. Fruit from the core area is normally cut and examined at the site. The larval separation method can be used in addition to fruit cutting (See Addendum D).
- D. Host Collection and Holding Fruit samples will be collected within 200 meters (m) (656 feet (ft)) of a larval find. Any recovered pupae will be held at developmental temperatures and humidity that complement diapause and adult development.
- Pupae recovered from the fruit holding procedures will be held for 1 month at 20° to 25° C. (68° F.). The pupae will then be held at 4° +/- 1° C. (39° +/- 33° F.) for 5 to 6 months (3 months minimum). After the 5- to 6-month holding period the pupae will again be held at 20° to 25° C. (68° to 77° F.) for a month to initiate eclosion. The time/temperature regime should yield 80 percent eclosion of the number of pupae held.
- The facility where the fruit is held must be secure to prevent any inadvertent release of fertile adult flies. Security measures must be equal to those established for a quarantine insect rearing facility. See Animal and Plant Health Inspection Service 81-61 for detailed information.
- E. Soil Screening Passing of soil through a screen for the detection of pupae. (See Addendum D). Soil samples will be collected within 200 m (656 ft) of a larval find. Any recovered pupae will be held at developmental temperatures and humidity that complement diapause and adult development.
- F. Detection Survey The area beyond the 6 kilometer (km) (3.8 mi) buffer zone can be trapped at a minimum rate of two per five sq km (one per sq mi) for a distance of 8 km (5 mi) with Rebell traps on a grid system. The traps will be placed in recognized hosts. The traps are to be serviced on a maximum of 2-week intervals. The traps are to be relocated after each servicing depending on availability of preferred hosts.
- G. Orientation of Survey Personnel New personnel will be trained, on the job, by experienced personnel. Three working days will be necessary to teach the many important facets of the European cherry fruit fly survey.

H. Survey
Records

Records noting the areas surveyed, sites trapped, dates, locations, and hosts in which detection were made will be maintained. See Addendum G of this Action Plan for detailed instructions.

III. REGULATORY PROCEDURES

A. Instructions to Officers

Because of the lengthy life cycle of the European cherry fruit fly, it is difficult to determine if an infestation has been eradicated in less than 3 years. Regulatory actions will be required until the pest is eradicated. Officers must follow instructions for regulatory treatments or other procedures when authorizing the movement of regulated articles. Understanding the instructions and procedures will serve as a basis for explaining such procedures to persons interested in moving articles affected by the quarantine and regulations. Only authorized treatment procedures may be used.

General instructions that are to be followed in regulatory treatments are found in the PPQ Treatment Manual.

Officers may aid shippers in selecting the authorized treatment or procedure that is most practical for the shippers. They should advise the shipper to apply selected treatments to small quantities of material prior to treating larger quantities to determine reaction or effects of treatment procedure. When treating commodities, which are particularly sensitive to the treatments selected, treat more of the commodity than is needed to allow for possible losses.

B. Regulated Articles

1. The following cherries and honeysuckle species are regulated.

<u>Common Name</u>	<u>Scientific Name</u>
Cherry	
European bird cherry	<u>Prunus padus</u>
Sour cherry	<u>Prunus cerasus</u>
Mazzard cherry	
Sweet cherry	<u>Prunus avium</u>
Mahaleb cherry	<u>Prunus mahaleb</u>
Alps honeysuckle	<u>Lonicera alpigena</u>
European fly honeysuckle	<u>Lonicera xylosteum</u>
Honeysuckle, a	<u>Lonicera nigra</u>
Tartarian honeysuckle	<u>Lonicera tatarica</u>

2. Soil

3. Any other products, articles, or means of conveyance, of any character whatsoever, when it is determined by an inspector that they present a hazard of spread of European cherry fruit fly and the person in possession thereof has been so notified.

C. Regulatory
Actions

When detections are made, implement the following in sequence:

1. With the detection site considered the epicenter, all growers and establishments that grow, handle, or process regulated articles within a minimum of 7 km (4.4 mi) will be issued emergency action notifications requiring treatment or other approved handling procedures. Emergency Action Notifications (PPQ Form 523) and/or comparable State notifications are issued by field personnel to the property owners or managers of all establishments handling, moving, or processing articles capable of spreading the European cherry fruit fly. A notification may be issued pending authoritative confirmation and/or further instruction from the Deputy Administrator.
2. If necessary, the Deputy Administrator will issue a letter directing PPQ field offices to initiate specific emergency action under the Federal Plant Pest Act (7 U.S.C. 150dd) until emergency regulations can be published in the Federal Register.

The Federal Plant Pest Act of 1957 provides for authority for emergency quarantine action. This provision is for interstate regulatory action only; intrastate regulatory action is provided under State authority. However, if the Secretary of Agriculture determines that an extraordinary emergency exists and that the measures taken by the State are inadequate, USDA can take intrastate regulatory action provided that the Governor of the State has been consulted and a notice has been published in the Federal Register.

The Organic Act of 1944, as amended, provides the Federal Government, either independently or in cooperation with States or political subdivisions thereof, farmers' associations and similar organizations, and individuals, the authority to carry out operations or measures to detect, eradicate, suppress, control, or to prevent or retard the spread of plant pests. This Act does not provide for trespassing on private property, but relies upon State authority and willingness to use State right-of-entry authority.

All program technology and methodology employed is determined through discussion, consultation, or agreement with the cooperating State officials.

3. The Deputy Administrator, through the National Regional Directors, will notify State cooperators of the European cherry fruit fly detection, actions taken, and actions contemplated.

A narrative description of the regulated area with support documents will be developed by USDA and cooperators and provided to the Regulatory Services Staff, National Program Planning Staff (NPPS). The regulated area will also be defined by the Universal Transverse Mecator grid marking system for use by the Project Manager.

4. APHIS Regulatory Coordination Staff will publish in the Federal Register emergency regulations under the Federal Plant Pest Act.

5. After a reasonable time, taking into consideration such factors as the biology of the pest, climatic conditions, and infestation spread, a proposal to promulgate a quarantine under the Plant Quarantine Act will be published. The proposal will announce a date for submitting written comments, which shall be approximately 60 days after publication.

6. After receipt of written comments, a final determination specifying the action decided upon will be published in the Federal Register. If after consideration of the comments a quarantine is warranted, it would be invoked under the Plant Quarantine Act.

D. **Regulated Establishments Inspection** Efforts to detect the pest within the regulated area will be made at all establishments where regulated articles are sold, handled, processed, or moved. Establishments that might be involved are: Airports, landfill sites, fruit stands, farmers' markets, produce markets, flea markets, and any other establishments that handle regulated articles. Two Rebell traps per establishment in the regulated area will be used.

E. **Use of Authorized Chemicals** The PPQ Treatment Manual and Addendum E of this Action Plan contain the authorized chemicals, methods and rates of application, and any special application instructions. Concurrence by PPQ's Survey and Emergency Response Staff, NPPS, is necessary for the use of any other chemical or procedure for regulatory purposes.

F. Approved
Regulatory
Treatments

1. Aerial Bait Treatment. Applying bait spray by aircraft to regulated crops within the treatment area.
2. Ground Bait Treatment. Using ground spray equipment to spray regulated crops with an insecticide and protein hydrolysate bait.

The decision to apply bait spray applications will be based on the best weather information available. In the event rain washes a bait application from the foliage, plans will be implemented to retreat the area.

Retreatment should not be considered if weather reports indicate a 50-percent or greater chance of precipitation in the 48-hour period following washoff.

The objective is to minimize environmental contamination via bait spray washoff while maintaining a viable bait spray on the regulated crops.

3. Soil Treatment. An approved insecticide applied to the soil of nursery stock and/or within the drip line of host plants.
4. Fumigation. The application of an approved fumigant as a treatment (methyl bromide, ethylene dibromide, Phostoxin) alone or in conjunction with cold treatment procedures.
5. Cold Treatment. The use of cold temperatures as a treatment on selected products alone or in conjunction with fumigation procedures.

G. Principal
Activities

The following identifies principal activities necessary for conducting a regulatory program to prevent the spread of European cherry fruit fly. The extent of regulatory activity required is dependent on the degree of infestation. For example, safeguarding fruit stands throughout the entire regulated area which are engaged in only local retail activity may not be necessary when the regulations that are imposed are based on a limited and light infestation. On the other hand, mandatory checks of passenger baggage at airports and the judicious use of road patrols and roadblocks may be necessary where general or heavy infestations occur.

1. Advising regulated industry of required treatment procedures.

2. Supervising, monitoring, and certifying commodity treatments of commercial lots of regulated articles.
3. Contacting:
 - a. Security and airline personnel.
 - b. Fruit stands.
 - c. Local growers and packers.
 - d. Farmers', produce, and flea markets.
 - e. Commercial haulers of regulated articles.
 - f. Public transportation.
4. Visiting canneries and other processing establishments.
5. Monitoring the movement of waste material to and from landfills to ensure adequate disposal of regulated article refuse.
6. Monitoring the movement of regulated articles through major airports and other transportation centers.
7. Observing major highway and quarantine boundaries for movement of host materials.

H. Orientation of Regulatory Personnel Only trained or experienced personnel will be used initially. Replacement personnel will be trained by the individual being replaced. A training period of 3 working days is necessary for the orderly transfer of these functions.

I. Regulatory Records Records will be maintained, as necessary, to carry out an effective, efficient, and responsible regulatory program. See Addendum G of this Action Plan for detailed instructions.

Addendum F--Technical Survey Information

1. THE REBELL TRAP 78

The Rebell trap 78 (see Figure 1) is essentially two 15 x 20 cm yellow plastic strips locked together to form a frame. The surface is coated with stickem and the unit may then be hung in a tree. This trap has proved to be quite successful in Europe and relies primarily on the visual stimuli of the color.

Traps shall generally be placed on the sunny southern to southeastern side, near the top. Traps will be carefully placed within the foliage, about 1/2 m (1 1/2 ft) from the periphery. Shading foliage should be removed to allow full trap exposure to sunlight and for visual sighting by pest.

A homemade trap can be made. The main item is plexiglass that appears lemon yellow in color (Plexiglass DM 374 or equal product with the same specification). Holes should be drilled at the top for wire hangers. Stickem should be painted over this assembly when ready. The bait attractant may be added if desired.

2. LARVAL SEPARATION OR FLOATATION

a. Separation

Cut fruit into pieces and place in a container of appropriate size (i.e., large jars or for large volume work, a dip tank). Cover with warm water (approximately 100° F.) and let stand 2 to 12 hours. If larvae are recovered from the bottom of the container (or collected from the spout end of a dip tank), the fruit may then be disposed.

If no larvae were recovered, the fruit is poured onto a 20 mesh screen nesting over a 60 mesh screen on a stand. (Note: Golden nematode washing equipment is appropriate.) The pulp should be picked by hand from the screen and washed off over the screen by applying water to it from a spray nozzle on a flexible tube. Use of this technique results in larger larvae lodging on the 20 mesh screen and smaller ones on the 60 mesh screen. A wide-viewer magnifier with lamp attachment may be necessary to find the smaller larvae.

b. Floatation

Split the fruit and place the pieces into a beaker or other suitable container. Pour saline or sugared water over fruit, and then place a coarse mesh (1/4 inch steel cloth) over the fruit to hold it under the surface. The larvae will exit the fruit and float to the top.

3. SOIL SIEVING

A minimum 1-m (39-inch (in)) square, 8-cm (3-in) deep sample of soil is to be dug out from under the selected host and placed in a suitable container such as a plastic garbage bag. The bag is fully labeled with date and location before transport.

Place soil sample in the top of a 1 cm sieve and wash down with water until all the lumps are broken up and only solid objects remain in the sieve. Below the first sieve is a second 1 mm sieve which should catch any pupae in the sample.

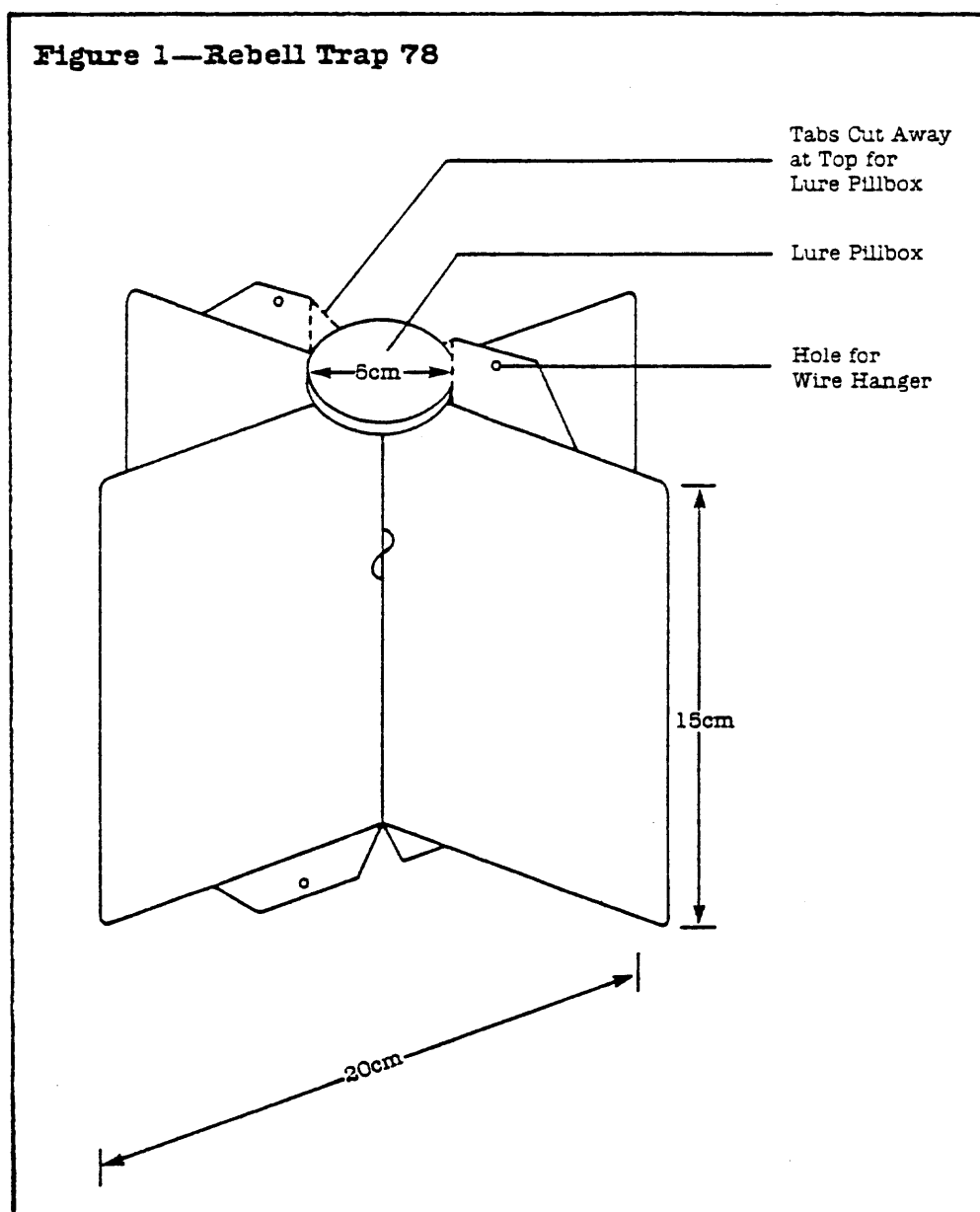

IV. ERADICATION PROCEDURES

Survey and Emergency Response Staff, in consultation with methods and research agencies, outlines treatments to be used and must be notified of all treatment plans. If treatments selected or proposed are not in conformance with current pesticide labels, an emergency exemption can be provided under Section 18 of the FIFRA, as amended. For further instructions, see Emergency Programs Manual, Section V, E.

Eradiation of a European cherry fruit fly infestation is essential within the continental United States. Local conditions will determine the most acceptable procedure to achieve eradication.

A. Recommended
Pesticides

1. Diazinon
2. Malathion

B. Approved
Eradiation
Treatments

1. Aerial Bait Spray: Full coverage aerial application of bait spray starting when infestation is confirmed. The area of full coverage spray will extend a minimum 2.5 km (approximately 1.5 mi) beyond any known infestation. Weather conditions may dictate changes in spray schedule. In subsequent years, aerial spraying will also be conducted from the estimated fly emergence date (based on day degree summation), initial fly detection, or 10 days prior to fruit color break and continue through harvest and/or cessation of honeysuckle flowering period. Application will continue for a minimum of three insect life cycles.

The decision to apply bait spray applications will be based on the best weather information available. In the event rain washes an application from the foliage, plans will be implemented to retreat the area. Only one retreatment should be scheduled within the established treatment cycle. This would allow, as an example, one retreatment in any given week, if applications normally occur once a week.

Retreatment should not be considered if weather reports indicate a 50-percent or greater chance of precipitation in the 48-hour period following washoff.

The objective is to minimize environmental contamination via spray washoff while maintaining a viable spray in the eradication zone. Any treatment or retreatment recommendations will be considered based on data from the environmental monitoring effort.

2. Ground Bait Spray: Spraying will be conducted starting when the flies are detected. In the years following it will be applied at first fly emergence. The area of full coverage spray will extend a minimum of 200 m (656 ft) beyond any known infestation. All hosts (fruit- or nonfruit-bearing) will be treated. Weather conditions may dictate changes in spray schedule. In subsequent years, ground spraying will also be conducted from the estimated fly emergence date (based on day degree summation), initial fly detection, or 10 days prior to fruit color break and continue through harvest and/or cessation of honeysuckle flowering period.

The decision to apply bait spray applications will be based on the best weather information available. In the event rain washes a bait application from the foliage, plans will be implemented to retreat the area. Only one retreatment should be scheduled within the established treatment cycle. This would allow, as an example, one retreatment in any given week, if applications normally occur once a week.

Retreatment should not be considered if weather reports indicate a 50-percent or greater chance of precipitation in the 48-hour period following washoff.

The objectives are to eradicate the pest and minimize environmental contamination. Any treatment or retreatment recommendations must consider these objectives.

3. Fruit Stripping: Properties with confirmed larval infestations in the fruit will be handled as in "1" and/or "2" above. In addition, all host fruit on the infested properties and those adjacent will be promptly stripped and properly disposed.

4. Soil Treatment: Properties with confirmed larval infestations and all properties within 200 m (656 ft) will have approved soil treatments applied within the drip line of all host plants. Treatment will be applied at the prescribed intervals.

5. Supplemental: Host destruction/removal and pruning can be used as supplemental procedures to augment other eradication treatments. As eradication measures, they will not stand alone but can be selectively applied to complement the eradication effort.

a. Host Destruction or Removal: In areas of extreme environmental sensitivity as a limited alternative to adulticide treatment, all host plants in the immediate areas are to be taken out and destroyed by burning or removed in a sealed plastic bag to an approved landfill for burial. Any commercial plantings are treated as in "1" above.

b. Pruning: If there are few host plants in the infested area or the area is small, pruning the plants back so that no fruits will be produced in 3 years could be an effective supplemental treatment procedure.

C. Eradication/
Control Method
Selection

The following parameters or criteria will determine the minimum treatment to be used in achieving eradication. Expanded or additional treatment actions can be applied if mutually agreed on with cooperating agencies. Eradication measures will be conducted for at least 3 years at the appropriate time and season. Trapping will be conducted for a minimum of 4 years at the appropriate time and season.

1. If one adult male or one adult female without eggs is detected, no control procedures are implemented.

2. If a mated female or multiple flies or fly forms are detected in an urban/residential area, aerial or ground application of bait, soil treatment, and fruit stripping will be used. Similar fly detections in a commercial area will require aerial bait application, ground bait application, soil treatment, and destruction and removal of honeysuckle hosts only.

D. Orientation
of Eradica-
tion/Control
Procedures

Only trained and experienced personnel will be utilized initially. Replacement personnel will be trained by the individual being replaced. A training period of 3 working days is necessary for the orderly transfer of these functions.

E. Eradication/
Control
Records

Records noting the location, dates, number and type of treatments, and materials and formulations used will be maintained for all areas treated. See Addendum G for detailed instructions.

F. Monitoring

An effective monitoring program will be implemented to aid in the evaluation of program efforts and environmental impact.

The application and use of pesticides and other controlled substances will be assessed through the use of appropriate monitoring program criteria. The evaluation must effectively address Agency, cooperators, and public concerns.

The monitoring program will include at the minimum the following elements:

1. Determine efficacy of the pesticide against the target pest.
2. Evaluating dye cards to monitor aerial bait applications.
 - a. Droplet size information.
 - b. Droplet distribution information.
 - c. Bait deposition information.
 - d. Identification of wind drift components.
 - e. Identification of skips.
3. Sampling to evaluate effect on environmental components.
 - a. Water sampling to detect insecticide levels through direct application, leaching, and runoff.
 - b. Soil sampling to determine insecticide levels and residues.
 - c. Foliage sampling to identify residues.
 - d. Biological organism sampling during applications and posttreatments to determine impact of insecticides.
 - e. Air sampling to determine presence of pesticide in respirable air.

The monitoring program is to be a combined effort between the State in which the emergency program is being conducted and PPQ. If specific plans need to be developed for monitoring activities, the Survey and Emergency Response Staff will request assistance and guidelines from other NPPS staffs.

V. CONTACTS

When a European cherry fruit fly eradication program has been implemented, its success will depend on the voluntary cooperation, assistance, and understanding from other involved groups. The following is a list of groups which either are involved in or must be kept informed of all operational phases of an emergency program.

- A. Other Federal, State, county, and municipal agricultural officials
- B. Grower groups
- C. Commercial interests
- D. Universities
- E. Foreign agricultural interests
- F. National, State, and local news media
- G. State and local law enforcement officials
- H. General public
- I. Public health

Addendum A--Definitions

Aerial Bait Treatment:	Applying bait spray by aircraft over a treatment area.
Array:	The trapping pattern in a 1-sq-mi (0.4-sq-mi) area.
Array Sequence:	The trapping pattern (array) beginning with the core area and continuing outward to and through each buffer area.
Attractant: (Lure)	A carbonate compound used as a chemical attractant for European cherry fruit fly.
Bait:	An attractant and food source (protein hydrolysate) mixed with an insecticide for treating European cherry fruit fly infestations.
Buffer Area:	The area extending beyond the boundary of the core--1-, 2-, 3-, 4-, 5-, and 6-km (0.6-, 1.2-, 1.9-, 2.5-, 3.1-, and 3.9-mi) buffer.
Cold Treatment:	The use of cold temperatures as a treatment on selected products alone or in conjunction with fumigation procedures.
Commercial Production Area:	An area where host material is grown for distribution.
Confirmed Detection:	A positive laboratory identification of a submitted life form (specimen) as European cherry fruit fly.
Core Area:	A minimum distance of 1 km (0.6 mi) beyond any confirmed European cherry fruit fly detection. This generally is the area where pruning, spraying, and soil treatments are made. That area determined to be infested by delimiting surveys.
Day Degrees:	An accumulation of heat units above a specified developmental temperature threshold during a life stage.
Delimiting Survey:	Determining the extent of infestation in an area where the European cherry fruit fly has been detected.
Detection:	The collection of any life stage of European cherry fruit fly.
Detection Survey:	A survey conducted in a susceptible area not known to be infested with the European cherry fruit fly.

Diapause: An obligatory arrestment of development in the pupal stage.

Epicenter/
Focal Point: The initial site of an infestation.

Host Collection
Survey: The taking of fruit samples from the core and buffer areas.
The fruit is held to identify the presence of European cherry
fruit fly.

Host Cutting
Survey: A survey conducted in the core and buffer areas by cutting
fruit and examining for larvae.

Host Stripping: The removal and proper disposal of all European cherry fruit
fly host fruit from a designated area.

Fumigation: The application of an approved fumigant as a treatment (methyl
bromide, ethylene dibromide, Phostoxin®) alone or in
conjunction with cold treatment procedures.

Generation:
(Life Cycle) The period of time for the pest to complete all stages of
development predicated on day degrees or on the basis of other
biological information.

Ground Bait
Spray: Using ground spray equipment to spray host vegetation in a
European cherry fruit fly infested area with an insecticide and
a protein hydrolysate bait.

Host: A plant species that provides for potential reproduction of
the European cherry fruit fly.

Infestation: The collection of two or more European cherry fruit flies or a
larva, a pupa, or a mated fly from within an area of 4 sq km
(1.5 sq mi).

Infested Area: Three kilometers distance from all detection sites unless
biological factors indicate the need for more or less area.

Monitoring/
Evaluation
Survey: Using interdependent visual and trapping surveys in an area
where an insecticide treatment has been applied to evaluate the
effectiveness of the application.

PPQ-APEIS-USDA: Plant Protection and Quarantine, Animal and Plant Health
Inspection Service, United States Department of Agriculture.

Quadrat: One-quarter sq km (0.1 sq mi). Four quadrats per sq km.

Rebell Traps: Survey trap used for detecting the European cherry fruit fly. The trap is produced by Eidg. Forschungsanstalt for the Obstund Weinbau, Wadenswil, Switzerland.

Regulated Area: The regulated area will extend a minimum of 7 linear km (4.4 mi) in any direction from an infested property.

Regulatory Inspection: Trapping conducted around establishments where regulated articles are sold, handled, processed, or moved.

Rhagoletis
cerasi
(Linnaeus): The scientific name of the European cherry fruit fly.

Soil Screening: The passing of soil through a screen for the detection of pupae.

Soil Treatment: The application of an approved insecticide (diazinon) to the soil of nursery stock and/or within the drip line of host plants.

Urban/Residential Area: Noncommercial crop production area generally containing multiple or single family dwellings.

Addendum B--Safety

Personnel and public safety must be a prime consideration at all times. Safety practices should be stressed in preprogram planning and through the duration of actual program operations. Supervisors must enforce on-the-job safety procedures. For complete instructions, see V, D, in the Emergency Programs Manual.

Addendum C--Hosts

The European cherry fruit fly host list has been separated to indicate those which are preferred and other hosts with appropriate comments. The hosts have been listed by common and scientific name. The common names are arranged in a manner that is indicative of their usage. The common names of a particular group or family of hosts are listed first. Any varieties of the group, and their corresponding scientific names, are listed beneath the group or family names. Following the variety names are colloquialized common names for which there are no known or accepted scientific names. In all instances, an attempt has been made to select the most widely recognized common name.

PREFERRED

<u>Common Name</u>	<u>Scientific Name</u>
Alps honeysuckle	<u>Lonicera alpigena</u>
European bird cherry	<u>Prunus padus</u>
European fly honeysuckle	<u>Lonicera xylosteum</u>
Honeysuckle, a	<u>Lonicera nigra</u>
Mahaleb cherry	<u>Prunus mahaleb</u>
Sour cherry	<u>Prunus cerasus</u>
Sweet cherry	<u>Prunus avium</u>
Tatarian honeysuckle	<u>Lonicera tatarica</u>

OTHER RECORDED

The literature indicates that these hosts could allow for European cherry fruit fly development but does not disclose all the conditions under which the host/pest relationship occurs. The available data does not support inclusion of these hosts as regulated articles.

Bloodtwig dogwood	<u>Cornus sanguinea</u>
Box thorn	<u>Lycium barbarum</u> and <u>Lycium halimifolium</u>
Cranberry, small	<u>Vaccinium oxycoccus</u>
Indian currant	<u>Symphoricarpos orbiculatus</u>
Snowberry	<u>Symphoricarpos albus</u>

POSSIBLE

Almond cherry	<u>Prunus glandulosa</u>
Barberry, common	<u>Berberis vulgaris</u>

Berries, general
Black cherry
Buckthorn honeysuckle
Bunge cherry
Cranberry, large
Cowberry
Dogwood
Giant honeysuckle
Ground cherry
Holly mahonia

Honeysuckle, a

Honeysuckle
Iberian honeysuckle
Indian currant
Japanese honeysuckle
Ledebour honeysuckle
Mistletoe honeysuckle
Morrow honeysuckle
Oregon-grape

Snowberry, common
Tibet honeysuckle
Trumpet honeysuckle
Woodbine

Vaccinium sp.
Prunus serotina
Lonicera orientalis
Prunus humilis
Vaccinium oxycoccus
Vaccinium vitis-idaea
Cornus sp.
Lonicera hildebrandiana
Prunus fruticosa
Mahonia aquifolium and
Mahonia repens
Lonicera caerulea
Lonicera chrysantha
Lonicera etrusca
Lonicera flava
Lonicera fragrantissima
Lonicera henri
Lonicera involucrata
Lonicera korolkowii
Lonicera maackii
Lonicera pileata
Lonicera prolifera
Lonicera ruprechtiana
Lonicera species
Lonicera iberica
Symphoricarpos orbiculatus
Lonicera japonica
Lonicera ledebouri
Lonicera quinquelocularis
Lonicera morrow
Mahonia nervosa and
Mahonia repens
Symphoricarpos albus
Lonicera thibetica
Lonicera sempervirens
Lonicera periclymenum

Addendum D--Life History

1. TAXONOMIC

European cherry fruit fly (Rhagoletis cerasi (L.) (Diptera, Tephritidae)

Closely related species in North America are:

Apple fruit fly (R. pomonella Walsh)

Blueberry maggot (R. mendax Curran)

Eastern cherry fruit fly (R. cingula (Loew))

Walnut husk fly (R. boycei Cresson), A Walnut husk fly (R. juglandis Cresson)

Walnut husk maggot (R. suavis (Loew)), black cherry fruit fly (R. fausta (Osten Sacken))

Western cherry fruit fly (R. indifferens Curran)

2. IDENTIFICATION CHARACTERS

Adults: Colorful black flies slightly smaller than house fly; scutellum yellow; wings clear with heavy bands. Female slightly larger than male and with sharp pointed ovipositor.

Eggs: Elongate, less than 1 millimeter, white.

Larvae: White legless maggot with sharp-points at ends, 1 to 3 millimeters long.

Pupae: Light brown, distinctly segmented, barrel-shaped, about 3 millimeters long.

3. BIOLOGY (Based on established population under European conditions.)

The insects overwinter in puparia in the soil, usually beneath the host. The flies emerge in May or June, depending on temperature. Sexual maturation is temperature dependent but usually takes about 5 days. Females can sometimes mate 3 to 4 days after emergence and each female usually mates only once. Oviposition may start as early as the 6th or 7th day but normally egg laying occurs about 10 to 11 days after emergence. The females prefer ripening fruit and lay 50 to 60 (maximum 100) eggs, usually one per fruit, beneath the skin of the fruit. The eggs hatch in 5 to 12 days and the larvae move to the center of the fruit and begin to feed near the pit. Larvae thrive on mature fruit, but cannot develop completely in green fruit. Larval development depends on temperature, and lasts 2 to 4 weeks. The mature larvae leave the fruit and pupate in the top 3 inches of soil. Diapause is obligatory and approximately 5 months (3 months minimum) is the period of low temperatures needed for further development. Some flies can overwinter a second year and few can overwinter yet a third year depending on the day degrees a pupae receives. Emerged adults

can survive up to 60 days but females usually die in 2 to 3 weeks. The flies generally do not disperse far if hosts are present, usually 350 meters at most, to locate a host.

Addendum E--Identification of Specimen(s)

As many specimens as possible of the pest are to be collected for screening/identification by the local designated identifier. Suspect adult specimens collected from Jackson traps should be handled carefully. The specimen(s) with the suspect fly(ies) should be folded, sticky sides in, only to the extent that it may be inserted into a paper bag. Care must be taken not to fold the sticky sides of the specimen(s) together tightly, thus making removal and identification of the fly(ies) difficult. Suspect adult specimens and other insect stages in vials of alcohol should be forwarded for confirmation to 1/ below. These specimens must be accompanied by PPQ Form 391 marked "Urgent" (see PPQ Manual M390.500).

INFORMATION FLOW FOR THE IDENTIFICATION OF SPECIMEN(S)

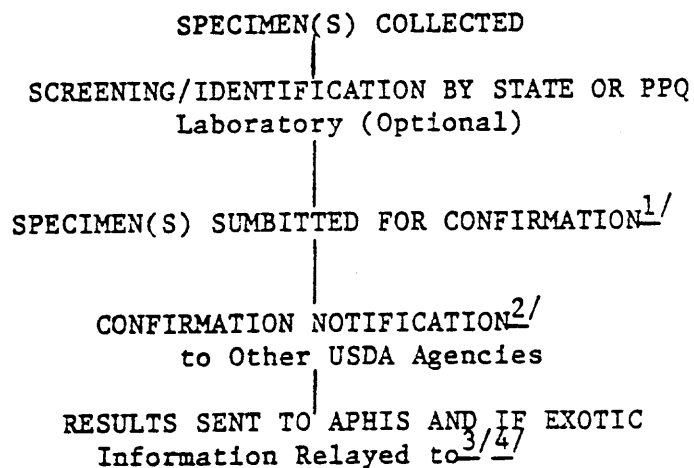

<u>1/</u>	Arizona, Louisiana, New Mexico, Texas	Mr. D. Riley PPQ, APHIS, USDA P.O. Box 306 Brownsville, Texas 78520
	Other States West of the Mississippi River	Ms. K. Corwin California Department of Food and Agriculture 1220 N Street Sacramento, California 95814
	States East of the Mississippi River	Dr. H. Weems Florida Department of Agriculture and Consumer Services P.O. Box 1269 Gainesville, Florida 32602

2/ APHIS Plant Protection and Quarantine

3/ All States State and Territory Agricultural Regulatory Officials

4/ NAPPO North American Plant Protection Organization

Addendum G--Technical Application Data

Some pesticides and/or bait and lure formulations can damage painted surfaces, plastic and some uncoated metal surfaces. Care must be exercised when formulating and applying these compounds. The result of accidental contamination can be eliminated or minimized by promptly cleaning the affected surface.

1. GROUND FOLIAGE SPRAY APPLICATIONS

Malathion 50 WP-----500 g (1 pound (lb)) ai/acre
Protein (Staley's)-----9.5 liters (L) (2.5 gallons (gal))

Add water to meet application equipment requirements.

The bait mix can be applied on the foliage of host plants by means of a backpack sprayer or equivalent unit. Each host shall be given a drench (until leaf surface is wet) sufficient for full coverage. Applications are sprayed on the crown of each host where sun exposure (especially the southern side) is strongest, as adults tend to congregate in such areas. Treatments are to be applied 2 weeks apart, during late spring to mid-summer when adult is present.

2. SOIL TREATMENT

Urban/Residential Areas:

Diazinon--104.7 (3.54 ounces (oz)) of Diazinon AG-4 per 7.7 L (20 gal) of water 1 L of solution per 1 sq m. Apply treatments at 10-day intervals in the early spring when adults are estimated to be moving up through the soil from their pupal cases. This formulation should also be applied at snow melt to kill diapausing pupae. Apply additional treatments at the end of the season in late summer when larvae are working their way down through the soil to pupate.

Material will be applied evenly, to thoroughly wet the soil, within the drip line paying special attention to the area near the trunk and southwestern parts of the crown shadow.

Commercial Production Area:

Diazinon--Work Diazinon 14G (Granular) into soil to 3 in (approximately 6 cm), at the rate of 6.35 to 12.7 kg (14 to 28 lb) per acre or 32.83 gm per 3.65 m (12 ft) diameter drip circle (10.5 sq m (113 sq ft)) with a rotary hoe, cultivator, disk, harrow or other suitable means. Start applications at snow melt to kill diapausing pupae.

3. AERIAL BAIT SPRAY APPLICATION

ULV Malathion Bait--0.071 L (2.4 oz) of 91 percent technical grade malathion plus 0.281 L (9.6 oz) of Staley's protein bait per acre. Apply full coverage bait spray on a 7- to 10-day schedule 7- to 10-day schedule during late spring to mid-summer when adult is present.

Addendum H--Forms

	<u>Number</u>	<u>Title</u>
CONTROL	PPQ-213	Airplane Inspection Record
	PPQ-431	Treatment Test Record
	PPQ-468	Caution--Pesticide Treatment in Progress
	PPQ-552	Pesticide Samples for Chemical Analysis
	PPQ-602	Environmental Monitoring
	PPQ-603	Residue Sample for Food or Feed Product
	PPQ-802	Daily Aircraft Record
REGULATORY	PPQ-214	Warning Quarantine Label
	PPQ-244	Warning Quarantine Tag
	PPQ-254	Disposition of Plants and Plant or Animal Products
	PPQ-287	Mail Interception Notice
	PPQ-405	EDB Fumigation Record
	PPQ-468	Caution--Pesticide Treatment in Progress
	PPQ-518	Report of Violation
	PPQ-519	Compliance Agreement
	PPQ-522	Certified Under All Applicable Federal or State Cooperative Domestic Plant Quarantines Tag
	PPQ-523	Emergency Action Notification
	PPQ-524	Issuance Record--Permits and Certificates
	PPQ-527	Package Certificate
	PPQ-530	Limited Permit
	PPQ-535	Certificate of Treatment Label
	PPQ-537	Limited Permit Label
	PPQ-540	Certificate of Treatment
	PPQ-551	Regulated Establishment Record
	PPQ-554	Certified Under All Applicable Federal or State Cooperative Domestic Plant Quarantine Label
	PPQ-577	Phytosanitary Certificate
	SURVEY	PPQ-343
PPQ-345		Caution Label for Trapping
PPQ-391		Specimens for Determination
PPQ-539		Trapping Survey Record

Addendum I—Contributors

Consultants

W. T. A. Nielson, Entomologist, Research Branch, Agriculture Canada, Kentville, Nova Scotia

E. F. Boiler, Swiss Federal Research Station for Arboriculture, Viticulture and Horticulure, Wadenswil, Switzerland

Industry

W. Schraeder, Farm Advisor, Cooperative Extension, Stockton, California

State Regulatory Officials

A. C. Ashorn, Assistant Director, Agricultural and Environmental Sciences Division, Texas Department of Agriculture, Austin, Texas

C. Poucher, Chief, Bureau of Pest Eradication and Control, Plant Industry Division, Florida Department of Agriculture and Consumer Services, Winter Haven, Florida

I. A. Siddiqui, Chief, Pest Detection and Emergency Projects, Division of Plant Industry, California Department of Food and Agriculture, Sacramento, California

University

M. T. Aliniyazee, Associate Professor of Fruit Insects, Department of Entomology, Oregon State University, Carvallis, Oregon

W. C. Mitchell, Professor, Department of Entomology, University of Hawaii, Honolulu, Hawaii

R. J. Prokopy, Associate Professor of Insect Biology, Entomology Department, University of Massachusetts, Amherst, Massachusetts

Governmental Agencies

E. L. Ayers, Jr., Staff Officer, Field Operations Support Staff, National Program Planning Staff, Plant Protection and Quarantine, Animal and Plant Health Inspection Service, U.S. Department of Agriculture, Hyattsville, Maryland

- D. L. Chambers, Laboratory Director, Insect Attractants, Behavior and Basic BioResearch Laboratory, Southern Region, Agricultural Research Service, Science and Education, U.S. Department of Agriculture, Gainesville, Florida
- H. L. Ford, Deputy Administrator, Plant Protection and Quarantine, Animal and Plant Health Inspection Service, U.S. Department, Hyattsville, Maryland
- B. G. Lee, Emergency Programs Coordinator, International and Emergency Programs, Plant Protection and Quarantine, Animal and Plant Health Inspection Service, U.S. Department of Agriculture, Hyattsville, Maryland
- G. G. Rohwer, Assistant Deputy Administrator for International and Emergency Programs, Plant Protection and Quarantine, Animal and Plant Health Inspection Service, U.S. Department of Agriculture, Washington, DC
- J. N. L. Stibick, Emergency Programs Staff Entomologist, International and Emergency Programs, Plant Protection and Quarantine, Animal and Plant Health Inspection Service, U.S. Department of Agriculture, Hyattsville, Maryland
- G. Tween, Assistant Emergency Programs Coordinator, International and Emergency Programs, Plant Protection and Quarantine, Animal and Plant Health Inspection Service, U.S. Department of Agriculture, Hyattsville, Maryland

Addendum J—References

This literature includes research on sterile insect (SIR) release. SIR is not recommended at this time for eradication. In addition, the scale of the infestation would likely be small enough that it would be impractical to take three years to gear up for an SIR effort even if the population or race was known. The environmental effect of these chemicals during the term of the eradication effort will be negligible.

Baker, C. R. B., and Miller, G. W., 1978. The effect of temperature on the post-diapause development of four geographical populations of the European cherry fruit fly. *Ent. Exp. and Appl.* 23:1-13.

Birkardesles, H., 1971. Insecticide trials in Marmara Region against cherry fruit flies. *Bitki Korma Bulteni* 11(1):15-32.

Boller, E. F., and Bush, G. L., 1974. Evidence for genetic variation in populations of the European cherry fruit fly, Rhagoletis cerasi, based on physiological parameters and hybridization experiments. *Ent. Exp. and Appl.* 17:279-293.

_____, Remund, U., Katsoyannos, B. I., and Berchtold, W., 1977. Quality control in European cherry fruit fly: evaluation of mating activity in laboratory and field-cage tests. *Z. ang. Ent.* 83:183-201.

_____ and Remund, U., 1977. Application of SIT on the European cherry fruit fly, Rhagoletis cerasi L., in Northwest Switzerland. IAEA, Vienna:77-82.

Delley, B., 1975. A preliminary test of trapping the cherry fly with the aid of sticky plates of yellow plexiglas. *Revue suisse Vitic. Arboric Hortic.* 7:109-204.

Engel, H., 1976. On the infestation of cherry fruits by the cherry fruit fly. *Zeitschr. fur Pflanz und Pflanz.* 83(1/2/3):53-58.

Haisch, A., 1976. Generic control of Rhagoletis cerasi L.: preconditions, present situation and prospects. IAEA, Vienna:27-35.

_____, 1977. Observations on the flying behaviour of the European cherry fruit fly. IAEA, Vienna:191-199.

_____, and Forster, S., 1970. Experiences in the capturing of the cherry fly with glued paper and sticky balls. *Gesunde Pflanzen.* 22(10):182-185.

_____, and Boller, E., 1973. On the prediction of the flight of the cherry fruit fly. *Landw. Jahrbuch Heft.* 50(1):113-119.

_____, 1975. The pupal diapause of the cherry fly. I. The effects of diapausing pupae of different temperatures and periods of exposure to cold. Z. ang. Ent. 81:1-11.

_____, and Forster, S., 1975. Origin specific diapause peculiarities in the cherry fly. Ent. Ger. 2(2):137-148.

_____, Boller, E., Russ, K., Vallo, V. and Fimiani, P., 1978. The European cherry fruit fly: Synopsis and bibliography. Bull. SROP, 6th Rpt. of the IOBC working group on genetic control of Rhagoletis cerasi. 43 pp.

_____, and Chwala, D., 1978. The effect of alternating temperatures on the course of diapause of the European cherry fruit fly, Rhagoletis cerasi. Entomol. Generalis 5(3):231-239.

_____, and Levinson, H. Z., 1980. Influences of fruit fly volatiles and coloration on oviposition of the cherry fruit fly. Naturwissenschaften. 67(1):44-45.

Herczeg, G., 1972. The cherry fruit fly and its control. Kertgazdasag 4(3):45-51.

Jenser, G., 1976. Analysing the applicability of colour traps for R. carasi forecasting in an orchard consisting of several varieties of cherry. 23rd Plant Protection Conference: Forecasting in Plant Protection., Budapest.:235-239.

Jona, R., and Arzone, A., 1979. Control of Rhagoletis cerasi in cherries by gamma irradiation. Jour. Hort. Sc. 54(3):167-170.

Katsoyannos, B. I., 1980. Second field applications of oviposition deterring pheromone of the European cherry fruit fly. Z. ang. Ent. 89(3):278-281.

Kuhnel, F., 1971. Experience gained in controlling the cherry fruit fly. Obstbau (Berlin) 11(6):89-90.

Leski, R., 1969. Population studies of the cherry fruit fly. Panel Insect Ecol. and Sterile-male Tech. Proc.:1-7.

Mariacci, L., 1972. The cherry fruit fly. Lotta Antiparassitaria 24(5):11.

Muller, W., 1970. Agro-meteorological investigations on the date of first emergence of the cherry fruit fly in Austria. Pflanzenschutzberichte 41(11/12):193-209.

_____, 1975. The effect of location of the critical temperature sum for the development of the cherry fruit fly. Pflanzenschutzberichte 45(1/3):13-32.

Prokopy, R. J., 1969. Visual responses of European cherry fruit flies. *Pol Pismo Entomol.* 39(3):539-566.

Remund, U., and Boller, E. F., 1975. The development and potential of a new visual trap for the cherry fly. *Z. ang. Ent.* 77:348-353.

_____, 1978. Cherry fly traps for prognosis and biotechnical control in advance. *Schweiz Z. Obst Weinbau* 114(9):229-232.

Russ, K., and Zelger, R., 1977. An apparatus for distinguishing between male and female pupae of the cherry fruit fly. *Pflanzenarzt.* 30(9):98-99.

_____, Boller, E. F., Vallo, V., Haisch, A. and Sezer, S., 1973. Development and application of visual traps for monitoring and control of populations of Rhagoletis cerasi. *Entomophaga.* 18:103-116.

Steiner, L. F., 1969. Control and eradication of fruit fly on citrus. *Proc. 1st Intern. Citrus Symposium.* 2:881-887.

Zivanovic, V., 1978. Experiments with olfactory traps baited with Prokobil III and Rebell to catch the cherry fruit fly. *Zastita Bilja.* 29(3):279-284.