

GenePix 4000B

ARRAY SCANNER

User's Guide

Part Number 2500-136 Rev E July 2001 Printed in USA

The GenePix 4000B Array Scanner is for research purposes only. It is not intended or approved for diagnosis of disease in humans or animals.

Copyright 1999 - 2001 Axon Instruments, Inc.

No part of this Guide may be reproduced, stored in a retrieval system or transmitted, in any form or by any means, electronic, mechanical, photocopying, microfilming, recording, or otherwise, without written permission from Axon Instruments, Inc.

For Technical Assistance

If you need help to resolve a problem, there are several ways to contact Axon Instruments:

World Wide Web

www.axon.com

Phone

+1 (510) 675-6200

Fax

+1 (510) 675-6300

E-mail

tech@axon.com

Important Safety Information for the GenePix 4000B

The operator of the GenePix 4000B Array Scanner instrument is assumed to be trained in the correct operation of the instrument and the safety issues. Throughout the *GenePix 4000B Array Scanner User's Guide*, the word "you" refers to this trained operator.

Using controls, making adjustments, or performing procedures other than those specified in the GenePix 4000B User's Guide may result in hazardous exposure to laser light, high voltage, or moving parts. Exposure to these hazards can cause severe or fatal injury.

Safety Text Used In This Guide

Make sure you follow the precautionary statements presented in this guide.



Warning: Indicates a possibility of severe or fatal injury to the user or other persons if the precautions or instructions are not observed.

Caution: Indicates that damage to the instrument, loss of data, or invalid data could occur if the user fails to comply with the advice given.

Important: Highlights information that is critical for optimal performance of the system.

Note: Identifies items of general interest.

The Protective Housing

The protective housing and instrument interlocks are designed to protect you from exposure to the laser light, high voltage, or moving parts. You do not need to access the interior of the instrument. There are no serviceable parts inside.



Warning: Do not defeat the interlock, open the protective housing, or try to gain access to the interior of the instrument through any other openings. Opening the housing can damage the instrument components and result in hazardous exposure to laser light, high voltage, or moving parts.

The GenePix 4000B is a Class I laser device. There are higher power lasers embedded inside it, but the user can not access these. Slides can be placed safely in the laser's scanning area because the slide-loading door has redundant interlocks that block the beams. There are two panels on the device that are not interlocked, but these are fastened with screws and require a tool to remove them. They are shown in the Non-Interlocked Panels section below. Do not remove any screws to open the housing!

- The lasers inside can cause eye damage before you have a chance to blink!
- There are high voltages inside.
- There are no user serviceable parts inside.
- The unit will be damaged if you attempt to open the protective housing.

Interlock Failure Symptoms

If you experience any of the following symptoms, you may have an interlock failure. It is unsafe to continue to use the GenePix 4000B with only one interlock functioning. Please contact Technical Support immediately at either of the numbers indicated on the rear panel of the GenePix 4000B.

1. Mirror and lens assembly keeps moving below the slide after the door is opened.
2. The blue "Scanning" LED on top of GenePix 4000B doesn't extinguish when the door is open.
3. You cannot scan any slides.
4. You can no longer hear the distinctive metal-on-metal sound that the mechanical interlock makes when it falls into place. This normally happens when the slide loading door has opened about ¼".

Lasers

Cautions

- Do not stick anything into the openings or vents of the GenePix 4000B, other than loading the slide. You may cause an interlock to fail.
- Do not attempt to move any parts below the slideholder. You may cause an interlock to fail.



Embedded Laser Classification and Power

Wavelength	Power	Divergence	Duration	Embedded Laser's Class
532 nm	20 mW	<1.2 mrad	Continuous	Class IIIb
635 nm	15 mW	0.7 mrad	Continuous	Class IIIb



Warning: Exposure to laser light can cause injury. For example, viewing the laser light directly can cause blindness.

Power Supply Classification

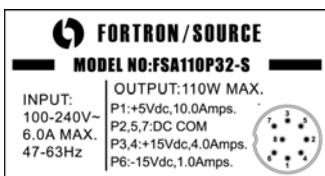

Axon Part Number 3420-014

High-Voltage Hazard

High-voltage electronics can be found in the GenePix 4000B Array Scanner instrument. Under normal operating conditions, you are protected from high voltage within the instrument.



Warning: Do not try to gain access to the interior of the instrument. Exposure to high-voltage electronics can cause severe or fatal injury.

High-voltage electronics can also be found in the scanner's controlling computer. See the computer manufacturer documentation on the high-voltage hazard warnings. Make sure you follow the instructions on the safe operation of the computer.

Electrical Ratings

Input (DC)	Max
+15 V	2.5 A
+5 V	5.5 A
-15 V	0.5 A

Moving Parts

The GenePix 4000B Array Scanner instrument contains moving parts that can cause injury. Under normal operating conditions, the instrument is designed to protect you from the moving parts. The interlock and protective housing are designed so that you cannot access the moving parts during a scan.



Warning: Do not try to gain access to the interior of the instrument. The moving parts inside the instrument can cause injury.

Fuses

There are no fuses in the GenePix 4000B.

Hazardous Material Precautions

Use standard laboratory procedures and cautions when working with chemicals.

Caution: Always follow the manufacturer's precautions when working with chemicals. The manufacturer and/or supplier is not responsible or liable for any damages caused by or as a consequence of the use of any hazardous material.

Non-Interlocked Panels

View of the bottom of the GenePix showing the screws which hold the top part of the protective housing.

DO NOT REMOVE THESE FIVE SCREWS!

DANGER
Laser radiation when open
AVOID DIRECT EXPOSURE TO BEAM

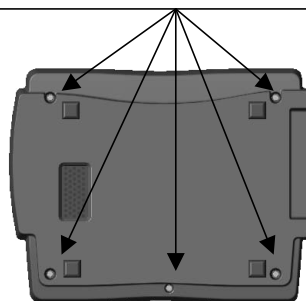

Maintenance and Service

No user maintenance is required. No user service is allowed. If there is a problem, please contact Technical Support.

List of Controls

This Guide constitutes a list of controls.

Caution: – Use of controls or adjustments or performance of procedures other than those specified herein may result in hazardous radiation exposure.

Safety Labels

If a label becomes illegible or is missing for any reason, please contact Array System Technical Support for a free replacement label. While waiting for the replacement label, copy the labels shown in this section and attach the copy of the label to the instrument.

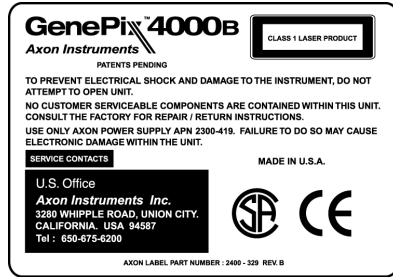

Figure 1. Service Contacts and Warning Label
Label is affixed at the rear of the GenePix 4000B on the upper half of the protective housing.

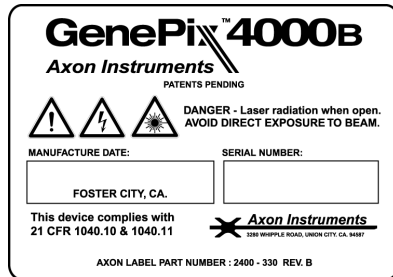

Figure 2. Identification and Certification Label
Label is affixed at the rear of the GenePix 4000B on the lower half of the protective housing.

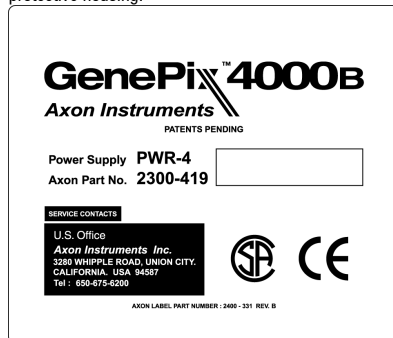
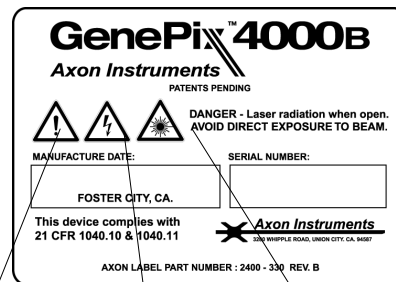

Figure 3. Power Supply Label
Label is affixed to the bottom of the power supply.

Symbol Explanations

	Device standby Ready to scan slide. Stage waiting at the start position.
	Scanning.
	Eject. Slideholder ready to be unloaded.



Attention, see instructions for use!

Attention, dangerous voltage!

Attention, laser radiation!

Site Requirements

The GenePix 4000B is designed to operate optimally if the site requirements are met. As with any precision optical instrument, care should be taken to maintain a low-dust, low-vibration environment. Temperature and humidity extremes may compromise performance.

Environmental Temperature: 50–86° F (10–30° C).

Environmental Humidity: 5–95% non-condensing

Power Requirements: Input 100–240V~, 6A max., 47–63 Hz.

Space Requirements: 18 in deep × 13 in wide × 7 in high (44.1 cm × 33.1 cm × 17.8 cm)

Weight Requirements: Sufficient to support 35.8 lb (16.2 kg) with minimal vibration.

Informations de sécurité importantes sur le GenePix 4000B

L'utilisateur de l'instrument à laser Array Scanner GenePix 4000B est supposé avoir reçu la formation adéquate sur l'utilisation de cet instrument et les consignes de sécurité associées. Le *GenePix 4000B Array Scanner User's Guide* s'adresse à un opérateur qualifié.

L'utilisation de commandes et l'exécution de réglages ou de procédures autres que ceux spécifiés dans le GenePix 4000B User's Guide entraîneraient de graves dangers d'exposition au faisceau laser, à des hautes tensions ou à des pièces mobiles. Ces dangers peuvent être à l'origine de dommages corporels sévères ou fatals.

Informations de sécurité utilisées dans ce Guide

Veillez à prendre les précautions indiquées dans ce guide.



Avertissement: Indique un risque de dommage corporel sévère ou fatal pour l'utilisateur ou d'autres personnes si les précautions ou les instructions indiquées n'étaient pas observées.

Attention: Indique un risque de dommage pour l'instrument, de perte de données ou de données invalides si l'utilisateur ne suit pas les recommandations de ce manuel.

Important: Désigne des informations vitales pour le fonctionnement optimal du système.

Note: Identifie des informations d'intérêt général.

Le boîtier de protection

Le boîtier et les verrouillages de sécurité de l'instrument sont conçus pour vous protéger du danger d'exposition au faisceau laser, à des hautes tensions ou à des pièces mobiles. Il n'est pas nécessaire que vous accédiez à l'intérieur de l'instrument, où aucune intervention n'est nécessaire.



Avertissement : Ne désactivez pas les verrouillages de sécurité, n'ouvrez pas le boîtier et ne tentez pas d'accéder à l'intérieur de l'instrument par aucune autre ouverture. L'ouverture du boîtier pourrait endommager les composants de l'instrument et entraîner un danger d'exposition au faisceau laser, à des hautes tensions ou à des pièces mobiles.

Le GenePix 4000B est un instrument à laser de Classe 1. Il incorpore des lasers de puissance, auxquels l'utilisateur ne peut pas accéder. Les lames peuvent être placées en toute sécurité dans la zone de balayage des lasers : la porte coulissante bloque automatiquement l'émission des rayons lors de son ouverture. Il y a deux accès potentiels sous l'appareil qui ne possèdent pas cette protection : ils sont

fermés par des vis et requièrent donc l'usage d'outils pour leur ouverture (voir les figures ci-dessous). N'enlevez aucune vis pour tenter d'ouvrir le boîtier ou pour aucune autre raison.

- Les lasers internes peuvent endommager vos yeux avant que vous n'ayez le temps de les fermer !
- Attention ! Présence de hautes tensions à l'intérieur.
- L'utilisateur ne doit procéder à aucune intervention à l'intérieur du boîtier.
- L'appareil peut être endommagé par une simple tentative d'ouverture du boîtier.

Symptômes Liés aux Problèmes de Verrouillage

Il est dangereux de continuer à utiliser le GenePix 4000B si seul l'un des deux verrouillages de sécurité fonctionne. Prière de contacter le fabricant et/ou le fournisseur immédiatement à l'un des numéros indiqués à l'arrière du GenePix 4000B.

L'apparition de l'un des symptômes suivants désigne un problème avec la double protection :

1. L'ensemble miroirs-lentilles continue à se déplacer sous la lame après l'ouverture de la porte coulissante.
2. La DEL "Scanning" (voyant bleu) sur le dessus du GenePix 4000B ne s'éteint pas quand la porte est ouverte.
3. Il vous est impossible de scanner une lame.
4. Vous n'entendez plus le bruit métallique caractéristique que provoque le verrouillage mécanique lorsqu'il est enclenché. Ce clic s'entend normalement dès que la porte coulissante est ouverte d'un quart de pouce (environ 6 mm).

Sécurité concernant les Lasers

Précautions à prendre

- Ne rien introduire dans les ouvertures ou aérations du GenePix 4000B, à part une lame de microscope dans le compartiment prévu pour son chargement. Vous pourriez provoquer une défaillance des systèmes de sécurité (systèmes à double verrouillage).
- Ne pas tenter de déplacer un composant derrière le support des lames. Ceci risquerait de provoquer une défaillance des systèmes de sécurité (systèmes à double verrouillage).

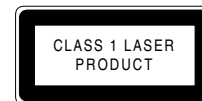

Puissance et Classification des Lasers Utilisés

Longueur d'onde	Puissance	Divergence	Durée	Classe des lasers embarqués
532 nm	20 mW	<1.2 mrad	Continue	Classe IIIb
635 nm	15 mW	0.7 mrad	Continue	Classe IIIb



Avertissement : L'exposition au faisceau laser peut entraîner des dommages corporels. Par exemple, fixer directement le laser entraîne un risque de cécité.

Classification de l'alimentation

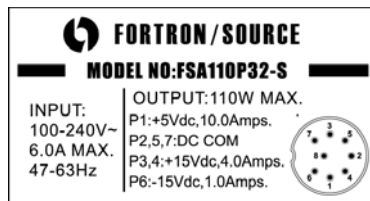

Référence Axon 3420-014

Danger de haute tension

Des circuits à haute tension se trouvent à l'intérieur de l'instrument à laser Array Scanner GenePix 4000B. Dans des conditions d'utilisation normales, vous êtes protégé(e) des hautes tensions à l'intérieur de l'instrument.



Avertissement : Ne tentez pas d'accéder à l'intérieur de l'instrument. L'exposition à des circuits à haute tension peut provoquer des dommages corporels sévères ou fatals.

Il existe également des circuits à haute tension dans l'ordinateur contrôlant le scanner. Reportez-vous à la documentation du fabricant de l'ordinateur sur les risques liés à ces hautes tensions. Suivez les instructions concernant les précautions d'utilisation de l'ordinateur.

Entrée (courant continu)	Maximum
+15 V	2.5 A
+5 V	5.5 A
-15 V	0.5 A

Pièces mobiles

L'instrument à laser Array Scanner GenePix 4000B contient des pièces mobiles pouvant entraîner des risques de dommages corporels. Dans des conditions d'utilisation normales, cet instrument est conçu pour vous éviter tout risque lié aux pièces mobiles. Le système de sécurité et le boîtier de protection sont conçus pour prévenir tout accès aux pièces mobiles durant l'utilisation du scanner.



Avertissement : Ne tentez pas d'accéder à l'intérieur de l'instrument. Il existe des pièces mobiles à l'intérieur susceptibles de provoquer des dommages corporels.

Fusible

Il n'existe pas de fusible à l'intérieur du GenePix 4000B.

Précautions contre les substances dangereuses

L'utilisateur doit suivre les procédures standard de laboratoires et prendre les précautions appropriées à la manipulation de produits chimiques.

Attention : Veillez à toujours suivre les consignes de sécurité du fabricant lors de la manipulation de produits chimiques. Le fabricant et/ou le fournisseur ne peuvent être tenus pour responsables de dommages éventuels, directs ou indirects, causés par l'utilisation de substances dangereuses.

Accès non verrouillés par la Double Protection

Vue de dessous du GenePix montrant les vis qui maintiennent la partie supérieure du boîtier.

NE PAS RETIRER CES CINQ VIS !

DANGER !
Radiation laser lorsque ouvert
**EVITER IMPERATIVEMENT L'EXPOSITION DIRECTE
AUX RAYONS**

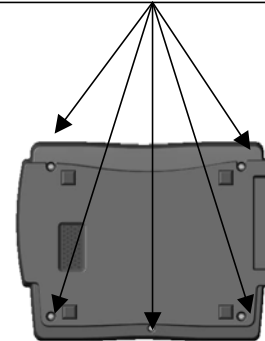

Maintenance et Service des accès non verrouillés par la Double Protection

Aucune maintenance de la part de l'utilisateur n'est nécessaire. De plus, aucun service de maintenance n'est autorisé de la part d'un tiers.

Liste des Contrôles

Ce guide constitue une liste des contrôles à effectuer régulièrement.

Attention : Tout contrôle, réglage ou exécution de procédures autres que celles spécifiées ci-dessus peut entraîner un risque d'exposition dangereuse à des rayonnements.

Étiquettes de sécurité

Si une étiquette devient illisible ou manque pour une raison quelconque, contactez le service Support du Array System pour obtenir gratuitement une étiquette de remplacement. En attendant, copiez les étiquettes illustrées dans ce manuel et attachez cette copie à l'instrument.

Symboles d'alerte (Signalétique)

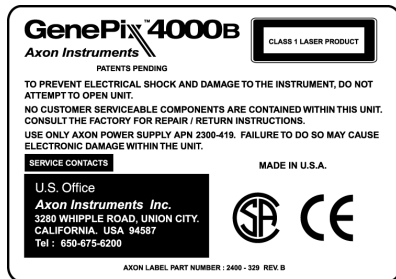

Figure 1. Adresse et avertissements

Cette étiquette est collée à l'arrière du GenePix 4000B sur la partie supérieure du boîtier.

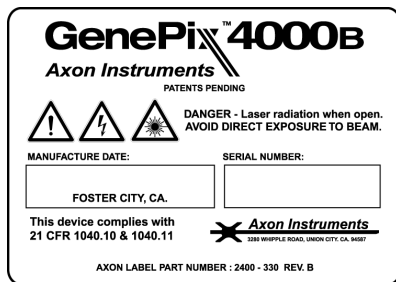

Figure 2. Identification et étiquette de certification

Cette étiquette est collée à l'arrière du GenePix 4000B sur la partie inférieure du boîtier.

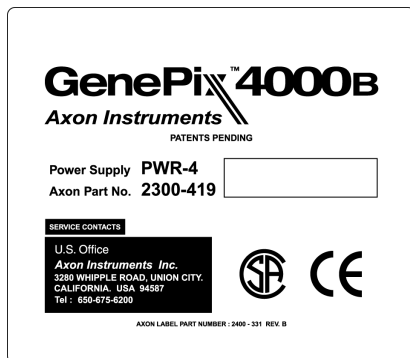
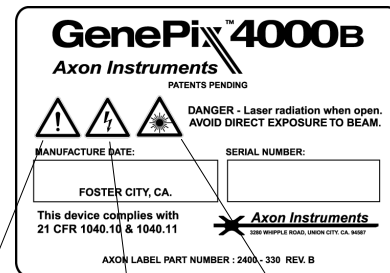

Figure 3. Étiquette de l'alimentation.

Cette étiquette est fixée sur le bas de l'alimentation.

Significations des Symboles

	Appareil en attente. Prêt à scanner une lame. Attend en position de départ.
	Balayage en cours.
	Ejection. Support de lame accessible.



Attention, voir les instructions d'utilisation !

Attention, haute tension !
Danger !

Attention, rayonnement Laser !

Conditions nécessaires sur le site

Le GenePix 4000B est conçu pour fonctionner au mieux de ses performances si les conditions nécessaires sur le site sont satisfaites. Comme pour tout autre instrument optique de précision, il ne doit pas être exposé à la poussière et aux vibrations. Des conditions extrêmes de température et d'humidité peuvent compromettre ses performances.

Température : 10-30° C.

Humidité : 5-95% sans condensation

Alimentation : 100-240V~, 6A max., 47-63 Hz.

Espace nécessaire : 44,1 cm × 33,0 cm × 17,8 cm

Poids : Structure suffisante pour supporter un poids de 16,2 kg pratiquement sans vibration.

Información Importante sobre la Seguridad del GenePix 4000B

Se asume que el operador del *GenePix 4000B Array Scanner* está entrenado en las precauciones de seguridad a seguir y en la utilización correcta del instrumento. La palabra “usted” como se utiliza en esta guía del usuario del *GenePix 4000B Array Scanner* se refiere a este operador entrenado.

Utilización o ajuste de los controles y la ejecución de procedimientos diferentes a los especificados en la guía del usuario del GenePix 4000B, puede resultar en exposición peligrosa a radiación láser, alto voltaje o a partes móviles. Exposición a estos peligros pueden producir lesiones severas o fatales.

Declaraciones de Seguridad Utilizadas en esta Guía

Cerciórese de observar las declaraciones de seguridad que se presentan en esta guía.



Advertencia: Indica la posibilidad de lesión severa o fatal al usuario u otras personas si no se siguen las instrucciones y precauciones.

Precaución: Indica que puede ocurrir daño del instrumento, pérdida o invalidez de la información obtenida si el usuario no obedece las instrucciones provistas.

Importante: Resalta información fundamental para el funcionamiento óptimo del sistema.

Nota: Identifica aspectos de interés general.

Cubierta Protectora

La cubierta protectora y el circuito de seguridad del instrumento están diseñados para protegerlo a usted de exposición a la radiación láser, alto voltaje o a partes móviles. Usted no necesita acceder al interior del instrumento. En el interior no hay partes que requieran su servicio.



Advertencia: No fuerce el circuito de seguridad, ni abra la cubierta protectora o intente acceder al interior del instrumento a través de cualquiera de sus aperturas. Abrir la cubierta protectora puede ocasionar daño en los componentes del instrumento y producir exposición accidental a la radiación láser, al alto voltaje o a partes móviles.

El GenePix 4000B es un equipo de láser de Clase 1. Adentro se localizan láseres de alta potencia fuera del alcance del usuario. Las placas pueden colocarse sin peligro en la región del área de barrido del láser porque la entrada de las placas tiene circuitos de seguridad

redundantes que bloquean los rayos de luz. Hay dos paneles en el equipo que no son parte del circuito de seguridad, pero que están asegurados con tornillos que requieren una herramienta para sacarlos. Estos están indicados mas adelante. No remueva ningún tornillo para abrir la cubierta!

- Los láseres interiores pueden dañar sus ojos antes de que pueda pestañear.
- Interiormente hay altos voltajes.
- En el interior no hay partes que requieran servicio por parte del usuario.
- La unidad se dañará si usted intenta abrir la cubierta protectora.

Síntomas de Daños en el Circuito de Seguridad

Si usted encuentra cualquiera de los siguientes síntomas, el circuito de seguridad podría estar dañado. Es peligroso continuar usando el GenePix 4000B cuando hay sólo un circuito de seguridad funcionando. Comuníquese al mantenimiento técnico a cualquiera de los números telefónicos indicados en la parte posterior del GenePix 4000B.

1. El espejo y el montaje de los lentes siguen moviéndose por debajo de la placa después de abrir la puerta.
2. La luz azul emitida por el diodo “LED” con etiqueta “Scanning” localizado en la parte superior del GenePix 4000B no se extingue cuando la puerta está abierta.
3. Usted no puede registrar ninguna placa.
4. No se puede escuchar el sonido característico del contacto entre metales producido por el circuito de seguridad cuando se ajusta en su lugar. Este ocurre normalmente cuando la apertura donde se coloca la placa se abre aproximadamente 6 mm.

Seguridad del Láser

Precauciones

- No inserte ningún objeto en las aperturas o respiraderos del GenePix 4000B diferente de la placa. Puede ocasionar fallas en el circuito de seguridad.
- No intente mover ningún componente debajo de la platina. Usted puede causar fallas en el circuito de seguridad.

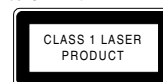

Clasificación y Potencia de los Láseres Incluidos

Longitud de Onda	Potencia	Divergencia	Duración	Tipo de Láser
532 nm	20 mW	<1.2 mrad	Continua	Clase IIIb
635 nm	15 mW	0.7 mrad	Continua	Clase IIIb



Advertencia: Exposición a la radiación láser puede ocasionar lesiones. Por ejemplo, mirar directamente a la luz del láser puede causar ceguera.

Clasificación de la Unidad de Poder

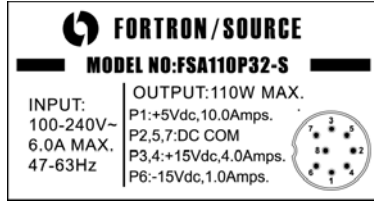

El número de Parte de Axon Instruments es 3420-014.

Peligro de Alto Voltaje

El GenePix 4000B Array Scanner contiene electrónica de alto voltaje. Bajo condiciones normales de operación, usted está protegido del alto voltaje del instrumento.



Advertencia: No intente acceder al interior del instrumento. Exposición a alto voltaje puede causar lesiones severas o fatales.

Electrónica de alto voltaje se encuentra en el computador que controla el escáner. Revise la documentación del fabricante sobre las advertencias al respecto. Cerciórese de seguir cuidadosamente las instrucciones sobre la utilización apropiada del computador.

ENTRADA (CORRIENTE CONTINUA)	Máxima
+15 V	2.5 A
+5 V	5.5 A
-15 V	0.5 A

Partes Móviles

El GenePix 4000B Array Scanner contiene partes móviles que pueden causar lesiones. El instrumento está diseñado para protegerlo a usted de las partes en movimiento en condiciones normales de funcionamiento. El circuito de seguridad y la cubierta protectora impiden el acceso al interior del instrumento durante un escan.



Advertencia: No intente acceder al interior del instrumento. Las partes móviles pueden causar lesiones.

Fusibles

El GenePix 4000B no contiene fusibles.

Precaucions con Materiales Peligrosos

El usuario debe utilizar procedimientos y precauciones de laboratorio estandarizados cuando trabaja con productos químicos.

Advertencia: Utilice siempre las instrucciones de la fábrica cuando trabaje con productos químicos. El fabricante y/o el proveedor no son responsables legalmente por daños o lesiones ocasionados como consecuencia del uso de materiales peligrosos.



Paneles Que No Forman Parte del Circuito de Seguridad

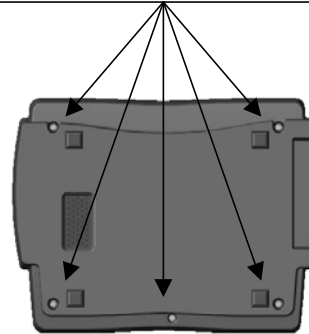
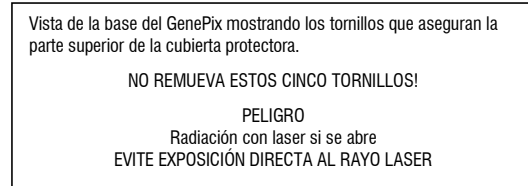

Mantenimiento y Reparación

No se requiere ningún mantenimiento por parte del usuario. Este no está autorizado para ejecutar ninguna reparación. Si hay algún problema por favor comuníquese al mantenimiento técnico a cualquiera de los números telefónicos indicados en la etiqueta.

Lista de Controles

Este guía provee una lista de controles.

Precaución – el uso de los controles, el ajuste o la ejecución de procedimientos diferentes de los especificados aquí puede resultar en exposición peligrosa a la radiación del laser.

Etiquetas de Seguridad

Si una etiqueta se hace ilegible o se pierde por algun motivo, por favor contacte el servicio técnico del sistema para obtener etiquetas sin costo alguno. Mientras espera por las etiquetas de reemplazo, copie las que aparecen en esta sección y pegue una copia en el instrumento.

Símbolos de Advertencia



Figura 1. Etiqueta con Advertencias y Contactos para Reparación
La etiqueta está fijada a la parte posterior del GenePix 4000B en la mitad superior de la cubierta protectora.



Figura 2. Etiqueta de Identificación y Certificación
La etiqueta está fijada a la parte posterior del GenePix 4000B en la mitad inferior de la cubierta protectora.



Figura 3. Etiqueta de la Unidad de Poder.
La etiqueta está fijada en la base de la unidad de poder.

Explicaciones de los Símbolos

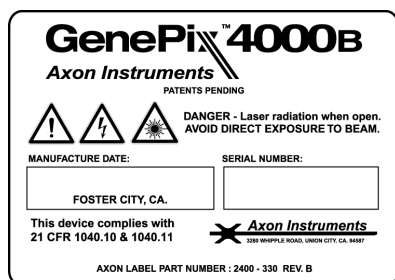
	El equipo está a la espera ("Standby"). La platina está lista en posición de cargar la diapositiva y empezar.
	Registrando ("Scanning").
	Expulse ("Eject"). La platina está lista para descargar.

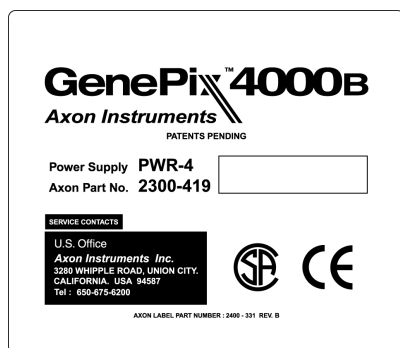
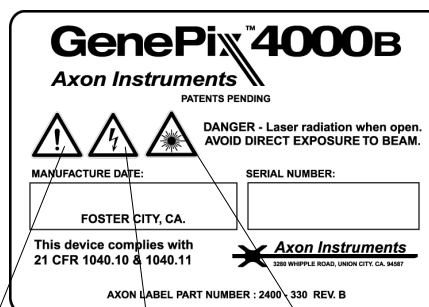

Atención, vea instrucciones para su uso!

Atención, voltajes peligrosos!

Atención, radiación del láser!

Requerimientos del Lugar de Instalación

El GenePix 4000B está diseñado para operar óptimamente si el lugar de instalación cumple con los requerimientos. Como con cualquier instrumento óptico de precisión debe tener cuidado de mantenerlo en un lugar bajo en polvo, y de poca vibración. Temperaturas extremas y humedad pueden comprometer su funcionamiento.

Temperatura ambiental: 50-86 °F (10-30 °C).

Humedad ambiental: 5-95% sin condensación.

Energía requerida: Entrada: 100-240V, 6 A máximo; 47-63 Hz.

Espacio requerido: 18" profundidad x 13" amplitud x 7" altura (44.1 cm x 33.0 cm x 17.8 cm).

Peso requerido: Suficiente para sostener 35.8 lb (16.2 kg) con mínima vibración.

Wichtige Sicherheitsmassnahmen für GenePix 4000B

Es wird vorausgesetzt, dass der Benutzer des GenePix 4000B qualifiziert ist, das Gerät richtig und sicher zu verwenden. Innerhalb der gesamten Beschreibung für den GenePix 4000B Array Scanner bezieht sich das Wort "Sie" auf diesen qualifizierten Benutzer.

Die Benutzung der Kontrollvorrichtungen, Änderungen oder das Ausführen anderer Handlungen ausser denen, die in der Gebrauchsanweisung des GenePix 4000B erklärt sind, können zu gefährlichen Strahlungen, hoher Voltzahl oder losen Teilen führen. Kontakt mit diesen Gefahren kann zu schweren oder tödlichen Verletzungen führen.

Sicherheitstext, der in dieser Gebrauchsanweisung verwendet wird

Versichern Sie sich bitte, dass Sie alle Vorsichtsmassnahmen beachten.

Warnung: Weist auf die Möglichkeit einer schweren oder tödlichen Verletzung hin, wenn die Anweisungen oder Vorsichtsmassnahmen nicht beachtet werden.

Achtung: Weist darauf hin, dass bei Nichtbeachtung der Vorschriften Schaden am Gerät entstehen kann und Datenausfall oder möglicherweise ungültige Daten resultieren können.

Wichtig: Weist auf Information hin, die wichtig ist um die optimale Leistung des Gerätes sicherzustellen.

Anmerkung: Deutet auf Themen von generellem Interesse hin.

Das Schutzgehäuse

Das Schutzgehäuse und die elektrische Verriegelung sind so konstruiert, dass Sie vor Laserstrahlen, Hochspannung und beweglichen Teilen geschützt sind. Sie brauchen das innere Teil des Gerätes nicht zu öffnen, weil keine für den Nutzer justierbaren Teile vorhanden sind.

Warnung: Verändern Sie nicht die elektrische Verriegelung. Öffnen Sie nicht das Schutzgehäuse oder versuchen Sie gleichermassen nicht, das Innere des Gerätes durch andere Öffnungen zu erreichen.

Der GenePix 4000B ist ein Laserprodukt der Klasse 1. Auf den Bereich der im Gerät entstehenden stärkeren Laserstrahlen hat der Benutzer kein Zugriff. Glasstreifen können sicher in den Laserrasterbereich eingeführt werden, weil die ladende Tür mehrere Verriegelungen hat, die Laserstrahlen blockieren. Es gibt zwei Öffnungen, die nicht elektrisch verriegelt, sondern mit Schrauben befestigt sind. Diese können nur mit Hilfe eines Werkzeuges entfernt werden. Sie sind unten abgebildet. Entfernen Sie niemals die Schrauben, um das Gehäuse zu

öffnen!

- Die im Gerät entstehenden Laserstrahlen können Ihre Augen beschädigen, bevor Sie Gelegenheit haben, sich zu schützen.
- Im Gerät entstehen hohe Spannungen.
- Es befinden sich im Gerät keine für den Nutzer justierbaren Teile.
- Wenn Sie versuchen, das Schutzgehäuse zu öffnen, kann dies eine Beschädigung des Gerätes zur Folge haben.

Hinweise auf ein Versagen der elektrischen Verriegelung

Wenn eines der nachfolgenden Probleme auftritt, hat wahrscheinlich eine Verriegelung versagt. Es ist sehr gefährlich, weiterhin den GenePix 4000B zu benutzen, wenn nur eine elektrische Verriegelung funktioniert. Bitte rufen Sie sofort den Technischen Hilfsdienst an, sobald eines der unten beschriebenen Symptome auftritt. Die Service-Nummern befinden sich auf der hinteren Seite des Gerätes.

1. Spiegel- und Linsensysteme bewegen sich weiterhin unter dem Objektträger, nachdem die Tür geöffnet wurde.
2. Die blaue "Scanning" Lichtdiode oben auf dem GenePix 4000B erlischt nicht, wenn die Tür geöffnet wird.
3. Sie können keine Glasstreifen ablesen.
4. Der Benutzer hört nicht mehr das metallene Geräusch, welches bei normaler Funktion durch das Einrasten der mechanischen Verriegelung ausgelöst wird. Dies passiert normalerweise, wenn die Tür ungefähr 6 mm geöffnet ist.

Lasersicherheit

Achtung

- Mit Ausnahme des Objektträgers dürfen unter keinen Umständen Gegenstände in die Öffnungen oder Ausgänge des GenePix 4000B gesteckt werden, da sonst ein Versagen der elektrischen Verriegelung verursacht werden könnte.
- Unterhalb des Objektträgers dürfen keine Teile bewegt werden, auch dies könnte ein Versagen der elektrischen Verriegelung verursachen.



Klassifizierung und Intensität der benutzten Laser

Wellenlänge	Stärke	Divergenz	Betriebsart	Klassifizierung
532 nm	20 mW	<1.2 mrad	Kontinuierlich	Klasse IIIb
635 nm	15 mW	0.7 mrad	Kontinuierlich	Klasse IIIb

Warnung: Verletzungen können entstehen, wenn man Laserstrahlen ausgesetzt wird. Direkter Kontakt mit den Strahlen kann zu Blindheit führen.

Stromversorgung (Klassifikation)

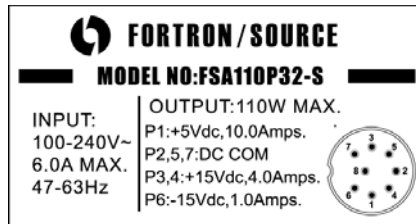

Axon Teil Nr. 3420-014.

Hochspannungsgefahr

Der GenePix 4000B Array Scanner enthält Hochspannungselektronik. Unter normalen Gebrauchskonditionen sind Sie vor diesen Spannungen geschützt.

Warnung: Versuchen Sie nicht an das innere Teil des Scanners heranzukommen. Kontakt mit der Hochspannungselektronik kann schwere oder tödliche Verletzungen verursachen.

Hochspannungselektronik befindet sich auch im Kontrollrechner des Gerätes. Lesen Sie sich bitte die Gebrauchsanweisung über die Hochspannungsgefahr durch. Befolgen Sie alle Anweisungen über die Sicherheitsmassnahmen beim Gebrauch des Rechners.

Eingabe (Gleichstrom)	Maximal
+15 V	2.5 A
+5 V	5.5 A
-15 V	0.5 A

Bewegliche Teile

Der GenePix 4000B Array Scanner enthält bewegliche Teile, die Verletzungen verursachen können. Unter normalen Umständen ist das Gerät so konstruiert um Sie vor den beweglichen Teilen zu schützen. Die Verriegelung und das Schützgehäuse sind da, damit ein Zugriff auf die beweglichen Teile während einer Ablesung nicht möglich ist.

Warnung: Versuchen Sie nicht, das innere Teil des Gerätes zu öffnen. Die darin enthaltenen beweglichen Teile können Verletzungen verursachen.

Sicherung

Es befinden sich im GenePix 4000B keine Sicherungen.

Sicherheitsvorkehrungen

Der Benutzer muss alle normalen Laboranweisungen und Sicherheitsvorkehrungen befolgen, wenn Chemikalien verwendet werden.

Achtung: Befolgen Sie immer die Anweisungen der Hersteller, wenn Sie mit Chemikalien arbeiten. Der Hersteller und/oder der Lieferant übernehmen keine Verantwortung für Schäden, die durch den Missbrauch von gefährlichen Chemikalien verursacht werden.

Geräteöffnungen Ohne Elektrische Verriegelung

Die untere Ansicht des GenePix zeigt die Schrauben welche den oberen Teil des Schutzgehäuses zusammenhalten.

ENTFERNEN SIE DIESE FÜNF SCHRAUBEN UNTER KEINEN UMSTÄNDEN!

VORSICHT!!

Laserbestrahlung wenn geöffnet!!

VERMEIDEN SIE DIREKTEN KONTAKT MIT DEM LASERSTRAHL!

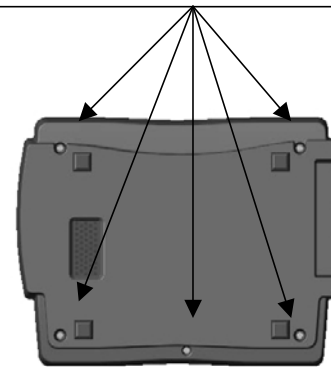

Instandhaltung und Vorsorge

Es ist keine Vorsorge durch den Benutzer nötig. Jede eigenmächtige Reparatur durch den Benutzer ist untersagt. Wenn ein Problem auftritt, dann rufen Sie bitte den Technischen Hilfsdienst an.

Liste von Kontrollvorrichtungen

Diese Gebrauchsanweisung enthält eine Liste der Kontrollvorrichtungen.

Achtung – Der Gebrauch von Kontrollvorrichtungen oder Einstellungen bzw. die Ausführung von Handlungen außer denen, die in dieser Anweisung beschrieben sind, können zu gefährlichen Strahlungen führen.

Sicherheitsmassnahmen

Sicherheitsetiketten

Sollte ein Etikett unlesbar werden oder aus unbekanntem Gründen fehlen, setzen Sie sich bitte mit dem Technischen Hilfsdienst für einen kostenlosen Ersatz des Etiketts in Verbindung. Während Sie auf das Etikett warten, kopieren Sie die Etiketten am Ende dieses Abschnitts und befestigen Sie eine Kopie des Etiketts am Gerät.

Abbildungen mit Sicherheitshinweisen



Abbildung 1: Kundendienst und Warnetiketten
Das Etikett ist auf der Rückseite des GenePix 4000B auf dem oberen Teil des Schutzgehäuses befestigt.



Abbildung 2: Identifikations- und Beglaubigungsetikett
Das Etikett ist auf der Rückseite des GenePix 4000B an der unteren Hälfte des Schutzgehäuses befestigt.

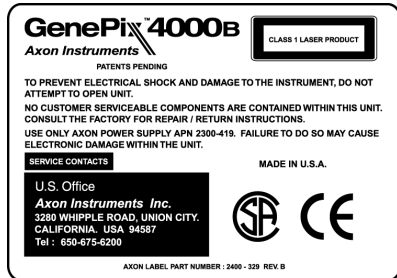

Abbildung 3: Stromversorgungs etikett.
Das Etikett befindet sich am boden der Stromversorgung.

Erklärung Der Symbole

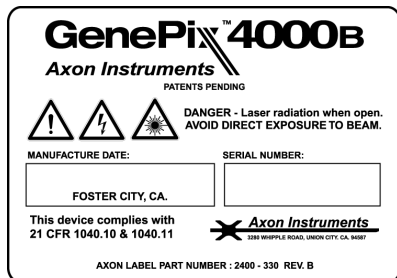
	Standby-Modus. (Gerät ist bereit einen Objektträger zu lesen. Führung des Objektträgers in Startposition)
	Scanning.
	Eject. (Gerät ist bereit zur Ausgabe des Objektträgers)

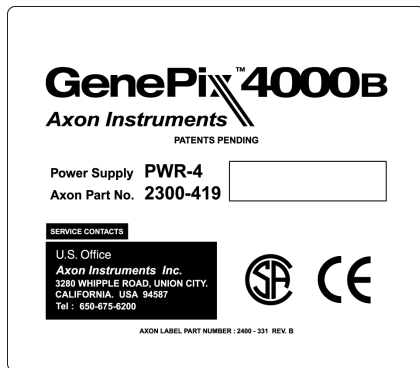
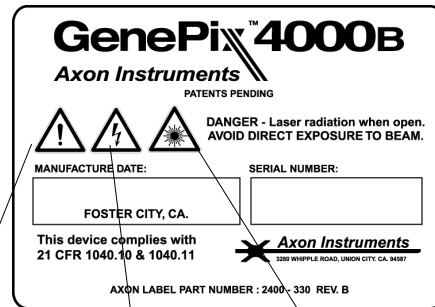

Achtung!!
Vor Benutzung unbedingt die Gebrauchsanweisung lesen!

Achtung!!
Gefährlicher Stromkreis!

Achtung!!
Laserbestrahlung!!

Örtliche Voraussetzungen

Der GenePix 4000B arbeitet optimal, wenn alle Umfeldvoraussetzungen gegeben sind. Genau wie bei anderen optischen Geräten, sollte auch hier ein staub- und schwingungsfreies Umfeld existieren. Extreme Temperaturen und Luftfeuchtigkeit können die optimalen Funktionen des Gerätes beeinträchtigen.

Umgebungstemperatur: 10–30 °C.

Umgebungs luftfeuchtigkeit: 5–95% unkondensiert.

Stromvoraussetzung: Zufuhr 100–240 V~, 6 A max, 47–63 Hz.

Platzvoraussetzung: 44,1 cm × 33,0 cm × 17,8 cm.

Gewichtsvoraussetzung: Genug um 16,2 kg zu unterstützen mit minimalen Schwingungen.

Declaration of Conformity

Manufacturer: Axon Instruments, Inc.
3280 Whipple Road
Union City, CA 94587 USA

Type of Equipment: Array Scanner

Model Number: GenePix 4000B

Serial Number: _____

Year of Manufacture: 2000

Application of Council Directives:

EC Low Voltage Directive 73/23/EEC as amended
EC EMC Directive 89/336/EEC as amended

Harmonized Standards to which Conformity is Declared:

EN 61326 04: 1997 (Emissions), EN 61326 04: 1997 (Immunity)
EN 61010-1:1993 +A1 +A2:1995
EN 60825-1:1994 +A 11:1996

I, the undersigned, hereby declare that the equipment specified above conforms to the above Directives and Standards.

Authorized Signature and Date: (signature on file)

Title of Signatory: _____

Customer License Agreement

Customer License Agreement for Single User of GenePix Pro 3.0.

This software is licensed by Axon Instruments, Inc. ("Axon") to you for use on the terms set forth below. By opening the sealed software package, and/or by using the software, you agree to be bound by the terms of this agreement.

AXON hereby agrees to grant you a non-exclusive license to use the enclosed AXON software (the "SOFTWARE") subject to the terms and restrictions set forth in this License Agreement.

Copyright

The SOFTWARE and its documentation are owned by AXON and are protected by United States copyright laws and international treaty provisions. This SOFTWARE may not be copied for resale or for bundling with other products without prior written permission from AXON.

Restrictions on Use and Transfer

You may not reverse engineer, decompile, disassemble, or create derivative works from the SOFTWARE.

Export of Software

You agree not to export the SOFTWARE in violation of any United States statute or regulation.

Ownership of Software and Media (CD-ROM)

You own the media (CD-ROM) on which the SOFTWARE is recorded, but AXON owns the SOFTWARE and all copies of the SOFTWARE.

Product Improvements

AXON reserves the right to make corrections or improvements to the SOFTWARE and its documentation and to the related media at any time without notice, and with no responsibility to provide these changes to purchasers of earlier versions of such products.

Term

This license is effective until terminated. You may terminate it by destroying the SOFTWARE and its documentation and all copies thereof. This License will also terminate if you fail to comply with any term or condition of this Agreement. You agree upon such termination to destroy all copies of the SOFTWARE and its documentation.

Limited Warranty and Disclaimer of Liability

AXON warrants that the media on which the SOFTWARE is recorded and the documentation provided with the SOFTWARE are free from defects in materials and workmanship under normal use. For 90 days from the date of receipt, AXON will repair or replace without cost to you any defective products returned to the factory properly packaged with transportation charges prepaid. AXON will pay for the return of the product to you, but if the return shipment is to a location outside the United States, you will be responsible for paying all duties and taxes.

Before returning defective products to the factory, you must contact AXON to obtain a Return Merchandise Authorization (RMA) number and shipping instructions. Failure to do so will cause long delays and additional expense to you.

AXON has no control over your use of the SOFTWARE. Therefore, AXON does not, and cannot, warrant the results or performance that may be obtained by its use. The entire risk as to the results and performance of the SOFTWARE is assumed by you. Should the SOFTWARE or its documentation prove defective, you assume the entire cost of all necessary servicing, repair or correction. Neither AXON nor anyone else who has been involved in the creation, production, or delivery of this SOFTWARE and its documentation shall be liable for any direct, indirect, consequential, or incidental damages arising out of the use or inability to use such products, even if AXON has been advised of the possibility of such damages or claim.

This warranty is in lieu of all other warranties, expressed or implied. Some states do not allow the exclusion or limitation of implied warranties or liability for incidental or consequential damages, so the above limitations or exclusions may not apply to you.

U.S. Government Restricted Rights

The SOFTWARE and its documentation are provided with RESTRICTED RIGHTS. Use, duplication or disclosure by the U.S. Government is subject to restrictions as set forth in subparagraph (c)(1)(ii) of The Rights in Technical Data and Computer Software clause at DFARS 252.227-7013, or subparagraphs (c)(1) and (2) of the Commercial Computer Software -Restricted Rights at 48 CFR 52.227-19, or clause 18-52.227-86(d) of the NASA Supplement to the FAR, as applicable. Manufacturer is Axon Instruments, Inc., 3280 Whipple Road, Union City, CA, 94587.

Governing Body

This Agreement is governed by the laws of the State of California.

COPYRIGHT

The information in this Guide is copyrighted and must not be reproduced in any form whatsoever without written permission from Axon Instruments, Inc.

VERIFICATION

This instrument is extensively tested and thoroughly calibrated before leaving the factory. Nevertheless, researchers should independently verify the basic accuracy of the instrument using suitable test samples.

Table of Contents

For Technical Assistance	i
Important Safety Information for the GenePix 4000B	iii
Informations de sécurité importantes sur le GenePix 4000B	vi
Información Importante sobre la Seguridad del GenePix 4000B	ix
Wichtige Sicherheitsmassnahmen für "GenePix 4000B"	xii
Declaration of Conformity	xv
Customer License Agreement	xvii
Chapter 1 Installing GenePix	1
About This User's Guide	1
Checklist of Parts	1
Computer Requirements	2
Preparing to Install GenePix	3
Quick Overview of GenePix Hardware and Software Installation.....	3
Installation of the SCSI card.....	4
Installation of GenePix Pro 3.0.....	5
Connecting the GenePix 4000B to the Computer.....	5
Windows 98, Windows Millennium and Windows 2000.....	6
Windows NT	6
Connecting the Security Dongle	6
Starting GenePix Pro 3.0	7

Troubleshooting Installation.....	7
SCSI Card Installation Problems	7
Hardware Problems	8
Software Problems.....	8
Chapter 2 Introduction to GenePix 4000B.....	9
Chapter 3 Functional Checkout	11
Chapter 4 Imaging System Hardware.....	13
Overall Features.....	13
Discussion of Hardware Components	13
Optics.....	13
Excitation.....	14
Mirrors, Lenses, and Filters.....	14
Photo-Detection	15
Mechanical.....	16
Electronic.....	16
General Items of Interest	17
Spatial Resolution.....	17
Dynamic Range and Sensitivity.....	17
Limitations.....	18
Summary.....	18
Acknowledgments.....	19
Index	21

Chapter 1

Installing GenePix

About This User's Guide

This User's Guide focuses on the technical and theoretical aspects of the GenePix 4000B hardware. We recommend that you use this Guide in conjunction with the GenePix Pro 3.0 User's Guide, and the on-line Help within GenePix Pro 3.0 (press "F1"). For information on setting up your GenePix 4000B scanner and software, please refer to Chapter 1. For a guided tutorial on scanning your first slide, see Chapter 4 of the GenePix Pro 3.0 User's Guide.

Checklist of Parts

The following items are included in your GenePix package:

- GenePix 4000B bench top instrument APN: 2300-343
- PCI-SCSI adapter for host computer APN: 6130-004
- Driver diskette for SCSI card APN: 2700-089
- SCSI data transfer cable APN: 2100-408
- Power supply unit power cord APN: 3420-014
- Power cord for power supply APN: 3010-011, 013, 014 or 015
- GenePix 4000B User's Guide

2 • Installing GenePix

- Three copies of GenePix Pro 3.0 software for Windows 95/98 or NT. Each copy contains:
 - GenePix Pro 3.0 Installation CD-ROM APN: 2700-090
 - GenePix Pro 3.0 User's Guide APN: 2500-137
 - Parallel port security dongle APN: 6190-014
- GenePix cover letter APN: 9320-090
- GenePix Test Slides APN: GP-2, GP-4
- Bundled host computer (optional)

Computer Requirements

Minimum System Requirements

- IBM-AT compatible computer with a Pentium 400 MHz or faster processor
- Windows 98 or ME operating system (dual-boot systems are not recommended)
- 512 MB RAM
- Hard disk with 20 GB free (for image storage)
- CD-ROM drive
- 1024×768 display system with 65K colors
- Parallel port
- Internet Explorer 5.0

Recommended System Requirements

- IBM-AT compatible computer with a Pentium III 800 MHz or faster processor
- Windows NT 4.0 or Windows 2000 operating system (dual-boot systems are not recommended)
- 768 MB RAM or more
- Hard disk with 30 GB or more free (for image storage)
- Recordable / Rewriteable CD-ROM or Jaz drive
- 1280×1024 display system with 16M colors
- Parallel port
- Internet Explorer 5.0 (or higher)

Preparing to Install GenePix

If you have purchased GenePix *without the optional host computer* please follow the instructions below. If you purchased GenePix with a bundled host computer, the necessary hardware and software are already installed. If so, skip to “Connecting the GenePix 4000B to the Computer”.

Quick Overview of GenePix Hardware and Software Installation

For users who require a minimal level of detail, the following outlines the steps necessary to install GenePix hardware and software.

Caution: If you do not follow the instructions in the order specified below you may damage your instrument.

Important: Initially, do not attach the GenePix 4000B to your computer.

1. **Optional:** Install the SCSI card. This step is not required if the scanner is shipped with a computer.

2. **Optional:** Start the computer. This step is not required if the scanner is shipped with a computer.
3. **Optional:** Install GenePix Pro 3.0. This step is not required if the scanner is shipped with a computer.
4. Shutdown the computer.
5. Attach the GenePix 4000B to the computer with the SCSI cable.
6. Attach the power supply to the GenePix 4000B, making sure the power supply is turned off while you are doing this.
7. Turn on the power supply.
8. Attach the security dongle to parallel port.
9. Turn on the computer.
10. Windows will automatically find the scanner and install the appropriate driver.
11. Start GenePix Pro 3.0 using the GenePix Pro icon on the desktop.
12. Start scanning!

Installation of the SCSI card

Included with your GenePix 4000B is a SCSI adapter card for your host computer. This card is used to transfer data and instructions between the host computer and the GenePix 4000B hardware.

The SCSI card that is included with GenePix 4000B is a PCI-based Plug'n'Play card that will install easily on most computers. We recommend that you use the included SCSI card. Please follow the instructions included with the adapter for the proper installation of the card.

If you already have a SCSI card installed on your host computer and do not want to replace it with the included SCSI card, you must verify that it is a SCSI-2 device that is Win-ASPI compliant. You must also ensure that you have the proper cabling to connect the SCSI card to the GenePix 4000B. While it is possible that an existing SCSI card may work with the GenePix 4000B, technical support is provided only for the SCSI card that is bundled with the GenePix 4000B. If you are using the GenePix 4000B on a computer with multiple SCSI devices please ensure that there are no SCSI ID conflicts. At the factory, the GenePix SCSI ID

is set to 4, but the ID can be easily changed using the SCSI ID switch found at the back of the GenePix 4000B.

Installation of GenePix Pro 3.0

First, to be able to install GenePix 3.0 under Windows NT 4.0 or Windows 2000, a user must be logged in as an Administrator.

GenePix Pro 3.0 is on the included CD-ROM. Simply insert the CD-ROM into your computer and the installation program automatically starts. If the installation program does not start automatically, perhaps because you have the auto-start feature of Windows disabled, you can manually start the installation by running the Setup.exe program file on the CD-ROM. This file is found in the GenePix subdirectory on the CD-ROM.

To start the setup program manually, from the *Start* menu select “Run”, and type `x:\GenePix\setup.exe` where “x” is the drive letter of your CD-ROM drive.

When the installer has finished, you will be given the choice of restarting or shutting down your computer. Select the “Yes, I want to shut down my computer now and install the hardware” option. Once your computer has shut down, proceed below to “Connecting the GenePix 4000B to the Computer” section.

Connecting the GenePix 4000B to the Computer

Caution: Failure to follow these instructions in the correct order can lead to damage to your instrument.

Before connecting the GenePix 4000B to your SCSI connector, please ensure that your computer has been turned off, and that the GenePix power supply is turned off. Once the computer has been turned off, connect the 50-pin data cable between the SCSI adapter of your computer and the GenePix hardware. The SCSI connector and power connector are located at the back of the GenePix 4000B.

Once the SCSI connection has been made, check that the power supply is turned off, then connect the power cord to GenePix. Turn on the power supply, and then turn on your computer.

Windows 98, Windows Millennium and Windows 2000

If the connections have been made correctly, when you restart your computer Windows will show a message that indicates that “New Hardware” has been detected. Windows will automatically install the necessary driver for the GenePix 4000B scanner.

If Windows does not automatically find the driver, you can manually select the driver using the *Add New Hardware Wizard*. This wizard starts any time a new Plug’n’Play device is detected. Working through the wizard, select the option to “Search for the best driver for your device”. Press *Next*. Select the CD-ROM as one of the locations to search for the driver. Press *Next*. Windows will now find the correct driver for the GenePix 4000B.

If you are connecting the GenePix 4000B to a computer that was purchased with the GenePix, the driver is already installed.

Windows NT

You will be able to verify that the GenePix scanner has been successfully installed when you start GenePix Pro 3.0. This is outlined further below.

Connecting the Security Dongle

GenePix Pro 3.0 requires a security dongle to operate. If the dongle is absent you will be able to open images in GenePix Pro, but you will not be able to save your settings files or save your analysis results. In addition, you can analyze only 100 features without a dongle.

Installation of the dongle is straightforward. Simply connect it to the parallel port of your computer. If you have a printer already installed, do not worry. The dongle is a “pass-through” device and you simply connect the dongle to the parallel port, then connect your printer to the dongle.

Starting GenePix Pro 3.0

After the successful installation of the software, you will find the entry “Axon Laboratory” in your list of Programs in the Start menu, and there will be two new icons your desktop. There are “GenePix Pro 3.0”, and “GenePix Pro 3.0 (demo)” entries in your Axon Laboratory group, and icons for these on your desktop. Both of these shortcuts will start GenePix Pro. *The only difference between the demo version and the non-demo version is that the demo version does not interact with the scanner.* Typically if you are only analyzing data and are not doing any image acquisition, you would select the demo version. For acquisition, select “GenePix Pro 3.0”.

After the software has completed loading and the scanner has successfully initialized, you will see a message in the bottom left corner of the software that indicates “Eject position – the slide may be removed”. This message indicates that the GenePix 4000B had been initialized and you can load your first slide!

Note for Windows 2000 Users

Due to security changes in the Windows 2000 operating system, a user must belong to the **Administrator** or **Power User** group (also known as “Standard user”) in order to run Internet Explorer (IE) scripts from the Reports Tab in GenePix Pro 3.0. If a user does not have Standard user access, *i.e.*, if they have “guest” or “restricted user” access, the Windows 2000 environment does not allow such users access to the scripting library required by IE, and therefore will encounter a ‘Library not registered’ error when running scripts in GenePix Pro 3.0.

Troubleshooting Installation

SCSI Card Installation Problems

If you encounter any problems with the installation of the included SCSI card, please refer to the instructions that came with the card. If you require further assistance on installation of the included SCSI card, contact Technical Support. If you are using a SCSI card that was not provided with your GenePix scanner, you should contact the supplier of that SCSI card for technical support.

Hardware Problems

GenePix Pro 3.0 automatically detects the GenePix 4000B. If this does not occur please verify the following items:

- The data cable between the computer and GenePix 4000B is securely connected.
- The GenePix 4000B has power (the green power light on the top of the scanner will be glowing).
- The SCSI card is operational (see above).
- The GenePix SCSI ID 4 does not conflict with any other SCSI devices that you may have already installed on your computer (*e.g.*, a Jaz drive).

Software Problems

If you have purchased your GenePix with a bundled host computer, the software has already been installed. If you are using a previously purchased computer, please consider the following:

- GenePix Pro 3.0 requires a minimum of 256 MB of RAM to acquire images. GenePix Pro is capable of analyzing data when less than 256 MB of RAM is present, but the maximum image size is reduced and performance will be non-optimal.
- GenePix Pro 3.0 requires a security dongle to enable saving of results or settings files. If the dongle is not found, the software operates with limited file-saving functionality.
- GenePix Pro 3.0 requires Internet Explorer 4.0 or later to be installed for its Report tab and on-line Help to function correctly.

Chapter 2

Introduction to GenePix 4000B

The GenePix™ 4000B is the latest array scanner from Axon Instruments, Inc., succeeding the GenePix 4000A scanner. The 4000B has the same basic design as the 4000A, but with the following new features:

- Data Scan resolution has been increased from 10 μm to 5 μm ;
- User-attenuatable laser power;
- User-adjustable focus.
- Pixel-by-pixel laser power correction

Axon Instruments has consulted widely among the scientific pioneers of array techniques to produce an instrument that fulfills all their image acquisition and primary analysis needs.

GenePix 4000B Features

The GenePix 4000B scanner:

- simultaneously scans array slides at two wavelengths using a dual-laser scanning system, which dramatically reduces scan time (5 minutes for full scan), and which eliminates the need for image alignment after acquisition;
- has precisely controlled laser temperature and pixel-by-pixel laser correction for constant power output;
- uses 16-bit digitization;
- has a dynamic detection range of four orders of magnitude;

- possesses extra-high signal-to-noise scan mode;
- offers two scanning modes: a Preview Scan at 40- μm resolution and a Data Scan at 5- μm resolution.

Chapter 3

GenePix 4000B Functional Checkout

The Functional Checkout procedure is to help you confirm that your GenePix 4000B array scanner is performing according to the specifications set by Axon Instruments, Inc. A similar, but much more detailed procedure was performed at the factory prior to shipping this unit to you. We recommend that you follow the procedure once upon receiving the instrument and then any time after that if you wish to check the performance of the instrument.

The GenePix 4000B array scanner has been designed to provide robust, long-lived array scanning for years of normal use. However, if the images you acquire on the GenePix 4000B scanner do not appear correct and if you believe there is a problem with the scanner, it is important to follow these instructions before contacting Technical Support:

1. Start the GenePix software and click the Report tab.
2. Click the Hardware Diagnostic Reports link.
3. Click the Functional Checkout link.
4. Follow the Functional Checkout procedure.

Chapter 4

Imaging System Hardware

The GenePix 4000B scanner is one of the fastest and most sensitive scanners currently available. This chapter introduces some of the fundamental hardware concepts needed to understand the operation of the GenePix 4000B.

Overall Features

The GenePix 4000B is designed for simultaneous scanning of two wavelengths of excitation laser light. Axon's patent-pending design eliminates the image alignment problems associated with sequential scanning systems while also abolishing channel crosstalk problems associated with multi-wavelength designs, permitting high-precision real-time acquisition and display of ratio images.

Discussion of Hardware Components

When discussing the hardware components of the GenePix 4000B it is convenient to reduce the system to its optical, mechanical and electrical components.

Optics

Fundamentally, the GenePix 4000B uses a laser-excitation-based epifluorescence scanning system. The optical system can be considered in terms of excitation light, mirrors, lenses, filters and photo-detection.

Excitation

In the GenePix 4000B laser excitation is provided by individual 635 nm and 532 nm lasers. These wavelengths correspond to the ideal wavelengths used to excite the fluorophores Cy3 and Cy5 (Amersham Pharmacia Biotech), which are currently the most widely used fluorescent probes for array imaging. The individual lasers have been selected because of their superior optical performance and reliability. Since the performance of such lasers is often sensitive to external temperature fluctuations, the GenePix 4000B uses an active temperature stabilization design to minimize temperature-based laser fluctuations. Furthermore, each laser has stabilized feedback output to ensure that photon output is constant.

User-attenuatable laser power is a new feature in the GenePix 4000B. The software allows you to scan at 10%, 30% or 100% of the full laser power. Laser power cannot be attenuated during scanning.

Laser excitation sources are often used in scanning systems instead of conventional wide-band white light sources such as a xenon or mercury light source. The reasons for this are quite simple: conventional wide-band light sources do not deliver high enough photon density at the appropriate wavelength to a sample in a scanning system. In addition, it is often difficult to use optical filters to obtain spectrally pure, narrow-band excitation light.

Mirrors, Lenses, and Filters

Excitation laser light is directed onto the slide after passing through a series of filters and mirrors. While laser light is by definition very narrow band, the GenePix 4000B employs additional optical filters to ensure that no spurious excitation light is directed onto the slide. If the laser light impinges on an appropriate fluorophore bound on the slide, emission light of a different wavelength is emitted. These emission photons are directed back through the optical system where they pass through another set of filters before reaching the dual photodetectors.

One of the problems faced by a dual scanning system is *crosstalk*, where the two different wavelengths of light are not sufficiently separated in the scanning system. For example, emission light from one fluorophore can be recorded by the detector for the second fluorophore, or spurious excitation light for the first fluorophore can bleed back into the detector for the second fluorophore. Crosstalk is often a concern when

one is using a pair of fluorophores that have similar spectral properties. The result can be an erroneous contribution of fluorescence from one optical channel to the other.

The GenePix 4000B employs two approaches to reduce crosstalk to negligible levels. First, the filter sets and excitation lasers have been carefully chosen to ensure that crosstalk between the two fluorophores is minimized. Second, and more importantly, the patent-pending optical design guarantees that spectral overlap is zero.

User-controlled focusing is a new feature in the GenePix 4000B. The focal point at the zero position is at the surface of the glass slide, with a total depth of focus of 64 μm , equally distributed on both sides of the focal plane (depth of focus is defined as the range over which the signal is within 50% of the maximum signal). The GenePix software allows the focal point to change from $-50 \mu\text{m}$ to $+200 \mu\text{m}$ relative to the zero position.

Photo-Detection

The GenePix 4000B uses a pair of high-sensitivity, low-noise photo-multiplier tubes (PMTs) to detect the emitted fluorescent light. Loosely defined, PMTs are optical components that convert incident photons into electrons via the photoelectric effect. When an incident photon impinges on the active surface of the PMT (the photocathode), an electron is generated. This electron flows through a series of electron multipliers (dynodes) to the anode. The amount of current that flows from the anode is directly proportional to the amount of incident light at the photocathode.

The amount of amplification that a PMT can produce depends on the number of dynodes in the PMT, and the voltage that is applied to the PMT. With PMTs it is possible to achieve a gain of 10^7 . When you increase the PMT voltage setting in the GenePix 4000B software, you are increasing the gain of the PMTs.

Note: It is important to realize that when you increase the gain of the system, you are also increasing the sensitivity to non-specific fluorescence, thus increasing any electronic noise in the system. This increase in noise can often be overcome by line averaging but the cost is decreased acquisition speed. In general, the signal-to-noise ratio is not improved by increasing the PMT voltage.

The output of a PMT is typically linear over a wide range of incident light. However, there is a very non-linear relationship between the gain of the PMT and the applied

PMT voltage. **Therefore, a slide scanned at a PMT voltage of 800 V will *not* be twice as bright as the same slide scanned at 400 V.**

The PMTs in the GenePix 4000B meet two essential criteria for high-quality imaging. First, since different photocathodes have varying sensitivities to specific wavelengths of light (quantum efficiency), the PMTs have been optimized for the typical wavelengths of fluorescence emission light produced by arrays. Second, the PMTs have been further selected for their reliability and optimal signal-to-noise performance.

Mechanical

The GenePix 4000B is a mechanical device. Its laser-based scanning system uses a patent-pending mechanical design. The GenePix 4000B operates by slowly scanning the slide in the *y*-direction, and rapidly scanning in the *x*-direction. The design of the GenePix 4000B allows a scan of a 25 mm × 75 mm slide at 5- μ m resolution in about 12 minutes.

When using such a mechanical device, one must be able to monitor the variability in the performance of its mechanical components. The GenePix 4000B has been designed with a number of optimizations to ensure that variability in the mechanical performance is monitored in real time during acquisition, and corrected. The utmost attention has been given to selecting and implementing components to create a highly reliable, high-performance instrument.

Electronic

While the optical components of the GenePix 4000B are indispensable for generating the electrical current from PMTs, the electronic components are just as important. They govern the operation of the PMTs and the conversion of their analog current signals into a digital signal that can be processed by the host computer.

Axon Instruments is the world leader in the design and construction of low-noise amplifiers. Our amplifiers are used around the world by researchers in the neuroscience community. We have worked hard for over a decade to create low-noise amplifiers and high-performance computer hardware to digitize these signals. Our expertise in this area has been applied to the GenePix 4000B. Integrated with the GenePix 4000B is not only our high-performance analog-digital converter, but also the experience and knowledge to create low-noise, high-performance amplifiers. We have employed a unique design to ensure that the PMTs in GenePix are linear

over a wide dynamic range, and that the signal-to-noise level exceeds all other currently available array scanners.

General Items of Interest

Spatial Resolution

The GenePix 4000B is a scanning instrument. This means that a single point of light is rapidly scanned across the array, and a composite image is created from the digitized signals from the PMT. The spatial resolution of the system refers to the size of this single scanning point. In the GenePix 4000B, the spatial resolution is 5- μm for a *Data Scan*, and 40- μm for a *Preview Scan*. During the Preview Scan, the same 5- μm spot is scanned, however the slow *y*-direction scanning operates eight times faster, and only one eighth of the samples in the *x*-direction are used.

It is possible to change the resolution of Data Scans. Using the software you can specify a resolution that is a multiple of 5. When the slide is scanned the appropriate number of pixels are averaged to create a single-pixel representation. For example, if you set the resolution to 10 μm , 4 raw data pixels are averaged to produce each pixel in the final image. This option is often useful if you have large features and you do not need to scan at maximum resolution. As you decrease the resolution, you will decrease the final image size (in MB). However, keep in mind that you need to acquire enough pixels for each feature in order to make accurate measurements. Finally, reducing the scanner resolution in software does not reduce the scan time: it only reduces the final image file size. It also increases signal-to-noise by the square root of the number of pixels averaged.

Dynamic Range and Sensitivity

The dynamic range of an instrument is the signal width that can be resolved above the noise the instrument produces. The dynamic range depends on all the components in a given system. For example, if you use a PMT with a dynamic range of 10^6 but process the signals through a sub-standard 8-bit analog-to-digital converter, you will end up with an instrument with a poor dynamic range. Furthermore, while an instrument may have a large dynamic range, one may not be able to use the whole range reliably if the response is non-linear. Therefore when rating

an instrument one must consider the range over which its response remains linear. For the GenePix 4000B, the dynamic range is 10^4 .

The dynamic range of an instrument is often considered in conjunction with its sensitivity. The sensitivity is defined as the minimum detectable signal above background noise. Although you may be able to see features below this level, the minimum signal that can be accurately quantified is the dye concentration for which the signal is three times the background noise. For the GenePix 4000B, the sensitivity is on the order of 0.1 fluorophores / μm^2 for Cy3 and Cy5.

Limitations

GenePix 4000B is an acquisition and first-pass data analysis system for array experiments. It has been designed to fulfill all your primary acquisition and analysis needs, extracting data from arrays and exporting it to advanced data analysis and presentation software.

The data extracted and displayed by GenePix 4000B can only be as good as the preparation of the slides: the better the slides, the better the data that GenePix will return to you.

Summary

The GenePix 4000B is a high-performance instrument that has been designed to maximize the quality of data that it generates. The utmost attention has been given to creating a fast, low-noise, high-sensitivity instrument.

Acknowledgments

Axon Instruments, Inc., would like to extend its thanks to the numerous academic and corporate scientists who provided critical input during the planning, evaluation and testing of the GenePix 4000B system. In particular, Drs Stephen J. Smith and Michael B. Eisen of the Stanford University School of Medicine and Dr. Joseph L. DeRisi of the University of California at San Francisco were instrumental in the development of the GenePix scanner and software, helping to make the GenePix 4000B an instrument designed for the research community.

Index

acknowledgments, 19
amplifiers, 16

Copyright, i
crosstalk, 14
Cy3, Cy5, 14

Data Scan, 17
digitization, 9
dynamic range, 9

fluorophore, 14. See Cy3, Cy5

GenePix
installation, 1

hardware, 13
amplifiers, 16
laser excitation, 14
quantum efficiency, 16
spatial resolution, 17

Help
on-line, 1

image
size, 17

lasers
temperature fluctuations, 14
limitations
software, 18

on-line Help, 1

photo-multiplier tube
gain, 15
Preview Scan, 17

scanning modes, 10
spatial resolution, 17

temperature fluctuations, 14

