



The Revised Up-and-Down Procedure: A Test Method for Determining the Acute Oral Toxicity of Chemicals

Results of an Independent Peer Review Evaluation Organized by the Interagency
Coordinating Committee on the Validation of Alternative Methods (ICCVAM)
and the
National Toxicology Program (NTP) Interagency Center for the Evaluation of Alternative
Toxicological Methods (NICEATM)

Volume 2 of 2

National Institute of Environmental Health Sciences
National Institutes of Health
U.S. Public Health Service
Department of Health and Human Services

**THE INTERAGENCY COORDINATING COMMITTEE
ON THE VALIDATION OF ALTERNATIVE METHODS
AND
THE NTP INTERAGENCY CENTER FOR THE
EVALUATION OF ALTERNATIVE TOXICOLOGICAL METHODS**

The Interagency Coordinating Committee on the Validation of Alternative Methods (ICCVAM) was established in 1997 by the Director of the National Institute of Environmental Health Sciences (NIEHS) to implement NIEHS directives in Public Law 103-43. P.L. 103-43 directed NIEHS to develop and validate new test methods, and to establish criteria and processes for the validation and regulatory acceptance of toxicological testing methods. P. L. 106-545, the ICCVAM Authorization Act of 2000, established ICCVAM as a permanent committee. The Committee is composed of representatives from 15 Federal regulatory and research agencies and programs that generate, use, or provide information from toxicity test methods for risk assessment purposes. The Committee coordinates cross-agency issues relating to development, validation, acceptance, and national/international harmonization of toxicological test methods.

The National Toxicology Program Interagency Center for the Evaluation of Alternative Toxicological Methods (Center) was established in 1998 to provide operational support for the ICCVAM, and to carry out committee-related activities such as peer reviews and workshops for test methods of interest to Federal agencies. The Center and ICCVAM coordinate the scientific review of the validation status of proposed methods and provide recommendations regarding their usefulness to appropriate agencies. The NTP Center and ICCVAM seek to promote the validation and regulatory acceptance of toxicological test methods that will enhance agencies' abilities to assess risks and make decisions, and that will refine, reduce, and replace animal use. The ultimate goal is the validation and regulatory acceptance of new test methods that are more predictive of human and ecological effects than currently available methods.

Additional Information

Additional information can be found at the ICCVAM/Center Website: <http://iccvam.niehs.nih.gov> and in the publication: *Validation and Regulatory Acceptance of Toxicological Test Methods, a Report of the ad hoc Interagency Coordinating Committee on the Validation of Alternative Methods* (NIH Publication No. 97-3981, or you may contact the Center at telephone 919-541-3398, or by e-mail at iccvam@niehs.nih.gov. Specific questions about ICCVAM and the Center can be directed to the ICCVAM Co-chairs:

*Dr. William S. Stokes, NIEHS, EC-17, P.O. Box 12233
Research Triangle Park, NC, 27709; 919-541-7997
stokes@niehs.nih.gov*

*Dr. Richard N. Hill, US EPA, MC-7101, 401 M Street, SW
Washington, DC, 20460; 202-260-2894
hill.richard@epa.gov*

ICCVAM Agencies and Programs

Agency for Toxic Substances and Disease Registry	National Cancer Institute
Consumer Product Safety Commission	National Institute of Environmental Health Sciences
Department of Agriculture	National Institutes of Health, Office of the Director
Department of Defense	National Institute of Occupational Safety and Health
Department of Energy	National Library of Medicine
Department of Interior	Occupational Safety and Health Administration
Department of Transportation	
Environmental Protection Agency	
Food and Drug Administration	

The Up-and-Down Procedure:
*A Test Method For Determining the Acute
Oral Toxicity of Chemicals*

**Results of an Independent Peer Review Evaluation
Organized by the Interagency Coordinating Committee on
the Validation of Alternative Methods (ICCVAM)
and the
National Toxicology Program (NTP) Interagency Center for the
Evaluation of Alternative Toxicological Methods (NICEATM)**

Volume 2 of 2

**National Toxicology Program
P.O. Box 12233
Research Triangle Park, NC 27709**

**November 2001
NIH Publication No. 02-4501**

**National Institute of Environmental Health Sciences
National Institutes of Health
U.S. Public Health Service
Department of Health and Human Services**

Printed: 11/30/2001

Table of Contents

Volume 1 of 2

List of Abbreviations	vii
Peer Review Panel Members	ix
Acknowledgements	x
Preface	xv
Executive Summary	xix
I. Up-and-Down Procedure (UDP) Peer Panel Report, July 25, 2000 Meeting	I-1
1. Introduction	I-3
2. UDP Protocol: General Considerations.....	I-6
3. UDP Protocol: Revised Primary Test.....	I-10
4. UDP Protocol: Revised Limit Test.....	I-14
5. UDP Protocol: Supplemental Test for Slope and Confidence Limits	I-20
6. References	I-25
Addendum I: Estimating a Point on the Dose-Response Curve.....	I-29
Addendum II: Considerations for Estimating the Slope	I-30
Addendum III: Summary of the Statistical Evaluation of the Revised UDP	I-31
Addendum IV: Modified Isotonic Estimates of the Dose-Response Function	I-33
II. UDP Peer Panel Report, August 21, 2001 Meeting	II-1
1. Introduction	II-3
2. Revised Draft UDP Test Guideline (July 12, 2001).....	II-4
3. Proposed Confidence Interval Procedure.....	II-7
4. Software Program.....	II-8
5. References	II-9
III. References	III-1

Appendices

A - ICCVAM Test Method Recommendations.....	A-1
B - Final Revised UDP Test Guideline (U.S. EPA 10/31/01).....	B-1
C - August 2001 Peer Panel Meeting Review Materials	C-1
C-1 Acute Oral Toxicity: Revised UDP Test Guideline, July 12, 2001	C-3
C-2 A Proposed Procedure for Calculating Confidence Intervals	C-33
C-3 Description of the Acute Oral Toxicity Software Program.....	C-109
C-4 Evaluation Guidance to the Panel for the Revised UDP	C-111
D - Federal Register Notices for the UDP	D-1
D-1 Vol. 65, No. 34, February 18, 2000.....	D-3
Request for Data and Nomination of Expert Scientists	
D-2 Vol. 65, No. 106, June 1, 2000.....	D-5
Notice of Peer Review Panel Meeting and Request for Comments	
D-3 Vol. 66, No. 121, June 22, 2001	D-7
Notice of Availability and Request for Comments	
D-4 Vol. 66, No. 133, July 21, 2001	D-11
Notice of Peer Review Panel Meeting	
E - Summary Minutes and Public Comments from the UDP Meetings.....	E-1
E-1 Minutes and Public Comments of the Peer Review Panel Meeting.....	E-3
July 25, 2000 in Crystal City, Arlington, VA	
E-2 Minutes of the Peer Review Panel Meeting	E-13
August 21, 2001 in Research Triangle Park, NC	
E-3 Submitted Public Comment for the August 21, 2001 Meeting	E-19

Table of Contents

Volume 2 of 2

Note: The April 14, 2000 Background Review Document (BRD), evaluated for the July 25, 2000 Peer Review Panel Meeting, is available at <http://iccvam.niehs.nih.gov/methods/udpdocs/AllBRDlk.pdf>. For this final report, the April 14, 2000 BRD was revised to address comments from the Panel (Appendix F). Selected BRD appendices from the April 14, 2000 BRD are provided for reference (Appendices G-Q).

F - Revised Background Review Document (BRD) on the UDP (October 31, 2001)	F-1
G - Acute Oral Toxicity: Modified UDP	G-1
(U.S. EPA Revised Test Guideline 425N, April 2000)	
H - Acute Oral Toxicity: UDP	H-1
(OECD Test Guideline 425, adopted 21 September 1998)	
I - Acute Oral Toxicity	I-1
(OECD Test Guideline 401, adopted 24 February 1987)	
J - Development of OECD 425	J-1
J-1 UDP: Is there a Need for Further Validation?.....	J-3
J-2 Rationale for the UDP as Submitted to OECD	J-11
J-3 Presentation for Test Guideline 425 – UDP	J-15
K - UDP Primary Test: Proposed Revision of the Guideline 425	K-1
"Primary Procedure" for Point Estimation of the LD50	
L - UDP Primary Test: Comparison of Stopping Rules and LD50 Estimators.....	L-1
M - The UDP Limit Test: Accuracy of <i>In Vivo</i> Limit Dose Tests	M-1
N - Proposed UDP Supplemental Procedure to Estimate Slope and	
Confidence Interval	N-1
N-1 Considerations for Supplemental Procedure	N-3
N-2 Supplemental Procedure to Determine Slope and Confidence Interval	N-5
N-3 Summary Tables.....	N-9
N-4 Simulation Tables and Legends	N-23
N-5 Additional Simulations: Supplemental Procedures to Determine Slope.....	N-105
O - The Basis for Revising the UDP.....	O-1
O-1 Statistical Basis for Estimating Acute Oral Toxicity	O-3
O-2 Comparison of Classification Probabilities.....	O-13
O-3 Brief Statistical Description of the Method.....	O-17

P - Selection of the Appropriate Animal Gender for the UDP.....	P-1
P-1 Gender Sensitivity of Xenobiotics	P-3
P-2 Comparison of Male and Female Rat Oral and Dermal LD50 Values	P-23
P-3 Toxicological Evaluation of Pesticide Hazard to Avian Wildlife	P-45
P-4 Sex Dependent Metabolism of Xenobiotics	P-69
Q - U.S. Federal Regulations for Acute Oral Toxicity	Q-1
Q-1 CPSC Regulations, Administration and Enforcement	Q-3
Q-2 OSHA Regulations, Hazard Communication	Q-11
Q-3 U.S. EPA Regulations, Pesticide Registration	Q-17
Q-4 U.S. EPA Regulations, Pesticide Labeling.....	Q-25
Q-5 U.S. EPA Regulations, Data Requirements	Q-33
Q-6 U.S. EPA Regulations, New Uses	Q-57
Q-7 U.S. DOT Regulations, Shipping Requirements	Q-69

List of Abbreviations and Acronyms

ASTM	American Society for Testing and Materials
ATCM	Acute Toxic Class Method
BRD	Background Review Document
°C	Degrees Centigrade
CASRN	Chemical Abstract Service Registry Number
CFR	Code of Federal Regulations
CI	Confidence Interval
CIIT	CIIT Centers for Health Research (formerly: Chemical Industry Institute of Toxicology)
CPSC	Consumer Product Safety Commission
ECETOC	European Centre for Ecotoxicology and Toxicology of Chemicals
ECVAM	European Centre for the Validation of Alternative Methods
EU	European Union
FDA	Food and Drug Administration
FDP	Fixed-Dose Procedure
FIFRA	Federal Insecticide, Fungicide and Rodenticide Act
FR	<i>Federal Register</i>
g	gram
GHS	Globally Harmonized System
GLP	Good Laboratory Practice
ICCVAM	Interagency Coordinating Committee on the Validation of Alternative Methods
IUCLID	International Uniform Chemical Information Database
kg	kilogram
LD50	Median lethal dose
MEIC	Multicentre Evaluation of <i>In Vitro</i> Cytotoxicity
mg	milligrams
mL	milliliter
NICEATM	NTP Interagency Center for the Evaluation of Alternative Toxicological Methods
NIEHS	National Institute of Environmental Health Sciences
NTP	National Toxicology Program
OECD	Organisation of Economic Co-operation and Development
OPP	Office of Pesticide Programs/U.S. EPA
OPPT	Office of Pollution Prevention and Toxics/U.S. EPA
OPPTS	Office of Prevention, Pesticides, and Toxic Substances/U.S. EPA
PL	Public Law
SAS	Statistical Analysis System – (SAS Institute, Inc., Cary, NC, USA)
TG	Test Guideline
TG 401	Test Guideline 401 (Acute Oral Toxicity) [OECD]
TG 420	Test Guideline 420 (Acute Oral Toxicity - Fixed Dose Method) [OECD]

List of Abbreviations and Acronyms

(continued)

TG 423	Test Guideline 423 (Acute Oral Toxicity - Acute Toxic Class Method) [OECD]
TG 425	Test Guideline 425 (Acute Oral Toxicity - Up-and-Down Procedure) [OECD]
UDP	Up-and-Down Procedure
U.S. DOT	U.S. Department of Transportation
U.S. EPA	U.S. Environmental Protection Agency
ZEBET	Center for Documentation and Evaluation of Alternative Methods to Animal Experiments
3Rs	Refinement, Reduction, and Replacement (of animal use)

Peer Review Panel

*The following individuals served as members of the
Up-and-Down Procedure Peer Review Panel:*

Curtis Klaassen, Ph.D. (Co-Chair)
University of Kansas Medical Center
Kansas City, KS

Diane Gerken, D.V.M., Ph.D. (Co-Chair)
Battelle Memorial Institute
Columbus, OH

PANEL SECTIONS

1. Revised UDP Protocol: General Considerations

Janice Kuhn, Ph.D., D.A.B.T. (Leader)
Stillmeadow, Inc.
Sugarland, TX

Kimberly Bonnette, M.S., L.A.T.G.
Springborn Laboratories, Inc.
Spencerville, OH

Gary Wnorowski, B.S.
Product Safety Labs
East Brunswick, NJ

2. Revised UDP Primary Test

Wallace Hayes, Ph.D., D.A.B.T., D.A.T.S.
(Leader)
The Gillette Company
Boston, MA

Bas Blaauboer, Ph.D.
Utrecht University
Utrecht, The Netherlands

Robert Copeland, Ph.D.
Howard University
Washington, DC

John Reeve, M.S.
Ministry of Agriculture and Forestry
Food Assurance Authority
Wellington, New Zealand

Nigel Stallard, Ph.D.
University of Reading
East Gate Reading, UK

3. Revised UDP Limit Test

George Alexeeff, Ph.D., D.A.B.T. (Leader)
California Environmental Protection Agency
Sacramento, CA

Robert Condon, Ph.D.
Consulting Biostatistician
Myersville, MD

A.A.J. van Iersel, Ph.D.
RIVM-Institute's Centre for Alternatives to
Animal Testing
National Institute for Public Health and the
Environment
Roosendaal, The Netherlands

4. UDP Supplemental Test for Slope/ Confidence Limits

Robert Scala, Ph.D., D.A.B.T., D.A.T.S.
(Leader)
Toxicology Consultant
Tucson, AZ

Philip Botham, Ph.D.
Zeneca Ltd.
Cheshire, UK

Wyman Dorough, Ph.D.
Mississippi State University
Starkville, MS

Nancy Fluornoy, Ph.D.
American University
Washington, DC

Charles Hastings, Ph.D., D.A.B.T.
BASF Corporation
Research Triangle Park, NC

Acknowledgements

The following individuals developed the revised test method protocol and supporting documentation for the Up-and-Down Procedure. Those marked with an astrisk () were members of the UDP Technical Task Force:*

***Dr. Greg Carr**
Proctor & Gamble Company

***Dr. Deborah McCall**
U.S. EPA

Mr. Wolfgang Diener
Federal Institute for Health Protection of
Consumers and Veterinary Medicine
(BgVV)

***Mr. William Meyer**
U.S. EPA

***Mr. David Farrar**
U.S. EPA

Dr. Cheryl Mugford
CIIT

***Dr. Michael Green**
CPSC

Dr. Harold Podall
U.S. EPA

***Dr. Kailash Gupta**
CPSC

Dr. Carrie Rabe
Clement International Corporation

Dr. Elwood F. Hill
Patuxent Environmental Science Center

***Dr. Amy Rispin (Leader)**
U.S. EPA

***Dr. Timothy Barry**
U.S. EPA

Dr. Sharon Segel
Clement International Corporation

Dr. Gregory Kedderis
CIIT

***Dr. Katherine Stitzel**
Proctor & Gamble Company

***Dr. Elizabeth Margosches**
U.S. EPA

Mrs. Anne Whitehead
University of Reading

***Mr. John Redden**
U.S. EPA

The following individuals are acknowledged for their contribution to the Revised Up-and-Down Procedure review process:

**Interagency Coordinating Committee on the Validation of Alternative Methods (ICCVAM)
Acute Toxicity Working Group (ATWG)**

**Agency for Toxic Substances and
Disease Registry (ATSDR)**

Dr. John Wheeler

**Consumer Product Safety Commission
(CPSC)**

Dr. Marilyn Wind, Director
Dr. Kailash Gupta
Dr. Susan Aitken

Department of Defense (DOD)

Dr. Harry Salem

Department of Transportation (DOT)

Dr. George Cushmac

Food and Drug Administration (FDA)

Dr. Nakissa Sadrieh
Dr. Antonia Mattia
Dr. Patrick G. Swann
Ms. Suzanne Fitzpatrick

National Cancer Institute (NCI)

Dr. Victor A. Fung

**National Institute of Environmental
Health Sciences (NIEHS)**

Dr. William S. Stokes (Co-Chair)
Dr. Rajendra Chhabra

**National Institute for Occupational
Safety and Health (NIOSH)**

Dr. Joe Antonini
Dr. Surender Ahir

**U.S. Environmental Protection Agency
(U.S. EPA)**

Dr. Richard Hill (Co-Chair)
Dr. Angela Auletta
Dr. Byron Backus
Dr. Diane Beal
Mr. David Farrar
Dr. Roger Gardner
Dr. Bentley Gregg
Dr. Karen Hamernik
Dr. Masih Hashim
Ms. Marianne Lewis
Dr. Elizabeth Margosches
Dr. Jeanie McAndrew
Dr. Debbie McCall
Dr. Mark Perry
Dr. John Redden
Dr. Daniel Rieder
Dr. Amy Rispin
Dr. Roy Sjoblad

**Interagency Coordinating Committee on the Validation
of Alternative Methods (ICCVAM)
Designated Agency Representatives**

Agency for Toxic Substances and Disease Registry

*William Cibulas, Ph.D.
Moiz Mumtaz, Ph.D.

Consumer Product Safety Commission

*Marilyn L. Wind, Ph.D.
Susan Aitken, Ph.D.
Kailash C. Gupta, Ph.D.
Patricia Bittner

Department of Agriculture

*Jodie Kulpa, D.V.M.
Elizabeth Goldentyer, D.V.M.

Department of Defense

*Robert E. Foster, Ph.D.
Patty Boll
Harry Salem, Ph.D.
John M. Frazier, Ph.D.

Department of Energy

*Marvin E. Frazier, Ph.D.
Marvin Stodolsky, Ph.D.

Department of the Interior

*Barnett A. Rattner, Ph.D.
Sarah Gerould, Ph.D.

Department of Transportation

*George Cushmac, Ph.D.
Steve Hwang, Ph.D.

Environmental Protection Agency

*Vanessa Vu, Ph.D.

Office of Pollution Prevention and Toxics

Richard N. Hill, M.D., Ph.D. (Co-Chair)
Angela Auletta, Ph.D.

Office of Pesticides Programs

Karen Hamernik, Ph.D.

Office of Research and Development

Harold Zenick, Ph.D.
Suzanne McMaster, Ph.D.

OECD Test Guidelines Program

Maurice Zeeman, Ph.D.

Food and Drug Administration

*Leonard M. Schechtman, Ph.D.
Suzanne C. Fitzpatrick, Ph.D., D.A.B.T.

Center for Drug Evaluation and Research

Joseph J. DeGeorge, Ph.D.
Abby C. Jacobs, Ph.D.

Center for Devices and Radiological Health

Raju Kammula., D.V.M., Ph.D., D.A.B.T.
Melvin E. Stratmeyer, Ph.D.

Center for Biologics Evaluation and Research

Anne M. Pilaro, Ph.D.
Martin D. Green, Ph.D.

Center for Food Safety and Nutrition

David G. Hattan, Ph.D.

Center for Veterinary Medicine

Devaraya Jagannath, Ph.D.
Louis T. Mulligan, D.V.M.

National Center for Toxicological Research

William T. Allaben, Ph.D.
Martha M. Moore, Ph.D.

Office of Regulatory Affairs

Atin R. Datta, Ph.D.

National Cancer Institute

*David G. Longfellow, Ph.D.
◇Alan Poland, Ph.D.

National Institute of Environmental Health Sciences

*William S. Stokes, D.V.M., D.A.C.L.A.M.
(Co-Chair)

John R. Bucher, Ph.D., D.A.B.T.
Rajendra S. Chhabra, Ph.D., D.A.B.T.
Jerrold J. Heindel, Ph.D.

National Institute for Occupational Safety and Health

*Paul Nicolaysen, V.M.D.
Douglas Sharpnack, D.V.M., M.S., D.A.C.V.P.

National Institutes of Health

*Margaret D. Snyder, Ph.D.
Nelson Garnett, D.V.M., D.A.C.L.A.M.

National Library of Medicine

*Vera Hudson, M.S.
◇Jeanne Goshorn, M.S.

Occupational Safety and Health Administration

*Surender Ahir, Ph.D.

* Principal Agency Representative
Alternate Principal Agency Representative

**National Toxicology Program (NTP)
Interagency Center for the Evaluation of Alternative Toxicological Methods (NICEATM)**

Mr. Brad Blackard
ILS, Inc.

Ms. Christina Inhof
ILS, Inc.

Ms. Sue Brenzel
ILS, Inc.

Ms. Linda Litchfield
ILS, Inc.

Ms. Bonnie Carson
ILS, Inc.

Dr. Barry Margolin
UNC-Chapel Hill

Dr. Finis Cavender
ILS, Inc.

Ms. Debbie McCarley
NIEHS

Ms. Loretta Frye
NIEHS

Dr. William S. Stokes, Director
NIEHS

Dr. Thomas Goldsworthy
ILS, Inc.

Dr. Raymond Tice
ILS, Inc.

APPENDIX F

Up-and-Down Procedure Revised Background Review Document (BRD)

October 31, 2001

Note: The April 2000 Background Review Document (BRD) was reviewed by the Peer Review Panel at the July 25, 2000 Panel meeting. This document was subsequently revised in accordance with the Panel's discussions, recommendations, and conclusions. To maintain continuity between the two BRDs, the designation for each appendix cited in the original BRD as well as the designation used in the UDP Peer Panel Report are provided. This revised BRD does not include information provided to the UDP Peer Panel for their August 21, 2001 deliberations.

TABLE OF CONTENTS

EXECUTIVE SUMMARY	F-3
1.0 Introduction and Rationale of the Revised UDP	F-6
2.0 Proposed Protocol for the Revised UDP	F-18
3.0 Characterization of the Substances Tested	F-28
4.0 Reference Data Used for Performance Assessment	F-30
5.0 Test Method Data and Results	F-40
6.0 Test Method Performance	F-42
7.0 Test Method Reliability (Repeatability/Reproducibility)	F-51
8.0 Test Method Data Quality	F-59
9.0 Other Scientific Reports and Reviews	F-59
10.0 Animal Welfare Considerations	F-60
11.0 Other Considerations	F-63
12.0 References	F-65

EXECUTIVE SUMMARY

Introduction: The acute oral toxicity test is a fundamental component in defining the toxicity of a test material for hazard classification and labeling purposes. There are two types of acute oral tests: a) those that identify a dose range in which the median lethal dose (LD50) falls, and b) those that determine a point estimate of the median lethal dose of the material. In tests that estimate the LD50, if sufficient data are available, an estimate of the slope of the dose-response curve and confidence interval can also be determined. In 1981, the Organization of Economic Co-operation and Development (OECD) adopted a test guideline (TG 401) for acute oral toxicity that estimated the LD50 and in many cases, the slope and confidence interval. TG 401 has become the traditional acute oral toxicity test. TG 401 was revised in 1987 to utilize three dose groups of five rats of one sex with confirmation in the other sex using one group of five rats. This resulted in reduced animal use from 50 or more in the 1981 version to 20 in the 1987 version.

Since 1987, OECD has adopted three additional acute oral toxicity tests, one of which is the up-and-down procedure (UDP) in 1998. With the new test guidelines adopted, OECD is considering a proposal to delete TG 401. Of the three alternative tests, the UDP is the only test providing a point estimate of the LD50 and does this rather efficiently for many chemicals by only using six or seven animals. However, the UDP does not provide an estimate of the slope of the dose-response curve and confidence interval. With TG 401 to be deleted, there would be no method available to regulatory agencies that provided an estimate of slope and confidence interval. In addition, the global harmonization of the classification scheme has resulted in the need to revise the Fixed-Dose Procedure (FDP) and the Acute Toxic Class Method (ATCM). As a result, OECD agreed to revise all three alternative methods. The U.S. Environmental Protection Agency (EPA) agreed to revise the UDP to include a procedure that would provide slope and corresponding confidence interval estimates. The UDP described in this document has been revised to include: a) a modified up-and-down procedure with improved performance; b) a modified Limit Test utilizing only females and providing a limit dose of 5000 mg/kg for specific regulatory purposes; and c) an added supplemental test for determining the slope and confidence interval.

Test Method Protocol: The Revised UDP has three tests: a) the primary test to estimate the LD50; b) a Limit Test allowing testing at 5000 mg/kg for specific regulatory purposes; and c) the added supplemental test to estimate the slope and confidence interval. In the primary test, one animal is dosed at 175 mg/kg and observed for 14 days. If the animal is alive at 48 hours, a second animal is dosed at a 0.5 log higher dose. If the first animal dies, then the second animal is dosed at a 0.5 log lower dose. Dosing stops when the stopping criteria are satisfied. In the Limit Test, one animal is dosed at 2000/5000 mg/kg. If the animal dies, the primary test is conducted. If the animal lives, two more are dosed at the limit dose. If they both live, the Limit Test is satisfied because three animals have survived at the limit dose. If one or both of the two animals die, then two more are tested at the limit dose. If a total of three animals live, the Limit Test is satisfied. If three animals die, the primary test is conducted. In the supplemental test, three up and down tests (runs) are started at slightly differing doses below the LD50. Dosing continues in each run until an animal dies.

Characterization of the Materials Used: There have been three validation studies of the UDP. A total of 25 chemicals were tested in which data using the UDP were compared to data generated using TG 401. A wide variety of chemicals from a number of chemical classes were tested, which affected different target organs and exhibited a wide range of LD50s (ranging from 48 to greater than 20,000 mg/kg).

Reference Data: Reference data consisted of acute oral toxicity data generated using TG 401. In two of the studies, the data for TG 401 and the UDP were generated concurrently in the same laboratory. In the third study, the chemicals were selected from published data from a validation study of ATCM. The data were generated in compliance with national or international GLP guidelines.

In Vivo Test Method Data and Results: Although the UDP was not adopted at the time, the protocol used a default starting dose of 100 mg/kg, a dose spacing factor of 1.3, and a stopping rule of testing four animals after the first reversal.

Computer Simulation Validation of Revised UDP: A statistical procedure involving 1000 to 5000 computer simulations examined many permutations of testing conditions and the range of results provided insight into the factors affecting the slope. These simulations allowed the determination of the recommended starting dose, the dose spacing factor, and the stopping rules.

In Vivo Test Method Performance Assessment: For the three validation studies, the absolute ratio of the LD50 from TG 401 studies to the LD50 from UDP studies average 1.76, well within expected variability. If one apparent outlier is eliminated, the ratio becomes 1.28. The one exception was for mercuric chloride.

Computer Simulation Performance Assessment: Simulations have resulted in changing the starting dose, the dose spacing factor, and stopping rules. The default starting dose was increased from 100 mg/kg to 175 mg/kg as a compromise between the possibility of severe toxicity and starting too far from the LD50. The dose spacing factor was changed to 3.2 to allow the investigator to move more quickly toward the LD50 if the starting dose was far from the LD50 and to better estimate the LD50 for chemicals with a shallow slope. The stopping criteria include maximum likelihood ratios and allow a more accurate estimate of the LD50 without utilizing too many animals.

Test Method Reliability: There are no known *in vivo* data on the reliability of the Revised UDP. A number of inter- and intra-laboratory validation studies were conducted prior to 1981. Considering the extremes in testing conditions, it is remarkable that the LD50 varied by no more than a factor of 2 to 3. These studies showed the need to standardize the protocol for toxicity methods. Under standardized protocols, the variability was greatly reduced. In the three validation studies, the absolute ratio of the LD50 for the UDP data and TG 401 data was 1.76. When mercuric chloride was not considered, the ratio was 1.28. These ratios are well within the expected reliability factor of three.

Test Method Data Quality: The data for the three validation studies were generated under applicable GLPs and no discrepancies were noted that altered the general conclusions of the study reports.

Other Scientific Reports and Reviews: No other published UDP data in mammals are available. Unpublished data in birds dosed two at a time results in using large numbers of animals. Consideration was given to the moving-average method for estimating the slope and confidence interval.

Animal Welfare Considerations: There was a clear reduction in incidence of pain and suffering in animals in the UDP study compared to TG 401 animals. The UDP reduced animal usage by 77% compared to animal usage in TG 401 studies. The Revised UDP emphasizes the utilization of humane endpoints and the handling of moribund animals. Although it has been suggested that cytotoxicity tests replace acute oral testing in animals, *in vitro* cytotoxicity tests have not been validated as replacement tests.

Other Practical Considerations: Gender differential sensitivity, equipment, and training were addressed. Based on studies that display sex differences in sensitivity, the female is considered more sensitivity and will be used except when known male sensitivity dictates otherwise. To conduct Revised UDP studies, laboratories will need a computer and access to readily available commercial software. Software may be made available on the OECD and EPA websites. The technical staff will need to be familiar with humane endpoints and the handling of moribund animals. In addition, they will need to be able to use the computer to conduct the studies properly to evaluate stopping rule criteria as well as the LD50 and slope

estimates. The Revised UDP will take at least two weeks to complete dosing and therefore at least four weeks to complete the study. Although there will be fewer animals to observe at any given time, the cost of the study may increase because of the extended time to conduct the study.

1.0 Introduction and Rationale of the Revised UDP

1.1 Introduction

1.1.1 Human Poisonings

Acute exposure to poisonous substances is a common occurrence. For example, in the United States, based on data for 1998 from the Toxic Exposure Surveillance System (65 Poison Control Centers serving 257.5 million people), a total of 2,241,082 human exposures were reported resulting in 8.7 exposures per 1000 people. Of these exposures, 775 fatalities were reported with the highest incidence (432, 56%) in persons between 20 and 49 years of age. Of these totals, 1,749,792 exposures (78%) and 638 fatalities (82%) were via oral ingestion. Of the total exposures, 86,289 (3.9%) were to pesticides while the highest incidence of exposure was to cleaning substances (229,500; 10.2%). Insecticides accounted for only 16 deaths (2.1%) compared to 246 (32%) following ingestion of analgesics.

1.1.2 Acute Toxicity Testing

The purpose of acute toxicity testing is to identify and categorize those chemical substance (hereafter referred to as substances) that pose a potential hazard to humans and other species. Historically, in determining the acute toxicity of a substance, one of the first tests to be conducted has been an acute oral toxicity test designed to estimate an acute oral LD50. The LD50, or median lethal dose, is the dose expected to kill 50% of the test population. The test animal of choice for acute lethality testing has been the rat, although acute oral LD50 values have been calculated for mice and other mammalian species. Birds, fish, and other species have been used for ecological considerations. The classical method for estimating the LD50 has been to orally dose individual animals, in groups of five to ten per sex, with varying concentrations of the test substance and to subsequently observe whether the animal lived or died over a defined period of time (generally 14 days). The calculation of the LD50 is derived from the dose-response curve for lethality. The confidence limits of the LD50 and an estimate of the slope of the dose-response curve can be calculated under two conditions: (1) when there are at least two doses in which at least one, but not all, of the animals are killed, or (2) if the dose range for surviving animals overlaps sufficiently the dose range for animals that die.¹

A procedure for calculating the oral LD50 was first described by Trevan in 1927. This approach has been used as a benchmark for comparing the acute toxicity of substances and relating their toxicity to human health. Inspection of oral LD50 data in large databases (e.g., the Registry of Toxic Effects of Chemical Substances [RTECS], the International Uniform Chemical Information Database [IUCLID]) indicates that multiple values obtained for the same test substance in the same species can be quite variable. However, much of these data were generated using experimental conditions varying widely with respect to strain, sex, age, husbandry, and health status of the animals. As regulatory agencies began to require

¹ Slope (of the dose-response curve) has been defined by the U.S. EPA and the OECD as a value related to the angle at which the dose-response curve rises from the dose axis. In the case of probit analysis, when responses are analyzed on a probit scale against dose on a log scale, this curve will be a straight line and the slope is the reciprocal of *sigma*, the standard deviation of the underlying test subject tolerances, which are assumed to be normally distributed.

The U.S. EPA defines probit as an abbreviation for the term “probability integral transformation” and a probit dose-response model permits a standard normal distribution of expected responses (i.e., one centered to its mean and scaled to its standard deviation, *sigma*) to doses (typically in a logarithmic scale) to be analyzed as if it were a straight line with slope the reciprocal of *sigma*. A standard normal lethality distribution is symmetric; hence, its mean is also its true LD50 or median response.

Further, the U.S. EPA defines *sigma* as the standard deviation of a log normal curve describing the range of tolerances of test subjects to the chemical (where a subject is expected capable of responding if the chemical dose exceeds the subject's tolerance). The estimated *sigma* provides an estimate of the variation among test animals in response to a full range of doses.

acute oral toxicity data, it became evident that a standardized protocol(s) must be used if data for test substances are to be valid and useful.

The U.S. Environmental Protection Agency (EPA) published test guidelines for acute toxicity in October 1982 as part of Subdivision F of the Pesticide Assessment Guidelines for the Office of Pesticides and in September 1985 as part of 40 CFR part 797 for the Office of Toxic Substances. Since publication of the guidelines, the results of more than 15,000 acute oral toxicity tests have been submitted for consideration to the U.S. EPA's Office of Pesticides. Similarly, the Consumer Product Safety Commission (CPSC) utilizes acute oral toxicity in regulating commercial products in the United States (16 CFR Part 1500; original BRD **Appendix E**, currently **Appendix Q-1**). In contrast, the Food and Drug Administration (FDA) does not require this type of acute toxicity testing for drugs.

1.1.3 The Traditional LD50 Test

The LD50 method was further standardized in 1981 by the international acceptance among the member countries of the Organisation for Economic Co-operation and Development (OECD) of Test Guideline (TG) 401. In this test, the test substance is typically administered by oral gavage to fasted young adult animals (five animals per sex). The guideline calls for a minimum of three dose levels in the toxic/lethal range; generally, however, the test typically included at least five dose levels to ensure adequate data for calculating an LD50. For test substances with no information regarding their potential for acute oral toxicity, a range-finding or sighting study of up to five animals could be conducted to identify the range of lethal doses. In such situations, at least 30 animals per sex are utilized in each test.

Generally, to minimize study duration and variation in dosing solutions, all dose groups are treated simultaneously. The animals are observed periodically during the first 24 hours with special attention given during the first four hours, then at least once a day for 14 days or until they recover. Clinical signs, including time of onset, duration, severity, and reversibility of toxic manifestations, are recorded at each observation period. Body weights are determined pre-treatment, weekly thereafter, and at the death of the animals or termination of the study. All surviving animals are humanely killed at 14 days or after recovery, whichever is earlier. Gross necropsies are conducted on all animals in the study. The goal of the test is to have at least two groups for each sex in which at least one, but not all, animals are killed by the test substance. If this circumstance occurs, the slope of the dose-response curve and confidence interval can be calculated using probit analysis. A Limit Test, which involves the dosing of five animals of each sex at 5000 mg/kg, is used for substances with low toxicity. If, for each sex, no more than two animals die, then the LD50 for that sex is considered to be greater than 5000 mg/kg. Variation in the results due to inter-animal variability, intra- and inter-laboratory variability, and to differences in strain, sex, estrus cycle, and species have been characterized. Based on intra- and inter-laboratory testing, the point estimate of the LD50 appears to be reliable within a factor of two or three (Griffith, 1964; Weil et al., 1966; Weil and Wright, 1967). If appropriate data are obtained, OECD TG 401 can provide the LD50, the slope, the confidence interval, and the hazard classification.

In 1987, in response to concerns about the numbers of animals used in LD50 testing, OECD TG 401 was revised to require only one sex with confirmation in the other sex at one dose level only (OECD, 1987) (original BRD **Appendix A**, final report **Appendix I**). This revision reduced the minimum number of animals required for each test from 50 to 60 to between 25 and 30. Also, in the 1987 version of OECD TG 401, the number of animals for the Limit Test was reduced to five animals of a single sex dosed at 2000 mg/kg.

Additional efforts have been made to reduce the number of animals used while maintaining the accuracy of the method for assessing the acute toxicity of a test substance. These alternative approaches **do not** involve a change in the treatment of the animals or in the endpoints examined. Since 1987, OECD has

approved three additional acute oral toxicity test guidelines that reduce animal use: TG 420 (the Fixed-Dose Procedure; FDP) in July 1992 (OECD, 1992); TG 423 (the Acute Toxic Class Method, ATCM) in March 1996 (OECD, 1996); and TG 425 (the UDP) in October 1998 (OECD, 1998). OECD TG 420 and TG 423 do not provide a point estimate of the LD50, but do provide a dose range in which the LD50 is expected to occur.

1.1.4 The UDP (OECD TG 425)

The UDP, a sequential test method, was first described by Bruce (1985). Three validation studies have been conducted to evaluate the ability of the UDP to estimate the LD50 when compared to the traditional LD50 method described in OECD TG 401 (Bruce, 1987; Bonnyns et al., 1988; Yam et al., 1991). Based on these studies and other considerations, in 1998, the OECD adopted the UDP (TG 425) as an acute oral toxicity test. The 1998 OECD TG 425 entitled "Acute Oral Toxicity: Up-And-Down Procedure" is provided in **Appendix H** of this final report (original BRD **Appendix A**).

In this test, one animal (usually a female) is dosed at the best estimate of the LD50, with 200 or 500 mg/kg suggested as a default-starting dose level if no toxicity information is available. If the animal dies or is moribund within 24 hours of dosing, a second animal is dosed at a lower dose level. If feasible, a dose-spacing factor of 1.3 is used, but other dose-spacing factors may be used if justified. If the first animal survives, a second animal is dosed at an appropriate higher dose level. Dosing continues until four animals are dosed after the first reversal (minimum of 6 animals). Information from one sex may be adequate to assess acute toxicity. However, if desirable, comparability of response in the other sex can be evaluated by administering to generally not more than three animals, dose levels around the estimated LD50. In the Limit Test, if the first animal dosed at 2000 mg/kg survives, the second animal is treated with the same dose level. When three animals have survived at the limit dose level, three animals of the opposite sex are dosed at the same dose level to verify the absence of acute toxicity. If all animals survive, then the LD50 is considered to be greater than 2000 mg/kg. The UDP employs a parameterized maximum likelihood method to estimate the LD50, which is used to identify the toxic class of the substance for labeling purposes (see U.S. EPA Document 4; original BRD **Appendix C**, final report **Appendix J-3**).

At the March 1999 OECD Expert Meeting (Washington, DC, U.S.), it was recognized that there were strengths and weakness in each of the acute oral toxicity tests (OECD TG 401, TG 420, TG 423, TG 425). Although acute toxicity information is used primarily to classify and label substances, some authorities also use acute toxicity test results to perform various risk assessment functions, including a determination of confidence interval and slope to make risk projections at the low end of the dose-response curve. Among the acute toxicity tests, only OECD TG 401 provided the ability to measure risk assessment parameters and OECD had decided to phase out this guideline. In recognition of the concerns identified at this meeting, it was decided that the alternative test guidelines to OECD TG 401 required revision. As part of the revision process, authorities revising the guidelines were charged with incorporating a number of considerations, including: (1) restricting the test to females only; (2) incorporating the new globally harmonized classification scheme (OECD, 1998); (3) adding an optional range-finding assay; (4) incorporating an ability to evaluate toxicity in the range of LD50 values of 2000 to 5000 mg/kg body weight; and (5) changing the test design to improve the operating characteristics of the method when the approximate LD50 is unknown or for substances with a low dose-response slope. In the case of OECD TG 425, the U.S. EPA was asked also to add a procedure for estimating the slope of the dose-response curve (the slope of the dose-response curve defines the confidence interval for the LD50) (see U.S. EPA Document 12; original BRD **Appendix C**, final report **Appendix O**). Other major motivations for revising the UDP were:

1. computer simulations had revealed that the UDP was biased towards the starting dose level for test substances with a shallow slope; and

2. the UDP could require significantly more animals per test if the starting dose level was far from the LD50.

Computer simulations were performed to evaluate the performance of the UDP as described in OECD TG 425 and to determine appropriate changes to optimize the method's performance without actually testing animals in the laboratory. Efforts to revise the UDP proceeded along two lines:

1. To revise the single-sequence version of the UDP to improve its performance when the approximate LD50 and dose-response slope are not known or for substances with wide variability of response, and to allow for lethality to be evaluated in the 2000 to 5000 mg/kg range for certain hazard classification purposes.
2. To provide a multi-sequence test method that can simultaneously address the issues in #1, while also providing the confidence interval and slope. This method would allow for both hazard classification and risk assessment needs.

1.1.5 The Regulatory Need for Slope and LD50 Confidence Intervals

The regulatory need for slope and confidence limits is based on the requirements of ecological risk assessment. In assessing the risk of pesticides to nontarget organisms, the U.S. EPA compares toxicity information with the expected environmental concentration and subsequently determines the likelihood that nontarget organisms will be exposed. When lethality is the toxic effect of concern, the results of acute toxicity testing are used. Laboratory data on the rat are used as surrogate information for naturally occurring populations of terrestrial animals. For assessment of hazard to other nontarget species, the U.S. EPA receives data on aquatic and avian species. Acute toxicity data used include the LD50 value, the slope of the dose-response curve, and information on dose effects. Risk assessment involves comparison of hazard and exposure to characterize risk. Risk assessments are performed to determine the existence of a population loss potential from the use of pesticides in the environment. In addition, the U.S. Endangered Species Act mandates that the U.S. EPA assess the potential for individual deaths of listed species due to use of pesticides.

1.1.5.1 Range of Data Available

Data available at the time of registration or reregistration of a pesticide consist of laboratory studies of toxicity and environmental fate. In addition, pesticide registrants submit small plot field studies of pesticide behavior in the environment. Effects in nontarget organisms are characterized primarily by using single-species laboratory toxicity tests, which yield dose-response curves of lethality and effect. This information can be augmented by data on effects of the substance in other nontarget species. Exposure estimates can be based on laboratory studies and any available monitoring data. Computer modeling can be used to generate distributions of expected environmental concentrations.

1.1.5.2 Use of Point Estimates

Preliminary risk assessments involve comparison of point estimates of toxic effects with point estimates of exposure (i.e., the most probable expected exposure). For acute toxicity to terrestrial vertebrates, for example, the expected environmental exposure can be compared at 20% of the LD50 as a regulatory threshold. The value of 20% LD50 has been traditionally used to initiate regulatory action in the pesticide program and is based on the presumption that significant lethality will not occur at concentrations below this level of toxicity. However, the slopes of dose-response curves for acute toxicity of the various pesticides must be considered in examining the validity of the assumption of negligible lethality at environmental concentrations less than or equal to 20% of the LD50. Examination of slopes for acute toxicity has shown that the criterion of 20% LD50 may be insufficiently protective for some substances,

while for others it is a worst case value and may be overly conservative. Thus, slope values of LD50 are just as important as the point estimates of lethality.

1.1.5.3 Monte Carlo and Other Probabilistic Assessment Techniques

In 1996, the U.S. EPA's Scientific Advisory Panel recommended a number of improvements in the risk assessment of pesticides, including the use of probabilistic methods. In addition, on May 15, 1997, the deputy administrator of the U.S. EPA signed a Policy for Use of Probabilistic Analysis in Risk Assessment, stating that probabilistic techniques would be used in determining ecological risk and would integrate both stressor and dose-response assessments. Such probabilistic analysis techniques are to be part of a tiered approach to risk assessment. This approach would progress from the use of simpler techniques such as quotient methods to compare point estimates of toxic effects with expected environmental exposure, to probabilistic methods that involve integration of effects and exposure distributions. Preliminary risk assessment methods using quotients are extremely useful as a screening tool to identify pesticides that may be safely used in the environment under conditions that are efficacious for their intended purpose. However, for pesticides that appear to pose significant risk, the application of Monte Carlo and other probabilistic techniques allows the analyst to account for the relationship between stressor and dose-response variables and express this relationship as likelihood of damage. Probabilistic techniques also provide a framework for expression of variability and uncertainty in risk assessments; in this way, sensitivity analyses can be performed to determine the relationship of exposure assumptions and mitigation options to risk.

The Ecological Committee on the Federal Insecticide, Fungicide, and Rodenticide Act (FIFRA) Risk Assessment Methods (ECOFRAM) is a peer involvement workgroup with a mission to develop probabilistic methods for pesticide risk assessment. Assessment endpoints, which are meaningful and attainable, are characterized. ECOFRAM has defined a progression of methods for risk assessment from quotients of toxicity to exposure, involving point estimates to probabilistic determinations. Initially, toxic effects are described in terms of the dose-response characteristics of a pesticide in a single test species. The slope of the dose-response curve accounts for the variance of mortality in that particular species. Retrospective analysis of toxicity information in birds and mammals has given rise to models and uncertainty factors which can be used to identify other uncertainty factors to allow for the increased sensitivity of other species (Luttik and Aldenberg, 1997; Sheehan et al. 1995). As data become available for additional species, the uncertainty factor is reduced.

Pesticide exposure assessments are based on an array of laboratory and field studies of environmental fate, which contain details regarding agricultural application rates and frequency of use. Modeling can be used to predict the range of environmental exposure levels. Monte Carlo simulation techniques are then used to integrate the dose response and exposure information. The results of risk assessment can be expressed as a probability of mortality to terrestrial nontarget populations. An estimation of the proportion of the population with at least a 90%, 75%, or 50% likelihood of dying as a result of pesticide exposure can be determined. The degree to which the distribution is sensitive to various parameters in the risk assessment model can also be examined. This aspect allows the effect of mitigation to be evaluated.

As environmental fate prediction is refined, increasing weight is given to the initial model for characterizing toxic effects of the substance to nontarget species. ECOFRAM suggests establishing additional test concentrations near the lethal threshold in acute toxicity tests to reduce variability and improve performance characteristics. In addition, to reduce the uncertainty associated with interspecies extrapolation, additional species should be tested for lethality. Approximate lethal dose methods, such as the UDP, are under consideration for this purpose. When acute toxicity studies in rats indicate that a substance poses significant risk to terrestrial mammals, an additional acute toxicity test may be required in an appropriate species of naturally occurring terrestrial populations. Similar recommendations were

made for interspecies extrapolation in avian species as part of a SETAC (Society of Environmental Toxicology and Analytical Chemistry)-OECD conference in 1994.

1.1.5.4 Endangered Species

Assessment of the potential risks of pesticides to endangered species requires that the probability of the loss of an individual be carefully assessed. An U.S. EPA agency team systematically assesses site-specific risk to endangered species using acute toxicity results. Not only is the LD50 value used, but the slope of the dose-response curve is also taken into consideration. The slope value will help to ensure that the possibility of adverse effects is carefully considered, rather than rely on a regulatory trigger based on a fixed fraction of the LD50 value. As noted above, this consideration allows the validity of assumptions of negligible risk to be tested more precisely.

1.1.6 Revised UDP

1.1.6.1 Dose Progression Factor

The current OECD UDP test guideline calls for sequential dosing with a dose progression factor of 1.3. Simulations with this progression factor clearly demonstrate that if the starting dose level is not close to the actual LD50 value for a test substance, many additional animals (as many as 30) might be needed before an adequate estimate of the LD50 is obtained. In addition, a significant bias toward the starting dose will be introduced in the results. Inclusion of a dose range-finding study was considered in order to determine the best initial dose. However, the sequential nature of dose progression in the test design of the UDP provides results that lead to centering the test doses around the LD50. Therefore, incorporation of several aspects of range-finding into the basic test was achieved by adjusting the dose spacing.

The use of simulations resulted in optimization of the test performance and increases in its applicability, by adjusting the size of the dose progression factor to 0.5 log dose (or 3.2 dose). The test should perform well with this spacing for most situations (i.e., where the slope is equal to or greater than 3.5) and will result in a more efficient use of animals.

1.1.6.2 Stopping Rule

In simulations, the number of animals needed was found to be dependent on the slope. However, in many cases, the slope is not known prior to testing and the results of the test fail to provide confidence intervals. To allow the UDP to be applied to a wide variety of test substances with reasonable reliability, the test utilizes a flexible stopping rule with criteria based on an index related to the statistical error. For test substances with higher slopes, the stopping rule will be satisfied with four animals after the first reversal. Additional animals might be needed for test substances with slopes below 4.

1.1.6.3 Limit Test

A sequential Limit Test has been designed which improves reliability of correct classification when compared to batch testing. The revised test guideline calls for attainment of three survivals or three deaths following testing at the limit dose level. In many cases, the test will be complete with three animals, although four or five animals may be needed in some cases.

1.1.6.4 Supplemental Test

A multi-sequence test has been developed as an option for determination of slope and confidence intervals. The option included in the revised guideline calls for use of multiple independent test sequences. To allow for a wide range of slope values from steep to shallow, combinations of dose progression factors can be used. To conserve animal usage, dosing for each sequence stops after reversal of outcome. Testing can be tiered in that results from the basic test can be combined with the outcome of optional testing for probit calculation of the slope and confidence intervals.

1.1.6.5 Use of a Single Sex

As agreed upon at the OECD's March 1999 Expert meeting the revised UDP uses a single sex, typically females. Female rats have a lower relative detoxification capacity for most substances, as measured by specific activity of phase I and II enzymes. Therefore, for test substances that are direct acting in their toxic mechanism, females would generally be more sensitive. If metabolic activation is required for a substance's toxicity, consideration must be given as to whether the preferred sex for testing is the male. In addition to consideration of metabolic activation and detoxification, all other information should be evaluated. Information on substance analogues or the results of testing for other toxicological endpoints of the substance itself can also indicate potential gender differences. If the investigator has reason to believe that males may be more sensitive than females, then males may be used for testing.

1.2 The Scientific Basis of the Revised UDP

It is generally accepted that the acute oral toxicity in rats and other laboratory species can serve as an indicator of the potential for acute oral toxicity in humans. Animal studies are never perfect in their prediction of human effects; the best data for effects in humans are human data. An analysis of the historical database has demonstrated that the ranking of the LD50 values is similar between laboratory species and humans. Substances that are not toxic in the rat are often not toxic in humans and substances that are highly toxic in the rat are often highly toxic in humans. Since human testing for acute lethality is unethical and illegal, animal bioassays have provided data that are reasonable approximations of the effects in humans. The revised UDP method permits estimation of an LD50 with a confidence interval and the results allow a substance to be ranked and classified according to the OECD Globally Harmonised System for the classification of substances that cause acute toxicity.

The primary test consists of a single ordered dose progression in which animals are dosed, one at a time, at 48-hour intervals. The first animal receives a dose level a step below the level of the best estimate of the LD50. If the animal survives, the dose level for the next animal is increased to a default factor of 3.2 times the original dose level; if it dies, the dose level for the next animal is decreased by a similar dose progression factor. Each animal should be observed carefully for up to 48 hours before making a decision on whether and how much to dose the next animal--a decision which is based on the 48-hour survival pattern of all the animals up to that time. A combination of stopping criteria is used to keep the number of animals low while adjusting the dosing pattern to reduce the effect of a poor starting value or low slope. Dosing is stopped when one of these criteria is satisfied, at which time an estimate of the LD50 and a confidence interval are calculated for the test based on the status of all the animals at termination. For most applications, testing will be completed with only 4 animals after initial reversal in animal outcome. The LD50 is calculated using the method of maximum likelihood.

The Limit Test is a sequential test that uses a maximum of five animals. A test dose of up to 2000 or, exceptionally, 5000 mg/kg, may be used. The selection of a sequential test plan increases the statistical power and also has been made to intentionally bias the procedure toward rejection of the limit test for test

substances with LD50s near the limit dose (i.e., to err on the side of safety). As with any limit test protocol, the probability of correctly classifying a compound will decrease as the actual LD50 more nearly resembles the limit dose. Figure 1-1 shows a flowchart schematic for the UDP Limit Test procedure.

Figure 1-1. Flowchart Schematic for the UDP Limit Test Procedure, using 2000 mg/kg as the Limit Dose

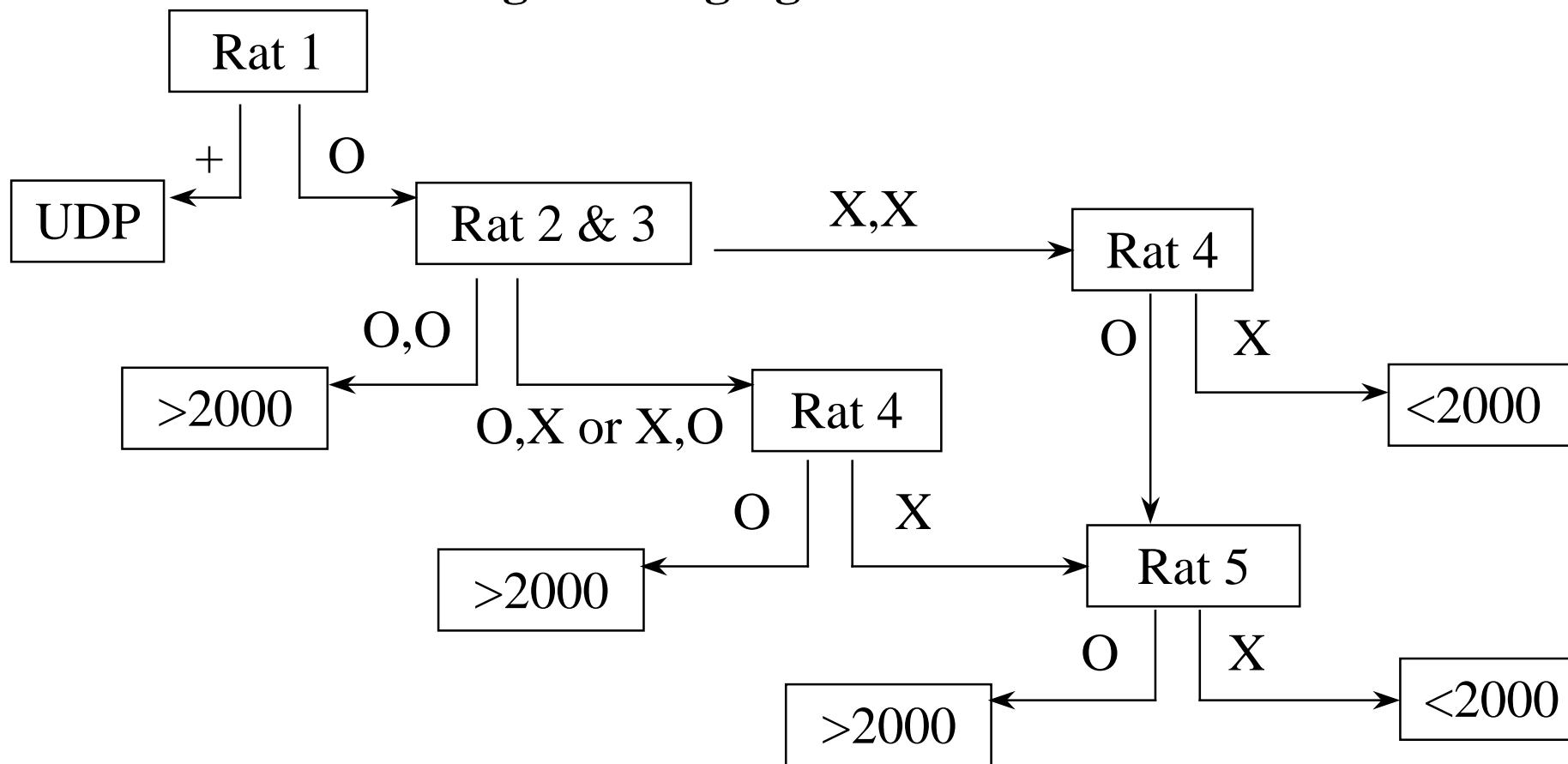

Note: O equates to non-toxic and X equates to toxic

1.3 Intended Regulatory Uses of the Revised UDP

The regulatory basis for the Revised UDP is the need to identify the toxic effects of a given test substance as part of a safety evaluation for potentially exposed humans. Acute toxicity testing provides information on the health hazards likely to arise from short-term exposure and is typically an initial step in the evaluation of the toxic characteristics of a chemical substance. Data from acute studies may serve many different roles, such as to:

- provide a basis for hazard classification and labeling
- establish dosing levels for repeated-dose toxicity studies
- generate information on affected organs
- give clues as to the mode of toxic action
- aid in the diagnosis and treatment of toxic reactions
- provide information for comparison of toxicity and dose response among members of chemical classes
- help standardize biological products
- serve as a standard for evaluating alternatives to the animal test
- help judge the consequences of exposures in the workplace, at home, and on accidental release

The Revised UDP will replace the current regulations on acute oral toxicity testing for the CPSC, the U.S. EPA, and the U.S. Department of Transportation (DOT). The Revised UDP will specifically provide the following:

1. Point Estimate of Lethality for Classification:
 - classification of pure substances - CPSC, DOT, Occupational Safety and Health Administration (OSHA)
 - classification of mixtures - CPSC, DOT, OSHA
 - classification of pesticide active ingredients and formulations - U.S. EPA
 - characterization of inerts in pesticide formulations – U.S. EPA
2. Range Estimate of Lethality for Classification:
 - classification of pure substances - CPSC, DOT, OSHA
 - classification of pesticide formulations – U.S. EPA
3. Risk Assessment (Slope, Confidence Intervals, Dose-Effect)
 - human health assessment, pure substances and mixtures - CPSC, OSHA; and pesticides – U.S. EPA
 - environmental assessment of pesticides – U.S. EPA
4. Limit Dose at 5000 mg/kg:
 - Pesticides, safer chemical policy/incentives, biological agents – U.S. EPA
 - consumer products - CPSC

Because the Revised UDP provides an estimate of the slope of the dose-response curve and the confidence interval for the LD50, the data can also be used for risk assessment purposes and probabilistic modeling.

1.4 Currently Accepted Acute Oral Toxicity Test Methods

Should the Revised UDP be adopted by the OECD, it is expected that U.S. Federal agencies requiring

acute toxicity data as generated by OECD TG 401 will accept the UDP as the alternative acute oral toxicity test. Guidelines and regulations for acute oral toxicity are shown in **Table 1-1**. The current guidelines of U.S. Federal agencies for acute oral testing are:

1. Under the Federal Hazardous Substances Act, the CPSC requires testing of groups of 10 rats weighing between 200 and 300 g at doses between 50 and 5000 mg/kg followed by a 14-day observation period to obtain an LD50 (16 CFR 1500; original BRD **Appendix E**, final report **Appendix Q-1**). OECD TG 401 is an accepted test method. For the Limit Test, a group of 10 rats is dosed at 5000 mg/kg and observed for 14 days.
2. Under FIFRA, the U.S. EPA requires the testing of rats weighing between 200 and 300 g at doses between 5 and 5000 mg/kg followed by a 14-day observation period (40 CFR 152; original BRD **Appendix E**, final report **Appendix Q-3**). OECD TG 401 and TG 425 are accepted test methods.
3. Under FIFRA, the U.S. EPA requires the identification of the range of the acute oral LD50s by testing rats weighing between 200 and 300 g followed by a 14-day observation period (40 CFR 156; original BRD **Appendix E**, final report **Appendix Q-4**). OECD TG 401, TG 420, TG 423, and TG 425 are accepted test methods.
4. Under FIFRA, the U.S. EPA requires acute oral testing of chemicals and products which may become a residue in food and nonfood crops (40 CFR 158; original BRD **Appendix E**, final report **Appendix Q-5**). OECD TG 401 and TG 425 are accepted test methods.
5. Under the Toxic Substances Control Act (TSCA), the U.S. EPA requires acute oral toxicity data for chemicals proposed for a significant new use (40 CFR 721; original BRD **Appendix E**, final report **Appendix Q-6**). OECD TG 401 and TG 425 are accepted test methods.
6. The U.S. DOT and its 11 administrations require the identification of the range of the acute oral LD50s by testing in young adult rats (49 CFR 173; original BRD **Appendix E**, final report **Appendix Q-7**). OECD TG 401, TG 420, TG 423, and TG 425 are accepted test methods.

For the U.S. EPA OPP, the LD50 for a test substance may be obtained using several methods including, (1) OECD TG 401 in which three groups of five female rats, 8 to 12 weeks of age, receive a single oral dose of the test substance and are observed for 14 days with a single confirming dose given to five male rats; (2) a conventional LD50 test in which several groups of five male and five female rats are given a single oral dose of the test substance and are observed for 14 days, with the selected dose levels based on a range-finding study, and (3) the UDP method can be used, but requires the submission of an acceptable protocol (e.g., OECD TG 425). In addition, a Limit Test may be conducted for a group of five male and five female rats given a single oral dose of 2000 or 5000 mg/kg and observed for 14 days.

Table 1-1 Guidelines and Regulations for Acute Oral Toxicity

AGENCY OR ORGANIZATION	GUIDELINES AND REGULATIONS ¹	COMMENTS
Consumer Product Safety Commission (CPSC)	<p>16CFR1500 Hazardous Substances and Articles: Administration and Enforcement</p> <p>§1500.3 Definitions</p>	<p>The CPSC, as mandated under the Federal Hazardous Substances Control Act, requires acute oral toxicity and other testing be conducted on chemicals in commerce. The purpose is to provide adequate labeling and warning to consumers of goods that are hazardous via oral, dermal, or inhalation during purposeful or accidental exposure.</p> <p>A single oral dose in rats followed by a 14-day observation period, for classification purposes.</p>
U.S. Department of Transportation (U.S. DOT)	<p>49CFR173 Shippers – General Requirements for Shipments and Packaging</p> <p>§173.132 Definitions §173.133 Assignment of packing group and hazardous zones for Division 6.1 materials</p>	<p>The DOT, in compliance with Hazardous Materials Regulations, outlines the requirements to be observed in preparing hazardous materials for shipment by air, highway, rail, or water, or any combination thereof. These regulations are based on the Recommendations of the United Nations Committee of Experts on the Transport of Dangerous Goods, the International Civil Aviation Organization, and the International Maritime Organization.</p> <p>Classification based on LD50 for packing requirements.</p>
U.S. Environmental Protection Agency (EPA) Office of Pesticide Programs (OPP)	<p>40CFR152 Pesticide Registration and Classification Procedures</p> <p>§152.3 Definitions</p> <p>§156.10 Labeling requirements for Pesticides and Devices</p> <p>§158.20 Data Requirements for Registration</p> <p>§158.70 Acceptable protocols</p>	<p>The U. S. EPA is required under the Federal Insecticide, Fungicide, and Rodenticide Act (FIFRA) to register all pesticides available for use in the U.S. This section sets forth the procedures, requirements, and criteria for registration and reregistration of pesticide products, and regulatory activities affecting registration. Testing must be in compliance with Good Laboratory Practices (GLPs) (40 CFR Part 792).</p> <p>A statistical-derived estimate of the single oral dose level of a substance causing 50% mortality to the test population under specified conditions.</p> <p>The U. S. EPA is required under FIFRA to adequately label all pesticide products for use in the U.S. Such labeling is primarily for worker protection and must include information on toxicity, symptoms, treatment, and recommended personal protective equipment. Testing must be in compliance with GLPs (40 CFR Part 792). Classification based on the LD50 for labeling requirements.</p> <p>This section specifies the types and amounts of data and information required by the Agency to make informed decisions on the risks and benefits of various pesticide products. Testing must be in compliance with GLPs (40 CFR Part 792). An acute oral LD50 is part of the minimum data package for registration.</p> <p>OECD protocols can be used to develop data necessary to data requirements.</p>

U.S. Environmental Protection Agency (U.S. EPA) Office of Pesticide Programs (OPP)	40CFR721 Significant new uses of chemical substances	The U. S. EPA requires vendors under the Toxic Substances Control Act (TSCA) to conduct acute oral toxicity studies according to harmonized test guidelines (OECD TG 401). A safety evaluation must be conducted for each proposed new use of a chemical substance. Testing must be in compliance with GLPs (40 CFR Part 792).
U.S. EPA, Office of Pollution Prevention and Toxic Substances (OPPTS)	OPPTS 870.1100 Acute Oral Toxicity	EPA Health Effects Test Guidelines http://www.epa.gov/docs/OPPTS_Harmonized/870_Health_Effects_Test_Guidelines/Drafts/

¹ Unless otherwise specified in the comments column, guidelines may be accessed via the U.S. Government Printing Office (GPO) Code of Regulations database <http://www.access.gpo.gov/nara/cfr/cfr-table-search.html>.

1.5 Intended Range of Substances Amenable to Testing Using the Revised UDP

Because the method of dosing (i.e., oral gavage) is the same for OECD TG 401 and the Revised UDP, any class of substances and products that can or have been tested using TG 401 can be tested using the Revised UDP. The test is designed for substances that can be administered neat (i.e., without dilution) or in a solvent. The test is not restricted to water-soluble substances. Any solvent or vehicle can be used, but the solvent or vehicle must not add to or mask the toxicity of the test substance.

2.0 Proposed Protocol for the Revised UDP

2.1 Detailed Protocol and Rationale

OECD adopted the UDP as TG 425 in October 1998 (original BRD **Appendix A**, final report **Appendix H**). The UDP Primary test has now been revised by changing the default starting dose level, the dose-spacing factor, the time period before the dosing of the next animal, and the stopping criteria. The UDP Limit Test was changed to utilize females only and to allow, for specific regulatory purposes, a limit dose level of 5000 mg/kg. In addition, an UDP Supplemental Test has been added to provide the estimation of the slope of the dose-response curve and the 95% confidence interval of the LD50. The Revised UDP guideline has been prepared using OECD test guideline format and is entitled, “Acute Oral Toxicity: Modified Up-and-Down Procedure (Revised UDP)” (see U.S. EPA Document 1B – original BRD **Appendix C**, final report **Appendix G**). A description of the Revised UDP follows; exact wording from the UDP guideline (version 425N) is set in quotation marks.

2.1.1 Materials, Equipment, and Supplies

2.1.1.1 Selection of animal species

“The preferred rodent species is the rat although other rodent species may be used. In the normal procedure, female rats are used because literature surveys of conventional LD50 tests show that, although there is little difference of sensitivity between sexes, in those cases where differences were observed, females were in general more sensitive. When there is adequate information to infer that males are more sensitive, they should replace females in the test” (see paragraph 12, Revised UDP, U.S. EPA Document 1B - original BRD **Appendix C**, final report **Appendix G**).

This section has not been altered from that provided in the original UDP.

“Healthy young adult animals should be employed. Littermates should be randomly assigned to treatment levels. The females should be nulliparous and non-pregnant. At the commencement of the study, the weight variation of the animals should be minimal and not exceed $\pm 20\%$ of the mean weight for each sex. The test animals should be characterized as to species, strain, source, sex, weight and/or age” (see paragraph 13, Revised UDP, U.S. EPA Document 1B – original BRD **Appendix C**, final report **Appendix G**).

Because the UDP requires at least 48 hours between the sequential dosing of animals, the $\pm 20\%$ variation rule for body weight may be too restrictive. Utilizing animals from the same shipment in a randomized manner in which dosing may occur over a two to three week period may result in many animals exceeding this specified weight range, leading to increased animal use and associated costs.

2.1.1.2 Housing and feeding conditions

“The temperature in the experimental animal room should be 22°C ($\pm 3^{\circ}\text{C}$). Although the relative humidity should be at least 30% and preferably not exceed 60% other than during room cleaning, the aim should be 50-60%. Lighting should be artificial, the sequence being 12 hours light and 12 hours dark. The animals are housed individually. Unlimited supply of conventional rodent laboratory diets and drinking water should be provided” (see paragraph 14, Revised UDP, U.S. EPA Document 1B - original BRD **Appendix C**, final report **Appendix G**).

This section has not been altered from that provided in the original UDP.

2.1.1.3 Preparation of animals

“The animals are uniquely identified and kept in their cages for at least five days prior to dosing for acclimatization to the laboratory conditions. During acclimatization the animals should be observed for ill health. Animals demonstrating signs of spontaneous disease or abnormality prior to the start of the study are eliminated from the study” (see paragraph 15, Revised UDP, U.S. EPA Document 1B - original BRD **Appendix C**, final report **Appendix G**).

This section has not been altered from that provided in the original UDP.

2.1.1.4 Preparation of doses

“When necessary, the test substance is dissolved or suspended in a suitable vehicle. It is recommended that, whenever possible, the use of an aqueous solution or suspension be considered first, followed by consideration of a solution or emulsion in oil (e.g., corn oil) and then by possible solution in other vehicles. For vehicles other than water, the toxicity of the vehicle must be known. In rodents, the volume should not normally exceed 1 mL/100 g body weight; however, in the case of aqueous solutions 2 mL/100 g body weight can be considered.” (see paragraph 16, Revised UDP, U.S. EPA Document 1B - original BRD **Appendix C**, final report **Appendix G**).

This section has not been altered from that provided in the original UDP.

2.1.2 Procedure

2.1.2.1 Primary testing using a single-sequence of dosing

“For selecting the starting dose, all available information should be used, including information on structure-activity relationships. When the information suggests that mortality is unlikely, a limit test should be conducted. When there is no information on the substance to be tested, it is recommended that the starting dose of 175 mg/kg body weight be used. This dose serves to reduce the level of pain and suffering by starting at a dose level which in most cases will be sublethal. In addition, this dose reduces the chance that hazard of the chemical will be underestimated” (see paragraph 17, Revised UDP, U.S. EPA Document 1B - original BRD **Appendix C**, final report **Appendix G**).

“For each run, single animals are dosed in sequence usually at 48-hour intervals. However, the time intervals between dosing should not be fixed rigidly and may be adjusted as appropriate (e.g., in case of delayed mortality). The first animal is dosed a step below the toxicologist’s best estimate of the LD50. If no estimate of the chemical’s lethality is available, dosing should be initiated at 175 mg/kg. If the animal survives, the second animal receives a higher dose. If the first animal dies or appears moribund, the second animal receives a lower dose. Animals killed for humane reasons are considered in the same way as animals that died on test. Dosing should not normally exceed 2000 mg/kg body weight or 5000 mg/kg body weight as justified by specific regulatory needs” (see paragraph 18, Revised UDP, U.S. EPA Document 1B - original BRD **Appendix C**, final report **Appendix G**).

Prior to conducting the study, the testing laboratory should consider all available information on the test substance. Such information will include the identity and chemical structure of the substance; its physical chemical properties; the results of any other *in vitro* or *in vivo* toxicity tests on the substance; toxicological data on structurally related substances or similar mixtures; and the anticipated use(s) of the substance. This information is useful to determine the relevance of the test for the protection of human health and the environment, and will help in the selection of an appropriate starting dose.

The UDP suggested a dosing sequence of 24 hours. Since some animals die between 24 and 48 hours post-dosing and because fasting of the next animal to be dosed typically does not start until at least 24 hours after the treatment of the preceding animal, the dosing sequence in the revised UDP is at least 48 hours.

“Moribund state is characterized by symptoms such as shallow, labored or irregular respiration, muscular weakness or tremors, absence of voluntary response to external stimuli, cyanosis, and coma. Criteria for making the decision to humanely kill moribund and severely suffering animals are the subject of the separate OECD *Guidance Document on the Recognition, Assessment and Use of Clinical Signs as Humane Endpoints for Experimental Animals used in Safety Evaluation*” (see paragraph 19, Revised UDP, U.S. EPA Document 1B - original BRD **Appendix C**, final report **Appendix G**). The Guidance Document was provided the original BRD as **Appendix B**, but is not appended to this final report.

The Revised UDP emphasizes careful cageside and in-hand observations as described in the Guidance Document.

2.1.2.2 Dose-Spacing Factor and Stopping Rules

“The dose for each successive animal is adjusted up or down, depending on the outcome of the previous animal. At the outset, if feasible, a slope of the dose response should also be estimated based on all information available to the toxicologist including structure activity relationships. The dose progression factor should be chosen to be the antilog of 1/(the estimated slope of the dose-response curve). When there is no information on the substance to be tested, a dose progression factor of 3.2 is used. Dosing continues depending on the outcomes of all the animals up to that time. In any event, if 15 animals have been tested, testing stops. Prior to that, the test is stopped based on the outcome pattern if:

- 1) the upper testing bound is reached and 3 consecutive animals survive at that bound or if the lower bound is reached and 3 consecutive animals die at that bound, or
- 2) the next animal to be tested would be the 7th and each surviving animal to this point has been followed by a death and vice versa (i.e., 5 reversals occur in 6 animals started), otherwise;
- 3) evaluation whether testing stops or continues is based on whether a certain stopping criterion is met: Starting following the fourth animal after the first reversal (which may be as early as the decision about the seventh animal), three measures of test progress are compared via two ratios. If the first measure is at least two-and-one-half times both of the other measures (i.e., both ratios are 2.5), testing is stopped.

For a wide variety of combinations of LD50 and slopes as low as 2.5, the stopping rule will be satisfied with four to six additional animals, with fortuitously well-placed tests using even fewer. However, for chemicals with shallow dose-response slope (large variance), more animals may be needed. If animal tolerances to the chemical are expected to be highly variable (i.e., slopes are expected to be less than 3), consideration should be given to increasing the dose progression factor beyond the default 0.5 log dose (i.e., 3.2 progression factor) prior to starting the test.”

When the stopping criteria have been attained after the initial reversal, the LD50 should be calculated using the method described in” Section 2.1.7.3 (see paragraph 20 and 21, Revised UDP, U.S. EPA Document 1B - original BRD **Appendix C**, final report **Appendix G**).

In the current UDP, the dose-spacing factor was 1.3. This factor has been changed to 3.2 in the Revised UDP because:

1. if the starting dose level is far from the LD50, a dose-spacing factor of 1.3 may use many animals to reach the LD50; and
2. if the dose-response curve is very shallow (2.5 or less), a factor of 1.3 leads to a significant possibility of bias toward the starting dose level.

For example, if the LD50 is 1878 mg/kg and the starting dose level is 175 mg/kg, it would require 12 animals to approach the LD50. A spacing factor of 3.2 requires the use of only three animals. If the slope is shallow and the starting dose level is far from the LD50, it is likely that there will be a reversal of outcome far from the LD50. Since the current UDP stops with four animals after the first reversal, the test often does not reach the LD50 prior to meeting stopping criteria. A complete description of the development of the stopping criteria is given in U.S. EPA Document 5 (original BRD **Appendix C**, final report **Appendix K**).

2.1.3 The Supplemental Test: Estimate of an LD50 and Slope of the Dose-Response Curve

“Following the primary test, a supplemental test to estimate the slope of the dose-response curve can be implemented when necessary. This procedure uses multiple testing sequences similar to the primary test, with the exception that the sequences are intentionally begun well below the LD50 estimate from the primary test. These test sequences should be started at doses at least 10 times less than the LD50 estimate from the primary test and not more than 32 times less. Testing continues in each sequence until the first animal dies. Doses within each sequence are increased by the standard 3.2 factor. The starting dose level for each test sequence should be staggered, as described in Appendix II, paragraph 6. Upon completion of up to six of these supplemental test sequences, a standard probit analysis should be run on the entire collection of data, including the outcomes of the primary test. Good judgment will be required in cases where the primary test yields estimates of LD50 that are too close to the lower limit of doses tested. When this occurs, testing may be required to begin well above the LD50, where deaths are likely, and each sequence will terminate with the first survivor. If slope may be highly variable, an alternate

procedure, using varying dose progression sizes, may be appropriate” (see paragraph 22, Revised UDP, U.S. EPA Document 1B - original BRD **Appendix C**, final report **Appendix G**).

A complete description of the development of the Supplemental Test is given in U.S. EPA Document 8 (original BRD **Appendix C**, final report **Appendix N**).

2.1.4 The Limit Test

“Dosing should not normally exceed 2000 mg/kg body weight. However, when justified by specific regulatory needs, testing up to 5000 mg/kg body weight may be considered. One animal is dosed at the upper limit dose; if it survives, two more animals are dosed sequentially at the limit dose; if both animals survive, the test is stopped. If one or both of these two animals die, two animals are dosed sequentially at the limit dose until a total of three survivals or three deaths occur. If three animals survive, the LD50 is estimated to be above the limit dose. If three animals die, the LD50 is estimated to be at or below the limit dose. If the first animal dies, a primary test should be run to determine the LD50.” A flow chart delineating the procedures for the Revised UDP Limit Test is shown in **Table 2-1**.

“As with any limit test protocol, the probability of correctly classifying a compound will decrease as the actual LD50 approaches the limit dose. The selection of a sequential test plan increases the statistical power and also has been made to intentionally bias the procedure toward rejection of the limit test for compounds with LD50 values near the limit dose (i.e., to err on the side of safety)” (see paragraph 23, Revised UDP, U.S. EPA Document 1B; original BRD **Appendix C**, final report **Appendix G**).

In the Revised UDP, the test stops when testing is complete in females; whereas, in the current UDP, three males are tested following testing in females. A complete description of the rationale for the Limit Test is given in U.S. EPA Document 7 (original BRD **Appendix C**, final report **Appendix M**).

Table 2-1 Flow Chart for the Revised UDP Limit Test

1.	Test one animal (first animal)	-	if it survives, then test two additional animals if it dies, then conduct the Primary Test
2.	Test two animals (second and third animals)	-	if both survive, then the test is complete if one or both die, then test two additional animals sequentially
3.	Test two animals sequentially (fourth and fifth animals)	-	stop the test as soon as three animals have survived or died. If three animals have died, then conduct the Primary Test

2.1.5 Dosing Procedures

2.1.5.1 Administration of doses

“The test substance is administered in a single dose to the animals by gavage using a stomach tube or a suitable intubation cannula. The maximum volume of liquid that can be administered at one time depends on the size of the test animal. In rodents, the volume should not normally exceed 1 ml/100 g body weight; however, in the case of aqueous solutions 2 ml/100 g body weight can be considered. When a vehicle other than water is used, variability in test volume should be minimized by adjusting the concentration to ensure a constant volume at all dose levels. If administration in a single dose is not possible, the dose may be given in smaller fractions over a period not exceeding 24 hours.

Animals should be fasted prior to dosing (e.g., with the rat, food but not water should be withheld overnight; with the mouse, food but not water should be withheld for 3-4 hours). Following the period of fasting, the animals should be weighed and the test substance administered. The fasted body weight of each animal is determined and the dose is calculated according to the body weight. After the substance has been administered, food may be withheld for a further 3-4 hours in rats or 1-2 hours in mice. Where a dose is administered in fractions over a period of time, it may be necessary to provide the animals with food and water depending on the length of the period” (see paragraphs 24 and 25, Revised UDP, U.S. EPA Document 1B - original BRD **Appendix C**, final report **Appendix G**).

This section has not been altered from that provided in the original UDP.

2.1.6 Endpoints Recorded

2.1.6.1 Observations

“After dosing, animals are observed individually at least once during the first 30 minutes, periodically during the first 24 hours, with special attention given during the first 4 hours, and at least once daily thereafter. The animals should normally be observed for 14 days, except where animals need to be removed from the study and humanely killed for animal welfare reasons or are found dead; however, the duration of observation should not be fixed rigidly. The length of the observation period should be determined by the toxic reactions, time of onset, and length of recovery period, and may thus be extended when considered necessary. The times at which signs of toxicity appear and disappear are important, especially if there is a tendency for toxic signs to be delayed. All observations are systematically recorded with individual records being maintained for each animal. Toxicology texts should be consulted for information on the types of clinical signs that might be observed” (see paragraph 26, Revised UDP, U.S. EPA Document 1B - original BRD **Appendix C**, final report **Appendix G**).

In the revised UDP, more emphasis is placed on humane endpoints and clinical signs. Examples of clinical signs were provided in the original BRD in **Appendix B**; this appendix is not included in this final report.

“Careful clinical observations should be made at least twice on the day of dosing, or more frequently when indicated by the response of the animals to the treatment, and at least once daily thereafter. Animals found in a moribund condition and animals showing severe pain and enduring signs of severe distress should be humanely killed. When animals are killed for humane reasons or found dead, the time of death should be recorded as precisely as possible. Additional observations will be necessary if the animals continue to display signs of toxicity. Observations should include changes in skin and fur, eyes and mucous membranes, and also respiratory, circulatory, autonomic and central nervous systems, and somatomotor activity and behavior pattern. Attention should be directed to observations of tremors, convulsions, salivation, diarrhea, lethargy, sleep, and coma” (see paragraph 27, Revised UDP, U.S. EPA Document 1B - original BRD **Appendix C**, final report **Appendix G**).

More emphasis is placed on humane endpoints and clinical signs in the Revised UDP. Humane treatment of animals was described in the original BRD in **Appendix B**; this appendix is not included in this final report.

2.1.6.2 Body weight

“Individual weights of animals should be determined shortly before the test substance is administered, at least weekly thereafter, at the time of death or at day 14 in the case of survival. Weight changes should

be calculated and recorded” (see paragraph 28, Revised UDP, U.S. EPA Document 1B - original BRD **Appendix C**, final report **Appendix G**).

This section has not been altered from that provided in the original UDP.

2.1.6.3 Pathology

“All animals, including those which die during the test or are killed for animal welfare reasons during the test and those that survive at day 14, are subjected to gross necropsy. The necropsy should entail a macroscopic inspection of the visceral organs. As deemed appropriate, microscopic analysis of target organs and clinical chemistry may be included to gain further information on the nature of the toxicity of the test material” (see paragraph 29, Revised UDP, U.S. EPA Document 1B - original BRD **Appendix C**, final report **Appendix G**).

This section has not been altered from that provided in the original UDP.

2.1.7 Data and Reporting

2.1.7.1 Data

“Individual animal data should be provided. Additionally, all data should be summarized in tabular form, showing the following for each test concentration: the number of animals used; the number of animals displaying signs of toxicity; the number of animals found dead or killed for humane reasons; time of death for each animal; a description and the time course of toxic effects and reversibility; and necropsy findings. A rationale for the starting dose and the dose progression and any data used to support this choice should be provided” (see paragraph 30, Revised UDP, U.S. EPA Document 1B - original BRD **Appendix C**, final report **Appendix G**).

This section has not been altered from that provided in the original UDP.

2.1.7.2 Data Storage

Original data are collected and maintained in study books according to Agency-accepted Good Laboratory Practices (GLPs). Data are then entered into computerized spreadsheets for manipulation and analysis.

2.1.7.3 Calculation of LD50 for the Primary Test

“The LD50 is calculated using the maximum likelihood method, other than in exceptional cases given below. The following statistical details may be helpful in implementing the maximum likelihood calculations suggested (with an assumed *sigma*). All deaths, whether immediate or delayed or humane kills, are incorporated for the purpose of the maximum likelihood analysis. Following Dixon (1991a), the likelihood function is written as follows:

$$L = L_1 L_2 \dots L_n ,$$

where

L is the likelihood of the experimental outcome, given *mu* and *sigma*, and *n* is the total number of animals tested.

$L_i = 1 - F(Z_i)$ if the i^{th} animal survived, or
 $L_i = F(Z_i)$ if the i^{th} animal died,

where

F = cumulative standard normal distribution,

$Z_i = [\log(d_i) - \mu] / \sigma$

d_i = dose given to the i^{th} animal, and

σ = standard deviation in log units of dose (which is not the log standard deviation).

When identifying the maximum of the likelihood L to get an estimate of the true LD50, μ is set = log LD50 and automated calculations solve for it.

An estimate of σ of 0.5 is used unless a better generic or case-specific value is available.

(a) If testing stopped based on criterion (1) (i.e., a boundary dose was tested repeatedly; see Section 2.1.2.2), or if the upper bound dose ended testing, then the LD50 is reported to be above the upper bound; if the lower bound dose ended testing then the LD50 is reported to be below the lower bound dose. Classification is completed on this basis.

(b) If all the dead animals have higher doses than all the live animals, or vice versa, the LD50 is between the doses for the live and the dead animals; these observations give no further information on the exact value of the LD50. Still, a maximum likelihood LD50 estimate can be made provided there is a value for σ . Stopping criterion (2) (i.e., 5 reversals occur in 6 animals started; see Section 2.1.2.2) describes one such circumstance.

(c) If the live and dead animals have only one dose in common and all the other dead animals have higher doses and all the other live animals lower doses, or vice versa, then the LD50 equals their common dose. If there is ever cause to repeat the test, testing should proceed with a smaller dose progression.

If none of the above situations occurs, then the LD50 is calculated using the maximum likelihood method.

Maximum likelihood calculation can be performed using either SAS (e.g., PROC NLIN) or BMDP (e.g., program AR) computer program packages as described (SAS, 1990; BMDP, 1990). Other computer programs may also be used. Typical instructions for these packages are given in appendices to the American Society for Testing and Materials (ASTM) Standard E 1163-87. The σ used in the BASIC program will need to be edited to reflect the changes in this version of the OECD 425 Guideline. The program's output is an estimate of log(LD50) and its standard error.

The stopping criterion (3) (i.e., is based on three measures of test progress that are of the form of the likelihood (see Section 2.1.2.2) with different values for μ , and comparisons are made after each animal tested after the sixth that does not already satisfy criterion (1) or (2). The equations for criterion (3) are provided in Appendix III. These comparisons are most readily performed in an automated manner and can be executed repeatedly, for instance, by a spreadsheet routine such as that also provided in Appendix III. If the criterion is met, testing stops and the LD50 can be calculated by the maximum likelihood method" (see paragraph 31 to 33, Revised UDP, U.S. EPA Document 1B - original BRD **Appendix C**, final report **Appendix G**).

After the sixth animal is dosed, the stopping rule is checked after each additional animal is tested. When the stopping rule is satisfied, the LD50 is calculated.

2.1.7.4 Calculation of LD50 and Slope Using Supplemental Procedure

“A Supplemental Procedure is based on running three independent replicates of the Up-and-Down Procedure. Each replicate starts at least one log, but not greater than 1.5 log, below the estimated LD50. Each run stops when the first animal dies. All data from these runs and the original Up-and-Down run are combined and an LD50 and slope are calculated using a standard probit method” (see paragraph 34, Revised UDP, U.S. EPA Document 1B - original BRD **Appendix C**, final report **Appendix G**).

No statistical procedures are required for the Limit Test.

2.1.8 Report

“The test report must include the following information:

Test substance:

- physical nature, purity and physicochemical properties (including isomerization);
- identification data

Vehicle (if appropriate):

- justification for choice of vehicle, if other than water

Test animals:

- species/strain used;
- microbiological status of the animals, when known;
- number, age, and sex of animals;
- rationale for use of males instead of females;
- source, housing conditions, diet, etc.;
- individual weights of animals at the start of the test, at day 7, and at day 14

Test conditions:

- rationale for initial dose level selection, dose progression factor, and for follow-up dose levels;
- details of test substance formulation;
- details of the administration of the test substance;
- details of food and water quality (including diet type/source, water source)

Results:

- body weight/body weight changes;
- tabulation of response data by sex (if both sexes are used) and dose level for each animal (i.e., animals showing signs of toxicity including nature, severity, duration of effects, and mortality);
- time course of onset of signs of toxicity and whether these were reversible for each animal;
- necropsy findings and any histopathological findings for each animal, if available;
- slope of the dose-response curve (when determined);
- LD50 data;
- statistical treatment of results (description of computer routine used and spreadsheet tabulation of calculations)

Discussion and interpretation of results

Conclusions:

(see paragraph 35, Revised UDP, U.S. EPA Document 1B - original BRD **Appendix C**, final report **Appendix G**).

This section has not been altered from that provided in the original UDP.

2.1.9 Equipment and Training

2.1.9.1 Equipment

Equipment needed is the same as the standard equipment for any oral toxicity test, including: cages, balances, analytical equipment as necessary to confirm the identity of the test substance, possibly waterbaths or mixers to dissolve the substance, dosing syringes, gavage catheters, and necropsy equipment. The only special piece of equipment needed for this method is a standard personal computer to run a spreadsheet program and a means to run maximum likelihood estimates using SAS or a similar program. It is anticipated that stopping rule program will be made available in Excel® or some other standard format on the OECD or U.S. EPA websites or on a floppy disk. It could also be written, as described in the guideline, by the toxicologists themselves if preferred.

2.1.9.2 Training

Technicians running the Revised UDP must be trained to properly calculate, mix, and administer test substances to rats via oral gavage and trained to make and record observations in an acute toxicity study, including the gross necropsy. They should also be familiar with OECD guidelines on humane endpoints and able to make decisions on when to sacrifice a terminally ill animal.

Staff must also be able to use the computer programs. A full description of how to use the stopping rule, with examples, is included in the guideline. The use of the maximum likelihood method for calculating the LD50 is a standard statistical program and would require experience in these programs. Training may be available for those unfamiliar with this type of computer program. Dosing and observations are similar to other acute toxicity protocols. For all acute toxicity studies, technicians conducting the studies must be trained in making and recording observations correctly; this training is a very important aspect of the guideline and is often overlooked.

2.1.10 Basis for the Selection of Females

In revising TG 401 in 1987, OECD required the use of only one sex of the test species. Differences in gender sensitivity may include, but are not limited to, differences in specific enzyme systems (e.g., cytochrome P450 or conjugation pathways) and differences in absorption, distribution, and excretion (e.g., body fat content and distribution). A complete discussion of gender considerations is given in U.S. EPA Document 14 (original BRD **Appendix C**, final report **Appendix P**).

2.1.11 Confidential Information

There are no confidential data associated with the Revised UDP.

2.1.12 Decision Criteria for the Revised UDP

The decision criteria for the Revised UDP are detailed in the test guideline. Decision criteria for an adequate test and for stopping testing are proposed to be part of the computer program (see U.S. EPA Document 6 - original BRD **Appendix C**, final report **Appendix L**).

2.2 Basis for the Number of Replicate and Repeat Experiments

Historically, only a single experiment has been required to estimate the LD50 for a test substance (see OECD TG 401, TG 425, Revised UDP). The scientific basis for this requirement is unknown, but is most likely based on limiting animal use and the realization that the resulting LD50 is only a reasonable approximation. Similarly, the Limit Test is based on a single test. In contrast, the Supplemental Test in the Revised UDP, in order to calculate the slope of the dose-response curve and the corresponding confidence interval of the LD50, is based on three to four replicate tests. The justification for this number of replications is provided in U.S. EPA Document 1B (original BRD **Appendix C**, final report **Appendix G**).

2.3 Protocol Modifications as a Result of Validation Studies

The Revised UDP is a test guideline constructed and validated using computer simulations. The computer simulation studies were used to optimize the protocol as to starting dose level, dose-spacing factor, and stopping rules. The starting dose level has been changed to 175 mg/kg as part of the process to reduce animal use for test substances with a shallow slope in the dose-response curve. The dose-spacing factor was increased to 3.2 to curtail excess animal use prior to the first reversal when the starting dose level is far from the LD50. The stopping criteria allow for a more accurate estimate of the LD50 for test substances with a shallow slope and yet require only six or seven animals when the slope is steep.

3.0 Characterization of the Substances Tested

Three *in vivo* studies have been conducted using the UDP. The test substances used in each study are presented below. For the Bruce (1987) study, selection of the test substances was based on a wide variation in LD50 values (from 273 to more than 20,000 mg/kg). The rationale for selecting the five substances in the Bonnyns et al. (1988) study was that each compound affected different target organs; the published LD50 values ranged between 200 to 2000 mg/kg. In the Yam et al. (1991) study, the ten compounds were arbitrarily selected from the 20 test substances studied by van den Heuvel (1990), with consideration given to the range of LD50 values (48 to greater than 3000 mg/kg).

**Table 3-1 Reference Test Substances
Bruce (1987)**

Test Substance	Chemical/Product Class	CAS Number
Proprietary	Ingredient	-
Proprietary	Laundry detergent	-
Proprietary	Ingredient	-
Proprietary	Laundry detergent	-
Proprietary	Laundry detergent	-
Proprietary	Shampoo	-
Proprietary	Flavor	-
Caffeine	Stimulant	58-08-2
Potassium hydroxide	Strong base	1310-58-3
Proprietary	Dishwashing detergent	-

Bonnyns et al. (1988)

Test Substance	Chemical/Product Class	CAS Number
Barium acetate	Metal salt	543-80-6
Barbital	CNS depressant	57-44-3
Coumarin	anticoagulant drug	91-64-5
Allyl heptanoate	alkyl ester	-
Diquat	Herbicide	85-00-7

Yam et al. (1991)

Test Substance	Chemical/Product Class	CAS Number
Nicotine	plant product	54-11-5
Na pentachlorophenate	chlorinated organic salt	-
Na arsenite	metal salt	7784-46-5
p-Dichlorobenzene	chlorinated solvent	106-46-7
Fentin hydroxide	organic tin fungicide	76-87-9
Acetanilide	medicinal/intermediate	103-84-4
Tetrachlorvinphos	organophosphate pesticide	-
Piperidene	solvent	110-89-4
Mercuric chloride	metal salt	7487-94-7
4-Aminophenol	solvent	123-30-8

4.0 Reference Data Used for Performance Assessment

In LD50 studies using OECD TG 401, it was common practice to dose 50 or more animals simultaneously and evaluate lethality based on a 14-day observation period. The UDP involves the dosing of animals in a sequential manner. Sequential sampling is a novel approach to LD50 testing, although it has been used successfully in other areas. Bruce (1987) evaluated the UDP using a series of ten substances and the results were compared with LD50 values generated using TG 401. In this series, the test substances consisted primarily of surfactant-based cleaners, but also included a flavoring substance, caffeine, and potassium hydroxide. Subsequently, two other studies (Bonnyns et al., 1988; Yam et al., 1991) compared the results of the UDP with the classical LD50 test (OECD TG 401). In the Yam et al. (1991) study, the OECD TG 401 data used for comparison were taken from the van den Heuvel et al. (1990) study. In total, 25 substances were evaluated in these studies, as detailed in Lipnick et al. (1995). This number of compounds for validation studies is similar to that run for the FDP (20 compounds) (van den Heuvel et al., 1990) and the ATCM (30 compounds) (Schlede et al., 1992).

4.1 Protocol for Reference Data (OECD TG 401)

The reference data were generated using OECD TG 401. No deviations to the protocol were noted in the Bruce (1987), Bonnyns et al. (1988), or the van den Heuvel (1990) studies.

4.2 Results for OECD TG 401 Studies

Listings of the substances in the three comparison studies of the UDP are provided in **Table 4-1**. In the Bruce (1987) and the Bonnyns et al. (1988) studies, the authors simultaneously conducted acute oral testing using OECD TG 401. The Yam et al. (1991) study was part of the validation study for FDP and the OECD TG 401 data for both studies were taken from the van den Heuvel (1990) study.

Table 4-1 Results from TG 401 Studies

Test Substance	LD50 (mg/kg)
Bruce (1987)	
Ingredient	>20,000
Laundry detergent	10,110
Ingredient	>10,000
Shampoo	9,280
Dishwashing detergent	5,560
Laundry detergent	4,040
Laundry detergent	3,510
Flavor	3,490
Caffeine	344
Potassium hydroxide	273
Bonnyns et al. (1988)	
Diquat	1,036
Allyl heptanoate	991
Barium acetate	571
Coumarine	470
Barbital	404
Yam et al. (1991)	
4-Aminophenol	>3,000
p-Dichlorobenzene	>2,000
Tetrachlorvinphos	>2,000
Acetanilide	1,893
Piperidene	488
Na pentachlorophenate	309
Mercuric chloride	160
Fentin hydroxide	119
Nicotine	71
Na arsenite	48

4.3 Original Data Sheets

Proctor and Gamble Company provided original datasheets for portions of the Bruce (1987) and the Yam et al. (1991) studies. Additional original datasheets are available and can be obtained, if necessary.

4.4 Quality of Reference Data

The three studies that generated reference data were conducted using CFR Part 792 or CFR 160 GLPs.

4.5 Availability of Human Data

Relevant human data exist for each of the substances tested in the reference data studies. Human data were not used in generating the reference data.

4.6 Reference Data for the Computer Simulations

The computer simulations did not utilize any specific *in vivo* data; instead, the simulations encompassed the range of possible LD50 values and slopes as noted in the U.S. EPA's Office of Pesticides database.

4.7 Data Considerations

4.7.1 Data on Slopes and LD50 Values

A comparison of dose-response slope estimates for OECD TG 401 data using rats (29 substances from van den Heuvel et al., 1987) and U.S. EPA avian data (135 Office of Pesticides avian studies) is provided below in **Table 4-2**.

Table 4-2 Comparison of Dose-Response Slope Estimates for OECD TG 401 Rat Data (van den Heuvel et al., 1987) and U.S. EPA Avian Data (135 Office of Pesticides Avian Studies)

Slope	Number of substances (percent)	
	van den Heuvel	Avian
< 2.5	1 (3.4)	14 (10.4)
2.5 -6.0	11 (37.9)	77 (57.0)
> 6.0	17 (58.6)	44 (32.6)
	29	135

4.7.2 Avian Acute Toxicity and Slope Data

The avian data provided below are for registered pesticide active ingredients from the Environmental Fate and Effects Division (EFED) of the U.S. EPA database. The database file, called "bird_slopes", contains only those studies for which a slope was recorded. Only 135 out of a total of 919 studies have reported slopes. Reasons for the slope not being reported include: (1) the study was a limit test, conducted at only a single dose level; (2) the study did not yield at least two doses with mortality between 0% and 100%, which is the minimal requirement of the analytical program (TOXANAL) U.S. EPA uses to calculate a

probit slope; (3) the study was conducted at dose levels either too high or too low; (4) mortality failed to follow a dose-response pattern; or (5) the slope was not calculated or recorded (common with older studies). It should be noted that studies with steeper slopes would likely not have a slope calculated for reason (2). Therefore, there may be a bias in the data in that steep slope values may be missing more frequently than shallow slope values.

Description of Field Names

CHEMICAL	Chemical common name
SHAUGHNESSEY	U.S. EPA identification number for active ingredient (Shaughnessey number)
USEPATTERN	Class of pesticide based on target organism (Ex. "insecticide")
COMMONNAME	Species common name
TGL	Indicates if the toxicity value is ">" or "<"
TOXICITY	LD50 value in mg/kg
TOXLEVEL	Unit of toxicity value (MGK=mg/kg)
CL	95% confidence limit for LD50 estimate
CURVESLOPE	Probit slope estimate
EPAIDENT	U.S. EPA identification number for the study (MRID)

4.7.3 Data from Six Completed OECD TG 401 Studies

Summarized outcomes from six studies on five pesticides carried out according to OECD TG 401 are provided in this BRD. Issues relating to the analysis of pesticide data were the impetus for reexamining the performance of all alternative guidelines under various circumstances (i.e., shallow slopes). The data are tabulated giving proportion responding at each dose level, along with any estimates of LD50, slope, and associated confidence intervals, as well as the calculation method(s) cited by the study investigators. These data were cited in an U.S. EPA Office of Pesticide Programs study with confidential substance identity.

Compound 1: shallow dose response

Dose (mg/kg)	Males	Females
25 (prelim.)	0/2	0/2
100 (prelim.)	2/2	0/2
50	0/5	0/5
80	2/5	2/5
126	4/5	4/5
200	5/5	4/5
“LD50(95%CI)”	92(64-128)	103(73-141)

Using Finney’s method for probits (1978), the male and female estimated slope is 5.5 (i.e., 1.4 with log transformation of dose), compared to a combined data estimated slope of 5.4 [i.e., 1.4 with log transformation of dose; LD50(95%CI) = 97(76-122)] (Finney, 1971).

Compound 2: shallow dose response

Dose (mg/kg)	Males	Females
987	0/5	0/5
1481	0/5	0/5
2222	3/5	3/5
3333	4/5	5/5
5000	5/5	not run
0	0/5	0/5
“LD50(95%CI)”	2314(1790-2990)	2132(1748-2600)

Using Weil (1952), the estimated LD50 and confidence intervals for combined male and female data was 2221 (1869-2639) mg/kg.

Compound 3: shallow dose response

Dose (mg/kg)	Males	Females
4000	0/5	0/5
4500	0/5	4/5
4800	0/5	5/5
5050	3/5	5/5
5200	2/5	not run
“LD50(95%CI)”	5150(4940- 5380)	4380(4210- 4560)

Using Litchfield and Wilcoxon (1949), the LD50 and confidence intervals for combined male and female data was 4810(4550-5080) mg/kg.

Compound 4: shallow dose response

Dose (mg/kg)	Males	Females
1	0/5	0/5
2	1/5	1/5
3	4/5	5/5
5	4/5	5/5
10	5/5	5/5
“LD50(95%CI)”	2.7(1.8-4.0)	2.7(1.8-4.2)

Using Litchfield and Wilcoxon (1949), the slope $[(0.5)\log(\text{LD84}/\text{LD16})]$ was 0.23 for males and 0.15 for females, using the definition for compound 5.

Compound 5: variable dose response

Dose (mg/kg)	Males	Females
130	0/6	0/6
250	0/6	0/6
500	1/6	0/6
1000	0/6	3/6
2000	5/6	6/6
4000	6/6	6/6
“LD50(95%CI)”	1414(927-2598)	1000(733-1364)

Using Thompson and Weil (Biometrics 8:51-54) per C. Stephan (1978) the slope $[(0.5)\log(\text{LD84}/\text{LD16})]$ was 4.1 for males and 3.8 for females.

Compound 6: steep dose response

Dose (mg/kg)	Males	Females
294/192	0/5	0/5
429/235	3/5	4/5
552/294	4/5	4/5
“LD50(95%CI)”	435(302-581)	234(183-296)

The calculation method is unspecified. However, a computer program of C.E. Stephan (1982) resulted in a slope of 10.6 for males and 13.4 for females.

5.0 Test Method Data and Results

There have been three studies in which data obtained using the UDP are compared with data obtained using OECD TG 401. A list of the substances tested in each study is provided in **Table 5-1**. In the Bruce (1987) and Bonnyns et al. (1988) studies, the OECD TG 401 data were generated simultaneously with the UDP data. In the Yam et al. (1991) study, the OECD TG 401 data were taken from a validation study for FDP (van den Heuvel et al., 1990) and little is known about the differences between animals and substances in the two studies.

5.1 In Vivo Data Using the UDP

5.1.1 Bruce (1987) Study

In the Bruce (1987) study, 10 substances were tested using a dose-spacing factor of 1.4 for OECD TG 401 tests and 1.3 for the UDP tests. For OECD TG 401, the animals were dosed simultaneously and observed for 14 days. For the UDP, the animals were dosed sequentially at least 24 hours apart and observed for 7 days. The stopping rule was that four animals were tested after the first reversal of outcome. The LD50 values for these substances ranged from 0.39 to 22 mg/kg and all calculated LD50 values for the two methods were within a factor of 1.4, well with the range observed in inter- and intra-laboratory variation studies (See **Section 7.0**).

5.1.2 Bonnyns et al. (1988) Study

In the Bonnyns et al. (1988) study, the UDP dose-spacing factor was 1.3 and five animals were tested after the first reversal. The selected substances affected different organs as follows:

barium acetate	heart
allyl heptanoate	central nervous system
barbital	central nervous system
coumarine	homeostasis
diquat	kidney

The published LD50 values ranged between 200 and 2000 mg/kg. All calculated LD50 values for the two methods were within a factor of 1.9, well within the range observed in inter- and intra-laboratory studies (See **Section 7.0**). Both OECD TG 401 and the UDP tests would have classified all substances as harmful.

5.1.3 Yam et al. (1991) Study

In the Yam et al. (1991) study, ten substances were tested in the UDP using a dose-spacing factor of 1.3 and the stopping rule was to test four animals after the first reversal. Animals were dosed sequentially, separated by 24 hours. The substances were also tested using the FDP by using five males and five females starting at one of the fixed dose levels. The animals weighed between 190 and 300 g, were fasted for 16 to 20 hours prior to dosing, and were observed for 14 days. The UDP LD50 data were compared to OECD TG 401 LD50 data of van den Heuvel et al. (1990). The OECD TG 401 data were generated in a single laboratory using the 1981 OECD guideline rather than the 1987 guideline, but no details as to strain, age, or weight of the animals were provided. The absolute ratio of each set of LD50 values for the UDP and OECD TG 401 were within a factor of 1.9, except for mercuric chloride where the ratio was 13. It is not clear why this discrepancy was present for mercuric chloride; it may be related to the purity/batch of the substance, solubility, weight or age of the animals, or other possible sources of variation as the OECD TG 401 data were taken from van den Heuvel et al. (1990). Additionally, one of the data points could represent an outlier. It should be noted that data in RTECS indicate that the LD50 for mercuric chloride is considerably less than 160 mg/kg.

Table 5-1 Substances and Results for the UDP Validation Studies

Test Substance	UDP LD50 (mg/kg)
Bruce (1987)	
Ingredient	22,400
Laundry detergent	11,090
Ingredient	>10,100
Shampoo	8,700
Dishwashing detergent	5,700
Flavor	4,120
Laundry detergent	4,020
Laundry detergent	3,520
Caffeine	421
Potassium hydroxide	388
Bonnyns et al. (1988)	
Diquat	1,022
Allyl heptanoate	582
Barbital	581
Coumarine	517
Barium acetate	302
Yam et al. (1991)	
p-Dichlorobenzene	2,495
Tetrachlorvinphos	2,208
4-Aminophenol	1,557
Acetanilide	1,107
Na pentachlorophenate	425
Piperidene	337
Fentin hydroxide	152
Nicotine	70
Na arsenite	53
Mercuric chloride	12

In the three validation studies involving the UDP, the resulting estimate of the LD50 was compared to an LD50 generated using OECD TG 401. The Revised UDP utilizes the same methodology as the UDP except in the dose-spacing factor and the stopping rules. On this basis, these studies can be applied to the validation of the Revised UDP. There was excellent concordance between OECD TG 401 and the UDP data for all 25 substances, except for mercuric chloride. The LD50 values ranged from 0.05 to 22 mg/kg and several chemical classes were represented.

6.0 Test Method Performance

The performance characteristics of the UDP and the Revised UDP can be evaluated using four criteria:

1. the point estimate of the LD50 as compared with OECD TG 401 data;
2. the estimation of the slope of the dose-response curve for mortality and the confidence interval for the LD50 as compared to OECD TG 401 data;
3. the hazard classification as compared to the hazard classification using OECD TG 401 data; and
4. the number of animals used in the study as compared to OECD TG 401.

6.1 *In Vivo* Validation Studies

In **Table 6-1**, the results of three *in vivo* validation studies involving OECD TG 401 and the UDP are provided along with the ratio of the LD50 values for the two methods. For all 25 substances, the average ratio of the LD50 values for the two methods is 1.76. If mercuric chloride is not included, the average ratio is 1.28. The LD50 using the Revised UDP was the higher value for 15 of the 25 substances and was the lower value for the remaining 10 substances. These data indicate that the two methods provide essentially the same point estimate of the LD50 for the substances tested. The single exception is mercuric chloride. Without access to the data for the OECD TG 401 LD50 values in the van den Heuvel (1990) study, it is impossible to determine whether significant differences (e.g., age or weight of the animals or purity of the test substance) between the two studies may have affected the outcome. In the Bruce (1987) and the Bonnyns et al. (1988) studies, the same laboratory determined the LD50 values using both OECD TG 401 and the UDP.

A comparison of rat oral LD50 data with estimated human lethality data is given in **Table 6-2**. The average ratio of the UDP LD50 to the lower estimate of human lethality is a factor of 46. This factor compares well with the safety factor of 100 often applied in risk assessment procedures to derive a safe level for humans while utilizing animal data. These data also illustrate and support the conservative approach of using safety factors in human risk assessment. On this basis, the UDP provides suitable data for risk assessment purposes and probabilistic modeling.

Table 6-1 Validation Studies for the UDP

Test Substance	LD50 (mg/kg)		Absolute Ratio of LD50 values
	OECD TG 401	UDP	
Bruce (1987)			
Ingredient	>10,000	>10,100	1.01
Laundry detergent	4,040	3,520	1.15
Ingredient	>20,000	22,400	1.12
Laundry detergent	3,510	4,020	1.15
Laundry detergent	10,110	11,090	1.10
Shampoo	9,280	8,700	1.07
Flavor	3,490	4,120	1.18
Caffeine	344	421	1.22
Potassium hydroxide	273	388	1.42
Dishwashing detergent	5,560	5,700	1.03
Bonnyns et al. (1988)			
Barium acetate	571	302	1.89
Barbital	404	581	1.44
Coumarine	470	517	1.10
Allyl heptanoate	991	582	1.70
Diquat	1,036	1,022	1.01
Yam et al. (1991)			
Nicotine	71	70	1.01
Na pentachlorophenate	309	425	1.38
Na arsenite	48	53	1.10
p-Dichlorobenzene	>2,000	2,495	1.25
Fentin hydroxide	119	152	1.28
Acetanilide	1,893	1,107	1.71
Tetrachlorvinphos	>2,000	2,208	1.10
Piperidene	488	337	1.45
Mercuric chloride	160	12	13.3
4-Aminophenol	>3,000	1,557	1.93
Average Ratio			1.76
Average Ratio (without mercuric chloride)			1.28

Table 6-2 UDP Study Substances with Human Oral Lethality Data

	UDP Rat LD50 (mg/kg)	OECD TG 401 Dosage for Rat LD50 (mg/kg)	60 kg person* (mg/kg)
Bruce (1987)			
Caffeine	421	344	50 - 167
Bonnyns et al. (1988)			
Barbital	581	404	100 - 167
Diquat	1,022	1,036	67 - 100
Yam et al. (1991)			
Nicotine	70	71†	0.67 - 1.0
Sodium Arsenite	53	48†	1 - 20
Fentin Hydroxide	152	119†	1.17
Acetanilide	1,107	1,893†	0.83 - 8.33
Mercuric Chloride	12	160†	8.33
4-Aminophenol	1,557	>3000†	16.7

* Data from the Hazardous Substances Data Bank, National Library of Medicine (May 2000)

† Data from van den Heuvel et al. (1990)

6.2 Computer Simulation Validation of the Revised UDP

The Revised UDP is a statistical sampling technique designed to determine the mean and variance of the population of a test species. The Revised UDP has not been validated in *in vivo* studies; however, the current UDP has been validated against OECD TG 401 using *in vivo* studies. Because the Revised UDP involves only a change in statistical sampling technique, its performance cannot easily be determined using *in vivo* studies. Since computer simulations are more appropriate, the Revised UDP has been validated using this approach (see U.S. EPA Documents 5 and 6 - original BRD **Appendix C**, final report **Appendices K and L**, respectively).

6.2.1 Rationale for Statistical Approach for the Revised UDP

Acute oral toxicity tests provide quantal data because the result in any animal can be only one of two possibilities – either the animal lives or it dies. In evaluating a statistical method, the question will be, “How well does the method predict the mean and variance of the population based on a small sample taken from that population?” Consider an experiment to determine how often a flipped coin will come up heads or tails. Clearly the results of a single trial would be insufficient to determine the correct answer; even several trials would fail to provide the correct answer. Instead, the trials must be repeated over and over to determine how often the sampling technique will predict the correct answer.

6.2.2 How the Computer Simulations Work

The simulations are meant to represent all possible types of response configurations anticipated under the assumed conditions. To simulate an experiment, the following details should be known: the starting dose level; the underlying distribution of tolerances which is characterized by the LD50 and the slope of the dose-response curve; hazard classification; boundary doses; rules for handling boundary doses; and stopping rules. Additional information is needed for slope estimation experiments. By simulating

experiments under a set of assumed conditions, the distribution of possible outcomes can be characterized. The simulations take into account the variety of possible outcomes and the probabilities with which they are observed. In some cases, simulations are not necessary because distributional results can be used to determine test procedure performance.

For the Revised UDP, one experiment is simulated at a time and the LD50 is estimated. A total of 1000 to 5000 simulation experiments are conducted for each experimental design. This number of simulations is sufficient to achieve good representation of all of the experimental results likely to occur. The distribution of the LD50 estimates is then summarized and the 5th and 95th percentiles are reported.

The simulations are aimed at evaluating all of the permutations possible for the multiple experiments and do not provide the permutations possible for any one animal. If a given dose has 30% expected mortality, then on the average, in simulated experiments, that dose would produce lethality 30% of the time. However, as with any sample from a larger population, for any given set of animals receiving that dose, it should not be expected that exactly three of these ten animals (30%) would die.

6.2.3 Validation Using Computer Simulations

During a recent OECD evaluation of acute oral tests, all currently accepted designs were shown by simulation techniques to have poor ability to estimate the LD50 of the underlying population under two conditions: 1) when the dose-response curve is shallow and 2) when the starting dose level for the test is far from the actual LD50 (see U.S. EPA Document 1A – original BRD **Appendix C**, currently **Section 1.1.4** of this revised BRD). To determine if improvements in the sampling technique can be made to improve the ability of the Revised UDP to correctly estimate the LD50, simulations have been conducted (see U.S. EPA Documents 5 and 6 – original BRD **Appendix C**, final report **Appendix K and L**, respectively). Using simulations, the Revised UDP has a greater chance than the current UDP of placing the estimated LD50 near the mean of the underlying population, even when the starting dose level is inappropriate (**Table 6-1**). This type of comparison would be impossible using actual animal tests, since no determination could be made regarding which small sample tested is providing the correct estimate of the underlying population and which sample is incorrect.

Instead, using LD50 data generated in past studies, a series of assumptions as to the slope, true LD50, and the starting dose level have been used to evaluate the Revised UDP as a statistical sampling technique. Using these assumed values, the UDP has been simulated to evaluate how well it estimates the true LD50 and slope using the various assumed values. The assumed values have been treated as though they are the mean and variance of the population. When both the mean and variance of the population are known, it is possible, using a computer, to simulate the generation of a random sequence of responses. Using this method, the computer can simulate the results from repeatedly taking small samples from a much larger population. The population is sampled in such a way that the results from the small sample have the best chance of correctly estimating the mean and variance of the entire population. By using a series of such simulations, it is possible to test how often the Revised UDP will accurately estimate the mean and variance or standard deviation of the population.

Animal testing is not only unnecessary, but is without value in determining the validity of the new statistical design. The characteristics of the test animal and the test methodology remain unchanged from the current UDP. Assay variability has previously been characterized and deemed acceptable by both the United States and international regulatory community. Thus, computer simulations provide the most suitable approach for evaluating changes in dose spacing and the decision criteria on estimating the LD50.

6.3 Results of Computer Simulations

Simulations and calculations have been conducted to explore the performance of the Revised UDP (see U.S. EPA Document 5 – original BRD **Appendix C**, final report **Appendix K**). Computer simulations have been used to optimize the protocol. The simulations have examined the spacing of doses, the efficiency of animal usage, starting dose level, assumed slope, and certain other factors. Simulations have also been used to examine the effects of steep and shallow slopes and the effects of the starting dose level being far from the LD50.

The UDP, as adopted, is designed to efficiently determine the LD50; to accomplish this task, a value for the slope and an estimate of the LD50, based on information available for the test substance, must be assumed. Nevertheless, the UDP does an excellent job of determining the LD50 except for substances with a shallow slope or in cases where the starting dose level is far from the “true” LD50. The U.S. EPA and other regulatory agencies need the slope of the dose-response curve and the confidence interval of the LD50 for certain substances for probabilistic modeling and risk assessment purposes.

The primary test in the Revised UDP is identical to the current UDP except for the dose-spacing factor, stopping rule, and other improvements. This procedure has been shown to efficiently estimate the LD50. The areas of improvement as evaluated via computer simulations are described below. Most of the changes evident in the Revised UDP involve the Supplemental Test and have been implemented to improve the estimation of the slope of the dose-response curve and the calculation of confidence interval of the LD50.

6.3.1 Dose-Spacing Factor

A discussion of the dose-spacing factor requires knowledge of slope and variance. The standard deviation for a data set is designated as *sigma* (σ) and *sigma* is the inverse of the slope of the dose-response curve; thus, a *sigma* of 0.5 corresponds to a slope of 2. *Sigma* is a measure the spread of the data around the center point in a lognormal bell-shaped curve (i.e., around the LD50). The method is optimized when the slope of the dose-response curve for the substance is near the assumed slope (the default spacing factor of 3.2 is optimized for a slope of 2). With the large spacing factor, the performance of the method is unaffected by the starting dose level, although the number of animals used will increase if the starting dose level is far from the LD50. For a shallow slope, the method is more likely to provide a correct estimate if the starting dose level is closer to the LD50. For a steep slope, the method provides a good estimate even if the starting dose level is far from the LD50 because the first reversal will be close to the LD50. For a shallow slope, the first reversal may occur far from the LD50 resulting in a bias toward the starting dose level. Thus, the probability of an early reversal (far from the LD50) depends on the slope, not the starting dose level.

The dose spacing in the current UDP is 1.3d, where d is the previous dose. This spacing corresponds to a slope value of 8 in the dose-response curve and a *sigma* of 0.125 in the normal curve of animal responses to the substance in a test for lethality. Simulations of the values for the LD50 calculated using the current UDP demonstrate that performance is optimum when the starting dose level is very close to the true LD50 and the assumed or assigned *sigma* is small and/or close to the true *sigma*. In fact, simulations show that the method works well for “true” *sigma* values < 0.25 (i.e., the median value estimated for LD50 is very close to the true LD50) and the 90% ratio (difference between 5th and 95th percentile predictions) of LD50 is relatively small (i.e., < 3). The probability of an early first reversal in test outcome depends on the distance of the initial dose from the true LD50.

If the starting dose level diverges significantly from the true LD50 and the spacing factor is 1.3d, the number of animals utilized to reach the LD50 can be excessive. When the starting dose level is far from

the true LD50 and the slope is shallow, a bias is introduced in the median value of the estimated LD50; in these cases, the bias is toward the starting dose level. When σ is larger than the spacing factor, the spread of estimated LD50 increases. Simulations show that under these conditions, the 95/5% ratio may be highly variable and range from one or two orders of magnitude. For a spacing factor of 1.3d, shallow slopes do not increase animal usage, instead, the test terminates early because the first reversal is far from the LD50. However, steep slopes may cause an increase in animal usage if the starting dose level is far from the LD50 because it may take several doses to reach the lethal range for the substance when the spacing factor is small.

To reduce this inefficiency, consideration was given to changing the dose-spacing factor. After a number of simulation trials, it was found that use of a larger dose step size, namely 3.2d (or 0.5 log d), improved the efficiency of animal usage. In addition, when simulation experiments were performed with a 3.2d step size and calculations of LD50 used an assumed σ value of 0.5 (corresponding to a slope of 2), the bias was minimized or eliminated in the median value of estimated LD50. However, there was only a slight improvement in the precision or the spread of estimated LD50 values (i.e., the 95/5% ratio). For substances with very shallow slopes or a large spread ($\sigma = 1.25$), a bias in median value of LD50 reappears and the 95/5% ratio increases, but the problems are not as severe as with the smaller (1.3d) dose spacing.

A comparison of the median estimated LD50 (based on 1000 runs) and the number of animals used for dose-spacing factor of 1.3 and 3.2 is provided in U.S. EPA Document 5 (original BRD **Appendix C**, final report **Appendix K**). By increasing the spacing of doses, the efficiency of animal usage is improved and certain other characteristics are optimized in many simulations. The LD50 estimate using a spacing factor of 1.3 is very close to the actual LD50 for simulations using a steep slope; however, animal usage can be as high as 21. While the LD50 using a spacing factor of 3.2 is below the actual LD50, it never requires more than 10 animals. For moderate and shallow slopes, the spacing factor of 3.2 results in LD50 estimates that are more accurate and uses fewer animals than for LD50 estimates using the 1.3 spacing factor.

6.3.2 Use of a Stopping Rule

In cases where the slope of the dose-response curve is shallow, it may take many animals to determine an accurate LD50. If the test stops with four animals after the first reversal of outcome as is the case for the current UDP, the estimate of the LD50 is not very accurate; therefore, a stopping rule is needed to eliminate this inaccuracy. To obtain an accurate LD50, the test must be extended to include more animals when evaluating substances with a shallow slope. The stopping rule allows an accurate estimate of the LD50 while limiting the total number of animals to 15. If the slope is steep, the stopping rule has been designed to allow the test to stop at four animals after the first reversal. Based on the low percentage of substances with a shallow slope, the stopping rule will not increase animal usage for a majority of test substances. Five stopping rules have been considered as follows:

1. Based on fixed nominal size -- testing four additional animals after the first reversal; if a reversal is observed at the second dose level, the nominal size will be six.
2. Based on the number of reversals -- testing stops after five reversals; under the most favorable conditions (each dose level after the first resulting in a reversal), the number of necessary animals would be six.
3. Based on the convergence of estimators of the LD50 -- two estimators of the LD50 are the maximum likelihood estimate and the geometric average dose; testing stops when the ratio of the two estimators falls below 2 or other preassigned factor.
4. Based on a likelihood ratio with optimized slope -- values close to the geometric mean carry more weight than values far from the geometric mean; weight is determined using the likelihood ratio.

5. Based on a likelihood ratio with default slope -- identical to stopping rule #4 except a default slope is used, reducing the complexity of the calculations.

As stated above, stopping rule #1 does not work for shallow slopes. U.S. EPA Document 6 (original BRD **Appendix C**, final report **Appendix L**) provides a comparison of the number of animals used for each of the stopping rules with slopes varying from 0.5 to 8.3. Data are presented for starting dose levels of 0.1 LD50, LD50, and 100 LD50. On the basis of these data, stopping rules #1, #3, and #4 were not considered further.

The final stopping rule criteria are as follows:

1. The upper bound is reached and three consecutive animals survive at that bound or the lower bound is reached and three consecutive animals die at that bound.
2. The next animal to be tested would be the 7th and each surviving animal has been followed by a death and vice versa (i.e., five reversals occur in six animals dosed).
3. Beginning with the fourth animal after the first reversal (which may be as early as the 7th animal), three measures (likelihood estimates) of the test progress are compared using two ratios. If the first measure is at least two-and-one-half times both of the other measures (i.e., both ratios are at least 2.5), testing stops (see Appendix III in U.S. EPA Document 1B – original BRD **Appendix C**, final report **Appendix G**)

6.3.3 Other Considerations

6.3.3.1 Bounding of the Range of Test Dose Levels

The UDP has been revised so that test dose levels are bounded below by 1 mg/kg and above by 2000 or 5000 mg/kg. The features of the current algorithm (see U.S. EPA Document 5 - original BRD **Appendix C**, final report **Appendix K**) are the identification of a finite set of testable doses and a modification of the dose-spacing factor.

6.3.3.2 Stopping at the Bound Dose, “Out-of-Bound” Estimates (The Limit Test)

Testing stops if there is a sequence of three survivals at the designated upper limit dose level or a sequence of three deaths at the designated lower limit dose level. In those cases, the finding from the study is that the LD50 is outside the testable range (e.g., below 1 mg/kg or above 2000 or 5000 mg/kg). When the LD50 is calculated to be greater than 2000 or 5000 mg/kg, the experimenter would not use the point estimate of the LD50, but would merely conclude that the LD50 is above the upper limit dose level.

6.3.3.3 Performance Indices and Other Statistics Reported

The performance indices have been extended by including the percent of estimates “within a factor of 2” of the true LD50. The index is denoted PF2, standing for Percentage with Factor-of-2 accuracy. The index combines bias and precision.

When calculating measures of bias or spread, “out-of-bound” estimates are replaced with the nearest bound value (1 or 5000).

6.3.3.4 Maximum Number of Animals

The maximum number of animals tested has been set at 15. When 25 was used as the maximum number of animals, the number of animals tested was inflated in some situations even when the initial test dose was reasonable. Results using 15 animals were not markedly different from those using 25 animals.

6.3.3.5 Simulated Outlier Scenario

Due to concern regarding whether the simulation models adequately characterize the range of events occurring in actual lab situations, an “outlier scenario” has been simulated as follows: the initial test was assumed to be below the true LD50 (here 750 mg/kg) by a factor of 10 or 100 and the first animal tested was assumed to respond, regardless of the probability of response calculated from the probit model. The idea is that such an event could result from background mortality, mishandling, or administration of an incorrect dose level. When dealing with data which include an outlier, there is practically no chance for the nominal number ($n = 6$) stopping rule to provide a reasonable estimate of the LD50. This inability suggests that the stopping rule based on a nominal number of animals should be abandoned. The use of flexible- n stopping rules (e.g., based on the number of reversions or based on the maximum likelihood using a default slope) provided an appreciably higher probability of reasonable results as shown in U.S. EPA Document 5 (original BRD **Appendix C**, final report **Appendix K**).

6.4 Calculation of the Slope and Confidence Interval

A number of computer simulations have tracked the calculation of the slope depending on the assumed slope, the starting dose level, and the true LD50. These data are shown in U.S. EPA Document 6 (original BRD **Appendix C**, final report **Appendix L**). Two methods have been considered for calculation of the slope and confidence interval. One utilizes the UDP in the Supplemental Test and involves a multiple sequence dosing procedure in which three of four runs are conducted simultaneously. The second method (Group Method) is a modification of OECD TG 401 for the Supplemental Test.

6.4.1 Multiple Sequence Dosing

A number of variations of multiple sequence dosing have been simulated. In all cases, the LD50 is determined first. Then, three or four UDP tests are run in parallel beginning at slightly different starting dose levels. Each of these runs is complete when the first animal dies. The individual data for all runs, including the initial LD50 run, are then combined and used in a probit analysis to estimate the LD50 and slope of the dose-response curve. Data from computer simulations for this procedure are provided in U.S. EPA Document 6 (original BRD **Appendix C**, final report **Appendix L**). The number of animals used is greater than in the Primary Test, but only one animal per run (three or four total) should be killed by the test substance in the Supplemental Test.

6.4.2 Group Method Dosing

This method involves dosing groups of ten or more animals at established lethality points (e.g., LD10, LD16, LD84) derived from the dose-response curve. Data for this procedure are given in U.S. EPA Document 6, Part B (original BRD **Appendix C**, final report **Appendix L**). The group method labeled “Best Estimate” provides better results, but utilizes 30 animals not including those required for the LD50 determination (an additional seven animals for the LD50 determination). The group method works fairly well for steep slopes, but generally uses more animals than OECD TG 401 (37 animals plus seven animals for the LD50 determination).

6.5 Hazard Classification

All three of the *in vivo* validation studies resulted in the estimation of the LD50 for the substances studied; a direct comparison of the UDP to the OECD TG 401 in toxic classification is shown in **Table 6-3**. For the Bruce (1987) and the Bonnyns et al. (1988) studies, there is 100% agreement between the current UDP and OECD TG 401 in the classification of the tested substances. The Yam et al. (1991)

study, the FDP was conducted along with the UDP and the results were compared with the published results of van den Heuvel et al. (1990). The UDP gave the same classification as OECD TG 401 for eight of the ten substances tested. For the remaining substances, the UDP provided a more conservative classification. The FDP resulted in the same classification as OECD TG 401 for seven of the ten substances tested, was less risk averse for two substances, and was more risk averse for the other substance. When compared to the FDP, the UDP gave the same classification for eight of the ten substances and was more conservative for the other two substances (mercuric chloride and 4-aminophenol). A comparison of the results for FDP, ATC, and UDP is provided in **Table 6-4**. Overall, the UDP gave the same classification as OECD TG 401 for 92% of the substances tested and was more conservative (higher classification) for the remaining 8% of the substances tested.

Table 6-3 Toxic Classification

Test Substance	Toxic Classification		
	OECD TG 401	UDP	FDP
Bruce (1987)			
Ingredient	Unclassified	Unclassified	ND
Laundry detergent	Unclassified	Unclassified	ND
Ingredient	Unclassified	Unclassified	ND
Laundry detergent	Unclassified	Unclassified	ND
Laundry detergent	Unclassified	Unclassified	ND
Shampoo	Unclassified	Unclassified	ND
Flavor	Unclassified	Unclassified	ND
Caffeine	Harmful	Harmful	ND
Potassium hydroxide	Harmful	Harmful	ND
Dishwashing detergent	Unclassified	Unclassified	ND
Bonnyns et al. (1988)			
Barium acetate	Harmful	Harmful	ND
Barbital	Harmful	Harmful	ND
Coumarine	Harmful	Harmful	ND
Allyl heptanoate	Harmful	Harmful	ND
Diquat	Harmful	Harmful	ND
Yam et al. (1991)			
Nicotine	Toxic	Toxic	Toxic
Na pentachlorophenate	Harmful	Harmful	Harmful
Na arsenite	Toxic	Toxic	Toxic
p-Dichlorobenzene	Unclassified	Unclassified	Unclassified
Fentin hydroxide	Toxic	Toxic	Harmful
Acetanilide	Harmful	Harmful	Unclassified
Tetrachlorvinphos	Unclassified	Unclassified	Unclassified
Piperidene	Harmful	Harmful	Harmful
Mercuric chloride	Toxic	Very Toxic	Toxic
4-Aminophenol	Unclassified	Harmful	Harmful

VT = Very Toxic = LD50 ≤ 50 mg/kg; T = Toxic = LD50 > 50 mg/kg but ≤ 500 mg/kg;

H = Harmful = LD50 > 500 mg/kg but ≤ 2000 mg/kg; U = Unclassified = LD50 > 2000 mg/kg

ND = no data

Table 6-4 Comparison of the FDP, the ATC, and the UDP

OECD Test Alternative	Number of Test Substances	Number of Test Comparisons	Alternative Test Hazard Classification Compared to That of Standard Test (%)			Reference
			Same Hazard	Greater Hazard	Lesser Hazard	
FDP	41	41	75.6	4.9	19.5	van den Heuvel et al., 1987
	20	414	80.2	3.5	16.3	van den Heuvel et al., 1990
ATC	30	179	86	9.0	5.0	Schlede et al., 1992
	20	175	86	5.3	8.7	Schlede et al., 1995
UDP	25	25	92.0	8.0	0	Lipnick et al., 1995

7.0 Test Method Reliability (Repeatability/Reproducibility)

There are no known *in vivo* data on the reliability and repeatability of the Revised UDP. The current UDP has been shown to perform well when compared to OECD TG 401 (see **Section 6.0**). The OECD agreed when approving the UDP that the dosing method and observations were identical to OECD TG 401 and the ATCM, therefore, the inter- and intra-laboratory variability should also be identical. Data are presented for the repeatability and reproducibility acute oral toxicity studies. Using computer simulations, the repeatability and reproducibility of the Revised UDP has led to an optimized protocol.

7.1 Inter-laboratory Reproducibility for Acute Oral Toxicity Studies

In 1964, Griffith studied inter-laboratory variation in determining the acute oral LD50. Four substances were tested at six contract or industrial toxicity testing laboratories. Four laboratories utilized male and female Sprague-Dawley rats weighing between 200 and 300 g and two laboratories used male rats only. Four laboratories fasted the rats before dosing, whereas two laboratories did not fast the rats. The laboratories were free to decide how to prepare the doses and when a vehicle should be used. Five laboratories used water and one used corn oil. All substances were delivered to the laboratory as coded substances and all doses were administered via oral gavage. A total of four different statistical methods were used to calculate the LD50.

The ratio of the highest LD50 value to the lowest LD50 value ranged from 2.0 for sodium bicarbonate to 2.8 for sodium alkyl benzene sulfonate. The results for each substance are given in **Table 7-1**. For laboratories using the same concentration of the test substance in water, the resulting LD50 values were less variable. Dosing in corn oil seemed to lessen the toxic effects of the three substances administered in a vehicle, at least when the concentration in corn oil was the same as the concentration in water. Despite all of the differences in the acute oral toxicity protocol for these four substances, the LD50 values were all within a factor of 2.8.

In 1967, Weil and Wright completed an inter-laboratory comparison of eight laboratories studying the acute oral toxicity of 10 substances. Each laboratory conducted the test using three protocols. The first or standardized protocol specified the dose-spacing factor, the strain, weight, and number of rats, the rat diet,

and required overnight fasting of the animals. The second protocol was identical to the first except the laboratory could choose the strain of rat. The third protocol was not directed in any way (i.e., the laboratory conducted the test according to their standard procedures).

Using a standardized protocol, the ratio of the highest LD50 to the lowest LD50 for nine substances ranged from 1.5 to 2.8 as shown in **Table 7-2**. For the 10th substance, the ratio was 5.0. Some of the variability resulted from one laboratory inadvertently utilizing specific pathogen free rats instead of conventional stock rats as specified in the protocol. For that laboratory, the LD50 values were relatively higher when compared to the other laboratories.

Table 7-1 Ratio of Highest to Lowest Inter-Laboratory LD50 values from Griffith (1964)

Test Substance	Highest LD50	Lowest LD50	Ratio
Sodium Bicarbonate	8.29	4.22	1.96
Akylbenzene sulfonate	5.82	2.05	2.84
Granular detergent	7.92	3.56	2.60
Liquid detergent	16.15	7.25	2.23

Table 7-2 Inter-Laboratory LD50 values from Weil and Wright (1967)

Laboratory	Substance									
	1	2	3	4	5	6	7	8	9	10
1	2.24	2.59	0.71	5.66	0.21	3.25	8.00	6.73	0.77	6.50
2	2.12	1.50	0.42	5.60	0.20	2.38	8.48	4.06	1.23	4.24
3	2.46	2.80	0.28	5.90	0.21	4.92	9.90	8.91	1.97	8.12
4	1.62	1.87	0.71	4.92	0.27	4.92	7.46	7.46	1.23	2.83
5	2.46	1.23	0.54	4.29	0.13	2.83	6.50	2.83	0.81	3.36
6	2.26	1.97	0.57	4.53	0.17	3.94	6.86	9.05	0.70	4.85
7	1.54	1.54	0.34	3.54	0.13	4.06	8.12	14.1	1.17	5.45
8	2.14	1.19	0.71	4.24	0.16	4.00	9.85	5.04	1.29	3.57
Absolute LD50 Ratio	1.6	2.4	2.5	1.7	2.0	2.1	1.5	5.0	2.8	2.8

The results using the second protocol were almost identical to the results for the standardized protocol; the results using the third protocol were much more variable. For these third protocol studies, nonfasted rats and more mature rats (weighing between 220 and 310 g) resulted in significant differences in the LD50 values.

7.2 Intra-Laboratory Repeatability for Acute Lethality Studies

In 1966, Weil and coworkers reported results for an intra-laboratory study of the acute oral toxicity of 26 substances. The LD50 values were determined for almost all substances in 11 of 12 consecutive years. Each test utilized nonfasted rats (predominantly males) weighing between 90 and 120 g. Over the 12 years, six strains of rats were used and eleven technicians were involved with dosing. The substances were administered neat, in water, in corn oil, or in Tergitol®.

The ratio of the highest LD50 to the lowest LD50 value for each substance ranged from 1.33 for dipropylene glycol to 3.18 for monoethanolamine. The results for all 26 substances are provided in **Table 7-3**. Considering the variations in strains of rat, varying use of a vehicle, and different technicians, the acute oral toxicity test is quite reproducible.

In 1967, Weil and Wright reported the results of an acute oral toxicity study conducted in eight laboratories using ten different substances. Each laboratory conducted the test using three protocols. By comparing the results for the three protocols for each laboratory, an indication of intra-laboratory variation was ascertained. The specific LD50 data were not provided, but the data were reported using a ranking procedure. Using a relative rank procedure based on the sum of ranks for all 10 substances, essentially no differences were noted in the three protocols as the sum of ranks were 15, 15, and 17, respectively, as shown in **Table 7-4**.

Table 7-3 Intra-Laboratory Repeatability from Weil et al. (1966)

Test Substance	LD50 Ratio (High/Low)
Mesityl oxide	2.00
2,4-Pentane dione	1.63
2-Ethyl butyric acid	3.02
Isophorone	2.96
Diethanolamine	2.19
Morpholine	1.74
Monoethanolamine	3.18
Butyl cellosolve	2.11
2-Ethyl hexanoic acid	2.19
2-Ethyl hexanol	2.11
Methyl cellosolve	1.65
n-Butanol	2.43
Diethyl carbitol	2.28
2-Ethylhexenediol	3.15
Diisobutyl ketone	2.25
Diacetone alcohol	1.50
Butyl carbitol	2.72
Triethanolamine	2.05
Ethylene glycol	2.00
Methyl carbitol	1.56
Carbitol	1.96
UCON LB-400	2.79
Dipropylene glycol	1.33
Diethylene glycol	1.74
Triethylene glycol	1.92
Propylene glycol	1.52

Table 7-4 Relative Rank of Sum of Ranks for LD50 values (Weil and Wright, 1967)

Procedure	Laboratory								Sum
	1	2	3	4	5	6	7	8	
I	3	1	2	2.5	1	3	1.5	1	15
II	2	2	1	2.5	2	1	1.5	3	15
III	1	3	3	1	3	2	3	2	17

7.3 Other Studies

Zbinden and Flury-Roversi (1981) reviewed acute oral toxicity data from the open literature and noted many factors that may affect the determination of the LD50 including:

animal species	ambient temperature
age of the animals	housing conditions
weight of the animals	seasonal variations
sex of the animals	humidity
genetic influence (strain differences)	light/dark cycle
animal health	noise
diet	weather (barometric pressure)
food deprivation	technician training
dosing procedure	acclimation period

All of these factors are important and over time the protocol has become standardized in an attempt to minimize variability. After Zbinden and Flury-Roversi (1981) noted these factors affecting variability, they claimed the LD50 test was unreliable because the open literature shows values ranging from 3.66 to 11.89 fold. It should be noted that the data producing high variability were not generated using a standardized protocol (e.g., the weight of the male rats varied from 52 to 400 g); had the data been generated using a standard protocol, they likely would not have varied beyond a factor of three, as observed in the studies summarized above.

Based on inspection of LD50 data available from RTECS or other reference texts and databases, the LD50 reported for several species and multiple strains using differing protocols varies by a factor of 10 or more. Such a compilation is not adequate to evaluate inter- or intra-laboratory variation.

7.4 The Need for Additional Repeatability/Reproducibility Studies

Reference acute oral toxicity data were obtained from inter- and intra-laboratory studies using protocols predating OECD TG 401. It is clear from these results that the protocols for acute oral toxicity studies needed to be standardized if the results for various studies are to be compared. OECD TG 401 is standardized and the results in inter- and intra-laboratory studies show that the method provides an estimate of the true LD50 within a factor of approximately three. As OECD TG 401 has been considered the classical method for many years, new or alternative methods should yield results comparable to those obtained using this protocol.

7.5 Inter-Laboratory Reproducibility Studies Using the FDP and the ATC

Two multi-laboratory international studies have generated data regarding the inter-laboratory reproducibility of two acute toxicity methods. In the first study, van den Heuvel et al. (1990) reported the results of 33 laboratories in 11 countries studying 20 coded substances using the FDP. With participation from 33 laboratories, one laboratory advised on preparation and distribution of the 20 substances, a second laboratory performed a classical LD50 test on each substance, and the remaining 31 laboratories conducted the FDP. The laboratories performing the FDP were free to choose the strain of rat; 21 used Sprague-Dawley rats, 9 used Wistar rats, and one used Fischer 344 rats. The age of rats at study initiation was from 8 to 12 weeks and their weight was $\pm 20\%$ of the mean. The exact strain, age, and weight used in each study were not provided. Animals were dosed at 5, 50, 500, or 2000 mg/kg and the results were matched with the then current European Commission (EC) classification scheme. The reproducibility of the FDP is illustrated in **Table 7-5**.

Of 516 comparisons, the authors reported 414 (80.2%) of the FDP classifications were the same as the LD50 test. For 84 comparisons (16.3%), the FDP underclassified the substances and for 18 comparisons (3.5%), the FDP overclassified the substances. Fentin hydroxide, 2-chloroethanol, and 4-aminophenol were underclassified by 69%, 27%, and 35% of the testing laboratories, respectively. 1-Phenyl-2-thiourea was overclassified by 46% of the testing laboratories. The authors stated that the variability of the results for 1-phenyl-2-thiourea was probably due to solubility problems. For fentin hydroxide, wide variations were due in part to strain and weight differences in the rats; the Fischer 344 rats used by one laboratory were reported to be twice as large as the other strains. This variation equates to large differences in age because Fischer 344 rats are usually smaller than Sprague-Dawley or Wistar rats of the same age. The results for 4-aminophenol and 2-chloroethanol were not readily explained. According to the authors, the FDP produces “consistent results that are not substantially affected by inter-laboratory variation.”

In the second study, Schlede et al. (1995) reported the results of nine laboratories in five countries studying 20 coded substances using the ATC. Six laboratories used Sprague-Dawley rats, and three laboratories used Wistar rats. No specifications as to age or weight were given except that the weights for all rats used were reported to be $\pm 20\%$ of the mean at study initiation for each laboratory. Based on a comparison with LD50 data (selected from various sources in the open literature), eight of the 20 substances were classified correctly by all laboratories reporting data. The reliability of the ATC is illustrated in **Table 7-6**.

Of 173 comparisons, 136 (79%) of the ATC classifications were the same for all laboratories reporting data. Indomethacin, *N*-phenylthiourea, and bis(tributyltin)oxide were underclassified by 56%, 56%, and 78% of the testing laboratories, respectively. Cadmium chloride was overclassified by 67% of the testing laboratories. No explanation was provided for these deviations. According to the authors, the ATC is “a reliable alternative to the LD50 test.”

Despite the variability due to strain, age, and weight of rats, the FDP and the ATC were reasonably consistent for all of the substances tested (only three substances spanned three classes). These two international studies support the overall reproducibility of *in vivo* acute toxicity data and would suggest that there is no need for additional *in vivo* inter-laboratory validation studies for the UDP (see U.S. EPA Document 13; original BRD **Appendix C**, final report **Appendix J-1**).

Table 7-5 Inter-Laboratory Reproducibility of FDP (van den Heuvel et al., 1990)

Substance	LD50 (mg/kg)	Number of Labs Classifying (n=26)*		
		Correctly	Over	Under
Class 3 (0 - 25 mg/kg)†				
Aldicarb (10%)	3.2-5.0	22		
Class 2 (25 – 200 mg/kg)				
Phenyl mercury acetate	37	24	2	
Sodium arsenite	48	25		1
2-Chloroethanol	60	19		7
Nicotine	71	23		3
Fentin hydroxide	119	8		18
1-Phenyl-2-thiourea	126-400	12	12	2
Mercuric chloride	160	25		1
Class 1 (200 – 2000 mg/kg)				
Sodium pentachlorophenate	309	25	1	
Piperidine	488	24	2	
Resourcinol	489	25		1
Ferrocene	1260-2000	3		23
Acetanilide	1893	4		22
Class 0 (2000 – ∞ mg/kg)				
<i>p</i> -Dichlorobenzene	>2000	26		
Quercetin dihydrate	>2000	26		
Tetrachloevinphos	>2000	25	1	
Naphthalene	>2000	26		
Acetonitrile	>2000	22	4	
Dimethyl formamide	>2000	26		
4-Aminophenol	>3000	17	9	
Totals (n=516)		407	31	78

*Correctly = predicted same hazard classification as OECD TG 401; Over = predicted greater hazard than OECD TG 401; Under = predicted lesser hazard than OECD TG 401

†Actual doses utilized were 5, 50, 500, or 2000 mg/kg

Table 7-6 Inter-Laboratory Reproducibility of ATC (Schlede et al., 1995)

Substance	LD50 (mg/kg)	Number of Labs Classifying (n=9)*		
		Correctly	Over	Under
Class 3 (0 – 25 mg/kg)				
Aldicarb	1	9		
Parathion	4	9		
N-Phenylthiourea	9	4		5
Thiosemicarbazide	12	9		
Indomethacin	13	4		5
Class 2 (25 – 200 mg/kg)				
Mercuric oxide	29	8	1	
Sodium arsenite	38	8	1	
Bis(tributyltin)oxide	147	2		7
Acrylamide	163	8		1
Class 1 (200 – 2000 mg/kg)				
Cadmium chloride	237	3	6	
Caffeine	270	8	1	
Aniline	822	9		
Ferrocene	1280	9		
Sodium salicylate	1601	6		
Acetanilide	1689	5		3
Class 0 (2000 - ∞ mg/kg)				
Acetonitrile	2515	5	3	
Butylated hydroxyanisole	2853	5	3	
N,N-Dimethylformamide	4604	7	1	
Quercetin dihydrate	>2000	9		
Ethylene glycol	6336	9		
Totals (n=173)		136	16	21

*Correctly = predicted same hazard classification as OECD TG 401; Over = predicted greater hazard than OECD TG 401; Under = predicted lesser hazard than OECD TG 401

8.0 Test Method Data Quality

8.1 Adherence to Good Laboratory Practices (GLPs)

The studies of Bruce (1987) and Yam et al. (1991) were conducted under CFR Part 792 GLPs. The Bonnyns et al. (1988) study was conducted in Belgium under GLPs of the European Community.

8.2 Results of Data Quality Audits

The QA audit report for the Bruce (1987) study was not available; however, the signed report regarding the conduct of the study according to GLPs was provided. For the Yam et al. (1991) study, the laboratory report including all observations, body weights, and pathology were provided. Individual data sheets for one of the substances were also provided. The QA audit report was not available, but from the data provided, no serious deviations from GLPs were noted. QA audits, study reports, and animal data were not available for the Bonnyns et al. (1988) study or the van den Heuvel et al. (1990) study (the source of the OECD TG 401 data for the Bonnyns study).

8.3 Impact of GLP Deviations and/or Data Audit Non-Compliance

A review of the Bruce (1987) and the Yam et al. (1991) studies did not reveal any discrepancies that would have significantly altered the general conclusions of the study reports.

9.0 Other Scientific Reports and Reviews

9.1 Availability of Additional UDP Data

The only other known toxicity data using the UDP are the unpublished data from the Netherlands (see original BRD **Appendix D**; this appendix was not included in this final report). These data are quite different in that birds were used and were dosed two at a time, resulting in the use of many birds (some sixty animals per study).

9.2 Inhalation Testing and the UDP

Inhalation toxicity testing is more complex than oral or dermal toxicity testing. The purpose of an acute inhalation toxicity study is to provide an assessment and evaluation of the toxic characteristics of an inhalable substance, such as gases, volatile substances, or aerosols/particulates. It also provides information of possible health hazards to a human if exposed via the inhalation route. An acute inhalation toxicity study determines the median lethal concentration (LC50) and its statistical limits and slope using a single exposure duration (usually of 4 hours) and a 14-day post-exposure observation period. Data from an acute study can serve as a basis for classification and labeling; it is also an initial step in establishing a dosage regimen in subchronic and other studies, and might provide additional information on the mode of toxic action of a substance (Technical Committee of the Inhalation Specialty Section, 1992).

Current U.S. EPA guidance indicates that at least five animals of the same sex should be used at each test concentration (Gross and Vocci, 1988; Gross, 1989). After completion of the study in one sex, at least one group of animals of the other sex is exposed to characterize any differential sensitivity to the test substance. The U.S. EPA encourages the use of fewer animals if justified in individual circumstances. Where adequate information is available to demonstrate that animals of the sex tested are markedly more sensitive, testing of the other sex is not required. Where appropriate, a Limit Test may be considered. In the Limit Test, a single group of five males and five females is exposed to 2 mg/L for four hours. In

situations where this concentration is not possible due to the physical properties of the test substance, the animals are exposed to the maximum attainable concentration. If no lethality is observed, no further testing for acute inhalation toxicity is needed. If compound-related mortality results, further study may need to be considered.

Testing one animal at a time, in either a nose only or a whole body exposure chamber, would greatly increase the cost of the assay. The increase in study cost results primarily from the additional chamber time needed, as well as the additional analyses for concentration and particle size required for each run. Study costs would also be increased because the exposure chamber will be unavailable for a different study until the UDP is completed, since only then could the generation system be cleaned and prepared for another test substance. Additionally, from a practical standpoint, compared to simultaneously exposing all animals to the same test concentration, exposing single animals at different times to exactly the same test concentration is more difficult. Thus, it does not appear currently that using a sequential dosing procedures such as the UDP for inhalation toxicity testing is a viable alternative.

9.3 Other Acute Toxicity Methodology

One method worth considering as an alternative to the UPD is the method of Weil (1983). In this method, four groups of three or four animals are dosed using a dose-spacing factor of 2 and the LD50 and slope are calculated using the moving-average method. Using a dose-spacing factor of 1.26 or 2.0, Weil et al. (1953) showed that groups of three or four animals yield an estimate of the LD50 equivalent to that determined using groups of ten animals; thus, with 12 to 16 animals, the LD50, slope, and confidence interval could be determined in a single study. The moving-average method can accommodate dose groups that have 0% or 100% kills. Calculating the slope using probit analysis requires the use of many more animals. In a comparison of 35 pairs of slopes determined using probit analysis and the moving-average method, the correlation coefficient was 0.85. If the dosing is performed in sequence, three dose levels may be sufficient for the study, thereby requiring only 9 to 12 animals total.

Weil (1975) summarized the results of 490 probit analyses for acute oral tests; these summaries generated a median slope of 7.8. Only 8 of 490 had a slope of 2 or less and more than 50 had a slope of 16 or greater, ranging up to a slope of 60; this fact confirms that relatively few test substances have a slope of 2 or less. It also indicates that even for a relatively simple one-dose test, the slope of the dose-response curve for different test substances is quite variable. The uncertainty of the slope in each assay is large compared to the relatively low degree of uncertainty of the LD50. Even with this uncertainty, the slope estimate is critical for risk assessment purposes and probabilistic modeling.

10.0 Animal Welfare Considerations

10.1 Refinement to Address Animal Pain and Suffering

In the Yam et al. (1991) study, the number of toxic signs and deaths in the UDP and OECD TG 401 were compared. The results clearly show that in the UDP, the incidence and severity of pain and suffering were reduced when compared to OECD TG 401. The Revised UDP specifically refers to the OECD Guidance 19 (original BRD **Appendix B**; this appendix is not appended to this final report) on humane endpoints and handling of moribund animals. The use of this guidance document in the training of technicians is key to the refinement process.

10.2 Reduction in Animal Usage

The 1981, OECD TG 401 utilized 50 or more animals to calculate the LD50, slope, and confidence interval. The 1987 revision of OECD TG 401 reduced that number to 20 to 30 animals. The Revised UDP is designed to use 6 to 15 animals in the LD50 determination. The utilization of animals is compared in **Table 10-1** for the three validation studies. A summary table comparing the Revised UDP to OECD TG 401 is presented in **Table 10-2**.

Table 10-1 Animal Usage in OECD TG 401 and the UDP

	Number of animals	
	OECD TG 401	UDP
Bruce (1987)	370	68
Bonnyns et al. (1988)	150	40
Yam et al. (1991)	260	75
TOTALS	780	183

The UDP utilized only 23% of the animals used in OECD TG 401, yet the estimated LD50 values were in good agreement. For the LD50 determination, the Revised UDP will use the same or fewer numbers of animals (usually females) as is used by the current UDP.

Table 10-2 Summary Table of Acute Oral Toxicity Tests
(Assume nothing is known about test substance)

	TG 401 (1981)	TG 401 (1987)	TG 425 (1998)	Revised UDP (2001)
Range-finding study (RFS)	yes	yes	NA	NA
# doses	≥ 3 ^a	≥ 3 ^a		
# animals/dose	5	3		
males/females	both	one		
total animals	30+	9+		
duration ^b	7 days	7 days		
LD50 Estimate	yes	yes	yes	yes
# animals/dose	5/sex	5	1	1
# dose levels	3-6	3+1 ^c	2-13 ^d	2-6 ^c
males/females	both	1/confirm	females	females
total animals	30-60	20 ^c	6-18 ^d	6-10 ^c
starting dose	from RFS	from RFS	100 mg/kg	175 mg/kg
duration ^b	14 days	21 days	22-39 days	26-35 days
Totals for RFS plus LD50 Estimate				
# animals	60 - 90+	29+	6 - 18	6 - 10
duration ^b	21-28 days	28-35 days	22-39 days	26-35 days
Slope Estimate	possible ^f	possible ^f	NA	yes (Supplemental Test)
# runs				4
# doses/run	0-2	0-2		1-4
# animals/dose	5/sex	5		1
total animals	0-10	0-10		4 - 16 ^g
duration ^b	0-14 days	0-14 days		14-18 days
Combined Totals (LD50 and Slope estimates)				
# animals	60 - 100+	29 - 39+	NA	16 - 25
duration ^b	21-42 days	28-49 days	NA	42-53 days

^a minimum of three doses; more if lethality range not bracketed in the first three doses.

^b assume dosing on Monday – Friday only; duration for all tests includes a 14-day post-dosing observation period.

^c three doses tested in first sex plus one dose tested in second sex.

^d starting at 100 mg/kg with a spacing factor of 1.3, 13 dose treatments could occur prior to the first reversal (e.g., the first death at 2000 mg/kg in this example) – 100, 130, 169, 220, 286, 371, 483, 627, 816, 1060, 1380, 1790, and 2000 mg/kg. The total number of animals used would then be 13 plus the 4 after the first reversal or 17 animals. If the animal dosed at 2000 mg/kg lived, then a Limit Test would be conducted (up to 5 more animals for a total of 18 animals).

^e starting at 175 mg/kg with a spacing factor of 3.2, six dose treatments could occur prior to the first reversal (e.g., the first animal to survive in this example was at a dose of 1.0 mg/kg) – 175, 55, 17.5, 5.5, 1.75, and 1.0 mg/kg. The total number of animal would then be 6 plus the 4 after the first reversal or 10 animals. If the animals dosed at 1.0 mg/kg died, then a lower Limit Test would be conducted (up to 4 more animals, also a total of 10 animals).

^f slope estimation requires three dose groups for each sex with partial kills; if not achieved in the LD50 determination, then one or more dose groups may be required.

^g if the first animal in each run dies, then the total is four animals; if death is not observed until the 4th animal in each run, then the total is 16 animals.

10.3 Replacement of the Acute Oral Toxicity Test

Concern has been expressed about the reliability and usefulness of acute oral toxicity tests (Zbinden and Flury-Roversi, 1981). Recently, for humane reasons, increasing interest and support have been given to the use of *in vitro* cytotoxicity methods. Recent advances in *in vitro* cytotoxicity methodology, especially through the Multicentre Evaluation of *In Vitro* Cytotoxicity (MEIC) Program and through validation studies conducted at the Center for Documentation and Evaluation of Alternative Methods to Animal Experiments (ZEBET), have been reported (Ekwall, 1999; Halle, 1998). However, *in vitro* cytotoxicity tests have not yet been validated as a replacement for acute oral toxicity tests. It is possible that such tests could be used to determine the starting dose level in animal studies. An *In Vitro* Cytotoxicity Workshop, sponsored by ICCVAM, has been scheduled for October 17 - 19, 2000 in Crystal City, VA, U.S. to explore these issues.

11.0 Other Considerations

11.1 Gender Sensitivity

Several documents regarding sex sensitivity issues have been reviewed (see U.S. EPA Document 14 - original BRD **Appendix C**, final report **Appendix P**). Because data suggest that the female is more sensitive in the majority of instances, the use of females in the Revised UDP will result in a more protective number in risk assessment action and probabilistic modeling.

11.2 Equipment and Training

The equipment requirements for the Revised UDP are no different than for other acute oral toxicity studies, with the possible exception of the requirement of a computer. Cages, balances, analytical equipment as necessary to confirm the identity of the test substance, possibly waterbaths or mixers to dissolve the substance, dosing syringes, gavage catheters, and necropsy equipment are needed. The only special piece of equipment needed for this revised method is a computer to run a spreadsheet program and a means to run maximum likelihood estimates using an appropriate statistical program. It is anticipated that the stopping rule program will be made available in Excel® or another standard format to interested individuals via the OECD or U.S. EPA websites. A program could also be written, as described in the UDP guideline, by the investigator.

Training requirements are similar to any acute oral toxicity test with emphasis on recognizing animals in a moribund condition and other humane endpoints (see original BRD **Appendix B**; this appendix is not appended to this final report). Technicians must be trained to properly calculate, mix, and administer test substances to rats via oral gavage and trained to make and record observations in an acute toxicity study, including the gross necropsy. They should also be able to make decisions on when to sacrifice a terminally ill animal.

Staff must also be able to use the computer programs. A full description of how to use the stopping rule, with examples, is in the guideline. The use of the maximum likelihood method for calculating the LD50 is a standard statistical program and would require someone with appropriate experience. Dosing and observations are similar to any other acute toxicity protocol. It is important for all acute toxicity studies that the technicians running the studies be trained in making and recording observations correctly.

11.3 Costs Comparisons for TG 401 and UDP Studies

Three commercial toxicology laboratories were contacted regarding costs of conducting OECD TG 401 and OECD TG 425. The comparisons are given below.

Test	Laboratory 1	Laboratory 2	Laboratory 3
Range-Finding Study	\$800	\$950	\$2,900
Limit Test	\$2,000	\$1,650	\$2,900
TG 401 (3 dose levels)	\$5,000	\$3,600	\$6,900
UDP			\$6,900
Primary Test	\$2,000	\$3,300	
Limit Test	\$2,000	\$1,650	
Supplemental	\$800/run	\$300/animal	

For Laboratory 1, the cost for an OECD TG 401 study is \$5,000. For the UDP, the cost would be \$2,000 for the Primary Study plus \$3,200 (four runs) for the Supplemental Test for a total of \$5,200. Thus, the costs are essentially equal.

For Laboratory 2, the cost for the OECD TG 401 study is \$950 plus \$3,600 for three levels for a total of \$4,550. For the UDP, the Primary Test is \$3,300 plus \$2,400 (four runs with 2 animals each) for a total of \$5,700. In this laboratory, the UDP cost is slightly greater than that for TG 401.

For Laboratory 3, the cost of the OECD TG 401 study and the UDP study (Primary and Supplemental) are equal.

Overall, the cost of the UDP study appears to be essentially the same as for the OECD TG 401 study. However, as many laboratories are not experienced with the UDP, these costs estimates may be expected to change.

11.4 Time Comparisons for Conducting TG 401 and UDP Studies

The UDP will require approximately two additional weeks when compared to OECD TG 401. This added time is attributed to the sequential dosing of all animals at 48-hour intervals in each UDP run and to the fact that the Primary Test is completed prior to the start of the Supplemental Test. In terms of technician time, there is little difference between the two tests as suggested in the above cost analysis.

12.0 References

- ASTM (American Society for Testing and Materials). 1987. Standard Test Method for Estimating Acute Oral Toxicity in Rats. ASTM E1163-87. In: Annual Book of ASTM Standards, Philadelphia.
- BMDP Statistics Software, Inc. (1990). BMDP Statistical Software Manual. W.J. Dixon, Chief Ed. 1990 rev. or later. University of California Press, Berkeley, CA, USA.
- Bonnyns, E., M.P. Delcour, and A. Vral. 1988. Up-and-Down method as an alternative to the EC-method for acute toxicity testing. IHE Project No. 2153/88/11. Institute of Hygiene and Epidemiology, Ministry of Public Health and the Environment, Brussels. 33 pp.
- Bruce, R.D. 1987. A confirmatory study for the up-and-down method for acute toxicity testing. *Fundam. Appl. Toxicol.* 8: 97-100.
- Bruce, R.D. 1985. An up-and-down procedure for acute toxicity testing. *Fundam. Appl. Toxicol.* 5: 151-157.
- Dixon, W.J. 1991. Design and analysis of quantal dose-response experiments (with emphasis on staircase designs). Dixon Statistical Associates, Los Angeles CA, USA.
- Ekwall, B. 1999. Overview of the Final MEIC Results: II. The *in vitro/in vivo* evaluation, including the selection of a practical battery of cell tests for prediction of acute lethal blood concentrations in humans. *Toxicol. In Vitro* 13(4-5):665-673.
- Finney, D.J. 1978. *Statistical Methods in Biological Assay*. Griffin, London.
- Finney, D.J. 1971. *Probit analysis*. 3rd ed. Cambridge Univ. Press, Cambridge, U.K.
- Griffith, J.F. 1964. Interlaboratory variations in the determination of acute oral LD50. *Toxicol. Appl. Pharmacol.* 6: 726-730.
- Gross, S.B. April 18, 1989. Memorandum subject: comments on standard evaluation procedure. Inhalation Toxicology Testing (SEP/Inhalation).
- Gross, S.B., and F.J. Vocci. August 1988. Hazard evaluation division standard evaluation procedure inhalation toxicity testing. U.S. EPA-540/09-88-101.
- Halle, W. 1998. Toxizitätsprüfungen in zellkulturen für eine vorhersage der akuten toxizität (LD50) zur einsparung von tierversuchen. *Life Sciences/ Lebens-wissenschaften*, Volume 1, 94 pp., Jülich: Forschungszentrum Jülich.
- Lipnick, R.L., J.A. Cotruvo, R.N. Hill, R.D. Bruce, K.A. Stitzel, A.P. Walker, I. Chu, M. Goddard, L. Segal, J.A. Springer, and R.C. Myers. 1995. Comparison of the up-and-down, conventional ld50, and fixed-dose acute toxicity procedures. *Food Chem. Toxicol.* 33: 223-231.
- Litchfield, J.T., Jr. and F. Wilcoxon. 1949. A simplified method of evaluating dose-effect experiments. *J. Pharmacol. Exp. Ther.* 96:99-113.

- Luttik, R. and T. Aldenberg. 1997. Extrapolation Factors for Small Samples of Pesticide Toxicity: A Special Focus on LD50 Values for Birds and Mammals. *Environ. Toxicol. Chem.* 16: 1785-1788.
- Organisation for Economic Co-operation and Development (OECD). 1999. OECD Guideline for Testing Chemicals Revised 420: Acute Oral Toxicity - Fixed Dose Procedure. OECD, Paris. [updated in 2000]
- OECD. 1999. OECD Guideline for Testing Chemicals Revised 423: Acute Oral Toxicity - Acute Toxic Class Method. OECD, Paris. [updated in 2000]
- OECD. 1998. OECD Guideline for Testing Chemicals 425: Acute Oral Toxicity: Up-and-Down Procedure. OECD, Paris.
- OECD. 1998. Harmonized Integrated Hazard Classification System for Human Health and Environmental Effects of Chemical Substances as endorsed by the 28th Joint Meeting of the Chemicals Committee and Working Party on Chemicals in November 1998, Part2, pg 11.
<http://www.oecd.org/ehs/Class/HCL6.htm>
- OECD. 1987. OECD Guideline for Testing Chemicals 401: Acute Oral Toxicity. OECD, Paris.
- OECD. 1981. OECD Guideline for Testing Chemicals 401: Acute Oral Toxicity. OECD, Paris.
- OPPTS Harmonized Test Guidelines. August 1998. Series 870 Health Effects, Volume I of III, Guideline OPPTS 870.1300 Acute Inhalation Toxicity.
- SAS Institute Inc. (1990). SAS/STAT® User's Guide. Version 6, Fourth Ed. or later. Cary, NC, USA.
- Schlede, E., W. Diener, U. Mischke, and D. Kayser. 1994. OECD expert meeting: acute toxic class method. January 26-28, 1994, Berlin, Germany.
- Schlede, E., U. Mischke, W. Diener, and D. Kayser. 1995. The international validation study of the acute toxic class method (oral). *Arch. Toxicol.* 69: 659-670.
- Schlede, E., U. Mischke, R. Roll, and D. Kayser. 1992. A national validation study of the acute toxic class method - an alternative to the LD50 test. *Arch. Toxicol.* 66: 455-470.
- Sheehan P.J., A. Baril, P. Mineau and D. Paustenbach. 1995. "Predicting the Effects of Pesticides on Aquatic Systems and the Waterfowl that Use Them. Chapter 30 in "Fundamentals of Aquatic Toxicology". Second edition, G.M. Rand (Ed.), Taylor and Francis, North Palm Beach, Florida. pp. 827-857.
- Technical Committee of the Inhalation Specialty Section. 1992. Society of Toxicology recommendations for the conduct of acute inhalation limit tests. *Fundam. Appl. Toxicol.* 18: 321-327.
- Trevan, J.W. 1927. The error of determination of toxicity. *Proc. Royal Soc.* 101B: 483-514.
- van den Heuvel, M.J., D.G. Clark, R.J. Fielder, P.P. Koundakjian, G.J.A. Oliver, D. Pelling, N.J. Tomlinson, and A.P. Walker. 1990. The international validation of a fixed-dose procedure as an alternative to the classical LD50 test. *Food Chem. Toxicol.* 28: 469-482.
- van den Heuvel, M.J., A.D. Dayan, and R.O. Shillaker. 1987. Evaluation of the BTS approach to the testing of substances and preparations for their acute toxicity. *Human Toxicol.* 6: 279-291.

Weil, C.S. 1983. Economical LD50 and slope determinations. *Drug Chem. Toxicol.* 6 :595-603.

Weil, C.S. 1975. Toxicology experimental design and conduct as measured by interlaboratory collaborative studies. *J. Off. Anal. Chem.* 58: 683-688.

Weil, C.S., and G.J. Wright. 1967. Intra- and interlaboratory comparative evaluation of a single oral test. *Toxicol. Appl. Pharm.* 11: 378-388.

Weil, C.S., C.P. Carpenter, and H.F. Smyth. 1953. The median effective dose. *Ind. Hyg. Q.* 14: 200-206.

Weil, C.S., C.P. Carpenter, J.S. West, and H.F. Smyth. 1966. Reproducibility of single oral dose toxicity testing. *Am. Ind. Hyg. Assoc. J.* 27: 483-487.

Yam, J., P.J. Reer, and R.D. Bruce. 1991. Comparison of the up-and-down method and the fixed-dose procedure for acute oral toxicity testing. *Food Chem. Toxicol.* 29:259-263.

Zbinden, G., and M. Flury-Roversi. 1981. Significance of the LD50 test for the toxicological evaluation of chemical substances. *Arch Toxicol.* 47: 77-99.

OECD GUIDELINE FOR THE TESTING OF CHEMICALS

The Up-and-Down Procedure for Acute Oral Toxicity: Proposed Test Guideline

INTRODUCTION

1. OECD guidelines for the Testing of Chemicals are periodically reviewed in the light of scientific progress or changing assessment practices. The concept of the up-and-down testing approach was first described by Dixon and Mood (1)(2)(3)(4). In 1985, Bruce proposed to use an up-and-down procedure (UDP) for the determination of acute toxicity of chemicals (5). There exist several variations of the up-and-down experimental design for estimating an LD50. This guideline is based on the procedure of Bruce as adopted by ASTM in 1987 (6) and revised in 1990. A study comparing the results obtained with the UDP, the conventional LD50 test and the Fixed Dose Procedure (FDP, Guideline 420) was published in 1995 (7). Since the early papers of Dixon and Mood, papers have continued to appear in the biometrical and applied literature, examining the best conditions for use of the approach (8)(9)(10)(11). Based on the recommendations of several expert meetings in 1999, an additional revision was considered timely because: i) international agreement had been reached on harmonised LD50 cut-off values for the classification of chemical substances, ii) testing in one sex (usually females) is generally considered sufficient, and iii) revision was being undertaken concurrently for two other alternatives to the conventional acute oral toxicity test, described in Test Guideline 401.

2. This test procedure is of value in minimizing the number of animals required to estimate the acute oral toxicity of a chemical as indicated by an estimated LD50, given knowledge before testing of the approximate LD50 and slope. In addition to the observation of mortality, the test allows the observation of signs of toxicity. A supplemental procedure also allows estimation of the slope of the dose response curve.

3. Definitions of some terms are in Appendix I.

INITIAL CONSIDERATIONS

4. All available information on the test substance should be considered by the testing laboratory prior to conducting the study. Such information will include the identity and chemical structure of the substance; its physical chemical properties; the results of any other *in vitro* or *in vivo* toxicity tests on the substance; toxicological data on structurally related substances; and the anticipated use(s) of the substance. This information is necessary to satisfy all concerned that the test is relevant for the protection of human health, and will help in the selection of an appropriate starting dose.

5. When designing a UDP test, if no information is available to make a preliminary estimate of the LD50 and/or the slope of the dose response curve, results of computer simulations have suggested that starting near 175 mg/kg and using half-log units (corresponding to a dose progression of 3.2) between doses will produce the best results. The half-log spacing balances a more efficient use of animals, while reducing bias in the prediction of the LD50 value. Coupled

with this concern, in order that any bias will not lead to under-classification, it is essential that initial dosing occur below the estimated LD50. However, for chemicals with large variability (i.e., shallow dose-response slopes), simulations indicate that bias can still be introduced in the lethality estimates and the LD50 has a large statistical error, similar to other acute toxicity methods. To correct for this, the single-sequence test as described herein includes a stopping rule not keyed to a fixed number of test observations but to properties of the estimate. Although the stopping rule is applied to all data, simulations have shown that it will make no essential difference in animal usage for the great majority of chemicals.

6. The UDP is easiest to apply to materials that produce death within one or two days. The method would not be practical to use when considerably delayed death (five days or more) can be expected.
7. Computers are used to facilitate animal-by-animal calculations that establish testing sequences and provide final estimates.
8. During the test, all animals obviously in pain or showing signs of severe distress should be humanely killed.
9. A limit test can be used efficiently to identify chemicals that are likely to have low toxicity.

PRINCIPLE OF THE PRIMARY (SINGLE ESTIMATE) TEST

10. For each run, animals are dosed, one at a time, at 48 hour intervals. The first animal receives a dose a step below the level of the best estimate of the LD50. If the animal survives, the dose for the next animal is increased to a factor of 3.2 times the original dose; if it dies, the dose for the next animal is decreased by a similar dose progression. (Note: 3.2 is the default factor. Paragraph 20 provides further guidance for choice of dose spacing factor.) Each animal should be observed carefully for 48 hours (unless the animal dies) before making a decision on whether and how much to dose the next animal. That decision is based on the survival pattern of all the animals up to that time. A combination of stopping criteria is used to keep the number of animals low while adjusting the dosing pattern to reduce the effect of a poor starting value (see paragraph 20). Dosing may be stopped when an estimate of LD50 is obtained which satisfies these criteria (see paragraphs 20 and 33). In typical cases for most applications, testing will be completed with only 4 animals after initial reversal in animal outcome. In any event, the test uses no more than 15 animals. The LD50 is calculated using the method of maximum likelihood (12)(13). A description of the maximum likelihood procedure is in paragraphs 31 and 32.

PRINCIPLE OF THE SUPPLEMENTAL TEST

11. When an estimation of slope is desired, the primary procedure serves as the starting point for a tailored testing and estimation routine. The supplemental procedure also provides a confidence interval for the LD50. A description of this supplemental procedure starts at paragraph 22 and the formula for this calculation is provided in paragraph 34. It is based on the

principle that multiple sequences with associated LD50s give an estimate of the standard error of the estimate of the LD50, which is related to the slope in a known way.

DESCRIPTION OF THE METHOD

Selection of animals species

12. The preferred rodent species is the rat although other rodent species may be used. In the normal procedure, female rats are used because literature surveys of conventional LD50 tests show that, although there is little difference of sensitivity between sexes, in those cases where differences were observed, females were in general more sensitive. When there is adequate information to infer that males are more sensitive, they should replace females in the test.

13. Healthy young adult animals should be employed. Littermates should be randomly assigned to treatment levels. The females should be nulliparous and non-pregnant. At the commencement of the study, the weight variation of the animals should be minimal and not exceed $\pm 20\%$ of the mean weight for each sex. The test animals should be characterised as to species, strain, source, sex, weight and/or age.

Housing and feeding conditions

14. The temperature in the experimental animal room should be 22°C ($\pm 3\%$ C). Although the relative humidity should be at least 30 % and preferably not exceed 60 % other than during room cleaning, the aim should be 50-60 %. Lighting should be artificial, the sequence being 12 hours light and 12 hours dark. The animals are housed individually. Unlimited supply of conventional rodent laboratory diets and drinking water should be provided.

Preparation of animals

15. The animals are uniquely identified and kept in their cages for at least five days prior to dosing for acclimatization to the laboratory conditions. During acclimatization the animals should be observed for ill health. Animals demonstrating signs of spontaneous disease or abnormality prior to the start of the study are eliminated from the study.

Preparation of doses

16. When necessary, the test substance is dissolved or suspended in a suitable vehicle. It is recommended that, whenever possible, the use of an aqueous solution or suspension be considered first, followed by consideration of a solution or emulsion in oil (e.g. corn oil) and then by possible solution in other vehicles. For vehicles other than water, the toxicity of the vehicle must be known. In rodents, the volume should not normally exceed 1 mL/100 g body weight; however, in the case of aqueous solutions 2 mL/100 g body weight can be considered.

PROCEDURE

Primary testing using a single-sequence of dosing

17. For selecting the starting dose, all available information should be used, including information on structure-activity relationships. When the information suggests that mortality is unlikely, a limit test should be conducted (see paragraph 23). When there is no information on the substance to be tested, it is recommended that the starting dose of 175 mg/kg body weight be used (see Appendix II). This dose serves to reduce the level of pain and suffering by starting at a dose which in most cases will be sublethal. In addition, this dose reduces the chance that hazard of the chemical will be underestimated.

18. For each run, single animals are dosed in sequence usually at 48 h intervals. However, the time intervals between dosing should not be fixed rigidly and may be adjusted as appropriate (e.g., in case of delayed mortality). The first animal is dosed a step below the toxicologist's best estimate of the LD50. If no estimate of the chemical's lethality is available, dosing should be initiated at 175 mg/kg. If the animal survives, the second animal receives a higher dose. If the first animal dies or appears moribund, the second animal receives a lower dose (see paragraph 20 for size of dose spacing). Animals killed for humane reasons are considered in the same way as animals that died on test. Dosing should not normally exceed 2000 mg/kg body weight. However, when justified by specific regulatory needs, testing up to 5000 mg/kg body weight may be considered.

19. Moribund state is characterised by symptoms such as shallow, labored or irregular respiration, muscular weakness or tremors, absence of voluntary response to external stimuli, cyanosis and coma. Criteria for making the decision to humanely kill moribund and severely suffering animals are the subject of the separate OECD *Guidance Document on the Recognition, Assessment and Use of Clinical Signs as Humane Endpoints for Experimental Animals used in Safety Evaluation*

20. The dose for each successive animal is adjusted up or down, depending on the outcome of the previous animal. At the outset, if feasible, a slope of the dose response should also be estimated based on all information available to the toxicologist including structure activity relationships. The dose progression factor should be chosen to be the antilog of 1/(the estimated slope of the dose response curve). When there is no information on the substance to be tested, a dose progression factor of 3.2 is used. Dosing continues depending on the outcomes of all the animals up to that time. In any event, if 15 animals have been tested, testing stops. Prior to that, the test is stopped based on the outcome pattern if:

- (1) the upper testing bound is reached and 3 consecutive animals survive at that bound or if the lower bound is reached and 3 consecutive animals die at that bound, or
- (2) the next animal to be tested would be the 7th and each surviving animal to this point has been followed by a death and vice versa (i.e., 5 reversals occur in 6 animals started), otherwise;
- (3) evaluation whether testing stops or continues is based on whether a certain stopping criterion is met: Starting following the fourth animal after the first reversal (which may be as early as the decision about the seventh animal), three measures of test progress are

compared via two ratios. If the first measure is at least two-and-one-half times both the other measures (i.e., both ratios are 2.5), testing is stopped. (see paragraph 33 and Appendix III). For a wide variety of combinations of LD50 and slopes as low as 2.5, the stopping rule will be satisfied with four to six additional animals, with fortuitously well-placed tests using even fewer. However, for chemicals with shallow dose-response slope (large variance), more animals may be needed. If animal tolerances to the chemical are expected to be highly variable (i.e., slopes are expected to be less than 3), consideration should be given to increasing the dose progression factor beyond the default 0.5 log dose (i.e., 3.2 progression factor) prior to starting the test.

21. When the stopping criteria have been attained after the initial reversal, the LD50 should be calculated using the method described in paragraphs 31 and 32.

Supplemental Test: Estimate an LD50 and Slope of the Dose Response Curve

22. Following the primary test, a supplemental test to estimate the slope of the dose-response curve can be implemented when necessary. This procedure uses multiple testing sequences similar to the primary test, with the exception that the sequences are intentionally begun well below the LD50 estimate from the primary test. These test sequences should be started at doses at least 10 times less than the LD50 estimate from the primary test, and not more than 32 times less. Testing continues in each sequence until the first animal dies. Doses within each sequence are increased by the standard 3.2 factor. The starting doses for each test sequence should be staggered, as described in Appendix II, paragraph 6. Upon completion of up to six of these supplemental test sequences, a standard probit analysis should be run on the entire collection of data, including the outcomes of the primary test. Good judgment will be required in cases where the primary test yields estimates of LD50 that are too close to the lower limit of doses tested. When this occurs, testing may be required to begin well above the LD50, where deaths are likely, and each sequence will terminate with the first survivor. If slope may be highly variable, an alternate procedure, using varying dose progression sizes, may be appropriate as shown in Appendix IV.

Limit test

23. Dosing should not normally exceed 2000 mg/kg body weight. However, when justified by specific regulatory needs, testing up to 5000 mg/kg body weight may be considered. One animal is dosed at the upper limit dose; if it survives, two more animals are dosed sequentially at the limit dose; if both animals survive, the test is stopped. If one or both of these two animals die, two animals are dosed sequentially at the limit dose until a total of three survivals or three deaths occurs. If three animals survive, the LD50 is estimated to be above the limit dose. If three animals die, the LD50 is estimated to be at or below the limit dose. If the first animal dies, a primary test should be run to determine the LD50 (see paragraph 11 of appendix II). As with any limit test protocol, the probability of correctly classifying a compound will decrease as the actual LD50 approaches the limit dose. The selection of a sequential test plan increases the statistical power and also has been made to intentionally bias the procedure towards rejection of the limit test for compounds with LD50s near the limit dose, i.e., to err on the side of safety.

Administration of doses

24. The test substance is administered in a single dose to the animals by gavage using a stomach tube or a suitable intubation cannula. The maximum volume of liquid that can be administered at one time depends on the size of the test animal. In rodents, the volume should not normally exceed 1 ml/100 g body weight; however, in the case of aqueous solutions 2 ml/100 g body weight can be considered. When a vehicle other than water is used, variability in test volume should be minimised by adjusting the concentration to ensure a constant volume at all dose levels. If administration in a single dose is not possible, the dose may be given in smaller fractions over a period not exceeding 24 hours.

25. Animals should be fasted prior to dosing (e.g., with the rat, food but not water should be withheld overnight; with the mouse, food but not water should be withheld for 3-4 hours). Following the period of fasting, the animals should be weighed and the test substance administered. The fasted body weight of each animal is determined and the dose is calculated according to the body weight. After the substance has been administered, food may be withheld for a further 3-4 hours in rats or 1-2 hours in mice. Where a dose is administered in fractions over a period of time, it may be necessary to provide the animals with food and water depending on the length of the period.

Observations

26. After dosing, animals are observed individually at least once during the first 30 minutes, periodically during the first 24 hours, with special attention given during the first 4 hours, and at least once daily thereafter. The animals should normally be observed for 14 days, except where animals need to be removed from the study and humanely killed for animal welfare reasons or are found dead. However, the duration of observation should not be fixed rigidly. It should be determined by the toxic reactions, time of onset and length of recovery period, and may thus be extended when considered necessary. The times at which signs of toxicity appear and disappear are important, especially if there is a tendency for toxic signs to be delayed (14). All observations are systematically recorded with individual records being maintained for each animal. Toxicology texts should be consulted for information on the types of clinical signs that might be observed.

27. Careful clinical observations should be made at least twice on the day of dosing, or more frequently when indicated by the response of the animals to the treatment, and at least once daily thereafter. Animals found in a moribund condition and animals showing severe pain and enduring signs of severe distress should be humanely killed. When animals are killed for humane reasons or found dead, the time of death should be recorded as precisely as possible. Additional observations will be necessary if the animals continue to display signs of toxicity. Observations should include changes in skin and fur, eyes and mucous membranes, and also respiratory, circulatory, autonomic and central nervous systems, and somatomotor activity and behaviour pattern. Attention should be directed to observations of tremors, convulsions, salivation, diarrhoea, lethargy, sleep and coma.

Body weight

28. Individual weights of animals should be determined shortly before the test substance is administered, at least weekly thereafter, at the time of death or at day 14 in the case of survival. Weight changes should be calculated and recorded.

Pathology

29. All animals, including those which die during the test or are killed for animal welfare reasons during the test and those that survive at day 14, are subjected to gross necropsy. The necropsy should entail a macroscopic inspection of the visceral organs. As deemed appropriate, microscopic analysis of target organs and clinical chemistry may be included to gain further information on the nature of the toxicity of the test material.

DATA AND REPORTING**Data**

30. Individual animal data should be provided. Additionally, all data should be summarised in tabular form, showing for each test concentration the number of animals used, the number of animals displaying signs of toxicity (Chan and Hayes, 14), the number of animals found dead during the test or killed for humane reasons, time of death of individual animals, a description and the time course of toxic effects and reversibility, and necropsy findings. A rationale for the starting dose and the dose progression and any data used to support this choice should be provided.

Calculation of LD50 for the primary test

31. The LD50 is calculated using the maximum likelihood method (12)(13), other than in exceptional cases given below. The following statistical details may be helpful in implementing the maximum likelihood calculations suggested (with an assumed *sigma*). All deaths, whether immediate or delayed or humane kills, are incorporated for the purpose of the maximum likelihood analysis. Following Dixon (4), the likelihood function is written as follows:

$$L = L_1 L_2 \dots L_n ,$$

where

L is the likelihood of the experimental outcome, given μ and σ , and n the total number of animals tested.

$L_i = 1 - F(Z_i)$ if the i^{th} animal survived, or
 $L_i = F(Z_i)$ if the i^{th} animal died,

where

F = cumulative standard normal distribution,

$Z_i = [\log(d_i) - \mu] / \sigma$

d_i = dose given to the i^{th} animal, and

σ = standard deviation in log units of dose (which is not the log standard deviation).

When identifying the maximum of the likelihood L to get an estimate of the true LD50, μ is set = log LD50, and automated calculations solve for it (see paragraph 32).

An estimate of σ of 0.5 is used unless a better generic or case-specific value is available.

(a) If testing stopped based on criterion (1) (i.e., a boundary dose was tested repeatedly), or if the upper bound dose ended testing, then the LD50 is reported to be above the upper bound; if the lower bound dose ended testing then the LD50 is reported to be below the lower bound dose. Classification is completed on this basis.

(b) If all the dead animals have higher doses than all the live animals or, vice versa, the LD50 is between the doses for the live and the dead animals, these observations give no further information on the exact value of the LD50. Still, a maximum likelihood LD50 estimate can be made provided there is a value for σ . Stopping criterion (2) in paragraph 20 describes one such circumstance.

(c) If the live and dead animals have only one dose in common and all the other dead animals have higher doses and all the other live animals lower doses, or vice versa, then the LD50 equals their common dose. If there is ever cause to repeat the test, testing should proceed with a smaller dose progression.

If none of the above situations occurs, then the LD50 is calculated using the maximum likelihood method.

32. Maximum likelihood calculation can be performed using either SAS (12)(e.g., PROC NLIN) or BMDP (13)(e.g., program AR) computer program packages as described in Appendix 1D in Reference 3. Other computer programs may also be used. Typical instructions for these packages are given in appendices to the ASTM Standard E 1163-87 (6). The σ used in the BASIC program in (6) will need to be edited to reflect the changes in this version of the OECD 425 Guideline. The program's output is an estimate of log(LD50) and its standard error.

33. The stopping criterion (3) in paragraph 20 is based on three measures of test progress, that are of the form of the likelihood in paragraph 31, with different values for μ , and comparisons are made after each animal tested after the sixth that does not already satisfy criterion (1) or (2). The equations for criterion (3) are provided in Appendix III. These comparisons are most readily performed in an automated manner and can be executed repeatedly, for instance, by a spreadsheet routine such as that also provided in Appendix III. If the criterion is met, testing stops and the LD50 can be calculated by the maximum likelihood method.

Calculation of LD50 and Slope Using Supplemental Procedure

34. A Supplemental Procedure is based on running three independent replicates of the Up-and-Down Procedure. Each replicate starts at least one log, but not more than 1.5 log, below the estimated LD50. Each run stops when the first animal dies. All data from these runs and the original Up-an-Down run are combined and an LD50 and slope are calculated using a standard probit method.

Report

35. The test report must include the following information:

Test substance:

- physical nature, purity and physicochemical properties (including isomerisation);
- identification data.

Vehicle (if appropriate):

- justification for choice of vehicle, if other than water.

Test animals:

- species/strain used;
- microbiological status of the animals, when known;
- number, age and sex of animals;
- rationale for use of males instead of females;
- source, housing conditions, diet, etc.;
- individual weights of animals at the start of the test, at day 7, and at day 14.

Test conditions:

- rationale for initial dose level selection, dose progression factor and for follow-up dose levels;
- details of test substance formulation;
- details of the administration of the test substance;
- details of food and water quality (including diet type/source, water source).

Results:

- body weight/body weight changes;
- tabulation of response data by sex (if both sexes are used) and dose level for each animal (i.e. animals showing signs of toxicity including nature, severity, duration of effects, and mortality);
- time course of onset of signs of toxicity and whether these were reversible for each animal;
- necropsy findings and any histopathological findings for each animal, if available;
- slope of the dose response curve (when determined);

- LD50 data;
- statistical treatment of results (description of computer routine used and spreadsheet tabulation of calculations)

Discussion and interpretation of results.

Conclusions.

LITERATURE

- (1) Dixon, W.J. and A.M. Mood. (1948). A Method for Obtaining and Analyzing Sensitivity Data. *J. Amer. Statist. Assoc.*, 43, 109-126.
- (2) Dixon, W.J. (1965). The Up-and-Down Method for Small Samples. *J. Amer. Statist. Assoc.*, 60, 967-978.
- (3) Dixon, W.J. (1991). Staircase Bioassay: The Up-and-Down Method. *Neurosci. Biobehav. Rev.*, 15, 47-50.
- (4) Dixon, W.J. (1991) Design and Analysis of Quantal Dose-Response Experiments (with Emphasis on Staircase Designs). Dixon Statistical Associates, Los Angeles, CA, USA.
- (5) Bruce, R.D. (1985). An Up-and-Down Procedure for Acute Toxicity Testing. *Fundam. Appl. Tox.*, 5, 151-157.
- (6) ASTM (1987). E 1163-87, Standard Test Method for Estimating Acute Oral Toxicity in Rats. American Society for Testing and Materials, Philadelphia, PA, USA.
- (7) Lipnick, R.L., J.A. Cotruvo, R.N. Hill, R.D. Bruce, K.A. Stitzel, A.P. Walker, I. Chu, M. Goddard, L. Segal, J.A. Springer, and R.C. Myers. (1995). Comparison of the Up-and-Down, Conventional LD₅₀ and Fixed Dose Acute Toxicity Procedures. *Fd. Chem. Toxicol.*, 33, 223-231.
- (8) Choi, S.C. (1990). Interval estimation of the LD₅₀ based on an up-and-down experiment. *Biometrics* 46, 485-492.
- (9) Vågerö, M. and R. Sundberg. (1999). The distribution of the maximum likelihood estimator in up-and-down experiments for quantal dose-response data. *J. Biopharmaceut. Statist.*, 9(3), 499-519.
- (10) Hsi, B.P. (1969). The multiple sample up-and-down method in bioassay. *J. Amer. Statist. Assoc.*, 64, 147-162.
- (11) Noordwijk, A.J. van and J. van Noordwijk. (1988). An accurate method for estimating an approximate lethal dose with few animals tested with a Monte Carlo procedure. *Arch. Toxicol.*, 61, 333-343.

- (12) SAS Institute Inc. (1990). SAS/STAT® User's Guide. Version 6, Fourth Ed. or later. Cary, NC, USA.
- (13) BMDP Statistics Software, Inc. (1990). BMDP Statistical Software Manual. W.J. Dixon, Chief Ed. 1990 rev. or later. University of California Press, Berkeley, CA, USA.
- (14) Lotus Development Corporation. (1999). Lotus® 1-2-3. Version 9.5, Millennium Edition. Cambridge, MA, USA.
- (15) Microsoft Corporation. (1985-1997). Microsoft® Excel. Version 5.0 or later. Seattle, WA, USA.

APPENDIX I

DEFINITIONS

Acute oral toxicity is the adverse effects occurring within a short time of oral administration of a single dose of a substance or multiple doses given within 24 hours.

Delayed death means that an animal does not die or appear moribund within 24 hours but dies later during the 14-day observation period.

Dosage is a general term comprising the dose, its frequency and the duration of dosing.

Dose is the amount of test substance administered. Dose is expressed as weight (g, mg) or as weight of test substance per unit weight of test animal (e.g. mg/kg).

LD50 (median lethal dose), oral, is a statistically derived single dose of a substance that can be expected to cause death in 50 per cent of animals when administered by the oral route. The LD50 value is expressed in terms of weight of test substance per unit weight of test animal (mg/kg).

Moribund status of an animal is the result of the toxic properties of a test substance where death is anticipated. For making decisions as to the next step in this test, animals killed for humane reasons are considered in the same way as animals that died.

Nominal sample size refers to the total number of tested animals reduced by one less than the number of like responses at the beginning of the series, or by the number of tested animals up to but not including the pair that creates the first reversal. For example, for a series as follows: OOOXXOXO, we have the total number of tested animals (or sample size in the conventional sense) as 8 and the nominal sample size as 6. It is important to note whether a count in a particular part of the guideline refers to the nominal sample size or to the total number tested. For example, the maximum actual number tested is 15. When testing is stopped based on that basis, the nominal sample size will be less than or equal to 15. Members of the nominal sample start with the animal numbered (r-1) (see reversal below).

Probit is an abbreviation for the term “probability integral transformation” and a probit dose-response model permits a standard normal distribution of expected responses (i.e., one centered to its mean and scaled to its standard deviation, *sigma*) to doses (typically in a logarithmic scale) to be analyzed as if it were a straight line with slope the reciprocal of *sigma*. A standard normal lethality distribution is symmetric; hence, its mean is also its true LD50 or median response.

Reversal is a situation where non-response is observed at some dose, and a response is observed at the next dose tested, or vice versa (i.e., response followed by non-response). Thus, a reversal is created by a pair of responses. The first such pair occurs at animals numbered r-1 and r.

Sigma is the standard deviation of a log normal curve describing the range of tolerances of test subjects to the chemical. *Sigma* provides an estimate of the variation among test animals in response to doses throughout the dose-response curve.

Slope (of the dose response curve) is the value that describes the angle at which the dose response curve rises from the dose axis. This value is the reciprocal of sigma.

APPENDIX II

DOSING PROCEDURE

Dose Sequence for Primary or Single-Sequence Test

1. For each run, animals are dosed, one at a time, at 48-hour intervals. The first animal receives a dose a step below the level of the best estimate of the LD50. This selection reflects an adjustment for a tendency to upward bias in the final estimate (see paragraph 5); as the test progresses, dosing will adjust for the overall pattern of outcomes. If the animal survives, the dose for the next animal is increased to a factor of 3.2 times the original dose; if it dies, the dose for the next animal is decreased by a similar dose progression. (Note: 3.2 is the default factor. Paragraph 3 below provides further guidance for choice of dose spacing factor). Each animal should be observed carefully for 48 hours (unless the animal dies) before making a decision on whether and how much to dose the next animal. That decision is based on the survival pattern of all the animals up to that time.

2. A combination of stopping criteria is used to keep the number of animals low while adjusting the dosing pattern to reduce the effect of a poor starting value. In any event, the test uses no more than 15 animals. Reaching one of the boundary doses and “staying there” for three animals stops the test. Unless this happens, the minimum number tested starting with the first reversal (called the nominal sample size) is 6. Testing stops at this point if and only if every response has been followed by a nonresponse or vice versa. (This outcome can be symbolized by ...XOXOXO or ...OXOXOX where X denotes dies within 48 hours, O denotes survives, and ... indicates a possible run of Xs or Os, respectively, preceding the example.) This type of outcome suggests the LD50 is very likely to be between the two particular test doses and that there is low variability in response sensitivity (e.g., a steep slope for an assumed probit dose-response model), a situation favorable for accurate results based on this guideline. Counting which contributes to the stopping decision is carried out from the first reversal to adjust for cases where there is an initial run of nonresponses or only responses, which tends to be associated with a poor starting dose. If there have been fewer than 5 reversals by this nominal sample size of 6, there is somewhat higher probability that more animals will be needed to achieve an accurate estimate. Possible problems include a relatively flat dose response, a starting value distant from the true LD50, an apparent adverse response not actually related to exposure to the test substance, or some combination of these factors. Therefore, in this case testing continues until it satisfies a criterion based on how likely it was to see the observed pattern, or the maximum allowable number of animals is reached.

3. Dose spacing is most successful if it can be related to the slope of dose response. At the outset, if feasible, a slope of the dose response should be estimated based on all information available to the toxicologist including structure activity relationships. The dose progression factor should be chosen to be the *sigma* or antilog of 1/(the estimated slope of the dose response curve). When there is no information on the substance to be tested, a dose progression factor of 3.2 is used.

4. Once the starting dose and dose spacing are decided, the toxicologist should list all possible doses including the upper (usually 2000 or 5000 mg/kg) and lower bounds. Doses that are close to the upper and lower bounds should be removed from the progression. Setting of lower bounds may need to include consideration of the ability to accurately dilute the test material).
5. The stepped nature of the TG 425 design provides for the first few doses to function as a self-adjusting sequence. Because of the tendency for positive bias, in the event that nothing is known about the substance, a starting dose of 175 mg/kg is recommended. If the default procedure is to be used for the primary test, dosing will be initiated at 175 mg/kg and doses will be spaced by a factor of 0.5 (\log_{10} dose). The doses to be used are 1, 5.5, 17.5, 55, 175, 550, 1750 2000, or, for specific regulatory needs, 5000 instead of 2000.
6. Only the doses in the predetermined dose progression (either one analytically based or the default progression) should be used. This avoids changing the dose progression if either the upper or lower limit is reached during the study. If there is no reversal before reaching either the upper or lower bounds, no more than three animals should be dosed at these limiting doses (see stopping criterion (1) in paragraph 20).

Setting Starting Doses for Supplemental Multi-Sequence Procedure

7. In order to maximize information on the dose response curve, the starting doses of each sequence should be staggered in such a way that the doses tested in one sequence are between the doses of neighboring sequences. The factor 3.2 comes from the fact that this value forces alternating doses in the full list of possible doses to be separated by approximately one order of magnitude, i.e., a 10-fold difference. For example, the dose list 1, 3.2, 10, 32, 100... is one where every other dose is separated by a 10-fold increment. Furthermore, the same list, on the base 10 log-scale is 0.0, 0.5, 1.0, 1.5, 2.0... which illustrates the fact that a constant multiplicative factor separating doses on the mg/kg dose scale translates to an additive equal spacing on the base 10 log scale. It also exhibits the fact that $\log_{10}(3.2) = 0.5$, i.e., one-half of one order of magnitude.
8. By working on the log-scale, staggering doses is straightforward. On that scale, one need only partition the log-scale dosing increment into the number of staggered start doses needed. For example, $0.5/5 = 0.1$, so that starting doses for five separate sequences could be 1.0, 1.1, 1.2, 1.3, 1.4 on the log-scale, which translates to 10.0, 12.6, 15.8, 20.0, 25.1. The next dose in this list of starting doses, 1.5 (or 31.6), is the next dose in the testing sequence that starts at 1.0 (or 10.0). It is also worth noting that the factor that separates each starting dose on the actual dose scale, 1.26, is the fifth-root of 3.2.
9. The specific steps to be followed are:
 1. Select a dose about which one wishes to stagger doses.
 2. Convert the dose in (1) to log-scale, and calculate the \log_{10} of the dosing increment.
 3. Divide the log of the dosing increment by the number of sequences to be use.
 4. Add or subtract the dosing increment to the dose in (1), repeatedly until the correct number of starting doses is created.

5. Convert the log doses back to the original scale.

10. As a second example, (1) Suppose we want to stagger four starting doses around a dose of 120, and the dosing increment is 3.2. (2) The log starting value is $\log_{10}(120) = 2.079$, and $\log_{10}(3.2) = 0.5$. For step (3), $0.5/4 = .125$. (4) Since there are an even number of starts, we will put 2 starts below 120, and one above. The starts below 120 are $2.079 - 0.125 = 1.954$, $1.954 - 0.125 = 1.829$. The start above 120 is $2.079 + 0.125 = 2.204$, or together, 1.829, 1.954, 2.079, 2.204. (5) Finally, converting the original dose scale, these starts are 67, 90-, 120 160.

Limit Test

11. The Limit Test is a sequential test that may use up to 5 animals. A test dose of up to 2000 (and exceptionally 5000) mg/kg may be used.

12. Dose one animal at the test dose. If the animal dies, conduct the primary test to determine the LD50. If the animal survives, dose two additional animals. If both animals survive, the LD50 is greater than the limit dose and the test is terminated. If one or both animals die, then dose an additional two animals, one at a time. The results are evaluated as follows (S=survival, D=death).

13. The LD50 is less than test dose (2000 mg/kg or 5000 mg/kg) when three or more animals die.

S DS DD
S SD DD
S DD DX
S DD SD
S DD DX

14. The LD50 is greater than the test dose (2000 mg/kg or 5000 mg/kg) when three or more animals survive.

S DS DS
S DS SX (X can be S or D, the dosing of 5th animal is not necessary)
S SD DS
S SD SX (X can be S or D, the dosing of 5th animal is not necessary)
S DD SS

APPENDIX III

Computations for the Likelihood-Ratio Stopping Rule

As described in Guideline paragraph 20, a likelihood-ratio stopping rule is evaluated after testing each animal, starting with the fourth tested following the reversal. Three "measures of test progress" are calculated. Technically, these measures of progress are likelihoods, as recommended for the maximum-likelihood estimation of the LD50. The procedure is closely related to calculation of a confidence interval by a likelihood-based procedure.

The basis of the procedure is that when enough data have been collected, a point estimate of the LD50 should be more strongly supported than values above and below the point estimate, where statistical support is quantified using likelihood. Therefore three likelihood values are calculated, a likelihood for an LD50 point estimate, a likelihood for a value below the point estimate, and a likelihood for a value above the point estimate. Specifically, the low value is taken to be the point estimate divided by 2.5 and the high value is taken to be the point estimate multiplied by 2.5.

The likelihood values are compared by calculating ratios of likelihoods, and then determining whether the likelihood ratios (LR) exceed a critical value. Testing stops when the ratio of the likelihood for the point estimate exceeds each of the other likelihoods by a factor of 2.5, which is taken to indicate relatively strong statistical support for the point estimate. Therefore two likelihood ratios (LRs) are calculated, a ratio of likelihoods for the point estimate and the point estimate divided by 2.5, and a ratio for the point estimate and the estimate times 2.5. The values of 2.5 here have been shown using simulations to yield a useful stopping rule.

The calculations are easily performed in any spreadsheet with normal probability functions. The calculations are illustrated in the following table, which is structured to promote spreadsheet implementation. The computation steps are illustrated using an example where the upper boundary dose is 5000 mg/kg, but the computational steps are identical when the upper boundary dose is 2000 mg/kg. Empty spreadsheets preprogrammed with the necessary formulas are available for direct downloading on the OECD and EPA websites.

Hypothetical example using upper boundary 5000 mg/kg (Table 1)

In the hypothetical example utilizing an upper boundary dose of 5000 mg/kg, the LR stopping criterion was met after nine animals had been tested. The first "reversal" occurred with the 3rd animal tested. The stopping criterion is checked when four animals have been tested following the reversal. In this example, the fourth animal tested following the reversal is the seventh animal actually tested. Therefore, for this example, the data would have been entered into the spreadsheet only after the seventh animal had been tested. Subsequently, the stopping criterion would have been checked after testing the seventh animal, the eighth animal, and the ninth. The stopping criterion is satisfied after the ninth animal is tested.

A. Enter the dose-response information.

After each animal is tested, the results are entered at the end of the matrix in Columns 1-4.

Column 1. Steps are numbered 1-15. A maximum of 15 animals may be tested.

Column 2. Enter the dose received by the i^{th} animal.

Column 3. Indicate whether the animal responded (we use an X) or did not respond (we use an O).

The results should be entered in the same order as animals are tested.

B. The nominal and actual sample sizes.

The nominal sample consists of the two animals that represent the reversal (here the second and third), plus all animals tested subsequently. Here, we use Column 4 to indicate whether or not a given animal is included in the nominal sample.

- Enter the nominal sample size (nominal n) in Row 16. This is the number of animals in the nominal sample. In the example, nominal n is 8.
- Enter the actual number tested in Row 17.

C. Rough estimate of the LD50.

As a rough estimate of the LD50 from which to gauge progress, we use the geometric mean of doses for the animals in the nominal sample. In the table, this is called the “dose-averaging estimator.” We restrict this average to the nominal sample in order to allow for a poor choice of initial test dose, which could generate either an initial string of non-responses or an initial string of non-responses. (However, we will use the results for all animals in the likelihood calculations below.) Recall that the geometric mean of n numbers is the product of the n numbers, raised to a power of $1/n$.

- Enter the dose-averaging estimate in Row 18. In the example, the value in Row 18 is equal to $(320 (1000 (\dots (1000)^{1/8} = 754$.
- Enter in Row 19 the logarithm (base 10) of the value in Row 18. The value in Row 19 is $\log_{10} 754 = 2.9$.

A more refined procedure could use the maximum-likelihood estimate of the LD50. The dose-averaging estimator is used to simplify the calculations.

D. Likelihood for the crude LD50 estimate.

“Likelihood” is a statistical measure of how strongly the data support an estimate of the LD50 or other parameter. Ratios of likelihood values can be used to compare how well the data support different estimates of the LD50.

In Column 7 we calculate the likelihood for the estimate of the LD50 that was calculated at Step C. The likelihood (Row 21) is the product of likelihood contributions for individual animals. The likelihood contribution for the i^{th} animal is denoted L_i . (In our implementation, we use the algebraically equivalent approach of summing the logarithms of the L_i values, then taking the antilog of the sum.)

Column 6. Enter the estimate of the probability of response at dose d_i , denoted P_i . P_i is calculated from a dose-response curve. Note that the parameters of the probit dose-response curve are the slope and the LD50, so values are needed for each of those parameters. For the LD50 we use the dose-averaging estimate from Row 18. For the slope we use the default value of 2. The following steps may be used to calculate the response probability P_i .

1. Calculate the base-10 log of dose d_i (Column 5).
2. For each animal calculate the z-score, denoted Z_i (not shown in the table), using the formulae

$$\begin{aligned} \sigma &= 1 / \text{slope}, \\ Z_i &= (\log_{10}(d_i) - \log_{10}(\text{LD50})) / \sigma \end{aligned}$$

For example, for the first animal (Row 1), we have

$$\begin{aligned} \sigma &= 1 / 2 \\ Z_1 &= (2.000 - 2.878) / 0.500 = -1.756 \end{aligned}$$

3. For the i^{th} dose the estimated response probability is

$$P_i = F(Z_i)$$

where F denotes the cumulative distribution function for the standard normal distribution (i.e., the normal distribution with mean 0 and variance 1).

For example (Row 1), we have

$$P_1 = F(-1.756) = 0.0396$$

The function F (or something very close) is ordinarily what is given for the normal distribution in statistical tables, but the function is also widely available as a spreadsheet function. It is available under different names, for example the @NORMAL function of Lotus 1-2-3 (14) and the @NORMDIST function in Excel (15). To confirm that you have used correctly the function available in your software, you may wish to verify familiar values such as $F(1.96) \approx 0.975$ or $F(1.64) \approx 0.95$.

Column 7. Calculate the natural log of the likelihood contribution ($\ln(L_i)$). L_i is simply the probability of the response that actually was observed for the i^{th} animal:

$$\begin{aligned} \text{responding animals: } \ln(L_i) &= \ln(P_i) \\ \text{non-responding animals: } \ln(L_i) &= \ln(1 - P_i) \end{aligned}$$

Note that here we have used the natural logarithm (ln), whereas elsewhere we use the base-10 (common) logarithm. These choices are what are ordinarily expected in a given context.

The steps above are performed for each animal. Finally:

Row 20: Sum the log-likelihood contributions in Column 7.

Row 21: Calculate the likelihood by applying the exp function applied to the log-likelihood value in Row 20. In the example, $\exp(-3.385) = e^{-3.385} = 0.0338$.

E. Calculate likelihoods for two dose values above and below the crude estimate.

If the data permit a precise estimate, then the likelihood should be high for a reasonable estimate of the LD50, relative to likelihoods for values distant from our estimate. We compare the likelihood for the dose-averaging estimate (754, Row 18) to values differing by a factor of 2.5 from that value (i.e., to 754×2.5 and $754/2.5$). The calculations (displayed in Columns 8-11) are similar to those described above, except that the values 301.7 ($=754/2.5$) and 1986 ($=754 \times 2.5$) have been used for the LD50, instead of 754. The likelihoods and log-likelihoods are displayed in Rows 20-21.

F. Calculate likelihood ratios.

The three likelihood values (Row 21) are used to calculate two likelihood ratios (Row 22). A likelihood ratio is used to compare the statistical support for the estimate of 754 to the support for each of the other values, 301.7 and 1985.9. The two likelihood ratios are therefore:

$$\begin{aligned} \text{LR1} &= [\text{likelihood of 754}] / [\text{likelihood of 301.7}] \\ &= 0.0338 / 0.0082 \\ &= 4.10 \end{aligned}$$

and

$$\begin{aligned} \text{LR2} &= [\text{likelihood of 754}] / [\text{likelihood of 1985.9}] \\ &= 0.0338 / 0.0097 \\ &= 3.49 \end{aligned}$$

G. Determine if the likelihood ratios exceed the critical value.

High likelihood ratios are taken to indicate relatively high support for the point estimate of the LD50. Both of the likelihood ratios calculated in Step F (4.10 and 3.49) exceed the critical likelihood ratio that we use, which is 2.5. Therefore the LR stopping criterion is satisfied and testing stops.

TABLE
1

	1	2	3	4	5	6	7	8	9	10	11		
Step <i>I</i>	Dose	(X) response (O) non-resp.	Included in nominal <i>n</i>	log10 Dose <i>d_i</i>	LD50 = 794.1	LD50 = 301.7	LD50 = 1885.9	Prob. of response	ln(<i>L_i</i>)	Prob. of response	ln(<i>L_i</i>)	Prob. of response	ln(<i>L_i</i>)
1	1	100	O	NO	2.00	0.0396	-0.0404	0.1687	-0.1848	0.0054	-0.0054		
2	2	320	O	YES	2.50	0.2282	-0.2590	0.5203	-0.7347	0.0617	-0.0637		
3	3	1000	X	YES	3.00	0.5967	-0.5163	0.8510	-0.1613	0.2908	-1.2351		
4	4	320	O	YES	2.50	0.2282	-0.2590	0.5203	-0.7347	0.0617	-0.0637		
5	5	1000	X	YES	3.00	0.5967	-0.5163	0.8510	-0.1613	0.2908	-1.2351		
6	6	320	O	YES	2.50	0.2282	-0.2590	0.5203	-0.7347	0.0617	-0.0637		
7	7	1000	O	YES	3.00	0.5967	-0.9081	0.8510	-1.9038	0.2908	-0.3436		
8	8	3200	X	YES	3.70	0.8953	-0.1106	0.9799	-0.0203	0.6770	-0.3901		
9	9	1000	X	YES	3.00	0.5967	-0.5163	0.8510	-0.1613	0.2908	-1.2351		
10	10			-	-	-	-	-	-	-	-		
11	11			-	-	-	-	-	-	-	-		
12	12			-	-	-	-	-	-	-	-		
13	13			-	-	-	-	-	-	-	-		
14	14			-	-	-	-	-	-	-	-		
15	15			-	-	-	-	-	-	-	-		
16	Nominal Sample size =			8									
17	Actual number tested =			9									
18	Dose-averaging estimator			754.35									
19	log10 =			2.878									
20	log-likelihood sums:							-3.3851		-4.7970		-4.6354	
21	likelihoods:							0.03387		0.00825		0.00970	
22	likelihood ratios:									4.1039		3.4915	
23	Individual ratios exceed critical value?			critical=	2.5				TRUE		TRUE		
24	Both ratios exceed critical value?									TRUE			

APPENDIX IV

Alternate Supplemental Procedure

The design for slope estimation involves multiple stages of testing. The first stage is execution of the Primary Procedure. Subsequent stages involve concurrent up-and-down testing sequences with nominal sample size 2, with (at each stage) some sequences initiated at a relatively low dose and others at a higher dose, compared to the LD50. This design is considered to provide adequate precision for estimation of the slope in most situations. (It is thought that the precision required will not usually exceed the precision provided by the design.) If there are situations where the required precision can be stated precisely, it may be possible to reduce the number of animals tested by terminating the study, when the data collected up to a given point permit an estimate with the precision required.

The design has 5 stages. At Stages 2 and following, all testing sequences have nominal sample size of two, i.e., the sequence terminates when a reversal is observed.

Stage 1: Execute the primary procedure, with the guideline stopping criteria.

Stage 2: Execute two up-and-down testing sequences, each with successive test doses spaced by 2 log units (a progression factor of 100). One sequence is started at a low dose relative to the LD50 and the other at a high dose relative to the LD50.

Stage 3: Execute 2 sequences with doses spaced by 0.5 log unit (a factor of approximately 3.2), one starting at a low dose and one starting at a high dose, relative to the LD50.

Stage 4: Execute 2 sequences with doses spaced by 0.25 log units, one starting at a low dose and one at a high dose, relative to the LD50.

Stage 5: Execute 3 sequences with doses spaced by 0.125 log units, 2 starting at a low dose and one at a high dose, relative to the LD50.

The following procedure is to be used for selecting initial test doses, for up-and-down sequences at Stage 2 and following. Where the intent is for the sequence to be initiated at a low dose relative to the LD50, the initial test dose equals the highest dose tested, such that an adverse affect has not been observed at that dose, or at any lower doses tested, considering the results of all completed stages of the study. Where the intent is for the sequence to be initiated above the LD50, the initial test dose is chosen to equal the lowest test dose that is associated with 100% response in all tests of that dose, as well as at all higher tested doses. In cases where the lowest dose tested is associated with an adverse effect for one or more animal, the initial test dose is chosen to equal that dose, divided by the progression factor for the current stage. In cases where the highest dose tested is associated with no adverse effects, the initial test dose is chosen to equal that dose, multiplied by the progression factor for the current stage.

Where the range of test doses is restricted (e.g., if the test doses may not exceed 2000 units or may not exceed 5000 units), and the application of these criteria would result in a dose beyond a bound of the range, the dose is chosen to equal the corresponding bounding dose (e.g., chosen equal to 2000 units or 5000 units). Whenever a bounding dose is tested, the next dose to be tested (in the same sequence) may equal the same bounding dose, or may be chosen strictly within the dose range, based on precisely the same criteria as for the Primary Procedure. As for

the Primary Procedure, a single up-and-down testing sequence is stopped if three successive test doses equal a bounding dose, with no responses (when the dose is an upper bound dose) or with three responses (for a lower bound dose).

The number of animals that can be tested is restricted as follows. Upon completion of a given stage, testing stops if the number tested (in that stage and previous stages) equals or exceeds 40. The minimum number, based on the minimum nominal sample size for each sequence, is 24 ($=6 + 2*2 + 2*2 + 2*2 + 3*2$). In practice, it is believed that the numbers tested will usually not exceed 40.

After all stages of the test are completed, results of all stages are combined in a single probit analysis. The statistics reported are to include confidence intervals for the slope and LD50, as well as point estimates for those parameters, where available, calculated using standard procedures of probit analysis.

OECD GUIDELINE FOR THE TESTING OF CHEMICALS

Acute Oral Toxicity: Up-and-Down Procedure

INTRODUCTION

1. The proposal for this guideline was submitted by the United States. The concept of the up-and-down testing approach was first described by Dixon and Mood (1)(2). In 1985, Bruce proposed to use an up-and-down procedure (UDP) for the determination of acute toxicity of chemicals (3). There exist several variations of the up-and-down experimental design for estimating an LD50. This guideline is based on the procedure of Bruce as adopted by ASTM in 1987 (4).
2. A study comparing the results obtained with the UDP, the conventional LD50 test and the Fixed Dose Procedure (FDP, Guideline 420) was published in 1995 (5). The study showed that i) the UDP yields an estimate of the LD50 which is similar to that obtained by the conventional LD50 test and hence leads to similar classification in LD50-based classification schemes, ii) classifications in the EC scheme were similar for the UDP and the FDP, and iii) of the three protocols, the UDP required the smallest number of animals: from 6 to 10 animals of one sex. Also for the Acute Toxic Class method (Guideline 423) classifications in the EC scheme were similar to the conventional LD50 test and the ATC and UDP methods require comparably small numbers of animals (6)(7).
3. Some terms used are defined in the Annex.

INITIAL CONSIDERATIONS

4. This test procedure is of principal value in minimising the number of animals required to estimate the acute oral toxicity of a chemical and in estimating a median lethal dose. The median lethal dose allows for comparison with historical data. In addition to the observation of mortality, it allows the observation of signs of toxicity. The latter is useful for classification purposes and in the planning of additional toxicity tests.
5. The procedure is easiest to apply to materials that produce death within one or two days. The method would not be practical to use when considerably delayed death (5 days or more) can be expected.
6. During the test, animals obviously in pain or showing signs of severe distress should be humanely killed.

PRINCIPLE OF THE TEST

7. Animals are dosed, one at a time, at 24 hour intervals. The first animal receives a dose at the level of the best estimate of the LD50. Depending on the outcome for the previous animal, the dose for the next animal is adjusted up or down. If an animal survives, the dose for the next animal is increased; if it dies, the dose for the next animal is decreased. After reaching the reversal of the initial outcome, i.e. the point where an increasing (or decreasing) dose pattern is reversed by giving a smaller (or a higher) dose, four additional animals are dosed following the same UDP. The LD50 is calculated using the method of maximum likelihood (8)(9).

DESCRIPTION OF THE METHOD

Selection of animals species

8. The preferred rodent species is the rat although other rodent species may be used. In the normal procedure female rats are used, because literature surveys of conventional LD50 tests show that, although there is little difference of sensitivity between sexes, in those cases where differences were observed, females were in general slightly more sensitive (5). When there is adequate information to infer that males are more sensitive, they should replace females in the test.

9. Healthy young adult animals should be employed. The females should be nulliparous and non-pregnant. At the commencement of the study, the weight variation of the animals should be minimal and not exceed $\pm 20\%$ of the mean weight for each sex. The test animals should be characterised as to species, strain, source, sex, weight and/or age.

Housing and feeding conditions

10. The temperature in the experimental animal room should be $22^{\circ}\text{C} (\pm 3^{\circ}\text{C})$. Although the relative humidity should be at least 30 % and preferably not exceed 70 % other than during room cleaning, the aim should be 50-60 %. Lighting should be artificial, the sequence being 12 hours light and 12 hours dark. The animals are housed individually. For feeding, conventional laboratory diets may be used with an unlimited supply of drinking water.

Preparation of animals

11. The animals are uniquely identified and kept in their cages for at least five days prior to dosing for acclimatisation to the laboratory conditions. During acclimatisation the animals should be observed for ill health. Animals demonstrating signs of spontaneous disease or abnormality prior to the start of the study are eliminated from the study.

Preparation of doses

12. When necessary, the test substance is dissolved or suspended in a suitable vehicle. It is recommended that, whenever possible, the use of an aqueous solution or suspension be considered first, followed by consideration of a solution or emulsion in oil (e.g. corn oil) and then by possible solution in other vehicles. For vehicles other than water, the toxicity of the vehicle must be known.

PROCEDURE

Full test

13. Individual animals are dosed in sequence at 24 h intervals, one at a time, and then observed for a minimum of 24 hours. However, the time intervals between dosing should not be fixed rigidly and may be adjusted as appropriate, in case of delayed mortality. The first animal is dosed at the toxicologist's best estimate of the LD50. If the animal survives, the second animal receives a higher dose, unless the limit dose was used as the starting dose. If the first animal dies or appears moribund the second animal receives a lower dose. Moribund state is characterised by symptoms such as shallow, laboured or irregular respiration, muscular weakness or tremors, absence of voluntary response to external stimuli, cyanosis and coma. Criteria for making the decision to humanely kill moribund and severely suffering animals are the subject of a separate Guidance Document. Animals killed for humane reasons are considered in the same way as animals that died on test.

14. For selecting the starting dose, all available information should be used, including information on structure-activity relationships. When the information suggests that mortality is unlikely then a limit test should be conducted (see paragraph 16). When there is no information on the substance to be tested, for animal welfare reasons it is recommended to use the starting dose of 200 or 500 mg/kg body weight.

15. The dose for each successive animal is adjusted up or down, depending on the outcome of the previous animal. If feasible, a dose progression factor of 1.3 is used. Other factors may be used, if justified. After reaching the reversal of the initial direction (the point where a decreasing dose pattern requires an increase due to a tested animal's survival or an increasing dose pattern results in a decrease due to lethality), four additional animals are dosed using the same UDP. This is the end of the normal test.

Limit test

16. Doses should not exceed 2000 mg/kg which is considered the upper limit dose. When the first animal is dosed with the upper limit dose and survives, the second animal receives the same dose. When a total of three animals have been dosed with the limit dose and no deaths have occurred, then three animals of the other sex should be tested at the limit dose level. If there is again no lethality, the test can be terminated.

Optional testing

17. Information from one sex may be adequate to assess acute toxicity. However, if found desirable, comparability of response in the other sex can be evaluated by administering to generally not more than 3 animals, doses above and below the estimated LD50. The point intermediate between doses where responses change can be taken as an approximate estimate of the lethal dose.

Administration of doses

18. The test substance is administered in a single dose by gavage, using an oral dosing needle or rubberised tubing.

19. The animals should be fasted prior to dosing by withholding food overnight. Fasted body weight of each rat is determined and the dose is calculated according to the body weight. After dosing food may be withheld for a further 3-4 hours. The volume should not exceed 1 ml/100g body weight, except in the case of aqueous solutions where 2 ml/100g body may be used.

Observations

20. Animals are observed individually after dosing at least once during the first 30 minutes, periodically during the first 24 hours, with special attention given during the first 4 hours, and daily thereafter for a total of 14 days. However, the duration of the observation period should not be fixed rigidly. It should be determined by the toxic reactions, time of onset and length of recovery period, and may thus be extended when considered necessary.

21. Observations include mortality and clinical signs. These include changes in skin and fur, eyes and mucous membranes, and also respiratory, circulatory, autonomic and central nervous systems, and somatomotor activity and behaviour pattern. Attentions should be directed to observations of tremors, convulsions, salivation, diarrhoea, lethargy, sleep and coma.

Body weight

22. Individual weights of animals should be determined shortly before the test substance is administered, at least weekly thereafter, at the time of death or at day 14 in the case of survival. Weight changes should be calculated and recorded.

Pathology

23. All animals, including those which die during the test or are killed for animal welfare reasons during the test and those that survive at day 14, are subjected to gross necropsy. The necropsy should entail a macroscopic inspection of the visceral organs. As deemed appropriate, microscopic analysis of target organs and clinical chemistry may be included to gain further information on the nature of the toxicity of the test material.

DATA AND REPORTING

Data

24. Individual animal data should be provided. Additionally, all data should be summarised in tabular form, showing for each test concentration the number of animals used, the number of animals displaying signs of toxicity, the number of animals found dead during the test or killed for humane reasons, time of death of individual animals, a description and the time course of toxic effects and reversibility, and necropsy findings.

Calculation of LD50

25. The LD50 is calculated using the maximum likelihood method (8)(9). The following statistical details may be helpful in implementing the maximum likelihood calculations suggested.

All deaths, whether immediate or delayed or humane kills, are incorporated for the purpose of the maximum likelihood analysis. Following Dixon (8), the likelihood function is written as follows:

$$L = L_1 L_2 \dots L_n ,$$

where

L is likelihood of the experimental outcome, given μ and σ , and n the number of animals tested.

$$L_i = 1 - F(Z_i) \text{ if the } i^{\text{th}} \text{ animal survived, or}$$

$$L_i = F(Z_i) \text{ if the } i^{\text{th}} \text{ animal died ,}$$

where

F = cumulative, standard normal density,

$$Z_i = [\log(d_i) - \mu] / \sigma$$

d_i = dose given to the i^{th} animal

μ = log LD50, and

σ = standard deviation

An estimate of σ of 0.12 is used unless a better generic or case-specific value is available.

26. The calculation can be performed using either SAS (10) or BMDP (11) computer program packages. Other computer programs may also be used. Typical instructions for these packages are given in appendices to the ASTM Standard E 1163-87 (4). The program output is an estimate of log LD50 and its standard error.

Report

27. The test report must include the following information:

Test substance:

- physical nature, purity and physicochemical properties (including isomerisation);
- identification data.

Vehicle (if appropriate):

- justification for choice of vehicle, if other than water.

Test animals:

- species/strain used;
- microbiological status of the animals, when known;
- number, age and sex of animals;
- rationale for use of males instead of females;
- source, housing conditions, diet, etc.;
- individual weights of animals at the start of the test, at day 7, and at day 14.

Test conditions:

- rationale for initial dose level selection and for follow-up dose levels;
- details of test substance formulation;
- details of the administration of the test substance;
- details of food and water quality (including diet type/source, water source).

Results:

- body weight/body weight changes;
- tabulation of response data by sex and dose level for each animal (i.e. animals showing signs of toxicity including nature, severity, duration of effects, and mortality);
- time course of onset of signs of toxicity and whether these were reversible for each animal;
- necropsy findings and any histopathological findings for each animal, if available.
- LD₅₀ data;
- statistical treatment of results.

Discussion and interpretation of results.

Conclusions.

LITERATURE

- (1) Dixon W.J. and Mood A.M. (1948). A Method for Obtaining and Analyzing Sensitivity Data. *J. Amer. Statist. Assoc.*, 43, 109-126.
- (2) Dixon W.J. (1991). Staircase Bioassay: The Up-and-Down Method. *Neurosci. Biobehav. Rev.*, 15, 47-50.
- (3) Bruce R.D. (1985). An Up-and-Down Procedure for Acute Toxicity Testing. *Fundam. Appl. Tox.*, 5, 151-157.
- (4) ASTM (1987). E 1163-87, Standard Test Method for Estimating Acute Oral Toxicity in Rats. American Society for Testing and Materials, Philadelphia Pa, USA.
- (5) Lipnick R.L., Cotruvo J.A., Hill R.N., Bruce R.D., Stitzel K.A., Walker A.P., Chu I., Goddard M., Segal L., Springer J.A. and Myers R.C. (1995). Comparison of the Up-and-Down, Conventional LD₅₀ and Fixed Dose Acute Toxicity Procedures. *Fd Chem Toxicol.*, 33, 223-231.
- (6) Schlede E., Mischke U., Diener W. and Kayser D. (1995). The international validation study of the acute toxic class method (oral). *Arch. Toxicol.*, 69, 659-670.
- (7) Diener W., Mischke U., Schlede E. and Kayser D. (1995). The biometrical evaluation of the OECD modified version of the acute toxic class method (oral). *Arch. Toxicol.*, 69, 729-734.
- (8) Dixon W.J. (1965). The Up-and-Down Method for Small Samples. *J. Amer. Statist. Assoc.*, 60, 967-978.

- (9) Finney D.J. (1971) Probit Analysis, 3rd ed., Cambridge University Press, Cambridge, England, 50-80.
- (10) SAS User's Guide: Statistics. SAS Institute Inc., Cary, NC, USA.
- (11) Dixon W.J., ed., BMDP Statistics Software. University of California Press, Berkeley, CA, USA.

ANNEXDEFINITIONS

Acute oral toxicity is the adverse effects occurring within a short time of oral administration of a single dose of a substance or multiple doses given within 24 hours.

Delayed death means that an animal does not die or appear moribund within 24 hours but dies later during the observation period.

Dosage is a general term comprising the dose, its frequency and the duration of dosing.

Dose is the amount of test substance administered. Dose is expressed as weight (g, mg) or as weight of test substance per unit weight of test animal (e.g. mg/kg).

Moribund status of an animal is the result of the toxic properties of a test substance where death is anticipated. For making decisions as to the next step in this test, animals killed for humane reasons are considered in the same way as animals that died.

LD50 (median lethal dose), oral, is a statistically derived single dose of a substance that can be expected to cause death in 50 per cent of animals when administered by the oral route. The LD50 value is expressed in terms of weight of test substance per unit weight of test animal (mg/kg).



"Acute Oral Toxicity"

1. INTRODUCTORY INFORMATION

- Prerequisites
 - Solid or liquid test substance
 - Chemical identification of test substance
 - Purity (impurities) of test substance
 - Solubility characteristics
 - Melting point/boiling point
 - pH (where appropriate)
- Standard documents

There are no relevant international standards.

2. METHOD

A. INTRODUCTION, PURPOSE, SCOPE, RELEVANCE, APPLICATION AND LIMITS OF TEST

In the assessment and evaluation of the toxic characteristics of a substance, determination of acute oral toxicity is usually an initial step. It provides information on health hazards likely to arise from a short-term exposure by the oral route. Data from an acute study may serve as a basis for classification and labelling. It is an initial step in establishing a dosage regimen in subchronic and other studies and may provide initial information on the mode of toxic action of a substance.

- Definitions

Acute oral toxicity is the adverse effects occurring within a short time of oral administration of a single dose of a substance or multiple doses given within 24 hours.

Dose is the amount of test substance administered. Dose is expressed as weight (g, mg) or as weight of test substance per unit weight of test animal (e.g. mg/kg).

LD50 (median lethal dose), oral, is a statistically derived single dose of a substance that can be expected to cause death in 50 per cent of animals when administered by the oral route. The LD50 value is expressed in terms of weight of test substance per unit weight of test animal (mg/kg).

Dosage is a general term comprising the dose, its frequency and the duration of dosing.

Dose-response is the relationship between the dose and the proportion of a population sample showing a defined effect.

Dose-effect is the relationship between the dose and the magnitude of a defined biological effect either in an individual or in a population sample.

- Principle of the test method

The test substance is administered orally by gavage in graduated doses to several groups of experimental animals, one dose being used per group. The doses chosen may be based on the results of a range finding test. Subsequently observations of effects and deaths are made. Animals which die during the test are necropsied, and at the conclusion of the test the surviving animals are sacrificed and necropsied. This guideline is directed primarily to studies in rodent species but may be adapted for studies in non-rodents. Animals showing severe and enduring signs of distress and pain may need to be humanely killed. Dosing test substances in a way known to cause marked pain and distress due to corrosive or irritating properties need not be carried out.

B. DESCRIPTION OF THE TEST PROCEDURE

- Preparations

Healthy young adult animals are acclimatised to the laboratory conditions for at least 5 days prior to the test before the test animals are randomised and assigned to the treatment groups.

Where necessary, the test substance is dissolved or suspended in a suitable vehicle. It is recommended that wherever possible the use of an aqueous solution be considered first, followed by consideration of a solution in oil (e.g. corn oil) and then by consideration of possible solution in other vehicles. For non-aqueous vehicles the toxic characteristics of the vehicle should be known, and if not known should be determined before the test. The maximum volume of liquid that can be administered at one time depends on the size of the test animal. In rodents, the volume should not exceed 1 ml/100 g body weight, except in the cases of aqueous solutions where 2 ml/100 g may be used. Variability in test volume should be minimised by adjusting the concentration to ensure a constant volume at all dose levels.

"Acute Oral Toxicity"

- Experimental animals

Selection of species

Although several mammalian test species may be used, the rat is the preferred rodent species. Commonly used laboratory strains should be employed. The weight variation in animals used in a test should not exceed ± 20 per cent of the mean weight.

Note: In acute toxicity tests with animals of a higher order than rodents, the use of smaller numbers should be considered. Doses should be carefully selected, and every effort should be made not to exceed moderately toxic doses. In such tests, administration of lethal doses of the test substance should be avoided.

Number and sex

At least 5 rodents are used at each dose level. They should all be of the same sex. If females are used they should be nulliparous and non-pregnant.

Housing and feeding conditions

The temperature of the experimental animal room should be 22°C ($\pm 3^\circ$) and the relative humidity 30-70 per cent. Animals may be group-caged by sex, but the number of animals per cage must not interfere with clear observation of each animal. The biological properties of the test substance or toxic effects (e.g. morbidity, excitability) may indicate a need for individual caging. Where the lighting is artificial, the sequence should be 12 hours light, 12 hours dark. For feeding, conventional laboratory diets may be used with an unlimited supply of drinking water.

- Test conditions

Dose levels

These should be sufficient in number, at least three, and spaced appropriately to produce test groups with a range of toxic effects and mortality rates. The data should be sufficient to produce a dose response curve and, where possible, permit an acceptable determination of the LD50.

Limit test

When rodents are used, a limit test at one dose level of a least 2000 mg/kg bodyweight may be carried out in a group of 5 males and 5 females using the procedures described above.

If compound-related mortality is produced, a full study may need to be considered.

Observation period

The observation period should be at least 14 days. However, the duration of observation should not be fixed rigidly. It should be determined by the toxic reactions, rate of onset and length of recovery period, and may thus be extended when considered necessary. The time at which signs of toxicity appear and disappear and the time of death are important, especially if there is a tendency for deaths to be delayed.

- Procedure

Animals should be fasted prior to substance administration. For the rat, food should be withheld over-night; for other rodents with higher metabolic rates a shorter period of fasting is appropriate. Following the period of fasting, the animals should be weighed and then the test substance administered in a single dose to animals by groups by gavage using a stomach tube or a suitable intubation cannula. If a single dose is not possible, the dose may be given in smaller fractions over a period not exceeding 24 hours. After the substance has been administered, food may be withheld for a further 3-4 hours. Where a dose is administered in fractions over a period, it may be necessary to provide the animals with food and water depending on the length of the period. Following administration, observations are made and recorded systematically with individual records being maintained for each animal.

- Clinical examinations

A careful clinical examination should be made at least once each day. Additional observations should be made daily with appropriate actions taken to minimise loss of animals to the study, e.g. necropsy or refrigeration of those animals found dead and isolation or sacrifice of weak or moribund animals. Cageside observations should include changes in the skin and fur, eyes and mucous membranes, and also respiratory, circulatory, autonomic and central nervous system, and somatomotor activity and behaviour pattern. Particular attention should be directed to observation of tremors, convulsions, salivation, diarrhoea, lethargy, sleep and coma. The time of death should be recorded as precisely as possible. Individual weights of animals should be determined shortly before the test substance is administered, weekly

"Acute Oral Toxicity"

thereafter and at death; changes in weight should be calculated and recorded when survival exceeds one day. At the end of the test surviving animals are weighed and then sacrificed.

- Pathology

Necropsy of all animals should be carried out, and all gross pathological changes should be recorded. Microscopic examination of organs showing evidence of gross pathology in animals surviving 24 or more hours should also be considered because it may yield useful information.

- Assessment of toxicity in the other sex

After completion of the study in one sex, at least one group of 5 animals of the other sex is dosed to establish that animals of this sex are not markedly more sensitive to the test substance. The use of fewer animals may be justified in individual circumstances. Where adequate information is available to demonstrate that animals of the sex tested are markedly more sensitive, testing in animals of the other sex may be dispensed with.

3. DATA AND REPORTING

- Treatment of results

Data may be summarised in tabular form showing for each test group the number of animals at the start of the test, time of death of individual animals at different dose levels, number of animals displaying other signs of toxicity, description of toxic effects and necropsy findings.

Animals which are humanely killed due to compound-related distress and pain are recorded as compound-related deaths.

The LD50 may be determined by any accepted method, e.g. Bliss (7), Litchfield and Wilcoxon (4), Finney (8), Weil (9), Thompson (10), Miller and Tainter (11).

- Evaluation of results

The LD50 value should always be considered in conjunction with the observed toxic effects and any necropsy findings. The LD50 value is a relatively coarse measurement, useful only as a reference value for classification and labelling purposes, and for an expression of the lethal potential of the test substance by the ingestion route. Reference should always be made to the experimental animal species in which the LD50 value was obtained.

An evaluation should include the relationship, if any, between the animals' exposure to the test substance and the incidence and severity of all abnormalities, including behavioural and clinical abnormalities, gross lesions, body weight changes, effects on mortality, and any other toxic effects.

- Test report

The test report should include the following information:

- species/strain/source used; diet; environmental conditions;
- sex of animals dosed;
- tabulation of response data by dose level (i.e. number of animals that died or were killed during the test; number of animals showing signs of toxicity; number of animals exposed);
- time of dosing and time of death after dosing;
- LD50 values for the sex dosed, determined at 14 days (with the method of determination specified);
- 95 per cent confidence interval for the LD50;
- dose-mortality curve and slope (where permitted by the method of determination);
- pathology findings; and
- results of any test on the other sex.

- Interpretation of the results

A study of acute toxicity by the oral route and determination of an LD50 provides an estimate of the relative toxicity of a substance. Extrapolation of the results of acute oral toxicity studies and oral LD50 values in animals to man is valid only to a very limited degree.

4. LITERATURE

1. WHO Publication: Environmental Health Criteria 6, *Principles and Methods for Evaluating the Toxicity of Chemicals*. Part 1, Geneva, 1978.

"Acute Oral Toxicity"

2. National Academy of Sciences, Committee for the Revision of NAS Publication 1138, *Principles and Procedures for Evaluating the Toxicity of Household Substances*, Washington, 1977.
3. Food Safety Council, *Proposed System for Food Safety Assessment*, Food and Cosmetic Toxicology, 16, 2, 1978.
4. Litchfield, J.T. and Wilcoxon, F., *J. Pharmacol. Exp. Ther.* 96, 99-113, 1949.
5. Lingk, W., *A European Community Study on an Intercomparison Exercise on the Determination of Single Dose Oral LD50 in Rats*, Commission of the European Communities, Health and Safety Directorate, 1978.
6. Hunter, W.J., Lingk, W., and Recht, P., *Intercomparison Study on the Determination of Single Administration Toxicity in Rats*, Commission of the European Communities, Health and Safety Directorate. *J. Assoc. Off. Anal. Chem.* 62, 864-873, 1979.
7. Bliss, C.I., *Quart. J. Pharm. Pharmacol.*, 11, 192-216, 1938.
8. Finney, D.G., *Probit Analysis*. (3rd Edn.) London, Cambridge University Press, 1971.
9. Weil, C.S., *Biometrics*, 8, 249-263, 1952.
10. Thompson, W., *Bact. Rev.*, 11: 115-141, 1947.
11. Miller, L.C. and Tainter, M.L., *Proc. Soc. Exp. Biol. Med. NY*, 57, 261-264, 1944.
12. Paget, G.E. (editor), *Methods in Toxicology*, Blackwell Scientific Publications, Oxford, 1970.

APPENDIX J

Development of OECD 425

J-1	UDP: Is there a need for further validation?.....	J-3
	(Rispin, A., U.S. EPA and K. Stitzel, Procter & Gamble Company – 03/21/2000)	
J-2	Rationale for the UDP as Submitted to OECD	J-11
	(Acute Toxicity Working Group, ICCVAM – February 1996)	
J-3	Test Guideline 425 – Up and Down Procedure	J-15
	(Presentation by K.Stitzel, Procter & Gamble Company – 04/03/2000)	

March 31, 2000

**UP AND DOWN PROCEDURE:
IS THERE NEED FOR FURTHER
COMPUTER SIMULATIONS AND *IN VIVO* VALIDATION?**

BACKGROUND

Acute Oral Toxicity Testing

The acute oral toxicity test seeks to estimate the dose at which 50% of the organisms in a defined population will die (LD50) after exposure to a test material. The statistical basis for the classic study design was first described in the 1920s and remained in use until current times. In this test, groups of animals were administered varying doses of test material, and a dosed animal either lived or died. As the dose in an acute toxicity test is increased, the probability that a given animal dies increases. These results established a relationship between dose and response. Responses in an acute toxicity study can be characterized by a mean (the LD50) and variance (or slope) of the dose-response curve.

Over the years many attempts have been made to expand test outputs and to adjust statistical sampling so as to minimize the number of animals used and decrease their pain and suffering. These changes in sampling technique do not involve any change in the actual treatment of the animals or the lethal endpoint of the test. Over the years, the classic LD50 protocol has been modified to reduce the number of animals from scores of animals to 15 to 30 per study. Other modifications include such things as:

1. The dose is usually administered by oral gavage to fasted young adult animals.
2. Animals are observed periodically during the first 24 hours with special attention given to the first four hours, then at least once a day for 14 days or until they die or recover.
3. Clinical signs including their nature, severity, time of onset and to recovery are recorded at observation times.
4. Body weights are determined before treatment, weekly thereafter and at death.
5. All animals that survive are sacrificed at 14 days.
6. Gross necropsies are done on all animals in the study; histopathology of lesions and clinical chemistries may be included.

Response Variability

Variations in results from a study of a given chemical can be divided into many different components:

1. animal age, sex, estrus cycle, strain and species
2. among animals in a study

3. among groups of animals in a study
4. studies at the same or different times within a laboratory
5. studies conducted in different laboratories.

It is recognized that as long as the animals in a test are individually housed, the animal to animal variability and variation with age, sex, strain and species will not change with the sampling procedure, i.e. for protocols with sequential vs. simultaneous dosing. It is important that adequate population variability be built into the computer simulations and enough is known about the endpoint to be able to write a computer program that can accurately predict experimental results.

Computer Simulation as an Aid in Test Design

An experimenter wants to use sampling designs with small numbers of animals which adequately estimate the mean and variance of the entire population. When both the mean and variance of the population are known, it is possible using a computer to run the specified test hundreds or thousands of times by generating random sequences of responses. Thus, the computer simulates overall results by repeatedly taking small samples from a much larger population. Simulations provide a way to select among designs those with the greatest accuracy in estimating the mean and variance (or standard deviation) of the population. No level of in vivo testing could ever generate the number of runs that are possible using simulation.

In Life Testing

Certain aspects of test designs may not be totally addressed by computer simulations. In going from theory to practice, there are other considerations. For instance, for each design, has the protocol been ably articulated so that laboratories can consistently carry out the study and accurately assess study outcomes? Without some laboratory experience it is not possible to unequivocally assert that the method can be appropriately utilized. Generally, some laboratory information is needed to confirm that a new test method performs in the way hypothesized against a "gold standard" method. Likewise, across acute toxicity designs, there is similar variability within and among laboratories. The same is the case for variability within a laboratory over time. However, if the test method is the same across various toxicity test designs, there should be similar variability within and among laboratories. The same is the case for variability within a laboratory over time.

UP AND DOWN PROCEDURE (UDP)

Significant work has been performed on the UDP. Theoretical studies have demonstrated the characteristics of the method and indicated that the procedure and its modifications are the most efficient means of deriving an estimate of the median effective dose per expenditure of test animals (Brownlee et al., 1953; Wetherill et al., 1966; Dixon, 1965; Hsi, 1969; Little, 1974a,b). Practical determinations of acute toxicity bear this out, where savings in animals in comparison to the classical test and the FDP can be significant; the UDP and the acute toxic class method appear to use quite comparable numbers of animals (Bonnyns et al., 1988; Brownlee et al., 1953; Bruce, 1985, 1987; Yam et al., 1991; Schlede et al., 1994; Lipnick et al., 1995).

Data from 35 published test materials have been summarized which compare the UDP, which were assumed to have a sigma of 1.2 which is representative of many consumer chemicals, with the classic or other acute oral toxicity designs (Lipnick et al., 1995). This number of compounds for validation studies is similar to that run for some other acute toxicity and eye irritation validation studies. The results of these studies showed the UDP design was most often able to predict the LD50 determined by the classical LD50 test. The method was accepted as an American Standard Test Method and by OECD (1997) without further testing and validation (U.S. EPA, 1995)

However, there have been indications that all OECD acute toxicity methods, including the UDP, would not provide necessary information about all types of compounds and mixtures. During an evaluation in spring, 1999 of the four acute oral toxicity designs already accepted by OECD, all were shown by simulation techniques to have poor ability to estimate the LD50 of the underlying population when the slope of the dose response curve is shallow and the starting doses for the tests were far from the actual LD50.

Subsequently, the U.S. was asked to determine if improvements in the sampling technique could be made that would improve the ability of the UDP to estimate the LD50 of the underlying population. Modifications have been developed which adjust the design of the UDP regarding the spacing of doses, add rules for the cessation of animal testing and formulate a more efficient use of animals in a limit dose test. In addition, proposals for generation of dose response slope determination have been developed. It is recognized that the new proposed UDP is more complicated than that in the current OECD guideline.

Significant numbers of simulations have been performed to justify the new designs of the UDP. However, no in vivo testing has been performed to illustrate the applicability of the designs. Likewise, there have not been any comparisons of the new UDP and the classic LD50 design. Some believe that the extensive simulations provide data representative of the population which an animal experiment replicated few times will not provide. Others believe that it is critical to observe that the method can be used successfully in a laboratory, considering the complexity of the proposed method and the fact that the results obtained reflect computer simulations. The Pesticide Program of EPA has a substantial database of classic acute toxicity test results, some with repeat tests done by independent laboratories, that could be used as a comparison for actual in vivo UDP.

QUESTIONS FOR THE PEER PANEL

It is recognized that many further studies on the performance of the proposed UDP procedures could be undertaken. Some of them might include such things as:

1. ability to transfer the test method among laboratories
2. actual performance of the method with chemicals of steep and shallow slopes
3. actual performance of the method with chemicals from different toxicity categories

4. practicality of the UDP or other sequential dosing methods for chemicals with somewhat delayed deaths ?
5. impact on test results of changing animal age and weight which could occur for chemicals with delayed toxicities or shallow slopes?
6. outliers. Simulations can show the impact of many outlier responses. However, when one animal is tested at each dose, how would outlier responses in the laboratory be identified by the investigator or the regulatory agency?
7. inability of small sample size designs being able to identify the breadth and severity of toxic signs
8. comparison of the ability of the new UDP test and the classic design to predict chemical hazard classification
9. real life test variability, in comparison to that predicted from simulations
10. determine that the relevant ICCVAM criteria for validation have been reached
11. get information on chemical mixtures as compared to single substances.

Recognizing that any number of these areas could be investigated with further simulations or in vivo tests, the peer panel is asked to provide comment and recommendation on the following questions.

1. Are the simulations that have been performed appropriate for demonstrating the operating characteristics of the modified UDP? Are there further simulations that would be helpful in evaluating the strengths and weaknesses of the method?
2. Are there in vivo tests that would aid in the determination of the usefulness of the proposed test procedures?
3. If there are further simulations that would be helpful in ascertaining the usefulness of the test proposals, provide guidance as to the priority that they should receive, given that resources for further investigations are limited.
4. Is a limited in-vivo validation necessary to (a) determine practical applicability of this complex method in a contract laboratory, including influence of variables such as changes in animal age/weight in the course of the test or effect of changing animal batches to stay within age/weight range; (b) determine the performance of the method relative to confidence intervals of simulations and © compare in-vivo results with LD50 values available from existing data bases.

REFERENCES

ASTM 1987 (American Society for Testing and Materials) Standard test method for estimating acute oral toxicity in rats. Designation: E 1163-87. Philadelphia: American Society for Testing and Materials.

Blick, D.W., Murphy, M.R., Weathersby, F.R., Brown, G.C., Yochmowitz, M.G., Fanton, J.W., & Harris, R.K. 1987a Primate equilibrium performance following soman exposure: Effects of repeated daily exposure to low soman doses. Report USAFSAM-TR-87-19. Brooks Air Force Base, TX: USAF School of Aerospace Medicine. 18 pp.

Blick, D.W., Murphy, M.R., Brown, G.C., Yochmowitz, M.G., & Farrer, D.N. 1987b Effects of carbamate pretreatment and oxime therapy on soman-induced performance decrements and blood cholinesterase activity in primates. Report USAFSAM-TR-87-23. Brooks Air Force Base, TX: USAF School of Aerospace Medicine. 12 pp.

Blick, D.W., Murphy, M.R., Brown, G.C. & Yochmowitz, M.G. 1987c Primate equilibrium performance following soman exposure: Effects of repeated acute exposure with atropine therapy. Report USAFSAM-TR-87-43. Brooks Air Force Base, TX: USAF School of Aerospace Medicine. 11 pp.

Bonnyns, E., Delcour, M.P. & Vral, A. 1988 Up-and-down method as an alternative to the EC-method for acute toxicity testing. Brussels: Institute of Hygiene and Epidemiology, Ministry of Public Health and the Environment. IHE project no. 2153/88/11. 33 pp.

Brownlee, K.A., Hodges, J.L. & Rosenblatt, M. 1953 The up-and-down method with small samples. *J. Amer. Statist. Assn.* 458: 262-277. •6

Bruce, R.D. 1985 An up-and-down procedure for acute toxicity testing. *Fundam. Appl. Toxicol.* 5: 151-157.

Bruce, R.D. 1987 A confirmatory study for the up-and-down method for acute toxicity testing. *Fundam. App. Toxicol.* 8: 97-100.

Cordts, R.E. & Yochmowitz, M.G. 1983 Antiemetic studies both pre and post exposure: Preliminary findings. Report USAFSAM-TR-83-23. Brooks Air Force Base, TX: USAF School of Aerospace Medicine. 9 pp.

Dixon, W.J. 1965 The up-and-down method for small samples. *J. Amer. Statist. Assoc.* 60: 967-978. Hsi, B.P. 1969 The multiple sample up-and-down method in bioassay. *J. Amer. Statist. Assoc.* 64: 147-162.

ICCVAM. 1997 Validation and regulatory acceptance of toxicological test methods. A report of the ad hoc Interagency Coordinating Committee on the Validation of Alternative Methods. NIH publication no: 97-3981. National Institute of Environmental Health Sciences: Research Triangle Park, NC.

- Klaasen, C.D. & Plaa, G.L. 1967 Relative effects of various chlorinated hydrocarbons on liver and kidney function in dogs. *Toxicol. Appl. Pharmacol.* 10: 119-131.
- Lipnick, R.L., Cotruvo, J.A., Hill, R.N., Bruce, R.D., Stitzel, K.A., Walker, A.P., Chu, I., Goddard, M., Segal, L., Springer, J.A. & Myers, R.C. 1995 Comparison of the up-and-down, conventional LD50, and fixed-dose acute toxicity procedures. *Fd. Chem. Toxicol.* 33: 223-231.
- Little, R.E. 1974a A mean square error comparison of certain median response estimates for the up-and-down method with small samples. *J. Amer. Statist. Assoc.* 69: 202-206.
- Little, R.E. 1974b The up-and-down method for small samples with extreme value response distributions. *J. Amer. Statist. Assoc.* 69: 803-806.
- Meyer, J.H., Elashoff, J., Porter-Fink, V., Dressman, J. & Amidon, G.L. 1988 Human postprandial gastric emptying of 1-3 millimeter spheres. *Gastroenterology.* 94: 1315-1325.
- OECD. 1997 OECD guideline for the testing of chemicals. Acute oral toxicity: Up-and-down procedure. OECD guideline 425. Organization of Economic Cooperation and Development: Paris.
- Schlede, E., Diener, W., Mischke, U. & Kayser, D. 1994 OECD expert meeting: Acute toxic class method. January 26-28, 1994, Berlin, Germany.
- U.S. EPA 1995 Rationale for the up and down procedure. Submission to OECD concerning the acceptance process for the method. (Included in ICCVAM review package)
- Wetherill, G.B., Chen, H. & Vasudeva, R.B. 1966 Sequential estimation of quantal response curves: A new method of estimation. *Biometrika.* 53: 439-454.
- Yam, J., Reer, P.J. & Bruce, R.D. 1991 Comparison of the up-and-down method and the fixed dose procedure for acute oral toxicity testing. *Fd. Chem. Toxicol.* 29:259-263.

Computer Simulations in Study design

Statistical simulations allow us to determine the accuracy of the test design in estimating LD50 in ways that would not be possible with a single sample or even a small number of samples run in actual animals. Since the laboratory to laboratory and intra laboratory variability is not different with the new test designs, the only question is how well they can accurately predict the 'true' values.

Prediction of the 'true' LD50 for a population of rats will depend both on the size of the sample of the population that is sampled, the degree of variability of the response with the population of rats, and the statistical method that is used to estimate the result. Because the LD50 test results in a simple yes/no answer, it is possible to use computers to simulate the degree to which any specific statistical procedure can estimate the 'true' LD50 of the population.

Simulations are done in a stepwise fashion. First the 'true' result is assigned to a 'virtual population' of rats, secondly the population is assigned a known or 'true' degree of variability (or slope of the dose response curve). Because the simulations are being run on a computer, a very large number of 'virtual populations' can be defined each with a different combination of 'true' LD50 and 'true' slope. Simulations can be done for any, (and as many as desired) combinations of 'true' LD50 and 'true' slope as the investigator is willing to simulate. This allows for very rigorous examination of the robustness of the statistical procedures that would not be possible in animal studies.

Once the 'virtual population' is defined, the computer picks animals at random from the population as the sample that would be chosen for the actual test. For each animal the computer, based on the probabilities assigned to the 'virtual population', assigns where it will die on the dose response curve. These probabilities are based on normal statistical estimates of population responses. This mimics exactly what happens in actual practice where the study director picks a small number of animals at random to run his or her test each of which has a built in biological variability. The only difference is that the study director only runs the test with one sample or possibly two samples from the populations and assumes that samples were representative of the full population. The computer on the other hand, can pick random samples over and over again and determine how often the test design used will accurately estimate the 'true' LD50 of the population. For instance, in the simulations that were done for the UDP, between 2500 and 10,000 different random samples were picked from each well-defined population of rats. The results of these simulations provide statistical values on the chance that any one random sample of animals will accurately be able to predict the 'true' LD50 of the population. This information is not available if only one random sample is examined via an actual animal study.

One question has been whether a computer simulations isn't 'too' perfect in that the simulated animals will always give results that fit within the assigned parameters for their 'virtual population'. Using simulations it is possible to address this issue by setting up the computer runs to include one, or more animals, that do not respond correctly. For instance, EPA has calculated the ability of one of the 8 test designs to accurately predict the LD50 if the first animal dies independently of whether this was the 'correct' response for that animal. These questions could

not easily be answered by actual animal studies since it would be impossible for the study director to know that the result from the first animal was not predictive of the 'true' population.

RATIONALE FOR THE UP-AND-DOWN PROCEDURE AS SUBMITTED TO THE OECD

Introduction

1. Acute toxicity tests are used to evaluate various toxic manifestations following a single exposure to an agent. One of the uses of data coming from such tests is to estimate the median lethal dose so as to place agents into one of a number of groups for hazard classification and labeling purposes. OECD presently has approved three test methods for acute oral toxicity: Test Guideline 401: the classical Acute Toxicity Test, and two substitutes, Test Guideline 420 the Fixed Dose Method (FDM) and Test Guideline 423: the Acute Toxic Class Method (ATC). The Up-and-Down Procedure (UDP) would be a fourth such option.

Background

2. All of the acute oral toxicity tests measure a spectrum of non-lethal toxic manifestations. Both the classical method (TG 401) and the UDP give point estimates of the median lethal dose, whereas the FDM (TG 420) and ATC (TG 423) give estimates of the lethal range. The classical test relies on simultaneous testing of a preset number of groups of animals, while the other three tests employ consecutive testing in a staircase design, where the dose in one trial is a function of the outcome of testing in the previous trial. The UDP and the ATC are quite consistent, except that the UDP uses single animals per trial, while the ATC employs three animals per dose.

3. Significant work has been performed on the UDP. Theoretical studies have demonstrated the characteristics of the method and indicated that the procedure and its modifications are very efficient means of deriving an estimate of the median effective dose per expenditure of test animals (1)(2)(3)(4)(5)(6). Practical determinations of acute toxicity bear this out, where savings in animals in comparison to the classical test and the FDM can be significant; the UDP and the ATC appear to use quite comparable numbers of animals (1)(7)(8)(9)(10)(11)(12). In addition, practical use of the test method goes far beyond acute toxicity testing and includes such things as (a) evaluation of target organ effects in dogs (13); (b) evaluation of the efficacy of antiemetic drug treatments (14); determination and treatment of adverse organophosphate-induced effects (15)(16)(17); and (d) testing of the movement of chemicals imbedded in microspheres through the human stomach (18).

4. Before being accepted by OECD the FDM and the ATC each underwent validation ring tests. Validation of a new method depends upon determining the reliability and reproducibility of the method, proving its predictive capacity, and establishing its relevance. Since data on the UDP demonstrate all of these, it seems to be both unnecessary and undesirable to undertake extensive validation testing of this method.

Reliability and Reproducibility

5. The test method for the UDP is like that used in the classical test, FDM and ATC: the species of animal used is the same; the method of administration of the test material is the same; and the observations and toxic endpoints are the same. These ensure that the animal data gathered by a laboratory for the UDP are just like those from the other acute toxicity test methods that have

already been adopted as OECD Test Guideline. Further validation of the UDP to demonstrate that multiple laboratories can reliably administer test substances to experimental animals and determine acute toxicity manifestations including whether they survive or die is not necessary.

Predictivity

6. Acute toxicity findings using the UDP have been generally similar to those achieved with the classical method: there was an excellent linear correlation for the estimates of the median lethal dose, and the same EEC acute toxicity classification was reached in 23 of 25 cases (12). In the two remaining cases, the UDP classification was more stringent than the classical method. These data on 25 test materials clearly indicate that the UDP can predict the appropriate hazard classes of test materials as well as the classical method. In addition, the mathematical model used in the UDP to predict the median lethal dose of test materials has been published as an American Society for Testing and Materials standard method (19).

7. Both the FDM and the ATC were found acceptable after testing 20 chemicals, a number similar to that accumulated in multiple studies for the UDP (11)(12)(20). In addition, FDM, ATC and UDP testing led to the same hazard classification decisions as did the classical test in 80, 85 and 92% of cases, respectively. Certainly, the data base supporting the UDP is comparable to other methods that have been accepted by OECD Member countries.

Relevance

8. Test methods must be relevant to the regulatory agencies that are going to use the test data. As stated previously, the UDP has become a standard test method by the American Society for Testing and Materials (ASTM, 1987). In addition to capturing all of the toxic manifestations following acute exposure to an agent, the UDP test provides an estimate of the median lethal dose which is directly referable to any hazard classification system in use today. Such an estimate of the median lethal dose is also often helpful in setting doses for subchronic toxicity tests and for comparisons of acute toxicity with other test materials and by other routes of administration.

9. Regulatory agencies are also concerned about the use of animals in toxicity tests. The UDP has been shown to use fewer animals than the classical test and the FDM, and while a direct comparison between the UDP and ATC method is only available for three materials, the UDP used either the same or fewer animals (Schlede et al., 1994; Lipnick, et al., 1995). The UDP provides in a single test the ability to correctly classify acute toxicity as well as to estimate the median lethal dose, data that can be useful in preventing unnecessary animal use in future toxicity studies.

Conclusion

10. All acute toxicity tests are trying to develop the same data on the consequences of a single chemical exposure: they measure morbid endpoints and lethality. Like other acute toxicity tests, the UDP can be used to reliably and reproducibly evaluate acute toxicity. Methods differ in regard to details of their design and means of determining values used for hazard classification. Certainly the UDP is as efficient a means of estimating a median lethal dose as exists. It predicts an appropriate hazard classification as well as other acute toxicity alternatives, and its relevance to

regulatory objectives is ably demonstrated by developing requisite toxicity data, estimating the median lethal dose and minimizing animal usage. To commit more animals in order to show that the method works would be contrary to good science, good policy and good economics.

References

1. Brownlee, K.A., Hodges, J.L. & Rosenblatt, M. 1953 The up-and-down method with small samples. *J. Amer. Statist. Assn.* 458: 262-277.
2. Wetherill, G.B., Chen, H. & Vasudeva, R.B. 1966 Sequential estimation of quantal response curves: A new method of estimation. *Biometrika.* 53: 439-454.
3. Dixon, W.J. 1965 The up-and-down method for small samples. *J. Amer. Statist. Assoc.* 60: 967-978.
4. Hsi, B.P. 1969 The multiple sample up-and-down method in bioassay. *J. Amer. Statist. Assoc.* 64: 147-162.
5. Little, R.E. 1974a A mean square error comparison of certain median response estimates for the up- and-down method with small samples. *J. Amer. Statist. Assoc.* 69: 202-206.
6. Little, R.E. 1974b The up-and-down method for small samples with extreme value response distributions. *J. Amer. Statist. Assoc.* 69: 803-806.
7. Bonnyns, E., Delcour, M.P. & Vral, A. 1988 Up-and-down method as an alternative to the EC-method for acute toxicity testing. Brussels: Institute of Hygiene and Epidemiology, Ministry of Public Health and the Environment. IHE project no. 2153/88/11. 33 pp.
8. Bruce, R.D. 1985 An up-and-down procedure for acute toxicity testing. *Fundam. Appl. Toxicol.* 5: 151-157.
9. Bruce, R.D. 1987 A confirmatory study for the up-and-down method for acute toxicity testing. *Fundam. App. Toxicol.* 8: 97-100.
10. Yam, J., Reer, P.J. & Bruce, R.D. 1991 Comparison of the up-and-down method and the fixed dose procedure for acute oral toxicity testing. *Fd. Chem. Toxicol.* 29:259-263.
11. Schlede, E., Diener, W., Mischke, U. & Kayser, D. 1994 OECD expert meeting: Acute toxic class method. January 26-28, 1994, Berlin, Germany.
12. Lipnick, R.L., Cotruvo, J.A., Hill, R.N., Bruce, R.D., Stitzel, K.A., Walker, A.P., Chu, I., Goddard, M., Segal, L., Springer, J.A. & Myers, R.C. 1995 Comparison of the up-and-down, conventional LD50, and fixed-dose acute toxicity procedures. *Fd. Chem. Toxicol.* 33: 223-231.

13. Klaasen, C.D. & Plaa, G.L. 1967 Relative effects of various chlorinated hydrocarbons on liver and kidney function in dogs. *Toxicol. Appl. Pharmacol.* 10: 119-131.
14. Cordts, R.E. & Yochmowitz, M.G. 1983 Antiemetic studies both pre and post exposure: Preliminary findings. Report USAFSAM-TR-83-23. Brooks Air Force Base, TX: USAF School of Aerospace Medicine. 9 pp.
15. Blick, D.W., Murphy, M.R., Weathersby, F.R., Brown, G.C., Yochmowitz, M.G., Fanton, J.W., & Harris, R.K. 1987a Primate equilibrium performance following soman exposure: Effects of repeated daily exposure to low soman doses. Report USAFSAM-TR-87-19. Brooks Air Force Base, TX: USAF School of Aerospace Medicine. 18 pp.
16. Blick, D.W., Murphy, M.R., Brown, G.C., Yochmowitz, M.G., & Farrer, D.N. 1987b Effects of carbamate pretreatment and oxime therapy on soman-induced performance decrements and blood cholinesterase activity in primates. Report USAFSAM-TR-87-23. Brooks Air Force Base, TX: USAF School of Aerospace Medicine. 12 pp.
17. Blick, D.W., Murphy, M.R., Brown, G.C. & Yochmowitz, M.G. 1987c Primate equilibrium performance following soman exposure: Effects of repeated acute exposure with atropine therapy. Report USAFSAM-TR-87-43. Brooks Air Force Base, TX: USAF School of Aerospace Medicine. 11 pp.
18. Meyer, J.H., Elashoff, J., Porter-Fink, V., Dressman, J. & Amidon, G.L. 1988 Human postprandial gastric emptying of 1-3 millimeter spheres. *Gastroenterology.* 94: 1315-1325.
19. ASTM 1987 (American Society for Testing and Materials) Standard test method for estimating acute oral toxicity in rats. Designation: E 1163-87. Philadelphia: American Society for Testing and Materials.
20. Van den Heuvel, M.J., Clark, D.G., Fielder, R.J., Koundakjian, P.P., Oliver, G.J.A., Pelling, D., Tomlinson, N.J. & Walker, A.P. 1990 The international validation of a fixed-dose procedure as an alternative to the classical LD50 test. *Fd. Chem. Toxicol.* 28: 469-482.

Test Guideline 425
Up-and-Down Procedure
Katherine Stitzel, D.V.M.
The Procter & Gamble Company

Overview

- Based on staircase design
- Dose single animals in sequence
- Set initial dose at toxicologist's best estimate of the LD50
- Following each death (or moribund state), the dose is lowered
- Following each survival, the dose is increase
- After the first reversal, dose four additional animals following the up-and-down design

Example

- First animal dosed at 200 mg/kg and lives
 - Second animal dosed at 260 mg/kg and dies
 - Third animal dosed at 200 mg/kg and dies
 - Fourth animal dosed at 154 mg/kg and lives
 - Fifth animal dosed at 200 mg/kg and lives
 - Sixth animal dosed at 260 mg/kg and dies
- LD50 = 209 mg/kg

Protocol

- Default dose progression is 1.3
- Default is to use only females
- Observe each animal 24 hours before dosing the next animal
- Count all deaths including delayed deaths and humanely killed
- Observe for 14 days - record weekly body weights, all clinical signs and gross necropsy results

Options

- Initial dose based on all available information
- Most sensitive sex should be used
- LD50 can be confirmed in opposite sex
- Dose progression can be adapted
- Observation period between animals can be increased
- Limit study described

Study Outputs

- Test substance, vehicle, test animals, test conditions
- Individual responses including nature of signs, time of onset, severity, duration and outcome
- Time course of reversible signs
- Gross necropsy results, histopathology if warranted
- Calculated point estimate of LD50

Calculations

- Based on staircase design
- Uses maximum likelihood method to calculate LD50
- Can be run with SAS or BMDP program
- Slope is assumed and not calculated

First Test Evaluation

- First proposed by Bruce, based on Dixon's design
- Reviewed 48 standard LD50 studies
 - average value of σ was 0.121
 - 85% of animal died within 48 hours
 - Males more likely to have higher LD50 values
- Simulated 10 studies - LD50 agreed closely

First Validation

- Conducted 10 tests in parallel with 401
- Excellent agreement with 401 standard except
- potassium hydroxide a material that produced delayed deaths

Second Validation

- Conducted 5 tests in parallel with 401
- Compared results from females in both methods
- Excellent agreement with 401 standard

Third Validation

- Conducted 10 tests in parallel with 401 and FDP
- FDP sighting study was used
- Compared results from females only
- Excellent agreement with 401 standard except mercuric Cl
- 401 method - 160 mg/kg
- UDP - 12 mg/kg
- Textbook (Gosselin 1984) - 37 mg/kg

Summary of Classification Results Using EU System

- Twenty-Five Test Materials:
- Twenty-Three Identical to 401
- Two more Stringent

Strengths

- Reduced Number of Animals
- Point Estimate of LD50
- Meets all classification systems
- Death as an Endpoint
- Similar Observations as 401

Weaknesses

- Slope is given not calculated
- Females only, males may be added
- Arbitrary upper limit of 2000mg/kg
- Not suitable for delayed toxicity
- Not suitable for inhalation studies
- Increased test duration

Results of First Validation (Bruce)

Results of Second Validation

(Bonnyns, et al.)

Results of Third Validation (Yam, et al.)

Statistical Procedure

Likelihood of experimental outcome = L (given μ , σ , and n) $L_i = 1 - F(Z_i)$ if the i^{th} animal survived or $L_i = F(Z_i)$ if the i^{th} animal diedWhere $Z = [\log(d_i) - \mu] / \sigma$; $\mu = \log \text{LD50}$; and $F =$ cumulative, standard normal density

The UDP Primary Test: Proposed Revision of the Guideline 425 "Primary Procedure" for Point Estimation of the LD50: Rationale for Design, Statistical Analysis, and Simulation Studies

Prepared for Review of Proposed Guideline 425 Revisions by the
Interagency Committee for Validation of Alternative Methods (ICCVAM)

David Farrar (USEPA), March 10, 2000

A Guideline 425 is being proposed for evaluation of mammalian acute toxicity to satisfy OECD member requirements. A previous version was examined together with several other OECD guidelines in March 1999. Revisions were undertaken as part of a general effort to address statistical issues and improve performance of the procedure. Elements of the Guideline 425 include a dose progression factor, the number of animals tested at each time and dose, and a formula and procedure for toxicity estimation. Proposed revisions as included in the proposal before the Panel include an increased dose progression factor, an increased slope value assumed in the estimation procedure (but a slope is still assumed), use of a likelihood-based stopping rule, and explicit language to ensure that test doses do not progress beyond a specific experimental range.

The following text develops a number of issues for consideration by ICCVAM. In addition, we refer to ICCVAM the following overarching question: Is the most appropriate course of action to (1) use the guideline without the modifications proposed; (2) use the guideline with the revisions proposed; or (3) delay further use of the guideline until critical issues (to be identified by ICCVAM) can be resolved?

Contents.

1.	Statistical Rationale for the Primary Procedure	G-3
1.1	Design ⁴	
1.1.1	The Dixon-Mood procedure as modified for a restricted range of test doses.	G-3
1.1.2	Rule for stopping testing at a bounding dose.	G-4
1.1.3	Use of a progression factor of 3.2.	G-4
1.1.4	Variants of Up-and-Down testing.	G-5
1.2	Analysis	G-6
1.2.1	Use of the probit dose-response model.	G-6
1.2.2	Use of an assumed value for the probit slope	G-6
1.2.3	Lack of a confidence interval for the LD50.	G-7
1.2.4	Viability of a Bayesian approach to uncertainty in the slope.	G-7
1.2.5	Use of maximum likelihood, and measurement of statistical information.	G-7
1.2.6	How test performance depends on the probit slope.	G-8
1.2.7	Rationale for a stopping rule with a variable nominal sample size.	G-9
1.2.8	The proposed likelihood-ratio stopping rule.	G-10
1.2.9	Stopping based on “perfect alternation” of response and non-response.	G-11
1.2.10	Justification for numerical parameters in the stopping criteria.	G-11
1.2.11	Outliers.	G-12
2.	Simulation Results	G-14
2.1	Classification probabilities plotted against LD50 and slope	G-14
2.2	Monte Carlo comparison of three stopping rules and two LD50 estimators for the primary procedure	G-18
2.2.1	Estimators of the LD50	G-18
2.2.2	Stopping Criteria Evaluated.	G-18
2.2.3	Performance Statistics	G-19
2.2.4	Results and Discussion	G-20
2.2.4	Conclusions	G-23
2.2.5	Tables of Monte Carlo results: percentiles of the distribution of LD50 estimates	G-24
2.2.6	Tables of Monte Carlo Results for Numbers Tested	G-30
2.2.7	Tables of Monte Carlo Results: Performance Statistics	G-33
2.3	Simulation of an outlier scenario	G-39
2.4	Classification probabilities for standard OECD scenarios	G-40
2.4.1	OECD-Type scenarios: Distribution of LD50 Estimates	G-41
2.4.2	OECD-Type scenarios: Results for Numbers Tested	G-52
2.4.3	OECD-Type scenarios: Classification Probabilities	G-58
2.5	Sensitivity to the assumed slope	G-64
	References	G-68

1. Statistical Rationale for the Primary Procedure

1.1 Design

1.1.1 The Dixon-Mood procedure as modified for a restricted range of test doses.

The basic procedure of Dixon and Mood is adequately described in the Guideline so the description will not be repeated here. Appendix I of the Guideline defines some terms used here, in particular *reversal*, and *nominal sample size*. We follow the Guideline in using the term *progression factor* to denote the ratio of successive test doses.

We propose to restrict the test doses to values not exceeding 2000 mg/kg or 5000 mg/kg, depending on the regulatory context. In addition, in practice it will be appropriate to establish a lower bound, which may depend on the test substance: “Setting of lower bounds may need to include consideration of the ability to accurately dilute the test material.” It is important that modifications of the procedure associated with bounding the range of test doses not “clash” with other features of the procedure, such as stopping rules or procedures for statistical analysis. We think this has been reasonably well confirmed by Monte Carlo simulations in which the true LD50 was varied, including LD50 values beyond bounds of 1 and 5000, and removed to various degrees above or below those bounds.

The essential procedure for restricting the range of test doses was suggested in discussions with Procter and Gamble. The stepping rule is similar to the rule for the unrestricted procedure, except that steps are among a finite set of permitted doses. Here we use the term *dose progression* (or just *progression*) to denote the set of permitted test doses ranked from smallest to largest. Also, let L (for lower) denote the lowest permitted dose and let U (for upper) denote the highest permitted dose. (Thus $U=2000$ mg/kg or 5000 mg/kg.)

It is proposed that the dose progression will comprise doses that could be tested with the basic, unrestricted procedure, except that (1) doses below L or above U are excluded; (2) L and U are included in the progression, although this may result in a progression for which some successive doses differ by a factor not equal to the progression factor; and (3) doses can be excluded if they are permitted by the unrestricted procedure and strictly within the bounds, but considered too close to L or U, relative to the progression factor.

The proposed “default” set of test doses (to be used at least when there is little prior information about the LD50) is to be “1.75, 5.5, 17.5, 55, 175, 550, 1750, 2000, or, for specific regulatory needs, 5000 instead of 2000.” The default initial test dose is to be 175 units. Note that while the progression factor for this sequence is 3.2 (equal to 0.5 in the \log_{10} scale), the two highest doses may differ by a factor of 2.86 ($=5000/1750$) or 1.14 ($=2000/1750$).

When some prior estimate is available for the LD50, it is proposed that the initial test dose should equal the prior estimate, divided by the progression factor. That approach is justified on the grounds of reducing suffering (because then testing tends to be concentrated below the LD50). Also, when the dose response curve is shallow there is some tendency for the estimate of the LD50 to be biased in the direction of the initial test dose. If a bias of this type occurs, and if

the initial test dose is selected below the LD50, the bias will be in the direction of a lower LD50 estimate.

Also, the stepping rule (the rule for determining the next dose, given results for the current dose), must be modified to accommodate restriction on the range of test doses. We have proposed that if the current test dose is strictly within the range of permitted doses (greater than L and less than U), the stepping rule is as for the unrestricted Dixon-Mood procedure except that steps are to adjacent doses within the progression, so that the ratio of successive test doses does not necessarily equal the progression factor.

If the current dose is U and the subject does not respond, we propose that the next dose tested will also be U, else the next dose tested will be the dose just below U in the progression (e.g., 3200 in a default progression with U=5000). Similarly, when the current dose is L and there is an adverse response, the next dose tested will also be L, otherwise the next dose tested will be the dose immediately above L in the progression.

1.1.2 Rule for stopping testing at a bounding dose.

According to the procedure just described, if the response probability is low at U (which occurs if the LD50 is much larger than U relative to the slope) or if the response probability is high at L (the LD50 much smaller than L's relative to slope) the bound value may be tested many times, unless this is prevented by a special rule. We propose that if the dose U is tested three times in sequence without a response then testing is stopped. Similarly, three tests in a row at dose L, with each of the three animals responding, results in the study being stopped.

There has been some discussion of how the LD50 should be estimated when testing is stopped based on this rule. One option is to decide in these cases that the LD50 is beyond the bound ($<L$ or $>U$). This approach has been adopted in simulations. An estimate based on the probit model might or might not generate an estimate outside the bounds.

1.1.3 Use of a progression factor of 3.2.

The relatively large progression factor (3.2) was adopted based on discussions with Proctor and Gambel. It is thought that a relatively large factor is advantageous in situations involving little prior information, because that allows for the range of test doses to be traversed in a relatively small number of steps. We also believe that a relatively large factor is appropriate when the dose-response curve is shallow, a type of situation of particular concern.

However it seems that, when there is actually a good prior estimate of the LD50, the use of a relatively coarse grid of test doses will result in some loss of accuracy. We believe that, in general, the up-and-down procedure cannot distinguish between LD50 values that differ by a factor lower than the progression factor. In particular, when the dose-response relationship is steep, most individuals may have tolerances between two test doses. In those cases testing may alternate between a dose with low response probability and a higher dose with high response probability. We have observed in simulations that as the probit slope is made more steep, the

estimates tend to converge on a set of values separated by a factor equal to the progression factor.

It appears that the selection of a dose progression factor involves striking some balance between different types of statistical effects. Noordwijk and Noordwijk (1988) provide an analysis of different types of bias in up-and-down testing, which appears to be useful in this context.

1.1.4 Variants of Up-and-Down testing.

We mention two variants of the up-and-down procedure which may be advocated but which have not been made the principal focus of the evaluation: (1) The dose progression factor may be varied within a single study. (Most likely, the initial step size in a study would be doubled or halved.) (2) More than one animal may be tested per step (e.g., Hsi, 1969). Both of these options have been investigated in some preliminary simulations, which were not organized into reports and distributed.

Neither of these approaches is dismissed. Increasing the number of animals tested per step can be beneficial, by decreasing the number of steps and thus decreasing the duration of the study. If the study is carried out over too long a period in time, maintenance of experimental control may be difficult. For example the animals age and experimental conditions may drift. In particular, more animals may be needed for designs to estimate the probit slope, so such designs may need to involve multiple animals per step. It has also been pointed out that a design with multiple animals per step may be helpful in the event of an "outlier," as discussed in the section below on outliers.

However, if the initial test dose is poorly chosen, the result may be an initial series of results of the same type (either all response or all nonresponse). Then, if more than one animal is tested per step, the result can easily be an increase of the numbers tested by 3 or 4, with little information added. That increase would be a substantial percentage increase relative to a baseline of 6 animals (or a few more) per test. It may be desirable to increase the number per step only after a reversal has occurred.

In principle, it seems that the step size can be decreased when there is some indication that the up-down sequence has converged to the vicinity of the LD50 (e.g., after a reversal). Options that involve a variable progression factor were not a significant focus of the evaluation, because the primary concern has been the poor performance of the procedures when the dose-response curve is shallow. With a shallow dose-response, we think it is generally better for the dose-progression factor to be relatively large. Some early simulations (not developed into a report) considered the possibility of changing the progression from 0.5 to 0.25 (in the log scale). The results of those simulations actually suggested worse performance, relative to use of the same number of animals and a uniform progression factor of 0.5. In view of the concern for shallow-slope situations, more promising may be an approach in which the progression factor ranges up to 1.0.

1.2 Analysis

1.2.1 Use of the probit dose-response model.

The statistical procedures proposed are based on the probit model, for which the parameters are the LD50 and the slope. The probit model is customarily described in terms of a “tolerance distribution.” It is supposed that each individual has a “tolerance” dose, which is the lowest dose that will affect that individual adversely. For the probit model, the tolerances are assumed to have a log-normal distribution. For some purposes it is more convenient to choose as parameters $m = \log_{10} \text{LD50}$ and $\sigma = 1/\text{slope}$. Then, in the log scale (base 10), the mean of the tolerance distribution is m and the standard deviation is σ .

Some scientists will advocate consideration of alternatives to the probit model. In particular, the logit model, like the probit model, assumes a tolerance distribution that is symmetric in the log scale. The logit model would assume a higher proportion of individuals with relatively extreme sensitivity, and also more animals with relatively extreme lack of sensitivity, relative to the probit model. We do not hold that the probit model is the only possible dose-response model for analysis of acute test data, but exploration of alternatives was not considered the highest priority in the context of review of Guideline 425. Therefore we have relied on the probit model, which is conventional in toxicology.

1.2.2 Use of an assumed value for the probit slope.

In standard probit analysis, the two parameters of the probit model (the slope and the LD50) are both estimated from the data. The current guideline indicates that the LD50 will be estimated, with a value of 2 assumed for the slope. The review by Dixon Associates emphasizes that the same feature of up-and-down testing which makes the procedure work well for estimation of the LD50, namely that the approach concentrates the test doses close to the LD50, will tend to make the approach work poorly for estimating the slope.

Actually, in standard probit situations, it is sometimes not possible to estimate the slope. In particular, we do not have information on how well Guideline 401 performs for estimating the slope.

When evaluating variants of the up-and-down procedure, we have usually assumed the same value for σ as used (in the log scale) for the step size. In particular, we use a step size of 0.5 in the log scale, and we use the same value for σ when estimating the LD50 by maximum likelihood. It is known that the optimal choice of a step size for estimation of the LD50 is approximately σ (see Dixon Stat. Assoc. 1991). However, application of that principle involves using information on slopes to select a step size. Here the choice of step size is not based primarily on information on the slope. Simulations suggest that in some situations results may be sensitive to the value assumed for slopes.

The use of an assumed slope is a feature of the study by Lipnick et al. (1995). That study is significant in the development of Guideline 425. In analyses with up-and-down data for specific chemicals, Lipnick et al. found little sensitivity of the LD50 estimate to the assumed value of

σ , for σ as high as 0.25 (slope as low as 4). Such comparisons with real data are highly desirable; however, the question always arises whether the data used will adequately cover the range of situations encountered in practice.

At present, no strong case can be made that default statistical calculations should assume some value for σ , or that they should assume the value 0.5 in particular. The strongest case that can be made is that such an approach may result in acceptable accuracy for estimating the LD50. We have not conducted a review of alternative approaches, except that limited evaluation has been conducted for a simple dose-averaging estimator.

1.2.3 Lack of a confidence interval for the LD50.

The traditional “fiducial” interval in probit analysis requires, as an intermediate computation, the fitting of the 2-parameter probit model, including estimation of the slope. We suppose that the standard interval can be adapted to the situation where the a value is assumed for the slope. That approach was not pursued because it was decided that the uncertainty in the LD50 depends on uncertainty in the slope, and may be underestimated when a slope value is assumed. At present no confidence interval is proposed for the LD50. Some consideration may be given to intervals based on likelihood (see Meeker and Escobar, 1995), a Bayesian approach, or some other approach to be identified.

1.2.4 Viability of a Bayesian approach to uncertainty in the slope.

In the long run, the possibility of handling the slope parameter based on Bayesian procedures should not be dismissed. For the slope parameter, this approach would combine the limited slope information from a specific study with external information, in the form of a prior distribution for the slope based on historical information. For the LD50, the prior would most likely be chosen to be relatively flat so that the estimate would be determined primarily by the data from the study, and little affected by the prior.

A Bayesian procedure may be particularly viable in this situation because (1) the data from an up-and-down study will often contain little information on the slope, for which an inference is nevertheless required if a parametric estimator is used; (2) a good basis (historical information) may exist for choosing a particular prior for the slope; and (3) external information would be used primarily for the slope, which for the primary procedure is a nuisance parameter rather than a parameter of direct interest. These features of the situation may allay objections to the introduction of external information. The approach would yield the Bayesian version of a confidence interval for the LD50.

1.2.5 Use of maximum likelihood, and measurement of statistical information.

Within the context of an assumed probit model, the proposed statistical procedures are based on *likelihood* (in the technical meaning of that term in statistics). In particular, the point estimate of the LD50 is taken to be the maximum-likelihood estimate (MLE), which is the dose value for which the likelihood is highest. Maximum-likelihood is usually viewed as the basis for estimating the LD50 parametrically, for conventional probit analysis as well as for up-and-down

testing. The likelihood we use is identical to that for conventional probit analysis for the 2-parameter probit model, except that the slope is fixed at 2 (*sigma* is fixed at 0.5), so that the likelihood is a function of the LD50 only.

Somewhat less widely known than maximum-likelihood estimation is the closely related concept of statistical *information*, which we invoke to justify a particular type of stopping rule. This concept can be explained as follows. Note that the MLE exists when the likelihood function has a peak. Conversely, in the extreme case where the data is completely uninformative regarding a parameter of interest, the likelihood is flat. More generally, the curvature of the likelihood in the vicinity of the MLE is regarded as measuring the information the data contain, regarding a parameter of interest. The text by Edwards (1972) may be helpful with regard to these concepts.

In statistics, information is usually quantified using second order partials of the log-likelihood. We have used a simple ratio of likelihoods comparing the likelihood at an estimate of the LD50 to values fixed factors above and below that estimate. The resulting computations are easily carried out in a spreadsheet.

1.2.6 How test performance depends on the probit slope.

Simulations suggest that the most important influence on test performance is the steepness of the dose-response curve (e.g., magnitude of the probit slope). Steeper dose-response curves are generally associated with better performance. This can be seen as a case of a general statistical principle, which is that when the data are more variable, more data are needed to achieve a given statistical precision or power. In this context it is useful to note that the slope is inversely related to *sigma*, which is the standard deviation of log tolerances. Of somewhat less importance than the slope is the choice of an initial test dose. The choice of an initial test dose is more important when the slope is shallow.

In analyses conducted for OECD, it has become customary to consider *sigma* values of 2, 1.25, 0.5, and 0.12 (or slope values of 0.5, 0.8, 2, and 8.33). (It can be helpful to consider some additional slope values in order to characterize the relationship between the slope and test performance.) In simulations we find that, despite considerable efforts to improve test performance, this range of slopes includes values for which the primary procedure will perform poorly. We suggest that as a rule the performance of the primary procedure will tend to break down when the slope is lower than some value in the range 2-3.

Given the spacing of category boundaries in the acute oral classification, it seems reasonable to be able to estimate the LD50 within a factor of 2. In simulations with LD50=600 units, initial test dose of 60 units, and our proposed likelihood-ratio stopping rule, it was found that there would be a 90% chance of an estimate within a factor of 2 of the true values, only if the slope is 2.6 or higher (Table 2 in the Feb. 24 simulation report). If the number of test animals is kept at 15 (the Guideline 401 requirement) or lower, it is probably not possible to reliably estimate the LD50 within a factor of 2, for the full range of slope values 0.5-8. If the up-and-down procedure is used with a fixed nominal sample size of 15, a slope of 2 or higher is required for a 90% chance of an estimate accurate within a factor of 2, for the scenario described above.

1.2.7 Rationale for a stopping rule with a variable nominal sample size.

Simple versions of up-and down testing called for termination of the experiment after a fixed number of animals have been tested, counting from the reversal. (Thus, the nominal sample size is fixed while the actual number tested may vary somewhat.) At the start of our evaluation, our "working" version of up-and-down testing involved a fixed nominal sample size of 6 and a step size of 0.5. Here, denote this approach SUDP/6/0.5, SUDP stands for simple up-and-down procedure.

SUDP/6/0.5 performs poorly in some situations, in terms of the bias and/or variability of estimates. Specifically, situations involving low slopes are problematic, particularly if the initial test dose is far from the true LD50. Use of this procedure therefore assumes that such situations are relatively uncommon in practice. To obtain reliable results in these situations would require testing of more animals. Unfortunately, it is difficult if not impossible to know when one is actually in this type of situation. A possibility would be simply to increase the nominal n "across the board." However, that would be wasteful for the situations where the procedure already performs well.

SUDP/6/0.5 keeps the number of animals tested fairly constant, while performance is variable (depending on the slope and starting dose). The purpose of an alternative stopping rule would be to reverse this situation: We would hope for the performance to be uniformly comparable to performance of SUDP/6/0.5, and somewhat better in the problematic situations. In situations where SUDP/6/0.5 performs well, an alternative should also perform well, without substantial increase in the numbers of animals tested. However, it is reasonable that the number of animals tested should go up where SUDP/6/0.5 performs poorly (situations which, we hope, are relatively uncommon).

We have developed a specific, simple stopping rule that appears to have the characteristics suggested. According to the approach proposed, the nominal sample size may vary from study to study, subject to a requirement that the maximum number of animals tested will not exceed 15 in a given study. (This constraint refers to the actual number tested, not to the nominal sample size.) In effect, testing is stopped based on a measure of statistical information, rather than based on a count of test units, as explained in more detail in the section following. The approach is simple enough to be easily implemented in a spreadsheet program, as indicated in a Guideline appendix. We have prepared a spreadsheet program using Microsoft ©Excel. To use the program, the user should need to do little more than enter the dose-response information as it accumulates.

With the approach proposed, performance is still poor in situations involving very low slopes, although much better in those situations than SUDP/6/0.5. However, it is probably unrealistic to hold that any up-down procedure will work well with such low slopes and at the same time keep the numbers tested at the low levels which give good performance in more "ordinary" situations. (What is really needed to address the possibility of very low slopes may be some crude information on the slope, e.g., a bound.)

In principle, it is better to design a study to achieve a fixed statistical error, rather than based on a fixed number of experimental units. If a confidence interval were available for the LD50, a reasonable approach might be to stop when the upper bound and lower bound differ by some factor (e.g., if the lower bound is not more than the lower bound times 4). However, in the context of simple up-and-down testing a confidence interval is not currently available.

In cases where 15 animals have been tested and the proposed stopping rule is not satisfied, it is proposed that testing will stop. Such an outcome may indicate an estimate of low reliability, because of a shallow slope and/or a poor choice of initial test dose. However, in simulations we find that in those situations, the stopping rules are often satisfied when fewer than 15 animals have been tested.

As a matter of policy we seek an approach that will work uniformly well for a wide range of slopes. We suggest that it is preferable *not* to depend on an argument such as “the test will probably work well in practice because situations where the procedure works poorly are expected to be infrequent.” While any statistical procedure will have some frequency of false positives and false negatives, it is preferable for the error rates are to be kept uniformly low for a wide range of situations.

1.2.8 The proposed likelihood-ratio stopping rule.

Based on likelihood theory we expect that as data accumulates, the likelihood will display a more clearly defined peak. The maximum-likelihood estimate (MLE) of the LD50 or other parameter is the value where the likelihood is highest. As discussed, it is recognized in likelihood theory that the information available from the data can be measured based on the curvature of the likelihood function, close to the MLE.

We measure curvature using likelihood ratios, which compare the likelihood at an estimate of the LD50 to likelihoods above and below the LD50, by factors of 2.5. Higher likelihood ratios are taken to indicate that the LD50 estimate is more strongly supported by the data, relative to values distant from the estimate. (It is recognized in likelihood theory that likelihoods are compared via ratios, i.e., log-likelihoods are compared by differences.) Testing stops when both likelihood ratios achieve a critical value of 2.5. The stopping rule is not evaluated until the nominal sample size is 6.

This approach suggests that the estimate of the LD50 should be the MLE. However, the MLE requires iterative computations. In order to achieve more simple computations, we have substituted an alternative estimator, which can be termed a “dose-averaging estimator.” This is simply the geometric mean test dose, calculated over the nominal sample (*cf.* Brownlee et al., 1953). (The number of dose values averaged is the nominal sample size.)

Close analogies can be drawn between the approach and other approaches:

1. The possibility of using a stopping rule based on some measure of information has been suggested previously for sequential designs, if not for the up-and-down procedure (Armitage, 1991).

2. The possibility was mentioned above of a convergence criterion based on the width of a confidence interval. A certain type of confidence interval is based on likelihood ratios of the type suggested (see Meeker and Escobar, 1995). That approach would be very computationally intensive, as it would require a line search for parameter values above and below the MLE for which a critical likelihood ratio is attained precisely. The approach can be simplified by noting that (at least if the likelihood is unimodal), requiring that the confidence bounds fall within a given factor of the MLE is equivalent to requiring that the critical likelihood ratio is exceeded, for values separated from the MLE by that factor. The latter is the approach proposed here.

In practice likelihood-based tests and bounds usually rely on asymptotic results. Those results might be questionable in our situation because of (1) the use of an assumed slope value; and (2) small sample sizes. Therefore if asymptotic results are used, it may be desirable to confirm their accuracy using simulations. However, it seems more straightforward to use simulations to justify a critical likelihood ratio directly.

1.2.9 Stopping based on “perfect alternation” of response and non-response.

We propose that testing can be stopped when the nominal sample size reaches 6, without evaluation of the likelihood-ratio rule, provided that there have been 5 reversals between response and non-response, with the nonresponses at a dose lower than the responses. We believe that in practice such an outcome will most often represent a situation where testing alternates between a dose with low response probability and a dose with high response probability, so that the LD50 is between the two doses. Also, the criterion will sometimes simplify the conduct of the study because the likelihood-based rule will not need to be evaluated in some cases.

We have not evaluated the frequencies of such perfect alternations when slope values are very low. Also, it is possible that the procedure will work well if, say, testing can be terminated if 4 reversals occur in a nominal sample size of 5, or 4 or more reversals occur in a nominal sample size of 6, and so on. These possibilities have not been evaluated.

1.2.10 Justification for numerical parameters in the stopping criteria.

The stopping criteria that we suggest involve several numerical parameters, which can potentially be adjusted to improve the performance of the procedures, in terms of better precision and/or fewer animals tested. These parameters include the maximum number tested (15), two parameters of the likelihood-ratio rule (both currently set at 2.5), the assumed slope (2), the rule for stopping at a boundary (3 of same response type at L or U). No strong justification can be provided at this time for the specific values we have proposed: We believe that simulations indicate that, taken as a whole, our procedures will result in improved performance. However, we cannot say at this time that other choices would not result in equivalent performance or better performance.

Before setting the maximum number tested at 15, we used a maximum of 25. Use of a maximum of 25 was felt to substantially increase in the numbers tested in some situations, with marginal improvement in accuracy.

A formal approach for optimizing the parameters of the stopping criterion would require assumptions regarding the relative value of increasing precision, versus reducing numbers tested. There would be no strong basis for any specific numerical weights for these two types of criteria. However, it could happen that some choices of parameters may simultaneously increase precision and lower the numbers tested. Therefore there may be some value in conducting a formal optimization in which equal weights are assumed (in some scale) for precision and numbers tested, despite the fact that the approach would involve some arbitrariness.

The following may be considered. First develop response surfaces that relate measures of precision, and also relate the numbers tested, to the probit slope and to the parameters that can be manipulated. For example, let $f(\text{slope}, \theta)$ denote the probability that the estimated LD50 will be within a factor of 2 of the true value, where θ denotes parameters that can be manipulated. Let $g(\text{slope}, \theta)$ denote the expected number of animals tested. Formulae for f and g can be obtained by fitting curves to output of Monte Carlo simulations, involving various combinations of the slope and θ . Having developed the surfaces f and g , determine the value of θ that minimizes an objective function such as

$$w_1 / |f(1, \theta) - 0.9| + w_2 / |g(4, \theta) - 6|$$

where w_1 and w_2 denote relative weights for precision and numbers tested. This expression says that the target precision is an LD50 estimate that is accurate within a factor of 2, with 90% probability, when the slope is 1 (a low value) and that the target for animal testing is an average of 6 animals when the slope is 4 (a moderately low value). The minimization of the objective function would probably involve a numerical approach. If the θ that minimizes the objective function results in better precision as well as fewer numbers tested relative to the current proposal, that choice would represent an unambiguous improvement.

1.2.11 Outliers.

There has been some concern among scientists regarding whether the simulation models adequately characterize how the performance of the procedure may be affected for the range of events that may occur in actual lab situations, when the numbers tested are drastically reduced.

To address this kind of concern, an “outlier scenario” has been simulated: The initial test was assumed to be below the true LD50 (here 750 units) by a factor of 10 or 100, and the first animal tested was assumed to respond, regardless of the probability of response calculated from the probit model. The idea is that such an event could result from background mortality, mishandling, or administration of an incorrect dose. (We hope these kinds of events are rare, but even so we would like the procedures to be robust if they occur.) The question is whether the simple up-down procedure can recover in this type of situation to give an accurate estimate, with appreciable probability.

It appeared that with the scenarios simulated there was practically no chance of a reasonable estimate using the up-and-down procedure with a fixed nominal sample size of 6. Performance was substantially improved by adoption of either of two stopping rules that allow a variable nominal sample size, the rule proposed and a rule based on the number of reversals.

It could be desirable to consider some additional outlier scenarios. It could be argued that the possibility for outliers is limited because the up-and-down converges rapidly to the LD50: A test cannot be an outlier unless the dose is far from the LD50.

While the use of the new stopping rules appeared to be helpful in this situation, other solutions may also be considered. In particular, it has been suggested that use of more than one animal per step may be helpful. An outlier resistant version of the dose averaging estimator could be developed by using medians instead of averages. One might use the following estimator: $(A+B)/2$ where A is the median dose for responding animals and B the median dose for non-responding animals. Finally, the stopping criteria could include a requirement that the average dose for responding animals must exceed the average dose for non-responding animals (geometric averaging would be used).

2. Simulation Results

2.1 Classification probabilities plotted against LD50 and slope

The following is abbreviated from a document distributed on March 6, 2000. The graphs attached display the probability of correct classification, as well as the probability of each kind of miss-classification (under protective or over protective classification), as a function of the LD50. A separate line is used for each of the standard slopes. The simulations follow the default procedure indicated in the Guidelines, with an initial test dose of 175 units, a minimum test dose of 1 unit, a maximum test dose of 5000 units, and use of a likelihood-ratio stopping rule. As with all the simulations conducted for this report, a probit model is assumed.

Unfortunately, it appears that when a chemical is miss-classified, it will be more often assigned to a less-toxic category than to a more-toxic category. The only explanation that comes to mind is that this is bad luck having to do with the relationship between the initial test dose and the category boundaries. It should be noted that the precision of the up-down procedure is limited by the dose progression factor (here 3.2). In particular, in steep-slope situations, the MLE may be the geometric average of two test doses which differ by a factor of 3.2 and may straddle a category boundary. Therefore, chemicals with LD50s within certain intervals may be consistently over classified or consistently under classified.

There would be some justification for additional simulations in which the initial test dose varies from 175 units. Such a simulation will be undertaken, tentatively with doses shifted by 0.25 log units, specifically 1.75, 5.5, 17.5, 55, 175, 550, 1750, and 5000 units.

**% Assigned Category
Less Toxic than True Category
(slopes 0.5, 0.8, 2, 4, 8)**

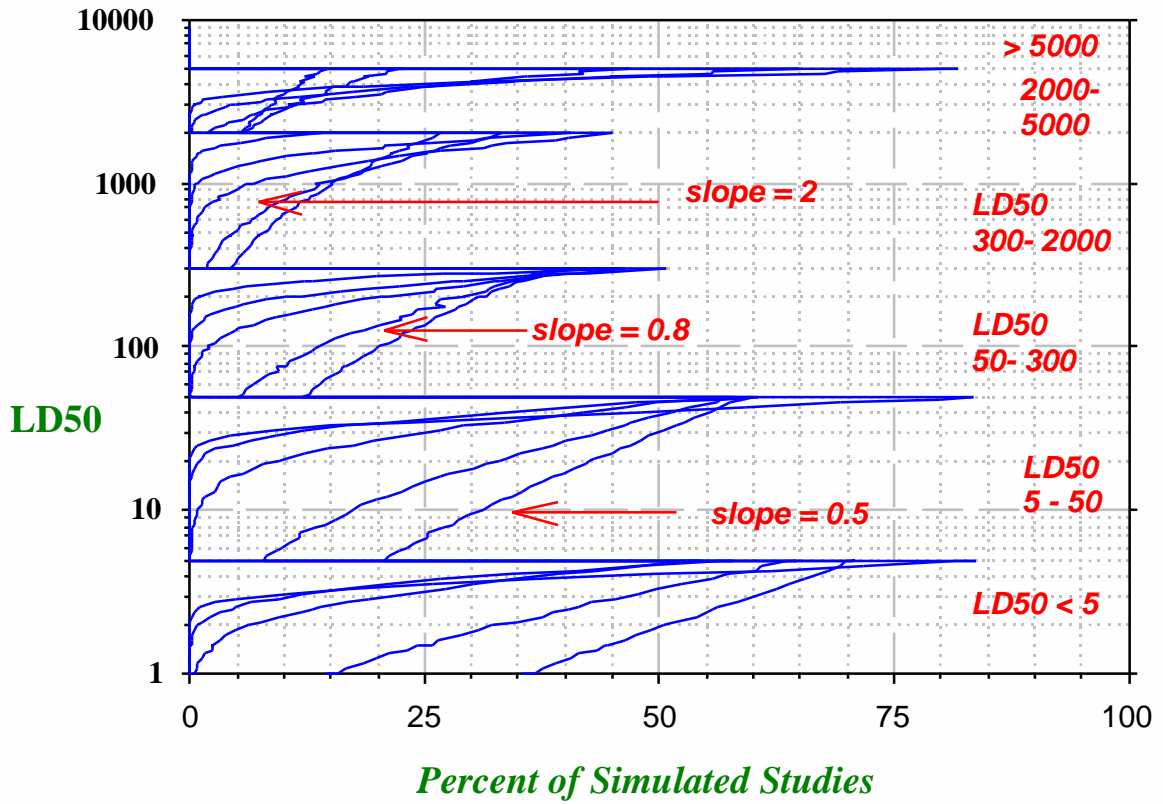

% Correctly Classified
(slopes 0.5, 0.8, 2, 4, 8)

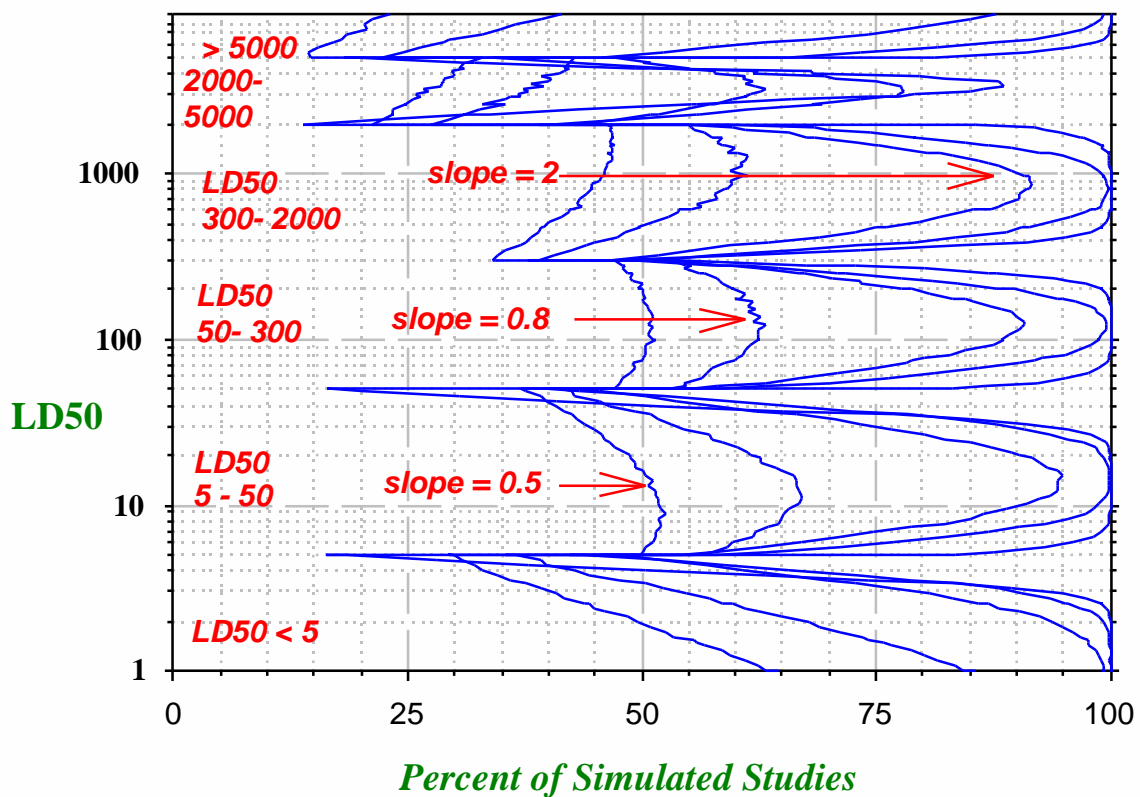

*% Assigned Category
More Toxic than True Category*

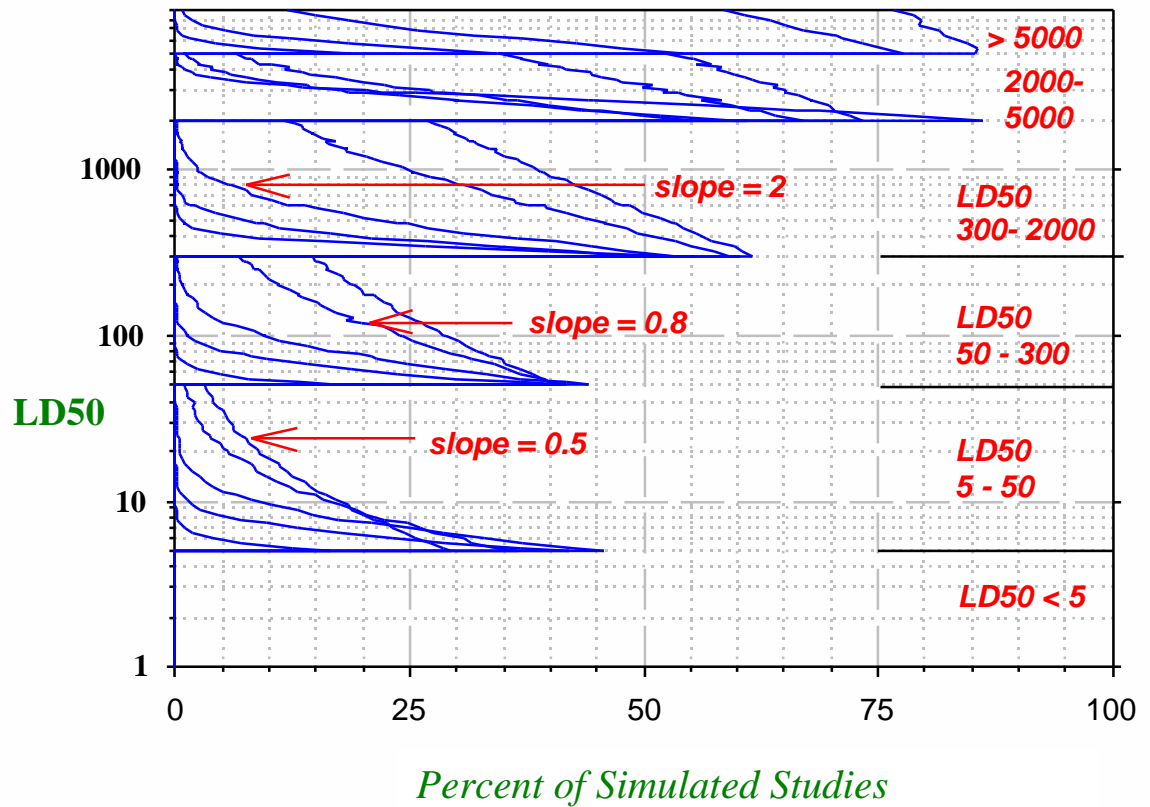

2.2 Monte Carlo comparison of three stopping rules and two LD50 estimators for the primary procedure

The following is abbreviated from a report distributed on February 14, 2000.

The scenarios assumed for these simulations (starting dose, slope, and LD50) are not the standard scenarios used in recent OECD work, or the current default guideline approach. The LD50 is assumed to equal 600 units and three choices of initial test dose are considered (6, 60, and 600 units). This differs from the OECD practice, which is to use the LD10, LD50, and LD80 as the initial test doses. The slopes evaluated include the standard OECD selections as a subset. Performance is evaluated based on several "performance indices" which are calculated from Monte Carlo output. In particular, we focus on the probability of an estimate that is within a factor of 2 of the true LD50 value.

In addition to an initial test dose of 600 units, the simulations deviate from the Guideline default scenario in that the dose of 3200 was not included in the dose progression.

2.2.1 Estimators of the LD50

Estimates of the LD50 were calculated using two procedures: (1) The maximum likelihood estimate was calculated assuming a probit slope of 2 (denoted MLE(2)). (2) A "dose averaging" estimator (DAE) somewhat similar to the proposal of Brownlee et al. (1953): The LD50 estimate is the geometric average dose, for animals tested at the reversal and subsequently. (The number of values averaged is the "nominal sample size.")

While the DAE uses only the animals in the nominal sample, the MLE uses results for all animals tested. For the DAE, it seemed sensible to allow for a string of responses or non-responses before the reversal, in case of a poor choice of initial test dose. For the MLE, there is no apparent harm from including such observations: They contribute some (but probably relatively little) information on the LD50.

Where the MLE(2) is outside the permitted range of test doses (below 1 or above 5000), it is assumed that the point estimate is not used and that the experimenter only concludes that the LD50 is below 1 or above 5000.

2.2.2 Stopping Criteria Evaluated.

Three stopping criteria have been evaluated. These are denoted #1, #2, and #5. The gap in numbering is a result of dropping two criteria considered in a previous document.

The following features are common to each of the criteria. (1) There is a maximum number of animals that can be tested, here set at 15. (2) Testing always stops if there is a "perfect alternation" of response and non-response for the first 6 animals in the nominal. (3) Testing is stopped if 3 consecutive tests at a dose of 1 unit (or another lower bound) all yield responses, or 3 consecutive tests at 5000 units (or another upper bound) result in no responses.

The stopping criteria are evaluated after each test, provided that the nominal sample is 6 or more. Therefore the number tested is always 6 or more.

Criterion 1 (Based on fixed “nominal” sample size). After the reversal, 4 additional animals are tested. The "nominal sample size" is 6.

Criterion 2 (Based on number of reversals). A stopping rule based on number of reversals was considered because the approach is simple, and has been proposed previously. For the version implemented here, testing stops after 5 reversals. The basis for the value of 5 is that in the most favorable situations, 6 test animals will tend to represent 5 reversals, i.e., there is “perfect alternation” between response and nonresponse.

Criterion 5 (LR rule with default slope of 2). This is the rule described in the current guideline.

2.2.3 Performance Statistics

Having simulated a large number of studies (here 5000) for a given scenario, and estimated the LD50 for each simulated study, statistics are calculated that characterize the performance of the procedure in terms of (1) whether or not the LD50 estimates tend to be close to the true value of the LD50; (2) whether or not the procedure tends to correctly classify a chemical with a given LD50; and (3) the number of animals tested. This section describes the statistics calculated and documents notation used in output.

Statistics calculated for numbers tested. For numbers tested I report mean number, the 95th percentile (denoted P_{95}), and the percent of studies for which the number tested is the maximum (here 15).

Statistics calculated for estimates of the LD50. The following are calculated for each scenario, and separately for two estimators of the LD50 (MLE(2) and DAE). These results are reported only for “My” scenarios.

P_5 , P_{50} , P_{95} . These denote the 5th percentile, 50th percentile (median) and 95th percentile of the distribution of LD50 estimates for a given scenario. These provide a characterization of the distribution of LD50 estimates.

$\%$ in range. This is the percent of simulated studies that resulted in a point estimate of the LD50 in the range 1 unit to 5000 unit. "Out of bound" estimates resulted from either (1) stopping the experiment after repeated nonresponse at the upper bound, or repeated response at the lower bound; or (2) an MLE(2) outside the range 1-5000 units.

$P_{50} / LD50$ (index of bias) Bias represents a tendency of estimates to fall below the true value with some degree of consistency, or else above with some consistency. If this ratio equals 1, then exactly 50% of estimates fall below the true value and exactly 50% fall above. Thus values close to 1 are desirable, indicating unbiasedness. A value below 50% indicates that most estimates fall below the true value, etc.

In the log scale, the statistic is approximately equal to the bias in the strict sense of the term in statistics (the difference between the mean estimate and the true value), for a tolerance distribution that is symmetric in the log scale.

P95 / P5 (index of spread). As an index of the spread of the distribution I use the ratio of the 95th percentile to the 5th percentile. Small values are desirable provided they are not combined with too high bias.

For a lognormal distribution, and perhaps for some other distributions, this index has a simple relationship to the log-scale standard error.

These indices of bias and spread are not scaled to be comparable, *e.g.*, do not allow one to directly assess whether bias or variance contributes more importantly to the error of estimation.

PF2. This is the percent of estimates that fall within a factor of 2 of the true LD50, i.e., the percent of estimates that satisfy $LD50/2 \leq \text{estimate} \leq LD50*2$. (PF2 stands for Percent within Factor of 2 of true value.) Note that this index combines bias and precision. The index ranges between 0 and 100%, values close to 100% indicating better performance.

A value of 90% for PF2 would be obtained for an unbiased estimator with a spread index value (P95/P5) of about 4. That would permit most of estimates to fall within a single category of the acute oral toxicity classifications, provided that the estimate is close to the geometric center of the category, and the upper and lower bounds for the category are separated by a factor greater than 4. In the acute toxicity classification, the bounds are separated by a factors as low as 6 (the 50-300 range) and 2.5 (the 2000-5000) range. On this basis a PF2 of 90% or larger is suggested as a criterion for good performance.

2.2.4 Results and Discussion

Results for Estimation of the LD50. Based on the performance statistics described in the previous section with my scenarios, a marked improvement in performance is obtained by using Criteria 2 or 5, under conditions involving relatively extreme slopes and starting values (Table 2). Under other conditions, the improvement is relatively modest. More complete output of the simulations is given in Appendices 1.1 to 1.3.

In the previous section it was suggested that a criterion for good performance could be values 90% and higher for the index PF2. It is observed that the value of this index increases with the slope. Therefore a compact table of output is obtained by interpolating in the Monte Carlo results the slope that corresponds to PF2=90%, for a given choice of initial test dose. Then the interpolated slope can be used as a bound on the range of slopes for which the procedure works well.

Results of this type of calculation are displayed below. Row 2 of the table gives, for purposes of comparison, the results from applying the procedure with a fixed nominal sample size of 15, the number used in Guideline 401. A modification of the stopping rule cannot achieve the performance indicated in Row 1, if the numbers tested are generally kept below 15.

The application of flexible- n stopping rules (Criteria 2-5) appears to significantly extend the range of slopes for which the procedure will work well, relative to the fixed- n criterion (Criterion 1), and the former should therefore be preferred if they do not result in an unacceptable increase in numbers tested. However the range of slopes that are acceptable according to this criterion does not include the complete range of slopes that we think are possible.

Table 2.2.1. Comparison of Stopping Criteria in situations involving extreme slopes and starting values: examples with low slope and poor choice of initial test dose.

Stopping Criterion	slope	Method of Estimating LD50					
		Dose Averaging			MLE		
		P50/LD50	P95/P5	PF2	P50/LD50	P95/P5	PF2
1. fixed nominal $n=6$	0.5	0.08	209	14	0.17	212	12
	0.8	0.26	97	25	0.42	96	32
2. number of reversals = 5	0.5	0.18	125	20	0.28	157	27
	0.8	0.37	50	35	0.56	47	42
5. LR > 2.5	0.5	0.25	142	23	0.36	194	31
	0.8	0.44	33	37	0.59	39	43

Explanation: Calculations are based on an LD50 of 600 units and an initial test dose of 6 units. The table gives values of performance statistics.

P50 / LD50 = ratio of median estimated LD50 to true LD50 (closer to 1 is better)

P95 / P5 = ratio of 95th percentile estimated LD50 to 5th percentile (smaller is better)

PF2 = percent of estimates that satisfy $LD50/2 < \text{estimate} < LD50*2$ (larger is better)

For example (row 1) if the slope is 0.5, the initial test dose is 6 units, the true LD50 is 600 units, and the LD50 is estimated by the dose averaging method, then there is a 14% chance of an estimate within a factor of 2 of the correct value, when using Criterion 1 (column 5). There would be a 23% chance of such an outcome using Criterion 5 (row 5).

Table 2.2.2. Minimal slope for at least 90% of estimates to be within a factor of 2 of the true LD50.

Stopping Criterion	Initial Test dose		
	LD50/100	LD50/10	LD50
1. fixed nominal $n = 6$	3.4	3.4	2.5
$n = 15$ †	2.1	2.0	1.6
2. number of reversals = 5	2.9	2.9	2.5
5. LR > 2.5	2.8	2.6	2.7

Explanation. For example (see 1st row of slopes) if the initial test dose is LD50/100 then the index PF2 will be at least 90%, provided the slope is 3.44 or larger, when stopping is based on Criterion 1. In this sense 3.4 is the lower bound for the range of slopes where Criterion 1 works well, when starting at LD50/100.

The true LD50 was assumed to be 600 units for this calculation. Results are based on the DA estimator. Linear interpolation has been used. Based on 5000 simulated studies per scenario, except row 2 based on 3000 simulated studies.

† Given for purposes of comparison (see text).

Results for Numbers Tested. Estimated mean numbers tested per study are displayed below for each Stopping Criterion. Comparing Criteria #2 and #5 it appears that more or tested with Criterion #5 at low slopes, but more or tested with #2 at high slopes. We believe that in practice slopes will be distributed so that in the long run Criterion #5 will use somewhat fewer animals. Furthermore Criterion #5 has somewhat better statistical performance.

Table 3. Mean numbers tested

Dose0 = LD50 / 100			
slope	Crit. #1	Crit. #2	Crit. #5
0.5	7.6	11.1	12.4
0.8	8.2	11.4	12.7
1.5	9.1	11.5	12.1
2.0	9.3	11.4	11.8
2.5	9.4	11.2	11.5
3.0	9.4	11.1	11.4
3.5	9.4	11.0	11.2
4.0	9.5	10.9	11.2
8.3	9.5	10.8	11.0
Dose0 = LD50 / 10			
0.5	6.8	10.1	10.0
0.8	6.9	10.0	10.3
1.5	7.2	9.7	10.1
2.0	7.3	9.4	9.9
2.5	7.4	9.3	9.6
3.0	7.4	9.0	9.4
3.5	7.5	9.0	9.3
4.0	7.5	8.9	9.2
8.3	7.5	8.8	9.0
Dose0 = LD50			
0.5	6.6	9.6	8.7
0.8	6.4	9.3	8.1
1.5	6.3	8.7	7.2
2.0	6.2	8.4	6.8
2.5	6.1	8.1	6.5
3.0	6.1	7.9	6.3
3.5	6.0	7.7	6.2
4.0	6.0	7.6	6.1
8.3	6.0	7.4	6.0

Based on 5000 simulated studies per combination of LD50 and slope

2.2.4 Conclusions

Criterion 5 is simple to apply and gives relatively good performance, considering precision in the estimation of the LD50 as well as numbers of animals tested. In particular, the numbers tested are appreciably increased only for combinations of slope and initial test dose that we think are unusual.

2.2.5 Tables of Monte Carlo results: percentiles of the distribution of LD50 estimates

Convergence criterion #1 [fixed nominal N]

Critical nominal N	=	6
slope assumed in probit calculations	=	2.00
step size (dose progression) log10	=	0.50
max num. animals to test	=	15
doses restricted to range	=	1.0,5000.0(min,max)
Num. simulated studies per scenario	=	5000

	LD50	slope	Dose0	Dose Averaging				MLE (slope= 2.00)			
				percentiles			%in range	percentiles			%in range
				5%	50%	95%		5%	50%	95%	
1	600.0	0.50	6.0	7.3	49.5	1519.2	99.9	9.4	101.1	1986.4	99.1
2	600.0	0.80	6.0	15.7	156.6	1519.2	99.8	24.9	252.3	2404.1	99.2
3	600.0	1.50	6.0	72.7	337.4	1519.2	100.0	112.6	509.4	1764.9	99.9
4	600.0	2.00	6.0	156.6	495.2	1519.2	100.0	198.6	569.0	1579.4	99.9
5	600.0	2.50	6.0	156.6	495.2	1067.0	100.0	252.3	628.2	1401.5	100.0
6	600.0	3.00	6.0	229.9	495.2	1067.0	100.0	294.2	628.2	1397.0	100.0
7	600.0	3.50	6.0	229.9	495.2	1067.0	100.0	356.2	628.2	1126.3	100.0
8	600.0	4.00	6.0	337.4	495.2	1067.0	100.0	356.2	628.2	1126.3	100.0
9	600.0	8.33	6.0	337.4	495.2	1067.0	100.0	356.2	628.2	1126.3	100.0
10	600.0	0.50	60.0	23.0	156.6	1785.5	99.8	23.0	199.4	2404.1	98.8
11	600.0	0.80	60.0	49.5	229.9	1519.2	99.9	49.4	299.5	2404.1	99.4
12	600.0	1.50	60.0	106.7	337.4	1519.2	100.0	135.0	508.1	1764.9	99.9
13	600.0	2.00	60.0	156.6	495.2	1519.2	100.0	194.5	568.0	1579.2	100.0
14	600.0	2.50	60.0	156.6	495.2	1067.0	100.0	249.4	627.2	1401.3	100.0
15	600.0	3.00	60.0	229.9	495.2	1067.0	100.0	291.2	627.2	1395.2	100.0
16	600.0	3.50	60.0	229.9	495.2	1067.0	100.0	354.1	627.2	1126.0	100.0
17	600.0	4.00	60.0	337.4	495.2	1067.0	100.0	354.1	627.2	1126.0	100.0
18	600.0	8.33	60.0	337.4	495.2	1067.0	100.0	354.1	797.4	1126.0	100.0
19	600.0	0.50	600.0	72.7	705.2	3080.1	99.4	63.4	655.2	4345.9	96.5
20	600.0	0.80	600.0	106.7	495.2	2163.2	99.8	81.5	542.0	3230.0	98.6
21	600.0	1.50	600.0	229.9	705.2	1519.2	100.0	180.5	655.2	1945.0	99.8

	LD50	slope	Dose0	Dose Averaging				MLE (slope= 2.00)			
				percentiles			%in	percentiles			%in
				5%	50%	95%	range	5%	50%	95%	range
22	600.0	2.00	600.0	229.9	705.2	1519.2	100.0	204.6	655.2	1725.3	100.0
23	600.0	2.50	600.0	229.9	495.2	1519.2	100.0	230.4	542.0	1531.0	100.0
24	600.0	3.00	600.0	337.4	495.2	1067.0	100.0	284.5	494.1	1246.1	100.0
25	600.0	3.50	600.0	337.4	495.2	1067.0	100.0	337.4	494.1	1067.0	100.0
26	600.0	4.00	600.0	337.4	495.2	1067.0	100.0	337.4	494.1	1067.0	100.0
27	600.0	8.30	600.0	337.4	495.2	1067.0	100.0	337.4	494.1	1067.0	100.0

Values of 1.0 indicate < 1.0 and values of 5000.0 indicate >5000.0

'%in range' means % > 1.0 and <5000.0

**** Distribution of LD50 estimates ****

Convergence criterion # 2 [#reversals]

Critical nominal N = 6
 slope assumed in probit calculations = 2.00
 step size (dose progression) log10 = 0.50
 Generate outlier (1=>yes;0=>no) = 0
 (if Crit #2) Critical num reversals = 5

max num. animals to test = 15
 doses restricted to range 1.0,5000.0 (min,max)
 Num. simulated studies per scenario = 5000

	LD50	slope	Dose0	Dose Averaging				MLE (slope= 2.00)			
				percentiles			%in	percentiles			%in
				5%	50%	95%	range	5%	50%	95%	range
1	600.0	0.50	6.0	10.7	106.7	1330.4	99.9	12.8	170.1	2006.0	99.1
2	600.0	0.80	6.0	31.6	223.7	1568.2	99.8	42.6	338.9	2011.6	99.6
3	600.0	1.50	6.0	106.7	431.8	1390.8	100.0	171.6	564.3	1762.3	100.0
4	600.0	2.00	6.0	189.7	509.0	1330.4	100.0	228.5	579.8	1437.7	100.0
5	600.0	2.50	6.0	233.9	534.8	1067.0	100.0	269.9	610.0	1244.8	100.0
6	600.0	3.00	6.0	253.0	600.0	1067.0	100.0	349.2	610.0	1126.3	100.0
7	600.0	3.50	6.0	337.4	600.0	1067.0	100.0	356.2	655.7	1126.3	100.0
8	600.0	4.00	6.0	337.4	600.0	1067.0	100.0	356.2	655.7	1126.3	100.0
9	600.0	8.33	6.0	337.4	600.0	1067.0	100.0	356.2	655.7	1126.3	100.0
10	600.0	0.50	60.0	33.7	221.2	1801.1	99.6	29.9	301.7	2612.7	98.8
11	600.0	0.80	60.0	60.0	337.4	1775.7	99.9	65.7	414.2	2404.1	99.3
12	600.0	1.50	60.0	136.6	449.9	1390.8	100.0	176.0	568.0	1762.2	100.0
13	600.0	2.00	60.0	189.7	509.0	1330.4	100.0	228.5	578.9	1437.5	100.0
14	600.0	2.50	60.0	253.0	534.8	1067.0	100.0	267.8	609.3	1294.9	100.0
15	600.0	3.00	60.0	253.0	600.0	1067.0	100.0	347.9	609.3	1126.0	100.0
16	600.0	3.50	60.0	337.4	600.0	1067.0	100.0	354.1	655.1	1126.0	100.0
17	600.0	4.00	60.0	337.4	600.0	1067.0	100.0	354.1	609.3	1126.0	100.0

	LD50	slope	Dose0	Dose Averaging				MLE (slope= 2.00)			
				percentiles			%in	percentiles			%in
				5%	50%	95%	range	5%	50%	95%	range
18	600.0	8.33	60.0	337.4	600.0	1067.0	100.0	354.1	655.1	1126.0	100.0
19	600.0	0.50	600.0	80.0	590.1	2568.2	99.4	63.4	600.0	3462.9	97.6
20	600.0	0.80	600.0	129.3	600.0	2123.0	99.7	110.5	600.0	3035.0	99.0
21	600.0	1.50	600.0	223.7	600.0	1568.2	100.0	204.6	600.0	1725.3	100.0
22	600.0	2.00	600.0	263.6	600.0	1390.8	100.0	253.7	600.0	1439.3	100.0
23	600.0	2.50	600.0	316.5	600.0	1114.6	100.0	281.0	600.0	1202.7	100.0
24	600.0	3.00	600.0	337.4	600.0	1067.0	100.0	337.4	600.0	1067.0	100.0
25	600.0	3.50	600.0	337.4	600.0	1067.0	100.0	337.4	600.0	1067.0	100.0
26	600.0	4.00	600.0	337.4	600.0	1067.0	100.0	337.4	600.0	1067.0	100.0
27	600.0	8.30	600.0	337.4	600.0	1067.0	100.0	337.4	600.0	1067.0	100.0

Values of 1.0 indicate < 1.0 and values of 5000.0 indicate >5000.0

'%in range' means % > 1.0 and <5000.0

**** Distribution of LD50 estimates ****

Convergence criterion # 5 [LR]

Critical nominal N = 6
 slope assumed in probit calculations = 2.00
 step size (dose progression) log10 = 0.50
 Generate outlier (1=>yes;0=>no) = 0
 (if Crit #5) factor above/below g.mean = 2.50
 (if Crit #5) Critical likelihood ratio = 2.50
 max num. animals to test = 15
 doses restricted to range 1.0,5000.0 (min,max)
 Num. simulated studies per scenario = 5000

	LD50 slope		Dose0	Dose Averaging				MLE (slope= 2.00)			
				percentiles		%in	percentiles		%in		
	5%	50%		5%	50%	95%	range	5%	50%	95%	range
1	600.0	0.50	6.0	10.7	148.3	1519.2	99.8	10.7	213.1	2070.6	99.2
2	600.0	0.80	6.0	47.7	263.6	1569.8	99.9	50.8	356.2	1983.0	99.7
3	600.0	1.50	6.0	148.3	495.2	1519.2	100.0	161.1	512.4	1579.4	100.0
4	600.0	2.00	6.0	206.0	509.0	1519.2	100.0	253.8	604.5	1579.4	100.0
5	600.0	2.50	6.0	253.0	586.5	1128.6	100.0	281.6	610.0	1201.2	100.0
6	600.0	3.00	6.0	337.4	600.0	1067.0	100.0	349.5	655.7	1126.3	100.0
7	600.0	3.50	6.0	337.4	600.0	1067.0	100.0	356.2	655.7	1126.3	100.0
8	600.0	4.00	6.0	337.4	600.0	1067.0	100.0	356.2	655.7	1126.3	100.0
9	600.0	8.33	6.0	337.4	600.0	1067.0	100.0	356.2	655.7	1126.3	100.0
10	600.0	0.50	60.0	25.3	268.0	1812.8	99.7	25.4	291.0	2641.1	99.0
11	600.0	0.80	60.0	49.5	366.3	1796.4	99.9	49.4	425.8	2062.1	99.7
12	600.0	1.50	60.0	156.6	495.2	1519.2	100.0	156.3	511.5	1579.2	100.0
13	600.0	2.00	60.0	189.7	509.0	1519.2	100.0	213.2	576.3	1437.5	100.0
14	600.0	2.50	60.0	288.4	600.0	1390.8	100.0	337.4	609.3	1437.5	100.0
15	600.0	3.00	60.0	337.4	600.0	1067.0	100.0	350.5	609.3	1126.0	100.0
16	600.0	3.50	60.0	337.4	600.0	1067.0	100.0	354.1	655.1	1126.0	100.0
17	600.0	4.00	60.0	337.4	600.0	1067.0	100.0	354.1	655.1	1126.0	100.0
18	600.0	8.33	60.0	337.4	600.0	1067.0	100.0	354.1	655.1	1126.0	100.0
19	600.0	0.50	600.0	72.7	584.6	2836.9	99.2	70.4	596.4	3246.3	98.1

LD50	slope	Dose0	Dose Averaging				MLE (slope= 2.00)				
			percentiles		%in	95% range	percentiles		%in		
			5%	50%			5%	50%	95%	range	
20	600.0	0.80	600.0	106.7	584.6	2220.6	99.7	102.3	596.4	2650.2	99.2
21	600.0	1.50	600.0	223.7	584.6	1568.2	100.0	226.9	596.4	1642.4	100.0
22	600.0	2.00	600.0	229.9	515.6	1519.2	100.0	230.4	494.1	1531.0	100.0
23	600.0	2.50	600.0	253.0	668.2	1390.8	100.0	253.7	673.4	1398.8	100.0
24	600.0	3.00	600.0	337.4	495.2	1128.6	100.0	337.4	494.1	1067.0	100.0
25	600.0	3.50	600.0	337.4	495.2	1067.0	100.0	337.4	494.1	1067.0	100.0
26	600.0	4.00	600.0	337.4	495.2	1067.0	100.0	337.4	494.1	1067.0	100.0
27	600.0	8.30	600.0	337.4	726.9	1067.0	100.0	337.4	728.6	1067.0	100.0

Values of 1.0 indicate < 1.0 and values of 5000.0 indicate >5000.0

'%in range' means % > 1.0 and <5000.0

2.2.6 Tables of Monte Carlo Results for Numbers Tested

Convergence criterion # 1 [fixed nominal N]
 Critical nominal N = 6
 slope assumed in probit calculations = 2.00
 step size (dose progression) log10 = 0.50
 max num. animals to test = 15
 doses restricted to range 1.0,5000.0 (min,max)
 Num. simulated studies per scenario = 5000

	LD50	slope	Dose0	mean	95th %ile	(%)N=max (= 15)
1	600.0	0.50	6.0	7.61	11.00	0.00
2	600.0	0.80	6.0	8.21	11.00	0.00
3	600.0	1.50	6.0	9.07	11.00	0.00
4	600.0	2.00	6.0	9.28	11.00	0.00
5	600.0	2.50	6.0	9.37	10.00	0.00
6	600.0	3.00	6.0	9.43	10.00	0.00
7	600.0	3.50	6.0	9.44	10.00	0.00
8	600.0	4.00	6.0	9.48	10.00	0.00
9	600.0	8.33	6.0	9.50	10.00	0.00
10	600.0	0.50	60.0	6.79	9.00	0.00
11	600.0	0.80	60.0	6.91	9.00	0.00
12	600.0	1.50	60.0	7.17	9.00	0.00
13	600.0	2.00	60.0	7.29	9.00	0.00
14	600.0	2.50	60.0	7.38	8.00	0.00
15	600.0	3.00	60.0	7.42	8.00	0.00
16	600.0	3.50	60.0	7.45	8.00	0.00
17	600.0	4.00	60.0	7.47	8.00	0.00
18	600.0	8.33	60.0	7.51	8.00	0.00
19	600.0	0.50	600.0	6.55	8.00	0.00
20	600.0	0.80	600.0	6.44	8.00	0.00
21	600.0	1.50	600.0	6.25	7.00	0.00
22	600.0	2.00	600.0	6.16	7.00	0.00
23	600.0	2.50	600.0	6.11	7.00	0.00
24	600.0	3.00	600.0	6.07	7.00	0.00
25	600.0	3.50	600.0	6.04	6.00	0.00
26	600.0	4.00	600.0	6.02	6.00	0.00
27	600.0	8.30	600.0	6.00	6.00	0.00

**** Numbers Tested ******Convergence criterion # 2 [#reversals]**

Critical nominal N = 6
 slope assumed in probit calculations = 2.00
 step size (dose progression) log10 = 0.50
 Generate outlier (1=>yes;0=>no) = 0
 (if Crit #2) Critical num reversals = 5

 max num. animals to test = 15
 doses restricted to range 1.0,5000.0 (min,max)
 Num. simulated studies per scenario = 5000

	LD50	slope	Dose0	mean	95th %ile	(%)N=max (= 15)
1	600.0	0.50	6.0	11.08	15.00	10.96
2	600.0	0.80	6.0	11.40	15.00	11.70
3	600.0	1.50	6.0	11.47	15.00	8.52
4	600.0	2.00	6.0	11.37	15.00	6.04
5	600.0	2.50	6.0	11.23	14.00	3.96
6	600.0	3.00	6.0	11.09	14.00	2.44
7	600.0	3.50	6.0	10.95	14.00	1.50
8	600.0	4.00	6.0	10.89	13.00	0.72
9	600.0	8.33	6.0	10.79	13.00	0.00
10	600.0	0.50	60.0	10.10	15.00	5.62
11	600.0	0.80	60.0	9.95	14.00	4.24
12	600.0	1.50	60.0	9.68	13.00	2.02
13	600.0	2.00	60.0	9.41	13.00	1.18
14	600.0	2.50	60.0	9.31	12.00	0.54
15	600.0	3.00	60.0	9.03	12.00	0.14
16	600.0	3.50	60.0	8.98	12.00	0.04
17	600.0	4.00	60.0	8.89	11.00	0.00
18	600.0	8.33	60.0	8.79	11.00	0.00
19	600.0	0.50	600.0	9.63	14.00	4.50
20	600.0	0.80	600.0	9.33	14.00	2.54
21	600.0	1.50	600.0	8.71	12.00	0.74
22	600.0	2.00	600.0	8.36	12.00	0.16
23	600.0	2.50	600.0	8.09	11.00	0.10
24	600.0	3.00	600.0	7.86	10.00	0.00
25	600.0	3.50	600.0	7.70	10.00	0.00
26	600.0	4.00	600.0	7.56	10.00	0.00
27	600.0	8.30	600.0	7.44	10.00	0.00

**** Numbers Tested ******Convergence criterion # 5 [LR]**

Critical nominal N = 6
 slope assumed in probit calculations = 2.00
 step size (dose progression) log10 = 0.50
 Generate outlier (1=>yes;0=>no) = 0
 (if Crit #5) factor above/below g.mean = 2.50
 (if Crit #5) Critical likelihood ratio = 2.50
 max num. animals to test = 15
 doses restricted to range 1.0,5000.0 (min,max)
 Num. simulated studies per scenario = 5000

	LD50	slope	Dose0	mean	95th %ile	(%)N=max (= 15)
1	600.0	0.50	6.0	12.37	15.00	44.36
2	600.0	0.80	6.0	12.68	15.00	41.04
3	600.0	1.50	6.0	12.13	15.00	22.12
4	600.0	2.00	6.0	11.78	15.00	13.60
5	600.0	2.50	6.0	11.54	15.00	8.00
6	600.0	3.00	6.0	11.44	15.00	5.86
7	600.0	3.50	6.0	11.20	14.00	3.28
8	600.0	4.00	6.0	11.16	14.00	1.88
9	600.0	8.33	6.0	11.01	14.00	0.00
10	600.0	0.50	60.0	9.98	15.00	16.42
11	600.0	0.80	60.0	10.25	15.00	16.06
12	600.0	1.50	60.0	10.13	15.00	9.42
13	600.0	2.00	60.0	9.87	15.00	6.44
14	600.0	2.50	60.0	9.64	13.00	3.70
15	600.0	3.00	60.0	9.39	13.00	2.32
16	600.0	3.50	60.0	9.26	12.00	1.30
17	600.0	4.00	60.0	9.19	12.00	0.98
18	600.0	8.33	60.0	8.99	12.00	0.00
19	600.0	0.50	600.0	8.71	15.00	5.52
20	600.0	0.80	600.0	8.13	13.00	2.76
21	600.0	1.50	600.0	7.20	10.00	0.26
22	600.0	2.00	600.0	6.78	10.00	0.02
23	600.0	2.50	600.0	6.50	8.00	0.00
24	600.0	3.00	600.0	6.32	8.00	0.00
25	600.0	3.50	600.0	6.17	8.00	0.00
26	600.0	4.00	600.0	6.10	6.00	0.00
27	600.0	8.30	600.0	6.00	6.00	0.00

2.2.7 Tables of Monte Carlo Results: Performance Statistics

Convergence criterion # 1 [fixed nominal N]

Critical nominal N = 6
 slope assumed in probit calculations = 2.00
 step size (dose progression) log10 = 0.50
 max num. animals to test = 15
 doses restricted to range 1.0,5000.0 (min,max)
 Num. simulated studies per scenario = 5000

	LD50	slope	Dose0	Dose Averaging		PF2	MLE		PF2
				P50/LD50	P95/P5		P50/LD50	P95/P5	
1	600.0	0.50	6.0	0.08	209.00	13.62	0.17	211.50	19.70
2	600.0	0.80	6.0	0.26	97.01	24.68	0.42	96.41	31.98
3	600.0	1.50	6.0	0.56	20.90	51.74	0.85	15.67	58.12
4	600.0	2.00	6.0	0.83	9.70	66.34	0.95	7.95	70.80
5	600.0	2.50	6.0	0.83	6.81	77.28	1.05	5.55	80.16
6	600.0	3.00	6.0	0.83	4.64	85.04	1.05	4.75	86.70
7	600.0	3.50	6.0	0.83	4.64	91.12	1.05	3.16	92.34
8	600.0	4.00	6.0	0.83	3.16	95.30	1.05	3.16	95.48
9	600.0	8.33	6.0	0.83	3.16	100.00	1.05	3.16	100.00
10	600.0	0.50	60.0	0.26	77.67	21.06	0.33	104.34	26.82
11	600.0	0.80	60.0	0.38	30.68	30.68	0.50	48.65	35.34
12	600.0	1.50	60.0	0.56	14.24	52.34	0.85	13.08	57.40
13	600.0	2.00	60.0	0.83	9.70	64.38	0.95	8.12	69.84
14	600.0	2.50	60.0	0.83	6.81	77.16	1.05	5.62	79.50
15	600.0	3.00	60.0	0.83	4.64	86.00	1.05	4.79	87.84
16	600.0	3.50	60.0	0.83	4.64	90.62	1.05	3.18	91.40
17	600.0	4.00	60.0	0.83	3.16	95.36	1.05	3.18	95.74
18	600.0	8.33	60.0	0.83	3.16	100.00	1.33	3.18	100.00
19	600.0	0.50	600.0	1.18	42.37	53.12	1.09	68.57	41.58
20	600.0	0.80	600.0	0.83	20.27	60.90	0.90	39.63	46.98

	LD50	slope	Dose0	Dose Averaging			MLE		
				P50/LD50	P95/P5	PF2	P50/LD50	P95/P5	PF2
21	600.0	1.50	600.0	1.18	6.61	75.98	1.09	10.77	63.98
22	600.0	2.00	600.0	1.18	6.61	84.22	1.09	8.43	75.14
23	600.0	2.50	600.0	0.83	6.61	89.62	0.90	6.64	82.44
24	600.0	3.00	600.0	0.83	3.16	93.28	0.82	4.38	88.94
25	600.0	3.50	600.0	0.83	3.16	95.78	0.82	3.16	92.72
26	600.0	4.00	600.0	0.83	3.16	97.86	0.82	3.16	95.64
27	600.0	8.30	600.0	0.83	3.16	100.00	0.82	3.16	100.00

**** Measures of performance for estimation of LD50 ******Convergence criterion # 2 [#reversals]**

Critical nominal N = 6
 slope assumed in probit calculations = 2.00
 step size (dose progression) log10 = 0.50
 Generate outlier (1=>yes;0=>no) = 0
 (if Crit #2) Critical num reversals = 5

 max num. animals to test = 15
 doses restricted to range 1.0,5000.0 (min,max)
 Num. simulated studies per scenario = 5000

	LD50	slope	Dose0	Dose Averaging			MLE		
				P50/LD50	P95/P5	PF2	P50/LD50	P95/P5	PF2
1	600.0	0.50	6.0	0.18	124.69	19.70	0.28	156.59	26.66
2	600.0	0.80	6.0	0.37	49.55	34.58	0.56	47.21	41.68
3	600.0	1.50	6.0	0.72	13.03	62.78	0.94	10.27	68.34
4	600.0	2.00	6.0	0.85	7.01	75.96	0.97	6.29	80.06
5	600.0	2.50	6.0	0.89	4.56	85.78	1.02	4.61	87.76
6	600.0	3.00	6.0	1.00	4.22	91.20	1.02	3.23	92.04
7	600.0	3.50	6.0	1.00	3.16	94.88	1.09	3.16	95.34
8	600.0	4.00	6.0	1.00	3.16	97.52	1.09	3.16	97.86
9	600.0	8.33	6.0	1.00	3.16	100.00	1.09	3.16	100.00
10	600.0	0.50	60.0	0.37	53.38	32.16	0.50	87.25	36.52
11	600.0	0.80	60.0	0.56	29.59	43.02	0.69	36.59	47.78
12	600.0	1.50	60.0	0.75	10.18	64.96	0.95	10.01	69.08
13	600.0	2.00	60.0	0.85	7.01	75.72	0.96	6.29	78.66
14	600.0	2.50	60.0	0.89	4.22	86.66	1.02	4.84	87.74
15	600.0	3.00	60.0	1.00	4.22	90.90	1.02	3.24	91.64
16	600.0	3.50	60.0	1.00	3.16	94.48	1.09	3.18	95.16
17	600.0	4.00	60.0	1.00	3.16	96.98	1.02	3.18	97.34
18	600.0	8.33	60.0	1.00	3.16	100.00	1.09	3.18	100.00
19	600.0	0.50	600.0	0.98	32.10	48.68	1.00	54.64	42.90

	LD50	slope	Dose0	Dose Averaging			MLE		
				P50/LD50	P95/P5	PF2	P50/LD50	P95/P5	PF2
20	600.0	0.80	600.0	1.00	16.42	59.00	1.00	27.46	51.12
21	600.0	1.50	600.0	1.00	7.01	76.76	1.00	8.43	70.44
22	600.0	2.00	600.0	1.00	5.28	84.42	1.00	5.67	79.24
23	600.0	2.50	600.0	1.00	3.52	90.64	1.00	4.28	86.68
24	600.0	3.00	600.0	1.00	3.16	94.08	1.00	3.16	91.18
25	600.0	3.50	600.0	1.00	3.16	96.68	1.00	3.16	95.06
26	600.0	4.00	600.0	1.00	3.16	98.06	1.00	3.16	97.06
27	600.0	8.30	600.0	1.00	3.16	100.00	1.00	3.16	100.00

**** Measures of performance for estimation of LD50 ******Convergence criterion # 5 [LR]**

Critical nominal N = 6
 slope assumed in probit calculations = 2.00
 step size (dose progression) log10 = 0.50
 Generate outlier (1=>yes;0=>no) = 0
 (if Crit #5) factor above/below g.mean = 2.50
 (if Crit #5) Critical likelihood ratio = 2.50
 max num. animals to test = 15
 doses restricted to range 1.0,5000.0 (min,max)
 Num. simulated studies per scenario = 5000

	LD50	slope	Dose0	Dose Averaging			MLE		
				P50/LD50	P95/P5	PF2	P50/LD50	P95/P5	PF2
1	600.0	0.50	6.0	0.25	142.39	22.60	0.36	194.07	30.52
2	600.0	0.80	6.0	0.44	32.94	37.00	0.59	39.03	43.38
3	600.0	1.50	6.0	0.83	10.25	66.12	0.85	9.80	69.22
4	600.0	2.00	6.0	0.85	7.37	79.02	1.01	6.22	81.46
5	600.0	2.50	6.0	0.98	4.46	87.94	1.02	4.27	89.48
6	600.0	3.00	6.0	1.00	3.16	91.94	1.09	3.22	93.10
7	600.0	3.50	6.0	1.00	3.16	95.36	1.09	3.16	96.22
8	600.0	4.00	6.0	1.00	3.16	97.84	1.09	3.16	98.40
9	600.0	8.33	6.0	1.00	3.16	100.00	1.09	3.16	100.00
10	600.0	0.50	60.0	0.45	71.65	36.30	0.48	104.09	33.74
11	600.0	0.80	60.0	0.61	36.27	48.14	0.71	41.73	45.86
12	600.0	1.50	60.0	0.83	9.70	69.56	0.85	10.11	70.32
13	600.0	2.00	60.0	0.85	8.01	80.52	0.96	6.74	81.58
14	600.0	2.50	60.0	1.00	4.82	87.96	1.02	4.26	88.92
15	600.0	3.00	60.0	1.00	3.16	92.80	1.02	3.21	93.68
16	600.0	3.50	60.0	1.00	3.16	95.62	1.09	3.18	96.34
17	600.0	4.00	60.0	1.00	3.16	97.34	1.09	3.18	97.84
18	600.0	8.33	60.0	1.00	3.16	100.00	1.09	3.18	100.00

	LD50	slope	Dose0	Dose Averaging			MLE		
				P50/LD50	P95/P5	PF2	P50/LD50	P95/P5	PF2
19	600.0	0.50	600.0	0.97	39.03	44.44	0.99	46.13	43.26
20	600.0	0.80	600.0	0.97	20.81	53.64	0.99	25.90	52.26
21	600.0	1.50	600.0	0.97	7.01	72.48	0.99	7.24	71.84
22	600.0	2.00	600.0	0.86	6.61	81.96	0.82	6.64	81.66
23	600.0	2.50	600.0	1.11	5.50	87.62	1.12	5.51	87.56
24	600.0	3.00	600.0	0.83	3.35	92.90	0.82	3.16	92.88
25	600.0	3.50	600.0	0.83	3.16	95.88	0.82	3.16	95.88
26	600.0	4.00	600.0	0.83	3.16	97.72	0.82	3.16	97.72
27	600.0	8.30	600.0	1.21	3.16	100.00	1.21	3.16	100.00

2.3 Simulation of an outlier scenario

The following is an extension of the analysis described in the previous section, distributed originally on February 14, 2000. An "outlier scenario" has been simulated as follows. The initial test was assumed to be below the true LD50 (here 750 units) by a factor of 10 or 100, and the first animal tested was assumed to respond, regardless of the probability of response calculated from the probit model. Stopping Criteria 1, 2, and 5 were simulated. Results are displayed below for the index PF2 (probability of an estimate within factor of 2 of correct value). The results tabulated are based on the MLE(2) estimates of the LD50, which appeared to perform better than the dose-averaging estimator in this situation.

Table 2.3.1. Results for performance index PF2 (%) with "outlier" scenario.

Dose0 = LD50 / 100			
slope	Crit.#1	Crit.#2	Crit.#5
0.5	0.1%	11%	16%
1.0	0.0	19	29
1.5	0.0	24	38
2.0	0.0	24	42
2.5	0.0	22	43
3.0	0.0	23	47
3.5	0.0	19	50
4.0	0.0	20	49
8.3	0.0	19	51
Dose0 = LD50 / 10			
0.5	6.2%	22%	22%
1.0	9.1	37	36
1.5	7.8	47	49
2.0	6.5	57	55
2.5	4.1	64	59
3.0	2.9	69	62
3.5	1.7	70	68
4.0	1.1	73	71
8.3	0.0	75	73

Explanation: The index PF2 is the probability of an estimate within a factor of 2 of the true value. For example (see first row). If the slope is 0.5 and the initial test dose is 100th of the LD50 (here LD50=750), then the probability is 0.001 that the estimate will fall between 750/2 and 750*2 when stopping is based on Criterion 1 (fixed nominal n). In the same situation, the probability of that accuracy is 0.11 for Criterion 2 (fixed number of reversals) and 0.16 for Criterion 5 (simplified LR).

2.4 Classification probabilities for standard OECD scenarios

The following is abbreviated from an analysis distributed on February 14, 2000. For OECD evaluation of guidelines it has been customary to consider a standard set of slope and LD50 values, and to assume initial test doses equal to the LD10, LD50, and LD80. The tables below give probabilities of classification into categories of the acute oral toxicity classification, which has cut-points 5, 50, 300, 2000, and 5000 units. Based on the current guideline, initial test doses below 1 unit or above 5000 units have been excluded. The dose progression deviates from the guideline, in that a dose of 3200 was not included in the progression. Two stopping rules are simulated: a procedure with the nominal sample size fixed at 6, and the likelihood-ratio criterion recommended in the proposed guideline.

2.4.1 OECD-Type scenarios: Distribution of LD50 Estimates

Convergence criterion # 1 [fixed nominal NR]

Critical nominal N = 6
 slope assumed in probit calculations = 2.00
 step size (dose progression) log10 = 0.50
 Generate outlier (1=>yes;0=>no) = 0

max num. animals to test = 15
 doses restricted to range 1.0,5000.0 (min,max)
 Num. simulated studies per scenario = 3000
 Classification cutpoints 5 50 300 2000 5000

	LD50 slope		Dose0	Dose Averaging				MLE (slope= 2.00)			
				percentiles		%in		percentiles		%in	
				5%	50%	95%	range	5%	50%	95%	range
1	1.5	8.33	1.1	1.5	1.9	1.9	100.0	1.5	1.9	1.9	99.0
2	1.5	8.33	1.5	1.2	1.6	2.7	100.0	1.0	1.5	2.7	94.8
3	1.5	8.33	1.9	1.4	1.4	2.5	100.0	1.0	1.4	2.4	91.5
4	1.5	4.00	1.5	1.1	1.6	2.7	99.4	1.0	1.5	2.7	80.7
5	1.5	4.00	2.4	1.3	1.6	3.1	98.9	1.0	1.6	3.0	74.5
6	1.5	2.00	1.5	1.1	1.6	3.9	98.0	1.0	1.5	3.9	74.5
7	1.5	2.00	4.0	1.3	2.0	4.6	96.3	1.0	1.6	4.7	79.5
8	1.5	0.80	1.5	1.1	2.1	8.4	95.4	1.0	1.9	10.4	71.1
9	1.5	0.80	16.9	1.3	4.5	20.5	95.2	1.0	3.1	20.5	83.4
10	1.5	0.50	1.5	1.0	2.1	12.4	94.6	1.0	2.0	14.2	72.2
11	1.5	0.50	72.3	1.3	18.9	87.6	97.7	1.0	6.9	87.8	91.7
12	2.5	8.33	1.8	2.3	3.1	3.1	100.0	2.3	3.1	3.1	100.0
13	2.5	8.33	2.5	1.6	2.2	4.4	100.0	1.6	2.2	4.4	100.0
14	2.5	8.33	3.1	1.8	1.8	3.8	100.0	1.8	1.8	3.8	100.0
15	2.5	4.00	1.2	1.7	2.1	4.6	100.0	1.7	2.3	5.8	99.6
16	2.5	4.00	2.5	1.6	2.2	4.4	100.0	1.5	2.2	4.4	98.4
17	2.5	4.00	4.1	2.0	2.0	4.7	100.0	1.1	2.0	4.8	99.4
18	2.5	2.00	2.5	1.6	2.7	6.5	99.6	1.0	2.2	6.5	93.0
19	2.5	2.00	6.6	1.4	3.5	8.0	99.7	1.0	2.4	8.0	95.2

	LD50 slope		Dose0	Dose Averaging				MLE (slope= 2.00)			
				percentiles		%in	percentiles		%in		
				5%	50%		5%	50%		95%	range
20	2.5	0.80	2.5	1.4	3.1	14.1	96.9	1.0	2.6	14.8	86.5
21	2.5	0.80	28.2	1.4	7.5	34.1	98.6	1.0	5.0	34.2	91.9
22	2.5	0.50	2.5	1.2	3.1	20.6	96.5	1.0	3.1	21.2	83.1
23	2.5	0.50	120.5	1.6	31.5	146.0	98.8	1.0	11.5	146.4	95.0
24	20.0	8.33	14.0	17.0	24.9	24.9	100.0	17.0	24.9	24.9	100.0
25	20.0	8.33	20.0	11.2	16.5	35.6	100.0	11.2	16.5	35.6	100.0
26	20.0	8.33	25.2	14.2	14.2	30.6	100.0	14.2	14.2	30.6	100.0
27	20.0	4.00	9.6	11.6	17.0	36.6	100.0	11.6	17.0	39.7	100.0
28	20.0	4.00	20.0	11.2	16.5	35.6	100.0	11.2	16.5	35.6	100.0
29	20.0	4.00	32.5	12.4	18.3	39.3	100.0	10.0	18.3	39.4	100.0
30	20.0	2.00	4.6	5.2	17.5	55.4	100.0	6.8	19.0	60.7	100.0
31	20.0	2.00	20.0	7.7	24.2	52.2	100.0	6.8	24.3	58.7	100.0
32	20.0	2.00	52.7	8.6	29.6	63.8	100.0	6.7	20.2	64.0	100.0
33	20.0	0.80	20.0	5.0	24.2	76.6	100.0	3.4	22.0	118.0	100.0
34	20.0	0.80	225.4	5.9	58.8	273.1	100.0	4.6	38.2	273.8	99.9
35	20.0	0.50	20.0	2.6	24.2	165.1	99.9	2.2	22.0	169.4	99.4
36	20.0	0.50	964.4	8.0	171.5	1377.8	99.9	5.4	94.9	884.7	99.6
37	50.0	8.33	35.1	42.5	62.4	62.4	100.0	42.6	62.4	62.4	100.0
38	50.0	8.33	50.0	28.1	60.6	88.9	100.0	28.1	60.7	88.9	100.0
39	50.0	8.33	63.1	35.5	35.5	76.4	100.0	35.5	35.5	76.6	100.0
40	50.0	4.00	23.9	29.0	42.5	91.6	100.0	29.0	42.5	116.0	100.0
41	50.0	4.00	50.0	28.1	60.6	88.9	100.0	28.1	60.7	88.9	100.0
42	50.0	4.00	81.2	31.1	45.6	98.3	100.0	25.0	45.6	98.6	100.0
43	50.0	2.00	11.4	13.8	43.8	138.5	100.0	13.9	47.5	151.9	100.0
44	50.0	2.00	50.0	19.2	60.6	130.5	100.0	19.2	60.7	146.6	100.0
45	50.0	2.00	131.8	23.4	74.1	159.6	100.0	17.6	50.6	160.0	100.0
46	50.0	0.80	1.3	2.2	15.1	151.4	100.0	3.0	21.1	193.8	99.8

	LD50	slope	Dose0	Dose Averaging				MLE (slope= 2.00)			
				percentiles		%in	percentiles		%in		
				5%	50%		95%	range		5%	50%
47	50.0	0.80	50.0	8.9	41.3	281.2	100.0	7.0	45.4	295.1	100.0
48	50.0	0.80	563.6	14.7	147.1	682.9	100.0	11.5	95.5	684.4	100.0
49	50.0	0.50	50.0	5.6	60.6	412.7	99.9	6.2	55.0	508.1	99.8
50	50.0	0.50	2411.1	19.9	629.3	2537.8	99.9	13.5	254.7	2187.0	99.4
51	150.0	8.33	105.3	127.5	187.2	187.2	100.0	127.8	187.2	187.2	100.0
52	150.0	8.33	150.0	84.4	123.8	266.7	100.0	84.4	123.5	266.7	100.0
53	150.0	8.33	189.3	106.4	106.4	229.3	100.0	106.4	106.4	229.9	100.0
54	150.0	4.00	71.7	86.9	127.6	274.8	100.0	87.1	127.6	348.1	100.0
55	150.0	4.00	150.0	84.4	181.7	266.7	100.0	84.4	165.1	266.7	100.0
56	150.0	4.00	243.5	93.3	136.9	295.0	100.0	75.1	136.9	295.7	100.0
57	150.0	2.00	34.3	41.6	131.4	415.6	100.0	41.7	142.5	455.8	100.0
58	150.0	2.00	150.0	57.5	123.8	391.5	100.0	51.1	123.5	439.9	100.0
59	150.0	2.00	395.3	70.3	222.3	478.9	100.0	52.7	151.8	480.0	100.0
60	150.0	0.80	3.8	6.5	45.4	454.3	100.0	8.4	63.2	581.4	100.0
61	150.0	0.80	150.0	39.2	123.8	579.7	100.0	25.4	136.3	885.3	99.9
62	150.0	0.80	1690.9	44.1	441.4	2003.3	100.0	34.5	286.5	2015.1	99.8
63	150.0	0.50	150.0	18.2	181.7	1040.0	100.0	17.7	165.1	1277.2	99.7
64	600.0	8.33	421.0	510.1	748.7	748.7	100.0	511.2	748.7	748.7	100.0
65	600.0	8.33	600.0	337.4	726.9	1067.0	100.0	337.4	728.6	1067.0	100.0
66	600.0	8.33	757.2	425.8	425.8	917.3	100.0	425.8	425.8	919.4	100.0
67	600.0	4.00	286.9	347.6	510.2	1322.8	100.0	348.4	510.2	1365.3	100.0
68	600.0	4.00	600.0	337.4	495.2	1067.0	100.0	337.4	494.1	1067.0	100.0
69	600.0	4.00	974.0	373.2	547.7	1386.8	100.0	300.5	547.7	1339.8	100.0
70	600.0	2.00	137.2	166.2	525.7	1159.6	100.0	170.2	570.2	1890.9	99.9
71	600.0	2.00	600.0	229.9	726.9	1519.2	100.0	204.6	728.6	1725.3	100.0
72	600.0	2.00	1581.1	281.2	889.1	1915.6	100.0	210.9	607.1	1920.0	99.9
73	600.0	0.80	15.0	26.7	181.7	1849.5	99.7	33.7	252.7	2346.2	99.1

	LD50	slope	Dose0	Dose Averaging				MLE (slope= 2.00)			
				percentiles			%in	percentiles			%in
				5%	50%	95%	range	5%	50%	95%	range
74	600.0	0.80	600.0	156.6	495.2	2163.2	99.8	106.7	535.9	3246.3	98.4
75	600.0	0.50	1.6	2.9	42.8	1345.4	99.8	4.3	80.4	1549.4	99.1
76	600.0	0.50	600.0	72.7	705.2	2542.3	99.5	63.4	655.2	4117.6	96.6
77	1500.0	8.33	1052.5	1460.4	2294.1	2294.1	100.0	1421.2	2294.1	2294.1	100.0
78	1500.0	8.33	1500.0	843.5	1849.5	2738.6	100.0	843.5	1848.1	2738.6	100.0
79	1500.0	8.33	1892.9	1064.5	1064.5	2159.8	100.0	1064.5	1064.5	2184.1	100.0
80	1500.0	4.00	717.3	869.0	1275.6	2436.6	100.0	871.0	1275.6	3263.2	99.9
81	1500.0	4.00	1500.0	843.5	1526.6	2738.6	100.0	843.5	1848.1	2738.6	99.6
82	1500.0	4.00	2435.0	932.9	1369.3	2554.6	100.0	751.1	1369.3	2606.2	100.0
83	1500.0	2.00	343.0	415.6	953.4	2328.9	99.9	416.5	1566.9	4563.0	98.3
84	1500.0	2.00	1500.0	574.7	1249.0	2738.6	99.8	511.5	1242.1	3909.0	96.0
85	1500.0	2.00	3952.8	702.9	1908.0	3528.5	100.0	527.2	1517.8	3644.1	97.7
86	1500.0	0.80	37.5	66.7	454.4	2435.3	98.7	84.4	631.9	4709.9	95.2
87	1500.0	0.80	1500.0	266.7	1249.0	3347.2	98.3	254.2	1242.1	5000.0	89.4
88	1500.0	0.50	4.1	7.0	107.0	2546.1	99.2	12.0	173.4	3270.6	97.6
89	1500.0	0.50	1500.0	181.7	1249.0	3347.2	96.9	158.4	1242.1	5000.0	86.2
90	3000.0	8.33	2105.1	2318.3	3244.3	3244.3	100.0	2354.3	3244.3	5000.0	94.8
91	3000.0	8.33	3000.0	1687.0	2935.9	3873.0	100.0	1687.0	3008.8	3873.0	97.6
92	3000.0	8.33	3785.8	2128.9	2128.9	3428.4	100.0	2128.9	2128.9	3522.0	99.7
93	3000.0	4.00	1434.6	1795.3	2678.3	3297.8	99.5	1789.0	2678.3	5000.0	92.3
94	3000.0	4.00	3000.0	1687.0	2935.9	3873.0	99.6	1687.0	3008.8	5000.0	85.8
95	3000.0	4.00	4870.0	1865.8	2738.6	4055.2	99.9	1502.3	2738.6	5000.0	94.2
96	3000.0	2.00	686.0	831.1	1952.3	3785.2	97.9	1073.9	3146.9	5000.0	82.0
97	3000.0	2.00	3000.0	1149.4	2423.3	4217.2	98.2	1152.0	3008.8	5000.0	77.1
98	3000.0	0.80	75.0	90.9	849.5	3899.8	97.6	168.7	1263.7	5000.0	88.5
99	3000.0	0.80	3000.0	703.8	2225.5	4591.9	95.7	533.5	2502.1	5000.0	72.7
100	3000.0	0.50	8.2	14.6	214.0	3600.7	98.7	18.4	346.9	5000.0	93.5

	LD50	slope	Dose0	Dose Averaging				MLE (slope= 2.00)			
				percentiles			%in	percentiles			%in
				5%	50%	95%	range	5%	50%	95%	range
101	3000.0	0.50	3000.0	363.5	2225.5	4591.9	95.7	316.9	2278.9	5000.0	73.9
102	3500.0	8.33	2455.9	2569.2	3504.2	3945.1	100.0	2621.8	3504.2	5000.0	86.2
103	3500.0	8.33	3500.0	1968.2	3253.6	4183.3	99.9	1968.2	3340.7	5000.0	91.9
104	3500.0	8.33	4416.8	2483.7	2483.7	3799.5	100.0	2483.7	2483.7	4307.3	96.7
105	3500.0	4.00	1673.7	1989.7	2892.8	3471.7	98.6	2000.3	3678.9	5000.0	63.5
106	3500.0	4.00	3500.0	1968.2	3253.6	4439.5	99.0	1968.2	3340.7	5000.0	80.5
107	3500.0	2.00	800.4	969.7	2163.6	3984.8	97.2	1252.8	3566.3	5000.0	77.7
108	3500.0	2.00	3500.0	1340.9	3253.6	4439.5	97.2	1344.0	3340.7	5000.0	71.9
109	3500.0	0.80	87.5	106.0	965.9	4105.3	97.6	196.9	1474.3	5000.0	85.6
110	3500.0	0.80	3500.0	800.2	2685.6	4711.4	96.0	593.0	3340.7	5000.0	70.6
111	3500.0	0.50	9.6	17.0	249.8	2881.5	97.4	22.2	469.2	5000.0	92.7
112	3500.0	0.50	3500.0	424.0	2530.6	5000.0	94.1	413.3	3340.7	5000.0	70.0

Values of 1.0 indicate < 1.0 and values of 5000.0 indicate >5000.0
 '%in range' means % > 1.0 and <5000.0

Convergence criterion # 5 [LR]

Critical nominal N = 6
 slope assumed in probit calculations = 2.00
 step size (dose progression) log10 = 0.50
 Generate outlier (1=>yes;0=>no) = 0
 (if Crit #5) factor above/below g.mean = 2.50
 (if Crit #5) Critical likelihood ratio = 2.50
 max num. animals to test = 15
 doses restricted to range 1.0,5000.0 (min,max)
 Num. simulated studies per scenario = 3000
 Classification cutpoints 5 50 300 2000 5000

	LD50 slope		Dose0	Dose Averaging				MLE (slope= 2.00)			
				percentiles		%in		percentiles		%in	
				5%	50%	95%	range	5%	50%	95%	range
1	1.5	8.33	1.1	1.5	1.9	1.9	100.0	1.5	1.9	1.9	99.9
2	1.5	8.33	1.5	1.2	1.6	2.7	100.0	1.2	1.5	2.7	99.1
3	1.5	8.33	1.9	1.3	1.4	2.5	100.0	1.0	1.4	2.4	99.2
4	1.5	4.00	1.5	1.2	1.6	2.7	99.4	1.0	1.5	2.7	94.0
5	1.5	4.00	2.4	1.3	1.6	3.1	98.8	1.0	1.6	3.0	91.5
6	1.5	2.00	1.5	1.1	1.7	3.9	97.8	1.0	1.5	3.9	87.6
7	1.5	2.00	4.0	1.3	2.0	3.7	96.2	1.0	1.7	3.8	80.1
8	1.5	0.80	1.5	1.1	2.0	8.4	95.5	1.0	1.7	8.9	81.7
9	1.5	0.80	16.9	1.3	3.4	14.3	95.4	1.0	2.2	14.8	84.0
10	1.5	0.50	1.5	1.0	2.0	12.4	94.9	1.0	1.7	12.7	79.6
11	1.5	0.50	72.3	1.4	6.6	59.7	98.0	1.0	4.0	59.6	91.4
12	2.5	8.33	1.8	2.3	3.1	3.1	100.0	2.3	3.1	3.1	
100.0											
13	2.5	8.33	2.5	1.6	2.2	4.4	100.0	1.6	2.2	4.4	100.0
14	2.5	8.33	3.1	1.8	2.6	3.8	100.0	1.8	2.6	3.8	100.0
15	2.5	4.00	1.2	1.7	2.4	3.8	100.0	1.7	2.3	4.1	100.0
16	2.5	4.00	2.5	1.6	2.2	4.4	100.0	1.6	2.2	4.4	99.9
17	2.5	4.00	4.1	1.9	2.0	3.8	100.0	1.6	2.0	3.9	100.0
18	2.5	2.00	2.5	1.5	2.7	6.5	99.7	1.3	2.5	6.0	98.3

	LD50 slope		Dose0	Dose Averaging				MLE (slope= 2.00)			
				percentiles		%in		percentiles		%in	
				5%	50%	95%	range	5%	50%	95%	range
19	2.5	2.00	6.6	1.4	2.7	8.0	99.6	1.2	2.7	8.0	98.0
20	2.5	0.80	2.5	1.4	3.1	14.1	97.2	1.0	2.5	14.6	91.8
21	2.5	0.80	28.2	1.5	4.6	34.1	98.2	1.0	3.5	34.2	93.1
22	2.5	0.50	2.5	1.3	3.1	20.6	96.4	1.0	3.1	21.3	88.4
23	2.5	0.50	120.5	1.8	9.7	120.6	98.4	1.0	6.4	120.6	95.1
24	20.0	8.33	14.0	17.0	24.9	24.9	100.0	17.0	24.9	24.9	100.0
25	20.0	8.33	20.0	11.2	16.5	35.6	100.0	11.2	16.5	35.6	100.0
26	20.0	8.33	25.2	14.2	14.2	30.6	100.0	14.2	14.2	30.6	100.0
27	20.0	4.00	9.6	11.6	17.0	30.2	100.0	11.6	17.0	32.6	100.0
28	20.0	4.00	20.0	11.2	16.5	35.6	100.0	11.2	16.5	35.6	100.0
29	20.0	4.00	32.5	12.1	18.3	39.3	100.0	12.5	18.3	39.4	100.0
30	20.0	2.00	4.6	7.8	19.3	45.7	100.0	8.0	20.4	49.9	100.0
31	20.0	2.00	20.0	7.7	20.0	52.2	100.0	7.7	20.0	52.1	100.0
32	20.0	2.00	52.7	8.1	20.2	63.8	100.0	8.8	22.1	64.0	100.0
33	20.0	0.80	20.0	3.8	17.8	112.5	100.0	3.5	17.7	118.0	100.0
34	20.0	0.80	225.4	5.8	30.1	273.1	100.0	4.9	27.1	273.8	100.0
35	20.0	0.50	20.0	2.8	22.7	169.7	100.0	2.7	22.8	202.1	99.8
36	20.0	0.50	964.4	6.8	68.1	799.4	100.0	5.1	51.4	776.3	99.9
37	50.0	8.33	35.1	42.5	62.4	62.4	100.0	42.6	62.4	62.4	100.0
38	50.0	8.33	50.0	28.1	60.6	88.9	100.0	28.1	60.7	88.9	100.0
39	50.0	8.33	63.1	35.5	35.5	76.4	100.0	35.5	35.5	76.6	100.0
40	50.0	4.00	23.9	29.0	42.5	75.6	100.0	29.0	42.5	81.5	100.0
41	50.0	4.00	50.0	28.1	41.3	88.9	100.0	28.1	41.2	88.9	100.0
42	50.0	4.00	81.2	30.3	45.6	98.3	100.0	31.2	45.6	98.6	100.0
43	50.0	2.00	11.4	13.8	48.2	114.3	100.0	13.9	51.0	116.1	100.0
44	50.0	2.00	50.0	19.2	60.6	130.5	100.0	19.2	60.7	130.2	100.0

	LD50	slope	Dose0	Dose Averaging				MLE (slope= 2.00)			
				percentiles			%in	percentiles			%in
				5%	50%	95%	range	5%	50%	95%	range
45	50.0	2.00	131.8	22.4	50.5	159.6	100.0	22.3	55.2	160.0	100.0
46	50.0	0.80	1.3	3.4	26.9	173.7	100.0	3.5	33.6	215.6	100.0
47	50.0	0.80	50.0	9.8	50.0	281.2	100.0	8.5	50.0	289.9	100.0
48	50.0	0.80	563.6	14.3	72.8	554.1	100.0	12.0	66.6	561.5	100.0
49	50.0	0.50	50.0	7.0	56.8	418.8	100.0	6.3	56.4	443.6	99.9
50	50.0	0.50	2411.1	14.2	180.8	1855.0	100.0	9.9	130.8	1888.0	100.0
51	150.0	8.33	105.3	127.5	187.2	187.2	100.0	127.8	187.2	187.2	100.0
52	150.0	8.33	150.0	84.4	181.7	266.7	100.0	84.4	182.1	266.7	100.0
53	150.0	8.33	189.3	106.4	106.4	229.3	100.0	106.4	106.4	229.9	100.0
54	150.0	4.00	71.7	86.9	127.6	226.8	100.0	87.1	127.6	244.6	100.0
55	150.0	4.00	150.0	84.4	181.7	266.7	100.0	84.4	182.1	266.7	100.0
56	150.0	4.00	243.5	90.8	136.9	295.0	100.0	93.5	136.9	295.7	100.0
57	150.0	2.00	34.3	41.6	144.6	343.0	100.0	41.7	153.1	374.5	100.0
58	150.0	2.00	150.0	57.5	123.8	391.5	100.0	57.6	123.5	390.6	100.0
59	150.0	2.00	395.3	70.3	151.4	478.9	100.0	67.0	165.6	480.0	100.0
60	150.0	0.80	3.8	12.6	78.6	518.4	100.0	13.3	100.7	645.5	100.0
61	150.0	0.80	150.0	26.7	150.0	843.5	100.0	25.7	150.0	872.7	100.0
62	150.0	0.80	1690.9	40.1	241.0	1658.8	100.0	37.6	220.6	1775.9	100.0
63	150.0	0.50	150.0	18.2	150.7	1168.8	100.0	17.7	150.0	1277.2	99.8
64	600.0	8.33	421.0	510.1	748.7	748.7	100.0	511.2	748.7	748.7	100.0
65	600.0	8.33	600.0	337.4	495.2	1067.0	100.0	337.4	494.1	1067.0	100.0
66	600.0	8.33	757.2	425.8	425.8	917.3	100.0	425.8	425.8	919.4	100.0
67	600.0	4.00	286.9	347.6	546.9	1042.5	100.0	348.4	522.8	1067.1	100.0
68	600.0	4.00	600.0	337.4	726.9	1067.0	100.0	337.4	728.6	1067.0	100.0
69	600.0	4.00	974.0	363.1	547.7	1099.4	100.0	374.0	547.7	1054.2	100.0
70	600.0	2.00	137.2	208.5	578.6	1421.6	100.0	203.4	612.4	1444.8	100.0

	LD50	slope	Dose0	Dose Averaging				MLE (slope= 2.00)			
				percentiles			%in	percentiles			%in
				5%	50%	95%	range	5%	50%	95%	range
71	600.0	2.00	600.0	229.9	495.2	1519.2	100.0	230.4	494.1	1531.0	100.0
72	600.0	2.00	1581.1	259.0	616.4	1915.6	100.0	267.9	668.7	1920.0	100.0
73	600.0	0.80	15.0	39.2	312.1	1521.7	99.8	39.1	402.7	2118.6	99.5
74	600.0	0.80	600.0	106.7	584.6	2220.6	99.8	102.7	596.4	2650.2	99.4
75	600.0	0.50	1.6	9.6	115.1	1345.4	99.8	9.7	179.9	1976.6	99.2
76	600.0	0.50	600.0	70.7	525.1	2568.2	99.5	66.7	596.4	3246.3	97.8
77	1500.0	8.33	1052.5	1165.3	2294.1	2294.1	100.0	1126.4	2294.1	2294.1	100.0
78	1500.0	8.33	1500.0	843.5	1849.5	2738.6	100.0	843.5	1848.1	2738.6	100.0
79	1500.0	8.33	1892.9	1064.5	1064.5	2159.8	100.0	1064.5	1064.5	2184.1	100.0
80	1500.0	4.00	717.3	869.0	1275.6	2411.8	100.0	871.0	1275.6	2283.5	100.0
81	1500.0	4.00	1500.0	843.5	1849.5	2738.6	100.0	843.5	1848.1	2738.6	100.0
82	1500.0	4.00	2435.0	907.7	1369.3	2554.6	100.0	935.0	1369.3	2606.2	100.0
83	1500.0	2.00	343.0	415.6	1328.0	2403.2	99.8	416.5	1470.8	3174.5	99.2
84	1500.0	2.00	1500.0	574.7	1249.0	2738.6	99.9	629.6	1242.1	2886.1	99.5
85	1500.0	2.00	3952.8	647.4	1514.4	3528.5	100.0	669.7	1517.8	3625.5	99.8
86	1500.0	0.80	37.5	118.6	695.0	2599.9	98.7	127.9	967.2	4261.2	96.2
87	1500.0	0.80	1500.0	266.7	1249.0	3347.2	97.9	256.8	1250.1	5000.0	93.5
88	1500.0	0.50	4.1	30.7	248.3	2546.1	99.3	34.7	448.1	3805.4	96.9
89	1500.0	0.50	1500.0	181.7	1249.0	3347.2	97.0	177.1	1250.1	5000.0	90.6
90	3000.0	8.33	2105.1	2318.3	3244.3	3374.4	100.0	2354.3	3244.3	3949.0	99.9
91	3000.0	8.33	3000.0	1687.0	2754.0	3873.0	100.0	1687.0	2881.6	3873.0	99.5
92	3000.0	8.33	3785.8	2128.9	2128.9	3428.4	100.0	2128.9	2128.9	3522.0	100.0
93	3000.0	4.00	1434.6	1795.3	2678.3	3297.8	99.6	1789.0	2678.3	4965.0	95.9
94	3000.0	4.00	3000.0	1687.0	2935.9	3873.0	99.8	1687.0	3008.8	4713.0	96.4
95	3000.0	4.00	4870.0	1815.3	2738.6	4055.2	99.9	1870.0	2738.6	4167.6	98.4
96	3000.0	2.00	686.0	831.1	2356.3	3785.2	98.5	833.0	2858.2	5000.0	88.1

	LD50	slope	Dose0	Dose Averaging				MLE (slope= 2.00)			
				percentiles			%in	percentiles			%in
				5%	50%	95%	range	5%	50%	95%	range
97	3000.0	2.00	3000.0	1149.4	2754.0	4128.4	98.6	1172.1	3008.8	5000.0	90.5
98	3000.0	0.80	75.0	211.4	1268.1	3812.7	97.6	228.8	1786.6	5000.0	90.0
99	3000.0	0.80	3000.0	533.5	2498.3	4272.8	96.3	513.6	2968.0	5000.0	82.6
100	3000.0	0.50	8.2	50.1	453.4	3286.1	99.1	58.9	825.4	5000.0	
											94.7
101	3000.0	0.50	3000.0	363.5	2225.5	4591.9	95.1	351.9	2550.0	5000.0	
											81.6
102	3500.0	8.33	2455.9	2569.2	3504.2	3945.1	99.8	2621.8	3504.2	4661.5	
											98.4
103	3500.0	8.33	3500.0	1968.2	3253.6	4183.3	99.9	1968.2	3340.7	4402.7	
											97.4
104	3500.0	8.33	4416.8	2483.7	2483.7	3799.5	99.9	2483.7	2483.7	3904.2	
											99.8
105	3500.0	4.00	1673.7	1989.7	2892.8	3471.7	98.4	2000.3	2976.3	5000.0	
											83.6
106	3500.0	4.00	3500.0	1968.2	3253.6	4267.0	99.1	1968.2	3340.7	5000.0	
											90.3
107	3500.0	2.00	800.4	1029.0	2629.7	3984.8	97.1	1033.8	3305.6	5000.0	
											81.0
108	3500.0	2.00	3500.0	1340.9	3052.0	4439.5	97.1	1344.0	3340.7	5000.0	
											83.8
109	3500.0	0.80	87.5	276.8	1440.0	4105.3	97.7	298.5	2163.6	5000.0	
											85.6
110	3500.0	0.80	3500.0	622.4	2530.6	4604.9	95.8	593.0	2986.7	5000.0	
											80.7

	LD50	slope	Dose0	Dose Averaging				MLE (slope= 2.00)			
				percentiles			%in	percentiles			%in
				5%	50%	95%	range	5%	50%	95%	range
111	3500.0	0.50	9.6	74.1	481.5	2881.5	97.4	81.0	935.0	5000.0	
				92.1							
112	3500.0	0.50	3500.0	412.6	2530.6	5000.0	94.9	368.8	2986.7	5000.0	
				77.8							

Values of 1.0 indicate < 1.0 and values of 5000.0 indicate >5000.0
 '%in range' means % > 1.0 and <5000.0

2.4.2 OECD-Type scenarios: Results for Numbers Tested

Convergence criterion # 1 [fixed nominal NR]

Critical nominal N = 6
 slope assumed in probit calculations = 2.00
 step size (dose progression) log10 = 0.50
 Generate outlier (1=>yes;0=>no) = 0

max num. animals to test = 15
 doses restricted to range 1.0,5000.0 (min,max)
 Num. simulated studies per scenario = 3000
 Classification cutpoints 5 50 300 2000 5000

	LD50	slope	Dose0	mean	95th %ile	(%)N=max (= 15)
1	1.5	8.33	1.1	6.01	6.00	0.00
2	1.5	8.33	1.5	6.03	6.00	0.00
3	1.5	8.33	1.9	6.05	7.00	0.00
4	1.5	4.00	1.5	6.14	7.00	0.00
5	1.5	4.00	2.4	6.20	7.00	0.00
6	1.5	2.00	1.5	6.25	7.00	0.00
7	1.5	2.00	4.0	6.25	8.00	0.00
8	1.5	0.80	1.5	6.35	8.00	0.00
9	1.5	0.80	16.9	6.73	9.00	0.00
10	1.5	0.50	1.5	6.40	8.00	0.00
11	1.5	0.50	72.3	7.22	10.00	0.00
12	2.5	8.33	1.8	6.00	6.00	0.00
13	2.5	8.33	2.5	6.00	6.00	0.00
14	2.5	8.33	3.1	6.00	6.00	0.00
15	2.5	4.00	1.2	6.21	7.00	0.00
16	2.5	4.00	2.5	6.04	6.00	0.00
17	2.5	4.00	4.1	6.05	7.00	0.00
18	2.5	2.00	2.5	6.20	7.00	0.00
19	2.5	2.00	6.6	6.48	8.00	0.00
20	2.5	0.80	2.5	6.36	8.00	0.00
21	2.5	0.80	28.2	6.88	9.00	0.00
22	2.5	0.50	2.5	6.42	8.00	0.00
23	2.5	0.50	120.5	7.22	10.00	0.00
24	20.0	8.33	14.0	6.00	6.00	0.00
25	20.0	8.33	20.0	6.00	6.00	0.00
26	20.0	8.33	25.2	6.00	6.00	0.00
27	20.0	4.00	9.6	6.21	7.00	0.00
28	20.0	4.00	20.0	6.02	6.00	0.00
29	20.0	4.00	32.5	6.10	7.00	0.00
30	20.0	2.00	4.6	6.69	8.00	0.00
31	20.0	2.00	20.0	6.15	7.00	0.00
32	20.0	2.00	52.7	6.40	7.00	0.00
33	20.0	0.80	20.0	6.42	8.00	0.00
34	20.0	0.80	225.4	6.99	9.00	0.00
35	20.0	0.50	20.0	6.55	8.00	0.00
36	20.0	0.50	964.4	7.29	10.00	0.00
37	50.0	8.33	35.1	6.00	6.00	0.00
38	50.0	8.33	50.0	6.00	6.00	0.00
39	50.0	8.33	63.1	6.00	6.00	0.00
40	50.0	4.00	23.9	6.22	7.00	0.00
41	50.0	4.00	50.0	6.02	6.00	0.00
42	50.0	4.00	81.2	6.11	7.00	0.00
43	50.0	2.00	11.4	6.66	8.00	0.00
44	50.0	2.00	50.0	6.16	7.00	0.00
45	50.0	2.00	131.8	6.41	7.00	0.00
46	50.0	0.80	1.3	7.65	10.00	0.00
47	50.0	0.80	50.0	6.44	8.00	0.00

	LD50	slope	Dose0	mean	95th %ile	(%)N=max (= 15)
48	50.0	0.80	563.6	6.95	9.00	0.00
49	50.0	0.50	50.0	6.57	8.00	0.00
50	50.0	0.50	2411.1	7.28	10.00	0.00
51	150.0	8.33	105.3	6.00	6.00	0.00
52	150.0	8.33	150.0	6.00	6.00	0.00
53	150.0	8.33	189.3	6.00	6.00	0.00
54	150.0	4.00	71.7	6.22	7.00	0.00
55	150.0	4.00	150.0	6.03	6.00	0.00
56	150.0	4.00	243.5	6.09	7.00	0.00
57	150.0	2.00	34.3	6.69	8.00	0.00
58	150.0	2.00	150.0	6.17	7.00	0.00
59	150.0	2.00	395.3	6.42	7.00	0.00
60	150.0	0.80	3.8	7.64	10.00	0.00
61	150.0	0.80	150.0	6.41	8.00	0.00
62	150.0	0.80	1690.9	6.99	9.00	0.00
63	150.0	0.50	150.0	6.55	8.00	0.00
64	600.0	8.33	421.0	6.00	6.00	0.00
65	600.0	8.33	600.0	6.00	6.00	0.00
66	600.0	8.33	757.2	6.00	6.00	0.00
67	600.0	4.00	286.9	6.21	7.00	0.00
68	600.0	4.00	600.0	6.03	6.00	0.00
69	600.0	4.00	974.0	6.09	7.00	0.00
70	600.0	2.00	137.2	6.72	8.00	0.00
71	600.0	2.00	600.0	6.17	7.00	0.00
72	600.0	2.00	1581.1	6.39	7.00	0.00
73	600.0	0.80	15.0	7.58	10.00	0.00
74	600.0	0.80	600.0	6.42	8.00	0.00
75	600.0	0.50	1.6	8.31	12.00	0.00
76	600.0	0.50	600.0	6.52	8.00	0.00
77	1500.0	8.33	1052.5	6.00	6.00	0.00
78	1500.0	8.33	1500.0	6.00	6.00	0.00
79	1500.0	8.33	1892.9	6.00	6.00	0.00
80	1500.0	4.00	717.3	6.21	7.00	0.00
81	1500.0	4.00	1500.0	6.02	6.00	0.00
82	1500.0	4.00	2435.0	6.10	7.00	0.00
83	1500.0	2.00	343.0	6.61	8.00	0.00
84	1500.0	2.00	1500.0	6.17	7.00	0.00
85	1500.0	2.00	3952.8	6.43	7.00	0.00
86	1500.0	0.80	37.5	7.53	10.00	0.00
87	1500.0	0.80	1500.0	6.36	8.00	0.00
88	1500.0	0.50	4.1	8.24	11.00	0.00
89	1500.0	0.50	1500.0	6.43	8.00	0.00
90	3000.0	8.33	2105.1	6.03	6.00	0.00
91	3000.0	8.33	3000.0	6.01	6.00	0.00
92	3000.0	8.33	3785.8	6.01	6.00	0.00
93	3000.0	4.00	1434.6	6.17	7.00	0.00
94	3000.0	4.00	3000.0	6.10	7.00	0.00
95	3000.0	4.00	4870.0	6.14	7.00	0.00
96	3000.0	2.00	686.0	6.74	8.00	0.00
97	3000.0	2.00	3000.0	6.24	7.00	0.00
98	3000.0	0.80	75.0	7.60	10.00	0.00
99	3000.0	0.80	3000.0	6.34	8.00	0.00
100	3000.0	0.50	8.2	8.23	12.00	0.00
101	3000.0	0.50	3000.0	6.44	8.00	0.00
102	3500.0	8.33	2455.9	6.10	7.00	0.00
103	3500.0	8.33	3500.0	6.06	7.00	0.00
104	3500.0	8.33	4416.8	6.02	6.00	0.00
105	3500.0	4.00	1673.7	6.24	7.00	0.00
106	3500.0	4.00	3500.0	6.14	7.00	0.00
107	3500.0	2.00	800.4	6.73	9.00	0.00

	LD50	slope	Dose0		mean	95th	(%)N=max
						%ile	(= 15)
108	3500.0	2.00	3500.0		6.22	7.00	0.00
109	3500.0	0.80	87.5		7.58	10.00	0.00
110	3500.0	0.80	3500.0		6.37	8.00	0.00
111	3500.0	0.50	9.6		8.11	11.00	0.00
112	3500.0	0.50	3500.0		6.38	8.00	0.00

**** Numbers Tested ****

Convergence criterion # 5 [LR]

Critical nominal N = 6
 slope assumed in probit calculations = 2.00
 step size (dose progression) log10 = 0.50
 Generate outlier (1=>yes;0=>no) = 0
 (if Crit #5) factor above/below g.mean = 2.50
 (if Crit #5) Critical likelihood ratio = 2.50
 max num. animals to test = 15
 doses restricted to range 1.0 5000.0 (min,max)
 Num. simulated studies per scenario = 3000
 Classification cutpoints 5 50 300 2000 5000

	LD50	slope	Dose0	mean	95th %ile	(%)N=max (= 15)
1	1.5	8.33	1.1	6.05	6.00	0.03
2	1.5	8.33	1.5	6.29	9.00	0.03
3	1.5	8.33	1.9	6.54	9.00	0.33
4	1.5	4.00	1.5	7.07	13.00	2.47
5	1.5	4.00	2.4	8.12	15.00	8.50
6	1.5	2.00	1.5	7.77	14.00	4.70
7	1.5	2.00	4.0	9.75	15.00	23.03
8	1.5	0.80	1.5	8.47	15.00	6.40
9	1.5	0.80	16.9	10.46	15.00	24.67
10	1.5	0.50	1.5	8.69	15.00	7.10
11	1.5	0.50	72.3	11.52	15.00	34.00
12	2.5	8.33	1.8	6.01	6.00	0.00
13	2.5	8.33	2.5	6.00	6.00	0.00
14	2.5	8.33	3.1	6.00	6.00	0.00
15	2.5	4.00	1.2	6.97	9.00	0.00
16	2.5	4.00	2.5	6.28	8.00	0.10
17	2.5	4.00	4.1	7.37	11.00	0.80
18	2.5	2.00	2.5	7.39	13.00	2.33
19	2.5	2.00	6.6	8.45	15.00	6.00
20	2.5	0.80	2.5	8.39	15.00	6.10
21	2.5	0.80	28.2	10.42	15.00	22.37
22	2.5	0.50	2.5	8.61	15.00	6.27
23	2.5	0.50	120.5	11.38	15.00	31.33
24	20.0	8.33	14.0	6.01	6.00	0.00
25	20.0	8.33	20.0	6.00	6.00	0.00
26	20.0	8.33	25.2	6.00	6.00	0.00
27	20.0	4.00	9.6	6.97	9.00	0.00
28	20.0	4.00	20.0	6.10	6.00	0.00
29	20.0	4.00	32.5	6.43	8.00	0.00
30	20.0	2.00	4.6	9.04	13.00	2.07
31	20.0	2.00	20.0	6.71	9.00	0.00
32	20.0	2.00	52.7	7.77	11.00	0.03
33	20.0	0.80	20.0	8.01	12.00	1.40
34	20.0	0.80	225.4	10.47	15.00	18.07
35	20.0	0.50	20.0	8.65	14.00	4.17
36	20.0	0.50	964.4	11.97	15.00	37.80
37	50.0	8.33	35.1	6.01	6.00	0.00
38	50.0	8.33	50.0	6.00	6.00	0.00
39	50.0	8.33	63.1	6.00	6.00	0.00
40	50.0	4.00	23.9	6.94	9.00	0.00
41	50.0	4.00	50.0	6.10	6.00	0.00
42	50.0	4.00	81.2	6.47	8.00	0.00
43	50.0	2.00	11.4	8.74	12.00	1.17
44	50.0	2.00	50.0	6.74	9.00	0.00
45	50.0	2.00	131.8	7.87	11.00	0.13
46	50.0	0.80	1.3	11.86	15.00	30.03

	LD50	slope	Dose0	mean	95th %ile	(%)N=max (= 15)
47	50.0	0.80	50.0	7.98	12.00	1.17
48	50.0	0.80	563.6	10.42	15.00	15.57
49	50.0	0.50	50.0	8.70	14.00	4.23
50	50.0	0.50	2411.1	11.60	15.00	33.90
51	150.0	8.33	105.3	6.01	6.00	0.00
52	150.0	8.33	150.0	6.00	6.00	0.00
53	150.0	8.33	189.3	6.00	6.00	0.00
54	150.0	4.00	71.7	6.94	9.00	0.00
55	150.0	4.00	150.0	6.08	6.00	0.00
56	150.0	4.00	243.5	6.43	8.00	0.00
57	150.0	2.00	34.3	8.69	12.00	1.17
58	150.0	2.00	150.0	6.69	9.00	0.00
59	150.0	2.00	395.3	7.82	11.00	0.10
60	150.0	0.80	3.8	12.05	15.00	32.80
61	150.0	0.80	150.0	8.00	12.00	0.90
62	150.0	0.80	1690.9	10.30	15.00	15.80
63	150.0	0.50	150.0	8.68	14.00	4.33
64	600.0	8.33	421.0	6.01	6.00	0.00
65	600.0	8.33	600.0	6.00	6.00	0.00
66	600.0	8.33	757.2	6.00	6.00	0.00
67	600.0	4.00	286.9	7.40	10.00	0.00
68	600.0	4.00	600.0	6.10	6.00	0.00
69	600.0	4.00	974.0	7.30	10.00	0.00
70	600.0	2.00	137.2	8.79	13.00	1.67
71	600.0	2.00	600.0	6.79	10.00	0.00
72	600.0	2.00	1581.1	7.82	11.00	0.13
73	600.0	0.80	15.0	11.84	15.00	31.27
74	600.0	0.80	600.0	8.23	13.00	3.53
75	600.0	0.50	1.6	13.22	15.00	55.77
76	600.0	0.50	600.0	8.73	15.00	5.90
77	1500.0	8.33	1052.5	6.52	8.00	0.00
78	1500.0	8.33	1500.0	6.00	6.00	0.00
79	1500.0	8.33	1892.9	6.00	6.00	0.00
80	1500.0	4.00	717.3	6.97	10.00	0.03
81	1500.0	4.00	1500.0	6.11	6.00	0.10
82	1500.0	4.00	2435.0	6.49	8.00	0.00
83	1500.0	2.00	343.0	9.36	15.00	8.37
84	1500.0	2.00	1500.0	7.00	11.00	1.60
85	1500.0	2.00	3952.8	7.86	11.00	0.23
86	1500.0	0.80	37.5	11.89	15.00	34.07
87	1500.0	0.80	1500.0	8.16	15.00	5.50
88	1500.0	0.50	4.1	13.23	15.00	54.27
89	1500.0	0.50	1500.0	8.61	15.00	7.57
90	3000.0	8.33	2105.1	6.28	8.00	0.10
91	3000.0	8.33	3000.0	6.13	6.00	0.00
92	3000.0	8.33	3785.8	6.03	6.00	0.00
93	3000.0	4.00	1434.6	8.19	15.00	12.57
94	3000.0	4.00	3000.0	6.83	11.00	1.10
95	3000.0	4.00	4870.0	6.67	9.00	0.20
96	3000.0	2.00	686.0	9.89	15.00	19.07
97	3000.0	2.00	3000.0	7.73	14.00	3.93
98	3000.0	0.80	75.0	11.83	15.00	35.10
99	3000.0	0.80	3000.0	8.41	15.00	5.67
100	3000.0	0.50	8.2	13.24	15.00	56.17
101	3000.0	0.50	3000.0	8.55	15.00	6.73
102	3500.0	8.33	2455.9	6.83	11.00	1.23
103	3500.0	8.33	3500.0	6.34	9.00	0.27
104	3500.0	8.33	4416.8	6.12	6.00	0.03
105	3500.0	4.00	1673.7	8.93	15.00	15.37
106	3500.0	4.00	3500.0	7.13	13.00	2.37

	LD50	slope	Dose0		mean	95th	(%)N=max
						%ile	(= 15)
107	3500.0	2.00	800.4		10.00	15.00	20.20
108	3500.0	2.00	3500.0		7.84	14.00	4.90
109	3500.0	0.80	87.5		12.01	15.00	37.37
110	3500.0	0.80	3500.0		8.44	15.00	6.47
111	3500.0	0.50	9.6		12.95	15.00	51.43
112	3500.0	0.50	3500.0		8.63	15.00	7.50

2.4.3 OECD-Type scenarios: Classification Probabilities

** Classification percentages based on MLE **

Convergence criterion # 1 [fixed nominal NR]

Critical nominal N = 6
 slope assumed in probit calculations = 2.00
 step size (dose progression) log10 = 0.50
 Generate outlier (1=>yes;0=>no) = 0
 max num. animals to test = 15
 doses restricted to range 1.0,5000.0 (min,max)
 Num. simulated studies per scenario = 3000
 Classification cutpoints 5 50 300 2000 5000

	LD50 slope		Dose0	True Catgry	%Estimates in category, by category number					
	1	2			1	2	3	4	5	6
1	1.5	8.33	1.1	1	100.0	0.0	0.0	0.0	0.0	0.0
2	1.5	8.33	1.5	1	100.0	0.0	0.0	0.0	0.0	0.0
3	1.5	8.33	1.9	1	100.0	0.0	0.0	0.0	0.0	0.0
4	1.5	4.00	1.5	1	100.0	0.0	0.0	0.0	0.0	0.0
5	1.5	4.00	2.4	1	100.0	0.0	0.0	0.0	0.0	0.0
6	1.5	2.00	1.5	1	97.8	2.2	0.0	0.0	0.0	0.0
7	1.5	2.00	4.0	1	98.2	1.8	0.0	0.0	0.0	0.0
8	1.5	0.80	1.5	1	86.3	13.6	0.1	0.0	0.0	0.0
9	1.5	0.80	16.9	1	67.9	31.6	0.4	0.0	0.0	0.0
10	1.5	0.50	1.5	1	82.3	17.1	0.6	0.0	0.0	0.0
11	1.5	0.50	72.3	1	42.1	48.6	8.9	0.4	0.0	0.0
12	2.5	8.33	1.8	1	99.7	0.3	0.0	0.0	0.0	0.0
13	2.5	8.33	2.5	1	100.0	0.0	0.0	0.0	0.0	0.0
14	2.5	8.33	3.1	1	99.0	1.0	0.0	0.0	0.0	0.0
15	2.5	4.00	1.2	1	94.6	5.4	0.0	0.0	0.0	0.0
16	2.5	4.00	2.5	1	98.1	1.9	0.0	0.0	0.0	0.0
17	2.5	4.00	4.1	1	99.2	0.8	0.0	0.0	0.0	0.0
18	2.5	2.00	2.5	1	87.4	12.6	0.0	0.0	0.0	0.0
19	2.5	2.00	6.6	1	81.7	18.3	0.0	0.0	0.0	0.0
20	2.5	0.80	2.5	1	73.5	26.1	0.4	0.0	0.0	0.0
21	2.5	0.80	28.2	1	49.3	48.3	2.4	0.0	0.0	0.0
22	2.5	0.50	2.5	1	68.6	30.0	1.3	0.0	0.0	0.0
23	2.5	0.50	120.5	1	29.4	51.5	18.0	1.1	0.0	0.0
24	20.0	8.33	14.0	2	0.0	100.0	0.0	0.0	0.0	0.0
25	20.0	8.33	20.0	2	0.0	100.0	0.0	0.0	0.0	0.0
26	20.0	8.33	25.2	2	0.0	100.0	0.0	0.0	0.0	0.0
27	20.0	4.00	9.6	2	0.0	98.9	1.1	0.0	0.0	0.0
28	20.0	4.00	20.0	2	0.0	98.7	1.3	0.0	0.0	0.0
29	20.0	4.00	32.5	2	0.0	99.1	0.9	0.0	0.0	0.0
30	20.0	2.00	4.6	2	1.2	93.1	5.8	0.0	0.0	0.0
31	20.0	2.00	20.0	2	2.1	90.0	7.9	0.0	0.0	0.0
32	20.0	2.00	52.7	2	0.7	92.9	6.3	0.0	0.0	0.0
33	20.0	0.80	20.0	2	11.7	68.2	19.2	0.9	0.0	0.0
34	20.0	0.80	225.4	2	5.4	53.7	37.6	3.3	0.0	0.0
35	20.0	0.50	20.0	2	17.4	58.0	21.9	2.7	0.0	0.0
36	20.0	0.50	964.4	2	4.7	27.7	46.8	19.2	1.7	0.0
37	50.0	8.33	35.1	2	0.0	25.5	74.5	0.0	0.0	0.0
38	50.0	8.33	50.0	2	0.0	49.9	50.1	0.0	0.0	0.0
39	50.0	8.33	63.1	2	0.0	52.0	48.0	0.0	0.0	0.0
40	50.0	4.00	23.9	2	0.0	51.0	49.0	0.0	0.0	0.0
41	50.0	4.00	50.0	2	0.0	48.7	51.3	0.0	0.0	0.0
42	50.0	4.00	81.2	2	0.0	62.2	37.8	0.0	0.0	0.0
43	50.0	2.00	11.4	2	0.0	52.8	46.9	0.2	0.0	0.0

	LD50	slope	Dose0	True Catgry	%Estimates in category, by category number					
					1	2	3	4	5	6
44	50.0	2.00	50.0	2	0.0	48.8	51.0	0.2	0.0	0.0
45	50.0	2.00	131.8	2	0.0	47.4	52.4	0.2	0.0	0.0
46	50.0	0.80	1.3	2	11.5	57.8	28.8	1.9	0.0	0.0
47	50.0	0.80	50.0	2	1.5	48.5	45.7	4.2	0.1	0.0
48	50.0	0.80	563.6	2	0.8	30.3	52.8	15.8	0.3	0.0
49	50.0	0.50	50.0	2	3.5	46.2	40.8	8.9	0.6	0.1
50	50.0	0.50	2411.1	2	1.8	17.0	33.8	42.0	4.7	0.6
51	150.0	8.33	105.3	3	0.0	0.0	99.6	0.4	0.0	0.0
52	150.0	8.33	150.0	3	0.0	0.0	100.0	0.0	0.0	0.0
53	150.0	8.33	189.3	3	0.0	0.0	99.3	0.7	0.0	0.0
54	150.0	4.00	71.7	3	0.0	0.1	94.6	5.4	0.0	0.0
55	150.0	4.00	150.0	3	0.0	0.3	97.8	1.9	0.0	0.0
56	150.0	4.00	243.5	3	0.0	0.2	98.7	1.0	0.0	0.0
57	150.0	2.00	34.3	3	0.0	5.5	82.1	12.4	0.0	0.0
58	150.0	2.00	150.0	3	0.0	3.9	82.8	13.3	0.0	0.0
59	150.0	2.00	395.3	3	0.0	3.6	76.7	19.7	0.0	0.0
60	150.0	0.80	3.8	3	1.6	40.3	46.8	10.9	0.4	0.0
61	150.0	0.80	150.0	3	0.0	15.3	57.8	25.8	1.0	0.1
62	150.0	0.80	1690.9	3	0.0	6.9	44.6	43.4	4.9	0.2
63	150.0	0.50	150.0	3	0.9	18.4	49.2	28.6	2.6	0.3
64	600.0	8.33	421.0	4	0.0	0.0	0.0	100.0	0.0	0.0
65	600.0	8.33	600.0	4	0.0	0.0	0.0	100.0	0.0	0.0
66	600.0	8.33	757.2	4	0.0	0.0	0.1	99.9	0.0	0.0
67	600.0	4.00	286.9	4	0.0	0.0	2.2	96.6	1.2	0.0
68	600.0	4.00	600.0	4	0.0	0.0	2.1	97.8	0.1	0.0
69	600.0	4.00	974.0	4	0.0	0.0	3.0	96.3	0.7	0.0
70	600.0	2.00	137.2	4	0.0	0.0	13.5	83.4	3.0	0.1
71	600.0	2.00	600.0	4	0.0	0.0	12.5	85.5	2.0	0.0
72	600.0	2.00	1581.1	4	0.0	0.0	12.7	85.6	1.6	0.1
73	600.0	0.80	15.0	4	0.0	12.2	43.0	37.4	6.5	0.9
74	600.0	0.80	600.0	4	0.0	1.0	26.0	62.9	8.5	1.6
75	600.0	0.50	1.6	4	5.6	37.7	32.1	20.3	3.5	0.8
76	600.0	0.50	600.0	4	0.1	3.4	27.2	53.4	12.4	3.4
77	1500.0	8.33	1052.5	4	0.0	0.0	0.0	25.7	74.3	0.0
78	1500.0	8.33	1500.0	4	0.0	0.0	0.0	86.2	13.8	0.0
79	1500.0	8.33	1892.9	4	0.0	0.0	0.0	89.8	10.2	0.0
80	1500.0	4.00	717.3	4	0.0	0.0	0.0	68.5	31.4	0.1
81	1500.0	4.00	1500.0	4	0.0	0.0	0.0	85.8	13.9	0.4
82	1500.0	4.00	2435.0	4	0.0	0.0	0.0	90.8	9.2	0.0
83	1500.0	2.00	343.0	4	0.0	0.0	1.5	68.7	28.1	1.7
84	1500.0	2.00	1500.0	4	0.0	0.0	0.2	76.1	19.8	4.0
85	1500.0	2.00	3952.8	4	0.0	0.0	0.7	63.5	33.5	2.3
86	1500.0	0.80	37.5	4	0.0	2.2	28.0	50.5	14.6	4.8
87	1500.0	0.80	1500.0	4	0.0	0.1	6.2	60.2	22.9	10.6
88	1500.0	0.50	4.1	4	1.1	24.2	34.4	29.5	8.4	2.4
89	1500.0	0.50	1500.0	4	0.0	0.4	10.5	54.0	21.3	13.8
90	3000.0	8.33	2105.1	5	0.0	0.0	0.0	2.8	92.0	5.2
91	3000.0	8.33	3000.0	5	0.0	0.0	0.0	12.4	85.2	2.4
92	3000.0	8.33	3785.8	5	0.0	0.0	0.0	0.2	99.5	0.3
93	3000.0	4.00	1434.6	5	0.0	0.0	0.0	18.5	73.7	7.7
94	3000.0	4.00	3000.0	5	0.0	0.0	0.0	15.0	70.8	14.2
95	3000.0	4.00	4870.0	5	0.0	0.0	0.0	20.8	73.5	5.8
96	3000.0	2.00	686.0	5	0.0	0.0	0.1	27.2	54.8	18.0
97	3000.0	2.00	3000.0	5	0.0	0.0	0.0	24.2	52.9	22.9
98	3000.0	0.80	75.0	5	0.0	0.3	11.1	53.3	23.7	11.5
99	3000.0	0.80	3000.0	5	0.0	0.0	1.6	34.6	36.6	27.3
100	3000.0	0.50	8.2	5	0.3	13.9	33.9	33.6	11.8	6.5
101	3000.0	0.50	3000.0	5	0.0	0.2	4.4	36.7	32.5	26.1
102	3500.0	8.33	2455.9	5	0.0	0.0	0.0	2.4	83.8	13.8

	LD50	slope	Dose0	True Catgry	%Estimates in category, by category number					
					1	2	3	4	5	6
103	3500.0	8.33	3500.0	5	0.0	0.0	0.0	12.0	79.9	8.1
104	3500.0	8.33	4416.8	5	0.0	0.0	0.0	0.1	96.7	3.3
105	3500.0	4.00	1673.7	5	0.0	0.0	0.0	2.2	61.3	36.5
106	3500.0	4.00	3500.0	5	0.0	0.0	0.0	13.4	67.1	19.5
107	3500.0	2.00	800.4	5	0.0	0.0	0.0	20.5	57.2	22.3
108	3500.0	2.00	3500.0	5	0.0	0.0	0.0	21.6	50.3	28.1
109	3500.0	0.80	87.5	5	0.0	0.3	12.9	48.0	24.4	14.4
110	3500.0	0.80	3500.0	5	0.0	0.0	1.1	32.7	36.7	29.4
111	3500.0	0.50	9.6	5	0.2	13.4	30.6	34.7	13.7	7.3
112	3500.0	0.50	3500.0	5	0.0	0.1	3.4	32.8	33.7	30.0

**** Classification percentages based on MLE ****

Convergence criterion # 5 [LR]

Critical nominal N = 6
 slope assumed in probit calculations = 2.00
 step size (dose progression) log10 = 0.50
 Generate outlier (1=>yes;0=>no) = 0
 (if Crit #5) factor above/below g.mean = 2.50
 (if Crit #5) Critical likelihood ratio = 2.50
 max num. animals to test = 15
 doses restricted to range 1.0,5000.0 (min,max)
 Num. simulated studies per scenario = 3000
 Classification cutpoints 5 50 300 2000 5000

	LD50	slope	Dose0	True Catgry	%Estimates in category, by category number					
					1	2	3	4	5	6
1	1.5	8.33	1.1	1	100.0	0.0	0.0	0.0	0.0	0.0
2	1.5	8.33	1.5	1	100.0	0.0	0.0	0.0	0.0	0.0
3	1.5	8.33	1.9	1	100.0	0.0	0.0	0.0	0.0	0.0
4	1.5	4.00	1.5	1	100.0	0.0	0.0	0.0	0.0	0.0
5	1.5	4.00	2.4	1	99.9	0.1	0.0	0.0	0.0	0.0
6	1.5	2.00	1.5	1	98.4	1.6	0.0	0.0	0.0	0.0
7	1.5	2.00	4.0	1	96.9	3.1	0.0	0.0	0.0	0.0
8	1.5	0.80	1.5	1	87.8	12.2	0.0	0.0	0.0	0.0
9	1.5	0.80	16.9	1	76.6	23.1	0.3	0.0	0.0	0.0
10	1.5	0.50	1.5	1	81.6	17.8	0.6	0.0	0.0	0.0
11	1.5	0.50	72.3	1	55.9	36.2	7.9	0.1	0.0	0.0
12	2.5	8.33	1.8	1	100.0	0.0	0.0	0.0	0.0	0.0
13	2.5	8.33	2.5	1	100.0	0.0	0.0	0.0	0.0	0.0
14	2.5	8.33	3.1	1	99.3	0.7	0.0	0.0	0.0	0.0
15	2.5	4.00	1.2	1	96.9	3.1	0.0	0.0	0.0	0.0
16	2.5	4.00	2.5	1	99.0	1.0	0.0	0.0	0.0	0.0
17	2.5	4.00	4.1	1	97.5	2.5	0.0	0.0	0.0	0.0
18	2.5	2.00	2.5	1	91.4	8.6	0.0	0.0	0.0	0.0
19	2.5	2.00	6.6	1	79.0	21.0	0.0	0.0	0.0	0.0
20	2.5	0.80	2.5	1	77.5	22.5	0.1	0.0	0.0	0.0
21	2.5	0.80	28.2	1	63.6	34.0	2.3	0.0	0.0	0.0
22	2.5	0.50	2.5	1	71.2	27.3	1.5	0.0	0.0	0.0
23	2.5	0.50	120.5	1	42.4	44.1	12.8	0.7	0.0	0.0
24	20.0	8.33	14.0	2	0.0	100.0	0.0	0.0	0.0	0.0
25	20.0	8.33	20.0	2	0.0	100.0	0.0	0.0	0.0	0.0
26	20.0	8.33	25.2	2	0.0	100.0	0.0	0.0	0.0	0.0
27	20.0	4.00	9.6	2	0.0	98.8	1.2	0.0	0.0	0.0
28	20.0	4.00	20.0	2	0.0	99.3	0.7	0.0	0.0	0.0
29	20.0	4.00	32.5	2	0.0	99.1	0.9	0.0	0.0	0.0
30	20.0	2.00	4.6	2	1.2	96.1	2.7	0.0	0.0	0.0
31	20.0	2.00	20.0	2	0.8	93.6	5.6	0.0	0.0	0.0
32	20.0	2.00	52.7	2	0.5	92.1	7.4	0.0	0.0	0.0
33	20.0	0.80	20.0	2	8.5	72.3	18.6	0.5	0.0	0.0
34	20.0	0.80	225.4	2	5.1	64.3	28.1	2.4	0.0	0.0
35	20.0	0.50	20.0	2	15.1	60.1	22.4	2.4	0.0	0.0
36	20.0	0.50	964.4	2	4.9	44.4	35.6	13.8	1.3	0.0
37	50.0	8.33	35.1	2	0.0	26.2	73.8	0.0	0.0	0.0
38	50.0	8.33	50.0	2	0.0	49.3	50.7	0.0	0.0	0.0
39	50.0	8.33	63.1	2	0.0	51.5	48.5	0.0	0.0	0.0
40	50.0	4.00	23.9	2	0.0	55.8	44.2	0.0	0.0	0.0
41	50.0	4.00	50.0	2	0.0	50.9	49.1	0.0	0.0	0.0
42	50.0	4.00	81.2	2	0.0	60.2	39.8	0.0	0.0	0.0
43	50.0	2.00	11.4	2	0.1	45.1	54.8	0.1	0.0	0.0
44	50.0	2.00	50.0	2	0.0	49.3	50.7	0.0	0.0	0.0
45	50.0	2.00	131.8	2	0.0	41.2	58.5	0.3	0.0	0.0

	LD50	slope	Dose0	True Catgry	%Estimates in category, by category number					
					1	2	3	4	5	6
46	50.0	0.80	1.3	2	7.5	55.5	34.6	2.4	0.0	0.0
47	50.0	0.80	50.0	2	0.7	50.3	45.6	3.5	0.0	0.0
48	50.0	0.80	563.6	2	0.4	37.2	47.9	14.4	0.1	0.0
49	50.0	0.50	50.0	2	3.4	46.0	41.8	8.7	0.2	0.0
50	50.0	0.50	2411.1	2	1.6	24.1	44.0	25.7	4.7	0.0
51	150.0	8.33	105.3	3	0.0	0.0	100.0	0.0	0.0	0.0
52	150.0	8.33	150.0	3	0.0	0.0	100.0	0.0	0.0	0.0
53	150.0	8.33	189.3	3	0.0	0.0	99.0	1.0	0.0	0.0
54	150.0	4.00	71.7	3	0.0	0.2	96.9	2.9	0.0	0.0
55	150.0	4.00	150.0	3	0.0	0.0	98.9	1.1	0.0	0.0
56	150.0	4.00	243.5	3	0.0	0.3	98.9	0.9	0.0	0.0
57	150.0	2.00	34.3	3	0.0	5.5	86.8	7.7	0.0	0.0
58	150.0	2.00	150.0	3	0.0	1.9	88.5	9.6	0.0	0.0
59	150.0	2.00	395.3	3	0.0	1.8	79.7	18.4	0.0	0.0
60	150.0	0.80	3.8	3	0.7	23.9	59.8	15.2	0.4	0.0
61	150.0	0.80	150.0	3	0.0	13.6	61.9	24.3	0.2	0.0
62	150.0	0.80	1690.9	3	0.0	8.0	55.3	31.9	4.8	0.0
63	150.0	0.50	150.0	3	0.4	19.5	51.2	27.1	1.6	0.2
64	600.0	8.33	421.0	4	0.0	0.0	0.0	100.0	0.0	0.0
65	600.0	8.33	600.0	4	0.0	0.0	0.0	100.0	0.0	0.0
66	600.0	8.33	757.2	4	0.0	0.0	0.1	99.9	0.0	0.0
67	600.0	4.00	286.9	4	0.0	0.0	1.9	97.2	1.0	0.0
68	600.0	4.00	600.0	4	0.0	0.0	1.0	99.0	0.0	0.0
69	600.0	4.00	974.0	4	0.0	0.0	2.1	97.2	0.7	0.0
70	600.0	2.00	137.2	4	0.0	0.0	12.5	85.2	2.3	0.0
71	600.0	2.00	600.0	4	0.0	0.0	10.3	88.9	0.9	0.0
72	600.0	2.00	1581.1	4	0.0	0.0	12.7	85.9	1.4	0.0
73	600.0	0.80	15.0	4	0.0	6.0	33.4	55.5	4.7	0.5
74	600.0	0.80	600.0	4	0.0	0.8	23.8	66.9	8.0	0.6
75	600.0	0.50	1.6	4	3.0	16.9	41.6	33.7	4.0	0.8
76	600.0	0.50	600.0	4	0.0	3.7	25.6	58.1	10.4	2.2
77	1500.0	8.33	1052.5	4	0.0	0.0	0.0	26.2	73.8	0.0
78	1500.0	8.33	1500.0	4	0.0	0.0	0.0	86.4	13.6	0.0
79	1500.0	8.33	1892.9	4	0.0	0.0	0.0	88.9	11.1	0.0
80	1500.0	4.00	717.3	4	0.0	0.0	0.0	83.8	16.2	0.0
81	1500.0	4.00	1500.0	4	0.0	0.0	0.0	84.4	15.6	0.0
82	1500.0	4.00	2435.0	4	0.0	0.0	0.0	89.9	10.1	0.0
83	1500.0	2.00	343.0	4	0.0	0.0	1.3	68.8	29.1	0.8
84	1500.0	2.00	1500.0	4	0.0	0.0	0.2	76.7	22.5	0.5
85	1500.0	2.00	3952.8	4	0.0	0.0	0.2	60.7	39.0	0.2
86	1500.0	0.80	37.5	4	0.0	1.6	12.9	64.0	17.6	3.8
87	1500.0	0.80	1500.0	4	0.0	0.0	6.1	63.9	23.6	6.5
88	1500.0	0.50	4.1	4	0.3	6.6	32.8	45.8	11.4	3.1
89	1500.0	0.50	1500.0	4	0.0	0.3	10.8	54.5	24.9	9.4
90	3000.0	8.33	2105.1	5	0.0	0.0	0.0	3.1	96.9	0.1
91	3000.0	8.33	3000.0	5	0.0	0.0	0.0	13.1	86.4	0.5
92	3000.0	8.33	3785.8	5	0.0	0.0	0.0	0.1	99.9	0.0
93	3000.0	4.00	1434.6	5	0.0	0.0	0.0	18.4	77.5	4.1
94	3000.0	4.00	3000.0	5	0.0	0.0	0.0	14.6	81.8	3.6
95	3000.0	4.00	4870.0	5	0.0	0.0	0.0	10.4	88.0	1.6
96	3000.0	2.00	686.0	5	0.0	0.0	0.0	26.7	61.4	11.9
97	3000.0	2.00	3000.0	5	0.0	0.0	0.0	22.2	68.3	9.5
98	3000.0	0.80	75.0	5	0.0	0.3	6.2	48.1	35.5	10.0
99	3000.0	0.80	3000.0	5	0.0	0.0	1.1	30.3	51.2	17.4
100	3000.0	0.50	8.2	5	0.2	4.5	19.7	50.7	19.5	5.3
101	3000.0	0.50	3000.0	5	0.0	0.1	3.9	32.6	44.9	18.4
102	3500.0	8.33	2455.9	5	0.0	0.0	0.0	2.5	95.8	1.6
103	3500.0	8.33	3500.0	5	0.0	0.0	0.0	13.8	83.6	2.6
104	3500.0	8.33	4416.8	5	0.0	0.0	0.0	0.1	99.7	0.2

	LD50	slope	Dose0	True	%Estimates in category, by category number					
				Catgry	1	2	3	4	5	6
105	3500.0	4.00	1673.7	5	0.0	0.0	0.0	1.8	81.7	16.4
106	3500.0	4.00	3500.0	5	0.0	0.0	0.0	13.8	76.5	9.7
107	3500.0	2.00	800.4	5	0.0	0.0	0.0	23.0	58.0	19.0
108	3500.0	2.00	3500.0	5	0.0	0.0	0.0	21.5	62.3	16.2
109	3500.0	0.80	87.5	5	0.0	0.3	5.4	39.9	40.0	14.4
110	3500.0	0.80	3500.0	5	0.0	0.0	0.6	32.4	47.6	19.3
111	3500.0	0.50	9.6	5	0.1	3.1	17.5	50.6	20.7	7.9
112	3500.0	0.50	3500.0	5	0.0	0.1	3.5	31.6	42.5	22.2

2.5 Sensitivity to the assumed slope

The following is abbreviated from an analysis distributed on November 24, 1999. Because the guideline proposal was still under development, the up-down procedure simulated deviates from the procedure actually proposed in the guideline. In particular, test doses have not been restricted to the range 1 to 5000 units in these simulations. This difference is expected to strongly affect the results, particularly when the slopes are shallow. Therefore the results are perhaps best viewed as providing qualitative information on how the test performance may be affected by interaction of the slope, the initial test dose, and the statistical estimator.

Two estimators have been evaluated, the maximum-likelihood estimator with the slope varied, and a “nonparametric” estimator, which is simply the geometric average of doses tested at the reversal and subsequently. Elsewhere I have termed that estimator the “dose-averaging estimator.”

In general it appears that in those situations where the parametric approach would give acceptable performance with an appropriate choice of slope, the performance of the nonparametric estimator is comparable. The parametric and nonparametric estimators differ in bias and variance, depending primarily on the slope. Bias is minimized by using the parametric approach with the assumed slope close to the true slope. However, that is to make use of knowledge that is not generally available. Furthermore, the parametric estimates tend to have large variance. The nonparametric estimates tend to have small variance but are subject to a strong bias of the LD50 estimate in the direction of the starting dose, particularly for shallow slopes and/or small numbers tested. An index of relative error is used to combine the bias and variance.

Indices of estimator performance. In general, indices have been used which can be interpreted as measures of relative, rather than absolute error.

- As an index of bias I use the ratio of the median of the distribution of LD50 values, to the true LD50 value. This is reported as "P50/LD50" in the tables below. In the log scale, this would be approximately the bias as usually defined in statistics, for a symmetric distribution.
- As an index of the spread of the distribution I use the ratio of the ratio of the 95th percentile to the 5th percentile, denoted "P95/P5" in the tables below. For a lognormal distribution, this index has a simple relationship to the log-scale standard deviation.
- As a measure of relative error, combining the bias and the spread, I calculate the mean square error in the log scale, take the square root to calculate the "root mean square error" (in a sense, reversing the effect of squaring the errors). Finally I transform the result back to the original scale (take the antilog) so that the result can be interpreted as a multiplicative factor. I admit that this index is less transparent than the preceding two.

Scenarios simulated.

Num. Simulated Studies per scenario: 1000

Assumed slope, true slope: 0.5, 1, 2, 4, 8 (all combinations of true and assumed);

Step size: 0.5 log₁₀ units, or doses spaced by a factor of about 3.2

True LD50: 2500

Initial dose: Denoted "Dose0" in tables. A selection of combinations of slope and Dose0 were simulated.

Nominal n: 6, 12

Results for nominal n=6 (Explanation in text) bold lines: assumed and true slope equal

Estimator	Nom. n	slope		Dose0	P50/LD50	P95/P5	Rel. Error
		True	Assumed				
param.	6	0.50	0.50	2500.0	0.83	1164	9.72
	6	0.50	1.00	2500.0	0.97	141	4.82
	6	0.50	2.00	2500.0	1.21	96	4.13
	6	0.50	4.00	2500.0	1.01	72	3.71
	6	0.50	8.00	2500.0	1.00	78	4.01
nonparam.	6	0.50	.	2500.0	1.21	46	3.30
param.	6	0.50	0.50	50.0	0.73	2437	9.69
	6	0.50	1.00	50.0	0.36	366	8.01
	6	0.50	2.00	50.0	0.21	216	8.95
	6	0.50	4.00	50.0	0.16	215	10.34
	6	0.50	8.00	50.0	0.18	201	10.64
nonparam.	6	0.50	.	50.0	0.11	215	11.58
param.	6	0.50	0.50	5.0	0.71	1766	9.42
	6	0.50	1.00	5.0	0.21	736	12.94
	6	0.50	2.00	5.0	0.11	478	16.88
	6	0.50	4.00	5.0	0.08	456	20.48
	6	0.50	8.00	5.0	0.11	490	19.93
nonparam.	6	0.50	.	5.0	0.05	681	32.50
param.	6	1.00	0.50	4500.0	1.24	293	5.08
	6	1.00	1.00	4500.0	1.01	35	2.97
	6	1.00	2.00	4500.0	1.01	24	2.70
	6	1.00	4.00	4500.0	1.01	22	2.48
	6	1.00	8.00	4500.0	1.01	25	2.82
nonparam.	6	1.00	.	4500.0	1.49	22	2.54
param.	6	1.00	0.50	350.0	1.96	191	5.45
	6	1.00	1.00	350.0	0.99	44	3.20
	6	1.00	2.00	350.0	0.70	33	2.99
	6	1.00	4.00	350.0	0.55	28	2.94
	6	1.00	8.00	350.0	0.50	26	3.08
nonparam.	6	1.00	.	350.0	0.54	32	3.19
param.	6	2.00	0.50	500.0	2.12	51	3.84
	6	2.00	1.00	500.0	1.42	14	2.24
	6	2.00	2.00	500.0	0.97	8	1.94
	6	2.00	4.00	500.0	0.79	10	1.93
	6	2.00	8.00	500.0	0.72	6	1.92
nonparam.	6	2.00	.	500.0	0.77	10	2.06
param.	6	4.00	0.50	4000.0	0.90	17	2.16
	6	4.00	1.00	4000.0	0.90	6	1.65
	6	4.00	2.00	4000.0	0.90	4	1.49
	6	4.00	4.00	4000.0	0.90	3	1.44
	6	4.00	8.00	4000.0	0.90	3	1.47
nonparam.	6	4.00	.	4000.0	0.90	3	1.41
param.	6	4.00	0.50	400.0	2.38	9	3.61
	6	4.00	1.00	400.0	1.13	4	1.88
	6	4.00	2.00	400.0	0.94	3	1.48
	6	4.00	4.00	400.0	0.90	3	1.48
	6	4.00	8.00	400.0	0.90	3	1.49
nonparam.	6	4.00	.	400.0	0.90	5	1.52
param.	6	8.00	0.50	3500.0	0.79	1	1.31
	6	8.00	1.00	3500.0	0.79	1	1.28
	6	8.00	2.00	3500.0	0.79	1	1.28
	6	8.00	4.00	3500.0	0.79	1	1.27
	6	8.00	8.00	3500.0	0.79	2	1.29
nonparam.	6	8.00	.	3500.0	0.79	1	1.26
param.	6	8.00	0.50	2500.0	0.83	3	1.40
	6	8.00	1.00	2500.0	0.82	3	1.39
	6	8.00	2.00	2500.0	1.21	3	1.40
	6	8.00	4.00	2500.0	1.21	3	1.40
	6	8.00	8.00	2500.0	1.13	3	1.38
nonparam.	6	8.00	.	2500.0	0.83	3	1.39

Results for nominal n=12 (Explanation in text)

Estimator	Nom. n	slope		Dose0	P50/LD50	P95/P5	Rel. Error
		true	Assumed				
param.	12	0.50	0.50	2500	1.21	214	5.31
	12	0.50	1.00	2500	1.00	90	3.76
	12	0.50	2.00	2500	1.00	58	3.52
	12	0.50	4.00	2500	1.06	55	3.36
	12	0.50	8.00	2500	0.96	70	3.55
nonparam.	12	0.50	.	2500	1.21	38	3.15
param.	12	0.50	0.50	50	1.00	295	5.48
	12	0.50	1.00	50	0.44	115	4.90
	12	0.50	2.00	50	0.41	109	5.33
	12	0.50	4.00	50	0.34	86	5.82
	12	0.50	8.00	50	0.25	82	6.18
nonparam.	12	0.50	.	50	0.24	83	6.94
param.	12	0.50	0.50	5	0.91	206	5.11
	12	0.50	1.00	5	0.38	139	5.78
	12	0.50	2.00	5	0.28	131	7.04
	12	0.50	4.00	5	0.21	136	8.47
	12	0.50	8.00	5	0.18	199	11.06
nonparam.	12	0.50	.	5	0.14	178	12.19
param.	12	1.00	0.50	4500	0.86	30	2.90
	12	1.00	1.00	4500	1.01	16	2.35
	12	1.00	2.00	4500	1.01	13	2.19
	12	1.00	4.00	4500	1.16	12	2.12
	12	1.00	8.00	4500	1.16	13	2.16
nonparam.	12	1.00	.	4500	1.23	12	2.13
param.	12	1.00	0.50	350	1.49	28	3.00
	12	1.00	1.00	350	0.93	15	2.33
	12	1.00	2.00	350	0.90	13	2.26
	12	1.00	4.00	350	0.79	12	2.29
	12	1.00	8.00	350	0.79	16	2.35
nonparam.	12	1.00	.	350	0.65	12	2.30
param.	12	2.00	0.50	500	1.58	9	2.21
	12	2.00	1.00	500	1.09	5	1.66
	12	2.00	2.00	500	0.96	5	1.59
	12	2.00	4.00	500	0.94	5	1.60
	12	2.00	8.00	500	0.92	5	1.60
nonparam.	12	2.00	.	500	0.93	5	1.64
param.	12	4.00	0.50	4000	1.09	4	1.53
	12	4.00	1.00	4000	1.01	3	1.36
	12	4.00	2.00	4000	1.09	3	1.32
	12	4.00	4.00	4000	1.03	3	1.30
	12	4.00	8.00	4000	1.04	3	1.36
nonparam.	12	4.00	.	4000	1.09	2	1.29
param.	12	4.00	0.50	400	1.51	4	2.01
	12	4.00	1.00	400	1.22	3	1.44
	12	4.00	2.00	400	1.03	2	1.31
	12	4.00	4.00	400	0.94	3	1.30
	12	4.00	8.00	400	0.91	3	1.36
nonparam.	12	4.00	.	400	0.90	3	1.34
param.	12	8.00	0.50	3500	0.95	1	1.20
	12	8.00	1.00	3500	0.95	1	1.21
	12	8.00	2.00	3500	0.95	1	1.20
	12	8.00	4.00	3500	0.96	1	1.20
	12	8.00	8.00	3500	1.06	2	1.21
nonparam.	12	8.00	.	3500	0.95	1	1.20
param.	12	8.00	0.50	2500	1.00	2	1.28
	12	8.00	1.00	2500	1.00	2	1.27
	12	8.00	2.00	2500	1.00	2	1.27
	12	8.00	4.00	2500	1.00	2	1.26
	12	8.00	8.00	2500	1.00	2	1.20
nonparam.	12	8.00	.	2500	1.00	2	1.26

References

Armitage, P.A. 1991. Sequential Methods. Ch. 6 Hinkley, D.V., Reid, N., and Snell, E.J. *Statistical Theory and Modelling*. Chapman and Hall.

Brownlee, K.A., Hodges, J.L., and Rosenblatt, M. 1953. The up-and-down method with small samples.

Dixon Statistical Associates. 1991. Design and Analysis of Quantal Dose-Response Experiments (with Emphasis on Staircase Designs). Unpublished manuscript.

Finney, D.J. 1971. *Probit Analysis*. (3rd ed.) Cambridge U. Press.

Edwards, A.W.F. 1992. *Likelihood* (2nd ed.) Johns Hopkins.

Hsi, B. 1969. The multiple up-and-down method in bioassay. *J. Amer. Statl. Assoc.* V? 147-162.

Meeker, W.Q., and Escobar, L.A. 1995. Teaching about approximate confidence regains based on maximum likelihood estimation. *The Amer. Statn.* 49(1):48-52.

Comparison of 5 Stopping Rules and 2 LD50 Estimators Using Monte Carlo Simulation

David Farrar, March 2000

Attached are graphs presented at an ICCVAM meeting in January 2000.

Note the following:

1. For these graphs, the maximum number that could be tested was set at 25. Currently we propose to set the maximum at 15.
2. The test doses were not constrained to a range such as 1 to 5000 units, as in later simulations and as in our current guideline proposal.
3. The graphs include consideration of 2 stopping rules that were subsequently abandoned. The number of stopping rules has been retained, so that Rules number 1, 2, and 5 in later work correspond to the procedures here with the same numbers.
4. While here we do illustrate the use of an LR stopping rule, it is not precisely the rule proposed in the current guideline. The procedure in the current guideline is more simple, uses fewer animals, and results in better precision.

LD50 Estimators Evaluated:

- Maximum likelihood estimator, slope = 2
-
- Geometric average dose (animals at/following reversal).

Stopping Rules Evaluated:

1. Fixed nominal sample size of 6
2. Stop after 5 reversals.
- 3a. Convergence of estimators:
 $0.5 < [\text{estimate 1}] / [\text{estimate 2}] < 2$

estimate 1 = geometric average dose;
estimate 2 = MLE with slope=0.5
- 3b. Like 3a but "factor" of #5 instead of #2.
4. For H:LD50=GM versus H:LD50=GM/2 (or H:LD50=GM*2),

profile likelihood ratio = 2
 - Nominal sample size = 6; Number tested capped at 15 or 25

Performance Measurement based on Monte Carlo

- Bias index
median estimate / true value
?Acceptable . 0.8 - 1.2 X (or .20% bias)
- Spread Index
Ratio of high and low percentiles P95 / P5

?Acceptable . 3-4 X
- Numbers tested (mean, 95th percentile)

Design of Monte Carlo Study

- True LD50 = 1500 units
- Initial dose 15, 100, 150, 1000, 1500
- Probit slope 0.5 - 8
- Max. number tested 15, 25

Graph Sets

- Comparison of 2 estimators based on stopping criterion 4 with max tested = 25
- Comparison of stopping criteria 1 and 4 based on geometric mean, max tested = 25
- Comparison of max. tested 15 versus 25 based on stopping criterion 4 and geometric mean.

Initial Dose = LD50 / 100

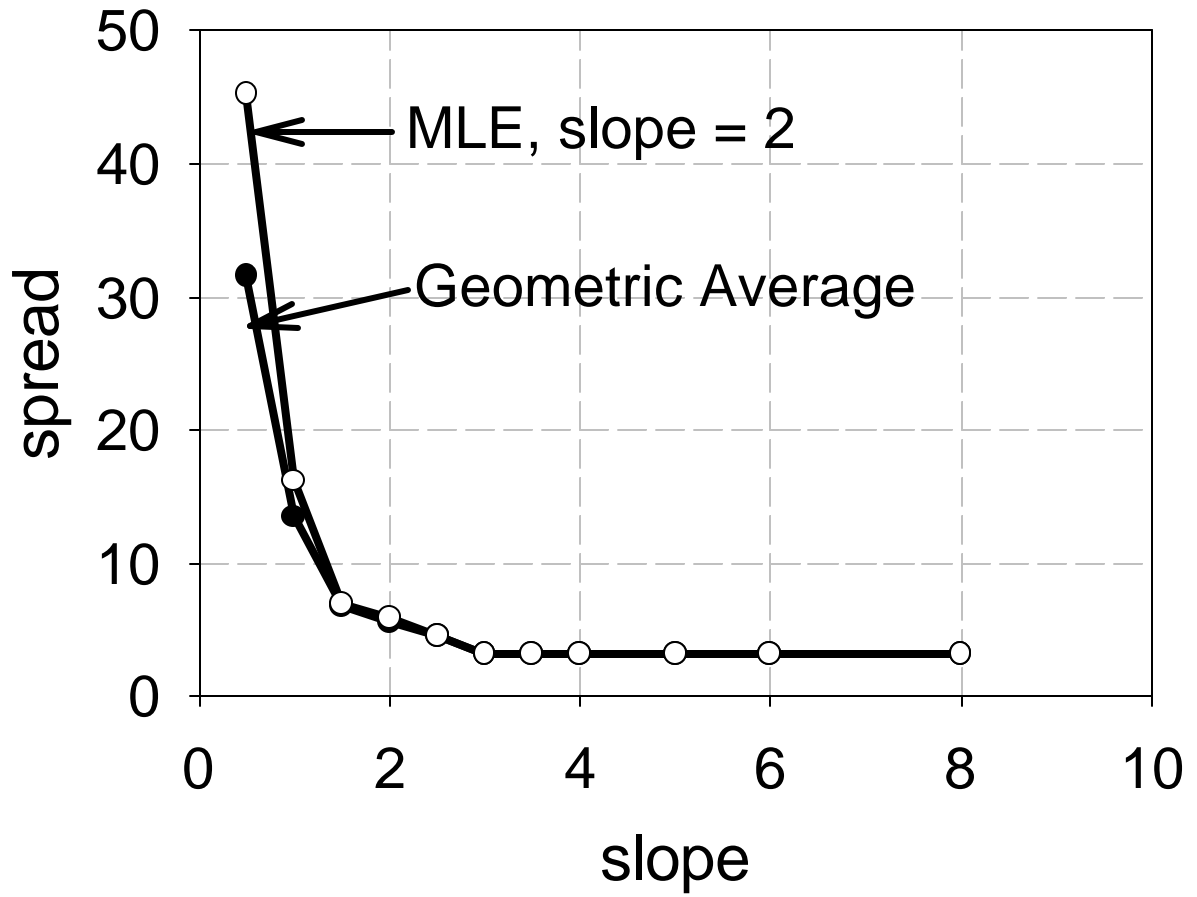

Initial Dose = LD50 / 100

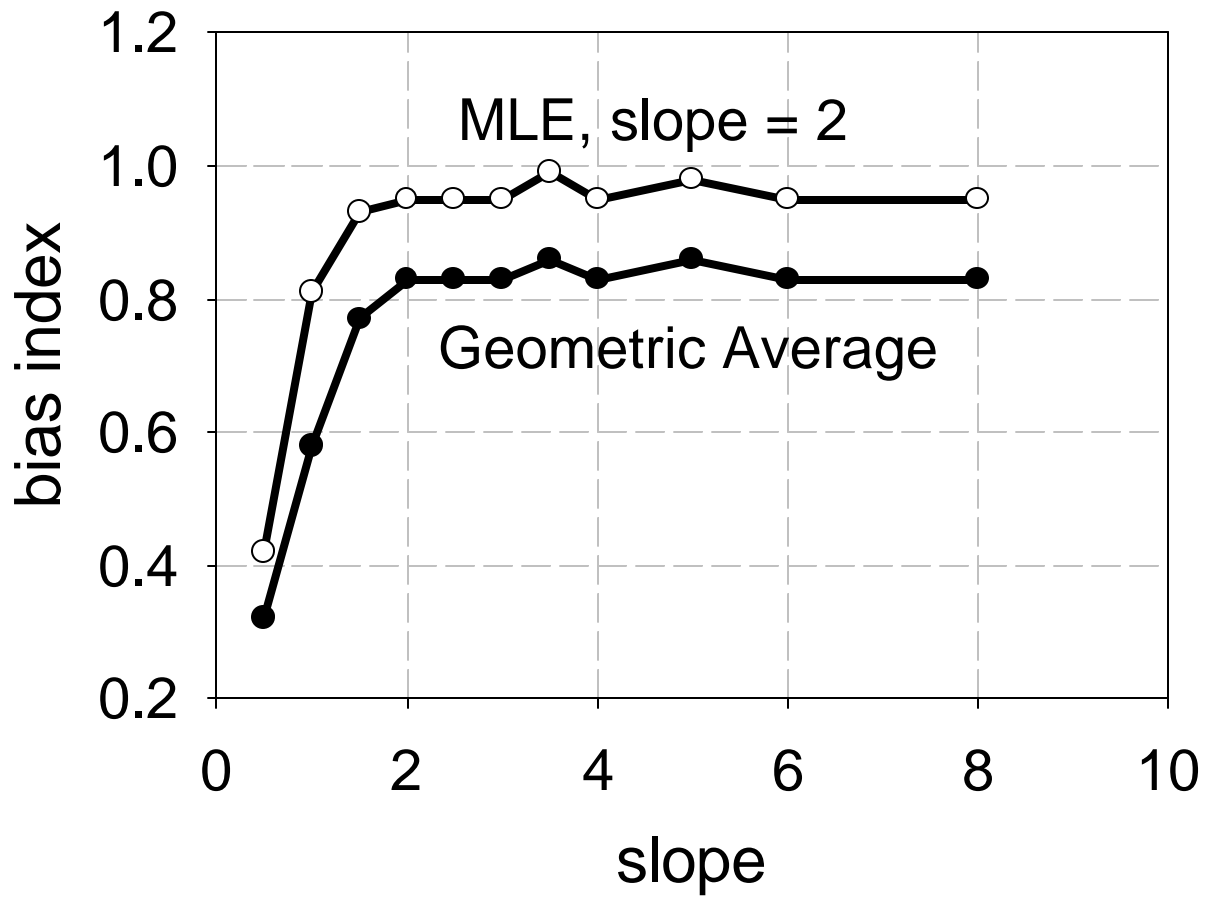

Initial Dose = LD50 / 10

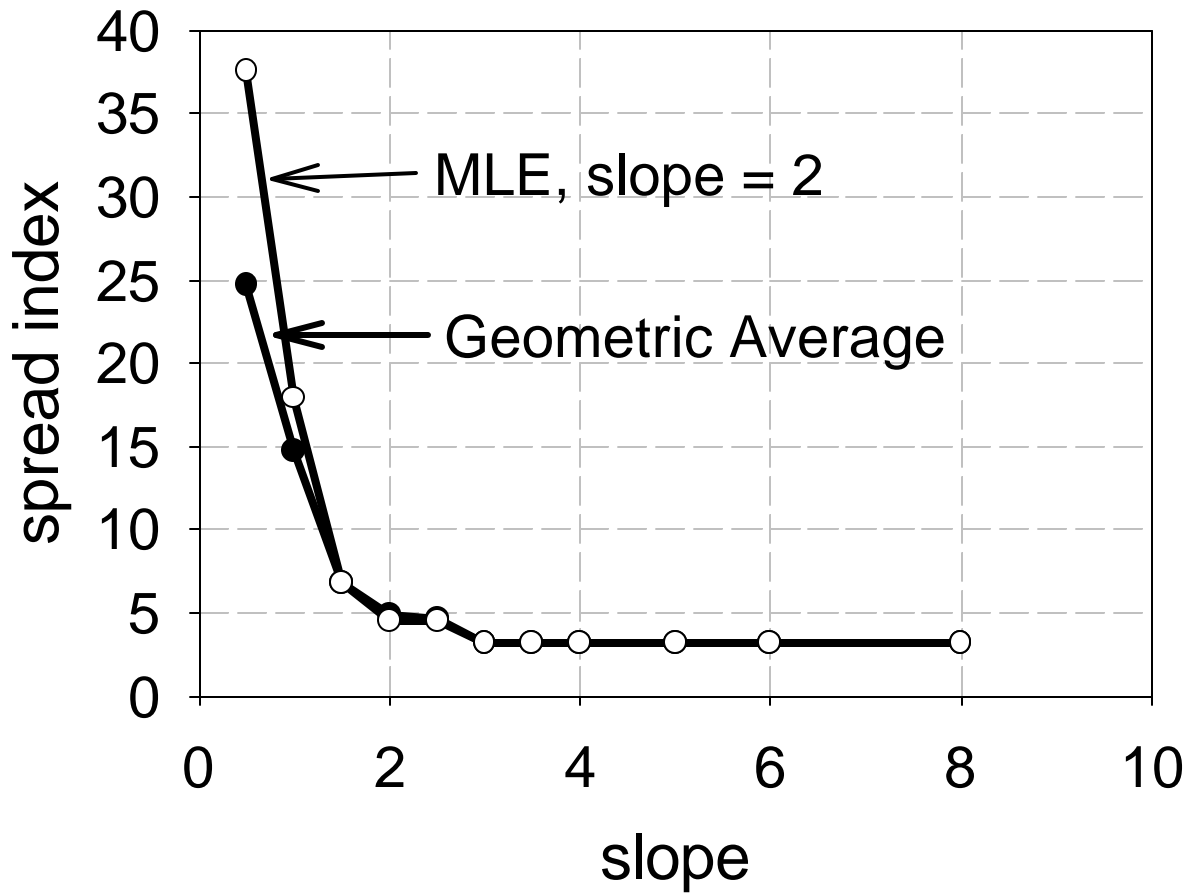

Initial Dose = LD50 / 10

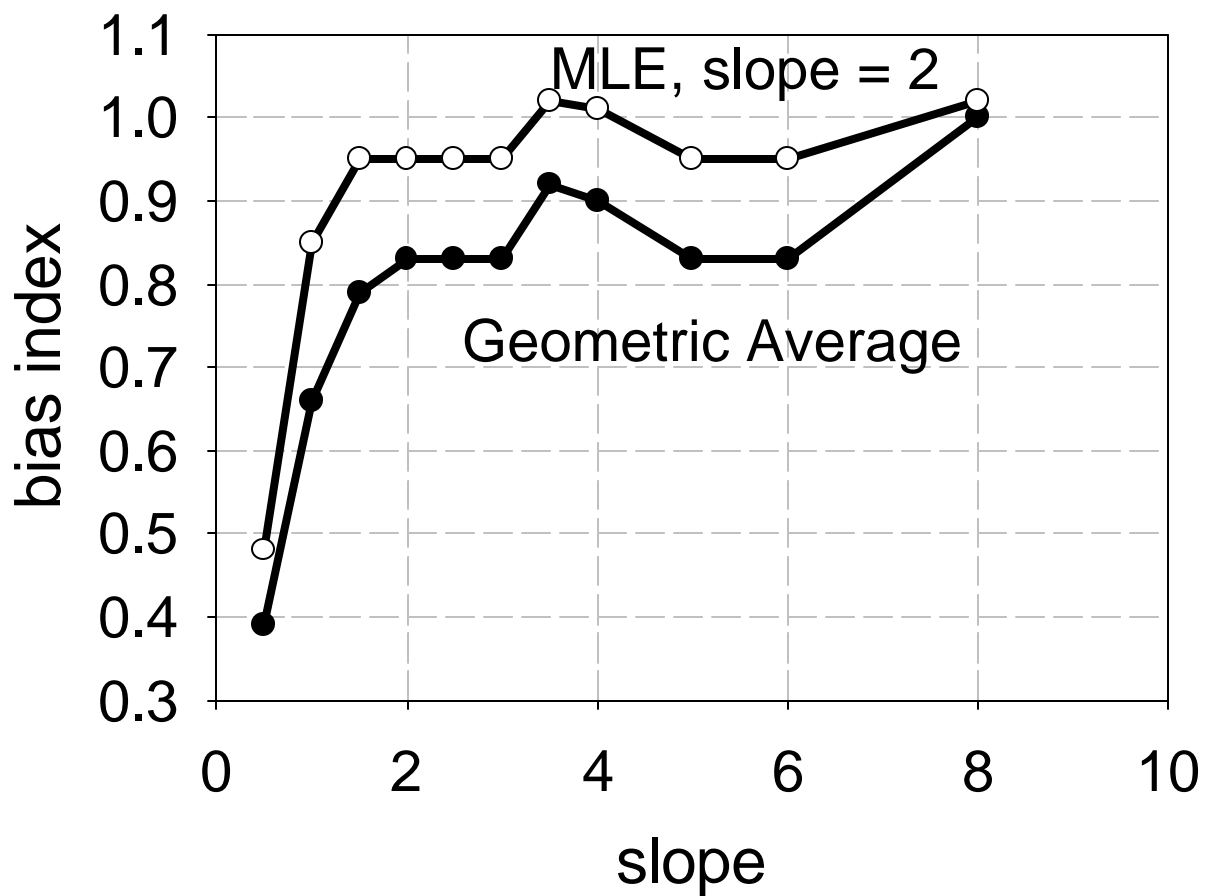

Initial Dose = LD50

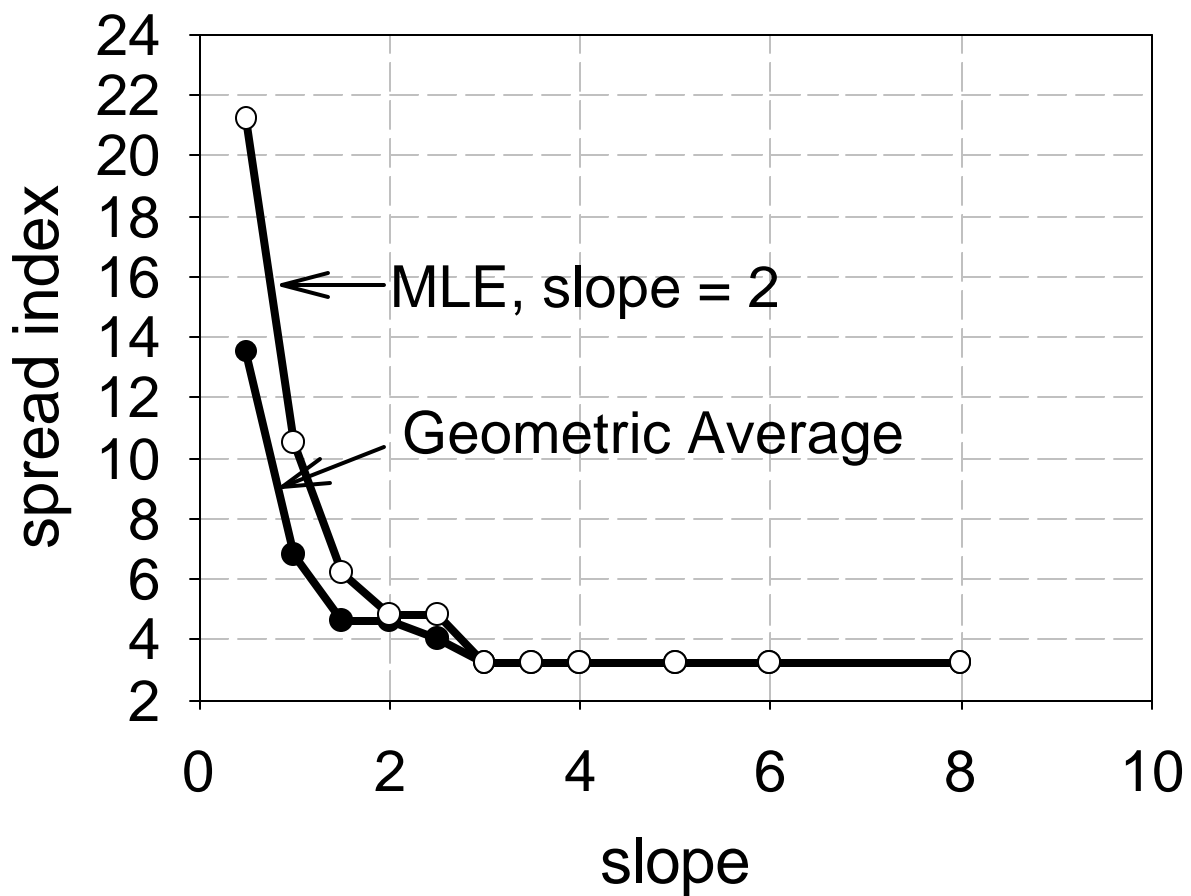

Initial Dose = LD50

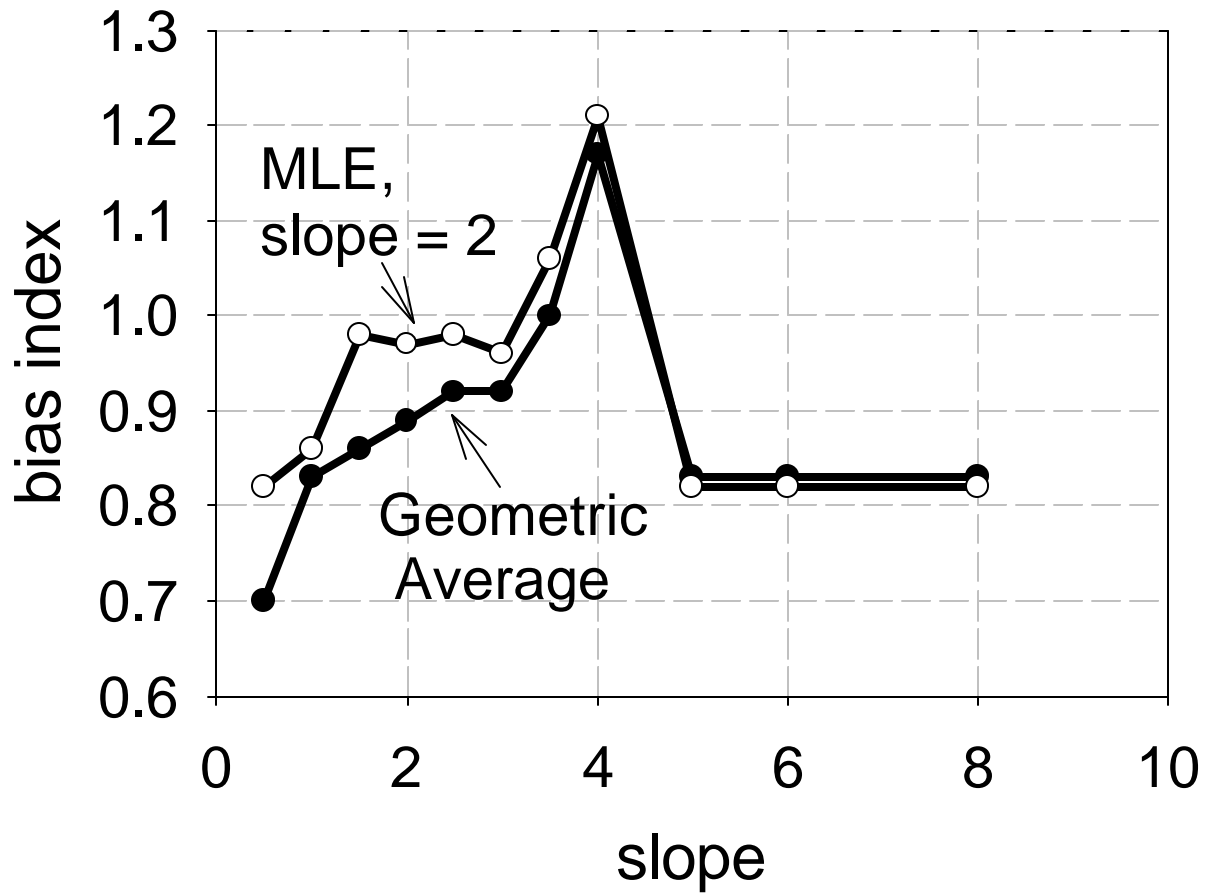

Initial Dose = LD50 / 100

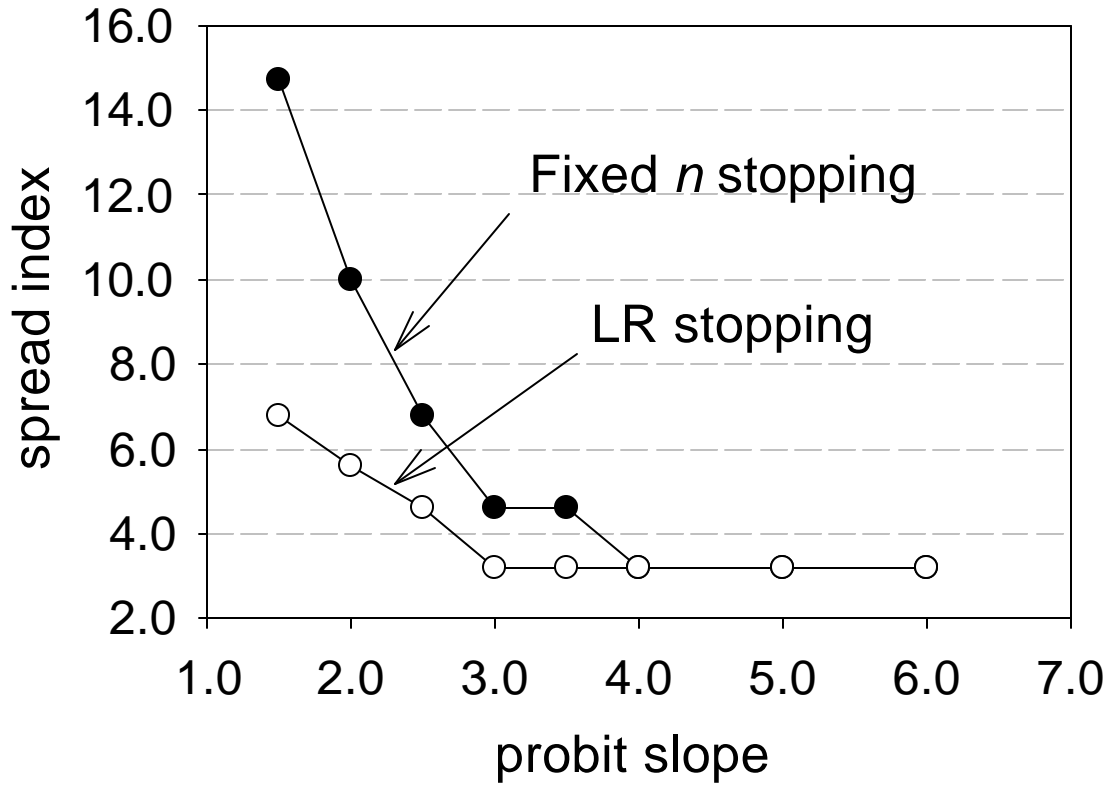

Initial Dose = LD50 / 100

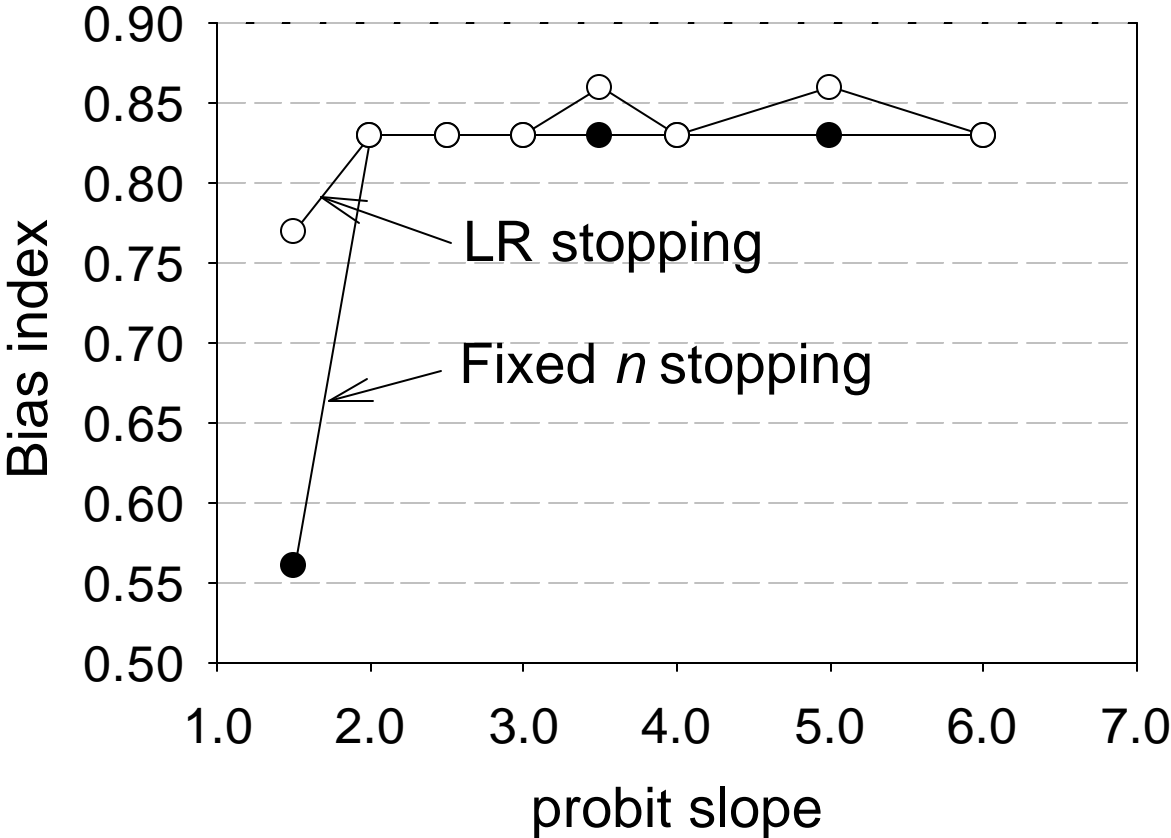

Initial Dose = LD50 / 100

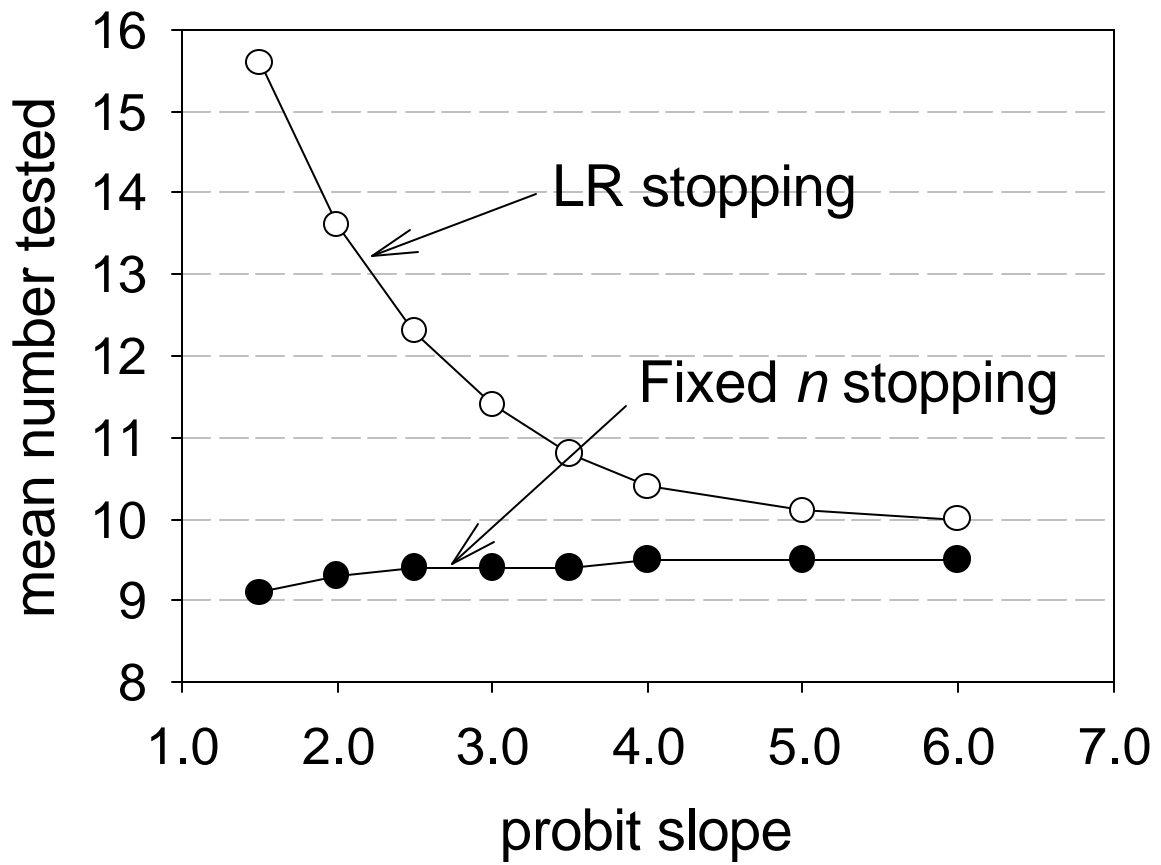

Initial Dose = LD50 / 10

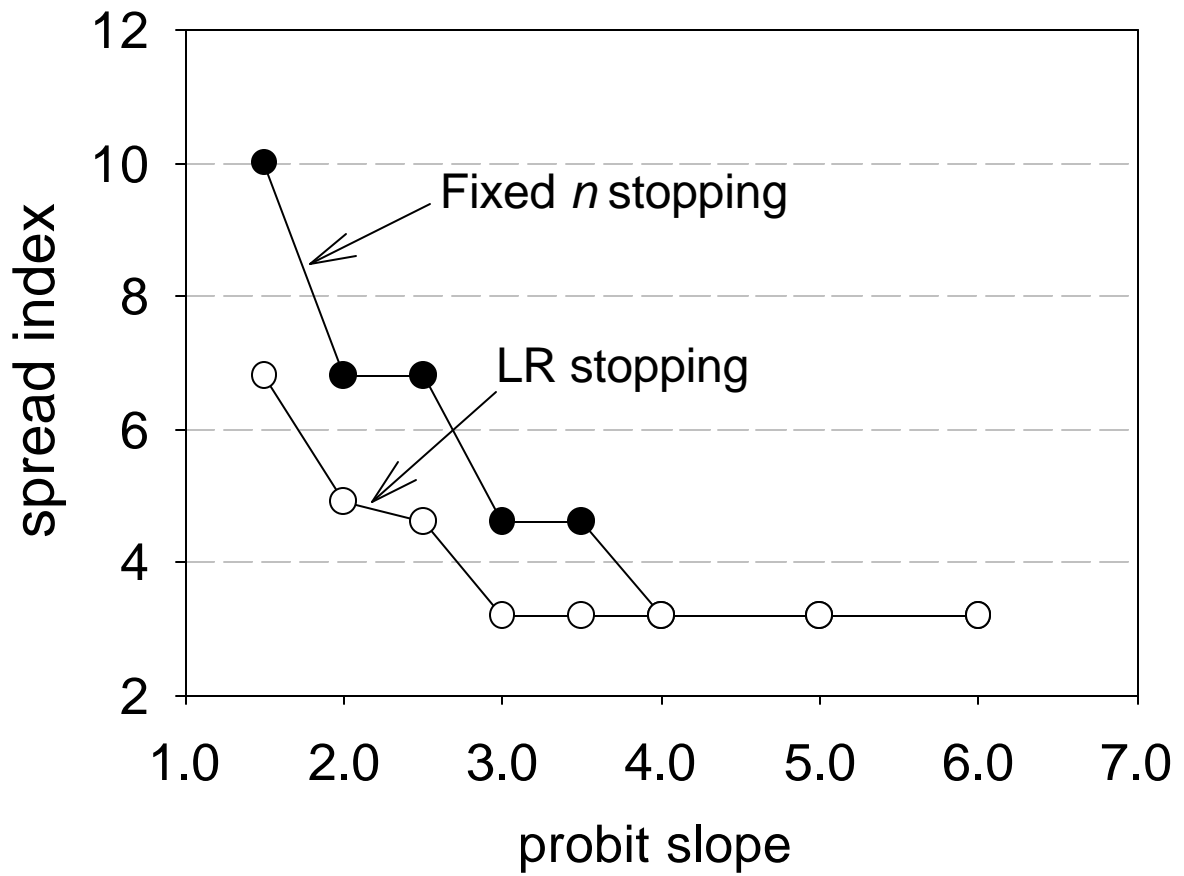

Initial Dose = LD50 / 10

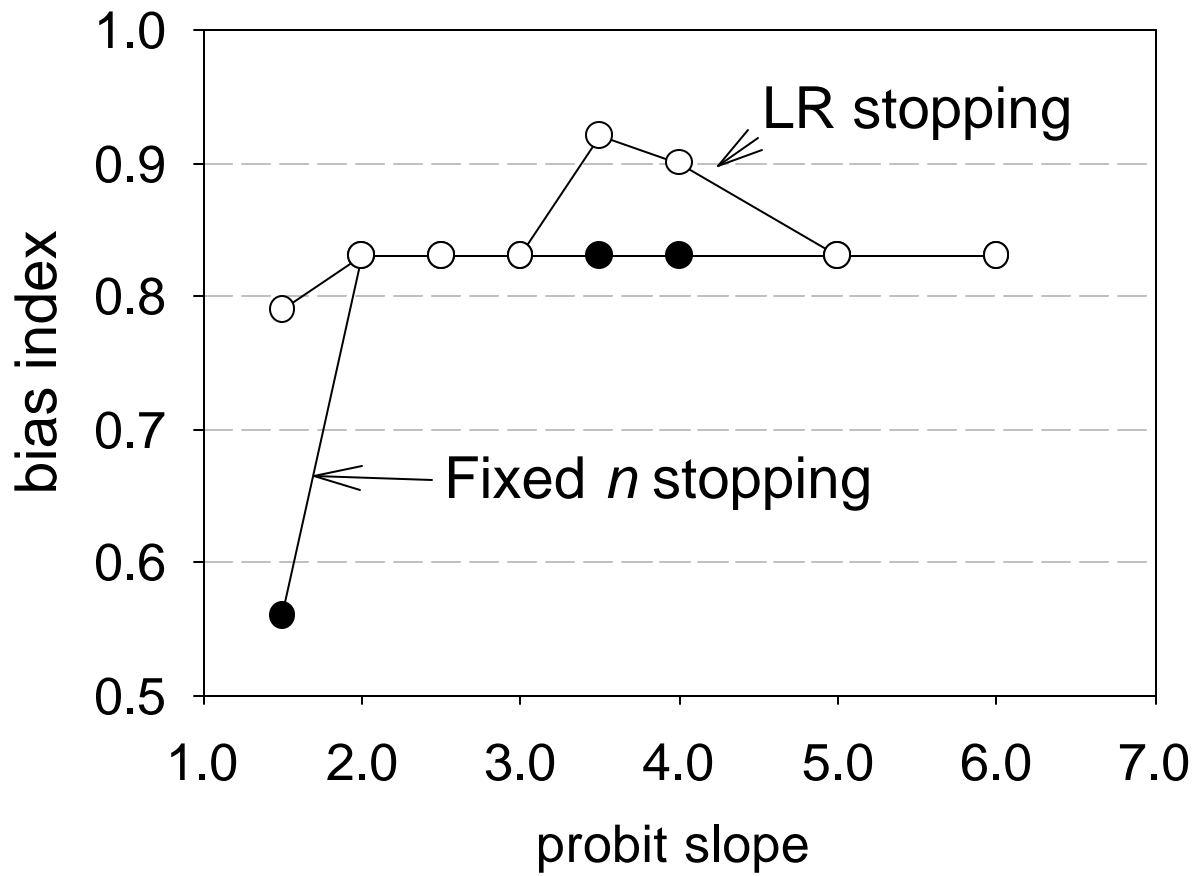

Initial Dose = LD50 / 10

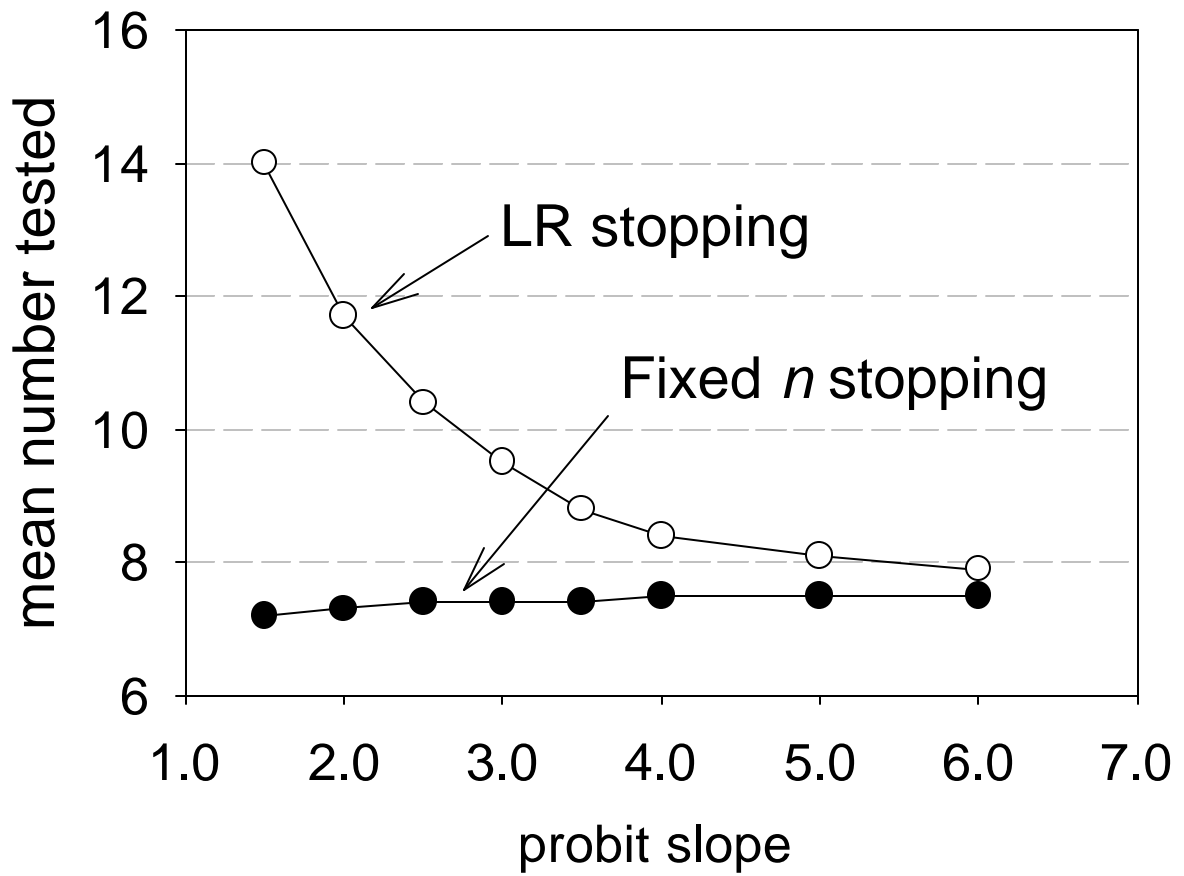

Initial Dose = LD50

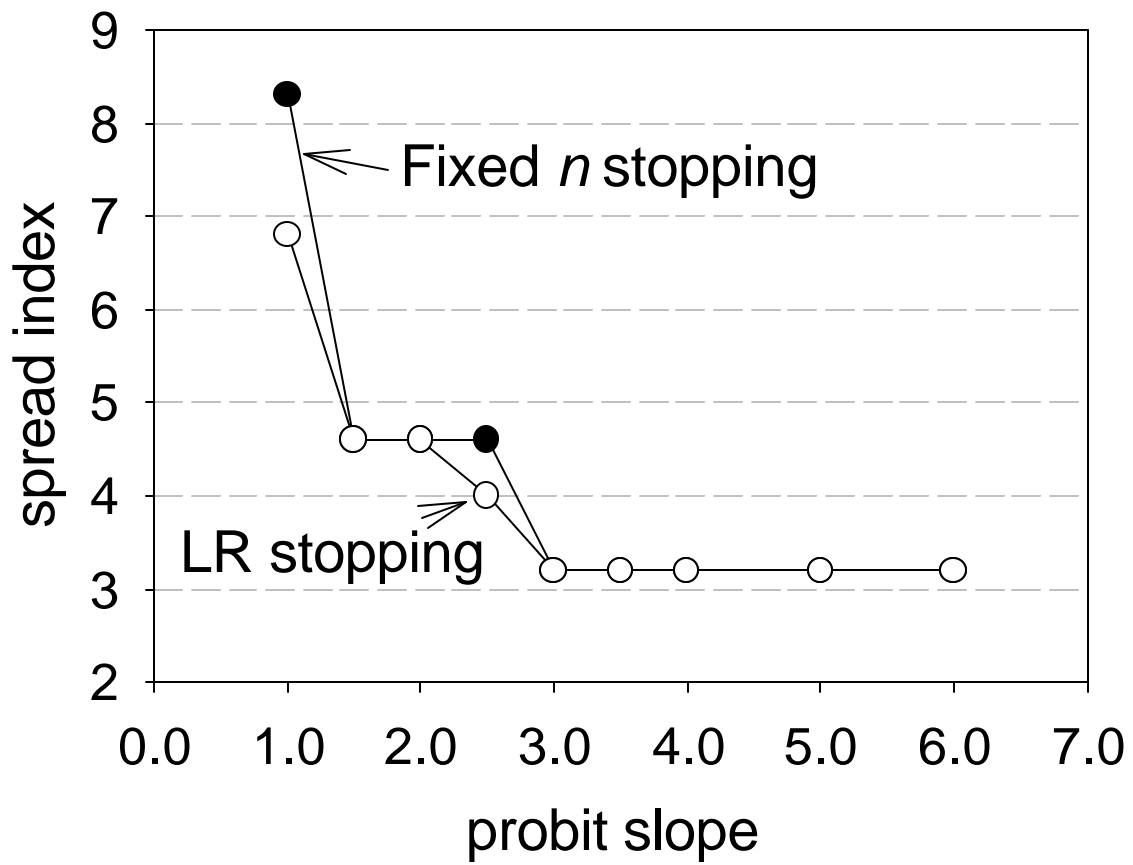

Initial Dose = LD50

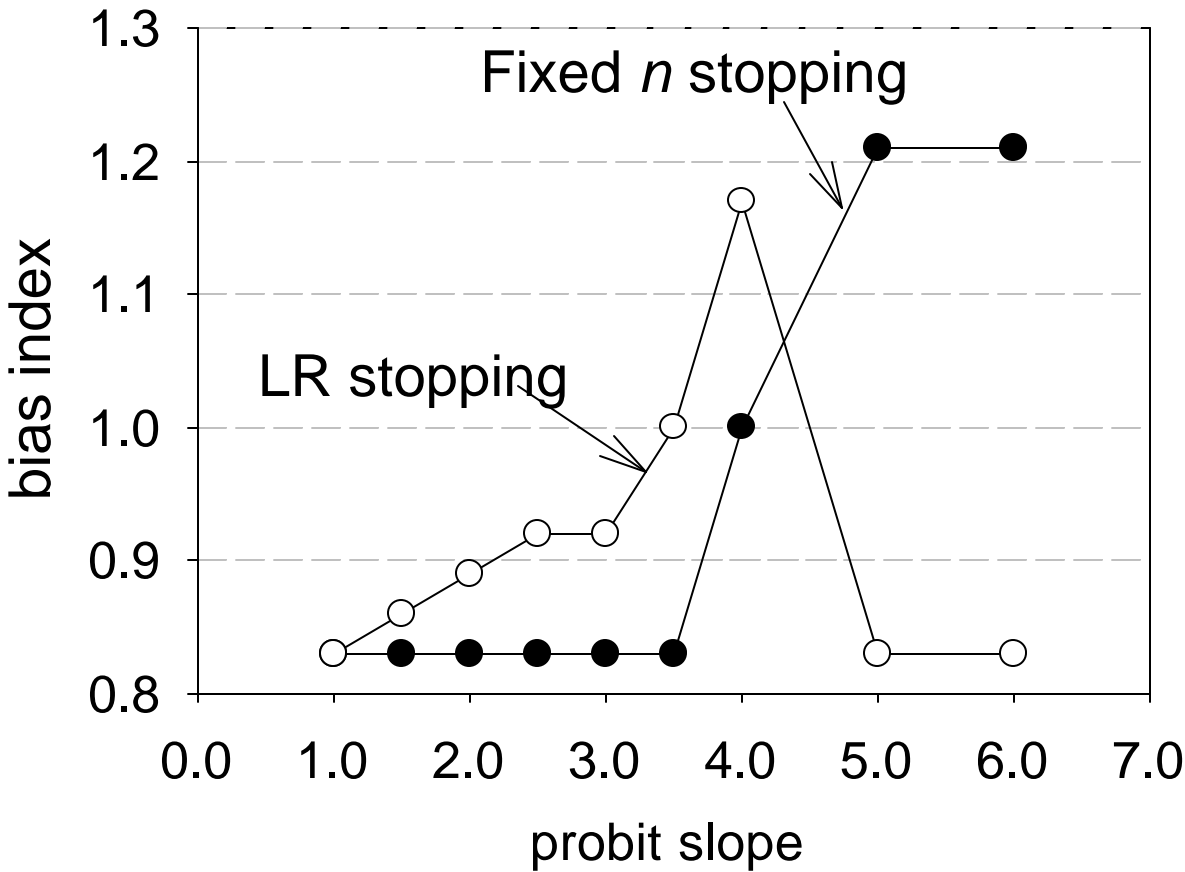

Initial Dose = LD50

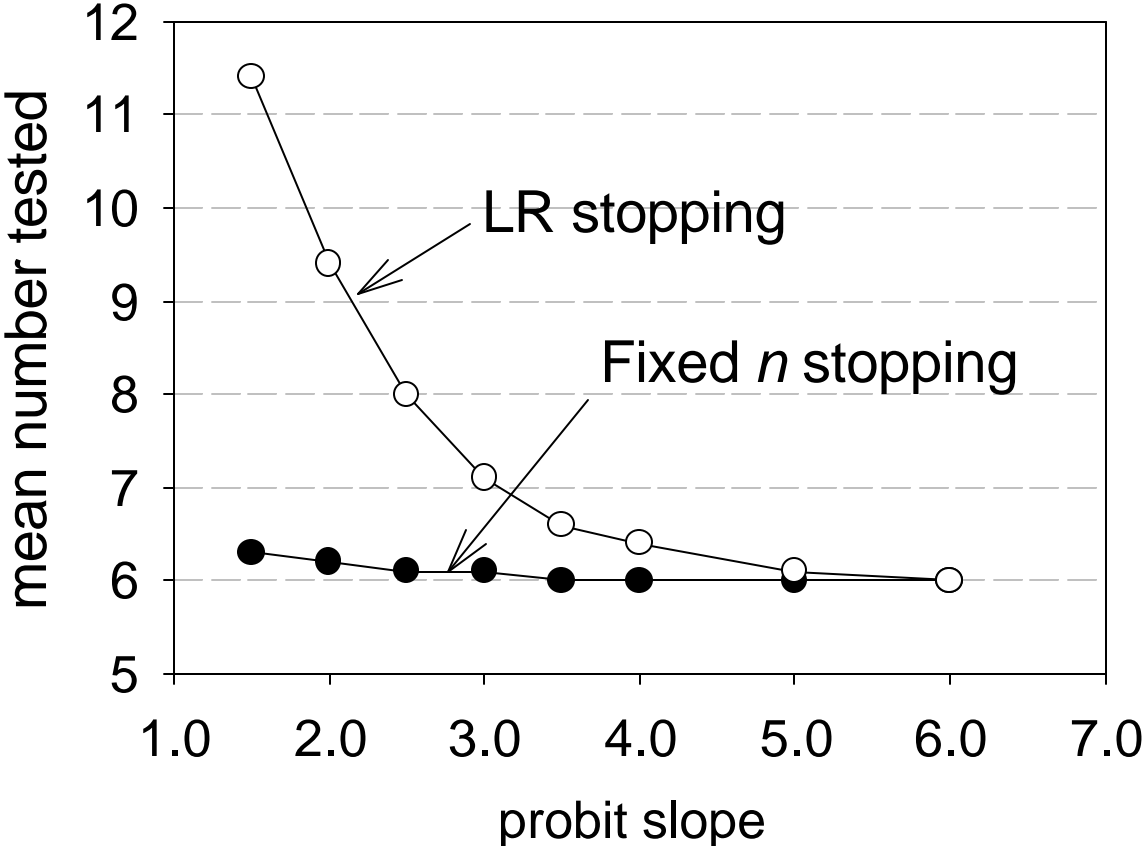

Initial Dose = LD50 / 100

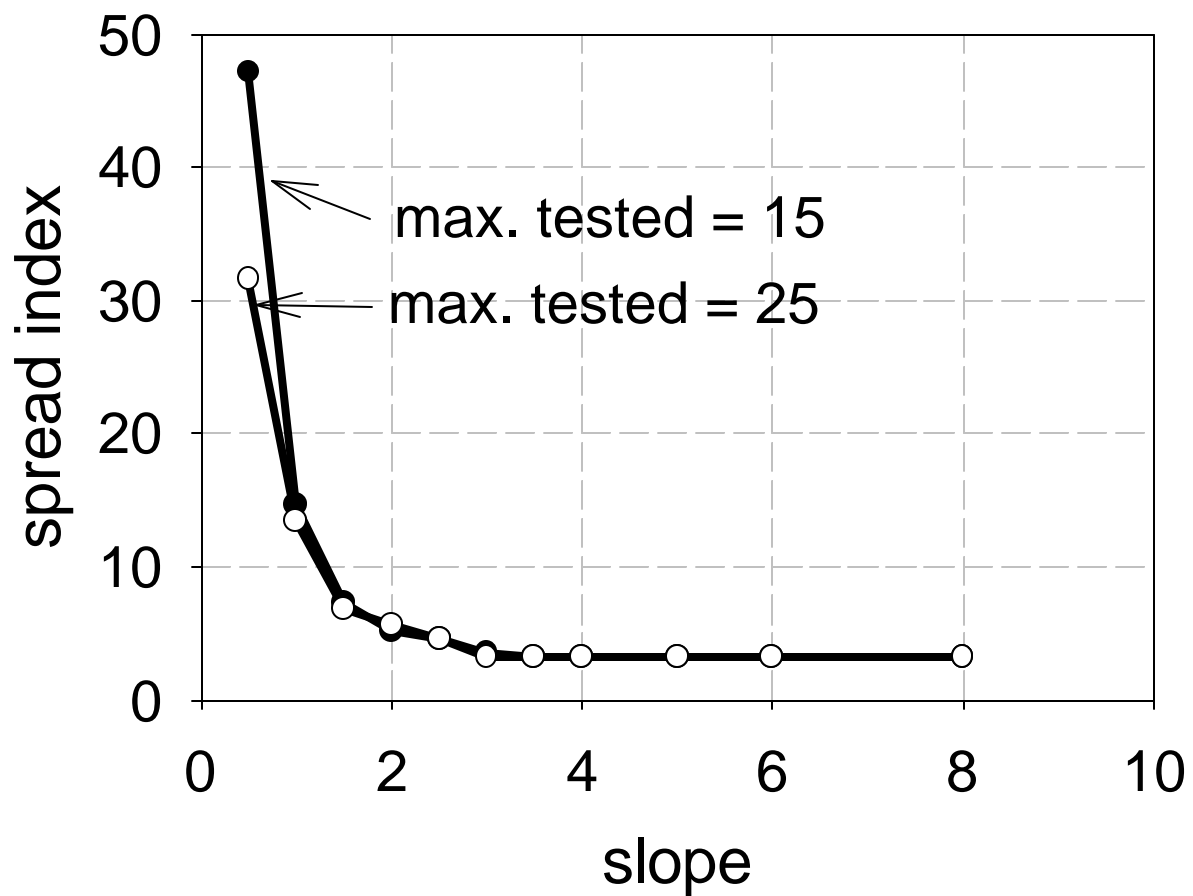

Initial Dose = LD50 / 100

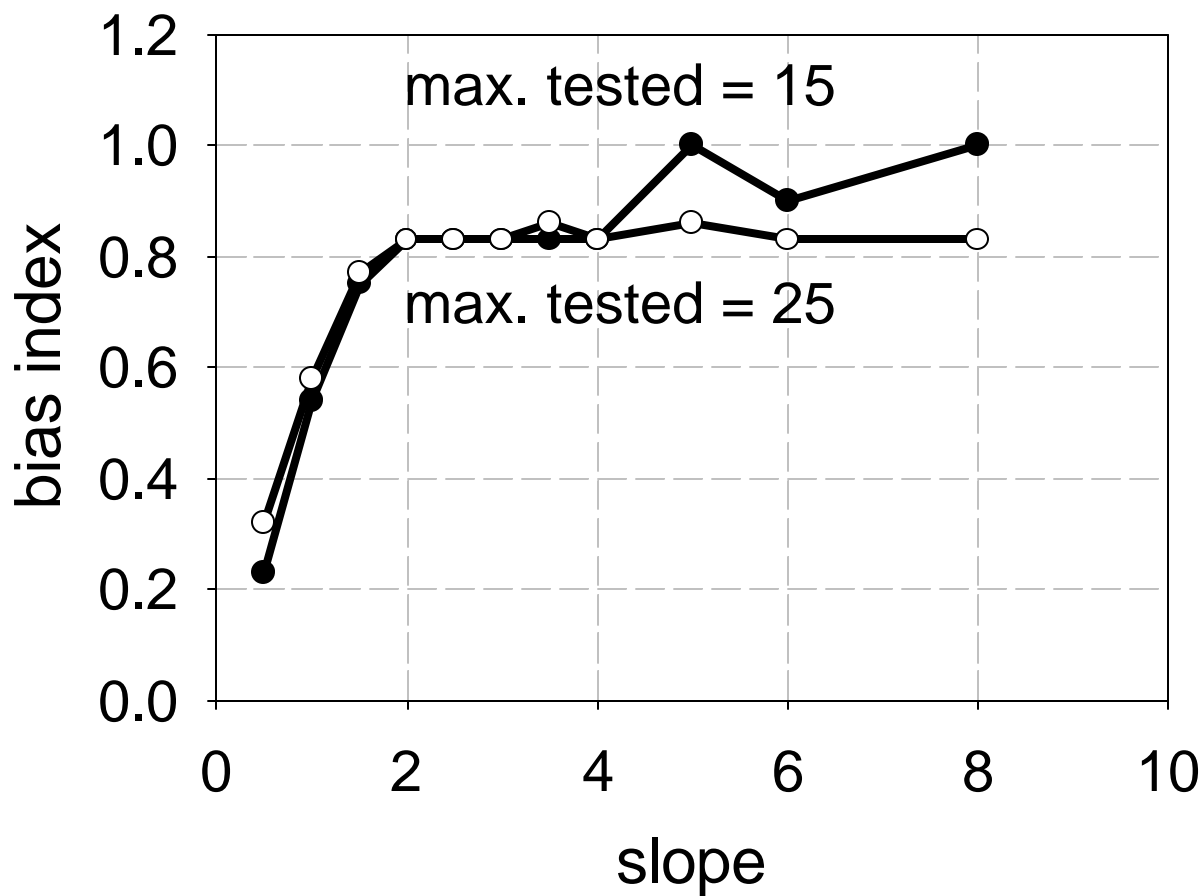

Initial Dose = LD50 / 100

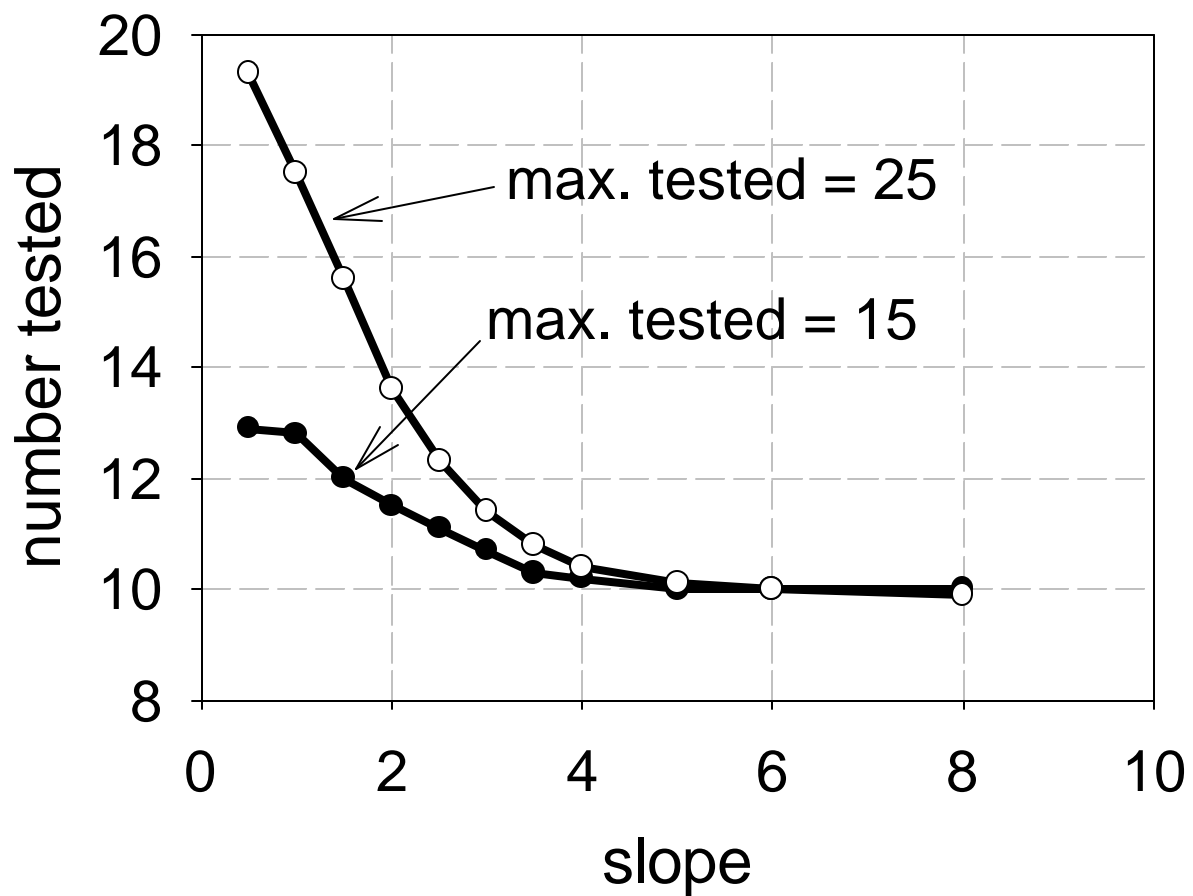

Initial Dose = LD50 / 10

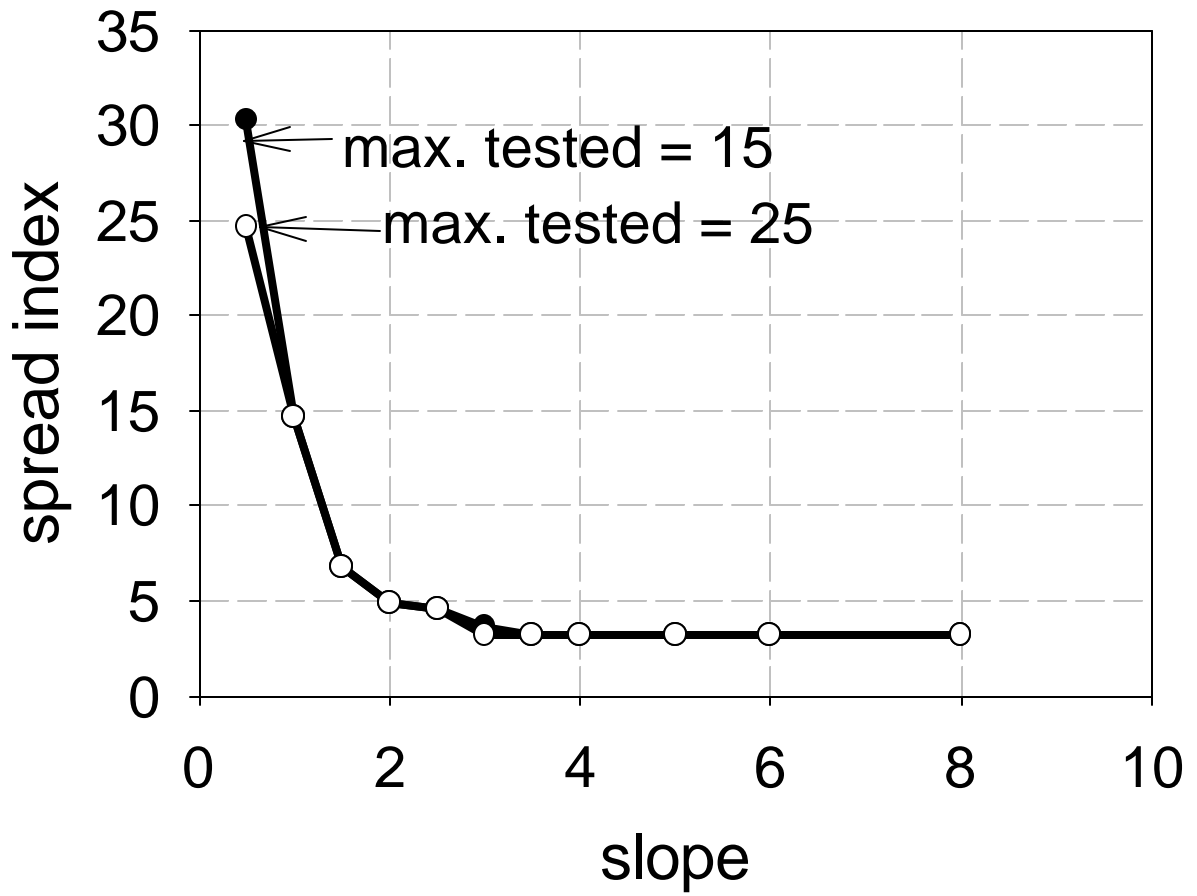

Initial Dose = LD50 / 10

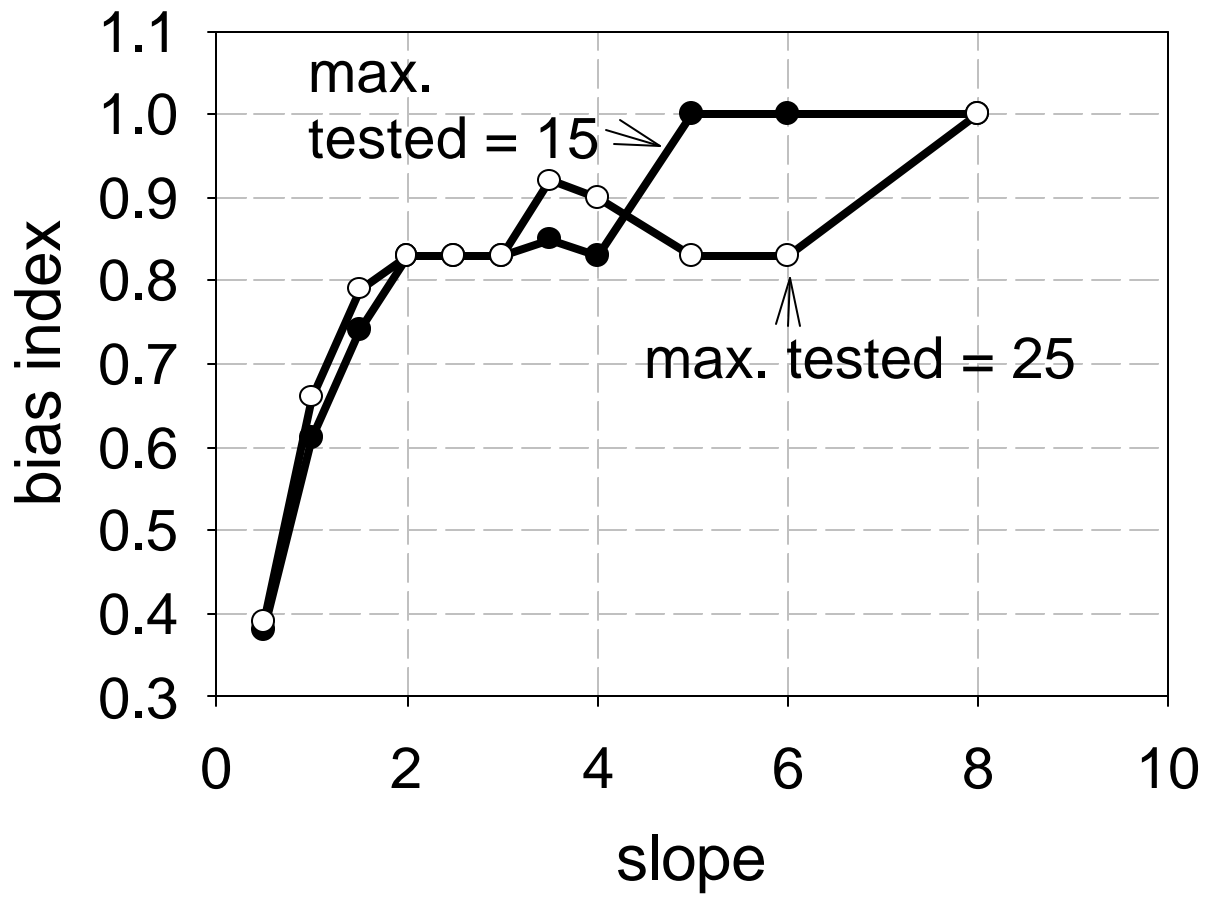

Initial Dose = LD50 / 10

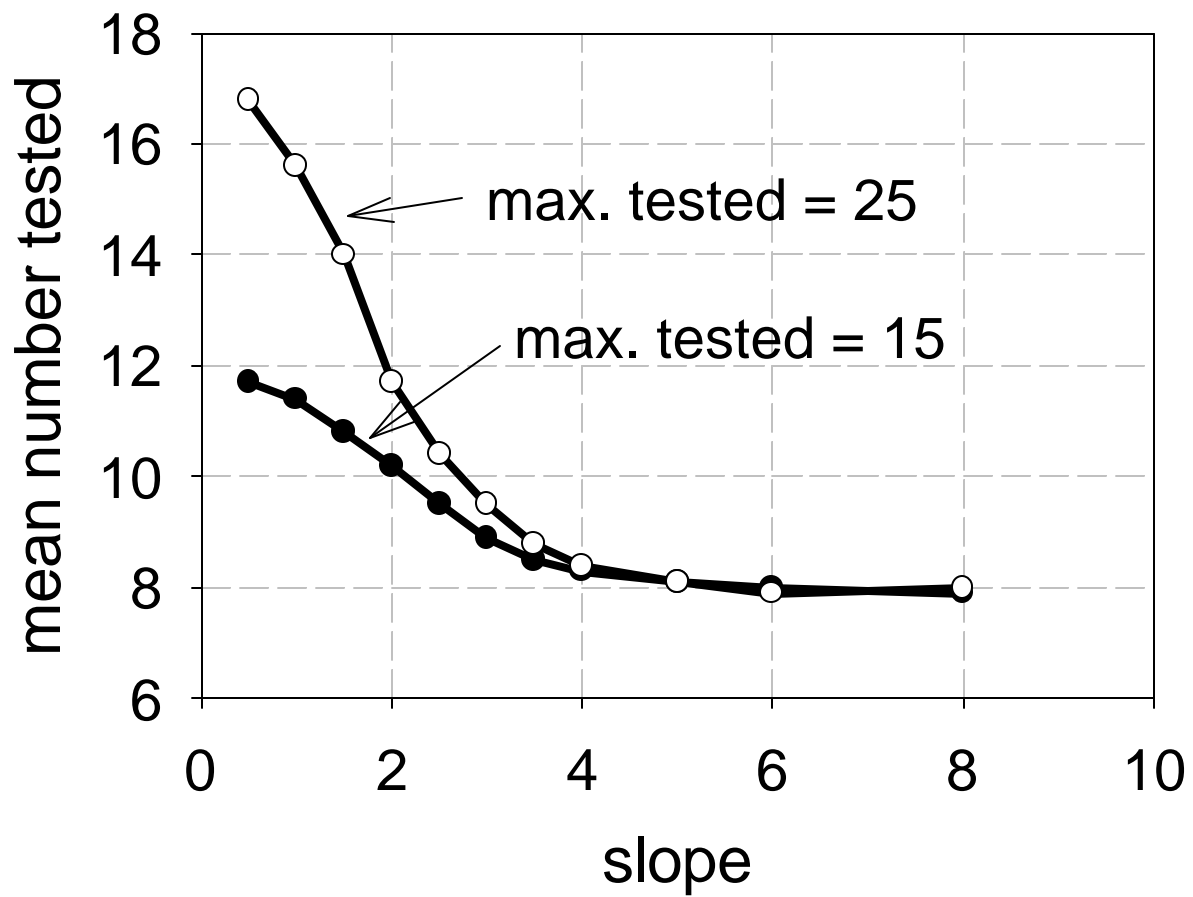

Initial Dose = LD50

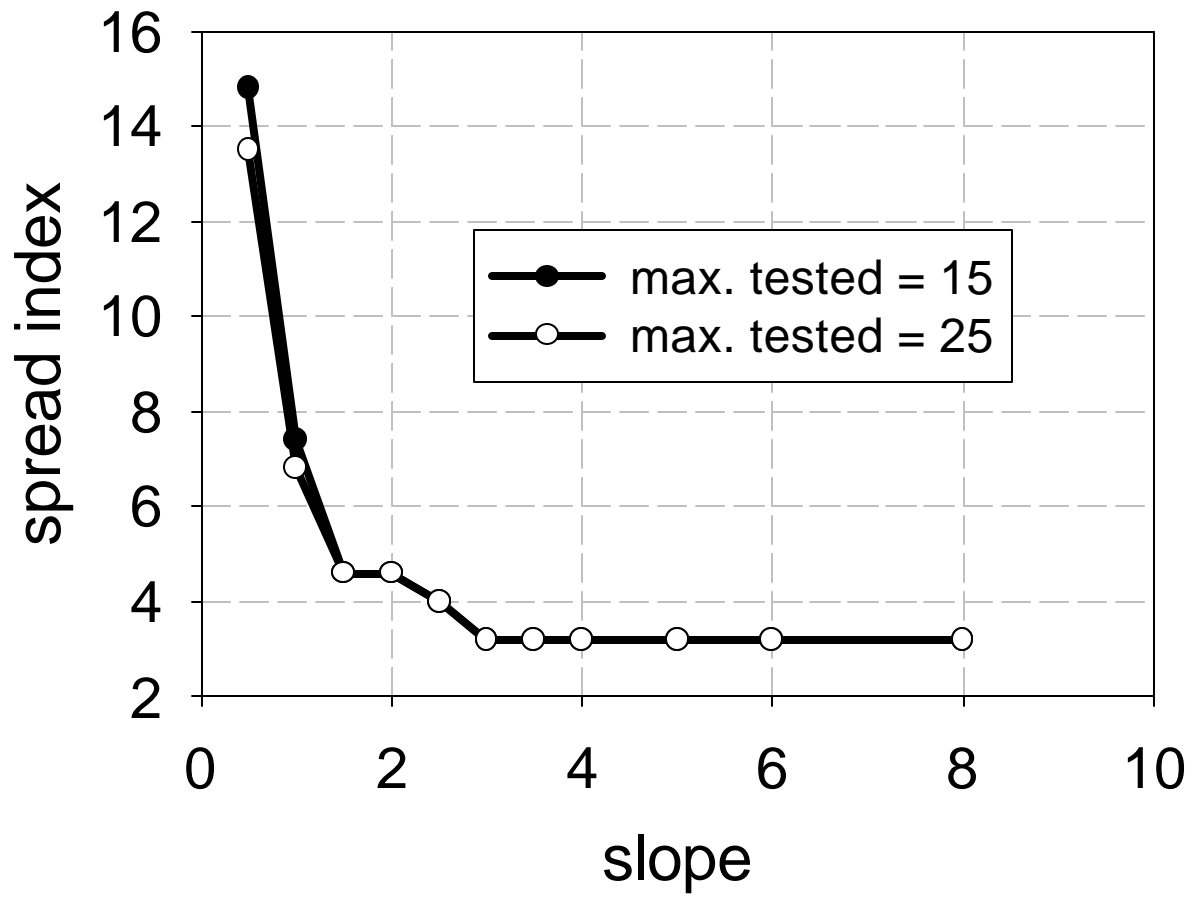

Initial Dose = LD50

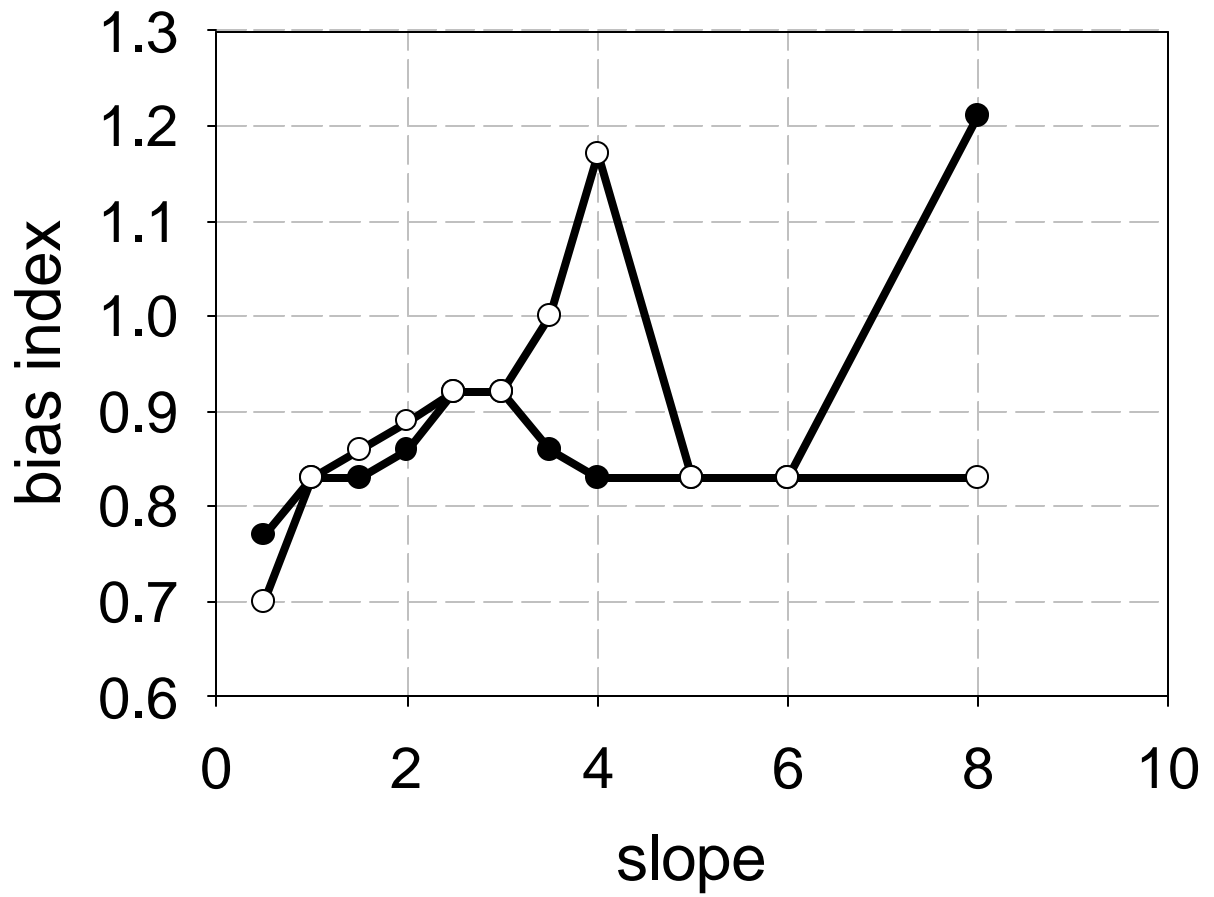

Initial Dose = LD50

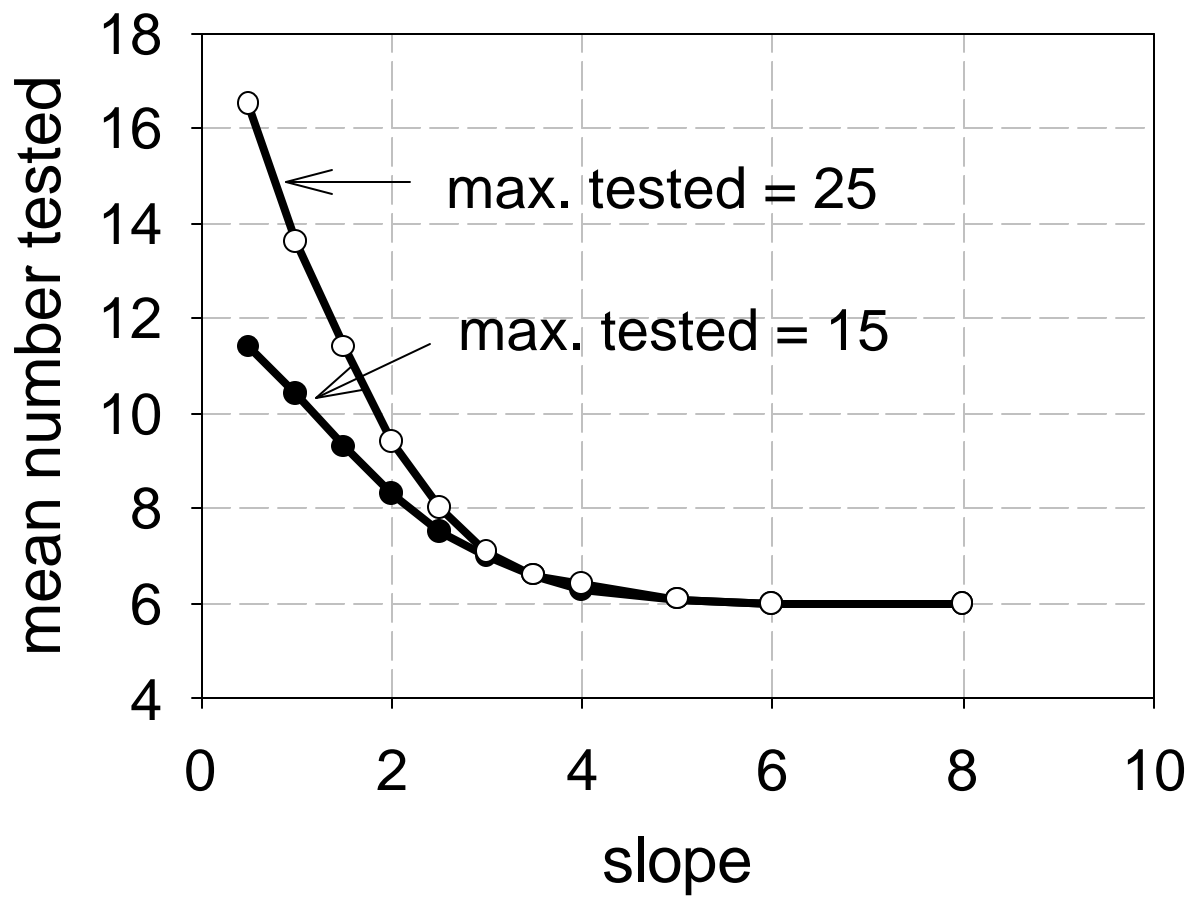



U.S. Consumer Product Safety Commission
Office of Hazard Identification and Reduction

Accuracy of In-vivo Limit Dose Tests

Prepared for the Acute Toxicity Working Group
Interagency Committee on Validation of Alternative Methods

Michael A. Greene
Mathematical Statistician
Division of Hazard Analysis

March 2000

Accuracy of In-vivo Limit Dose Tests

Michael A. Greene, Ph.D.
Mathematical Statistician

Division of Hazard Analysis
Directorate for Epidemiology
U. S. Consumer Product Safety Commission

The analysis in this paper is intended to determine the accuracy of various limit dose tests. A limit dose test involves dosing a number of animals with a chemical at a single dose, the limit dose. All animals may be dosed at once or animals may be dosed one or two at a time. The test outcome is a series of deaths and survivals. A set of rules associates a test outcome with a decision as to whether the median lethal dose or LD50 is above or below the limit dose. An example of a decision rule would be to classify the LD50 as over the limit dose when more than half the animals die.

The analysis in this paper uses a computer model to evaluate the accuracy of these decision rules. A decision rule is defined to be correct when the LD50 is correctly classified as above or below the limit dose. This classification is probabilistic because it depends on the deaths and survivals observed in the limit dose test. In assessing the test accuracy, the model begins by assuming the existence of a probit dose-response curve with a known LD50 and slope. This curve is used to estimate the probability that an animal will die or survive at a given dose. The computer model then extends this result to the number of animals tested by calculating the probability of each possible sequence of deaths and survivals for all these animals. The computer model then adds up the probability that the correct outcomes occur. This would be

- the probabilities associated with outcomes that classify the LD50 below the limit dose if the true LD50 is below the limit dose, or
- the probabilities associated with outcomes that classify the LD50 above the limit dose if the true LD50 is above the limit dose.

The test accuracy is defined as the probability that the test result is correct. This is the probability that the correct outcomes occur.

The accuracy of different plans is compared in this paper. Plans differ by the number of animals involved and whether a fixed or sequential sample design is used. Accuracy is evaluated at a wide range of hypothetical LD50's and slopes of the dose-response curve. For sequential testing plans, the model also estimates the expected number of animals that would be required.

The limit dose test provides a gross classification of the toxicity of a chemical. Using a limit dose test, it is possible to determine if a chemical has an LD50 above the limit dose by using a small number of animals. A precise estimate of the LD50 may not

be required for such low toxicity chemicals. For chemicals where the test classifies the LD50 below the limit dose, an estimate of the LD50 can be obtained from an up and down test (Dixon 1991). A more general discussion of limit dose tests is in Springer et al (1993).

The limit dose test is part of the draft OECD Guideline for the Testing of Chemicals (OECD 425). It is under review by the Acute Toxicity Working Group of the Interagency Committee on Validation of Alternative Methods (ICCVAM). This committee represents a number of government agencies including the Environmental Protection Administration, the Department of Transportation, the Consumer Product Safety Commission, and the Food and Drug Administration. The guideline specifies a limit dose test at 5000 mg/kg body weight. This is in accordance with the Federal Hazardous Substances Act Regulation for acute oral toxicity in section 1500.3 (1997, page 377). Limit dose tests at 2000 mg/kg body weight are in use in Europe.

The next section describes the methods. It is followed by results and the discussion. Only limit dose tests at 5000 mg/kg are discussed in the paper. Tests at 2000 mg/kg are presented in Appendix 1.

Methods

This section describes the procedure for computing the accuracy of a limit dose test.

It is assumed that animal mortality at a given dose follows a probit dose-response curve. Let p be the probability that an individual animal dies following a dose at a given level. Then, with hypothesized values for the LD50 and σ , p is computed from the dose response curve using the following equation:

$$p = p(\text{death}; \text{dose}, LD_{50}, \sigma) = \Phi\left(\frac{\log_{10}(\text{LimitDose}) - \log_{10}(LD_{50})}{\sigma}\right) \quad (1)$$

where Φ is the standard normal cumulative distribution.

The probabilities associated with individual outcomes are then aggregated to possible sequences of test outcomes. Each animal represents an independent trial, i.e. an identical, independent (i.i.d.) realization of equation (1). The probability distribution of any given outcome involving m deaths and n animals is given by the binomial distribution as

$$P(m; n, p) = \binom{n}{m} p^m (1 - p)^{n-m} \quad (2)$$

where p is from equation (1).

The decision rules involve specifying the outcomes that classify the chemical's LD50 under the limit dose and the outcomes that involve classifying the LD50 as over the limit dose. Outcomes with more deaths tend to be associated with decision rules that classify the LD50 as under the limit dose. Suppose that n animals are to be dosed all at once with a decision rule that m or more deaths are required to classify the LD50 as under the limit dose. Then the probability that m or more deaths occur is given in equation (3) as

$$P(LD50 \leq LimitDose) = \sum_{j=m}^n P(j; n, p) \quad (3)$$

where $P(j; n, p)$ is given in the binomial distribution found in equation (2).

If the hypothetical LD50 is under the limit dose, then the accuracy of a test is measured by adding all the probabilities for the outcomes that lead to classifying the LD50 as under the limit dose. This requires equation (3). On the other hand, if the LD50 for the chemical is above the limit dose, the accuracy is measured by adding all the probabilities associated with the outcomes that classify as over the limit dose. This can be computed as $1 - P(LimitDose \leq LD50)$.

So far, the discussion has assumed that there will be a fixed sample size. In such a plan, all animals are dosed at one time. For fixed sample size plans with n animals tested, the LD50 is considered to be below the limit dose when $n/2$ or more animals die (n even) or $(n+1)/2$ or more die (n odd). For example, three or more deaths out of five animals, or five or more deaths with ten animals would be classification rules for establishing the LD50 dose below the limit dose.

Sequential sampling plans are defined to have a nominal size of n animals, indicating that no more than n animals can be dosed. Animals are dosed one or two at a time, depending on the outcomes from earlier animals in the same study. Sequential sampling plans can follow almost the same decision rules for classifying outcomes, with the exception that once enough animals survive or die to reach a conclusion, it becomes unnecessary to test more animals. When sequential sampling plans have the same decision rules as fixed sampling plans, they have the same accuracy. However, sequential plans do not have to follow the same rules and can take advantage of the order of survivals or deaths. A sequential plan can have a rule like "if the first or second animal dies then ..."

The sequential plans that are considered in this paper depart from the "majority rule" classifications. They have the following general characteristics:

1. If the first animal dies, the chemical is suspected as having an LD50 below the limit dose. Limit testing is then discontinued and an up and down test conducted.
2. Otherwise animals are dosed one or two at a time. Testing is discontinued when $(n+1)/2$ die or survive (n odd).
3. If there were $(n+1)/2$ deaths, then the chemical is classified as having the LD50 below the limit dose. If the testing is discontinued when $(n+1)/2$ animals survive, the chemical is classified as having an LD50 above the limit dose. For example, in a five animal test plan with the first animal surviving, the LD50 would be classified as under the limit dose as soon as three die. It would be classified as over the LD50 if three (i.e. two more after the first) survive.

The first characteristic takes advantage of the order of deaths or survivals. This can only be done with sequential designs.

The equations presented above have only addressed the accuracy of a plan with a fixed sample size. When fixed and sequential plans have the same classification rules, such as “majority rules,” the procedures for calculating accuracy are identical, because the outcome probabilities are identical. However, equations (2) and (3) can be used with sequential testing plans even when there is no fixed plan equivalent. A mathematically correct, but tedious approach is to write all the fixed sample outcomes that would correspond to a sequential plan outcome and then sum all the probabilities. There are more clever approaches that take into account the independence of the events.

The last issue for this analysis is the computation of the expected or average number of animals used in a sequential sample plan. Recall that an animal used in the trial counts toward the expected value whether the animal survives or dies, because a surviving animal cannot be used for other tests. However, animals do not count if the test is discontinued before the animal is (scheduled to be) used. The various outcomes with different numbers of animals need to be identified and the probability of the simple events needs to be calculated. For example, here are the outcomes for a five sequential sample plan:

- one animal (the first animal dies)
- three animals all survivors (S SS),
- four animals (S DD D or S SD S or S DS S) or
- five animals (all other sequences)

Let j denote the number of animals used in a test plan. Then the expected number of animals used is given in equation (4)

$$ExpectedAnimalsUsed = \sum_{j=1}^n j \sum_{k \in J} p^k (1-p)^{n-k} \quad (4)$$

where p is given in equation (1) and J is the set of sequences that use j animals.

These equations are implemented in the SAS program in Appendix 2. Equation (1) is in the linked routine *getprob*, called in *data test*. Equation (2) computes the binomial distribution in the linked routine *fillprob*, also in *data test*. This step uses either the built-in binomial cumulative distribution function in the SAS function *probbnml* or the binomial density function in (*%macro pbinom*) or some combination of the two. The rules, which are specific to each test plan, are found in an external routine called by *fillprob*. An example is on the last page of the appendix shown as *rule5f.sas*. This produces the components of equation (3), with the summation completed by *proc summary* following the data step. The calculation for the expected value in equation (4) uses similar logic. This requires a separate run of the program with a different external routine to be linked in by *fillprob*. See *rule5x.sas* at the end of the appendix.

The question addressed in this paper is how these limit dose test plans work over a wide variety of chemicals. We used LD50 values of 1.5, 50, 250, 1500, 2000, 3000, 5000, and 6000 mg/kg body weight. Values for σ (the inverse of the slope of the dose response curve) were 0.12, 0.25, 0.5, 1.25, and 2.00. Each pair of LD50 and σ values were modeled, i.e. 1.5 and 0.12, 1.5 and 0.25, etc, resulting in a total of 40 values for each test plan.

Both fixed and sequential test plans were modeled. Fixed sample size plans of five, seven and ten animals and sequential plans using up to five and seven animals were modeled. Limit doses were evaluated at 2000 mg/kg and 5000 mg/kg. Tables for 2000 mg/kg are in Appendix 1.

Results

This section contains results for fixed and sequential test plans at 5000 mg/kg. First, the ten animal fixed sample test plan is presented. This is the present standard procedure for limit dose tests. Next, seven animal and five animal sequential test plans are shown. The purpose of these comparisons is to determine how much (or how little) is lost when using sequential test plans that economize on the number of animals.

In the third part of the results section, fixed sample size plans with seven and five animals are presented. The purpose is to examine the difference between fixed and sequential using the same nominal number of animals. The next part of the section compares results between fixed and sequential sampling plans. The last part of the section presents the expected number of animals used in five and seven animal test plans.

The appendix contains tables in the same sequence for the 2000 mg/kg results.

The results show for each combination of LD50 and σ , the probability that the limit dose plan classifies correctly.

Ten Animal Fixed Sample (5000 mg/kg limit dose)

Table 1 shows the probability of correct classifications using the ten animal fixed sample test plan for the 5000 mg/kg limit dose.

Table 1
Probability of Correct Classification for Ten Animal Fixed Plan
(Limit Dose = 5000 mg/kg)

LD50	σ					
	0.12	0.25	0.5	1.25	2	
1.5	1.00	1.00	1.00	1.00	1.00	1.00
50	1.00	1.00	1.00	1.00	1.00	1.00
250	1.00	1.00	1.00	1.00	1.00	0.98
1500	1.00	1.00	1.00	1.00	0.92	0.84
2000	1.00	1.00	0.99	0.87	0.87	0.80
3000	1.00	1.00	0.93	0.78	0.78	0.73
5000	0.62	0.62	0.62	0.62	0.62	0.62
6000	0.92	0.69	0.54	0.44	0.44	0.42

Rule: five or more deaths classifies as under the limit dose. A classification is correct if the LD50 is 5000 or below, and the outcome leads to a classification of 5000 or below. It is also correct if the LD50 is 6000 and the outcome leads to a classification of over 5000.

Each entry in the table represents the probability that the correct classification would occur given the values of the LD50, σ and the classification rule of five or more deaths classifies the LD50 below the limit dose. Table 1 shows that the plan is very accurate for chemicals with low LD50s. For example, the ten animal test plan is perfect (to 2 decimal places) with LD50s between 1.5 and 3000 mg/kg for $\sigma = 0.12$ and 0.25 . When $\sigma = 0.5$, there is a 93% correct classification rate at 3000 mg/kg. With σ at 2.0, there is a 98% correct classification rate at 250 mg/kg, 84% correct at 1500 mg/kg, 80% correct at 2000 and 73% correct at 3000.

To summarize the results from table 1, both low and high values of the LD50 produce the most accuracy.¹ Values close to the LD50 produce the least accuracy in fact, just above the limit dose of 5000 mg/kg, the accuracy is only (100%-62%=) 38%. The decision is correct at 5000 mg/kg if the outcome is consistent with under 5000 mg/kg. So at 5000 the probability of an incorrect decision is 38%. Just above 5000 mg/kg a decision is correct when the outcome is consistent with over 5000 mg/kg. For a dosage

¹ This finding is even more apparent in Appendix 1, which uses a limit dose of 2000 mg/kg. In the tables in the Appendix, 3000, 5000 and 6000 mg/kg are above the limit dose. The accuracy can be seen to increase as the LD50 becomes much greater than the limit dose.

infinitesimally greater than 5000, the outcomes would be just about the same as at 5000. So then the probability of a correct decision (over 5000) would be 38% and the probability of an incorrect decision (under 5000) would be 62%.

In a similar manner, increases in σ result in decreases in accuracy. Equation (1) shows that as σ increases, the term inside the parentheses approaches zero and the normal cumulative distribution function approaches 0.5. Consequently, when the LD50 is below the limit dose, increases in σ cause the accuracy to approach 62% asymptotically. When the LD50 is above the limit dose, increases in σ , would have the accuracy approaching 38%.

Also, increases in σ result in decreases in accuracy. However, the tests perform well in the upper part of the table, where the LD50 is low, representing the most toxic chemicals.

In the 10 animal fixed plan, the probability of a correct result when the LD50 is just below the limit dose is much greater than the probability of a correct result when the LD50 is slightly above the limit dose. This is a characteristic of a biased plan. Biased tests are discussed later in this paper.

Seven and Five Animal Sequential Test Plans

Tables 2 and 3 show seven and five animal sequential test plans.

Table 2

Probability of Correct Classification for Seven Animal Sequential Test Plan
(Limit Dose = 5000 mg/kg)

LD50	σ					
	0.12	0.25	0.5	1.25	2	
1.5	1.00	1.00	1.00	1.00	1.00	1.00
50	1.00	1.00	1.00	1.00	1.00	0.99
250	1.00	1.00	1.00	1.00	0.99	0.95
1500	1.00	1.00	0.99	0.89	0.89	0.82
2000	1.00	1.00	0.98	0.85	0.85	0.79
3000	1.00	0.98	0.90	0.78	0.78	0.74
5000	0.67	0.67	0.67	0.67	0.67	0.67
6000	0.72	0.53	0.43	0.37	0.37	0.35

Rule: LD50 is under limit dose if first animal dies, or 4 animals die. LD50 is over 5000 mg/kg if 4 animals survive.

Table 2 shows the same pattern as table 1. In comparing the probabilities between this plan and the 10 animal fixed plan of table 1, the results appear to be fairly close. The difference between correct classification probabilities for the two plans for LD50s at 3000 mg/kg and under is never more than 0.03. The difference of 0.03 is reached when σ is 0.5 at 3000 mg/kg, where table 1 shows 93% correct classification, while table 2 shows 90%. Also at $\sigma = 1.25$ and the LD50 of 1500, table 1 shows 92% correct classifications while table 2 shows 89%.

When the LD50 is equal to the limit dose, the seven animal sequential test plan has a correct classification probability of 67%, somewhat higher than the 62% in table 1. This means that for values slightly above the limit dose, the seven animal plan will be correct 33% of the time, while the 10 animal plan will be correct 38% of the time. For example as shown in table 1, 92% of the time chemicals with LD50s of 6000 mg/kg will be classified as above the limit dose at $\sigma=0.12$, while 72% of the time this will occur with the seven animal test plan.

Table 3 shows the correct classification probability from a five animal sequential test plan. The purpose of this table is to determine how much is lost by using a plan that would nominally have fewer animals.

Table 3

Probability of Correct Classification for Five Animal Sequential Test Plan
(Limit Dose = 5000 mg/kg)

LD50	σ					
	0.12	0.25	0.5	1.25	2	
1.5	1.00	1.00	1.00	1.00	1.00	
50	1.00	1.00	1.00	1.00	0.98	
250	1.00	1.00	1.00	0.98	0.93	
1500	1.00	1.00	0.98	0.86	0.79	
2000	1.00	1.00	0.96	0.82	0.76	
3000	1.00	0.97	0.87	0.75	0.72	
5000	0.66	0.66	0.66	0.66	0.66	
6000	0.71	0.53	0.44	0.38	0.37	

Rule: LD50 is under limit dose if first animal dies, or three animals die. LD50 is over if three animals survive.

As would be expected from a plan with fewer animals, the correct classification probabilities decrease somewhat from the seven animal plan in table 2. For LD50 values of 3000 mg/kg or lower, the largest difference between a five animal and ten animal plan is 6%. The largest differences occur in the same place as the seven animal plan compared with ten animals. These are at $\sigma = 1.25$ and LD50 = 1500 mg/kg (92% vs.

86%) and $\sigma = 0.5$ and $LD50 = 3000$ (93% vs. 87%). At an $LD50$ of 6000 mg/kg, the five animal test plan has almost the same results as the seven animal test plan, differing by less than 1% in probability of correct classification.

To summarize, five and seven animal sequential test plans produce very similar results to the ten animal fixed test plan. For low values of the $LD50$ the results are very close among all three plans. For values of the $LD50$ s over the limit dose, the sequential plans tend to classify correctly less frequently than the ten animal fixed dose plan. This means that more chemicals would be erroneously considered to have the $LD50$ below the limit dose. This type of misclassification is probably better than erroneously classifying the $LD50$ above the limit dose.

Before comparing the five and seven animal sequential plans with fixed sample size plans, it is important to address bias in test plans.

Bias

Some definitions are necessary. An unbiased test plan classifies the $LD50$ as under the limit dose with exactly the same probability that a single animal would die when administered the limit dose. That means $p = P(LD50 \leq \text{Limit Dose})$, where p is the probability of death and the probability $P(LD50 \leq \text{Limit Dose})$ can be found in equation (3). In general most plans will be somewhat biased, because the two probabilities will not be exactly equal. This is really a small sample problem.²

However, many but not all limit dose tests will be unbiased when $p = 0.5$. Since the value of p in equation (1) is 0.5 when the limit dose is equal to the $LD50$, a biased plan occurs when there are more outcomes resulting in a classification of under (over) 5000 than over (under) 5000. This means that all fixed sample size plans with an even number of animals and a majority rule classification scheme are biased. For example, with a two animal plan, no deaths would classify the $LD50$ as over the limit dose, while two deaths would classify it as under the limit dose. The way that one death would be classified would determine the direction of the bias.

Plans can be arbitrarily made to be biased as well. A fixed or sequential sample plan with an odd number of animals could be almost unbiased. However, a sequential plan could stop after the first death (as shown in this paper) classifying the outcome as under the limit dose. This plan would then be biased.

²For a very simple example, consider a fixed test plan with 3 animals. Outcomes associated with classification of a chemical's $LD50$ above the limit dose would be 0 or 1 death, while 2 or 3 deaths would lead to classification below the limit dose. An unbiased plan would put the probability of classification below the limit dose at p . It can be shown that the probability of 2 or 3 deaths is $p^2(3-2p)$ where p is the probability that an animal dies. The probability the chemical is classified below the limit dose is can be shown to be below p for $p \leq 0.5$ and above p for $p > 0.5$. Some values for this probability of 2 or 3 deaths, i.e. the probability that the chemical is classified below the limit dose are 0.03 ($p=0.1$), 0.16 ($p=0.25$), 0.5 ($p=0.5$), 0.84 ($p=0.75$), and 0.97 ($p = 0.9$).

Comparison Between Five and Seven Animal Fixed Sample Size Plans

Table 4 shows the probability of correct classifications for seven animal fixed test plans. Recall that a fixed test plan involves dosing all the animals at once.

Table 4
Probability of Correct Classification for Seven Animal Fixed Test Plan
(Limit Dose = 5000 mg/kg)

LD50	0.12	0.25	σ 0.5	1.25	2
1.5	1.00	1.00	1.00	1.00	1.00
50	1.00	1.00	1.00	1.00	0.99
250	1.00	1.00	1.00	0.99	0.92
1500	1.00	1.00	0.99	0.82	0.72
2000	1.00	1.00	0.96	0.76	0.67
3000	1.00	0.97	0.83	0.65	0.60
5000	0.50	0.50	0.50	0.50	0.50
6000	0.93	0.76	0.64	0.56	0.53

Rule: Classify as LD50 under the limit dose if four or more animals die, as over if four or more animals survive.

The differences between the seven animal plan and the ten animal plan are considerably greater than with the sequential plans considered in earlier tables. The reason is that the five and seven animal fixed plans are unbiased, in contrast to the sequential plans that are biased. For example, with an LD50 at 3000 mg/kg and $\sigma = 1.25$, the ten animal plan had a 78% chance of a correct classification, while the seven animal plan in table 4 had a 65% probability. Values of σ of 1.25 and 2.0 and LD50s between 1500 and 3000 generally had differences this large between the two plans. However, the seven animal fixed test plan classifies correctly more often than the ten animal plan for values of 6000 mg/kg. The seven animal plan is 76% correct at $\sigma = 0.25$ as compared with 69% for the ten animal plan. It is 53% correct, as compared with 42% correct at $\sigma = 2$.

For comparison, the five animal fixed sample test plan is shown below in table 5. The results are about the same as the seven animal plan with some small decreases in the percent correctly classified.

Table 5
Probability of Correct Classification for Five Animal Fixed Test Plan
(Limit Dose = 5000 mg/kg)

LD50	0.12	0.25	σ 0.5	1.25	2
1.5	1.00	1.00	1.00	1.00	1.00
50	1.00	1.00	1.00	1.00	0.97
250	1.00	1.00	1.00	0.97	0.89
1500	1.00	1.00	0.97	0.78	0.69
2000	1.00	1.00	0.93	0.72	0.65
3000	1.00	0.95	0.80	0.63	0.58
5000	0.50	0.50	0.50	0.50	0.50
6000	0.89	0.72	0.62	0.55	0.53

Rule: Classify as LD50 under the limit dose if three or more animals die, as over if three or more animals survive.

Comparison between fixed and sequential sampling plans

Fixed and sequential sampling plans that have the same decision rules will have the same accuracy. This does not require empirical estimates, instead just the understanding that the sequential plan would be identical to the fixed sample plan if the sequential plan is required (unnecessarily) to be carried out even after enough animals have been tested to reach a decision.

But the five and seven animal sequential plans have different rules than the fixed plans. Recall that the sequential plans in this paper stop the test with the death of the first animal. This cannot be done with the fixed plans. The result is that the sequential plans in this paper are more accurate than fixed when the test uses chemicals that have LD50s below the limit dose. The fixed plans are more accurate with chemicals that have an LD50 above the limit dose. When the LD50 is very low or very high and σ is low, both types of tests perform accurately.

Expected Number of Animals Used in Sequential Tests

The benefit of the sequential sample size plans over fixed sample size plans is a decrease in the number of animals used in the test. The expected number of animals used in seven and five animal sequential tests are shown in tables 6 and 7 below.

Table 6

Expected Number of Animals in Seven Animal Sequential Test Plan
(Limit Dose = 5000 mg/kg)

LD50	σ				
	0.12	0.25	0.5	1.25	2
1.5	1.00	1.00	1.00	1.01	1.16
50	1.00	1.00	1.00	1.23	1.73
250	1.00	1.00	1.02	1.68	2.26
1500	1.00	1.07	1.68	2.68	2.97
2000	1.00	1.24	2.02	2.87	3.09
3000	1.13	1.89	2.64	3.12	3.24
5000	3.41	3.41	3.41	3.41	3.41
6000	3.94	3.76	3.61	3.49	3.46

Note: for classification rules see table 2.

Table 6 shows that with low values of the LD50, on average slightly more than one animal is used. This is because the test plan calls for classifying LD50 as under the limit dose when the first animal dies. For chemicals with an LD50 of 1.5 or 50 or 250 mg/kg and a limit dose of 5000 mg/kg, survival of the first animal is unlikely.

On the other hand as the LD50 and σ or increases, more animals are required on average, approaching four. Four animals would be the exact number required for a chemical with an infinite LD50, as the most likely outcome to discontinue the test would be four survivals.

Table 7

Expected Number of Animals in Five Animal Sequential Test Plan
(Limit Dose = 5000 mg/kg)

LD50	0.12	0.25	σ 0.5	1.25	2
1.5	1.00	1.00	1.00	1.01	1.12
50	1.00	1.00	1.00	1.17	1.53
250	1.00	1.00	1.01	1.49	1.87
1500	1.00	1.06	1.49	2.13	2.30
2000	1.00	1.18	1.71	2.24	2.37
3000	1.10	1.63	2.10	2.39	2.46
5000	2.56	2.56	2.56	2.56	2.56
6000	2.93	2.79	2.69	2.62	2.60

Note: for classification rules see table 3.

Five animal test plans, as shown in Table 7, use fewer animals on average than seven animal sequential test plans. At low LD50's where the most likely outcome is the death of the first animal, the two test plans are not very different in average number of animals. As the LD50 increases, the expected number of animals approaches three, one animal fewer, on average than the seven animal test plan. Three animals would be the exact number required for a chemical with an infinite LD50, because the test termination conditions would be three consecutive survivals.

Appendix 1 shows similar results for the 2000 mg/kg limit dose plan.

Conclusion

From the analysis it appears that sequential testing plans based on five and seven animals classify adequately. This is especially true when the LD50 is either far below or far above the limit dose. The classification deteriorates when the LD50 approaches the limit dose. Classifications are also less accurate when the variance of the dose response curve (symbolized as σ^2) increases.

Theoretically, fixed sample size and sequential plans would have identical accuracy with the same decision rules. However, in contrast to fixed plans, sequential plans can use the order of survivals and deaths as part of the decision rules. The model shows that fixed and sequential plans perform equally well when the LD50 is low relative

to the limit dose and δ is also reasonably low. When the LD50 gets close to the limit dose, the sequential plans tend to perform better than the fixed plans. For values of the LD50 that are above the limit dose, the fixed plans classify more accurately. And finally, as the LD50 continues to increase, the sequential plans start to catch up with the fixed plans in accuracy. The reason for these differences between plans is the use of the bias in the sequential plans. This bias makes it that the more toxic chemicals with low values of the LD50 will be classified correctly.

The other benefit of the sequential plans is that they use fewer animals than the fixed plans. The OECD recommended plan that uses up to five animals sequentially, will average three or fewer animals depending on the LD50 and σ . A seven animal sequential test plan averages up to four animals. The five animal sequential plan produces results that are almost as good as the present ten animal fixed sample plan while averaging one to three animals per test. That is seven to nine fewer animals than the ten animal fixed sample plan.

References

Code of Federal Regulations (1997), "Commerical Practices: Subchapter C-Federal Hazardous Substances Act Regulations, part 1500 to 1512, Revised as of January 1, 1997.

Dixon W J (1991), "Design and Analysis of Quantal Dose-Response Experiments (with Emphasis on Staircase Designs)." Dixon Statistical Associates, Los Angeles, CA.

OECD draft Guideline 425(2000).

Springer JA, Chambers WA, Green S, Gupta KC, Hills RN, Hurley PM, Lambert LA, Lee CC, Lee JK, Liu PT, Lowther DK, Roberts CD, Seabaugh VM and Wilcox NL (1993), "Number of Animals for Sequential Testing," *Food and Chemical Toxicology*, 31,2 pp 105-109.

Appendix 1

Limit Dose Test Results for 2000 mg/kg

The tables below present the limit test dose results for 2000 mg/kg. The order is the same as in the text. The first five tables present the probability of correct classifications as follows:

- Table A1: Ten Animals, Fixed Sample Size
- Table A2: Seven Animals Sequential Test
- Table A3: Five Animals Sequential Test
- Table A4: Seven Animals Fixed Sample Size
- Table A5: Five Animals Fixed Sample Size

The last two tables present the expected numbers of animals in the seven and five animal sequential tests.

The results are generally the same as for the 5000 mg/kg dosages. The U-shaped probability function is more apparent in these tables because there are three values of the LD50 above the limit dose (3000, 5000 and 6000 mg/kg). In general the five animal variable sample size plan works adequately.

Table A1

Probability of Correct Classification for 10 Animal Fixed Plan
(Limit Dose = 2000 mg/kg)

LD50	0.12	0.25	σ 0.5	1.25	2
1.5	1.00	1.00	1.00	1.00	1.00
50	1.00	1.00	1.00	1.00	0.99
250	1.00	1.00	1.00	0.99	0.93
1500	1.00	0.95	0.83	0.72	0.68
2000	0.62	0.62	0.62	0.62	0.62
3000	1.00	0.93	0.72	0.52	0.47
5000	1.00	1.00	0.96	0.69	0.58
6000	1.00	1.00	0.98	0.75	0.62

Majority Rule Classification.

Table A2

Probability of Correct Classification for Seven Animal Sequential Test Plan
(Limit Dose = 2000 mg/kg)

LD50	0.12	0.25	σ 0.5	1.25	2
1.5	1.00	1.00	1.00	1.00	1.00
50	1.00	1.00	1.00	1.00	0.98
250	1.00	1.00	1.00	0.97	0.90
1500	0.99	0.92	0.82	0.73	0.71
2000	0.67	0.67	0.67	0.67	0.67
3000	0.93	0.73	0.55	0.42	0.39
5000	1.00	0.94	0.77	0.53	0.46
6000	1.00	0.97	0.82	0.57	0.48

Rule: LD50 is under limit dose if first animal dies, or four animals die. LD50 is over 2000 mg/kg if four animals survive.

Table A3

Probability of Correct Classification for Five Animal Sequential Test Plan
(Limit Dose = 2000 mg/kg)

LD50	0.12	0.25	σ 0.5	1.25	2
1.5	1.00	1.00	1.00	1.00	1.00
50	1.00	1.00	1.00	0.99	0.96
250	1.00	1.00	1.00	0.94	0.87
1500	0.98	0.89	0.79	0.71	0.69
2000	0.66	0.66	0.66	0.66	0.66
3000	0.93	0.72	0.55	0.43	0.40
5000	1.00	0.94	0.76	0.53	0.46
6000	1.00	0.97	0.82	0.57	0.48

Rule: LD50 is under limit dose if first animal dies, or three animals die. LD50 is over 2000 mg/kg if three animals survive.

Table A4

Probability of Correct Classification for Seven Animal Fixed Test Plan
(Limit Dose = 2000 mg/kg)

LD50	0.12	0.25	σ 0.5	1.25	2
1.5	1.00	1.00	1.00	1.00	1.00
50	1.00	1.00	1.00	1.00	0.96
250	1.00	1.00	1.00	0.94	0.84
1500	0.99	0.86	0.71	0.59	0.55
2000	0.50	0.50	0.50	0.50	0.50
3000	1.00	0.94	0.78	0.62	0.58
5000	1.00	1.00	0.96	0.76	0.67
6000	1.00	1.00	0.98	0.80	0.70

Rule: Classify as LD50 under the limit dose if four or more animals die, as over if four or more animals survive.

Table A5

Probability of Correct Classification for Five Animal Fixed Test Plan
(Limit Dose = 2000 mg/kg)

LD50	0.12	0.25	σ 0.5	1.25	2
1.5	1.00	1.00	1.00	1.00	1.00
50	1.00	1.00	1.00	0.99	0.93
250	1.00	1.00	1.00	0.91	0.80
1500	0.97	0.83	0.68	0.57	0.55
2000	0.50	0.50	0.50	0.50	0.50
3000	1.00	0.91	0.75	0.60	0.57
5000	1.00	1.00	0.93	0.72	0.65
6000	1.00	1.00	0.96	0.76	0.67

Rule: Classify as LD50 under the limit dose if three or more animals die, as over if three or more animals survive.

Table A6

Expected Number of Animals in Seven Animal Sequential Test Plan
(Limit Dose = 2000 mg/kg)

LD50	0.12	0.25	σ 0.5	1.25	2
1.5	1.00	1.00	1.00	1.03	1.25
50	1.00	1.00	1.00	1.44	2.01
250	1.00	1.00	1.15	2.14	2.62
1500	1.68	2.53	3.00	3.25	3.31
2000	3.41	3.41	3.41	3.41	3.41
3000	4.00	3.95	3.79	3.59	3.53
5000	4.00	4.00	3.97	3.76	3.65
6000	4.00	4.00	3.99	3.81	3.69

Note: for classification rules see table A2.

Table A7

Expected Number of Animals in Five Animal Sequential Test Plan
(Limit Dose = 2000 mg/kg)

LD50	0.12	0.25	σ 0.5	1.25	2
1.5	1.00	1.00	1.00	1.02	1.19
50	1.00	1.00	1.00	1.32	1.71
250	1.00	1.00	1.11	1.79	2.09
1500	1.49	2.03	2.31	2.47	2.50
2000	2.56	2.56	2.56	2.56	2.56
3000	3.00	2.94	2.81	2.68	2.64
5000	3.00	3.00	2.96	2.80	2.72
6000	3.00	3.00	2.98	2.83	2.75

Note: for classification rules see table A3.

Appendix 2 SAS Program

```
*****
program to compute correct classification property and
  expected values of the number of animals used
  for limit doses

  michael a. greene
  division of hazard analysis
  us consumer product safety commission

  last modified 1/19/2000
*****;

%macro pbinom(n,x,p);
  /* binomial pdf, used in data step;
  ((gamma(&n+1)/ (gamma(&x+1) * gamma(&n-&x+1)))
  * (&p**&x) * (1-&p)**(&n-&x))
  %mend;

%macro prt(ds=,title=);
title &title;
data _null_; /* pretty printing */
  retain temp1-temp&nsigma;
  array temp {*} temp1-temp&nsigma;
  file print;
  set &ds;
  by ld_50;
  if first.ld_50 then i=0;
  i+1;
  temp{i}=t_prob;
  if last.ld_50 then put ld_50 6.1 (temp{*) (8.4);
%mend;

data doseres;                                * read in sigmas and ld50s;
  infile cards missover;
  retain sigmal-sigma99 ld1-ld99;
  input sigmal-sigma99;
  input ld1-ld99;
  call symput("nsigma",trim(left(put(n(of sigmal-sigma99),2.))));
  call symput("nld", trim(left(put(n(of ld1-ld99)          ,2.))));
cards;
0.12 0.25 .5 1.25 2
1.5 50 250 1500 2000 3000 5000 6000
;

proc print data=doseres;
  var sigmal-sigma&nsigma ld1-ld&nld;
  title1 "dose response assumptions";
run;
```

```

*****
this datastep uses the inputted slopes and ld50s from doseres
to compute the classification probabilities
*****;

data test;
  retain dose 2000.; *test dosage.  always 5000 micrograms per kg;

  keep  sigma ld_50 rule prob t_prob dose;
  retain signal-sigma&nsigma ld1-ld&nld;

  array  sigmaex {*} signal-sigma&nsigma; /* animal char sigma */
  array  ld50x  {*}  ld1-ld&nld;          /* animal ld 50      */

  set doseres;                               /* ld50s and sigmas */

  do i = 1 to &nld;
    ld_50=ld50x{i};          /* get an ld50      */
    do j = 1 to &nsigma;
      sigma = sigmaex{j};/* get a sigma      */
      link getprob;      /* get the one animal death probability */
      link fillprob;    /* get multi animal death probabilities */
    end;
  end;
  return;

getprob:  /* probability of a single animal dying */
  prob = probnorm( (log10(dose) - log10(ld_50))/sigma);
/* probit fn */
return;

fillprob:

%inc "g:\users\epha\mag\pig\425\rule7.sas"; *y=# yx=expectedval;

return;

/* add up the cases by ld50 sigma and rule */
proc summary data=test;
  class ld_50 sigma rule;
  var t_prob;
  output out=new sum=t_prob;

data over under;
  set new;
  if _type_ = 7 & not(rule) then output under;
  else if _type_=7 & rule then output over;

%prt(ds=over,title="Over 5000");
run;
%prt(ds=under,title="Under 5000");
run;

```

```

* rule5.sas 5 animal variable plan;

rule=0; /* toxic */

t_prob=prob;          output;
*1 animal dies;

t_prob=(1-prob)*(prob**3);    output;
*S DDD;

t_prob=(1-prob)*%pbinom(3,2,prob)*prob ;output;
*S XXX D   XXX=2 of 3 D;

rule=1; /* over */

t_prob=(1-prob)**3;          output;
*3 survivors;

t_prob=(1-prob)*%pbinom(2,1,prob)*(1-prob); output;
*S XX  S XX=1 of 2 D;

t_prob=(1-prob)*%pbinom(3,2,prob)*(1-prob); output;
*S XXX S XXX=2 of 3 D;

* rule5x.sas  expected value computation 5 animal variable plan;

rule = 0; /* toxic ...not used in expected value computations*/

t_prob = prob;          output;
*1 animal dies;

t_prob = 4* (1-prob)*(prob**3);    output;
*S DDD;

t_prob = 5*(1-prob)*%pbinom(3,2,prob)*prob ; output;
*S XXX D   XXX=2 of 3 D;

t_prob = 3*(1-prob)**3;          output;
*3 survivors;

t_prob = 4*(1-prob)*%pbinom(2,1,prob)*(1-prob);  output;
*S XX S XX=1 of 2 D;

t_prob=5*(1-prob)*%pbinom(3,2,prob)*(1-prob);  output;
*S XXX S           XXX=2 of 3 D;

```

APPENDIX N

Proposed UDP Supplemental Procedure to Estimate Slope and Confidence Interval

N-1	Considerations for Supplemental Procedure to Estimate Slope and Confidence Intervals (D. Farrar, U.S. EPA – 04/06/2000)	N-3
N-2	Supplemental Procedure to Determine Slope and Confidence Interval (D. Farrar, U.S. EPA – 04/06/2000)	N-5
N-3	Summary Tables (Comparison of Various Supplemental Procedures to Determine LD50, CI and Slope) (K. Gupta, U.S. CPSC - 04/05/2000)	N-9
N-4	Simulation Tables and Legends (K. Stitzel and G. Carr, Proctor & Gamble Company - 04/05/2000)	N-23
N-5	Additional Simulations: Supplemental Procedures to Determine Slope (D. Farrar, U.S. EPA - 03/27/2000)	N-105

April 6, 2000

Considerations For Supplemental Procedure To Estimate Slope And Confidence Intervals

In order to design a procedure to yield estimates of slope and confidence intervals, a great many methods were tried by means of computer simulation. Performance criteria USED were the accuracy of the median LD50 and slope calculated and the 95/5% ratios for slope. For situations with very high slopes, the ratio of 95%/median slope prediction was found to be more reliable.

Three approaches were found to yield reasonable results: (a) multiple independent Up-Down dosing sequences, with fixed dose progressions of 0.5 log units and testing stopping after the first reversal of outcome (nominal sample size 2), (b) a hybrid procedure using groups of 5 - 10 animals at each of two or three doses in the tails and the mid-point of the dose-response curve, and (c) multiple independent Up-Down sequences with nominal sample size 2 but with variable dose progression factors ranging from 2 log units to 0.125 log units. Each procedure is meant to be supplemental to the primary tier I procedure used to determine LD50. For each case, results of supplemental testing were pooled and combined with data from the tier I analysis and probit analyses were performed to estimate slope, confidence intervals, and LD50.

The hybrid procedure, case (b), could not be optimized for both high slope and low slope situations. Setting multiple doses at each of LD13, LD40, and LD70 worked best for steep slopes (slope of 8.3). Setting multiple doses at LD13, LD45 and LD87 worked best for shallow slopes (slope of 2).

Procedure (a) performed well for simulations with assumed slopes from 2 to 8 and demonstrated efficient use of animals. The optimum procedure was to use 4 modified Up-Down sequences, each starting in the region of 3 standard deviations from the approximate LD50 determined in tier I (denoted 4,3). The starting doses were offset slightly to spread out dosing as much as possible. Additional independent sequences did not provide significantly improved performance. Two variations of this "4,3" method were tried: The first was to start all dose progressions below the LD50; the second was to start two dose progressions below and two above the LD50. They were found to be roughly comparable in performance. Starting all four sequences below the LD50 is likely to lead to fewer deaths in the test animals, whereas starting two sequences above and two below is slightly more efficient in terms of overall animal usage.

The procedure in case (c) used variable dose progressions to accommodate a wide range of possible slopes. It uses somewhat more animals, but may be warranted when chemicals are anticipated to have highly variable results. For example, although laboratory rats are inbred to minimize variability in response to xenobiotic chemicals, birds and other species chosen as surrogates for wildlife are generally outbred.

The modified 4,3 Up-Down procedure described in case (a) was chosen as the supplemental procedure for the draft 425 guideline since it performs well and is reasonably efficient in animal usage. The procedure with variable dose spacing described in case (c) was inserted as an alternate supplemental method in appendix IV.

April 6, 2000

SUPPLEMENTAL PROCEDURE TO DETERMINE SLOPE AND CI

Introduction:

The improved single sequence Up and Down Procedure (UDP) provides a reasonable estimate of the LD₅₀. However, it does not provide an acceptable estimation of slope for the dose-response curve, or confidence intervals of LD₅₀ and slope. Among others, the US needs, data on the slope of the dose response curve. At the OECD working group meeting last March the US agreed to attempt to develop a method to calculate slope and confidence intervals around the LD₅₀ and slope. Because the original UDP procedure, which calls for several test doses after the first reversal of outcome, concentrates most of the doses near the LD₅₀, it is not an efficient method for estimating slope.

Results were improved using two approaches involving a modified up and down testing procedure: (1) multiple sequence UDP runs, and (2) a hybrid approach, a combination of the initial up and down procedure and replicate doses at each of two or three doses, are presented in this summary document. To maximize use of already developed data, both revisions focused on a tiered approach and built on the values determined in the initial test for LD₅₀. For this task, several approaches were tried using computer simulations. Tables summarizing all the simulations are presented in the Appendix with with arabic numbers; actual simulations are tabulated with roman numbers.

Each summary table shows, for comparison, "BEST CASE" simulations in which the correct LD₅₀ and slope was used to assess the expected performance of two groups of 15 animals, dosed at each of LD₁₃ and LD₈₇. This simulation provides a standard for comparison of other simulations in the tables, although it can not be duplicated in the laboratory because It was assumed that the Investigator knew and used the correct LD₅₀ and slope values to set the doses given. (See Best Case Simulation Table I).

All simulation trials, except the Best Case, utilized the estimated LD₅₀ from the primary (tier I) single sequence UDP. Simulations involving one to two thousand trials each, were used to assess performance of animal populations with sigma 0.12, 0.5, 1.25, and 2, (and in some cases 0.25) corresponding to slopes of 8.3, 2.0, 0.8, and 0.5 (and 4). Tables focus on simulations that converged to estimates. In addition, actual dose and response data from the primary UDP approach were combined with additional data from the supplemental procedure (tier II) for calculation of slopes and LD₅₀ values. Several dose selection procedures were simulated in an attempt to move toward the ideal dosing situation, but because the actual slope of the dose-response curve is not known when the doses are selected for study, it is difficult to devise selection rules that provide for the variety of possible slopes. Because this work was done simultaneously with development of the improved UDP, simulations for tier I were performed without use of the final stopping rule and with a nominal size of seven; i.e., the test was stopped when six additional animals had been dosed after the first reversal (death) occurred.

Early Trials to Determine Slope

In developing the optimized approaches, discussed above, preliminary simulations using the basic unmodified Up-and-Down procedure were performed and found not to provide adequate performance. For completeness they are described here.

Slope Averaging From a Series of Up and Down Sequences:

Initially we attempted to use a series of UDP procedures and average the results of the individual estimates of slope (Simulation Tables VIII, IX). . This was an estimation approach developed in consultation by W. Dixon. The results of these simulations indicated that the estimate of slope depends critically upon the original assumed slope and are not accurate if the actual slope is considerably different from the assumed slope. In addition, because the basic UDP procedure concentrates most of the meaningful results near the LD50, continued work on this approach was deemed not useful for estimating slope.

Probit calculation Using Three Independent Up and Down Sequences:

Next, we used the same UDP procedure but pooled all the results from the three runs and developed an estimate of slope using a probit analysis (Simulation Table XII). This change also did not provide acceptable results because of the large number of doses administered very near the middle of the dose-response curve, in the region of the LD50, while the most efficient slope estimations are provided when dose-related partial kills are observed at doses on both ends of the dose-response curve.

Optimized Approaches

Hybrid Approach, Multiple Doses at Each of Two or Three levels Following a Single Up and Down Sequence:

The hybrid procedure uses groups of animals dosed at the tails of the dose-response curve. In these simulations we assumed a single UDP run was run first to obtain an estimate of the LD50 and then the subsequent doses (LD13, LD40, LD45, LD70 or LD87) were chosen based on that estimate together with an arbitrary assumed slope of 1. The procedure is summarized as the Hybrid approach and the results provided in Tables 1A, 2A, 3A, and 4A. Also see Simulation Tables II, III, and IV.

Various combinations of sample sizes and doses were simulated to test the performance of the hybrid approach combining information from the tier I UDP with responses from replicate groups of animals mainly dosed at the tails of the dose-response curve. After estimation of the LD50 using the tier I UDP, doses were selected from among LD13, LD40, LD45, LD70, LD87, calculated using an assumed slope of one. Data from tier I were also included in the analysis.

Multiple Independent Up and Down Sequences Using a Modified Dosing Procedure:

Finally, recognizing that even animal-efficient slope estimates require larger numbers of animals at the tails of the dose-response curve, we attempted to utilize a modified UDP-based procedure. For these simulations we assumed the dose-response curve would be symmetrical and to reduce the number of animals that would die during the test, we attempted to define only the bottom half of the curve. Additionally, to maximize the number of animals at the tails of the dose-response curve, we began each test either two or three sigmas (in this case sigma was assumed to be 0.5) below the LD50. Also, in order to make efficient use of animals, each run stopped when the first animal died; that is, a run of nominal size 2. This procedure ensures that testing is distributed along the dose-response curve and minimizes unnecessary doses near the LD50. To do otherwise would be less efficient in animal use with little or no return in information about slope. The simulations are described below (Simulation Tables V, VI) and results are presented in Tables 1B, 2B, 3B, 4B and 5.

3, 4, 5, and 6 sequences were tested with starting doses near two sigma units or three sigma units below the LD50 (as estimated by a single UDP). Starting doses were staggered or offset in order to minimize duplicate testing at any one dose level. These sequences were in addition to the UDP sequence used in tier I, however, data from tier I were included in the analysis. Starting doses at two sigmas below the estimated LD50 did not perform in an acceptable fashion and so thereafter, starting doses were set at 3 sigmas below. Results from all independent dosing sequences were pooled to estimate slope, LD50 and confidence intervals using probit analysis.

Results of Optimized Procedures

The attached Summary Tables 6, 7, 8, and 9 provide the results of these simulations, with results regarded as acceptable, based on combined evaluation of median slope value ($< \pm 5\%$), ratio of 95 percentile and 5 percentile (< 6 , except for slope of 0.5 when < 10 was acceptable), and difference between highest and median values (difference $<$ value of sigma for sigma of 0.12 and 0.5 and difference $<$ twice sigma for sigma of 1.25 and 2), in light of similar results for the BEST CASE, are shown in boldface type.

Table 1A
COMPARISON OF VARIOUS SUPPLEMENTAL PROCEDURES TO DETERMINE
LD₅₀, CI and Slope (Hybrid Method)

METHOD	ESTMATED LD ₅₀ (range)	ESTIMATED SIGMA				ANIMALS USED Median
		MEDIAN (range)	Factor 95%/5%	Difference High-Median	Slope	
(2000 simulations each unless specified in the footnote)						
TRUE SIGMA 0.12				Slope 8.3		
BEST CASE ¹	250 (199-314)	0.12 (0.09-0.185)	2.0	0.06	8.3	30+
10 at LD13, 45, & 70²	250 (200-291)	0.13 (0.036-0.21)	5.8	0.08	7.6	30
7 at LD13, 45, & 70³	250 (205-297)	0.15 (0.032-0.22)	6.2	0.07	6.7	21
5 at LD13, 45, & 70⁴	250 (199-304)	0.12 (0.036-0.23)	6.4	0.11	8.3	15
10 at LD13 & 70; & 5 at 45⁵	250 (192-304)	0.12 (0.036-0.21)	5.8	0.09	8.3	25
10 at LD13 & 45⁶	250 (209-293)	0.129 (0.036-0.23)	6.3	0.10	7.8	20
10 at LD13 & 70 ⁷	169 (169-203)	0.23 (0.23-30)				
10 at LD13, 40, & 87 ⁸	291 (241-308)	0.211 (0.118-0.268)	2.3	0.075	4.7	30
10 at LD13, 40, & 87 ⁹	291 (241-305)	0.18 (0.12-0.27)	2.3	0.09	4.7	30
7 at LD13, 40, & 87 ¹⁰	296 (238-308)	0.2 (0.15+P54-0.28)	2.0	0.08	5.0	21
5 at LD13, 40, & 87 ¹¹	282 (230-307)	0.22 (0.17-0.29)	1.7	0.07	4.5	15
10 at LD13 & 87; & 5 at 40 ¹²	282 (230-307)	0.22 (0.17-0.27)	1.6	0.05	4.5	20
10 at LD13 and LD87	NONE	CONVERGED				

¹ Only includes the 769 out of 1000 runs that converged

³ Only includes the 1047 runs that converged

⁵ Only includes the 929 runs that converged

⁷ Only includes the 59 runs that converged

⁹ Only includes the 584 runs that converged

¹¹ Only includes the 418 runs that converged

² Only includes the 1154 runs that converged

⁴ Only includes the 884 runs that converged

⁶ Only includes the 575 out of 1000 runs that converged

⁸ Only includes the 315 out of 1000 runs that converged

¹⁰ Only includes the 496 runs that converged

¹² Only includes the 428 runs that converged

Table 1B
COMPARISON OF VARIOUS SUPPLEMENTAL PROCEDURES TO DETERMINE
LD₅₀, CI and Slope (Multiple UDP)

METHOD	ESTMATED LD ₅₀ (range)	ESTIMATED SIGMA				ANIMALS USED Median
		MEDIAN (range)	Factor 95%/5%	Difference High-Median	Slope	
(2000 simulations each unless specified in the footnote)						
		TRUE SIGMA 0.12		Slope 8.3		
BEST CASE ¹	250 (199-314)	0.12 (0.09-0.185)	2.0	0.06	8.3	30+
Multiple UDP 6, 3²	251 (207-312)	0.1 (0.035-0.21)	6.0	0.10	10	30
Multiple UDP 5, 3³	250 (202-305)	0.12 (0.032-0.20)	6.25	0.08	8.3	25
Multiple UDP 4,3⁴	247 (197-318)	0.119 (0.074-0.23)	3.1	0.11	8.4	21
Multiple UDP 4,2⁵	249 (196-318)	0.119 (0.074-0.22)	3.0	0.10	8.4	16
Multiple UDP 3,3 ⁶	248 (191-326)	0.098 (0.058-0.227)	3.9	0.129	10.2	16
Current 401* (LD ₅₀ =50)	51 (46-54)	0.04 (0.02-0.05)	2.5	0.01	25	15

¹ Only includes the 769 out of 1000 runs that converged

³ Only includes the 1272 runs that converged

⁵ Only includes the 542 out of 1000 runs that converged

* Five at 20, 50, and 100 mg/kg, and 130 out of 1000 runs converged

² Only includes the 1147 runs that converged

⁴ Only includes the 513 out of 1000 runs that converged

⁶ Only includes the 507 out of 1000 runs that converged

Table 2A
COMPARISON OF VARIOUS SUPPLEMENTAL PROCEDURES TO DETERMINE
LD₅₀, CI and Slope (Hybrid Method)

METHOD	ESTMATED LD ₅₀ (range)	ESTIMATED SIGMA				ANIMALS USED Median
		MEDIAN (range)	Factor (95%/5%)	Difference High-Median	Slope	
(2000 simulations each unless specified in the footnote)						
		TRUE SIGMA 0.5			Slope 2	
BEST CASE ¹	250 (146-427)	0.507(0.375-0.769)	2.05	0.262	2	30+
10 at LD13, 45, & 70²	257 (155-418)	0.44 (0.13-0.72)	5.5	0.28	2.3	30
7 at LD13, 45, & 70 ³	265 (141-447)	0.41 (0.064-0.75)	11.7	0.34	2.44	21
5 at LD13, 45, & 70 ⁴	255 (136-477)	0.41 (0.040-0.81)	11.7	0.40	2.44	15
10 at LD13 & 70; & 5 at 45 ⁵	265 (150-482)	0.44 (0.12-0.73)	6	0.29	2.3	25
10 at LD13 & 45 ⁶	216 (89.2-402)	0.24 (0.026-0.778)	29	0.53	4.1	20
10 at LD13 & 70⁷	268 (143-488)	0.45 (0.30-0.77)	2.6	0.32	2.2	20
10 at LD13, 40, & 87 ⁸	228 (122-425)	0.369 (0.048-0.711)	32.5	0.342	2.7	30
10 at LD13, 40, & 87⁹	228 (131-423)	0.39 (0.15-0.71)	4.8	0.32	2.6	30
7 at LD13, 40, & 87¹⁰	230 (114-453)	0.37 (0.19-0.74)	3.9	0.37	2.7	21
5 at LD13, 40, & 87¹¹	230 (110-471)	0.36 (0.20-0.76)	3.8	0.40	2.8	15
10 at LD13 & 87; & 5 at 40¹²	231 (130-448)	0.41 (0.21-0.72)	3.4	0.31	2.4	25
10 at LD13 and LD87	245 (123-494)	0.58 (0.38-0.79)	2.1	0.21	1.72	20

¹ Only includes the 783 out of 1000 runs that converged

³ Includes all runs, however 63 did not converge

⁵ Includes all runs, however 42 did not converge

⁷ Only includes the 1727 runs that converged

⁹ Includes all runs, however 93 did not converge

¹¹ Only includes the 1705 runs that converged

¹³ Only includes the 1104 runs that converged

² Includes all runs, however 30 did not converge

⁴ Includes all runs, however 85 did not converge

⁶ Includes all 1000 runs, however 75 did not converge

⁸ Includes all 1000 runs, however 11 did not converge

¹⁰ Only includes the 1803 runs that converged

¹² Only includes the 1753 runs that converged

Table 2B
COMPARISON OF VARIOUS SUPPLEMENTAL PROCEDURES TO DETERMINE
LD₅₀, CI and Slope (Multiple UDP)

METHOD	ESTMATED LD ₅₀ (range)	ESTIMATED SIGMA				ANIMALS USED Median
		MEDIAN (range)	Factor (95%/5%)	Difference High-Median	Slope	
(2000 simulations each unless specified in the footnote)						
TRUE SIGMA 0.5				Slope 2		
BEST CASE ¹	250 (146-427)	0.507(0.375-0.769)	2.05	0.262	2	30+
Multiple UDP 6, 3²	247 (138-444)	0.42 (0.18-0.74)	4.1	0.32	2.38	30
Multiple UDP 5, 3³	250 (138-455)	0.41 (0.15-0.75)	5	0.34	2.44	25
Multiple UDP 4,3	247 (131-469)	0.4 (0.147-0.761)	5.17	0.361	2.5	21
Multiple UDP 4,2	249 (131-470)	0.38 (0.083-0.82)	9.9	0.44	2.6	16
Multiple UDP 3,3	250 (129-490)	0.37 (0.011-0.75)	68	0.38	2.7	15
Current 401* (LD ₅₀ =50)	51 (19-155)	0.41 (0.04-1.5)	37.5	1.09	2.4	15

¹ Only includes the 783 out of 1000 runs that converged

² Includes all runs, however 14 did not converge

³ Includes all runs, however 22 did not converge

*Five at 20, 50, and 100 mg/kg, and 1930 runs converged

Table 3A
COMPARISON OF VARIOUS SUPPLEMENTAL PROCEDURES TO DETERMINE
LD₅₀, CI and Slope (Hybrid Method)

METHOD	ESTMATED LD ₅₀ (range)	ESTIMATED SIGMA				ANIMALS USED Median
		MEDIAN (range)	Factor 95%/5%	Difference High-Mean	Slope	
(2000 simulations each unless specified in the footnote)						
TRUE SIGMA 1.25					Slope 0.8	
BEST CASE ¹	250 (65.4-955)	1.27 (0.938-1.92)	2.0	0.65	0.79	30+
10 at LD13, 45, & 70²	237 (76-875)	1.06 (0.53-2.6)	4.9	1.54	0.94	30
7 at LD13, 45, & 70³	226 (58-925)	1.0 (0.47-2.8)	5.9	1.8	1.0	21
5 at LD13, 45, & 70 ⁴	242 (55-1103)	0.91 (0.36-3.0)	8.3	2.09	1.1	15
10 at LD13 & 70; & 5 at 45⁵	243 (67-973)	1.1 (0.5-2.8)	3.4	1.7	0.9	25
10 at LD13 & 45 ⁶	182 (36-998)	0.96 (0.2-3.37)	16.8	2.41	1.04	20
10 at LD13 & 70⁷	244 (63-1060)	1.1 (0.53-2.6)	4.9	1.5	0.9	20
10 at LD13, 40, & 87⁸	242 (80.8-762)	1.13 (0.63-2.21)	3.5	1.08	0.88	30
10 at LD13, 40, & 87	248 (75-760)	1.14 (0.63-2.2)	3.5	1.06	0.87	30
7 at LD13, 40, & 87⁹	236 (67-925)	1.1 (0.57-2.6)	4.5	1.5	0.90	21
5 at LD13, 40, & 87 ¹⁰	244 (55-1238)	1.0 (0.34-2.9)	2.9	1.9	1.0	15
10 at LD13 & 87; & 5 at 40¹¹	236 (75-833)	1.1 (0.61-2.4)	3.9	1.3	0.9	25
10 at LD13 and LD87 ¹²	251 (27-2269)	1.7 (0.88-7.5)	8.5	5.8	0.64	20

¹ Only includes the 768 out of 1000 runs that converged

³ Includes all runs, however 1 did not converge

⁵ All runs converged

⁷ Includes all runs, however 1 did not converge

⁹ Includes all runs, however 2 did not converge

¹¹ Includes all runs, however 3 did not converge

² All runs converged

⁴ Includes all runs, however 8 did not converge

⁶ All 1000 runs converged

⁸ All 1000 runs converged

¹⁰ Includes all runs, however 8 did not converge

¹² Includes all runs, however 16 did not converge

Table 3B
COMPARISON OF VARIOUS SUPPLEMENTAL PROCEDURES TO DETERMINE
LD₅₀, CI and Slope (Multiple UDP)

METHOD	ESTMATED LD ₅₀ (range)	ESTIMATED SIGMA				ANIMALS USED Median
		MEDIAN (range)	Factor 95%/5%	Difference High-Mean	Slope	
(2000 simulations each unless specified in the footnote)						
TRUE SIGMA 1.25				Slope 0.8		
BEST CASE ¹	250 (65.4-955)	1.27 (0.938-1.92)	2.0	0.65	0.79	30+
Multiple UDP 6, 3²	213 (54-1378)	1.1 (0.52-3.1)	6.0	2.0	0.9	30
Multiple UDP 5, 3	200 (50-1481)	1.0 (0.48-3.5)	7.3	2.5	1.0	20
Multiple UDP 4,3	189 (41-1277)	1.05 (0.40-3.78)	9.4	2.73	0.95	21
Multiple UDP 4,2	209 (45-1051)	0.96 (0.4-3.9)	9.8	2.94	1.04	16
Multiple UDP 3,3	195 (43-1239)	0.93 (0.34-4.47)	13	3.54	1.07	16
Current 401* (LD ₅₀ =50)	51 (7.4-846)	0.63 (-14- 15)	2.5	14.37	1.6	15

¹ Only includes the 768 out of 1000 runs that converged
* Five at 20, 50, and 100 mg/kg, and all runs converged

² Includes 11 runs where sigma was <0, that were set to high values

Table 4A
COMPARISON OF VARIOUS SUPPLEMENTAL PROCEDURES TO DETERMINE
LD₅₀, CI and Slope (Hybrid Method)

METHOD	ESTMATED LD ₅₀ (range)	ESTIMATED SIGMA				ANIMALS USED Median
		MEDIAN (range)	Factor 95%/5%	Difference High-Mean	Slope	
(2000 simulations each unless specified in the footnote)						
		TRUE SIGMA 2.00		Slope 0.5		
BEST CASE ¹	250 (5.6-11078)	1.92 (0.52-3.08)	5.9	1.16	0.52	30+
10 at LD13, 45, & 70 ²	233 (29-2187)	1.6 (0.73-8.3)	11.37	6.7	0.625	30
7 at LD13, 45, & 70 ³	217 (21-2544)	1.5 (0.6-27)	45	25.5	0.67	21
5 at LD13, 45, & 70 ⁴	229 (20-2843)	1.3 (0.5->5.5)	>11	>4.2	0.77	15
10 at LD13 & 70; & 5 at 45 ⁵	239 (27-2438)	1.5 (0.74-7.7)	10.4	6.2	0.67	25
10 at LD13 & 45 ⁶	164 (17.2-2961)	1.27 (0.09-5.3)	58.4	4.04	0.79	20
10 at LD13 & 70 ⁷	240 (20-3017)	1.6 (0.73-12.0)	16.4	10.4	0.625	20
10 at LD13, 40, & 87⁸	234 (34.7-2056)	1.67 (0.88-5.14)	5.8	3.47	0.6	30
10 at LD13, 40, & 87	236 (32-2048)	1.7 (0.86-6.9)	8.0	5.2	0.58	30
7 at LD13, 40, & 87 ⁹	242 (26-3011)	1.6 (0.77-13)	16.8	11.4	0.625	21
5 at LD13, 40, & 87 ¹⁰	229 (19-4039)	1.6 (0.68-23)	33.8	21.4	0.625	15
10 at LD13 & 87; & 5 at 40¹¹	238 (30-1806)	1.7 (0.88-6.2)	7.0	4.5	0.58	25
10 at LD13 and LD87¹²	251 (27-2269)	1.7 (0.88-7.5)	8.5	5.8	0.58	20

¹ Includes all 1000 runs, however 228 did not converge

³ Includes 76 runs where sigma was <0, that were set to high values

⁵ Includes 40 runs where sigma was <0, that were set to high values

⁷ Includes 67 runs where sigma was <0, that were set to high values

⁹ Includes 61 runs where sigma was <0, that were set to high values

¹¹ Includes 24 runs where sigma was <0, that were set to high values

² Includes 41 runs where sigma was <0, that were set to high values

⁴ Includes 101 runs where sigma was <0, that were set to high values

⁶ Includes (1K) 48 runs where sigma was <0, that were set to high values

⁸ Includes (1K) 12 runs where sigma was <0, that were set to high values

¹⁰ Includes 81 runs where sigma was <0, that were set to high values

¹² Includes 41 runs where sigma was <0, that were set to high values

Table 4B
COMPARISON OF VARIOUS SUPPLEMENTAL PROCEDURES TO DETERMINE
LD₅₀, CI and Slope (Multiple UDP)

METHOD	ESTMATED LD ₅₀ (range)	ESTIMATED SIGMA				ANIMALS USED Median
		MEDIAN (range)	Factor 95%/5%	Difference High-Mean	Slope	
(2000 simulations each unless specified in the footnote)						
		TRUE SIGMA 2.00		Slope 0.5		
BEST CASE ¹	250 (5.6-11078)	1.92 (0.52-3.08)	5.9	1.16	0.52	30+
Multiple UDP 6, 3 ²	162 (19-5635)	1.6 (0.73-27)	37	25.4	0.625	30
Multiple UDP 5, 3 ³	156 (16-4947)	1.5 (0.69-34)	49.2	32.5	0.67	20
Multiple UDP 4,3	158 (12-6186)	1.6 (0.6-1000 ⁺)			0.625	21
Multiple UDP 4,2		1.33 (0.54-1000 ⁺)			0.75	16
Multiple UDP 3,3		1.41 (0.5-1000 ⁺)			0.71	15
Current 401 (LD ₅₀ =50)						

¹ Includes all runs, however 228 did not converge

² Includes 77 runs where sigma was <0, that were set to high values

³ Includes 11 runs where sigma was <0, that were set to high values

⁺ Negative values set to 1000

Table 5

**COMPARISON OF VARIOUS SUPPLEMENTAL PROCEDURES TO DETERMINE
LD₅₀, CI and Slope (Multiple UDP)**

METHOD	ESTMATED LD₅₀ (range)	ESTIMATED SIGMA				ANIMALS USED Median
		MEDIAN (range)	Factor 95%/5%	Difference High-Mean	Slope	
		TRUE SIGMA 0.25		Slope 4		
Multiple UDP 6, 3 ¹	250 (183-342)	0.2 (0.0059-0.38)	63.0	0.18	5.0	30
Multiple UDP 5, 3 ²	250 (183-345)	0.2 (0.0033-0.38)	115.1	0.18	5.0	20

¹ Includes all runs, however 110 did not converge

² Includes all runs, however 205 did not converge

Table 6

**COMPARISON OF VARIOUS SUPPLEMENTAL PROCEDURES TO DETERMINE
LD₅₀, CI and Slope
Comparison of Acceptable Methods**

METHOD	ESTMATED LD ₅₀ (range)	ESTIMATED SIGMA				ANIMALS USED Median
		MEDIAN (range)	Factor 95%/5%	Difference High-Median	Slope	
(2000 simulations each unless specified in the footnote)						
		TRUE SIGMA 0.12		Slope 8.3		
BEST CASE ¹	250 (199-314)	0.12 (0.09-0.185)	2.0	0.06	8.3	30+
10 at LD13, 45, & 70²	250 (200-291)	0.13 (0.036-0.21)	5.8	0.08	7.6	30
10 at LD13, 45, & 70 ²	250 (208-291)	0.115 (0.036-0.205)	5.6	0.17	8.7	30
7 at LD13, 45, & 70 ³	250 (205-297)	0.15 (0.032-0.22)	6.2	0.07	6.7	21
5 at LD13, 45, & 70⁴	250 (199-304)	0.12 (0.036-0.23)	6.4	0.11	8.3	15
10 at LD13 & 70; & 5 at 45 ⁵	250 (192-304)	0.12 (0.036-0.21)	5.8	0.09	8.3	25
10 at LD13 & 45 ⁶	250 (209-293)	0.129 (0.036-0.23)	6.3	0.10	7.8	20
Multiple UDP 6, 3 ⁷	251 (207-312)	0.1 (0.035-0.21)	6.0	0.10	10	30
Multiple UDP 5, 3 ⁸	250 (202-305)	0.12 (0.032-0.20)	6.25	0.08	8.3	25
Multiple UDP 4,3 ⁹	247 (197-318)	0.119 (0.074-0.23)	3.1	0.11	8.4	21
Multiple UDP 4,2¹⁰	249 (196-318)	0.119 (0.074-0.22)	3.0	0.10	8.4	16

¹ Only includes the 769 out of 1000 runs that converged

³ Only includes the 1047 runs that converged

⁵ Only includes the 929 runs that converged

⁷ Only includes the 1147 runs that converged

⁹ Only includes the 513 runs that converged

² Only includes the 1154 runs that converged

⁴ Only includes the 884 runs that converged

⁶ Only includes the 575 out of 1000 runs that converged

⁸ Only includes the 1272 runs that converged

¹⁰ Only includes the 542 runs that converged

Table 7
**COMPARISON OF VARIOUS SUPPLEMENTAL PROCEDURES TO DETERMINE
LD₅₀, CI and Slope**
Comparison of Acceptable Methods

METHOD	ESTMATED LD ₅₀ (range)	ESTIMATED SIGMA				ANIMALS USED Median
		MEDIAN (range)	Factor (95%/5%)	Difference High-Median	Slope	
(2000 simulations each unless specified in the footnote)						
		TRUE SIGMA 0.5		Slope 2		
BEST CASE ¹	250 (146-427)	0.507(0.375-0.769)	2.05	0.262	2	30+
10 at LD13, 45, & 70²	257 (155-418)	0.44 (0.13-0.72)	5.5	0.28	2.3	30
10 at LD13 & 70³	268 (143-488)	0.45 (0.30-0.77)	2.6	0.32	2.2	20
10 at LD13, 40, & 87 ⁴	228 (131-423)	0.39 (0.15-0.71)	4.8	0.32	2.6	30
7 at LD13, 40, & 87 ⁵	230 (114-453)	0.37 (0.19-0.74)	3.9	0.37	2.7	21
5 at LD13, 40, & 87⁶	230 (110-471)	0.36 (0.20-0.76)	3.8	0.40	2.8	15
10 at LD13 & 87; & 5 at 40 ⁷	231 (130-448)	0.41 (0.21-0.72)	3.4	0.31	2.4	25
10 at LD13 and LD87	245 (123-494)	0.58 (0.38-0.79)	2.1	0.21	1.72	20
Multiple UDP 6, 3 ⁸	247 (138-444)	0.42 (0.18-0.74)	4.1	0.32	2.38	30
Multiple UDP 5, 3 ⁹	250 (138-455)	0.41 (0.15-0.75)	5	0.34	2.44	25
Multiple UDP 4,3	247 (131-469)	0.4 (0.147-0.761)	5.17	0.361	2.5	21

¹ Only includes the 783 out of 1000 runs that converged
³ Only includes the 1727 runs that converged
⁵ Only includes the 1803 runs that converged
⁷ Only includes the 1753 runs that converged
⁹ Includes all runs, however 22 did not converge

² Includes all runs, however 30 did not converge
⁴ Includes all runs, however 93 did not converge
⁶ Only includes the 1705 runs that converged
⁸ Includes all runs, however 14 did not converge

Table 8
**COMPARISON OF VARIOUS SUPPLEMENTAL PROCEDURES TO DETERMINE
LD₅₀, CI and Slope**
Comparison of Acceptable Methods

METHOD	ESTMATED LD ₅₀ (range)	ESTIMATED SIGMA			ANIMALS USED Median	
		MEDIAN (range)	Factor 95%/5%	Difference High-Mean		Slope
(2000 simulations each unless specified in the footnote)						
TRUE SIGMA 1.25					Slope 0.8	
BEST CASE ¹	250 (65.4-955)	1.27 (0.938-1.92)	2.0	0.65	0.79	30+
10 at LD13, 45, & 70²	237 (76-875)	1.06 (0.53-2.6)	4.9	1.54	0.94	30
7 at LD13, 45, & 70 ³	226 (58-925)	1.0 (0.47-2.8)	5.9	1.8	1.0	21
10 at LD13 & 70; & 5 at 45⁴	243 (67-973)	1.1 (0.5-2.8)	3.4	1.7	0.9	25
10 at LD13 & 70⁵	244 (63-1060)	1.1 (0.53-2.6)	4.9	1.5	0.9	20
10 at LD13, 40, & 87 ⁶	242 (80.8-762)	1.13 (0.63-2.21)	3.5	1.08	0.88	30
10 at LD13, 40, & 87	248 (75-760)	1.14 (0.63-2.2)	3.5	1.06	0.87	30
10 at LD13 & 87; & 5 at 40⁷	236 (75-833)	1.1 (0.61-2.4)	3.9	1.3	0.9	25
Multiple UDP 6, 3 ⁸	213 (54-1378)	1.1 (0.52-3.1)	6.0	2.0	0.9	30
Multiple UDP 5, 3	200 (50-1481)	1.0 (0.48-3.5)	7.3	2.5	1.0	20

¹ Only includes the 768 out of 1000 runs that converged

³ Includes all runs, however 1 did not converge

⁵ Includes all runs, however 1 did not converge

⁷ Includes all runs, however 3 did not converge

² All runs converged

⁴ All runs converged

⁶ All runs converged

⁸ Includes 11 runs where sigma was <0, that were set to high values

Table 9
**COMPARISON OF VARIOUS SUPPLEMENTAL PROCEDURES TO DETERMINE
 LD₅₀, CI and Slope**
Comparison of Acceptable Methods

METHOD	ESTMATED LD ₅₀ (range)	ESTIMATED SIGMA				ANIMALS USED Median
		MEDIAN (range)	Factor 95%/5%	Difference High-Mean	Slope	
(2000 simulations each unless specified in the footnote)						
		TRUE SIGMA 2.00			Slope 0.5	
BEST CASE ¹	250 (5.6-11078)	1.92 (0.52-3.08)	5.9	1.16	0.52	30+
10 at LD13, 40, & 87²	234 (34.7-2056)	1.67 (0.88-5.14)	5.8	3.47	0.6	30
10 at LD13, 40, & 87	236 (32-2048)	1.7 (0.86-6.9)	8.0	5.2	0.58	30
10 at LD13 & 87; & 5 at 40³	238 (30-1806)	1.7 (0.88-6.2)	7.0	4.5	0.58	25
10 atLD13 and LD87⁴	251 (27-2269)	1.7 (0.88-7.5)	8.5	5.8	0.58	20

¹ Includes all runs, however 228 did not converge

³ Includes 24 runs where sigma was <0, that were set to high values

² Includes 12 runs where sigma was <0, that were set to high values

⁴ Includes 41 runs where sigma was <0, that were set to high values

Simulation Table I. Best Case Simulation. The simulations in this table represent the best possible case. It is assumed both the true LD50 and the true slope of the population dose response curve was known to the hypothetical investigator.

Each line of the table represents a separate study. For each study

The hypothetical investigator did not run an LD50 test because this value is known.

The hypothetical investigator dosed groups of 15 animals at the known LD13 and LD87.

For each run the computer randomly picked the appropriate number of animals from the entire population assigning each individual animal an LD50 based on the known variability of the population.

Boundary rules were NOT observed, that is the animals were dosed at the true LD13 and true LD87 even if those values were less than 1 mg/kg bw or greater than 5000 mg/kg bw.

Estimates of LD50 and slope were made using probit analyses. Probit fits were judged to converge if the variance of the intercept parameter estimate was less than 1,000,000.

The median, 5% and 95% confidence limits of the results of 1000 separate simulation runs are presented for each study.

Table I

"True"		Estimated LD50			Estimated Sigma		
True LD50	True Sigma	Median	5%	95%	Median	5%	95%
250 mg/kg	0.12	250	199	314	0.115	0.0313	0.185
	All runs including 231 runs that did not converge						
250 mg/kg	0.12	250	220	284	0.122	0.0900	0.185
	Only includes the 769 runs that converge.						
250 mg/kg	0.5	250	96.9	645	0.481	0.13	0.769
	Includes all runs including 217 that did not converge						
250 mg/kg	0.5	250	146	427	0.507	0.375	0.769
	Only includes the 783 runs that converge						
250 mg/kg	1.25	250	23.4	2673	1.20	0.326	1.92
	Includes all runs including 263 that did not converge						
250 mg/kg	1.25	250	65.4	955	1.27	0.938	1.92
	Only includes the 768 runs that did converge						
250 mg/kg	2.00	250	5.64	11078	1.923	0.521	3.08
	Includes 228 runs that did not converge						

Simulation Table II. Hybrid Approach Using Ten Animals at Various Levels. The simulations in this table explore a series of test designs based on using different groups of 10 rats dosed at estimated preset distances from the estimated LD50. Only one true LD50 was simulated.

All populations had a true LD50 of 250 mg/kg bw. The sigma of the dose response curve (reciprocal of slope) varied as detailed in the table. The hypothetical investigator did not know the true LD50 or slope, but began the initial LD50 run at 250 mg/kg bw because of previous data on other compounds that indicated this was the likely LD50.

Each line of the table represents one study design tested:

The true sigma for the population sampled is as given in the table

For each run the computer randomly picked the appropriate number of animals from the entire population assigning each individual animal an LD50 based on the known variability of the population.

Initially a single standard up-and-down run was performed to estimate the LD50. This single run ended when six animals had been dosed after the first reversal. Dosing boundaries were respected but no stopping rule was used. The assumed sigma for this initial UDP run was 0.5.

Based on the LD50 estimated from the UDP run, the hypothetical investigator assumed the population had a slope (or sigma) of 1, and chose doses for the supplemental procedure as given in the table.

The number of animals for each run included the animals used in the initial LD50 run.

Estimates of LD50 and slope were made using probit analyses of all data, including the results of the initial LD50 run. Probit fits were judged to converge if the variance of the intercept parameter estimate was less than 1,000,000.

For each line the median, 5% and 95% confidence limits of the results of 1000 separate simulation runs are presented. For each run the median, 5% and 95% confidence limits for the number of animals used in the entire study, including the initial LD50 run, are presented.

Table II

Supplemental test includes dose groups of	TRUE	Estimated LD50			Estimated Sigma			Number of Animals		
	Sigma	Median	5%	95%	Median	5%	95%	Median	5%	95%
10 rats at LD13, 40 and 87	0.12	250	140	305	0.0449	0.00914	0.242	37	37	37
10 rats at LD13 and 45	0.12	250	150	313	0.0458	0.0121	0.203	27	27	27
10 rats at LD13, 45, and 70	0.12	250	194	313	0.0458	0.0120	0.189	37	37	37
All runs including 685, 425, and 428 runs respectively that did not converge										
For comparison, data from current 401 (True LD 50 is 50 mg/kg), 5 rats at 20, 50, 100 mg/kg 970 runs did NOT converge										
		51	46	54	0.04	0.02	0.05	15	15	15
10 rats at LD13, 40 and 87	0.12	291	241	308	0.211	0.118	0.268			
10 rats at LD13 and 45	0.12	250	209	293	0.129	0.0362	0.230			
10 rats at LD13, 45, and 70	0.12	250	208	291	0.115	0.0362	0.205			
Only includes the 315, 575, and 572 runs respectively that converge.										
10 rats at LD13, 40 and 87	0.5	228	122	425	0.369	0.0486	0.711	37	37	38
10 rats at LD13 and 45	0.5	216	89.2	402	0.240	0.262	0.778	27	27	28
10 rats at LD13, 45, and 70	0.5	262	154	439	0.442	0.125	0.723	37	37	38
Includes all runs including 59, 75, 11 respectively that did not converge										
For comparison, data from current 401 (True LD 50 is 50 mg/kg), 5 rats at 20, 50, 100 mg/kg 70 runs did NOT converge										
		51	19	155	0.41	0.04	1.5	15	15	15
10 rats at LD13, 40 and 87	1.25	242	80.8	762	1.13	0.634	2.21	37	37	39
10 rats at LD13 and 45	1.25	182	35.6	998	0.961	0.200	3.37	27	27	29
10 rats at LD13, 45, and 70	1.25	225	67.5	799	1.06	0.534	2.62	37	37	39
For comparison, data from current 401 (True LD 50 is 50 mg/kg), 5 rats at 20, 50, 100 mg/kg										
		51	7.4	846	0.63	-14	15	15	15	15
10 rats at LD13, 40 and 87	2.00	234	34.7	2056	1.67	0.878	5.14	37	37	39
10 rats at LD13 and 45	2.00	164	17.2	2961	1.27	0.091	5.31	27	27	29
10 rats at LD13, 45, and 70	2.00	228	29.3	2251	1.47	0.657	6.42	37	37	39
Includes 12, 48, and 24 runs respectively with a negative slope										

Simulation Table III. Hybrid Approach Using Five, Seven, and Ten Animals. The simulations in this table explore a series of test designs based on using different size groups of rats dosed at estimated preset distances from the estimated LD50. Only one true LD50 was simulated.

All populations had a true LD50 of 250 mg/kg bw. The sigma of the dose response curve (reciprocal of slope) varied as detailed in the table. The hypothetical investigator did not know the true LD50 or slope, but began the initial LD50 run at 250 mg/kg bw because of previous data on other compounds that indicated this was the likely LD50.

Each line of the table represents one study design tested:

The true sigma (reciprocal of slope) for the population sampled is as given in the table.

For each run the computer randomly picked the appropriate number of animals from the entire population assigning each individual animal an LD50 based on the known variability of the population.

Initially a single standard up-and-down run was performed to estimate the LD50. This single run ended when six animals had been dosed after the first reversal. Dosing boundaries were respected but no stopping rule was used. The assumed sigma for this initial UDP run was 0.5.

Based on the LD50 estimated from the UDP run, the hypothetical investigator assumed the population had a slope (or sigma) of 1, and chose doses for the supplemental procedure as given in the table.

The number of animals for each run included the animals used in the initial LD50 run.

Estimates of LD50 and slope were made using probit analyses of all data, including the results of the initial LD50 run. Probit fits were judged to converge if the variance of the intercept parameter estimate was less than 1,000,000.

For each line the median, 5% and 95% confidence limits of the results of 2000 separate simulation runs are presented. In this table the number of animals that died from the treatment were also tracked and are presented for each study design.

Table III

TRUE Sigma	Total Number of Animals			Total Number That Die			Estimated LD50			Estimated Sigma			
	Median	5%	95%	Median	5%	95%	Median	5%	95%	Median	5%	95%	
<u>Three doses of five animals at doses of LD13; LD45; and LD70</u>													
0.12	22	(22 - 22)		9	(8 - 13)		250	(150 - 313)		0.04	(0.012 - 0.20)		
	All runs including 1116 runs that did not converge							250	(199 - 304)		0.12	(0.036 - 0.23)	
	Only includes the 884 runs that converge.												
0.5	22	(22 - 23)		10	(7 - 13)		255	(136 - 477)		0.41	(0.40 - 0.81)		
	Includes all runs including 85 that did not converge												
1.25	22	(22 - 24)		10	(7 - 14)		242	(55 - 1103)		0.91	(0.36 - 3.0)		
	Includes all runs including 8 that did not converge												
2	22	(22 - 24)		10	(7 - 14)		229	(20 - 2843)		1.3	(0.50 - >5.5)		
	Includes 101 runs where sigma was <0; these were set to high values)												
<u>Three doses of seven animals at doses of LD13; LD45; and LD70</u>													
0.12	28	(28 - 28)		12	(10 - 17)		249	(189 - 313)		0.04	(0.012 - 0.20)		
	All runs including 953 that did not converge							250	(205 - 297)		0.15	(0.32 - 0.22)	
	Only includes 1047 runs that did converge												

Table III

TRUE Sigma	Total Number of Animals			Total Number That Die			Estimated LD50			Estimated Sigma		
	Median	5%	95%	Median	5%	95%	Median	5%	95%	Median	5%	95%
0.5	28	(28 - 29)		12	(8 - 16)		265	(141 - 447)		0.41	(0.064 - 0.75)	
	All runs including 63 that did not converge											
1.25	28	(28 - 30)		13	(8 - 18)		226	(58 - 925)		1	(0.47 - 2.8)	
	All runs including 1 that did not converge											
2	28	(28 - 30)		13	(9 - 18)		217	(21 - 2544)		1.5	(0.60 - 27)	
	Includes 76 runs where sigma was <0; these were set to high values)											
<u>Two runs of 10 animals at LD13 and LD70</u>												
0.12	27	(27 - 27)		13	(13 - 14)		250	(169 - 445)		0.66	(0.30 - 0.71)	
	Includes all runs including the 1941 that did not converge											
							169	(169 - 203)		0.23	(0.23 - 0.30)	
	Includes only the 59 runs that converged											
0.5	27	(27 - 28)		12	(9 - 14)		268	(144 - 516)		0.44	(0.066 - 0.75)	
	Includes 273 runs that did not converge											
							268	(143 - 488)		0.45	(0.30 - 0.77)	
	Includes only 1727 runs that do converge											
1.25	27	(27 - 29)		12	(8 - 17)		244	(63 - 1060)		1.1	(0.53 - 2.6)	
	Includes 1 run that did not converge											
2	27	(27 - 29)		13	(9 - 17)		240	(20 - 3017)		1.6	(0.73 - 12)	
	Includes 67 runs where sigma was <0; these were set to high values)											

Table III

TRUE Sigma	Total Number of Animals			Total Number That Die			Estimated LD50			Estimated Sigma			
	Median	5%	95%	Median	5%	95%	Median	5%	95%	Median	5%	95%	
<u>Two groups of 10 animals at LD13 and LD70 plus one group of 5 animals at LD45</u>													
0.12	32	(32 - 32)		14	(13 - 18)		250	(192 - 313)		0.039	(0.012 - 0.19)		
	Includes all runs including 1071 that did not converge												
							250	(192 - 304)		0.12	(0.036 - 0.21)		
	Includes only the 929 runs that converged												
0.5	32	(32 - 33)		14	(9 - 18)		265	(150 - 482)		0.44	(0.12 - 0.73)		
	Includes all runs including 42 that did not converge												
1.25	32	(32 - 34)		14	(9 - 20)		243	(67 - 973)		1.1	(0.50 - 2.8)		
2	32	(32 - 34)		15	(11 - 20)		239	(27 - 2438)		1.5	(0.74 - 7.7)		
	Includes 40 runs where sigma was <0; these were set to high values)												
<u>Three doses of 10 animals at LD13, LD45 and LD70</u>													
0.12	37	(37 - 37)		15	(13 - 22)		250	(194 - 313)		0.046	(0.12 - 0.19)		
	Includes all runs including the 846 did not converge												
							250	(200 - 291)		0.13	(0.36 - 0.21)		
	Includes only the 1154 runs that converged												
0.5	37	(37 - 38)		16	(10 - 22)		257	(155 - 418)		0.44	(0.13 - 0.72)		
	Includes all runs including the 30 runs that did not converge												
1.25	37	(37 - 39)		17	(10 - 23)		237	(76 - 875)		1.06	(0.53 - 2.6)		
2	37	(37 - 39)		17	(11 - 23)		223	(29 - 2187)		1.6	(0.73 - 8.3)		
	Includes 41 runs where sigma was <0; these were set to high values)												

Simulation Table IV. Hybrid Approach Using Five, Seven and Ten Animals. The simulations in this table explore a series of test designs based on using different size groups of rats dosed at the estimated preset distances from the estimated LD50. Only one true LD50 was simulated.

All populations had a true LD50 of 250 mg/kg bw. The sigma of the dose response curve (reciprocal of slope) varied as detailed in the table. The hypothetical investigator did not know the true LD50 or slope, but began the initial LD50 run at 250 mg/kg bw because of previous data on other compounds that indicated this was the likely LD50.

Each line of the table represents one study design tested:

The true sigma (reciprocal of slope) for the population sampled is as given in the table.

For each run the computer randomly picked the appropriate number of animals from the entire population assigning each individual animal an LD50 based on the known variability of the population.

Initially a single standard up-and-down run was performed to estimate the LD50. This single run ended when six animals had been dosed after the first reversal. Dosing boundaries were respected but no stopping rule was used. The assumed sigma for this initial UDP run was 0.5.

Based on the LD50 estimated from the UDP run, the hypothetical investigator assumed the population had a slope (or sigma) of 1, and chose doses for the supplemental procedure as given in the table.

The number of animals for each run included the animals used in the initial LD50 run.

Estimates of LD50 and slope were made using probit analyses of all data, including the results of the initial LD50 run. Probit fits were judged to converge if the variance of the intercept parameter estimate was less than 1,000,000.

For each line the median, 5% and 95% confidence limits of the results of 2000 separate simulation runs are presented. In this table the number of animals that died from the treatment were also tracked and are presented for each study design.

Table IV

TRUE Sigma	Total Number of Animals			Total Number That Die			Estimated LD50			Estimated Sigma		
	Median	5%	95%	Median	5%	95%	Median	5%	95%	Median	5%	95%
<u>Three doses of five animals at doses of LD13; LD40; and LD87</u>												
0.12	22	(22 - 22)		9	(8 - 11)		250	(140 - 307)		0.041	(0.0094 - 0.23)	
	All runs including 1582 runs that did not converge						282	(230 - 307)		0.22	(0.17 - 0.29)	
	Only includes the 418 runs that converge.											
0.5	22	(22 - 23)		10	(8 - 13)		230	(100 - 461)		0.32	(0.30 - 0.76)	
	Includes all runs including 295 that did not converge						230	(110 - 471)		0.36	(0.20 - 0.77)	
	Only includes the 1705 runs that converge											
1.25	22	(22 - 24)		11	(8 - 14)		244	(55 - 1238)		1	(0.34 - 2.9)	
	Includes all runs including 8 that did not converge											
2	22	(22 - 24)		11	(8 - 14)		229	(19 - 4039)		1.6	(0.68 - 23)	
	Includes 81 runs where sigma was <0; these were set to high values)											
<u>Three doses of seven animals at doses of LD13; LD40; and LD87</u>												
0.12	28	(28 - 28)		11	(10 - 14)		250	(140 - 304)		0.041	(0.01 - 0.24)	
	All runs including 1504 that did not converge						296	(238 - 308)		0.2	(0.15 - 0.28)	
	Only includes 496 runs that did converge											

Table IV

TRUE Sigma	Total Number of Animals			Total Number That Die			Estimated LD50			Estimated Sigma		
	Median	5%	95%	Median	5%	95%	Median	5%	95%	Median	5%	95%
0.5	28	(28 - 29)		13	(10 - 16)		233	(110 - 451)		0.34	(0.030 - 0.73)	
	All runs including 197 that did not converge						230	(114 - 453)		0.37	(0.19 - 0.74)	
Only includes 1803 runs that did converge												
1.25	28	(28 - 30)		14	(9 - 18)		236	(67 - 925)		1.1	(0.57 - 2.6)	
	All runs including 2 that did not converge											
2	28	(28 - 30)		14	(10 - 18)		242	(26 - 3011)		1.6	(0.77 - 13)	
	Includes 61 runs where sigma was <0; these were set to high values)											
<u>Two runs of 10 animals at LD13 and LD87</u>												
0.12	27	(27 - 27)		14	(13 - 14)		250	(140 - 445)		0.65	(0.3 - 0.72)	
	No runs converged											
0.5	27	(27 - 28)		14	(12 - 15)		250	(123 - 494)		0.38	(0.064 - 0.73)	
	Includes 952 runs that did not converge						245	(123 - 494)		0.58	(0.38 - 79)	
Includes only 1048 runs that do converge												
1.25	27	(27 - 29)		14	(10 - 17)		248	(67 - 1006)		1.1	(0.62 - 2.4)	
	Includes 16 runs that did not converge											
2	27	(27 - 29)		13	(10 - 17)		251	(27 - 2269)		1.7	(0.88 - 7.5)	
	Includes 41 runs where sigma was <0; these were set to high values)											

Table IV

TRUE Sigma	Total Number of Animals			Total Number That Die			Estimated LD50			Estimated Sigma		
	Median	5%	95%	Median	5%	95%	Median	5%	95%	Median	5%	95%
<u>Two groups of 10 animals at LD13 and LD87 plus one group of 5 animals at LD40</u>												
0.12	32	(32 - 32)		14	(13 - 16)		250	(140 - 307)		0.042	(0.0093 - 0.23)	
	Includes all runs including 1572 that did not converge						282	(230 - 307)		0.22	(0.17 - 0.27)	
0.5	32	(32 - 33)		15	(13 - 18)		233	(126 - 437)		0.37	(0.03 - 0.71)	
	Includes all runs including 247 that did not converge						231	(130 - 448)		0.41	(0.21 - 0.72)	
1.25	32	(32 - 34)		16	(11 - 21)		236	(75 - 833)		1.1	(0.61 - 2.4)	
	Includes 3 runs that did not converge											
2	32	(32 - 34)		16	(11 - 21)		238	(30 - 1806)		1.7	(0.88 - 6.2)	
<u>Three doses of 10 animals at LD13, LD40 and LD87</u>												
0.12	37	(37 - 37)		14	(13 - 18)		250	(140 - 305)		0.045	(0.11 - 0.24)	
	Includes all runs including the 1416 did not converge						291	(241 - 305)		0.18	(0.12 - 0.27)	
0.5	37	(37 - 38)		17	(13 - 21)		228	(131 - 423)		0.39	(0.15 - 0.71)	
	Includes all runs including the 93 runs that did not converge											
1.25	37	(37 - 39)		18	(12 - 23)		248	(75 - 760)		1.14	(0.63 - 2.2)	
2	37	(37 - 39)		18	(12 - 24)		236	(32 - 2048)		1.7	(0.86 - 6.9)	

Simulation Table V. Multiple Up-and-Down Sequences Using Modified Dosing Procedures. The simulations in this table explore a series of test designs based on using different multiple UDP runs to obtain data used in probit analysis to estimate sigma. In order to maximize the ability to detect very shallow dose response situations and still minimize the number of animals actually dying from the treatment, all runs are started three sigmas (with sigma assumed to be 0.5) below the estimated LD50 and each run stopped when the first animal died. The supplemental runs were run in parallel. Only one true LD50 was simulated.

All populations had a true LD50 of 250 mg/kg bw. The sigma of the dose response curve (reciprocal of slope) varied as detailed in the table. The hypothetical investigator did not know the true LD50 or slope, but began the initial LD50 run at 250 mg/kg bw because of previous data on other compounds that indicated this was the likely LD50.

Each line of the table represents one study design tested:

The true sigma (reciprocal of slope) for the population sampled is as given in the table.

For each run the computer randomly picked the appropriate number of animals from the entire population assigning each individual animal an LD50 based on the known variability of the population.

Initially a single standard up-and-down run was performed to estimate the LD50. This single run ended when six animals had been dosed after the first reversal. Dosing boundaries were respected but no stopping rule was used. The assumed sigma for this initial UDP run was 0.5.

Based on the LD50 estimated from the UDP run, the hypothetical investigator started five or six supplemental runs at three sigmas, (sigma estimated to be 0.5) below the LD50 as given in the table. For each run the boundary rules were respected but the stopping rule detailed in the guideline was not followed since each run stopped with the first death. The dose spacing for these runs was also based on an estimated sigma of 0.5.

For each set of parallel runs the hypothetical investigator used the protocol in the proposed guideline to offset the starting doses just slightly so no two animals in the set were dosed at the exact same dose.

The number of animals for each run included the animals used in the initial LD50 run.

Estimates of LD50 and slope were made using probit analyses of all data, including the results of the initial LD50 run. Probit fits were judged to converge if the variance of the intercept parameter estimate was less than 1,000,000.

For each line the median, 5% and 95% confidence limits of the results of 2000 separate simulation runs are presented. In this table the number of animals that died from the treatment were also tracked and are presented for each study design.

Table V

TRUE Sigma	Total Number of Animals			Total Number That Die			Estimated LD50			Estimated Sigma		
	Median	5%	95%	Median	5%	95%	Median	5%	95%	Median	5%	95%
<u>Six runs of nominal size 2 starting approximately 3 sigma below LD50 (includes data from original UDP LD50 run)</u>												
0.12	37	(34 - 41)		9	(9 - 10)		250	(208 - 304)		0.07	(0.0020 - 0.20)	
	All runs including 530 runs that did not converge						251	(207 - 312)		0.1	(0.035 - 0.21)	
Only includes the 1470 runs that converge.												
0.25	37	(33 - 41)		10	(9 - 10)		250	(183 - 342)		0.2	(0.0059 - 0.38)	
	All runs including 110 that did not converge											
0.5	36	(30 - 42)		10	(9 - 10)		247	(138 - 444)		0.42	(0.18 - 0.74)	
	Includes all runs including 14 that did not converge											
1.25	30	(21 - 39)		10	(8 - 11)		213	(54 - 1378)		1.1	(0.52 - 3.1)	
	Includes 11 runs where sigma was <0; these were set to high values)											
2	26	(19 - 35)		10	(8 - 11)		162	(19 - 5635)		1.6	(0.73 - 27)	
	Includes 77 runs where sigma was <0; these were set to high values)											

Table V

TRUE Sigma	Total Number of Animals			Total Number That Die			Estimated LD50			Estimated Sigma		
	Median	5%	95%	Median	5%	95%	Median	5%	95%	Median	5%	95%
<u>Five runs of nominal size 2 starting approximately 3 sigma below LD50 (includes data from original UDP LD50 run)</u>												
0.12	32	(30 - 35)		9	(8 - 9)		250	(205 - 305)		0.073	(0.0012 - 0.20)	
	All runs including 728 that did not converge						250	(205 - 305)		0.12	(0.032 - 0.20)	
Only includes 1272 runs that did converge												
0.25	32	(29 - 36)		9	(8 - 9)		250	(183 - 345)		0.2	(0.0033 - 0.38)	
	All runs including 205 runs that did not converge						252	(182 - 346)		0.21	(0.058 - 0.39)	
Only includes 1795 runs that did converge												
0.5	31	(26 - 37)		9	(8 - 9)		250	(138 - 455)		0.41	(0.15 - 0.75)	
All runs including 22 that did not converge												
1.25	26	(19 - 34)		9	(7 - 10)		200	(50 - 1481)		1	(0.48 - 3.5)	
2	23	(16 - 31)		9	(7 - 10)		156	(16 - 4947)		1.5	(0.69 - 34)	
Includes 81 runs where sigma was <0; these were set to high values)												

Simulation Table VI. Multiple Up-and-Down Sequences. The simulations in this table explore a series of test designs based on using different multiple UDP runs to obtain data used in probit analysis to estimate sigma. In order to maximize the ability to detect very shallow dose response situations and still minimize the number of animals actually dying from the treatment, all runs are started below the estimated LD50 and each run stopped when the first animal died. The supplemental runs were run in parallel. Only one true LD50 was simulated.

All populations had a true LD50 of 250 mg/kg bw. The sigma of the dose response curve (reciprocal of slope) varied as detailed in the table. The hypothetical investigator did not know the true LD50 or slope, but began the initial LD50 run at 250 mg/kg bw because of previous data on other compounds that indicated this was the likely LD50.

Each line of the table represents one study design tested:

The true sigma (reciprocal of slope) for the population sampled is as given in the table.

For each run the computer randomly picked the appropriate number of animals from the entire population assigning each individual animal an LD50 based on the known variability of the population.

Initially a single standard up-and-down run was performed to estimate the LD50. This single run ended when six animals had been dosed after the first reversal. Dosing boundaries were respected but no stopping rule was used. The assumed sigma for this initial UDP run was 0.5.

Based on the LD50 estimated from the UDP run, the hypothetical investigator started three or four supplemental runs at a given distance below the estimated LD50 as given in the table. For these estimates the hypothetical investigator used an assumed sigma of 0.5. For each run the boundary rules were respected but the stopping rule detailed in the guideline was not followed since each run stopped with the first death. The dose spacing for these runs was determined using a estimated sigma of 0.5.

For each set of parallel runs the investigator used the protocol in the proposed guideline to offset the starting doses just slightly so no two animals in the set were dosed at the exact same dose.

The number of animals for each run included the animals used in the initial LD50 run.

Estimates of LD50 and slope were made using probit analyses of all data, including the results of the initial LD50 run. Probit fits were judged to converge if the variance of the intercept parameter estimate was less than 1,000,000.

For each line the median, 5% and 95% confidence limits of the results of 1000 separate simulation runs are presented. In this table the number of animals that died from the treatment were also tracked and are presented for each study design.

Table VI

No. of repetitions	No of sigmas between LD50 and starting dose	No. of runs that do not converge	Estimated LD50			Estimated Sigma			Number of Animals Used (Includes initial LD50 run)		
			Median	5%	95%	Median	5%	95%	Median	5%	95%
True sigma = 0.12 all runs											
4	3	487	250	211	297	0.0744	0.00418	0.199	27	25	30
3	3	493	250	208	301	0.0582	0.00196	0.214	23	21	24
4	2	458	250	211	296	0.0772	0.0042	0.194	23	21	26
For comparison, data from current 401 (True LD 50 is 50 mg/kg), 5 rats at 20, 50, 100 mg/kg						970 runs did NOT converge					
			51	46	54	0.04	0.02	0.05	15	15	15
True sigma = 0.12, only runs that converge (all others would be considered steep slopes)											
4	3		247	197	318	0.119	0.0744	0.230			
3	3		248	191	326	0.098	0.0582	0.227			
4	2		249	196	318	0.119	0.0745	0.220			
True sigma = 0.5, all runs											
4	3	18	247	131	469	0.402	0.147	0.761	27	23	31
3	3	52	250	129	490	0.368	0.011	0.75	22	19	25
4	2	32	249	131	470	0.384	0.083	0.82	23	18	27
For comparison, data from current 401 (True LD 50 is 50 mg/kg), 5 rats at 20, 50, 100 mg/kg						70 runs did NOT converge					
			51	19	155	0.41	0.04	1.5	15	15	15
True sigma = 1.25, all runs											
4	3	1	189	41.0	1277	1.03	0.371	3.30	22	16	29
3	3	5	195	43.1	1239	0.91	0.285	2.95	19	14	25
4	2	0	209	45.1	1051	0.94	0.375	3.16	20	14	27
For comparison, data from current 401 (True LD 50 is 50 mg/kg), 5 rats at 20, 50, 100 mg/kg											
			51	7.4	846	0.63	-14	15	15	15	15
True sigma = 1.25, runs with negative slopes arbitrarily set to sigma estimate = 1000											
4	3		189	41.0	1277	1.053	0.405	3.78			
3	3		195	43.1	1239	0.934	0.336	4.47			
4	2		209	45.1	1051	0.962	0.4	3.9			
The number of runs with negative slopes is 13, 14 and 13 respectively.											
True sigma = 2.00, all runs											
4	3		158	12.0	6186	1.44	-1.92	6.71	20	14	26
3	3		168	10.9	4920	1.3	-2.92	5.8	17	12	23
4	2		147	10.5	4852	1.21	-2.22	5.36	18	13	25
True sigma = 2.00, runs with negative slopes arbitrarily set to sigma estimate = 1000											
4	3		158	12.0	6186	1.60	0.602	1000			
3	3					1.41	0.502	1000			
4	2					1.33	0.541	1000			
The number of runs with negative slopes is 57, 66, and 58 respectively.											

Simulation Table VII. Simulation of Current OECD Test Guideline 401. The simulations in this table explore the ability of the current OECD Guideline 401 to estimate the slope of a dose response curve. Simulations were done with four different choices of dose progressions. The choices were selected after talking to actual contract laboratories to obtain their usual dose progressions when little is known of the LD50 or slope of the test material.

Several different populations were tested with variations in both the true LD50 and the true slope (reciprocal of sigma) of the populations as detailed in the table. The hypothetical investigator did not know the true LD50 or slope, and was able to select from one of four possible dose progressions again as detailed in the table. Certain dose selections were completely unsatisfactory for certain populations, and in this case the simulations failed completely and are not listed in the table. It could be assumed the hypothetical investigator would begin a second study with a different dose progression in these cases.

Each line of the table represents one study design tested:

The true LD and sigma (reciprocal of slope) for the population sampled is as given in the table.

For each run the computer randomly picked the appropriate number of animals from the entire population assigning each individual animal an LD50 based on the known variability of the population.

Three doses were selected for each design. These doses were chosen based on the suggestion of several contract laboratories as defaults when little is known of the LD50 or slope. For each dose five animals of one sex were tested.

Fifteen animals were used for each run.

Estimates of LD50 and slope were made using probit analyses of all data. Probit fits were judged to converge if the variance of the intercept parameter estimate was less than 1,000,000.

For each line the median, 5% and 95% confidence limits of the results of 1000 separate simulation runs are presented. In this table the number of animals that died from the treatment were also tracked and are presented for each study design.

Table VII

"True" LD50 mg/kg	"True" Sigma	Starting Dose mg/kg	Estimated LD50		Estimated sigma		% that do NOT converge	% with any failure	No. of animals that die (15 dosed)
			Median	90% Range	Median	90% Range			
1.5	0.12	.1, 1.5, 5	1.5	1.3 - 1.7	0.07	0.07 - 0.08	99.9%	99.9%	8
		20,50,100	*	*	*	*	0	100%	15
	0.25	.1, 1.5, 5	1.6	1.3 - 2.0	0.08	0.07 - 0.45	92%	91%	7
		20,50,100	18	18	0.06	0.06	0%	100%	15
0.5	.1, 1.5, 5	1.6	0.76 - 3.8	0.31	0.06 - 0.79	45%	45%	7	
	20,50,100	18	18 - 7.4 E+07	0.06	-4.1 - 0.06	6%	99.9%	15	
1.25	.1, 1.5, 5	1.4	0.13 - 17	1.0	0.07 - 4.3	6%	11%	7	
	20,50,100	18	0.0 - 7.4 E+07	0.06	-4.1 - 8.8	31%	64%	13	
50	0.12	.1, 1.5, 5	*	*	*	*	0%	100%	0
		20,50,100	51	46 - 54	0.04	0.02 - 0.05	97%	97%	8
		150,300,500	137	137	0.05	0.05	0.02%	100%	15
		1000, 2000, 3000	*	*	*	*	0%	100%	15
	0.25	.1, 1.5, 5	5.9	5.9	0.08	0.08	0.02%	100%	0
		20,50,100	51	32 - 74	0.22	0.04 - 0.43	42%	42%	7
		150,300,500	137	137 - 146	0.05	0.04 - 0.05	13%	99.9%	15
		1000, 2000, 3000	911	911	0.05	0.05	0%	100%	15
	0.5	.1, 1.5, 5	5.9	5.9 - 29	0.08	0.08 - 1.1	11%	99%	0.1
		20,50,100	51	19 - 155	0.41	0.04 - 1.5	7%	12%	7
		150,300,500	137	58 - 5 E+06	0.05	(-2.8) - 0.79	43%	80%	14
		1000, 2000, 3000	911	911 - 3.2 E+05	0.05	(-1.5) - 0.05	2%	99.99%	15
1.25	.1, 1.5, 5	5.9	0.07 - 2.4 E+05	0.47	(-0.19) - 3.5	37%	56%	2	
	20,50,100	51	7.4 - 846	0.63	(-14) - 15	1%	28%	7	
	150,300,500	166	5 E-05 - 5 E+06	0.31	(-10) - 9.7	8%	40%	11	
	1000, 2000, 3000	911	0.44 - 3.2 E+05	0.05	(-4.4) - 3.2	31%	73%	13	

Table VII

"True" LD50 mg/kg	"True" Sigma	Starting Dose mg/kg	Estimated LD50		Estimated sigma		% that do NOT converge	% with any failure	No. of animals that die (15 dosed)
			Median	90% Range	Median	90% Range			
1500	0.12	20,50,100	*	*	*	*	0%	100%	0
		150,300,500	536	536	0.04	0.04	0.02%	100%	0
		1000, 2000, 3000	1416	1076 - 1970	0.03	0.02 - 0.19	80%	80%	10
		1500, 3000, 5000	1536	1367 - 1614	0.04	0.04 - 0.05	94%	97%	13
	0.25	20,50,100	110	110	0.05	0.05	0.001%	100%	0
		150,300,500	536	510 - 5 E+06	0.04	0.03 - 2.8	13%	99%	0.2
		1000, 2000, 3000	1520	890 - 2232	0.22	0.02 - 0.75	20%	21%	9
		1500, 3000, 5000	1536	641 - 2350	0.05	0.04 - 0.67	50%	53%	12
	0.5	20,50,100	110	110 - 7.4 E+07	0.05	0.05 - 4.1	5%	99%	0.1
		150,300,500	536	0.00 - 5 E+06	0.04	(-6.1) - 2.8	38%	67%	1
		1000, 2000, 3000	1545	327 - 5281	0.39	(-1.3) - 5.2	4%	15%	8
		1500, 3000, 5000	1739	4.0 - 10,701	0.31	(-4.5) - 4.6	10%	22%	10
1.25	20,50,100	110	0.00 - 7.4 E+07	0.05	(-8.8) - 4.1	29%	60%	2	
	150,300,500	473	0.00 - 5 E+06	0.32	(-10) - 8.3	7%	39%	4	
	1000, 2000, 3000	1693	11 - 6432	0.42	(-4.4) - 3.8 E+15	1%	32%	8	
	1500, 3000, 5000	2327	0.19 - 20,671	0.46	(-8.3) - 10	2%	31%	9	
3000	0.12	150,300,500	*	*	*	*	0%	100%	0
		1000, 2000, 3000	2958	2450 - 5132	0.03	0.02 - 0.35	68%	70%	3
		1500, 3000, 5000	3054	2635 - 3870	0.03	0.02 - 0.19	83%	83%	7
	0.25	150,300,500	536	536	0.04	0.04	0.5%	99.98%	0
		1000, 2000, 3000	2958	2028 - 6432	0.20	0.02 - 0.86	23%	26%	4
		1500, 3000, 5000	3054	2069 - 4735	0.20	0.03 - 0.57	21%	21%	7
	0.5	150,300,500	536	137 - 5E+06	0.04	(-0.05) - 2.8	25%	89%	0.4
		1000, 2000, 3000	2665	602 - 11,881	0.32	(-0.96) - 4.4	5%	19%	5
		1500, 3000, 5000	3050	1032 - 10,599	0.39	(-1.1) - 6.1	4%	13%	7
	1.25	150,300,500	510	0.00 - 5 E+06	0.26	(-2.3 E+15) - 4.5	14%	47%	3
		1000, 2000, 3000	2033	54 - 9259	0.43	(-2.8) - 3.8 E+15	1%	34%	7
		1500, 3000, 5000	3050	0.19 - 20,671	0.47	(-8.3) - 1.2 E+16	1%	31%	7

Simulation Table VIII. Multiple Up-and-Down Sequences with Varying Nominals and Averaging Slopes – Dose and Progression Set Sequentially. The simulations in this table explore a test design to estimate slope based on using three, four or five full UDP runs and also varying the number of animals tested after the first reversal. The slopes and LD50's from the individual runs were averaged to obtain the final estimate of the LD50 and slope. The estimated LD50 of each run was used to set the starting dose and dose progression for the next run.

The actual LD50 and sigma of the dose response curve (reciprocal of slope) varied as detailed in the table. The hypothetical investigator did not know the true LD50 or slope and began the initial LD50 run at a series of different starting doses as indicated in the table. The starting doses the hypothetical investigator chose were (unknown to him or her) the actual LD10, LD50 and LD80. In addition, the length of the UDP runs was varied by changing the number of animals tested after the first reversal.

Each line of the table represents one study design tested:

Each line summarizes the results of 2500 simulated tests from a population with a true LD50 and sigma (reciprocal of slope) as detailed in the table.

For each run the computer randomly picked the appropriate number of animals from the entire population assigning each individual animal an LD50 based on the known variability of the population.

The number of animals tested after the first reversal is as detailed in the table.

Initially a single standard up-and-down run was performed to estimate the LD50. This single run ended when six animals had been dosed after the first reversal. Dosing boundaries were respected but no stopping rule was used. The assumed sigma for this initial UDP run was 0.5.

Based on the LD50 estimated from the first UDP run, the investigator started a second full UDP LD50 run beginning at the LD50 estimated from the first run. Based on the results of the second run a third full UDP run was started. This procedure continued until the final number of full runs was completed.

Final estimates of LD50 and slope were made by averaging the LD50's and slopes obtained from all the runs.

For each line the median, 5%, and 95% confident limits of the results of 2500 separate simulation runs are presented. In this table the number of animals used were tracked and are presented for each study design.

Table VIII

True LD50	True Sigma	# of Runs	# of Animals After Reversal	Prelim. Starting Dose *	Median LD50	LD50 5%	LD50 95%	Median Sigma	Sigma 5%	Sigma 95%	Median # of Animals	# of Animals 5%	# of Animals 95%
1.50	0.12	3	3	1.05	1.38	1.01	1.92	0.23	0.00	0.43	15	15	16
1.50	0.12	3	3	1.50	1.31	1.03	1.92	0.23	0.00	0.43	15	15	16
1.50	0.12	3	3	1.89	1.41	1.03	1.92	0.23	0.00	0.46	15	15	16
1.50	0.12	3	4	1.05	1.60	1.12	1.93	0.17	0.00	0.41	18	18	19
1.50	0.12	3	4	1.50	1.57	1.12	1.93	0.17	0.00	0.41	18	18	19
1.50	0.12	3	4	1.89	1.59	1.13	1.97	0.17	0.00	0.43	18	18	19
1.50	0.12	3	5	1.05	1.40	1.12	1.84	0.21	0.04	0.41	21	21	22
1.50	0.12	3	5	1.50	1.40	1.12	1.90	0.21	0.04	0.41	21	21	22
1.50	0.12	3	5	1.89	1.40	1.12	1.85	0.20	0.04	0.41	21	21	22
1.50	0.12	4	3	1.05	1.36	1.04	1.84	0.23	0.11	0.41	20	20	21
1.50	0.12	4	3	1.50	1.38	1.04	1.85	0.23	0.11	0.41	20	20	21
1.50	0.12	4	3	1.89	1.38	1.03	1.83	0.23	0.11	0.42	20	20	21
1.50	0.12	4	4	1.05	1.53	1.17	1.90	0.19	0.10	0.37	24	24	25
1.50	0.12	4	4	1.50	1.53	1.23	1.91	0.19	0.10	0.37	24	24	25
1.50	0.12	4	4	1.89	1.53	1.19	1.89	0.19	0.10	0.37	24	24	25
1.50	0.12	4	5	1.05	1.43	1.15	1.78	0.21	0.09	0.38	28	28	29
1.50	0.12	4	5	1.50	1.43	1.15	1.80	0.21	0.09	0.38	28	28	29
1.50	0.12	4	5	1.89	1.41	1.15	1.79	0.22	0.09	0.39	28	28	29
1.50	0.12	5	3	1.05	1.35	1.07	1.73	0.23	0.10	0.39	25	25	26
1.50	0.12	5	3	1.50	1.34	1.08	1.71	0.22	0.10	0.39	25	25	26
1.50	0.12	5	3	1.89	1.35	1.05	1.75	0.23	0.10	0.40	25	25	26
1.50	0.12	5	4	1.05	1.52	1.22	1.85	0.19	0.09	0.37	30	30	31
1.50	0.12	5	4	1.50	1.53	1.22	1.86	0.19	0.09	0.35	30	30	31
1.50	0.12	5	4	1.89	1.53	1.23	1.85	0.19	0.09	0.34	30	30	31
1.50	0.12	5	5	1.05	1.39	1.17	1.70	0.21	0.09	0.36	35	35	36
1.50	0.12	5	5	1.50	1.41	1.18	1.72	0.22	0.09	0.36	35	35	36
1.50	0.12	5	5	1.89	1.41	1.16	1.71	0.21	0.09	0.36	35	35	36

True LD50	True Sigma	# of Runs	# of Animals After Reversal	Prelim. Starting Dose *	Median LD50	LD50 5%	LD50 95%	Median Sigma	Sigma 5%	Sigma 95%	Median # of Animals	# of Animals 5%	# of Animals 95%
1.50	0.25	3	3	1.00	1.44	0.96	2.28	0.30	0.08	0.62	15	15	17
1.50	0.25	3	3	1.50	1.45	0.94	2.29	0.30	0.10	0.62	15	15	17
1.50	0.25	3	3	2.43	1.46	0.94	2.28	0.30	0.09	0.62	15	15	17
1.50	0.25	3	4	1.00	1.52	1.01	2.17	0.29	0.08	0.57	18	18	20
1.50	0.25	3	4	1.50	1.48	0.97	2.16	0.29	0.09	0.56	18	18	20
1.50	0.25	3	4	2.43	1.52	1.00	2.28	0.27	0.07	0.57	18	18	20
1.50	0.25	3	5	1.00	1.46	1.01	2.10	0.28	0.09	0.58	21	21	23
1.50	0.25	3	5	1.50	1.47	1.00	2.10	0.29	0.09	0.60	21	21	23
1.50	0.25	3	5	2.43	1.47	1.02	2.13	0.28	0.07	0.59	21	21	23
1.50	0.25	4	3	1.00	1.48	1.00	2.10	0.31	0.12	0.57	20	20	22
1.50	0.25	4	3	1.50	1.47	1.00	2.16	0.31	0.12	0.57	20	20	22
1.50	0.25	4	3	2.43	1.47	1.00	2.10	0.32	0.12	0.58	20	20	22
1.50	0.25	4	4	1.00	1.51	1.05	2.10	0.31	0.11	0.53	24	24	26
1.50	0.25	4	4	1.50	1.49	1.04	2.10	0.30	0.11	0.54	24	24	26
1.50	0.25	4	4	2.43	1.49	1.05	2.04	0.30	0.11	0.52	24	24	26
1.50	0.25	4	5	1.00	1.47	1.06	2.02	0.30	0.11	0.55	28	28	31
1.50	0.25	4	5	1.50	1.48	1.06	2.02	0.30	0.11	0.54	28	28	30
1.50	0.25	4	5	2.43	1.47	1.06	2.04	0.30	0.11	0.56	28	28	30
1.50	0.25	5	3	1.00	1.44	1.03	2.02	0.32	0.14	0.54	26	25	28
1.50	0.25	5	3	1.50	1.46	1.03	2.05	0.32	0.14	0.55	26	25	28
1.50	0.25	5	3	2.43	1.46	1.03	2.05	0.32	0.14	0.54	26	25	28
1.50	0.25	5	4	1.00	1.49	1.06	2.02	0.32	0.15	0.51	31	30	33
1.50	0.25	5	4	1.50	1.48	1.09	1.99	0.32	0.15	0.52	31	30	33
1.50	0.25	5	4	2.43	1.50	1.07	2.02	0.32	0.14	0.52	31	30	33
1.50	0.25	5	5	1.00	1.46	1.09	1.93	0.30	0.14	0.51	36	35	38
1.50	0.25	5	5	1.50	1.46	1.10	1.93	0.31	0.13	0.53	36	35	38
1.50	0.25	5	5	2.43	1.46	1.09	1.96	0.31	0.13	0.52	36	35	38

Table VIII

True LD50	True Sigma	# of Runs	# of Animals After Reversal	Prelim. Starting Dose *	Median LD50	LD50 5%	LD50 95%	Median Sigma	Sigma 5%	Sigma 95%	Median # of Animals	# of Animals 5%	# of Animals 95%
1.50	0.50	3	3	1.00	1.57	0.88	2.98	0.39	0.11	0.79	16	15	18
1.50	0.50	3	3	1.50	1.59	0.87	3.03	0.38	0.10	0.79	16	15	18
1.50	0.50	3	3	3.95	1.60	0.90	2.95	0.38	0.10	0.81	16	15	18
1.50	0.50	3	4	1.00	1.58	0.92	2.86	0.37	0.11	0.78	19	17	21
1.50	0.50	3	4	1.50	1.59	0.92	2.79	0.38	0.11	0.78	19	17	21
1.50	0.50	3	4	3.95	1.58	0.92	2.81	0.39	0.10	0.82	19	16	21
1.50	0.50	3	5	1.00	1.56	0.94	2.72	0.38	0.11	0.81	22	19	24
1.50	0.50	3	5	1.50	1.57	0.94	2.71	0.39	0.11	0.79	22	18	24
1.50	0.50	3	5	3.95	1.56	0.93	2.64	0.38	0.11	0.81	22	18	24
1.50	0.50	4	3	1.00	1.60	0.95	2.77	0.40	0.14	0.72	21	20	23
1.50	0.50	4	3	1.50	1.58	0.96	2.74	0.41	0.14	0.74	21	20	23
1.50	0.50	4	3	3.95	1.58	0.98	2.70	0.42	0.16	0.73	21	20	23
1.50	0.50	4	4	1.00	1.58	0.99	2.56	0.41	0.16	0.72	25	22	27
1.50	0.50	4	4	1.50	1.58	0.97	2.56	0.41	0.17	0.75	25	22	27
1.50	0.50	4	4	3.95	1.58	0.97	2.58	0.41	0.16	0.76	25	22	27
1.50	0.50	4	5	1.00	1.55	0.99	2.48	0.41	0.16	0.74	29	25	31
1.50	0.50	4	5	1.50	1.56	1.01	2.45	0.40	0.15	0.75	29	25	31
1.50	0.50	4	5	3.95	1.55	1.02	2.49	0.41	0.16	0.76	29	26	31
1.50	0.50	5	3	1.00	1.61	1.01	2.59	0.42	0.19	0.69	26	25	29
1.50	0.50	5	3	1.50	1.59	1.02	2.62	0.42	0.19	0.70	26	24	29
1.50	0.50	5	3	3.95	1.58	1.02	2.60	0.42	0.19	0.70	26	25	29
1.50	0.50	5	4	1.00	1.58	1.05	2.45	0.42	0.20	0.71	31	29	34
1.50	0.50	5	4	1.50	1.58	1.04	2.47	0.42	0.20	0.72	31	29	34
1.50	0.50	5	4	3.95	1.57	1.02	2.46	0.42	0.19	0.71	31	28	34
1.50	0.50	5	5	1.00	1.56	1.04	2.34	0.42	0.19	0.71	36	32	39
1.50	0.50	5	5	1.50	1.57	1.05	2.37	0.42	0.19	0.71	36	33	39
1.50	0.50	5	5	3.95	1.56	1.03	2.36	0.42	0.19	0.71	36	32	39

Table VIII

True LD50	True Sigma	# of Runs	# of Animals After Reversal	Prelim. Starting Dose *	Median LD50	LD50 5%	LD50 95%	Median Sigma	Sigma 5%	Sigma 95%	Median # of Animals	# of Animals 5%	# of Animals 95%
1.50	1.25	3	3	1.00	2.01	0.89	5.96	0.53	0.14	1.13	16	15	19
1.50	1.25	3	3	1.50	1.98	0.87	5.77	0.51	0.13	1.11	16	14	18
1.50	1.25	3	3	16.91	2.40	0.98	8.23	0.57	0.15	1.24	17	15	19
1.50	1.25	3	4	1.00	1.98	0.93	5.68	0.54	0.13	1.16	19	16	22
1.50	1.25	3	4	1.50	1.96	0.92	5.69	0.53	0.12	1.15	19	16	21
1.50	1.25	3	4	16.91	2.31	1.02	7.10	0.60	0.15	1.23	19	17	22
1.50	1.25	3	5	1.00	1.95	0.94	5.33	0.55	0.14	1.19	22	18	25
1.50	1.25	3	5	1.50	1.96	0.90	5.46	0.55	0.15	1.21	22	18	25
1.50	1.25	3	5	16.91	2.25	1.00	6.53	0.61	0.17	1.29	22	19	25
1.50	1.25	4	3	1.00	2.07	1.02	5.39	0.58	0.20	1.08	21	20	25
1.50	1.25	4	3	1.50	2.03	1.00	5.67	0.57	0.21	1.08	22	20	24
1.50	1.25	4	3	16.91	2.40	1.06	6.81	0.63	0.22	1.14	22	20	25
1.50	1.25	4	4	1.00	2.03	1.01	5.11	0.58	0.22	1.09	25	22	28
1.50	1.25	4	4	1.50	2.00	0.98	4.80	0.59	0.21	1.12	25	23	28
1.50	1.25	4	4	16.91	2.25	1.07	5.93	0.64	0.25	1.18	26	23	29
1.50	1.25	4	5	1.00	1.98	1.02	4.68	0.59	0.21	1.13	29	25	32
1.50	1.25	4	5	1.50	1.97	1.04	4.61	0.60	0.21	1.13	29	25	32
1.50	1.25	4	5	16.91	2.25	1.15	5.52	0.65	0.23	1.22	30	26	33
1.50	1.25	5	3	1.00	2.08	1.07	4.95	0.59	0.26	1.03	27	25	30
1.50	1.25	5	3	1.50	2.09	1.06	4.99	0.59	0.25	1.02	27	25	30
1.50	1.25	5	3	16.91	2.34	1.12	5.92	0.63	0.27	1.08	27	25	31
1.50	1.25	5	4	1.00	2.06	1.09	4.65	0.61	0.27	1.07	32	29	35
1.50	1.25	5	4	1.50	2.11	1.11	4.68	0.62	0.28	1.07	32	29	35
1.50	1.25	5	4	16.91	2.20	1.13	5.33	0.65	0.29	1.11	32	29	35
1.50	1.25	5	5	1.00	2.04	1.09	4.40	0.62	0.27	1.10	37	32	40
1.50	1.25	5	5	1.50	2.02	1.11	4.22	0.62	0.27	1.10	37	32	40
1.50	1.25	5	5	16.91	2.20	1.16	4.96	0.67	0.28	1.15	37	33	41

True LD50	True Sigma	# of Runs	# of Animals After Reversal	Prelim. Starting Dose *	Median LD50	LD50 5%	LD50 95%	Median Sigma	Sigma 5%	Sigma 95%	Median # of Animals	# of Animals 5%	# of Animals 95%
1.50	2.00	3	3	1.00	2.33	0.90	10.70	0.59	0.14	1.33	16	15	19
1.50	2.00	3	3	1.50	2.32	0.93	11.40	0.58	0.13	1.33	16	14	19
1.50	2.00	3	3	72.33	4.22	1.17	25.65	0.76	0.20	1.57	17	15	21
1.50	2.00	3	4	1.00	2.27	0.95	9.76	0.62	0.17	1.40	19	16	22
1.50	2.00	3	4	1.50	2.33	0.96	9.52	0.61	0.16	1.39	19	17	22
1.50	2.00	3	4	72.33	3.97	1.23	21.32	0.77	0.20	1.63	20	18	23
1.50	2.00	3	5	1.00	2.25	0.93	8.50	0.64	0.16	1.47	22	18	25
1.50	2.00	3	5	1.50	2.31	0.94	9.02	0.65	0.17	1.50	22	18	25
1.50	2.00	3	5	72.33	3.71	1.11	20.29	0.82	0.20	1.76	23	21	27
1.50	2.00	4	3	1.00	2.44	1.04	9.52	0.65	0.25	1.29	22	20	25
1.50	2.00	4	3	1.50	2.41	1.02	9.16	0.65	0.22	1.25	22	20	25
1.50	2.00	4	3	72.33	3.91	1.22	20.22	0.79	0.27	1.52	23	20	26
1.50	2.00	4	4	1.00	2.41	1.02	8.63	0.67	0.26	1.32	26	23	29
1.50	2.00	4	4	1.50	2.41	1.06	8.01	0.67	0.24	1.32	26	23	29
1.50	2.00	4	4	72.33	3.72	1.32	15.65	0.83	0.30	1.55	27	24	30
1.50	2.00	4	5	1.00	2.44	1.08	8.01	0.72	0.27	1.40	30	26	33
1.50	2.00	4	5	1.50	2.36	1.05	7.63	0.71	0.26	1.39	30	25	33
1.50	2.00	4	5	72.33	3.47	1.26	13.35	0.87	0.31	1.63	31	27	34
1.50	2.00	5	3	1.00	2.50	1.12	8.77	0.69	0.29	1.23	27	25	31
1.50	2.00	5	3	1.50	2.48	1.12	8.80	0.68	0.30	1.26	27	25	31
1.50	2.00	5	3	72.33	3.72	1.35	15.12	0.83	0.33	1.46	28	25	32
1.50	2.00	5	4	1.00	2.47	1.12	7.82	0.73	0.31	1.33	32	29	36
1.50	2.00	5	4	1.50	2.55	1.15	7.58	0.74	0.32	1.34	32	29	36
1.50	2.00	5	4	72.33	3.53	1.34	12.28	0.85	0.37	1.50	33	30	37
1.50	2.00	5	5	1.00	2.52	1.16	7.57	0.75	0.33	1.38	37	33	41
1.50	2.00	5	5	1.50	2.46	1.15	7.36	0.74	0.31	1.40	37	33	41
1.50	2.00	5	5	72.33	3.36	1.33	11.68	0.88	0.37	1.57	38	34	42

Table VIII

True LD50	True Sigma	# of Runs	# of Animals After Reversal	Prelim. Starting Dose *	Median LD50	LD50 5%	LD50 95%	Median Sigma	Sigma 5%	Sigma 95%	Median # of Animals	# of Animals 5%	# of Animals 95%
50.00	0.12	3	3	35.09	60.08	40.74	63.91	0.34	0.15	0.37	15	15	15
50.00	0.12	3	3	50.00	50.00	36.37	73.56	0.34	0.13	0.47	15	15	15
50.00	0.12	3	3	63.09	43.80	36.85	63.10	0.34	0.13	0.43	15	15	15
50.00	0.12	3	4	35.09	51.51	40.03	58.76	0.23	0.09	0.31	18	18	18
50.00	0.12	3	4	50.00	50.00	38.69	64.63	0.23	0.09	0.31	18	18	18
50.00	0.12	3	4	63.09	48.82	42.79	63.10	0.23	0.09	0.31	18	18	18
50.00	0.12	3	5	35.09	54.29	41.57	64.00	0.32	0.10	0.38	21	21	21
50.00	0.12	3	5	50.00	50.00	38.22	65.83	0.32	0.10	0.46	21	21	21
50.00	0.12	3	5	63.09	47.12	38.54	60.15	0.32	0.14	0.41	21	21	21
50.00	0.12	4	3	35.09	52.52	41.84	62.62	0.34	0.21	0.38	20	20	20
50.00	0.12	4	3	50.00	50.18	38.85	66.80	0.34	0.18	0.46	20	20	20
50.00	0.12	4	3	63.09	46.49	38.29	61.37	0.34	0.15	0.39	20	20	20
50.00	0.12	4	4	35.09	51.48	42.54	62.40	0.21	0.09	0.27	24	24	24
50.00	0.12	4	4	50.00	50.00	41.18	60.82	0.21	0.09	0.37	24	24	24
50.00	0.12	4	4	63.09	47.32	39.17	57.55	0.21	0.09	0.31	24	24	24
50.00	0.12	4	5	35.09	50.79	43.20	61.89	0.30	0.16	0.39	28	28	28
50.00	0.12	4	5	50.00	50.03	40.62	61.56	0.30	0.15	0.41	28	28	28
50.00	0.12	4	5	63.09	47.71	39.81	60.26	0.30	0.17	0.39	28	28	28
50.00	0.12	5	3	35.09	53.34	42.97	60.06	0.32	0.23	0.38	25	25	25
50.00	0.12	5	3	50.00	49.74	39.97	62.71	0.32	0.23	0.41	25	25	26
50.00	0.12	5	3	63.09	47.05	38.89	60.65	0.32	0.23	0.38	25	25	25
50.00	0.12	5	4	35.09	49.70	42.61	57.98	0.23	0.13	0.30	30	30	30
50.00	0.12	5	4	50.00	48.30	41.24	60.64	0.23	0.13	0.32	30	30	30
50.00	0.12	5	4	63.09	48.21	41.39	60.61	0.23	0.13	0.31	30	30	30
50.00	0.12	5	5	35.09	52.06	43.77	58.94	0.31	0.18	0.37	35	35	35
50.00	0.12	5	5	50.00	50.15	41.59	60.56	0.31	0.18	0.41	35	35	35
50.00	0.12	5	5	63.09	48.56	40.48	58.05	0.31	0.18	0.37	35	35	35

True LD50	True Sigma	# of Runs	# of Animals After Reversal	Prelim. Starting Dose *	Median LD50	LD50 5%	LD50 95%	Median Sigma	Sigma 5%	Sigma 95%	Median # of Animals	# of Animals 5%	# of Animals 95%
50.00	0.25	3	3	23.91	51.75	35.18	76.14	0.30	0.13	0.57	15	15	17
50.00	0.25	3	3	50.00	50.00	33.81	74.96	0.34	0.13	0.58	15	15	16
50.00	0.25	3	3	81.17	47.46	32.30	71.06	0.32	0.13	0.57	15	15	16
50.00	0.25	3	4	23.91	51.28	35.06	74.59	0.26	0.09	0.58	18	18	20
50.00	0.25	3	4	50.00	50.00	34.14	73.49	0.23	0.09	0.57	18	18	19
50.00	0.25	3	4	81.17	48.70	34.07	71.32	0.25	0.09	0.58	18	18	19
50.00	0.25	3	5	23.91	51.56	36.83	71.71	0.31	0.08	0.54	21	21	22
50.00	0.25	3	5	50.00	50.00	35.91	70.44	0.31	0.08	0.58	21	21	22
50.00	0.25	3	5	81.17	48.74	34.89	68.56	0.31	0.08	0.54	21	21	22
50.00	0.25	4	3	23.91	50.87	36.17	72.90	0.31	0.12	0.54	20	20	22
50.00	0.25	4	3	50.00	50.00	35.18	71.08	0.34	0.14	0.53	20	20	21
50.00	0.25	4	3	81.17	49.09	34.40	69.17	0.31	0.14	0.54	20	20	22
50.00	0.25	4	4	23.91	51.35	36.14	70.25	0.27	0.12	0.52	24	24	26
50.00	0.25	4	4	50.00	50.00	37.30	67.02	0.26	0.09	0.51	24	24	25
50.00	0.25	4	4	81.17	50.21	36.80	67.68	0.26	0.09	0.52	24	24	25
50.00	0.25	4	5	23.91	50.38	38.48	67.70	0.30	0.15	0.52	28	28	30
50.00	0.25	4	5	50.00	50.11	37.14	68.38	0.31	0.15	0.53	28	28	29
50.00	0.25	4	5	81.17	49.39	36.96	65.96	0.30	0.15	0.51	28	28	29
50.00	0.25	5	3	23.91	50.45	36.91	68.46	0.32	0.15	0.50	25	25	27
50.00	0.25	5	3	50.00	50.26	36.72	69.40	0.33	0.18	0.51	25	25	27
50.00	0.25	5	3	81.17	49.18	35.93	67.46	0.33	0.16	0.51	25	25	27
50.00	0.25	5	4	23.91	49.80	37.56	67.48	0.29	0.13	0.50	30	30	32
50.00	0.25	5	4	50.00	50.31	38.21	65.82	0.28	0.13	0.50	30	30	31
50.00	0.25	5	4	81.17	49.40	37.41	66.85	0.27	0.13	0.49	30	30	32
50.00	0.25	5	5	23.91	50.72	39.03	66.11	0.31	0.15	0.50	35	35	37
50.00	0.25	5	5	50.00	49.65	38.57	65.85	0.32	0.16	0.50	35	35	36
50.00	0.25	5	5	81.17	49.23	38.18	64.31	0.31	0.16	0.49	35	35	37

True LD50	True Sigma	# of Runs	# of Animals After Reversal	Prelim. Starting Dose *	Median LD50	LD50 5%	LD50 95%	Median Sigma	Sigma 5%	Sigma 95%	Median # of Animals	# of Animals 5%	# of Animals 95%
50.00	0.50	3	3	11.43	49.31	26.21	96.15	0.43	0.13	0.89	16	15	18
50.00	0.50	3	3	50.00	50.00	24.98	97.89	0.42	0.13	0.86	16	15	17
50.00	0.50	3	3	131.76	50.54	26.03	97.53	0.42	0.13	0.86	16	15	18
50.00	0.50	3	4	11.43	49.64	26.83	92.03	0.42	0.09	0.86	19	18	21
50.00	0.50	3	4	50.00	50.00	26.71	93.62	0.42	0.09	0.87	19	18	20
50.00	0.50	3	4	131.76	49.69	28.27	91.83	0.42	0.09	0.86	19	18	21
50.00	0.50	3	5	11.43	49.86	27.51	86.26	0.43	0.12	0.85	22	21	24
50.00	0.50	3	5	50.00	49.93	27.93	86.87	0.42	0.10	0.83	21	21	23
50.00	0.50	3	5	131.76	50.17	27.87	90.13	0.42	0.13	0.85	22	21	24
50.00	0.50	4	3	11.43	49.61	27.33	87.76	0.44	0.18	0.80	21	20	24
50.00	0.50	4	3	50.00	50.00	28.12	90.09	0.44	0.17	0.79	21	20	23
50.00	0.50	4	3	131.76	50.53	28.82	89.33	0.43	0.17	0.80	21	20	23
50.00	0.50	4	4	11.43	49.50	29.27	83.28	0.44	0.15	0.80	25	24	27
50.00	0.50	4	4	50.00	50.00	28.78	86.28	0.45	0.19	0.80	25	24	27
50.00	0.50	4	4	131.76	50.28	29.83	86.95	0.45	0.18	0.79	25	24	27
50.00	0.50	4	5	11.43	49.43	30.74	79.24	0.44	0.17	0.81	29	28	31
50.00	0.50	4	5	50.00	50.40	30.40	84.48	0.44	0.17	0.79	29	28	31
50.00	0.50	4	5	131.76	51.04	30.71	83.68	0.44	0.17	0.79	29	28	31
50.00	0.50	5	3	11.43	49.77	29.79	83.03	0.46	0.23	0.76	27	25	29
50.00	0.50	5	3	50.00	49.86	29.35	84.53	0.45	0.23	0.76	26	25	28
50.00	0.50	5	3	131.76	49.88	29.69	84.54	0.46	0.23	0.76	26	25	29
50.00	0.50	5	4	11.43	49.93	31.20	79.95	0.46	0.19	0.77	32	30	34
50.00	0.50	5	4	50.00	49.94	30.39	80.05	0.45	0.19	0.75	31	30	33
50.00	0.50	5	4	131.76	49.80	30.30	80.93	0.46	0.20	0.77	31	30	34
50.00	0.50	5	5	11.43	49.47	31.79	77.96	0.46	0.22	0.78	37	35	39
50.00	0.50	5	5	50.00	49.77	32.55	78.55	0.45	0.21	0.75	36	35	38
50.00	0.50	5	5	131.76	50.61	32.57	78.28	0.46	0.21	0.76	36	35	38

True LD50	True Sigma	# of Runs	# of Animals After Reversal	Prelim. Starting Dose *	Median LD50	LD50 5%	LD50 95%	Median Sigma	Sigma 5%	Sigma 95%	Median # of Animals	# of Animals 5%	# of Animals 95%
50.00	1.25	3	3	1.25	32.75	8.00	154.80	0.72	0.17	1.45	17	15	20
50.00	1.25	3	3	50.00	50.22	13.49	192.27	0.64	0.15	1.35	16	15	19
50.00	1.25	3	3	563.63	66.29	16.23	266.03	0.68	0.17	1.49	17	15	20
50.00	1.25	3	4	1.25	35.52	9.83	140.26	0.73	0.21	1.59	20	18	24
50.00	1.25	3	4	50.00	49.73	14.11	179.37	0.67	0.18	1.41	19	18	22
50.00	1.25	3	4	563.63	64.53	16.90	245.35	0.69	0.21	1.47	20	18	23
50.00	1.25	3	5	1.25	36.51	11.11	135.03	0.75	0.20	1.58	23	21	27
50.00	1.25	3	5	50.00	49.05	14.96	167.10	0.69	0.18	1.49	22	21	25
50.00	1.25	3	5	563.63	61.25	18.25	209.64	0.74	0.19	1.57	23	21	26
50.00	1.25	4	3	1.25	35.85	10.56	136.33	0.75	0.28	1.41	23	20	27
50.00	1.25	4	3	50.00	51.38	14.92	167.37	0.67	0.26	1.32	22	20	25
50.00	1.25	4	3	563.63	63.22	17.33	215.78	0.74	0.27	1.33	22	20	26
50.00	1.25	4	4	1.25	38.55	12.58	128.59	0.80	0.28	1.44	27	24	31
50.00	1.25	4	4	50.00	50.87	16.40	158.99	0.72	0.29	1.34	26	24	29
50.00	1.25	4	4	563.63	62.86	19.57	191.92	0.77	0.29	1.45	26	24	30
50.00	1.25	4	5	1.25	40.67	13.10	114.57	0.79	0.30	1.46	31	28	34
50.00	1.25	4	5	50.00	49.50	16.87	141.17	0.74	0.28	1.40	30	28	33
50.00	1.25	4	5	563.63	59.44	19.91	177.98	0.79	0.29	1.47	30	28	34
50.00	1.25	5	3	1.25	38.49	12.39	125.21	0.78	0.35	1.36	28	26	32
50.00	1.25	5	3	50.00	50.79	16.74	152.49	0.71	0.32	1.27	27	25	31
50.00	1.25	5	3	563.63	59.47	19.16	178.10	0.76	0.34	1.33	28	26	32
50.00	1.25	5	4	1.25	41.05	14.75	120.60	0.80	0.37	1.38	33	31	37
50.00	1.25	5	4	50.00	50.70	18.37	145.68	0.76	0.33	1.34	32	30	36
50.00	1.25	5	4	563.63	57.79	20.25	161.07	0.78	0.35	1.35	33	30	37
50.00	1.25	5	5	1.25	41.74	15.60	115.73	0.83	0.37	1.45	38	36	42
50.00	1.25	5	5	50.00	50.69	19.36	138.07	0.78	0.36	1.35	37	35	41
50.00	1.25	5	5	563.63	58.75	21.82	153.79	0.81	0.37	1.40	38	35	42

True LD50	True Sigma	# of Runs	# of Animals After Reversal	Prelim. Starting Dose *	Median LD50	LD50 5%	LD50 95%	Median Sigma	Sigma 5%	Sigma 95%	Median # of Animals	# of Animals 5%	# of Animals 95%
50.00	2.00	3	3	1.00	21.84	3.87	166.77	0.82	0.21	1.78	17	15	21
50.00	2.00	3	3	50.00	50.71	7.86	321.77	0.73	0.17	1.60	17	15	20
50.00	2.00	3	3	2411.09	128.75	14.09	793.07	0.87	0.19	1.93	18	15	21
50.00	2.00	3	4	1.00	24.66	4.87	164.89	0.87	0.23	1.94	20	18	24
50.00	2.00	3	4	50.00	49.91	9.09	283.46	0.76	0.23	1.67	20	18	23
50.00	2.00	3	4	2411.09	116.17	15.77	696.88	0.92	0.24	2.02	21	18	24
50.00	2.00	3	5	1.00	27.83	5.36	160.56	0.89	0.24	1.98	23	21	27
50.00	2.00	3	5	50.00	49.95	8.96	267.23	0.81	0.20	1.75	23	21	26
50.00	2.00	3	5	2411.09	100.93	15.52	571.19	0.97	0.27	2.12	24	21	27
50.00	2.00	4	3	1.00	27.90	5.29	167.64	0.89	0.31	1.74	23	20	27
50.00	2.00	4	3	50.00	52.30	9.39	286.83	0.79	0.28	1.54	22	20	26
50.00	2.00	4	3	2411.09	106.15	16.02	567.69	0.94	0.32	1.81	23	21	28
50.00	2.00	4	4	1.00	29.48	5.62	160.11	0.95	0.32	1.80	27	24	31
50.00	2.00	4	4	50.00	50.11	9.79	250.38	0.85	0.33	1.61	26	24	30
50.00	2.00	4	4	2411.09	95.52	16.28	473.55	0.99	0.35	1.89	27	24	31
50.00	2.00	4	5	1.00	31.08	6.78	166.23	1.01	0.38	1.90	31	28	35
50.00	2.00	4	5	50.00	51.32	11.24	229.46	0.92	0.34	1.74	30	28	34
50.00	2.00	4	5	2411.09	86.12	17.54	411.71	1.04	0.37	1.97	31	29	35
50.00	2.00	5	3	1.00	31.80	7.36	177.65	0.95	0.40	1.65	29	26	33
50.00	2.00	5	3	50.00	50.68	10.70	245.35	0.85	0.38	1.58	28	25	32
50.00	2.00	5	3	2411.09	89.57	15.85	451.95	1.00	0.43	1.76	29	26	33
50.00	2.00	5	4	1.00	33.82	7.35	160.54	1.01	0.45	1.75	34	31	38
50.00	2.00	5	4	50.00	52.59	11.52	238.42	0.89	0.39	1.60	33	30	37
50.00	2.00	5	4	2411.09	80.43	17.29	372.20	1.04	0.43	1.81	34	31	38
50.00	2.00	5	5	1.00	34.22	8.34	155.68	1.05	0.48	1.79	38	36	43
50.00	2.00	5	5	50.00	49.72	13.17	208.13	0.97	0.42	1.70	38	35	42
50.00	2.00	5	5	2411.09	76.39	17.89	324.54	1.09	0.51	1.89	39	36	43

True LD50	True Sigma	# of Runs	# of Animals After Reversal	Prelim. Starting Dose *	Median LD50	LD50 5%	LD50 95%	Median Sigma	Sigma 5%	Sigma 95%	Median # of Animals	# of Animals 5%	# of Animals 95%
250.00	0.12	3	3	175.45	300.41	203.25	326.36	0.34	0.15	0.37	15	15	15
250.00	0.12	3	3	250.00	249.98	173.53	367.76	0.34	0.13	0.47	15	15	15
250.00	0.12	3	3	315.45	229.66	184.24	315.43	0.34	0.13	0.43	15	15	15
250.00	0.12	3	4	175.45	257.55	200.17	293.82	0.23	0.09	0.31	18	18	18
250.00	0.12	3	4	250.00	249.98	193.40	323.10	0.23	0.09	0.31	18	18	18
250.00	0.12	3	4	315.45	244.04	189.24	315.43	0.23	0.09	0.31	18	18	18
250.00	0.12	3	5	175.45	274.24	207.84	320.17	0.32	0.10	0.38	21	21	21
250.00	0.12	3	5	250.00	249.98	190.29	327.08	0.32	0.10	0.46	21	21	21
250.00	0.12	3	5	315.45	236.02	192.65	296.77	0.32	0.10	0.38	21	21	21
250.00	0.12	4	3	175.45	262.62	209.20	313.66	0.34	0.21	0.37	20	20	20
250.00	0.12	4	3	250.00	249.98	190.28	328.70	0.34	0.15	0.46	20	20	20
250.00	0.12	4	3	315.45	232.43	192.86	310.38	0.33	0.19	0.39	20	20	20
250.00	0.12	4	4	175.45	257.41	212.71	312.03	0.21	0.09	0.27	24	24	24
250.00	0.12	4	4	250.00	249.98	205.51	303.55	0.21	0.09	0.37	24	24	24
250.00	0.12	4	4	315.45	236.54	195.46	287.72	0.21	0.12	0.31	24	24	24
250.00	0.12	4	5	175.45	253.98	216.02	309.41	0.30	0.17	0.39	28	28	28
250.00	0.12	4	5	250.00	249.82	203.05	307.75	0.30	0.16	0.41	28	28	28
250.00	0.12	4	5	315.45	236.93	200.98	301.23	0.30	0.16	0.39	28	28	28
250.00	0.12	5	3	175.45	266.73	214.87	302.65	0.32	0.23	0.37	25	25	25
250.00	0.12	5	3	250.00	251.38	199.55	309.13	0.32	0.23	0.41	25	25	26
250.00	0.12	5	3	315.45	234.41	194.42	306.38	0.31	0.22	0.40	25	25	25
250.00	0.12	5	4	175.45	248.20	212.78	290.30	0.23	0.13	0.29	30	30	30
250.00	0.12	5	4	250.00	242.32	206.14	303.13	0.23	0.13	0.32	30	30	30
250.00	0.12	5	4	315.45	241.01	206.90	302.38	0.23	0.13	0.29	30	30	30
250.00	0.12	5	5	175.45	258.37	218.94	294.49	0.31	0.18	0.37	35	35	35
250.00	0.12	5	5	250.00	250.44	207.89	300.70	0.31	0.17	0.41	35	35	35
250.00	0.12	5	5	315.45	241.66	202.38	285.80	0.31	0.18	0.37	35	35	35

True LD50	True Sigma	# of Runs	# of Animals After Reversal	Prelim. Starting Dose *	Median LD50	LD50 5%	LD50 95%	Median Sigma	Sigma 5%	Sigma 95%	Median # of Animals	# of Animals 5%	# of Animals 95%
250.00	0.25	3	3	119.55	258.78	175.90	380.72	0.32	0.13	0.57	15	15	17
250.00	0.25	3	3	250.00	249.98	166.37	387.08	0.34	0.13	0.58	15	15	16
250.00	0.25	3	3	405.83	237.26	161.19	356.13	0.32	0.13	0.57	15	15	16
250.00	0.25	3	4	119.55	256.42	175.50	373.25	0.26	0.09	0.58	18	18	20
250.00	0.25	3	4	250.00	249.98	170.70	366.08	0.23	0.09	0.56	18	18	19
250.00	0.25	3	4	405.83	243.45	172.22	357.33	0.26	0.09	0.58	18	18	19
250.00	0.25	3	5	119.55	257.74	181.76	346.83	0.31	0.08	0.54	21	21	22
250.00	0.25	3	5	250.00	249.98	178.40	350.28	0.31	0.08	0.58	21	21	22
250.00	0.25	3	5	405.83	244.26	176.66	345.77	0.31	0.08	0.54	21	21	22
250.00	0.25	4	3	119.55	255.30	184.29	358.59	0.31	0.12	0.51	20	20	22
250.00	0.25	4	3	250.00	249.98	175.86	355.34	0.34	0.15	0.54	20	20	21
250.00	0.25	4	3	405.83	241.98	175.60	343.98	0.31	0.14	0.52	20	20	22
250.00	0.25	4	4	119.55	254.01	176.30	350.71	0.27	0.12	0.53	24	24	26
250.00	0.25	4	4	250.00	249.98	186.49	335.07	0.26	0.09	0.51	24	24	25
250.00	0.25	4	4	405.83	251.03	184.19	343.81	0.26	0.09	0.52	24	24	25
250.00	0.25	4	5	119.55	253.52	187.83	336.01	0.30	0.12	0.52	28	28	30
250.00	0.25	4	5	250.00	248.76	184.64	334.64	0.31	0.15	0.52	28	28	29
250.00	0.25	4	5	405.83	246.92	184.00	329.82	0.30	0.13	0.51	28	28	29
250.00	0.25	5	3	119.55	254.49	188.11	343.07	0.32	0.15	0.50	25	25	27
250.00	0.25	5	3	250.00	251.88	184.58	343.20	0.33	0.18	0.52	25	25	27
250.00	0.25	5	3	405.83	245.63	181.15	331.39	0.33	0.16	0.52	25	25	27
250.00	0.25	5	4	119.55	248.69	186.94	336.98	0.28	0.13	0.49	30	30	32
250.00	0.25	5	4	250.00	251.82	190.48	328.06	0.28	0.13	0.49	30	30	32
250.00	0.25	5	4	405.83	246.96	187.57	334.63	0.27	0.13	0.50	30	30	32
250.00	0.25	5	5	119.55	252.61	196.28	327.96	0.31	0.15	0.49	35	35	37
250.00	0.25	5	5	250.00	249.57	192.34	323.23	0.32	0.16	0.50	35	35	36
250.00	0.25	5	5	405.83	248.60	192.23	318.62	0.31	0.15	0.49	35	35	37

True LD50	True Sigma	# of Runs	# of Animals After Reversal	Prelim. Starting Dose *	Median LD50	LD50 5%	LD50 95%	Median Sigma	Sigma 5%	Sigma 95%	Median # of Animals	# of Animals 5%	# of Animals 95%
250.00	0.50	3	3	57.17	246.85	124.47	488.00	0.43	0.13	0.89	16	15	18
250.00	0.50	3	3	250.00	249.98	125.47	497.11	0.43	0.13	0.86	15	15	17
250.00	0.50	3	3	658.80	255.84	129.72	488.79	0.42	0.13	0.84	16	15	18
250.00	0.50	3	4	57.17	247.68	137.26	457.35	0.42	0.09	0.85	19	18	21
250.00	0.50	3	4	250.00	249.98	136.86	469.24	0.42	0.09	0.85	18	18	20
250.00	0.50	3	4	658.80	253.08	135.56	460.44	0.42	0.09	0.84	19	18	21
250.00	0.50	3	5	57.17	246.98	139.02	446.74	0.44	0.10	0.84	22	21	24
250.00	0.50	3	5	250.00	247.22	137.00	431.84	0.43	0.12	0.86	21	21	23
250.00	0.50	3	5	658.80	250.17	143.11	428.87	0.43	0.10	0.84	22	21	24
250.00	0.50	4	3	57.17	248.05	136.29	442.11	0.44	0.17	0.79	21	20	24
250.00	0.50	4	3	250.00	248.45	138.88	440.55	0.44	0.18	0.79	21	20	23
250.00	0.50	4	3	658.80	253.45	136.51	442.36	0.43	0.17	0.79	21	20	23
250.00	0.50	4	4	57.17	251.52	148.02	435.08	0.46	0.17	0.80	25	24	28
250.00	0.50	4	4	250.00	250.98	150.95	426.45	0.44	0.19	0.80	25	24	27
250.00	0.50	4	4	658.80	249.27	151.18	430.41	0.46	0.19	0.81	25	24	27
250.00	0.50	4	5	57.17	246.94	148.42	398.39	0.45	0.17	0.80	29	28	31
250.00	0.50	4	5	250.00	249.84	157.96	410.20	0.44	0.17	0.79	29	28	31
250.00	0.50	4	5	658.80	252.43	153.16	411.72	0.44	0.19	0.81	29	28	31
250.00	0.50	5	3	57.17	245.18	150.92	411.53	0.46	0.23	0.77	27	25	29
250.00	0.50	5	3	250.00	252.49	149.78	416.45	0.47	0.23	0.77	26	25	29
250.00	0.50	5	3	658.80	250.40	149.83	425.00	0.45	0.22	0.76	26	25	29
250.00	0.50	5	4	57.17	249.44	154.47	404.72	0.46	0.20	0.76	32	30	34
250.00	0.50	5	4	250.00	248.42	155.63	395.07	0.45	0.20	0.77	31	30	33
250.00	0.50	5	4	658.80	248.87	154.99	399.97	0.46	0.20	0.76	31	30	34
250.00	0.50	5	5	57.17	249.29	161.80	391.40	0.46	0.21	0.77	37	35	39
250.00	0.50	5	5	250.00	248.35	157.09	390.03	0.46	0.22	0.75	36	35	38
250.00	0.50	5	5	658.80	249.25	161.23	387.49	0.45	0.21	0.76	36	35	38

True LD50	True Sigma	# of Runs	# of Animals After Reversal	Prelim. Starting Dose *	Median LD50	LD50 5%	LD50 95%	Median Sigma	Sigma 5%	Sigma 95%	Median # of Animals	# of Animals 5%	# of Animals 95%
250.00	1.25	3	3	6.25	164.74	37.29	714.49	0.72	0.17	1.55	18	15	21
250.00	1.25	3	3	250.00	247.53	66.41	955.19	0.63	0.15	1.35	16	15	19
250.00	1.25	3	3	2818.17	345.07	87.38	1288.15	0.64	0.16	1.40	17	15	20
250.00	1.25	3	4	6.25	169.71	48.18	694.23	0.72	0.21	1.57	21	18	24
250.00	1.25	3	4	250.00	254.37	72.68	879.56	0.67	0.15	1.44	19	18	22
250.00	1.25	3	4	2818.17	331.06	85.24	1154.21	0.69	0.18	1.45	20	18	23
250.00	1.25	3	5	6.25	185.01	52.04	629.03	0.76	0.20	1.62	24	21	27
250.00	1.25	3	5	250.00	251.83	75.01	782.41	0.69	0.19	1.44	22	21	25
250.00	1.25	3	5	2818.17	323.76	94.64	1002.32	0.74	0.20	1.55	23	21	26
250.00	1.25	4	3	6.25	186.12	53.65	661.09	0.77	0.28	1.43	23	21	27
250.00	1.25	4	3	250.00	252.10	77.31	796.38	0.69	0.26	1.28	22	20	25
250.00	1.25	4	3	2818.17	311.91	84.69	999.62	0.72	0.27	1.32	22	20	26
250.00	1.25	4	4	6.25	181.85	53.85	588.29	0.77	0.31	1.48	27	25	31
250.00	1.25	4	4	250.00	247.42	83.23	733.63	0.72	0.29	1.33	26	24	29
250.00	1.25	4	4	2818.17	299.35	94.02	909.10	0.73	0.28	1.35	26	24	30
250.00	1.25	4	5	6.25	203.71	65.71	588.09	0.82	0.30	1.52	31	29	35
250.00	1.25	4	5	250.00	247.36	86.56	703.22	0.76	0.29	1.39	30	28	33
250.00	1.25	4	5	2818.17	289.84	102.30	828.31	0.77	0.27	1.43	30	28	34
250.00	1.25	5	3	6.25	195.25	60.49	589.86	0.80	0.35	1.40	29	26	33
250.00	1.25	5	3	250.00	250.38	85.06	734.67	0.72	0.33	1.27	27	25	31
250.00	1.25	5	3	2818.17	297.97	101.39	819.59	0.75	0.34	1.28	28	25	32
250.00	1.25	5	4	6.25	202.84	71.26	571.86	0.82	0.37	1.42	34	31	38
250.00	1.25	5	4	250.00	249.93	92.09	672.95	0.74	0.35	1.29	32	30	36
250.00	1.25	5	4	2818.17	293.39	97.19	855.34	0.77	0.35	1.32	33	30	37
250.00	1.25	5	5	6.25	215.91	79.52	573.53	0.86	0.37	1.43	39	36	43
250.00	1.25	5	5	250.00	242.43	93.85	610.27	0.78	0.36	1.35	37	35	41
250.00	1.25	5	5	2818.17	284.01	106.13	718.35	0.81	0.36	1.38	38	35	42

True LD50	True Sigma	# of Runs	# of Animals After Reversal	Prelim. Starting Dose *	Median LD50	LD50 5%	LD50 95%	Median Sigma	Sigma 5%	Sigma 95%	Median # of Animals	# of Animals 5%	# of Animals 95%
250.00	2.00	3	3	1.00	88.79	10.76	749.96	0.91	0.21	2.06	18	15	22
250.00	2.00	3	3	250.00	250.00	41.47	1375.87	0.72	0.17	1.51	17	15	20
250.00	2.00	3	3	5000.00	437.80	63.55	2161.44	0.77	0.17	1.67	17	15	20
250.00	2.00	3	4	1.00	99.94	13.97	674.93	0.95	0.26	2.08	21	18	25
250.00	2.00	3	4	250.00	237.91	43.96	1324.22	0.76	0.22	1.67	20	18	23
250.00	2.00	3	4	5000.00	399.38	58.80	1881.63	0.79	0.21	1.80	20	18	23
250.00	2.00	3	5	1.00	105.58	16.54	709.06	1.04	0.28	2.19	24	21	28
250.00	2.00	3	5	250.00	245.28	47.56	1200.09	0.81	0.21	1.76	23	21	26
250.00	2.00	3	5	5000.00	390.51	68.20	1635.89	0.84	0.21	1.81	23	21	26
250.00	2.00	4	3	1.00	108.16	16.81	652.29	0.99	0.36	1.96	24	21	28
250.00	2.00	4	3	250.00	241.68	44.37	1145.40	0.79	0.28	1.54	22	20	26
250.00	2.00	4	3	5000.00	374.03	67.58	1593.61	0.83	0.30	1.65	23	20	27
250.00	2.00	4	4	1.00	119.81	21.81	648.73	1.05	0.38	2.02	28	25	32
250.00	2.00	4	4	250.00	249.95	49.44	1104.20	0.85	0.32	1.60	26	24	30
250.00	2.00	4	4	5000.00	362.13	71.07	1457.67	0.89	0.33	1.69	27	24	30
250.00	2.00	4	5	1.00	131.80	25.58	664.90	1.07	0.38	2.04	32	29	36
250.00	2.00	4	5	250.00	255.08	53.06	1028.73	0.89	0.32	1.70	30	28	34
250.00	2.00	4	5	5000.00	349.72	69.47	1326.01	0.94	0.37	1.75	31	28	34
250.00	2.00	5	3	1.00	125.62	22.53	648.59	1.03	0.46	1.82	29	26	34
250.00	2.00	5	3	250.00	231.46	51.07	1014.00	0.85	0.37	1.50	28	25	32
250.00	2.00	5	3	5000.00	337.68	68.33	1381.27	0.89	0.38	1.58	28	25	33
250.00	2.00	5	4	1.00	134.20	26.42	595.83	1.06	0.46	1.88	34	31	39
250.00	2.00	5	4	250.00	244.71	56.27	972.75	0.92	0.40	1.60	33	30	37
250.00	2.00	5	4	5000.00	312.91	73.61	1262.54	0.95	0.42	1.63	33	30	37
250.00	2.00	5	5	1.00	142.54	33.69	631.28	1.12	0.51	1.97	39	36	44
250.00	2.00	5	5	250.00	242.50	59.88	902.35	0.95	0.42	1.68	38	35	42
250.00	2.00	5	5	5000.00	313.69	71.65	1108.21	1.00	0.45	1.74	38	35	43

True LD50	True Sigma	# of Runs	# of Animals After Reversal	Prelim. Starting Dose *	Median LD50	LD50 5%	LD50 95%	Median Sigma	Sigma 5%	Sigma 95%	Median # of Animals	# of Animals 5%	# of Animals 95%
1500.00	0.12	3	3	1052.70	1863.40	1249.15	2218.29	0.37	0.16	0.43	15	15	15
1500.00	0.12	3	3	1500.00	1553.75	1071.79	2366.02	0.38	0.14	0.46	15	15	15
1500.00	0.12	3	3	1892.72	1313.94	1105.58	2055.10	0.34	0.14	0.42	15	15	15
1500.00	0.12	3	4	1052.70	1698.28	1315.75	1958.95	0.27	0.10	0.34	18	18	18
1500.00	0.12	3	4	1500.00	1630.90	1162.66	1995.40	0.29	0.09	0.40	18	18	18
1500.00	0.12	3	4	1892.72	1471.37	1220.70	1872.20	0.28	0.09	0.35	18	18	18
1500.00	0.12	3	5	1052.70	1789.99	1325.90	2155.66	0.33	0.18	0.48	21	21	21
1500.00	0.12	3	5	1500.00	1529.75	1149.29	1962.29	0.36	0.10	0.45	21	21	21
1500.00	0.12	3	5	1892.72	1396.67	1228.74	1797.44	0.40	0.13	0.43	21	21	21
1500.00	0.12	4	3	1052.70	1699.46	1277.62	2013.90	0.37	0.24	0.42	20	20	20
1500.00	0.12	4	3	1500.00	1610.18	1170.32	2013.45	0.35	0.20	0.45	20	20	20
1500.00	0.12	4	3	1892.72	1527.31	1220.73	1961.89	0.31	0.14	0.40	20	20	21
1500.00	0.12	4	4	1052.70	1649.99	1352.19	1937.42	0.26	0.13	0.35	24	24	24
1500.00	0.12	4	4	1500.00	1539.16	1248.57	1864.55	0.26	0.12	0.37	24	24	24
1500.00	0.12	4	4	1892.72	1565.29	1266.31	1833.77	0.23	0.09	0.36	24	24	24
1500.00	0.12	4	5	1052.70	1662.26	1321.84	1965.89	0.34	0.19	0.41	28	28	28
1500.00	0.12	4	5	1500.00	1580.92	1236.47	1868.86	0.34	0.17	0.45	28	28	28
1500.00	0.12	4	5	1892.72	1557.08	1227.76	1843.92	0.33	0.13	0.41	28	28	28
1500.00	0.12	5	3	1052.70	1662.49	1307.98	2111.94	0.34	0.24	0.41	25	25	25
1500.00	0.12	5	3	1500.00	1569.11	1204.46	1802.43	0.33	0.21	0.39	25	25	25
1500.00	0.12	5	3	1892.72	1566.93	1197.99	1802.43	0.33	0.23	0.39	25	25	26
1500.00	0.12	5	4	1052.70	1627.09	1356.00	1907.41	0.24	0.17	0.33	30	30	30
1500.00	0.12	5	4	1500.00	1556.99	1283.80	1786.68	0.24	0.11	0.32	30	30	30
1500.00	0.12	5	4	1892.72	1523.66	1278.78	1765.91	0.23	0.11	0.32	30	30	30
1500.00	0.12	5	5	1052.70	1678.16	1341.61	1946.91	0.33	0.21	0.41	35	35	35
1500.00	0.12	5	5	1500.00	1556.15	1298.41	1785.15	0.32	0.18	0.40	35	35	35
1500.00	0.12	5	5	1892.72	1548.11	1296.04	1785.15	0.32	0.18	0.39	35	35	35

True LD50	True Sigma	# of Runs	# of Animals After Reversal	Prelim. Starting Dose *	Median LD50	LD50 5%	LD50 95%	Median Sigma	Sigma 5%	Sigma 95%	Median # of Animals	# of Animals 5%	# of Animals 95%
1500.00	0.25	3	3	717.30	1523.74	1054.81	2227.85	0.33	0.12	0.56	15	15	16
1500.00	0.25	3	3	1500.00	1523.30	982.77	2243.31	0.36	0.12	0.57	15	15	16
1500.00	0.25	3	3	2434.99	1439.64	999.86	2092.97	0.34	0.12	0.56	15	15	16
1500.00	0.25	3	4	717.30	1494.28	1067.96	2102.17	0.27	0.10	0.55	18	18	19
1500.00	0.25	3	4	1500.00	1507.37	1052.34	2118.86	0.26	0.09	0.55	18	18	19
1500.00	0.25	3	4	2434.99	1493.43	1070.56	2108.48	0.26	0.09	0.55	18	18	19
1500.00	0.25	3	5	717.30	1550.09	1071.15	2072.40	0.31	0.06	0.53	21	21	22
1500.00	0.25	3	5	1500.00	1505.26	1075.27	2106.35	0.32	0.07	0.55	21	21	22
1500.00	0.25	3	5	2434.99	1466.00	1044.79	2019.61	0.31	0.06	0.53	21	21	22
1500.00	0.25	4	3	717.30	1540.31	1088.25	2110.23	0.32	0.13	0.51	20	20	22
1500.00	0.25	4	3	1500.00	1504.79	1071.63	2131.26	0.34	0.15	0.53	20	20	21
1500.00	0.25	4	3	2434.99	1490.48	1048.74	2062.02	0.33	0.14	0.52	20	20	22
1500.00	0.25	4	4	717.30	1525.66	1117.61	2035.61	0.27	0.11	0.51	24	24	26
1500.00	0.25	4	4	1500.00	1516.41	1111.62	2035.58	0.27	0.10	0.50	24	24	25
1500.00	0.25	4	4	2434.99	1489.93	1089.87	1994.21	0.27	0.10	0.50	24	24	25
1500.00	0.25	4	5	717.30	1525.29	1161.01	1977.67	0.31	0.13	0.50	28	28	30
1500.00	0.25	4	5	1500.00	1521.55	1126.64	2012.80	0.33	0.15	0.52	28	28	29
1500.00	0.25	4	5	2434.99	1477.33	1116.97	1947.09	0.31	0.13	0.51	28	28	29
1500.00	0.25	5	3	717.30	1524.66	1135.87	2012.16	0.33	0.15	0.49	25	25	27
1500.00	0.25	5	3	1500.00	1487.42	1093.92	1967.70	0.33	0.15	0.50	25	25	27
1500.00	0.25	5	3	2434.99	1491.15	1096.52	2014.48	0.33	0.16	0.50	25	25	27
1500.00	0.25	5	4	717.30	1519.97	1151.06	1973.17	0.28	0.12	0.47	30	30	32
1500.00	0.25	5	4	1500.00	1501.10	1147.24	1948.65	0.28	0.13	0.47	30	30	32
1500.00	0.25	5	4	2434.99	1513.16	1136.51	1926.47	0.27	0.12	0.47	30	30	32
1500.00	0.25	5	5	717.30	1525.21	1174.37	1962.95	0.31	0.16	0.48	35	35	37
1500.00	0.25	5	5	1500.00	1486.02	1154.82	1916.32	0.32	0.16	0.48	35	35	36
1500.00	0.25	5	5	2434.99	1483.14	1146.39	1878.80	0.32	0.16	0.48	35	35	36

True LD50	True Sigma	# of Runs	# of Animals After Reversal	Prelim. Starting Dose *	Median LD50	LD50 5%	LD50 95%	Median Sigma	Sigma 5%	Sigma 95%	Median # of Animals	# of Animals 5%	# of Animals 95%
1500.00	0.50	3	3	343.02	1471.04	748.89	2685.37	0.42	0.14	0.83	16	15	18
1500.00	0.50	3	3	1500.00	1490.21	765.00	2753.17	0.41	0.13	0.83	15	15	17
1500.00	0.50	3	3	3952.77	1454.18	768.97	2714.86	0.42	0.13	0.82	16	15	17
1500.00	0.50	3	4	343.02	1496.51	804.54	2630.15	0.40	0.10	0.82	19	18	21
1500.00	0.50	3	4	1500.00	1476.31	802.49	2606.34	0.40	0.10	0.81	18	18	20
1500.00	0.50	3	4	3952.77	1472.67	815.74	2640.36	0.40	0.10	0.82	19	18	20
1500.00	0.50	3	5	343.02	1482.52	835.84	2590.74	0.41	0.11	0.86	22	21	24
1500.00	0.50	3	5	1500.00	1481.18	847.98	2536.61	0.41	0.10	0.81	21	21	23
1500.00	0.50	3	5	3952.77	1477.28	836.85	2569.13	0.39	0.12	0.82	22	21	23
1500.00	0.50	4	3	343.02	1458.55	863.67	2531.22	0.42	0.16	0.77	21	20	23
1500.00	0.50	4	3	1500.00	1468.40	838.29	2528.95	0.43	0.17	0.77	21	20	23
1500.00	0.50	4	3	3952.77	1469.72	842.82	2526.95	0.42	0.15	0.76	21	20	23
1500.00	0.50	4	4	343.02	1488.00	878.54	2431.96	0.43	0.15	0.79	25	24	27
1500.00	0.50	4	4	1500.00	1503.65	860.42	2473.28	0.42	0.14	0.77	25	24	27
1500.00	0.50	4	4	3952.77	1482.11	881.29	2418.16	0.44	0.15	0.78	25	24	27
1500.00	0.50	4	5	343.02	1464.69	896.39	2397.81	0.44	0.18	0.80	29	28	31
1500.00	0.50	4	5	1500.00	1501.25	902.07	2376.90	0.43	0.17	0.77	29	28	31
1500.00	0.50	4	5	3952.77	1485.19	925.55	2368.60	0.43	0.18	0.78	29	28	31
1500.00	0.50	5	3	343.02	1472.71	906.01	2450.88	0.44	0.22	0.72	26	25	29
1500.00	0.50	5	3	1500.00	1482.45	892.22	2406.31	0.44	0.22	0.73	26	25	28
1500.00	0.50	5	3	3952.77	1479.19	884.86	2369.85	0.44	0.22	0.73	26	25	28
1500.00	0.50	5	4	343.02	1481.37	934.97	2339.10	0.45	0.19	0.74	31	30	34
1500.00	0.50	5	4	1500.00	1479.30	920.90	2345.76	0.44	0.19	0.72	31	30	33
1500.00	0.50	5	4	3952.77	1490.80	929.99	2327.59	0.44	0.19	0.74	31	30	33
1500.00	0.50	5	5	343.02	1476.48	963.62	2264.98	0.44	0.20	0.73	36	35	39
1500.00	0.50	5	5	1500.00	1477.91	963.30	2236.80	0.44	0.21	0.73	36	35	38
1500.00	0.50	5	5	3952.77	1482.24	970.00	2265.22	0.44	0.21	0.71	36	35	38

True LD50	True Sigma	# of Runs	# of Animals After Reversal	Prelim. Starting Dose *	Median LD50	LD50 5%	LD50 95%	Median Sigma	Sigma 5%	Sigma 95%	Median # of Animals	# of Animals 5%	# of Animals 95%
1500.00	1.25	3	3	37.51	899.56	227.29	3075.48	0.68	0.17	1.46	18	15	21
1500.00	1.25	3	3	1500.00	1401.94	407.57	3676.97	0.57	0.14	1.22	16	15	19
1500.00	1.25	3	3	5000.00	1550.58	445.94	4008.40	0.56	0.15	1.23	16	15	19
1500.00	1.25	3	4	37.51	997.18	263.77	3018.59	0.69	0.18	1.47	21	18	24
1500.00	1.25	3	4	1500.00	1370.77	410.78	3643.68	0.60	0.17	1.27	19	18	22
1500.00	1.25	3	4	5000.00	1486.70	449.69	3647.49	0.60	0.15	1.29	19	18	22
1500.00	1.25	3	5	37.51	1034.21	297.39	2892.91	0.70	0.18	1.49	23	21	26
1500.00	1.25	3	5	1500.00	1339.92	456.05	3440.27	0.62	0.17	1.30	22	21	25
1500.00	1.25	3	5	5000.00	1423.85	466.77	3576.90	0.62	0.17	1.33	22	21	25
1500.00	1.25	4	3	37.51	983.58	303.80	2772.08	0.73	0.27	1.32	23	20	26
1500.00	1.25	4	3	1500.00	1331.40	457.30	3294.99	0.63	0.24	1.19	22	20	25
1500.00	1.25	4	3	5000.00	1461.21	483.44	3468.04	0.63	0.24	1.17	22	20	25
1500.00	1.25	4	4	37.51	1079.51	339.97	2780.06	0.72	0.27	1.37	27	24	30
1500.00	1.25	4	4	1500.00	1365.96	458.15	3243.62	0.66	0.25	1.21	26	24	29
1500.00	1.25	4	4	5000.00	1428.71	528.90	3357.76	0.65	0.26	1.20	26	24	29
1500.00	1.25	4	5	37.51	1095.90	390.14	2758.26	0.74	0.28	1.41	31	28	34
1500.00	1.25	4	5	1500.00	1383.67	498.68	3040.28	0.69	0.26	1.22	30	27	32
1500.00	1.25	4	5	5000.00	1411.04	530.45	3161.62	0.68	0.25	1.22	30	28	33
1500.00	1.25	5	3	37.51	1068.65	362.33	2746.96	0.74	0.33	1.25	29	26	32
1500.00	1.25	5	3	1500.00	1386.87	512.68	3099.90	0.65	0.30	1.15	27	25	31
1500.00	1.25	5	3	5000.00	1400.91	511.10	3233.64	0.65	0.29	1.13	27	25	31
1500.00	1.25	5	4	37.51	1085.29	408.66	2605.68	0.76	0.33	1.30	33	31	37
1500.00	1.25	5	4	1500.00	1358.01	529.27	3012.43	0.68	0.30	1.16	32	30	35
1500.00	1.25	5	4	5000.00	1381.90	516.78	2955.98	0.68	0.31	1.17	32	30	35
1500.00	1.25	5	5	37.51	1155.59	450.50	2560.42	0.76	0.34	1.30	38	35	42
1500.00	1.25	5	5	1500.00	1405.15	570.30	2817.08	0.71	0.32	1.21	37	35	40
1500.00	1.25	5	5	5000.00	1396.01	551.35	2852.02	0.71	0.31	1.20	37	35	40

True LD50	True Sigma	# of Runs	# of Animals After Reversal	Prelim. Starting Dose *	Median LD50	LD50 5%	LD50 95%	Median Sigma	Sigma 5%	Sigma 95%	Median # of Animals	# of Animals 5%	# of Animals 95%
1500.00	2.00	3	3	4.10	413.81	48.02	2571.45	0.93	0.24	2.06	19	16	22
1500.00	2.00	3	3	1500.00	1246.35	221.95	3997.86	0.63	0.16	1.42	16	15	19
1500.00	2.00	3	3	5000.00	1391.29	273.72	4249.04	0.64	0.16	1.43	16	15	20
1500.00	2.00	3	4	4.10	467.50	69.61	2685.63	0.96	0.26	2.12	22	19	25
1500.00	2.00	3	4	1500.00	1316.22	251.17	4115.95	0.68	0.17	1.52	19	17	23
1500.00	2.00	3	4	5000.00	1379.14	287.40	4126.50	0.68	0.17	1.51	19	18	22
1500.00	2.00	3	5	4.10	520.51	86.05	2379.19	1.00	0.27	2.18	24	21	28
1500.00	2.00	3	5	1500.00	1242.74	269.92	3684.77	0.73	0.20	1.60	22	19	25
1500.00	2.00	3	5	5000.00	1388.35	286.52	3968.39	0.71	0.19	1.56	22	19	25
1500.00	2.00	4	3	4.10	516.50	76.59	2403.98	0.99	0.36	1.92	24	21	28
1500.00	2.00	4	3	1500.00	1232.98	277.68	3662.07	0.71	0.26	1.39	22	20	25
1500.00	2.00	4	3	5000.00	1358.80	281.99	3807.41	0.71	0.25	1.39	22	20	25
1500.00	2.00	4	4	4.10	585.27	109.68	2459.41	1.02	0.36	1.95	28	25	32
1500.00	2.00	4	4	1500.00	1260.85	289.68	3429.77	0.75	0.28	1.44	26	24	29
1500.00	2.00	4	4	5000.00	1317.22	322.96	3482.70	0.76	0.28	1.49	26	24	30
1500.00	2.00	4	5	4.10	658.33	116.92	2357.14	1.03	0.37	1.96	32	29	36
1500.00	2.00	4	5	1500.00	1231.84	302.77	3283.36	0.80	0.29	1.54	30	27	33
1500.00	2.00	4	5	5000.00	1276.26	331.38	3469.37	0.82	0.30	1.53	30	27	33
1500.00	2.00	5	3	4.10	622.33	109.43	2437.08	0.99	0.42	1.80	30	27	34
1500.00	2.00	5	3	1500.00	1255.97	299.75	3426.87	0.76	0.33	1.38	28	25	31
1500.00	2.00	5	3	5000.00	1234.88	289.60	3476.52	0.77	0.32	1.36	28	25	31
1500.00	2.00	5	4	4.10	659.52	145.87	2377.65	1.03	0.42	1.83	35	31	39
1500.00	2.00	5	4	1500.00	1270.11	329.15	3203.55	0.80	0.34	1.48	32	30	36
1500.00	2.00	5	4	5000.00	1268.22	330.44	3250.65	0.80	0.36	1.44	32	30	37
1500.00	2.00	5	5	4.10	732.61	173.42	2280.89	1.07	0.47	1.91	39	36	44
1500.00	2.00	5	5	1500.00	1287.43	366.85	3129.29	0.83	0.36	1.48	37	34	41
1500.00	2.00	5	5	5000.00	1244.09	347.73	3107.98	0.83	0.38	1.49	37	34	41

True LD50	True Sigma	# of Runs	# of Animals After Reversal	Prelim. Starting Dose *	Median LD50	LD50 5%	LD50 95%	Median Sigma	Sigma 5%	Sigma 95%	Median # of Animals	# of Animals 5%	# of Animals 95%
3000.00	0.12	3	3	2105.40	3093.15	2211.29	4356.43	0.27	0.11	0.47	15	15	16
3000.00	0.12	3	3	3000.00	3084.16	2152.68	4356.43	0.27	0.11	0.50	15	15	16
3000.00	0.12	3	3	3785.44	3102.79	2191.61	4356.43	0.27	0.10	0.50	15	15	16
3000.00	0.12	3	4	2105.40	2832.43	2217.24	3574.53	0.17	0.00	0.37	18	18	19
3000.00	0.12	3	4	3000.00	2832.43	2217.24	3702.69	0.17	0.00	0.39	18	18	19
3000.00	0.12	3	4	3785.44	2832.43	2319.40	3543.31	0.17	0.00	0.39	18	18	19
3000.00	0.12	3	5	2105.40	2954.73	2296.92	3869.95	0.24	0.09	0.44	21	21	22
3000.00	0.12	3	5	3000.00	2954.73	2296.92	3869.95	0.24	0.08	0.42	21	21	22
3000.00	0.12	3	5	3785.44	2947.01	2298.23	3869.95	0.24	0.08	0.44	21	21	22
3000.00	0.12	4	3	2105.40	3094.26	2301.24	4136.65	0.26	0.11	0.42	20	20	21
3000.00	0.12	4	3	3000.00	3056.38	2314.06	4136.65	0.27	0.11	0.43	20	20	21
3000.00	0.12	4	3	3785.44	3054.85	2319.10	4121.60	0.27	0.11	0.43	20	20	21
3000.00	0.12	4	4	2105.40	2838.20	2318.69	3490.55	0.19	0.10	0.36	24	24	25
3000.00	0.12	4	4	3000.00	2795.45	2343.40	3487.59	0.19	0.09	0.36	24	24	25
3000.00	0.12	4	4	3785.44	2838.20	2349.50	3490.55	0.19	0.10	0.37	24	24	25
3000.00	0.12	4	5	2105.40	3004.75	2431.54	3751.28	0.25	0.10	0.39	28	28	29
3000.00	0.12	4	5	3000.00	2990.63	2430.68	3786.55	0.25	0.10	0.39	28	28	29
3000.00	0.12	4	5	3785.44	2998.93	2415.91	3784.66	0.25	0.10	0.40	28	28	29
3000.00	0.12	5	3	2105.40	3140.37	2476.23	4012.78	0.27	0.12	0.40	25	25	26
3000.00	0.12	5	3	3000.00	3144.89	2443.84	3964.53	0.27	0.12	0.40	25	25	26
3000.00	0.12	5	3	3785.44	3156.35	2480.42	3964.53	0.27	0.12	0.40	25	25	26
3000.00	0.12	5	4	2105.40	2845.00	2398.32	3416.76	0.18	0.10	0.33	30	30	31
3000.00	0.12	5	4	3000.00	2859.52	2414.19	3471.60	0.18	0.09	0.33	30	30	31
3000.00	0.12	5	4	3785.44	2845.00	2397.19	3442.59	0.18	0.09	0.33	30	30	31
3000.00	0.12	5	5	2105.40	3065.15	2522.57	3710.56	0.24	0.10	0.38	35	35	36
3000.00	0.12	5	5	3000.00	3048.34	2491.17	3716.38	0.24	0.12	0.38	35	35	36
3000.00	0.12	5	5	3785.44	3047.20	2531.39	3679.47	0.25	0.12	0.38	35	35	36

True LD50	True Sigma	# of Runs	# of Animals After Reversal	Prelim. Starting Dose *	Median LD50	LD50 5%	LD50 95%	Median Sigma	Sigma 5%	Sigma 95%	Median # of Animals	# of Animals 5%	# of Animals 95%
3000.00	0.25	3	3	1434.61	3088.93	2020.51	4637.64	0.29	0.09	0.60	15	15	17
3000.00	0.25	3	3	3000.00	2968.59	1935.07	4715.63	0.31	0.10	0.59	15	15	17
3000.00	0.25	3	3	4869.97	3037.56	1960.00	4758.41	0.30	0.10	0.62	15	15	17
3000.00	0.25	3	4	1434.61	2995.27	2065.73	4514.02	0.26	0.07	0.55	18	18	20
3000.00	0.25	3	4	3000.00	2960.28	2067.03	4470.20	0.27	0.07	0.55	18	18	20
3000.00	0.25	3	4	4869.97	2926.64	2049.42	4465.59	0.27	0.07	0.55	18	18	20
3000.00	0.25	3	5	1434.61	3086.51	2261.28	4403.56	0.27	0.06	0.57	21	21	23
3000.00	0.25	3	5	3000.00	2973.09	2097.38	4303.43	0.29	0.08	0.57	21	21	23
3000.00	0.25	3	5	4869.97	2954.73	2107.43	4340.47	0.30	0.08	0.57	21	21	23
3000.00	0.25	4	3	1434.61	3107.23	2192.98	4440.87	0.30	0.11	0.53	20	20	22
3000.00	0.25	4	3	3000.00	2997.99	2054.16	4332.92	0.31	0.12	0.55	20	20	22
3000.00	0.25	4	3	4869.97	3014.97	2092.07	4328.29	0.33	0.12	0.57	20	20	22
3000.00	0.25	4	4	1434.61	2974.23	2198.89	4211.65	0.29	0.11	0.51	24	24	26
3000.00	0.25	4	4	3000.00	2939.67	2161.82	4210.10	0.29	0.10	0.50	24	24	26
3000.00	0.25	4	4	4869.97	2933.74	2126.72	4070.74	0.29	0.11	0.52	24	24	26
3000.00	0.25	4	5	1434.61	3052.76	2255.52	4209.34	0.29	0.11	0.54	28	28	30
3000.00	0.25	4	5	3000.00	2995.41	2235.50	4116.39	0.30	0.12	0.55	28	28	30
3000.00	0.25	4	5	4869.97	2997.34	2230.05	4100.37	0.30	0.12	0.55	28	28	30
3000.00	0.25	5	3	1434.61	3021.72	2155.32	4282.47	0.33	0.16	0.53	25	25	27
3000.00	0.25	5	3	3000.00	2993.59	2195.22	4222.35	0.33	0.14	0.52	25	25	27
3000.00	0.25	5	3	4869.97	3027.80	2227.17	4265.87	0.32	0.16	0.54	25	25	28
3000.00	0.25	5	4	1434.61	2949.70	2219.28	4025.10	0.31	0.13	0.50	30	30	32
3000.00	0.25	5	4	3000.00	2949.89	2206.76	4067.76	0.30	0.14	0.50	30	30	32
3000.00	0.25	5	4	4869.97	2931.96	2209.29	3981.40	0.30	0.13	0.50	30	30	32
3000.00	0.25	5	5	1434.61	3019.03	2292.06	4017.35	0.31	0.14	0.52	35	35	37
3000.00	0.25	5	5	3000.00	3016.21	2317.20	4026.13	0.31	0.15	0.52	35	35	37
3000.00	0.25	5	5	4869.97	3029.45	2287.24	3962.82	0.31	0.14	0.50	35	35	37

True LD50	True Sigma	# of Runs	# of Animals After Reversal	Prelim. Starting Dose *	Median LD50	LD50 5%	LD50 95%	Median Sigma	Sigma 5%	Sigma 95%	Median # of Animals	# of Animals 5%	# of Animals 95%
3000.00	0.50	3	3	686.03	2855.28	1528.95	5140.53	0.39	0.10	0.80	16	15	18
3000.00	0.50	3	3	3000.00	2864.03	1519.98	5146.75	0.39	0.12	0.81	16	15	17
3000.00	0.50	3	3	5000.00	2816.38	1500.19	5224.04	0.40	0.12	0.80	16	15	18
3000.00	0.50	3	4	686.03	2844.94	1575.26	5033.88	0.39	0.10	0.81	19	18	21
3000.00	0.50	3	4	3000.00	2855.55	1596.82	4915.18	0.37	0.11	0.78	19	17	21
3000.00	0.50	3	4	5000.00	2915.62	1659.55	5005.71	0.39	0.11	0.80	19	17	21
3000.00	0.50	3	5	686.03	2896.60	1660.84	4921.20	0.39	0.11	0.80	22	20	24
3000.00	0.50	3	5	3000.00	2917.64	1693.82	4789.25	0.38	0.10	0.80	22	19	24
3000.00	0.50	3	5	5000.00	2872.39	1671.93	4788.47	0.40	0.10	0.82	21	19	24
3000.00	0.50	4	3	686.03	2852.91	1620.80	4761.14	0.41	0.16	0.75	21	20	24
3000.00	0.50	4	3	3000.00	2824.10	1653.57	4789.67	0.42	0.16	0.74	21	20	23
3000.00	0.50	4	3	5000.00	2858.51	1689.97	4635.54	0.42	0.15	0.74	21	20	23
3000.00	0.50	4	4	686.03	2817.16	1694.00	4544.43	0.41	0.16	0.74	25	24	28
3000.00	0.50	4	4	3000.00	2881.49	1779.95	4734.41	0.41	0.16	0.75	25	23	27
3000.00	0.50	4	4	5000.00	2891.31	1712.21	4649.12	0.42	0.15	0.75	25	23	27
3000.00	0.50	4	5	686.03	2863.12	1814.81	4524.35	0.42	0.16	0.75	29	26	32
3000.00	0.50	4	5	3000.00	2913.67	1817.42	4642.79	0.41	0.16	0.76	29	26	31
3000.00	0.50	4	5	5000.00	2899.05	1801.95	4534.83	0.41	0.16	0.75	29	26	31
3000.00	0.50	5	3	686.03	2830.68	1733.61	4639.91	0.43	0.21	0.71	27	25	29
3000.00	0.50	5	3	3000.00	2869.08	1739.09	4556.62	0.43	0.19	0.71	26	25	29
3000.00	0.50	5	3	5000.00	2871.00	1713.64	4573.68	0.43	0.19	0.71	26	25	29
3000.00	0.50	5	4	686.03	2847.88	1824.72	4467.48	0.43	0.20	0.70	32	29	34
3000.00	0.50	5	4	3000.00	2860.28	1811.37	4401.75	0.42	0.19	0.71	31	29	34
3000.00	0.50	5	4	5000.00	2851.22	1834.93	4352.84	0.42	0.20	0.71	31	29	33
3000.00	0.50	5	5	686.03	2899.04	1940.28	4294.07	0.42	0.19	0.71	37	34	39
3000.00	0.50	5	5	3000.00	2867.18	1855.70	4338.73	0.43	0.20	0.72	36	33	39
3000.00	0.50	5	5	5000.00	2905.78	1946.13	4321.85	0.42	0.19	0.72	36	33	39

True LD50	True Sigma	# of Runs	# of Animals After Reversal	Prelim. Starting Dose *	Median LD50	LD50 5%	LD50 95%	Median Sigma	Sigma 5%	Sigma 95%	Median # of Animals	# of Animals 5%	# of Animals 95%
3000.00	1.25	3	3	75.02	1708.65	479.62	4539.75	0.63	0.16	1.33	17	15	21
3000.00	1.25	3	3	3000.00	2358.82	763.33	5236.49	0.51	0.13	1.13	16	15	19
3000.00	1.25	3	3	5000.00	2424.62	768.98	5361.37	0.53	0.14	1.12	16	14	19
3000.00	1.25	3	4	75.02	1834.10	546.44	4696.03	0.65	0.17	1.38	20	18	23
3000.00	1.25	3	4	3000.00	2395.79	843.85	5266.16	0.55	0.13	1.18	19	17	21
3000.00	1.25	3	4	5000.00	2351.85	786.34	5350.18	0.56	0.13	1.17	19	17	22
3000.00	1.25	3	5	75.02	1962.74	620.54	4572.50	0.63	0.17	1.41	23	21	26
3000.00	1.25	3	5	3000.00	2367.57	851.09	5054.34	0.57	0.14	1.22	22	19	25
3000.00	1.25	3	5	5000.00	2396.29	859.55	5171.18	0.55	0.14	1.21	22	18	24
3000.00	1.25	4	3	75.02	1793.16	617.05	4122.13	0.67	0.23	1.25	23	20	26
3000.00	1.25	4	3	3000.00	2292.78	866.06	4977.94	0.57	0.21	1.08	22	20	24
3000.00	1.25	4	3	5000.00	2280.60	861.07	4817.12	0.57	0.22	1.10	21	20	24
3000.00	1.25	4	4	75.02	1902.45	682.60	4289.21	0.68	0.26	1.26	27	24	30
3000.00	1.25	4	4	3000.00	2392.30	958.28	4618.20	0.58	0.23	1.10	25	23	28
3000.00	1.25	4	4	5000.00	2320.41	928.14	4642.03	0.60	0.23	1.13	25	23	28
3000.00	1.25	4	5	75.02	1924.45	752.14	3984.88	0.69	0.26	1.27	31	27	34
3000.00	1.25	4	5	3000.00	2367.83	976.48	4579.70	0.61	0.21	1.17	29	25	32
3000.00	1.25	4	5	5000.00	2376.15	982.37	4579.09	0.61	0.23	1.17	29	26	32
3000.00	1.25	5	3	75.02	1858.05	680.13	3972.64	0.68	0.30	1.18	28	25	32
3000.00	1.25	5	3	3000.00	2264.25	953.58	4623.90	0.60	0.27	1.04	27	25	30
3000.00	1.25	5	3	5000.00	2228.53	907.99	4539.60	0.60	0.27	1.03	27	25	30
3000.00	1.25	5	4	75.02	1963.42	797.73	4072.53	0.68	0.31	1.20	33	30	37
3000.00	1.25	5	4	3000.00	2278.14	988.96	4375.02	0.62	0.29	1.10	32	29	35
3000.00	1.25	5	4	5000.00	2316.42	1022.00	4389.73	0.63	0.27	1.08	32	29	35
3000.00	1.25	5	5	75.02	2031.99	872.56	4005.28	0.70	0.32	1.23	38	34	42
3000.00	1.25	5	5	3000.00	2319.96	1081.17	4305.00	0.64	0.29	1.11	37	33	40
3000.00	1.25	5	5	5000.00	2341.15	1041.87	4246.77	0.63	0.28	1.10	37	33	40

True LD50	True Sigma	# of Runs	# of Animals After Reversal	Prelim. Starting Dose *	Median LD50	LD50 5%	LD50 95%	Median Sigma	Sigma 5%	Sigma 95%	Median # of Animals	# of Animals 5%	# of Animals 95%
3000.00	2.00	3	3	8.20	759.86	96.96	3728.50	0.87	0.21	1.96	19	16	22
3000.00	2.00	3	3	3000.00	2091.98	443.93	5407.60	0.58	0.16	1.34	16	14	19
3000.00	2.00	3	3	5000.00	2034.75	464.47	5398.54	0.59	0.14	1.32	16	14	19
3000.00	2.00	3	4	8.20	870.95	148.31	3828.73	0.92	0.23	2.01	21	18	25
3000.00	2.00	3	4	3000.00	2048.31	464.47	5160.04	0.63	0.15	1.42	19	16	22
3000.00	2.00	3	4	5000.00	2062.40	503.67	5347.79	0.63	0.14	1.43	19	17	22
3000.00	2.00	3	5	8.20	979.18	167.89	3876.05	0.94	0.22	2.06	24	21	28
3000.00	2.00	3	5	3000.00	2059.22	489.01	5029.26	0.65	0.17	1.49	22	18	25
3000.00	2.00	3	5	5000.00	2103.50	518.06	5001.64	0.65	0.17	1.53	22	18	25
3000.00	2.00	4	3	8.20	961.80	153.36	3723.79	0.92	0.31	1.82	24	21	28
3000.00	2.00	4	3	3000.00	1916.66	489.86	4614.15	0.65	0.23	1.29	22	20	25
3000.00	2.00	4	3	5000.00	1987.52	478.31	4689.37	0.65	0.23	1.29	22	20	25
3000.00	2.00	4	4	8.20	1067.23	189.84	3609.56	0.92	0.34	1.84	28	25	32
3000.00	2.00	4	4	3000.00	2007.55	565.57	4634.82	0.70	0.24	1.39	26	23	29
3000.00	2.00	4	4	5000.00	2017.51	560.07	4763.65	0.68	0.25	1.35	26	23	29
3000.00	2.00	4	5	8.20	1149.78	263.90	3445.14	1.00	0.36	1.90	32	28	36
3000.00	2.00	4	5	3000.00	2003.77	558.29	4531.29	0.73	0.28	1.44	30	25	33
3000.00	2.00	4	5	5000.00	1928.43	571.71	4336.82	0.72	0.25	1.45	30	26	33
3000.00	2.00	5	3	8.20	1045.97	217.44	3465.11	0.95	0.38	1.68	30	26	34
3000.00	2.00	5	3	3000.00	1901.90	535.32	4352.07	0.68	0.28	1.29	27	25	31
3000.00	2.00	5	3	5000.00	1884.44	551.20	4403.93	0.69	0.29	1.27	27	25	31
3000.00	2.00	5	4	8.20	1124.68	285.70	3282.97	0.98	0.42	1.75	34	31	39
3000.00	2.00	5	4	3000.00	1895.01	577.36	4214.21	0.72	0.30	1.34	32	29	36
3000.00	2.00	5	4	5000.00	1881.89	568.70	4208.01	0.73	0.32	1.33	32	29	36
3000.00	2.00	5	5	8.20	1228.00	342.21	3333.77	1.00	0.42	1.79	39	35	44
3000.00	2.00	5	5	3000.00	1902.55	640.38	4059.19	0.77	0.33	1.38	37	33	41
3000.00	2.00	5	5	5000.00	1914.85	612.05	4047.19	0.76	0.33	1.38	37	33	41

Simulation Table IX. Multiple Up-and-Down Sequences with Varying Nominals and Averaging Slopes – Dose and Progression Set Independently. The simulations in this table explore a test design to estimate slope based on using three, four or five full UDP runs and also varying the number of animals tested after the first reversal. The slopes and LD50's from the individual runs were averaged to obtain the final estimate of the LD50 and slope. All the UDP runs were run in parallel with the results of each independent of the others.

The actual LD50 and sigma of the dose response curve (reciprocal of slope) varied as detailed in the table. The hypothetical investigator did not know the true LD50 or slope, and began the initial LD50 run at a series of different starting doses as indicated in the table. The starting doses the hypothetical investigator chose were (unknown to him or her) the actual LD10, LD50 and LD80. In addition, the length of the UDP runs was varied by changing the number of animals tested after the first reversal.

Each line of the table represents one study design tested:

Each line summarizes the results of 2500 simulated tests from a population with a true LD50 and sigma (reciprocal of slope) as detailed in the table.

For each run the computer randomly picked the appropriate number of animals from the entire population assigning each individual animal an LD50 based on the known variability of the population.

The number of animals tested after the first reversal is as detailed in the table.

All runs were standard up-and-down runs performed to estimate the LD50. Each run ended when six animals had been dosed after the first reversal. Dosing boundaries were respected but no stopping rule was used. The assumed sigma for all runs was 0.5.

Final estimates of LD50 and slope were made by averaging the LD50's and slopes obtained from all the runs.

For each line the median, 5% and 95% confidence limits of the results of 2500 separate simulation runs are presented. In this table the number of animals used in the study were tracked and are presented for each study design.

Table IX

True LD50	True Sigma	# of runs	# of animals after reversal	Prelim. starting dose *	Median LD50	LD50 5%	LD50 95%	Median Sigma	Sigma 5%	Sigma 95%	Median # of animals	# of animals 5%	# of animals 95%
1.50	0.12	3	3	1.05	1.32	1.03	1.87	0.20	0.04	0.44	15	15	16
1.50	0.12	3	3	1.50	1.32	1.02	1.85	0.20	0.04	0.44	15	15	16
1.50	0.12	3	3	1.89	1.32	1.03	1.85	0.20	0.04	0.46	15	15	16
1.50	0.12	3	4	1.05	1.51	1.15	2.00	0.18	0.04	0.40	18	18	19
1.50	0.12	3	4	1.50	1.51	1.15	2.01	0.18	0.04	0.40	18	18	19
1.50	0.12	3	4	1.89	1.51	1.15	2.01	0.18	0.04	0.41	18	18	19
1.50	0.12	3	5	1.05	1.39	1.12	1.84	0.19	0.05	0.40	21	21	22
1.50	0.12	3	5	1.50	1.35	1.11	1.84	0.19	0.05	0.41	21	21	22
1.50	0.12	3	5	1.89	1.35	1.11	1.84	0.17	0.05	0.41	21	21	22
1.50	0.12	4	3	1.05	1.31	1.06	1.73	0.20	0.08	0.41	20	20	21
1.50	0.12	4	3	1.50	1.31	1.06	1.81	0.19	0.08	0.38	20	20	21
1.50	0.12	4	3	1.89	1.31	1.06	1.74	0.19	0.08	0.40	20	20	21
1.50	0.12	4	4	1.05	1.54	1.18	1.90	0.18	0.07	0.36	24	24	25
1.50	0.12	4	4	1.50	1.54	1.17	1.90	0.18	0.07	0.37	24	24	25
1.50	0.12	4	4	1.89	1.54	1.21	1.90	0.18	0.07	0.36	24	24	25
1.50	0.12	4	5	1.05	1.37	1.15	1.70	0.17	0.06	0.35	28	28	29
1.50	0.12	4	5	1.50	1.39	1.15	1.71	0.17	0.06	0.36	28	28	29
1.50	0.12	4	5	1.89	1.38	1.16	1.71	0.17	0.06	0.36	28	28	29
1.50	0.12	5	3	1.05	1.32	1.09	1.71	0.18	0.08	0.37	25	25	26
1.50	0.12	5	3	1.50	1.32	1.09	1.70	0.18	0.08	0.36	25	25	27
1.50	0.12	5	3	1.89	1.32	1.09	1.70	0.18	0.08	0.36	25	25	26
1.50	0.12	5	4	1.05	1.56	1.25	1.85	0.18	0.08	0.33	30	30	31
1.50	0.12	5	4	1.50	1.56	1.24	1.85	0.18	0.08	0.33	30	30	31
1.50	0.12	5	4	1.89	1.56	1.25	1.85	0.19	0.08	0.33	30	30	31
1.50	0.12	5	5	1.05	1.38	1.19	1.65	0.17	0.08	0.33	35	35	37
1.50	0.12	5	5	1.50	1.39	1.19	1.66	0.17	0.08	0.33	35	35	37
1.50	0.12	5	5	1.89	1.39	1.19	1.66	0.17	0.08	0.33	35	35	37

Table IX

True LD50	True Sigma	# of runs	# of animals after reversal	Prelim. starting dose *	Median LD50	LD50 5%	LD50 95%	Median Sigma	Sigma 5%	Sigma 95%	Median # of animals	# of animals 5%	# of animals 95%
1.50	0.25	3	3	1.00	1.47	0.92	2.32	0.28	0.07	0.62	15	15	17
1.50	0.25	3	3	1.50	1.46	0.93	2.33	0.29	0.08	0.61	15	15	17
1.50	0.25	3	3	2.43	1.47	0.92	2.33	0.29	0.08	0.61	15	15	17
1.50	0.25	3	4	1.00	1.51	0.98	2.23	0.29	0.07	0.57	18	18	20
1.50	0.25	3	4	1.50	1.51	0.96	2.24	0.29	0.08	0.56	18	18	20
1.50	0.25	3	4	2.43	1.51	0.96	2.23	0.28	0.08	0.57	18	18	20
1.50	0.25	3	5	1.00	1.46	1.01	2.15	0.27	0.07	0.59	21	21	23
1.50	0.25	3	5	1.50	1.46	0.99	2.17	0.28	0.06	0.59	21	21	23
1.50	0.25	3	5	2.43	1.47	1.00	2.17	0.27	0.08	0.60	21	21	23
1.50	0.25	4	3	1.00	1.42	0.97	2.13	0.30	0.12	0.56	20	20	22
1.50	0.25	4	3	1.50	1.43	0.98	2.11	0.30	0.11	0.56	20	20	23
1.50	0.25	4	3	2.43	1.44	0.99	2.17	0.30	0.11	0.55	20	20	22
1.50	0.25	4	4	1.00	1.50	1.02	2.08	0.30	0.12	0.53	24	24	26
1.50	0.25	4	4	1.50	1.46	1.02	2.07	0.31	0.12	0.54	24	24	26
1.50	0.25	4	4	2.43	1.49	1.03	2.08	0.31	0.12	0.54	24	24	27
1.50	0.25	4	5	1.00	1.44	1.03	2.01	0.30	0.11	0.54	28	28	31
1.50	0.25	4	5	1.50	1.45	1.04	2.01	0.29	0.10	0.55	29	28	31
1.50	0.25	4	5	2.43	1.44	1.05	1.99	0.30	0.11	0.54	28	28	30
1.50	0.25	5	3	1.00	1.42	1.03	1.97	0.31	0.12	0.54	26	25	28
1.50	0.25	5	3	1.50	1.42	1.02	2.02	0.31	0.13	0.53	26	25	28
1.50	0.25	5	3	2.43	1.41	1.00	1.99	0.31	0.13	0.54	26	25	28
1.50	0.25	5	4	1.00	1.47	1.05	1.99	0.32	0.15	0.51	31	30	33
1.50	0.25	5	4	1.50	1.48	1.05	2.01	0.31	0.15	0.51	31	30	33
1.50	0.25	5	4	2.43	1.47	1.07	1.99	0.32	0.15	0.52	31	30	33
1.50	0.25	5	5	1.00	1.43	1.08	1.92	0.30	0.13	0.52	36	35	38
1.50	0.25	5	5	1.50	1.43	1.09	1.93	0.30	0.13	0.52	36	35	38
1.50	0.25	5	5	2.43	1.44	1.07	1.92	0.30	0.13	0.51	36	35	38

Table IX

True LD50	True Sigma	# of runs	# of animals after reversal	Prelim. starting dose *	Median LD50	LD50 5%	LD50 95%	Median Sigma	Sigma 5%	Sigma 95%	Median # of animals	# of animals 5%	# of animals 95%
1.50	0.50	3	3	1.00	1.58	0.89	2.90	0.38	0.09	0.80	16	15	18
1.50	0.50	3	3	1.50	1.59	0.88	2.96	0.38	0.10	0.79	16	14	18
1.50	0.50	3	3	3.95	1.60	0.90	3.02	0.39	0.10	0.81	16	15	19
1.50	0.50	3	4	1.00	1.54	0.90	2.76	0.39	0.10	0.80	19	16	21
1.50	0.50	3	4	1.50	1.60	0.92	2.73	0.38	0.10	0.80	19	17	21
1.50	0.50	3	4	3.95	1.60	0.93	2.86	0.39	0.10	0.82	19	17	21
1.50	0.50	3	5	1.00	1.57	0.93	2.68	0.39	0.10	0.80	22	19	24
1.50	0.50	3	5	1.50	1.55	0.92	2.69	0.38	0.10	0.80	22	19	24
1.50	0.50	3	5	3.95	1.55	0.92	2.66	0.38	0.10	0.82	22	19	24
1.50	0.50	4	3	1.00	1.59	0.96	2.73	0.41	0.15	0.73	21	20	23
1.50	0.50	4	3	1.50	1.58	0.97	2.73	0.41	0.15	0.73	21	20	23
1.50	0.50	4	3	3.95	1.62	0.97	2.74	0.41	0.16	0.76	21	20	24
1.50	0.50	4	4	1.00	1.58	0.99	2.50	0.41	0.16	0.74	25	23	27
1.50	0.50	4	4	1.50	1.57	0.98	2.61	0.40	0.15	0.74	25	22	27
1.50	0.50	4	4	3.95	1.59	0.98	2.65	0.41	0.16	0.76	25	23	28
1.50	0.50	4	5	1.00	1.57	0.99	2.47	0.41	0.15	0.75	29	26	31
1.50	0.50	4	5	1.50	1.57	0.99	2.48	0.41	0.15	0.74	29	25	31
1.50	0.50	4	5	3.95	1.57	1.00	2.50	0.41	0.16	0.77	29	26	32
1.50	0.50	5	3	1.00	1.59	1.02	2.56	0.43	0.19	0.70	26	25	29
1.50	0.50	5	3	1.50	1.59	1.03	2.59	0.42	0.19	0.70	26	25	29
1.50	0.50	5	3	3.95	1.60	1.01	2.56	0.43	0.19	0.71	27	25	29
1.50	0.50	5	4	1.00	1.58	1.02	2.47	0.42	0.20	0.70	31	28	34
1.50	0.50	5	4	1.50	1.58	1.03	2.44	0.42	0.20	0.72	31	28	34
1.50	0.50	5	4	3.95	1.59	1.03	2.47	0.43	0.21	0.73	32	29	34
1.50	0.50	5	5	1.00	1.57	1.05	2.36	0.42	0.20	0.71	36	33	39
1.50	0.50	5	5	1.50	1.55	1.05	2.37	0.42	0.19	0.71	36	32	39
1.50	0.50	5	5	3.95	1.57	1.04	2.37	0.42	0.19	0.74	37	33	40

Table IX

True LD50	True Sigma	# of runs	# of animals after reversal	Prelim. starting dose *	Median LD50	LD50 5%	LD50 95%	Median Sigma	Sigma 5%	Sigma 95%	Median # of animals	# of animals 5%	# of animals 95%
1.50	1.25	3	3	1.00	1.93	0.89	5.06	0.53	0.13	1.13	16	14	18
1.50	1.25	3	3	1.50	1.99	0.92	4.98	0.53	0.14	1.14	16	14	18
1.50	1.25	3	3	16.91	3.13	1.16	9.19	0.66	0.18	1.31	17	15	21
1.50	1.25	3	4	1.00	1.94	0.94	4.89	0.56	0.14	1.18	19	16	21
1.50	1.25	3	4	1.50	1.91	0.91	4.75	0.54	0.14	1.18	19	16	21
1.50	1.25	3	4	16.91	2.96	1.16	8.11	0.67	0.18	1.36	20	18	24
1.50	1.25	3	5	1.00	1.94	0.95	4.59	0.56	0.14	1.21	22	18	24
1.50	1.25	3	5	1.50	1.93	0.94	4.39	0.58	0.15	1.24	22	18	24
1.50	1.25	3	5	16.91	2.88	1.20	7.71	0.66	0.17	1.39	23	21	26
1.50	1.25	4	3	1.00	2.01	1.00	4.47	0.59	0.21	1.09	21	19	24
1.50	1.25	4	3	1.50	2.02	1.01	4.49	0.58	0.22	1.08	21	19	24
1.50	1.25	4	3	16.91	3.22	1.37	8.45	0.70	0.27	1.20	23	21	27
1.50	1.25	4	4	1.00	2.01	1.02	4.19	0.60	0.23	1.11	25	22	28
1.50	1.25	4	4	1.50	2.01	1.01	4.35	0.59	0.22	1.10	25	22	28
1.50	1.25	4	4	16.91	3.01	1.34	7.18	0.71	0.28	1.24	27	24	31
1.50	1.25	4	5	1.00	1.95	1.05	4.19	0.61	0.22	1.17	29	25	32
1.50	1.25	4	5	1.50	1.94	1.03	4.14	0.61	0.23	1.13	29	25	32
1.50	1.25	4	5	16.91	2.77	1.29	6.44	0.72	0.29	1.26	31	28	35
1.50	1.25	5	3	1.00	2.03	1.09	4.12	0.61	0.27	1.01	27	24	30
1.50	1.25	5	3	1.50	2.03	1.07	4.27	0.60	0.27	1.02	27	25	30
1.50	1.25	5	3	16.91	3.24	1.52	7.35	0.73	0.34	1.19	29	26	33
1.50	1.25	5	4	1.00	2.02	1.14	4.06	0.62	0.26	1.06	32	28	35
1.50	1.25	5	4	1.50	2.00	1.13	3.80	0.62	0.29	1.05	32	28	35
1.50	1.25	5	4	16.91	3.02	1.50	6.70	0.74	0.34	1.20	34	31	38
1.50	1.25	5	5	1.00	2.00	1.14	3.86	0.64	0.29	1.11	37	32	40
1.50	1.25	5	5	1.50	2.00	1.12	3.83	0.64	0.29	1.10	37	32	40
1.50	1.25	5	5	16.91	2.85	1.44	6.09	0.75	0.35	1.23	39	35	43

Table IX

True LD50	True Sigma	# of runs	# of animals after reversal	Prelim. starting dose *	Median LD50	LD50 5%	LD50 95%	Median Sigma	Sigma 5%	Sigma 95%	Median # of animals	# of animals 5%	# of animals 95%
1.50	2.00	3	3	1.00	2.20	0.89	7.11	0.60	0.14	1.40	16	14	19
1.50	2.00	3	3	1.50	2.22	0.93	7.35	0.62	0.16	1.34	16	14	19
1.50	2.00	3	3	72.33	8.43	2.15	35.32	0.94	0.28	1.78	18	15	23
1.50	2.00	3	4	1.00	2.24	0.92	6.61	0.64	0.17	1.46	19	16	22
1.50	2.00	3	4	1.50	2.15	0.94	6.87	0.66	0.17	1.44	19	16	22
1.50	2.00	3	4	72.33	7.41	2.03	30.91	0.97	0.26	1.82	21	18	25
1.50	2.00	3	5	1.00	2.18	0.96	6.35	0.68	0.16	1.50	22	18	25
1.50	2.00	3	5	1.50	2.22	0.99	6.34	0.69	0.18	1.51	22	18	25
1.50	2.00	3	5	72.33	6.47	1.92	25.88	0.98	0.27	1.91	24	21	28
1.50	2.00	4	3	1.00	2.25	1.05	5.72	0.67	0.25	1.26	22	19	24
1.50	2.00	4	3	1.50	2.27	1.05	5.84	0.66	0.26	1.27	22	19	25
1.50	2.00	4	3	72.33	8.29	2.47	27.42	0.98	0.42	1.64	25	21	29
1.50	2.00	4	4	1.00	2.29	1.08	5.68	0.71	0.27	1.36	26	22	29
1.50	2.00	4	4	1.50	2.28	1.07	5.77	0.70	0.26	1.34	26	22	29
1.50	2.00	4	4	72.33	7.29	2.38	24.32	1.01	0.42	1.71	29	25	33
1.50	2.00	4	5	1.00	2.32	1.06	5.98	0.73	0.27	1.41	29	25	33
1.50	2.00	4	5	1.50	2.26	1.08	5.56	0.74	0.27	1.39	30	25	33
1.50	2.00	4	5	72.33	6.45	2.12	20.10	1.02	0.41	1.77	33	29	38
1.50	2.00	5	3	1.00	2.32	1.15	5.45	0.70	0.30	1.24	27	24	30
1.50	2.00	5	3	1.50	2.34	1.13	5.47	0.70	0.30	1.24	27	25	30
1.50	2.00	5	3	72.33	8.51	3.03	25.62	1.01	0.49	1.59	31	27	36
1.50	2.00	5	4	1.00	2.34	1.17	5.51	0.74	0.33	1.32	32	28	35
1.50	2.00	5	4	1.50	2.34	1.13	5.37	0.73	0.33	1.29	32	29	35
1.50	2.00	5	4	72.33	7.44	2.59	20.63	1.05	0.50	1.64	36	32	41
1.50	2.00	5	5	1.00	2.31	1.20	5.22	0.75	0.35	1.35	37	32	40
1.50	2.00	5	5	1.50	2.35	1.17	5.36	0.76	0.34	1.34	37	32	40
1.50	2.00	5	5	72.33	6.69	2.51	18.96	1.06	0.52	1.70	41	36	46

Table IX

True LD50	True Sigma	# of runs	# of animals after reversal	Prelim. starting dose *	Median LD50	LD50 5%	LD50 95%	Median Sigma	Sigma 5%	Sigma 95%	Median # of animals	# of animals 5%	# of animals 95%
50.00	0.12	3	3	35.09	58.05	41.87	78.61	0.23	0.09	0.46	15	15	16
50.00	0.12	3	3	50.00	48.42	38.21	65.42	0.34	0.12	0.46	15	15	15
50.00	0.12	3	3	63.09	48.22	32.77	65.15	0.28	0.05	0.46	15	15	15
50.00	0.12	3	4	35.09	48.39	39.52	64.92	0.17	0.00	0.35	18	18	19
50.00	0.12	3	4	50.00	53.22	41.27	60.58	0.17	0.00	0.35	18	18	18
50.00	0.12	3	4	63.09	52.08	40.29	59.27	0.17	0.00	0.35	18	18	18
50.00	0.12	3	5	35.09	55.74	42.18	73.52	0.20	0.05	0.46	21	21	22
50.00	0.12	3	5	50.00	48.69	39.07	63.98	0.30	0.11	0.46	21	21	21
50.00	0.12	3	5	63.09	47.36	37.37	61.21	0.23	0.05	0.46	21	21	21
50.00	0.12	4	3	35.09	55.99	43.98	71.39	0.26	0.11	0.41	20	20	21
50.00	0.12	4	3	50.00	50.00	37.43	66.80	0.32	0.18	0.45	20	20	20
50.00	0.12	4	3	63.09	47.15	35.30	63.10	0.28	0.11	0.42	20	20	20
50.00	0.12	4	4	35.09	51.48	42.47	62.40	0.20	0.10	0.31	24	24	25
50.00	0.12	4	4	50.00	50.00	41.25	60.62	0.20	0.10	0.31	24	24	24
50.00	0.12	4	4	63.09	52.05	40.72	63.10	0.20	0.10	0.32	24	24	24
50.00	0.12	4	5	35.09	55.07	43.20	67.80	0.22	0.11	0.43	28	28	29
50.00	0.12	4	5	50.00	50.00	40.62	61.68	0.28	0.14	0.43	28	28	28
50.00	0.12	4	5	63.09	47.27	37.06	58.19	0.24	0.11	0.43	28	28	28
50.00	0.12	5	3	35.09	56.93	45.10	71.77	0.25	0.12	0.39	25	25	26
50.00	0.12	5	3	50.00	50.90	38.85	64.35	0.30	0.19	0.43	25	25	25
50.00	0.12	5	3	63.09	46.59	35.56	61.81	0.28	0.14	0.42	25	25	25
50.00	0.12	5	4	35.09	49.57	42.49	62.36	0.21	0.09	0.31	30	30	31
50.00	0.12	5	4	50.00	48.16	41.29	60.55	0.21	0.09	0.31	30	30	30
50.00	0.12	5	4	63.09	48.28	41.33	60.69	0.21	0.09	0.31	30	30	31
50.00	0.12	5	5	35.09	54.69	44.69	66.16	0.23	0.12	0.38	35	35	36
50.00	0.12	5	5	50.00	50.92	40.42	61.85	0.28	0.17	0.40	35	35	35
50.00	0.12	5	5	63.09	46.56	38.99	58.06	0.26	0.12	0.39	35	35	36

Table IX

True LD50	True Sigma	# of runs	# of animals after reversal	Prelim. starting dose *	Median LD50	LD50 5%	LD50 95%	Median Sigma	Sigma 5%	Sigma 95%	Median # of animals	# of animals 5%	# of animals 95%
50.00	0.25	3	3	23.91	54.66	36.41	81.46	0.28	0.08	0.56	16	15	17
50.00	0.25	3	3	50.00	51.63	32.51	82.71	0.31	0.12	0.59	15	15	16
50.00	0.25	3	3	81.17	45.91	30.83	72.19	0.28	0.07	0.58	15	15	16
50.00	0.25	3	4	23.91	51.94	35.39	75.35	0.27	0.05	0.54	19	18	20
50.00	0.25	3	4	50.00	50.68	34.93	74.00	0.24	0.00	0.53	18	18	19
50.00	0.25	3	4	81.17	48.97	33.06	69.65	0.27	0.05	0.54	18	18	19
50.00	0.25	3	5	23.91	54.12	38.06	76.01	0.25	0.05	0.53	22	21	23
50.00	0.25	3	5	50.00	51.15	34.93	73.39	0.30	0.08	0.56	21	21	22
50.00	0.25	3	5	81.17	47.89	33.54	67.83	0.26	0.05	0.55	21	21	22
50.00	0.25	4	3	23.91	54.46	37.55	77.05	0.28	0.11	0.51	21	20	22
50.00	0.25	4	3	50.00	50.00	33.41	74.71	0.32	0.13	0.54	20	20	21
50.00	0.25	4	3	81.17	46.62	31.93	68.08	0.29	0.11	0.52	20	20	22
50.00	0.25	4	4	23.91	51.20	37.57	71.96	0.28	0.11	0.52	25	24	26
50.00	0.25	4	4	50.00	50.00	36.46	68.63	0.27	0.10	0.50	24	24	25
50.00	0.25	4	4	81.17	49.23	34.95	67.08	0.29	0.10	0.51	24	24	26
50.00	0.25	4	5	23.91	53.55	39.53	71.39	0.27	0.11	0.49	29	28	30
50.00	0.25	4	5	50.00	50.00	36.19	69.22	0.31	0.12	0.52	28	28	29
50.00	0.25	4	5	81.17	47.55	35.29	65.93	0.28	0.11	0.52	28	28	30
50.00	0.25	5	3	23.91	54.56	39.47	75.38	0.28	0.13	0.49	26	25	28
50.00	0.25	5	3	50.00	50.52	35.08	71.79	0.32	0.15	0.52	25	25	26
50.00	0.25	5	3	81.17	46.13	33.26	64.60	0.30	0.14	0.52	26	25	27
50.00	0.25	5	4	23.91	52.57	38.31	69.91	0.29	0.13	0.48	31	30	33
50.00	0.25	5	4	50.00	50.25	37.68	65.95	0.28	0.13	0.48	30	30	31
50.00	0.25	5	4	81.17	48.79	36.14	66.94	0.29	0.13	0.49	31	30	32
50.00	0.25	5	5	23.91	53.76	40.76	69.58	0.28	0.13	0.47	36	35	38
50.00	0.25	5	5	50.00	50.64	37.85	68.06	0.31	0.14	0.50	35	35	36
50.00	0.25	5	5	81.17	47.00	36.13	62.55	0.29	0.13	0.48	36	35	37

Table IX

True LD50	True Sigma	# of runs	# of animals after reversal	Prelim. starting dose *	Median LD50	LD50 5%	LD50 95%	Median Sigma	Sigma 5%	Sigma 95%	Median # of animals	# of animals 5%	# of animals 95%
50.00	0.50	3	3	11.43	47.73	24.58	90.18	0.42	0.13	0.86	17	15	19
50.00	0.50	3	3	50.00	50.61	25.44	97.39	0.41	0.14	0.88	15	15	17
50.00	0.50	3	3	131.76	50.15	26.73	99.70	0.41	0.13	0.86	16	15	18
50.00	0.50	3	4	11.43	49.17	27.06	87.82	0.41	0.10	0.88	20	18	22
50.00	0.50	3	4	50.00	50.68	27.32	91.29	0.41	0.11	0.84	18	18	20
50.00	0.50	3	4	131.76	51.06	28.43	95.55	0.42	0.11	0.89	19	18	21
50.00	0.50	3	5	11.43	49.38	27.42	85.45	0.42	0.11	0.85	23	21	25
50.00	0.50	3	5	50.00	50.91	28.18	89.38	0.42	0.12	0.89	21	21	23
50.00	0.50	3	5	131.76	50.01	28.38	86.78	0.41	0.12	0.84	22	21	24
50.00	0.50	4	3	11.43	47.92	27.69	86.33	0.45	0.17	0.81	23	21	25
50.00	0.50	4	3	50.00	50.00	27.93	90.02	0.46	0.18	0.81	21	20	22
50.00	0.50	4	3	131.76	51.23	28.23	91.89	0.44	0.17	0.80	22	20	24
50.00	0.50	4	4	11.43	48.83	29.30	81.53	0.44	0.18	0.80	27	25	29
50.00	0.50	4	4	50.00	50.05	30.85	82.71	0.43	0.16	0.79	25	24	26
50.00	0.50	4	4	131.76	51.01	30.38	85.99	0.45	0.18	0.80	26	24	28
50.00	0.50	4	5	11.43	49.69	29.30	81.34	0.44	0.16	0.79	31	29	33
50.00	0.50	4	5	50.00	49.99	30.24	81.29	0.44	0.17	0.80	29	28	30
50.00	0.50	4	5	131.76	50.31	30.57	82.84	0.44	0.17	0.81	30	28	32
50.00	0.50	5	3	11.43	48.57	29.08	81.95	0.46	0.22	0.77	28	26	31
50.00	0.50	5	3	50.00	49.77	29.27	81.70	0.46	0.21	0.77	26	25	28
50.00	0.50	5	3	131.76	51.43	31.25	83.76	0.45	0.20	0.76	27	25	29
50.00	0.50	5	4	11.43	49.06	30.61	77.44	0.46	0.21	0.78	33	31	36
50.00	0.50	5	4	50.00	50.46	31.27	79.94	0.45	0.21	0.78	31	30	33
50.00	0.50	5	4	131.76	51.52	31.89	82.82	0.47	0.21	0.77	32	30	34
50.00	0.50	5	5	11.43	49.00	31.18	76.15	0.46	0.21	0.75	39	36	41
50.00	0.50	5	5	50.00	50.30	32.21	77.18	0.46	0.20	0.77	36	35	38
50.00	0.50	5	5	131.76	50.35	32.34	77.37	0.45	0.21	0.76	37	35	39

Table IX

True LD50	True Sigma	# of runs	# of animals after reversal	Prelim. starting dose *	Median LD50	LD50 5%	LD50 95%	Median Sigma	Sigma 5%	Sigma 95%	Median # of animals	# of animals 5%	# of animals 95%
50.00	1.25	3	3	1.25	21.61	6.52	71.72	0.81	0.21	1.60	19	16	23
50.00	1.25	3	3	50.00	49.39	17.39	150.52	0.69	0.19	1.37	16	15	18
50.00	1.25	3	3	563.63	100.40	29.33	305.73	0.75	0.20	1.56	18	15	21
50.00	1.25	3	4	1.25	23.29	7.71	79.04	0.82	0.23	1.63	22	19	26
50.00	1.25	3	4	50.00	49.75	16.65	141.76	0.71	0.18	1.52	19	18	21
50.00	1.25	3	4	563.63	90.56	29.43	276.52	0.79	0.21	1.61	21	18	24
50.00	1.25	3	5	1.25	25.61	8.29	82.20	0.84	0.25	1.64	25	22	29
50.00	1.25	3	5	50.00	49.05	18.02	136.89	0.74	0.20	1.55	22	21	24
50.00	1.25	3	5	563.63	85.23	28.68	249.49	0.80	0.22	1.67	24	21	27
50.00	1.25	4	3	1.25	21.68	7.56	67.38	0.84	0.33	1.48	25	21	30
50.00	1.25	4	3	50.00	50.00	19.08	129.38	0.75	0.28	1.34	22	20	24
50.00	1.25	4	3	563.63	99.00	32.98	269.28	0.81	0.33	1.46	24	21	28
50.00	1.25	4	4	1.25	24.08	9.41	65.32	0.87	0.34	1.55	29	26	34
50.00	1.25	4	4	50.00	50.46	20.85	122.38	0.78	0.29	1.40	26	24	28
50.00	1.25	4	4	563.63	89.85	31.56	235.71	0.83	0.33	1.45	28	25	32
50.00	1.25	4	5	1.25	26.01	10.25	66.52	0.89	0.34	1.55	33	30	38
50.00	1.25	4	5	50.00	50.98	20.75	115.50	0.79	0.30	1.45	30	28	32
50.00	1.25	4	5	563.63	84.08	34.07	215.97	0.85	0.34	1.55	32	29	36
50.00	1.25	5	3	1.25	22.08	8.49	57.79	0.87	0.41	1.40	31	27	36
50.00	1.25	5	3	50.00	50.66	21.97	117.14	0.76	0.35	1.27	27	25	30
50.00	1.25	5	3	563.63	98.07	38.67	240.22	0.82	0.36	1.38	30	26	34
50.00	1.25	5	4	1.25	23.73	10.36	60.93	0.88	0.40	1.46	36	32	41
50.00	1.25	5	4	50.00	50.23	22.71	112.93	0.79	0.36	1.32	32	30	35
50.00	1.25	5	4	563.63	90.26	37.15	211.91	0.85	0.39	1.41	35	31	39
50.00	1.25	5	5	1.25	27.21	11.49	62.92	0.91	0.43	1.51	42	37	46
50.00	1.25	5	5	50.00	49.90	22.38	109.69	0.82	0.37	1.39	37	35	40
50.00	1.25	5	5	563.63	83.96	36.66	186.20	0.88	0.41	1.45	40	36	44

Table IX

True LD50	True Sigma	# of runs	# of animals after reversal	Prelim. starting dose *	Median LD50	LD50 5%	LD50 95%	Median Sigma	Sigma 5%	Sigma 95%	Median # of animals	# of animals 5%	# of animals 95%
50.00	2.00	3	3	1.00	11.69	3.33	54.68	0.90	0.23	1.91	18	15	22
50.00	2.00	3	3	50.00	51.54	13.16	186.86	0.85	0.22	1.76	16	15	19
50.00	2.00	3	3	2411.09	266.78	53.61	1055.78	0.99	0.25	2.07	19	15	23
50.00	2.00	3	4	1.00	13.49	3.71	58.34	0.95	0.25	2.02	21	18	25
50.00	2.00	3	4	50.00	49.84	13.47	184.48	0.86	0.21	1.88	19	18	22
50.00	2.00	3	4	2411.09	233.63	48.92	913.12	1.03	0.26	2.06	22	18	26
50.00	2.00	3	5	1.00	15.31	4.28	61.66	0.99	0.27	2.09	24	21	28
50.00	2.00	3	5	50.00	51.02	13.78	181.28	0.95	0.23	1.96	22	21	25
50.00	2.00	3	5	2411.09	206.82	43.63	791.70	1.05	0.30	2.19	25	21	30
50.00	2.00	4	3	1.00	12.39	4.02	47.31	0.95	0.38	1.73	24	21	29
50.00	2.00	4	3	50.00	49.89	16.33	159.26	0.90	0.33	1.64	22	20	25
50.00	2.00	4	3	2411.09	252.26	62.99	849.17	1.04	0.39	1.90	25	21	30
50.00	2.00	4	4	1.00	14.45	4.66	52.50	1.03	0.41	1.89	28	25	33
50.00	2.00	4	4	50.00	49.55	15.99	156.99	0.97	0.36	1.73	26	24	29
50.00	2.00	4	4	2411.09	224.70	59.29	759.83	1.08	0.42	1.94	29	25	34
50.00	2.00	4	5	1.00	15.89	5.21	52.45	1.06	0.40	1.92	32	28	37
50.00	2.00	4	5	50.00	50.13	16.42	155.54	1.00	0.37	1.84	30	28	33
50.00	2.00	4	5	2411.09	197.48	52.67	647.83	1.11	0.43	2.05	33	29	39
50.00	2.00	5	3	1.00	13.17	4.69	40.93	0.98	0.45	1.68	30	26	35
50.00	2.00	5	3	50.00	49.83	17.79	139.92	0.92	0.42	1.57	28	25	31
50.00	2.00	5	3	2411.09	258.52	69.59	761.75	1.06	0.49	1.81	31	27	37
50.00	2.00	5	4	1.00	14.20	5.20	43.66	1.05	0.48	1.78	35	31	40
50.00	2.00	5	4	50.00	51.88	17.74	137.80	0.97	0.45	1.65	33	30	36
50.00	2.00	5	4	2411.09	220.97	69.03	645.98	1.11	0.50	1.83	36	32	42
50.00	2.00	5	5	1.00	16.57	6.05	48.38	1.10	0.51	1.86	40	36	45
50.00	2.00	5	5	50.00	48.82	18.83	135.43	1.05	0.48	1.73	38	35	41
50.00	2.00	5	5	2411.09	197.35	63.15	570.35	1.16	0.54	1.96	41	37	47

Table IX

True LD50	True Sigma	# of runs	# of animals after reversal	Prelim. starting dose *	Median LD50	LD50 5%	LD50 95%	Median Sigma	Sigma 5%	Sigma 95%	Median # of animals	# of animals 5%	# of animals 95%
250.00	0.12	3	3	175.45	280.91	197.28	393.04	0.23	0.09	0.46	15	15	16
250.00	0.12	3	3	250.00	242.11	177.53	327.11	0.34	0.12	0.46	15	15	15
250.00	0.12	3	3	315.45	241.09	163.87	325.73	0.28	0.12	0.46	15	15	15
250.00	0.12	3	4	175.45	241.95	212.57	312.01	0.17	0.00	0.35	18	18	19
250.00	0.12	3	4	250.00	266.10	206.35	302.88	0.17	0.00	0.35	18	18	18
250.00	0.12	3	4	315.45	260.38	201.45	296.36	0.17	0.00	0.33	18	18	18
250.00	0.12	3	5	175.45	278.71	210.89	345.82	0.20	0.05	0.46	21	21	22
250.00	0.12	3	5	250.00	252.96	195.37	319.89	0.30	0.11	0.46	21	21	21
250.00	0.12	3	5	315.45	236.78	186.84	306.04	0.20	0.05	0.46	21	21	21
250.00	0.12	4	3	175.45	279.95	219.89	354.07	0.25	0.11	0.41	20	20	21
250.00	0.12	4	3	250.00	249.98	187.13	333.93	0.32	0.18	0.45	20	20	20
250.00	0.12	4	3	315.45	235.72	176.46	315.43	0.28	0.11	0.42	20	20	20
250.00	0.12	4	4	175.45	257.41	212.34	312.03	0.20	0.10	0.32	24	24	25
250.00	0.12	4	4	250.00	249.98	206.21	303.03	0.20	0.10	0.30	24	24	24
250.00	0.12	4	4	315.45	260.21	203.57	315.43	0.20	0.10	0.31	24	24	24
250.00	0.12	4	5	175.45	275.39	216.21	339.04	0.22	0.11	0.42	28	28	29
250.00	0.12	4	5	250.00	249.98	202.87	318.40	0.28	0.13	0.43	28	28	28
250.00	0.12	4	5	315.45	236.29	191.61	290.90	0.24	0.11	0.43	28	28	28
250.00	0.12	5	3	175.45	284.68	225.50	358.89	0.25	0.13	0.39	25	25	26
250.00	0.12	5	3	250.00	254.83	194.24	321.71	0.30	0.19	0.43	25	25	25
250.00	0.12	5	3	315.45	232.89	177.52	294.00	0.28	0.14	0.42	25	25	25
250.00	0.12	5	4	175.45	247.86	212.49	303.00	0.21	0.09	0.31	30	30	31
250.00	0.12	5	4	250.00	259.52	206.43	302.72	0.21	0.09	0.31	30	30	30
250.00	0.12	5	4	315.45	249.31	206.62	303.41	0.21	0.09	0.31	30	30	31
250.00	0.12	5	5	175.45	273.48	224.34	325.04	0.23	0.12	0.38	35	35	36
250.00	0.12	5	5	250.00	245.48	202.09	309.00	0.28	0.16	0.41	35	35	35
250.00	0.12	5	5	315.45	238.95	194.93	290.26	0.26	0.12	0.39	35	35	36

Table IX

True LD50	True Sigma	# of runs	# of animals after reversal	Prelim. starting dose *	Median LD50	LD50 5%	LD50 95%	Median Sigma	Sigma 5%	Sigma 95%	Median # of animals	# of animals 5%	# of animals 95%
250.00	0.25	3	3	119.55	271.68	181.62	407.30	0.28	0.08	0.56	16	15	17
250.00	0.25	3	3	250.00	258.14	162.56	384.47	0.31	0.11	0.59	15	15	16
250.00	0.25	3	3	405.83	228.56	153.46	360.93	0.28	0.08	0.57	15	15	16
250.00	0.25	3	4	119.55	259.71	184.15	387.40	0.28	0.06	0.55	19	18	20
250.00	0.25	3	4	250.00	246.62	176.58	357.84	0.24	0.00	0.53	18	18	19
250.00	0.25	3	4	405.83	249.09	170.09	349.01	0.27	0.05	0.54	18	18	19
250.00	0.25	3	5	119.55	266.94	189.61	375.66	0.25	0.05	0.53	22	21	23
250.00	0.25	3	5	250.00	251.15	174.65	357.84	0.30	0.05	0.56	21	21	22
250.00	0.25	3	5	405.83	236.56	168.15	337.63	0.25	0.05	0.54	21	21	22
250.00	0.25	4	3	119.55	272.34	185.82	390.86	0.28	0.11	0.52	21	20	22
250.00	0.25	4	3	250.00	249.98	167.02	374.14	0.32	0.13	0.55	20	20	21
250.00	0.25	4	3	405.83	229.21	160.47	332.42	0.28	0.11	0.53	20	20	22
250.00	0.25	4	4	119.55	260.87	185.26	366.03	0.29	0.11	0.50	25	24	26
250.00	0.25	4	4	250.00	249.98	187.14	343.40	0.26	0.10	0.49	24	24	25
250.00	0.25	4	4	405.83	244.10	177.54	334.75	0.29	0.10	0.51	24	24	26
250.00	0.25	4	5	119.55	269.65	196.46	359.82	0.27	0.11	0.51	29	28	30
250.00	0.25	4	5	250.00	249.98	181.21	338.10	0.31	0.11	0.52	28	28	29
250.00	0.25	4	5	405.83	237.61	175.65	328.73	0.27	0.11	0.50	28	28	30
250.00	0.25	5	3	119.55	273.93	199.91	378.75	0.29	0.13	0.50	26	25	28
250.00	0.25	5	3	250.00	250.24	176.54	353.56	0.32	0.15	0.52	25	25	26
250.00	0.25	5	3	405.83	230.06	168.96	325.40	0.30	0.14	0.50	26	25	27
250.00	0.25	5	4	119.55	262.68	195.99	353.99	0.29	0.14	0.49	31	30	33
250.00	0.25	5	4	250.00	248.80	186.77	328.90	0.28	0.13	0.48	30	30	31
250.00	0.25	5	4	405.83	242.42	184.13	327.22	0.29	0.13	0.48	31	30	32
250.00	0.25	5	5	119.55	268.60	204.66	347.90	0.28	0.13	0.47	36	35	38
250.00	0.25	5	5	250.00	252.60	188.94	333.23	0.31	0.15	0.49	35	35	36
250.00	0.25	5	5	405.83	237.60	180.63	310.60	0.29	0.14	0.49	36	35	37

Table IX

True LD50	True Sigma	# of runs	# of animals after reversal	Prelim. starting dose *	Median LD50	LD50 5%	LD50 95%	Median Sigma	Sigma 5%	Sigma 95%	Median # of animals	# of animals 5%	# of animals 95%
250.00	0.50	3	3	57.17	239.91	120.61	460.42	0.41	0.14	0.84	17	15	19
250.00	0.50	3	3	250.00	252.95	128.58	486.06	0.41	0.15	0.84	15	15	17
250.00	0.50	3	3	658.80	250.22	135.23	494.92	0.41	0.12	0.85	16	15	18
250.00	0.50	3	4	57.17	244.50	133.59	451.91	0.41	0.11	0.88	20	18	22
250.00	0.50	3	4	250.00	252.07	139.60	454.39	0.42	0.14	0.86	18	18	20
250.00	0.50	3	4	658.80	256.69	139.19	466.82	0.41	0.11	0.86	19	18	21
250.00	0.50	3	5	57.17	247.24	141.91	425.21	0.41	0.11	0.87	23	21	25
250.00	0.50	3	5	250.00	245.97	140.25	439.44	0.41	0.11	0.85	21	21	23
250.00	0.50	3	5	658.80	251.39	144.14	453.46	0.42	0.12	0.86	22	21	24
250.00	0.50	4	3	57.17	242.03	136.92	425.88	0.44	0.17	0.79	23	21	25
250.00	0.50	4	3	250.00	249.98	139.66	453.91	0.45	0.18	0.80	21	20	22
250.00	0.50	4	3	658.80	256.98	146.08	443.71	0.45	0.17	0.81	22	20	24
250.00	0.50	4	4	57.17	242.80	145.50	413.31	0.44	0.17	0.82	27	25	29
250.00	0.50	4	4	250.00	249.98	146.40	428.54	0.44	0.16	0.81	25	24	26
250.00	0.50	4	4	658.80	256.69	152.61	428.88	0.44	0.18	0.81	26	24	28
250.00	0.50	4	5	57.17	249.96	152.00	402.53	0.44	0.17	0.82	31	29	33
250.00	0.50	4	5	250.00	249.54	154.46	418.67	0.44	0.18	0.81	29	28	30
250.00	0.50	4	5	658.80	250.53	153.30	418.25	0.44	0.17	0.81	30	28	32
250.00	0.50	5	3	57.17	242.32	142.84	397.95	0.46	0.22	0.78	28	26	31
250.00	0.50	5	3	250.00	253.19	148.12	417.96	0.46	0.22	0.77	26	25	28
250.00	0.50	5	3	658.80	256.29	155.84	432.70	0.46	0.20	0.76	27	25	29
250.00	0.50	5	4	57.17	245.23	149.72	395.12	0.46	0.21	0.78	33	31	36
250.00	0.50	5	4	250.00	248.33	156.15	402.73	0.45	0.21	0.76	31	30	33
250.00	0.50	5	4	658.80	256.09	159.18	407.94	0.46	0.21	0.77	32	30	34
250.00	0.50	5	5	57.17	247.90	158.89	381.96	0.46	0.21	0.77	38	36	41
250.00	0.50	5	5	250.00	250.66	160.50	384.95	0.46	0.21	0.77	36	35	38
250.00	0.50	5	5	658.80	248.45	160.41	395.51	0.46	0.22	0.77	37	35	39

Table IX

True LD50	True Sigma	# of runs	# of animals after reversal	Prelim. starting dose *	Median LD50	LD50 5%	LD50 95%	Median Sigma	Sigma 5%	Sigma 95%	Median # of animals	# of animals 5%	# of animals 95%
250.00	1.25	3	3	6.25	95.81	27.49	350.18	0.82	0.24	1.67	20	16	24
250.00	1.25	3	3	250.00	251.99	82.91	739.72	0.67	0.17	1.41	16	15	18
250.00	1.25	3	3	2818.17	486.16	136.95	1451.68	0.72	0.21	1.45	18	15	21
250.00	1.25	3	4	6.25	111.79	34.21	378.55	0.83	0.23	1.67	23	19	27
250.00	1.25	3	4	250.00	246.62	90.41	695.98	0.71	0.17	1.48	19	18	21
250.00	1.25	3	4	2818.17	428.06	142.91	1247.28	0.75	0.21	1.56	21	18	24
250.00	1.25	3	5	6.25	119.21	37.09	385.39	0.84	0.22	1.76	26	22	30
250.00	1.25	3	5	250.00	250.00	91.84	665.19	0.74	0.19	1.56	22	21	24
250.00	1.25	3	5	2818.17	412.91	142.24	1160.12	0.75	0.21	1.56	24	21	27
250.00	1.25	4	3	6.25	101.48	33.68	326.00	0.87	0.34	1.56	27	22	32
250.00	1.25	4	3	250.00	249.16	96.49	619.84	0.74	0.30	1.33	22	20	24
250.00	1.25	4	3	2818.17	471.35	176.68	1202.10	0.78	0.30	1.38	23	20	27
250.00	1.25	4	4	6.25	107.22	39.64	315.57	0.89	0.35	1.59	30	26	35
250.00	1.25	4	4	250.00	247.45	97.87	609.06	0.76	0.29	1.37	26	24	28
250.00	1.25	4	4	2818.17	427.51	167.36	1055.00	0.81	0.31	1.44	27	25	31
250.00	1.25	4	5	6.25	122.25	45.30	340.84	0.90	0.34	1.63	34	30	39
250.00	1.25	4	5	250.00	249.42	104.85	577.56	0.79	0.31	1.42	30	28	32
250.00	1.25	4	5	2818.17	402.63	157.05	964.91	0.83	0.32	1.45	32	29	36
250.00	1.25	5	3	6.25	98.01	36.31	271.41	0.90	0.42	1.48	33	28	38
250.00	1.25	5	3	250.00	252.60	107.47	576.64	0.75	0.35	1.26	27	25	30
250.00	1.25	5	3	2818.17	462.38	192.31	1056.57	0.79	0.37	1.30	29	26	33
250.00	1.25	5	4	6.25	110.13	44.38	285.78	0.92	0.44	1.50	38	34	43
250.00	1.25	5	4	250.00	244.95	111.13	565.71	0.78	0.37	1.30	32	30	35
250.00	1.25	5	4	2818.17	432.02	176.86	979.38	0.82	0.38	1.36	34	31	38
250.00	1.25	5	5	6.25	124.00	47.62	301.92	0.93	0.43	1.52	43	38	48
250.00	1.25	5	5	250.00	250.83	115.74	546.36	0.81	0.38	1.35	37	35	40
250.00	1.25	5	5	2818.17	401.74	179.31	879.24	0.84	0.39	1.37	39	36	43

Table IX

True LD50	True Sigma	# of runs	# of animals after reversal	Prelim. starting dose *	Median LD50	LD50 5%	LD50 95%	Median Sigma	Sigma 5%	Sigma 95%	Median # of animals	# of animals 5%	# of animals 95%
250.00	2.00	3	3	1.00	32.53	7.50	203.73	1.07	0.28	2.14	20	16	25
250.00	2.00	3	3	250.00	240.32	63.62	849.52	0.82	0.20	1.73	16	15	19
250.00	2.00	3	3	5000.00	662.45	162.33	2190.88	0.81	0.21	1.78	17	15	21
250.00	2.00	3	4	1.00	40.35	9.04	234.48	1.11	0.29	2.21	23	19	28
250.00	2.00	3	4	250.00	250.33	67.34	900.88	0.90	0.24	1.83	19	18	22
250.00	2.00	3	4	5000.00	608.75	157.05	1938.58	0.88	0.23	1.85	20	18	24
250.00	2.00	3	5	1.00	46.21	11.14	224.67	1.13	0.31	2.33	26	22	31
250.00	2.00	3	5	250.00	242.54	67.97	847.27	0.94	0.26	1.92	22	21	25
250.00	2.00	3	5	5000.00	567.13	149.60	1771.08	0.91	0.26	1.90	23	21	27
250.00	2.00	4	3	1.00	35.61	9.71	165.37	1.12	0.45	2.01	27	22	33
250.00	2.00	4	3	250.00	242.51	79.61	750.18	0.89	0.34	1.65	22	20	25
250.00	2.00	4	3	5000.00	634.96	187.61	1783.87	0.88	0.32	1.61	23	20	27
250.00	2.00	4	4	1.00	40.97	11.00	169.62	1.16	0.46	2.05	31	26	36
250.00	2.00	4	4	250.00	246.67	78.26	766.37	0.95	0.35	1.69	26	24	29
250.00	2.00	4	4	5000.00	607.81	183.44	1631.58	0.93	0.37	1.73	27	24	31
250.00	2.00	4	5	1.00	46.87	13.04	188.78	1.18	0.44	2.09	34	30	40
250.00	2.00	4	5	250.00	240.87	84.80	692.00	0.97	0.38	1.79	30	28	33
250.00	2.00	4	5	5000.00	557.16	172.03	1558.22	0.98	0.38	1.80	31	28	35
250.00	2.00	5	3	1.00	34.87	10.33	139.12	1.14	0.51	1.89	33	28	40
250.00	2.00	5	3	250.00	250.11	88.29	678.14	0.91	0.41	1.54	28	25	31
250.00	2.00	5	3	5000.00	640.89	215.51	1589.16	0.91	0.40	1.59	29	26	33
250.00	2.00	5	4	1.00	42.77	13.65	148.39	1.20	0.56	1.95	38	33	44
250.00	2.00	5	4	250.00	244.78	91.34	637.10	0.98	0.46	1.61	33	30	36
250.00	2.00	5	4	5000.00	582.56	199.65	1458.51	0.96	0.46	1.62	34	31	38
250.00	2.00	5	5	1.00	48.83	15.08	154.48	1.26	0.57	2.03	43	38	49
250.00	2.00	5	5	250.00	249.97	95.14	644.22	1.02	0.49	1.69	38	35	41
250.00	2.00	5	5	5000.00	543.51	196.45	1366.70	0.99	0.46	1.70	39	35	43

Table IX

True LD50	True Sigma	# of runs	# of animals after reversal	Prelim. starting dose *	Median LD50	LD50 5%	LD50 95%	Median Sigma	Sigma 5%	Sigma 95%	Median # of animals	# of animals 5%	# of animals 95%
1500.00	0.12	3	3	1052.70	1705.97	1250.40	2516.41	0.27	0.09	0.51	15	15	16
1500.00	0.12	3	3	1500.00	1620.21	1176.54	2113.36	0.39	0.14	0.53	15	15	15
1500.00	0.12	3	3	1892.72	1453.51	990.09	1890.36	0.29	0.07	0.49	15	15	15
1500.00	0.12	3	4	1052.70	1551.14	1183.19	2060.46	0.23	0.05	0.38	18	18	19
1500.00	0.12	3	4	1500.00	1514.89	1288.14	1971.70	0.24	0.05	0.39	18	18	18
1500.00	0.12	3	4	1892.72	1580.55	1216.89	1823.24	0.19	0.03	0.34	18	18	18
1500.00	0.12	3	5	1052.70	1732.31	1323.60	2192.27	0.25	0.07	0.54	21	21	22
1500.00	0.12	3	5	1500.00	1562.80	1217.58	2071.26	0.38	0.15	0.54	21	21	21
1500.00	0.12	3	5	1892.72	1422.94	1120.94	1827.25	0.23	0.05	0.51	21	21	21
1500.00	0.12	4	3	1052.70	1808.06	1353.17	2314.70	0.27	0.17	0.47	20	20	21
1500.00	0.12	4	3	1500.00	1594.22	1183.32	2155.70	0.36	0.19	0.51	20	20	20
1500.00	0.12	4	3	1892.72	1205.88	1068.25	1480.85	0.14	0.05	0.30	20	20	21
1500.00	0.12	4	4	1052.70	1683.55	1344.08	2065.92	0.25	0.12	0.37	24	24	25
1500.00	0.12	4	4	1500.00	1610.92	1295.86	1967.29	0.25	0.11	0.35	24	24	24
1500.00	0.12	4	4	1892.72	1478.40	1237.56	1633.61	0.15	0.05	0.26	24	24	25
1500.00	0.12	4	5	1052.70	1781.27	1390.90	2222.08	0.29	0.15	0.49	28	28	29
1500.00	0.12	4	5	1500.00	1604.94	1269.97	1993.84	0.33	0.17	0.47	28	28	28
1500.00	0.12	4	5	1892.72	1249.42	1137.27	1521.50	0.16	0.06	0.29	28	28	29
1500.00	0.12	5	3	1052.70	1775.09	1371.89	2265.62	0.27	0.14	0.42	25	25	26
1500.00	0.12	5	3	1500.00	1216.54	1015.60	1527.45	0.18	0.07	0.39	25	25	26
1500.00	0.12	5	3	1892.72	1216.54	1015.60	1520.61	0.18	0.07	0.38	25	25	25
1500.00	0.12	5	4	1052.70	1561.75	1298.21	1914.79	0.24	0.10	0.33	30	30	31
1500.00	0.12	5	4	1500.00	1473.78	1249.30	1710.13	0.15	0.07	0.27	30	30	31
1500.00	0.12	5	4	1892.72	1473.78	1272.68	1714.17	0.15	0.07	0.27	30	30	31
1500.00	0.12	5	5	1052.70	1703.55	1382.57	2065.53	0.27	0.12	0.41	35	35	36
1500.00	0.12	5	5	1500.00	1282.08	1085.89	1530.83	0.18	0.07	0.33	35	35	36
1500.00	0.12	5	5	1892.72	1282.08	1085.89	1523.04	0.17	0.08	0.32	35	35	36

Table IX

True LD50	True Sigma	# of runs	# of animals after reversal	Prelim. starting dose *	Median LD50	LD50 5%	LD50 95%	Median Sigma	Sigma 5%	Sigma 95%	Median # of animals	# of animals 5%	# of animals 95%
1500.00	0.25	3	3	717.30	1693.74	1106.18	2552.13	0.29	0.07	0.55	16	15	17
1500.00	0.25	3	3	1500.00	1548.72	941.53	2372.38	0.33	0.09	0.59	15	15	16
1500.00	0.25	3	3	2434.99	1326.67	928.45	2022.16	0.22	0.07	0.52	15	15	16
1500.00	0.25	3	4	717.30	1591.61	1061.59	2288.06	0.26	0.06	0.53	19	18	20
1500.00	0.25	3	4	1500.00	1514.89	1056.05	2165.15	0.25	0.08	0.51	18	18	19
1500.00	0.25	3	4	2434.99	1449.71	966.73	2026.46	0.24	0.07	0.50	18	18	20
1500.00	0.25	3	5	717.30	1607.61	1143.28	2257.80	0.26	0.07	0.52	22	21	23
1500.00	0.25	3	5	1500.00	1533.95	1064.46	2183.94	0.29	0.09	0.55	21	21	22
1500.00	0.25	3	5	2434.99	1355.05	994.24	1906.67	0.22	0.07	0.51	21	21	22
1500.00	0.25	4	3	717.30	1669.66	1144.40	2334.71	0.28	0.11	0.51	21	20	22
1500.00	0.25	4	3	1500.00	1542.79	1027.33	2231.72	0.33	0.14	0.54	20	20	21
1500.00	0.25	4	3	2434.99	1339.88	957.39	1916.79	0.28	0.10	0.52	20	20	22
1500.00	0.25	4	4	717.30	1566.39	1113.73	2165.67	0.28	0.11	0.50	25	24	26
1500.00	0.25	4	4	1500.00	1534.02	1101.30	2048.35	0.27	0.10	0.49	24	24	25
1500.00	0.25	4	4	2434.99	1465.55	1055.07	1918.79	0.26	0.09	0.48	24	24	26
1500.00	0.25	4	5	717.30	1616.25	1188.41	2181.61	0.27	0.11	0.48	29	28	30
1500.00	0.25	4	5	1500.00	1529.49	1092.52	2107.27	0.31	0.13	0.52	28	28	29
1500.00	0.25	4	5	2434.99	1376.42	1038.04	1887.03	0.27	0.10	0.49	28	28	30
1500.00	0.25	5	3	717.30	1702.96	1213.32	2336.81	0.30	0.14	0.50	26	25	28
1500.00	0.25	5	3	1500.00	1368.32	999.99	1913.12	0.29	0.13	0.48	25	25	27
1500.00	0.25	5	3	2434.99	1367.61	997.11	1878.15	0.29	0.13	0.48	25	25	27
1500.00	0.25	5	4	717.30	1599.28	1178.55	2111.75	0.28	0.14	0.48	31	30	33
1500.00	0.25	5	4	1500.00	1469.58	1099.22	1929.18	0.28	0.11	0.47	30	30	32
1500.00	0.25	5	4	2434.99	1449.65	1093.17	1917.74	0.27	0.12	0.45	30	30	32
1500.00	0.25	5	5	717.30	1645.72	1245.57	2118.60	0.29	0.13	0.47	36	35	38
1500.00	0.25	5	5	1500.00	1400.30	1080.70	1834.55	0.28	0.13	0.46	35	35	37
1500.00	0.25	5	5	2434.99	1394.42	1064.52	1852.22	0.29	0.12	0.47	35	35	37

Table IX

True LD50	True Sigma	# of runs	# of animals after reversal	Prelim. starting dose *	Median LD50	LD50 5%	LD50 95%	Median Sigma	Sigma 5%	Sigma 95%	Median # of animals	# of animals 5%	# of animals 95%
1500.00	0.50	3	3	343.02	1432.00	765.72	2694.29	0.41	0.12	0.86	17	15	19
1500.00	0.50	3	3	1500.00	1468.15	780.73	2757.22	0.39	0.12	0.85	15	15	17
1500.00	0.50	3	3	3952.77	1465.60	774.22	2694.43	0.39	0.09	0.81	16	15	17
1500.00	0.50	3	4	343.02	1456.40	794.35	2619.70	0.41	0.11	0.84	20	18	22
1500.00	0.50	3	4	1500.00	1495.09	830.35	2706.83	0.40	0.11	0.84	18	18	20
1500.00	0.50	3	4	3952.77	1483.05	786.44	2664.00	0.40	0.11	0.84	19	18	20
1500.00	0.50	3	5	343.02	1460.79	804.57	2530.37	0.41	0.11	0.84	23	21	25
1500.00	0.50	3	5	1500.00	1486.81	873.06	2595.99	0.40	0.11	0.83	21	21	23
1500.00	0.50	3	5	3952.77	1466.78	865.33	2510.51	0.41	0.10	0.83	22	21	23
1500.00	0.50	4	3	343.02	1451.28	820.83	2511.62	0.44	0.18	0.79	23	21	25
1500.00	0.50	4	3	1500.00	1454.60	846.16	2574.62	0.44	0.17	0.77	21	20	22
1500.00	0.50	4	3	3952.77	1456.55	869.33	2509.80	0.42	0.16	0.77	21	20	23
1500.00	0.50	4	4	343.02	1472.49	861.56	2422.42	0.43	0.17	0.78	27	25	29
1500.00	0.50	4	4	1500.00	1506.66	904.91	2488.48	0.43	0.16	0.77	25	24	26
1500.00	0.50	4	4	3952.77	1480.19	890.30	2402.86	0.43	0.16	0.75	25	24	27
1500.00	0.50	4	5	343.02	1474.05	902.85	2333.36	0.45	0.18	0.80	31	29	33
1500.00	0.50	4	5	1500.00	1487.03	922.85	2354.33	0.43	0.16	0.80	29	28	30
1500.00	0.50	4	5	3952.77	1484.13	922.64	2347.98	0.42	0.16	0.76	29	28	31
1500.00	0.50	5	3	343.02	1439.53	878.59	2377.95	0.45	0.21	0.73	28	26	31
1500.00	0.50	5	3	1500.00	1478.48	903.85	2397.92	0.44	0.21	0.72	26	25	28
1500.00	0.50	5	3	3952.77	1465.55	903.92	2336.05	0.44	0.20	0.73	26	25	28
1500.00	0.50	5	4	343.02	1454.40	907.03	2311.00	0.45	0.20	0.75	33	31	36
1500.00	0.50	5	4	1500.00	1476.38	943.60	2267.89	0.44	0.20	0.73	31	30	33
1500.00	0.50	5	4	3952.77	1497.29	943.79	2327.92	0.44	0.21	0.72	31	30	33
1500.00	0.50	5	5	343.02	1464.06	948.14	2185.18	0.44	0.21	0.75	38	36	41
1500.00	0.50	5	5	1500.00	1486.90	960.84	2243.35	0.45	0.21	0.75	36	35	38
1500.00	0.50	5	5	3952.77	1475.96	968.87	2262.31	0.44	0.19	0.72	36	35	38

Table IX

True LD50	True Sigma	# of runs	# of animals after reversal	Prelim. starting dose *	Median LD50	LD50 5%	LD50 95%	Median Sigma	Sigma 5%	Sigma 95%	Median # of animals	# of animals 5%	# of animals 95%
1500.00	1.25	3	3	37.51	579.38	166.76	2018.56	0.82	0.23	1.55	20	16	24
1500.00	1.25	3	3	1500.00	1400.39	494.00	3514.40	0.61	0.17	1.29	16	15	18
1500.00	1.25	3	3	5000.00	1634.11	574.33	3906.21	0.59	0.16	1.23	16	15	19
1500.00	1.25	3	4	37.51	641.59	209.63	2046.33	0.81	0.21	1.61	23	19	27
1500.00	1.25	3	4	1500.00	1403.48	529.50	3345.04	0.64	0.19	1.31	19	17	21
1500.00	1.25	3	4	5000.00	1574.36	597.93	3849.48	0.61	0.18	1.30	19	18	22
1500.00	1.25	3	5	37.51	704.61	227.97	2037.50	0.79	0.22	1.62	26	22	30
1500.00	1.25	3	5	1500.00	1363.73	505.32	3363.71	0.65	0.17	1.35	22	20	24
1500.00	1.25	3	5	5000.00	1566.24	622.41	3509.09	0.65	0.18	1.34	22	21	25
1500.00	1.25	4	3	37.51	571.43	200.01	1710.67	0.85	0.33	1.46	26	22	31
1500.00	1.25	4	3	1500.00	1396.21	577.28	3035.81	0.67	0.27	1.16	21	20	24
1500.00	1.25	4	3	5000.00	1591.56	663.55	3374.21	0.64	0.25	1.19	22	20	24
1500.00	1.25	4	4	37.51	659.86	233.72	1663.63	0.87	0.34	1.51	30	26	35
1500.00	1.25	4	4	1500.00	1370.10	611.01	2965.77	0.70	0.28	1.22	25	24	28
1500.00	1.25	4	4	5000.00	1575.38	666.21	3178.49	0.67	0.26	1.21	26	24	28
1500.00	1.25	4	5	37.51	715.61	263.21	1736.83	0.88	0.34	1.53	34	30	39
1500.00	1.25	4	5	1500.00	1402.97	597.66	2836.65	0.71	0.29	1.29	29	27	32
1500.00	1.25	4	5	5000.00	1498.12	652.62	2989.27	0.69	0.27	1.27	30	27	32
1500.00	1.25	5	3	37.51	563.36	222.17	1442.34	0.90	0.42	1.41	33	28	38
1500.00	1.25	5	3	1500.00	1543.38	695.74	3128.99	0.67	0.30	1.12	27	25	30
1500.00	1.25	5	3	5000.00	1546.40	712.45	3063.04	0.65	0.30	1.10	27	25	30
1500.00	1.25	5	4	37.51	636.39	259.64	1554.79	0.89	0.44	1.43	38	33	43
1500.00	1.25	5	4	1500.00	1497.75	719.50	3007.22	0.70	0.33	1.16	32	30	35
1500.00	1.25	5	4	5000.00	1483.34	699.15	2913.66	0.68	0.33	1.19	32	30	35
1500.00	1.25	5	5	37.51	709.38	308.70	1639.49	0.90	0.45	1.45	43	38	48
1500.00	1.25	5	5	1500.00	1501.22	756.75	2875.69	0.72	0.34	1.22	37	34	40
1500.00	1.25	5	5	5000.00	1487.63	726.59	2820.87	0.72	0.34	1.20	37	34	40

Table IX

True LD50	True Sigma	# of runs	# of animals after reversal	Prelim. starting dose *	Median LD50	LD50 5%	LD50 95%	Median Sigma	Sigma 5%	Sigma 95%	Median # of animals	# of animals 5%	# of animals 95%
1500.00	2.00	3	3	4.10	152.98	27.26	832.02	1.19	0.33	2.20	22	17	27
1500.00	2.00	3	3	1500.00	1320.31	408.52	3632.35	0.71	0.19	1.48	16	15	19
1500.00	2.00	3	3	5000.00	1650.05	484.04	4192.65	0.68	0.19	1.46	16	15	19
1500.00	2.00	3	4	4.10	183.31	37.16	965.62	1.21	0.32	2.34	25	20	30
1500.00	2.00	3	4	1500.00	1307.19	398.13	3533.58	0.76	0.22	1.59	19	17	22
1500.00	2.00	3	4	5000.00	1592.07	507.86	4214.70	0.71	0.18	1.57	19	17	22
1500.00	2.00	3	5	4.10	219.09	44.95	1111.91	1.20	0.33	2.39	28	23	33
1500.00	2.00	3	5	1500.00	1263.96	386.60	3421.87	0.81	0.22	1.63	22	19	25
1500.00	2.00	3	5	5000.00	1582.85	484.18	3971.57	0.75	0.20	1.59	22	19	25
1500.00	2.00	4	3	4.10	146.91	31.36	763.90	1.26	0.51	2.06	29	23	35
1500.00	2.00	4	3	1500.00	1302.14	466.21	3253.94	0.76	0.30	1.43	22	20	25
1500.00	2.00	4	3	5000.00	1555.33	544.29	3650.06	0.73	0.28	1.39	22	20	25
1500.00	2.00	4	4	4.10	182.89	45.86	804.64	1.25	0.51	2.11	33	27	39
1500.00	2.00	4	4	1500.00	1298.91	460.94	3210.44	0.81	0.32	1.47	26	23	29
1500.00	2.00	4	4	5000.00	1537.08	554.77	3732.27	0.74	0.28	1.46	26	23	29
1500.00	2.00	4	5	4.10	220.02	52.97	872.30	1.29	0.51	2.17	37	31	43
1500.00	2.00	4	5	1500.00	1268.22	474.06	3051.80	0.86	0.34	1.55	30	26	33
1500.00	2.00	4	5	5000.00	1497.67	558.58	3360.89	0.81	0.32	1.53	30	26	33
1500.00	2.00	5	3	4.10	150.39	39.51	625.28	1.27	0.64	1.97	36	30	43
1500.00	2.00	5	3	1500.00	1530.98	591.11	3300.14	0.76	0.34	1.32	27	25	31
1500.00	2.00	5	3	5000.00	1539.54	580.40	3431.21	0.76	0.34	1.32	27	25	31
1500.00	2.00	5	4	4.10	180.30	48.86	663.08	1.30	0.60	2.00	41	35	48
1500.00	2.00	5	4	1500.00	1506.56	608.39	3164.65	0.82	0.37	1.40	32	29	36
1500.00	2.00	5	4	5000.00	1500.60	600.97	3190.14	0.80	0.38	1.38	32	29	36
1500.00	2.00	5	5	4.10	214.52	63.28	742.84	1.31	0.65	2.04	46	39	53
1500.00	2.00	5	5	1500.00	1472.89	579.91	3076.81	0.83	0.37	1.44	37	33	41
1500.00	2.00	5	5	5000.00	1496.16	624.28	3195.65	0.85	0.39	1.45	37	33	41

Table IX

True LD50	True Sigma	# of runs	# of animals after reversal	Prelim. starting dose *	Median LD50	LD50 5%	LD50 95%	Median Sigma	Sigma 5%	Sigma 95%	Median # of animals	# of animals 5%	# of animals 95%
3000.00	0.12	3	3	2105.40	3059.12	2144.18	4395.22	0.24	0.06	0.49	15	15	16
3000.00	0.12	3	3	3000.00	3059.12	2151.99	4406.87	0.25	0.06	0.49	15	15	16
3000.00	0.12	3	3	3785.44	3059.12	2144.18	4440.35	0.25	0.06	0.49	15	15	16
3000.00	0.12	3	4	2105.40	2748.52	2240.69	3643.38	0.18	0.06	0.37	18	18	19
3000.00	0.12	3	4	3000.00	2748.52	2240.69	3643.38	0.18	0.06	0.37	18	18	19
3000.00	0.12	3	4	3785.44	2748.52	2232.86	3643.38	0.18	0.06	0.38	18	18	19
3000.00	0.12	3	5	2105.40	2989.50	2294.59	3988.93	0.21	0.06	0.43	21	21	22
3000.00	0.12	3	5	3000.00	3038.66	2290.59	4032.35	0.21	0.06	0.43	21	21	22
3000.00	0.12	3	5	3785.44	3040.97	2284.32	4032.35	0.21	0.06	0.43	21	21	22
3000.00	0.12	4	3	2105.40	3244.05	2454.32	4158.52	0.24	0.08	0.43	20	20	21
3000.00	0.12	4	3	3000.00	3244.05	2318.67	4148.41	0.24	0.08	0.43	20	20	21
3000.00	0.12	4	3	3785.44	3244.05	2318.67	4142.86	0.23	0.08	0.43	20	20	21
3000.00	0.12	4	4	2105.40	2831.36	2398.70	3530.65	0.16	0.05	0.34	24	24	25
3000.00	0.12	4	4	3000.00	2831.36	2397.81	3508.90	0.17	0.07	0.34	24	24	25
3000.00	0.12	4	4	3785.44	2831.36	2397.34	3500.25	0.17	0.07	0.34	24	24	25
3000.00	0.12	4	5	2105.40	3120.86	2441.18	3861.76	0.22	0.07	0.39	28	28	29
3000.00	0.12	4	5	3000.00	3119.59	2448.90	3893.21	0.21	0.08	0.39	28	28	29
3000.00	0.12	4	5	3785.44	3120.22	2448.90	3916.54	0.22	0.08	0.39	28	28	29
3000.00	0.12	5	3	2105.40	3326.91	2541.28	4067.88	0.23	0.10	0.39	25	25	26
3000.00	0.12	5	3	3000.00	3326.91	2540.62	4066.24	0.23	0.10	0.40	25	25	26
3000.00	0.12	5	3	3785.44	3322.93	2543.74	4066.24	0.23	0.09	0.40	25	25	26
3000.00	0.12	5	4	2105.40	2860.18	2394.36	3513.92	0.16	0.08	0.32	30	30	31
3000.00	0.12	5	4	3000.00	2860.18	2395.70	3427.73	0.16	0.08	0.31	30	30	31
3000.00	0.12	5	4	3785.44	2862.90	2385.81	3430.84	0.16	0.08	0.32	30	30	31
3000.00	0.12	5	5	2105.40	3188.86	2618.02	3778.22	0.20	0.09	0.36	35	35	36
3000.00	0.12	5	5	3000.00	3187.77	2608.87	3762.61	0.20	0.09	0.36	35	35	36
3000.00	0.12	5	5	3785.44	3177.56	2603.21	3773.40	0.20	0.09	0.36	35	35	36

Table IX

True LD50	True Sigma	# of runs	# of animals after reversal	Prelim. starting dose *	Median LD50	LD50 5%	LD50 95%	Median Sigma	Sigma 5%	Sigma 95%	Median # of animals	# of animals 5%	# of animals 95%
3000.00	0.25	3	3	1434.61	3243.36	2156.96	4630.53	0.22	0.08	0.54	15	15	17
3000.00	0.25	3	3	3000.00	3029.12	1898.33	4726.45	0.30	0.08	0.61	15	15	17
3000.00	0.25	3	3	4869.97	3015.72	1888.34	4738.92	0.30	0.08	0.59	15	15	17
3000.00	0.25	3	4	1434.61	2984.88	2068.30	4558.38	0.29	0.08	0.56	18	18	20
3000.00	0.25	3	4	3000.00	2966.47	2012.54	4471.08	0.27	0.07	0.55	18	18	20
3000.00	0.25	3	4	4869.97	2989.37	2026.46	4412.32	0.27	0.07	0.55	18	18	20
3000.00	0.25	3	5	1434.61	3146.32	2226.57	4397.39	0.24	0.06	0.53	21	21	23
3000.00	0.25	3	5	3000.00	3021.39	2049.31	4316.45	0.28	0.06	0.58	21	21	23
3000.00	0.25	3	5	4869.97	3017.91	1971.87	4385.03	0.28	0.07	0.57	21	21	23
3000.00	0.25	4	3	1434.61	3215.70	2293.37	4546.37	0.25	0.09	0.51	21	20	22
3000.00	0.25	4	3	3000.00	3050.07	2068.86	4442.57	0.31	0.12	0.55	20	20	22
3000.00	0.25	4	3	4869.97	3060.06	2074.24	4462.80	0.31	0.13	0.54	20	20	22
3000.00	0.25	4	4	1434.61	2987.63	2213.18	4218.94	0.30	0.10	0.51	24	24	26
3000.00	0.25	4	4	3000.00	2974.31	2087.58	4269.65	0.29	0.11	0.50	24	24	26
3000.00	0.25	4	4	4869.97	2980.73	2117.12	4196.00	0.29	0.11	0.51	24	24	26
3000.00	0.25	4	5	1434.61	3123.26	2342.46	4181.29	0.25	0.09	0.50	28	28	30
3000.00	0.25	4	5	3000.00	2995.73	2159.58	4185.52	0.29	0.11	0.54	28	28	30
3000.00	0.25	4	5	4869.97	3051.81	2158.12	4248.54	0.29	0.11	0.53	28	28	30
3000.00	0.25	5	3	1434.61	3093.53	2151.04	4309.94	0.31	0.14	0.54	26	25	27
3000.00	0.25	5	3	3000.00	3097.64	2167.16	4269.67	0.32	0.14	0.52	25	25	28
3000.00	0.25	5	3	4869.97	3101.84	2162.79	4301.72	0.31	0.14	0.54	25	25	27
3000.00	0.25	5	4	1434.61	2996.26	2206.74	4068.32	0.31	0.13	0.50	30	30	32
3000.00	0.25	5	4	3000.00	2992.29	2207.90	4096.80	0.30	0.13	0.51	30	30	33
3000.00	0.25	5	4	4869.97	2988.14	2211.98	4140.89	0.30	0.14	0.50	30	30	32
3000.00	0.25	5	5	1434.61	3079.08	2275.41	4076.04	0.30	0.13	0.50	35	35	38
3000.00	0.25	5	5	3000.00	3078.41	2260.86	4066.23	0.30	0.14	0.51	35	35	37
3000.00	0.25	5	5	4869.97	3063.03	2297.94	4035.23	0.30	0.14	0.50	35	35	37

Table IX

True LD50	True Sigma	# of runs	# of animals after reversal	Prelim. starting dose *	Median LD50	LD50 5%	LD50 95%	Median Sigma	Sigma 5%	Sigma 95%	Median # of animals	# of animals 5%	# of animals 95%
3000.00	0.50	3	3	686.03	2832.54	1475.33	5109.18	0.40	0.10	0.84	17	15	19
3000.00	0.50	3	3	3000.00	2844.89	1486.12	5188.15	0.38	0.10	0.80	16	15	17
3000.00	0.50	3	3	5000.00	2845.00	1536.15	5086.62	0.39	0.10	0.80	16	15	18
3000.00	0.50	3	4	686.03	2870.47	1540.45	4946.55	0.39	0.11	0.81	20	18	22
3000.00	0.50	3	4	3000.00	2920.37	1624.72	5033.43	0.39	0.11	0.81	18	18	20
3000.00	0.50	3	4	5000.00	2825.95	1614.05	4857.96	0.37	0.10	0.79	19	18	20
3000.00	0.50	3	5	686.03	2899.01	1658.66	4886.58	0.40	0.12	0.84	23	20	25
3000.00	0.50	3	5	3000.00	2883.44	1680.19	4860.67	0.39	0.11	0.81	22	19	23
3000.00	0.50	3	5	5000.00	2876.61	1658.08	4812.74	0.39	0.11	0.79	22	20	24
3000.00	0.50	4	3	686.03	2833.89	1627.19	4729.75	0.42	0.16	0.76	23	21	25
3000.00	0.50	4	3	3000.00	2850.57	1679.91	4789.89	0.42	0.15	0.75	21	20	23
3000.00	0.50	4	3	5000.00	2882.04	1656.00	4758.27	0.42	0.16	0.74	21	20	23
3000.00	0.50	4	4	686.03	2858.05	1724.07	4674.24	0.42	0.16	0.77	26	24	30
3000.00	0.50	4	4	3000.00	2832.30	1747.58	4567.06	0.41	0.16	0.74	25	23	27
3000.00	0.50	4	4	5000.00	2902.10	1752.64	4636.47	0.40	0.15	0.74	25	23	27
3000.00	0.50	4	5	686.03	2897.20	1827.13	4548.06	0.42	0.17	0.76	30	28	33
3000.00	0.50	4	5	3000.00	2902.72	1839.02	4465.21	0.42	0.16	0.78	29	26	31
3000.00	0.50	4	5	5000.00	2916.42	1823.91	4568.79	0.42	0.16	0.76	29	26	31
3000.00	0.50	5	3	686.03	2769.47	1750.95	4504.77	0.43	0.20	0.73	28	26	32
3000.00	0.50	5	3	3000.00	2834.79	1780.33	4511.24	0.43	0.19	0.71	26	25	29
3000.00	0.50	5	3	5000.00	2856.77	1765.04	4453.18	0.43	0.20	0.71	26	25	29
3000.00	0.50	5	4	686.03	2878.40	1815.11	4423.36	0.44	0.20	0.73	33	31	37
3000.00	0.50	5	4	3000.00	2900.34	1827.23	4444.59	0.42	0.20	0.72	31	29	33
3000.00	0.50	5	4	5000.00	2860.13	1819.07	4433.70	0.42	0.19	0.72	31	29	33
3000.00	0.50	5	5	686.03	2886.73	1936.49	4317.17	0.44	0.20	0.73	38	35	41
3000.00	0.50	5	5	3000.00	2897.12	1892.65	4328.08	0.43	0.20	0.71	36	33	39
3000.00	0.50	5	5	5000.00	2911.80	1908.87	4326.98	0.43	0.19	0.72	36	33	38

Table IX

True LD50	True Sigma	# of runs	# of animals after reversal	Prelim. starting dose *	Median LD50	LD50 5%	LD50 95%	Median Sigma	Sigma 5%	Sigma 95%	Median # of animals	# of animals 5%	# of animals 95%
3000.00	1.25	3	3	75.02	1106.89	342.51	3291.87	0.78	0.23	1.51	19	16	23
3000.00	1.25	3	3	3000.00	2416.90	938.47	5212.46	0.55	0.13	1.15	16	14	18
3000.00	1.25	3	3	5000.00	2411.16	934.31	5231.81	0.55	0.13	1.14	16	14	18
3000.00	1.25	3	4	75.02	1226.10	391.92	3524.23	0.76	0.21	1.49	22	19	26
3000.00	1.25	3	4	3000.00	2463.47	979.90	5251.35	0.56	0.15	1.21	19	17	21
3000.00	1.25	3	4	5000.00	2485.98	975.82	5256.23	0.56	0.14	1.20	19	16	21
3000.00	1.25	3	5	75.02	1382.46	460.86	3568.65	0.74	0.20	1.52	25	22	30
3000.00	1.25	3	5	3000.00	2450.76	997.86	5007.53	0.58	0.15	1.25	22	18	24
3000.00	1.25	3	5	5000.00	2450.19	1002.98	5080.98	0.57	0.15	1.23	22	18	24
3000.00	1.25	4	3	75.02	1091.13	396.79	3001.32	0.82	0.32	1.38	26	22	31
3000.00	1.25	4	3	3000.00	2352.62	1095.53	4647.38	0.59	0.23	1.07	21	19	24
3000.00	1.25	4	3	5000.00	2351.43	1053.05	4769.63	0.59	0.20	1.08	21	20	24
3000.00	1.25	4	4	75.02	1196.23	450.42	3021.64	0.82	0.32	1.39	30	26	35
3000.00	1.25	4	4	3000.00	2399.31	1112.08	4674.17	0.61	0.22	1.11	25	23	28
3000.00	1.25	4	4	5000.00	2362.47	1117.30	4664.20	0.62	0.23	1.14	25	22	28
3000.00	1.25	4	5	75.02	1311.86	525.83	3087.22	0.81	0.33	1.41	34	30	39
3000.00	1.25	4	5	3000.00	2380.65	1115.59	4525.27	0.63	0.25	1.19	29	26	32
3000.00	1.25	4	5	5000.00	2401.49	1086.82	4509.64	0.62	0.24	1.16	29	26	32
3000.00	1.25	5	3	75.02	1097.66	436.92	2627.26	0.83	0.40	1.33	33	28	38
3000.00	1.25	5	3	3000.00	2344.19	1100.36	4391.54	0.61	0.27	1.04	27	25	30
3000.00	1.25	5	3	5000.00	2333.04	1134.19	4387.53	0.60	0.27	1.03	27	25	29
3000.00	1.25	5	4	75.02	1215.84	515.21	2843.24	0.84	0.39	1.32	38	33	42
3000.00	1.25	5	4	3000.00	2299.65	1158.76	4300.75	0.62	0.30	1.08	32	29	35
3000.00	1.25	5	4	5000.00	2341.81	1141.99	4274.53	0.63	0.28	1.06	32	29	35
3000.00	1.25	5	5	75.02	1330.84	601.72	2844.11	0.84	0.41	1.36	42	38	47
3000.00	1.25	5	5	3000.00	2344.83	1146.31	4166.88	0.64	0.29	1.09	37	33	39
3000.00	1.25	5	5	5000.00	2327.64	1186.26	4163.59	0.65	0.29	1.10	37	33	40

Table IX

True LD50	True Sigma	# of runs	# of animals after reversal	Prelim. starting dose *	Median LD50	LD50 5%	LD50 95%	Median Sigma	Sigma 5%	Sigma 95%	Median # of animals	# of animals 5%	# of animals 95%
3000.00	2.00	3	3	8.20	298.46	53.65	1649.57	1.16	0.31	2.12	22	17	27
3000.00	2.00	3	3	3000.00	2241.15	692.21	5315.09	0.62	0.17	1.35	16	14	19
3000.00	2.00	3	3	5000.00	2242.02	673.97	5382.67	0.60	0.14	1.34	16	14	19
3000.00	2.00	3	4	8.20	352.76	72.57	1686.22	1.16	0.33	2.21	24	20	30
3000.00	2.00	3	4	3000.00	2135.08	692.61	5021.90	0.65	0.17	1.44	19	17	22
3000.00	2.00	3	4	5000.00	2203.57	700.00	5179.08	0.64	0.17	1.44	19	17	22
3000.00	2.00	3	5	8.20	414.35	88.61	1900.05	1.17	0.32	2.22	27	23	33
3000.00	2.00	3	5	3000.00	2119.79	771.67	5088.56	0.69	0.17	1.52	22	19	25
3000.00	2.00	3	5	5000.00	2214.19	700.75	5092.09	0.68	0.16	1.47	22	18	25
3000.00	2.00	4	3	8.20	291.38	64.44	1264.48	1.20	0.47	1.98	29	23	35
3000.00	2.00	4	3	3000.00	2101.12	811.34	4630.36	0.68	0.23	1.33	22	20	25
3000.00	2.00	4	3	5000.00	2141.00	807.73	4775.54	0.68	0.24	1.30	22	20	25
3000.00	2.00	4	4	8.20	345.33	83.49	1394.80	1.24	0.48	2.05	33	27	39
3000.00	2.00	4	4	3000.00	2073.28	806.67	4405.42	0.71	0.27	1.35	26	22	29
3000.00	2.00	4	4	5000.00	2103.24	845.05	4508.86	0.71	0.26	1.37	26	22	29
3000.00	2.00	4	5	8.20	421.56	110.94	1503.86	1.27	0.50	2.10	37	31	42
3000.00	2.00	4	5	3000.00	2081.46	822.96	4349.82	0.76	0.27	1.43	30	26	33
3000.00	2.00	4	5	5000.00	2095.36	823.15	4375.30	0.74	0.27	1.41	30	26	32
3000.00	2.00	5	3	8.20	298.15	77.34	1094.71	1.24	0.60	1.90	36	30	43
3000.00	2.00	5	3	3000.00	2062.01	893.37	4221.31	0.69	0.31	1.23	27	25	30
3000.00	2.00	5	3	5000.00	2067.09	899.72	4212.43	0.71	0.31	1.22	27	25	30
3000.00	2.00	5	4	8.20	350.27	100.98	1244.92	1.25	0.60	1.92	41	35	48
3000.00	2.00	5	4	3000.00	2044.50	896.16	3894.64	0.76	0.34	1.31	32	29	35
3000.00	2.00	5	4	5000.00	2041.39	890.41	4058.15	0.75	0.32	1.31	32	29	35
3000.00	2.00	5	5	8.20	413.44	122.43	1313.75	1.29	0.63	1.99	46	40	52
3000.00	2.00	5	5	3000.00	2017.02	873.18	3981.59	0.76	0.34	1.35	37	33	40
3000.00	2.00	5	5	5000.00	1998.48	880.20	3989.64	0.78	0.34	1.38	37	33	40

Simulation Table X. Simulation of Performance of Current OECD Test Guideline 425.

The simulations in this table simulate the current OECD TG 425 guideline to test its ability to estimate LD50.

The actual LD50 and sigma of the dose response curve (reciprocal of slope) varied as detailed in the table. The hypothetical investigator did not know the true LD50 or slope and began the initial LD50 run at a series of different starting doses as indicated in the table. The tests were run according the current TG 425 guideline

Each line of the table represents one study design tested:

Each line summarizes the results of 1000 simulated tests from a population with a true LD50 and sigma (reciprocal of slope) as detailed in the table.

For each run the computer randomly picked the appropriate number of animals from the entire population assigning each individual animal an LD50 based on the known variability of the population.

Initially a single standard up-and-down run was performed to estimate the LD50. This single run ended when four animals had been dosed after the first reversal. Dosing boundaries were respected but no stopping rule was used. The assumed sigma for this UDP run was 0.12, the default in the guideline.

Final estimates of LD50 and slope were performed using the maximum likelihood method detailed in the guideline.

For each line the median, 5% and 95% confidence limits of the results of 1000 separate simulation runs are presented. In this table the number of animals used were tracked and are presented for each study design.

"True" LD50 mg/kg	"True" Sigma	Starting Dose mg/kg	<i>Estimated LD50</i>		<i>Animals Used</i>	
			Median	90% Range	Median	90% Range
1.5	0.12	5	1.5	1.1 - 2.0	10	8 - 11
		50	1.5	1.2 - 2.0	18	16 - 19
		100	1.5	1.2 - 2.0	20	19 - 22
		300	1.5	1.2 - 1.9	24	23 - 26
		2000	1.5	1.2 - 1.9	31	30 - 33
0.25	0.25	5	1.8	1.1 - 2.8	9	6 - 11
		50	1.7	1.1 - 3.1	17	14 - 20
		100	1.7	1.1 - 3.0	20	17 - 22
		300	1.7	1.1 - 2.9	24	21 - 26
		2000	1.8	1.1 - 3.1	31	28 - 33
0.5	0.5	5	2.5	1.2 - 4.5	7	6 - 11
		50	2.8	1.2 - 8.4	15	10 - 19
		100	3.0	1.3 - 9.7	18	13 - 21
		300	2.9	1.2 - 9.6	21	16 - 26
		2000	3.1	1.3 - 9.3	28	23 - 32
1.25	1.25	5	3.4	1.5 - 7.3	7	6 - 10
		50	15	2.8 - 38	9	6 - 16
		100	19	3.3 - 62	10	6 - 17
		300	25	3.7 - 155	13	6 - 21
		2000	31	3.7 - 443	19	9 - 28
50	0.12	5	49	38 - 64	14	12 - 15
		50	52	39 - 63	6	6 - 7
		100	49	39 - 68	8	6 - 9
		300	50	39 - 66	12	10 - 13
		2000	50	39 - 65	19	17 - 20
0.25	0.25	5	43	25 - 69	13	10 - 15
		50	49	34 - 76	6	6 - 7
		100	58	37 - 87	7	6 - 9
		300	59	37 - 98	11	8 - 13
		2000	59	36 - 95	18	15 - 20
0.5	0.5	5	26	10 - 64	11	6 - 15
		50	52	31 - 89	6	6 - 8
		100	68	36 - 115	7	6 - 9
		300	88	40 - 204	9	6 - 13
		2000	102	39 - 336	15	11 - 20
1.25	1.25	5	10	4.5 - 32	7	6 - 12
		50	52	24 - 101	6	6 - 9
		100	83	37 - 162	6	6 - 9
		300	182	61 - 344	7	6 - 11
		2000	538	107 - 1513	9	6 - 16

"True" LD50 mg/kg	"True" Sigma	Starting Dose mg/kg	Estimated LD50		Animals Used	
			Median	90% Range	Median	90% Range
1500	0.12	5	1461	1168 - 1926	26	24 - 27
		50	1475	1161 - 1944	18	16 - 19
		100	1483	1140 - 1947	15	14 - 16
		300	1473	1148 - 1930	11	10 - 12
		2000	1508	1166 - 1909	6	6 - 8
0.25	0.25	5	1345	752 - 2039	25	22 - 27
		50	1286	740 - 2058	17	14 - 19
		100	1287	776 - 2036	14	12 - 17
		300	1327	764 - 1941	10	8 - 13
		2000	1545	1036 - 2296	6	6 - 8
0.5	0.5	5	819	261 - 1877	23	18 - 27
		50	782	226 - 1792	15	9 - 18
		100	784	260 - 1843	12	7 - 16
		300	846	422 - 1967	9	6 - 12
		2000	1742	990 - 2932	6	6 - 8
1.25	1.25	5	90	10 - 638	15	6 - 23
		50	171	61 - 801	9	6 - 15
		100	232	105 - 922	8	6 - 13
		300	484	245 - 1354	7	6 - 10
		2000	1909	921 - 3861	6	6 - 9
3000	0.12	5	3081	2337 - 3835	28	27 - 30
		50	3033	2301 - 3839	20	19 - 21
		100	2949	2321 - 3888	18	16 - 19
		300	2930	2306 - 3862	14	12 - 15
		2000	2942	2296 - 3861	7	6 - 8
0.25	0.25	5	2539	1461 - 4062	28	25 - 30
		50	2659	1530 - 3957	19	16 - 22
		100	2573	1481 - 4115	17	14 - 19
		300	2559	1471 - 4170	13	10 - 15
		2000	2815	1899 - 4166	6	6 - 8
0.5	0.5	5	1433	471 - 3543	25	21 - 29
		50	1530	517 - 3505	17	12 - 21
		100	1592	451 - 3671	15	9 - 19
		300	1471	591 - 3561	11	6 - 14
		2000	2516	1418 - 4653	6	6 - 9
1.25	1.25	5	156	13 - 1307	16	7 - 25
		50	226	73 - 1281	10	6 - 17
		100	329	121 - 1524	9	6 - 15
		300	585	263 - 1941	7	6 - 12
		2000	2273	1139 - 4878	6	6 - 9

"True" LD50 mg/kg	"True" Sigma	Starting Dose mg/kg
1.5	2.0	100
50	2.0	100
1500	2.0	100
3000	2.0	100

Estimated LD50

Median	90% Range
43	6.8 - 95
87	35 - 195
165	82 - 603
197	87 - 995

Animals Used

Median	90% Range
8	6 - 14
6	6 - 9
7	6 - 11
7	6 - 13

Simulation Table XI. Simulation of Up-and-Down Procedure with Progression of 0.5 dose.

The simulations in this table simulate the first proposed revision of the guideline - the change of the default assumed sigma to 0.5 to test this new design's ability to estimate LD50 while not significantly increasing animal use .

The actual LD50 and sigma of the dose response curve (reciprocal of slope) varied as detailed in the table. The hypothetical investigator did not know the true LD50 or slope and began the initial LD50 run at a series of different starting doses as indicated in the table. The tests were run according the current TG 425 guideline except for the change in the default assumed sigma.

Each line of the table represents one study design tested:

Each line summarizes the results of 1000 simulated tests from a population with a true LD50 and sigma (reciprocal of slope) as detailed in the table.

For each run the computer randomly picked the appropriate number of animals from the entire population assigning each individual animal an LD50 based on the known variability of the population.

Initially a single standard up-and-down run was performed to estimate the LD50. This single run ended when four animals had been dosed after the first reversal. Dosing boundaries were respected but no stopping rule was used. The assumed sigma for this UDP run was 0.5.

Final estimates of LD50 were performed using the maximum likelihood method detailed in the guideline.

For each line the median, 5% and 95% confidence limits of the results of 1000 separate simulation runs are presented. In this table the number of animals used were tracked and are presented for each study design.

"True" LD50 mg/kg	"True" Sigma	Starting Dose mg/kg	Estimated LD50		Animals Used	
			Median	90% Range	Median	90% Range
1.5	0.12	5	1.5	1.1 - 2.8	7	6 - 8
		50	1.4	0.93 - 2.7	9	8 - 9
		100	1.7	0.96 - 1.7	9	9 - 10
		300	1.6	0.94 - 1.6	10	10 - 11
		2000	1.3	0.79 - 1.7	12	11 - 13
0.25	0.25	5	1.5	0.71 - 2.8	7	6 - 8
		50	1.4	0.67 - 2.7	9	8 - 10
		100	1.7	0.75 - 2.4	9	8 - 10
		300	1.6	0.74 - 2.3	10	9 - 12
		2000	1.3	0.65 - 2.5	12	11 - 13
0.5	0.5	5	1.5	0.61 - 4.1	6	6 - 9
		50	1.5	0.60 - 4.8	8	7 - 11
		100	1.7	0.62 - 4.6	9	7 - 11
		300	1.6	0.61 - 5.1	10	8 - 12
		2000	1.4	0.63 - 4.1	12	10 - 14
1.25	1.25	5	2.2	0.58 - 13	6	6 - 9
		50	3.7	0.60 - 28	7	6 - 10
		100	3.7	0.75 - 32	8	6 - 11
		300	4.0	0.74 - 40	9	6 - 12
		2000	3.8	0.63 - 44	10	7 - 14
50	0.12	5	52	30 - 94	7	7 - 8
		50	61	28 - 89	6	6
		100	56	34 - 56	6	6 - 7
		300	51	32 - 51	7	7
		2000	34	34 - 67	9	8 - 9
0.25	0.25	5	52	30 - 94	8	7 - 8
		50	41	28 - 89	6	6
		100	56	24 - 82	6	6 - 7
		300	51	23 - 72	7	6 - 8
		2000	48	24 - 84	9	8 - 9
0.5	0.5	5	47	16 - 134	7	6 - 9
		50	41	19 - 147	6	6 - 7
		100	56	20 - 121	6	6 - 7
		300	51	19 - 133	7	6 - 8
		2000	48	20 - 150	8	7 - 10
1.25	1.25	5	25	4 - 245	7	6 - 9
		50	41	8 - 295	6	6 - 8
		100	56	9 - 320	6	6 - 8
		300	72	11 - 533	6	6 - 9
		2000	119	13 - 876	7	6 - 10

"True" LD50 mg/kg	"True" Sigma	Starting Dose mg/kg
1500	0.12	5
		50
		100
		300
		2000

Estimated LD50

Median	90% Range
1655	939 - 2968
1655	938 - 2968
1877	1329 - 1877
1771	1247 - 1771
1125	1125 - 2271

Animals Used

Median	90% Range
10	10 - 11
8	8 - 9
8	7 - 8
7	7
6	6

0.25	5
	50
	100
	300
	2000

1655	939 - 2968
1655	938 - 2968
1697	847 - 3311
1771	880 - 3136
1604	768 - 2271

10	10 - 11
8	8 - 9
8	7 - 9
7	6 - 8
6	6 - 7

0.5	5
	50
	100
	300
	2000

1342	523 - 4087
1499	473 - 4021
1550	485 - 4289
1456	470 - 3337
1604	596 - 4092

10	9 - 12
8	7 - 10
8	6 - 9
7	6 - 8
6	6 - 7

1.25	5
	50
	100
	300
	2000

665	57 - 4087
664	89 - 4087
750	121 - 4507
997	169 - 4577
1604	266 - 6451

9	6 - 12
7	6 - 10
7	6 - 9
6	6 - 8
6	6 - 8

3000	0.12	5
		50
		100
		300
		2000

2968	2968 - 5235
2968	2968 - 4087
3311	1877 - 4319
3136	1771 - 4167
3162	2271 - 5596

11	11
9	9
8	8 - 9
7	7 - 8
6	6

0.25	5
	50
	100
	300
	2000

2968	2103 - 6225
2968	2103 - 6225
3311	1877 - 6406
3337	1771 - 6829
3162	1604 - 5914

11	10 - 12
9	8 - 10
8	8 - 10
7	7 - 9
6	6 - 7

0.5	5
	50
	100
	300
	2000

2968	939 - 7425
2968	938 - 6693
2762	947 - 7463
3136	973 - 7346
3128	1114 - 7059

11	9 - 13
9	7 - 11
8	7 - 10
7	6 - 9
6	6 - 8

1.25	5
	50
	100
	300
	2000

1168	84 - 6693
1190	162 - 6225
1329	225 - 7463
1609	247 - 7346
2271	412 - 8622

10	6 - 13
8	6 - 11
7	6 - 10
7	6 - 9
6	6 - 8

Simulation Table XII Multiple Up-and-Down Sequences - Probit Calculations. The simulations in this table explore a test design to estimate slope based on using probit analysis on the results of three full UDP runs each using five animals after the first reversal. The data from all runs was combined and a probit model was used to estimate the LD50 and slope from all the data. All the UDP runs were run in parallel with the results of each independent of the others.

All populations had a true LD50 of 250 mg/kg bw. The sigma of the dose response curve (reciprocal of slope) varied as detailed in the table. The hypothetical investigator did not know the true LD50 or slope, but began the initial LD50 run at 250 mg/kg bw based on data from other related compounds..

Each line of the table represents one study design tested:

Each line summarizes the results of 1000 simulated tests from a population with a true LD50 of 250 mg/kg bw and sigma (reciprocal of slope) as detailed in the table.

For each run the computer randomly picked the appropriate number of animals from the entire population assigning each individual animal an LD50 based on the known variability of the population.

Five animals were tested after the first reversal.

All runs were standard up-and-down runs performed to estimate the LD50. Each run ended when five animals had been dosed after the first reversal. Dosing boundaries were respected but no stopping rule was used. The assumed sigma for all runs was 0.5.

Final estimates of LD50 and slope were made by averaging the LD50's and slopes obtained from all the runs.

For each line the median, 5% and 95% confidence limits of the results of 1000 separate simulation runs are presented. In this table the number of animals used in the study were tracked and are presented for each study design.

Table XII

"True"		Estimated LD50			Estimated Sigma			Number of Animals Used		
True LD50	True Sigma	Median	5%	95%	Median	5%	95%	Median	5%	95%
250 mg/kg	0.12	250	206	303	0.0098	0.023	0.19	21	21	27
	All runs including 524 runs that did not converge									
250 mg/kg	0.12				0.135	0.105	0.21			
	Only includes the 476 runs that converge.									
250 mg/kg	2	236	23	2029	1.09	0.3	5.6	22	21	25
	Includes all runs									
250mg/kg	2				1.1	0.4	8.2			
	For 26 runs with negative slopes, sigma arbitrarily set to 1000 (rather than a negative value)									

David Farrar
03/27/2000 02:38 AM

To: Amy Rispin/DC/USEPA/US@EPA, Elizabeth Margosches/DC/USEPA/US@EPA
cc:
Subject: slope estimation procedure with parallel up-down sequences

In order for a procedure with parallel UD sequences to work for estimating the slope, I conjecture that it is best for the initial doses to be selected so that they have either high or low response probability, so that sequences with a nominal n of 2 will be likely to terminate in the tails of the tolerance distribution rather than close to the LD50. The procedure I simulated is carried out in stages, with parallel sequences of nominal n 2 in each stage. At each stage, initial test doses are chosen to equal either (1) the highest dose tested at all previous stages, such that there were no observed responses at that dose or at any lower tested doses; or (2) the lowest dose tested, such that there were always observed responses at that dose as well as at any higher tested doses.

- Stage 1: Tier I procedure with proposed LR stopping rule;
- Stage 2: Two sequences with step size 2 (log scale), one starting with the highest non-response dose, and one starting with the lowest all-response dose.
- Stage 3: Two sequences with step size 0.5, ... [as for Stage 2]
- Stage 4: Two sequences with step size 0.25, ... [as for Stage 2]
- Stage 5: 3 sequences with step size 0.125, 2 starting from the highest non-response dose, and one starting from the lowest all-response dose.

In cases where the lowest tested dose had at least one response, the starting dose was chosen to be the lowest tested dose, divided by the progression factor. Similarly, in cases where the highest tested dose had no responses Where these decisions would result in a value outside the range 1-5000 units, the initial test dose was chosen to equal the corresponding bound value (1 or 5000).

Following are features only used in Tier I and not for the additional Tier II sequences. No maximum number was used. No rule was used related to stopping at a bound value. Test doses close to but not exceeding a bound value were not set equal to the bound value. Otherwise, the restriction on the range of test doses was as we have discussed (the test doses can be constant at a bound value or move to the interior of the range).

(Based on 2000 simulated studies per scenario, LD50 = 250 units, initial test dose 25 units for the Tier I test.)

		slope results				
mea.num.		mean	5%	95%	F95/5	tested
slope	#fitted (%)					
2	1963. (98%)	2.6438	1.4314	4.8040	3.3562	40.
4	1674. (84%)	5.3881	2.7250	9.5593	3.5080	36.
8	1060. (53%)	8.1532	4.8074	12.941	2.6919	33.

* the number tested includes the number for Tier I;

* the probit model was fitted when there were at least 2 doses with partial mortality; also,

when there were exactly 2 with partial mortality, the higher dose was required to have higher mortality.

The slope was required to be positive.

APPENDIX O

The basis for revising the UDP

- O-1 Statistical Basis for Estimating Acute Oral Toxicity –O-3
Comparison of OECD Guidelines 401, 420, 423, and 425
(K. Stitzel and G. Carr, Proctor & Gamble Company - 03/18/1999)

- O-2 Comparison of Classification Probabilities Based on EUO-13
Classification Levels
(G. Carr, Proctor & Gamble Company; N. Stallard and A. Whitehead,
University of Reading; W. Diener, BgVV; E. Margosches and T. Barry,
U.S. EPA - 03/1999)

- O-3 Up and Down Procedure: Brief Description of the MethodO-17
and Results of a Study of Some Statistical Properties
(E. Margosches and T. Barry, U.S. EPA – 03/19/1999)

Statistical Basis for Estimating Acute Oral Toxicity Comparison of OECD Guidelines 401, 420, 423 and 425

Introduction

This document serves to provide short summaries of the scientific basis for each of the four acute oral toxicity tests. It will attempt to describe the statistical strengths and limitations of the various methods for accurately determining a point estimate of the LD50, slope of the dose-response curve for LD50, confidence limits around the point estimate of LD50 and the slope, a point estimate of an LD10 and information on the dose-effect response. In this context, a dose-response curve applies to the estimation of lethality and a dose-effect response applies to the estimation of the change in the variety and distribution of all other types of toxicological signs with the change in dose.

By design not all of the guidelines will provide estimates for all of these endpoints. However, in the context of the comparison of the four tests, it was felt that a detailed comparison of the four methods was warranted. This document is still in draft form and will be finalized after the meeting.

Because the response of a test population to a chemical is influenced by the choice of test species and strain, test conditions, and age, sex or body weight of the animals, the LD50 is commonly described as the lethal response of a compound in a particular population under a discrete set of experimental conditions. As a result, the LD50 values, along with slope and confidence intervals are not absolute, but rather provide a relative index of xenobiotic response for comparison of chemicals. Of course, a similar statement would apply to quantitative endpoints of most laboratory animal toxicology tests. For that reason, test guidelines seek to standardize test conditions, to the extent feasible. A well standardized acute test provides a sound method for comparing acute sensitivity to toxic chemicals.

What follows is a brief description of the motivation for and the mathematical and biological principles underlying each acute oral toxicity method followed by a listing of how each test estimates or does not estimate the specific parameters mentioned above. This document is a supplement to the larger guidance document prepared for the OECD meeting and only covers these points. The larger document should be consulted for a complete description of each test and comparisons of the other benefits and weaknesses of each method. Statistical simulations of all four tests will be presented at the meeting.

Acute Oral Toxicity, Guideline 401

A. Principles underlying the test method: Guideline 401 (1987) is an alternative to the 1981 version incorporating provisions for reduction and refinement. The current guideline calls for a test chemical to be administered to the test population in three positive dose levels, generally spaced logarithmically such that they will span the expected 10% to 90% mortality levels. Dose levels may be based on results from a range-finding study. In the main study, groups of 5 animals of a single sex are tested at each dose. After completion of the study, a single group of animals of the opposite sex is tested.

As a traditional acute oral toxicity test, guideline 401 is based on the fact that lethality is a quantal response. Its measurement will give rise to a frequency distribution of responses reflecting the composite tolerances of the test population upon exposure to graded doses of the test chemical. In practice, most chemicals give rise to an approximately lognormal distribution of deaths versus dose, skewed toward hypersensitivity. When this frequency population is transformed to a logarithmic abscissa, a (symmetric) normal distribution generally results that can be characterized by two parameters, the median and the standard deviation, σ . The median is the dose at which 50% of the animals are killed by the test chemical and is called the LD50. Not all animals will react in the same way to the chemical and thus σ represents the square root of the variance of the test population's response to the chemical. The dose-response curve is sigmoidal in nature and represents the cumulative response of the test animals to the chemical. The inflection point of this sigmoidal curve coincides with the LD50 for the test population.

To analyze the data from test guideline 401, the dose response curve can be linearized by transforming the percentage response for log dosage to probits. The slope, β , of the transformed dose response curve is $1/\sigma$. Responses can be analyzed by probit analysis (1) which calculates the maximum likelihood fit of the probit log dose line by an iterative weighted linear regression method. This can also be done graphically.

B. Point estimate of LD50: Probit analysis of mortality provides a point estimate of the LD50 provided there are at least two doses with mortality rates not equal to 0% or 100%.

C. Confidence limits on the estimate of LD50: The method of probit analysis can provide interpretive statistics such as the 95% confidence interval of the LD50 in this case.

D. Estimate of the slope of the dose-response curve for lethality Guideline 401 provides the slope of the dose-response curve as a study endpoint providing there are at least two doses which have mortality rates not equal to 0% or 100%.

E. Confidence limits on the slope of the dose-response curve for lethality Confidence limits for the slope of the dose-response curve can be calculated if a slope can be determined.

F. Dose-effect curve for the LD50 Toxic signs and pathology results are measured for the animals in each dose level. Thus, a dose-effect curve can be calculated for specific effects observed if they are quantal provided there are at least two doses in which the effect was not present in either 0% or 100% of the animals.. However, not all effects are quantal and some analysis additional to the probit may be needed to estimate the extent and shape of dose-effect curves.

G. Point estimate of LD10: Guideline 401 can provide a point estimate of the LD10 if a slope of the dose-response curve can be determined.

Fixed Dose Procedure, Guideline 420

A. Principles underlying the test method: The Fixed Dose Procedure (FDP) is a method for assessing acute oral toxicity that involves the identification of a dose level that causes evidence

of non-lethal toxicity (termed *evident* toxicity) rather than a dose level that causes lethality. The method was first suggested by the British Toxicology Society in 1984 (2) as an alternative to the traditional acute toxicity methods, with the aim of reducing both the numbers of animals and the level of pain associated with acute toxicity testing. The stimuli for the development of the FDP were a combination of ethical and scientific concerns regarding the traditional methods that use lethality as the key endpoint.

Evident toxicity is a general term describing clear signs of toxicity following administration of test substance, such that an increase to the next highest fixed dose would result in the development of severe toxic signs and probably mortality.

Underpinning the FDP is a belief that the toxic profile of a substance can be characterized with sufficient reliability for most regulatory situations without the need for the identification of a lethal dose. That is, observations made at non-lethal doses will allow substances to be ranked, or classified, according to their acute toxicity, provide information to aid dose level selection for repeat dose studies and provide hazard data for use in a risk assessment.

Fixed dose levels of 5, 50 and 500 mg/kg were initially chosen as dose levels that would be expected to allow the identification of a dose producing evident toxicity for the majority of substances. These doses also provide information that lead to a similar classification to that based on the LD50 value. The assumption that the severe toxicity/mortality will result at the next highest fixed dose from that producing evident toxicity was a pragmatic one, based on general experience. The validity of this assumption was tested in the subsequent extensive validation exercises that provided a comparison between classification (EU system) resulting from the FDP and that based on the LD50 value obtained from guideline 401.

The test is a group sequential procedure and uses five animals of each sex at each dose. Four preassigned starting levels are possible.

As a preliminary validation step, a literature-based survey of acute toxicity data on 153 substances was conducted, which suggested that for about 80% of these substances classification using the FDP would be the same as that based on the LD50 value. About 14% of the substances would probably be classified in a less severe category and the remainder could be classified in a more severe category (2). The results of a national validation study involving 5 laboratories and 41 substances were published in 1987 (3) followed by an international validation study involving 33 laboratories in 11 countries and 20 substances, published in 1990 (4). The validation studies showed that even with the use of fewer animals and the use of evident toxicity as an endpoint there were no significant inter-laboratory variations in the test results. In relation to classification, the FDP was in agreement with 401 for about 80% of tests, produced a less severe classification in about 16% of tests and a more severe classification in about 3% of tests.

During the validation procedure, a fixed dose of 2000 mg/kg was added to provide more information on substances of low acute toxicity. Also, a sighting study was added as an integral part of the method, to assist the selection of an appropriate starting dose and to provide additional information on the acute toxicity profile of the substance if the sighting study is carried to its completion.

The FDP was published as an OECD Test Guideline in 1992. The performance of the FDP was subjected to biometric analysis in 1992 (5) and 1995 (6). The likelihood of the FDP producing the same classification (EU system) as that based on the LD50 value was estimated for a range of slopes and LD50 values. The mathematical model predicted that for substances with a dose-response slope for lethality of less than about 2, the FDP was likely to lead to a more severe classification than guideline 401. If the slope was between 2 and 6, the FDP was most likely to lead to the same classification. However, for substances with a slope of more than about 6, there was an increasing likelihood of less severe classification; for example, assuming an LD50 of 75 mg/kg and a slope of 6, the FDP classification is more likely to be in the harmful category than the correct toxic category.

B. Point estimate of LD50: The FDP was not originally designed to determine a point estimate of LD50. However, a rule of thumb was developed that permits an approximate LD50 range to be inferred from the classification that results from an FDP. The ability of the FDP to correctly classify (i.e. assign to an LD50 range) in comparison with methods in which the LD50 is estimated is discussed above.

C. Confidence limits on the estimate of LD50: Since the FDP was not designed to determine a point estimate of LD50, confidence limits are also not estimated.

D. Estimate of the slope of the dose-response curve for lethality: The dose-response slope cannot be estimated using the FDP, although some information on dose-response relationship may be available from a sighting study and when more than one fixed dose is used in the main study.

E. Confidence limits on the slope of the dose-response curve for lethality: Confidence limits on the dose-response slope are not provided by the FDP.

F. Dose-effect curve for the LD50: Since lethality is not the preferred endpoint for the FDP, toxicological effects seen only at dose levels close to a lethal dose will not be observed. However, it has been shown in a number of validation and comparative studies (2,3,4,7,8) that while there were a number of instances where clinical signs observed in FDP tests differed from those observed in 401 tests, in only a few cases were these meaningful. In the majority of cases, the clinical signs observed in 401 tests and not observed in the FDP tests were non-specific signs of approaching death.

G. Point estimate of an LD10: The ability of the FDP to predict the LD10 has not been assessed. However, biometric analysis indicated that the most likely classification resulting from the FDP depends on the LD7 of the substance (6), suggesting that this procedure can reliably produce a point estimate of the LD7.

Acute Toxic Class, Guideline 423

A. Principles underlying the test method: The acute toxic class (ATC) method has been developed for hazard assessment, for hazard classification purposes, and for risk assessment. The

method enables the toxicologist to allocate chemical substances to all classification systems currently in use (Example: the LD50 is between 50 and 500 mg/kg body weight) (9,13). It is a group sequential procedure using three animals of one sex per step. Three preidentified starting doses are possible. Three animals of the opposite sex are then dosed at the final dose level used with the first sex. The method was tested in validation studies with animals. Very good congruent results were obtained with animal data and biometrical evaluations, being in the range of 88% (9-13).

The ATC Method is based on the probit model; i.e., the dose-response relationship follows the Gaussian distribution for log-dose values with two parameters, the mean (LD50) and the slope β in probit units based on the log-scaled dose-axis (logarithm according to base 10). Then, following the test scheme of the method, expected probabilities of a correct, of a lower and of a more stringent classification in dependence on the true oral LD50 value of a substance and its slope can be derived. Also expected numbers of animals used and of moribund/dead animals can be calculated.

The classification procedures were developed in such a manner that on the one hand the probabilities of correct classification are large, and on the other hand the test procedures are simple enough for practical use.

The test doses have been selected with respect to the classification system of chemicals and liquid pesticides of the European Union. It has been shown that

- in the case when test doses and class limits are identical in general the probabilities of correct classification are greater than otherwise.
- the minimal distance factor between two neighboring toxic classes has to be 4 for slopes of $\beta \geq 1$ to achieve a probability of correct classification of at least 0.5 for at least one LD50 value in each class.
- for a slope of $\beta \geq 1$ the probability of an allocation to a lower than correct toxic class is limited to 0.256.
- the expected numbers of animals are on average 30% compared to the Guideline 401 (1981) or 45% according to Guideline 401 (1987).
- sex differences with respect to classification are addressed by classifying the substance according to its acute toxicity to the more sensitive sex.
- the classification procedure can be further refined by carrying out a second option - taking into consideration additional class limits as for example 50 or 500 mg/kg body weight.
- this method can be carried out for all acute oral classification systems currently in use.
- there is only a low dependence on the starting dose with respect to classification results, especially for slopes of $\beta > 1$. With increasing slopes or increasing LD50 values this influence decreases and tends toward zero for an unlimited increase of β or LD50. Also for infinitely low values of LD50 the influence becomes zero.
- there is a strong dependence on the starting dose with respect to expected numbers of animals used and of moribund/dead animals. Therefore an appropriate starting dose should be near the true LD50 of the substance to be tested, which leads on average to the least number of animals used.

B. Point estimate of LD50: The ATC was not designed to determine a point estimate of LD50. However, a point estimate of the LD50 can be calculated by the maximum likelihood method providing there are at least two doses with mortality rates not equal to 0% or 100%. However, the probability of this case is rather low because the distance between two neighboring doses is 8- to 10-fold and no more than six animals per dose are used (12).

C. Confidence limits on the estimate of LD50: The ATC was not designed to determine a point estimate of LD50. However, confidence limits on the LD50 can be calculated by the maximum likelihood method providing there are at least three doses, two of which must have mortality rates not equal to 0% or 100%.

D. Estimate of the slope of the dose-response curve for lethality: The ATC was not designed to determine the slope of a dose-response curve for lethality. However, an estimate of the slope of the dose-response curve can be calculated by the maximum likelihood method providing there are at least three doses, two of which must have mortality rates not equal to 0% or 100%.

E. Confidence limits on the slope of the dose-response curve for lethality: Confidence limits on the dose-response slope are not provided by the ATC. However, confidence limits on the slope can be calculated by the maximum likelihood method providing there are at least three doses, two of which show the selected effect and are not equal to 0% or 100%.

F. Dose-effect curve for the LD50: The ATC was not designed to determine a dose-effect curve for the LD50. However, dose-effect curves can be calculated by the maximum likelihood method providing there are at least three doses, two with the specific toxic signs not present in 0% or 100% of the animals.

G. Point estimate of an LD10: The ATC was not designed to determine a point estimate of LD10. However, a point estimate of the LD10 can be calculated by the maximum likelihood method providing there are at least two doses with different mortality rates not equal to 0% or to 100%.

Up-and-Down Method, Guideline 425

A. Principles underlying the test method: The concept of the up-and-down (UDP) testing approach (sometimes called a Staircase Design) was first described by Dixon and Mood (14,15). There have been papers on such issues as its use with small samples (16) and its use with multiple animals per dose (17). One of the most extensive discussions appears in a draft monograph prepared by W. Dixon and Dixon Statistical Associates for a U.S. National Institutes of Health [NIH] Phase I Final Report, Reduction in Vertebrate Animal Use in Research, produced under SBIR Grant No. 1-R43-RR06151-01(18). This draft monograph is available from its author for a fee or from the National Center for Research Resources of the NIH to individuals under the Freedom of Information Act.

In 1985, Bruce proposed the use of the UDP for the determination of acute toxicity of chemicals (19). While there exist several variations of the up-and-down experimental design, Guideline 425 is based on the procedure of Bruce as adopted by ASTM in 1987 (20). The UDP calls for

dosing individual animals of a single sex, usually females, in sequence at 24-hour intervals, with the initial dose set at “the toxicologist’s best estimate of the LD50.” Following each death (or moribund state) the dose is lowered; following each survival, it is increased, according to a prespecified dose progression factor. If a death follows an initial direction of increasing doses, or a survival follows an initial direction of decreasing dose, four additional animals are tested following the same dose adjustment pattern and then testing is ended. The OECD 425 protocol calls for a default dose progression factor of 1.3 and default σ for maximum likelihood calculations of 0.12 (i.e., $\log(1.3)$).

The first animal is dosed at the toxicologist’s best estimate of the LD50. When there is no information on the substance to be tested, for animal welfare reasons it is recommended in the guideline to use the starting dose of 200 to 500 mg/kg body weight.

B. Point estimate of the LD50: From the data a point estimate of the LD50 is calculated using the maximum likelihood method (21,22), provided a suitable historical or other sound estimate of the standard deviation can be employed.

C. Confidence limits on the estimate of LD50: From the data confidence limits around the LD50 value can be calculated using the maximum likelihood method (21,22), provided a suitable historical or other sound estimate of the standard deviation can be employed. However, built into the calculation is a presumption that the parameter σ (standard deviation) is known. σ is the reciprocal of the slope of the probit versus \log_{10} dose line. An estimate of σ of 0.12 is used unless a better generic or case-specific value is available. The method indicates that the σ value for a previously tested related substance can be used. For compounds of high toxicity with steep slope, this assumption will have little effect on the estimate of the LD50, but the standard error of that estimate is affected and may be unreliable (23).

D. Estimate of the slope of the dose-response curve for lethality: Some dose response information will usually be gained if more than one dose level is used, but an accurate dose response cannot be determined with the procedure as written since default assumptions usually place the σ at 0.12. Dixon (18) has proposed methods to improve the accuracy of the dose-response curve. These require increased numbers of animals but usually less than the guideline 401. These methods are not described in the current OECD protocol.

E. Confidence limits on the slope of the dose-response curve for lethality: Dixon (18) has proposed methods to improve the accuracy of the dose response estimate including determining the confidence limits on the slope of the dose-response curve. These require increased numbers of animals but usually less than guideline 401. These methods are not described in the current OECD protocol.

F. Dose-effect curve for the LD50: Some dose effect information will usually be gained if more than one dose level is used, but an accurate dose effect cannot be determined with the procedure as written since typically some doses will have only one observation. Dixon (18) has proposed methods to improve the accuracy of the dose response estimate. These would also improve a dose-effect estimate but require increased numbers of animals but usually less than guideline 401. These methods are not described in the current OECD protocol.

G. Point estimate of an LD10: The UDP as described in Guideline 425 does not estimate an LD10. Dixon (18) discusses the use of a staircase approach to the estimation of percentage points other than LD50. Such an approach could be explored when LD10 estimates are needed.

References

1. Finney, D J (1971) *Probit Analysis*, Cambridge University Press, Cambridge, U.K.
2. British Toxicology Society (1984) Special report: a new approach to the classification of substances and preparations on the basis of their acute toxicity, *Human Toxicol.*, 3:85-92.
3. Van den Heuvel, M J, A D Dayan and R O Shillaker (1987). Evaluation of the BTS approach to the testing of substances and preparations for their acute toxicity, *Human Toxicol.*, 6:279-291.
4. Van den Heuvel, M J, D G Clark, R J Fielder, P P Koundakjian, G J A Oliver, D Pelling, N J Tomlinson, and A P Walker (1990). The international validation of a fixed-dose procedure as an alternative to the classical LD50 test, *Fd. Chem. Toxicol.*, 28:469-482.
5. Whitehead, A and R N Curnow (1992). Statistical evaluation of the fixed-dose procedure, *Fd. Chem. Toxic.*, 30:313-324.
6. Stallard N and A Whitehead (1995). Reducing numbers in the fixed-dose procedure, *Human Expt. Toxicol.*, 14:315-323.
7. Lipnick, R L, J A Cotruvo, R N Hill, R D Bruce, K A Stitzel, A P Walker, I Chu, M Goddard, L Segal, J A Springer, and R C Myers (1995). *Comparison of the Up-and-Down, Conventional LD50, and Fixed-Dose Acute Toxicity Procedures*. *Fd Chem. Toxic.* 33: 223-231.
8. Yam, J, P J Reer, and R D Bruce (1991). *Comparison of the Up-and-Down Method and the Fixed-Dose Procedure for Acute Oral Toxicity Testing*. *Fd Chem. Toxic.* 29:259-263.
9. Diener, W; U Mischke, E Schlede and D Kayser (1995). *The biometric evaluation of the OECD modified version of the acute toxic class method (oral)*. *Arch.Toxicol.* 69: 729-734.
10. Diener, W; and E Schlede. (1996). *Brief an den Herausgeber: ML Prinzip und ATC-Methode*. *ALTEX* 13(4): 238-239.
11. Diener, W; and E Schlede (1996). *Letter to the Editor: FDP and ATC method: a mathematical comparison*. *Human Experim.Toxicol.* 15: 855-856.
12. Diener, W; L Siccha, U Mischke, D Kayser and E Schlede (1994). *The biometric evaluation of the acute-toxic-class method (oral)*. *Arch.Toxicol.* 68: 599-610.
13. Schlede, E; U Mischke, W Diener and D Kayser. (1995). *The international validation study of the acute-toxic-class method (oral)*. *Arch.Toxicol.* 69: 659-670.
14. Dixon, W J, and A M Mood (1948). A method for obtaining and analyzing sensitivity data. *J. Amer. Statist. Assoc.* 43:109-126.

15. Dixon, W J (1991). Staircase Bioassay: The Up-and-Down Method. *Neurosci. Biobehav. Rev.* 15:47-50.
16. Brownlee, K A , J L Hodges, Jr., and M Rosenblatt (1953). *J Amer. Stat. Assoc.*, 48:262-277.
17. Hsi, B P (1969). *J Amer. Stat. Assoc.*, 64:147-162.
18. Dixon, W J and Dixon Statistical Associates (1991). Design and Analysis of Quantal Dose-Response Experiments (with Emphasis on Staircase Designs).
19. Bruce, R D (1985). An up-and-down procedure for acute toxicity testing. *Fundam. Appl. Tox.*, 5:151-157.
20. ASTM (1987) E 1163-87, Standard test method for estimating acute oral toxicity in rats. American Society for Testing Materials, Philadelphia PA, USA.
21. Dixon, W J (1965). The up-and down method for small samples. *J. Amer. Statist. Assoc.*, 60:967-978.
22. Finney, D J (1971). *Probit Analysis*, 3rd ed., Cambridge University Press, Cambridge, England, 50-80.
23. Stallard, N and A Whitehead (1996). A preliminary statistical evaluation of the up-and-down procedure. Medical and Pharmaceutical Research Unit, University of Reading.

Comparison of classification probabilities (based on EU classification cut points; i.e., 25, 200, 2000)

LD50	slope	Correct				More Stringent				Less Stringent			
		FDP	ATC	UDP	401	FDP	ATC	UDP	401	FDP	ATC	UDP	401
1.5	8.33	100	100	100	100	-	-	-	-	0	0	0	0
	2.0	100	100	100	99.9	-	-	-	-	0	0	0	0.1
	0.8	100	99.5	100	96.8	-	-	-	-	0	0.5	0	3.2
	0.5	100	96.6	100	95.1	-	-	-	-	0	3.4	0	4.9
50	8.33	99.9	100	100	100	0	0	0	0	0.1	0	0	0
	2.0	79.4	66.6	98.3	87.0	20.5	33.3	1.7	9.3	0.1	0.1	0	3.7
	0.8	9.2	39.3	92.1	67.0	90.7	56.7	7.9	21.9	0.1	3.9	0	11.1
	0.5	2.5	31.7	92.7	62.9	97.4	60.4	6.4	24.4	0.1	7.8	0.9	6.7
1500	8.33	0	99.6	98.5	97.9	0	0	0	0	100	0.4	1.5	2.1
	2.0	86.6	87.6	82.4	64.7	1.5	0.9	0	4.4	11.9	11.5	17.6	30.9
	0.8	24.2	58.6	75.3	48.8	75.2	31.0	0	6.9	0.7	10.7	24.7	44.3
	0.5	5.7	39.6	75.8	46.3	94.0	50.9	0	7.2	0.3	9.5	24.2	46.5
3000	8.33	100	97.1	99.9	99.9	0	2.9	0.1	0.1	-	-	-	-
	2.0	50.2	48.3	89.8	83.4	49.8	51.7	10.2	16.6	-	-	-	-
	0.8	2.5	22.3	85.2	73.5	97.5	77.5	14.8	26.5	-	-	-	-
	0.5	0.8	15.1	83.8	71.9	99.2	84.9	16.2	28.1	-	-	-	-

FDP and ATC are averaged across starting doses; FDP is the R=5 results; UDP is the LD50 results.

From the comparison table

For the most toxic substances (LD50=1.5), all seem to do well for various slopes.

For the substances with LD50=50, UDP does better than FDP & ATC as slope decreases (variance increases).

For less toxic substances (LD50=1500), UDP is still more often correct, but is more likely to underclassify as the slope decreases. (This may be a consequence of a poor (default) dose progression and an assumed (small) sigma.)

For the least toxic substances (LD50=3000), none underclassify, but the percentage overclassified increases dramatically with decreased slope.

Who did the work?

The analyses represent the work of:

401: Gregory Carr, USA
Proctor and Gamble

FDP(420): Nigel Stallard and Anne Whitehead, UK
University of Reading

ATC(423): Wolfgang Diener, Germany
BGVV

UDP(425): Elizabeth Margosches and Timothy Barry, USA
EPA

How was the work

All agreed to examine the behavior of the methods for substances with specific LD50/variance combinations. In order to have a common ground, all treated the data as lognormal, amenable to probit manipulations, and used the terminology LD50 and slope to designate the data characteristics. The EU classification cut offs (25, 200, 2000 mg/kg) were used.

The selection of doses is predetermined for FDP and ATC, but each proceeds differently according to start dose. *Calculated* probabilities of classification were provided for each start dose for the ATC and the FDP.

The selection of doses is arbitrary for UDP and 401 (in practice, informed by auxiliary information); 401 proceeds in a predetermined fashion once started; UDP proceeds differently according to each outcome. *Simulated* distributions of experimental LD50's were provided for three starting locations for the UDP and for three sets of dose arrays for the 401. From these distributions, probabilities of classification were *observed*.

All the analyses used LD50= 1.5, 50, 1500, 3000 and slope= 8.33, 2.0, 0.8, 0.5.

FDP analyses assumed 10 animals available at each dose tested. 401 analyses assumed 5 animals at each dose tested. ATC analyses assumed 3 animals at each dose tested. UDP used 1 animal at each dosing, but each dose may be visited repeatedly.

The summary table of comparisons was prepared by:

- Averaging FDP and ATC across starting dose.

Successful classification by both the FDP and ATC becomes more dependent on starting dose as the LD50 increases closer to the greatest EU classification boundary (i.e., 2000) and the slope decreases.

For LD50=3000, their classification at higher slopes is more dependent on starting dose, since the LD50 is greater than the boundary for the least stringent classification.

- Selecting the LD50 start for UDP.

While probabilities of classification have not been calculated for the other starting doses, the spread of values in Table 3 of percentiles of the estimated LD50 indicates higher starting doses with decreasing slope give increased overestimation of LD50; lower starting doses with decreasing slope give increased underestimation.

This is true for 401 as well, where the dose array bracketing the LD50 is the one in the summary comparison table.

- Using the FDP results for R=5

(R defines the proportionality of the evident toxicity curve).

While the probability of correct or more stringent classification is not much affected by this choice for the workshop analyses, the numbers of animals used are very different from those for R=50.

How could the alternative assays be improved?

- All will be improved by a sighting study, since all are affected by starting dose.
- To accommodate the harmonized classification system, the ATC and FDP will need changed prespecified doses.

UDP:

This method depends on the dose progression, which is related to the spread of responses, the length of the run, and the numbers of animals run per dose. Optimal dose progression has intervals equal to $1/\text{slope}$; without information on slope, larger intervals increasing and smaller decreasing may provide better information. Multiple simultaneous starts (e.g., 3 trials concurrently) may provide better data. Two-parameter estimation is NOT necessarily better, since the estimate of sigma is still bound to be unreliable, and for the most part the LD50 estimate is similar.

FDP:

This method depends on the criterion for evident toxicity (which corresponds to the choice of R), the number of animals, and the prespecified doses at which it's performed. Whitehead and Curnow have noted a change in the last alone could give better concordance with LD50 results. Additionally, changing the number of animals responding to identify "less than 100% survival" or the number of animals tested for the base, can improve the performance.

ATC:

This method depends on the prespecified doses at which it's performed. These should conform with the desired classification system to give best performance.

Up-and-Down Procedure:

Brief description of the method and results of a study of some statistical properties

Elizabeth H. Margosches, Ph.D., USEPA/OPPTS/OPPT

with programming assistance from Timothy Barry, Sc.D., USEPA/OP

One of the alternatives offered as a replacement for the Acute Oral Toxicity Assay (OECD 401) is a specific form of an Up-and-Down method (OECD 425), as specified by the ASTM in Standard E1 163-87 (note this standard has been reissued in 1997 as E1163-90). This alternative offers the opportunity to reduce the total number of animals used for the toxicity test itself, when that test is used for identifying the LD50, provided certain requirements are met. It has the prospect, however, of utilizing many more animals than the OECD 401 if, for instance, it is used to estimate a percentile considerably distant from the median or the spacing of doses is inefficient. Since each animal can only be dosed after the outcome of the previous one is known, there can be problems in identifying in advance a cadre for testing where weights and other measures are comparable so that randomization is not in question.

Background on the Method

This test calls for dosing individual animals in sequence singly at 24-hour intervals, with the initial dose set at "the toxicologist's best estimate of the LD50." Following each death (or moribund state) the dose is lowered; following each survival, it is increased, according to a prespecified dose progression factor. If a death follows an initial direction of increasing doses, or a survival follows an initial direction of decreasing dose, four additional animals are tested following the same dose adjustment pattern and then testing is ended. The OECD 425 protocol calls for a default dose progression factor of 1.3 and default sigma for maximum likelihood calculations of 0.12, i.e., $\log(1.3)$.

The method has been described over the years in the statistical literature. An Up-and-Down Procedure (sometimes called a Staircase Design) was first proposed in the 1940's by Wilfrid Dixon and Alexander Mood; there have been papers on such issues as its use with small samples (Brownlee, K.A, J. L. Hodges, Jr., & M. Rosenblatt, 1953, J Amer Stat Assoc 48:262-277) and its use with multiple animals per dose (Hsi, B.P, 1969, J Amer Stat Assoc 64:147-162). One of the most extensive discussions appears in a draft monograph entitled Design and Analysis of Quantal DoseResponse Experiments (with Emphasis on Staircase Designs) prepared by W. Dixon and Dixon Statistical Associates for a U.S. National Institutes of Health [[NIH]] Phase I Final Report, Reduction in Vertebrate Animal Use in Research, produced under SBIR Grant No. 1-R43-RR06151-01, on April 19, 1991. This draft monograph, available from its author for a fee or from the National Center for Research Resources of the NIH to individuals under the Freedom of Information Act, will be the Dixon source quoted below.

Most of the statistical treatment has assumed that there will be some form of prior or historical information available on the tested compound. This means, for instance, that Brownlee et al. write "We have not considered the problem of estimating the scale parameter σ [sigma]. The reason for this is...primarily that with small samples no estimate for σ [sigma] can be accurate enough to have much value. Even if μ [mu] were known, and even if the trials are conducted at stimuli giving the most efficient estimation, over 200 trials would be required to estimate [sigma] within 20 per cent with confidence of 95 per cent. Our experience is that in most experimental situations, the scale parameter is sufficiently stable that the experimenter can guess its value in advance from past experience more accurately than he can estimate it from a small sample. Fortunately, our procedures require only that σ be known within rough limits, and the performance of the estimates for μ [mu] are not sensitive to errors in the guessed value of σ [sigma]."

[$\sigma = \text{sigma}$, $\mu = \text{mu}$]

Because testing submitted to the member nations of the OECD may be the first ever done on compounds of a given family, it may be that σ will not be known even so well as Brownlee assumes. In addition to relying on the monograph of Dr. Dixon, EPA has carried some simulations out based on theoretical distributions, where the underlying μ (LD50 in base 10 logarithmic units) and σ (standard deviation in base 10 logarithmic units) are known, and the Up-and-Down Procedure is performed with the default values identified in the DECO 425 method. These simulations indicate that there can be considerable bias in the estimates when the starting value for testing is distant from the LD50 and, when the starting value is considerably above the LD50, the consequent estimate would have a high probability of overestimating the safety of the compound. That is, the estimated LD50 can be considerably greater than the true one (in the case of the computer runs, the starting LD50 for the simulations) with a potential to place a compound in a less severe hazard classification, depending on the size of the classes and the location of the LD50. As Dixon points out, based on Hsi's results, bias is influenced by the initial test level, the step size, the stopping rule, the number of trials, the number of organisms per trial and the phasing factor [the distance from the true LD50 to the nearest test level].

Simulation trials

To carry out the simulations, with 1000 trials each, the EPA assumed lognormality with 3 possible magnitudes of LD50 (1.5, 50, 1500), 3 possible log sigmas (including the one specified by the Up-and-Down protocol, 0.12; the dosing interval, 1.3; 2.5), and 3 possible starting points (LD10, LD50, LD80), along with routines to estimate only the LD50 with an assumed log sigma of 0.12 and to estimate both parameters. For the most part the two estimation procedures plot on the 45deg. line; namely, their estimated LD50 values are essentially equal.

Although some of these results are rather higher than would probably be tested in a laboratory (owing to limit tests and the ability of real live animals to absorb some doses that are very large), the general tendency seems to be counter-conservative (i.e., to say one has a larger LD50 than is the case). For log sigma the same as the assumption, while there is quite a spread of estimates, they're pretty balanced about the "true" LD50 regardless of starting value (although the spread can be pretty wide), but as log sigma increases to the dosing interval (Dixon suggests that a dose progression factor equal to sigma will improve design) and above, there is a pronounced tendency to overestimate the LD50 (i.e., underestimate hazard) with increasing starting value. These results are shown via a table with the percentiles of the UDP-estimated LD50 (Table 1). The spread of values can be seen by reading the median estimated LD50 value and observing how high the 75th and 90th percentile and how low the 25th and 10th percentile are. The underlining in the table indicates the interval which covers the "true" LD50. The simulation parameters (i.e., LD50 magnitude, log sigma) were chosen to reflect a gamut of possible compounds; six actual studies selected by the Office of Pesticide Programs show these values are not unreasonable, and there can be quite a bit of variability between tests on the same compound.

It is quite likely these results reflect the poor information going into the default design. That means, however, some form of adjustment to the starting dose and dose progression factor must be possible. That could be based on a sighting study for the compound or several related compounds together with quantitative information on structure activity relationships. Another possibility is to carry out several short sequences to estimate the standard error of the ED50. (This, by the way, is consistent with Dixon's and Brownlee et al.'s assertion, and the EPA simulations' suggestion, that single short series of trials provide limited information concerning the variance of the ED50 and thus it's not useful to get an MLE from such a single series). Performing such repeated testing will, of course, increase the number of animals used. It will not, however, be sufficient to discriminate the type of dose response -- all shapes being presumed one of a particular family of symmetric distributions. That means, all the testing methods for examining dose response or related parameters are based on a symmetric distribution, typically a normal or Gaussian one which assumes two parameters (the mean and variance or functions of

them) are needed to define its shape. There are not enough observations (and, hence, degrees of freedom) in many studies to add estimation of the shape to the list of statistical tests. That's part of why the Up-and-Down method requires a historical sigma be provided when the LD50 is estimated. A sighting study with one animal at each of several doses is equally subject to the variability of small samples, but with two or more animals per dose it can give a crude estimate of the LD50 location for starting an Up-and-Down test intended to estimate the LD50.

In particular, if the underlying shape in log dose can reasonably be assumed normal, Dixon provides a table (Dixon, Table 4.2) for use in estimating the LD50. He bases this on the following strategy:

"A series of test levels is chosen with equal spacing between doses (usually in log units) and encompassing a starting level located at the initial estimate of the [LD50]. The spacing is equal to the initial estimate of σ .

"A nominal sample size is selected. [This is done based on a desired standard error of the LD50 in σ -units, from his Table 4.1.]

"A series of trials is carried out following the rule of a decrease in level following a response and an increase in level following a non-response. The initial level should be close to the [LD50].

"Testing continues until the desired sample size is reached. [This nominal sample size, denoted N by Dixon, appears to correspond to the number of trails in addition to the trials in the initial run of constant sign, plus one, Brownlee et al.'s n . For OECD 425 that would appear to be 5: 4 additional animals, plus one. Dixon, however, interprets the stopping rule as described in Bruce (1985), which seems to be the same as OECD 425, to be a nominal sample size of six.]

"This strategy is based on the assumption that the response curve fits a normal model... and thus is not good for estimating small or large percentage points unless normality of the distribution throughout a wide range is assured. It is also assumed that the interval between testing levels is approximately equal to the standard deviation. This assumption will be well enough satisfied if the interval used is less than twice the standard deviation. [Note that the variety of sigmas used for sensitivity testing in Lipnick, R.L., J.A. Cotruvo, R.N. Hill, et al., 1995, *Fd Chem Toxic* 33:223-231 falls in a range that meets this assumption (e.g., $0.05 \times 2 = 0.1$ compared to 0.12, the interval of testing in log dose units), unlike the variety of sigmas considered in the EPA simulations. Thus it could be expected that Lipnick et al. would not necessarily have seen the anomalies shown in the EPA simulations.]

"...To obtain an estimate of [LD50 in log units] for the results of an up-and-down sequence, look up the configuration of responses and nonresponses in Table 4.2 and compute

$$[\text{LD50}] = X_f + kd$$

where X_f = last dose administered; k = value from Table 4.2; d = interval between dose levels [difference in log units]." Because the EPA has not automated the look-up into this table, the EPA has not examined how this procedure compares in its simulations. It is, however, based on maximum likelihood solutions and should compare well to the solutions from the computer runs.

In his correspondence with the EPA regarding his monograph and EPA's simulations, Dr. Dixon has suggested:

"If you are concerned that the method should be cautious toward testing at levels too high for the biology of the animal, one can use shorter steps up than down after reversal and then use a ML estimate. However, in my experience, concern is apt to arise about large doses since the investigator does not really believe the fog normal character of the biological response even when it actually is true. Another safety approach is to use smaller spacing and start at a conservative initial value. Loss of efficiency will not be great."

Additional possible uses following from method adaptations

The Dixon monograph also summarizes several modifications in the procedure that would permit estimation of other percentiles. One estimates a discrete set of percentage points p , that may be other than $p = 50\%$. This modification, based on the logistic model (by contrast to the normal or Gaussian, for the standard method), was proposed by Wetherill et al. (Wetherill, G.B., H. Chen, & R.B. Vasudeva, 1966, *Biometrika* 53:439-454). From a preliminary estimate of the LD p with equally spaced dose levels centered about it, apply the usual procedure, until a nonresponse is observed. After each subsequent trial, estimate the proportion p' of positive responses (if $p > 0.5$) or zero responses (if $p < 0.5$) at the level used for the current trial, counting only those trials used since the last change of level. The dose progression rule requires specification of the minimum number of trials required for a change in response type and the relation of p' to p in deciding whether to change dosage levels.

Wetherill proposes stopping after a specified number of changes in response type. Dixon shows the Average Sample Number estimates (expected sample size) for several percentiles and two stopping rules. Estimation of the 80th percentile with as few as 2 changes of response type can take 8 animals, or as many as 32 if 8 changes of response type are required for stopping. For percentiles other than the median, Dixon believes the estimates from this Up-and-Down transformed response rule are likely to be better than extrapolating from an LD50 with an assumed standard deviation, particularly if little is known about the underlying standard

deviation or distributional form. Note that the sample size will increase rapidly as the percentile desired moves away from the 50th. It may still be worthwhile, however, to carry out such a test or some other test designed for dose response estimation as an adjunct for specific instances where a specific other percentile is needed.

Conclusions and summary

Performing toxicity testing sequentially can introduce some additional considerations in implementation. For instance, compared to OECD 401, while all animals that MIGHT start on test will be identified at the outset, their dosing regimens will not start for them at the same age. Although use of a bodyweight-adjusted concentration may roughly account for size differences, the potential effects of weight and other growth changes on response should be considered in such choices as rodent strain, starting age, litter mate usage, etc.

The Up-and-Down method has been suggested as a generally useful alternative to the OECD 401. The EPA results, however, suggest that the Up-and-Down Method may have serious problems with under or over estimation of LD50's, depending on how well the starting value and progression factor are chosen and how well the assumed sigma reflects the true variability of response across doses. Adjunct studies (e.g., sighting and structure activity relationship work) are needed to improve its performance.

Table 1
Up- and-Down Procedure
PERCENTILES of the estimated LD50
by "true" LD50, sigma, starting point
1000 simulated sets each row

'True' LD50	'True' Slope	Starting Dose	10% of results were this value or less	25% of results were this value or less	50% of results were this value or less	75% of results were this value or less	90% of results were this value or less
1.5	8.33	LD10	1.2003	1.3485	1.4596	1.6697	1.8087
		LD50	1.2408	1.3308	1.4641	1.5678	1.8134
		LD80	1.2606	1.3651	1.5217	1.6600	1.8109
	0.80	LD10	0.0515	0.0809	0.1367	0.2489	0.5074
		LD50	0.9428	1.1443	1.5678	1.9828	2.4444
		LD80	3.1598	5.1987	7.9219	12.839	16.339
	0.40	LD10	1.907E-03	2.896E-03	5.530E-03	0.0142	0.0323
		LD50	0.7773	1.1347	1.4641	2.0791	2.7127
		LD80	20.547	41.889	76.291	120.25	167.18
50	8.33	LD10	40.009	45.117	50.569	55.784	60.291
		LD50	41.359	44.943	48.805	54.822	60.446
		LD80	42.020	45.503	50.725	55.334	60.362
	0.80	LD10	1.6849	2.6954	4.5553	7.6984	14.321
		LD50	27.648	37.825	47.838	64.049	83.744
		LD80	113.13	187.90	277.87	430.90	544.64
	0.40	LD10	0.0496	0.0785	0.1716	0.3771	1.0531
		LD50	27.648	37.825	48.805	66.094	90.423
		LD80	807.03	1504.7	2543.0	4408.9	5711.1
1500	8.33	LD10	1200.3	1348.5	1488.3	1669.7	1763.1
		LD50	1206.0	1315.6	1464.1	1690.8	1813.4
		LD80	1260.6	1365.1	1521.7	1660.0	1810.9
	0.80	LD10	51.492	80.863	136.66	248.68	420.62
		LD50	942.82	1171.0	1567.8	1982.8	2505.5
		LD80	3150.3	5322.3	8336.2	1.284E+04	1.634E+04
	0.40	LD10	1.4924	2.7252	5.1489	14.380	32.309
		LD50	829.50	1141.2	1567.8	1982.8	2895.0
		LD80	2.297E+04	4.514E+04	7.629E+04	1.323E+05	1.713E+05

Each table entry represents the percentile LD50 value estimated by the single-parameter maximum likelihood method and assuming a sigma of 0.12, from an up-and-down procedure starting at the specified "start" with observations from a lognormal distribution with LD50 as shown by "True LD50" and "True Slope". Slope = 1 / sigma. Underlining is explained in the accompanying text.

Table 2
"Central" Starting Points
PERCENTILES of the estimated LD50
by "true" LD50, sigma, starting point
1000 simulated sets each row

'True' LD50	'True' Slope	Starting Dose	10% of results were this value or less	25% of results were this value or less	50% of results were this value or less	75% of results were this value or less	90% of results were this value or less
1.5	2.00	LD30	0.7193	0.8572	1.1371	<u>1.4091</u>	<u>1.7868</u>
		LD40	0.8747	1.0721	<u>1.2776</u>	<u>1.6148</u>	1.925
		LD60	1.1989	<u>1.3934</u>	<u>1.7611</u>	2.0988	2.5722
	0.80	LD30	0.2738	0.3473	0.4529	0.6755	<u>1.0139</u>
		LD40	0.5316	0.6703	0.8495	<u>1.1138</u>	<u>1.6522</u>
		LD60	<u>1.3617</u>	<u>2.0538</u>	2.6488	3.6510	4.6462
50	2.00	LD30	23.977	30.414	37.892	<u>46.972</u>	<u>61.094</u>
		LD40	28.256	35.735	<u>45.154</u>	<u>54.194</u>	67.547
		LD60	37.041	<u>46.446</u>	<u>58.705</u>	69.959	87.981
	0.80	LD30	9.2311	11.864	15.097	24.464	<u>35.555</u>
		LD40	17.718	22.409	28.315	<u>37.263</u>	<u>55.079</u>
		LD60	<u>47.763</u>	<u>67.090</u>	88.292	111.89	153.24
1500	2.00	LD30	719.32	857.22	1084.1	<u>1409.1</u>	<u>1917.6</u>
		LD40	874.73	1069.0	<u>1277.6</u>	<u>1614.8</u>	2026.4
		LD60	1182.7	<u>1393.4</u>	<u>1761.1</u>	2098.8	2654.3
	0.80	LD30	273.78	347.28	452.92	646.48	<u>1013.9</u>
		LD40	487.58	623.37	849.45	<u>1109.2</u>	<u>1652.4</u>
		LD60	<u>1361.7</u>	<u>2018.9</u>	2648.8	3356.6	4439.8

Each table entry represents the percentile LD50 value estimated by the single-parameter maximum likelihood method and assuming a sigma of 0.12, from an up-and-down procedure starting at the specified "start" with observations from a lognormal distribution with LD50 as shown by "True LD50" and "True Slope". Slope = 1 /sigma. Underlining identifies the range of estimated LD50 values that includes the "true" one.

Table 3
Up-and-Down Procedure
PERCENTILES of the estimated LD50
by "true" LD50, sigma, starting point
1000 simulated sets each row

"True" LD50	"True" Slope	Starting Dose	10% of results were this value or less	25% of results were this value or less	50% of results were this value or less	75% of results were this value or less	90% of results were this value or less
1.5	8.33	LD10	1.2003	1.3485	1.4596	1.6697	1.8087
		LD50	1.2408	1.3308	1.4641	1.5678	1.8134
		LD80	1.2606	1.3651	1.5217	1.6600	1.8109
	2.00	LD10	0.4756	0.6203	0.8720	1.2010	1.5980
		LD50	1.0120	1.2400	1.5678	1.8657	2.2521
		LD80	1.2930	1.6809	2.3600	2.9903	3.5530
	0.80	LD10	0.0515	0.0809	0.1367	0.2489	0.5074
		LD50	0.9428	1.1443	1.5678	1.9828	2.4444
		LD80	3.1598	5.1987	7.9219	12.839	16.339
	0.50	LD10	6.526E-03	0.0110	0.0220	0.0495	0.1091
		LD50	0.8294	1.1347	1.4641	1.9717	2.5773
		LD80	9.4059	17.131	28.951	50.192	69.184
50	8.33	LD10	40.009	45.117	50.569	55.784	60.291
		LD50	41.359	44.943	48.805	54.822	60.446
		LD80	42.020	45.503	50.725	55.334	60.362
	2.00	LD10	16.478	21.483	28.567	39.888	52.028
		LD50	33.302	40.200	48.805	62.189	75.072
		LD80	43.099	53.933	76.686	99.675	115.56
	0.80	LD10	1.6849	2.6954	4.5553	7.6984	14.321
		LD50	27.648	37.825	47.838	64.049	83.744
		LD80	113.13	187.90	277.87	430.90	544.64
	0.50	LD10	0.2290	0.3681	0.6713	1.4749	3.6227
		LD50	29.101	39.032	52.260	65.726	90.423
		LD80	298.06	561.21	965.03	1661.7	2136.6

Table 3 (continued)
Up-and-Down Procedure
PERCENTILES of the estimated LD50
by "true" LD50, sigma, starting point
1000 simulated sets each row

"True" LD50	"True" Slope	Starting Dose	10% of results were this value or less	25% of results were this value or less	50% of results were this value or less	75% of results were this value or less	90% of results were this value or less
1500	8.33	LD10	1200.3	1348.5	<u>1488.3</u>	<u>1669.7</u>	1763.1
		LD50	1206.0	1315.6	<u>1464.1</u>	<u>1690.8</u>	1813.4
		LD80	1260.6	<u>1365.1</u>	<u>1521.7</u>	1660.0	1810.9
	2.00	LD10	494.33	644.49	871.99	<u>1200.7</u>	1554.3
		LD50	999.05	<u>1206.0</u>	<u>1500.4</u>	1865.7	2330.0
		LD80	<u>1376.9</u>	<u>1768.8</u>	2425.6	3007.2	3553.0
	0.80	LD10	51.492	80.863	136.66	248.68	<u>420.62</u>
		LD50	942.82	<u>1171.0</u>	<u>1567.8</u>	1982.8	2505.5
		LD80	<u>3150.3</u>	5322.3	8336.2	1.284E+04	1.634E+04
0.50	LD10	6.6846	11.045	22.516	43.969	<u>108.68</u>	
	LD50	829.50	<u>1134.7</u>	<u>1567.8</u>	1982.8	2712.7	
	LD80	<u>9.600E+04</u>	1.769E+04	2.961E+04	5.019E+04	6.502E+04	
3000	8.33	LD10	2400.5	<u>2697.0</u>	<u>3034.1</u>	3337.2	3526.3
		LD50	2481.5	<u>2737.9</u>	<u>3135.6</u>	3337.5	3626.8
		LD80	2521.2	<u>2730.2</u>	<u>3043.5</u>	3320.0	3621.7
	2.00	LD10	906.86	1289.0	1839.5	<u>2458.4</u>	3274.9
		LD50	1998.1	2412.0	<u>2928.3</u>	<u>3731.3</u>	4677.3
		LD80	<u>2585.9</u>	<u>3361.7</u>	4601.1	5980.5	6933.6
	0.80	LD10	102.98	161.73	273.32	461.91	<u>861.24</u>
		LD50	1840.9	2282.3	<u>2928.3</u>	<u>3943.4</u>	4888.9
		LD80	<u>6679.9</u>	1.040E+04	1.667E+04	2.687E+04	3.268E+04
	0.50	LD10	13.012	20.497	44.033	98.936	<u>234.24</u>
		LD50	1746.0	<u>2288.7</u>	<u>3073.5</u>	3965.7	5425.4
		LD80	<u>1.882E+04</u>	3.830E + 04	5.922E + 04	1.004E + 04	1.300E + 04

Each table entry represents the percentile LD50 value estimated by the single-parameter maximum likelihood method and assuming a sigma of 0.12, from an up-and-down procedure starting at the specified "start" with observations from a lognormal distribution with LD50 as shown by "True LD50" and "True Slope". Slope = 1/sigma. Underlining identifies the range of estimated LD50 values that includes the "true" one.

Table 4
Up-and-Down Procedure
Number of Animals Used
by "true" LD50, sigma, starting point
1000 simulated sets each row

'True' LD50	'True' Slope	Starting Dose	mean no. of animals (s.d.)	median no. of animals	maximum no. of animals	% using 6 animals	% using 7 animals
1.5	2.00	LD10	8.6(1.95)	8	15	16	18
		LD50	6.6(0.82)	6	11	55	32
		LD80	7.5(1.48)	7	14	33	26
	0.50	LD10	11.3(4.21)	10	28	9	11
		LD50	6.9(1.23)	6	14	52	26
		LD80	8.7(2.72)	8	20	24	20
50	2.00	LD10	8.6(1.91)	8	15	15	19
		LD50	6.5(0.80)	6	11	61	28
		LD80	7.5(1.46)	7	14	35	24
	0.50	LD10	11.2(4.07)	10	30	8	11
		LD50	6.8(1.17)	6	13	53	25
		LD80	8.7(2.76)	8	23	24	19
1500	2.00	LD10	8.6(1.85)	9	16	14	17
		LD50	6.6(0.87)	6	11	59	28
		LD80	7.4(1.45)	7	13	36	26
	0.50	LD10	11.3(4.04)	11	28	8	11
		LD50	6.9(1.23)	7	14	50	27
		LD80	8.6(2.75)	8	20	27	19
3000	8.3	LD10	6.8(0.74)	7	9	41	41
		LD50	6.2(0.38)	6	8	85	15
		LD80	6.4(0.60)	6	8	64	31
	2.00	LD10	8.6(1.93)	8	15	16	16
		LD50	6.6(0.82)	6	10	58	28
		LD80	7.5(1.52)	7	13	33	24
	0.80	LD10	10.4(3.17)	10	22	9	12
		LD50	6.8(1.02)	6	12	53	28
		LD80	8.4(2.31)	8	18	27	18
	0.50	LD10	11.3(4.21)	11	27	10	11
		LD50	7.0(1.29)	7	15	49	28
		LD80	8.6(2.68)	8	21	25	20

Slope = 1/sigma

APPENDIX P

Considerations for Selection of the Appropriate Animal Gender for the UDP

- P-1 Gender Sensitivity of Xenobiotics P-3
(A. Rispin, H. Podall and W. Meyer, U.S. EPA – 04/03/2000)
- P-2 Comparison of Male and Female Rat Oral and Dermal LD50 P-23
Values on OPP’s One-Liner Database
(C. Rabe and S. Segal, Clement International Corp. – March 22-24, 1999)
- P-3 Acute and Subacute Toxicology In Evaluation of Pesticide P-45
Hazard to Avian Wildlife
(E. Hill, Patuxent Environmental Science Center – 1993)
- P-4 Sex Dependent Metabolism of Xenobiotics P-69
(G. Kedderis and C. Mugford, CIIT – August 1998)

GENDER SENSITIVITY OF XENOBIOTICS

Summary of the Literature

In order to conserve animals in acute toxicity testing, OECD experts have recommended the use of test animals of a single sex. Sex as a cause of differences in metabolism, transformation, and toxicity, have been reviewed by a number of authors. These authors have compiled available data on gender sensitivity to toxicants in rats, mice and humans. See, for example, Reviews by Salem, Trimbell, Sipes and Gandolpho, DeBethizy and Hayes, and Moser (1, 2, 3, 4, 5). However, we are not aware of systematic investigations into differences in sensitivity for lethality of xenobiotics of males and females across chemicals.

Surveys of the literature show that generally, the responses in male and female rats are similar. When differences in sensitivity occur, it is often the female that is more sensitive (Kedderis and Mugford, 6). Summarizing acute toxicity data on 766 chemicals, no significant sexual differences are noted in 711 cases, constituting 93% of the cases. When differences are noted, females are more sensitive in 42 cases, while males are more sensitive in 13 cases. (See Table 1.) In other tabulations, for 91 chemicals the female average LD50 value is slightly lower than that for males, while for 143 chemicals, the opposite is true. In some cases, dissimilarities in sensitivity between male and female rats can be significant. For example, in a comparison of male and female rat oral and dermal LD50 values for pesticides (EPA, 7), 14 out of 79 pesticides showed significant differences in sensitivity in male and female rats. In this report, difference in response was deemed to be significant if there was no overlap of the 95% confidence intervals characterizing each sex's response. As shown in Tables 1 and 2, for 11 cases, females were more sensitive and for 3 cases, males were more sensitive. Properties and structures for the chemicals in Table 2 are given in Table 2A. The three chemicals which showed greater sensitivity in the male rat were Landrin, a carbamate insecticide, Triflumizole, an imidazole fungicide, and vitamin D3, a steroidal pesticide. Additional disparities in sex sensitivity were seen for many of the rest of the chemicals in the pesticide data base, although for these chemicals, 95% confidence intervals overlapped to some extent. While these data suggest that the sexes are not equally sensitive to all of the chemicals tested, no clear cut generalizations about sex sensitivity could be made; although females were often more sensitive, this was not always true.

The published literature records cases when male rodents are more sensitive to xenobiotics than females. A detailed review of the metabolism of Chlorpyrifos can be found in Moser. Trimbell notes that Chlorpyrifos is more acutely toxic to male rats than to females. Differences in the way that vital organs react to toxins can also have a significant impact on overall toxicity. Chloroform induces nephrotoxicity in male mice, but not females; chloroform is converted to a reactive intermediate (phosgene) an order of magnitude faster by microsomes from male mouse kidneys than in those from female mice (Sipes and Gandolpho). Metabolic differences due to gender can also have an effect on sensitivity for acute effects. The insecticides aldrin and heptachlor are metabolized more rapidly to the toxic epoxide forms in male rats. These chemicals demonstrate a lower toxicity in the female rat (Trimbell).

Sensitivity Differences in Avian Species:

In a separate review, Elwood Hill (8) compared the toxicity of ten insecticides in birds (sex unspecified). The list contained both organophosphate and carbamate pesticides. (Tables 3 and 3A). The redwing blackbird has lower specific hepatic microsomal monooxygenase activity than most other animals (for example, rock dove, chukar, mallard, or ring-necked pheasant). By analogy to female rats with their lower biotransformation capacity, one would expect the redwing blackbird to have lower LD50 values for these insecticides than the other species. In fact, the redwing blackbird was more sensitive than the other avian species to seven chemicals. However, for two chemicals, chlorpyrifos and mexacarbate, the redwing blackbird was generally less sensitive than the other species.

Biotransformation and Differences in Sensitivity:

If gender differences are seen in toxic responses to xenobiotics, differences in biotransformation are the probable cause. Because male rats metabolize most foreign compounds faster than females, one would expect the biological half-life of most xenobiotics to be longer in the female than the male rat. However, if a metabolite or intermediate is responsible for the toxic response, male rats would be expected to show the greater susceptibility (Sipes and Gandolfo).

In general, CYP mediated reactions lead to detoxification and subsequent excretion of xenobiotics (phase I metabolism). For example, certain organophosphate pesticides are detoxified by glutathione S-transferases. However, CYP mediated metabolism can also cause formation of reactive metabolites. Female rats are known to have 10 - 30% less total CYP as compared with male rats. (Kedderis and Mugford).

Phase II conjugative enzymes, i.e. sulfotransferases, glutathione S-transferases, and glucuronyltransferases, also play a role in detoxification. Sex-dependent differences have also been found in expression of phase II enzymes. When such sex-dependent differences are seen, it is generally the male rats which have higher enzyme activities. For example, glutathione protects tissues against electrophilic attack by xenobiotics. DeBethizy and Hayes note that glutathione conjugating activity toward dichloronitrobenzene is two- to three-fold higher in male than female rats.

Biotransformation does not always lead to detoxification. Examples of activation of xenobiotics to their toxic forms by mixed function oxidase enzymes are:

- epoxidation of chlorobenzene and coumarin to generate hepatotoxic metabolites,
- oxidative group transfer of certain organophosphorous pesticides to the toxic organophosphate, e.g. conversion of parathion to paraoxon,
- reductive dechlorination of carbon tetrachloride to a trichloro methyl free radical,
- oxidative dechlorination of chloroform to phosgene,
- activation of ethyl carbamate to (urethan)

However, many of these same chemicals are also detoxified by cytochrome P450 by conversion to less toxic metabolites. In some cases, the same enzyme may catalyze activation and detoxification reactions for a given chemical. The resulting toxic effect of a xenobiotic chemical is thus due to a balance between metabolic activation and deactivation (Casarett and Doull, 9).

Although female rats generally have less total CYP activity than males, there are important exceptions. For example, microsomal 16-hydroxylase is male specific and is not expressed in females. Whereas steroid sulfate 15 hydroxylase occurs in higher concentrations in females. One could speculate that these differences may account for the fact that vitamin D3 is more toxic in males than females.

De Bethizy and Hayes also note that phase II conjugation of xenobiotics may not always lead to more rapid excretion of the conjugated metabolite. In fact, some compounds are toxic only after conjugation with glutathione. Glutathionyl conjugates which are implicated in nephrotoxicity would be likely to show greater toxicity in males than females.

Choice of Sex for Acute Toxicity Testing:

As noted above, fourteen pesticides, from a sample of 84, were found to exhibit significant differences in sensitivity between male and female rats (Table 2). When they occur, dissimilarities in sensitivity of male and female rats can also have important implications for regulation. In five of the fourteen cases, the disparity of response was such that had only one sex been tested, and it was the least sensitive sex, the chemical would have been assigned for classification to a less toxic class.

The revised test guideline #425 uses a single sex, usually females. If the investigator has a priori reasons to believe that males may be more sensitive than the other, then it may be used for testing. Female rats have a lower relative detoxification capacity for most chemicals, as measured by specific activity of their mixed function oxidase enzymes. Therefore, for chemicals which are direct acting in their toxic mechanism, females would generally be the most sensitive. However, if metabolic activation is required for a chemical's toxicity, consideration must be given as to whether the preferred sex for testing is the male.

Table 1. LD50 sensitivity of the sexes

(See Lipnick, R.L., et al. 1995 Comparison of the up-and-down, conventional LD50, and fixed-dose acute toxicity procedures. *Fd. Chem. Toxicol.* 33: 223-231).

Author	No. Chemicals	LD50 Average (mg/kg)		
		Females	Males	
DePass et al., 1984	91	2130	2470	
Weil et al., 1953	143	8960	8360	
Weighted Average	234	6313	6069	
		LD50 Sensitivity of the Sexes		
		Sexes Same	Sex More Sensitive	
			Female	Male
Bruce, 1985	48	35	13	0
EPA, 1991	79	65	11	3
HSE, 1999	449	446	1	2
Lipnick et al., 1995	20	18	0	2
Muller & Kley, 1982	170	147	17	6
Totals	766	711 (93%)	42	13

Table 2. Chemicals without overlapping male and female LD50 (95% confidence limits)

CHEMICAL NAME	CHEMICAL CLASS	USE	MALE LD50 mg/kg	FEMALE mg/kg
1. Isazofos technical (93+%)	Organophosphate	Insecticide	118.68	48.21
2. Trimethacarb	Carbamate	Insecticide	7.20	9.30
3. Flusilazole (97%)	Fluorophenyl triazole silane	Fungicide	1110.00	674.00
4. Cadusafos (94.9%) (in corn oil)	Organophosphate	Insecticide	47.50	20.10
5. Cycloate technical (98%)	Carbamate	Herbicide	3200.00	2275.00
6. Clomazone (88.8% a.i.)	Chlorophenyl isoxazolidinone	Herbicide	2077.00	1369.00
7. Troysan polyphase (99%)	Iodo-acetylenic carbamate	Fungicide/wood preservative	1795.00	1065.00
8. Parathion technical (in corn oil)	Organophosphate	Insecticide	10.80	2.52
9. Chlorethoxyfos (86% a.i.)	Organophosphate	Insecticide	4.60	1.80
10. ASPON technical (90%); (inerts 10%)	Organophosphate	Insecticide	2800.00	740.00
11. Triflumizol technical	Imidazole	Fungicide	1057.00	1780.00

Table 2. Chemicals without overlapping male and female LD50 (95% Confidence limits) (cont'd.)

CHEMICAL NAME	CHEMICAL CLASS	USE	MALE LD50 mg/kg	FEMALE mg/kg
12 Thiodicarb (in methyl cellulose)	Carbamate	Insecticide	129.00	59.10
13. Vitamin D3 technical	Steroid	Antirachitic	352.00	619.00

Table 2A. Identification of Chemicals in Table 2

1) CGA-123 technical

This substance is identified in the MRID as CGA 12223 from Ciba, Ltd.

According to the Farm Chemicals Handbook (FCH), vol.86 (2000), the following information was obtained :

Common Name: Isazofos

Chemical Name: O -5-chloro- 1-isopropyl-1H-1,2,4-triazol-3-yl-O,O-diethyl-phosphorothioate

CAS No. 42509-80-8

Chemical Class: organophosphate

Use: Insecticide

Structure:

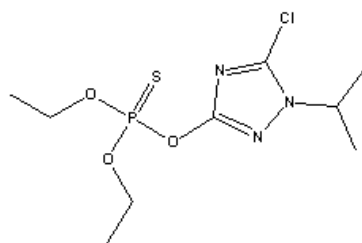

Empirical Formula: C₉ H₁₇ N₃ P O₃ S Cl

Molecular Weight: 313.5

2) EI-919

Tradename (of Shell): Landrin

Common Name: Trimethacarb

Chemical Name: 3,4,5- trimethylphenyl methylcarbamate

CAS No. 2655-15-4

Chemical Class: carbamate

Use: Insecticide

Structure:

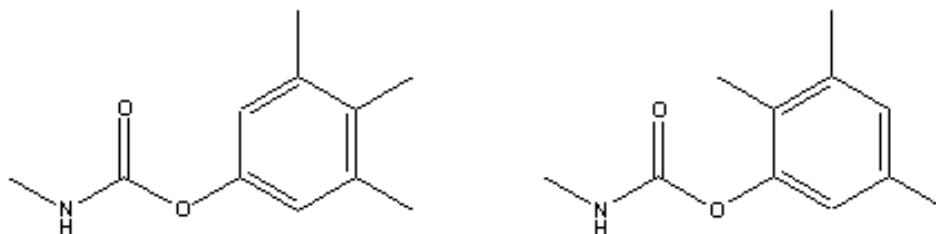

(Note: The pesticide is a mixture of both forms, 3,4,5- and 2,3,5- trimethylphenyl methylcarbamate)

Empirical Formula: C₁₁ H₁₅ O₂ N

Molecular Weight: 182

- 3) 1-[[bis (4-fluorophenyl) methylsilyl] methyl]-1H-1,2,4-triazole
CAS No. 85509-19-9
Common Name: Flusilazole
Tradename: Nustar
Chemical Class: fluorophenyl triazole silane
Use: Fungicide
Structure:

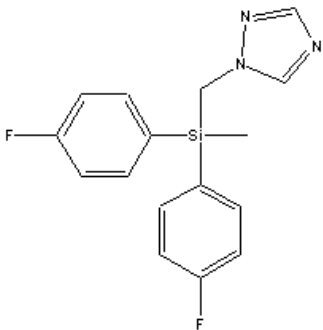

Empirical Formula: C₁₆ H₁₅ F₂ N₃ Si
Molecular Weight: 315.4

- 4) FMC 67825
Tradename: Rugby ; Apache
Common Name: Cadusafos
Chemical Name: O-ethyl-S,S- di-sec-butyl phosphorodithioate
Chemical Class: organophosphate
Use: Insecticide
Structure:

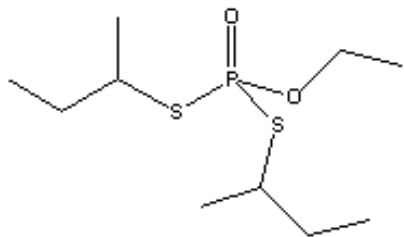

Empirical Formula: C₁₀ H₂₃ P O₂ S₂
Molecular Weight: 270

- 5) Cycloate technical
Chemical Name: S-ethyl cyclohexyl (ethyl) thiocarbamate
CAS No. 1134-23-2
Chemical Class: carbamate
Use: Herbicide
Structure:

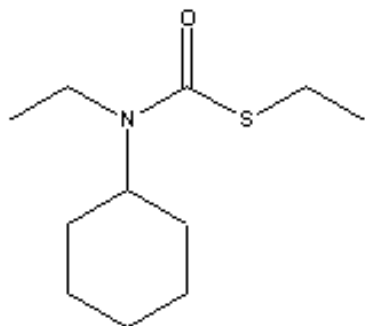

Empirical Formula: C₁₁ H₂₁ N O S
Molecular Weight: 204

- 6) FMC 57020
Tradename: Command
Common Name: Clomazone
Chemical Name: 2- [(2-chlorophenyl) methyl]-4,4-dimethyl -3-isoxazolidinone
Chemical Class: chlorophenyl isoxazolidinone
CAS No. 81777-89-1
Use: Herbicide
Structure:

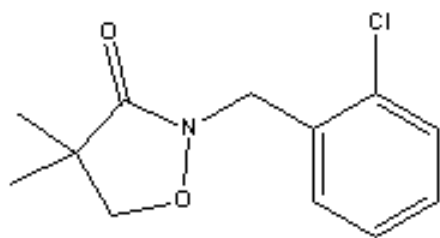

Empirical Formula: C₁₂ H₁₄ N O₂ Cl
Molecular Weight: 239.5

- 7) 3-iodo-2-propynyl butylcarbamate
Complete Chemical Name: 3-iodo-2-propynyl N-n-butyl carbamate
Tradename: Troysan polyphase
Chemical Class: iodo-acetylenic carbamate
Use: fungicide/ wood preservative
Structure:

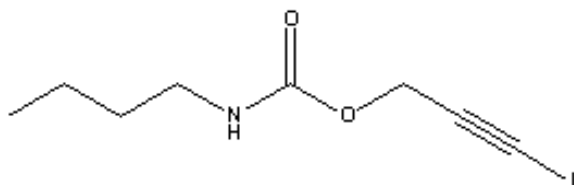

Empirical Formula: C₈ H₁₂ O₂ N I
Molecular Weight: 281

- 8) Parathion technical
Chemical Name: O, O-diethyl- O-(4-nitrophenyl) phosphorothioate
CAS No. 56-38-2
Tradename: Thiophos
Chemical Class: organophosphate
Use: Insecticide
Structure:

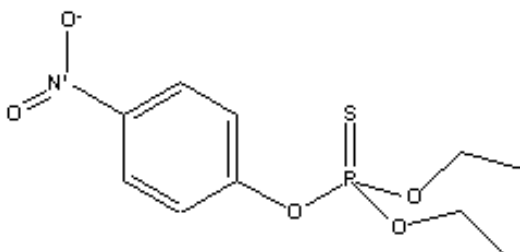

Empirical Formula: C₁₀ H₁₄ N PO₅ S
Molecular Weight: 291

- 9) Fortress (tradename- Dupont)
Common Name: Chlorethoxyfos
Chemical Name: O,O-diethyl-O-(1,2,2,2-tetrachloroethyl) phosphorothioate
Chemical Class: organophosphate
Use: Insecticide
Structure:

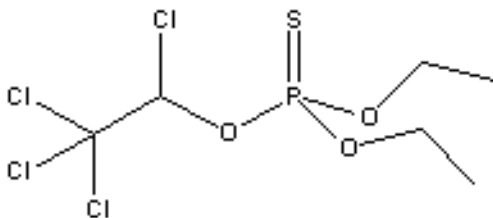

Empirical Formula: C₆ H₁₁ P O₃ S Cl₄
Molecular Weight: 336

- 10) O,O,O,O-tetrapropyl dithiopyrophosphate
CAS No. 3244-90-4
Tradename: ASPON technical (Stauffer Chemical Co.)-- discontinued 1987 by Stauffer.
Chemical Class: Organophosphate
Use: Insecticide
Structure:

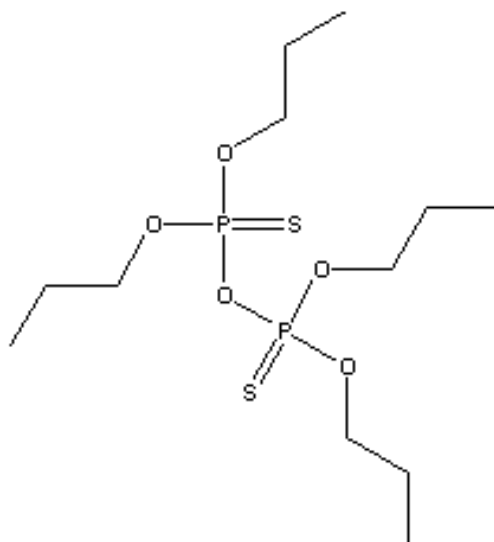

Empirical Formula: C₁₂ H₂₈ O₅ P₂ S₂
Molecular Weight: 378

- 11) Triflumizole
Chemical Name: (E)- 4-chloro-aaa- trifluoro-N-(1-imidazole)-1 yl- 2-propoxy-ethylidene-o-toluidine
CAS No. 99387-89-0
Chemical Class: Imidazole
Use: Fungicide
Structure:

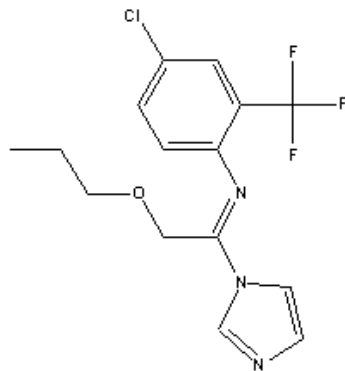

Empirical Formula: C₁₅ H₁₅ N₃ O Cl F₃
Molecular Weight: 345.5

- 12) Larvin (tradename / Rhone-Poulenc)
Common Name: Thiodicarb
Chemical Name: dimethyl N,N-(thiobis (methylimino) carbonyloxy) bis-ethanimidothioate)
CAS No. 59669-26-0
Chemical Class: Carbamate
Use: Insecticide
Structure:

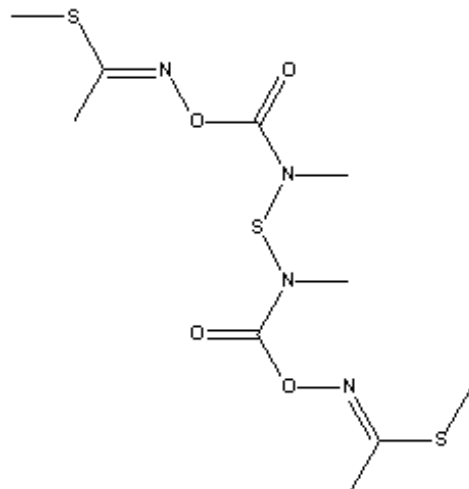

Empirical Formula: C₁₀ H₁₈ N₄ S₃ O₄
Molecular Weight: 354

13) Vitamin D3

Chemical Names: (3b,5Z,7E)-9,10-secocholesta-5,7,10-(19)-trien-3-ol;
or activated 7-dehydro-cholesterol; or cholcalciferol

Use (Merck Index, p.1711): antirachitic

Structure:

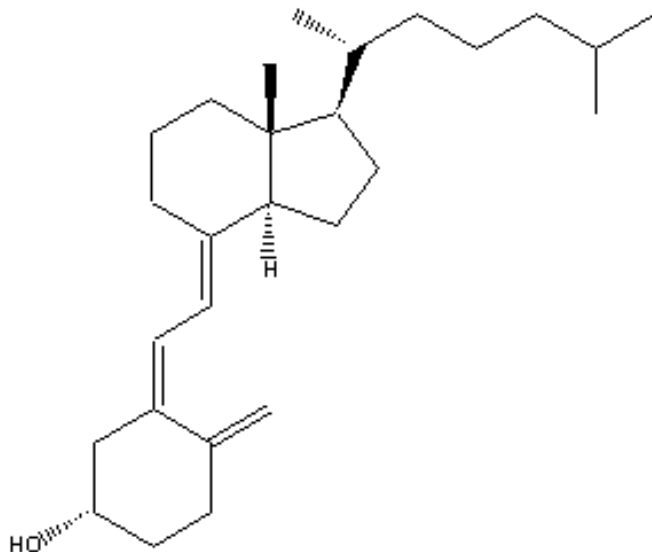

Empirical Formula: C₂₇ H₄₄ O
Molecular Weight: 385

* References:

1. Farm Chemicals Handbook, vol.86 (2000)
2. Merck Index, 12th edition (1996)

Table 3. Most sensitive cases.

Pesticide	Red-winged blackbird	Other avian species
Monocrotophos	X	
Dicrotophos	X	
Parathion		Mallard
EPN		Ring-necked pheasant
Propoxur	X	
Chlorpyrifos		European starling
Fenthion	X	
Temephos	X	Ring-necked pheasant*
Landrin	X	
Mexacarbate		Ring-necked pheasant, Chukar, Rock dove

* Red-winged black bird and Ring-necked pheasant are very close in sensitivity.

Table 3A. Identification of Chemicals in Table 3 *

- 1) Monocrotophos (common name)
Chemical Name: dimethyl (E)-1-methyl-2-(methylcarbamoyl) vinylphosphate
CAS No. 6923-22-4
Chemical Class: Organophosphate
Use: Insecticide
Structure:

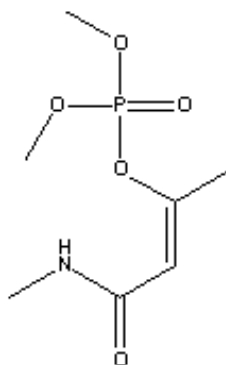

Empirical Formula: C₇ H₁₄ P O₅ N
Molecular Weight: 223

- 2) Dicrotophos (common name)
Chemical Name: (E)-2-dimethylcarbamoyl - 1- methylvinyl dimethylphosphate
CAS No. 141-66-2
Chemical Class: Organophosphate
Use: Insecticide
Structure:

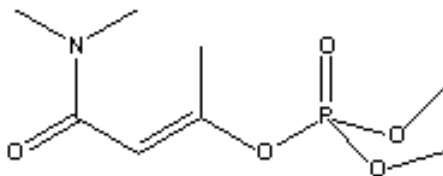

Empirical Formula: C₈ H₁₆ P O₅ N
Molecular Weight: 237

- 3) Parathion -----(same as 8 in Table 2A)

- 4) EPN (common name)
Chemical Name: O-ethyl-O-4-nitrophenyl phenylphosphonothioate
CAS No. 2104-64-5
Chemical Class: Organophosphate
Use: Insecticide
Structure:

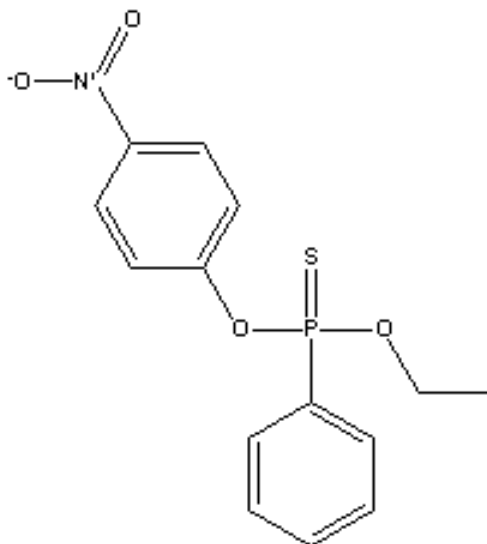

Empirical Formula: C₁₄ H₁₄ N O₄ P S
Molecular Weight: 323

- 5) Propoxur (common name)
Chemical Name: 2-(1-methylethoxy) phenyl methylcarbamate
CAS No. 114-26-1
Chemical Class: Carbamate
Use: Insecticide
Structure:

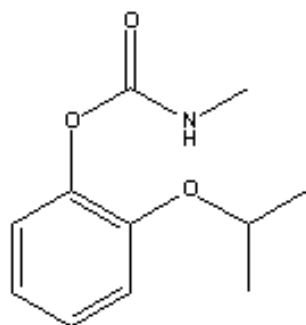

Empirical Formula: C₁₁ H₁₅ N O₃
Molecular Weight: 209

- 6) Chlorpyrifos (common name)
Chemical Name: O,O-diethyl- O-(3,5,6-trichloro-2-pyridinyl) phosphorothioate
CAS No. 2921-88-2
Chemical Class: Organophosphate
Use: Insecticide
Structure:

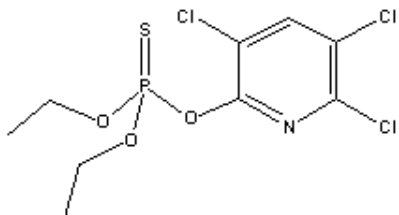

Empirical Formula: C₉ H₁₁ Cl₃ N P O₃ S
Molecular Weight: 350.6

- 7) Fenthion (common name)
Chemical Name: O,O- dimethyl-O- [3-methyl-4-(methylthio) phenyl] phosphorothioate
CAS No. 55-38-9
Chemical Class: Organophosphate
Use: Insecticide
Structure:

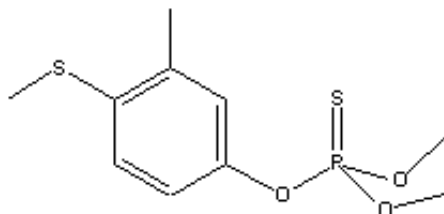

Empirical Formula: C₁₀ H₁₅ P O₃ S₂
Molecular Weight: 278

- 8) Temephos (common name)
 Chemical Name: O,O- thiodo-4,1-phenylene- O,O,O',O'-tetramethyl-
 phosphorothioate
 CAS No. 3383-96-8
 Chemical Class: Organophosphate
 Use: Insecticide
 Structure:

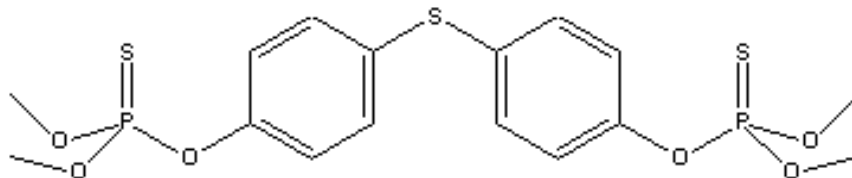

Empirical Formula: C₁₆ H₂₀ P₂ S₃ O₆
 Molecular Weight: 466

- 9) Landrin (tradename of Shell) - discontinued by Shell
 Common Name: trimethacarb
 Chemical Name: 3,4,5- trimethylphenyl methyl carbamate
 CAS No. 2655- 15- 4
 Chemical Class: Carbamate
 Use: Insecticide
 Structure:

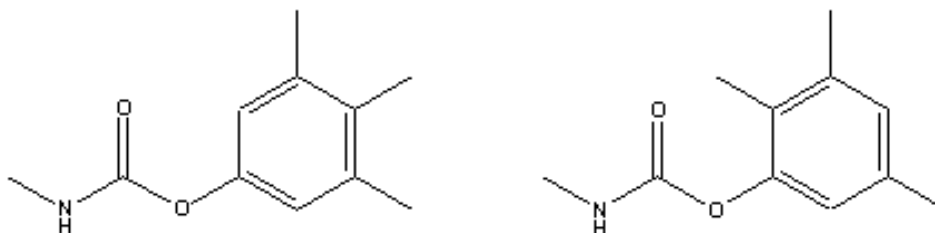

(Note: The pesticide is a mixture of both forms, 3,4,5- and 2,3,5- trimethylphenyl methylcarbamate)

Empirical Formula: C₁₁ H₁₅ O₂ N
 Molecular Weight: 193

- 10) Mexacarbate ; Zectram
Chemical Name: 4- dimethylamino-3,5-xyllyl methylcarbamate
Chemical Class: Carbamate
Use: Insecticide
Structure:

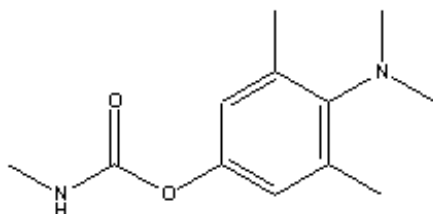

Empirical Formula: C₁₂ H₁₈ N₂ O₂
Molecular Weight: 222.3

*** References:**

1. Farm Chemical Handbook, vol.86 (2000)
2. Merck Index, 12th edition (1996)

Literature.

1. Salem, H. Factors Influencing Toxicity. Chapter 2 in Inhalation Toxicology, Residue Methods Application and Evaluation. H. Salem, Ed. Dekker (1987).
2. Trimbell, J.A. Principles of Biochemical Toxicology. Pp. 144-147. Taylor and Francis. London. Second Edition (1991).
3. Sipes, I.G. and Gandolfo, A. J. Biotransformation of Toxicants. In Casarett and Doull's Toxicology. Amdur, M.O, Doull, J. And Klassen, C.D., Editors. Pergamon Press. New York. Second Edition (1991).
4. DeBethizy, J.D. and J.aR. Hayes. Metabolism: A Determinant of Toxicity, in Principles and Methods of Toxicology. A.W. Hayes, Editor. Raven Press, N.Y. Third Edition 1994.
5. Moser, V.C. et al. Age- and Gender-Related Differences in Sensitivity to Chlorpyrifos in the Rat Reflect Developmental Profiles of Esterase Activities. Toxicological Sciences 46, 211-222 (1998).
6. Kedderis G.L. and C.A. Mugford. Sex-Dependent Metabolism of Xenobiotics. CIIT Activities, July- August 1998. Chemical Industry Institute of Toxicology.
7. Environmental Protection Agency. Comparison of Male and Female Rat Oral and Dermal LD50 Values in OPP'S One-Liner Data Base. Clement International Corporation. December 1991.
8. Hill, E.F. Acute and Subacute Toxicology in Evaluation of Pesticide Hazard to Avian Wildlife. Chapter 22 in Wildlife Toxicology and Population Modeling. R.J. Kendall and T.E.Lacher, Eds. Lewis Publishers, Boca Raton, FL. (1993).
9. Casarett and Doull's Toxicology. . Chapter 6. Biotransformation in Xenobiotics. by A. Parkinson. C. D Klassen, Editor. McGraw-Hill. New York. Fifth Edition (1996).

**COMPARISON OF MALE AND FEMALE RAT
ORAL AND DERMAL LD50 VALUES
IN OPP'S ONE-LINER DATABASE**

Prepared for:

Office of Pesticide Programs
U.S. Environmental Protection Agency
1921 Jefferson Davis Highway
Arlington, VA 22202

Prepared by:

Clement International Corporation
9300 Lee Highway
Fairfax, VA 22031-1207

December 2, 1991

Contract Number: 68D10075
Work Assignment Number: 1-23
Project Officer: Mr. Jim Scott

Contract Number: 68D10075
Work Assignment Number: 1-23
December 2, 1991

**COMPARISON OF MALE AND FEMALE RAT ORAL AND DERMAL LD50 VALUES
IN OPP'S ONE-LINER DATABASE**

Prepared by:

Carrie Rabe, Ph.D.
Principal Author
Clement International Corp.

Signature: _____

Date: _____

Sharon Segal, Ph.D.
Independent Reviewer and
QA/QC Manager
Clement International Corp.

Signature: _____

Date: _____

Approved by:

Robert Zendzian, Ph.D.
Science Analysis and
Coordination Branch
Registration Section

Signature: _____

Date: _____

SUMMARY

Male and female LD50 values from acute oral and dermal studies in the rat were extracted from the Office of Pesticide Programs' (OPP) One-liner Database and compared to determine whether one sex was uniformly more sensitive in these types of tests. Results from 125 acute oral and 8 acute dermal studies on technical grade material or metabolites were analyzed. Comparison of the LD50 values found only 3 male LD50 values that were at least 1/2 of a log greater than the corresponding female LD50 value and 1 male LD50 value that was at least 1/2 of a log less than the corresponding female LD50 value. Comparison of the 95% confidence intervals for the LD50 values showed that in 14 cases no overlap of the confidence limits existed. In 11 of the 14 cases, the confidence interval of the male LD50 value was greater than the confidence interval of the female LD50 value, and in the remaining 3 cases, the male confidence interval was less than that of the females. However, comparison of the distribution of the male and female LD50 values revealed no significant differences. These data do not support the selection of either sex as a "uniformly most sensitive sex" for use in acute oral and dermal toxicity testing.

For most chemicals, acute oral and dermal toxicity tests are required for registration under the Federal Insecticide, Fungicide, and Rodenticide Act (FIFRA). Only those manufacturing or end-use products that are highly volatile or corrosive substances that cannot be administered orally or dermally are exempted. Acute oral and dermal toxicity tests provide information on the health hazards associated with short-term oral and dermal exposure, give some information on the mechanisms underlying toxicity, and provide information useful for the design of longer-term studies. The results of these tests also serve as the basis for regulatory decisions such as whether to require use restrictions or special packaging or labeling.

Guidelines for acute oral and dermal testing have been developed by the Office of Pesticide Programs to provide registrants with information on the standards by which test results submitted to OPP for the purpose of registration under FIFRA will be evaluated.

The Health Effects Division of OPP is currently reevaluating and revising the pesticide assessment guidelines. As part of this process, public comment has been solicited. One issue that

was raised during the public comment period was the possibility of further reducing the number of animals required for these tests by identifying a most sensitive sex and conducting acute oral and dermal toxicity tests only, on that sex.

In order to evaluate the potential impact of single-sex testing, LD50 data from acute oral and dermal toxicity tests in OPP's One-liner Database were examined. OPP's One-liner Database contains a compilation of toxicity test results from over 30,000 studies on over 950 chemicals submitted to OPP over the past 7-12 years to support pesticide registrations under FIFRA. As such, the database contains a typical cross section of the range of acute oral and dermal toxicity test results likely to be submitted to OPP in the future.

METHODS

OPP's One-liner Database was searched and all acute oral and dermal toxicity study test results were extracted. The search was limited to studies on technical grade materials and metabolites. From this, male and female rat oral and dermal LD50 values (with their 95% confidence limits) from studies with core grade evaluations of minimum or guideline were extracted (Tables 1 and 2) and analyzed for sex-based differences. Only those studies with LD50 values for both males and females were used. In addition, only LD50 values expressed as discrete numerical values were used. LD50 values expressed as \leq or \geq a given number were not used. A study was not excluded if the 95% confidence interval was not presented. Statistical analysis of the data for differences between male and female LD50 values was performed using the Wilcoxin Rank Sum Test.

RESULTS AND DISCUSSION

A total of 125 paired acute oral LD50 values and 8 paired acute dermal LD50 values for male and female rats were extracted from the One-liner Database. Seventy-seven of the male and female oral LD50 values and 2 of the male and female dermal LD50 values were accompanied by their respective 95% confidence limits. The most direct approach for analyzing for potential differences between male and female LD50 data would have been to determine the number of

chemicals for which the male LD50 value for a chemical was significantly different from the female LD50 value for that chemical.

However, the One-liner Database did not contain this information. Therefore, the paired male and female LD50 values were examined for differences using a number of criteria. The first criteria used was to determine those male LD50 values that differed from the corresponding female LD50 values by % of a log or greater. A total of 4 out of 133 male LD50 values differed from the corresponding female LD50 values by this amount (Table 3). All 4 of the values were oral LD50 values. Three of the male oral LD50 values were 1/2 of a log greater than the corresponding female oral LD50 values and one was 1/2 of a log less.

The next criteria used for analyzing the LD50 data was to determine the number of male LD50 values with 95% confidence limits that fell outside the range defined by the 95% confidence limits from the corresponding female LD50 values. A total of 14 out of 79 male LD50 values had 95% confidence limits that met this criteria (Table 4 and Figure 1). All of these were from oral studies. In 11 cases, the range defined by the 95% confidence limits of the male value was greater than the range defined by the 95% confidence limits for the female LD50 value. In the remaining 3 cases, the range defined by the 95% confidence limits of the male LD50 values was less.

Finally, the distribution of male and female oral and dermal LD50 values was examined for differences. Figures 2-4 demonstrate the frequency distribution of extracted male and female LD50 values from oral and dermal studies and the combined oral and dermal data. Although males had slightly more high LD50 values than females, statistical analysis of the data showed no significant difference ($p > 0.3796$) between the distribution of male and female LD50 values.

These results demonstrate that neither sex can be identified as the uniformly most sensitive sex for use in acute toxicity testing of rats. In addition, the data examined suggest that the sexes are not equally sensitive to all of the chemicals tested. Analysis of the overlap of 95% confidence limits for paired male and female LD50 values suggests that in some cases males were more sensitive than females and in other cases the reverse was true. In approximately 14% (11/79) of the results, female rats appeared to be more sensitive than male rats, and in 4% (3/79) of the

results, males appeared to be more sensitive. This finding indicates that the choice of a single sex as representative of both sexes would also be unreliable. Thus, the proposed use of a single sex in acute toxicity tests, either because one sex is more sensitive or because both sexes are equally sensitive, cannot be supported by the data currently in the One-liner Database.

TABLE 1. RAT ORAL LD₅₀ DATA^a

MRID No. ^b	CHEMICAL NAME	MALE LD ₅₀	LOWER 95% CONFIDENCE LIMIT	UPPER 95% CONFIDENCE LIMIT	FEMALE LD ₅₀	LOWER 95% CONFIDENCE LIMIT	UPPER 95% CONFIDENCE LIMIT
241253	Acephate tech 97%	1400.00	ND ^c	ND	1000.00	ND	ND
40504833	Methylthioacetate 99.2% (structural analog)	426.00	349.00	523.00	519.00	420.00	750.00
258740	Flucythrinate	33.00	24.00	47.00	29.00	21.00	41.00
99807	Acetochlor MON 097	3712.00	2794.00	5297.00	2018.00	ND	ND
249878	MON-4620 technical	8762.00	4764.00	12760.00	6395.00	5691.00	7099.00
4072242	Ethiozin tech (90% pure) Batch 5-25-0023D	1115.00	ND	ND	59.00	ND	ND
71466	KWG 0519 (Baytan) Tech (92.7%)	689.00	571.00	831.00	752.00	647.00	874.00
246070	Bis(tri-n-butyltin)oxide (95%)	193.00	136.00	250.00	123.00	97.00	149.00
246070	Bis (tributyltin) oxide (Alkyl-sourced) (95%)	180.00	130.00	230.00	150.00	130.00	160.00
265147	Boric acid (100%)	5280.00	4630.00	6020.00	5830.00	4690.00	7230.00
247193	Bronopol (2-bromo-2-nitro-1,3-propanediol) Tech.	307.00	ND	ND	342.00	ND	ND
70894	Buctril	782.00	596.00	1026.00	793.00	500.00	1258.00
70894	Bromoxynil octanoate (Buctril)	720.00	596.00	1026.00	793.00	500.00	1258.00
148500	Carbaryl (99.0%)	302.60	272.00	336.50	311.50	280.50	345.90
4570701	Mevinphos Tech.	3.50	ND	ND	2.30	1.00	3.60
244164	Chloro-m-cresol Technical	5129.00	ND	ND	3636.00	ND	ND

TABLE 1. (Continued)

MRID No. ^b	CHEMICAL NAME	MALE LD ₅₀	LOWER 95% CONFIDENCE LIMIT	UPPER 95% CONFIDENCE LIMIT	FEMALE LD ₅₀	LOWER 95% CONFIDENCE LIMIT	UPPER 95% CONFIDENCE LIMIT
247692	CGA-1223 tech (93+%)	118.68	99.23	141.95	48.21	40.94	56.77
41662409	SAN 582H Tech. (91.4% a.i.)	2139.80	1444.90	3168.90	1296.80	899.00	1871.50
73530	DPX-Y6202 (99.1%)	1670.00	ND	ND	1480.00	ND	ND
41206105	NC-302 (Levo minus S compound) (97% Assure)	1088.00	ND	ND	870.00	ND	ND
41206104	NC-302 (Dextro plus R compd) 97% (Assure)	1209.56	ND	ND	1181.75	ND	ND
72932	Anilino acid (98.6%)	424.00	382.00	471.00	346.00	310.00	385.00
259425	Cupric hydroxide (77%)	1330.10	1001.10	1768.00	682.60	332.90	1399.60
159371	Cupric hydroxide (77%)	2500.00	1714.00	3360.00	2200.00	1497.00	3234.00
261127	Copper oxychloride (94.1%)	1537.00	1319.00	1791.00	1370.00	1138.00	1649.00
248166	Cosan 145 Tech. (50% a.i.)	1950.00	1620.00	2420.00	1620.00	1270.00	1990.00
71466	KWG 0519 (Baytran) tech (92.7%)	689.00	ND	ND	752.00	ND	ND
40345406	Uniconazole (97.2%) [E/Z = 96.3/3.8; ES/ER = 79.2/20.8]	2020.00	1740.00	2340.00	1790.00	1490.00	2150.00
72008	Cyfluthrin Tech.	869.00	ND	ND	1271.00	ND	ND
41235004	Hexazinone tech (98% pure), white solid; A3674-207	1100.00	810.00	1800.00	1200.00	1000.00	2000.00
41776115	FMC 56701 Tech. (Cypermethrin S; 88.1% a.i.)	134.40	100.40	168.50	86.00	45.70	126.30
99855	Cypermethrin Tech, 53:47 cis-trans	247.00	187.00	329.00	309.00	150.00	500.00

TABLE 1. (Continued)

MRID No. ^b	CHEMICAL NAME	MALE LD ₅₀	LOWER 95% CONFIDENCE LIMIT	UPPER 95% CONFIDENCE LIMIT	FEMALE LD ₅₀	LOWER 95% CONFIDENCE LIMIT	UPPER 95% CONFIDENCE LIMIT
41563908	CGA 163935 Tech. (96.6%)	4613.00	ND	ND	4212.00	ND	ND
40607713	Cyproconazole tech (95.7%)	1020.00	ND	ND	1330.00	ND	ND
249937	Fenpropathrin (91.8%)	70.60	53.70	92.70	66.70	50.60	87.90
249937	Fenpropathrin (97.3%)	164.00	115.00	234.00	107.00	69-80	164.00
401264	DTEA (2-Decylthioethane amine) (99.8%)	3940.00	3164.00	5556.00	2272.00	1361.00	3362.00
263861	Dicamba (3,6-dichloro-o-anisic Acid Tech.	3299.80	1849.60	5887.20	3604.00	3021.30	4299.00
73661	MON-4660(4-Dichloroacetyl-1-oxa- 4-azaspiro[4.5]decane) (94.97%)	2800.00	ND	ND	2400.00	ND	ND
251863	Diallate EC [S-(2,3-Dichlorallyl diisopropylthiocarbamate)	1256.00	961.00	1642.00	865.00	417.00	1149.00
150953	Dichlorocyanurate sodium salt tech.	2094.00	1555.00	2636.00	1671.00	1423.00	1962.00
253099	Isopropylester of 2,4-D Tech.	640.00	500.00	829.00	440.00	275.00	704.00
41164301	Sodium salt of 2,4-D	594.30	488.90	722.50	449.70	354.00	571.30
128854	2,4-DB (98%)	2.33	1.45	3.76	1.54	1.14	2.08
73192	RO 15-197/000 (99% pure)	3095.00	1990.00	4436.00	2864.00	1519.00	4033.00
41062506	Quinclorac (BAS 514 H Tech) Reg. # 150 732	3060.00	ND	ND	2190.00	ND	ND
5467	DDVP tech.	80.00	ND	ND	56.00	ND	ND
146179	Diazol Tech. (Diazinon)	775.00	583.00	967.00	499.00	363.00	635.00

TABLE 1. (Continued)

MRID No. ^b	CHEMICAL NAME	MALE LD ₅₀	LOWER 95% CONFIDENCE LIMIT	UPPER 95% CONFIDENCE LIMIT	FEMALE LD ₅₀	LOWER 95% CONFIDENCE LIMIT	UPPER 95% CONFIDENCE LIMIT
246501	Diiodomethyl-para-tolyl-sulfone	15400.00	ND	ND	15400.00	. ND	ND
246798	Metacil 180 oil flowable	148.00	131.00	168.00	162.00	137.00	190.00
40583901	Dimethyl formamide tech (99.1%)	477.50	ND	ND	387.50	ND	ND
243414	Methyl parathion tech (after 1 year storage)	14.00	11.02	17.78	18.50	11.21	30.53
256258	NIRAN M/8 (80%) (AEML-05001)	10.00	ND	ND	15.00	ND	ND
40280101	Azinphos-methyl tech (85%)	9.00	7.20	11.40	6.70	5.60	7.90
261098	Bidrin (dicrotophos) tech. (88.3% a.i.)	11.00	ND	ND	8.00	ND	ND
248349	Diodine (98.9%)	1931.00	ND	ND	1117.00	ND	ND
70652	EL-919	7.20	6.70	7.70	9.30	8.88	9.72
71259	Isouron (94.4%)	613.00	ND	ND	484.00	ND	ND
40042106	1[[Bis(4-fluorophenyl)methyl- silyl]methyl]-1H,1,2,4-triazole (97%)	1110.00	1008.00	1222.00	674.00	563.00	765.00
40042106	INH-6573 tech (97%) Batch #	1110.00	ND	ND	674.00	ND	ND
249155	3,5-Dibromo-4-hydroxy- benzonitrile (94.0%) Inerts (6%)	81.	ND	ND	93.30	ND	ND
157590	Ethion tech (purity 98.8%)	191.00	ND	ND	21.00	ND	ND
255690	FMC 67825 (94.9%) (in corn oil)	47.50	40.30	54.70	30.10	26.50	33.80
72165	Cycloate Tech. (98.0%)	3200.00	2717.00	3769.00	2275.00	2066.00	2505.00

TABLE 1. (Continued)

MRID No. ^b	CHEMICAL NAME	MALE LD ₅₀	LOWER 95% CONFIDENCE LIMIT	UPPER 95% CONFIDENCE LIMIT	FEMALE LD ₅₀	LOWER 95% CONFIDENCE LIMIT	UPPER 95% CONFIDENCE LIMIT
254690	Butylate Tech. (98.0%) Lot # GGC-0301	4850.00	ND	ND	4785.00	ND	ND
261729	EPTC tech	1465.00	1290.00	1663.00	1712.00	1324.00	2214.00
41379716	Flucyclozuron (PH 70-23 liq 25)	4061.00	ND	ND	4585.00	ND	ND
248473	FMC 54800 Tech. (91.4%)	70.10	57.07	83.13	53.80	48.88	58.72
265046	Flutriafol Tech. (93%) Batch PIO,D2518/75	1140.00	880.00	1470.00	1480.00	1090.00	1980.00
40700917	HWG 1608 (97.1% a.i.) (Terbuconazole)	4264.00	3952.30	5330.20	3352.00	2341.40	3977.50
253165	Folpet tech (91.2% a.i.) (code SX-1346)	43800.00	35000.00	55600.00	19500.00	7500.00	51000.00
263525	Hexaconazole (PP523) (92.3% a.i.)	2189.00	1076.00	4083.00	6071.00	2283.00	0.00
257431	3-Iodo-2-propynyl butyl carbamate (99%)	1795.00	1437.00	2243.00	1065.00	783.00	1329.00
41013703	Chlorpropham Tech. (SX-1817) (99.7% pure)	4100.00	0.00	7000.00	4800.00	2900.00	7100.00
72853	S-(1,1-dimethyl)-o-ethyl-ethyl-phosphorothioate Tech. (93%)	3.90	3.20	4.60	2.10	ND	ND
263461	Butoxyethyl ester of 2-methyl-4-chlorophenoxyacetic acid (93.3%)	1000.00	ND	ND	785.00	ND	ND
245474	Vydate (97.1%) Inerts (2.9%)	3.10	2.60	3.50	2.50	2.40	2.70
364390	Methylisothiocyanate (97%)	82.00	43.00	155.00	55 00	12.00	99 00
264268	Zectran Tech. (90.5% a.i.)	8.51	ND	ND	9.12	ND	ND
72962	HOE 39866 (92.1% a.i.)	2000.00	1600.00	2490.00	1620.00	1190.00	1740.00

TABLE 1. (Continued)

MRID No. ^b	CHEMICAL NAME	MALE LD ₅₀	LOWER 95% CONFIDENCE LIMIT	UPPER 95% CONFIDENCE LIMIT	FEMALE LD ₅₀	LOWER 95% CONFIDENCE LIMIT	UPPER 95% CONFIDENCE LIMIT
253414	NAK-1654 tech (97.2% pure)	85.00	69.00	101.00	87.00	69.00	106.00
247582	1-Sodium naphthyl acetate (95%)	1350.00	1120.00	1640.00	930.00	630.00	1380.00
248688	Paclobutrazol (97% pure)	1954.00	1147.00	4985.00	1336.00	837.00	1969.00
40521001	p-Dichlorobenzene	3863.00	3561.00	4153.00	3790.00	3425.00	4277.00
243412	Parathion Tech. (in corn oil)	10.80	6.75	15.12	2.52	1.33	4.76
248286	Pentachlorobenzene (99%)	1125.00	1015.00	1247.00	1080.00	ND	ND
40883711	Fortress (86% a.i.)	4.80	4.40	5.30	1.80	1.70	2.00
40667411	XRD-429 (Lot # AGR-185781) (98.8% purity)	3.20	ND	ND	1.10	ND	ND
73280	Pyridate Tech. (90.3% a.i.)	5993.00	3164.00	33610.00	3544.00	871.00	8848.00
248855	Sulfaquinoxaline Tech. (99.5%)	1370.00	940.00	1860.00	1600.00	1140.00	2100.00
40974507	RE-45601 tech (SX-1688) (83.3%)	1630.00	ND	ND	1360.00	ND	ND
72896	RH-53,866 Tech. (Lot # 83159-5) (91.9% pure)	1600.00	ND	ND	2290.00	ND	ND
259842	Gokilaht tech (93.6%)	318.00	219.00	463.00	419.00	281.00	624.00
259805	Karate (92.6% & 96%)	79.00	ND	ND	56.00	40.00	78.00
264268	Zectran tech (96.5% a.i.)	9.77	ND	ND	12.00	ND	ND
73203	Cyhalothrin - 94% pyrethoid, 97% cis-isomer	243.00	183.00	312.00	144.00	100.00	320.00

TABLE 1. (Continued)

MRID No. ^b	CHEMICAL NAME	MALE LD ₅₀	LOWER 95% CONFIDENCE LIMIT	UPPER 95% CONFIDENCE LIMIT	FEMALE LD ₅₀	LOWER 95% CONFIDENCE LIMIT	UPPER 95% CONFIDENCE LIMIT
256581	Trophy tech	2479.00	ND	ND	2283.00	ND	ND
252599	Captafol Tech. (98.3%)	6780.00	ND	ND	6330.00	ND	ND
246326	Captafol (80%)	5600.00	4000.00	7700.00	3800.00	2400.00	6100.00
261401	PP93 tech	21.80	ND	ND	34.60	ND	ND
251666	Dazomet (99%)	596.00	ND	ND	415.00	ND	ND
246892	o,o,o,o-tetrapropyldithio- pyrophosphate (90%) Inerts (10%)	2800.00	2314.00	3388.00	740.00	623.00	879.00
247279	Thiabendazole (98.5%) [2-(4-thiazolyl)benzimidazole]	5070.00	3982.00	6389.00	4734.00	3371.00	6541.00
244531	2-(4-thiazolyl)bezimidazole (98.5%) (43410-T)	3970.00	2920.00	5400.00	3540.00	2140.00	5850.00
41127501	AO159 tech insecticide (98.0%) (2H-1,3-thiazine-tetrahydro-2 nitromethylene)	285.00	ND	ND	314.00	192.00	398.00
163854	Thiram tech (99.4%)	3700.00	ND	ND	1800.00	ND	ND
150959	Trichlorocyanurate Tech.	787.00	585.00	1059.00	868.00	622.00	1114.00
242367	Trichlopyr tech (Dow233) intubation in acetone/corn oil (1:9)	729.00	515.00	1127.00	630.00	450.00	829.00
73463	Triflumizole tech	1057.00	863.00	1297.00	1780.00	1369.00	2314.00
249422	Landrin tech (in corn oil)	125.00	ND	ND	134.00	ND	ND
71364	Triphenyltin hydroxide tech	165.00	113.00	230.00	156.00	115.00	208.00
252512	Triphenyltin hydroxide (96%)	165.00	ND	ND	156.00	ND	ND

TABLE 1. (Continued)

MRID No. ^b	CHEMICAL NAME	MALE LD ₅₀	LOWER 95% CONFIDENCE LIMIT	UPPER 95% CONFIDENCE LIMIT	FEMALE LD ₅₀	LOWER 95% CONFIDENCE LIMIT	UPPER 95% CONFIDENCE LIMIT
71811	Larvin tech (in corn oil)	84.10	61.50	115.00	50.00	34.90	71.70
/1811	Larvin tech (in methyl cellulose)	82.70	65.70	104.00	50.80	39.30	65.70
71811	Larvin tech (in methyl cellulose)	96.10	59.90	154.00	57.40	39.80	82.80
71811	Larvin tech (in methyl cellulose)	51.60	46.30	57.50	36.70	28.60	47.20
718111	Larvin tech (in methyl cellulose)	74.80	59.90	106.00	72.00	49.20	102.00
71811	Larvin tech (in methyl cellulose)	46.50	33.40	64.70	50.90	46.10	56.20
71811	Larvin tech (in methyl cellulose)	129.00	89.60	186.00	59.10	40.70	86.00
71811	Larvin tech (in methyl cellulose)	68.90	56.60	83.80	39.10	29.40	52.10
248139	U56215 Tech.	9098.00	ND	ND	7652.00	ND	ND
251418	Vitamin D3 tech	352.00	263.00	484.00	619.00	495.00	782.00
72330	SY-83 (L+)Lactic acid	4936	ED	ND	3543	ND	ND
248258	Haloxypop methyl (99.0%)	393	339	465	599	453	874
248473	FMC 57020 Tech. (88.8% a.i.) (Dimethazone)	2077	1976	2358	1369	1127	1611

^aData presented in mg/kg.

^bMRID No., Master Record Identification Number A unique identifying number assigned to each document submitted to the Office of Pesticide Programs. The numbers listed identify the report of the Acute Toxicity Study from which the compound-related data were extracted.

^cNo Data

TABLE 2. RAT DERMAL LD₅₀ DATA^a

MRID No. ^b	CHEMICAL NAME	MALE LD ₅₀	LOWER 95% CONFIDENCE LIMIT	UPPER 95% CONFIDENCE LIMIT	FEMALE LD ₅₀	LOWER 95% CONFIDENCE LIMIT	UPPER 95% CONFIDENCE LIMIT
261971	Methylthioacetate (SX-1500) (99% pure)	1590.00	ND ^c	ND	1580.00	ND	ND
40504836	Methylthioacetate (99.2%) (conaminant)	1920.00	1550.00	2390.00	1410.00	1140.00	1760.00
261971	Methylthioacetate (SX 1500) (99% pure) (conaminant)	1590.00	ND	ND	1580.00	ND	ND
40364203	Benazolin tech (97.6%) Batch CR16/343/3	2100.00	ND	ND	2100.00	ND	ND
5467	DDVP Tech.	107.00	ND	ND	75.00	ND	ND
261098	Bidrin (dicrotophos) tech (88.3% a.i.)	876.00	ND	ND	487.00	ND	ND
259805	Karate (92.6%)	632.00	300.00	900.00	696.00	309.00	1169.00
261401	FP993 Tech.	316.00	ND	ND	177.00	ND	ND

^aData presented in mg/kg.

^bMRID No., Master Record Identification Number A unique identifying number assigned to each document submitted to the Office of Pesticide Programs. The numbers listed identify the report of the Acute Toxicity Study from which the compound-related data were extracted.

^cNo Data

TABLE 3. CHEMICALS WITH MALE AND FEMALE LD₅₀ VALUES DIFFERING BY GREATER THAN 1/2 LOG^a

MRID No. ^b	CHEMICAL NAME	MALE LD50	LOWER 95% CONFIDENCE LIMIT	UPPER 95% CONFIDENCE LIMIT	FEMALE LD50	LOWER 95% CONFIDENCE LIMIT	UPPER 95% CONFIDENCE LIMIT
40042106	1[[Bis(4-fluorophenyl)methylsilyl]methyl]-1H,1,2,4-triazole (97%)	1110.00	1008.00	1222.00	674.00	563.00	765.00
157590	Ethion tech (purity 98.8%)	191.00	ND ^c	ND	21.00	ND	ND
243412	Parathion Tech (in corn oil)	10.80	6.75	15.12	2.52	1.33	4.76
246892	o,o,o,o-tetrapropylthiopyro phosphate (90%); Inerts (10%)	2800.00	2314.00	3388.00	740.00	623.00	879.00

^aData presented in mg/kg.

^bMRID No., Master Record Identification Number A unique identifying number assigned to each document submitted to the Office of Pesticide Programs. The numbers listed identify the report of the Acute Toxicity Study from which the compound-related data were extracted.

^cNo Data

TABLE 4. CHEMICALS WITHOUT OVERLAPPING MALE AND FEMALE LD₅₀ 95% CONFIDENCE LIMITS^a

MRID No. ^b	CHEMICAL NAME	MALE LD50	LOWER 95% CONFIDENCE LIMIT	UPPER 95% CONFIDENCE LIMIT	FEMALE LD50	LOWER 95% CONFIDENCE LIMIT	UPPER 95% CONFIDENCE LIMIT
247692	CCA-123 tech (93+%)	118.68	99.23	141.95	48.21	40.94	56.77
70652	EL-919	7.20	6.70	7.70	9.30	8.88	9.72
40042106	1[[Bis(4-fluorophenyl)methyl- silyl]methyl]-1H,1,2,4-triazole (97%)	1110.00	1008.00	1222.00	674.00	563.00	765.00
255690	FMC 67825 94.9% (in corn oil)	47.50	40.30	54.70	30.10	26.50	33.80
72165	Cycloate Tech (98%)	3200.00	2717.00	3769.00	2275.00	2066.00	2505.00
248473	FMD 57020 Tech. (88.8% a.i.) (Dimethazone)	2077.00	1976.00	2358.00	1369.00	1127.00	1611.00
257431	3-Iodo-2-propynyl butyl carbamate (99%)	1795.00	1437.00	2243.00	1065.00	783.00	1329.00
243412	Parathion Tech (in corn oil)	10.80	6.75	15.12	2.52	1.33	4.76
40883711	Fortress (86% a.i.)	4.80	4.40	5.30	1.80	1.70	2.00
246892	o,o,o,o-tetrapropylthiopyro phosphate (90%); Inerts (10%)	2800.00	2314.00	3388.00	740.00	623.00	879.00
73463	Tiflumizole tech	1057.00	863.00	1297.00	1780.00	1369.00	2314.00
71181	Larvin Tech. (in methyl cellulose)	129.00	89.60	186.00	59.10	40.70	86.00
71181	Larvin Tech. (in methyl cellulose)	68.90	56.60	83.80	39.10	29.40	52.10
251418	Vitamin D3 Technical	352.00	263.00	484.00	619.00	495.00	782.00

^aData presented in mg/kg.

^bMRID No., Master Record Identification Number A unique identifying number assigned to each document submitted to the Office of Pesticide Programs. The numbers listed identify the report of the Acute Toxicity Study from which the compound-related data were extracted.

^cNo Data

Figure 1

Comparison of Overlap of 95% Confidence Limits of Oral and Dermal LD₅₀ Values

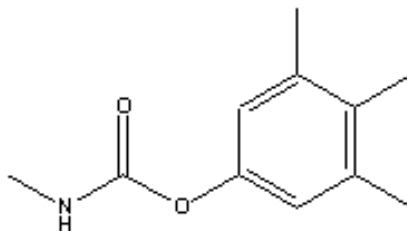

Figure 2
LD₅₀ Frequencies, Oral Dosing

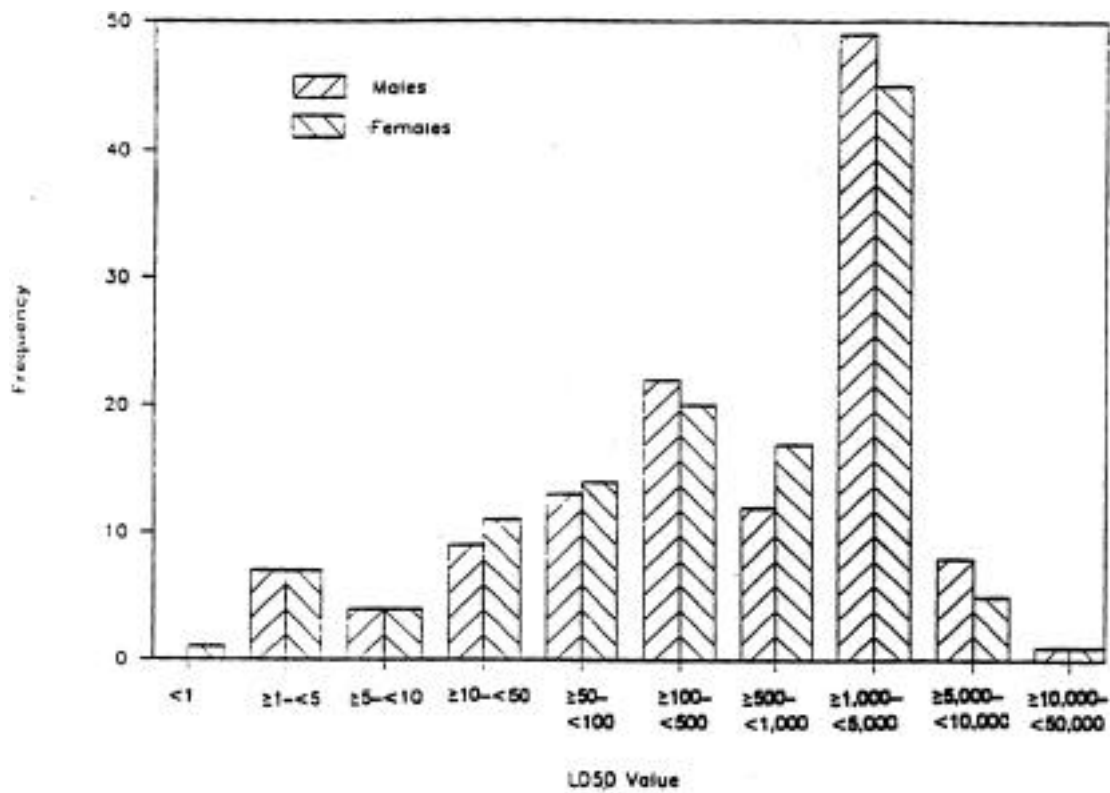

Figure 3

LD₅₀ Frequencies, Dermal Dosing

Figure 4

LD₅₀ Frequencies, Combined Dosing Data

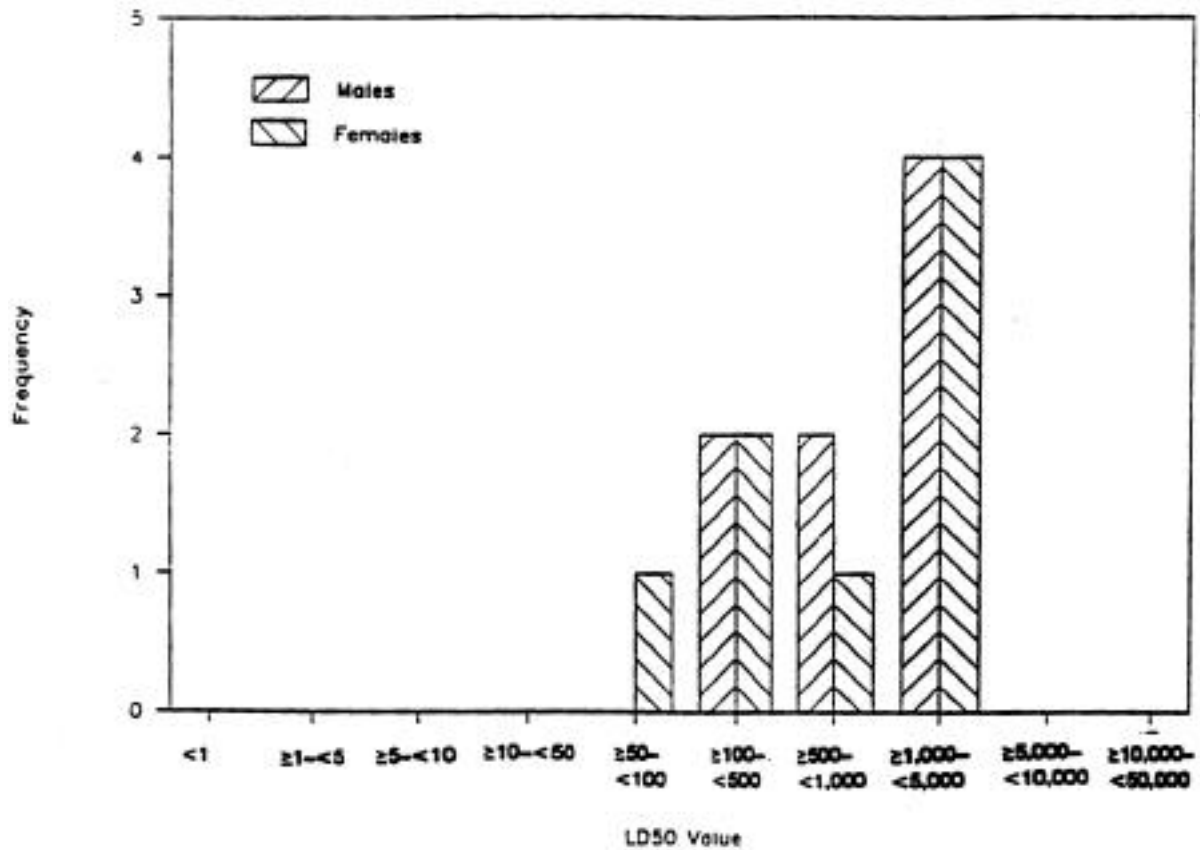
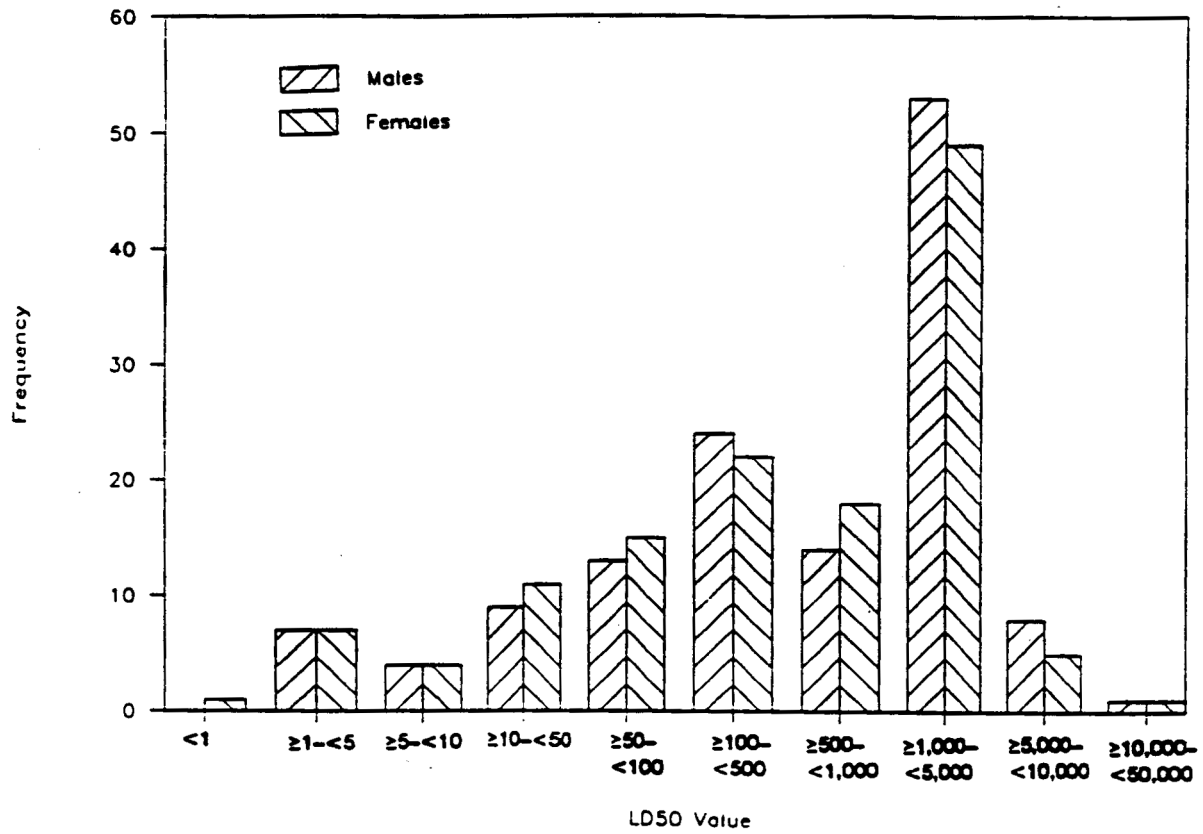

Acute and Subacute Toxicology in Evaluation of Pesticide Hazard to Avian Wildlife

Elwood F. Hill

ABSTRACT

Single-dose acute oral and short-term subacute dietary toxicity tests with captive birds provide critical information on the potential hazard of pesticides to wild populations. The two tests have similar experimental designs and both generate a lethality curve and estimation of its midpoint, the median lethal dosage (LD₅₀) or concentration (LC₅₀). Although LD₅₀s and LC₅₀s are widely used to characterize pesticide toxicity, the lethality curve and critical observation of animal response to chemical challenge provide necessary insight for hazard evaluation. The highly controlled acute test is based on graded dosage by body mass and provides a sound method of comparing naive sensitivity to toxicant and a means of detecting pesticides that may cause large-scale field kills. In contrast, the subacute test presents graded concentrations of a chemical in the diet for a specified duration, usually 5 days. This feeding trial provides an evaluation of response to repeated chemical exposures as may be encountered in the field. This chapter is an appraisal of the two basic tests of lethality with an emphasis on factors that may affect interpretation of potential hazard.

KEY WORDS

birds, pesticides, lethal toxicity, hazard

INTRODUCTION

The single-dose acute oral toxicity test is used in preliminary evaluation of virtually all substances of suspected biological activity. The test is based on administration of graded dosage of chemical in relation to body mass. The primary objective is to generate estimates of the dose-response or lethality curve and its midpoint, the median lethal dosage or LD₅₀.¹ Once these statistical parameters and their associated errors are properly determined this test of lethality provides a proven means of quantifying chemical potency and comparing substances of different mechanisms and sites of action.² The value of an acute test is greatly enhanced by detailed observation of each animal from the time of dosage to its death or recovery. Too often, however, comparisons and interpretation of acute tests are focused on the LD₅₀ exclusive of its statistical reliability and without reference to the lethality curve or other supplemental observations that provide important clues about acute toxicity and hazard evaluation. The LD₅₀, per se, is simply a convenient index of toxicity that is subject to error, and its indiscriminate use can be misleading.³

In wildlife toxicology, two tests of lethality are routinely required on birds for pesticide registration in the United States.⁴ The first is a standardized acute test of captive reared adult mallards (*Anas platyrhynchos*) or northern bobwhites (*Colinus virginianus*).⁵ The second test is similar to the acute test except graded concentrations of chemical are presented ad libitum in the

feed for 5 days to young mallards or northern bobwhites of specified ages, and the midpoint of the lethality curve is quantified as the median lethal concentration or LC₅₀.⁶ This subacute feeding trial is intended to augment the acute test by measuring response to repeated exposures and accumulative effects. Whereas the acute test provides a measure of a species' naive sensitivity to a toxic substance and a convenient index for rating its potency, the subacute test provides a measure of the species' ability to cope with a contaminated diet for a specified duration, allowing for the metabolic changes that occur over time.⁷ Careful observation for changes in behavior and rate of feeding and for onset and course of toxic signs is especially important during subacute tests because the subjects voluntarily eat the potentially lethal diets. These two tests of lethality must never be viewed casually because they are often the only required avian tests for pesticide registration.^{4,8}

This chapter is an appraisal of avian single-dose acute oral and 5-day dietary subacute toxicity tests as they are used in the evaluation of pesticide hazard. The basic tests of lethality, their toxicologic rationale, and key statistical treatments are described. Data are presented to illustrate experimental factors that affect toxicologic interpretation. The focus of the examples is on contemporary pesticides, many of which work through the same toxic mechanisms but often yield profound differences in response and potential environmental hazard.

THE BASIC TESTS

Classical acute toxicity tests are designed to determine exposures that cause death under a prescribed protocol with treatment levels that are based on animal response rather than practical residues. When treatments are properly arranged, however, the resultant lethality curve provides estimates of the LD₅₀ and other dose-response coordinates that may be used in hazard assessment. Once the basic lethality curve and response to a substance are determined for several appropriate species, determination of only the general order of the substance's toxicity by approximate tests^{9,10} with alternative species or finished product formulations may then be adequate. The choice between use of a full-scale or an approximate test depends on the purpose of the study. Although one should always strive to use the smallest number of animals, good science that is supported by sound statistical analysis must never be compromised.

Toxicologic Rationale

Toxic response is graded by the concentration of the substance that penetrates the target and remains in contact for a sufficient time to elicit change. The concentration of substance that penetrates the target is usually correlated directly with the dosage that is received by the organism. However, various biological, chemical, and physical factors influence translocation and penetration of substances, and individuals may not be equally sensitive to a chemical. Therefore, response will vary even within a homogeneous population.¹¹ This natural diversity is approximated by a normal Gaussian distribution with about one third of the population divided equally between hyper- and hyposensitive individuals. When individual responses are described quantitatively, the frequency-response curve tends to be skewed toward hypersensitive respondents because their arithmetic range of tolerance is smaller than that of hyposensitive individuals.¹ Because the representation of hyper- and hyposensitive individuals is assumed to be equal in a homogeneous population, a series of groups may be randomly selected from the population and gradation of dose-related responses between groups may be generated if dosages

of test substance are properly spaced. Responses can be quantified as qualitative changes by a preselected all or nothing (binary) endpoint. In acute testing of lethality, the endpoint is alive or dead, and the responses can be evaluated quantitatively because the percentage of respondents increases with dosage. This concept and the factors responsible for diversity of response among individuals are well documented.^{1,2, 9-14}

Dose-Response or Lethality Curve

The percentage of respondents in a lethality test is related to the composite tolerances of the population.^{1,13} The pattern of response to graded dosages of substance is analogous to the graded tolerances of individual specimens and gives a frequency distribution skewed toward hypersensitivity and an asymmetric sigmoid curve when percentage response is plotted against dosage. The resultant dose-response curve is quite steep from its origin to the inflection point (at about the 30% response level) and then becomes gradual until virtually asymptotic. Because skewed data are difficult to analyze statistically, test dosages are usually arranged logarithmically to normalize the distribution of responses.^{1,12} Normalization gives a symmetric sigmoid dose-response curve with the inflection point at the exact midpoint, the 50% response level.

The symmetric dose-response curve represents a cumulative normal distribution of log-tolerances. Steepness of the curve is similar for many substances but may become significantly steeper or shallower depending on the substance's mechanism of action, route or method of exposure, or shift of tolerance in the population. Thus, the dose-curve has interpretive value in addition to determination of probable dose-response coordinates. However, the linear portion of the curve is limited to a range of only 30 to 35 percentage points on either side of the 50% response level. The entire curve can be made linear by transforming the percentage response for log-dosage to probits.^{1,12} Responses can then be analyzed by probit analysis, a method of calculating maximum likelihood fit of a probit-log-dose line by an iterative weighted regression analysis. The analysis provides critical interpretive statistics such as the median response level and its 95% confidence interval, and the slope of the weighted linear regression of probits on log-dose and its error. A systematic probit analysis, including calculation of all relevant toxicity statistics, is presented by Finney.¹ Although probit analysis or shortcut procedures by probit analysis are traditionally used in statistical evaluation of acute-type lethality tests, the movement is toward use of logit analysis as a more convenient computational method.¹²

Toxicity Comparisons

Comparison of toxicity between chemicals is possible with data generated by probit analyses if the level of tolerance of test populations is the same and the probit regression lines are parallel.¹ The level of tolerance can be assumed comparable if the test subjects are selected randomly from a single population and are tested concurrently in a completely randomized experiment.¹ In hazard evaluation of pesticides, data sets from many laboratories usually provide the basis of comparison, and such restrictive criteria cannot often be met. Even when tests are conducted in one laboratory, problems as indicated by Finney,¹³ may arise: "One feature possessed by all biological assays is the variability in the reaction of the test subjects and the consequent impossibility of reproducing at will the same results in successive trials, however carefully the experimental conditions are controlled." This variability can be corrected

statistically by concurrent testing of a standard preparation that has the same biologically active principle as the test preparation.¹³ This too is impractical because even pesticides that act on the same physiologic system may do so in different ways; e.g., central nervous system (CNS) stimulation by chlorinated cyclodiene insecticides or cholinesterase (ChE) inhibition by organophosphorus (OP) insecticides. Nonetheless, the researchers who generated most of the early avian subacute lethality data on pesticides believed that the test of a general standard substance should accompany all tests irrespective of mechanism of action.^{16,17} Dieldrin was used as the standard and results have been summarized.¹⁷⁻¹⁹ Even though the basic data from these reports have been widely used in hazard evaluation, a literature search failed to reveal evidence that the dieldrin standard was ever used as suggested for correction of LC₅₀s. Such specific corrections may best not be made on the basis of the dieldrin standard because consensus presently favors use of a nonspecific standard primarily for intralaboratory quality control rather than routine adjustment of LD₅₀s or LC₅₀s.¹⁹⁻²¹

Statistical techniques for comparison of potency among chemicals, including median response levels and slope of the probit regression curves, have been described.¹ A simplified method for separation of LD₅₀s or LC₅₀s is to compare the 95% confidence intervals for overlap; if they do not overlap, the median response levels may be considered different at $p < 0.05$. Other methods such as the two-tailed t test and Bonferroni s t statistics²² are also used for comparison of median response levels. Median response levels must be statistically separable ($p < 0.05$) before quantitative comparison is credible. Toxicologic literature is replete with conclusions from comparison of LD₅₀s that are obviously not different or the data are inconclusive because of omission of the 95% confidence interval or other estimate of variation. Even when the median response levels are statistically different, the same relationship cannot be assumed at different response levels without testing the slopes of the dose-response curves for parallelism.^{1,17} When the slope of the dose-response curve and the median (50%) response level are known, any derived response level can be estimated.^{1,17-19} Although response levels other than the 50% response may be desired, estimates of this type must be used cautiously because extrapolation from a standard probit regression line can be misleading if the true regression equation has some curvature.¹ In wildlife toxicology, the historical focus of acute toxicity testing has been on estimation and general comparison of LD₅₀s with approximate statistical procedures that do not provide for statistical estimation of the dose-response curve.^{23,24}

Test Protocols

Single-Dose Acute Oral Toxicity Test

Optimal use of the acute test in hazard evaluation requires statistical estimation of the lethality curve and its midpoint and descriptive information on toxic response. The test for birds is basically the same as that described for laboratory animals.^{3,10} The test involves dosage of test substance as a proportion of body mass and detailed observation of response until death or recovery. Ideally, a statistically adequate number of adult nonbreeding birds are drawn from a homogeneous population, weighed, and randomly assigned to individual test pens in a controlled environment room about 2 weeks prior to testing. A few extra birds are provided in case substitution is necessary. Room temperature and photoperiod are maintained at about 24° to 28°C and 10L:14D. The short day ensures reproductive quiescence to minimize sex differences. After 1 week the birds are evaluated and any that appear obviously substandard are replaced. On the

morning of the day prior to testing, birds are weighed in order to calculate dosage and are given a general health check. That evening, feed is removed in preparation for dosing the next morning.

Overnight-fasted birds receive a single dose of the test substance at midmorning. Feed is provided immediately after dosing, and observations for signs of intoxication are continued throughout the day. Special attention is given to the time of first evidence of toxicity, recovery, or death. Observations are continued twice daily or more often as indicated for 2 weeks after treatment or as long as toxic signs persist. Excellent summaries of observed toxic signs in acute tests of birds are available.^{3,25} Gross necropsy should be performed on all birds that die and on a subsample of survivors to document significant toxic lesions.

Test substance is usually administered to the proventriculus in gelatin capsule or by gavage in water or suitable organic solvent. About five birds per sex are tested at each of five or six geometrically arranged dosage levels spanning the expected 10 to 90% mortality levels. Dosage levels are determined from a preliminary study of three widely spaced dosages administered to three to five birds each. Three kinds of controls (negative or sham, vehicle, and positive) may accompany each test; negative and vehicle are mandatory. The size of negative and vehicle control groups must each be equal to at least one dosage level; e.g., five birds per sex, with individuals integrated into the initial experimental design and treated exactly the same as those on test substance. Negative controls receive sham treatment - insertion of empty dosing apparatus. Vehicle controls receive vehicle minus test substance. Positive controls, if used, receive a standard substance of known potency with the same biological action as the test substance. Use of the standard substance requires a full test to compare the slope of the dose-response curve and LD₅₀.¹³ The LD₅₀ and its 95 % confidence interval, expressed as milligram of active ingredient per kilogram of body mass, and the slope and error of the dose-response curve are derived by probit,¹ logit,¹² or other appropriate analysis.^{3,10,15}

When only the general order of acute toxicity is desired, (e.g., to compare many species or fin shed product formulations), an approximate test of lethality may be used.^{9,10,25,26} The treatment of test animals and post-dosage observations in these studies are the same as described for the full-scale acute test. The difference is that as few as three groups of three to five subjects are tested against a series of prearranged dosages, with LD₅₀ and its 95% confidence interval calculated from published tables.^{9,24}

Five-Day Subacute Dietary Toxicity Test

The design of the subacute test is based on the single-dose acute oral test.⁸ The test was developed to quantify the toxicity of contaminants for which the diet was considered an important source of exposure.¹⁶ The subacute test was optimized with young precocial birds, such as ducks and quail, but virtually any species can be tested under the protocol if it can be maintained in captivity in good health and cannot survive for 5 days without eating.^{21,27,28} If a portion of the test population can fast for 5 days, the results are erratic and not easily reproduced. Thus, the species of choice must be susceptible to the test protocol. This condition of susceptibility has been questioned because death by starvation does not represent the direct toxicity of a chemical.²⁹ Others have demonstrated that susceptible birds eventually eat rather

than starve,³⁰ and even though death is undoubtedly influenced by nutritional status, it remains primarily a chemical effect.²⁸

Like the acute test, the subacute test generates a lethality curve and its midpoint as well as descriptive information on toxic response. The basic design uses the same number of animals, treatment levels, and control groups as the full-scale acute test. However, when testing very young precocial species, birds must be maintained in groups in heated brooder units with at least 14 hours of light.^{6,18} Therefore, only one pen of equal-aged birds is usually tested at each concentration of test substance. To ensure susceptibility to the 5-day test, the recommended test ages for the most common model species are 5 days for mallard, 10 days for ring-necked pheasant (*Phasianus colchicus*), and 14 days for northern bobwhite and Japanese quail (*Coturnix japonica*).^{6,18,21} Because of the young age at start, randomization to test pen is usually 2 days prior to testing. Any apparently substandard birds are replaced by surplus hatchmates.

Test substance is presented midmorning in an ad libitum diet to birds of the prescribed age and is continued for 5 days. Mortality and signs of intoxication are monitored at least twice daily. Food consumption is measured at 24-hour intervals. Fresh feed is added to all pens each day. After the fifth day, all feed, including that of control groups, is replaced with untreated feed and the study is continued for at least 3 days. When toxic signs persist, observation is continued through complete remission. The LC₅₀ and its 95% confidence interval, expressed as milligram of active ingredient per kilogram of feed (or parts per million) in a 5-day ad libitum diet, and the slope and error of the dose-response curve are derived by probit analysis or other suitable method exactly as acute tests.

COMPARATIVE TOXICOLOGY

Birds vs Laboratory Rats

Acute tests of laboratory rodents are the most readily available toxicologic data on vertebrates and often serve as the primary factor in decisions on pesticide hazard to wildlife. For example, a rat LD₅₀ above 200 mg/kg is generally considered only moderately toxic; if the pesticide also has poor affinity for lipids and is therefore not likely to bioaccumulate, the pesticide use may be considered low risk for general purposes of environmental impact, and often no additional attention is paid to potential wildlife hazard. However, such a conclusion may be inappropriate because the pesticide may be applied many times during the year, with its fate influenced by widely diverse factors, and the sensitivity to acute exposure may be quite different in birds than in laboratory rats.

Acute sensitivity to pesticides is not the same in birds as in laboratory rats. In Table 1, LD₅₀s for ring-necked pheasants and red-winged blackbirds (*Agelaius phoeniceus*) are compared to LD₅₀s for laboratory rats for OP insecticides of widely variable toxicity. All tests of each species were conducted at a single laboratory. Pheasants and blackbirds are presented because both species have general feeding habits, but represent extreme body mass compared to rats. The pesticides are all anticholinesterases that require metabolic activation for maximum potency, but whose extreme mammalian toxicity (i.e., rat LD₅₀ for phorate or temephos) varies over 4000-fold. By most criteria for ranking acute toxicity, phorate is classed highly or extremely toxic and

temephos is practically nontoxic.^{2,10,18} Phorate is also highly toxic to ring-necked pheasants, but it is about three times more toxic to rats than pheasants whereas temephos is about 250 times more toxic to pheasants than rats. The blackbirds are consistently most sensitive to OP exposure, possibly because of influences of differential metabolic rate, but more likely because red-winged blackbirds are especially deficient in hepatic microsomal monooxygenase activity that is often essential for detoxication.^{34,35}

Beyond phorate and disulfoton, the rank of the individual pesticides is quite variable among the species, but the real importance to acute hazard evaluation is in comparison of the compounds with rat LD₅₀s above 200 mg/kg. As mentioned, this level implies only moderate toxicity to rats and therefore little acute field hazard would be expected from dimethoate, fenitrothion, malathion, or temephos. However, of the four pesticides, only malathion is not classed as extremely toxic (i.e., LD₅₀<40 mg/kg to both pheasants and blackbirds, and field application of fenitrothion has killed wild birds.³⁶ All insecticides listed in Table 1 elicit primary toxicity through the same mechanism, yet produce marked differences in toxicologic relationships between birds and rats; birds are much more sensitive than rats to the less toxic anticholinesterase. The differential sensitivity of birds and mammals to anticholinesterases is reviewed elsewhere.³⁷ This remarkably different response by birds and rats in response to chemicals of like action suggests that equal or greater differences should be expected for dissimilar pesticides and therefore reliance on rat data for prediction of hazard to birds is not adequate.

Interspecies Sensitivity

LD₅₀

Avian species vary widely in sensitivity to acute pesticide exposure.^{25,26,33 38} Table 2 presents LD₅₀s for ten anticholinesterase pesticides tested at a single laboratory on an array of species that weigh between 25 g (house sparrow, *Passer domesticus*) and 1.2 kg (ring-necked pheasant). Anticholinesterases are again presented because chemicals of the same toxic mechanism should yield the most conservative results. In contrast to OP compounds (Table 1), all of which require metabolic activation for maximum potency, examples (Table 2) include compounds that are direct ChE inhibitors; i.e., monocrotophos, dicrotophos, and the three carbamates. Monocrotophos and

Table 1. Avian Sensitivity to Organophosphorus Pesticides of Widely Variable Toxicity In Mammals

	Rat ^a		Pheasant ^b		Blackbird ^c	
	Rank	LD ₅₀ ^{d,e}	Rank	LD ₅₀ ^d	Rank	LD ₅₀ ^d
Phorate	1	2	1	7	1	1
Disulfoton	2	7	2	12	2	3
Azinophos methyl	3	13	7	75	5	8
EPN	4	36	6	53	2	3
Ethion	5	65	10	1297	9	45
Phosmet	6	113	9	237	6	18
Dimethoate	7	215	3	20	4	7
Fenitrothion	8	740	4	26	7	25
Malathion	9	1375	5	167	10	>100
Temephos	10	8600	8	35	8	42

^aSherman strain male laboratory rats, 3 months old, n = 5-60 per test; dosage by gavage in peanut oil.^{31,32}

^bFarm-reared male and female ring-necked pheasants, 3 to 4 months old, n = 8-28 per test; dosage by gelatin capsule.²⁵

^cWild-captured pen conditioned male and female red-winged blackbirds, adult, n = 8-28 per test; dosage by gavage in propylene glycol.^{28,33}

^dLD₅₀ = mg active ingredient (technical grade) per kg of body mass calculated to kill 50% of test population.

^eAll rat LD₅₀s are statistically separable ($p < 0.05$).

Table 2 Sensitivity of Seven Avian Species to Diverse Anticholinesterase Pesticides^{a,b}

Pesticide	House Sparrow		Red-winged blackbird		European Sterling		Rock Dove		Chukar		Mallard		Ring-necked pheasant	
	Rank	LD ₅₀	Rank	LD ₅₀	Rank	LD ₅₀	Rank	LD ₅₀	Rank	LD ₅₀	Rank	LD ₅₀	Rank	LD ₅₀
Monochrotophos	1	1.6	1	1.0	2	3.3	3	2.8	2	6.5	4	4.8	1	2.8
Dicrotophos	2	3.0	2	1.8	1	2.7	1	2.4	3	10	3	4.2	3	3.2
Parathion	3	3.4	4	2.4	5	5.6	2	2.5	5	24	1	2.1	6	12
EPN	4	13	5	3.2	6	7.5	5	5.9	4	14	8	53	2	3.1
Propoxur	4	13	6	3.8	7	15	9	60	5	24	6	12	8	20
Chlorpyritos	6	21	8	13	3	5.0	7	27	9	61	9	76	5	8.4
Fenthion	7	23	3	1.8	4	5.3	4	4.8	7	26	5	5.9	7	18
Temephos	8	35	9	42	9	> 100	8	50	10	270	10	79	9	32
Landrin	9	46	7	10	9	> 100	10	168	8	60	7	22	10	52
Mexacarbate	10	50	7	10	8	32	6	6.5	1	5.2	2	3.0	4	4.5
Sensitivity rank ^c	3		1		6		3		7		5		2	

^aToxicity as LD₅₀ = mg active ingredient (technical grade) per kg of body mass calculated to kill 50% of test population.

^bTable reconstructed from Tucker and Haegele³⁸ with red-winged blackbird and European starling data from Schafer³³ and Schafer et al.²⁶ All studies were conducted at the Denver Wildlife Research Center (Denver, CO) by the same protocol. Mallards and gallinaceous species were farm-reared males and females, 2 to 4 months old; rock doves and passerine species were wild-captured pen-conditioned male and female adults. Eight to 28 birds were dosed per test either by gavage in propylene glycol (blackbirds and starlings) or by gelatin capsule.

^cSensitivity rank is based on the mean of across-species order of sensitivity to each pesticide.

dicrotophos, whose primary structural difference is a single methyl group, rank as the most or second most toxic compound to all species except mallard, and both yield the most consistent results across the seven species. The extreme LD₅₀s differ by factors of about 6 to 7x for dicrotophos and monocrotophos with a median difference of 15x across species for all ten compounds. In contrast, the carbamates give highly variable results across species and among compounds. Extreme carbamate LD₅₀s differ across species by about 16 to 17x.

The red-winged blackbird is either the most or second most sensitive species to seven to ten compounds, whereas the chukar (*Alectoris chukar*) is either the most or second most tolerant species of eight of ten compounds (Table 2). The other five species are from four taxonomic orders and each species is either most or least sensitive of the seven species to at least one compound. When the seven species are compared in all possible combinations, LD₅₀s of the ten compounds correlated well between species in 18 of 21 comparisons ($r = 0.74$, $p < 0.05$ to $r = 0.99$, $p < 0.01$). The three exceptions ($0.05 < p < 0.1$) are mallard compared with chukar ($r = 0.68$), ring-necked pheasant ($r = 0.58$), and European starling (*Sturnus vulgaris*, $r = 0.59$). These data suggest any of the test species, except possibly mallard, represent the acute sensitivity of birds to anticholinesterase pesticides, but the response of one species cannot be used to predict the sensitivity of another species to a specific pesticide. The same conclusions are also reported for pesticides with other toxic mechanisms.³⁸

Neither body mass nor close taxonomic relation can be consistently used to predict the sensitivity of birds to pesticides. A list of species in ascending size reveals no apparent trend in sensitivity (Table 2). The largest (ring-necked pheasant) and smallest (house sparrow) are ranked second and third in across-species sensitivity, whereas the chukar, a Phasianidae, is ranked seventh. LD₅₀ is lower for pheasants than for chukars for listed pesticides, but the difference varies from 1.2 (NS) to 8.4x ($p < 0.05$). It may be significant that the pesticides yielding the least difference between chukar and pheasants are the three carbamates and the two yielding the largest difference of 7.3 and 8.4x are the least toxic OP pesticides, chlorpyrifos and temephos.

LC₅₀

Species response to the subacute protocol has been thoroughly studied only for young of the precocial northern bobwhite, Japanese quail, ring-necked pheasant, and mallard.^{18,19,21,30} The differences in LC₅₀s usually are not as large among the young as among adults of the same species." When the subacute tests are conducted on birds of about the same level of susceptibility to the 5-day trial (i.e., recommended ages for regulatory purposes⁶), the order of response most often negatively correlates with body mass: bobwhite = Japanese quail > ring-necked pheasant > mallard.¹⁸ This is probably an interactive function of differential maturation of detoxicating processes and rate of feeding and subsequent exposure in relation to body mass. Even though all combinations of species order of response occurred during tests of more than 100 pesticides, a typical species order tends to prevail within each class of chemicals and LC₅₀s for any two of the test species strongly correlate.¹⁸ Nonetheless, tests of multiple species are always desirable.

LD₅₀ vs LC₅₀

Acute and subacute tests yield different toxicologic relationships.^{7,37} The differences are exemplified by listing a series of diverse pesticides in ascending order of LD₅₀ for young adult

mallards and comparing to LC₅₀s for 5-day-old ducklings (Table 3). All studies of each type were conducted at a single laboratory^{18,25} with birds of the preferred age for regulation purposes.^{5,6} The pesticides represent a near continuum of acute toxicities by overlapping confidence intervals for successive LD₅₀s that result in clusters of several consecutive inseparable LD₅₀s. When the subacute toxicities are compared for pesticides within a cluster of LD₅₀s (e.g., parathion through endrin), the LC₅₀s are almost always statistically separable. The disparity of response to the two tests is indicated by the arithmetic difference between LD₅₀s of little more than 2x for parathion and endrin, monocrotophos and methyl parathion, and endrin and methiocarb. In contrast, the difference in subacute toxicities within each of these LD₅₀ clusters is about 60x between LC₅₀s for monocrotophos and aldicarb, 130x for monocrotophos and DDVP (dichlorvos), and 70x for endrin and DDVP. Each of the clusters of four or five pesticides contains both latent and direct ChE inhibiting OP compounds, a carbamate, and a chlorinated hydrocarbon. When the pesticides are ranked by ascending LC₅₀, no more than two successive compounds have overlapping confidence intervals. Overall, no statistically significant correlation exists between the paired LD₅₀s and LC₅₀s.

Some Factors Affecting Interpretation of LD₅₀ and LC₅₀

LD₅₀s and LC₅₀s change significantly during growth and development of precocial birds.^{21,30,39,40} The direction and amount of change often differ widely between the two tests of lethality. In the acute test, change is believed to be primarily influenced by developing metabolic processes that affect both toxication and detoxication of xenobiotics and an immature immune system. The subacute test is influenced by these same processes and by the highly individualistic response of the experimental animal to the ad libitum toxic diet. Changes in sensitivity as reflected by the oral LD₅₀ often follow different patterns depending on the basic toxic mechanism of the pesticide (Table 4). For example, mallard LD₅₀s for anticholinesterases that require activation for maximum potency (i.e., latent cholinesterase inhibitors) tend to decrease between hatch and 7 days and then increase with maturation to adulthood, whereas the opposite pattern occurs for direct acting OP and carbamate anticholinesterases. LD₅₀s for both CNS stimulating chlorinated hydrocarbons follow the pattern of the latent ChE inhibitors. Significant change in LD₅₀ occurs between successive ages at least once for each of the pesticides, but little change is evident in the overall order of toxicity among the compounds at the different test ages.

In contrast to the dichotomy of change between successive LD₅₀s during early avian maturation, LC₅₀s typically increase in variable degrees with age during early growth of precocial species.^{21,30} The increase occurs across chemical class and is assumed to be primarily due to a change in the ability to cope with the toxic diet for the duration of the subacute protocol; i.e., larger (= older) chicks that eat less proportional to body mass are better able to survive a 5-day trial by reducing food consumption and, therefore, toxic exposure. This is demonstrated by a series of subacute tests with Japanese quail from a single hatch.³⁰ Food consumption of controls in proportion to body mass averaged 48 g/100 g at 3 days of age, 31 g at 10 days, 24 g at 17 days, and 19 g at 24 days, which is a reduction of about 35, 23, and 21%/week from hatch to 3 weeks of age. During this period, the average increase in LC₅₀ for nine pesticides (three organophosphorus and two each of carbamate, chlorinated hydrocarbon, and methyl mercury) is 36% between 1 and 7 days, 43% between 7 and 14 days, and 28% between 14 and 21 days. In an acute study with mallards,³⁹ eight pesticides are compared and the LD₅₀s increase between 1 and

7 days for two compounds by an average of 70% decrease for three compounds by an average of 80% and are unchanged for three compounds (Table 4).

Table 3. Comparative Toxicity of Diverse Pesticides to Mallards Tested Acutely and Subacutely

Pesticide	Class ^c	Rank	Acute ^a		Rank	Subacute ^b	
			LD ₅₀	(95% CI ^d)		LD ₅₀	(95% CI)
Fensulfothion	OP-L	1	0.7	(0.6-0.9)	3	41	(32-55)
Parathion	OP-	2	2.4	(1.7-4.0)	5	76	(61-93)
Aldicarb	CB	3	3.4	(2.7-4.3)	10	594	(507-695)
Monocrotophos	OP-D	4	4.8	(3.4-6.6)	1	10	(8-12)
Endrin	CH	5	5.6	(2.7-11.7)	2	18	(15-21)
DDVP	OP-D	6	7.8	(6.0-10.1)	12	1317	(1043-1674)
Methyl parathion	OP-L	7	10	(6.1-16.3)	8	336	(269-413)
Ethoprop	OP-D	8	13	(11-15)	7	287	(215-382)
Methiocarb	CB	8	13	(7-22)	11	1071	(808-1405)
Morsodren	Hg	10	53	(32-89)	4	51	(43-60)
Toxaphene	CH	11	71	(38-133)	9	538	(474-614)
Dieldrin	CH	12	381	(141-1030)	6	153	(123-196)

^aSingle-dose oral toxicity: LD₅₀ as mg active Ingredient (technical grade) per kg of body mass calculated to kill 50% of test population. Farm-reared male and female, 3 to 7 months old, n = 8-28 per test; dosage by gelatin capsule.²⁵

^bFive-day dietary toxicity: LC₅₀ as mg active ingredient (technical grade) per kg of feed in ad libitum diet calculated to kill 50% of test population. Five groups of 10 unsexed ducklings (5 days old) were tested per pesticide.¹⁸

^cPesticide class: CB, carbamate; CH, chlorinated hydrocarbon; Hg, organic mercury; OP-D, organophosphorus-direct cholinesterase inhibitor; OP-L, organophosphorus-latent cholinesterase inhibitor.

^dCI = confidence interval.

LC₅₀s must be used cautiously in comparison of pesticide toxicity among species because the species may not be equally challenged by the test protocol. However, as discussed previously, a reproducible LC₅₀ can probably be obtained for any species that cannot survive for 5 days without eating.^{27,28} When a portion of the population can survive severe food reductions for the duration of the test, responses tend to be erratic and produce an expanded 95% confidence interval for LC₅₀ and a shallow lethality curve that may be a product of factors other than sensitivity. These relationships are demonstrated by subacute tests conducted at a single laboratory with 5- and 10-day-old mallards.^{18,41} (Note: About 50% of 10-day-old mallards can fast for 5 days, whereas 5-day-old ducklings cannot.²¹) Comparable data sets for nine pesticides indicate variable degrees of increase between LC₅₀s at 5 and 10 days of age (Table 5). LC₅₀s for five of six anticholinesterases increase by an average of 180% while the sixth, fensulfothion, the two chlorinated hydrocarbons, and the methyl mercury are essentially unchanged. Overall, the proportional size of the 95% confidence interval (division of upper by lower bound) averages about 20% smaller and the slope of the lethality curve about 25% steeper for 5-day-old than 10-day-old ducklings. Methiocarb, the only carbamate, has the largest difference in LC₅₀s between

ages, extremely wide confidence intervals at both ages, and the steepest lethality curve at 10 days. Carbamates typically yield the most erratic response by birds to both acute (controlled dosage) and subacute (uncontrolled dosage) toxicity tests.^{19,25,30,41}

Table 4. Acute Oral Toxicity of Anticholinesterase and CNS Stimulating Pesticides to Mallards from Hatch through Adulthood³⁹

Pesticide	LD ₅₀ ^a (95% CI)			
	1.5 days	1 week	1month	6months
Carbofuran ^b	0.4 (0.3-0.5)	0.6 (0.5-0.7)	0.6 (0.4-0.6)	0.4 (0.3-0.5)
Aldicarb ^b	1.9 (1.6-2.4)	3.6 (2.9-4.5)	6.7 (5.3-8.6)	4.4 (3.5-5.6)
Monocrotophos ^c	5.9 (4.7-7.3)	7.2 (5.8-9.0)	5.1 (4.4-5.9)	3.4 (2.8-4.1)
Demeton ^c	13 (11 - 16)	15 (13-18)	15 (12-19)	8.2 (6.6-10.2)
Parathion ^d	1.6 (1.4-2.0)	1.4 (1.1-1.8)	1.6 (1.4-2.0)	2.3 (2.0-2.8)
Chlorpyrifos ^d	145 (56-377)	29 (19-47)	50 (32-78)	83 (44-158)
Endrin ^e	22 (10-50)	3.4 (2.4-4.8)	2.9 (2.2-3.9)	5.3 (3.7-7.7)
Endosulfan ^e	28 (23-34)	6.5 (5.2-8.1)	7.9 (5.8-10.8)	34 (26-45)

^aToxicity as LD₅₀ = mg active ingredient (technical grade) per kg of body mass calculated to kill 50% of test population.

^bCarbamate (direct ChE inhibitor).

^cOrganophosphorus (direct ChE inhibitor).

^dOrganophosphorus (latent ChE inhibitor).

^eChlorinated hydrocarbon (CNS simulator).

Table 5. Subacute Dietary Toxicity^a of Widely Diverse Pesticides to 5- and 10-Day Old Mallards¹⁸

Pesticide	5-day Old			10-day-old		
	LC ₅₀	(95% CI)	Slope ^b	LC ₅₀	(95% CI)	Slope ^b
Monocrotophos ^c	10	(8-12)	5.4	32*	(19-57)	1.7
Endrin ^d	18	(15-21)	5.7	22	(17-31)	3.4
Fensulfothion ^e	41	(32-55)	5.1	43	(36-51)	4.4
Morsodren ^f	51	(43-60)	8.2	60	(47-76)	7.5
Parathion ^e	76	(61-93)	4.4	275*	(183-373)	9.7
Dicrotophos ^c	94	(80-111)	3.9	144*	(110-185)	3.3
Dieldrin ^d	153	(123-196)	5.4	169	(131-217)	4.9
Methyl parathion ^c	336	(269-413)	5.3	682*	(541-892)	3.2
Methiocarb ^g	1071	(808-1405)	2.5	4113*	(2817-7504)	5.1

^aFive-day dietary toxicity: LC₅₀ as mg active ingredient (technical grade) per kg of feed in ad libitum diet calculated to kill 50% of test population. Asterisk indicates paired LC₅₀s are statistically separable ($p < 0.05$).

^bSlope probit on log concentration.

^cOrganophosphorus (direct cholinesterase inhibitor).

^dChlorinated hydrocarbon (CNS stimulator).

^eOrganophosphorus (latent cholinesterase inhibitor).

^fOrganic mercury.

^gCarbamate (direct cholinesterase Inhibitor).

Sex, reproductive condition, genetic lineage, nutritional status, and exogenous and endogenous stress may have variable effects on LD₅₀ and LC₅₀ determinations, but the importance of the factors is not well established for birds. Historically, most acute avian studies tested nonbreeding subadult game birds or adult passerines of both sexes.^{25,26,33} This was done to reduce sex effect and thereby conserve the number of birds required for testing species sensitivity and ranking the acute toxicity of pesticides. The legitimacy of pooling sexes of reproductively quiescent birds has been validated for acute toxicity testing.^{27,33,38,42} However, beyond general comparisons, this narrow focus may not be adequate for hazard assessment because pesticides are intensively applied in nature during avian breeding seasons and knowledge of sex differences in sensitivity is essential. The importance of this variable is indicated by an acute test of fenthion toxicity that showed female northern bobwhite to be 2.3 times ($p < 0.05$) as sensitive as males.⁴³

Research on birds usually is with captive-reared specimens from haphazardly outbred stocks or wild-captured birds of unknown origin. Reproducibility of acute toxicity tests with birds of such vague genetic lineage is not known. However, in a study with equal-aged farm-reared northern bobwhites of both sexes from eight commercial breeders, extreme LD₅₀s for technical grade diazinon were 13 and 17 mg/kg body mass.⁴⁴ These two extremes are statistically inseparable, although the eight stocks differed in apparent vigor and body mass at dosing. Both factors are known to affect acute response,⁴⁵ but genetic variability from outbreeding could obscure detection of minor differences based on LD₅₀ alone.

Adequate methods are not available to evaluate the suitability of a wild-captured individual or species for acute toxicity testing. Simple survival and weight maintenance for a few weeks in captivity may not reflect subtleties such as nutritional imbalance or stress response to confinement, isolation, or crowding. Whether captive specimens, either wild or farm hatched and reared, truly represent their free-living counterparts is not known. For example, DDT and several organophosphorus insecticides were tested subacutely on wild bluejays (*Cyanocitta cristata*), house sparrows, northern cardinals (*Cardinalis cardinalis*), and wild and farm northern bobwhites.²⁷ All birds were at their capture weight and believed to be adequately conditioned to captivity at the time of testing. Bluejays were the most sensitive species to all compounds and farm bobwhites the most tolerant. Bluejays are adaptable generalized feeders that are reputed to be quite resilient in contaminated environments⁴⁶ and are easily kept in captivity, yet based on LC₅₀s they are about 1.5 to 50 times as sensitive as the other species to the various insecticides. Wild bobwhites had much less subcutaneous and visceral fat than their farm counterparts, weighed about 25% less, and consistently gave lower LC₅₀s. The difference is attributed in large part to consumption of significantly more toxic feed proportional to body mass by the wild birds during the 5-day trial rather than to differential sensitivity. Neither body mass nor rate of feeding explains the unexpected bluejay sensitivity because they are nearly twice as heavy and eat proportionally less than either house sparrows or cardinals.

HAZARD EVALUATION

It is clear from the foregoing that the most often used criteria of toxicity, the single-dose acute oral LD₅₀, varies unpredictably among avian species, and responses by laboratory rats to acute tests do not adequately represent avian response. When feeding for 5 days is substituted for controlled dosage, the resultant subacute LC₅₀ often produces relationships among species and chemicals that are quite different from those for LD₅₀s. Acute and subacute tests provide complementary measures of relative potency for the identification of chemical substances of potential lethal toxicity to wildlife. Although neither the LD₅₀ nor LC₅₀ per se is more than a convenient statistical reference point, evaluation of associated dose-response curves and observations of toxic responses enhance the utility of acute-type lethality tests in hazard assessment. These tests are meager considering that avian habitat is routinely treated with a variety of formulations and combinations of pesticides and that many factors alter the chemical fate and availability of a pesticide. However, ingestion is believed to be the most common route of pesticidal exposure in birds,⁴⁶ and therefore these oral tests of lethality provide a sound basis for preliminary screening.

LD₅₀ and LC₅₀ provide a statistical measurement that can be used to classify pesticides by an established scale of toxicity.^{5,6,18,36} This criterion provides simplistic guidance in first-line reviews of any array of pesticides for lethal hazard. Caution must be exercised to ensure that comparisons are based on test subjects that are equally susceptible to the experimental protocol (e.g., special attention to age, body mass, and feeding habits) and that the median response level is supported by its 95% confidence interval. LD₅₀ is derived by controlled dosage and therefore provides a tangible measure of naive sensitivity to toxic challenge that can be used for direct comparison of species, life stages, and chemicals. Although the emphasis herein is on oral dosage, the basic acute test can also be used to evaluate percutaneous toxicity. In comparative

studies with mallards and several passerines, oral LD₅₀s were consistently lower ($p < 0.05$) than percutaneous LD₅₀s for an array of pesticides.^{47,48} An LD₅₀ is difficult to relate to a field application of pesticide because some combination of inhalation, percutaneous, and ingestive exposure is probably the rule.

LC₅₀ provides a basis for comparison of the ability of the test population to cope with chemically contaminated feed for 5 days. This subacute test is believed by some to be more practical than its acute predecessor because the birds must voluntarily ingest the pesticide and are then subject to the effects of repeated dosage as might be experienced in nature. However, subacute studies usually use technical grade pesticide mixed into dry feed, whereas natural ingestion of the finished product formulation may be from varied sources such as water, seeds, foliage, invertebrates, vertebrates, and granular pesticides,⁴⁶ and the toxicity of the pesticide may be different in each matrix because of its form or availability. In a realistic sense, except for some carbamates, a field residue equivalent to an LC₅₀ in a specific food matrix may not be especially hazardous to a mobile population if the birds choose to emigrate. Emigration is more likely due to food deprivation (i.e., reduced arthropod population) than toxicity.⁴⁹⁻⁵¹

Some insight into potential hazard associated with a specific level of 5-day subacute toxicity is provided by comparison of cumulative mortality patterns during exposure to LC₅₀ concentration of carbamate, OP, chlorinated hydrocarbon, and organic mercury (Figure 1). The response curves are based on studies of 14-day-old Japanese quail and are typical for most compounds in the represented pesticidal classes.^{19,30} (Comparable mortality patterns occur for 5-day-old mallards and 10-day-old ring-necked pheasants.⁵⁵) LC₅₀ is presented because it is the focus of the experimental design, and therefore responses are least variable, but lower or higher response levels produce the same characteristic pattern, with the sigmoid response beginning about 1 day later at lower levels and 1 day earlier at higher levels.

The mortality pattern for dicotophos is consistent with the cumulative response theoretically necessary to kill a portion of the test population during 5-day exposure to a nonaccumulative toxicant. Mortality from OP compounds is rare after withdrawal of

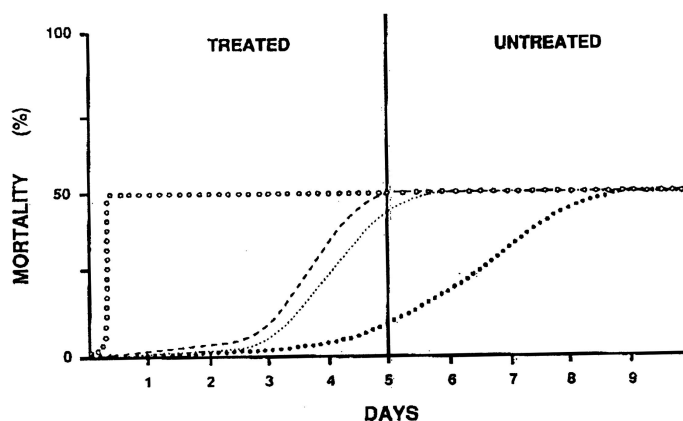

FIGURE 1. Cumulative mortality patterns for 14-day-old Japanese quail fed LC₅₀ concentration of carbofuran (open circle), dicrotophos (dash), dieldrin (dot), and Ceresan M[®] (closed circle) for 5 days followed by untreated feed.

treated feed.¹⁹ A typical response to OP exposure occurred with dicrotophos. Consumption decreased by 30% compared with controls during the first-day of exposure, by 55% during the second and third days, and by 60% during the fourth and fifth days.⁵⁵ Feeding at lower and higher response levels is described in detail elsewhere for many species.^{19,27,28,30,41} Dieldrin produced essentially the same cumulative response pattern as dicrotophos but some mortality occurred during the first day on untreated feed. Although dieldrin is lipophilic and accumulative, latent mortality is not common, provided ad libitum untreated feed is available.^{19,30} Consumption of dieldrin-treated feed decreased compared with controls by about 15, 30, 40, 45, and 45% during the first through fifth days.⁵⁵ Quail fed Ceresan M[®] showed little evidence of toxicity preceding the first death on the last day of exposure, then toxic signs began to intensify and deaths ensued through the fourth day of untreated feed; all toxic signs remised in survivors by day 13.³⁰ Consumption of Ceresan M[®]-treated feed was consistently about 5 to 15% less than control consumption, but daily differences were not significant. A detailed account of subacute response to mercury is presented elsewhere.⁴⁰ In contrast to each of the above patterns, all deaths from carbofuran occurred during the first few hours of feed presentation. After an initial decrease of about 60% feed consumption was reduced by only 25% on the second day and comparable to or in excess of controls thereafter.⁵⁵ This temporal pattern also occurs at higher and lower response levels and is generally representative of other carbamates.¹⁹ The OP fensulfothion produced a carbamate-type response pattern with mallards,¹⁷ but a typical OP pattern with Japanese quail.³⁰

When the subacute response patterns depicted in Figure 1 are considered with their corresponding rates of consumed toxic feed, many different exposure scenarios can be developed to enhance the evaluation of the potential hazard. For example, potential effects on migrants can be compared to resident populations, and mobile residents to breeders, and so on. Certainly, from these patterns it would not have been difficult to predict that carbofuran poses an acute hazard to birds, which it does;^{52,53} or that Ceresan M[®] is much more hazardous than indicated by its single-dose LD₅₀ of 668 mg/kg (95% confidence interval, 530 to 842 mg/kg) for adult Japanese quail.²⁵ Nonetheless, caution must be used when projecting results of subacute studies to the field because in the laboratory, reasonably consistent exposure can be provided over time, whereas field exposure is erratic because pesticide is naturally degraded and translocated. Care must also

be used in the interpretation of experimental feed consumption because subacute trials usually test technical grade chemical mixed into dry mash. Pesticide presented in this way may be easily sensed and consumption reduced; in the field, finished product formulation may be less easily detected when present in natural matrices including plant and animal tissues. Thus, different factors may render a pesticide either more or less toxic in the field than predicted from laboratory studies.

The dose-response or lethality curve calculated from acute and subacute toxicity tests is critical to the evaluation of potential pesticide hazard to wildlife. The curve is used in the same general way for both tests, but their interpretive implications are somewhat different because of the method of exposure. The most important concept applicable to both tests is that a steep lethality curve indicates increased hazard if for no reason other than proportionally less chemical increases effect; thus, applicator precision is essential. However, chemicals that produce shallow curves may be even more hazardous if the slope is not known. These somewhat contradictory notions are explained by comparison of hypothetical pesticides A and B with slopes (probit on log dose) of 8.0 and 2.0 and both with an arbitrary LD_{50} of 10 mg/kg (Figure 2). Assume the slope is known for pesticide A and the expected exposure is 6 mg/kg which may kill about 5% of the population; if treatment is accidentally doubled and results in exposure of 12 mg/kg it would kill about 75% of the population, a 15-fold increase. In contrast, assume the slope is not known for pesticide B, but its LD_{50} of 10 mg/kg is the same as for pesticide A, and this time the target exposure of 6 mg/kg is met. The shallow slope indicates that about 35% of the population would be killed. Pesticides such as carbofuran tend to yield shallow slopes^{30,42} and have been implicated in numerous avian die-offs.⁵⁴

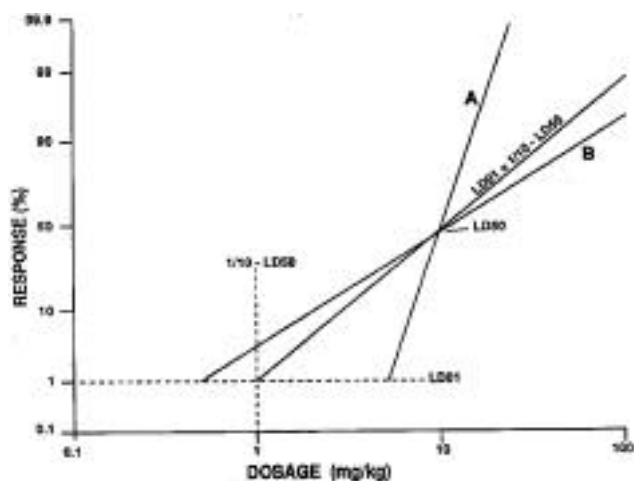

FIGURE 2. Dose-response curves of hypothetical pesticides A (slope 8.0) and B (slope 2.0) and a line (slope 2.3) intercepting the coordinates of the LD_{01} and $1/10 LD_{50}$.

For regulatory purposes, a popular method is to use some fraction of the LD_{50} or LC_{50} to denote hazard and restrict use of treatments that probably yield an exposure potential to wildlife. Suppose the acceptable residue in the equivalent of one feeding bout is set at $1/10$ of the LD_{50} , or 1 mg/kg. In this example, pesticide A would appear safe and pesticide B lethal to about 5% of the exposed population (Figure 2). In Figure 2 the $1/10 LD_{50}$ is arbitrarily intercepted with the calculated LD_{01} for reference. The resultant slope is about 2.5, which is much more shallow than

that calculated for most pesticides tested either acutely or subacutely with birds.^{18,19,42} Therefore, the 1/10 LD₅₀ or LC₅₀ criterion appears to be a reasonably conservative parameter for most purposes when the slope of the dose-response curve is not known.⁴² Even when the dose-response curve is known, use of coordinates outside the linear limits (i.e., ± 1 S.D. of the midpoint of the curve or the 16 and 84% response level) is discouraged.^{1,17}

In a practical sense, the steepness of the dose-response curve can be reduced to a qualitative index based on the ratio between two constant response levels; e.g., LD₁₀ and LD₅₀. The smaller the ratio, the more hazardous the substance because proportionally smaller amounts increase effect and thereby reduce the acceptable margin of error in a pesticidal application. In contrast, shallow slopes indicate greater inherent safety because it takes proportionally more chemical to increase effect; however, low levels may cause unacceptable effects.

CONCLUSIONS

Single-dose acute oral and 5-day subacute dietary toxicity studies are the preponderance of available data for preliminary assessment of pesticidal hazard to wildlife. Properly designed, these tests provide a method of comparing pesticides by lethality from one, (acute) or multiple (subacute) exposures that generate statistical estimates of the dose-response curve and its midpoint, LD₅₀ or LC₅₀. When these tests are supplemented with detailed observations of individual responses and food consumption through remission of toxicity, a meaningful appraisal of potential lethal hazard is possible.

Historically, only LD₅₀ or LC₅₀ has received extensive use, and often without consideration of its statistical validity. This approach is inappropriate because both LD₅₀s and LC₅₀s vary widely in unpredictable ways between chemicals, species, and the life stage of the test subjects. Therefore, careful review of test compatibility is essential before any comparisons are attempted. However, once the credibility of the study is ascertained, LD₅₀ and LC₅₀ provide useful guides to chemical potency for comparing pesticides of different mechanisms of toxic action. Specifically, LD₅₀ provides a direct measure of sensitivity, whereas LC₅₀ yields information on sensitivity to the chemical and the ability of birds to cope with toxic feed for a specified duration. A review of the responses indicated from mortality patterns and slopes of dose-response curves gives insight into potential hazards of both an acute and chronic nature.

However, literal projection of either acute or subacute tests to nature is not possible. Most laboratory tests use a technical grade chemical, either administered directly to the bird or in a dry feed. Field application almost always uses a finished product formulation of pesticide, and formulations may vary in toxicity and availability depending on the use and factors of environmental degradation. Therefore, extreme care is recommended in the use of acute and subacute toxicity tests; when used in combination and judiciously, the two tests of lethality are invaluable tools for preliminary evaluation of potential hazard of pesticides to wild birds.

REFERENCES

1. Finney, D. J., *Probit Analysis*, 3rd ed., Cambridge University Press, Cambridge, U.K., 1971.
2. Casarett, L. I., Toxicologic evaluation, in *Toxicology: the Basic Science of Poisons*, L.J. Casarett and J. Doull, Eds., Macmillan, New York, 1975, pp. 11-25.
3. Chan, P. K., and A. W. Hayes, Principles and methods for acute toxicity and eye irritancy, in *Principles and Methods of Toxicology*, 2nd ed., A. W. Hayes, Ed., Raven Press, New York, 1989, pp. 69-220.
4. Pesticide Assessment Guidelines, Subdivision E, Hazard Evaluation: Wildlife and Aquatic Organisms, EPA-540/9-82-024, Ecological Effects Branch, Hazard Evaluation Division, Office of Pesticide Programs, Washington, DC, 1982.
5. Bascietto, J., Hazard Evaluation Division Standard Evaluation Procedure Avian Single dose Oral LD₅₀, EPA-S40/9-85-007, U.S. Environmental Protection Agency, Washington, DC, 1985.
6. Bascietto, J., Hazard Evaluation Division Standard Evaluation Procedure Avian Dietary LC₅₀ Test, EPA-S40/9-85-008, U.S. Environmental Protection Agency, Washington, DC, 1985.
7. Heinz, C. H., B. F. Hill, W. H. Stickel and L. F. Stickel, Environmental contaminant studies by the Patuxent Wildlife Research Center, in *Avian and Mammalian Wildlife Toxicology*, STP 693, E. E. Kenaga, Ed., American Society for Testing and Materials, Philadelphia, 1979, pp. 9-35.
8. Hill, E. F., and D. J. Hoffman, Avian models for toxicity testing, *J. Am. Coll. Toxicol.*, 3, 357-376, 1984.
9. Gad, S., and C. Weil, *Statistics and Experimental Design for Toxicologists*, Telford Press, Caldwell, NJ, 1986.
10. Gad, S. C., and C. P. Chengelis, *Acute Toxicology Testing*, Telford Press, Caldwell, NJ, 1988.
11. Albert, A., *Selective Toxicity*, 4th ed., Butler & Tanner, London, 1965.
12. Hewlett, P. S., and R. L. Plackett, *The Interpretation of Quanta/ Responses in Biology*, University Park Press, Baltimore, MD, 1979.
13. Finney, D. J., *Statistical Methods in Bioassay*, 2nd ed., Hafner, New York, 1964.
14. Klaassen, C. D., Principles of toxicology, in *Casarett and Doull's Toxicology: The Basic Science of Poisons*, 3rd ed., C. D. Klaassen, M. O. Amdur and J. Doull, Eds., Macmillan, New York, 1986, pp. 11-32.
15. Litchfield, J., and F. Wilcoxon, A simplified method of evaluating dose-effect experiments, *J. Pharmacol. Exp. Ther.*, 96, 99-113, 1949.
16. Heath, R. G., and L. F. Stickel, Protocol for testing the acute and relative toxicity of pesticides to penned birds, in *The Effects of Pesticides on Wildlife*, Circular 226, U.S. Fish and Wildlife Service, Washington, DC, 1965, pp. 18-24.
17. Heath, R. G., J. W. Spann, E. F. Hill and J. F. Kreitzer, *Comparative Dietary Toxicities of Pesticides to Birds*, Spec. Sci. Rep. 152, U.S. Fish and Wildlife Service, Washington, DC, 1972.
18. Hill, E. F., R. G. Heath, J. W. Spann and J. D. Williams, *Lethal Dietary Toxicities of Environmental Pollutants to Birds*, Spec. Sci. Rep. 191, U.S. Fish and Wildlife Service, Washington, DC, 1975.

19. Hill, E. P., and M. B. Camardese, *Lethal Dietary Toxicities of Environmental Contaminants and Pesticides to Coturnix*, Fish and Wildlife Tech. Rep. 2, U.S. Fish and Wildlife Service, Washington, DC, 1986.
20. Tucker, R. K., and J. S. Leitzke, *Comparative toxicology of insecticides for vertebrate wildlife and fish*, *Pharmacol. Ther.*, 6, 167-220, 1979.
21. Hill, E. F., J. W. Spann and I. D. Williams, Responsiveness of 6 to 14 generations of birds to dietary dieldrin toxicity, *Toxicol. Appl. Pharmacol.*, 42, 425-431, 1977.
22. Miller, R. G., Jr., *Simultaneous Statistical Inference*, 2nd ed., Springer-Verlag, New York, 1981.
23. Thompson, W. R., Use of moving averages and interpolation to estimate median effective dose. 1. Fundamental formulas estimation of error, and relation to other methods, *Bacteriol. Rev.*, 11, 115-145, 1947.
24. Weil, C. S., Tables for convenient calculation of median effective dose (LD₅₀ or ED₅₀) and instruction in their use, *Biometrics*, 8, 249-263, 1952.
25. Hudson, R. H., R. K. Tucker and M. A. Haegele, *Handbook of Toxicity of Pesticides to Wildlife*, Resource Publ. 153, U.S. Fish and Wildlife Service, Washington, DC, 1984.
26. Schafer, E. W., W. A. Bowles, Jr., and J. Hurlbut, The acute oral toxicity, repellency, and hazard potential of 998 chemicals to one or more species of wild and domestic birds, *Arch. Environ. Contam. Toxicol.*, 12, 355-382, 1983.
27. Hill, E. F., Toxicity of selected mosquito larvicides to some common avian species, *J. Wildl. Manage.*, 35, 757-762, 1971.
28. Grue, C. E., Response of common grackles to dietary concentrations of four organophosphate pesticides, *Arch. Environ. Contam. Toxicol.*, 11, 617-626, 1982.
29. Turner, L. W., Development of an avian dietary LC₅₀ toxicity test for potential use under the Toxic Substances Control Act, in *Avian and Mammalian Wildlife Toxicology: Second Conference*, STP 757, D. W. Lamb and E. E. Kenaga, Eds., American Society for Testing and Materials, Philadelphia, 1981, pp. 98-104.
30. Hill, E. F., and M. B. Camardese, Subacute toxicity testing with young birds: response in relation to age and intertest variability of LC₅₀ estimates in *Avian and Mammalian Wildlife Toxicology: Second Conference*, STP 757, D. W. Lamb and E. E. Kenaga, Eds., American Society for Testing and Materials, Philadelphia, 1981, pp. 41-75.
31. Gaines, T. B., The acute toxicity of pesticides to rats, *Toxicol. Appl. Pharmacol.*, 2, 88-99, 1960.
32. Gaines, T. B., Acute toxicity of pesticides, *Toxicol. Appl. Pharmacol.*, 14, 515-534, 1969.
33. Schafer, E. W., Jr., The acute oral toxicity of 369 pesticidal, pharmaceutical and other chemicals to birds, *Toxicol. Appl. Pharmacol.* 21, 315-330, 1972.
34. Pan, H. P., J. R. Fouts and T. R. Devereaux, Hepatic microsomal N-hydroxylation of *p*-chloroaniline and *p*-chloro-N-methylaniline in red-winged blackbird compared with rat, *Xenobiotica*, 9, 441-446, 1979.
35. Walker, C. H., Species variation in some hepatic microsomal enzymes, *Prog. Drug. Metab.*, 5, 113-164, 1980.
36. Smith, G. J., Pesticide Use and Toxicology in Relation to Wildlife: Organophosphorus and Carbamate Compounds, Resource Publ. 170, U.S. Fish and Wildlife Service, Washington, DC, 1987.

37. Hill, E. F., Avian toxicology of anticholinesterases, in *Clinical and Experimental Toxicology of Anticholinesterases*, B. Ballantyne and T. C. Marrs, Eds., Butterworth, London, 1991, pp. 272-294.
38. Tucker, R. K., and M. A. Haegele, Comparative acute oral toxicity of pesticides to six species of birds, *Toxicol. Appl. Pharmacol.*, 20, 57-65, 1971.
39. Hudson, R. H., R. K. Tucker and M. A. Haegele, Effect of age on sensitivity: acute oral toxicity of 14 pesticides to mallard ducks of several ages, *Toxicol. Appl. Pharmacol.*, 22, 556-561, 1972.
40. Hill, E. F., and J. H. Soares, Jr., Oral and intramuscular toxicity of inorganic and organic mercury chloride to growing quail, *J. Toxicol. Environ. Health*, 20, 105-116, 1987.
41. Hill, E. F., Subacute dietary toxicities of dicrotophos and dieldrin in time-replicated trials with young ring-necked pheasants and mallards, in *Avian and Mammalian Wildlife Toxicology Second Conference*, STP 757, D. W. Lamb and E. E. Kenaga, Eds., American Society for Testing and Materials, Philadelphia, 1982, pp. 105-120.
42. Hill, E. F., and M. B. Camardese, Toxicity of anticholinesterase insecticides to birds: technical grade versus granular formulations, *Ecotoxicol. Environ. Safety*, 8, 551-563, 1984.
43. Wiemeyer, S. N., and D. W. Sparling, Acute toxicity of four anticholinesterase insecticides to American kestrels, eastern screech-owls, and northern bobwhite, *Environ. Toxicol. Chem.*, 10, 1139-1148, 1991.
44. Hill, E. F., M. B. Camardese, G. H. Heinz, J. W. Spann and A. B. BeBevac, Acute toxicity of diazinon is similar to eight stocks of bobwhite, *Environ. Toxicol. Chem.*, 3, 61-66, 1984.
45. Weil, C. S., C. P. Carpenter, J. S. West and H. F. Smyth Jr., Reproducibility of single oral dose toxicity testing, *Am. Indust. Hyg. Assoc. J.*, 27, 483-487, 1966.
46. Grue, C. E., W. J. Fleming, D. G. Busby and E. F. Hill, Assessing hazards of organophosphate pesticide to wildlife, *Trans. North Am. Wildl. Nat. Res. Conf.*, 48, 200-220, 1983.
47. Schafer, E. W., Jr., R. B. Bunton, N. F. Lockyer and J. W. DeGrazio, Comparative toxicity of seventeen pesticides to the *Quelea*, house sparrow, and red-winged blackbird, *Toxicol. Appl. Pharmacol.*, 26, 154-157, 1973.
48. Hudson, R. H., M. A. Haegele and R. K. Tucker, Acute oral and percutaneous toxicity of pesticides to mallards: correlations with mammalian toxicity data, *Toxicol. Appl. Pharmacol.*, 47, 451-460, 1979.
49. DeWeese, L. R., C. J. Henny, R. L. Ford, K. A. Bobal and A. W. Shultz, Response of Breeding Birds to Aerial Sprays of Triachlorfon (Dylox) and Carbaryl (Sevin-4-Oil) in Montana Forests, Spec. Sci. Rep. 224, U.S. Fish and Wildlife Service, Washington, DC, 1979.
50. McEwen, L. C., L. R. DeWeese and P. Schaladweiler, Bird predation on cutworms (Lepidoptera:Noctuidae) in wheat fields and chlorpyrifos effects on brain cholinesterase activity, *Environ. Entomol.* 15, 147-151, 1986.
51. Stromborg, K. L., C. E. Grue, J. D. Nichols, G. H. Hepp, J. E. Hines and H. C. Bourne, Postfledging survival of European starlings exposed to an organophosphorus insecticide, *Ecology*, 69, 590-601, 1988.
52. Flickinger, E. L., C. A. Mitchell, D. H. White and E. J. Kolbe, Bird poisoning from misuse of the carbamate Furadan in a Texas rice field, *Wildl. Soc. Bull.*, 14, 59-62, 1986.
53. Littrell, E. E., Waterfowl mortality in rice fields treated with the carbamate, carbofuran, *Calif. Fish Game*, 74, 226-231, 15 18.

54. Office of Pesticides and Toxic Substances, Carbofuran Special Review Technical Support Document, U.S. Environmental Protection Agency, Washington, DC, 1989.
55. Hill, E. F., unpublished data.

July-August 1998

Sex-Dependent Metabolism of Xenobiotics

Gregory L. Kedderis and Cheryl A. Mugford

[This article is based on a review article by the same title that was published by Dr. Mugford and Dr. Kedderis in *Drug Metabolism Reviews* 30, 441-498; 1998. The article was condensed for publication in *CIIT Activities* by courtesy of Marcel Dekker, Inc.]

Sex-dependent differences in xenobiotic metabolism are most pronounced in rats. Consequently, this species quickly became the most popular animal model to study sexual dimorphisms in xenobiotic metabolism. Exaggerated sex-dependent variations in metabolism by rats may be the result of extensive inbreeding or differential evolution of cytochrome P450 (CYP) isoforms in mammals. Sex-dependent differences in other xenobiotic-metabolizing enzymes such as sulfotransferases, glutathione transferases, and glucuronyltransferases have also been observed. Animal studies are used to help determine the metabolism and toxicity of many chemical agents in an attempt to extrapolate the risk to humans from exposure to these agents. One of the most important concepts to consider in using rodent studies to identify sensitive individuals in the human population is that human CYPs differ from rodent CYPs in both isoform composition and catalytic activities. Metabolism of xenobiotics by male rats can reflect human metabolism when the compound of interest is metabolized by CYP1A or CYP2E because there is strong regulatory conservation of these isoforms between rodents and humans. However, problems can arise when rats are used as animal models to predict the potential for sex-dependent differences in xenobiotic handling in humans. Information from numerous studies has shown that the identification of sex-dependent differences in metabolism by rats does not translate across other animal species or humans. To date, sex-specific isoforms of CYP have not been identified in humans. This lack of expression of sex-dependent isoforms in humans indicates that the male rat is not an accurate model for the prediction of sex-dependent differences in humans. Differences in xenobiotic metabolism among humans are more likely the consequence of intraindividual variations as a result of genetics or environmental exposures rather than being due to sex-dependent differences in enzyme composition.

Sex-Dependent Differences in Metabolism in Rats

Over 50 years ago, female rats were observed to be more sensitive to the effects of barbiturates than male rats. Females showed a prolonged sleep time after exposure to hexobarbital (Holck et al., 1937). Results from early studies designed to examine the mechanism of this sex-dependent difference in response to specific barbiturates demonstrated that females had higher and more prolonged serum concentrations of the parent compound due to a lower rate of metabolism as compared with male rats. Subsequent studies with a variety of chemicals and drugs have shown that, in general, male rats have higher rates of xenobiotic metabolism than females.

In the last 25 years, large advances have been made in the study of xenobiotic metabolism. Detailed experiments have characterized the most important group of xenobiotic-metabolizing enzymes found in mammals, the cytochromes P450 (CYP). CYP isoforms catalyze the oxidation

and reduction of a variety of endogenous compounds such as steroid hormones, fatty acids, and prostaglandins as well as xenobiotics. In general, CYP-mediated reactions facilitate the excretion of xenobiotics. However, reactive metabolites can also be formed via CYP-dependent metabolism. Approximately 40 genes code for specific isoforms in the rat genome (Nelson et al., 1996), with four major subfamilies of CYP isoforms in rat liver exhibiting different but somewhat overlapping substrate specificities.

Female rats have 10-30% less total CYP as compared with male rats. This helps to explain why female rats in general metabolize many drugs and compounds more slowly than male rats. In many instances where a sex-dependent difference in metabolism is observed, there can be a 2- to 20-fold difference in the metabolism of a specific agent, however. This suggests that the isoform or isoforms of CYP that metabolize the chemical are very different between males and females.

There are sex-dependent differences in the expression of microsomal CYP450 isoforms that catalyze the hydroxylation of steroids (Waxman et al., 1985). These differences are developmentally regulated and are manifest in adult animals. Immunological data have shown that CYP2C12 (steroid sulfate 15 β -hydroxylase) is in higher concentration in female than in male rat liver. CYP2C12 is female-specific in adults but is present in appreciable levels in immature and old male rats. Isoforms CYP2C7 and CYP2A1 are female-predominant. In contrast, CYP2C11 (microsomal 16-hydroxylase) is male-specific. This isoform is not expressed in females at all but is present in highest concentration in sexually mature males. Studies in castrated males and in females supplemented with testosterone show that CYP2C11 is under the regulatory control of androgens. Male-predominant isoforms are CYP2A2, CYP3A2, and CYP2A1.

Sexual dimorphisms have been observed in the response to inducing agents in rats. Male rats are generally more responsive to the effects of agents that induce specific isoforms of hepatic CYP450 than are female rats. For example, treatment of Sprague-Dawley rats with phenobarbital (1, 3, or 20 mg/kg) for six days resulted in increases in hexobarbital hydroxylase activity and aminopyrine N-demethylation in hepatic microsomes prepared from male, but not female, rats (Shapiro, 1986).

Sex-dependent differences have also been observed in the expression of conjugative enzymes such as sulfotransferases (Mulder, 1986), glutathione S-transferases (Srivastava and Waxman, 1993), and glucuronyltransferases (Zhu et al., 1996). In general, male rats tend to have higher enzyme activities than do females. With some substrates, however, females have higher rates of conjugation than do males.

Hormonal Regulation of Enzyme Expression

Holck et al. (1937) made the seminal observation that anesthesia induced by hexobarbital and pentobarbital was of a much longer duration in female than in male rats. They reported that this sex-dependent difference was not observed in immature rats three to four weeks of age. Castration of male rats increased the time of hexobarbital-induced anesthesia to the duration observed in female rats. Administration of testosterone to intact and ovariectomized females shortened hexobarbital-induced anesthesia. Holck et al. (1937) concluded that the observed

sexual dimorphism in response to certain barbiturates was a result of the action of the male sex hormone testosterone.

A later study conducted by Brodie (1956) showed that plasma levels of pentobarbital decreased more rapidly in male rats than in females. Administration of testosterone to females increased the rate of the removal of pentobarbital from the plasma. Conversely, administration of estradiol to males slowed the removal of pentobarbital from the plasma. Liver microsomes from male rats metabolized hexobarbital faster than microsomes prepared from females. Microsomes prepared from female rats treated with testosterone metabolized hexobarbital at rates that were similar to the rates observed with male rat microsomes. These data indicate an important role for testosterone in the sex differences in barbiturate metabolism in rats.

Agent	Differences
Cocaine	Males metabolize the agent two times faster than females
Diazepam	Metabolism is greater in males than females
Hexobarbital	Metabolism in females is slower, resulting in higher blood levels and a prolonged sleep time
Indinavir	Males metabolize the agent three times faster than females
Morphine	Metabolism is greater in males than females
Pentobarbital	Metabolism in females is slower, resulting in higher blood levels and a prolonged sleep time
Tolbutamide	Metabolism is greater in males than females

Various studies subsequent to these early, key findings have illustrated that, in general, male rats have a higher rate of xenobiotic metabolism as compared with females (Table 1). For example, many anesthetics and antidepressants are metabolized more rapidly in male rats. This sex-specific difference results in many chemicals and drugs having longer half-lives and slower clearance in female rats (Table 1). The slower metabolism in female rats produces higher tissue concentrations of xenobiotics that may induce target organ toxicity.

Extensive studies conducted in the 1970s through the 1980s showed that specific concentrations of testicular androgens in the neonate imprint the expression of specific isoforms of CYP450 in the adult rat (Gustafsson et al., 1983). This early imprinting is required for males to express the entire complement of male-specific isoforms. The age of the male is important for castration to affect the expression of CYP450 isoforms. Castration of adult males did not reduce enzyme activity to female levels. However, castration of male neonates brought about complete feminization of the isoforms expressed in the adult male liver. Castration caused a decrease in the expression of CYP2C18 and CYP3A2 and an increase in the expression of CYP2C19. Castration did not affect the expression of the male forms of CYP450 when it was done after five weeks of age. Also, the expression of CYP450 isoforms in a castrated neonate was not affected if the animal was supplemented with testosterone on day three after castration. These observations indicate that critical levels of androgens in the male neonate imprint the liver to express the male complement of CYP450 isoforms. In contrast, females are not as dependent on circulating levels

of estradiol for the expression of the female isoforms of CYP450. Ovariectomy of female neonates reduces but does not abolish the expression of CYP2C19 (Table 2).

Treatment	Males	Females
Steroid administration to intact animals	Estradiol reduces expression of male isoforms.	Testosterone reduces expression of female isoforms, but increases expression of some male-specific isoforms.
Castration*	Reduces male-specific isoforms.	Reduces female-specific isoforms.
Castration followed by steroid administration	Testosterone increases expression of male isoforms.	Estradiol restores levels of female-specific isoforms.
Hypophysectomy	Significantly reduces the level of male-specific isoforms.	Causes expression of male-specific isoforms.
Hypophysectomy followed by steroid administration	No effect of estradiol.	No effect of testosterone.
Hypophysectomy followed by growth hormone administration	Isoform expression reflects pattern of growth hormone secretion.	Isoform expression reflects pattern of growth hormone secretion.

*The age of the animal at the time of castration determines the effect on the composition of hepatic cytochrome P450 isoforms. For example, castration does not have an effect if animals are older than five weeks of age.

In addition to androgens, growth hormone, somatostatin, insulin, and thyroxine each play a specific role in the sex-specific expression of CYP450 isoforms in rats. Elegant studies investigating the mechanism of sex-dependent differences in the expression of CYP450 isoforms have demonstrated that regulation of male or female isoforms is at the level of the hypothalamic-pituitary axis. Investigations conducted in the early 1970s (Gustafsson and Stenberg, 1974) demonstrated that hypophysectomy abolished sex-dependent differences in metabolism (Table 2). Xenobiotic metabolism in male rats following hypophysectomy was reduced to the levels seen in females in the 1970s (Gustafsson and Stenberg, 1974). The fact that administration of testosterone did not reverse the effect of hypophysectomy in males indicates that endogenous factors in addition to androgens modulate sexual dimorphism in xenobiotic metabolism.

Subsequent studies showed that the pattern of growth hormone secretion regulates the expression of uniquely male versus uniquely female isoforms of CYP450. The pattern of growth hormone secretion in male and female rats is similar until about the age of 25 days. By 30 days of age, unique patterns of growth hormone secretion develop between male and female rats (Mode et al., 1982). Female rats have constant, low levels of growth hormone with small bursts of secretion (Figure 1). In contrast, males have undetectable levels of growth hormone in the absence of episodic bursts of secretion every 3.5 to 4 hours (Figure 1). The expression of male-specific CYP2C11 is regulated by the pulsatile bursts of growth hormone secretion, while these bursts inhibit the expression of CYP2C12, the female-specific isoform (Legraverend et al., 1992).

Control of the growth hormone secretion pattern in male and female rats is regulated by sex hormones (Mode et al., 1982). In male rats, testosterone stimulates the release of somatostatin, which inhibits the release of growth hormone (Figure 1). This level of regulation at somatostatin is what causes the pulsatile pattern of growth hormone secretion that masculinizes the liver in the expression of CYP450 isoforms. In contrast, secretion of estrogen in female rats stimulates the secretion of growth hormone releasing hormone. Secretion of growth hormone releasing hormone stimulates the release of growth hormone, which results in constant, low levels of growth hormone in female rats (Figure 1). The data suggest that this pattern of regulation of growth hormone secretion by estrogen in the female results in the expression of female-specific isoforms of CYP450 (Figure 1).

An interesting observation in the studies of sex-dependent metabolism is the fact that sex-dependent differences in CYP450 content and monooxygenase activities disappear as rats age (Kamataki et al., 1985). In general, the livers of male rats feminize with regard to CYP450 isoform expression and activities. Enzyme activities in young rats that were much greater in males than in females declined with age in the male and became similar to the activities of a young female (Kamataki et al., 1985). Studies to address the mechanism of the loss of sex-dependent differences in xenobiotic metabolism as rats age have focused on changes in the pattern of growth hormone secretion. As male rats age, the pattern of growth hormone secretion dramatically changes to resemble that of females (Kamataki et al., 1985). Aging male rats no longer show peaks of growth hormone secretion but rather exhibit constant, lower levels of the hormone, as is observed in females (Kamataki et al., 1985).

Sex-Dependent Differences in Other Species

In contrast to the large body of literature detailing the sex-dependent differences in xenobiotic metabolism in rats, less information on this topic exists for other animal species. As molecular biology techniques have improved over the last 10 years, sex-dependent differences in metabolism have been shown to exist in other animals as well. However, the sexual dimorphisms observed in other species are far less exaggerated as compared with the sex-dependent differences observed in the rat.

After the rat, xenobiotic metabolism is best characterized in the mouse. Sex-specific differences in xenobiotic metabolism are observed in certain strains of mice. When a sex-dependent difference in metabolism is observed in rats, male rats always have a higher rate of metabolism than females. When a sex-dependent difference is expressed in mice, however, the difference is dependent on the strain of mouse. Males have higher xenobiotic metabolism in some strains of mice, while females have higher rates of metabolism in other strains (MacLeod et al., 1987). In general, female mice more commonly have higher rates of metabolism than males (MacLeod et al., 1987). Another important difference is that the magnitude of sex-dependent differences is very different in mice as compared with rats. For example, male rats can have an enzyme activity as much as five-fold greater as compared with females. In contrast, when a sex-dependent difference occurs in a specific strain of mouse, the greatest degree of sexual dimorphism is usually about two-fold.

As in rats, serum growth hormone levels and the pattern of growth hormone secretion are the regulatory points for xenobiotic metabolism in mice. However, the pattern of secretion (pulsatile versus constant) appears to have opposite effects on the expression of enzymes in male mice as compared with male rats. Testicular androgens induce hepatic monooxygenases in male rats, while testosterone represses the expression and activity of these enzymes in male mice.

There are fewer studies identifying sex-dependent differences in metabolism in higher animals compared with the amount of work that has been done to address sexual dimorphisms in rats and mice. However, the literature contains information on studies conducted in rabbits, dogs, and monkeys. Sex-dependent differences in xenobiotic metabolism in rabbits occur in the family of flavin-containing monooxygenases, flavo-proteins that oxidize molecules containing nitrogen and sulfur (Tynes and Philpot, 1987). There are examples of sex-dependent differences in metabolism by beagle dogs that appear to be due to differential expression of CYP isoforms (Lin et al., 1996). One study with patas and cynomolgus monkeys did not observe sex differences in metabolism (Jones et al., 1992).

Sex-Dependent Differences in Humans

Progress has been made in identifying the CYP isoforms that are present in human liver (Nelson et al., 1996), with 28 genes identified as coding for this superfamily of enzymes in the human genome. As in rodents, only gene families 1, 2, and 3 are involved in xenobiotic metabolism in humans. However, the major CYP isoform detected in human liver, CYP3A, is in relatively low concentration in rat liver (Table 3). Another key difference is that several CYP450 subfamilies have different substrate specificities in rodent as compared with human liver (Wrighton et al., 1993). For example, human CYP3A has coumarin-7-hydroxylase activity, but none of the isoforms in the rat CYP3A subfamily show significant coumarin-7-hydroxylase activity. Sex-dependent differences have not been reported for any of the isoforms of CYP450 expressed in human liver (Guengerich, 1990).

Table 3 - Comparison of Major Isoforms of Cytochrome P450 in Rodent and Human Liver		
Isoform	Rodent	Human
CYP1A		
1A1	Present; induced by polycyclic aromatic hydrocarbons.	Present in liver and lung; induced by cigarette smoke.
1A2	Present; induced by polycyclic aromatic hydrocarbons.	Present in liver only; induced by cigarette smoke.
CYP2A		
2A1	Rat testosterone 7 α -hydroxylase.	Not present.
2A2	Present.	Not present.
2A3	Present in liver and lung; induced by 3-methylcholanthrene.	Not present.
2A4	Mouse testosterone 15 α -hydroxylase.	Not present.
2A5	Present.	Coumarin 7-hydroxylase activity; 7-ethoxycoumarin <i>O</i> -deethylase activity.
CYP2B		
2B1	Phenobarbital-induced.	Not present.
2B2	Constitutive and phenobarbital-induced.	Not present.
2B6		Gene identified.
CYP2C	Major subfamily in rats; sex-specific isozymes.	Not present.
2C5	Rabbit progesterone 21-hydroxylase.	Not present.
2C8		Retinol metabolism.
2C9/10		Hexobarbital, tolbutamide metabolism.
2C18		Mephénytoin metabolism.
CYP2D		
2D6		Desbrisoquine metabolism.
CYP2E		
2E1	Induced by ethanol, isoniazid, acetone.	Induced by ethanol, isoniazid, acetone.
CYP3A		Major subfamily in adult liver.
3A1	Phenobarbital-inducible.	
3A2	Present in males only; phenobarbital inducible.	
3A3	Present.	
3A3/4		Major isoform in adult liver.
3A5		Higher in adolescent liver.
3A7		Major fetal form; not present in adults.
CYP4A		Small role in metabolism of some fatty acids; induced by clofibrate, ciprofibrate, clofribic acid.

Although the composition and relative proportions of specific CYP isoforms are different in humans and rats, there is strong catalytic and regulatory conservation of the CYP1A1, CYP1A2,

and CYP2E1 subfamilies among the rat isoforms and their human orthologs. Since many chemicals and pharmaceutical agents are metabolized by these isoforms, rats are suitable animal models for investigating the metabolism and toxicity of a wide variety of chemical agents. These enzymes are not expressed in a sex-dependent manner in rat liver.

Most of the information on xenobiotic metabolism in humans has been gathered from clinical studies examining the pharmacokinetics of pharmaceutical agents. Quite often, examining the potential for sex-dependent differences in the handling of a particular xenobiotic was not a primary objective of a study, but both men and women were included in the studies. The pharmacokinetics of many compounds are the same in men and women. However, the pharmacokinetics of some xenobiotics are different in men and women (Table 4).

Agent	Reported difference
Acetaminophen	Higher parent plasma concentration in females due to lower glucuronidation
Aspirin	Higher esterase activity in males; lower plasma levels in males.
Chloramphenicol	Higher plasma levels in females.
Chlordiazepoxide	Lower clearance in females as compared with males.
Diazepam	Lower clearance in females as compared with males.
Erythromycin	Higher clearance in females.
Lidocaine	Greater half-life and volume of distribution in females.
Mephobarbital	Greater total body clearance and shorter half-life in young males.
Nortriptyline	Higher metabolism in males; females have higher plasma levels of parent compound.
Oxazepam	Lower clearance levels in females.
Phenytoin	Higher plasma levels in males.
Propranolol	Lower clearance in females due to lower glucuronidation.
Rifampicin	Higher plasma levels in females; higher urinary excretion of parent compound.
Tetracycline	Higher plasma levels in females.

In general, when a sex-dependent difference is observed in humans, females have higher plasma concentrations of the drug as compared with men. These differences have been observed with certain antibiotics, some tricyclic antidepressants, lithium, and aspirin (Giudicelli and Tillement, 1977). A wealth of information is available in the literature regarding sex-dependent differences in benzodiazepam pharmacokinetics in men and women. For example, the distribution of chlordiazepoxide is more extensive in women than in men (MacLeod et al., 1979). Women have a greater distribution of diazepam, which is metabolized by N-demethylation in the liver, than do men. In addition, diazepam clearance is higher in women than in men. Interestingly, the pharmacokinetics of benzodiazepams change in the elderly, with elderly patients showing a reduced clearance and volume of distribution of these drugs as compared with young patients (MacLeod et al., 1979).

Establishing the etiology of sex-dependent differences in drug pharmacokinetics is obviously more difficult in humans than in animals. Potential factors that may contribute to sex-specific differences in the pharmacokinetics of a compound include differences in absorption, bioavailability, distribution, and metabolism. Therefore targeting the contribution of metabolism alone to sex-dependent differences in drug pharmacokinetics in humans is difficult. Differences in the absorption, bioavailability, and distribution of some compounds are related to basic differences in physiology and body composition. For example, the absorption of certain drugs from the gastrointestinal tract may be affected by the fact that both gastric acid secretion and gastric emptying are lower in women as compared with men (Giudicelli and Tillement, 1977). The differences in rates of gastric absorption cause men to achieve peak sodium salicylate plasma concentrations more quickly than women. Also, the volume of distribution of certain chemicals can be affected by the fact that lean body mass is greater in males, while adipose tissue content is greater in women (Giudicelli and Tillement, 1977). For example, intramuscular injections of drugs are handled differently between men and women because of sex differences in the distribution of gluteal fat. Because of this difference, lipophilic chemicals can have a greater volume of distribution in women as compared with men.

Data from clinical studies indicate that hormonal regulation may play a role in xenobiotic metabolism in humans. There is evidence that the manipulation of normal levels of circulating steroid hormones can alter the way men and women handle xenobiotics. The best examples illustrating the effects of steroid hormones on drug pharmacokinetics come from clinical studies that contain detailed information on oral contraceptive use and menstrual cycle information from female volunteers. For example, there is evidence that the phase of a woman's menstrual cycle can affect the kinetics of a number of xenobiotics by altering drug distribution and clearance. There are changes in gastric emptying rate and acidity of the stomach contents at about day 14 of a 28-day menstrual cycle (MacDonald, 1956). As progesterone rises, ovulation increases the gastric emptying rate and the secretion of acid in the stomach. Therefore the bioavailability of a compound may change depending upon the phase of a woman's menstrual cycle. The phase of the menstrual cycle also has been shown to affect the volume of distribution and half-life of a number of chemicals, including diazepam and acetaminophen (MacLeod et al., 1979).

The data suggest that the hypothalamic-pituitary axis may be the control point for xenobiotic metabolism in humans. The sex difference in the pattern of growth hormone secretion in humans is qualitatively similar to the difference that is observed in rodents (Winer et al., 1990). Growth hormone is secreted in a pulsatile, circadian pattern in both men and women, but women have higher mean growth hormone serum concentrations than men (Winer et al., 1990). The etiology of sex-dependent differences in serum growth hormone levels in humans is not entirely clear.

Although there are sex-dependent differences between men and women in the handling of certain xenobiotics, the differences are not related to differences in CYP isoforms (Guengerich, 1990). Furthermore, the differences in humans are not nearly as distinct as those observed in rodents. In humans, intraindividual differences in metabolism apparently outweigh any differences regulated by sex-specific factors. For example, exposure to inducers of CYP isoforms through either the diet or workplace can produce a profile of hepatic CYP isoforms that may make an individual metabolize a compound differently. Also, genetic polymorphisms in the expression of CYP isoforms can produce wide differences in the metabolism of some compounds as compared with

individuals in the general population. This is in contrast to laboratory animals, where sex and strain can determine how an animal metabolizes a chemical.

Conclusions

Sex-dependent differences in xenobiotic metabolism are most pronounced in rats. Exaggerated sex-dependent variations in metabolism by rats may be the result of extensive inbreeding or differential evolution of CYP isoforms in mammals. Animal studies are used to help determine the metabolism and toxicity of many chemical agents in an attempt to anticipate the potential health risks of human exposure to these agents. One of the most important concepts to consider in using rodent studies to identify sensitive individuals in the human population is that human CYPs differ from rodent CYPs in both isoform composition and catalytic activities. Xenobiotic metabolism by male rats can reflect human metabolism when the compound of interest is metabolized by CYP1A or CYP2E because there is strong regulatory conservation of these isoforms between rodents and humans.

However, problems can arise when rats are used as animal models to predict the potential for sex-dependent differences in xenobiotic handling in humans. Information from countless studies has shown that the identification of sex-dependent differences in metabolism by rats does not translate across other animal species or humans. To date, sex-specific CYP isoforms have not been identified in humans. The lack of expression of sex-dependent CYP isoforms in humans indicates that the male rat is not an accurate model for the prediction of sex-dependent differences in humans. Differences in xenobiotic metabolism among humans are more likely the consequence of intraindividual variations as a result of genetics or environmental exposures rather than from sex-dependent differences in enzyme composition.

A major component of the safety assessment process is to identify, at the earliest stage possible, the potential for toxicity in humans. Earlier identification of individual differences in xenobiotic metabolism and the potential for toxicity will be facilitated by improving techniques to make better use of human tissues to prepare accurate *in vitro* systems such as isolated hepatocytes and liver slices to study xenobiotic metabolism and toxicity. Accurate systems should possess an array of bioactivation enzymes similar to the *in vivo* expression of human liver. In addition, compound concentrations and exposure times used in these *in vitro* test systems should mimic those achieved in the target tissues of humans. Consideration of such factors will allow the development of compounds with improved efficacy and low toxicity at a more efficient rate. The development of accurate *in vitro* systems utilizing human tissue will also aid in the investigation of the molecular mechanisms by which the CYP genes are regulated in humans. Such studies will facilitate our understanding of the basis for differences in the expression of CYP isoforms in humans.

Acknowledgments

This article is based on a review article by the same title that was published by Dr. Mugford and Dr. Kedderis in *Drug Metabolism Reviews* 30, 441–498; 1998. The article was condensed for publication in *CIIT Activities* by courtesy of Marcel Dekker, Inc.

Dr. Mugford's research at CIIT was supported in part by a National Research Service Award (ES 05718) from the National Institute of Environmental Health Sciences.

References

- Brodie, B. B. (1956). Pathways of drug metabolism. *J. Pharm. Pharmacol.* 8, 1-17.
- Giudicelli, J. F. and Tillement, J. P. (1977). Influence of sex on drug kinetics in man. *Clin. Pharmacokinet.* 2, 157-166.
- Guengerich, F. P. (1990). Mechanism-based inactivation of human liver microsomal cytochrome P-450 IIIA4 by gestodene. *Chem. Res. Toxicol.* 3, 363-371.
- Gustafsson, J. A., Mode, A., Norstedt, G., and Skett, P. (1983). Sex steroid induced changes in hepatic enzymes. *Annu. Rev. Physiol.* 45, 51-60.
- Gustafsson, J. A. and Stenberg, A. (1974). Masculinization of rat liver enzyme activities following hypophysectomy. *Endocrinology* 95, 891-896.
- Holck, H. G. O., Munir, A. K., Mills, L. M., and Smith, E. L. (1937). Studies upon the sex-difference in rats in tolerance to certain barbiturates and to nicotine. *J. Pharmacol. Exp. Ther.* 60, 323-346.
- Jones, C. R., Guengerich, F. P., Rice, J. M., and Lubet, R. A. (1992). Induction of various cytochromes CYP2B, CYP2C and CYP3A by phenobarbitone in non-human primates. *Pharmacogenetics* 2, 160-172.
- Kamataki, T., Maeda, K., Shimada, M., Kitani, K., Nagai, T., and Kato, R. (1985). Age-related alteration in the activities of drug-metabolizing enzymes and contents of sex-specific forms of cytochrome P-450 in liver microsomes from male and female rats. *J. Pharmacol. Exp. Ther.* 233, 222-228.
- Legraverend, C., Mode, A., Wells, T., Robinson, I., and Gustafsson, J. A. (1992). Hepatic steroid hydroxylating enzymes are controlled by the sexually dimorphic pattern of growth hormone secretion in normal and dwarf rats. *FASEB J.* 6, 711-718.
- Lin, J. H., Chiba, M., Chen, I. W., Nishime, J. A., and Vastag, K. J. (1996). Sex-dependent pharmacokinetics of indinavir: in vivo and in vitro evidence. *Drug Metab. Dispos.* 24, 1298-1306.
- MacDonald, I. (1956). Gastric activity during the menstrual cycle. *Gastroenterology* 30, 602-607.
- MacLeod, J. N., Sorensen, M. P., and Shapiro, B. H. (1987). Strain independent elevation of hepatic mono-oxygenase enzymes in female mice. *Xenobiotica* 17, 1095-1102.
- MacLeod, S. M., Giles, H. G., Bengeret, B., Lui, F. F., and Sellers, E. M. (1979). Age- and gender-related differences in diazepam pharmacokinetics. *J. Clin. Pharmacol.* 19, 15-19.

Mode, A., Gustafsson, J. A., Jansson, J. O., Eden, S., and Isaksson, O. (1982). Association between plasma level of growth hormone and sex differentiation of hepatic steroid metabolism in the rat. *Endocrinology* 111, 1692-1697.

Mulder, G. J. (1986). Sex differences in drug conjugation and their consequences for drug toxicity. Sulfation, glucuronidation and glutathione conjugation. *Chem. Biol. Interactions* 57, 1-15.

Nelson, D. R., Koymans, L., Kamataki, T., Stegeman, J. J., Feyereisen, R., Waxman, D. J., Waterman, M. R., Gotoh, O., Coon, M. J., Estabrook, R. W., Gunsalus, I. C., and Nebert, D. W. (1996). P450 superfamily: update on new sequences, gene mapping, accession numbers and nomenclature. *Pharmacogenetics* 6, 1-42.

Shapiro, B. H. (1986). Sexually dimorphic response of rat hepatic monooxygenases to low-dose phenobarbital. *Biochem. Pharmacol.* 35, 1766-1768.

Srivastava, P. K. and Waxman, D. J. (1993). Sex-dependent expression and growth hormone regulation of class alpha and class mu glutathione S-transferase mRNAs in adult rat liver. *Biochem. J.* 294, 159-165.

Tynes, R. E. and Philpot, R. M. (1987). Tissue- and species-dependent expression of multiple forms of mammalian microsomal flavin-containing monooxygenase. *Mol. Pharmacol.* 31, 569-574.

Waxman, D. J., Dannan, G. A., and Guengerich, F. P. (1985). Regulation of rat hepatic cytochrome P-450: age-dependent expression, hormonal imprinting, and xenobiotic inducibility of sex-specific iso-enzymes. *Biochemistry* 24, 4409-4417.

Winer, L. M., Shaw, M. A., and Baumann, G. (1990). Basal plasma growth hormone levels in man: new evidence for rhythmicity of growth hormone secretion. *J. Clin. Endocrinol. Metab.* 70, 1678-1686.

Wrighton, S. A., Stevens, J. C., Becker, G. W., and VandenBranden, M. (1993). Isolation and characterization of human liver cytochrome P450 2C19: correlation between 2C19 and S-mephenytoin 4-hydroxylation. *Arch. Biochem. Biophys.* 306, 240-245.

Zhu, B. T., Suchar, L. A., Huang, M. T., and Conney, A. H. (1996). Similarities and differences in the glucuronidation of estradiol and estrone by UDP-glucuronosyltransferase in liver microsomes from male and female rats. *Biochem. Pharmacol.* 51, 1195-1202.

The Authors

Gregory L. Kedderis received a Ph.D. degree in biochemistry in 1982 from Northwestern University Medical and Dental School, Chicago. He was a postdoctoral fellow at CIIT from 1982 to 1984 and subsequently joined Merck Sharp & Dohme Research Laboratories as a senior research biochemist. He returned to CIIT in 1988 as a staff scientist and is currently acting manager of the Toxicokinetics Subprogram in the Chemical Carcinogenesis Program. His research interests include mechanisms of toxicity of drugs and xenobiotics, mechanisms of genotoxicity and chemical carcinogenesis, and the relationship between chemical dosimetry and biological effects. Dr. Kedderis serves on the Editorial Boards of Drug Metabolism and Disposition and Cell Biology and Toxicology and is Reviews Editor of Chemico-Biological Interactions. He is a member of the International Society for the Study of Xenobiotics, Society of Toxicology, and Chemical Substances Threshold Limit Values Committee of the American Conference of Governmental Industrial Hygienists. He is cochair of the steering committee of the Hepatocyte Users Group of North America. Dr. Kedderis holds an adjunct faculty appointment in the Nicholas School of the Environment and the Integrated Toxicology Program at Duke University.

Cheryl A. Mugford received a Ph.D. degree in pharmacology and toxicology in 1994 from the Philadelphia College of Pharmacy and Science. Her dissertation research involved the role of cytochrome P450-dependent metabolism in acetaminophen nephrotoxicity in Sprague-Dawley rats. She came to CIIT as a postdoctoral fellow in 1994 to work with Dr. Gregory Kedderis on the mechanisms of furan-mediated cytolethality. Dr. Mugford received a National Research Service Award from the National Institute of Environmental Health Sciences in 1996 in partial support of her research at CIIT. She completed her training at CIIT in 1997 and is currently a research scientist in the Drug Safety Division at Wyeth-Ayerst Research, Princeton, New Jersey. Dr. Mugford is a member of the International Society for the Study of Xenobiotics, Society of Toxicology, and Association for Women in Science.

APPENDIX Q

Excerpts from U.S. Federal Agency Guidelines and Regulations for Acute Oral Toxicity

- Q-1 Excerpt from **16 CFR Part 1500** - pages 378 - 383.....Q-3
Hazardous Substances and Articles: Administration and Enforcement
- Q-2 Excerpt from **29 CFR Part 1910.1200** - pages 479 - 481Q-11
Hazard Communication
- Q-3 Excerpt from **40 CFR Part 152** - pages 5 - 10.....Q-17
Pesticide Registration and Classification Procedures
- Q-4 Excerpt from **40 CFR Part 156** - pages 53 - 58
Labeling Requirements for Pesticides and Devices.....Q-25
- Q-5 Excerpt from **40 CFR Part 158** - pages 74 - 95.....Q-33
Data Requirements for Registration
- Q-6 Excerpt from **40 CFR Part 721** - pages 119 - 128.....Q-57
Significant New Uses of Chemical Substances
- Q-7 Excerpts from **49 CFR Part 173** - pages 342 - 348, 441 - 443.....Q-69
Shippers - General Requirements for Shipments and Packages

REGULATIONS

Excerpt from

16 CFR Part 1500

Pages 378 - 383

**Hazardous Substances and Articles:
Administration and Enforcement**

The Consumer Product Safety Commission, under the authority of the Federal Hazardous Substances Control Act, requires acute oral toxicity and other testing to be conducted on chemicals in commerce. The purpose is to provide adequate labeling and warning to consumers of goods that are hazardous via oral, dermal, or inhalation during purposeful or accidental exposure.

SUBCHAPTER C—FEDERAL HAZARDOUS SUBSTANCES ACT REGULATIONS

PART 1500—HAZARDOUS SUBSTANCES AND ARTICLES; ADMINISTRATION AND ENFORCEMENT REGULATIONS

Sec.

- 1500.1 Scope of subchapter.
- 1500.2 Authority.
- 1500.3 Definitions.
- 1500.4 Human experience with hazardous substances.
- 1500.5 Hazardous mixtures.
- 1500.12 Products declared to be hazardous substances under section 3(a) of the act.
- 1500.13 Listing of “strong sensitizer” substances.
- 1500.14 Products requiring special labeling under section 3(b) of the act.
- 1500.15 Labeling of fire extinguishers.
- 1500.17 Banned hazardous substances.
- 1500.18 Banned toys and other banned articles intended for use by children.
- 1500.19 Misbranded toys and other articles intended for use by children.
- 1500.40 Method of testing toxic substances.
- 1500.41 Method of testing primary irritant substances.
- 1500.42 Test for eye irritants.
- 1500.43 Method of test for flashpoint of volatile flammable materials by Tagliabue open-cup apparatus.
- 1500.43a Method of test for flashpoint of volatile flammable materials.
- 1500.44 Method for determining extremely flammable and flammable solids.
- 1500.45 Method for determining extremely flammable and flammable contents of self-pressurized containers.
- 1500.46 Method for determining flashpoint of extremely flammable contents of self-pressurized containers.
- 1500.47 Method for determining the sound pressure level produced by toy caps.
- 1500.48 Technical requirements for determining a sharp point in toys and other articles intended for use by children under 8 years of age.
- 1500.49 Technical requirements for determining a sharp metal or glass edge in toys and other articles intended for use by children under 8 years of age.
- 1500.50 Test methods for simulating use and abuse of toys and other articles intended for use by children.
- 1500.51 Test methods for simulating use and abuse of toys and other articles intended for use by children 18 months of age or less.
- 1500.52 Test methods for simulating use and abuse of toys and other articles intended

for use by children over 18 but not over 36 months of age.

- 1500.53 Test methods for simulating use and abuse of toys and other articles intended for use by children over 36 but not over 96 months of age.
- 1500.81 Exemptions for food, drugs, cosmetics, and fuels.
- 1500.82 Exemption from full labeling and other requirements.
- 1500.83 Exemptions for small packages, minor hazards, and special circumstances.
- 1500.85 Exemptions from classification as banned hazardous substances.
- 1500.86 Exemptions from classification as a banned toy or other banned article for use by children.
- 1500.121 Labeling requirements; prominence, placement, and conspicuousness.
- 1500.122 Deceptive use of disclaimers.
- 1500.123 Condensation of label information.
- 1500.125 Labeling requirements for accompanying literature.
- 1500.126 Substances determined to be “special hazards.”
- 1500.127 Substances with multiple hazards.
- 1500.128 Label comment.
- 1500.129 Substances named in the Federal Caustic Poison Act.
- 1500.130 Self-pressurized containers: labeling.
- 1500.133 Extremely flammable contact adhesives; labeling.
- 1500.134 Policy on first aid labeling for saline emesis.
- 1500.135 Summary of guidelines for determining chronic toxicity.
- 1500.210 Responsibility.
- 1500.211 Guaranty.
- 1500.212 Definition of guaranty; suggested forms.
- 1500.213 Presentation of views under section 7 of the act.
- 1500.214 Examinations and investigations; samples.
- 1500.230 Guidance for lead (Pb) in consumer products.
- 1500.231 Guidance for hazardous liquid chemicals in children’s products.

IMPORTS

- 1500.265 Imports; definitions.
- 1500.266 Notice of sampling.
- 1500.267 Payment for samples.
- 1500.268 Hearing.
- 1500.269 Application for authorization.
- 1500.270 Granting of authorization.
- 1500.271 Bonds.
- 1500.272 Costs chargeable in connection with relabeling and reconditioning inadmissible imports.

Consumer Product Safety Commission

§ 1500.3

AUTHORITY: 15 U.S.C. 1261-1278.

SOURCE: 38 FR 27012, Sept. 27, 1973, unless otherwise noted.

§ 1500.1 Scope of subchapter.

Set forth in this subchapter C are the regulations of the Consumer Product Safety Commission issued pursuant to and for the implementation of the Federal Hazardous Substances Act as amended (see § 1500.3(a)(1)).

§ 1500.2 Authority.

Authority under the Federal Hazardous Substances Act is vested in the Consumer Product Safety Commission by section 30(a) of the Consumer Product Safety Act (15 U.S.C. 2079(a)).

§ 1500.3 Definitions.

(a) *Certain terms used in this part.* As used in this part:

(1) *Act* means the Federal Hazardous Substances Act (Pub. L. 86-613, 74 Stat. 372-81 (15 U.S.C. 1261-74)) as amended by:

(i) The Child Protection Act of 1966 (Pub. L. 89-756, 80 Stat. 1303-05).

(ii) The Child Protection and Toy Safety Act of 1969 (Pub. L. 91-113, 83 Stat. 187-90).

(iii) The Poison Prevention Packaging Act of 1970 (Pub. L. 91-601, 84 Stat. 1670-74).

(2) *Commission* means the Consumer Product Safety Commission established May 14, 1973, pursuant to provisions of the Consumer Product Safety Act (Pub. L. 92-573, 86 Stat. 1207-33 (15 U.S.C. 2051-81)).

(b) *Statutory definitions.* Except for the definitions given in section 2 (c) and (d) of the act, which are obsolete, the definitions set forth in section 2 of the act are applicable to this part and are repeated for convenience as follows (some of these statutory definitions are interpreted, supplemented, or provided with alternatives in paragraph (c) of this section):

(1) *Territory* means any territory or possession of the United States, including the District of Columbia and the Commonwealth of Puerto Rico but excluding the Canal Zone.

(2) *Interstate commerce* means (i) commerce between any State or territory and any place outside thereof and (ii) commerce within the District of Co-

lumbia or within any territory not organized with a legislative body.

(3) *Person* includes an individual, partnership, corporation, and association.

(4)(i) *Hazardous substance* means:

(A) Any substance or mixture of substances which is toxic, corrosive, an irritant, a strong sensitizer, flammable or combustible, or generates pressure through decomposition, heat, or other means, if such substance or mixture of substances may cause substantial personal injury or substantial illness during or as a proximate result of any customary or reasonably foreseeable handling or use, including reasonably foreseeable ingestion by children.

(B) Any substance which the Commission by regulation finds, pursuant to the provisions of section 3(a) of the act, meet the requirements of section 2(f)(1)(A) of the act (restated in (A) above).

(C) Any radioactive substance if, with respect to such substance as used in a particular class of article or as packaged, the Commission determines by regulation that the substance is sufficiently hazardous to require labeling in accordance with the act in order to protect the public health.

(D) Any toy or other article intended for use by children which the Commission by regulation determines, in accordance with section 3(e) of the act, presents an electrical, mechanical, or thermal hazard.

(ii) *Hazardous substance* shall not apply to pesticides subject to the Federal Insecticide, Fungicide, and Rodenticide Act, to foods, drugs, and cosmetics subject to the Federal Food, Drug, and Cosmetic Act, nor to substances intended for use as fuels when stored in containers and used in the heating, cooking, or refrigeration system of a house. "Hazardous substance" shall apply, however, to any article which is not itself a pesticide within the meaning of the Federal Insecticide, Fungicide, and Rodenticide Act but which is a hazardous substance within the meaning of section 2(f)(1) of the Federal Hazardous Substances Act (restated in paragraph (b)(4)(i) of this section) by reason of bearing or containing such a pesticide.

(iii) *Hazardous substance* shall not include any source material, special nuclear material, or byproduct material as defined in the Atomic Energy Act of 1954, as amended, and regulations issued pursuant thereto by the Atomic Energy Commission.

(5) *Toxic* shall apply to any substance (other than a radioactive substance) which has the capacity to produce personal injury or illness to man through ingestion, inhalation, or absorption through any body surface.

(6)(i) *Highly toxic* means any substance which falls within any of the following categories:

(A) Produces death within 14 days in half or more than half of a group of 10 or more laboratory white rats each weighing between 200 and 300 grams, at a single dose of 50 milligrams or less per kilogram of body weight, when orally administered; or

(B) Produces death within 14 days in half or more than half of a group of 10 or more laboratory white rats each weighing between 200 and 300 grams, when inhaled continuously for a period of 1 hour or less at an atmospheric concentration of 200 parts per million by volume or less of gas or vapor or 2 milligrams per liter by volume or less of mist or dust, provided such concentration is likely to be encountered by man when the substance is used in any reasonably foreseeable manner; or

(C) Produces death within 14 days in half or more than half of a group of 10 or more rabbits tested in a dosage of 200 milligrams or less per kilogram of body weight, when administered by continuous contact with the bare skin for 24 hours or less.

(ii) If the Commission finds that available data on human experience with any substance indicate results different from those obtained on animals in the dosages and concentrations specified in paragraph (b)(6)(i) of this section, the human data shall take precedence.

(7) *Corrosive* means any substance which in contact with living tissue will cause destruction of tissue by chemical action, but shall not refer to action on inanimate surfaces.

(8) *Irritant* means any substance not corrosive within the meaning of section 2(i) of the act (restated in para-

graph (b)(7) of this section) which on immediate, prolonged, or repeated contact with normal living tissue will induce a local inflammatory reaction.

(9) *Strong sensitizer* means a substance which will cause on normal living tissue through an allergic or photodynamic process a hypersensitivity which becomes evident on reapplication of the same substance and which is designated as such by the Commission. Before designating any substance as a strong sensitizer, the Commission, upon consideration of the frequency of occurrence and severity of the reaction, shall find that the substance has a significant potential for causing hypersensitivity.

(10) The terms *extremely flammable*, *flammable*, and *combustible* as they apply to any substances, liquid, solid, or the contents of any self-pressurized container, are defined by regulations issued by the Commission and published at §1500.3(c)(6).

(11) *Radioactive substance* means a substance which emits ionizing radiation.

(12) *Label* means a display of written, printed, or graphic matter upon the immediate container of any substance or, in the cases of an article which is unpackaged or is not packaged in an immediate container intended or suitable for delivery to the ultimate consumer, a display of such matter directly upon the article involved or upon a tag or other suitable material affixed thereto. A requirement made by or under authority of the act that any word, statement, or other information appear on the label shall not be considered to be complied with unless such word, statement, or other information also appears (i) on the outside container or wrapper, if any there be, unless it is easily legible through the outside container or wrapper and (ii) on all accompanying literature where there are directions for use, written or otherwise.

(13) *Immediate container* does not include package liners.

(14) *Misbranded hazardous substance* means a hazardous substance (including a toy, or other article intended for use by children, which is a hazardous substance, or which bears or contains a hazardous substance in such manner as

to be susceptible of access by a child to whom such toy or other article is entrusted) intended, or packaged in a form suitable, for use in the household or by children, if the packaging or labeling of such substance is in violation of an applicable regulation issued pursuant to section 3 or 4 of the Poison Prevention Packaging Act of 1970 or if such substance, except as otherwise provided by or pursuant to section 3 of the act (Federal Hazardous Substances Act), fails to bear a label:

(i) Which states conspicuously:

(A) The name and place of business of the manufacturer, packer, distributor, or seller;

(B) The common or usual name or the chemical name (if there be no common or usual name) of the hazardous substance or of each component which contributes substantially to its hazard, unless the Commission by regulation permits or requires the use of a recognized generic name;

(C) The signal word "DANGER" on substances which are extremely flammable, corrosive, or highly toxic;

(D) The signal word "WARNING" or "CAUTION" on all other hazardous substances;

(E) An affirmative statement of the principal hazard or hazards, such as "Flammable," "Combustible," "Vapor Harmful," "Causes Burns," "Absorbed Through Skin," or similar wording descriptive of the hazard;

(F) Precautionary measures describing the action to be followed or avoided, except when modified by regulation of the Commission pursuant to section 3 of the act;

(G) Instruction, when necessary or appropriate, for first-aid treatment;

(H) The word *Poison* for any hazardous substance which is defined as "highly toxic" by section 2(h) of the act (restated in paragraph (b)(6) of this section);

(I) Instructions for handling and storage of packages which require special care in handling or storage; and

(J) The statement (1) "Keep out of the reach of children" or its practical equivalent, or, (2) if the article is intended for use by children and is not a banned hazardous substance, adequate directions for the protection of children from the hazard; and

(ii) On which any statements required under section 2(p)(1) of the act (restated in paragraph (b)(14)(i) of this section) are located prominently and are in the English language in conspicuous and legible type in contrast by typography, layout, or color with other printed matter on the label.

Misbranded hazardous substance also means a household substance as defined in section 2(2)(D) of the Poison Prevention Packaging Act of 1970 if it is a substance described in section 2(f)(1) of the Federal Hazardous Substances Act (restated in paragraph (b)(4)(i)(A) of this section) and its packaging or labeling is in violation of an applicable regulation issued pursuant to section 3 or 4 of the Poison Prevention Packaging Act of 1970.

(15)(i) *Banned hazardous substance* means:

(A) Any toy, or other article intended for use by children, which is a hazardous substance, or which bears or contains a hazardous substance in such manner as to be susceptible of access by a child to whom such toy or other article is entrusted; or

(B) Any hazardous substance intended, or packaged in a form suitable, for use in the household, which the Commission by regulation classifies as a "banned hazardous substance" on the basis of a finding that, notwithstanding such cautionary labeling as is or may be required under the act for that substance, the degree or nature of the hazard involved in the presence or use of such substance in households is such that the objective of the protection of the public health and safety can be adequately served only by keeping such substance, when so intended or packaged, out of the channels of interstate commerce; *Provided*, That the Commission by regulation (1) shall exempt from section 2(q)(1)(A) of the act (restated in paragraph (b)(15)(i)(A) of this section) articles, such as chemistry sets, which by reason of their functional purpose require the inclusion of the hazardous substance involved, or necessarily present an electrical, mechanical, or thermal hazard, and which bear labeling giving adequate directions and warnings for safe use and are intended for use by children who have attained sufficient maturity, and may

§ 1500.3

16 CFR Ch. II (1–1–99 Edition)

reasonably be expected, to read and heed such directions and warnings, and (2) shall exempt from section 2(q)(1)(A) of the act (restated in paragraph (b)(15)(i)(A) of this section), and provide for the labeling of, common fireworks (including toy paper caps, cone fountains, cylinder fountains, whistles without report, and sparklers) to the extent that the Commission determines that such articles can be adequately labeled to protect the purchasers and users thereof.

(ii) Proceedings for the issuance, amendment, or repeal of regulations pursuant to section 2(q)(1)(B) of the act (restated in paragraph (b)(15)(i)(B) of this section) shall be governed by the provisions of section 701 (e), (f), and (g) of the Federal Food, Drug, and Cosmetic Act: *Provided*, That if the Commission finds that the distribution for household use of the hazardous substance involved presents an imminent hazard to the public health, the Commission may by order published in the FEDERAL REGISTER give notice of such finding, and thereupon such substance when intended or offered for household use, or when so packaged as to be suitable for such use, shall be deemed to be a “banned hazardous substance” pending the completion of proceedings relating to the issuance of such regulations.

(16) “Electrical hazard”—an article may be determined to present an electrical hazard if, in normal use or when subjected to reasonably foreseeable damage or abuse, its design or manufacture may cause personal injury or illness by electric shock.

(17) “Mechanical hazard”—an article may be determined to present a mechanical hazard if, in normal use or when subjected to reasonably foreseeable damage or abuse, its design or manufacture presents an unreasonable risk of personal injury or illness:

- (i) From fracture, fragmentation, or disassembly of the article;
- (ii) From propulsion of the article (or any part or accessory thereof);
- (iii) From points or other protrusions, surfaces, edges, openings, or closures;
- (iv) From moving parts;
- (v) From lack or insufficiency of controls to reduce or stop motion;

(vi) As a result of self-adhering characteristics of the article;

(vii) Because the article (or any part or accessory thereof) may be aspirated or ingested;

(viii) Because of instability; or

(ix) Because of any other aspect of the article’s design or manufacture.

(18) “Thermal hazard”—an article may be determined to present a thermal hazard if, in normal use or when subjected to reasonably foreseeable damage or abuse, its design or manufacture presents an unreasonable risk of personal injury or illness because of heat as from heated parts, substances, or surfaces.

(c) *Certain statutory definitions interpreted, supplemented, or provided with alternatives.* The following items interpret, supplement, or provide alternatives to definitions set forth in section 2 of the act (and restated in paragraph (b) of this section):

(1) To provide flexibility as to the number of animals tested, the following is an alternative to the definition of “highly toxic” in section 2(h) of the act (and paragraph (b)(6) of this section); *Highly toxic* means:

(i) A substance determined by the Commission to be highly toxic on the basis of human experience; and/or

(ii) A substance that produces death within 14 days in half or more than half of a group of:

(A) White rats (each weighing between 200 and 300 grams) when a single dose of 50 milligrams or less per kilogram of body weight is administered orally;

(B) White rats (each weighing between 200 and 300 grams) when a concentration of 200 parts per million by volume or less of gas or vapor, or 2 milligrams per liter by volume or less of mist or dust, is inhaled continuously for 1 hour or less, if such concentration is likely to be encountered by man when the substance is used in any reasonably foreseeable manner; and/or

(C) Rabbits (each weighing between 2.3 and 3.0 kilograms) when a dosage of 200 milligrams or less per kilogram of body weight is administered by continuous contact with the bare skin for 24 hours or less by the method described in § 1500.40.

The number of animals tested shall be sufficient to give a statistically significant result and shall be in conformity with good pharmacological practices.

(2) To give specificity to the definition of "toxic" in section 2(g) of the act (and restated in paragraph (b)(5) of this section), the following supplements that definition. The following categories are not intended to be inclusive.

(i) *Acute toxicity.* *Toxic* means any substance that produces death within 14 days in half or more than half of a group of:

(A) White rats (each weighing between 200 and 300 grams) when a single dose of from 50 milligrams to 5 grams per kilogram of body weight is administered orally. Substances falling in the toxicity range between 500 milligrams and 5 grams per kilogram of body weight will be considered for exemption from some or all of the labeling requirements of the act, under §1500.82, upon a showing that such labeling is not needed because of the physical form of the substances (solid, a thick plastic, emulsion, etc.), the size or closure of the container, human experience with the article, or any other relevant factors;

(B) White rats (each weighing between 200 and 300 grams) when an atmospheric concentration of more than 200 parts per million but not more than 20,000 parts per million by volume of gas or vapor, or more than 2 but not more than 200 milligrams per liter by volume of mist or dust, is inhaled continuously for 1 hour or less, if such concentration is likely to be encountered by man when the substance is used in any reasonably foreseeable manner: and/or

(C) Rabbits (each weighing between 2.3 and 3.0 kilograms) when a dosage of more than 200 milligrams but not more than 2 grams per kilogram of body weight is administered by continuous contact with the bare skin for 24 hours by the method described in §1500.40.

The number of animals tested shall be sufficient to give a statistically significant result and shall be in conformity with good pharmacological practices. "Toxic" also applies to any substance that is "toxic" (but not "highly toxic") on the basis of human experience.

(ii) *Chronic toxicity.* A substance is toxic because it presents a chronic hazard if it falls into one of the following categories. (For additional information see the chronic toxicity guidelines at 16 CFR 1500.135.)

(A) *For Carcinogens.* A substance is toxic if it is or contains a known or probable human carcinogen.

(B) *For Neurotoxicological Toxicants.* A substance is toxic if it is or contains a known or probable human neurotoxin.

(C) *For Developmental or Reproductive Toxicants.* A substance is toxic if it is or contains a known or probable human developmental or reproductive toxicant.

(3) The definition of *corrosive* in section 2(i) of the act (restated in paragraph (b)(7) of this section) is interpreted to also mean the following: *Corrosive* means a substance that causes visible destruction or irreversible alterations in the tissue at the site of contact. A test for a corrosive substance is whether, by human experience, such tissue destruction occurs at the site of application. A substance would be considered corrosive to the skin if, when tested on the intact skin of the albino rabbit by the technique described in §1500.41, the structure of the tissue at the site of contact is destroyed or changed irreversibly in 24 hours or less. Other appropriate tests should be applied when contact of the substance with other than skin tissue is being considered.

(4) The definition of *irritant* in section 2(j) of the act (restated in paragraph (b)(8) of this section) is supplemented by the following: *Irritant* includes "primary irritant to the skin" as well as substances irritant to the eye or to mucous membranes. *Primary irritant* means a substance that is not corrosive and that human experience data indicate is a primary irritant and/or means a substance that results in an empirical score of five or more when tested by the method described in §1500.41. *Eye irritant* means a substance that human experience data indicate is an irritant to the eye and/or means a substance for which a positive test is obtained when tested by the method described in §1500.42.

REGULATIONS

Excerpt from

29 CFR Part 1910.1200

Pages 479 - 481

Hazard Communication

OSHA requires the use of acute lethality data to implement chemical and product labeling requirements for the hazard communication program to protect employees (29 CFR 1910).

(ii) If a chemical manufacturer, importer, or employer demonstrates to OSHA that the execution of a confidentiality agreement would not provide sufficient protection against the potential harm from the unauthorized disclosure of a trade secret specific chemical identity, the Assistant Secretary may issue such orders or impose such additional limitations or conditions upon the disclosure of the requested chemical information as may be appropriate to assure that the occupational health services are provided without an undue risk of harm to the chemical manufacturer, importer, or employer.

(11) If a citation for a failure to release specific chemical identity information is contested by the chemical manufacturer, importer, or employer, the matter will be adjudicated before the Occupational Safety and Health Review Commission in accordance with the Act's enforcement scheme and the applicable Commission rules of procedure. In accordance with the Commission rules, when a chemical manufacturer, importer, or employer continues to withhold the information during the contest, the Administrative Law Judge may review the citation and supporting documentation *in camera* or issue appropriate orders to protect the confidentiality of such matters.

(12) Notwithstanding the existence of a trade secret claim, a chemical manufacturer, importer, or employer shall, upon request, disclose to the Assistant Secretary any information which this section requires the chemical manufacturer, importer, or employer to make available. Where there is a trade secret claim, such claim shall be made no later than at the time the information is provided to the Assistant Secretary so that suitable determinations of trade secret status can be made and the necessary protections can be implemented.

(13) Nothing in this paragraph shall be construed as requiring the disclosure under any circumstances of process or percentage of mixture information which is a trade secret.

(j) *Effective dates.* Chemical manufacturers, importers, distributors, and employers shall be in compliance with all provisions of this section by March 11, 1994.

NOTE: The effective date of the clarification that the exemption of wood and wood products from the Hazard Communication standard in paragraph (b)(6)(iv) only applies to wood and wood products including lumber which will not be processed, where the manufacturer or importer can establish that the only hazard they pose to employees is the potential for flammability or combustibility, and that the exemption does not apply to wood or wood products which have been treated with a hazardous chemical covered by this standard, and wood which may be subsequently sawed or cut generating dust has been stayed from March 11, 1994 to August 11, 1994.

APPENDIX A TO § 1910.1200—HEALTH HAZARD DEFINITIONS (MANDATORY)

Although safety hazards related to the physical characteristics of a chemical can be objectively defined in terms of testing requirements (e.g. flammability), health hazard definitions are less precise and more subjective. Health hazards may cause measurable changes in the body—such as decreased pulmonary function. These changes are generally indicated by the occurrence of signs and symptoms in the exposed employees—such as shortness of breath, a non-measurable, subjective feeling. Employees exposed to such hazards must be apprised of both the change in body function and the signs and symptoms that may occur to signal that change.

The determination of occupational health hazards is complicated by the fact that many of the effects or signs and symptoms occur commonly in non-occupationally exposed populations, so that effects of exposure are difficult to separate from normally occurring illnesses. Occasionally, a substance causes an effect that is rarely seen in the population at large, such as angiosarcomas caused by vinyl chloride exposure, thus making it easier to ascertain that the occupational exposure was the primary causative factor. More often, however, the effects are common, such as lung cancer. The situation is further complicated by the fact that most chemicals have not been adequately tested to determine their health hazard potential, and data do not exist to substantiate these effects.

There have been many attempts to categorize effects and to define them in various ways. Generally, the terms "acute" and "chronic" are used to delineate between effects on the basis of severity or duration. "Acute" effects usually occur rapidly as a result of short-term exposures, and are of short duration. "Chronic" effects generally occur as a result of long-term exposure, and are of long duration.

The acute effects referred to most frequently are those defined by the American

National Standards Institute (ANSI) standard for Precautionary Labeling of Hazardous Industrial Chemicals (Z129.1-1988)—irritation, corrosivity, sensitization and lethal dose. Although these are important health effects, they do not adequately cover the considerable range of acute effects which may occur as a result of occupational exposure, such as, for example, narcosis.

Similarly, the term chronic effect is often used to cover only carcinogenicity, teratogenicity, and mutagenicity. These effects are obviously a concern in the workplace, but again, do not adequately cover the area of chronic effects, excluding, for example, blood dyscrasias (such as anemia), chronic bronchitis and liver atrophy.

The goal of defining precisely, in measurable terms, every possible health effect that may occur in the workplace as a result of chemical exposures cannot realistically be accomplished. This does not negate the need for employees to be informed of such effects and protected from them. Appendix B, which is also mandatory, outlines the principles and procedures of hazard assessment.

For purposes of this section, any chemicals which meet any of the following definitions, as determined by the criteria set forth in Appendix B are health hazards. However, this is not intended to be an exclusive categorization scheme. If there are available scientific data that involve other animal species or test methods, they must also be evaluated to determine the applicability of the HCS.⁷

1. *Carcinogen*: A chemical is considered to be a carcinogen if:

(a) It has been evaluated by the International Agency for Research on Cancer (IARC), and found to be a carcinogen or potential carcinogen; or

(b) It is listed as a carcinogen or potential carcinogen in the Annual Report on Carcinogens published by the National Toxicology Program (NTP) (latest edition); or,

(c) It is regulated by OSHA as a carcinogen.

2. *Corrosive*: A chemical that causes visible destruction of, or irreversible alterations in, living tissue by chemical action at the site of contact. For example, a chemical is considered to be corrosive if, when tested on the intact skin of albino rabbits by the method described by the U.S. Department of Transportation in appendix A to 49 CFR part 173, it destroys or changes irreversibly the structure of the tissue at the site of contact following an exposure period of four hours. This term shall not refer to action on inanimate surfaces.

3. *Highly toxic*: A chemical falling within any of the following categories:

(a) A chemical that has a median lethal dose (LD₅₀) of 50 milligrams or less per kilogram of body weight when administered orally to albino rats weighing between 200 and 300 grams each.

(b) A chemical that has a median lethal dose (LD₅₀) of 200 milligrams or less per kilogram of body weight when administered by continuous contact for 24 hours (or less if death occurs within 24 hours) with the bare skin of albino rabbits weighing between two and three kilograms each.

(c) A chemical that has a median lethal concentration (LC₅₀) in air of 200 parts per million by volume or less of gas or vapor, or 2 milligrams per liter or less of mist, fume, or dust, when administered by continuous inhalation for one hour (or less if death occurs within one hour) to albino rats weighing between 200 and 300 grams each.

4. *Irritant*: A chemical, which is not corrosive, but which causes a reversible inflammatory effect on living tissue by chemical action at the site of contact. A chemical is a skin irritant if, when tested on the intact skin of albino rabbits by the methods of 16 CFR 1500.41 for four hours exposure or by other appropriate techniques, it results in an empirical score of five or more. A chemical is an eye irritant if so determined under the procedure listed in 16 CFR 1500.42 or other appropriate techniques.

5. *Sensitizer*: A chemical that causes a substantial proportion of exposed people or animals to develop an allergic reaction in normal tissue after repeated exposure to the chemical.

6. *Toxic*. A chemical falling within any of the following categories:

(a) A chemical that has a median lethal dose (LD₅₀) of more than 50 milligrams per kilogram but not more than 500 milligrams per kilogram of body weight when administered orally to albino rats weighing between 200 and 300 grams each.

(b) A chemical that has a median lethal dose (LD₅₀) of more than 200 milligrams per kilogram but not more than 1,000 milligrams per kilogram of body weight when administered by continuous contact for 24 hours (or less if death occurs within 24 hours) with the bare skin of albino rabbits weighing between two and three kilograms each.

(c) A chemical that has a median lethal concentration (LC₅₀) in air of more than 200 parts per million but not more than 2,000 parts per million by volume of gas or vapor, or more than two milligrams per liter but not more than 20 milligrams per liter of mist, fume, or dust, when administered by continuous inhalation for one hour (or less if death occurs within one hour) to albino rats weighing between 200 and 300 grams each.

7. *Target organ effects*.

The following is a target organ categorization of effects which may occur, including examples of signs and symptoms and chemicals which have been found to cause such effects. These examples are presented to illustrate the range and diversity of effects and hazards found in the workplace, and the

broad scope employers must consider in this area, but are not intended to be all-inclusive.

- a. Hepatotoxins: Chemicals which produce liver damage³
Signs & Symptoms: Jaundice; liver enlargement
Chemicals: Carbon tetrachloride; nitrosamines
- b. Nephrotoxins: Chemicals which produce kidney damage
Signs & Symptoms: Edema; proteinuria
Chemicals: Halogenated hydrocarbons; uranium
- c. Neurotoxins: Chemicals which produce their primary toxic effects on the nervous system
Signs & Symptoms: Narcosis; behavioral changes; decrease in motor functions
Chemicals: Mercury; carbon disulfide
- d. Agents which act on the blood or hemopoietic system: Decrease hemoglobin function; deprive the body tissues of oxygen
Signs & Symptoms: Cyanosis; loss of consciousness
Chemicals: Carbon monoxide; cyanides
- e. Agents which damage the lung: Chemicals which irritate or damage pulmonary tissue
Signs & Symptoms: Cough; tightness in chest; shortness of breath
Chemicals: Silica; asbestos
- f. Reproductive toxins: Chemicals which affect the reproductive capabilities including chromosomal damage (mutations) and effects on fetuses (teratogenesis)
Signs & Symptoms: Birth defects; sterility
Chemicals: Lead; DBCP
- g. Cutaneous hazards: Chemicals which affect the dermal layer of the body
Signs & Symptoms: Defatting of the skin; rashes; irritation
Chemicals: Ketones; chlorinated compounds
- h. Eye hazards: Chemicals which affect the eye or visual capacity
Signs & Symptoms: Conjunctivitis; corneal damage
Chemicals: Organic solvents; acids

APPENDIX B TO § 1910.1200—HAZARD DETERMINATION (*Mandatory*)

The quality of a hazard communication program is largely dependent upon the adequacy and accuracy of the hazard determination. The hazard determination requirement of this standard is performance-oriented. Chemical manufacturers, importers, and employers evaluating chemicals are not required to follow any specific methods for determining hazards, but they must be able to demonstrate that they have adequately ascertained the hazards of the chemicals produced or imported in accordance with the criteria set forth in this Appendix.

Hazard evaluation is a process which relies heavily on the professional judgment of the evaluator, particularly in the area of chronic hazards. The performance-orientation of the hazard determination does not diminish the duty of the chemical manufacturer, importer or employer to conduct a thorough evaluation, examining all relevant data and producing a scientifically defensible evaluation. For purposes of this standard, the following criteria shall be used in making hazard determinations that meet the requirements of this standard.

1. *Carcinogenicity*: As described in paragraph (d)(4) of this section and Appendix A of this section, a determination by the National Toxicology Program, the International Agency for Research on Cancer, or OSHA that a chemical is a carcinogen or potential carcinogen will be considered conclusive evidence for purposes of this section. In addition, however, all available scientific data on carcinogenicity must be evaluated in accordance with the provisions of this Appendix and the requirements of the rule.

2. *Human data*: Where available, epidemiological studies and case reports of adverse health effects shall be considered in the evaluation.

3. *Animal data*: Human evidence of health effects in exposed populations is generally not available for the majority of chemicals produced or used in the workplace. Therefore, the available results of toxicological testing in animal populations shall be used to predict the health effects that may be experienced by exposed workers. In particular, the definitions of certain acute hazards refer to specific animal testing results (see Appendix A).

4. *Adequacy and reporting of data*. The results of any studies which are designed and conducted according to established scientific principles, and which report statistically significant conclusions regarding the health effects of a chemical, shall be a sufficient basis for a hazard determination and reported on any material safety data sheet. *In vitro* studies alone generally do not form the basis for a definitive finding of hazard under the HCS since they have a positive or negative result rather than a statistically significant finding.

The chemical manufacturer, importer, or employer may also report the results of other scientifically valid studies which tend to refute the findings of hazard.

APPENDIX C TO § 1910.1200—[RESERVED]

APPENDIX D TO § 1910.1200—DEFINITION OF "TRADE SECRET" (MANDATORY)

The following is a reprint of the *Restatement of Torts* section 757, comment *b* (1939):

REGULATIONS

Excerpt from

40 CFR Part 152

Pages 5 - 10

Pesticide Registration and Classification Procedures

The U. S. Environmental Protection Agency is required under the Federal Insecticide, Fungicide, and Rodenticide Act to register all pesticides available for use in the United States. This section sets forth the procedures, requirements, and criteria for registration and reregistration of pesticide products, and regulatory activities affecting registration. Testing must be in compliance with Good Laboratory Practices (40 CFR Part 792).

SUBCHAPTER E—PESTICIDE PROGRAMS

PARTS 150–151 [RESERVED]

PART 152—PESTICIDE REGISTRATION AND CLASSIFICATION PROCEDURES

Subpart A—General Provisions

- Sec.
- 152.1 Scope.
- 152.3 Definitions.
- 152.5 Pests.
- 152.8 Products that are not pesticides because they are not for use against pests.
- 152.10 Products that are not pesticides because they are not deemed to be used for a pesticidal effect.
- 152.15 Pesticide products required to be registered.

Subpart B—Exemptions

- 152.20 Exemptions for pesticides regulated by another Federal agency.
- 152.25 Exemptions for pesticides of a character not requiring FIFRA regulation.
- 152.30 Pesticides that may be transferred, sold, or distributed without registration.

Subpart C—Registration Procedures

- 152.40 Who may apply.
- 152.42 Application for new registration.
- 152.43 Alternate formulations.
- 152.44 Application for amended registration.
- 152.46 Notification and non-notification changes to registrations.
- 152.50 Contents of application.
- 152.55 Where to send applications and correspondence.

Subpart D [Reserved]

Subpart E—Procedures To Ensure Protection of Data Submitters' Rights

- 152.80 General.
- 152.81 Applicability.
- 152.83 Definitions.
- 152.84 When materials must be submitted to the Agency.
- 152.85 Formulators' exemption.
- 152.86 The cite-all method.
- 152.90 The selective method.
- 152.91 Waiver of a data requirement.
- 152.92 Submission of a new valid study.
- 152.93 Citation of a previously submitted valid study.
- 152.94 Citation of a public literature study or study generated at government expense.

- 152.95 Citation of all studies in the Agency's files pertinent to a specific data requirement.
- 152.96 Documentation of a data gap.
- 152.97 Rights and obligations of data submitters.
- 152.98 Procedures for transfer of exclusive use or compensation rights to another person.
- 152.99 Petitions to cancel registration.

Subpart F—Agency Review of Applications

- 152.100 Scope.
- 152.102 Publication.
- 152.104 Completeness of applications.
- 152.105 Incomplete applications.
- 152.107 Review of data.
- 152.108 Review of labeling.
- 152.110 Time for Agency review.
- 152.111 Choice of standards for review of applications.
- 152.112 Approval of registration under FIFRA sec. 3(c)(5).
- 152.113 Approval of registration under FIFRA sec. 3(c)(7)—Products that do not contain a new active ingredient.
- 152.114 Approval of registration under FIFRA sec 3(c)(7)—Products that contain a new active ingredient.
- 152.115 Conditions of registration.
- 152.116 Notice of intent to register to original submitters of exclusive use data.
- 152.117 Notification to applicant.
- 152.118 Denial of application.
- 152.119 Availability of material submitted in support of registration.

Subpart G—Obligations and Rights of Registrants

- 152.122 Currency of address of record and authorized agent.
- 152.125 Submission of information pertaining to adverse effects.
- 152.130 Distribution under approved labeling.
- 152.132 Supplemental distribution.
- 152.135 Transfer of registration.

Subpart H [Reserved]

Subpart I—Classification of Pesticides

- 152.160 Scope.
- 152.161 Definitions.
- 152.164 Classification procedures.
- 152.166 Labeling of restricted use products.
- 152.167 Distribution and sale of restricted use products.
- 152.168 Advertising of restricted use products.
- 152.170 Criteria for restriction to use by certified applicators.

§ 152.1

- 152.171 Restrictions other than those relating to use by certified applicators.
152.175 Pesticides classified for restricted use.

Subparts J-T [Reserved]

Subpart U—Registration Fees

- 152.400 Purpose.
152.401 Inapplicability of fee provisions to applications filed prior to October 1, 1997.
152.403 Definitions of fee categories.
152.404 Fee amounts.
152.406 Submission of supplementary data.
152.408 Special considerations.
152.410 Adjustment of fees.
152.412 Waivers and refunds.
152.414 Procedures.

Subparts V-Y [Reserved]

Subpart Z—Devices

- 152.500 Requirements for devices.

AUTHORITY: 7 U.S.C. 136-136y; Subpart U is also issued under 31 U.S.C. 9701.

Subpart A—General Provisions

SOURCE: 53 FR 15975, May 4, 1988, unless otherwise noted.

§ 152.1 Scope.

Part 152 sets forth procedures, requirements and criteria concerning the registration and reregistration of pesticide products under FIFRA sec. 3, and for associated regulatory activities affecting registration. These latter regulatory activities include data compensation and exclusive use (subpart E), and the classification of pesticide uses (subpart I).

[53 FR 15975, May 4, 1988, as amended at 60 FR 32096, June 19, 1995]

§ 152.3 Definitions.

Terms used in this part have the same meaning as in the Act. In addition, the following terms have the meanings set forth in this section.

(a) *Act* or *FIFRA* means the Federal Insecticide, Fungicide, and Rodenticide Act, as amended (7 U.S.C. 136-136y).

(b) *Active ingredient* means any substance (or group of structurally similar substances if specified by the Agency) that will prevent, destroy, repel or mitigate any pest, or that functions as a plant regulator, desiccant, or defo-

40 CFR Ch. I (7-1-99 Edition)

liant within the meaning of FIFRA sec. 2(a).

(c) *Acute dermal LD₅₀* means a statistically derived estimate of the single dermal dose of a substance that would cause 50 percent mortality to the test population under specified conditions.

(d) *Acute inhalation LC₅₀* means a statistically derived estimate of the concentration of a substance that would cause 50 percent mortality to the test population under specified conditions.

(e) *Acute oral LD₅₀* means a statistically derived estimate of the single oral dose of a substance that would cause 50 percent mortality to the test population under specified conditions.

(f) *Administrator* means the Administrator of the United States Environmental Protection Agency or his delegate.

(g) *Agency* means the United States Environmental Protection Agency (EPA), unless otherwise specified.

(h) *Applicant* means a person who applies for a registration, amended registration, or reregistration, under FIFRA sec. 3.

(i) *Biological control agent* means any living organism applied to or introduced into the environment that is intended to function as a pesticide against another organism declared to be a pest by the Administrator.

(j) *Distribute or sell* and other grammatical variations of the term such as "distributed or sold" and "distribution or sale," means the acts of distributing, selling, offering for sale, holding for sale, shipping, holding for shipment, delivering for shipment, or receiving and (having so received) delivering or offering to deliver, or releasing for shipment to any person in any State.

(k) *End use product* means a pesticide product whose labeling

(1) Includes directions for use of the product (as distributed or sold, or after combination by the user with other substances) for controlling pests or defoliating, desiccating, or regulating the growth of plants, and

(2) Does not state that the product may be used to manufacture or formulate other pesticide products.

(l) *Final printed labeling* means the label or labeling of the product when

Environmental Protection Agency

§ 152.5

distributed or sold. Final printed labeling does not include the package of the product, unless the labeling is an integral part of the package.

(m) *Inert ingredient* means any substance (or group of structurally similar substances if designated by the Agency), other than an active ingredient, which is intentionally included in a pesticide product.

(n) *Institutional use* means any application of a pesticide in or around any property or facility that functions to provide a service to the general public or to public or private organizations, including but not limited to:

- (1) Hospitals and nursing homes.
- (2) Schools other than preschools and day care facilities.
- (3) Museums and libraries.
- (4) Sports facilities.
- (5) Office buildings.

(o) *Manufacturing use product* means any pesticide product that is not an end-use product.

(p) *New use*, when used with respect to a product containing a particular active ingredient, means:

(1) Any proposed use pattern that would require the establishment of, the increase in, or the exemption from the requirement of, a tolerance or food additive regulation under section 408 or 409 of the Federal Food, Drug and Cosmetic Act;

(2) Any aquatic, terrestrial, outdoor, or forestry use pattern, if no product containing the active ingredient is currently registered for that use pattern; or

(3) Any additional use pattern that would result in a significant increase in the level of exposure, or a change in the route of exposure, to the active ingredient of man or other organisms.

(q) *Operated by the same producer*, when used with respect to two establishments, means that each such establishment is either owned by, or leased for operation by and under the control of, the same person. The term does not include establishments owned or operated by different persons, regardless of contractual agreement between such persons.

(r) *Package* or *packaging* means the immediate container or wrapping, including any attached closure(s), in which the pesticide is contained for

distribution, sale, consumption, use, or storage. The term does not include any shipping or bulk container used for transporting or delivering the pesticide unless it is the only such package.

(s) *Pesticide* means any substance or mixture of substances intended for preventing, destroying, repelling, or mitigating any pest, or intended for use as a plant regulator, defoliant, or desiccant, other than any article that:

(1) Is a new animal drug under FFDCA sec. 201(w), or

(2) Is an animal drug that has been determined by regulation of the Secretary of Health and Human Services not to be a new animal drug, or

(3) Is an animal feed under FFDCA sec. 201(x) that bears or contains any substances described by paragraph (s) (1) or (2) of this section.

(t) *Pesticide product* means a pesticide in the particular form (including composition, packaging, and labeling) in which the pesticide is, or is intended to be, distributed or sold. The term includes any physical apparatus used to deliver or apply the pesticide if distributed or sold with the pesticide.

(u) *Residential use* means use of a pesticide directly:

- (1) On humans or pets,
- (2) In, on, or around any structure, vehicle, article, surface, or area associated with the household, including but not limited to areas such as non-agricultural outbuildings, non-commercial greenhouses, pleasure boats and recreational vehicles, or
- (3) In any preschool or day care facility.

§ 152.5 Pests.

An organism is declared to be a pest under circumstances that make it deleterious to man or the environment, if it is:

(a) Any vertebrate animal other than man;

(b) Any invertebrate animal, including but not limited to, any insect, other arthropod, nematode, or mollusk such as a slug and snail, but excluding any internal parasite of living man or other living animals;

(c) Any plant growing where not wanted, including any moss, alga, liverwort, or other plant of any higher

§ 152.8

order, and any plant part such as a root; or

(d) Any fungus, bacterium, virus, or other microorganisms, except for those on or in living man or other living animals and those on or in processed food or processed animal feed, beverages, drugs (as defined in FDCA sec. 201(g)(1)) and cosmetics (as defined in FDCA sec. 201(i)).

§ 152.8 Products that are not pesticides because they are not for use against pests.

A substance or article is not a pesticide, because it is not intended for use against "pests" as defined in § 152.5, if it is:

(a) A product intended for use only for the control of fungi, bacteria, viruses, or other microorganisms in or on living man or animals, and labeled accordingly.

(b) A product intended for use only for control of internal invertebrate parasites or nematodes in living man or animals, and labeled accordingly.

(c) A product of any of the following types, intended only to aid the growth of desirable plants:

(1) A fertilizer product not containing a pesticide.

(2) A plant nutrient product, consisting of one or more macronutrients or micronutrient trace elements necessary to normal growth of plants and in a form readily usable by plants.

(3) A plant inoculant product consisting of microorganisms applied to the plant or soil for the purpose of enhancing the availability or uptake of plant nutrients through the root system.

(4) A soil amendment product containing a substance or substances added to the soil for the purpose of improving soil characteristics favorable for plant growth.

(d) A product intended to force bees from hives for the collection of honey crops.

§ 152.10 Products that are not pesticides because they are not deemed to be used for a pesticidal effect.

A product that is not intended to prevent, destroy, repel, or mitigate a pest, or to defoliate, desiccate or regulate the growth of plants, is not considered to be a pesticide. The following types

40 CFR Ch. I (7-1-99 Edition)

of products or articles are not considered to be pesticides unless a pesticidal claim is made on their labeling or in connection with their sale and distribution:

(a) Deodorizers, bleaches, and cleaning agents;

(b) Products not containing toxicants, intended only to attract pests for survey or detection purposes, and labeled accordingly;

(c) Products that are intended to exclude pests only by providing a physical barrier against pest access, and which contain no toxicants, such as certain pruning paints to trees.

§ 152.15 Pesticide products required to be registered.

No person may distribute or sell any pesticide product that is not registered under the Act, except as provided in §§ 152.20, 152.25, and 152.30. A pesticide is any substance (or mixture of substances) intended for a pesticidal purpose, i.e., use for the purpose of preventing, destroying, repelling, or mitigating any pest or use as a plant regulator, defoliant, or desiccant. A substance is considered to be intended for a pesticidal purpose, and thus to be a pesticide requiring registration, if:

(a) The person who distributes or sells the substance claims, states, or implies (by labeling or otherwise):

(1) That the substance (either by itself or in combination with any other substance) can or should be used as a pesticide; or

(2) That the substance consists of or contains an active ingredient and that it can be used to manufacture a pesticide; or

(b) The substance consists of or contains one or more active ingredients and has no significant commercially valuable use as distributed or sold other than (1) use for pesticidal purpose (by itself or in combination with any other substance), (2) use for manufacture of a pesticide; or

(c) The person who distributes or sells the substance has actual or constructive knowledge that the substance will be used, or is intended to be used, for a pesticidal purpose.

Subpart B—Exemptions

SOURCE: 53 FR 15977, May 4, 1988, unless otherwise noted.

§ 152.20 Exemptions for pesticides regulated by another Federal agency.

The pesticides or classes of pesticide listed in this section are exempt from all requirements of FIFRA. The Agency has determined, in accordance with FIFRA sec. 25(b)(1), that they are adequately regulated by another Federal agency.

(a) *Certain biological control agents.* (1) Except as provided by paragraph (a)(3) of this section, all biological control agents are exempt from FIFRA requirements.

(2) If the Agency determines that an individual biological control agent or class of biological control agents is no longer adequately regulated by another Federal agency, and that it should not otherwise be exempted from the requirements of FIFRA, the Agency will revoke this exemption by amending paragraph (a)(3) of this section.

(3) The following biological control agents are not exempt from FIFRA requirements:

- (i) Eucaryotic microorganisms, including protozoa, algae and fungi;
- (ii) Procaryotic microorganisms, including bacteria; and
- (iii) Viruses.

(b) *Certain human drugs.* A pesticide product that is offered solely for human use and also is a new drug within the meaning of FFDCA sec. 201(p) or is an article that has been determined by the Secretary of Health and Human Services not to be a new drug by a regulation establishing conditions of use for the article, is exempt from the requirements of FIFRA. Such products are subject to regulation in accordance with the Federal Food, Drug, and Cosmetic Act and implementing regulations.

§ 152.25 Exemptions for pesticides of a character not requiring FIFRA regulation.

The pesticides or classes of pesticides listed in this section have been determined to be of a character not requiring regulation under FIFRA, and are therefore exempt from all provisions of

FIFRA when intended for use, and used, only in the manner specified.

(a) *Treated articles or substances.* An article or substance treated with, or containing, a pesticide to protect the article or substance itself (for example, paint treated with a pesticide to protect the paint coating, or wood products treated to protect the wood against insect or fungus infestation), if the pesticide is registered for such use.

(b) *Pheromones and pheromone traps.* Pheromones and identical or substantially similar compounds labeled for use only in pheromone traps (or labeled for use in a manner which the Administrator determines poses no greater risk of adverse effects on the environment than use in pheromone traps), and pheromone traps in which those compounds are the sole active ingredient(s).

(1) For the purposes of this paragraph, a pheromone is a compound produced by an arthropod which, alone or in combination with other such compounds, modifies the behavior of other individuals of the same species.

(2) For the purposes of this paragraph, a synthetically produced compound is identical to a pheromone only when their molecular structures are identical, or when the only differences between the molecular structures are between the stereochemical isomer ratios of the two compounds, except that a synthetic compound found to have toxicological properties significantly different from a pheromone is not identical.

(3) When a compound possesses many characteristics of a pheromone but does not meet the criteria in paragraph (a)(2) of this section, it may, after review by the Agency, be deemed a substantially similar compound.

(4) For the purposes of this paragraph, a pheromone trap is a device containing a pheromone or an identical or substantially similar compound used for the sole purpose of attracting, and trapping or killing, target arthropods. Pheromone traps are intended to achieve pest control by removal of target organisms from their natural environment and do not result in increased levels of pheromones or identical or substantially similar compounds over a significant fraction of the treated area.

§ 152.25

40 CFR Ch. I (7-1-99 Edition)

(c) *Preservatives for biological specimens.* (1) Embalming fluids.

(2) Products used to preserve animal or animal organ specimens, in mortuaries, laboratories, hospitals, museums and institutions of learning.

(3) Products used to preserve the integrity of milk, urine, blood, or other body fluids for laboratory analysis.

(d) *Vitamin hormone products.* Vitamin hormone horticultural products consisting of mixtures of plant hormones, plant nutrients, inoculants, or soil amendments, which meet the following criteria:

(1) The product, in the undiluted package concentration at which it is distributed or sold, meets the criteria of § 156.10(h)(1) of this chapter for Toxicity Category III or IV; and

(2) The product is not intended for use on food crop sites, and is labeled accordingly.

(e) *Foods.* Products consisting of foods and containing no active ingredients, which are used to attract pests.

(f) *Natural cedar.* (1) Natural cedar blocks, chips, shavings, balls, chests, drawer liners, paneling, and needles that meet all of the following criteria:

(i) The product consists totally of cedarwood or natural cedar.

(ii) The product is not treated, combined, or impregnated with any additional substance(s).

(iii) The product bears claims or directions for use solely to repel arthropods other than ticks or to retard mildew, and no additional claims are made in sale or distribution. The labeling must be limited to specific arthropods, or must exclude ticks if any general term such as "arthropods," "insects," "bugs," or any other broad inclusive term, is used. The exemption does not apply to natural cedar products claimed to repel ticks.

(2) The exemption does not apply to cedar oil, or formulated products which contain cedar oil, other cedar extracts, or ground cedar wood as part of a mixture.

(g) *Minimum risk pesticides*—(1) *Exempted products.* Products containing the following active ingredients are exempt from the requirements of FIFRA, alone or in combination with other substances listed in this paragraph,

provided that all of the criteria of this section are met.

Castor oil (U.S.P. or equivalent)
Cedar oil
Cinnamon and cinnamon oil
Citric acid
Citronella and citronella oil
Cloves and clove oil
Corn gluten meal
Corn oil
Cottonseed oil
Dried blood
Eugenol
Garlic and garlic oil
Geraniol
Geranium oil
Lauryl sulfate
Lemongrass oil
Linseed oil
Malic acid
Mint and mint oil
Peppermint and peppermint oil
2-Phenethyl propionate (2-phenylethyl propionate)
Potassium sorbate
Putrescent whole egg solids
Rosemary and rosemary oil
Sesame (includes ground sesame plant) and sesame oil
Sodium chloride (common salt)
Sodium lauryl sulfate
Soybean oil
Thyme and thyme oil
White pepper
Zinc metal strips (consisting solely of zinc metal and impurities)

(2) *Permitted inerts.* A pesticide product exempt under paragraph (g)(1) of this section may only include inert ingredients listed in the most current List 4A. This list is updated periodically and is published in the FEDERAL REGISTER. The most current list may be obtained by writing to Registration Support Branch (4A Inerts List) Registration Division (7505C), Office of Pesticide Programs, Environmental Protection Agency, 401 M St., SW., Washington DC 20460.

(3) *Other conditions of exemption.* All of the following conditions must be met for products to be exempted under this section:

(i) Each product containing the substance must bear a label identifying the name and percentage (by weight) of each active ingredient and the name of each inert ingredient.

(ii) The product must not bear claims either to control or mitigate microorganisms that pose a threat to human health, including but not limited to

REGULATIONS

Excerpt from

40 CFR Part 156

Pages 53 - 58

Labeling Requirement for Pesticides and Devices

The U. S. Environmental Protection Agency is required under the Federal Insecticide, Fungicide, and Rodenticide Act to adequately label all pesticide products for use in the United States. Such labeling is primarily for worker protection and must include information on toxicity, symptoms, treatment, and recommended personal protective equipment. Testing must be in compliance with Good Laboratory Practices (40 CFR Part 792).

(7) With respect to a Registration Standard for which the Agency has determined that a substantially complete chronic health and teratology data base exists, a copy of the FEDERAL REGISTER notice concerning availability of a proposed Registration Standard, and a copy of each comment received in response to that notice (within 10 working days after receipt by the Agency, or 15 working days if the submitter has asserted a confidential business information claim concerning the material).

(8) A copy of the FEDERAL REGISTER notice announcing the issuance of the Registration Standard (within 10 working days after the publication of the notice).

(c) *Index of the docket.* The Agency will establish and keep current an index to the docket for each Registration Standard. The index will include, but is not limited to:

(1) A list of each meeting between the Agency and any person or party outside of government, containing the date and subject of the meeting, the names of participants and the name of the person requesting the meeting.

(2) A list of each document in the docket by title, source or recipient(s), and the date the document was received or provided by the Agency.

(d) *Availability of docket and indices.*

(1) The Agency will make available to the public for inspection and copying the docket and index for any Registration Standard.

(2) The Agency will establish and maintain a mailing list of persons who have specifically requested that they receive indices for Registration Standard dockets. On a quarterly basis, EPA will distribute the indices of new materials placed in the public docket to these persons. Annually, EPA will require that persons on the list renew their requests for inclusion on the list.

(3) The Agency will issue annually in the FEDERAL REGISTER (in conjunction with the annual schedule notice specified in §155.25) a notice announcing the availability of docket indices.

(4) Each FEDERAL REGISTER notice of availability of a Registration Standard will announce the availability of the docket index for that Standard.

§ 155.34 Notice of availability.

(a) The Agency will issue in the FEDERAL REGISTER a notice announcing the issuance and availability of Registration Standard which:

(1) Concerns a previously unregistered active ingredient; or

(2) Concerns a previously registered active ingredient, and the Registration Standard states that registrants will be required (under FIFRA section 3(c)(2)(B)) to submit chronic health (including, but not limited to, chronic feeding, oncogenicity and reproduction) or teratology studies.

(b) Interested persons may submit comments concerning any Registration Standard described by paragraph (a) of this section at any time.

(c) The Agency will issue in the FEDERAL REGISTER a notice announcing the availability of, and providing opportunity for comment on, each proposed Registration Standard which concerns a previously registered active ingredient for which the Agency has determined that a substantially complete chronic health and teratology data base exists. Following the comment period and issuance of the Registration Standard, the Agency will issue in the FEDERAL REGISTER a notice of availability of the Registration Standard.

PART 156—LABELING REQUIREMENTS FOR PESTICIDES AND DEVICES

Subpart A—General Provisions

Sec.

156.10 Labeling requirements.

Subparts B–J [Reserved]

Subpart K—Worker Protection Statements

156.200 Scope and applicability.

156.203 Definitions.

156.204 Modification and waiver of requirements.

156.206 General statements.

156.208 Restricted-entry statements.

156.210 Notification-to-workers statements.

156.212 Personal protective equipment statements.

AUTHORITY: 7 U.S.C. 136–136y.

Subpart A—General Provisions**§ 156.10 Labeling requirements.**

(a) *General*—(1) *Contents of the label.* Every pesticide products shall bear a label containing the information specified by the Act and the regulations in this part. The contents of a label must show clearly and prominently the following:

- (i) The name, brand, or trademark under which the product is sold as prescribed in paragraph (b) of this section;
- (ii) The name and address of the producer, registrant, or person for whom produced as prescribed in paragraph (c) of this section;
- (iii) The net contents as prescribed in paragraph (d) of this section;
- (iv) The product registration number as prescribed in paragraph (e) of this section;
- (v) The producing establishment number as prescribed in paragraph (f) of this section;
- (vi) An ingredient statement as prescribed in paragraph (g) of this section;
- (vii) Warning or precautionary statements as prescribed in paragraph (h) of this section;
- (viii) The directions for use as prescribed in paragraph (i) of this section; and
- (ix) The use classification(s) as prescribed in paragraph (j) of this section.

(2) *Prominence and legibility.* (i) All words, statements, graphic representations, designs or other information required on the labeling by the Act or the regulations in this part must be clearly legible to a person with normal vision, and must be placed with such conspicuousness (as compared with other words, statements, designs, or graphic matter on the labeling) and expressed in such terms as to render it likely to be read and understood by the ordinary individual under customary conditions of purchase and use.

- (ii) All required label text must:
 - (A) Be set in 6-point or larger type;
 - (B) Appear on a clear contrasting background; and
 - (C) Not be obscured or crowded.

(3) *Language to be used.* All required label or labeling text shall appear in the English language. However, the Agency may require or the applicant may propose additional text in other

languages as is considered necessary to protect the public. When additional text in another language is necessary, all labeling requirements will be applied equally to both the English and other-language versions of the labeling.

(4) *Placement of Label*—(i) *General.* The label shall appear on or be securely attached to the immediate container of the pesticide product. For purposes of this section, and the misbranding provisions of the Act, “securely attached” shall mean that a label can reasonably be expected to remain affixed during the foreseeable conditions and period of use. If the immediate container is enclosed within a wrapper or outside container through which the label cannot be clearly read, the label must also be securely attached to such outside wrapper or container, if it is a part of the package as customarily distributed or sold.

(ii) *Tank cars and other bulk containers*—(A) *Transportation.* While a pesticide product is in transit, the appropriate provisions of 49 CFR parts 170–189, concerning the transportation of hazardous materials, and specifically those provisions concerning the labeling, marking and placarding of hazardous materials and the vehicles carrying them, define the basic Federal requirements. In addition, when any registered pesticide product is transported in a tank car, tank truck or other mobile or portable bulk container, a copy of the accepted label must be attached to the shipping papers, and left with the consignee at the time of delivery.

(B) *Storage.* When pesticide products are stored in bulk containers, whether mobile or stationary, which remain in the custody of the user, a copy of the label of labeling, including all appropriate directions for use, shall be securely attached to the container in the immediate vicinity of the discharge control valve.

(5) *False or misleading statements.* Pursuant to section 2(q)(1)(A) of the Act, a pesticide or a device declared subject to the Act pursuant to §152.500, is misbranded if its labeling is false or misleading in any particular including both pesticidal and non-pesticidal

Environmental Protection Agency

§ 156.10

claims. Examples of statements or representations in the labeling which constitute misbranding include:

(i) A false or misleading statement concerning the composition of the product;

(ii) A false or misleading statement concerning the effectiveness of the product as a pesticide or device;

(iii) A false or misleading statement about the value of the product for purposes other than as a pesticide or device;

(iv) A false or misleading comparison with other pesticides or devices;

(v) Any statement directly or indirectly implying that the pesticide or device is recommended or endorsed by any agency of the Federal Government;

(vi) The name of a pesticide which contains two or more principal active ingredients if the name suggests one or more but not all such principal active ingredients even though the names of the other ingredients are stated elsewhere in the labeling;

(vii) A true statement used in such a way as to give a false or misleading impression to the purchaser;

(viii) Label disclaimers which negate or detract from labeling statements required under the Act and these regulations;

(ix) Claims as to the safety of the pesticide or its ingredients, including statements such as "safe," "nonpoisonous," "noninjurious," "harmless" or "nontoxic to humans and pets" with or without such a qualifying phrase as "when used as directed"; and

(x) Non-numerical and/or comparative statements on the safety of the product, including but not limited to:

(A) "Contains all natural ingredients";

(B) "Among the least toxic chemicals known"

(C) "Pollution approved"

(6) *Final printed labeling.* (i) Except as provided in paragraph (a)(6)(ii) of this section, final printed labeling must be submitted and accepted prior to registration. However, final printed labeling need not be submitted until draft label texts have been provisionally accepted by the Agency.

(ii) Clearly legible reproductions or photo reductions will be accepted for unusual labels such as those silk-

screened directly onto glass or metal containers or large bag or drum labels. Such reproductions must be of microfilm reproduction quality.

(b) *Name, brand, or trademark.* (1) The name, brand, or trademark under which the pesticide product is sold shall appear on the front panel of the label.

(2) No name, brand, or trademark may appear on the label which:

(i) Is false or misleading, or

(ii) Has not been approved by the Administrator through registration or supplemental registration as an additional name pursuant to § 152.132.

(c) Name and address of producer, registrant, or person for whom produced. An unqualified name and address given on the label shall be considered as the name and address of the producer. If the registrant's name appears on the label and the registrant is not the producer, or if the name of the person for whom the pesticide was produced appears on the label, it must be qualified by appropriate wording such as "Packed for * * *" "Distributed by * * *," or "Sold by * * *" to show that the name is not that of the producer.

(d) *Net weight or measure of contents.*

(1) The net weight or measure of content shall be exclusive of wrappers or other materials and shall be the average content unless explicitly stated as a minimum quantity.

(2) If the pesticide is a liquid, the net content statement shall be in terms of liquid measure at 68 °F (20 °C) and shall be expressed in conventional American units of fluid ounces, pints, quarts, and gallons.

(3) If the pesticide is solid or semi-solid, viscous or pressurized, or is a mixture of liquid and solid, the net content statement shall be in terms of weight expressed as avoirdupois pounds and ounces.

(4) In all cases, net content shall be stated in terms of the largest suitable units, i.e., "1 pound 10 ounces" rather than "26 ounces."

(5) In addition to the required units specified, net content may be expressed in metric units.

(6) Variation above minimum content or around an average is permissible only to the extent that it represents

deviation unavoidable in good manufacturing practice. Variation below a stated minimum is not permitted. In no case shall the average content of the packages in a shipment fall below the stated average content.

(e) *Product registration number.* The registration number assigned to the pesticide product at the time of registration shall appear on the label, preceded by the phrase "EPA Registration No.," or the phrase "EPA Reg. No." The registration number shall be set in type of a size and style similar to other print on that part of the label on which it appears and shall run parallel to it. The registration number and the required identifying phrase shall not appear in such a manner as to suggest or imply recommendation or endorsement of the product by the Agency.

(f) *Producing establishments registration number.* The producing establishment registration number preceded by the phrase "EPA Est.," of the final establishment at which the product was produced may appear in any suitable location on the label or immediate container. It must appear on the wrapper or outside container of the package if the EPA establishment registration number on the immediate container cannot be clearly read through such wrapper or container.

(g) *Ingredient statement—(1) General.* The label of each pesticide product must bear a statement which contains the name and percentage by weight of each active ingredient, the total percentage by weight of all inert ingredients; and if the pesticide contains arsenic in any form, a statement of the percentages of total and water-soluble arsenic calculated as elemental arsenic. The active ingredients must be designated by the term "active ingredients" and the inert ingredients by the term "inert ingredients," or the singular forms of these terms when appropriate. Both terms shall be in the same type size, be aligned to the same margin and be equally prominent. The statement "Inert Ingredients, none" is not required for pesticides which contain 100 percent active ingredients. Unless the ingredient statement is a complete analysis of the pesticide, the term "analysis" shall not be used as a heading for the ingredient statement.

(2) *Position of ingredient statement.* (i) The ingredient statement is normally required on the front panel of the label. If there is an outside container or wrapper through which the ingredient statement cannot be clearly read, the ingredient statement must also appear on such outside container or wrapper. If the size or form of the package makes it impracticable to place the ingredient statement on the front panel of the label, permission may be granted for the ingredient statement to appear elsewhere.

(ii) The text of the ingredient statement must run parallel with other text on the panel on which it appears, and must be clearly distinguishable from and must not be placed in the body of other text.

(3) *Names to be used in ingredient statement.* The name used for each ingredient shall be the accepted common name, if there is one, followed by the chemical name. The common name may be used alone only if it is well known. If no common name has been established, the chemical name alone shall be used. In no case will the use of a trademark or proprietary name be permitted unless such name has been accepted as a common name by the Administrator under the authority of section 25(c)(6).

(4) *Statements of percentages.* The percentages of ingredients shall be stated in terms of weight-to-weight. The sum of percentages of the active and the inert ingredients shall be 100. Percentages shall not be expressed by a range of values such as "22-25%." If the uses of the pesticide product are expressed as weight of active ingredient per unit area, a statement of the weight of active ingredient per unit volume of the pesticide formulation shall also appear in the ingredient statement.

(5) *Accuracy of stated percentages.* The percentages given shall be as precise as possible reflecting good manufacturing practice. If there may be unavoidable variation between manufacturing batches, the value stated for each active ingredient shall be the lowest percentage which may be present.

(6) *Deterioration.* Pesticides which change in chemical composition significantly must meet the following labeling requirements:

Environmental Protection Agency

§ 156.10

(i) In cases where it is determined that a pesticide formulation changes chemical composition significantly, the product must bear the following statement in a prominent position on the label: "Not for sale or use after [date]."

(ii) The product must meet all label claims up to the expiration time indicated on the label.

(7) *Inert ingredients.* The Administrator may require the name of any inert ingredient(s) to be listed in the ingredient statement if he determines that such ingredient(s) may pose a hazard to man or the environment.

(h) *Warnings and precautionary statements.* Required warnings and precautionary statements concerning the

general areas of toxicological hazard including hazard to children, environmental hazard, and physical or chemical hazard fall into two groups; those required on the front panel of the labeling and those which may appear elsewhere. Specific requirements concerning content, placement, type size, and prominence are given below.

(1) *Required front panel statements.* With the exception of the child hazard warning statement, the text required on the front panel of the label is determined by the Toxicity Category of the pesticide. The category is assigned on the basis of the highest hazard shown by any of the indicators in the table below:

Hazard indicators	Toxicity categories			
	I	II	III	IV
Oral LD ₅₀	Up to and including 50 mg/kg.	From 50 thru 500 mg/kg	From 500 thru 5000 mg/kg.	Greater than 5000 mg/kg.
Inhalation LC ₅₀ ..	Up to and including .2 mg/liter.	From .2 thru 2 mg/liter ...	From 2. thru 20 mg/liter	Greater than 20 mg/liter.
Dermal LD ₅₀	Up to and including 200 mg/kg.	From 200 thru 2000	From 2,000 thru 20,000	Greater than 20,000.
Eye effects	Corrosive; corneal opacity not reversible within 7 days.	Corneal opacity reversible within 7 days; irritation persisting for 7 days.	No corneal opacity; irritation reversible within 7 days.	No irritation.
Skin effects	Corrosive	Severe irritation at 72 hours.	Moderate irritation at 72 hours.	Mild or slight irritation at 72 hours.

(i) *Human hazard signal word—(A) Toxicity Category I.* All pesticide products meeting the criteria of Toxicity Category I shall bear on the front panel the signal word "Danger." In addition if the product was assigned to Toxicity Category I on the basis of its oral, inhalation or dermal toxicity (as distinct from skin and eye local effects) the word "Poison" shall appear in red on a background of distinctly contrasting color and the skull and crossbones shall appear in immediate proximity to the word "poison."

(B) *Toxicity Category II.* All pesticide products meeting the criteria of Toxicity Category II shall bear on the front panel the signal word "Warning."

(C) *Toxicity Category III.* All pesticide products meeting the criteria of Toxicity Category III shall bear on the front panel the signal word "Caution."

(D) *Toxicity Category IV.* All pesticide products meeting the criteria of Toxicity

Category IV shall bear on the front panel the signal word "Caution."

(E) *Use of signal words.* Use of any signal word(s) associated with a higher Toxicity Category is not permitted except when the Agency determines that such labeling is necessary to prevent unreasonable adverse effects on man or the environment. In no case shall more than one human hazard signal word appear on the front panel of a label.

(ii) *Child hazard warning.* Every pesticide product label shall bear on the front panel the statement "keep out of reach of children." Only in cases where the likelihood of contact with children during distribution, marketing, storage or use is demonstrated by the applicant to be extremely remote, or if the nature of the pesticide is such that it is approved for use on infants or small children, may the Administrator waive this requirement.

(iii) *Statement of practical treatment—(A) Toxicity Category I.* A statement of

§ 156.10

40 CFR Ch. I (7-1-99 Edition)

practical treatment (first aid or other) shall appear on the front panel of the label of all pesticides falling into Toxicity Category I on the basis of oral, inhalation or dermal toxicity. The Agency may, however, permit reasonable variations in the placement of the statement of practical treatment is some reference such as "See statement of practical treatment on back panel" appears on the front panel near the word "Poison" and the skull and crossbones.

(B) *Other toxicity categories.* The statement of practical treatment is not required on the front panel except as described in paragraph (h)(1)(iii)(A) of this section. The applicant may, however, include such a front panel statement at his option. Statements of practical treatment are, however, required elsewhere on the label in accord with paragraph (h)(2) of this section if they do not appear on the front panel.

(iv) *Placement and prominence.* All the require front panel warning statements shall be grouped together on the label, and shall appear with sufficient prominence relative to other front panel text and graphic material to make them unlikely to be overlooked under customary conditions of purchase and use. The following table shows the minimum type size requirements for the front panel warning statements on various sizes of labels:

Size of label front panel in square inches	Points	
	Required signal word, all capitals	"Keep out of reach of children"
5 and under	6	6
Above 5 to 10	10	6
Above 10 to 15	12	8
Above 15 to 30	14	10
Over 30	18	12

(2) *Other required warnings and precautionary statements.* The warnings and precautionary statements as required below shall appear together on the label under the general heading "Precautionary Statements" and under appropriate subheadings of "Hazard to Humans and Domestic Animals," "Environmental Hazard" and "Physical or Chemical Hazard."

(i) *Hazard to humans and domestic animals.* (A) Where a hazard exists to humans or domestic animals, precautionary statements are required indicating the particular hazard, the route(s) of exposure and the precautions to be taken to avoid accident, injury or damage. The precautionary paragraph shall be immediately preceded by the appropriate hazard signal word.

(B) The following table depicts typical precautionary statements. These statements must be modified or expanded to reflect specific hazards.

Toxicity category	Precautionary statements by toxicity category	
	Oral, inhalation, or dermal toxicity	Skin and eye local effects
I	Fatal (poisonous) if swallowed [inhaled or absorbed through skin]. Do not breathe vapor [dust or spray mist]. Do not get in eyes, on skin, or on clothing [Front panel statement of practical treatment required.].	Corrosive, causes eye and skin damage [or skin irritation]. Do not get in eyes, on skin, or on clothing. Wear goggles or face shield and rubber gloves when handling. Harmful or fatal if swallowed. [Appropriate first aid statement required.]
II	May be fatal if swallowed [inhaled or absorbed through the skin]. Do not breathe vapors [dust or spray mist]. Do not get in eyes, on skin, or on clothing. [Appropriate first aid statements required.].	Causes eye [and skin] irritation. Do not get in eyes, on skin, or on clothing. Harmful if swallowed. [Appropriate first aid statement required.]
III	Harmful if swallowed [inhaled or absorbed through the skin]. Avoid breathing vapors [dust or spray mist]. Avoid contact with skin [eyes or clothing]. [Appropriate first aid statement required.].	Avoid contact with skin, eyes or clothing. In case of contact immediately flush eyes or skin with plenty of water. Get medical attention if irritation persists.
IV	[No precautionary statements required.]	[No precautionary statements required.]

(ii) *Environmental hazards.* Where a hazard exists to non target organisms excluding humans and domestic animals, precautionary statements are required stating the nature of the hazard and the appropriate precautions to

avoid potential accident, injury or damage. Examples of the hazard statements and the circumstances under which they are required follow:

(A) If a pesticide intended for outdoor use contains an active ingredient with

REGULATIONS

Excerpt from

40 CFR Part 158

Pages 74 - 95

Data Requirements for Registration

The U. S. Environmental Protection Agency is required under the Federal Insecticide, Fungicide, and Rodenticide Act to register all pesticides available for use in the United States. This section specifies the types and amounts of data and information required by the Agency to make informed decisions on the risks and benefits of various pesticide products. Testing must be in compliance with Good Laboratory Practices (40 CFR Part 792).

PART 158—DATA REQUIREMENTS FOR REGISTRATION

Subpart A—General Provisions

- Sec.
- 158.20 Overview.
- 158.25 Applicability of data requirements.
- 158.30 Timing of the imposition of data requirements.
- 158.32 Format of data submission.
- 158.33 Procedures for claims of confidentiality of data.
- 158.34 Flagging of studies for potential adverse effects.
- 158.35 Flexibility of the data requirements.
- 158.40 Consultation with the Agency.
- 158.45 Waivers.
- 158.50 Formulators' exemption.
- 158.55 Agricultural vs. non-agricultural pesticides.
- 158.60 Minor uses.
- 158.65 Biochemical and microbial pesticides.
- 158.70 Acceptable protocols.
- 158.75 Requirements for additional data.
- 158.80 Acceptability of data.
- 158.85 Revision of data requirements and guidelines.

Subpart B—How To Use Data Tables

- 158.100 How to determine registration data requirements.
- 158.101 Required vs. conditionally required data.
- 158.102 Distinguishing between what data are required and what substance is to be tested.
- 158.108 Relationship of Pesticide Assessment Guidelines to data requirements.

Subpart C—Product Chemistry Data Requirements

- 158.150 General.
- 158.153 Definitions.
- 158.155 Product composition.
- 158.160 Description of materials used to produce the product.
- 158.162 Description of production process.
- 158.165 Description of formulation process.
- 158.167 Discussion of formation of impurities.
- 158.170 Preliminary analysis.
- 158.175 Certified limits.
- 158.180 Enforcement analytical method.
- 158.190 Physical and chemical characteristics.

Subpart D—Data Requirement Tables

- 158.202 Purposes of the registration data requirements.
- 158.240 Residue chemistry data requirements.
- 158.290 Environmental fate data requirements.

- 158.340 Toxicology data requirements.
- 158.390 Reentry protection data requirements.
- 158.440 Spray drift data requirements.
- 158.490 Wildlife and aquatic organisms data requirements.
- 158.540 Plant protection data requirements.
- 158.590 Nontarget insect data requirements.
- 158.640 Product performance data requirements.
- 158.690 Biochemical pesticides data requirements.
- 158.740 Microbial pesticides—Product analysis data requirements.

APPENDIX A TO PART 158—DATA REQUIREMENTS FOR REGISTRATION: USE PATTERN INDEX.

AUTHORITY: 7 U.S.C. 136-136y.

SOURCE: 49 FR 42881, Oct. 24, 1984, unless otherwise noted.

Subpart A—General Provisions

§ 158.20 Overview.

(a) *Legal authority.* These requirements are promulgated under the authority of sections 3, 5, 12, and 25 of the Federal Insecticide, Fungicide and Rodenticide Act, as amended (FIFRA) (7 U.S.C. 136-136y).

(b) *Purposes of this part.* (1) The primary purpose of this part is to specify the types and minimum amounts of data and information the Agency requires in order to make regulatory judgments about the risks and benefits of various kinds of pesticide products under the criteria set forth in FIFRA sections 3(c)(5) (C) and (D) and 3(c)(7).

(2) This part also specifies the types and minimum amounts of data and information the Agency requires to decide whether to approve applications for experimental use permits under FIFRA section 5.

(3) Finally, this part specifies the types and minimum amounts of data and information that an applicant for registration, amended registration, or reregistration must submit or cite in support of an application in order to satisfy the requirements of FIFRA section 3(c)(1)(D) and sections 3(c)(5)(B) or 3(c)(7). Use of the term "registration" in this part will pertain to new registrations and amended registrations as well as reregistration accomplished under section 3(g), unless stated otherwise.

(c) *Availability of related guidelines.* The data requirements for pesticide registration specified in this part pertain to product chemistry, residue chemistry, environmental fate, toxicology, reentry protection, aerial drift evaluation, wildlife and aquatic organisms, plant protection, nontarget insects, product performance, and biochemical and microbial pesticides. The standards for conducting acceptable tests, guidance on evaluation and reporting of data, further guidance on when data are required, definition of most terms, and examples of protocols are not specified in this part. This information is available in advisory documents (collectively referred to as Pesticide Assessment Guidelines) through the National Technical Information Service, 5285 Port Royal Road, Springfield, VA 22161 (telephone: 703-487-4650).

§ 158.25 Applicability of data requirements.

(a) Some kinds of data and information are specified in subparts C and D of this part as “required” (“R”) for the evaluation of some or all types of products. Other kinds of data and information are specified in those sections as “conditionally required” (“CR”), that is, they are required if the product’s proposed pattern of use, results of other tests, or other pertinent factors meet the criteria specified in those sections. The terms “required” and “conditionally required” are further discussed in §§ 158.100 and 158.101.

(b) The Agency recognizes that certain data requirements may not be applicable to (or should be waived for) some products, and has made provisions for such cases in this part as specified in § 158.35 *Flexibility of the data requirements*, § 158.40 *Consultation with the Agency*, § 158.45 *Waivers*, and § 158.60 *Minor uses*.

[49 FR 42881, Oct. 24, 1984, as amended at 53 FR 15999, May 4, 1988]

§ 158.30 Timing of the imposition of data requirements.

This part establishes requirements for the types of data which are necessary to support the unconditional registration of a pesticide product under section 3(c)(5) of the Act. While every registered pesticide product

must eventually be supported by the data required by part 158, when an applicant or registrant must initially satisfy these data requirements depends on the factors listed below in this section.

(a) *Existing Registrations.* A registrant of a currently registered pesticide product is not obligated to satisfy any data requirement in part 158 with respect to that product until he receives a notice under section 3(c)(2)(B) of the Act that additional data are required to support the continued registration of the product, until he applies for an amendment to the registration, or until the product is subject to reregistration.

(b) *Applications.* The amount of data required by the Agency to evaluate an application for initial or amended registration depends on whether the product is being reviewed under section 3(c)(5) of the Act (unconditional registration) or section 3(c)(7) of the Act (conditional registration). Refer to § 152.111 of this chapter or consult with the appropriate EPA Product Manager to determine under which section of the Act the application will be reviewed. The following paragraphs identify, for each different type of application, the minimum amount of data that must be available for EPA review to permit EPA to make the statutory risk-benefit determinations required by section 3(c)(5) or 3(c)(7) of the Act. In addition to satisfying these minimum data requirements, applicants may be required to submit or cite additional data, either to permit EPA to assess the safety or efficacy of the product (refer to § 158.75) or to comply with the statutory requirements of section 3(c)(1)(D) of the Act, or both.

(1) *Applications for unconditional registration under section 3(c)(5) of the Act.* EPA will not approve an application for unconditional registration unless all data required by this part which have not been waived are available for EPA to review.

(2) *Applications for conditional registration of a new chemical under section 3(c)(7)(C) of the Act.* EPA will not approve an application for conditional registration of a pesticide containing an active ingredient not contained in any currently registered product unless

data required by this part are available for EPA to review except for:

(i) Those data for which the requirement has been waived.

(ii) Those data for which the requirement was imposed so recently that the applicant has not had sufficient time to produce the data.

(3) *Applications for conditional registration of products which are identical or substantially similar to currently registered products under section 3(c)(7)(A) of the Act.* EPA will not approve an application for conditional registration of a pesticide product which is identical or substantially similar to a currently registered pesticide unless the following data are available for EPA to review:

(i) Product chemistry data, as required by subpart C of this part.

(ii) Product performance data, to the extent required by § 158.160.

(4) *Applications for conditional registration of new uses of currently registered products under section 3(c)(7)(B) of the Act.* EPA will not approve an application for registration of a pesticide for a new use of a currently registered pesticide product unless the following data are available for EPA to review:

(i) Product chemistry data, as required by subpart C of this part.

(ii) Product performance data, to the extent required by § 158.160.

(iii) Other data pertaining solely to the new use. The applicant may generally determine which data pertain solely to the new use by comparing the data requirements for all existing uses of all currently registered products containing the same active ingredient(s) with those for all uses including the new use. Any differences are attributable to the new use and must be submitted with the application.

[49 FR 42881, Oct. 24, 1984, as amended at 53 FR 15999, May 4, 1988; 58 FR 34203, June 23, 1993]

§ 158.32 Format of data submission.

(a) *Transmittal document.* All data submitted at the same time and for review in support of a single administrative action (e.g., an application for registration, reregistration, experimental use permit, or in response to a requirement for data under the authority of FIFRA sec. 3(c)(2)(B), must be accom-

panied by a single transmittal document including the following information:

(1) The identity of the submitter, or the identity of each joint submitter and of the agent for joint submitters;

(2) The date of the submission;

(3) The identification of the Agency action in support of which the data are being submitted, such as the registration number or file symbol, petition number, experimental use permit number, or registration standard review; and

(4) A bibliography of all specific documents included in the submission and covered by the transmittal.

(b) *Individual studies.* (1) All data must be submitted in the form of individual studies. Unless otherwise specified by the Agency, each study should address a single data requirement, and be listed separately in the bibliography.

(2) Each study must include the following elements in addition to the study itself:

(i) A title page, as described in paragraph (c) of this section;

(ii) A Statement of Data Confidentiality Claims and, if desired, a Supplemental Statement of Data Confidentiality Claims, in accordance with § 158.33;

(iii) A certification with respect to Good Laboratory Practice standards, if required by § 160.12 of this chapter;

(iv) If the original study is not in the English language, a complete and accurate English translation under the same cover; and

(v) If the study is of a type listed in § 158.34(b), the statement prescribed by paragraph (c) of that section.

(3) Three identical copies of each study must be submitted. If the study is submitted in conjunction with a pending Special Review or Registration Standard under development, four copies must be submitted. Three copies must be identical and must conform to the requirements of § 158.33 with respect to claims of confidentiality. The fourth copy will be placed in the public docket and must conform to the requirements of § 154.15(c) of this chapter or § 155.30(c) of this chapter with respect to claimed confidential business information.

(4) All copies must be in black ink on uniform pages of white, 8½ × 11 inch paper. Copies must have high contrast and good resolution for microfilming. Frayed or oversize pages and glued bindings are not acceptable.

(c) *Contents of title page.* Each individual study must have a title page bearing the following identifying information:

(1) The title of the study, including identification of the substance(s) tested and the test name or data requirement addressed;

(2) The author(s) of the study;

(3) The date the study was completed;

(4) If the study was performed in a laboratory, the name and address of the laboratory and any laboratory project numbers or other identifying codes;

(5) If the study is a commentary on or supplement to another previously submitted study, full identification of the other study with which it should be associated in review; and

(6) If the study is a reprint of a published document, all relevant facts of publication, such as the journal title, volume, issue, inclusive page numbers, and date of publication.

(d) *EPA identification number.* EPA will assign each study an EPA Master Record Identification (MRID) number, and will promptly notify the submitter of the number assigned. This number should be used in all further communications with the Agency about the study.

(e) *Reference to previously submitted data.* Data which previously have been submitted need not be resubmitted unless resubmission is specifically requested by the Agency. If an applicant or registrant wishes the Agency to consider such data in the review of an Agency action, he should cite the data by providing:

(1) The title or adequate description of the study;

(2) The transmittal information required by paragraph (a) (1), (2), and (3) of this section; and

(3) The MRID number assigned in accordance with paragraph (d) of this section.

[53 FR 15991, May 4, 1988]

§ 158.33 Procedures for claims of confidentiality of data.

(a) *General.* A data submitter must clearly identify any information which he claims is entitled to confidential treatment under FIFRA sec. 10. The procedures in this section must be followed to assert a claim of confidentiality.

(b) *Claims of confidentiality for information described by FIFRA sec. 10(d)(1) (A), (B), and (C).* Any information claimed to be confidential under FIFRA sec. 10(d)(1) (A) through (C) must be submitted in accordance with the following procedures:

(1) The information must be contained in a separate attachment to the study. If any information is included in the body of the study rather than in the confidential attachment, the submitter waives a claim of confidentiality for such information under FIFRA sec. 10(d)(1) (A), (B), or (C).

(2) The attachment must have a cover page which is clearly marked to indicate that the material contained in the attachment falls within the scope of FIFRA sec. 10(d)(1) (A), (B), or (C).

(3) Each item in the attachment must be numbered. For each item, the submitter must cite the applicable portion of FIFRA sec. 10(d)(1) (A), (B), or (C) on which the claim of confidentiality is based. In addition, for each item, the submitter must provide a list of page numbers in the study where the item is cited (i.e., identified by number).

(4) Each item in the attachment must be referenced in the body of the study by its number in the attachment.

(5) The following statement must appear on the Statement of Data Confidentiality Claims:

Information claimed confidential on the basis of its falling within the scope of FIFRA sec. 10(d)(1)(A), (B), or (C) has been removed to a confidential appendix, and is cited by cross-reference number in the body of the study.

The statement must bear the name, title, and signature of the submitter or his properly designated agent, and the date of signature.

(c) *No claim of confidentiality under FIFRA sec. 10(d)(1)(A), (B), or (C).* If no claim of confidentiality is being made

§ 158.34

40 CFR Ch. I (7-1-99 Edition)

for information described by FIFRA sec. 10(d)(1)(A), (B), or (C), or if such information is not contained in the body of the study, the Statement of Data Confidentiality Claims must include the following statement:

No claim of confidentiality is made for any information contained in this study on the basis of its falling within the scope of FIFRA sec. 10(d)(1)(A), (B), or (C).

This statement must bear the name, title and signature of the submitter or his properly designated agent, and the date of signature.

(d) *Claim of confidentiality for information not described by FIFRA sec. 10(d)(1)(A), (B), or (C).* Any information not described by FIFRA sec. 10(d)(1)(A), (B), or (C) for which a claim of confidentiality is made must be submitted in accordance with the following procedures:

(1) The information must be clearly marked in the body of the study as being claimed confidential.

(2) A separate Supplemental Statement of Data Confidentiality Claims must be submitted identifying by page and line number the location within the study of each item claimed con-

fidential, and stating the basis for the claim.

(3) The Supplemental Statement of Data Confidentiality Claims must bear the name, title, and signature of the submitter or his properly designated agent, and the date of signature.

[53 FR 15991, May 4, 1988]

§ 158.34 Flagging of studies for potential adverse effects.

(a) Any person who submits a study of a type listed in paragraph (b) of this section to support an application for new or amended registration, or to satisfy a requirement imposed under FIFRA sec. 3(c)(2)(B), must submit with the study a statement in accordance with paragraph (c) of this section.

(b) The following table indicates that study types and the criteria to be applied to each. Column 1 lists the study types by name. Column 2 lists the associated Pesticide Assessment Guideline number. Column 3 lists the criteria applicable to each type of study. Column 4 lists the reporting code to be included in the statement specified in §158.34(c) when any criterion is met or exceeded.

TABLE—FLAGGING CRITERIA

Toxicity studies	Pesticide assessment guidelines No.	Criteria	Reporting code
Oncogenicity [or combined oncogenicity/chronic feeding study] or Subchronic feeding study	83-2	Treated animals show any of the following:	
	82-1	An incidence of neoplasms in male or female animals which increases with dose;	1
		or A statistically significant ($p \leq 0.05$) incidence of any type of neoplasm in any test group (male or female animals at any dose level) compared to concurrent control animals of the same sex;	2
		or An increase in any type of uncommon or rare neoplasms in any test group (male or female animals at any dose level) compared to concurrent control animals	3
	or A decrease in the time to development of any type of neoplasms in any test group (male or female animals at any dose level) compared to concurrent control animals	4	
Teratogenicity	83-3	When compared with concurrent controls, treated animals show a dose-related increase in malformations (or deaths) on a litter basis in the absence of significant maternal toxicity at the same dose levels	5
Neurotoxicity	81-7	When compared with controls, treated animals show a response indicative of acute delayed neurotoxicity	6

TABLE—FLAGGING CRITERIA—Continued

Toxicity studies	Pesticide assessment guidelines No.	Criteria	Reporting code
Chronic feeding study or combined chronic feeding/ oncogenicity study	83-1	Cholinesterase inhibition NOEL less than 10 times the current existing ADI.	7
		or General (systemic) toxicity NOEL less than 100 times the current existing ADI.	8
Reproduction study	83-4	Reproductive effects NOEL less than 100 times the current ADI	9
Subchronic feeding study	82-1	Cholinesterase inhibition NOEL less than 100 times the current existing ADI.	10
		or General (systemic) toxicity NOEL less than 1000 times the current existing ADI.	11

(c) *Identification of studies.* For each study of a type identified in paragraph (b) of this section, the applicant (or registrant in the case of information submitted under FIFRA sec. 3(c)(2)(B)) shall include the appropriate one of the following two statements, together with the signature of the authorized representative of the company, and the date of signature:

(1) "I have applied the criteria of 40 CFR 158.34 for flagging studies for potential adverse effects to the results of the attached study. This study neither meets nor exceeds any of the applicable criteria."

(2) "I have applied the criteria of 40 CFR 158.34 for flagging studies for potential adverse effects to the results of the attached study. This study meets or exceeds the criteria numbered [insert all applicable reporting codes.]"

[53 FR 15992, May 4, 1988, as amended at 58 FR 34203, June 23, 1993]

§ 158.35 Flexibility of the data requirements.

Several provisions of this part provide EPA flexibility in requiring (or not requiring) data and information for the purposes specified in §158.20(b). These provisions are summarized in this section and discussed elsewhere in this part.

(a) The Agency encourages each applicant, particularly a person applying for registration for the first time, to consult with the Product Manager for his product to resolve questions relat-

ing to the protocols or the data requirements before undertaking extensive testing under §158.40.

(b) Any applicant who believes that a data requirement is inapplicable to a specific pesticide product may request a waiver of a data requirement under §158.45.

(c) The Agency may require an applicant to provide additional data or information beyond that specified in subparts C and D of this part when these data are not sufficient to permit EPA to evaluate the applicant's product under §158.75.

(d) Several policies are in effect that govern the data requirements for registration of products having minor uses. These policies reduce substantially the data requirements that need to be met on the basis of limited exposures and economic equity, and allow case-by-case decision making to determine the specific needs for each kind of use under §158.60.

(e) The data requirements and guidelines are not static documents. Section 3(c)(2) of FIFRA states that the administrator "shall revise such guidelines from time to time." Therefore, the data requirements and guidelines will be revised periodically to reflect new scientific knowledge, new trends in pesticide development, and new Agency policies under §158.80.

[49 FR 42881, Oct. 24, 1984, as amended at 53 FR 15999, May 4, 1988]

§ 158.40

40 CFR Ch. I (7-1-99 Edition)

§ 158.40 Consultation with the Agency.

This part establishes data requirements applicable to various general use patterns of pesticide products, but some unique or unanticipated aspect of a proposed product's use pattern or composition may result in the need for conferences between registration applicants and the Agency. Such conferences may be initiated by the Agency or by registration applicants. Applicants are expected to contact their respective Product Managers to arrange discussions. The Agency welcomes suggestions for changes to improve the clarity, accuracy, or some other aspect of the data requirements set forth in this part. Specific suggestions should be forwarded to the Director of the Hazard Evaluation Division.

§ 158.45 Waivers.

(a) *Rationale and policy.* (1) The data requirements specified in this part as applicable to a category of products will not always be appropriate for every product in that category. Some products may have unusual physical, chemical, or biological properties or atypical use patterns which would make particular data requirements inappropriate, either because it would not be possible to generate the required data or because the data would not be useful in the Agency's evaluation of the risks or benefits of the product. The Agency will waive data requirements it finds are inappropriate, but will ensure that sufficient data are available to make the determinations required by the applicable statutory standards.

(2) The Agency will waive data requirements on a case-by-case basis in response to specific written requests by applicants. Because of the wide variety of types and use patterns of pesticides, it is impossible to spell out all of the circumstances which might serve as a basis for waiving data requirements. The Agency, however, will take into account, as appropriate, the factors enumerated in sections 3(c)(2)(A) and 25(a)(1) of FIFRA.

(b) *Procedure for requesting waiver.* (1) An applicant should discuss his plans to request a waiver with the EPA Product Manager responsible for his product before developing and submitting

extensive support information for the request.

(2) To request a waiver, an applicant must submit a written request to the appropriate Product Manager. The request must specifically identify the data requirement for which a waiver is requested, explain why he thinks data requirement(s) should be waived, describe any unsuccessful attempts to generate the required data, furnish any other information which he believes would support the request, and when appropriate, suggest alternative means of obtaining data to address the concern which underlies the data requirement.

(c) *Notification of waiver decision.* The Agency will review each waiver request and inform the applicant in writing of its decision. In addition, for decisions that could apply to more than a specific product, the Agency may choose to send a notice to all registrants or to publish a notice in the FEDERAL REGISTER announcing its decision. An Agency decision denying a written request to waive a data requirement shall constitute final Agency action for purposes of FIFRA section 16(a).

(d) *Availability of waiver decisions.* Agency decisions under this section granting waiver requests will be available to the public at the Office of Pesticide Programs Reading Room, Rm. 236, Crystal Mall #2, 1921 Jefferson Davis Highway, Arlington, VA 22202 from 8:00 a.m. to 4:00 p.m., Monday through Friday, except legal holidays. Any person may obtain a copy of any waiver decision by written request in the manner set forth in 40 CFR part 2.

§ 158.50 Formulators' exemption.

(a) FIFRA section 3(c)(2)(D) provides that an applicant for registration of an end-use pesticide product need not submit or cite any data that pertain to the safety of another registered pesticide product which is purchased by the applicant and used in the manufacture or formulation of the product for which registration is sought.

(b) This exemption applies only to data concerning safety of a product or its ingredients, not to efficacy data. Data concerning safety includes toxicity, metabolism, environmental fate,

Environmental Protection Agency

§ 158.60

product chemistry, and residue chemistry data.

(c) This exemption does not apply to data concerning the safety of the applicant's end-use product itself, unless the composition of the applicant's product and that of the purchased product are identical, i.e., data which this part indicates must be developed by tests using the end-use product for which registration is sought as the test substance. These requirements can be identified by the notation "EP*" in the "test substance" column of the tables in subparts C and D of this part and these are the minimum data requirements that the applicant described in paragraph (a) of this section (i.e., the "formulator") must satisfy.

(d) The data to which this exemption applies usually will concern the safety of one or more of the end-use product's active ingredients, specifically, those active ingredients which are contained in the purchased product. These data requirements normally can be identified by the notations "TGAI" (technical grade of active ingredient), "PAI" (pure active ingredients), "PAIRA" (pure active ingredient, radiolabeled), or "TEP" (typical end-use product) in the "test substance" column of the tables in subparts C and D of this part.

(e) EPA interprets FIFRA section 3(c)(2)(D) as allowing an applicant to use the formulator's exemption with respect to a data requirement concerning the safety of an ingredient of his product only if:

(1) His application indicates that the ingredient's presence in his product is attributable solely to his purchase from another person of an identified, registered product containing that ingredient and his use of the purchased product in formulating his product; and

(2) The purchased product is a registered manufacturing-use product whose label does not prohibit its use for making an end-use product with any use for which the applicant's product will be labeled; or

(3) The purchased end-use product is a registered end-use product labeled for each use for which the applicant's product will be labeled.

(f) Notwithstanding FIFRA section 3(c)(2)(D), EPA will not approve an application unless there is available to EPA for its review whatever data is necessary in order to make the required risk/benefit finding under FIFRA section 3(c)(5) or section 3(c)(7).

[49 FR 42881, Oct. 24, 1984, as amended at 53 FR 15999, May 4, 1988]

§ 158.55 Agricultural vs. non-agricultural pesticides.

Section 25(a)(1) of FIFRA instructs the Administrator to "take into account the difference in concept and usage between various classes of pesticides and differences in environmental risk and the appropriate data for evaluating such risk between agricultural and non-agricultural pesticides." This part distinguishes the various classes of pesticide use (e.g., crop vs. non-crop) and the corresponding data necessary to support registration under FIFRA. This information is present in each data requirement table. In addition, the Use Pattern Index (appendix A) is a comprehensive list of pesticide use patterns, cross-referenced to the general use patterns appearing in the tables; the index will further assist the reader in distinguishing agricultural versus non-agricultural uses of pesticides.

[49 FR 42881, Oct. 24, 1984, as amended at 53 FR 15999, May 4, 1988]

§ 158.60 Minor uses.

(a) *Minor use policy.* A minor use of a pesticide is a use on a "minor crop" (a crop which is planted on a small total amount of acreage) or a use which is otherwise limited such that the potential market volume of the product for that use is inherently small. EPA's policy concerning data requirements for minor uses of pesticides includes the following elements:

(1) Since the market volume for a minor use of a pesticide is intrinsically low, and the risk associated with the use often is also correspondingly low, EPA will adjust the data requirements concerning the minor use appropriately.

(2) A new data requirement pertinent to both an unregistered minor use and

§ 158.65

a registered major use will not be applied to a minor use applicant until it is applied to the major use registrations.

(3) EPA will accept extrapolations and regional data to support establishment of individual minor use tolerances.

(4) Group tolerances will be established to assist applicants for registration of products for minor uses as described in 40 CFR 180.34.

(b) *Advice on data requirements to support minor uses.* Applicants for registration are advised to contact the appropriate EPA Product Manager of the Minor Use Officer for advice on developing data to support new applications for minor uses of pesticides.

§ 158.65 Biochemical and microbial pesticides.

Biochemical and microbial pesticides are generally distinguished from conventional chemical pesticides by their unique modes of action, low use volume, target species specificity or natural occurrence. In addition, microbial pesticides are living entities capable of survival, growth reproduction and infection. Biochemical and microbial pesticides are subject to a different set of data requirements, as specified in §§ 158.165 and 158.170, respectively.

(a) *Biochemical pesticides.* Biochemical pesticides include, but are not limited to, products such as semichemicals (e.g., insect pheromones), hormones (e.g., insect juvenile growth hormones), natural plant and insect regulators, and enzymes. When necessary the Agency will evaluate products on an individual basis to determine whether they are biochemical or conventional chemical pesticides.

(b) *Microbial pesticides.* (1) Microbial pesticides include microbial entities such as bacteria, fungi, viruses, and protozoans. The data requirements apply to all microbial pesticides, including those that are naturally-occurring as well as those that are genetically modified. Each "new" variety, subspecies, or strain of an already registered microbial pest control agent must be evaluated, and may be subject to additional data requirements.

(2) Novel microbial pesticides (i.e., genetically modified or non-indigenous

40 CFR Ch. I (7-1-99 Edition)

microbial pesticides) will be subject to additional data or information requirements on a case-by-case basis depending on the particular micro-organism, its parent microorganism, the proposed pesticide use pattern, and the manner and extent to which the organism has been genetically modified. Additional requirements may include information on the genetic engineering techniques used, the identity of the inserted or deleted gene segment (base sequence data or enzyme restriction map of the gene), information on the control region of the gene in question, a description of the "new" traits or characteristics that are intended to be expressed, tests to evaluate genetic stability and exchange, and/or selected Tier II environmental expression and toxicology tests.

(3) Pest control organisms such as insect predators, nematodes, and macroscopic parasites are exempt from the requirements of FIFRA as authorized by section 25(b) of FIFRA and specified in § 152.20 (a) of this chapter.

[49 FR 42881, Oct. 24, 1984, as amended at 53 FR 15999, May 4, 1988]

§ 158.70 Acceptable protocols.

The Agency has published Pesticide Assessment Guidelines, as indicated in § 158.20(d), which contain suggested protocols for conducting tests to develop the data required by this part.

(a) *General policy.* Any appropriate protocol may be used provided that it meets the purpose of the test standards specified in the guidelines and provides data of suitable quality and completeness as typified by the protocols cited in the guidelines. Applicants should use the test procedure which is most suitable for evaluation of the particular ingredient, mixture, or product. Accordingly, failure to follow a suggested protocol will not invalidate a test if another appropriate methodology is used.

(b) *Organization for Economic Cooperation and Development (OECD) Protocols.* Tests conducted in accordance with the requirements and recommendations of the applicable OECD protocols can be used to develop data necessary to meet the requirements specified in this part. Readers should note, however, that certain of the OECD recommended test

standards, such as test duration and selection of test species, are less restrictive than those recommended by EPA. Therefore, when using the OECD protocols, care should be taken to observe the test standards in a manner such that the data generated by the study will satisfy the requirements of this part.

(c) *Procedures for requesting advice on protocols.* Normally, all contact between the Agency and applicants or registrants is handled by the assigned Product Manager in the Registration Division of the Office of Pesticide Programs. Accordingly, questions concerning protocols should be directed, preferably in writing, to the Product Manager responsible for the registration or application which would be affected.

§ 158.75 Requirements for additional data.

(a) *General policy.* The data routinely required by part 158 may not be sufficient to permit EPA to evaluate every pesticide product. If the information required under this part is not sufficient to evaluate the potential of the product to cause unreasonable adverse effects on man or the environment, additional data requirements will be imposed. However, EPA expects that the information required by this part will be adequate in most cases for an assessment of the properties of pesticide.

(b) *Policy on test substance.* In general, where the technical grade of the active ingredient is specified as the substance to be tested, tests may be performed using a technical grade which is substantially similar to the technical grade used in the product for which registration is sought. In addition to or in lieu of the testing required in subparts C and D of this part the Administrator will, on a case-by-case basis, require testing to be conducted with:

(1) An analytical pure grade of an active ingredient, with or without radioactive tagging.

(2) The technical grade of an active ingredient.

(3) The representative technical grade of an active ingredient.

(4) An intentionally added inert ingredient in a pesticide product.

(5) A contaminant or impurity of an active or inert ingredient.

(6) A plant or animal metabolite or degradation product of an active or inert ingredient.

(7) The end-use pesticide product.

(8) The end-use pesticide product plus any recommended vehicles and adjuvants.

(9) Any additional substance which could act as a synergist to the product for which registration is sought.

(10) Any combination of substances in paragraphs (b) (1) through (9) of this section.

[49 FR 42881, Oct. 24, 1984, as amended at 53 FR 15999, May 4, 1988; 58 FR 34203, June 23, 1993]

§ 158.80 Acceptability of data.

(a) *General policy.* The Agency will determine whether the data submitted to fulfill the data requirements specified in this part are acceptable. This determination will be based on the design and conduct of the experiment from which the data were derived, and an evaluation of whether the data fulfill the purpose(s) of the data requirement. In evaluating experimental design, the Agency will consider whether generally accepted methods were used, sufficient numbers of measurements were made to achieve statistical reliability, and sufficient controls were built into all phases of the experiment. The Agency will evaluate the conduct of each experiment in terms of whether the study was conducted in conformance with the design, good laboratory practices were observed, and results were reproducible. The Agency will not reject data merely because they were derived from studies which, when initiated were in accordance with an Agency-recommended protocol, even if the Agency subsequently recommends a different protocol, as long as the data fulfill the purposes of the requirements as described in this paragraph.

(b) *Previously developed data.* The Agency will consider that data developed prior to the effective date of this part would be satisfactory to support applications provided good laboratory practices were followed, the data meet the purposes of this part, and the data permit sound scientific judgments to be made. Such data will not be rejected

merely because they were not developed in accordance with suggested protocols.

(c) *Data developed in foreign countries.* The Agency considers all applicable data developed from laboratory and field studies anywhere to be suitable to support pesticide registrations except for data from tests which involved field test sites or a test material, such as a native soil, plant, or animal, that is not characteristic of the United States. When studies at test sites or with materials of this type are anticipated, applicants should take steps to assure that United States materials are used or be prepared to supply data or information to demonstrate the lack of substantial or relevant differences between the selected material or test site and the United States material or test site. Once comparability has been established, the Agency will assess the acceptability of the data as described in paragraph (a) of this section.

(d) *Data from monitoring studies.* Certain data are developed to meet the monitoring requirements of FIFRA sections 5, 8 or 20. Applicants may wish to determine whether some of these data may meet the requirements of this part. In addition, data developed independently of FIFRA regulations or requirements may also satisfy data requirements in this part. Consultation with appropriate EPA Product Managers would be helpful if applicants are unsure about suitability of such data.

§ 158.85 Revision of data requirements and guidelines.

(a) Data requirements will be revised from time to time to keep up with policy changes and technology. Revisions to this part will be made in accordance with the Administrative Procedure Act (5 U.S.C. 551 *et seq.*). Changes having a significant impact on the registration process, applicants, testers, or other parties, or on the outcome and evaluation of studies, will be made only after public notice and opportunity for comment. Until final rules reflecting a change have been promulgated, the Agency can implement changes in the data requirements on a case-by-case basis.

(b) The Agency invites registration applicants, registrants, and the general

public to suggest changes in the data requirements or the Pesticide Assessment Guidelines. Suggestions may be submitted at any time. Those making suggestions are requested to contact, in writing, the Director of the Hazard Evaluation Division. When suggestions consist of new suggested methods, representative test results should accompany the submittals.

Subpart B—How To Use Data Tables

§ 158.100 How to determine registration data requirements.

To determine the specific kinds of data needed to support the registration of each pesticide product, the registration applicant should:

(a) Refer to subparts C and D (§§ 158.150 through 158.740). These subparts describe the data requirements, including data tables for each subject area. The corresponding subdivisions in the Pesticide Assessment Guidelines are listed in § 158.108.

(b) Select the general use pattern(s) that best covers the use pattern(s) specified on the pesticide product label. Selection of the appropriate general use pattern(s) will usually be obvious. However, unique or ambiguous cases will arise occasionally. These situations may be clarified by reference to the Use Pattern Index presented in the appendix to the Data Requirements for Registration. The applicant can look up a specific use pattern in appendix A and it will be cross referenced to the appropriate general use patterns to be used in each Data Requirement table.

(c) Proceed down the appropriate general use pattern column in the table and note which tests (listed along the left hand side of the table) are required (“R”), conditionally required (“CR”) or usually not required (“—”). After reading through each data requirement table, the applicant will have a complete list of required and conditionally required data for the pesticide product and the substance to be tested in developing data to meet each requirement. The data EPA must have available to review the registration of a specific product consists of all the data designated as required for that product and all the applicable data designated

Environmental Protection Agency

§ 158.108

as conditionally required for that product.

[49 FR 42881, Oct. 24, 1984, as amended at 53 FR 15993, May 4, 1988]

§ 158.101 Required vs. conditionally required data.

(a) Data designated as “required” (“R”) for products with a given general use pattern are needed by EPA to evaluate the risks or benefits of a product having that use pattern unless the data requirement has been waived under §158.45 for that particular product or unless the product is covered by a specific exception set forth in a note accompanying the requirement.

(b) Data designated as “conditionally required” (“CR”) for products with a given general use pattern are needed by EPA to evaluate the risks or benefits of a product having that use pattern if the product meets the conditions specified in the corresponding notes accompanying the data requirements table. As indicated in the notes, the determination of whether the data must be submitted is based on the product’s use pattern, physical or chemical properties, expected exposure of nontarget organisms, and/or results of previous testing (e.g., tier testing). Applicants must evaluate each applicable note to determine whether or not conditionally required data must be submitted as indicated by the conditions and criteria specified in the accompanying notes unless the Agency has granted a waiver request submitted by the registrant in accordance with §158.45.

(c) For certain of the required or conditionally required data, the “R” or “CR” designations and are enclosed in brackets (i.e., [R], [CR]). The brackets designate those data that are required or conditionally required to support a product when an experimental use permit is being sought. In all other situations (i.e., other than support of an experimental use permit), the brackets have no meaning and the designations R and CR are equivalent to [R] and [CR], respectively.

[49 FR 42881, Oct. 24, 1984, as amended at 58 FR 34203, June 23, 1993]

§ 158.102 Distinguishing between what data are required and what substance is to be tested.

(a) Readers should be careful to distinguish between what data are required and what substance is to be tested, as specified in this part and in each corresponding section of the guidelines. Each data requirement table specifies whether a particular data requirement is required to support the registration of manufacturing-use products, end-use products, or both. The test substance column specifies which substance is to be subjected to testing. Thus, the data from a certain kind of study may be required to support the registration of each end-use product, but the test substance column may state that the particular test shall be performed using, for example, the technical grade of the active ingredient(s) in the end-use product.

(b) Manufacturing-use products (MP) and end-use products (EP) containing a single active ingredient and no inert ingredients are identical in composition to each other and to the technical grade of the active ingredient (TGAI) from which they were derived, and therefore, the data from a test conducted using any one of these as the test substance (e.g., TGAI) is also suitable to meet the requirement (if any) for the same test to be conducted using either of the other substances (i.e., MP or EP).

[49 FR 42881, Oct. 24, 1984, as amended at 53 FR 15999, May 4, 1988]

§ 158.108 Relationship of Pesticide Assessment Guidelines to data requirements.

The Pesticide Assessment Guidelines contain the standards for conducting acceptable tests, guidance on evaluation and reporting of data, definition of terms, further guidance on when data are required, and examples of acceptable protocols. They are available through the National Technical Information Service, 5285 Port Royal Road, Springfield, VA 22161 (703-487-4650). The following Subdivisions of the Pesticide Assessment Guidelines, referenced to the appropriate sections of this part, are currently available:

Subdivision	Title	NTIS order no.	Corresponding section(s) in this part
D	Product Chemistry	PB83-153890	§§ 158.150–158.190
E	Hazard Evaluation: Wildlife and Aquatic Organisms	PB83-153908	§ 158.490
F	Hazard Evaluation: Humans and Domestic Animals	PB83-153916	§ 158.340
G	Product Performance	PB83-153924	§ 158.640
I	Experimental Use Permits	PB83-153932	§§ 158.20–158.740
J	Hazard Evaluation: Nontarget Plants	PB83-153940	§ 158.540
K	Reentry Protection	PB85-120962	§ 158.390
L	Hazard Evaluation: Nontarget Insect	PB83-153957	§ 158.590
M	Biorational Pesticides	PB83-153965	§§ 158.690–158.740
N	Environmental Fate	PB83-153973	§ 158.290
O	Residue Chemistry	PB83-153961	§ 158.240
R	Spray Drift Evaluation	PB84-189216	§ 158.440

[53 FR 15993, May 4, 1988]

Subpart C—Product Chemistry Data Requirements

SOURCE: 53 FR 15993, May 4, 1988, unless otherwise noted.

§ 158.150 General.

(a) *Applicability.* This subpart describes the product chemistry data that are required to support the registration of each pesticide product. The information specified in this subpart must be submitted with each application for new or amended registration or for reregistration, if it has not been submitted previously or if the previously submitted information is not complete and accurate. References in this subpart to the “applicant” include the registrant if the information is required for a registered product.

(b) *Purpose—(1) Product composition.*
 (i) Data on product composition are needed to support the conclusions expressed in the statement of formula. These data include information on the starting materials, production or formulating process, possible formation of impurities, results of preliminary analysis of product samples, a description of analytical methods to identify and quantify ingredients and validation data for such methods. In addition, an applicant is required to certify the limits for ingredients of his product.

(ii) Product composition data are compared to the composition of materials used in required testing under subpart D of this part. This comparison indicates which components of a pesticide product have been evaluated by a particular study, and might lead to a conclusion that another study is need-

ed. Based on conclusions concerning the product’s composition and its toxic properties, appropriate use restrictions, labeling requirements, or special packaging requirements may be imposed.

(iii) Product composition data, including certified limits of components, are used to determine whether a product is “identical or substantially similar” to another product or “differs only in ways that do not significantly increase the risk of unreasonable adverse effects on the environment” (FIFRA sec. 3(c)(7)(A)). In nearly every case, this determination involves a comparison of the composition of an applicant’s product with that of currently registered products.

(2) *Certified limits.* Certified limits required by § 158.175 are used in two ways. First, the Agency considers the certified limits in making the registration determination required by sections 3(c)(5), 3(c)(7) and 3(d) of the Act and making other regulatory decisions required by the Act. Second, the Agency may collect commercial samples of the registered products and analyze them for the active ingredient(s), inert ingredients, or impurities determined by the Agency to be toxicologically significant. If, upon analysis the composition of such a sample is found to differ from that certified, the results may be used by the Agency in regulatory actions under FIFRA sec. 12(a)(1)(C) and other pertinent sections.

(3) *Nominal concentration.* The nominal concentration required by § 158.155 is the amount of active ingredient that is most likely to be present in the product when produced. Unlike the certified limits, which are the outer limits

of the range of the product's ingredients and thus are present only in a small proportion of the products, the nominal concentration is the amount that typically is expected to result from the applicant's production or formulating process. The nominal concentration together with production process information is used to gauge the acceptability of the certified limits presented by the applicant. The nominal concentration is used by the Agency as the basis for enforceable certified limits if the applicant has chosen not to specify certified limits of his own (thereby agreeing to abide by the standard limits in § 158.175).

(4) *Physical and chemical characteristics.* (i) Data on the physical and chemical characteristics of pesticide active ingredients and products are used to confirm or provide supportive information on their identity. Such data are also used in reviewing the production or formulating process used to produce the pesticide or product. For example, data that indicate significant changes in production or formulation might indicate the need for additional information on product composition.

(ii) Certain information (e.g., color, odor, physical state) is needed for the Agency to respond to emergency requests for identification of unlabeled pesticides involved in accidents or spills. Physicians, hospitals, and poison control centers also request this information to aid in their identification of materials implicated in poisoning episodes.

(iii) Certain physical and chemical data are used directly in the hazard assessment. These include stability, oxidizing and reducing action, flammability, explosibility, storage stability, corrosion, and dielectric breakdown voltage. For example, a study of the corrosion characteristics of a pesticide is needed to evaluate effects of the product formulation on its container. If the pesticide is highly corrosive, measures can be taken to ensure that lids, liners, seams or container sides will not be damaged and cause the contents to leak during storage, transport, handling, or use. The storage stability study provides data on change (or lack of change) in product composition over time. If certain ingredients decompose,

other new chemicals are formed whose toxicity and other characteristics must be considered.

(iv) Certain data are needed as basic or supportive evidence in initiating or evaluating other studies. For example, the octanol/water partition coefficient is used as one of the criteria to determine whether certain fish and wildlife toxicity or accumulation studies must be conducted. Vapor pressure data are needed, among other things, to determine suitable reentry intervals and other label cautions pertaining to worker protection. Data on viscosity and miscibility provide necessary information to support acceptable labeling for tank mix and spray applications.

§ 158.153 Definitions.

The following terms are defined for the purposes of this subpart:

(a) *Active ingredient* means any substance (or group of structurally similar substances, if specified by the Agency) that will prevent, destroy, repel or mitigate any pest, or that functions as a plant regulator, desiccant, or defoliant within the meaning of FIFRA sec. 2(a).

(b) *End use product* means a pesticide product whose labeling

(1) Includes directions for use of the product (as distributed or sold, or after combination by the user with other substances) for controlling pests or defoliating, desiccating or regulating growth of plants, and

(2) Does not state that the product may be used to manufacture or formulate other pesticide products.

(c) *Formulation* means

(1) The process of mixing, blending, or dilution of one or more active ingredients with one or more other active or inert ingredients, without an intended chemical reaction, to obtain a manufacturing use product or an end use product, or

(2) The repackaging of any registered product.

(d) *Impurity* means any substance (or group of structurally similar substances if specified by the Agency) in a pesticide product other than an active ingredient or an inert ingredient, including unreacted starting materials,

side reaction products, contaminants, and degradation products.

(e) *Impurity associated with an active ingredient* means:

(1) Any impurity present in the technical grade of active ingredient; and

(2) Any impurity which forms in the pesticide product through reactions between the active ingredient and any other component of the product or packaging of the product.

(f) *Inert ingredient* means any substance (or group of structurally similar substances if designated by the Agency), other than an active ingredient, which is intentionally included in a pesticide product.

(g) *Integrated system* means a process for producing a pesticide product that:

(1) Contains any active ingredient derived from a source that is not an EPA-registered product; or

(2) Contains any active ingredient that was produced or acquired in a manner that does not permit its inspection by the Agency under FIFRA sec. 9(a) prior to its use in the process.

(h) *Manufacturing use product* means any pesticide product other than an end use product. A product may consist of the technical grade of active ingredient only, or may contain inert ingredients, such as stabilizers or solvents.

(i) *Nominal concentration* means the amount of an ingredient which is expected to be present in a typical sample of a pesticide product at the time the product is produced, expressed as a percentage by weight.

(j) *Starting material* means a substance used to synthesize or purify a technical grade of active ingredient (or the practical equivalent of the technical grade ingredient if the technical grade cannot be isolated) by chemical reaction.

(k) *Technical grade of active ingredient* means a material containing an active ingredient:

(1) Which contains no inert ingredient, other than one used for purification of the active ingredient; and

(2) Which is produced on a commercial or pilot-plant production scale (whether or not it is ever held for sale).

§ 158.155 Product composition.

Information on the composition of the pesticide product must be fur-

nished. The information required by paragraphs (a), (b) and (f) of this section must be provided for each product. In addition, if the product is produced by an integrated system, the information on impurities required by paragraphs (c) and (d) must be provided.

(a) *Active ingredient*. The following information is required for each active ingredient in the product:

(1) If the source of any active ingredient in the product is an EPA-registered product:

(i) The chemical and common name (if any) of the active ingredient, as listed on the source product.

(ii) The nominal concentration of the active ingredient in the product, based upon the nominal concentration of active ingredient in the source product.

(iii) Upper and lower certified limits of the active ingredient in the product, in accordance with § 158.175.

(2) If the source of any active ingredient in the product is not an EPA-registered product:

(i) The chemical name according to Chemical Abstracts Society nomenclature, the CAS Registry Number, and any common names.

(ii) The molecular, structural, and empirical formulae, and the molecular weight or weight range.

(iii) The nominal concentration.

(iv) Upper and lower certified limits in accordance with § 158.175.

(v) The purpose of the ingredient in the formulation.

(b) *Inert ingredients*. The following information is required for each inert ingredient (if any) in the product:

(1) The chemical name of the ingredient according to Chemical Abstracts Society nomenclature, the CAS Registry Number, and any common names (if known). If the chemical identity or chemical composition of an ingredient is not known to the applicant because it is proprietary or trade secret information, the applicant must ensure that the supplier or producer of the ingredient submits to the Agency (or has on file with the Agency) information on the identity or chemical composition of the ingredient. Generally, it is not required that an applicant know the identity of each ingredient in a mixture that he uses in his product. However, in certain circumstances, the

Environmental Protection Agency

§ 158.160

Agency may require that the applicant know the identity of a specific ingredient in such a mixture. If the Agency requires specific knowledge of an ingredient, it will notify the applicant in writing.

(2) The nominal concentration in the product.

(3) Upper and lower certified limits in accordance with § 158.175.

(4) The purpose of the ingredient in the formulation.

(c) *Impurities of toxicological significance associated with the active ingredient.* For each impurity associated with the active ingredient that is determined to be toxicologically significant, the following information is required:

(1) Identification of the ingredient as an impurity.

(2) The chemical name of the impurity.

(3) The nominal concentration of the impurity in the product.

(4) A certified upper limit, in accordance with § 158.175.

(d) *Other impurities associated with the active ingredient.* For each other impurity associated with an active ingredient that was found to be present in any sample at a level equal to or greater than 0.1 percent by weight of the technical grade active ingredient, the following information is required:

(1) Identification of the ingredient as an impurity.

(2) Chemical name of the impurity.

(3) The nominal concentration of the impurity in the final product.

(e) *Impurities associated with an inert ingredient.* [Reserved]

(f) *Ingredients that cannot be characterized.* If the identity of any ingredient or impurity cannot be specified as a discrete chemical substance (such as mixtures that cannot be characterized or isomer mixtures), the applicant must provide sufficient information to enable EPA to identify its source and qualitative composition.

§ 158.160 Description of materials used to produce the product.

The following information must be submitted on the materials used to produce the product:

(a) *Products not produced by an integrated system.*

(1) For each active ingredient that is derived from an EPA-registered product:

(i) The name of the EPA-registered product.

(ii) The EPA registration number of that product.

(2) For each inert ingredient:

(i) Each brand name, trade name, or other commercial designation of the ingredient.

(ii) All information that the applicant knows (or that is reasonably available to him) concerning the composition (and, if requested by the Agency, chemical and physical properties) of the ingredient, including a copy of technical specifications, data sheets, or other documents describing the ingredient.

(iii) If requested by the Agency, the name and address of the producer of the ingredient or, if that information is not known to the applicant, the name and address of the supplier of the ingredient.

(b) *Products produced by an integrated system.* (1) The information required by paragraph (a)(1) of this section concerning each active ingredient that is derived from an EPA-registered product (if any).

(2) The following information concerning each active ingredient that is not derived from an EPA-registered product:

(i) The name and address of the producer of the ingredient (if different from the applicant).

(ii) Information on each starting material used to produce the active ingredient, as follows:

(A) Each brand name, trade name, or other commercial designation of the starting material.

(B) The name and address of the person who produces the starting material or, if that information is not known to the applicant, the name and address of each person who supplies the starting material.

(C) All information that the applicant knows (or that is reasonably available to him) concerning the composition (and if requested by the Agency, chemical or physical properties) of the starting material, including a copy of all technical specifications, data

§ 158.162

40 CFR Ch. I (7–1–99 Edition)

sheets, or other documents describing it.

(3) The information required by paragraph (a)(2) of this section concerning each inert ingredient.

(c) *Additional information.* On a case-by-case basis, the Agency may require additional information on substances used in the production of the product.

§ 158.162 Description of production process.

If the product is produced by an integrated system, the applicant must submit information on the production (reaction) processes used to produce the active ingredients in the product. The applicant must also submit information on the formulation process, in accordance with § 158.165.

(a) Information must be submitted for the current production process for each active ingredient that is not derived from an EPA-registered product. If the production process is not continuous (a single reaction process from starting materials to active ingredient), but is accomplished in stages or by different producers, the information must be provided for each such production process.

(b) The following information must be provided for each process resulting in a separately isolated substance:

(1) the name and address of the producer who uses the process, if not the same as the applicant.

(2) A general characterization of the process (e.g., whether it is a batch or continuous process).

(3) A flow chart of the chemical equations of each intended reaction occurring at each step of the process, the necessary reaction conditions, and the duration of each step and of the entire process.

(4) The identity of the materials used to produce the product, their relative amounts, and the order in which they are added.

(5) A description of the equipment used that may influence the composition of the substance produced.

(6) A description of the conditions (e.g., temperature, pressure, pH, humidity) that are controlled during each step of the process to affect the composition of the substance produced, and the limits that are maintained.

(7) A description of any purification procedures (including procedures to recover or recycle starting materials, intermediates or the substance produced).

(8) A description of the procedures used to assure consistent composition of the substance produced, e.g., calibration of equipment, sampling regimens, analytical methods, and other quality control methods.

§ 158.165 Description of formulation process.

The applicant must provide information on the formulation process of the product (unless the product consists solely of a technical grade of active ingredient), as required by the following sections:

(a) Section 158.162(b)(2), pertaining to characterization of the process.

(b) Section 158.162(b)(4), pertaining to ingredients used in the process.

(c) Section 158.162(b)(5), pertaining to process equipment.

(d) Section 158.162(b)(6), pertaining to the conditions of the process.

(e) Section 158.162(b)(8), pertaining to quality control measures.

§ 158.167 Discussion of formation of impurities.

The applicant must provide a discussion of the impurities that may be present in the product, and why they may be present. The discussion should be based on established chemical theory and on what the applicant knows about the starting materials, technical grade of active ingredient, inert ingredients, and production or formulation process. If the applicant has reason to believe that an impurity that EPA would consider toxicologically significant may be present, the discussion must include an expanded discussion of the possible formation of the impurity and the amounts at which it might be present. The impurities which must be discussed are the following, as applicable:

(a) *Technical grade active ingredients and products produced by an integrated system.* (1) Each impurity associated with the active ingredient which was found to be present in any analysis of the product conducted by or for the applicant.

(2) Each other impurity which the applicant has reason to believe may be present in his product at any time before use at a level equal to or greater than 0.1 percent (1000 ppm) by weight of the technical grade of the active ingredient, based on what he knows about the following:

(i) The composition (or composition range) of each starting material used to produce his product.

(ii) The impurities which he knows are present (or believes are likely to be present) in the starting materials, and the known or presumed level (or range of levels) of those impurities.

(iii) The intended reactions and side reactions which may occur in the production of the product, and the relative amounts of byproduct impurities produced by such reactions.

(iv) The possible degradation of the ingredients in the product after its production but prior to its use.

(v) Post-production reactions between the ingredients in the product.

(vi) The possible migration of components of packaging materials into the pesticide.

(vii) The possible carryover of contaminants from use of production equipment previously used to produce other products or substances.

(viii) The process control, purification and quality control measures used to produce the product.

(b) *Products not produced by an integrated system.* Each impurity associated with the active ingredient which the applicant has reason to believe may be present in the product at any time before use at a level equal to or greater than 0.1 percent (1000 ppm) by weight of the product based on what he knows about the following:

(1) The possible carryover of impurities present in any registered product which serves as the source of any of the product's active ingredients. The identity and level of impurities in the registered source need not be discussed or quantified unless known to the formulator.

(2) The possible carryover of impurities present in the inert ingredients in the product.

(3) Possible reactions occurring during the formulation of the product between any of its active ingredients, be-

tween the active ingredients and inert ingredients, or between the active ingredients and the production equipment.

(4) Post-production reactions between any of the product's active ingredients and any other component of the product or its packaging.

(5) Possible migration of packaging materials into the product.

(6) Possible contaminants resulting from earlier use of equipment to produce other products.

(c) *Expanded discussion.* On a case-by-case basis, the Agency may require an expanded discussion of information of impurities:

(1) From other possible chemical reactions;

(2) Involving other ingredients; or

(3) At additional points in the production or formulation process.

§ 158.170 Preliminary analysis.

(a) If the product is produced by an integrated system, the applicant must provide a preliminary analysis of each technical grade of active ingredient contained in the product to identify all impurities present at 0.1 percent or greater of the TGAI. The preliminary analysis should be conducted at the point in the production process after which no further chemical reactions designed to produce or purify the substance are intended.

(b) Based on the preliminary analysis, a statement of the composition of the technical grade of active ingredient must be provided. If the technical grade of active ingredient cannot be isolated, a statement of the composition of the practical equivalent of the technical grade of active ingredient must be submitted.

§ 158.175 Certified limits.

The applicant must propose certified limits for the ingredients in the product. Certified limits become legally binding limits upon approval of the application. Certified limits will apply to the product from the date of production to date of use, unless the product label bears a statement prohibiting use after a certain date, in which case the certified limits will apply only until that date.

(a) *Ingredients for which certified limits are required.* Certified limits are required on the following ingredients of a pesticide product:

- (1) An upper and lower limit for each active ingredient.
- (2) An upper and lower limit for each inert ingredient.
- (3) If the product is a technical grade of active ingredient or is produced by an integrated system, an upper limit for each impurity of toxicological significance associated with the active ingredient and found to be present in any sample of the product.

(4) On a case-by-case basis, certified limits for other ingredients or impurities as specified by EPA.

(b) *EPA determination of certified limits for active and inert ingredients.* (1) Unless the applicant proposes different limits as provided in paragraph (c) of this section, the upper and lower certified limits for active and inert ingredients will be determined by EPA. EPA will calculate the certified limits on the basis of the nominal concentration of the ingredient in the product, according to the table in paragraph (b)(2) of this section.

(2) Table of standard certified limits.

If the nominal concentration (N) for the ingredient is:	The certified limits for that ingredient will be as follows:	
	Upper limit	Lower limit
$N \leq 1.0\%$	$N + 10\%N$	$N - 10\%N$
$1.0\% < N \leq 20.0\%$	$N + 5\%N$	$N - 5\%N$
$20.0\% < N \leq 100.0\%$	$N + 3\%N$	$N - 3\%N$

(c) *Applicant proposed limits.* (1) The applicant may propose a certified limit for an active or inert ingredient that differs from the standard certified limit calculated according to paragraph (b)(2) of this section.

(2) If certified limits are required for impurities, the applicant must propose a certified limit. The standard certified limits may not be used for such substances.

(3) Certified limits should:

- (i) Be based on a consideration of the variability of the concentration of the ingredient in the product when good manufacturing practices and normal quality control procedures are used.
- (ii) Allow for all sources of variability likely to be encountered in the production process.

(iii) Take into account the stability of the ingredient in the product and the possible formation of impurities between production and sale of distribution.

(4) The applicant may include an explanation of the basis of his proposed certified limits, including how the certified limits were arrived at (e.g., sample analysis, quantitative estimate based on production process), and its accuracy and precision. This will be particularly useful if the range of the certified limit for an active or inert ingredient is greater than the standard certified limits.

(d) *Special cases.* If the Agency finds unacceptable any certified limit (either standard or applicant-proposed), the Agency will inform the applicant of its determination and will provide supporting reasons. EPA may also recommend alternative limits to the applicant. The Agency may require, on a case-by-case basis, any or all of the following:

- (1) More precise limits.
- (2) More thorough explanation of how the certified limits were determined.
- (3) A narrower range between the upper and lower certified limits than that proposed.

(e) *Certification statement.* The applicant must certify the accuracy of the information presented, and that the certified limits of the ingredients will be maintained. The following statement, signed by the authorized representative of the company, is acceptable:

I hereby certify that, for purposes of FIFRA sec. 12(a)(1)(C), the description of the composition of [product name], EPA Reg. No. [insert registration number], refers to the composition set forth on the Statement of Formula and supporting materials. This description includes the representations that: (1) no ingredient will be present in the product in an amount greater than the upper certified limit or in an amount less than the lower certified limit (if required) specified for that ingredient in a currently approved Statement of Formula (or as calculated by the Agency); and (2) if the Agency requires that the source of supply of an ingredient be specified, that all quantities of such ingredient will be obtained from the source specified in the Statement of Formula.

Environmental Protection Agency

§ 158.202

§ 158.180 Enforcement analytical method.

An analytical method suitable for enforcement purposes must be provided for each active ingredient in the product and for each other ingredient or impurity that is determined to be toxicologically significant.

§ 158.190 Physical and chemical characteristics.

(a) *Table.* Sections 158.50 and 158.100 through 158.102 describe how to use this table to determine the physical and chemical characteristics data requirements and the substance to be tested.

Kind of data required	(b) Notes	All general use patterns (requirements are the same for every use pattern)	Test substance		Guidelines reference No.
			Data to support MP	Data to support EP	
Color		[R]	MP and TGAI	EP* and TGAI	63-2
Physical state		[R]	MP and TGAI	EP* and TGAI	63-3
Odor		[R]	MP and TGAI	EP* and TGAI	63-4
Melting point	(1)	[R]	TGAI	TGAI	63-5
Boiling point	(2)	[R]	TGAI	TGAI	63-6
Density, bulk density, or specific gravity		[R]	MP and TGAI	EP* and TGAI	63-7
Solubility		[R]	TGAI or PAI	TGAI or PAI	63-8
Vapor pressure		[R]	TGAI or PAI	TGAI or PAI	63-9
Dissociation constant		[R]	TGAI or PAI	TGAI or PAI	63-10
Octanol/water partition coefficient	(3)	[CR]	PAI	PAI	63-11
pH	(4)	[CR]	MP and TGAI	EP* and TGAI	63-12
Stability		[R]	TGAI	TGAI	63-13
Oxidizing or reducing action	(5)	[CR]			
Flammability	(6)	[CR]	MP	EP*	63-15
Explosibility	(7)	[R]	MP	EP*	63-16
Storage stability		[R]	MP	EP*	63-17
Viscosity	(8)	[CR]	MP	EP*	63-18
Miscibility	(9)	[CR]	MP	EP*	63-19
Corrosion characteristics		[R]	MP	EP*	63-20
Dielectric breakdown voltage	(10)	[CR]		EP*	63-21
Other requirements: Submittal of samples ..	(11)	[CR]	MP, TGAI, PAI	EP*, TGAI, PAI	64-1

Key: R = Required; CR = Conditionally Required; [] = Brackets (i.e. [R],[CR]) indicate data requirements that apply when an experimental use permit is being sought; MP = Manufacturing Use Product, EP* = End Use Product; asterisk indicates those registrants that end-use applicants (i.e. formulators) need not satisfy, if their active ingredient(s) is (are) purchased from a registered source; TGAI = Technical Grade of the Active Ingredient; PAI = Pure Active Ingredient.

- (b) Notes.—The following notes are referenced in column two of the table contained in paragraph (a) of this section.
- (1) Required if technical chemical is a solid at room temperature.
 - (2) Required if technical chemical is a liquid at room temperature.
 - (3) Required if technical chemical is organic and non-polar.
 - (4) Required if test substance is dispersible with water.
 - (5) Required if product contains an oxidizing or reducing agent.
 - (6) Required if product contains combustible liquids.
 - (7) Required if product is potentially explosive.
 - (8) Required if product is a liquid.
 - (9) Required if product is an emulsifiable liquid and is to be diluted with petroleum solvents.
 - (10) Required if end-use product is a liquid and is to be used around electrical equipment.
 - (11) Basic manufacturers are required to provide the Agency with a sample of each TGAI used to formulate a product produced by an integrated system when the new TGAI is first used as a formulating ingredient in products registered under FIFRA. A sample of the active ingredient (PAI) suitable for use as an analytical standard is also required at this time. Samples of end use products produced by an integrated system must be submitted on a case-by-case basis.

[49 FR 42881, Oct. 24, 1984, as amended at 58 FR 34203, June 23, 1993]

Subpart D—Data Requirement Tables

§ 158.202 Purposes of the registration data requirements.

(a) *General.* The data requirements for registration are intended to generate data and information necessary to address concerns pertaining to the identity, composition, potential ad-

verse effects and environmental fate of each pesticide.

(b) [Reserved]

(c) *Residue chemistry.* (1) Residue Chemistry Data are used by the Agency to estimate the exposure of the general population to pesticide residues in food and for setting and enforcing tolerances for pesticide residues in food or feed.

(2) Information on the chemical identity and composition of the pesticide product, the amounts, frequency and time of pesticide application, and results of test on the amount of residues remaining on or in the treated food or feed, are needed to support a finding as to the magnitude and identity of residues which result in food or animal feed as a consequence of a proposed pesticide usage.

(3) Residue chemistry data are also needed to support the adequacy of one or more methods for the enforcement of the tolerance, and to support practicable methods for removing residues that exceed any proposed tolerance.

(d) *Environmental fate*—(1) *General*. The data generated by environmental fate studies are used to: assess the toxicity to man through exposure of humans to pesticide residues remaining after application, either upon reentering treated areas or from consuming inadvertently-contaminated food; assess the presence of widely distributed and persistent pesticides in the environment which may result in loss of usable land, surface water, ground water, and wildlife resources; and, assess the potential environmental exposure of other nontarget organisms, such as fish and wildlife, to pesticides. Another specific purpose of the environmental fate data requirements is to help applicants and the Agency estimate expected environmental concentrations of pesticides in specific habitats where threatened or endangered species or other wildlife populations at risk are found.

(2) *Degradation studies*. The data from hydrolysis and photolysis studies are used to determine the rate of pesticide degradation and to identify pesticides that may adversely affect nontarget organisms.

(3) *Metabolism studies*. Data generated from aerobic and anaerobic metabolism studies are used to determine the nature and availability of pesticides to rotational crops and to aid in the evaluation of the persistence of a pesticide.

(4) *Mobility studies*. These data requirements pertain to leaching, adsorption/desorption, and volatility of pesticides. They provide information on the mode of transport and eventual destination of the pesticide in the envi-

ronment. This information is used to assess potential environmental hazards related to: contamination of human and animal food; loss of usable land and water resources to man through contamination of water (including ground water); and habitat loss of wildlife resulting from pesticide residue movement or transport in the environment.

(5) *Dissipation studies*. The data generated from dissipation studies are used to assess potential environmental hazards (under actual field use conditions) related to: reentry into treated areas; hazards from residues in rotational crop and other food sources; and the loss of land as well as surface and ground water resources.

(6) *Accumulation studies*. Accumulation studies indicate pesticide residue levels in food supplies that originate from wild sources or from rotational crops. Rotational crop studies are necessary to establish realistic crop rotation restrictions and to determine if tolerances may be needed for residues on rotational crops. Data from irrigated crop studies are used to determine the amount of pesticide residues that could be taken up by representative crops irrigated with water containing pesticide residues. These studies allow the Agency to establish label restrictions regarding application of pesticides on sites where the residues can be taken up by irrigated crops. These data also provide information that aids the Agency in establishing any corresponding tolerances that would be needed for residues on such crops. Data from pesticides accumulation studies in fish are used to establish label restrictions to prevent applications in certain sites so that there will be minimal residues entering edible fish or shell fish. These residue data are also used to determine if a tolerance or action level is needed for residues in aquatic animals eaten by humans.

(e) *Hazard to humans and domestic animals*. Data required to assess hazards to humans and domestic animals are derived from a variety of acute, subchronic and chronic toxicity tests, and tests to assess mutagenicity and pesticide metabolism.

(1) *Acute studies.* Determination of acute oral, dermal and inhalation toxicity is usually the initial step in the assessment and evaluation of the toxic characteristics of a pesticide. These data provide information on health hazards likely to arise soon after, and as a result of, short-term exposure. Data from acute studies serve as a basis for classification and precautionary labeling. For example, acute toxicity data are used to calculate farmworker reentry intervals and to develop precautionary label statements pertaining to protective clothing requirements for applicators. They also: provide information used in establishing the appropriate dose levels in subchronic and other studies; provide initial information on the mode of toxic action(s) of a substance; and determine the need for child resistant packaging. Information derived from primary eye and primary dermal irritation studies serves to identify possible hazards from exposure of the eyes, associated mucous membranes and skin.

(2) *Subchronic studies.* Subchronic tests provide information on health hazards that may arise from repeated exposures over a limited period of time. They provide information on target organs and accumulation potential. The resulting data are also useful in selecting dose levels for chronic studies and for establishing safety criteria for human exposure. These tests are not capable of detecting those effects that have a long latency period for expression (e.g., carcinogenicity).

(3) *Chronic studies.* Chronic toxicity (usually conducted by feeding the test substance to the test species) studies are intended to determine the effects of a substance in a mammalian species following prolonged and repeated exposure. Under the conditions of this test, effects which have a long latency period or are cumulative should be detected. The purpose of long-term oncogenicity studies is to observe test animals over most of their life span for the development of neoplastic lesions during or after exposure to various doses of a test substance by an appropriate route of administration.

(4) *Teratogenicity and reproduction studies.* The teratogenicity study is designed to determine the potential of

the test substance to induce structural and/or other abnormalities to the fetus as the result of exposure of the mother during pregnancy. Two-generation reproduction testing is designed to provide information concerning the general effects of a test substance on gonadal function, estrus cycles, mating behavior, conception, parturition, lactation, weaning, and the growth and development of the offspring. The study may also provide information about the effects of the test substance on neonatal morbidity, mortality, and preliminary data on teratogenesis and serve as a guide for subsequent tests.

(5) *Mutagenicity studies.* For each test substance a battery of tests are required to assess potential to affect the mammalian cell's genetic components. The objectives underlying the selection of a battery of tests for mutagenicity assessment are:

(i) To detect, with sensitive assay methods, the capacity of a chemical to alter genetic material in cells.

(ii) To determine the relevance of these mutagenic changes to mammals.

(iii) When mutagenic potential is demonstrated, to incorporate these findings in the assessment of heritable effects, oncogenicity, and possibly, other health effects.

(6) *Metabolism studies.* Data from studies on the absorption, distribution, excretion, and metabolism of a pesticide aid in the valuation of test results from other toxicity studies and in the extrapolation of data from animals to man. The main purpose of metabolism studies is to produce data which increase the Agency's understanding of the behavior of the chemical in its consideration of the human exposure anticipated from intended uses of the pesticide.

(f) *Reentry Protection.* Data required to assess hazard to farm employees resulting from reentry into areas treated with pesticides are derived from studies on toxicity, residue dissipation, and human exposure. Monitoring data generated during exposure studies are used to determine the quantity of pesticide to which people may be exposed after application and to develop reentry intervals.

(g) *Pesticide Spray Drift Evaluation.* Data required to evaluate pesticide

REGULATIONS

Excerpt from

40 CFR Part 721

Pages 119 - 128

Significant New Uses of Chemical Substances

The U.S. Environmental Protection Agency requires vendors under the Toxic Substances Control Act (TSCA) to conduct acute oral toxicity studies according to harmonized test guidelines (TG 401). A safety evaluation must be conducted for each proposed new use of a chemical substance. Testing must be in compliance with Good Laboratory Practices (40 CFR Part 792).

Subpart G—Compliance and Inspections

§ 720.120 Compliance.

(a) Failure to comply with any provision of this part is a violation of section 15 of the Act (15 U.S.C. 2614).

(b) A person who manufactures or imports a new chemical substance before a notice is submitted and the notice review period expires is in violation of section 15 of the Act even if that person was not required to submit the notice under § 720.22.

(c) Using for commercial purposes a chemical substance or mixture which a person knew or had reason to know was manufactured, processed, or distributed in commerce in violation of section 5 of this rule is a violation of section 15 of the Act (15 U.S.C. 2614).

(d) Failure or refusal to establish and maintain records or to permit access to or copying of records, as required by the Act, is a violation of section 15 of the Act (15 U.S.C. 2614).

(e) Failure or refusal to permit entry or inspection as required by section 11 is a violation of section 15 of the Act (15 U.S.C. 2614).

(f) Violators may be subject to the civil and criminal penalties in section 16 of the Act (15 U.S.C. 2615) for each violation. Persons who submit materially misleading or false information in connection with the requirements of any provision of this rule may be subject to penalties calculated as if they never filed their notices.

(g) EPA may seek to enjoin the manufacture or processing of a chemical substance in violation of this rule or act to seize any chemical substance manufactured or processed in violation of this rule or take other actions under the authority of section 7 of this Act (15 U.S.C. 2606) or section 17 or this Act (15 U.S.C. 2616).

§ 720.122 Inspections.

EPA will conduct inspections under section 11 of the Act to assure compliance with section 5 of the Act and this rule, to verify that information submitted to EPA under this rule is true and correct, and to audit data submitted to EPA under this rule.

PART 721—SIGNIFICANT NEW USES OF CHEMICAL SUBSTANCES

Subpart A—General Provisions

Sec.

- 721.1 Scope and applicability.
- 721.3 Definitions.
- 721.5 Persons who must report.
- 721.11 Applicability determination when the specific chemical identity is confidential.
- 721.20 Exports and imports.
- 721.25 Notice requirements and procedures.
- 721.30 EPA approval of alternative control measures.
- 721.35 Compliance and enforcement.
- 721.40 Recordkeeping.
- 721.45 Exemptions.
- 721.47 Conditions for research and development exemption.

Subpart B—Certain Significant New Uses

- 721.50 Applicability.
- 721.63 Protection in the workplace.
- 721.72 Hazard communication program.
- 721.80 Industrial, commercial, and consumer activities.
- 721.85 Disposal.
- 721.90 Release to water.
- 721.91 Computation of estimated surface water concentrations: Instructions.

Subpart C—Recordkeeping Requirements

- 721.100 Applicability.
- 721.125 Recordkeeping requirements.

Subpart D—Expedited Process for Issuing Significant New Use Rules for Selected Chemical Substances and Limitation or Revocation of Selected Significant New Use Rules

- 721.160 Notification requirements for new chemical substances subject to section 5(e) orders.
- 721.170 Notification requirements for selected new chemical substances that have completed premanufacture review.
- 721.185 Limitation or revocation of certain notification requirements.

Subpart E—Significant New Uses for Specific Chemical Substances

- 721.225 2-Chloro-N-methyl-N-substituted acetamide (generic name).
- 721.267 N-[2-[(substituted dinitrophenyl)azo]diallylamino-4-substituted phenyl] acetamide (generic name).
- 721.275 Halogenated-N-(2-propenyl)-N-(substituted phenyl) acetamide.
- 721.285 Acetamide, N-[4-(pentyloxy)phenyl]-, acetamide, N-[2-nitro-4-

- (pentyloxy)phenyl]-, and acetamide, *N*-[2-amino-4-(pentyloxy)phenyl]-.
- 721.305 Di-substituted acetophenone (generic).
- 721.320 Acrylamide-substituted epoxy.
- 721.323 Substituted acrylamide.
- 721.336 Perfluoroalkylethyl acrylate copolymer (generic name).
- 721.405 Polyether acrylate.
- 721.430 Oxo-substituted aminoalkanoic acid derivative.
- 721.435 Alkylphenylpolyetheralkanolamines (generic).
- 721.445 Substituted ethyl alkenamide.
- 721.450 Hydrofluorochloroalkene (generic).
- 721.484 Fluorinated acrylic copolymer (generic name).
- 721.505 Halogenated acrylonitrile.
- 721.520 Alanine, *N*-(2-carboxyethyl)-*N*-alkyl-, salt.
- 721.524 Alcohols, C₆₋₁₂, ethoxylated, reaction product with maleic anhydride.
- 721.530 Substituted aliphatic acid halide (generic name).
- 721.536 Halogenated phenyl alkane.
- 721.537 Organosilane ester.
- 721.538 Phenol, 4-(1,1-dimethylethyl)-, homopolymer.
- 721.539 Poly(oxy-1,2-ethanediyl), α -sulfo- ω -[1-[(4-nonylphenoxy)methyl]-2-(2-propenyloxy)ethoxy]-, branched, ammonium salts.
- 721.540 Alkylphenoxyalkoxyamine (generic name).
- 721.550 Alkyl alkenoate, azobis-.
- 721.555 Alkyl amino nitriles (generic).
- 721.558 Salt of a fatty alkylamine derivative (generic).
- 721.562 Substituted alkylamine salt.
- 721.575 Substituted alkyl halide.
- 721.600 3-Alkyl-2-(2-anilino)vinyl thiazolinium salt (generic name).
- 721.625 Alkylated diarylamine, sulfurized (generic name).
- 721.630 Salt of a modified tallow alkylenediamine (generic).
- 721.639 Amine aldehyde condensate.
- 721.640 Amine substituted metal salts.
- 721.641 Alkylpoly(oxyalkylene)amine.
- 721.642 Amines, *N*-(C₁₄₋₁₈ and C₁₆₋₁₈ unsaturated alkyl)] dipropylene-tri-, and tetrapropylene-penta-.
- 721.643 Ethoxylated alcohol, phosphated, amine salt.
- 721.646 Aminofluoran derivative (generic name).
- 721.650 11-Aminoundecanoic acid.
- 721.655 Ethoxylated alkyl quaternary ammonium compound.
- 721.715 Trisubstituted anthracene.
- 721.720 Alkoxyated fatty acid amide, alkylsulfate salt.
- 721.750 Aromatic amine compound.
- 721.757 Polyoxyalkylene substituted aromatic azo colorant.
- 721.775 Brominated aromatic compound (generic name).
- 721.785 Halogenated alkane aromatic compound (generic name).
- 721.805 Benzenamine, 4,4'-[1,3-phenylenebis(1-methylethylidene)]bis[2,6-dimethyl]-.
- 721.825 Certain aromatic ether diamines.
- 721.840 Alkyl substituted diaromatic hydrocarbons.
- 721.875 Aromatic nitro compound.
- 721.925 Substituted aromatic (generic).
- 721.950 Sodium salt of an alkylated, sulfonated aromatic (generic name).
- 721.977 Aryloxyarene.
- 721.980 Sodium salt of azo acid dye.
- 721.981 Substituted naphtholoazo-substituted naphthalenyl-substituted azonaphthol chromium complex.
- 721.982 Calcium, bis(2,4-pentanedionato-*O,O'*).
- 721.987 Dialkylaminophenyl imino pyrazole acid ester (generic).
- 721.988 Pyrazolone azomethine dye (generic).
- 721.1000 Benzenamine, 3-chloro-2,6-dinitro-*N,N*-dipropyl-4-(trifluoromethyl)-.
- 721.1025 Benzenamine, 4-chloro-2-methyl-; benzenamine, 4-chloro-2-methyl-, hydrochloride; and benzenamine, 2-chloro-6-methyl-.
- 721.1050 Benzenamine, 2,5-dibutoxy-4-(4-morpholinyl)-, sulfate.
- 721.1068 Benzenamine, 4-isocyanato-*N,N*-bis(4-isocyanatophenyl)-2,5-dimethoxy-.
- 721.1075 Benzenamine, 4-(1-methylbutoxy)-, hydrochloride.
- 721.1105 Benzenamine, 4,4'-methylenebis[2-methyl-6-(1-methylethyl)]-.
- 721.1120 Benzenamine, 4,4'-[1,4-phenylenebis(1-methylethylidene)]bis[2,6-dimethyl]-.
- 721.1150 Substituted polyglycidyl benzenamine.
- 721.1155 1,4-benzenediol, 2-(1,1,3,3-tetramethylbutyl)-and Bis(dimethylamino substituted)carbomonocycle.
- 721.1187 Bis(imidoethylene) benzene.
- 721.1193 Benzene, 2-bromo-1,4-dimethoxy-.
- 721.1210 Benzene, (2-chloroethoxy)-.
- 721.1225 Benzene, 1,2-dimethyl-, polypropene derivatives, sulfonated, potassium salts.
- 721.1300 [(Dinitrophenyl)azo]-[2,4-diamino-5-methoxybenzene] derivatives.
- 721.1325 Benzene, 1-(1-methylbutoxy)-4-nitro-.
- 721.1350 Benzene, (1-methylethyl)(2-phenylethyl)-.
- 721.1372 Substituted nitrobenzene.
- 721.1375 Disubstituted nitrobenzene (generic name).
- 721.1425 Pentabromoethylbenzene.
- 721.1430 Pentachlorobenzene.
- 721.1435 1,2,4,5-Tetrachlorobenzene.
- 721.1440 1,3,5-Trinitrobenzene.

Environmental Protection Agency

Pt. 721

- 721.1450 1,3-Benzenediamine, 4-(1,1-dimethylethyl)-ar-methyl.
- 721.1500 1,2-Benzenediamine, 4-ethoxy, sulfate.
- 721.1550 Benzenediazonium, 4-(dimethyl-amino)-, salt with 2-hydroxy-5-sulfo-benzoic acid (1:1).
- 721.1555 Substituted phenyl azo substituted benzenediazonium salt.
- 721.1568 Substituted benzenediazonium.
- 721.1580 Disubstituted benzene ether, polymer with substituted phenol (generic).
- 721.1612 Substituted 2-nitro- and 2-aminobenzenesulfonamide.
- 721.1625 Alkylbenzene sulfonate, amine salt.
- 721.1630 1,2-Ethanediol bis(4-methylbenzenesulfonate); 2,2-oxybis-ethane bis(4-methylbenzenesulfonate); ethanol, 2,2'-[oxybis(2,1-ethanediyl oxy)]bis-, bis(4-methylbenzenesulfonate); ethanol, 2,2'-[oxybis(2,1-ethane diylxy)] bis-, bis(4-methylbenzenesulfonate); ethanol, 2,2'-[[1-(2-propenyloxy) methyl]-1,2-ethanediyl] bis(oxy)]bis-, bis(4-methylbenzene sulfonate); and ethanol, 2-[1-[2-[2-[[4-methylphenyl)sulfonyl]oxy]ethoxy] ethoxy]methyl]-2-(2-propenyloxy)ethoxy]-, 4-methylbenzenesulfonate.
- 721.1637 1,2-Propanediol, 3-(2-propenyloxy)-, bis(4-methylbenzene sulfonate); 2-propanol, 1-[2-[[4-methylphenyl)sulfonyl]oxy]ethoxy]-3-(2-propenyloxy)-4-methylbenzenesulfonate; and 2-propanol, 1-[2-[2-[[4-methylphenyl)sulfonyl]oxy] ethoxy]ethoxy]-3-(2-propenyloxy)-, 4-methylbenzenesulfonate.
- 721.1640 3,6,9,12,-Tetraoxatetradecane-1,14-diol, bis(4-methylbenzenesulfonate); 3,6,9,13-tetraoxahexadec-15-ene-1,11-diol, bis(4-methylbenzenesulfonate); 3,6,9,12,16-pentaoxanonadec-18-ene-1,14-diol, bis(4-methyl benzenesulfonate); and 3,6,9,12-tetraoxatetradecane-1,14-diol, 7-[(2-propenyloxy)methyl]-, bis(4-methylbenzenesulfonate).
- 721.1643 Benzenesulfonic acid, amino substituted phenylazo-.
- 721.1645 Benzenesulfonic acid, 4-methyl-, reaction products with oxirane mono[(C₁₀₋₁₆-alkyloxy)methyl] derivatives and 2,2,4(or 2,4,4)-trimethyl-1,6-hexanediamine.
- 721.1650 Alkylbenzenesulfonic acid and sodium salts.
- 721.1660 Benzidine-based chemical substances.
- 721.1675 Disulfonic acid rosin amine salt of a benzidine derivative (generic name).
- 721.1700 Halonitrobenzoic acid, substituted (generic name).
- 721.1705 Benzoic acid, 3-amino-, diazotized, coupled with 6-amino-4-hydroxy-2-naphthalenesulfonic acid, diazotized, (3-aminophenyl)phosphonic acid and diazotized 2,5-diethoxybenzenamine.
- 721.1710 Methoxy benzoic acid derivative (generic).
- 721.1725 Benzoic acid, 3,3'-methylenebis [6 amino-, di-2-propenyl ester.
- 721.1728 Benzoic acid, 2-(3-phenylbutylidene)amino-, methyl ester.
- 721.1732 Nitrobenzoic acid octyl ester.
- 721.1734 Substituted benzonitrile (generic).
- 721.1735 Alkylbisoxalkyl (substituted-1,1-dimethylethylphenyl) benzotriazole (generic name).
- 721.1738 Substituted benzotriazole (generic name).
- 721.1745 Ethoxybenzothiazole disulfide.
- 721.1750 1*H*-Benzotriazole, 5-(pentyloxy)- and 1*H*-benzotriazole, 5-(pentyloxy)-, sodium and potassium salts.
- 721.1755 Methylenebisbenzotriazole.
- 721.1760 Substituted benzotriazole derivatives.
- 721.1765 2-Substituted benzotriazole.
- 721.1775 6-Nitro-2(3*H*)-benzoxazolone.
- 721.1790 Polybrominated biphenyls.
- 721.1800 3,3',5,5'-Tetramethylbiphenyl-4,4'-diol.
- 721.1805 Substituted bisaniline.
- 721.1820 Bisphenol derivative.
- 721.1825 Bisphenol A, epichlorohydrin, polyalkylenepolyol and polyisocyanato derivative.
- 721.1850 Toluene sulfonamide bisphenol A epoxy adduct.
- 721.1875 Boric acid, alkyl and substituted alkyl esters (generic name).
- 721.1900 Substituted bromothiophene.
- 721.1907 Butanamide, 2,2'-[3'dichloro[1,1'-biphenyl]-4,4'-diyl]bisazobis N-2,3-dihydro-2-oxo-1*H*-benzimidazol-5-yl)-3-oxo-.
- 721.1920 1,4-Bis(3-hydroxy-4-benzoylphenoxy)butane.
- 721.1925 Substituted carboheterocyclic butane tetracarboxylate.
- 721.1930 Butanoic acid, antimony (3=) salt.
- 721.1950 2-Butenedioic acid (Z), mono(2-((1-oxopropenyloxy)ethyl) ester).
- 721.2025 Substituted phenylimino carbamate derivative.
- 721.2075 Carbamodithioic acid, methyl-, compound with methanamine (1:1).
- 721.2077 Substituted carbazate (generic).
- 721.2078 1-Piperidinecarboxylic acid, 2-[(dichloro-hydroxy-carbomonocycle)hydrazono]-, methyl ester (generic).
- 721.2079 Dichloro, hydroxy, hydrazino-carbomonocycle (generic).
- 721.2081 Dichloro, hydroxy, hydrazino-carbomonocycle-monohydrochloride (generic).
- 721.2083 Polysubstituted carbomonocyclic hydroxylamine (generic).
- 721.2084 Carbon oxyfluoride (Carbonic difluoride).
- 721.2085 Hydroxyalkylquinoline dioxindandialkylcarboxamide.

Pt. 721

40 CFR Ch. I (7-1-99 Edition)

- 721.2086 Coco acid triamine condensate, polycarboxylic acid salts.
- 721.2088 Carboxylic acids, (C6-C9) branched and linear.
- 721.2089 Tetrasubstituted aminocarboxylic acid.
- 721.2091 Chloroalkane.
- 721.2092 3-Methylcholanthrene.
- 721.2094 N,N'-di(alkyl heteromonocycle)amino chlorotriazine.
- 721.2095 Chromate(3), bis 2-[[substituted-3-(5-sulfo-1-naphthalenyl)azo]phenyl]azo]substituted monocycle, trisodium (generic name).
- 721.2097 Azo chromium complex dyestuff preparation (generic name).
- 721.2120 Cyclic amide.
- 721.2122 Substituted phenyl azo substituted sulfo carbopolycycle.
- 721.2140 Carbopolycyclic azoalkylaminoalkylcarbomonocyclic ester, halogen acid salt.
- 721.2145 Cetareth-25 sorbate.
- 721.2175 Salt of cyclodiamine and mineral acid.
- 721.2222 Cyclohexanamine, N,N-dimethyl-, compd. with alpha-isotridecyl-omega-hydroxypoly(oxy-1,2-ethanediyl) phosphate.
- 721.2250 1,4-Cyclohexanediamine, cis- and trans-.
- 721.2260 1,2-Cyclohexanedicarboxylic acid, 2,2-bis[[[2-(oxiranylmethoxy) carbonyl]cyclohexyl]carbonyl]oxy]methyl]-1,3-propanediyl bis(oxiranylmethyl) ester.
- 721.2270 Aliphatic dicarboxylic acid salt.
- 721.2275 N,N,N',N'-Tetrakis(oxiranyl methyl)-1,3-cyclohexane dimethanamine.
- 721.2280 Cyclopropanecarboxaldehyde.
- 721.2287 DDT (Dichlorodiphenyltrichloroethane).
- 721.2340 Dialkenylamide (generic name).
- 721.2345 Alkyletherpropyl dialkylamines.
- 721.2350 Alkyltri-, tetra-, and pentaamines.
- 721.2355 Diethylstilbestrol.
- 721.2380 Disubstituted diamino anisole.
- 721.2410 Alkoxyated alkyl-diethylenetriamine, alkyl sulfate salts.
- 721.2420 Alkoxyated dialkyl-diethylenetriamine, alkyl sulfate salt.
- 721.2475 Dimetridazole.
- 721.2480 Isoalkyldimethylamine (generic).
- 721.2485 1,3-Dioxolane, 2-ethenyl-.
- 721.2520 Alkylated diphenyls.
- 721.2527 Substituted diphenylazo dye (generic name).
- 721.2532 Substituted diphenylmethane (generic).
- 721.2535 Benzene, 1,1'-methylanebis[4-isocyanato-, homopolymer, Bu alc.-blocked.
- 721.2540 Diphenylmethane diisocyanate (MDI) modified.
- 721.2560 Alkylated diphenyl oxide (generic name).
- 721.2565 Alkylated sulfonated diphenyl oxide, alkali and amine salts.
- 721.2570 Alkylated diphenyls (generic).
- 721.2575 Disubstituted diphenylsulfone.
- 721.2580 C.I. Disperse Red 152 (generic).
- 721.2585 Sodium salts of dodecylphenol (generic).
- 721.2600 Epibromohydrin.
- 721.2625 Reaction product of alkanediol and epichlorohydrin.
- 721.2675 Perfluoroalkyl epoxide (generic name).
- 721.2725 Trichlorobutylene oxide.
- 721.2800 Erionite fiber.
- 721.2805 Acrylate ester.
- 721.2825 Alkyl ester (generic name).
- 721.2900 Substituted aminobenzoic acid ester (generic name).
- 721.2920 tert-Amyl peroxy alkylene ester (generic name).
- 721.2925 Brominated aromatic ester.
- 721.2950 Carboxylic acid glycidyl esters.
- 721.3000 Dicarboxylic acid monoester.
- 721.3020 1,1-Dimethylpropyl peroxyester (generic name).
- 721.3031 Boric acid (H₃BO₃), zinc salt (2=3).
- 721.3032 Boric acid (H₃BO₃), zinc salt.
- 721.3034 Methylamine esters.
- 721.3063 Substituted phenyl azo substituted phenyl esters (generic name).
- 721.3080 Substituted phosphate ester (generic).
- 721.3085 Brominated phthalate ester.
- 721.3100 Oligomeric silicic acid ester compound with a hydroxylalkylamine.
- 721.3140 Vinyl epoxy ester.
- 721.3152 Ethanaminium, N-ethyl-2-hydroxy-N,N-bis(2-hydroxyethyl)-, diester with C₁₂₋₁₈ fatty acids, ethyl sulfates (salts).
- 721.3155 3,8-Dioxa-4,7-disiladecane, 4,4,7,7-tetraethoxy-.
- 721.3160 1-Chloro-2-bromoethane.
- 721.3180 Ethane, 2-chloro-1,1,1,2-tetrafluoro-.
- 721.3220 Pentachloroethane.
- 721.3248 Ethane, 1,2,2-trichlorodifluoro-.
- 721.3260 Ethanediimidic acids.
- 721.3320 Ethanol, 2-amino-, compound with N-hydroxy-N-nitrosobenzenamine (1:1).
- 721.3340 Ethanol, 2,2'-(hexylamino)bis-.
- 721.3350 N-Nitrosodiethanolamine.
- 721.3360 Substituted ethanolamine.
- 721.3364 Aliphatic ether.
- 721.3374 Alkylenediolalkyl ether.
- 721.3380 Anilino ether.
- 721.3420 Brominated arylalkyl ether.
- 721.3430 4-Bromophenyl phenyl ether.
- 721.3435 Butoxy-substituted ether alkane.
- 721.3437 Dialkyl ether.
- 721.3440 Haloalkyl substituted cyclic ethers.
- 721.3460 Diglycidyl ether of disubstituted carbopolycycle (generic name).
- 721.3465 Stilbene diglycidyl ether.
- 721.3480 Halogenated biphenyl glycidyl ethers.
- 721.3485 Hydrofluorocarbon alkyl ether.
- 721.3486 Polyglycerin mono(4-nonylphenyl) ether.

Environmental Protection Agency

Pt. 721

- 721.3488 Poly(oxy-1,2-ethanediyl), alpha substituted-omega-hydroxy-, C₁₆₋₂₀ alkyl ethers.
- 721.3500 Perhalo alkoxy ether.
- 721.3520 Aliphatic polyglycidyl ether.
- 721.3550 Dipropylene glycol dimethyl ether.
- 721.3560 Derivative of tetrachloroethylene.
- 721.3565 Ethylenediamine, substituted, sodium salt.
- 721.3620 Fatty acid amine condensate, polycarboxylic acid salts.
- 721.3625 Fatty acid amine salt (generic name).
- 721.3627 Branched synthetic fatty acid.
- 721.3628 Fatty acids, C(14-18)- unsaturated, branched and linear, methyl and butyl esters.
- 721.3629 Triethanolamine salts of fatty acids.
- 721.3635 Octadecanoic acid, ester with 1,2-propanediol, phosphate, anhydride with silicic acid (H₄SiO₄).
- 721.3680 Ethylene oxide adduct of fatty acid ester with pentaerythritol.
- 721.3700 Fatty acid, ester with styrenated phenol, ethylene oxide adduct.
- 721.3720 Fatty amide.
- 721.3740 Bisalkylated fatty alkyl amine oxide
- 721.3760 Fluorene-containing diaromatic amines.
- 721.3764 Fluorene substituted aromatic amine.
- 721.3790 Polyfluorocarboxylates.
- 721.3800 Formaldehyde, condensated polyoxyethylene fatty acid, ester with styrenated phenol, ethylene oxide adduct.
- 721.3815 Furan, 2-(ethoxymethyl)-tetrahydro-
- 721.3840 Tetraglycidalamines (generic name).
- 721.3860 Glycol monobenzoate.
- 721.3880 Polyalkylene glycol substituted acetate.
- 721.3900 Alkyl polyethylene glycol phosphate, potassium salt.
- 721.4000 Polyoxy alkylene glycol amine.
- 721.4040 Glycols, polyethylene-, 3-sulfo-2-hydroxypropyl-p-(1,1,3,3-tetramethylbutyl)phenyl ether, sodium salt.
- 721.4060 Alkylene glycol terephthalate and substituted benzoate esters (generic name).
- 721.4080 MNNG (N-methyl-N'-nitro-N-nitrosoguanidine).
- 721.4085 Guanidine, pentaethyl-
- 721.4090 Ethanaminium, N-[bis(diethylamino)-methylene]-N-ethyl-, bromide.
- 721.4095 Quaternary ammonium alkyltherpropyl trialkylamine halides.
- 721.4097 7-Oxabicyclo[4.1.0]heptane-3-carboxylic acid, methyl ester.
- 721.4098 Substituted heteroaromatic-2[[4-(dimethylamino) phenyl]azo]-3-methyl-, salts (generic).
- 721.4100 Tris(disubstituted alkyl) heterocycle.
- 721.4110 Allyloxysubstituted heterocycle.
- 721.4128 Dimethyl-3-substituted heteromonocycle.
- 721.4133 Dimethyl-3-substituted heteromonocyclic amine.
- 721.4140 Hexachloronorbornadiene.
- 721.4155 Hexachloropropene.
- 721.4158 Hexadecanoic acid, ethenyl ester.
- 721.4160 Hexafluoropropylene oxide.
- 721.4180 Hexamethylphosphoramide.
- 721.4200 Substituted alkyl peroxyhexane carboxylate (mixed isomers) (generic name).
- 721.4215 Hexanedioic acid, diethenyl ester.
- 721.4240 Alkyl peroxy-2-ethyl hexanoate.
- 721.4250 Hexanoic acid, 2-ethyl-, ethenyl ester.
- 721.4255 1,4,7,10,13,16-Hexaoxacyclooctadecane, 2-[(2-propenyl oxy)methyl]-.
- 721.4257 Hydrazine, (2-fluorophenyl).
- 721.4259 Aliphatic polyisocyanate homopolymer.
- 721.4260 Hydrazine, [4-(1-methylbutoxy)phenyl]-, monohydrochloride.
- 721.4270 Nitrophenoxylalkanoic acid substituted thiazino hydrazide (generic name).
- 721.4280 Substituted hydrazine.
- 721.4300 Hydrazinecarboxamide, N,N'-1,6-hexanediylbis [2,2-dimethyl-].
- 721.4320 Hydrazinecarboxamide, N,N'-(methylenedi-4,1-phenylene)bis [2,2-dimethyl-].
- 721.4340 Substituted thiazino hydrazine salt (generic name).
- 721.4360 Certain hydrogen containing chlorofluorocarbons.
- 721.4380 Modified hydrocarbon resin.
- 721.4390 Trisubstituted hydroquinone diester.
- 721.4420 Substituted hydroxylamine.
- 721.4460 Amidinothiopropionic acid hydrochloride.
- 721.4462 Hydrochlorofluorocarbon.
- 721.4463 Hydrochlorofluorocarbon.
- 721.4464 Mixture of hydrofluoro alkanes and hydrofluoro alkene.
- 721.4465 Hydrofluoroalkane.
- 721.4466 3-Hydroxy-1,1-dimethylbutyl derivative.
- 721.4467 Quaternary ammonium hydroxide.
- 721.4468 1H-Imidazole, 2-ethyl-4,5-dihydro-4-methyl-.
- 721.4469 Imidazolethione.
- 721.4470 2,4-Imidazolidinedione, bromochloro-5,5-dimethyl-.
- 721.4473 Dialkylamidoimidazoline.
- 721.4476 Substituted imines.
- 721.4480 2-Imino-1,3-thiazin-4-one-5,6-dihydromonohydrochloride.
- 721.4484 Halogenated indane (generic name).
- 721.4490 Capped aliphatic isocyanate.
- 721.4494 Polycyclic isocyanate.
- 721.4497 Aliphatic polyisocyanates (generic name).

Pt. 721

40 CFR Ch. I (7-1-99 Edition)

- 721.4500 Isopropylamine distillation residues and ethylamine distillation residues.
- 721.4520 Isopropylidene, bis(1,1-dimethylpropyl) derivative.
- 721.4550 Diperoxy ketal.
- 721.4568 Methylpolychloro aliphatic ketone.
- 721.4585 Lecithins, phospholipase A2-hydrolyzed.
- 721.4587 Lithium manganese oxide (LiMn2O4) (generic name).
- 721.4589 Propanedioic acid, [(4-methoxyphenyl)methylene]-, bis(1,2,2,6,6-pentamethyl-4-piperidyl) ester (9CI).
- 721.4590 Mannich-based adduct.
- 721.4594 Substituted azo metal complex dye.
- 721.4596 Diazo substituted carbomonocyclic metal complex.
- 721.4600 Recovered metal hydroxide.
- 721.4620 Dialkylamino alkanoate metal salt.
- 721.4660 Alcohol, alkali metal salt.
- 721.4663 Fluorinated carboxylic acid alkali metal salts.
- 721.4668 Hydrated alkaline earth metal salts of metalloxy anions.
- 721.4680 Metal salts of complex inorganic oxyacids (generic name).
- 721.4685 Substituted purine metal salt (generic name).
- 721.4700 Metalated alkylphenol copolymer (generic name).
- 721.4720 Disubstituted phenoxazine, chlorometalate salt.
- 721.4740 Alkali metal nitrites.
- 721.4794 Polypiperidinol-acrylate methacrylate.
- 721.4820 Methane, bromodifluoro-.
- 721.4840 Substituted triphenylmethane.
- 721.4880 Methanol, trichloro-, carbonate (2:1).
- 721.4885 Methanone, [5-[[3-(2H-benzotriazol-2-yl)-2-hydroxy-5-(1,1,3,3-tetramethylbutyl)phenyl]methyl]-2-hydroxy-4-(octyloxy) phenyl]phenyl-.
- 721.4925 Methyl n-butyl ketone.
- 721.5050 2,2'-(1-Methylethylidene)bis[4,1-phenyloxy[1-(butoxymethyl)-(2,1-ethanediyl)oxymethylene]]bisoxirane, reaction product with a diamine.
- 721.5075 Mixed methyltin mercaptoester sulfides.
- 721.5175 Mitomycin C.
- 721.5192 Substituted 1,6-dihydroxy naphthalene.
- 721.5200 Disubstituted phenylazo trisubstituted naphthalene.
- 721.5225 Naphthalene, 1,2,3,4-tetrahydro(1-phenylethyl) (specific name).
- 721.5250 Trimethyl spiropolyheterocyclic naphthalene compound.
- 721.5255 2-Naphthalenol, mono and diethyl derivs.
- 721.5275 2-Naphthalenecarboxamide-N-aryl-3-hydroxy-4-arylazo (generic name).
- 721.5276 2-Naphthalenol, heptyl-1-[[4-(phenylazo)phenyl]azo]-, *ar'*, *ar''*-Me derivs.
- 721.5278 Substituted naphthalenesulfonic acid, alkali salt.
- 721.5279 2,7-Naphthalenedisulfonic acid, 4-amino-3-[[4'-amino-4-[(3-butoxy-2-hydroxypropyl)amino]phebyl]azo]-3,3'-dimethyl[1,1'-biphenyl]-4-yl]azo]-5-hydroxy-6-(phenylazo)-, disodium salt.
- 721.5280 2,7-Naphthalenedisulfonic acid, 4-amino-5-hydroxy-, coupled with diazotized 4-butylbenzamine, diazotized 4,4'-cyclohexylidenebis[benzamine] and m-phenylenediamine, sodium salt.
- 721.5281 2-Naphthalenesulfonic acid, 3-[[4-[(2,4-dimethyl-6-sulfophenyl)azo]-2-methoxy-5-methylphenyl]azo]-4-hydroxy-7-(phenylamino)-, sodium salt, compd. With 2,2',2''-nitrioltris [ethanol] (9CI).
- 721.5282 Trisodium chloro [(trisubstituted heteromonocycle amino) propylamino]triazinylamino hydroxyazo naphthalenetrisulfonate.
- 721.5285 Ethoxylated substituted naphthol.
- 721.5290 Phenylazoalkoxy naphthylamines (generic).
- 721.5300 Neodecaneperoxoic acid, 1,1,3,3-tetramethylbutyl ester.
- 721.5310 Neononanoic acid, ethenyl ester.
- 721.5325 Nickel acrylate complex.
- 721.5330 Nickel salt of an organo compound containing nitrogen.
- 721.5350 Substituted nitrile (generic name).
- 721.5356 Ethanol, 2,2,2''-nitrioltris-, compound with alpha-2,4,6-tris (1-phenylethyl)phenyl]-omega-hydroxypoly (oxy-1,2-ethanediyl) phosphate.
- 721.5360 Substituted nitrobenzene (generic).
- 721.5375 Nitrothiophenecarboxylic acid, ethyl ester, bis[[[(substituted) amino]alkylphenyl]azo] (generic name).
- 721.5385 Octanoic acid, hydrazide.
- 721.5400 3,6,9,12,15,18,21-Heptaooxatetra-trioctanoic acid, sodium salt.
- 721.5425 α -Olefin sulfonate, potassium salts.
- 721.5450 α -Olefin sulfonate, sodium salt.
- 721.5460 Organosolv lignin.
- 721.5475 1-Oxa-4-azaspiro[4.5]decane, 4-dichloroacetyl-.
- 721.5500 7-Oxabicyclo[4.1.0]heptane, 3-ethenyl, homopolymer, ether with 2-ethyl-2-(hydroxymethyl)-1,3-propanediol (3:1), epoxidized.
- 721.5525 Substituted spiro oxazine.
- 721.5540 1*H*,3*H*,5*H*-oxazolo [3,4-*c*] oxazole, dihydro-7*a*-methyl-.
- 721.5545 3-(Dichloroacetyl)-5-(2-furanyl)-2,2-dimethyl-oxazolidine.
- 721.5547 Antimony double oxide.
- 721.5548 Mixed metal oxide (generic).
- 721.5549 Lithiated metal oxide.
- 721.5550 Substituted dialkyl oxazolone (generic name).
- 721.5575 Oxirane, 2,2'-(1,6-hexanediyl)bis (oxymethylene) bis-.

Environmental Protection Agency

Pt. 721

- 721.5580 Oxirane, 2,2'-[methylenebis[(2,6-dimethyl-4,1-phenylene)oxymethylene]]bis-
- 721.5600 Substituted oxirane.
- 721.5625 Oxiranemethanamine, N,N'-[methylenebis(2-ethyl-4,1-phenylene)]bis[N-(oxiranylmethyl)]-
- 721.5645 Pentane 1,1,1,2,3,4,4,5,5,5,-decafluoro.
- 721.5650 Pentanediol light residues.
- 721.5700 Pentanenitrile, 3-amino-
- 721.5708 2-Pentene, 1,1,1,2,3,4,4,5,5,5,-decafluoro-
- 721.5710 Phenacetin.
- 721.5740 Phenol, 4,4'-methylenebis (2,6-dimethyl)-
- 721.5760 Phenol, 4,4'-[methylenebis (oxy-2,1-ethanediylothio)]bis-
- 721.5763 Methylenebisbenzotriazolyl phenols.
- 721.5769 Mixture of nitrated alkylated phenols.
- 721.5775 Phenol, 5-amino-2,4-dichloro-, hydrochloride.
- 721.5780 Phenol, 4,4'-(oxybis(2,1-ethanediylothio))bis-
- 721.5800 Sulfurized alkylphenol.
- 721.5820 Aminophenol.
- 721.5840 Ethylated aminophenol.
- 721.5860 Methylphenol, bis(substituted)alkyl.
- 721.5867 Substituted phenol.
- 721.5880 Sulfur bridged substituted phenols (generic name).
- 721.5900 Trisubstituted phenol (generic name).
- 721.5913 Phenothiazine derivative.
- 721.5915 Polysubstituted phenylazopoly-substitutedphenyl dye.
- 721.5920 Phenyl(disubstituted)polycyclic).
- 721.5930 Phenylenebis(imino (chlorotriazinyl)-imino (substituted naphthyl)azo (substituted phenyl)azo, sodium salt (generic name).
- 721.5960 N,N'-Bis(2-(2-(3-alkyl)thiazoline)vinyl)-1,4-phenylenediamine methyl sulfate double salt (generic name).
- 721.5965 Substituted S-phenylthiazole (generic).
- 721.5970 Phosphated polyarylphenol ethoxylate, potassium salt.
- 721.5980 Dialkyl phosphorodithioate phosphate compounds.
- 721.5995 Polyalkyl phosphate.
- 721.6000 Tris (2,3-dibromopropyl) phosphate.
- 721.6020 Phosphine, dialkylphenyl.
- 721.6045 Phosphinothioic acid, bis(2,4,4-trimethylpentyl)- (9CI).
- 721.6060 Alkylaryl substituted phosphite.
- 721.6070 Alkyl phosphonate ammonium salts.
- 721.6075 Phosphonic acid, 1,1-methylenebis-tetrakis(1-methylethyl) ester.
- 721.6078 Substituted ethoxyethylamine phosphonate.
- 721.6080 Phosphonium salt (generic name).
- 721.6085 Phosphonocarboxylate salts.
- 721.6090 Phosphoramidate.
- 721.6097 Phosphoric acid derivative (generic name).
- 721.6100 Phosphoric acid, C₆₋₁₂-alkyl esters, compounds with 2-(dibutylamino) ethanol.
- 721.6110 Alkyldi(alkyloxyhydroxypropyl) derivative, phosphoric acid esters, potassium salts.
- 721.6120 Phosphoric acid, 1,2-ethanediyol tetrakis(2-chloro-1-methylethyl) ester.
- 721.6140 Dialkyldithiophosphoric acid, aliphatic amine salt.
- 721.6160 Piperazinone, 1,1',1''-[1,3,5-triazine-2,4,6-triyltris[(cyclohexylimino)-2,1-ethanediyol]]tris-[3,3,4,5,5-pentamethyl]-.
- 721.6165 Polysubstituted piperidine.
- 721.6170 Siloxanes and silicones, Me hydrogen, reaction products with 2,2,6,6-tetramethyl-4-(2-propenyloxy)piperidine.
- 721.6175 2-Piperdinone, 1,3-dimethyl-
- 721.6176 2-Piperdinone, 1,5-dimethyl-
- 721.6186 Polyamine dithiocarbamate.
- 721.6193 Polyalkylene polyamine.
- 721.6200 Fatty acid polyamine condensate, phosphoric acid ester salts.
- 721.6220 Aryl sulfonate of a fatty acid mixture, polyamine condensate.
- 721.6440 Polyamine ureaformaldehyde condensate (specific name).
- 721.6470 Polyaminopolyacid.
- 721.6475 Alkyl polycarboxylic acids, esters with ethoxylated fatty alcohols.
- 721.6477 Alkyl polycarboxylic acids, esters with ethoxylated fatty alcohols, reaction products with maleic anhydride.
- 721.6485 Hydroxy terminated polyester.
- 721.6490 Alkyl phenyl polyetheramines.
- 721.6495 Aliphatic polyisocyanate.
- 721.6498 Modified polyisocyanates (generic).
- 721.6505 Polymers of C₁₅C₁₅ oxoalcohol ethoxalates.
- 721.6520 Acrylamide, polymer with substituted alkylacrylamide salt (generic name).
- 721.6540 Acrylamide, polymers with tetraalkyl ammonium salt and polyalkyl, aminoalkyl methacrylamide salt.
- 721.6560 Acrylic acid, polymer with substituted ethene.
- 721.6620 Alkanaminium, polyalkyl-[(2-methyl-1-oxo-2-propenyl)oxy] salt, polymer with acrylamide and substituted alkyl methacrylate.
- 721.6660 Polymer of alkanepolyol and polyalkylpolyisocyanatocarbomonocycle, acetone oxime-blocked (generic name).
- 721.6680 Alkanoic acid, butanediol and cyclohexanealkanol polymer (generic name).
- 721.6820 Polymer of substituted aryl olefin.
- 721.6900 Polymer of bisphenol A diglycidal ether, substituted alkenes, and butadiene.

Pt. 721

40 CFR Ch. I (7-1-99 Edition)

- 721.6920 Butyl acrylate, polymer with substituted methyl styrene, methyl methacrylate, and substituted silane.
- 721.6980 Dimer acids, polymer with polyalkylene glycol, bisphenol A-diglycidyl ether, and alkylene polyols polyglycidyl ethers (generic name).
- 721.7000 Polymer of disodium maleate, allyl ether, and ethylene oxide.
- 721.7020 Distillates (petroleum), C(3-6), polymers with styrene and mixed terpenes (generic name).
- 721.7046 Formaldehyde, polymer with substituted phenols, glycidyl ether.
- 721.7160 2-Oxepanone, polymer with 4,4'-(1-methylethylidene)bisphenol and 2,2-[(1-methylethylidene)bis(4,1-phenyleneoxymethylene)]bisoxirane, graft.
- 721.7200 Perfluoroalkyl aromatic carbamate modified alkyl methacrylate copolymer.
- 721.7210 Epoxidized copolymer of phenol and substituted phenol.
- 721.7220 Polymer of substituted phenol, formaldehyde, epichlorohydrin, and disubstituted benzene.
- 721.7260 Polymer of polyethylenepolyamine and alkanediol diglycidyl ether.
- 721.7280 1,3-Propanediamine, N,N'-1,2-ethanediylbis-, polymer with 2,4,6-trichloro-1,3,5-triazine, reaction products with N-butyl-2,2,6,6-tetramethyl-4-piperidinamine.
- 721.7285 Amines, N-cocoalkyltrimethylenedi-, citrates.
- 721.7286 Amines, N-tallowalkyltripropylene tetra-, citrates.
- 721.7375 Potassium salt of polyolefin acid.
- 721.7378 Substituted polyoxyethylene.
- 721.7440 Polyalkylenepolyol alkylamine. (generic name).
- 721.7450 Aromatic amine polyols.
- 721.7480 Isocyanate terminated polyols.
- 721.7500 Nitrate polyether polyol (generic name).
- 721.7600 Alkyl(heterocyclic) phenylazoheptero monocyclic polyone (generic name).
- 721.7620 Alkyl(heterocyclic) phenylazoheptero monocyclic polyone, ((alkylimidazolyl) methyl) derivative (generic name).
- 721.7655 Alkylsulfonium salt.
- 721.7700 Poly(oxy-1,2-ethanediyl), α -hydro- ω -(oxiranylmethoxy)-, ether with 2-ethyl-2-(hydroxymethyl)-1,3-propanediol (3:1).
- 721.7710 Polyepoxy polyol.
- 721.7720 Poly(oxy-1,2-ethanediyl), α,α' -[(1-methylethylidene) di-4,1-phenylene] bis [ω -(oxiranylmethoxy)-].
- 721.7770 Alkylphenoxypoly(oxyethylene) sulfuric acid ester, substituted amine salt.
- 721.7780 Poly[oxy(methyl-1,2-ethanediyl)], α,α' -(2,2-dimethyl-1,3-propanediyl)bis[ω -(oxiranylmethoxy)-].
- 721.7785 Substituted alkyl aminomethylene polyphosphonic acid, salt (generic).
- 721.8079 Isophorone diisocyanate neopentyl glycol adipate polyurethane prepolymer.
- 721.8082 Polyester polyurethane acrylate.
- 721.8090 Polyurethane polymer.
- 721.8095 Silylated polyurethane.
- 721.8100 Potassium N,N-bis (hydroxyethyl) cocoamine oxide phosphate, and potassium N,N-bis (hydroxyethyl) tallowamine oxide phosphate.
- 721.8153 Di-substituted propanedione (generic).
- 721.8155 Propanenitrile, 3-[amino, N-tallowalkyl] dipropylene tri- and tripropylene tri- and propanenitrile, 3-[amino, (C₁₄₋₁₈ and C₁₆₋₁₈ unsaturated alkyl)] trimethylenedi-, dipropylene tri-, and tripropylene tetra-.
- 721.8160 Propanoic acid, 2,2-dimethyl-, ethenyl ester.
- 721.8170 Propanol, [2-(1,1-dimethylethoxy)methylethoxy]-.
- 721.8225 2-Propenamide, N-[3-dimethylamino]propyl]-.
- 721.8250 1-Propanol, 3,3'-oxybis[2,2-bis(bromomethyl)-].
- 721.8350 2-Propenoic acid, 7-oxabicyclo[4.1.0]hept-3-ylmethyl ester.
- 721.8450 2-Propenoic acid, 2-methyl-, 2-[3-(2H-benzotriazol-2-yl)-4-hydroxyphenyl]ethyl ester.
- 721.8500 2-Propenoic acid, 2-methyl-, 7-oxabicyclo [4.1.0]hept-3-ylmethyl ester.
- 721.8654 2-Propenoic acid 3-(trimethoxysilyl)propyl ester.
- 721.8660 Propionic acid methyl ester (generic).
- 721.8670 Alkylcyano substituted pyridazo benzoate.
- 721.8673 [(Disubstituted phenyl)azo dihydro hydroxy alkyl oxo alkyl-substituted-pyridines (generic name).
- 721.8675 Halogenated pyridines.
- 721.8700 Halogenated alkyl pyridine.
- 721.8750 Halogenated substituted pyridine.
- 721.8775 Substituted pyridines.
- 721.8780 Substituted pyridine azo substituted phenyl.
- 721.8825 Substituted methylpyridine and substituted 2-phenoxy pyridine.
- 721.8850 Disubstituted halogenated pyridinol.
- 721.8875 Substituted halogenated pyridinol.
- 721.8900 Substituted halogenated pyridinol, alkali salt.
- 721.8965 1*H*-Pyrole-2, 5-dione, 1-(2,4,6-tribromophenyl)-.
- 721.9000 N-Nitrosopyrrolidine.
- 721.9005 2-Pyrrolidinone, 1,1'-(2-methyl-1,5-pentandiyl)bis-.
- 721.9010 2-pyrrolidone, 1-ethenyl-3-ethylidene-, (E)-.
- 721.9075 Quaternary ammonium salt of fluorinated alkylaryl amide.
- 721.9080 Nitro methyl quinoline.
- 721.9100 Substituted quinoline.
- 721.9220 Reaction products of secondary alkyl amines with a substituted

Environmental Protection Agency

Pt. 721

- benzenesulfonic acid and sulfuric acid (generic name).
- 721.9265 Reaction product of dichlorobenzidine and substituted alkylamide.
- 721.9270 Reaction product of epoxy with anhydride and glycerol and glycol.
- 721.9280 Reaction product of ethoxylated fatty acid oils and a phenolic pentaerythritol tetraester.
- 721.9285 Reaction products of formalin (37%) with amine C₁₂.
- 721.9300 Reaction products of substituted hydroxyalkanes and polyalkylpolyisocyanatocarbomonocycle.
- 721.9400 Reaction product of phenolic pentaerythritol tetraesters with fatty acid esters and oils, and glyceride triesters.
- 721.9460 Tall oil fatty acids, reaction products with polyamines, alkyl substituted.
- 721.9470 Reserpine.
- 721.9480 Resorcinol, formaldehyde substituted carbomonocycle resin.
- 721.9488 Substituted resorcinols.
- 721.9490 Coco alklydimethyl amine salts (generic).
- 721.9492 Polymers of styrene, cyclohexyl methacrylate and substituted methacrylate.
- 721.9495 Acrylosilane resins.
- 721.9497 Trifunctional ketoximino silane.
- 721.9499 Modified silicone resin.
- 721.9500 Silane, (1,1-dimethylethoxy) dimethoxy(2-methyl propyl)-.
- 721.9503 Silane, (3,3,4,4,5,5,6,6,7,7,8,8,9,9,10,10,10-heptadecafluorodecyl)trimethoxy-.
- 721.9505 Silanes substituted macrocycle polyethyl.
- 721.9507 Polyester silane.
- 721.9515 Aminofunctional alkoxy alkyl siloxane.
- 721.9516 Siloxanes and silicones, 3-[(2-aminoethyl) amino]propyl Me, di-Me, reaction products with polyethylene-polypropylene glycol Bu glycidal ether.
- 721.9517 Siloxanes and silicones, de-Me, 3-[4-[[[3-(dimethyl amino) propyl] amino]carbonyl]-2-oxo-1-pyrrolidinyl] propyl Me.
- 721.9518 Sinorhizobium meliloti strain RMBPC-2.
- 721.9526 Sodium perthiocarbonate.
- 721.9527 Bis(1,2,2,6,6-pentamethyl-4-piperidin-4-ol) ester of cycloaliphatic spiroketal.
- 721.9530 Bis(2,2,6,6-tetramethylpiperidinyl) ester of cycloalkyl spiroketal.
- 721.9540 Polysulfide mixture.
- 721.9545 Substituted phenyl azo substituted sulfocarbopolycle, sodium salt.
- 721.9550 Sulfonamide.
- 721.9570 Halophenyl sulfonamide salt.
- 721.9575 Chromate(3-), bis[3-[[5-(aminosulfonyl)-2-hydroxyphenyl]azo]-4-hydroxy-7-[[2-oxo-1-(phenylamino)carbonyl] propyl]azo]-2-naphthalenesulfonato(3-)-, trisodium (9CI).
- 721.9576 Chromate(3-), bis[7-[(aminohydroxyphenyl)azo]-3-[[5-(aminosulfonyl)-2-hydroxyphenyl]azo]-4-hydroxy-2-naphthalene-sulfonato (3-)-, trisodium (9CI).
- 721.9577 Chromate(3-), bis[7-[(aminohydroxyphenyl)azo]-3-[[5-(aminosulfonyl)-2-hydroxyphenyl] azo]-4-hydroxy-2-naphthalene sulfonato (3-)-, -[[5-(aminosulfonyl)-2-hydroxyphenyl]azo]-4-hydroxy-7-[[2-hydroxy-1-(phenylamino) carbonyl]-1-propenyl]azo]-2-naphthalenesulfonato(3-)-, trisodium (9CI).
- 721.9580 Ethyl methanesulfonate.
- 721.9595 Alkyl benzene sulfonic acids and alkyl sulfates, amine salts (generic).
- 721.9620 Aromatic sulfonic acid compound with amine.
- 721.9630 Polyfluorosulfonic acid salt.
- 721.9635 Terpene residue distillates.
- 721.9650 Tetramethylammonium salts of alkylbenzenesulfonic acid.
- 721.9656 Thiaalkanethiol.
- 721.9657 Disubstituted thiadiazole.
- 721.9658 Thiadiazole derivative.
- 721.9659 Disubstituted thiadiazosulfone.
- 721.9660 Methylthiouracil.
- 721.9661 Diphenol tars (generic).
- 721.9662 Thieno[3,4-b]-1,4-dioxin, 2,3-dihydro-(9CI).
- 721.9663 Poly(oxy-1,2-ethanediy), alpha, alpha'-[thiobis (1-oxo-3,1-propanediyl)]bis [omega-hydroxy-bis (C₁₁₋₁₅ and C_{11-15-isalkyl}) ethers.
- 721.9664 9H-Thioxanthen-9-one,2,4-diethyl.
- 721.9665 Organotin catalysts.
- 721.9668 Organotin lithium compound.
- 721.9675 Titanate [Ti₆ O₁₃ (2-)], dipotassium.
- 721.9680 Alkaline titania silica gel (generic name).
- 721.9685 Mixed trialkylamines (generic).
- 721.9700 Monosubstituted alkoxyaminotriazines (generic name).
- 721.9717 Azo monochloro triazine reactive dye.
- 721.9719 Tris carbamoyl triazine (generic).
- 721.9720 Disubstituted alkyl triazines (generic name).
- 721.9730 1,3,5-Triazin-2-amine, 4-dimethylamino-6-substituted-.
- 721.9740 Brominated triazine derivative.
- 721.9750 2-Chloro-4,6-bis(substituted)-1,3,5-triazine, dihydrochloride.
- 721.9800 Poly(substituted triazinyl) piperazine (generic name).
- 721.9820 Substituted triazole.
- 721.9825 Phenyl substituted triazolinones.
- 721.9830 1-Tridecyn-3-ol, 3-methyl.
- 721.9840 Tungstate (W12(OH)2O386-) hexasodium (9CI).
- 721.9850 2,4,8,10-Tetraoxa-3,9-diphosphaspiro[5.5]undecane, 3,9-bis[2,4,6-tris(1,1-dimethylethyl)phenoxy]-.
- 721.9892 Alkylated urea.

§ 721.1

40 CFR Ch. I (7–1–99 Edition)

- 721.9900 Urea, condensate with poly[oxy(methyl-1,2ethanediyl)]- α -(2-aminomethylethyl)- μ -(2-aminoethylethoxy) (generic name).
- 721.9920 Urea, (hexahydro-6-methyl-2-oxopyrimidinyl)-.
- 721.9925 Aminoethylethylene urea methacrylamide.
- 721.9928 Urea, tetraethyl-.
- 721.9930 Urethane.
- 721.9957 N-Nitroso-N-methylurethane.
- 721.9969 3,6-Bis(dialkylamino) -9-[2-alkoxycarbonyl] phenyl]-xanthylium salt (generic).
- 721.9970 o-Xylene compound (generic name).
- 721.9973 Zirconium dichlorides (generic).

AUTHORITY: 15 U.S.C. 2604, 2607, and 2625(c).

Subpart A—General Provisions

§ 721.1 Scope and applicability.

(a) This part identifies uses of chemical substances, except for microorganisms regulated under part 725 of this chapter, which EPA has determined are significant new uses under the authority of section 5(a)(2) of the Toxic Substances Control Act. In addition, it specifies procedures for manufacturers, importers, and processors to report on those significant new uses. This subpart A contains general provisions applicable to this part. subpart B of this part identifies generic requirements for certain significant new uses cross referenced in specific provisions of subpart E of this part. subpart C of this part identifies generic reporting requirements for certain significant new uses cross referenced in specific provisions of subpart E of this part. subpart E of this part identifies chemical substances and their significant new uses.

(b) This subpart A contains provisions governing submission and review of notices for the chemical substances and significant new uses identified in subpart E of this part. The provisions of this subpart A apply to the chemical substances and significant new uses identified in subpart E of this part, except to the extent that they are specifically modified or supplanted by specific requirements in subpart E of this part. In the event of a conflict between the provisions of this subpart A and the provisions of subpart E of this part, the provisions of subpart E of this part shall govern.

(c) The provisions of part 720 of this chapter apply to this part 721. For purposes of this part 721, wherever the phrase “new chemical substance” appears in part 720 of this chapter, it shall mean the chemical substance subject to this part 721. In the event of a conflict between the provisions of part 720 of this chapter and the provisions of this part 721, the provisions of this part 721 shall govern.

[53 FR 28358, July 27, 1988, as amended at 62 FR 17932, Apr. 11, 1997]

§ 721.3 Definitions.

The definitions in section 3 of the Act, 15 U.S.C. 2602, and § 720.3 of this chapter apply to this part. In addition, the following definitions apply to this part:

Acutely toxic effects A chemical substance produces acutely toxic effects if it kills within a short time period (usually 14 days):

(1) At least 50 percent of the exposed mammalian test animals following oral administration of a single dose of the test substance at 25 milligrams or less per kilogram of body weight (LD_{50}).

(2) At least 50 percent of the exposed mammalian test animals following dermal administration of a single dose of the test substance at 50 milligrams or less per kilogram of body weight (LD_{50}).

(3) At least 50 percent of the exposed mammalian test animals following administration of the test substance for 8 hours or less by continuous inhalation at a steady concentration in air at 0.5 milligrams or less per liter of air (LC_{50}).

CAS Number means Chemical Abstracts Service Registry Number assigned to a chemical substance on the Inventory.

Chemical name means the scientific designation of a chemical substance in accordance with the nomenclature system developed by the International Union of Pure and Applied Chemistry or the Chemical Abstracts Service’s rules of nomenclature, or a name which will clearly identify a chemical substance for the purpose of conducting a hazard evaluation.

Chemical protective clothing means items of clothing that provide a protective barrier to prevent dermal contact

REGULATIONS

Excerpt from

49 CFR Part 173

Pages 342 - 348, 441 - 443

Shippers - General Requirements for Shipments and Packaging

The Department of Transportation in compliance with Hazardous Materials Regulations outlines the requirements to be observed in preparing hazardous materials for shipment by air, highway, rail, or water, or any combination thereof. These regulations are based on the Recommendations of the United Nations Committee of Experts on the Transport of Dangerous Goods, the International Civil Aviation Organization, and the International Maritime Organization.

APPENDIX C TO PART 172—DIMENSIONAL SPECIFICATIONS FOR RECOMMENDED PLACARD HOLDER

APPENDIX C—DIMENSIONAL SPECIFICATIONS FOR RECOMMENDED PLACARD HOLDER

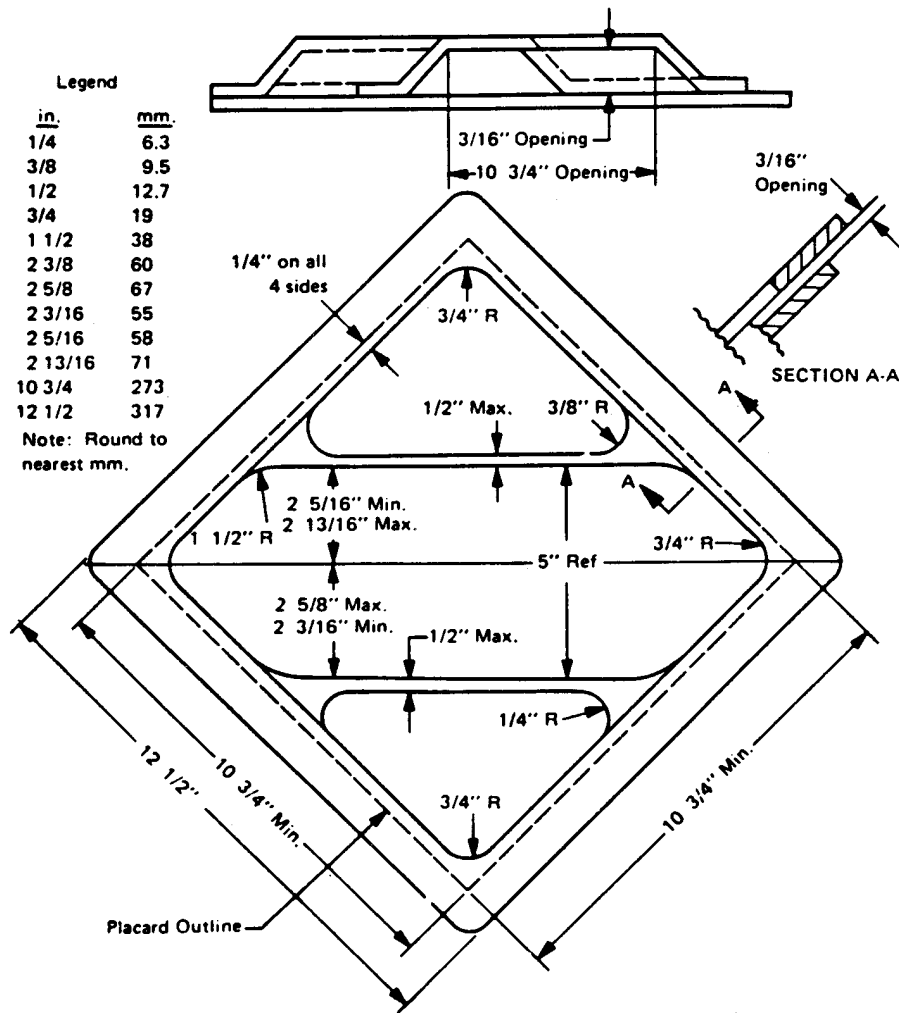

PART 173—SHIPPERS—GENERAL REQUIREMENTS FOR SHIPMENTS AND PACKAGINGS

Subpart A—General

Sec.
173.1 Purpose and scope.

- 173.2 Hazardous materials classes and index to hazard class definitions.
- 173.2a Classification of a material having more than one hazard.
- 173.3 Packaging and exceptions.
- 173.4 Small quantity exceptions.
- 173.5 Agricultural operations.
- 173.5a Oilfield service vehicles.
- 173.6 Materials of trade exceptions.

- 173.7 U.S. Government material.
- 173.8 Exceptions for non-specification packagings used in intrastate transportation.
- 173.9 Transport vehicles or freight containers containing lading which has been fumigated.
- 173.10 Tank car shipments.
- 173.12 Exceptions for shipment of waste materials.
- 173.13 Exceptions for Class 3, Divisions 4.1, 4.2, 4.3, 5.1, 6.1, and Classes 8 and 9 materials.

Subpart B—Preparation of Hazardous Materials for Transportation

- 173.21 Forbidden materials and packages.
- 173.22 Shipper's responsibility.
- 173.22a Use of packagings authorized under exemptions.
- 173.23 Previously authorized packaging.
- 173.24 General requirements for packagings and packages.
- 173.24a Additional general requirements for non-bulk packagings and packages.
- 173.24b Additional general requirements for bulk packagings.
- 173.25 Authorized packages and overpacks.
- 173.26 Quantity limitations.
- 173.27 General requirements for transportation by aircraft.
- 173.28 Reuse, reconditioning and remanufacture of packagings.
- 173.29 Empty packagings.
- 173.30 Loading and unloading of transport vehicles.
- 173.31 Use of tank cars.
- 173.32 Qualification, maintenance and use of portable tanks other than Specification IM portable tanks.
- 173.32a Approval of Specification IM portable tanks.
- 173.32b Periodic testing and inspection of Specification IM portable tanks.
- 173.32c Use of Specification IM portable tanks.
- 173.33 Hazardous materials in cargo tank motor vehicles.
- 173.34 Qualification, maintenance, and use of cylinders.
- 173.35 Hazardous materials in intermediate bulk containers.
- 173.40 General packaging requirements for poisonous materials required to be packaged in cylinders.

Subpart C—Definitions, Classification and Packaging for Class 1

- 173.50 Class 1—Definitions.
- 173.51 Authorization to offer and transport explosives.
- 173.52 Classification codes and compatibility groups of explosives.
- 173.53 Provisions for using old classifications of explosives.
- 173.54 Forbidden explosives.

- 173.55 [Reserved]
- 173.56 New explosives—Definition and procedures for classification and approval.
- 173.57 Acceptance criteria for new explosives.
- 173.58 Assignment of class and division for new explosives.
- 173.59 Description of terms for explosives.
- 173.60 General packaging requirements for explosives.
- 173.61 Mixed packaging requirements.
- 173.62 Specific packaging requirements for explosives.
- 173.63 Packaging exceptions.

Subpart D—Definitions, Classification, Packing Group Assignments and Exceptions for Hazardous Material Other Than Class 1 and Class 7

- 173.115 Class 2, Divisions 2.1, 2.2, and 2.3—Definitions.
- 173.116 Class 2—Assignment of hazard zone.
- 173.117–173.119 [Reserved]
- 173.120 Class 3—Definitions.
- 173.121 Class 3—Assignment of packing group.
- 173.124 Class 4, Divisions 4.1, 4.2 and 4.3—Definitions.
- 173.125 Class 4—Assignment of packing group.
- 173.127 Class 5, Division 5.1—Definition and assignment of packing groups.
- 173.128 Class 5, Division 5.2—Definitions and types.
- 173.129 Class 5, Division 5.2—Assignment of packing group.
- 173.132 Class 6, Division 6.1—Definitions.
- 173.133 Assignment of packing group and hazard zones for Division 6.1 materials.
- 173.134 Class 6, Division 6.2—Definitions, exceptions and packing group assignments.
- 173.136 Class 8—Definitions.
- 173.137 Class 8—Assignment of packing group.
- 173.140 Class 9—Definitions.
- 173.141 Class 9—Assignment of packing group.
- 173.144 Other Regulated Materials (ORM)—Definitions.
- 173.145 Other Regulated Materials—Assignment of packing group.
- 173.150 Exceptions for Class 3 (flammable) and combustible liquids.
- 173.151 Exceptions for Class 4.
- 173.152 Exceptions for Division 5.1 (oxidizers) and Division 5.2 (organic peroxides).
- 173.153 Exceptions for Division 6.1 (poisonous materials).
- 173.154 Exceptions for Class 8 (corrosive materials).
- 173.155 Exceptions for Class 9 (miscellaneous hazardous materials).
- 173.156 Exceptions for ORM materials.

Subpart E—Non-bulk Packaging for Hazardous Materials Other Than Class 1 and Class 7

- 173.158 Nitric acid.
- 173.159 Batteries, wet.
- 173.160 Bombs, smoke, non-explosive (corrosive).
- 173.161 Chemical kits.
- 173.162 Gallium.
- 173.163 Hydrogen fluoride.
- 173.164 Mercury (metallic and articles containing mercury).
- 173.166 Air bag inflators, air bag modules and seat-belt pretensioners.
- 173.170 Black powder for small arms.
- 173.171 Smokeless powder for small arms.
- 173.172 Aircraft hydraulic power unit fuel tank.
- 173.173 Paint, paint-related material, adhesives and ink and resins.
- 173.174 Refrigerating machines.
- 173.181 Pyrophoric materials (liquids).
- 173.182 Barium azide—50 percent or more water wet.
- 173.183 Nitrocellulose base film.
- 173.184 Highway or rail fusee.
- 173.185 Lithium batteries and cells.
- 173.186 Matches.
- 173.187 Pyrophoric solids, metals or alloys, n.o.s.
- 173.188 White or yellow phosphorous.
- 173.189 Batteries containing sodium or cells containing sodium.
- 173.192 Packaging for certain Packing Group I poisonous materials.
- 173.193 Bromoacetone, methyl bromide, chloropicrin and methyl bromide or methyl chloride mixtures, etc.
- 173.194 Gas identification sets.
- 173.195 Hydrogen cyanide, anhydrous, stabilized (hydrocyanic acid, aqueous solution).
- 173.196 Infectious substances (etiologic agents).
- 173.197 Regulated medical waste.
- 173.198 Nickel carbonyl.
- 173.201 Non-bulk packagings for liquid hazardous materials in Packing Group I.
- 173.202 Non-bulk packagings for liquid hazardous materials in Packing Group II.
- 173.203 Non-bulk packagings for liquid hazardous materials in Packing Group III.
- 173.204 Non-bulk, non-specification packagings for certain hazardous materials.
- 173.205 Specification cylinders for liquid hazardous materials.
- 173.211 Non-bulk packagings for solid hazardous materials in Packing Group I.
- 173.212 Non-bulk packagings for solid hazardous materials in Packing Group II.
- 173.213 Non-bulk packagings for solid hazardous materials in Packing Group III.
- 173.214 Packagings which require approval by the Associate Administrator for Hazardous Materials Safety.
- 173.216 Asbestos, blue, brown, or white.
- 173.217 Carbon dioxide, solid (dry ice).
- 173.218 Fish meal or fish scrap.
- 173.219 Life-saving appliances.
- 173.220 Internal combustion engines, self-propelled vehicles, and mechanical equipment containing internal combustion engines or wet batteries.
- 173.221 Polymeric beads, expandable.
- 173.222 Wheelchairs equipped with wet electric storage batteries.
- 173.224 Packaging and control and emergency temperatures for self-reactive materials.
- 173.225 Packaging requirements and other provisions for organic peroxides.
- 173.226 Materials poisonous by inhalation, Division 6.1, Packing Group I, Hazard Zone A.
- 173.227 Materials poisonous by inhalation, Division 6.1, Packing Group I, Hazard Zone B.
- 173.228 Bromine pentafluoride or bromine trifluoride.
- 173.229 Chloric acid solution or chlorine dioxide hydrate, frozen.

Subpart F—Bulk Packaging for Hazardous Materials Other Than Class 1 and Class 7

- 173.240 Bulk packaging for certain low hazard solid materials.
- 173.241 Bulk packagings for certain low hazard liquid and solid materials.
- 173.242 Bulk packagings for certain medium hazard liquids and solids, including solids with dual hazards.
- 173.243 Bulk packaging for certain high hazard liquids and dual hazard materials which pose a moderate hazard.
- 173.244 Bulk packaging for certain pyrophoric liquids (Division 4.2), dangerous when wet (Division 4.3) materials, and poisonous liquids with inhalation hazards (Division 6.1).
- 173.245 Bulk packaging for extremely hazardous materials such as poisonous gases (Division 2.3).
- 173.247 Bulk packaging for certain elevated temperature materials (Class 9) and certain flammable elevated temperature materials (Class 3).
- 173.249 Bromine.

Subpart G—Gases; Preparation and Packaging

- 173.300 [Reserved]
- 173.300a Approval of independent inspection agency.
- 173.300b Approval of non-domestic chemical analyses and tests.
- 173.300c Termination of approval.
- 173.301 General requirements for shipment of compressed gases in cylinders and spherical pressure vessels.
- 173.302 Charging of cylinders with non-liquefied compressed gases.

- 173.303 Charging of cylinders with compressed gas in solution (acetylene).
- 173.304 Charging of cylinders with liquefied compressed gas.
- 173.305 Charging of cylinders with a mixture of compressed gas and other material.
- 173.306 Limited quantities of compressed gases.
- 173.307 Exceptions for compressed gases.
- 173.308 Cigarette lighter or other similar device charged with fuel.
- 173.309 Fire extinguishers.
- 173.314 Compressed gases in tank cars and multi-unit tank cars.
- 173.315 Compressed gases in cargo tanks and portable tanks.
- 173.316 Cryogenic liquids in cylinders.
- 173.318 Cryogenic liquids in cargo tanks.
- 173.319 Cryogenic liquids in tank cars.
- 173.320 Cryogenic liquids; exceptions.
- 173.321 Ethylamine.
- 173.322 Ethyl chloride.
- 173.323 Ethylene oxide.
- 173.334 Organic phosphates mixed with compressed gas.
- 173.335 Gas generator assemblies.
- 173.336 Nitrogen dioxide, liquefied, or dinitrogen tetroxide, liquefied.
- 173.337 Nitric oxide.
- 173.338 Tungsten hexafluoride.
- 173.340 Tear gas devices.
- 173.426 Excepted packages for articles containing natural uranium or thorium.
- 173.427 Transport requirements for low specific activity (LSA) Class 7 (radioactive) materials and surface contaminated objects (SCO).
- 173.428 Empty Class 7 (radioactive) materials packaging.
- 173.431 Activity limits for Type A and Type B packages.
- 173.433 Requirements for determining A₁ and A₂ values for radionuclides and for the listing of radionuclides on shipping papers and labels.
- 173.434 Activity-mass relationships for uranium and natural thorium.
- 173.435 Table of A₁ and A₂ values for radionuclides.
- 173.441 Radiation level limitations.
- 173.442 Thermal limitations.
- 173.443 Contamination control.
- 173.447 Storage incident to transportation—general requirements.
- 173.448 General transportation requirements.
- 173.453 Fissile materials—exceptions.
- 173.457 Transportation of fissile material, controlled shipments—specific requirements.
- 173.459 Mixing of fissile material packages.
- 173.461 Demonstration of compliance with tests.
- 173.462 Preparation of specimens for testing.
- 173.465 Type A packaging tests.
- 173.466 Additional tests for Type A packages designed for liquids and gases.
- 173.467 Tests for demonstrating the ability of Type B and fissile materials packages to withstand accident conditions in transportation.
- 173.468 Test for LSA-III material.
- 173.469 Tests for special form Class 7 (radioactive) materials.
- 173.471 Requirements for U.S. Nuclear Regulatory Commission approved packages.
- 173.472 Requirements for exporting DOT Specification Type B and fissile packages.
- 173.473 Requirements for foreign-made packages.
- 173.474 Quality control for construction of packaging.
- 173.475 Quality control requirements prior to each shipment of Class 7 (radioactive) materials.
- 173.476 Approval of special form Class 7 (radioactive) materials.

Subpart H [Reserved]

Subpart I—Class 7 (Radioactive) Materials

- 173.401 Scope.
- 173.403 Definitions.
- 173.410 General design requirements.
- 173.411 Industrial packagings.
- 173.412 Additional design requirements for Type A packages.
- 173.413 Requirements for Type B packages.
- 173.415 Authorized Type A packages.
- 173.416 Authorized Type B packages.
- 173.417 Authorized fissile materials packages.
- 173.418 Authorized packages—pyrophoric Class 7 (radioactive) materials.
- 173.419 Authorized packages—oxidizing Class 7 (radioactive) materials.
- 173.420 Uranium hexafluoride (fissile, fissile excepted and non-fissile).
- 173.421 Excepted packages for limited quantities of Class 7 (radioactive) materials.
- 173.422 Additional requirements for excepted packages containing Class 7 (radioactive) materials.
- 173.423 Requirements for multiple hazard limited quantity Class 7 (radioactive) materials.
- 173.424 Excepted packages for radioactive instruments and articles.
- 173.425 Table of activity limits—excepted quantities and articles.
- 173.465 Type A packaging tests.
- 173.466 Additional tests for Type A packages designed for liquids and gases.
- 173.467 Tests for demonstrating the ability of Type B and fissile materials packages to withstand accident conditions in transportation.
- 173.468 Test for LSA-III material.
- 173.469 Tests for special form Class 7 (radioactive) materials.
- 173.471 Requirements for U.S. Nuclear Regulatory Commission approved packages.
- 173.472 Requirements for exporting DOT Specification Type B and fissile packages.
- 173.473 Requirements for foreign-made packages.
- 173.474 Quality control for construction of packaging.
- 173.475 Quality control requirements prior to each shipment of Class 7 (radioactive) materials.
- 173.476 Approval of special form Class 7 (radioactive) materials.

Subparts J–O [Reserved]

- APPENDIX A TO PART 173 [RESERVED]
- APPENDIX B TO PART 173—PROCEDURE FOR TESTING CHEMICAL COMPATIBILITY AND RATE OF PERMEATION IN PLASTIC PACKAGING AND RECEPTACLES

§ 173.1

49 CFR Ch. I (10–1–98 Edition)

APPENDIX C TO PART 173—PROCEDURE FOR BASE-LEVEL VIBRATION TESTING

APPENDIX D TO PART 173—TEST METHODS FOR DYNAMITE (EXPLOSIVE, BLASTING, TYPE A)

APPENDIXES E–G TO PART 173 [RESERVED]

APPENDIX H TO PART 173—METHOD OF TESTING FOR SUSTAINED COMBUSTIBILITY

AUTHORITY: 49 U.S.C. 5101–5127, 44701; 49 CFR 1.45, 1.53.

Subpart A—General

§ 173.1 Purpose and scope.

- (a) This part includes:
 - (1) Definitions of hazardous materials for transportation purposes;
 - (2) Requirements to be observed in preparing hazardous materials for shipment by air, highway, rail, or water, or any combination thereof; and
 - (3) Inspection, testing, and retesting responsibilities for persons who retest, recondition, maintain, repair and rebuild containers used or intended for use in the transportation of hazardous materials.
- (b) A shipment of hazardous materials that is not prepared in accordance with this subchapter may not be offered for transportation by air, highway, rail, or water. It is the responsibility of each hazmat employer subject to the requirements of this subchapter to ensure that each hazmat employee is trained in accordance with the requirements prescribed in this subchapter. It is the duty of each person who offers hazardous materials for transportation to instruct each of his officers, agents, and employees having any responsibility for preparing hazardous materials for shipment as to applicable regulations in this subchapter.

(c) When a person other than the person preparing a hazardous material for shipment performs a function required by this part, that person shall perform the function in accordance with this part.

(d) In general, the Hazardous Materials Regulations (HMR) contained in this subchapter are based on the Recommendations of the United Nations Committee of Experts on the Transport of Dangerous Goods and are consistent with international regulations issued by the International Civil Aviation Organization (ICAO Technical Instructions) and the International Maritime Organization (IMDG Code). However, the HMR are not consistent in all respects with the UN Recommendations, the ICAO Technical Instructions or the IMDG Code, and compliance with the HMR will not guarantee acceptance by regulatory bodies outside of the United States.

[Amdt. 173–94, 41 FR 16062, Apr. 15, 1976, as amended by Amdt. 173–100, 41 FR 40476, Sept. 20, 1976; Amdt. 173–161, 48 FR 2655, Jan. 20, 1983; Amdt. 173–224, 55 FR 52606, Dec. 21, 1990; Amdt. 173–231, 57 FR 20953, May 15, 1992]

§ 173.2 Hazardous materials classes and index to hazard class definitions.

The hazard class of a hazardous material is indicated either by its class (or division) number, its class name, or by the letters “ORM–D”. The following table lists class numbers, division numbers, class or division names and those sections of this subchapter which contain definitions for classifying hazardous materials, including forbidden materials.

Class No.	Division No. (if any)	Name of class or division	49 CFR reference for definitions
None	Forbidden materials	173.21
None	Forbidden explosives	173.54
1	1.1	Explosives (with a mass explosion hazard)	173.50
1	1.2	Explosives (with a projection hazard)	173.50
1	1.3	Explosives (with predominately a fire hazard)	173.50
1	1.4	Explosives (with no significant blast hazard)	173.50
1	1.5	Very insensitive explosives; blasting agents	173.50
1	1.6	Extremely insensitive detonating substances	173.50
2	2.1	Flammable gas	173.115
2	2.2	Non-flammable compressed gas	173.115
2	2.3	Poisonous gas	173.115
3	Flammable and combustible liquid	173.120
4	4.1	Flammable solid	173.124
4	4.2	Spontaneously combustible material	173.124
4	4.3	Dangerous when wet material	173.124
5	5.1	Oxidizer	173.127

Class No.	Division No. (if any)	Name of class or division	49 CFR reference for definitions
5	5.2	Organic peroxide	173.128
6	6.1	Poisonous materials	173.132
6	6.2	Infectious substance (Etiologic agent)	173.134
7	Radioactive material	173.403
8	Corrosive material	173.136
9	Miscellaneous hazardous material	173.140
None	Other regulated material: ORM-D	173.144

[Amdt. 173-224, 55 FR 52606, Dec. 21, 1990, as amended at 57 FR 45460, Oct. 1, 1992; Amdt. 173-234, 58 FR 51531, Oct. 1, 1993]

§ 173.2a Classification of a material having more than one hazard.

(a) *Classification of a material having more than one hazard.* Except as provided in paragraph (c) of this section, a material not specifically listed in the §172.101 table that meets the definition of more than one hazard class or division as defined in this part, shall be classed according to the highest applicable hazard class of the following hazard classes, which are listed in descending order of hazard:

- (1) Class 7 (radioactive materials, other than limited quantities).
- (2) Division 2.3 (poisonous gases).
- (3) Division 2.1 (flammable gases).
- (4) Division 2.2 (nonflammable gases).
- (5) Division 6.1 (poisonous liquids), Packing Group I, poisonous-by-inhalation only.
- (6) A material that meets the definition of a pyrophoric material in

§173.124(b)(1) of this subchapter (Division 4.2).

(7) A material that meets the definition of a self-reactive material in §173.124(a)(2) of this subchapter (Division 4.1).

(8) Class 3 (flammable liquids), Class 8 (corrosive materials), Division 4.1 (flammable solids), Division 4.2 (spontaneously combustible materials), Division 4.3 (dangerous when wet materials), Division 5.1 (oxidizers) or Division 6.1 (poisonous liquids or solids other than Packing Group I, poisonous-by-inhalation). The hazard class and packing group for a material meeting more than one of these hazards shall be determined using the precedence table in paragraph (b) of this section.

(9) Combustible liquids.

(10) Class 9 (miscellaneous hazardous materials).

(b) *Precedence of hazard table for Classes 3 and 8 and Divisions 4.1, 4.2, 4.3, 5.1 and 6.1.* The following table ranks those materials that meet the definition of Classes 3 and 8 and Divisions 4.1, 4.2, 4.3, 5.1 and 6.1:

PRECEDENCE OF HAZARD TABLE
[Hazard class and packing group]

	4.2	4.3	5.1 I ¹	5.1 II ¹	5.1 III ¹	6.1, I dermal	6.1, I oral	6.1 II	6.1 III	8, I liquid	8, I solid	8, II liquid	8, II solid	8, III liquid	8, III solid
3 I	3	3	3	3	3	(3)	3	(3)	3	(3)
3 II	3	3	3	3	8	(3)	3	(3)	3	(3)
3 III	6.1	6.1	6.1	3 ⁺	8	(3)	8	(3)	3	(3)
4.1 II ²	4.2	4.3	5.1	4.1	4.1	6.1	6.1	4.1	4.1	(3)	8	(3)	4.1	(3)	4.1
4.1 III ²	4.2	4.3	5.1	4.1	4.1	6.1	6.1	6.1	4.1	(3)	8	(3)	8	(3)	4.1
4.2 II	4.3	5.1	4.2	4.2	6.1	6.1	4.2	4.2	8	8	4.2	4.2	4.2	4.2
4.2 III	4.3	5.1	5.1	4.2	6.1	6.1	6.1	4.2	8	8	8	8	4.2	4.2
4.3 I	5.1	4.3	4.3	6.1	4.3	4.3	4.3	4.3	4.3	4.3	4.3	4.3	4.3
4.3 II	5.1	4.3	4.3	6.1	4.3	4.3	4.3	8	8	8	4.3	4.3	4.3
4.3 III	5.1	5.1	4.3	6.1	6.1	6.1	4.3	8	8	8	8	4.3	4.3
5.1 I ¹	5.1	5.1	5.1	5.1	5.1	5.1	5.1	5.1	5.1	5.1
5.1 II ¹	6.1	5.1	5.1	5.1	8	8	8	5.1	5.1	5.1
5.1 III ¹	6.1	6.1	6.1	5.1	8	8	8	8	5.1	5.1
6.1 I, Dermal	8	6.1	6.1	6.1	6.1	6.1
6.1 I, Oral	8	6.1	6.1	6.1	6.1	6.1
6.1 II, Inhalation	8	6.1	6.1	6.1	6.1	6.1
6.1 II, Dermal	8	6.1	8	6.1	6.1	6.1
6.1 II, Oral	8	8	8	6.1	6.1	6.1

PRECEDENCE OF HAZARD TABLE—Continued
[Hazard class and packing group]

	4.2	4.3	5.1 I ¹	5.1 II ¹	5.1 III ¹	6.1, I dermal	6.1, I oral	6.1 II	6.1 III	8, I liquid	8, I solid	8, II liquid	8, II solid	8, III liquid	8, III solid
6.1 III	8	8	8	8	8	8

¹ There are at present no established criteria for determining Packing Groups for liquids in Division 5.1. For the time being, the degree of hazard is to be assessed by analogy with listed substances, allocating the substances to Packing Group I, great; II, medium; or III, minor danger.

² Substances of Division 4.1 other than self-reactive substances.

³ Denotes an impossible combination.

⁴ For pesticides only, where a material has the hazards of Class 3, Packing Group III, and Division 6.1, Packing Group III, the primary hazard is Division 6.1, Packing Group III.

NOTE 1: The most stringent packing group assigned to a hazard of the material takes precedence over other packing groups; for example, a material meeting Class 3 PG II and Division 6.1 PG I (oral toxicity) is classified as Class 3 PG I.

NOTE 2: A material which meets the definition of Class 8 and has an inhalation toxicity by dusts and mists which meets criteria for Packing Group I specified in §173.133(a)(1) must be classed as Division 6.1 if the oral or dermal toxicity meets criteria for Packing Group I or II. If the oral or dermal toxicity meets criteria for Packing Group III or less, the material must be classed as Class 8.

(c) The following materials are not subject to the provisions of paragraph (a) of this section because of their unique properties:

(1) A Class 1 (explosive) material that meets any other hazard class or division as defined in this part shall be assigned a division in Class 1. Class 1 materials shall be classed and approved in accordance with §173.56 of this part;

(2) A Division 5.2 (organic peroxide) material that meets the definition of any other hazard class or division as defined in this part, shall be classed as Division 5.2;

(3) A Division 6.2 (infectious substance) material that also meets the definition of another hazard class or division, other than Class 7, or that also is a limited quantity Class 7 material, shall be classed as Division 6.2;

(4) A material that meets the definition of a wetted explosive in §173.124(a)(1) of this subchapter (Division 4.1). Wetted explosives are either specifically listed in the §172.101 table or are approved by the Associate Administrator for Hazardous Materials Safety (see §173.124(a)(1) of this subchapter); and

(5) A limited quantity of a Class 7 (radioactive) material that meets the

definition for more than one hazard class or division shall be classed in accordance with §173.423.

[Amdt. 173-224, 55 FR 52606, Dec. 21, 1990, as amended at 56 FR 66264, Dec. 20, 1991; Amdt. 173-241, 59 FR 67490, Dec. 29, 1994; Amdt. 173-247, 60 FR 48787, Sept. 20, 1995; Amdt. 173-244, 60 FR 50307, Sept. 28, 1995]

§ 173.3 Packaging and exceptions.

(a) The packaging of hazardous materials for transportation by air, highway, rail, or water must be as specified in this part. Methods of manufacture, packing, and storage of hazardous materials, that affect safety in transportation, must be open to inspection by a duly authorized representative of the initial carrier or of the Department. Methods of manufacture and related functions necessary for completion of a DOT specification or U.N. standard packaging must be open to inspection by a representative of the Department.

(b) The regulations setting forth packaging requirements for a specific material apply to all modes of transportation unless otherwise stated, or unless exceptions from packaging requirements are authorized.

(c) Salvage drums. Packages of hazardous materials that are damaged, defective, or found leaking and hazardous materials that have spilled or leaked may be placed in a metal or plastic removable head salvage drum that is compatible with the lading and shipped for repackaging or disposal under the following conditions:

(1) Except as provided in paragraph (c)(7) of this section, the drum must be a UN 1A2, 1B2, 1N2 or 1H2 tested and marked for Packing Group III or higher performance standards for liquids or solids and a leakproofness test of 20

(6) *Type F.* Organic peroxide type F is an organic peroxide which will not detonate in a cavitated state, does not deflagrate, shows only a low, or no, effect if heated when confined, and has low, or no, explosive power.

(7) *Type G.* Organic peroxide type G is an organic peroxide which will not detonate in a cavitated state, will not deflagrate at all, shows no effect when heated under confinement, and shows no explosive power. A type G organic peroxide is not subject to the requirements of this subchapter for organic peroxides of Division 5.2 provided that it is thermally stable (self-accelerating decomposition temperature is 50 °C (122 °F) or higher for a 50 kg (110 pounds) package). An organic peroxide meeting all characteristics of type G except thermal stability and requiring temperature control is classed as a type F, temperature control organic peroxide.

(c) *Procedure for assigning an organic peroxide to a generic type.* An organic peroxide shall be assigned to a generic type based on—

(1) Its physical state (i.e., liquid or solid), in accordance with the definitions for liquid and solid in §171.8 of this subchapter;

(2) A determination as to its control temperature and emergency temperature, if any, under the provisions of §173.21(f); and

(3) Performance of the organic peroxide under the test procedures specified in the UN Manual of Tests and Criteria, and the provisions of paragraph (d) of this section.

(d) *Approvals.* (1) An organic peroxide must be approved, in writing, by the Associate Administrator for Hazardous Materials Safety, before being offered for transportation or transported, including assignment of a generic type and shipping description, except for—

(i) An organic peroxide which is identified by technical name in the Organic Peroxides Table in §173.225(b);

(ii) A mixture of organic peroxides prepared according to §173.225(c)(5); or

(iii) An organic peroxide which may be shipped as a sample under the provisions of §173.225(c).

(2) A person applying for an approval must submit all relevant data concerning physical state, temperature controls, and tests results or an approval

issued for the organic peroxide by the competent authority of a foreign government.

(e) *Tests.* The generic type for an organic peroxide shall be determined using the testing protocol from Figure 20.1(a) (Classification and Flow Chart Scheme for Organic Peroxides) from the UN Manual of Tests and Criteria.

[Amdt. 173-224, 55 FR 52634, Dec. 21, 1990, as amended at 56 FR 66268, Dec. 20, 1991; Amdt. 173-234, 58 FR 51532, Oct. 1, 1993; Amdt. 173-241, 59 FR 67508, Dec. 29, 1994; Amdt. 173-261, 62 FR 24732, May 6, 1997]

§ 173.129 Class 5, Division 5.2—Assignment of packing group.

All Division 5.2 materials are assigned to Packing Group II in column 5 of the §172.101 table.

§ 173.132 Class 6, Division 6.1—Definitions.

(a) For the purpose of this subchapter, *poisonous material* (Division 6.1) means a material, other than a gas, which is known to be so toxic to humans as to afford a hazard to health during transportation, or which, in the absence of adequate data on human toxicity:

(1) Is presumed to be toxic to humans because it falls within any one of the following categories when tested on laboratory animals (whenever possible, animal test data that has been reported in the chemical literature should be used):

(i) *Oral Toxicity.* A liquid with an LD₅₀ for acute oral toxicity of not more than 500 mg/kg or a solid with an LD₅₀ for acute oral toxicity of not more than 200 mg/kg.

(ii) *Dermal Toxicity.* A material with an LD₅₀ for acute dermal toxicity of not more than 1000 mg/kg.

(iii) *Inhalation Toxicity.* (A) A dust or mist with an LC₅₀ for acute toxicity on inhalation of not more than 10 mg/L; or

(B) A material with a saturated vapor concentration in air at 20 °C (68 °F) of more than one-fifth of the LC₅₀ for acute toxicity on inhalation of vapors and with an LC₅₀ for acute toxicity on inhalation of vapors of not more than 5000 ml/m³; or

(2) Is an irritating material, with properties similar to tear gas, which

§ 173.132

49 CFR Ch. I (10–1–98 Edition)

causes extreme irritation, especially in confined spaces.

(b) For the purposes of this subchapter—

(1) LD₅₀ for acute oral toxicity means that dose of the material administered to both male and female young adult albino rats which causes death within 14 days in half the animals tested. The number of animals tested must be sufficient to give statistically valid results and be in conformity with good pharmacological practices. The result is expressed in mg/kg body mass.

(2) LD₅₀ for acute dermal toxicity means that dose of the material which, administered by continuous contact for 24 hours with the shaved intact skin (avoiding abrading) of an albino rabbit, causes death within 14 days in half of the animals tested. The number of animals tested must be sufficient to give statistically valid results and be in conformity with good pharmacological practices. The result is expressed in mg/kg body mass.

(3) LC₅₀ for acute toxicity on inhalation means that concentration of vapor, mist, or dust which, administered by continuous inhalation for one hour to both male and female young adult albino rats, causes death within 14 days in half of the animals tested. If the material is administered to the animals as a dust or mist, more than 90 percent of the particles available for inhalation in the test must have a diameter of 10 microns or less if it is reasonably foreseeable that such concentrations could be encountered by a human during transport. The result is expressed in mg/L of air for dusts and mists or in mL/m³ of air (parts per million) for vapors. See § 173.133(b) for LC₅₀ determination for mixtures and for limit tests.

(i) When provisions of this subchapter require the use of the LC₅₀ for acute toxicity on inhalation of dusts and mists based on a one-hour exposure and such data is not available, the LC₅₀ for acute toxicity on inhalation based on a four-hour exposure may be multiplied by four and the product substituted for the one-hour LC₅₀ for acute toxicity on inhalation.

(ii) When the provisions of this subchapter require the use of the LC₅₀ for acute toxicity on inhalation of vapors

based on a one-hour exposure and such data is not available, the LC₅₀ for acute toxicity on inhalation based on a four-hour exposure may be multiplied by two and the product substituted for the one-hour LC₅₀ for acute toxicity on inhalation.

(iii) A solid substance should be tested if at least 10 percent of its total mass is likely to be dust in a respirable range, e.g. the aerodynamic diameter of that particle-fraction is 10 microns or less. A liquid substance should be tested if a mist is likely to be generated in a leakage of the transport containment. In carrying out the test both for solid and liquid substances, more than 90% (by mass) of a specimen prepared for inhalation toxicity testing must be in the respirable range as defined in this paragraph (b)(3)(iii).

(c) For purposes of classifying and assigning packing groups to mixtures possessing oral or dermal toxicity hazards according to the criteria in § 173.133(a)(1), it is necessary to determine the acute LD₅₀ of the mixture. If a mixture contains more than one active constituent, one of the following methods may be used to determine the oral or dermal LD₅₀ of the mixture:

(1) Obtain reliable acute oral and dermal toxicity data on the actual mixture to be transported;

(2) If reliable, accurate data is not available, classify the formulation according to the most hazardous constituent of the mixture as if that constituent were present in the same concentration as the total concentration of all active constituents; or

(3) If reliable, accurate data is not available, apply the formula:

$$\frac{C_A}{T_A} = \frac{C_B}{T_B} + \frac{C_Z}{T_Z} = \frac{100}{T_M}$$

where:

C = the % concentration of constituent A, B ... Z in the mixture;

T = the oral LD₅₀ values of constituent A, B ... Z;

T_M = the oral LD₅₀ value of the mixture.

NOTE TO FORMULA IN PARAGRAPH (c)(3): This formula also may be used for dermal toxicities provided that this information is available on the same species for all constituents. The use of this formula does not take into account any potentiation or protective phenomena.

(d) The foregoing categories shall not apply if the Associate Administrator for Hazardous Materials Safety has determined that the physical characteristics of the material or its probable hazards to humans as shown by documented experience indicate that the material will not cause serious sickness or death.

[Amdt. 173-224, 55 FR 52634, Dec. 21, 1990, as amended at 56 FR 66268, Dec. 20, 1991; Amdt. 173-234, 58 FR 51532, Oct. 1, 1993; Amdt. 173-261, 62 FR 24732, May 6, 1997; 62 FR 45702, August 28, 1997]

§ 173.133 Assignment of packing group and hazard zones for Division 6.1 materials.

(a) The packing group of Division 6.1 materials shall be as assigned in column 5 of the §172.101 table. When the §172.101 table provides more than one packing group or hazard zone for a hazardous material, the packing group and hazard zone shall be determined by applying the following criteria:

(1) The packing group assignment for routes of administration other than inhalation of vapors shall be in accordance with the following table:

Packing Group	Oral toxicity LD ₅₀ (mg/kg)	Dermal toxicity LD ₅₀ (mg/kg)	Inhalation toxicity by dusts and mists LC ₅₀ (mg/L)
I	≤ 5	≤ 40	≤ 0.5
II	> 5, ≤ 50	> 40, ≤ 200	> 0.5, ≤ 2
III	solids: > 50, ≤ 200; liquids: > 50, ≤ 500 ..	> 200, ≤ 1000	> 2, ≤ 10

(2)(i) The packing group and hazard zone assignments for liquids (see §173.115(c) of this subpart for gases)

based on inhalation of vapors shall be in accordance with the following table:

Packing Group	Vapor concentration and toxicity
I (Hazard Zone A)	V ≥ 500 LC ₅₀ and LC ₅₀ ≤ 200 mL/M ³ .
I (Hazard Zone B)	V ≥ 10 LC ₅₀ ; LC ₅₀ ≤ 1000 mL/m ³ ; and the criteria for Packing Group I, Hazard Zone A are not met.
II	V ≥ LC ₅₀ ; LC ₅₀ ≤ 3000 mL/m ³ ; and the criteria for Packing Group I, are not met.
III	V ≥ .2 LC ₅₀ ; LC ₅₀ ≤ 5000 mL/m ³ ; and the criteria for Packing Groups I and II, are not met.

Note 1: V is the saturated vapor concentration in air of the material in mL/m³ at 20C° and standard atmospheric pressure.
 Note 2: A liquid in Division 6.1 meeting criteria for Packing Group I, Hazard Zones A or B stated in paragraph (a)(2) of this section is a material poisonous by inhalation subject to the additional hazard communication requirements in §§ 172.203(m)(3), 172.313 and table 1 of § 172.504(e) of this subchapter.

(ii) These criteria are represented graphically in Figure 1: