

NTP TECHNICAL REPORT
ON THE
CARCINOGENESIS STUDIES OF
2,2-BIS(BROMOMETHYL)-1,3-PROPANEDIOL,
NITROMETHANE,
AND 1,2,3-TRICHLOROPROPANE
(CAS NOS. 3296-90-0, 75-52-5, and 96-18-4)
IN GUPPIES (*Poecilia reticulata*)
AND MEDAKA (*Oryzias latipes*)
(WATERBORNE STUDIES)



NATIONAL TOXICOLOGY PROGRAM
P.O. Box 12233
Research Triangle Park, NC 27709

October 2005

NTP TR 528

NIH Publication No. 06-4464

U.S. DEPARTMENT OF HEALTH AND HUMAN SERVICES
Public Health Service
National Institutes of Health

FOREWORD

The National Toxicology Program (NTP) is made up of four charter agencies of the U.S. Department of Health and Human Services (DHHS): the National Cancer Institute (NCI), National Institutes of Health; the National Institute of Environmental Health Sciences (NIEHS), National Institutes of Health; the National Center for Toxicological Research (NCTR), Food and Drug Administration; and the National Institute for Occupational Safety and Health (NIOSH), Centers for Disease Control and Prevention. In July 1981, the Carcinogenesis Bioassay Testing Program, NCI, was transferred to the NIEHS. The NTP coordinates the relevant programs, staff, and resources from these Public Health Service agencies relating to basic and applied research and to biological assay development and validation.

The NTP develops, evaluates, and disseminates scientific information about potentially toxic and hazardous chemicals. This knowledge is used for protecting the health of the American people and for the primary prevention of disease.

The studies described in this Technical Report were performed under the direction of the NIEHS and were conducted in compliance with NTP laboratory health and safety requirements and must meet or exceed all applicable federal, state, and local health and safety regulations. Animal care and use were in accordance with the Public Health Service Policy on Humane Care and Use of Animals. The prechronic and chronic studies were conducted in compliance with Food and Drug Administration (FDA) Good Laboratory Practice Regulations, and all aspects of the chronic studies were subjected to retrospective quality assurance audits before being presented for public review.

These studies are designed and conducted to characterize and evaluate the toxicologic potential, including carcinogenic activity, of selected chemicals in laboratory animals (usually two species, rats and mice). Chemicals selected for NTP toxicology and carcinogenesis studies are chosen primarily on the bases of human exposure, level of production, and chemical structure. The interpretive conclusions presented in this Technical Report are based only on the results of these NTP studies. Extrapolation of these results to other species and quantitative risk analyses for humans require wider analyses beyond the purview of these studies. Selection *per se* is not an indicator of a chemical's carcinogenic potential.

Details about ongoing and completed NTP studies, abstracts of all NTP Technical Reports, and full versions of the completed reports are available at the NTP's World Wide Web site: <http://ntp.niehs.nih.gov>. In addition, printed copies of these reports are available from NTP as supplies last by contacting (919) 541-3419.

NTP TECHNICAL REPORT
ON THE
CARCINOGENESIS STUDIES OF
2,2-BIS(BROMOMETHYL)-1,3-PROPANEDIOL,
NITROMETHANE,
AND 1,2,3-TRICHLOROPROPANE
(CAS NOS. 3296-90-0, 75-52-5, and 96-18-4)
IN GUPPIES (*Poecilia reticulata*)
AND MEDAKA (*Oryzias latipes*)
(WATERBORNE STUDIES)



NATIONAL TOXICOLOGY PROGRAM
P.O. Box 12233
Research Triangle Park, NC 27709

October 2005

NTP TR 528

NIH Publication No. 06-4464

U.S. DEPARTMENT OF HEALTH AND HUMAN SERVICES
Public Health Service
National Institutes of Health

CONTRIBUTORS

National Toxicology Program

Evaluated and interpreted results and reported findings

N.J. Bernheim, M.S., Study Scientist
 G.A. Boorman, D.V.M., Ph.D., Study Scientist
 R.A. Herbert, D.V.M., Ph.D., Study Pathologist
 D.W. Bristol, Ph.D.
 J.R. Bucher, Ph.D.
 J.R. Hailey, D.V.M.
 J.K. Haseman, Ph.D.
 G.E. Kissling, Ph.D.
 R.R. Maronpot, D.V.M.
 A. Nyska, D.V.M.
 C.S. Smith, Ph.D.
 G.S. Travlos, D.V.M.
 K.L. Witt, M.S.

University of Southern Mississippi, Gulf Coast Research Laboratory

Conducted study

W.E. Hawkins, Ph.D., Principal Investigator
 M. Brouwer, Ph.D.

Experimental Pathology Laboratories, Inc.

Evaluated pathology findings

J.F. Hardisty, D.V.M., Principal Investigator
 M.J. Wolfe, D.V.M., Ph.D.

Pathology Associates International A Charles River Company

Provided pathology quality assurance

M.P. Jokinen, D.V.M.

Dynamac Corporation

Prepared quality assurance audits

S. Brecher, Ph.D., Principal Investigator

NTP Pathology Working Group

*Evaluated slides and prepared pathology reports for the
 2,2-bis(bromomethyl)-1,3-propanediol, nitromethane,
 and 1,2,3-trichloropropane studies in guppies and medaka
 (July 11, 2002)*

M.P. Jokinen, D.V.M., Chairperson
 Pathology Associates International, A Charles River Company
 G.A. Boorman, D.V.M., Ph.D.
 National Toxicology Program
 J.W. Fournie, Ph.D.
 Environmental Protection Agency
 J.C. Harshbarger, Ph.D.
 Georgetown University
 W.E. Hawkins, Ph.D.
 Gulf Coast Research Laboratory
 R.A. Herbert, D.V.M., Ph.D.
 National Toxicology Program
 J.M. Law, D.V.M., Ph.D.
 North Carolina State University
 M.J. Wolfe, D.V.M., Ph.D.
 Experimental Pathology Laboratories, Inc.

Analytical Sciences, Inc.

Provided statistical analyses

P.W. Crockett, Ph.D., Principal Investigator
 L.J. Betz, M.S.
 K.P. McGowan, M.B.A.
 J.T. Scott, M.S.

Biotechnical Services, Inc.

Prepared Technical Report

S.R. Gunnels, M.A., Principal Investigator
 P.H. Carver, B.A.
 L.M. Harper, B.S.
 E.S. Rathman, M.S.
 D.C. Serbus, Ph.D.

CONTENTS

ABSTRACT	5
TECHNICAL REPORTS REVIEW SUBCOMMITTEE	11
SUMMARY OF TECHNICAL REPORTS REVIEW SUBCOMMITTEE COMMENTS	12
OVERVIEW	15
INTRODUCTION	17
MATERIALS AND METHODS	25
RESULTS	35
DISCUSSION AND CONCLUSIONS	79
REFERENCES	85
APPENDIX A Summary of Lesions in Guppies in the 16-Month Waterborne Study of 2,2-Bis(bromomethyl)-1,3-propanediol	91
APPENDIX B Summary of Lesions in Medaka in the 14-Month Waterborne Study of 2,2-Bis(bromomethyl)-1,3-propanediol	105
APPENDIX C Summary of Lesions in Guppies in the 16-Month Waterborne Study of Nitromethane	119
APPENDIX D Summary of Lesions in Medaka in the 13-Month Waterborne Study of Nitromethane	133
APPENDIX E Summary of Lesions in Guppies in the 16-Month Waterborne Study of 1,2,3-Trichloropropane	149
APPENDIX F Summary of Lesions in Medaka in the 13-Month Waterborne Study of 1,2,3-Trichloropropane	161
APPENDIX G Chemical Characterization and Generation of Aquaria Concentrations	175
APPENDIX H Nutrient Composition and Contaminant Levels in Fish Feed and Aquaria Water	189

SUMMARY

Background

The National Toxicology Program has used rats and mice to test if chemicals can cause cancer in animals. We wanted to see if fish could be used as a test animal for cancer testing. In this study, we exposed two species of fish, guppies and medaka, to three different chemicals that caused cancer in rodents to see if fish had the same response.

Methods

We held groups of approximately 110 guppies or 170 medaka in aquaria each containing a specific concentration of a chemical. Three different chemicals were tested, and three different concentrations of each chemical were used. Similar groups of fish were held in aquaria containing only clean water and served as the control groups. The three chemicals used were 2,2-bis(bromomethyl)-1,3-propanediol, nitromethane, or 1,2,3-trichloropropane. After nine months of exposure, some of the fish were transferred into aquaria with just clean water, and the others remained exposed to chemical for another four to seven months. At the end of the studies, about 20 tissue sites from each fish were examined microscopically.

Results

At higher concentrations, 2,2-bis(bromomethyl)-1,3-propanediol was toxic to guppies, and many of the females died. Some of the male guppies and male medaka developed liver cancer, but few female medaka did.

Nitromethane in the water promoted the growth of algae in the aquaria, and the tanks had to be cleaned often. The cleaning process may have resulted in the death of several of the fish. Not enough male guppies were left to evaluate, and very few tumors were seen in the surviving female guppies or male or female medaka.

Male and female guppies exposed to 1,2,3-trichloropropane had higher rates of liver tumors than the control guppies did, and male and female medaka developed tumors of the liver and gallbladder.

Conclusions

While all three test chemicals caused cancer in several different tissues in laboratory rodents, the response in fish was not as consistent, as cancer was seen only mainly in the liver. Fish that died during the study often were eaten by the other fish or dissolved and could not be evaluated. We conclude that several technical problems remain to be solved before fish can be a reliable replacement for rodents in cancer testing.

ABSTRACT

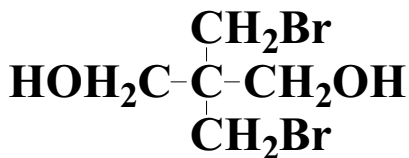

2,2-BIS(BROMOMETHYL)-1,3-PROPANEDIOL (FR-1138®)

(Technical Grade: 78.6% 2,2-bis(bromomethyl)-1,3-propanediol, 6.6% 2,2-bis(hydroxymethyl)-1-bromo-3-hydroxypropane, 6.9% 2,2-bis(bromomethyl)-1-bromo-3-hydroxypropane, 0.2% pentaerythritol, and 7.7% dimers and structural isomers)

CAS No. 3296-90-0

Chemical Formula: $\text{C}_5\text{H}_{10}\text{Br}_2\text{O}_2$ Molecular Weight: 261.94

Synonyms: 2,2-Bis(2-bromomethyl)-1,3-propanediol; 1,3-dibromo-2,2-dihydroxymethylpropane; 1,3-dibromo-2,2-dimethylolpropane; 2,2-dibromomethyl-1,3-propanediol; dibromopentaerythritol; dibromoneopentyl glycol; pentaerythritol dibromide; pentaerythritol dibromohydrin



NITROMETHANE

CAS No. 75-52-5

Molecular Weight: 61.04

Synonym: Nitrocarbol

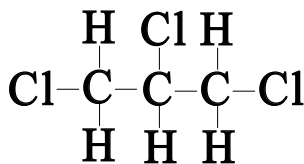

1,2,3-TRICHLOROPROPANE

CAS No. 96-18-4

Chemical Formula: $\text{C}_3\text{H}_5\text{Cl}_3$ Molecular Weight: 147.44

Synonyms: Allyl trichloride, glycerol trichlorohydrin, glyceryl trichlorohydrin, trichlorohydrin

The NTP chose to initiate studies in fish as an exploration of alternate or additional models for examining chemical toxicity and carcinogenicity. The use of small fish species in carcinogenicity testing offered potential advantages as a bioassay test system, including significant savings in cost and time over rodent studies. Large numbers of small fish could be easily maintained in a limited area. The two species chosen for study were guppy (*Poecilia reticulata*) and medaka (*Oryzias latipes*), both of which are hardy, easily maintained, and have a low occurrence of background lesions.

The three chemicals chosen for study in fish had already been studied by the NTP in rodents, permitting a comparison of results between the two models. Two of the chemicals used (2,2-bis(bromomethyl)-1,3-propanediol and 1,2,3-trichloropropane) were mutagenic and multi-site carcinogens in rats and mice. The third chemical, nitromethane, was nonmutagenic with a more modest carcinogenic response in rodents. Male and female guppies and medaka were exposed to 2,2-bis(bromomethyl)-1,3-propanediol (greater than 99% pure), nitromethane, (greater than 99% pure), or 1,2,3-trichloropropane (99% pure) in aquaria water for up to 16 months.

OVERALL STUDY DESIGN

Groups of approximately 220 guppies (two replicates of 110) were maintained in aquaria water containing nominal concentrations of 0, 24, 60, or 150 mg/L 2,2-bis(bromomethyl)-1,3-propanediol; 0, 10, 30, or 70 mg/L nitromethane; or 0, 4.5, 9.0, or 18.0 mg/L 1,2,3-trichloropropane. Groups of approximately 340 medaka (two replicates of 170) were maintained in aquaria water containing 0, 24, 60, or 150 mg/L 2,2-bis(bromomethyl)-1,3-propanediol; 0, 10, 20, or 40 mg/L nitromethane; or 0, 4.5, 9.0, or 18.0 mg/L 1,2,3-trichloropropane. The overall study durations were 16 months for all guppy studies, 14 months for 2,2-bis(bromomethyl)-1,3-propanediol-exposed medaka, and 13 months for nitromethane- and 1,2,3-trichloropropane-exposed medaka.

Ten guppies and 10 medaka from each group replicate were sacrificed at 9 months for histopathologic analysis. Approximately one third of the remaining fish from each group were placed in chemical-free water at 9 months and constituted a stop-exposure study component. The remainder of the fish were exposed for the duration of the study and constituted the core study component. A stop-exposure component was added to determine if

stopping the exposure at 9 months and transferring to chemical-free aquaria might allow for better survival and tumor development. The sex of guppies and medaka was determined at histopathologic analysis.

2,2-BIS(BROMOMETHYL)- 1,3-PROPANEDIOL 16-MONTH STUDY IN GUPPIES

2,2-Bis(bromomethyl)-1,3-propanediol was chronically toxic to guppies in the 60 and 150 mg/L core and stop-exposure groups. Due to mortality, exposure of core study animals in the 150 mg/L group was terminated on day 443, after approximately 64 weeks on study, and fish were maintained in 2,2-bis(bromomethyl)-1,3-propanediol-free water in the exposure system until the end of the study at 69 weeks. Nominal exposure concentrations of 24, 60, and 150 mg/L provided actual aquaria water exposure concentrations of 20.0, 53.5, and 139.0 mg/L 2,2-bis(bromomethyl)-1,3-propanediol, respectively. There were no treatment-related differences between the control and exposed groups in body weights or lengths.

At 9 months, hepatocellular adenomas occurred in one 24 mg/L male and in one 150 mg/L male. In the core study, the incidence of hepatocellular adenoma or carcinoma (combined) in 150 mg/L males was greater than that in the controls; multiple adenomas occurred in two 150 mg/L males and in one 150 mg/L female. Cholangioma occurred in a small number of exposed males and females. In the stop-exposure study, incidences of hepatocellular adenoma (including multiple) and of hepatocellular carcinoma were greater in 150 mg/L males than in controls. One cholangioma and one cholangiocarcinoma occurred in the 150 mg/L female group.

14-MONTH STUDY IN MEDAKA

Exposure to 2,2-bis(bromomethyl)-1,3-propanediol did not result in any significant reduction in survival, although the mortality of fish was somewhat greater in the 60 and 150 mg/L core study groups than in the control and 24 mg/L groups. After reallocation, mortality of medaka in the 60 and 150 mg/L core groups was slightly increased over the corresponding stop-exposure groups.

Nominal exposure concentrations of 24, 60, and 150 mg/L provided actual exposure concentrations of 19.4, 56.9, and 137.8 mg/L 2,2-bis(bromomethyl)-1,3-propanediol, respectively. Core study animals in the 60 and 150 mg/L groups were significantly larger, in both body length and weight, than control group fish.

In the core study, the incidence of hepatocellular adenoma or carcinoma (combined) was increased in 150 mg/L males. Cholangiocarcinomas occurred in a few exposed males and females, with all but one occurring in 150 mg/L fish. One cholangioma occurred in a 150 mg/L female, and one occurred in a control female. In the stop-exposure study, incidences of hepatocellular adenoma or carcinoma (combined) were marginally increased in the 150 mg/L group of males and in the 60 and 150 mg/L groups of females as compared with controls. Cholangiocarcinoma occurred in one male and one female in the 150 mg/L groups and in one control female.

NITROMETHANE

16-MONTH STUDY IN GUPPIES

Although the cause of death could not be confirmed in many cases, mortality in the 70 mg/L groups appeared to indicate that this level of nitromethane exposure was chronically toxic. This is confirmed by the similar survival rate of guppies from all treatments following removal from treatment aquaria and placement in stop-exposure. Due to the high mortality of fish in the 70 mg/L core study groups, these fish were removed from treatment (day 396) and fixed for histological analyses after approximately 57 weeks on study. The controls and other exposed groups were sacrificed at 70 weeks. Nominal exposure concentrations of 10, 30, and 70 mg/L provided actual exposure concentrations of 9.9, 28.7, and 66.4 mg/L nitromethane, respectively. There were no treatment-related differences between the control and exposed groups in body lengths or weights.

13-MONTH STUDY IN MEDAKA

Nitromethane in the aquaria supported a substantial microfaunal growth which, without frequent cleaning, affected water quality and treatment concentrations. To maintain acceptable water quality and treatment concentrations potentially affected by the rapid microfaunal growth, the study aquaria were brushed once and siphoned three times each day. Due to this frequent

activity, a number of fish probably died due to mechanical injury. Unfortunately, the cause of death could not be confirmed in many cases; the mortality from this activity is believed to have been approximately uniform among treatments and should not have affected the comparison of survival between treatments. Based on mortality in this study and the previous life-span evaluation, the life phase of this study was terminated approximately 13.5 months after hatching.

Nominal exposure concentrations of 10, 20, and 40 mg/L resulted in actual exposure concentrations of 9.3, 20.8, and 41.7 mg/L nitromethane, respectively. No differences between control and exposed groups were found in body lengths or weights at the 9-month interim evaluation. Due to mortality, unequal numbers of fish were distributed among the core study and stop-exposure aquaria at 9 months. Differences in lengths and weights were found at 13 months. The biological significance of this finding is unknown.

At 9 months, a single cholangiocarcinoma occurred in a 40 mg/L male. Hepatocellular adenomas occurred in two 20 mg/L males and in one 40 mg/L female. In the core study, one cholangioma occurred in a 20 mg/L male, and cholangiocarcinomas were seen in a few exposed males, but none occurred in control males.

1,2,3-TRICHLOROPROPANE

16-MONTH STUDY IN GUPPIES

The survival of exposed guppies was less than that of the control group at 9 months. Reduced survival was evident at 6 months in the 18.0 mg/L groups and at 7 months in the 4.5 and 9.0 mg/L groups. Survival was significantly reduced in the 18.0 mg/L core study group within 1 month of the 9-month interim evaluation, and mortality in this group was 42.6% between 9 months and study termination. Nominal exposure concentrations of 4.5, 9.0, and 18.0 mg/L resulted in actual exposure concentrations of 4.4, 8.8, and 18.2 mg/L 1,2,3-trichloropropane, respectively. Guppies in the 18.0 mg/L core study group were significantly longer and weighed more than the controls. Fish in the 18.0 mg/L stop-exposure group also weighed more than the controls. Mortality of fish during the study resulted in unequal numbers of individuals distributed to core study and stop-exposure aquaria at 9 months. This appears to have influenced the length and weight of fish measured at study termination (i.e., the smaller tank population allowed the fish to grow

more). Observed differences in weight and length between controls and 18.0 mg/L fish was most likely an artifact of the reduced numbers of fish in the 18.0 mg/L aquaria.

At 9 months, multiple hepatocellular adenomas occurred in one 4.5 mg/L male, and one hepatocellular adenoma occurred in a control male. In the core study, increased incidences of cholangiocellular (bile duct) and hepatocellular neoplasms occurred in exposed groups of males and females. Cholangioma and cholangiocarcinoma were seen in several exposed males and females. In the stop-exposure study, increased incidences of hepatocellular neoplasms occurred in 18.0 mg/L males and increased incidences of cholangiocellular (bile duct) neoplasms occurred in 18.0 mg/L females.

13-MONTH STUDY IN MEDAKA

Survival in the 9.0 and 18.0 mg/L groups indicated that 1,2,3-trichloropropane was chronically toxic to the medaka; reduced survival was evident beginning at 9 months of exposure. Mortality in the 18.0 mg/L core study group was 26.3% and mortality in the 9.0 mg/L group was 17.3% between 9 months and study termination at 13 months. Survival was also reduced in stop-exposure fish from the 9.0 and 18.0 mg/L groups at the end of the study. Nominal exposure concentrations of 4.5, 9.0, and 18.0 mg/L resulted in actual exposure concentrations of 4.6, 9.2, and 18.0 mg/L 1,2,3-trichloropropane, respectively. At 9 months, the weights of medaka in the 9.0 and 18.0 mg/L groups were significantly increased. Core study medaka in the 18.0 mg/L group were both longer and weighed more than the controls at the end of the study. Observed differences in length and/or weight between controls and 9.0 or 18.0 mg/L fish were most likely an artifact of the reduced numbers of fish in these exposure aquaria.

The incidences of cholangiocarcinomas in the 9.0 and 18.0 mg/L groups of males were significantly increased at 9 months. In the core study, the incidences of cholangiocarcinoma were significantly increased in all exposed groups of males and females; the incidences of hepatocellular neoplasms and hepatocholangiocarcinomas were significantly increased in 18.0 mg/L medaka.

In the stop-exposure study, increased incidences of cholangiocarcinoma occurred in all exposed groups of

males and females. The incidence of hepatocellular carcinoma was significantly increased in 18.0 mg/L females.

At 9 months, papillary adenomas of the gallbladder occurred in two 18.0 mg/L males. No gallbladder neoplasms were seen in the controls or any of the other exposed groups. In the core study, papillary adenoma of the gallbladder occurred in a number of exposed males and females, and incidences were significantly increased in the 9.0 and 18.0 mg/L groups. In the stop-exposure study, the incidence of papillary adenoma in males exposed to 18.0 mg/L was significantly increased; papillary adenoma and carcinoma were observed in most exposed groups of males and females.

CONCLUSIONS

Under the conditions of these waterborne studies, 2,2-bis(bromomethyl)-1,3-propanediol at concentrations of up to 150 mg/L for 16 months was considered carcinogenic for male guppies based on increased incidences of hepatocellular adenomas or carcinomas. The study in female guppies was considered inadequate based on reduced survival. Under the conditions of these waterborne studies, 2,2-bis(bromomethyl)-1,3-propanediol at concentrations of up to 150 mg/L for 14 months was considered carcinogenic for male medaka based on increased incidences of hepatocellular adenomas or carcinomas. The study in female medaka was considered negative.

Under the conditions of these waterborne studies, the study of nitromethane in male guppies was considered inadequate based on reduced survival. The study in female guppies at concentrations up to 70 mg/L for 16 months was considered negative. The study in male and female medaka was considered negative.

Under the conditions of these waterborne studies, 1,2,3-trichloropropane at concentrations of up to 18 mg/L for 16 months was considered carcinogenic for male and female guppies based on increased incidences of a variety of liver neoplasms. Under the conditions of these waterborne studies, 1,2,3-trichloropropane at concentrations of up to 18 mg/L for 13 months was considered carcinogenic for male and female medaka based on increased incidences of a variety of liver neoplasms and papillary adenoma of the gallbladder.

Summary of the Carcinogenesis Studies of 2,2-Bis(bromomethyl)-1,3-propanediol in Guppies and Medaka

	Guppies		Medaka	
Concentrations in aquaria water	0, 24, 60, and 150 mg/L		0, 24, 60, and 150 mg/L	
Study duration	16 months		14 months	
Survival	24 mg/L group similar to the control group. 60 and 150 mg/L groups decreased.		Exposed groups similar to the control group.	
	Male	Female	Male	Female
Neoplastic effects	<u>Liver (Core Study):</u> hepatocellular adenoma (3/61, 4/50, 4/41, 8/38); hepatocellular adenoma or carcinoma (4/61, 6/50, 6/41, 10/38) <u>Liver (Stop-Exposure Study):</u> hepatocellular adenoma (0/28, 3/22, 3/21, 6/24); hepatocellular adenoma or carcinoma (0/28, 3/22, 3/21, 9/24)	None	<u>Liver (Core Study):</u> hepatocellular adenoma (1/47, 0/59, 0/56, 6/59); hepatocellular adenoma or carcinoma (1/47, 0/59, 0/56, 8/59) <u>Liver (Stop-Exposure Study):</u> hepatocellular adenoma (1/27, 0/21, 1/31, 3/29); hepatocellular adenoma or carcinoma (1/27, 0/21, 1/31, 4/29)	None
Carcinogenic response	Positive	Inadequate study ^a	Positive	Negative

^a Inadequate based on loss of animals early in study which hindered interpretation of results.

Summary of the Carcinogenesis Studies of Nitromethane in Guppies and Medaka

	Guppies		Medaka	
Concentrations in aquaria water	0, 10, 30, and 70 mg/L		0, 10, 20, and 40 mg/L	
Study duration	16 months		13 months	
Survival	70 mg/L group less than the control group. Core study animals in the 70 mg/L group were sacrificed at 57 weeks.		Exposed groups similar to the control group.	
	Male	Female	Male	Female
Neoplastic effects	None	None	None	None
Carcinogenic response	Inadequate study ^a	Negative	Negative	Negative

^a Inadequate based on loss of animals early in study which hindered interpretation of results.

Summary of the Carcinogenesis Studies of 1,2,3-Trichloropropane in Guppies and Medaka

	Guppies		Medaka	
Concentrations in aquaria water	0, 4.5, 9.0, and 18.0 mg/L		0, 4.5, 9.0, and 18.0 mg/L	
Study duration	16 months		13 months	
Survival	All groups less than control groups		9.0 and 18.0 mg/L groups less than control groups	
	Male	Female	Male	Female
Neoplastic effects	<p><u>Liver (Core Study):</u> cholangiocarcinoma (0/61, 0/47, 0/67, 3/27); hepatocellular adenoma (3/61, 8/47, 17/67, 9/27); hepatocellular carcinoma (0/61, 1/47, 0/67, 7/27); hepatocellular adenoma or carcinoma (3/61, 9/47, 17/67, 15/27)</p> <p><u>Liver (Stop-Exposure Study):</u> cholangiocarcinoma (0/32, 0/19, 0/26, 1/19); hepatocellular adenoma (3/32, 4/19, 5/26, 7/19); hepatocellular carcinoma (0/32, 0/19, 1/26, 4/19); hepatocellular adenoma or carcinoma (3/32, 4/19, 5/26, 10/19)</p>	<p><u>Liver (Core Study):</u> cholangioma (0/64, 3/64, 4/47, 2/33); cholangiocarcinoma (0/64, 0/64, 0/47, 6/33); hepatocellular adenoma or carcinoma (5/64, 4/64, 4/47, 8/33)</p> <p><u>Liver (Stop-Exposure Study):</u> cholangioma (2/31, 2/31, 0/31, 2/27); cholangiocarcinoma (0/31, 0/31, 0/31, 5/27); hepatocellular adenoma or carcinoma (2/31, 1/31, 2/31, 3/27)</p>	<p><u>Liver (Core Study):</u> cholangioma (0/95, 6/94, 2/65, 1/78); cholangiocarcinoma (0/95, 32/94, 43/65, 45/78); hepatocellular adenoma or carcinoma (0/95, 2/94, 1/65, 6/78); hepatocholangiocarcinoma (0/95, 0/94, 2/65, 6/78)</p> <p><u>Liver (Stop-Exposure Study):</u> cholangioma (0/42, 0/47, 3/33, 1/46); cholangiocarcinoma (0/42, 19/47, 16/33, 26/46); hepatocellular adenoma (0/42, 1/47, 0/33, 0/46); hepatocellular adenoma or carcinoma (0/42, 2/47, 0/33, 1/46)</p> <p><u>Gallbladder (Core Study):</u> adenoma, papillary (0/91, 0/83, 4/61, 9/72)</p> <p><u>Gallbladder (Stop-Exposure Study):</u> adenoma, papillary (0/41, 0/42, 3/30, 4/46)</p>	<p><u>Liver (Core Study):</u> cholangiocarcinoma (0/95, 29/93, 53/94, 41/67); hepatocellular adenoma (1/95, 1/93, 5/94, 8/67); hepatocellular carcinoma (1/95, 1/93, 2/94, 5/67); hepatocellular adenoma or carcinoma (2/95, 2/93, 7/94, 13/67); hepatocholangiocarcinoma (0/95, 0/93, 4/94, 7/67)</p> <p><u>Liver (Stop-Exposure Study):</u> cholangiocarcinoma (1/57, 15/44, 31/49, 21/31); hepatocellular adenoma (4/57, 2/44, 2/49, 1/31); hepatocellular carcinoma (0/57, 2/44, 1/49, 4/31); hepatocellular adenoma carcinoma (4/57, 4/44, 2/49, 5/31); hepatocholangiocarcinoma (0/57, 0/44, 0/49, 1/31);</p> <p><u>Gallbladder (Core Study):</u> adenoma, papillary (0/85, 1/80, 5/88, 6/65)</p> <p><u>Gallbladder (Stop-Exposure Study):</u> adenoma, papillary (0/56, 1/40, 1/45, 1/30)</p>
Carcinogenic response	Positive	Positive	Positive	Positive

**NATIONAL TOXICOLOGY PROGRAM BOARD OF SCIENTIFIC COUNSELORS
TECHNICAL REPORTS REVIEW SUBCOMMITTEE**

The members of the Technical Reports Review Subcommittee who evaluated the draft NTP Technical Report on Fish Studies on February 18, 2004, are listed below. Subcommittee members serve as independent scientists, not as representatives of any institution, company, or governmental agency. In this capacity, subcommittee members have five major responsibilities in reviewing the NTP studies:

- to ascertain that all relevant literature data have been adequately cited and interpreted,
- to determine if the design and conditions of the NTP studies were appropriate,
- to ensure that the Technical Report presents the experimental results and conclusions fully and clearly,
- to judge the significance of the experimental results by scientific criteria, and
- to assess the evaluation of the evidence of carcinogenic activity and other observed toxic responses.

Mary Anna Thrall, D.V.M., Chairperson
Department of Pathology
Colorado State University
Fort Collins, CO

James E. Klaunig, Ph.D., Principal Reviewer
Division of Toxicology
Indiana University School of Medicine
Indianapolis, IN

Larry S. Andrews, Ph.D.
Toxicology Department
Rohm and Haas Company
Spring House, PA

Charlene A. McQueen, Ph.D.*
Department of Pharmacology and Toxicology,
College of Pharmacy
University of Arizona
Tucson, AZ

Diane F. Birt, Ph.D.
Department of Food Science & Human Nutrition
Iowa State University
Ames, IA

Walter W. Piegorsch, Ph.D., Principal Reviewer
Department of Statistics
University of South Carolina
Columbia, SC

Kim Boekelheide, M.D., Ph.D., Principal Reviewer
Division of Biology and Medicine
Department of Pathology and Laboratory Medicine
Brown University
Providence, RI

Stephen M. Roberts, Ph.D.
Center for Environmental & Human Toxicology
University of Florida
Gainesville, FL

Michael R. Elwell, D.V.M., Ph.D.
Pathology, Drug Safety Evaluation
Pfizer Global Research and Development
Groton, CT

Richard D. Storer, M.P.H., Ph.D.
Department of Genetic and Cellular Toxicology
Merck Research Laboratories
West Point, PA

Thomas A. Gasiewicz, Ph.D.*
Department of Environmental Medicine
Environmental Health Sciences Center
University of Rochester School of Medicine
Rochester, NY

Mary Vore, Ph.D.
Graduate Center for Toxicology
University of Kentucky
Lexington, KY

Shuk-Mei Ho, Ph.D.
Department of Surgery, Division of Urology
University of Massachusetts Medical School
Worcester, MA

Cheryl Lyn Walker, Ph.D.*
Department of Carcinogenesis
M.D. Anderson Cancer Center
The University of Texas
Smithville, TX

* Did not attend.

Special Ad Hoc Reviewers

George S. Bailey, Ph.D.
Department of Environmental and Molecular Toxicology
Oregon State University
Corvallis, OR

Jerry M. Law, D.V.M., Ph.D.
Department of Environmental and Molecular Toxicology
North Carolina State University
Raleigh, NC

SUMMARY OF TECHNICAL REPORTS REVIEW SUBCOMMITTEE COMMENTS

On February 18, 2004, the draft Technical Report on the carcinogenesis studies of 2,2-bis(bromomethyl)-1,3-propanediol, nitromethane, and 1,2,3-trichloropropane received public review by the National Toxicology Program's Board of Scientific Counselors' Technical Reports Review Subcommittee. The review meeting was held at the National Institute of Environmental Health Sciences, Research Triangle Park, North Carolina.

Dr. G.S. Bailey, a special reviewer, presented an overview of the history of carcinogenesis research in fish models. Dr. Bailey summarized the results of a variety of studies in different fish species, noting there were certainly variations in responses to given carcinogens for different species. He cited advantages of fish compared to rodents, including the smaller cost and space requirement per individual, which allow studies to have large sample numbers per dose group. Drawbacks include the absence of certain organ systems found in mammalian species.

Dr. G.A. Boorman, NIEHS, introduced the carcinogenesis studies of 2,2-bis(bromomethyl)-1,3-propane-diol, nitromethane, and 1,2,3-trichloropropane in guppies and medaka by explaining that the intent of these studies was to test the feasibility of the fish models. Thus, the test chemicals chosen were three chemicals characterized as carcinogenic in NTP rodent studies. For each chemical study, he discussed the survival and compared the responses of the two fish species with the results of the rodent studies.

For these studies, the conclusions were not framed in the standard Levels of Evidence categories. The proposed conclusions were:

Under the conditions of these waterborne studies, 2,2-bis(bromomethyl)-1,3-propanediol at concentrations of up to 150 mg/L for 16 months was considered carcinogenic for male guppies based on increased incidences of hepatocellular adenomas or carcinomas. The study in female guppies was considered inadequate based on reduced survival. Under the conditions of these waterborne studies, 2,2-bis(bromomethyl)-1,3-propanediol at concentrations of up to 150 mg/L for 14 months was considered carcinogenic for male medaka based on increased incidences of hepatocellular

adenomas or carcinomas. The study in female medaka was considered negative.

Under the conditions of these waterborne studies, the study of nitromethane in male guppies was considered inadequate based on reduced survival. The study in female guppies at concentrations up to 70 mg/L for 16 months was considered negative. Under the conditions of these waterborne studies, the study of nitromethane at concentrations of up to 40 mg/L for 13 months was considered equivocal for male medaka based on the occurrence of cholangiomas or cholangiocarcinomas. The study in female medaka was considered negative.

Under the conditions of these waterborne studies, 1,2,3-trichloropropane at concentrations of up to 18 mg/L for 16 months was considered carcinogenic for male and female guppies based on increased incidences of a variety of liver neoplasms. Under the conditions of these waterborne studies, 1,2,3-trichloropropane at concentrations of up to 18 mg/L for 13 months was considered carcinogenic for male and female medaka based on increased incidences of a variety of liver neoplasms and papillary adenoma of the gallbladder.

Dr. Boorman also noted that the performance of the studies was not as inexpensive as anticipated, and the models were less sensitive than rodent studies, as gauged by the number of sites eliciting responses. Interpretation was also limited by lack of time-to-tumor data and some of the fish dying early.

Dr. Boekelheide, the first principal reviewer, had several concerns about the technical limitations of these studies. The fish were not initially sexed and were potentially reproducing, their sizes varied with the number of fish per tank, and the occurrence of algal blooms and a background infection of granulomata presented other confounders. He did concur with the proposed concluding assessments.

Dr. Piegorsch, the second principal reviewer, applauded the effort to explore new test systems but agreed that many design and control issues need to be resolved. For the studies at hand, he noted a number of cases where very low tumor incidences were presented as supporting an equivocal conclusion. He inquired about the

inclusion of stop-exposure study data and discussed the fundamental flaw of fish dying and being cannibalized, resulting in a loss of key data.

Dr. Klaunig, the third principal reviewer, also mentioned the issues of survival and husbandry and expressed concern about the possibility of fish dying from lesions and then disappearing. He felt larger fish species might offer better opportunities to observe tumors, particularly tumor multiplicity.

Dr. Bailey said that doing sex determinations at the beginning of a study would not be possible, but he did not consider that a severe limitation. Based on these studies, he felt optimistic about the prospects for fish research.

Dr. J.M. Law was the second special reviewer. Dr. Law suggested that fish studies offered some economy of scale for tests involving very large numbers of animals. He was concerned about the extent of the granuloma infection and the effects of the resultant inflammation. He felt the pathology diagnoses could have been completed more quickly with fewer slides per fish.

Dr. Boorman acknowledged the recommendations of the reviewers and suggested that this report be part of the Technical Report series rather than a summary article to permit full reporting of the study details and lessons learned. Dr. J.R. Hailey, NIEHS, indicated that stop-exposure study data were becoming a regular part of NTP studies.

Dr. Bailey pointed out that no false positives had ever been reported in fish studies. He also mentioned that the survival rates were much higher for larger fish like trout.

Dr. Boekelheide moved, and Dr. Klaunig seconded, that the proposed conclusions be accepted as written.

Dr. Piegorsch offered an amendment that the proposed conclusion for nitromethane in male medaka be changed from equivocal to negative. Dr. Birt seconded the amendment. The amendment was approved with seven members in favor and three opposing. The overall conclusion as amended was approved with eight members in favor and two opposing.

In further discussion, Dr. C.J. Portier, NIEHS, suggested presenting these studies in the existing Technical Report series rather than creating a new series for each study design. Dr. Klaunig said that fish were a valid model for carcinogenicity. Dr. Andrews recalled that discussions about the vision for the future of the program included exploring different and predictive models, and this study was one such attempt. Dr. Storer distinguished the fish studies from the transgenic mouse studies, noting that some of the latter might be characterized as a reporter gene model, whereas for fish cancer, itself is the endpoint. Dr. Piegorsch noted that many of the technical and analytic refinements had not been developed at the beginning of the rodent bioassay series either. Dr. Ho favored keeping this report in the Technical Report series because fish have long been used as a model for carcinogenesis.

Drs. Storer and Klaunig noted that most of the fish studies involved testing carcinogens rather than noncarcinogens. Dr. Boekelheide said that if more studies were performed using fish models, a major investment would be required. Dr. Portier felt most confounders could be overcome, but the key problem was the loss of fish and data during studies. Dr. Bailey felt this problem could be resolved with an appropriate species and husbandry system. Drs. Birt and Storer felt these models could be promising for low-dose extrapolation studies requiring very large numbers of animals.

OVERVIEW

In the past 20 years, the National Toxicology Program (NTP) has primarily used rodents in studies to determine the potential carcinogenic hazard from chemicals that occur in the workplace or environment (Page *et al.*, 1977; Weisburger and Williams, 1981; Weisburger *et al.*, 1984; Goodman and Wilson, 1991; Faccini *et al.*, 1992). Because rodent cancer studies are costly and require years to complete, the NTP continues to investigate other animal models that may offer advantages in terms of time, cost, and mechanistic information.

Several small fish species have been suggested to be more sensitive for detecting carcinogens in assays that would be less expensive and faster than rodent studies (Sinnhuber *et al.*, 1978; Ishikawa and Takayama, 1979; Bailey *et al.*, 1984; Simon and Lapis, 1984; Walker *et al.*, 1985). Since large numbers of small fish can be easily maintained in a limited space, this model appeared to offer real advantages to the NTP. However, the NTP has found that other types of short-term tests have limitations for predicting carcinogenicity when systematically evaluated under controlled conditions in a contract laboratory situation (Zeiger *et al.*, 1990).

To examine fish as a test species for cancer hazard identification, the NTP decided to evaluate two small fish models using three chemicals under standard study conditions. Most fish cancer studies reported in the literature used potent carcinogens that caused liver tumors in rodents and also in the fish models (Hawkins *et al.*, 1998; Law *et al.*, 1998; Brown-Peterson *et al.*, 1999; Okihiro and Hinton, 1999; Liu *et al.*, 2003). The spectrum of tumors in organs and tissues in rodents has often provided clues as to the mechanisms of toxicity and carcinogenicity of the test chemicals. Therefore, 1,2,3-trichloropropane and 2,2-bis(bromomethyl)-1,3-propanediol, both mutagens that caused a broad spectrum of cancers in rodents, were selected to test the spectrum of tissue response in the fish models. 1,2,3-Trichloropropane was shown to cause increased incidences of tumors of the oral cavity, forestomach, kidney, harderian gland, Zymbal's gland, liver, uterus, pancreas, and other sites in rodents. 2,2-Bis(bromomethyl)-1,3-propanediol caused increased incidences of tumors of the mammary gland, skin, oral cavity, forestomach,

harderian gland, Zymbal's gland, lung, urinary bladder, seminal vesicle, and other sites in rodents.

To date, most carcinogens tested in fish studies are also hepatocarcinogens in rodents. To test the sensitivity of the small fish models, nitromethane, a nonmutagen with a modest carcinogenic response in rodents, was selected. Nitromethane did not cause increased tumors in male rats, but was clearly carcinogenic for female rats with increased mammary gland neoplasms, and clearly carcinogenic for male and female mice with increased lung and harderian gland tumors plus increased liver tumors in female mice. Another factor for the selection of nitromethane was that it was a rodent carcinogen that did not primarily target the liver.

On December 2 and 3, 1991, a "Workshop of Carcinogenesis Testing with Fish" was held at the National Institute of Environmental Health Sciences to evaluate the utility of the small fish model. A National Toxicology Program Pathology Working Group (PWG) was convened, and diagnostic criteria for degenerative, inflammatory, proliferative neoplastic and nonneoplastic lesions in the liver of medaka were published (Boorman *et al.*, 1997). This report consolidated hepatic lesion criteria into a simplified scheme for comparison of findings from different studies and laboratories. Later, a competitive contract was awarded to Gulf Coast Research Laboratory to conduct up to 16-month exposure studies in two species of small fish. The contract was a part of the NTP's effort to develop alternative test methods. The species of fish used for these studies were the medaka (*Oryzias latipes*) and the guppy (*Poecilia reticulata*).

The ultimate test of the small fish models is whether the data generated allow an equally informed decision of the potential carcinogenicity of the test chemical. Evaluating three chemicals already evaluated in NTP rodent studies allows some assessment of these two fish models.

Rodent cancer evaluations have benefited from careful attention to study details. Therefore, the NTP attempted

to follow standard chemistry, pathology, statistical, and QA evaluations of the data for the fish studies. It was found that, in many cases, the rodent standards could not be applied to the fish studies for a variety of reasons.

NTP scientists were asked to evaluate the data for carcinogenicity determinations as would be done for an

unknown chemical. Thus, for each chemical, the carcinogenic response was judged to be positive, negative, or equivocal for each sex and species combination. In one instance, the study was judged to be inadequate because of poor survival. This report details the experience with the medaka and guppy for three rodent carcinogens.

INTRODUCTION

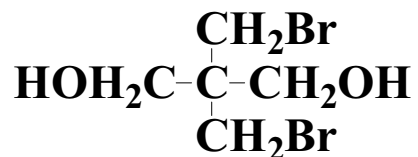

2,2-BIS(BROMOMETHYL)-1,3-PROPANEDIOL (FR-1138®)

(Technical Grade: 78.6% 2,2-bis(bromomethyl)-1,3-propanediol, 6.6% 2,2-bis(hydroxymethyl)-1-bromo-3-hydroxypropane, 6.9% 2,2-bis(bromomethyl)-1-bromo-3-hydroxypropane, 0.2% pentaerythritol, and 7.7% dimers and structural isomers)

CAS No. 3296-90-0

Chemical Formula: $\text{C}_5\text{H}_{10}\text{Br}_2\text{O}_2$ Molecular Weight: 261.94

Synonyms: 2,2-Bis(2-bromomethyl)-1,3-propanediol; 1,3-dibromo-2,2-dihydroxymethylpropane; 1,3-dibromo-2,2-dimethylolpropane; 2,2-dibromomethyl-1,3-propanediol; dibromopentaerythritol; dibromoneopentyl glycol; pentaerythritol dibromide; pentaerythritol dibromohydrin



NITROMETHANE

CAS No. 75-52-5

Molecular Weight: 61.04

Synonym: Nitrocarbol

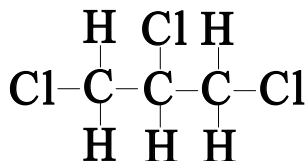

1,2,3-TRICHLOROPROPANE

CAS No. 96-18-4

Chemical Formula: $\text{C}_3\text{H}_5\text{Cl}_3$ Molecular Weight: 147.44

Synonyms: Allyl trichloride, glycerol trichlorohydrin, glyceryl trichlorohydrin, trichlorohydrin

CHEMICAL AND PHYSICAL PROPERTIES

2,2-Bis(bromomethyl)-1,3-propanediol

2,2-Bis(bromomethyl)-1,3-propanediol is a white solid material with a slight, mild, musty odor. It has a melting point of 75° to 95° C for technical grade material and 109° to 110° C for pure material. It is soluble in acetone, ethanol, and ether, and slightly soluble in water (2 g/1,000 g water at 25° C). Complete information on chemical and physical properties of 2,2-bis(bromomethyl)-1,3-propanediol is available in NTP Technical Report 452 (NTP, 1996).

Nitromethane

Nitromethane is a colorless, oily liquid with a moderately strong, disagreeable odor (*Merck Index*, 1989). Nitromethane has a melting point of -29° C, a boiling point of 101.2° C, a flash point of 112° F, and a lower explosive limit of 7.3%. Its density is 1.1322 at 25° C; the vapor density is 2.11, and the vapor pressure is 27.8 mm Hg at 20° C. Nitromethane is soluble in alcohol, ether, N,N-dimethylformamide, acetone, and alkali and is slightly soluble in water (9.5 g/L at 20° C). Complete information on chemical and physical properties of nitromethane is available in NTP Technical Report 461 (NTP, 1997).

1,2,3-Trichloropropane

1,2,3-Trichloropropane is a colorless liquid with a strong acidic odor. It has a boiling point of 156° C (760 mm Hg), a vapor pressure of 3 mm Hg at 25° C, a specific gravity of 1.370 g/mL, and a flash point of 71.1° C (*Hawley's*, 1987). 1,2,3-Trichloropropane is only slightly soluble in water but freely soluble in alcohol and ether. Complete information on chemical and physical properties of 1,2,3-trichloropropane is available in NTP Technical Report 384 (NTP, 1993).

PRODUCTION, USE, AND HUMAN EXPOSURE

2,2-Bis(bromomethyl)-1,3-propanediol

2,2-Bis(bromomethyl)-1,3-propanediol is used as a flame retardant in unsaturated polyester resins, for molded products, and in rigid polyurethane foam. This flame retardant may enter the environment as fugitive dust and through wastewater. 2,2-Bis(bromomethyl)-

1,3-propanediol is expected to remain for long periods of time in water (USEPA, 1983). Complete information on production, use, and human exposure of 2,2-bis(bromomethyl)-1,3-propanediol is available in NTP Technical Report 452 (NTP, 1996).

Nitromethane

In the past, nitromethane was used extensively as a chemical stabilizer to prevent the decomposition of various halogenated hydrocarbons such as metal degreasers and aerosol propellants such as 1,1,1-trichloroethane. Nitromethane is used as a fuel or fuel additive to increase the power output of rockets, race cars, boats, and model engines. Nitromethane is also used as a synthesis intermediate for a variety of chemicals, such as trichloronitromethane (chloropicrin), an agricultural soil and grain fumigant; the nitroalcohol 2-hydroxymethyl-2-nitro-1,3-propanediol, which is used as a biocide for cutting fluids and as a source of formaldehyde for cross-linking amino resins; and the alkanolamine 2-hydroxymethyl-2-amino-1,3-propanediol, which is used as a formaldehyde scavenger in resin curing and polyester resin modification and as a buffer. Nitromethane is used in a variety of solvent applications, such as solvent-extraction separation of aromatics from aliphatic compounds, in the crystallization of nitrofurantoin, as a reaction medium for aluminum chloride in Friedel-Crafts reactions, and as a solvent for resins such as α -cyanoacrylate. Nitromethane is used in mixtures with ammonium nitrate as an explosive in mining, oil-well drilling, and seismic exploration (*Biocides*, U.S.A., 1974; *Remington's Pharmaceutical Sciences*, 1975; *Kirk-Othmer*, 1978; SRI International, 1980).

Nitromethane is fairly reactive and therefore does not persist in the environment; the half-life ($t_{1/2}$) of nitromethane is from 4 to 9 hours in air and about 1 day in water (HSDB, 1995). However, because nitromethane is slightly soluble in water and evaporates at about the same rate as water, the $t_{1/2}$ is somewhat dependent on the rate of evaporation. In the atmosphere and in water, nitromethane is degraded through its reaction with hydroxyl radicals; it may also undergo aerobic or anaerobic degradation. It may react with chlorine in water to form trichloronitromethane if the pH of the medium is high (Wade *et al.*, 1977). Information on production, use, and human exposure of nitromethane is available in NTP Technical Report 461 (NTP, 1997).

1,2,3-Trichloropropane

1,2,3-Trichloropropane is commonly used as a paint and varnish remover, solvent, and degreasing agent, but the extent of these uses is uncertain. 1,2,3-Trichloropropane is used as a crosslinking agent in the synthesis of polysulfides and hexafluoropropylene, and it may be found as an impurity in certain nematicides and soil fumigants (Aharonson, 1987). The general routes of exposure are inhalation, ingestion, and skin and eye contact (Sittig, 1985). Complete information on production, use, and human exposure of 1,2,3-trichloropropane is available in NTP Technical Report 384 (NTP, 1993).

ABSORPTION, DISTRIBUTION, METABOLISM, AND EXCRETION

Information on the absorption, distribution, metabolism, and excretion of 2,2-bis(bromomethyl)-1,3-propanediol, nitromethane, and 1,2,3-trichloropropane is available in NTP Technical Reports 452 (NTP, 1996), 461 (NTP, 1997), and 384 (NTP, 1993), respectively.

TOXICITY

2,2-Bis(bromomethyl)-1,3-propanediol

and Nitromethane

Toxicity information for 2,2-bis(bromomethyl)-1,3-propanediol and nitromethane can be found in NTP Technical Reports 452 and 461, respectively (NTP, 1996, 1997).

1,2,3-Trichloropropane

Acute and subchronic toxicity of 1,2,3-trichloropropane has been studied by inhalation, gavage, dermal exposure, and ingestion of drinking water. Inhalation studies are particularly relevant due to the similarity of aquatic total exposures and inhalation total exposures. Complete toxicity information about 1,2,3-trichloropropane can be found in NTP Technical Report 384 (NTP, 1993).

REPRODUCTIVE AND DEVELOPMENTAL TOXICITY

Reproductive and developmental toxicity information for 2,2-bis(bromomethyl)-1,3-propanediol can be found in NTP Technical Report 452 (NTP, 1996). No information on the reproductive or developmental toxicity of

nitromethane or 1,2,3-trichloropropane in humans has been reported in the literature.

CARCINOGENICITY

Experimental Animals

2,2-Bis(bromomethyl)-1,3-propanediol

In a 2-year toxicity/carcinogenicity study, Sprague-Dawley rats were administered the flame retardant 2,2-bis(bromomethyl)-1,3-propanediol [FR-1138®: 80% dibromopentyl glycol(2,2-bis(bromomethyl)-1,3-propanediol); 8% tribromoneopentyl alcohol (bis(bromomethyl)-1-bromo-3-hydroxypropane) and 6% monobromoneopentyl triol (2,2-bis(hydroxymethyl)-1-bromo-3-hydroxypropane)] in feed at concentrations that delivered 0, 5, or 100 mg 2,2-bis(bromomethyl)-1,3-propanediol/kg body weight per day (Keyes *et al.*, 1979). No carcinogenic effect was observed. However, degenerative changes in the liver and lens of the eye were attributed to chemical exposure. The article did not provide details on the preparation or stability of the chemical in the feed. No dose-related effects on the feed consumption, weight gain, clinical signs, or mortality were observed, suggesting that the animals may have been able to tolerate higher doses.

2,2-Bis(bromomethyl)-1,3-propanediol was administered in feed for 13-week and 2-year studies (NTP, 1996). In the 2-year study increased tumors were found in F344/N rats and B6C3F₁ mice. In both male and female rats, there were increased incidences of neoplasms of the oral cavity, esophagus, thyroid gland and mammary gland. Male rats also had increased incidences of neoplasms of the skin, subcutaneous tissue, Zymbal's gland, forestomach, small and large intestines, mesothelium, urinary bladder, lung, seminal vesicle and of mononuclear cell leukemia. Slight increases in incidences of neoplasms of the pancreas and kidney of male rats many have also been related to treatment.

Male and female mice had increased incidences of neoplasms of the harderian gland and lung, male mice had increased neoplasms of the kidney, and female mice had increased neoplasms of subcutaneous tissue (NTP, 1996). Slight increases in the incidences of neoplasms in the forestomach, mammary gland and circulatory system in female mice may have also been related to treatment.

Nitromethane

Nitromethane was evaluated for toxicity and carcinogenicity in 16-day, 13-week, and 2-year studies in F344/N rats and B6C3F₁ mice, with whole body inhalation as the route of exposure (NTP, 1997). Increased incidences of several tumors were found in the 2-year inhalation studies. Increased incidences of mammary gland fibroadenomas and carcinomas were found in female rats. In male and female B6C3F₁ mice there were increased incidences of harderian gland adenomas and carcinomas. Female mice had an increased incidence of liver neoplasms (primarily adenomas). Male and female mice also had increased incidences of adenomas and carcinomas in the lung that were considered to be related to chemical administration. Male and female mice also had increased incidences of nasal lesions including degeneration and metaplasia of the olfactory epithelium and degeneration of the respiratory epithelium.

Chemicals that are structurally related to nitromethane are also carcinogenic in rodents. Sprague-Dawley rats exposed to 207 ppm 2-nitropropane by inhalation for 6 months had multiple hepatocellular carcinomas (Lewis *et al.*, 1979). Male and female Long-Evans rats exposed to 100 or 200 ppm nitroethane by inhalation for 2 years (Griffin *et al.*, 1988) or to 100 ppm 1-nitropropane by inhalation for 21 months (Griffin *et al.*, 1982) had no neoplasms or nonneoplastic lesions associated with treatment.

1,2,3-Trichloropropane

1,2,3-Trichloropropane was administered in corn oil by gavage to F344/N rats and B6C3F₁ mice in 17-week and 2-year studies (NTP, 1993). Increased incidences of a variety of hyperplasias and tumors were found in rats in the 2-year studies. Increased incidences of squamous cell papillomas and carcinomas of the oral mucosa and forestomach and carcinomas of the Zymbal's gland were seen in male and female rats. Male rats also had increased incidences of adenomas of the pancreas and kidney and adenomas or carcinomas of the preputial gland. Female rats had increased incidences of adenomas or carcinomas of the clitoral gland and adenocarcinomas of the mammary gland. A few adenocarcinomas of the intestine found in male and female treated rats may have been related to trichloropropane administration. Increased severity of renal disease in male rats was associated with exposure to trichloropropane.

1,2,3-Trichloropropane exposure in male and female mice was associated with increased incidences of squamous cell papillomas and carcinomas of the forestomach, hepatocellular adenomas or carcinomas of the liver and harderian gland adenomas (NTP, 1993). Female mice also had increased incidences of uterine adenomas, adenocarcinomas, and stromal polyps. In female mice there were increased incidences of squamous cell carcinomas of the oral mucosa. A few squamous cell papillomas of the oral mucosa in male mice may have been related to trichloropropane administration.

Humans

No epidemiological studies of 2,2-bis(bromomethyl)-1,3-propanediol, nitromethane, or 1,2,3-trichloropropane exposure in humans were found in the literature.

GENETIC TOXICITY

2,2-Bis(bromomethyl)-1,3-propanediol

The genotoxicity test data for 2,2-bis(bromomethyl)-1,3-propanediol were recently reviewed (IARC, 2000). 2,2-Bis(bromomethyl)-1,3-propanediol gave positive results in a limited number of genetic toxicity assays under specific experimental conditions. In the two *Salmonella typhimurium* gene mutation assays presented in NTP (1996), 2,2-bis(bromomethyl)-1,3-propanediol gave a positive response only in strain TA100 in the presence of 30% induced hamster liver S9 activation enzymes (Zeiger *et al.*, 1992); 10% hamster S9 was ineffective, as was 10% or 30% S9 derived from livers of pretreated rats. No other *Salmonella* strain/activation combination was responsive to the effects of 2,2-bis(bromomethyl)-1,3-propanediol (Mortelmans *et al.*, 1986; Zeiger *et al.*, 1992).

In cytogenetic tests with Chinese hamster ovary cells, 2,2-bis(bromomethyl)-1,3-propanediol did not induce sister chromatid exchanges with or without induced rat liver S9, but a dose-related increase in chromosomal aberrations was observed in cultured Chinese hamster ovary cells when testing occurred in the presence of S9 (Galloway *et al.*, 1987). A majority of the breaks that were observed in the aberrations assay were located in the heterochromatic region of the long arm of the X chromosome. The reason for this preferential breakage site is not known (Galloway *et al.*, 1987). The

pattern of damage seen with 2,2-bis(bromomethyl)-1,3-propanediol (induction of chromosomal aberrations with no concomitant induction of sister chromatid exchanges) is unusual (Galloway *et al.*, 1987).

2,2-Bis(bromomethyl)-1,3-propanediol was shown to be genotoxic *in vivo*. Significant increases in micronucleated erythrocytes were seen in peripheral blood samples obtained from male and female B6C3F₁ mice administered 2,2-bis(bromomethyl)-1,3-propanediol (625 to 10,000 ppm) for 3 months in dosed feed (Witt *et al.*, 2000). Equivocal results were obtained in an acute bone marrow micronucleus test with 2,2-bis(bromomethyl)-1,3-propanediol administered over a dose range of 100 to 400 mg/kg to male mice by gavage, three times at 24-hour intervals (NTP, 1996). A second micronucleus test was conducted in which 2,2-bis(bromomethyl)-1,3-propanediol was administered as a single intraperitoneal injection (150 to 600 mg/kg) to male and female mice; bone marrow was sampled 24 hours after treatment, and significant increases in micronucleated erythrocytes were seen in both male and female mice.

Nitromethane

The genetic toxicity test data for nitromethane were reviewed in NTP (1997); results of all *in vivo* and *in vitro* tests were negative. Tests for mutagenicity induction using a number of different strains of *Salmonella typhimurium*, with and without exogenous metabolic activation (S9 liver enzymes), were negative (Chiu *et al.*, 1978; Mortelmans *et al.*, 1986; Dayal *et al.*, 1989; Dellarco and Prival, 1989). The nitronate form of nitromethane was also reported to be negative for induction of mutations in *S. typhimurium* strains TA100 and TA102 (Dayal *et al.*, 1989). No induction of sister chromatid exchanges or chromosomal aberrations was observed in cultured Chinese hamster ovary cells treated with up to 5,000 µg/mL nitromethane, with and without S9 (NTP, 1997). No significant increases in sex-linked recessive lethal mutations were noted in germ cells of male *Drosophila melanogaster* after administration of nitromethane by feeding (Gocke *et al.*, 1981). No induction of micronuclei was observed in bone marrow erythrocytes of male NMRI mice administered two intraperitoneal injections of 205 to 1,830 mg/kg nitromethane (Gocke *et al.*, 1981). In this test, bone marrow was sampled 6 hours after the second injection, so the effect of the second treatment is not likely to be reflected in these results; however, this negative result is in agreement with the results of the 3-month micronu-

cleus study conducted by the NTP (1997). In this latter study, male and female B6C3F₁ mice showed no significant increases in micronucleated erythrocytes in peripheral blood following 3 months of inhalation exposure to nitromethane at levels up to 1,500 ppm (Witt *et al.*, 2000).

1,2,3-Trichloropropane

1,2,3-Trichloropropane contains two chlorinated methyl groups that are structural alerts to potential DNA reactivity (Ashby and Tennant, 1988); this molecular structure is consistent with the results of a limited number of genetic toxicity assays showing significant activity for 1,2,3-trichloropropane. All mutagenic responses were obtained in *in vitro* assays and were observed only in the presence of metabolic activation provided by induced rat or hamster S9 liver enzymes. 1,2,3-Trichloropropane induced gene mutations in *Salmonella typhimurium* strains TA97, TA98, TA100, and TA1535 (Stolzenberg and Hine, 1980; Haworth *et al.*, 1983; Ratpan and Plaumann, 1988) and in mouse lymphoma L5178Y tk^{+/-} cells (NTP, 1993). In cytogenetic tests with cultured hamster cells, 1,2,3-trichloropropane induced both sister chromatid exchanges (von der Hude *et al.*, 1987; NTP, 1993) and chromosomal aberrations (NTP, 1993).

In contrast to these positive results, 1,2,3-trichloropropane did not induce unscheduled DNA synthesis in hepatocytes of male F344/N rats treated *in vitro* (Mirsalis *et al.*, 1983; Williams *et al.*, 1989) or *in vivo* (Mirsalis *et al.*, 1983). Negative results were also obtained in an *in vivo* test for induction of chromosomal damage measured as dominant lethal mutations in male Sprague-Dawley rats treated once daily for 5 consecutive days with 80 mg/kg 1,2,3-trichloropropane (Saito-Suzuki *et al.*, 1982).

DOSE SELECTION RATIONALE

2,2-Bis(bromomethyl)-1,3-propanediol

2,2-Bis(bromomethyl)-1,3-propanediol has been identified as a multisite carcinogen in both male and female rats and mice (Dunnick *et al.*, 1997). The purpose of this study was to determine the carcinogenic potential of chronic exposure to sublethal concentrations of 2,2-bis(bromomethyl)-1,3-propanediol in two small fish species; guppies (*Poecilia reticulata*) and medaka (*Oryzias latipes*). Following 2-day static tests and 7-day flow-through tests, 28-day range finding studies using guppies and medaka were conducted to determine

maximum 2,2-bis(bromomethyl)-1,3-propanediol concentrations to use in the subsequent chronic exposure studies. Two replicates containing each of six nominal concentrations (0.0, 19.4, 32.4, 54.0, 90.0, and 150.0 mg/L) were employed. The maximum 2,2-bis(bromomethyl)-1,3-propanediol concentration for the chronic studies was established at 150 mg/L based upon the sublethal responses observed from the range finding study. The low concentration and the mid-level concentration were selected as 60% of the next higher concentration for even spacing and adequate separation of treatments. Guppies and medaka were exposed to 2,2-bis(bromomethyl)-1,3-propanediol in a flow-through system to each of four nominal concentrations (0, 24, 60, and 150 mg/L; measured concentrations were 0.0, 20.0, 53.5, and 139.0 mg/L, respectively for guppies, and 0.0, 19.4, 56.9, and 137.8 mg/L, respectively for medaka). Nine months after test initiation, approximately one-third of the fish from each exposure group was transferred from the exposure system to aquaria receiving 2,2-bis(bromomethyl)-1,3-propanediol-free water under flow-through conditions for an additional 7 (guppies) or 5 (medaka) months. Fish remaining in the exposure system continued to be exposed to 2,2-bis(bromomethyl)-1,3-propanediol at the medium and low treatment for a total of 16 months (488 days; guppies) or 14 months (428 days; medaka). Guppies in the high treatment were exposed for approximately 14.5 months (443 days) when the treatment was terminated due to increasing mortality of fish. Surviving fish in both the exposure system and those placed in 2,2-bis(bromomethyl)-1,3-propanediol-free aquaria at 9 months were examined for clinical signs of toxicity and carcinogenicity, sacrificed, and preserved for histopathologic evaluation. To assess the toxic and carcinogenic effects of 2,2-bis(bromomethyl)-1,3-propanediol, histopathologic evaluations were conducted on major tissues and organs in each fish.

Nitromethane

The purpose of this study was to determine the carcinogenic potential of chronic exposure to sublethal concentrations of nitromethane in two small fish species, guppies (*Poecilia reticulata*) and medaka (*Oryzias latipes*). Following 2-day static tests and 7-day flow-through tests, 28-day range finding studies using guppies and medaka were conducted to determine maximum nitromethane concentrations to use in the subsequent chronic exposure studies. The treatment concentration selection was adjusted to incorporate the approximate

highest no-observable-effect concentration from the 28-day range finding studies as the high concentration in the chronic studies; 70 mg/L for guppies and 40 mg/L for medaka. The low concentration selected was 10 mg/L and the mid-level concentration selected was 30 mg/L for guppies and 20 mg/L for medaka, each a mid point between the high and low concentrations. Guppies were exposed to nitromethane in a flow-through system to each of four nominal concentrations (0, 10, 30, and 70 mg/L; measured concentrations were 0.0, 9.9, 28.7, and 66.4 mg/L, respectively). Medaka were similarly exposed to nitromethane at four nominal concentrations (0, 10, 20, and 40 mg/L; measured concentrations were 0.0, 9.3, 20.8, and 41.7 mg/L, respectively). Nine months after the test initiation, approximately one-third of the fish from each exposure group was transferred from the exposure system to aquaria receiving nitromethane-free water under flow-through conditions for an additional 7 (guppies) or 4 (medaka) months. Fish remaining in the exposure system continued nitromethane exposure for approximately 16 months (495 days; guppies) or 13 months (398 days; medaka). Surviving fish in both the exposure system and those placed in nitromethane-free aquaria at 9 months were examined for clinical signs of toxicity and carcinogenicity, sacrificed, and preserved for histopathologic evaluation. Histopathologic evaluations were conducted on major tissues and organs in each fish to assess the toxic and carcinogenic effects of nitromethane.

1,2,3-Trichloropropane

The National Toxicology Program tested 1,2,3-trichloropropane because it is a high production chemical which has been found as an impurity in certain nematicides and soil fumigants. This chemical has also been detected in drinking water and ground water in the United States. The purpose of this study was to determine the carcinogenic potential of chronic exposure to sublethal concentrations of 1,2,3-trichloropropane in two small fish species, guppies (*Poecilia reticulata*) and medaka (*Oryzias latipes*). Following 2-day static tests and 7-day flow-through tests, 28-day range finding studies using guppies and medaka were conducted to determine maximum 1,2,3-trichloropropane concentrations to use in the subsequent chronic exposure studies. Two replicates containing each of six nominal concentrations (0.0, 6.4, 10.8, 18.0, 30.0, and 50.0 mg/L) were employed. Exposure concentrations above 18 mg/L compromised the growth rates of study animals. The 18 mg/L, though it produced lethargy in the study animals, did not seem

to produce any visible health effects; thus, 18 mg/L was selected as the high exposure concentration for guppies and medaka. Each of the two lower concentrations were set at 4.5 and 9 mg/L, each being 50% of the next higher concentration. These concentrations, it was hoped, would produce at least one effect and one no-effect 1,2,3-trichloropropane treatment.

Guppies and medaka were exposed to 1,2,3-trichloropropane in a flow-through system to each of four nominal concentrations, 0, 4.5, 9.0, and 18.0 mg/L (measured concentrations were 0.0, 4.4, 8.8, and 18.2 mg/L for guppies and 0.0, 4.6, 9.2, and 18.0 mg/L for medaka). Nine months after the test initiation, approximately one-third of the fish from each exposure group were

transferred from the exposure system to aquaria receiving 1,2,3-trichloropropane-free water under flow-through conditions. They remained in this system for an additional 7 (guppies) or 4 (medaka) months. Fish remaining in the exposure system continued 1,2,3-trichloropropane exposure for a total of approximately 16 months (487 days; guppies) or 13 months (396 days; medaka). Surviving fish in both the exposure system and those placed in 1,2,3-trichloropropane-free aquaria at 9 months were examined for clinical signs of toxicity and carcinogenicity, sacrificed, and preserved for histopathologic evaluation. Histopathologic evaluations were conducted on major tissues and organs in each fish to assess the toxic and carcinogenic effects of 1,2,3-trichloropropane.

MATERIALS AND METHODS

PROCUREMENT AND CHARACTERIZATION

2,2-Bis(bromomethyl)-1,3-propanediol

2,2-Bis(bromomethyl)-1,3-propanediol was obtained from Aldrich Chemical Company (Milwaukee, WI) in three lots (16728PG, 11215BQ, and 00713BQ) that were used in the 14- and 16-month studies. Lots 11215BQ and 00713BQ were manufactured in the same batch but were assigned different lot numbers by the supplier because they were received on different dates. Identity, purity, and stability analyses were conducted by the study laboratory, University of Southern Mississippi, Gulf Coast Research Laboratory (Gulf Springs, MS).

Lots 16728PG and 11215BQ were identified as 2,2-bis(bromomethyl)-1,3-propanediol by the University of Mississippi (Oxford, MS) (lot 16728PG) and by the University of Southern Mississippi (Hattiesburg, MS) (lot 11215BQ) using infrared spectroscopy. The spectra were consistent with the structure of 2,2-bis(bromomethyl)-1,3-propanediol.

The purities of lots 16728PG and 11215BQ were determined by the study laboratory using gas chromatography (GC). GC revealed that both lots contained no contaminants. Information provided by the supplier indicated that the purity of lot 16728PG was greater than 99%. The overall purity of lots 16728PG and 11215BQ was determined to be greater than 99%.

The bulk chemical was stored at approximately 4° C (lot 16728PG) or at room temperature (lots 11215BQ and 00713BQ). The stability of bulk 2,2-bis(bromomethyl)-1,3-propanediol was monitored monthly during the 14- and 16-month studies using GC. No contaminants were found during the course of the studies.

Nitromethane

Nitromethane was obtained from Aldrich Chemical Company in one lot (CG02304HF) that was used in the

13- and 16-month studies. Identity, purity, and stability analyses were conducted by the study laboratory.

Lot CG02304HF, a colorless liquid, was identified as nitromethane by the University of Mississippi using infrared spectroscopy. The spectrum was consistent with the structure of nitromethane.

The purity of nitromethane was determined by the study laboratory using GC; lot CG02304HF contained no contaminants other than water. Information provided by the supplier indicated that the purity of lot CG02304HF was greater than 99%. The overall purity of lot CG02304HF was determined to be greater than 99%.

The bulk chemical was stored at approximately 4° C. The stability of bulk nitromethane was monitored monthly during the 13- and 16-month studies using GC. No contaminants were found during the course of the studies.

1,2,3-Trichloropropane

1,2,3-Trichloropropane was obtained from Aldrich Chemical Company in one lot (01628HG) that was used in the 13- and 16-month studies. Identity and purity analyses were conducted by the study laboratory.

Lot 01628HG, a colorless to straw-colored liquid, was identified as 1,2,3-trichloropropane by the University of Southern Mississippi and by the supplier using infrared spectroscopy. The spectra were consistent with a reference spectrum (Aldrich, 1985).

The purity of lot 01628HG was determined by the University of Southern Mississippi, the chemical supplier, and the study laboratory using GC. GC by several methods indicated that lot 01628HG was either highly pure or 99% pure. The overall purity of lot 01628HG was determined to be 99%. The bulk chemical was stored at approximately 4° C.

EXPOSURE SOLUTION GENERATION AND EXPOSURE SYSTEM

Exposure was conducted in a closed chamber similar to that described by Walker *et al.* (1985) (Figure G4). A schematic of the exposure solution delivery systems used in the 13-, 14-, and 16-month studies is shown in Figure G5. Stock solutions of 2,2-bis(bromomethyl)-1,3-propanediol, nitromethane, or 1,2,3-trichloropropane were prepared by adding neat chemical to diluent well water in glass carboys to produce concentrations sufficient to provide the required concentrations in exposure aquaria. A water partitioner was regulated to perform at least five volume additions per day to each exposure aquarium. Diluent well water entered the water partitioner through a solenoid-controlled valve immediately after filtration and ultraviolet light sterilization. A float switch within the water partitioner activated liquid dispensing pumps (Hamilton Company, Reno, NV) which were preset to remove the appropriate volume of stock solution from the carboy containers. The dispensing pumps injected the stock solution through Teflon[®] microbore tubing into glass mixing/splitter boxes immediately prior to delivery of two liters of diluent water. Diluent water alone was delivered to the control aquaria mixing/splitter boxes. Exposure solutions were delivered from mixing/splitter boxes to duplicate 35 L exposure aquaria through calibrated glass delivery lines. Aquaria volumes were maintained by an overflow drain siphon designed to remove water from near the bottom of each aquarium.

The resin-coated plywood exposure chamber measured 333 cm long, 118 cm wide, and 244 cm high. Access to the chamber was through sliding polycarbonate doors on each side of the chamber. Aquaria were placed at random in a central waterbath maintained at $26^{\circ} \pm 1^{\circ}$ C. Timer-controlled fluorescent lights with dimmer ballasts provided 16 hours of light per 24 hours with 30-minute transitions simulating dawn and dusk. The chamber was maintained at a slightly negative pressure.

Individual test aquaria measured 48 cm long, 35.5 cm wide, and 24 cm high. A water depth of 20.5 cm was maintained. Aquaria were individually covered and covers of adjacent tanks were not raised simultaneously.

EXPOSURE SOLUTION CONCENTRATION MONITORING

Concentrations of 2,2-bis(bromomethyl)-1,3-propanediol, nitromethane, and 1,2,3-trichloropropane in the exposure aquaria were monitored using GC, approximately 3 times each week. Duplicate samples were analyzed from each aquarium. Summaries of the aquaria solution concentrations are given in Tables G2 through G4.

EXPOSURE SOLUTION CHARACTERIZATION

2,2-Bis(bromomethyl)-1,3-propanediol

Exposure solution characterization was performed prior to the start of the 14- and 16-month studies. The generation of target concentrations of 2,2-bis(bromomethyl)-1,3-propanediol exposure solution in exposure aquaria was determined with and without fish present. Duplicate aquaria at target concentrations of 10, 35, and 100 mg/L were sampled prior to the first injection and 3, 6, 9, 12, 14, and 24 hours after the initial injection. Samples were analyzed using GC. All aquaria reached their approximate target 2,2-bis(bromomethyl)-1,3-propanediol concentrations within 24 hours of the initial injection.

The uniformity of distribution of 2,2-bis(bromomethyl)-1,3-propanediol in single 10 and 100 mg/L aquaria was determined following 6-day intermittent flow-through generation and stability studies. Samples were collected from nine locations at 2 cm below the surface of each aquarium solution and from nine locations within 2 cm of the bottom of each aquarium. Samples were analyzed using GC and uniformity of distribution was established.

The persistence of 2,2-bis(bromomethyl)-1,3-propanediol in the exposure aquaria was determined by monitoring the exposure solution concentration with intermittent flow through of diluent water only after stable target concentrations were reached. Samples were collected every 3 hours for 12 hours and analyzed using GC. The measured concentration was below the limit of detection after 6 hours in the 10 mg/L aquaria, after 12 hours in the 35 mg/L aquaria, and was less than 6 mg/L after 12 hours in the 100 mg/L aquaria.

Stability of 2,2-bis(bromomethyl)-1,3-propanediol in the intermittent flow-through exposure solution was monitored with and without fish present for 132 hours after approximate target concentrations were reached in 10, 35, and 100 mg/L exposure aquaria. Samples were collected approximately every 4 hours and analyzed using GC. Stability was confirmed for at least 132 hours. The stability of 2,2-bis(bromomethyl)-1,3-propanediol in exposure solution without intermittent flow-through was monitored with and without fish present for 24 hours. The 2,2-bis(bromomethyl)-1,3-propanediol exposure solution was stable for up to 24 hours in the absence of intermittent flow-through.

Nitromethane

Exposure solution characterization was performed prior to the start of the 13- and 16-month studies. The generation of target concentrations of nitromethane exposure solution in exposure aquaria by intermittent flow-through was determined with and without fish present. Duplicate aquaria at target concentrations of 8.6, 24.5, and 70.0 mg/L were sampled prior to the first injection and every 2 hours for 14 hours after the initial injection. Samples were analyzed using GC. All aquaria reached their approximate target nitromethane concentrations within 14 hours of the initial injection.

The uniformity of distribution of nitromethane in a single 70.0 mg/L aquarium was determined during 6-day intermittent flow-through generation and stability studies. Samples were collected from nine locations 2 cm below the surface of the aquarium solution and from nine locations within 2 cm of the bottom of the aquarium. Samples were analyzed using GC and uniformity of distribution was established.

The persistence of nitromethane in the exposure aquaria was determined by monitoring the exposure solution concentration of a 100 mg/L exposure solution prepared by injection of neat nitromethane into the mixing/splitter box. Intermittent flow-through contained diluent water only after stable target concentrations were reached. Samples were collected every hour for 13 hours and analyzed using GC. The nitromethane concentration was below the limit of detection after 13 hours.

Stability of nitromethane in the intermittent flow-through exposure solution was monitored with and without fish present for 132 hours after approximate target concentrations were reached in 8.6, 24.5, and 70.0 mg/L

exposure aquaria. Samples were collected approximately every 4 hours and analyzed using GC. Stability was confirmed for up to 132 hours. The stability of nitromethane stock carboy solutions was monitored for 144 hours. Samples were collected approximately every 24 hours and analyzed using GC. The results indicated that nitromethane solution was stable in stock carboys for at least 144 hours. The stability of nitromethane in exposure solution without intermittent flow-through was monitored for approximately 70 hours with and without fish present in 100 mg/L exposure solutions prepared by injection of neat nitromethane into the mixing/splitter box. Nitromethane concentrations decreased to approximately 60% of initial target concentrations after 3.5 hours.

1,2,3-Trichloropropane

Exposure solution characterization was performed prior to the start of the 13- and 16-month studies. The generation of target concentrations of 1,2,3-trichloropropane exposure solution in exposure aquaria by intermittent flow-through was determined with and without fish present. Duplicate aquaria at target concentrations of 10, 35, and 100 mg/L were sampled prior to the first injection and 3, 6, 9, 12, 14, and 24 hours after the initial injection. Samples were analyzed using GC. All aquaria reached their approximate target 1,2,3-trichloropropane concentrations within 24 hours of the initial injection.

The uniformity of distribution of 1,2,3-trichloropropane in single 10 and 100 mg/L aquaria was determined during 6-day intermittent flow-through generation and stability studies. Samples were collected from nine locations 2 cm below the surface of the aquarium solution and from nine locations within 2 cm of the bottom of the aquarium. Samples were analyzed using GC and uniformity of distribution was established.

The persistence of 1,2,3-trichloropropane in the exposure aquaria was determined by monitoring the exposure solution concentration with intermittent flow-through of diluent water only after stable target concentrations were reached. Samples were collected every 3 hours for 12 hours and analyzed using GC. After 12 hours, the measured concentrations were 0.96 mg/L in the 10 mg/L aquaria, 3.63 mg/L in the 35 mg/L aquaria, and 9.16 mg/L in the 100 mg/L aquaria.

Stability of 1,2,3-trichloropropane in the intermittent flow-through exposure solution was monitored with and

without fish present for 120 hours after approximate target concentrations were reached in 10, 35, and 100 mg/L exposure aquaria. Samples were collected approximately every 4 hours and analyzed using GC. Stability was confirmed for at least 120 hours. The stability of 1,2,3-trichloropropane in exposure solution without intermittent flow-through was monitored with and without fish present for 24 hours. After 24 hours, the average 1,2,3-trichloropropane exposure solution concentrations in all aquaria declined to approximately 54% of the measured concentrations before flow-through was terminated.

16-MONTH STUDIES IN GUPPIES AND 13- AND 14-MONTH STUDIES IN MEDAKA

Study Design

The results of previous studies of life span and dose range-finding studies (2-day static, 7-day flow-through, and 28-day range-finding studies) were used to determine the overall study lengths and the individual study dose ranges. Groups of approximately 220 guppies (two replicates of 110) were maintained in aquaria water containing 0, 24, 60, or 150 mg/L 2,2-bis(bromomethyl)-1,3-propanediol; 0, 10, 30, or 70 mg/L nitromethane; or 0, 4.5, 9.0, or 18.0 mg/L 1,2,3-trichloropropane. Groups of approximately 340 medaka (two replicates of 170) were maintained in aquaria water containing 0, 24, 60, or 150 mg/L 2,2-bis(bromomethyl)-1,3-propanediol; 0, 10, 20, or 40 mg/L nitromethane, or 0, 4.5, 9.0, or 18.0 mg/L 1,2,3-trichloropropane. The overall study durations were 16 months for all guppy studies, 14 months for 2,2-bis(bromomethyl)-1,3-propanediol-exposed medaka, and 13 months for nitromethane- and 1,2,3-trichloropropane-exposed medaka. More medaka were used because of the expected shorter lifespan.

Nine months after initiation of exposure, all treatment and control fish were removed from the test aquaria and counted. Ten guppies and 10 medaka from each group replicate were sacrificed for histopathologic analysis. The remaining fish from each group were distributed into either continuing exposure groups or stop-exposure groups in chemical-free water. This distribution was performed such that roughly two-thirds of the remaining fish from each group were placed in continuing exposure groups and the remaining third were placed into stop-

exposure groups for the remainder of the studies. The stop-exposure component was added since this was a new system for NTP and for fish studies, and it was thought that stopping the exposure at 9 months and transferring to exposure chemical-free aquaria would allow for better survival and tumor development. The sex of guppies and medaka was not determined until histopathologic analysis.

Source and Specification of Animals

Guppy (*Poecilia reticulata*) and medaka (*Oryzias latipes*) fry used in the 13-, 14-, and 16-month studies were obtained from established Gulf Coast Research Laboratory (GCRL) cultures. Guppy cultures originating from Aqua World (St. Louis, MO) and medaka cultures originating from Carolina Biological Supply (Burlington, NC) had been maintained at GCRL for more than 10 years prior to the initiation of the studies. Brood cultures were established from the GCRL cultures for the purpose of producing fry for use in these studies.

Fry were collected from brood cultures to create the various dose groups in the studies. Dose groups were established by randomly pooling fry into transfer vessels that were in turn randomly assigned to exposure aquaria. Fry were 14 days old (nitromethane and 1,2,3-trichloropropane) or 16 days old [2,2-bis(bromomethyl)-1,3-propanediol] on the first day of the studies.

Animal Maintenance

Animals were maintained in all glass aquaria throughout the studies. Aquaria were cleaned at least once weekly except for the nitromethane study aquaria which were cleaned 2 (guppy) or 3 (medaka) times per day due to microfauna growth. Aquaria water was carbon-filtered, aerated, unchlorinated well water containing the appropriate chemical concentration. All exposure aquaria for each study and species were partially submerged in a single water bath to maintain consistent temperature within and between exposure concentrations and their replicates. For the first 9 months, fish were maintained in aquaria that were 48 cm long × 38 cm wide × 24 cm high, containing approximately 35 L of test solution. To adjust for loss of fish volume at 9 months, fish were moved to smaller aquaria that were 44 cm long × 25 cm wide × 23 cm high, containing approximately 21 L of test solution. A water depth of 19 cm was maintained by a drain siphon that removed water from near the bottom of each aquarium. Throughout the studies, aquaria were covered with polycarbonate covers to prevent the escape

of fish and aerosol mixing of test chemical between exposure groups. Covers were raised only for feeding, observations, tank maintenance, and sample collection. Covers were not raised from adjacent aquaria simultaneously. Animals were fed flake food and rehydrated brine shrimp larvae once daily. Flake food was withheld 24 to 48 hours before sacrifice and brine shrimp larvae were withheld during the last week of study to clear the gut. Information on feed composition and contaminants is provided in Appendix H. Further details of animal maintenance are given in Table 1.

Visual External Examinations and Pathology

All animals were observed twice daily. Visual external findings were recorded daily and body weights and lengths were recorded at the time of sacrifice. Sacrifice was via tricane methanesulfonate (MS222). Individual animal worksheets were prepared prior to the start of mounting and sectioning. These sheets were used throughout the entire histopathology process. Whole fish were fixed in Bouin's fixative solution for 96 hours, preserved in 10% neutral buffered formalin, processed, and embedded in paraffin. Whole fish were processed unless trimming was required to fit a female guppy into a cassette or to capture a gross lesion. Ten longitudinal step sections (two serial sections at each of five steps) through the whole fish at a thickness of 4 to 6 μm were prepared for microscopic examination by staining with hematoxylin and eosin. Fish that died early were generally not evaluated histologically due to severe autolysis or cannibalism. Tissues examined microscopically are listed in Table 1.

Microscopic evaluations were completed by a study pathologist. Following the evaluation, the slides and blocks were sent to the NTP Archives for inventory. The slides, individual animal data records, pathology tables, and study pathologists reports were sent to an independent quality assessment pathologist who conducted a pathology quality assessment review of each study of each exposure chemical and both fish species. The quality assessment reviews were conducted in two phases. In the first phase, the quality assessment pathologist reviewed all diagnoses, neoplastic and nonneoplastic, from all tissues from a randomly selected 40% of the fish each from the control and high exposure groups from each of the studies. Only fish that survived to study termination were examined. No fish that died early and

none of the interim evaluation fish were reviewed. In each study, the quality assessment review of all diagnoses in all tissues from 40% of the fish from the control and high exposure groups confirmed the study pathologist's findings concerning potential chemical-related neoplastic and nonneoplastic effects. The primary focus of these studies was to assess the performance of this model relative to the neoplastic responses, with less concern for the nonneoplastic responses. For animals in which tissues were reviewed for nonneoplastic lesions there was good agreement. However, because of the magnitude of the studies, the nonneoplastic diagnoses were not reviewed with the same rigor as the neoplastic diagnoses. The most important nonneoplastic lesions were included in the results section of the report, and there is confidence in the accuracy of the presented data.

Consequently, in the second phase another review was undertaken for each study in which all neoplasms diagnosed by the study pathologist in potential target organs that had not been reviewed previously during the first phase of the review were examined by the quality assessment pathologist in order to confirm the diagnoses. Only diagnosed neoplasms were reviewed since during the initial review of tissues from 40% of the control and high exposure fish no additional proliferative lesions in any of the potential target organs were observed. Thus it was considered highly unlikely that the review of target organs from fish in which no neoplasm had been diagnosed by the study pathologist would reveal any additional neoplasms.

Following completion of the quality assessment reviews for all studies, an NTP Pathology Working Group (PWG) was convened with the quality assessment pathologist now serving as the PWG chairperson. A single PWG was held which included all the studies of all three exposure chemicals in both fish species. Representative histopathology slides containing examples of lesions related to chemical administration, disagreements in diagnoses between the study pathologist and quality assessment pathologist/PWG chairperson, or lesions of general interest were presented to the PWG by the chairperson for review. The PWG consisted of pathologists experienced in fish and/or rodent pathology. This group examined the tissues without any knowledge of exposure groups or previously rendered diagnoses. Overall, the PWG confirmed the study pathologist's findings in each study.

TABLE 1
Experimental Design and Materials and Methods in the Waterborne Studies
of 2,2-Bis(bromomethyl)-1,3-propanediol, Nitromethane, 1,2,3-Trichloropropane

2,2-Bis(bromomethyl)- 1,3-propanediol	Nitromethane	1,2,3-Trichloropropane
Study Laboratory University of Southern Mississippi, Gulf Coast Research Laboratory (Ocean Springs, MS)	University of Southern Mississippi, Gulf Coast Research Laboratory (Ocean Springs, MS)	University of Southern Mississippi, Gulf Coast Research Laboratory (Ocean Springs, MS)
Strain and Species Guppy (<i>Poecilia reticulata</i>) Medaka (<i>Oryzias latipes</i>)	Guppy (<i>Poecilia reticulata</i>) Medaka (<i>Oryzias latipes</i>)	Guppy (<i>Poecilia reticulata</i>) Medaka (<i>Oryzias latipes</i>)
Animal Source University of Southern Mississippi, Gulf Coast Research Laboratory (Ocean Springs, MS)	University of Southern Mississippi, Gulf Coast Research Laboratory (Ocean Springs, MS)	University of Southern Mississippi, Gulf Coast Research Laboratory (Ocean Springs, MS)
Time Held Before Studies 16 Days	14 Days	14 Days
Average Age When Studies Began 16 Days	14 Days	14 Days
Date of First Exposure August 16, 1995	May 17, 1995	May 30, 1996
Duration of Exposure Guppy: 9 months (stop-exposure and interim evaluation groups), 16 months (core group), or 14.5 months (150 mg/L group) Medaka: 9 months (stop-exposure and interim evaluation groups) or 14 months (core group)	Guppy: 9 months (stop-exposure and interim evaluation groups), 16 months (core group), or 13 months (70 mg/L group) Medaka: 9 months (stop-exposure and interim evaluation groups) or 13 months (core group)	Guppy: 9 months (stop-exposure and interim evaluation groups) or 16 months (core group) Medaka: 9 months (stop-exposure and interim evaluation groups) or 13 months (core group)
Date of Last Exposure Guppy: December 15, 1996 Medaka: October 16, 1996	Guppy: September 23, 1996 Medaka: June 17, 1996	Guppy: September 28, 1997 Medaka: June 30, 1997
Sacrifice Dates Guppy: June 5 (interim evaluation group), November 2 (150 mg/L core group), December 16 (remaining core groups), or December 17 (stop-exposure group), 1996 Medaka: June 5 (interim evaluation group), October 17 (core group), or October 18 (stop-exposure group), 1996	Guppy: March 1 (interim evaluation group), June 17 (70 mg/L group), or September 24 (remaining core and stop-exposure groups), 1996 Medaka: February 29 (interim evaluation group), June 18 (core group), or June 19 (stop-exposure group), 1996	Guppy: March 12 (interim evaluation group) or September 29 (core and stop- exposure groups), 1997 Medaka: March 11 (interim evaluation group) or July 1, (core and stop-exposure groups), 1997
Average Age at Sacrifice Guppy: 57 weeks (150 mg/L core group), 72 weeks (remaining core groups and stop-exposure group), or 45 weeks (interim analysis group) Medaka: 64 weeks (core and stop-exposure groups) or 45 weeks (interim analysis group)	Guppy: 74 weeks (core and stop-exposure groups), 57 weeks (70 mg/L core group), or 44 weeks (interim analysis group) Medaka: 60 weeks (core and stop-exposure groups) or 44 weeks (interim analysis group)	Guppy: 72 weeks (core and stop-exposure groups) or 44 weeks (interim analysis group) Medaka: 59 weeks (core and stop-exposure groups) or 43 weeks (interim analysis group)

TABLE 1
Experimental Design and Materials and Methods in the Waterborne Studies
of 2,2-Bis(bromomethyl)-1,3-propanediol, Nitromethane, 1,2,3-Trichloropropane

2,2-Bis(bromomethyl)-1,3-propanediol	Nitromethane	1,2,3-Trichloropropane
Approximate Size of Study Groups		
Guppy: 220 fish Medaka: 340 fish	Guppy: 220 fish Medaka: 340 fish	Guppy: 220 fish Medaka: 340 fish
Method of Distribution		
Animals were distributed randomly into groups of equal numbers.	Animals were distributed randomly into groups of equal numbers.	Animals were distributed randomly into groups of equal numbers.
Approximate Animals per Aquarium		
Guppy: 110 Medaka: 170	Guppy: 110 Medaka: 170	Guppy: 110 Medaka: 170
Diet		
Aqua-Tox (Specialized Formula) Flake (Ziegler Brothers, Inc., Gardners, PA) once a day until 24 hours before sacrifice and rehydrated brine shrimp (<i>Artemia</i>) larvae (Aquarium Products, Glen Burnie, MD) once daily except during the last week of the study.	Aqua-Tox (Specialized Formula) Flake (Ziegler Brothers, Inc., Gardners, PA) once a day until 24 hours before sacrifice and rehydrated brine shrimp (<i>Artemia</i>) larvae (Aquarium Products, Glen Burnie, MD) once daily except during the last week of the study.	Aqua-Tox (Specialized Formula) Flake (Ziegler Brothers, Inc., Gardners, PA) once a day until 24 hours before sacrifice and rehydrated brine shrimp (<i>Artemia</i>) larvae (Aquarium Products, Glen Burnie, MD) once daily except during the last week of the study.
Aquaria Water		
Aged, aerated, carbon-filtered, unchlorinated well water (University of Southern Mississippi, Ocean Springs, MS)	Aged, aerated, carbon-filtered, unchlorinated well water (University of Southern Mississippi, Ocean Springs, MS)	Aged, aerated, carbon-filtered, unchlorinated well water (University of Southern Mississippi, Ocean Springs, MS)
Aquaria		
Glass (Oceanview Aquarium Products, Inc., Pascagoula, MS) with polycarbonate covers; brushed daily and siphoned at least once weekly.	Glass (Oceanview Aquarium Products, Inc., Pascagoula, MS) with polycarbonate covers; brushed two (guppy) or three (medaka) times per day.	Glass (Oceanview Aquarium Products, Inc., Pascagoula, MS) with polycarbonate covers; brushed daily and siphoned at least once weekly.
Aquatic Environment		
Temperature: 26° ± 1.0° C, pH: 8.9 ± 0.1	Temperature: 26° ± 0.3° C, pH: 8.8 ± 0.2	Temperature: 26° ± 0.3° C, pH: 8.8 ± 0.2
Room fluorescent light: 16 hours light/ 8 hours dark with 30 minute transition to simulate dawn and dusk.	Room fluorescent light: 16 hours light/ 8 hours dark with 30 minute transition to simulate dawn and dusk.	Room fluorescent light: 16 hours light/ 8 hours dark with 30 minute transition to simulate dawn and dusk.
Dissolved oxygen: ≥50% saturation	Dissolved oxygen: ≥40% saturation	Dissolved oxygen: ≥40% saturation
Exposure Concentrations		
0, 24, 60, or 150 mg/L	Guppy: 0, 10, 30, or 70 mg/L Medaka: 0, 10, 20, or 40 mg/L	0, 4.5, 9.0, or 18.0 mg/L
Type and Frequency of Observation		
Observed twice daily at intervals at least 6 hours apart. Body weights and lengths were recorded at necropsy.	Observed twice daily at intervals at least 6 hours apart. Body weights and lengths were recorded at necropsy.	Observed twice daily at intervals at least 6 hours apart. Body weights and lengths were recorded at necropsy.

TABLE 1
Experimental Design and Materials and Methods in the Waterborne Studies
of 2,2-Bis(bromomethyl)-1,3-propanediol, Nitromethane, 1,2,3-Trichloropropane

2,2-Bis(bromomethyl)- 1,3-propanediol	Nitromethane	1,2,3-Trichloropropane
<p>Method of Sacrifice Anesthetization with tricaine methanesulfonate</p>	<p>Anesthetization with tricaine methanesulfonate</p>	<p>Anesthetization with tricaine methanesulfonate</p>
<p>Histopathology^a Complete histopathology was performed on all animals sacrificed at 9 months and at the end of the studies. In addition to gross lesions and tissue masses, the following tissues were examined: bone, brain, chromaffin tissue, corpuscle of Stannius, esophagus, eye, gallbladder, gill, heart, hematopoietic tissue, interrenal tissue, intestine, kidney, liver, olfactory tissue, oral cavity, ovary, pancreas, peripheral nerve, pineal gland, pituitary gland, psuedobranch, skeletal muscle, skin, spinal cord, spleen, statoacoustic organ, swim bladder, testes, thymus, thyroid tissue, and urinary bladder.</p>	<p>Complete histopathology was performed on all animals sacrificed at 9 months and at the end of the studies. In addition to gross lesions and tissue masses, the following tissues were examined: bone, brain, chromaffin tissue, corpuscle of Stannius, esophagus, eye, gallbladder, gill, heart, hematopoietic tissue, interrenal tissue, intestine, kidney, liver, olfactory tissue, oral cavity, ovary, pancreas, peripheral nerve, pineal gland, pituitary gland, psuedobranch, skeletal muscle, skin, spinal cord, spleen, statoacoustic organ, swim bladder, testes, thymus, thyroid tissue, and urinary bladder.</p>	<p>Complete histopathology was performed on all animals sacrificed at 9 months and at the end of the studies. In addition to gross lesions and tissue masses, the following tissues were examined: bone, brain, chromaffin tissue, corpuscle of Stannius, esophagus, eye, gill, gallbladder, heart, hematopoietic tissue, interrenal tissue, intestine, kidney, liver, olfactory tissue, oral cavity, ovary, pancreas, peripheral nerve, pineal gland, pituitary gland, psuedobranch, skeletal muscle, skin, spinal cord, spleen, statoacoustic organ, swim bladder, testes, thymus, thyroid tissue, and urinary bladder.</p>

^a A gross observation list was employed to record all gross abnormalities which included skeletal abnormalities and the number and description of tissue masses.

STATISTICAL METHODS

Survival Analyses

The probability of survival was estimated by the product-limit procedure of Kaplan and Meier (1958). Fish that were sacrificed or transferred to another tank were censored; fish found dead before the 9-month and terminal sacrifices were not censored. Possible dose-related trends were tested with Tarone's (1975) life table test; pairwise comparisons with the control group were made with Cox's (1972) method for testing the equality of two groups.

Incidence of Lesions

For each chemical, data were collected from the two replicate tanks in the control group and at each dose level. For each combination of sex, species, and chemical, tank effects were tested using Fisher's exact test for the neoplasm of interest. The frequency of significant differences in tumor incidences between the two replicates was consistent with what would be expected by chance. Therefore, lesions and tissue counts from each replicate were pooled within each sex, species, chemical study, and treatment (9-month, core, or stop-exposure study) combination for the control groups and for each dose group. Each combination of chemical study, sex, species, and treatment were analyzed separately. Lesion incidences are based on the number of tissues examined in which the lesion was present.

Analysis of Lesions

Because lesions were generally examined only in fish that were sacrificed and not those that died early, survival adjustments were not made.

Neoplastic and nonneoplastic lesions were analyzed as follows. Dose-related trends were tested with the Cochran-Armitage trend test (Armitage, 1971; Gart *et al.*, 1979). When a small number of lesions were present and they were disproportionately distributed at one extreme of the dose range, an exact permutation trend test was used (Plackett, 1981). Fisher's exact test was used for pairwise comparisons of each dose group to the control group. P-values for the trend tests and Fisher's exact test are one sided.

Analysis of Continuous Variables

Body weight and body length, which have approximately normal distributions, were analyzed by analysis of variance followed by Dunnett's multiple comparison procedure (1955) to compare each dose group to the control group.

QUALITY ASSURANCE METHODS

The 13-, 14-, and 16-month studies were conducted in compliance with Food and Drug Administration Good Laboratory Practice Regulations (21 CFR, Part 58). In addition, as records from the studies were submitted to the NTP Archives, these studies were audited retrospectively by an independent quality assurance contractor. Separate audits covered completeness and accuracy of the pathology data, pathology specimens, final pathology tables, and a draft of this NTP Technical Report. Audit procedures and findings are presented in the reports and are on file at NIEHS. The audit findings were reviewed and assessed by NTP staff, and all comments were resolved or otherwise addressed during the preparation of this Technical Report.

RESULTS

2,2-BIS(BROMOMETHYL)- 1,3-PROPANEDIOL

16-MONTH STUDY IN GUPPIES

Survival

2,2-Bis(bromomethyl)-1,3-propanediol was chronically toxic to guppies in the exposed core and stop-exposure groups (Table 2). Due to mortality, exposure of core study fish in the 150 mg/L group was terminated on day 443, after approximately 64 weeks on study, and fish were maintained in 2,2-bis(bromomethyl)-1,3-propanediol-free water in the exposure system until the end of the study.

Exposure Concentrations, Body Lengths, and Body Weights

Nominal exposure concentrations of 24, 60, and 150 mg/L (analyzed three times per week) provided actual aquaria water exposure concentrations of 20.0, 53.5, and 139.0 mg/L 2,2-bis(bromomethyl)-1,3-propanediol, respectively. The only treatment-related difference between the control and exposed groups occurred at the 9-month interim evaluation at which time the 150 mg/L fish were longer than the control fish (Tables 3 and 4).

TABLE 2
Survival of Guppies in the 16-Month Waterborne Study of 2,2-Bis(bromomethyl)-1,3-propanediol

	0 mg/L	24 mg/L	60 mg/L	150 mg/L
Animals initially in study	220	220	220	220
Died before the 9-month interim evaluation	3	9	13	16
Unaccounted for ^a	6	2	8	6
9-Month interim evaluation	20	20	20	20
Died after reallocation ^b				
Core study	4	8	18	40
Stop-exposure study	1	3	10	22
Survivors				
Core study	123	117	101	78 ^d
Stop-exposure study	63	61	50	38
Survival analysis ^c				
Core study	<0.0001	0.0360	<0.0001	<0.0001
Stop-exposure study	<0.0001	0.0429	0.0001	<0.0001

^a The laboratory report did not account for these fish at 9 months.

^b At 9 months, approximately one third of the fish in each replicate was reassigned to stop-exposure aquaria; the remaining fish (core study) were returned to their original exposure aquaria.

^c The result of life table trend test (Tarone, 1975) is in the control column, and the results of the life table pairwise comparison (Cox, 1972) between the controls and exposed animals appear in the exposure concentration columns.

^d Exposure was stopped during week 64 (day 443), and fish were maintained in exposure chemical-free aquaria until the end of the study.

TABLE 3
Mean Body Lengths of Guppies in the 16-Month Waterborne Study
of 2,2-Bis(bromomethyl)-1,3-propanediol^a

Treatment	9-Month Interim Evaluation	Core Study	Stop-Exposure Study
0 mg/L	28.4 ± 1.0	34.2 ± 1.1	34.5 ± 1.16
24 mg/L	28.9 ± 1.1	33.8 ± 1.2	36.5 ± 1.2
60 mg/L	30.4 ± 1.2	34.7 ± 1.2	35.2 ± 1.3
150 mg/L	30.2 ± 1.7	34.1 ± 1.2	34.2 ± 1.6

^a Data are presented as mean length ± standard error (mm).

TABLE 4
Mean Body Weights of Guppies in the 16-Month Waterborne Study
of 2,2-Bis(bromomethyl)-1,3-propanediol

Treatment	9-Month Interim Evaluation	Core Study	Stop-Exposure Study
0 mg/L	0.55 ± 0.07	1.01 ± 0.09	1.08 ± 0.01
24 mg/L	0.55 ± 0.07	1.03 ± 0.11	1.26 ± 0.11
60 mg/L	0.63 ± 0.07	1.16 ± 0.02	1.23 ± 0.13
150 mg/L	0.66 ± 0.09	1.16 ± 0.12	1.22 ± 0.18

^a Data are presented as mean wet weight ± standard error (g).

Pathology and Statistical Analyses

This section describes the statistically or biologically noteworthy changes in incidences of neoplasms and/or nonneoplastic lesions of the liver, gallbladder, kidney, and pituitary gland. Summaries of incidences of neoplasms by replicate are presented in Appendix A.

Liver (9-Month Interim Evaluation): Hepatocellular adenomas occurred in one 24 mg/L male and in one 150 mg/L male (Table 5 and A1). A single cholangioma occurred in a control female (Table A3).

Liver (Core Study): Incidences of hepatocellular adenoma or carcinoma (combined) in 150 mg/L males were greater than those in the controls (Tables 5, A1, and A3). The incidence of basophilic focus was significantly greater in 150 mg/L males than in controls. Hepatocellular adenoma was a distinct, well demarcated, nodular lesion that produced some degree of compression of adjacent normal liver. Adenomas often were relatively small but some were quite large and replaced much of the normal liver. Adenomas consisted of a relatively uniform population of polygonal cells, generally with increased eosinophilic to basophilic cytoplasmic staining, arranged in normal appearing to slightly irregular, hypercellular hepatic tubules. Sometimes varying numbers of cells with slightly to highly vacuolated clear cytoplasm were present. Hepatocellular carcinoma was generally a large lesion that replaced much or, occasion-

ally, all of the observable liver parenchyma. The border was irregular with varying numbers of projections of neoplastic cells into the surrounding parenchyma that appeared to represent localized invasion. Neoplastic cells within carcinomas stained eosinophilic to basophilic, were polygonal to elongated, and were arranged in irregular, highly cellular, densely packed cords that were thicker than the normal tubules. Carcinomas also often tended to form solid clusters of cells. The neoplastic cells within some carcinomas were moderately to markedly pleomorphic with nuclear atypia. Cholangioma was a discrete, small to moderately large, nodular lesion, consisting of a cluster of variably sized, often irregular bile ducts surrounded by varying amounts of stroma, that replaced and often compressed adjacent hepatic parenchyma. The bile duct structures were composed of normal-appearing flattened to cuboidal to low columnar biliary epithelial cells. Basophilic focus was generally a small, round to irregular cluster of hepatocytes, with increased basophilic to amphophilic cytoplasmic staining, that caused little or no evidence of compression of the adjacent liver. Often a basophilic focus had indistinct borders although some foci, especially those with more prominent staining, appeared well demarcated from the surrounding liver.

Liver (Stop-Exposure Study): Incidences of hepatocellular adenoma (including multiple) and of hepatocellular carcinoma were greater in 150 mg/L males than in controls (Tables 5 and A2).

TABLE 5
Incidences of Neoplasms and Nonneoplastic Lesions of the Liver in Guppies
in the 16-Month Waterborne Study of 2,2-Bis(bromomethyl)-1,3-propanediol

	0 mg/L	24 mg/L	60 mg/L	150 mg/L	Trend Test P-Value ^a
Male					
<i>9-Month Interim Evaluation</i>					
Number Examined Microscopically	13	13	10	11	
Hepatocellular Adenoma ^b	0	1	0	1	0.2104
<i>Core Study</i>					
Number Examined Microscopically	61	50	41	38	
Basophilic Focus	3	4	3	8*	0.0039
Cholangioma	0	0	0	1	0.2000
Hepatocellular Adenoma, Multiple	0	0	0	2	0.0392
Hepatocellular Adenoma (includes multiple)	3	4	4	8*	0.0040
Hepatocellular Carcinoma	1	2	2	2	0.1933
Hepatocellular Adenoma or Carcinoma	4	6	6	10**	0.0027
<i>Stop-Exposure Study</i>					
Number Examined Microscopically	28	22	21	24	
Hepatocellular Adenoma, Multiple	0	0	1	2	0.0565
Hepatocellular Adenoma (includes multiple)	0	3	3	6**	0.0062
Hepatocellular Carcinoma	0	0	0	3	0.0146
Hepatocellular Adenoma or Carcinoma	0	3	3	9**	0.0001
Eosinophilic Focus	0	0	1	0	
Female					
<i>Core Study</i>					
Number Examined Microscopically	61	69	58	46	
Basophilic Focus	5	2	4	8	0.0109
Cholangioma	0	2	0	0	0.2323
Hepatocellular Adenoma, Multiple	0	0	0	1	0.1966
Hepatocellular Adenoma (includes multiple)	2	1	2	5	0.0106
Eosinophilic Focus	0	1	0	0	
<i>Stop-Exposure Study</i>					
Number Examined Microscopically	35	36	28	13	
Cholangioma	0	0	0	1	0.1161
Cholangiocarcinoma	0	0	0	1	0.1161
Cholangioma or Cholangiocarcinoma	0	0	0	2	0.0126
Hepatocellular Adenoma	1	1	1	0	0.3206
Basophilic Focus	0	1	0	0	

* Significantly different ($P \leq 0.05$) from the control group by the Fisher exact test

** $P \leq 0.01$

^a Cochran-Armitage trend test or exact permutation test (Plackett, 1981)

^b Number of animals with lesion

Gallbladder (Core Study): Incidences of dilatation, enlargement, and epithelial hyperplasia were greater in exposed core study males and females than in the controls (Table 6). Rupture of the gallbladder wall, accompanied by wall fibrosis and/or granulomatous inflammation, occurred in three 150 mg/L females. Dilatation was characterized by distention of the gallbladder lumen up to several times normal diameter, generally with thinning of the gallbladder wall. Enlargement was characterized by a gallbladder that was not only larger than normal, but that also had a wall that was thicker than normal and that usually had the epithelium thrown into folds. Epithelial hyperplasia was a focal to diffuse lesion

characterized by an increase in the number of epithelial cells and sometimes the number of cell layers with subsequent thickening of the epithelium. In more severe cases the hyperplastic epithelium formed folds and few to numerous papillary projections. The single carcinoma that was observed in a female in the 60 mg/L group was a small lesion consisting of relatively normal-appearing cuboidal cells to anaplastic spindle-shaped epithelial cells that had invaded the gallbladder wall.

Gallbladder (Stop-Exposure Study): The incidence of enlargement in the 150 mg/L males was slightly increased compared to that in the controls (Table 6).

TABLE 6
Incidences of Neoplasms and Nonneoplastic Lesions of the Gallbladder in Guppies
in the 16-Month Waterborne Study of 2,2-Bis(bromomethyl)-1,3-propanediol

	0 mg/L	24 mg/L	60 mg/L	150 mg/L	Trend Test P-Value ^a
Male					
<i>Core Study</i>					
Number Examined Microscopically	56	48	41	36	
Dilatation ^b	0	1	4*	5**	0.0010
Enlargement	0	4*	5*	9**	<0.0001
Epithelium, Hyperplasia	1	0	0	9**	<0.0001
<i>Stop-Exposure Study</i>					
Number Examined Microscopically	27	21	21	23	
Enlargement	0	2	0	6**	0.0008
Epithelium, Hyperplasia	0	1	0	3	0.0147
Inflammation, Granulomatous	0	1	1	3	0.0235
Female					
<i>Core Study</i>					
Number Examined Microscopically	61	68	57	46	
Dilatation	0	15**	18**	17**	<0.0001
Enlargement	0	3	12**	10**	<0.0001
Epithelium, Hyperplasia	0	6*	4	7**	0.0043
Inflammation, Granulomatous	0	0	1	3	0.0074
Carcinoma	0	0	1	0	0.4369
<i>Stop-Exposure Study</i>					
Number Examined Microscopically	35	34	28	13	
Dilatation	2	4	4	3	0.0473
Enlargement	2	2	3	3	0.0243

* Significantly different ($P \leq 0.05$) from the control group by the Fisher exact test

** $P \leq 0.01$

^a Cochran-Armitage trend test or exact permutation test (Plackett, 1981)

^b Number of animals with lesion

Kidney (Stop-Exposure Study): The incidence of mineralization in 150 mg/L males was increased compared with controls (Table 7). Mineralization consisted of scattered irregular bits of basophilic material within the kidney stroma and/or tubular lumens. Casts were characterized by aggregates of amphophilic to basophilic granular material within the lumens of scattered tubules. Renal tubule dilatation was characterized by varying degrees of enlargement of the renal tubular lumen up to several times normal diameter.

Pituitary Gland (Core Study): The incidence of hyperplasia was increased in the 150 mg/L group of females as

compared with controls (0 mg/L, 3/61; 24 mg/L, 3/69; 60 mg/L, 9/58; 150 mg/L, 10/46). Pituitary gland hyperplasia was characterized by varying degrees of enlargement of the pituitary gland. The normal pituitary gland consisted of an anterior portion and a posterior portion. Hyperplasia was characterized by a mild to moderate, diffuse enlargement of the anterior portion, the posterior portion, or both. The normal architecture of the gland was maintained and the cells of the anterior and posterior portions appeared normal.

TABLE 7
Incidences of Nonneoplastic Lesions of the Kidney in Guppies
in the 16-Month Waterborne Study of 2,2-Bis(bromomethyl)-1,3-propanediol

	0 mg/L	24 mg/L	60 mg/L	150 mg/L	Trend Test P-Value ^a
Male					
<i>Stop-Exposure Study</i>					
Number Examined Microscopically	28	22	21	24	
Casts ^b	16	15	14	18	0.1117
Mineralization	1	4	4	8**	0.0043
Female					
<i>Core Study</i>					
Number Examined Microscopically	61	69	58	46	
Bowman's Space, Dilatation	10	23*	12	31**	<0.0001
Bowman's Space, Hemorrhage	1	7*	2	8**	0.0048
<i>Stop-Exposure Study</i>					
Number Examined Microscopically	35	36	28	13	
Mineralization	3	6	5	4	0.0350
Renal Tubule, Dilatation	18	20	20	10	0.0279

* Significantly different ($P \leq 0.05$) from the control group by the Fisher exact test

** $P \leq 0.01$

^a Cochran-Armitage trend test or exact permutation test (Plackett, 1981)

^b Number of animals with lesion

14-MONTH STUDY IN MEDAKA

Survival

At the concentrations used in this study 2,2-bis(bromomethyl)-1,3-propanediol did not result in significant reductions in survival (Table 8).

Exposure Concentrations, Body Lengths, and Body Weights

Nominal exposure concentrations of 24, 60, and 150 mg/L provided actual exposure concentrations of

19.4, 56.9, and 137.8 mg/L 2,2-bis(bromomethyl)-1,3-propanediol, respectively. Core study animals in the 60 and 150 mg/L groups were significantly larger, in both body lengths and weights, than control group fish. Otherwise, there were no treatment differences determined between the control and any treatment in body lengths or lengths in any group (Tables 9 and 10).

TABLE 8
Survival of Medaka in the 14-Month Waterborne Study of 2,2-Bis(bromomethyl)-1,3-propanediol

	0 mg/L	24 mg/L	60 mg/L	150 mg/L
Animals initially in study	340	340	340	340
Died before the 9-month interim evaluation	13	11	15	10
Unaccounted for ^a	4	1	0	7
9-Month interim evaluation	20	20	20	20
Died after reallocation ^b				
Core study	15	13	28	26
Stop-exposure study	13	8	7	5
Survivors				
Core study	186	192	175	175
Stop-exposure study	89	95	95	97
Survival analysis ^c				
Core study	0.1648	0.5426	0.0675	0.2983
Stop-exposure study	0.1383N	0.2738N	0.5510N	0.0772N

^a The laboratory report did not account for these fish at 9 months.

^b At 9 months, approximately one third of the fish in each replicate was reassigned to stop-exposure aquaria; the remaining fish (core study) were returned to their original exposure aquaria.

^c The result of life table trend test (Tarone, 1975) is in the control column, and the results of the life table pairwise comparison (Cox, 1972) between the controls and exposed animals appear in the exposure concentration columns.

TABLE 9
Body Lengths of Medaka in the 14-Month Waterborne Study
of 2,2-Bis(bromomethyl)-1,3-propanediol^a

Treatment	9-Month Interim Evaluation	Core Study	Stop-Exposure Study
0 mg/L	23.5 ± 0.5	25.0 ± 0.4	26.5 ± 0.3
24 mg/L	22.9 ± 0.4	25.6 ± 0.3	26.2 ± 0.3
60 mg/L	24.6 ± 0.5	26.7 ± 0.3**	26.7 ± 0.4
150 mg/L	25.2 ± 0.7	26.4 ± 0.4*	26.8 ± 0.3

* Significantly different ($P \leq 0.05$) from the control group by Dunnett's test

** $P \leq 0.01$

^a Data are presented as mean length ± standard error (mm).

TABLE 10
Body Weights of Medaka in the 14-Month Waterborne Study
of 2,2-Bis(bromomethyl)-1,3-propanediol^a

Treatment	9-Month Interim Evaluation	Core Study	Stop-Exposure Study
0 mg/L	0.203 ± 0.013	0.274 ± 0.013	0.340 ± 0.016
24 mg/L	0.186 ± 0.012	0.287 ± 0.008	0.340 ± 0.021
60 mg/L	0.238 ± 0.013	0.329 ± 0.011**	0.319 ± 0.016
150 mg/L	0.241 ± 0.016	0.318 ± 0.015*	0.322 ± 0.012

* Significantly different ($P \leq 0.05$) from the control group by Dunnett's test

** $P \leq 0.01$

^a Data are presented as mean weight ± standard error (mm).

Pathology and Statistical Analyses

This section describes the statistically or biologically noteworthy changes in incidences of neoplasms and/or nonneoplastic lesions of the liver, gallbladder, kidney, and thyroid tissue. Summaries of incidences of neoplasms by replicate are presented in Appendix B.

No potentially exposure-related neoplasms were observed in male and female medaka exposed to 2,2-bis(bromomethyl)-1,3-propanediol and evaluated at 9 months.

Liver (Core Study): The incidence of hepatocellular adenoma or carcinoma (combined) was increased in 150 mg/L males (Tables 11 and B1).

Cholangiocarcinomas occurred in a few exposed males and females, with all but one occurring in 150 mg/L fish (Tables 11, B1, and B3). No cholangiocarcinomas occurred in controls. One cholangioma occurred in a 150 mg/L female, and one occurred in a control female. Microscopically, hepatocellular adenoma and carcinoma, cholangioma, and cholangiocarcinoma appeared similar to those previously described. The cholangiocarcinoma had highly irregular borders and invaded into the adjacent normal parenchyma. It was composed of numerous small, atypical, densely packed, proliferating biliary structures within small to abundant amounts of fibrous and/or proliferating spindle cell stroma. The biliary structures consisted of small, moderately pleomorphic, cuboidal to columnar to fusiform epithelial cells.

Incidences of bile duct dilatation were increased in 150 mg/L females compared to controls (Table 11). Bile

duct hyperplasia was generally a slight change characterized by few to several, small to moderately large, normal-appearing bile ducts scattered within the liver. Occasionally the hyperplastic bile ducts formed small clusters. Bile duct dilatation was characterized by few to several scattered bile ducts that were variably dilated, sometimes up to several times normal diameter.

Incidences of cysts were increased in exposed groups of males and females, and incidences of hepatocellular vacuolation in 24 and 60 mg/L females were lower than in controls. Cysts were single or multiple clear cavities, usually lined by flattened epithelium, scattered within the liver. Macrophage aggregates consisted of scattered, variably sized aggregates of small to moderate numbers of plump, pigmented macrophages. Hepatocellular vacuolation consisted of variably sized, clear vacuoles within the hepatocyte cytoplasm.

Liver (Stop-Exposure Study): Cholangiocarcinoma occurred in one male and one female in the 150 mg/L groups and in one control female (Tables 11, B2, and B4). The incidences of bile duct hyperplasia in 60 and 150 mg/L males and the incidences of hepatocellular vacuolation and vacuolated hepatocyte foci in all exposed male groups were greater than those in the controls. Vacuolated hepatocyte foci blended with the surrounding parenchyma without producing compression and consisted of round to irregular clusters of hepatocytes containing variably sized, clear, discrete vacuoles, resembling fat droplets, within the cytoplasm. Except for the presence of the vacuoles, cells within vacuolated foci resembled normal hepatocytes.

TABLE 11
Incidences of Neoplasms and Nonneoplastic Lesions of the Liver in Medaka
in the 14-Month Waterborne Study of 2,2-Bis(bromomethyl)-1,3-propanediol

	0 mg/L	24 mg/L	60 mg/L	150 mg/L	Trend Test P-Value ^a
Male					
<i>Core Study</i>					
Number Examined Microscopically	47	59	56	59	
Bile Duct, Hyperplasia ^b	1	3	0	4	0.1302
Cyst	1	10*	18**	22**	<0.0001
Macrophage Aggregates	18	28	27	33	0.0481
Eosinophilic Focus	0	1	0	0	
Cholangiocarcinoma	0	1	0	2	0.0788
Hepatocellular Adenoma, Multiple	0	0	0	1	0.2670
Hepatocellular Adenoma (includes multiple)	1	0	0	6	0.0008
Hepatocellular Carcinoma	0	0	0	2	0.0704
Hepatocellular Adenoma or Carcinoma	1	0	0	8*	<0.0001
<i>Stop-Exposure Study</i>					
Number Examined Microscopically	27	21	31	29	
Bile Duct, Dilatation	2	6	5	5	0.3684
Bile Duct, Hyperplasia	0	2	5*	6*	0.0120
Hepatocellular Vacuolation	1	5*	6	6	0.1212
Macrophage Aggregates	9	10	16	15	0.1263
Vacuolated Hepatocyte Focus	0	1	1	4	0.0117
Cholangiocarcinoma	0	0	0	1	0.2685
Hepatocellular Adenoma	1	0	1	3	0.0568
Hepatocellular Carcinoma	0	0	0	1	0.2685
Hepatocellular Adenoma or Carcinoma	1	0	1	4	0.0182

TABLE 11
Incidences of Neoplasms and Nonneoplastic Lesions of the Liver in Medaka
in the 14-Month Waterborne Study of 2,2-Bis(bromomethyl)-1,3-propanediol

	0 mg/L	24 mg/L	60 mg/L	150 mg/L	Trend Test P-Value
Female					
Core Study					
Number Examined Microscopically	59	47	50	47	
Bile Duct, Dilatation	6	10	5	14*	0.0096
Cyst	22	27*	35**	30**	0.0076
Macrophage Aggregates	22	25	27	23	0.2070
Hepatocellular Vacuolation	20	4**	6**	9	0.1410
Eosinophilic Focus	0	0	1	0	
Cholangioma	1	0	0	1	0.3082
Cholangiocarcinoma	0	0	0	1	0.2315
Cholangioma or Cholangiocarcinoma	1	0	0	2	0.0828
Hepatocellular Adenoma	5	3	6	3	0.4042
Hepatocellular Carcinoma	0	0	1	1	0.1673
Hepatocellular Adenoma or Carcinoma	5	3	7	4	0.4227
Ectopic Thyroid Follicular Cell Carcinoma	0	1	0	0	0.2909
Lymphosarcoma	0	1	0	0	0.2909
Stop-Exposure Study					
Number Examined Microscopically	26	33	23	25	
Cholangiocarcinoma	1	0	0	1	0.3084
Hepatocellular Adenoma	1	0	1	3	0.0284
Hepatocellular Carcinoma	0	0	2	0	0.4528
Hepatocellular Adenoma or Carcinoma	1	0	3	3	0.0454

* Significantly different ($P \leq 0.05$) from the control group by the Fisher exact test

** $P \leq 0.01$

^a Cochran-Armitage trend test or exact permutation test (Plackett, 1981)

^b Number of animals with lesion

Gallbladder (Core Study): Stromal polyps occurred in one exposed male and in one exposed female (Tables 12, B1, and B3). Stromal polyp was a small lesion consisting of an irregular mass composed of a core of abundant loose stroma that was covered by a single layer of tall columnar epithelium. Epithelial hyperplasia of the gallbladder was microscopically similar to that previously described. Cystic duct hyperplasia, consisting of hyper-

plasia of the cystic duct epithelium, had a similar appearance to hyperplasia within the gallbladder lumen and was accompanied by varying degrees of enlargement of the duct secondary to the epithelial hyperplasia.

Gallbladder (Stop-Exposure Study): A stromal polyp occurred in one 150 mg/L male (Tables 12 and B2).

TABLE 12
Incidences of Neoplasms and Nonneoplastic Lesions of the Gallbladder in Medaka
in the 14-Month Waterborne Study of 2,2-Bis(bromomethyl)-1,3-propanediol

	0 mg/L	24 mg/L	60 mg/L	150 mg/L	Trend Test P-Value ^a
Male					
<i>Core Study</i>					
Number Examined Microscopically	46	53	55	57	
Epithelium, Hyperplasia ^b	3	2	3	8	0.0249
Cystic Duct, Hyperplasia	0	1	2	4	0.0193
Stromal Polyp	0	0	1	0	0.4847
<i>Stop-Exposure Study</i>					
Number Examined Microscopically	25	19	30	28	
Epithelium, Hyperplasia	1	1	1	6	0.0061
Stromal Polyp	0	0	0	1	0.2745
Female					
<i>Core Study</i>					
Number Examined Microscopically	55	44	48	45	
Epithelial Hyperplasia	0	1	3	2	0.1065
Stromal Polyp	0	0	0	1	0.2344

^a Cochran-Armitage trend test or exact permutation test (Plackett, 1981)

^b Number of animals with lesion

Kidney (Core Study): Compared to the control group, incidences of casts and mineralization were increased in all exposed female groups, and the incidences of renal tubule degeneration were increased in the 60 and 150 mg/L female groups (Table 13). Additionally, the incidence of dilatation of Bowman's space was

increased in 150 mg/L females compared to that in controls. Renal tubule degeneration was characterized by irregular shrinkage and/or varying degrees of flattening of the tubular epithelium. Degeneration was often seen within dilated tubules. Other kidney changes were microscopically similar to those previously described.

TABLE 13
Incidences of Nonneoplastic Lesions of the Kidney in Female Medaka
in the 14-Month Waterborne Study of 2,2-Bis(bromomethyl)-1,3-propanediol

	0 mg/L	24 mg/L	60 mg/L	150 mg/L	Trend Test P-Value ^a
<i>Core Study</i>					
Number Examined Microscopically	59	47	50	47	
Bowman's Space, Dilatation ^b	1	3	3	6*	0.0135
Casts	3	11**	12**	13**	0.0066
Mineralization	1	9**	15**	13**	0.0010
Renal Tubule, Degeneration	0	3	7**	9**	0.0003

* Significantly different ($P \leq 0.05$) from the control group by the Fisher exact test

** $P \leq 0.01$

^a Cochran-Armitage trend test or exact permutation test (Plackett, 1981)

^b Number of animals with lesion

Thyroid Tissue (Core Study): Incidences of hyperplasia in 150 mg/L males and increased basophilia of the follicular epithelium in exposed males and 60 and 150 mg/L females were greater than those in the controls (Table 14). Microscopically, normal thyroid tissue consisted of a few follicles located just caudal to the gills and ventral to the esophagus. Hyperplasia consisted of a slight increase above normal in the number of thyroid follicles as compared with normal. The follicles were generally small, composed of small eosinophilic cuboidal follicular cells, and contained colloid.

Hypertrophy consisted of an increase in the size of follicular epithelial cells. Increased basophilia was characterized by increased basophilic staining of follicular cells as compared with normal cells, and may have represented a normal anatomic variation.

Thyroid Tissue (Stop-Exposure Study): The incidence of follicular cell hypertrophy of the thyroid tissue was increased in the 150 mg/L male group as compared with the control group (Table 14).

TABLE 14
Incidences of Nonneoplastic Lesions of Thyroid Tissue in Medaka in the 14-Month Waterborne Study of 2,2-Bis(bromomethyl)-1,3-propanediol

	0 mg/L	24 mg/L	60 mg/L	150 mg/L	Trend Test P-Value ^a
Male					
<i>Core Study</i>					
Number Examined Microscopically	47	59	56	59	
Hyperplasia ^b	0	1	2	11**	<0.0001
Follicular Cell Hypertrophy	13	19	25	24	0.0851
Increased Basophilia	39	55	52	50	0.2957
<i>Stop-Exposure Study</i>					
Number Examined Microscopically	27	21	31	29	
Hyperplasia	2	2	2	7	0.0177
Follicular Cell, Hypertrophy	6	5	11	15*	0.0051
Female					
<i>Core Study</i>					
Number Examined Microscopically	59	47	50	47	
Follicular Cell, Hypertrophy	14	8	19	12	0.2730
Increased Basophilia	4	4	10*	12**	0.0016
<i>Stop-Exposure Study</i>					
Number Examined Microscopically	26	33	23	25	
Follicular Cell, Hypertrophy	7	3	7	3	0.2329
Increased Basophilia	7	6	6	2	0.0600

* Significantly different ($P \leq 0.05$) from the control group by the Fisher exact test

** $P \leq 0.01$

^a Cochran-Armitage trend test or exact permutation test (Plackett, 1981)

^b Number of animals with lesion

NITROMETHANE

16-MONTH STUDY IN GUPPIES

Survival

The rapid growth of microfauna in the treatment aquaria required the study aquaria to be brushed once and siphoned twice each day. A number of fish deaths were due to mechanical injury related to this activity. Although the cause of death could not be confirmed in many cases, mortality in the 70 mg/L treatment

appeared to indicate that this level of nitromethane exposure was chronically toxic. This is confirmed by the similar survival rate of guppies from all treatments following removal from treatment aquaria and placement in stop-exposure (Table 15). When removed from the nitromethane, survival of stop-exposure fish improved over those fish returned to the 70 mg/L core study aquaria. Due to the high mortality of fish in the 70 mg/L core study groups, these fish were removed from treatment (day 396) and fixed for histological analyses after approximately 57 weeks on study.

TABLE 15
Survival of Guppies in the 16-Month Waterborne Study of Nitromethane

	0 mg/L	10 mg/L	30 mg/L	70 mg/L
Animals initially in study	220	220	221	220
Died before the 9-month interim evaluation	9	16	7	60
Unaccounted for ^a	7	6	0	15
9-Month interim evaluation	20	20	20	20
Died after reallocation ^b				
Core study	12	10	13	30
Stop-exposure study	4	4	4	6
Survivors				
Core study	108	100	111	50 ^d
Stop-exposure study	60	64	66	39
Survival analysis ^c				
Core study	<0.0001	0.3669	0.8145	<0.0001
Stop-exposure study	<0.0001	0.1724	0.6177	<0.0001

^a The laboratory report did not account for these fish at 9 months.

^b At 9 months, approximately one third of the fish in each replicate was reassigned to stop-exposure aquaria; the remaining fish (core study) were returned to their original exposure aquaria.

^c The result of life table trend test (Tarone, 1975) is in the control column, and the results of the life table pairwise comparison (Cox, 1972) between the controls and exposed animals appear in the exposure concentration columns.

^d Exposure was stopped on day 396, and fish were sacrificed on day 397 after approximately 57 weeks on study.

Exposure Concentrations, Body Lengths, and Body Weights

Nominal exposure concentrations of 10, 30, and 70 mg/L provided actual exposure concentrations of 9.9, 28.7, and 66.4 mg/L nitromethane, respectively. The observed differences in weight and length between

controls and 70 mg/L fish may have been an artifact of the reduced numbers of fish in the 70 mg/L aquaria (Tables 16 and 17).

TABLE 16
Body Lengths of Guppies in the 16-Month Waterborne Study of Nitromethane^a

Treatment	9-Month Interim Evaluation	Core Study	Stop-Exposure Study
0 mg/L	31.8 ± 1.2	36.1 ± 1.4	33.4 ± 1.2
10 mg/L	32.6 ± 1.3	33.7 ± 1.4	35.3 ± 1.3
30 mg/L	31.8 ± 1.4	34.2 ± 1.4	35.4 ± 1.3
70 mg/L	34.2 ± 1.7	— ^b	38.8 ± 1.5*

* Significantly different ($P \leq 0.05$) from the control group by the Dunnett's test

^a Data are presented as mean length ± standard error (mm).

^b 70 mg/L core group terminated at 57 weeks

TABLE 17
Body Weights of Guppies in the 16-Month Waterborne Study of Nitromethane^a

Treatment	9-Month Interim Evaluation	Core Study	Stop-Exposure Study
0 mg/L	0.74 ± 0.09	1.37 ± 0.15	1.08 ± 0.12
10 mg/L	0.91 ± 0.11	1.14 ± 0.14	1.10 ± 0.10
30 mg/L	0.85 ± 0.14	1.19 ± 0.14	1.16 ± 0.12
70 mg/L	1.01 ± 0.15	— ^b	1.58 ± 0.16**

* Significantly different ($P \leq 0.05$) from the control group by the Dunnett's test

** $P \leq 0.01$

^a Data are presented as mean weight ± standard error (g).

^b 70 mg/L core group terminated at 57 weeks

Pathology and Statistical Analyses

This section describes the statistically or biologically noteworthy changes in incidences of neoplasms and/or nonneoplastic lesions of the liver. Nonneoplastic lesions of the pituitary gland, thyroid tissue, and kidney are also discussed. Summaries of incidences of neoplasms by replicate are presented in Appendix C.

No potentially treatment-related neoplasms were observed in male or female guppies exposed to nitromethane and evaluated at 9 months.

In the core study, a number of lesions occurred with greater incidences in the 10 and/or 30 mg/L groups but not in the 70 mg/L groups, as compared with controls. This may have been due, at least in part, to the reduced survival in the 70 mg/L groups, particularly the males.

Liver (Core Study): The incidence of bile duct hyperplasia in the 30 mg/L male group was increased (Tables 18 and C1). The incidence of granuloma was greater in the 30 mg/L female group than in the controls. Granulomas were focal to multifocal, discrete, variably sized, nodular lesions composed of densely packed macrophages with lightly pigmented cytoplasm and generally surrounded by a periphery of small cells with deeply basophilic nuclei. There was a marginally increased incidence of hepatocellular adenoma or carcinoma (combined) in 30 mg/L males, compared to the controls.

Liver (Stop-Exposure Study): A single hepatocholangiocarcinoma, a malignant liver neoplasm consisting of both malignant cholangiocellular (bile duct) and hepatocellular components, occurred in one female in the 10 mg/L group (Table 18).

TABLE 18
Incidences of Neoplasms and Nonneoplastic Lesions of the Liver in Guppies
in the 16-Month Waterborne Study of Nitromethane

	0 mg/L	10 mg/L	30 mg/L	70 mg/L ^a	Trend Test P-Value ^b
Male					
<i>Core Study</i>					
Number Examined Microscopically	60	42	60	12	
Bile Duct, Hyperplasia ^c	3	6	13**	3	0.0046
Cholangiocarcinoma	0	1	0	0	0.3883
Hepatocellular Adenoma, Multiple	0	1	1	0	0.4285
Hepatocellular Adenoma (includes multiple)	4	2	8	0	0.0728
Hepatocellular Carcinoma	0	1	2	0	0.1561
Hepatocellular Adenoma or Carcinoma	4	3	10	0	0.0287
<i>Stop-Exposure Study</i>					
Number Examined Microscopically	29	29	29	14	
Basophilic Focus	1	1	2	0	0.2470
Eosinophilic Focus	0	2	2	2	0.1369
Cholangioma	0	0	1	0	0.3333
Hepatocellular Adenoma (includes multiple)	5	2	1	0	0.0459N
Hepatocellular Carcinoma	0	3	0	0	0.3188
Hepatocellular Adenoma or Carcinoma	5	5	1	0	0.0423N
Female					
<i>Core Study</i>					
Number Examined Microscopically	47	57	50	32	
Bile Duct, Hyperplasia	4	5	8	6	0.0972
Basophilic Focus	1	6	4	1	0.2046
Granuloma	13	24	23*	7	0.0470
Cholangiocarcinoma	0	1	0	0	0.3885
Hepatocellular Adenoma	1	2	2	0	0.3166
<i>Stop-Exposure Study</i>					
Number Examined Microscopically	30	34	33	25	
Hepatocellular Adenoma (includes multiple)	2	0	0	0	0.0934N
Hepatocellular Carcinoma	0	0	1	0	0.3402
Hepatocellular Adenoma or Carcinoma	2	0	1	0	0.2989
Hepatocholangiocarcinoma	0	1	0	0	0.3816

* Significantly different ($P \leq 0.05$) from the control group by the Fisher exact test

** $P \leq 0.01$

^a 70 mg/L group was not included in trend test or Fisher exact test because the fish were sacrificed earlier than the controls and other exposed groups

^b Cochran-Armitage trend test or exact permutation test (Plackett, 1981) (excludes 70 mg/L group). A negative trend or a lower incidence in an exposure group is indicated by N.

^c Number of animals with lesion

Pituitary Gland (Core Study): The incidence of hyperplasia was increased in 30 mg/L females (0 mg/L, 1/47; 10 mg/L, 2/57; 30 mg/L, 14/50; 70 mg/L, 4/32). Hyperplasia was characterized by a mild to moderate, diffuse enlargement of the anterior or posterior portion of the gland or both portions. The normal architecture of the gland was maintained and the cells of the anterior and posterior portions appeared normal.

Pituitary Gland (Stop-Exposure Study): The incidences of hyperplasia were not increased in females (1/30, 3/34, 2/33, 1/25).

Thyroid Tissue (Core Study): Incidences of follicular cell hyperplasia were greater in the 10 and 30 mg/L male groups (0/60, 5/42, 7/60, and 0/12) and were substantially greater in all exposed female groups (4/47, 43/57, 38/50, 23/32) than those in the control groups. Thyroid tissue hyperplasia was characterized by a diffuse

increase in the number of thyroid follicles that were more widely scattered than in normal thyroid tissue.

Thyroid Tissue (Stop-Exposure Study): The incidence of follicular cell hyperplasia was greater in the 30 mg/L female group than in any other group, but the difference was not statistically significant (0 mg/L, 4/30; 10 mg/L, 3/34; 30 mg/L, 9/33; 70 mg/L, 4/25).

Kidney (Core Study): Renal tubule dilatation occurred with greater incidences in 30 mg/L males (18/60, 13/42, 32/60, 6/12) and 30 mg/L females (27/47, 38/57, 38/50, 20/32) than in the controls. Renal tubule dilatation was characterized by varying degrees of enlargement of the renal tubular lumen up to several times normal diameter. Mineralization occurred with greater incidences in 70 mg/L females (22/47, 33/57, 31/50, 22/32) and consisted of scattered irregular bits of basophilic material within the kidney stroma and/or renal tubule lumens.

13-MONTH STUDY IN MEDAKA

Survival

To maintain acceptable water quality and treatment concentrations potentially affected by the rapid microfaunal growth, the study aquaria were brushed once and siphoned three times each day. Due to this frequent activity, a number of fish probably died due to mechanical injury. Unfortunately, the cause of death could not be confirmed in many cases; the mortality from this activity is believed to have been approximately uniform

among treatments and does not appear to have affected the comparison of survival between treatments (Table 19).

The effect of this aggressive maintenance can be demonstrated in the frequency of dead removed from core study aquaria after 9 months compared to the frequency in stop-exposure aquaria during the same period (Table 19). The holding aquaria, which received dilution water without nitromethane, were brushed only once each week and siphoned of debris twice per week.

TABLE 19
Survival of Medaka in the 13-Month Waterborne Study of Nitromethane

	0 mg/L	10 mg/L	20 mg/L	40 mg/L
Animals initially in study	340	340	340	340
Died before the 9-month interim evaluation	37 ^d	28 ^e	25 ^f	48 ^g
Unaccounted for ^a	26	29	49	28
9-Month interim evaluation	20	20	20	20
Died after reallocation ^b				
Core study	17	19	27	14
Stop-exposure study	5	2	5	2
Survivors				
Core study	143	156	136	143
Stop-exposure study	92	86	78	85
Survival analysis ^c				
Core study	0.5414	0.2079N	0.5621	0.3430
Stop-exposure study	0.4885	0.1019	0.0627	0.3409

^a The laboratory report did not account for these fish at 9 months.

^b At 9 months, approximately one third of the fish in each replicate was reassigned to stop-exposure aquaria; the remaining fish (core study) were returned to their original exposure aquaria.

^c The result of life table trend test (Tarone, 1975) is in the control column, and the results of the life table pairwise comparison (Cox, 1972) between the controls and exposed animals appear in the exposure concentration columns.

^d Includes 3 accidental deaths

^e Includes 5 accidental deaths

^f Includes 6 accidental deaths

^g Includes 19 accidental deaths

Exposure Concentrations, Body Lengths, and Body Weights

Nominal exposure concentrations of 10, 20, and 40 mg/L resulted in actual exposure concentrations of 9.3, 20.8, and 41.7 mg/L nitromethane, respectively.

No differences between control and exposed groups were found in body lengths or weights at the 9-month

interim evaluation. Significant increases in length and weight were observed in the exposed groups at 13 months. The biological significance of these changes is unknown (Tables 20 and 21).

TABLE 20
Body Lengths of Medaka in the 13-Month Waterborne Study of Nitromethane^a

Treatment	9-Month Interim Evaluation	Core Study	Stop-Exposure Study
0 mg/L	25.0 ± 0.7	26.7 ± 0.2	26.9 ± 0.1
10 mg/L	25.9 ± 0.5	26.3 ± 0.1	27.5 ± 0.2*
20 mg/L	25.8 ± 0.5	27.5 ± 0.2**	27.8 ± 0.2**
40 mg/L	26.9 ± 0.6	27.9 ± 0.2**	27.7 ± 0.2**

* Significantly different ($P \leq 0.05$) from the control group by Dunnett's test

** $P \leq 0.01$

^a Data are presented as mean length ± standard error (mm).

TABLE 21
Body Weights of Medaka in the 13-Month Waterborne Study of Nitromethane^a

Treatment	9-Month Interim Evaluation	Core Study	Stop-Exposure Study
0 mg/L	0.25 ± 0.02	0.32 ± 0.01	0.30 ± 0.01
10 mg/L	0.29 ± 0.02	0.29 ± 0.01*	0.32 ± 0.01
20 mg/L	0.28 ± 0.01	0.34 ± 0.01	0.32 ± 0.01
40 mg/L	0.30 ± 0.02	0.36 ± 0.01*	0.33 ± 0.01

* Significantly different ($P \leq 0.05$) from the control group by Dunnett's test

^a Data are presented as mean length ± standard error (mm).

Pathology and Statistical Analyses

This section describes the statistically or biologically noteworthy changes in incidences of neoplasms and/or nonneoplastic lesions of the liver, kidney, and thyroid tissue. Summaries of incidences of neoplasms by replicate are presented in Appendix D.

Liver (9-Month Interim Evaluation): A single cholangiocarcinoma occurred in a 40 mg/L male (Tables 22 and D1). Hepatocellular adenomas occurred in two 20 mg/L males and in one 40 mg/L female (Tables 22, D1, and D3). Otherwise, no potentially exposure-related neoplasms were observed.

Liver (Core Study): One cholangioma occurred in a 20 mg/L male, and cholangiocarcinomas occurred in a few exposed males, but none occurred in control males (Tables 22 and D1). Microscopically, the hepatocellular adenomas, cholangioma, and cholangiocarcinomas were similar to those previously described.

The incidences of cysts were greater in 20 mg/L males and cystic degeneration occurred with greater incidence

in the 40 mg/L female group than in controls. Incidences of hepatocellular vacuolization were greater in 40 mg/L males and in 20 and 40 mg/L females than in controls. The incidences of macrophage aggregates were increased in 10 and 40 mg/L males. Incidences of granuloma were decreased in all exposed groups of males and in 10 and 40 mg/L females compared with controls.

Cystic degeneration was characterized by clusters of numerous small, cyst-like cavities separated by fine cytoplasmic extensions of perisinusoidal cells. The small cavities contained fine flocculant material and commonly a few inflammatory cells. The other liver lesions appeared microscopically similar to those previously described.

Liver (Stop-Exposure Study): Cysts occurred with somewhat greater incidences in 20 and 40 mg/L females as compared with controls (Table 22). The incidences of granuloma were decreased in 10 and 40 mg/L males and females.

TABLE 22
Incidences of Neoplasms and Nonneoplastic Lesions of the Liver in Medaka
in the 13-Month Waterborne Study of Nitromethane

	0 mg/L	10 mg/L	20 mg/L	40 mg/L	Trend Test P-Value ^a
Male					
<i>9-Month Interim Evaluation</i>					
Number Examined Microscopically	12	15	14	14	
Cholangiocarcinoma ^b	0	0	0	1	0.2546
Hepatocellular Adenoma	0	0	2	0	0.4216
<i>Core Study</i>					
Number Examined Microscopically	72	91	90	76	
Cyst	12	14	27*	19	0.0439
Hepatocellular Vacuolation	5	4	9	15*	0.0008
Macrophage Aggregates	22	45*	34	41**	0.0119
Vacuolated Hepatocyte Focus	1	1	1	4	0.0342
Granuloma	64	19**	49**	10**	<0.0001N
Cholangioma	0	0	1	0	0.4293
Cholangiocarcinoma	0	1	2	1	0.2381
Cholangioma or Cholangiocarcinoma	0	1	3	1	0.2363
Hepatocellular Adenoma	1	2	1	1	0.4072
Hemangiopericytoma	0	0	0	1	0.2310
Lymphosarcoma	0	0	1	0	0.4293
<i>Stop-Exposure Study</i>					
Number Examined Microscopically	47	35	36	41	
Cystic Degeneration	32	23	25	23	0.1263
Granuloma	25	10*	23	11*	0.0330N
Female					
<i>9-Month Interim Evaluation</i>					
Number Examined Microscopically	13	15	9	20	
Hepatocellular Adenoma	0	0	0	1	0.3509
<i>Core Study</i>					
Number Examined Microscopically	74	69	59	70	
Cystic Degeneration	50	50	44	58*	0.0168
Hepatocellular Vacuolation	7	9	15*	31**	<0.0001
Macrophage Aggregates	40	42	31	46	0.1112
Vacuolated Hepatocyte Focus	12	10	7	16	0.1235
Granuloma	25	6**	14	5**	0.0005N
Eosinophilic Focus	1	0	0	0	
Cholangiocarcinoma	1	0	0	0	0.1279N
Hepatocellular Adenoma	2	2	1	3	0.2957
Hepatocellular Carcinoma	0	0	0	1	0.2574
Hepatocellular Adenoma or Carcinoma	2	2	1	4	0.1542

TABLE 22
Incidences of Neoplasms and Nonneoplastic Lesions of the Liver in Medaka
in the 13-Month Waterborne Study of Nitromethane

	0 mg/L	10 mg/L	20 mg/L	40 mg/L	Trend Test P-Value
Female (continued)					
<i>Stop-Exposure Study</i>					
Number Examined Microscopically	44	51	42	44	
Cyst	20	29	28*	35**	0.0003
Granuloma	8	2*	7	1*	0.0320N
Cholangiocarcinoma	0	1	0	0	0.3115
Hepatocellular Adenoma	1	2	1	1	0.4274
Hepatocellular Carcinoma	0	1	0	0	0.3115
Hepatocellular Adenoma or Carcinoma	1	3	1	1	0.3553

* Significantly different ($P \leq 0.05$) from the control group by the Fisher exact test

** $P \leq 0.01$

^a Cochran-Armitage trend test or exact permutation test (Plackett, 1981). A negative trend or a lower incidence in an exposure group is indicated by N.

^b Number of animals with lesion

Kidney (Core Study): A number of nonneoplastic changes occurred with greater incidences in all exposed groups of males than in the controls (Table 23). These changes included casts, mineralization, and renal tubule

dilatation. Renal tubule degeneration occurred with greater incidence in 10 and 20 mg/L males than in the controls. These changes appeared microscopically similar to those previously described.

TABLE 23
Incidences of Nonneoplastic Lesions of the Kidney in Medaka
in the 13-Month Waterborne Study of Nitromethane

	0 mg/L	10 mg/L	20 mg/L	40 mg/L	Trend Test P-Value ^a
Male					
<i>Core Study</i>					
Number Examined Microscopically	72	91	90	76	
Casts ^b	11	26*	30**	32**	0.0003
Mineralization	10	50**	26*	24**	0.3178
Renal Tubule, Dilatation	10	34**	31**	37**	<0.0001
Renal Tubule, Degeneration	7	20*	19*	12	0.3183
<i>Stop-Exposure Study</i>					
Number Examined Microscopically	47	35	36	41	
Casts	6	2	8	11	0.0138
Mineralization	13	8	17	16	0.0635
Female					
<i>Stop-Exposure Study</i>					
Number Examined Microscopically	44	51	42	44	
Renal Tubule, Dilatation	1	6	3	6	0.0642
Mineralization	1	5	2	3	0.3279

* Significantly different ($P \leq 0.05$) from the control group by the Fisher exact test

** $P \leq 0.01$

^a Cochran-Armitage trend test or exact permutation test (Plackett, 1981)

^b Number of animals with lesion

Thyroid Tissue (Core Study): Incidences of hypertrophy and vacuolation of follicular cells were substantially greater in all exposed groups of males than those in controls (Table 24). The incidence of increased basophilia in the 40 mg/L male group was less than in controls. Hypertrophy consisted of slight enlargement of the follicular cells as compared with normal cells. Vacuolation was characterized by clear vacuolation of follicular cell

cytoplasm. Increased basophilia was characterized by increased basophilic staining of follicular cells. The significance of increased basophilia was unclear but may have represented normal anatomic variation.

Thyroid Tissue (Stop-Exposure Study): Follicular cell vacuolation occurred with greater incidences in 10 and 40 mg/L males as compared with controls (Table 24).

TABLE 24
Incidences of Nonneoplastic Lesions of the Thyroid in Male Medaka
in the 13-Month Waterborne Study of Nitromethane

	0 mg/L	10 mg/L	20 mg/L	40 mg/L	Trend Test P-Value ^a
<i>Core Study</i>					
Number Examined Microscopically	72	91	90	76	
Follicular Cells, Hypertrophy ^b	18	47**	51**	33*	0.0540
Follicular Cells, Vacuolation	16	71**	57**	63**	<0.0001
Increased Basophilia	67	82	78	56**	0.0001N
<i>Stop-Exposure Study</i>					
Number Examined Microscopically	47	35	36	41	
Follicular Cells, Vacuolation	6	11*	10	14*	0.0214

* Significantly different ($P \leq 0.05$) from the control group by the Fisher exact test

** $P \leq 0.01$

^a Cochran-Armitage trend test or exact permutation test (Plackett, 1981). A negative trend is indicated by N.

^b Number of animals with lesion

1,2,3-TRICHLOROPROPANE 16-MONTH STUDY IN GUPPIES

Survival

The survival of exposed guppies was less than that of the control group at 9 months. Reduced survival was evident at 6 months in the 18.0 mg/L groups, and at 7 months in the 4.5 and 9.0 mg/L groups (data not shown). Survival was significantly reduced in the 18.0 mg/L core study group within one month of the 9-month interim evaluation (data not shown), and mortality in this group after reallocation at 9 months was 42.6% at study termination (Table 25).

Exposure Concentrations, Body Lengths, and Body Weights

Nominal exposure concentrations of 4.5, 9.0, and 18.0 mg/L (analyzed three times per week) resulted

in actual exposure concentrations of 4.4, 8.8, and 18.2 mg/L 1,2,3-trichloropropane, respectively. Guppies in the 18.0 mg/L core study group were significantly longer and weighed more than the controls. Fish in the 18.0 mg/L stop-exposure group also weighed more than the controls (Tables 26 and 27).

Mortality of fish during the study resulted in unequal numbers of individuals distributed to core study and stop-exposure aquaria at 9 months (Table 25). This appears to have influenced the length and weight of fish measured at study termination (i.e., the smaller tank population allowed the fish to grow more). Observed differences in weight and length between controls and 18.0 mg/L fish may have been an artifact of the reduced fish numbers in the 18.0 mg/L aquaria.

TABLE 25
Survival of Guppies in the 16-Month Waterborne Study of 1,2,3-Trichloropropane

	0 mg/L	4.5 mg/L	9.0 mg/L	18.0 mg/L
Animals initially in study	220	220	220	220
Died before the 9-month interim evaluation	3	14	17	32
Unaccounted for ^a	1	2	1	7
9-Month interim evaluation	20	20	20	20
Died after reallocation ^b				
Core study	5	10	7	46
Stop-exposure study	3	13	3	9
Survivors				
Core study	125	112	114	61
Stop-exposure study	63	49	58	45
Survival analysis ^c				
Core study	<0.0001	0.0047	0.0019	<0.0001
Stop-exposure study	<0.0001	0.0015	0.0026	<0.0001

^a The laboratory report did not account for these fish at 9 months.

^b At 9 months, approximately one third of the fish in each replicate was reassigned to stop-exposure aquaria; the remaining fish (core study) were returned to their original exposure aquaria.

^c The result of life table trend test (Tarone, 1975) is in the control column, and the results of the life table pairwise comparison (Cox, 1972) between the controls and exposed animals appear in the exposure concentration columns.

TABLE 26
Standard Lengths of Guppies in the 16-Month Waterborne Study of 1,2,3-Trichloropropane^a

Treatment	9-Month Interim Evaluation	Core Study	Stop-Exposure Study
0 mg/L	30.6 ± 1.0	31.1 ± 0.5	30.3 ± 0.7
4.5 mg/L	30.2 ± 1.1	32.5 ± 0.6	32.1 ± 0.9
9.0 mg/L	29.8 ± 1.3	31.3 ± 0.7	32.5 ± 0.1
18.0 mg/L	31.6 ± 1.6	33.9 ± 1.0*	32.8 ± 1.2

* Significantly different ($P \leq 0.05$) from the control group by Dunnett's test

^a Data are presented as mean length ± standard error (mm).

TABLE 27
Standard Weights of Guppies in the 16-Month Waterborne Study of 1,2,3-Trichloropropane^a

Treatment	9-Month Interim Evaluation	Core Study	Stop-Exposure Study
0 mg/L	0.69 ± 0.09	0.78 ± 0.04	0.68 ± 0.05
4.5 mg/L	0.67 ± 0.08	0.90 ± 0.05	0.86 ± 0.06
9.0 mg/L	0.67 ± 0.09	0.90 ± 0.06	0.87 ± 0.07
18.0 mg/L	0.78 ± 0.11	1.13 ± 0.09**	1.00 ± 0.09**

* Significantly different ($P \leq 0.05$) from the control group by Dunnett's test

** $P \leq 0.01$

^a Data are presented as mean length ± standard error (mm).

Pathology and Statistical Analyses

This section describes the statistically or biologically noteworthy changes in neoplasms and/or nonneoplastic lesions of the liver, gallbladder, kidney, and pituitary gland. Summaries of incidences of neoplasms by replicate are presented in Appendix E.

Liver (9-Month Interim Evaluation): Multiple hepatocellular adenomas occurred in one 4.5 mg/L male, and one hepatocellular adenoma occurred in a control male (Table 28). No other hepatocellular neoplasms were observed; consequently, the hepatocellular adenomas seen in the one exposed male were considered to be incidental and unrelated to exposure. Liver neoplasms were not found in females at 9 months.

Liver (Core Study): Increased incidences of cholangiocellular (bile duct) and hepatocellular neoplasms were observed in 18.0 mg/L males and 9.0 and 18.0 mg/L females as compared with controls (Table 28). Cholangiocarcinomas in 18.0 mg/L females metastasized to intestine, mesentery, and spleen. Combined incidences of hepatocellular adenoma and multiple hepatocellular adenoma were increased in exposed groups of males as compared with controls. In addition, hepatocellular carcinoma occurred with greater incidence in 18.0 mg/L males than in the controls. Microscopically, these liver lesions appeared similar to those previously described.

Incidences of basophilic focus were increased in 9.0 and 18.0 mg/L males as compared with controls. The incidences of granuloma and cystic degeneration in exposed males, and granuloma in 18.0 mg/L females were less than those in the controls. Mononuclear cell infiltrate consisted of multiple, small, scattered aggregates of mixed mononuclear inflammatory cells, generally macrophages and lymphocytes. The microscopic

appearances of granuloma and cystic degeneration were similar to those described previously. The decreased incidences of granuloma, mononuclear cell infiltrate, and cystic degeneration may have been secondary to the presence of other exposure-related lesions that obscured the presence of these lesions.

Liver (Stop-Exposure Study): Increased incidences of cholangiocellular (bile duct) neoplasms were observed in 18.0 mg/L females, and increased incidences of hepatocellular neoplasms occurred in 18.0 mg/L males (Table 28).

Cholangiomas occurred in a few exposed females, including controls. However, a few cholangiocarcinomas occurred in the 18.0 mg/L females only, and the combined incidence of cholangioma and cholangiocarcinoma was greater in the 18.0 mg/L females than in the controls. One of the cholangiocarcinomas in females metastasized to the peritoneum. A single cholangiocarcinoma occurred in a 18.0 mg/L male. Incidences of bile duct hyperplasia were slightly increased in the 9.0 mg/L males as compared with controls.

Hepatocellular adenoma occurred with a greater incidence in 18.0 mg/L males, and multiple hepatocellular adenoma and hepatocellular carcinoma occurred with greater incidence in 18.0 mg/L males compared to controls. Incidences of hepatocellular neoplasms in females were similar across the control and exposed groups. Basophilic focus occurred with slightly greater incidences in exposed groups of males and females as compared with controls. Eosinophilic focus occurred in a small number of exposed males but not in control males. Incidences in females were similar across groups. Microscopically, eosinophilic foci appeared similar to those previously described.

TABLE 28
Incidences of Neoplasms and Nonneoplastic Lesions of the Liver in Guppies
in the 16-Month Waterborne Study of 1,2,3-Trichloropropane

	0 mg/L	4.5 mg/L	9.0 mg/L	18.0 mg/L	Trend Test P-Value ^a
Male					
<i>9-Month Interim Evaluation</i>					
Number Examined Microscopically	9	8	12	10	
Hepatocellular Adenoma, Multiple ^b	0	1	0	0	0.2785
Hepatocellular Adenoma	1	0	0	0	0.2308
<i>Core Study</i>					
Number Examined Microscopically	61	47	67	27	
Basophilic Focus	2	4	14**	6**	0.0011
Cystic Degeneration	43	22*	24**	9**	<0.0001N
Granuloma	57	34**	44**	11**	<0.0001N
Cholangioma	0	0	1	0	0.3285
Cholangiocarcinoma	0	0	0	3*	0.0022
Cholangioma or Cholangiocarcinoma	0	0	1	3*	0.0032
Hepatocellular Adenoma, Multiple	1	1	5	4**	0.0033
Hepatocellular Adenoma (includes multiple)	3	8*	17**	9**	0.0002
Hepatocellular Carcinoma	0	1	0	7**	<0.0001
Hepatocellular Adenoma or Carcinoma	3	9*	17**	15**	<0.0001
Hepatocholangiocarcinoma	0	0	3	2	0.0079
<i>Stop-Exposure Study</i>					
Number Examined Microscopically	32	19	26	19	
Bile Duct, Hyperplasia	3	2	8*	5	0.0299
Basophilic Focus	1	2	3	4	0.0277
Eosinophilic Focus	0	1	2	2	0.0453
Cholangiocarcinoma	0	0	0	1	0.1979
Hepatocellular Adenoma, Multiple	0	0	1	2	0.0311
Hepatocellular Adenoma (includes multiple)	3	4	5	7*	0.0113
Hepatocellular Carcinoma	0	0	1	4*	0.0018
Hepatocellular Adenoma or Carcinoma	3	4	5	10**	0.0003
Female					
<i>Core Study</i>					
Number Examined Microscopically	64	64	47	33	
Basophilic Focus	5	10	9	4	0.2266
Granuloma	29	27	16	8*	0.0147N
Bile Duct, Hyperplasia	7	9	10	6	0.1153
Mononuclear Cell, Infiltrate Multifocal	21	23	17	5*	0.0480N
Cholangioma, Multiple	0	0	1	1	0.3846
Cholangioma (includes multiple)	0	3	4*	2	0.0509
Cholangiocarcinoma	0	0	0	6**	<0.0001
Cholangioma or Cholangiocarcinoma	0	3	4*	8**	<0.0001
Hepatocellular Adenoma, Multiple	0	0	1	2	0.0168
Hepatocellular Adenoma (includes multiple)	5	3	4	7	0.0125
Hepatocellular Carcinoma	0	1	0	2	0.0186
Hepatocellular Adenoma or Carcinoma	5	4	4	8*	0.0059
Hepatocholangiocarcinoma	0	0	0	2	0.0245

TABLE 28
Incidences of Neoplasms and Nonneoplastic Lesions of the Liver in Guppies
in the 16-Month Waterborne Study of 1,2,3-Trichloropropane

	0 mg/L	4.5 mg/L	9.0 mg/L	18.0 mg/L	Trend Test P-Value
Female (continued)					
<i>Stop-Exposure Study</i>					
Number Examined Microscopically	31	31	31	27	
Basophilic Focus	1	4	2	4	0.1110
Eosinophilic Focus, Multiple	0	0	0	2	
Eosinophilic Focus, One	2	1	2	1	
Granuloma	19	19	12	11	0.0275N
Carcinoma, Invasive	0	1	0	0	0.3194
Cholangioma	2	2	0	2	0.4942
Cholangiocarcinoma	0	0	0	5*	0.0004
Cholangioma or Cholangiocarcinoma	2	2	0	7*	0.0056
Hepatocellular Adenoma	2	0	2	3	0.1245
Hepatocellular Carcinoma	0	1	0	0	0.3194
Hepatocellular Adenoma or Carcinoma	2	1	2	3	0.1808

* Significantly different ($P \leq 0.05$) from the control group by the Fisher exact test

** $P \leq 0.01$

^a Cochran-Armitage trend test or exact permutation test (Plackett, 1981). A negative trend or a lower incidence in an exposure group is indicated by N.

^b Number of animals with lesion

Gallbladder (Core Study): Carcinoma occurred in one 18.0 mg/L male (Tables 29 and E1).

Gallbladder (Stop-Exposure Study): A single carcinoma occurred in a 4.5 mg/L female (Table E3).

TABLE 29
Incidences of Neoplasms and Nonneoplastic Lesions of the Gallbladder in Guppies
in the 16-Month Waterborne Study of 1,2,3-Trichloropropane

	0 mg/L	4.5 mg/L	9.0 mg/L	18.0 mg/L	Trend Test P-Value ^a
Males					
<i>Core Study</i>					
Number Examined Microscopically	59	44	59	24	
Epithelium, Hyperplasia ^b	2	0	1	4	0.0064
Concretion	0	0	1	5**	<0.0001
Carcinoma	0	0	0	1	0.1290
Females					
<i>Core Study</i>					
Number Examined Microscopically	61	60	44	30	
Epithelium, Hyperplasia	2	2	1	3	0.0880

* Significantly different ($P \leq 0.05$) from the control group by the Fisher exact test

** $P \leq 0.01$

^a Cochran-Armitage trend test or exact permutation test (Plackett, 1981)

^b Number of animals with lesion

Kidney (Core Study): A number of lesions occurred with greater incidences in exposed groups of males and females (Table 30). These included Bowman's capsule hyperplasia; dilatation and hemorrhage in Bowman's space; glomerular dilatation, hyalinization (primarily in males), and proliferation; mineralization; casts; and renal tubule dilatation, degeneration, hyperplasia, and hypertrophy. In addition, renal tubule peritubular proliferation was seen in a few exposed males and females.

The normal glomerulus was approximately twice the diameter of a normal tubule and consisted of a few capillary loops with a small amount of mesangium composed of a few mesangial cells and scant mesangial matrix. The glomerulus was surrounded by a narrow clear Bowman's space outside of which was a thin Bowman's capsule composed of a single layer of flattened epithelial cells lying upon a thin connective tissue layer. Hyperplasia of Bowman's capsule was characterized by increased numbers of epithelial cells, many of which were cuboidal, as opposed to the normal flattened cells, with proliferation of the underlying connective tissue leading to slight to marked thickening of the connective tissue layer. Dilatation of Bowman's space consisted of a pronounced increase in the size of Bowman's space sometimes up to many times normal size. Hemorrhage in Bowman's space consisted of free blood filling a usually dilated Bowman's space. Glomerular dilatation was characterized by prominent, mild to marked dilatation of one or more glomerular capillary loops producing variably sized, cyst-like spaces filled with lightly eosinophilic, granular material (presumably plasma) and a few blood cells, with a subsequent enlargement of the glomerulus. Glomerular hyalinization was characterized by the filling of one or more capillary loops with homogeneous eosinophilic material that effaced the normal structure. Glomerular proliferation consisted of an increase in the number of glomerular capillary loops and proliferation of mesangial cells with a mild to marked increase in the amount of mesangial

matrix resulting in variable degrees of glomerular enlargement. Mineralization consisted of scattered irregular bits of basophilic material within the kidney stroma and/or tubular lumens. Casts consisted of aggregates of amphophilic to basophilic, granular material within the lumens of scattered tubules. Renal tubule dilatation was characterized by varying degrees of enlargement of the renal tubular lumen up to several times normal diameter. Renal tubule degeneration was characterized by irregular shrinkage and/or varying degrees of flattening of the tubular epithelium. Degeneration was often seen within dilated tubules. Renal tubule hyperplasia consisted of a focal to multifocal to diffuse increase in the number of epithelial cells in the renal tubular epithelial layer, sometimes producing some degree of thickening of the tubular epithelium. Renal tubule hypertrophy was characterized by an increase in the size of renal tubular epithelial cells. Renal tubule peritubular proliferation consisted of proliferation of the stromal elements surrounding the tubule.

Kidney (Stop-Exposure Study): Incidences of renal tubule dilation were increased in 4.5 and 18.0 mg/L males and in the 9.0 and 18.0 mg/L female groups (Table 30). Incidences of mineralization and casts in exposed females were increased compared to controls.

Pituitary Gland (Core Study): The incidences of hyperplasia were increased in 9.0 and 18.0 mg/L females (0 mg/L, 0/64; 4.5 mg/L, 0/64; 9.0 mg/L, 7/47; 18.0 mg/L, 16/33), and the incidence was highest in the 18.0 mg/L group. Hyperplasia was not present in any controls. A single adenoma was present in a 9.0 mg/L female (Table E3). The normal pituitary gland was a relatively small structure consisting of an anterior portion and a posterior portion. Hyperplasia was characterized by a mild to moderate, diffuse enlargement of the anterior portion or the posterior portion or both. The normal architecture of the gland was maintained and the cells of the anterior and posterior portions appeared normal.

TABLE 30
Incidences of Nonneoplastic Lesions of the Kidney in Guppies
in the 16-Month Waterborne Study of 1,2,3-Trichloropropane

	0 mg/L	4.5 mg/L	9.0 mg/L	18.0 mg/L	Trend Test P-Value ^a
Male					
<i>Core Study</i>					
Number Examined Microscopically	61	47	67	27	
Cast ^b	46	35	60*	24	0.0172
Mineralization	21	30**	58**	26**	<0.0001
Bowman's Capsule, Hyperplasia	1	5	10**	6**	0.0010
Bowman's Space, Dilatation	7	11	19*	19**	<0.0001
Bowman's Space, Hemorrhage	1	0	1	7**	<0.0001
Glomerulus, Dilatation	1	0	2	6**	<0.0001
Glomerulus, Hyalinization	0	3	2	2	0.0678
Glomerulus, Proliferation	0	0	2	4**	0.0001
Renal Tubule, Degeneration	9	5	6	15**	<0.0001
Renal Tubule, Hyperplasia	1	4	7*	4*	0.0121
Renal Tubule, Hypertrophy	0	1	5*	0	0.2179
Renal Tubule, Peritubular Proliferation	0	1	2	2	0.0197
Renal Tubule, Dilatation	32	36**	61**	26**	<0.0001
<i>Stop-Exposure Study</i>					
Number Examined Microscopically	32	19	26	19	
Cast	24	16	17	18	0.1116
Mineralization	19	14	20	19**	0.0007
Bowman's Capsule, Hyperplasia	0	0	1	2	0.0144
Bowman's Space, Dilatation	2	5	3	6*	0.0237
Glomerulus, Dilatation	0	0	0	1	0.0435
Renal Tubule, Hyperplasia	1	1	1	4	0.0125
Renal Tubule, Dilatation	14	14*	13	14*	0.0469
Female					
<i>Core Study</i>					
Number Examined Microscopically	64	64	47	33	
Cast	35	40	34*	33**	<0.0001
Mineralization	30	53**	40**	30**	<0.0001
Bowman's Capsule, Hyperplasia	0	2	3	10**	<0.0001
Bowman's Space, Dilatation	20	32*	29**	25**	<0.0001
Bowman's Space, Hemorrhage	2	4	6	11**	<0.0001
Glomerulus, Dilatation	0	1	5*	12**	<0.0001
Glomerulus, Hyalinization	0	1	0	1	0.1212
Glomerulus, Proliferation	0	0	1	3*	0.0008
Renal Tubule, Degeneration	2	5	7*	19**	<0.0001
Renal Tubule, Hyperplasia	1	2	4	3	0.0260
Renal Tubule, Hypertrophy	0	1	2	2	0.0211
Renal Tubule, Peritubular Proliferation	0	1	1	1	0.1114
Renal Tubule, Dilatation	40	45	44**	33**	<0.0001

TABLE 30
Incidences of Nonneoplastic Lesions of the Kidney in Guppies
in the 16-Month Waterborne Study of 1,2,3-Trichloropropane

	0 mg/L	4.5 mg/L	9.0 mg/L	18.0 mg/L	Trend Test P-Value
Female (continued)					
<i>Stop-Exposure Study</i>					
Number Examined Microscopically	31	31	31	27	
Cast	12	17	17	19*	0.0107
Mineralization	17	23	25*	26**	0.0001
Bowman's Capsule, Hyperplasia	0	0	0	2	0.0108
Bowman's Space, Dilatation	5	12*	10	19**	<0.0001
Glomerulus, Dilatation	0	0	0	2	0.0108
Renal Tubule, Hyperplasia	2	0	0	3	0.1258
Renal Tubule, Dilatation	15	19	27**	22**	0.0013

* Significantly different ($P \leq 0.05$) from the control group by the Fisher exact test

** $P \leq 0.01$

^a Cochran-Armitage trend test or exact permutation test (Plackett, 1981)

^b Number of animals with lesion

13-MONTH STUDY IN MEDAKA

Survival

Survival in the 9.0 and 18.0 mg/L groups indicated that 1,2,3-trichloropropane was chronically toxic to the medaka; reduced survival was evident beginning at 9 months of exposure (Table 31). Mortality in the 18.0 mg/L core study group was 26.3% and mortality in the 9.0 mg/L group was 17.3% between 9 months and study termination at 13 months. Survival was also reduced in stop-exposure fish from the 9.0 and 18.0 mg/L groups at the end of the study.

Exposure Concentrations, Body Lengths, and Body Weights

Nominal exposure concentrations of 4.5, 9.0, and 18.0 mg/L resulted in actual exposure concentrations of 4.6, 9.2, and 18.0 mg/L 1,2,3-trichloropropane, respec-

tively. Core study medaka in the 18.0 mg/L group were both longer and weighed more than the controls at the end of the study (Tables 32 and 33). At 9 months, the lengths and weights of medaka in the 9.0 and 18.0 mg/L groups were significantly increased (Table 33).

Mortality of fish during the study resulted in unequal numbers of individuals distributed to core study and stop-exposure aquaria at 9 months (Table 31). This appears to have influenced the length and weight of fish measured at study termination (i.e., the smaller tank population allowed the fish to grow more). Observed differences in weight and/or length between controls and 9.0 or 18.0 mg/L fish may have been an artifact of the reduced numbers of fish in these exposure aquaria.

TABLE 31
Survival of Medaka in the 13-Month Waterborne Study of 1,2,3-Trichloropropane

	0 mg/L	4.5 mg/L	9.0 mg/L	18.0 mg/L
Animals initially in study	340	340	340	340
Died before the 9-month interim evaluation	11	6	18	26
Unaccounted for ^a	3	4	6	3
9-Month interim evaluation	20	20	20	20
Died after reallocation ^b				
Core study	11	18	35	51
Stop-exposure study	4	11	14	18
Survivors				
Core study	192	188	161	143
Stop-exposure study	99	93	86	79
Survival analysis ^c				
Core study	<0.0001	0.7867	0.0004	<0.0001
Stop-exposure study	<0.0001	0.7274	0.0232	<0.0001

^a The laboratory report did not account for these fish at 9 months.

^b At 9 months, approximately one third of the fish in each replicate was reassigned to stop-exposure aquaria; the remaining fish (core study) were returned to their original exposure aquaria.

^c The result of life table trend test (Tarone, 1975) is in the control column, and the results of the life table pairwise comparison (Cox, 1972) between the controls and exposed animals appear in the exposure concentration columns.

TABLE 32
Body Lengths of Medaka in the 13-Month Waterborne Study of 1,2,3-Trichloropropane^a

Treatment	9-Month Interim Evaluation	Core Study	Stop-Exposure Study
0 mg/L	22.9 ± 0.4	24.0 ± 0.4	26.0 ± 0.5
4.5 mg/L	23.8 ± 0.4	24.6 ± 0.4	25.4 ± 0.3
9.0 mg/L	24.5 ± 0.6*	25.2 ± 0.4	25.9 ± 0.4
18.0 mg/L	24.6 ± 0.4*	26.5 ± 0.4**	26.2 ± 0.3

* Significantly different ($P \leq 0.05$) from the control group by Dunnett's test

** $P \leq 0.01$

^a Data are presented as mean length ± standard error (mm).

TABLE 33
Body Weights of Medaka in the 13-Month Waterborne Study of 1,2,3-Trichloropropane^a

Treatment	9-Month Interim Evaluation	Core Study	Stop-Exposure Study
0 mg/L	0.183 ± 0.012	0.220 ± 0.010	0.253 ± 0.011
4.5 mg/L	0.208 ± 0.013	0.227 ± 0.013	0.229 ± 0.008
9.0 mg/L	0.248 ± 0.019*	0.257 ± 0.013	0.246 ± 0.012
18.0 mg/L	0.241 ± 0.019*	0.264 ± 0.012*	0.241 ± 0.009

* Significantly different ($P \leq 0.05$) from the control group by Dunnett's test

^a Data are presented as mean length ± standard error (g).

Pathology and Statistical Analyses

This section describes the statistically or biologically noteworthy changes in incidences of neoplasms and/or nonneoplastic lesions of the liver, gallbladder, kidney, and thyroid tissue. Summaries of incidences of neoplasms by replicate are presented in Appendix F.

Liver (9-Month Interim Evaluation): The incidences of cholangiocarcinomas in 9.0 and 18.0 mg/L males were significantly increased at 9 months (Tables 34 and F1). Small numbers of cholangiocarcinomas occurred with similar incidences in each of the exposed female groups, and a cholangioma occurred in one 4.5 mg/L female (Tables 34 and F3). A hepatocholangiocarcinoma, a malignant liver neoplasm consisting of both neoplastic cholangiocellular (bile duct) and hepatocellular components, occurred in one 4.5 mg/L male, an hepatocellular adenoma occurred in one 18.0 mg/L male, and an hepatocellular carcinoma occurred in one 9.0 mg/L female. No cholangiocellular or hepatocellular neoplasms occurred in control males or females.

Liver (Core Study): Increased incidences of cholangiocellular and hepatocellular neoplasms occurred in exposed groups of males and females (Tables 34, F1, and F3).

One to a few cholangiomas occurred in each of the exposed groups of males and females but not in controls (Tables 34, F1, and F3). Incidences of cholangiocarcinomas were significantly increased in all exposed groups of males and females; no cholangiocarcinomas were observed in controls. Cholangiocarcinomas metastasized to a number of tissues including heart, kidney, eye, mesentery, adipose tissue, swim bladder, spleen, esophagus, ovary, pericardial cavity, and intestine. Moreover, incidences of bile duct hyperplasia were substantially increased in exposed groups of females and 9.0 and 18.0 mg/L males as compared with controls.

Incidences of hepatocellular adenoma and hepatocellular carcinoma (combined) were increased in 18.0 mg/L males and females as compared with controls. One 18.0 mg/L female had multiple hepatocellular adenomas. One hepatocellular adenoma and one hepatocellular carcinoma occurred in control females, otherwise there were no hepatocellular neoplasms in

control fish. A number of hepatocholangiocarcinomas also occurred in exposed groups of males and females, but not in controls. Hepatocholangiocarcinomas metastasized to a number of tissues including esophagus, adipose tissue, intestine, mesentery, pericardial cavity, and spleen.

Incidences of granuloma of the liver were decreased in 4.5 and 18.0 mg/L males and 18.0 mg/L females. The decreased incidences of granuloma may have been secondary to the presence of other exposure-related lesions that obscured the presence of granulomas.

The incidences of cyst were lower in 18.0 mg/L males and in all exposed groups of females than in the controls. The decreased incidences of cyst may be secondary to the presence of other exposure-related lesions that obscured the presence of cysts.

Microscopically, all of the liver lesions observed in this study appeared similar to those previously described.

Liver (Stop-Exposure Study): Increased incidences of cholangiocellular (bile duct) neoplasms were observed in exposed groups of males and females as compared with controls (Tables 34, F2, and F4). An increased incidence of hepatocellular carcinoma was observed in 18.0 mg/L females.

Cholangiocarcinoma occurred with moderately high incidences in all groups of exposed males and females. Cholangiocarcinoma also occurred in one control female. Cholangiocarcinomas metastasized to a number of tissues including esophagus, adipose tissue, eye, heart, kidney, mesentery, pericardial cavity, peritoneum, and spleen. Cholangioma occurred in a few exposed males and females but not in controls. Bile duct hyperplasia occurred with greater incidences in the 9.0 and 18.0 mg/L male groups than in the control group. The incidences of bile duct hyperplasia were similar in control and exposed groups of females. The incidences of cystic degeneration were higher in 9.0 and 18.0 mg/L females than in controls. Incidences of cysts were lower in exposed groups of males and females than in controls. The decreased incidences of cysts may be secondary to the presence of other exposure-related lesions that obscured the presence of cysts.

TABLE 34
Incidences of Neoplasms and Nonneoplastic Lesions of the Liver in Medaka
in the 13-Month Waterborne Study of 1,2,3-Trichloropropane

	0 mg/L	4.5 mg/L	9.0 mg/L	18.0 mg/L	Trend Test P-Value ^a
Male					
<i>9-Month Interim Evaluation</i>					
Number Examined Microscopically	10	10	11	13	
Cholangiocarcinoma ^b	0	2	5*	8**	0.0007
Hepatocellular Adenoma	0	0	0	1	0.2954
Hepatocholangiocarcinoma	0	1	0	0	0.2726
<i>Core Study</i>					
Number Examined Microscopically	95	94	65	78	
Granuloma	36	13**	18	0**	<0.0001N
Cyst	16	11	10	4*	0.0158N
Cholangioma	0	6*	2	1	0.4521
Cholangiocarcinoma	0	32**	43**	45**	<0.0001
Cholangioma or Cholangiocarcinoma	0	38**	45**	46**	<0.0001
Hepatocellular Adenoma	0	0	1	3	0.0128
Hepatocellular Carcinoma	0	2	0	3	0.0365
Hepatocellular Adenoma or Carcinoma	0	2	1	6**	0.0011
Hepatocholangiocarcinoma	0	0	2	6**	0.0001
<i>Stop-Exposure Study</i>					
Number Examined Microscopically	42	47	33	46	
Bile Duct, Hyperplasia	3	2	13**	14**	0.0002
Cyst	8	6	6	4	
Cholangioma	0	0	3	1	0.1653
Cholangiocarcinoma	0	19**	16**	26**	<0.0001
Cholangioma or Cholangiocarcinoma	0	19**	19**	27**	<0.0001
Hepatocellular Adenoma	0	1	0	0	0.3066
Hepatocellular Carcinoma	0	1	0	1	0.2471
Hepatocellular Adenoma or Carcinoma	0	2	0	1	0.3950
Female					
<i>9-Month Interim Evaluation</i>					
Number Examined Microscopically	11	11	10	8	
Cholangiocarcinoma	0	3	2	3	0.0366
Cholangioma	0	1	0	0	0.3400
Hepatocellular Carcinoma	0	0	1	0	0.3803
<i>Core Study</i>					
Number Examined Microscopically	95	93	94	67	
Bile Duct Hyperplasia	3	15**	30**	21**	<0.0001
Eosinophilic Focus	2	1	4	5	0.0164
Granuloma	11	6	5	1*	0.0061N
Cyst	37	18**	17**	15*	0.0136N
Cholangioma	0	1	2	1	0.1642
Cholangiocarcinoma	0	29**	53**	41**	<0.0001
Cholangioma or Cholangiocarcinoma	0	30**	55**	42**	<0.0001
Hepatocellular Adenoma, Multiple	0	0	0	1	0.1920
Hepatocellular Adenoma (includes multiple)	1	1	5	8**	0.0001
Hepatocellular Carcinoma	1	1	2	5*	0.0043
Hepatocellular Adenoma or Carcinoma	2	2	7	13**	<0.0001
Hepatocholangiocarcinoma	0	0	4	7**	<0.0001

TABLE 34
Incidences of Neoplasms and Nonneoplastic Lesions of the Liver in Medaka
in the 13-Month Waterborne Study of 1,2,3-Trichloropropane

	0 mg/L	4.5 mg/L	9.0 mg/L	18.0 mg/L	Trend Test P-Value
Female (continued)					
<i>Stop-Exposure Study</i>					
Number Examined Microscopically	57	44	49	31	
Bile Duct, Hyperplasia	4	6	8	5	0.0926
Cystic Degeneration	34	30	43**	26*	0.0014
Cyst	31	18	21	10	
Cholangioma	0	1	2	0	0.4016
Cholangiocarcinoma	1	15**	31**	21**	<0.0001
Cholangioma or Cholangiocarcinoma	1	16**	33**	21**	<0.0001
Hepatocellular Adenoma	4	2	2	1	0.2121
Hepatocellular Carcinoma	0	2	1	4*	0.0033
Hepatocellular Adenoma or Carcinoma	4	4	2	5	0.1224
Hepatocholangiocarcinoma	0	0	0	1	0.1713

* Significantly different ($P \leq 0.05$) from the control group by the Fisher exact test

** $P \leq 0.01$

^a Cochran-Armitage trend test or exact permutation test (Plackett, 1981). A negative trend is indicated by N.

^b Number of animals with lesion

Gallbladder (9-Month Interim Evaluation): Papillary adenomas occurred in two 18.0 mg/L males (Tables 35 and F1). No gallbladder neoplasms were seen in the controls or any of the other exposed groups.

Gallbladder (Core Study): Papillary adenoma occurred with increased incidences in 9.0 and 18.0 mg/L males and females (Tables 35, F1, and F3). In addition, carcinoma occurred in one exposed male and in one exposed female. No gallbladder neoplasms were present in controls. Epithelial hyperplasia of the gallbladder occurred with greater incidence in 18.0 mg/L males and females. Hyperplasia of the cystic duct of the gallbladder occurred with greater incidences in 9.0 and 18.0 mg/L males and females than those in the controls.

Papillary adenoma was generally a small- to moderate-sized papillary structure composed of a branching stromal core, indicative of a complex structure, covered by tall columnar epithelium. Some papillomas consisted of a series of multiple branching papillary structures, while some other papillomas were pedunculated masses composed of branching structures supported by a stalk. Carcinoma was a moderate-sized to large lesion composed of multiple highly complex papillary structures, some of which were covered by multiple layers of

epithelium, accompanied by localized invasion of the neoplastic epithelium through the gallbladder wall. Epithelial hyperplasia of the gallbladder was a focal to diffuse lesion characterized by an increase in the number of epithelial cells with thickening of the epithelium. Papillary hyperplasia was characterized by thickened epithelium that formed few to many irregular, simple, nonbranching papillary projections composed of a small stromal core covered by tall columnar epithelial cells, the greater the severity of the hyperplasia the greater the number of papillary projections. The papillary projections formed a continuous line producing a sessile, flat-based lesion. Cystic duct hyperplasia, consisting of hyperplasia of the cystic duct epithelium, had a similar appearance to hyperplasia within the gallbladder lumen and was accompanied by varying degrees of enlargement of the duct secondary to the epithelial hyperplasia.

Gallbladder (Stop-Exposure Study): The incidence of papillary adenoma in males exposed to 18.0 mg/L was significantly increased; papillary adenoma and carcinoma were observed in most exposed groups of males and females (Tables 35, F2, and F4). Cystic duct hyperplasia occurred with greater incidences in 18.0 mg/L males than in controls.

TABLE 35
Incidences of Neoplasms and Nonneoplastic Lesions of the Gallbladder in Medaka
in the 13-Month Waterborne Study of 1,2,3-Trichloropropane

	0 mg/L	4.5 mg/L	9.0 mg/L	18.0 mg/L	Trend Test P-Value ^a
Male					
<i>9-Month Interim Evaluation</i>					
Number Examined Microscopically	10	9	11	13	
Adenoma, Papillary ^b	0	0	0	2	0.0864
<i>Core Study</i>					
Number Examined Microscopically	91	83	61	72	
Epithelium, Hyperplasia	1	0	1	12**	<0.0001
Hyperplasia, Papillary	0	2	2	0	0.4434
Cystic Duct, Hyperplasia	0	1	7**	19**	<0.0001
Concretion	3	2	3	4	0.1760
Adenoma, Papillary	0	0	4*	9**	<0.0001
Carcinoma	0	0	0	1	0.2345
<i>Stop-Exposure Study</i>					
Number Examined Microscopically	41	42	30	46	
Epithelium, Hyperplasia	1	0	3	6	0.0058
Hyperplasia, Papillary	0	0	2	1	0.1642
Cystic Duct, Hyperplasia	0	1	3	5*	0.0085
Concretion	1	0	0	6	0.0023
Adenoma, Papillary	0	0	3	4*	0.0074
Carcinoma	0	0	1	1	0.1820
Female					
<i>Core Study</i>					
Number Examined Microscopically	85	80	88	65	
Epithelium, Hyperplasia	1	0	3	10**	<0.0001
Hyperplasia, Papillary	0	0	4	2	0.0338
Cystic Duct, Hyperplasia	1	3	8*	16**	<0.0001
Concretion	11	6	11	10	0.2189
Adenoma, Papillary	0	1	5*	6**	0.0006
Carcinoma	0	1	0	0	0.3295
<i>Stop-Exposure Study</i>					
Number Examined Microscopically	56	40	45	30	
Cystic Duct, Hyperplasia	1	1	5	1	0.1961
Adenoma, Papillary	0	1	1	1	0.1382
Carcinoma	0	0	0	1	0.1754

* Significantly different ($P \leq 0.05$) from the control group by the Fisher exact test

** $P \leq 0.01$

^a Cochran-Armitage trend test or exact permutation test (Plackett, 1981)

^b Number of animals with lesion

Kidney (Core Study): Incidences of casts and mineralization were increased in 9.0 and 18.0 mg/L males and in 18.0 mg/L females as compared with controls (Table 36). The incidences of renal tubule dilatation were increased in 18.0 mg/L males and females. The incidences of renal tubule vacuolation in 18.0 mg/L females and of dilatation of Bowman's space in 18.0 mg/L males were increased relative to the controls. Microscopically, these lesions appeared similar to those previously described. In addition, the incidences of clear cytoplasmic vacuolation of tubular epithelium in some exposed groups of males and females, and the incidences of dilatation of Bowman's space of the renal glomerulus in some groups of exposed males were marginally greater than those in the controls.

Kidney (Stop-Exposure Study): The incidence of renal tubule dilatation was increased in 18.0 mg/L females (Table 36).

Thyroid Tissue (Core Study): Incidences of hyperplasia, consisting of an increase in the number of thyroid follicles, were increased in 18.0 mg/L males (0 mg/L, 9/95; 4.5 mg/L, 12/94; 9.0 mg/L, 10/65; 18.0 mg/L, 22/78). Incidences of increased basophilia, characterized by increased basophilic staining of follicular cells, were greater in 18.0 mg/L females than in the controls (6/95, 13/93, 13/94, 29/67). The significance of the increased basophilia was questionable and may have represented a normal anatomic variation rather than an actual lesion.

Thyroid Tissue (Stop-Exposure Study): Incidences of increased basophilia were increased in 18.0 mg/L females compared to the controls (2/57, 6/44, 4/49, 6/31).

TABLE 36
Incidences of Nonneoplastic Lesions of the Kidney in Medaka
in the 13-Month Waterborne Study of 1,2,3-Trichloropropane

	0 mg/L	4.5 mg/L	9.0 mg/L	18.0 mg/L	Trend Test P-Value ^a
Male					
<i>Core Study</i>					
Number Examined Microscopically	95	94	65	78	
Casts ^b	11	17	17*	23**	0.0012
Mineralization	14	21	20*	25**	0.0030
Renal Tubule, Dilatation	13	19	10	24**	0.0043
Renal Tubule, Vacuolation	0	0	2	3	0.0083
Bowman's Space, Dilatation	1	3	1	8**	0.0012
<i>Stop-Exposure Study</i>					
Number Examined Microscopically	42	47	33	46	
Renal Tubule, Dilatation	7	7	6	12	0.0893
Female					
<i>Core Study</i>					
Number Examined Microscopically	95	93	94	67	
Casts	5	13*	11	15**	0.0014
Mineralization	4	6	3	10*	0.0071
Renal Tubule, Dilatation	6	6	10	19**	<0.0001
Renal Tubule, Vacuolation	1	1	1	6*	0.0009
<i>Stop-Exposure Study</i>					
Number Examined Microscopically	57	44	49	31	
Renal Tubule, Dilatation	4	6	8	7*	0.0193
Casts	3	3	5	5	0.0360
Mineralization	3	1	3	3	0.1553
Renal Tubule, Degeneration	0	1	3	2	0.0315

* Significantly different ($P \leq 0.05$) from the control group by the Fisher exact test

** $P \leq 0.01$

^a Cochran-Armitage trend test or exact permutation test (Plackett, 1981)

^b Number of animals with lesion

DISCUSSION AND CONCLUSIONS

One of the major efforts of the National Toxicology Program (NTP) has been to determine the potential carcinogenic hazard from chemicals that occur in the workplace or environment (Page *et al.*, 1977; Weisburger and Williams, 1981; Weisburger *et al.*, 1984; Goodman and Wilson, 1991; Faccini *et al.*, 1992). While rodent studies are costly and time consuming, their strengths and weaknesses are fairly well understood (Haseman, 2000; Bennett and Davis, 2002), and rodent studies have provided a wealth of information on chemicals that occur in the environment and in the workplace (Gold *et al.*, 1998; Kielhorn *et al.*, 2000). While long-term rodent studies provide safety assessment for pharmaceuticals and support many regulatory policies, the search for better models continues (Festing, 1995; Alden *et al.*, 1996; Eastin, 1998; Law 2001, 2003). The United States Congress has also instructed the National Institutes of Health (NIH) to investigate the use of alternatives to animal models as well as lower phylogenetic animals (Salem and Katz, 1998).

Assays using fish species have been reported to be more sensitive to carcinogens (Ishikawa *et al.*, 1984; Zimmerer, 1984; Liu *et al.*, 2003) and less expensive and faster to perform than rodent studies in carcinogenicity testing (Sinnhuber *et al.*, 1978; Ishikawa and Takayama, 1979; Bailey *et al.*, 1984; Simon and Lapis, 1984; Walker *et al.*, 1985). Use of a research model under standard test procedures may reveal limitations that might not be obvious from limited use in a research laboratory setting. Therefore, the NTP decided to use two small fish models to evaluate three chemicals previously tested in NTP standard rodent studies.

While rodent studies generally involve pathogen-free genetically-defined animals maintained on standard rodent chow, these parameters are less well established for fish studies (ILAR, 1974). For example, genetically defined medaka and guppies were not available. Therefore, laboratory-bred fish from Gulf Coast Laboratory (University of Mississippi, Ocean Springs, MS), where the study was conducted, were used. The fish had been maintained as a closed colony for approximately 10 years at Gulf Coast Laboratory after they

were purchased from a commercial supplier. Since there are no standard breeding programs to reduce genetic drift, it may be assumed that the medaka and guppies used in the NTP studies vary somewhat from other similar fish colonies in the United States and other countries (ILAR, 1974; Zimmerer, 1984; Ishikawa, 2000; Reznick *et al.*, 2001). It has been shown that natural populations of guppies can rapidly evolve due to predators (Reznick *et al.*, 2001). While rodent chow has been standardized, small fish models are fed a variety of foods for which much less is known (ILAR, 1974). In NTP fish studies, the fish were fed a combination of commercial fish flake food (Ziegler Brothers) and brine shrimp. Finally, the NTP goes to great lengths to assure that its studies maintain pathogen-free rodents, but the fish in this study had histological evidence of parasitic, fungal, and bacterial infections. These issues are not unlike those experienced when the NTP began large-scale use of rodents for carcinogenicity testing.

The fish rooms were on a 16-hour light and 8-hour dark cycle, a photoperiod used by many investigators for long-term studies (Zimmerer, 1984; Davis *et al.*, 2002). The disadvantage of the photoperiod used in this study was that it does not inhibit reproduction. Embryos were present in female guppies, which bear live young, and developing follicles were present in the ovaries of female medaka. A reduced light photoperiod can be used to inhibit reproduction in the medaka (Koger *et al.*, 1999; Davis *et al.*, 2002). However, fish exposed to restricted light are significantly smaller (Davis *et al.*, 2002), and the impact this may have on carcinogenesis is not known. Therefore, the 16-hour light, 8-hour dark was used, which is more common for medaka studies. However, it should be assumed that female guppies delivered live young during the study and that the female medaka produced eggs. The aquaria were examined daily, and immature fish were not seen during the study. While this is standard practice with the assumption that young born or hatched during the study will not reach maturity (Yamamoto, 1975; Overstreet *et al.*, 2000), it does introduce a degree of uncertainty about age and length of exposure for those fish harvested at the end of the study.

One of the chemicals, nitromethane, proved especially problematic because the chemical served as a source of nitrogen that promoted bacterial and algal growth in the aquaria. This effect necessitated brushing the aquaria once and siphoning two (guppies) or three (medaka) times each day instead of once per week. The frequent cleaning may have caused more stress on the fish than was experienced by fish in the 2,2-bis(bromomethyl)-1,3-propanediol and 1,2,3-trichloropropane studies. Despite efforts to keep the fish as healthy as possible, microscopic granulomas related to bacteria and fungi were seen in multiple organs in fish from all three studies. Generally, more than half of the fish in any group had microscopic granulomas. In the nitromethane study, there was some increase in the incidences of granulomas with increasing dose, while in the 2,2-bis(bromomethyl)-1,3-propanediol study, the incidences of granulomas decreased with increasing dose. It was speculated that 2,2-bis(bromomethyl)-1,3-propanediol at higher doses inhibited bacterial growth.

In rodent studies, the dose selection is usually based on toxicokinetic studies, clinical pathology findings, clinical signs, and histopathology using 14-day and 90-day exposures. For the current fish studies, doses were determined using 2-day static tests and 7-day and 28-day flow-through range finding studies. Mortality and lethargy were the endpoints used. The highest concentration that was predicted not to cause excessive mortality was chosen for 16-month studies. While the guppies could tolerate the chemical exposures for 16 months, excessive mortality occurred in the medaka. Medaka studies were terminated at 13 months for the 1,2,3-trichloropropane study and at 14 months for the 2,2-bis(bromomethyl)-1,3-propanediol, where the doses were the same as that for the guppy. In the studies of guppies exposed to these same two chemicals, survival to 16 months was adequate. In the nitromethane study, the dose-range finding studies indicated that medaka were more sensitive, so the doses selected were 0, 10, 20, and 40 mg/L for medaka in contrast to the 0, 10, 30, and 70 mg/L doses selected for the guppies. Again, the medaka had to be terminated at 13 months due to high mortality, while the guppies survived to 16 months. This may not be surprising since guppies are considered to have a longer life span and to be less sensitive to carcinogens than medaka (Hawkins *et al.*, 2003).

The length of exposure that would be necessary for detection of carcinogenicity of these three chemicals was not known. The time for tumor induction in guppies has

been reported to be from 3 to 11 months (Zimmerer, 1984), while medaka exposed to potent carcinogens may show liver tumors in 2 to 3 months (Hinton *et al.*, 1984). Since animals dying early are often lost for examination in the experimental studies, an interim sacrifice was included at 9 months for the detection of microscopic tumors and preneoplastic lesions. Significantly increased incidences of tumors at 9 months were seen only in medaka and only for 1,2,3-trichloropropane. Significantly increased incidences of tumors were not seen for the other chemicals at 9 months including 1,2,3-trichloropropane in guppies, a study that was clearly positive at study termination.

A hypothesis tested during these studies was that for toxic chemicals, the fish would live longer and neoplasms might develop more readily if the chemical was removed during the last few study months, perhaps providing a more sensitive assay than one involving continued exposure. Therefore, at 9 months, one third of the remaining fish were placed in chemical-free water (stop-exposure study) while the other two thirds were continued on exposure (core study). The 9-month interim sacrifice and the transfer of some fish to chemical-free water (stop-exposure groups) were used to provide ancillary information. An observation period in chemical-free water following exposure has been used in other fish studies (Simon and Lapis, 1984).

The goal was to examine approximately 100 fish in the continued exposure study (core study) since the sex of the animals would not be known until histological examination. This would make the fish studies comparable to the groups of 50 males and 50 females in rodent studies.

While large numbers of fish are easier to maintain in many respects than rodents, they do present unique challenges. Fish counts were approximate during the study and, since fish could be lost during the study, duplicate aquaria containing more fish than needed were used. The goal was to sample 20 fish per species and dose concentration at 9 months; approximately 50 per sex, species, and dose concentration with continued exposure (core study); and approximately 25 per sex, species, and dose concentration for the stop-exposure study. To accomplish these goals each group started with 220 guppies (110 per aquarium) and 340 medaka (170 per aquarium). In order to avoid bias, fish were randomly assigned to study groups at the initiation of exposure, and at 9 months randomly assigned for examination, and randomly assigned for continued exposure or

stop-exposure (Hawkins *et al.*, 2003). In most groups, enough fish survived to allow random selection of animals for examination at terminal sacrifice.

The number of medaka examined for nitromethane and 1,2,3-trichloropropane exceeded 1,000. In the 1,2,3-trichloropropane study, the total number of medaka examined varied from 222 fish in the high exposure group to 291 in the control group. For this study, 188 control guppies were examined, but only 106 high exposed guppies were examined. For the nitromethane study, more than 220 medaka were examined for each control and exposure group, with over 160 guppies in each group except for the high exposure where only 89 fish were available for examination. For the 2,2-bis(bromomethyl)-1,3-propanediol studies, approximately 270 medaka were examined in each group, while approximately 115 to 190 guppies were examined for each dose or control group.

Concentrations of each chemical were set at the highest levels compatible with survival, and exposure lengths were set at 13 to 16 months to maximize the possibility of detecting a carcinogenic response. It is possible that animals lost to mortality may have experienced more toxicity or tumors than the survivors. However, most early death animals were cannibalized and could not be examined. Nitromethane was considered negative for carcinogenicity, but less than 50% of the high exposure guppies and approximately 70% of the high exposure medaka were examined. Whether examination of the early death animals would have changed this assessment is not known. Toxicity precluded testing of these chemicals at higher concentrations.

The small size of the fish confers both advantages and disadvantages. In contrast to rodents, there is no gross necropsy, and most tumors are found histologically. A whole fish fits on a histological slide, and the five longitudinal sections taken to evaluate fish include most tissues. Therefore, it is usually not possible to examine multiple samples of tumors or take samples at different sites within a tumor. The small size of fish also means that many small tissues such as the thymus are easily missed during sectioning.

Growth and size are related to the density of fish in the aquaria (Davis *et al.*, 2002). With increasing mortality at higher exposure concentrations, it is nearly impossible to maintain fish densities across exposure groups that are comparable to those in the control aquaria. 1,2,3-Trichloropropane exposure caused increased mor-

talities in both guppies and medaka, and in both cases there was an increase in fish length and/or body weight. While increased body weight might be explained by the increased liver tumors found with 1,2,3-trichloropropane exposure, body length is more likely related to the reduced number of fish in the aquaria. This may introduce a confounding factor for study interpretation because increased incidences of liver tumors are correlated with increased body weights as observed in mice (Fullerton *et al.*, 1992; Cohen *et al.*, 1994; Haseman *et al.*, 1997; Rogers *et al.*, 1999). However, Rao and Crockett (2003) have pointed out that increased body weights and liver tumors do not always correlate for mice when housed under different conditions.

In the current studies, survival and body weight and/or body length do not always correlate. For example, in medaka exposed to nitromethane, there were increased body weights, while the number of survivors was similar across exposure concentrations. Conversely, decreased survival was seen in guppies exposed to 2,2-bis(bromomethyl)-1,3-propanediol with little or no effect on fish size. However, in four of the six studies, the fish in one or more of the exposed groups were larger than in the control group. This may be critical since body weight gain can greatly affect tumor multiplicity, especially when occurring during the initiation and promotion stages of the cancer process (Rodriguez-Burford *et al.*, 1999). Keeping aquaria concentrations and fish size comparable across dose and control groups will reduce uncertainty especially when a marginal increase in tumors is found in exposed fish.

Rodents have a rich history of carcinogenicity and mechanistic studies, so much more information on classification and potential significance of rodent lesions is available compared to the tumors that occur in fish. This could change as fish models become more widely used in carcinogenicity studies.

It was anticipated that evaluating the step sections from fish would be much faster than evaluating the 10 to 12 slides usually available for each rodent in NTP studies. However, this did not prove to be the case. Searching the whole fish and several sections for each tissue proved to be nearly as time consuming as the evaluation for a rat or mouse. Thus, there was minimal cost reduction for pathology effort for the fish models. Since tumors were found essentially only in the liver, it may be possible in the future to limit pathological evaluation to the liver. This, of course, would limit the information available from a fish study.

This disadvantage might be somewhat compensated if the overall cost of the fish studies were significantly less than for rodents. While the fish studies were less expensive, the overall cost of evaluating three chemicals in two fish models was still approximately half of the cost of evaluating the three chemicals in two rodent species. The rodent studies included a gavage study, an inhalation study, and a feed study.

Nitromethane was selected for evaluation in small fish models because nitromethane is a nonmutagen that gave clear evidence of carcinogenicity in three of the four sex/species combinations in the NTP study (NTP, 1997) but did not primarily affect the liver. Nitromethane by inhalation exposure was not carcinogenic for male rats but was clearly carcinogenic for female rats with increased mammary gland fibroadenomas and carcinomas. Nitromethane was clearly carcinogenic for male and female mice with increased incidence of harderian gland adenomas and carcinomas. There were increased incidences of liver neoplasms in female mice exposed to nitromethane. The increased incidences of alveolar/bronchiolar adenomas and carcinomas in mice may have been related to nitromethane exposure. Guppies and medaka exposed to 70 mg/L of nitromethane experienced increased mortality by 9 months. There were no increased incidences of neoplasms at any site in male or female medaka or male or female guppies at 9 months. At 16 months, there were no increased incidences of neoplasms at any site in female guppies. Despite a small increase in hepatocellular neoplasms in the 30 mg/L core-study group, the study in male guppies was considered inadequate. In medaka, where the study was terminated at 13 months, there was equivocal evidence for increased liver neoplasms in the male medaka for the continued exposure but not the stop-exposure study. No increased incidences of neoplasms at any site were found in female medaka. Thus nitromethane, that was carcinogenic in rodents (NTP, 1997) generally at sites other than the liver, was not predicted to be carcinogenic by these two fish species.

2,2-Bis(bromomethyl)-1,3-propanediol was selected for study because it is mutagenic and a multisite carcinogen and judged to give clear evidence of carcinogenic activity in male and female rats and male and female mice (NTP, 1996). The sites of increased neoplasm incidences in the rodents included oral cavity, skin, esophagus, and urinary bladder, sites where cancer may be predicted to occur in fish, as well as other sites including lung, harderian gland, subcutaneous tissue, Zymbal's

gland, and others. There was no increased mortality in medaka exposed to 2,2-bis(bromomethyl)-1,3-propanediol, but mortality was increased in guppies exposed to 2,2-bis(bromomethyl)-1,3-propanediol. At the 9-month interim sacrifice, there was no significantly increased incidence of neoplasms at any site in male or female guppies or medaka. By 16 months, the incidences of hepatocellular adenomas and carcinomas were clearly increased in male guppies for both the stop-exposure and continued exposure groups. There was no significant increase in neoplasms at any site in female guppies at 16 months. At 14 months, there was an increase in the incidences of hepatocellular adenomas and carcinomas in male medaka in the continued exposure group, supported by a marginal increase in the stop-exposure group. Both the continued exposure and stop-exposure groups were considered negative for carcinogenicity in the female medaka. This is a more modest response than in rodents, where neoplasms of the skin subcutaneous tissue, mammary gland, Zymbal's gland, oral cavity, esophagus, forestomach, small and large intestine, mesothelium, urinary bladder, lung, thyroid gland, seminal vesicle, and mononuclear cells were found in male rats (NTP, 1996). Three or more sites for increased neoplasm incidences were also found in female rats and male and female mice.

1,2,3-Trichloropropane was selected as a second mutagenic multisite rodent carcinogen (NTP, 1993). The spectrum of induced incidences of neoplasms in rodents (oral cavity, Zymbal's gland, harderian gland, and forestomach) was similar to 2,2-bis(bromomethyl)-1,3-propanediol but included other sites such as uterus, clitoral gland, intestine, and pancreas. Increased incidences of liver neoplasms were found in male medaka at 9 months with a suggestive increase in the incidences of liver neoplasms in female medaka but were not found in the liver of male or female guppies at 9 months. The incidences of liver neoplasms were clearly increased in male and female medaka at all dose concentrations at 13 months and at all dose concentrations in male guppies at 16 months. The incidences of liver neoplasms were clearly increased at the two highest doses in the female guppy at 16 months. The response was greater in medaka compared to guppies, and generally greater in males. The incidences of neoplasms were greater in the continued exposure groups compared to the stop-exposure groups. 1,2,3-Trichloropropane by gavage at up to 30 mg/kg in rats and 60 mg/kg in mice caused increased cancer at multiple sites in a 15-month interim evaluation in both rats and mice (NTP, 1993). Thus, this small

series of three chemicals in two fish models provides little evidence that these chemicals can be detected more quickly or at lower concentrations than in rodents.

Stop-exposure groups after 9 months were compared to continued exposure groups with the hypothesis that less toxicity might enhance the growth of neoplasms, providing greater sensitivity to detect carcinogens by these fish species. In every instance, the incidence of liver neoplasms was higher in groups exposed continuously when compared to the stop-exposure groups. This would suggest that stop-exposure studies are not more sensitive than continued exposure studies. While our studies are limited to three chemicals, the effect was consistent for both sexes in two fish species.

It might be expected that mutagenicity or the carcinogenic response in rodents would predict the carcinogenic response in fish. However, the traditional predictors of toxicity in rodents fail to characterize the bioavailability of the chemical for fish, one of the more important predictors of toxicity for aquatic species (Boudou and Ribeyre, 1997; Parkerton *et al.*, 2000). Hydrophobic compounds would be expected to accumulate in the lipid-rich tissues of fish, including the liver (Meador *et al.*, 1995), while hydrophilic chemicals would remain in the water. Nitromethane and 2,2-bis(bromomethyl)-1,3-propanediol have calculated bioaccumulation factors of 1.0 (American Chemical Society, 2003) and were negative or of limited carcinogenicity in our studies. 1,2,3-Trichloropropane was clearly carcinogenic in both medaka and guppies and has a calculated bioaccumulation factor of 18.2 (American Chemical Society, 2003). Thus, the bioavailability factor may be one of the most important criteria in selecting chemicals for evaluation in small fish models.

The spectrum of neoplasms in organs and tissues in rodents has often provided clues as to the mechanisms of toxicity and carcinogenicity of the test chemicals. However, most fish studies report primarily liver neoplasms (Hinton *et al.*, 1984; Ishikawa *et al.*, 1984; Boorman *et al.*, 1997; Hawkins *et al.*, 2003). Therefore, three chemicals were selected that caused a broad spectrum of cancers in rodents including neoplasms of the mammary gland, oral cavity, forestomach, harderian gland, Zymbal's gland, lung, pancreas, kidney, and other sites. While it may be difficult to predict a target site for a chemical that causes increased mammary gland or Zymbal's gland neoplasms, it was surprising to find that both sexes and both species of fish responded with only

neoplasms of the liver and gallbladder. The fish response appeared less informative than the wide spectrum of neoplasms found in the rodent studies.

The loss of specimens during the study limited the information that was available for analysis. For example, time to neoplasm and presence of preneoplastic lesions could not be analyzed with the present study design. It is possible that multiple interim sacrifices would be helpful. It is worth noting that generally the 9-month sacrifice showed few or no neoplasms, and the medaka studies were terminated at 13 months (16 months for guppies), providing a very small window to study neoplasm development. One concern that was difficult to address was the possibility that fish that developed neoplasms died early and were lost to the study. For example, all three guppy studies had markedly reduced survival in the highest exposure group after the animals were assigned to the core study at 9 months. As a result, only a relatively small proportion of the animals in these groups (ranging from 55% in the nitromethane study to 71% in the 2,2-bis(bromomethyl)-1,3-propanediol study) were examined for liver neoplasms. It is unknown how this early death and the resulting possibility of underestimating the true neoplasm incidences affected the studies sensitivity for detecting carcinogenicity.

CONCLUSIONS

Under the conditions of these waterborne studies, 2,2-bis(bromomethyl)-1,3-propanediol at concentrations of up to 150 mg/L for 16 months was considered carcinogenic for male guppies based on increased incidences of hepatocellular adenomas or carcinomas. The study in female guppies was considered inadequate based on reduced survival. Under the conditions of these waterborne studies, 2,2-bis(bromomethyl)-1,3-propanediol at concentrations of up to 150 mg/L for 14 months was considered carcinogenic for male medaka based on increased incidences of hepatocellular adenomas or carcinomas. The study in female medaka was considered negative.

Under the conditions of these waterborne studies, the study of nitromethane in male guppies was considered inadequate based on reduced survival. The study in female guppies at concentrations up to 70 mg/L for 16 months was considered negative. The study in male and female medaka was considered negative.

Under the conditions of these waterborne studies, 1,2,3-trichloropropane at concentrations of up to 18 mg/L for 16 months was considered carcinogenic for male and female guppies based on increased incidences of a variety of liver neoplasms. Under the conditions of

these waterborne studies, 1,2,3-trichloropropane at concentrations of up to 18 mg/L for 13 months was considered carcinogenic for male and female medaka based on increased incidences of a variety of liver neoplasms and papillary adenoma of the gallbladder.

REFERENCES

- Aharonson, N. (1987). Direct gas chromatographic determination of insecticides. *Pure Appl. Chem.* **59**, 1419-1446.
- Alden, C.L., Smith, P.F., Piper, C.E., and Brej, L. (1996). A critical appraisal of the value of the mouse cancer bioassay in safety assessment. *Toxicol. Pathol.* **24**, 722-725.
- The Aldrich Library of FT-IR Spectra* (1985). 1st ed. (C.J. Pouchert, Ed.), Vol. 1, pg. 85b. Aldrich Chemical Company, Inc., Milwaukee, WI.
- American Chemical Society (2003). Chemical Abstract Service. Retrieved from the World Wide Web: <<http://www.cas.org/SCIFINDER/>>
- Armitage, P. (1971). *Statistical Methods in Medical Research*, pp. 362-365. John Wiley and Sons, Inc., New York.
- Ashby, J., and Tennant, R.W. (1988). Chemical structure, Salmonella mutagenicity and extent of carcinogenicity as indicators of genotoxic carcinogenesis among 222 chemicals tested in rodents by U.S. NCI/NTP. *Mutat. Res.* **204**, 17-115.
- Bailey, G.S., Hendricks, J.D., Nixon, J.E., and Pawlowski, N.E. (1984). The sensitivity of rainbow trout and other fish to carcinogens. *Drug Metab. Rev.* **15**, 725-750.
- Bennett, L.M., and Davis, B.J. (2002). Identification of mammary carcinogens in rodent bioassays. *Environ. Mol. Mutagen.* **39**, 150-157.
- Biocides*, U.S.A. (1974). p. 156. Charles H. Kline and Company, Fairfield, NJ.
- Boorman, G.A., Botts, S., Bunton, T.E., Fournie, J.W., Harshbarger, J.C., Hawkins, W.E., Hinton, D.E., Jokinen, M.P., Okihira, M.S., and Wolfe, M.J. (1997). Diagnostic criteria for degenerative, inflammatory, proliferative nonneoplastic and neoplastic liver lesions in medaka (*Oryzias latipes*): Consensus of a National Toxicology Program Pathology Working Group. *Toxicol. Pathol.* **25**, 202-210.
- Boudou, A., and Ribeyre, F. (1997). Aquatic ecotoxicology: From the ecosystem to the cellular and molecular levels. *Environ. Health Perspect.* **105** (Suppl. 1), 21-35.
- Brown-Peterson, N.J., Krol, R.M., Zhu, Y., and Hawkins, W.E. (1999). N-nitrosodiethylamine initiation of carcinogenesis in Japanese medaka (*Oryzias latipes*): Hepatocellular proliferation, toxicity, and neoplastic lesions resulting from short term, low level exposure. *Toxicol. Sci.* **50**, 186-194.
- Chiu, C.W., Lee, L.H., Wang, C.Y., and Bryan, G.T. (1978). Mutagenicity of some commercially available nitro compounds for Salmonella typhi-murium. *Mutat. Res.* **58**, 11-22.
- Code of Federal Regulations (CFR) **21**, Part 58.
- Cohen, L.A., Epstein, M., Saa-Pabon, V., Meschter, C., and Zang, E. (1994). Interactions between 4-HPR and diet in NMU-induced mammary tumorigenesis. *Nutr. Cancer* **21**, 271-283.
- Cox, D.R. (1972). Regression models and life-tables. *J. R. Stat. Soc.* **B34**, 187-220.
- Davis, C.R., Okihira, M.S., and Hinton, D.E. (2002). Effects of husbandry practices, gender and normal physiological variation on growth and reproduction of Japanese medaka, *Oryzias latipes*. *Aquatic Toxicol.* **60**, 185-201.

- Dayal, R., Gescher, A., Harpur, E.S., Pratt, I., and Chipman, J.K. (1989). Comparison of the hepatotoxicity in mice and the mutagenicity of three nitroalkanes. *Fundam. Appl. Toxicol.* **13**, 341-348.
- Dellarco, V.L., and Prival, M.J. (1989). Mutagenicity of nitro compounds in *Salmonella typhimurium* in the presence of flavin mononucleotide in a pre-incubation assay. *Environ. Mol. Mutagen.* **13**, 116-127.
- Dunnett, C.W. (1955). A multiple comparison procedure for comparing several treatments with a control. *J. Am. Stat. Assoc.* **50**, 1096-1121.
- Dunnick, J.K., Heath, J.E., Farnell, D.R., Prejean, J.D., Haseman, J.K., and Elwell, M.R. (1997). Carcinogenic activity of the flame retardant, 2,2-bis(bromomethyl)-1,3-propanediol in rodents, and comparison with the carcinogenicity of other NTP brominated chemicals. *Toxicol. Pathol.* **25**, 541-548.
- Eastin, W.C. (1998). The U. S. National Toxicology Program evaluation of transgenic mice as predictive models for identifying carcinogens. *Environ. Health Perspect.* **106** (Suppl. 1), 81-84.
- Faccini, J.M., Butler, W.R., Friedmann, J., Hess, R., Reznik, G.K., Ito, N., Hayashi, Y., and Williams, G.M. (1992). IFSTP guidelines for the design and interpretation of the chronic rodent carcinogenicity bioassay. *Exp. Toxicol. Pathol.* **44**, 443-456.
- Festing, M.F. (1995). Use of a multistrain assay could improve the NTP carcinogenesis bioassay. *Environ. Health Perspect.* **103**, 44-52.
- Fullerton, F.R., Greenman, D.L., and Bucci, T.J. (1992). Effects of diet type on incidence of spontaneous and 2-acetylaminofluorene-induced liver and bladder tumors in BALB/c mice fed AIN-76A diet versus NIH-07 diet. *Fundam. Appl. Toxicol.* **18**, 193-199.
- Galloway, S.M., Armstrong, M.J., Reuben, C., Colman, S., Brown, B., Cannon, C., Bloom, A.D., Nakamura, F., Ahmed, M., Duk, S., Rimpo, J., Margolin, G.H., Resnick, M.A., Anderson, B., and Zeiger, E. (1987). Chromosome aberrations and sister chromatid exchanges in Chinese hamster ovary cells: Evaluations of 108 chemicals. *Environ. Mol. Mutagen.* **10** (Suppl. 10), 1-175.
- Gart, J.J., Chu, K.C., and Tarone, R.E. (1979). Statistical issues in interpretation of chronic bioassay tests for carcinogenicity. *JNCI* **62**, 957-974.
- Gocke, E., King, M.-T., Eckhardt, K., and Wild, D. (1981). Mutagenicity of cosmetics ingredients licensed by the European Communities. *Mutat. Res.* **90**, 91-109.
- Gold, L.S., Slone, T.H., and Ames, B.N. (1998). What do animal cancer tests tell us about human cancer risk?: Overview of analyses of the carcinogenic potency database. *Drug Metab. Rev.* **30**, 359-404.
- Goodman, G., and Wilson, R. (1991). Predicting the carcinogenicity of chemicals in humans from rodent bioassay data. *Environ. Health Perspect.* **94**, 195-218.
- Griffin, T.B., Stein, A.A., and Coulston, F. (1982). Inhalation exposure of rats to vapors of 1-nitropropane at 100 ppm. *Ecotoxicol. Environ. Safety* **6**, 268-282.
- Griffin, T.B., Stein, A.A., and Coulston, F. (1988). Chronic inhalation exposure of rats to vapors of nitroethane. *Ecotoxicol. Environ. Safety* **16**, 11-24.
- Haseman, J.K. (2000). Using the NTP database to assess the value of rodent carcinogenicity studies for determining human cancer risk. *Drug Metab. Rev.* **32**, 169-186.
- Haseman, J.K., Young, E., Eustis, S.L., and Hailey, J.R. (1997). Body weight-tumor incidence correlations in long-term rodent carcinogenicity studies. *Toxicol. Path.* **25**, 256-263.
- Hawkins, W.E., Walker, W.W., James, M.O., Manning, C.S., Barnes, D.H., Hearn, C.S., and Overstreet, R.M. (1998). Carcinogenic effects of 1,2-dibromoethane (ethylene dibromide; EDB) in Japanese medaka (*Oryzias latipes*). *Mutat. Res.* **399**, 221-232.
- Hawkins, W.E., Walker, W.W., Fournie, J.W., Manning, C.S., and Krol, R.M. (2003). Use of the Japanese medaka (*Oryzias latipes*) and guppy (*Poecilia reticulata*) in carcinogenesis testing under National Toxicology Program protocols. *Toxicol. Pathol.* **31**, 88-91.
- Hawley's Condensed Chemical Dictionary* (1987). 11th ed. (N.I. Sax and R.J. Lewis, Sr., Eds.) p. 1176. Van Nostrand and Reinhold Co., New York.

- Haworth, S., Lawlor, T., Mortelmans, K., Speck, W., and Zeiger, E. (1983). Salmonella mutagenicity test results for 250 chemicals. *Environ. Mutagen.* **5** (Suppl. 1), 3-142.
- Hazardous Substances Data Bank (HSDB) (1995). National Institute for Occupational Safety and Health, HSDB database available through the National Library of Medicine MEDLARS System.
- Hinton, D.E., Lantz, R.C., and Hampton, J.A. (1984). Effect of age and exposure to a carcinogen on the structure of the Medaka liver: A morphometric study. *J. Natl. Cancer Inst.* **65**, 239-249.
- Institute of Laboratory Animal Resources (ILAR) (1974). Fishes: Guidelines for the breeding, care and management of laboratory animals. In *Guidelines for the breeding, care and management of laboratory animals*, 1st ed., Vol. 1, p. 85. National Academy of Sciences, Washington, D.C.
- International Agency for Research on Cancer (IARC) (2000). *IARC Monographs on the Evaluation of Carcinogenic Risks to Humans*. Some Industrial Chemicals, Vol. 77. IARC, Lyon, France.
- Ishikawa, T., and Takayama, S. (1979). Importance of hepatic neoplasms in lower vertebrate animals as a tool in cancer research. *J. Toxicol. Environ. Health* **5**, 537-550.
- Ishikawa, T., Masahito, P., and Takayama, S. (1984). Usefulness of the medaka, *Oryzias latipes*, as a test animal: DNA repair processes in medaka exposed to carcinogens. *J. Natl. Cancer Inst.* **65**, 35-43.
- Ishikawa, Y. (2000). Medaka fish as a model system for vertebrate developmental genetics. *Bioessays* **22**, 487-495.
- Kaplan, E.L., and Meier, P. (1958). Nonparametric estimation from incomplete observations. *J. Am. Stat. Assoc.* **53**, 457-481.
- Keyes, D.G., Kociba, R.J., Schwetz, R.W., Wade, C.E., Dittenber, D.A., Quinn, T., Gorzinski, S.J., Hermann, E.A., Momany, J.J., and Schwetz, B.A. (1979). Results of a two-year toxicity and oncogenic study of rats ingesting diets containing dibromo-neopentyl glycol (FR-1138). *J. Combustion Toxicol.* **7**, 77-98.
- Kielhorn, J., Melber, C., Wahnschaffe, U., Aitio, A., and Mangelsdorf, I. (2000). Vinyl chloride: Still a cause for concern. *Environ. Health Perspect.* **108**, 579-588.
- Kirk-Othmer Encyclopedia of Chemical Technology* (1978). 3rd ed., Vol. 1, pp. 961-967. John Wiley and Sons, New York.
- Koger, C.S., Teh, S.J., and Hinton, D.E. (1999). Variations of light and temperature regimes and resulting effects on reproductive parameters in medaka (*Oryzias latipes*). *Biol. Reprod.* **61**, 1287-1293.
- Law, J.M. (2001). Mechanistic considerations in small fish carcinogenicity testing. *ILAR* **42**, 274-284.
- Law, J.M. (2003). Issues related to the use of fish models in toxicologic pathology: Session introduction. *Toxicol. Pathol.* **31** (Suppl. 49-52).
- Law, J.M., Bull, M., Nakamura, J., and Swenberg, J.A. (1998). Molecular dosimetry of DNA adducts in the medaka small fish model. *Carcinogenesis* **19**, 515-518.
- Lewis, T.R., Ulrich, C.E., and Busey, W.M. (1979). Subchronic inhalation toxicity of nitromethane and 2-nitropropane. *J. Environ. Pathol. Toxicol.* **2**, 233-249.
- Liu, Z., Kullman, S.W., Bencic, D.S., Torten, M., and Hinton, D.E. (2003). *ras* oncogene mutations in diethylnitrosamine-induced hepatic tumors in medaka (*Oryzias latipes*), a teleost fish. *Mutat. Res.* **539**, 43-53.
- Meador, J.P., Stein, J.E., Reichert, W.L., and Varanasi, U. (1995). Bioaccumulation of polycyclic aromatic hydrocarbons by marine organisms. *Rev. Environ. Contam. Toxicol.* **143**, 79-165.
- The Merck Index* (1989). 11th ed. (S. Budavari, Ed.), p. 1046. Merck and Company, Rahway, NJ.
- Mirsalis, J., Tyson, K., Beck, J., Loh, F., Steinmetz, K., Contreras, C., Austere, L., Martin, S., and Spalding, J. (1983). Induction of unscheduled DNA synthesis (UDS) in hepatocytes following *in vitro* and *in vivo* treatment. *Environ. Mutagen.* **5**, 482 (Abstr.).
- Mortelmans, K., Haworth, S., Lawlor, T., Speck, W., Tainer, B., and Zeiger, E. (1986). *Salmonella* mutagenicity tests: II. Results from the testing of 270 chemicals. *Environ. Mutagen.* **8** (Suppl. 7), 1-119.

- National Toxicology Program (NTP) (1993). Toxicology and Carcinogenesis Studies of 1,2,3-Trichloropropane (CAS No. 96-18-4) in F344/N Rats and B6C3F₁ Mice (Gavage Studies). Technical Report Series No. 384. NIH Publication No. 94-2839. U.S. Department of Health and Human Services, Public Health Service, National Institutes of Health, Research Triangle Park, NC.
- National Toxicology Program (NTP) (1996). Toxicology and Carcinogenesis Studies of 2,2-Bis(bromomethyl)-1,3-propanediol (FR-1138®) (CAS No. 3296-90-0) in F344/N Rats and B6C3F₁ Mice (Feed Studies). Technical Report Series No. 452. NIH Publication No. 96-3368. U.S. Department of Health and Human Services, Public Health Service, National Institutes of Health, Research Triangle Park, NC.
- National Toxicology Program (NTP) (1997). Toxicology and Carcinogenesis Studies of Nitromethane (CAS No. 75-52-5) in F344/N Rats and B6C3F₁ Mice (Inhalation Studies). Technical Report Series No. 461. NIH Publication No. 97-3377. U.S. Department of Health and Human Services, Public Health Service, National Institutes of Health, Research Triangle Park, NC.
- Okihiro, M.S., and Hinton, D.E. (1999). Progression of hepatic neoplasia in medaka (*Oryzias latipes*) exposed to diethylnitrosamine. *Carcinogenesis* **20**, 933-940.
- Overstreet, R.O., Barnes, C.S., Manning, C.S., and Hawkins, W.E., Eds. (2000). Facilities and husbandry; small fish models. In *The Laboratory Fish*, G. Ostrander, pp. 41-63. Academic Press, Ltd., London.
- Page, N., Kraybill, H.F., and Mehlman, H.A., Eds. (1977). Concept of a bioassay program in environmental carcinogenesis. In *Advances in Medicinal Toxicology*, Vol. 3, pp. 87-171. John Wiley and Sons, New York.
- Parkerton, T.F., Stone, M.A., and Letinski, D.J. (2000). Assessing the aquatic toxicity of complex hydrocarbon mixtures using solid phase microextraction. *Toxicol. Lett.* **15**, 273-282.
- Plackett, R.L. (1981). *The Analysis of Categorical Data*, 2nd ed. Griffin, London.
- Rao, G.N., and Crockett, P.W. (2003). Effect of diet and housing on growth, body weight, survival and tumor incidences of B6C3F₁ mice in chronic studies. *Toxicol. Pathol.* **31**, 243-250.
- Ratpan, F., and Plaumann, H. (1988). Mutagenicity of halogenated propanes and their methylated derivatives. *Environ. Mol. Mutagen.* **12**, 253-259.
- Remington's Pharmaceutical Sciences* (1975). 15th ed. (J.E. Hoover, Ed.), p. 773. Mack Publishing Company, Easton, PA.
- Reznick, D., Buckwalter, G., Groff, J., and Elder, D. (2001). The evolution of senescence in natural populations of guppies (*Poecilia reticulata*): A comparative approach. *Exp. Gerontol.* **36**, 791-812.
- Rodriguez-Burford, C., Lubet, R.A., Eto, I., Juliana, M.M., Kelloff, G.J., Grubb, C.J., and Steele, V.E. (1999). Effect of reduced body weight gain on the evaluation of chemopreventive agents in methyl-nitrosourea-induced mammary cancer model. *Carcinogenesis* **20**, 71-76.
- Rogers, A.E., Sullivan, L.M., and Hafer, L.J. (1999). Dietary fat, body weight, and cancer: Contributions of studies in rodents to understanding these cancer risk factors in humans. *Toxicol. Sci.* **52**, 66-71.
- Saito-Suzuki, R., Teramoto, S., and Shirasu, Y. (1982). Dominant lethal studies in rats with 1,2-dibromo-3-chloropropane and its structurally related compounds. *Mutat. Res.* **101**, 321-327.
- Salem, H., and Katz, S. (1998). *Advances in Animal Alternatives for Safety and Efficacy Testing*. Taylor and Francis, Philadelphia, PA.
- Simon, K., and Lapis, K. (1984). Carcinogenesis studies on guppies. *Natl. Cancer Inst. Monogr.* **65**, 71-81.
- Sinnhuber, R.O., Hendricks, J.D., Wales, J.H., and Putnam, G.B. (1978). Neoplasms in rainbow trout, a sensitive animal model for environmental carcinogenesis. *Ann. N. Y. Acad. Sci.* **298**, 389-408.
- Sittig, M. (1985). *Handbook of Toxic and Hazardous Chemicals and Carcinogens*, 2nd ed. Noyes Publications, Park Ridge, NJ.

- SRI International (1980). *Chemical Economics Handbook*, pp. 573.9001C,P. Menlo Park, CA.
- Stolzenberg, S.J., and Hine, C.H. (1980). Mutagenicity of 2- and 3-carbon halogenated compounds in the Salmonella/mammalian-microsome test. *Environ. Mutagen.* **2**, 59-66.
- Tarone, R.E. (1975). Tests for trend in life table analysis. *Biometrika* **62**, 679-682.
- U.S. Environmental Protection Agency (USEPA) (1983). Draft Report: An Overview of the Exposure Potential of Commercial Flame Retardants. Assessment Division, Washington, D.C.
- von der Hude, W., Scheutwinkel, M., Gramlich, U., Fissler, B., and Basler, A. (1987). Genotoxicity of three-carbon compounds evaluated in the SCE test in vitro. *Environ. Mutagen.* **9**, 401-410.
- Wade, A.E., Evans, J.S., Sternson, L.A., and Gammans, R.E. (1977). Interaction of nitromethane with reduced hepatic microsomal cytochrome P-450. *Biochem. Pharmacol.* **26**, 963-967.
- Walker, W.W., Manning, C.S., Overstreet, R.M., and Hawkins, W.E. (1985). Development of aquarium fish models for environmental carcinogenesis: An intermittent-flow exposure system for volatile hydrophobic chemicals. *J. Appl. Toxicol.* **5**, 255-260.
- Weisburger, J.H., and Williams, G.M. (1981). Carcinogen testing: Current problems and new approaches. *Science* **214**, 401-407.
- Weisburger, J.H., Williams, G.M., and Searle, C.E. (1984). Bioassay of carcinogens: *in vitro* and *in vivo* tests. In *Chemical Carcinogens* (C.E. Searle, Ed.), pp. 1323-1373. American Chemical Society, Washington, DC
- Williams, G.M., Mori, H., and McQueen, C.A. (1989). Structure-activity relationships in the rat hepatocyte DNA-repair test for 300 chemicals. *Mutat. Res.* **221**, 263-286.
- Witt, K.L., Knapton, A., Wehr, C.M., Hook, G.J., Mirsalis, J., Shelby, M.D., and McGregor, J.T. (2000). Micronucleated erythrocytes frequency in peripheral blood of B6C3F₁ mice from short-term, prechronic, and chronic studies of the NTP Carcinogenesis Bioassay Program. *Environ. Mol. Mutagen.* **36**, 163-194.
- Yamamoto, T.O. (1975). *Medaka (killifish) biology and strains*, Vol. 1, p. 213. Keigaku Publishing, Tokyo.
- Zeiger, E., Haseman, J.K., Shelby, M.D., Margolin, B.H., and Tennant, R.W. (1990). Evaluation of four in vitro genetic toxicity tests for predicting rodent carcinogenicity: Confirmation of earlier results with 41 additional chemicals. *Environ. Mol. Mutagen.* **16** (Suppl. 18), 1-14.
- Zeiger, E., Anderson, B., Haworth, S., Lawlor, T., and Mortelmans, K. (1992). Salmonella mutagenicity tests: V Results from the testing of 311 chemicals. *Environ. Mol. Mutagen.* **19** (Suppl. 21), 2-141.
- Zimmerer, E.J. (1984). Usefulness of the guppy, *Poecilia reticulata*, in carcinogenicity testing: Special advantages and problems. *J. Natl. Cancer Inst.* **65**, 59-64.

APPENDIX A
SUMMARY OF LESIONS IN GUPPIES
IN THE 16-MONTH WATERBORNE STUDY
OF 2,2-BIS(BROMOMETHYL)-1,3-PROPANEDIOL

TABLE A1	Summary of the Incidence of Neoplasms in Male Guppies in the 16-Month Waterborne Study of 2,2-Bis(bromomethyl)-1,3-propanediol (Core Study)	92
TABLE A2	Summary of the Incidence of Neoplasms in Male Guppies in the 16-Month Waterborne Study of 2,2-Bis(bromomethyl)-1,3-propanediol (Stop-Exposure)	95
TABLE A3	Summary of the Incidence of Neoplasms in Female Guppies in the 16-Month Waterborne Study of 2,2-Bis(bromomethyl)-1,3-propanediol (Core Study)	97
TABLE A4	Summary of the Incidence of Neoplasms in Female Guppies in the 16-Month Waterborne Study of 2,2-Bis(bromomethyl)-1,3-propanediol (Stop-Exposure)	100
TABLE A5	Summary of the Incidences of Granuloma in Selected Tissues of Guppies in the 16-Month Waterborne Study of 2,2-Bis(bromomethyl)-1,3-propanediol (Core Study)	102

TABLE A1
Summary of the Incidence of Neoplasms in Male Guppies in the 16-Month Waterborne Study
of 2,2-Bis(bromomethyl)-1,3-propanediol (Core Study)

	0 mg/L		24 mg/L		60 mg/L		150 mg/L	
	Group A	Group B	Group A	Group B	Group A	Group B	Group A	Group B
<i>16-Month Study</i> (continued)								
Nares (Olfactory Tissue)	(14)	(16)	(15)	(16)	(4)	(17)	(13)	(12)
Oral Cavity	(26)	(35)	(27)	(23)	(11)	(30)	(20)	(18)
Pancreas	(26)	(35)	(27)	(23)	(11)	(30)	(20)	(18)
Islet cells, adenoma		1						
Pericardial Cavity	(2)	(5)	(2)	(4)	(1)	(4)	(1)	(3)
Peripheral Nerve	(26)	(35)	(27)	(23)	(11)	(30)	(20)	(18)
Peritoneum	(2)	(4)	(5)	(3)	(0)	(5)	(1)	(0)
Pharynx	(6)	(4)	(2)	(6)	(0)	(3)	(0)	(1)
Pineal Organ	(19)	(21)	(22)	(12)	(8)	(17)	(14)	(10)
Pituitary Gland	(22)	(32)	(24)	(21)	(11)	(28)	(16)	(15)
Adenoma		1						
Pseudobranch	(26)	(35)	(27)	(23)	(11)	(30)	(20)	(18)
Skeletal Muscle	(26)	(35)	(27)	(23)	(11)	(30)	(20)	(18)
Sertoli cell tumor, invasive								1
Skin	(26)	(35)	(27)	(23)	(11)	(30)	(20)	(18)
Sertoli cell tumor, invasive								1
Spinal Cord	(25)	(35)	(27)	(21)	(11)	(29)	(20)	(17)
Spleen	(22)	(34)	(25)	(20)	(10)	(26)	(18)	(17)
Stato-acoustic Organ	(26)	(35)	(27)	(23)	(11)	(30)	(20)	(18)
Swim Bladder	(26)	(35)	(27)	(23)	(11)	(30)	(20)	(18)
Carcinoma						1		
Testis	(26)	(35)	(27)	(23)	(11)	(30)	(20)	(18)
Sertoli cell tumor								1
Thymus	(1)	(2)	(0)	(0)	(3)	(3)	(0)	(1)
Thyroid Tissue	(26)	(35)	(27)	(20)	(11)	(30)	(20)	(18)
Urinary Bladder	(21)	(35)	(26)	(17)	(9)	(29)	(19)	(17)

^a Exposure of the 150 mg/L core group was stopped at 64 weeks and the animals were held until 69 weeks when all groups were sacrificed and examined.

^b Number of animals examined microscopically at the site

^c Number of animals with neoplasm

TABLE A2
Summary of the Incidence of Neoplasms in Male Guppies in the 16-Month Waterborne Study
of 2,2-Bis(bromomethyl)-1,3-propanediol (Stop-Exposure)

	0 mg/L		24 mg/L		60 mg/L		150 mg/L	
	Group A	Group B	Group A	Group B	Group A	Group B	Group A	Group B
Abdominal Cavity	(0)	(0)	(1)	(0)	(0)	(0)	(0)	(0)
Adipose Tissue	(11)	(7)	(5)	(7)	(4)	(4)	(6)	(6)
Blood Vessel	(0)	(0)	(0)	(0)	(1)	(1)	(1)	(0)
Bone ^a Vertebra, chondroma ^b	(15)	(13)	(10)	(12)	(7)	(14)	(9)	(15)
		1						
Brain	(15)	(13)	(10)	(12)	(7)	(14)	(9)	(15)
Chromaffin Tissue	(15)	(13)	(10)	(12)	(7)	(13)	(9)	(15)
Corpuscle of Stannius	(3)	(4)	(2)	(5)	(2)	(3)	(2)	(4)
Cranial Cavity	(3)	(4)	(3)	(1)	(1)	(0)	(0)	(0)
Esophagus	(15)	(13)	(10)	(12)	(7)	(14)	(9)	(15)
Eye	(15)	(13)	(10)	(12)	(7)	(14)	(9)	(15)
Gallbladder	(14)	(13)	(9)	(12)	(7)	(14)	(8)	(15)
Gill	(15)	(13)	(10)	(12)	(7)	(14)	(9)	(15)
Heart	(15)	(13)	(10)	(12)	(7)	(14)	(9)	(15)
Hematopoietic Tissue	(15)	(13)	(10)	(12)	(7)	(14)	(9)	(15)
Interrenal Tissue	(15)	(13)	(10)	(12)	(7)	(13)	(9)	(15)
Intestine	(15)	(13)	(10)	(12)	(7)	(14)	(9)	(15)
Kidney	(15)	(13)	(10)	(12)	(7)	(14)	(9)	(15)
Liver	(15)	(13)	(10)	(12)	(7)	(14)	(9)	(15)
Hepatocellular adenoma			1	2	1	1	3	1
Hepatocellular adenoma, multiple					1			2
Hepatocellular carcinoma								3
Mesentery	(11)	(10)	(7)	(8)	(5)	(10)	(5)	(7)
Nares (Olfactory Tissue)	(8)	(7)	(5)	(11)	(4)	(3)	(2)	(9)
Oral Cavity	(15)	(13)	(10)	(12)	(7)	(14)	(9)	(15)
Pancreas	(15)	(13)	(10)	(12)	(7)	(14)	(9)	(15)
Islet cells, adenoma					1			
Pericardial Cavity	(4)	(4)	(2)	(3)	(4)	(1)	(0)	(1)
Peripheral Nerve	(15)	(13)	(10)	(12)	(7)	(14)	(9)	(15)

TABLE A2
Summary of the Incidence of Neoplasms in Male Guppies in the 16-Month Waterborne Study
of 2,2-Bis(bromomethyl)-1,3-propanediol (Stop-Exposure)

	0 mg/L		24 mg/L		60 mg/L		150 mg/L	
	Group A	B	Group A	B	Group A	B	Group A	B
Peritoneum	(2)	(3)	(2)	(2)	(1)	(0)	(2)	(2)
Pharynx	(3)	(4)	(4)	(2)	(1)	(0)	(0)	(0)
Pineal Organ	(3)	(9)	(8)	(7)	(6)	(9)	(6)	(11)
Pituitary Gland Adenoma	(13)	(11)	(7)	(10)	(7)	(12) 1	(8)	(15)
Pseudobranch	(15)	(13)	(10)	(12)	(7)	(14)	(9)	(15)
Skeletal Muscle	(15)	(13)	(10)	(12)	(7)	(14)	(9)	(15)
Skin	(15)	(13)	(10)	(12)	(7)	(14)	(9)	(15)
Spinal Cord	(14)	(12)	(10)	(12)	(7)	(13)	(9)	(15)
Spleen	(15)	(13)	(7)	(12)	(7)	(14)	(9)	(15)
Stato-acoustic Organ	(15)	(13)	(10)	(12)	(7)	(14)	(9)	(15)
Swim Bladder	(15)	(13)	(10)	(12)	(7)	(14)	(9)	(15)
Testis	(15)	(13)	(10)	(12)	(7)	(14)	(9)	(15)
Thymus	(0)	(0)	(0)	(0)	(0)	(0)	(0)	(1)
Thyroid Tissue	(15)	(13)	(9)	(11)	(6)	(13)	(9)	(15)
Urinary Bladder	(15)	(13)	(9)	(11)	(7)	(14)	(9)	(15)

^a Number of animals examined microscopically at the site

^b Number of animals with neoplasm

TABLE A3
Summary of the Incidence of Neoplasms in Female Guppies in the 16-Month Waterborne Study
of 2,2-Bis(bromomethyl)-1,3-propanediol (Core Study)

	0 mg/L Group		24 mg/L Group		60 mg/L Group		150 mg/L Group ^a	
	A	B	A	B	A	B	A	B
<i>9-Month Interim Evaluation</i>								
Liver ^b	(4)	(4)	(6)	(2)	(4)	(7)	(4)	(8)
Cholangioma ^c		1						
<i>Tissues Examined at 9 Months with No Neoplasms Observed</i>								
Adipose Tissue								
Bone								
Brain								
Chromaffin Tissue								
Corpuscle of Stannius								
Cranial Cavity								
Esophagus								
Eye								
Gallbladder								
Gill								
Heart								
Hematopoietic Tissue								
Interrenal Tissue								
Intestine								
Kidney								
Mesentery								
Nares (Olfactory Tissue)								
Oral Cavity								
Ovary								
Pancreas								
Pericardial Cavity								
Peripheral Nerve								
Pharynx								
Pineal Organ								
Pituitary Gland								
Pseudobranch								
Skeletal Muscle								
Skin								
Spinal Cord								
Spleen								
Stato-acoustic Organ								
Swim Bladder								
Thymus								
Thyroid Tissue								
Urinary Bladder								
<i>16-Month Study</i>								
Abdominal Cavity	(0)	(0)	(0)	(0)	(0)	(0)	(1)	(0)
Adipose Tissue	(16)	(23)	(21)	(19)	(11)	(15)	(13)	(6)
Head, hemangioma						1		
Blood Vessel	(1)	(0)	(2)	(4)	(0)	(2)	(4)	(1)
Bone	(32)	(29)	(30)	(39)	(31)	(27)	(22)	(24)

TABLE A3
Summary of the Incidence of Neoplasms in Female Guppies in the 16-Month Waterborne Study
of 2,2-Bis(bromomethyl)-1,3-propanediol (Core Study)

	0 mg/L		24 mg/L		60 mg/L		150 mg/L	
	Group A	B	Group A	B	Group A	B	Group A	B
<i>16-Month Study</i> (continued)								
Pericardial Cavity	(2)	(9)	(5)	(8)	(3)	(5)	(4)	(2)
Peripheral Nerve Schwannoma	(32)	(29)	(30)	(39)	(31)	(27) 1	(22)	(24)
Peritoneum	(1)	(6)	(3)	(5)	(1)	(2)	(2)	(1)
Pharynx	(7)	(5)	(4)	(3)	(4)	(2)	(3)	(0)
Pineal Organ	(17)	(11)	(18)	(26)	(21)	(16)	(10)	(17)
Pituitary Gland	(24)	(26)	(28)	(35)	(26)	(21)	(22)	(23)
Pseudobranch	(32)	(29)	(29)	(38)	(31)	(25)	(22)	(24)
Skeletal Muscle	(32)	(29)	(30)	(39)	(31)	(27)	(22)	(24)
Skin	(32)	(29)	(30)	(39)	(31)	(27)	(22)	(24)
Spinal Cord	(30)	(26)	(28)	(37)	(29)	(27)	(21)	(23)
Spleen Carcinoma, invasive Hemangiosarcoma	(28)	(27)	(23)	(34)	(22)	(15) 1	(19)	(20) 1
Stato-acoustic Organ	(32)	(29)	(30)	(39)	(31)	(27)	(22)	(24)
Swim Bladder Epithelioma	(31)	(29)	(29)	(39) 1	(31)	(27)	(22)	(24) 1
Thymus	(23)	(21)	(22)	(24)	(21)	(21)	(13)	(17)
Thyroid Tissue Follicular cell carcinoma	(30)	(29)	(30)	(37)	(30)	(25)	(22)	(24) 1
Urinary Bladder	(27)	(15)	(21)	(34)	(24)	(20)	(15)	(15)

- ^a Exposure of the 150 mg/L core group was stopped at 64 weeks and the animals were held until 69 weeks when all groups were sacrificed and examined.
^b Number of animals examined microscopically at the site
^c Number of animals with neoplasm

TABLE A4
Summary of the Incidence of Neoplasms in Female Guppies in the 16-Month Waterborne Study of 2,2-Bis(bromomethyl)-1,3-propanediol (Stop-Exposure)

	0 mg/L		24 mg/L		60 mg/L		150 mg/L	
	Group A	Group B	Group A	Group B	Group A	Group B	Group A	Group B
Pericardial Cavity	(6)	(5)	(7)	(3)	(3)	(4)	(1)	(1)
Peripheral Nerve	(17)	(18)	(19)	(17)	(14)	(14)	(6)	(7)
Peritoneum Hemangiopericytoma, invasive	(3)	(4)	(2)	(3)	(1)	(2)	(0)	(1) 1
Pharynx	(4)	(5)	(4)	(3)	(1)	(3)		(1)
Pineal Organ	(15)	(11)	(7)	(8)	(8)	(10)	(1)	(5)
Pituitary Gland	(17)	(14)	(10)	(9)	(12)	(12)	(6)	(7)
Pseudobranch	(16)	(16)	(16)	(17)	(13)	(12)	(4)	(7)
Skeletal Muscle	(17)	(18)	(19)	(17)	(14)	(14)	(6)	(7)
Skin	(17)	(18)	(19)	(17)	(14)	(14)	(6)	(7)
Spinal Cord	(17)	(18)	(16)	(16)	(12)	(14)	(6)	(7)
Spleen	(12)	(11)	(14)	(17)	(14)	(13)	(6)	(6)
Stato-acoustic Organ	(17)	(18)	(19)	(17)	(14)	(14)	(6)	(7)
Swim Bladder Carcinoma Epithelioma	(17)	(18)	(19)	(17)	(14)	(14) 1 1	(6)	(7)
Thymus	(11)	(7)	(13)	(11)	(8)	(9)	(4)	(5)
Thyroid Tissue	(17)	(17)	(15)	(17)	(14)	(13)	(6)	(7)
Urinary Bladder	(16)	(15)	(13)	(15)	(10)	(10)	(4)	(5)

^a Number of animals examined microscopically at the site

^b Number of animals with neoplasm

TABLE A5
Summary of the Incidences of Granuloma in Selected Tissues of Guppies in the 16-Month Waterborne Study of 2,2-Bis(bromomethyl)-1,3-propanediol (Core Study)

	0 mg/L	24 mg/L	60 mg/L	150 mg/L
Male				
Number Examined Microscopically	(61)	(50)	(41)	(38)
Adipose Tissue				
Head ^a	17	14	8	7
Retroperitoneal	18	9	5	2
Bone				
Lower Jaw	1	0	0	0
Vertebra/Perivertebral	9	6	2	2
Cranial Cavity	7	8	7	2
Gill				
Arches	11	9	2	2
Branchial Wall	2	2	1	1
Heart				
Atrium	15	13	5	3
Ventricle	11	5	8	1
Mesentery	20	18	12	10
Peritoneum	3	7	3	0
Pharynx	10	7	3	1
Pseudobranch	5	4	2	1
Spinal Cord				
Meninges	11	6	4	3
Spleen	14	10	5	3
Testis	17	15	6	3
Female				
Number Examined Microscopically	(61)	(69)	(58)	(46)
Adipose Tissue				
Head	22	16	14	3
Retroperitoneal	27	25	14	6
Bone				
Lower Jaw	2	2	0	0
Vertebra/Perivertebral	12	10	2	2
Cranial Cavity	12	3	4	1
Eye				
Choroid Rete	1	0	1	0
Choroid	10	6	2	4
Optic Nerve	4	0	1	0
Gill				
Arches	12	8	4	0
Branchial Wall	3	4	2	0
Granuloma, NOS	1	2	0	0
Heart				
Atrium	16	15	9	6
Bulbus Arteriosus	5	4	1	0
Ventricle	16	13	6	6

TABLE A5
Summary of the Incidences of Granuloma in Selected Tissues of Guppies in the 16-Month Waterborne Study of 2,2-Bis(bromomethyl)-1,3-propanediol (Core Study)

	0 mg/L	24 mg/L	60 mg/L	150 mg/L
Female (continued)				
Number Examined Microscopically	(61)	(69)	(58)	(46)
Mesentery	25	31	19	11
Peritoneum	5	7	3	1
Pharynx	10	6	5	1
Pseudobranch	2	2	0	0
Spinal Cord				
Meninges	12	8	4	0
Granuloma, NOS	1	1	0	0
Skeletal Muscle	11	8	4	2

^a Number of animals with lesion

APPENDIX B
SUMMARY OF LESIONS IN MEDAKA
IN THE 14-MONTH WATERBORNE STUDY
OF 2,2-BIS(BROMOMETHYL)-1,3-PROPANEDIOL

TABLE B1	Summary of the Incidence of Neoplasms in Male Medaka in the 14-Month Waterborne Study of 2,2-Bis(bromomethyl)-1,3-propanediol (Core Study)	106
TABLE B2	Summary of the Incidence of Neoplasms in Male Medaka in the 14-Month Waterborne Study of 2,2-Bis(bromomethyl)-1,3-propanediol (Stop-Exposure)	109
TABLE B3	Summary of the Incidence of Neoplasms in Female Medaka in the 14-Month Waterborne Study of 2,2-Bis(bromomethyl)-1,3-propanediol (Core Study)	111
TABLE B4	Summary of the Incidence of Neoplasms in Female Medaka in the 14-Month Waterborne Study of 2,2-Bis(bromomethyl)-1,3-propanediol (Stop-Exposure)	115
TABLE B5	Summary of the Incidences of Granuloma and Granulomatous Inflammation in Selected Tissues of Medaka in the 14-Month Waterborne Study of 2,2-Bis(bromomethyl)-1,3-propanediol	117

TABLE B1
Summary of the Incidence of Neoplasms in Male Medaka in the 14-Month Waterborne Study
of 2,2-Bis(bromomethyl)-1,3-propanediol (Core Study)

	0 mg/L		24 mg/L		60 mg/L		150 mg/L	
	Group A	B	Group A	B	Group A	B	Group A	B
<i>14-Month Study</i>								
Adipose Tissue	(5)	(10)	(6)	(3)	(4)	(2)	(4)	(1)
Blood Vessel	(0)	(3)	(1)	(2)	(0)	(0)	(0)	(0)
Bone	(26)	(21)	(35)	(24)	(32)	(24)	(32)	(27)
Brain	(26)	(21)	(35)	(24)	(32)	(24)	(32)	(27)
Chromaffin Tissue	(26)	(21)	(35)	(24)	(31)	(24)	(32)	(27)
Corpuscle of Stannius	(16)	(12)	(21)	(18)	(10)	(14)	(20)	(15)
Cranial Cavity	(1)	(1)	(0)	(1)	(1)	(0)	(0)	(0)
Esophagus	(26)	(21)	(35)	(24)	(32)	(24)	(32)	(27)
Eye	(26)	(21)	(35)	(24)	(32)	(24)	(32)	(27)
Gallbladder Stromal polyp	(25)	(21)	(32)	(21)	(32)	(23) 1	(32)	(25) 1
Gill	(26)	(21)	(35)	(24)	(32)	(24)	(32)	(27)
Heart	(26)	(21)	(35)	(24)	(32)	(24)	(32)	(27)
Hematopoietic Tissue	(26)	(21)	(35)	(24)	(32)	(24)	(32)	(27)
Interrenal Tissue	(26)	(21)	(35)	(24)	(31)	(24)	(32)	(27)
Intestine Carcinoma, invasive	(26)	(21)	(35)	(24)	(32)	(24)	(32)	(27) 1
Kidney	(26)	(21)	(35)	(24)	(32)	(24)	(32)	(27)
Liver Cholangiocarcinoma	(26)	(21)	(35)	(24) 1	(32)	(24)	(32)	(27) 2
Hepatocellular adenoma	1						4	1
Hepatocellular adenoma, multiple							1	
Hepatocellular carcinoma							1	1
Mesentery	(5)	(7)	(4)	(5)	(1)	(0)	(5)	(5)
Nares (Olfactory Tissue)	(9)	(5)	(16)	(8)	(9)	(11)	(13)	(10)
Oral Cavity	(26)	(21)	(35)	(24)	(32)	(24)	(32)	(27)
Pancreas Carcinoma	(26)	(21)	(35)	(24)	(32)	(24)	(32)	(27) 1

TABLE B1
Summary of the Incidence of Neoplasms in Male Medaka in the 14-Month Waterborne Study
of 2,2-Bis(bromomethyl)-1,3-propanediol (Core Study)

	0 mg/L		24 mg/L		60 mg/L		150 mg/L	
	Group A	Group B	Group A	Group B	Group A	Group B	Group A	Group B
<i>14-Month Study</i> (continued)								
Pericardial Cavity	(3)	(7)	(1)	(0)	(1)	(1)	(0)	(1)
Peripheral Nerve	(26)	(21)	(35)	(24)	(32)	(24)	(32)	(27)
Peritoneum Seminoma, invasive	(2)	(5)	(0)	(3)	(3)	(2)	(0)	(3) 1
Pharynx	(1)	(1)	(0)	(3)	(0)	(1)	(1)	(0)
Pineal Organ	(23)	(18)	(33)	(19)	(22)	(21)	(30)	(22)
Pituitary Gland	(24)	(18)	(33)	(23)	(32)	(22)	(30)	(24)
Pseudobranch	(26)	(21)	(35)	(24)	(32)	(24)	(32)	(26)
Skeletal Muscle	(26)	(21)	(35)	(24)	(32)	(24)	(32)	(27)
Skin	(26)	(21)	(35)	(24)	(32)	(24)	(32)	(27)
Spinal Cord	(26)	(21)	(35)	(24)	(32)	(24)	(32)	(27)
Spleen	(15)	(15)	(30)	(14)	(15)	(16)	(12)	(9)
Stato-acoustic Organ	(26)	(21)	(35)	(24)	(32)	(24)	(32)	(27)
Swim Bladder	(26)	(21)	(35)	(24)	(32)	(24)	(32)	(27)
Testis	(26)	(21)	(35)	(24)	(32)	(24)	(32)	(27)
Fibrosarcoma					1			1
Seminoma	3	1	2	5	2	3	2	7
Thymus	(9)	(11)	(19)	(14)	(27)	(9)	(24)	(21)
Thyroid Tissue	(26)	(21)	(35)	(24)	(32)	(24)	(32)	(27)
Follicular cell adenoma			1					
Urinary Bladder	(24)	(19)	(31)	(22)	(31)	(23)	(32)	(23)
Multiple Organs ^c	(26)	(21)	(35)	(24)	(32)	(24)	(32)	(27)

^a Number of animals examined microscopically at the site

^b Number of animals with neoplasm

^c Number of animals with any tissue examined microscopically

TABLE B2
Summary of the Incidence of Neoplasms in Male Medaka in the 14-Month Waterborne Study
of 2,2-Bis(bromomethyl)-1,3-propanediol (Stop-Exposure)

	0 mg/L		24 mg/L		60 mg/L		150 mg/L	
	Group A	Group B	Group A	Group B	Group A	Group B	Group A	Group B
Adipose Tissue^a Retroperitoneal, liposarcoma ^b	(1)	(2)	(0)	(1)	(1)	(1)	(3)	(2)
Blood Vessel	(0)	(0)	(1)	(0)	(0)	(0)	(0)	(0)
Bone	(16)	(11)	(11)	(10)	(16)	(15)	(17)	(12)
Brain	(16)	(11)	(11)	(10)	(16)	(15)	(17)	(12)
Chromaffin Tissue	(16)	(11)	(11)	(10)	(16)	(14)	(17)	(12)
Corpuscle of Stannius	(8)	(6)	(8)	(10)	(10)	(12)	(15)	(7)
Esophagus	(16)	(11)	(11)	(10)	(16)	(15)	(17)	(12)
Eye	(16)	(11)	(11)	(10)	(16)	(15)	(17)	(12)
Gallbladder	(14)	(11)	(11)	(8)	(16)	(14)	(16)	(12)
Gill	(16)	(11)	(11)	(10)	(16)	(15)	(17)	(12)
Heart	(16)	(11)	(11)	(10)	(16)	(15)	(17)	(12)
Hematopoietic Tissue	(16)	(11)	(11)	(10)	(16)	(15)	(17)	(12)
Interrenal Tissue	(16)	(11)	(11)	(10)	(16)	(15)	(17)	(12)
Intestine	(16)	(11)	(11)	(10)	(16)	(15)	(17)	(12)
Kidney	(16)	(11)	(11)	(10)	(16)	(15)	(17)	(12)
Liver	(16)	(11)	(11)	(10)	(16)	(15)	(17)	(12)
Cholangiocarcinoma							1	
Hepatocellular adenoma			1		1		2	1
Hepatocellular carcinoma							1	
Mesentery	(3)	(2)	(2)	(0)	(3)	(2)	(4)	(3)
Seminoma, invasive					1			
Seminoma, metastatic						1		
Nares (Olfactory Tissue)	(6)	(4)	(3)	(7)	(8)	(6)	(10)	(3)
Oral Cavity	(16)	(11)	(11)	(10)	(16)	(15)	(17)	(12)
Pancreas	(16)	(11)	(11)	(10)	(16)	(15)	(17)	(12)
Pericardial Cavity	(2)	(1)	(0)	(1)	(0)	(1)	(0)	(0)
Peripheral Nerve	(16)	(11)	(11)	(10)	(16)	(15)	(17)	(12)
Peritoneum	(2)	(0)	(0)	(0)	(0)	(0)	(1)	(1)
Pharynx	(0)	(0)	(0)	(0)	(1)	(0)	(0)	(0)

TABLE B2
Summary of the Incidence of Neoplasms in Male Medaka in the 14-Month Waterborne Study
of 2,2-Bis(bromomethyl)-1,3-propanediol (Stop-Exposure)

	0 mg/L		24 mg/L		60 mg/L		150 mg/L	
	Group A	Group B	Group A	Group B	Group A	Group B	Group A	Group B
Pineal Organ	(11)	(8)	(9)	(7)	(14)	(9)	(15)	(10)
Pituitary Gland	(16)	(11)	(10)	(10)	(16)	(14)	(15)	(10)
Pseudobranch	(16)	(11)	(11)	(10)	(16)	(15)	(17)	(12)
Skeletal Muscle	(16)	(11)	(11)	(10)	(16)	(15)	(17)	(12)
Skin	(16)	(11)	(11)	(10)	(16)	(15)	(17)	(12)
Spinal Cord	(16)	(11)	(11)	(10)	(16)	(15)	(17)	(12)
Spleen	(9)	(6)	(5)	(7)	(8)	(8)	(10)	(6)
Stato-acoustic Organ	(16)	(11)	(11)	(10)	(16)	(15)	(17)	(12)
Swim Bladder	(16)	(11)	(11)	(10)	(16)	(15)	(17)	(12)
Testis	(16)	(11)	(11)	(10)	(16)	(15)	(17)	(12)
Seminoma	3	1	1		4	2	2	2
Thymus	(10)	(6)	(8)	(7)	(10)	(7)	(10)	(5)
Thyroid Tissue	(16)	(11)	(11)	(10)	(16)	(15)	(17)	(12)
Urinary Bladder	(16)	(11)	(11)	(10)	(15)	(15)	(17)	(12)
Neoplasm, NOS					1			

^a Number of animals examined microscopically at the site

^b Number of animals with neoplasm

TABLE B3
Summary of the Incidence of Neoplasms in Female Medaka in the 14-Month Waterborne Study
of 2,2-Bis(bromomethyl)-1,3-propanediol (Core Study)

	0 mg/L		24 mg/L		60 mg/L		150 mg/L	
	Group		Group		Group		Group	
	A	B	A	B	A	B	A	B
9-Month Interim Evaluation								
Pharynx ^a	(0)	(0)	(2)	(0)	(0)	(0)	(0)	(0)
Squamous cell carcinoma ^b			1					
Tissues Examined at 9 Months with No Neoplasms Observed								
Adipose Tissue								
Bone								
Brain								
Chromaffin Tissue								
Corpuscle of Stannius								
Esophagus								
Eye								
Gallbladder								
Gill								
Heart								
Hematopoietic Tissue								
Interrenal Tissue								
Intestine								
Kidney								
Liver								
Mesentery								
Nares (Olfactory Tissue)								
Oral Cavity								
Ovary								
Pancreas								
Peripheral Nerve								
Pineal Organ								
Pituitary Gland								
Pseudobranch								
Skeletal Muscle								
Skin								
Spinal Cord								
Spleen								
Stato-acoustic Organ								
Swim Bladder								
Thymus								
Thyroid Tissue								
Urinary Bladder								
14-Month Study								
Adipose Tissue	(3)	(6)	(4)	(3)	(0)	(2)	(1)	(1)
Head, lymphosarcoma			1				1	
Retroperitoneal, lymphosarcoma							1	
Retroperitoneal, sarcoma, NOS			1					
Blood Vessel	(0)	(1)	(0)	(0)	(0)	(0)	(0)	(0)
Bone	(27)	(32)	(18)	(29)	(21)	(29)	(21)	(26)

TABLE B3
Summary of the Incidence of Neoplasms in Female Medaka in the 14-Month Waterborne Study
of 2,2-Bis(bromomethyl)-1,3-propanediol (Core Study)

	0 mg/L		24 mg/L		60 mg/L		150 mg/L	
	Group A	Group B	Group A	Group B	Group A	Group B	Group A	Group B
<i>14-Month Study</i> (continued)								
Nares (Olfactory Tissue)	(18)	(17)	(10)	(10)	(8)	(13)	(8)	(6)
Oral Cavity Submucosa, lymphosarcoma	(27)	(32)	(18)	(29)	(21)	(29)	(21)	(26) 1
Ovary Neoplasm, NOS	(27)	(32) 1	(18)	(29)	(21)	(29)	(21)	(26)
Pancreas Lymphosarcoma	(27)	(32)	(18)	(29) 1	(21)	(29)	(21)	(26)
Pericardial Cavity Lymphosarcoma	(2)	(3)	(0)	(0)	(0)	(0)	(1)	(1) 1
Peripheral Nerve Lymphosarcoma	(27)	(32)	(18)	(29)	(21)	(29)	(21)	(26) 1
Peritoneum	(1)	(3)	(0)	(3)	(0)	(0)	(0)	(0)
Pharynx Lymphosarcoma	(0)	(2)	(1)	(0)	(1)	(0)	(1)	(1) 1
Pineal Organ	(18)	(25)	(10)	(23)	(10)	(19)	(15)	(15)
Pituitary Gland	(19)	(23)	(17)	(23)	(18)	(23)	(16)	(18)
Pseudobranch Lymphosarcoma	(27)	(32)	(18)	(29) 1	(21)	(29)	(21)	(26)
Skeletal Muscle Lymphosarcoma	(27)	(32)	(18)	(29)	(21)	(29)	(21)	(26) 1
Skin Lymphosarcoma	(27)	(32)	(18)	(29)	(21)	(29)	(21)	(26) 1
Spinal Cord	(26)	(32)	(18)	(29)	(21)	(29)	(21)	(26)
Spleen Hemangiosarcoma Lymphosarcoma	(20)	(16)	(9)	(17) 1	(15)	(19) 1	(9)	(15)
Stato-acoustic Organ Lymphosarcoma	(27)	(32)	(18)	(29)	(21)	(29)	(21)	(26) 1

TABLE B3
Summary of the Incidence of Neoplasms in Female Medaka in the 14-Month Waterborne Study
of 2,2-Bis(bromomethyl)-1,3-propanediol (Core Study)

	0 mg/L		24 mg/L		60 mg/L		150 mg/L	
	Group		Group		Group		Group	
	A	B	A	B	A	B	A	B
<i>14-Month Study</i> (continued)								
Swim Bladder	(26)	(32)	(18)	(29)	(21)	(29)	(21)	(26)
Thymus	(9)	(23)	(7)	(14)	(19)	(15)	(12)	(24)
Lymphosarcoma							1	
Thyroid Tissue	(27)	(32)	(18)	(29)	(21)	(29)	(21)	(26)
Follicular cell adenoma								
Urinary Bladder	(24)	(28)	(15)	(23)	(14)	(22)	(18)	(23)
Multiple Organs^c	(27)	(32)	(18)	(29)	(21)	(29)	(21)	(26)
Lymphosarcoma			1				1	

^a Number of animals examined microscopically at the site

^b Number of animals with neoplasm

^c Number of animals with any tissue examined microscopically

TABLE B4
Summary of the Incidence of Neoplasms in Female Medaka in the 14-Month Waterborne Study
of 2,2-Bis(bromomethyl)-1,3-propanediol (Stop-Exposure)

	0 mg/L		24 mg/L		60 mg/L		150 mg/L	
	Group A	B	Group A	B	Group A	B	Group A	B
Pharynx	(0)	(2)	(0)	(1)	(1)	(1)	(0)	(1)
Pineal Organ	(6)	(11)	(15)	(12)	(9)	(8)	(6)	(11)
Pituitary Gland	(10)	(15)	(15)	(17)	(9)	(11)	(10)	(14)
Pseudobranch	(11)	(15)	(16)	(17)	(11)	(12)	(10)	(15)
Skeletal Muscle	(11)	(15)	(16)	(17)	(11)	(12)	(10)	(15)
Skin	(11)	(15)	(16)	(17)	(11)	(12)	(10)	(15)
Spinal Cord	(11)	(15)	(16)	(17)	(11)	(12)	(9)	(15)
Spleen	(8)	(6)	(6)	(13)	(6)	(6)	(6)	(10)
Stato-acoustic Organ	(11)	(15)	(16)	(17)	(11)	(12)	(10)	(15)
Swim Bladder	(11)	(15)	(16)	(17)	(11)	(12)	(10)	(15)
Gas gland, adenoma							1	
Thymus	(6)	(13)	(11)	(9)	(8)	(9)	(6)	(7)
Thyroid Tissue	(11)	(15)	(16)	(17)	(11)	(12)	(10)	(15)
Urinary Bladder	(10)	(14)	(16)	(14)	(10)	(11)	(7)	(12)

^a Number of animals examined microscopically at the site

^b Number of animals with neoplasm

TABLE B5
Summary of the Incidences of Granuloma and Granulomatous Inflammation in Selected Tissues of Medaka in the 14-Month Waterborne Study of 2,2-Bis(bromomethyl)-1,3-propanediol

	0 mg/L	24 mg/L	60 mg/L	150 mg/L
Male				
<i>Core Study</i>				
Number Examined Microscopically	(47)	(59)	(56)	(59)
Granuloma ^a				
Adipose Tissue				
Head	2	1	0	0
Heart				
Atrium	14	4	2	0
Ventricle	8	2	2	0
Hematopoietic Tissue	16	11	4	0
Mesentery	8	1	1	0
Pericardial Cavity	7	1	2	0
Peritoneum	6	3	2	0
Pseudobranch	1	1	1	0
Spleen	7	1	0	0
Liver	28	12	12	0
Granulomatous Inflammation				
Adipose Tissue				
Head	6	4	3	0
Retroperitoneal	3	0	1	0
Mesentery	4	2	1	1
Oral Cavity Submucosa	7	7	1	2
Pericardial Cavity	3	0	0	1
Pseudobranch	12	6	0	0
Skin				
Head	1	1	0	0
Lower Jaw	7	4	0	0
Upper Jaw	9	6	0	1
<i>Stop-Exposure Study</i>				
Number Examined Microscopically	(27)	(21)	(31)	(29)
Granuloma(s)				
Hematopoietic Tissue	15	5	9	7
Heart				
Atrium	8	1	4	0
Ventricle	6	0	1	0
Granulomatous Inflammation				
Eye, Choroid Rete	5	0	1	0
Oral Cavity, Submucosa	11	3	4	4
Skin				
Dorsum	1	0	0	0
Head	1	0	0	1
Lower Jaw	9	2	7	7
Upper Jaw	8	1	2	1

TABLE B5
Summary of the Incidences of Granuloma and Granulomatous Inflammation in Selected Tissues of Medaka
in the 14-Month Waterborne Study of 2,2-Bis(bromomethyl)-1,3-propanediol

	0 mg/L	24 mg/L	60 mg/L	150 mg/L
Female				
<i>Core Study</i>				
Number Examined Microscopically	(59)	(47)	(50)	(47)
Granulomatous Inflammation				
Pseudobranch	7	1	1	0
Granuloma				
Liver	9	1	7	3
Hematopoietic Tissue	4	1	1	1
Macrophage Aggregates				
Heart				
<i>Stop-Exposure Study</i>				
Number Examined Microscopically	(26)	(33)	(23)	(25)
Granulomatous Inflammation				
Mesentary	3	0	1	5
Granuloma				
Mesentary	4	3	2	0
Liver	7	2	4	3

^a Number of animals with lesion

APPENDIX C
SUMMARY OF LESIONS IN GUPPIES
IN THE 16-MONTH WATERBORNE STUDY
OF NITROMETHANE

TABLE C1	Summary of the Incidence of Neoplasms in Male Guppies in the 16-Month Waterborne Study of Nitromethane (Core Study)	120
TABLE C2	Summary of the Incidence of Neoplasms in Male Guppies in the 16-Month Waterborne Study of Nitromethane (Stop-Exposure)	123
TABLE C3	Summary of the Incidence of Neoplasms in Female Guppies in the 16-Month Waterborne Study of Nitromethane (Core Study)	125
TABLE C4	Summary of the Incidence of Neoplasms in Female Guppies in the 16-Month Waterborne Study of Nitromethane (Stop-Exposure)	128
TABLE C5	Summary of the Incidences of Selected Nonneoplastic Lesions in Guppies in the 16-Month Waterborne Study of Nitromethane	130

TABLE C1
Summary of the Incidence of Neoplasms in Male Guppies in the 16-Month Waterborne Study of Nitromethane (Core Study)

	0 mg/L		10 mg/L		30 mg/L		70 mg/L	
	Group		Group		Group		Group ^a	
	A	B	A	B	A	B	A	B
<i>9-Month Interim Evaluation</i>								
<i>Tissues Examined at 9 Months with No Neoplasms Observed</i>								
Adipose Tissue								
Bone								
Brain								
Chromaffin Tissue								
Corpuscle of Stannius								
Esophagus								
Eye								
Gallbladder								
Gill								
Heart								
Hematopoietic Tissue								
Interrenal Tissue								
Intestine								
Kidney								
Liver								
Mesentery								
Nares (Olfactory Tissue)								
Oral Cavity								
Pancreas								
Pericardial Cavity								
Peripheral Nerve								
Peritoneum								
Pharynx								
Pineal Organ								
Pituitary Gland								
Pseudobranch								
Skeletal Muscle								
Skin								
Spinal Cord								
Spleen								
Stato-acoustic Organ								
Swim Bladder								
Testis								
Thymus								
Thyroid Tissue								
Urinary Bladder								
<i>16-Month Study</i>								
Adipose Tissue ^b	(19)	(11)	(17)	(17)	(13)	(17)	(3)	(1)
Blood Vessel	(1)	(0)	(0)	(1)	(1)	(0)	(0)	(0)
Bone	(30)	(30)	(22)	(20)	(31)	(29)	(8)	(4)
Brain	(30)	(30)	(22)	(20)	(31)	(29)	(8)	(4)

TABLE C1
Summary of the Incidence of Neoplasms in Male Guppies in the 16-Month Waterborne Study
of Nitromethane (Core Study)

	0 mg/L		10 mg/L		30 mg/L		70 mg/L	
	Group A	Group B	Group A	Group B	Group A	Group B	Group A	Group B
<i>16-Month Study</i> (continued)								
Chromaffin Tissue	(28)	(28)	(21)	(18)	(29)	(28)	(6)	(4)
Corpuscle of Stannius	(4)	(8)	(7)	(8)	(9)	(10)	(2)	(1)
Cranial Cavity	(0)	(3)	(3)	(9)	(3)	(6)	(0)	(0)
Esophagus	(30)	(30)	(22)	(20)	(31)	(29)	(8)	(4)
Eye	(30)	(30)	(22)	(20)	(31)	(29)	(8)	(4)
Gallbladder	(28)	(30)	(22)	(20)	(28)	(24)	(8)	(4)
Gill	(30)	(30)	(22)	(20)	(31)	(29)	(8)	(4)
Heart	(30)	(30)	(22)	(20)	(31)	(29)	(8)	(4)
Hematopoietic Tissue	(30)	(30)	(22)	(20)	(31)	(29)	(8)	(4)
Interrenal Tissue	(28)	(28)	(21)	(18)	(29)	(28)	(6)	(4)
Intestine	(30)	(30)	(22)	(20)	(31)	(29)	(8)	(4)
Kidney	(30)	(30)	(22)	(20)	(31)	(29)	(8)	(4)
Liver	(30)	(30)	(22)	(20)	(31)	(29)	(8)	(4)
Cholangiocarcinoma ^c			1					
Hepatocellular adenoma	2	2	1		3	4		
Hepatocellular adenoma, multiple			1		1			
Hepatocellular carcinoma			1			2		
Mesentery	(17)	(16)	(13)	(18)	(20)	(15)	(3)	(0)
Nares (Olfactory Tissue)	(20)	(15)	(14)	(12)	(19)	(16)	(3)	(3)
Oral Cavity	(30)	(30)	(22)	(20)	(31)	(29)	(8)	(4)
Pancreas	(30)	(30)	(22)	(20)	(31)	(29)	(8)	(4)
Pericardial Cavity	(7)	(5)	(4)	(7)	(2)	(5)	(1)	
Peripheral Nerve	(30)	(30)	(22)	(20)	(31)	(29)	(8)	(4)
Peritoneum	(6)	(0)	(2)	(4)	(3)	(2)	(0)	(0)
Pharynx	(5)	(4)	(6)	(4)	(4)	(4)	(1)	(0)
Pineal Organ	(16)	(16)	(14)	(13)	(21)	(19)	(5)	(3)

TABLE C1
Summary of the Incidence of Neoplasms in Male Guppies in the 16-Month Waterborne Study of Nitromethane (Core Study)

	0 mg/L		10 mg/L		30 mg/L		70 mg/L	
	Group A	Group B	Group A	Group B	Group A	Group B	Group A	Group B
<i>16-Month Study</i> (continued)								
Pituitary Gland	(27)	(22)	(18)	(19)	(22)	(21)	(5)	(1)
Pseudobranch	(30)	(30)	(22)	(20)	(31)	(29)	(8)	(4)
Skeletal Muscle	(30)	(30)	(22)	(20)	(31)	(29)	(8)	(4)
Skin	(30)	(30)	(22)	(20)	(31)	(29)	(8)	(4)
Spinal Cord	(30)	(29)	(21)	(19)	(31)	(27)	(8)	(3)
Spleen	(29)	(29)	(22)	(19)	(28)	(29)	(7)	(3)
Stato-acoustic Organ	(30)	(30)	(22)	(20)	(31)	(29)	(8)	(4)
Swim Bladder	(30)	(30)	(22)	(20)	(31)	(29)	(8)	(4)
Epithelioma					1			
Gas gland, adenoma		1						
Testis	(30)	(30)	(22)	(20)	(31)	(29)	(8)	(4)
Thymus	(0)	(0)	(1)	(0)	(1)	(0)	(0)	(0)
Thyroid Tissue	(30)	(28)	(22)	(20)	(25)	(28)	(8)	(3)
Urinary Bladder	(29)	(28)	(20)	(20)	(30)	(29)	(7)	(4)

^a The 70 mg/L group was removed and examined at 57 weeks. The control, 10, and 30 mg/L groups were removed and examined at 70 weeks.

^b Number of animals examined microscopically at the site

^c Number of animals with neoplasm

TABLE C2
Summary of the Incidence of Neoplasms in Male Guppies in the 16-Month Waterborne Study
of Nitromethane (Stop-Exposure)

	0 mg/L		10 mg/L		30 mg/L		70 mg/L	
	Group A	Group B	Group A	Group B	Group A	Group B	Group A	Group B
Adipose Tissue^a	(7)	(11)	(12)	(9)	(7)	(10)	(4)	(6)
Blood Vessel	(0)	(0)	(0)	(0)	(0)	(1)	(0)	(0)
Bone	(12)	(17)	(16)	(13)	(16)	(13)	(7)	(7)
Brain	(12)	(17)	(16)	(13)	(16)	(13)	(7)	(7)
Chromaffin Tissue	(11)	(17)	(15)	(13)	(16)	(12)	(7)	(7)
Corpuscle of Stannius	(3)	(3)	(6)	(7)	(6)	(4)	(1)	(2)
Cranial Cavity	(0)	(4)	(3)	(5)	(3)	(3)	(1)	(3)
Esophagus	(12)	(17)	(16)	(13)	(16)	(13)	(7)	(7)
Eye	(12)	(17)	(16)	(13)	(16)	(13)	(7)	(7)
Gallbladder	(11)	(16)	(13)	(12)	(15)	(13)	(7)	(6)
Adenoma, papillary ^b							1	
Carcinoma			1					
Gill	(12)	(17)	(16)	(13)	(16)	(13)	(7)	(7)
Heart	(12)	(17)	(16)	(13)	(16)	(13)	(7)	(7)
Hematopoietic Tissue	(12)	(17)	(16)	(13)	(16)	(13)	(7)	(7)
Interrenal Tissue	(11)	(17)	(15)	(13)	(16)	(12)	(7)	(7)
Intestine	(12)	(17)	(16)	(13)	(16)	(13)	(7)	(7)
Kidney	(12)	(17)	(16)	(13)	(16)	(13)	(7)	(7)
Liver	(12)	(17)	(16)	(13)	(16)	(13)	(7)	(7)
Carcinoma, invasive			1					
Cholangioma					1			
Hepatocellular adenoma	2	2	1	1	1			
Hepatocellular adenoma, multiple	1				1			
Hepatocellular carcinoma			1	2				
Mesentery	(5)	(11)	(12)	(8)	(12)	(8)	(2)	(2)
Nares (Olfactory Tissue)	(9)	(10)	(12)	(9)	(10)	(8)	(5)	(3)
Oral Cavity	(12)	(17)	(16)	(13)	(16)	(13)	(7)	(7)
Pancreas	(12)	(17)	(16)	(13)	(16)	(13)	(7)	(7)
Pericardial Cavity	(2)	(2)	(6)	(5)	(3)	(7)	(0)	(3)

TABLE C2
Summary of the Incidence of Neoplasms in Male Guppies in the 16-Month Waterborne Study of Nitromethane (Stop-Exposure)

	0 mg/L		10 mg/L		30 mg/L		70 mg/L	
	Group A	Group B	Group A	Group B	Group A	Group B	Group A	Group B
Peripheral Nerve Schwannoma	(12)	(17)	(16)	(13) 1	(16)	(13)	(7)	(7)
Peritoneum	(1)	(0)	(0)	(1)	(0)	(1)	(0)	(0)
Pharynx	(3)	(1)	(3)	(2)	(2)	(1)	(0)	(0)
Pineal Organ	(8)	(9)	(11)	(7)	(13)	(10)	(4)	(6)
Pituitary Gland Adenoma	(7)	(9) 1	(15)	(11)	(12)	(13) 1	(4)	(5)
Pseudobranch	(12)	(17)	(16)	(13)	(16)	(13)	(7)	(7)
Skeletal Muscle	(12)	(17)	(16)	(13)	(16)	(13)	(7)	(7)
Skin	(12)	(17)	(16)	(13)	(16)	(13)	(7)	(7)
Spinal Cord	(12)	(17)	(15)	(13)	(15)	(13)	(7)	(6)
Spleen	(8)	(14)	(16)	(13)	(15)	(13)	(6)	(7)
Stato-acoustic Organ	(12)	(17)	(16)	(13)	(16)	(13)	(7)	(7)
Swim Bladder Epithelioma	(12)	(17)	(16)	(13)	(16)	(13) 1	(7)	(7)
Testis	(12)	(17)	(16)	(13)	(16)	(13)	(7)	(7)
Thymus	(1)	(0)	(0)	(0)	(0)	(0)	(2)	(0)
Thyroid Tissue	(8)	(11)	(16)	(13)	(16)	(12)	(7)	(7)
Urinary Bladder	(12)	(15)	(16)	(12)	(16)	(13)	(7)	(7)

^a Number of animals examined microscopically at the site

^b Number of animals with neoplasm

TABLE C3
Summary of the Incidence of Neoplasms in Female Guppies in the 16-Month Waterborne Study of Nitromethane (Core Study)

	0 mg/L Group		10 mg/L Group		30 mg/L Group		70 mg/L Group ^a	
	A	B	A	B	A	B	A	B
<i>16-Month Study</i>								
Adipose Tissue	(15)	(19)	(26)	(22)	(16)	(22)	(8)	(14)
Blood Vessel	(1)	(2)	(1)	(0)	(2)	(0)	(0)	(1)
Bone	(24)	(23)	(32)	(25)	(20)	(30)	(15)	(17)
Brain	(24)	(23)	(32)	(25)	(20)	(30)	(15)	(17)
Chromaffin Tissue	(21)	(16)	(23)	(24)	(12)	(21)	(10)	(12)
Corpuscle of Stannius	(2)	(10)	(8)	(7)	(5)	(8)	(1)	(6)
Cranial Cavity	(2)	(2)	(8)	(11)	(6)	(6)	(3)	(2)
Esophagus	(24)	(23)	(32)	(25)	(20)	(30)	(15)	(17)
Eye	(24)	(23)	(32)	(25)	(20)	(30)	(15)	(17)
Gallbladder	(20)	(19)	(21)	(18)	(16)	(26)	(14)	(15)
Gill	(24)	(23)	(32)	(25)	(20)	(30)	(15)	(17)
Heart	(24)	(23)	(32)	(25)	(20)	(30)	(14)	(17)
Hematopoietic Tissue Sarcoma, NOS, invasive ^c	(24)	(23)	(32)	(25) 1	(20)	(30)	(15)	(17)
Interrenal Tissue	(21)	(17)	(24)	(24)	(12)	(21)	(10)	(13)
Intestine Sarcoma, NOS	(24)	(23)	(32)	(25) 1	(20)	(30)	(15)	(17)
Kidney	(24)	(23)	(32)	(25)	(20)	(30)	(15)	(17)
Liver Cholangiocarcinoma Hepatocellular adenoma Sarcoma, NOS, invasive	(24)	(23)	(32)	(25) 1 2 1	(20)	(30) 2	(15)	(17)
Mesentery	(15)	(22)	(30)	(25)	(18)	(27)	(12)	(15)
Nares (Olfactory Tissue)	(18)	(15)	(28)	(18)	(14)	(25)	(10)	(12)
Oral Cavity	(24)	(23)	(32)	(25)	(20)	(30)	(15)	(17)

TABLE C3
Summary of the Incidence of Neoplasms in Female Guppies in the 16-Month Waterborne Study of Nitromethane (Core Study)

	0 mg/L		10 mg/L		30 mg/L		70 mg/L	
	Group A	Group B	Group A	Group B	Group A	Group B	Group A	Group B
<i>16-Month Study</i> (continued)								
Ovary	(23)	(23)	(32)	(25)	(20)	(30)	(15)	(17)
Sarcoma, NOS, invasive			1					
Pancreas	(24)	(23)	(32)	(25)	(20)	(30)	(15)	(17)
Pericardial Cavity	(4)	(6)	(10)	(4)	(2)	(7)	(0)	(1)
Peripheral Nerve	(24)	(23)	(32)	(25)	(20)	(30)	(15)	(17)
Schwannoma		1						
Peritoneum	(2)	(2)	(3)	(3)	(3)	(4)	(0)	(1)
Pharynx	(4)	(3)	(4)	(4)	(7)	(0)	(1)	(1)
Pineal Organ	(6)	(5)	(9)	(5)	(7)	(16)	(5)	(11)
Pituitary Gland	(8)	(14)	(25)	(18)	(18)	(27)	(12)	(15)
Pseudobranch	(23)	(20)	(30)	(25)	(19)	(29)	(15)	(16)
Skeletal Muscle	(24)	(23)	(32)	(25)	(20)	(30)	(15)	(17)
Skin	(24)	(23)	(32)	(25)	(20)	(30)	(15)	(17)
Spinal Cord	(14)	(21)	(32)	(25)	(20)	(30)	(11)	(16)
Spleen	(19)	(17)	(28)	(22)	(18)	(25)	(9)	(14)
Stato-acoustic Organ	(24)	(23)	(32)	(25)	(20)	(30)	(15)	(17)
Swim Bladder	(23)	(23)	(31)	(25)	(20)	(30)	(15)	(17)
Epithelioma			2					
Gas gland, adenoma		1						
Thymus	(21)	(17)	(25)	(20)	(14)	(24)	(8)	(14)
Thyroid Tissue	(15)	(22)	(32)	(23)	(20)	(30)	(15)	(17)
Urinary Bladder	(14)	(12)	(15)	(18)	(8)	(15)	(9)	(13)

^a The 70 mg/L group was removed and examined at 57 weeks. The control, 10, and 30 mg/L groups were removed and examined at 70 weeks.

^b Number of animals examined microscopically at the site

^c Number of animals with neoplasm

TABLE C4
Summary of the Incidence of Neoplasms in Female Guppies in the 16-Month Waterborne Study
of Nitromethane (Stop-Exposure)

	0 mg/L		10 mg/L		30 mg/L		70 mg/L	
	Group A	B	Group A	B	Group A	B	Group A	B
Adipose Tissue^a	(8)	(11)	(10)	(16)	(12)	(13)	(10)	(5)
Blood Vessel	(0)	(1)	(0)	(0)	(1)	(0)	(0)	(0)
Bone	(16)	(14)	(13)	(21)	(17)	(16)	(16)	(9)
Brain	(16)	(14)	(13)	(21)	(17)	(16)	(16)	(9)
Chromaffin Tissue	(12)	(11)	(11)	(19)	(13)	(11)	(11)	(9)
Corpuscle of Stannius	(6)	(4)	(3)	(6)	(4)	(2)	(3)	(2)
Cranial Cavity	(3)	(6)	(4)	(8)	(1)	(5)	(6)	(7)
Esophagus	(16)	(14)	(13)	(21)	(17)	(16)	(16)	(9)
Eye	(16)	(14)	(13)	(21)	(17)	(16)	(16)	(9)
Gallbladder^b Carcinoma	(15)	(13) 1	(12)	(21)	(16)	(11)	(15)	(7)
Gill	(16)	(14)	(13)	(21)	(17)	(16)	(16)	(9)
Heart	(16)	(14)	(13)	(21)	(17)	(16)	(16)	(9)
Hematopoietic Tissue	(16)	(14)	(13)	(21)	(17)	(16)	(16)	(9)
Interrenal Tissue	(12)	(11)	(11)	(19)	(13)	(11)	(11)	(9)
Intestine	(16)	(14)	(13)	(21)	(17)	(16)	(16)	(9)
Kidney	(16)	(14)	(13)	(21)	(17)	(16)	(16)	(9)
Liver	(16)	(14)	(13)	(21)	(17)	(16)	(16)	(9)
Carcinoma, invasive		1						
Hepatocellular adenoma	1							
Hepatocellular adenoma, multiple		1						
Hepatocellular carcinoma					1			
Hepatocholangiocarcinoma			1					
Mesentery	(8)	(11)	(11)	(16)	(17)	(14)	(15)	(7)
Nares (Olfactory Tissue)	(12)	(11)	(12)	(16)	(11)	(8)	(11)	(4)
Oral Cavity	(16)	(14)	(13)	(21)	(17)	(16)	(16)	(9)
Ovary	(16)	(14)	(13)	(21)	(17)	(16)	(16)	(9)
Pancreas	(16)	(14)	(13)	(21)	(17)	(16)	(16)	(9)
Pericardial Cavity	(2)	(4)	(2)	(6)	(4)	(4)	(1)	(1)

TABLE C4
Summary of the Incidence of Neoplasms in Female Guppies in the 16-Month Waterborne Study of Nitromethane (Stop-Exposure)

	0 mg/L		10 mg/L		30 mg/L		70 mg/L	
	Group A	Group B	Group A	Group B	Group A	Group B	Group A	Group B
Peripheral Nerve Sarcoma, NOS	(16)	(14)	(13)	(21)	(17)	(16)	(16)	(9) ¹
Peritoneum	(0)	(1)	(1)	(4)	(0)	(3)	(0)	(0)
Pharynx	(1)	(3)	(2)	(3)	(3)	(3)	(2)	(2)
Pineal Organ	(13)	(10)	(0)	(5)	(6)	(4)	(10)	(6)
Pituitary Gland	(15)	(12)	(7)	(15)	(10)	(7)	(12)	(6)
Pseudobranch	(14)	(12)	(13)	(18)	(16)	(15)	(16)	(8)
Skeletal Muscle	(16)	(14)	(13)	(21)	(17)	(16)	(16)	(9)
Skin	(16)	(14)	(13)	(21)	(17)	(16)	(16)	(9)
Spinal Cord	(16)	(14)	(12)	(20)	(17)	(13)	(15)	(8)
Spleen Hemangiosarcoma	(12)	(11)	(10)	(21)	(17)	(16)	(16)	(8) ¹
Stato-acoustic Organ	(16)	(14)	(13)	(21)	(17)	(16)	(16)	(9)
Swim Bladder	(16)	(14)	(13)	(21)	(17)	(16)	(16)	(9)
Thymus	(15)	(9)	(12)	(14)	(17)	(13)	(11)	(7)
Thyroid Tissue	(16)	(14)	(13)	(21)	(17)	(16)	(16)	(9)
Urinary Bladder	(9)	(7)	(8)	(15)	(12)	(11)	(12)	(1)

^a Number of animals examined microscopically at the site

^b Number of animals with neoplasm

TABLE C5
Summary of the Incidences of Selected Nonneoplastic Lesions in Guppies in the 16-Month Waterborne Study of Nitromethane

	0 mg/L	10 mg/L	30 mg/L	70 mg/L
Male				
<i>Core Study</i>				
Number Examined Microscopically	(60)	(42)	(60)	(12)
Granuloma				
Adipose Tissue				
Head ^d	11	16	16	1
Retroperitoneal	22	14	14	2
Cranial Cavity	1	9	5	0
Eye				
Choroid Rete	3	2	7	0
Choroid	10	8	4	1
Cornea	1	0	0	0
Iris	2	0	0	0
Retina	1	0	1	0
Swim Bladder				
Gas Gland	3	5	8	1
Gill				
Arches	1	0	0	0
Branchial Wall	3	12	8	1
Branchial Wall	3	3	5	0
Heart				
Atrium	15	11	20	1
Bulbus Arteriosus	3	0	2	0
Ventricle	13	8	10	1
Hematopoietic Tissue	42	35	56	5
Skeletal Muscles	11	10	13	1
<i>Stop-Exposure Study</i>				
Number Examined Microscopically	(29)	(29)	(29)	(14)
Granuloma				
Pericardial Cavity	3	10	8	3
Mononuclear Cell Infiltrate				
Urinary Bladder	1	9	7	3
Female				
<i>Core Study</i>				
Number Examined Microscopically	(47)	(57)	(50)	(32)
Granuloma				
Adipose Tissue				
Head	16	35	26	9
Retroperitoneal	20	28	25	12
Cranial Cavity	0	12	8	4
Eye				
Choroid Rete	4	5	13	1
Choroid	1	16	3	4
Cornea	0	0	1	0
Iris	0	0	1	0
Retina	0	1	2	0

TABLE C5
Summary of the Incidences of Selected Nonneoplastic Lesions in Guppies in the 16-Month Waterborne Study of Nitromethane

	0 mg/L	10 mg/L	30 mg/L	70 mg/L
Female (continued)				
<i>Core Study</i> (continued)				
Number Examined Microscopically	(47)	(57)	(50)	(32)
Granuloma (continued)				
Swim Bladder				
Gas Gland	10	19	15	5
Gill	0	2	2	1
Arches	5	20	16	2
Branchial Wall	1	8	7	2
Heart				
Atrium	8	17	25	2
Bulbus Arteriosus	1	6	5	2
Ventricle	9	16	20	1
Hematopoietic Tissue	31	45	42	25
Intestine				
Serosa	0	1	0	0
Submucosa	4	20	10	2
Ovary	18	39	30	5
Embryo	0	1	0	0
Oviduct	2	6	5	2
Peripheral Nerve	3	6	10	1
Skeletal Muscle	7	22	13	5
Spinal Cord	0	1	0	0
Meninges	3	12	15	2
Spleen	13	28	17	2
Liver	13	24	23	7
Macrophage Aggregates				
Adipose Tissue				
Head	2	3	2	0
Retroperitoneal	16	29	27	15
Cranial Cavity	1	10	6	1
Heart				
Atrium	29	43	40	23
Bulbus Arteriosus	0	1	0	0
Ventricle	6	11	12	0
Ovary	0	23	11	2
Skeletal Muscle	1	0	0	0
Swim Bladder				
Gas Gland	4	4	0	1
Wall	4	13	4	1
Mononuclear Cell Infiltrate				
Adipose Tissue				
Head	6	3	1	0
Perivertebral	1	0	0	0
Retroperitoneal	3	0	0	0
Cranial Cavity	2	1	0	0
Gill				
Arches	31	53	40	17
Branchial Wall	5	12	7	6
Infiltrate Cellular	4	4	3	1

TABLE C5
Summary of the Incidences of Selected Nonneoplastic Lesions in Guppies in the 16-Month Waterborne Study of Nitromethane

	0 mg/L	10 mg/L	30 mg/L	70 mg/L
Female (continued)				
Core Study (continued)				
Number Examined Microscopically	(47)	(57)	(50)	(32)
Mononuclear Cell Infiltrate (continued)				
Heart				
Atrium, Focal	1	1	2	1
Atrium, Multifocal	11	7	2	3
Bulbus Arteriosus	0	4	1	2
Ventricle, Focal	1	1	3	0
Ventricle, Multifocal	12	6	10	1
Intestine	2	10	8	2
Ovary	0	1	1	1
Skeletal Muscle				
Focal	1	2	6	1
Multifocal	1	12	5	2
Swim Bladder				
Gas Gland	3	4	2	3
Stop-Exposure Study				
Number Examined Microscopically	(30)	(34)	(33)	(25)
Granuloma				
Ovary	12	20	15	12
Oviduct	4	3	7	4
Macrophage Aggregates				
Ovary	10	22	11	11

^a Number of animals with lesion

APPENDIX D
SUMMARY OF LESIONS IN MEDAKA
IN THE 13-MONTH WATERBORNE STUDY
OF NITROMETHANE

TABLE D1	Summary of the Incidence of Neoplasms in Male Medaka in the 13-Month Waterborne Study of Nitromethane (Core Study)	134
TABLE D2	Summary of the Incidence of Neoplasms in Male Medaka in the 13-Month Waterborne Study of Nitromethane (Stop-Exposure)	138
TABLE D3	Summary of the Incidence of Neoplasms in Female Medaka in the 13-Month Waterborne Study of Nitromethane (Core Study)	140
TABLE D4	Summary of the Incidence of Neoplasms in Female Medaka in the 13-Month Waterborne Study of Nitromethane (Stop-Exposure)	144
TABLE D5	Summary of the Incidences of Selected Nonneoplastic Lesions in Medaka in the 13-Month Waterborne Study of Nitromethane (Core Study)	146

TABLE D1
Summary of the Incidence of Neoplasms in Male Medaka in the 13-Month Waterborne Study
of Nitromethane (Core Study)

	0 mg/L		10 mg/L		20 mg/L		40 mg/L	
	Group A	B	Group A	B	Group A	B	Group A	B
<i>13-Month Study</i>								
Adipose Tissue	(15)	(12)	(6)	(9)	(9)	(14)	(7)	(6)
Head, lymphosarcoma					1			
Retroperitoneal, lymphosarcoma			1					
Blood Vessel	(0)	(0)	(1)	(0)	(1)	(5)	(1)	(1)
Bone	(41)	(31)	(48)	(43)	(46)	(44)	(36)	(40)
Brain	(41)	(31)	(48)	(43)	(46)	(44)	(36)	(40)
Chromaffin Tissue	(41)	(30)	(48)	(42)	(45)	(44)	(36)	(40)
Corpuscle of Stannius	(15)	(15)	(28)	(18)	(24)	(22)	(21)	(23)
Cranial Cavity	(0)	(0)	(0)	(1)	(0)	(1)	(0)	(0)
Esophagus	(41)	(31)	(48)	(43)	(46)	(44)	(36)	(40)
Eye	(41)	(31)	(48)	(43)	(46)	(44)	(36)	(40)
Lymphosarcoma			1		1			
Gallbladder	(40)	(31)	(48)	(42)	(45)	(43)	(34)	(38)
Gill	(41)	(31)	(48)	(43)	(46)	(44)	(36)	(40)
Lymphosarcoma					1			
Heart	(41)	(31)	(48)	(43)	(46)	(44)	(36)	(40)
Lymphosarcoma			1		1			
Hematopoietic Tissue	(41)	(31)	(48)	(43)	(46)	(44)	(36)	(40)
Lymphosarcoma			1		1			
Interrenal Tissue	(41)	(30)	(48)	(42)	(45)	(44)	(36)	(40)
Intestine	(41)	(31)	(48)	(43)	(46)	(44)	(36)	(40)
Lymphosarcoma			1					
Kidney	(41)	(31)	(48)	(43)	(46)	(44)	(36)	(40)
Lymphosarcoma			1					
Liver	(41)	(31)	(48)	(43)	(46)	(44)	(36)	(40)
Cholangiocarcinoma			1		1	1		1
Cholangioma					1			
Hemangiopericytoma								1
Hepatocellular adenoma	1		1	1				1
Hepatocellular adenoma, multiple						1		
Lymphosarcoma					1			

TABLE D1
Summary of the Incidence of Neoplasms in Male Medaka in the 13-Month Waterborne Study
of Nitromethane (Core Study)

	0 mg/L		10 mg/L		20 mg/L		40 mg/L	
	Group A	B	Group A	B	Group A	B	Group A	B
<i>13-Month Study</i> (continued)								
Mesentery	(13)	(8)	(4)	(7)	(7)	(11)	(9)	(7)
Lymphosarcoma			1		1			
Nares (Olfactory Tissue)	(25)	(10)	(7)	(14)	(23)	(16)	(22)	(24)
Oral Cavity	(41)	(31)	(48)	(43)	(46)	(44)	(36)	(40)
Pancreas	(41)	(31)	(48)	(43)	(46)	(44)	(36)	(40)
Lymphosarcoma			1					
Pericardial Cavity	(7)	(7)	(1)	(1)	(1)	(1)	(3)	(0)
Carcinoma, invasive	1							
Peripheral Nerve	(41)	(31)	(48)	(43)	(46)	(44)	(36)	(40)
Peritoneum	(3)	(1)	(2)	(1)	(1)	(1)	(1)	(1)
Pharynx	(0)	(2)	(1)	(0)	(0)	(3)	(2)	(0)
Pineal Organ	(28)	(23)	(40)	(22)	(31)	(31)	(26)	(23)
Pituitary Gland	(31)	(26)	(43)	(31)	(27)	(31)	(26)	(32)
Pseudobranch	(41)	(31)	(48)	(43)	(46)	(44)	(36)	(40)
Lymphosarcoma					1			
Skeletal Muscle	(41)	(31)	(48)	(43)	(46)	(44)	(36)	(40)
Carcinoma, invasive	1							
Lymphosarcoma					1			
Skin	(41)	(31)	(48)	(43)	(46)	(44)	(36)	(40)
Lymphosarcoma					1			
Spinal Cord	(40)	(30)	(48)	(43)	(45)	(44)	(36)	(38)
Spleen	(37)	(25)	(17)	(36)	(40)	(35)	(31)	(27)
Lymphosarcoma			1		1			
Seminoma, metastatic								
Stato-acoustic Organ	(41)	(31)	(48)	(43)	(46)	(44)	(36)	(40)
Swim Bladder	(41)	(31)	(48)	(43)	(46)	(44)	(36)	(40)
Testis	(41)	(31)	(48)	(43)	(46)	(44)	(36)	(40)
Hemangioma							1	
Lymphosarcoma			1					
Seminoma	1		2	2	1		1	3
Thymus	(18)	(13)	(21)	(11)	(28)	(14)	(9)	(15)
Lymphosarcoma					1			

TABLE D1
Summary of the Incidence of Neoplasms in Male Medaka in the 13-Month Waterborne Study of Nitromethane (Core Study)

	0 mg/L		10 mg/L		20 mg/L		40 mg/L	
	Group		Group		Group		Group	
	A	B	A	B	A	B	A	B
<i>13-Month Study</i> (continued)								
Thyroid Tissue	(41)	(31)	(48)	(43)	(46)	(44)	(36)	(40)
Carcinoma	1		1					
Urinary Bladder	(31)	(26)	(46)	(36)	(38)	(35)	(33)	(38)
Multiple Organs^c	(41)	(31)	(48)	(43)	(46)	(44)	(36)	(40)
Lymphosarcoma			1		1			

^a Number of animals examined microscopically at the site

^b Number of animals with neoplasm

^c Number of animals with any tissue examined microscopically

TABLE D2
Summary of the Incidence of Neoplasms in Male Medaka in the 13-Month Waterborne Study
of Nitromethane (Stop-Exposure)

	0 mg/L		10 mg/L		20 mg/L		40 mg/L	
	Group A	Group B	Group A	Group B	Group A	Group B	Group A	Group B
Adipose Tissue^a Retroperitoneal, schwannoma, malignant, invasive ^b	(4)	(7)	(1)	(1)	(4)	(4)	(3)	(5)
							1	
Blood Vessel	(0)	(1)	(0)	(0)	(1)	(0)	(0)	(0)
Bone	(27)	(20)	(20)	(15)	(20)	(16)	(22)	(19)
Brain	(27)	(20)	(20)	(15)	(20)	(16)	(22)	(19)
Chromaffin Tissue	(27)	(20)	(20)	(15)	(19)	(16)	(21)	(19)
Corpuscle of Stannius	(11)	(7)	(12)	(5)	(11)	(8)	(11)	(8)
Cranial Cavity	(0)	(0)	(0)	(0)	(0)	(1)	(0)	(0)
Esophagus Schwannoma, malignant, invasive	(27)	(20)	(20)	(15)	(20)	(16)	(22)	(19)
							1	
Eye Choroid rete, seminoma, metastatic	(27)	(20)	(20)	(15)	(20)	(16)	(22)	(19)
	1							
Gallbladder	(25)	(20)	(19)	(15)	(20)	(15)	(21)	(19)
Gill	(27)	(20)	(20)	(15)	(20)	(16)	(22)	(19)
Heart	(27)	(19)	(20)	(15)	(20)	(16)	(22)	(19)
Hematopoietic Tissue	(27)	(20)	(20)	(15)	(20)	(16)	(22)	(19)
Interrenal Tissue	(27)	(20)	(20)	(15)	(19)	(16)	(21)	(19)
Intestine Sarcoma, NOS, invasive	(27)	(20)	(20)	(15)	(20)	(16)	(22)	(19)
							1	
Kidney Schwannoma, malignant, invasive	(27)	(20)	(20)	(15)	(20)	(16)	(22)	(19)
							1	
Liver	(27)	(20)	(20)	(15)	(20)	(16)	(22)	(19)
Mesentery Sarcoma, NOS Schwannoma, malignant, invasive	(5)	(10)	(6)	(5)	(6)	(5)	(6)	(4)
							1	
							1	
Nares (Olfactory Tissue)	(10)	(5)	(6)	(4)	(2)	(4)	(9)	(5)
Oral Cavity	(27)	(20)	(20)	(15)	(20)	(16)	(22)	(19)
Pancreas	(27)	(19)	(20)	(15)	(20)	(16)	(22)	(19)
Pericardial Cavity	(1)	(3)	(0)	(1)	(4)	(2)	(0)	(0)

TABLE D2
Summary of the Incidence of Neoplasms in Male Medaka in the 13-Month Waterborne Study of Nitromethane (Stop-Exposure)

	0 mg/L		10 mg/L		20 mg/L		40 mg/L	
	Group A	Group B	Group A	Group B	Group A	Group B	Group A	Group B
Peripheral Nerve	(27)	(20)	(20)	(15)	(20)	(16)	(22)	(19)
Peritoneum Schwannoma, malignant	(2)	(2)	(0)	(0)	(4)	(0)	(0)	(1) 1
Pharynx	(0)	(0)	(0)	(0)	(0)	(1)	(2)	(0)
Pineal Organ	(19)	(18)	(13)	(8)	(15)	(11)	(17)	(15)
Pituitary Gland	(19)	(15)	(10)	(8)	(17)	(10)	(14)	(17)
Pseudobranch	(27)	(20)	(20)	(15)	(20)	(16)	(22)	(19)
Skeletal Muscle Schwannoma, malignant, invasive	(27)	(20)	(20)	(15)	(20)	(16)	(22)	(19) 1
Skin Ventrum, sarcoma, NOS, invasive	(27)	(20)	(20)	(15)	(20)	(16)	(22)	(19) 1
Spinal Cord	(26)	(20)	(20)	(14)	(20)	(16)	(21)	(19)
Spleen	(15)	(17)	(13)	(9)	(6)	(12)	(10)	(5)
Stato-acoustic Organ	(27)	(20)	(20)	(15)	(20)	(16)	(22)	(19)
Swim Bladder	(27)	(20)	(20)	(15)	(19)	(16)	(22)	(19)
Testis Schwannoma, malignant, invasive	(27)	(20)	(20)	(15)	(20)	(16)	(22)	(19) 1
Seminoma	1		1		1		2	2
Thymus	(12)	(10)	(4)	(8)	(16)	(7)	(8)	(14)
Thyroid Tissue	(27)	(20)	(20)	(15)	(20)	(16)	(22)	(19)
Urinary Bladder	(24)	(15)	(20)	(15)	(19)	(15)	(19)	(14)

^a Number of animals examined microscopically at the site

^b Number of animals with neoplasm

TABLE D3
Summary of the Incidence of Neoplasms in Female Medaka in the 13-Month Waterborne Study of Nitromethane (Core Study)

	0 mg/L		10 mg/L		20 mg/L		40 mg/L	
	Group A	Group B	Group A	Group B	Group A	Group B	Group A	Group B
<i>9-Month Interim Evaluation</i>								
Adipose Tissue^a	(0)	(0)	(0)	(0)	(1)	(3)	(1)	(1)
Head, lymphosarcoma ^b					1		1	
Retroperitoneal, lymphosarcoma					1		1	
Cranial Cavity	(0)	(0)	(0)	(0)	(0)	(0)	(1)	(0)
Lymphosarcoma							1	
Esophagus	(7)	(6)	(10)	(5)	(4)	(5)	(10)	(10)
Lymphosarcoma							1	
Eye	(7)	(6)	(10)	(5)	(4)	(5)	(10)	(10)
Choroid rete, lymphosarcoma							1	
Lymphosarcoma					1			
Gill	(7)	(6)	(10)	(5)	(4)	(5)	(10)	(10)
Lymphosarcoma					1		1	
Heart	(7)	(6)	(10)	(4)	(4)	(5)	(10)	(10)
Lymphosarcoma					1		1	
Hematopoietic Tissue	(7)	(6)	(10)	(5)	(4)	(5)	(10)	(10)
Lymphosarcoma		-			1		1	
Intestine	(7)	(6)	(10)	(5)	(4)	(5)	(10)	(10)
Lymphosarcoma							1	
Liver	(7)	(6)	(10)	(5)	(4)	(5)	(10)	(10)
Hepatocellular adenoma								1
Lymphosarcoma							1	
Mesentery	(1)	(0)	(0)	(0)	(0)	(2)	(2)	(1)
Lymphosarcoma							1	
Seminoma, metastatic								1
Oral Cavity	(7)	(6)	(10)	(5)	(4)	(5)	(10)	(10)
Lymphosarcoma							1	
Ovary	(7)	(6)	(10)	(5)	(4)	(5)	(10)	(10)
Lymphosarcoma							1	
Seminoma								1
Peripheral Nerve	(7)	(6)	(10)	(5)	(4)	(5)	(10)	(10)
Lymphosarcoma							1	
Pharynx	(0)	(0)	(0)	(0)	(1)	(1)	(2)	(0)
Lymphosarcoma					1		1	

TABLE D3
Summary of the Incidence of Neoplasms in Female Medaka in the 13-Month Waterborne Study of Nitromethane (Core Study)

	0 mg/L Group		10 mg/L Group		20 mg/L Group		40 mg/L Group	
	A	B	A	B	A	B	A	B
<i>13-Month Study</i> (continued)								
Nares (Olfactory Tissue)	(26)	(20)	(11)	(17)	(21)	(11)	(20)	(26)
Oral Cavity	(33)	(41)	(31)	(38)	(35)	(24)	(35)	(35)
Ovary	(33)	(41)	(31)	(38)	(35)	(24)	(35)	(35)
Dysgerminoma				1				1
Schwannoma, malignant, invasive				1				
Seminoma		1		1		1		1
Pancreas	(33)	(41)	(31)	(38)	(35)	(24)	(35)	(35)
Pericardial Cavity	(3)	(2)	(0)	(1)	(1)	(2)	(1)	(0)
Carcinoma, invasive								
Peripheral Nerve	(33)	(41)	(31)	(38)	(35)	(24)	(35)	(35)
Peritoneum	(0)	(0)	(0)	(1)	(0)	(1)	(0)	(1)
Schwannoma, malignant				1				
Seminoma, metastatic								1
Pharynx	(5)	(5)	(2)	(2)	(3)	(2)	(0)	(0)
Pineal Organ	(22)	(28)	(21)	(22)	(20)	(16)	(24)	(23)
Pituitary Gland	(23)	(31)	(23)	(22)	(22)	(12)	(23)	(23)
Pseudobranch	(33)	(41)	(31)	(38)	(35)	(24)	(35)	(35)
Skeletal Muscle	(33)	(41)	(31)	(38)	(35)	(24)	(35)	(35)
Skin	(33)	(41)	(31)	(38)	(35)	(24)	(35)	(35)
Spinal Cord	(32)	(41)	(31)	(36)	(35)	(24)	(35)	(33)
Spleen	(29)	(30)	(15)	(30)	(26)	(19)	(31)	(21)
Dysgerminoma, metastatic								1
Seminoma, metastatic								1
Stato-acoustic Organ	(33)	(41)	(31)	(38)	(35)	(24)	(35)	(35)
Swim Bladder	(33)	(41)	(31)	(38)	(35)	(24)	(35)	(35)
Thymus	(19)	(18)	(9)	(15)	(19)	(6)	(11)	(20)
Thyroid Tissue	(33)	(41)	(31)	(38)	(35)	(24)	(35)	(35)
Urinary Bladder	(17)	(28)	(24)	(23)	(27)	(16)	(23)	(23)

^a Number of animals examined microscopically at the site

^b Number of animals with neoplasm

TABLE D4
Summary of the Incidence of Neoplasms in Female Medaka in the 13-Month Waterborne Study of Nitromethane (Stop-Exposure)

	0 mg/L		10 mg/L		20 mg/L		40 mg/L	
	Group A	Group B	Group A	Group B	Group A	Group B	Group A	Group B
Adipose Tissue ^a Retroperitoneal, seminoma, metastatic ^b	(8)	(6)	(11)	(6)	(5)	(8)	(5)	(3)
			1					
Blood Vessel	(0)	(0)	(0)	(2)	(0)	(0)	(1)	(1)
Bone	(20)	(24)	(23)	(28)	(21)	(21)	(25)	(19)
Brain	(20)	(24)	(23)	(28)	(21)	(21)	(25)	(19)
Chromaffin Tissue	(20)	(24)	(20)	(26)	(20)	(19)	(25)	(19)
Corpuscle of Stannius	(7)	(7)	(9)	(13)	(9)	(10)	(12)	(10)
Cranial Cavity	(0)	(0)	(0)	(0)	(0)	(0)	(0)	(1)
Esophagus	(20)	(24)	(23)	(28)	(21)	(21)	(25)	(19)
Eye	(20)	(24)	(23)	(28)	(21)	(21)	(25)	(19)
Gallbladder	(17)	(24)	(22)	(28)	(21)	(21)	(22)	(19)
Gill	(20)	(24)	(23)	(28)	(21)	(21)	(25)	(19)
Heart	(20)	(24)	(23)	(28)	(21)	(21)	(25)	(19)
Hematopoietic Tissue	(20)	(24)	(23)	(28)	(21)	(21)	(25)	(19)
Interrenal Tissue	(20)	(24)	(20)	(26)	(20)	(19)	(25)	(19)
Intestine Mesothelioma	(20)	(24)	(23)	(28)	(21)	(21)	(25)	(19)
							1	
Kidney	(20)	(24)	(23)	(28)	(21)	(21)	(25)	(19)
Liver Cholangiocarcinoma Hepatocellular adenoma Hepatocellular carcinoma	(20)	(24)	(23)	(28)	(21)	(21)	(25)	(19)
	1		1	2	1		1	
			1					
Mesentery Hemangioma Sarcoma, NOS Seminoma, metastatic	(11)	(11)	(8)	(12)	(8)	(5)	(10)	(5)
		1						
			1	1				
Nares (Olfactory Tissue)	(9)	(16)	(15)	(21)	(10)	(15)	(12)	(10)
Oral Cavity	(20)	(24)	(23)	(28)	(21)	(21)	(25)	(19)
Ovary Sarcoma, NOS Seminoma	(20)	(24)	(23)	(28)	(21)	(21)	(25)	(19)
			1	2			1	

TABLE D4
Summary of the Incidence of Neoplasms in Female Medaka in the 13-Month Waterborne Study
of Nitromethane (Stop-Exposure)

	0 mg/L		10 mg/L		20 mg/L		40 mg/L	
	Group A	Group B	Group A	Group B	Group A	Group B	Group A	Group B
Pancreas	(20)	(24)	(23)	(28)	(21)	(21)	(25)	(19)
Pericardial Cavity Seminoma, metastatic	(1)	(0)	(1)	(1) 1	(0)	(0)	(1)	(0)
Peripheral Nerve	(20)	(24)	(23)	(28)	(21)	(21)	(25)	(19)
Peritoneum Seminoma, metastatic	(0)	(0)	(1)	(2) 1 1	(0)	(0)	(0)	(0)
Pharynx	(1)	(0)	(0)	(0)	(1)	(1)	(1)	(1)
Pineal Organ	(12)	(14)	(6)	(9)	(16)	(10)	(15)	(14)
Pituitary Gland	(8)	(12)	(5)	(14)	(20)	(8)	(18)	(12)
Pseudobranch	(20)	(24)	(23)	(28)	(21)	(21)	(25)	(19)
Skeletal Muscle Seminoma, invasive	(20)	(24)	(23)	(28) 1	(21)	(21)	(25)	(19)
Skin	(20)	(24)	(23)	(28)	(21)	(21)	(25)	(19)
Spinal Cord	(19)	(24)	(23)	(22)	(20)	(21)	(24)	(17)
Spleen Seminoma, metastatic	(12)	(18)	(14)	(24) 1	(8)	(16)	(15)	(5)
Stato-acoustic Organ	(20)	(24)	(23)	(28)	(21)	(21)	(25)	(19)
Swim Bladder Gas gland, adenoma	(20)	(24) 1	(23)	(28)	(21)	(21)	(25)	(19)
Thymus	(6)	(11)	(9)	(15)	(16)	(10)	(14)	(12)
Thyroid Tissue	(20)	(24)	(23)	(28)	(21)	(21)	(25)	(19)
Urinary Bladder	(14)	(12)	(10)	(21)	(18)	(16)	(17)	(13)

^a Number of animals examined microscopically at the site
^b Number of animals with neoplasm

TABLE D5
Summary of the Incidences of Selected Nonneoplastic Lesions in Medaka in the 13-Month Waterborne Study of Nitromethane (Core Study)

	0 mg/L	10 mg/L	20 mg/L	40 mg/L
Male				
Number Examined Microscopically	(72)	(91)	(90)	(76)
Granuloma				
Adipose Tissue ^a				
Head	0	0	1	0
Retroperitoneal	2	0	1	1
Heart				
Atrium	47	8	20	6
Ventricle	25	2	10	0
Hematopoietic Tissue	48	10	39	13
Pericardial Cavity	11	1	0	1
Liver	64	19	49	10
Granulomatous Inflammation				
Adipose Tissue				
Head	21	3	14	3
Eye				
Choroid Rete	16	1	6	3
Optic Nerve	1	0	1	0
Right, Inflammation	1	0	0	0
Granuloma, NOS	1	0	1	0
Oral Cavity Submucosa	31	9	18	2
Pericardial Cavity	2	1	2	1
Pseudobranch	35	7	22	6
Skeletal Muscle				
Focal	8	1	5	2
Multifocal	18	1	12	4
Skin				
Fin	1	0	0	0
Head	1	0	0	0
Multifocal	1	0	0	0
Lower Jaw	61	15	51	15
Upper Jaw	48	17	42	6
Mononuclear Cell Infiltrate				
Oral Cavity Mucosa	29	19	17	7

TABLE D5
Summary of the Incidences of Selected Nonneoplastic Lesions in Medaka in the 13-Month Waterborne Study of Nitromethane (Core Study)

	0 mg/L	10 mg/L	20 mg/L	40 mg/L
Female				
Number Examined Microscopically	(74)	(69)	(59)	(70)
Granuloma				
Adipose Tissue				
Head	1	1	0	0
Retroperitoneal	2	0	2	2
Heart				
Atrium	16	1	7	2
Ventricle	7	0	3	0
Hematopoietic Tissue	16	2	12	4
Ovary	5	3	1	6
Pericardial Cavity	2	0	1	0
Liver	25	6	14	5
Granulomatous Inflammation				
Adipose Tissue				
Head	9	2	7	3
Eye				
Choroid Rete	7	1	3	0
Oral Cavity Submucosa	2	1	0	0
Ovary	5	5	3	0
Pericardial Cavity	2	1	2	0
Pseudobranch	15	5	6	4
Skeletal Muscle				
Focal	2	1	1	1
Multifocal	6	0	4	0
Skin				
Lower Jaw	3	1	4	2
Upper Jaw	1	1	2	0
Mononuclear Cell Infiltrate				
Oral Cavity Mucosa	6	3	3	2

^a Number of animals with lesion

APPENDIX E
SUMMARY OF LESIONS IN GUPPIES
IN THE 16-MONTH WATERBORNE STUDY
OF 1,2,3-TRICHLOROPROPANE

TABLE E1	Summary of the Incidence of Neoplasms in Male Guppies in the 16-Month Waterborne Study of 1,2,3-Trichloropropane (Core Study)	150
TABLE E2	Summary of the Incidence of Neoplasms in Male Guppies in the 16-Month Waterborne Study of 1,2,3-Trichloropropane (Stop-Exposure)	153
TABLE E3	Summary of the Incidence of Neoplasms in Female Guppies in the 16-Month Waterborne Study of 1,2,3-Trichloropropane (Core Study)	155
TABLE E4	Summary of the Incidence of Neoplasms in Female Guppies in the 16-Month Waterborne Study of 1,2,3-Trichloropropane (Stop-Exposure)	158
TABLE E5	Summary of Incidences of Granuloma in Selected Tissues of Guppies in the 16-Month Waterborne Study of 1,2,3-Trichloropropane	160

TABLE E1
Summary of the Incidence of Neoplasms in Male Guppies in the 16-Month Waterborne Study
of 1,2,3-Trichloropropane (Core Study)

	0 mg/L		4.5 mg/L		9 mg/L		18 mg/L	
	Group A	Group B	Group A	Group B	Group A	Group B	Group A	Group B
<i>16-Month Study</i>								
Adipose Tissue	(19)	(25)	(11)	(16)	(23)	(23)	(6)	(12)
Blood Vessel	(0)	(0)	(0)	(0)	(1)	(4)	(0)	(0)
Bone Vertebra, osteofibroma	(27)	(34)	(20)	(27)	(33)	(34)	(9)	(18)
					1			
Brain	(27)	(34)	(20)	(27)	(33)	(34)	(9)	(18)
Chromaffin Tissue	(26)	(32)	(20)	(26)	(31)	(30)	(8)	(18)
Corpuscle of Stannius	(7)	(12)	(4)	(6)	(7)	(10)	(5)	(8)
Cranial Cavity	(3)	(4)	(4)	(6)	(6)	(12)	(3)	(1)
Esophagus	(27)	(34)	(20)	(27)	(33)	(34)	(9)	(18)
Eye	(27)	(34)	(20)	(27)	(33)	(34)	(9)	(18)
Gallbladder Carcinoma	(25)	(34)	(19)	(25)	(30)	(29)	(7)	(17)
							1	
Gill	(27)	(34)	(20)	(27)	(33)	(34)	(9)	(18)
Heart	(27)	(34)	(20)	(27)	(32)	(34)	(9)	(18)
Hematopoietic Tissue	(27)	(34)	(20)	(27)	(33)	(34)	(9)	(18)
Interrenal Tissue	(26)	(32)	(20)	(26)	(31)	(30)	(8)	(18)
Intestine Carcinoma, invasive	(27)	(34)	(20)	(27)	(33)	(34)	(9)	(18)
		1						
Kidney	(27)	(34)	(20)	(27)	(33)	(34)	(9)	(18)
Liver Cholangiocarcinoma	(27)	(34)	(20)	(27)	(33)	(34)	(9)	(18)
							3	
Cholangioma					1			
Hepatocellular adenoma		2	2	5	8	4	1	4
Hepatocellular adenoma, multiple	1		1		2	3		4
Hepatocellular carcinoma			1				2	5
Hepatocholangiocarcinoma					2	1	1	1
Mesentery	(18)	(19)	(9)	(17)	(17)	(20)	(3)	(5)
Nares (Olfactory Tissue)	(12)	(17)	(5)	(15)	(19)	(25)	(6)	(10)

TABLE E1
Summary of the Incidence of Neoplasms in Male Guppies in the 16-Month Waterborne Study
of 1,2,3-Trichloropropane (Core Study)

	0 mg/L		4.5 mg/L		9 mg/L		18 mg/L	
	Group A	Group B	Group A	Group B	Group A	Group B	Group A	Group B
<i>16-Month Study</i> (continued)								
Oral Cavity	(27)	(34)	(20)	(27)	(33)	(34)	(9)	(18)
Pancreas Carcinoma	(27)	(34) 1	(20)	(27)	(33)	(34)	(9)	(18)
Pericardial Cavity	(4)	(6)	(1)	(3)	(4)	(7)	(2)	(1)
Peripheral Nerve	(27)	(34)	(20)	(27)	(33)	(34)	(9)	(18)
Peritoneum	(5)	(7)	(2)	(1)	(4)	(3)	(1)	(1)
Pharynx	(7)	(5)	(5)	(8)	(3)	(7)	(1)	(1)
Pineal Organ	(16)	(25)	(14)	(20)	(21)	(26)	(6)	(14)
Pituitary Gland	(21)	(26)	(15)	(23)	(28)	(28)	(9)	(13)
Pseudobranch	(26)	(34)	(20)	(27)	(33)	(34)	(9)	(18)
Skeletal Muscle	(27)	(34)	(20)	(27)	(33)	(34)	(9)	(18)
Skin	(27)	(34)	(20)	(27)	(33)	(34)	(9)	(18)
Spinal Cord	(27)	(34)	(20)	(27)	(31)	(31)	(9)	(18)
Spleen	(26)	(34)	(19)	(26)	(30)	(33)	(8)	(18)
Stato-acoustic Organ	(27)	(34)	(20)	(27)	(33)	(34)	(9)	(18)
Swim Bladder Carcinoma	(27)	(34)	(20)	(27)	(33)	(34)	(9)	(18) 1
Testis	(27)	(34)	(20)	(27)	(33)	(34)	(9)	(18)
Thymus	(2)		(2)	(2)	(5)	(1)	(2)	(1)
Thyroid Tissue	(27)	(33)	(20)	(27)	(33)	(34)	(9)	(18)
Urinary Bladder	(25)	(33)	(20)	(26)	(31)	(32)	(9)	(15)

^a Number of animals examined microscopically at the site

^b Number of animals with neoplasm

^c Number of animals with any tissue examined microscopically

TABLE E2
Summary of the Incidence of Neoplasms in Male Guppies in the 16-Month Waterborne Study
of 1,2,3-Trichloropropane (Stop-Exposure)

	0 mg/L		4.5 mg/L		9 mg/L		18 mg/L	
	Group A	B	Group A	B	Group A	B	Group A	B
Adipose Tissue ^a	(12)	(8)	(7)	(6)	(10)	(7)	(3)	(6)
Bone	(17)	(15)	(10)	(9)	(15)	(11)	(9)	(10)
Brain	(17)	(15)	(10)	(9)	(15)	(11)	(9)	(10)
Chromaffin Tissue	(17)	(14)	(9)	(9)	(14)	(11)	(9)	(8)
Corpuscle of Stannius	(10)	(6)	(5)	(3)	(7)	(3)	(1)	-
Cranial Cavity	(5)	(3)	(2)	(2)	(5)	(2)	(2)	(3)
Esophagus	(17)	(15)	(10)	(9)	(15)	(11)	(9)	(10)
Eye	(17)	(15)	(10)	(9)	(15)	(11)	(9)	(10)
Gallbladder	(17)	(15)	(8)	(9)	(15)	(9)	(9)	(9)
Gill	(17)	(15)	(10)	(9)	(15)	(11)	(9)	(10)
Heart	(17)	(15)	(10)	(9)	(15)	(11)	(9)	(10)
Hematopoietic Tissue	(17)	(15)	(10)	(9)	(15)	(11)	(9)	(10)
Interrenal Tissue	(17)	(14)	(9)	(9)	(14)	(11)	(9)	(8)
Intestine	(17)	(15)	(10)	(9)	(15)	(11)	(9)	(10)
Kidney	(17)	(15)	(10)	(9)	(15)	(11)	(9)	(10)
Liver	(17)	(15)	(10)	(9)	(15)	(11)	(9)	(10)
Cholangiocarcinoma ^b							1	
Hepatocellular adenoma	3		3	1	2	2	2	3
Hepatocellular adenoma, multiple					1		1	1
Hepatocellular carcinoma					1		4	
Mesentery	(15)	(9)	(7)	(8)	(12)	(8)	(8)	(7)
Nares (Olfactory Tissue)	(6)	(5)	(4)	(6)	(6)	(4)	(2)	(3)
Oral Cavity	(17)	(15)	(10)	(9)	(15)	(11)	(9)	(10)
Pancreas	(17)	(15)	(10)	(9)	(15)	(11)	(9)	(10)
Pericardial Cavity	(5)	(2)	(3)	(3)	(0)	(3)	(1)	(1)
Peripheral Nerve	(17)	(15)	(10)	(9)	(15)	(11)	(9)	(10)
Peritoneum	(4)	(4)	(2)	(2)	(2)	(0)	(0)	(0)
Pharynx	(12)	(2)	(6)	(7)	(5)	(2)	(2)	(1)

TABLE E2
Summary of the Incidence of Neoplasms in Male Guppies in the 16-Month Waterborne Study
of 1,2,3-Trichloropropane (Stop-Exposure)

	0 mg/L		4.5 mg/L		9 mg/L		18 mg/L	
	Group A	Group B	Group A	Group B	Group A	Group B	Group A	Group B
Pineal Organ	(10)	(9)	(8)	(5)	(12)	(8)	(8)	(8)
Pituitary Gland	(10)	(11)	(7)	(6)	(14)	(7)	(8)	(7)
Pseudobranch	(17)	(15)	(10)	(9)	(15)	(11)	(9)	(10)
Skeletal Muscle Fibrosarcoma	(17)	(15)	(10)	(9) 1	(15)	(11)	(9)	(10)
Skin	(17)	(15)	(10)	(9)	(15)	(11)	(9)	(10)
Spinal Cord	(17)	(14)	(10)	(9)	(15)	(10)	(9)	(9)
Spleen Hemangiosarcoma	(17)	(15)	(9)	(8)	(15)	(11)	(9)	(10) 1
Stato-acoustic Organ	(17)	(15)	(10)	(9)	(15)	(11)	(9)	(10)
Swim Bladder Carcinoma	(17)	(15) 1	(10)	(9)	(15)	(11)	(9)	(10)
Testis	(17)	(15)	(10)	(9)	(15)	(11)	(9)	(10)
Thymus	(0)	(0)	(0)	(0)	(1)	(0)	(1)	(2)
Thyroid Tissue	(17)	(15)	(10)	(9)	(15)	(11)	(9)	(8)
Urinary Bladder	(17)	(14)	(10)	(9)	(15)	(11)	(9)	(10)

^a Number of animals examined microscopically at the site

^b Number of animals with neoplasm

TABLE E3
Summary of the Incidence of Neoplasms in Female Guppies in the 16-Month Waterborne Study
of 1,2,3-Trichloropropane (Core Study)

	0 mg/L Group		4.5 mg/L Group		9 mg/L Group		18 mg/L Group	
	A	B	A	B	A	B	A	B
<i>16-Month Study</i>								
Adipose Tissue^a	(22)	(20)	(20)	(23)	(17)	(16)	(13)	(9)
Blood Vessel	(1)	(0)	(1)	(1)	(3)	(3)	(2)	(0)
Bone	(36)	(28)	(33)	(31)	(25)	(22)	(19)	(14)
Brain	(36)	(28)	(33)	(30)	(25)	(22)	(19)	(14)
Chromaffin Tissue	(33)	(18)	(28)	(27)	(17)	(15)	(14)	(13)
Corpuscle of Stannius	(5)	(3)	(7)	(3)	(5)	(2)	(7)	(1)
Cranial Cavity	(4)	(8)	(8)	(7)	(1)	(3)	(1)	(2)
Esophagus	(36)	(28)	(33)	(30)	(25)	(22)	(19)	(14)
Eye	(36)	(28)	(33)	(31)	(25)	(22)	(19)	(14)
Gallbladder	(35)	(26)	(31)	(29)	(22)	(22)	(17)	(13)
Gill	(36)	(28)	(33)	(31)	(25)	(22)	(19)	(14)
Heart	(35)	(28)	(29)	(29)	(25)	(20)	(19)	(14)
Hematopoietic Tissue	(36)	(28)	(33)	(31)	(25)	(22)	(19)	(14)
Interrenal Tissue	(33)	(19)	(28)	(27)	(17)	(15)	(14)	(13)
Intestine	(36)	(28)	(33)	(31)	(25)	(22)	(19)	(14)
Cholangiocarcinoma, invasive ^b							1	
Kidney	(36)	(28)	(33)	(31)	(25)	(22)	(19)	(14)
Liver	(36)	(28)	(33)	(31)	(25)	(22)	(19)	(14)
Cholangiocarcinoma							4	2
Cholangioma			3		2	1	1	
Cholangioma, multiple						1	1	
Hepatocellular adenoma	3	2	1	2	2	1	2	3
Hepatocellular adenoma, multiple					1		2	
Hepatocellular carcinoma			1				2	
Hepatocholangiocarcinoma								2
Mesentery	(22)	(19)	(21)	(20)	(18)	(17)	(11)	(11)
Cholangiocarcinoma, metastatic								1
Nares (Olfactory Tissue)	(20)	(16)	(21)	(20)	(20)	(15)	(12)	(8)
Oral Cavity	(35)	(28)	(33)	(30)	(25)	(22)	(19)	(14)
Ovary	(36)	(28)	(33)	(30)	(24)	(22)	(19)	(14)

TABLE E3
Summary of the Incidence of Neoplasms in Female Guppies in the 16-Month Waterborne Study
of 1,2,3-Trichloropropane (Core Study)

	0 mg/L Group		4.5 mg/L Group		9 mg/L Group		18 mg/L Group	
	A	B	A	B	A	B	A	B
<i>16-Month Study</i> (continued)								
Pancreas	(36)	(28)	(33)	(31)	(25)	(22)	(19)	(14)
Carcinoma					1	1		
Islet cells, adenoma	1						1	
Pericardial Cavity	(10)	(4)	(3)	(6)	(3)	(6)	(2)	(3)
Peripheral Nerve	(36)	(28)	(33)	(31)	(25)	(22)	(19)	(14)
Peritoneum	(7)	(6)	(3)	(2)	(0)	(4)	(2)	(1)
Pharynx	(11)	(7)	(11)	(11)	(6)	(14)	(1)	(2)
Pineal Organ	(23)	(9)	(11)	(9)	(16)	(7)	(12)	(2)
Pituitary Gland	(33)	(22)	(19)	(17)	(22)	(15)	(19)	(12)
Adenoma					1			
Pseudobranch	(34)	(21)	(31)	(29)	(23)	(18)	(13)	(13)
Skeletal Muscle	(36)	(28)	(33)	(31)	(25)	(22)	(19)	(14)
Skin	(36)	(28)	(33)	(31)	(25)	(22)	(19)	(14)
Spinal Cord	(32)	(19)	(21)	(19)	(18)	(15)	(16)	(5)
Spleen	(25)	(16)	(22)	(23)	(16)	(12)	(14)	(11)
Cholangiocarcinoma, invasive							1	
Stato-acoustic Organ	(36)	(28)	(33)	(31)	(25)	(22)	(19)	(14)
Swim Bladder	(36)	(28)	(33)	(30)	(25)	(22)	(19)	(14)
Carcinoma			1	1				
Epithelioma			2		1	1		
Thymus	(23)	(15)	(26)	(24)	(19)	(17)	(12)	(7)
Thyroid Tissue	(34)	(28)	(30)	(29)	(25)	(18)	(19)	(14)
Transverse Septum	(0)	(0)	(0)	(0)	(1)	(0)	(0)	(0)
Urinary Bladder	(21)	(16)	(22)	(14)	(16)	(12)	(15)	(6)

^a Number of animals examined microscopically at the site

^b Number of animals with neoplasm

TABLE E4
Summary of the Incidence of Neoplasms in Female Guppies in the 16-Month Waterborne Study
of 1,2,3-Trichloropropane (Stop-Exposure)

	0 mg/L		4.5 mg/L		9 mg/L		18 mg/L	
	Group A	Group B	Group A	Group B	Group A	Group B	Group A	Group B
Adipose Tissue^a	(7)	(14)	(11)	(12)	(9)	(12)	(11)	(8)
Blood Vessel	(1)	(0)	(0)	(1)	(1)	(0)	(2)	(2)
Bone	(14)	(17)	(16)	(15)	(14)	(17)	(15)	(12)
Brain	(14)	(17)	(16)	(15)	(14)	(17)	(15)	(12)
Chromaffin Tissue	(11)	(16)	(14)	(13)	(12)	(13)	(11)	(11)
Corpuscle of Stannius	(2)	(3)	(5)	(2)	(1)	(3)	(4)	(2)
Cranial Cavity	(3)	(2)	(3)	(3)	(3)	(4)	(6)	(4)
Esophagus	(14)	(17)	(16)	(15)	(14)	(17)	(15)	(12)
Eye	(14)	(17)	(16)	(15)	(14)	(17)	(15)	(12)
Gallbladder^b Carcinoma	(13)	(17)	(16)	(15) 1	(13)	(17)	(15)	(12)
Gill	(14)	(17)	(16)	(15)	(14)	(17)	(15)	(12)
Heart	(13)	(17)	(16)	(14)	(14)	(16)	(15)	(12)
Hematopoietic Tissue	(14)	(17)	(16)	(15)	(14)	(17)	(15)	(12)
Interrenal Tissue	(11)	(17)	(15)	(14)	(12)	(14)	(11)	(11)
Intestine	(14)	(17)	(16)	(15)	(14)	(17)	(15)	(12)
Kidney Adenoma, tubular	(14)	(17)	(16)	(15)	(14)	(17)	(15)	(12) 1
Liver Carcinoma, invasive	(14)	(17)	(16)	(15) 1	(14)	(17)	(15)	(12)
Cholangiocarcinoma							3	2
Cholangioma	1	1		2				1
Cholangioma, multiple							1	
Hepatocellular adenoma		2			1	1	2	
Hepatocellular adenoma, multiple							1	
Hepatocellular carcinoma			1					
Mesentery	(11)	(14)	(11)	(14)	(11)	(15)	(10)	(12)
Nares (Olfactory Tissue)	(7)	(7)	(7)	(8)	(11)	(10)	(10)	(10)
Oral Cavity	(14)	(17)	(16)	(15)	(14)	(17)	(15)	(12)
Ovary	(14)	(17)	(16)	(15)	(14)	(17)	(15)	(12)
Pancreas	(14)	(17)	(16)	(15)	(14)	(17)	(15)	(12)

TABLE E4
Summary of the Incidence of Neoplasms in Female Guppies in the 16-Month Waterborne Study
of 1,2,3-Trichloropropane (Stop-Exposure)

	0 mg/L		4.5 mg/L		9 mg/L		18 mg/L	
	Group A	Group B	Group A	Group B	Group A	Group B	Group A	Group B
Pericardial Cavity	(2)	(6)	(5)	(4)	(5)	(4)	(4)	(2)
Peripheral Nerve	(14)	(17)	(16)	(15)	(14)	(17)	(15)	(12)
Peritoneum Cholangiocarcinoma, invasive	(2)	(4)	(2)	(2)	(1)	(4)	(3)	(0) 1
Pharynx	(8)	(11)	(9)	(9)	(4)	(12)	(6)	(6)
Pineal Organ	(8)	(10)	(9)	(9)	(10)	(7)	(11)	(3)
Pituitary Gland	(12)	(12)	(14)	(12)	(13)	(10)	(15)	(10)
Pseudobranch	(10)	(17)	(16)	(14)	(12)	(16)	(12)	(10)
Skeletal Muscle	(14)	(17)	(16)	(15)	(14)	(17)	(15)	(12)
Skin	(14)	(17)	(16)	(15)	(14)	(17)	(15)	(12)
Spinal Cord	(11)	(14)	(13)	(10)	(11)	(11)	(15)	(10)
Spleen	(6)	(17)	(12)	(8)	(9)	(9)	(11)	(5)
Stato-acoustic Organ	(14)	(17)	(16)	(15)	(14)	(17)	(15)	(12)
Swim Bladder Epithelioma	(14)	(17)	(16)	(15) 2	(14)	(17)	(15)	(12)
Thymus	(8)	(12)	(13)	(11)	(11)	(15)	(9)	(7)
Thyroid Tissue	(14)	(15)	(16)	(12)	(14)	(15)	(15)	(12)
Urinary Bladder	(10)	(10)	(14)	(9)	(8)	(8)	(7)	(3)

^a Number of animals examined microscopically at the site

^b Number of animals with neoplasm

TABLE E5
Summary of Incidences of Granuloma in Selected Tissues of Guppies in the 16-Month Waterborne Study of 1,2,3-Trichloropropane

	0 mg/L	4.5 mg/L	9 mg/L	18 mg/L
Male				
<i>Core Study</i>				
Number Examined Microscopically	(61)	(47)	(67)	(27)
Heart ^a				
Atrium	21	10	16	3
Testis				
Granuloma, NOS	35	19	24	9
Sperm	30	24	41	18
<i>Stop Exposure</i>				
Number Examined Microscopically	(32)	(19)	(26)	(19)
Adipose Tissue				
Head	14	10	9	3
Vertebra and Perivertebral Area	8	8	9	1
Eye, Choroid	11	5	7	4
Heart, Atrium	10	5	6	6
Mesentery	18	8	15	8
Skeletal Muscle	8	5	7	2
Testis	11	10	11	11
Female				
<i>Core Study</i>				
Number Examined Microscopically	(64)	(64)	(47)	(33)
Ovary				
Granuloma, NOS	46	24	20	12

^a Number of animals with lesion

APPENDIX F
SUMMARY OF LESIONS IN MEDAKA
IN THE 13-MONTH WATERBORNE STUDY
OF 1,2,3-TRICHLOROPROPANE

TABLE F1	Summary of the Incidence of Neoplasms in Male Medaka in the 13-Month Waterborne Study of 1,2,3-Trichloropropane (Core Study)	162
TABLE F2	Summary of the Incidence of Neoplasms in Male Medaka in the 13-Month Waterborne Study of 1,2,3-Trichloropropane (Stop-Exposure)	166
TABLE F3	Summary of the Incidence of Neoplasms in Female Medaka in the 13-Month Waterborne Study of 1,2,3-Trichloropropane (Core Study)	168
TABLE F4	Summary of the Incidence of Neoplasms in Female Medaka in the 13-Month Waterborne Study of 1,2,3-Trichloropropane (Stop-Exposure)	172

TABLE F1
Summary of the Incidence of Neoplasms in Male Medaka in the 13-Month Waterborne Study
of 1,2,3-Trichloropropane (Core Study)

	0 mg/L		4.5 mg/L		9 mg/L		18 mg/L	
	Group A	Group B	Group A	Group B	Group A	Group B	Group A	Group B
<i>13-Month Study</i>								
Adipose Tissue	(7)	(7)	(8)	(3)	(4)	(10)	(6)	(4)
Head, lymphosarcoma						1		
Retroperitoneal, cholangiocarcinoma, invasive			1				2	
Retroperitoneal, hepatocholangiocarcinoma, invasive								1
Retroperitoneal, lymphosarcoma					1		1	
Bone	(52)	(43)	(44)	(50)	(38)	(27)	(36)	(42)
Brain	(52)	(43)	(44)	(50)	(38)	(27)	(36)	(42)
Chromaffin Tissue	(50)	(43)	(44)	(49)	(38)	(27)	(36)	(42)
Corpuscle of Stannius	(34)	(19)	(15)	(30)	(21)	(12)	(16)	(24)
Cranial Cavity	(0)	(1)	(0)	(0)	(0)	(2)	(1)	(0)
Lymphosarcoma						1		
Esophagus	(52)	(43)	(44)	(50)	(38)	(27)	(36)	(42)
Cholangiocarcinoma, invasive							1	
Eye	(52)	(43)	(44)	(50)	(38)	(27)	(36)	(42)
Choroid rete, cholangiocarcinoma, metastatic			1					
Choroid rete, lymphosarcoma							1	
Lymphosarcoma					1			
Gallbladder	(49)	(42)	(39)	(44)	(35)	(26)	(35)	(37)
Adenoma, papillary					2	2	6	3
Carcinoma								1
Gill	(52)	(43)	(44)	(50)	(38)	(27)	(36)	(42)
Carcinoma, scirrhous, invasive							1	
Lymphosarcoma					1			
Heart	(52)	(43)	(43)	(50)	(38)	(27)	(36)	(42)
Lymphosarcoma							1	
Sinus venosus, cholangiocarcinoma, invasive			1		1		1	
Hematopoietic Tissue	(52)	(43)	(44)	(50)	(38)	(27)	(36)	(42)
Lymphosarcoma					1	1	1	
Interrenal Tissue	(50)	(43)	(44)	(49)	(38)	(27)	(36)	(42)
Intestine	(52)	(43)	(44)	(50)	(38)	(27)	(36)	(42)
Adenomatous polyp							1	
Cholangiocarcinoma, invasive							1	
Lymphosarcoma					1			
Wall, sarcoma, NOS, invasive						1		

TABLE F1
Summary of the Incidence of Neoplasms in Male Medaka in the 13-Month Waterborne Study
of 1,2,3-Trichloropropane (Core Study)

	0 mg/L		4.5 mg/L		9 mg/L		18 mg/L	
	Group A	Group B	Group A	Group B	Group A	Group B	Group A	Group B
<i>13-Month Study</i> (continued)								
Kidney	(52)	(43)	(44)	(50)	(38)	(27)	(36)	(42)
Cholangiocarcinoma, metastatic					1		1	
Lymphosarcoma							1	
Renal tubules, adenoma					1			
Renal tubules, carcinoma							1	
Liver	(52)	(43)	(44)	(50)	(38)	(27)	(36)	(42)
Cholangiocarcinoma			17	15	26	17	19	26
Cholangioma			5	1	2		1	
Hepatocellular adenoma					1		3	
Hepatocellular carcinoma				2				3
Hepatocholangiocarcinoma					1	1	3	3
Lymphosarcoma							1	
Mesentery	(10)	(14)	(6)	(10)	(6)	(14)	(3)	(5)
Lymphosarcoma					1		1	
Nares (Olfactory Tissue)	(24)	(19)	(20)	(18)	(12)	(11)	(15)	(18)
Lymphosarcoma						1		
Oral Cavity	(52)	(43)	(44)	(50)	(38)	(27)	(36)	(42)
Pancreas	(52)	(43)	(44)	(50)	(38)	(27)	(36)	(42)
Lymphosarcoma					1			
Pericardial Cavity	(4)	(2)	(2)	(2)	(1)	(4)	(2)	(1)
Lymphosarcoma						1		
Peripheral Nerve	(52)	(43)	(44)	(50)	(38)	(27)	(36)	(42)
Carcinoma, scirrhous, invasive							1	
Lymphosarcoma						1		
Peritoneum	(1)	(2)	(1)	(0)	(0)	(1)	(1)	(1)
Sarcoma, NOS						1		
Pharynx	(4)	(1)	(2)	(1)	(1)	(1)	(1)	(0)
Carcinoma, scirrhous							1	
Pineal Organ	(27)	(29)	(29)	(40)	(26)	(13)	(29)	(37)
Pituitary Gland	(48)	(31)	(35)	(48)	(34)	(21)	(35)	(39)
Pseudobranch	(52)	(43)	(44)	(50)	(38)	(27)	(36)	(42)
Skeletal Muscle	(52)	(43)	(44)	(50)	(38)	(27)	(36)	(42)
Carcinoma, scirrhous, invasive							1	
Lymphosarcoma						1		

TABLE F1
Summary of the Incidence of Neoplasms in Male Medaka in the 13-Month Waterborne Study
of 1,2,3-Trichloropropane (Core Study)

	0 mg/L		4.5 mg/L		9 mg/L		18 mg/L	
	Group A	Group B	Group A	Group B	Group A	Group B	Group A	Group B
<i>13-Month Study</i> (continued)								
Skin	(52)	(43)	(44)	(50)	(38)	(27)	(36)	(42)
Lymphosarcoma						1		
Spinal Cord	(50)	(43)	(44)	(49)	(38)	(27)	(36)	(42)
Spleen	(32)	(34)	(35)	(30)	(23)	(21)	(12)	(27)
Cholangiocarcinoma, metastatic						4		2
Hepatocholangiocarcinoma, metastatic								1
Lymphosarcoma								1
Stato-acoustic Organ	(52)	(43)	(44)	(50)	(38)	(27)	(36)	(42)
Lymphosarcoma						1		
Swim Bladder	(52)	(43)	(44)	(50)	(38)	(27)	(36)	(42)
Testis	(52)	(43)	(44)	(50)	(38)	(27)	(36)	(42)
Germ cell neoplasm				1				1
Lymphosarcoma								1
Sarcoma, NOS, invasive						1		
Seminoma		1				3		1 2
Thymus	(19)	(20)	(15)	(25)	(16)	(11)	(22)	(20)
Lymphosarcoma						1		
Thyroid Tissue	(52)	(43)	(44)	(50)	(38)	(27)	(36)	(42)
Carcinoma, scirrhus, invasive								1
Urinary Bladder	(46)	(42)	(40)	(43)	(32)	(21)	(36)	(41)
Multiple Organs^c	(52)	(43)	(44)	(50)	(38)	(27)	(36)	(42)
Lymphosarcoma						1 1		1

^a Number of animals examined microscopically at the site

^b Number of animals with neoplasm

^c Number of animals with any tissue examined microscopically

TABLE F2
Summary of the Incidence of Neoplasms in Male Medaka in the 13-Month Waterborne Study
of 1,2,3-Trichloropropane (Stop-Exposure)

	0 mg/L		4.5 mg/L		9 mg/L		18 mg/L	
	Group A	Group B	Group A	Group B	Group A	Group B	Group A	Group B
Adipose Tissue ^a	(4)	(4)	(3)	(1)	(0)	(3)	(0)	(2)
Head, lymphosarcoma ^b								1
Retroperitoneal, lymphosarcoma								1
Bone	(24)	(18)	(25)	(22)	(15)	(18)	(21)	(25)
Brain	(24)	(18)	(25)	(22)	(15)	(18)	(21)	(25)
Chromaffin Tissue	(24)	(18)	(25)	(22)	(15)	(18)	(21)	(24)
Corpuscle of Stannius	(9)	(11)	(9)	(11)	(10)	(8)	(13)	(11)
Esophagus	(24)	(18)	(25)	(22)	(15)	(18)	(21)	(25)
Eye	(24)	(18)	(25)	(22)	(15)	(18)	(21)	(25)
Choroid rete, cholangiocarcinoma, metastatic					1			
Gallbladder	(23)	(18)	(22)	(20)	(12)	(18)	(21)	(25)
Adenoma, papillary					3		1	3
Carcinoma					1		1	1
Gill	(24)	(18)	(25)	(22)	(15)	(18)	(21)	(25)
Heart	(24)	(18)	(25)	(22)	(15)	(18)	(21)	(25)
Atrium, cholangiocarcinoma, metastatic					1			
Lymphosarcoma								1
Hematopoietic Tissue	(24)	(18)	(25)	(22)	(15)	(18)	(21)	(25)
Lymphosarcoma								1
Interrenal Tissue	(24)	(18)	(25)	(22)	(15)	(18)	(21)	(24)
Intestine	(24)	(18)	(25)	(22)	(15)	(18)	(21)	(25)
Kidney	(24)	(18)	(25)	(22)	(15)	(18)	(21)	(25)
Liver	(24)	(18)	(25)	(22)	(15)	(18)	(21)	(25)
Cholangiocarcinoma			8	11	9	7	11	15
Cholangioma					1	2	1	
Hepatocellular adenoma				1				
Hepatocellular carcinoma			1				1	
Mesentery	(6)	(7)	(8)	(5)	(4)	(3)	(2)	(9)
Cholangiocarcinoma, invasive			1					
Nares (Olfactory Tissue)	(11)	(5)	(13)	(9)	(6)	(6)	(3)	(4)
Oral Cavity	(24)	(18)	(25)	(22)	(15)	(18)	(21)	(25)
Lymphosarcoma								1
Pancreas	(24)	(18)	(25)	(22)	(15)	(18)	(21)	(25)

TABLE F2
Summary of the Incidence of Neoplasms in Male Medaka in the 13-Month Waterborne Study
of 1,2,3-Trichloropropane (Stop-Exposure)

	0 mg/L		4.5 mg/L		9 mg/L		18 mg/L	
	Group A	Group B	Group A	Group B	Group A	Group B	Group A	Group B
Pericardial Cavity	(1)	(2)	(1)	(1)	(0)	(2)	(0)	(0)
Peripheral Nerve	(24)	(18)	(25)	(22)	(15)	(18)	(21)	(25)
Peritoneum Cholangiocarcinoma, metastatic	(1)	(2)	(4)	(0)	(0)	(0)	(0)	(0)
			1					
Pharynx Lymphosarcoma	(0)	(1)	(0)	(0)	(0)	(0)	(0)	(1)
								1
Pineal Organ	(19)	(17)	(21)	(18)	(10)	(15)	(19)	(16)
Pituitary Gland	(23)	(15)	(24)	(20)	(15)	(16)	(19)	(24)
Pseudobranch	(24)	(18)	(25)	(22)	(15)	(18)	(21)	(25)
Skeletal Muscle Lymphosarcoma	(24)	(18)	(25)	(22)	(15)	(18)	(21)	(25)
								1
Skin Lymphosarcoma	(24)	(18)	(25)	(22)	(15)	(18)	(21)	(25)
								1
Spinal Cord	(24)	(18)	(25)	(22)	(15)	(18)	(21)	(25)
Spleen Cholangiocarcinoma, metastatic	(16)	(13)	(19)	(10)	(9)	(13)	(13)	(9)
					1			
Stato-acoustic Organ Lymphosarcoma	(24)	(18)	(25)	(22)	(15)	(18)	(21)	(25)
								1
Swim Bladder	(24)	(18)	(25)	(22)	(14)	(18)	(21)	(25)
Testis Seminoma	(24)	(18)	(25)	(22)	(15)	(17)	(21)	(24)
		1					1	1
Thymus	(8)	(13)	(13)	(11)	(2)	(13)	(18)	(13)
Thyroid Tissue	(24)	(18)	(25)	(22)	(15)	(18)	(21)	(25)
Urinary Bladder	(16)	(14)	(19)	(19)	(11)	(16)	(17)	(24)
Multiple Organs^c Lymphosarcoma	(24)	(18)	(25)	(22)	(15)	(18)	(21)	(25)
								1

^a Number of animals examined microscopically at the site

^b Number of animals with neoplasm

^c Number of animals with any tissue examined microscopically

TABLE F3
Summary of the Incidence of Neoplasms in Female Medaka in the 13-Month Waterborne Study
of 1,2,3-Trichloropropane (Core Study)

	0 mg/L		4.5 mg/L		9 mg/L		18 mg/L	
	Group A	Group B	Group A	Group B	Group A	Group B	Group A	Group B
<i>13-Month Study</i>								
Adipose Tissue	(6)	(8)	(11)	(6)	(11)	(13)	(8)	(7)
Retroperitoneal, cholangiocarcinoma, invasive			1		1		1	
Bone	(48)	(47)	(49)	(44)	(44)	(50)	(39)	(28)
Brain	(48)	(47)	(49)	(44)	(44)	(50)	(39)	(28)
Chromaffin Tissue	(46)	(47)	(49)	(44)	(44)	(50)	(39)	(28)
Corpuscle of Stannius	(29)	(25)	(19)	(26)	(19)	(26)	(18)	(16)
Cranial Cavity	(0)	(0)	(0)	(0)	(2)	(0)	(1)	(0)
Esophagus	(48)	(47)	(49)	(44)	(44)	(50)	(39)	(28)
Cholangiocarcinoma, invasive					1		1	
Hepatocholangiocarcinoma, invasive					1			
Eye	(48)	(47)	(49)	(44)	(44)	(50)	(39)	(28)
Gallbladder	(42)	(43)	(45)	(35)	(40)	(48)	(39)	(26)
Adenoma, papillary			1		2	3	3	3
Carcinoma				1				
Gill	(48)	(47)	(49)	(44)	(44)	(50)	(39)	(28)
Heart	(48)	(47)	(49)	(43)	(44)	(50)	(39)	(28)
Atrium, cholangiocarcinoma, invasive					1			
Sinus venosus, cholangiocarcinoma, invasive			1		1		1	
Ventricle, cholangiocarcinoma, metastatic							1	
Hematopoietic Tissue	(48)	(47)	(49)	(44)	(44)	(50)	(39)	(28)
Interrenal Tissue	(46)	(47)	(49)	(44)	(44)	(50)	(39)	(28)
Intestine	(48)	(47)	(49)	(44)	(44)	(50)	(39)	(28)
Adenomatous polyp								1
Hepatocholangiocarcinoma, metastatic						1		
Wall, sarcoma, NOS, invasive						1		
Kidney	(48)	(47)	(49)	(44)	(44)	(50)	(39)	(28)
Liver	(48)	(47)	(49)	(44)	(44)	(50)	(39)	(28)
Cholangiocarcinoma			14	15	23	30	21	20
Cholangioma			1		1	1		1
Hepatocellular adenoma	1		1		2	3	3	4
Hepatocellular adenoma, multiple							1	
Hepatocellular carcinoma	1		1			2	4	1
Hepatocholangiocarcinoma					3	1	6	1

TABLE F3
Summary of the Incidence of Neoplasms in Female Medaka in the 13-Month Waterborne Study
of 1,2,3-Trichloropropane (Core Study)

	0 mg/L		4.5 mg/L		9 mg/L		18 mg/L	
	Group		Group		Group		Group	
	A	B	A	B	A	B	A	B
<i>13-Month Study</i> (continued)								
Thymus	(11)	(16)	(15)	(15)	(16)	(16)	(22)	(13)
Thyroid Tissue	(48)	(47)	(49)	(44)	(44)	(50)	(39)	(28)
Urinary Bladder	(40)	(41)	(37)	(36)	(40)	(39)	(33)	(22)

^a Number of animals examined microscopically at the site

^b Number of animals with neoplasm

TABLE F4
Summary of the Incidence of Neoplasms in Female Medaka in the 13-Month Waterborne Study
of 1,2,3-Trichloropropane (Stop-Exposure)

	0 mg/L		4.5 mg/L		9 mg/L		18 mg/L	
	Group A	Group B	Group A	Group B	Group A	Group B	Group A	Group B
Adipose Tissue^a	(3)	(9)	(4)	(4)	(6)	(5)	(5)	(4)
Retroperitoneal, cholangiocarcinoma, invasive ^b	1				1			
Bone	(28)	(29)	(21)	(23)	(26)	(23)	(15)	(16)
Brain	(28)	(29)	(21)	(23)	(26)	(23)	(15)	(16)
Chromaffin Tissue	(27)	(29)	(21)	(23)	(26)	(23)	(14)	(16)
Corpuscle of Stannius	(13)	(17)	(7)	(11)	(11)	(14)	(11)	(10)
Esophagus	(28)	(29)	(21)	(23)	(26)	(23)	(15)	(16)
Cholangiocarcinoma, invasive					1			
Eye	(28)	(29)	(21)	(23)	(26)	(23)	(15)	(16)
Gallbladder	(27)	(29)	(18)	(22)	(23)	(22)	(15)	(15)
Adenoma							1	
Adenoma, papillary			1		1			
Carcinoma							1	
Gill	(28)	(29)	(21)	(23)	(26)	(23)	(15)	(16)
Hemangiosarcoma							1	
Heart	(28)	(29)	(20)	(23)	(26)	(23)	(15)	(16)
Atrium, cholangiocarcinoma, invasive					1			
Sinus venosus, cholangiocarcinoma, invasive	1				1			
Hematopoietic Tissue	(28)	(29)	(21)	(23)	(26)	(23)	(15)	(16)
Interrenal Tissue	(27)	(29)	(21)	(23)	(26)	(23)	(14)	(16)
Intestine	(28)	(29)	(21)	(23)	(26)	(23)	(15)	(16)
Adenomatous polyp			1	1				
Wall, hemangiosarcoma			1					
Kidney	(28)	(29)	(21)	(23)	(26)	(23)	(15)	(16)
Cholangiocarcinoma, metastatic					1			
Liver	(28)	(29)	(21)	(23)	(26)	(23)	(15)	(16)
Cholangiocarcinoma	1		8	7	18	13	11	10
Cholangioma			1		2			
Hepatocellular adenoma	1	3		2	2		1	
Hepatocellular carcinoma			1	1	1		3	1
Hepatocholangiocarcinoma								1
Mesentery	(5)	(11)	(12)	(9)	(15)	(11)	(6)	(3)
Cholangiocarcinoma, invasive					2		1	
Cholangiocarcinoma, metastatic					2			
Nares (Olfactory Tissue)	(16)	(6)	(13)	(7)	(16)	(5)	(7)	(8)

TABLE F4
Summary of the Incidence of Neoplasms in Female Medaka in the 13-Month Waterborne Study
of 1,2,3-Trichloropropane (Stop-Exposure)

	0 mg/L		4.5 mg/L		9 mg/L		18 mg/L	
	Group A	Group B	Group A	Group B	Group A	Group B	Group A	Group B
Oral Cavity	(28)	(29)	(21)	(23)	(26)	(23)	(15)	(16)
Ovary	(28)	(29)	(21)	(23)	(26)	(23)	(15)	(16)
Dysgerminoma					1			
Pancreas	(28)	(29)	(21)	(23)	(26)	(23)	(15)	(16)
Pericardial Cavity	(0)	(1)	(0)	(1)	(1)	(1)	(0)	(1)
Cholangiocarcinoma, invasive					1			
Peripheral Nerve	(28)	(29)	(21)	(23)	(26)	(23)	(15)	(16)
Peritoneum	(0)	(0)	(1)	(0)	(0)	(1)	(0)	(1)
Pineal Organ	(23)	(20)	(13)	(17)	(16)	(16)	(12)	(11)
Pituitary Gland	(27)	(23)	(20)	(23)	(26)	(21)	(15)	(15)
Pseudobranch	(28)	(29)	(21)	(23)	(26)	(23)	(15)	(16)
Skeletal Muscle	(28)	(29)	(21)	(23)	(26)	(23)	(15)	(16)
Skin	(28)	(29)	(21)	(23)	(26)	(23)	(15)	(16)
Spinal Cord	(28)	(29)	(21)	(23)	(26)	(23)	(15)	(16)
Spleen	(22)	(18)	(15)	(11)	(19)	(16)	(4)	(10)
Stato-acoustic Organ	(28)	(29)	(21)	(23)	(26)	(23)	(15)	(16)
Swim Bladder	(28)	(29)	(21)	(23)	(26)	(23)	(15)	(16)
Thymus	(16)	(22)	(11)	(20)	(9)	(17)	(13)	(11)
Thyroid Tissue	(28)	(29)	(21)	(23)	(26)	(23)	(15)	(16)
Urinary Bladder	(25)	(18)	(17)	(18)	(20)	(20)	(14)	(13)

^a Number of animals examined microscopically at the site
^b Number of animals with neoplasm

APPENDIX G

CHEMICAL CHARACTERIZATION AND GENERATION OF AQUARIA CONCENTRATIONS

PROCUREMENT AND CHARACTERIZATION	176
EXPOSURE SOLUTION GENERATION AND EXPOSURE SYSTEM	177
EXPOSURE SOLUTION CONCENTRATION MONITORING	177
EXPOSURE SOLUTION CHARACTERIZATION	177
FIGURE G1 Infrared Absorption Spectrum of 2,2-Bis(bromomethyl)-1,3-propanediol	180
FIGURE G2 Infrared Absorption Spectrum of Nitromethane	181
FIGURE G3 Infrared Absorption Spectrum of 1,2,3-Trichloropropane	182
TABLE G1 Gas Chromatography Systems Used in the Waterborne Studies of 2,2-Bis(bromomethyl)-1,3-propanediol, Nitromethane, and 1,2,3-Trichloropropane ...	183
FIGURE G4 Exposure Chambers Used in the Waterborne Studies of 2,2-Bis(bromomethyl)-1,3-propanediol, Nitromethane, and 1,2,3-Trichloropropane ...	184
FIGURE G5 Schematic of the Exposure Solution Delivery System in the Waterborne Studies of 2,2-Bis(bromomethyl)-1,3-propanediol, Nitromethane, and 1,2,3-Trichloropropane ...	185
TABLE G2 Summary of Exposure Aquaria Concentrations Administered to Medaka and Guppies in the Waterborne Studies of 2,2-Bis(bromomethyl)-1,3-propanediol	186
TABLE G3 Summary of Exposure Aquaria Concentrations Administered to Medaka and Guppies in the Waterborne Studies of Nitromethane	186
TABLE G4 Summary of Exposure Aquaria Concentrations Administered to Medaka and Guppies in the Waterborne Studies of 1,2,3-Trichloropropane	187

CHEMICAL CHARACTERIZATION AND EXPOSURE SOLUTION STUDIES

PROCUREMENT AND CHARACTERIZATION

2,2-Bis(bromomethyl)-1,3-propanediol

2,2-Bis(bromomethyl)-1,3-propanediol was obtained from Aldrich Chemical Company (Milwaukee, WI) in three lots (16728PG, 11215BQ, and 00713BQ) that were used in the 14- and 16-month studies. Lots 11215BQ and 00713BQ were manufactured in the same batch but were assigned different lot numbers by the supplier because they were received on different dates. Identity, purity, and stability analyses were conducted by the study laboratory.

Lots 16728PG and 11215BQ were identified as 2,2-bis(bromomethyl)-1,3-propanediol by the University of Mississippi (Oxford, MS) (lot 16728PG) and by the University of Southern Mississippi (Hattiesburg, MS) (lot 11215BQ) using infrared spectroscopy. The spectra were consistent with the structure of 2,2-bis(bromomethyl)-1,3-propanediol. The infrared spectrum is presented in Figure G1.

The purities of lots 16728PG and 11215BQ were determined by the study laboratory using gas chromatography (GC) by system A (Table G1). GC indicated no contaminants in either lot. Information provided by the supplier indicated that the purity of lot 16728PG was greater than 99%. The overall purity of lots 16728PG and 11215BQ was determined to be greater than 99%.

The bulk chemical was stored at approximately 4° C (lot 16728PG) or at room temperature (lots 11215BQ and 00713BQ). The stability of bulk 2,2-bis(bromomethyl)-1,3-propanediol was monitored monthly during the 14- and 16-month studies using GC by system A. No contaminants were found during the course of the studies.

Nitromethane

Nitromethane was obtained from Aldrich Chemical Company in one lot (CG02304HF) that was used in the 13- and 16-month studies. Identity, purity, and stability analyses were conducted by the study laboratory.

Lot CG02304HF, a colorless liquid, was identified as nitromethane by the University of Mississippi using infrared spectroscopy. The spectrum was consistent with the structure of nitromethane and is presented in Figure G2.

The purity of nitromethane was determined by the study laboratory using GC by system B. GC indicated that lot CG02304HF contained no contaminants other than water. Information provided by the supplier indicated that the purity of lot CG02304HF was greater than 99%. The overall purity of lot CG02304HF was determined to be greater than 99%.

The bulk chemical was stored at approximately 4° C. The stability of bulk nitromethane was monitored monthly during the 13- and 16-month studies using GC by system B. No contaminants were found during the course of the studies.

1,2,3-Trichloropropane

1,2,3-Trichloropropane was obtained from Aldrich Chemical Company in one lot (01628HG) that was used in the 13- and 16-month studies. Identity, purity, and stability analyses were conducted by the study laboratory.

Lot 01628HG, a colorless to straw-colored liquid, was identified as 1,2,3-trichloropropane by the University of Southern Mississippi and by the supplier using infrared spectroscopy. The spectra were consistent with a reference spectrum (Aldrich, 1985). The infrared spectrum is presented in Figure G3.

The purity of lot 01628HG was determined by the University of Southern Mississippi using GC by system C, the chemical supplier using GC by system E, and the study laboratory using GC by system E. GC by system C indicated that lot 01628HG was highly pure; GC by system D indicated a purity of 99%; GC by system E indicated the absence of significant contamination. The overall purity of lot 01628HG was determined to be 99%.

The bulk chemical was stored at approximately 4° C.

EXPOSURE SOLUTION GENERATION AND EXPOSURE SYSTEM

Exposure was by intermittent flow through and was conducted in a closed chamber similar to that described by Walker *et al.* (1985) (Figure G4). A schematic of the exposure solution delivery systems used in the 13-, 14-, and 16-month studies is shown in Figure G5. Stock solutions of 2,2-bis(bromomethyl)-1,3-propanediol, nitromethane, or 1,2,3-trichloropropane were prepared by adding neat chemical to diluent well water in glass carboys (2,2-bis(bromomethyl)-1,3-propanediol, 19 L; nitromethane, 49 L; 1,2,3-trichloropropane, 19 L) to produce concentrations sufficient to provide the required concentrations in exposure aquaria. A water partitioner was timer-regulated to perform at least five volume additions per day to each exposure aquarium. Diluent well water entered the water partitioner through a solenoid-controlled valve immediately after filtration and ultraviolet light sterilization. A float switch within the water partitioner activated liquid dispensing pumps (Hamilton Company, Reno, NV) that were preset to remove the appropriate volume of stock solution from the carboy containers. The dispensing pumps injected the stock solution through Teflon[®] microbore tubing into glass mixing\splitter boxes immediately prior to delivery of two liters of diluent water. Diluent water alone was delivered to the control aquaria mixing\splitter boxes. Exposure solutions were delivered from mixing\splitter boxes to duplicate 35 L exposure aquaria through calibrated glass delivery lines. Aquaria volumes were maintained by an overflow drain siphon designed to remove water from near the bottom of each aquarium.

The resin-coated plywood exposure chamber measured 333 cm long, 118 cm wide, and 244 cm high. Access to the chamber was through sliding polycarbonate doors on each side of the chamber. Aquaria were placed at random in a central waterbath maintained at 26° ± 1° C. Timer-controlled fluorescent lights with dimmer ballasts provided 16 hours of light per 24 hours with 30-minute transitions simulating dawn and dusk. The chamber was maintained at a slightly negative pressure.

Individual test aquaria measured 48 cm long, 35.5 cm wide, and 24 cm high. A water depth of 20.5 cm was maintained. Aquaria were individually covered and covers of adjacent tanks were not raised simultaneously.

EXPOSURE SOLUTION CONCENTRATION MONITORING

Concentrations of 2,2-bis(bromomethyl)-1,3 propanediol, nitromethane, and 1,2,3-trichloropropane in the exposure aquaria were monitored using GC by systems A, B, and D, respectively, approximately 3 times each week. Duplicate samples were analyzed from each aquarium. Summaries of the aquaria solution concentrations are given in Tables G2 through G4.

EXPOSURE SOLUTION CHARACTERIZATION

2,2-Bis(bromomethyl)-1,3-propanediol

Exposure solution characterization was performed prior to the start of the 14- and 16-month studies. The generation of target concentrations of 2,2-bis(bromomethyl)-1,3-propanediol exposure solution in exposure aquaria by intermittent flow through was determined with and without fish present. Duplicate aquaria at target concentrations of 10, 35, and 100 mg/L were sampled prior to the first injection and 3, 6, 9, 12, 14, and 24 hours after the initial injection. Samples were analyzed using GC by system A. All aquaria reached their approximate target 2,2-bis(bromomethyl)-1,3-propanediol concentrations within 24 hours of the initial injection.

The uniformity of distribution of 2,2-bis(bromomethyl)-1,3-propanediol in single 10 and 100 mg/L aquaria was determined following 6-day intermittent flow-through generation and stability studies. Samples were collected from nine locations 2 cm below the surface of each aquarium solution and from nine locations within 2 cm of the bottom of each aquarium. Samples were analyzed using GC by system A. Uniformity of distribution was established.

The persistence of 2,2-bis(bromomethyl)-1,3-propanediol in the exposure aquaria was determined by monitoring the exposure solution concentration with intermittent flow through of diluent water only after stable target concentrations were reached. Samples were collected every 3 hours for 12 hours and analyzed using GC by system A. The measured concentration was below the limit of detection after 6 hours in the 10 mg/L aquaria, after 12 hours in the 35 mg/L aquaria, and was less than 6 mg/L after 12 hours in the 100 mg/L aquaria.

Stability of 2,2-bis(bromomethyl)-1,3-propanediol in the intermittent flow-through exposure solution was monitored with and without fish present for 132 hours after approximate target concentrations were reached in 10, 35, and 100 mg/L exposure aquaria. Samples were collected approximately every 4 hours and analyzed using GC by system A. Stability was confirmed for at least 132 hours. The stability of 2,2-bis(bromomethyl)-1,3-propanediol in exposure solution without intermittent flow through was monitored with and without fish present for 24 hours. The 2,2-bis(bromomethyl)-1,3-propanediol exposure solution was stable for up to 24 hours in the absence of intermittent flow through.

Nitromethane

Exposure solution characterization was performed prior to the start of the 13- and 16-month studies. The generation of target concentrations of nitromethane exposure solution in exposure aquaria by intermittent flow through was determined with and without fish present. Duplicate aquaria at target concentrations of 8.6, 24.5, and 70.0 mg/L were sampled prior to the first injection and every 2 hours for 14 hours after the initial injection. Samples were analyzed using GC by system B. All aquaria reached their approximate target nitromethane concentrations within 14 hours of the initial injection.

The uniformity of distribution of nitromethane in a single 70.0 mg/L aquarium was determined during 6-day intermittent flow-through generation and stability studies. Samples were collected from nine locations 2 cm below the surface of the aquarium solution and from nine locations within 2 cm of the bottom of the aquarium. Samples were analyzed using GC by system B. Uniformity of distribution was established.

The persistence of nitromethane in the exposure aquaria was determined by monitoring the exposure solution concentration of a 100 mg/L exposure solution prepared by injection of neat nitromethane into the mixing/splitter box. Intermittent flow through contained diluent water only after stable target concentrations were reached. Samples were collected every hour for 13 hours and analyzed using GC by system B. The nitromethane concentration was below the limit of detection after 13 hours.

Stability of nitromethane in the intermittent flow-through exposure solution was monitored with and without fish present for 132 hours after approximate target concentrations were reached in 8.6, 24.5, and 70.0 mg/L exposure aquaria. Samples were collected approximately every 4 hours and analyzed using GC by system B. Stability was confirmed for at least 132 hours. The stability of nitromethane stock carboy solutions was monitored for 144 hours. Samples were collected approximately every 24 hours and analyzed using GC by system B. The results indicated that nitromethane solution was stable in stock carboys for at least 144 hours. The stability of nitromethane in exposure solution without intermittent flow through was monitored for approximately 70 hours with and without fish present in 100 mg/L exposure solutions prepared by injection of neat nitromethane into the mixing/splitter box. Nitromethane concentrations decreased to approximately 60% of initial target concentrations after 3.5 hours.

1,2,3-Trichloropropane

Exposure solution characterization was performed prior to the start of the 13- and 16-month studies. The generation of target concentrations of 1,2,3-trichloropropane exposure solution in exposure aquaria by intermittent flow through was determined with and without fish present. Duplicate aquaria at target concentrations of 10, 35, and 100 mg/L were sampled prior to the first injection and 3, 6, 9, 12, 14, and 24 hours after the initial injection. Samples were analyzed using GC by system D. All aquaria reached their approximate target 1,2,3-trichloropropane concentrations within 24 hours of the initial injection.

The uniformity of distribution of 1,2,3-trichloropropane in single 10 and 100 mg/L aquaria was determined during 6-day intermittent flow-through generation and stability studies. Samples were collected from nine locations 2 cm below the surface of the aquarium solution and from nine locations within 2 cm of the bottom of the aquarium. Samples were analyzed using GC by system D. Uniformity of distribution was established.

The persistence of 1,2,3-trichloropropane in the exposure aquaria was determined by monitoring the exposure solution concentration with intermittent flow through of diluent water only after stable target concentrations were reached. Samples were collected every 3 hours for 12 hours and analyzed using GC by system D. After 12 hours, the measured concentrations were 0.96 mg/L in the 10 mg/L aquaria, 3.63 mg/L in the 35 mg/L aquaria, and 9.16 mg/L in the 100 mg/L aquaria.

Stability of 1,2,3-trichloropropane in the intermittent flow-through exposure solution was monitored with and without fish present for 120 hours after approximate target concentrations were reached in 10, 35, and 100 mg/L exposure aquaria. Samples were collected approximately every 4 hours and analyzed using GC by system D. Stability was confirmed for at least 120 hours. The stability of 1,2,3-trichloropropane in exposure solution without intermittent flow through was monitored with and without fish present for 24 hours. After 24 hours, the average 1,2,3-trichloropropane exposure solution concentrations in all aquaria declined to approximately 54% of the measured concentrations before flow through was terminated.

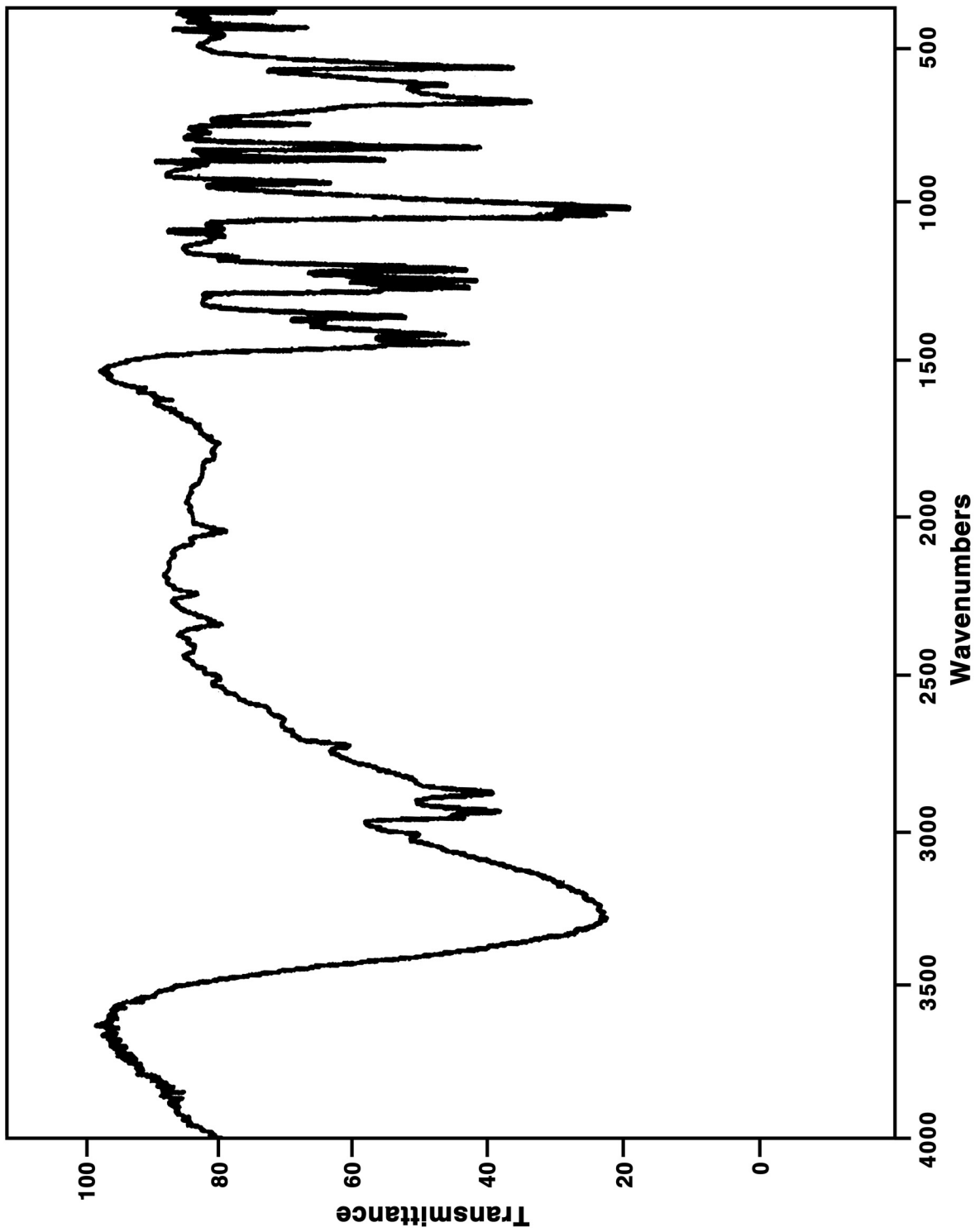

FIGURE G1
Infrared Absorption Spectrum of 2,2-Bis(bromomethyl)-1,3-propanediol

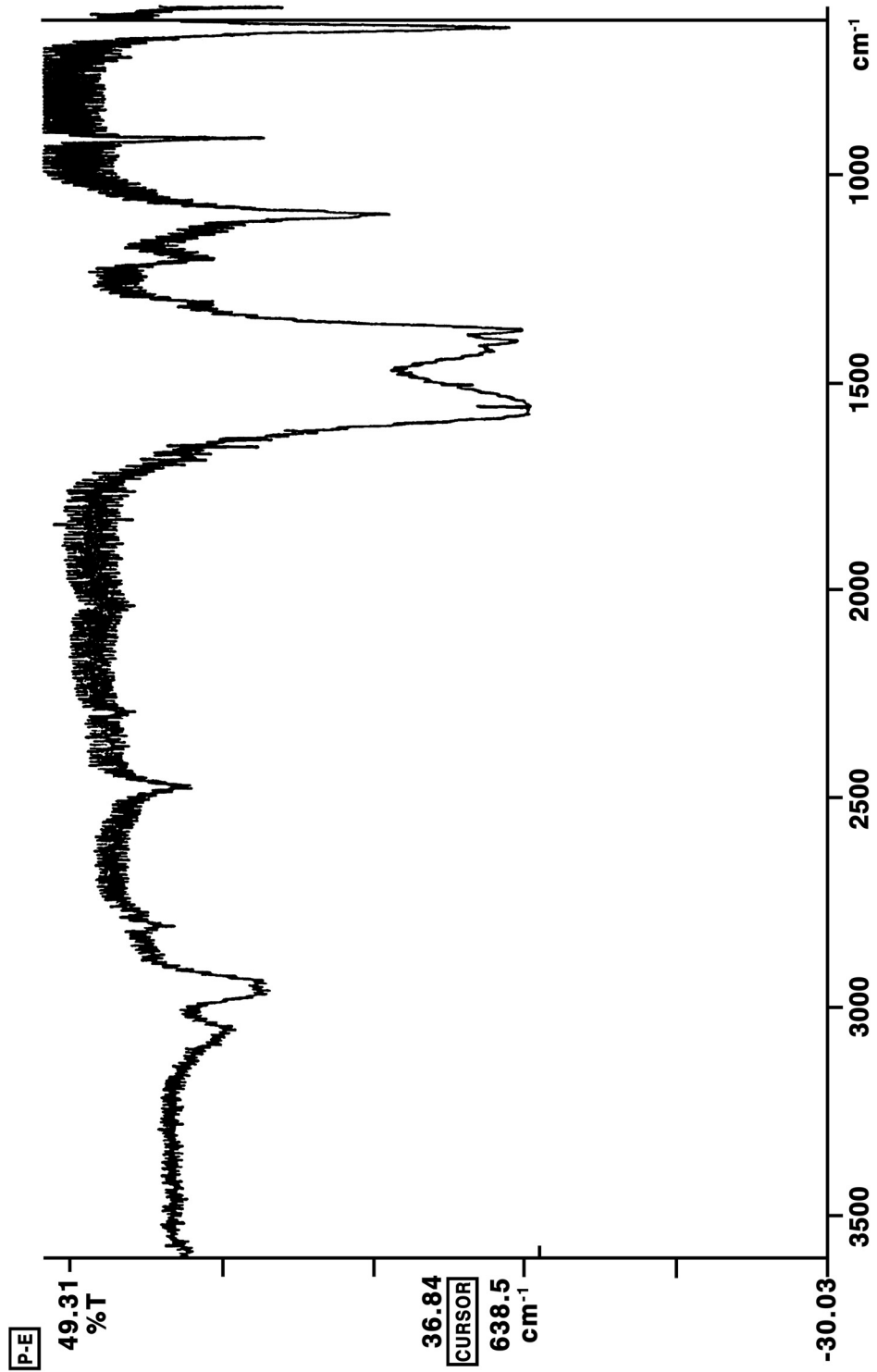

FIGURE G2
Infrared Absorption Spectrum of Nitromethane

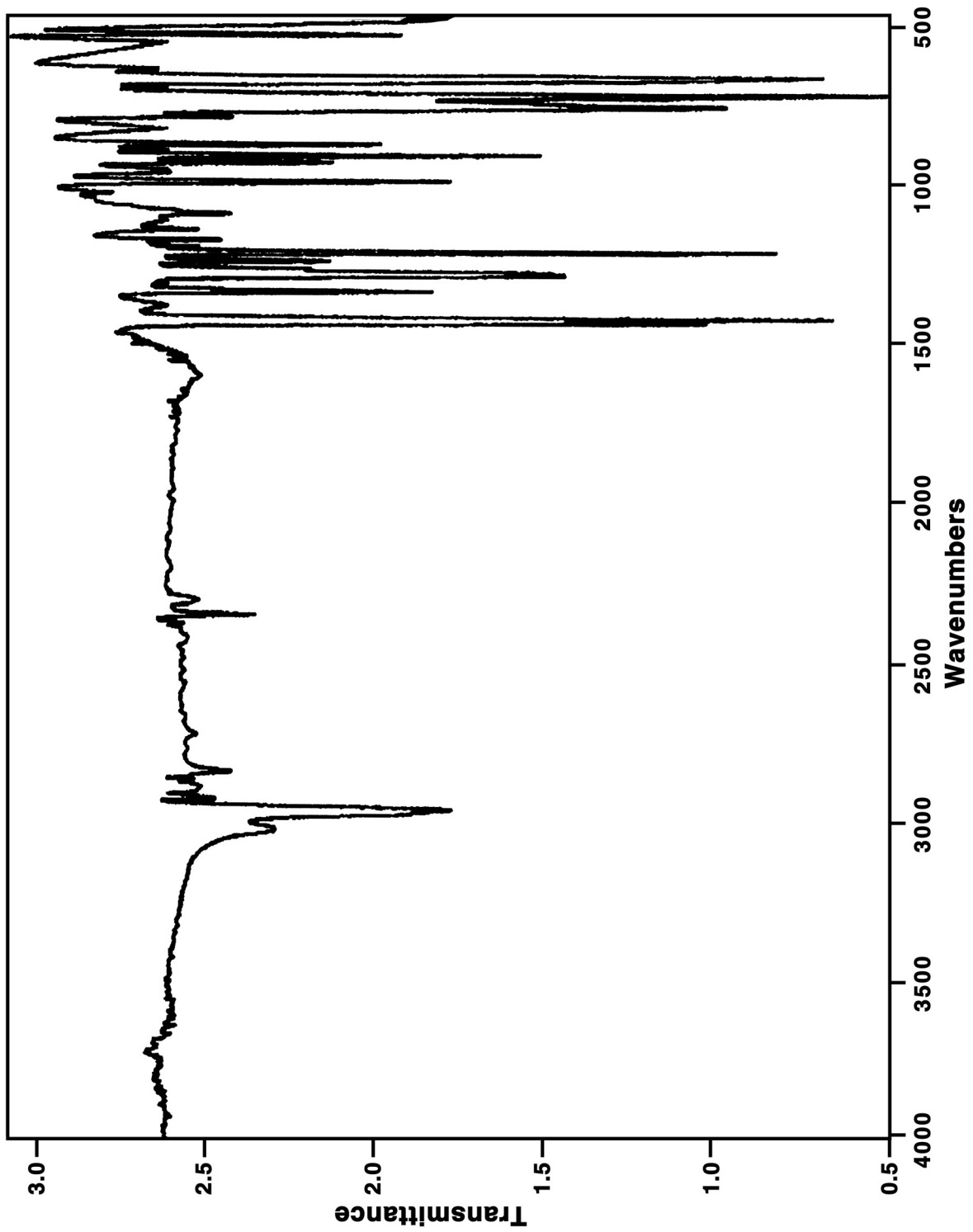

FIGURE G3
Infrared Absorption Spectrum of 1,2,3-Trichloropropane

TABLE G1
Gas Chromatography Systems Used in the Waterborne Studies
of 2,2-Bis(bromomethyl)-1,3-propanediol, Nitromethane, and 1,2,3-Trichloropropane^a

Detection System	Column	Carrier Gas	Oven Temperature Program
System A Flame ionization	DB-5, 15 m × 0.32 mm, 0.25-μm film thickness (J&W Scientific, Folsom, CA)	Helium at 2 mL/minute	150° C for 3 minutes, then 10° C/minute to 200° C, then held for 1 minute
System B Flame ionization	DB-Wax, 15 m × 0.32 mm, 0.5-μm film thickness (J&W Scientific)	Helium at 2 mL/minute	80° C for 4 minutes, then 20° C/minute to 120° C, then held for 4 minutes
System C Flame ionization	Not available	Not available	100° C for 2 minutes, then 10° C/minute to 195° C
System D Electron capture	20% FFAP on Chromosorb W HP, 6 ft × 3.5 mm	Nitrogen at 5 mL/minute	120° C isothermal
System E Flame ionization	D8-1701, 30 m × 0.25 mm (J&W Scientific)	Helium	80° C to 230° C at 10° C/minute, then held for 5 minutes

^a Gas chromatographs were manufactured by Perkin Elmer (Torrance, CA) (systems A and B), Tracor (Austin, TX) (system D), and Varian, Inc. (Palo Alto, CA) (system E).

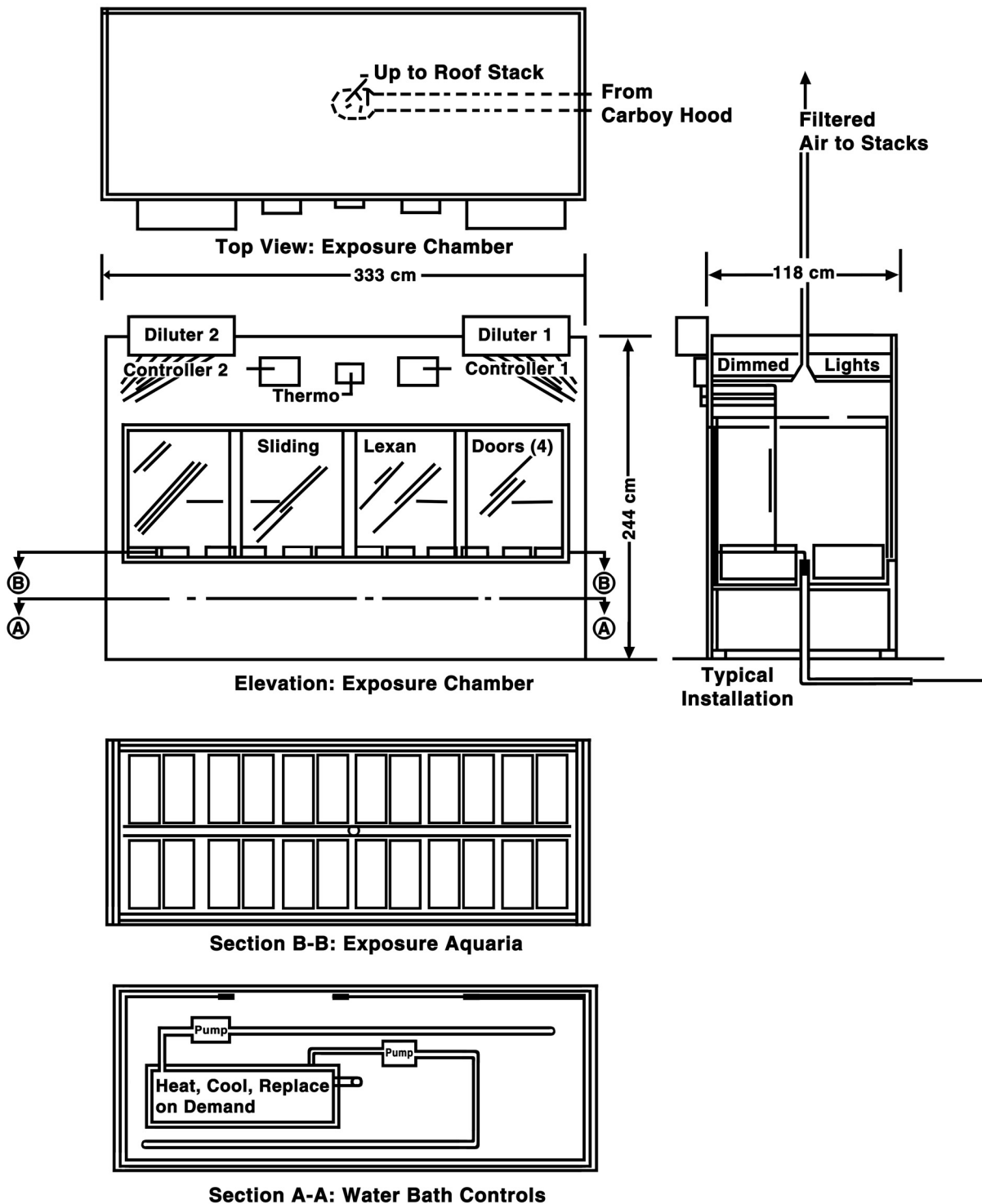

FIGURE G4
 Exposure Chambers Used in the Waterborne Studies
 of 2,2-Bis(bromomethyl)-1,3-propanediol, Nitromethane, and 1,2,3-Trichloropropane

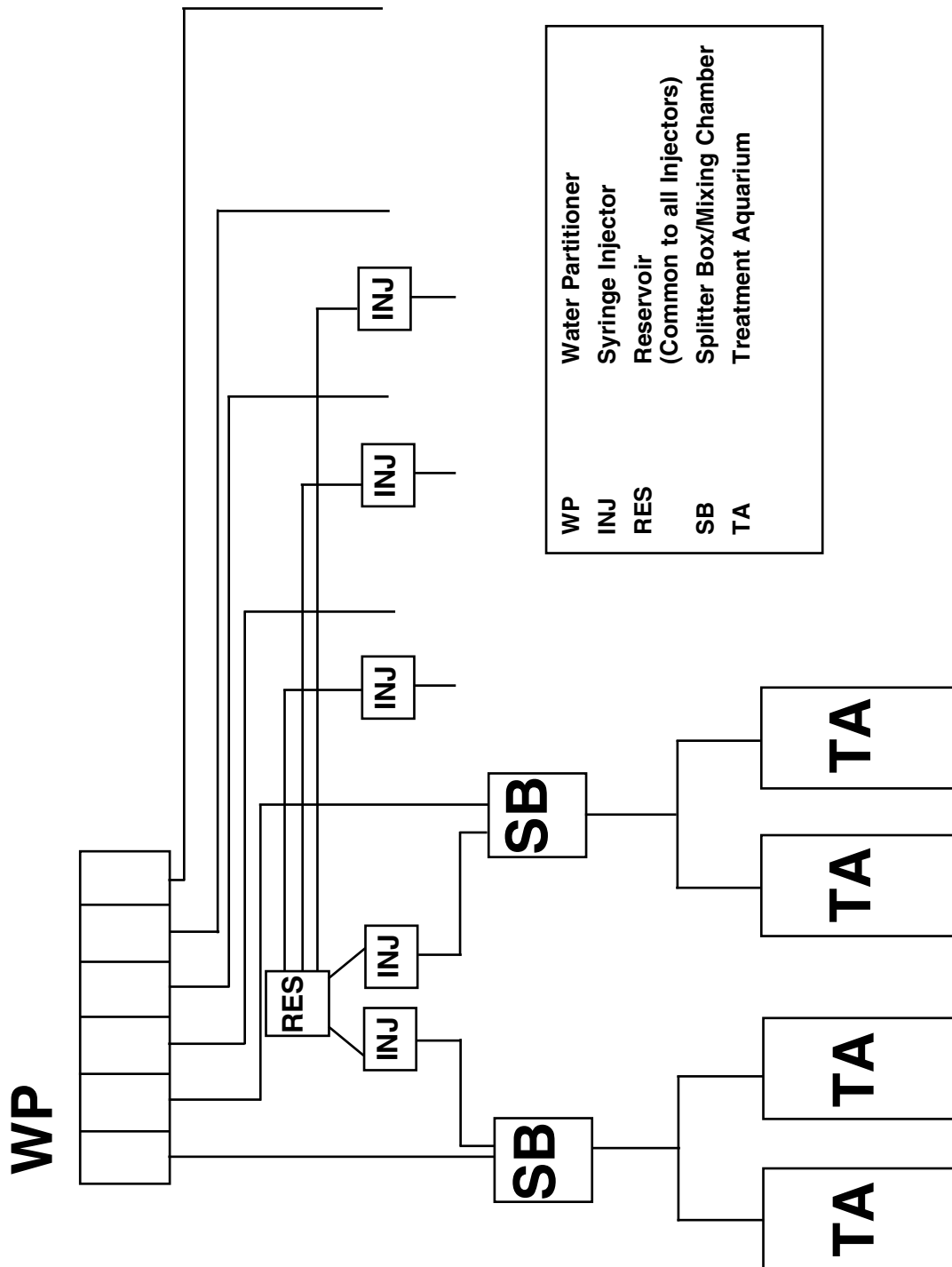

FIGURE G5
Schematic of the Exposure Solution Delivery System in the Waterborne Studies
of 2,2-Bis(bromomethyl)-1,3-propanediol, Nitromethane, and 1,2,3-Trichloropropane

TABLE G2
Summary of Exposure Aquaria Concentrations Administered to Medaka and Guppies
in the Waterborne Studies of 2,2-Bis(bromomethyl)-1,3-propanediol

	Target Concentration (mg/L)	Average Concentration ^a (mg/L)	Coefficient of Variation
14-Month Study (Medaka)			
	24	19.4 ± 3.9	19.9
	60	56.9 ± 11.0	19.2
	150	137.8 ± 27.3	19.8
16-Month Study (Guppy)			
	24	20.0 ± 6.3	31.3
	60	53.5 ± 10.1	19.9
	150	139.0 ± 16.6	12.0

^a Mean ± standard deviation

TABLE G3
Summary of Exposure Aquaria Concentrations Administered to Medaka and Guppies
in the Waterborne Studies of Nitromethane

	Target Concentration (mg/L)	Average Concentration ^a (mg/L)	Coefficient of Variation
13-Month Study (Medaka)			
	10	9.3 ± 2.4	26.2
	20	20.8 ± 3.2	15.6
	40	41.7 ± 5.9	14.2
16-Month Study (Guppy)			
	10	9.9 ± 2.5	24.8
	30	28.7 ± 3.5	12.1
	70	66.9 ± 6.9	10.4

^a Mean ± standard deviation

TABLE G4
Summary of Exposure Aquaria Concentrations Administered to Medaka and Guppies
in the Waterborne Studies of 1,2,3-Trichloropropane

	Target Concentration (mg/L)	Average Concentration ^a (mg/L)	Coefficient of Variation
13-Month Study (Medaka)			
	4.5	4.6 ± 0.3	7.7
	9.0	9.2 ± 0.6	6.6
	18.0	18.0 ± 1.9	10.5
16-Month Study (Guppy)			
	4.5	4.4 ± 0.4	9.3
	9.0	8.8 ± 0.7	8.4
	18.0	18.2 ± 1.6	8.9

^a Mean ± standard deviation

APPENDIX H
NUTRIENT COMPOSITION
AND CONTAMINANT LEVELS IN
FISH FEED AND AQUARIA WATER

TABLE H1	Nutrient Profile of Aqua-Tox (Specialized Formula) Flakes	190
TABLE H2	Contaminants in Brine Shrimp Larvae, Aqua-Tox (Specialized Formula) Flakes, and Well Water used in the Fish Studies	190

TABLE H1
Nutrient Profile of Aqua-Tox (Specialized Formula) Flakes^a

Protein	45%
Fat	10%
Fiber	3%
Ash	9%
Moisture	7%

^a Ziegler Brothers, Inc (Gardners, PA)

TABLE H2
**Contaminants in Brine Shrimp Larvae, Aqua-Tox (Specialized Formula) Flakes,
 and Well Water used in the Fish Studies**

Compound	Brine Shrimp Larvae		Aqua-Tox Flakes		Well Water	
	Value (µg/kg)	LDL ^a (µg/kg)	Value (µg/kg)	LDL (µg/kg)	Value (µg/kg)	LDL (µg/kg)
Toxaphene	ND ^b	700	ND	255	ND	0.1
α-BHC	ND	9	ND	3.2	ND	0.005
β-BHC	ND	18	ND	6.4	ND	0.005
δ-BHC	ND	26	ND	9.6	ND	0.005
Heptachlor	ND	9	ND	3.2	ND	0.005
Aldrin	ND	12	ND	4.25	ND	0.005
Heptachlor epoxide	ND	240	ND	88	ND	0.005
Endosulfan I	ND	41	ND	15	ND	0.03
Dieldrin	ND	6	ND	2.1	ND	0.01
<i>p,p'</i> -DDE	ND	12	ND	4.25	ND	0.01
Endrin	ND	18	ND	6.4	ND	0.01
Endosulfan II	ND	12	ND	4.25	ND	0.01
<i>p,p'</i> -DDD	ND	32	ND	11.5	ND	0.03
Endrin aldehyde	102	67	ND	25	ND	0.005
Endosulfan sulfate	----	----	ND	70	ND	0.03
Lindane	ND	12	ND	4.25	ND	0.02
<i>p,p'</i> -DDT	ND	35	ND	13	ND	0.03
Methoxychlor	----	----	ND	185	ND	0.1
Arochlor 1016	ND	300	ND	210	ND	0.1
Arochlor 1221	ND	300	ND	210	ND	0.1
Arochlor 1232	ND	300	ND	210	ND	0.1
Arochlor 1242	ND	300	ND	210	ND	0.1
Arochlor 1248	ND	300	ND	210	ND	0.1
Arochlor 1254	ND	300	ND	210	ND	0.1
Arochlor 1260	ND	300	ND	210	ND	0.1
Malathion	----	----	ND	105	ND	0.1
Methyl parathion	----	----	ND	105	ND	0.1
Parathion	----	----	ND	105	ND	0.1

^a LDL = lower detection limit;

^b ND = not detected;

^c Dashed line indicates no analysis