

Personal Genomics: Review of Current Practices

Kenneth Offit, MD, MPH
Chief, Clinical Genetics Service
Memorial Sloan Kettering Cancer Center





Victoria Roberts

"As if we didn't already know too much about ourselves, we're having our DNA done."

Genomics in Personalized Medicine

- "The integration of genomic technologies that are capable of tailoring treatment and prevention strategies to each patient's unique genetic characteristics and individual needs into general health care... The Initiative recognizes that the **accuracy**, **clinical validity**, and **clinical utility** of genetic tests are central to the realization of personalized health care."

SPECIAL ARTICLE

Statement of the American Society of Clinical Oncology: Genetic Testing for Cancer Susceptibility

Adopted on February 20, 1996 by the American Society of Clinical Oncology*

As the leader
with cancer
(ASCO) recom-
mended formed of the
cancer risk. 1

ASCO SPECIAL ARTICLE

American Society of Clinical Oncology Policy Statement Update: Genetic Testing for Cancer Susceptibility

Adopted on March 1, 2003, by the American Society of Clinical Oncology

- Genetic discrimination
- Physician education
- Reimbursement and access
- Ethical and legal Issues
- Efficacy of interventions
 - (clinical utility)
- Regulation to ensure
 - analytic validity

• *Protection From Insurance and Employment Discrimination:* ASCO supports establishing a federal law to prohibit discrimination by health insurance providers and employers on the basis of an individual's inherited susceptibility to cancer.

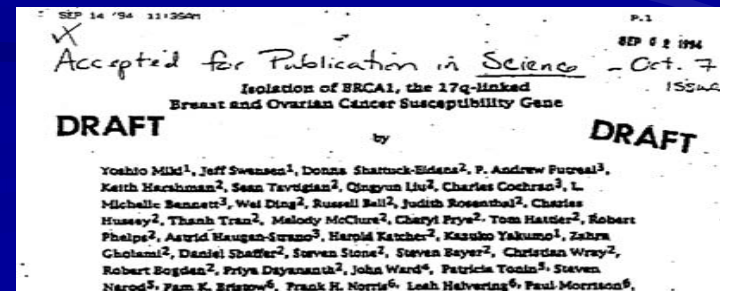

CLINICAL PRACTICE

Management of an Inherited Predisposition to Breast Cancer

Mark Robson, M.D., and Kenneth Offit, M.D., M.P.H.

Positive *BRCA1* or *BRCA2* test result

Identify at-risk adult relatives; offer genetic counseling/testing

Increased surveillance

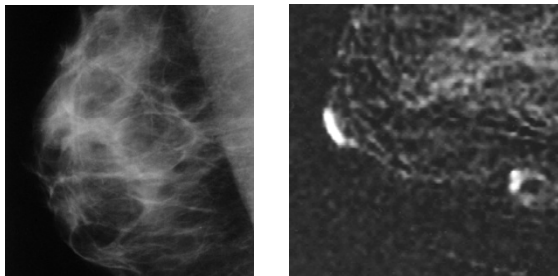

Chemo-prevention

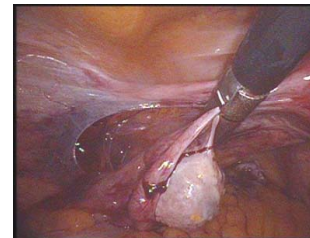

Prophylactic surgery

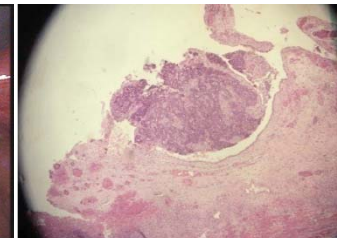

Factors Impacting Translation of Cancer Genetic Testing in U.S.

■ NIH Leadership: NCI, NHGRI

- ELSI RFA (NHGRI)

- Cancer genetics WG

 - CFR (Cooperative Registries)

 - CGN (Cancer Genetics Network)



■ Professional leadership: ASCO

- "Train the trainer"; syllabus; Genetics WG

■ Advocacy leadership: DOD grants, other

■ Laboratory quality: one reference lab

Interventions for hereditary cancer risk

<i>Gene</i>	<i>Intervention</i>
<i>KIT</i>	STI 571
<i>RET</i>	Thyroidectomy, adrenal screening;
<i>MET</i>	Renal screening
<i>CDK4/CDKN2</i>	Skin screening
<i>APC</i>	Colectomy, GI screening, CP
<i>VHL</i>	Renal, adrenal screening
<i>RB</i>	Eye screening
<i>MSH2/MLH1</i>	GI screening, colectomy
<i>BRCA1/2</i>	Breast/ovarian screening, CP, mastectomy, oophorectomy

Genome Wide Association Studies (GWAS)



Patients



Non-Patients



Patient DNA



Non-Patient DNA

C
A
T
T
A
C
T
G
T

C
A
T
C
T
G
T
G

with disease

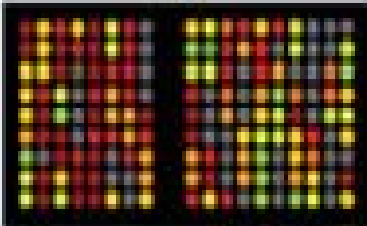

Disease-specific SNPS

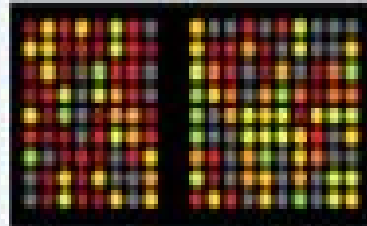

Non-disease-SNPS

Progress in Genotyping Technology

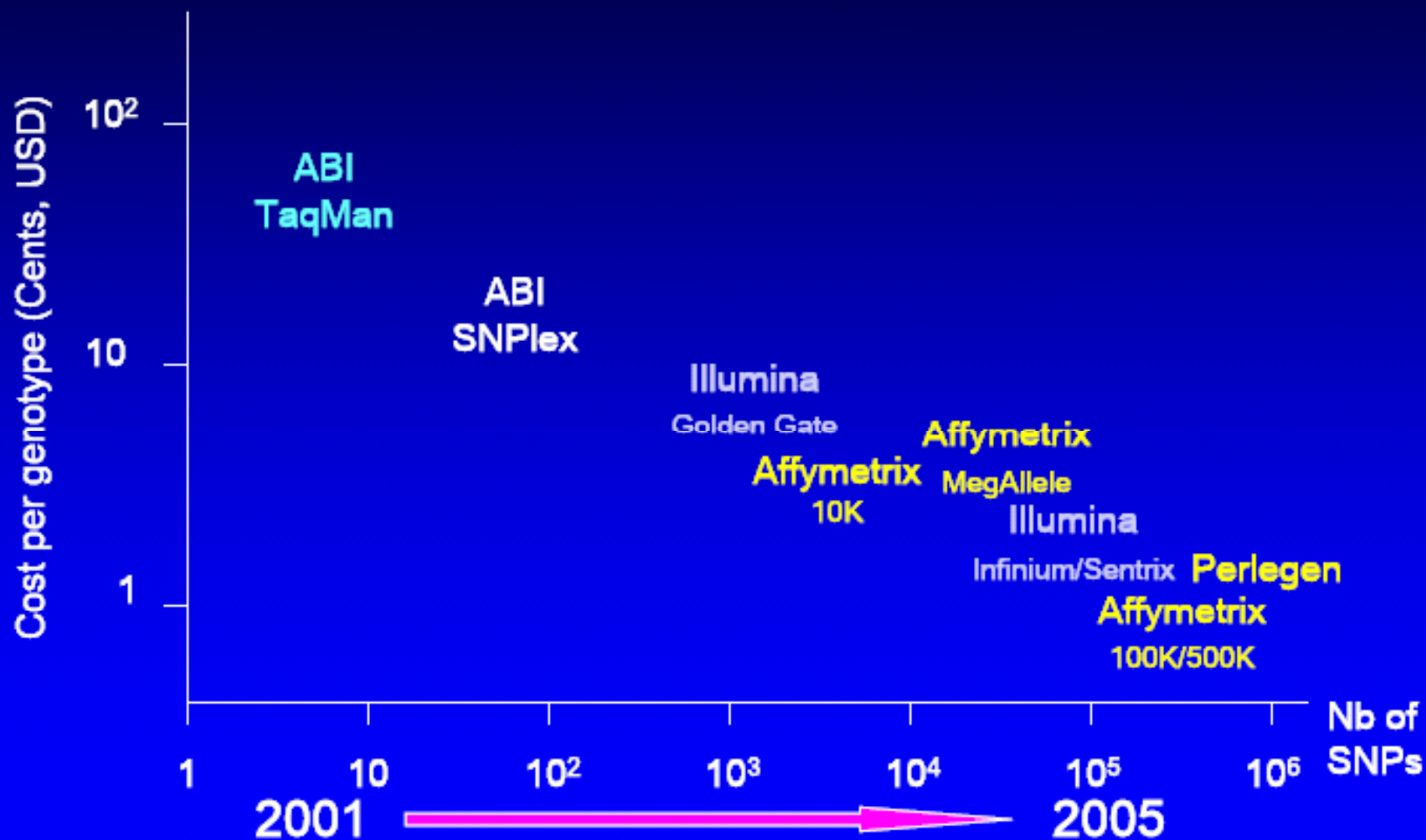

Courtesy S. Chanock, NCI

GWAS studies in NHGRI Catalogue

<http://www.genome.gov/gwastudies/#top>

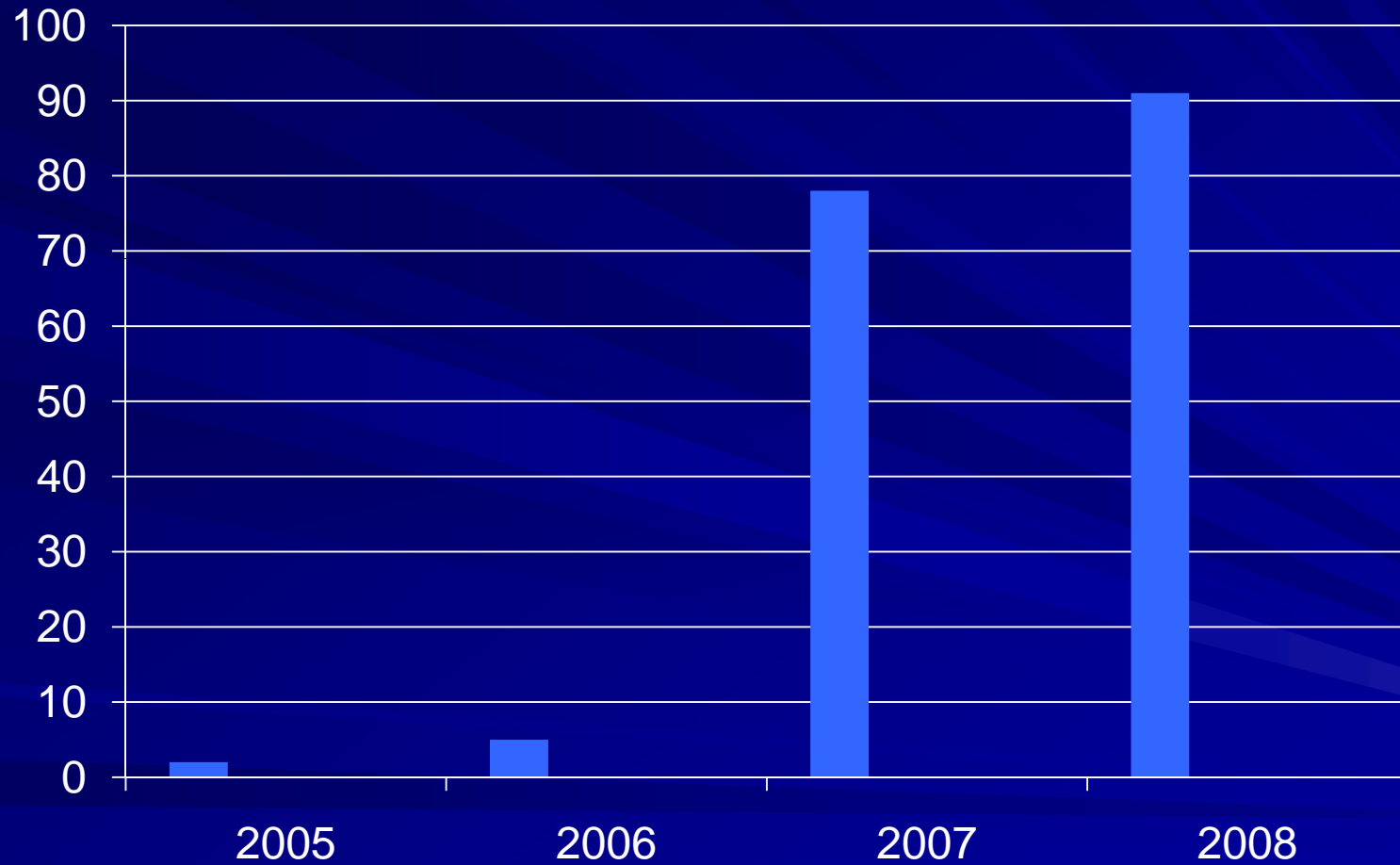

Breast Cancer Whole Genome Association Studies

BCAC	~400 fam'l cases/controls 4,000 cases/controls 25,000 cases/controls	Perlegen 266K Illumina TaqMan/Sequenom	<i>Nat Genet</i> 2007 39:870
MSKCC	250 fam'l cases/cont(AJ) 2,000 cases/controls 4,000 cases/controls	Affy500K Illumina TaqMan	<i>PNAS</i> 2008 105:4340
Iceland	1,600 cases/11,563 controls	Illumina 300K	<i>Nat Genet</i> 2007 9: 865
CGEMS	1,142 cases/1,142 controls	Illumina 500K	<i>Nature</i> 2007 447:1087

Breast Cancer Risk Alleles

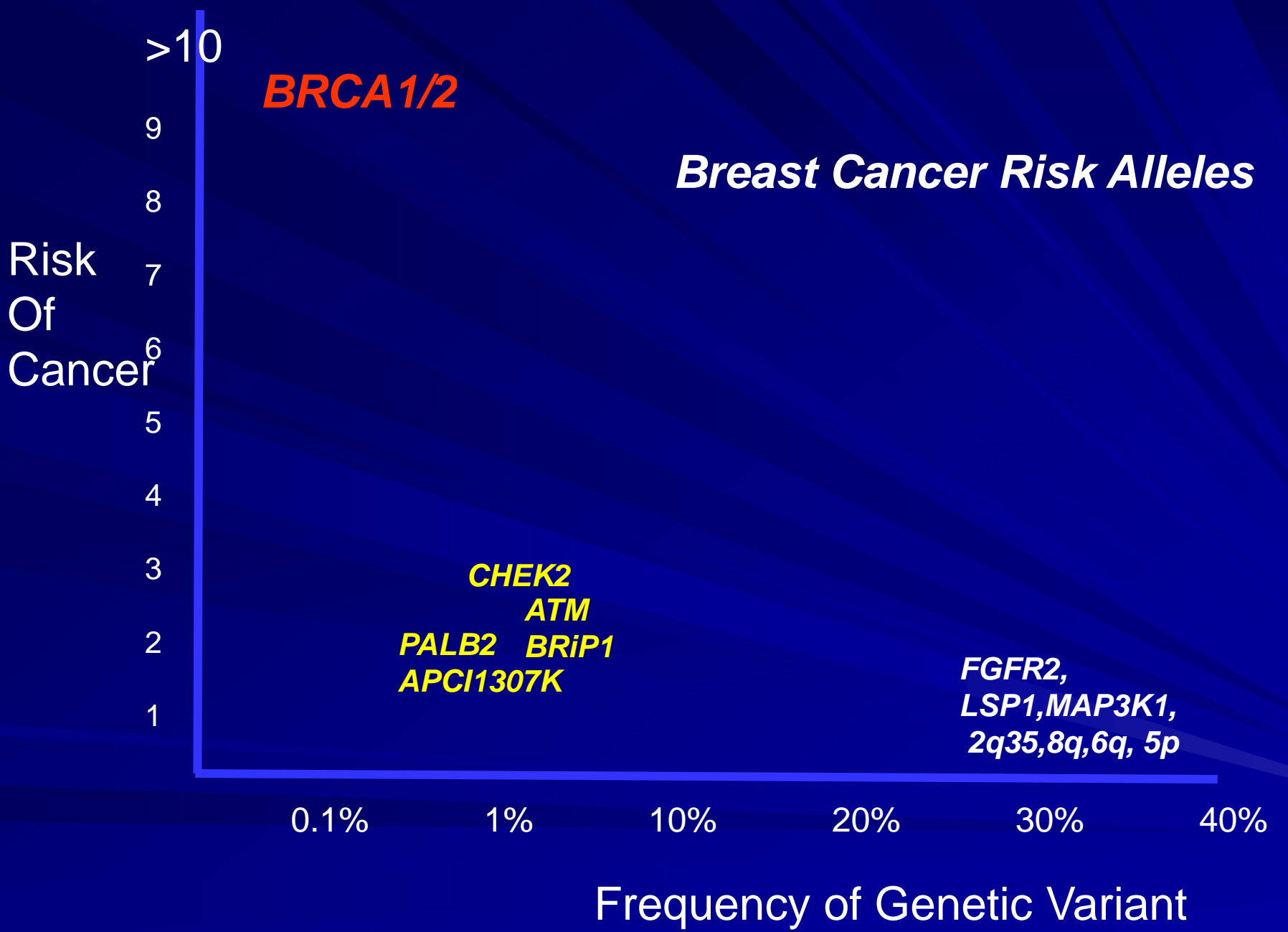

Gene Associations with 6 common diseases

Disease	No. of studies	Cases / controls	Gene(s)	Odds ratios (95% CI)
Age-related macular degeneration	10	>5k / >3.4k	<i>8 genes</i>	Range 1.6-8.6 / or 0.36 protective
Diabetes II	11	~50k / >100k	<i>8 loci</i>	Range 1.09-2.50
Myocardial infarction	2	8.9k / 33.2/k	<i>CDKN2B</i>	Range 1.64-1.90
Schizophrenia	6	11.8k / 22.6k	<i>7 loci</i>	Range 1.12-6.01
Breast cancer	6	36.7k / 47.5k	<i>9 loci</i>	Range 1.07-1.41
Prostate cancer	8	>30k / >66k	<i>8q24 and other loci</i>	Range 1.10-1.36

Functional Classification of 284 SNPs Associated with Complex Traits

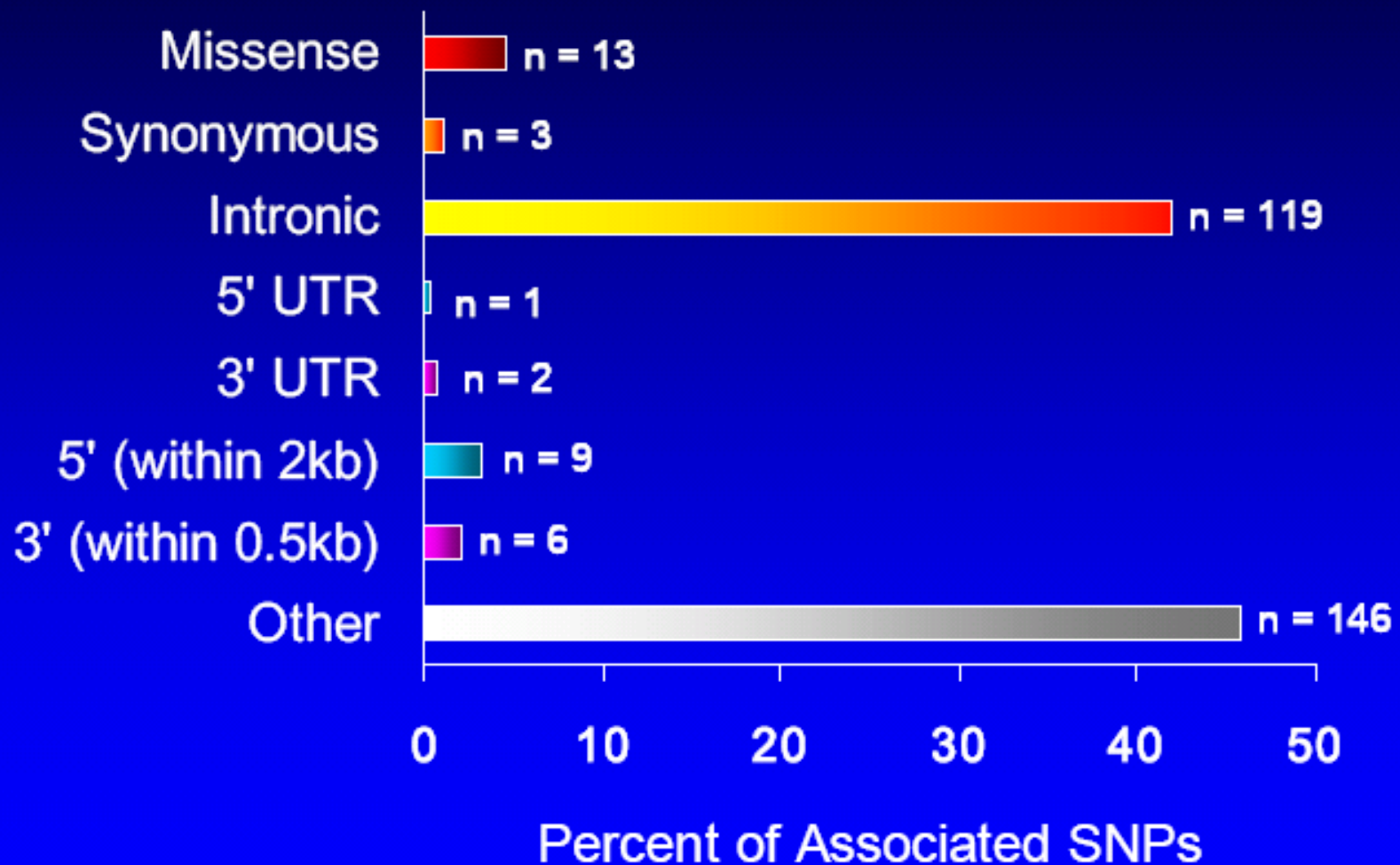

<http://www.genome.gov/gwastudies/>

deCODEme - Microsoft Internet Explorer

Address: http://www.decodeme.com/



deCODE genetics
the pioneers in gene discovery

deCODEme
the most comprehensive genome scan
with information on more diseases and genes

Know your CODE
Join deCODEme today

Home

- What is deCODEme?
- About deCODE
- Signup
- Family registration
- Login to myCODE

Login to myCODE

Graceful Earth Inc. - Microsoft Internet Explorer

Address: http://www.gracefulearth.com/



GRACEFUL EARTH INC.
Health Alternatives:
Customized Dietary, Nutritional and Herbal Information
1-877-697-7300

HOME | COMPANY INFO | CONTACT US | LOGIN | VIEW CART

PRODUCTS

- Alzheimer's Test
- Hair Analysis
- Pet Hair Analysis
- Home Allergy Test
- Pure Encapsulations
- Herbal Products
- TYFU
- Acai Berry
- Drinking Water Systems
- Shower Filters & Bath Filters
- Skin Care

WELCOME TO GRACEFUL EARTH INC. WE LOOK FORWARD TO ASSISTING YOU!

Please choose the product or service which best suits your needs.

Alzheimer's Test
Price \$280.00

[Buy](#)

38 Elements Hair Analysis with Interpretation
Price \$155.00

[Buy](#)

Pet Hair Analysis 22 and 57 Elements + Interpretation
Price \$120.00

[View](#)

TYFU High Grade Special Pack
Price \$60.00

[Buy](#)

MAILING LIST

MORE INFORMATION

- stopcancer.com
- Natural Solutions Foundation
- Environmental Working Group
- Food News
- analysisofhair.com
- purenutritional.com

pure encapsulations

SEARCH

SHIPPING CART

Your Cart Is Empty

SECURE PROFESSIONAL

VISA
DISCOVER
MasterCard
PayPal

GeneMakeover - Microsoft Internet Explorer

Address: http://www.gene makeover.com/

Order Dr. Giampapa

genetics™

DERMAGENETICS™

RETAILER INFO | FIND A SPA | CLINICALLY PROVEN | SHOP ONLINE



FAQS | TESTIMONIALS | CONTACT | HOME

Copyright © 2000-2007 GeneLink, Inc. All Rights Reserved

THE GENE MAKEOVER

THE 21ST CENTURY ANTI-AGEING BREAKTHROUGH

THE THREE SECRETS to Life Extension and Optimal Health Span

VINCENT C. GIAMPAPA, MD, FACS
FREDERICK F. BUECHEL, SR., MD, FACS
AND DHAN KARATOPRAK, MD

Go to Page: [Go](#) [Previous](#) [Next](#)

a Program Like the One Described in this Book

Sports

The New York Times

Test for Sports Gene



Internet 5:52 PM

Internet 6:21 PM



THE
PERFECT STORM

- Genome Wide Association Studies
- "Personalized Medicine" hype
- Direct to Consumer Advertising
- Direct to Consumer Marketing/Home Tests
- Venture capital
- Internet
- Well intentioned basic geneticists

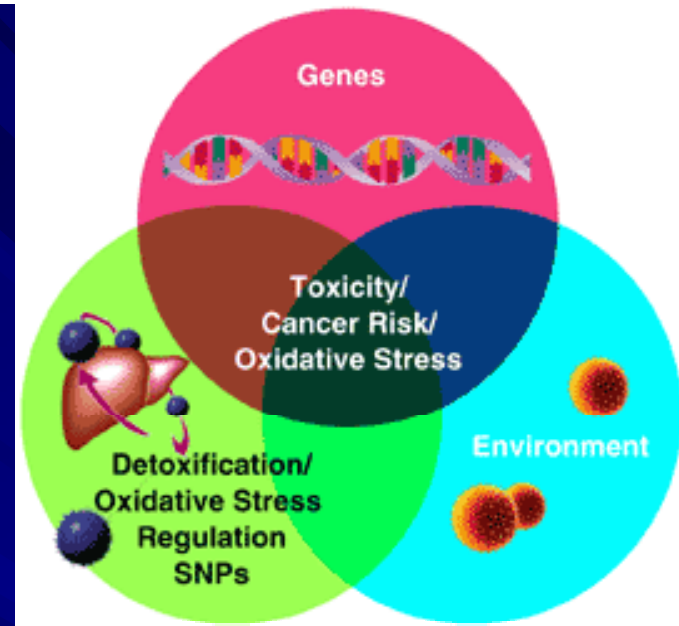
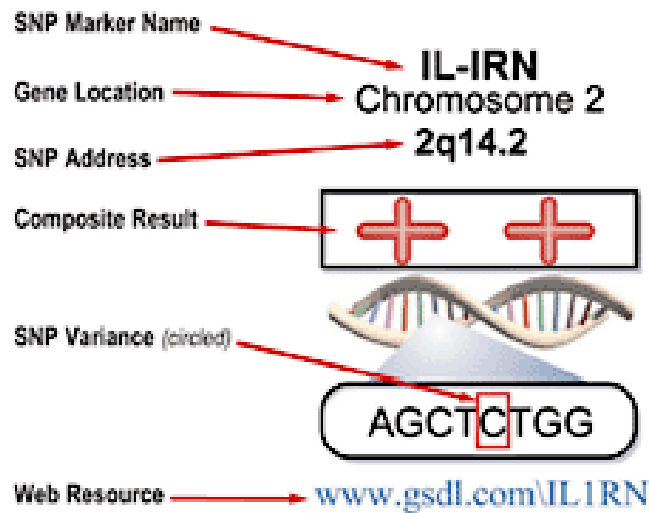

HEALTH IMPLICATIONS: Interleukin-1 receptor agonist (IL-1RA) is a naturally occurring competitive inhibitor of IL-1a and IL-1b-induced pro-inflammatory activity. A defect in the IL-1RA gene can contribute to a more prolonged and severe inflammatory response and has been associated with increased risk for chronic inflammatory conditions like atherosclerosis, osteoporosis, rheumatoid arthritis, lupus, colitis, and Crohn's disease. However, the IL-1RA SNP also confers benefit when fighting infections or cancer through amplified immune vigilance.

MINIMIZING RISKS: Eat a diet rich in anti-oxidants (colorful fruits and vegetables). Increase consumption of cold-water fish, like salmon, and reduce intake of vegetable oil and fatty meat.

Fish oil supplementation, silymarin (milk thistle) directly inhibit IL-1 production. Niacinamide and other anti-inflammatory botanicals like boswellia (frankincense), glycyrrhiza (licorice), and curcumin (turmeric) may mediate the pro-inflammatory effects of increased IL-1. Compounds in cannabis have also been shown to suppress IL-1 levels.

Corticosteroids and cyclosporin A inhibit IL-1 production but with significant immune suppression and numerous other side-

"I like to think I am pretty smart, but I am confused by this report"

-HHMxxxxxxSG, patient is a biostatistician and smoker, said after we told him to quit smoking.....

Summary

Macular degeneration

You: 3.4%
Avg: 3.1%

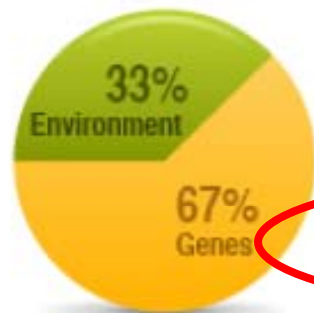

Your genetic markers

Gene or location	Risk marker	Your markers	Odds ratio	Source
LOC387715-S69A ¹	T	G G	1.0	American Journal of Human Genetics, 2005 ⁴
CFH-intron ²	A	A A	9.99	Nature Genetics, 2007 ²
CFB ³	T	T T	6.98	Nature Genetics, 2006 ⁶

Gene or location: The place we looked on your genome.

Courtesy of Steven Murphy, MD

"Wow! My report said I was at low risk"
-HHxxxxxxES after reviewing her family history

Summary

Colon cancer

You: 4.3%
Avg: 5%

Causes: colon cancer

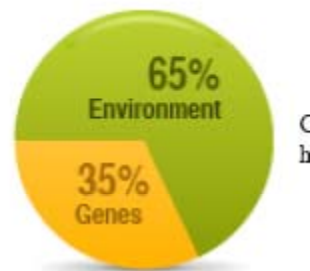

Your genetic markers

Gene or location	Risk marker	Your markers	Odds ratio	Source
8q24_R3 ¹	G	G T	1.04	Nature Genetics, 2007 ³
SMAD7 ²	A	G G	1.0	Nature Genetics, 2007 ⁴

Gene or location: The place we looked on your genome.

Your estimated risk

We took the average risk for women and used your genetic markers to estimate your lifetime risk for colon cancer: 4.3 percent, or 43 out of 1,000.

Courtesy of Steven Murphy, MD

might be considered.

Colon cancer: Pending evaluation and a detailed family history, it may be appropriate to consider early colon screening. Also note, our panel does not cover certain important monogenic familial colon cancer syndromes such as HNPCC or FAP. We tell our members that they may be at greater risk than we have reported and should consult a Genetic Counselor if they answer "yes" to any of these questions:

- Have you or anyone in your family had colon cancer before the age of 50, or multiple colon polyps?
- Have two or more close relatives on the same side of your family (maternal or paternal) had colon, uterine or ovarian cancer, or has one relative had more than one of these cancers?
- Do you have Ashkenazi (Eastern European) Jewish ancestry and at least one family member with colon cancer at any age?
- Do you have any relatives with an identified genetic mutation that increases their risk for cancer?

•Have you or anyone in your family had colon cancer before the age of 50, or multiple colon polyps?

•Have two or more close relatives on the same side of your family (maternal or paternal) had colon, uterine or ovarian cancer, or has one relative had more than one of these cancers?

•Do you have Ashkenazi (Eastern European) Jewish ancestry and at least one family member with colon cancer at any age?

•Do you have any relatives with an identified genetic mutation that increases their risk for cancer?

Courtesy of Steven Murphy, MD

Brother with Colon Cancer at 54,
Uncle with Sebaceomas died of a
heart attack at 50, Father who
died at 45 in a car crash.

MSH2 mutation carrier

Courtesy of Steven Murphy, MD

A 50 year old woman with an FGFR2 mutation comes for counseling....

Any Clinical Role For Breast SNPs?

THE NEW ENGLAND JOURNAL of MEDICINE

SPECIAL ARTICLE

Polygenes, Risk Prediction, and Targeted Prevention of Breast Cancer

Paul D.P. Pharoah, Ph.D., Antonis C. Antoniou, Ph.D., Douglas F. Easton, Ph.D., and Bruce A.J. Ponder, F.R.S.

BRIEF COMMUNICATION

Discriminatory Accuracy From Single-Nucleotide Polymorphisms in Models to Predict Breast Cancer Risk

Mitchell H. Gail

J Natl Cancer Inst 2008;100:1037-1041

One purpose for seeking comm

them to improve models for projecting individualized disease risk. Two genome

- MRI screening recommended in those with at hi risk (8% risk ages 40-50)
- With 7 loci, **none hi risk**, another 7 loci, 3.5% population mod risk, **none hi risk**
- All possible loci: 2% population at hi risk
- With 7 loci , or 14 loci **less discriminatory accuracy** than clinical model (Gail2)
- Add 7 SNPs increase AUC by only 0.025

ARMD / adapted from David Ewing Duncan, 2008 <http://oba.od.nih.gov/oba/SACGHS/meetings/july2008/Duncan.pdf>

ARMD / adapted from David Ewing Duncan, 2008
<http://oba.od.nih.gov/oba/SACGHS/meetings/july2008/Duncan.pdf>

Trait	Gene	Marker	Risk	Source	Life Risk DED Ave
A	<i>PLEKHA1/ ARMS2</i>	rs932275	0.68	deCODEme	1.1%
R	<i>CFH</i>	rs1329428	0.20	deCODEme	8.0%
M	<i>CFH</i>	rs10737680	1.0	Navigenics	0.36% / 3.1%
D	<i>CFH</i>	rs1061147	0.34	23andMe	1.2%
	<i>CFB</i>	rs541862	6.98	Navigenics	?
	<i>LOC387715</i>	rs10490924	1.0	Navigenics	?
	<i>LOC387715</i>	rs3750847	0.46	23andMe	0.19%

...ues/2008/nov-dec/cover-story-keeping-score-of-your-sequence.html?terms=davies

Google

Rival genetic tests leave buy... Bio-IT World

Bio-IT World.com
Indispensable Technologies Driving Discovery, Development, and Clinical Trials

Cambridge Healthtech Ins
CHI Home | Conferences | Reports

Drug Discovery | eClinical Trials | IT & Informatics | eNewsletters | Resource Center | Advertise

Search

November 26, 2008 | Bio-IT World > Keeping Score of Your Sequence

Podcasts
Webcasts
Life Science Jobs
White Papers & Special Reports
Reader Polls
RSS Feeds
Subscribe
About Us

Keeping Score of Your Sequence

Twelve months after the debut of the first personal genomics services, Kevin Davies expectorates and explores the pros, cons and controversies of "23 et al."

By Kevin **Davies**

Nov. 12, 2008 | One year ago, Iceland's deCODE Genetics kicked off a new era in personalized genetics with the launch of a direct-to-consumer service dubbed deCODEme. A few days later, California's 23andMe debuted its own service with the slogan: "Genetics just got personal. Don't worry. We're here to help."

For less than \$1000, deCODE and 23andMe offered customers the exciting opportunity to gander their unique genetic quirks and glitches, as revealed by the identities of more than 500,000 DNA markers (single nucleotide polymorphisms, or SNPs). Such services would have been unthinkable just two years ago, before the explosion of genome-wide association studies (GWAS) began pinpointing susceptibility genes for common, complex diseases such as cancer, heart disease, diabetes, and mental illness.

Some of the attraction of these web-based services is undoubtedly recreational—what's my haplogr... Do I have fast-twitch muscles? Am I a fast or slow caffeine metabolizer? Some people may be curious...

Learn how to recession-proof your business



The Freedom
to Experiment.



...hat
offer aggregate likelihood risks were in close agreement, but there were some intriguing disagreements. These could arise for a number of reasons, including different platforms and SNPs), statistical programs and criteria. For example:

- 23andMe reports a 50% increased risk for age-related macular degeneration based on three SNPs, but Navigenics and deCODEme indicate a lower than average risk.
- Navigenics reports a reduced risk of rheumatoid arthritis, contrary to deCODE and 23andMe.
- There is a wide discrepancy between the reported lifetime risks of abdominal aneurysm between deCODEme (17%) and Navigenics (3.1%).

...e publicity surrounding character traits earned 23andMe a "fri... and Wojcicki reject. "We really applaud the fact that people are her than just their health," says Avey. "The ancestry work we d

September 2008, 23andMe slashed the price of its service from \$999 to a mere \$399, using a second-generation Illumina

News Site of the Year | The 2008 Newspaper Awards

TIMES ONLINE



“There's a play' is bar dangerous

NEWS COMMENT BUSINESS MONEY SPORT LIFE & STYLE TRAVEL DRIVING ARTS & ENTS

UK NEWS WORLD NEWS POLITICS ENVIRONMENT WEATHER TECH & WEB VIDEO PHOTO GALLERIES TOPICS M

Where am I? > Home > News > UK News > Science News

From The Sunday Times

MY PROFILE | SHOP

September 7, 2008

MOST READ MOST COMME

Rival genetic tests leave buyers confused

Firms that offer to predict your risk of disease give worryingly varied results

- TODAY
- > Foreigners targeted in co-
 - > Europe's 20 best Christm
 - > Nicole Kidman drifts abou
 - > Pirate 'mothership' was re

Nic Fleming

TIMES RECOMMENDS

Leading genetic testing companies are providing clients with widely divergent and inaccurate predictions of their chances of developing serious diseases. That is the finding from tests conducted by different firms on the same person.

- > Spike Milligan has the last laugh
- > Pubs told to bring an end to happy hours
- > Pianist's bequeathed skull stars in Hamlet

Using my own DNA, I approached three firms who between them provide the majority of genetic tests for common diseases in the UK. They gave contradictory assessments of the risk I faced of developing illnesses, including Alzheimer's and glaucoma, and a confused verdict on my risk of suffering heart problems.

PARENT POWER

The findings reveal that those paying up to £825 for the tests may be receiving either misleading assurances that they face low health risks or are being caused needless anxiety by warnings of high risks.



Lord Taverne, a member of a Lords select committee investigating genetic testing, said: "This investigation confirms that some of

DELTA

BOOK AT D

Barriers to Translation to Practice

- Underlying clinical research questions
 - Genetic heterogeneity
 - Variable penetrance;
 - Epistasis
 - Population heterogeneity
 - poor models
- Clinical Misinterpretation, Error and Injury
- Risk of Loss of Trust, Added Expense

Solutions?

The majority of familial risk for breast cancer is not yet accounted for

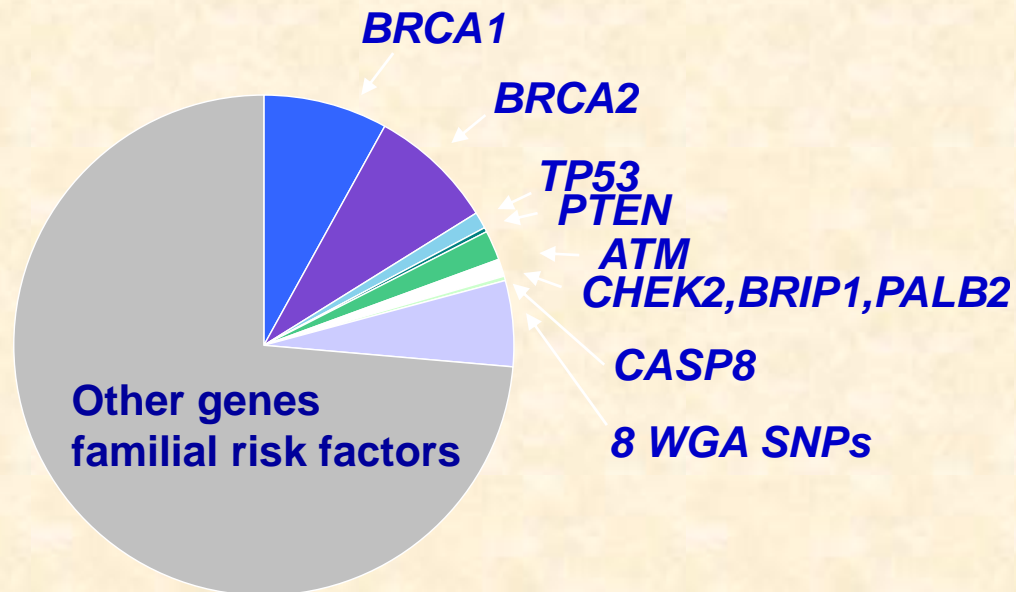

Doug Easton

Common and rare variants in multifactorial susceptibility to common diseases

Walter Bodmer & Carolina Bonilla

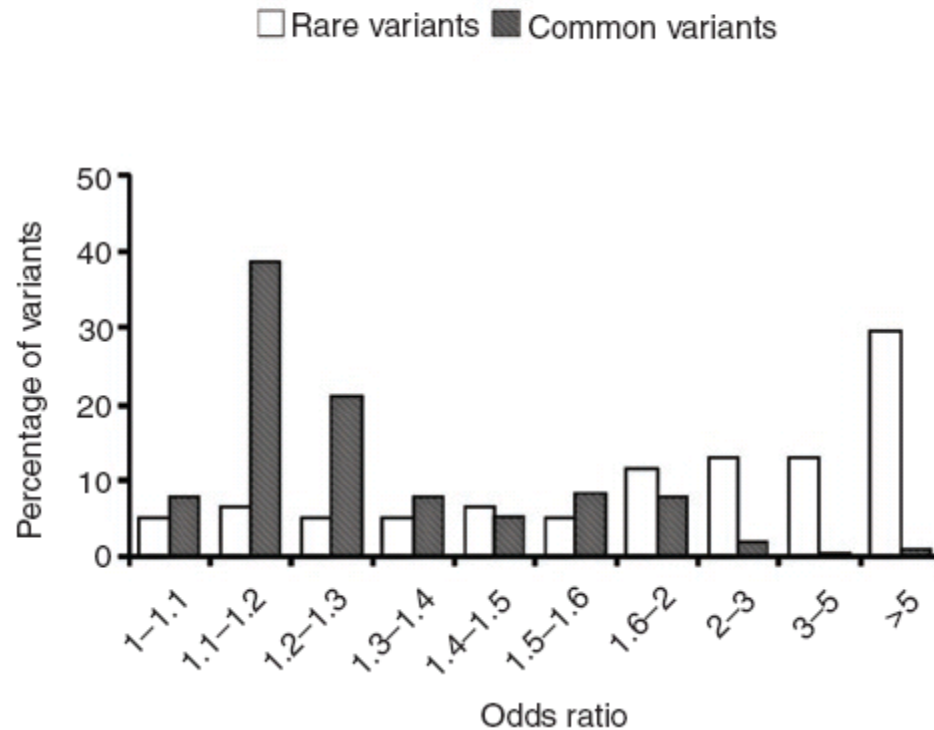
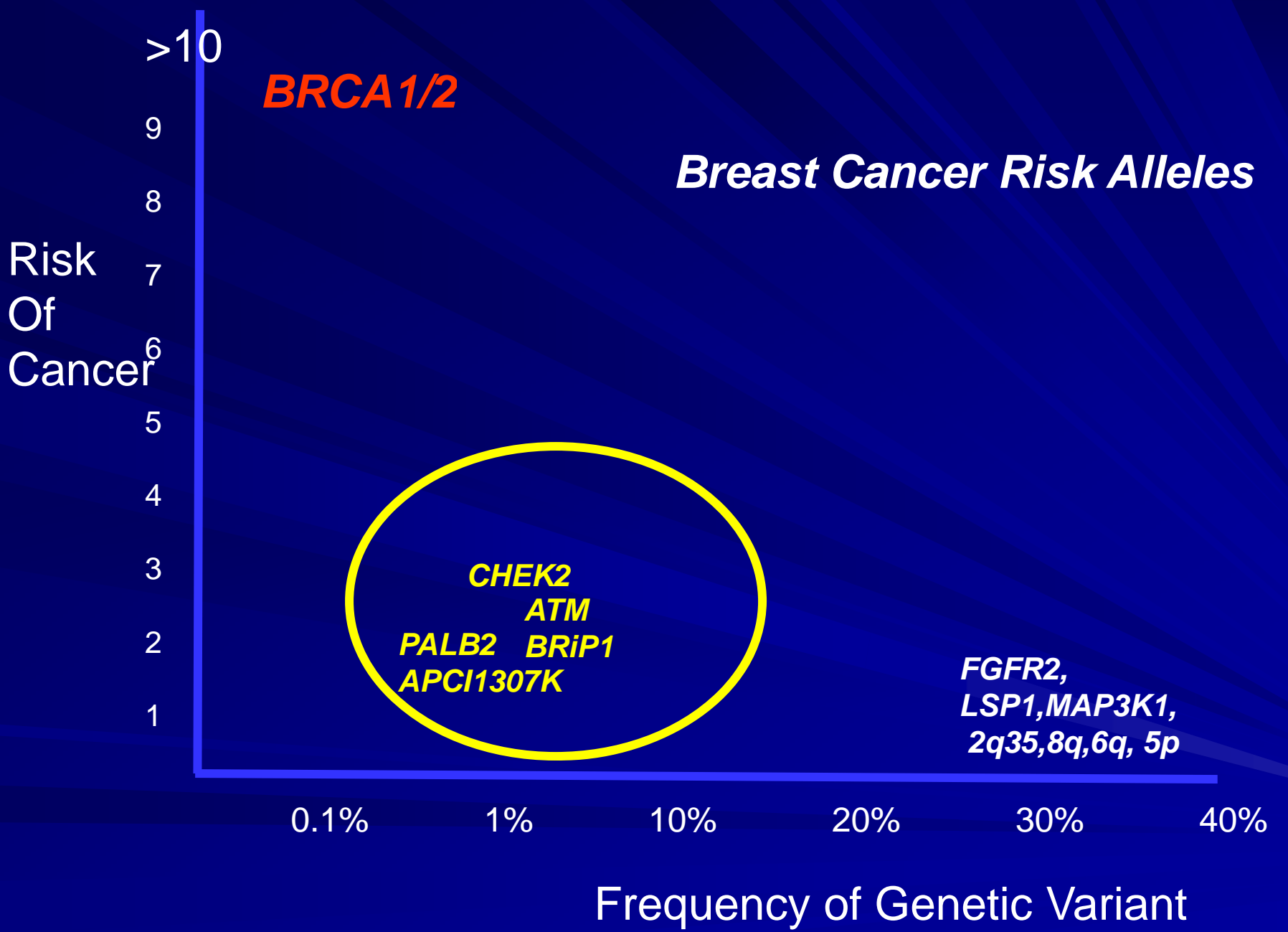
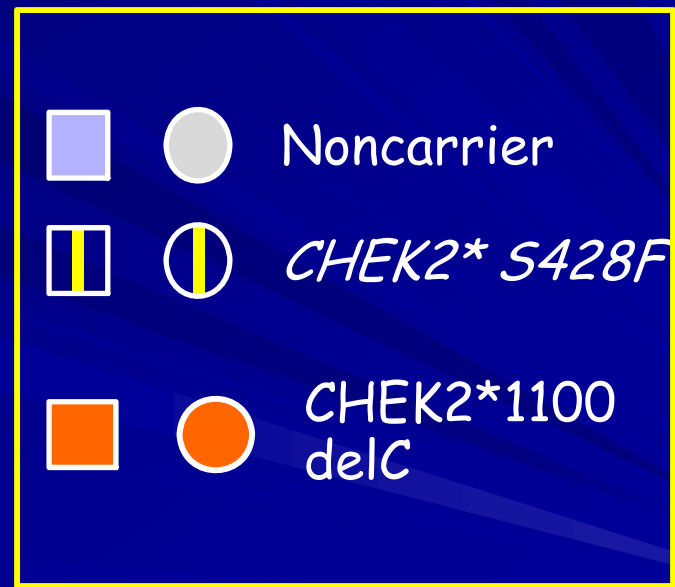
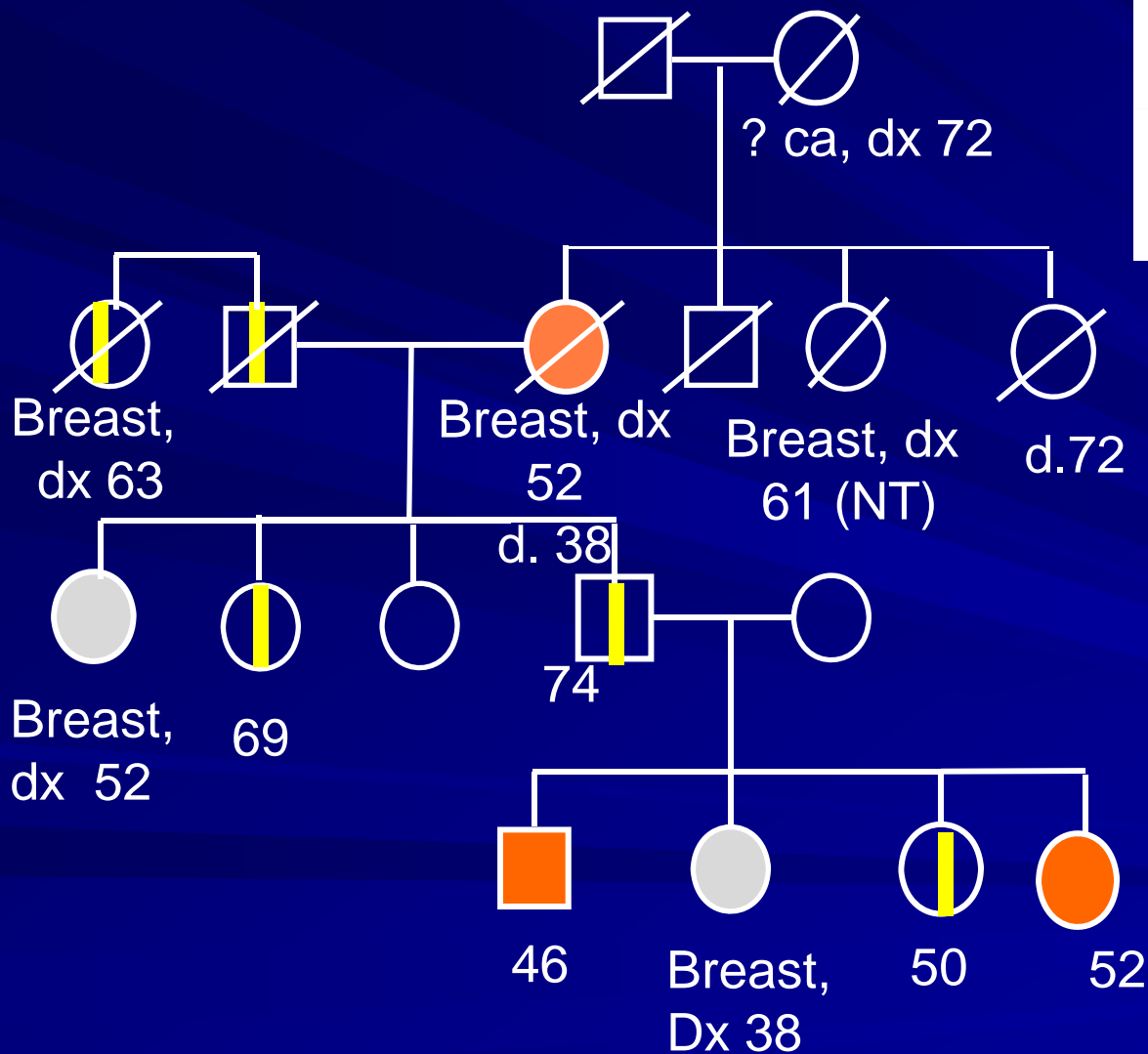

Figure 2 Distribution of odds ratios for common and rare variants. Odds ratios were obtained from the literature (**Supplementary Note**). We included 61 rare variants and 217 common variants in this analysis.

Breast Cancer Risk Alleles



The Hazards of Using Low-Penetrance Variants



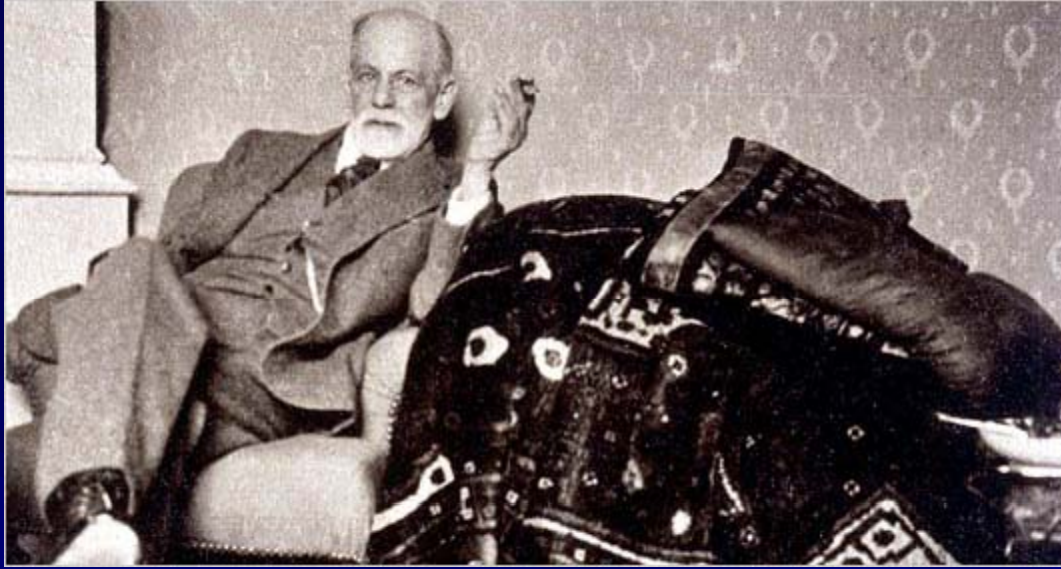

The absence of the regulating effect
offered by the payment of a fee...
makes itself very painfully felt...the
patient s deprived of a strong motive...

*Freud "On Beginning the Treatment"
1913*

Barriers to Translation to Practice

- Underlying clinical research questions
 - Genetic heterogeneity
 - Variable penetrance;
 - Epistasis
 - Population heterogeneity
 - poor models
- Clinical Misinterpretation, Error and Injury
- Risk of Loss of Trust, Added Expense

Solutions?

The science behind
the Navigenics Health Compass service

INTRODUCTION

All human disease has a genetic component. The Human Genome Project has provided us the three billion-letter genetic code which harbors instructions as to how we will grow and develop, as well as what diseases we are predisposed to. Case-control whole genome association studies have identified alleles at single nucleotide polymorphisms (SNPs) that are enriched in common and complex human disorders and have identified regions of the genome that predispose to disease. The studies have

The Models

- Average population risk (SEER for cancer, ?? other acute or chronic diseases)
- Adjust risk up or down depending on the individual's constellation of risk factors
- Need relative risks, can use large, well designed case-control study, assume risk factors act multiplicatively (i.e. independently)
- Mathematical energy spent converting OR to RR unnecessary
- Distinguish controls who will get the disease from those who won't? All controls at risk of the disease; appropriate incidence density sampling takes all this into account.
- Real validity threats:
 - underlying population average risks difficult to ascertain (except for cancer)
 - quality aspects: (e.g. how the subjects were ascertained, how controls were selected, participation rates, publication bias etc. etc.) of any case-control data they might use.

Technical method for obtaining risk is less crucial than the analytic biases that may intrude due to selectivity of published studies, multiple comparisons, poor quality study design, etc.

Barriers to Translation to Practice

- Underlying clinical research questions
 - Genetic heterogeneity
 - Variable penetrance;
 - Epistasis
 - Population heterogeneity
 - poor models
- Clinical Misinterpretation, Error and Excess expense and Possible Injury
- Risk of Loss of Trust, Added Expense

Solutions?

Table 3 Type and frequency of laboratory errors

Test phase	Error	Percent of directors that reported detecting this type of error during the past two years	"Which was the most common type of error over the past 2 years?"
Pre-analytic errors	Referrer ordered incorrect test	74	27
	Referrer labeled specimen incorrectly	68	10
	Contamination before receipt by laboratory	19	4
	Transcription error at specimen receipt	32	2
	Sample switch at specimen receipt	16	2
	Error in written protocol	7	1
	Patient's transfusion not reported by referrer	13	0
Total pre-analytic			45
Analytic errors	Faulty reagent	52	13
	Equipment failure	52	11
	Human error in data analysis	44	3
	Contamination during specimen testing	18	2
	Sample switch during specimen testing	27	1
Total analytic			30
Post-analytic errors	Typographical error on test report	55	17
	Data transcription error	42	5
	Misinterpretation of data	19	1
	Wrong results reported to patient/provider	20	1
	Software error in data analysis	8	0
Total post-analytic			24
Other	Other	4	1

Analytic
Validity

190
Genetic
testing
labs
surveyed
in 2006

	23andMe					deCODEMe					Navi- xgenics					
	Odds	Gene	SNP	Geno- type	OR (Eur)	Odds	Gene	SNP	Geno- type	RR	Odds	Gene	SNP	Geno- type	OR	
Age-Related Macular Degen.	11.3/100	CFH	rs1061147	AC	0.97	6.4%	CFH	rs1329428	AG	0.63	3.0	LOC387715	rs10490924	TG	2.72	
	Vs 7/100	C2	rs547154	GG	1.07	Vs 8.0%	ARMS2	rs932275	AG	1.26	Vs 3.1%	CFH	rs10737680	CA	3.16	
		ARMS2	rs3750847	CT	1.63							CFB	rs541862	TT	6.98	
Prostate Cancer	25.9/100	8q24	rs1447295	CC	0.95	19.7%	MSMB	rs10993994	CC	0.83	28%	8q24	rs16901979	CA	1.79	
	Vs 17,8/100		rs6983267	GT	1.01	Vs 16%	POU5F1P1	rs6983267	GT	0.99	Vs 17%	8q24	rs4242384	AA	1	
			rs10505483	CT	1.48		TCF2	rs4430796	AG	0.99		8q24	rs6983267	GT	1.26	
		17q24	rs1859962	GG	1.2		8	rs10505483	AG-	1.59		17q24	rs17765344	AA	1.45	
		TCF2	rs4430796	AG	0.94		11	rs10896449	AG	0.98						
							8	rs1447295	CC	0.91						
							17	rs1859962	GG	1.21						
							2	rs2710646	CC	0.95						
						X	rs5945572	G	0.93							
Abdominal aneurysm	N/A		rs10757278	AG	Typical	22.3%	CDKN2A/B	rs10116277	TT	1.31	3.1%	9p21	rs1333049	CG	1.36	
						Vs 17%					Vs 3.1%					
Rheumatoid arthritis	5.4/100	HLA	rs6457617	TT	1.96	2.2%	HLADRB1	rs660895	GG	5.45	1.5%	MHC	rs6457617	TT	5.21	
	Vs 42/100	PADI4	rs11203366	AG	N/A	Vs 1.0%	IL2	rs6822844	GT	0.8	Vs 1.6%	PTPN22	rs6679677	CC	1	
		PTPN22	rs2476601	GG	0.79		PTPN22	rs2476601	GG	0.89		Chr 6	rs13207033	AA	1	
		MMEL1	rs3890745	CT	0.92		RA-6q23	rs2327832	AA	0.62		Chr 6	rs6920220	GG	1	
		6q23	rs2327832	AA	0.93			rs13192841	AA							
		TRAF1	rs3761847	AG	0.97		STAT4	rs7574865	GG	0.87						
						TRAF1-C5	rs3761847	AG	1.03							

Why the Difference in AMD risk in the various Labs?

- 1. Differences in SNPs genotyped, which is the baseline at which the calculations start; most important SNPs are on chr. 1, chr10, chr. 6, and chr. 19.
- 2. Differences in the choice of SNPs to analyze, which can be driven by
 - a. Decision to include or exclude a whole locus (such as complement B and ApoE in AMD, which DeCode ignores)
 - b. Decision of which SNP or SNPs should be use to tag a locus, as different studies report different SNPs and haplotypes all in LD with each other
 - c. patenting and licensing considerations??
- 3. Differences in the choice of odds ratio from the literature for a given tag SNP/haplotype, and how to convert the odds ratio into a relative risk versus the average person.

Why Different Results?

- Different SNPs/studies used
- Different methods for determining SNP risk
 - deCodeme: Relative Risk
 - 23andme and Navigenics: odds ratios
- Different methods for determining combined SNPs risk/lifetime risk
- Reliance on correlative SNPs

End Result: head scratching,
what does it mean?

David Ewing Duncan, testimony to SACGHTS 8/08

Direct to Consumer Marketing of Research Based Testing

■ Can lead to :

- Uninformed decisions
- Inconsistent informed consent, appropriate education, or support
- May not have appropriate result interpretation
- Negative test does not always mean patient will be cancer free

Examples of dilemmas caused by premature translation of preventive technologies in oncology

JAMA[®]
Online article and related content current as of December 16, 2008.

Computed Tomography Screening and Lung Cancer Outcomes
Peter B. Bach; James R. Jett; Ugo Pastorino; et al.
JAMA. 2007;297(9):953-961 (doi:10.1001/jama.297.9.953)
<http://jama.ama-assn.org/cgi/content/full/297/9/953>

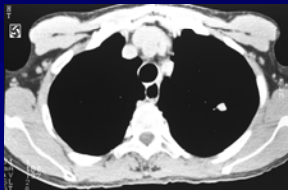

AACC Customer ID: [] LOGIN [] GO []
Email: [] Remember Me [] Quick Links []
Forgot your AACC Login? Sign up Now

About AACC | Members | Events | Government & Public Affairs | Resource Centers | Professor

Clinical Chemistry
Clinical Laboratory News
2008
December
November
October
September
August
July
June
May
April

AACC > Publications > Clinical Laboratory News > 2008 > December

December 2008 Clinical Laboratory News: LabCorp Cuts OvaSure Test

Clinical Laboratory News
THE AUTHORITATIVE SOURCE FOR THE CLINICAL LABORATORIAN

December 2008: Volume 34, Number 12

Lung cancer screening increased diagnoses and surgeries, but had no impact on mortality

Ovasure tested 6 proteins in blood (incl CA 125) to screen for ovarian cancer In Sept. 2008 warning letter, the FDA identified OvaSure as a device under section 201(h) of the Food, Drug, and Cosmetic Act intended for diagnosing or treating disease, and therefore requiring marketing clearance or approval from the agency. "Because you do not have marketing clearance or approval from the FDA, marketing OvaSure is in violation of the law."

Preimplantation Genetic Diagnosis for Cancer Syndromes A New Challenge for Preventive Medicine

Kenneth Offit, MD, MPH

Michal Sagi, PhD

Karan Hurlay, PhD

with their physicians and genetic counselors the option of genetic testing to guide reproductive choices.

Types of ART

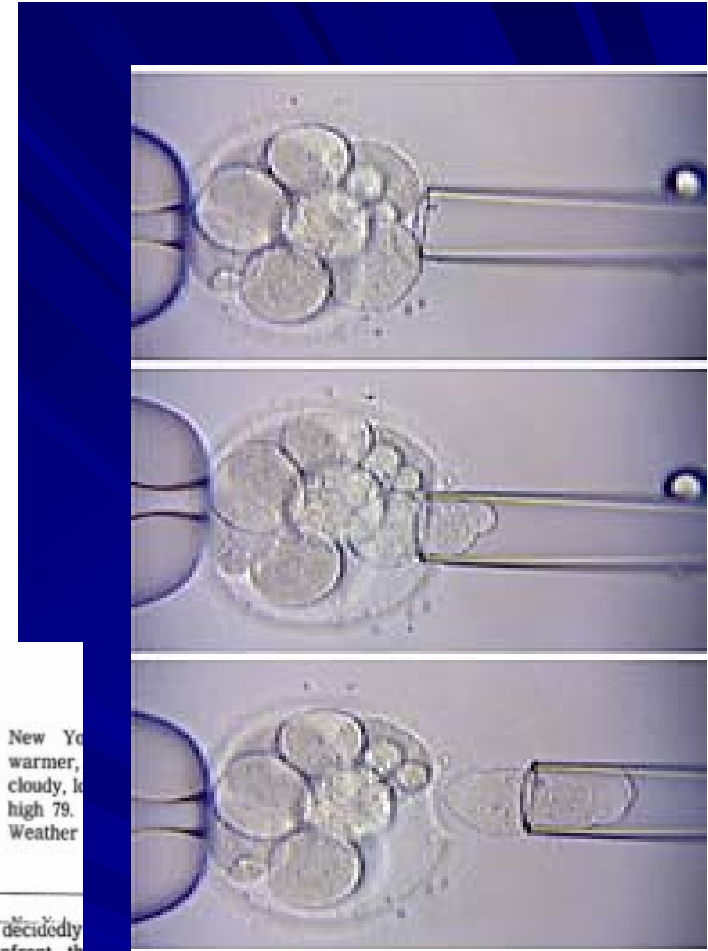

The New York Times

New York warmer, cloudy, high 79. Weather

© 2006 The New York Times

NEW YORK, SUNDAY, SEPTEMBER 3, 2006

Couples Cull Embryos to Halt Heritage of Cancer

By AMY HARMON

As Chad Kingsbury watches his daughter playing in the sandbox behind their suburban Chicago house, the thought that has flashed through his mind a million times in her two years of life comes again: Chloe will never be sick.

Not, at least, with the inherited form of colon cancer that has devastated his family, killing his mother, her father and her two brothers, and that he too may face because of a genetic mutation that makes him unusually susceptible.

THE DNA AGE

Choosing Genes

by the near certainty that diseases like cystic fibrosis and sickle cell anemia will afflict the children who carry the genetic mutation that causes them. The procedure has also been used to avoid passing on Huntington's disease, a severe neurological disease that typically does not surface until middle age but spares no one who carries the mutation that causes it.

Couples like the Kingsburys, by

relying largely on decidedly unscientific measures to confront the danger posed by explosives at airports, particularly at checkpoints. Members of Congress and domestic security officials have also faced opposition from search, turf fights, staff turf wars, underfinancing. Some airlines or been slowed by bureaucratic snarls. Among the delayed efforts are the following: The agency conducted a year that members of Congress a former Homeland Security department official called "disastrous" because the agency tested the smaller, cheaper screening device in the way it tended to be used.

Already, it is possible to test em-

relying largely on decidedly unscientific measures to confront the danger posed by explosives at airports, particularly at checkpoints.

Members of Congress and domestic security officials have also faced opposition from search, turf fights, staff turf wars, underfinancing. Some airlines or been slowed by bureaucratic snarls. Among the delayed efforts are the following:

The agency conducted a year that members of Congress a former Homeland Security department official called "disastrous" because the agency tested the smaller, cheaper screening device in the way it tended to be used.

After spending years as document scanner that w

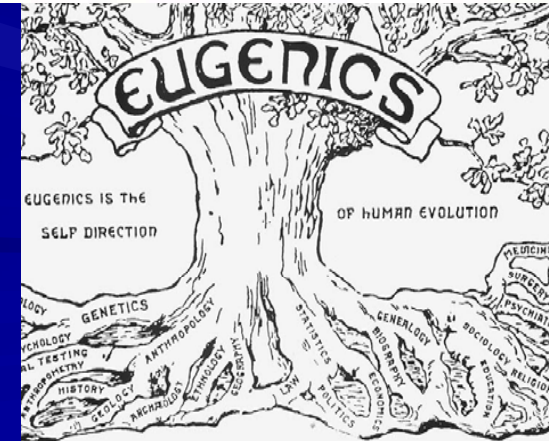

Karl
tical
Re
at
the
he
cials

COMMENTARY

Genomic Profiles for Disease Risk Predictive or Premature?

Kenneth Offit, MD, MPH

THERE HAS BEEN A RECENT EXPLOSION OF COMMERCIAL availability of genomic "tests" for diseases, conditions, traits, and ancestry. Dozens of companies

files seems to have escaped the careful vetting that accompanies the introduction of new biomedical technologies. Unlike the new harvest of genomic panels, *BRCA* testing and other cancer predisposition tests have been subject to a decade of prospective study and validation, physician education, and monitoring of laboratory quality by acc

How to do it better for our patients?

MediaDailyNews

Home > MediaDailyNews > Wednesday, Nov 5, 2008

Obama Expected To Regulate DTC Advertising

by Erik Sass, Tuesday, November 4, 2008, 11:47 PM

Article ▾ Comments ▾



As Democrats celebrated Barack Obama's victory on Tuesday, pharmaceutical companies, ad agencies and publishers braced for a possible series of new restrictions on direct-to-consumer pharmaceutical advertising after the president-elect takes office next year.

The industry has lobbied both parties intensively over the last few years, but the alignment of a left-leaning Democratic president with

TOOLS

- EMAIL
- PRINT
- REPLY
- SUBSCRIBE
- RSS
- SHARE ▾

RELATED ARTICLES

1. [Magna: Recession Can Be Catalyst For Growth](#)
2. [Grammarian Grumbles](#)
3. [Bottom Falls Out Of The Ad](#)

Seeking: the per
interactive medi



AUTHORS

» Wayne Friedman

Regulation of DTC Genomic Testing
is a vital first step but not enough...

The role of Prospective Registries/Cohorts

■ Then:

- Federally sponsored CFR's, CGN
- High penetrance; short f/u; endpoints

■ Now:

- Private public partnerships
- Large epidemiologic studies
- Low penetrance; behavioral/cost endpoints
- Appropriately powered design
- Independent scientific leadership
- Must involve/educate health care community!

SACGHS, April 2008

- Centers for Medicare & Medicaid Services: require proficiency testing (PT)
- FDA: address all laboratory tests, regardless of how they are produced
- HHS: fund a mandatory, publicly available, Web-based registry for lab tests.
- HHS: fund a public-private partnership to evaluate clinical utility of genetic tests
- HHS: education or training deficiencies; FDA: guidance on regulation of clinical decision support systems.

Primum non nocere

- “Outcomes of testing have not been studied. These tests may have no effect on health, or may have beneficial or harmful effects.”

JAMA, December 10, 2008—Vol 300, No. 22



With gratitude to colleagues at Memorial Sloan-Kettering Cancer Center, University of Cambridge, Broad Institute, the National Cancer Institute for helpful discussions; views expressed are my own and not those of any institution, or organization with whom I am affiliated including EGAPP (CDC), ASCO, and the Coriell Personalized Medicine Collaborative.