

RECEIVED

JUN 28 1996

OSTI

**Data Summary Report for M.W. Kellogg
Zinc Ferrite Test ZFMC-01
CRADA 92-008 Final Report**

(EG&G TSWV Report No. 33FF-R93-002)

**C. Elaine Everett
Steven J. Monaco**

May 1994

U.S. Department of Energy
Office of Fossil Energy
Morgantown Energy Technology Center
3610 Collins Ferry Road
Morgantown, WV 26505

and

EG&G Technical Services of West Virginia
990 Elmer Prince Drive
Morgantown, WV 26505-3276

MASTER

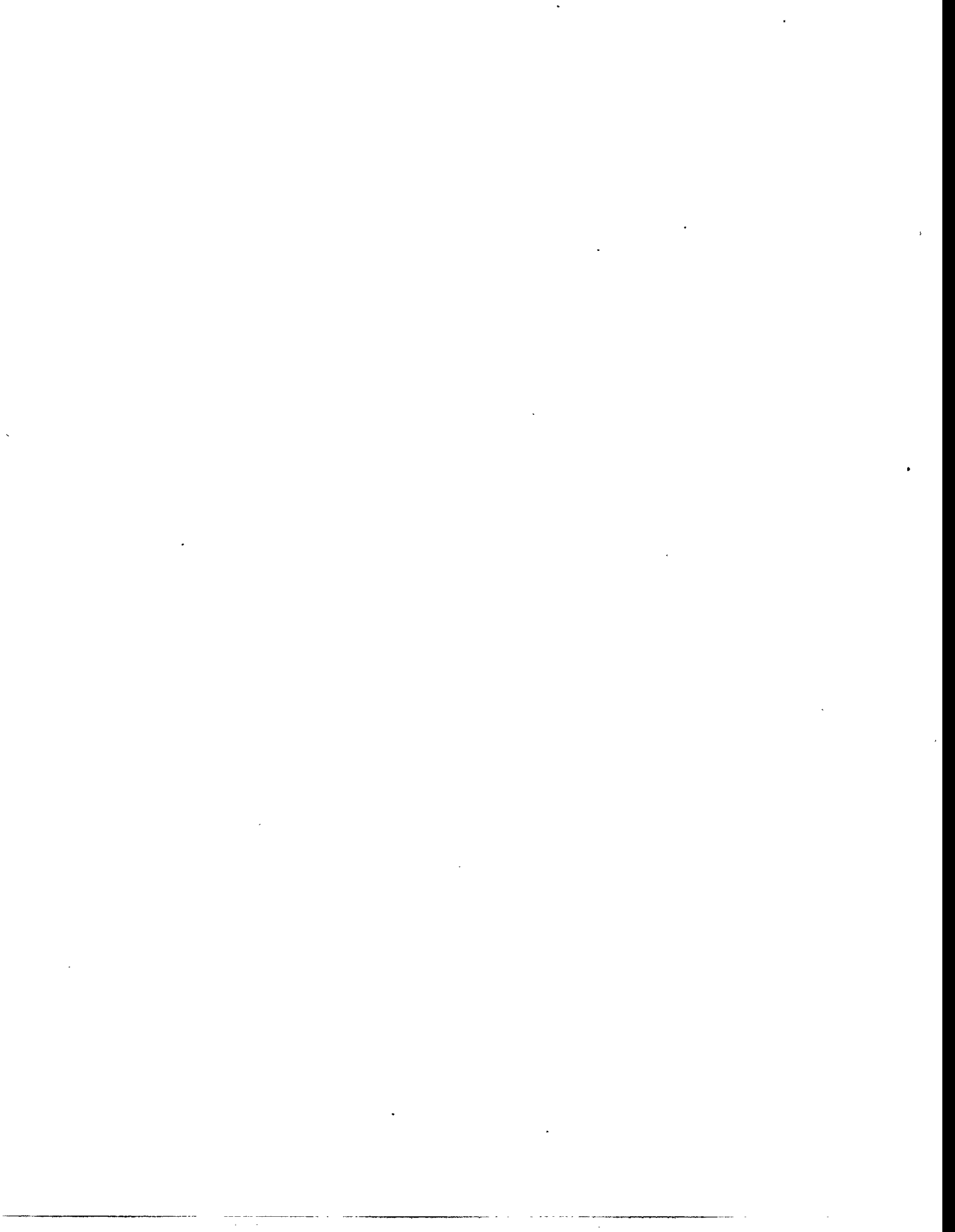

Data Summary Report
for M. W. Kellogg Zinc Ferrite Test Series

Report Number: 33FF-R93-002

DISCLAIMER

This report was prepared as an account of work sponsored by an agency of the United States Government. Neither the United States Government nor any agency thereof, nor any of their employees, makes any warranty, express or implied, or assumes any legal liability or responsibility for the accuracy, completeness, or usefulness of any information, apparatus, product, or process disclosed, or represents that its use would not infringe privately owned rights. Reference herein to any specific commercial product, process, or service by trade name, trademark, manufacturer, or otherwise does not necessarily constitute or imply its endorsement, recommendation, or favoring by the United States Government or any agency thereof. The views and opinions of authors expressed herein do not necessarily state or reflect those of the United States Government or any agency thereof.

NOTICE

This report was prepared to document work sponsored by the United States Government. Neither the United States nor its agent, the United States Department of Energy, nor any Federal employees, nor any of their contractors, subcontractors, or their employees makes any warranty, expressed or implied, or assumes any legal liability or responsibility for the accuracy, completeness, or the usefulness of any referenced information, apparatus, product or process disclosed, or represents that its use would not infringe privately-owned rights.

Reference to a company or product name does not imply approval or recommendation of the product by EG&G or the U. S. Department of Energy to the exclusion of others that may be suitable.

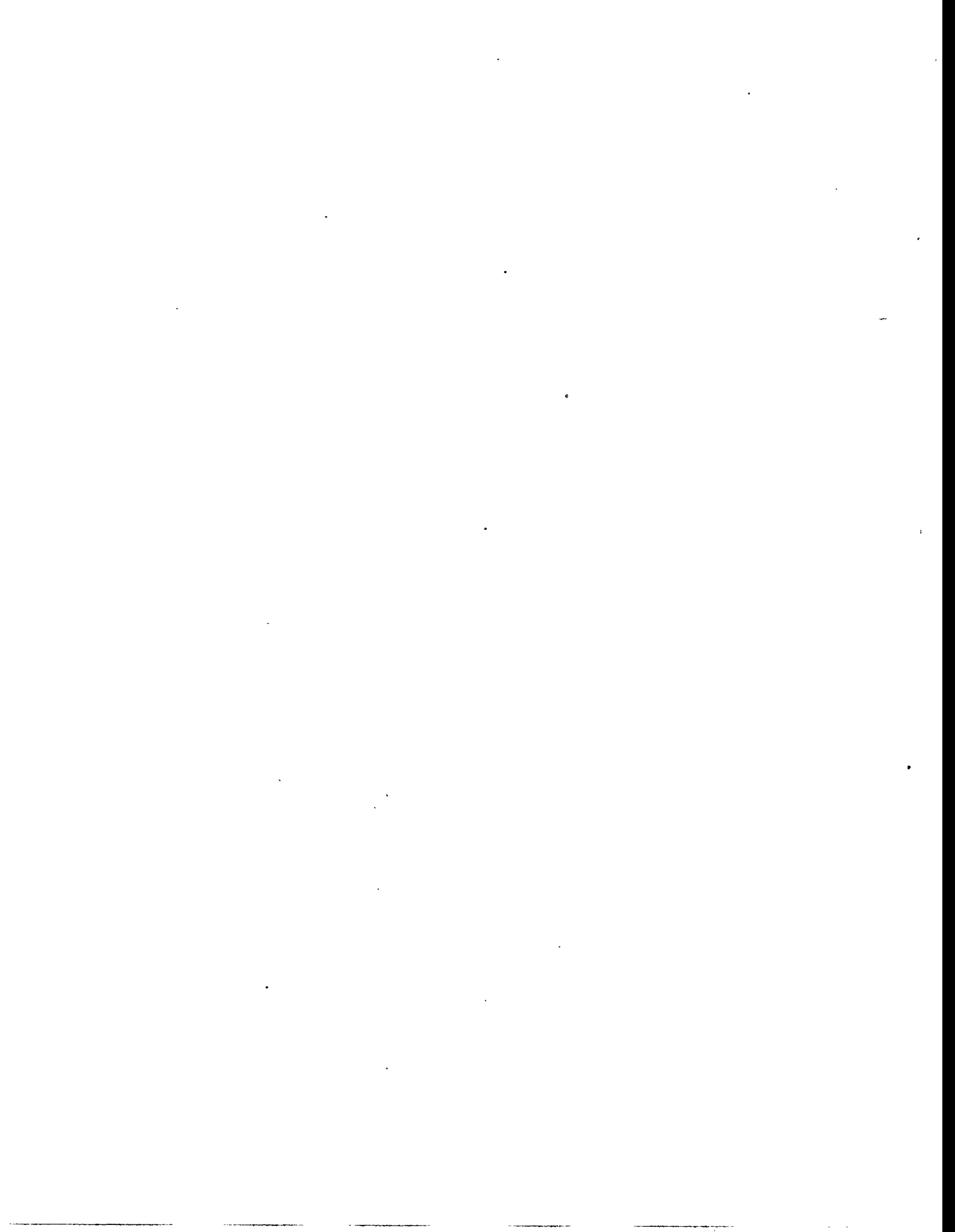

Table of Contents

Executive Summary	iii
1.0 Introduction	1
2.0 Test Plan Summary	5
3.0 Operations Summary	7
4.0 Test Data Summary	16
4.1 Gas Analysis	16
4.1.1 Gas Grab Analysis by Laboratory Gas Chromatograph	16
4.1.2 Detector Tube Analysis	21
4.1.3 Sulfur Species Trends	21
4.2 Condensate Analysis	38
4.3 Solid Analysis	41
4.3.1 Crush Strength	41
4.3.2 Sulfur Analysis	42
4.3.3 Bulk Elemental Analysis	42
4.3.4 Sieve Analysis	43
5.0 Results and Discussion	46
5.1 Sulfur Balance	46
5.2 Chloride Balance	49
5.3 Discussion of Results	52
APPENDIX A	
Data Acquisition Mass Flow Trends	A-1
APPENDIX B	
Data Acquisition Temperature Trends	B-1
APPENDIX C	
Data Acquisition Pressure Trends	C-1
APPENDIX D	
Data Acquisition Differential Pressure Trends	D-1
APPENDIX E	
Laboratory Gas Chromatograph Results	E-1
APPENDIX F	
Detector Tube Results	F-1

List of Figures

Figure 1:	Simplified Process Flow Diagram	3
Figure 2:	Reactor Schematic	4
Figure 3:	ZFMC-01 Sulfidations 1-8 Detector Tubes	54
Figure 4:	ZFMC-01 Sulfidations 1-8 Reactor Differential Pressure	55

List of Tables

Table 2.1:	Fresh Sorbent Characteristics	5
Table 2.2:	ZFMC-01 Nominal Test Conditions	6
Table 3.1:	Actual Test Period Parameters	8
Table 4.1:	Average Gas Compositions by GC Analysis	17
Table 4.2:	Condensate Analyses	39
Table 4.3:	Crush Strength Analysis	41
Table 4.4:	Sorbent Sulfur Loading	42
Table 4.5:	Sorbent Iron and Zinc Analysis	43
Table 4.6:	Sieve Analysis - Fresh T-2465 Zinc Ferrite	43
Table 4.7:	Sieve Analysis - Reactor Fines	44
Table 4.8:	Sieve Analysis - After 8th Reductive Regeneration	45
Table 5.1:	ZFMC-01 Sulfur Balance	47
Table 5.2:	ZFMC-01 Chloride Balance	50

Executive Summary

A series of tests were undertaken from August 6, 1992, through July 6, 1993, at METC's High Pressure Bench-Scale Hot Gas Desulfurization Unit to support a Cooperative Research and Development Agreement (CRADA) between METC's Sorbent Development Cluster and M. W. Kellogg. The M. W. Kellogg Company is currently developing a commercial offering of a hot gas clean-up system to be used in Integrated Gasification Combined Cycle (IGCC) systems. The intent of the CRADA agreement was to identify a suitable zinc-based sorbent for the Sierra Pacific Power Company Clean Coal Technology Project, to identify optimum operating conditions for the sorbent, and to estimate potential sorbent loss per year.

Task 1 of the CRADA agreement was to conduct fixed-bed zinc titanate sorbent testing. The results of Task 1 testing are presented in Topical Report Number 33FF-R93-001, entitled "Data Summary Report for M. W. Kellogg Zinc Titanate Test Series: ZTSC-01, ZTSC-02, ZTSC-03, ZTSC-04, ZTSC-05, ZTSC-06, ZTSC-07, ZTSC-08, ZTMC-01, ZTMC-02, ZTMC-03, ZTMC-04", by C. Elaine Everitt and Steven J. Monaco of EG&G Technical Services of West Virginia. A comprehensive summary of the detailed chemical and physical analysis of samples of the fresh and reacted zinc titanate sorbent are presented in the report entitled "Characterization of Molybdenum-Containing Zinc Titanate after Sulfidation and Regeneration", by Ranjani V. Siriwardane, James A. Poston, and Grover Evans of the U. S. Department of Energy/Morgantown Energy Technology Center, and C. Elaine Everitt of EG&G Technical Services of West Virginia.

Task 2 of the CRADA was to conduct fixed-bed zinc ferrite sorbent testing. The results of Task 2 are given in this report.

Task 3 of the CRADA was to conduct fixed-bed testing using Phillips Petroleum's Z-Sorb III sorbent. The results of Task 3 are presented in the Topical Report Number 33FF-R93-003, entitled "Data Summary Report for M. W. Kellogg Z-Sorb Tests (Z-Sorb-01, Z-Sorb-02, Z-Sorb-03)", by C. Elaine Everitt and Steven J. Monaco of EG&G Technical Services of West Virginia.

United Catalysts, Inc. T-2465 zinc ferrite sorbent was selected for this test. The sorbent is 98 weight percent zinc ferrite (50 mole % iron oxide, 50 mole % zinc oxide) with 2 weight percent bentonite as a binder. T-2465 is in the form of 3/16" extrudates. An eight sulfidation-oxidative regeneration-reductive regeneration cycle test was performed. A reactor temperature of 538 °C (1000 °F) and a linear velocity of 30.48 cm/s (1.0 ft/s) at 1030 kPa (150 psia) were utilized for the sulfidations. 15 ppmv HCl was present in the inlet gas stream. A five stage oxidative regeneration scheme was used in oxidative regenerations 1-3, where the reactor temperature was ramped from

538 °C (1000 °F) to 704 °C (1300 °F) simultaneously as the inlet oxygen concentration was ramped from 0.5 mole % to 21 mole %. Only the 579 °C (1075 °F), 2.5% O₂ and 704 °C (1300 °F), 21% O₂ stages were performed in cycles 4-8. The oxidative regenerations were performed at 172 kPa (25 psia). The reductive regeneration phases were conducted using a reactor temperature of 538 °C (1000 °F), a linear velocity of 30.48 cm/s (1.0 ft/s), and a system pressure of 1030 kPa (150 psia).

Some signs of sorbent decrepitation were seen when samples were taken after the 4th sulfidation. The sorbent was returned to the reactor and testing continued. The sorbent was removed from the reactor after the 6th sulfidation because of high differential pressure readings during the 5th and 6th sulfidations. Fines were screened from the sorbent and the remainder was returned to the reactor for the final 2 ½ cycles.

In terms of reactivity and sulfur capacity, the zinc ferrite formulation tested performed quite well under the test conditions. The major problem found was a decline in the physical integrity of the sorbent. This was indicated by the differential pressure increases during testing, and was confirmed by the results of crush strength tests and sieve analysis of the sorbent.

1.0 Introduction

This report summarizes the data gathered for the zinc ferrite test ZFMC-01 which was conducted at the Morgantown Energy Technology Center's (METC) High Pressure Bench-Scale Hot Gas Desulfurization Unit between December 7, 1992 and January 8, 1993. This test was conducted as part of a cooperative research and development agreement (CRADA) between METC and the M. W. Kellogg Company. M. W. Kellogg is involved in the design of a hot gas cleanup train for the integrated gasification combined-cycle (IGCC) clean coal project being developed by Sierra Pacific Power Company. In the conceptual stages of the design, a fixed bed operation was envisioned for the hot gas desulfurization system. As such, it was desired by METC and Kellogg to generate experimental data from a bench-scale fixed bed reactor for zinc-based desulfurization sorbents. Because of the relatively large steam requirement of the zinc ferrite sorbent system, and the expected better durability of zinc titanate, Kellogg considered zinc titanate as a possible alternative to zinc ferrite. However, the experimental data necessary for direct comparison and selection between the two sorbents had not been generated. Thus, the CRADA agreement was established to generate that data. After finding problems with sorbent decrepitation in the initial zinc titanate testing (see report number 33FF-R93-001, Data Summary Report for M.W. Kellogg Zinc Titanate Test Series), it was decided to test a zinc ferrite formulation as well for comparison.

Testing was conducted at METC's High Pressure Bench-Scale Hot Gas Desulfurization Unit. Three operating test phases (sulfidation, oxidative regeneration, and reductive regeneration) were carried out during the testing of the zinc ferrite sorbent. During the sulfidation of the sorbent, hydrogen sulfide was absorbed from the simulated coal gas stream. The oxidative regeneration of the sulfided sorbent was achieved by passing an oxidizing gas, air diluted with nitrogen and/or steam, over the sulfided sorbent bed. Reductive regenerations utilized a diluted (with nitrogen) simulated coal gas stream without any sulfur species present.

A simplified processes flow diagram of the high pressure reactor is shown in Figure 1. The reactor was constructed of a 3-inch diameter by five feet long Incoloy 800 H alloy steel shell. Inside the 3-inch shell was a removable, 2-inch diameter by 30-inch long 316 stainless steel cage for easy loading and unloading of the sorbent. The sorbent cage was suspended from the top flange of the Incoloy 800 H reactor shell. A gas distributor was fixed at the bottom of the cage to support the sorbent. The inside of the sorbent cage was Alon-processed to prevent corrosion of stainless steel by sulfur gases in the presence of steam. The reactor was housed inside a three-zone furnace equipped with separate temperature controllers for each zone. The high pressure HGD reactor system used bottled gases, house

air, and nitrogen and distilled water to make up the simulated coal gas. Oxidizing and reducing gas feed systems were separated and have multiple shut-off valves and in-line check valves to prevent inadvertent mixing. The delivery pressures to the system for inlet gas components, excluding water, were controlled with pressure regulators, and metered to the desired flow rate using a set of mass flow controllers. Water to the system was supplied by an Isco, Inc. dual syringe pump system. The process water was preheated using a small boiler and then fed to the process gas preheater along with the other gases. If hydrogen sulfide was being used, it was added to the bulk gas stream after the preheater to avoid added corrosion to the preheater. The heated gas stream, for the zinc ferrite test program, entered the top of the reactor vessel and flowed down through the sorbent bed and exited from the bottom of the reactor vessel. Condensate was collected in a two-level knock out pot system. The pots were set up such that the second pot could be depressurized independent of the first pot to allow for safe dumping of the condensate. Following the knock out pots, a filter was located in the line to capture any entrained moisture prior to exit flow meters and pressure reduction valves. The exit gas was passed through a final fixed bed absorber of zinc oxide to remove any hydrogen sulfide remaining in the exit gas before being vented to the atmosphere.

To determine the performance of the sorbent under specific test conditions, small slip streams of the inlet and exit gases were sampled in a vented sampling chamber with portions being fed to an on-line mass spectrometer. In addition, the outlet H_2S and SO_2 concentrations were also monitored using detector tubes during sulfidation and regeneration respectively.

High Pressure Bench-Scale Hot Gas Desulfurization Unit Simplified Process Flow Diagram

Figure 1

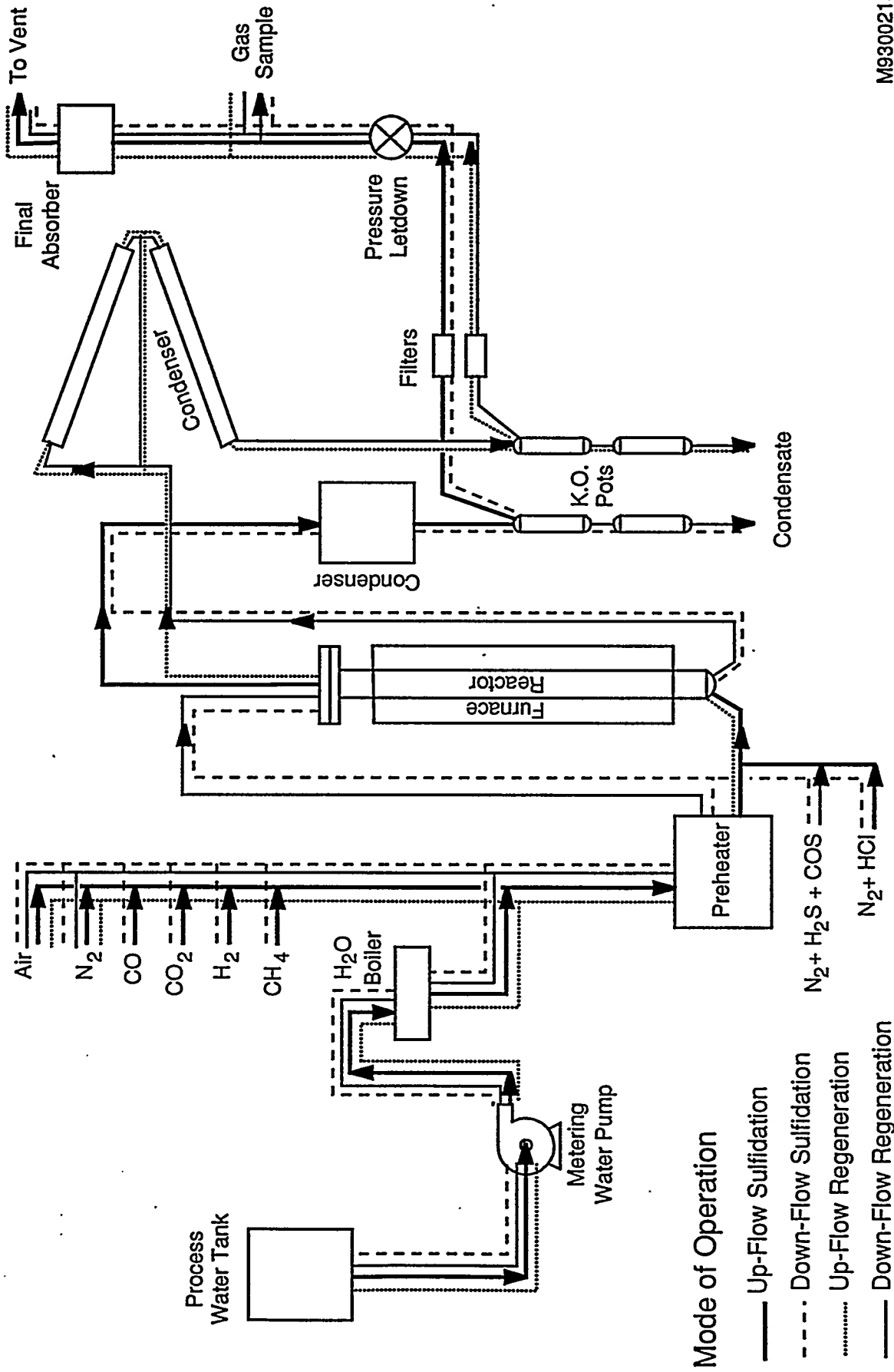
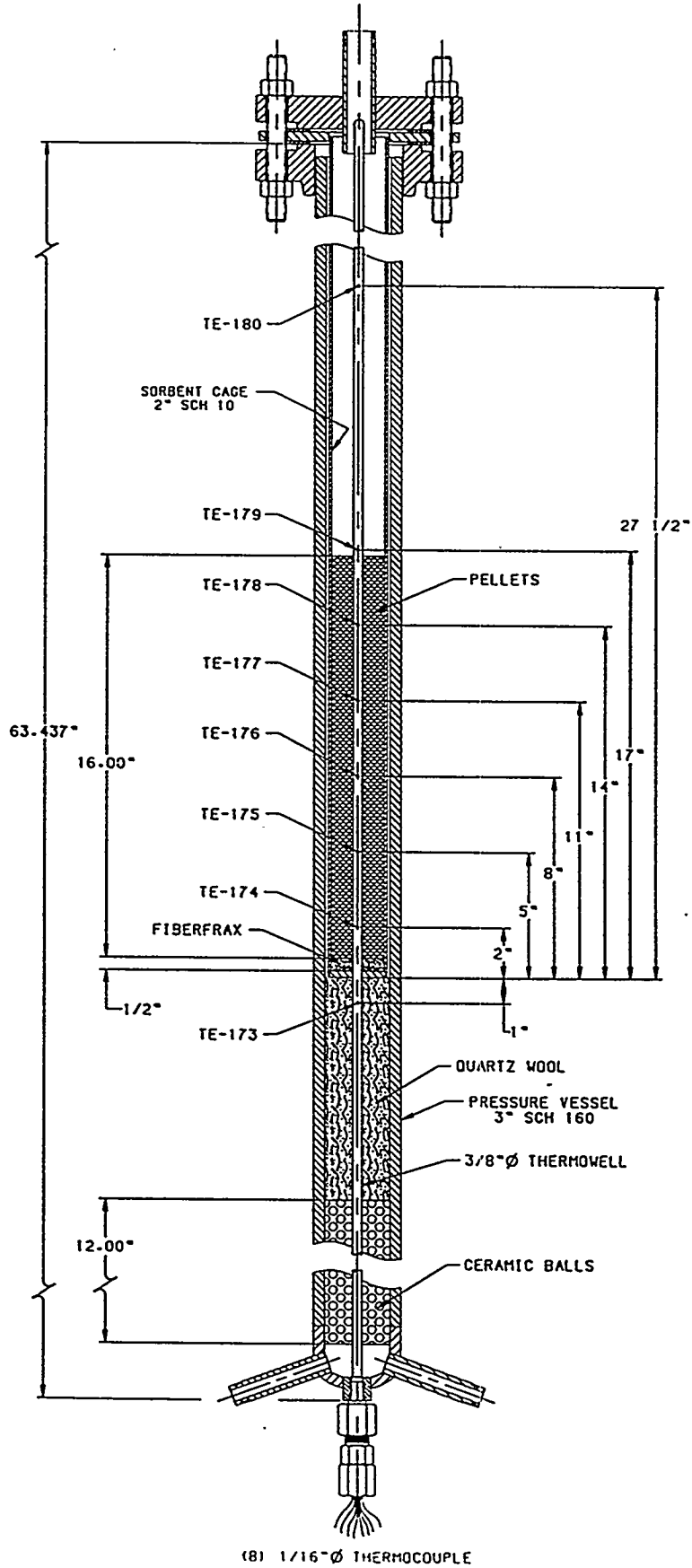

Figure 2: Reactor Schematic



2.0 Test Plan Summary

The objective of the zinc ferrite test series was to evaluate the sorbent's durability, reactivity, and sulfur capacity at the selected temperature and flow conditions over multiple sulfidation-regeneration cycles. The zinc ferrite sorbent was manufactured by United Catalysts, Inc. Sorbent characteristics of the fresh sorbent are detailed in Table 2.1.

Table 2.1: Fresh Sorbent Characteristics

United Catalysts, Inc. T-2465 Zinc Ferrite	
Zinc Oxide:Iron Oxide molar ratio	1:1
Bentonite, Wt %	2 %
Bulk Density, g/cc	1.34 (83.6 lb/ft ³)
BET Surface Area, m ² /g	3.7
Specific Pore Volume, cc/g	0.27
Crush Strength, N/mm	15.8 (3.55 lb _f /mm)

Planned test conditions are presented in Table 2.2. The nomenclature used for numbering test phases is the test number followed by an "S" (Sulfidation), "R" (Oxidative Regeneration), or "RR" (Reductive Regeneration) to indicate the appropriate test phase. This is followed by a number (i.e, 1,2,3, etc.) to indicate the cycle number. The test number, ZFMC, represents "Zinc Ferrite Multi-Cycle".

Table 2.2: ZFMC-01 Nominal Test Conditions

Test No.	Pressure (kPa)	Temperature (°C)	Gas Velocity			Gas Composition (Volume %)								
			(cm/s)	(sL/h)*	(l/h)	O ₂	H ₂ O	CO	CO ₂	H ₂	N ₂	ppm H ₂ S	ppm COS	ppm HCl
ZFMC-01-S1 through S8	1030	538	30.48	9290	10000.2	0	30	16.2	5.4	11.5	36.8	800	0	15
ZFMC-01-R1 through R8														
Stage 1	170.3	538	30.48	1529	1646.4	0.5	0	0	0	0	99.5	0	0	0
Stage 2	170.3	579	30.48	1455	1566.0	2.5	0	0	0	0	97.5	0	0	0
Stage 3	170.3	621	30.48	1387	1493.0	4.0	0	0	0	0	96.0	0	0	0
Stage 4	170.3	663	30.48	1325	1426.5	7.0	0	0	0	0	93.0	0	0	0
Stage 5	170.3	704	30.48	1269	1365.7	21.0	0	0	0	0	0	0	0	0
ZFMC-01-RR1 through RR8	1030	538	30.48	9290	10000.2	0	7.5	4.0	1.4	2.9	84.2	0	0	0

Note: R1-R3 used all 5 stages
R4-R8 used stages 2 and 5 only

* Standard liters at 16 °C and 101.3 kPa

3.0 Operations Summary

Test operations for the investigation of the United Catalysts, Inc. T-2465 zinc ferrite sorbent commenced on December 7, 1992 and were completed on January 8, 1993. The test series consisted of one eight-cycle test. Test durations, sorbent masses removed/loaded, and the actual average test conditions are presented in Table 3.1. Flow controller set-point data, temperature data, and pressure data were monitored continuously via a personal computer-based automatic data acquisition system. Data were collected by the system at rates of 2-6 scans per minute depending on the test (e.g., slower rates were utilized for long tests). Inlet gas compositions are based on the flow controller set-points and corrected with flow proving regression curves. Appendix A presents the data acquisition plots showing trends for the mass flow controllers for each test phase. Although only the average and maximum temperatures are presented below, temperature profile plots which illustrate the temperature history during testing are presented in Appendix B. Appendix C presents the system pressure history and Appendix D the differential pressure across the reactor.

Table 3.1: Actual Test Period Parameters

Test Period	ZFMC01-S1	ZFMC01-R1 Stage 1	ZFMC01-R1 Stage 2	ZFMC01-R1 Stage 3	ZFMC01-R1 Stage 4	ZFMC01-R1 Stage 5	ZFMC01-RR1	
Start Time/Date	18:03 12/07/92	3:00 12/09/92	4:00 12/09/92	13:35 12/09/92	15:30 12/09/92	17:30 12/09/92	20:30 12/09/92	
End Time/Date	23:07 12/08/92	4:00 12/09/92	13:35 12/09/92	15:30 12/09/92	17:30 12/09/92	18:05 12/09/92	23:33 12/09/92	
Duration, hr:min	28:37	1:00	7:35	1:55	2:00	0:35	3:03	
Comment	Off-Line: 19:28-19:55 (12/07)		Off-Line: 5:30-7:00, 7:30- 8:00 (12/09)			13:03 total time		
Weight of Sorbent, g	1209 loaded	-	-	-	-	-	-	
Bed Height, cm	40.6	-	-	-	-	-	-	
INLET Gas Composition based on Flow Controller Settings								
Carbon Monoxide, Volume %	15.80	0.00	0.00	0.00	0.00	0.00	3.84	
Carbon Dioxide, Volume %	5.82	0.00	0.00	0.00	0.00	0.00	2.79	
Hydrogen, Volume %	11.58	0.00	0.00	0.00	0.00	0.00	2.96	
Steam, Volume %	30.34	0.00	0.00	0.00	0.00	0.00	7.43	
Nitrogen, Volume %	36.37	99.41	97.02	95.16	91.47	79.00	82.98	
Oxygen, Volume %	0.00	0.59	2.98	4.84	8.53	21.00	0.00	
Hydrogen Sulfide, ppmv	814.42	0.00	0.00	0.00	0.00	0.00	0.00	
Carbonyl sulfide, ppmv	0.00	0.00	0.00	0.00	0.00	0.00	0.00	
Hydrogen Chloride, ppmv	16.82	0.00	0.00	0.00	0.00	0.00	0.00	
Inlet gas flow rate, l/hr	9188	1294	1221	1147	1078	1262	9382	
Space Velocity, hr ⁻¹	9889	1392	1314	1235	1161	1358	10097	
Linear Velocity, cm/s	31.09	26.21	24.69	25.60	25.30	27.43	31.39	
PT-165 Pressure, kPag	918.4	68.6	81.4	68.3	68.7	88.0	932.1	
Bed Temperatures, °C	Avg	Max	Avg	Max	Avg	Max	Avg	Max
TE-174, 5 cm Above Bottom	545	596	560	598	597	672	708	709
TE-175, 13 cm Above Bot.	552	598	556	598	607	684	707	708
TE-176, 20 cm Above Bot.	552	583	551	593	613	687	703	704
TE-177, 28 cm Above Bot.	543	564	549	589	618	687	704	704
TE-178, 36 cm Above Bot.	522	547	547	583	618	684	705	706

Table 3.1: Actual Test Period Parameters (Continued)

Test Period	ZFMC01-S2	ZFMC01-R2 Stage 1	ZFMC01-R2 Stage 2	ZFMC01-R2 Stage 3	ZFMC01-R2 Stage 4	ZFMC01-R2 Stage 5	ZFMC01-RR2					
Start Time/Date	1:30 12/10/92	23:00 12/14/92	10:05 12/15/92	16:15 12/15/92	18:45 12/15/92	20:30 12/15/92	23:00 12/15/92					
End Time/Date	21:03 12/14/92	10:05 12/15/92	16:15 12/15/92	18:45 12/15/92	20:30 12/15/92	21:40 12/15/92	1:00 12/16/92					
Duration, hr:min	26:33	11:05	6:10	2:30	1:45	1:10	2:00					
Comment	Off-Line: 12:00 (12/10) - 12:30 (12/11), 16:30 (12/11) - 9:00 (12/14)					22:40 total time						
Weight of Sorbent, grams	-	-	-	-	-	-	-					
Bed Height, cm	-	-	-	-	-	-	-					
INLET Gas Compositions based on Flow Controller Settings												
Carbon Monoxide, Volume %	15.90	0.00	0.00	0.00	0.00	0.00	3.62					
Carbon Dioxide, Volume %	5.81	0.00	0.00	0.00	0.00	0.00	2.77					
Hydrogen, Volume %	11.59	0.00	0.00	0.00	0.00	0.00	2.94					
Steam, Volume %	30.31	0.00	0.00	0.00	0.00	0.00	7.42					
Nitrogen, Volume %	36.30	99.40	97.02	95.07	90.89	79.00	83.25					
Oxygen, Volume %	0.00	0.60	2.98	4.93	9.11	21.00	0.00					
Hydrogen Sulfide, ppmv	820.39	0.00	0.00	0.00	0.00	0.00	0.00					
Carbonyl Sulfide, ppmv	0.00	0.00	0.00	0.00	0.00	0.00	0.00					
Hydrogen Chloride, ppmv	16.99	0.00	0.00	0.00	0.00	0.00	0.00					
Inlet gas flow rate, l/hr	9,197	1,309	1,220	1,124	1,011	1,267	9,389					
Space Velocity, hr ⁻¹	9,899	1,409	1,314	1,210	1,089	1,364	10,105					
Linear Velocity, cm/s	30.48	26.52	22.25	21.34	16.76	18.59	31.39					
PT-165 Pressure, kPag	931.7	67.4	103.2	97.0	138.8	178.3	931.8					
Bed Temperatures, °C												
TE-174, 5 cm Above Bottom	AVG 551	Max 608	AVG 552	Max 589	AVG 587	Max 654	AVG 675	Max 706	AVG 703	Max 708	AVG 542	Max 548
TE-175, 13 cm Above Bottom	556	620	548	585	610	683	637	664	677	711	707	560
TE-176, 20 cm Above Bottom	553	623	539	580	623	687	633	660	673	709	705	564
TE-177, 28 cm Above Bottom	542	608	536	579	632	697	631	657	672	708	705	565
TE-178, 36 cm Above Bottom	524	574	537	580	627	679	624	652	666	702	702	562

Table 3.1: Actual Test Period Parameters (Continued)

Test Period	ZFMC01-S3	ZFMC01-R3 Stage 1	ZFMC01-R3 Stage 2	ZFMC01-R3 Stage 3	ZFMC01-R3 Stage 4	ZFMC01-R3 Stage 5	ZFMC01-RR3	
Start Time/Date	3:30 12/16/92	5:30 12/17/92	10:02 12/17/92	17:30 12/17/92	19:30 12/17/92	21:30 12/17/92	0:00 12/18/92	
End Time/Date	2:30 12/17/92	10:02 12/17/92	17:30 12/17/92	19:30 12/17/92	21:30 12/17/92	22:30 12/17/92	2:00 12/18/92	
Duration, hr:min	23:00	4:32	7:28	2:00	2:00	1:00	2:00	
Comment						17:00 total time		
Weight of Sorbent, g	-	-	-	-	-	-	-	
Bed Height, cm	-	-	-	-	-	-	-	
INLET Gas Compositions Based on Flow Controller Settings								
Carbon Monoxide, Volume %	15.96	0.00	0.00	0.00	0.00	0.00	3.75	
Carbon Dioxide, Volume %	5.67	0.00	0.00	0.00	0.00	0.00	2.73	
Hydrogen, Volume %	11.57	0.00	0.00	0.00	0.00	0.00	2.89	
Steam, Volume %	30.31	0.00	0.00	0.00	0.00	0.00	7.38	
Nitrogen, Volume %	36.42	99.42	97.03	95.16	91.33	79.00	83.26	
Oxygen, Volume %	0.00	0.58	2.97	4.84	8.67	21.00	0.00	
Hydrogen Sulfide, ppmv	810.20	0.00	0.00	0.00	0.00	0.00	0.00	
Carbonyl sulfide, ppmv	0.00	0.00	0.00	0.00	0.00	0.00	0.00	
Hydrogen Chloride, ppmv	16.95	0.00	0.00	0.00	0.00	0.00	0.00	
Inlet gas flow rate, l/hr	9,197	1,318	1,214	1,146	1,064	1,268	9,443	
Space Velocity, hr ⁻¹	9,899	1,418	1,306	1,233	1,146	1,365	10,163	
Linear Velocity, cm/s	30.48	26.82	26.52	25.91	24.99	30.78	31.39	
PT-165 Pressure, kPag	931.7	67.6	67.8	67.4	67.5	67.3	931.5	
Bed Temperatures, °C	Avg	Max	Avg	Max	Avg	Max	Avg	Max
TE-174, 5 cm Above Bottom	547	618	558	590	595	679	705	707
TE-175, 13 cm Above Bottom	553	624	553	588	608	688	704	705
TE-176, 20 cm Above Bottom	553	622	546	583	613	688	674	700
TE-177, 28 cm Above Bottom	544	597	543	582	619	690	675	701
TE-178, 36 cm Above Bottom	536	568	542	582	621	686	676	703

Table 3.1: Actual Test Period Parameters (Continued)

Test Period	ZFMC01-S4	ZFMC01-R4 Stage 2	ZFMC01-R4 Stage 5	ZFMC01-RR4			
Start Time/Date	4:00 12/18/92	10:00 12/28/92	18:15 12/28/92	21:00 12/28/92			
End Time/Date	20:30 12/21/92	18:15 12/28/92	19:30 12/28/92	23:00 12/28/92			
Duration, hr:min	23:05	8:15	1:15	2:00			
Comment	Off-Line: 16:05 (12/18) - 9:30 (12/21)		9:30 total time				
Weight of Sorbent, g	1220 unloaded	1213.10 loaded	-	-			
Bed Height, cm	-	-	-	-			
INLET Gas Compositions based on Flow Controllers Settings							
Carbon Monoxide, Volume %	15.93	0.00	0.00	3.77			
Carbon Dioxide, Volume %	5.80	0.00	0.00	2.76			
Hydrogen, Volume %	11.56	0.00	0.00	2.92			
Steam, Volume %	30.24	0.00	0.00	7.36			
Nitrogen, Volume %	36.39	97.08	79.00	83.20			
Oxygen, Volume %	0.00	2.92	21.00	0.00			
Hydrogen Sulfide, ppmv	811.72	0.00	0.00	0.00			
Carbonyl Sulfide, ppmv	0.00	0.00	0.00	0.00			
Hydrogen Chloride, ppmv	16.86	0.00	0.00	0.00			
Inlet gas flow rate, l/hr	9,219	1,241	1,253	9,474			
Space Velocity, hr ⁻¹	9,922	1,474	1,488	11,251			
Linear Velocity, cm/s	30.48	26.52	30.18	31.70			
Pressure PT-165, kPag	931.6	74.5	67.5	931.7			
Bed Temperatures, °C	AVG	Max	AVG	Max	AVG	Max	
TE-174, 5 cm Above Bottom	544	589	607	700	704	539	544
TE-175, 13 cm Above Bottom	552	590	625	730	705	551	558
TE-176, 20 cm Above Bottom	552	583	631	722	701	557	565
TE-177, 28 cm Above Bottom	546	558	635	721	701	562	570
TE-178, 36 cm Above Bottom	533	542	639	723	700	563	571

Table 3.1: Actual Test Period Parameters (Continued)

Test Period	ZFMC01-S5	ZFMC01-R5 Stage 2	ZFMC01-R5 Stage 5	ZFMC01-RR5
Start Time/Date	2:00 12/29/92	2:00 12/30/92	10:50 12/30/92	13:00 12/30/92
End Time/Date	23:00 12/29/92	10:50 12/30/92	11:31 12/30/92	15:05 12/30/92
Duration, hr:min	21:00	8:50	0:41	2:05
Comment			9:31 total time	
Weight of Sorbent, g	-	-	-	-
Bed Height, cm	-	-	-	-
INLET Gas Compositions based on Flow Controller Settings				
Carbon Monoxide, Vol %	15.83	0.00	0.00	3.82
Carbon Dioxide, Vol %	5.94	0.00	0.00	2.99
Hydrogen, Vol %	11.59	0.00	0.00	2.94
Steam, Vol %	30.30	0.00	0.00	7.39
Nitrogen, Vol %	36.26	97.09	79.00	82.86
Oxygen, Vol %	0.00	2.91	21.00	0.00
Hydrogen Sulfide, ppmv	813.47	0.00	0.00	0.00
Carbonyl Sulfide, ppmv	0.00	0.00	0.00	0.00
Hydrogen Chloride, ppmv	16.97	0.00	0.00	0.00
Inlet gas flow, l/hr	9,199	1,239	1,257	9,430
Space Velocity, hr ⁻¹	10,925	1,472	1,493	11,199
Linear Velocity, cm/s	30.78	25.60	30.18	31.70
Pressure PT-165, kPag	931.9	79.6	69.5	931.9
Bed Temperatures, °C	Avg	Max	Avg	Max
TE-174, 5 cm Above Bottom	555	633	604	706
TE-175, 13 cm Above Bottom	559	638	622	733
TE-176, 20 cm Above Bottom	556	634	628	725
TE-177, 28 cm Above Bottom	547	613	629	720
TE-178, 36 cm Above Bottom	529	571	623	709
			700	703
			548	558
			554	563
			560	564
			558	564

Table 3.1: Actual Test Period Parameters (Continued)

Test Period	ZFMC01-S6	ZFMC01-R6 Stage 2	ZFMC01-R6 Stage 5	ZFMC01-RR6
Start Time/Date	18:30 12/30/92	20:00 1/04/93	4:30 1/05/93	7:30 1/05/93
End Time/Date	16:00 12/31/92	4:30 1/05/93	5:30 1/05/93	9:32 1/05/93
Duration, hr:min	21:30	8:30	1:00	2:02
Comment			9:30 total time	
Weight of Sorbent, g	1211.2 unloaded	1169.7 loaded	-	-
Bed Height, cm	-	35.6	-	-
INLET Gas Compositions based on Flow Controller Settings				
Carbon Monoxide, Vol %	15.96	0.00	0.00	3.58
Carbon Dioxide, Vol %	5.65	0.00	0.00	2.72
Hydrogen, Vol %	11.62	0.00	0.00	2.94
Steam, Vol %	30.39	0.00	0.00	7.42
Nitrogen, Vol %	36.29	97.17	79.00	83.33
Oxygen, Vol %	0.00	2.83	21.00	0.00
Hydrogen Sulfide, ppmv	819.29	0.00	0.00	0.00
Carbonyl Sulfide, ppmv	0.00	0.00	0.00	0.00
Hydrogen Chloride, ppmv	16.88	0.00	0.00	0.00
Inlet gas flow, l/h	9,172	1,266	1,267	9,387
Space Velocity, hr ⁻¹	10,892	1,557	1,558	11,546
Linear Velocity, cm/s	30.48	27.43	30.48	31.39
Pressure PT-165, kPag	932.0	70.9	68.4	932.7
Bed Temperatures, °C	Avg	Max	Avg	Max
TE-174, 5 cm Above Bottom	553	615	628	725
TE-175, 13 cm Above Bottom	559	627	635	729
TE-176, 20 cm Above Bottom	558	627	629	712
TE-177, 28 cm Above Bottom	549	612	620	706
TE-178, 36 cm Above Bottom	534	573	603	700
			696	698
			557	557
			544	548
			554	557
			558	561
			560	563
			557	560

Table 3.1: Actual Test Period Parameters (Continued)

Test Period	ZFMC01-S7	ZFMC01-R7 Stage 2	ZFMC01-R7 Stage 5	ZFMC01-RR7			
Start Time/Date	11:30 01/05/93	9:30 1/06/93	17:00 1/06/93	21:00 1/06/93			
End Time/Date	6:35 1/06/93	17:00 1/06/93	18:05 1/06/93	23:05 1/06/93			
Duration, hr:min	19:05	7:30	1:05	2:05			
Comment			8:35 total time				
Weight of Sorbent, g	-	-	-	-			
Bed Height, cm	-	-	-	-			
INLET Gas Compositions based on Flow Controller Settings							
Carbon Monoxide, Vol %	15.96	0.00	0.00	3.63			
Carbon Dioxide, Vol %	5.70	0.00	0.00	2.70			
Hydrogen, Vol %	11.59	0.00	0.00	2.97			
Steam, Vol %	30.29	0.00	0.00	7.42			
Nitrogen, Vol %	36.38	97.03	79.00	83.29			
Oxygen, Vol %	0.00	2.97	21.00	0.00			
Hydrogen sulfide, ppmv	813.17	0.00	0.00	0.00			
Carbonyl sulfide, ppmv	0.00	0.00	0.00	0.00			
Hydrogen Chloride, ppmv	16.93	0.00	0.00	0.00			
Inlet gas flow, l/hr	9,202	1,219	1,143	9,392			
Space Velocity, hr ⁻¹	11,319	1,500	1,406	11,552			
Linear Velocity, cm/s	30.48	24.69	27.13	31.39			
Pressure PT-165, kPag	931.7	82.5	72.2	931.2			
Bed Temperatures, °C	Avg	Max	Avg	Max			
TE-174, 5 cm Above Bottom	539	602	607	710	715	540	545
TE-175, 13 cm Above Bottom	547	609	618	714	708	710	549
TE-176, 20 cm Above Bottom	550	608	621	712	702	704	553
TE-177, 28 cm Above Bottom	547	595	627	718	703	704	556
TE-178, 36 cm Above Bottom	534	595	634	718	705	704	554

Table 3.1: Actual Test Period Parameters (Continued)

Test Period	ZFMC01-S8	ZFMC01-R8 Stage 2	ZFMC01-R8 Stage 5	ZFMC01-RR8
Start Time/Date	2:00 01/07/93	0:30 1/08/93	07:35 1/08/92	11:00 1/08/93
End Time/Date	22:33 1/07/93	7:35 1/08/93	8:32 1/08/92	13:03 1/08/93
Duration, hr:min	20:33	7:05	0:57	2:03
Comment	Ran out of HCl after 5:16 on-line		8:02 total time	
Weight of Sorbent, g	-	-	-	1095.4 unloaded
Bed Height, cm	-	-	-	-
INLET Gas Compositions based on Flow Controller Settings				
Carbon Monoxide, Vol %	15.84	0.00	0.00	3.88
Carbon Dioxide, Vol %	5.63	0.00	0.00	2.63
Hydrogen, Vol %	11.52	0.00	0.00	2.95
Steam, Vol %	30.14	0.00	0.00	7.41
Nitrogen, Vol %	36.79	97.03	79.00	83.12
Oxygen, Vol %	0.00	2.97	21.00	0.00
Hydrogen Sulfide, ppmv	809.04	0.00	0.00	0.00
Carbonyl Sulfide, ppmv	0.00	0.00	0.00	0.00
Hydrogen Chloride, ppmv	4.23	0.00	0.00	0.00
Inlet gas flow, l/hr	9,249	1,222	1,247	9,401
Space Velocity, hr ⁻¹	11,377	1,503	1,534	11,563
Linear Velocity, cm/s	30.48	27.43	30.18	31.09
Pressure PT-165, kPag	931.4	67.4	67.1	931.7
Bed Temperatures, °C				
	Avg	Max	Avg	Max
TE-174, 5 cm Above Bottom	539	585	706	707
TE-175, 13 cm Above Bottom	547	580	714	706
TE-176, 20 cm Above Bottom	548	568	714	702
TE-177, 28 cm Above Bottom	543	550	635	715
TE-178, 36 cm Above Bottom	529	537	642	714
			697	699
			548	548
			550	556
			548	554

4.0 Test Data Summary

4.1 Gas Analysis

During testing, the gas stream was sampled both from the inlet of the reactor and the reactor outlet. The inlet gas samples were taken to verify that the individual gases were mixed in proper proportions. The outlet gas samples were collected to provide an indication of the sorbent efficiency.

Analysis of gas samples was conducted with detector tubes, for a quick indication of sulfur level in the gas stream, and with laboratory analysis of gas grabs, to determine the composition of major gas and sulfur species. Gas samples were collected as a dewatered gas after the gas was cooled to knock-out moisture/condensate.

4.1.1 Gas Grab Analysis by Laboratory Gas Chromatograph

Gas grab samples were analyzed by laboratory gas chromatograph (GC) analysis. The gas was analyzed for both major components (H_2 , CO, CO_2 , N_2 , CH_4 , and O_2) and sulfur species (H_2S , COS, and SO_2). The GCs were calibrated daily to $\pm 1\%$ using certified standards. The results for each grab sample are presented in Appendix E. The simple arithmetic averages for each test phase are presented in Table 4.1. The results were normalized to sum to 100 percent. The results are normalized to 100% because it is assumed that the species which are analyzed consist of 100% of the contents of a given sample. This assumption is valid based on a knowledge of the possible reaction chemistry given the feed gas composition and the test conditions.

Table 4.1: Average Gas Compositions by GC Analysis

Test Period	ZFMCO1-S1		ZFMCO1-R1		ZFMCO1-RR1		ZFMCO1-S2		ZFMCO1-R2		ZFMCO1-RR2	
	Avg.	Std. Dev.	Avg.	Std. Dev.	Avg.	Std. Dev.	Avg.	Std. Dev.	Avg.	Std. Dev.	Avg.	Std. Dev.
Inlet Gas Composition, Dry Gas Basis												
No. of Samples	10		7		2		11		8		2	
H ₂ , %	14.10	1.59	0	0	1.96	0.03	13.70	3.19	0	0	3.53	1.21
O ₂ , %	0.59	1.58	5.28	7.15	0.17	0.08	1.50	4.68	4.32	6.91	0.14	0.02
N ₂ , %	54.46	2.46	94.66	7.13	92.10	0.04	55.29	5.29	95.60	6.90	90.79	1.09
CH ₄ , %	0	0	0	0	0	0	0	0	0	0	0	0
CO, %	22.19	2.09	0	0	3.95	0.03	21.45	5.02	0.01	0.02	2.13	1.02
CO ₂ , %	8.61	0.44	0.05	0.04	1.82	0.05	8.00	1.75	0.03	0.03	3.40	0.93
H ₂ S, ppmv	529.40	257.27	13.50	30.53	0.3	0	528.75	219.94	0.65	1.00	7.70	0.57
COS, ppmv	54.12	23.53	0.61	1.14	1.88	1.26	63.57	19.83	0.08	0.21	31.21	53.23
SO ₂ , ppmv	1.57	0.90	17.38	29.24	0	0	10.63	22.55	377.82	442.33	14.25	14.84
Outlet Gas Composition, Dry Gas Basis												
No. of Samples	25		16		5		31		24		3	
H ₂ , %	16.46	1.84	0.17	0.66	3.49	0.63	16.62	2.67	0	0	3.63	0.43
O ₂ , %	0.14	0.23	2.60	3.60	0.13	0.01	0.38	1.21	3.13	5.94	0.10	0.01
N ₂ , %	52.72	1.21	95.66	7.48	90.63	0.52	53.91	5.60	96.49	5.78	90.73	0.40
CH ₄ , %	0	0	0	0	0	0	0	0	0	0	0	0
CO, %	19.38	3.00	0.71	2.83	2.51	0.54	17.75	5.78	0	0	2.16	0.36
CO ₂ , %	11.28	2.39	0.45	1.50	3.24	0.44	11.29	3.26	0.02	0.02	3.37	0.34
H ₂ S, ppmv	243.39	237.25	11.33	37.37	2.74	1.38	243.33	208.88	0.50	0.34	4.57	1.45
COS, ppmv	16.75	15.69	1.27	3.12	0.06	0.13	18.67	16.58	0.11	0.22	0.10	0.17
SO ₂ , ppmv	1.38	1.41	4134.01	5167.93	0	0	102.58	446.24	3538.39	4426.25	1.22	1.29

Table 4.1: Average Gas Compositions by GC Analysis (Continued)

Test Period	ZFMC01-S3		ZFMC01-R3		ZFMC01-RR3		ZFMC01-S4		ZFMC01-R4		ZFMC01-RR4	
	Avg.	Std. Dev.	Avg.	Std. Dev.	Avg.	Std. Dev.	Avg.	Std. Dev.	Avg.	Std. Dev.	Avg.	Std. Dev.
Inlet Gas Composition, Dry Gas Basis												
No. of Samples	8		8		1		8		4		1	
H ₂ , %	14.38	0.52	0	0	4.42	-	14.90	0.35	0	0	4.15	-
O ₂ , %	0.44	0.75	4.80	6.74	0.11	-	0.13	0.12	6.23	9.72	0.11	-
N ₂ , %	54.19	0.96	95.08	6.70	89.93	-	53.55	0.31	93.56	9.55	89.78	-
CH ₄ , %	0	0	0	0	0	-	0	0	0	0	0	-
CO, %	22.43	1.00	0	0	1.34	-	22.22	0.74	0	0	1.82	-
CO ₂ , %	8.49	0.54	0.08	0.05	4.19	-	9.12	0.40	0.02	0.04	4.13	-
H ₂ S, ppmv	584.02	225.80	0.75	1.20	0.30	-	684.80	102.70	0.08	0.15	10.08	-
COS, ppmv	123.19	71.26	0.05	0.15	73.48	-	79.20	43.72	0	0	37.76	-
SO ₂ , ppmv	3.40	2.64	371.94	542.08	35.17	-	5.69	9.47	1945.62	3309.14	3.36	-
Outlet Gas Composition, Dry Gas Basis												
No. of Samples	26		19		3		26		13		4	
H ₂ , %	17.08	2.42	0	0	3.40	0.33	16.48	2.02	0	0	3.27	0.52
O ₂ , %	0.12	0.09	2.44	4.87	0.12	0.01	0.42	1.54	3.74	7.61	0.12	0.02
N ₂ , %	52.41	1.82	96.99	4.66	90.90	0.32	52.83	2.19	95.46	7.22	90.62	0.45
CH ₄ , %	0	0	0	0	0	0.00	0	0.01	0	0	0	0
CO, %	18.56	4.36	0	0	2.44	0.24	19.05	3.02	0	0	2.61	0.42
CO ₂ , %	11.81	3.82	0.09	0.05	3.15	0.23	11.20	2.34	0	0.02	3.38	0.35
H ₂ S, ppmv	223.30	220.82	0.42	0.15	3.23	1.14	220.29	194.12	0.42	0.36	3.12	1.52
COS, ppmv	19.80	19.12	0	0	0.16	0.29	21.87	19.05	0	0	0.15	0.19
SO ₂ , ppmv	1.68	2.46	4849.71	5580.03	1.12	0.50	0.48	0.74	8006.07	5940.82	0.27	0.55

Table 4.1: Average Gas Compositions by GC Analysis (Continued)

Test Period	ZFMCO1-S5		ZFMCO1-R5		ZFMCO1-RR5		ZFMCO1-S6		ZFMCO1-R6		ZFMCO1-RR6	
	Avg.	Std. Dev.	Avg.	Std. Dev.	Avg.	Std. Dev.	Avg.	Std. Dev.	Avg.	Std. Dev.	Avg.	Std. Dev.
Inlet Gas Composition, Dry Gas Basis												
No. of Samples	6		3		2		6		2		2	
H ₂ , %	15.85	0.76	0	0	4.25	0.15	15.10	0.15	0	0	4.74	0.00
O ₂ , %	0.09	0.01	8.18	10.84	0.15	0.01	0.09	0.01	1.85	0.07	0.10	0.01
N ₂ , %	54.09	3.04	91.71	10.78	89.51	0.10	53.24	0.13	98.08	0.00	89.97	0.01
CH ₄ , %	0	0	0	0	0	0	0	0	0	0	0	0
CO, %	19.58	4.15	0	0	1.72	0.28	22.62	0.26	0	0	1.44	0.01
CO ₂ , %	10.31	1.02	0.06	0.03	4.36	0.24	8.87	0.18	0.01	0.02	3.73	0.01
H ₂ S, ppmv	722.81	135.17	0	0	0.15	0.21	687.44	199.03	0.15	0.21	0.15	0.21
COS, ppmv	76.96	34.25	0.24	0.41	54.08	28.81	92.13	25.79	0	0	33.12	12.39
SO ₂ , ppmv	2.36	2.21	478.25	804.05	1.43	2.02	1.09	0.85	549.40	424.65	0	0
Outlet Gas Composition, Dry Gas Basis												
No. of Samples	22		12		6		23		11		6	
H ₂ , %	17.44	1.90	0	0	3.40	0.93	17.16	2.18	0	0	3.80	0.29
O ₂ , %	0.13	0.13	4.10	7.84	0.13	0.04	0.11	0.10	4.49	8.24	0.15	0.07
N ₂ , %	52.15	1.72	95.11	7.45	90.32	0.85	52.09	1.38	94.88	7.91	90.78	0.19
CH ₄ , %	0	0	0	0	0	0	0	0	0	0	0	0
CO, %	17.70	3.34	0	0	2.54	0.61	18.96	3.95	0	0	2.22	0.17
CO ₂ , %	12.56	2.67	0.06	0.03	3.61	0.52	11.65	3.12	0.01	0.01	3.05	0.13
H ₂ S, ppmv	194.00	201.24	0.54	0.67	1.78	2.29	234.66	210.96	0.51	0.46	1.18	1.38
COS, ppmv	17.50	18.82	0	0	0.18	0.44	23.68	22.56	0	0	0.05	0.12
SO ₂ , ppmv	2.14	4.63	7283.03	6048.15	0.82	1.42	0.42	0.89	6187.19	4971.80	2.06	1.46

Table 4.1: Average Gas Compositions by GC Analysis (Continued)

Test Period	ZFMC01-S7		ZFMC01-R7		ZFMC01-RR7		ZFMC01-S8		ZFMC01-R8		ZFMC01-RR8	
	Avg.	Std. Dev.	Avg.	Std. Dev.	Avg.	Std. Dev.	Avg.	Std. Dev.	Avg.	Std. Dev.	Avg.	Std. Dev.
Inlet Gas Composition, Dry Gas Basis												
No. of Samples	6		3		2		6		3		2	
H ₂ , %	16.13	0.13	0	0	4.31	0.20	15.95	0.25	0	0	4.75	0.01
O ₂ , %	0.08	0.01	8.19	10.90	0.15	0.06	0.09	0.01	8.15	10.93	0.11	0.01
N ₂ , %	53.30	0.11	91.79	10.88	90.40	0.15	53.65	0.16	91.73	10.85	89.98	0.04
CH ₄ , %	0	0	0	0	0	0	0	0	0	0	0	0
CO, %	21.90	0.21	0	0	1.45	0.04	21.85	0.33	0.02	0.04	1.38	0.10
CO ₂ , %	8.50	0.22	0.01	0.02	3.68	0.05	8.37	0.21	0.07	0.06	3.77	0.13
H ₂ S, ppmv	756.41	154.27	0.67	0.63	0.15	0.21	731.22	105.14	0	0	0	0
COS, ppmv	85.81	17.52	0.53	0.92	52.06	13.02	90.73	36.00	7.87	12.43	67.67	47.29
SO ₂ , ppmv	0.58	0.65	117.41	196.37	0	0	0.89	0.77	268.71	438.47	0	0
Outlet Gas Composition, Dry Gas Basis												
No. of Samples	20		11		5		22		11		5	
H ₂ , %	17.05	3.19	0	0	3.09	0.53	17.43	1.57	0	0	3.48	0.26
O ₂ , %	0.83	3.32	4.29	8.12	0.17	0.13	0.09	0.01	4.34	8.20	0.12	0.01
N ₂ , %	53.39	4.45	94.94	7.74	91.42	0.50	52.81	1.07	94.91	7.82	91.11	0.20
CH ₄ , %	0	0	0	0	0	0	0	0	0	0	0	0
CO, %	18.50	4.09	0	0	2.50	0.30	19.46	2.48	0	0	2.56	0.25
CO ₂ , %	10.20	2.87	0.03	0.03	2.72	0.23	10.18	2.01	0.10	0.08	2.74	0.18
H ₂ S, ppmv	217.11	230.82	0.37	0.16	1.26	1.34	243.69	217.97	0.98	1.40	2.66	0.65
COS, ppmv	18.95	19.85	0.46	0.70	0.14	0.31	22.02	20.05	1.98	2.07	0	0
SO ₂ , ppmv	1.12	1.95	8006.47	6241.96	1.08	1.43	1.03	0.82	6478.20	5309.28	2.18	1.88

4.1.2 Detector Tube Analysis

Detector tube sampling was performed during each test for the determination of hydrogen sulfide during sulfidation test phases and sulfur dioxide during oxidative regeneration test phases. Both hydrogen sulfide and sulfur dioxide detector tube readings were taken during reductive regeneration test phases. Detector tube measurements are only estimates of the actual concentration of the specie in the dry gas and are used primarily as an indicator for the completion of a test as defined in the test operations plan. Gastec detector tubes have a reported accuracy of $\pm 25\%$ full scale. The detector tube observations for each test are reported in Appendix F.

4.1.3 Sulfur Species Trends

The detector tube indicated levels of hydrogen sulfide during sulfidation and sulfur dioxide during oxidative regeneration test phases have been plotted versus cumulative time on stream for the various tests. The plots are presented on the following pages.

Zinc Ferrite Tests - ZFMC-01 Sulfidation 1

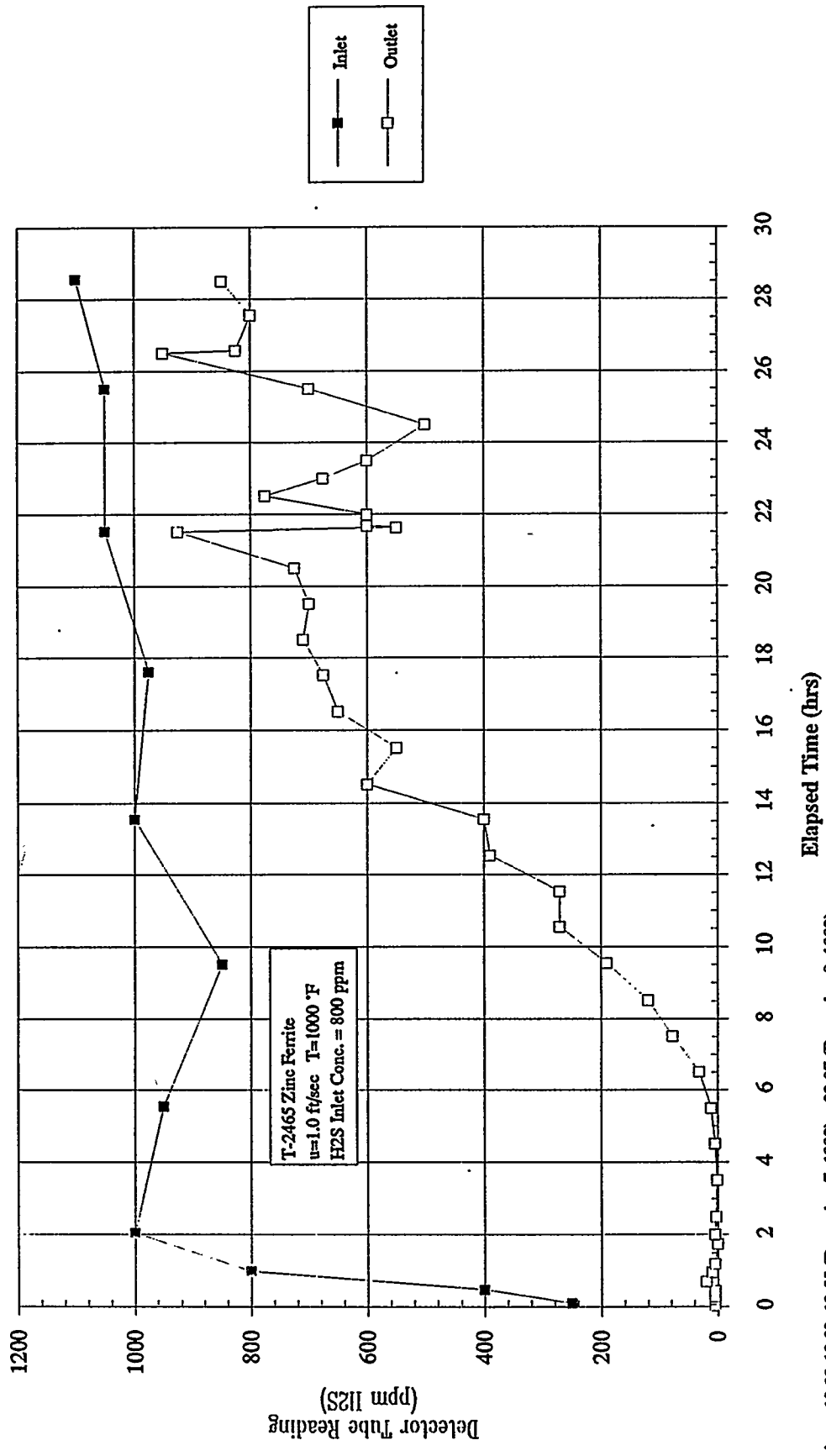

Elapsed Time (hrs)

Test time: 18:03-19:28, 19:55 (December 7, 1992) - 23:07 (December 8, 1992)
 Test duration: 28:37

Zinc Ferrite Tests - ZFMC-01 Oxidative Regeneration 1

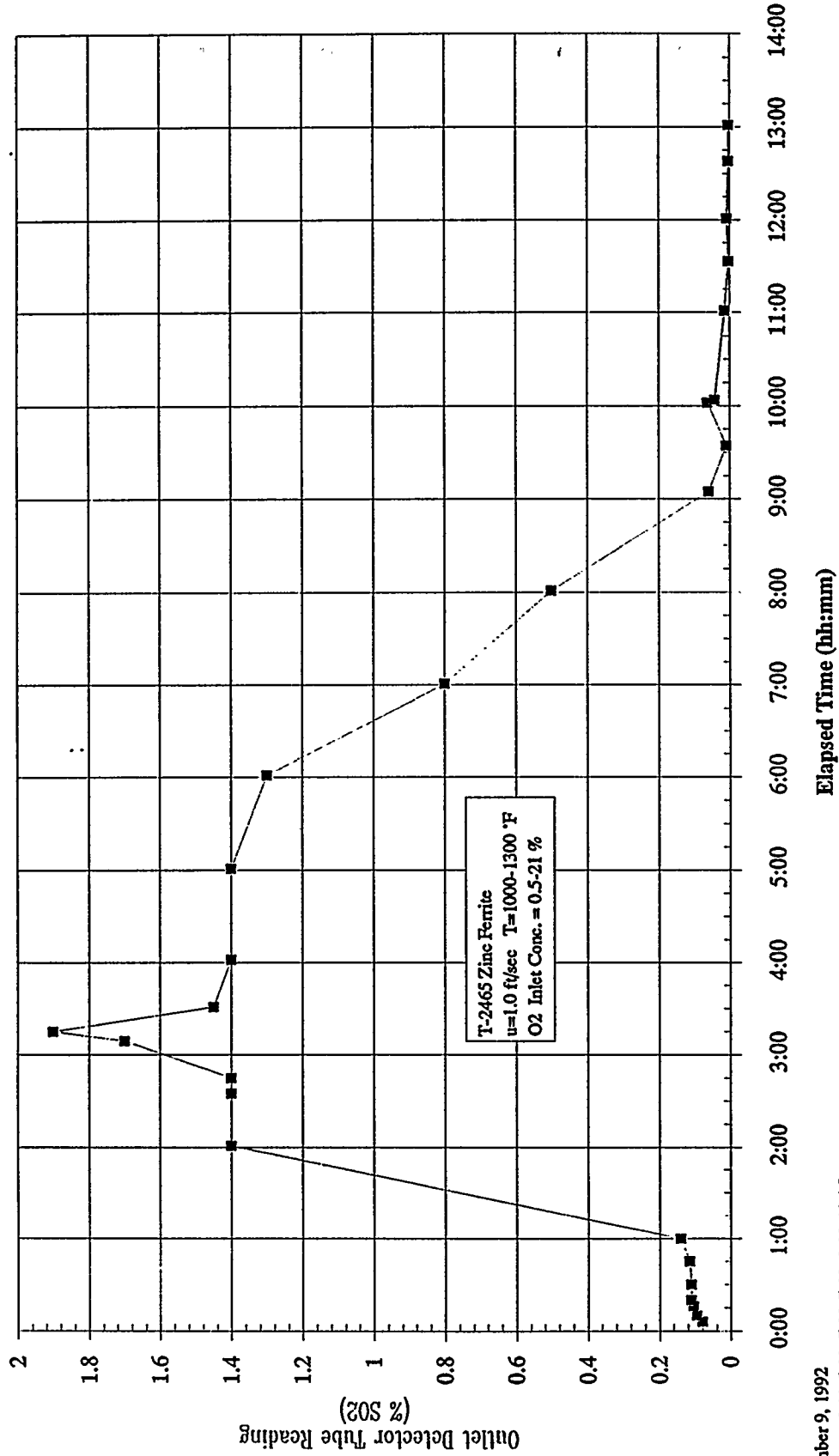

T-2465 Zinc Ferrite
 u=1.0 ft/sec T=1000-1300 °F
 O2 Inlet Conc. = 0.5-21 %

December 9, 1992
 Test time: 3:00-5:30, 7:00-7:30, 8:00-18:05
 Test duration: 13:05

Zinc Ferrite Tests - ZFMC-01 Sulfidation 2

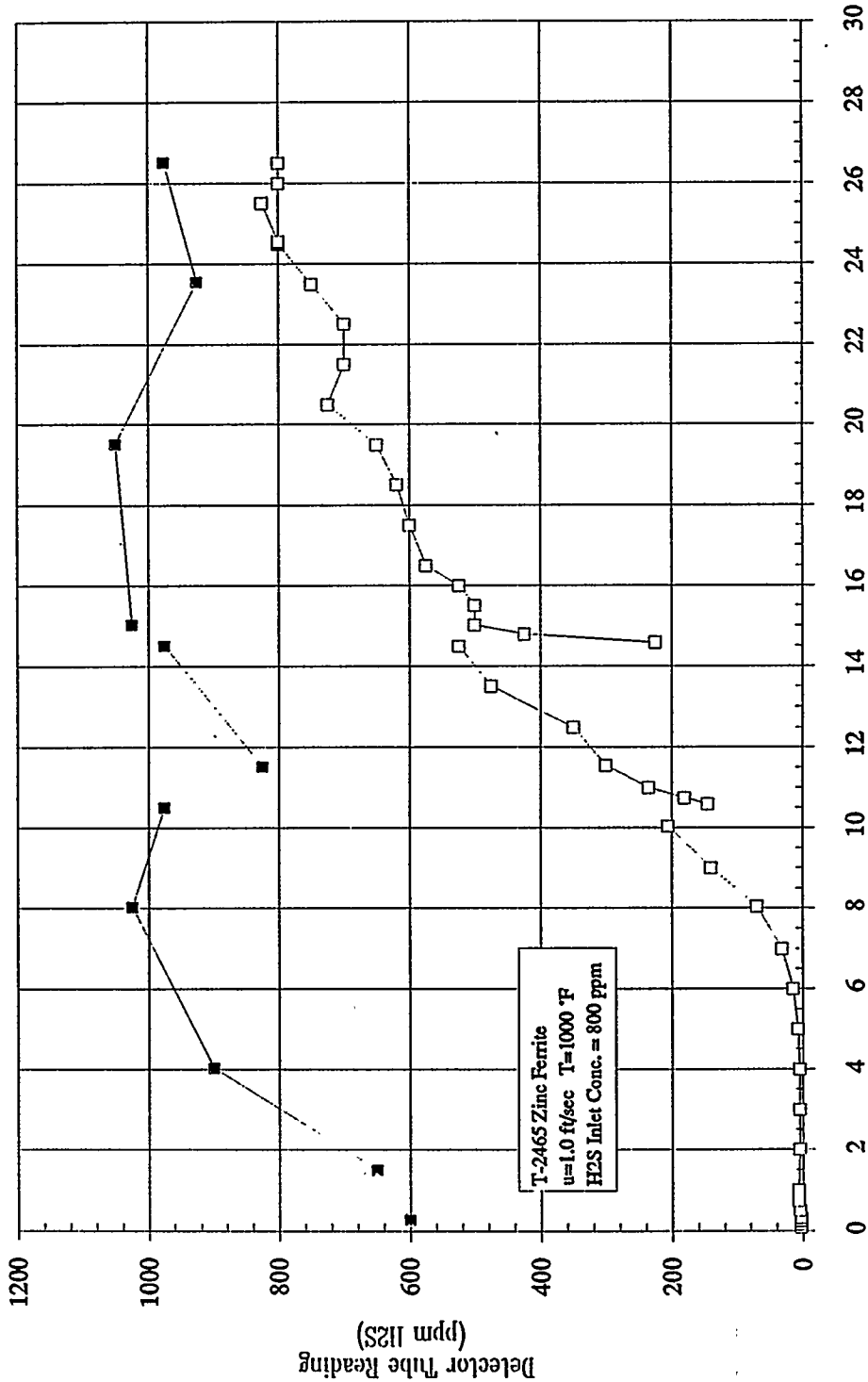

Test time: 1:30-12:00 (December 10, 1992), 12:30-16:30 (December 11, 1992), 9:00-21:03 (December 14, 1992)
 Test duration: 26:33

Zinc Ferrite Tests - ZFMC-01 Oxidative Regeneration 2

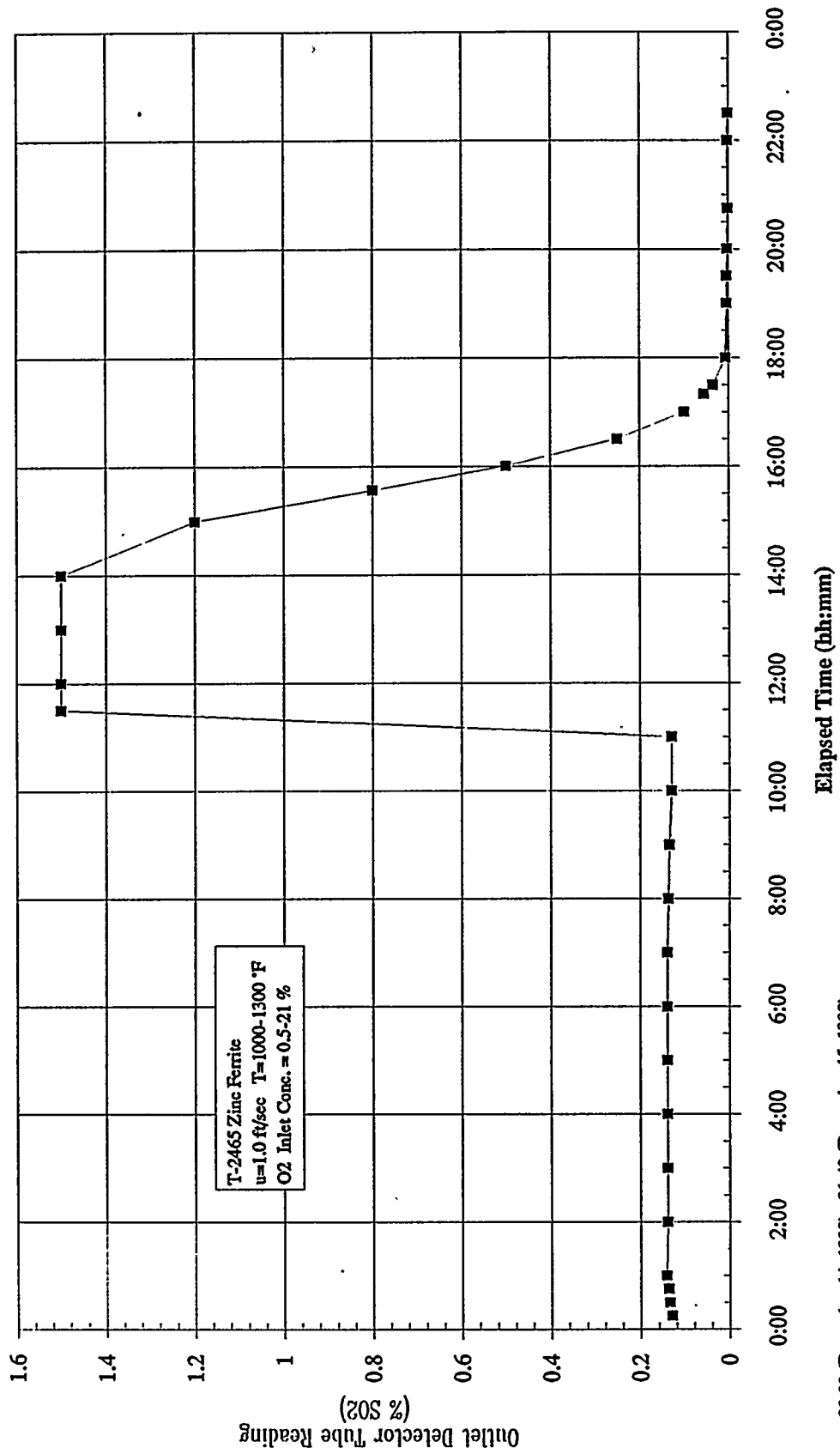

Test time: 23:00 (December 14, 1992) - 21:40 (December 15, 1992)
 Test duration: 22:40

Zinc Ferrite Tests - ZFMC-01 Sulfidation 3

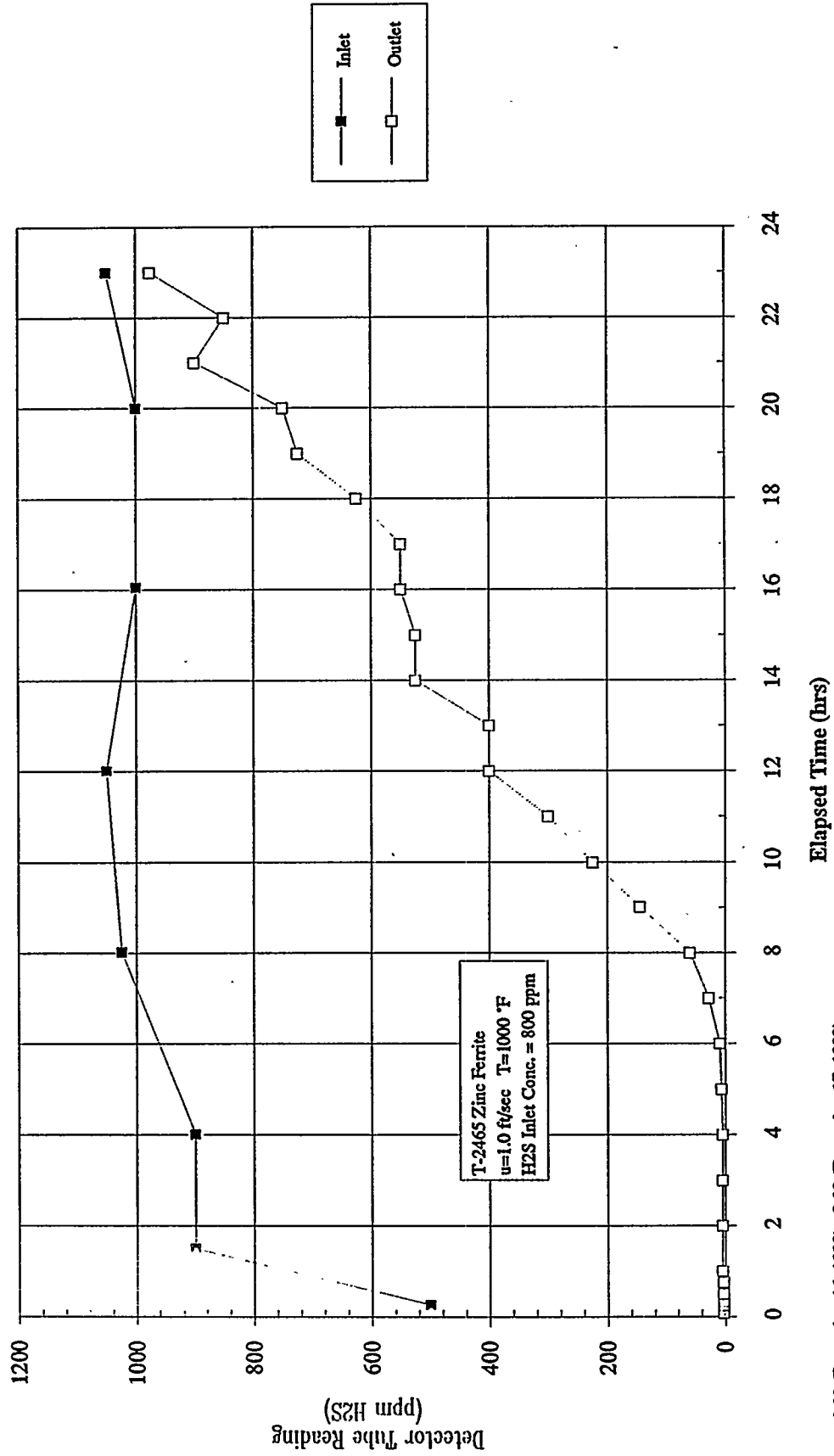

Test time: 3:30 (December 16, 1992) - 2:30 (December 17, 1992)
 Test duration: 23:00

Zinc Ferrite Tests - ZFMC-01 Oxidative Regeneration 3

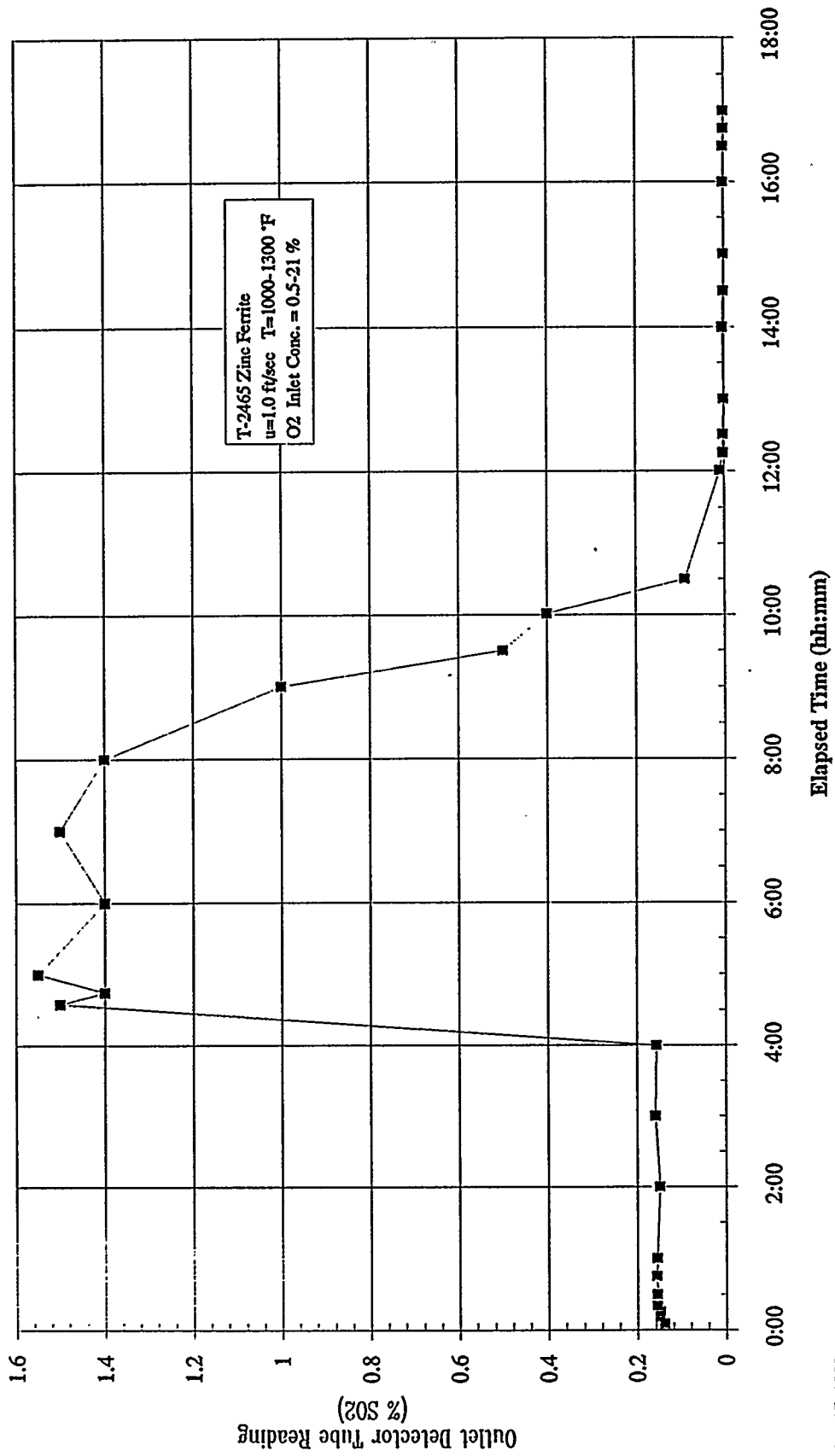

December 17, 1992
 Test time: 5:30-22:30 (Test duration: 17:00)

Zinc Ferrite Tests - ZFMC-01 Sulfidation 4

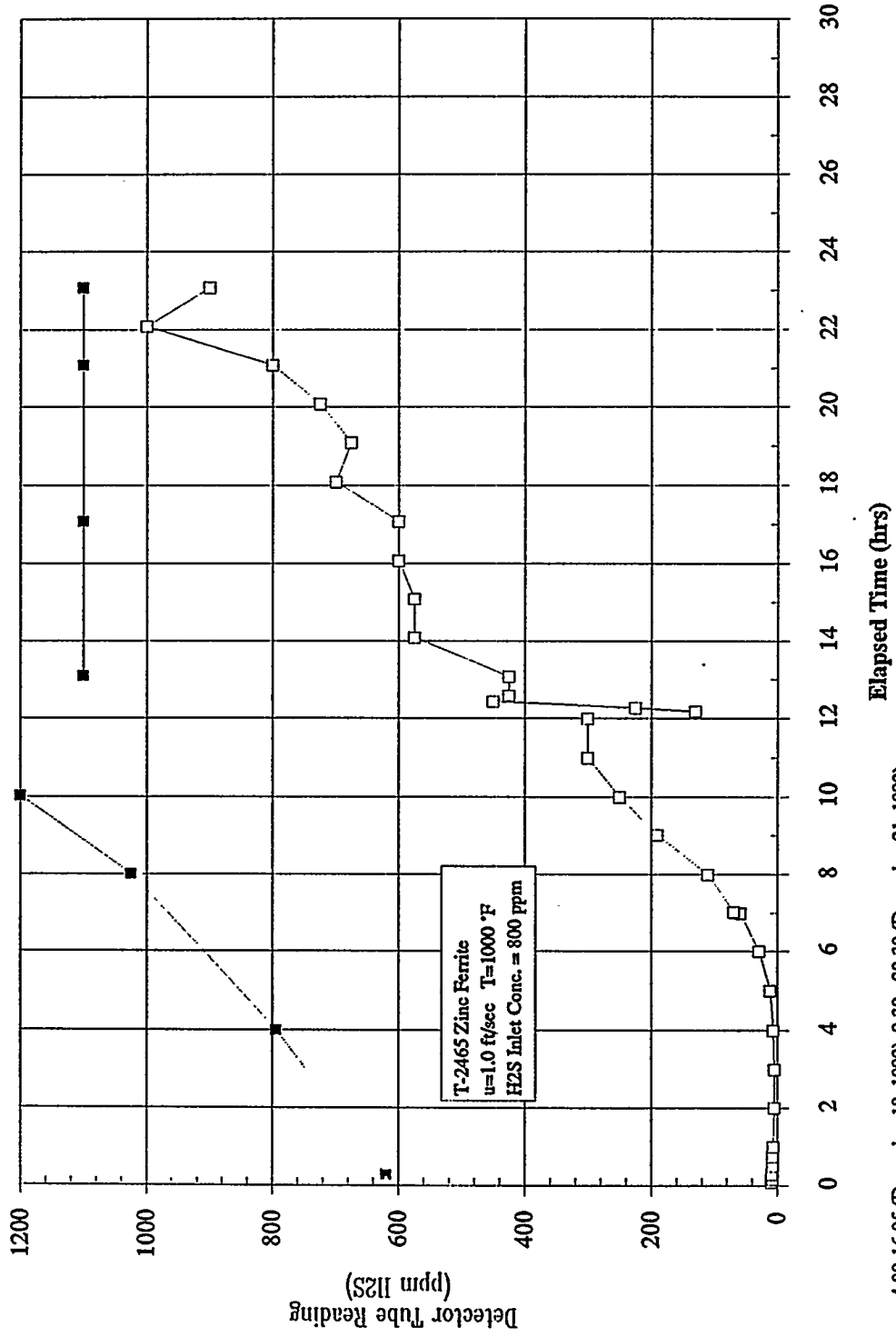

Test time: 4:00-16:05 (December 18, 1992), 9:30 - 20:30 (December 21, 1992)
 Test duration: 23:05

Zinc Ferrite Tests - ZFMC-01 Oxidative Regeneration 4

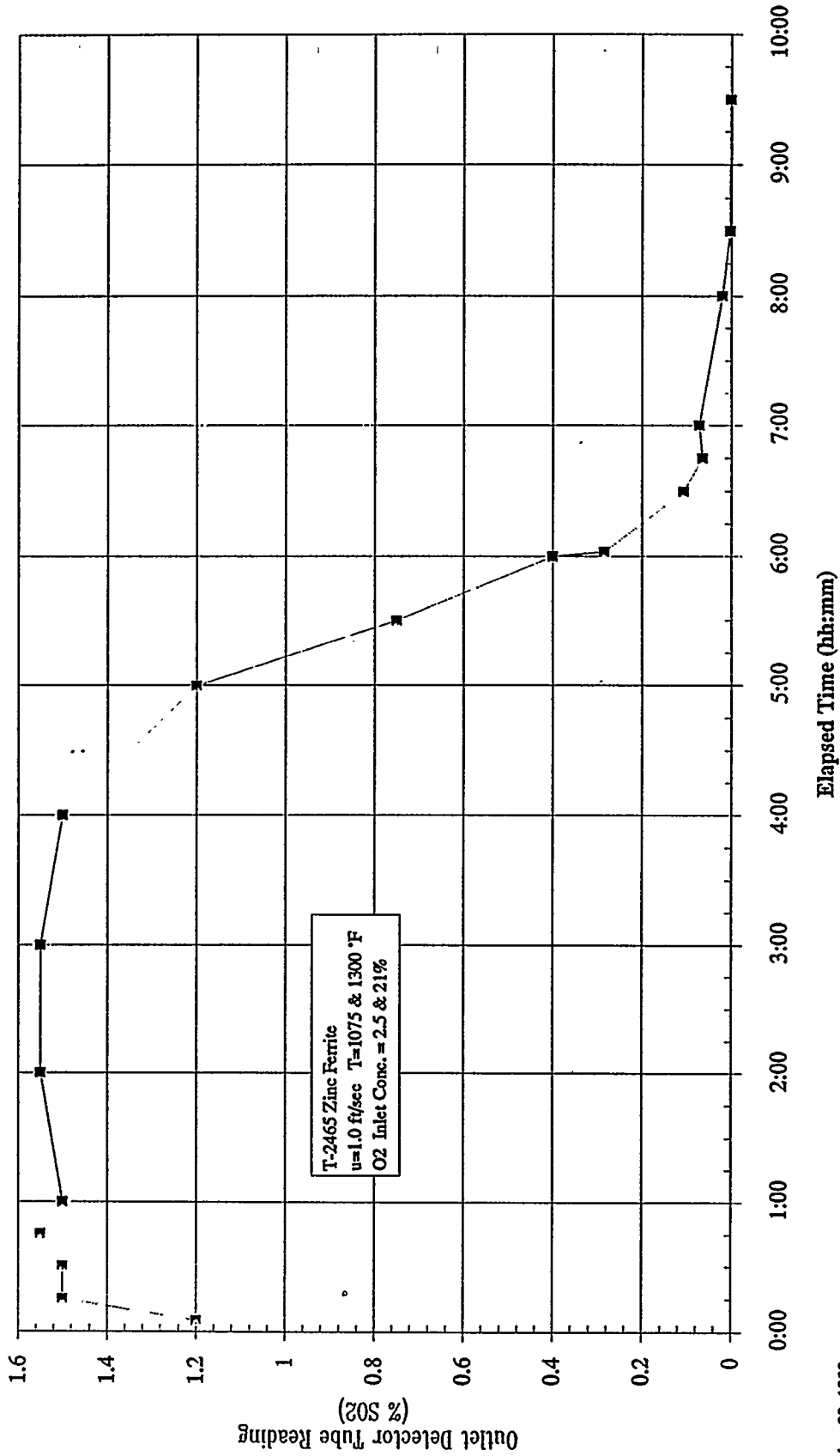

T-2465 Zinc Ferrite
 u=1.0 ft/sec T=1075 & 1300 °F
 O2 Inlet Conc. = 2.5 & 21%

December 28, 1992
 Test time: 10:00-19:30 (Test duration: 9:30)

Zinc Ferrite Tests - ZFMC-01 Sulfidation 5

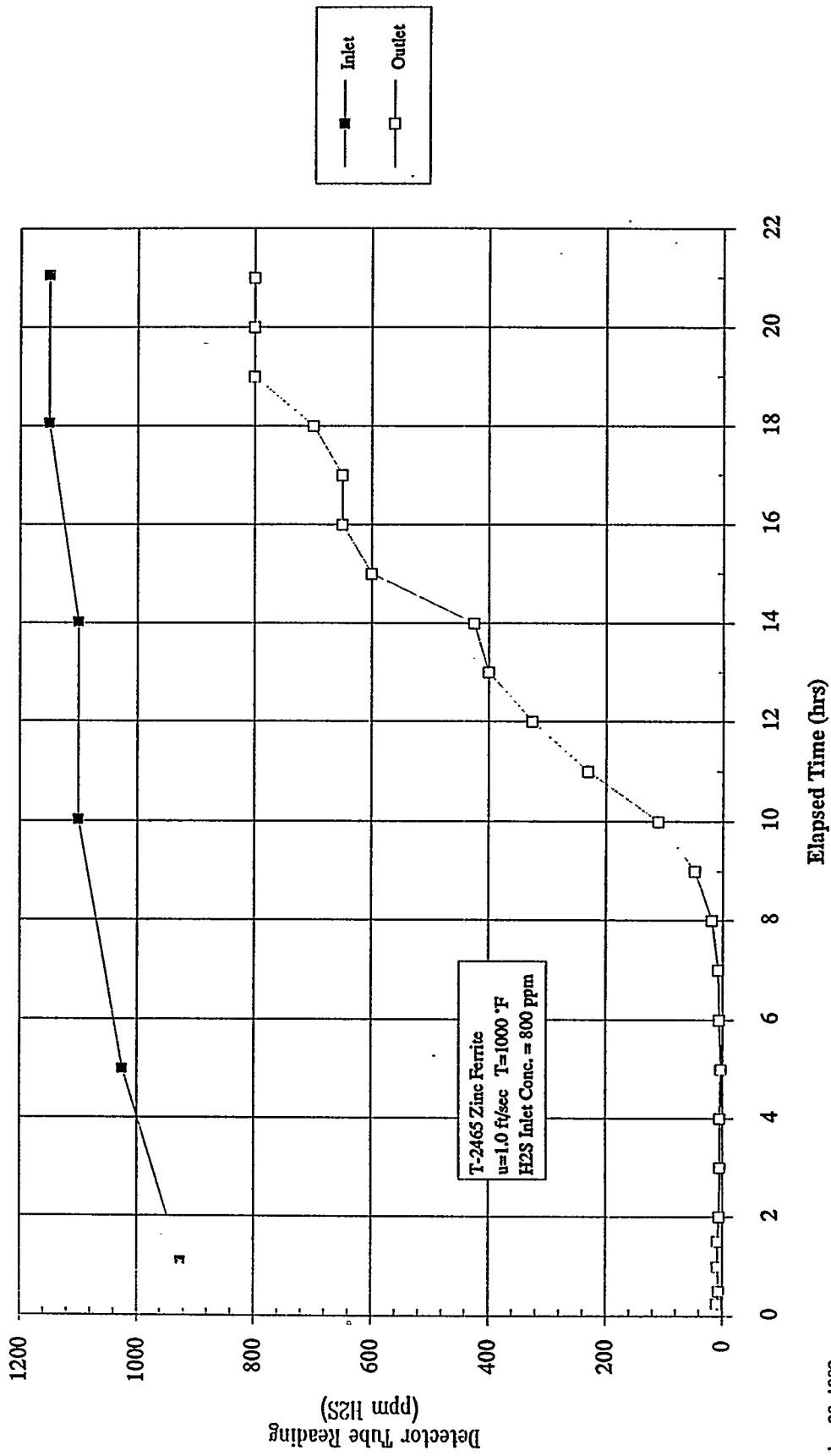

December 29, 1992
 Test time: 2:00 - 23:00 (Test duration: 21:00)

Zinc Ferrite Tests - ZFMC-01 Oxidative Regeneration 5

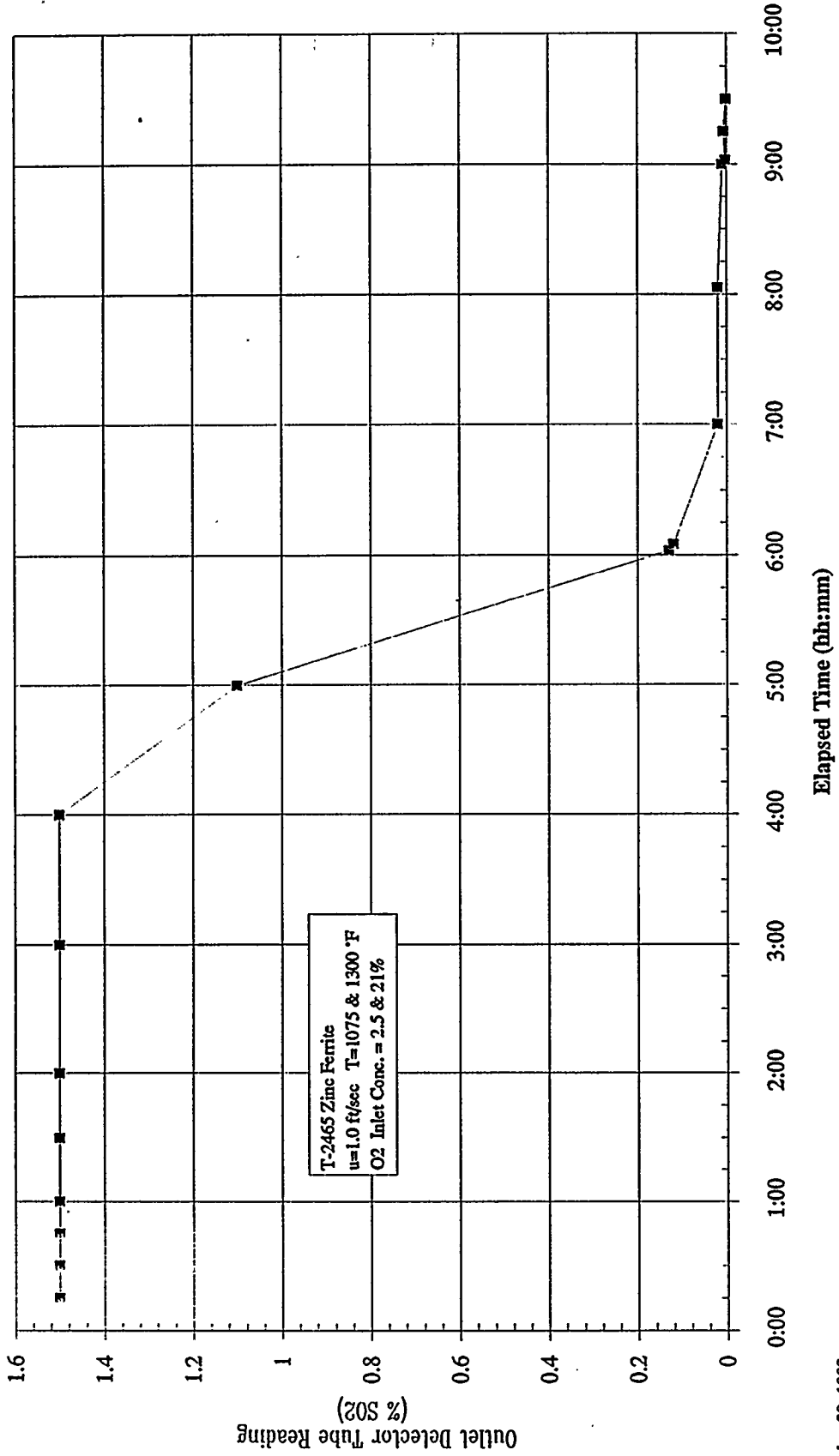

December 30, 1992
 Test time: 2:00-11:31 (Test duration: 9:31)

Zinc Ferrite Tests - ZFMC-01 Sulfidation 6

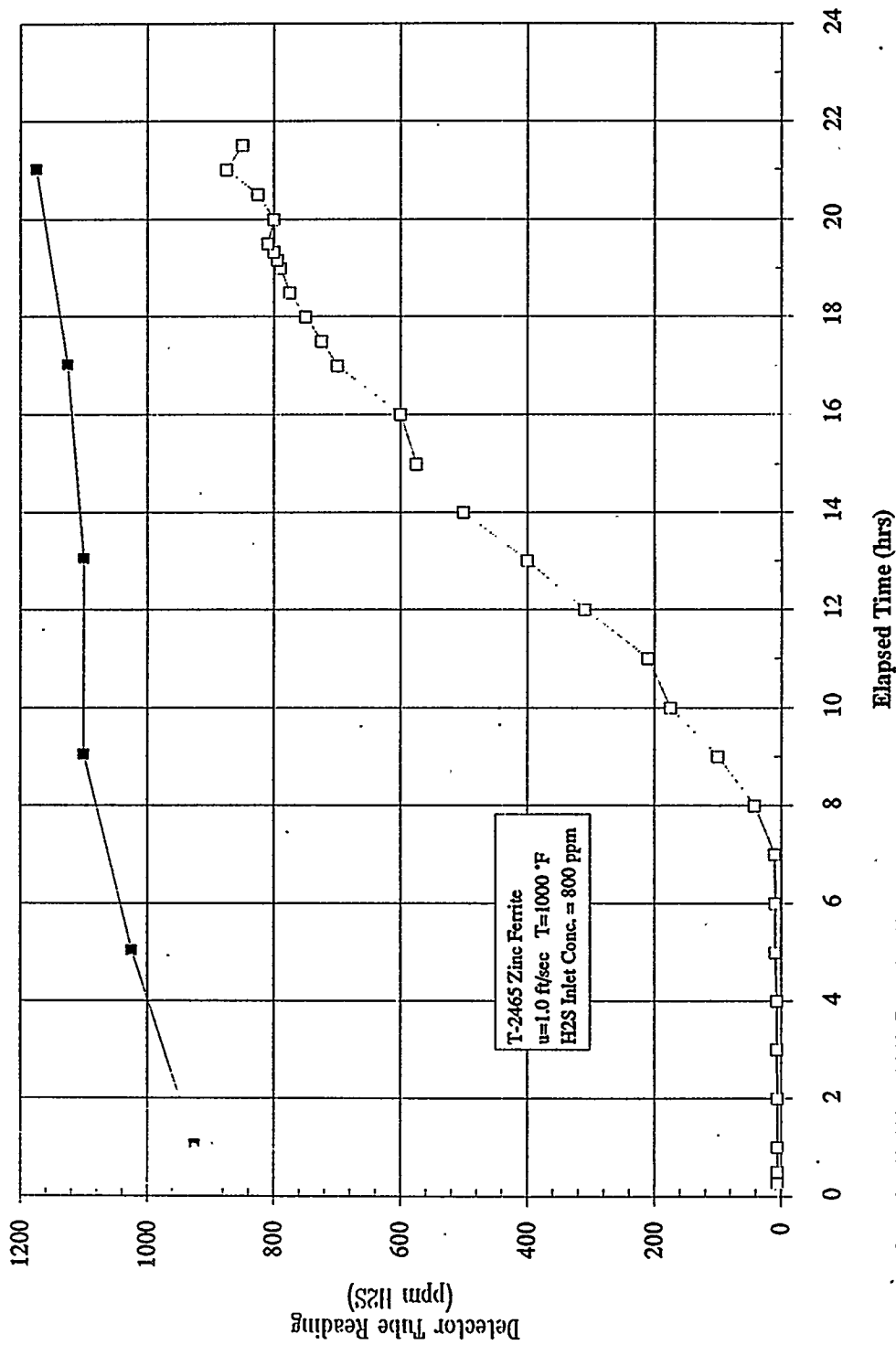

Test time: 18:30 (December 30, 1992) - 16:00 (December 31, 1992)
 Test duration: 21:30

Zinc Ferrite Tests - ZFMC-01 Oxidative Regeneration 6

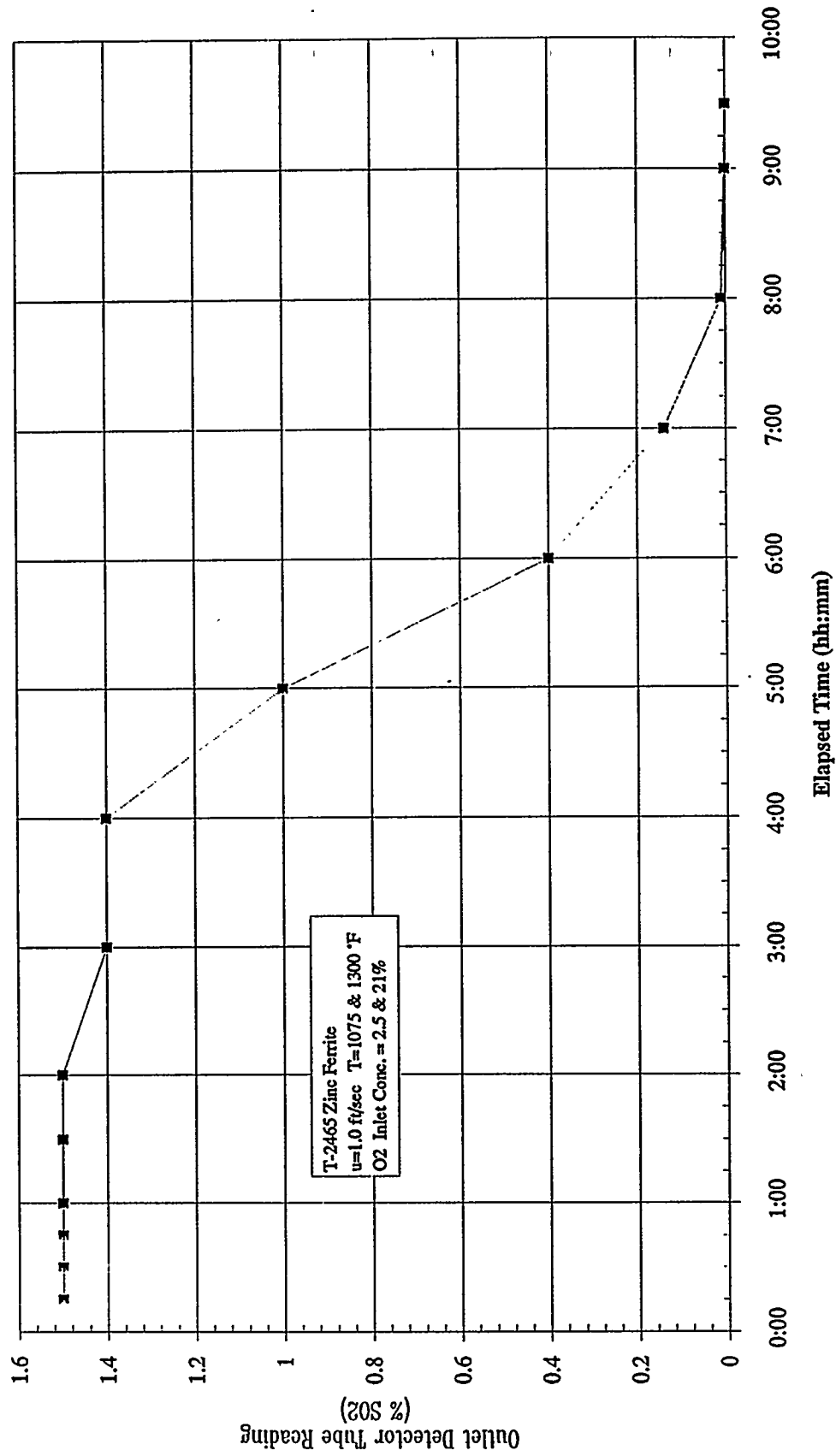

T-2465 Zinc Ferrite
 u=1.0 ft/sec T=1075 & 1300 °F
 O2 Inlet Conc. = 2.5 & 21%

Test time: 20:00 (January 4, 1993) - 5:30 (January 5, 1993)
 Test duration: 9:30

Zinc Ferrite Tests - ZFMC-01 Sulfidation 7

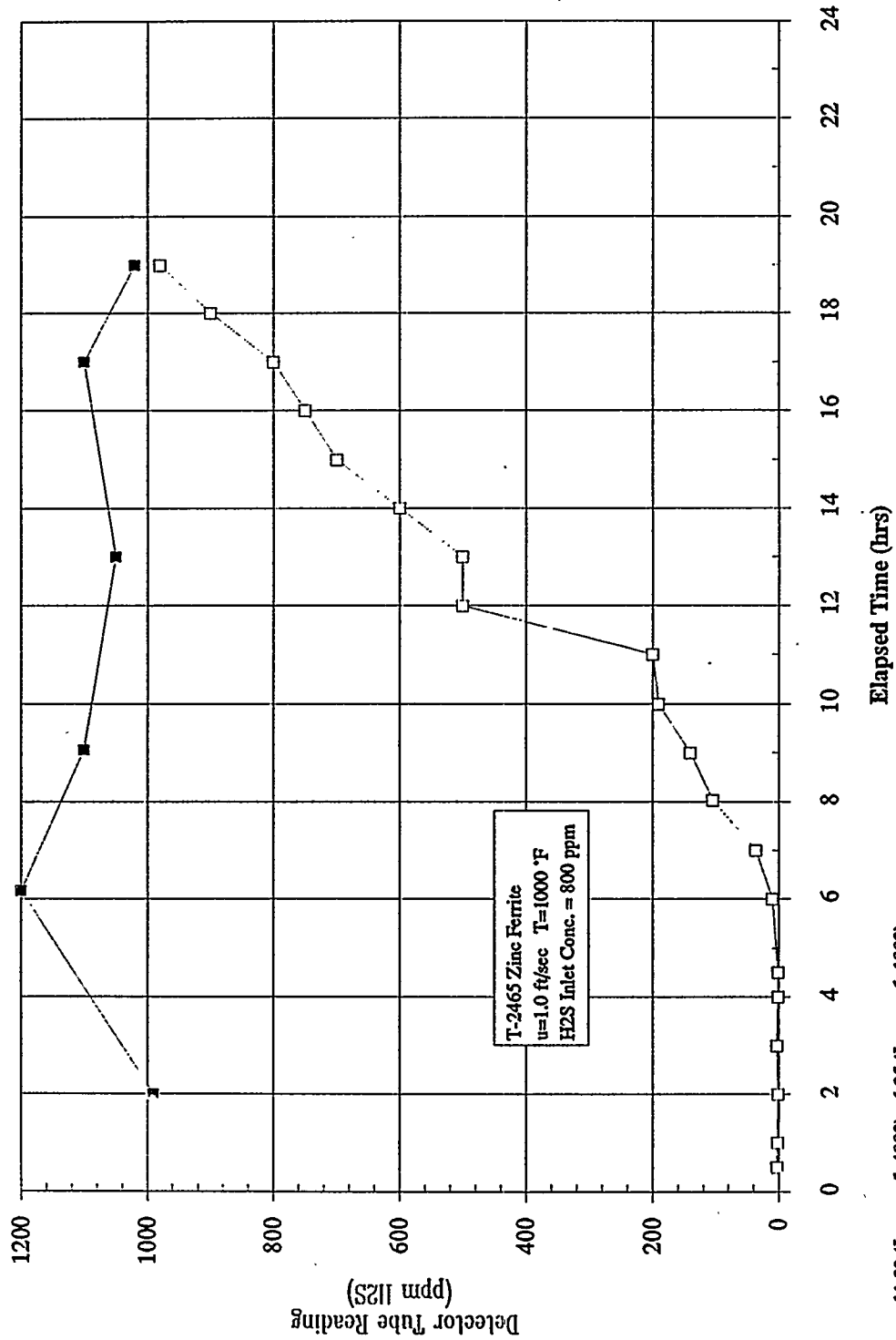

Test time: 11:30 (January 5, 1993) - 6:35 (January 6, 1993)
 Test duration: 19:05

Zinc Ferrite Tests - ZFMC-01 Oxidative Regeneration 7

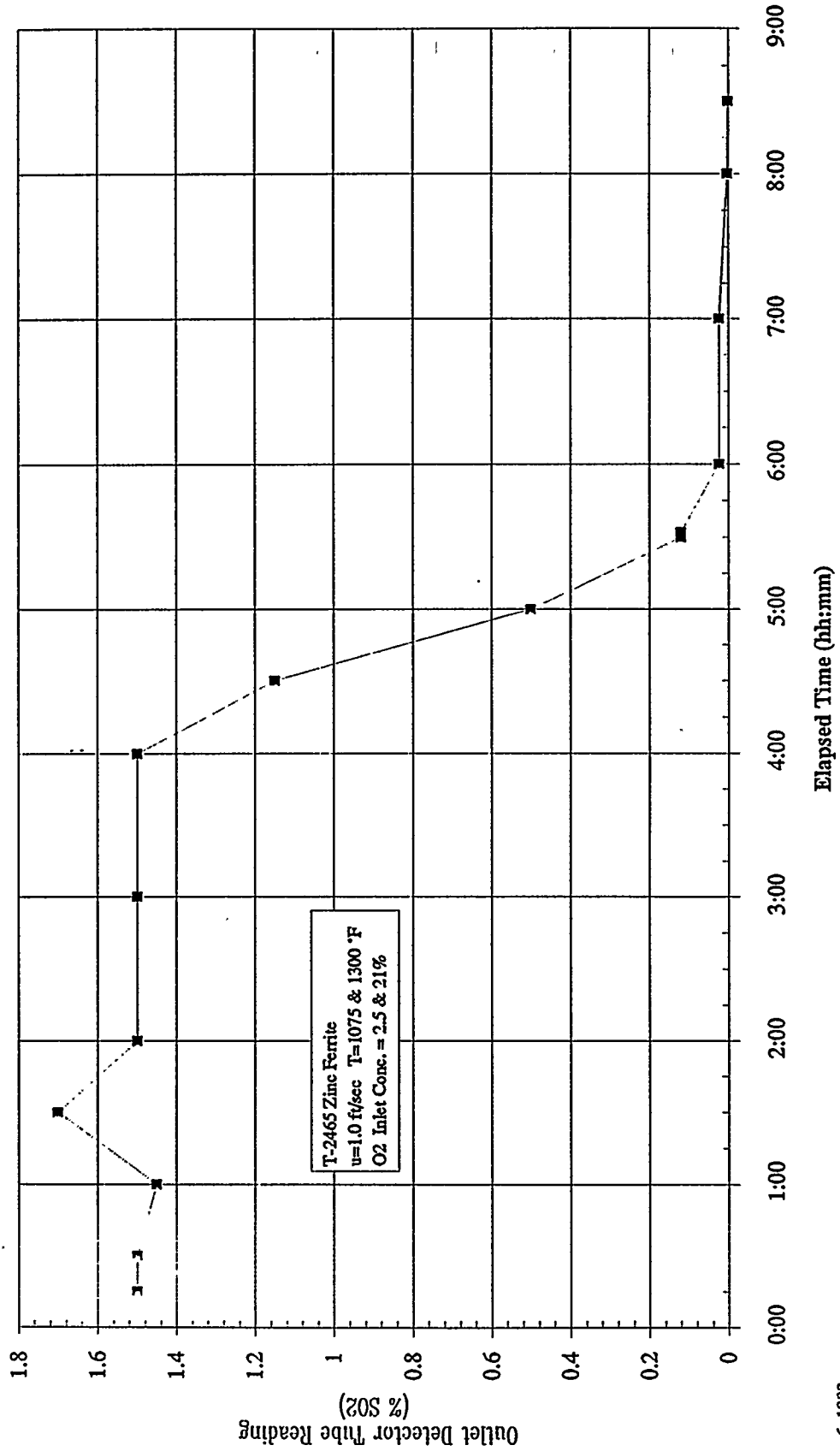

January 6, 1993
 Test time: 9:30-18:05 (Test duration: 8:35)

Zinc Ferrite Tests - ZFMC-01 Sulfidation 8

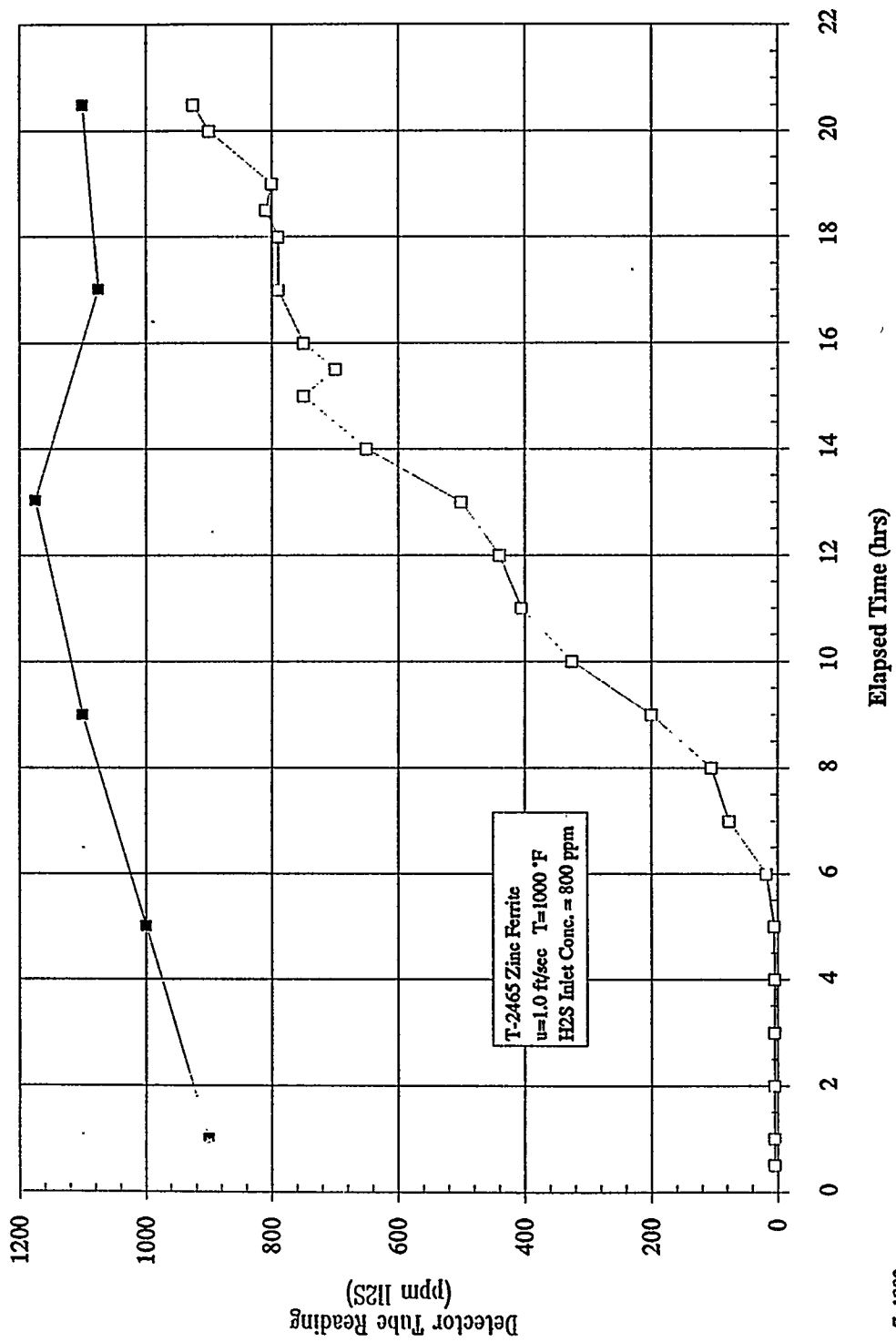

January 7, 1993
 Test time: 2:00-22:33 (Test duration: 20:33)

Zinc Ferrite Tests - ZFMC-01 Oxidative Regeneration 8

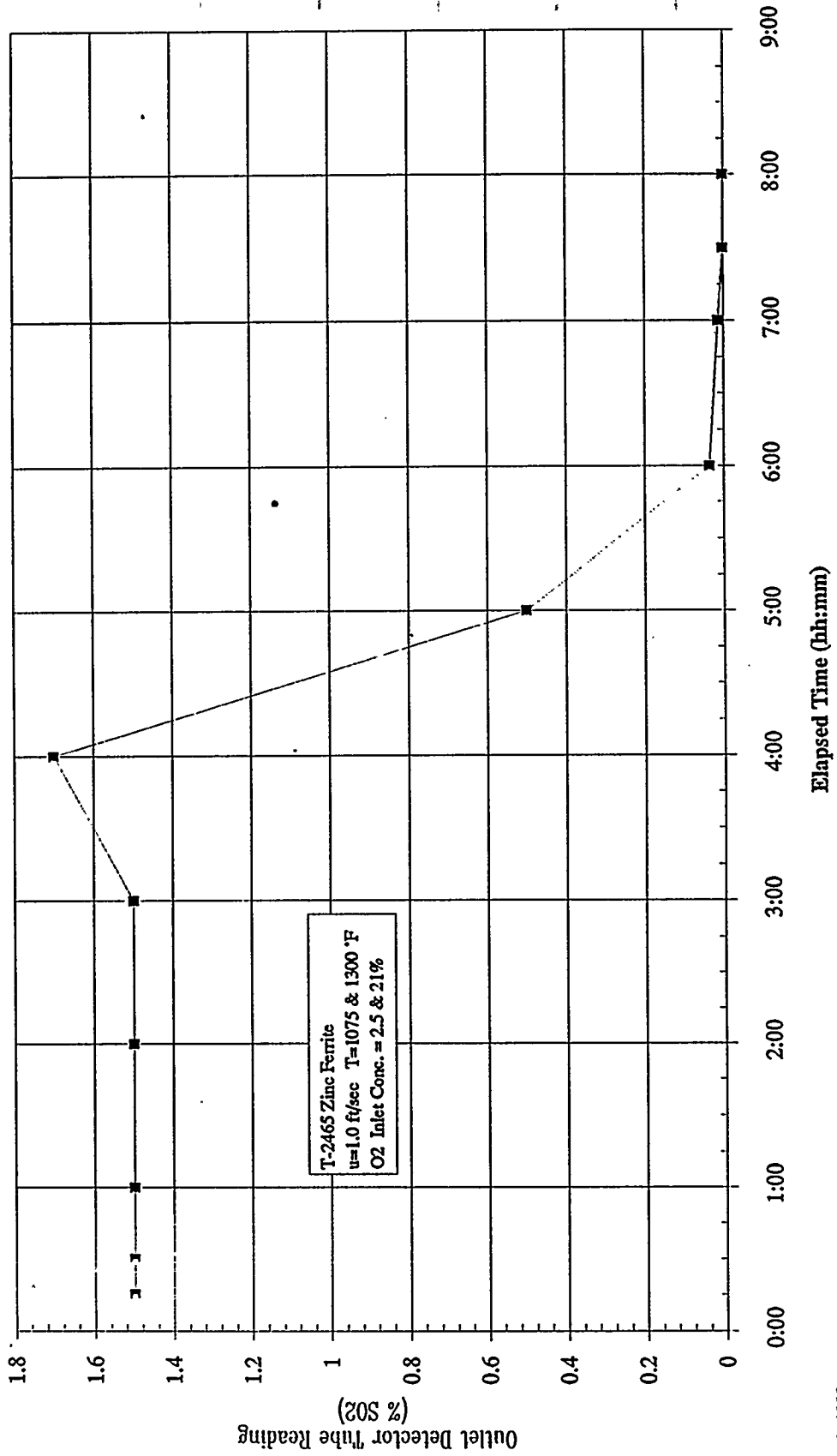

January 8, 1993
 Test time: 0:30-8:32 (Test duration: 8:02)

4.2 Condensate Analysis

Condensate samples collected from the project during testing were analyzed for metals by Flame Atomic Absorption (AA). The instrument used was a Perkin-Elmer Model 5000 Atomic Absorption Spectrophotometer. The expected accuracy of the method is 1% relative to the concentration with an expected precision of 0.5% relative to the concentration. Potassium sulfate was added to the condensate samples to eliminate interferences between zinc and other metals. Hydrochloric acid was added to dissolve any constituents which may have come out of solution. As a quality assurance method, each analysis is instrumentally integrated in triplicate.

The presence of metals in the condensate is an indication of metals depletion from the sorbent during testing. However, iron could be leached from the tubing walls to give a higher value of metal depletion from the sorbent than actually exists. Since chloride was introduced into the inlet gas stream, the condensate was also analyzed for chloride. The condensate was analyzed for chloride using a Dionex Ion Chromatograph. Condensates were also analyzed for sulfur, using a Dionex Ion Chromatograph, for the purposes of performing a sulfur balance around the system.

The results of condensate analyses are given in Table 4.2.

Table 4.2: Condensate Analyses

Sample Number	EG&G Laboratory Number	Sample Port	Sample Date	Sample Time	Condensate Collected (ml)	Zn (ppmw)	Fe (ppmw)	S (ppmw)	Cl (ppmw)
ZFMC01-S1-C1	#042731	Outlet	12/07/92	2000	8,720	34.7	1.77	93.2	8.20
ZFMC01-S1-C2	#42732	Inlet	12/08/92	2351	122	0.98	106.0	91.0	31.5
ZFMC01-S1-C3	#042733	Outlet	12/08/92	0600	18,670	5.29	28.8	9.38	77.2
ZFMC01-S1-C4	#042734	Outlet	12/08/92	1600	15,930	1.03	32.3	5.49	138
ZFMC01-S1-C5	#042735	Outlet	12/08/92	2350	12,270	1.63	33.3	9.94	120
ZFMC01-RR1-C1	#042744	Outlet	12/09/92	2359	1180	98.4	115.0	384	14.8
ZFMC01-S2-C1	#042745	Outlet	12/11/92	1335	17,157	1.78	18.0	5.28	115
ZFMC01-S2-C2	#042746	Outlet	12/14/92	1500	17,530	1.08	16.7	3.61	146
ZFMC01-S2-C3	#042747	Outlet	12/14/92	2135	12,160	0.30	15.9	1.76	141
ZFMC01-S2-C4	#042748	Inlet	12/14/92	2101	170.5	0.44	750	834	255
ZFMC01-R2-C1	#042779	Outlet	12/16/92	0130	68	981.0	1970.0	2520	92.6
ZFMC01-RR2-C1	#042780	Outlet	12/16/92	0130	815	68.9	193.0	690	15.7
ZFMC01-S3-C1	#042781	Outlet	12/16/92	1330	17623	0.85	18.9	4.96	142
ZFMC01-S3-C2	#042782	Outlet	12/16/92	2230	17690	0.20	22.3	9.43	150
ZFMC01-S3-C3	#042783	Outlet	12/17/92	0300	8305	0.30	24.4	14.3	144
ZFMC01-S3-C4	#042784	Inlet	12/17/92	0230	81.5	2.72	1450.0	1720	294
ZFMC01-R3-C1	#042803	Outlet	12/17/92	0615	12	380.0	2920.0	5290	103
ZFMC01-RR3	#042802	Outlet	12/18/92	0200	788	38.9	173.0	256	28.5
ZFMC01-S4-C1	#042804	Outlet	12/18/92	1400	18,200	1.08	17.3	3.29	122
ZFMC01-S4-C2	#042807	Outlet	12/21/92	1630	17,800	0.35	20.5	6.93	132
ZFMC01-S4-C3	#042806	Outlet	12/21/92	2100	9,030	0.39	12.0	6.29	109
ZFMC01-S4-C4	#042805	Inlet	12/21/92	2030	79	38.1	676.0	569	276
ZFMC01-RR4-C1	#042814	Outlet	12/29/92	0200	795	52.1	209.0	291	26.9
ZFMC01-S5-C1	#042810	Outlet	12/29/92	1200	17540	1.03	6.03	2.73	124
ZFMC01-S5-C2	#042811	Outlet	12/29/92	2000	15775	0.15	9.61	2.58	102

Sample Number	EG&G Laboratory Number	Sample Port	Sample Date	Sample Time	Condensate Collected (ml)	Zn (ppmw)	Fe (ppmw)	S (ppmw)	Cl (ppmw)
ZFMC01-S5-C3	#042812	Outlet	12/29/92	2330	6530	0.16	10.9	3.81	67.8
ZFMC01-S5-C4	#042813	Inlet	12/29/92	2403	62	0.15	294.0	120	199
ZFMC01-R5-C1	#042820	Outlet	12/30/92	1131	61	1150	2250	2920	124
ZFMC01-R5-C2	#042821	Inlet	12/30/92	1131	6	IS	IS	305	103
ZFMC01-RR5-C1	#042822	Outlet	12/30/92	1500	707	34.6	103	243	19.5
ZFMC01-RR5-C2	#042823	Inlet	12/30/92	1505	3	IS	IS	889	IS
ZFMC01-S6-C1	#042824	Outlet	12/31/92	0430	17,810	0.48	5.78	0.66	57.5
ZFMC01-S6-C2	#042825	Outlet	12/31/92	1330	18,010	0.48	11.0	2.63	60.8
ZFMC01-S6-C3	#042826	Outlet	12/31/92	1637	5,475	0.10	13.3	5.03	65.6
ZFMC01-S6-C4	#042829	Inlet	12/31/92	1600	74	1.66	771.0	747	169
ZFMC01-RR6-C1	#042833	Outlet	01/05/99	0930	785	7.81	24.2	74.3	13.3
ZFMC01-S7-C1	#042834	Outlet	01/05/93	2030	18,645	1.92	7.04	8.98	56.0
ZFMC01-S7-C2	#042835	Outlet	01/06/93	0630	20,200	0.23	10.3	12.0	78.9
ZFMC01-S7-C3	#042836	Outlet	01/06/93	0630	510	0.31	14.5	9.90	70.7
ZFMC01-S7-C4	#042837	Inlet	01/06/93	0630	69	0.07	194	147	171
ZFMC01-S7-C5	#042838	Inlet	01/06/93	0925	82	482	1390	47.0	143
ZFMC01-R7-C1	#042863	Inlet	01/06/93	0930	2	IS	IS	281	IS
ZFMC01-R7-C2	#042864	Outlet	01/06/93	0930	7	445.0	1180	1010	124
ZFMC01-RR7-C1	#042865	Outlet	01/06/93	2345	710	69.3	99.6	283	21.7
ZFMC01-S8-C1	#042868	Outlet	01/07/93	1100	16980	1.44	9.04	<0.5	39.5
ZFMC01-S8-C2	#042869	Outlet	01/07/93	2000	18,180	<0.02	3.34	3.57	2.81
ZFMC01-S8-C3	#042870	Outlet	01/07/93	2300	5510	<0.02	3.18	4.32	1.61
ZFMC01-S8-C4	#042871	Inlet	01/07/93	0200	77	7.58	785	745	118
ZFMC01-R8-C1	#042866	Outlet	01/08/93	0910	145	64.7	158	302	28.8
ZFMC01-RR8-C1	#042867	Outlet	01/08/93	1330	855	33.6	69.6	203	7.38
ZFMC01-RR8-C2	#042872	Inlet	01/08/93	1330	6	IS	IS	1200	IS

4.3 Solid Analysis

The sorbent was removed from the reactor after the fourth and sixth sulfidations, and after the eighth reductive regeneration. A 6.9 g sample was retained from the top bed sample from the fourth sulfidation. The sorbent removed from the reactor after the sixth sulfidation was screened with a Tyler #16 screen. 41.6 g of fines were removed from the sorbent, and the remainder was returned to the reactor. 25.3 g of fines were removed from the sorbent after the eighth reductive regeneration (the end of the test). The sorbent was removed from the reactor by pouring from the sorbent cage, then was divided into eight fractions by height. The solid samples were analyzed for various chemical and physical properties. The results of the analysis are reported here.

4.3.1 Crush Strength

Crush strength analyses were performed on samples of the fresh and the reacted zinc ferrite sorbent. The analysis consists of crushing pellets using a Chatillion Model LTC apparatus. The reported averages in Table 4.3 are for fifteen observations.

Table 4.3: Crush Strength Analysis

SAMPLE	Location	Median (N/pellet)	Average (N/pellet)	Standard Deviation
Fresh	-	215.7	203.78	73.4
ZFMC-01-S4-Top	Top	208.2	201.9	86.3
ZFMC-01-S6-Top	Top	236.6	243.3	95.2
ZFMC-01-S6-Bottom	Bottom	150.4	139.7	33.4
ZFMC-01-RR8-Top	Top	133.4	116.5	42.3
ZFMC-01-RR8-Bottom	Bottom	100.1	105.0	35.6

4.3.2 Sulfur Analysis

Sulfur analysis of the solid samples was performed to assess the absorptive capabilities of the sorbent. Total sulfur analyses were performed by EG&G utilizing a LECO Model SC-32 Total Sulfur Analyzer instrument. A 1 gram sample was combusted at approximately 1371 °C (2500 °F) in an oxygen atmosphere in which the sulfur oxidized to sulfur dioxide. The SO₂ gas was measured by a solid state infrared detector and total sulfur results were calculated by a microprocessor. Standard samples containing precisely known amounts of sulfur were analyzed daily to ensure proper instrument operation. Estimated accuracy and precision are ± 0.05% of the total sulfur value. The results are reported in Table 4.4.

Table 4.4: Sorbent Sulfur Loading

Sample Number	EG&G Laboratory Number	Sample Description	Fraction Weight (Grams)	EG&G Lab Sulfur (Wt %)
ZFMC-01-Fresh	#42809	Fresh	-	0.02
ZFMC-01-S4-Top	#42808	Top	6.9	13.3
ZFMC-01-S6-Top	#42831	Top	N/A	12.3
ZFMC-01-S6-Bottom	#42832	Bottom	N/A	8.38
ZFMC-01-RR8-Top	#42879	Top	172.6	0.04
ZFMC-01-RR8-Bottom	#42880	Bottom	134.1	0.06

4.3.3 Bulk Elemental Analysis

Samples of the sorbent bed were analyzed for zinc and iron content by bulk techniques. Total zinc and iron determinations were made by atomic absorption spectroscopy. Analyses were performed by the EG&G Analytical Laboratory. The instrument utilized was a Perkin Elmer Model 5000 Atomic Absorption Spectrophotometer. The estimated accuracy is ± 1% of the reported value. The estimated precision is ± 0.5% relative to the value. Little or no zinc and iron loss was detected over the course of this test.

Table 4.5: Sorbent Iron and Zinc Analysis

Sample Number	EG&G Laboratory ID Number	Location	Weight %	
			Zn	Fe
ZFMC-01-Fresh	#42809	-	26.9	47.9
ZFMC-01-S4-Top	#42808	Top	25.9	46.7
ZFMC-01-S6-Top	#42831	Top	25.5	47.6
ZFMC-01-S6-Bottom	#42832	Bottom	25.2	48.8
ZFMC-01-RR8-Top	#42879	Top	26.6	48.7
ZFMC-01-RR8-Bottom	#42880	Bottom	26.1	48.2

4.3.4 Sieve Analysis

Sieve analysis of fresh sorbent, reactor fines (after the 6th sulfidation and 8th reductive regeneration), and the sorbent after the final (8th) reductive regeneration was performed. The sorbent samples were sieved and the weight % of sorbent retained on each screen are reported in Tables 4.6 through 4.8.

Table 4.6: Sieve Analysis - Fresh T-2465 Zinc Ferrite

Screen Size Retained On	Sieve Opening (mm)	Weight % Retained on Screen
6.35mm (¼ inch)	6.35	0.00
3 ½ mesh	5.66	95.65
4 mesh	4.76	3.96
5 mesh	4.00	0.26
Pan	< 4.00	0.13
Total Weight %		100.00
Sample Size (grams)		184.05

Table 4.7: Sieve Analysis - Reactor Fines

Screen Size Retained On (mesh)	Sieve Opening (mm)	Weight % Retained on Screen	
		After 6th Sulfidation	After 8th Reductive Regeneration
8	2.38	42.79	56.47
14	1.41	23.47	19.22
16	1.19	6.11	4.71
30	0.595	15.16	10.98
60	0.250	8.07	5.49
Pan	<0.250	4.40	3.13
Total Weight %		100.00	100.00
Sample Size (grams)		40.90	25.5

Table 4.8: Sieve Analysis - After 8th Reductive Regeneration

Screen Size Retained On	Sieve Opening (mm)	WEIGHT PERCENT RETAINED ON SCREEN T-2465 Zinc Ferrite							
		Top of Bed	2nd Fraction from Top	3rd Fraction from Top	4th Fraction from Top	5th Fraction from Top	6th Fraction from Top	7th Fraction from Top	Bottom of Bed
6.35 mm (¼ inch)	6.35	0.0	0.0	0.0	0.0	0.0	0.0	0.0	0.0
3 ½ mesh	5.66	62.34	78.30	75.48	70.64	66.84	69.25	63.43	48.19
4 mesh	4.76	31.51	15.75	16.94	19.20	22.76	21.36	21.55	28.89
5 mesh	4.00	2.95	3.39	4.87	7.28	6.31	5.59	7.13	8.88
Pan	< 4.00	3.20	2.56	2.71	2.88	4.09	3.80	7.89	14.04
Total Weight %		100.00	100.00	100.00	100.00	100.00	100.00	100.00	100.00
Sample Size (grams)		162.5	132.7	129.3	131.8	117.3	128.8	131.8	110.40

5.0 Results and Discussion

5.1 Sulfur Balance

Calculations have been performed to evaluate an overall sulfur balance. The balances were computed using the results of the laboratory analyses (condensate and sorbent) and calculated inlet flows in conjunction with the inlet and outlet gas compositions as found by gas chromatography. A general overall sulfur balance can be written as:

$$M_{S, \text{ Initially in bed}} + \sum_{\text{Sulf/Reg}} M_{S, \text{ inlet gas}} = \sum_{\text{Sulf/Reg}} M_{S, \text{ outlet gas}} + \sum_{\text{Sulf/Reg}} M_{S, \text{ condensate}} + \sum_{\text{Sulf/Reg}} M_{S, \text{ Sorbent removed from reactor}}$$

The total amount of sulfur coming into the system with the inlet gas was calculated by a numerical integration (trapezoidal rule) of the inlet hydrogen sulfide flow rate over the time on stream. The hydrogen sulfide flow rate calculated from the mass flow controller settings or that calculated from the GC data was used for this calculation.

Sulfur leaving the system in the outlet gas was computed using a numerical integration of the exit sulfur concentration over the time on stream. The exit sulfur concentration as determined from the gas grab analyses and the calculated exit gas flows were used for this calculation. All sulfur species (SO_2 , COS , H_2S) were considered in the calculations involving GC data.

The amounts of sulfur in the condensate and the sorbent samples were calculated by multiplying the mass of the sample by the mass fraction of sulfur as determined by laboratory analysis.

Table 5.1 summarizes the sulfur balance for the zinc ferrite test series. Percent closure calculations were also calculated on a per cycle basis.

Table 5.1: ZFMC-01 Sulfur Balance

	Inlet (g Sulfur)			Outlet (g Sulfur)				% Closure (Out/In*100%)	
	Fresh Sorbent	MFC-based inlet	GC-based inlet	GC-based outlet	Sorbent removed	Condensate	MFC-based inlet	GC-based inlet	
ZFMC-01-S1	0.24	280.43	162.09	76.04	-	1.21	64.29	110.79	
ZFMC-01-R1	-	0.00	0.45	102.68	-	-	-	-	
ZFMC-01-RR1	-	0.00	0.08	0.07	-	0.45	-	-	
ZFMC-01-S2	-	262.35	139.36	79.40	-	0.32	83.09	137.28	
ZFMC-01-R2	-	0.00	18.01	137.38	-	0.17	-	-	
ZFMC-01-RR2	-	0.00	1.42	0.14	-	0.56	-	-	
ZFMC-01-S3	-	224.45	145.75	49.90	-	0.51	85.37	120.55	
ZFMC-01-R3	-	0.00	10.68	140.83	-	0.06	-	-	
ZFMC-01-RR3	-	0.00	2.53	0.11	-	0.20	-	-	
ZFMC-01-S4	-	226.21	146.63	47.93	0.92	0.28	74.42	103.41	
ZFMC-01-R4	-	0.00	14.97	118.90	-	-	-	-	
ZFMC-01-RR4	-	0.00	1.19	0.07	-	0.23	-	-	
ZFMC-01-S5	-	205.79	136.33	36.90	-	0.12	72.07	102.21	
ZFMC-01-R5	-	0.00	7.22	110.89	-	0.18	-	-	
ZFMC-01-RR5	-	0.00	1.58	0.06	-	0.17	-	-	
ZFMC-01-S6	-	211.57	141.87	44.54	N/A	0.14	70.24	98.63	
ZFMC-01-R6	-	0.00	7.94	103.81	-	-	-	-	
ZFMC-01-RR6	-	0.00	0.88	0.08	-	0.06	-	-	

	Inlet (g Sulfur)			Outlet (g Sulfur)			% Closure (Out/In*100%)	
	Fresh Sorbent	MFC-based inlet	GC-based inlet	GC-based outlet	Sorbent removed	Condensate	MFC-based inlet	GC-based inlet
ZFMC-01-S7	-	187.01	131.00	37.10	-	0.43		
ZFMC-01-R7	-	0.00	1.71	110.26	-	0.01	79.17	110.60
ZFMC-01-RR7	-	0.00	1.51	0.06	-	0.20		
ZFMC-01-S8	-	201.38	143.74	44.84	-	0.15		
ZFMC-01-R8	-	0.00	3.60	88.27	-	0.04	66.61	89.84
ZFMC-01-RR8	-	0.00	1.97	0.10	0.54	0.18		
Overall	0.24	1799.20	1222.14	1330.34	1.46	5.70	74.33	109.42

NOTE: Almost all of the regenerations had a high SO₂ reading in at least one of the inlet samples (possibly residual sulfur in the sample line), which would cause the integration to overestimate the actual amount of sulfur.

5.2 Chloride Balance

A chloride balance for test ZFMC-01 was calculated. HCl was introduced in the feed gas during all eight sulfidations. The balance calculation was essentially the same as that for the sulfur balance, with one exception. The chloride leaving the system in the outlet gas is assumed to be zero. This is for two reasons. The first is that the analytical techniques available are unable to analyze for chloride content in the gas grab samples, and the second is that the condensate is assumed to remove all of the chloride from the stream. In previous tests, no chloride was found in bubblers located downstream of the condensate pots, supporting the assumption that all the chloride is trapped in the condensate. The results of the chloride balances are shown in Table 5.2.

Table 5.2: ZFMC-01 Chloride Balance

	Inlet (g Chloride)			Outlet (g Chloride)			% Closure (Out/In*100%)	
	Fresh Sorbent	MFC-based inlet	GC-based inlet	GC-based outlet	Sorbent removed	Condensate	MFC-based inlet	GC-based inlet
ZFMC-01-S1	N/A	5.88	-	-	-	5.19	-	-
ZFMC-01-R1	-	0.00	-	-	-	-	88.48	-
ZFMC-01-RR1	-	0.00	-	-	-	0.02	-	-
ZFMC-01-S2	-	5.52	-	-	-	6.29	-	-
ZFMC-01-R2	-	0.00	-	-	-	0.01	114.37	-
ZFMC-01-RR2	-	0.00	-	-	-	0.01	-	-
ZFMC-01-S3	-	4.77	-	-	-	6.38	-	-
ZFMC-01-R3	-	0.00	-	-	-	0.00	134.16	-
ZFMC-01-RR3	-	0.00	-	-	-	0.02	-	-
ZFMC-01-S4	-	4.77	-	-	N/A	5.58	-	-
ZFMC-01-R4	-	0.00	-	-	-	-	117.27	-
ZFMC-01-RR4	-	0.00	-	-	-	0.02	-	-
ZFMC-01-S5	-	4.36	-	-	-	4.24	-	-
ZFMC-01-R5	-	0.00	-	-	-	0.01	97.74	-
ZFMC-01-RR5	-	0.00	-	-	-	0.01	-	-
ZFMC-01-S6	-	4.43	-	-	N/A	2.49	-	-
ZFMC-01-R6	-	0.00	-	-	-	-	56.48	-
ZFMC-01-RR6	-	0.00	-	-	-	0.01	-	-

	Inlet (g Chloride)			Outlet (g Chloride)				% Closure (Out/In*100%)	
	Fresh Sorbent	MFC-based inlet	GC-based inlet	GC-based outlet	Sorbent removed	Condensate	MFC-based inlet	GC-based inlet	
ZFMC-01-S7	-	3.95	-	-	-	2.70	-	-	
ZFMC-01-R7	-	0.00	-	-	-	0.00	68.64	-	
ZFMC-01-RR7	-	0.00	-	-	-	0.02	-	-	
ZFMC-01-S8	-	1.07	-	-	-	0.74	-	-	
ZFMC-01-R8	-	0.00	-	-	-	0.00	70.11	-	
ZFMC-01-RR8	-	0.00	-	-	N/A	0.01	-	-	
Overall	N/A	34.75	-	-	N/A	33.74	97.07	-	

5.3 Discussion of Results

- Figure 3 shows the sulfidation detector tube readings for the eight cycles together on a single plot. The plot shows that, in terms of reactivity, the zinc ferrite performed consistently over the course of testing, with no significant amount of decline. The scatter in the readings can be attributed to the imprecision of the detector tubes themselves and not on the performance of the sorbent. The sulfur balances also confirm this observation if the inlet and outlet values for the sulfidations are compared. These values show that the sorbent bed was absorbing approximately the same amount of sulfur over the course of each of the sulfidations.
- Defining 200 ppmv H₂S in the outlet as "breakthrough," the zinc ferrite had breakthrough times of nine to eleven hours. This can be compared to the zinc titanate tested for the M.W. Kellogg CRADA previously, which had breakthrough times of less than five hours under similar (30.48 cm/s, 538 °C) conditions.
- The major problem with the particular zinc ferrite formulation tested was found to be degradation in the physical integrity of the sorbent. The reactor differential pressure (DP) can be used as a rough indicator of the physical state of the sorbent. As shown in Figure 4, the DP over the reactor system increased dramatically during several sulfidations (S5, S6, and S8). The sorbent was removed for sampling after the fourth sulfidation, so the initial higher baseline DP of sulfidation five (20" H₂O vs. 6" H₂O) may be attributed to the sorbent packing slightly differently than when initially loaded. However, the differential pressure did increase substantially between nine and twelve hours on-line, eventually stabilizing at approximately 35" H₂O. Sulfidation six, which started out with a baseline DP similar to that of sulfidation five, saw the differential pressure climb significantly over the course of the test. The sorbent was again removed from the reactor in an attempt to determine the cause of the increase. The sorbent was sieved and fines were removed from the bed. The remaining sorbent was returned to the reactor and the test was continued. The DP for sulfidation seven returned to the levels of the first four sulfidations, indicating that the reactor fines were most likely the cause of the DP increase. Sulfidation eight remained at the level of sulfidation seven until fifteen hours on-stream, at which point the DP began to climb again. It was decided to end the test after the eighth reductive regeneration because of the questions surrounding the sorbent's further ability to physically withstand the test conditions.

- The indications of sorbent deterioration given by the DP increases were confirmed in the analysis of the sorbent after the completion of the test. The crush strength results for reductive regeneration eight seem to show that the sorbent was weaker when compared to the fresh sorbent. The large standard deviations in the measurements make it difficult to make any definite conclusions. The sieve analysis results indicate that, after the final reductive regeneration, the bed had proportionally more small particles than the fresh sorbent.
- This test utilized a staged, dry oxidative regeneration scheme. The effects of this scheme (positive or negative) on the physical integrity of the sorbent can not be determined from this single test.
- Comparing the top samples from sulfidations four and six shows that the sorbent sulfur loading was essentially unchanged over the course of these cycles. The sixth sulfidation samples show a gradient in sulfur loading across the bed even after attempting to fully saturate the bed. Comparing the eighth reductive regeneration samples to the fresh samples shows that little residual sulfur is present in the sorbent after it is regenerated.
- The low levels of HCl (15 ppmv) present in the feed gas passed through the bed without depositing on the sorbent and did not seem to have any obvious harmful effects. The chloride balance has an excellent closure - 97% overall. This indicates that the assumption that no chloride exits in the outlet gas is valid in this particular instance. The closure remained high despite not having chloride data for the sorbent samples, which indicates that the sorbent picks up little or no chloride. This conclusion is strengthened by the condensate chloride numbers, which show that virtually all of the chloride entering the system during a given sulfidation exits the system in the condensate.

Figure 3: ZFMC-01 Sulfidations 1-8 Detector Tubes

T-2465 Zinc Ferrite
u=1.0 ft/sec T=1000°F
H2S Inlet Conc. = 800 ppm

Zinc Ferrite Tests - ZFMC-01 Sulfidations 1-8

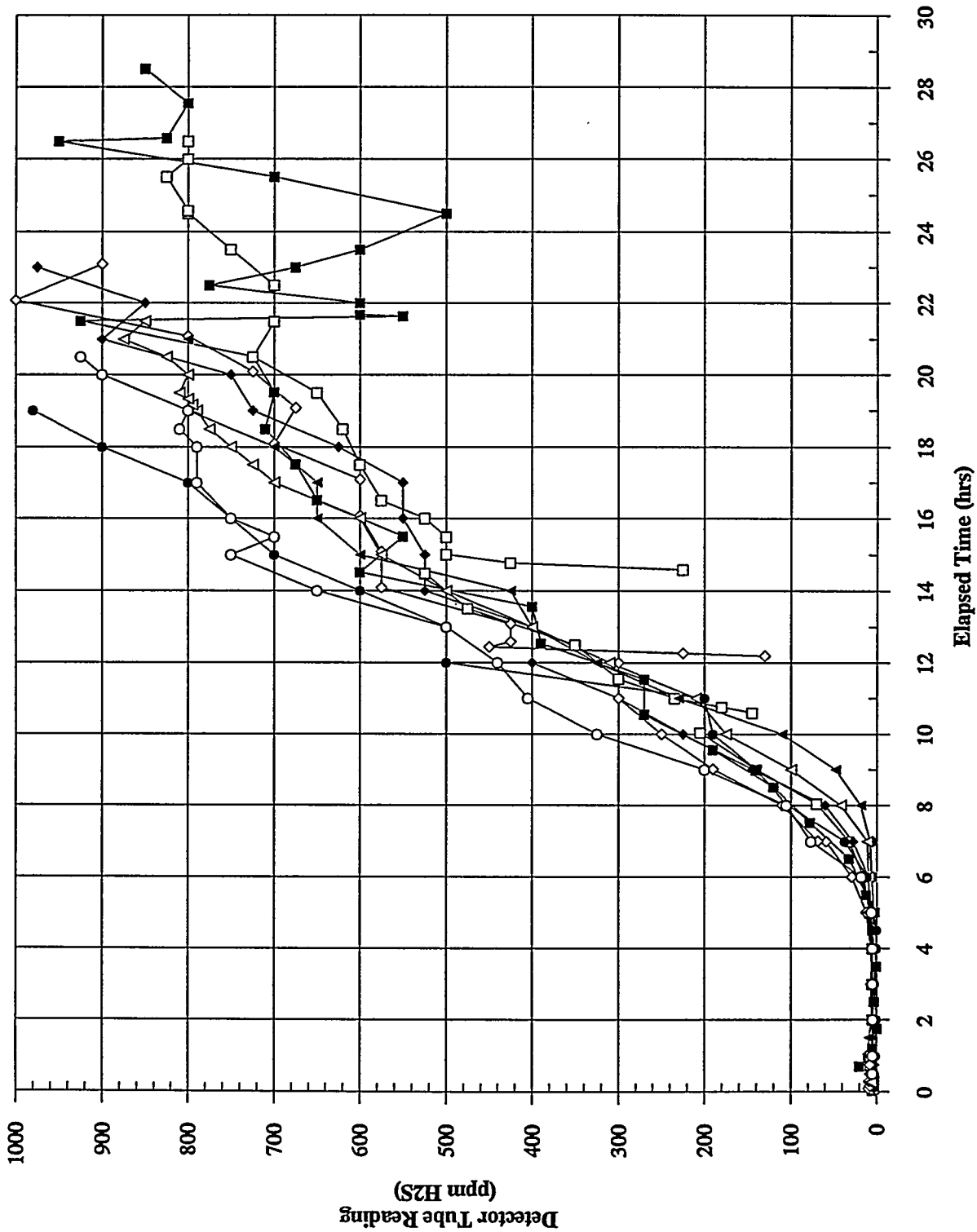
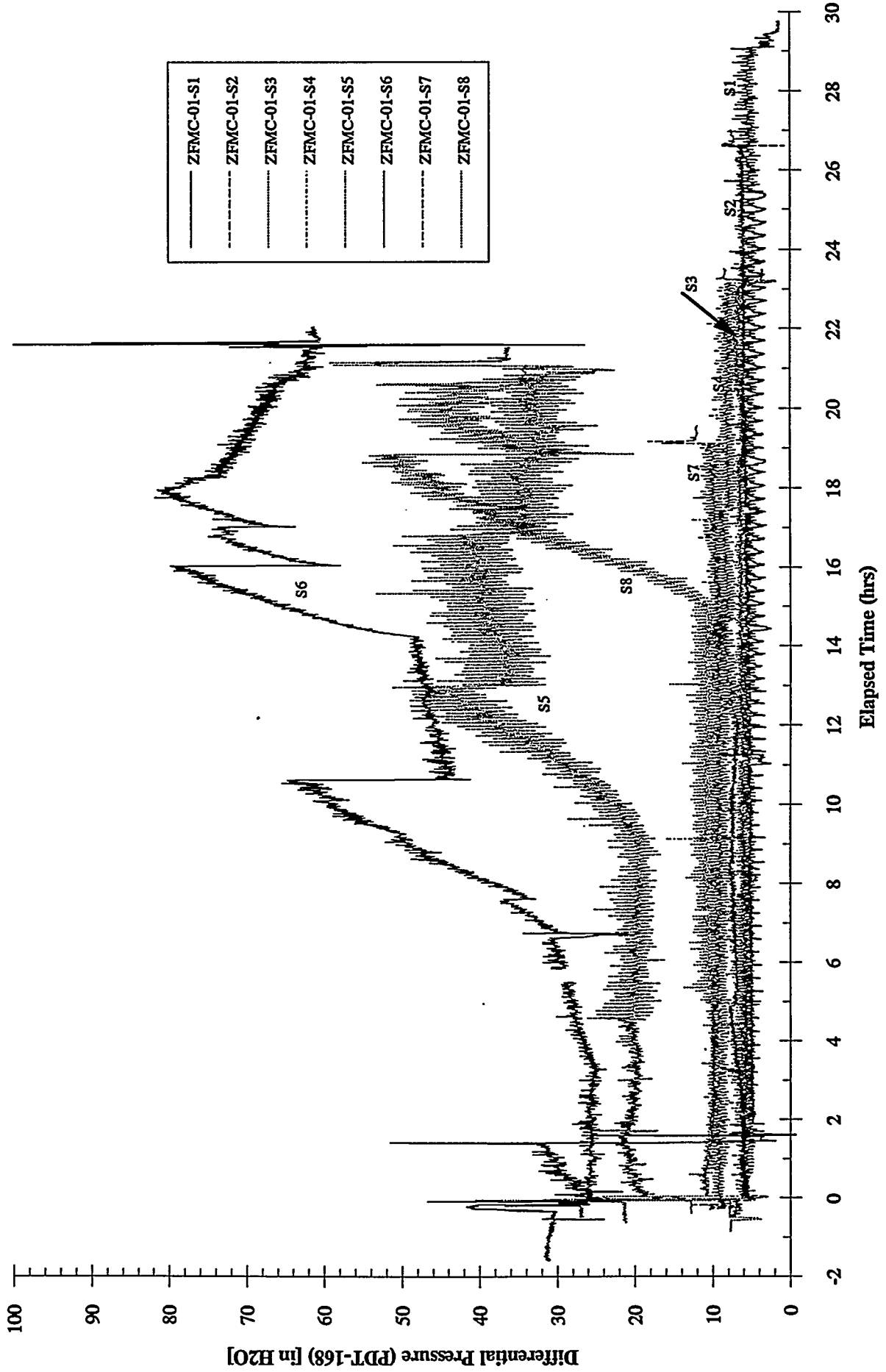

Figure 4: ZFMC-01 Sulfidations 1-8 Reactor Differential Pressure

Zinc Ferrite Tests - ZFMC-01 Sulfidations 1 through 8



APPENDIX A
Data Acquisition Mass Flow Trends

Component gas and water flow rates were monitored by DDAS, a PC-based automatic data acquisition system. Trend plots for mass flow controller and water pump settings are presented here. The mass flow controllers utilized were Teledyne Hastings-Raydist HFC-series flow controllers with a reported accuracy of $\pm 1\%$ full scale. The water was fed with an Isco, Inc. Model 500D continuous flow pump system, which has a reported accuracy of $\pm 0.5\%$ of the indicated value. The mass flow controllers and pump were calibrated prior to testing. Planned set-points for the mass flow controllers were not always at the conditions for which the controllers were originally sized. Therefore, flow proving over the range of 0 scfh to the maximum scfh for each controller was performed. Flow proving is a check over a range of flow rates of the controller's calibration by comparing the indicated flows (those recorded by the data acquisition system) against a flow calibration standard. At the high end of each controller, errors within $\pm 1\%$ of the indicated value were typical. Errors for flow proving at the low end of the controllers were as high as 30% of the indicated value. In order to establish the correct set-point, regression analysis was performed for the flow proving data. Water flow rates were recorded using an EG&G Flow Technology model FTO-2N1SW-LHC-1 turbine meter with a range of 10-150 ccpm. It should be noted that the flow rates used during this test series were at the extreme low range of the instrument, and the recorded values are not very accurate. For this reason several of the series do not have accompanying water flow plots. The gas and water flow rate plots show the raw data only and should only be used as an indication of trends. Numerical values reported throughout the body of this report have been corrected using the results of the regression analysis.

T-2465 Zinc Ferrite
 u=1.0 ft/sec T=1000 °F
 H2S Inlet Conc. = 800 ppm

Zinc Ferrite Tests - ZFMC-01 Sulfidation 1

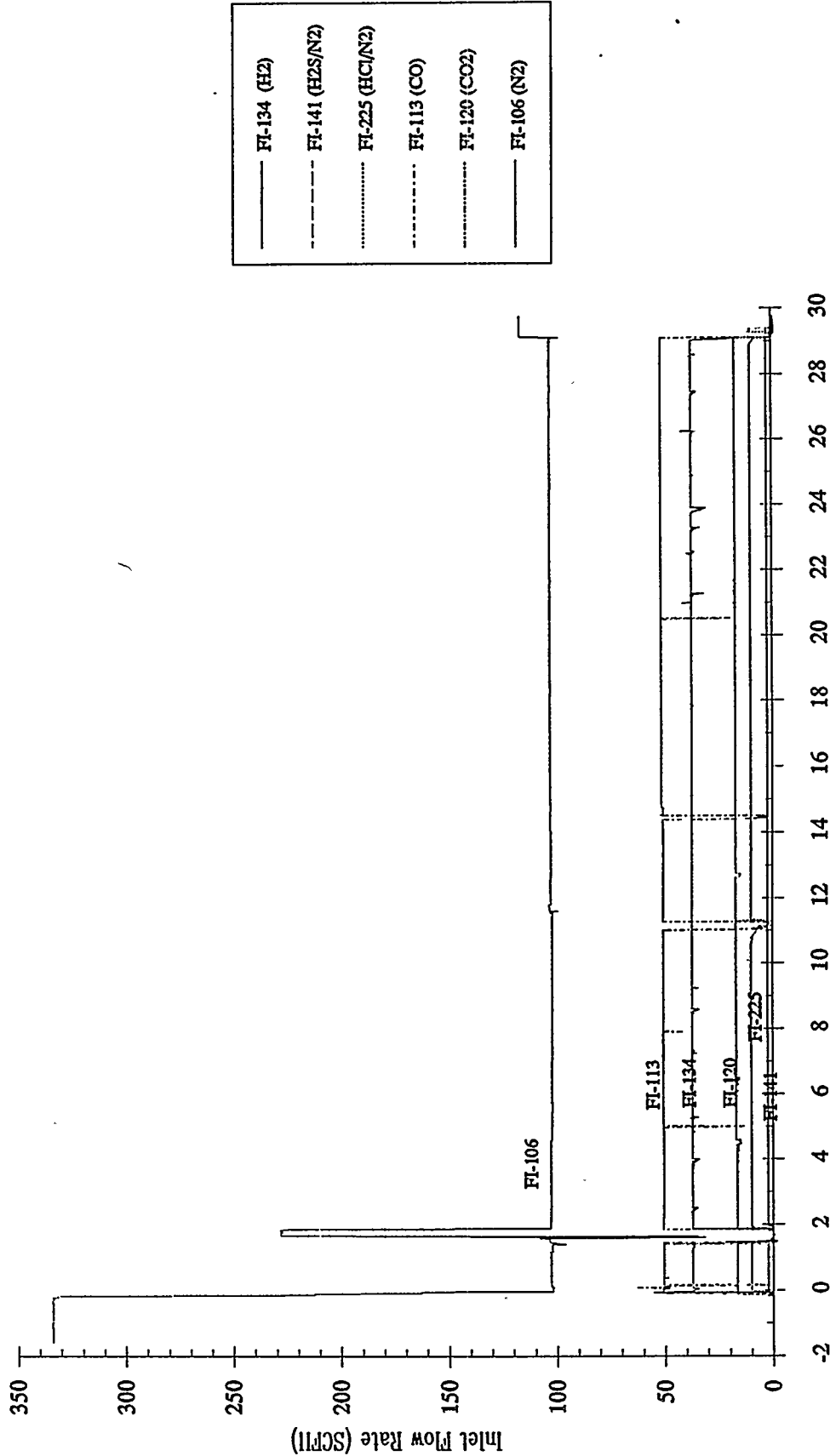

Test time: 18:03-19:28, 19:55 (December 7, 1992) - 23:07 (December 8, 1992)
 Test duration: 28:37

T-2465 Zinc Ferrite
u=1.0 ft/sec T=1000-1300 °F
O2 Inlet Conc. = 0.5-21 %

Zinc Ferrite Tests - ZFMC-01 Oxidative Regeneration 1

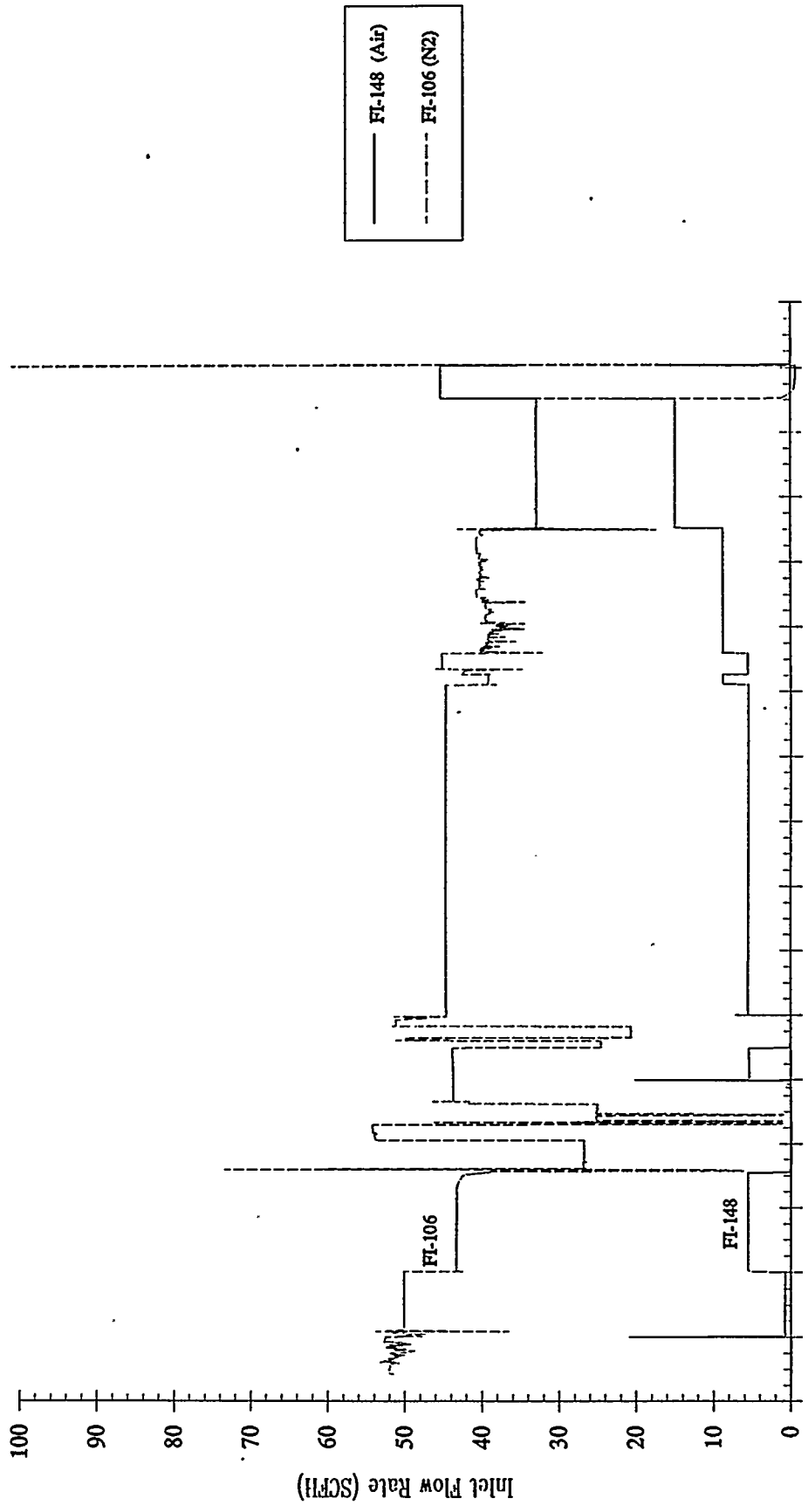

December 9, 1992:00 3:00 4:00 5:00 6:00 7:00 8:00 9:00 10:00 11:00 12:00 13:00 14:00 15:00 16:00 17:00 18:00 19:00
Test time: 3:00-5:30, 7:00-7:30, 8:00-18:05
Test duration: 13:05

T-2465 Zinc Ferrite
u=1.0 ft/sec T=1000 °F

Zinc Ferrite Tests - ZFMC-01 Reductive Regeneration 1

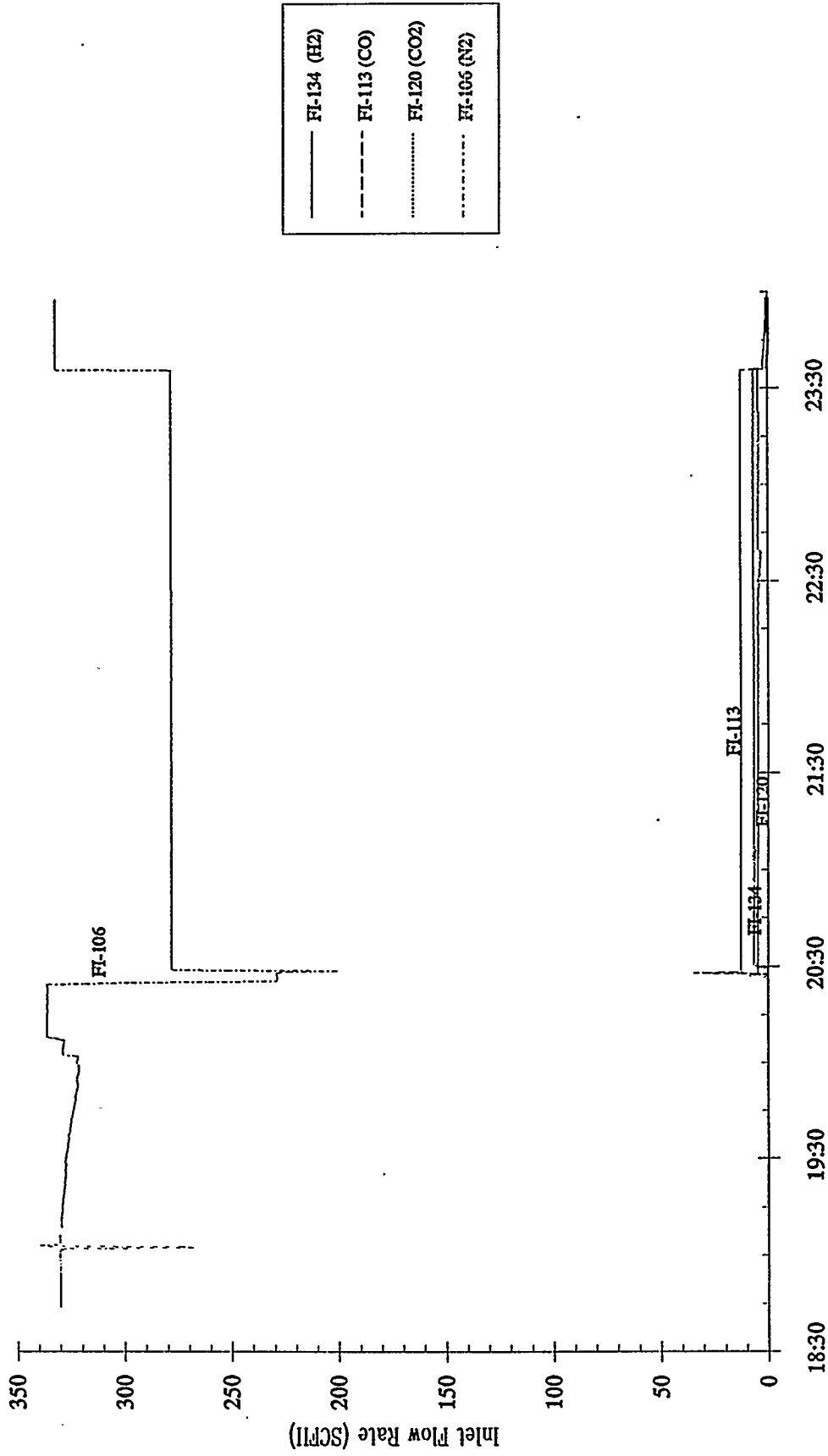

December 9, 1992
Test time: 20:30-23:33 (Test duration: 3:03)

T-2465 Zinc Ferrite
 u=1.0 ft/sec T=1000 °F
 H2S Inlet Conc. = 800 ppm

Zinc Ferrite Tests - ZFMC-01 Sulfidation 2

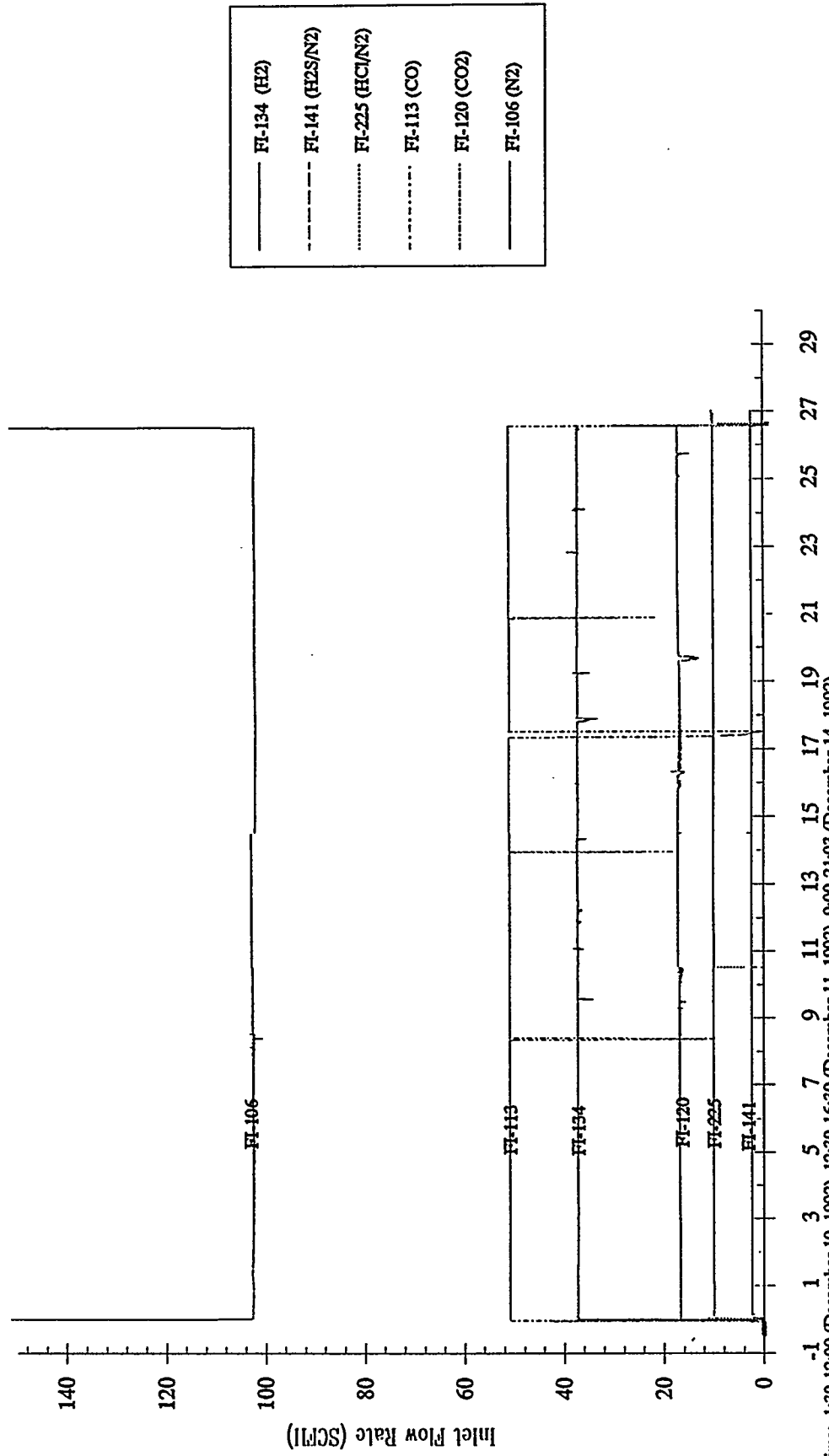

-1 1 3 5 7 9 11 13 15 17 19 21 23 25 27 29
 Test time: 1:30-12:00 (December 10, 1992), 12:30-16:30 (December 11, 1992), 9:00-21:03 (December 14, 1992)
 Test duration: 26:33

T-2465 Zinc Ferrite
u=1.0 ft/sec T=1000-1300 °F
O2 Inlet Conc. = 0.5-21 %

Zinc Ferrite Tests - ZFMC-01 Oxidative Regeneration 2

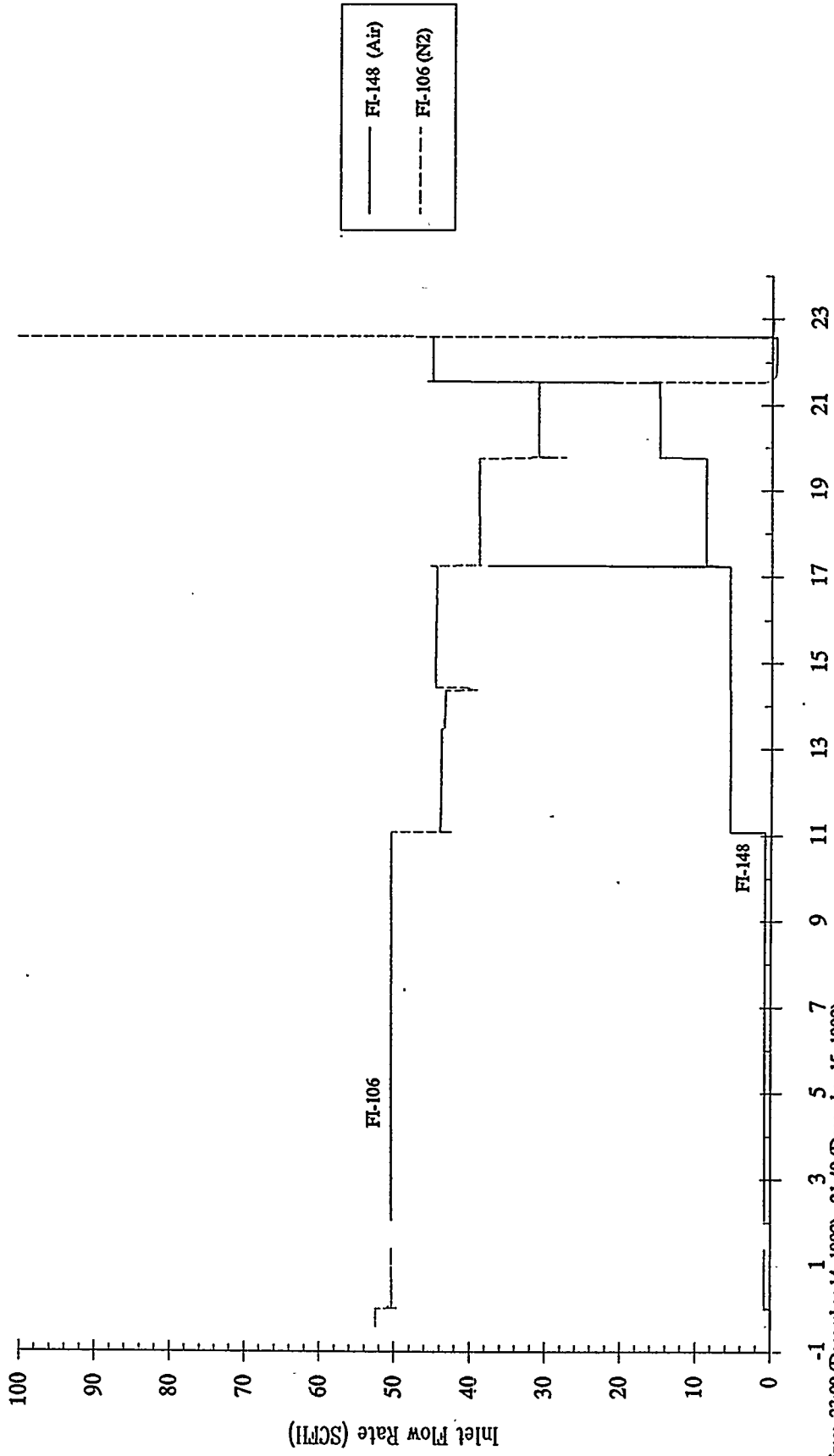

Test time: 23:00 (December 14, 1992) - 21:40 (December 15, 1992)
Test duration: 22:40

T-2465 Zinc Ferrite
u=1.0 ft/sec T=1000 °F

Zinc Ferrite Tests - ZFMC-01 Reductive Regeneration 2

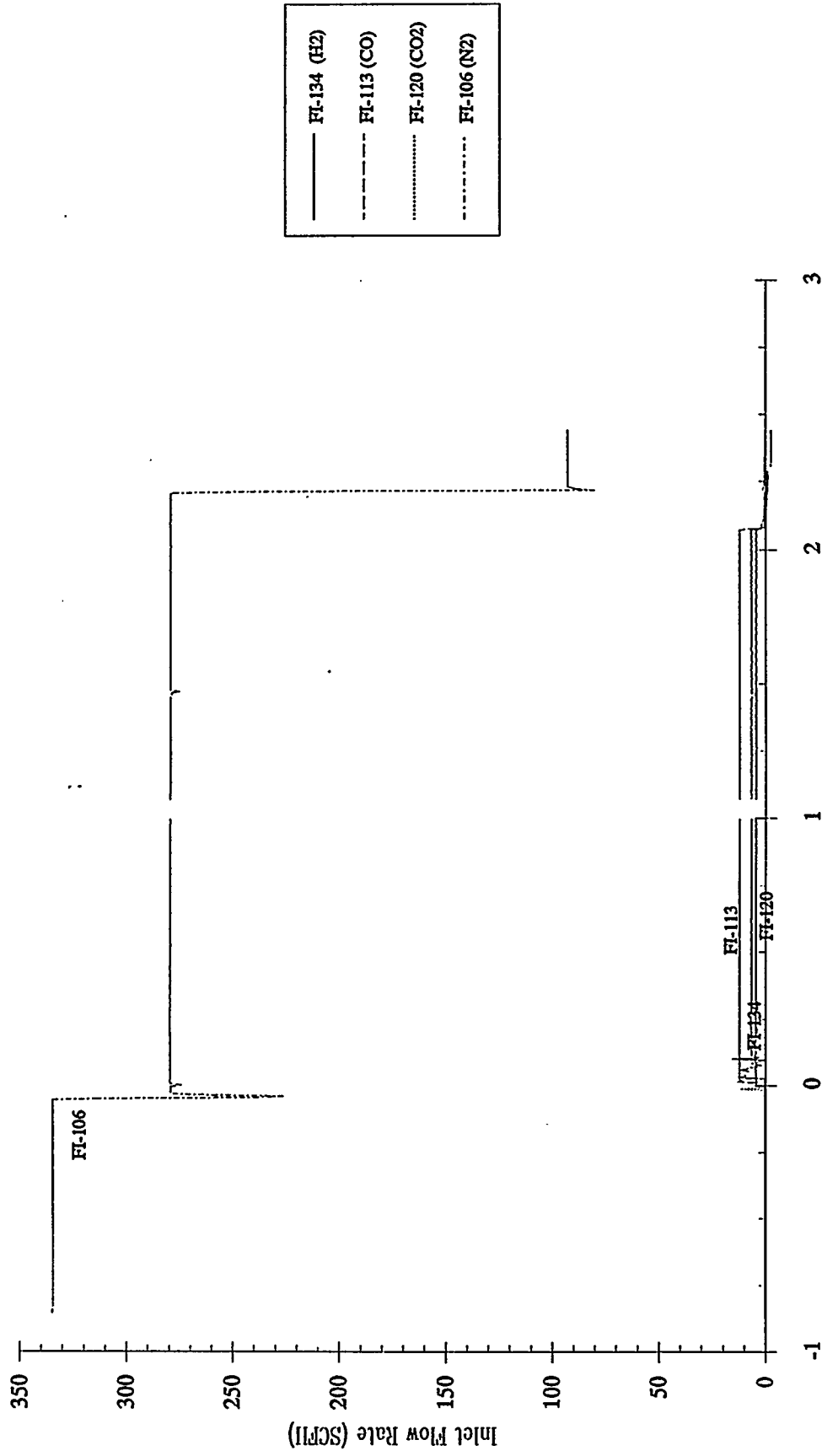

-1 0 1 2 3
Test time: 23:00 (December 15, 1992) - 1:00 (December 16, 1992)
Test duration: 2:00

T-2465 Zinc Ferrite
 u=1.0 ft/sec T=1000 °F
 H2S Inlet Conc. = 800 ppm

Zinc Ferrite Tests - ZFMC-01 Sulfidation 3

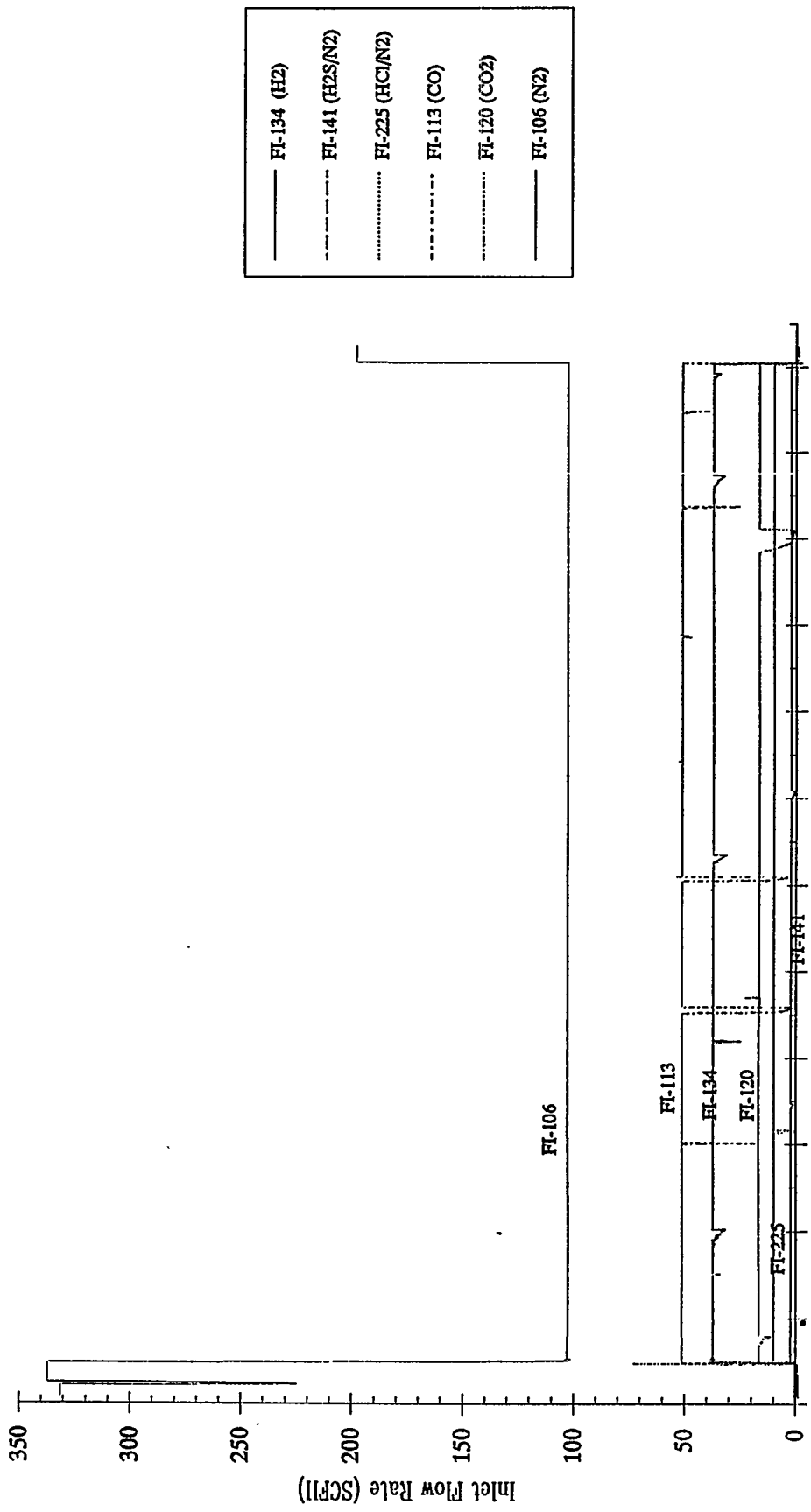

Test time: 3:30 (December 16, 1992) - 2:30 (December 17, 1992)
 Test duration: 23:00

T-2465 Zinc Ferrite
u=1.0 ft/sec T=1000-1300 °F
O2 Inlet Conc. = 0.5-21 %

Zinc Ferrite Tests - ZFMC-01 Oxidative Regeneration 3

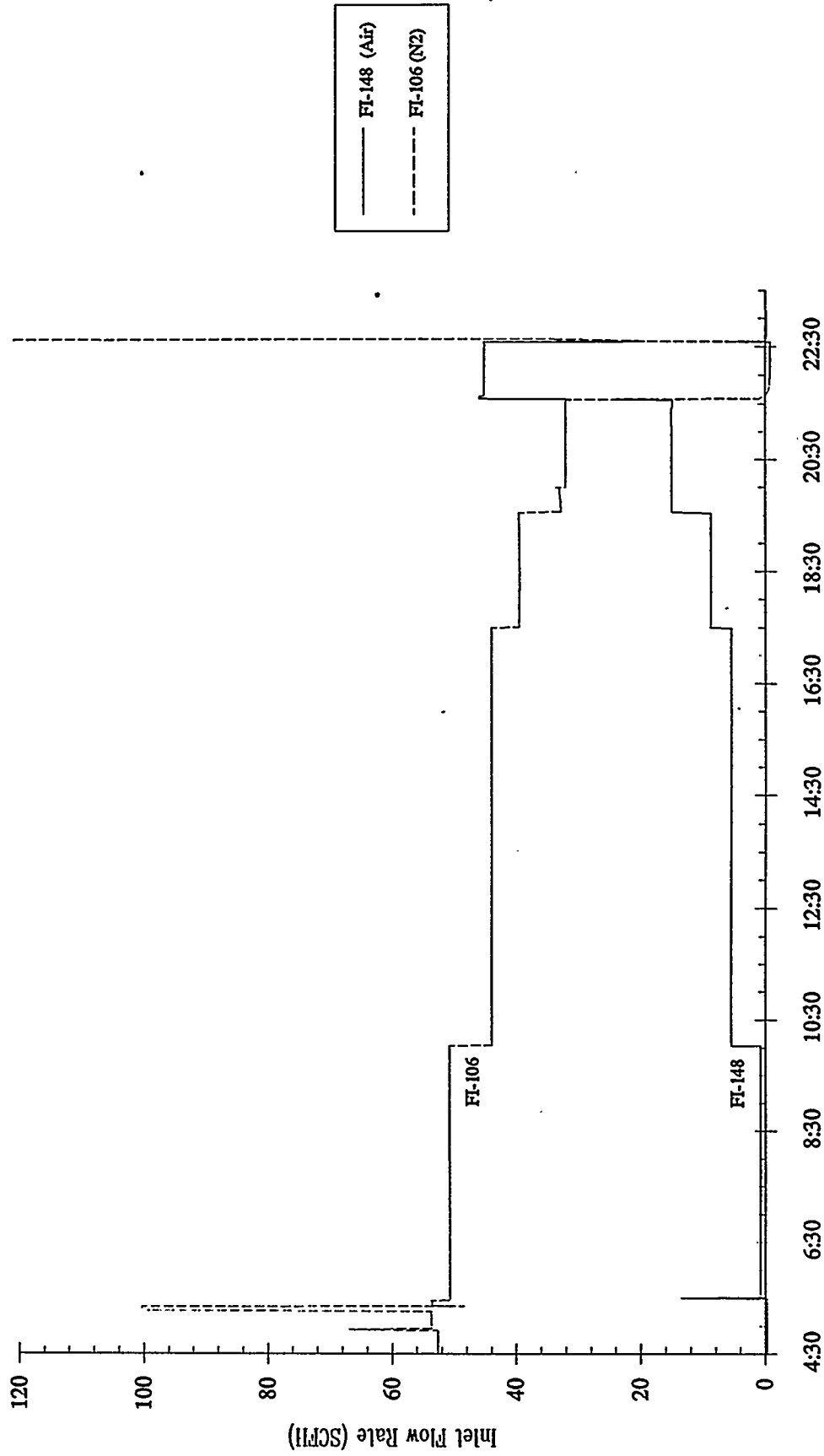

December 17, 1992
Test time: 5:30-22:30 (Test duration: 17:00)

T-2465 Zinc Ferrite
u=1.0 ft/sec T=1000 °F

Zinc Ferrite Tests - ZFMC-01 Reductive Regeneration 3

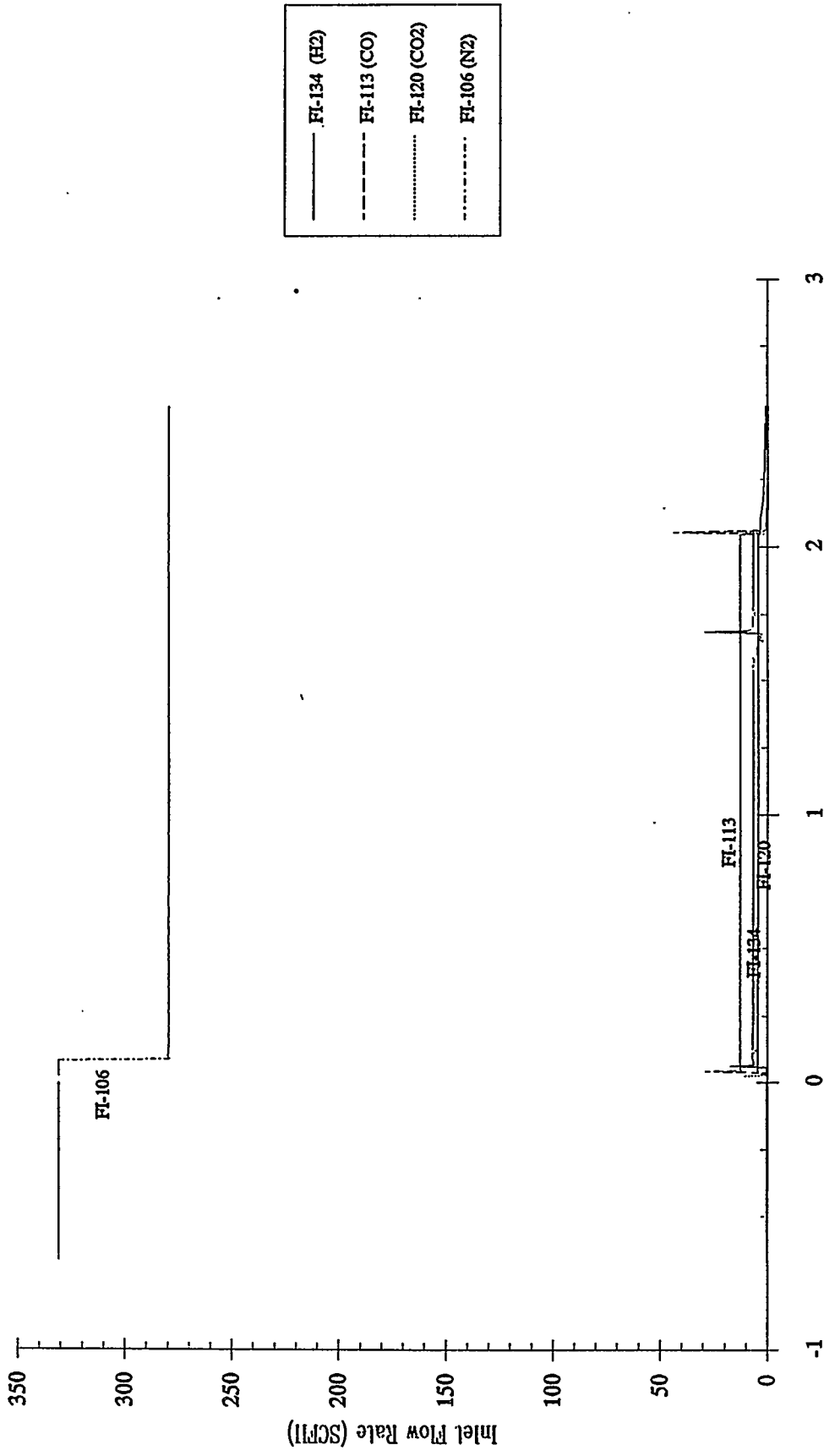

December 18, 1992
Test time: 0:00 - 2:00 (Test duration: 2:00)

T-2465 Zinc Ferrite
u=1.0 ft/sec T=1000 °F
H2S Inlet Conc. = 800 ppm

Zinc Ferrite Tests - ZFMC-01 Sulfidation 4

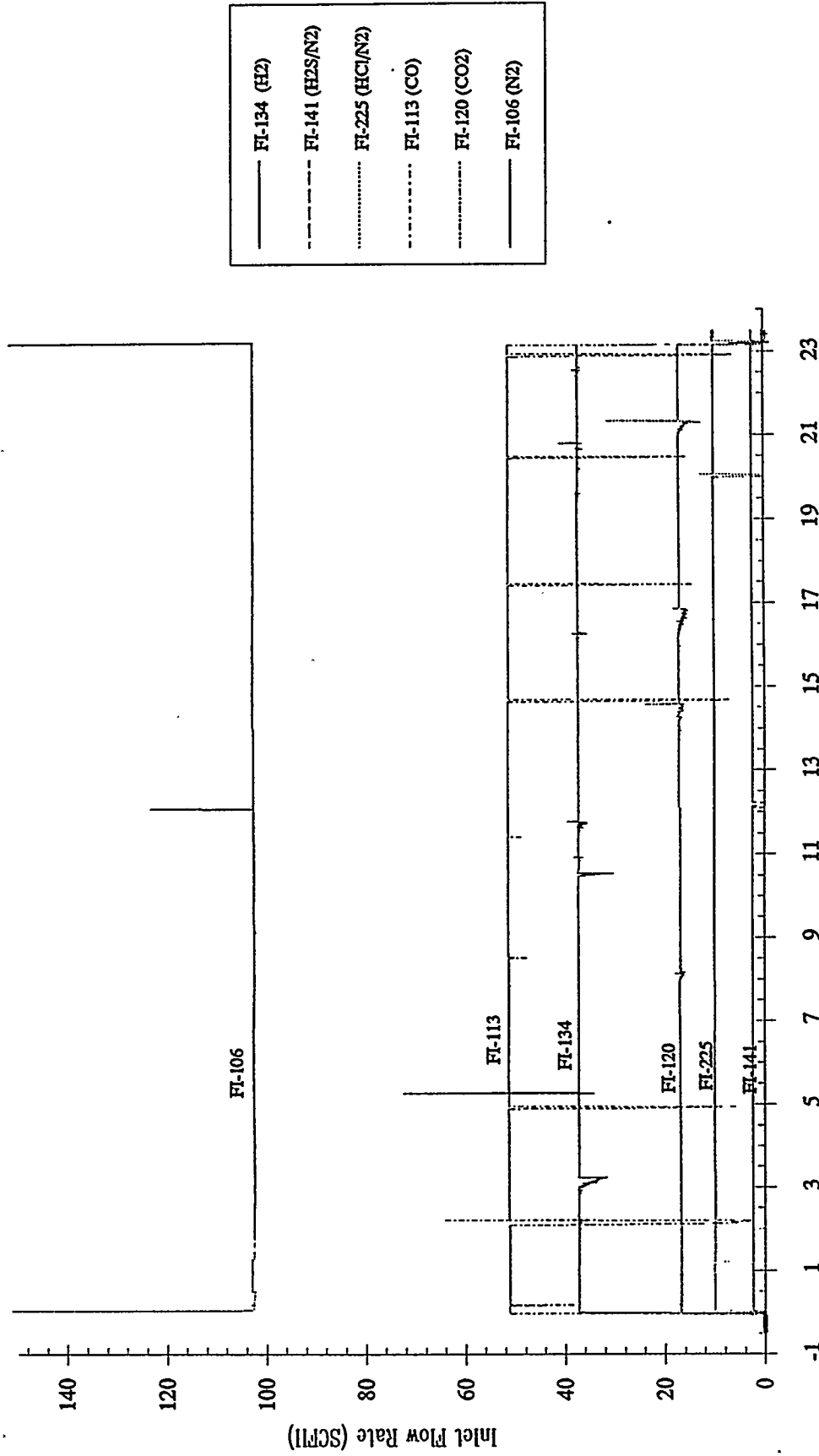

-1 1 3 5 7 9 11 13 15 17 19 21 23
Test time: 4:00-16:05 (December 18, 1992), 9:30 - 20:30 (December 21, 1992)
Test duration: 23:05

T-2465 Zinc Ferrite

u=1.0 ft/sec T=1075 & 1300 °F

O2 Inlet Conc. = 2.5 & 21%

Zinc Ferrite Tests - ZFMC-01 Oxidative Regeneration 4

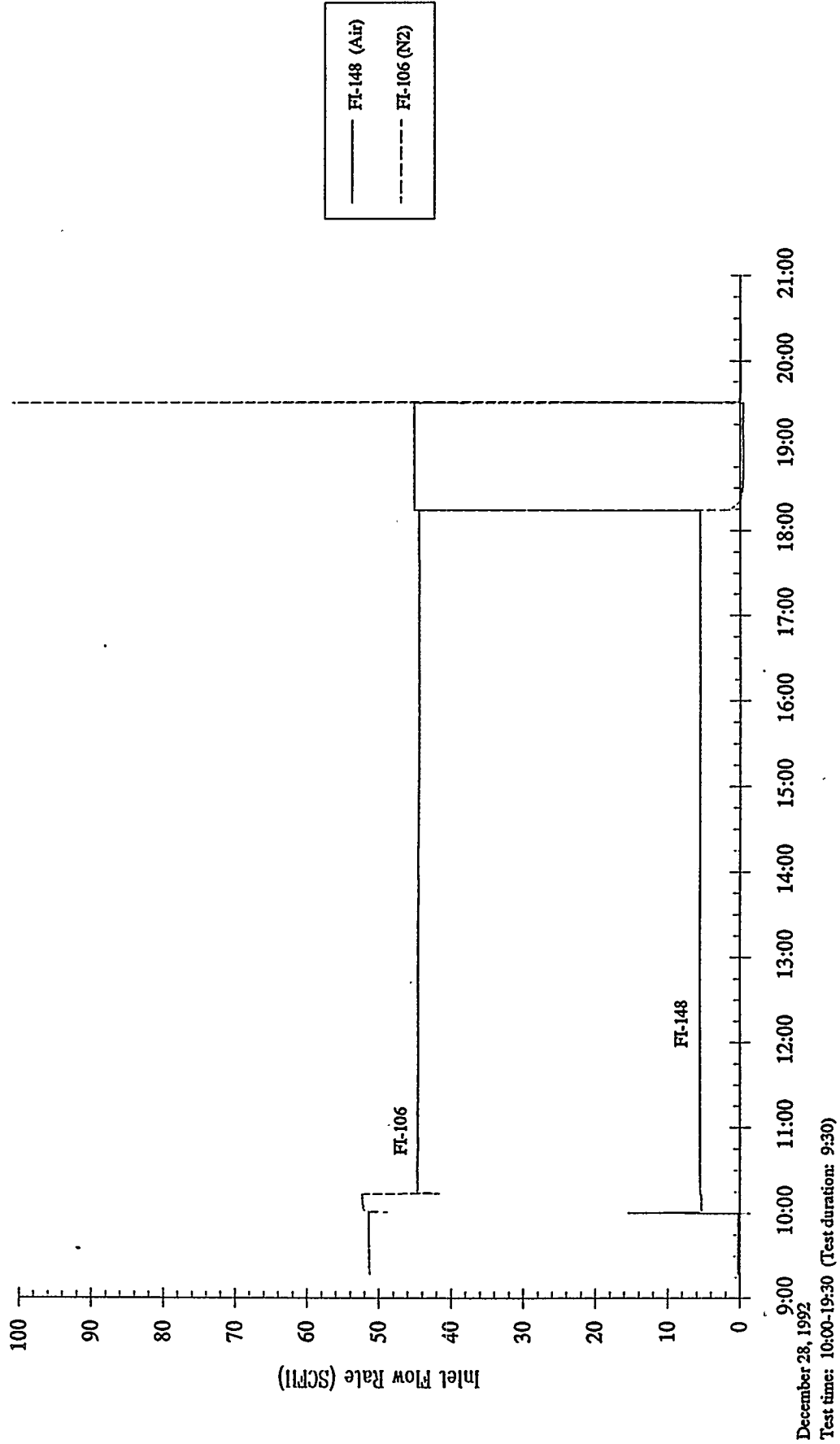

T-2465 Zinc Ferrite
u=1.0 ft/sec T=1000 °F

Zinc Ferrite Tests - ZFMC-01 Reductive Regeneration 4

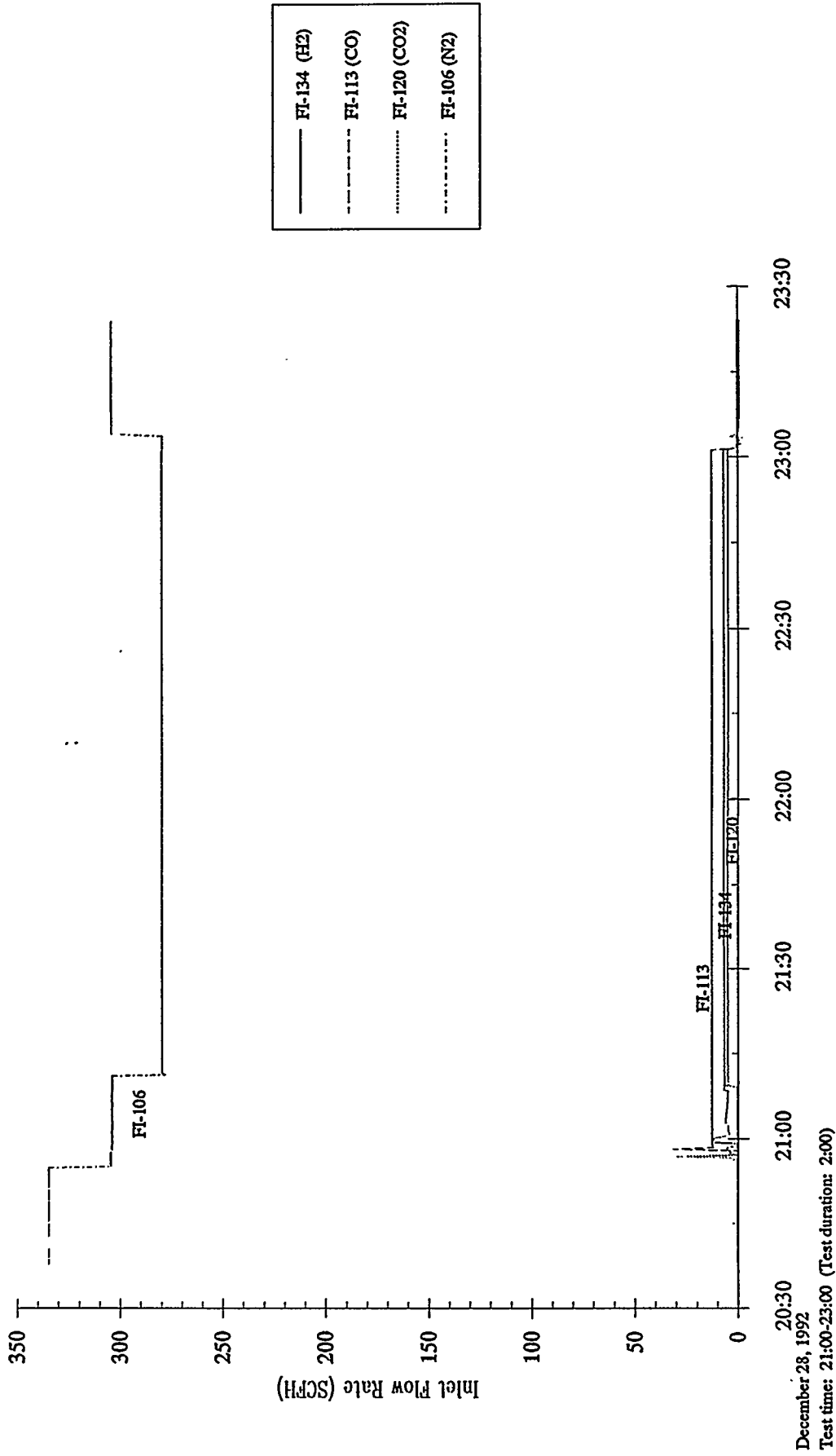

T-2465 Zinc Ferrite
 u=1.0 ft/sec T=1000 °F
 H2S Inlet Conc. = 800 ppm

Zinc Ferrite Tests - ZFMC-01 Sulfidation 5

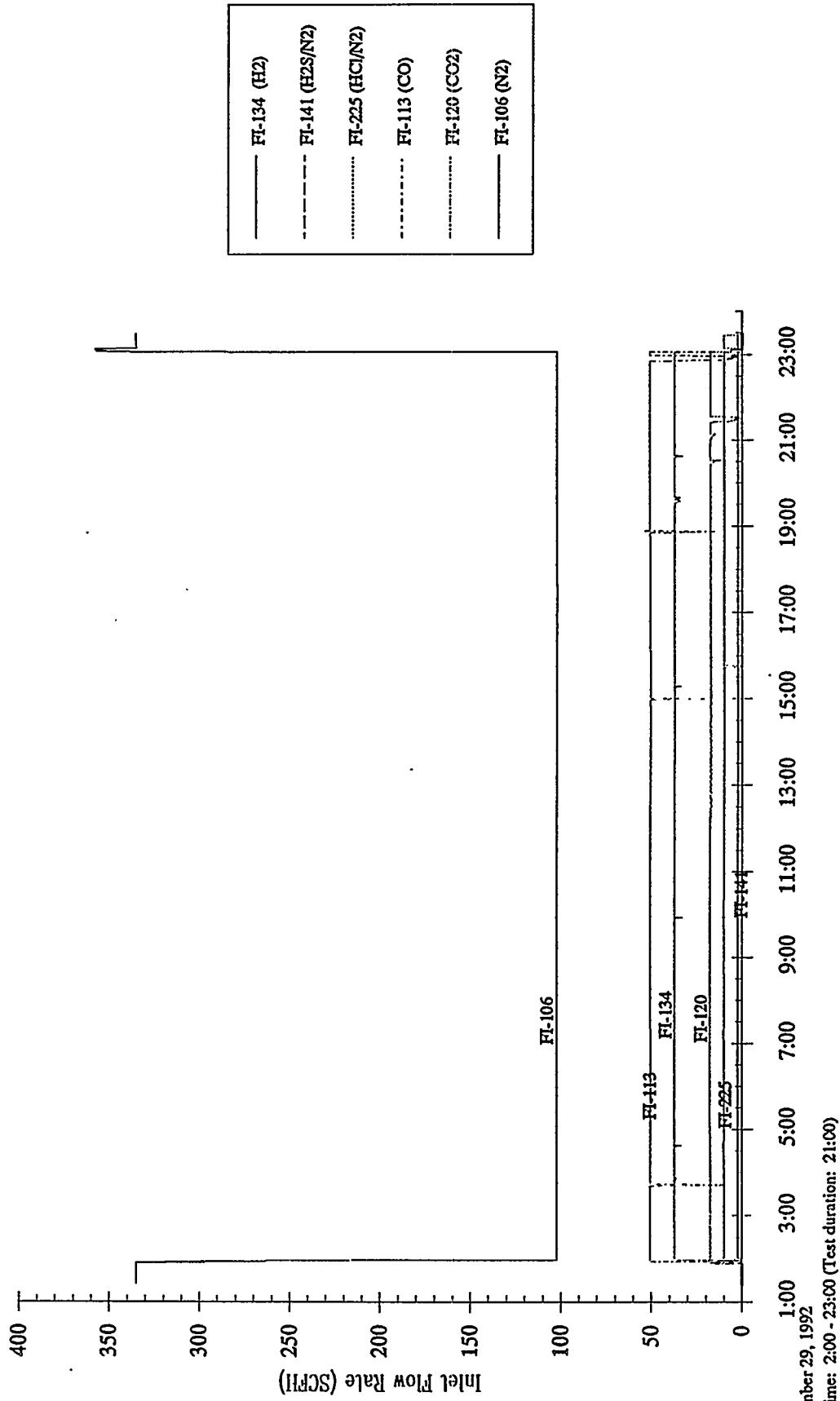

December 29, 1992
 Test time: 2:00 - 23:00 (Test duration: 21:00)

T-2465 Zinc Ferrite
u=1.0 ft/sec T=1075 & 1300 °F
O2 Inlet Conc. = 2.5 & 21%

Zinc Ferrite Tests - ZFMC-01 Oxidative Regeneration 5

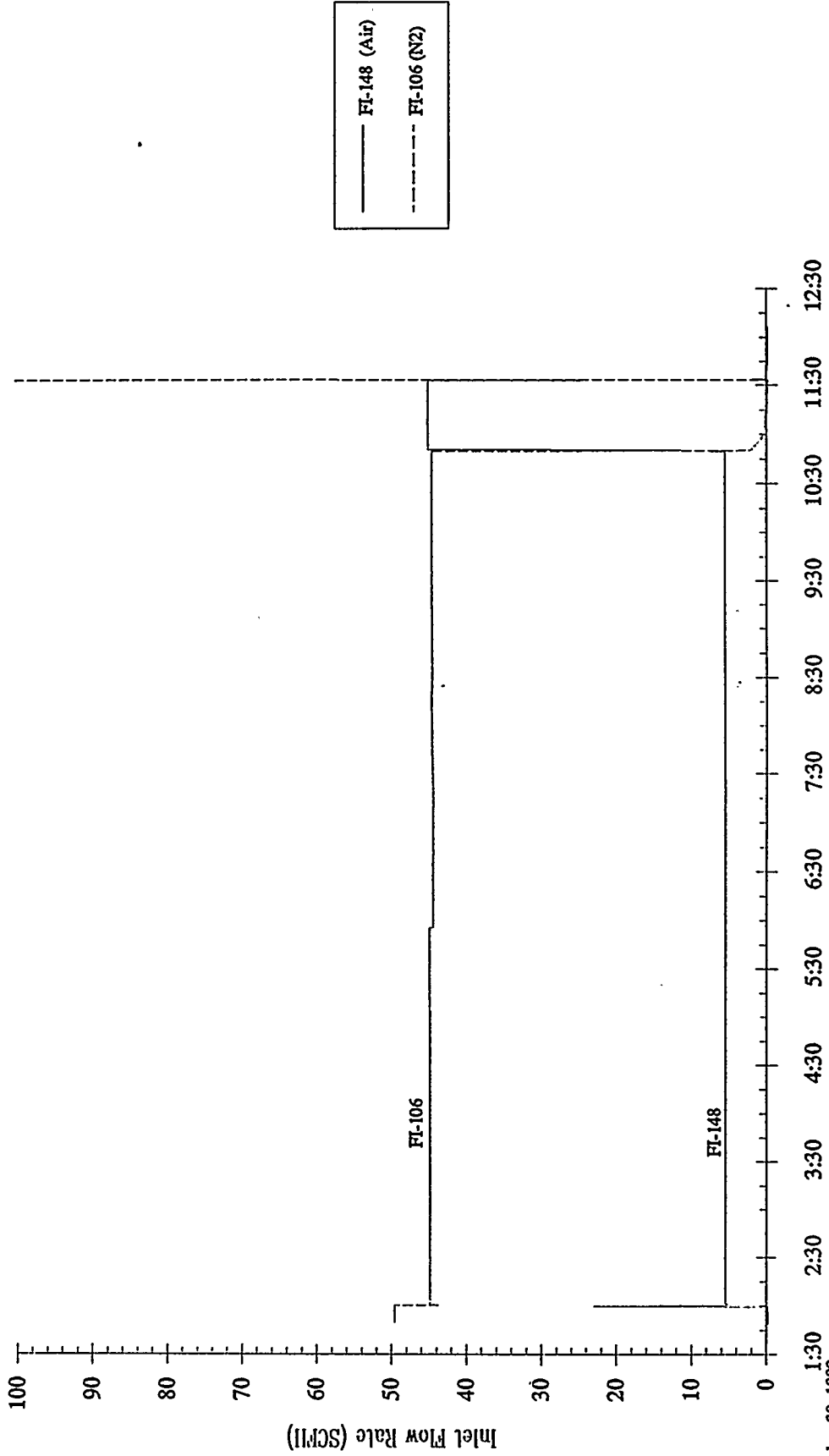

December 30, 1992
Test time: 2:00-11:31 (Test duration: 9:31)

T-2465 Zinc Ferrite
u=1.0 ft/sec T=1000 F

Zinc Ferrite Tests - ZFMC-01 Reductive Regeneration 5

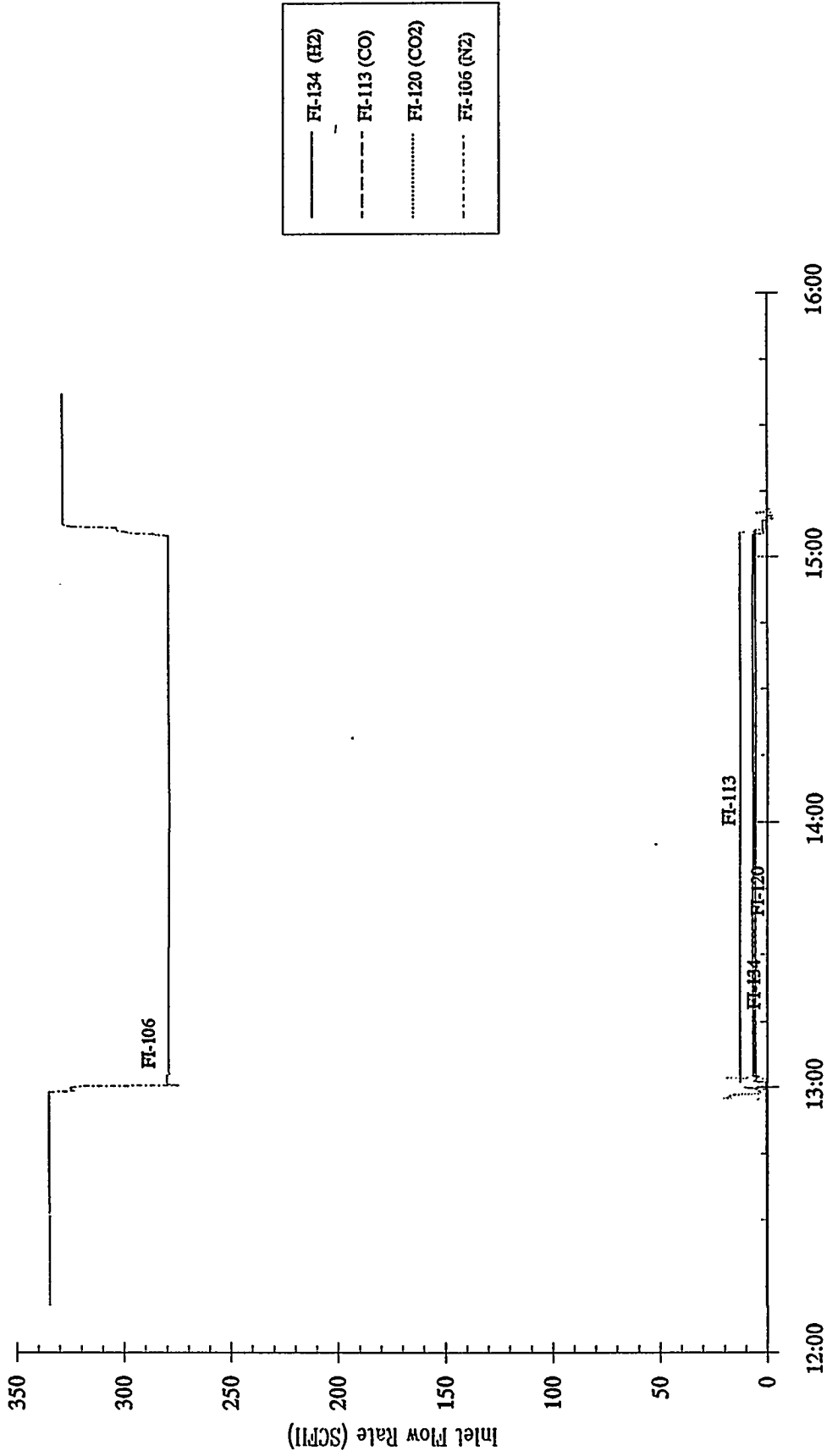

December 30, 1992
Test time: 13:00-15:05 (Test duration: 2:05)

T-2465 Zinc Ferrite
 u=1.0 ft/sec T=1000 °F
 H2S Inlet Conc. = 800 PPM

Zinc Ferrite Tests - ZFMC-01 Sulfidation 6

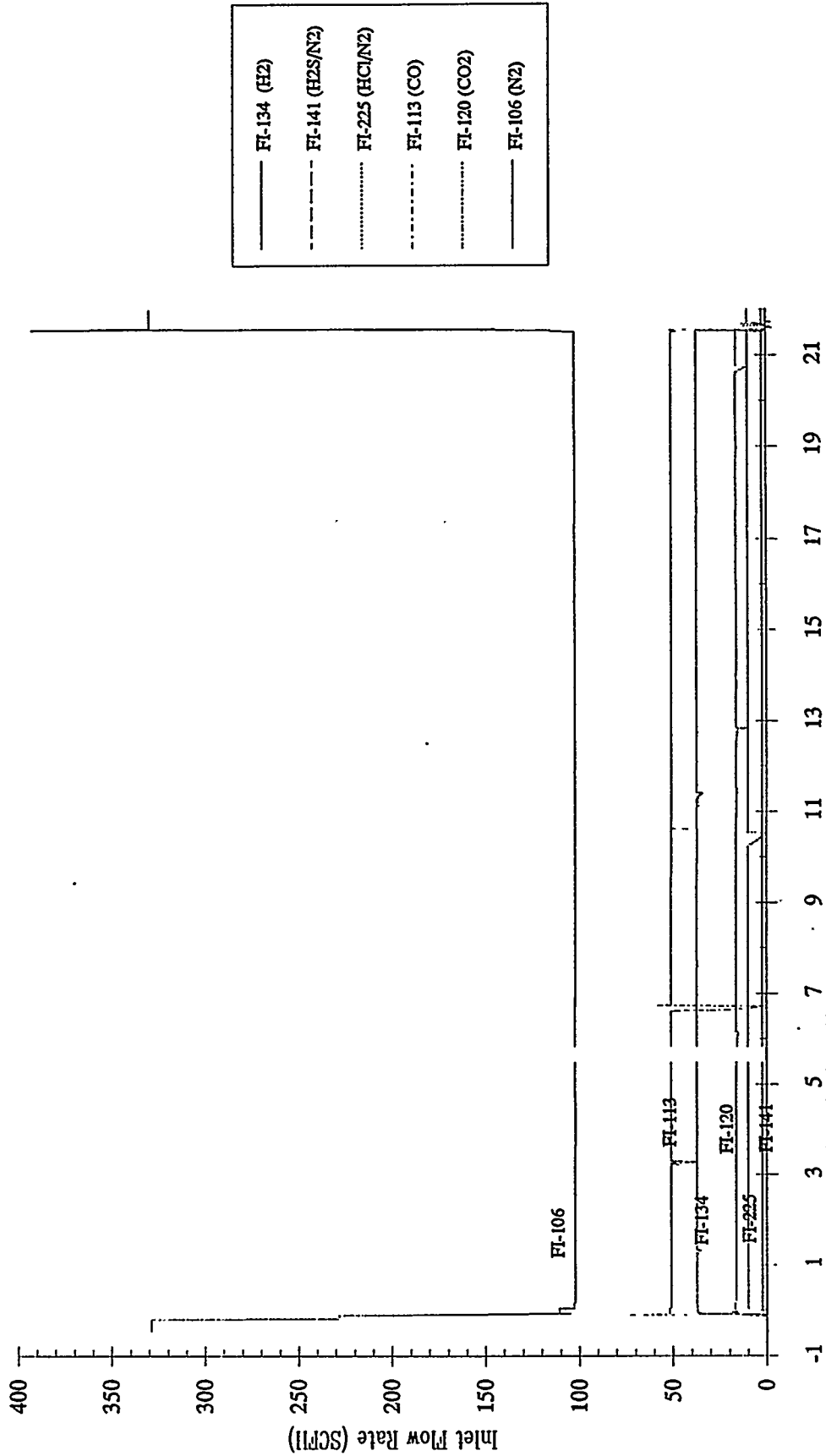

Test time: 18:30 (December 30, 1992) - 16:00 (December 31, 1992)
 Test duration: 21:30

T-2465 Zinc Ferrite
u=1.0 f/Sec T=1075 & 1300 °F
O2 Inlet Conc. = 2.5 & 21%

Zinc Ferrite Tests - ZFMC-01 Oxidative Regeneration 6

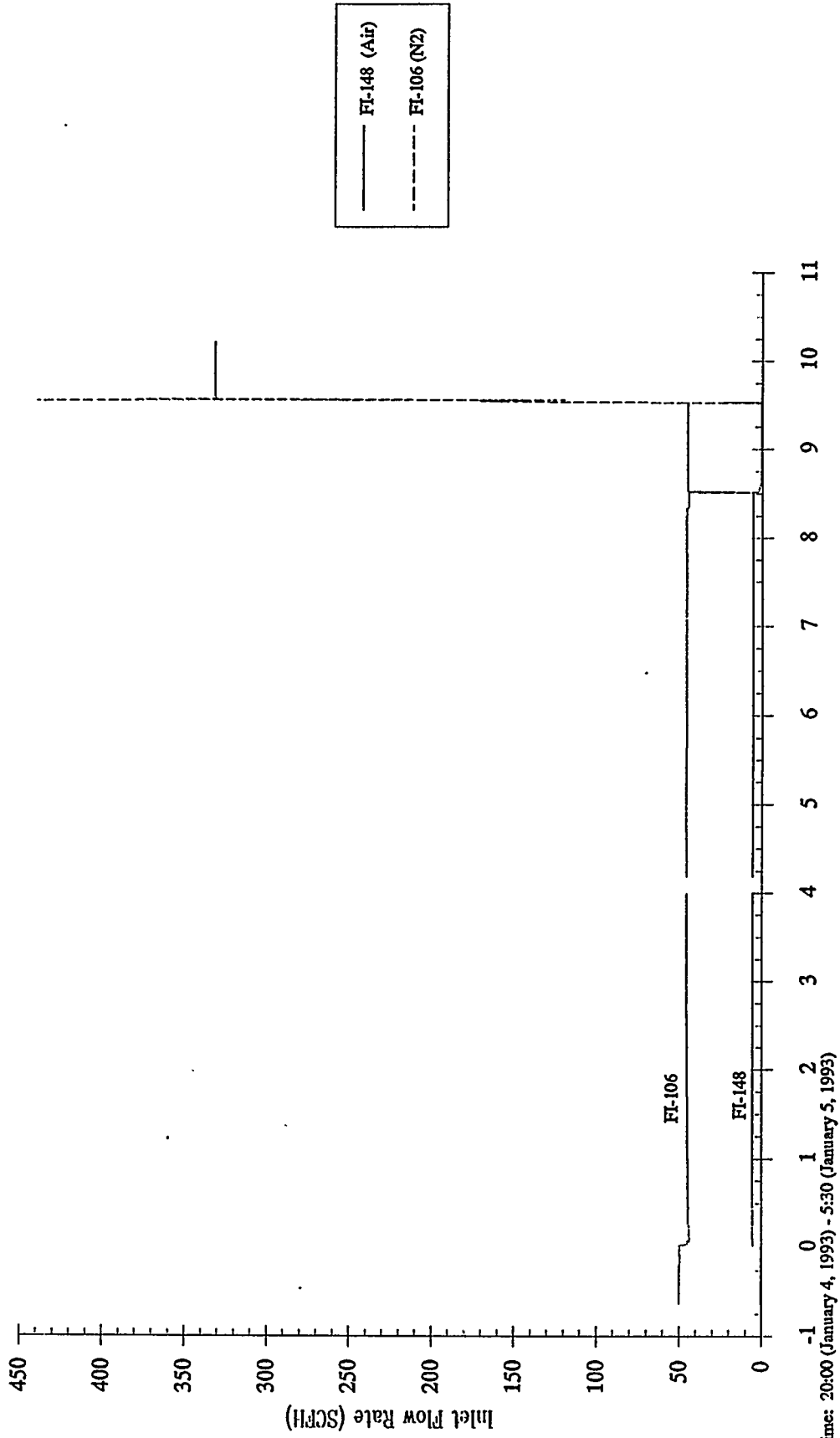

Test time: 20:00 (January 4, 1993) - 5:30 (January 5, 1993)
Test duration: 9:30

T-2465 Zinc Ferrite
u=1.0 ft/sec T=1000 °F

Zinc Ferrite Tests - ZFMC-01 Reductive Regeneration 6

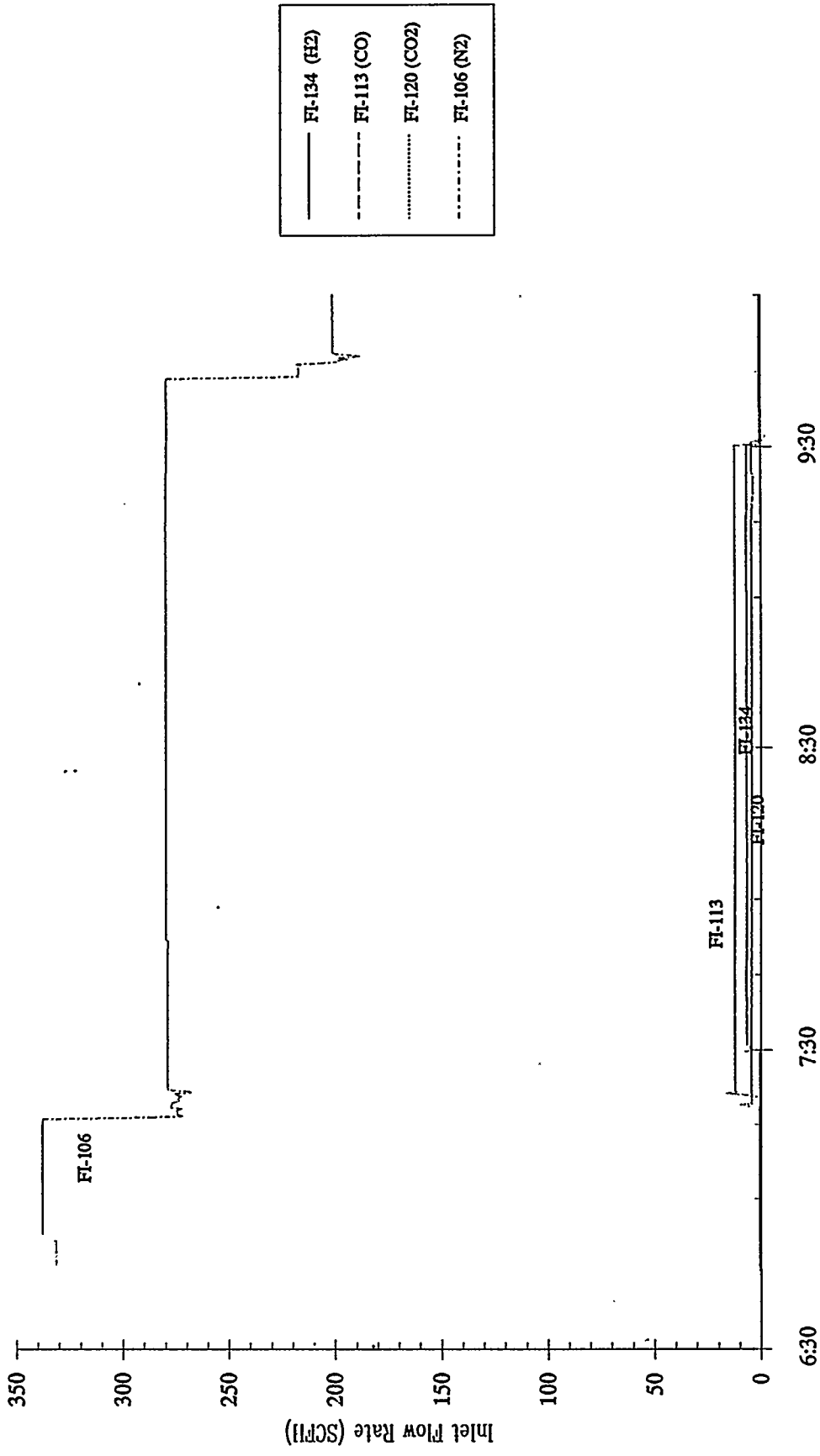

January 5, 1993
Test time: 7:30-9:32 (Test duration: 2:02)

T-2465 Zinc Ferrite
 u=1.0 ft/sec T=1000 °F
 H2S Inlet Conc. = 800 ppm

Zinc Ferrite Tests - ZFMC-01 Sulfidation 7

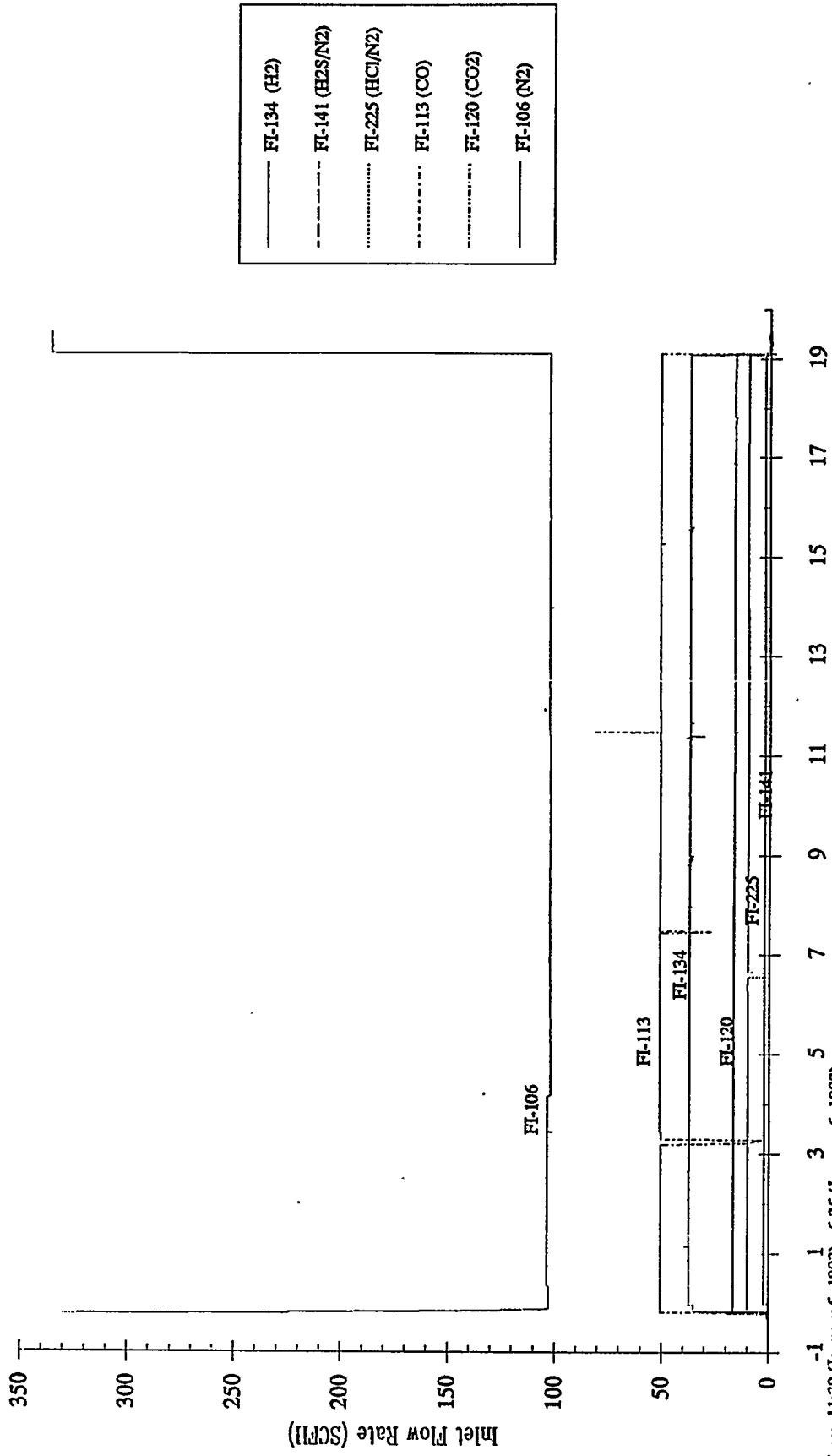

Test time: 11:30 (January 5, 1993) - 6:35 (January 6, 1993)
 Test duration: 19:05

T-2465 Zinc Ferrite
u=1.0 ft/sec T=1075 & 1300 °F
O2 Inlet Conc. = 2.5 & 21%

Zinc Ferrite Tests - ZFMC-01 Oxidative Regeneration 7

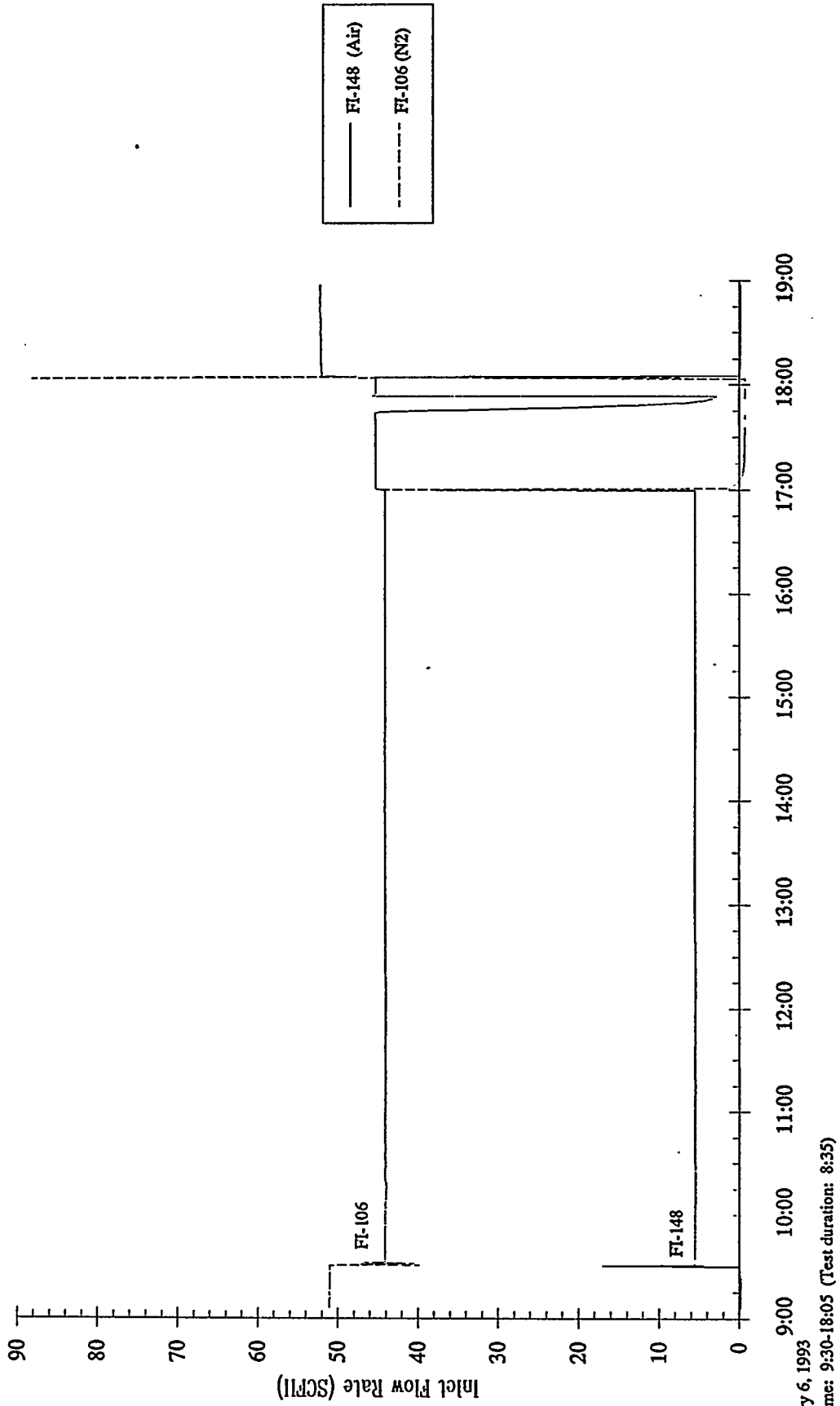

T-2465 Zinc Ferrite
u=1.0 f/sec T=1000 °F

Zinc Ferrite Tests - ZFMC-01 Reductive Regeneration 7

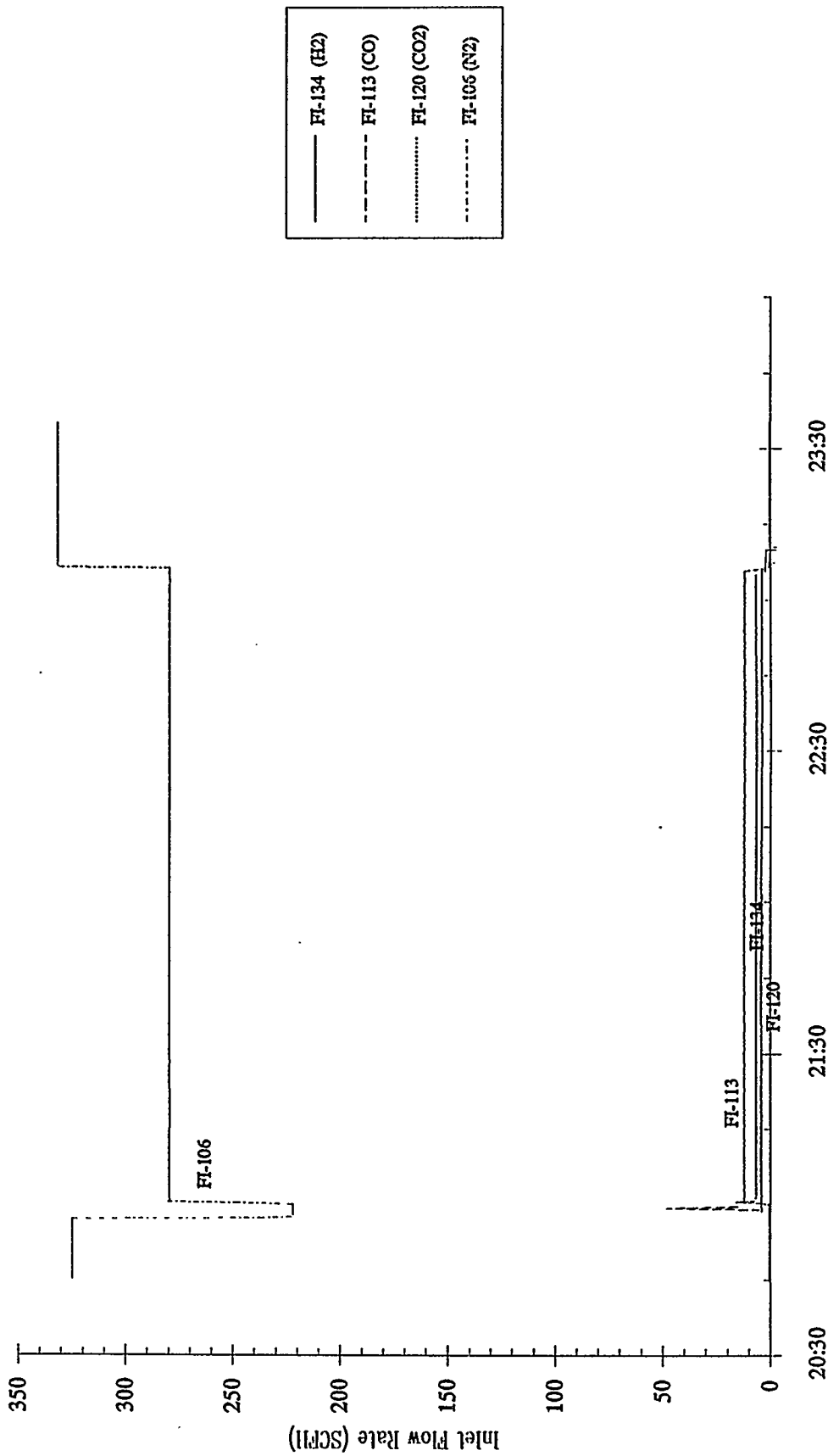

January 6, 1993
Test time: 21:00-23:05 (Test duration: 2:05)

T-2465 Zinc Ferrite
u=1.0 ft/sec T=1000 °F
H2S Inlet Conc. = 800 ppm

Zinc Ferrite Tests - ZFMC-01 Sulfidation 8

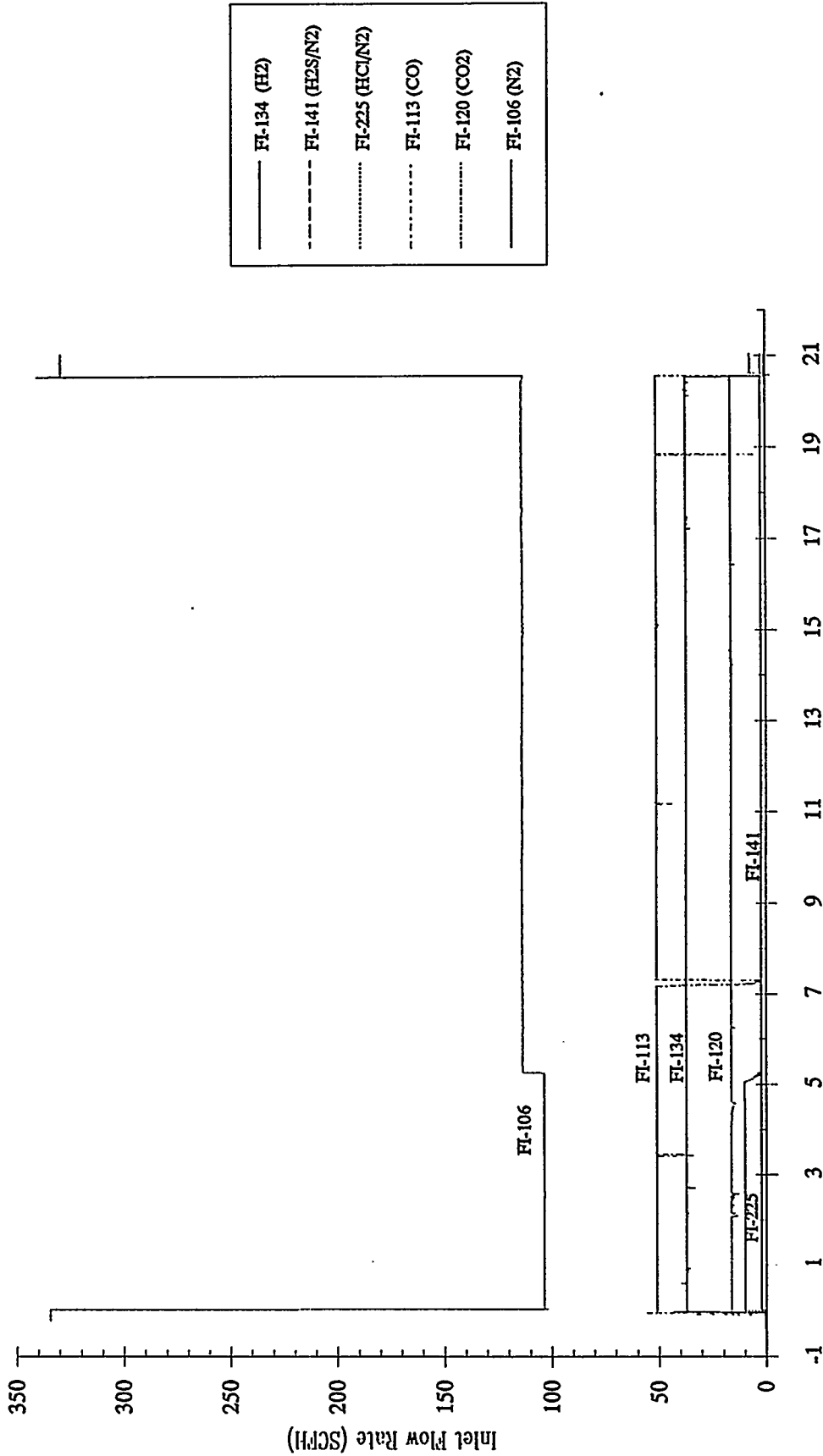

January 7, 1993
Test time: 2:00-22:33 (Test duration: 20:33)

T-2465 Zinc Ferrite

u=1.0 ft/sec T=1075 & 1300 °F

O2 Inlet Conc. = 2.5 & 21%

Zinc Ferrite Tests - ZFMC-01 Oxidative Regeneration 8

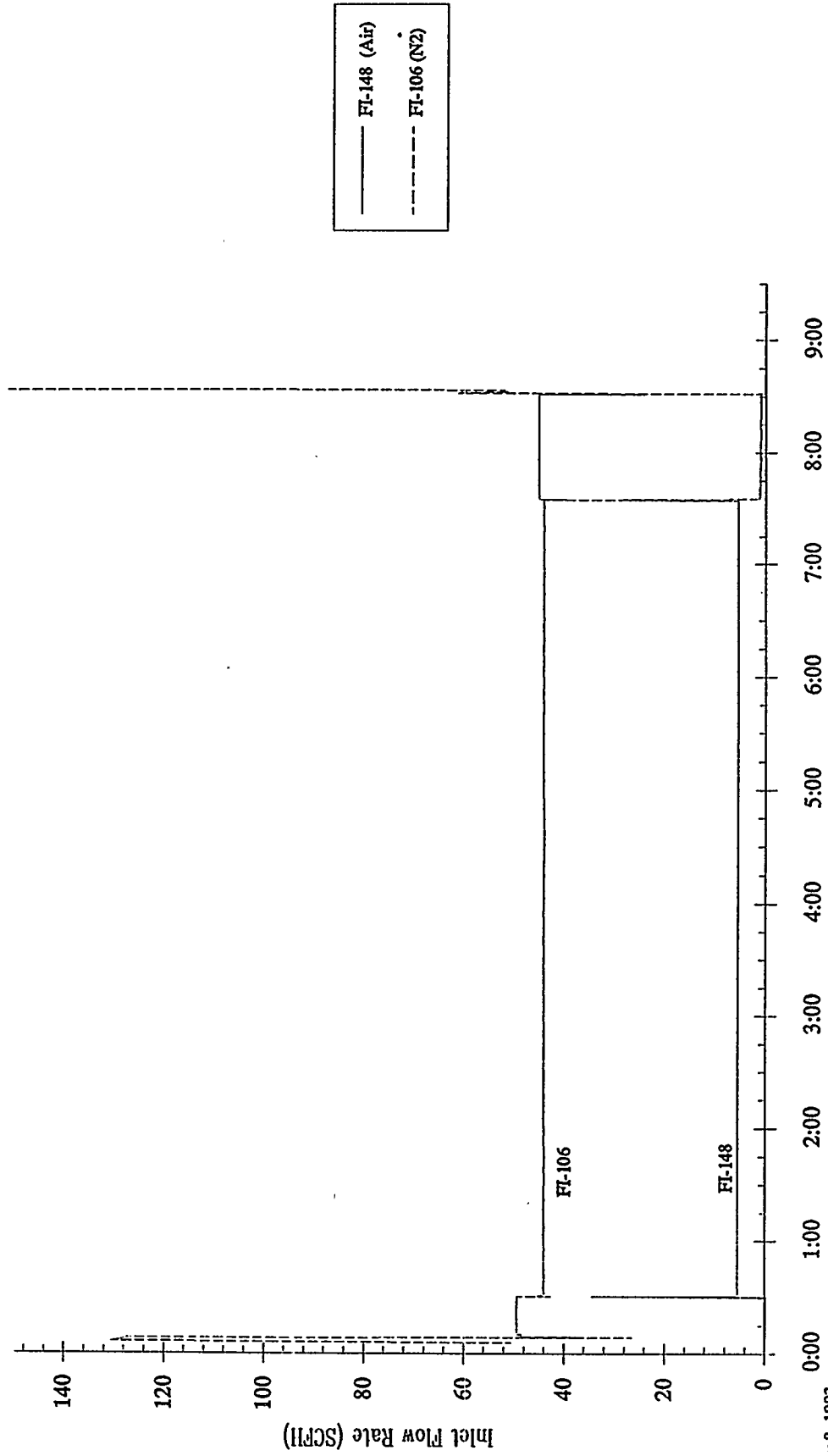

January 8, 1993

Test time: 0:30-8:32 (Test duration: 8:02)

T-2465 Zinc Ferrite
u=1.0 f/sec T=1000 °F

Zinc Ferrite Tests - ZFMC-01 Reductive Regeneration 8

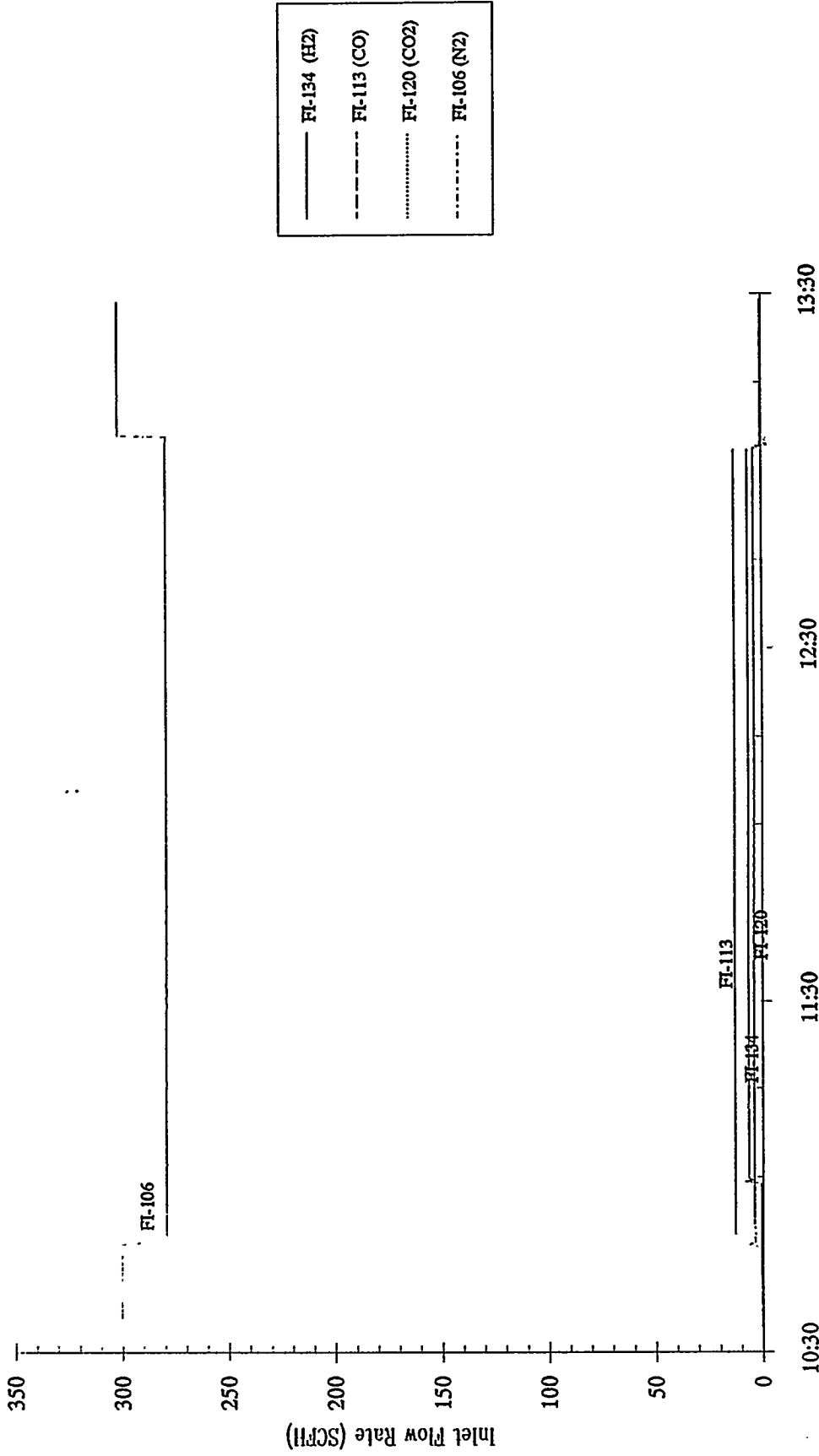

January 8, 1993
Test time: 11:00-13:03 (Test duration: 2:03)

T-2465 Zinc Ferrite
u=1.0 ft/sec T=1000 °F
H2S Inlet Conc. = 800 ppm

Zinc Ferrite Tests - ZFMC-01 Sulfidation 1

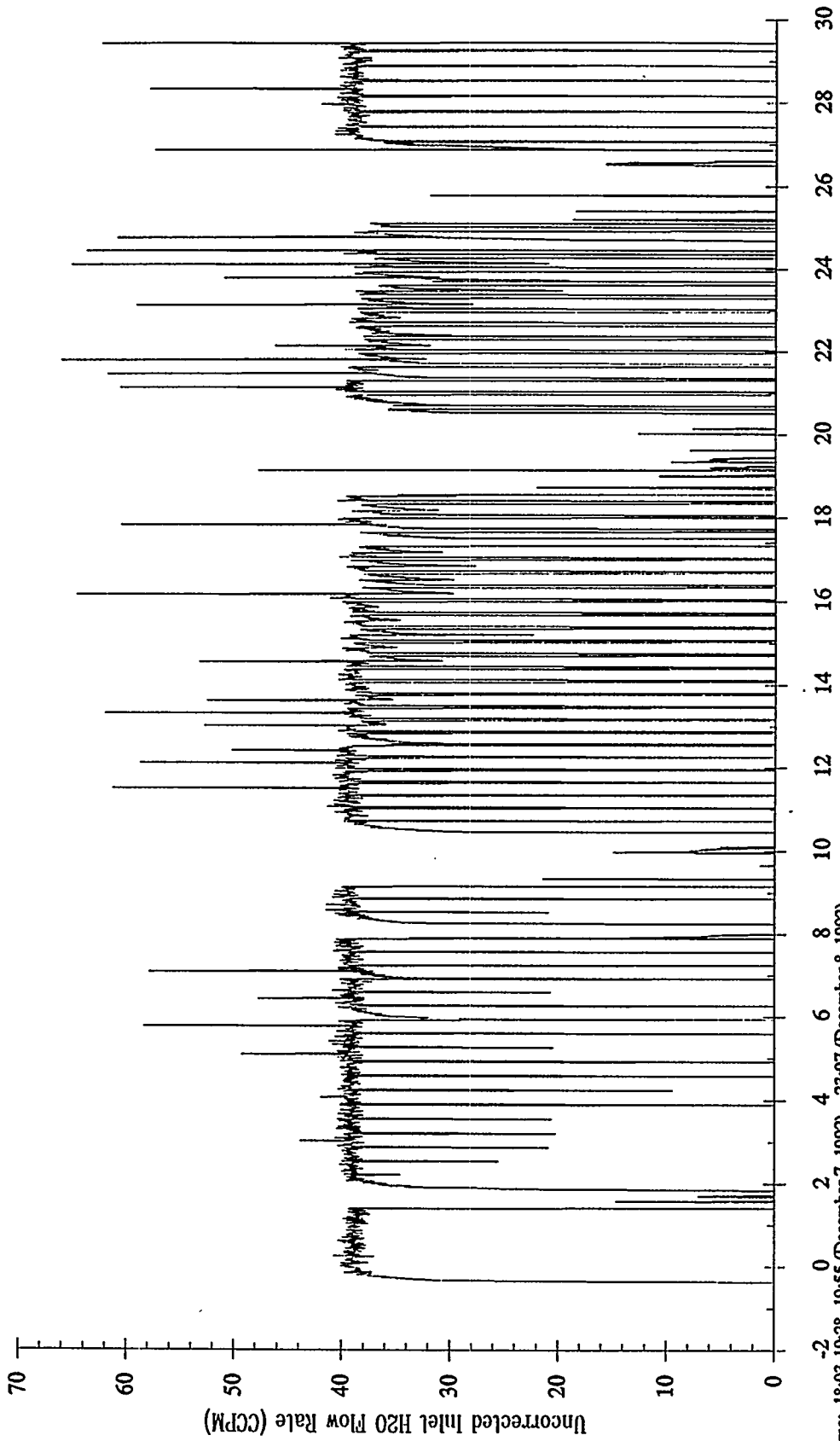

Test time: 18:03-19:28, 19:55 (December 7, 1992) - 23:07 (December 8, 1992)
Test duration: 28:37

T-2465 Zinc Ferrite
u=1.0 ft/sec T=1000 °F
H2S Inlet Conc. = 800 ppm

Zinc Ferrite Tests - ZFMC-01 Sulfidation 2

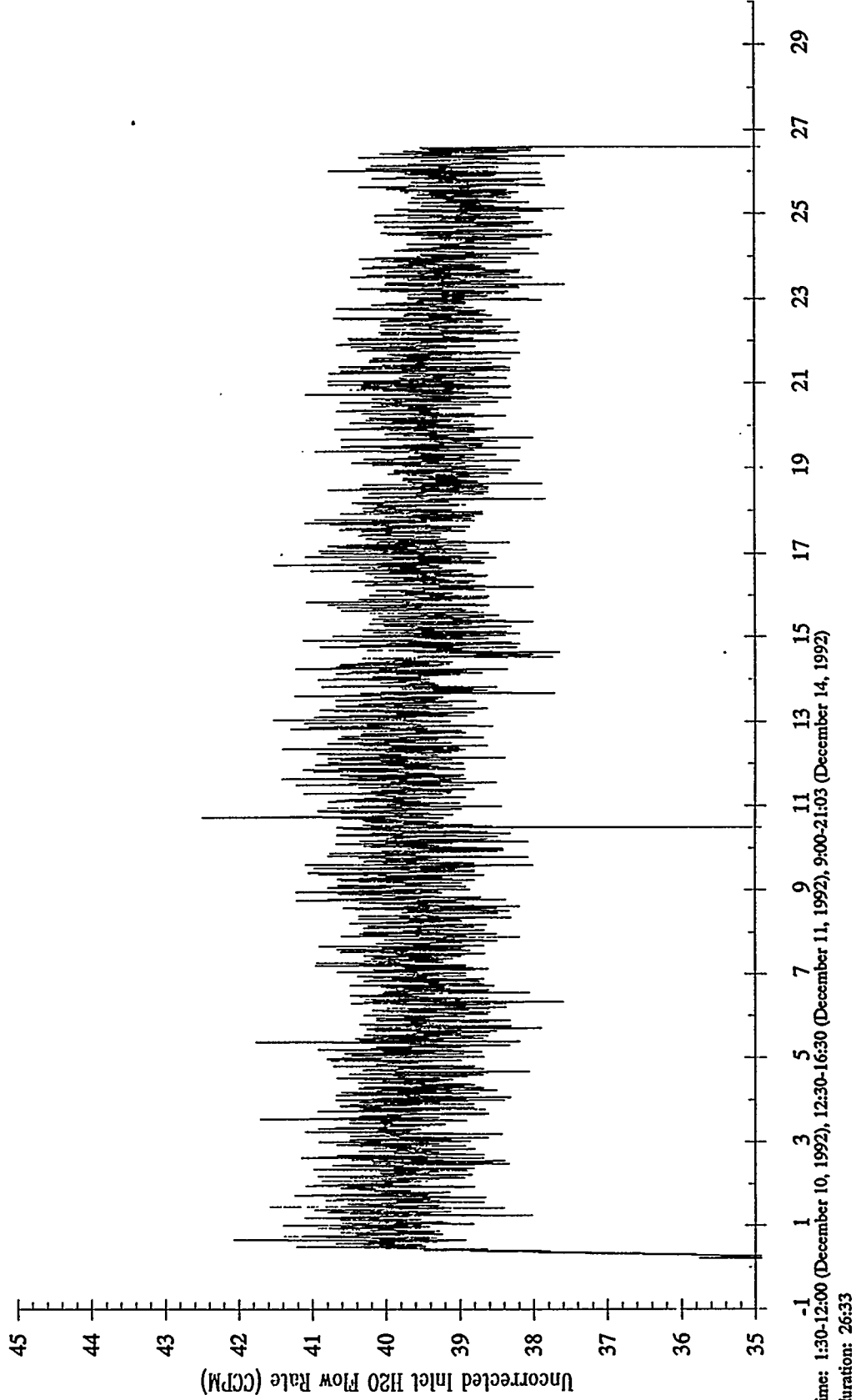

T-2465 Zinc Ferrite
u=1.0 ft/sec T=1000 °F
H2S Inlet Conc. = 800 ppm

Zinc Ferrite Tests - ZFMC-01 Sulfidation 3

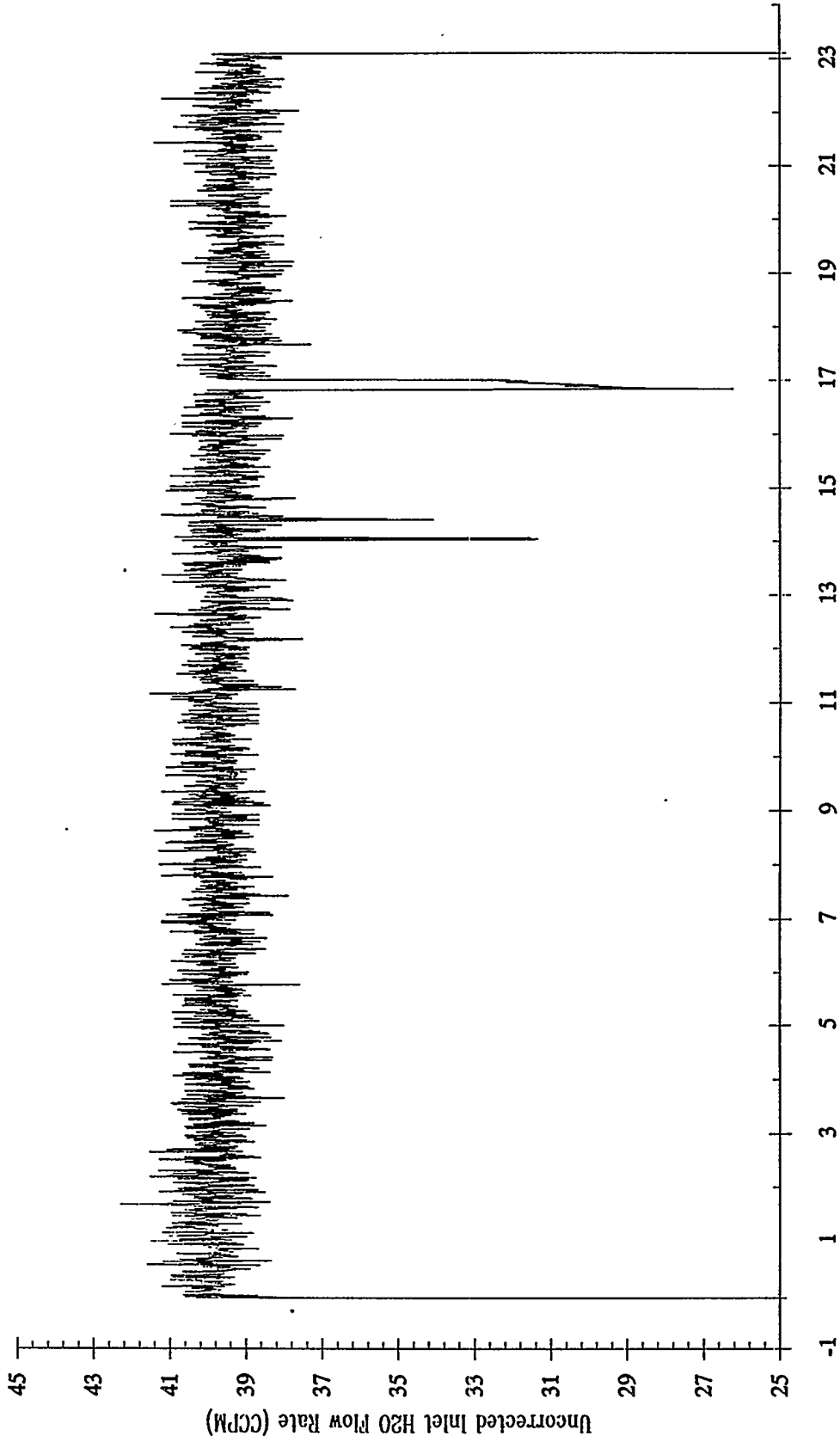

-1 1 3 5
Test time: 3:30 (December 16, 1992) - 2:30 (December 17, 1992)
Test duration: 23:00

T-2465 Zinc Ferrite
u=1.0 ft/sec T=1000 °F
H2S Inlet Conc. = 800 ppm

Zinc Ferrite Tests - ZFMC-01 Sulfidation 4

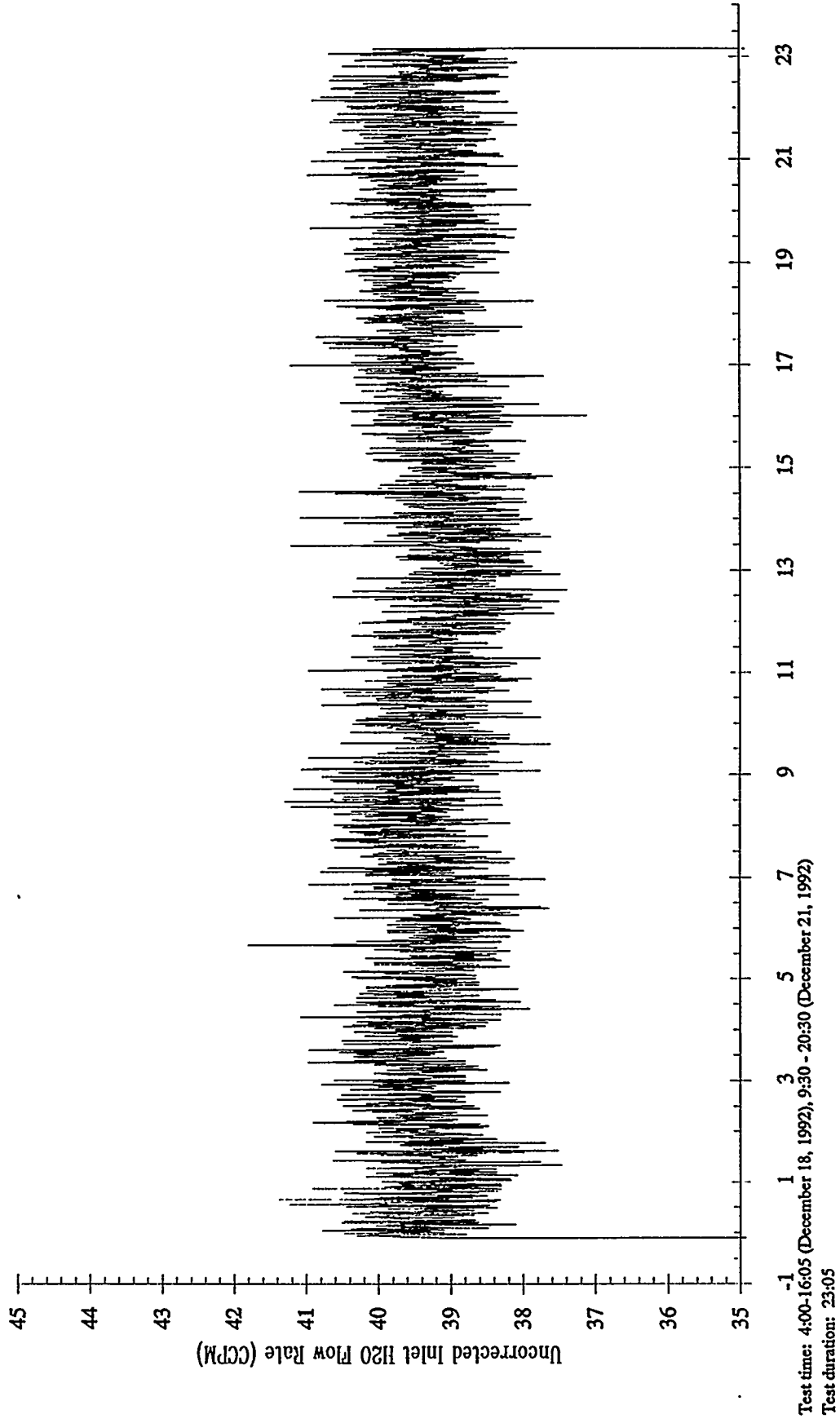

T-2465 Zinc Ferrite
u=1.0 ft/sec T=1000 °F
H2S Inlet Conc. = 800 ppm

Zinc Ferrite Tests - ZFMC-01 Sulfidation 5

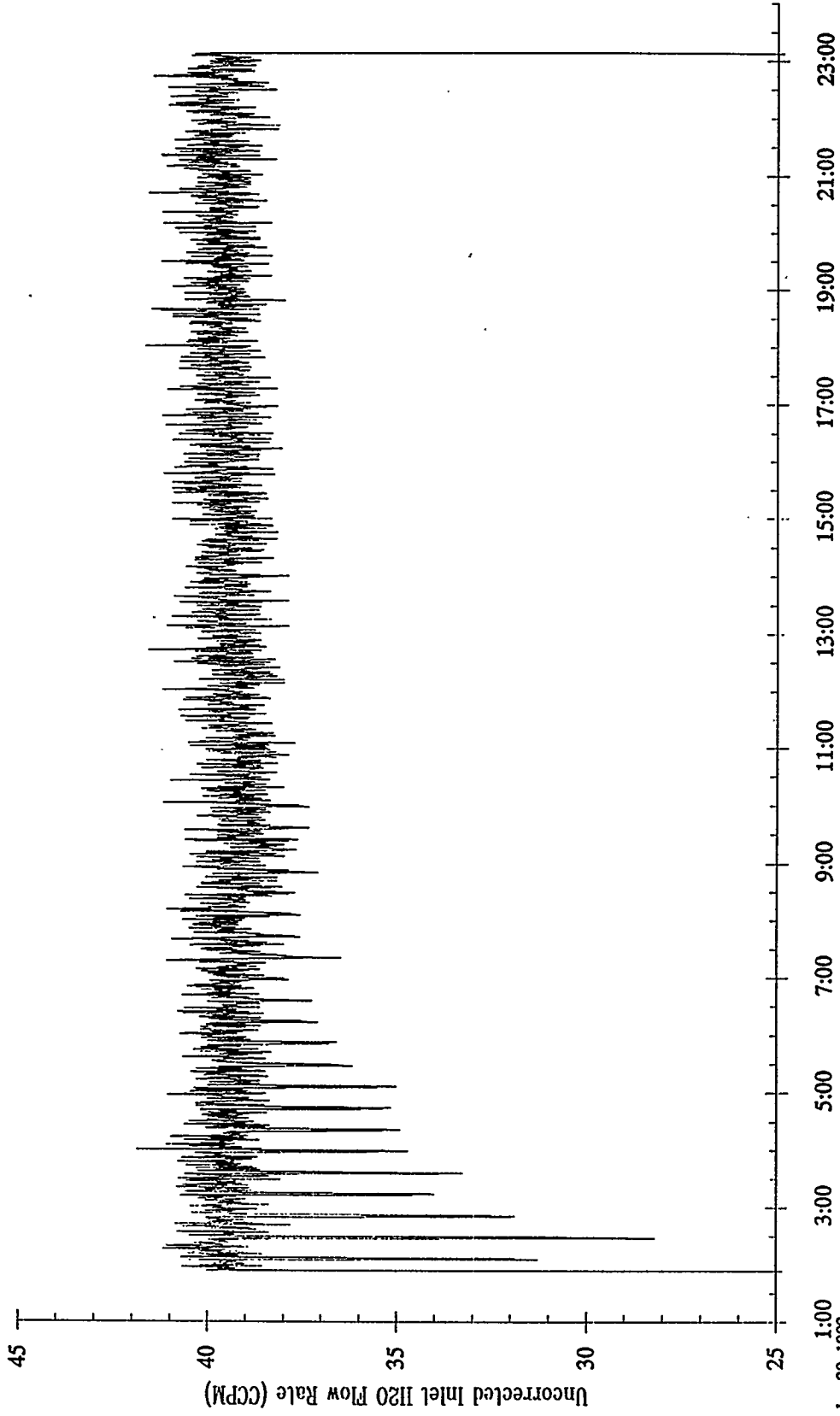

December 29, 1992
Test time: 2:00 - 23:00 (Test duration: 21:00)

T-2465 Zinc Ferrite
u=1.0 ft/sec T=1000 °F
H2S Inlet Conc. = 800 ppm

Zinc Ferrite Tests - ZFMC-01 Sulfidation 6

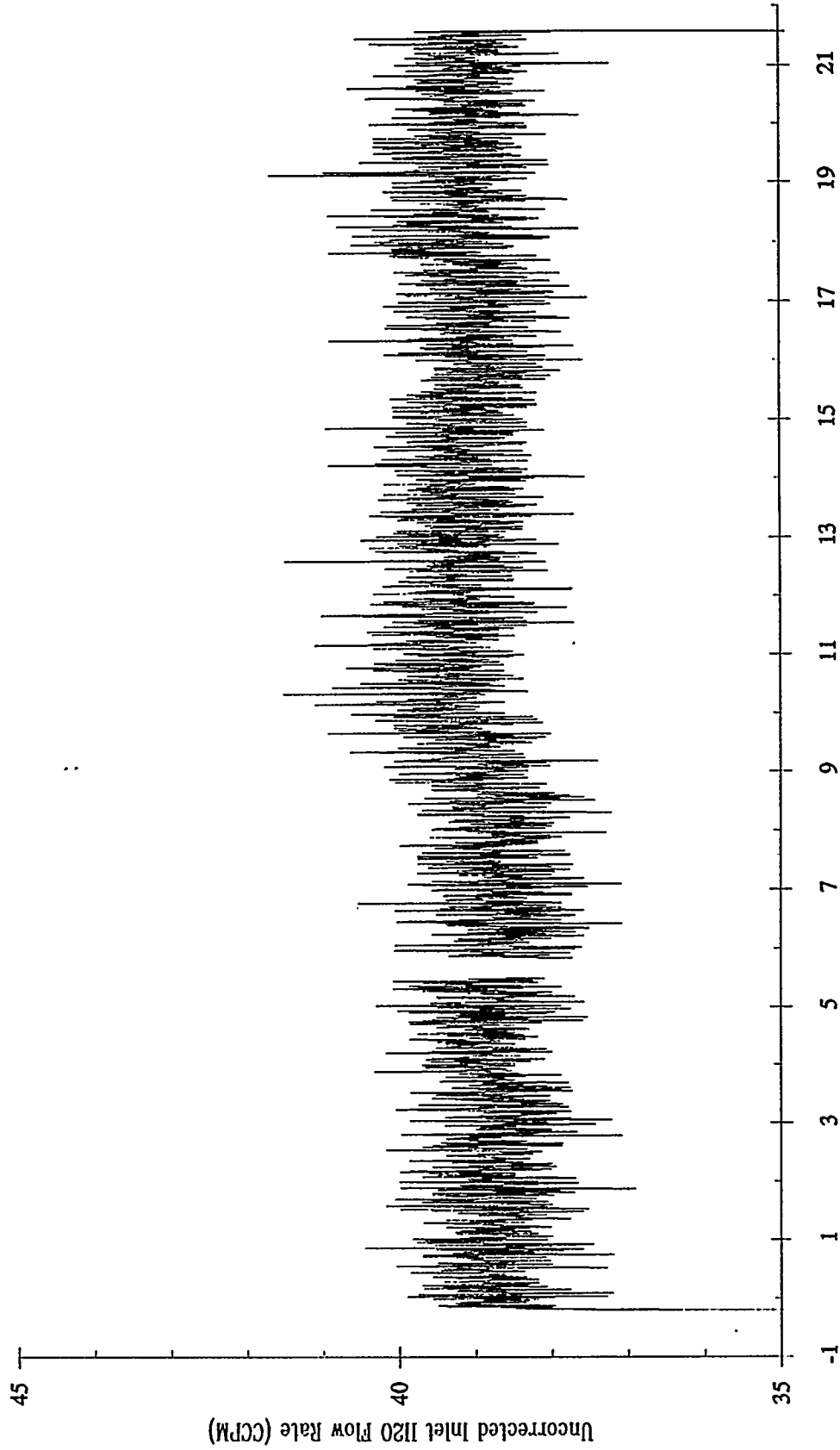

-1
1 3 5
Test time: 18:30 (December 30, 1992) - 16:00 (December 31, 1992)
Test duration: 21:30

T-2465 Zinc Ferrite
u=1.0 ft/sec T=1000 °F
H2S Inlet Conc. = 800 ppm

Zinc Ferrite Tests - ZFMC-01 Sulfidation 7

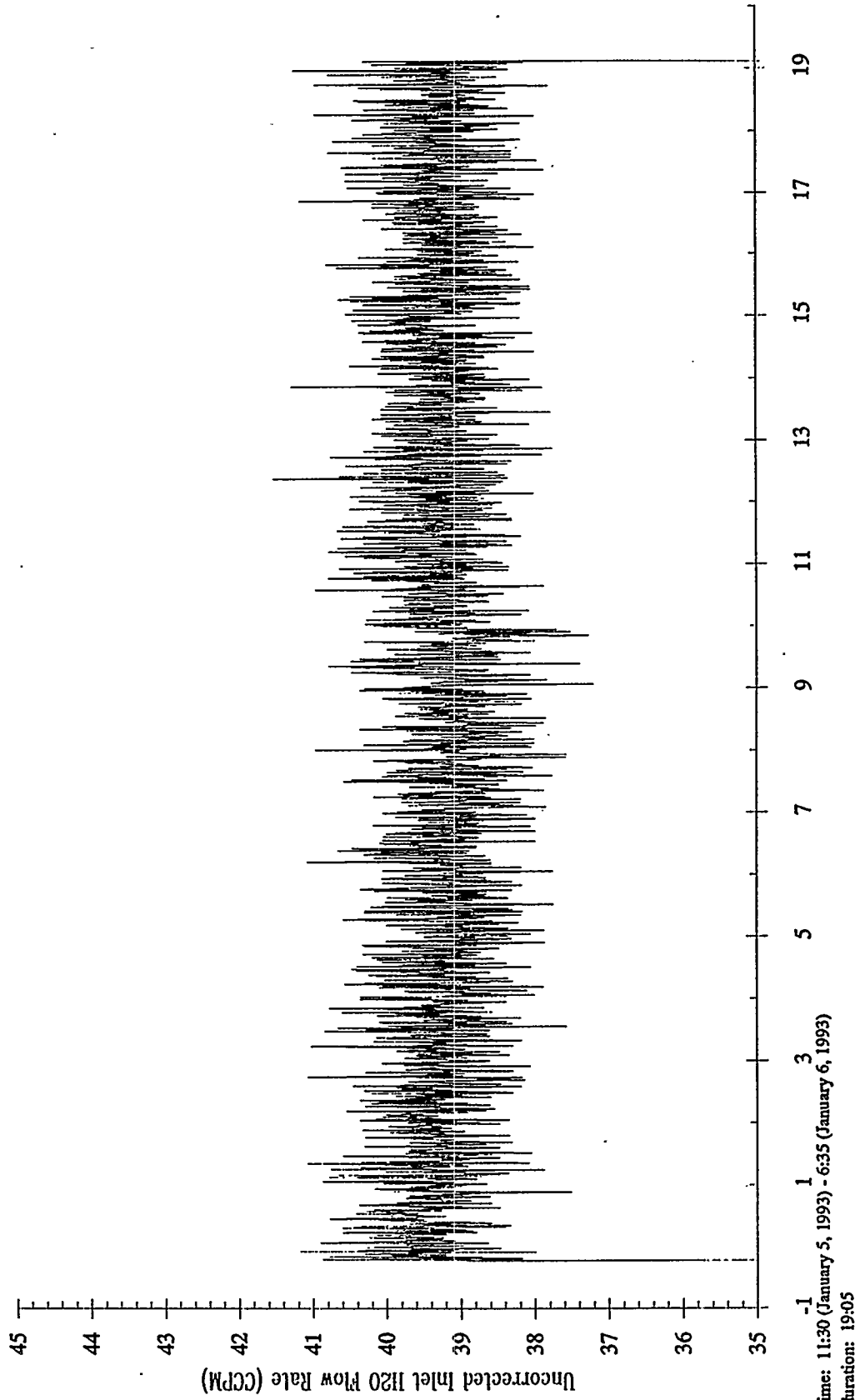

T-2465 Zinc Ferrite
u=1.0 ft/sec T=1000 °F
H2S Inlet Conc. = 800 ppm

Zinc Ferrite Tests - ZFMC-01 Sulfidation 8

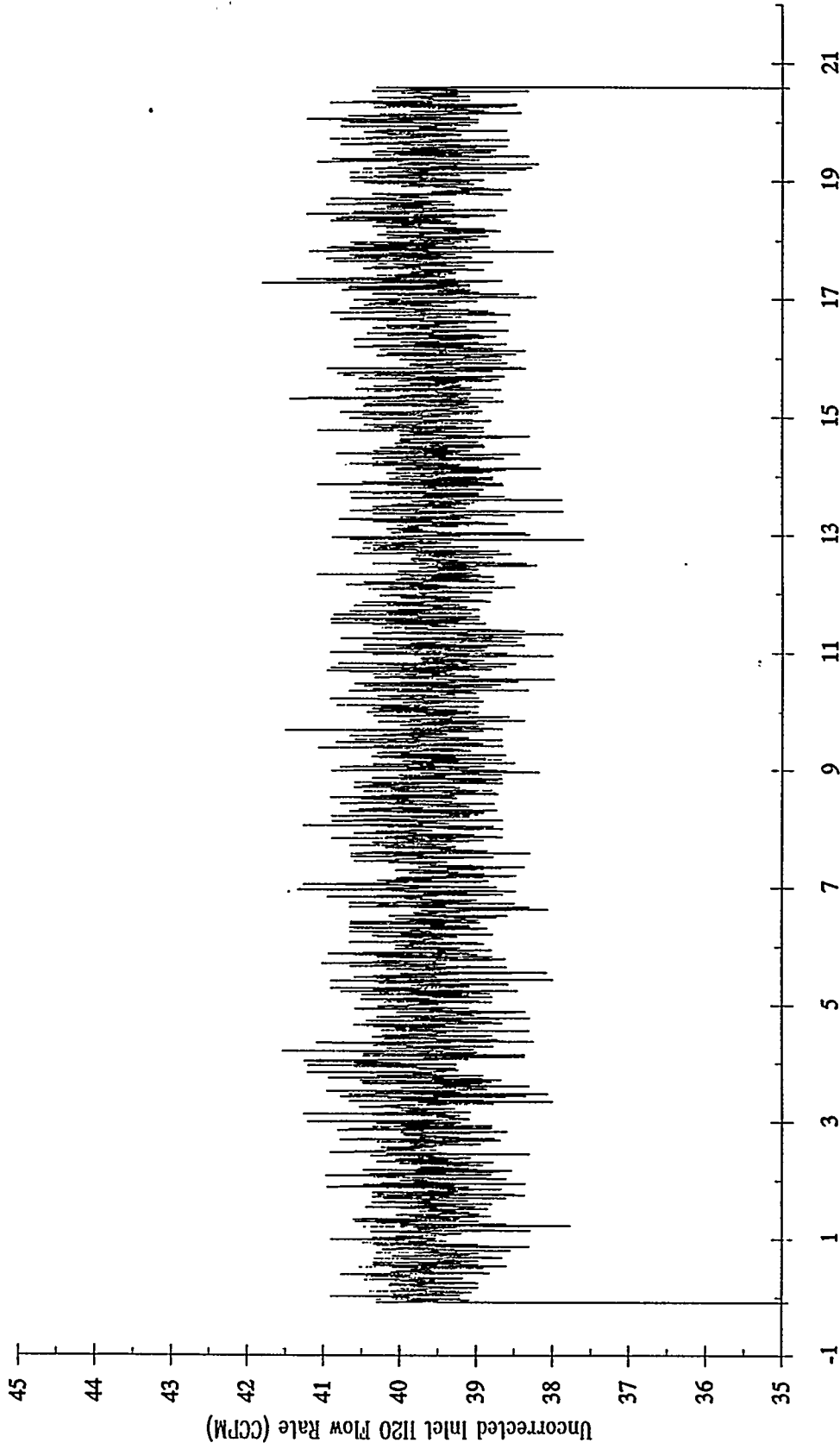

January 7, 1993
Test time: 2:00-22:33 (Test duration: 20:33)

APPENDIX B
Data Acquisition Temperature Trends

System temperatures were monitored by DDAS, a PC-based automatic data acquisition system. Trend plots for thermocouple (Omega Type K) readings in the sorbent bed zones are presented here.

Zinc Ferrite Tests - ZFMC-01 Sulfidation 1

T-2465 Zinc Ferrite
 u=1.0 ft/sec T=1000 °F
 H2S Inlet Conc. = 800 ppm

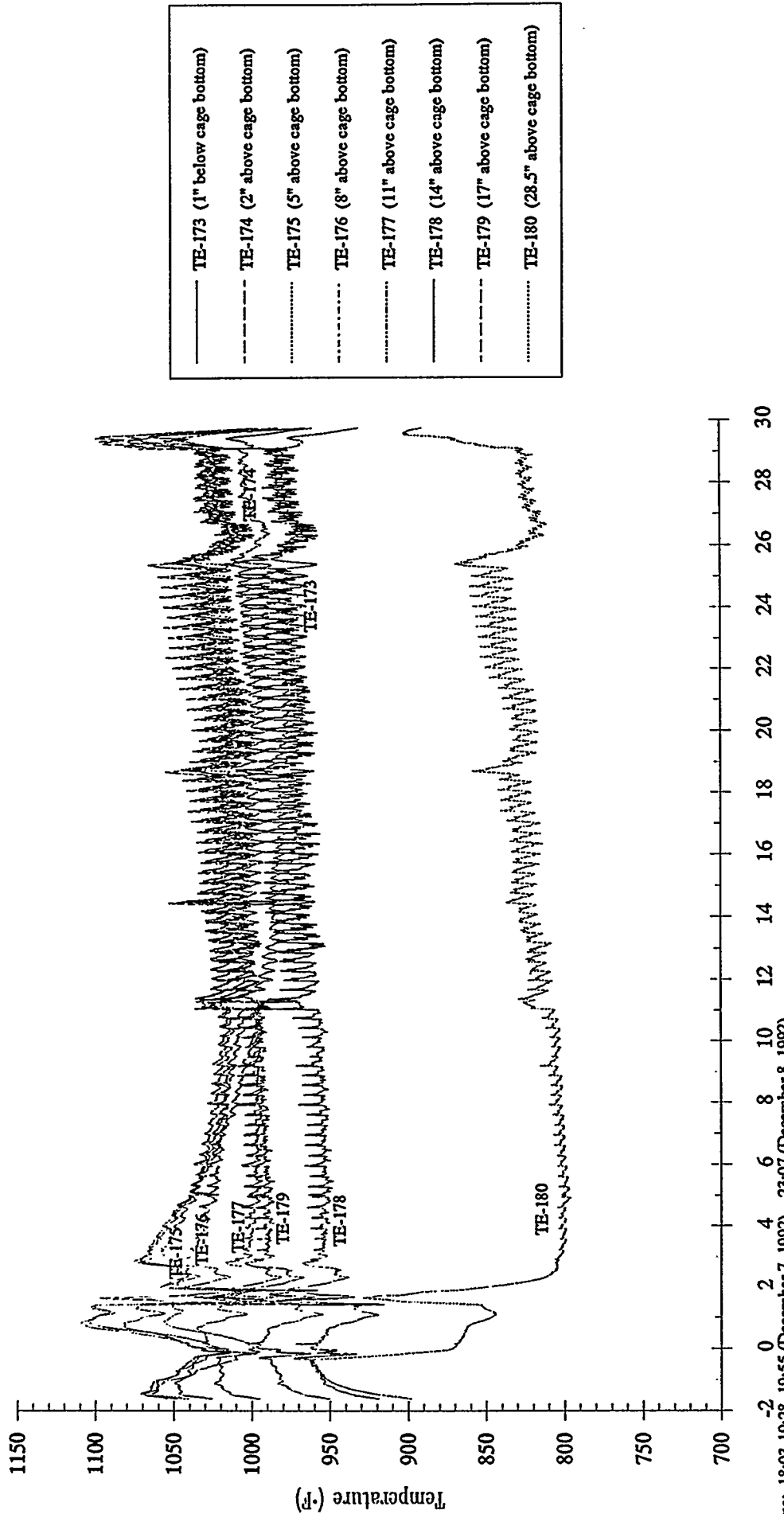

T-2465 Zinc Ferrite
 u=1.0 ft/sec T=1000-1300 °F
 O2 Inlet Conc. = 0.5-21 %

Zinc Ferrite Tests - ZFMC-01 Oxidative Regeneration 1

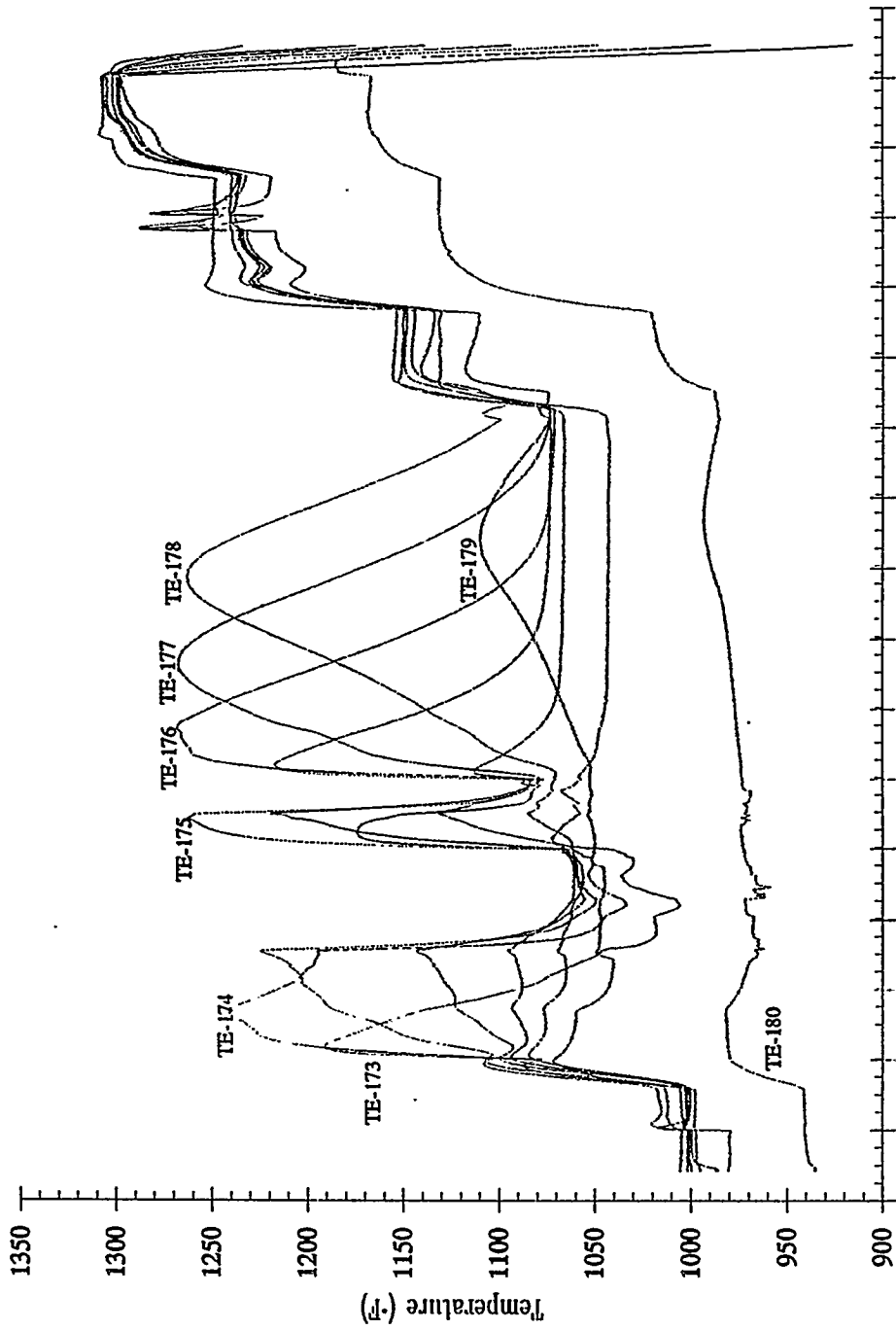

- TE-173 (1" below cage bottom)
- - - TE-174 (2" above cage bottom)
- TE-175 (5" above cage bottom)
- · - · - TE-176 (8" above cage bottom)
- · - · - TE-177 (11" above cage bottom)
- TE-178 (14" above cage bottom)
- - - TE-179 (17" above cage bottom)
- TE-180 (28.5" above cage bottom)

December 9, 1992 2:00 3:00 4:00 5:00 6:00 7:00 8:00 9:00 10:00 11:00 12:00 13:00 14:00 15:00 16:00 17:00 18:00 19:00
 Test time: 3:00-5:30, 7:00-7:30, 8:00-18:05
 Test duration: 13:05

T-2465 Zinc Ferrite
v=1.0 f/sec T=1000 °F

Zinc Ferrite Tests - ZFMC-01 Reductive Regeneration 1

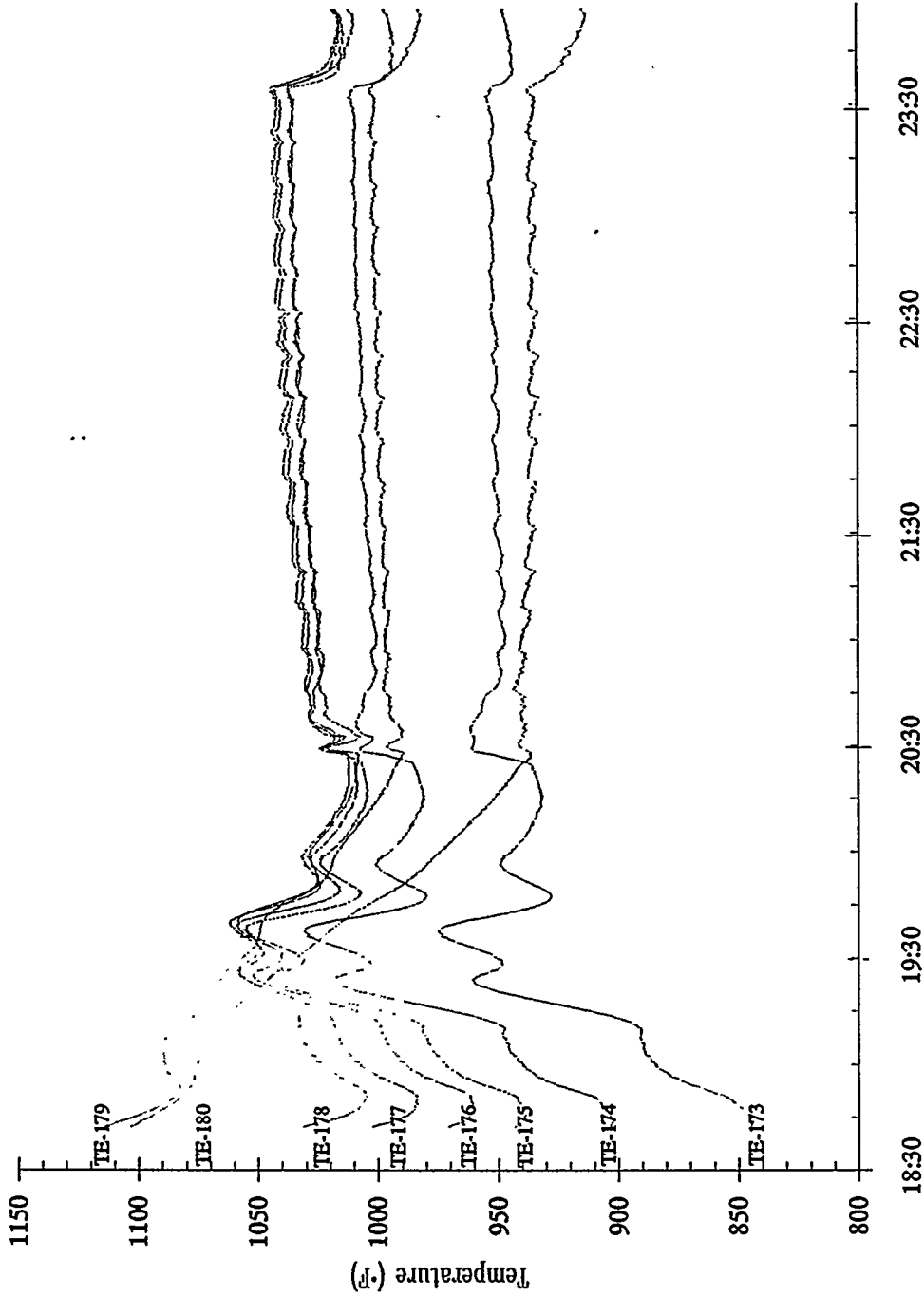

- TE-173 (1" below cage bottom)
- - - TE-174 (2" above cage bottom)
- TE-175 (5" above cage bottom)
- . - . - TE-176 (8" above cage bottom)
- TE-177 (11" above cage bottom)
- TE-178 (14" above cage bottom)
- - - TE-179 (17" above cage bottom)
- TE-180 (28.5" above cage bottom)

December 9, 1992
Test time: 20:30-23:33 (Test duration: 3:03)

T-2465 Zinc Ferrite
 u=1.0 ft/sec T=1000 °F
 H2S Inlet Conc. = 800 ppm

Zinc Ferrite Tests - ZFMC-01 Sulfidation 2

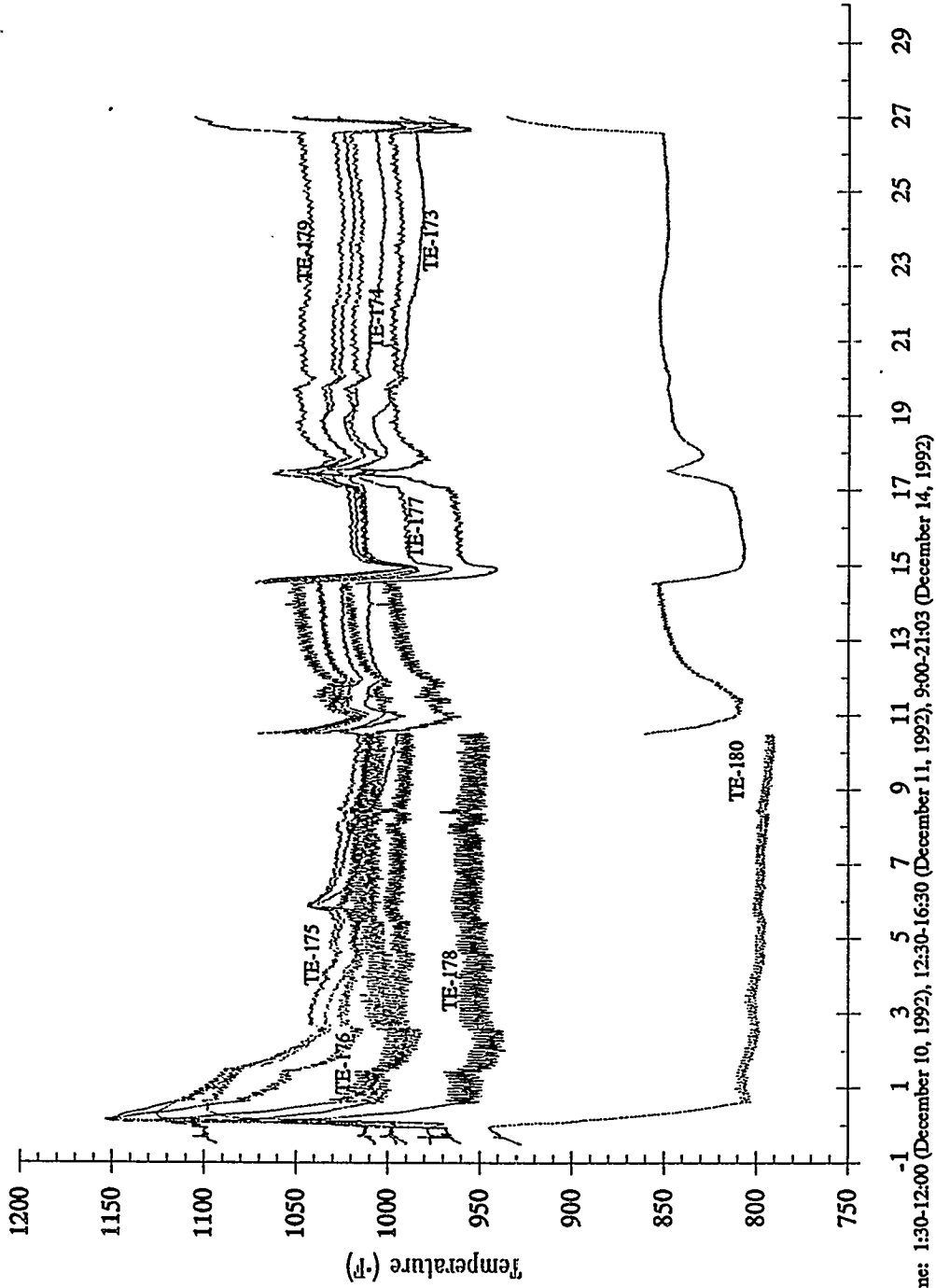

Test time: 1:30-12:00 (December 10, 1992), 12:30-16:30 (December 11, 1992), 9:00-21:03 (December 14, 1992)
 Test duration: 26:33

T-2465 Zinc Ferrite
 u=1.0 ft/sec T=1000-1300 °F
 O2 Inlet Conc. = 0.5-21 %

Zinc Ferrite Tests - ZFMC-01 Oxidative Regeneration 2

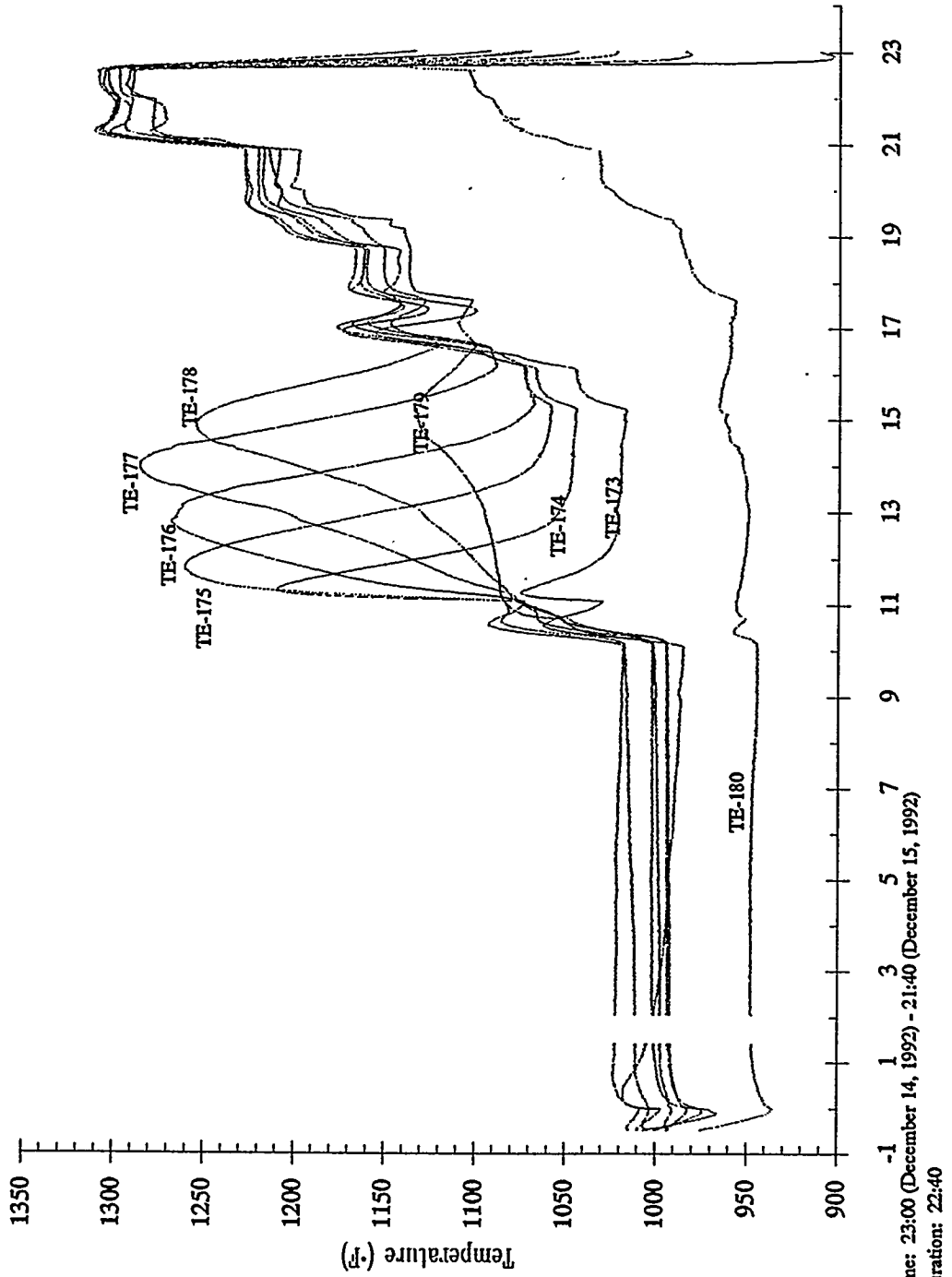

- TE-173 (1" below cage bottom)
- - - TE-174 (2" above cage bottom)
- TE-175 (3" above cage bottom)
- . - . - TE-176 (8" above cage bottom)
- TE-177 (11" above cage bottom)
- TE-178 (14" above cage bottom)
- - - TE-179 (17" above cage bottom)
- TE-180 (28.5" above cage bottom)

T-2465 Zinc Ferrite
u=1.0 ft/sec T=1000 °F

Zinc Ferrite Tests - ZFMC-01 Reductive Regeneration 2

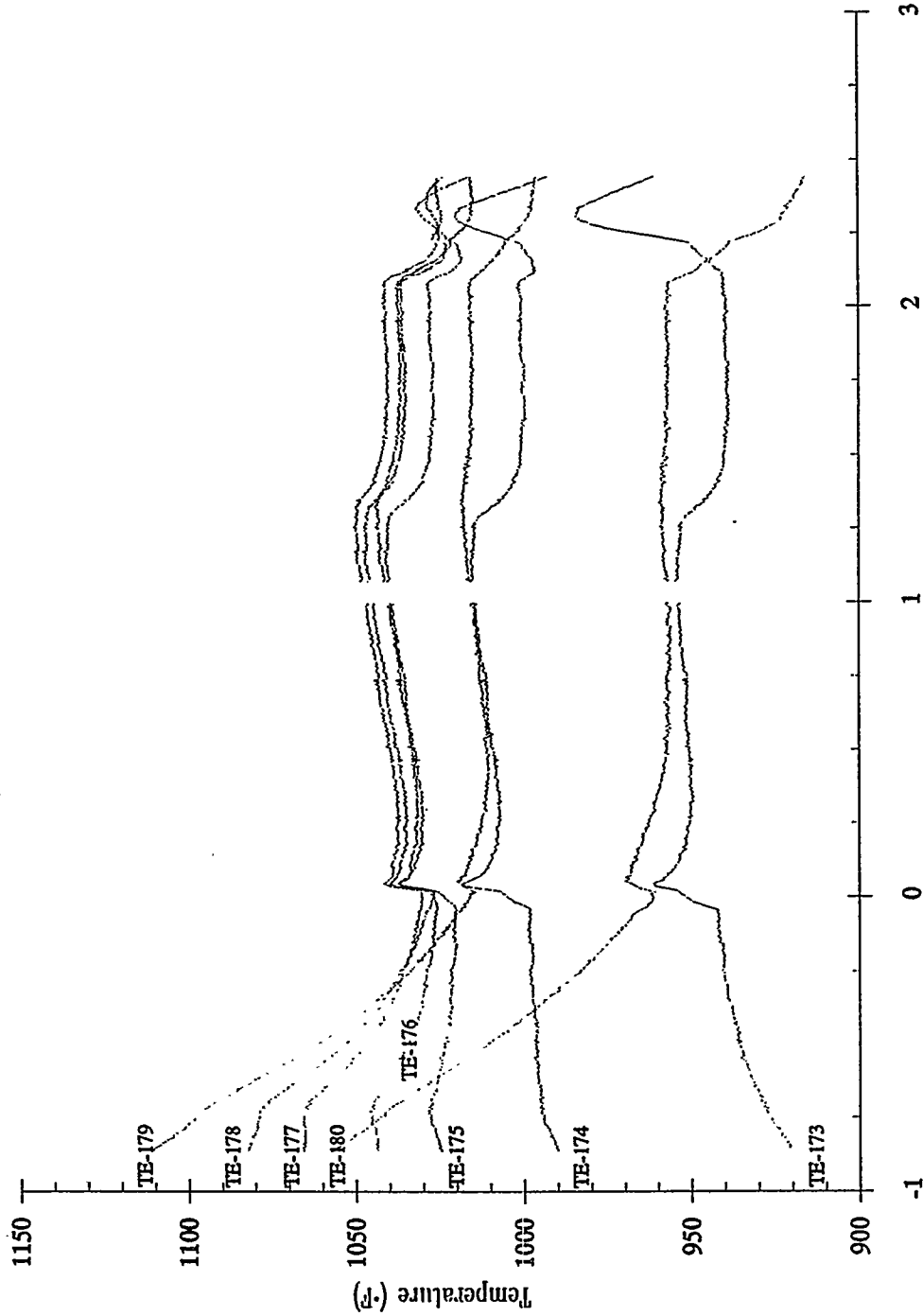

Test time: 23:00 (December 15, 1992) - 1:00 (December 16, 1992)
Test duration: 2:00

- TE-173 (1" below cage bottom)
- - - TE-174 (2" above cage bottom)
- TE-175 (5" above cage bottom)
- . - . - TE-176 (8" above cage bottom)
- TE-177 (11" above cage bottom)
- TE-178 (14" above cage bottom)
- - - TE-179 (17" above cage bottom)
- TE-180 (28.5" above cage bottom)

T-2465 Zinc Ferrite
 u=1.0 ft/sec T=1000 °F
 H2S Inlet Conc. = 800 ppm

Zinc Ferrite Tests - ZFMC-01 Sulfidation 3

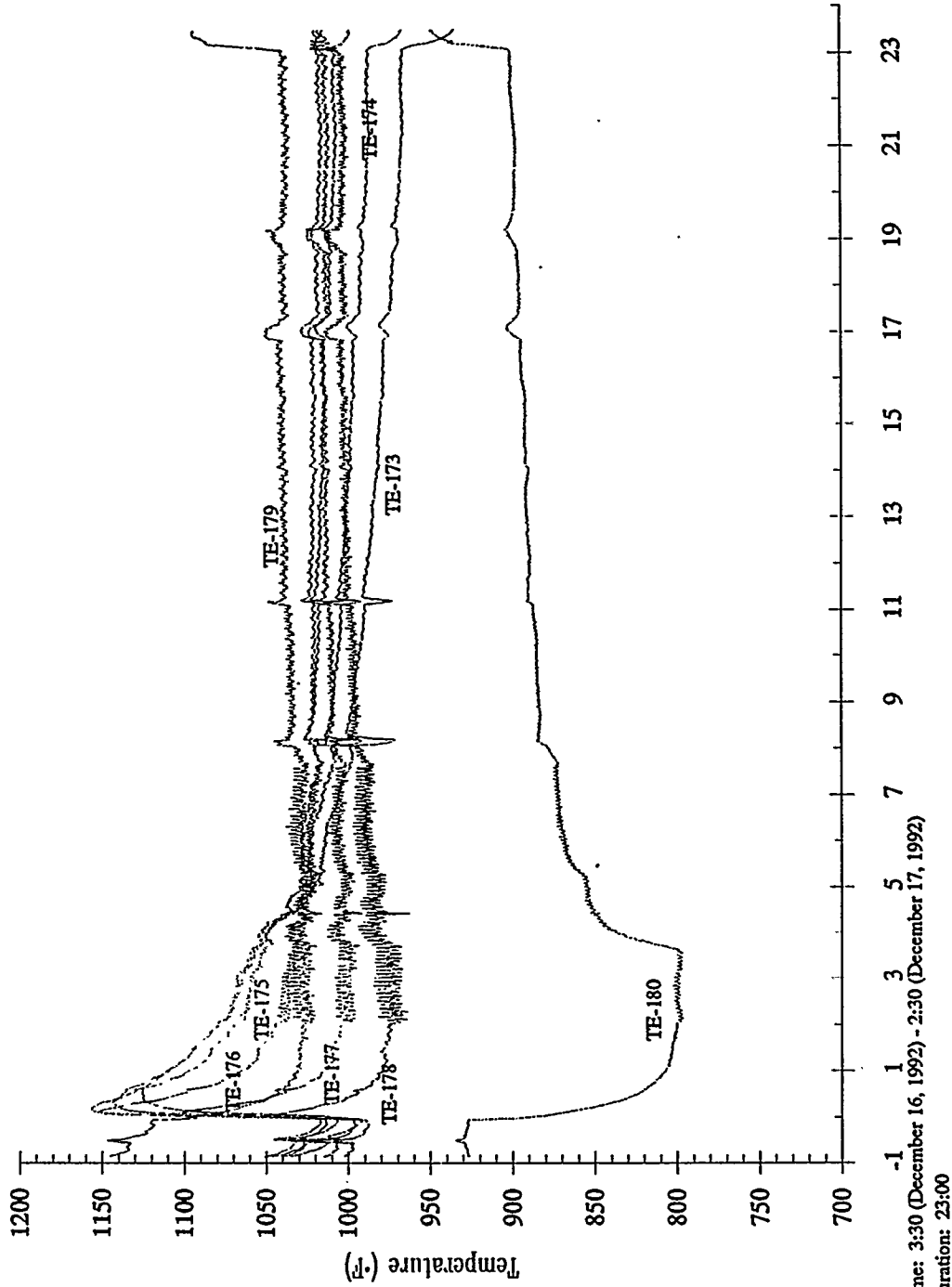

T-2465 Zinc Ferrite
 u=1.0 ft/sec T=1000-1300 °F
 O2 Inlet Conc. = 0.5-21 %

Zinc Ferrite Tests - ZFMC-01 Oxidative Regeneration 3

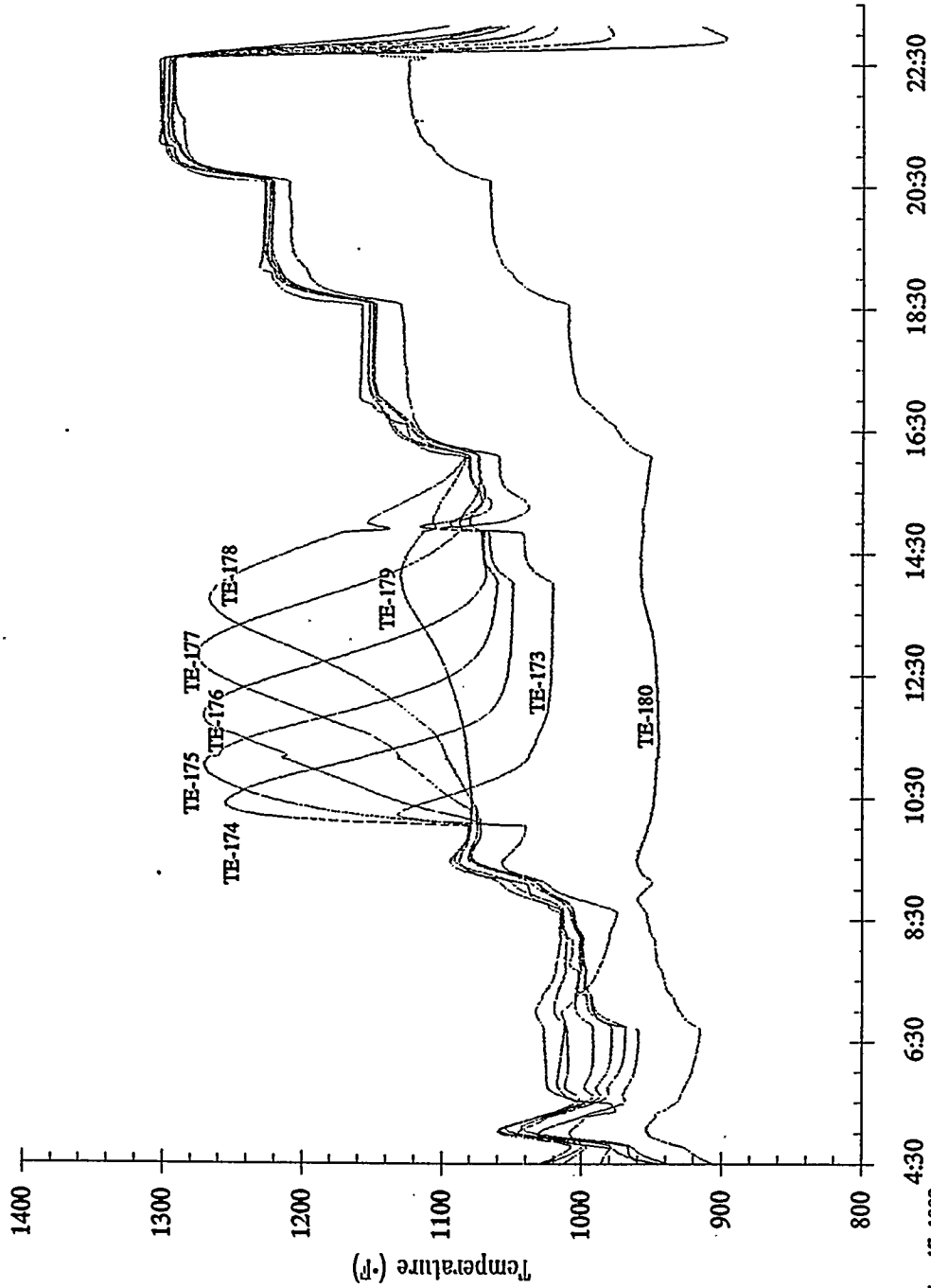

—	TE-173 (1" below cage bottom)
- - -	TE-174 (2" above cage bottom)
.....	TE-175 (5" above cage bottom)
- - -	TE-176 (8" above cage bottom)
.....	TE-177 (11" above cage bottom)
—	TE-178 (14" above cage bottom)
- - -	TE-179 (17" above cage bottom)
.....	TE-180 (28.5" above cage bottom)

December 17, 1992
 Test time: 5:30-22:30 (Test duration: 17:00)

T-2465 Zinc Ferrite
u=1.0 ft/sec T=1000 °F

Zinc Ferrite Tests - ZFMC-01 Reductive Regeneration 3

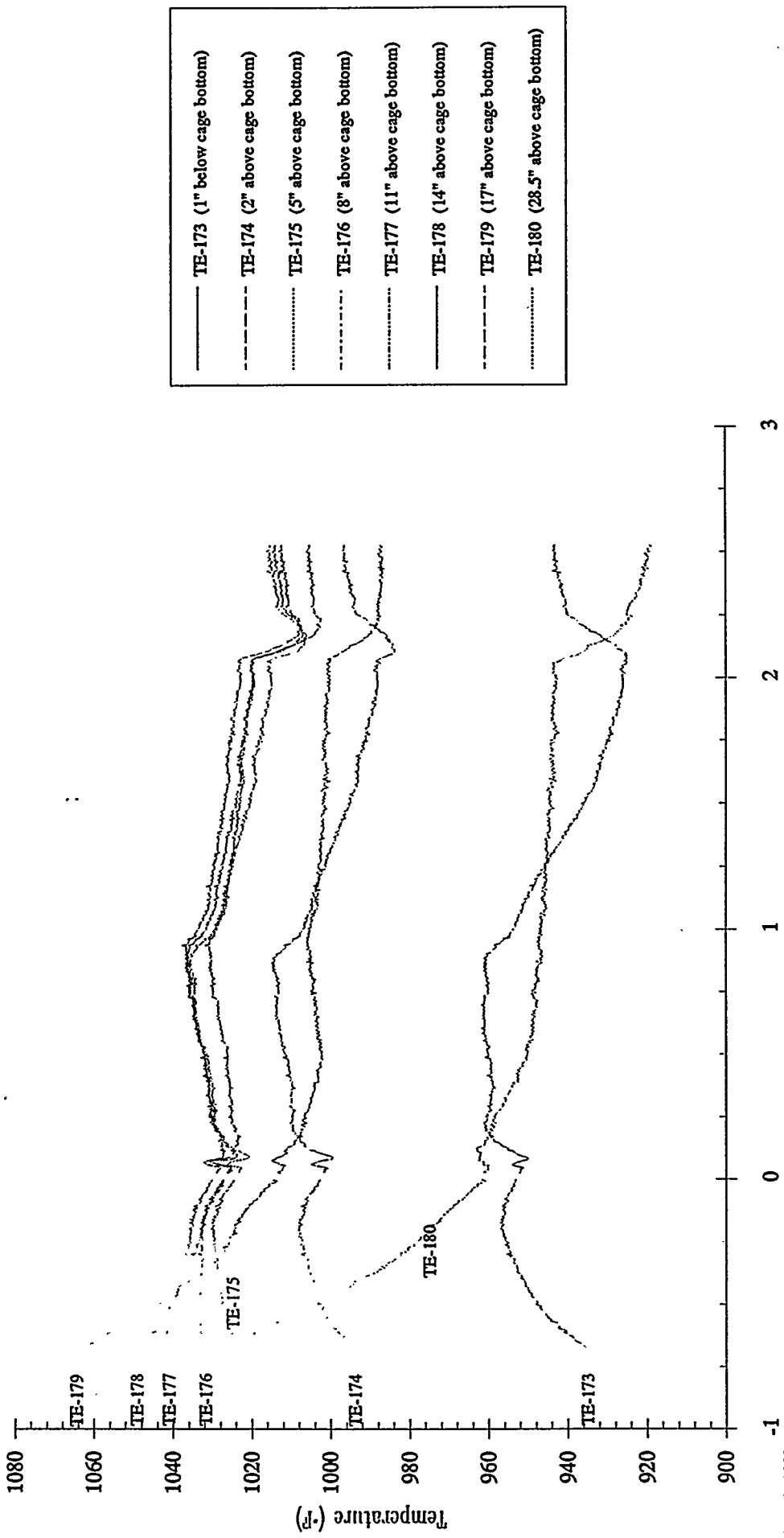

December 18, 1992
Test time: 0:00 - 2:00 (Test duration: 2:00)

T-2465 Zinc Ferrite
 u=1.0 ft/sec T=1000 °F
 H2S Inlet Conc. = 800 ppm

Zinc Ferrite Tests - ZFMC-01 Sulfidation 4

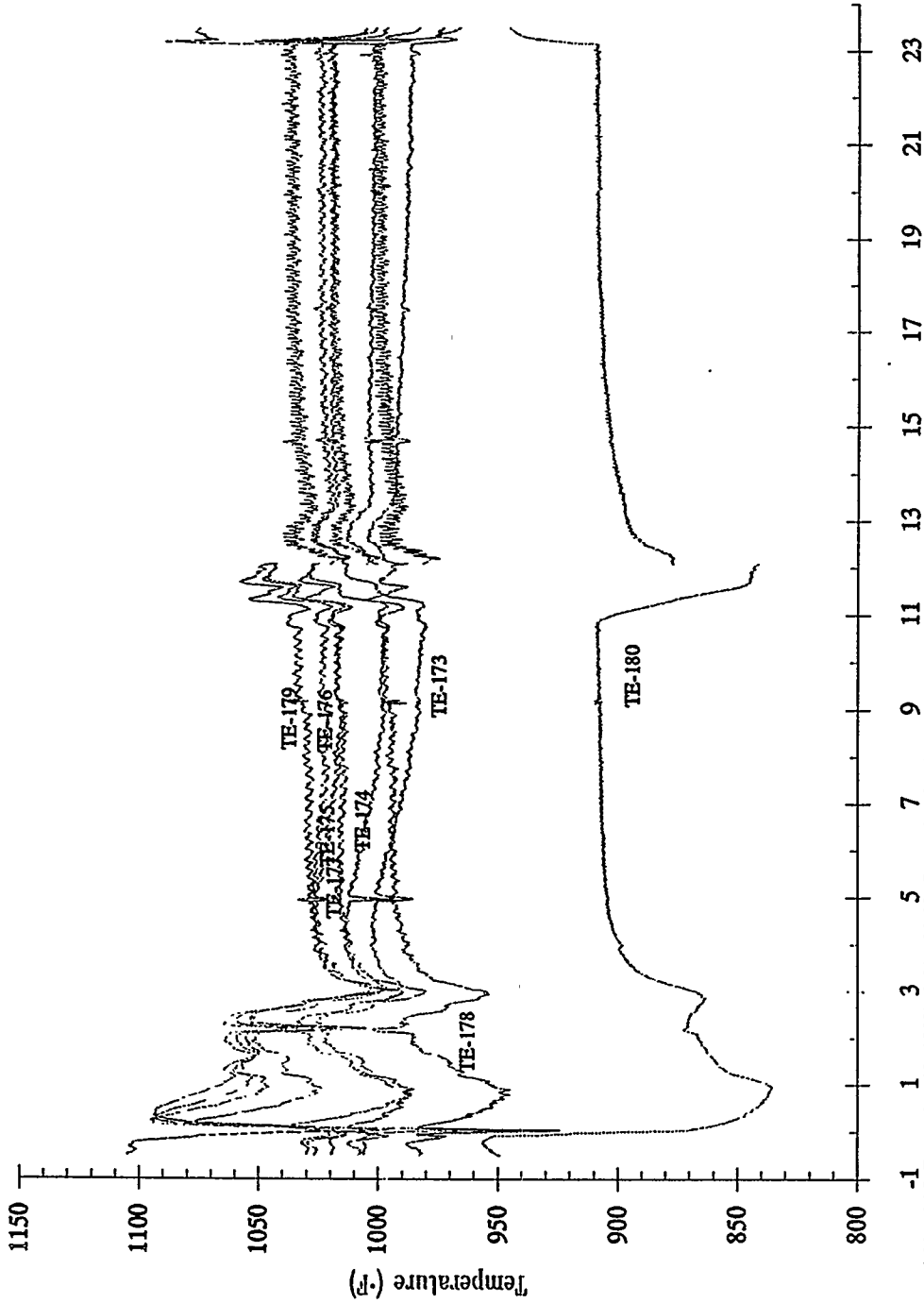

- TE-173 (1" below cage bottom)
- - - TE-174 (2" above cage bottom)
- TE-175 (5" above cage bottom)
- . - . TE-176 (8" above cage bottom)
- - - - TE-177 (11" above cage bottom)
- TE-178 (14" above cage bottom)
- - - TE-179 (17" above cage bottom)
- TE-180 (28.5" above cage bottom)

-1 1 3 5 7 9 11 13 15 17 19 21 23
 Test time: 4:00-16:05 (December 18, 1992), 9:30 - 20:30 (December 21, 1992)
 Test duration: 23:05

T-246S Zinc Ferrite
 u=1.0 ft/sec T=1075 & 1300 °F
 O2 Inlet Conc. = 2.5 & 21%

Zinc Ferrite Tests - ZFMC-01 Oxidative Regeneration 4

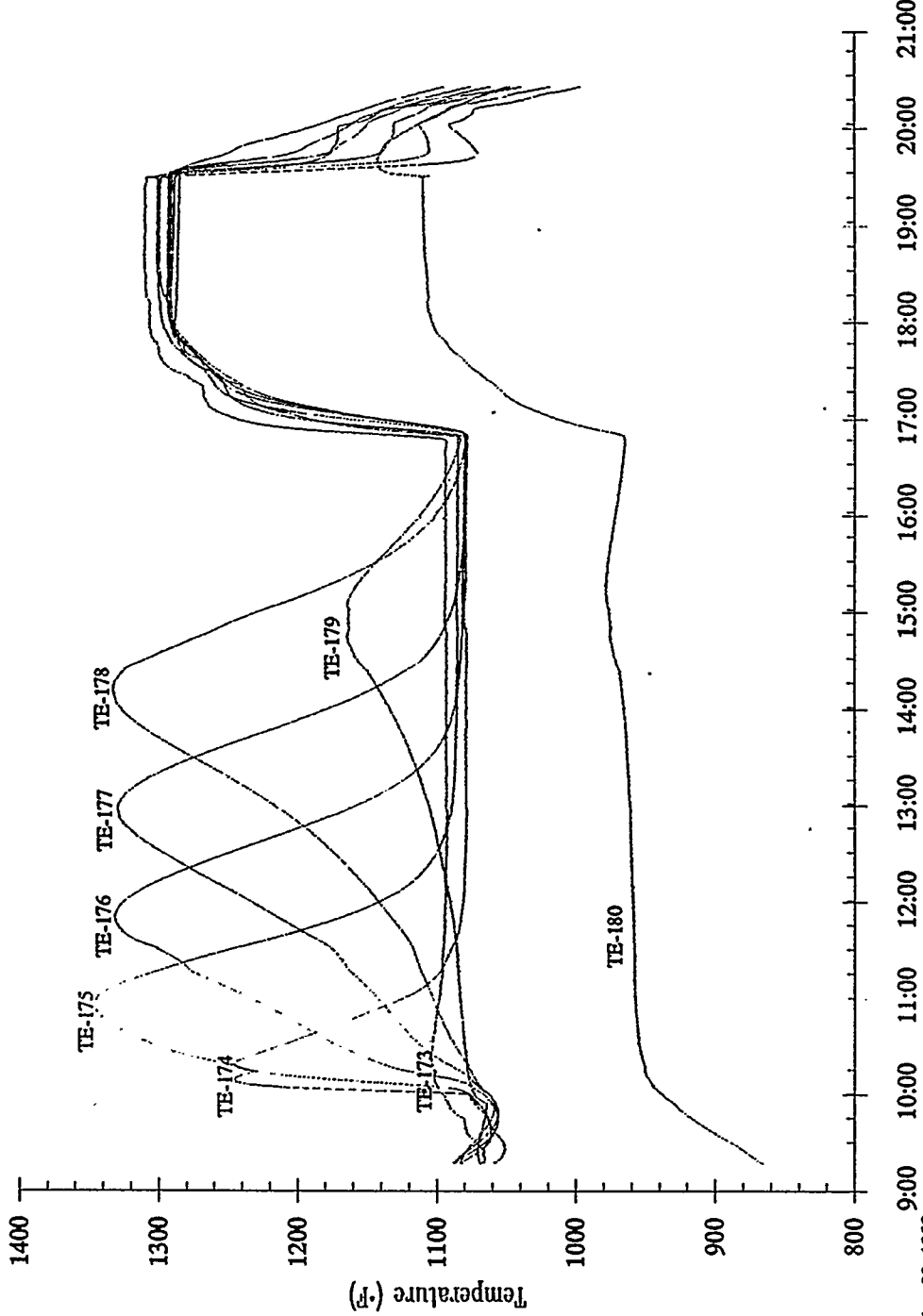

- TE-173 (1" below cage bottom)
- - - TE-174 (2" above cage bottom)
- TE-175 (5" above cage bottom)
- . - . - TE-176 (8" above cage bottom)
- TE-177 (11" above cage bottom)
- TE-178 (14" above cage bottom)
- - - TE-179 (17" above cage bottom)
- TE-180 (28.5" above cage bottom)

December 28, 1992
 Test time: 10:00-19:30 (Test duration: 9:30)

T-2465 Zinc Ferrite
u=1.0 ft/sec T=1000 F

Zinc Ferrite Tests - ZFMC-01 Reductive Regeneration 4

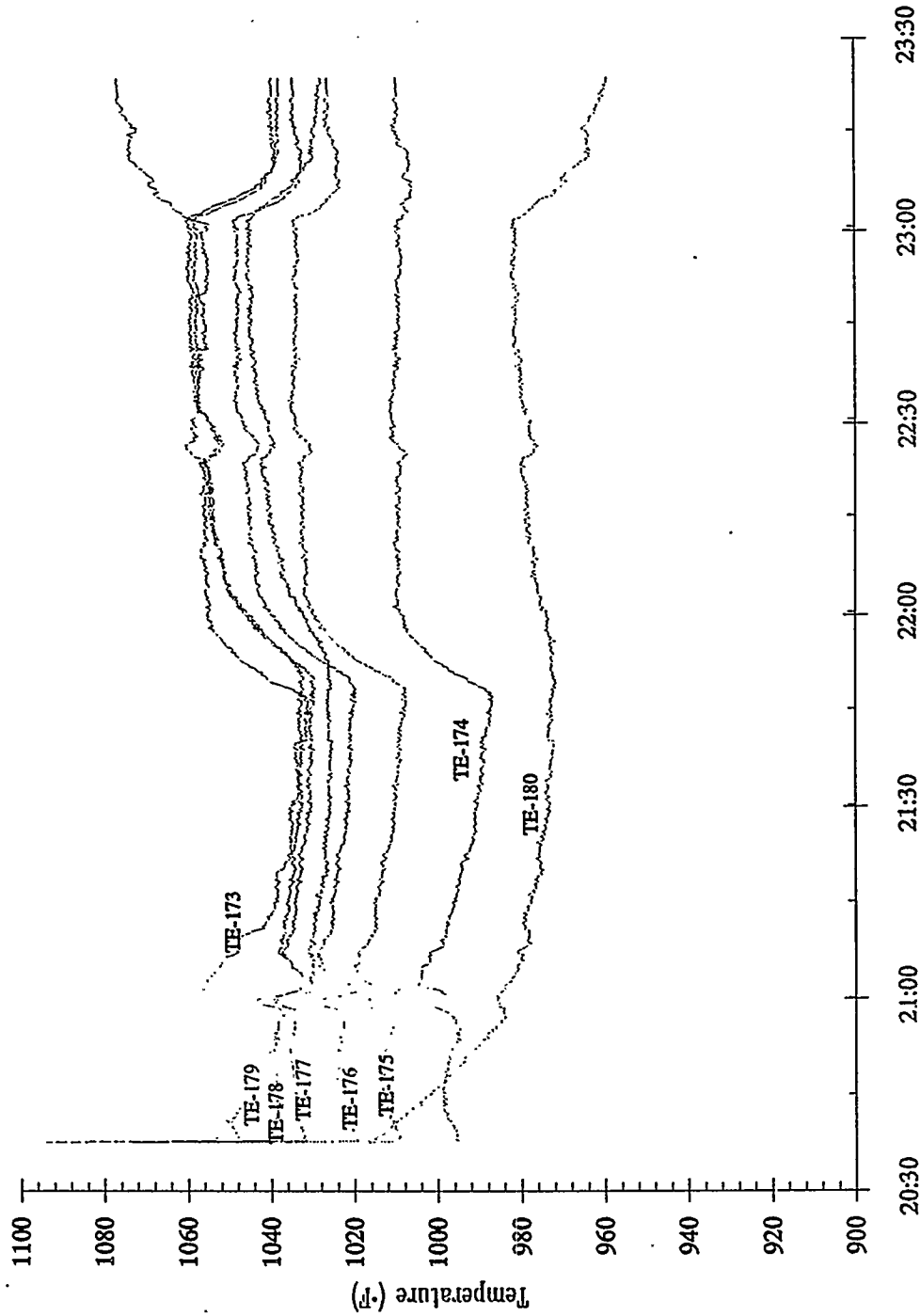

December 28, 1992
Test time: 21:00-23:00 (Test duration: 2:00)

Zinc Ferrite Tests - ZFMC-01 Sulfidation 5

T-2465 Zinc Ferrite
 u=1.0 ft/sec T=1000 °F
 H2S Inlet Conc. = 800 ppm

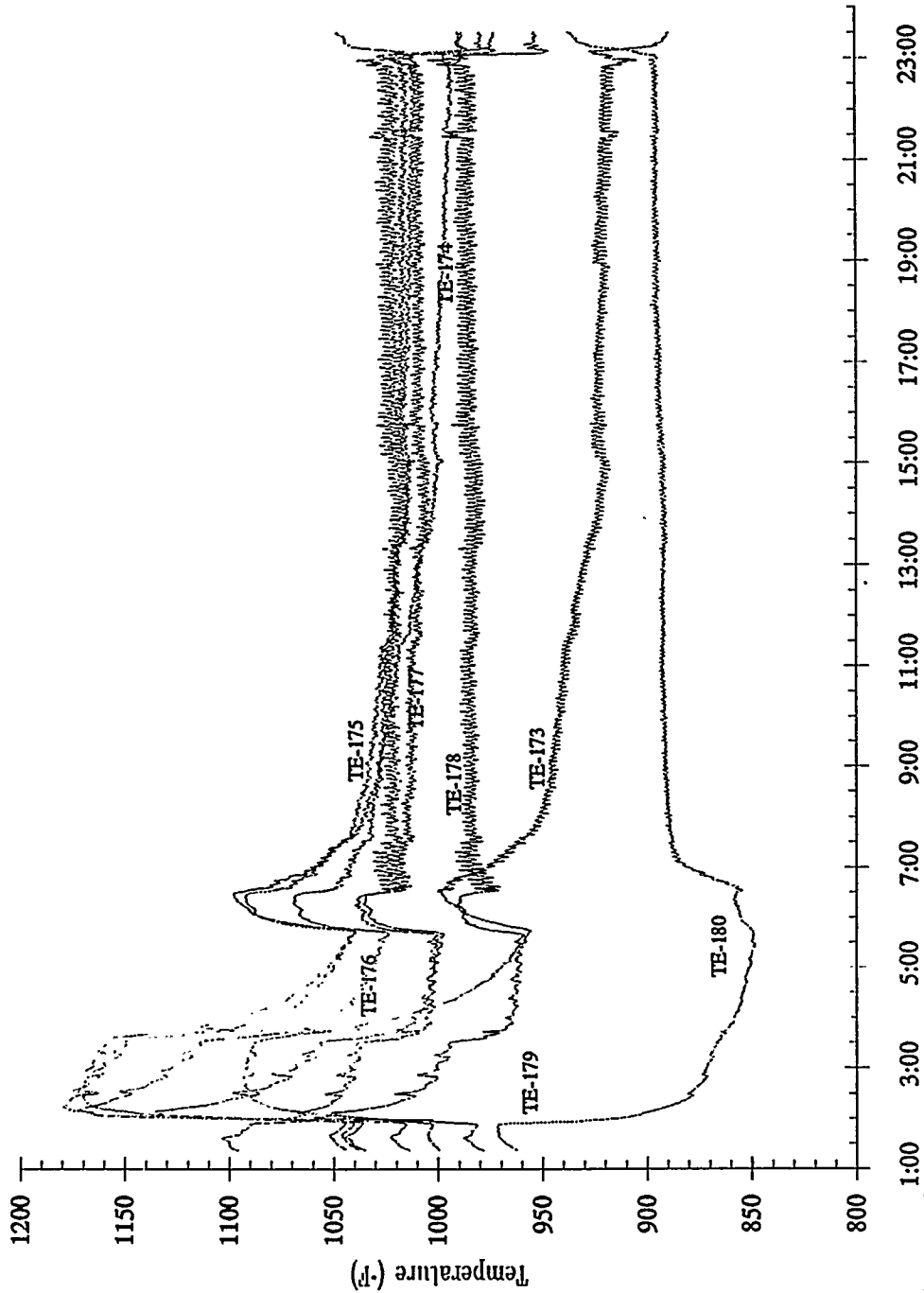

December 29, 1992
 Test time: 2:00 - 23:00 (Test duration: 21:00)

T-2465 Zinc Ferrite
 u=1.0 ft/sec T=1075 & 1300 °F
 O2 Inlet Conc. = 2.5 & 21%

Zinc Ferrite Tests - ZFMC-01 Oxidative Regeneration 5

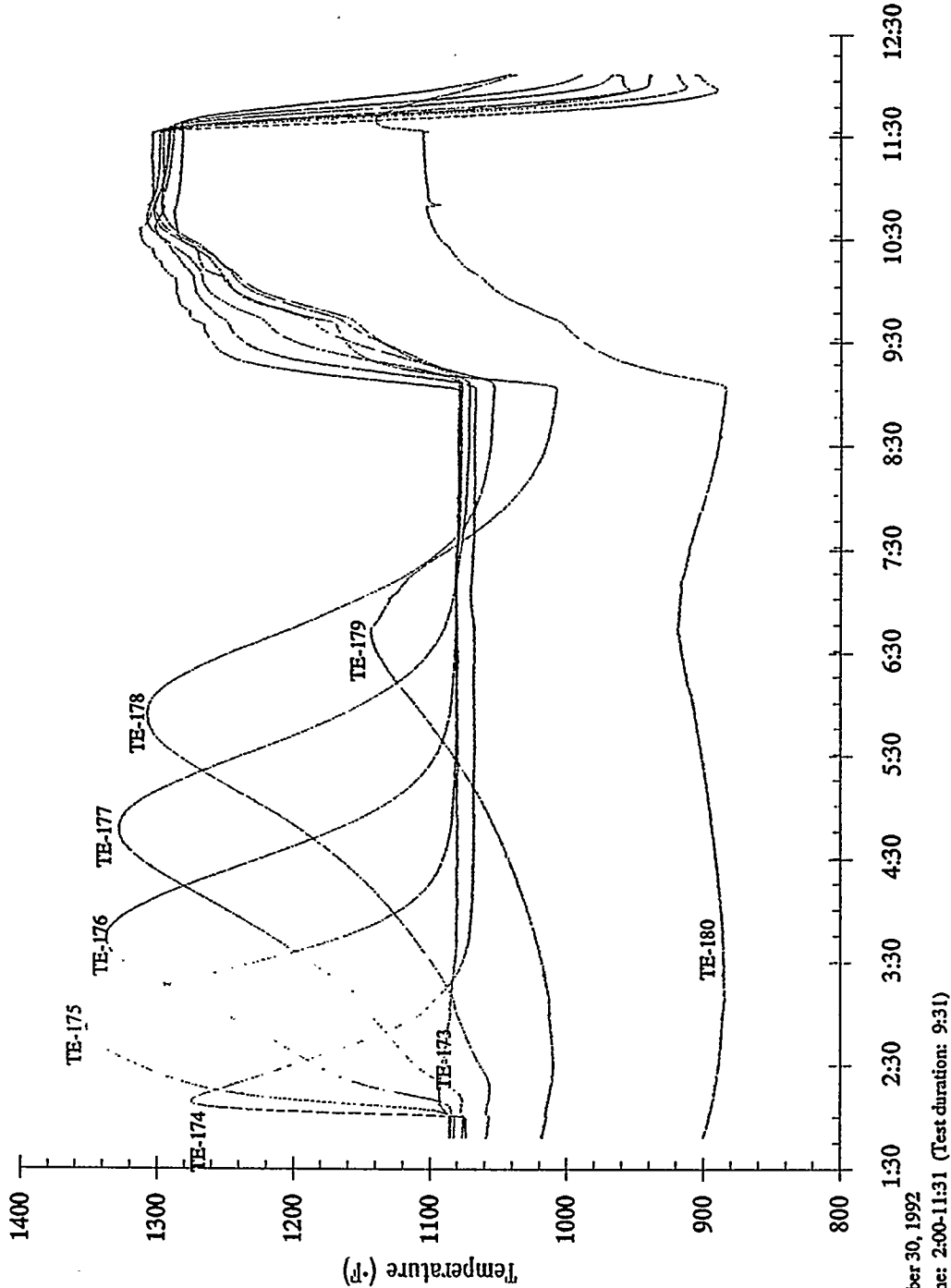

December 30, 1992
 Test time: 2:00-11:31 (Test duration: 9:31)

T-2465 Zinc Ferrite
u=1.0 ft/sec T=1000 °F

Zinc Ferrite Tests - ZFMC-01 Reductive Regeneration 5

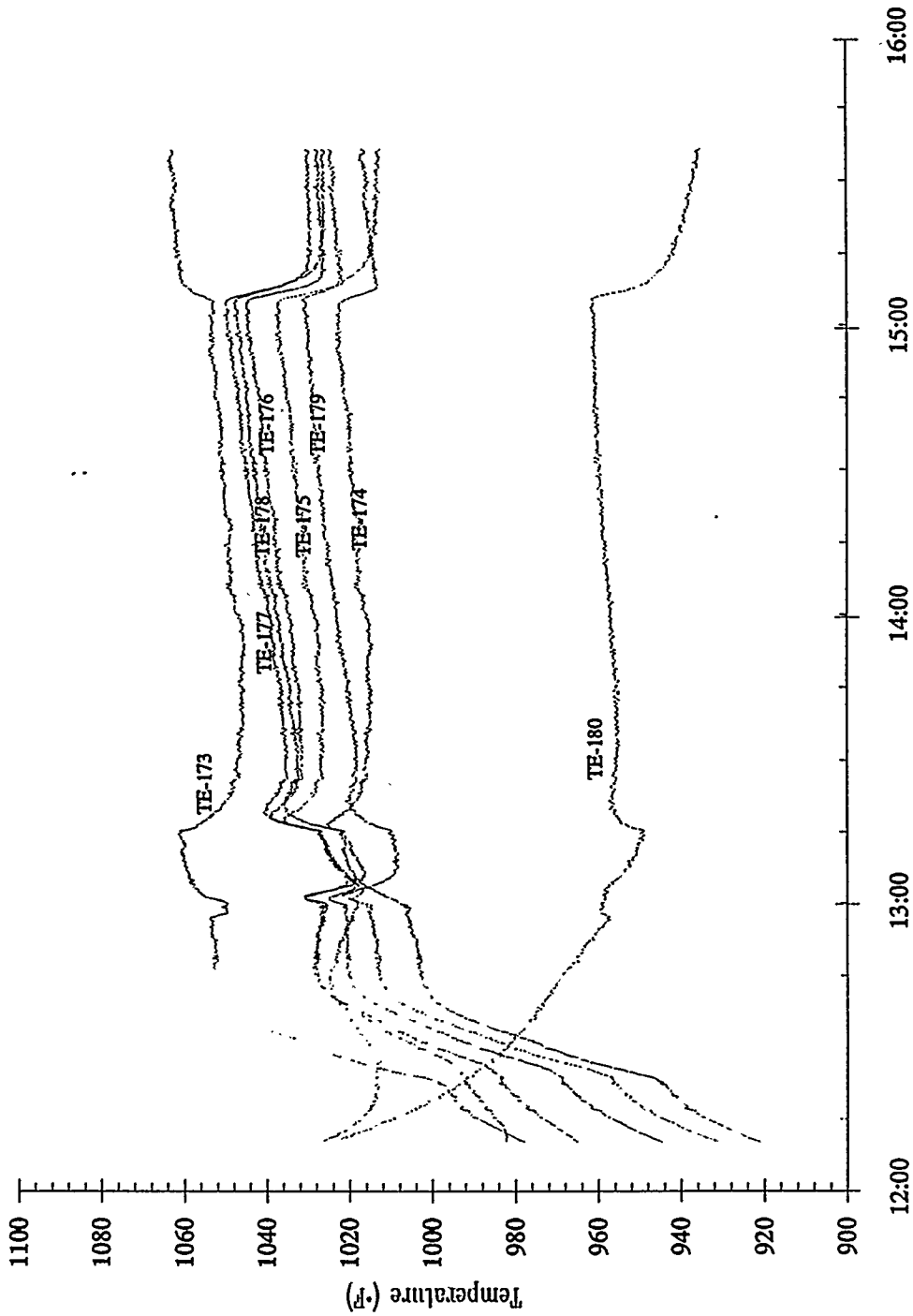

- TE-173 (1" below cage bottom)
- - - TE-174 (2" above cage bottom)
- TE-175 (5" above cage bottom)
- . - . - TE-176 (8" above cage bottom)
- TE-177 (11" above cage bottom)
- TE-178 (14" above cage bottom)
- - - TE-179 (17" above cage bottom)
- TE-180 (28.5" above cage bottom)

December 30, 1992
Test time: 13:00-15:05 (Test duration: 2:05)

Zinc Ferrite Tests - ZFMC-01 Sulfidation 6

T-2465 Zinc Ferrite
 u=1.0 ft/sec T=1000 °F
 H2S Inlet Conc. = 800 ppm

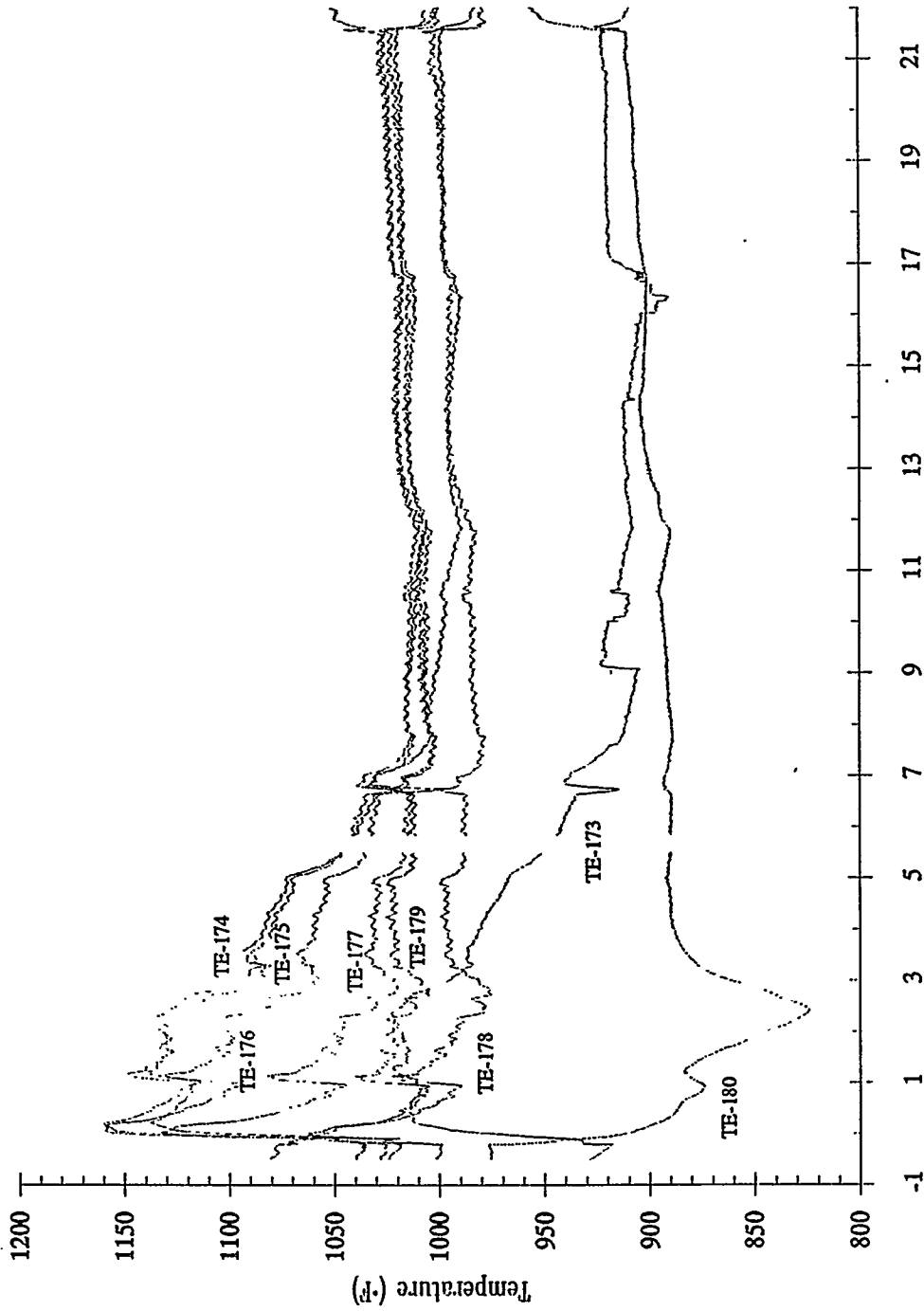

- TE-173 (1" below cage bottom)
- - - TE-174 (2" above cage bottom)
- TE-175 (5" above cage bottom)
- · - · - TE-176 (8" above cage bottom)
- · - · - TE-177 (11" above cage bottom)
- TE-178 (14" above cage bottom)
- - - TE-179 (17" above cage bottom)
- TE-180 (28.5" above cage bottom)

Test time: 18:30 (December 30, 1992) - 16:00 (December 31, 1992)
 Test duration: 21:30

T-2465 Zinc Ferrite
 u=1.0 ft/sec T=1075 & 1300 °F
 O2 Inlet Conc. = 2.5 & 21%

Zinc Ferrite Tests - ZFMC-01 Oxidative Regeneration 6

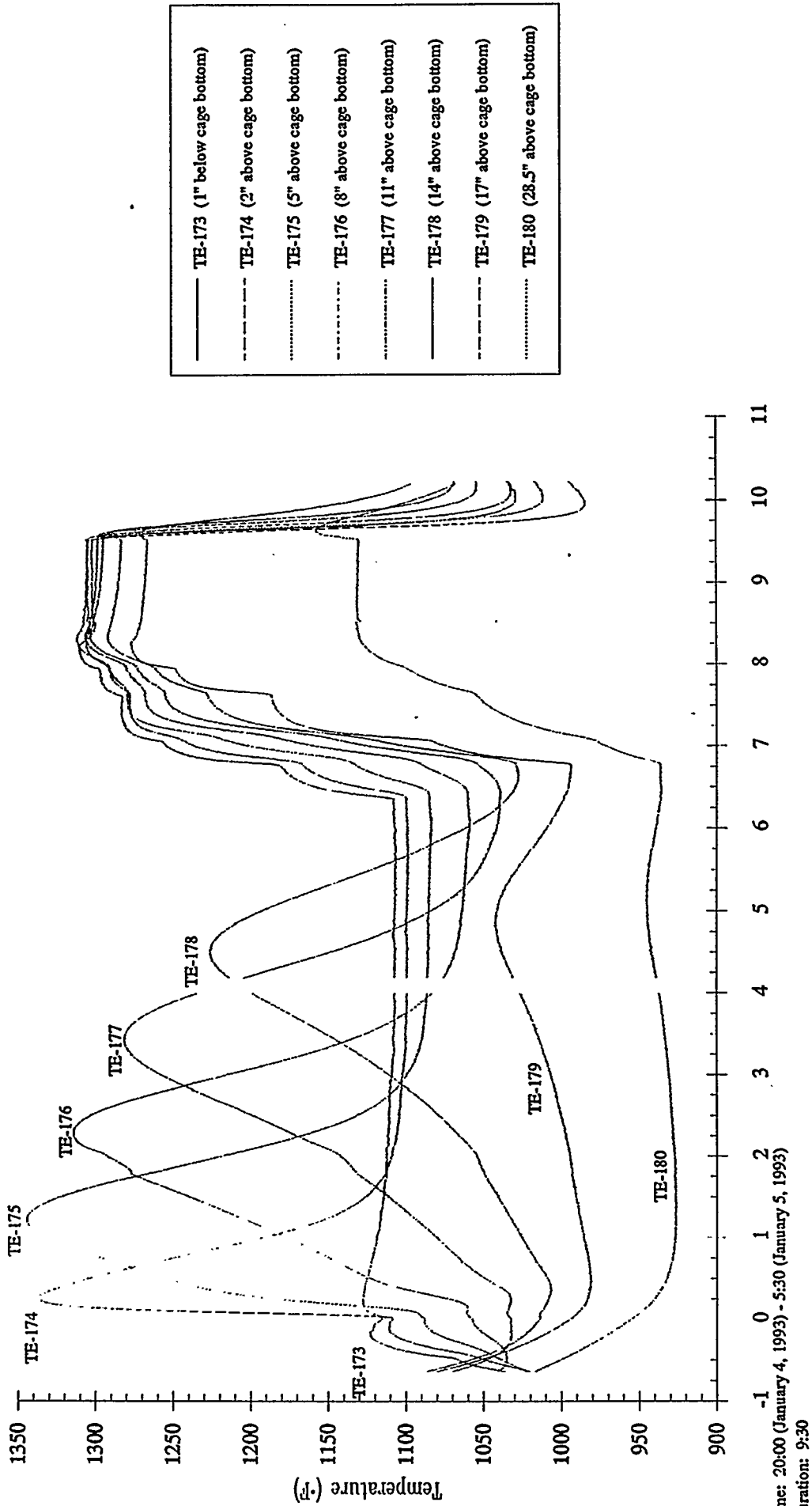

Test time: 20:00 (January 4, 1993) - 5:30 (January 5, 1993)
 Test duration: 9:30

T-2465 Zinc Ferrite
u=1.0 ft/sec T=1000 °F

Zinc Ferrite Tests - ZFMC-01 Reductive Regeneration 6

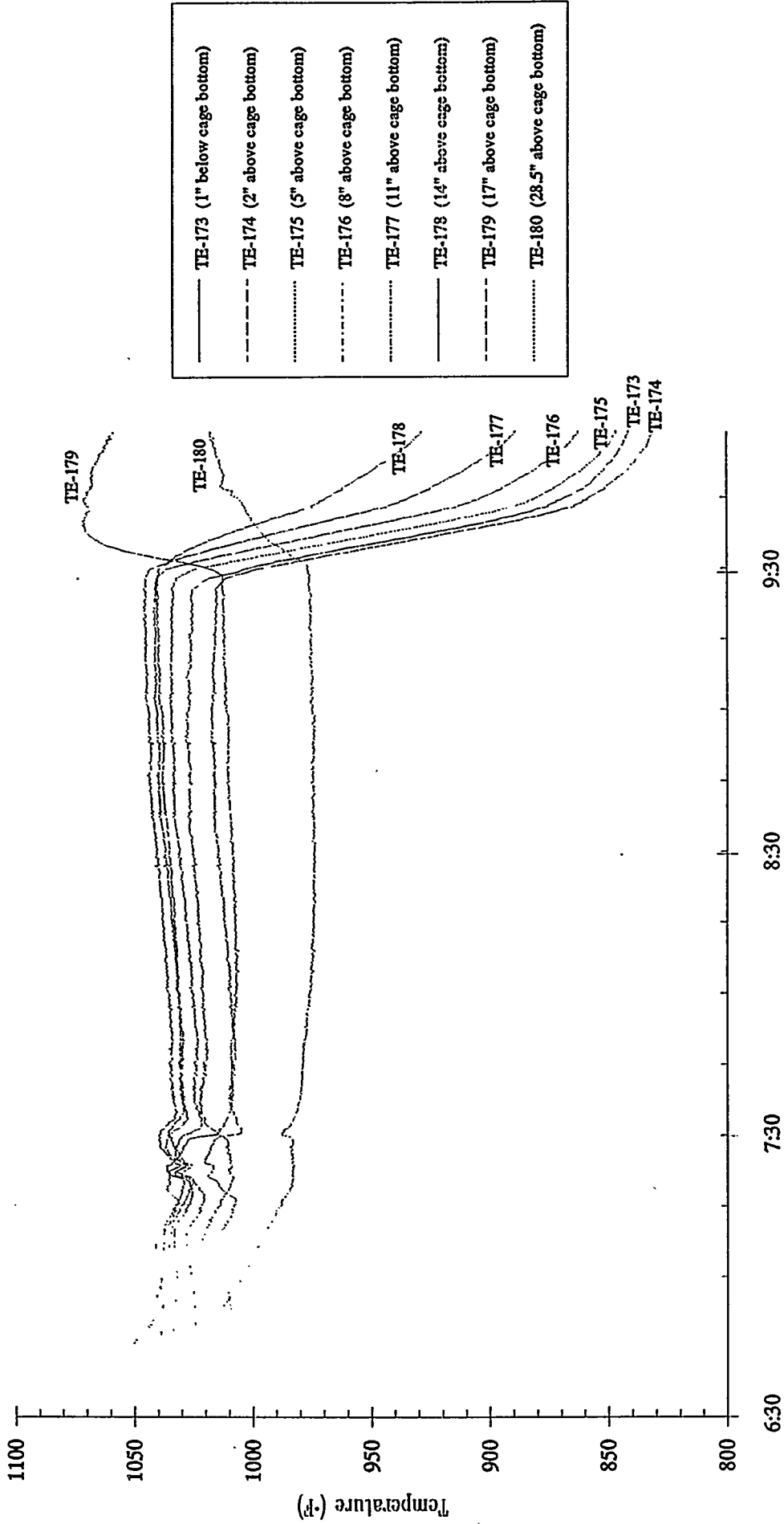

January 5, 1993
Test time: 7:30-9:32 (Test duration: 2:02)

T-2465 Zinc Ferrite
u=1.0 f/sec T=1000 F
H2S Inlet Conc. = 800 ppm

Zinc Ferrite Tests - ZFMC-01 Sulfidation 7

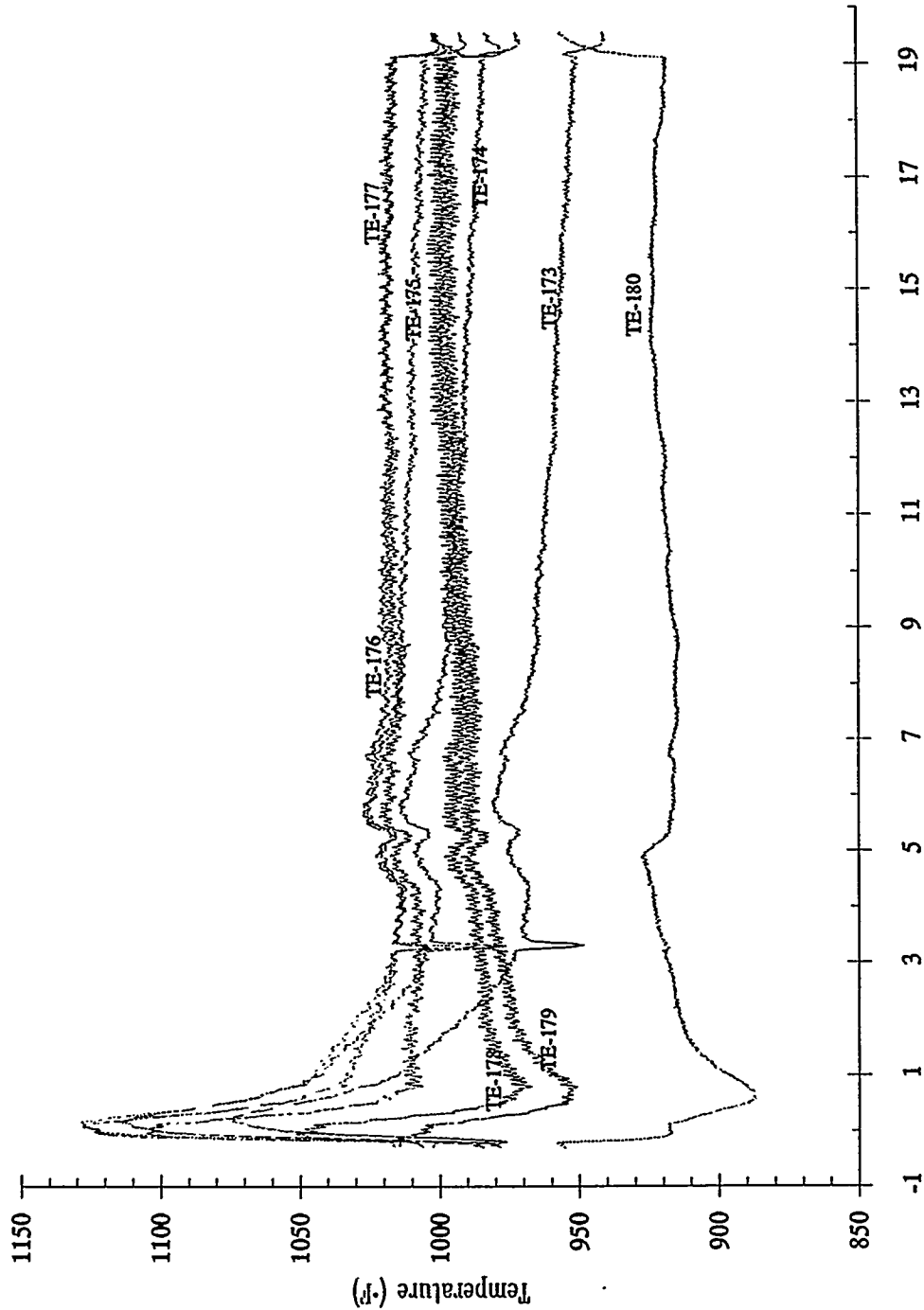

T-246S Zinc Ferrite
 u=1.0 ft/sec T=1075 & 1300 °F
 O2 Inlet Conc. = 2.5 & 21%

Zinc Ferrite Tests - ZFMC-01 Oxidative Regeneration 7

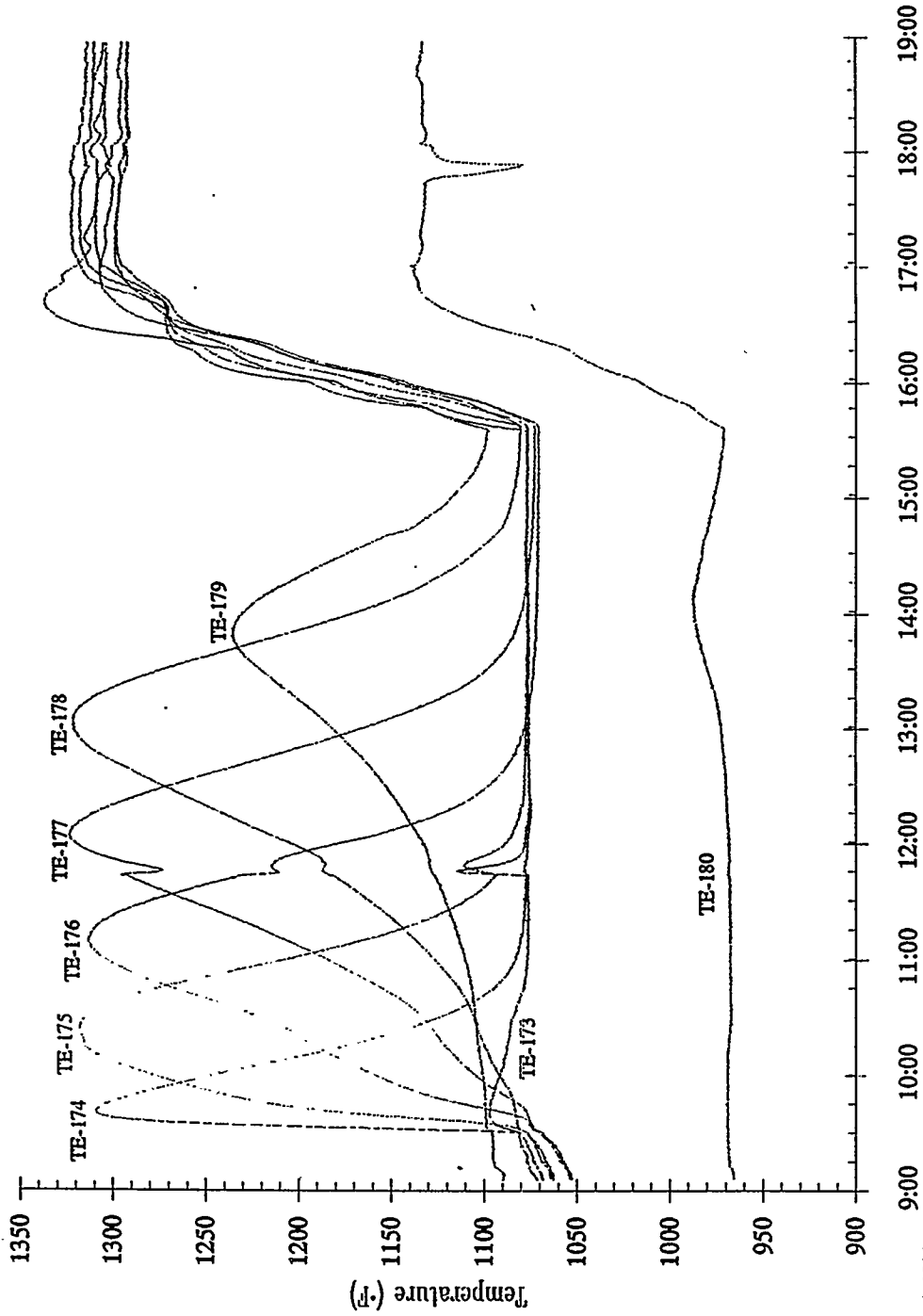

- TE-173 (1" below cage bottom)
- - - TE-174 (2" above cage bottom)
- TE-175 (5" above cage bottom)
- · - · - TE-176 (8" above cage bottom)
- - - - TE-177 (11" above cage bottom)
- TE-178 (14" above cage bottom)
- - - TE-179 (17" above cage bottom)
- TE-180 (28.5" above cage bottom)

January 6, 1993
 Test time: 9:30-18:05 (Test duration: 8:35)

T-2465 Zinc Ferrite
u=1.0 ft/sec T=1000 °F

Zinc Ferrite Tests - ZFMC-01 Reductive Regeneration 7

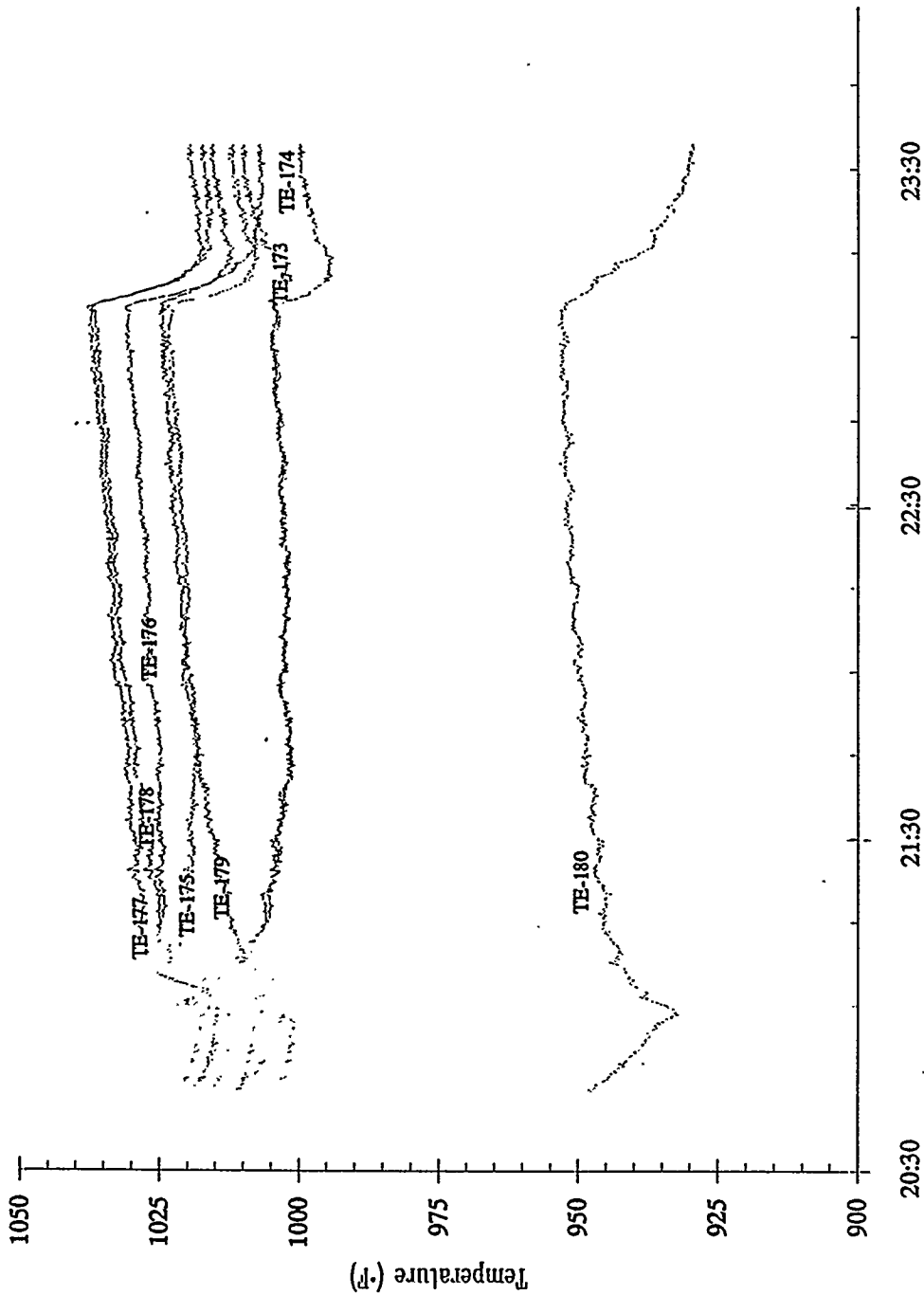

January 6, 1993
Test time: 21:00-23:05 (Test duration: 2:05)

Zinc Ferrite Tests - ZFMC-01 Sulfidation 8

T-2465 Zinc Ferrite
 u=1.0 ft/sec T=1000 °F
 H2S Inlet Conc. = 800 ppm

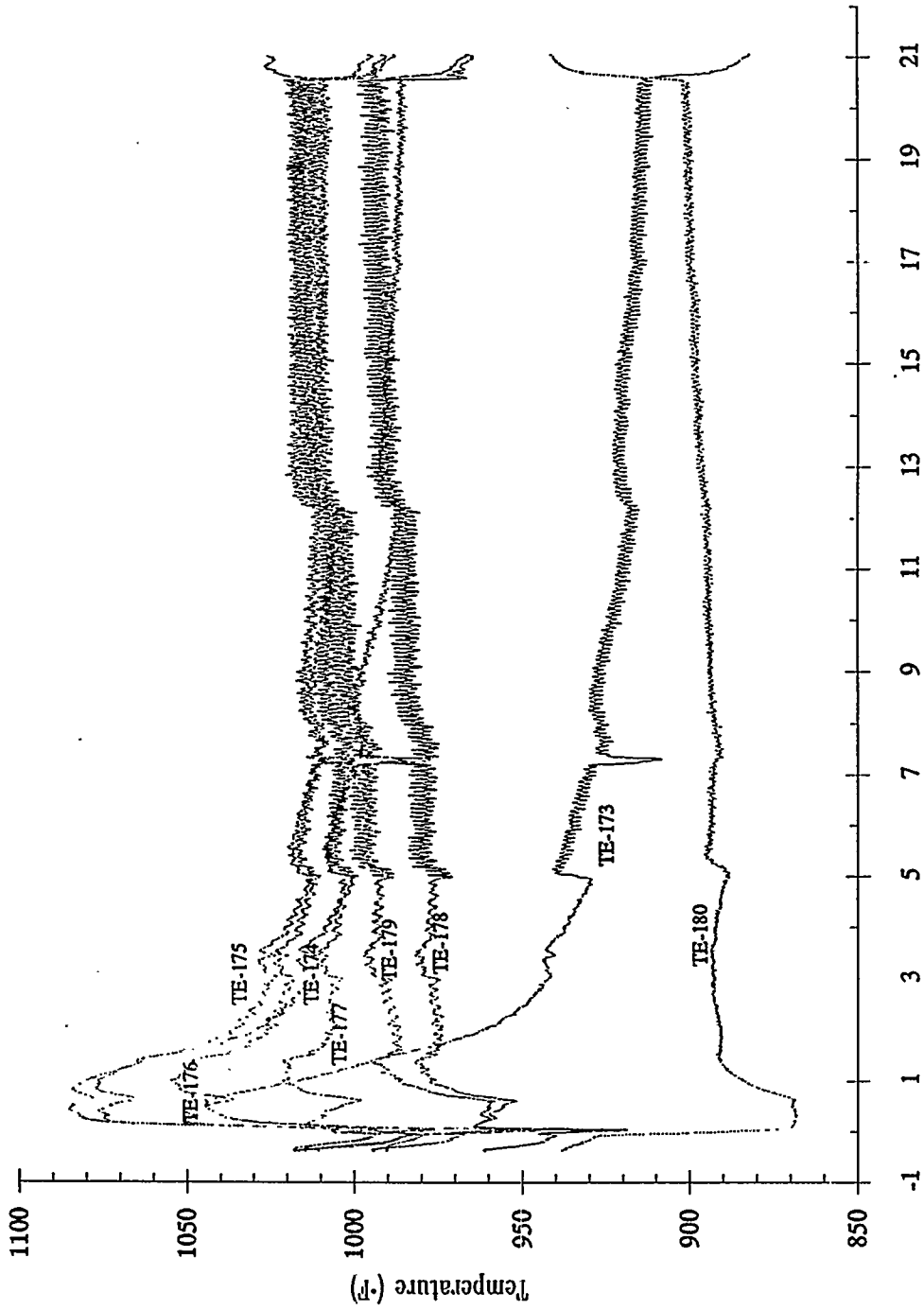

- TE-173 (1" below cage bottom)
- - - TE-174 (2" above cage bottom)
- TE-175 (5" above cage bottom)
- . - . - TE-176 (8" above cage bottom)
- TE-177 (11" above cage bottom)
- TE-178 (14" above cage bottom)
- - - TE-179 (17" above cage bottom)
- TE-180 (28.5" above cage bottom)

January 7, 1993
 Test time: 2:00-22:33 (Test duration: 20:33)

T-2465 Zinc Ferrite
 u=1.0 ft/sec T=1075 & 1300 °F
 O2 Inlet Conc. = 2.5 & 21%

Zinc Ferrite Tests - ZFMC-01 Oxidative Regeneration 8

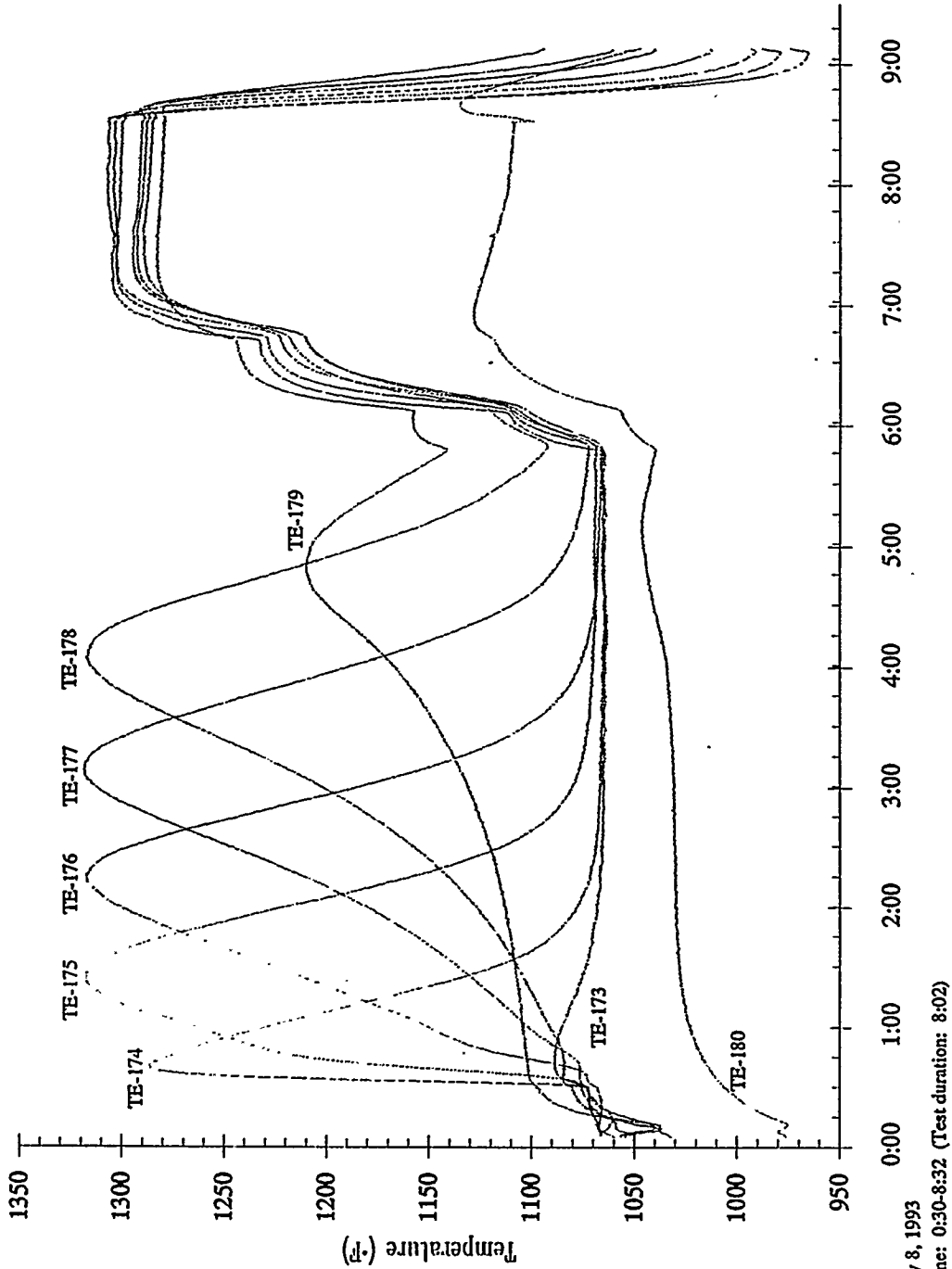

January 8, 1993
 Test time: 0:30-8:32 (Test duration: 8:02)

T-2465 Zinc Ferrite
u=1.0 ft/sec T=1000 °F

Zinc Ferrite Tests - ZFMC-01 Reductive Regeneration 8

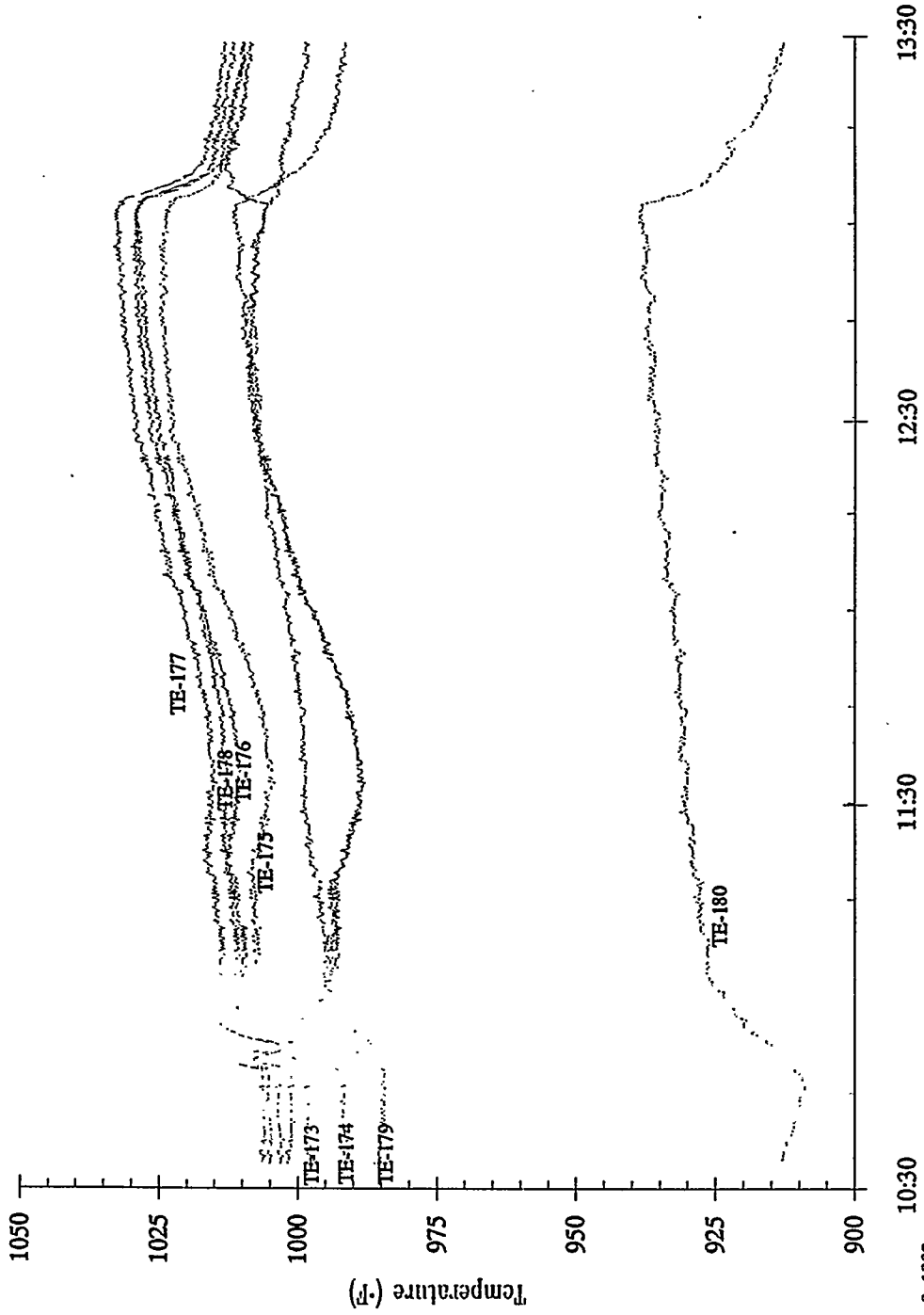

- TE-173 (1" below cage bottom)
- - - TE-174 (2" above cage bottom)
- TE-175 (5" above cage bottom)
- . - . - TE-176 (8" above cage bottom)
- TE-177 (11" above cage bottom)
- TE-178 (14" above cage bottom)
- - - TE-179 (17" above cage bottom)
- TE-180 (28.5" above cage bottom)

January 8, 1993
Test time: 11:00-13:03 (Test duration: 2:03)

APPENDIX C
Data Acquisition Pressure Trends

System pressures are monitored by DDAS, a PC-based automatic data acquisition system. Trend plots for the Rosemount pressure transmitter readings are presented here. Data are from the reactor inlet, reactor outlet, and system exit pressure.

T-246S Zinc Ferrite
u=1.0 ft/sec T=1000 °F
H2S Inlet Conc. = 800 ppm

Zinc Ferrite Tests - ZFMC-01 Sulfidation 1

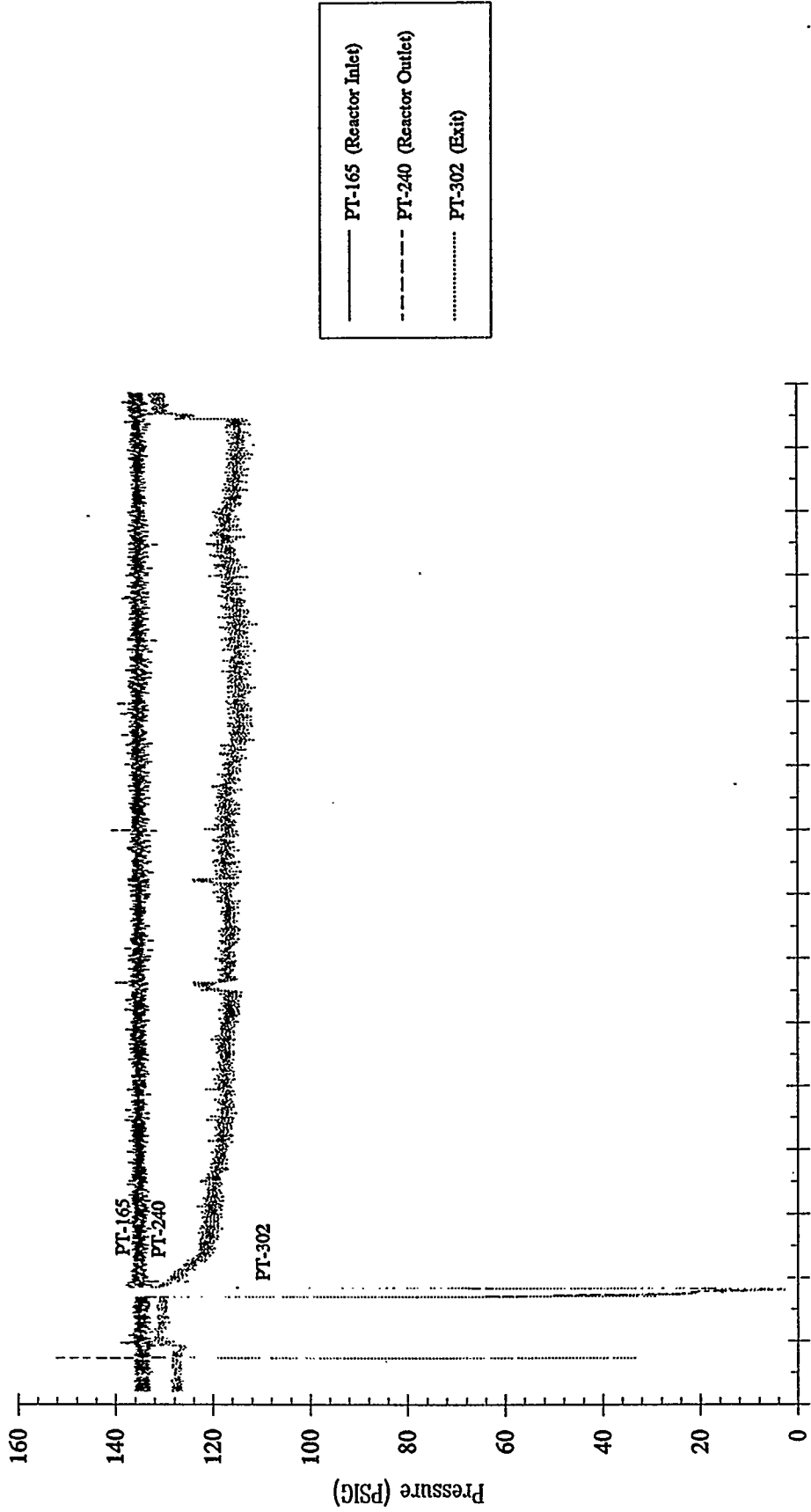

Test time: 18:03-19:28, 19:55 (December 7, 1992) --23:07 (December 8, 1992)
Test duration: 28:37

T-2465 Zinc Ferrite
u=1.0 ft/sec T=1000-1300 °F
O2 Inlet Cons. = 0.5-21 %

Zinc Ferrite Tests - ZFMC-01 Oxidative Regeneration 1

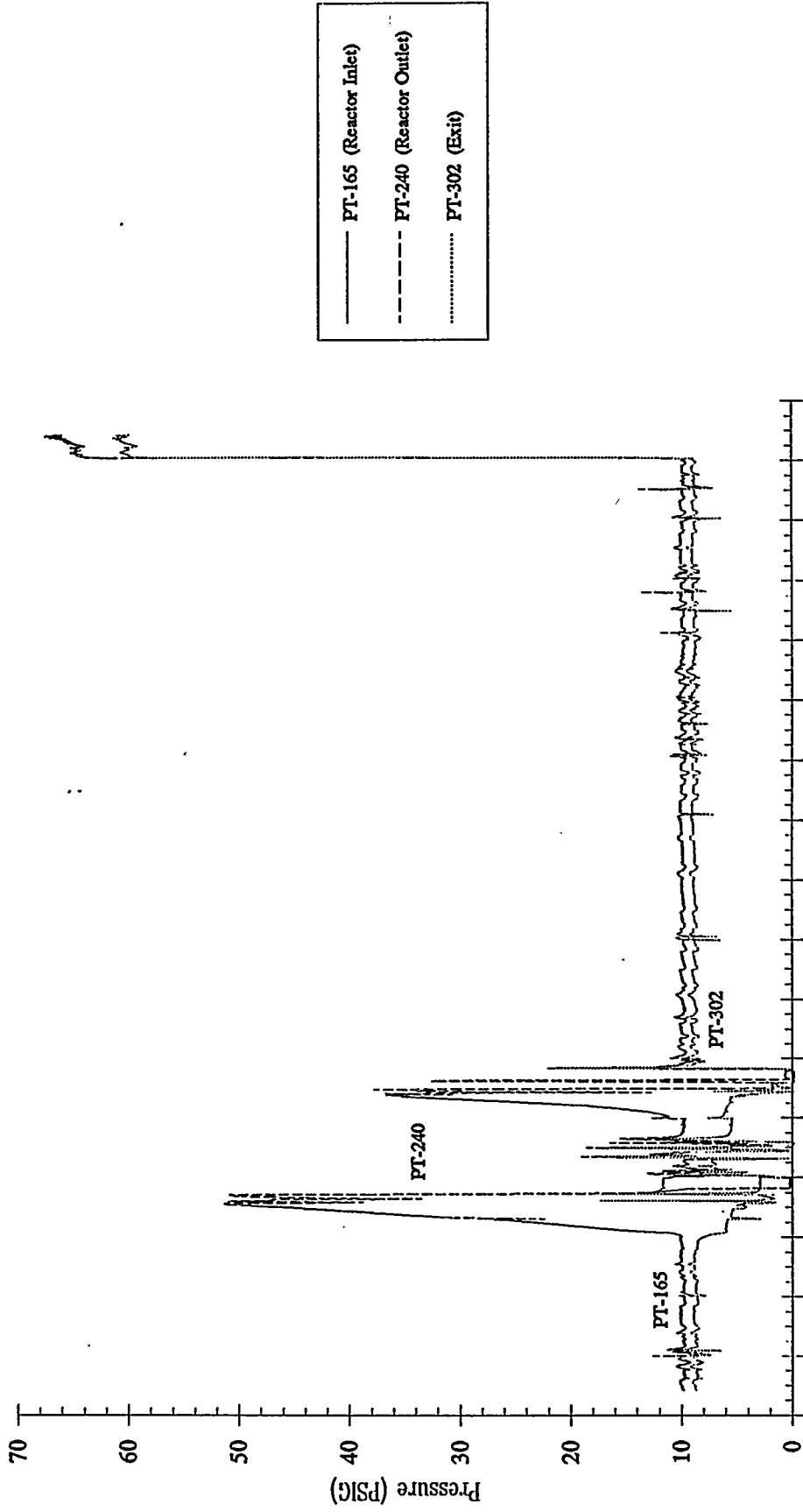

December 9, 1992:00 3:00 4:00 5:00 6:00 7:00 8:00 9:00 10:00 11:00 12:00 13:00 14:00 15:00 16:00 17:00 18:00 19:00
Test time: 3:00-5:30, 7:00-7:30, 8:00-18:05
Test duration: 13:05

T-2465 Zinc Ferrite
u=1.0 ft/sec T=1000 F

Zinc Ferrite Tests - ZFMC-01 Reductive Regeneration 1

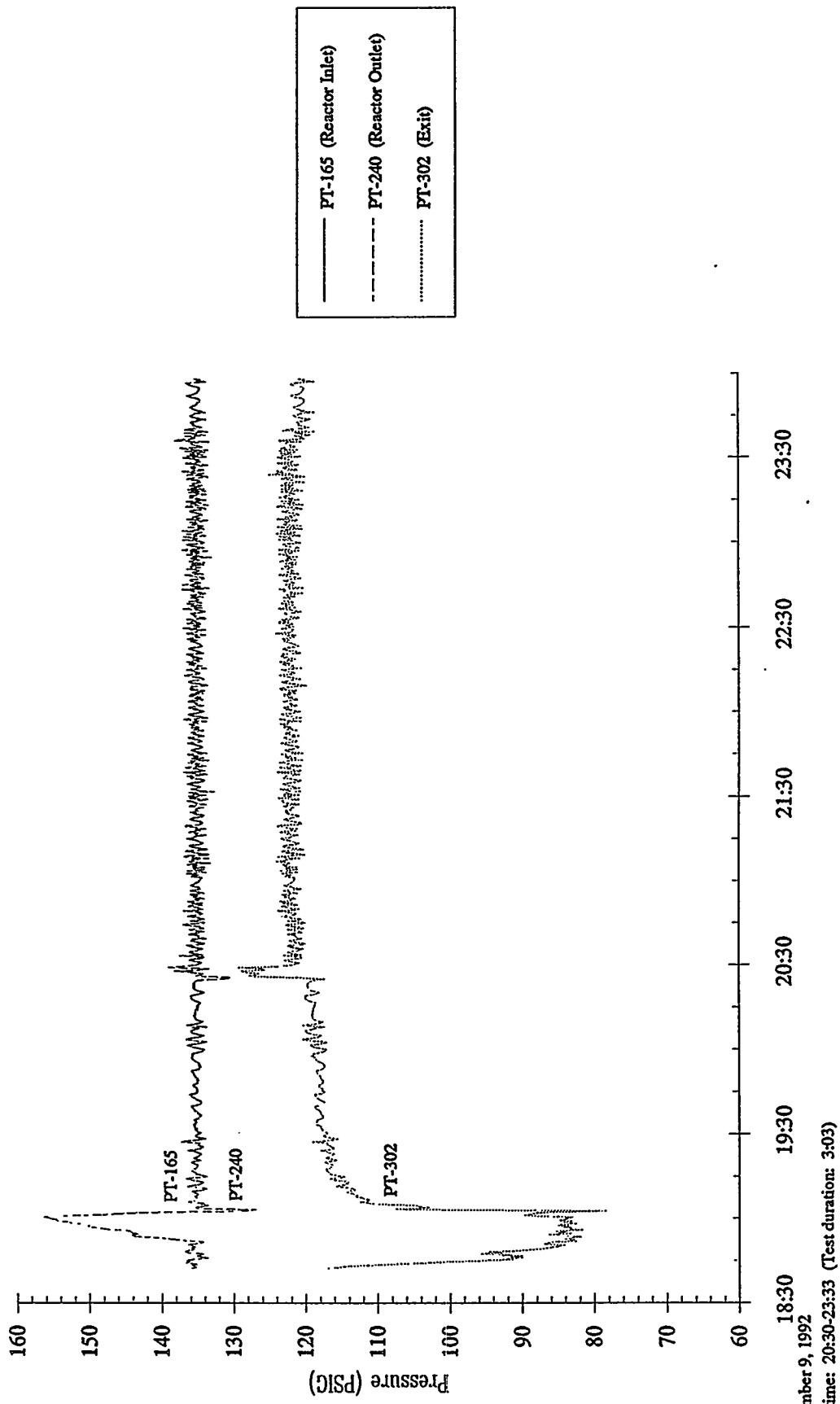

T-2465 Zinc Ferrite
u=1.0 ft/sec T=1000 °F
H2S Inlet Conc. = 800 ppm

Zinc Ferrite Tests - ZFMC-01 Sulfidation 2

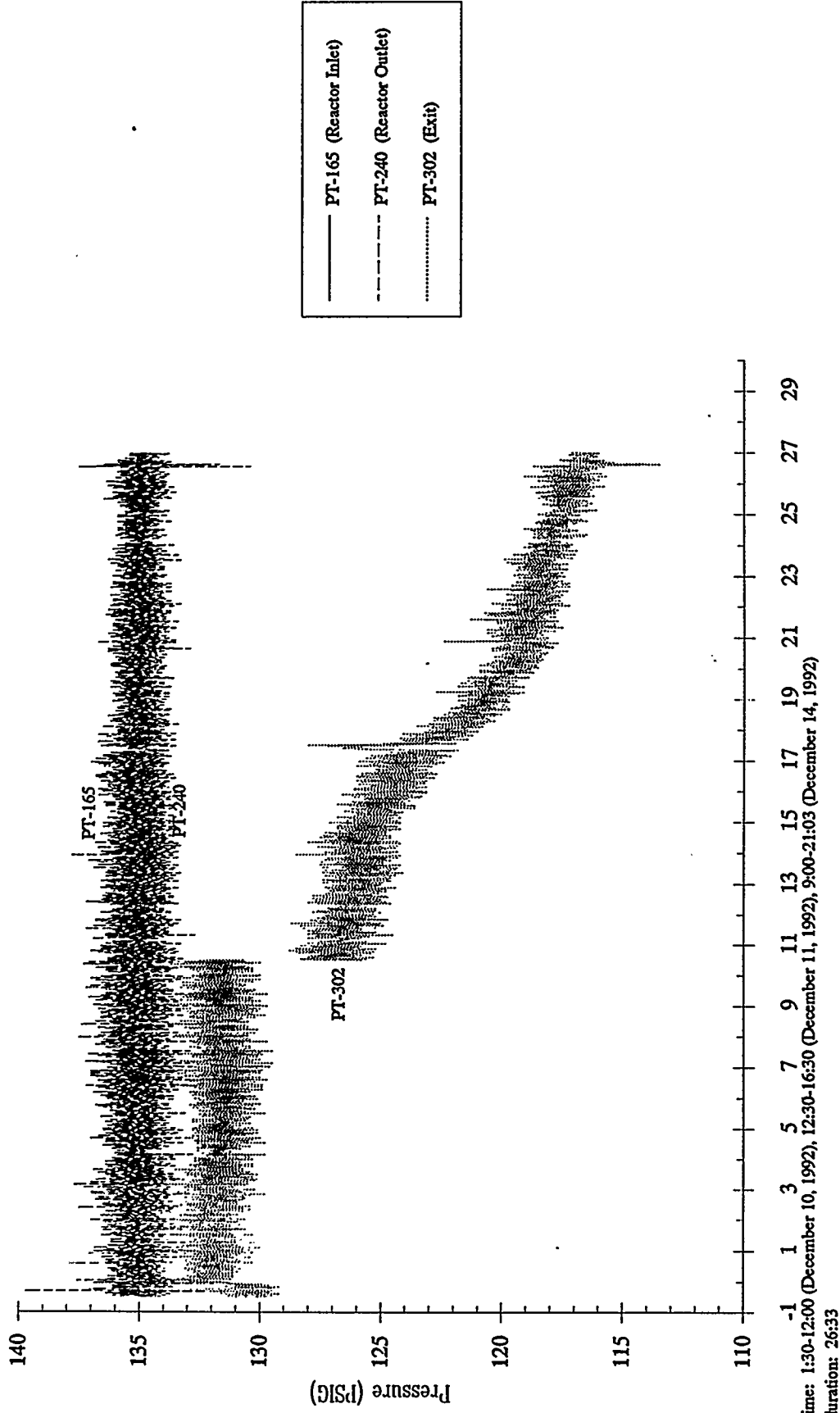

T-2465 Zinc Ferrite

u=1.0 ft/sec T=1000-1300 °F

O2 Inlet Conc. = 0.5-2.1 %

Zinc Ferrite Tests - ZFMC-01 Oxidative Regeneration 2

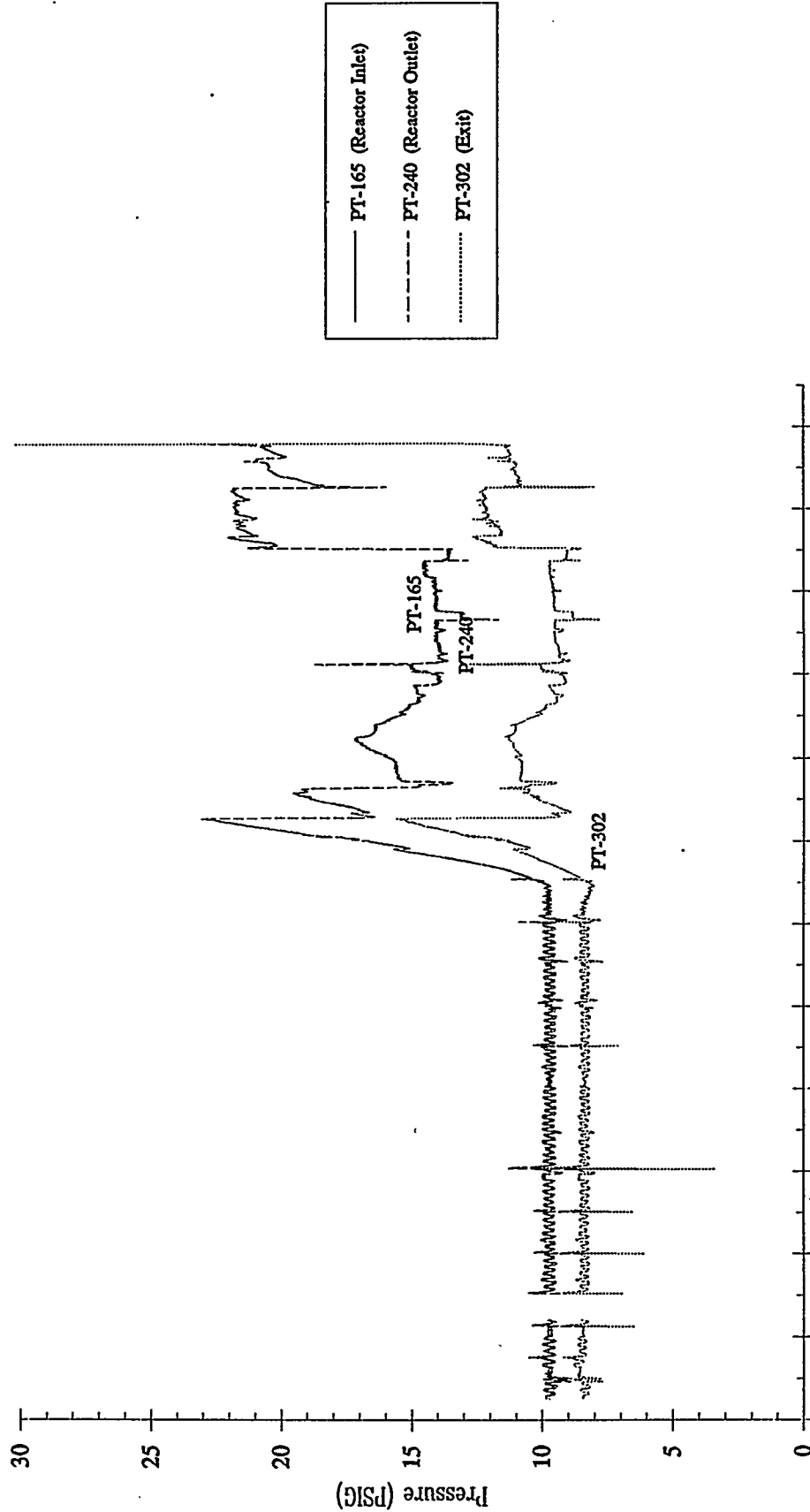

Test time: 23:00 (December 14, 1992) - 21:40 (December 15, 1992)

Test duration: 22:40

T-2465 Zinc Ferrite
u=1.0 ft/sec T=1000 °F

Zinc Ferrite Tests - ZFMC-01 Reductive Regeneration 2

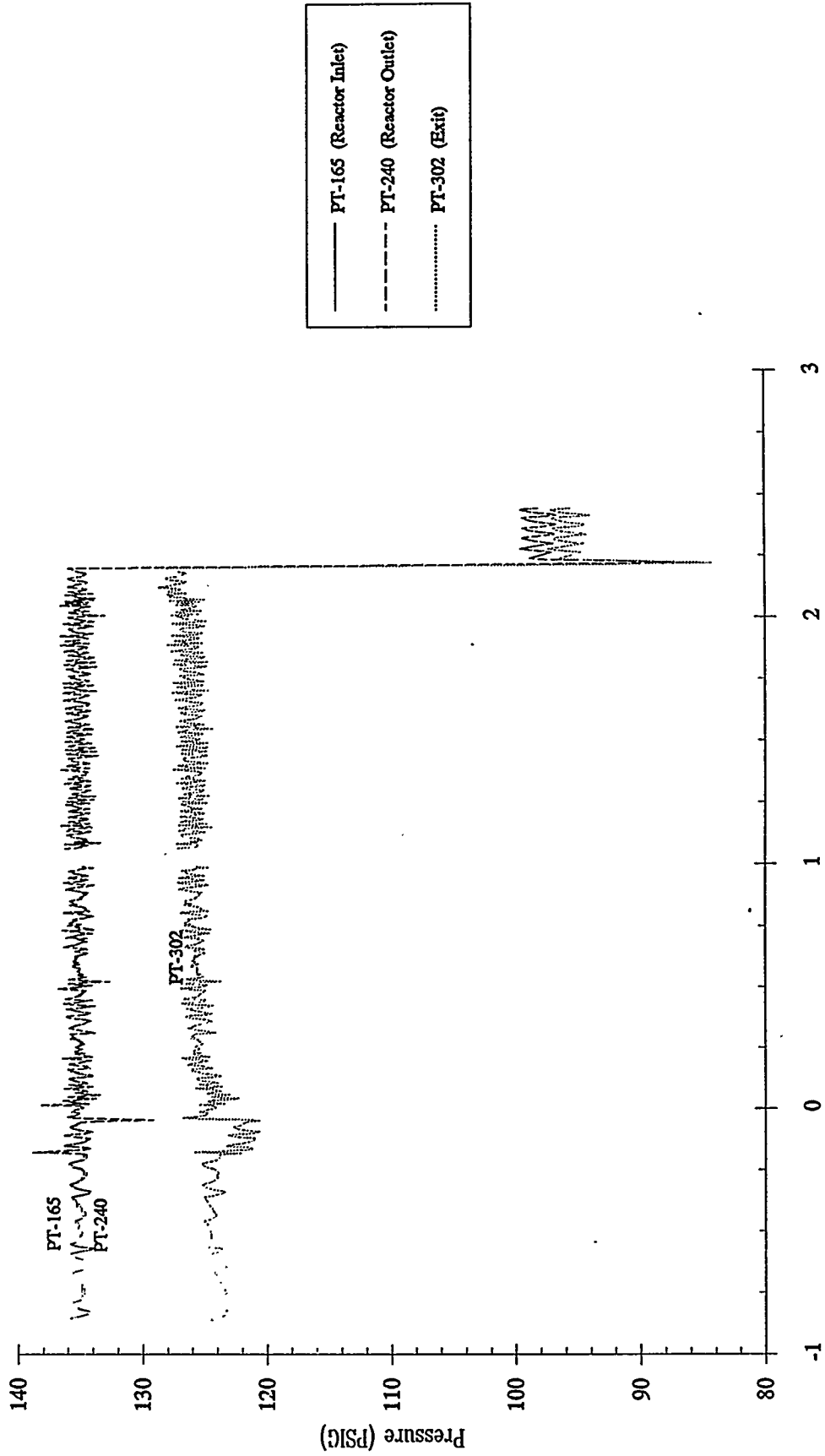

-1 0 1 2 3
Test time: 23:00 (December 15, 1992) - 1:00 (December 16, 1992)
Test duration: 2:00

T-2465 Zinc Ferrite
u=1.0 ft/sec T=1000 °F
H2S Inlet Conc. = 800 ppm

Zinc Ferrite Tests - ZFMC-01 Sulfidation 3

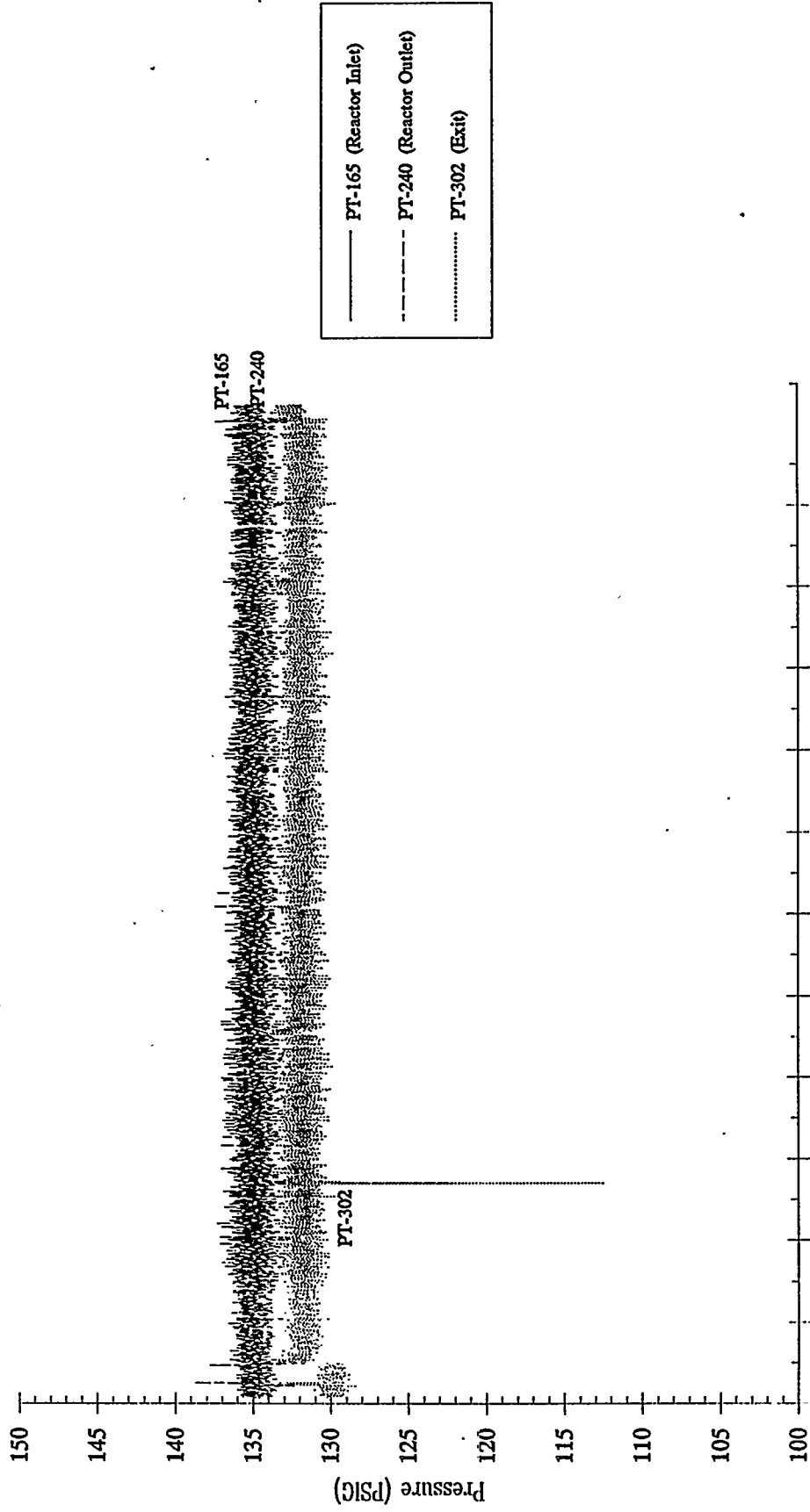

Test time: 3:30 (December 16, 1992) - 2:30 (December 17, 1992)
Test duration: 23:00

T-2465 Zinc Ferrite

u=1.0 ft/sec T=1000-1300 °F

O2 Inlet Conc. = 0.5-21 %

Zinc Ferrite Tests - ZFMC-01 Oxidative Regeneration 3

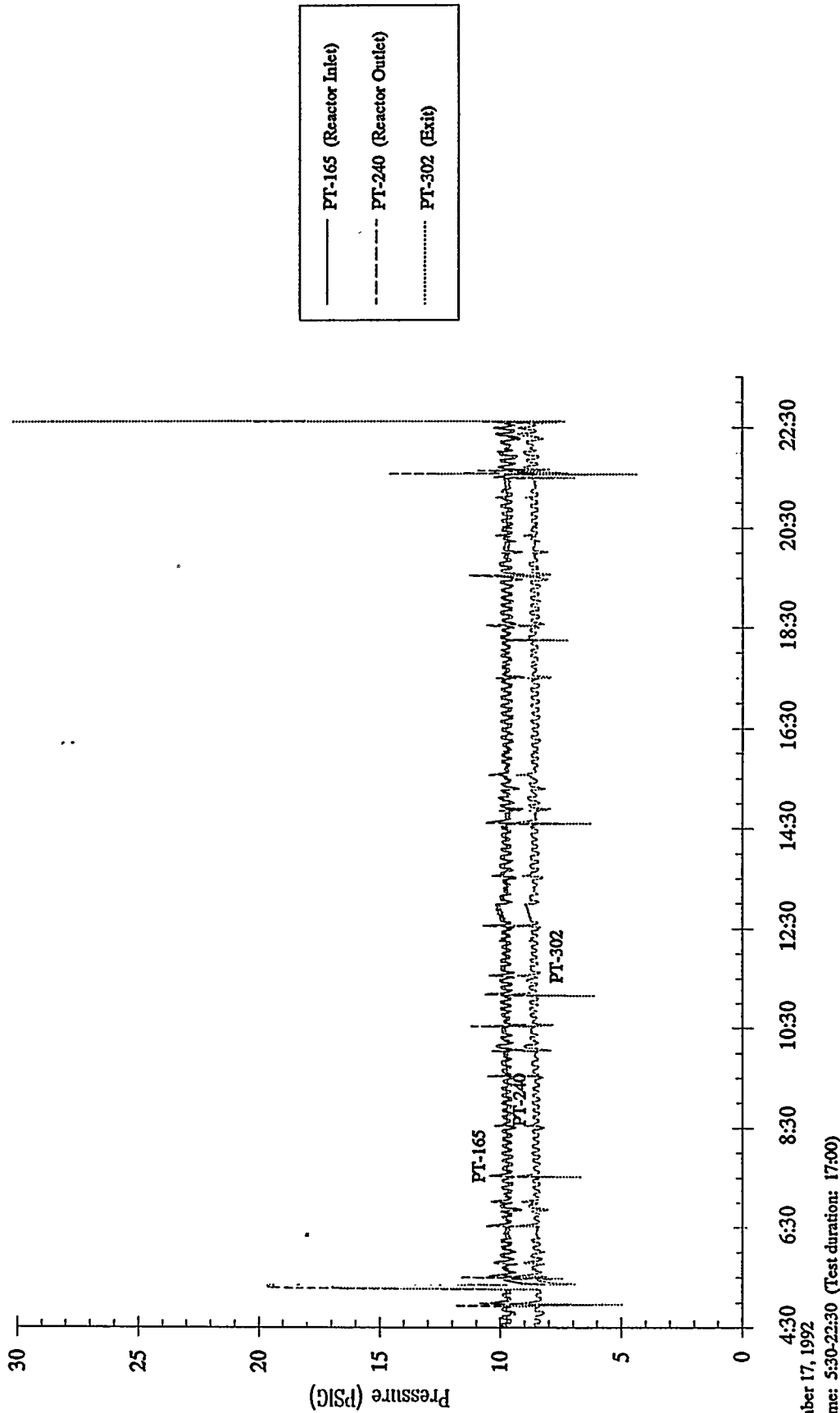

December 17, 1992

Test time: 5:30-22:30 (Test duration: 17:00)

T-2465 Zinc Ferrite
u=1.0 ft/sec T=1000 °F

Zinc Ferrite Tests - ZFMC-01 Reductive Regeneration 3

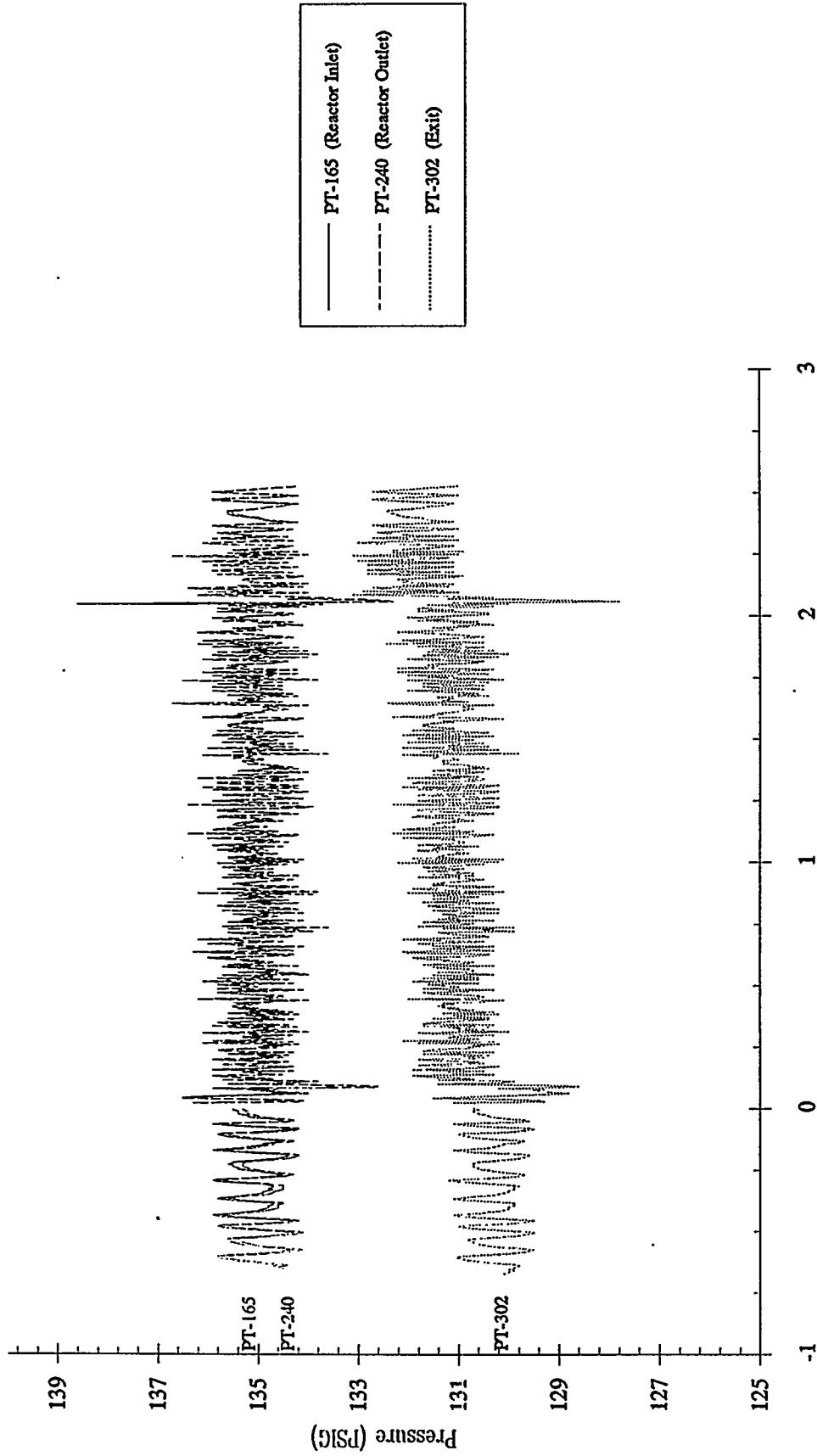

-1
December 18, 1992
Test time: 0:00 - 2:00 (Test duration: 2:00)

T-2465 Zinc Ferrite
u=1.0 ft/sec T=1000 °F
H2S Inlet Conc. = 800 ppm

Zinc Ferrite Tests - ZFMC-01 Sulfidation 4

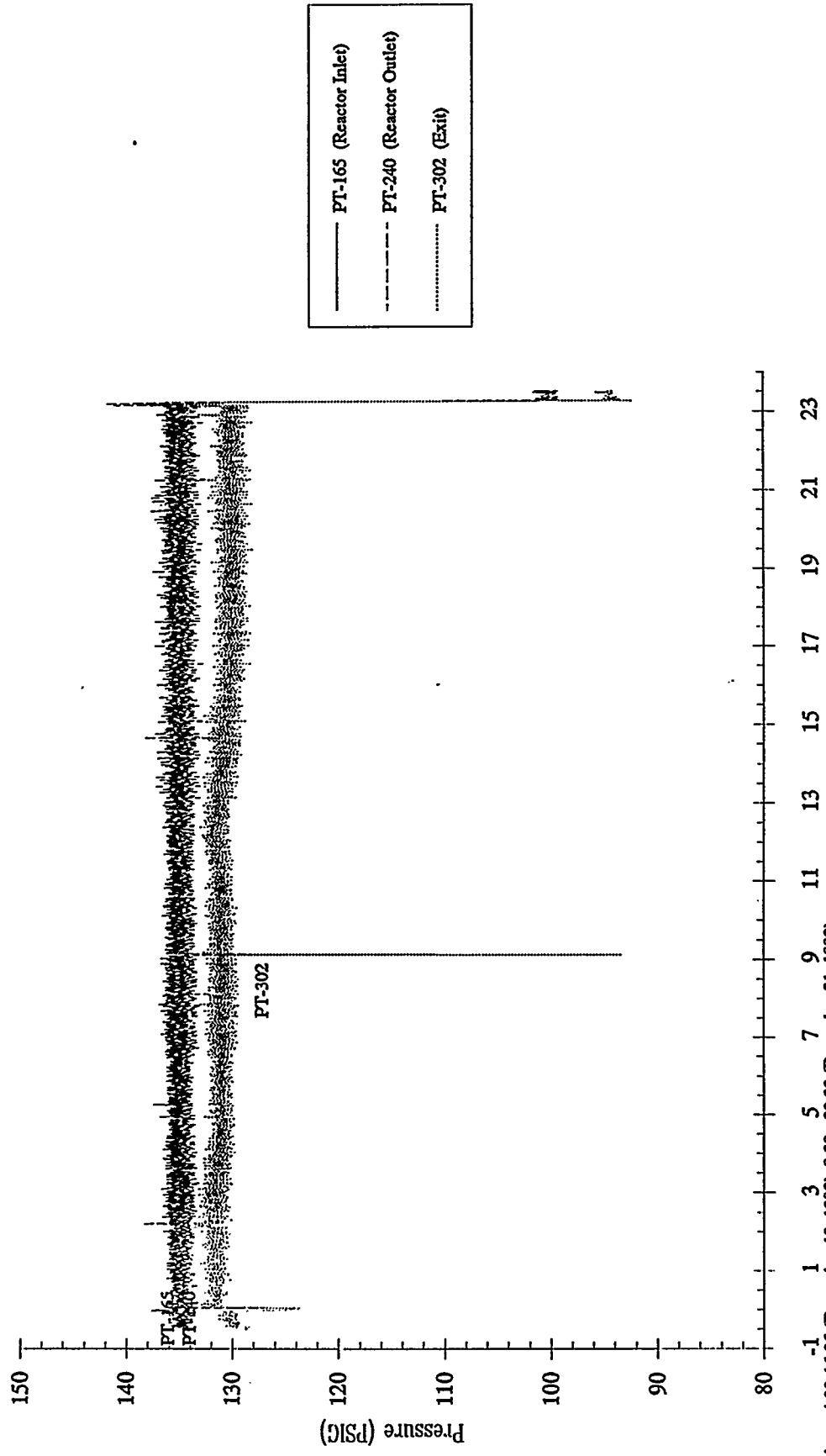

Test time: 4:00-16:05 (December 18, 1992), 9:30 - 20:30 (December 21, 1992)
Test duration: 23:05

T-2465 Zinc Ferrite

u=1.0 ft/sec T=1075 & 1300 °F

O2 Inlet Conc. = 2.5 & 21%

Zinc Ferrite Tests - ZFMC-01 Oxidative Regeneration 4

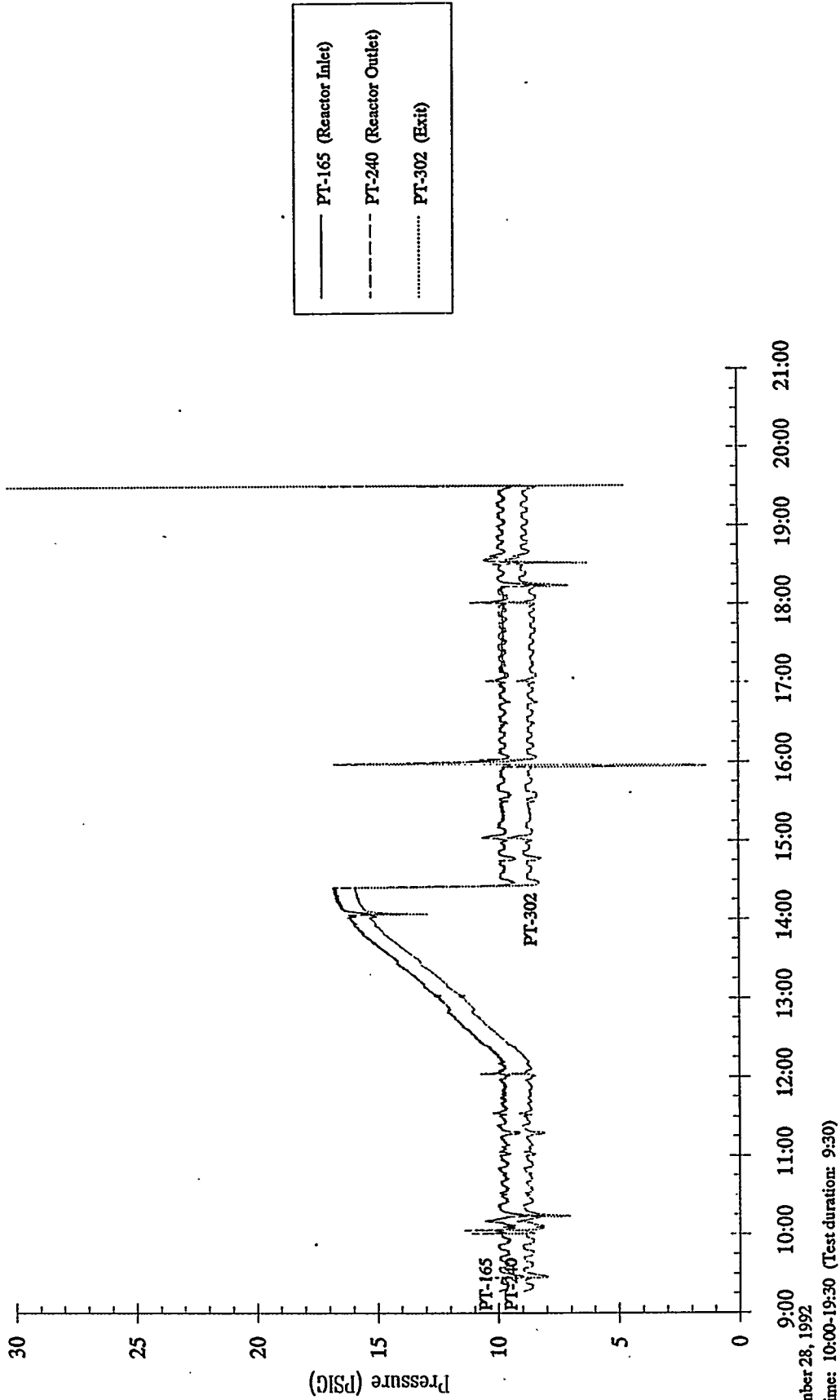

December 28, 1992

Test time: 10:00-19:30 (Test duration: 9:30)

T-2465 Zinc Ferrite
u=1.0 ft/sec T=1000 °F

Zinc Ferrite Tests - ZFMC-01 Reductive Regeneration 4

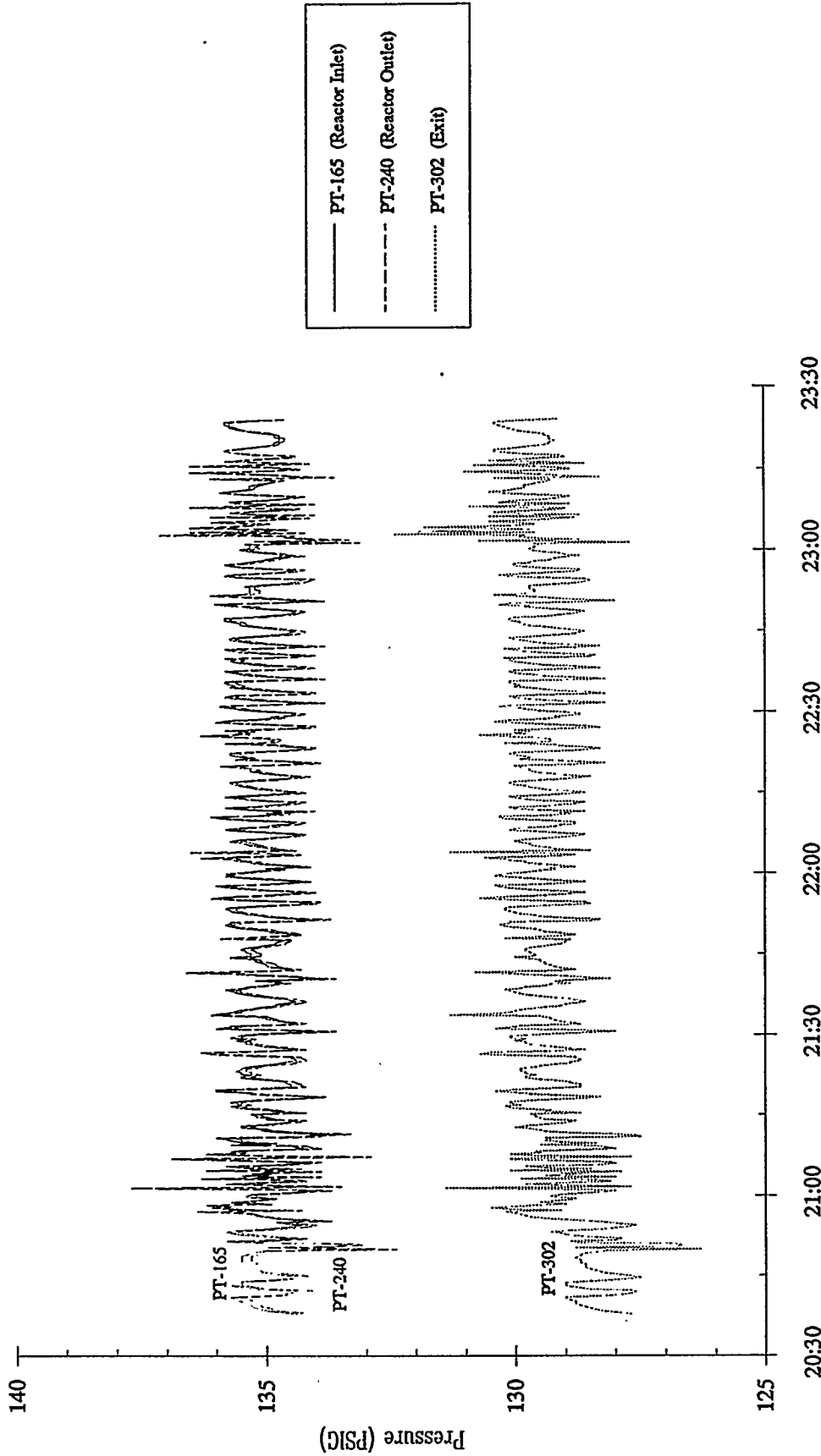

December 28, 1992
Test time: 21:00-23:00 (Test duration: 2:00)

T-2465 Zinc Ferrite
u=1.0 ft/sec T=1000 F
H2S Inlet Conc. = 800 ppm

Zinc Ferrite Tests - ZFMC-01 Sulfidation 5

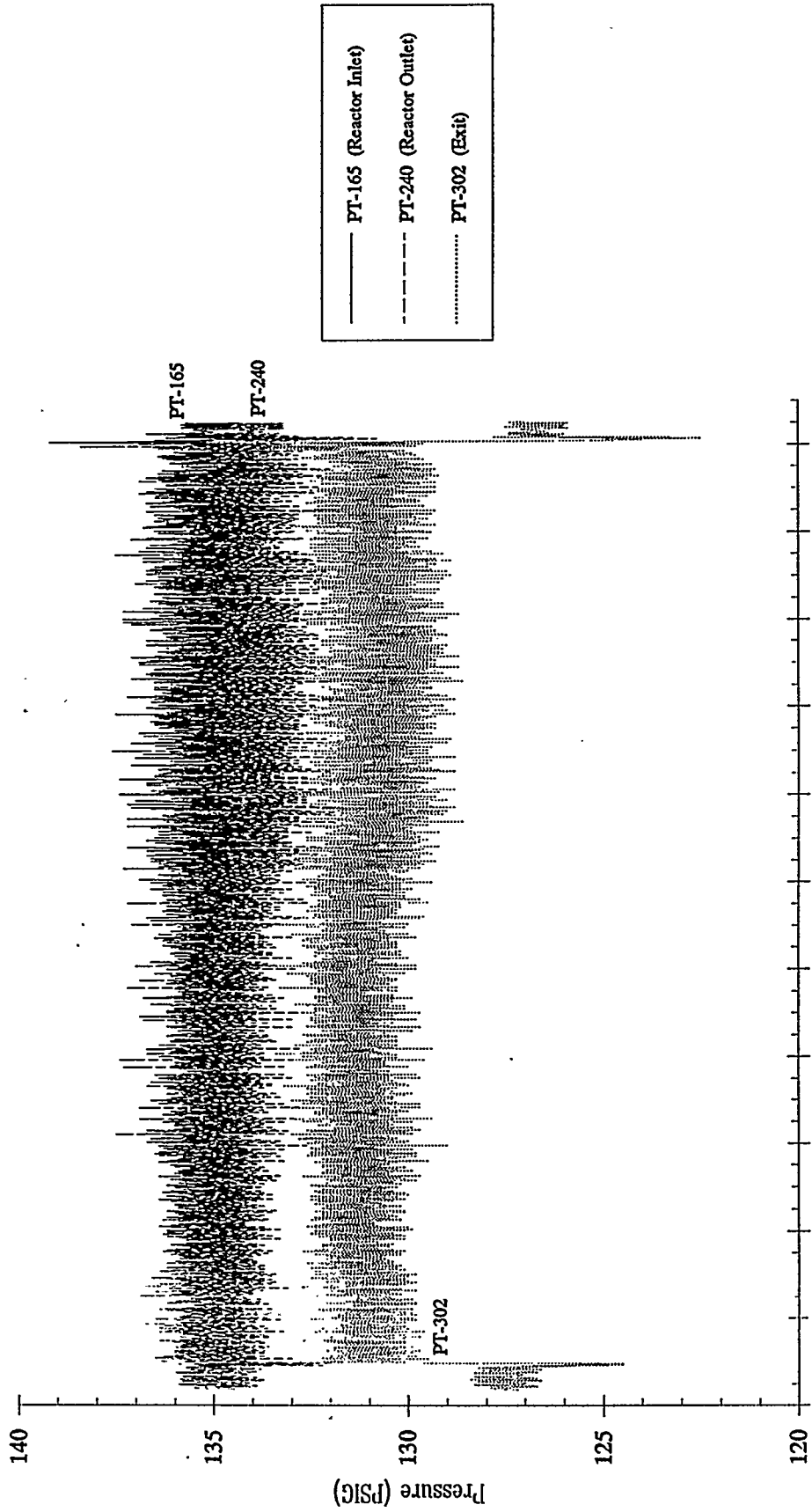

December 29, 1992
Test time: 2:00 - 23:00 (Test duration: 21:00)

T-2465 Zinc Ferrite

u=1.0 ft/sec T=1075 & 1300 °F

O2 Inlet Conc. = 2.5 & 21%

Zinc Ferrite Tests - ZFMC-01 Oxidative Regeneration 5

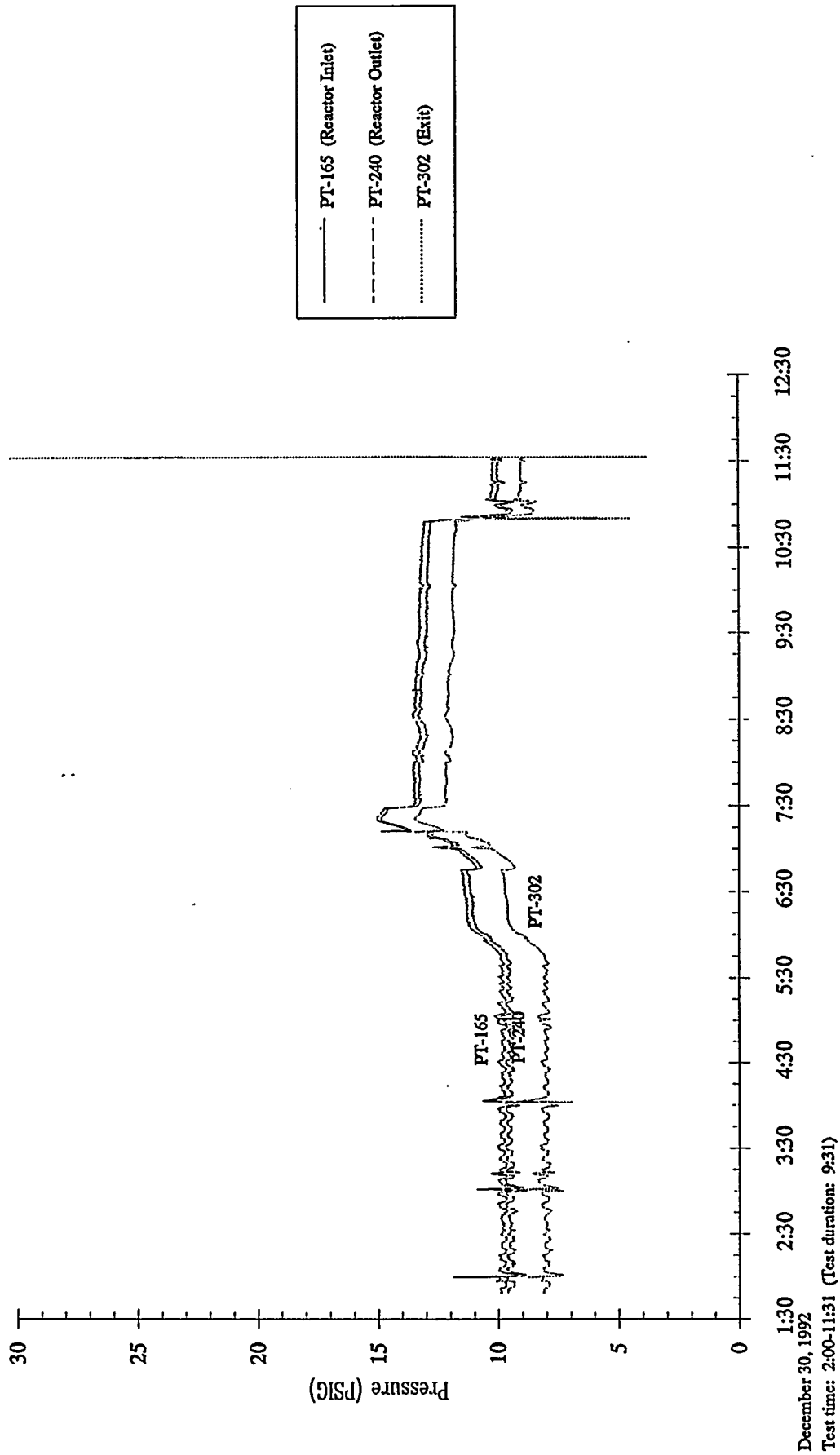

T-2465 Zinc Ferrite
u=1.0 ft/sec T=1000 °F

Zinc Ferrite Tests - ZFMC-01 Reductive Regeneration 5

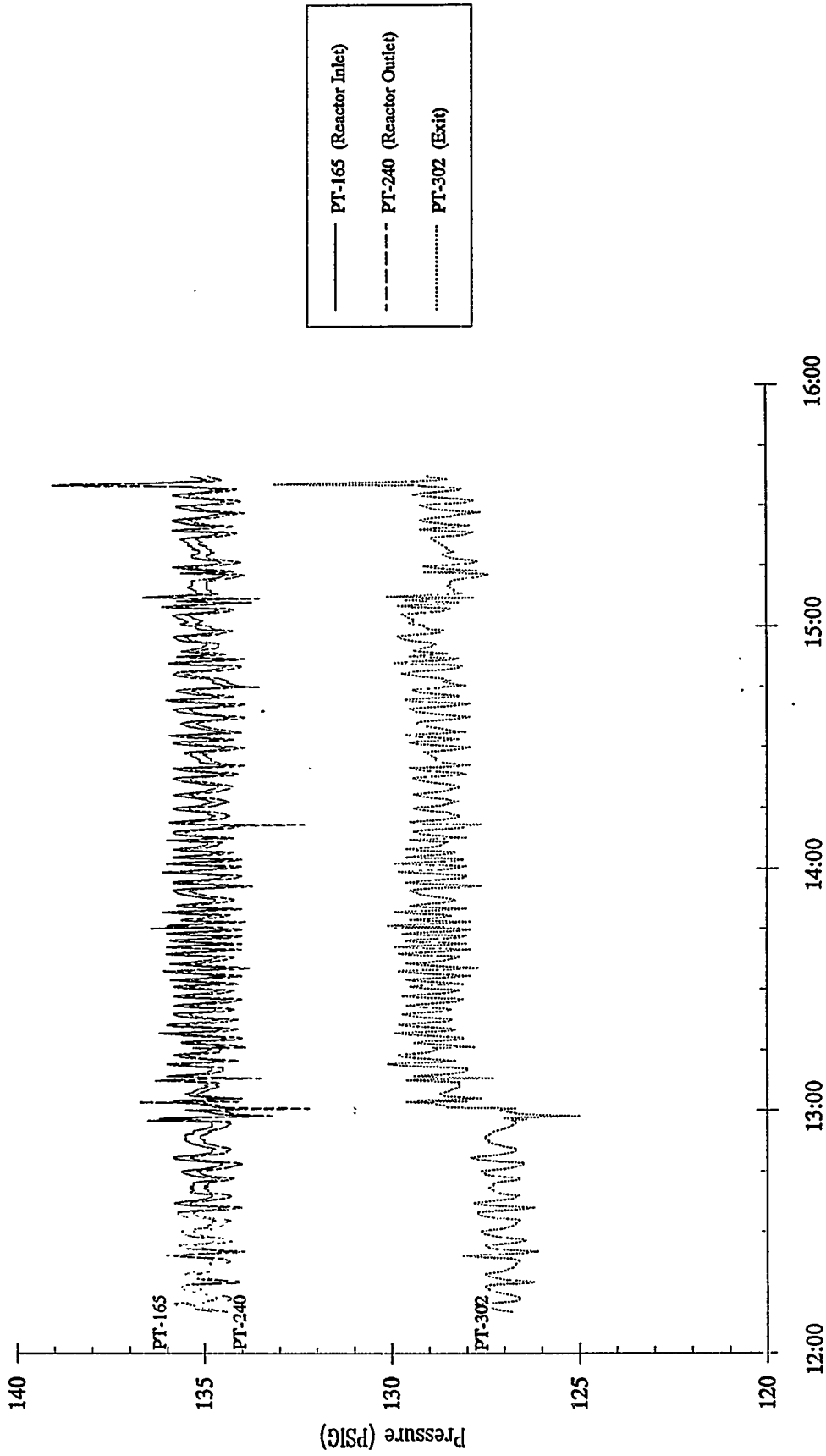

12:00
December 30, 1992
Test time: 13:00-15:05 (Test duration: 2:05)

T-2465 Zinc Ferrite
u=1.0 ft/sec T=1000 °F
H2S Inlet Conc. = 800 ppm

Zinc Ferrite Tests - ZFMC-01 Sulfidation 6

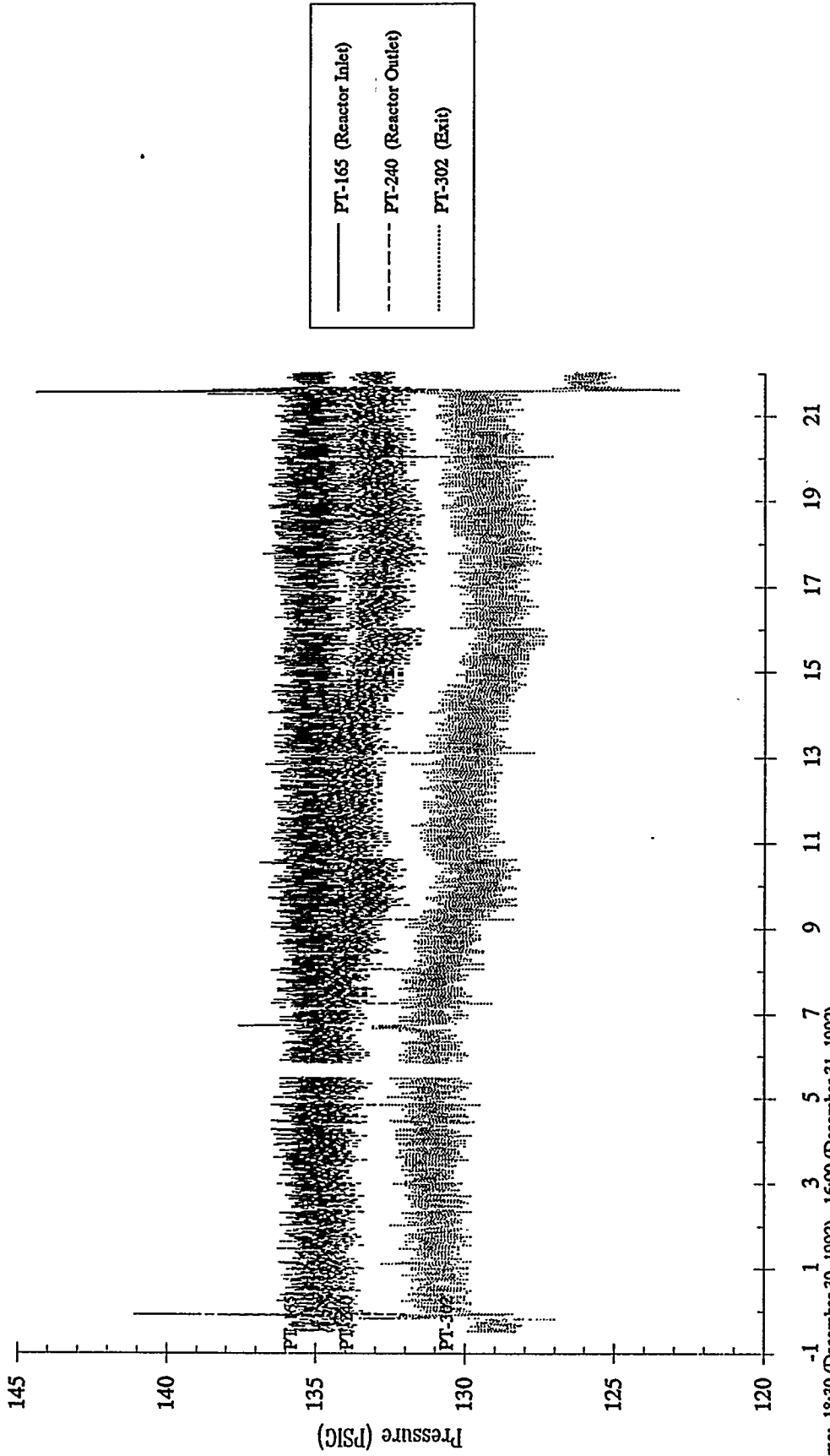

Test time: 18:30 (December 30, 1992) - 16:00 (December 31, 1992)
Test duration: 21:30

T-2465 Zinc Ferrite

u=1.0 ft/sec T=1075 & 1300 °F

O2 Inlet Conc. = 2.5 & 21%

Zinc Ferrite Tests - ZFMC-01 Oxidative Regeneration 6

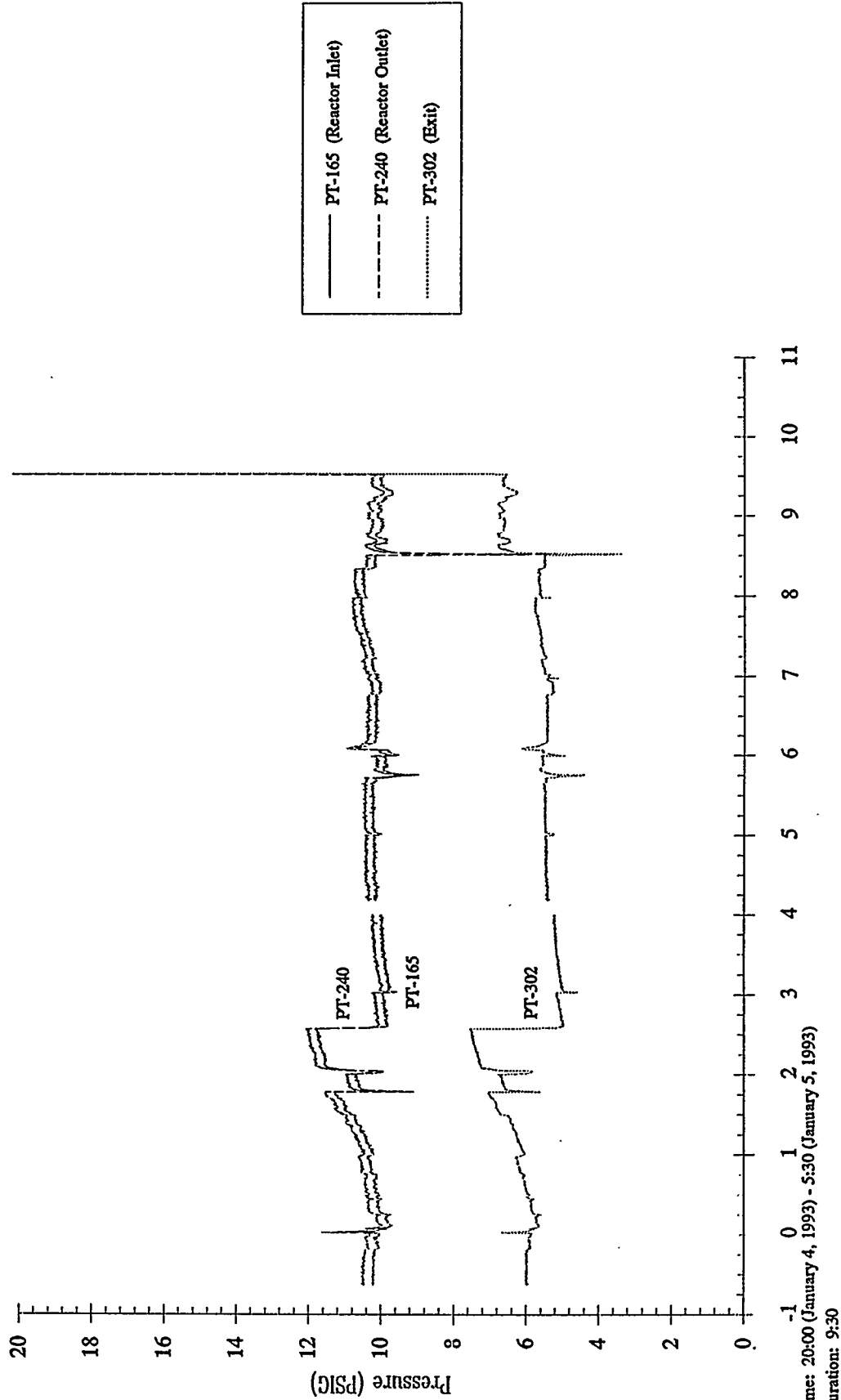

Test time: 20:00 (January 4, 1993) - 5:30 (January 5, 1993)

Test duration: 9:30

T-2465 Zinc Ferrite
u=1.0 ft/sec T=1000 °F

Zinc Ferrite Tests - ZFMC-01 Reductive Regeneration 6

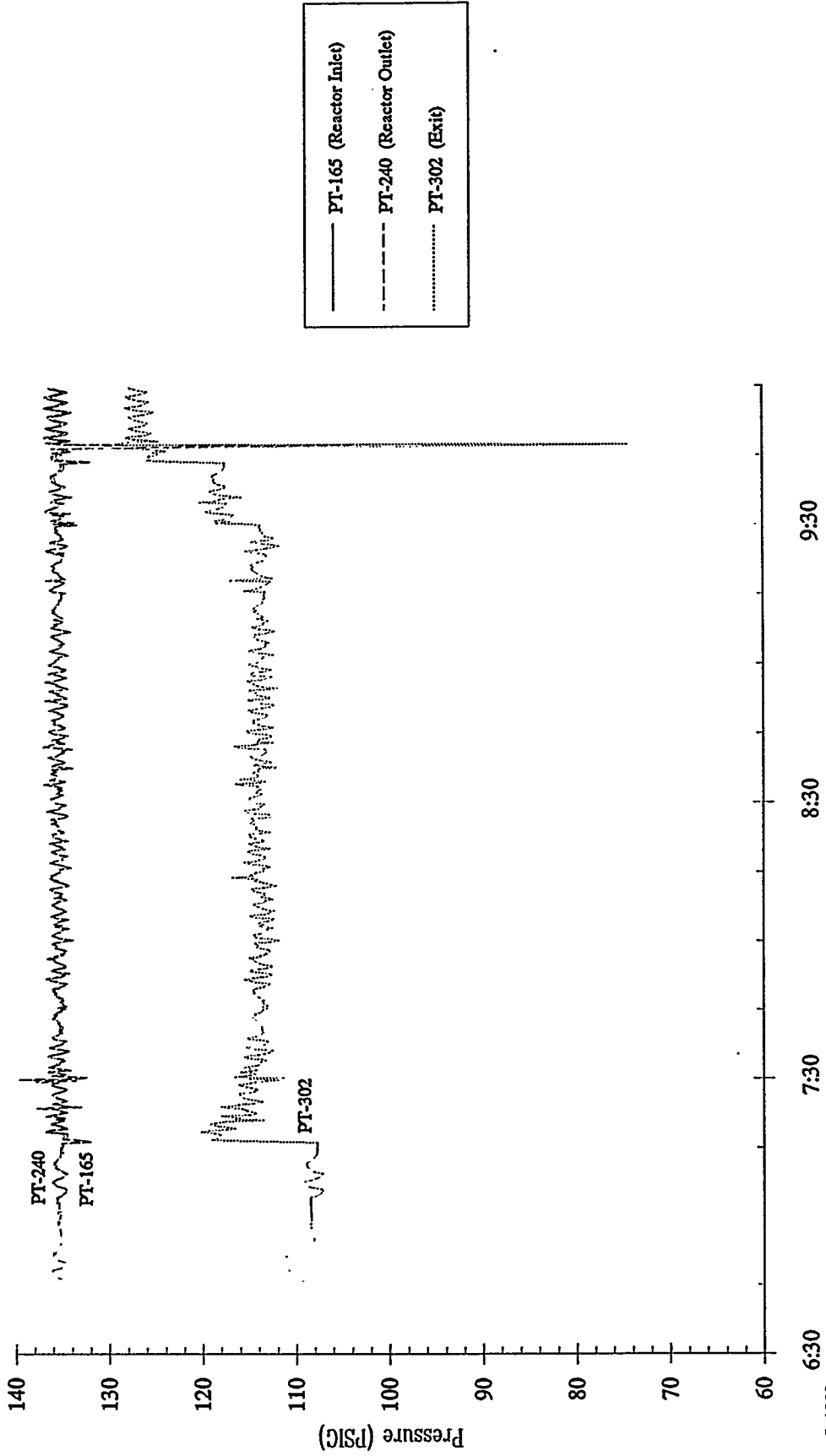

January 5, 1993
Test time: 7:30-9:32 (Test duration: 2:02)

T-2465 Zinc Ferrite
u=1.0 ft/sec T=1000 °F
H2S Inlet Conc. = 800 ppm

Zinc Ferrite Tests - ZFMC-01 Sulfidation 7

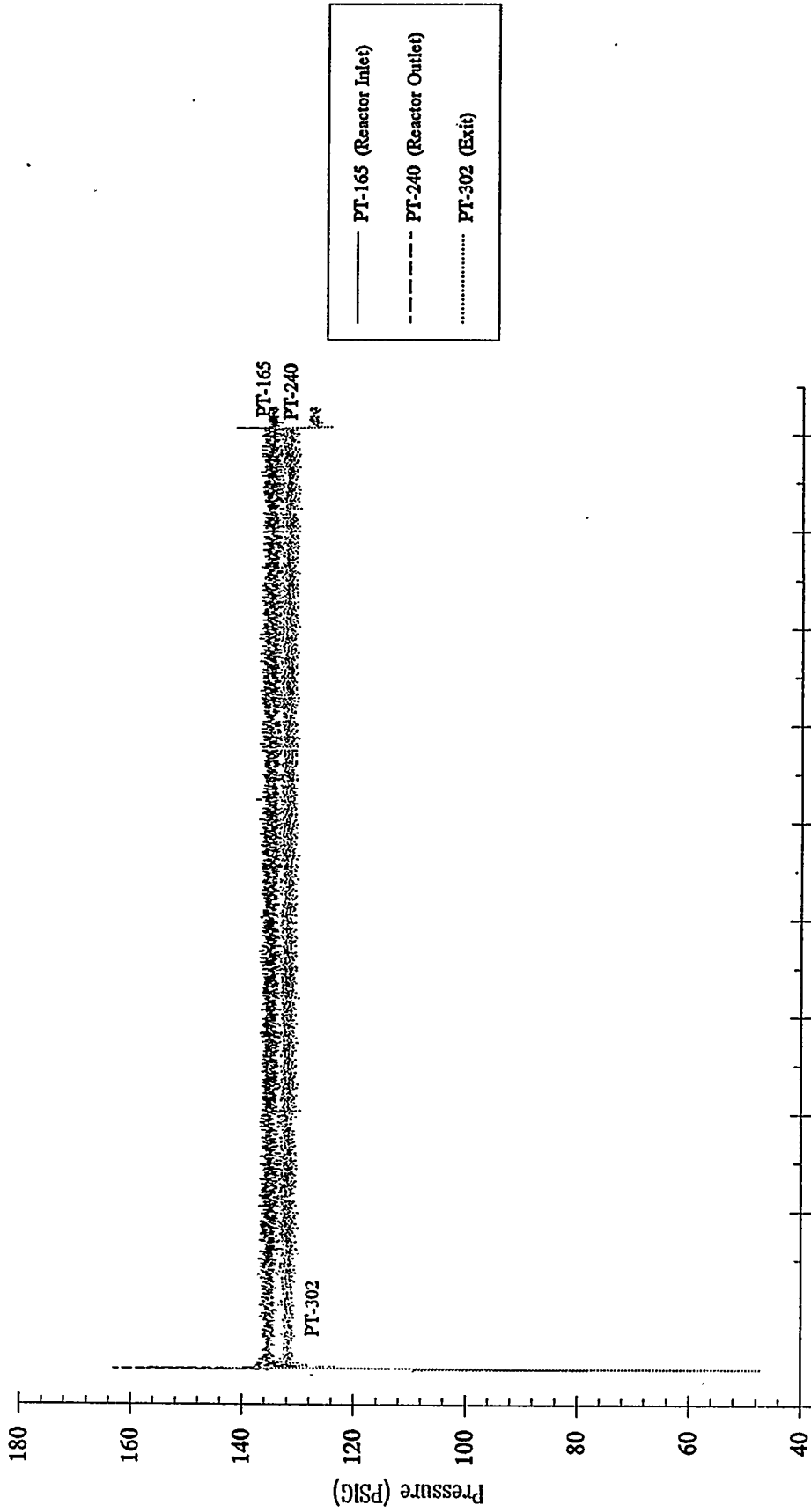

Test time: 11:30 (January 5, 1993) - 6:35 (January 6, 1993)
Test duration: 19:05

T-2465 Zinc Ferrite
u=1.0 ft/sec T=1075 & 1300 °F
O2 Inlet Conc. = 2.5 & 21%

Zinc Ferrite Tests - ZFMC-01 Oxidative Regeneration 7

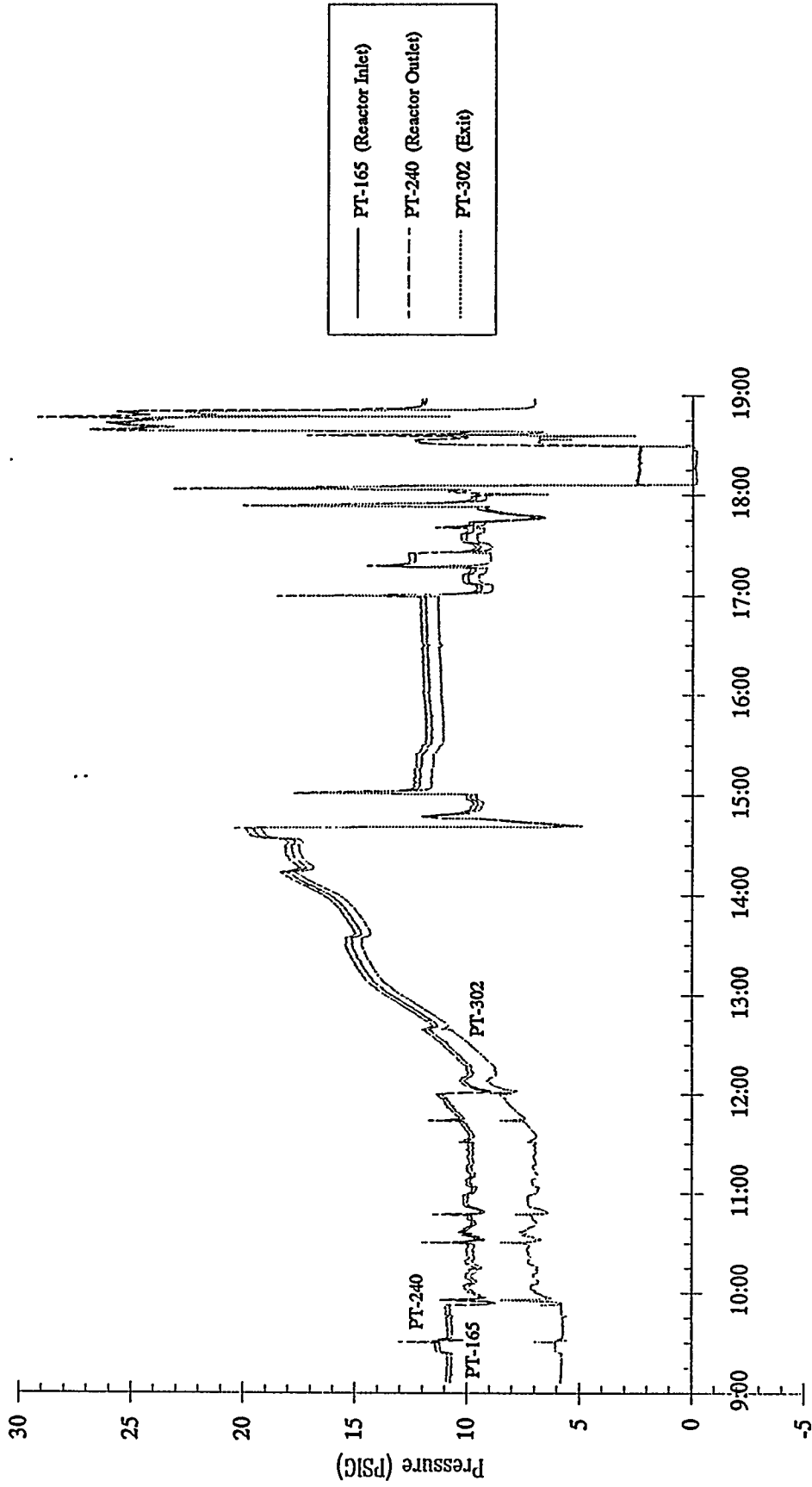

January 6, 1993
Test time: 9:30-18:05 (Test duration: 8:35)

T-2465 Zinc Ferrite
u=1.0 ft/sec T=1000 °F

Zinc Ferrite Tests - ZFMC-01 Reductive Regeneration 7

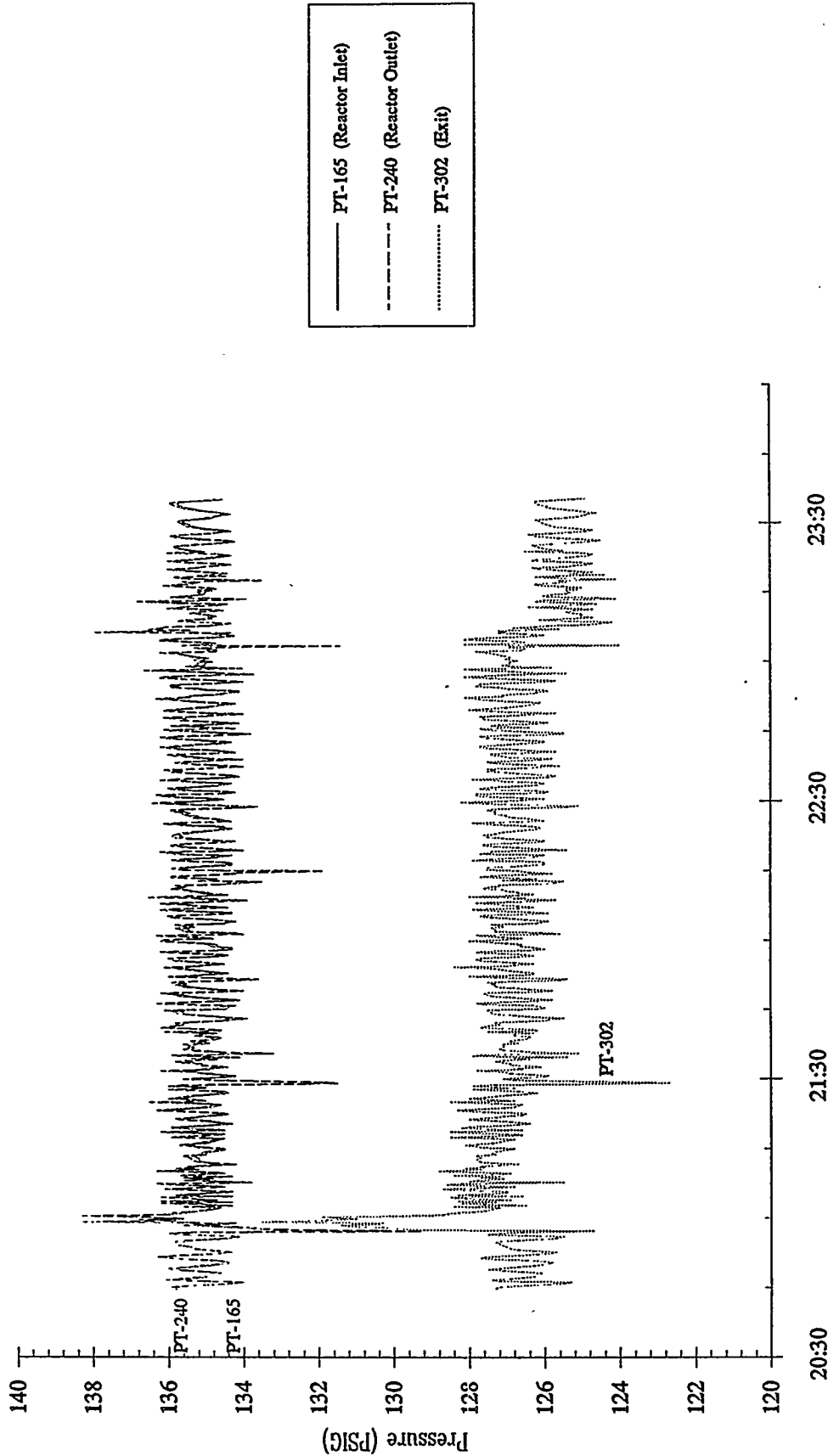

January 6, 1993
Test time: 21:00-23:05 (Test duration: 2:05)

T-2465 Zinc Ferrite
u=1.0 ft/sec T=1000 °F
H2S Inlet Conc. = 800 ppm

Zinc Ferrite Tests - ZFMC-01 Sulfidation 8

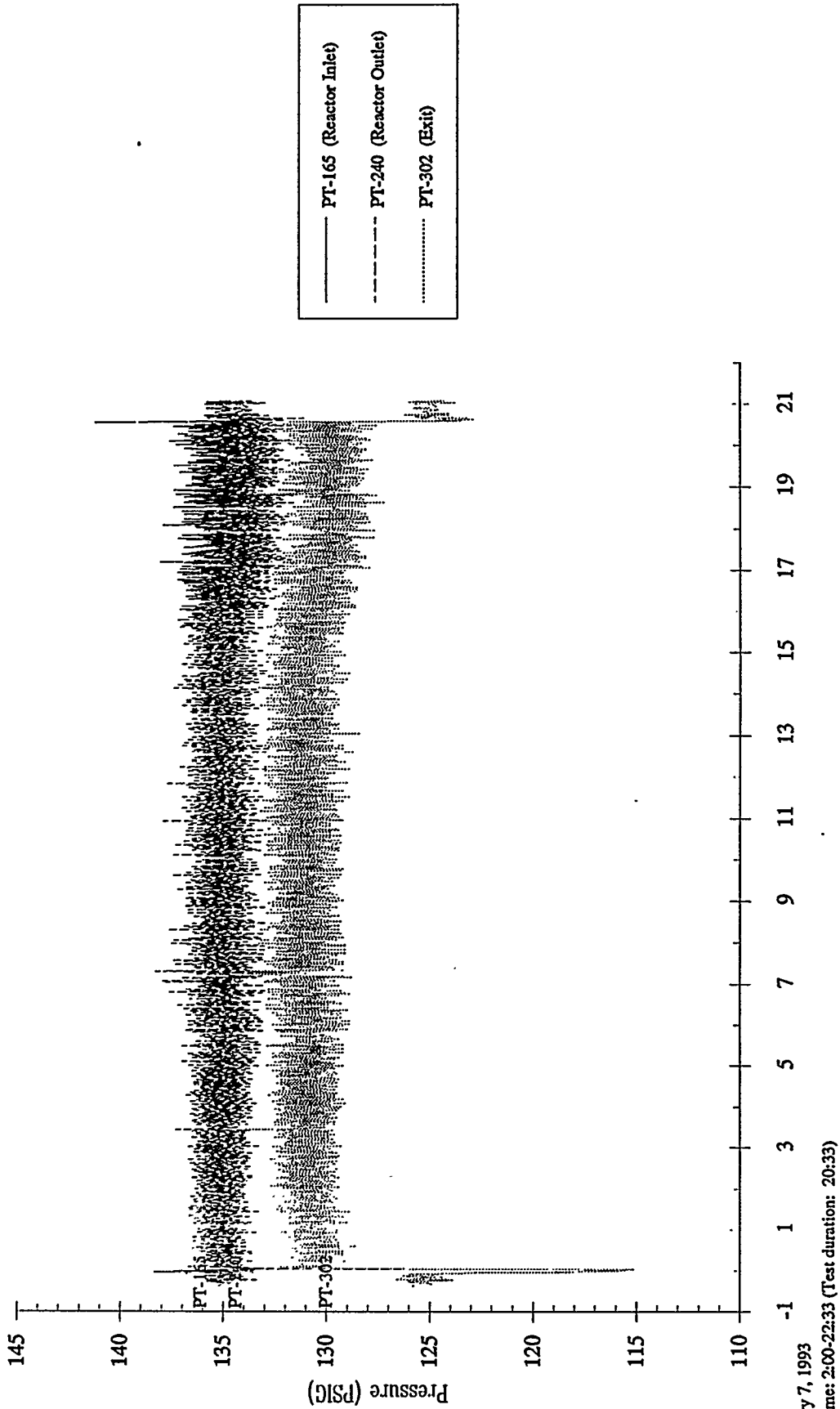

January 7, 1993
Test time: 2:00-22:33 (Test duration: 20:33)

T-2465 Zinc Ferrite
u=1.0 ft/sec T=1075 & 1300 °F
O2 Inlet Conc. = 2.5 & 21%

Zinc Ferrite Tests - ZFMC-01 Oxidative Regeneration 8

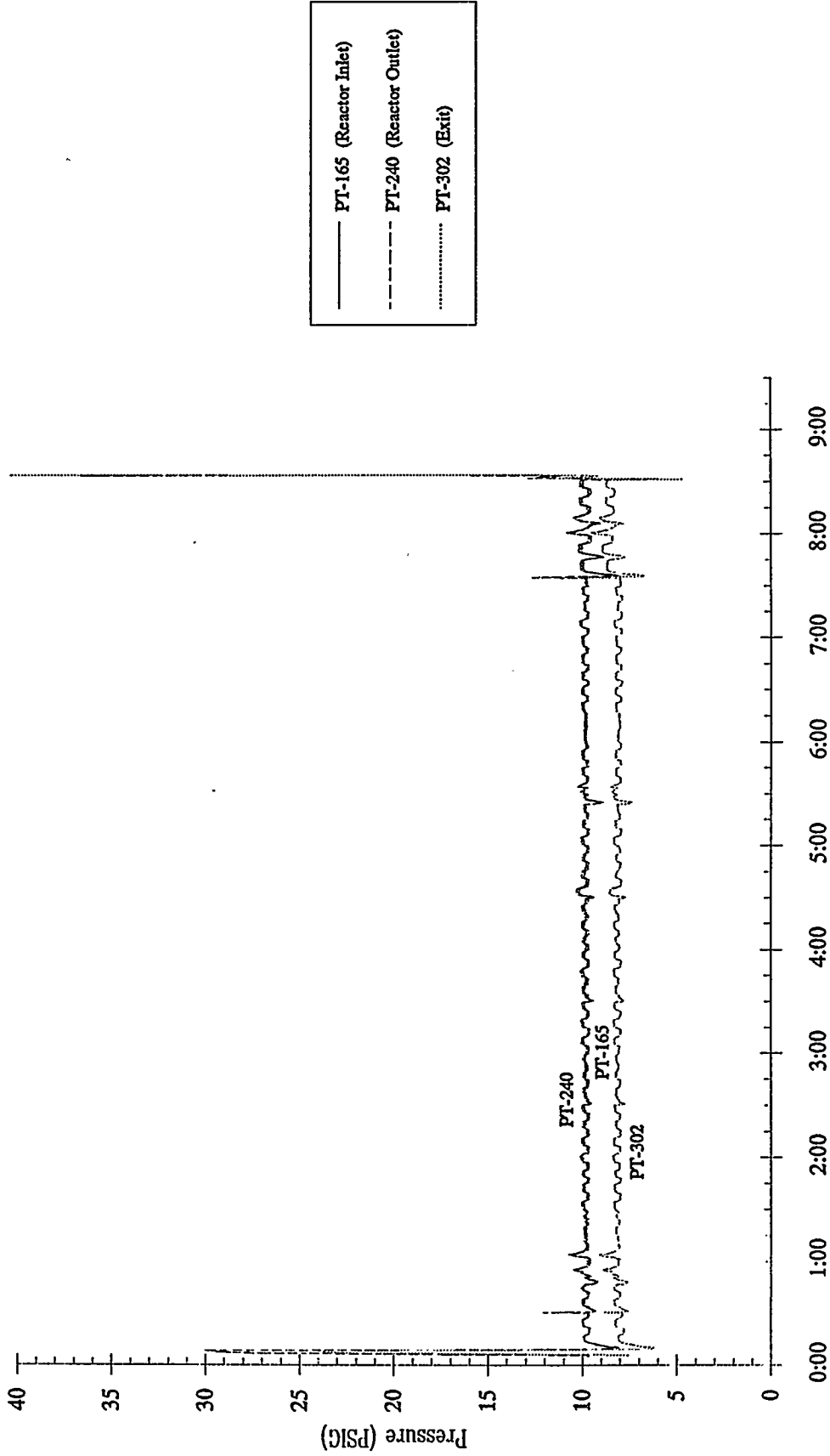

January 8, 1993
Test time: 0:30-8:32 (Test duration: 8:02)

T-2465 Zinc Ferrite
u=1.0 ft/sec T=1000 °F

Zinc Ferrite Tests - ZFMC-01 Reductive Regeneration 8

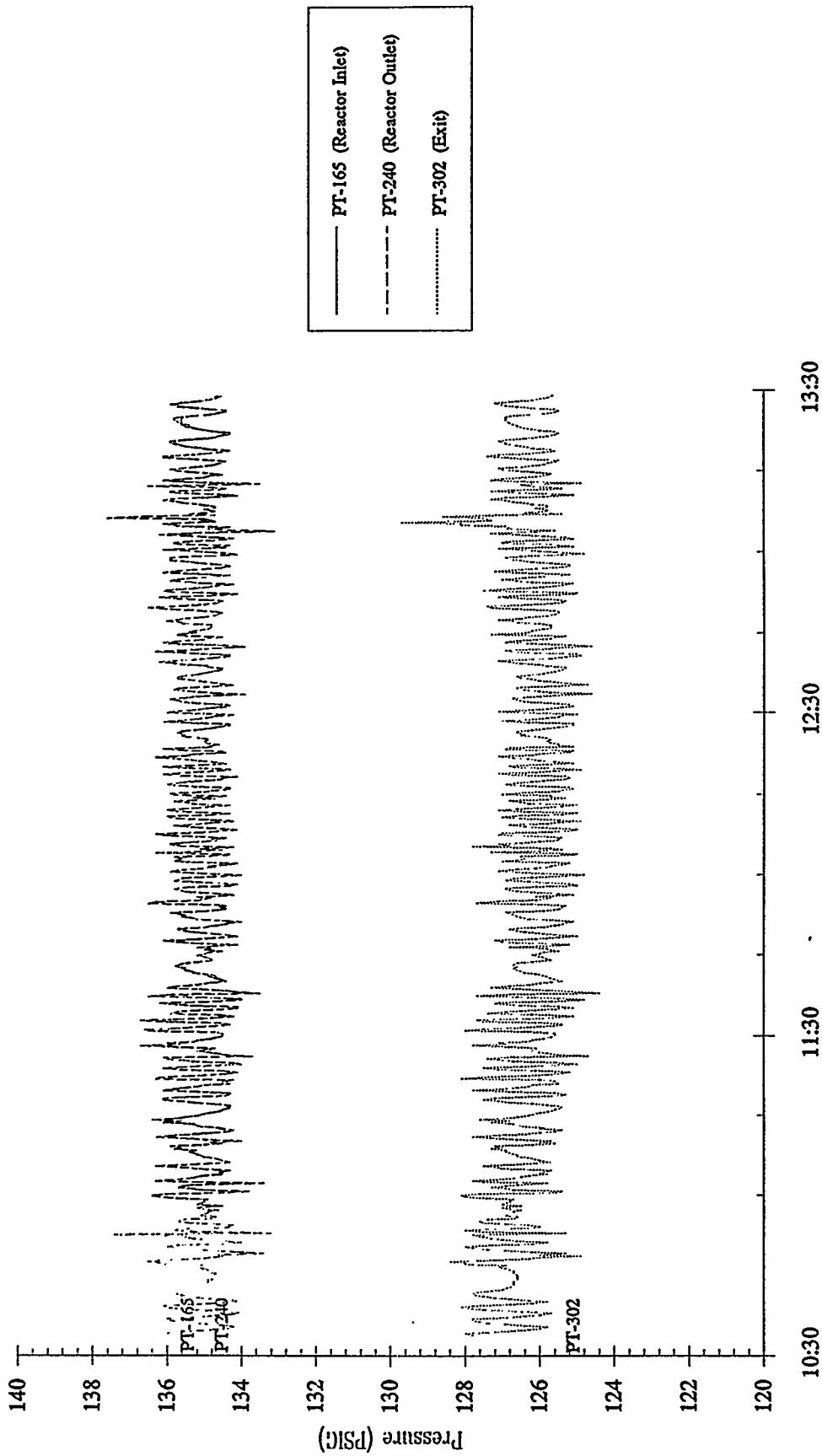

January 8, 1993
Test time: 11:00-13:03 (Test duration: 2:03)

APPENDIX D
Data Acquisition Differential Pressure Trends

Differential pressure across the reactor was monitored by DDAS, a PC-based automatic data acquisition system. Trend plots for the Precision Digital differential pressure transmitter readings are presented here. Pressure taps are located upstream and downstream of the entire reactor and do not measure the pressure drop across the sorbent bed only. The pressure drop measured is the sum total of all of the pressure drops between the two pressure taps. These pressure drops are caused by valves and fittings, distributor plates, ceramic balls, Fiberfrax, etc., in addition to the sorbent bed itself. Thus, any attempt to use these values as any more than a rough approximation of the actual pressure drop across the sorbent bed only should be met with caution.

T-2465 Zinc Ferrite
u=1.0 ft/sec T=1000 °F
H2S Inlet Conc. = 800 ppm

Zinc Ferrite Tests - ZFMC-01 Sulfidation 1

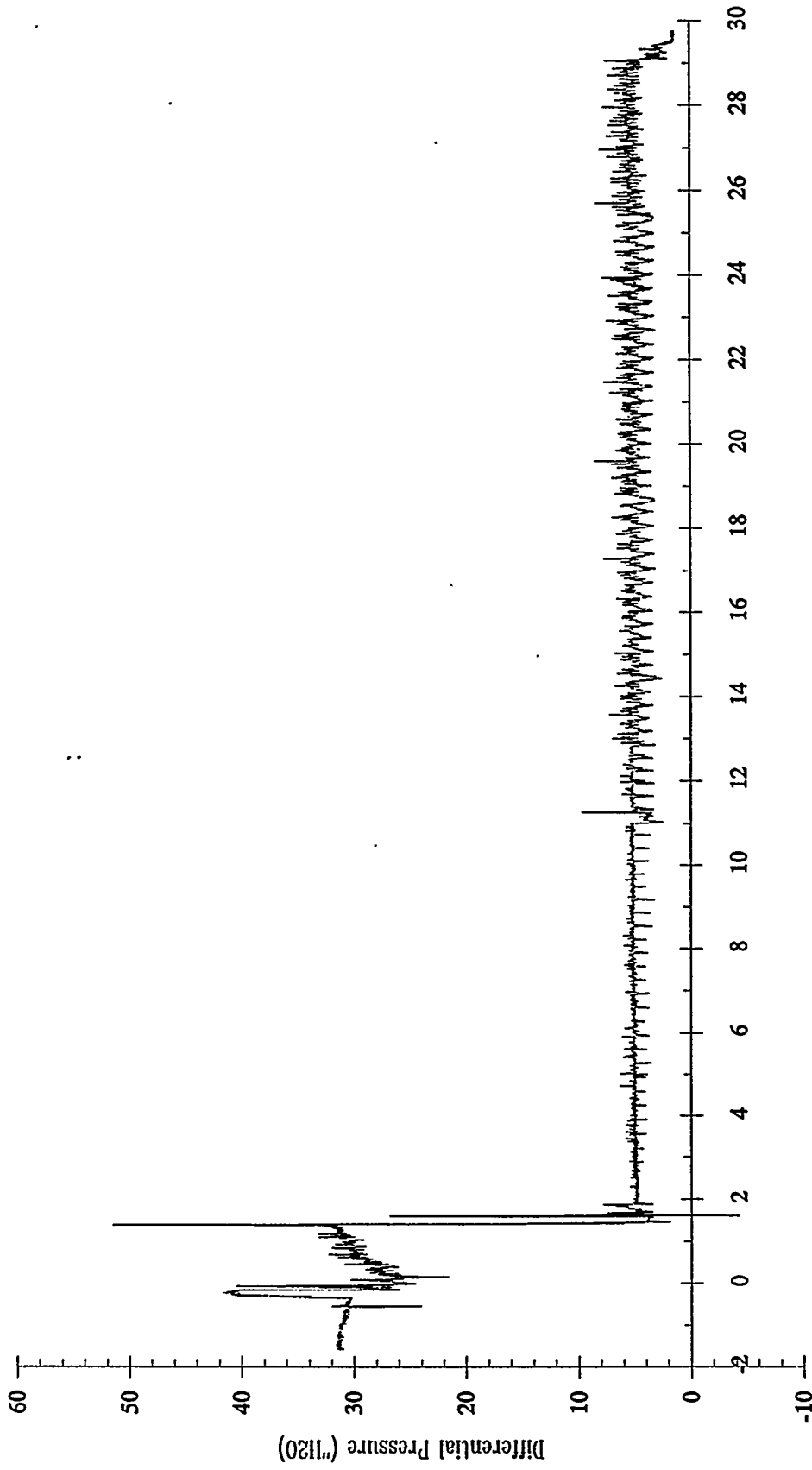

Test time: 18:03-19:28, 19:55 (December 7, 1992) - 23:07 (December 8, 1992)
Test duration: 28:37

T-2465 Zinc Ferrite
u=1.0 ft/sec T=1000-1300 °F
O2 Inlet Conc. = 0.5-21 %

Zinc Ferrite Tests - ZFMC-01 Oxidative Regeneration 1

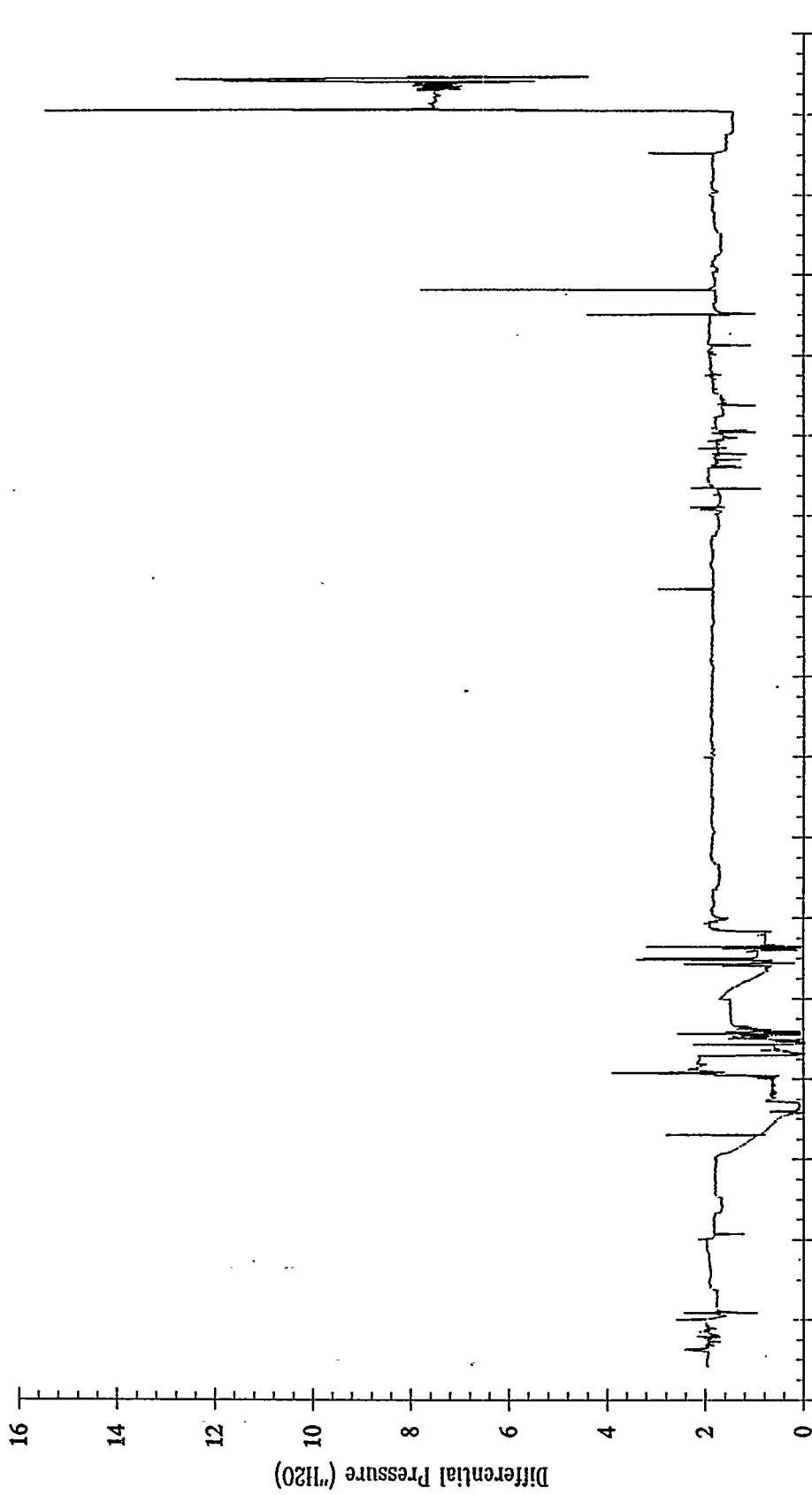

December 9, 1992 00 3:00 4:00 5:00 6:00 7:00 8:00 9:00 10:00 11:00 12:00 13:00 14:00 15:00 16:00 17:00 18:00 19:00
Test time: 3:00-5:30, 7:00-7:30, 8:00-18:05
Test duration: 13:05

T-2465 Zinc Ferrite
u=1.0 ft/sec T=1000 °F

Zinc Ferrite Tests - ZFMC-01 Reductive Regeneration 1

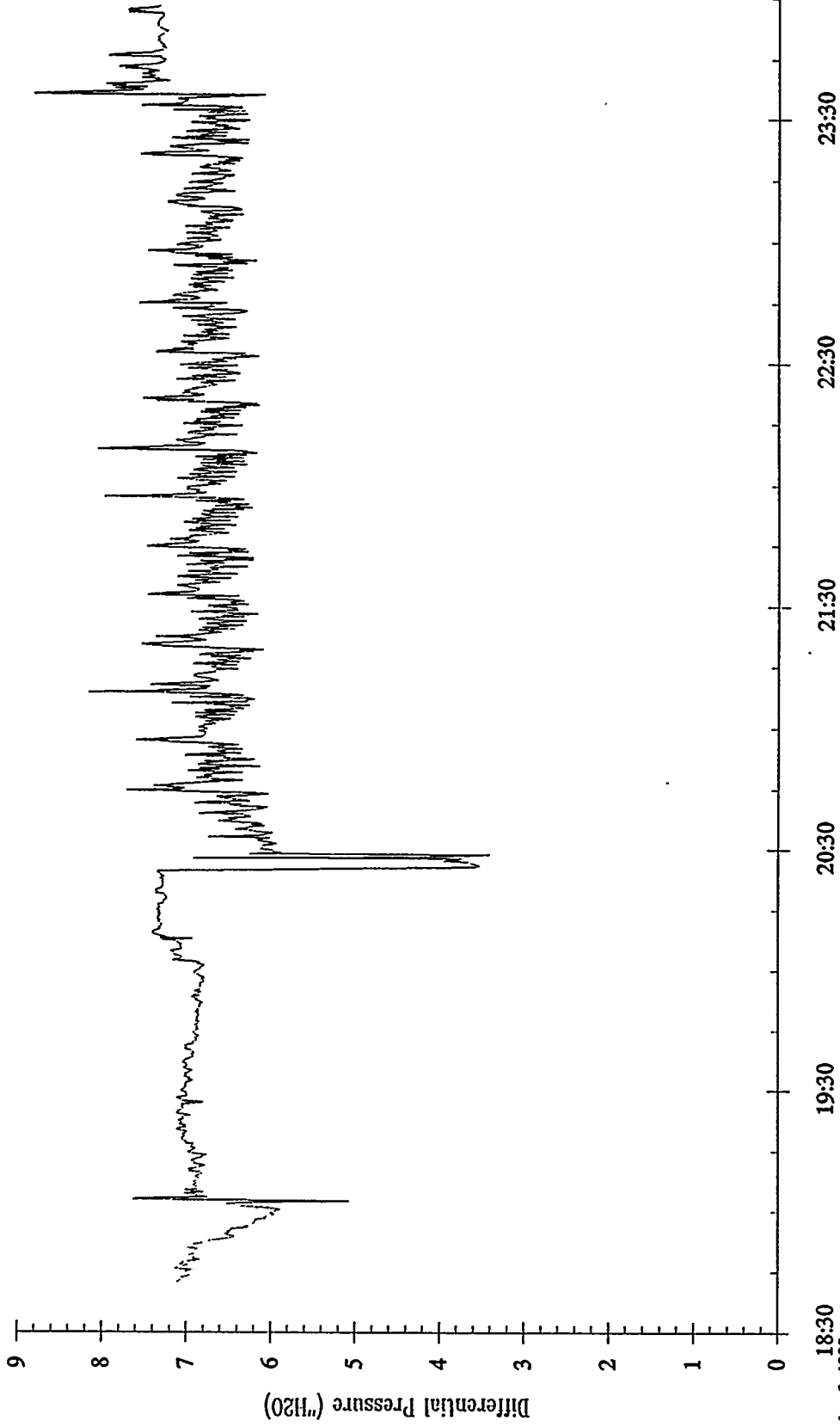

December 9, 1992
Test time: 20:30-23:33 (Test duration: 3:03)

T-2465 Zinc Ferrite
u=1.0 ft/sec T=1000 °F
H2S Inlet Conc. = 800 ppm

Zinc Ferrite Tests - ZFMC-01 Sulfidation 2

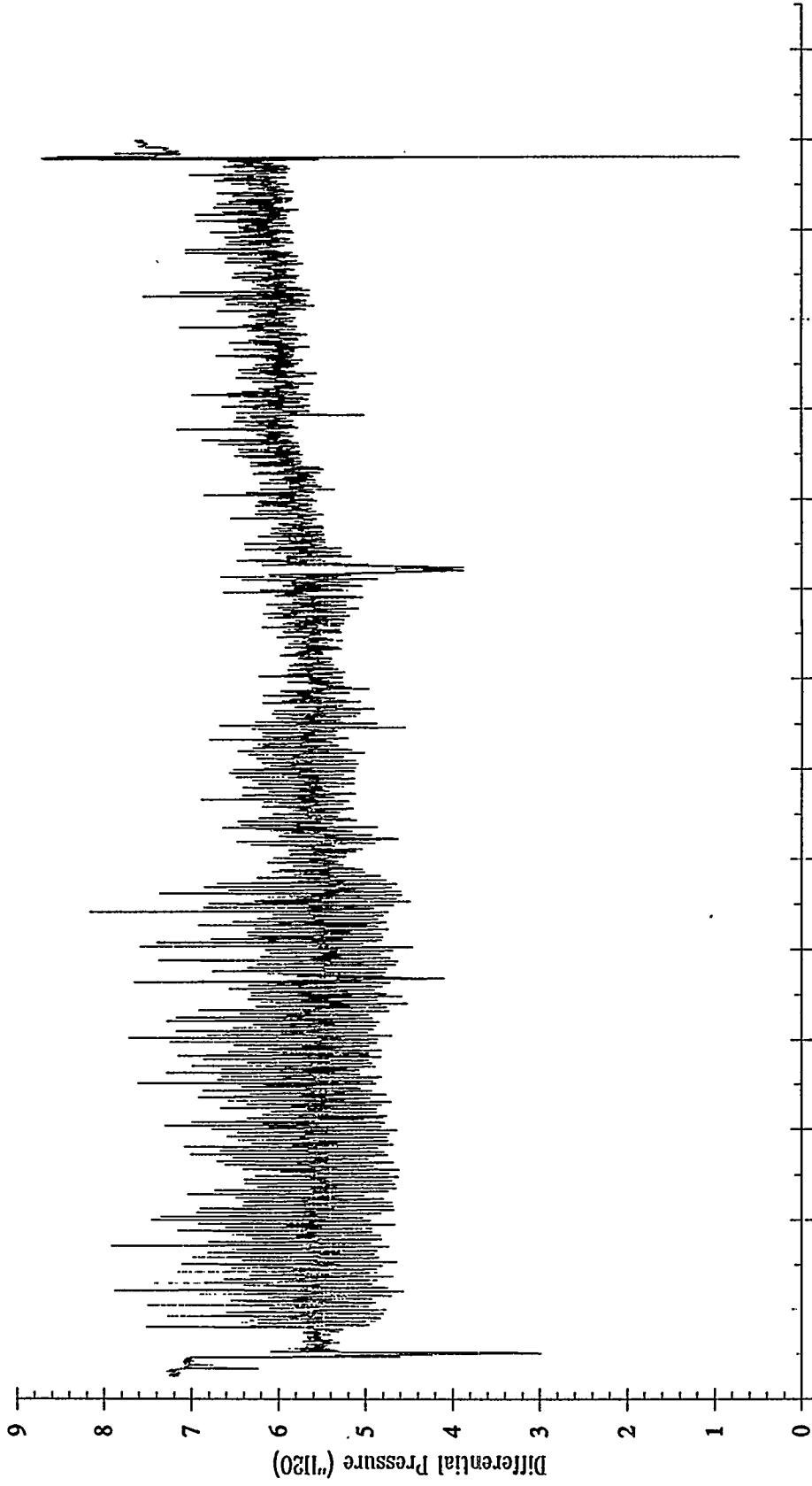

-1 1 3 5 7 9 11 13 15 17 19 21 23 25 27 29
Test time: 1:30-12:00 (December 10, 1992), 12:30-16:30 (December 11, 1992), 9:00-21:03 (December 14, 1992)
Test duration: 26:33

T-2465 Zinc Ferrite
u=1.0 ft/sec T=1000-1300 °F
O2 Inlet Conc. = 0.5-21 %

Zinc Ferrite Tests - ZFMC-01 Oxidative Regeneration 2

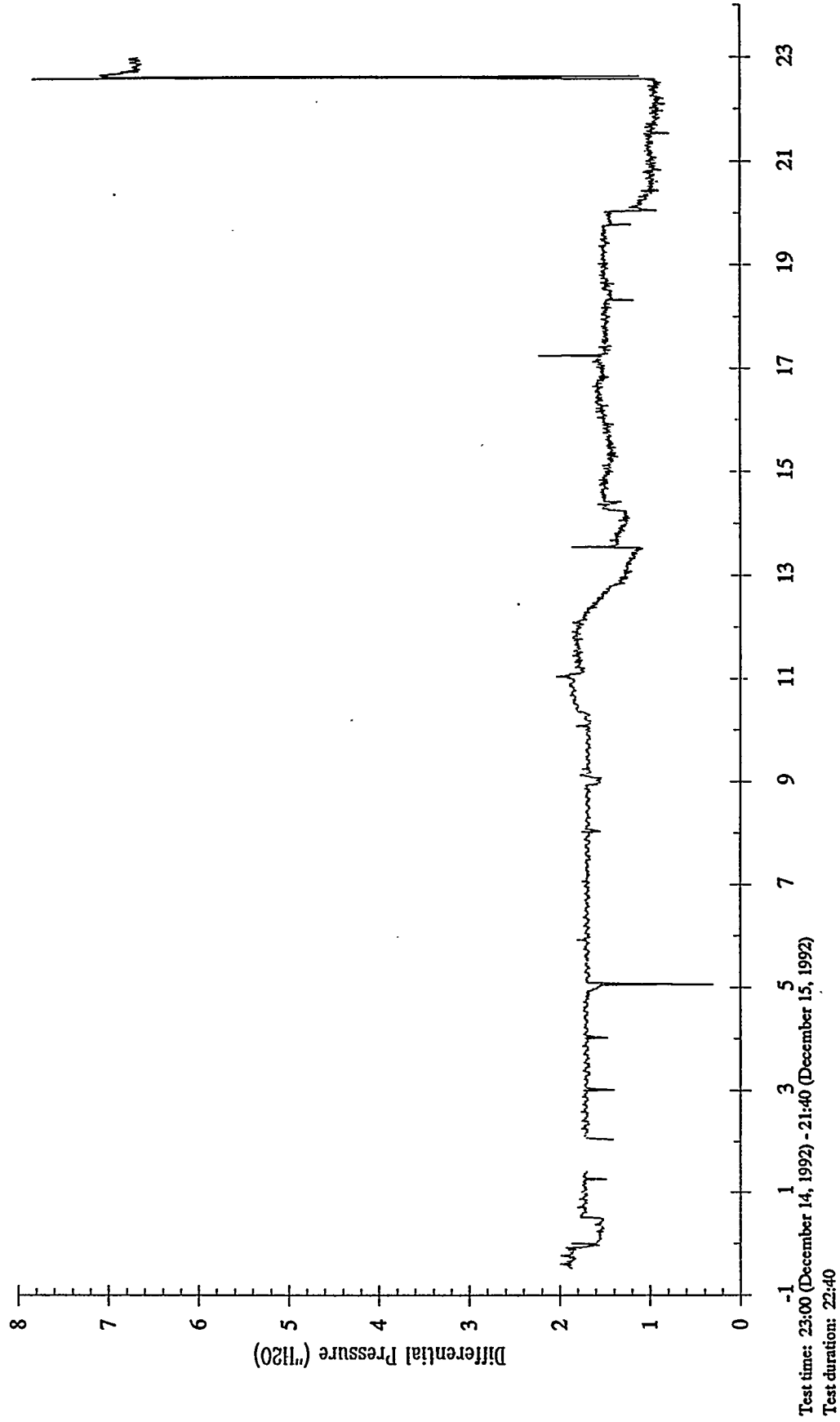

Test time: 23:00 (December 14, 1992) - 21:40 (December 15, 1992)
Test duration: 22:40

T-2465 Zinc Ferrite
u=1.0 ft/sec T=1000 °F

Zinc Ferrite Tests - ZFMC-01 Reductive Regeneration 2

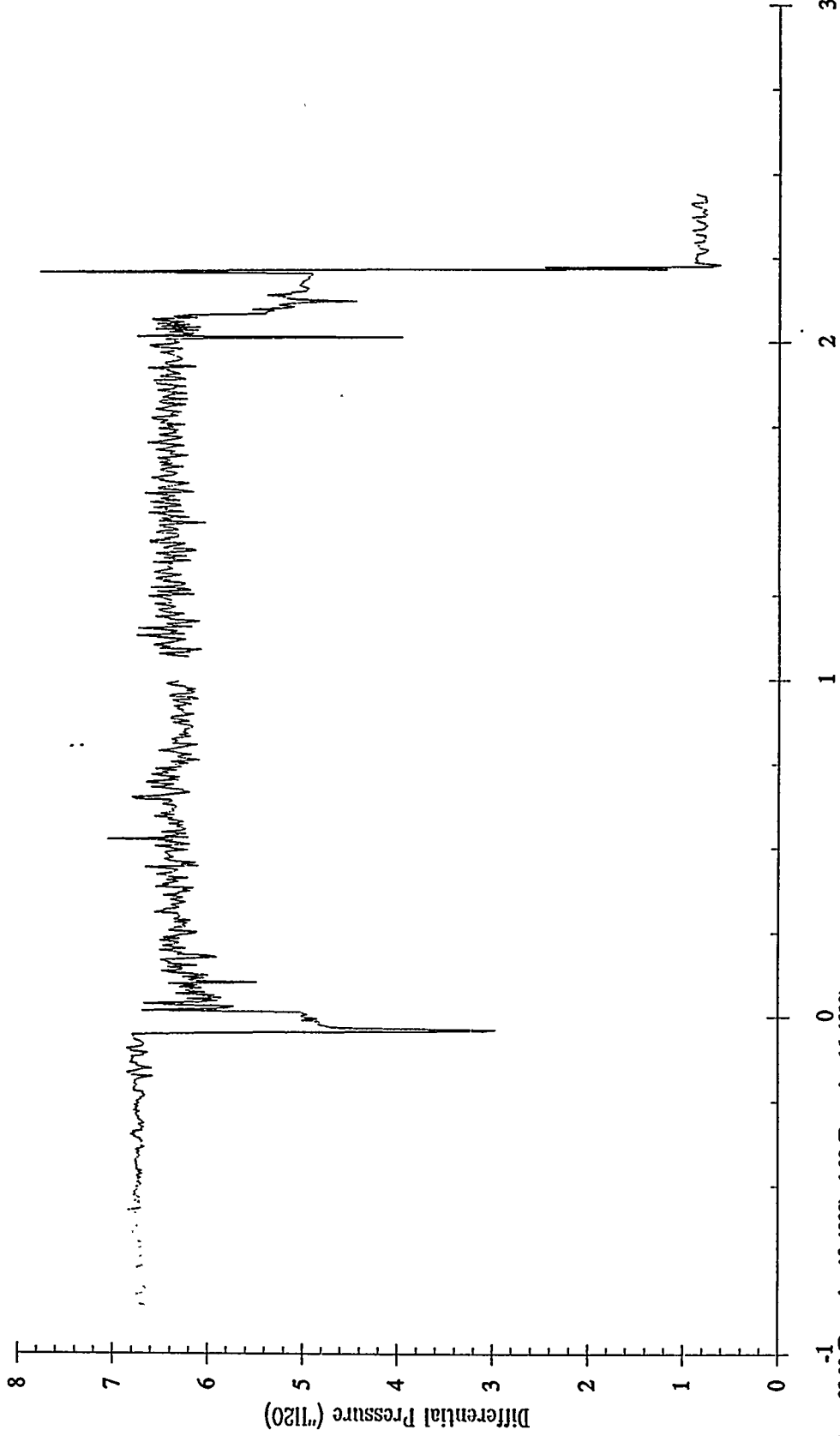

Test time: 23:00 (December 15, 1992) - 1:00 (December 16, 1992)
Test duration: 2:00

T-2465 Zinc Ferrite
v=1.0 ft/sec T=1000 °F
H2S Inlet Conc. = 800 ppm

Zinc Ferrite Tests - ZFMC-01 Sulfidation 3

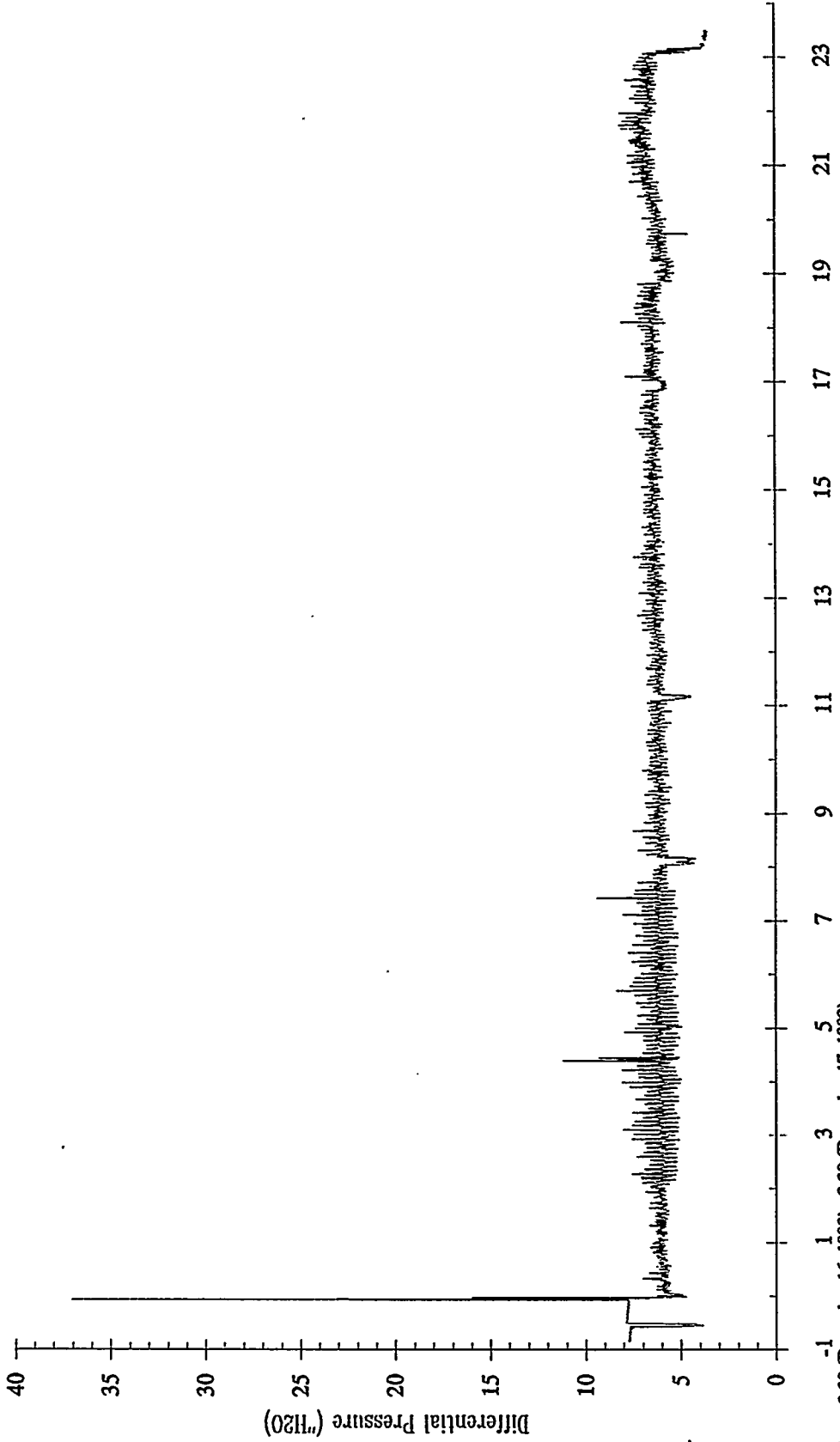

Test time: 3:30 (December 16, 1992) - 2:30 (December 17, 1992)
Test duration: 23:00

T-2465 Zinc Ferrite
u=1.0 ft/sec T=1000-1300 °F
O2 Inlet Conc. = 0.5-21 %

Zinc Ferrite Tests - ZFMC-01 Oxidative Regeneration 3

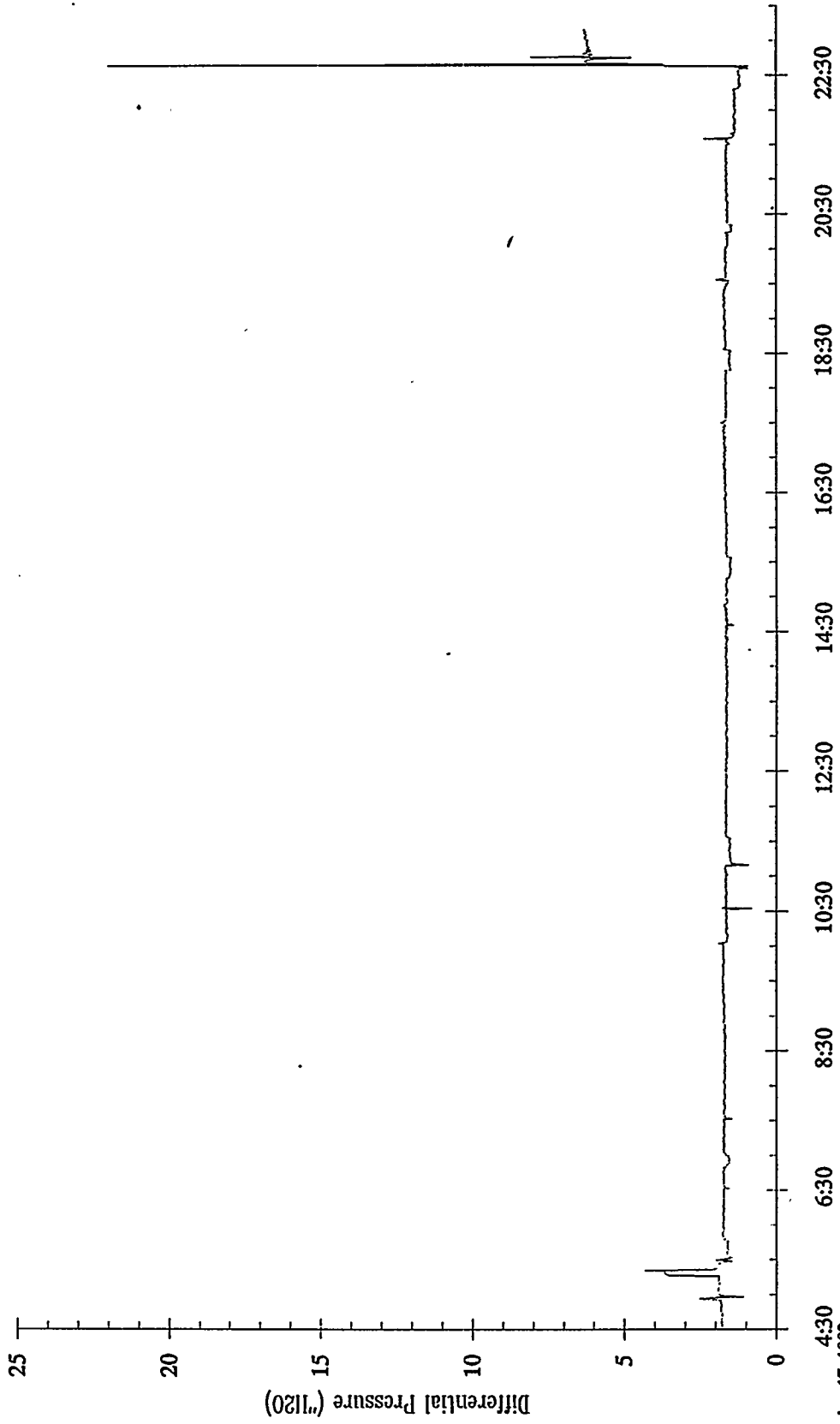

December 17, 1992
Test time: 5:30-22:30 (Test duration: 17:00)

T-2465 Zinc Ferrite
u=1.0 ft/sec T=1000 °F

Zinc Ferrite Tests - ZFMC-01 Reductive Regeneration 3

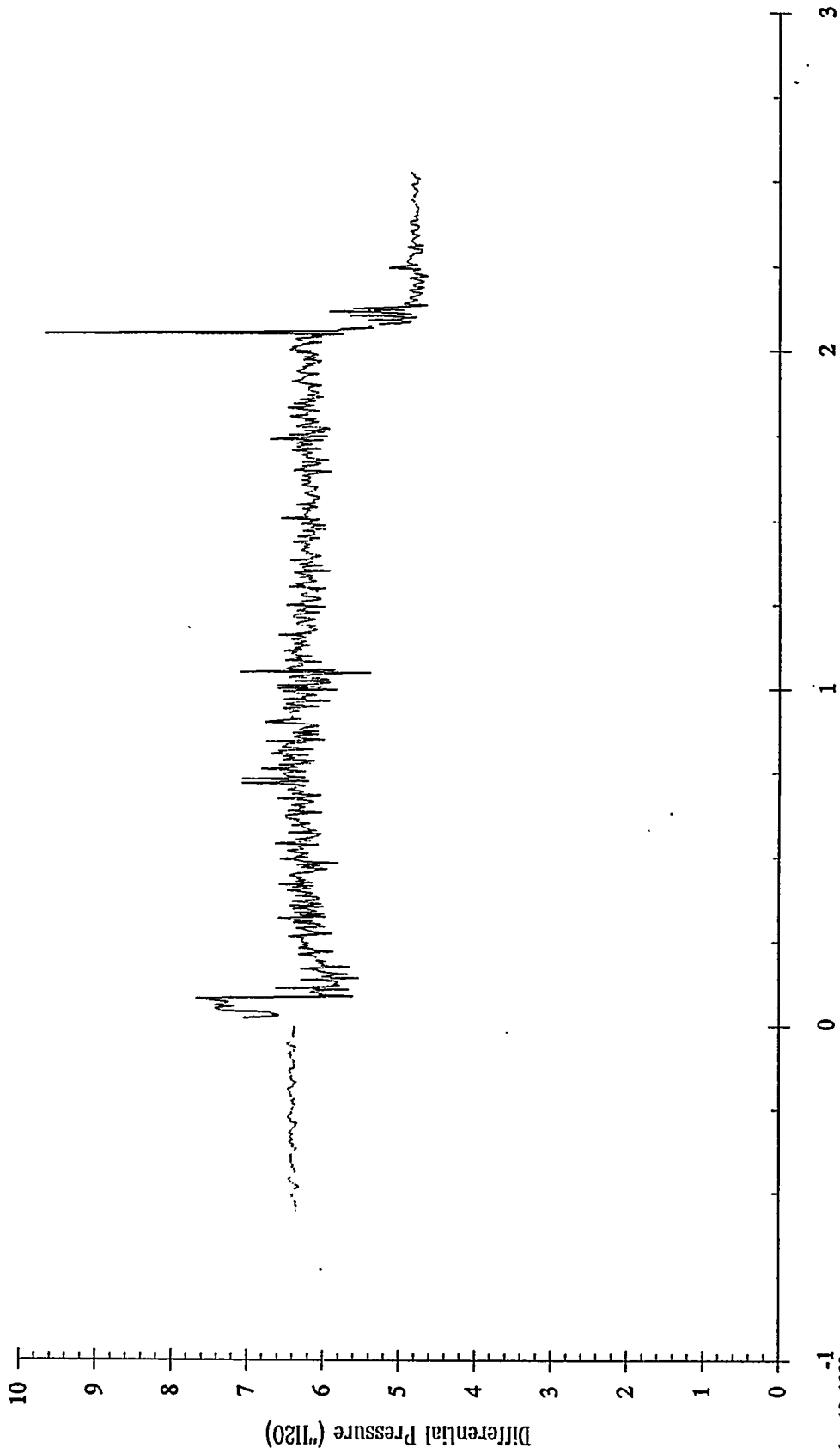

December 18, 1992
Test time: 0:00 - 2:00 (Test duration: 2:00)

T-2465 Zinc Ferrite
u=1.0 ft/sec T=1000 °F
H2S Inlet Conc. = 800 ppm

Zinc Ferrite Tests - ZFMC-01 Sulfidation 4

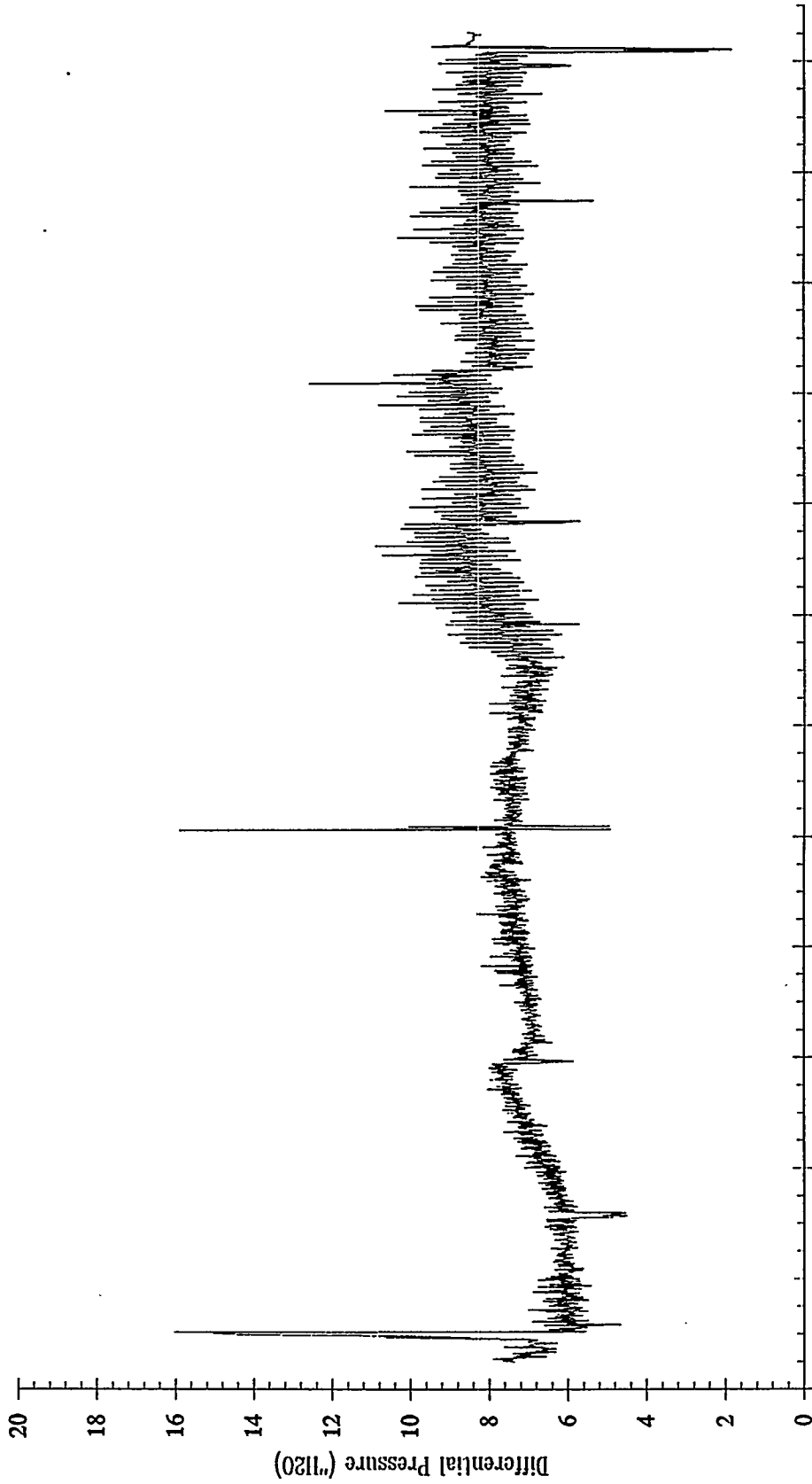

-1 1 3 5 7 9 11 13 15 17 19 21 23
Test time: 4:00-16:05 (December 18, 1992), 9:30 - 20:30 (December 21, 1992)
Test duration: 23:05

T-2465 Zinc Ferrite
u=1.0 ft/sec T=1075 & 1300 °F
O2 Inlet Conc. = 2.5 & 21%

Zinc Ferrite Tests - ZFMC-01 Oxidative Regeneration 4

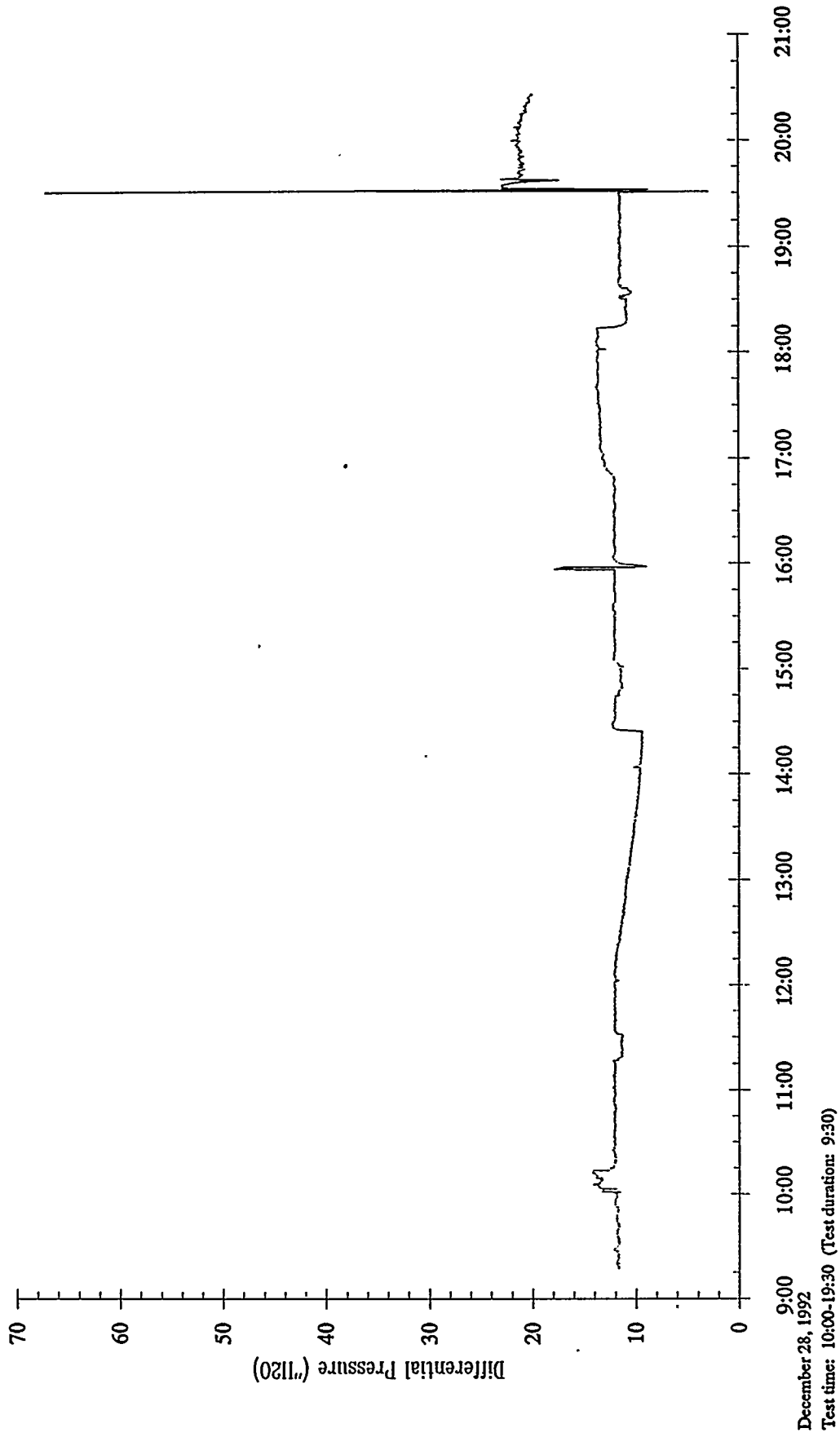

T-2465 Zinc Ferrite
u=1.0 ft/sec T=1000 °F

Zinc Ferrite Tests - ZFMC-01 Reductive Regeneration 4

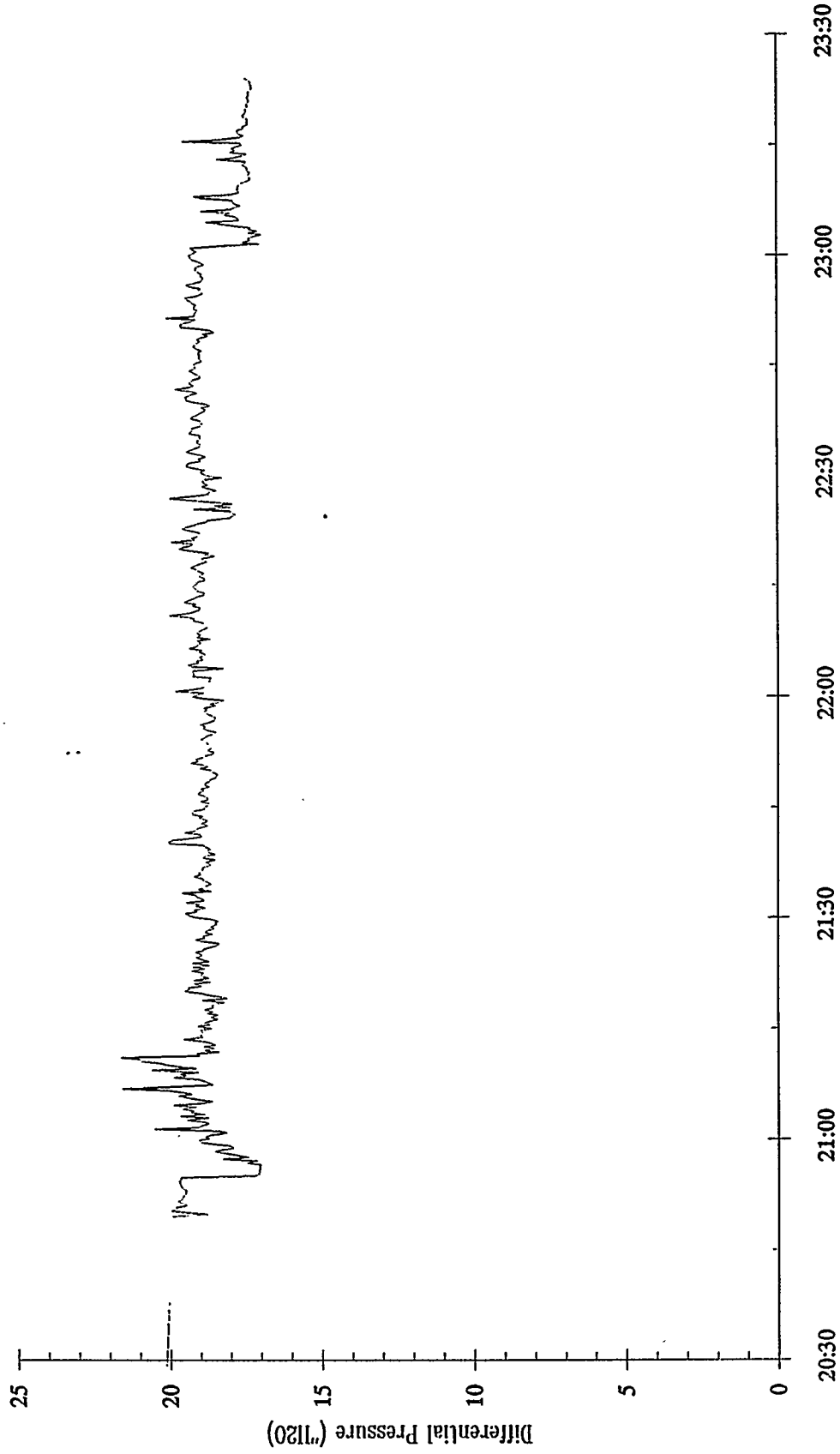

December 28, 1992
Test time: 21:00-23:00 (Test duration: 2:00)

T-2465 Zinc Ferrite
u=1.0 ft/sec T=1000 °F
H2S Inlet Conc. = 800 ppm

Zinc Ferrite Tests - ZFMC-01 Sulfidation 5

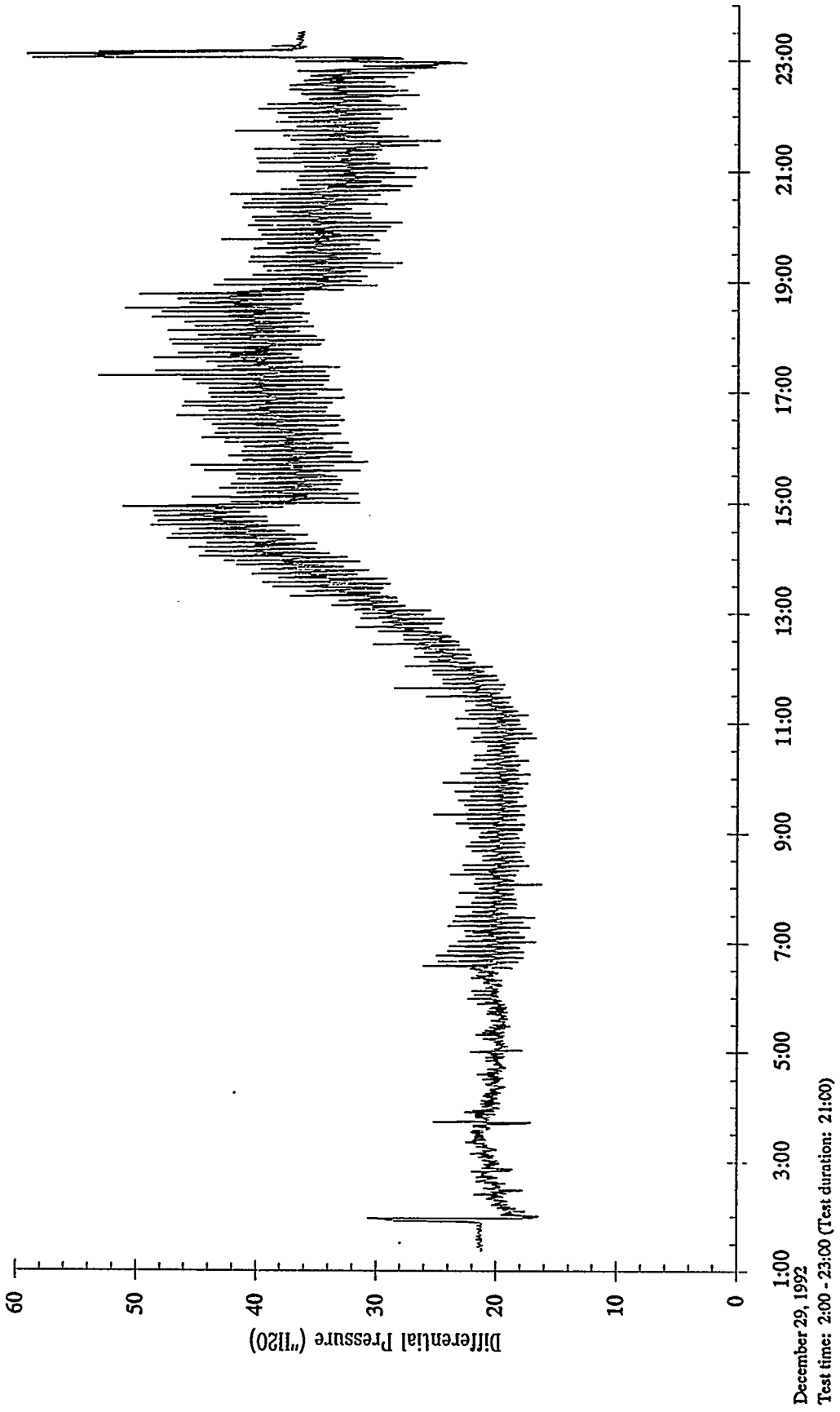

T-2465 Zinc Ferrite
u=1.0 ft/sec T=1075 & 1300 °F
O2 Inlet Conc. = 2.5 & 21%

Zinc Ferrite Tests - ZFMC-01 Oxidative Regeneration 5

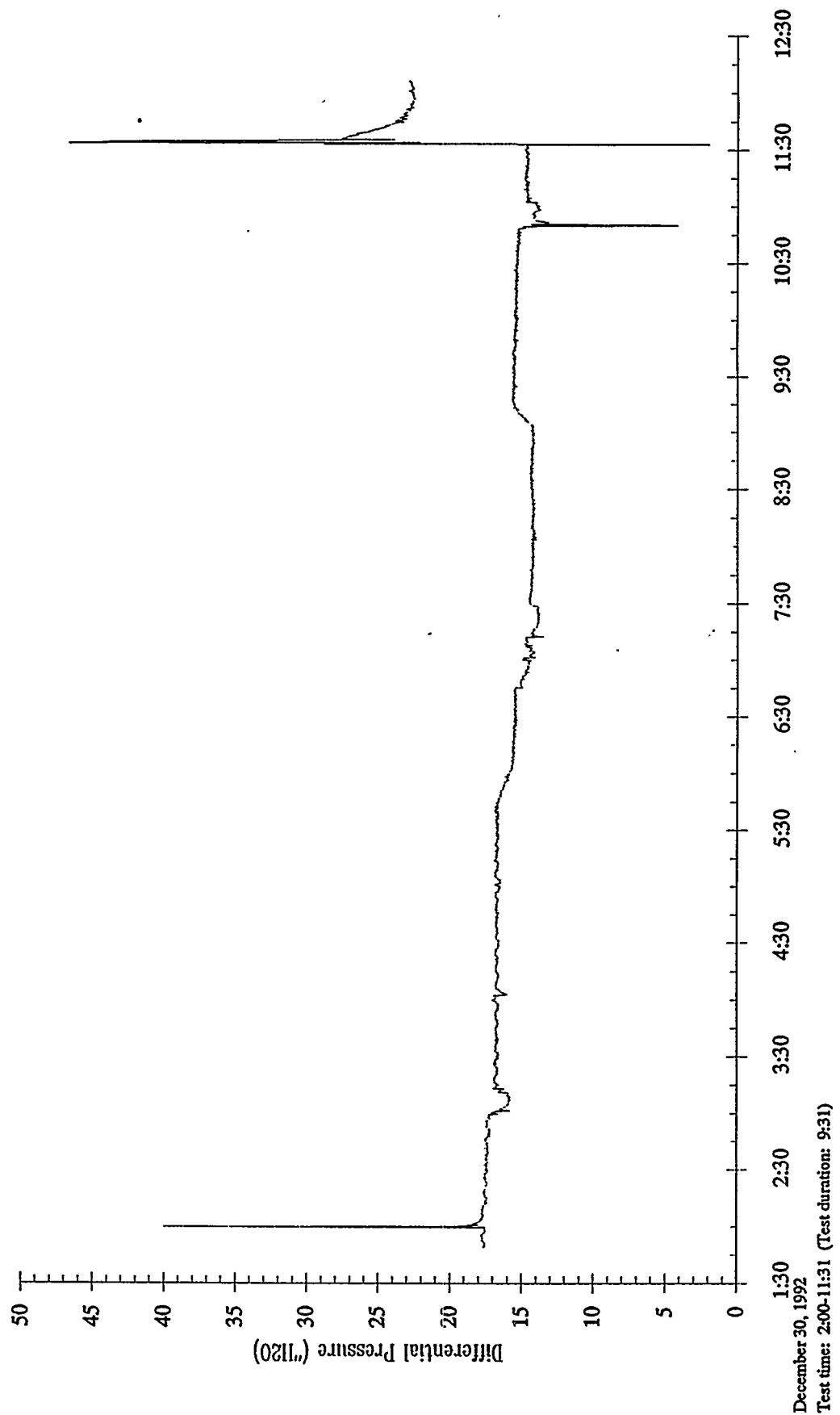

December 30, 1992
Test time: 2:00-11:31 (Test duration: 9:31)

T-2465 Zinc Ferrite
u=1.0 ft/sec T=1000 °F

Zinc Ferrite Tests - ZFMC-01 Reductive Regeneration 5

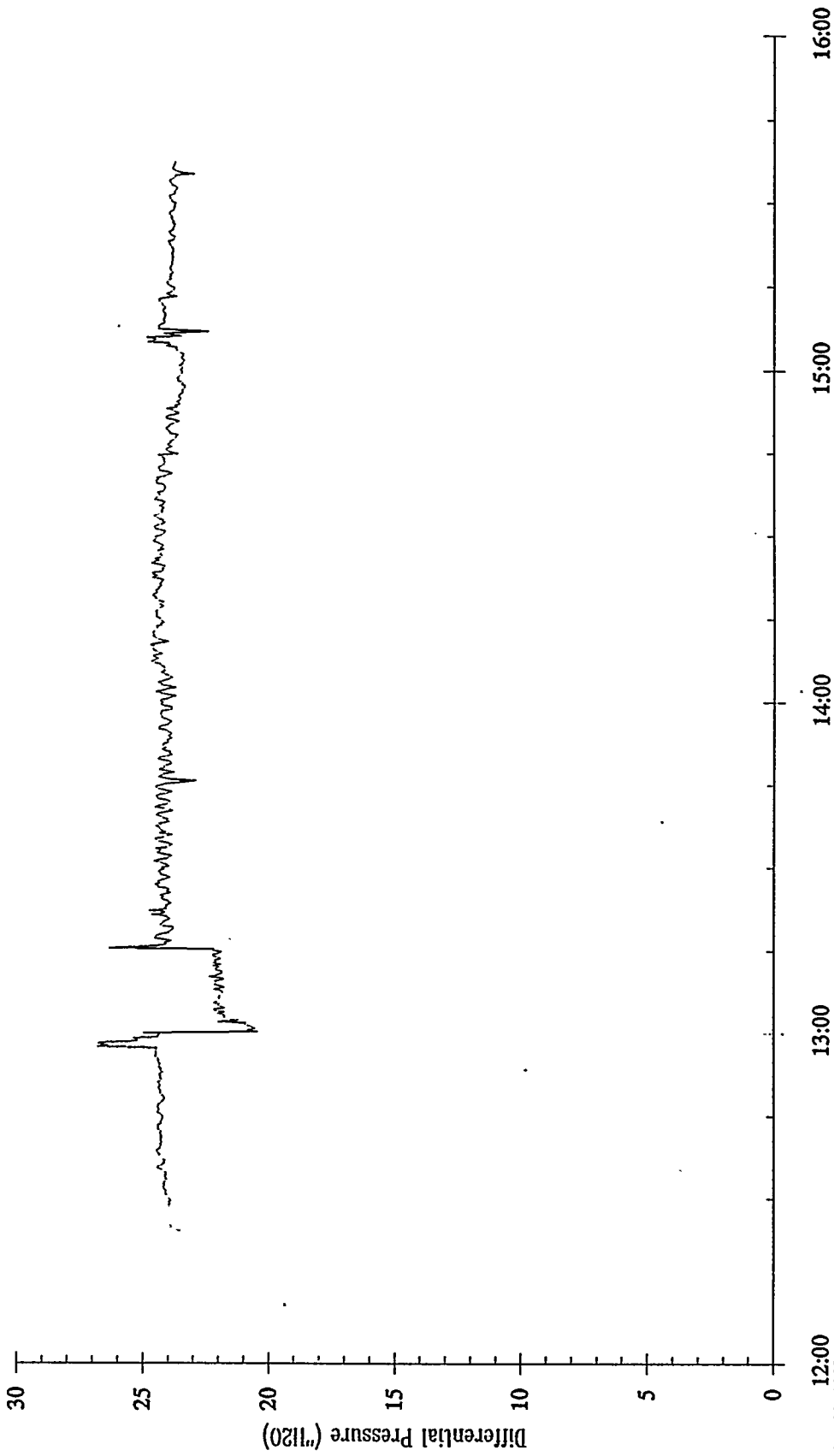

December 30, 1992
Test time: 13:00-15:05 (Test duration: 2:05)

T-2465 Zinc Ferrite
u=1.0 ft/sec T=1000 °F
H2S Inlet Conc. = 800 ppm

Zinc Ferrite Tests - ZFMC-01 Sulfidation 6

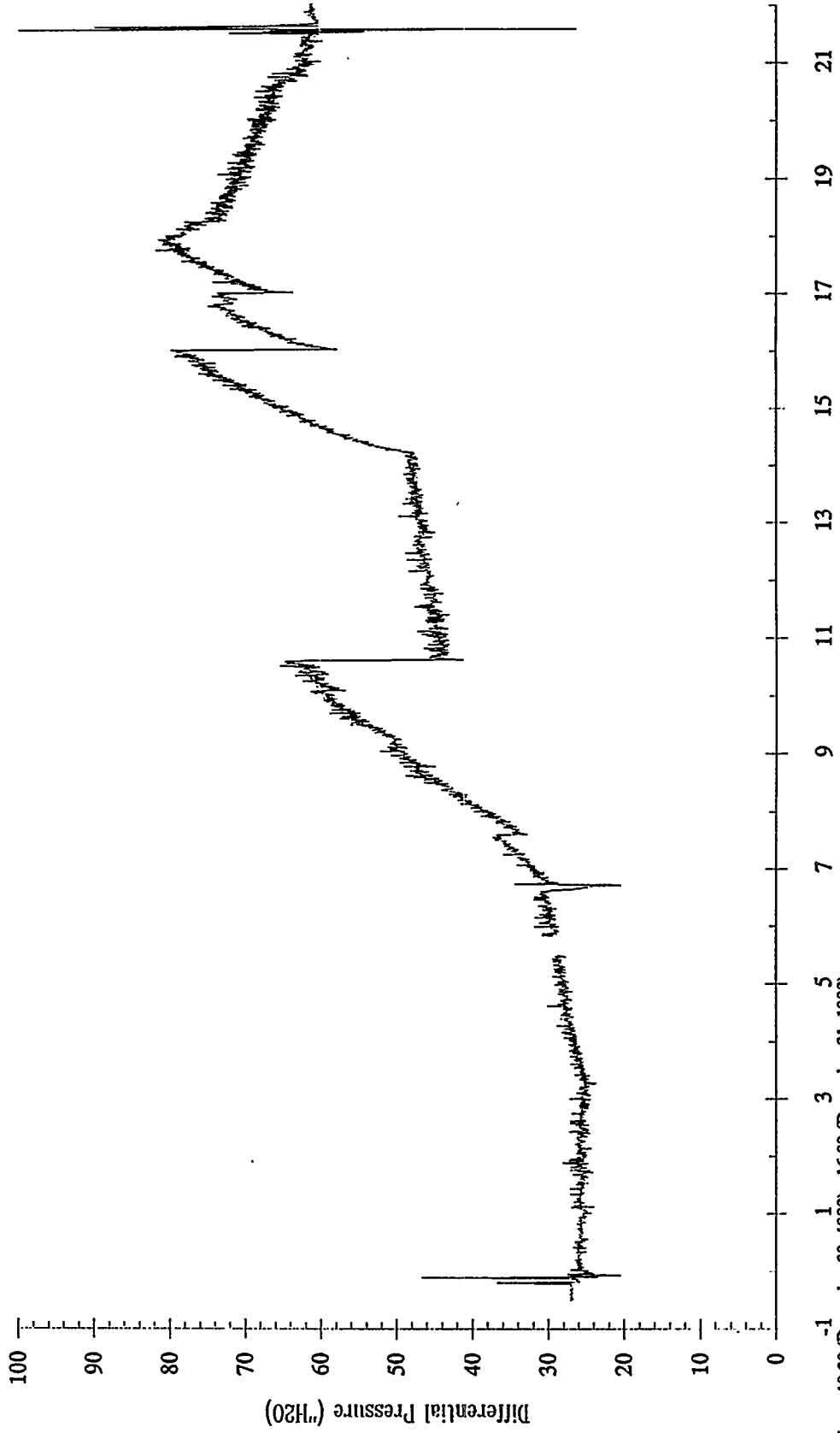

Test time: 18:30 (December 30, 1992) - 16:00 (December 31, 1992)
Test duration: 21:30

T-2465 Zinc Ferrite
u=1.0 ft/sec T=1075 & 1300 °F
O2 Inlet Conc. = 2.5 & 21%

Zinc Ferrite Tests - ZFMC-01 Oxidative Regeneration 6

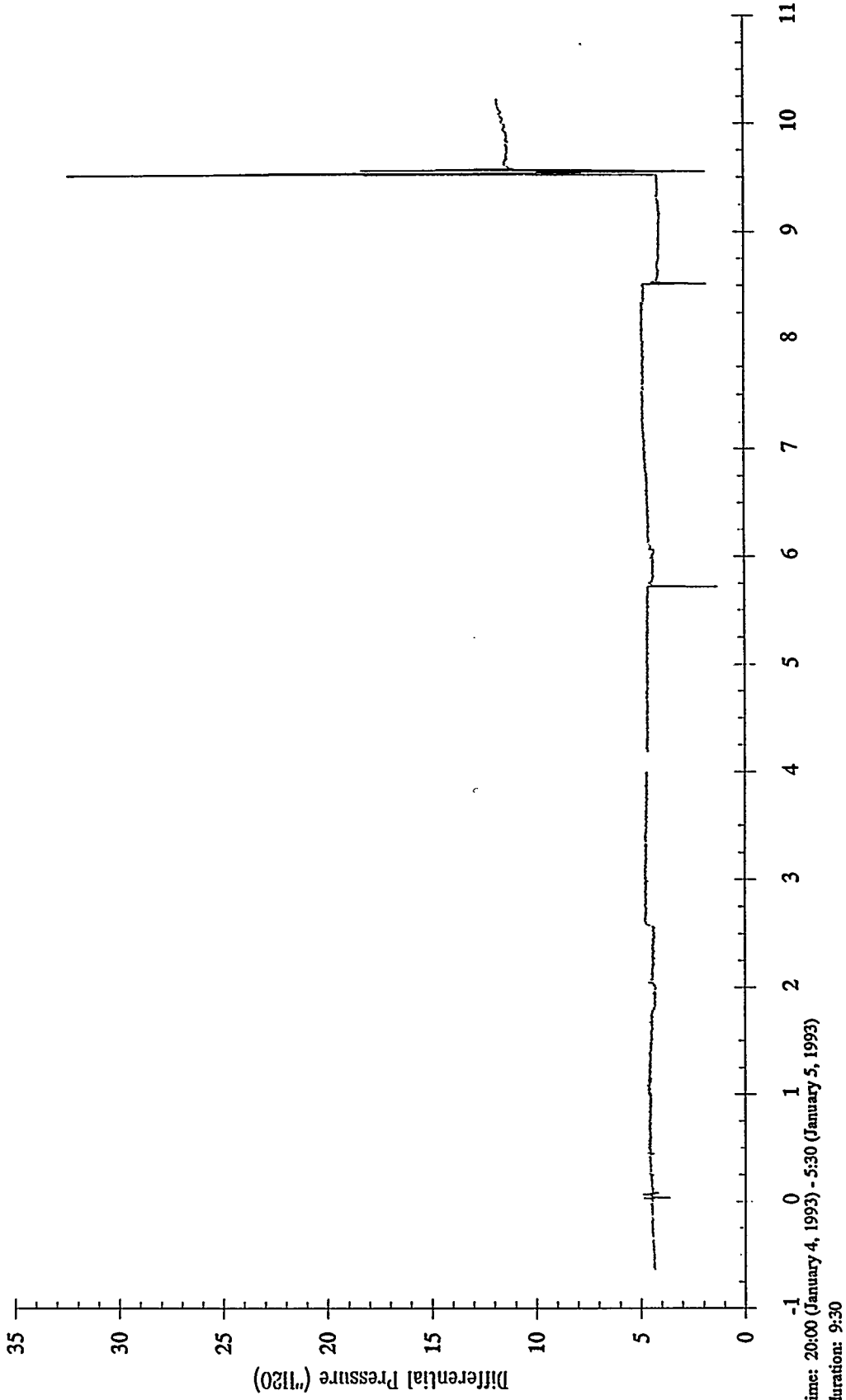

Test time: 20:00 (January 4, 1993) - 5:30 (January 5, 1993)
Test duration: 9:30

T-2465 Zinc Ferrite
u=1.0 ft/sec T=1000 °F

Zinc Ferrite Tests - ZFMC-01 Reductive Regeneration 6

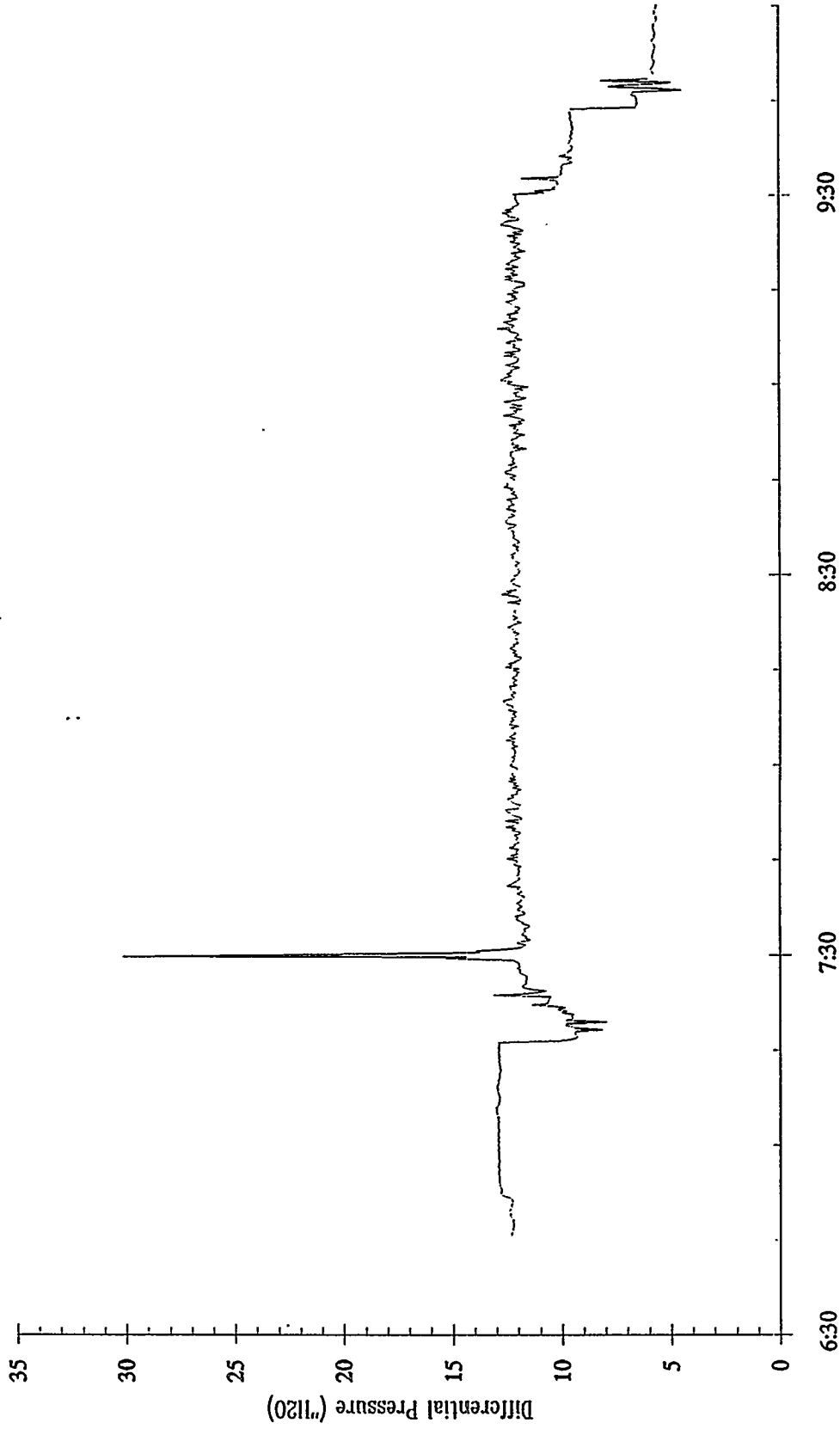

6:30
January 5, 1993
Test time: 7:30-9:32 (Test duration: 2:02)

T-2465 Zinc Ferrite
u=1.0 ft/sec T=1000 °F
H2S Inlet Conc. = 800 ppm

Zinc Ferrite Tests - ZFMC-01 Sulfidation 7

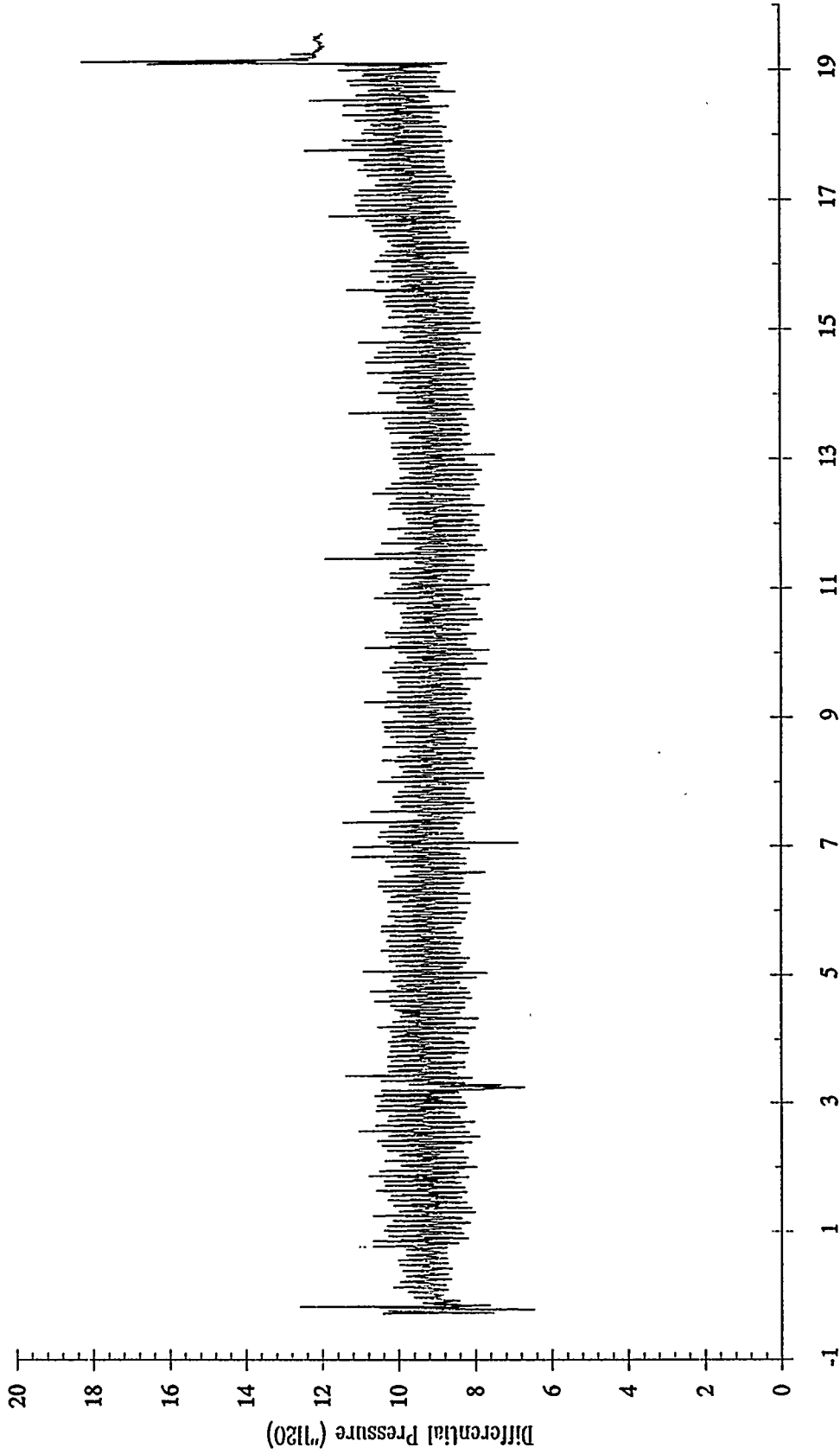

-1
Test time: 11:30 (January 5, 1993) - 6:35 (January 6, 1993)
Test duration: 19:05

T-2465 Zinc Ferrite
u=1.0 ft/sec T=1075 & 1300 °F
O2 Inlet Conc. = 2.5 & 21%

Zinc Ferrite Tests - ZFMC-01 Oxidative Regeneration 7

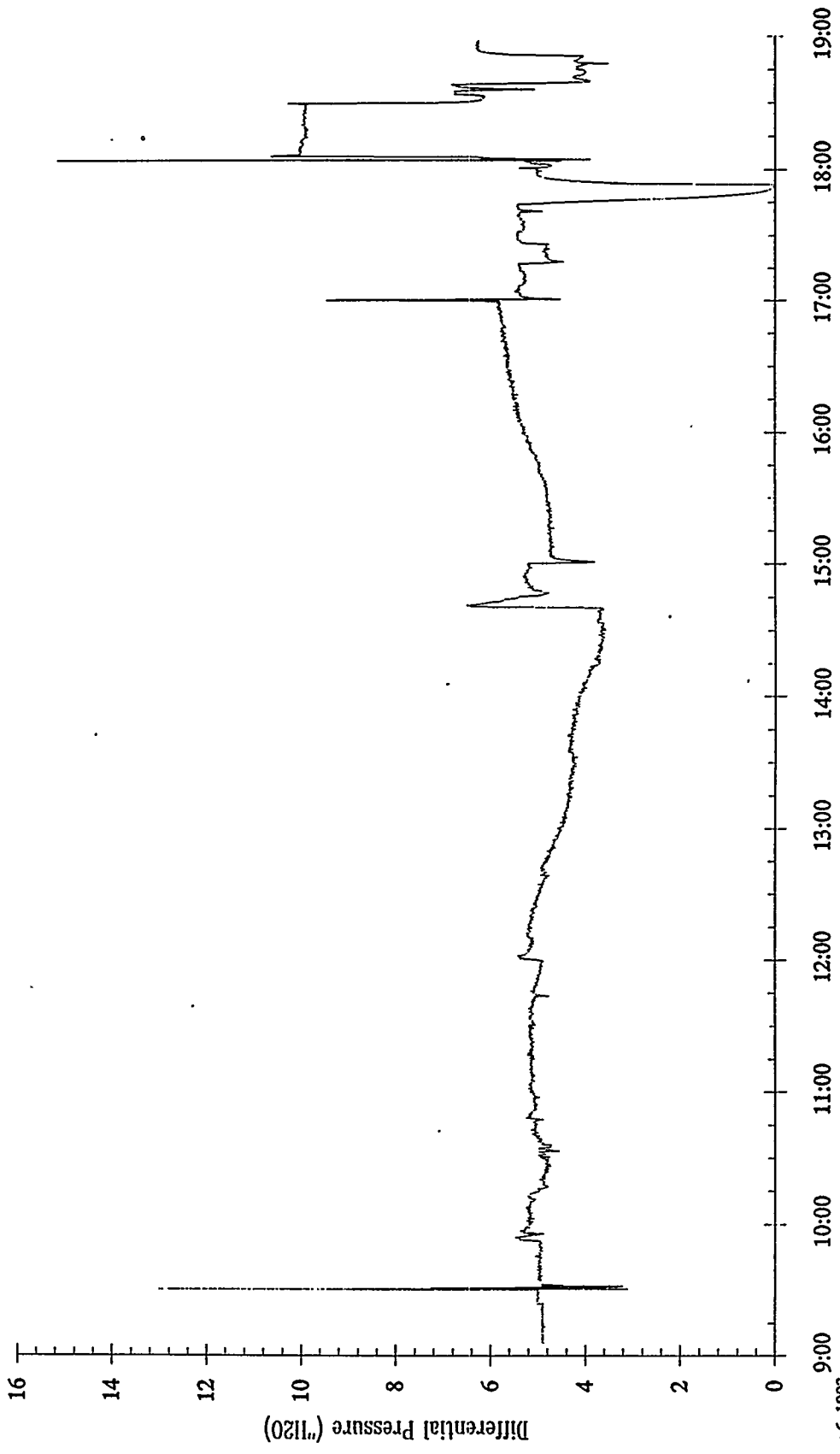

January 6, 1993
Test time: 9:30-18:05 (Test duration: 8:35)

T-2465 Zinc Ferrite
u=1.0 ft/sec T=1000 °F

Zinc Ferrite Tests - ZFMC-01 Reductive Regeneration 7

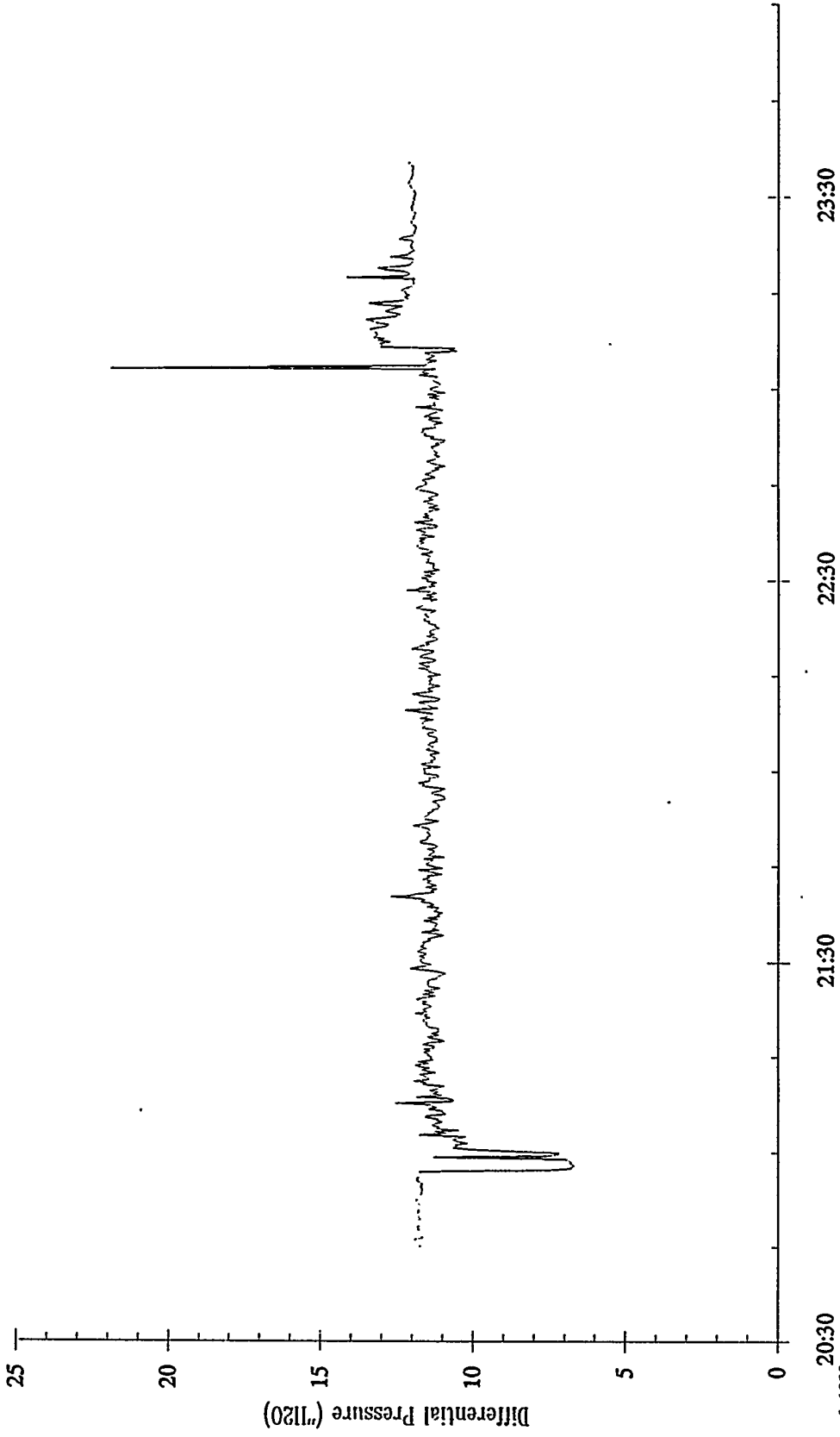

January 6, 1993
Test time: 21:00-23:05 (Test duration: 2:05)

T-2465 Zinc Ferrite
u=1.0 ft/sec T=1000 °F
H2S Inlet Conc. = 800 ppm

Zinc Ferrite Tests - ZFMC-01 Sulfidation 8

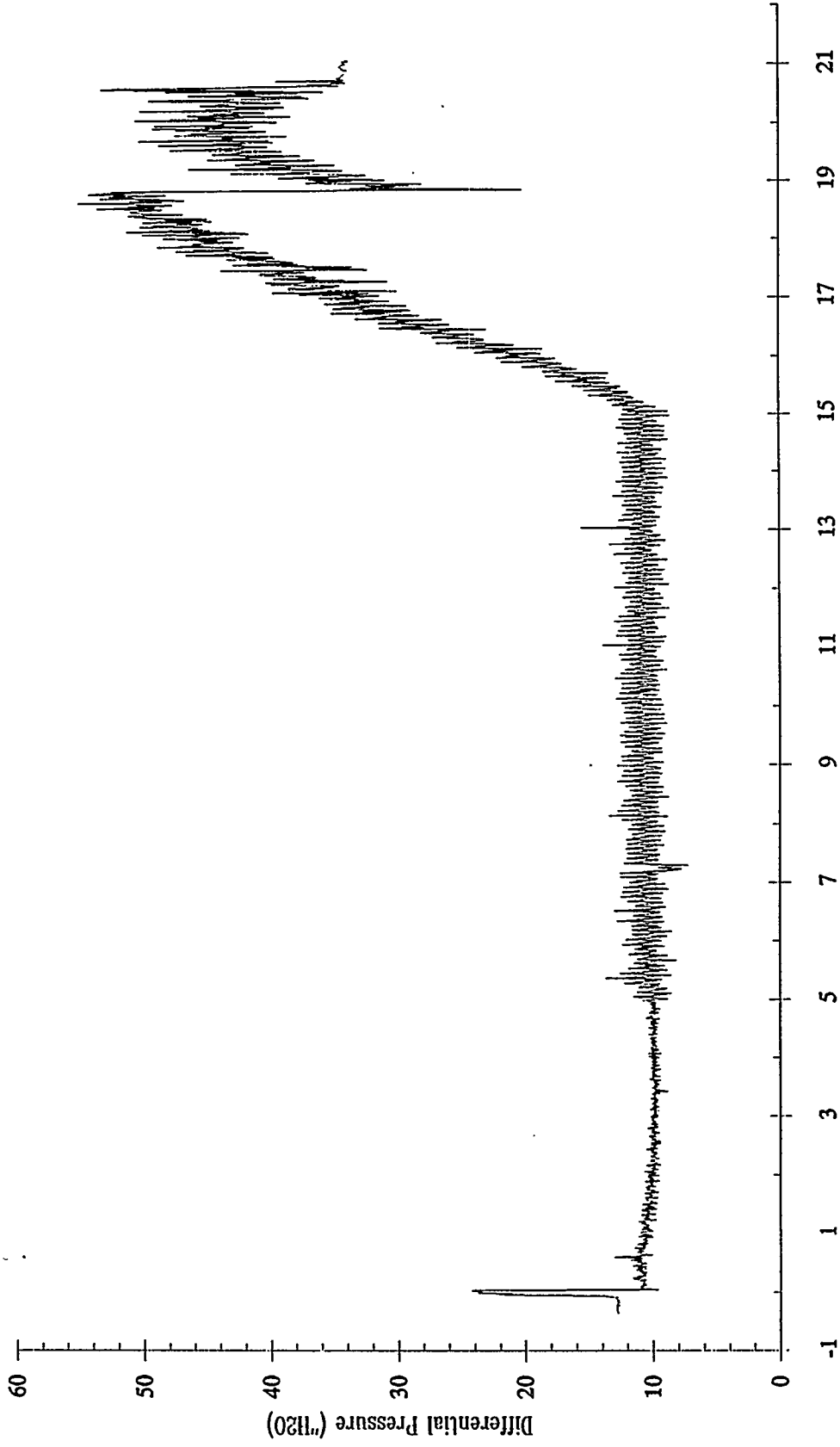

January 7, 1993
Test time: 2:00-22:33 (Test duration: 20:33)

T-2465 Zinc Ferrite
u=1.0 ft/sec T=1075 & 1300 °F
O2 Inlet Conc. = 2.5 & 21%

Zinc Ferrite Tests - ZFMC-01 Oxidative Regeneration 8

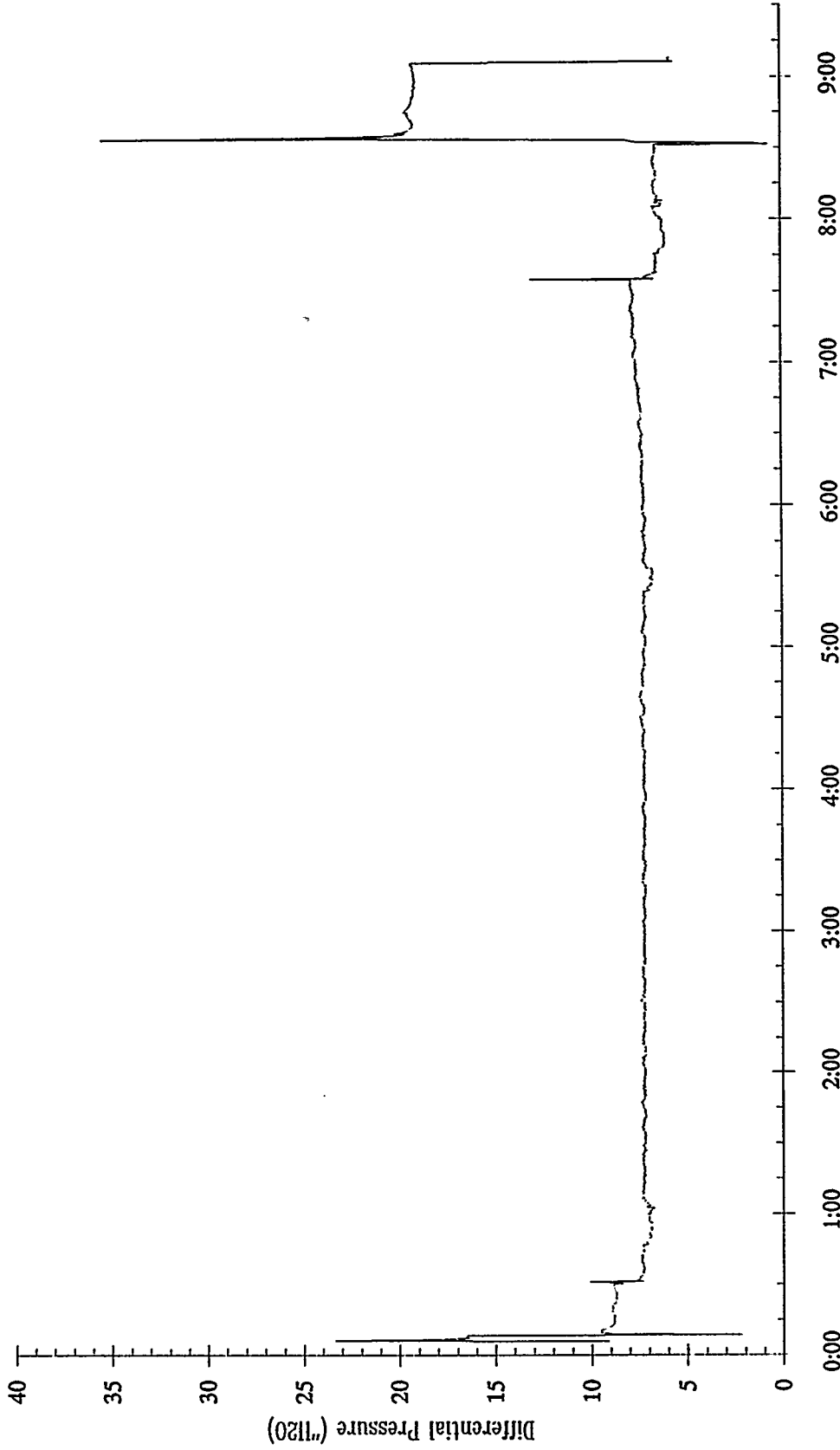

January 8, 1993
Test time: 0:30-8:32 (Test duration: 8:02)

T-2465 Zinc Ferrite
u=1.0 ft/sec T=1000 °F

Zinc Ferrite Tests - ZFMC-01 Reductive Regeneration 8

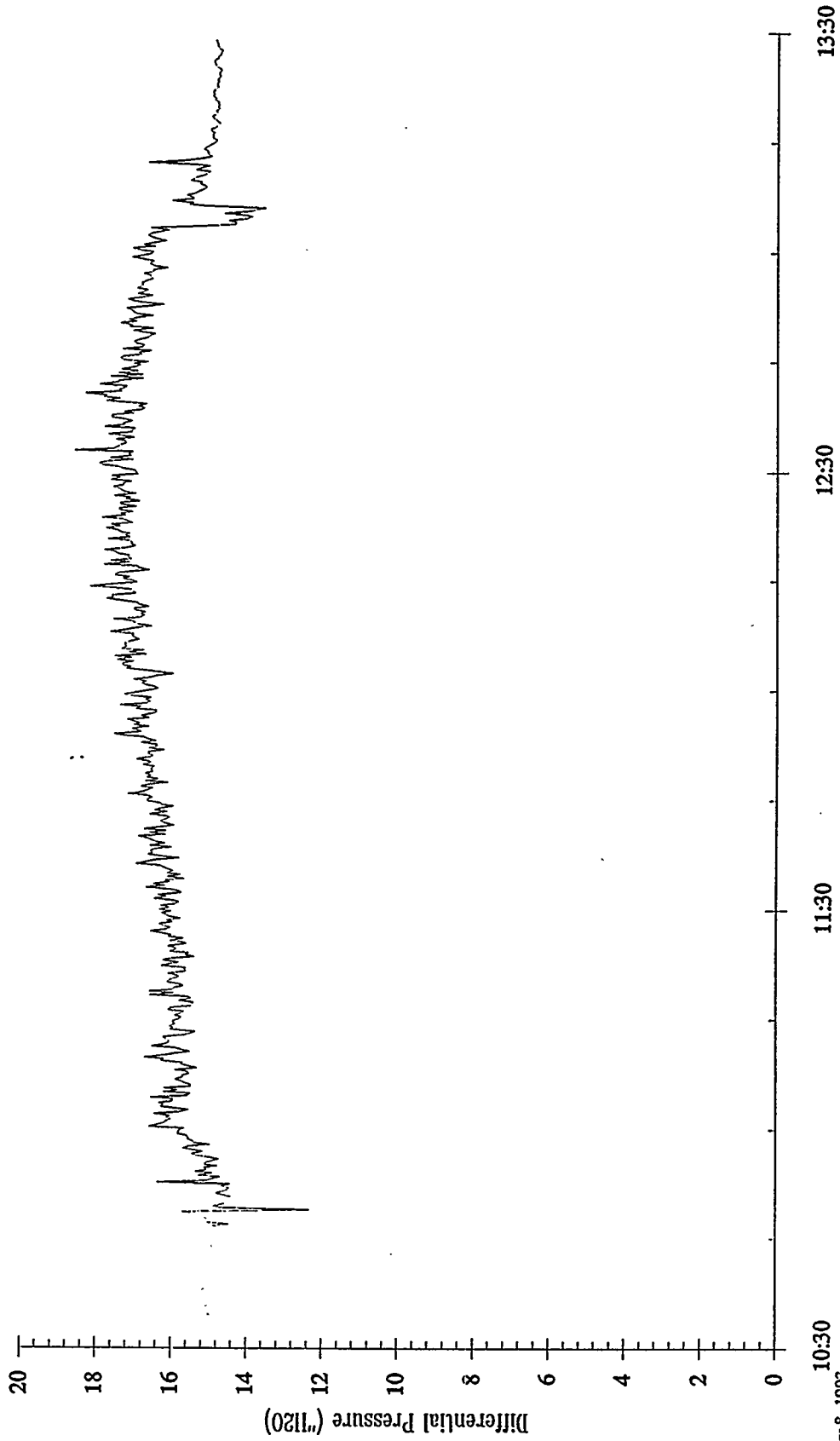

10:30

January 8, 1993

Test time: 11:00-13:03 (Test duration: 2:03)

11:30

12:30

13:30

APPENDIX E
Laboratory Gas Chromatograph Results

Grab samples of the exit gas stream were collected at specific intervals throughout the tests. The analyses for each sample are provided on a dry gas basis.

Some of the GC data sheets have a "H₂S Recalculated" heading. After a number of tests for the CRADA had been performed, it was determined that the H₂S level in a standard used to calibrate the gas chromatographs was decaying and causing inaccuracies in the GC data. The H₂S was apparently being adsorbed onto the cylinder walls and thus the actual H₂S concentration in the cylinder gas was slowly dropping over time. The daily calibration records, along with the beginning and ending actual values of H₂S in the bottle, were used to recalculate and thus correct the H₂S values for tests which were affected.

Outlet samples were taken using a slipstream of the process gas after the pressure control valves, while inlet samples were taken using another slipstream located between the gas preheater and the reactor vessel. Occasional samples were also taken using a sample port located after the final absorber to determine the effectiveness of the zinc oxide sorbent in the absorber.

The major, or fixed, gases (H₂, O₂, N₂, CH₄, CO, and CO₂) were analyzed using two separate gas chromatographs due to the different columns and oven temperatures required. H₂, O₂, N₂, CH₄, and CO were separated using a stainless steel 1/8" X 10' column packed with Molecular Sieve 13X. The gas chromatograph used with the molecular sieve column was a Hewlett Packard 5710A equipped with a Thermal Conductivity Detector (TCD). The detector and injector were held at 150 °C. Helium carrier flow was 25 mL/min and the oven was operated isothermally at 50 °C. CO₂ was separated using a Teflon 1/8" X 6' column packed with Poropak Q 80/100 mesh (Waters Associates Inc.). The Poropak column was used in a Perkin Elmer 8500 gas chromatograph equipped with a TCD. The detector and injector were held at 125 °C. The helium carrier flow was 25 mL/min and the oven was operated isothermally at 40 °C. A 200 µL aliquot of each sample was injected into the gas chromatograph using a gas tight syringe.

The sulfur gases H₂S, COS, and SO₂ were analyzed using four separate gas chromatographs. Low concentrations of H₂S, zero to approximately 150 ppmv, were analyzed using a glass column 1/8" x 6' packed with (40/60 mesh) Carbopack BHT 100. The column was used in a Perkin Elmer Sigma 300 gas chromatograph equipped with a Flame Photometric Detector (FPD). The detector and injector were held at 125 °C. The oven was temperature programmed as follows: 35° for 3 min.; ramped to 125°C at 10 °C/min. and held for 3 min. Helium at 17 mL/min was used as the carrier gas. 50 to 500 µL aliquots of the samples were injected into the gas chromatographs. Medium concentrations of H₂S, 150 to 3000 ppmv, COS, and SO₂ (below one percent) were separated using a 1/8" X

30" Teflon column packed with 18" of Supelcopak S (Supelco, Inc.). The column was used in a Perkin Elmer Sigma 1 gas chromatograph equipped with a Flame Photometric Detector (FPD). The detector and injector were held at 250 °C. The helium carrier gas flow was maintained at 25 mL/min. The oven was temperature programmed as follows: 40 °C for 2 min.; ramped at 10 °C/min to 130 °C and held for 1 min.; ramped at 40 °C/min. to 200 °F and held for 2 min. A 50 to 500 µL aliquot of each sample was injected into the gas chromatograph using a gas tight syringe. SO₂ concentrations greater than one percent were analyzed using a 1/8" X 30" Teflon column packed with 18" of Supelcopak S. The column was used in a Perkin Elmer Sigma 1 gas chromatograph equipped with a Thermal Conductivity Detector. The detector and injector were held at 125 °C while the oven was a constant 65 °C. Helium was used as the carrier gas at a flow rate of 25 mL/min. 100 µL of the samples were injected for this analysis.

High Pressure Hot Gas Desulfurization Lab Gas Analysis

Loca.	Time	December 7, 1992							Normalized to 100				H2S Recalculated			
		H2 %	O2 %	N2 %	CH4 %	CO %	CO2 %	H2S PPM	COS PPM	SO2 PPM						
Inlet	1805	9.59	5.08	61.46	ND	16.25	7.61	19.3	4.5	ND						
Outlet	1805	14.52	0.09	54.00	ND	22.51	8.88	3.3	ND	1.1						
Outlet	1830	17.48	0.10	52.14	ND	17.76	12.51	3.0	ND	ND						
Inlet	1830	14.71	0.10	53.88	ND	22.70	8.59	84.1	64.9	ND						
Inlet	2030	14.65	0.09	53.81	ND	22.83	8.56	559.3	57.0	2.1						
Outlet	2030	20.23	0.08	50.36	ND	12.77	16.56	1.5	ND	ND						
Outlet	2100	20.46	0.08	50.21	ND	12.53	16.72	1.2	ND	ND						
Outlet	2200	19.19	0.08	51.04	ND	14.07	15.62	1.8	ND	ND						
Outlet	2300	18.77	0.09	51.01	ND	15.60	14.53	4.3	ND	ND						

December 8, 1992										
Outlet	0000	18.14	0.08	51.36	ND	16.91	13.50	9.4	ND	2.6
Inlet	0000	14.62	0.09	53.55	ND	22.94	8.74	604.4	57.7	1.7
Outlet	0100	17.87	0.10	52.07	ND	17.61	12.34	26.4	0.7	ND
Outlet	0200	17.27	0.16	52.73	ND	17.86	11.97	80.7	3.4	1.7
Outlet	0300	17.17	0.09	52.39	ND	18.71	11.62	94.7	7.8	ND
Inlet	0400	14.70	0.08	53.89	ND	22.86	8.40	605.3	102.2	1.2
Outlet	0400	16.64	0.08	52.69	ND	19.31	11.27	133.0	10.3	1.0
Outlet	0500	16.68	0.09	52.30	ND	19.93	10.97	189.1	15.7	2.1
Outlet	0600	15.31	0.08	53.36	ND	21.15	10.10	62.7	6.7	ND
Outlet	0700	15.94	0.08	52.95	ND	20.56	10.45	233.8	15.1	1.4
Inlet	0800	14.72	0.08	53.59	ND	22.86	8.68	706.5	53.7	1.9
Outlet	0800	15.80	0.08	53.02	ND	20.97	10.10	336.9	21.4	1.4
Outlet	0900	15.80	0.08	52.90	ND	21.25	9.93	314.9	24.9	0.7
Outlet	1000	15.56	0.08	53.14	ND	21.42	9.76	379.5	28.2	0.4
Outlet	1100	15.24	0.09	53.43	ND	21.50	9.70	347.6	29.6	1.4

ZFMC-01-S1 cont. December 8, 1992

Normalized to 100

H2S Recalculated

Loca.	Time	H2 %	O2 %	N2 %	CH4 %	CO %	CO2 %	H2S PPM	COS PPM	SO2 PPM
Outlet	1200	15.23	0.09	53.34	ND	21.71	9.58	444.9	29.9	2.1
Inlet	1205	14.28	0.10	53.37	ND	22.76	9.42	654.0	49.7	2.1
Outlet	1400	15.11	0.09	53.53	ND	21.74	9.48	449.1	32.7	2.0
Outlet	1600	15.17	0.09	53.41	ND	21.96	9.32	439.5	32.7	2.5
Inlet	1600	14.60	0.09	53.71	ND	22.97	8.55	639.1	53.3	2.2
Outlet	1800	13.28	1.24	55.49	ND	20.94	8.99	561.8	33.0	2.9
Inlet	2000	14.53	0.10	53.71	ND	22.87	8.72	714.3	47.5	1.9
Outlet	2000	15.06	0.10	53.57	ND	21.82	9.37	621.2	38.9	6.0
Outlet	2200	14.92	0.12	53.51	ND	21.98	9.39	790.7	45.4	2.3
Inlet	2300	14.57	0.09	53.62	ND	22.85	8.79	707.7	50.8	2.6
Outlet	2300	14.72	0.12	53.91	ND	21.87	9.32	553.6	42.2	2.6

High Pressure Hot Gas Desulfurization Lab Gas Analysis

ZFMC-01-R1 December 9, 1992

Normalized to 100 H2S Recalculated

Loca.	Time	H2 %	O2 %	N2 %	CH4 %	CO %	CO2 %	H2S PPM	COS PPM	SO2 PPM
Inlet	0315	ND	0.11	99.75	ND	0.01	0.11	81.92	3.0	39.1
Outlet	0315	ND	0.13	99.65	ND	ND	0.14	0.70	1.7	0.08%
Outlet	0330	ND	0.13	99.63	ND	ND	0.13	1.00	2.0	0.11%
Outlet	0345	ND	0.12	99.64	ND	ND	0.13	1.89	1.3	0.11%
Outlet	0400	ND	0.13	99.64	ND	ND	0.12	2.19	1.0	0.11%
Inlet	0430	ND	1.96	97.93	ND	0.01	0.09	12.54	1.3	75.5
Outlet	0500	ND	0.14	98.46	ND	ND	0.11	1.80	0.9	1.29%
Outlet	0830	ND	0.14	98.61	ND	ND	0.06	5.30	0.4	1.19%
Inlet	0835	ND	2.01	97.93	ND	ND	0.05	ND	ND	4.5
Outlet	0900	ND	0.13	98.74	ND	ND	0.06	5.91	ND	1.07%
Outlet	1000	ND	0.12	98.61	ND	ND	0.07	6.37	0.4	1.20%
Outlet	1100	ND	0.17	98.82	ND	ND	0.06	0.30	ND	0.96%
Outlet	1200	ND	9.99	89.88	ND	ND	0.08	4.53	ND	482.1
Inlet	1300	ND	2.03	97.94	ND	ND	0.03	ND	ND	ND
Outlet	1300	ND	1.56	98.08	ND	ND	0.04	ND	ND	0.32%
Outlet	1400	ND	3.40	96.49	ND	ND	0.05	ND	ND	645.7
Inlet	1430	ND	3.30	96.67	ND	ND	0.03	ND	ND	1.7
Outlet	1500	ND	3.33	96.59	ND	ND	0.04	ND	ND	460.1
Outlet		ND	5.82	94.13	ND	ND	0.04	ND	ND	67.7
Inlet	1630	ND	6.70	93.27	ND	ND	0.03	ND	ND	ND
Outlet	1700	ND	5.84	94.13	ND	ND	0.02	ND	ND	83.4
Inlet	1800	ND	20.84*	79.15	ND	ND	0.01	ND	ND	0.9
Outlet	1800	2.66	10.45	69.48	ND	11.30	6.09	151.21	12.7	5.1

* Possible air in sample

High Pressure Hot Gas Desulfurization Lab Gas Analysis

ZFMC-01-RR1 December 9, 1992 Normalized to 100

Loca.	Time	H2 %	O2 %	N2 %	CH4 %	CO %	CO2 %	H2S PPM	COS PPM	SO2 PPM
Outlet	2045	2.62	0.13	91.35	ND	3.29	2.61	4.1	0.3	ND
Outlet	2100	3.08	0.12	90.99	ND	2.81	3.01	3.5	ND	ND
Inlet	2130	1.98	0.23	92.07	ND	3.93	1.79	<0.3	2.8	ND
Outlet	2130	3.66	0.12	90.45	ND	2.41	3.35	2.4	ND	ND
Outlet	2230	4.14	0.12	90.23	ND	2.03	3.48	1.0	ND	ND
Outlet	2330	3.96	0.15	90.13	ND	2.01	3.75	<0.3	ND	ND
Inlet	2330	1.94	0.11	92.13	ND	3.97	1.86	<0.3	1.0	ND

High Pressure Hot Gas Desulfurization Lab Gas Analysis

ZFMC-01-S2 December 10, 1992

Normalized to 100 H2S Recalculated

Loca.	Time	H2 %	O2 %	N2 %	CH4 %	CO %	CO2 %	H2S PPM	COS PPM	SO2 PPM
Inlet	0145	14.60	0.10	53.87	ND	22.91	8.49	139.7	103.2	ND
Outlet	0145	22.25	0.08	49.13	ND	9.01	19.52	4.8	ND	ND
Outlet	0200	22.35	0.08	48.95	ND	9.27	19.35	5.7	ND	ND
Outlet	0215	15.77	6.33*	57.83	ND	7.13	12.93	2.8	ND	10.6
Outlet	0230	21.36	0.09	49.72	ND	11.29	17.54	4.1	ND	ND
Inlet	0300	14.64	0.09	53.73	ND	22.98	8.52	389.0	82.7	1.2
Outlet	0330	19.79	0.09	50.56	ND	14.06	15.49	2.1	ND	ND
Outlet	0430	18.72	0.09	51.37	ND	15.67	14.15	4.4	ND	ND
Inlet	0530	14.65	0.07	53.66	ND	22.94	8.62	549.4	77.9	1.6
Outlet	0530	18.64	0.08	51.15	ND	16.43	13.69	2.1	ND	ND
Outlet	0630	17.98	0.08	51.61	ND	17.41	12.93	6.9	ND	1.8
Outlet	0730	18.13	0.08	51.49	ND	17.14	13.15	14.0	0.9	2.4
Outlet	0830	17.42	0.08	51.98	ND	18.23	12.29	42.7	2.5	ND
Inlet	0930	14.71	0.08	53.63	ND	22.91	8.59	679.0	54.1	2.7
Outlet	0930	17.32	0.08	52.03	ND	18.73	11.83	93.7	6.7	ND
Outlet	1030	8.06	2.84	76.40	ND	7.79	4.85	35.4	2.3	604.4
Outlet	1130	16.34	0.10	52.80	ND	20.05	10.69	154.9	16.3	0.9
Inlet	1200	14.64	0.11	53.86	ND	22.92	8.40	707.3	60.8	8.4
Hot Hold (Snow)										
December 11, 1992										
Inlet	1300	14.57	0.13	54.00	ND	22.61	8.63	494.5	82.3	3.5
Outlet	1300	16.62	0.07	52.71	ND	19.58	11.00	200.3	15.9	1.3
Outlet	1430	16.06	0.07	53.03	ND	20.16	10.64	229.2	22.4	4.9
Outlet	1530	15.99	0.08	53.02	ND	20.37	10.51	285.3	25.1	2.4
Inlet	1630	4.10	15.61*	71.23	ND	6.31	2.73	132.0	52.1	77.9
Outlet	1630	15.95	0.16	52.83	ND	20.14	10.66	257.5	23.6	2434.7

* Possible air in sample

ZFMC-01-S2 cont. December 14, 1992

Normalized to 100 H2S Recalculated

Loca.	Time	H2 %	O2 %	N2 %	CH4 %	CO %	CO2 %	H2S PPM	COS PPM	SO2 PPM
Outlet	0930	15.65	0.09	53.13	ND	21.71	9.39	289.8	28.2	1.3
Inlet	0930	14.69	0.09	53.60	ND	23.23	8.32	627.3	40.8	1.4
Outlet	1000	15.67	0.09	53.08	ND	21.41	9.72	302.7	31.4	4.3
Outlet	1030	15.84	0.11	53.09	ND	21.42	9.51	320.5	31.5	1.9
Outlet	1100	15.57	0.10	53.47	ND	21.65	9.17	342.2	31.8	1.0
Outlet	1200	18.22	0.10	71.30	ND	0.36	9.98	460.0	ND	0.7
Outlet	1300	15.35	0.09	53.35	ND	21.94	9.24	400.4	33.3	6.3
Outlet	1400	15.48	0.09	53.33	ND	22.04	9.01	431.3	34.8	1.2
Inlet	1400	14.75	0.09	53.71	ND	23.08	8.29	696.2	48.0	7.9
Outlet	1500	15.15	0.09	53.44	ND	22.20	9.07	465.7	39.4	4.1
Outlet	1600	15.07	0.10	53.47	ND	22.31	9.00	491.3	31.2	3.0
Outlet	1700	15.14	0.08	53.36	ND	22.48	8.89	535.4	37.3	2.2
Inlet	1800	14.65	0.09	53.50	ND	23.07	8.63	667.1	47.0	2.5
Outlet	1800	14.96	0.09	53.46	ND	22.49	8.94	517.5	44.2	1.1
Outlet	1900	14.90	0.10	53.50	ND	22.59	8.85	540.5	36.5	4.0
Outlet	2000	14.81	0.08	53.41	ND	22.60	9.03	500.5	40.4	82.4
Inlet	2100	14.69	0.07	53.42	ND	22.97	8.77	734.8	50.4	9.9
Outlet	2100	14.79	0.08	53.33	ND	22.67	9.07	599.2	43.0	3.2

High Pressure Hot Gas Desulfurization Lab Gas Analysis

ZFMC-01-R2 December 14, 1992 Normalized to 100

Loca.	Time	H2 %	O2 %	N2 %	CH4 %	CO %	CO2 %	H2S PPM	COS PPM	SO2 PPM
Inlet	2330	ND	0.11	99.74	ND	ND	0.03	3.1	0.6	1185.2
Outlet	2330	ND	0.12	99.62	ND	0.01	0.04	1.6	0.4	2122.2
December 15, 1992										
Outlet	0000	ND	0.11	99.62	ND	ND	0.04	1.0	0.5	2275.5
Outlet	0100	ND	0.12	99.64	ND	ND	0.02	0.9	0.7	2230.1
Outlet	0200	ND	0.12	99.63	ND	ND	0.03	0.6	ND	2176.6
Outlet	0300	ND	0.11	99.65	ND	ND	0.03	0.8	0.4	2164.7
Inlet	0400	ND	0.12	99.66	ND	0.06	0.10	<0.3	ND	529.8
Outlet	0400	ND	0.11	99.63	ND	ND	0.04	0.5	0.6	2194.9
Outlet	0500	ND	0.11	99.64	ND	ND	0.02	0.3	ND	2295.9
Outlet	0600	ND	0.11	99.58	ND	ND	0.10	<0.3	ND	2157.6
Outlet	0700	ND	9.21	90.64	ND	ND	0.04	<0.3	ND	1067.9
Outlet	0800	ND	0.18	99.59	ND	ND	0.02	<0.3	ND	2160.6
Inlet	0900	ND	0.11	99.82	ND	ND	0.02	<0.3	ND	531.3
Outlet	0900	ND	0.12	99.65	ND	ND	0.01	<0.3	ND	2248.1
Outlet	1000	ND	0.12	99.63	ND	ND	0.02	0.3	ND	2359.0
Outlet	1100	ND	0.12	98.59	ND	ND	0.02	0.5	ND	1.27%
Outlet	1200	ND	0.17	98.39	ND	ND	ND	0.3	ND	1.45%
Inlet	1200	ND	1.97	97.93	ND	ND	0.03	<0.3	ND	737.1
Outlet	1300	ND	0.11	98.59	ND	ND	0.03	<0.3	ND	1.27%
Outlet	1400	ND	0.39	98.53	ND	ND	0.02	0.5	ND	1.07%
Outlet	1500	ND	1.35	97.95	ND	ND	0.03	1.1	ND	6720.5
Outlet	1600	ND	1.95	97.86	ND	ND	ND	<0.3	ND	1827.5
Inlet	1600	ND	2.07	97.93	ND	ND	ND	<0.3	ND	23.0
Outlet	1700	ND	3.50	96.49	ND	ND	ND	<0.3	ND	102.6
Inlet	1730	ND	3.45	96.55	ND	ND	ND	<0.3	ND	7.7

ZFMC-01-R2 cont. December 15, 1992

Normalized to 100

Loca.	Time	H2 %	O2 %	N2 %	CH4 %	CO %	CO2 %	H2S PPM	COS PPM	SO2 PPM
Outlet	1800	ND	3.51	96.49	ND	ND	ND	<0.3	ND	69.0
Outlet	1900	ND	6.21	93.78	ND	ND	ND	<0.3	ND	57.3
Inlet	1945	ND	6.03	93.95	ND	ND	0.02	<0.3	ND	6.5
Outlet	1945	ND	6.01	93.98	ND	ND	ND	<0.3	ND	28.6
Outlet	2100	ND	20.69*	79.28	ND	ND	0.03	<0.3	ND	37.5
Outlet	2130	ND	20.69*	79.27	ND	ND	0.04	<0.3	ND	25.5
Inlet	2130	ND	20.67*	79.26	ND	ND	0.07	<0.3	ND	1.9

* possible air in sample

High Pressure Hot Gas Desulfurization Lab Gas Analysis

ZFMC-01-RR2		December 15, 1992		Normalized to 100									
Loca.	Time	H2 %	O2 %	N2 %	CH4 %	CO %	CO2 %	H2S PPM	COS PPM	SO2 PPM			
Outlet	2330	3.16	0.10	91.15	ND	2.54	3.05	6.1	0.3	2.6			
Inlet	2330	4.39	0.13	90.02	ND	1.41	4.05	7.3	54.7	24.7			
December 16, 1992													
Outlet	0000	3.75	0.11	90.70	ND	2.12	3.32	4.3	ND	1.1			
Inlet	0100	2.68	0.16	91.56	ND	2.86	2.74	8.1	7.7	3.8			
Outlet	0100	3.99	0.10	90.35	ND	1.83	3.73	3.2	ND	ND			

High Pressure Hot Gas Desulfurization Lab Gas Analysis

ZFMC-01-S3 December 16, 1992

Normalized to 100 H2S Recalculated

Loca.	Time	H2 %	O2 %	N2 %	CH4 %	CO %	CO2 %	H2S PPM	COS PPM	SO2 PPM
Inlet	0345	14.53	0.08	54.29	ND	23.24	7.83	106.6	181.3	1.2
Outlet	0345	22.47	0.07	49.24	ND	8.93	19.28	3.7	ND	ND
Outlet	0400	22.28	0.07	49.40	ND	9.50	18.74	5.0	ND	ND
Outlet	0415	21.58	0.07	49.42	ND	10.49	18.44	4.2	ND	ND
Outlet	0430	21.16	0.08	49.58	ND	11.41	17.76	3.9	ND	1.0
Inlet	0500	14.52	0.07	53.76	ND	22.98	8.60	501.4	111.1	3.4
Outlet	0530	19.73	0.08	50.50	ND	13.89	15.80	4.0	ND	0.8
Outlet	0630	18.36	0.09	51.42	ND	15.10	15.03	3.2	ND	2.1
Inlet	0730	14.74	0.07	53.46	ND	22.86	8.80	649.1	86.0	2.7
Outlet	0730	18.66	0.07	51.07	ND	16.18	14.01	4.4	ND	ND
Outlet	0830	17.66	0.08	51.72	ND	17.85	12.69	5.8	0.6	ND
Outlet	0930	16.51	0.43	52.81	ND	18.01	12.24	10.5	0.6	0.8
Outlet	1030	16.51	0.40	52.81	ND	18.73	11.55	31.2	3.9	1.0
Outlet	1130	16.73	0.09	52.45	ND	19.52	11.20	68.5	7.5	1.3
Inlet	1130	14.61	0.10	53.74	ND	22.83	8.63	720.2	87.5	3.6
Outlet	1230	16.29	0.08	52.72	ND	19.97	10.93	125.5	10.3	ND
Outlet	1330	16.08	0.09	52.83	ND	20.30	10.69	133.7	13.1	1.9
Outlet	1430	15.91	0.09	52.71	ND	21.03	10.24	174.6	18.2	1.5
Outlet	1530	15.78	0.08	52.96	ND	20.97	10.19	209.4	22.1	2.2
Inlet	1530	14.69	0.08	53.58	ND	22.84	8.73	724.9	75.4	1.0
Outlet	1630	15.45	0.21	53.05	ND	21.02	10.24	271.2	26.3	2.5
Outlet	1730	15.53	0.12	53.01	ND	21.25	10.04	342.8	29.4	0.9
Outlet	1830	15.40	0.08	53.05	ND	21.52	9.91	367.6	34.3	3.8
Inlet	1930	13.31	0.83	54.86	ND	21.97	8.95	733.1	79.4	8.2
Outlet	1930	15.38	0.08	53.13	ND	21.53	9.83	408.9	35.2	1.0
Outlet	2030	15.30	0.08	53.14	ND	21.63	9.80	403.2	37.4	ND
Outlet	2130	15.09	0.08	53.36	ND	21.92	9.49	481.8	38.6	3.7

ZFMC-01-S3 cont. December 16, 1992 Normalized to 100 H2S Recalculated

Loca.	Time	H2 %	O2 %	N2 %	CH4 %	CO %	CO2 %	H2S PPM	COS PPM	SO2 PPM
Outlet	2230	16.45	0.09	57.92	ND	23.30	2.18	524.9	44.8	2.4
Outlet	2330	14.97	0.10	53.54	ND	22.06	9.27	508.0	44.4	ND
Inlet	2330	14.78	0.09	53.54	ND	22.59	8.91	784.3	87.2	0.8

December 17, 1992

Outlet	0030	14.92	0.11	53.61	ND	22.06	9.24	515.2	45.9	12.3
Outlet	0130	14.96	0.07	53.49	ND	22.20	9.21	578.1	50.3	2.7
Inlet	0230	13.85	2.19	56.27	ND	20.14	7.48	452.6	277.7	6.3
Outlet	0230	14.86	0.07	53.60	ND	22.23	9.17	616.7	51.8	1.5

High Pressure Hot Gas Desulfurization Lab Gas Analysis

ZFMC-01-R3 December 17, 1992 Normalized to 100

Loca.	Time	H2 %	O2 %	N2 %	CH4 %	CO %	CO2 %	H2S PPM	COS PPM	SO2 PPM
Inlet	0545	ND	0.13	99.56	ND	ND	0.17	3.7	0.4	1410.5
Outlet	0545	ND	0.15	99.42	ND	ND	0.16	0.7	ND	2702.4
Outlet	0600	ND	0.13	99.40	ND	ND	0.17	0.7	ND	2974.5
Outlet	0615	ND	0.13	99.45	ND	ND	0.16	0.6	ND	2537.2
Outlet	0630	ND	0.12	99.38	ND	ND	0.19	0.5	ND	3090.6
Inlet	0700	ND	0.41	99.32	ND	ND	0.17	0.5	ND	1008.1
Outlet	0730	ND	0.13	99.40	ND	ND	0.15	0.5	ND	3179.5
Outlet	0830	ND	0.32	99.26	ND	ND	0.12	0.3	ND	2992.4
Outlet	0930	ND	0.14	99.47	ND	ND	0.09	0.5	ND	3027.1
Outlet	1030	ND	0.13	98.49	ND	ND	0.08	0.6	ND	1.30%
Outlet	1130	ND	0.13	98.22	ND	ND	0.06	0.4	ND	1.59%
Inlet	1130	ND	2.03	97.85	ND	ND	0.08	<0.3	ND	365.9
Outlet	1230	ND	0.13	98.53	ND	ND	0.05	0.4	ND	1.29%
Outlet	1330	ND	0.15	98.24	ND	ND	0.07	<0.3	ND	1.54%
Outlet	1430	ND	0.82	98.08	ND	ND	0.07	0.3	ND	1.03%
Outlet	1530	ND	1.74	97.83	ND	ND	0.04	<0.3	ND	3935.8
Inlet	1530	ND	2.09	97.85	ND	ND	0.04	<0.3	ND	152.6
Outlet	1730	ND	2.16	97.77	ND	ND	0.06	<0.3	ND	56.5
Outlet	1830	ND	3.47	96.49	ND	ND	0.04	<0.3	ND	25.5
Inlet	1830	ND	3.43	96.52	ND	ND	0.05	<0.3	ND	25.4
Outlet	1930	ND	3.46	96.49	ND	ND	0.04	<0.3	ND	48.6
Inlet	1930	ND	3.45	96.49	ND	ND	0.06	<0.3	ND	8.4
Inlet	2020	ND	6.02*	93.95	ND	ND	0.03	<0.3	ND	2.2
Outlet	2030	ND	6.07*	93.88	ND	ND	0.04	<0.3	ND	22.3
Outlet	2130	ND	6.08*	93.86	ND	ND	0.06	<0.3	ND	31.9
Outlet	2230	ND	20.81*	79.10	ND	ND	0.09	<0.3	ND	20.2
Inlet	2230	ND	20.84*	79.09	ND	ND	0.07	<0.3	ND	2.4

* possible air in sample

High Pressure Hot Gas Desulfurization Lab Gas Analysis

ZFMC-01-RR3 December 18, 1992 Normalized to 100

Loca.	Time	H2 %	O2 %	N2 %	CH4 %	CO %	CO2 %	H2S PPM	COS PPM	SO2 PPM
Outlet	0030	3.06	0.13	91.20	ND	2.70	2.91	4.3	0.5	1.2
Inlet	0100	4.42	0.11	89.93	ND	1.34	4.19	<0.3	73.5	35.2
Outlet	0100	3.40	0.12	90.91	ND	2.38	3.19	3.3	ND	1.6
Outlet	0200	3.73	0.11	90.57	ND	2.24	3.35	2.1	ND	0.6

High Pressure Hot Gas Desulfurization Lab Gas Analysis

Loca.	Time	December 18, 1992						Normalized to 100						H2S Recalculated		
		H2 %	O2 %	N2 %	CH4 %	CO %	CO2 %	CO %	CH4 %	CO %	CO2 %	H2S PPM	COS PPM	SO2 PPM		
Inlet	0415	14.53	0.09	53.65	ND	23.14	8.53	499.8	162.5	28.3						
Outlet	0430	20.44	0.43	50.36	ND	11.62	17.16	7.2	ND	ND						
Outlet	0445	20.17	0.06	50.46	ND	13.17	16.14	6.7	ND	ND						
Outlet	0500	19.81	0.07	50.73	ND	14.18	15.21	6.5	ND	ND						
Outlet	0600	19.25	0.08	50.91	ND	15.29	14.47	3.9	ND	ND						
Outlet	0700	17.32	0.11	52.29	0.01	18.19	12.08	3.0	ND	0.8						
Inlet	0800	15.15	0.11	53.61	0.01	21.96	9.09	587.3	123.0	7.3						
Outlet	0800	17.60	0.14	52.18	0.02	17.67	12.40	6.8	0.2	1.6						
Outlet	0900	17.28	0.08	52.08	ND	18.44	12.11	13.1	0.6	ND						
Outlet	1000	17.11	0.08	52.11	ND	18.94	11.76	27.5	0.8	ND						
Outlet	1100	17.00	0.08	52.26	ND	19.28	11.37	63.1	5.3	0.8						
Outlet	1200	16.71	0.07	52.45	ND	19.67	11.09	88.7	9.1	0.8						
Inlet	1200	15.12	0.08	53.26	ND	22.24	9.23	705.6	65.8	4.5						
Outlet	1300	16.32	0.23	52.80	ND	19.89	10.74	129.9	13.5	2.1						
Outlet	1400	16.23	0.14	52.79	ND	20.23	10.58	178.9	18.0	2.2						
Outlet	1500	15.75	0.09	53.05	ND	21.06	10.03	216.1	21.8	1.0						
Outlet	1600	15.92	0.09	52.92	ND	20.80	10.25	230.9	24.3	1.3						
Inlet	1600	14.36	0.11	53.77	ND	23.19	8.48	790.5	25.7	2.7						
December 21, 1992																
Outlet	1000	15.89	0.08	52.44	ND	20.60	10.97	241.1	24.0	ND						
Inlet	1030	14.95	0.08	53.08	ND	22.48	9.33	653.7	62.1	ND						
Outlet	1030	15.79	0.08	52.72	ND	20.97	10.41	284.3	28.7	ND						
Outlet	1130	15.78	0.08	52.95	ND	21.04	10.12	280.0	34.6	ND						
Outlet	1230	15.67	0.12	53.26	0.01	20.90	10.01	321.5	38.1	ND						
Outlet	1330	15.75	0.12	53.09	0.02	20.98	10.00	368.6	41.7	ND						
Inlet	1430	14.73	0.41	53.84	0.01	21.54	9.39	686.6	48.0	1.8						

ZFMC-01-S4 cont. December 21, 1992

Normalized to 100

H2S Recalculated

Loca.	Time	H2 %	O2 %	N2 %	CH4 %	CO %	CO2 %	H2S PPM	COS PPM	SO2 PPM
Outlet	1430	15.55	0.12	53.24	0.02	21.10	9.92	406.6	39.8	ND
Outlet	1530	15.42	0.09	53.21	ND	21.47	9.76	431.7	42.8	ND
Outlet	1630	10.11	7.98*	62.64	ND	13.22	6.03	250.9	27.2	ND
Outlet	1730	15.46	0.10	53.17	ND	21.45	9.76	545.5	46.5	ND
Outlet	1830	15.32	0.09	53.27	ND	21.65	9.61	495.3	46.1	ND
Inlet	1830	14.98	0.08	53.26	ND	22.19	9.40	791.1	65.0	ND
Outlet	1930	15.38	0.09	53.05	ND	21.74	9.67	582.9	49.3	1.7
Inlet	2030	15.41	0.08	53.92	ND	21.02	9.49	763.8	81.6	0.9
Outlet	2030	15.34	0.08	53.14	ND	21.74	9.64	536.6	56.2	ND

* possible air in sample

High Pressure Hot Gas Desulfurization Lab Gas Analysis

ZFMC-01-R4 December 28, 1992 Normalized to 100

Loca.	Time	H2 %	O2 %	N2 %	CH4 %	CO %	CO2 %	H2S PPM	COS PPM	SO2 PPM
Inlet		ND	0.13	99.10	ND	ND	0.08	ND	ND	0.69%
Outlet	1005	ND	0.13	98.72	ND	ND	0.06	1.1	ND	1.09%
Outlet	1030	ND	0.13	98.58	ND	ND	ND	0.8	ND	1.29%
Outlet	1045	ND	0.14	98.55	ND	ND	ND	0.9	ND	1.31%
Outlet	1100	ND	0.13	98.62	ND	ND	ND	0.7	ND	1.25%
Inlet	1130	ND	2.01	97.93	ND	ND	ND	ND	ND	559.7
Outlet	1200	ND	0.13	98.56	ND	ND	ND	0.4	ND	1.31%
Outlet	1300	ND	0.13	98.55	ND	ND	ND	0.3	ND	1.31%
Outlet	1400	ND	0.10	98.59	ND	ND	ND	ND	ND	1.31%
Outlet	1500	ND	0.38	98.55	ND	ND	ND	ND	ND	1.07%
Inlet	1500	ND	2.02	97.95	ND	ND	ND	ND	ND	255.1
Outlet	1600	ND	1.59	98.04	ND	ND	ND	0.3	ND	0.37%
Outlet	1700	ND	2.03	97.89	ND	ND	ND	<0.3	ND	824.6
Outlet	1800	ND	2.11	97.88	ND	ND	ND	ND	ND	110.2
Outlet	1830	ND	20.78*	79.22	ND	ND	ND	<0.3	ND	27.7
Inlet	1830	ND	20.74*	79.25	ND	ND	ND	<0.3	ND	67.7
Outlet	1930	ND	20.79*	79.20	ND	ND	ND	<0.3	ND	16.4

* possible air in sample

High Pressure Hot Gas Desulfurization Lab Gas Analysis

ZFMC-01-RR4 December 28, 1992 Normalized to 100

Loca.	Time	H2 %	O2 %	N2 %	CH4 %	CO %	CO2 %	H2S PPM	COS PPM	SO2 PPM
Outlet	2115	2.69	0.14	91.10	ND	3.07	3.00	5.3	0.4	1.1
Outlet	2130	2.98	0.11	90.89	ND	2.85	3.16	3.1	0.2	ND
Outlet	2200	3.62	0.15	90.28	ND	2.33	3.62	2.4	ND	ND
Inlet	2200	4.15	0.11	89.78	ND	1.82	4.13	10.1	37.8	3.4
Outlet	2300	3.79	0.10	90.19	ND	2.19	3.74	1.8	ND	ND

High Pressure Hot Gas Desulfurization Lab Gas Analysis

ZFMC-01-S5 December 29, 1992

Normalized to 100 H2S Recalculated

Loca.	Time	H2 %	O2 %	N2 %	CH4 %	CO %	CO2 %	H2S PPM	COS PPM	SO2 PPM
Outlet	0230	21.56	0.08	49.23	ND	10.74	18.39	5.6	ND	ND
Outlet	0300	21.90	0.07	49.24	ND	10.18	18.61	7.5	ND	ND
Inlet	0300	14.97	0.08	53.39	ND	22.29	9.20	558.3	141.1	6.1
Outlet	0400	19.24	0.64	51.06	ND	13.25	15.82	3.9	ND	ND
Outlet	0500	18.00	0.37	51.56	ND	15.97	14.09	2.8	ND	ND
Outlet	0600	18.98	0.10	50.83	ND	15.11	14.98	3.4	ND	ND
Outlet	0700	19.62	0.08	50.37	ND	14.53	15.40	4.1	ND	ND
Inlet	0700	16.86	0.10	52.09	ND	19.29	11.58	646.2	87.1	1.6
Outlet	0800	18.24	0.11	51.23	ND	16.75	13.66	5.2	ND	ND
Outlet	0900	17.95	0.10	51.37	ND	17.35	13.23	6.6	ND	ND
Outlet	1000	17.60	0.10	51.70	ND	17.83	12.77	16.8	1.4	ND
Outlet	1100	17.46	0.09	51.64	ND	18.18	12.61	86.0	3.5	ND
Inlet	1200	15.65	0.08	52.61	ND	21.33	10.25	773.2	56.2	2.2
Outlet	1200	17.00	0.09	51.96	ND	19.07	11.87	95.5	9.1	ND
Outlet	1300	17.18	0.09	52.43	ND	19.17	11.12	151.6	15.2	ND
Outlet	1400	16.38	0.11	52.92	ND	20.17	10.40	211.2	21.8	2.2
Outlet	1500	16.74	0.11	57.18	ND	15.40	10.55	254.7	20.3	0.7
Outlet	1600	16.32	0.11	52.85	ND	19.98	10.71	241.1	25.7	20.4
Inlet	1600	15.60	0.10	53.21	ND	21.37	9.63	715.2	64.5	0.7
Outlet	1700	16.18	0.10	52.78	ND	20.28	10.61	414.0	38.1	9.5
Outlet	1800	15.99	0.10	52.75	ND	20.40	10.72	305.2	30.0	2.9
Outlet	1900	15.63	0.09	52.85	ND	21.11	10.27	454.7	31.9	1.4
Outlet	2000	15.79	0.09	52.88	ND	20.87	10.31	475.1	38.2	2.3
Inlet	2000	15.31	0.09	53.02	ND	21.81	9.70	687.5	66.9	ND
Outlet	2100	15.72	0.09	52.74	ND	21.08	10.31	525.0	48.6	2.8
Outlet	2200	15.45	0.09	52.88	ND	21.40	10.13	509.0	50.2	1.4
Outlet	2300	14.70	0.13	54.87	ND	20.48	9.76	489.1	50.7	3.5
Inlet	2300	16.70	0.10	60.21	ND	11.36	11.52	956.4	45.9	3.5

High Pressure Hot Gas Desulfurization Lab Gas Analysis

ZFMC-01-R5 December 30, 1992 Normalized to 100

Loca.	Time	H2 %	O2 %	N2 %	CH4 %	CO %	CO2 %	H2S PPM	COS PPM	SO2 PPM
Outlet	0215	ND	0.24	98.38	ND	ND	0.12	1.5	ND	1.26%
Outlet	0230	ND	0.13	98.49	ND	ND	0.11	1.4	ND	1.27%
Outlet	0300	ND	0.13	98.50	ND	ND	0.09	1.3	ND	1.29%
Inlet	0310	ND	1.80	97.97	ND	ND	0.09	ND	0.7	1406.7
Outlet	0400	ND	0.13	98.57	ND	ND	0.07	1.3	ND	1.23%
Outlet	0500	ND	0.13	98.60	ND	ND	0.06	1.0	ND	1.22%
Outlet	0600	ND	0.12	98.57	ND	ND	0.06	ND	ND	1.26%
Outlet	0700	ND	0.70	98.32	ND	ND	0.04	ND	ND	0.94%
Inlet	0700	ND	2.05	97.90	ND	ND	0.05	ND	ND	11.5
Outlet	0800	ND	1.91	97.82	ND	ND	0.05	ND	ND	2260.1
Outlet	0900	ND	2.09 [†]	97.85	ND	ND	0.04	ND	ND	184.2
Outlet	1002	ND	2.11 [*]	97.82	ND	ND	0.05	ND	ND	191.5
Outlet	1100	ND	20.79 [*]	79.18	ND	ND	0.03	ND	ND	36.0
Inlet	1100	ND	20.70 [*]	79.26	ND	ND	0.04	ND	ND	16.5
Outlet	1130	ND	20.79 [†]	79.17	ND	ND	0.04	ND	ND	24.4

^{*} possible air in sample

High Pressure Hot Gas Desulfurization Lab Gas Analysis

ZFMC-01-RR5 .. December 30, 1992

Normalized to 100

Loca.	Time	H2 %	O2 %	N2 %	CH4 %	CO %	CO2 %	H2S PPM	COS PPM	SO2 PPM
Outlet	1315	1.54	0.11	91.99	ND	3.76	2.60	<0.3	1.1	3.5
Outlet	1330	3.50	0.11	90.36	ND	2.51	3.52	<0.3	ND	1.5
Outlet	1345	3.71	0.11	90.03	ND	2.38	3.78	4.7	ND	ND
Outlet	1400	3.75	0.10	89.96	ND	2.34	3.84	4.7	ND	ND
Inlet	1400	4.35	0.15	89.44	ND	1.52	4.53	ND	74.4	2.9
Outlet	1430	3.90	0.15	89.82	ND	2.19	3.93	<0.3	ND	ND
Outlet	1500	4.00	0.20	89.73	ND	2.07	4.01	<0.3	ND	ND
Inlet	1500	4.14	0.16	89.58	ND	1.92	4.19	<0.3	33.7	ND

High Pressure Hot Gas Desulfurization Lab Gas Analysis

ZFMC-01-S6		December 30, 1992				Normalized to 100				H2S Recalculated			
Loca.	Time	H2 %	O2 %	N2 %	CH4 %	CO %	CO2 %	H2S PPM	COS PPM	SO2 PPM			
Outlet	1900	22.27	0.15	49.08	ND	9.94	18.55	6.3	ND	ND			
Outlet	1930	21.69	0.10	49.36	ND	10.91	17.93	6.5	ND	ND			
Inlet	1930	14.95	0.11	53.44	ND	22.89	8.57	293.0	142.9	1.5			
Outlet	2030	20.24	0.59	50.25	ND	11.56	17.37	6.3	ND	ND			
Outlet	2130	20.05	0.09	50.05	ND	14.16	15.65	6.2	ND	ND			
Outlet	2230	19.49	0.08	50.45	ND	15.14	14.84	5.9	ND	ND			
Outlet	2330	18.81	0.08	50.86	ND	16.18	14.07	7.6	ND	ND			
Inlet	2330	14.92	0.07	53.18	ND	22.94	8.80	769.0	93.4	1.6			
December 31, 1992													
Outlet	0030	18.02	0.08	51.53	ND	18.14	12.24	6.7	0.4	ND			
Outlet	0130	17.46	0.08	51.84	ND	18.65	11.97	11.6	0.7	ND			
Outlet	0230	16.70	0.09	52.33	ND	19.95	10.92	45.2	3.0	ND			
Outlet	0330	16.12	0.08	52.62	ND	20.86	10.29	212.0	20.6	ND			
Inlet	0330	15.06	0.08	53.20	ND	22.68	8.89	819.3	82.7	1.8			
Outlet	0430	16.17	0.09	52.88	ND	20.66	10.18	138.6	15.0	ND			
Outlet	0530	16.14	0.08	52.73	ND	21.01	10.02	194.7	18.0	0.9			
Outlet	0630	16.01	0.08	52.66	ND	21.28	9.95	269.0	24.4	ND			
Outlet	0730	15.99	0.11	52.81	ND	21.16	9.90	291.5	26.4	1.8			
Inlet	0730	15.25	0.09	53.14	ND	22.33	9.11	816.1	74.6	1.6			
Outlet	0830	15.84	0.08	52.86	ND	21.42	9.76	362.1	29.7	3.1			
Outlet	0930	15.62	0.09	52.99	ND	21.66	9.59	419.4	37.7	2.4			
Outlet	1030	15.50	0.09	53.09	ND	21.80	9.47	480.8	48.3	1.4			
Outlet	1130	15.69	0.10	53.05	ND	21.80	9.31	452.5	51.1	ND			
Inlet	1130	15.31	0.09	53.13	ND	22.46	8.94	696.6	75.6	ND			
Outlet	1230	15.30	0.09	53.38	ND	21.89	9.30	392.7	48.2	ND			
Outlet	1330	15.40	0.09	53.47	ND	21.95	9.04	474.6	53.8	ND			
Outlet	1430	15.34	0.09	53.18	ND	21.98	9.35	522.9	55.4	ND			
Outlet	1530	15.36	0.10	53.29	ND	22.00	9.18	531.8	53.8	ND			
Inlet	1530	15.09	0.10	53.37	ND	22.41	8.95	730.6	83.6	ND			
Outlet	1600	15.40	0.09	53.34	ND	22.09	9.01	552.4	58.4	ND			

High Pressure Hot Gas Desulfurization Lab Gas Analysis

ZFMC-01-R6 January 4, 1993 Normalized to 100

Loca.	Time	H2 %	O2 %	N2 %	CH4 %	CO %	CO2 %	H2S PPM	COS PPM	SO2 PPM
Outlet	2030	ND	0.14	98.78	ND	ND	0.04	<0.3	ND	1.04%
Outlet	2100	ND	0.09	98.76	ND	ND	0.03	<0.3	ND	1.12%
Inlet	2200	ND	1.81	98.08	ND	ND	0.03	ND	ND	849.7
Outlet	2200	ND	0.10	98.80	ND	ND	ND	1.5	ND	1.10%
Outlet	2300	ND	1.06	97.86	ND	ND	ND	1.4	ND	1.08%
Outlet	0000	ND	0.10	98.87	ND	ND	ND	<0.3	ND	1.03%
Outlet	0100	ND	0.51	98.62	ND	ND	ND	<0.3	ND	0.87%
Inlet	0200	ND	1.90	98.07	ND	ND	ND	<0.3	ND	249.1
Outlet	0200	ND	1.51	98.19	ND	ND	ND	<0.3	ND	0.30%
Outlet	0300	ND	1.75	98.01	ND	ND	ND	<0.3	ND	0.25%
Outlet	0400	ND	1.96	98.03	ND	ND	ND	<0.3	ND	102.0
Outlet	0500	ND	21.34 [*]	78.65	ND	ND	ND	<0.3	ND	34.0
Outlet	0530	ND	20.83 [*]	79.17	ND	ND	ND	<0.3	ND	23.2

** possible air in sample*

High Pressure Hot Gas Desulfurization Lab Gas Analysis

ZFMC-01-RR6 January 5, 1993

Normalized to 100

Loca.	Time	H2 %	O2 %	N2 %	CH4 %	CO %	CO2 %	H2S PPM	COS PPM	SO2 PPM
Outlet	0745	3.36	0.24	91.06	ND	2.49	2.86	<0.3	0.3	4.1
Outlet	0800	3.64	0.26	90.82	ND	2.32	2.96	<0.3	ND	3.3
Outlet	0815	3.73	0.11	90.87	ND	2.23	3.06	3.2	ND	1.7
Outlet	0830	3.83	0.11	90.78	ND	2.15	3.13	2.7	ND	1.6
Inlet	0830	4.75	0.10	89.97	ND	1.45	3.74	ND	41.9	ND
Outlet	0900	4.05	0.11	90.64	ND	2.11	3.09	<0.3	ND	1.7
Outlet	0930	4.17	0.11	90.52	ND	1.99	3.22	<0.3	ND	ND
Inlet	0930	4.74	0.11	89.98	ND	1.44	3.73	<0.3	24.4	ND

High Pressure Hot Gas Desulfurization Lab Gas Analysis

ZFMC-01-S7 January 5, 1993

Normalized to 100 H2S Recalculated

Loca.	Time	H2 %	O2 %	N2 %	CH4 %	CO %	CO2 %	H2S PPM	COS PPM	SO2 PPM
Outlet	1200	21.63	0.10	49.86	ND	12.17	16.23	2.9	ND	ND
Outlet	1230	21.05	0.09	50.18	ND	13.34	15.34	2.8	ND	ND
Outlet	1330	19.58	0.08	51.14	ND	15.77	13.43	2.1	ND	ND
Inlet	1330	16.31	0.10	53.13	ND	21.52	8.87	585.1	119.3	ND
Outlet	1430	18.49	0.08	51.79	ND	17.52	12.13	2.9	ND	ND
Outlet	1530	18.36	0.09	52.07	ND	17.97	11.51	4.0	ND	ND
Outlet	1630	17.88	0.11	52.77	ND	18.04	11.19	6.0	ND	ND
Outlet	1730	17.82	0.08	52.35	ND	18.76	10.98	13.0	1.6	ND
Inlet	1740	16.12	0.09	53.35	ND	21.76	8.61	547.8	88.9	ND
Outlet	1830	17.66	0.09	52.46	ND	19.20	10.58	39.1	3.9	ND
Outlet	1930	17.31	0.09	52.58	0.01	19.79	10.21	135.4	7.4	ND
Inlet	2040	15.93	0.08	53.45	0.01	22.04	8.40	764.9	76.0	1.3
Outlet	2030	17.01	0.07	52.93	0.01	20.28	9.69	130.3	13.0	ND
Outlet	2130	16.86	0.08	53.08	0.01	20.41	9.54	176.0	19.0	2.8
Outlet	2230	16.99	0.08	52.81	0.01	20.74	9.34	240.7	26.0	2.2
Outlet	2330	16.71	0.08	53.02	ND	21.11	9.05	328.7	31.2	2.4

January 6, 1993

Inlet	0030	16.08	0.07	53.23	ND	22.00	8.52	872.1	77.9	1.0
Outlet	0030	16.41	0.07	53.20	ND	21.31	8.98	392.2	35.2	1.0
Outlet	0130	5.15	14.94*	71.84	ND	5.65	2.41	86.2	9.8	8.3
Outlet	0230	16.51	0.07	53.10	ND	21.41	8.85	472.1	41.6	1.2
Outlet	0330	16.49	0.08	53.09	ND	21.51	8.77	570.7	33.6	1.9
Outlet	0430	16.35	0.08	53.19	ND	21.67	8.65	523.0	49.2	1.6
Inlet	0430	16.25	0.08	53.27	ND	21.99	8.31	886.4	82.1	1.2
Outlet	0530	16.44	0.08	53.15	ND	21.60	8.66	584.8	50.4	0.9
Outlet	0630	16.32	0.08	53.26	ND	21.77	8.50	628.9	57.1	ND
Inlet	0630	16.12	0.07	53.36	ND	22.08	8.27	882.0	70.6	ND

*possible air in sample

High Pressure Hot Gas Desulfurization Lab Gas Analysis

ZFMC-01-R7 January 6, 1993

Normalized to 100

Loca.	Time	H2 %	O2 %	N2 %	CH4 %	CO %	CO2 %	H2S PPM	COS PPM	SO2 PPM
Outlet	0945	ND	0.09	98.60	ND	ND	0.08	<0.3	1.9	1.23%
Outlet	1000	ND	0.12	98.53	ND	ND	0.06	<0.3	1.0	1.29%
Outlet	1030	ND	0.10	98.60	ND	ND	0.05	0.6	1.5	1.25%
Inlet	1030	ND	1.81	98.11	ND	ND	0.04	1.4	1.6	344.2
Outlet	1130	ND	0.11	98.55	ND	ND	0.04	0.8	0.7	1.30%
Outlet	1230	ND	0.10	98.81	ND	ND	ND	<0.3	ND	1.09%
Outlet	1330	ND	0.13	98.59	ND	ND	ND	<0.3	ND	1.28%
Outlet	1430	ND	1.16	98.24	ND	ND	ND	<0.3	ND	1.30%
Inlet	1430	ND	1.97	98.03	ND	ND	ND	<0.3	ND	5.6
Outlet	1530	ND	2.02 [*]	97.94	ND	ND	ND	<0.3	ND	314.8
Outlet	1635	ND	2.11 [*]	97.87	ND	ND	ND	<0.3	ND	233.5
Outlet	1730	ND	20.58 [*]	79.37	ND	ND	0.04	<0.3	ND	59.2
Inlet	1800	ND	20.78 [*]	79.22	ND	ND	ND	<0.3	ND	2.5
Outlet	1800	ND	20.71 [*]	79.24	ND	ND	0.04	<0.3	ND	63.7

* possible air in sample

High Pressure Hot Gas Desulfurization Lab Gas Analysis

ZFMC-01-RR7 January 6, 1993

Normalized to 100

Loca.	Time	H2 %	O2 %	N2 %	CH4 %	CO %	CO2 %	H2S PPM	COS PPM	SO2 PPM
Outlet	2115	2.56	0.11	92.01	ND	2.91	2.41	<0.3	0.7	3.5
Outlet	2130	2.80	0.10	91.83	ND	2.67	2.61	<0.3	ND	ND
Outlet	2145	3.26	0.11	91.39	ND	2.47	2.76	3.1	ND	1.1
Outlet	2200	3.45	0.40	91.02	ND	2.34	2.79	2.3	ND	0.8
Inlet	2200	4.17	0.19	90.51	ND	1.48	3.65	ND	42.8	ND
Inlet	2300	4.45	0.11	90.30	ND	1.42	3.72	<0.3	61.3	ND
Outlet	2300	3.89	0.11	90.86	ND	2.12	3.03	<0.3	ND	ND

High Pressure Hot Gas Desulfurization Lab Gas Analysis

ZFMC-01-S8 January 7, 1993

Normalized to 100 H2S Recalculated

Loca.	Time	H2 %	O2 %	N2 %	CH4 %	CO %	CO2 %	H2S PPM	COS PPM	SO2 PPM
Outlet	0230	21.85	0.08	49.83	ND	12.33	15.90	6.1	0.2	1.1
Inlet	0300	15.76	0.08	53.56	ND	22.26	8.28	518.5	162.0	ND
Outlet	0300	21.26	0.09	50.25	ND	13.21	15.19	5.0	ND	0.8
Outlet	0400	19.20	0.09	51.50	ND	17.00	12.21	2.9	ND	ND
Outlet	0500	18.22	0.08	52.23	ND	18.17	11.30	2.8	ND	ND
Outlet	0600	17.88	0.09	52.39	ND	18.77	10.87	4.2	ND	ND
Outlet	0700	17.60	0.08	52.68	ND	19.33	10.30	8.1	0.3	ND
Inlet	0700	15.58	0.08	53.86	ND	22.19	8.21	772.7	90.0	1.5
Outlet	0800	17.97	0.09	52.52	ND	18.70	10.72	23.5	1.8	ND
Outlet	0900	17.79	0.08	52.70	ND	18.96	10.45	44.4	6.7	1.2
Outlet	1000	17.35	0.10	52.88	ND	19.44	10.22	89.6	8.8	1.1
Outlet	1100	17.06	0.09	53.01	ND	19.87	9.94	159.1	14.0	1.4
Inlet	1100	15.95	0.09	53.54	ND	21.75	8.57	792.3	84.1	1.1
Outlet	1200	17.17	0.09	52.75	ND	20.35	9.62	235.3	18.6	1.5
Outlet	1300	16.61	0.08	53.35	ND	20.71	9.23	254.6	25.5	0.9
Outlet	1400	16.57	0.09	53.34	ND	21.01	8.96	317.9	25.7	1.0
Outlet	1500	16.38	0.09	53.69	ND	20.95	8.85	292.3	26.4	ND
Inlet	1500	15.98	0.10	53.85	ND	21.84	8.15	783.4	68.1	0.9
Outlet	1600	16.42	0.11	53.58	ND	21.16	8.70	327.1	32.3	1.6
Outlet	1700	16.32	0.10	53.58	ND	21.28	8.67	447.7	37.5	2.0
Outlet	1800	16.36	0.09	53.52	ND	21.36	8.63	436.6	41.2	1.1
Inlet	1900	16.21	0.09	53.58	ND	21.70	8.34	751.0	70.3	1.9
Outlet	1900	16.28	0.08	53.56	ND	21.36	8.66	535.3	36.5	1.4
Outlet	2000	16.19	0.08	53.63	ND	21.13	8.91	531.6	51.1	1.3
Outlet	2100	16.36	0.14	53.64	ND	20.95	8.85	525.6	47.4	3.3
Outlet	2200	16.30	0.10	53.58	ND	21.08	8.87	567.1	54.9	1.8
Inlet	2230	16.24	0.09	53.53	ND	21.38	8.68	769.4	69.9	ND
Outlet	2230	16.24	0.11	53.69	ND	21.01	8.89	544.4	55.4	1.1

High Pressure Hot Gas Desulfurization Lab Gas Analysis

ZFMC-01-R8 January 08, 1993

Normalized to 100

Loca.	Time	H2 %	O2 %	N2 %	CH4 %	CO %	CO2 %	H2S PPM	COS PPM	SO2 PPM
Outlet	0045	ND	0.12	98.75	ND	ND	0.25	3.8	4.6	0.88%
Inlet	0100	ND	1.74	97.96	ND	0.07	0.14	ND	22.2	775.0
Outlet	0100	ND	0.15	98.50	ND	ND	0.24	3.3	5.2	1.11%
Outlet	0130	ND	0.12	98.63	ND	ND	0.17	1.3	4.1	1.08%
Outlet	0230	ND	0.12	98.63	ND	ND	0.10	1.6	3.1	1.15%
Outlet	0330	ND	0.11	98.62	ND	ND	0.09	0.8	2.3	1.18%
Outlet	0430	ND	0.12	98.72	ND	ND	0.05	ND	2.6	1.11%
Outlet	0530	ND	1.13	98.26	ND	ND	0.05	ND	ND	0.56%
Inlet	0530	ND	1.94	98.02	ND	ND	0.04	ND	1.4	21.1
Outlet	0630	ND	2.04 [*]	97.87	ND	ND	0.05	ND	ND	404.5
Outlet	0730	ND	2.10 [*]	97.84	ND	ND	0.05	ND	ND	78.6
Outlet	0800	ND	20.81 [*]	79.15	ND	ND	0.04	ND	ND	42.3
Inlet	0800	ND	20.77 [*]	79.20	ND	ND	0.03	ND	ND	10.0
Outlet	0830	ND	20.87 [*]	79.09	ND	ND	0.04	ND	ND	34.8

*possible air in sample

High Pressure Hot Gas Desulfurization Lab Gas Analysis

ZFMC-01-RR8 January 08, 1993

Normalized to 100

Loca.	Time	H2 %	O2 %	N2 %	CH4 %	CO %	CO2 %	H2S PPM	COS PPM	SO2 PPM
Outlet	1115	3.10	0.12	91.41	ND	2.88	2.49	3.4	ND	5.1
Outlet	1130	3.38	0.12	91.15	ND	2.72	2.63	3.2	ND	2.1
Outlet	1145	3.58	0.11	91.00	ND	2.57	2.74	2.8	ND	2.6
Outlet	1200	3.53	0.11	91.08	ND	2.39	2.89	2.0	ND	ND
Inlet	1200	4.74	0.12	89.95	ND	1.32	3.87	ND	101.1	ND
Outlet	1300	3.81	0.12	90.89	ND	2.26	2.92	2.0	ND	1.2
Inlet	1300	4.76	0.11	90.00	ND	1.45	3.68	ND	34.2	ND

APPENDIX F
Detector Tube Results

During testing, detector tubes were utilized as a quick indicator of hydrogen sulfide and sulfur dioxide concentration in the exit gas stream. These determinations are only estimates of the actual concentrations and are used primarily as an indicator for the completion of a test phase. It is noted that Gastec detector tubes have a reported precision of $\pm 25\%$ full scale. The analyses for each sample are provided on a dry gas basis.

ZFMC-01-S1				
Date	Time	Elapsed Time (hrs)	Inlet ppmv H ₂ S	Outlet ppmv H ₂ S
12/7/92	18:03	0.00 (Start Test)	-	-
12/7/92	18:05	0.03	-	5
12/7/92	18:09	0.10	250	-
12/7/92	18:15	0.20	-	5
12/7/92	18:20	0.28	-	5
12/7/92	18:30	0.45	-	5
12/7/92	18:32	0.48	400	-
12/7/92	18:45	0.70	-	20
12/7/92	19:00	0.95	-	10
12/7/92	19:02	0.98	800	-
12/7/92	19:15	1.20	-	5
12/7/92	19:28	1.25 (Off-Line)	-	-
12/7/92	19:55	1.25 (On-Line)	-	-
12/7/92	20:15	1.75	-	0
12/7/92	20:30	2.00	-	5
12/7/92	20:33	2.05	1000	-
12/7/92	21:00	2.50	-	3
12/7/92	22:00	3.50	-	1
12/7/92	23:00	4.50	-	5
12/8/92	0:00	5.50	-	12
12/8/92	0:02	5.53	950	-
12/8/92	1:01	6.52	-	32
12/8/92	2:01	7.52	-	78
12/8/92	3:01	8.52	-	120
12/8/92	4:01	9.52	850	-
12/8/92	4:03	9.55	-	190
12/8/92	5:03	10.55	-	270
12/8/92	6:02	11.53	-	270
12/8/92	7:02	12.53	-	390
12/8/92	8:04	13.57	1000	400
12/8/92	9:01	14.52	-	600
12/8/92	10:01	15.52	-	550
12/8/92	11:01	16.52	-	650
12/8/92	12:01	17.52	-	675
12/8/92	12:06	17.60	975	-

ZFMC-01-S1				
Date	Time	Elapsed Time (hrs)	Inlet ppmv H ₂ S	Outlet ppmv H ₂ S
12/8/92	13:00	18.50	-	710
12/8/92	14:01	19.52	-	700
12/8/92	15:01	20.52	-	725
12/8/92	16:01	21.52	-	925
12/8/92	16:02	21.53	1050	-
12/8/92	16:08	21.63	-	550
12/8/92	16:11	21.68	-	600
12/8/92	16:30	22.00	-	600
12/8/92	17:00	22.50	-	775
12/8/92	17:30	23.00	-	675
12/8/92	18:00	23.50	-	600
12/8/92	19:00	24.50	-	500
12/8/92	20:00	25.50	1050	700
12/8/92	21:00	26.50	-	950
12/8/92	21:05	26.58	-	825
12/8/92	22:03	27.55	-	800
12/8/92	23:00	28.50	-	850
12/8/92	23:04	28.57	1100	-
12/8/92	23:07	28.62 (End Test)	-	-

ZFMC-01-R1				
Stage	Date	Time	Elapsed Time (hrs)	Outlet % SO ₂
-	12/9/92	3:00	0.00 (Start Test)	-
1	12/9/92	3:06	0.10	0.0800
1	12/9/92	3:10	0.17	0.0950
1	12/9/92	3:16	0.27	0.1050
1	12/9/92	3:20	0.33	0.1100
1	12/9/92	3:30	0.50	0.1100
1	12/9/92	3:45	0.75	0.1150
1-2	12/9/92	4:00	1.00	0.1400
2	12/9/92	5:01	2.02	1.4
-	12/9/92	5:30	2.50 (Off-Line)	-
-	12/9/92	7:00	2.50 (On-Line)	-
2	12/9/92	7:05	2.58	1.4
2	12/9/92	7:15	2.75	1.4
-	12/9/92	7:30	3.00 (Off-Line)	-
-	12/9/92	8:00	3.00 (On-Line)	-
2	12/9/92	8:09	3.15	1.7
2	12/9/92	8:15	3.25	1.9
2	12/9/92	8:31	3.52	1.45
2	12/9/92	9:02	4.03	1.4
2	12/9/92	10:01	5.02	1.4
2	12/9/92	11:01	6.02	1.3
2	12/9/92	12:01	7.02	0.8
2	12/9/92	13:01	8.02	0.5
3	12/9/92	14:05	9.08	0.0600
3	12/9/92	14:34	9.57	0.0098
3	12/9/92	15:02	10.03	0.0625
3	12/9/92	15:04	10.07	0.0425
4	12/9/92	16:01	11.02	0.0150
4	12/9/92	16:33	11.55	0.0045
4	12/9/92	17:01	12.02	0.0080
5	12/9/92	17:38	12.63	0.0035
5	12/9/92	18:01	13.02	0.0025
-	12/9/92	18:05	13.08 (End Test)	-

ZFMC-01-RR1				
Date	Time	Elapsed Time (hrs)	Outlet ppmv SO ₂	Outlet ppmv H ₂ S
12/9/92	20:30	0.00 (Start Test)	-	-
12/9/92	20:35	0.08	0	3
12/9/92	20:45	0.25	0	4
12/9/92	21:01	0.52	-	4
12/9/92	21:15	0.75	-	0
12/9/92	21:30	1.00	-	0
12/9/92	22:00	1.50	-	0
12/9/92	22:30	2.00	-	2
12/9/92	23:30	3.00	-	0
12/9/92	23:33	3.05 (End Test)	-	-

ZFMC-01-S2				
Date	Time	Elapsed Time (hrs)	Inlet ppmv H ₂ S	Outlet ppmv H ₂ S
12/10/92	1:30	0.00 (Start Test)	-	-
12/10/92	1:35	0.08	-	3
12/10/92	1:40	0.17	-	3
12/10/92	1:45	0.25	-	3
12/10/92	1:46	0.27	600	-
12/10/92	1:50	0.33	-	3
12/10/92	2:00	0.50	-	5
12/10/92	2:15	0.75	-	7
12/10/92	2:30	1.00	-	7
12/10/92	3:00	1.50	650	-
12/10/92	3:30	2.00	-	5
12/10/92	4:30	3.00	-	5
12/10/92	5:30	4.00	-	5
12/10/92	5:32	4.03	900	-
12/10/92	6:30	5.00	-	8
12/10/92	7:30	6.00	-	15
12/10/92	8:30	7.00	-	32
12/10/92	9:32	8.03	1025	-
12/10/92	9:33	8.05	-	70
12/10/92	10:30	9.00	-	140
12/10/92	11:32	10.03	-	205
12/10/92	12:00	10.50	975	-
12/10/92	12:00	10.50 (Off-Line)	-	-
12/11/92	12:30	10.50 (On-Line)	-	-
12/11/92	12:36	10.60	-	145
12/11/92	12:45	10.75	-	180
12/11/92	13:00	11.00	-	235
12/11/92	13:31	11.52	825	-
12/11/92	13:33	11.55	-	300
12/11/92	14:30	12.50	-	350
12/11/92	15:30	13.50	-	475
12/11/92	16:29	14.48	-	525
12/11/92	16:30	14.50	975	-
12/11/92	16:30	14.50 (Off-Line)	-	-
12/14/92	9:00	14.50 (On-Line)	-	-

ZFMC-01-S2				
Date	Time	Elapsed Time (hrs)	Inlet ppmv H ₂ S	Outlet ppmv H ₂ S
12/14/92	9:05	14.58	-	225
12/14/92	9:17	14.78	-	425
12/14/92	9:31	15.02	-	500
12/14/92	9:32	15.03	1025	-
12/14/92	10:00	15.50	-	500
12/14/92	10:30	16.00	-	525
12/14/92	11:00	16.50	-	575
12/14/92	12:00	17.50	-	600
12/14/92	13:00	18.50	-	620
12/14/92	14:00	19.50	-	650
12/14/92	14:01	19.52	1050	-
12/14/92	15:00	20.50	-	725
12/14/92	16:00	21.50	-	700
12/14/92	17:00	22.50	-	700
12/14/92	18:00	23.50	-	750
12/14/92	18:03	23.55	925	-
12/14/92	19:00	24.50	-	800
12/14/92	19:04	24.57	-	800
12/14/92	20:00	25.50	-	825
12/14/92	20:30	26.00	-	800
12/14/92	21:00	26.50	-	800
12/14/92	21:01	26.52	975	-
12/14/92	21:04	26.57 (End Test)	-	-

ZFMC-01-R2				
Stage	Date	Time	Elapsed Time (hrs)	Outlet % SO ₂
-	12/14/92	23:00	0.00 (Start Test)	-
1	12/14/92	23:15	0.25	0.1300
1	12/14/92	23:30	0.50	0.1350
1	12/14/92	23:45	0.75	0.1375
1	12/14/92	0:00	1.00	0.1425
1	12/14/92	1:00	2.00	0.1400
1	12/14/92	2:00	3.00	0.1400
1	12/14/92	3:00	4.00	0.1400
1	12/14/92	4:00	5.00	0.1400
1	12/14/92	5:00	6.00	0.1400
1	12/14/92	6:00	7.00	0.1400
1	12/14/92	7:00	8.00	0.1375
1	12/14/92	8:00	9.00	0.1350
1	12/14/92	9:00	10.00	0.1300
1	12/14/92	10:00	11.00	0.1300
2	12/15/92	10:30	11.50	1.50
2	12/15/92	11:00	12.00	1.50
2	12/15/92	12:00	13.00	1.50
2	12/15/92	13:00	14.00	1.50
2	12/15/92	14:00	15.00	1.20
2	12/15/92	15:34	15.57	0.80
2	12/15/92	15:00	16.00	0.50
2	12/15/92	15:30	16.50	0.25
2	12/15/92	16:00	17.00	0.1000
3	12/15/92	16:20	17.33	0.0550
3	12/15/92	16:30	17.50	0.0350
3	12/15/92	17:00	18.00	0.0060
3	12/15/92	18:00	19.00	0.0040
3	12/15/92	18:30	19.50	0.0045
4	12/15/92	19:00	20.00	0.0035
4	12/15/92	19:45	20.75	0.0020
5	12/15/92	21:00	22.00	0.0025
5	12/15/92	21:30	22.50	0.0019
-	12/15/92	21:40	22.67 (End Test)	-

ZFMC-01-RR2				
Date	Time	Elapsed Time (hrs)	Outlet ppmv SO ₂	Outlet ppmv H ₂ S
12/15/92	23:00	0.00 (Start Test)	-	-
12/15/92	23:05	0.08	-	28
12/15/92	23:07	0.12	5	-
12/15/92	23:10	0.17	-	19
12/15/92	23:12	0.20	<2	-
12/15/92	23:15	0.25	-	10
12/15/92	23:30	0.50	-	5
12/16/92	00:00	1.00	-	5
12/16/92	00:02	1.03	0	-
12/16/92	00:30	1.50	-	5
12/16/92	01:00	2.00	-	3
12/16/92	01:01	2.02	0	-
12/16/92	01:00	2.00 (End Test)	-	-

ZFMC-01-S3				
Date	Time	Elapsed Time (hrs)	Inlet ppmv H ₂ S	Outlet ppmv H ₂ S
12/16/92	3:30	0.00 (Start Test)	-	-
12/16/92	3:35	0.08	-	3
12/16/92	3:40	0.17	-	3
12/16/92	3:45	0.25	-	3
12/16/92	3:46	0.27	500	-
12/16/92	3:50	0.33	-	3
12/16/92	4:00	0.50	-	3
12/16/92	4:15	0.75	-	3
12/16/92	4:30	1.00	-	5
12/16/92	5:00	1.50	900	-
12/16/92	5:30	2.00	-	5
12/16/92	6:30	3.00	-	5
12/16/92	7:30	4.00	-	5
12/16/92	7:31	4.02	900	-
12/16/92	8:30	5.00	-	7
12/16/92	9:30	6.00	-	10
12/16/92	10:30	7.00	-	28
12/16/92	11:30	8.00	-	60
12/16/92	11:31	8.02	1025	-
12/16/92	12:31	9.02	-	145
12/16/92	13:30	10.00	-	225
12/16/92	14:30	11.00	-	300
12/16/92	15:30	12.00	-	400
12/16/92	15:31	12.02	1050	-
12/16/92	16:30	13.00	-	400
12/16/92	17:30	14.00	-	525
12/16/92	18:30	15.00	-	525
12/16/92	19:30	16.00	-	550
12/16/92	19:33	16.05	1000	-
12/16/92	20:30	17.00	-	550
12/16/92	21:30	18.00	-	625
12/16/92	22:30	19.00	-	725
12/16/92	23:30	20.00	-	750
12/16/92	23:30	20.00	1000	-
12/16/92	0:30	21.00	-	900

ZFMC-01-S3				
Date	Time	Elapsed Time (hrs)	Inlet ppmv H ₂ S	Outlet ppmv H ₂ S
12/16/92	1:30	22.00	-	850
12/16/92	2:30	23.00	-	975
12/16/92	2:30	23.00	1050	-
12/16/92	2:30	23:00 (End Test)	-	-

ZFMC-01-R3				
Stage	Date	Time	Elapsed Time (hrs)	Outlet % SO ₂
-	12/17/92	5:30	0.00 (Start Test)	-
1	12/17/92	5:35	0.08	0.1400
1	12/17/92	5:40	0.17	0.1500
1	12/17/92	5:45	0.25	0.1500
1	12/17/92	5:50	0.33	0.1550
1	12/17/92	6:00	0.50	0.1550
1	12/17/92	6:15	0.75	0.1575
1	12/17/92	6:30	1.00	0.1550
1	12/17/92	7:30	2.00	0.1500
1	12/17/92	8:30	3.00	0.1600
1	12/17/92	9:30	4.00	0.1575
2	12/17/92	10:05	4.58	1.50
2	12/17/92	10:15	4.75	1.40
2	12/17/92	10:30	5.00	1.55
2	12/17/92	11:30	6.00	1.40
2	12/17/92	12:30	7.00	1.50
2	12/17/92	13:30	8.00	1.40
2	12/17/92	14:30	9.00	1.00
2	12/17/92	15:00	9.50	0.50
2	12/17/92	15:31	10.02	0.40
2	12/17/92	16:00	10.50	0.0900
2	12/17/92	17:30	12.00	0.0100
3	12/17/92	17:45	12.25	0.0030
3	12/17/92	18:00	12.50	0.0030
3	12/17/92	18:30	13.00	0.0020
3	12/17/92	19:30	14.00	0.0040
4	12/17/92	20:00	14.50	0.0023
4	12/17/92	20:30	15.00	0.0015
4	12/17/92	21:30	16.00	0.0035
5	12/17/92	22:00	16.50	0.0025
5	12/17/92	22:15	16.75	0.0020
5	12/17/92	22:30	17.00	0.0018
-	12/17/92	22:30	17.00 (End Test)	-

ZFMC-01-RR3				
Date	Time	Elapsed Time (hrs)	Outlet ppmv SO ₂	Outlet ppmv H ₂ S
12/18/92	0:00	(Start Test)	-	-
12/18/92	00:15	0.25	-	7
12/18/92	00:16	0.27	1.5	-
12/18/92	00:30	0.50	-	5
12/18/92	00:33	0.55	0.7	-
12/18/92	00:47	0.78	-	10
12/18/92	01:00	1.00	-	<5
12/18/92	01:03	1.05	-	20
12/18/92	01:30	1.50	-	<5
12/18/92	02:00	2.00	-	0
12/18/92	02:00	2.00 (End Test)	-	-

ZFMC-01-S4				
Date	Time	Elapsed Time (hrs)	Inlet ppmv H ₂ S	Outlet ppmv H ₂ S
12/18/92	4:00	0.00 (Start Test)	-	-
12/18/92	4:05	0.08	-	10
12/18/92	4:10	0.17	-	8
12/18/92	4:16	0.27	620	-
12/18/92	4:17	0.28	-	9
12/18/92	4:30	0.50	-	8
12/18/92	4:45	0.75	-	8
12/18/92	5:00	1.00	-	7
12/18/92	6:00	2.00	-	5
12/18/92	7:00	3.00	-	5
12/18/92	8:00	4.00	795	-
12/18/92	8:00	4.00	-	7
12/18/92	9:00	5.00	-	12
12/18/92	10:00	6.00	-	29
12/18/92	11:00	7.00	-	59
12/18/92	11:01	7.02	-	69
12/18/92	12:00	8.00	-	110
12/18/92	12:01	8.02	1025	-
12/18/92	13:01	9.02	-	190
12/18/92	14:00	10.00	-	250
12/18/92	14:01	10.02	1200	-
12/18/92	15:00	11.00	-	300
12/18/92	16:00	12.00	-	300
12/18/92	16:05	12.08 (Off-Line)	-	-
12/21/92	9:30	12.08 (On-Line)	-	-
12/21/92	9:36	12.18	-	130
12/21/92	9:41	12.27	-	225
12/21/92	9:51	12.43	-	450
12/21/92	10:00	12.58	-	425
12/21/92	10:30	13.08	-	425
12/21/92	10:31	13.10	1100	-
12/21/92	11:30	14.08	-	575
12/21/92	12:30	15.08	-	575
12/21/92	13:30	16.08	-	600
12/21/92	14:30	17.08	1100	-

ZFMC-01-S4				
Date	Time	Elapsed Time (hrs)	Inlet ppmv H ₂ S	Outlet ppmv H ₂ S
12/21/92	14:30	17.08	-	600
12/21/92	15:30	18.08	-	700
12/21/92	16:30	19.08	-	675
12/21/92	17:30	20.08	-	725
12/21/92	18:30	21.08	1100	-
12/21/92	18:30	21.08	-	800
12/21/92	19:30	22.08	-	1000
12/21/92	20:30	23.08	1100	-
12/21/92	20:30	23.08	-	900
12/21/92	20:30	23.08 (End Test)	-	-

ZFMC-01-R4				
Stage	Date	Time	Elapsed Time (hrs)	Outlet % SO ₂
-	12/28/92	10:00	0.00 (Start Test)	-
2	12/28/92	10:05	0.08	1.20
2	12/28/92	10:15	0.25	1.50
2	12/28/92	10:30	0.50	1.50
2	12/28/92	10:45	0.75	1.55
2	12/28/92	11:00	1.00	1.50
2	12/28/92	12:00	2.00	1.55
2	12/28/92	13:00	3.00	1.55
2	12/28/92	14:00	4.00	1.50
2	12/28/92	15:00	5.00	1.20
2	12/28/92	15:30	5.50	0.75
2	12/28/92	16:00	6.00	0.40
2	12/28/92	16:02	6.03	0.2850
2	12/28/92	16:30	6.50	0.1075
2	12/28/92	16:45	6.75	0.0650
2	12/28/92	17:00	7.00	0.0725
2	12/28/92	18:00	8.00	0.0200
5	12/28/92	18:30	8.50	0.0035
5	12/28/92	19:30	9.50	0.0018
-	12/28/92	19:30	9.50 (End Test)	-

ZFMC-01-RR4				
Date	Time	Elapsed Time (hrs)	Outlet ppmv SO ₂	Outlet ppmv H ₂ S
12/28/92	21:00	0.00 (Start Test)	-	-
12/28/92	21:05	0.08	-	3
12/28/92	21:10	0.17	-	3
12/28/92	21:15	0.25	-	3
12/28/92	21:18	0.30	-	0
12/28/92	21:30	0.50	-	5
12/28/92	22:00	1.00	-	3
12/28/92	22:02	1.03	-	15
12/28/92	22:30	1.50	-	<2
12/28/92	23:00	2.00	-	<2
12/28/92	23:00	2.00 (End Test)	-	-

ZFMC-01-S5				
Date	Time	Elapsed Time (hrs)	Inlet ppmv H ₂ S	Outlet ppmv H ₂ S
12/29/92	2:00	0.00 (Start Test)	-	-
12/29/92	2:15	0.25	-	10
12/29/92	2:30	0.50	-	7
12/29/92	3:00	1.00	-	9
12/29/92	3:05	1.08	925	-
12/29/92	3:30	1.50	-	9
12/29/92	4:00	2.00	-	6
12/29/92	5:00	3.00	-	5
12/29/92	6:00	4.00	-	5
12/29/92	7:00	5.00	1025	-
12/29/92	7:00	5.00	-	3
12/29/92	8:00	6.00	-	6
12/29/92	9:00	7.00	-	8
12/29/92	10:00	8.00	-	19
12/29/92	11:00	9.00	-	48
12/29/92	12:00	10.00	-	110
12/29/92	12:02	10.03	1100	-
12/29/92	13:00	11.00	-	230
12/29/92	14:00	12.00	-	325
12/29/92	15:00	13.00	-	400
12/29/92	16:00	14.00	-	425
12/29/92	16:01	14.02	1100	-
12/29/92	17:00	15.00	-	600
12/29/92	18:00	16.00	-	650
12/29/92	19:00	17.00	-	650
12/29/92	20:00	18.00	-	700
12/29/92	20:04	18.07	1150	-
12/29/92	21:00	19.00	-	800
12/29/92	22:00	20.00	-	800
12/29/92	23:00	21.00	-	800
12/29/92	23:03	21.05	1150	-
12/29/92	23:03	21.05 (End Test)	-	-

ZFMC-01-R5				
Stage	Date	Time	Elapsed Time (hrs)	Outlet % SO ₂
-	12/30/92	2:00	0.00 (Start Test)	-
2	12/30/92	2:15	0.25	1.50
2	12/30/92	2:30	0.50	1.50
2	12/30/92	2:45	0.75	1.50
2	12/30/92	3:00	1.00	1.50
2	12/30/92	3:30	1.50	1.50
2	12/30/92	4:00	2.00	1.50
2	12/30/92	5:00	3.00	1.50
2	12/30/92	6:00	4.00	1.50
2	12/30/92	7:00	5.00	1.10
2	12/30/92	8:02	6.03	0.1300
2	12/30/92	8:05	6.08	0.1200
2	12/30/92	9:00	7.00	0.0200
2	12/30/92	10:03	8.05	0.0200
5	12/30/92	11:00	9.00	0.0100
5	12/30/92	11:02	9.03	0.0032
5	12/30/92	11:15	9.25	0.0063
5	12/30/92	11:30	9.50	0.0020
-	12/30/92	11:31	9.52 (End Test)	-

ZFMC-01-RR5				
Date	Time	Elapsed Time (hrs)	Outlet ppmv SO ₂	Outlet ppmv H ₂ S
12/30/92	13:00	0.00 (Start Test)	-	-
12/30/92	13:15	0.25	-	<2.5
12/30/92	13:18	0.30	3.0	-
12/30/92	13:30	0.50	1	-
12/30/92	13:32	0.53	-	6
12/30/92	13:45	0.75	0.6	-
12/30/92	13:48	0.80	-	5
12/30/92	14:00	1.00	-	
12/30/92	14:02	1.03	-	7
12/30/92	14:04	1.07	-	0
12/30/92	14:05	1.08	2	-
12/30/92	14:30	1.50	-	
12/30/92	14:32	1.53	-	2.5
12/30/92	14:35	1.58	0.5	-
12/30/92	15:00	2.00	-	2.5
12/30/92	15:02	2.03	0.2	-
12/30/92	15:05	2.08	0.5	-
12/30/92	..15:05	2.08 (End Test)	-	-

ZFMC-01-S6				
Date	Time	Elapsed Time (hrs)	Inlet ppmv H ₂ S	Outlet ppmv H ₂ S
12/30/92	18:30	0.00 (Start Test)	-	-
12/30/92	18:46	0.27	-	6
12/30/92	19:00	0.50	-	6
12/30/92	19:30	1.00	-	6
12/30/92	19:33	1.05	925	-
12/30/92	20:30	2.00	-	6
12/30/92	21:30	3.00	-	7
12/30/92	22:30	4.00	-	7
12/30/92	23:30	5.00	-	10
12/30/92	23:33	5.05	1025	-
12/30/92	0:30	6.00	-	10
12/30/92	1:30	7.00	-	11
12/30/92	2:30	8.00	-	42
12/30/92	3:30	9.00	-	100
12/30/92	3:33	9.05	1100	-
12/30/92	4:30	10.00	-	175
12/30/92	5:30	11.00	-	210
12/30/92	6:30	12.00	-	310
12/30/92	7:30	13.00	-	400
12/30/92	7:33	13.05	1100	-
12/30/92	8:30	14.00	-	500
12/30/92	9:30	15.00	-	575
12/30/92	10:30	16.00	-	600
12/30/92	11:30	17.00	-	700
12/30/92	11:31	17.02	1125	-
12/30/92	12:00	17.50	-	725
12/30/92	12:30	18.00	-	750
12/30/92	13:00	18.50	-	775
12/30/92	13:30	19.00	-	790
12/30/92	13:40	19.17	-	795
12/30/92	13:50	19.33	-	800
12/30/92	14:00	19.50	-	810
12/30/92	14:30	20.00	-	800
12/30/92	15:00	20.50	-	825
12/30/92	15:30	21.00	-	875

ZFMC-01-S6				
Date	Time	Elapsed Time (hrs)	Inlet ppmv H ₂ S	Outlet ppmv H ₂ S
12/30/92	15:31	21.02	1175	-
12/30/92	16:00	21.50	-	850
12/30/92	16:00	21.50 (End Test)	-	-

ZFMC-01-R6				
Stage	Date	Time	Elapsed Time (hrs)	Outlet % SO ₂
-	01/04/93	20:00	0.00 (Start Test)	-
2	01/04/93	20:15	0.25	1.50
2	01/04/93	20:30	0.50	1.50
2	01/04/93	20:45	0.75	1.50
2	01/04/93	21:00	1.00	1.50
2	01/04/93	21:30	1.50	1.50
2	01/04/93	22:00	2.00	1.50
2	01/04/93	23:00	3.00	1.40
2	01/04/93	0:00	4.00	1.40
2	01/04/93	1:00	5.00	1.00
2	01/04/93	2:00	6.00	0.40
2	01/04/93	3:00	7.00	0.1400
2	01/04/93	4:00	8.00	0.0100
5	01/05/93	5:00	9.00	0.0020
5	01/05/93	5:30	9.50	0.0010
-	01/05/93	5:30	9.50 (End Test)	-

ZFMC-01-RR6				
Date	Time	Elapsed Time (hrs)	Outlet ppmv SO ₂	Outlet ppmv H ₂ S
01/05/93	07:30	0.00 (Start Test)	-	-
01/05/93	07:45	0.25	5	-
01/05/93	07:46	0.27	1.5	-
01/05/92	08:00	0.50	-	4
01/05/93	08:02	0.53	1.5	-
01/05/93	08:15	0.75	-	3.5
01/05/93	08:18	0.80	1.0	-
01/05/92	08:30	1.00	-	3
01/05/93	08:32	1.03	7	-
01/05/92	08:34	1.07	2	-
01/05/93	08:36	1.10	-	0
01/05/93	09:00	1.50	-	3
01/05/93	09:02	1.53	5	-
01/05/93	09:28	1.97	-	3
01/05/93	09:29	1.98	5	-
01/05/93	09:30	2.00	-	-
01/05/93	09:31	2.02	6	-
01/05/93	09:32	2.03 (End Test)	6	-

ZFMC-01-S7				
Date	Time	Elapsed Time (hrs)	Inlet ppmv H ₂ S	Outlet ppmv H ₂ S
01/05/93	11:30	0.00 (Start Test)	-	-
01/05/93	12:00	0.50	-	3
01/05/93	12:30	1.00	-	2
01/05/93	13:30	2.00	990	-
01/05/93	13:30	2.00	-	1
01/05/93	14:30	3.00	-	3
01/05/93	15:30	4.00	-	1
01/05/93	16:00	4.50	-	1
01/05/93	17:30	6.00	-	11
01/05/93	17:40	6.17	1200	-
01/05/93	18:30	7.00	-	37
01/05/93	19:32	8.03	-	105
01/05/93	20:30	9.00	-	140
01/05/93	20:34	9.07	1100	-
01/05/93	21:30	10.00	-	190
01/05/93	22:30	11.00	-	200
01/05/93	23:30	12.00	-	500
01/05/93	0:30	13.00	1050	-
01/05/93	0:30	13.00	-	500
01/05/93	1:30	14.00	-	600
01/05/93	2:30	15.00	-	700
01/05/93	3:30	16.00	-	750
01/05/93	4:30	17.00	1100	-
01/05/93	4:30	17.00	-	800
01/05/93	5:30	18.00	-	900
01/05/93	6:30	19.00	1020	-
01/05/93	6:30	19.00	-	980
01/05/93	6:35	19.08 (End Test)	-	-

ZFMC-01-R7				
Stage	Date	Time	Elapsed Time (hrs)	Outlet % SO ₂
-	01/06/93	9:30	0.00 (Start Test)	-
2	01/06/93	9:45	0.25	1.50
2	01/06/93	10:00	0.50	1.50
2	01/06/93	10:30	1.00	1.45
2	01/06/93	11:00	1.50	1.70
2	01/06/93	11:30	2.00	1.50
2	01/06/93	12:30	3.00	1.50
2	01/06/93	13:30	4.00	1.50
2	01/06/93	14:00	4.50	1.15
2	01/06/93	14:30	5.00	0.50
2	01/06/93	15:00	5.50	0.1200
2	01/06/93	15:02	5.53	0.1200
2	01/06/93	15:30	6.00	0.0250
2	01/06/93	16:30	7.00	0.0250
5	01/06/93	17:30	8.00	0.0040
5	01/06/93	18:00	8.50	0.0025
-	01/06/93	18:05	8.58 (End Test)	-

ZFMC-01-RR7				
Date	Time	Elapsed Time (hrs)	Outlet ppmv SO ₂	Outlet ppmv H ₂ S
01/06/93	21:00	0.00 (Start Test)	-	-
01/06/93	21:02	0.03	-	0
01/06/93	21:09	0.15	2	-
01/06/93	21:10	0.17	-	0
01/06/93	21:15	0.25	-	0
01/06/93	21:17	0.28	0.5	-
01/06/93	21:30	0.50	-	0
01/06/93	21:33	0.55	0.2	-
01/06/93	21:45	0.75	-	0
01/06/93	21:46	0.77	0.2	-
01/06/93	22:00	1.00	-	0
01/06/93	22:03	1.05	2	-
01/06/93	23:00	2.00	-	0
01/06/92	23:03	2.05	0	-
01/06/93	23:05	2.08 (End Test)	-	-

ZFMC-01-S8				
Date	Time	Elapsed Time (hrs)	Inlet ppmv H ₂ S	Outlet ppmv H ₂ S
01/07/93	2:00	0.00 (Start Test)	-	-
01/07/93	2:30	0.50	-	5
01/07/93	3:00	1.00	900	-
01/07/93	3:00	1.00	-	5
01/07/93	4:00	2.00	-	5
01/07/93	5:00	3.00	-	5
01/07/93	6:00	4.00	-	5
01/07/93	7:00	5.00	1000	-
01/07/93	7:00	5.00	-	6
01/07/93	8:00	6.00	-	18
01/07/93	9:00	7.00	-	77
01/07/93	10:00	8.00	-	105
01/07/93	11:00	9.00	1100	-
01/07/93	11:00	9.00	-	200
01/07/93	12:00	10.00	-	325
01/07/93	13:00	11.00	-	405
01/07/93	14:00	12.00	-	440
01/07/93	15:00	13.00	-	500
01/07/93	15:02	13.03	1175	-
01/07/93	16:00	14.00	-	650
01/07/93	17:00	15.00	-	750
01/07/93	17:30	15.50	-	700
01/07/93	18:00	16.00	-	750
01/07/93	19:00	17.00	-	790
01/07/93	19:01	17.02	1075	-
01/07/93	20:00	18.00	-	790
01/07/93	20:30	18.50	-	810
01/07/93	21:00	19.00	-	800
01/07/93	22:00	20.00	-	900
01/07/93	22:30	20.50	1100	-
01/07/93	22:30	20.50	-	925
01/07/93	22:33	20.55 (End Test)	-	-

ZFMC-01-R8				
Stage	Date	Time	Elapsed Time (hrs)	Outlet % SO ₂
-	01/08/93	0:30	0.00 (Start Test)	-
2	01/08/93	0:45	0.25	1.50
2	01/08/93	1:00	0.50	1.50
2	01/08/93	1:30	1.00	1.50
2	01/08/93	2:30	2.00	1.50
2	01/08/93	3:30	3.00	1.50
2	01/08/93	4:30	4.00	1.70
2	01/08/93	5:30	5.00	0.50
2	01/08/93	6:30	6.00	0.0375
2	01/08/93	7:30	7.00	0.0150
5	01/08/93	8:00	7.50	0.0020
5	01/08/93	8:30	8.00	0.0015
-	01/08/93	8:32	8.03 (End Test)	-

ZFMC-01-RR8				
Date	Time	Elapsed Time (hrs)	Outlet ppmv SO ₂	Outlet ppmv H ₂ S
01/08/93	11:00	0.00 (Start Test)	-	-
01/08/93	11:05	0.08	-	0
01/08/93	11:06	0.10	1.1	-
01/08/93	11:10	0.17	-	2
01/08/93	11:11	0.18	0.9	-
01/08/93	11:15	0.25	-	2
01/08/93	11:16	0.27	0.8	-
01/08/93	11:30	0.50	-	2
01/08/93	11:31	0.52	0.5	-
01/08/93	11:45	0.75	-	0.0
01/08/93	11:46	0.77	0.5	-
01/08/93	12:00	1.00	-	1
01/08/93	12:01	1.02	-	0.0
01/08/93	12:02	1.03	0.0	-
01/08/93	13:00	1.05	-	0.0
01/08/93	13:01	2.00	0.1	-
01/08/93	13:02	2.03	-	0.0
01/08/93	13:03	2.05	0.0	-
01/08/93	13:03	2.05 (End Test)	-	-

8

