

RECEIVED

JUN 28 1996

OSTI

Data Summary Report for M.W. Kellogg Zinc Titanite
Test Series: ZTSC-01, ZTSC-02, ZTSC-03, ZTSC-04, ZTSC-05,
ZTSC-06, ZTSC-07, ZTSC-08, ZTMC-01, ZTMC-02, ZTMC-03, ZTMC-05
CRADA 92-008 Final Report
(EG&G TSWV Report No. 33FF-R93-001)

C. Elaine Everett
Steven J. Monaco

May 1994

U.S. Department of Energy
Office of Fossil Energy
Morgantown Energy Technology Center
3610 Collins Ferry Road
Morgantown, WV 26505

and

EG&G Technical Services of West Virginia
990 Elmer Prince Drive
Morgantown, WV 26505-3276

MASTER

Data Summary Report
for M. W. Kellogg Zinc Titanate Test Series

Report Number: 33FF-R93-001

DISCLAIMER

This report was prepared as an account of work sponsored by an agency of the United States Government. Neither the United States Government nor any agency thereof, nor any of their employees, makes any warranty, express or implied, or assumes any legal liability or responsibility for the accuracy, completeness, or usefulness of any information, apparatus, product, or process disclosed, or represents that its use would not infringe privately owned rights. Reference herein to any specific commercial product, process, or service by trade name, trademark, manufacturer, or otherwise does not necessarily constitute or imply its endorsement, recommendation, or favoring by the United States Government or any agency thereof. The views and opinions of authors expressed herein do not necessarily state or reflect those of the United States Government or any agency thereof.

NOTICE

This report was prepared to document work sponsored by the United States Government. Neither the United States nor its agent, the United States Department of Energy, nor any Federal employees, nor any of their contractors, subcontractors, or their employees makes any warranty, expressed or implied, or assumes any legal liability or responsibility for the accuracy, completeness, or the usefulness of any referenced information, apparatus, product or process disclosed, or represents that its use would not infringe privately-owned rights.

Reference to a company or product name does not imply approval or recommendation of the product by EG&G or the U. S. Department of Energy to the exclusion of others that may be suitable.

Table of Contents

Executive Summary	iii
1.0 Introduction	1
2.0 Test Plan Summary	5
3.0 Operations Summary	8
4.0 Test Data Summary	17
4.1 Gas Analysis	17
4.1.1 Gas Grab Analysis by Laboratory Gas Chromatograph	17
4.1.2 Detector Tube Analysis	24
4.1.3 Sulfur Species Trends	24
4.2 Condensate Analysis	33
4.3 Solid Analysis	37
4.3.1 Crush Strength	37
4.3.2 Sulfur Analysis	39
4.3.3 Total Carbon Analysis	45
4.3.4 Bulk Elemental Analysis	47
4.3.5 Chloride Analysis	50
4.3.6 Helium Density	51
4.3.7 Nitrogen and Krypton Adsorption	53
4.3.8 Mercury Porosity	55
4.3.9 Mineral Analysis by X-Ray Diffraction	57
4.3.10 Sieve Analysis	60
5.0 Results and Discussion	66
5.1 Sulfur Balances	66
5.2 Chloride Balance	72
5.3 Discussion of Results	74
APPENDIX A	
Data Acquisition Mass Flow Trends	A-1
APPENDIX B	
Data Acquisition Temperature Trends	B-1
APPENDIX C	
Data Acquisition Pressure Trends	C-1
APPENDIX D	
Data Acquisition Differential Pressure Trends	D-1
APPENDIX E	
Laboratory Gas Chromatograph Results	E-1
APPENDIX F	
Detector Tube Results	F-1
APPENDIX G	
Porosity Plots	G-1

List of Figures

Figure 1:	Simplified Process Flow Diagram	3
Figure 2:	Reactor Schematic	4

List of Tables

Table 2.1:	Fresh Sorbent Characteristics	5
Table 2.2:	Nominal Test Conditions	6
Table 3.1:	Actual Test Period Parameters	9
Table 4.1:	Average Gas Compositions by GC Analysis	18
Table 4.2:	Condensate Analyses - Scoping Tests	34
Table 4.3:	Condensate Analyses - Multi-Cycle Tests	34
Table 4.4:	Crush Strength Analysis	38
Table 4.5:	Sorbent Sulfur Analyses	40
Table 4.6:	Sorbent Carbon Analysis	45
Table 4.7:	Sorbent Elemental Analyses	48
Table 4.8:	Sorbent Chloride Analysis	50
Table 4.9:	Sorbent Helium Density	51
Table 4.10:	Sorbent Krypton and Nitrogen Adsorption	53
Table 4.11:	Sorbent Mercury Porosity	56
Table 4.12:	Mineral Analysis By X-Ray Diffraction	58
Table 4.13:	Sieve Analysis - Test Number ZTSC07-R3 (After Third Regeneration)	61
Table 4.14:	Sieve Analysis - Test Number ZTMC01-S4 (After Fourth Sulfidation)	62
Table 4.15:	Sieve Analysis - Test Number ZTMC02-R3 (After Third Regeneration)	63
Table 4.16:	Sieve Analysis - Test Number ZTMC-04-S3 (After Fourth Sulfidation)	64
Table 4.17:	Sieve Analysis - Test Number ZTSC-08-S1 (After Sulfidation)	65
Table 5.1:	Single Cycle Test Sulfur Balances	67
Table 5.2:	Test ZTSC-07 Sulfur Balance	68
Table 5.3:	Test ZTMC-01 Sulfur Balance	69
Table 5.4:	Test ZTMC-02 Sulfur Balance	70
Table 5.5:	Test ZTMC-04 Sulfur Balance	71
Table 5.6:	Test ZTMC-01 Chloride Balance	73

Executive Summary

A series of tests were undertaken from August 6, 1992 through July 6, 1993 at METC's High Pressure Bench-Scale Hot Gas Desulfurization Unit to support a Cooperative Research and Development Agreement (CRADA) between METC's Sorbent Development Cluster and M. W. Kellogg. The M. W. Kellogg Company is currently developing a commercial offering of a hot gas clean-up system to be used in Integrated Gasification Combined Cycle (IGCC) systems. The intent of the CRADA agreement was to identify a suitable zinc-based desulfurization sorbent for the Sierra Pacific Power Company Clean Coal Technology Project, to identify optimum operating conditions for the sorbent, and to estimate potential sorbent loss per year.

Task 1 of the CRADA agreement was to conduct fixed-bed zinc titanate sorbent testing. The results of Task 1 testing are presented in this report. A comprehensive summary of the detailed chemical and physical analysis of samples of the fresh and reacted zinc titanate sorbent are presented in the report entitled "Characterization of Molybdenum-Containing Zinc Titanate after Sulfidation and Regeneration", by Ranjani V. Siriwardane, James A. Poston, and Grover Evans of the U. S. Department of Energy/ Morgantown Energy Technology Center and C. Elaine Everitt of EG&G Technical Services of West Virginia.

Task 2 of the CRADA was to conduct fixed-bed zinc ferrite sorbent testing. The results of Task 2 are reported in the Topical Report number 3FHP-R94-002, entitled "Data Summary Report for M. W. Kellogg Zinc Ferrite Test ZFMC-01", by C. Elaine Everitt and Steven J. Monaco of EG&G Technical Services of West Virginia.

Task 3 of the CRADA was to conduct fixed-bed testing using Phillips Petroleum's Z-Sorb III sorbent. The results of Task 3 are presented in the Topical Report Number 3FHP-R94-003, entitled "Data Summary Report for M. W. Kellogg Z-Sorb Tests, Z-Sorb-01, Z-Sorb-02, and Z-Sorb-03", by C. Elaine Everitt and Steven J. Monaco of EG&G Technical Services of West Virginia.

The United Catalysts, Inc. molybdenum-promoted zinc titanate, T-2535M sorbent was selected for this series of tests. This sorbent, which was originally developed for the GE moving-bed process, was in the form of 5 mm ellipsoids. The zinc to titanium molar ratio for this formulation was 2:1. Seven half cycle scoping tests and five multi-cycle tests were completed. Sorbent bed temperature and linear velocity were varied for the scoping tests. System pressure was fixed at 1030 kPa (150 psia) for sulfidation test phases and 446 kPa (50 psig) for most regeneration test phases. The results of those tests were to be utilized to select the optimum conditions for a multi-cycle test.

Signs of sorbent decrepitation were seen after the first multi-cycle test. As a result, several multi-cycle tests were run. Temperature and gas composition were varied in an attempt to isolate the cause of sorbent spalling.

1.0 Introduction

This report summarizes the data gathered for a zinc titanate test series which was conducted at the Morgantown Energy Technology Center's (METC) High Pressure Bench-Scale Hot Gas Desulfurization Unit between September 3, 1992 and January 27, 1993. The test series was conducted as part of a cooperative research and development agreement (CRADA) between METC and the M. W. Kellogg Company. M. W. Kellogg is involved in the design of a hot gas cleanup train for the integrated gasification combined-cycle (IGCC) clean coal project being developed by Sierra Pacific Power Company. In the conceptual stages, a fixed bed operation was envisioned for the hot gas desulfurization system. As such, it was desired by METC and Kellogg to generate experimental data from a bench-scale fixed bed reactor for zinc-based desulfurization sorbents. Because of the relatively large steam requirement of the zinc ferrite sorbent system and the expected durability of zinc titanate, Kellogg had wanted to consider zinc titanate as an alternative to zinc ferrite. The experimental data necessary for direct comparison and selection between the two sorbents had not been generated. Thus the CRADA agreement was established to generate that data.

Testing was conducted at METC's High Pressure Bench-Scale Hot Gas Desulfurization Unit. Figure 1 is a simplified process flow diagram of the High Pressure Bench-Scale test facility. The reactor was constructed of a 3-inch diameter by five feet long Incoloy 800 H alloy steel shell. Inside the 3-inch shell was a removable, 2-inch diameter by 30-inch long 316 stainless steel cage for easy loading and unloading of the sorbent. The sorbent cage was suspended from the top flange of the Incoloy 800 H reactor shell. A gas distributor was fixed at the bottom of the cage to support the sorbent. The inside of the sorbent cage was Alon-processed to prevent corrosion of stainless steel by sulfur gases in the presence of steam. The reactor was housed inside a three-zone furnace equipped with separate temperature controllers for each zone. A thermowell extended from the bottom of the pressure vessel, axial to the sorbent bed. Figure 2 illustrates the location of the thermowell and thermocouples in the reactor. The high pressure HGD reactor system used bottled gases, house air and nitrogen, and distilled water to make up the simulated coal gas. Oxidizing and reducing gas feed systems were separated and have multiple shut-off valves and in-line check valves to prevent inadvertent mixing of feed gases. The delivery pressures to the system for inlet gas components, excluding water, were controlled with pressure regulators, and metered to the desired flow rate using a set of mass flow controllers. Water to the system was supplied with a Milton Roy metering pump (tests ZTSC-01 through ZTSC-04) or, in subsequent tests, an Isco, Inc. dual syringe pump system. The process water was preheated using a small boiler and then fed to the process gas preheater along with the other gases. If hydrogen sulfide was being used, it was

added to the bulk gas stream after the preheater to avoid added corrosion to the preheater. During sulfidations, the heated gas stream entered the top of the reactor vessel and flowed down through the sorbent bed, exiting from the bottom of the reactor vessel. Regenerations were performed in the opposite direction. Condensate was collected in a two-level knock out pot system. The pots were set up such that the second pot can be depressurized independent of the first pot to allow for safe dumping of the condensate. Following the knock out pots, a filter was located in the line to capture any entrained moisture or particulates prior to the exit flow meters and pressure reduction valves. The exit gas was passed through a final fixed bed absorber of zinc oxide to remove any hydrogen sulfide remaining in the exit gas before being vented to the atmosphere.

To determine the performance of the sorbent under specific test conditions, small slip streams of the inlet and exit gases were sampled in a vented sampling chamber with portions being fed to an on line mass spectrometer. In addition, the outlet H_2S and SO_2 concentrations were also monitored using detector tubes during sulfidation and regeneration respectively.

High Pressure Bench-Scale Hot Gas Desulfurization Unit Simplified Process Flow Diagram

Figure 1

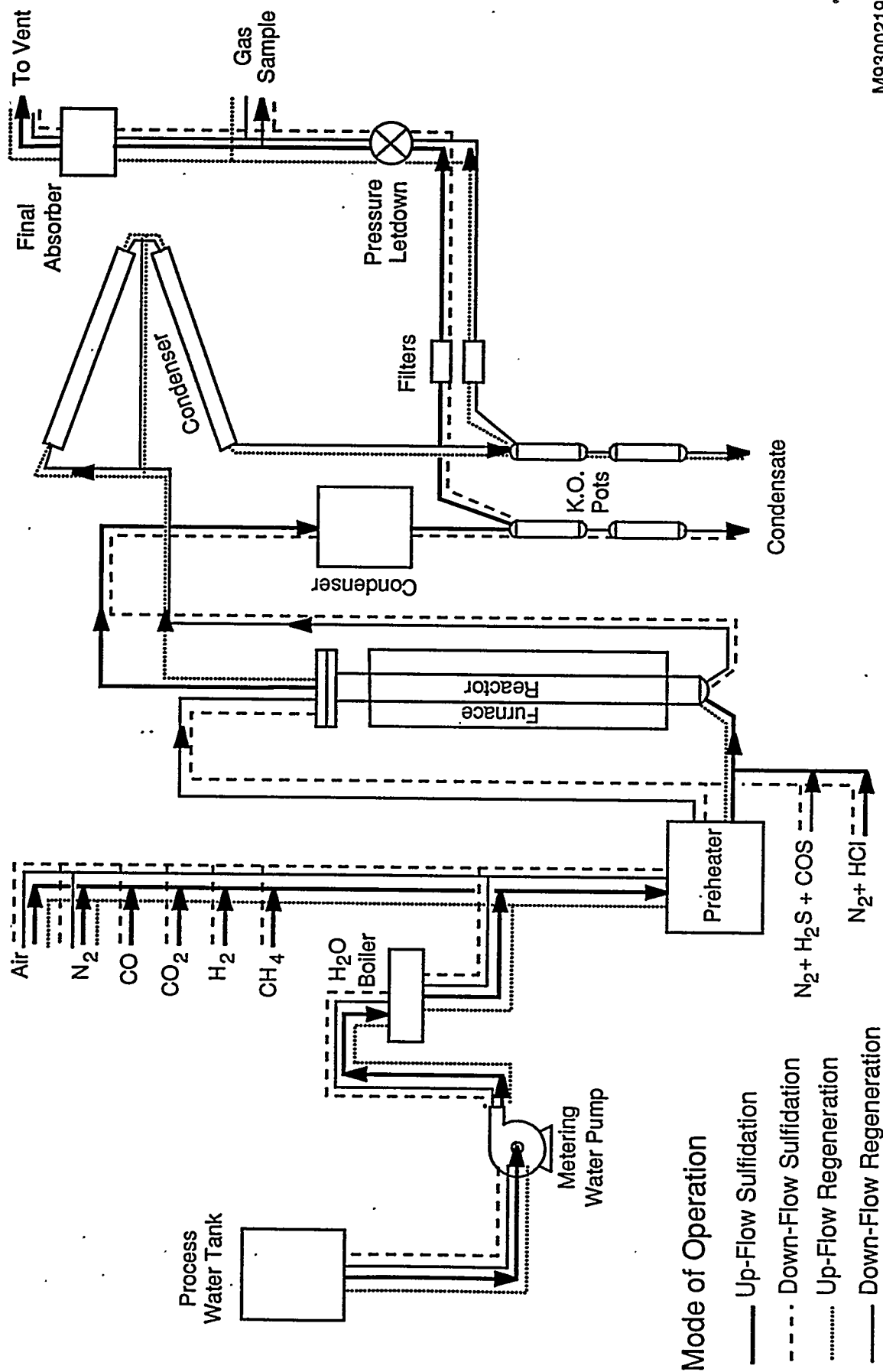

MS93002194

Figure 2: Reactor Schematic

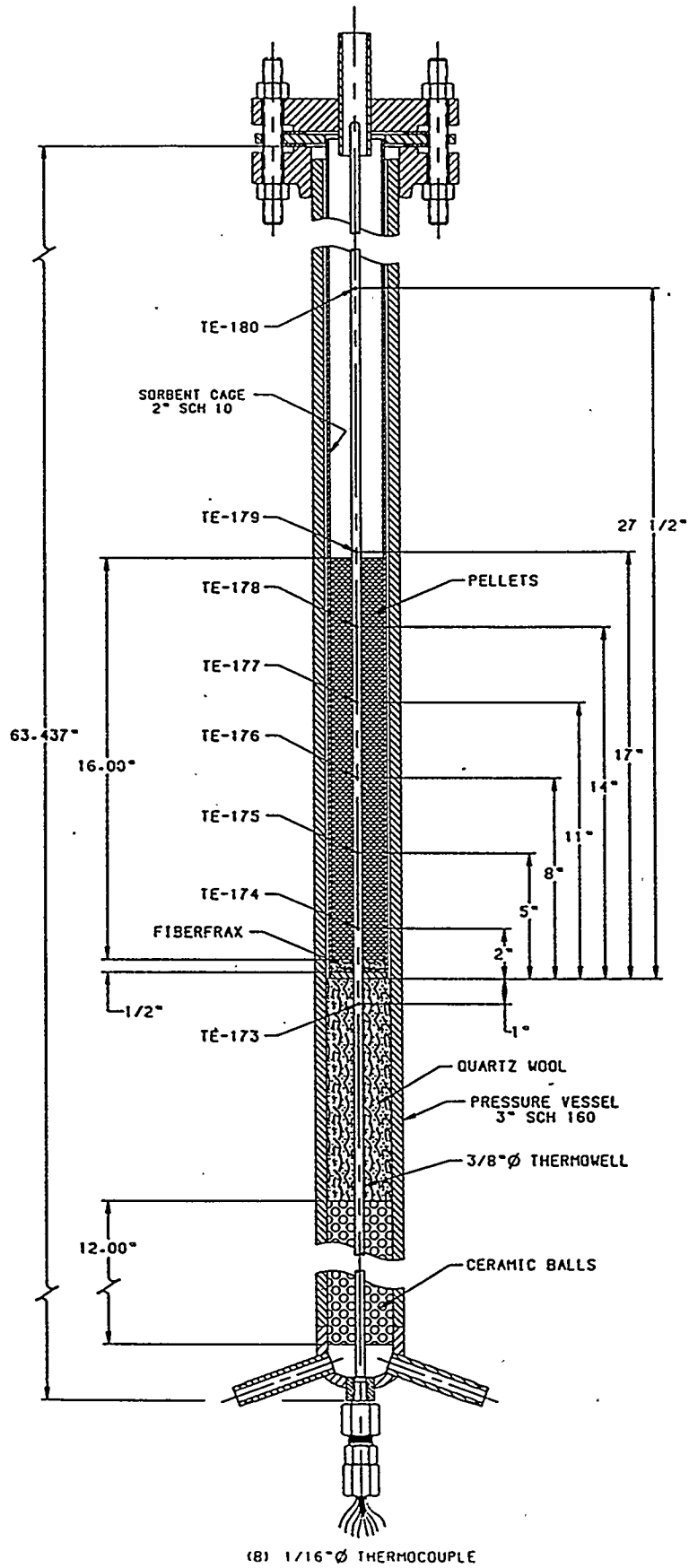

2.0. Test Plan Summary

The objective of the zinc titanate test series was to (1) select optimum operating conditions for the selected sorbent and (2) to evaluate the sorbent's durability, reactivity, and sulfur capacity at the selected temperature and flow conditions over multiple sulfidation-regeneration cycles. The zinc titanate sorbent was manufactured by United Catalysts, Inc. and provided to METC by GE. The ellipsoid-shaped sorbent pellets had been manufactured specifically for GE's moving bed process. Sorbent characteristics, which were provided with the fresh sorbent, are detailed in Table 2.1.

Table 2.1: Fresh Sorbent Characteristics

ZINC TITANATE United Catalysts, Inc. T-2535M (GE designation L-3787M)	
Pellet Diameter	5 mm
Shape	Ellipsoidal
Zn/Ti Molar Ratio	1.91
Additives	
Bentonite, Wt %	3
MoO ₃ , Wt %	2.37
Calcination Temperature	> 760 °C
Bulk Density	1.59 g/cc.
Median Pore Diameter	6688 Å
Specific Pore Volume	0.21 cc/g
Crush Strength	87.2 N/pellet

Planned test conditions are presented in Table 2.2. The nomenclature used for numbering test phases is the test number followed by an "S" or and "R", to indicated a sulfidation or a regeneration test phase, and a number to (i.e., 1,2,3, etc) to indicate the cycle number. ZTSC means zinc titanate single cycle and ZTMC means zinc titanate multi-cycle.

Table 2.2: Nominal Test Conditions

Test No.	Pressure (kPa)	Temperature (°C)	Velocity			Gas Composition Volume Percent									
			cm/s	scl/h	1/h	O ₂	H ₂ O	CO	CO ₂	H ₂	N ₂	ppm H ₂ S	ppm COS	ppm HCl	
ZTSC01-S1	1030	593	60.5	17386	18718	0	9	21	7	15	47.97	800	100	0	
ZTSC02-S1	1030	593	30.5	8693	9359	0	9	21	7	15	47.97	800	100	0	
ZTSC03-S1	1030	593	30.5	8693	9359	0	9	21	7	15	47.97	800	100	0	
ZTSC04-S1	1030	538	30.5	9288	10000	0	9	21	7	15	47.97	800	100	0	
ZTSC05-S1	1030	649	30.5	8183	8795	0	9	21	7	15	47.97	800	100	0	
ZTSC06-S1	1030	649	15.2	4078	4398	0	9	21	7	15	47.97	800	100	0	
ZTSC07-S1	1030	538	15.2	4644	5000	0	9	21	7	15	47.97	800	100	0	
ZTSC07-R1	345	649-760	15.2	1359	1466	2.5	90	0	0	0	7.5	0	0	0	
ZTSC07-S2	1030	538	15.2	4644	5000	0	9	21	7	15	47.97	800	100	0	
ZTSC07-R2	345	649-760	30.5	2718	2931	2.5	0	0	0	0	97.5	0	0	0	
ZTSC07-S3	1030	649	60.5	16338	17590	0	9	21	7	15	47.97	800	100	0	
ZTSC07-R3	1030	649-760	10.1	2718	2902	1.5	0	0	0	0	98.5	0	0	0	
ZTMC01-S1	1030	649	15.2	4078	5863	0	9	21	7	15	47.97	800	0	15	
ZTMC01-R1	345	649-760	30.5	2718	3909	1.5	50	0	0	0	48.5	0	0	0	
ZTMC01-S2	1030	649	15.2	4078	5863	0	9	21	7	15	47.97	800	0	15	
ZTMC01-R2	345	649-704	30.5	2718	3909	0.75	50	0	0	0	49.25	0	0	0	
ZTMC01-S3	1030	593	15.2	4332	6239	0	9	21	7	15	47.97	800	0	15	
ZTMC01-R3	345	649-704	30.5	2718	3909	0.75	50	0	0	0	49.25	0	0	0	
ZTMC01-S4	1030	593	15.2	4332	6239	0	9	21	7	15	47.97	800	0	15	
ZTMC02-S1	1030	538	30.5	4644	5000	0	30	8	11	16	34.92	800	0	0	
ZTMC02-R1	345	649-760	15.2	1359	1466	2.5	90	0	0	0	7.5	0	0	0	
ZTMC02-S2	1030	538	15.2	4644	5000	0	30	8	11	16	34.92	800	0	0	
ZTMC02-R2	345	649-760	30.5	2718	2931	2.5	0	0	0	0	97.5	0	0	0	
ZTMC02-S3	1030	649	60.5	16338	17590	0	30	8	11	16	34.92	800	0	0	
ZTMC02-R3	1030	649-760	10.1	2718	2902	1.5	0	0	0	0	98.5	0	0	0	
ZTMC03-S1,S2,S3,S4	1030	649	30.5	8183	8795	0	9	21	7	15	48	0	0	0	
ZTMC03-R1,R2,R3,R4	345	760	30.5	2435	2616	0.75	0	0	0	0	99.25	0	0	0	

Test No.	Pressure (kPa)	Temperature (°C)	Velocity		Gas Composition Volume Percent									
			cm/s	scL/h	1/h	O ₂	H ₂ O	CO	CO ₂	H ₂	N ₂	ppm H ₂ S	ppm COS	ppm HCl
ZTMC04-S1, S2, S3	1030	538	30.5	9288	10000	0	9	21	7	15	47.92	800	0	0
ZTMC04-R1, R2 Stage 1	172	538	30.5	1529	1646	0.5	0	0	0	0	99.5	0	0	0
Stage 2	172	579	30.5	1444	1566	2.5	0	0	0	0	97.5	0	0	0
Stage 3	172	621	30.5	1387	1493	4.0	0	0	0	0	96.0	0	0	0
Stage 4	172	635	30.5	1331	1427	7.0	0	0	0	0	93.0	0	0	0
Stage 5	172	704	30.5	1274	1366	21.0	0	0	0	0	79.0	0	0	0
Soak	172	760	33.5	1274	1366	21.0	0	0	0	0	79.0	0	0	0
ZTSC08-S1	1030	538	30.5	9288	10000	0	9	21	7	15	47.80	2000	0	0

3.0 Operations Summary

Test operations for the investigation of the United Catalysts, Inc. T-2535M zinc titanate sorbent commenced on September 3, 1992. The test series consisted of seven half-cycle scoping tests and five multi-cycle tests. Test ZTSC-07 was originally planned to be a single cycle test, but was extended into a three cycle test. Test durations, sorbent masses loaded for each test, and the actual average test conditions are presented in Table 3.1. Flow controller set-point data, temperature data and pressure data were monitored continuously by DDAS, a personal computer-based automatic data acquisition system. Data were collected by the system at rates of 10-30 scans per minute depending on the test (e.g., slower rates were utilized for long tests). Inlet gas compositions are based on the flow controller set-points and corrected with flow proving regression curves. Appendix A presents data acquisition plots showing trends for the mass flow controllers for the duration of the test. Although only the average and maximum temperatures are presented below, temperature profile plots which illustrate the temperature history during testing are presented in Appendix B. Appendix C presents the system pressure history and Appendix D the differential pressure across the reactor.

Table 3.1: Actual Test Period Parameters

Test Period	ZTSC01-S1	ZTSC02-S1	ZTSC03-S1	ZTSC04-S1	ZTSC05-S1	ZTSC06-S1
Start Time/Date	4:35 9/3/92	11:30 9/4/92	1:00 9/9/92	14:00 9/10/92	11:00 9/15/92	9:00 9/17/92
End Time/Date	8:08 9/3/92	19:45 9/4/92	10:05 9/9/92	21:33 9/10/92	18:43 9/15/92	6:05 9/19/92
Duration, hrs	3.55	8.25	9.08	6.93	7.57	45.08
Comment	45 g quartz wool packed above sorbent bed. 1/2" Fiberfrax above distributor. End test criteria: Detector tube reading of H ₂ S > 600 ppmv.	113 g quartz wool packed above sorbent bed. 1/2" Fiberfrax above distributor. Automatic data acquisition started late @1240. End test criteria: Detector tube reading of H ₂ S > 600 ppmv.	124 g quartz wool packed above sorbent bed. 1/2" Fiberfrax above distributor. Automatic data acquisition started late @ 2:00. End test criteria: Detector tube reading of H ₂ S > 600 ppmv.	150 g quartz wool packed above sorbent bed. 1/2" Fiberfrax above distributor. Off-line 14:23-15:00; H ₂ S flow controller malfunctioning. End test criteria: Detector tube reading of H ₂ S > 600 ppmv.	120 g quartz wool packed above sorbent bed. 1/2" Fiberfrax above distributor. Installed new water pump prior to test. End test criteria: Detector tube reading of H ₂ S > 600 ppmv.	125 g quartz wool packed above sorbent bed. 1/2" Fiberfrax above distributor. End test criteria: Detector tube reading of H ₂ S > 600 ppmv.
Weight of Sorbent, g	1395	1368	1370	1370	1370	1370
Bed Height, cm	40.64	40.64	40.64	40.64	40.64	40.64
INLET Gas Composition based on Flow Controller Settings						
Carbon Monoxide, Volume %	19.83	20.91	21.18	20.94	20.53	22.70
Carbon Dioxide, Volume %	6.79	7.16	6.90	7.05	7.05	8.37
Hydrogen, Volume %	14.58	15.66	15.75	15.04	14.99	17.09
Steam, Volume %	12.10	8.38	7.93	8.66	9.08	9.94
Nitrogen, Volume %	46.63	47.80	48.14	48.22	48.28	41.81
Hydrogen Sulfide, ppmv	778	807	809	760	760	971
Carbonyl Sulfide, ppmv	87.43	90.75	91.00	85.51	85.49	0
Hydrogen Chloride, ppmv	0	0	0	0	0	0
Inlet gas flow rate, SL/h	18108.26	8793.89	8735.36	9590.93	8523.05	4866.81
Space Velocity, 1/h	19489	9465	9402	10322	9173	4109
Linear Velocity, cm/s	62.51	31.80	30.86	32.61	31.85	14.23
PT-165 Pressure, kPag	931.67	931.74	931.33	931.81	931.74	931.54
Bed Temperatures, °C						
TE-174, 2" Above Bottom	Avg 629, Max 644	Avg 677, Max 718	Avg 590, Max 594	Avg 574, Max 584	Avg 661, Max 665	Avg 659, Max 678
TE-175, 5" Above Bottom	Avg 609, Max 629	Avg 662, Max 693	Avg 602, Max 606	Avg 581, Max 590	Avg 663, Max 668	Avg 666, Max 686
TE-176, 8" Above Bottom	Avg 581, Max 602	Avg 636, Max 654	Avg 606, Max 610	Avg 577, Max 585	Avg 658, Max 663	Avg 664, Max 683
TE-177, 11" Above Bottom	Avg 550, Max 571	Avg 596, Max 627	Avg 603, Max 609	Avg 564, Max 573	Avg 646, Max 650	Avg 648, Max 675
TE-178, 14" Above Bottom	Avg 527, Max 545	Avg 528, Max 572	Avg 594, Max 601	Avg 536, Max 548	Avg 620, Max 625	Avg 599, Max 641

Table 3.1: Actual Test Period Parameters (Continued)

Test Period	ZTSC07-S1	ZTSC07-R1	ZTSC07-S2	ZTSC07-R2	ZTSC07-S3	ZTSC07-R3
Start Time/Date	12:45 9/22/92	0:45 9/24/92	1:30 9/25/92	14:15 9/28/92	1:00 9/29/92	8:30 10/2/92
End Time/Date	18:20 9/23/92	10:26 9/24/92	3:50 9/26/92	18:49 9/28/92	12:50 10/1/92	14:18 10/2/92
Duration, hrs	29.58	9.68	25.32	4.57	29.92	5.80
Comment	Prior to testing, preheater was modified with addition of stainless steel packing inside preheater tube. End test Criteria: H ₂ S > 600 ppmv by detector tube.	Exothermic reaction controlled by adjusting air flow during test. End test Criteria: SO ₂ < 100 ppmv by detector tube. Unload reactor at completion of phase. Retain 15 gram samples from top, middle and bottom.	15" bed returned to reactor for test phase. Off-Line 9:14-10:15 9/25/92; H ₂ S flow controller malfunctioning. End test Criteria: H ₂ S > 600 ppmv by detector tube.	Exothermic reaction controlled by adjusting air flow during test. End test Criteria: SO ₂ < 100 ppmv by detector tube.	Off-Line 4:05 9/30/92 - 10:00 10/1/92 Unload reactor at completion of phase. Retain 15 gram samples from top, middle, bottom. Observed large pressure drop across preheater. End of test criteria: Saturation	14" bed returned to reactor for test phase. Steel packing removed from preheater before test phase. Wrong system pressure was used (135 psig instead of originally planned 35.3 psig.) End test Criteria: SO ₂ < 100 ppmv by detector tube.
Weight of Sorbent, grams	1370					
Bed Height, in	40.64	40.64	38.10	38.10	38.10	35.56
INLET Gas Compositions based on Flow Controller Settings						
Carbon Monoxide, Volume %	21.42	0	20.58	0	21.06	0
Carbon Dioxide, Volume %	7.57	0	7.88	0	7.20	0
Hydrogen, Volume %	14.66	0	14.85	0	14.96	0
Steam, Volume %	8.86	89.77	8.95	0	9.05	0
Nitrogen, Volume %	47.40	8.08	47.65	98.23	47.64	98.57
Oxygen, Volume %	0	2.15	0	1.77	0	1.43
Hydrogen Sulfide, ppmv	869	0	851	0	842	0
Carbonyl Sulfide, ppmv	0	0	0	0	0	0
Hydrogen Chloride, ppmv	0	0	0	0	0	0
Inlet gas flow rate, sL/h	4866.81	1229.72	4817.47	2439.08	16759.67	2704.68
Space Velocity, 1/h	5238	1324	5531	2800	19240	3327
Linear Velocity, cm/s	16.08	14.00	15.84	27.91	61.08	10.36
Pressure, kPag	931.47	241.74	931.40	243.95	933.22	932.02
Bed Temperatures, °C	AVG	Max	AVG	Max	AVG	Max
TE-174, 2" Above Bottom	534	538	533	546	668	702
TE-175, 5" Above Bottom	545	548	539	553	656	714
TE-176, 8" Above Bottom	548	552	542	557	636	727
TE-177, 11" Above Bottom	547	551	542	558	609	731
TE-178, 14" Above Bottom	537	542	535	551	571	718
					AVG	Max
					650	754
					668	773
					674	750
					683	753
					692	754

Table 3.1: Actual Test Period Parameters (Continued)

Test Period	ZTMC01-S1	ZTMC01-R1	ZTMC01-S2	ZTMC01-R2	ZTMC01-S3	ZTMC01-R3	ZTMC01-S4	
Start Time/Date	9:00 10/6/92	20:00 10/6/92	1:00 10/7/92	18:00 10/7/92	3:00 10/8/92	20:00 10/8/92	4:00 10/9/92	
End Time/Date	18:05 10/6/92	22:12 10/6/92	13:10 10/7/92	23:05 10/7/92	18:03 10/8/92	2:00 10/9/92	22:16 10/9/92	
Duration, hrs	9.08	2.20	12.17	5.08	15.05	5.80	18.27	
Comment	End test criteria: Detector tube reading of H ₂ S > 100 ppmv.	Air flow rate adjusted during testing to control temperature. End test criteria: Detector tube reading of SO ₂ < 100 ppmv.	End test criteria: Detector tube reading of H ₂ S > 100 ppmv.	End test criteria: Detector tube reading of SO ₂ < 100 ppmv.	End test criteria: Detector tube reading of H ₂ S > 100 ppmv.	End test criteria: Detector tube reading of SO ₂ < 100 ppmv.	End test criteria: Detector tube reading of H ₂ S > 100 ppmv.	
Weight of Sorbent, g	1021							
Bed Height, cm	30.48	30.48	30.48	30.48	30.48	30.48	30.48	
INLET Gas Compositions Based on Flow Controller Settings								
Carbon Monoxide, Volume %	21.08	0	21.09	0	20.84	0	20.47	
Carbon Dioxide, Volume %	7.69	0	7.75	0	7.75	0	7.92	
Hydrogen, Volume %	14.75	0	14.71	0	14.77	0	14.81	
Steam, Volume %	8.88	51.14	8.87	50.11	8.90	50.03	8.95	
Nitrogen, Volume %	47.51	47.72	47.50	49.26	47.65	49.33	47.76	
Oxygen, Volume %	0	1.14	0	0.63	0	0.64	0	
Hydrogen Sulfide, ppmv	856	0	815	0	819	0	838	
Carbonyl Sulfide, ppmv	0	0	0	0	0	0	0	
Hydrogen Chloride, ppmv	14	0	14	0	15	0	15	
Inlet gas flow rate, sL/h	4136.23	2663.59	4143.65	2718.29	4398.75	2722.44	4377.55	
Space Velocity, 1/h	5936	3822	5946	3901	6312	3907	6282	
Linear Velocity, cm/s	15.45	30.78	15.51	30.47	15.45	30.67	15.38	
PT-165 Pressure, kPag	932.23	243.74	930.09	244.09	932.57	244.02	932.43	
Bed Temperatures, °C	Avg	Max	Avg	Max	Avg	Max	Avg	Max
TE-174, 2" Above Bottom	644	654	646	678	650	668	648	686
TE-175, 5" Above Bottom	652	674	677	683	652	684	657	703
TE-176, 8" Above Bottom	649	685	687	678	652	690	659	698
TE-177, 11" Above Bottom	656	690	647	667	654	694	663	694
TE-178, 14" Above Bottom	656	690	652	668	653	690	662	689

Table 3.1: Actual Test Period Parameters (Continued)

Test Period	ZTMC02-S1	ZTMC02-R1	ZTMC02-S2	ZTMC02-R2	ZTMC02-S3	ZTMC02-R3
Start Time/Date	1:00 10/14/92	3:00 10/15/92	18:00 10/15/92	12:30 10/19/92	20:00 10/19/92	1:00 10/21/92
End Time/Date	0:03 10/15/92	8:13 10/15/92	18:03 10/16/92	16:45 10/19/92	14:05 10/20/92	6:03 10/21/92
Duration, hrs	23.05	5.21	24.05	4.25	18.08	5.05
Comment	End test criteria: Detector tube reading of H ₂ S > 600 ppmv.	Temperature controlled by adjusting air flow during testing. End test criteria: Detector tube reading of SO ₂ > 100 ppmv. Unload reactor at completion of test phase. 15 gram samples retained from top, middle, and bottom.	15" bed returned to reactor for test phase. End test criteria: Detector tube reading of H ₂ S > 600 ppmv.	Air flow adjusted during test phase to control temperatures. End test criteria: Detector tube reading of SO ₂ > 100 ppmv.	Check valve assembly on multiple water pump system failed. Intermittent water delivery during test phase. End test criteria: Saturation	14-1/2" bed returned to reactor for test phase. Air flow adjusted during test phase to control temperature. End test criteria: Detector tube reading of SO ₂ > 100 ppmv.
Weight of Sorbent, g	1370		1315 (Regenerated)			1320 (Sulfided)
Bed Height, cm	40.64	40.64	38.10	38.10	38.10	36.83
INLET Gas Compositions based on Flow Controllers Settings						
Carbon Monoxide, Volume %	8.22	0	8.35	0	8.22	0
Carbon Dioxide, Volume %	11.63	0	11.71	0	11.14	0
Hydrogen, Volume %	15.70	0	15.63	0	15.18	0
Steam, Volume %	29.57	79.36	29.48	0	30.08	0
Nitrogen, Volume %	34.79	18.81	34.76	98.06	34.68	98.62
Oxygen, Volume %	0	1.83	0	1.94	0	1.38
Hydrogen Sulfide, ppmv	785	0	758	0	800	0
Carbonyl Sulfide, ppmv	0	0	0	0	0	0
Hydrogen Chloride, ppmv	0	0	0	0	0	0
Inlet gas flow rate, sL/h	4711.81	1511.69	4726.56	2670.24	16301.39	2678.65
Space Velocity, 1/h	5071	1627	5426	3065	18714	3075
Linear Velocity, cm/s	15.50	17.30	15.59	30.55	60.36	10.22
Pressure PT-165, kPag	932.43	244.16	932.50	243.68	932.71	932.85
Bed Temperatures °C	Avg	Max	Avg	Max	Avg	Max
TE-174, 2" Above Bottom	534	554	542	556	673	722
TE-175, 5" Above Bottom	543	563	546	561	668	716
TE-176, 8" Above Bottom	546	564	547	562	654	703
TE-177, 11" Above Bottom	543	560	543	557	627	684
TE-178, 14" Above Bottom	531	546	531	546	588	647
					Avg	Max
					650	696
					664	760
					671	761
					680	760
					687	760

Table 3.1: Actual Test Period Parameters (Continued)

Test Period	ZTMC04-S1	ZTMC04-R1 Stage 1	ZTMC04-R1 Stage 2	ZTMC04-R1 Stage 3	ZTMC04-R1 Stage 4	ZTMC04-R1 Stage 5	ZTMC04-R1 Soak						
Start Time/Date	21:00 1/13/93	5:00 1/15/93	9:05 1/15/93	13:15 1/15/93	15:15 1/15/93	17:16 1/15/93	18:15 1/15/93						
End Time/Date	2:00 1/15/93	9:05 1/15/93	13:15 1/15/93	15:15 1/15/93	17:16 1/15/93	18:15 1/15/93	20:33 1/15/93						
Duration, hrs	29.00	4.08	4.17	2.00	2.02	0.98	2.30						
Comment							15.55 hr total						
Weight of Sorbent, g	1515 installed												
Bed Height, cm	41.28												
INLET Gas Compositions based on Flow Controller Settings													
Carbon Monoxide, Vol %	20.52	0	0	0	0	0	0						
Carbon Dioxide, Vol %	7.13	0	0	0	0	0	0						
Hydrogen, Vol %	15.07	0	0	0	0	0	0						
Steam, Vol %	9.00	0	0	0	0	0	0						
Nitrogen, Vol %	48.20	99.35	97.04	95.02	85.85	79.00	79.00						
Oxygen, Vol %	0	0.65	2.96	4.98	14.15	21.00	21.00						
Hydrogen Sulfide, ppmv	816	0	0	0	0	0	0						
Carbonyl Sulfide, ppmv	0	0	0	0	0	0	0						
Hydrogen Chloride, ppmv	0	0	0	0	0	0	0						
Inlet gas flow, sL/h	9289.95	1311.41	1221.13	1125.38	1343.28	1268.39	1266						
Space Velocity, 1/h	9998	1411	1314	1211	1446	1365	1363						
Linear Velocity, cm/s	30.92	27.05	27.05	25.28	31.46	30.74	32.04						
PT-165 Pressure, kPag	931.95	67.57	67.64	67.57	67.64	67.50	68.47						
Bed Temperatures, °C	Avg	Max	Avg	Max	Avg	Max	Avg	Max					
TE-174, 2" Above Bottom	544	562	561	587	605	687	664	711	711	711	757	764	
TE-175, 5" Above Bottom	551	568	564	585	615	698	633	659	674	705	704	753	762
TE-176, 8" Above Bottom	553	569	563	581	622	701	630	655	669	700	700	751	761
TE-177, 11" Above Bottom	552	563	559	582	629	707	632	657	671	701	702	754	764
TE-178, 14" Above Bottom	544	553	552	586	636	704	636	660	674	705	707	756	765

Table 3.1: Actual Test Period Parameters (Continued)

Test Period	ZTMC04-S2	ZTMC04-R2 Stage 1	ZTMC04-R2 Stage 2	ZTMC04-R2 Stage 3	ZTMC04-R2 Stage 4	ZTMC04-R2 Stage 5	ZTMC04-R2 Soak							
Start Time/Date	9:00 1/19/93	9:30 1/20/93	12:00 1/20/93	17:15 1/20/93	19:15 1/20/93	21:15 1/20/93	22:15 1/20/93							
End Time/Date	7:05 1/20/93	12:00 1/20/93	17:15 1/20/93	19:15 1/20/93	21:15 1/20/93	22:15 1/20/93	5:03 1/21/93							
Duration, hrs	22.08	2.50	5.25	2.00	2.00	1.00	6.80							
Comment							19.55 hr total							
Weight of Sorbent, g														
Bed Height, cm														
INLET Gas Compositions based on Flow Controller Settings														
Carbon Monoxide, Vol %	20.61	0.00	0.00	0.00	0.00	0.00	0.00							
Carbon Dioxide, Vol %	7.11	0.00	0.00	0.00	0.00	0.00	0.00							
Hydrogen, Vol %	14.94	0.00	0.00	0.00	0.00	0.00	0.00							
Steam, Vol %	9.01	0.00	0.00	0.00	0.00	0.00	0.00							
Nitrogen, Vol %	48.25	99.41	97.08	95.15	91.18	79.00	79.00							
Oxygen, Vol %	0.00	0.59	2.92	4.85	8.82	21.00	21.00							
Hydrogen Sulfide, ppmv	816.35	0.00	0.00	0.00	0.00	0.00	0.00							
Carbonyl Sulfide, ppmv	0.00	0.00	0.00	0.00	0.00	0.00	0.00							
Hydrogen Chloride, ppmv	0.00	0.00	0.00	0.00	0.00	0.00	0.00							
Inlet gas flow, sL/h	9280.92	1296.17	1230.06	1147.82	1056.17	1263.60	1265.73							
Space Velocity, 1/h	9989	1395	1324	1235	1137	1360	1362							
Linear Velocity, cm/s	30.61	26.43	26.92	25.87	24.82	30.68	32.17							
PT-165 Pressure, kPag	931.47	67.50	67.57	67.57	67.37	67.16	68.12							
Bed Temperatures, °C	Avg	Max	Avg	Max	Avg	Max	Avg	Max						
TE-174, 2" Above Bottom	541	554	551	588	598	675	641	664	677	703	706	707	757	769
TE-175, 5" Above Bottom	547	558	548	584	606	681	638	663	675	702	704	705	757	768
TE-176, 8" Above Bottom	546	555	546	578	611	680	635	661	672	700	703	704	756	766
TE-177, 11" Above Bottom	540	548	549	577	617	681	635	662	674	703	705	706	757	767
TE-178, 14" Above Bottom	531	539	554	579	620	673	634	662	674	704	706	707	753	764

Table 3.1: Actual Test Period Parameters (Continued)

Test Period	ZTMC04-S3	ZTSC08-S1		
Start Time/Date	8:30 1/21/93	10:00 1/26/93		
End Time/Date	14:32 1/22/93	11:53 1/27/93		
Duration, hrs	29.08	23.33		
Comment	Off-Line: 22:33 - 23:30 (1/21/93)	Off-Line 14:57 - 17:30 (1/26/93)		
Weight of Sorbent, g	1523 g removed	1515 g installed 1549.7 g removed		
Bed Height, cm		40.64		
INLET Gas Compositions based on Flow Controller Settings				
Carbon Monoxide, Vol %	20.60	20.34		
Carbon Dioxide, Vol %	7.06	7.11		
Hydrogen, Vol %	14.98	14.99		
Steam, Vol %	9.01	9.05		
Nitrogen, Vol %	48.27	48.32		
Oxygen, Vol %	0.00	0.00		
Hydrogen Sulfide, ppmv	812.58	1975.92		
Carbonyl Sulfide, ppmv	0.00	0.00		
Hydrogen Chloride, ppmv	0.00	0.00		
Inlet gas flow, sL/h	9285.61	9239.72		
Space Velocity, 1/h	9994	9944		
Linear Velocity, cm/s	30.80	30.73		
PT-165 Pressure, kPag	933.47	931.88		
Bed Temperatures, °C	Avg	Max	Avg	Max
TE-174, 2" Above Bottom	545	558	549	558
TE-175, 5" Above Bottom	552	562	555	563
TE-176, 8" Above Bottom	553	563	554	562
TE-177, 11" Above Bottom	549	559	546	556
TE-178, 14" Above Bottom	538	547	537	547

4.0 Test Data Summary

4.1 Gas Analysis

During testing, the gas stream was sampled both from the inlet of the reactor and at the reactor outlet. The inlet gas samples were taken to verify that the individual gases were mixed in proper proportions. The outlet gas samples were collected to provide an indication of the sorbent efficiency.

The gas sampling was conducted with detector tubes, for a quick indication of sulfur level in the gas stream, and gas grab samples collected to allow for determination of the composition of major gas species along with sulfur species. Gas samples were collected in 250 cc glass bottles as a dry gas after the gas was cooled to knock out moisture/condensate.

4.1.1 Gas Grab Analysis by Laboratory Gas Chromatograph

Gas grab samples were analyzed by laboratory gas chromatograph (GC) analysis. The gas was analyzed for both major components (H_2 , CO, CO_2 , N_2 , CH_4 , O_2) and sulfur species (H_2S , COS, SO_2). GCs were calibrated daily to $\pm 1\%$ using certified standards. The results for each grab sample are presented in Appendix E. The averages (arithmetic means) for each test phase are presented in Table 4.1. The results are presented normalized to a 100% total basis. The results are normalized to 100% because it is assumed that the species which are analyzed for consist of 100% of the contents of a given sample. This assumption is valid based on a knowledge the possible reaction chemistry given the feed gas composition and the test conditions.

Table 4.1: Average Gas Compositions by GC Analysis

Test Period	ZTSC01-S1		ZTSC02-S1		ZTSC03-S1		ZTSC04-S1		ZTSC05-S1		ZTSC06-S1	
	Avg.	Std. Dev.	Avg.	Std. Dev.	Avg.	Std. Dev.	Avg.	Std. Dev.	Avg.	Std. Dev.	Avg.	Std. Dev.
Inlet Gas Composition, Dry Gas Basis												
No. of Samples	4		3		3		4		3		6	
H ₂ , %	14.90	1.37	15.07	0.13	14.81	0.18	14.69	0.48	15.36	0.09	17.88	0.16
O ₂ , %	0.10	0.00	0.09	0.01	0.08	0.10	0.09	0.01	0.10	0.01	0.09	0.01
N ₂ , %	58.68	6.82	54.79	0.29	55.19	0.09	53.20	0.41	53.17	0.05	49.17	0.23
CH ₄ , %	0	0	0	0	0	0	0	0	0	0	0.01	0.01
CO, %	18.03	8.93	21.35	0.26	22.06	0.14	23.38	0.49	22.96	0.09	23.25	0.32
CO ₂ , %	8.21	0.73	8.63	0.26	7.77	0.16	8.52	0.47	8.35	0.06	9.55	0.27
H ₂ S, ppmv	776.35	82.98	721.57	39.93	831.55	72.99	1130.00	540.53	643.55	343.14	454.23	177.83
COS, ppmv	70.37	3.04	39.54	9.05	42.32	1.84	68.75	51.85	56.51	21.92	43.36	28.39
SO ₂ , ppmv	3.17	0.68	2.18	0.16	1.98	0.64	3.08	1.65	1.33	1.16	1.84	1.71
Outlet Gas Composition, Dry Gas Basis												
No. of Samples	13		19		21		17		18		55	
H ₂ , %	15.17	0.67	15.96	0.36	15.45	0.26	15.67	1.49	16.64	0.33	19.39	0.46
O ₂ , %	0.09	0.01	0.10	0.01	0.09	0.02	0.10	0.04	0.09	0.01	0.09	0.03
N ₂ , %	56.08	4.74	54.33	0.33	54.74	0.14	53.03	0.38	52.43	0.25	48.46	0.48
CH ₄ , %	0	0	0	0	0	0	0	0	0	0	0.00	0.01
CO, %	20.07	5.62	19.63	0.46	20.92	0.30	22.17	1.06	20.62	0.48	20.27	0.82
CO ₂ , %	8.56	0.29	9.96	0.43	8.78	0.19	9.01	0.74	10.20	0.40	11.78	0.94
H ₂ S, ppmv	178.14	148.15	118.16	134.93	151.55	154.14	191.35	167.70	118.55	151.88	99.78	116.50
COS, ppmv	9.37	9.65	5.42	7.69	6.02	6.56	9.58	9.42	5.07	7.89	5.17	7.15
SO ₂ , ppmv	0.69	1.00	0.03	0.12	1.56	6.07	0.51	0.96	0.13	0.39	0.25	1.28

Table 4.1: Average Gas Compositions by GC Analysis (Continued)

Test Period	ZTSC07-S1		ZTSC07-R1		ZTSC07-S2		ZTSC07-R2		ZTSC07-S3		ZTSC07-R3	
	Avg.	Std. Dev.	Avg.	Std. Dev.	Avg.	Std. Dev.	Avg.	Std. Dev.	Avg.	Std. Dev.	Avg.	Std. Dev.
Inlet Gas Composition, Dry Gas Basis												
No. of Samples	10		3		10		3		10		4	
H ₂ , %	14.36	1.06	0	0	13.98	0.89	0	0	14.67	0.35	0	0
O ₂ , %	0.09	0.01	20.71	0.01	0.10	0.01	2.18	0.65	0.09	0.01	1.44	0.17
N ₂ , %	57.14	0.90	79.29	0.01	55.52	1.58	97.78	0.68	54.50	0.36	98.56	0.17
CH ₄ , %	0.02	0.02	0	0	0.03	0.04	0	0	0.01	0.01	0	0
CO, %	18.75	1.21	0	0	19.26	1.21	0	0.01	22.67	0.54	0	0
CO ₂ , %	9.57	1.01	0	0	11.05	1.03	0.03	0.06	7.98	0.52	0	0
H ₂ S, ppmv	618.25	54.41	0.30	0	526.42	85.35	0.30	0.00	765.73	177.00	0.30	0
COS, ppmv	25.16	5.19	0	0	20.10	2.94	0.17	0.29	27.55	7.92	0.35	0.47
SO ₂ , ppmv	0.33	0.45	2.23	3.12	2.12	2.62	0	0	3.12	7.40	0.78	0.92
Outlet Gas Composition, Dry Gas Basis												
No. of Samples	34		20		31		11		38		10	
H ₂ , %	14.89	0.72	0.41	0.61	14.61	1.12	0	0	15.11	1.07	0	0
O ₂ , %	0.09	0.04	6.76	9.08	0.10	0.01	0.65	0.96	0.09	0.01	0.37	0.49
N ₂ , %	56.86	0.59	86.30	5.49	55.15	1.09	98.09	0.64	54.16	0.83	98.84	0.14
CH ₄ , %	0.01	0.01	0	0	0.02	0.02	0	0	0.01	0.03	0	0
CO, %	17.99	0.89	0.19	0.36	18.36	1.88	0.04	0.07	21.75	0.62	0	0
CO ₂ , %	10.14	0.72	3.30	4.76	11.77	0.78	0.42	0.64	8.83	0.61	0.06	0.16
H ₂ S, ppmv	111.30	119.98	119.09	385.46	42.02	56.23	0.55	0.59	485.08	273.11	0.58	0.62
COS, ppmv	4.96	5.80	7.70	10.63	2.23	3.24	9.77	14.42	21.32	12.49	0.36	0.90
SO ₂	0.12 ppm	0.29 ppm	3.02%	2.96%	3.67 ppm	7.11 ppm	0.80%	0.46%	1.44 ppm	2.76 ppm	0.68%	0.36%

Table 4.1: Average Gas Compositions by GC Analysis (Continued)

Test Period	ZTMC01-S1		ZTMC01-R1		ZTMC01-S2		ZTMC01-R2		ZTMC01-S3		ZTMC01-R3		ZTMC01-S4	
	Avg.	Std. Dev.	Avg.	Std. Dev.	Avg.	Std. Dev.	Avg.	Std. Dev.	Avg.	Std. Dev.	Avg.	Std. Dev.	Avg.	Std. Dev.
Inlet Gas Composition, Dry Gas Basis														
No. of Samples	4		3		5		3		6		3		6	
H ₂ , %	14.50	0.20	0	0	14.64	1.01	0	0	14.03	0.29	0	0	13.91	0.40
O ₂ , %	0.08	0.01	2.64	0.15	0.04	0.00	1.57	0.07	0.09	0.01	1.41	0.09	0.11	0.04
N ₂ , %	54.34	0.21	97.32	0.20	54.50	1.00	98.42	0.06	55.12	0.13	98.56	0.06	54.90	0.27
CH ₄ , %	0.02	0.02	0	0	0.04	0.03	0	0	0	0	0	0	0	0
CO, %	21.19	0.10	0.01	0.02	20.70	1.52	0	0	21.74	0.40	0	0	22.04	1.02
CO ₂ , %	9.79	0.18	0.03	0.03	9.97	1.41	0.01	0.01	8.96	0.26	0.03	0.04	8.98	0.80
H ₂ S, ppmv	696.31	63.22	3.60	5.46	569.18	313.04	0.30	0	543.68	202.09	0.30	0	587.66	258.01
COS, ppmv	68.56	4.04	0.91	1.57	70.80	41.47	0	0	68.92	11.67	0.33	0.30	70.42	6.32
SO ₂ , ppmv	0	0	12.86	8.39	0.26	0.58	1.13	1.02	0.38	0.59	6.38	7.73	0.75	1.83
Outlet Gas Composition, Dry Gas Basis														
No. of Samples	13		5		14		12		18		14		23	
H ₂ , %	15.37	0.55	0	0	14.74	3.23	0.01	0.03	14.93	1.02	0	0	14.78	0.67
O ₂ , %	0.09	0.03	2.41	2.30	0.95	3.23	0.54	0.60	0.09	0.02	0.50	0.53	0.25	0.45
N ₂ , %	54.00	0.31	96.56	2.30	55.30	4.85	98.63	0.23	54.66	0.70	98.82	0.18	54.53	0.73
CH ₄ , %	0.01	0.01	0	0	0.03	0.03	0	0	0	0	0	0	0	0
CO, %	19.74	0.94	0	0	18.46	3.19	0.03	0.06	20.19	1.51	0	0.01	20.38	1.17
CO ₂ , %	10.79	0.67	0.05	0.04	10.51	2.32	0.25	0.37	10.11	1.19	0.04	0.07	10.05	0.87
H ₂ S, ppmv	24.47	50.70	164.38	126.86	31.81	19.98	109.78	124.83	17.73	23.04	115.51	158.12	29.59	50.01
COS, ppmv	2.98	4.35	0	0	2.95	2.52	7.50	8.55	2.82	4.88	1.99	7.45	1.78	2.54
SO ₂	0.24 ppm	0.88	0.97 %	0.57	10.67 ppm	37.29	0.53 %	0.36	1.23 ppm	3.06	0.62 %	0.33	1.06 ppm	1.64

Table 4.1: Average Gas Compositions by GC Analysis (Continued)

Test Period	ZTMC02-S1		ZTMC02-R1		ZTMC02-S2		ZTMC02-R2		ZTMC02-S3		ZTMC02-R3	
	Avg.	Std. Dev.	Avg.	Std. Dev.	Avg.	Std. Dev.	Avg.	Std. Dev.	Avg.	Std. Dev.	Avg.	Std. Dev.
Inlet Gas Composition, Dry Gas Basis												
No. of Samples	8		3		8		2		7		3	
H ₂ , %	18.28	0.16	0	0	17.72	0.50	0	0	19.29	0.82	0	0
O ₂ , %	0.08	0.01	7.97	0.10	0.08	0.01	1.29	1.59	0.08	0.01	1.45	0.04
N ₂ , %	53.91	0.21	92.02	0.08	53.36	0.41	98.58	1.50	52.79	0.69	98.52	0.02
CH ₄ , %	0	0	0	0	0	0	0	0	0	0	0	0
CO, %	10.64	0.09	0	0	10.72	0.17	0	0	11.72	0.16	0.01	0.01
CO ₂ , %	16.98	0.22	0.02	0.03	18.03	0.19	0.08	0.02	16.04	0.69	0.02	0.03
H ₂ S, ppmv	960.78	81.88	0.30	0	777.67	383.41	0.30	0	789.09	130.88	0.30	0
COS, ppmv	43.82	5.13	0	0	49.05	15.15	0	0	36.28	14.89	0	0
SO ₂ , ppmv	5.63	5.75	0	0	6.52	11.19	562.14	619.23	14.18	22.04	0	0
Outlet Gas Composition, Dry Gas Basis												
No. of Samples	27		9		27		8		21		9	
H ₂ , %	18.45	0.32	0.12	0.13	17.46	2.46	0	0	19.25	0.93	0	0
O ₂ , %	0.13	0.13	3.22	4.23	0.91	3.13	1.03	1.15	0.18	0.27	0.54	0.63
N ₂ , %	54.13	0.50	93.73	3.71	54.36	3.59	98.34	0.83	53.01	0.72	98.78	0.22
CH ₄ , %	0	0	0	0	0	0	0	0	0	0	0	0
CO, %	10.14	0.26	0.09	0.17	9.71	1.69	0	0.01	11.55	1.29	0	0
CO ₂ , %	17.14	0.54	0.48	0.79	17.55	2.71	0.03	0.04	15.96	1.15	0.03	0.04
H ₂ S, ppmv	144.85	144.91	59.08	51.56	94.51	116.39	0.43	0.24	435.20	282.92	0.35	0.14
COS, ppmv	7.61	7.03	2.97	5.38	4.28	4.95	0.05	0.14	14.74	9.15	0	0
SO ₂	2.18 ppm	1.22	2.35 %	1.53	11.80 ppm	25.64	0.60 %	0.44	3.27 ppm	2.48	0.66 %	0.40

Table 4.1: Average Gas Compositions by GC Analysis (Continued)

Test Period	ZTMC03-S1		ZTMC03-R1		ZTMC03-S2		ZTMC03-R2		ZTMC03-S3		ZTMC03-R3		ZTMC03-S4		ZTMC03-R4	
	Avg.	Std. Dev.	Avg.	Std. Dev.	Avg.	Std. Dev.	Avg.	Std. Dev.	Avg.	Std. Dev.	Avg.	Std. Dev.	Avg.	Std. Dev.	Avg.	Std. Dev.
Inlet Gas Composition, Dry Gas Basis																
No. of Samples	1		1		1		1		1		1		1		1	
H ₂ , %	15.45	-	0	-	13.49	-	0	-	13.93	-	0	-	14.99	-	0	-
O ₂ , %	0.10	-	0.97	-	0.08	-	0.77	-	0.08	-	0.62	-	0.10	-	0.81	-
N ₂ , %	53.49	-	98.99	-	54.10	-	99.14	-	54.32	-	99.22	-	53.58	-	99.12	-
CH ₄ , %	0	-	0	-	0.01	-	0	-	0.01	-	0	-	0	-	0	-
CO, %	22.52	-	0	-	23.71	-	0.01	-	23.37	-	0	-	22.04	-	0	-
CO ₂ , %	8.44	-	0.04	-	8.61	-	0.08	-	8.30	-	0.16	-	9.29	-	0.07	-
H ₂ S, ppmv	0.30	-	0.3	-	0.30	-	0.30	-	0.30	-	0.30	-	0.30	-	0.30	-
COS, ppmv	14.27	-	0	-	30.93	-	0	-	21.34	-	0	-	25.35	-	0	-
SO ₂ , ppmv	0	-	0	-	0	-	0	-	1.19	-	0	-	0	-	0	-
Outlet Gas Composition, Dry Gas Basis																
No. of Samples	4		3		3		2		3		3		3		3	
H ₂ , %	16.54	0.40	0	0	13.73	1.73	0	0	12.74	0.13	0	0	14.99	0.90	0	0
O ₂ , %	0.14	0.04	0.63	0.43	0.08	0.01	0.36	0.33	0.10	0.01	0.40	0.41	0.10	0.03	0.60	0.42
N ₂ , %	53.74	2.23	99.33	0.41	54.01	1.12	99.23	0.23	55.05	0.23	99.38	0.30	53.62	0.76	99.34	0.39
CH ₄ , %	0.00	0.01	0	0	0.03	0.02	0	0	0.01	0	0	0	0.01	0.01	0	0
CO, %	20.57	0.60	0	0	23.38	2.19	0.05	0.06	24.76	0.03	0.03	0.04	21.48	1.33	0	0
CO ₂ , %	9.02	3.19	0.03	0.03	8.77	1.59	0.35	0.50	7.34	0.09	0.20	0.1	9.80	1.17	0.06	0.03
H ₂ S, ppmv	7.40	2.57	0.30	0	2.67	0.86	0.30	0.00	1.93	0.91	0.30	0.00	4.51	2.78	0.30	0
COS, ppmv	1.15	1.29	0	0	0.77	0.74	0	0	0.50	0.70	0	0	2.35	3.82	0	0
SO ₂ , ppmv	1.48	1.64	51.09	27.14	0.87	0.78	14.58	20.62	3.65	1.80	1.12	1.95	1.86	0.73	3.43	2.13

Table 4.1: Average Gas Compositions by GC Analysis (Continued)

Test Period	ZTMC04-S1		ZTMC04-R1		ZTMC04-S2		ZTMC04-R2		ZTMC04-S3		ZTSC08-S1	
	Avg.	Std. Dev.	Avg.	Std. Dev.	Avg.	Std. Dev.	Avg.	Std. Dev.	Avg.	Std. Dev.	Avg.	Std. Dev.
Inlet Gas Composition, Dry Gas Basis												
No. of Samples	8		6		7		6		8		7	
H ₂ , %	17.61	0.50	0	0	16.84	0.29	0	0	16.15	0.39	15.47	1.48
O ₂ , %	0.10	0.02	10.11	9.54	0.10	0.05	8.44	9.76	0.11	0.08	0.93	2.04
N ₂ , %	52.41	0.35	89.85	9.50	52.68	0.23	91.29	9.51	53.12	0.56	53.28	2.57
CH ₄ , %	0.01	0.01	0	0	0	0	0	0	0	0	0	0
CO, %	19.47	0.82	0	0	21.01	0.06	0	0	22.30	0.77	21.99	2.29
CO ₂ , %	10.34	0.65	0.02	0.01	9.32	0.12	0.03	0.03	8.24	0.67	8.16	0.84
H ₂ S, ppmv	471.88	151.77	9.34	22.14	479.26	116.26	1.76	4.30	585.23	79.87	1575.77	150.46
COS, ppmv	94.26	61.05	0.05	0.12	107.69	57.49	0.46	1.12	89.63	27.94	108.86	22.55
SO ₂ , ppmv	1.60	0.87	295.99	590.43	1.39	1.12	2450.80	5708.98	4.58	4.63	3.46	4.22
Outlet Gas Composition, Dry Gas Basis												
No. of Samples	31		18		23		22		31		25	
H ₂ , %	17.72	0.73	0	0	16.76	0.89	0	0	16.25	0.35	16.33	0.63
O ₂ , %	0.50	1.60	6.73	8.86	0.08	0.01	8.84	9.37	0.08	0.01	0.13	0.21
N ₂ , %	52.33	1.22	92.97	8.66	52.85	1.05	90.91	9.16	52.93	0.29	52.83	3.16
CH ₄ , %	0.01	0.01	0	0	0	0	0	0	0	0	0	0
CO, %	19.03	1.14	0	0	20.88	0.64	0.01	0.04	22.09	0.78	21.83	4.08
CO ₂ , %	10.38	0.74	0.04	0.03	9.39	0.39	0.02	0.05	8.60	0.51	8.76	0.39
H ₂ S, ppmv	349.08	169.80	0.31	0.02	328.34	167.96	0.25	0.81	417.15	144.67	1199.29	551.24
COS, ppmv	27.04	12.73	0.85	1.09	32.62	16.75	0.07	0.22	39.33	16.07	76.35	31.14
SO ₂ , ppmv	1.15	1.09	2615.15	4581.20	0.92	0.98	2115.79	4396.99	1.86	1.24	1.59	0.76

4.1.2 Detector Tube Analysis

Detector tube sampling was performed during each test for determination of hydrogen sulfide during sulfidation test phases and sulfur dioxide during regeneration test phases. Detector tube measurements are only estimates of the actual concentration of the specie in the dry gas and are used primarily as an indicator for the completion of a test as defined in the test operations plan. Gastec detector tubes have a reported accuracy of $\pm 25\%$ full scale. The detector tube observations for each test are reported in Appendix F.

4.1.3 Sulfur Species Trends

The detector tube indicated levels of hydrogen sulfide during sulfidation and sulfur dioxide during regeneration test phases have been plotted versus cumulative time on stream for the various tests. The plots are presented on the following pages. The reducing power presented on some of the graphs is defined as follows:

$$\text{Reducing Power} = \frac{[\text{CO}] + [\text{H}_2]}{[\text{CO}_2] + [\text{H}_2\text{O}]}$$

**HYDROGEN SULFIDE CONCENTRATION IN EXIT GAS STREAM
TESTS NO. ZTSC01-06, ZTSC08**

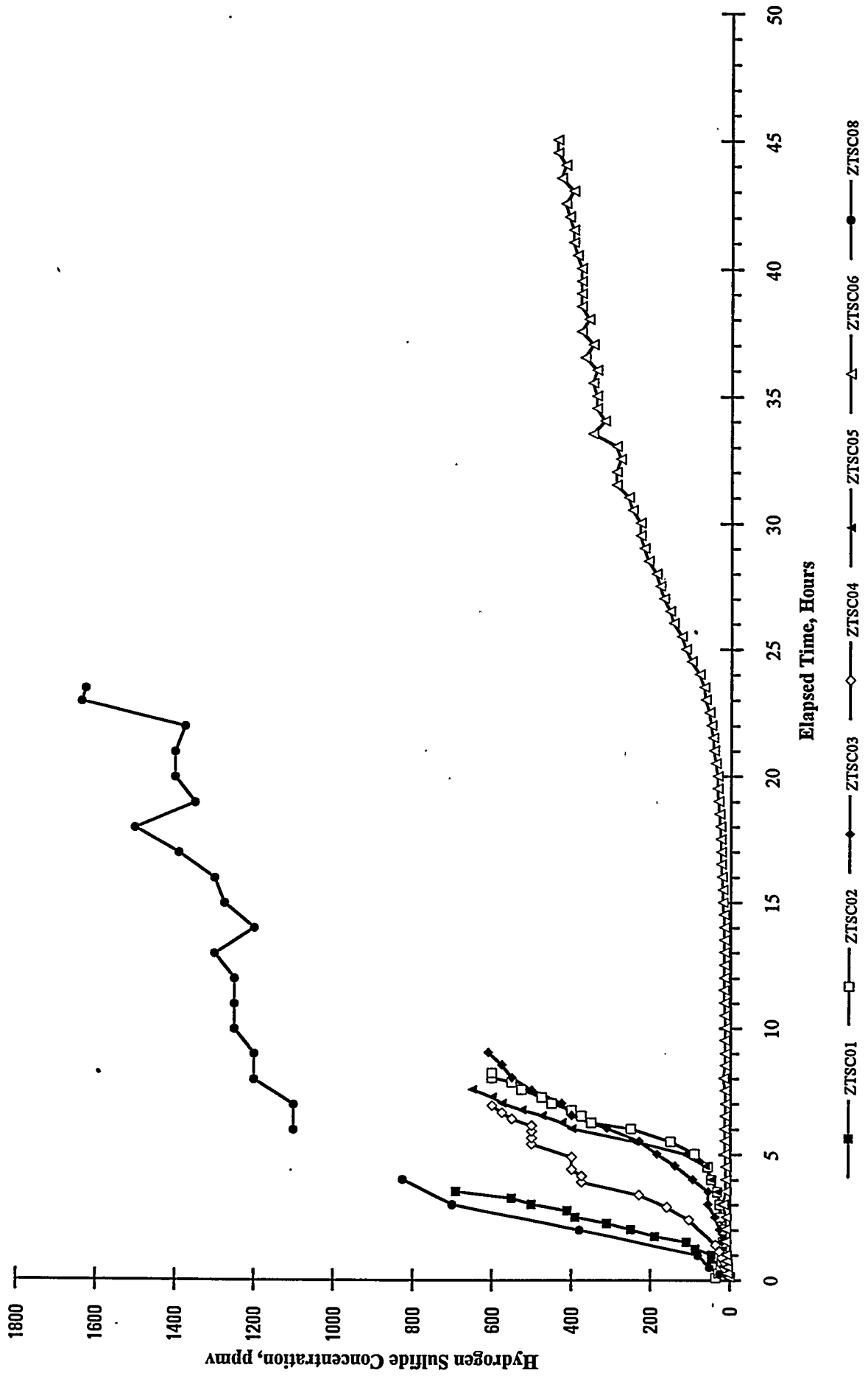

**HYDROGEN SULFIDE CONCENTRATION IN EXIT GAS STREAM
TESTS NO. ZTSC01-05**

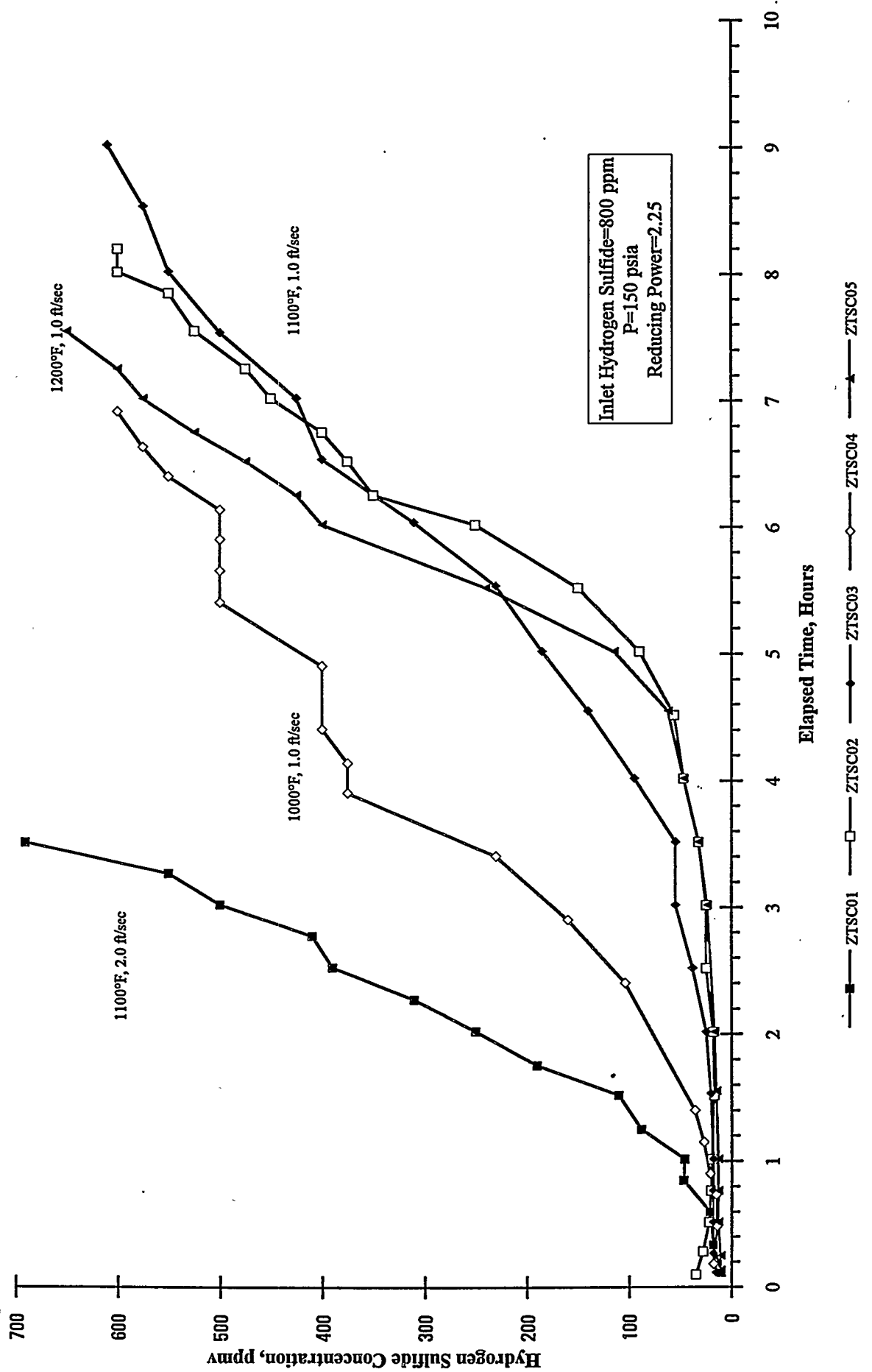

**HYDROGEN SULFIDE CONCENTRATION IN EXIT GAS STREAM
TEST NO. ZTSC06**

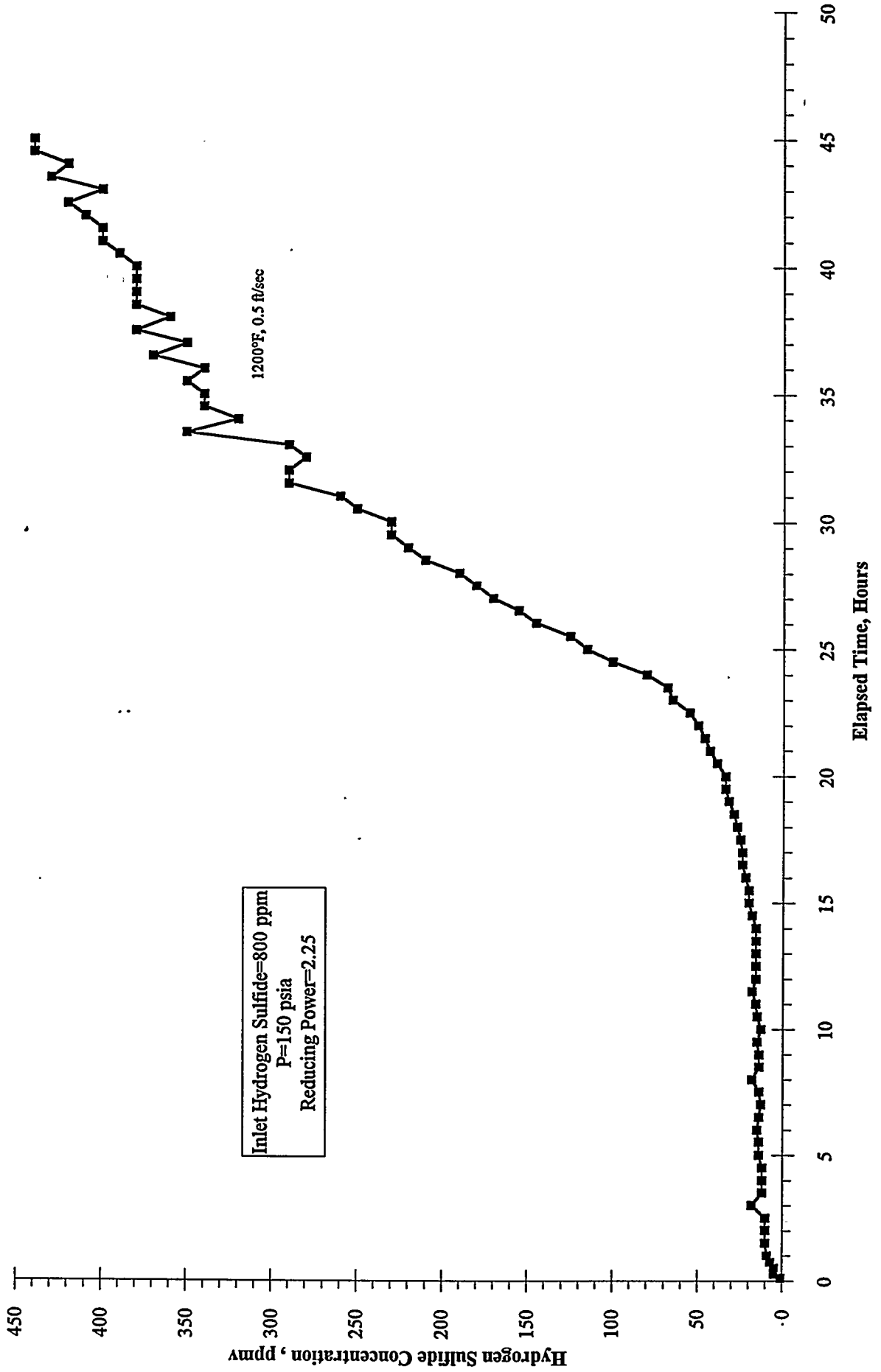

**HYDROGEN SULFIDE CONCENTRATION IN EXIT GAS STREAM
TEST NUMBER ZTSC07**

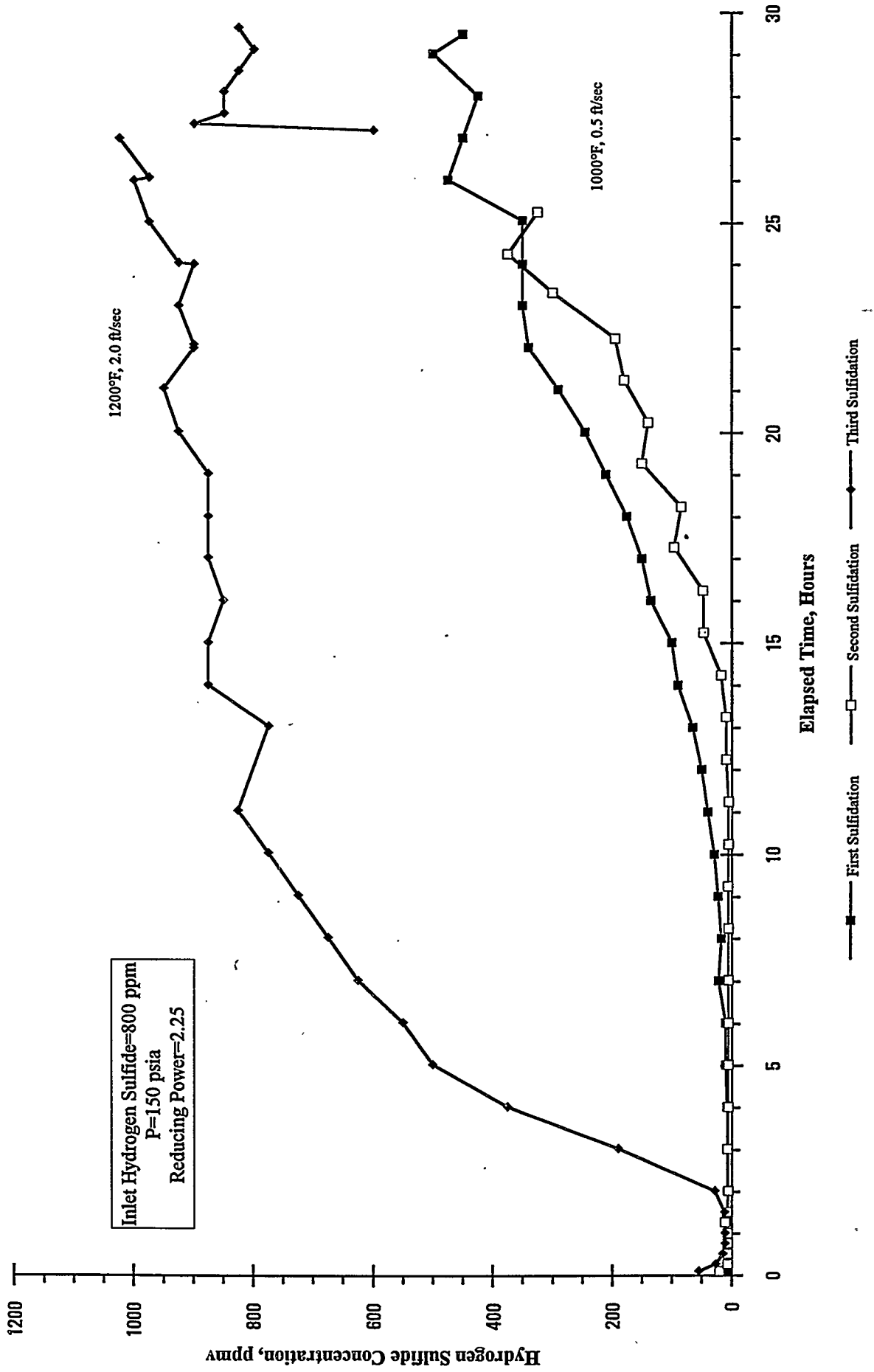

**HYDROGEN SULFIDE CONCENTRATION IN EXIT GAS STREAM
TEST NO. ZTSC08**

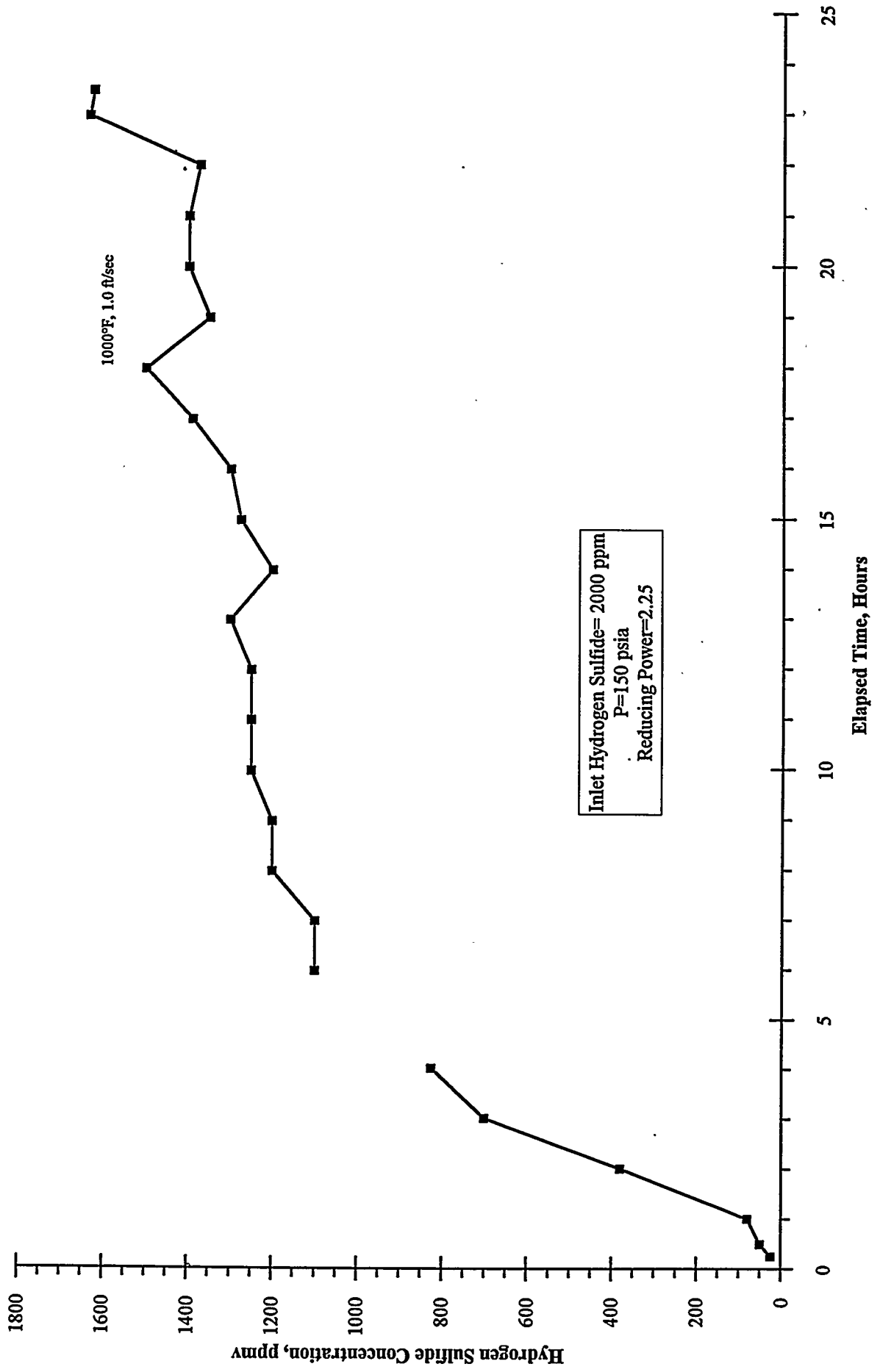

**HYDROGEN SULFIDE CONCENTRATION IN EXIT GAS STREAM
TEST NUMBER ZTMC01**

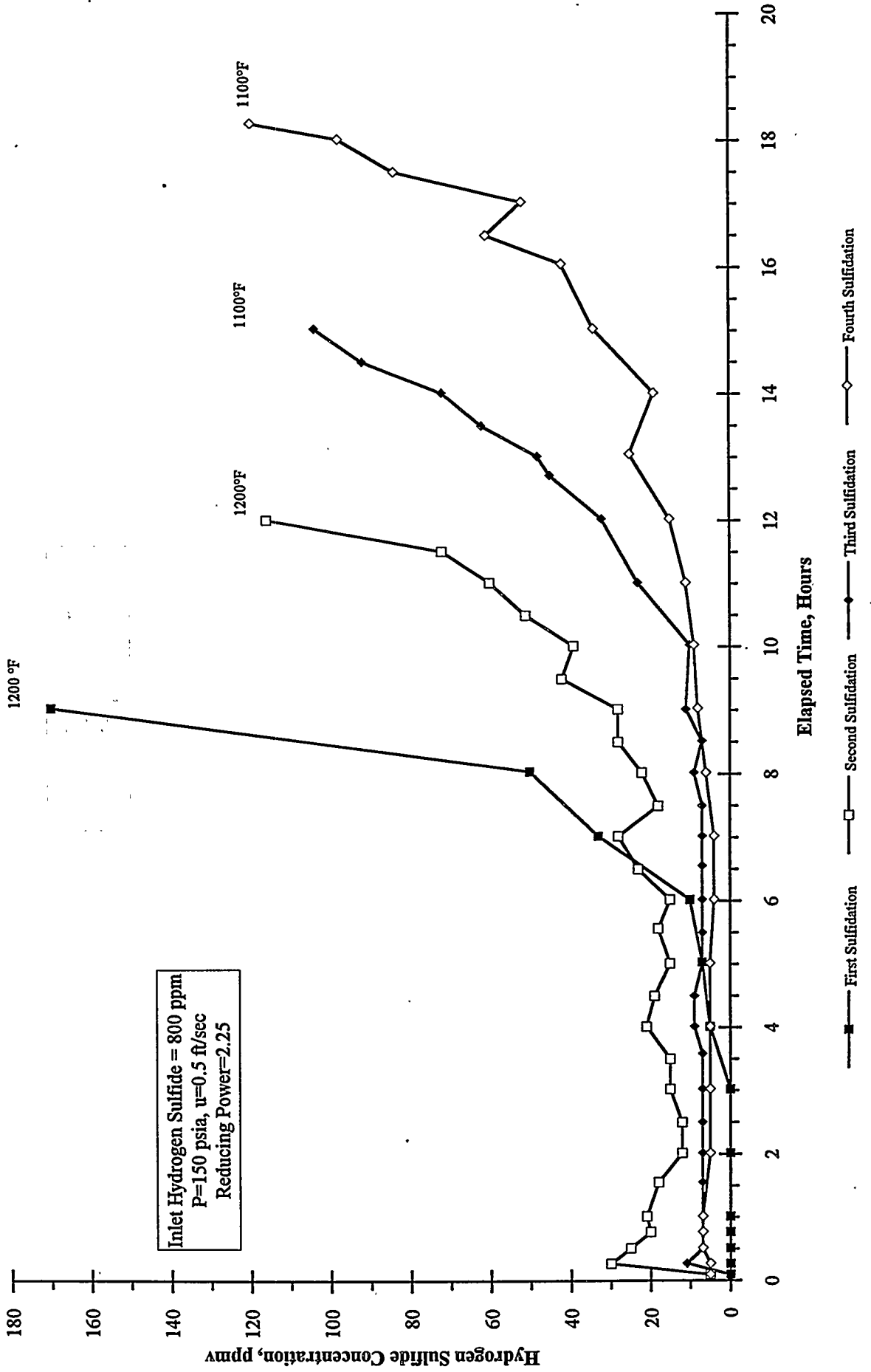

**HYDROGEN SULFIDE CONCENTRATION IN EXIT GAS STREAM
TEST NUMBER ZIMC02**

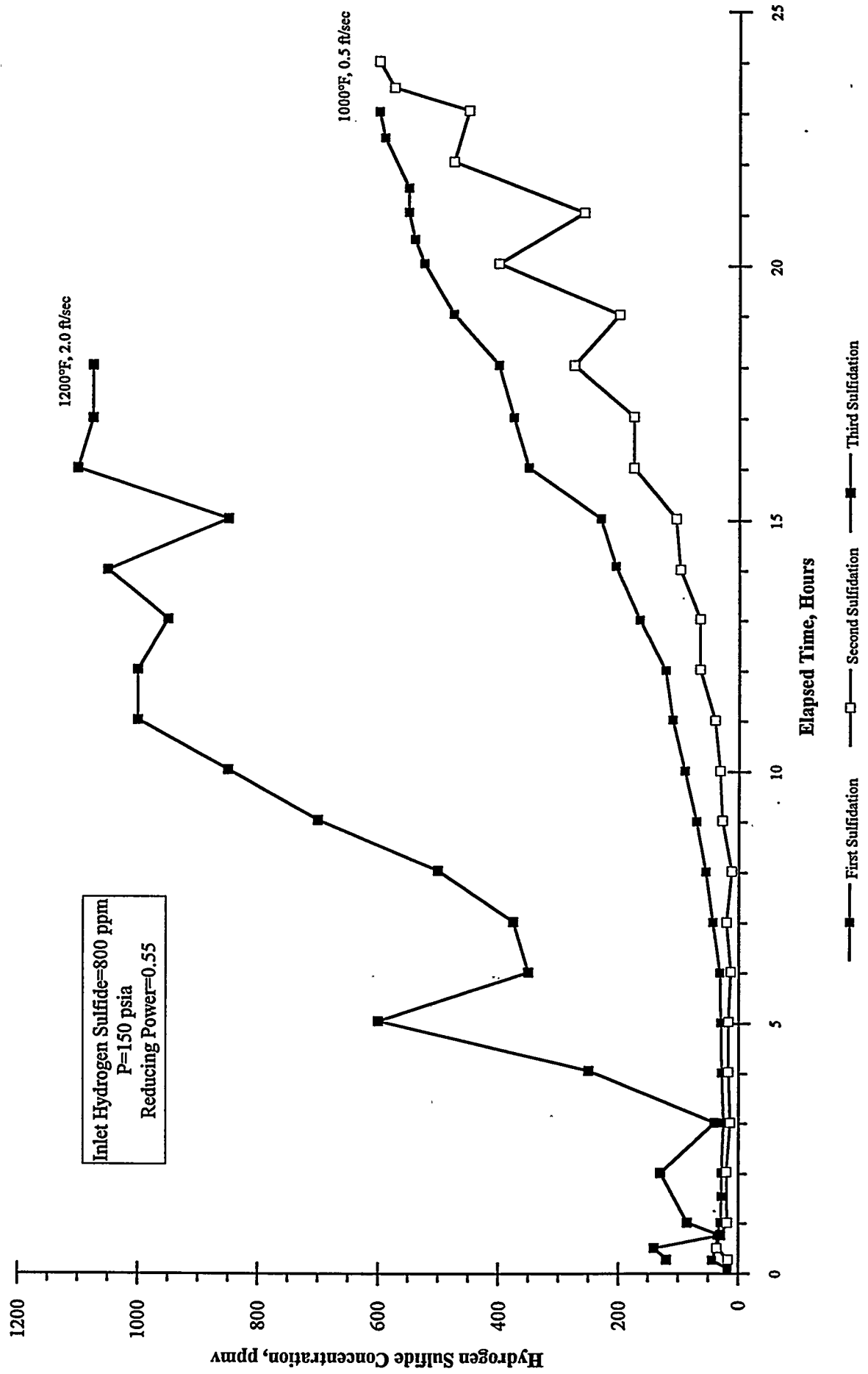

HYDROGEN SULFIDE CONCENTRATION IN EXIT GAS STREAM
TEST NO. ZITMC04

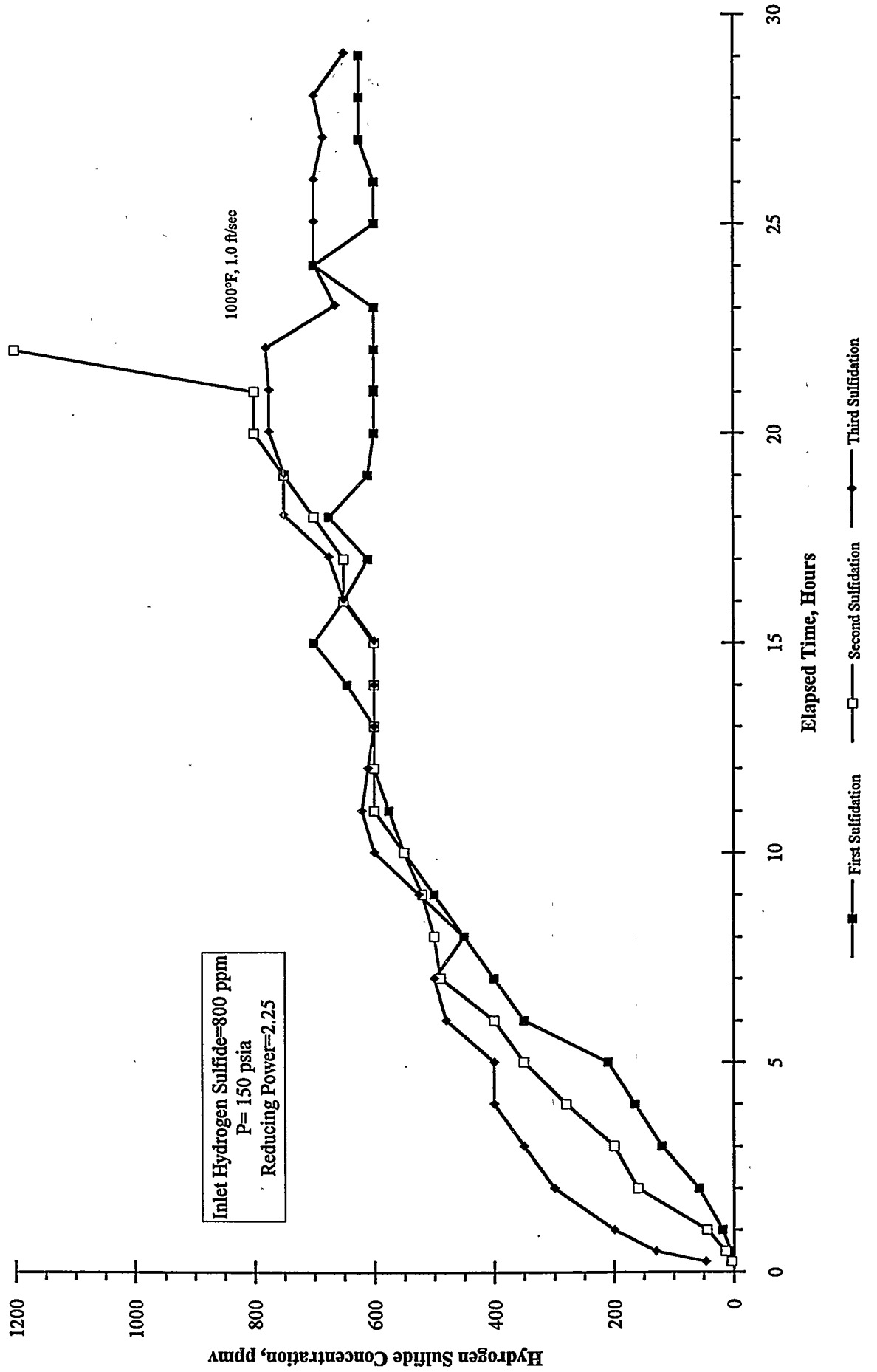

4.2 Condensate Analysis

Condensate samples collected from the project during testing were analyzed for metals by Flame Atomic Absorption (AA). The instrument used was a Perkin-Elmer Model 5000 Atomic Absorption Spectrophotometer. The expected accuracy of the method is 1% relative to the concentration and the expected precision 0.5% relative to the concentration. Potassium sulfate is added to the condensate samples to eliminate interferences among zinc, titanium and molybdenum. Hydrochloric acid is added to dissolve any constituents which may have come out of solution. As a quality assurance method, each analysis is instrumentally integrated in triplicate.

The presence of metals in the condensate is an indication of metals depletion from the sorbent during testing. For those tests in which chloride was introduced into the inlet gas stream, the condensate was analyzed for chloride using a Dionex Ion Chromatograph. Condensates were also analyzed for sulfur, using a Dionex Ion Chromatograph, for the purposes of performing a sulfur balance around the system.

Table 4.2: Condensate Analyses - Scoping Tests

Sample Number	EG&G Laboratory Number	Sample Port	Sample Date	Sample Time	Condensate Collected (ml)	Zn (ppm)	Ti (ppm)	Mo (ppm)	S (ppm)	Cl (ppm)	Fe (ppm)
ZTSC01-S1-C1	042465	Outlet	09/03/92	1928	2730	0.12	<0.5	<2.0	19	-	-
ZTSC02-S1-C1	042469	Outlet	09/04/92	2019	3265	0.46	<0.5	<2.0	23	-	-
ZTSC03-S1-C1	042473	Outlet	09/09/92	1110	4210	0.22	<0.5	<2.0	29	-	-
ZTSC04-S1-C1	042477	Outlet	09/10/92	2208	3875	0.10	<0.5	<2.0	11	-	-
ZTSC05-S1-C1	042508	Outlet	09/15/92	2000	3480	0.35	3.53	0.18	17.9	-	-
ZTSC06-S1-C1	042524	Outlet	09/19/92	0700	9505	0.18	4.70	<1	17	-	-
ZTSC06-S1-C2	042534	Inlet	09/19/92	0700	50	-	-	-	51.6	-	-

Table 4.3: Condensate Analyses - Multi-Cycle Tests

Sample Number	EG&G Laboratory Number	Sample Port	Sample Date	Sample Time	Condensate Collected (ml)	Zn (ppm)	Ti (ppm)	Mo (ppm)	S (ppm)	Cl (ppm)	Fe (ppm)
ZTSC07-S1-C1	042550	Outlet	09/23/92	1900	6395	0.04	1.96	<1	14.5	-	-
ZTSC07-S1-C2	042535	Inlet	09/23/92	1825	25	-	-	-	71.3	-	-
ZTSC07-R1-C1	042551	Outlet	09/24/92	1130	7570	146	<1	3.55	3780	-	-
ZTSC07-S2-C1	042552	Outlet	09/26/92	0345	6140	2.96	4.70	0.79	48.1	-	-
ZTSC07-S2-C2	042536	Inlet	09/26/92	0420	25	-	-	-	157	-	-
ZTSC07-R2-C1	042538	Outlet	09/28/92	1515	5	-	-	-	IS	-	-
ZTSC07-S3-C1A	042553	Outlet	09/29/92	2000	19235	0.09	5.88	<1	5.6	-	-
ZTSC07-S3-C1B	042554	Outlet	09/30/92	0445	8440	0.07	3.74	<1	4.3	-	-

Sample Number	EG&G Laboratory Number	Sample Port	Sample Date	Sample Time	Condensate Collected (ml)	Zn (ppm)	Ti (ppm)	Mo (ppm)	S (ppm)	Cl (ppm)	Fe (ppm)
ZTSC07-S3-C1C	042555	Outlet	10/01/92	1230	2020	0.12	6.23	<1	5.8	-	-
ZTSC07-S3-C2	042562	Inlet	10/01/92	1230	3	-	-	-	IS	-	-
ZTMC01-S1-C1	042563	Outlet	10/06/92	1850	1895	8.61	7.06	<1	47.1	148	-
ZTMC01-R1-C1	042564	Outlet	10/06/92	2245	2110	76.2	4.98	6.11	1600	142	-
ZTMC01-S2-C1	042565	Outlet	10/07/92	1440	2610	6.73	8.72	<1	42.8	163	-
ZTMC01-S2-C2	042566	Inlet	10/07/92	1440	2	-	-	-	IS	-	-
ZTMC01-R2-C1	042567	Outlet	10/07/92	2355	4900	24.8	8.31	3.55	877	52.8	-
ZTMC01-R2-C2	042568	Inlet	10/07/92	2300	43	-	-	-	45.2	60.5	-
ZTMC01-S3-C1	042572	Outlet	10/08/92	1840	3425	6.92	0.71	0.16	20.6	133	-
ZTMC01-S3-C2	042573	Inlet	10/08/92	1840	9	-	-	-	IS	302	-
ZTMC01-R3-C1	042574	Outlet	10/09/92	0230	5885	8.23	0.95	2.36	1350	72.7	-
ZTMC01-R3-C2	042575	Inlet	10/09/92	0202	11	-	-	-	IS	91.5	-
ZTMC01-S4-C1	042578	Outlet	10/09/92	2245	4650	8.28	2.25	<1	22.3	192	-
ZTMC01-S4-C2	042579	Inlet	10/09/92	2203	7	-	-	-	178	185	-
ZTMC02-S1-C1A	042580	Outlet	10/14/92	2100	19560	0.27	2.49	<1	5.8	7.43	-
ZTMC02-S1-C1B	042581	Outlet	10/15/92	0045	3340	0.10	1.42	<1	3.5	2.86	-
ZTMC02-S1-C2	042582	Inlet	10/15/92	0045	95	-	-	-	16.8	44.3	-
ZTMC02-R1-C1	042583	Outlet	10/15/92	0900	4400	12.6	-	8.67	3590	<0.1	-
ZTMC02-S2-C1	042591	Outlet	10/16/92	1830	19215	0.50	1.75	<1	10.2	1.24	-
ZTMC02-S2-C2	042592	Inlet	10/16/92	1800	92	-	-	-	101	-	-
ZTMC02-R2-C1	042597	Outlet	10/19/92	1750	19	502	IS	IS	656	-	-
ZTMC02-S3-C1A	042593	Outlet	10/20/92	0400	18120	0.12	1.63	<1	36	-	-

Sample Number	EG&G Laboratory Number	Sample Port	Sample Date	Sample Time	Condensate Collected (ml)	Zn (ppm)	Ti (ppm)	Mo (ppm)	S (ppm)	Cl (ppm)	Fe (ppm)
ZTMC02-S3-C1B	042594	Outlet	10/20/92	1200	18735	0.17	2.57	<1	36	-	-
ZTMC02-S3-C1C	042595	Outlet	10/20/92	1600	7735	0.05	1.17	<1	11.9	-	-
ZTMC02-S3-C2	042596	Inlet	10/20/92	1600	2	-	-	-	286	-	-
ZTMC03-S1-C1	042640 043141	Outlet	11/04/92	1403	120	15.5	<0.05	<1	104	130	-
ZTMC03-S2-C1	042641 043142	Outlet	11/05/92	0928	89	26.5	<0.05	<1	304	109	-
ZTMC03-S3-C1	042647	Outlet	11/05/92	1530	27	160	-	<1	403	104	-
ZTMC03-S4-C1	042648 043143	Outlet	11/06/92	1005	220	28.2	<0.05	<1	87.3	192	-
ZTMC04-S1-C1	42899	Outlet	1/15/93	0230	13275	0.36	-	-	2.93	3.77	7.70
ZTMC04-S1-C2	42900	Inlet	1/15/93	0100	3	IS	-	-	3980	IS	IS
ZTMC04-R1-C1	42898	Outlet	1/15/93	2030	43	194	-	-	55.6	306	661
ZTMC04-R1-C2	-	Inlet	1/15/93	1930	3	-	-	-	-	-	-
ZTMC04-S2-C1	42901	Outlet	1/20/93	0700	11560	0.22	-	-	20.5	1.49	8.14
ZTMC04-S2-C2	-	Inlet	1/20/93	0600	2	-	-	-	-	-	-
ZTMC04-S3-C1	42907	Outlet	1/22/93	1432	16625	0.49	-	-	34.5	1.18	8.92
ZTMC04-S3-C2	42908	Inlet	1/22/93	1432	7	-	-	-	-	-	-
ZTSC08-S1-C1	42928	Outlet	1/27/93	1330	13380	-	-	-	-	-	-
ZTSC08-S1-C2	42929	Inlet	1/27/93	1330	8.5	-	-	-	-	-	-

4.3 Solid Analysis

The sorbent was removed from the reactor at the completion of each test and also at specified intervals of the multi-cycle tests. When the sorbent was removed after a particular test phase of the multi-cycle tests, 15 gram samples were retained from the top, middle, and bottom of the reactor and the remaining sorbent was returned to the reactor for continued testing. For all tests except test number ZTMC01, the sorbent was removed from the reactor by vacuum. At the completion of test ZTMC01, the sorbent was poured from the sorbent cage so that it could be determined whether sorbent spalling might have been avoided by pouring, i.e. causing less sorbent attrition to occur. The solid samples were analyzed for various chemical and physical properties. The results of the analyses are reported here.

4.3.1 Crush Strength

Crush strength analyses were performed on samples of the fresh and the reacted zinc titanate sorbent. The analysis consists of crushing pellets using a Chatillion Model LTC apparatus. The reported averages in table 4.4 are for fifteen pellets.

Table 4.4: Crush Strength Analysis

SAMPLE	Location	Median N/pellet	Average N/pellet	Standard Deviation
Fresh	-	63.2	99.4	64.9
ZTSC01-S1-B1	Top	52.9	56.0	17.8
ZTSC01-S1-B8	Bottom	71.6	78.3	31.1
ZTSC02-S1-B1	Top	52.0	63.2	37.4
ZTSC02-S1-B8	Bottom	91.2	103.2	31.1
ZTSC03-S1-B1	Top	65.8	69.8	27.6
ZTSC03-S1-B8	Bottom	60.5	80.5	66.7
ZTSC04-S1-B1	Top	70.7	79.2	38.7
ZTSC04-S1-B8	Bottom	59.2	62.3	25.4
ZTSC05-S1-B1	Top	72.9	81.0	28.0
ZTSC05-S1-B8	Bottom	92.1	98.3	29.4
ZTSC06-S1-B1	Top	91.6	106.3	60.5
ZTSC06-S1-B8	Bottom	78.3	91.6	32.3
ZTSC07-R3-B1	Top	30.7	48.9	62.3
ZTSC07-R3-B7	Bottom	34.3	44.5	32.0
ZTMC01-S4-B1	Top	57.8	57.8	35.6
ZTMC01-S4-B8	Bottom	66.7	62.3	20.9
ZTMC02-R3-B1	Top	44.5	62.3	47.6
ZTMC02-R3-B8	Bottom	75.6	66.7	27.6
ZTMC03-R4-B1	Top	80.1	89.0	48.9
ZTMC03-R4-B8	Bottom	93.4	89.0	35.6

4.3.2 Sulfur Analysis

Sulfur analysis of the solid samples was performed to assess the absorptive capabilities of the sorbent. Sulfate analysis of regenerated samples was also performed since sulfate formation is known to inhibit the sorbent's performance.

Total sulfur analyses were performed by EG&G utilizing a LECO Model SC-32 Total Sulfur Analyzer instrument. A 1 gram sample was combusted at approximately 2500 °F in an oxygen atmosphere in which the sulfur was oxidized to sulfur dioxide. The SO₂ gas was measured by a solid state infrared detector and total sulfur results were formulated by a microprocessor. Standard samples containing precisely known amounts of sulfur were analyzed daily to ensure proper instrument operation. Expected accuracy and precision were ± 0.05% of the total sulfur value. The results are reported in Table 4.5.

Selected samples were sent to Galbraith Laboratories, Inc. to perform total sulfur, sulfate sulfur, sulfide sulfur, and sulfite sulfur analyses. Total sulfur was performed on a LECO Model SC-432 DR Sulfur Analyzer instrument (ASTM D4239-83). Sulfate sulfur was determined using a Dionex Model 10/14 Ion Chromatograph (ANSI/ASTM C791-79). Sulfide sulfur and sulfite sulfur were determined by volumetric methods (i.e., titration).

Table 4.5: Sorbent Sulfur Analyses

Sample Number	EG&G Laboratory Number	Sample Description	Fraction Weight (Grams)	EG&G Lab Total Sulfur (Wt%)	Galbraith Laboratories, Inc.			
					Total Sulfur (Wt %)	Sulfate (Wt %)	Sulfide (Wt %)	Sulfite (Wt %)
Fresh	042458	Fresh Sorbent	-	0.05	-	-	-	-
Scoping Tests								
ZTSC01-S1-B1	042466	Top 1" of bed	80	5.29	5.21	0.04	-	-
ZTSC01-S1-B2	042481	1-3" from top	132	4.59	-	-	-	-
ZTSC01-S1-B3	042482	3-5" from top	162	4.02	-	-	-	-
ZTSC01-S1-B4	042483	5-8" from top	169	3.69	-	-	-	-
ZTSC01-S1-B5	042467	8-10" from top	164	3.86	4.13	0.04	-	-
ZTSC01-S1-B6	042484	10-12" from top	287	3.52	-	-	-	-
ZTSC01-S1-B7	042485	12-14" from top	190	3.35	-	-	-	-
ZTSC01-S1-B8	042468	Bottom of bed	177	3.17	3.02	0.03	-	-
ZTSC02-S1-B1	042470	Top 1" of bed	85	6.70	6.80	0.03	-	-
ZTSC02-S1-B2	042486	1-3" from top	196	6.15	-	-	-	-
ZTSC02-S1-B3	042487	3-5" from top	135	5.89	-	-	-	-
ZTSC02-S1-B4	042488	5-8" from top	365	5.21	-	-	-	-
ZTSC02-S1-B5	042471	8-10" from top	170	4.66	4.75	0.08	-	-
ZTSC02-S1-B6	042489	10-12" from top	187	4.55	-	-	-	-
ZTSC02-S1-B7	042490	12-14" from top	147	3.61	-	-	-	-
ZTSC02-S1-B8	042472	Bottom of bed	203	3.54	-	-	-	-

Sample Number	EG&G Laboratory Number	Sample Description	Fraction Weight (Grams)	EG&G Lab Total Sulfur (Wt%)	Galbraith Laboratories, Inc.			
					Total Sulfur (Wt %)	Sulfate (Wt %)	Sulfide (Wt %)	Sulfite (Wt %)
ZTSC03-S1-B1	042474	Top 1" of bed	97	7.31	-	-	-	-
ZTSC03-S1-B2	042491	1-3" from top	151	6.90	-	-	-	-
ZTSC03-S1-B3	042492	3-5" from top	182	6.46	-	-	-	-
ZTSC03-S1-B4	042493	5-8" from top	304	5.86	-	-	-	-
ZTSC03-S1-B5	042475	8-10" from top	150	5.33	-	-	-	-
ZTSC03-S1-B6	042494	10-12" from top	200	5.30	-	-	-	-
ZTSC03-S1-B7	042495	12-14" from top	117	4.66	-	-	-	-
ZTSC03-S1-B8	042476	Bottom of bed	194	4.23	-	-	-	-
ZTSC04-S1-B1	042478	Top 1" of bed	100	6.75	6.83	0.02	-	-
ZTSC04-S1-B2	042496	1-3" from top	200	6.18	-	-	-	-
ZTSC04-S1-B3	042497	3-5" from top	175	6.15	-	-	-	-
ZTSC04-S1-B4	042498	5-8" from top	285	5.57	-	-	-	-
ZTSC04-S1-B5	042479	8-10" from top	153	4.87	5.05	0.02	-	-
ZTSC04-S1-B6	042499	10-12" from top	147	4.93	-	-	-	-
ZTSC04-S1-B7	042500	12-14" from top	151	4.25	-	-	-	-
ZTSC04-S1-B8	042480	Bottom of bed	185	3.87	4.02	0.01	-	-
ZTSC05-S1-B1	042505	Top 1" of bed	108	5.16	-	-	-	-
ZTSC05-S1-B2	042509	1-3" from top	163	5.25	-	-	-	-
ZTSC05-S1-B3	042510	3-5" from top	148	5.53	-	-	-	-
ZTSC05-S1-B4	042511	5-8" from top	288	5.11	-	-	-	-

Sample Number	EG&G Laboratory Number	Sample Description	Fraction Weight (Grams)	EG&G Lab Total Sulfur (Wt%)	Galbraith Laboratories, Inc.			
					Total Sulfur (Wt %)	Sulfate (Wt %)	Sulfide (Wt %)	Sulfite (Wt %)
ZTSC05-S1-B5	042506	8-10" from top	167	4.69	-	-	-	-
ZTSC05-S1-B6	042512	10-12" from top	172	4.30	-	-	-	-
ZTSC05-S1-B7	042513	12-14" from top	173	4.15	-	-	-	-
ZTSC05-S1-B8	042507	Bottom of bed	171	3.31	-	-	-	-
ZTSC06-S1-B1	042516	Top 1" of bed	65	9.39	-	-	-	-
ZTSC06-S1-B2	042519	1-3" from top	157	8.29	-	-	-	-
ZTSC06-S1-B3	042520	3-5" from top	192	8.10	-	-	-	-
ZTSC06-S1-B4	042521	5-8" from top	318	7.44	-	-	-	-
ZTSC06-S1-B5	042517	8-10" from top	199	7.62	-	-	-	-
ZTSC06-S1-B6	042522	10-12" from top	134	7.80	-	-	-	-
ZTSC06-S1-B7	042523	12-14" from top	145	7.54	-	-	-	-
ZTSC06-S1-B8	042518	Bottom of bed	204	7.18	-	-	-	-
Multi-Cycle Tests								
ZTSC07-R1-TOP	042525	Top of bed	15	1.67	-	0.18	0.89	0.0224
ZTSC07-R1-MIDDLE	042526	Middle of bed	15	0.23	-	0.20	<0.04	0.0186
ZTSC07-R1-BOTTOM	042527	Bottom of bed	15	0.24	-	0.21	<0.04	0.0223
ZTSC07-S3-B1	042539	Top of bed	15	14.0	-	-	-	-
ZTSC07-S3-B2	042540	Middle of bed	15	12.3	-	-	-	-
ZTSC07-S3-B3	042541	Bottom of bed	15	10.1	-	-	-	-
ZTSC07-R3-B1	042545	Top of Bed	185	0.30	-	0.27	0.086	-

Sample Number	EG&G Laboratory Number	Sample Description	Fraction Weight (Grams)	EG&G Lab Total Sulfur (Wt%)	Galbraith Laboratories, Inc.			
					Total Sulfur (Wt %)	Sulfate (Wt %)	Sulfide (Wt %)	Sulfite (Wt %)
ZTSC07-R3-B2	042558	2-4" from top	163	0.33	-	-	-	-
ZTSC07-R3-B3	042559	4-6" from top	159	0.32	-	-	-	-
ZTSC07-R3-B4	042546	Middle of Bed	129	0.28	-	0.27	<0.05	-
ZTSC07-R3-B5	042560	8-10" from top	152	0.30	-	-	-	-
ZTSC07-R3-B6	042561	10-12" from top	183	0.30	-	-	-	-
ZTSC07-R3-B7	042547	Bottom of bed	203	0.33	-	-	-	-
ZTMC01-S4-B1	042598	Top of bed	148	12.9	-	-	-	-
ZTMC01-S4-B2	042599	2nd fraction	149	10.9	-	-	-	-
ZTMC01-S4-B3	042600	3rd fraction	119	10.0	-	-	-	-
ZTMC01-S4-B4	042601	4th fraction	110	7.96	-	-	-	-
ZTMC01-S4-B5	042602	5th fraction	134	7.32	-	-	-	-
ZTMC01-S4-B6	042603	6th fraction	169	6.78	-	-	-	-
ZTMC01-S4-B7	042604	7th fraction	127	5.52	-	-	-	-
ZTMC01-S4-B8	042605	Bottom of bed	94	5.26	-	-	-	-
ZTMC02-R1-B1	042588	Top of bed	15	0.25	-	0.16	-	-
ZTMC02-R1-B2	042589	Middle of bed	15	0.21	-	0.16	-	-
ZTMC02-R1-B3	042590	Bottom of bed	15	0.26	-	0.18	-	-
ZTMC02-S3-B1	042606	Top of bed	15	9.74	-	-	-	-
ZTMC02-S3-B2	042607	Middle of bed	15	9.11	-	-	-	-
ZTMC02-S3-B3	042608	Bottom of bed	15	7.52	-	-	-	-

Sample Number	EG&G Laboratory Number	Sample Description	Fraction Weight (Grams)	EG&G Lab Total Sulfur (Wt%)	Galbraith Laboratories, Inc.			
					Total Sulfur (Wt %)	Sulfate (Wt %)	Sulfide (Wt %)	Sulfite (Wt %)
ZTMC02-R3-B1	042632	Top of bed	144	0.27	-	0.27	-	-
ZTMC02-R3-B2	042635	2-4" from top	166	0.26	-	-	-	-
ZTMC02-R3-B3	042536	4-6" from top	155	0.24	-	-	-	-
ZTMC02-R3-B4	042637	6-8" from top	178	0.24	-	-	-	-
ZTMC02-R3-B5	042633	8-10" from top	148	0.25	-	0.26	-	-
ZTMC02-R3-B6	042638	10-12" from top	152	0.22	-	-	-	-
ZTMC02-R3-B7	042639	12-14" from top	152	0.25	-	-	-	-
ZTMC02-R3-B8	042634	Bottom of bed	180	0.25	-	0.29	-	-
ZTMC03-R4-B1	42680	Top of bed	189	<0.01	-	-	-	-
ZTMC03-R4-B8	42681	Bottom of bed	163	<0.01	-	-	-	-
ZTMC04-S3-B1	42926 42970	Top of bed	146	5.67	5.94	0.0021	5.87	0.24
ZTMC04-S3-B8	42927 42969	Bottom of Bed	230	4.77	5.36	0.0019	4.54	0.033
ZTSC08-S1-B1	42967	Top of Bed	187	7.27	-	-	-	-
ZTSC08-S1-B8	42968	Bottom of Bed	203	6.96	-	-	-	-

4.3.3 Total Carbon Analysis

Solid samples were analyzed to determine whether or not carbon deposition had taken place. Analyses were performed by the on-site EG&G Analytical Laboratory using an UIC Model 5020 Total Carbon apparatus.

Table 4.6: Sorbent Carbon Analysis

Sample Number	EG&G Laboratory ID Number	C (Wt %)
Fresh	42458	0.04
ZTSC01-S1-B1	42466	0.12
ZTSC01-S1-B5	42467	0.04
ZTSC01-S1-B8	42468	0.04
ZTSC02-S1-B1	42470	0.08
ZTSC02-S1-B5	42471	0.08
ZTSC02-S1-B8	42472	0.08
ZTSC03-S1-B1	42474	0.05
ZTSC03-S1-B5	42475	0.05
ZTSC03-S1-B8	42476	0.05
ZTSC04-S1-B1	42478	0.05
ZTSC04-S1-B5	42479	0.07
ZTSC04-S1-B8	42480	0.08
ZTSC05-S1-B1	42505	0.03
ZTSC05-S1-B5	42506	0.02
ZTSC05-S1-B8	42507	< 0.01
ZTSC06-S1-B1	42516	0.08
ZTSC06-S1-B5	42517	0.06
ZTSC06-S1-B8	42518	0.04
ZTSC07-R1-TOP	42525	0.06
ZTSC07-R1-MIDDLE	42526	0.04

Sample Number	EG&G Laboratory ID Number	C (Wt %)
ZTSC07-R1-BOTTOM	42527	0.02
ZTSC07-S3-B1	42539	0.09
ZTSC07-S3-B2	42540	0.12
ZTSC07-S3-B3	42541	0.07
ZTSC07-R3-B1	42545	0.04
ZTSC07-R3-B4	42546	0.06
ZTSC07-R3-B7	42547	0.04
ZTMC01-S4-B1	42598	0.06
ZTMC01-S4-B2	42599	0.09
ZTMC01-S4-B3	42600	0.06
ZTMC01-S4-B4	42601	0.04
ZTMC01-S4-B5	42602	0.04
ZTMC01-S4-B6	42603	0.06
ZTMC01-S4-B7	42604	0.14
ZTMC01-S4-B8	42605	0.08
ZTMC02-R1-B1	42588	0.04
ZTMC02-R1-B2	42589	0.02
ZTMC02-R1-B3	42590	0.02
ZTMC02-S3-B1	42606	0.04
ZTMC02-S3-B2	42607	0.04
ZTMC02-S3-B3	42608	0.06
ZTMC02-R3-B1	42632	0.02
ZTMC02-R3-B5	42633	0.04
ZTMC02-R3-B8	42634	0.02
ZTMC03-R4-B1	42680	-
ZTMC03-R4-B8	42681	-
ZTMC04-S3-B1	42926 42970	0.05

Sample Number	EG&G Laboratory ID Number	C (Wt %)
ZTMC04-S3-B8	42927 42969	0.04
ZTSC08-S1-B1	42967	-
ZTSC08-S1-B8	42968	-

4.3.4 Bulk Elemental Analysis

Samples collected from the top, middle, and bottom of the sorbent bed were analyzed for zinc, titanium, and molybdenum content by bulk techniques. Total zinc and molybdenum determinations were made by atomic absorption spectroscopy. Analyses were performed by the EG&G Analytical Laboratory. The instrument utilized was a Perkin Elmer Model 5000 Atomic Absorption Spectrophotometer. The expected accuracy is $\pm 1\%$ of the reported value. The expected precision is $\pm 0.5\%$ relative error.

Titanium analyses were made by utilizing Inductively Coupled Plasma (ICP) instrumentation. Titanium analyses were performed by Galbraith Laboratories, Inc. The expected accuracy is $\pm 1\%$ of the reported value. A fresh sorbent sample was also analyzed by ICP for Zn and Mo. The results were Zn = 51.50% and Mo = 1.61%.

Several of the ceramic heat transfer spheres located below the sorbent cage were removed after test number ZTMC03. Two different methods were used to determine if zinc had been deposited on the spheres: (Method 1)- A 0.5 gram sample of the spheres were placed in 25 ml of hydrochloric acid and boiled for 5-10 minutes. The leachate was diluted to 100 ml and analyzed by atomic absorption. 754 ppm of zinc was detected. (Method 2)- A 0.5 g sample of ground spheres were placed in 25 ml of hydrochloric acid. The mixture was boiled for 5-10 minutes. The solution was diluted to 100 ml and analyzed by atomic absorption. 1.08% by weight zinc was detected.

Whereas new ceramic spheres were placed in the vessel prior to the Kellogg test series, both methods indicated that some zinc had left the sorbent and captured on the ceramic.

Table 4.7: Sorbent Elemental Analyses

Sample Number	EG&G Laboratory ID Number	Location	Weight %		
			Zn	Ti	Mo
Fresh	42458	-	51.7	18.24	1.62
ZTSC01-S1-B1	42466	Top	45.1	17.3	1.24
ZTSC01-S1-B5	42467	Middle	47.9	-	1.20
ZTSC01-S1-B8	42468	Bottom	46.4	-	1.18
ZTSC02-S1-B1	42470	Top	45.1	17.0	1.24
ZTSC02-S1-B5	42471	Middle	47.9	-	1.20
ZTSC02-S1-B8	42472	Bottom	48.0	-	1.22
ZTSC03-S1-B1	42474	Top	51.2	17.1	1.18
ZTSC03-S1-B5	42475	Middle	49.8	-	1.28
ZTSC03-S1-B8	42476	Bottom	50.9	-	1.19
ZTSC04-S1-B1	42478	Top	49.8	17.0	1.21
ZTSC04-S1-B5	42479	Middle	49.8	-	1.28
ZTSC04-S1-B8	42480	Bottom	51.0	-	1.24
ZTSC05-S1-B1	42505	Top	49.0	17.3	1.38
ZTSC05-S1-B5	42506	Middle	49.8	-	1.33
ZTSC05-S1-B8	42507	Bottom	50.0	-	1.42
ZTSC06-S1-B1	42516	Top	48.9	17.0	1.25
ZTSC06-S1-B5	42517	Middle	48.8	-	1.33
ZTSC06-S1-B8	42518	Bottom	49.4	-	1.29
ZTSC07-S3-B1	42539	Top	46.9	16.0	1.19
ZTSC07-S3-B2	42540	Middle	45.1	-	1.28
ZTSC07-S3-B3	42541	Bottom	48.2	-	1.08
ZTSC07-R3-B1	42545	Top	50.4	17.7	1.39
ZTSC07-R3-B4	42546	Middle	50.5	-	1.36
ZTSC07-R3-B7	42547	Bottom	49.9	17.7	1.37
ZTMC01-S4-B1	42598	Top	46.5	16.3	1.29

Sample Number	EG&G Laboratory ID Number	Location	Weight %		
			Zn	Ti	Mo
ZTMC01-S4-B5	42602	Middle	47.2	-	1.27
ZTMC01-S4-B8	42605	Bottom	48.6	17.5	1.28
ZTMC02-R1-B1	42588	Top	-	17.7	-
ZTMC02-R1-B2	42589	Middle	46.8	-	-
ZTMC02-R1-B3	42590	Bottom	-	17.0	-
ZTMC02-S3-B1	42606	Top	47.5	17.1	1.41
ZTMC02-S3-B2	42607	Middle	49.9	-	1.38
ZTMC02-S3-B3	42608	Bottom	46.3	-	1.34
ZTMC02-R3-B1	42632	Top	50.0	17.8	1.35
ZTMC02-R3-B5	42633	Middle	-	-	1.37
ZTMC02-R3-B8	42634	Bottom	48.7	17.7	1.33
ZTMC03-R4-B1	42680	Top	50.9	17.7	1.81
ZTMC03-R4-B8	42681	Bottom	51.0	17.7	1.73
ZTMC04-S3-B1	42926 42970	Top	54.2	17.8	1.75
ZTMC04-S3-B8	42927 42969	Bottom	53.7	17.9	1.76
ZTSC08-S1-B1	42967	Top	51.6	17.3	1.74
ZTSC08-S1-B8	42968	Bottom	51.7	17.6	1.84

4.3.5 Chloride Analysis

Chloride was introduced to the sorbent bed as a component of the gas stream during test number ZTMC01. Chloride analyses were performed on three fractions of the sorbent bed at the conclusion of the test to determine whether or not the chloride was absorbed by the sorbent.

Chloride analyses were performed by Galbraith Laboratories, Inc. utilizing a MCI TOX-10 Analyzer instrument. Their method procedure number ME-8B describes the technique. Samples were combusted in an oxygen atmosphere at 800 to 900 °C. Determination of chloride was achieved by microcoulometric cell trapping and titration of the combustion gases. However, this technique has reported interferences with extremely high levels of sulfur and the results should be considered with this in mind.

Table 4.8: Sorbent Chloride Analysis

Sample Number	Location	EG&G Laboratory ID Number	Chloride (ppmw)
Fresh		42458	16
ZTMC01-S4-B1	Top	42598	193
ZTMC01-S4-B5	Middle	42602	311
ZTMC01-S4-B8	Bottom	42605	348

4.3.6 Helium Density

The helium density for a sorbent sample is defined as the weight of the sample divided by the volume of helium that it displaces. Since helium is the smallest atom available, it has the best possibility of penetrating all of the pores in the solid. Hence, the helium density would be closest to the true density (i.e., skeletal density) of the solid. The measured helium densities are used for calculating the small pore porosity (as determined by nitrogen adsorption) of the sorbent fractions.

Table 4.9: Sorbent Helium Density

Sample Number	EG&G Laboratory ID Number	Helium Density (g/cc)
Fresh	42458	5.07
ZTSC01-S1-B1	42466	4.60
ZTSC01-S1-B5	42467	4.75
ZTSC01-S1-B8	42468	4.82
ZTSC02-S1-B1	42470	4.54
ZTSC02-S1-B5	42471	4.73
ZTSC02-S1-B8	42472	4.82
ZTSC03-S1-B1	42474	4.44
ZTSC03-S1-B5	42475	4.58
ZTSC03-S1-B8	42476	4.64
ZTSC04-S1-B1	42478	4.39
ZTSC04-S1-B5	42479	4.56
ZTSC04-S1-B8	42480	4.63
ZTSC05-S1-B1	42505	4.55
ZTSC05-S1-B5	42506	4.67
ZTSC05-S1-B8	42507	4.74
ZTSC06-S1-B1	42516	3.98

Sample Number	EG&G Laboratory ID Number	Helium Density (g/cc)
ZTSC06-S1-B5	42517	4.16
ZTSC06-S1-B8	42518	4.40
ZTSC07-R3-TOP	42545	5.04
ZTSC07-R3-MIDDLE	42546	5.08
ZTSC07-R3-BOTTOM	42547	5.17
ZTMC01-S4-B1	42598	4.21
ZTMC01-S4-B2	42599	4.20
ZTMC01-S4-B3	42600	4.33
ZTMC01-S4-B4	42601	4.41
ZTMC01-S4-B5	42602	4.48
ZTMC01-S4-B6	42603	4.56
ZTMC01-S4-B7	42604	4.63
ZTMC01-S4-B8	42605	4.64
ZTMC02-S3-B1	42606	4.05
ZTMC02-S3-B2	42607	4.31
ZTMC02-S3-B3	42608	4.32
ZTMC02-R3-B1	42632	4.96
ZTMC02-R3-B5	42633	5.00
ZTMC02-R3-B8	42634	5.00
ZTMC03-R4-B1	42680	-
ZTMC03-R4-B8	42681	-
ZTMC04-S3-B1	42926 42970	4.24
ZTMC04-S3-B8	42927 42969	4.30
ZTSC08-S1-B1	42967	-
ZTSC08-S1-B8	42968	-

4.3.7 Nitrogen and Krypton Adsorption

Krypton surface area analyses were performed on solid samples in accordance with ASTM method D4780-88 at Galbraith Laboratories, Inc. This test method covers the determination of the specific surface area of catalysts in the range from 0.05 to 10 m²/g via krypton adsorption. A volumetric measuring system is used to obtain at least three points which fit on the linear BET line. The krypton surface area is considered more accurate than the nitrogen BET surface area for the surface areas.

Nitrogen surface areas were likewise performed for selected solid samples. Nitrogen adsorption isotherms were generated at the EG&G Analytical Laboratory utilizing the Micromeritics Digisorb 2600 apparatus. Pore volume and pore area distributions up to a pore size of 600 angstroms were provided. The pore volume data and helium densities have been utilized to compute a small pore porosity, where the total small pore porosity can be computed from the equation:

$$\text{Porosity} = \frac{\text{He Density} \times \text{Total Pore Volume}}{1 + (\text{He Density} \times \text{Total Pore Volume})} \times 100$$

The pore volumes, porosities, and B.E.T. surface areas for the fresh and the reacted sorbent are tabulated in Table 4.10.

Table 4.10: Sorbent Krypton and Nitrogen Adsorption

Sample Number	EG&G Laboratory ID Number	KRYPTON ADSORPTION	NITROGEN ADSORPTION		
		BET Surface Area (m ² /g)	BET Surface Area (m ² /g)	Total Pore Volume (cc/g)	Calculated Porosity (%)
Fresh	42458	0.8518	1.4141	0.002291	1.15
ZTSC01-S1-B1	42466	1.0930	2.4430	0.007071	3.15
ZTSC01-S1-B5	42467	1.2186	0.7750	0.002003	0.94
ZTSC01-S1-B8	42468	0.8348	1.6460	0.003404	1.61
ZTSC02-S1-B1	42470	1.3516	2.7051	0.008303	3.63
ZTSC02-S1-B5	42471	1.3944	1.3305	0.002900	1.35
ZTSC02-S1-B8	42472	1.4821	1.8504	0.003189	1.51

Sample Number	EG&G Laboratory ID Number	KRYPTON ADSORPTION	NITROGEN ADSORPTION		
		BET Surface Area (m ² /g)	BET Surface Area (m ² /g)	Total Pore Volume (cc/g)	Calculated Porosity (%)
ZTSC03-S1-B1	42474	1.6912	2.1856	0.005698	2.47
ZTSC03-S1-B5	42475	0.9938	1.6428	0.004338	1.95
ZTSC03-S1-B8	42476	0.8638	1.7639	0.004380	1.99
ZTSC04-S1-B1	42478	0.7678	1.7358	0.004753	2.04
ZTSC04-S1-B5	42479	0.8681	1.2558	0.003030	1.36
ZTSC04-S1-B8	42480	0.9353	1.8897	0.003838	1.75
ZTSC05-S1-B1	42505	1.3337	2.1180	0.004199	1.87
ZTSC05-S1-B5	42506	1.3285	1.3834	0.002656	1.23
ZTSC05-S1-B8	42507	1.1020	1.4074	0.002362	1.11
ZTSC06-S1-B1	42516	0.7783	1.8466	0.004696	1.83
ZTSC06-S1-B5	42517	1.4281	2.0414	0.004013	1.64
ZTSC06-S1-B8	42518	1.4744	1.9813	0.004811	2.07
ZTSC07-S3-B1	42539	3.4430	-	-	-
ZTSC07-S3-B2	42540	1.9655	-	-	-
ZTSC07-S3-B3	42541	1.2764	-	-	-
ZTSC07-R3-TOP	42545	0.8958	1.2992	0.002258	1.13
ZTSC07-R3-MIDDLE	42546	0.9669	1.6255	0.003006	1.50
ZTSC07-R3-BOTTOM	42547	0.8651	1.3691	0.002225	1.14
ZTMC01-S4-B1	42598	2.1225	3.0477	0.010496	4.23
ZTMC01-S4-B2	42599	-	3.2143	0.010129	4.08
ZTMC01-S4-B3	42600	-	3.1591	0.008119	3.40
ZTMC01-S4-B4	42601	-	3.0860	0.010815	4.55
ZTMC01-S4-B5	42602	1.9737	2.4645	0.008264	3.57
ZTMC01-S4-B6	42603	-	2.6195	0.007775	3.42
ZTMC01-S4-B7	42604	-	2.4445	0.006458	2.90
ZTMC01-S4-B8	42605	1.3220	3.7478	0.010501	4.65
ZTMC02-R1-B1	42588	-	1.3026	-	-
ZTMC02-R1-B2	42589	-	1.4603	-	-
ZTMC02-R1-B3	42590	-	1.7162	-	-

Sample Number	EG&G Laboratory ID Number	KRYPTON ADSORPTION	NITROGEN ADSORPTION		
		BET Surface Area (m ² /g)	BET Surface Area (m ² /g)	Total Pore Volume (cc/g)	Calculated Porosity (%)
ZTMC02-S3-B1	42606	0.9812	1.4559	0.004694	1.87
ZTMC02-S3-B2	42607	0.7696	1.7901	0.003759	1.59
ZTMC02-S3-B3	42608	1.1949	1.9289	0.003493	1.49
ZTMC02-R3-B1	42632	0.8338	1.3362	0.002467	1.21
ZTMC02-R3-B5	42633	0.9806	1.1403	0.002182	1.08
ZTMC02-R3-B8	42634	0.6667	1.2077	0.001675	0.83
ZTMC03-R4-B1	42680	0.57	-	-	-
ZTMC03-R4-B8	42681	0.48	-	-	-
ZTMC04-S3-B1	42926 42970	0.3387	< 0.01	-	-
ZTMC04-S3-B8	42927 42969	0.2812	1.8580	0.002199	0.94
ZTSC08-S1-B1	42967	-	-	-	-
ZTSC08-S1-B8	42968	-	-	-	-

4.3.8 Mercury Porosity

Large pore porosity, contained in pores larger than 125 angstroms, was determined by mercury porosimetry. Mercury porosimetry analyses were performed at METC. The test method used was according to ASTM C699. Data supplied included pore volume data and a calculated porosity using the method applied to the nitrogen adsorption data. In this case, the porosity is calculated using a skeletal density obtained from mercury intrusion. The data is tabulated in Table 4.11.

Table 4.11: Sorbent Mercury Porosity

Sample Number	EG&G Laboratory ID Number	MERCURY INTRUSION				
		Total Pore Volume (ml/g)	Mean Pore Diameter (µm)	Particle Density (g/ml)	Skeletal Density (g/ml)	Calculated Porosity (%)
Fresh	42458	0.2104	0.1344	2.4155	4.9114	50.82
ZTSC01-S1-B1	42466	0.1834	0.0718	2.5097	4.6506	46.03
ZTSC01-S1-B5	42467	0.1797	0.0991	2.5348	4.6559	45.55
ZTSC01-S1-B8	42468	0.2051	0.1246	2.4462	4.9098	50.17
ZTSC02-S1-B1	42470	0.1683	0.0800	2.5863	4.5802	43.53
ZTSC02-S1-B5	42471	0.1728	0.0803	2.6090	4.7516	45.09
ZTSC02-S1-B8	42472	0.1845	0.0869	2.5483	4.8096	47.02
ZTSC03-S1-B1	42474	0.1586	0.0477	2.5992	4.4224	41.22
ZTSC03-S1-B5	42475	0.1536	0.1206	2.6441	4.4534	40.62
ZTSC03-S1-B8	42476	0.1911	0.0885	2.4579	4.6348	46.97
ZTSC04-S1-B1	42478	0.1501	0.0610	2.6680	4.4498	40.04
ZTSC04-S1-B5	42479	0.1610	0.1044	2.6110	4.5046	42.04
ZTSC04-S1-B8	42480	0.1785	0.0958	2.5637	4.7307	45.78
ZTSC05-S1-B1	42505	0.1681	0.0749	2.5541	4.4759	42.94
ZTSC05-S1-B5	42506	0.1883	0.0821	2.5257	4.8164	47.56
ZTSC05-S1-B8	42507	0.1813	0.0768	2.5533	4.7539	46.29
ZTSC06-S1-B1	42516	0.1373	0.0590	2.6474	4.1587	36.35
ZTSC06-S1-B5	42517	0.1664	0.0719	2.6205	4.6466	43.60
ZTSC06-S1-B8	42518	0.1722	0.0756	2.5616	4.5833	44.11
ZTSC07-S3-B1	42539	0.1254	0.0260	2.5827	3.8196	32.39
ZTSC07-S3-B2	42540	0.1565	0.0445	2.4646	4.0115	38.57
ZTSC07-S3-B3	42541	0.1765	0.0697	2.4523	4.3230	43.28
ZTSC07-R3-TOP	42545	0.2077	0.1155	2.4415	4.9535	50.71
ZTSC07-R3-MIDDLE	42546	0.2243	0.1093	2.3952	5.1756	53.72
ZTSC07-R3-BOTTOM	42547	0.2366	0.0921	2.3315	5.1994	55.16
ZTMC01-S4-B1	42598	0.1623	0.0603	2.4407	4.0416	39.61
ZTMC01-S4-B5	42602	0.1706	0.0739	2.4446	4.1934	41.70

Sample Number	EG&G Laboratory ID Number	MERCURY INTRUSION				
		Total Pore Volume (ml/g)	Mean Pore Diameter (μ m)	Particle Density (g/ml)	Skeletal Density (g/ml)	Calculated Porosity (%)
ZTMC01-S4-B8	42605	0.1628	0.1502	2.6089	4.5344	42.47
ZTMC02-S3-B1	42606	0.1307	0.0603	2.6740	4.1101	34.95
ZTMC02-S3-B2	42607	0.1607	0.0704	2.5012	4.1819	40.19
ZTMC02-S3-B3	42608	0.1574	0.0820	2.5279	4.1988	39.79
ZTMC02-R3-B1	42632	0.2293	0.1588	2.2836	4.7931	52.36
ZTMC02-R3-B5	42633	0.1857	0.1641	2.5723	4.9253	47.77
ZTMC02-R3-B8	42634	0.2061	0.1328	2.4677	5.0212	50.86
ZTMC03-R4-B1	42680	-	-	-	-	-
ZTMC03-R4-B8	42681	-	-	-	-	-
ZTMC04-S3-B1	42926 42970	0.1043	0.0993	2.9384	4.2376	30.65
ZTMC04-S3-B8	42927 42969	0.0976	0.0939	3.0272	4.2970	29.55
ZTSC08-S1-B1	42967	-	-	-	-	-
ZTSC08-S1-B8	42968	-	-	-	-	-

4.3.9 Mineral Analysis by X-Ray Diffraction

X-ray diffraction analyses were performed on sorbent samples taken from the top, middle, and bottom of the reactor. Diffractograms were run at West Virginia University in the Geology Department by Dr. John Renton using an APD1700 Automated Powder Diffractometer. Results are reported as percent of total Integrated Intensity (%TII) in Table 4.12. %TII is directly proportional to the concentration of the crystalline phase. It should be noted that the peaks for Zn_2TiO_4 and $Zn_2Ti_3O_8$ are nearly identical making it very difficult to discern between the two phases. The amorphous phase is not included.

**Table 4.12: Mineral Analysis By X-Ray Diffraction
Percent Total Integrated Intensity**

Sample	α -ZnS	β -ZnS	TiO ₂ (Rutile)	TiO ₂ (Anatase)	TiO ₂ (Brookite)	ZnSO ₄ ·H ₂ O	Zn ₂ TiO ₄ + Zn ₂ Ti ₃ O ₈
Fresh	0.7	-	-	-	-	-	99.3
ZTSC01-S1	Top	4.86	-	-	-	-	88.55
	Middle	5.31	-	-	-	-	91.36
	Bottom	4.05	-	-	-	-	93.49
ZTSC02-S1	Top	6.37	13.5	-	-	-	80.13
	Middle	6.41	15	-	-	-	78.59
	Bottom	7.14	8.88	-	-	-	83.98
ZTSC03-S1	Top	6.98	22.12	-	-	-	70.9
	Middle	6.13	16.57	-	-	-	77.3
	Bottom	4.14	5.67	-	-	-	90.19
ZTSC04-S1	Top	8.37	13.14	-	-	-	78.49
	Middle	6.74	16.13	-	-	-	77.13
	Bottom	3.77	5.53	-	-	-	90.70
ZTSC05-S1	Top	5.53	12.36	-	-	-	82.11
	Middle	4.96	8.18	-	-	-	86.85
	Bottom	4.31	11.39	-	-	-	84.30
ZTSC06-S1	Top	7.50	32.04	-	-	-	60.46
	Middle	11.73	24.15	-	-	-	64.11
	Bottom	8.20	24.82	-	-	-	66.98
ZTSC07-S3	Top	3.3	49.1	4.3	-	-	43.3
	Middle	5.8	50.9	3.2	-	0.4	39.7
	Bottom	-	39.4	0.9	-	-	59.7
ZTSC07-R3	Top	-	-	0.1	-	-	99.9
	Middle	-	-	-	-	-	100
	Bottom	-	-	-	-	-	100

Sample	α -ZnS	β -ZnS	TiO ₂ (Rutile)	TiO ₂ (Anatase)	TiO ₂ (Brookite)	ZnSO ₄ ·H ₂ O	Zn ₂ TiO ₄ + Zn ₂ Ti ₃ O ₈
ZTMC01-S4	Top	7.6	44.0	-	3.6	-	44.8
	Middle	3.3	24.6	-	1.8	-	70.4
	Bottom	2.7	26.7	-	1.3	-	69.3
ZTMC02-S3	Top	2.9	36.6	-	1.5	-	59.0
	Middle	3.5	36.2	-	1.2	-	59.1
	Bottom	-	28.4	-	0.5	-	71.1
ZTMC02-R3	Top	-	-	-	1.5	-	98.5
	Middle	-	-	-	2.6	-	97.4
	Bottom	-	-	-	1.2	-	98.8
ZTMC03-R4	Top	-	-	-	-	-	97.0
	Bottom	-	-	-	-	-	98.1
ZTMC04-S3	Top	2.7	9.4	-	-	1.4	72.4
	Bottom	6.1	6.4	-	-	0.8	85.4
ZTSC08-S1	Top	-	-	-	-	-	-
	Bottom	-	-	-	-	-	-

4.3.10 Sieve Analysis

Sorbent sieve analysis of fresh and reacted sorbent samples are shown in Table 4.13. The sorbent samples were sieved and the weight percentages of sorbent retained on each screen are reported.

Table 4.13: Sieve Analysis - Test Number ZTSC07-R3 (After Third Regeneration)

Screen Size Retained On (mesh)	Sieve Opening (mm)	WEIGHT PERCENT RETAINED ON SCREEN T-2535M Zinc Titanate									
		Fresh T-2535M	Top 2" of Bed	2"-4" from Top	4"-6" from Top	6"-8" from Top	8"-10" from Top	10"-12" from Top	12"-14" from Top		
1/4"	6.35	0.30	-	-	-	-	-	-	-	-	-
4	4.76	38.00	25.42	8.28	13.63	27.07	34.87	27.89	31.41		
6	3.36	61.65	42.79	26.37	36.21	49.22	43.40	48.41	46.28		
12	1.68	0.05	26.62	48.05	37.03	19.81	17.33	20.52	17.23		
14	1.41	0.00	1.74	6.67	3.78	1.25	1.60	1.13	1.36		
20	0.841	-	2.07	8.15	4.67	1.79	1.93	1.35	2.67		
25	0.707	-	0.11	0.62	0.44	0.08	0.07	0.05	0.05		
35	0.500	-	0.54	1.12	1.39	0.38	0.40	0.28	0.35		
45	0.354	-	0.29	0.31	0.70	0.16	0.20	0.11	0.15		
60	0.250	-	0.22	0.19	1.26	0.16	0.13	0.11	0.15		
80	0.177	-	0.05	0.06	0.19	0.08	0.00	0.05	0.05		
100	0.149	-	0.05	0.00	0.13	0.00	0.07	0.00	0.05		
120	0.125	-	0.00	0.00	0.13	0.00	0.00	0.00	0.05		
170	0.088	-	0.05	0.00	0.19	0.00	0.00	0.05	0.05		
230	0.063	-	0.00	0.06	0.06	0.00	0.00	0.05	0.05		
270	0.053	-	0.00	0.12	0.06	0.00	0.00	0.00	0.05		
325	0.044	-	0.00	0.00	0.00	0.00	0.00	0.00	0.00		
Pan	<0.044	0.00	0.05	0.00	0.13	0.00	0.00	0.00	0.05		
Total Weight &		100.00	100.00	100.00	100.00	100.00	100.00	100.00	100.00	100.00	100.00
Sample Size (grams)		201.8	183.7	161.9	158.5	128.2	150.0	185.7	206.6		

Table 4.14: Sieve Analysis - Test Number ZTMC01-S4 (After Fourth Sulfidation)

Screen Size Retained On (mesh)	Sieve Opening (mm)	WEIGHT PERCENT RETAINED ON SCREEN T-2535M Zinc Titanate											
		Fresh T-2535M	Top of Bed	2nd	3rd	4th	5th	6th	7th	Bottom of Bed			
1/4"	6.35	0.30	-	-	-	-	-	-	-	-	-	-	-
4	4.76	38.00	54.2	50.50	50.63	49.00	35.76	41.19	42.60	35.62			
6	3.36	61.65	43.86	46.85	46.12	45.21	55.70	51.41	50.15	53.25			
12	1.68	0.05	1.78	2.33	2.98	5.50	7.68	5.42	4.95	3.24			
14	1.41	0.00	0.03	0.11	0.06	0.08	0.39	0.60	0.85	1.08			
20	0.841	-	0.13	0.21	0.21	0.21	0.47	0.57	1.18	2.64			
25	0.707	-	-	-	-	-	-	-	0.08	0.17			
35	0.500	-	-	-	-	-	-	-	0.63	0.86			
45	0.354	-	-	-	-	-	-	-	0.07	0.50			
60	0.250	-	-	-	-	-	-	-	0.08	0.43			
80	0.177	-	-	-	-	-	-	-	0.03	0.26			
100	0.149	-	-	-	-	-	-	-	-	0.16			
120	0.125	-	-	-	-	-	-	-	-	0.18			
170	0.088	-	-	-	-	-	-	-	-	0.25			
230	0.063	-	-	-	-	-	-	-	-	0.22			
270	0.053	-	-	-	-	-	-	-	-	0.48			
325	0.044	-	-	-	-	-	-	-	-	-			
Pan	>0.044	0.00	-	-	-	-	-	-	-	0.66			
Total Weight &		100.00	100.00	100.00	100.00	100.00	100.00	100.00	100.00	100.00	100.00	100.00	100.00
Sample Size (grams)		201.8	143.82	145.31	117.75	109.22	131.78	169.47	125.53	92.62			

Table 4.15: Sieve Analysis - Test Number ZTMC02-R3 (After Third Regeneration)

Screen Size Retained On (mesh)	Sieve Opening (mm)	WEIGHT PERCENT RETAINED ON SCREEN T-2535M Zinc Titanate											
		Top 2" of Bed	2"-4" from Top	4"-6" from Top	6"-8" from Top	8"-10" from Top	10"-12" from Top	12-14" from Top	14"-16" from Top				
1/4"	6.35	-	-	-	-	-	-	-	-	-	-	-	-
4	4.76	24.40	22.00	35.75	29.15	27.98	47.16	40.96	44.61				
6	3.36	45.94	53.08	54.77	60.19	60.85	48.77	56.29	49.60				
12	1.68	24.93	21.46	8.26	9.22	8.24	3.43	2.22	3.95				
14	1.41	1.51	0.87	0.28	0.34	0.16	0.04	-	0.04				
20	0.841	2.01	1.39	0.31	0.54	0.87	0.28	0.22	0.60				
25	0.707	0.20	0.22	0.11	0.09	-	0.04	0.04	0.15				
35	0.500	0.42	0.38	0.20	0.20	0.25	0.11	0.11	0.40				
45	0.354	0.24	0.22	0.12	0.12	0.17	0.07	0.09	0.21				
60	0.250	0.20	0.20	0.12	0.11	0.16	0.09	0.07	0.16				
80	0.177	0.09	0.11	0.05	0.04	0.05	0.01	-	0.07				
100	0.149	0.03	0.07	0.03	-	0.07	-	-	0.04				
120	0.125	-	-	-	-	0.11	-	-	0.08				
170	0.088	0.03	-	-	-	0.11	-	-	0.05				
230	0.063	-	-	-	-	0.05	-	-	-				
270	0.053	-	-	-	-	0.28	-	-	0.04				
325	0.044	-	-	-	-	0.01	-	-	-				
Pan	>0.044	-	-	-	-	0.64	-	-	-				
Total Weight %		100.00	100.00	100.00	100.00	100.00	100.00	100.00	100.00	100.00	100.00	100.00	100.00
Sample Size (grams)		91.17	126.80	138.34	162.00	75.99	135.44	120.19	135.94				

Table 4.16: Sieve Analysis - Test Number ZTMC-04-S3 (After Fourth Sulfidation)

Screen Size Retained On (mesh)	Sieve Opening (mm)	WEIGHT PERCENT RETAINED ON SCREEN T-2535M Zinc Titanate											
		Fresh T-2535M	Top of Bed	2nd	3rd	4th	5th	6th	7th	Bottom of Bed			
1/4"	6.35	0.30	-	-	-	-	-	-	-	-	-	-	-
4	4.76	38.00	20.43	19.91	13.93	8.38	9.10	5.81	3.80	1.84			
6	3.36	61.65	79.33	79.53	84.75	85.31	77.36	86.83	87.00	74.24			
12	1.68	0.05	0.07	0.56	1.20	6.00	10.50	6.31	8.51	13.93			
14	1.41	0.00	0.07	-	0.04	0.13	1.47	0.41	0.37	2.18			
20	0.841	-	0.10	-	0.08	0.17	1.09	0.61	0.24	3.95			
25	0.707	-	-	-	-	0.01	0.10	-	0.04	0.71			
35	0.500	-	-	-	-	-	0.03	0.03	0.04	1.08			
45	0.354	-	-	-	-	-	0.01	-	-	0.21			
60	0.250	-	-	-	-	-	0.01	-	-	0.36			
80	0.177	-	-	-	-	-	0.00	-	-	0.24			
100	0.149	-	-	-	-	-	0.00	-	-	0.14			
120	0.125	-	-	-	-	-	0.03	-	-	0.20			
170	0.088	-	-	-	-	-	0.03	-	-	0.40			
230	0.063	-	-	-	-	-	-	-	-	0.15			
270	0.053	-	-	-	-	-	0.13	-	-	0.30			
325	0.044	-	-	-	-	-	-	-	-	0.00			
Pan	>0.044	0.00	-	-	-	-	0.14	-	-	0.07			
Total Weight %		100.00	100.00	100.00	100.00	100.00	100.00	100.00	100.00	100.00	100.00	100.00	100.00
Sample Size (grams)		201.8	144.30	128.45	156.65	200.19	201.16	227.16	223.11	227.90			

Table 4.17: Sieve Analysis - Test Number ZTSC-08-S1 (After Sulfidation)

Screen Size Retained On (mesh)	Sieve Opening (mm)	WEIGHT PERCENT RETAINED ON SCREEN T-2535M Zinc Titanate											
		Fresh T-2535M	Top of Bed	2nd	3rd	4th	5th	6th	7th	Bottom of Bed			
1/4"	6.35	0.30	-	-	-	-	-	-	-	-	-	-	-
4	4.76	38.00	23.33	24.45	19.38	17.67	16.21	18.26	13.28	9.53			
6	3.36	61.65	76.56	75.14	79.39	80.62	81.86	79.35	82.66	79.23			
12	1.68	0.05	0.11	0.41	1.21	1.70	1.93	2.38	3.45	7.80			
14	1.41	0.00	-	-	0.02	0.01	-	0.01	0.17	1.15			
20	0.841	-	-	-	-	-	-	-	0.26	1.28			
25	0.707	-	-	-	-	-	-	-	0.04	0.18			
35	0.500	-	-	-	-	-	-	-	0.08	0.22			
45	0.354	-	-	-	-	-	-	-	0.04	0.09			
60	0.250	-	-	-	-	-	-	-	0.02	0.06			
80	0.177	-	-	-	-	-	-	-	-	0.07			
100	0.149	-	-	-	-	-	-	-	-	0.03			
120	0.125	-	-	-	-	-	-	-	-	0.04			
170	0.088	-	-	-	-	-	-	-	-	0.04			
230	0.063	-	-	-	-	-	-	-	-	0.03			
270	0.053	-	-	-	-	-	-	-	-	0.09			
325	0.044	-	-	-	-	-	-	-	-	0.01			
Pan	>0.044	0.00	-	-	-	-	-	-	-	0.15			
Total Weight %		100.00	100.00	100.00	100.00	100.00	100.00	100.00	100.00	100.00			
Sample Size (grams)		201.8	187.64	207.91	182.05	192.15	188.45	179.64	209.86	203.65			

5.0 Results and Discussion

5.1 Sulfur Balances

Calculations have been performed to perform overall sulfur balances for each test (except ZTMC-03, which was the test which had no sulfur in the inlet). These balances were computed using the results of the laboratory analyses (condensate and sorbent) and calculated inlet flows in conjunction with the inlet and outlet gas compositions as found by gas chromatography. A general overall sulfur balance can be written as:

$$M_{S, \text{ initial in bed}} + \sum_{\text{Sulf/Reg}} M_{S, \text{ inlet gas}} = \sum_{\text{Sulf/Reg}} M_{S, \text{ outlet gas}} + \sum_{\text{Sulf/Reg}} M_{S, \text{ condensate}} + \sum_{\text{Sulf/Reg}} M_{S, \text{ Sorbent from reactor}}$$

The total amount of sulfur coming into the system with the inlet gas was calculated by a numerical integration (trapezoidal rule) of the inlet hydrogen sulfide flow rate over the time on stream. The hydrogen sulfide flow rate calculated from the mass flow controller settings or that calculated from the GC data was used for this calculation.

Sulfur leaving the system in the outlet gas was computed using a numerical integration of the exit sulfur concentration over the time on stream. The exit sulfur concentration as determined from the gas grab analyses and the calculated exit gas flows were used for this calculation. All sulfur species (SO_2 , COS , H_2S) were considered in the calculations involving GC data.

The amounts of sulfur in the condensate and the sorbent samples were calculated by multiplying the mass of the sample by the mass fraction of sulfur as determined by laboratory analysis.

Tables 5.1 through 5.5 summarize the sulfur balances for the zinc titanate test series. Percent closure calculations were also calculated on a per cycle basis whenever possible.

Table 5.1: Single Cycle Test Sulfur Balances

	Inlet (g Sulfur)			Outlet (g Sulfur)			% Closure (Out/In*100%)	
	Fresh Sorbent	MFC-based inlet	GC-based inlet	GC-based outlet	Sorbent removed	Condensate	MFC-based inlet	GC-based inlet
ZTSC-01-S1	0.70	73.83	57.23	12.42	51.45	0.05	85.76	110.34
ZTSC-02-S1	0.68	86.49	65.30	11.60	73.64	0.08	97.87	129.30
ZTSC-03-S1	0.69	94.85	83.26	16.01	79.33	0.12	99.93	113.73
ZTSC-04-S1	0.69	74.70	76.84	18.56	74.02	0.04	122.87	119.47
ZTSC-05-S1	0.69	72.43	64.08	10.50	65.110	0.06	103.48	116.82
ZTSC-06-S1	0.69	222.00	107.95	24.95	109.53	0.16	60.46	123.94
ZTSC-08-S1	0.76	565.69	455.97	351.43	110.19		81.49	101.07

NOTES:

- (1) ZTSC-06 inlet sulfur (MFC vs. GC) - the GC readings seemed low and infrequent, while the MFC readings seemed high (much greater than 800 ppmv inlet), which may account for the large discrepancy in the values.
- (2) ZTSC-08 sorbent removed - Sulfur analysis was performed only on the top and bottom samples. A linear relationship was assumed for the other samples for the purpose of the calculation.

Table 5.2: Test ZTSC-07 Sulfur Balance

	Inlet (g Sulfur)			Outlet (g Sulfur)				% Closure (Out/In*100%)	
	Fresh Sorbent	MFC-based inlet	GC-based inlet	GC-based outlet	Sorbent removed	Condensate	MFC-based inlet	GC-based inlet	
ZTSC-07-S1	0.69	166.10	100.68	19.66	-	0.09	54.84	90.23	
ZTSC-07-R1	-	0.00	0.01	42.79	0.32	28.61			
ZTSC-07-S2	-	137.89	80.02	7.16	-	0.30	94.98	163.64	
ZTSC-07-R2	-	0.00	0.01	123.50	-	-			
ZTSC-07-S3	-	560.71	494.05	333.93	5.46	0.16	85.93	97.51	
ZTSC-07-R3	-	0.00	0.03	138.61	3.64	-			
Overall	0.69	864.71	674.80	665.65	9.42	29.16	81.38	104.26	

NOTE: ZTSC-07-R1 condensate - Outlet condensate had an anomalously high sulfur reading.

Table 5.3: Test ZTMC-01 Sulfur Balance

	Inlet (g Sulfur)			Outlet (g Sulfur)			% Closure (Out/In*100%)	
	Fresh Sorbent	MFC-based inlet	GC-based inlet	GC-based outlet	Sorbent removed	Condensate	MFC-based inlet	GC-based inlet
ZTMC-01-S1	0.51	42.69	34.17	1.30	-	0.09	85.47	106.24
ZTMC-01-R1	-	0.00	0.08	32.16	-	3.38		
ZTMC-01-S2	-	54.58	42.71	1.88	-	0.11	104.63	133.63
ZTMC-01-R2	-	0.00	0.02	50.81	-	4.30		
ZTMC-01-S3	-	72.02	48.38	1.65	-	0.07	108.06	160.52
ZTMC-01-R3	-	0.00	0.10	68.15	-	7.95		
ZTMC-01-S4	-	88.98	68.00	2.44	89.21	0.10	103.11	134.94
Overall	0.51	258.27	193.46	158.39	89.21	16.01	101.86	135.90

Table 5.4: Test ZTMC-02 Sulfur Balance

	Inlet (g Sulfur)			Outlet (g Sulfur)				% Closure (Out/In*100%)	
	Fresh Sorbent	MFC-based inlet	GC-based inlet	GC-based outlet	Sorbent removed	Condensate	MFC-based inlet	GC-based inlet	
ZTMC-02-S1	0.69	113.27	95.44	15.34	-	0.13	74.20	87.97	
ZTMC-02-R1	-	0.00	0.00	53.19	0.11	15.80			
ZTMC-02-S2	-	114.40	91.44	10.67	-	0.21	77.62	88.76	
ZTMC-02-R2	-	0.00	8.62	77.91	-	0.01			
ZTMC-02-S3	-	313.29	221.46	127.38	3.96	1.42	83.61	118.28	
ZTMC-02-R3	-	0.00	0.01	126.04	3.15	-			
Overall	0.69	540.97	416.96	410.53	7.22	17.56	80.37	104.23	

NOTE: ZTMC-02-R2 GC inlet - One inlet sample had a very high (0.1%) SO₂ reading, probably due to sulfur retained on the tubing wall during sulfidation, which would cause the integration to overestimate the actual amount of sulfur.

Table 5.5: Test ZTMC-04 Sulfur Balance

	Inlet (g Sulfur)			Outlet (g Sulfur)			% Closure (Out/In*100%)	
	Fresh Sorbent	MFC-based inlet	GC-based inlet	GC-based outlet	Sorbent removed	Condensate	MFC-based inlet	GC-based inlet
ZTMC-04-S1	0.76	291.77	188.67	129.78	-	0.05	70.07	102.25
ZTMC-04-R1	-	0.00	11.03	75.13	-	0.00		
ZTMC-04-S2	-	222.18	149.13	95.97	-	0.24	77.00	72.28
ZTMC-04-R2	-	0.00	87.55	74.87	-	-		
ZTMC-04-S3	-	291.40	220.94	155.02	78.68	0.57	80.40	106.04
Overall	0.76	805.35	657.32	530.77	78.68	0.86	75.71	92.74

NOTES:

- (1) ZTMC-04-R1 and R2 GC inlet - Inlet GC samples had high SO₂ readings, probably due to sulfur retained on the tubing walls during sulfidation, which would cause the integration to overestimate the actual amount of sulfur.
- (2) ZTMC-04-S3 sorbent removed - Sulfur analysis was performed only on the top and bottom samples. A linear relationship was assumed for the other samples for the purpose of the calculation.

5.2 Chloride Balance

A chloride balance for test ZTMC-01 was performed. This was the only test in this series in which HCl was introduced in the feed gas. The balance calculation was essentially the same as that for the sulfur balance, with one exception. The chloride leaving the system in the outlet gas is assumed to be zero. This is for two reasons. The first is that the analytical techniques available are unable to analyze for chloride content in the gas grab samples, and the second is that the condensate is assumed to remove all of the chloride from the stream. This assumption allows at least an estimate of the chloride balance to be performed.

Table 5.6: Test ZTMC-01 Chloride Balance

	Inlet (g Chloride)			Outlet (g Chloride)			% Closure (Out/In*100%)	
	Fresh Sorbent	MFC-based inlet	GC-based inlet	GC-based outlet	Sorbent removed	Condensate	MFC-based inlet	GC-based inlet
ZTMC-01-S1	0.02	0.79	-	-	-	0.28	71.71	-
ZTMC-01-R1	-	0.00	-	-	-	0.30		
ZTMC-01-S2	-	1.06	-	-	-	0.43	65.00	-
ZTMC-01-R2	-	0.00	-	-	-	0.26		
ZTMC-01-S3	-	1.41	-	-	-	0.46	62.96	-
ZTMC-01-R3	-	0.00	-	-	-	0.43		
ZTMC-01-S4	-	1.70	-	-	0.29	0.89	69.76	-
Overall	0.02	4.96	-	-	0.29	3.05	67.14	-

5.3 Discussion of Results

- The first six ½-cycle tests were performed in order to examine the performance of the sorbent under various temperature and velocity conditions. Velocities between 15.24 and 60.46 cm/s (0.5 and 2.0 ft/s) and temperatures in the range of 538 to 649 °C (1000 to 1200 °F) were explored. Examining the sorbent sulfur loadings shows that the gas velocity has a greater effect than the temperature in the ranges studied. It must be noted that comparisons of the data from tests at different flow rates was done after correcting for different amounts of sulfur entering the reactor. Sulfur loading increased with lower velocities, while the temperature seems to have had little effect within the relatively narrow 1000-1200 °F range studied. This appears to indicate that the sorbent's reaction with H₂S is diffusion controlled. Visual inspection of the sorbent confirms this observation. Even after tests where the final outlet H₂S concentration was 600 ppmv or above (which indicates that the sorbent was saturated), the sorbent pellets had a white, unsulfided center with an easily discernable exterior layer of sulfided material.
- 100 ppmv COS was introduced in the feed gas during ZTSC-01 through ZTSC-05. GC results indicate that the sorbent reacts with both the H₂S and the COS. The increase in the outlet H₂S level over time is mirrored by a concurrent increase in the COS level.
- Regenerations with steam as a diluent (with or without additional N₂) were performed in tests ZTSC-07, ZTMC-01, and ZTMC-02. Dry regenerations were attempted in later tests in an effort to eliminate the cracking and spalling problems of the sorbent.
- Test ZTMC-01 was the only test in which HCl (15 ppmv) was introduced in the feed gas. The chloride balance for this test has a 67% closure, which makes it difficult to make any strong conclusions as to the effect of the chloride. Looking at the fourth sulfidation calculations, 17% of the chloride entering the reactor remained behind in the sorbent. It appears that the sorbent itself may pick up a quantity of any chloride entering the system.
- Test ZTMC-02 used a simulated GE coal gas (with 800 ppmv H₂S) instead of the typical KRW gas used in the other tests. This gas has a lower reducing power than the KRW gas - 0.55 vs. 2.25. Reducing power is defined as $\frac{[H_2]+[CO]}{[H_2O]+[CO_2]}$. This test can be compared to ZTSC-07, which had identical temperature, pressure, and velocity conditions. Comparing the detector tube plots, these two tests had very similar results in terms of reactivity.

- The purpose of test ZTMC-03 was to study the effect on the sorbent of the reducing power of the feed gas. No H₂S was introduced in the feed gas (simulated KRW) in order to separate any sorbent deterioration caused by the reducing conditions from that caused by sorbent expansion due to high sulfur loading. No significant amount of decrepitation was observed in this test.
- The results of ZTMC-02 and ZTMC-03 indicate that it is the cycling of the sorbent between the oxide and sulfide states that causes the decrepitation, and not external factors such as the gas composition.
- Test ZTMC-04 utilized a dry, staged oxidative regeneration scheme which ramped the bed temperature and O₂ feed percent from 538 °C (1000 °F) and 0.5% O₂ to 760 °C (1400 °F) and 21.0% O₂ over the course of six stages. The intent of this scheme was to provide a "gentler" regeneration for the sorbent and thus minimize sorbent cracking and spalling. The attempt was only partially successful - the sorbent did exhibit somewhat less deterioration, but the staged scheme did not fully eliminate the problem.
- The purpose of test ZTSC-08 was to provide a baseline for the zinc titanate formulation using an inlet gas containing 2000 ppmv H₂S instead of the previously tested 800 ppmv. The first test of Phillips Petroleum's Z-Sorb was to be run at 2000 ppmv, and this test was to provide a comparison to it. However, it was later decided to run the Z-Sorb test at 800 ppmv.
- In general, the sulfur balances have fairly good closure, with the GC-based inlet calculations tending to underestimate the amount of sulfur entering the system. This is most likely because the inlet samples are normally taken four hours apart and the first few samples tend to have low readings as compared to the computed MFC-based inlet flow rates. Each inlet reading has a significant effect upon the integral calculation due to the large time interval. The outlet GC values, which are based on readings taken one hour apart, do not exhibit this sort of behavior.

APPENDIX A
Data Acquisition Mass Flow Trends

Component gas and water flow rates were monitored by DDAS, a PC-based automatic data acquisition system. Trend plots for mass flow controller and water pump settings are presented here. The mass flow controllers utilized were Teledyne Hastings-Raydist HFC-series flow controllers with a reported accuracy of $\pm 1\%$ full scale. The water was fed in initial tests by a Milton Roy controlled volume water pump, MOD ER111-73, until ZTSC-05 (9/15/92) when it was replaced with an Isco, Inc. Model 500D continuous flow pump system, which has a reported accuracy of $\pm 0.5\%$ of the indicated value. The mass flow controllers and pump were calibrated prior to testing. Planned set-points for the mass flow controllers were not always at the conditions for which the controllers were originally sized. Therefore, flow proving over the range of 0 scfh to the maximum scfh for each controller was performed. Flow proving is a check over a range of flow rates of the controller's calibration by comparing the indicated flows (those recorded by the data acquisition system) against a flow calibration standard. At the high end of each controller, errors within $\pm 1\%$ of the indicated value were typical. Errors for flow proving at the low end of the controllers were as high as 30% of the indicated value. In order to establish the correct set-point, regression analysis was performed for the flow proving data. Water flow rates were recorded using an EG&G Flow Technology model FTO-2N1SW-LHC-1 turbine meter with a range of 10-150 ccpm. It should be noted that the flow rates used during this test series were at the extreme low range of the instrument, and the recorded values are not very accurate. For this reason several of the series do not have accompanying water flow plots. Also some of the series do not have water flow charts because a dry regeneration was used. The gas and water flow rate plots show the raw data only and should only be used as an indication of trends. Numerical values reported throughout the body of this report have been corrected using the results of the regression analysis.

L-3787M Zinc Titanate
u=2.0 ft/sec T=1100 °F
H2S Inlet Conc. = 800 ppm

Single Cycle Tests - ZTSC-01 Sulfidation 1

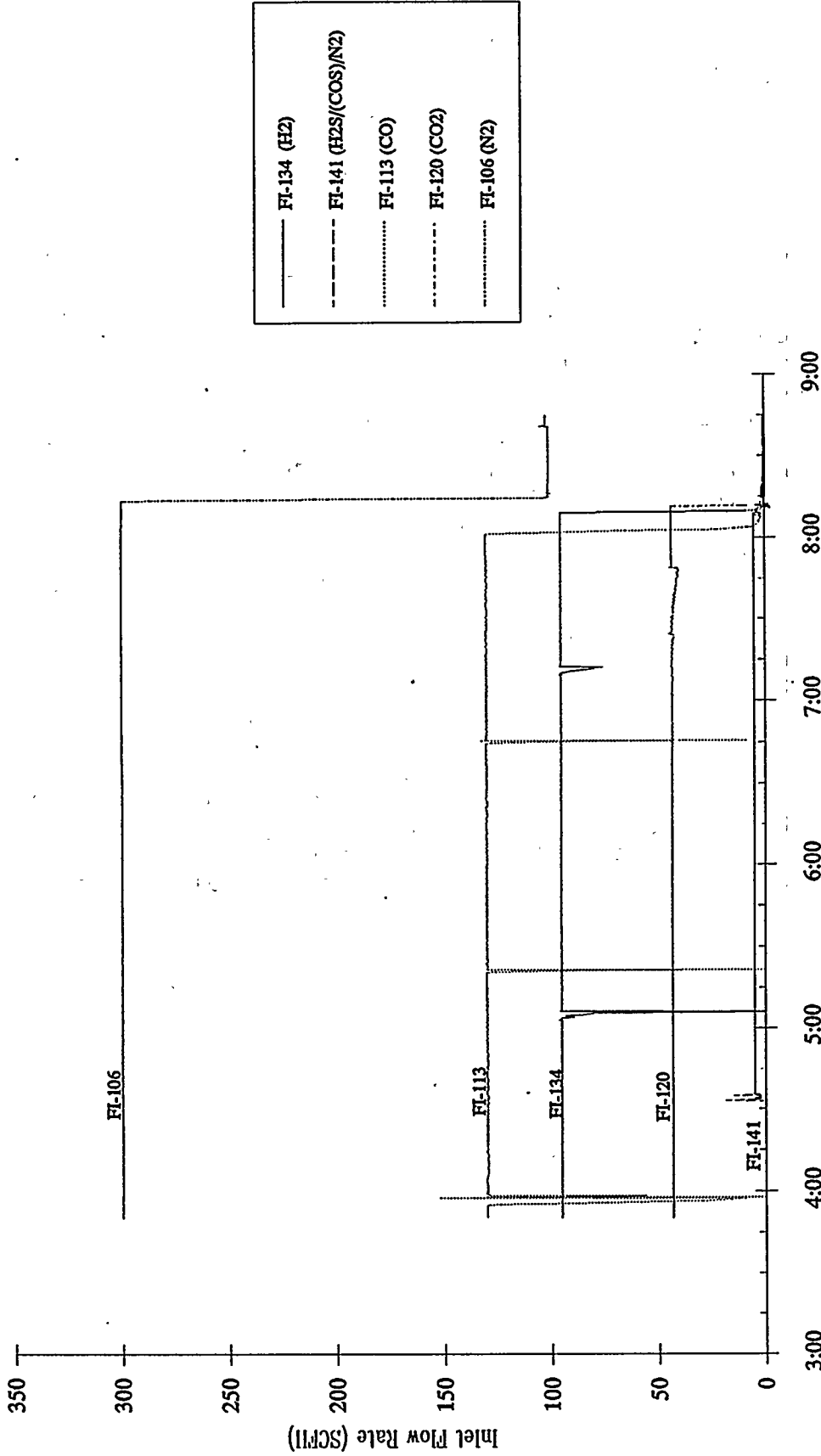

September 15, 1992
Test time: 4:35-8:08 (Test duration: 3:33)

L-3787M Zinc Titanate
u=1.0 ft/sec T=1100 °F
H2S Inlet Conc. = 800 ppm

Single Cycle Tests - ZTSC-02 Sulfidation 1

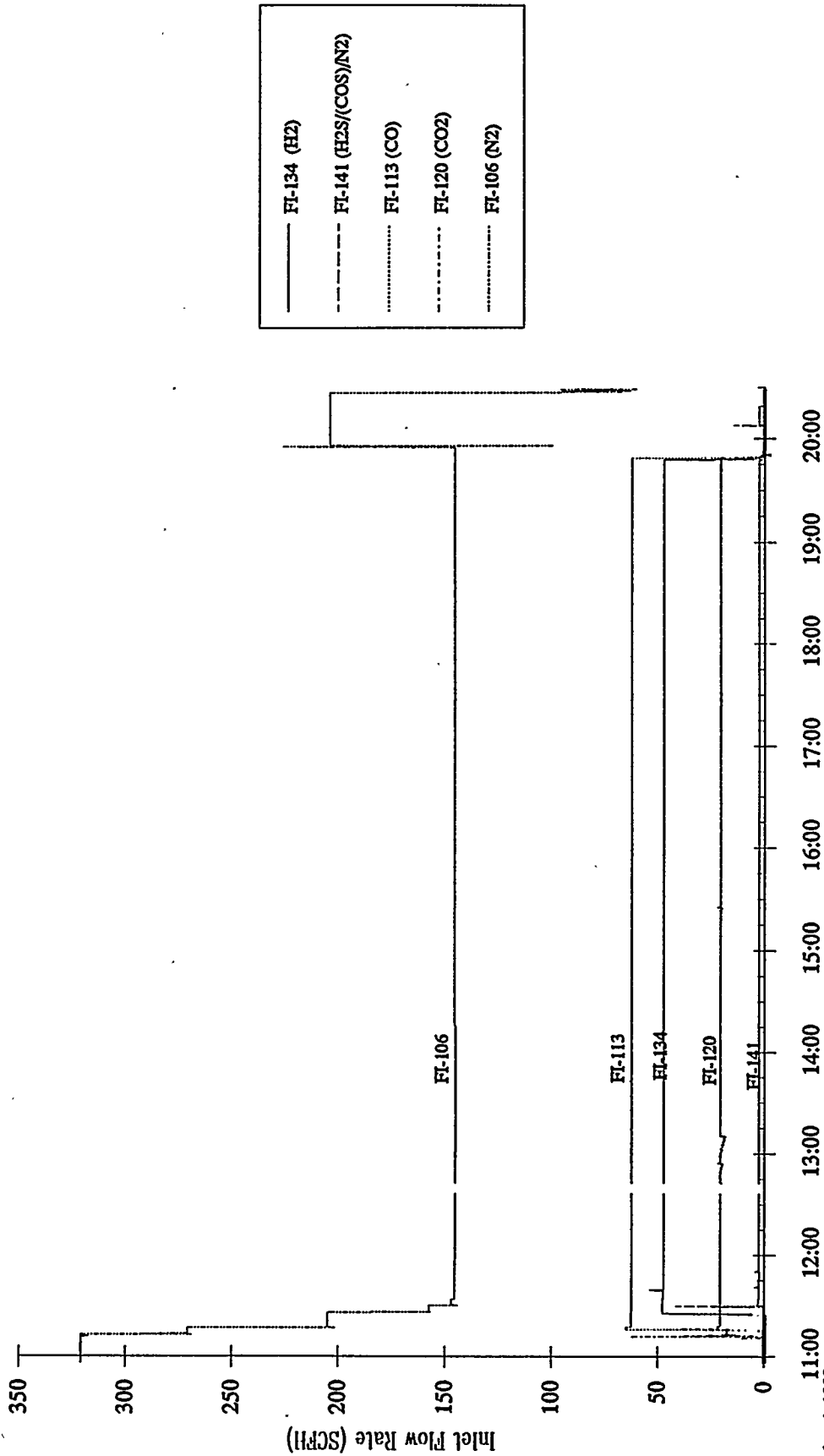

September 4, 1992
Test time: 11:30-19:45 (Test duration: 8:15)

L-3787M Zinc Titanate
 u=1.0 ft/sec T=1100 °F
 H2S Inlet Conc. = 800 ppm

Single Cycle Tests - ZTSC-03 Sulfidation 1

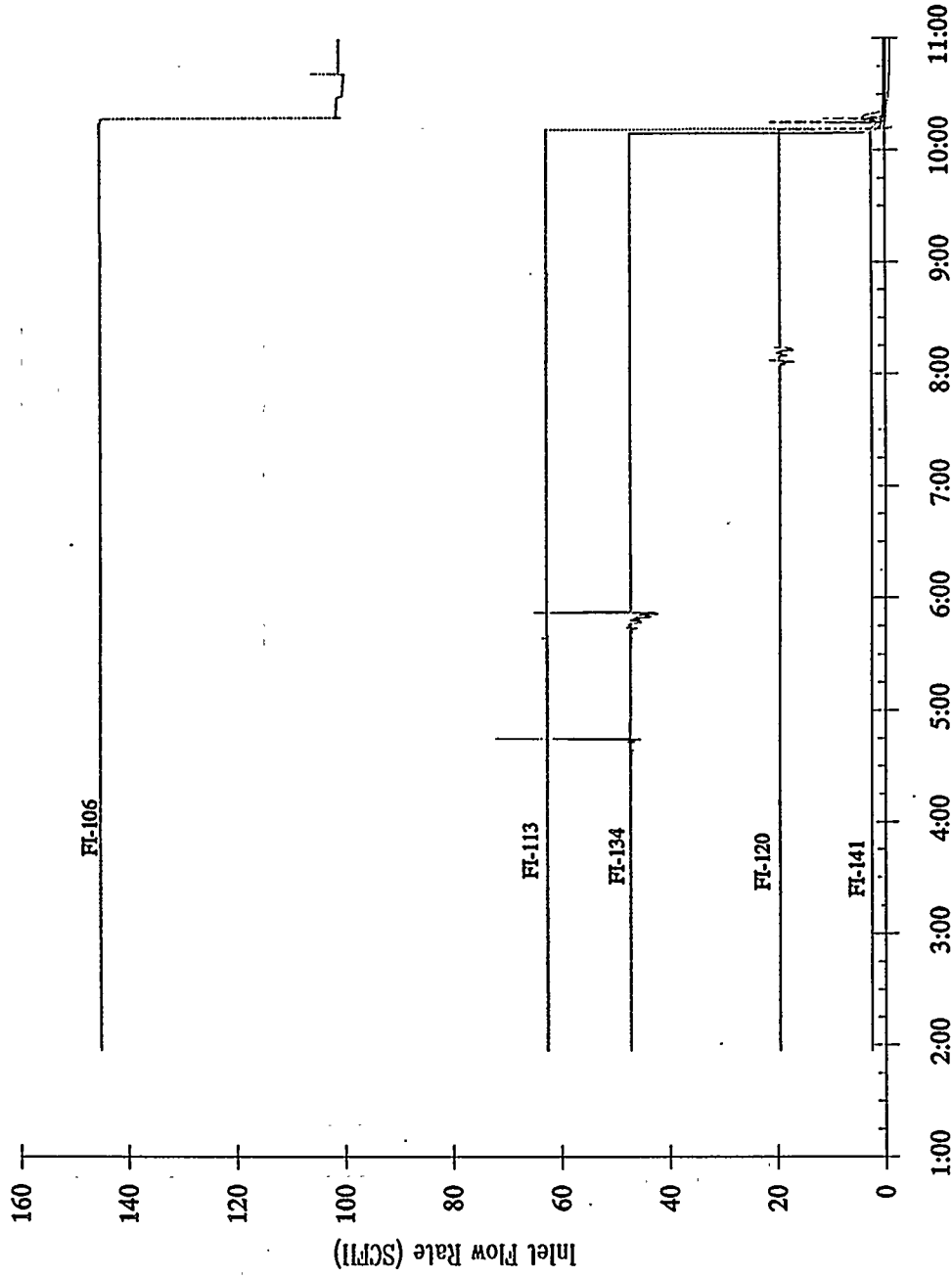

September 9, 1992
 Test time: 1:00-10:05 (Test duration: 9:05)

L-3787M Zinc Titanate
u=1.0 ft/sec T=1000 °F
H2S Inlet Conc. = 800 ppm

Single Cycle Tests - ZTSC-04 Sulfidation 1

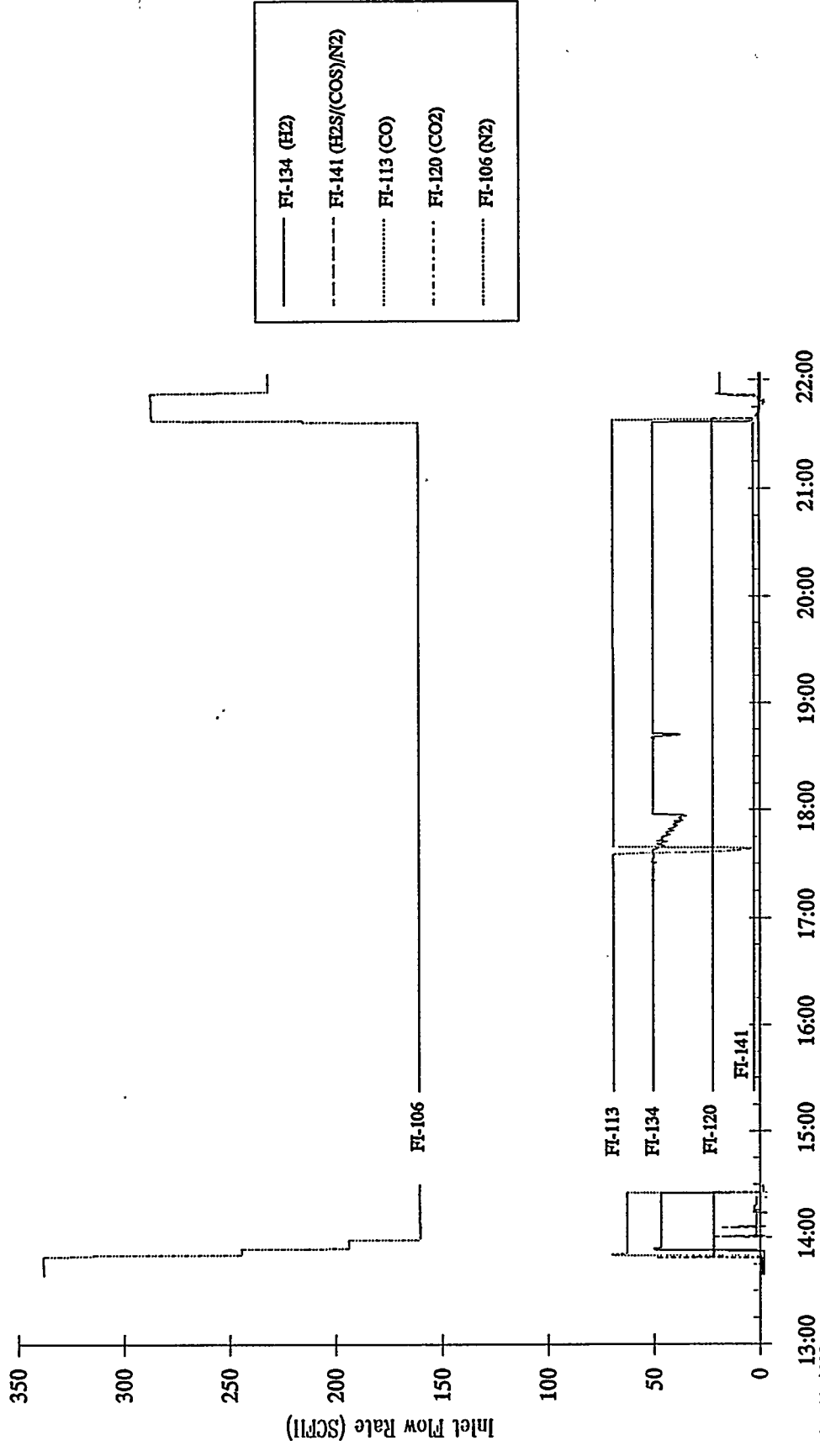

September 10, 1992
Test time: 14:00-14:23, 15:00-21:33 (Test duration: 6:56)

L-3787M Zinc Titanate
u=1.0 ft/sec T=1200 °F
H2S Inlet Conc. = 800 ppm

Single Cycle Tests - ZTSC-05 Sulfidation 1

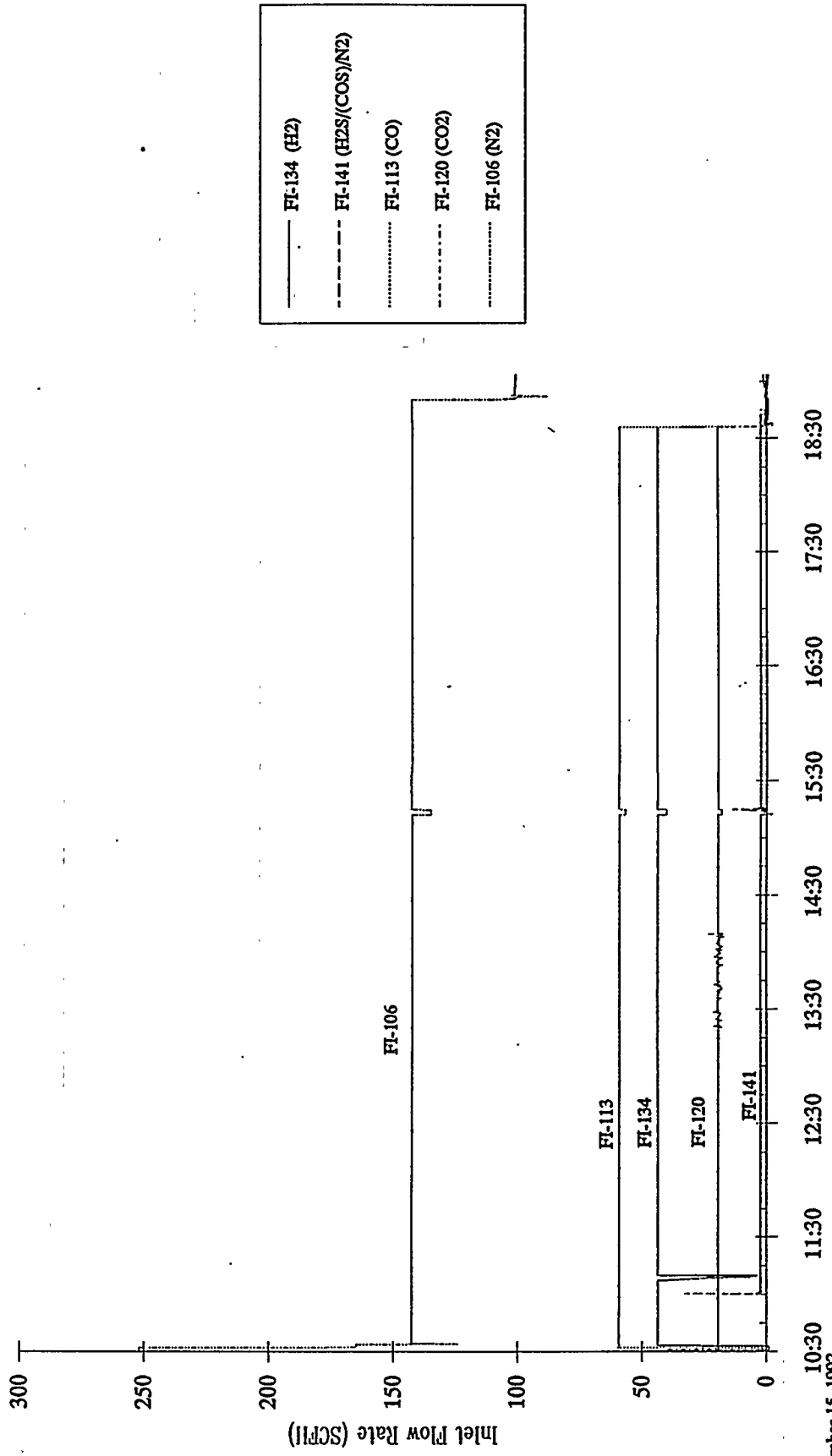

September 15, 1992
Test time: 11:00-18:34 (Test duration: 7:34)

L-3787M Zinc Titanate
v=0.5 ft/sec T=1200 °F
H2S Inlet Conc. = 800 ppm

Single Cycle Tests - ZTSC-06 Sulfidation 1

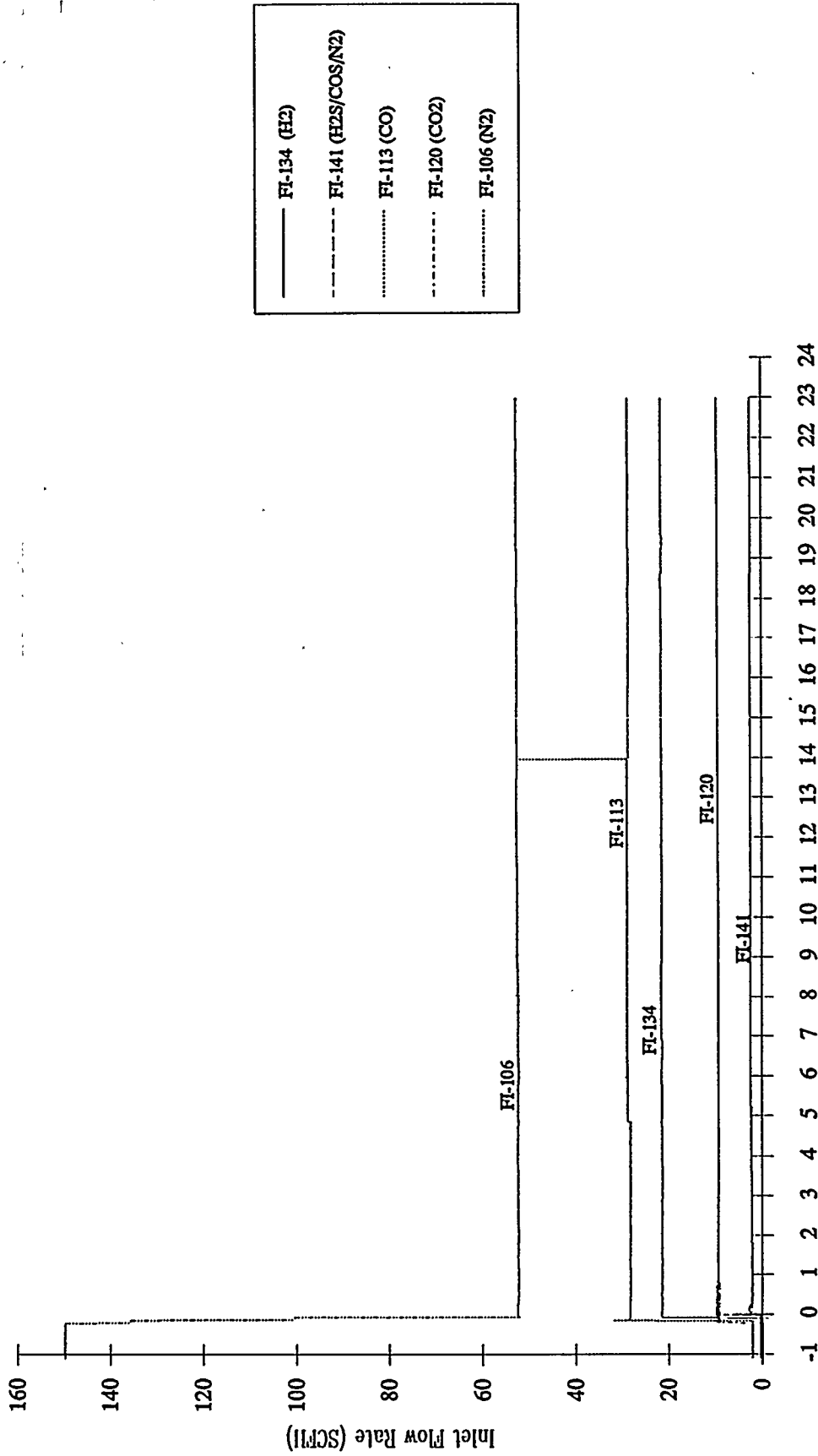

Test time: 9:00 (September 17, 1992) - 6:05 (September 19, 1992)

Test duration: 45:05

L-3787M Zinc Titanate
 u=0.5 ft/sec T=1200 °F
 H2S Inlet Conc. = 800 ppm

Single Cycle Tests - ZTSC-06 Sulfidation 1

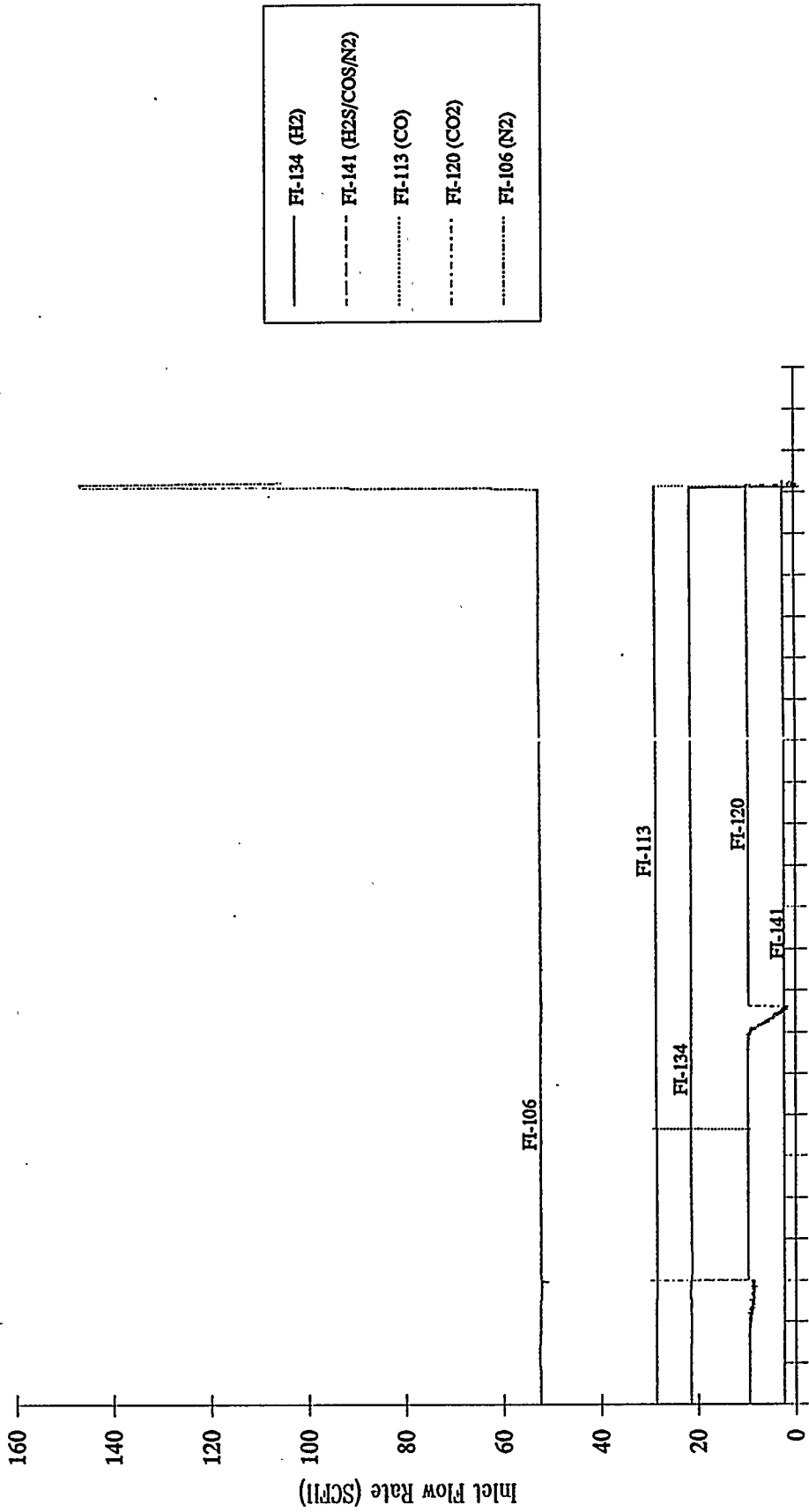

23 24 25 26 27 28 29 30 31 32 33 34 35 36 37 38 39 40 41 42 43 44 45 46 47 48
 Test time: 9:00 (September 17, 1992) - 6:05 (September 19, 1992)
 Test duration: 45:05

L-3787M Zinc Titanate
 u=0.5 ft/sec T=1000 °F
 H2S Inlet Conc. = 800 ppm

Single Cycle Tests - ZTSC-07 Sulfidation 1

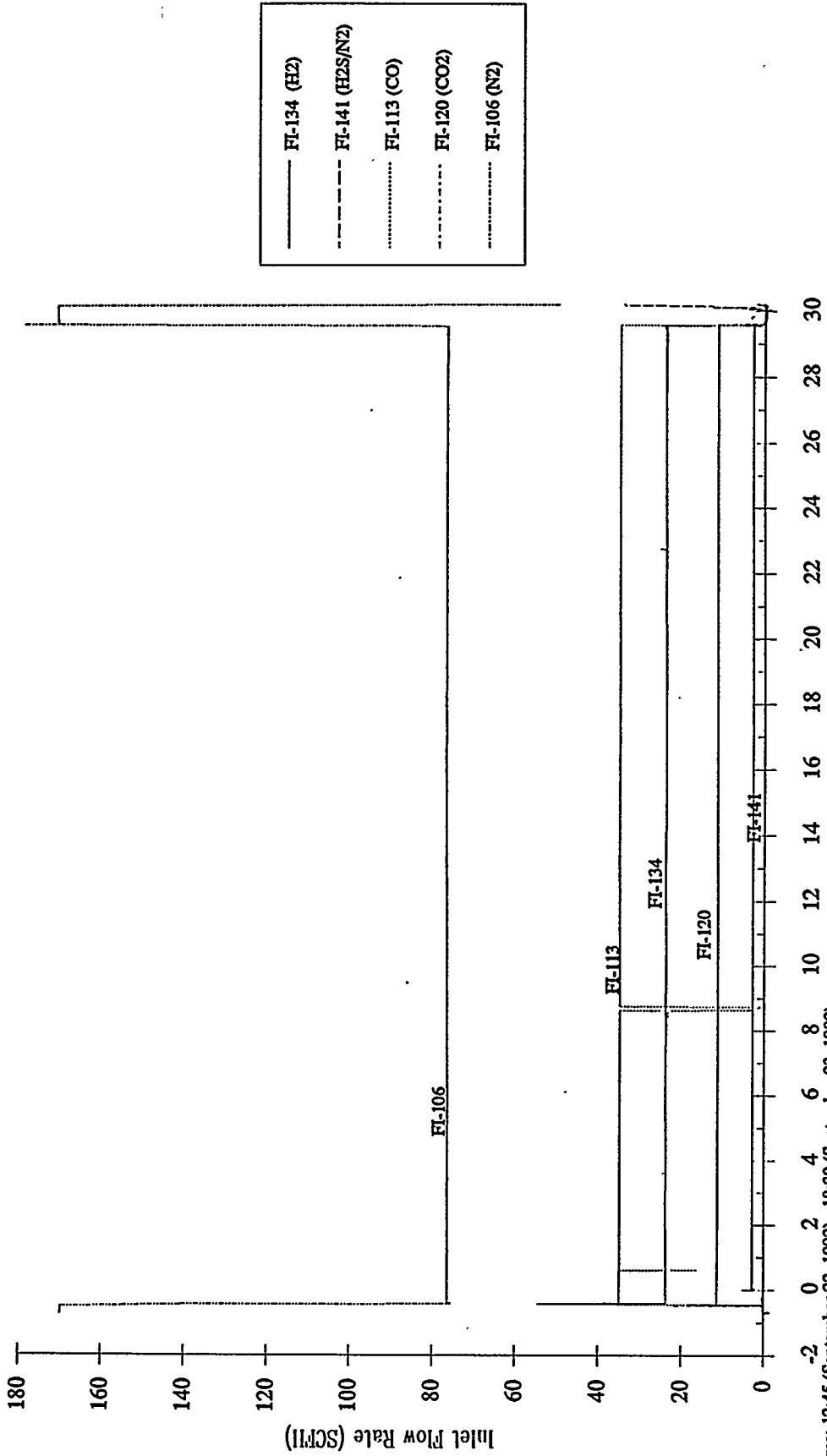

Test time: 12:45 (September 22, 1992) - 18:20 (September 23, 1992)
 Test duration: 29:35

L-3787M Zinc Titanate
u=0.5 ft/sec Tmax=1400 °F
O2 Inlet Conc. = 2.5 %

Single Cycle Tests - ZTSC-07 Regeneration 1

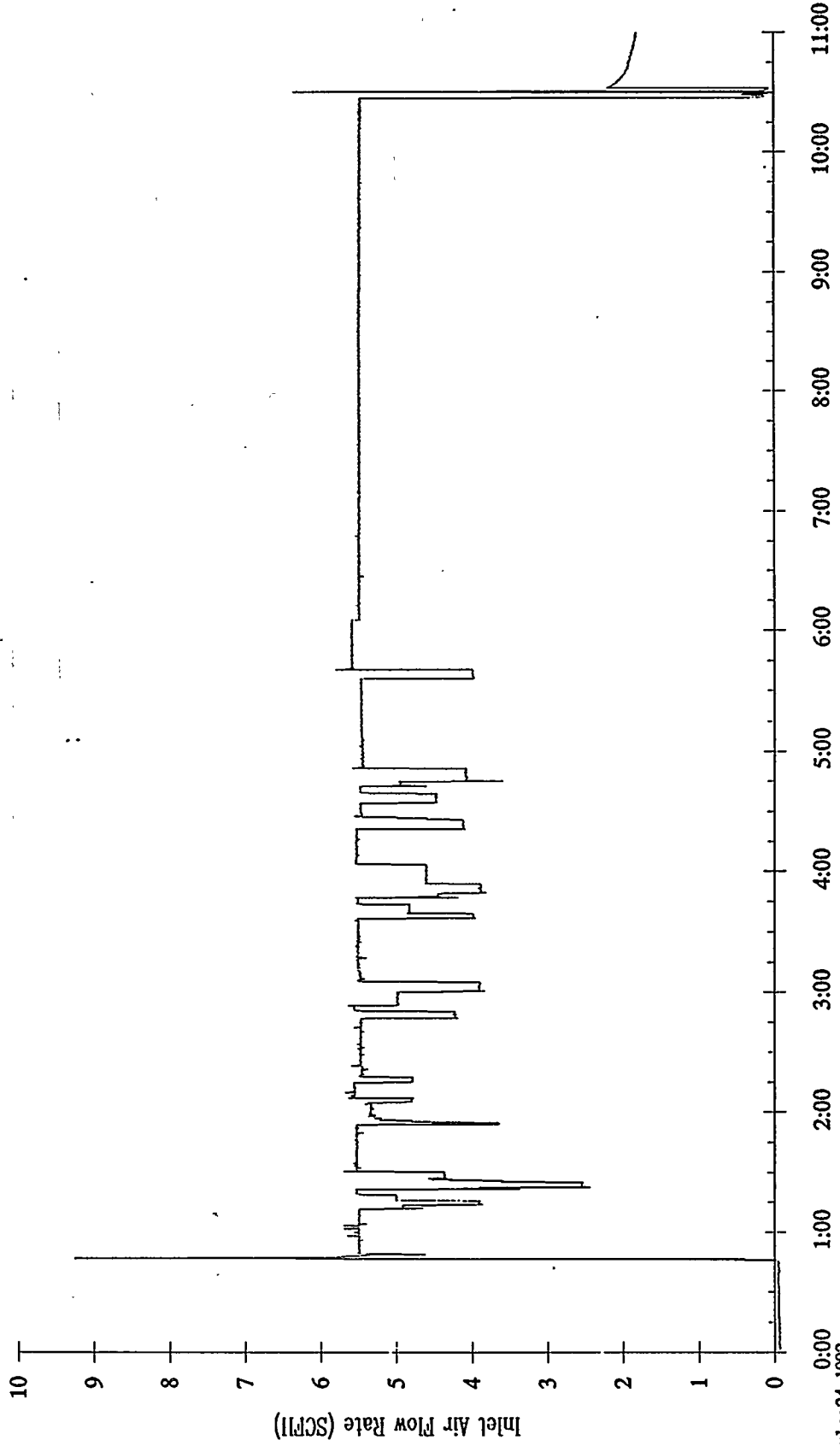

September 24, 1992
Test time: 0:45-10:26 (Test duration: 9:41)

L-3787M Zinc Titanate
u=0.5 ft/sec T=1000 °F
H2S Inlet Conc. = 800 ppm

Single Cycle Tests - ZTSC-07 Sulfidation 2

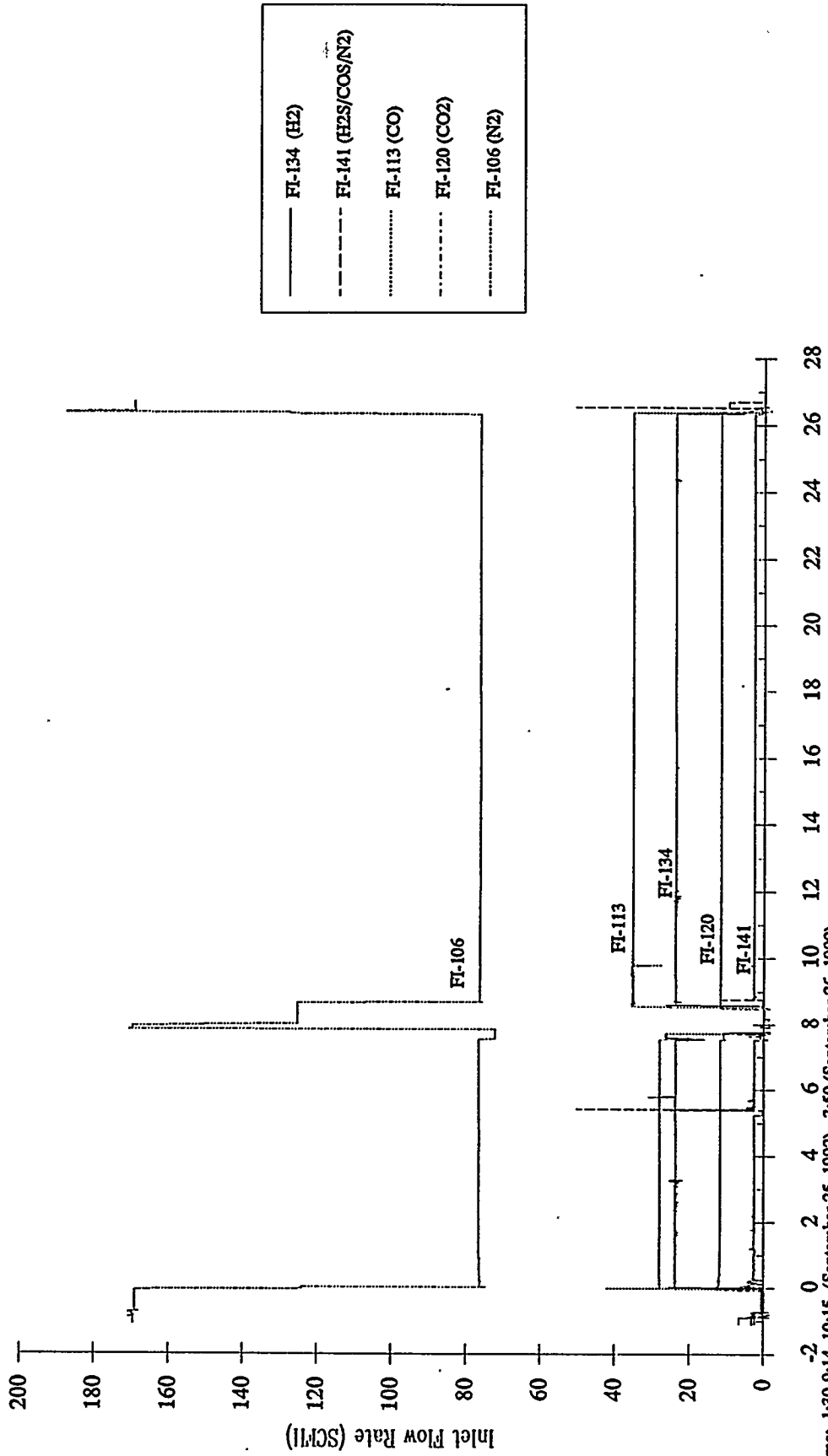

Test time: 1:30-9:14, 10:15- (September 25, 1992) - 3:50 (September 26, 1992)
Test duration: 25:19

L-3787M Zinc Titanate
u=1.0 ft/sec Tmax=1400 °F
O2 Inlet Conc. = 2.5 %

Single Cycle Tests - ZTSC-07 Regeneration 2

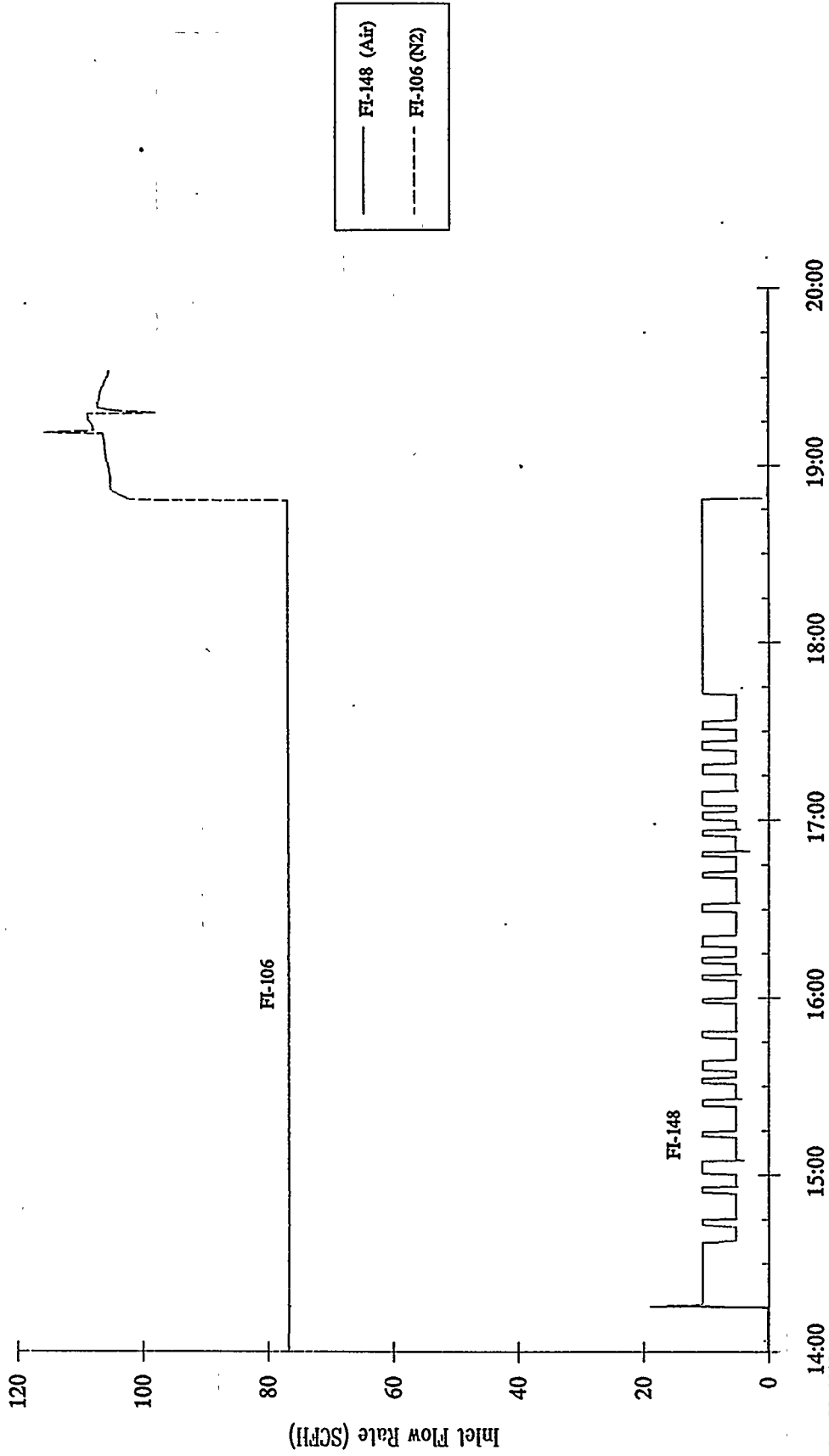

September 28, 1992
Test time: 14:15 - 18:49 (Test duration: 4:34)

L-3787M Zinc Titanate
u=2.0 ft/sec T=1200 °F
H2S Inlet Conc. = 800 ppm

Single Cycle Tests - ZTSC-07 Sulfidation 3

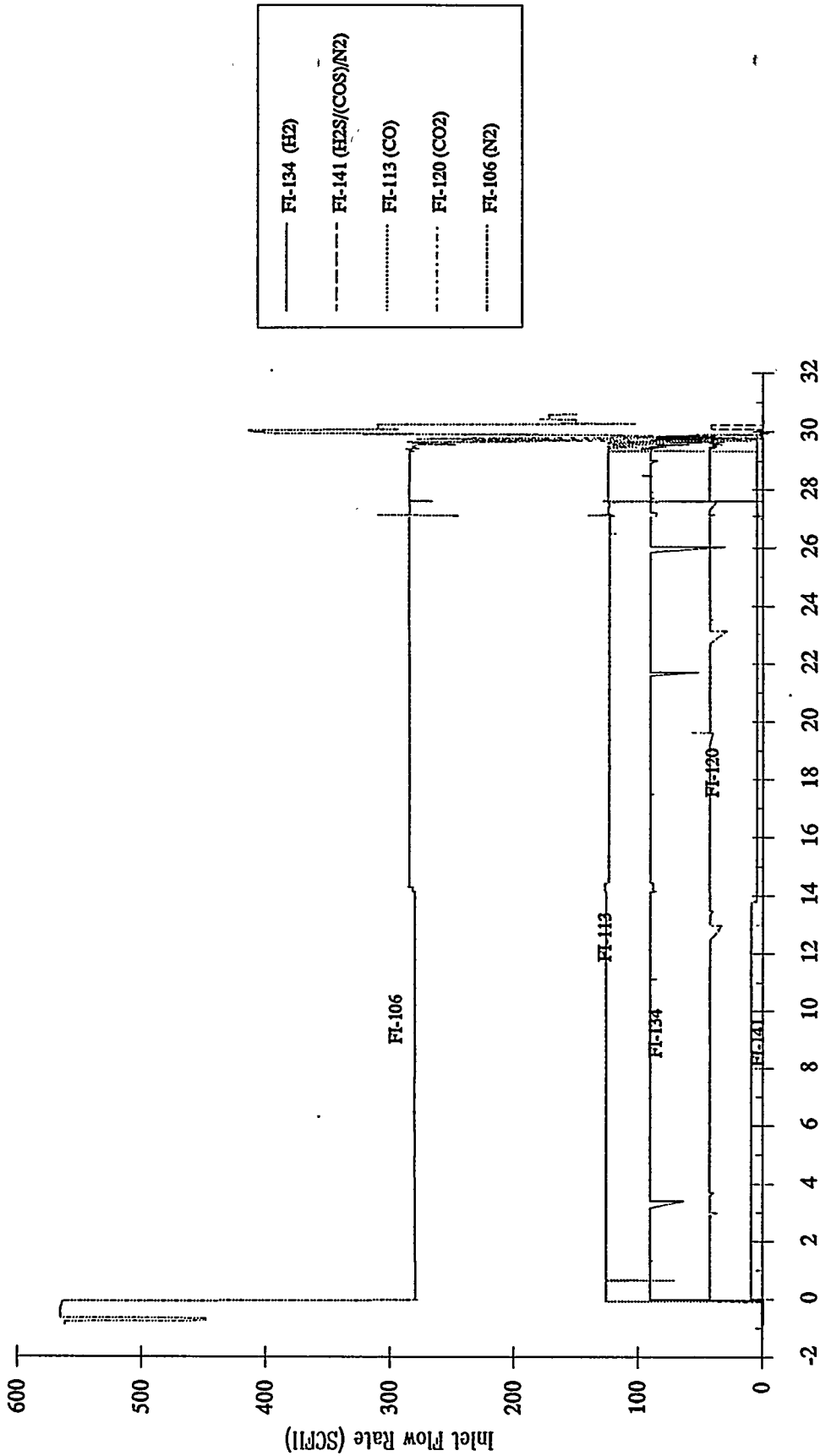

Test time: 1:00 (September 29, 1992) - 4:05 (September 30, 1992); 10:00-12:50 (October 1, 1992)
Test duration: 29:55

L-3787M Zinc Titanate
u=0.33 ft/sec Tmax=1400 F
O2 Inlet Conc. = 1.5 %

Single Cycle Tests - ZTSC-07 Regeneration 3

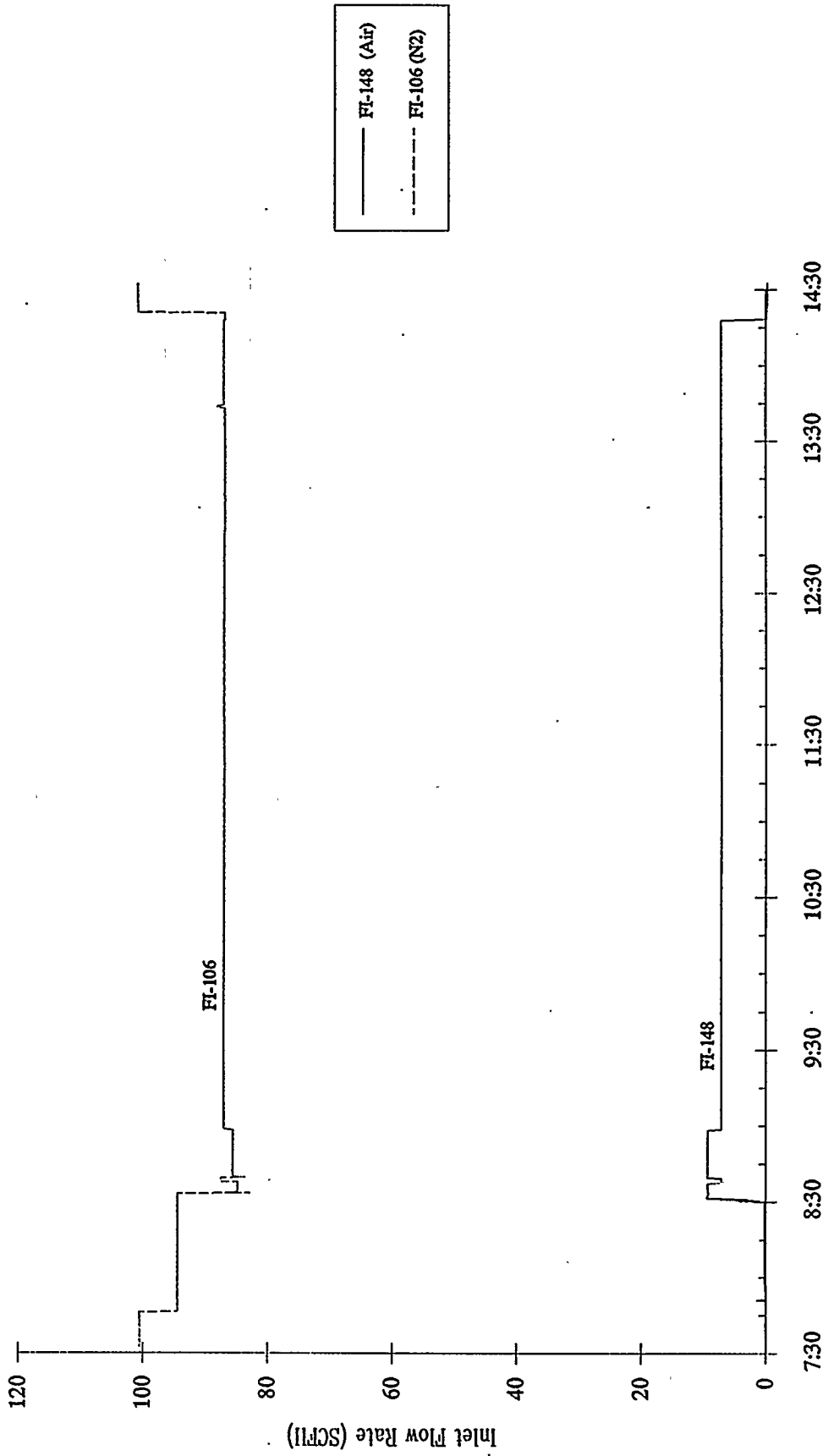

October 2, 1992
Test time: 8:30-14:18 (Test duration: 5:48)

L-3787M Zinc Titanate
u=0.5 ft/sec T=1200 F
H2S Inlet Conc. = 300 ppm

Multi-Cycle Tests - ZTMC-01 Sulfidation 1

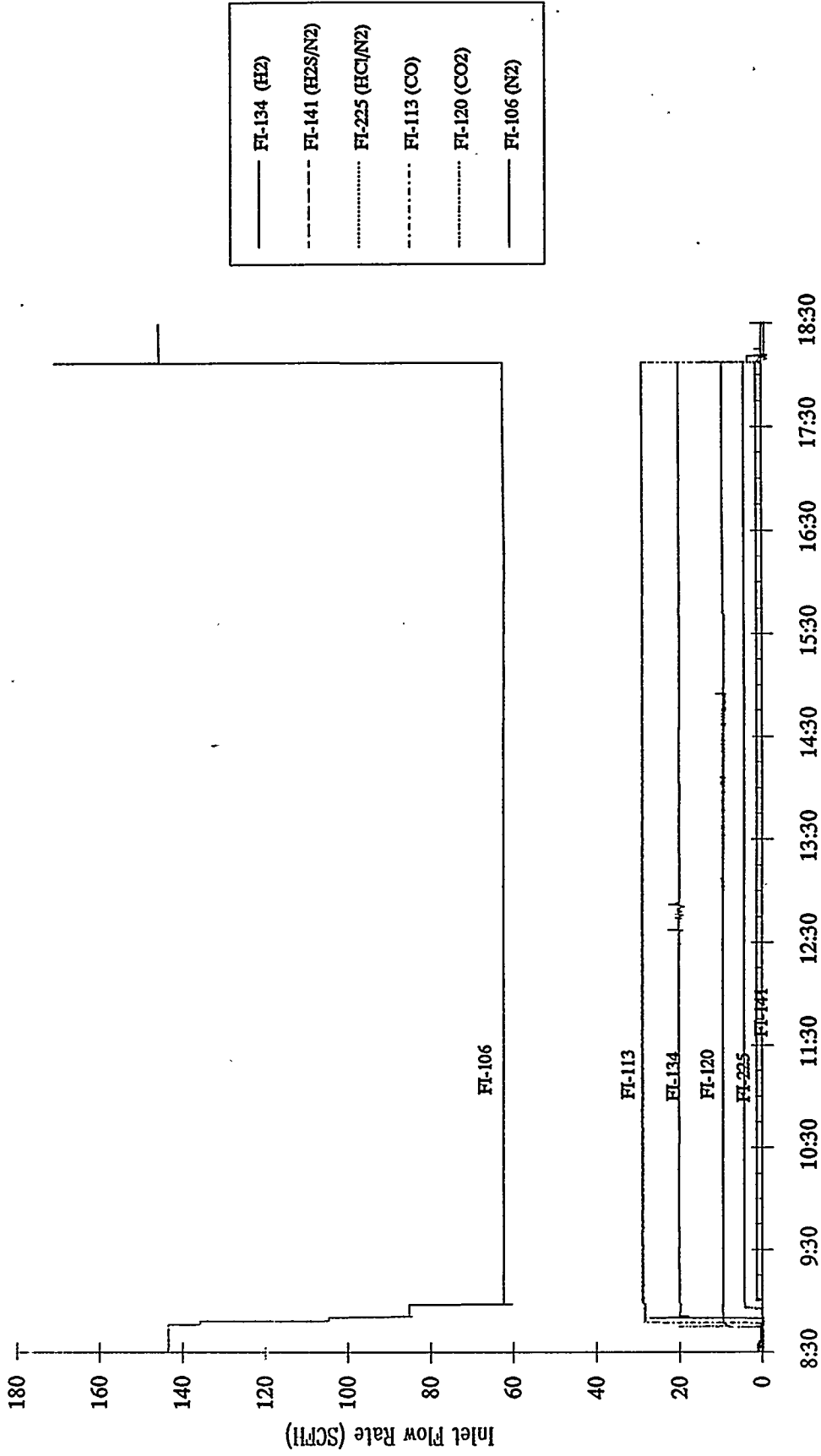

October 6, 1992
Test time: 9:00-18:05 (Test duration: 9:05)

L-3787M Zinc Titanate
u=1.0 ft/sec Tmax=1400 °F
O2 Inlet Conc. = 1.5 %

Multi-Cycle Tests - ZTMC-01 Regeneration 1

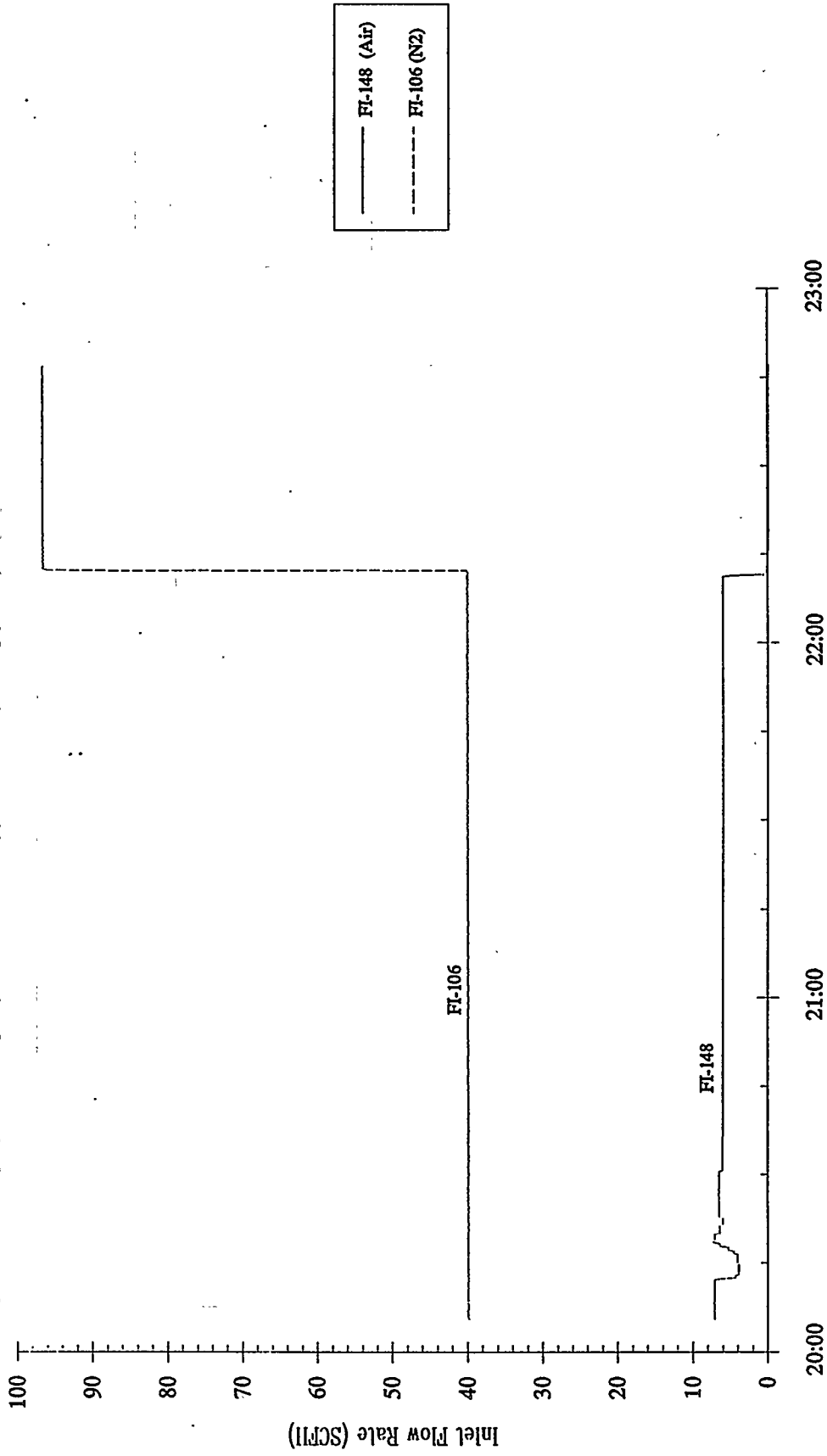

October 6, 1992
Test time: 20:00-22:12 (Test duration: 2:12)

L-3787M Zinc Titanate
u=0.5 ft/sec T=1200 °F
H2S Inlet Conc. = 300 ppm

Multi-Cycle Tests - ZTMC-01 Sulfidation 2

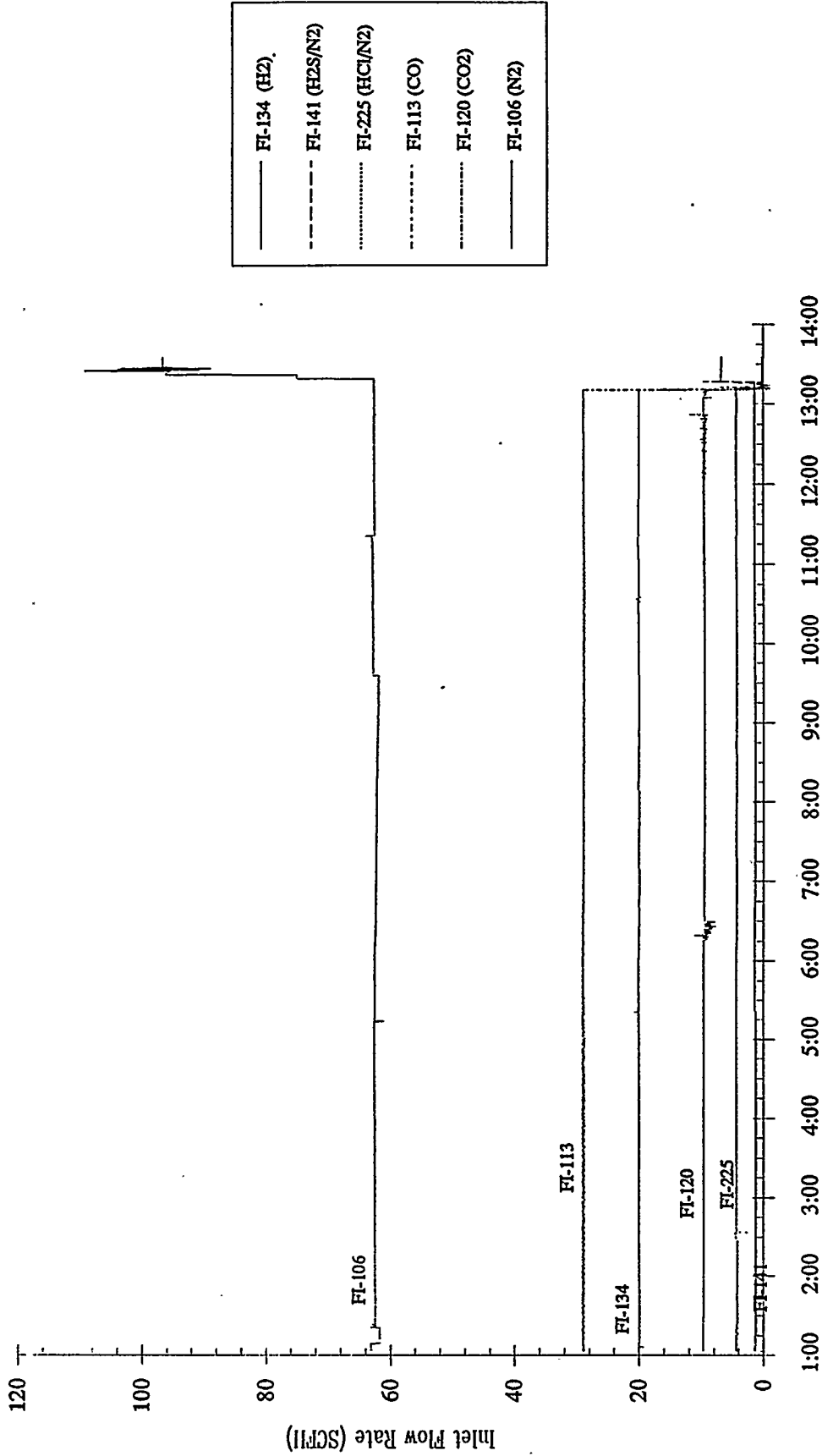

October 7, 1992
Test time: 1:00-13:10 (Test duration: 12:10)

L-3787M Zinc Titanate
u=1.0 ft/sec T_{max}=1300 °F
O₂ Inlet Conc. = 0.75 %

Multi-Cycle Tests - ZTMC-01 Regeneration 2

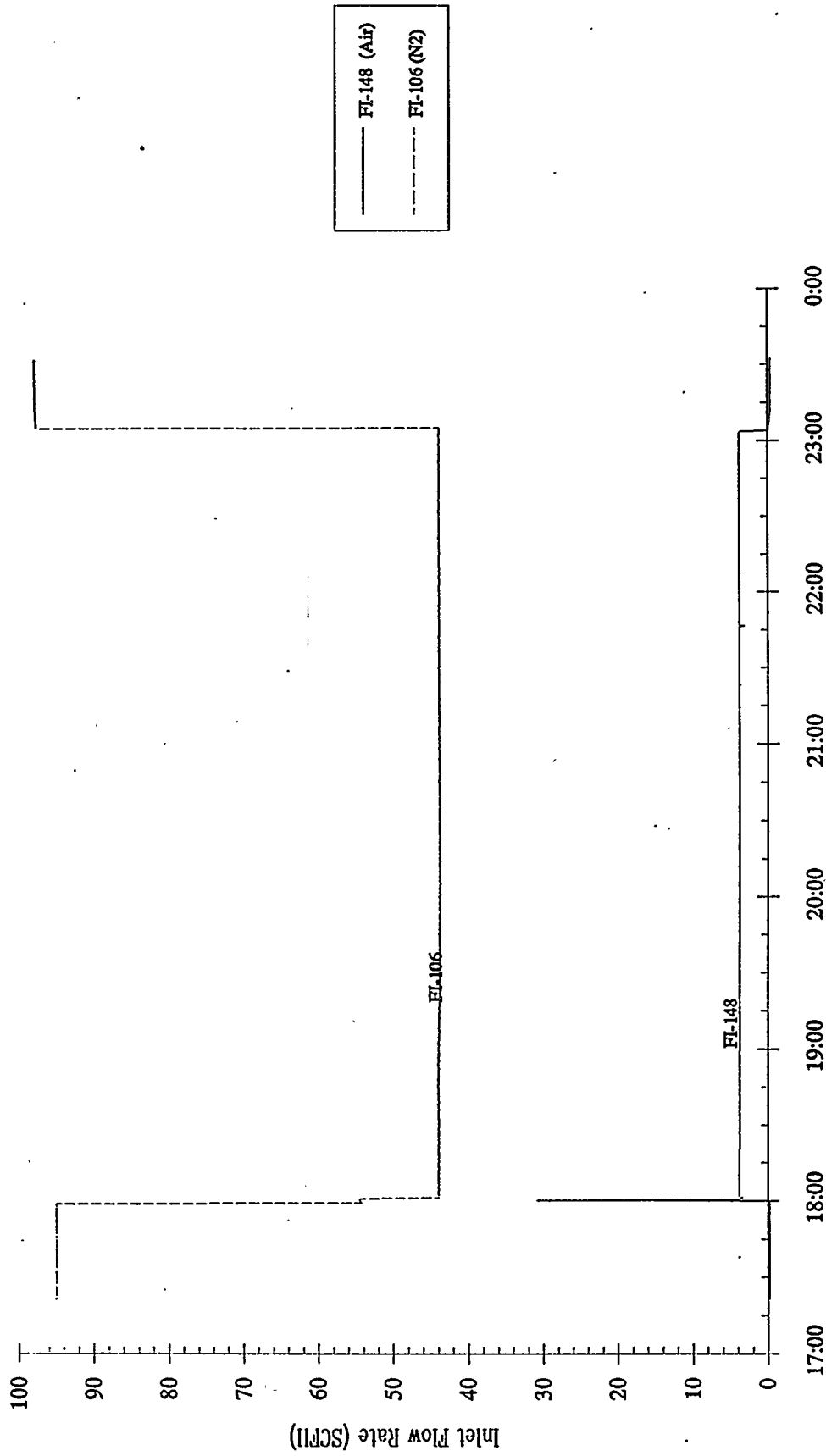

October 7, 1992
Test time: 18:00-23:05 (Test duration: 5:05)

L-3787M Zinc Titanate
u=0.5 ft/sec T=1100 °F
H2S Inlet Conc. = 300 ppm

Multi-Cycle Tests - ZTMC-01 Sulfidation 3

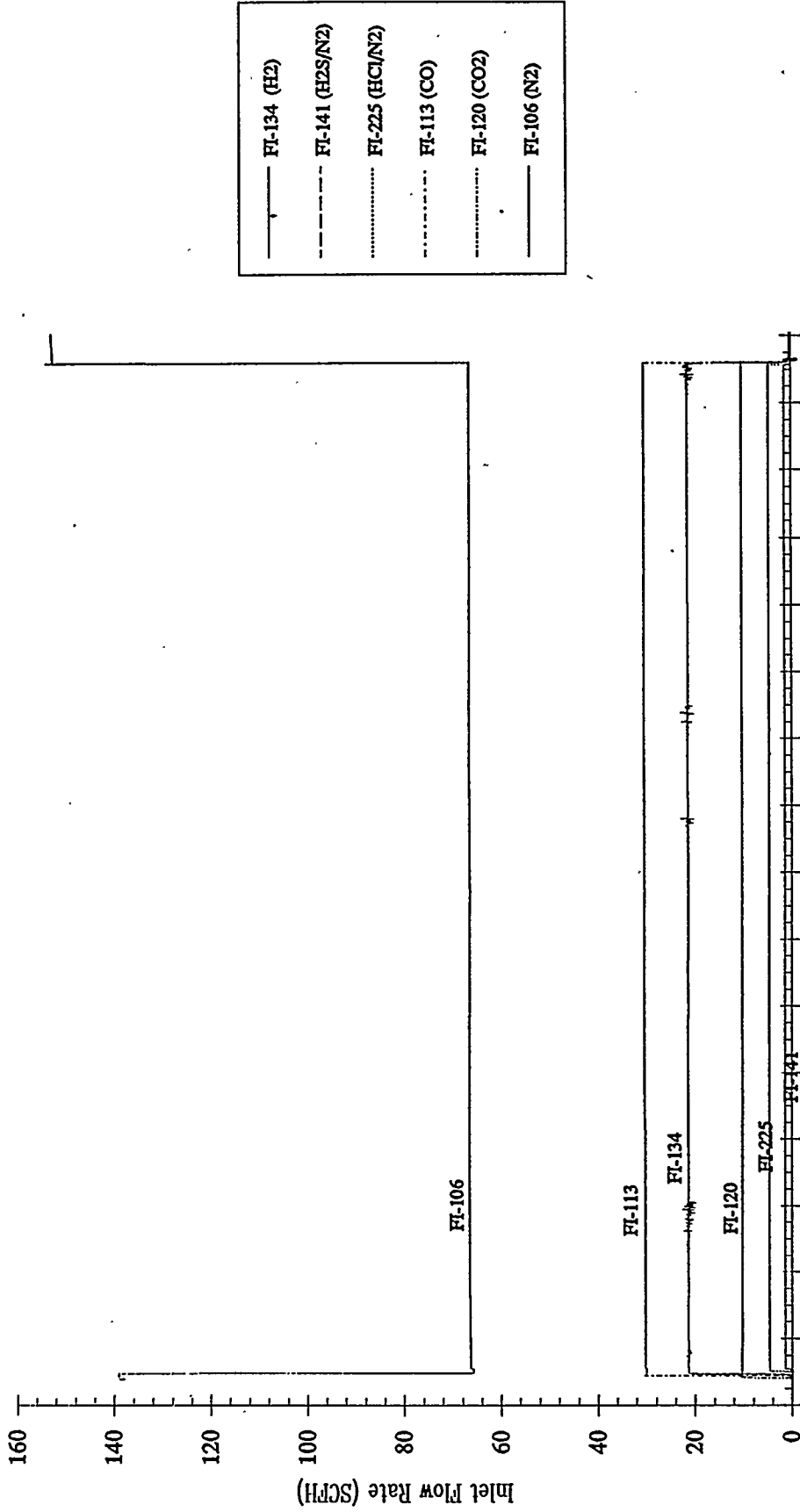

October 8, 1992
Test time: 3:00-18:03 (Test duration: 15:03)

L-3787M Zinc Titanate
u=1.0 ft/sec Tmax=1300 °F
O2 Inlet Conc. = 0.75 %

Multi-Cycle Tests - ZTMC-01 Regeneration 3

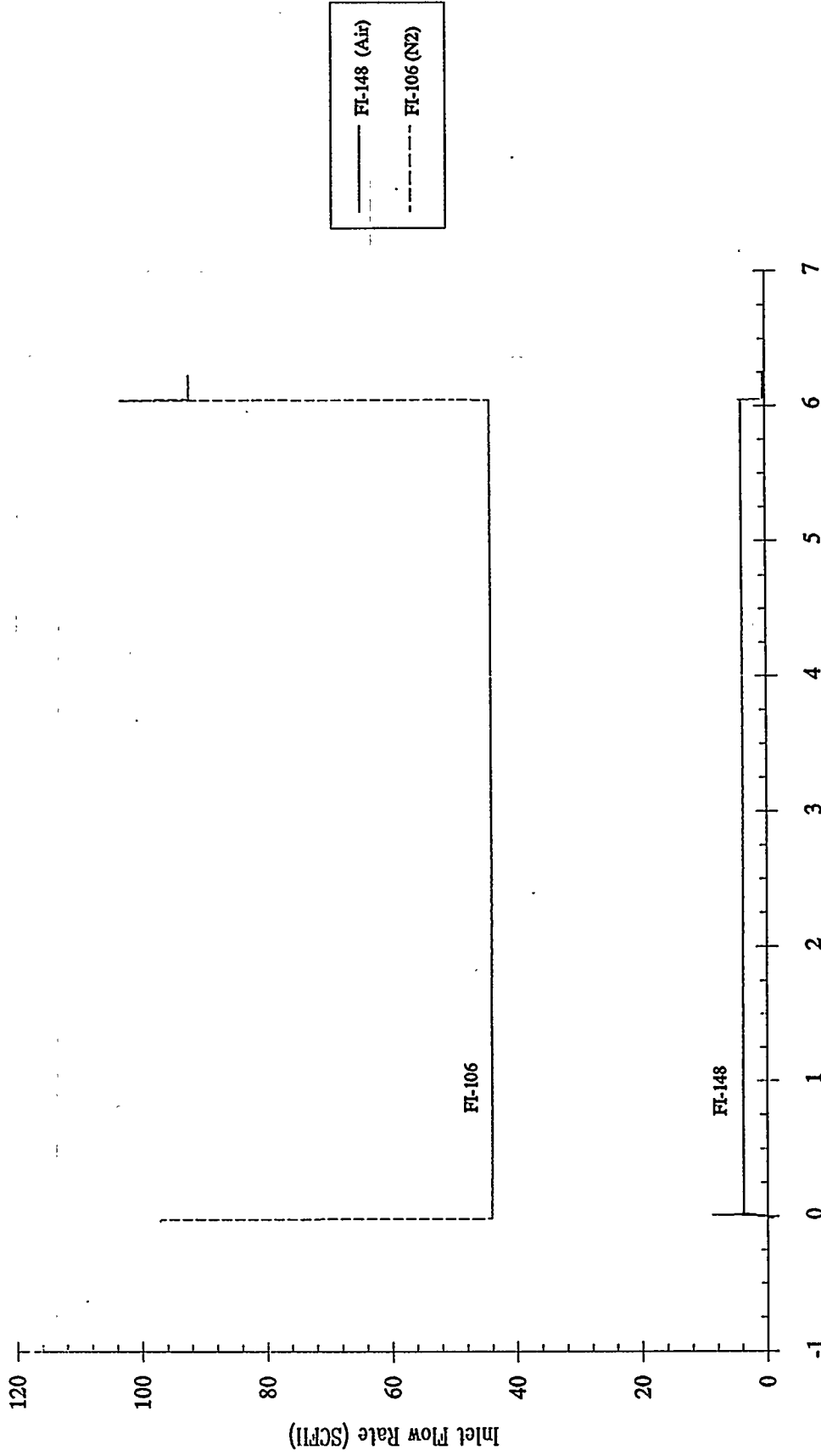

Test time: 20:00 (October 8, 1992) - 2:00 (October 9, 1992)
Test duration: 6:00

L-3787M Zinc Titanate
u=0.5 ft/sec T=1100 °F
H2S Inlet Conc. = 800 ppm

Multi-Cycle Tests - ZTMC-01 Sulfidation 4

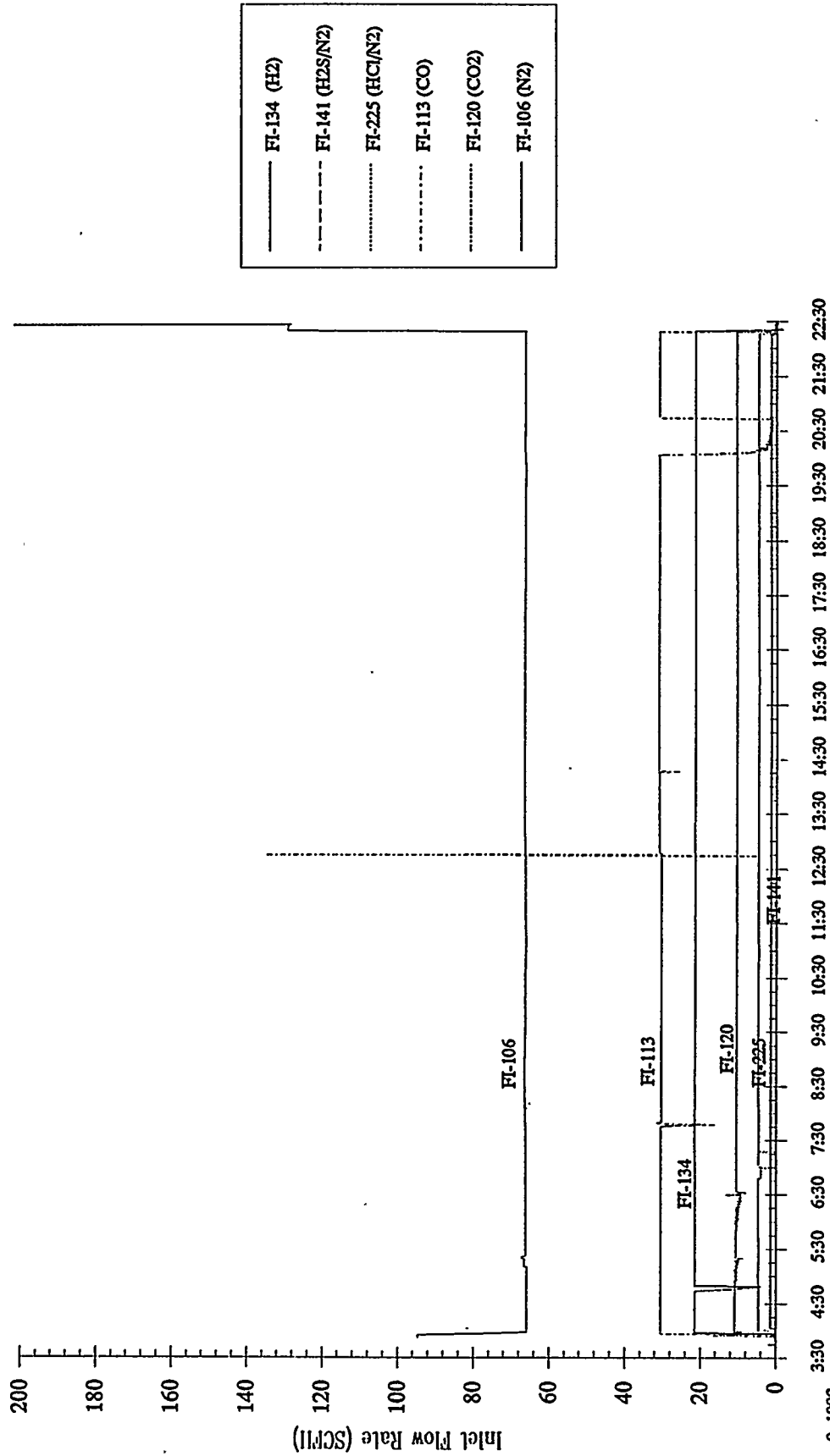

October 9, 1992
Test time: 4:00-22:16 (Test duration: 18:16)

L-3787M Zinc Titanate
 u=0.5 f/sec T=1000 °F
 H2S Inlet Conc. = 800 ppm

Multi-Cycle Tests - ZTMC-02 Sulfidation 1

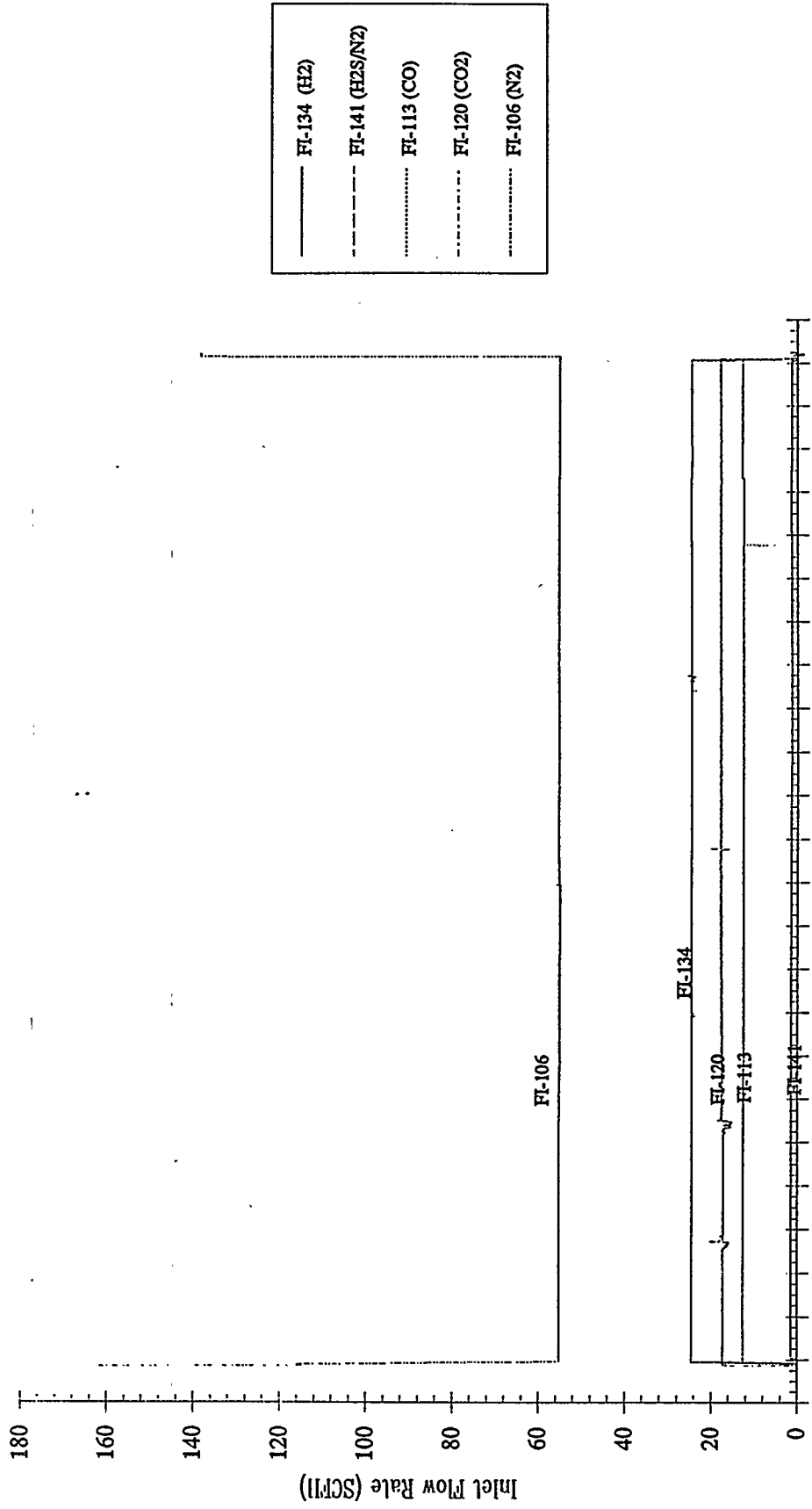

-1 0 1 2 3 4 5 6 7 8 9 10 11 12 13 14 15 16 17 18 19 20 21 22 23 24
 Test time: 1:00 (October 14, 1992) - 0:03 (October 15, 1992)
 Test duration: 23:03

L-3787M Zinc Titanate
u=0.5 ft/sec Tmax=1400 °F
O2 Inlet Conc. = 2.5 %

Multi-Cycle Tests - ZTMC-02 Regeneration 1

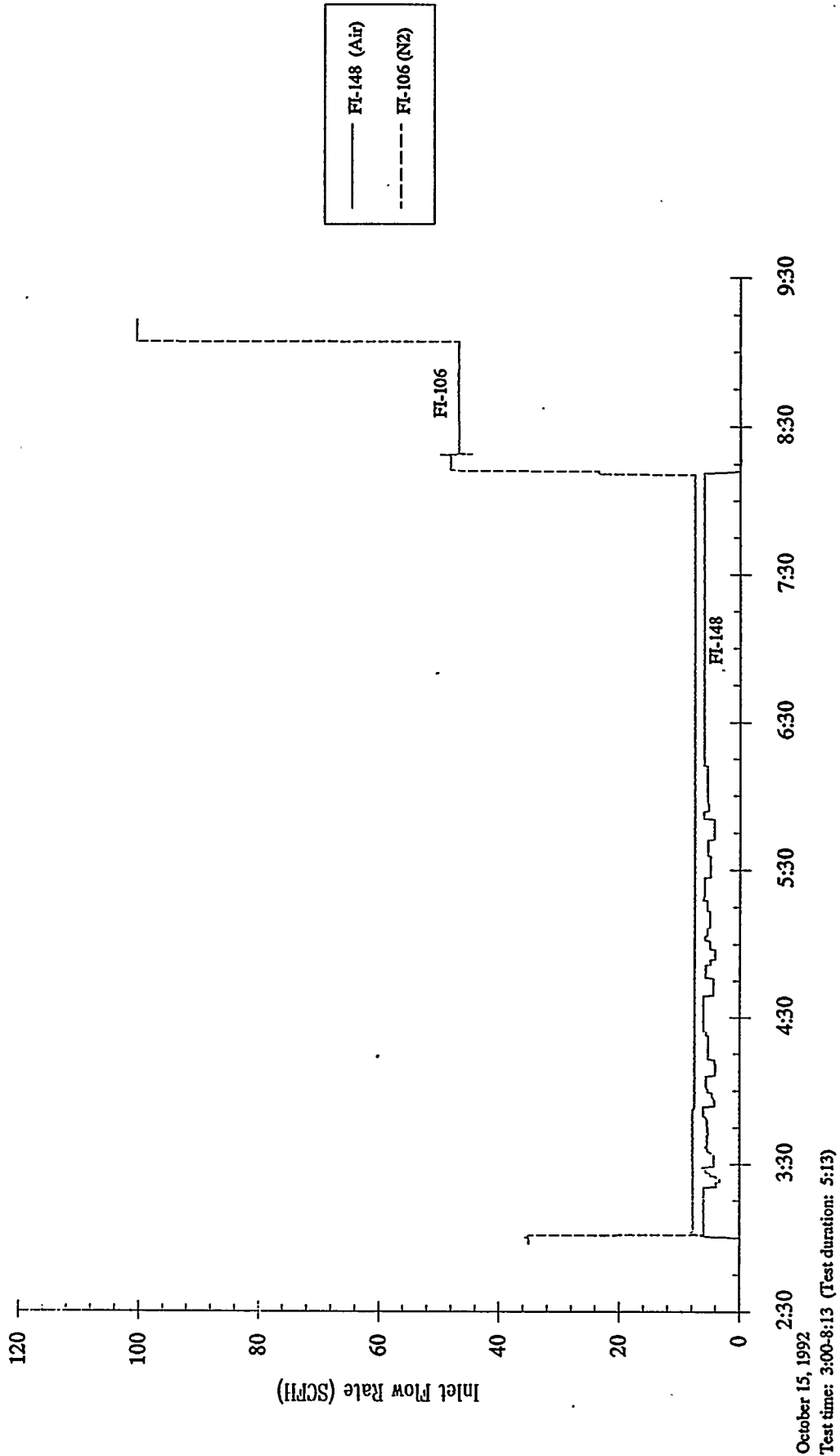

October 15, 1992
Test time: 3:00-8:13 (Test duration: 5:13)

L-3787M Zinc Titanate
 u=0.5 ft/sec T=1000 F
 H2S Inlet Conc. = 800 ppm

Multi-Cycle Tests - ZTMC-02 Sulfidation 2

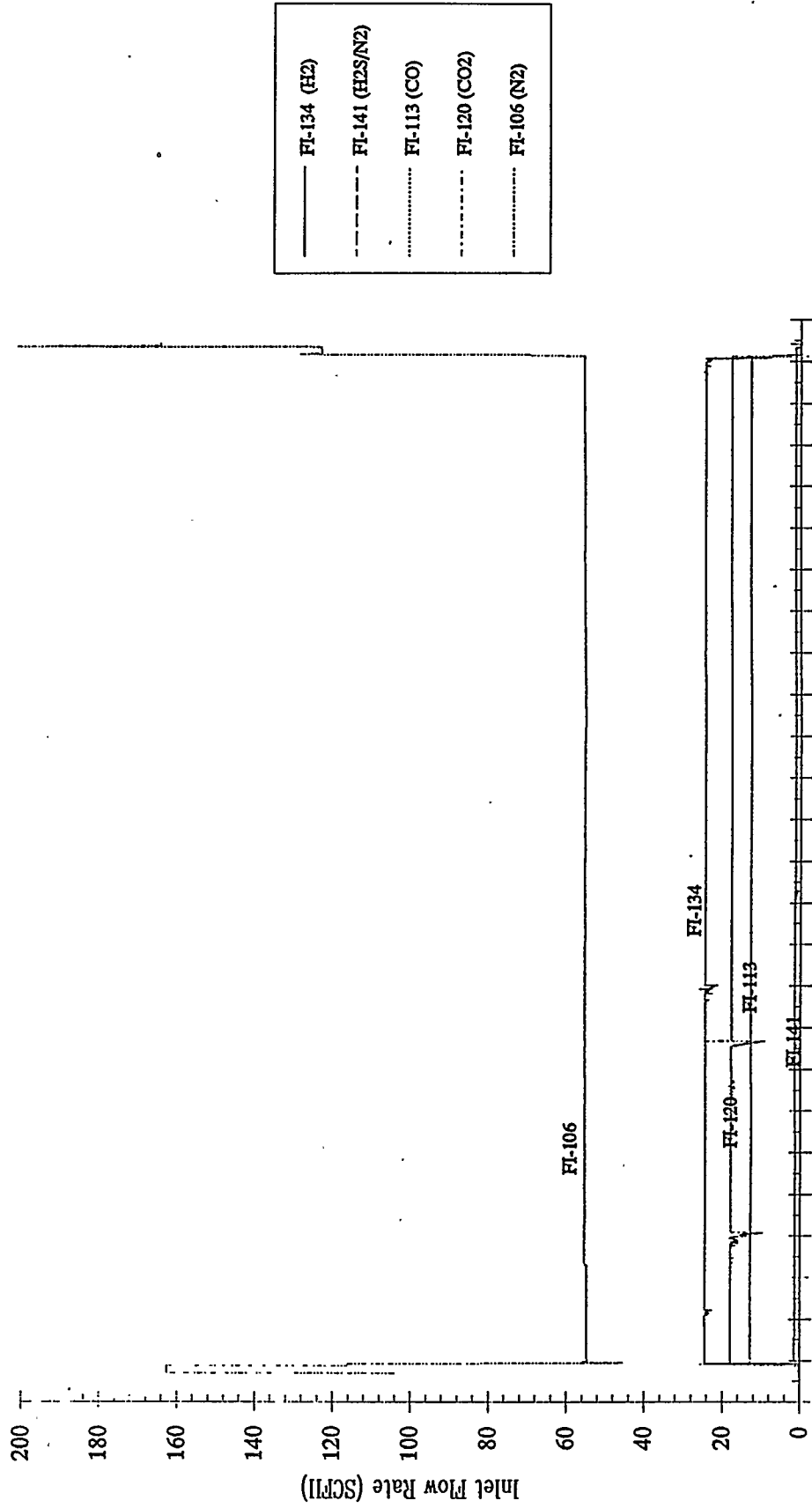

-1 0 1 2 3 4 5 6 7 8 9 10 11 12 13 14 15 16 17 18 19 20 21 22 23 24 25
 Test time: 18:00 (October 15, 1992) - 18:03 (October 16, 1992)
 Test duration: 24:03

L-3787M Zinc Titanate
u=1.0 ft/sec Tmax=1400 °F
O2 Inlet Conc. = 2.5 %

Multi-Cycle Tests - ZTMC-02 Regeneration 2

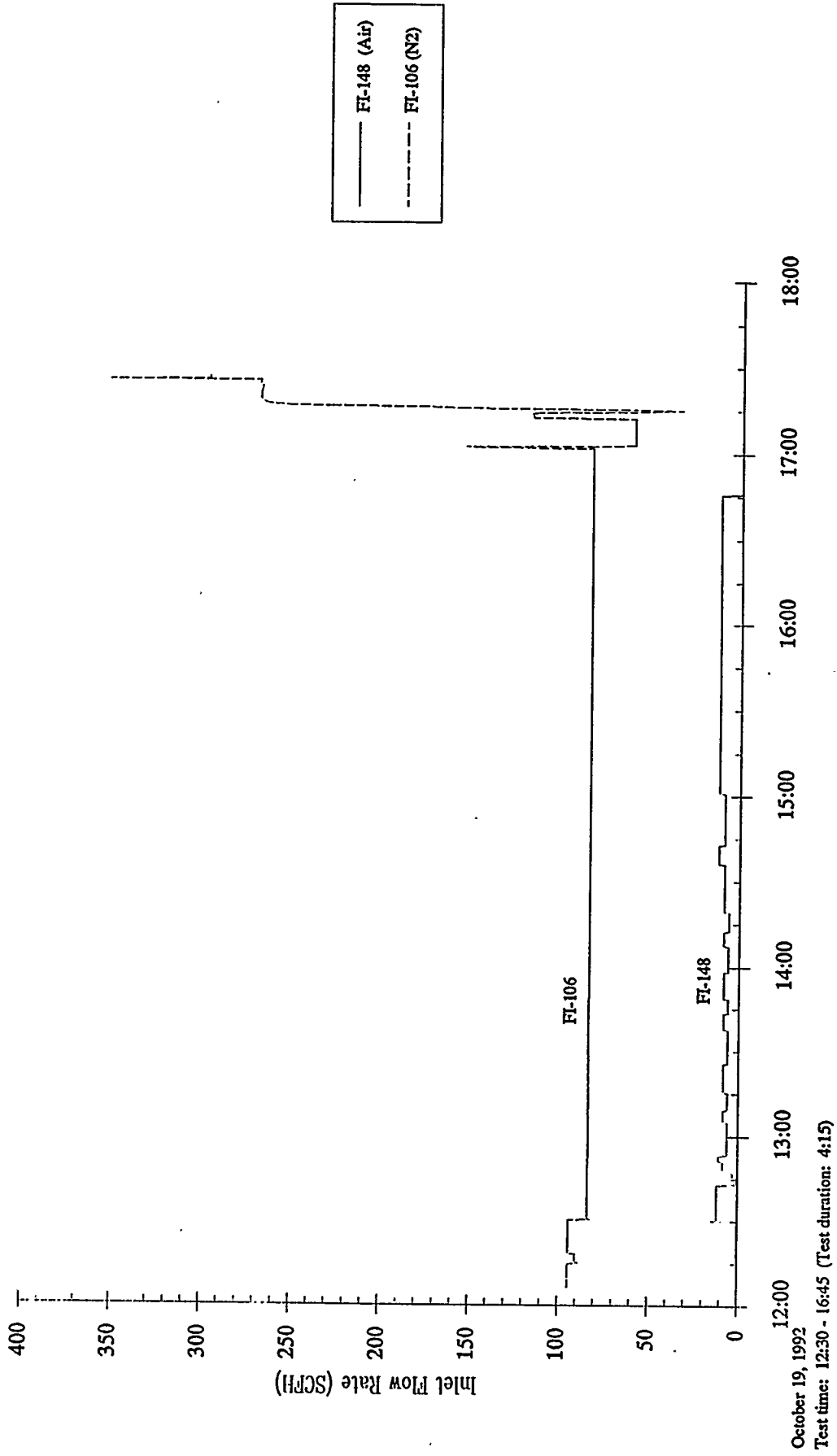

L-3787M Zinc Titanate
u=2.0 ft/sec T=1200 °F
H2S Inlet Conc. = 800 ppm

Multi-Cycle Tests - ZTMC-02 Sulfidation 3

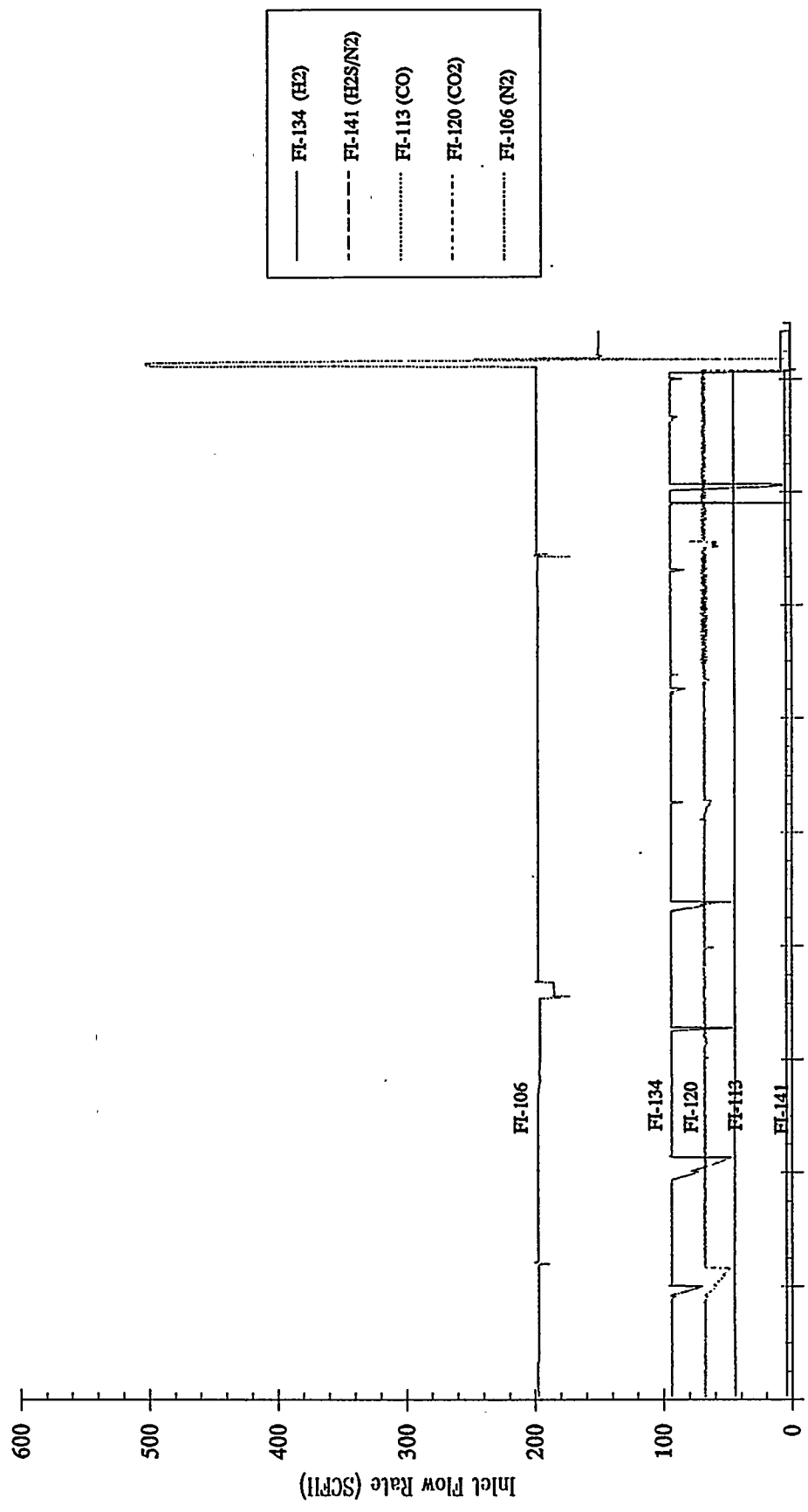

Test time: 20:00 (October 19, 1992) - 14:05 (October 20, 1992)
Test duration: 18:05

FI-134 (H2)
FI-141 (H2S/N2)
FI-113 (CO)
FI-120 (CO2)
FI-106 (N2)

L-3787M Zinc Titanate
u=0.33 ft/sec T_{max}=1400 °F
O₂ Inlet Conc. = 1.5%

Multi-Cycle Tests - ZTMC-02 Regeneration 3

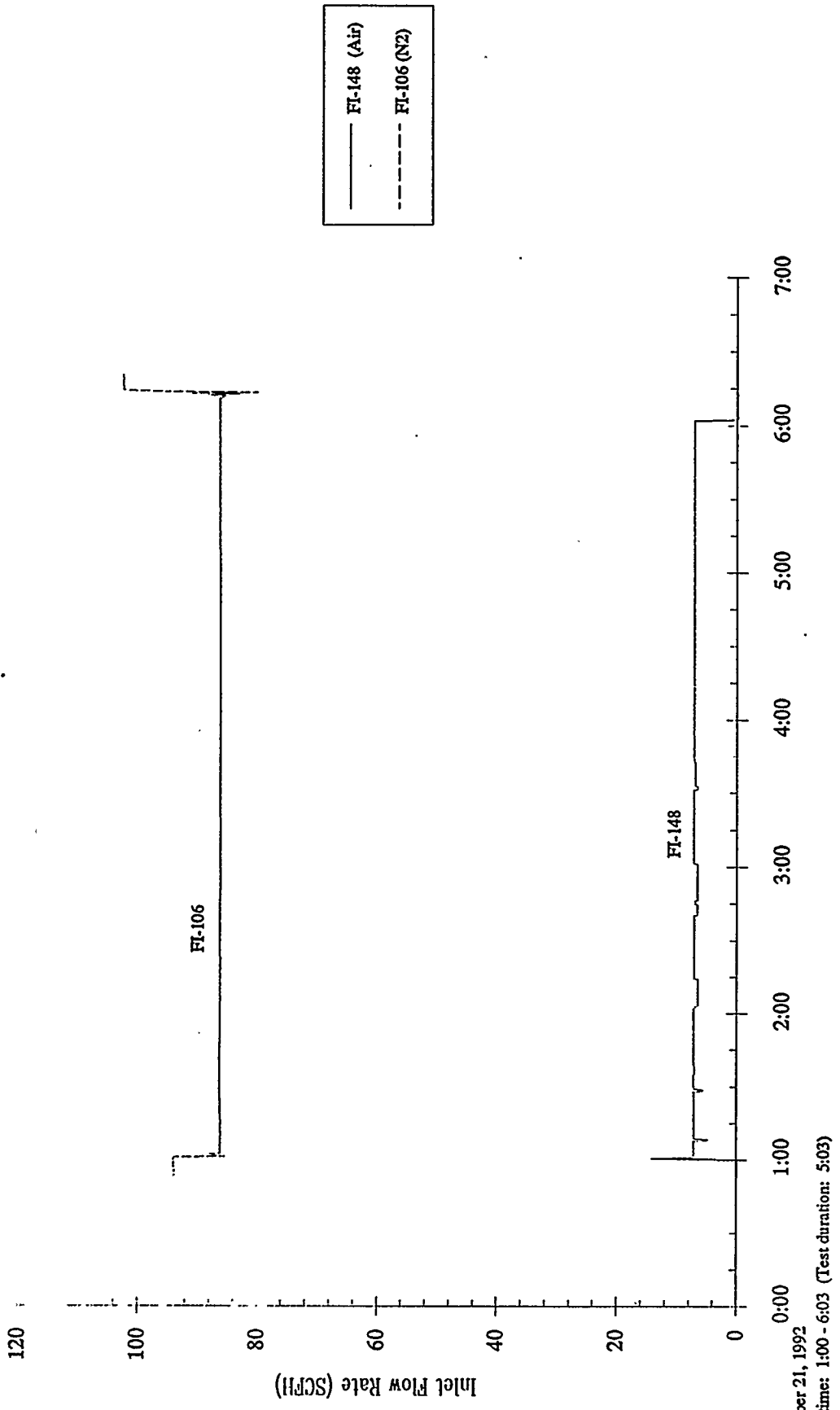

October 21, 1992
Test time: 1:00 - 6:03 (Test duration: 5:03)

L-3787M Zinc Titanate
u=1.0 ft/sec T=1200 °F
H2S Inlet Conc. = 0 ppm

Multi-Cycle Tests - ZTMC-03 Sulfidation 1

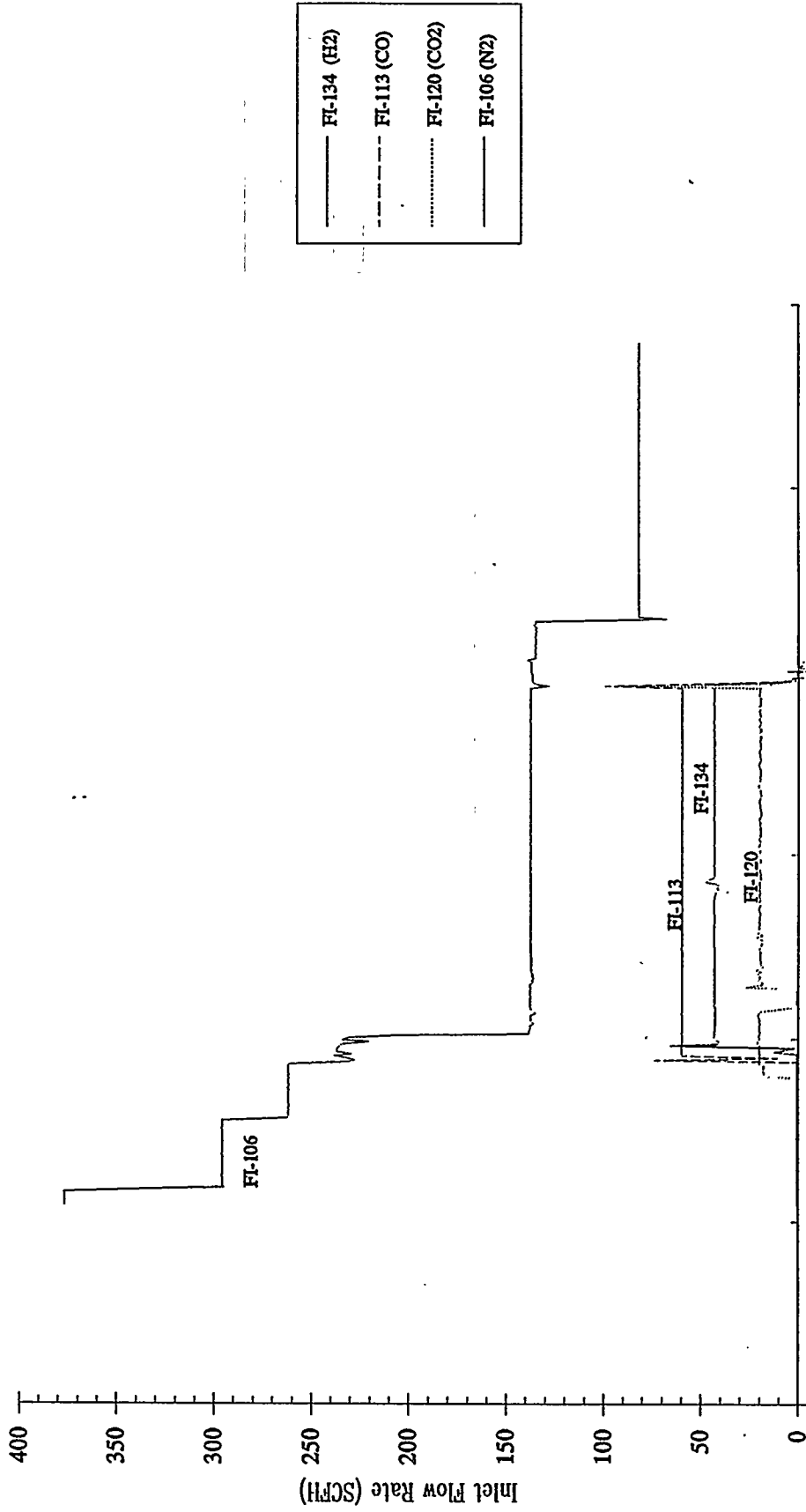

13:00

14:00

November 4, 1992
Test time: 13:30-14:00 (Test duration: 0:30)

L-3787M Zinc Titanate
u=1.0 ft/sec Tmax=1400 °F
O2 Inlet Conc. = 0.75 %

Multi-Cycle Tests - ZTMC-03 Regeneration 1

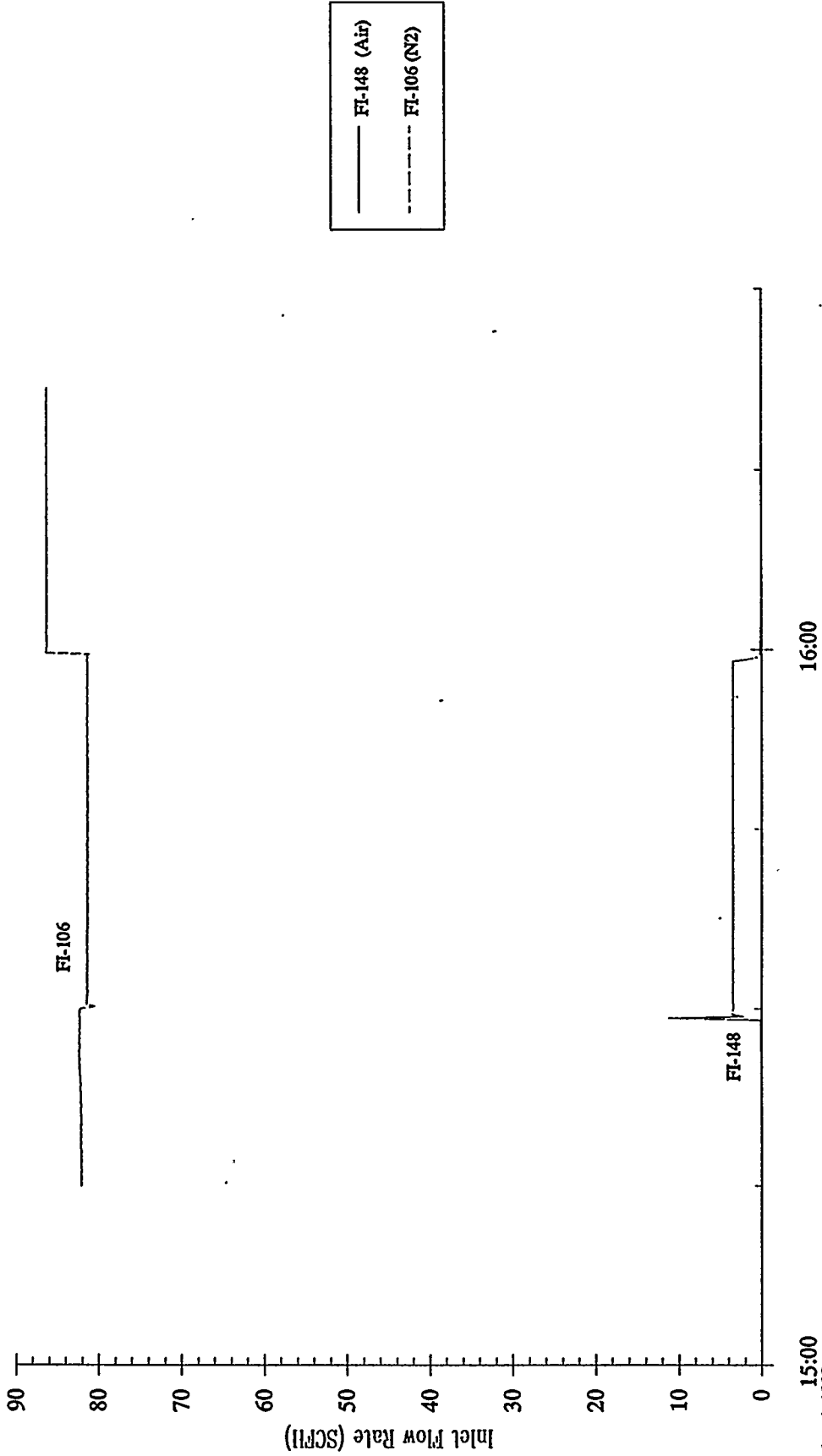

15:00
November 4, 1992
Test time: 15:30-16:00 (Test duration: 0:30)

L-3787M Zinc Titanate
u=1.0 ft/sec T=1200 °F
H2S Inlet Conc. = 0 ppm

Multi-Cycle Tests - ZTMC-03 Sulfidation 2

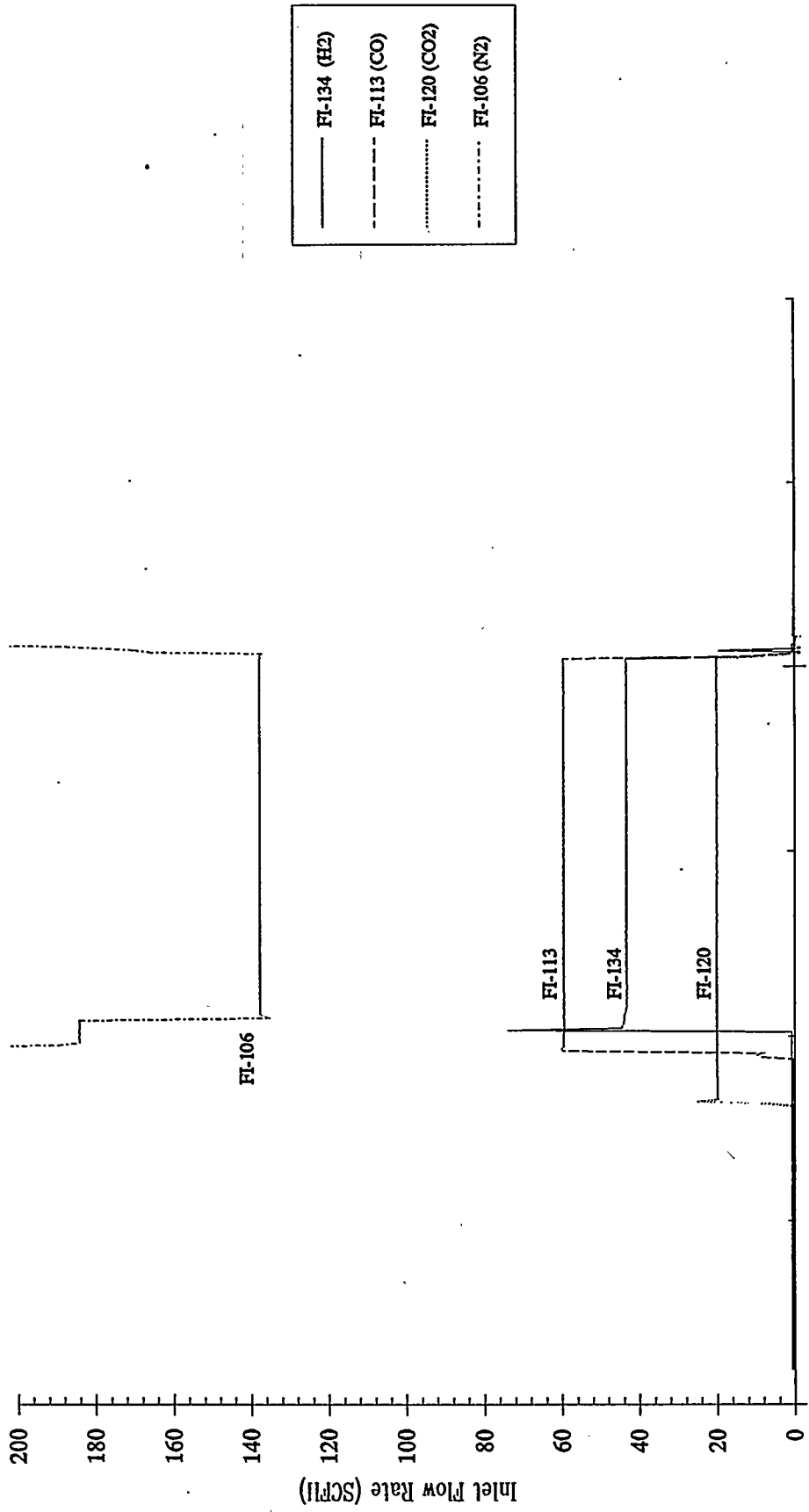

8:00
November 5, 1992

Test time: 8:30-9:00 (Test duration: 0:30)

9:00

L-3787M Zinc Titanate
u=1.0 ft/sec T_{max}=1400 °F
O₂ Inlet Conc. = 0.75 %

Multi-Cycle Tests - ZTMC-03 Regeneration 2

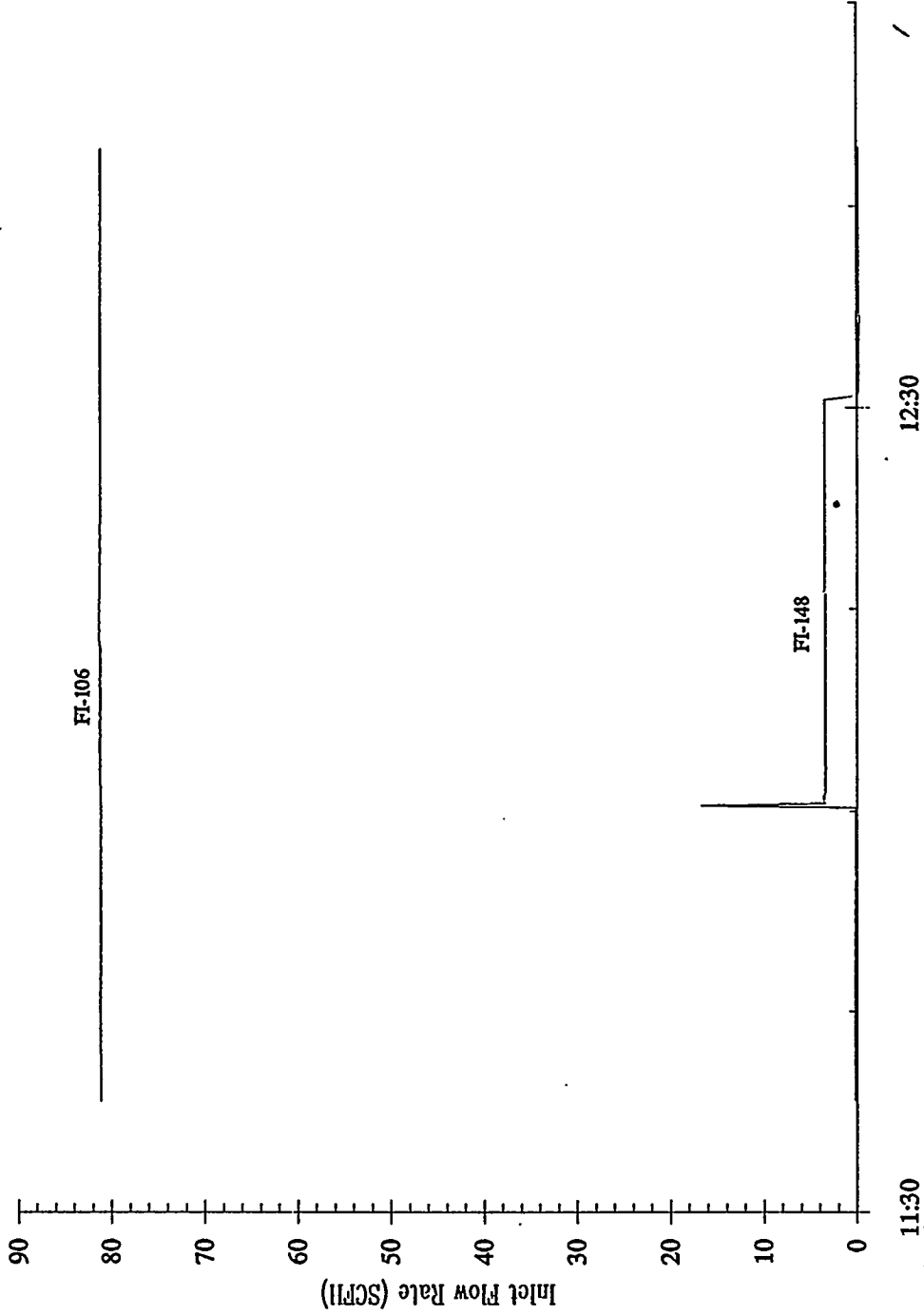

— FI-148 (Air)
- - - FI-106 (N₂)

11:30
November 5, 1992
Test time: 12:00-12:30 (Test duration: 0:30)

L-3787M Zinc Titanate
u=1.0 ft/sec T=1200 °F
H2S Inlet Conc. = 0 ppm

Multi-Cycle Tests - ZTMC-03 Sulfidation 3

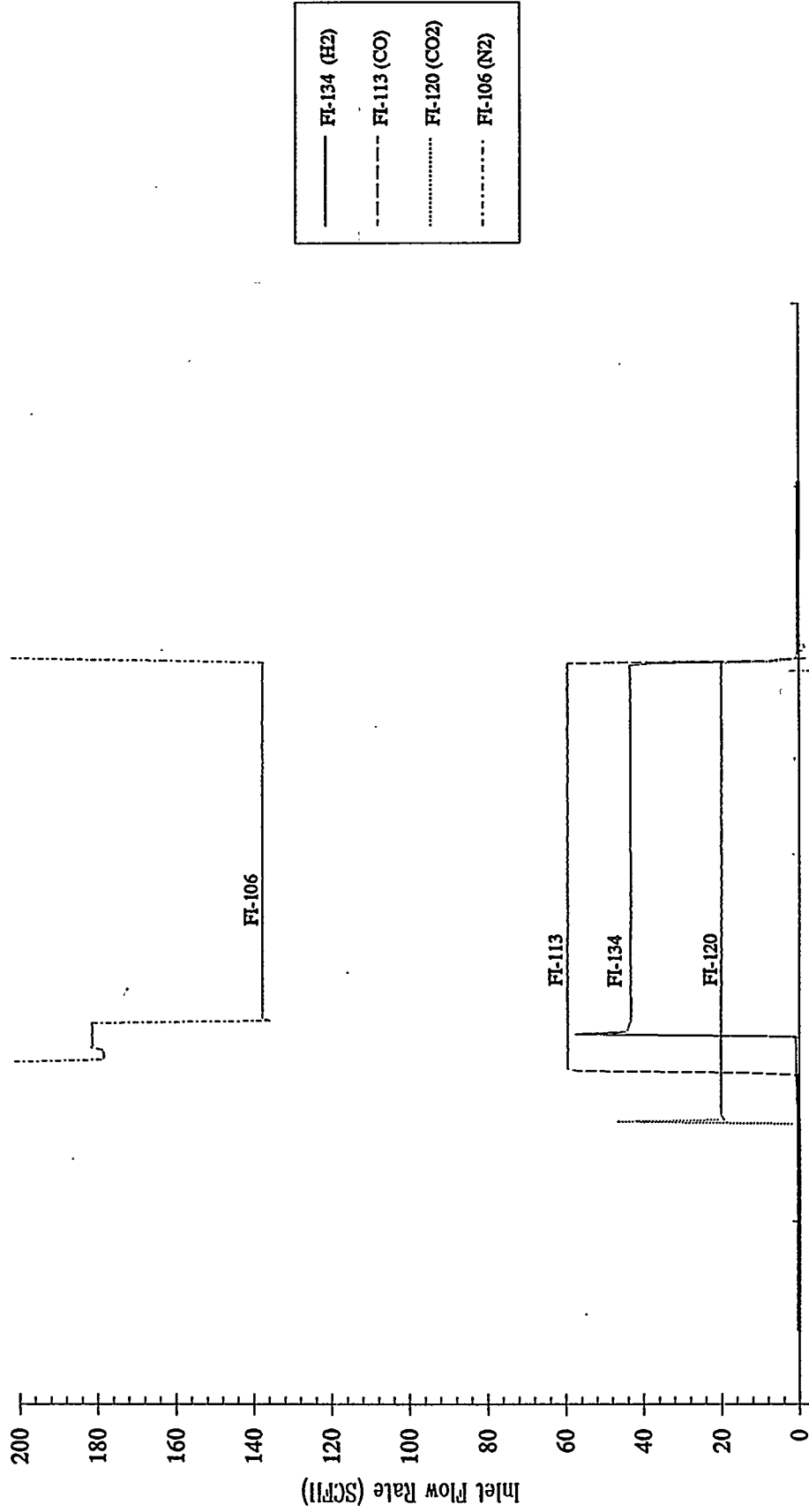

14:00

November 5, 1992

Test time: 14:30-15:00 (Test duration: 0:30)

L-3787M Zinc Titanate
u=1.0 ft/sec T_{max}=1400 °F
O₂ Inlet Conc. = 0.75 %

Multi-Cycle Tests - ZTMC-03 Regeneration 3

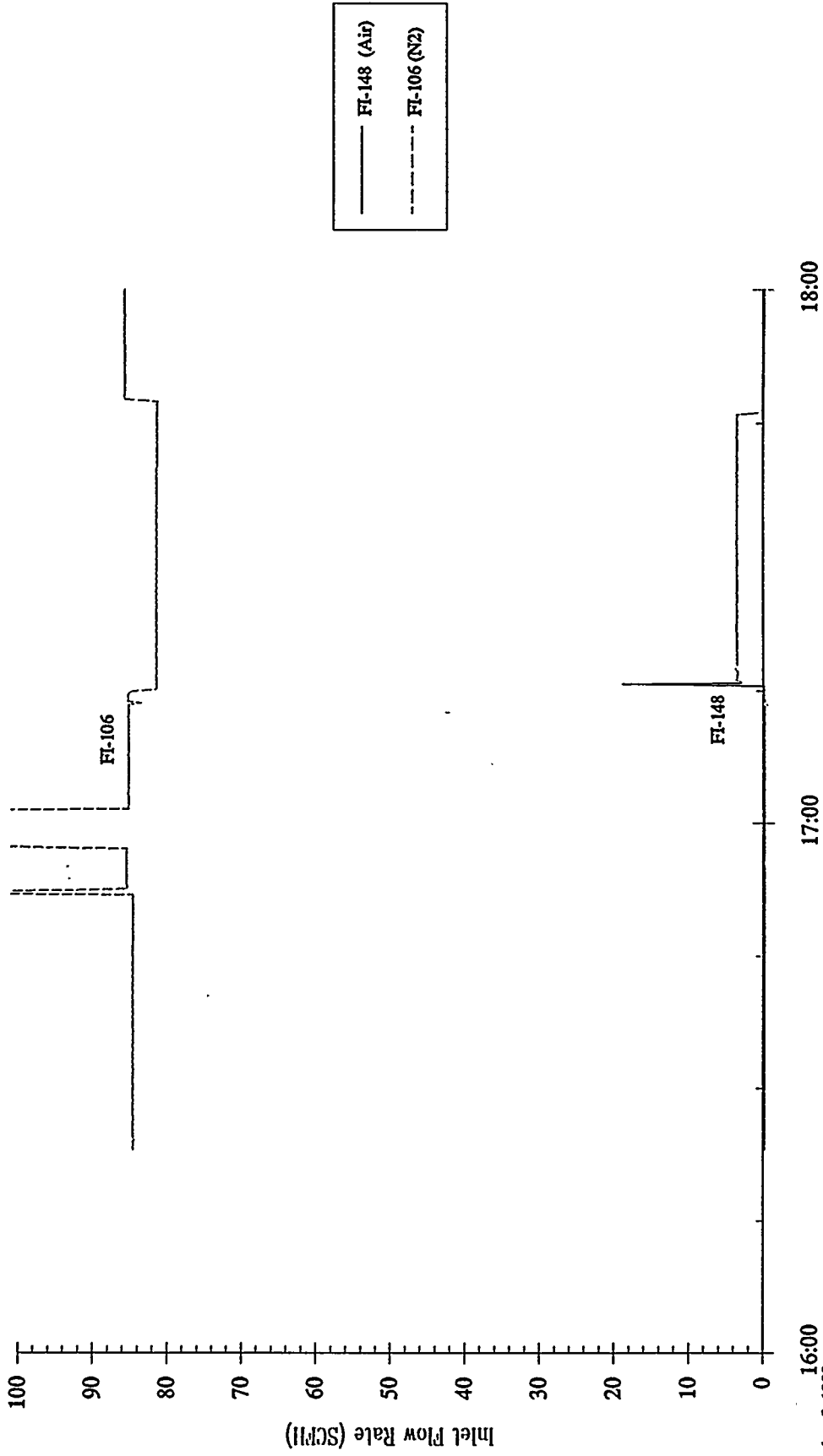

November 5, 1992

Test time: 17:15-17:45 (Test durations: 0:30)

L-3787M Zinc Titanate
u=1.0 ft/sec T=1200 °F
H2S Inlet Conc. = 0 ppm

Multi-Cycle Tests - ZTMC-03 Sulfidation 4

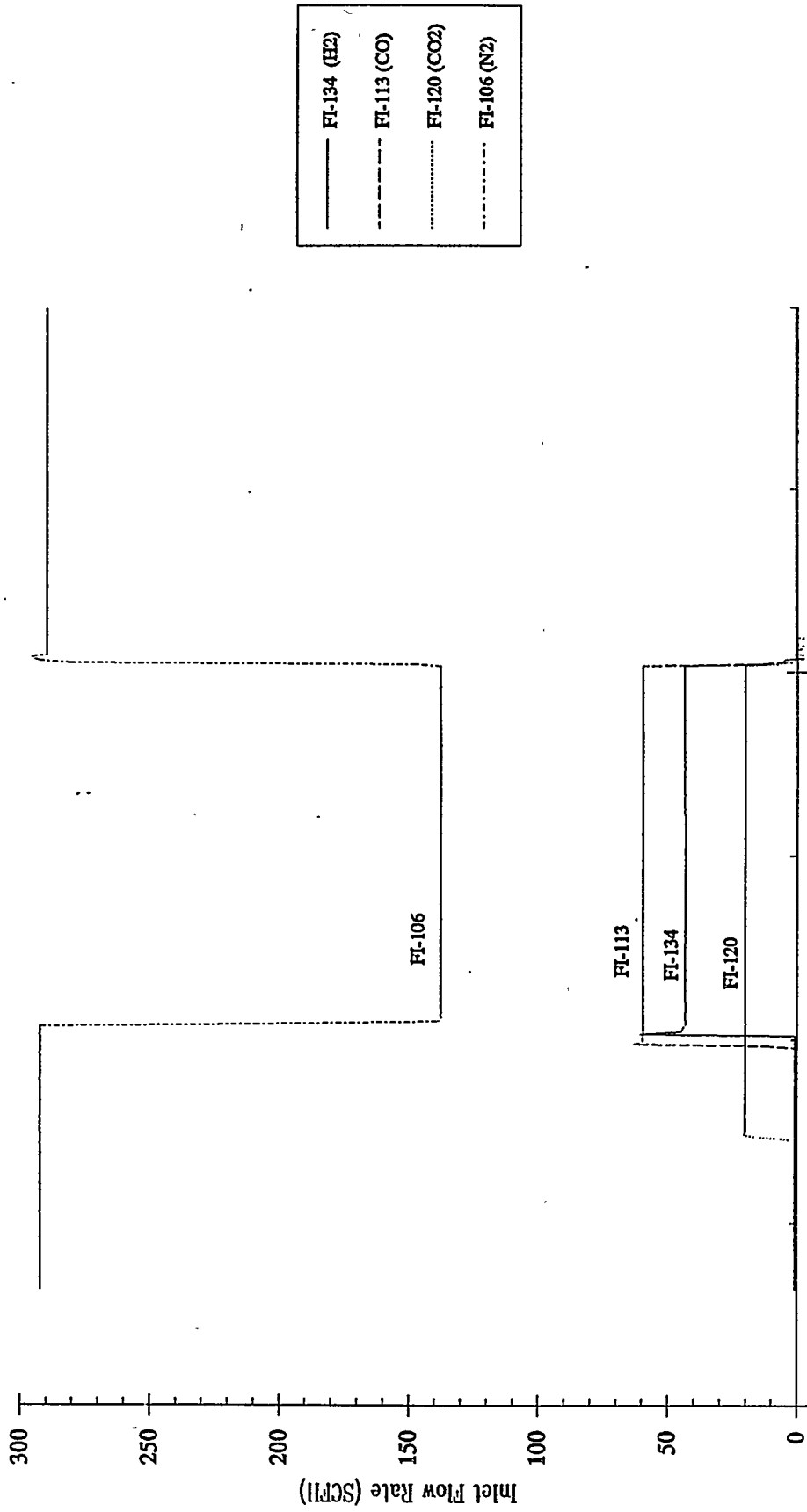

8:30

9:30

November 6, 1992

Test time: 9:00-9:30 (Test duration: 0:30)

L-3787M Zinc Titanate
u=1.0 ft/sec T_{max}=1400 °F
O₂ Inlet Conc. = 0.75 %

Multi-Cycle Tests - ZTMC-03 Regeneration 4

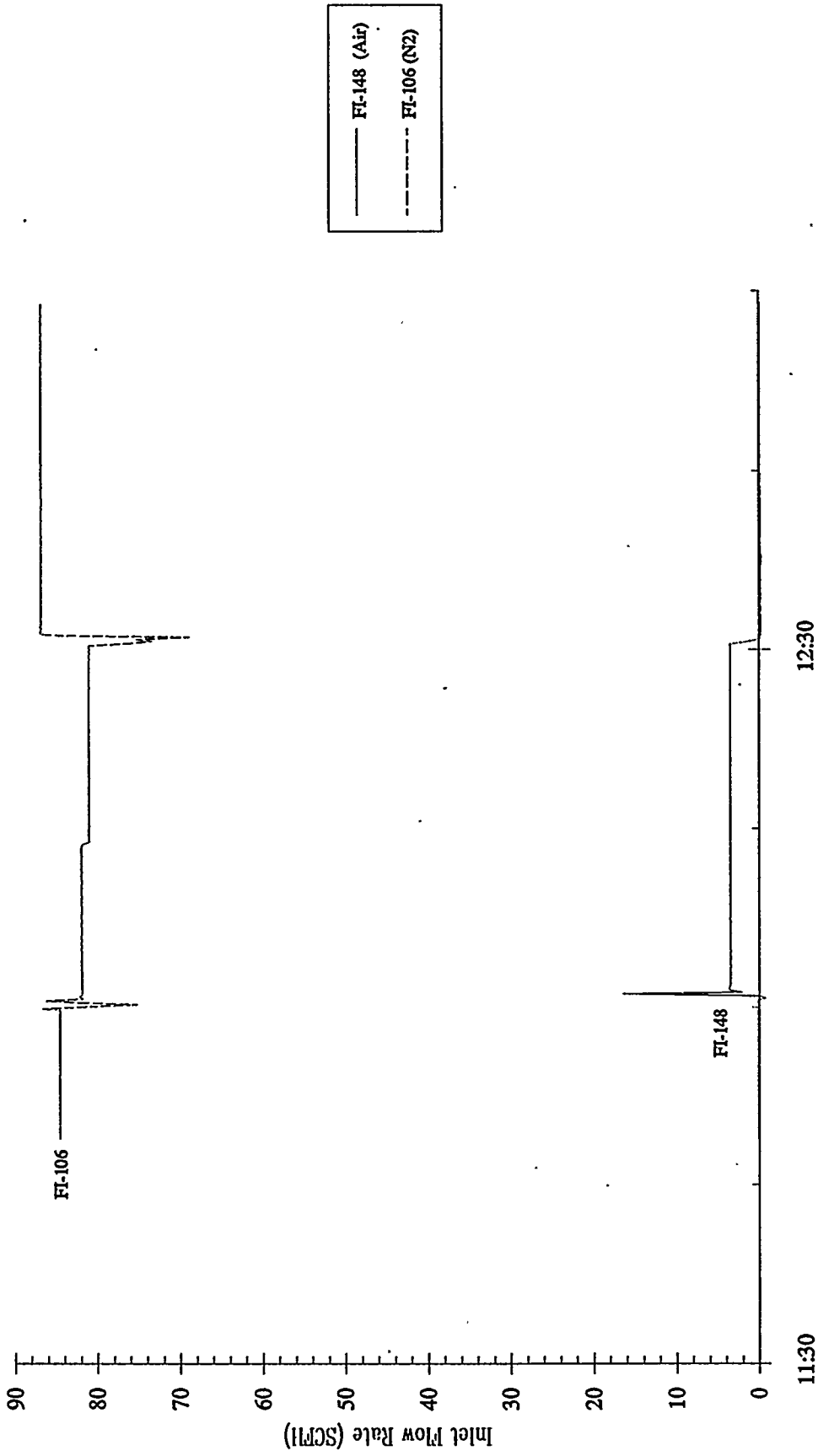

11:30
November 6, 1992
Test time: 12:00-12:30 (Test duration: 0:30)

L-3787M Zinc Titanate
u=1.0 ft/sec T=1000 F
H2S Inlet Conc. = 800 ppm

Multi-Cycle Tests - ZTMC-04 Sulfidation 1

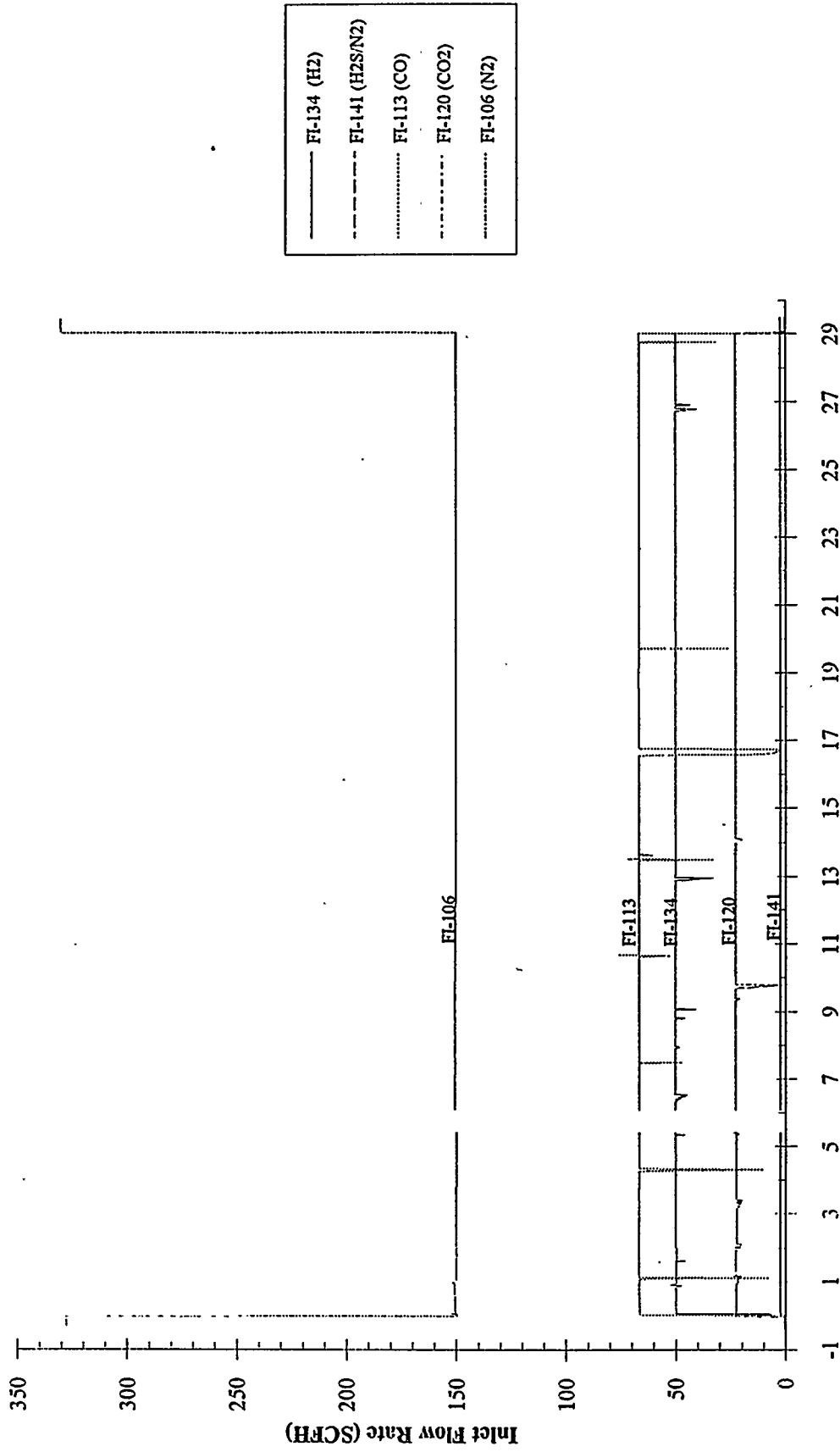

Test time: 21:00 (January 13, 1993) - 2:00 (January 15, 1993)
Test duration: 29:00

L-3787M Zinc Titanate
u=1.0 ft/sec T = 1000-1400 F
O2 Inlet Conc. = 0.5 - 21 %

Multi-Cycle Tests - ZTMC-04 Regeneration 1

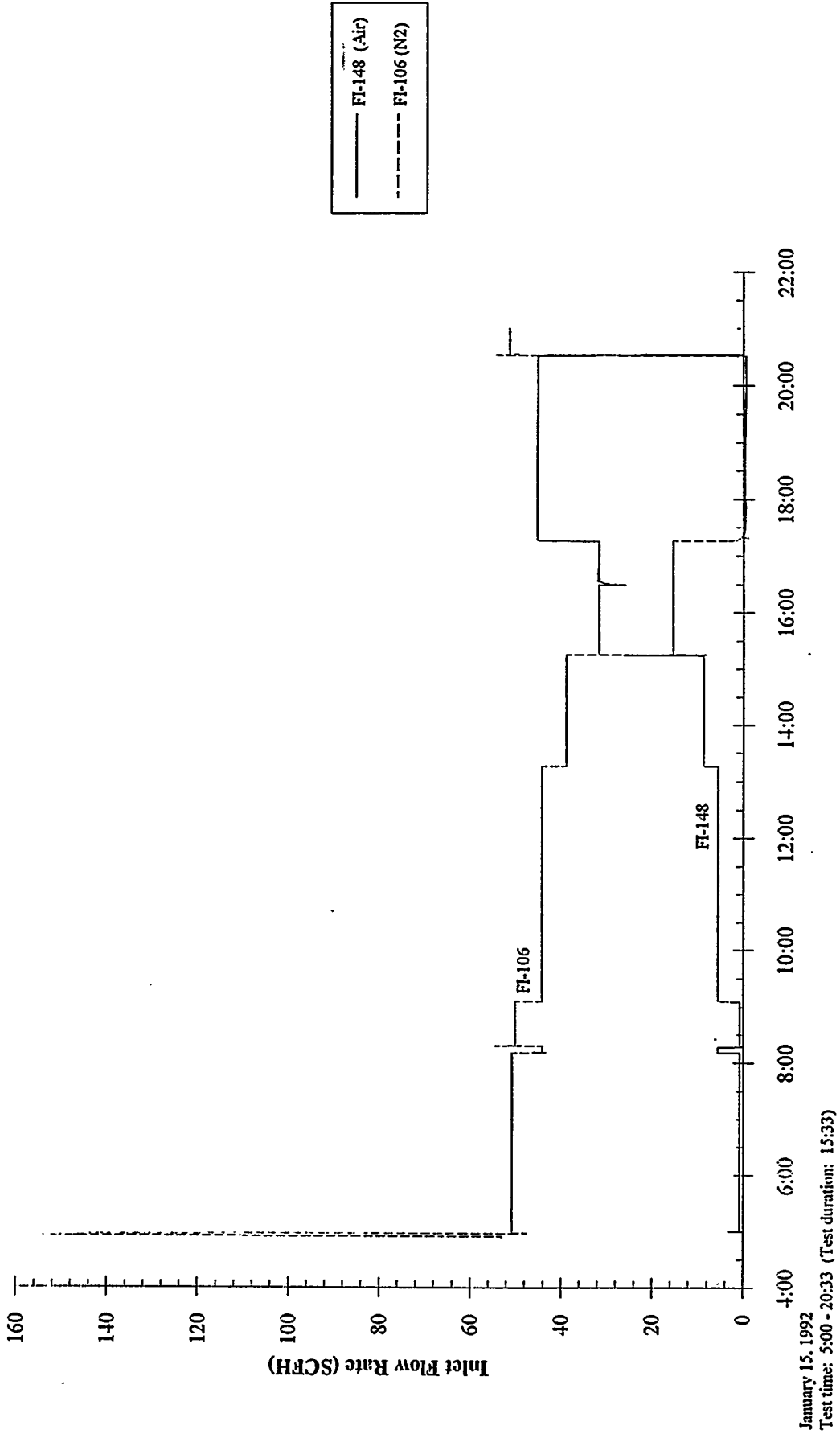

L-3787M Zinc Titanate
u=1.0 ft/sec T=1000 F
H2S Inlet Conc. = 800 ppm

Multi-Cycle Tests - ZTMC-04 Sulfidation 2

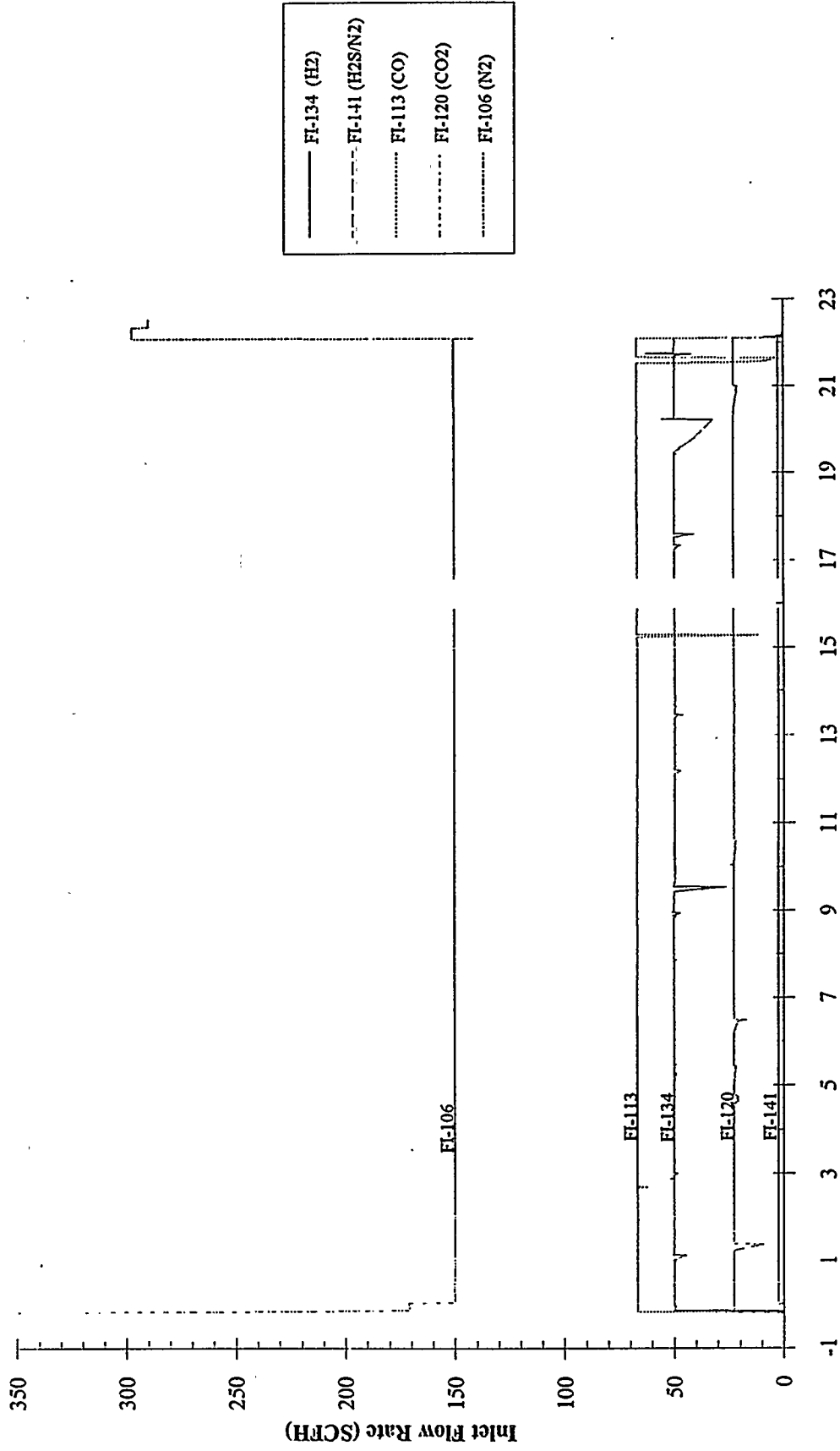

Test time: 9:00 (January 19, 1993) - 7:05 (January 20, 1993)
Test duration: 22:05

L-3787M Zinc Titanate
u=1.0 R/sec T = 1000-1400 F
O2 Inlet Conc. = 0.5 - 21 %

Multi-Cycle Tests - ZTMC-04 Regeneration 2

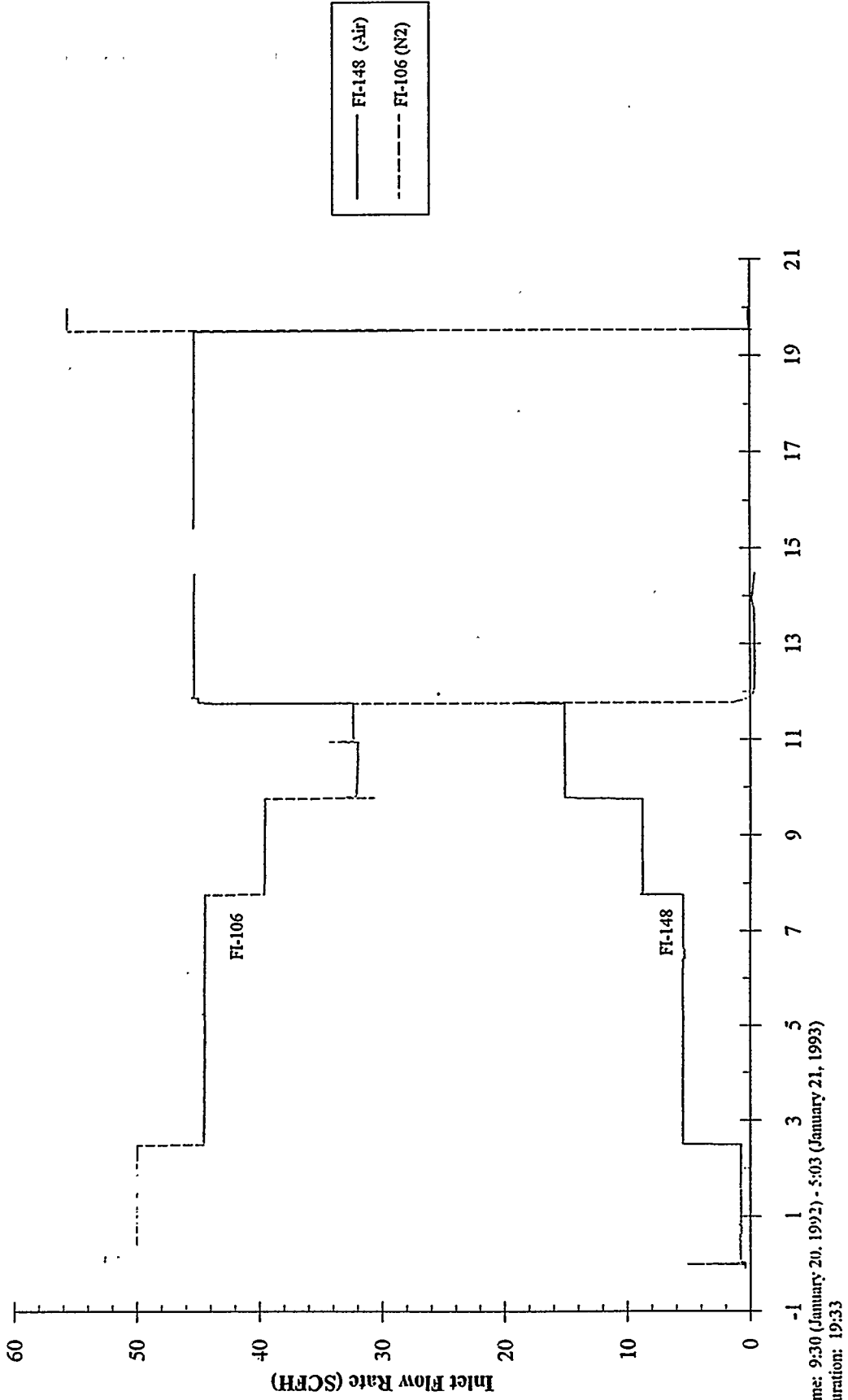

Test time: 9:30 (January 20, 1992) - 5:03 (January 21, 1993)
Test duration: 19:33

L-3787M Zinc Titanate
u=1.0 ft/sec T=1000 F
H2S Inlet Conc. = 800 ppm

Multi-Cycle Tests - ZTMC-04 Sulfidation 3

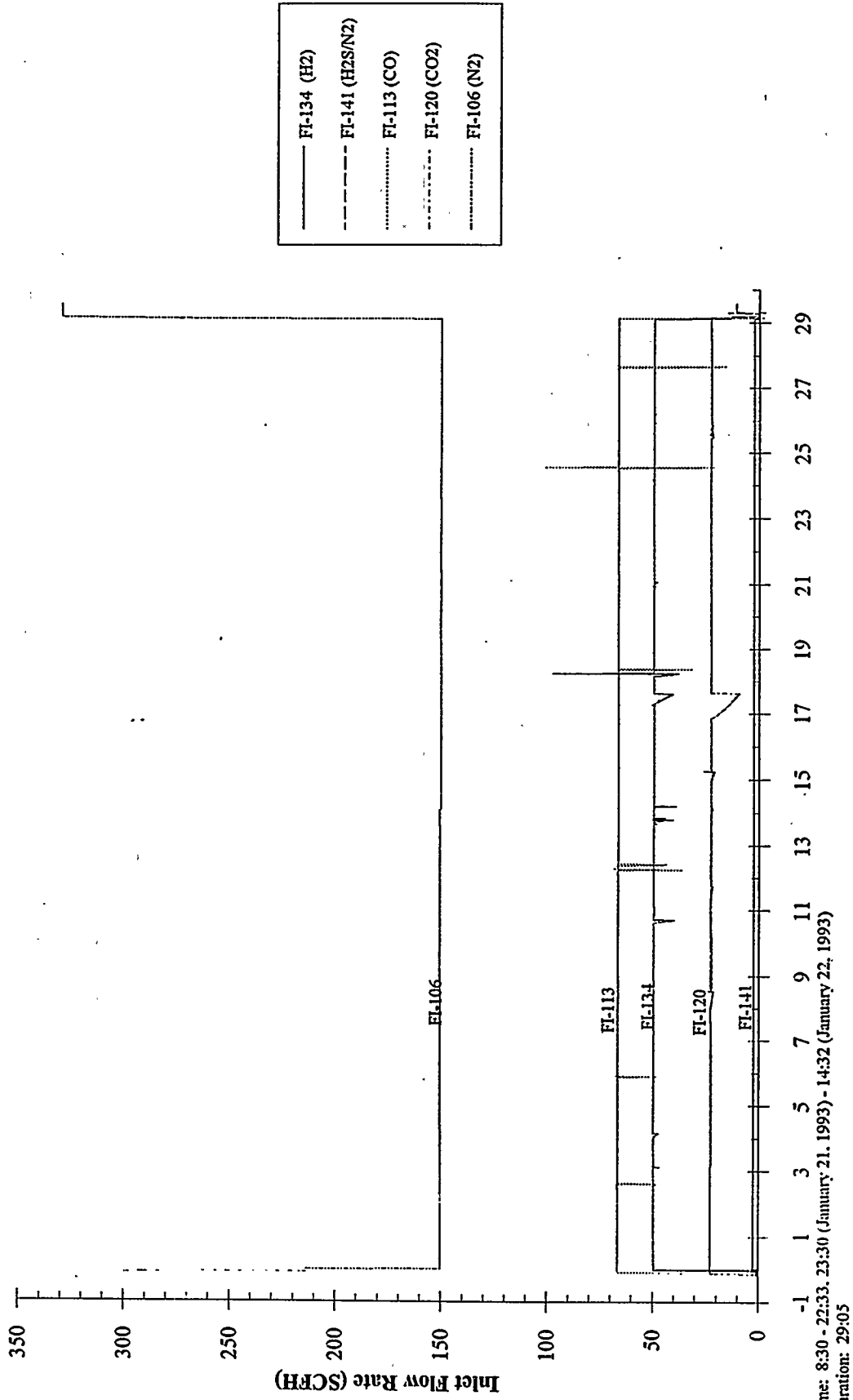

Test time: 8:30 - 22:33, 23:30 (January 21, 1993) - 14:32 (January 22, 1993)
Test duration: 29:05

L-3787M Zinc Titanate
u=1.0 ft/sec T=1000 F
H2S Inlet Conc. = 2000 ppm

Single Cycle Tests - ZTSC-08 Sulfidation 1

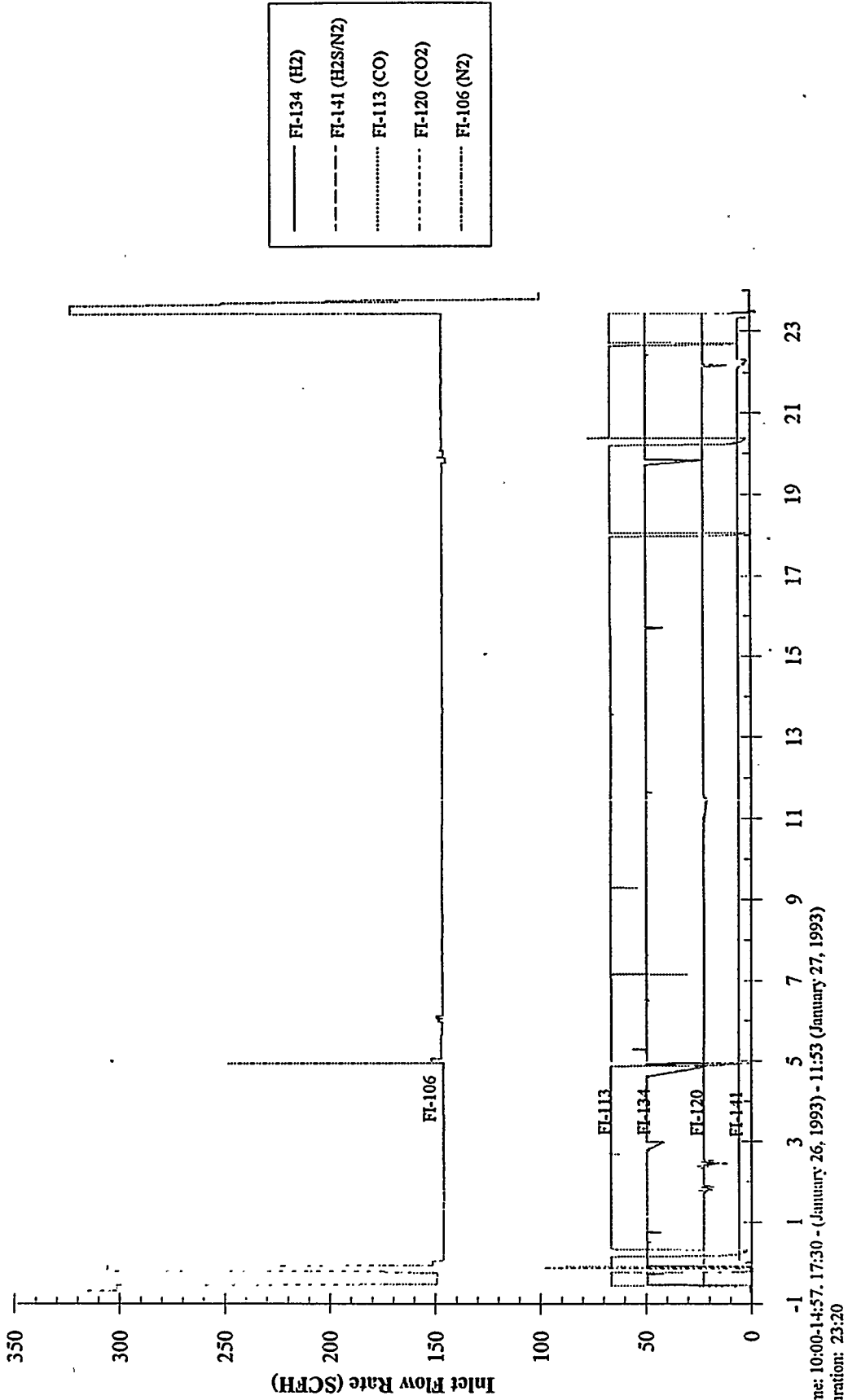

L-3787M Zinc Titanate
u=2.0 ft/sec T=1100 °F
H2S Inlet Conc. = 800 ppm

Single Cycle Tests - ZTSC-01 Sulfidation 1

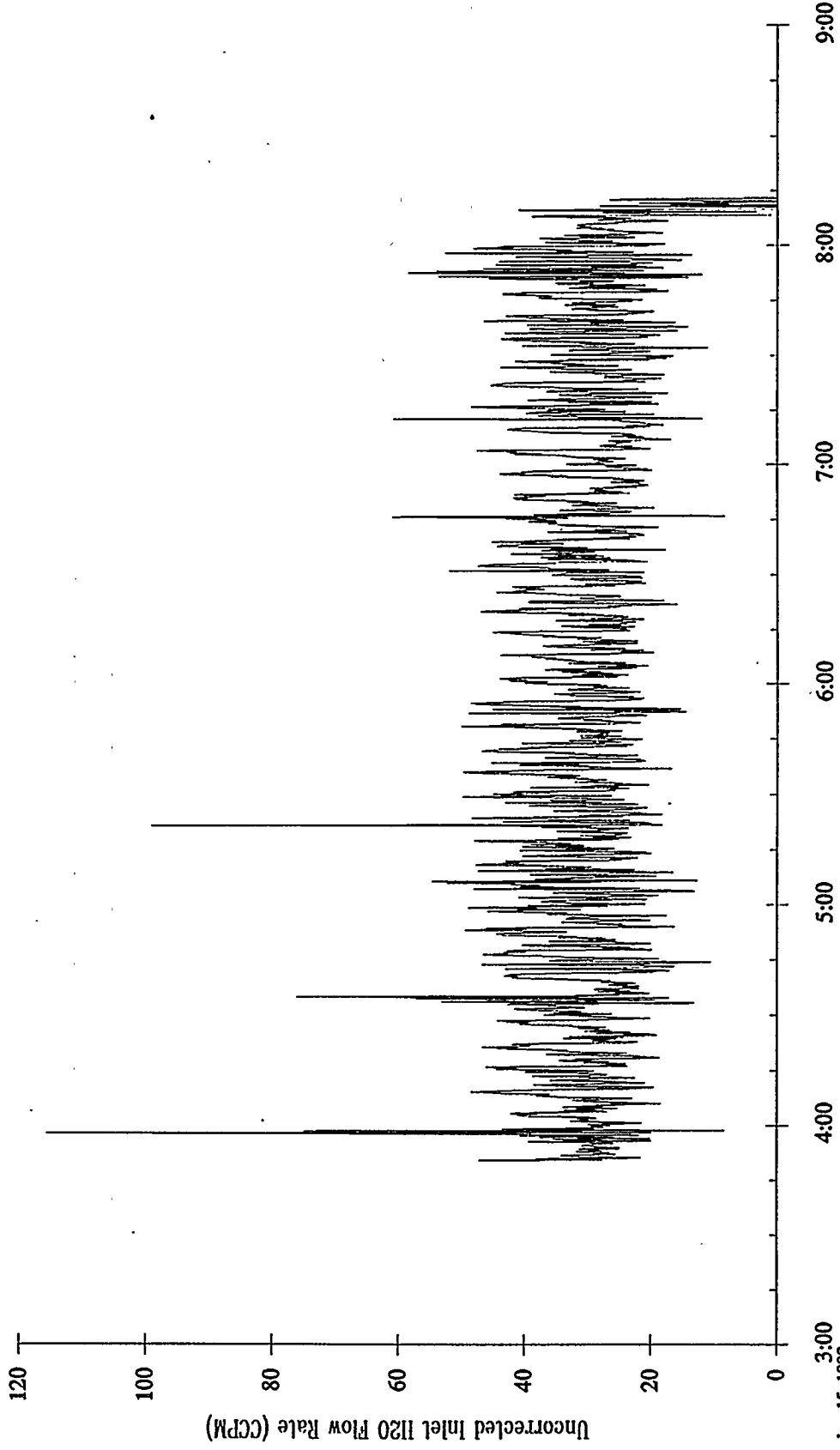

September 15, 1992
Test time: 4:35-8:08 (Test duration: 3:33)

L-3787M Zinc Titanate
u=1.0 ft/sec T=1100 °F
H2S Inlet Conc. = 800 ppm

Single Cycle Tests - ZTSC-02 Sulfidation 1

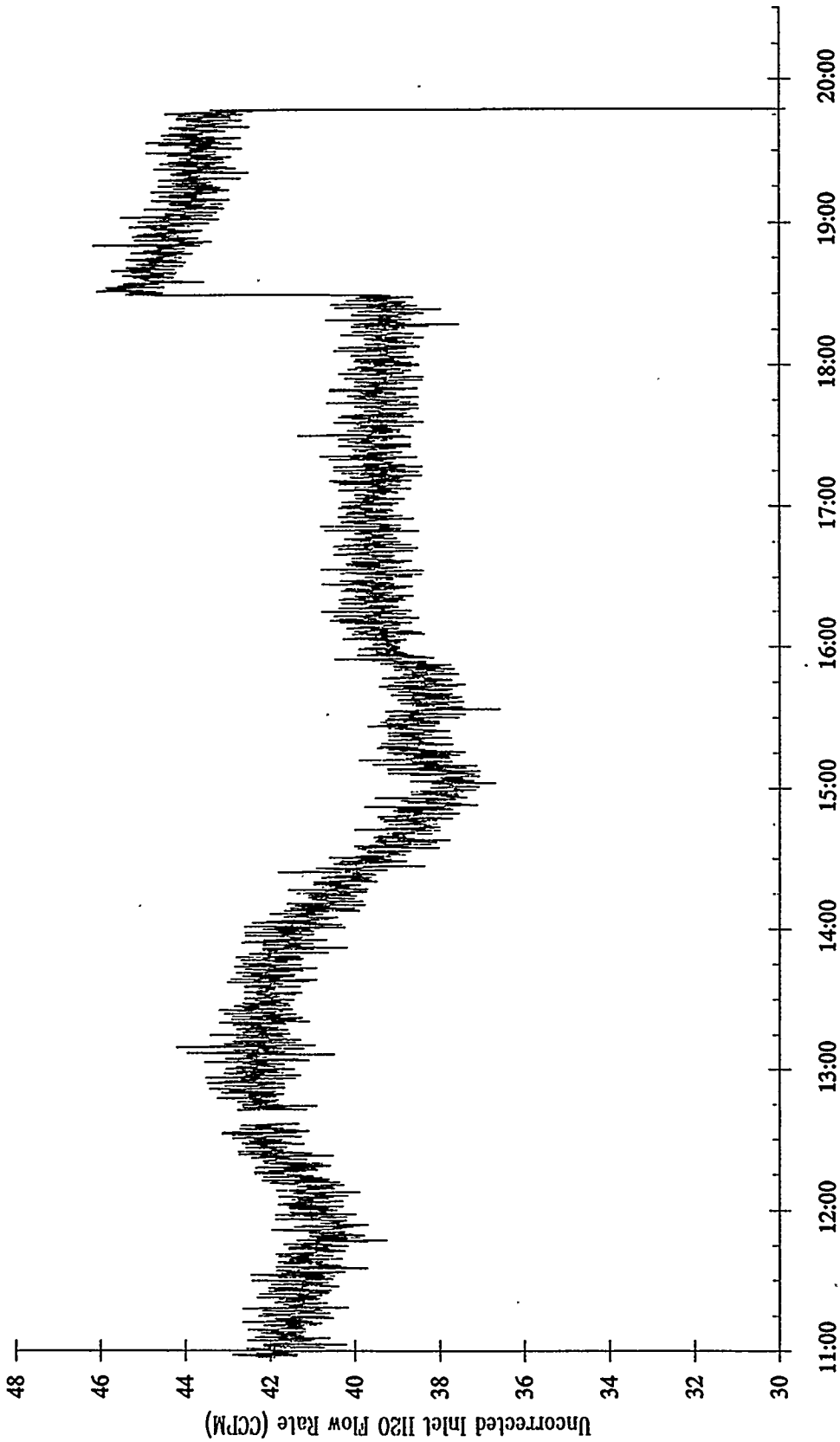

September 4, 1992
Test time: 11:30-19:45 (Test duration: 8:15)

L-3787M Zinc Titanate
u=1.0 f/sec T=1100 F
H2S Inlet Conc. = 800 ppm

Single Cycle Tests - ZTSC-03 Sulfidation 1

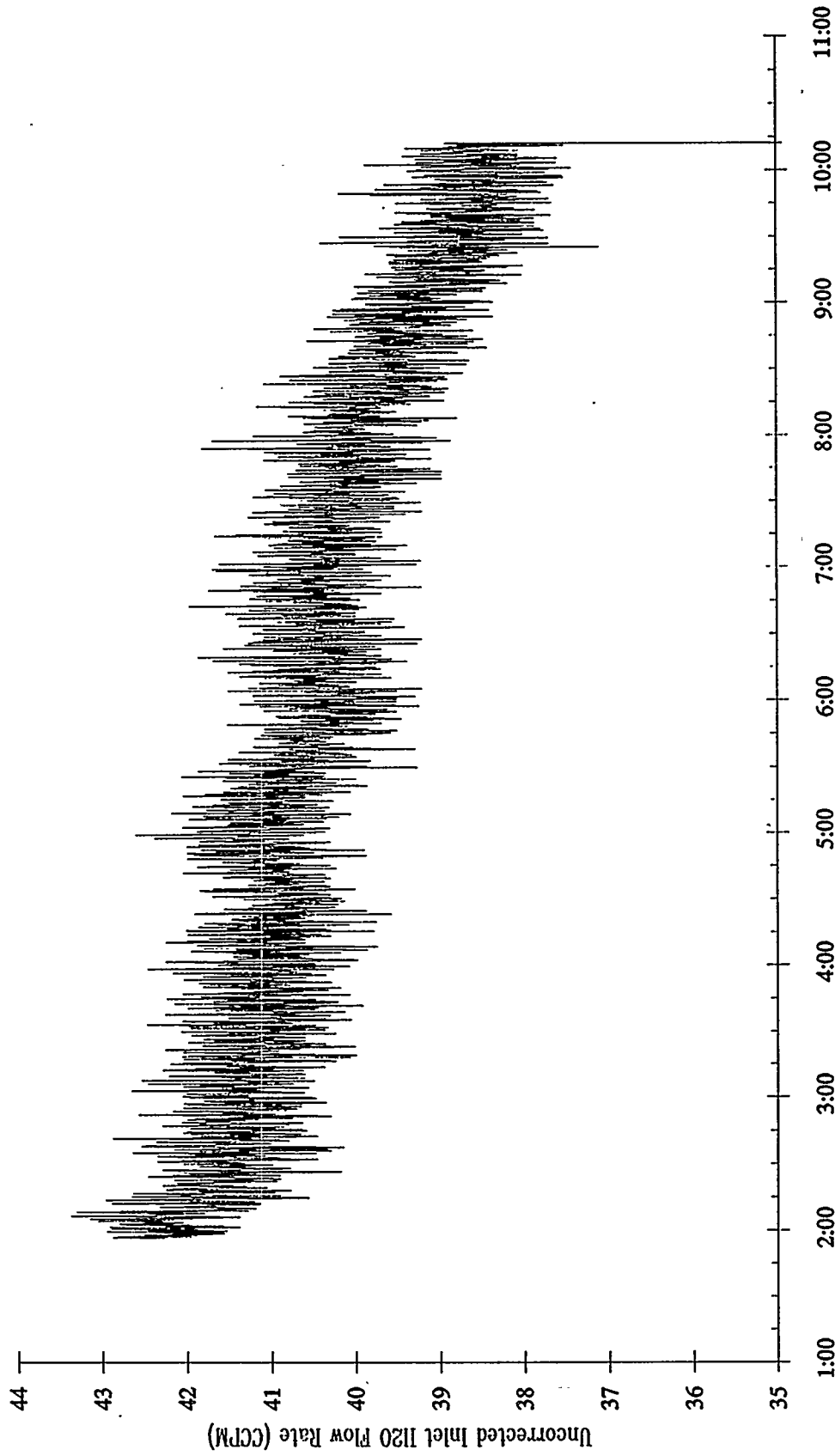

September 9, 1992
Test time: 1:00-10:05 (Test duration: 9:05)

L-3787M Zinc Titanate
u=1.0 ft/sec T=1000 °F
H2S Inlet Conc. = 800 ppm

Single Cycle Tests - ZTSC-04 Sulfidation 1

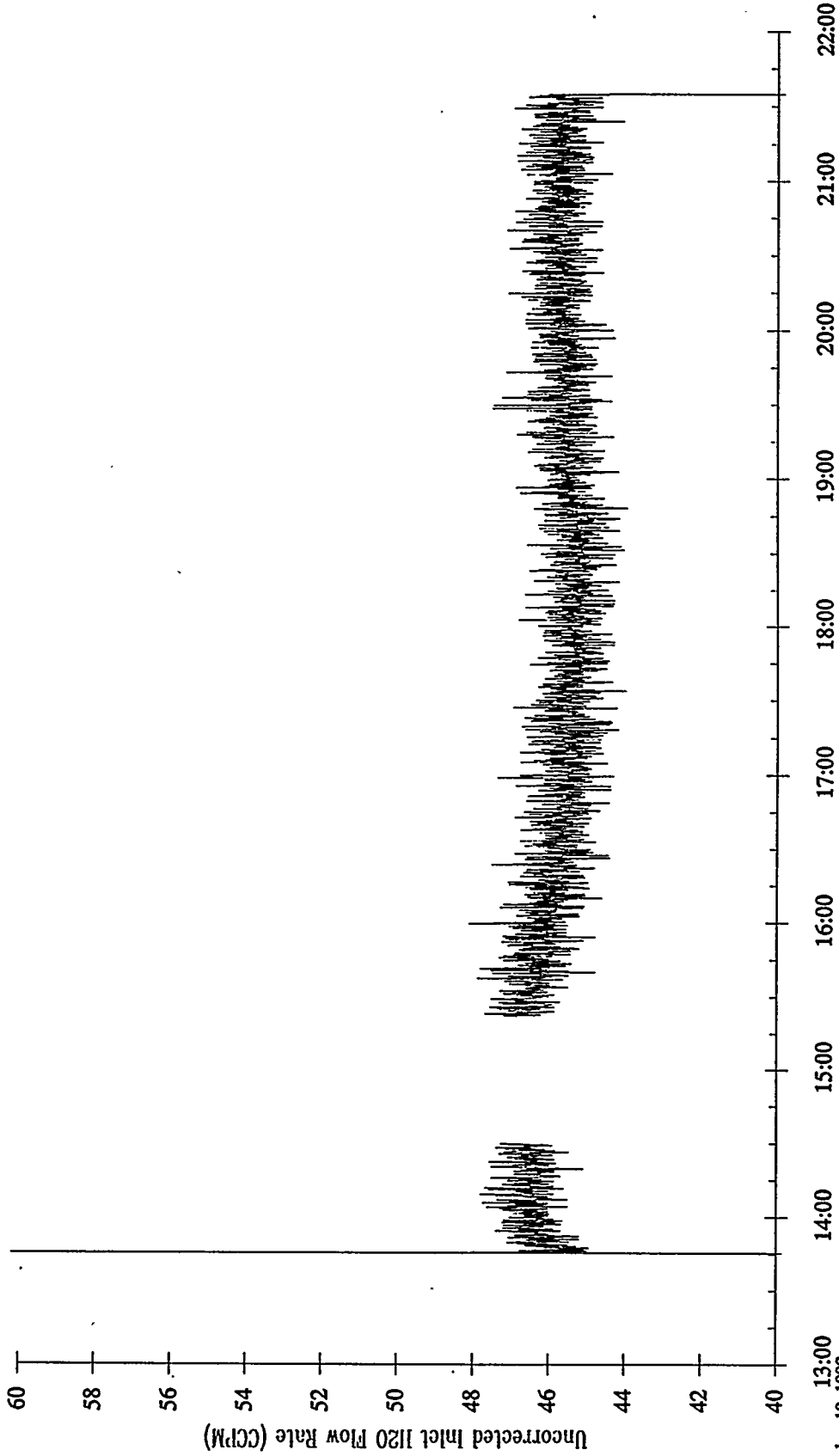

September 10, 1992
13:00
Test time: 14:00-14:23, 15:00-21:33 (Test duration: 6:56)

L-3787M Zinc Titanate
u=1.0 ft/sec T=1200 °F
H2S Inlet Conc. = 800 ppm

Single Cycle Tests - ZTSC-05 Sulfidation 1

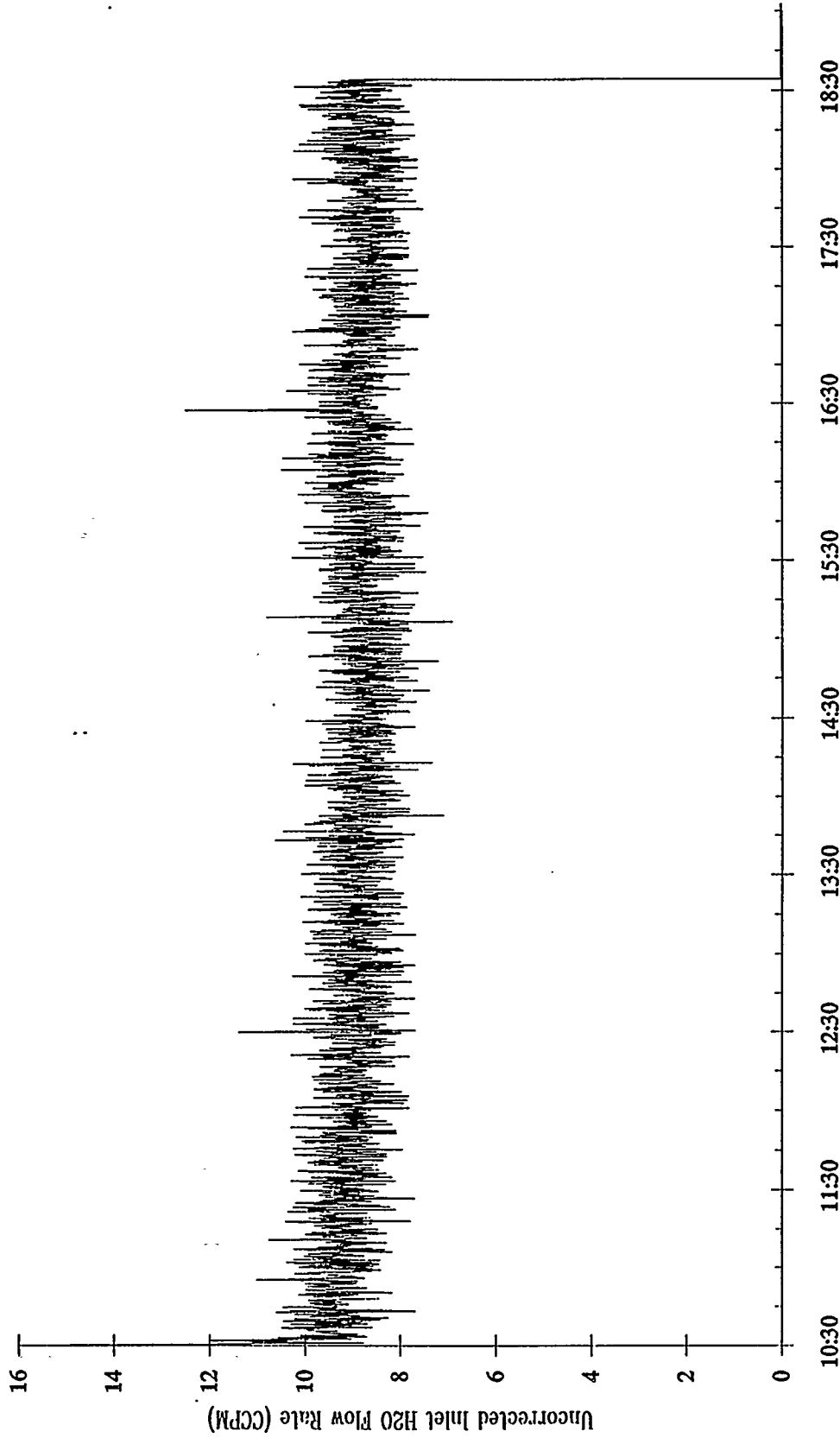

September 15, 1992
Test time: 11:00-18:34 (Test duration: 7:34)

L-3787M Zinc Titanate
u=2.0 ft/sec T=1200 °F
H2S Inlet Conc. = 800 ppm

Single Cycle Tests - ZTSC-07 Sulfidation 3

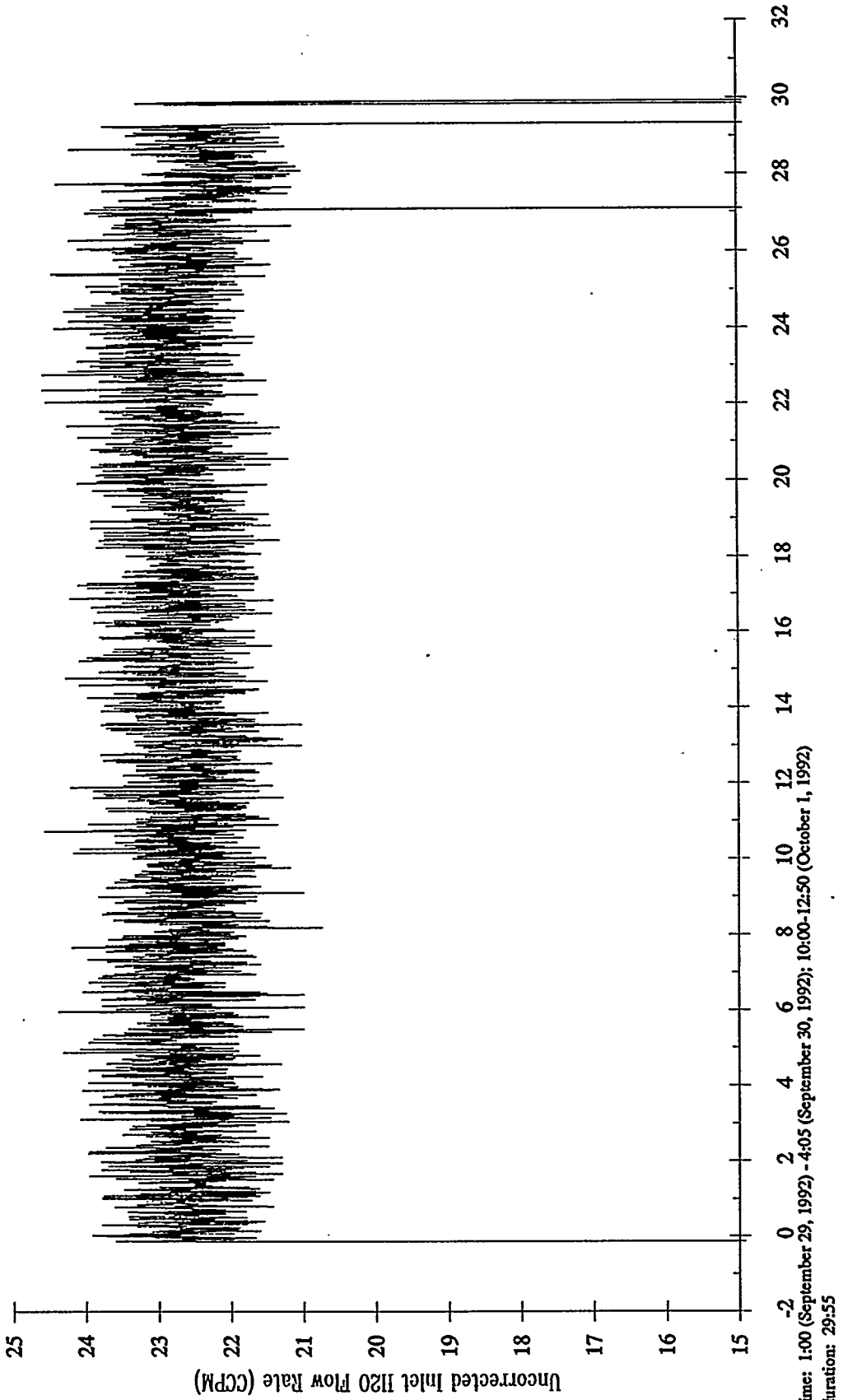

Test time: 1:00 (September 29, 1992) - 4:05 (September 30, 1992); 10:00-12:50 (October 1, 1992)
Test duration: 29:55

L-3787M Zinc Titanate
u=1.0 ft/sec Tmax=1400 °F
O2 Inlet Conc. = 1.5 %

Multi-Cycle Tests - ZTMC-01 Regeneration 1

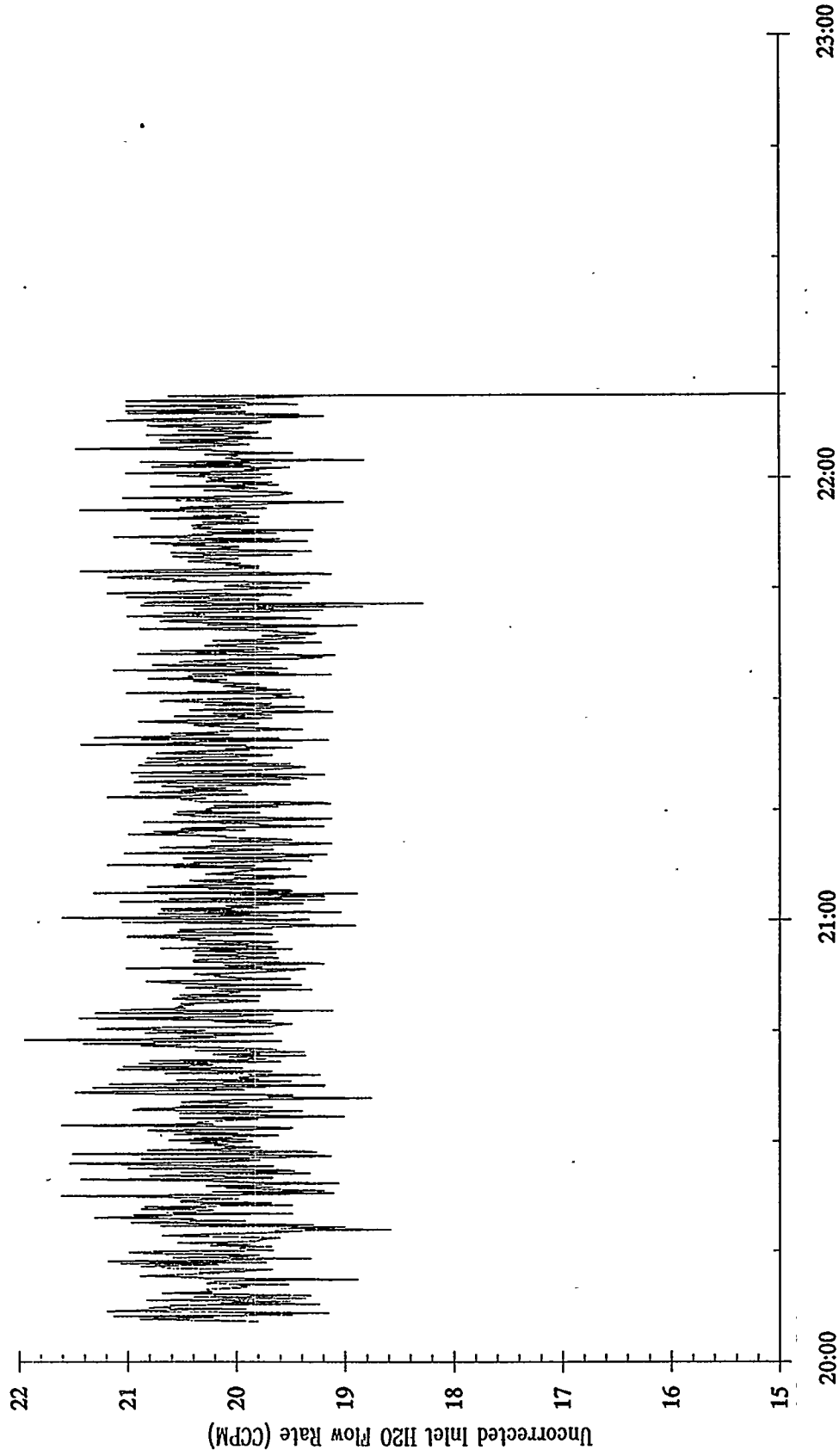

October 6, 1992
Test time: 20:00-22:12 (Test duration: 2:12)

Multi-Cycle Tests - ZTMC-01 Regeneration 2

L-3787M Zinc Titanate
u=1.0 ft/sec Tmax=1300 °F
O2 Inlet Conc. = 0.75 %

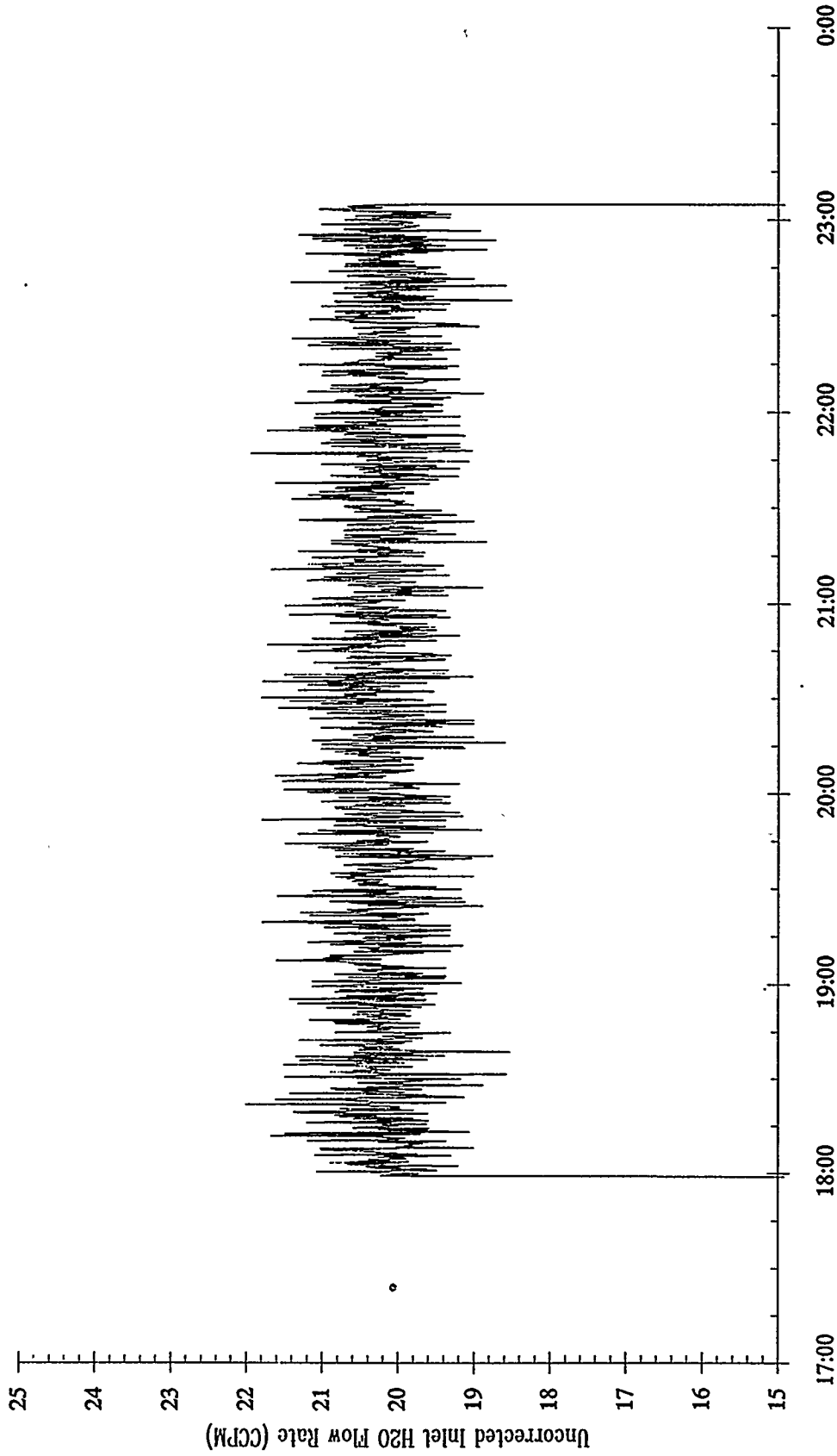

October 7, 1992
Test time: 18:00-23:05 (Test duration: 5:05)

L-3787M Zinc Titanate
u=1.0 ft/sec Tmax=1300 °F
O2 Inlet Conc. = 0.75 %

Multi-Cycle Tests - ZTMC-01 Regeneration 3

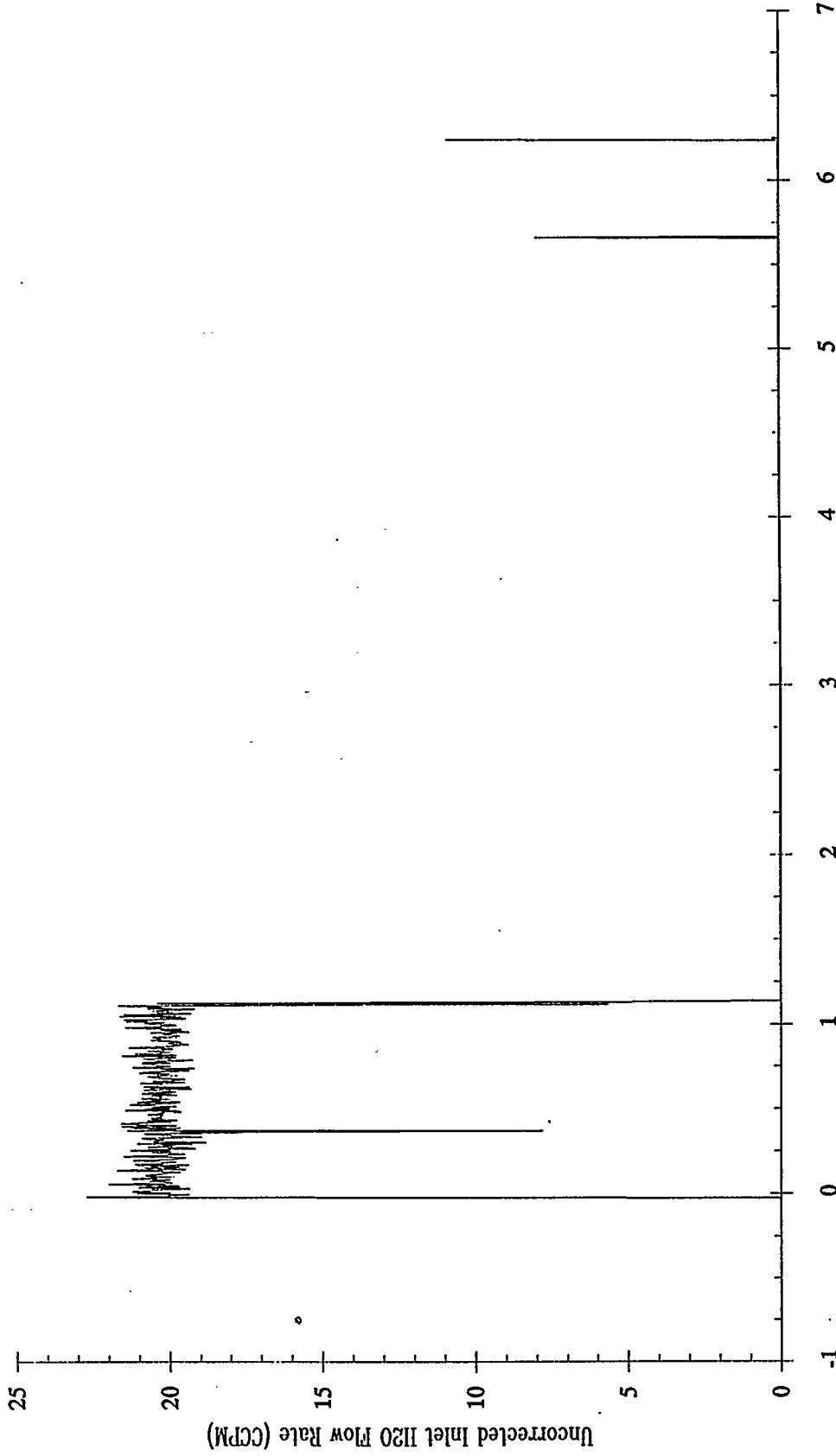

Test time: 20:00 (October 8, 1992) - 2:00 (October 9, 1992)
Test duration: 6:00

L-3787M Zinc Titanate
u=0.5 ft/sec T=1000 °F
H2S Inlet Conc. = 800 ppm

Multi-Cycle Tests - ZTMC-02 Sulfidation 1

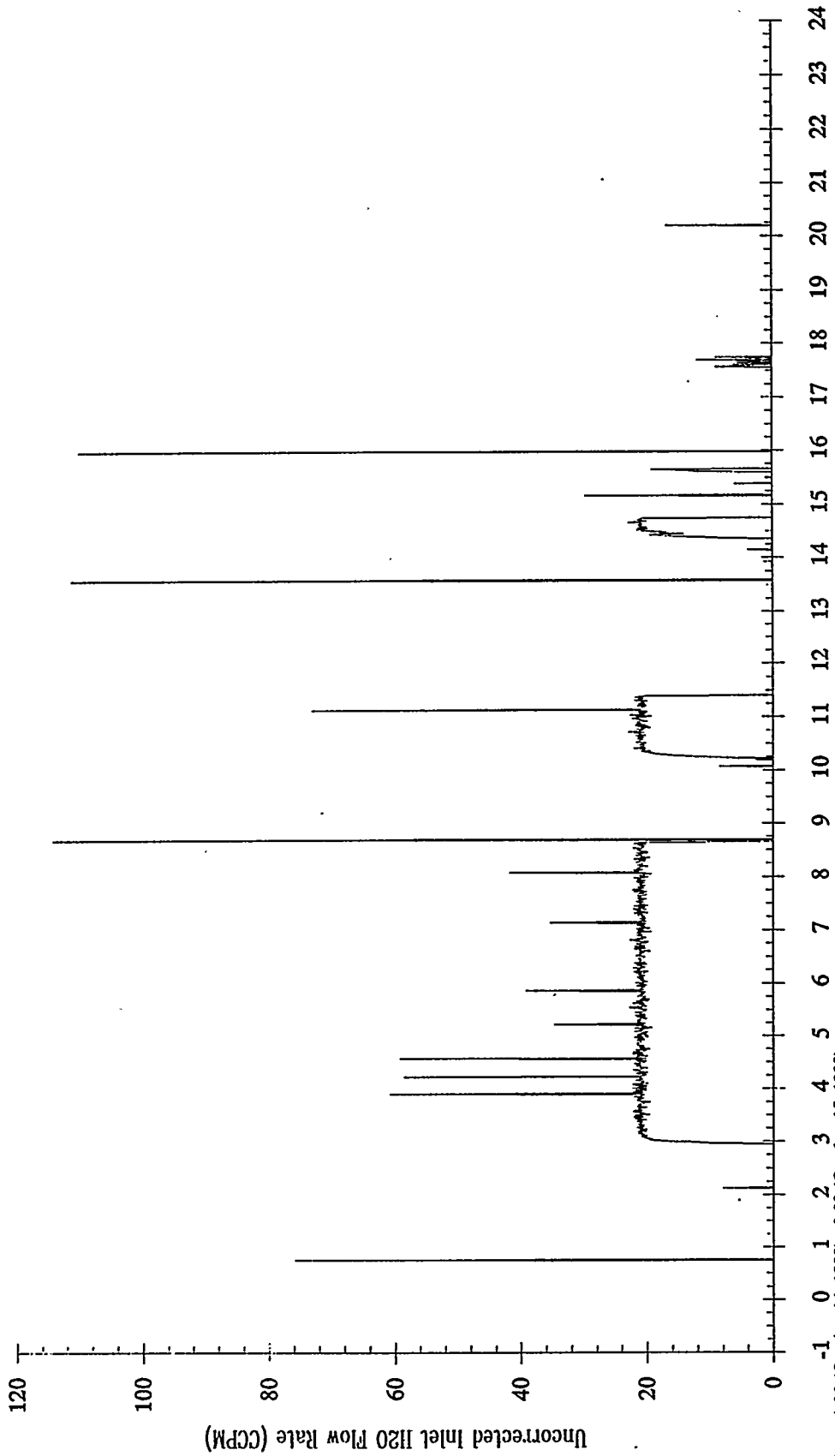

Test time: 1:00 (October 14, 1992) - 0:03 (October 15, 1992)
Test duration: 23:03

L-3787M Zinc Titanate
u=0.5 ft/sec T=1000 °F
H2S Inlet Conc. = 800 ppm

Multi-Cycle Tests - ZTMC-02 Sulfidation 2

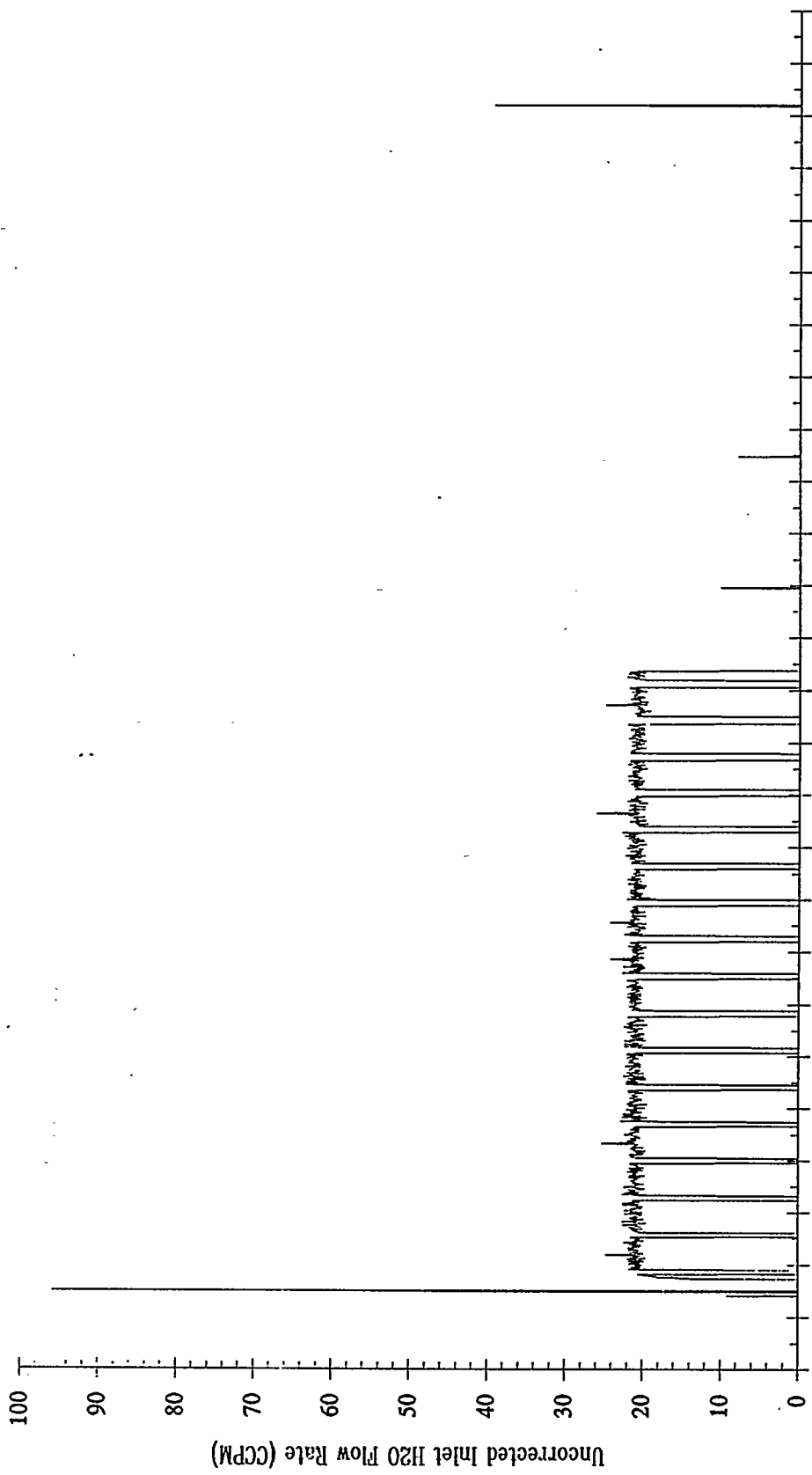

Test time: 18:00 (October 15, 1992) - 18:03 (October 16, 1992)
Test duration: 24:03

L-3787M Zinc Titanate
u=2.0 ft/sec T=1200 F
H2S Inlet Conc. = 800 ppm

Multi-Cycle Tests - ZTMC-02 Sulfidation 3

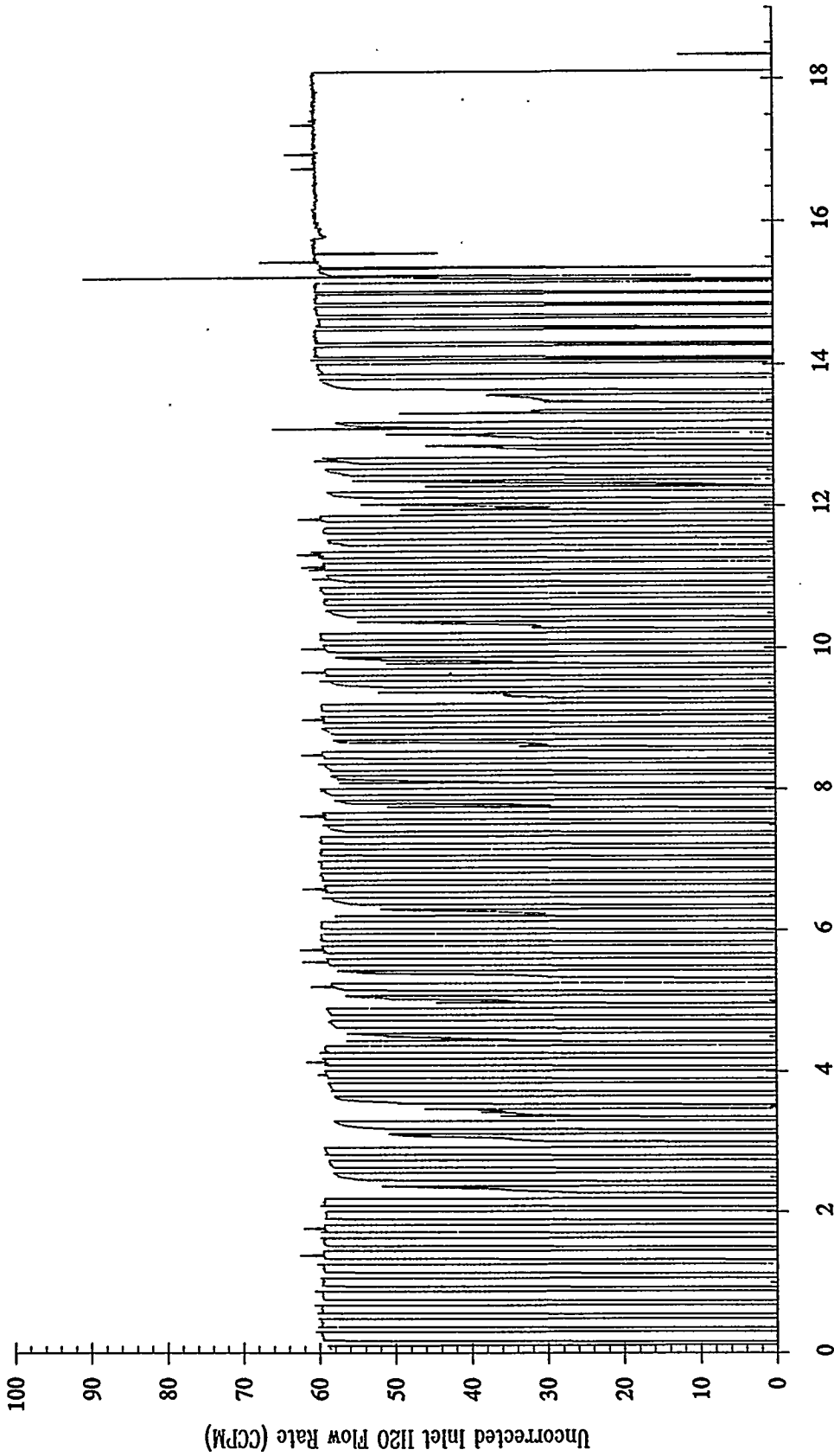

Test time: 20:00 (October 19, 1992) - 14:05 (October 20, 1992)
Test duration: 18:05

L-3787M Zinc Titanate
u=1.0 ft/sec T=1000 F
H2S Inlet Conc. = 800 ppm

Multi-Cycle Tests - ZTMC-04 Sulfidation 1

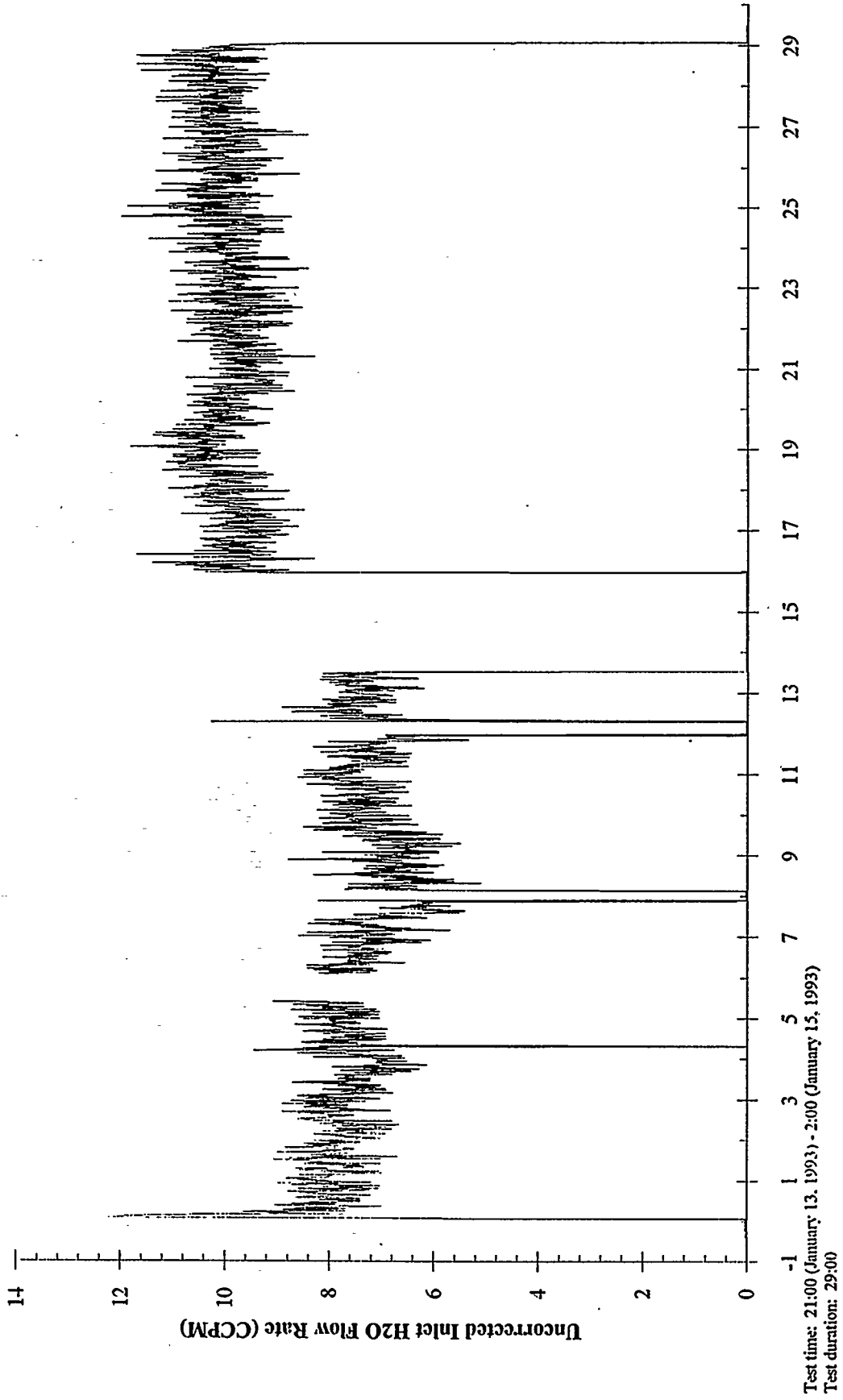

L-3787Al Zinc Titanate
u=1.0 ft/sec T=1000 F
H2S Inlet Conc. = 800 ppm

Multi-Cycle Tests - ZTMC-04 Sulfidation 2

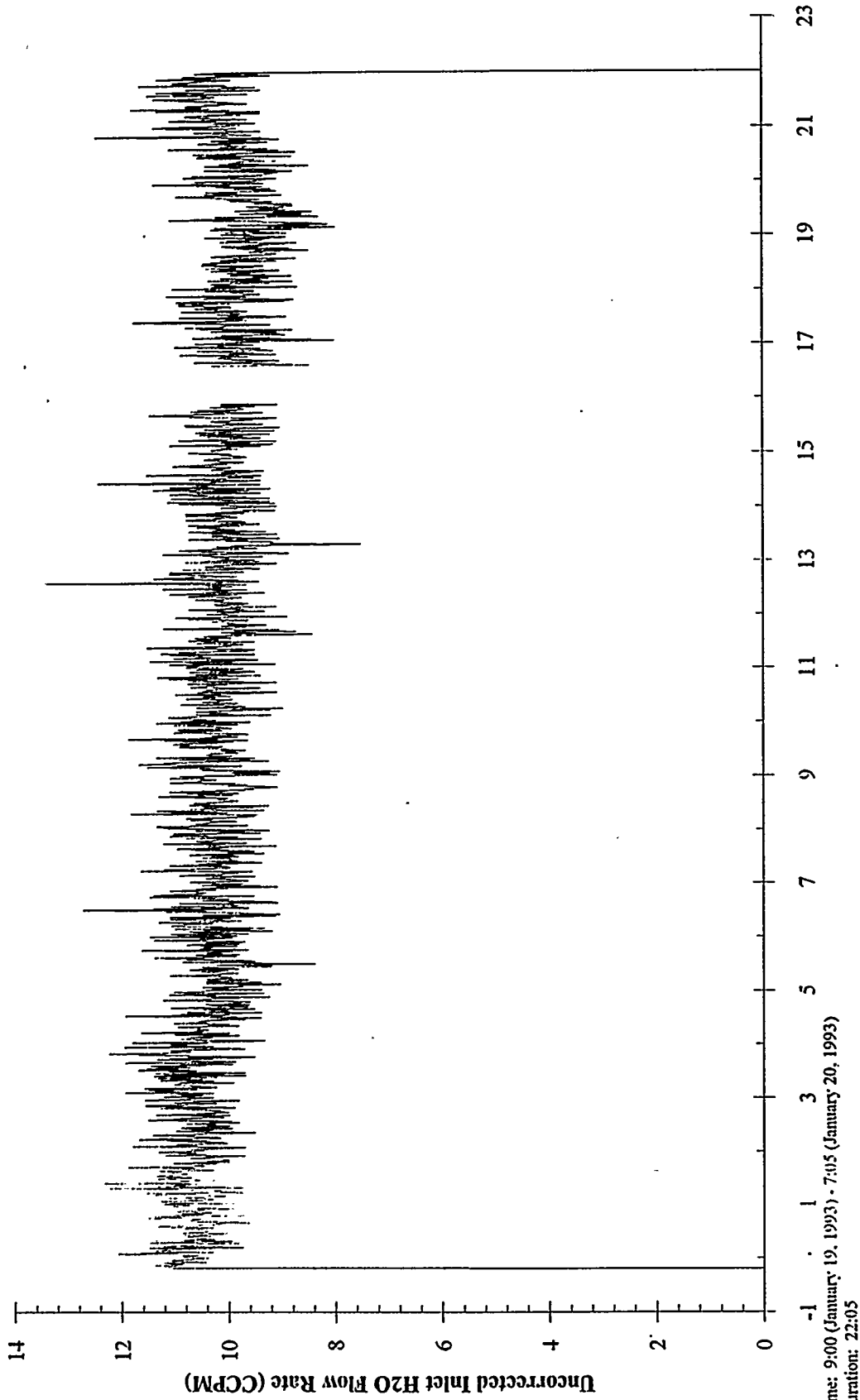

Test time: 9:00 (January 19, 1993) - 7:05 (January 20, 1993)
Test duration: 22:05

L-3787M Zinc Titanate
u=1.0 ft/sec T=1000 °F
H2S Inlet Conc. = 800 ppm

Multi-Cycle Tests - ZTMC-04 Sulfidation 3

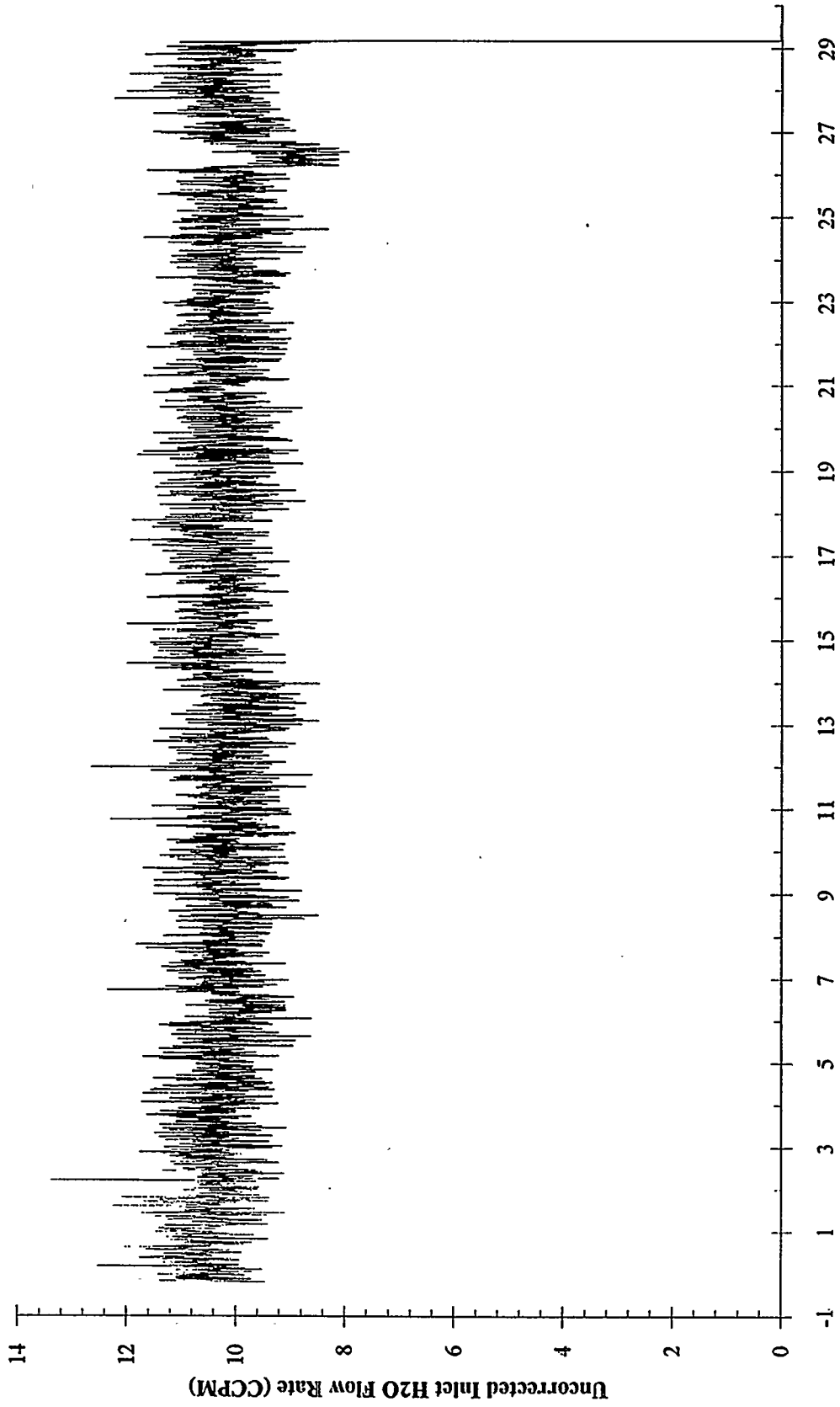

Test time: 8:30 - 22:33, 23:30 (January 21, 1993) - 14:32 (January 22, 1993)
Test duration: 29:05

L-3787A1 Zinc Titanate
u=1.0 ft/sec T=1000 F
H2S Inlet Conc. = 2000 ppm

Single Cycle Tests - ZTSC-08 Sulfidation 1

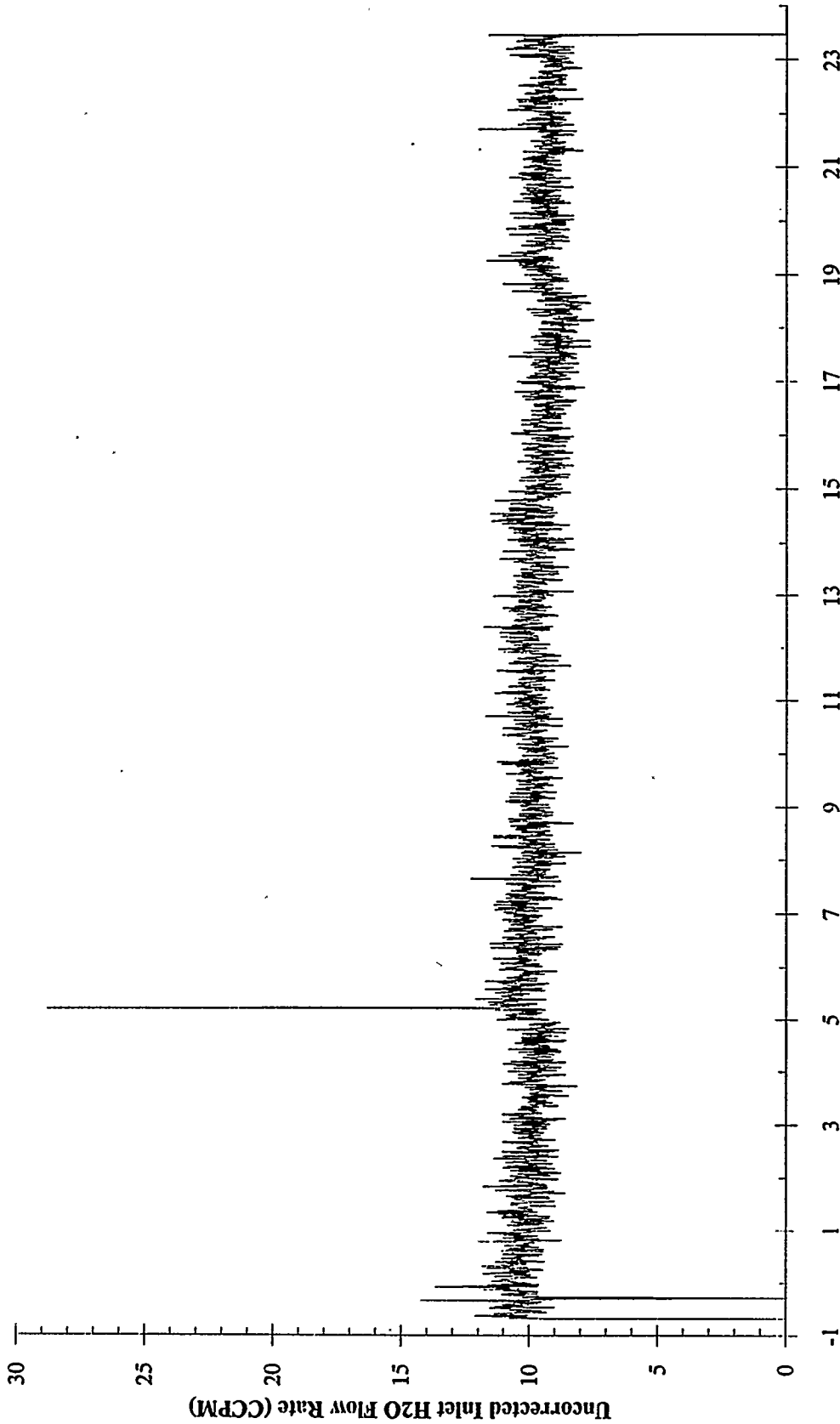

Test time: 10:00-14:57. 17:30 - (January 26, 1993) - 11:53 (January 27, 1993)
Test duration: 23:20

APPENDIX B
Data Acquisition Temperature Trends

System temperatures were monitored by DDAS, a PC-based automatic data acquisition system. Trend plots for thermocouple (Omega Type K) readings in the sorbent bed zones are presented here.

L-3787M Zinc Titanate
u=2.0 ft/sec T=1100 °F
E2S Inlet Conc. = 800 ppm

Single Cycle Tests - ZTSC-01 Sulfidation 1

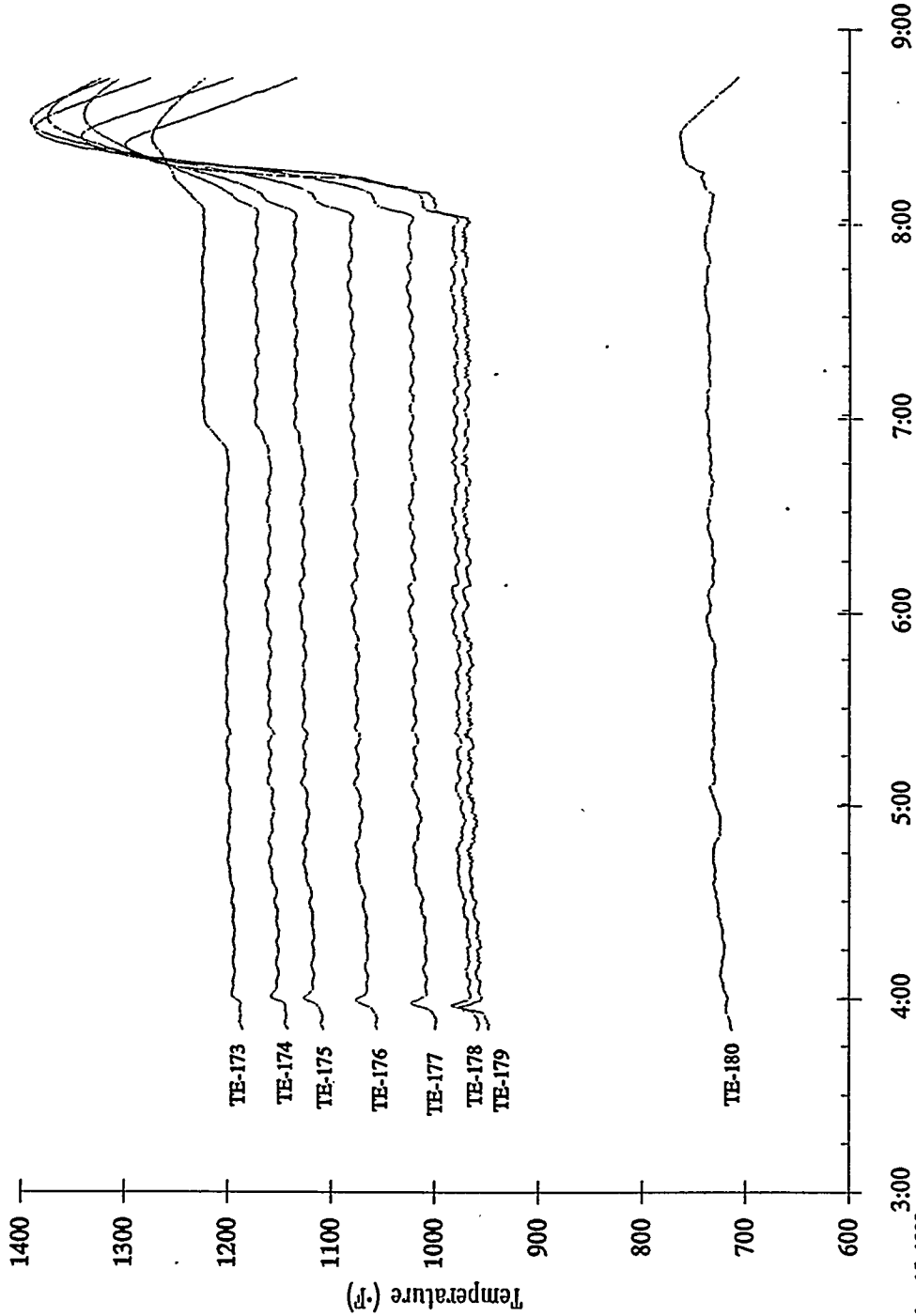

- TE-173 (1" below cage bottom)
- TE-174 (2" above cage bottom)
- TE-175 (5" above cage bottom)
- TE-176 (8" above cage bottom)
- TE-177 (11" above cage bottom)
- TE-178 (14" above cage bottom)
- TE-179 (1" above sorbent bed)
- TE-180 (12.5" above sorbent bed)

September 15, 1992
Test time: 4:35-8:08 (Test duration: 3:33)

L-3787M Zinc Titanate
u=1.0 ft/sec T=1100 F
H2S Inlet Conc. = 800 ppm

Single Cycle Tests - ZTSC-02 Sulfidation 1

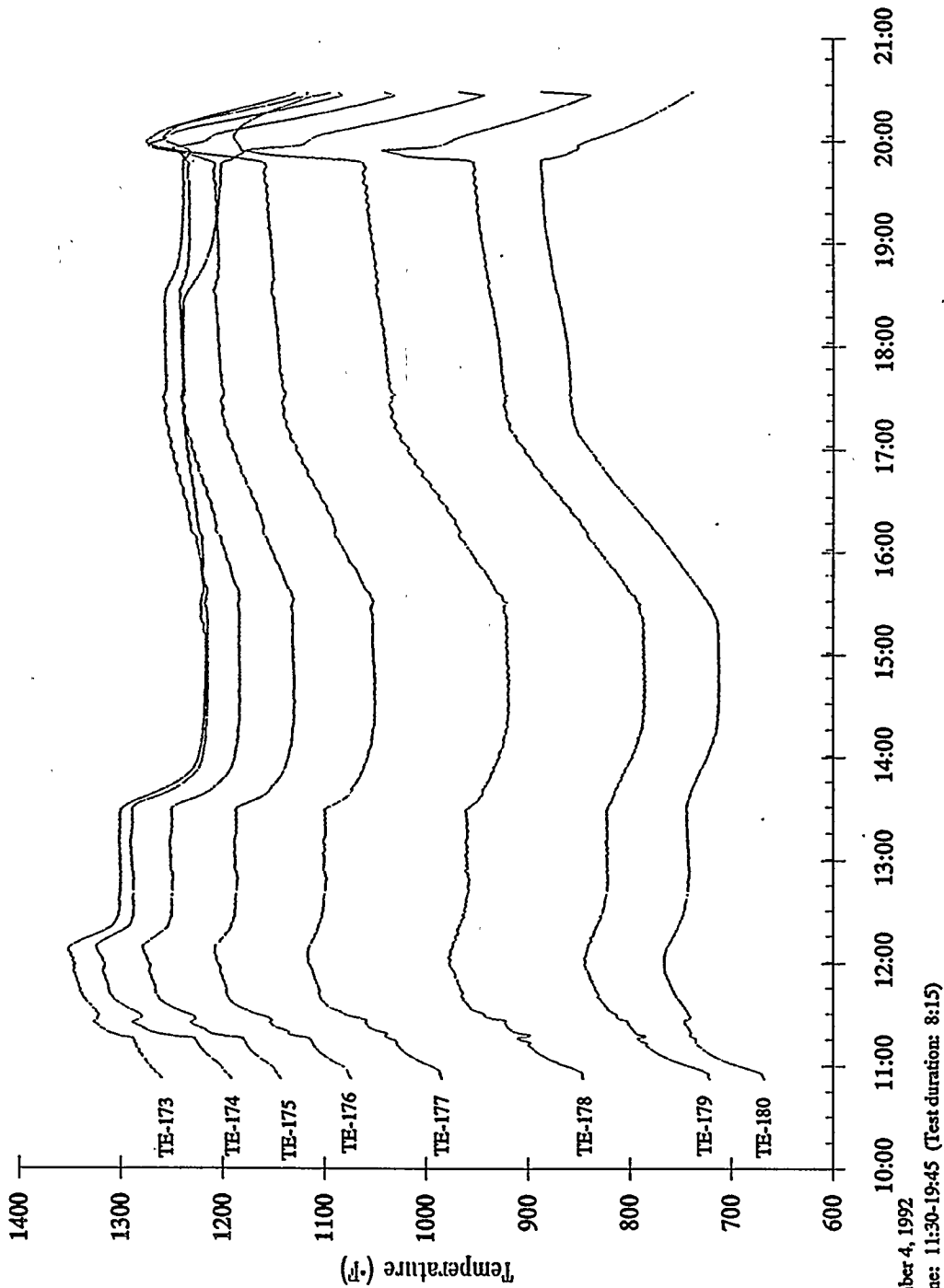

L-3787M Zinc Titanate
 u=1.0 ft/sec T=1100 °F
 H2S Inlet Conc. = 800 ppm

Single Cycle Tests - ZTSC-03 Sulfidation 1

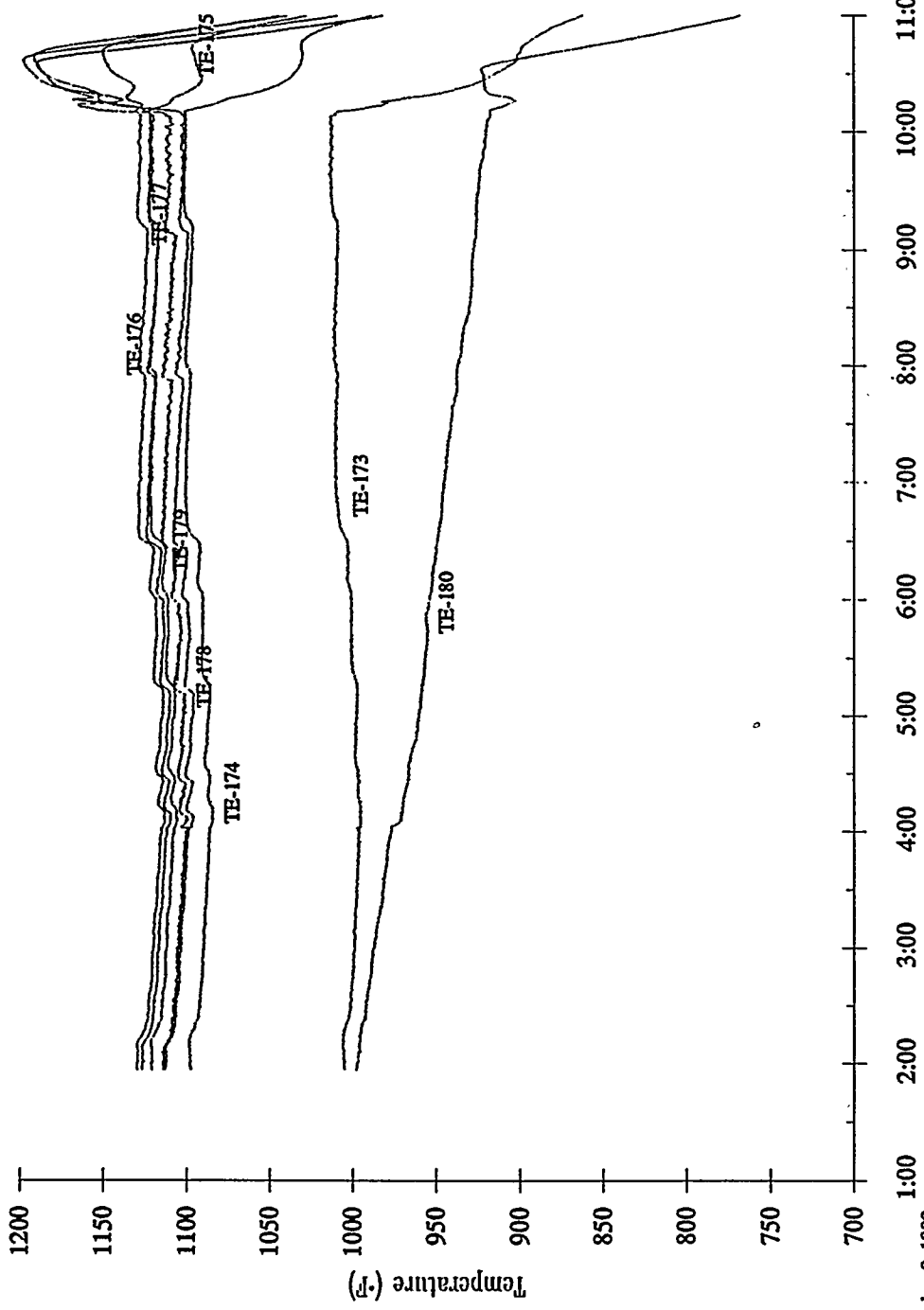

- TE-173 (1" below cage bottom)
- - - TE-174 (2" above cage bottom)
- TE-175 (5" above cage bottom)
- . - . - TE-176 (8" above cage bottom)
- TE-177 (11" above cage bottom)
- TE-178 (14" above cage bottom)
- - - TE-179 (1" above sorbent bed)
- TE-180 (12.5" above sorbent bed)

September 9, 1992
 Test time: 1:00-10:05 (Test Length: 9:05)

L-3787M Zinc Titanate
 u=1.0 f/sec T=1000 F
 H2S Inlet Conc. = 800 ppm

Single Cycle Tests - ZTSC-04 Sulfidation 1

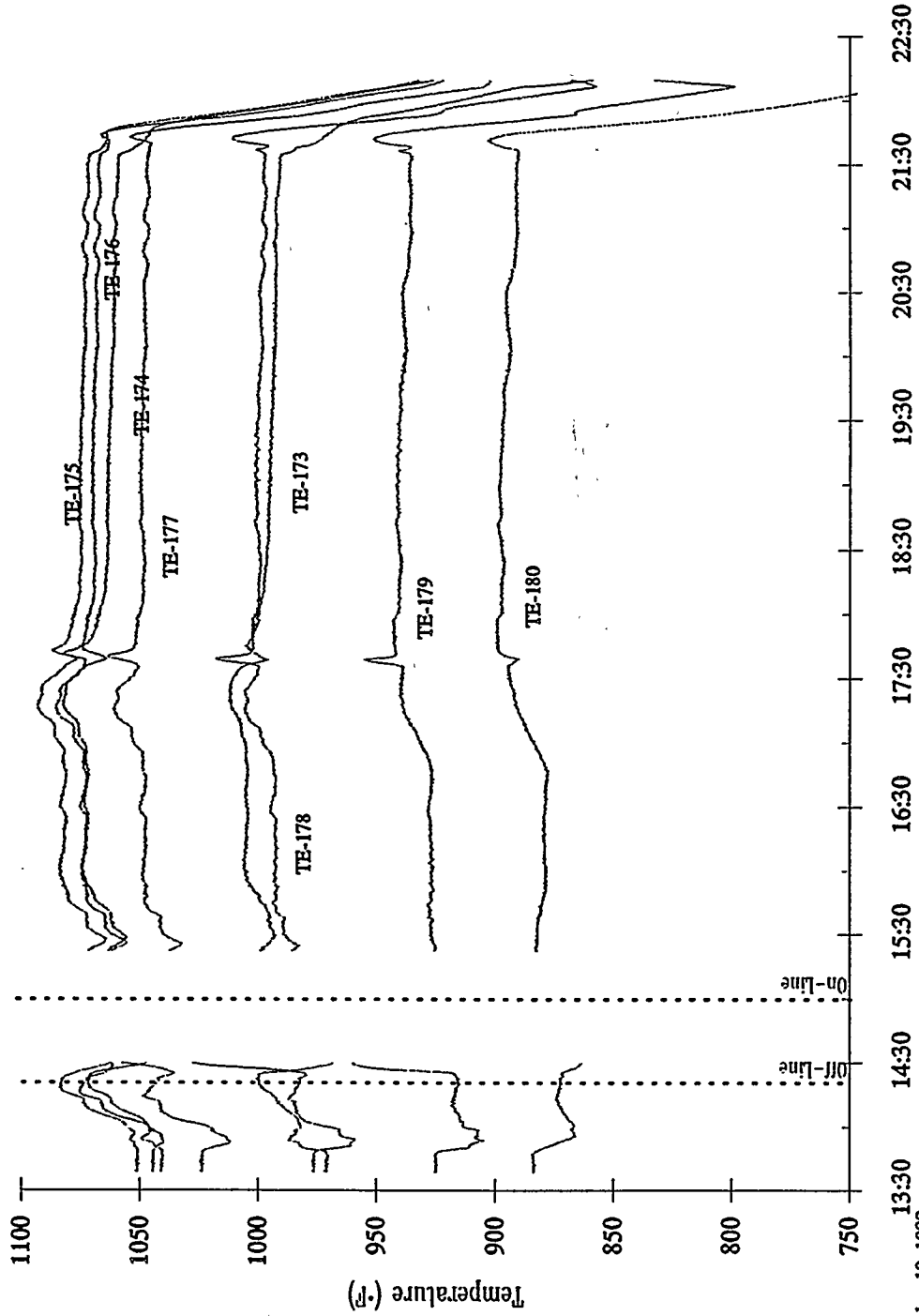

- TE-173 (1" below cage bottom)
- - - TE-174 (2" above cage bottom)
- TE-175 (5" above cage bottom)
- · - · - TE-176 (8" above cage bottom)
- · - · - TE-177 (11" above cage bottom)
- TE-178 (14" above cage bottom)
- - - TE-179 (1" above sorbent bed)
- TE-180 (12.5" above sorbent bed)

September 10, 1992
 Test time: 14:00-14:23, 15:00-21:33 (Test duration: 6:56)

L-3787M Zinc Titanate
u=1.0 ft/sec T=1200 °F
H2S Inlet Conc. = 800 ppm

Single Cycle Tests - ZTSC-05 Sulfidation 1

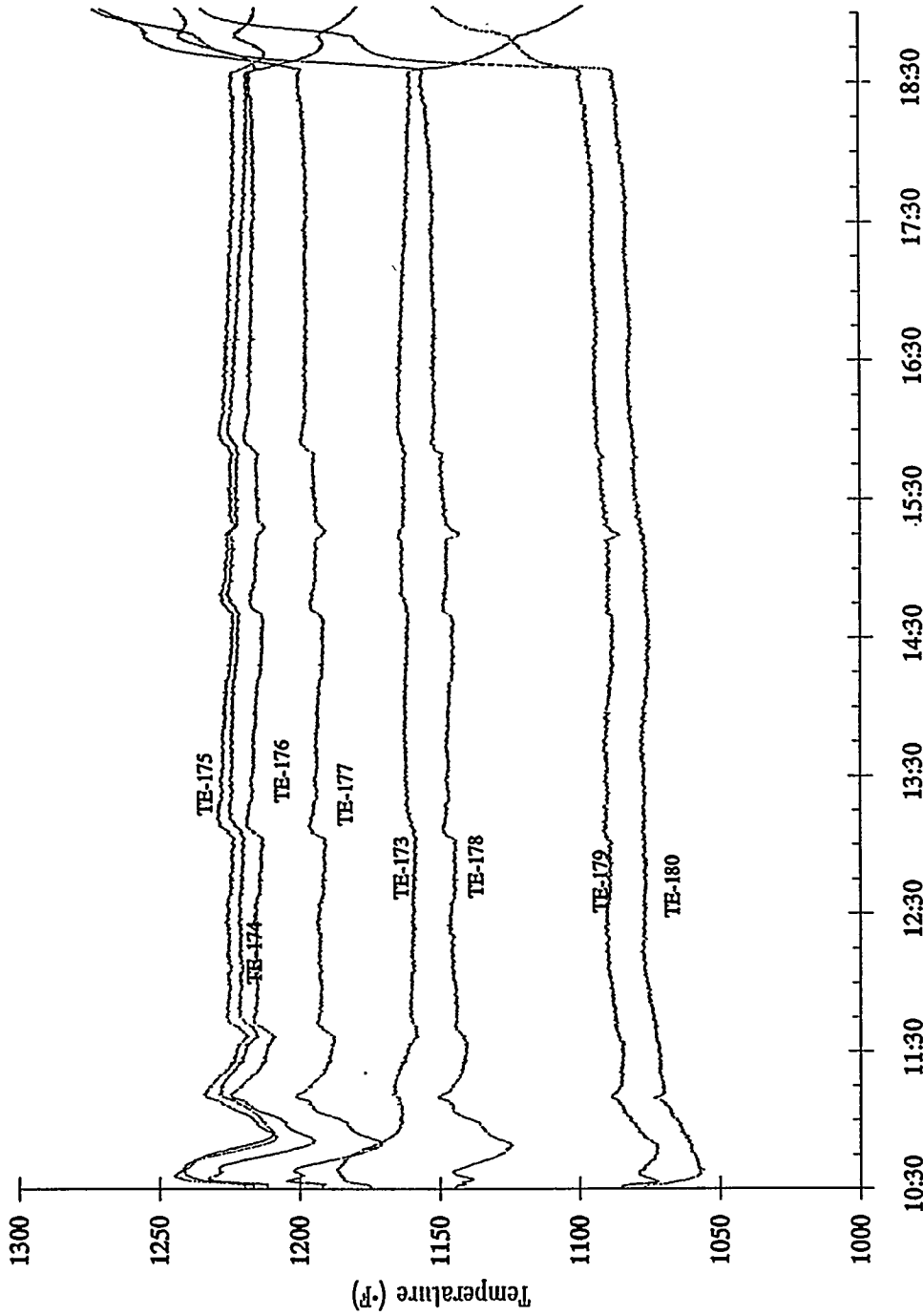

—	TE-173 (1" below cage bottom)
- - -	TE-174 (2" above cage bottom)
.....	TE-175 (5" above cage bottom)
- . - . -	TE-176 (8" above cage bottom)
- - -	TE-177 (11" above cage bottom)
—	TE-178 (14" above cage bottom)
- - -	TE-179 (1" above sorbent bed)
.....	TE-180 (12.5" above sorbent bed)

September 15, 1992
Test time: 11:00-18:34 (Test duration: 7:34)

L-3787M Zinc Titanate
 u=0.5 ft/sec T=1200 °F
 H2S Inlet Conc. = 800 ppm

Single Cycle Tests - ZTSC-06 Sulfidation 1

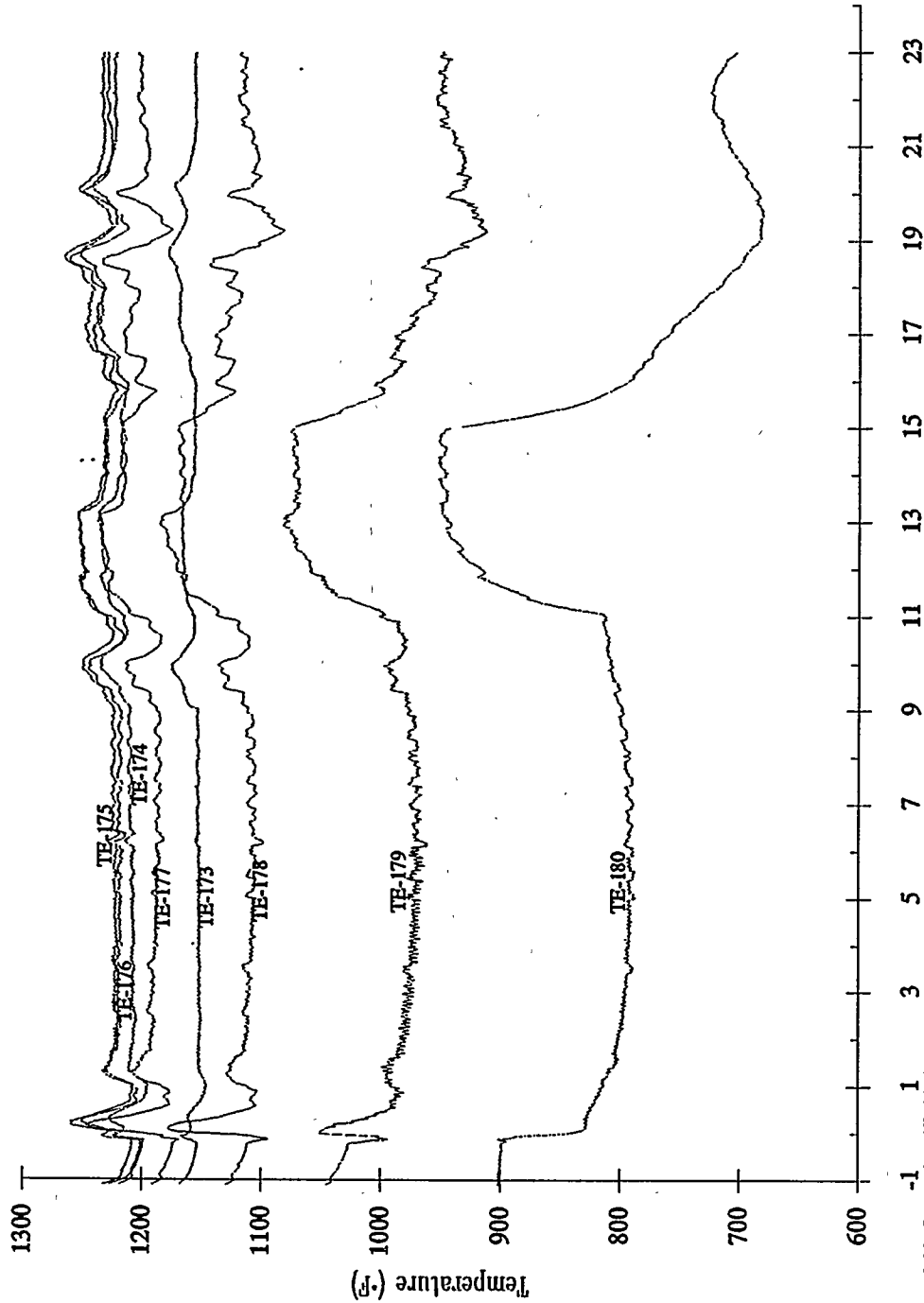

- TE-173 (1" below cage bottom)
- - - TE-174 (2" above cage bottom)
- TE-175 (5" above cage bottom)
- - - TE-176 (8" above cage bottom)
- TE-177 (11" above cage bottom)
- TE-178 (14" above cage bottom)
- - - TE-179 (1" above sorbent bed)
- TE-180 (12.5" above sorbent bed)

-1 1 3 5 7 9 11 13 15 17 19 21 23
 Test time: 9:00 (September 17, 1992) - 6:05 (September 19, 1992)
 Test duration: 45:05

L-3787M Zinc Titanate
 u=0.5 ft/sec T=1200 °F
 H2S Inlet Conc. = 800 ppm

Single Cycle Tests - ZTSC-06 Sulfidation 1

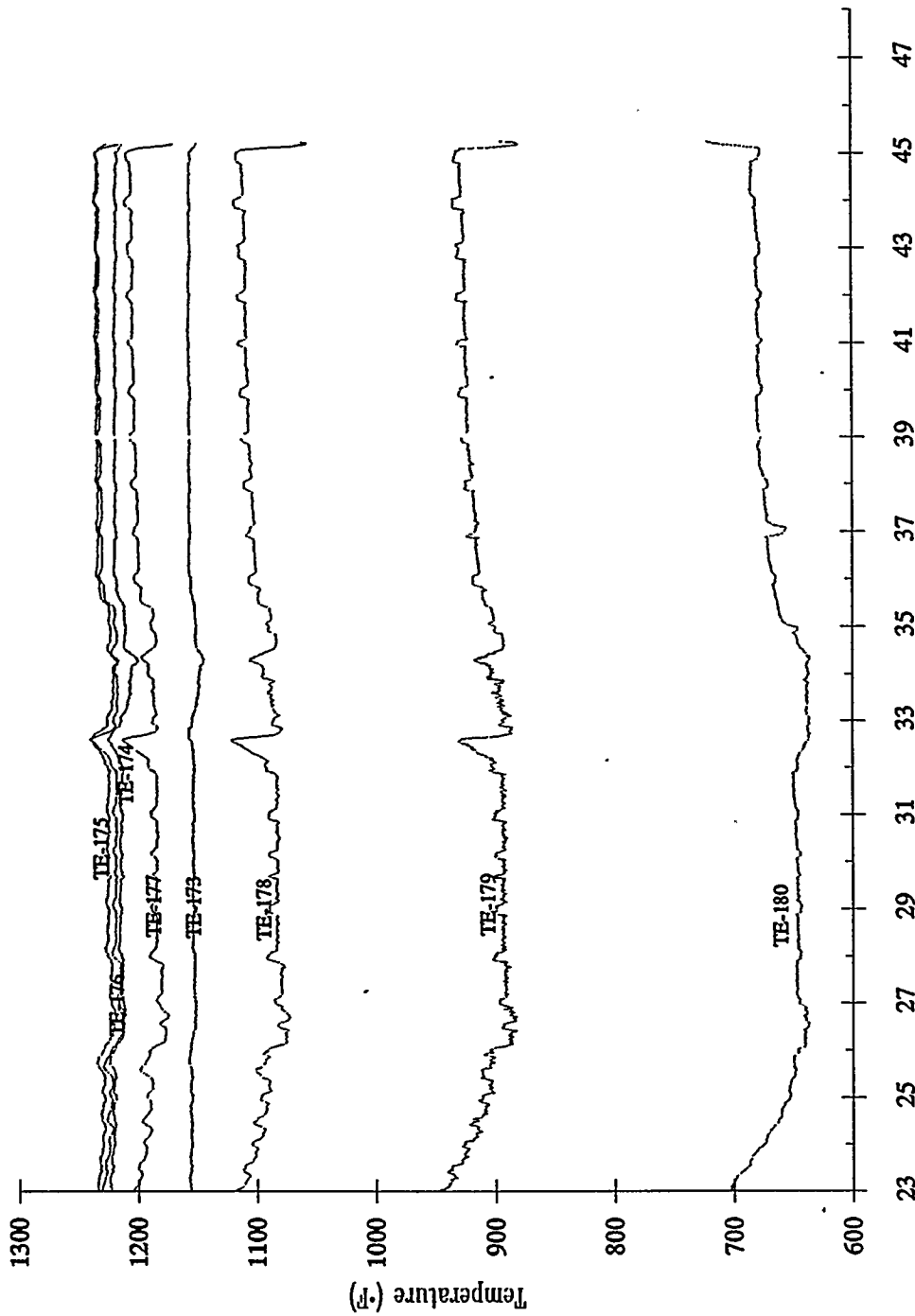

- TE-173 (1" below cage bottom)
- - - TE-174 (2" above cage bottom)
- TE-175 (5" above cage bottom)
- . - . - . TE-176 (8" above cage bottom)
- TE-177 (11" above cage bottom)
- TE-178 (14" above cage bottom)
- - - TE-179 (1" above sorbent bed)
- TE-180 (12.5" above sorbent bed)

Test time: 9:00 (September 17, 1992) - 6:05 (September 19, 1992)
 Test duration: 45:05

L-3787M Zinc Titanate
u=0.5 ft/sec T=1000 °F
H2S Inlet Conc. = 800 ppm

Single Cycle Tests - ZTSC-07 Sulfidation 1

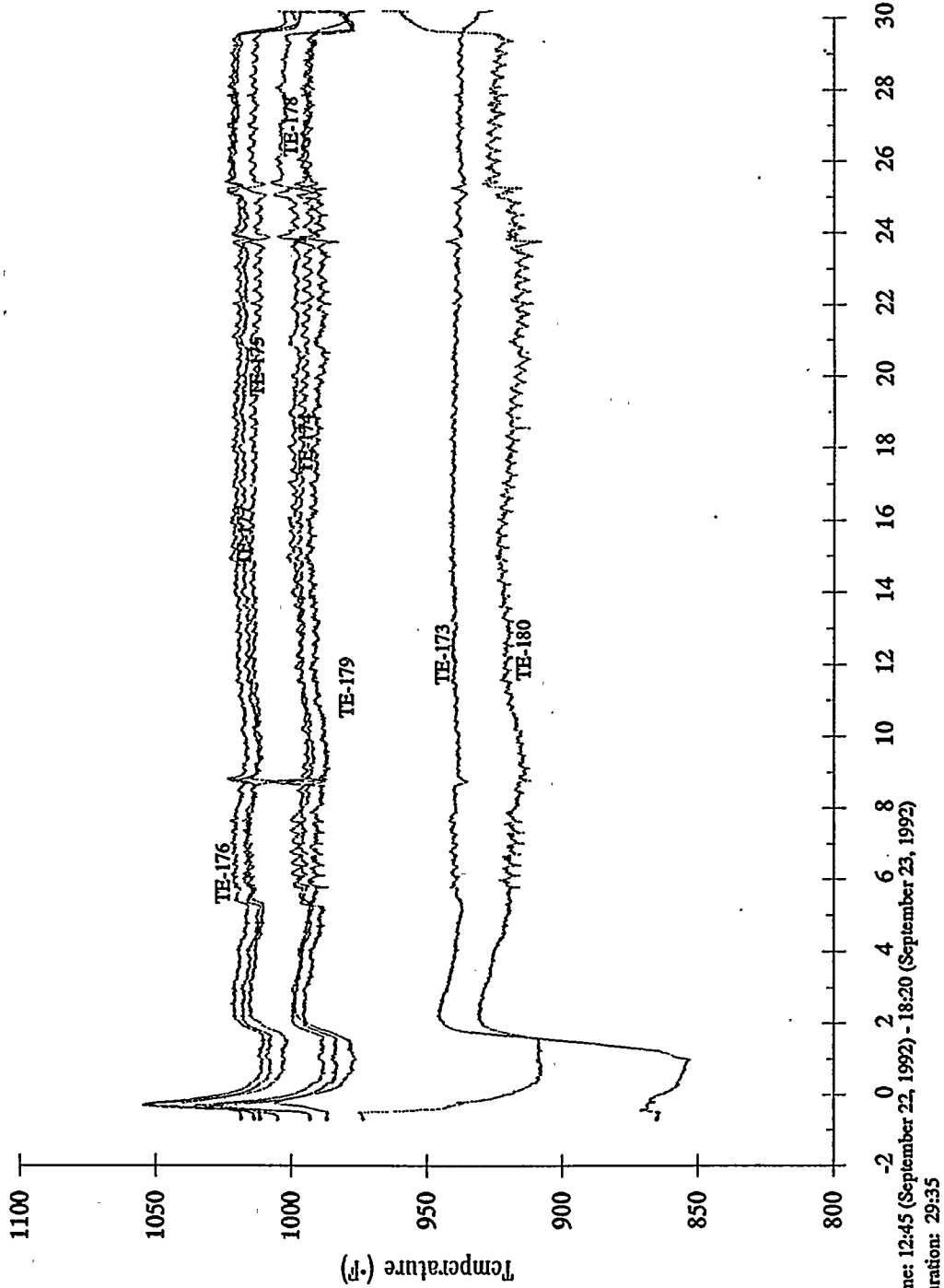

Test time: 12:45 (September 22, 1992) - 18:20 (September 23, 1992)
Test duration: 29:35

L-3787M Zinc Titanate
u=0.5 ft/sec T_{max}=1400 °F
O₂ Inlet Conc. = 2.5 %

Single Cycle Tests - ZTSC-07 Regeneration 1

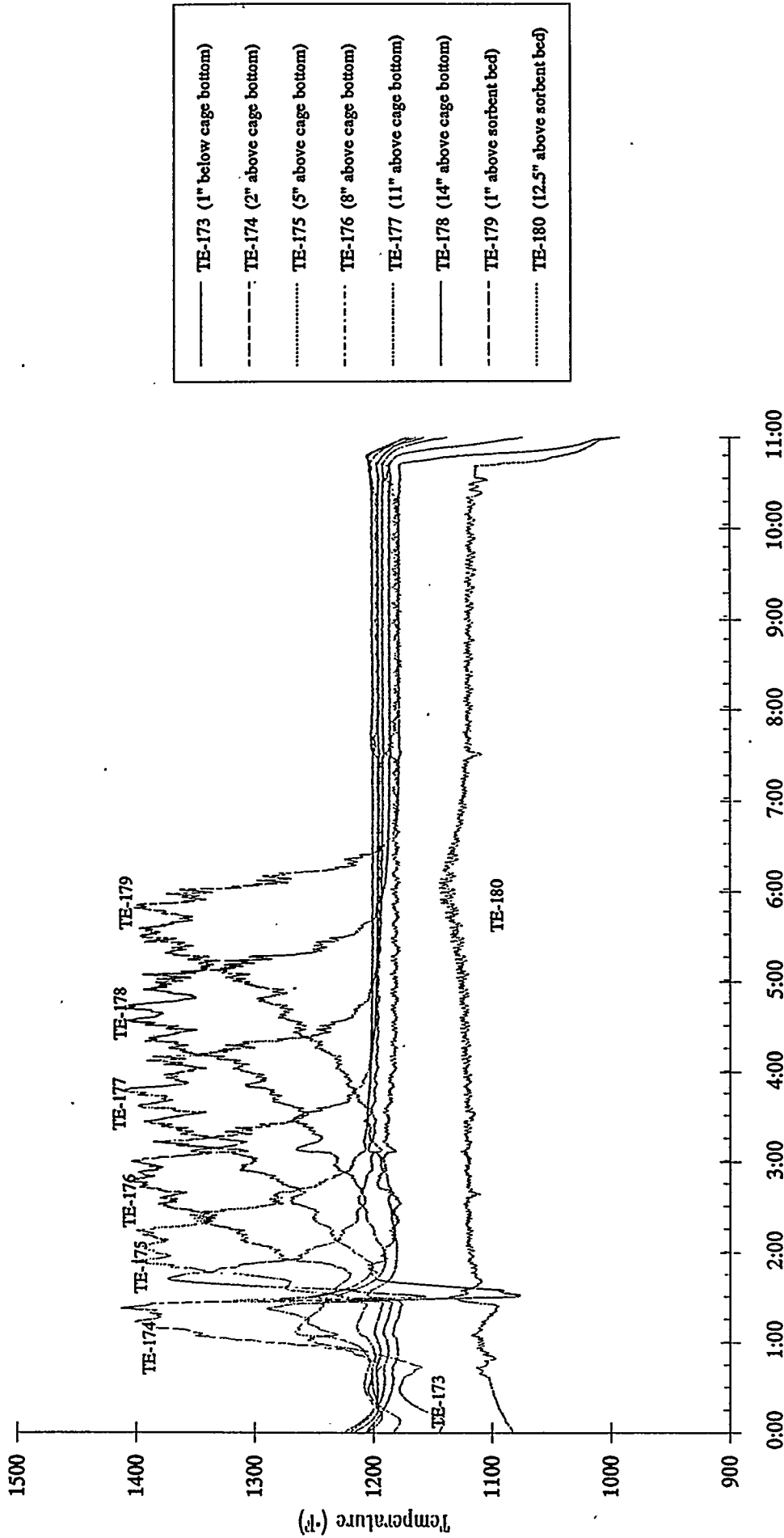

September 24, 1992
Test time: 0:45-10:26 (Test duration: 9:41)

L-3787M Zinc Titanate
 u=0.5 ft/sec T=1000 °F
 H2S Inlet Conc. = 800 ppm

Single Cycle Tests - ZTSC-07 Sulfidation 2

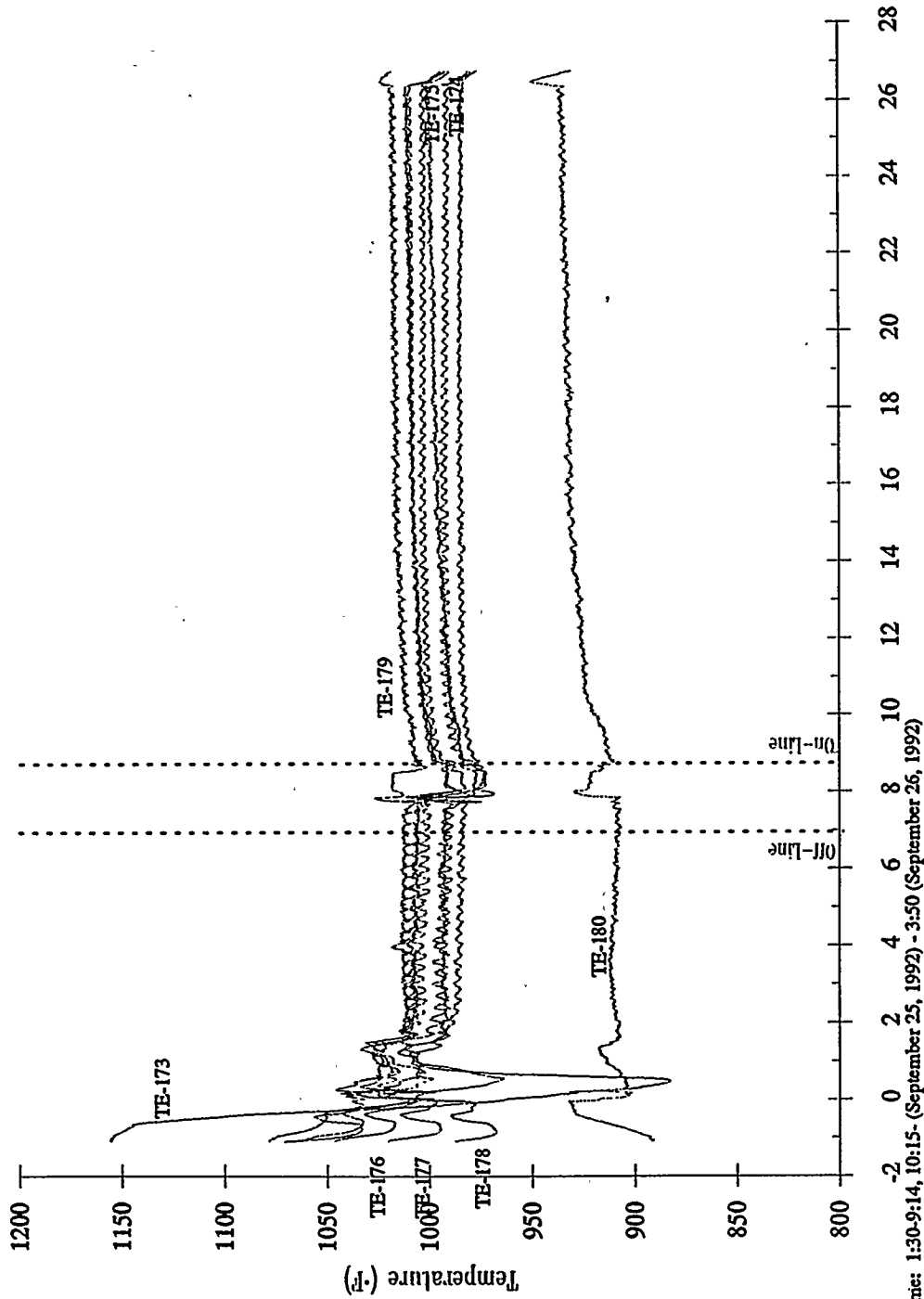

—	TE-173 (1" below cage bottom)
- - -	TE-174 (2" above cage bottom)
.....	TE-175 (5" above cage bottom)
- . - . - .	TE-176 (8" above cage bottom)
- - - - -	TE-177 (11" above cage bottom)
—	TE-178 (14" above cage bottom)
- - -	TE-179 (1" above sorbent bed)
.....	TE-180 (12.5" above sorbent bed)

Test time: 1:30-9:14, 10:15- (September 25, 1992) - 3:50 (September 26, 1992)
 Test duration: 25:19

L-3787M Zinc Titanate
 u=1.0 ft/sec Tmax=1400 °F
 O2 Inlet Conc. = 2.5 %

Single Cycle Tests - ZTSC-07 Regeneration 2

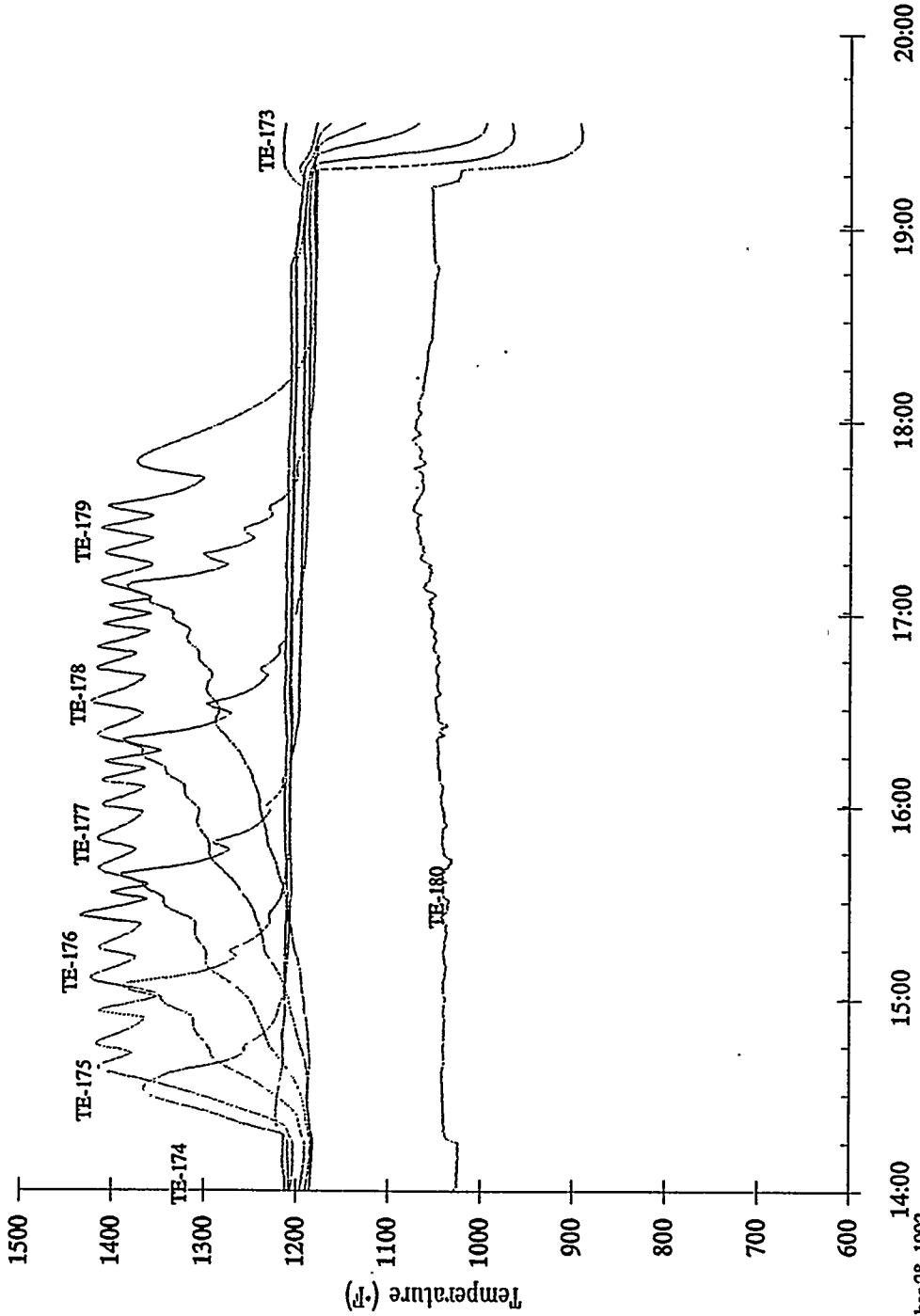

- TE-173 (1" below cage bottom)
- - - TE-174 (2" above cage bottom)
- TE-175 (5" above cage bottom)
- . - . - TE-176 (8" above cage bottom)
- TE-177 (11" above cage bottom)
- TE-178 (14" above cage bottom)
- - - TE-179 (1" above sorbent bed)
- TE-180 (12.5" above sorbent bed)

September 28, 1992
 Test time: 14:15 - 18:49 (Test duration: 4:34)

L-3787M Zinc Titanate
 u=2.0 ft/sec T=1200 °F
 H2S Inlet Conc. = 800 ppm

Single Cycle Tests - ZTSC-07 Sulfidation 3

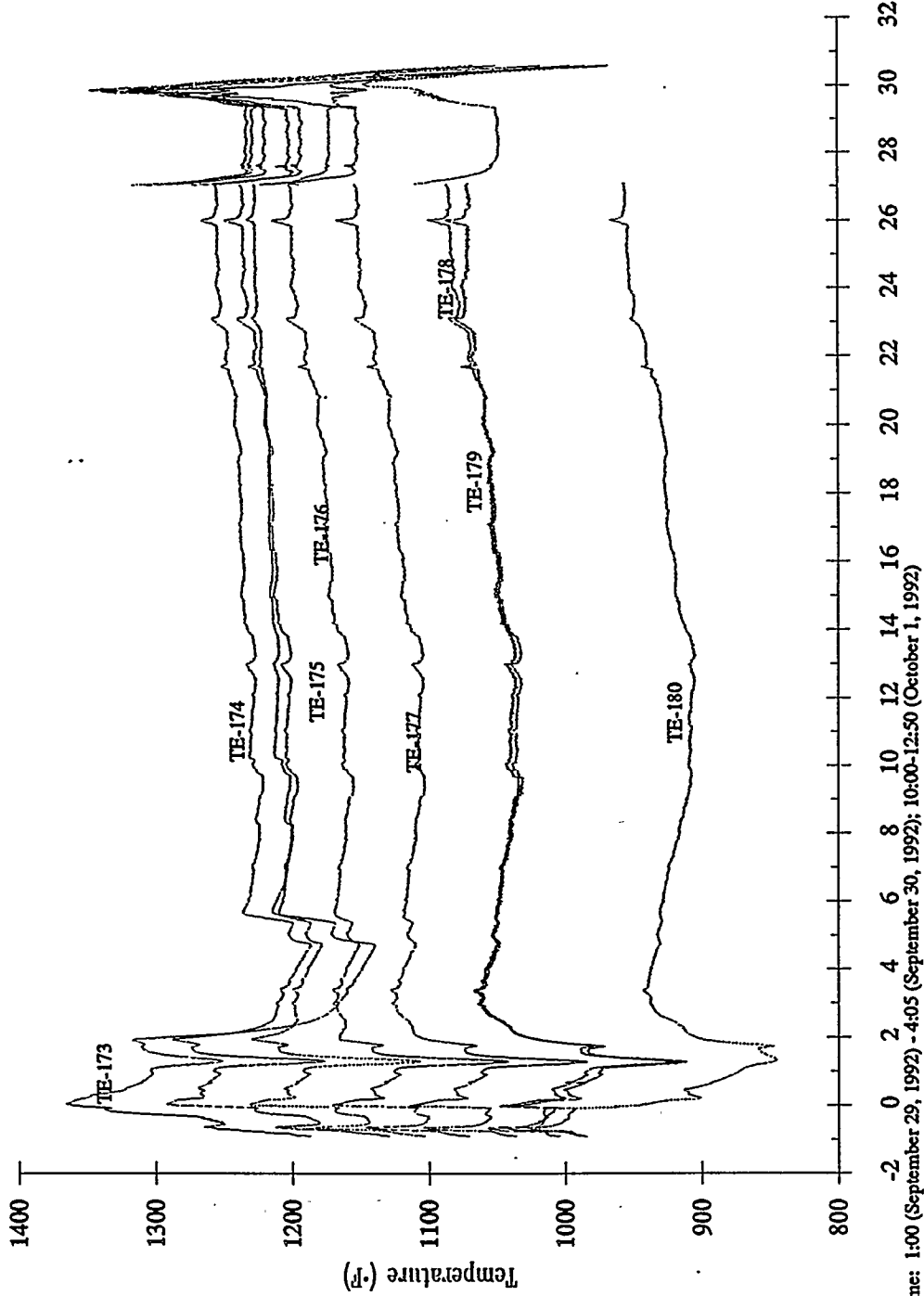

- TE-173 (1" below cage bottom)
- - - TE-174 (2" above cage bottom)
- TE-175 (5" above cage bottom)
- · - · - TE-176 (8" above cage bottom)
- · - · - TE-177 (11" above cage bottom)
- TE-178 (14" above cage bottom)
- - - TE-179 (1" above sorbent bed)
- TE-180 (12.5" above sorbent bed)

Test time: 1:00 (September 29, 1992) - 4:05 (September 30, 1992); 10:00-12:50 (October 1, 1992)
 Test duration: 29:55

L-3787M Zinc Titanate
 $u=0.33$ ft/sec $T_{max}=1400$ °F
 O_2 Inlet Conc. = 1.5 %

Single Cycle Tests - ZTSC-07 Regeneration 3

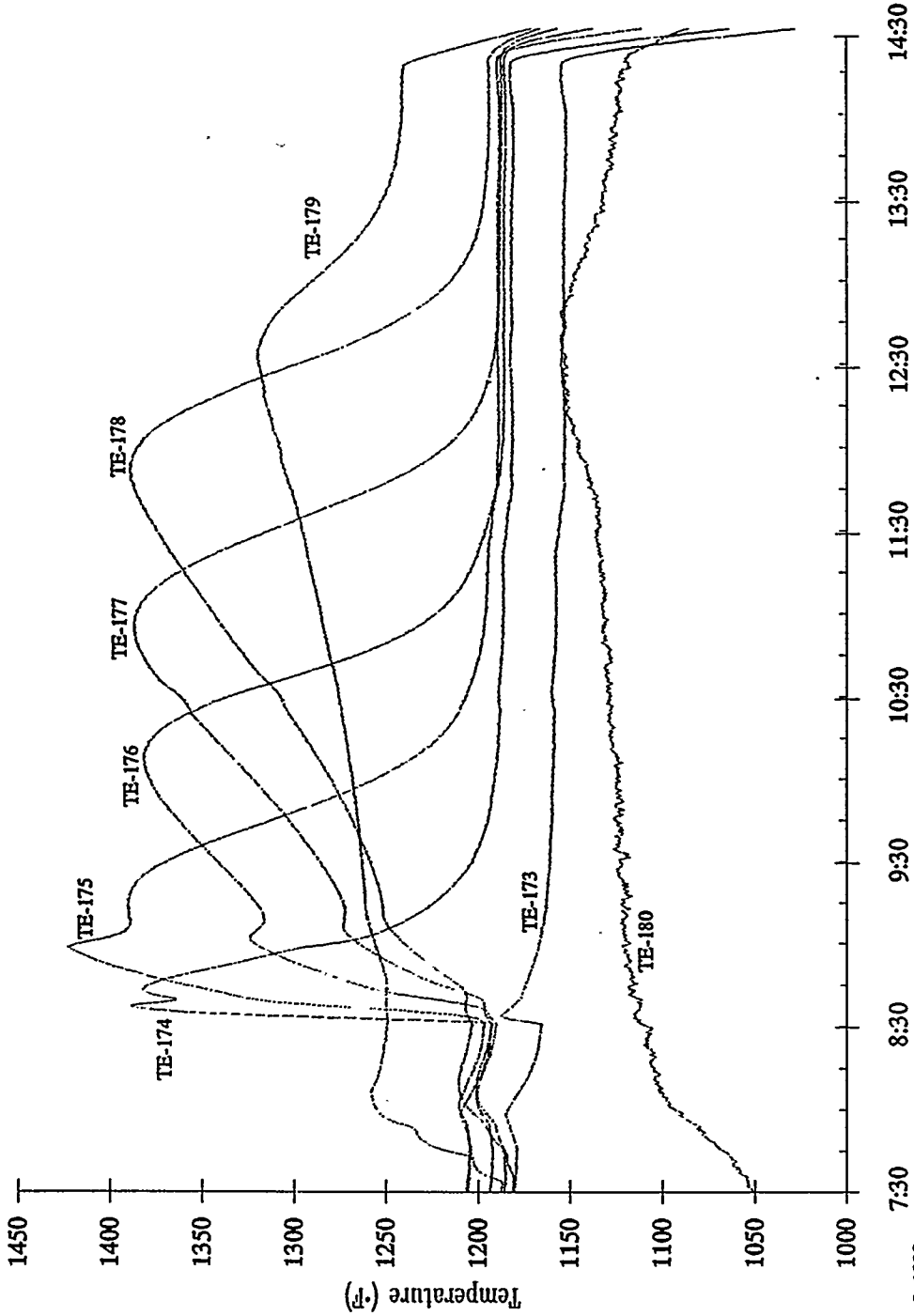

- TE-173 (1" below cage bottom)
- - - TE-174 (2" above cage bottom)
- TE-175 (5" above cage bottom)
- . - . - TE-176 (8" above cage bottom)
- TE-177 (11" above cage bottom)
- TE-178 (14" above cage bottom)
- - - TE-179 (1" above sorbent bed)
- TE-180 (12.5" above sorbent bed)

October 2, 1992
 Test time: 8:30-14:18 (Test duration: 5:48)

L-3787M Zinc Titanate
 u=0.5 ft/sec T=1200 °F
 H2S Inlet Conc. = 800 ppm

Multi-Cycle Tests - ZTMC-01 Sulfidation 1

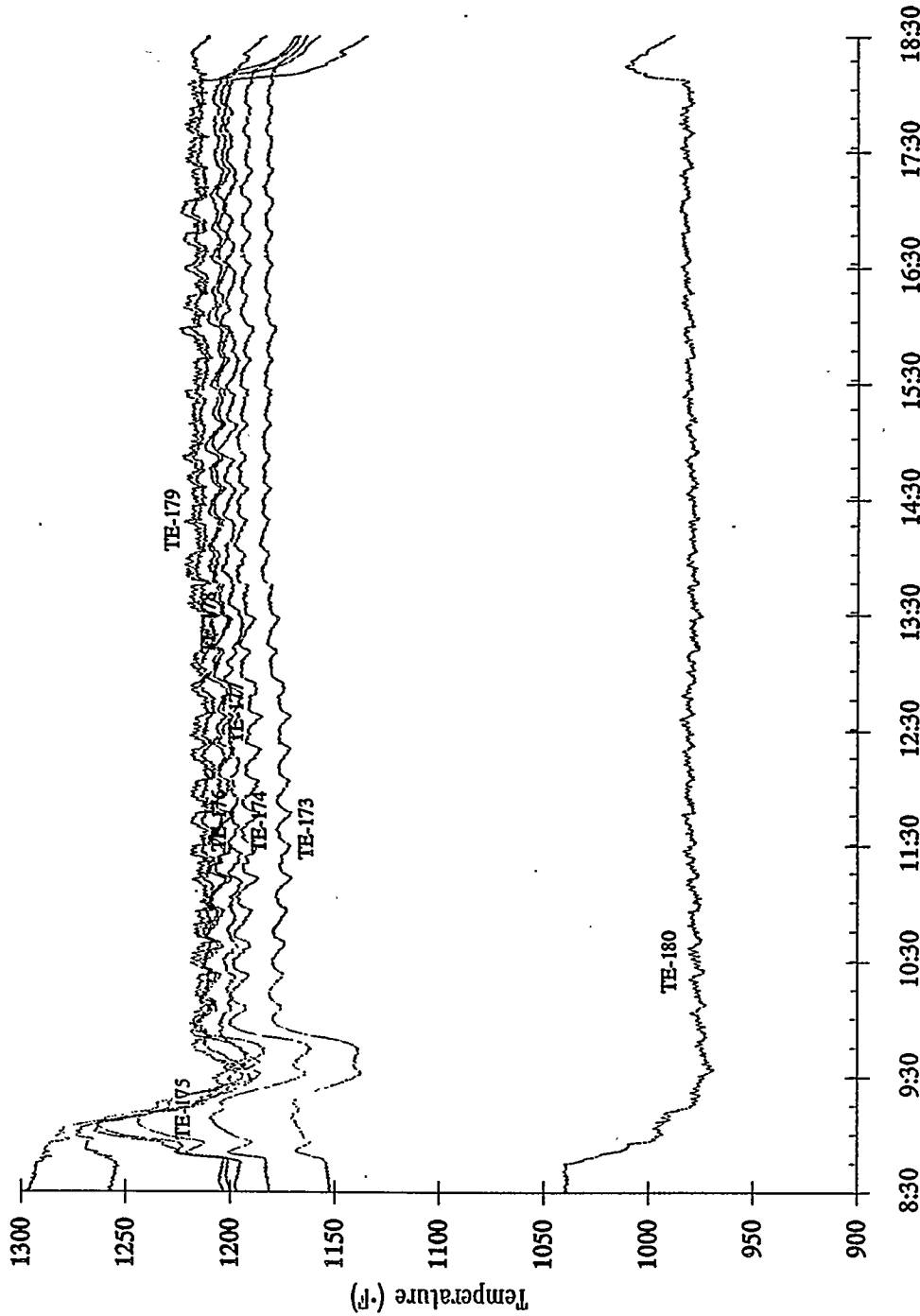

October 6, 1992
 Test time: 9:00-18:05 (Test duration: 9:05)

L-3787M Zinc Titanate
 u=1.0 ft/sec T_{max}=1400 °F
 O₂ Inlet Conc. = 1.5 %

Multi-Cycle Tests - ZTMC-01 Regeneration 1

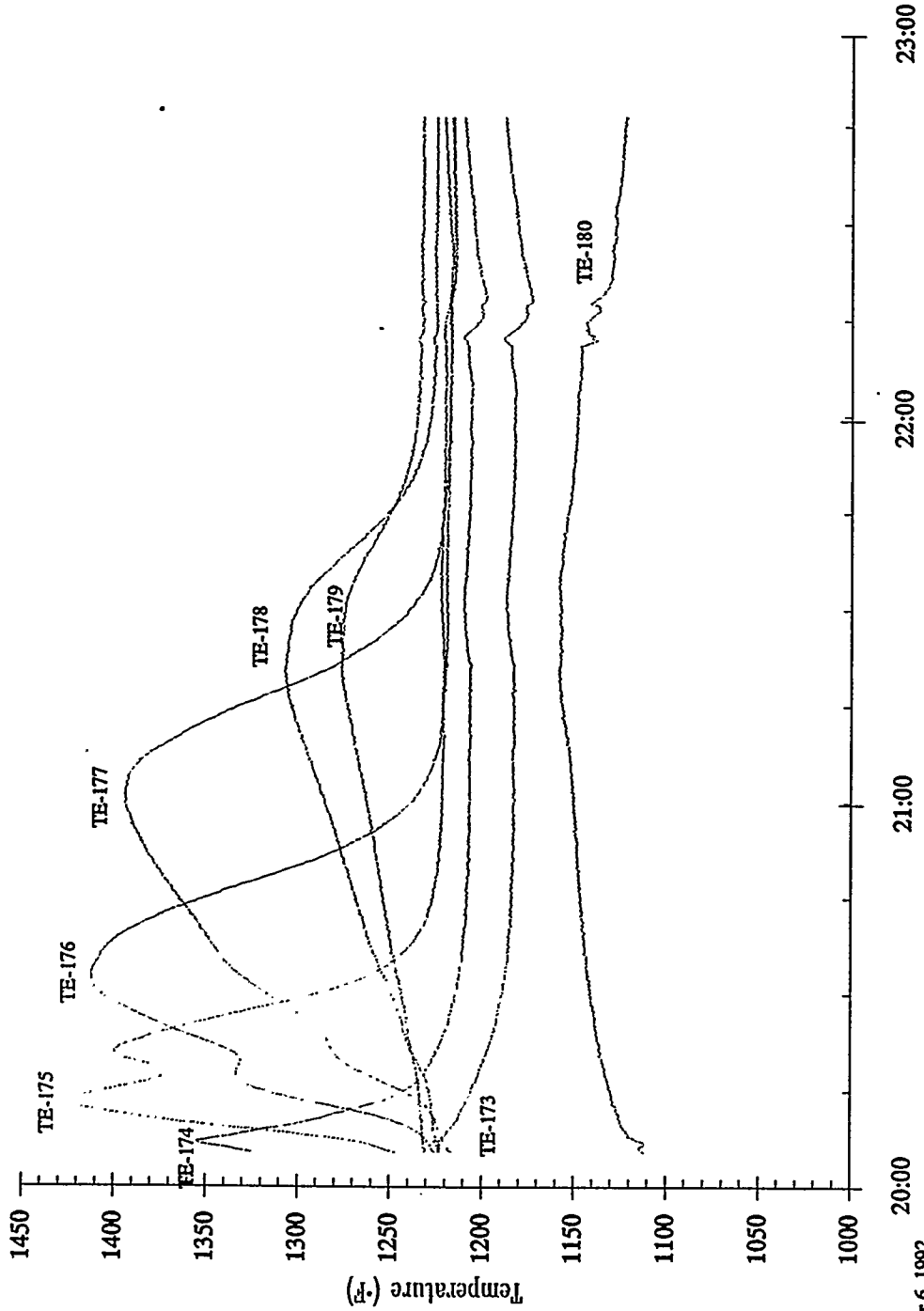

- TE-173 (1" below cage bottom)
- - - TE-174 (2" above cage bottom)
- TE-175 (5" above cage bottom)
- · - · - TE-176 (8" above cage bottom)
- · · · · TE-177 (11" above cage bottom)
- TE-178 (14" above cage bottom)
- - - TE-179 (17" above cage bottom)
- TE-180 (28.5" above cage bottom)

October 6, 1992
 Test time: 20:00-22:12 (Test duration: 2:12)

L-3787M Zinc Titanate
u=0.5 ft/sec T=1200 °F
H2S Inlet Conc. = 800 ppm

Multi-Cycle Tests - ZTMC-01 Sulfidation 2

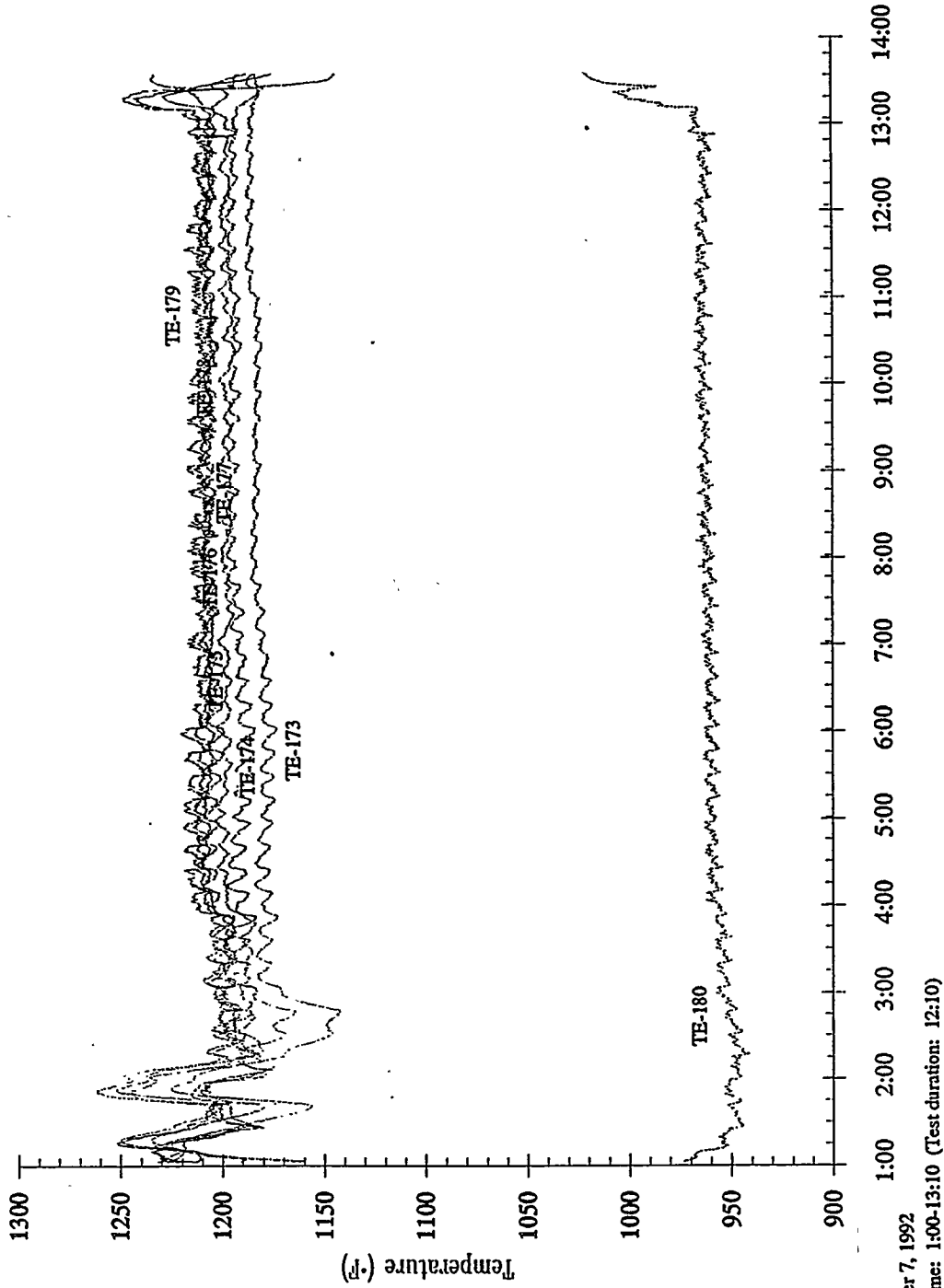

—	TE-173 (1" below cage bottom)
- - -	TE-174 (2" above cage bottom)
.....	TE-175 (5" above cage bottom)
- - -	TE-176 (8" above cage bottom)
.....	TE-177 (11" above cage bottom)
—	TE-178 (14" above cage bottom)
- - -	TE-179 (17" above cage bottom)
.....	TE-180 (28.5" above cage bottom)

L-3787M Zinc Titanate
u=1.0 ft/sec Tmax=1300 °F
O2 Inlet Conc. = 0.75 %

Multi-Cycle Tests - ZTMC-01 Regeneration 2

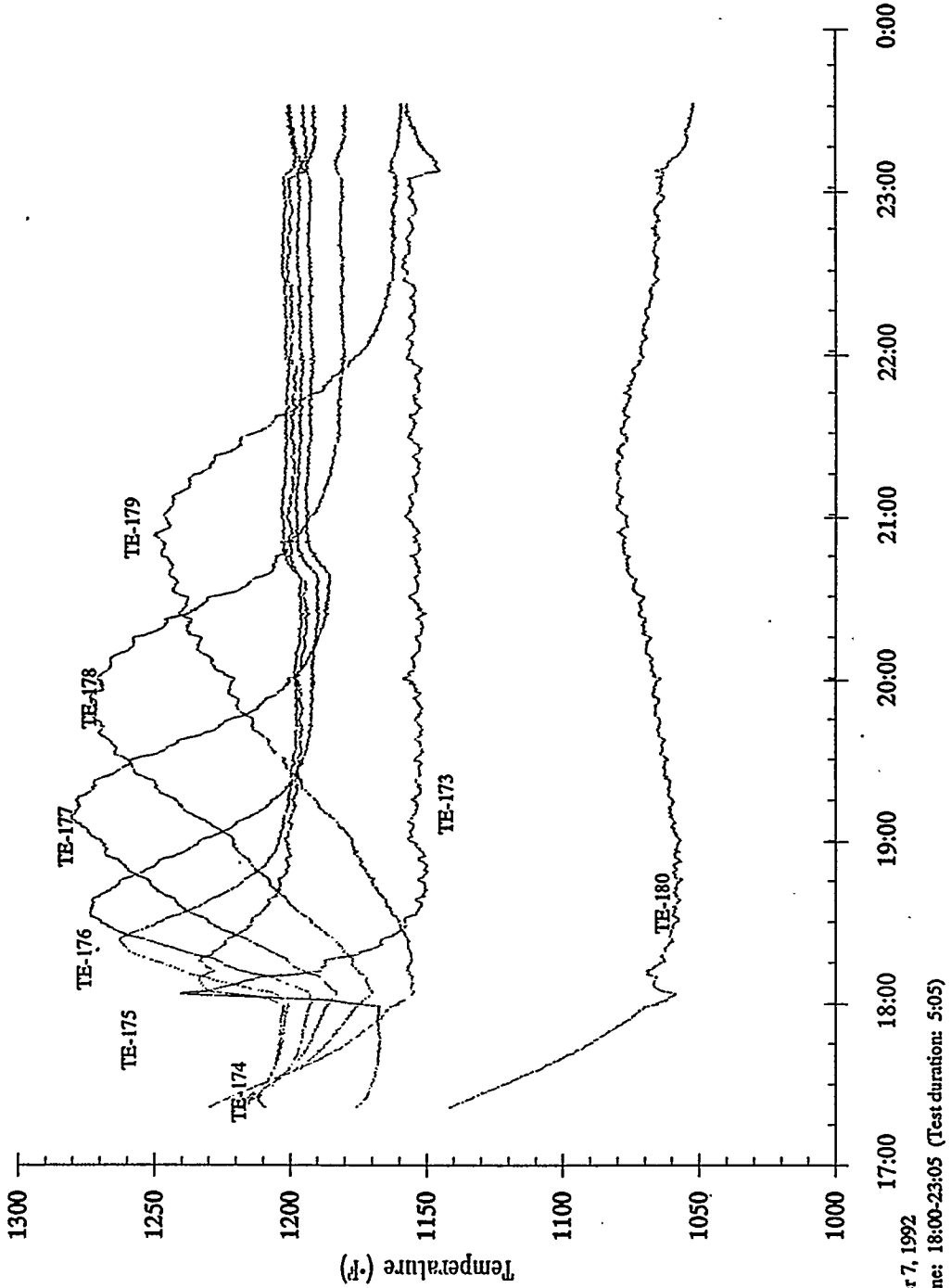

L-3787M Zirc Titanate
 u=0.5 ft/sec T=1100 °F
 H2S Inlet Conc. = 800 ppm

Multi-Cycle Tests - ZTMC-01 Sulfidation 3

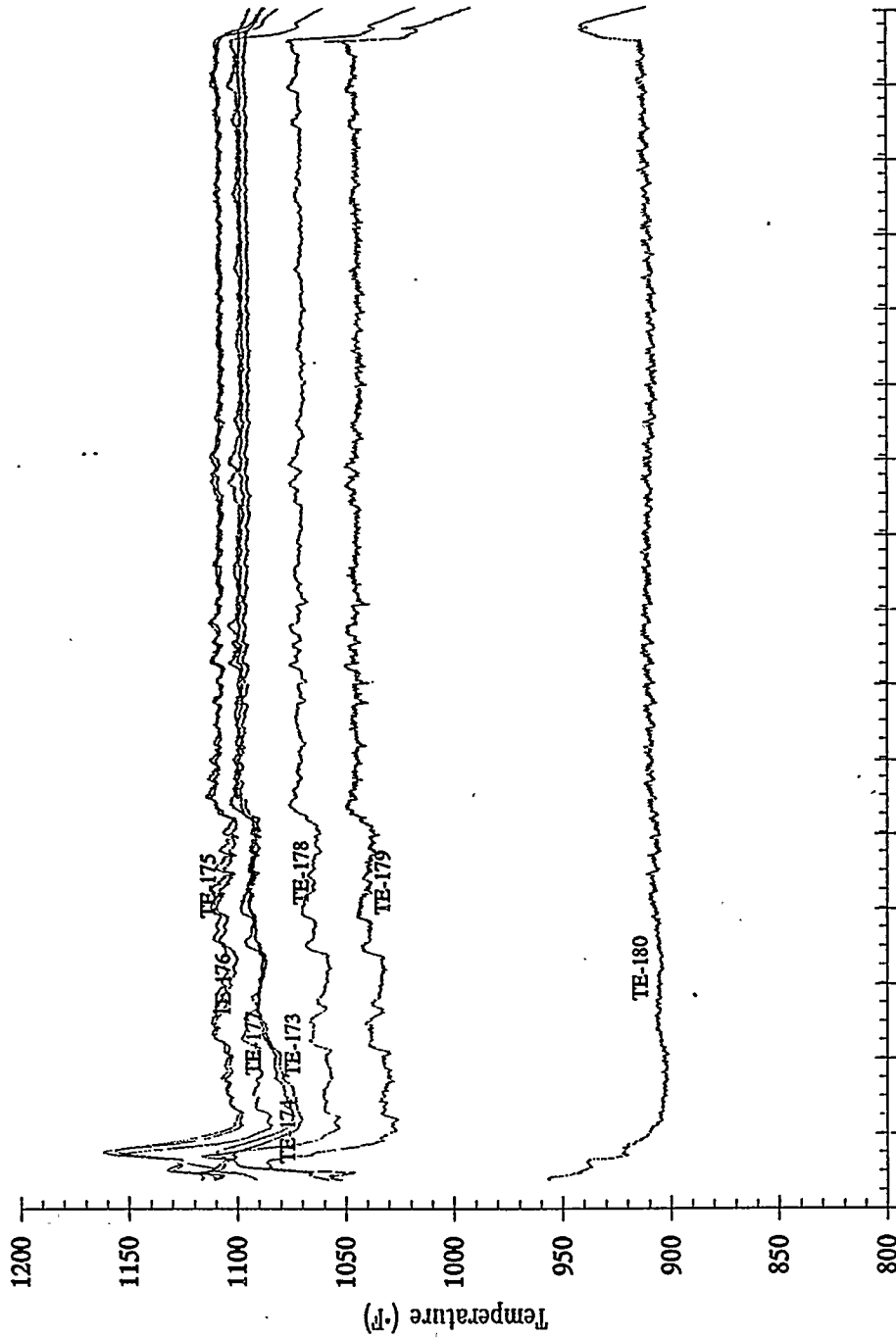

- TE-173 (1" below cage bottom)
- - - TE-174 (2" above cage bottom)
- TE-175 (5" above cage bottom)
- . - . - TE-176 (8" above cage bottom)
- TE-177 (11" above cage bottom)
- TE-178 (14" above cage bottom)
- - - TE-179 (17" above cage bottom)
- TE-180 (28.5" above cage bottom)

October 8, 1992
 Test time: 3:00-18:03 (Test duration: 15:03)

L-3787M Zinc Titanate
 u=1.0 ft/sec T_{max}=1300 °F
 O₂ Inlet Conc. = 0.75 %

Multi-Cycle Tests - ZTMC-01 Regeneration 3

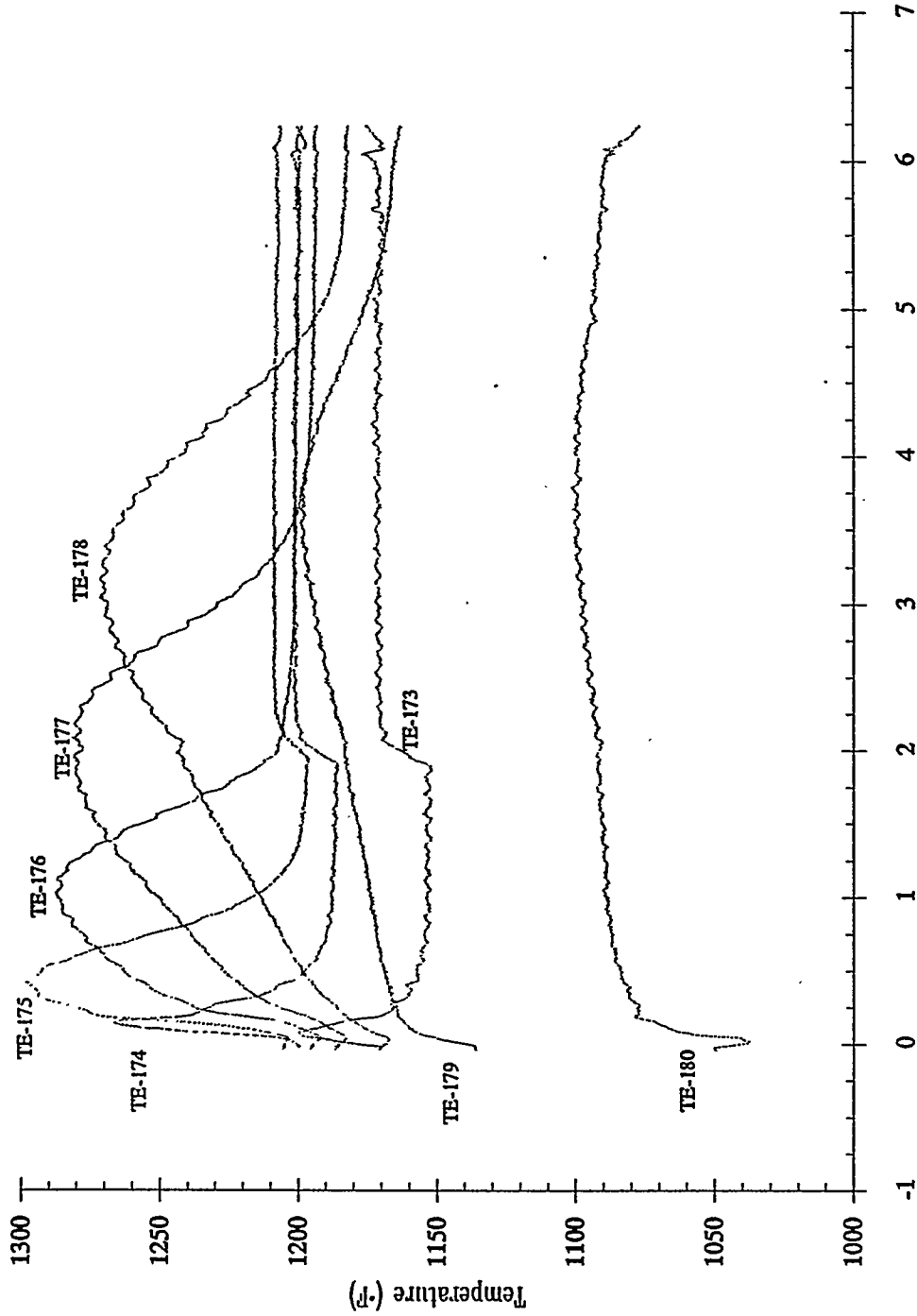

- TE-173 (1" below cage bottom)
- - - TE-174 (2" above cage bottom)
- TE-175 (5" above cage bottom)
- · - · - TE-176 (8" above cage bottom)
- TE-177 (11" above cage bottom)
- TE-178 (14" above cage bottom)
- - - TE-179 (17" above cage bottom)
- TE-180 (28.5" above cage bottom)

-1 0 1 2 3 4 5 6 7
 Test time: 20:00 (October 8, 1992) - 2:00 (October 9, 1992)
 Test duration: 6:00

L-3787M Zinc Titanate
 u=0.5 ft/sec T=1100 °F
 H2S Inlet Conc. = 800 ppm

Multi-Cycle Tests - ZTMC-01 Sulfidation 4

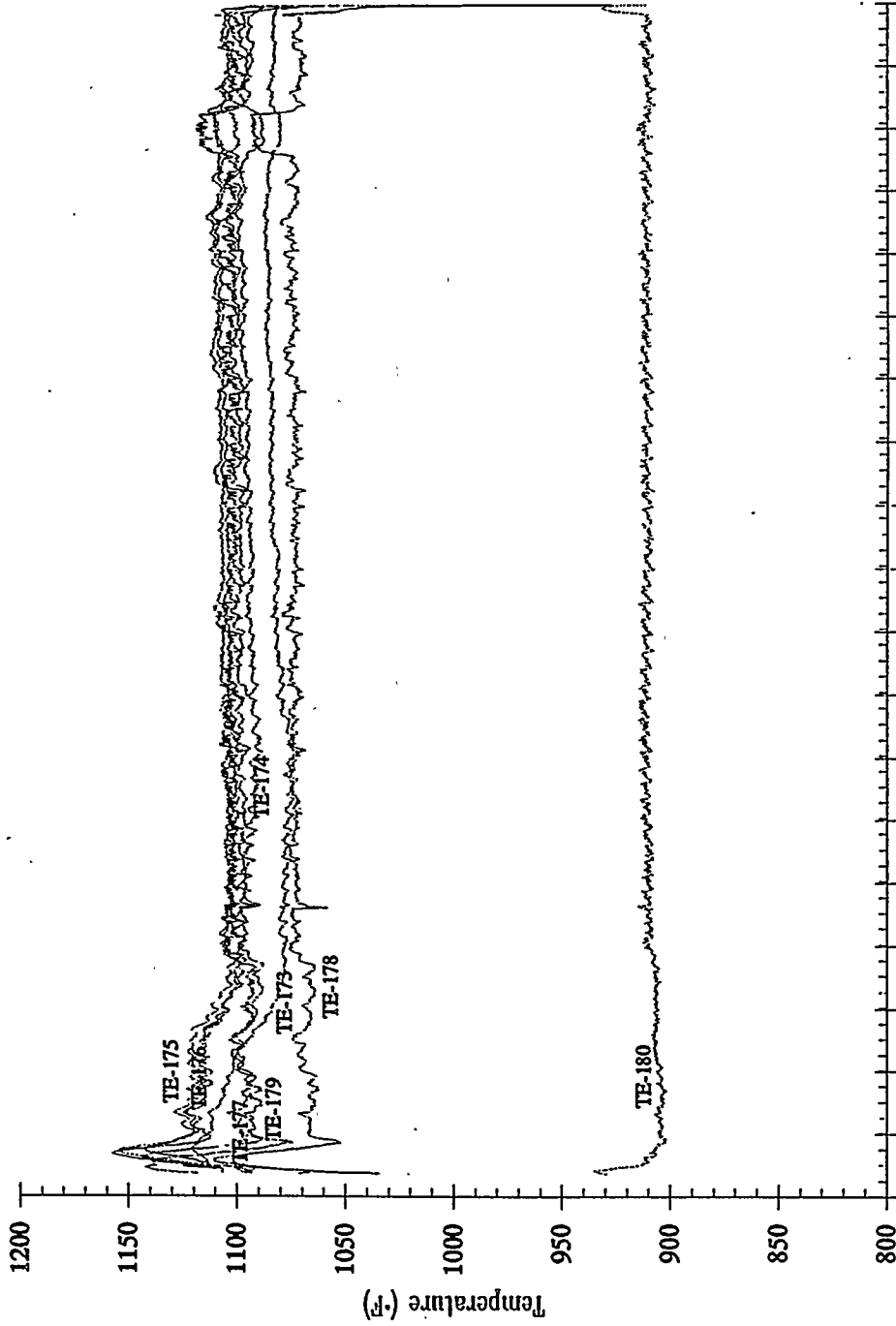

October 9, 1992
 Test time: 4:00-22:16 (Test duration: 18:16)

L-3787M Zinc Titanate
u=0.5 ft/sec T=1000 °F
H2S Inlet Conc. = 800 ppm

Multi-Cycle Tests - ZTMC-02 Sulfidation 1

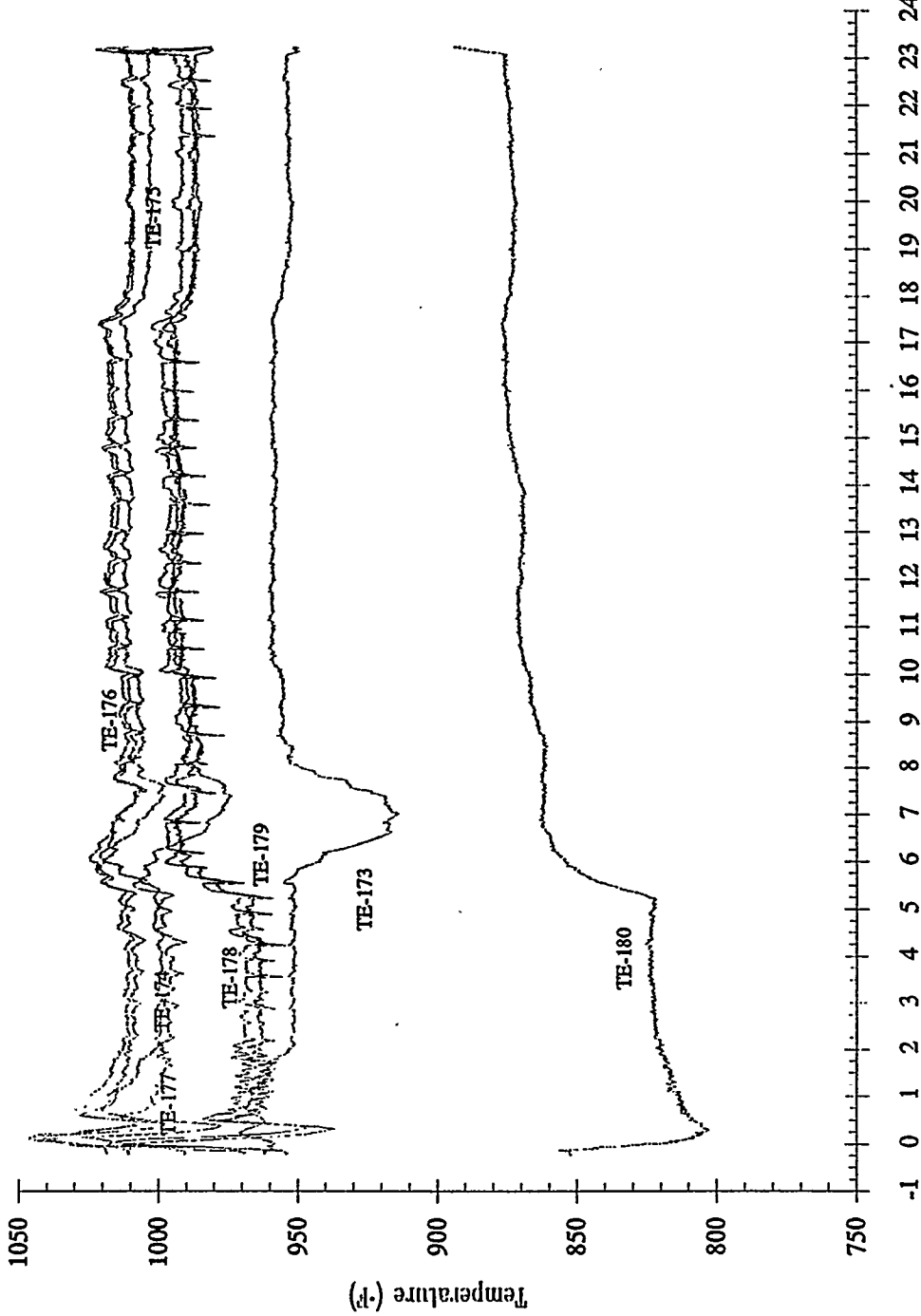

- TE-173 (1" below cage bottom)
- - - TE-174 (2" above cage bottom)
- TE-175 (5" above cage bottom)
- . - . - TE-176 (8" above cage bottom)
- TE-177 (11" above cage bottom)
- TE-178 (14" above cage bottom)
- - - TE-179 (17" above cage bottom)
- TE-180 (28.5" above cage bottom)

Test time: 1:00 (October 14, 1992) - 0:03 (October 15, 1992)
Test duration: 23:03

L-3787M Zinc Titanate
 u=0.5 ft/sec T_{max}=1400 °F
 O₂ Inlet Conc. = 2.5 %

Multi-Cycle Tests - ZTMC-02 Regeneration 1

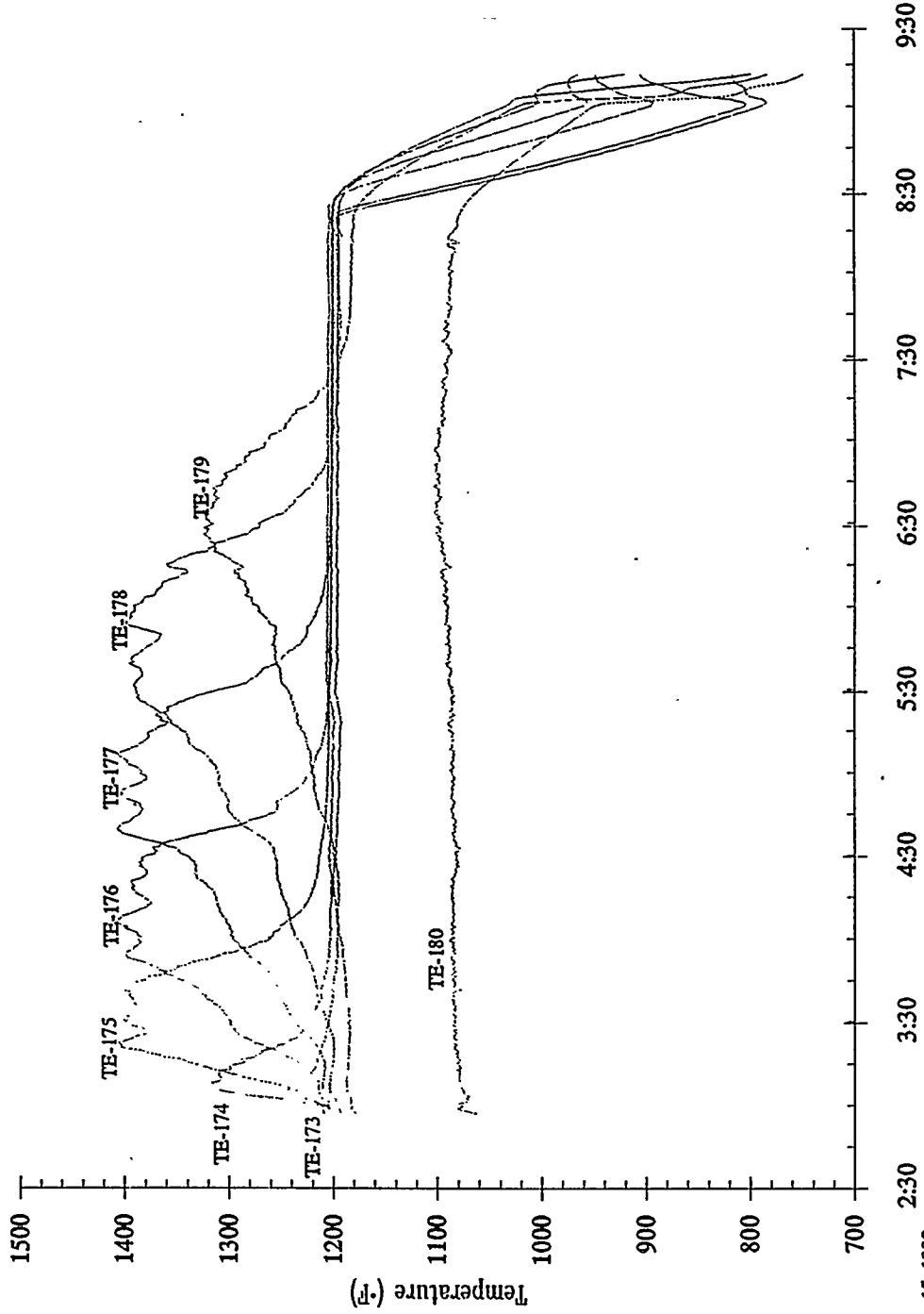

October 15, 1992
 Test time: 3:00-8:13 (Test duration: 5:13)

- TE-173 (1" below cage bottom)
- - - TE-174 (2" above cage bottom)
- TE-175 (5" above cage bottom)
- · - · - TE-176 (8" above cage bottom)
- · - · - TE-177 (11" above cage bottom)
- TE-178 (14" above cage bottom)
- - - TE-179 (17" above cage bottom)
- TE-180 (28.5" above cage bottom)

L-3787M Zinc Titanate
u=0.5 ft/sec T=1000 °F
H2S Inlet Conc. = 800 ppm

Multi-Cycle Tests - ZTMC-02 Sulfidation 2

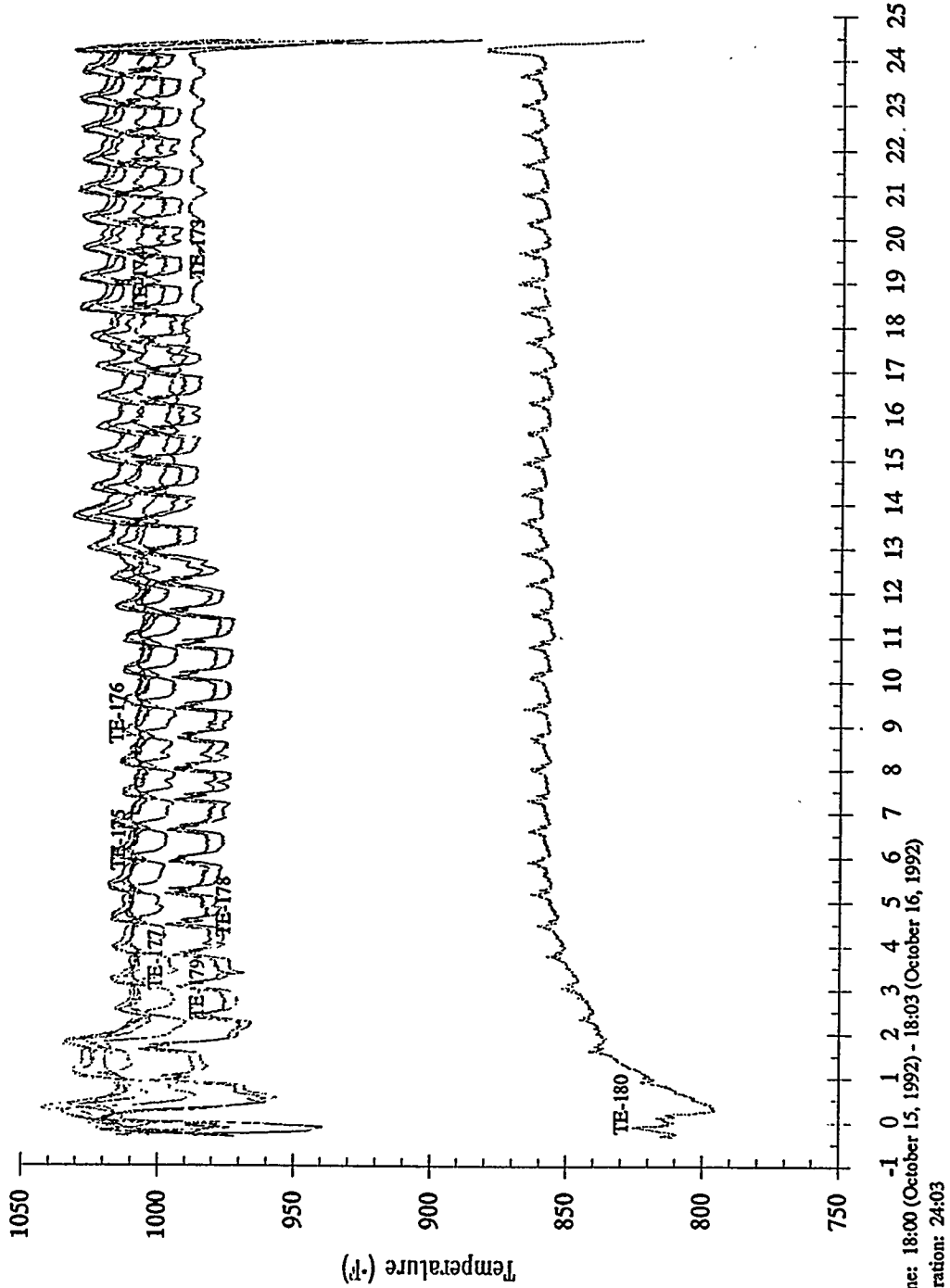

L-3787M Zinc Titanate
u=1.0 ft/sec Tmax=1400 °F
O2 Inlet Conc. = 2.5 %

Multi-Cycle Tests - ZTMC-02 Regeneration 2

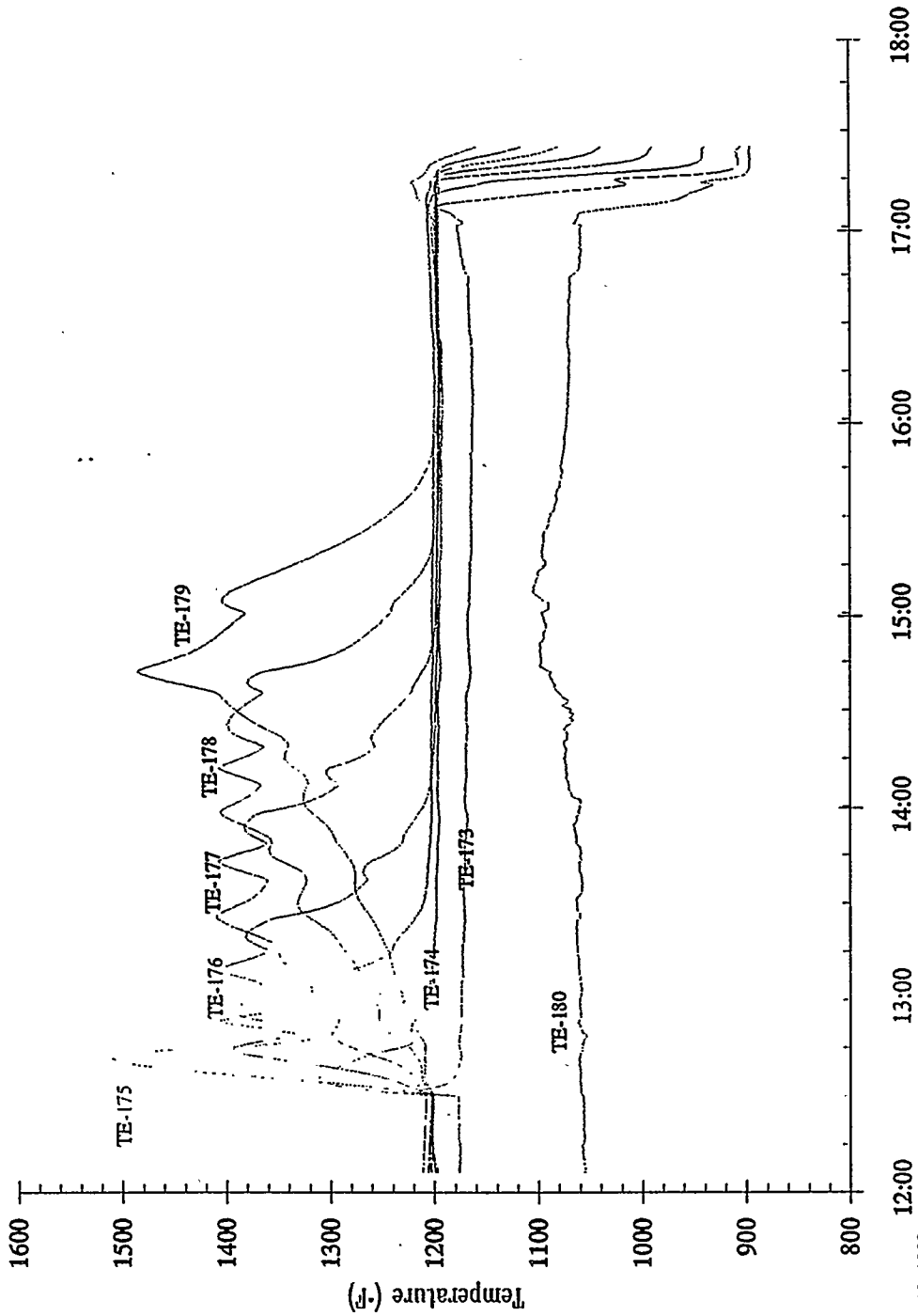

October 19, 1992
Test time: 12:30 - 16:45 (Test duration: 4:15)

L-3787M Zinc Titanate
u=2.0 ft/sec T=1200 °F
H2S Inlet Conc. = 800 ppm

Multi-Cycle Tests - ZTMC-02 Sulfidation 3

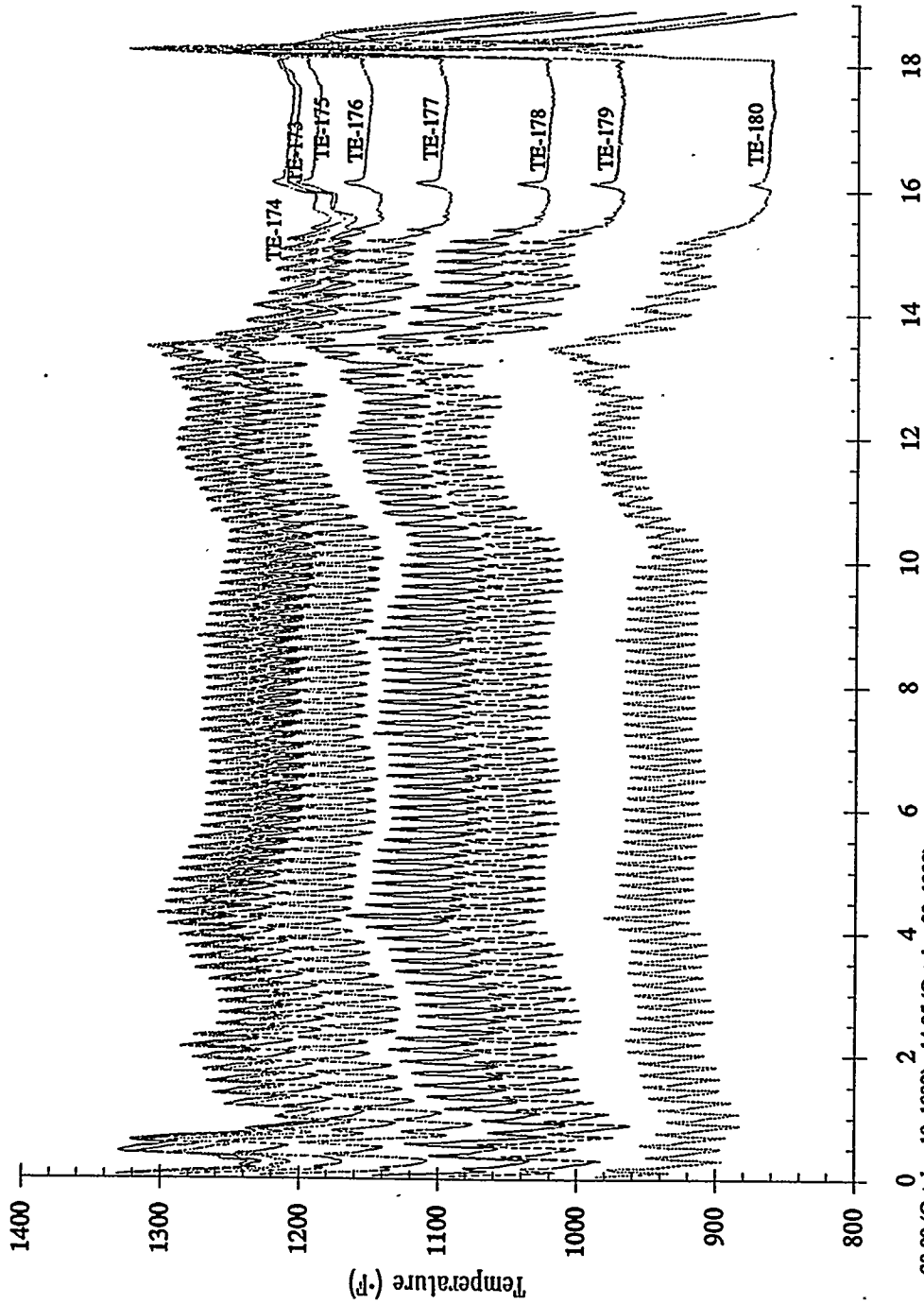

Test time: 20:00 (October 19, 1992) - 14:05 (October 20, 1992)
Test duration: 18:05

L-3787M Zinc Titanate
 u=0.33 ft/sec Tmax=1400 °F
 O2 Inlet Conc. = 1.5 %

Multi-Cycle Tests - ZTMC-02 Regeneration 3

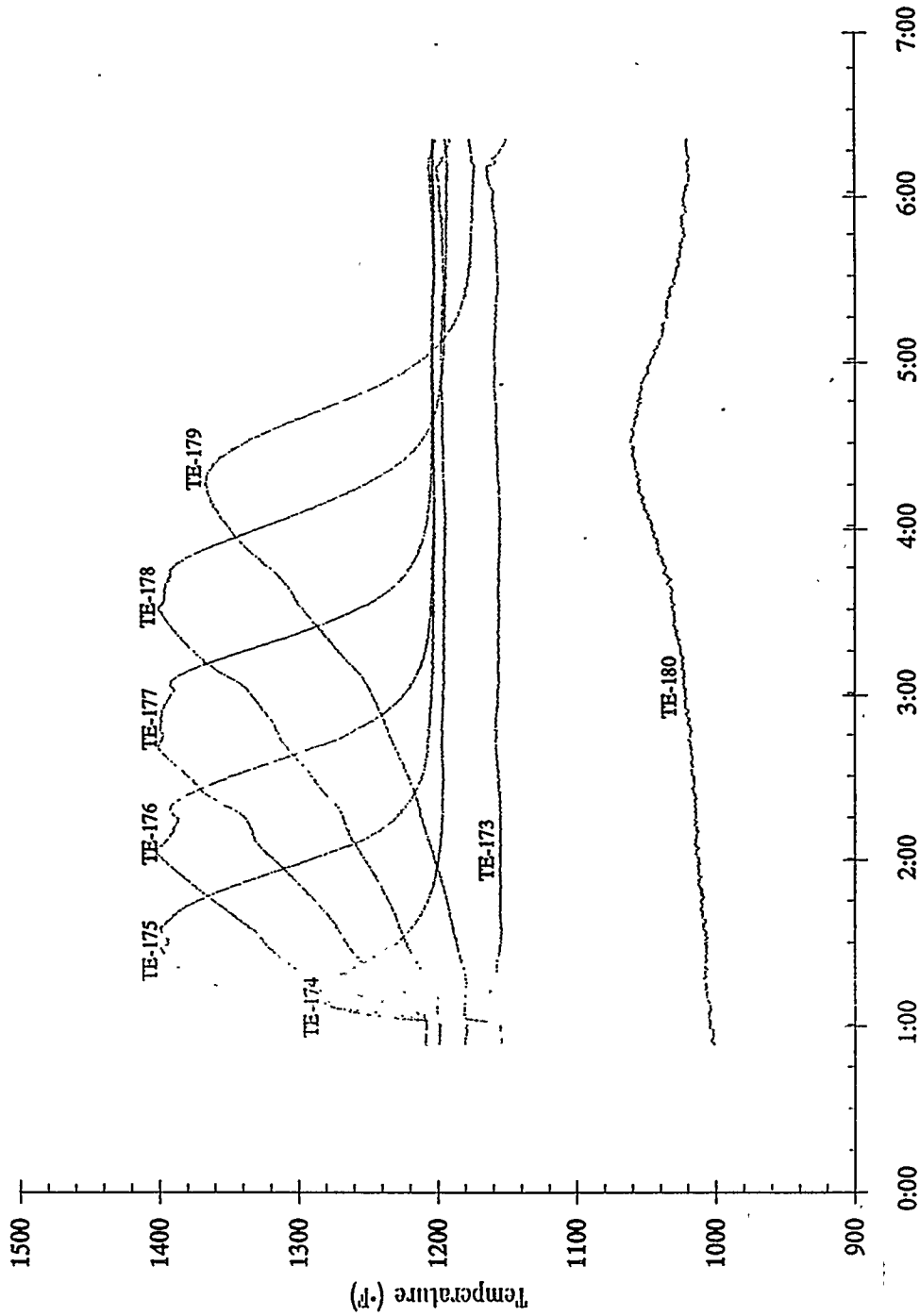

——	TE-173 (1" below cage bottom)
- - - -	TE-174 (2" above cage bottom)
.....	TE-175 (5" above cage bottom)
- . - . - .	TE-176 (8" above cage bottom)
- - - - -	TE-177 (11" above cage bottom)
——	TE-178 (14" above cage bottom)
- - - -	TE-179 (17" above cage bottom)
.....	TE-180 (28.5" above cage bottom)

October 21, 1992
 Test time: 1:00 - 6:03 (Test duration: 5:03)

L-3787M Zinc Titanate
u=1.0 ft/sec T=1200 °F
H2S Inlet Conc. = 0 ppm

Multi-Cycle Tests - ZTMC-03 Sulfidation 1

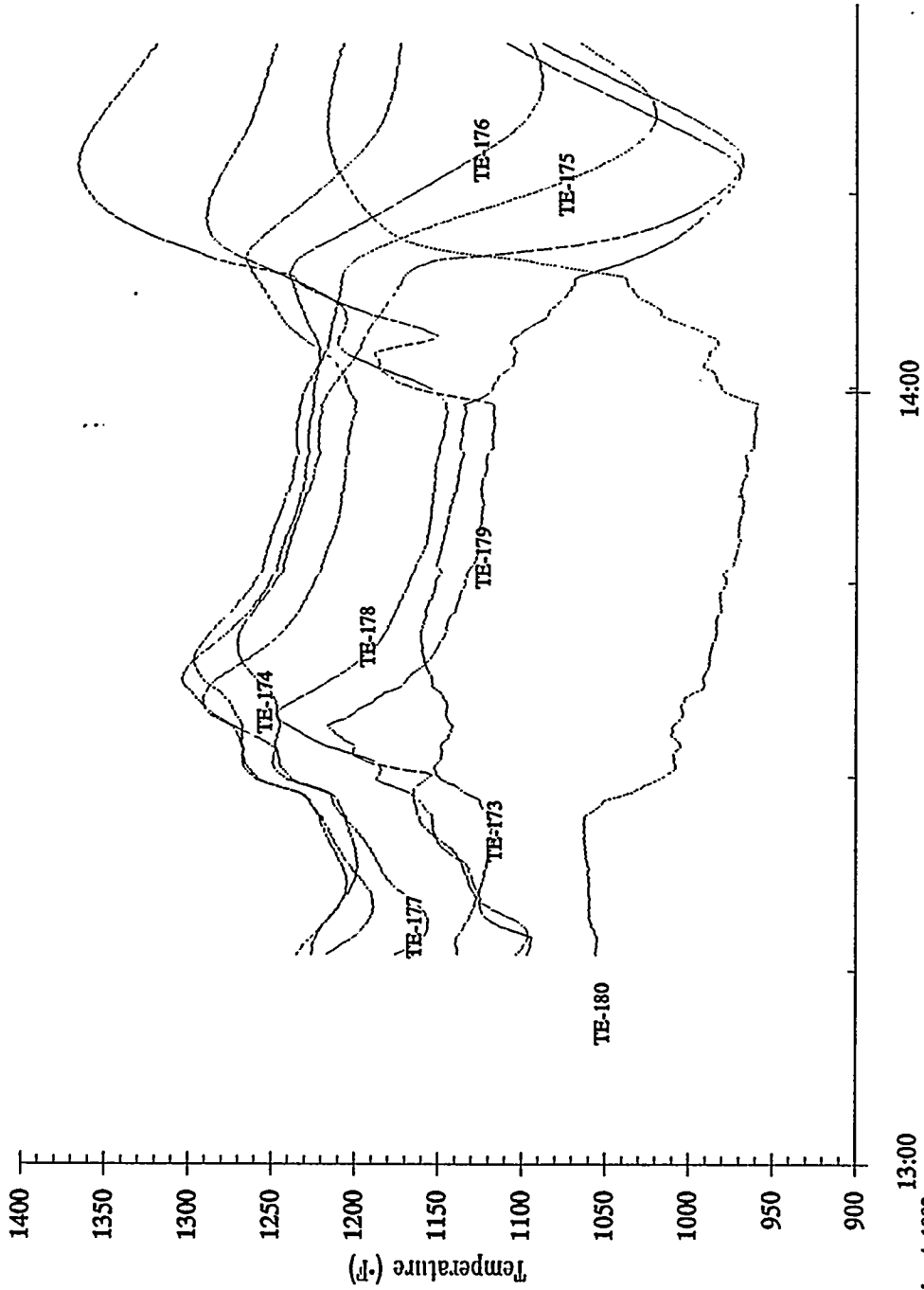

November 4, 1992
Test time: 13:30-14:00 (Test duration: 0:30)

L-3787M Zinc Titanate
u=1.0 ft/sec Tmax=1400 °F
O2 Inlet Conc. = 0.75 %

Multi-Cycle Tests - ZTMC-03 Regeneration 1

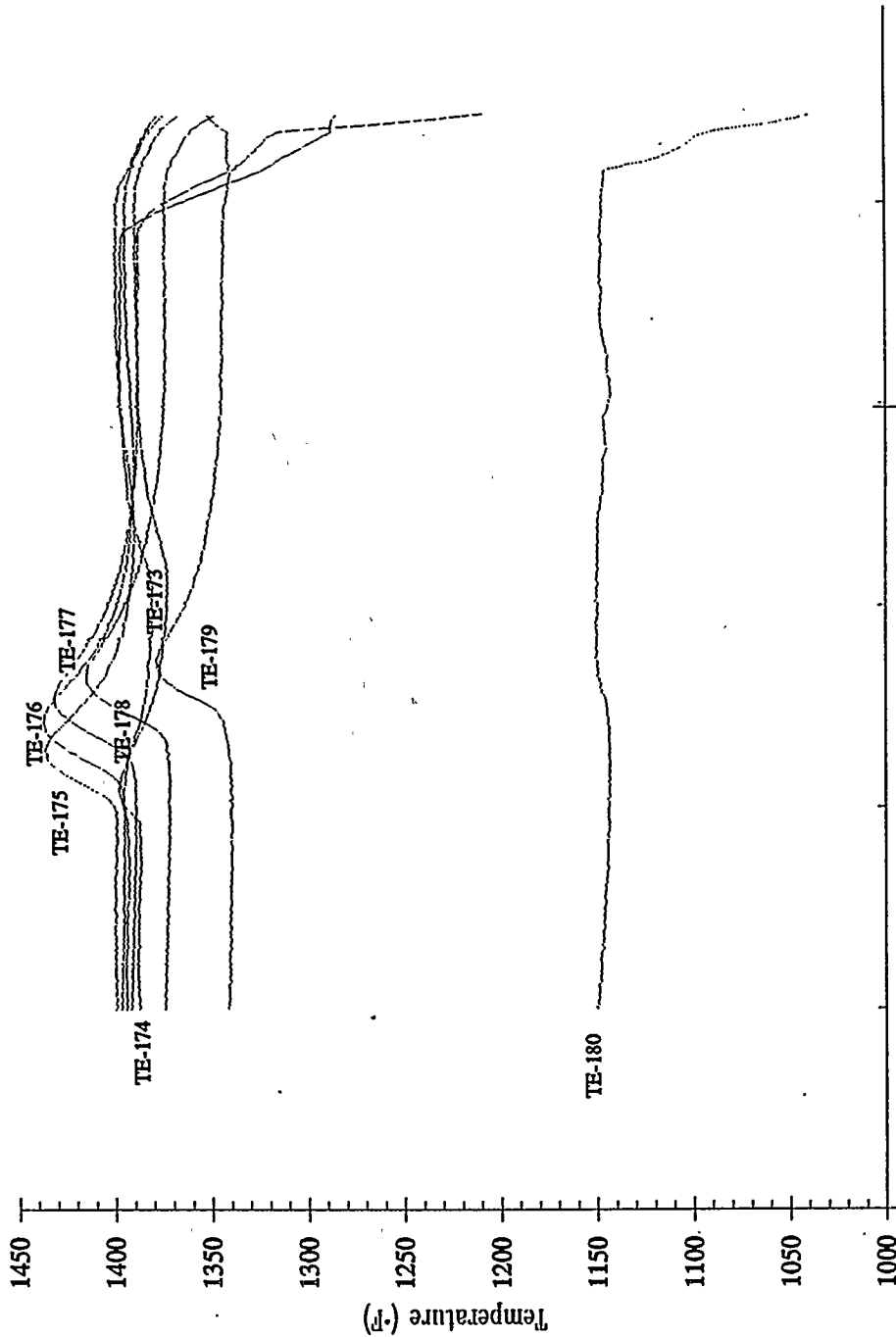

November 4, 1992
Test time: 15:30-16:00 (Test duration: 0:30)

L-3787M Zinc Titanate
u=1.0 ft/sec T=1200 F
H2S Inlet Conc. = 0 ppm

Multi-Cycle Tests - ZTMC-03 Sulfidation 2

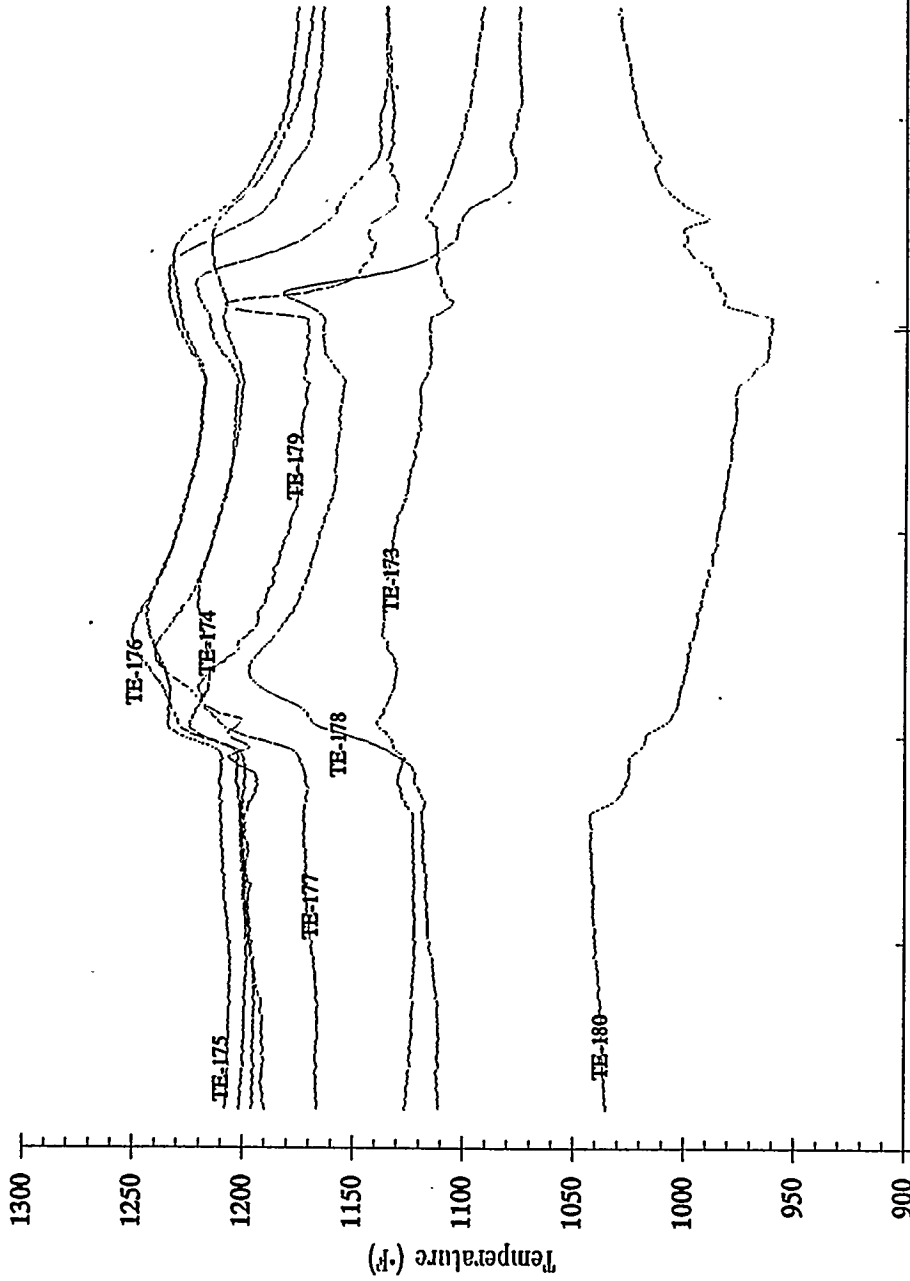

- TE-173 (1" below cage bottom)
- - - TE-174 (2" above cage bottom)
- TE-175 (5" above cage bottom)
- . - . - . TE-176 (8" above cage bottom)
- TE-177 (11" above cage bottom)
- TE-178 (14" above cage bottom)
- - - TE-179 (17" above cage bottom)
- TE-180 (28.5" above cage bottom)

November 5, 1992
Test time: 8:30-9:00 (Test duration: 0:30)

L-3787M Zinc Titanate
u=1.0 ft/sec Tmax=1400 °F
O2 Inlet Conc. = 0.75 %

Multi-Cycle Tests - ZTMC-03 Regeneration 2

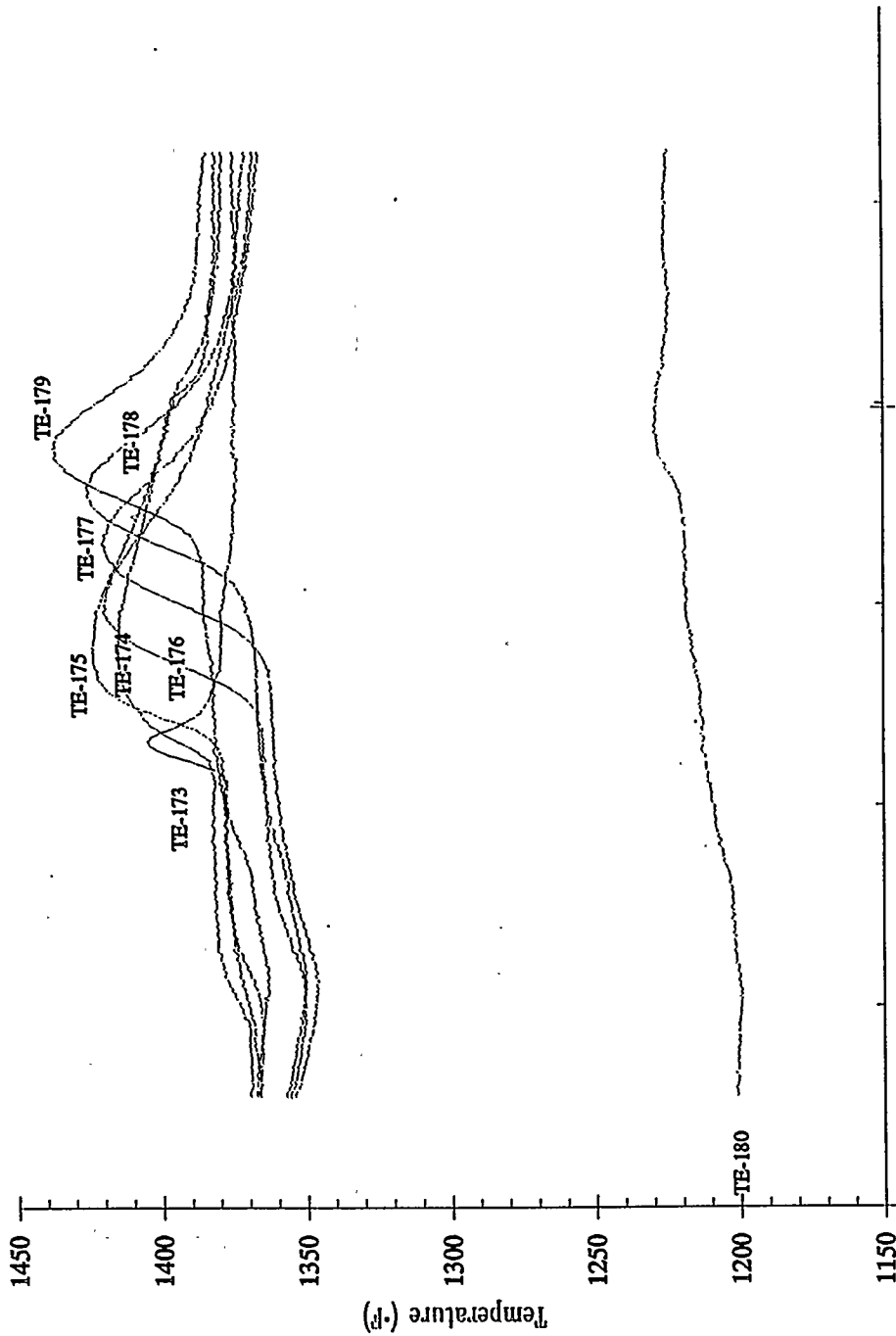

—	TE-173 (1" below cage bottom)
- - -	TE-174 (2" above cage bottom)
.....	TE-175 (5" above cage bottom)
- - -	TE-176 (8" above cage bottom)
.....	TE-177 (11" above cage bottom)
—	TE-178 (14" above cage bottom)
- - -	TE-179 (17" above cage bottom)
.....	TE-180 (28.5" above cage bottom)

11:30
November 5, 1992
Test time: 12:00-12:30 (Test duration: 0:30)

L-3787M Zinc Titanate
u=1.0 ft/sec T=1200 °F
H2S Inlet Conc. = 0 ppm

Multi-Cycle Tests - ZTMC-03 Sulfidation 3

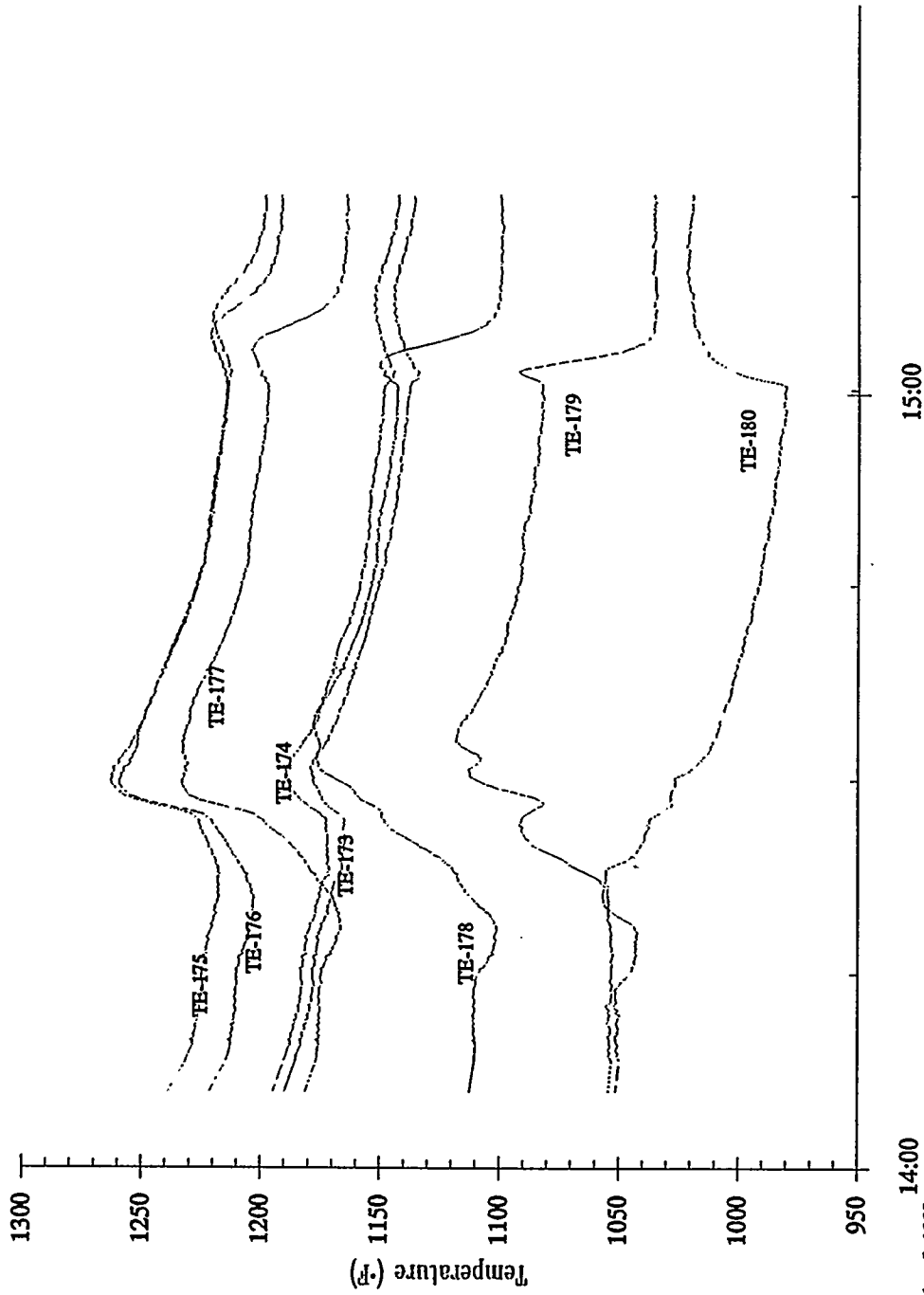

November 5, 1992
Test time: 14:30-15:00 (Test duration: 0:30)

L-3787M Zinc Titanate
u=1.0 ft/sec Tmax=1400 °F
O2 Inlet Conc. = 0.75 %

Multi-Cycle Tests - ZTMC-03 Regeneration 3

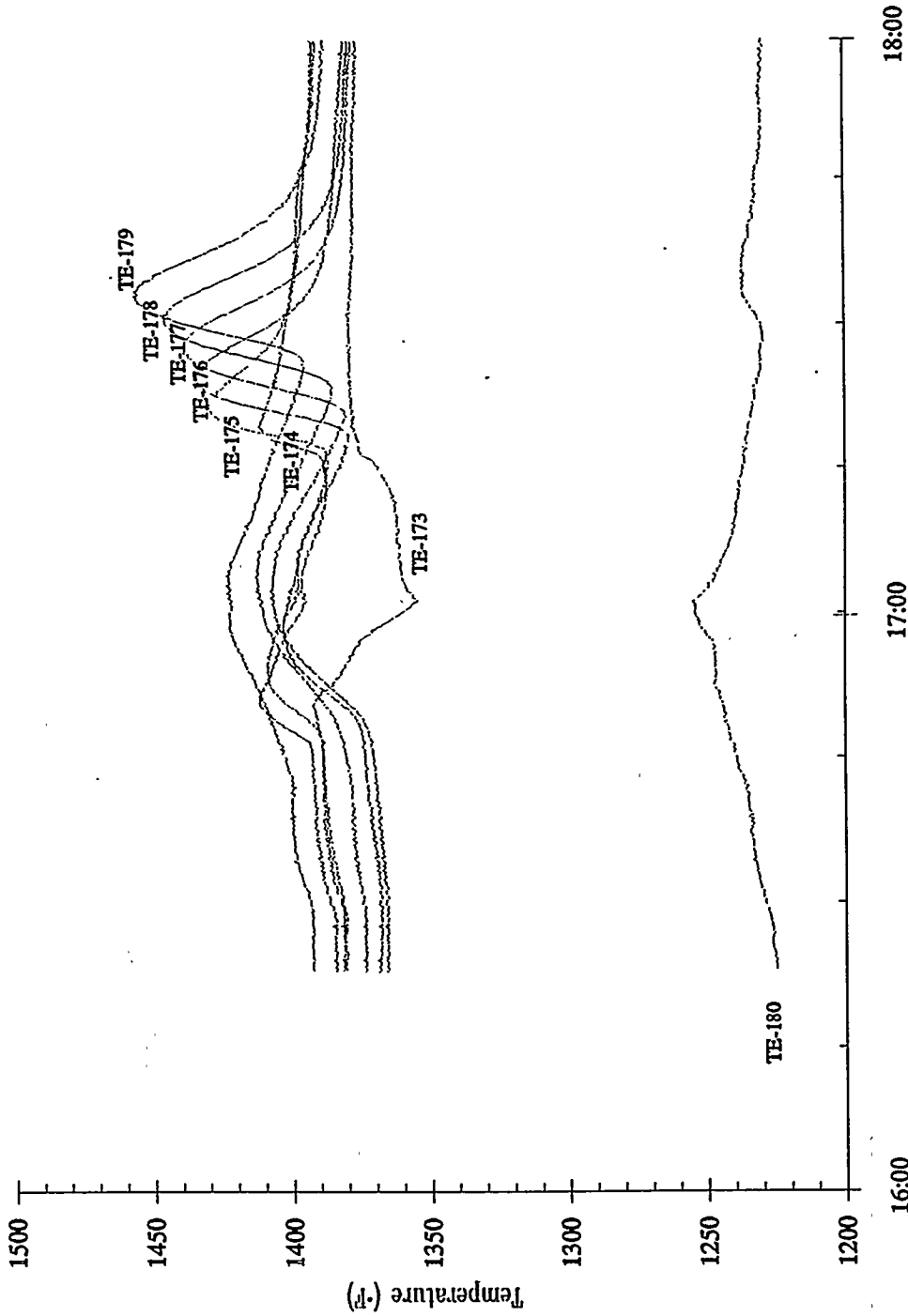

- TE-173 (1" below cage bottom)
- TE-174 (2" above cage bottom)
- TE-175 (5" above cage bottom)
- TE-176 (8" above cage bottom)
- TE-177 (11" above cage bottom)
- TE-178 (14" above cage bottom)
- TE-179 (17" above cage bottom)
- TE-180 (28.5" above cage bottom)

November 5, 1992
Test time: 17:15-17:45 (Test duration: 0:30)

L-3787M Zinc Titanate
u=1.0 ft/sec T=1200 F
H2S Inlet Conc. = 0 ppm

Multi-Cycle Tests - ZTMC-03 Sulfidation 4

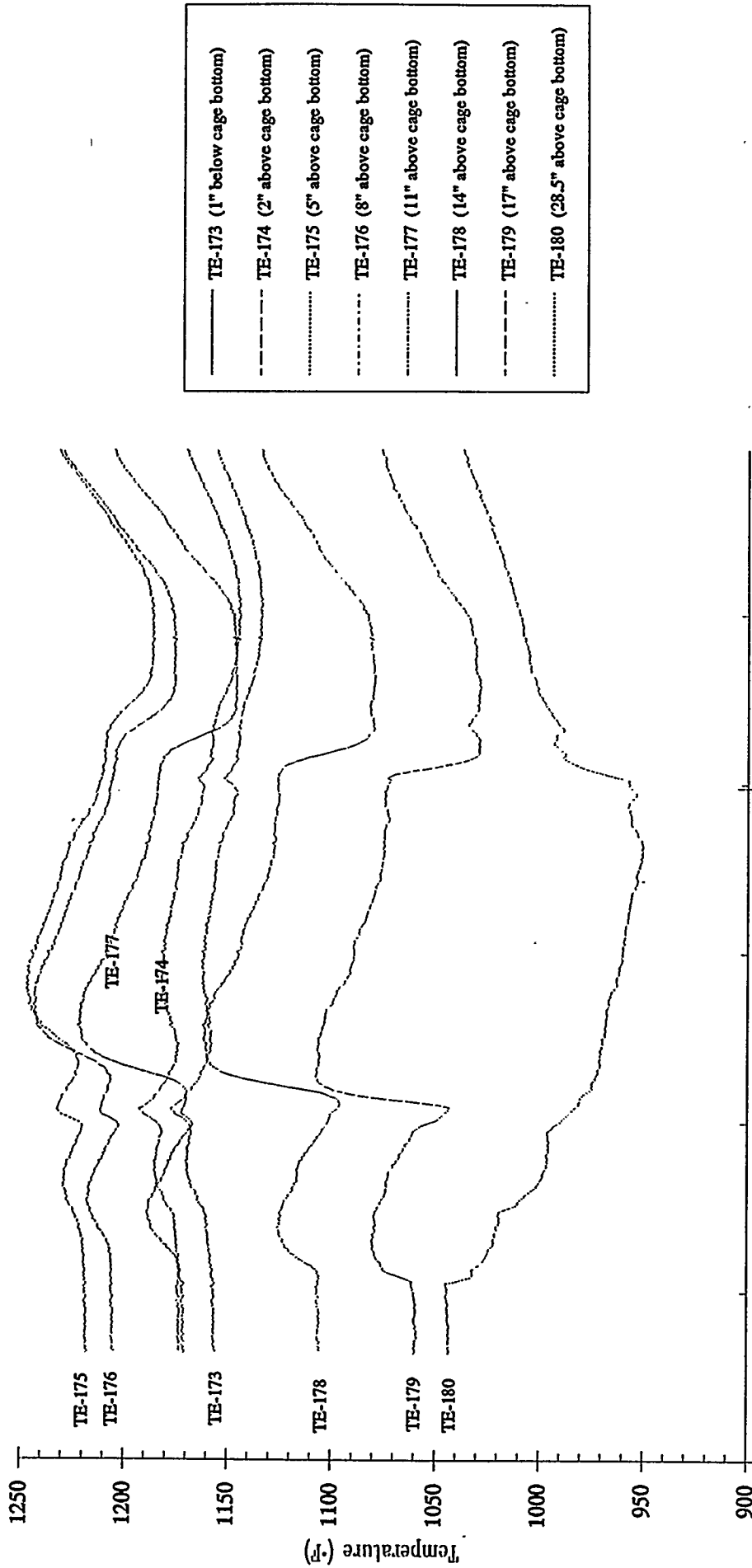

8:30
November 6, 1992
Test time: 9:00-9:30 (Test duration: 0:30)

9:30

L-3787M Zinc Titanate
 u=1.0 ft/sec T_{max}=1400 °F
 O₂ Inlet Conc. = 0.75 %

Multi-Cycle Tests - ZTMC-03 Regeneration 4

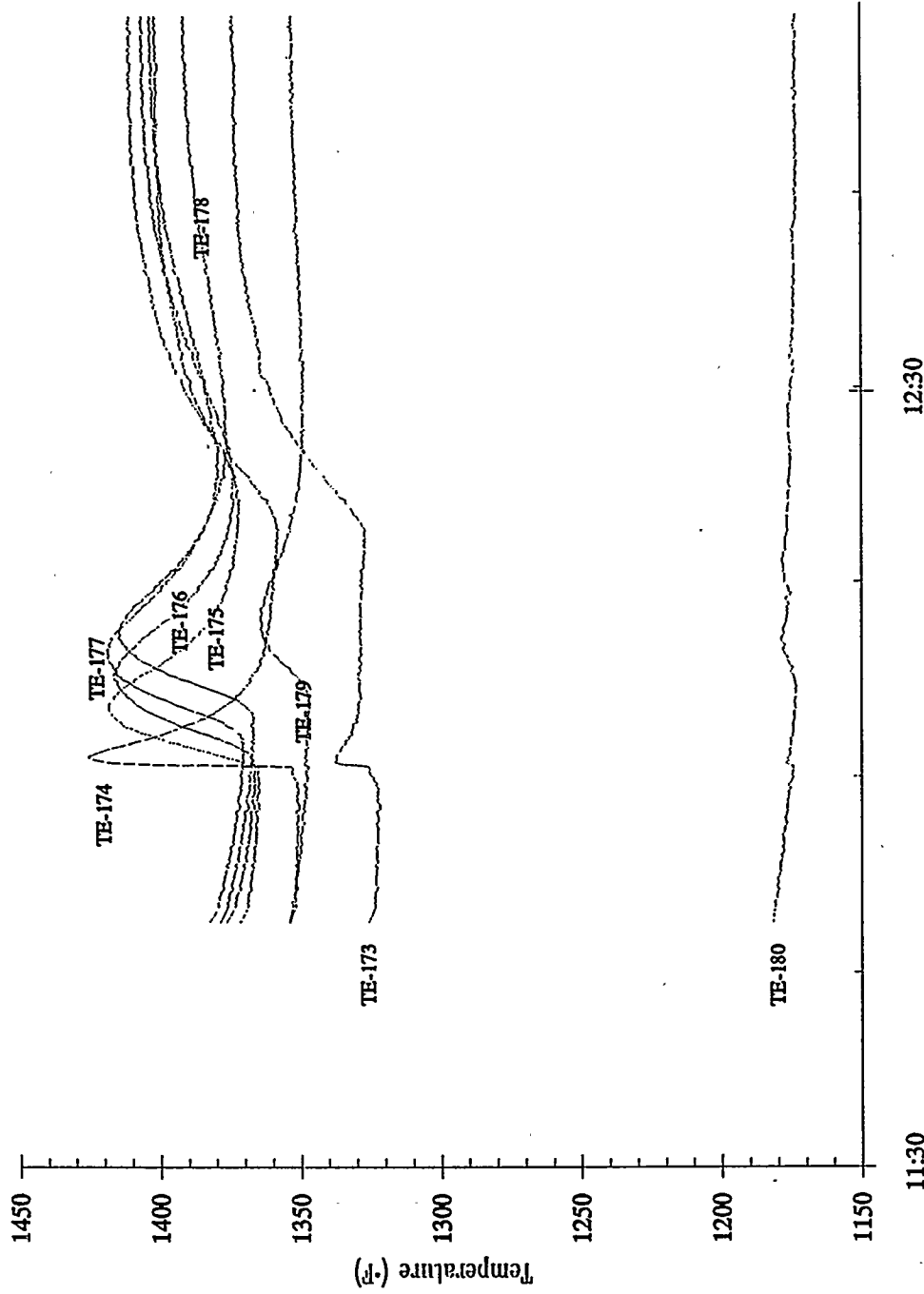

November 6, 1992
 Test time: 12:00-12:30 (Test duration: 0:30)

L-3787M Zinc Titanate
 u=1.0 ft/sec T=1000 °F
 H2S Inlet Conc. = 800 ppm

Multi-Cycle Tests - ZTMC-04 Sulfidation 1

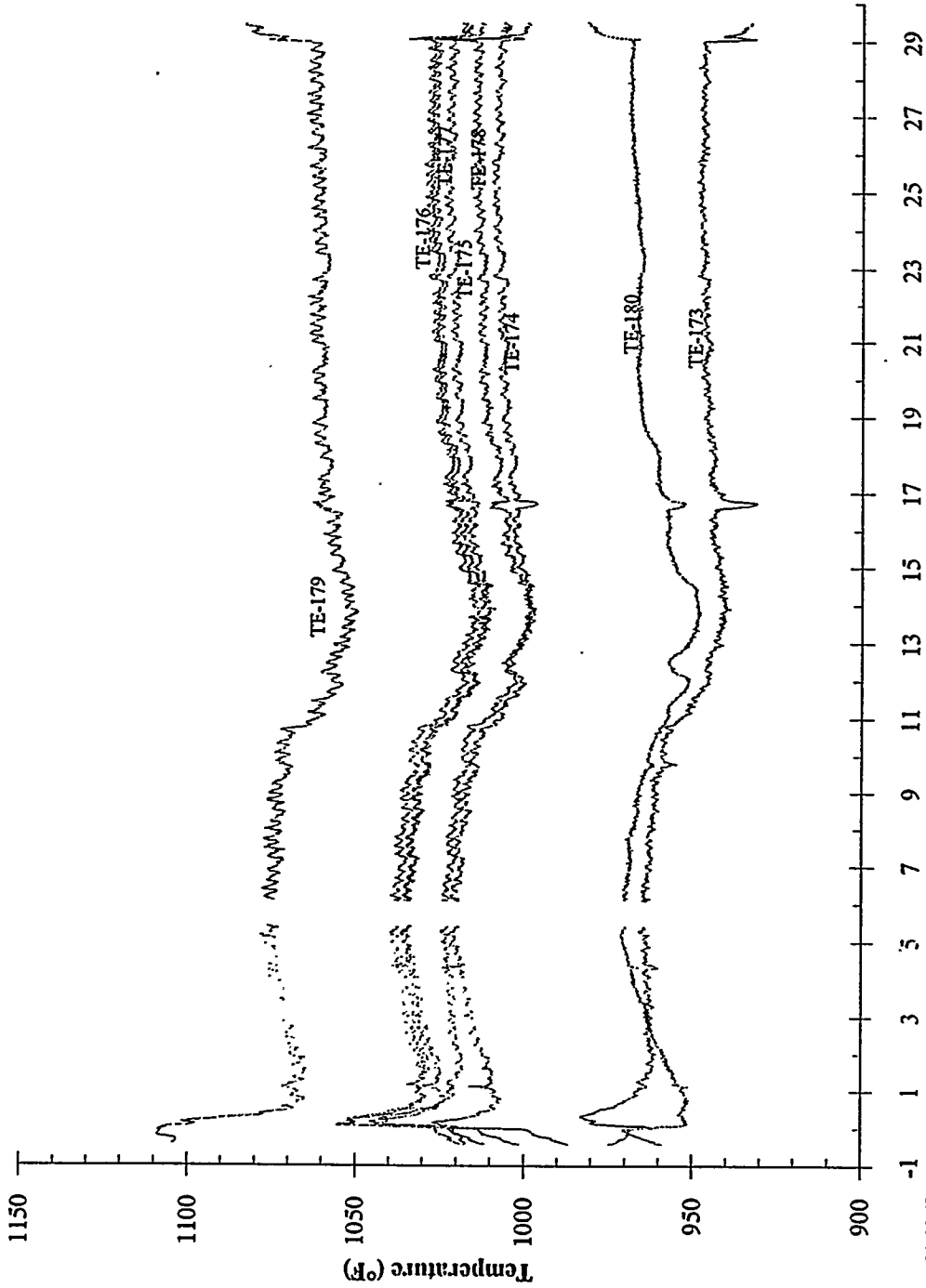

Test time: 21:00 (January 13, 1993) - 2:00 (January 15, 1993)
 Test duration: 29:00

L-3787M Zinc Titanate
u=1.0 ft/sec T = 1000-1400 F
O2 Inlet Conc. = 0.5 - 21 %

Multi-Cycle Tests - ZTMC-04 Regeneration 1

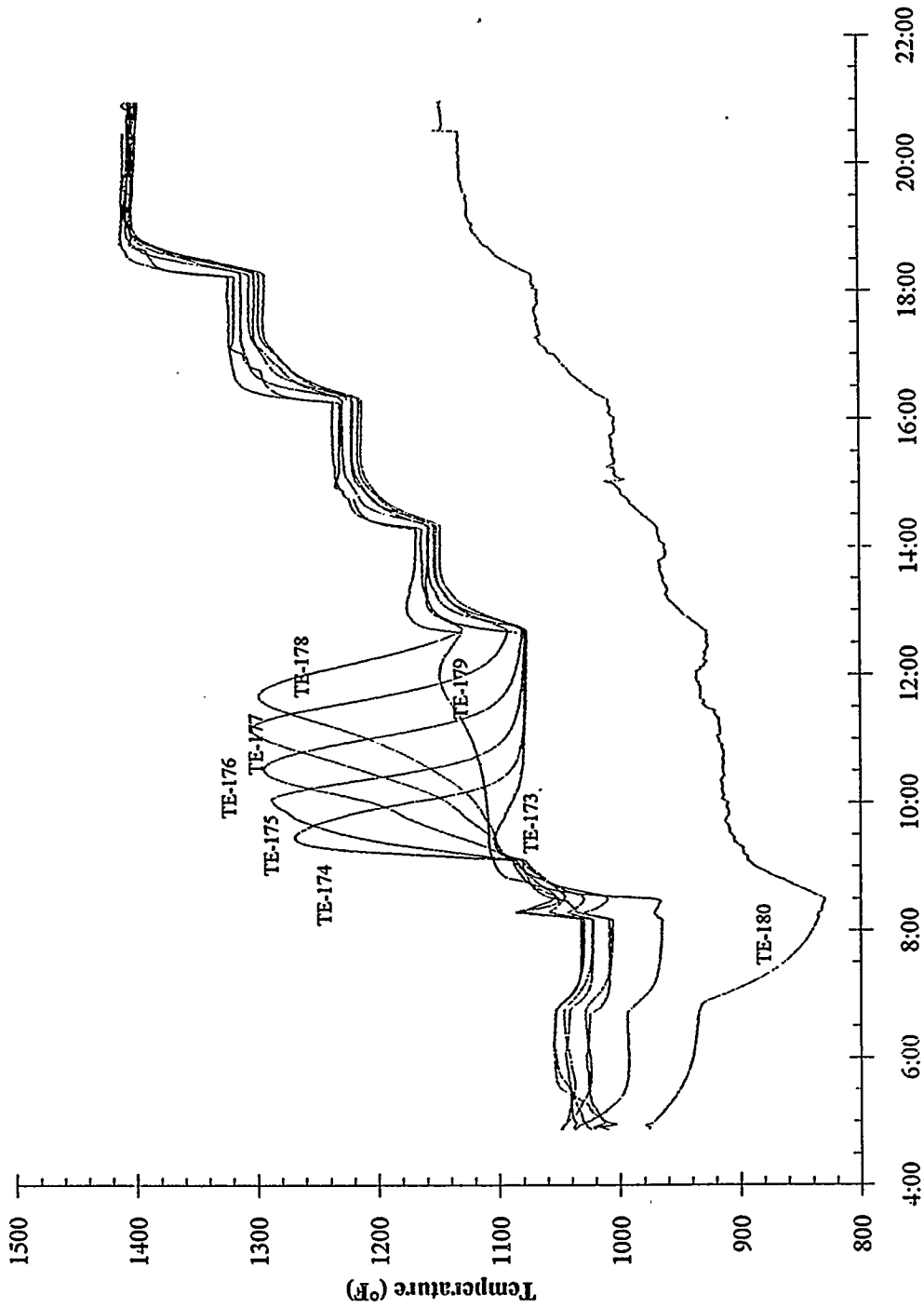

January 15, 1992
Test time: 5:00 - 20:33 (Test duration: 15:33)

L-3787M Zinc Titanate
u=1.0 ft/sec T=1000 °F
H2S Inlet Conc. = 800 ppm

Multi-Cycle Tests - ZTMC-04 Sulfidation 2

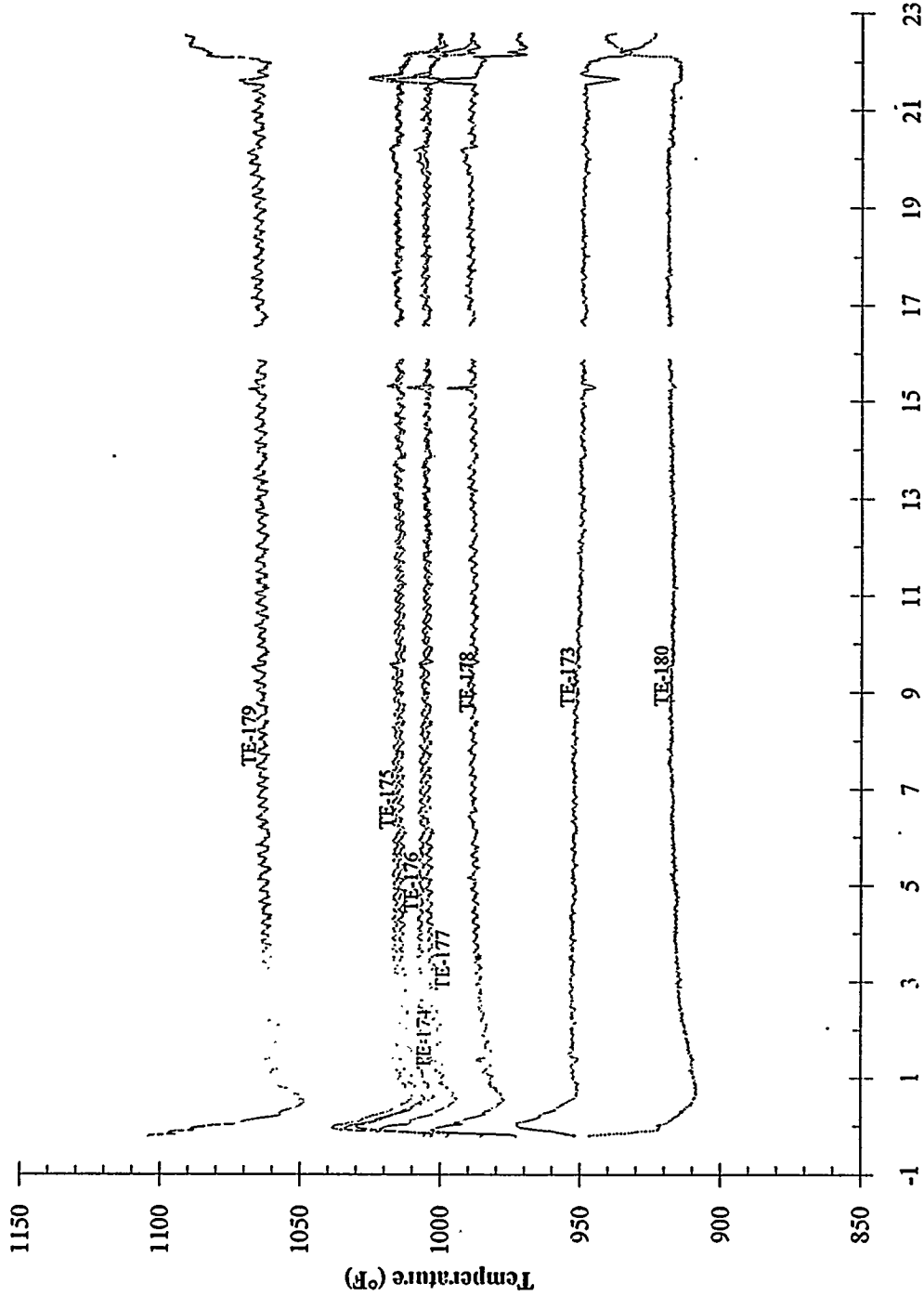

Test time: 9:00 (January 19, 1993) - 7:05 (January 20, 1993)
Test duration: 22:05

L-3787M Zinc Titanate
 u=1.0 ft/sec T = 1000-1400 F
 O2 Inlet Conc. = 0.5 - 21 %

Multi-Cycle Tests - ZTMC-04 Regeneration 2

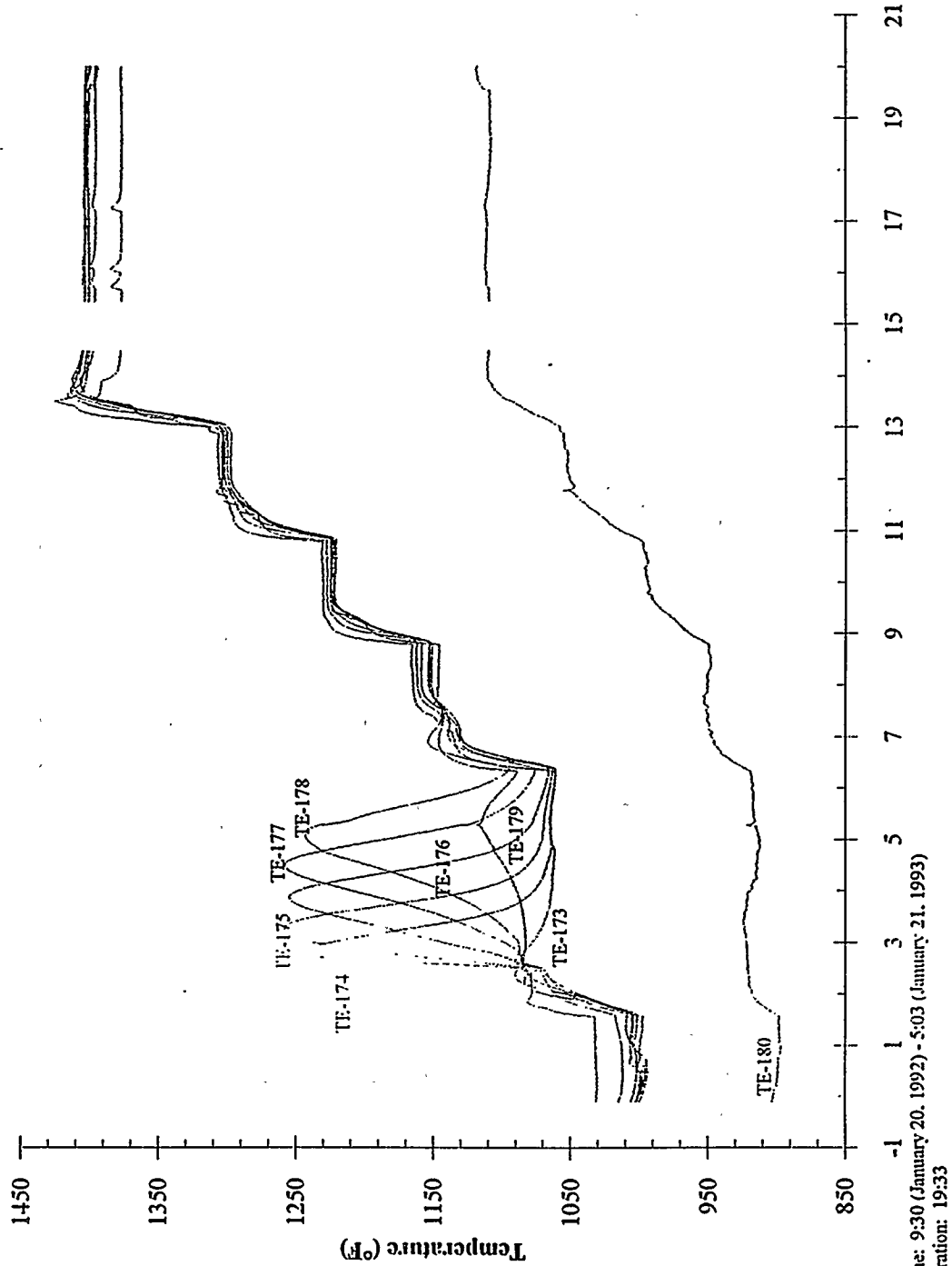

Test time: 9:30 (January 20, 1992) - 5:03 (January 21, 1993)
 Test duration: 19:33

L-3787M Zinc Titanate
u=1.0 ft/sec T=1000 °F
H2S Inlet Conc. = 800 ppm

Multi-Cycle Tests - ZTMC-04 Sulfidation 3

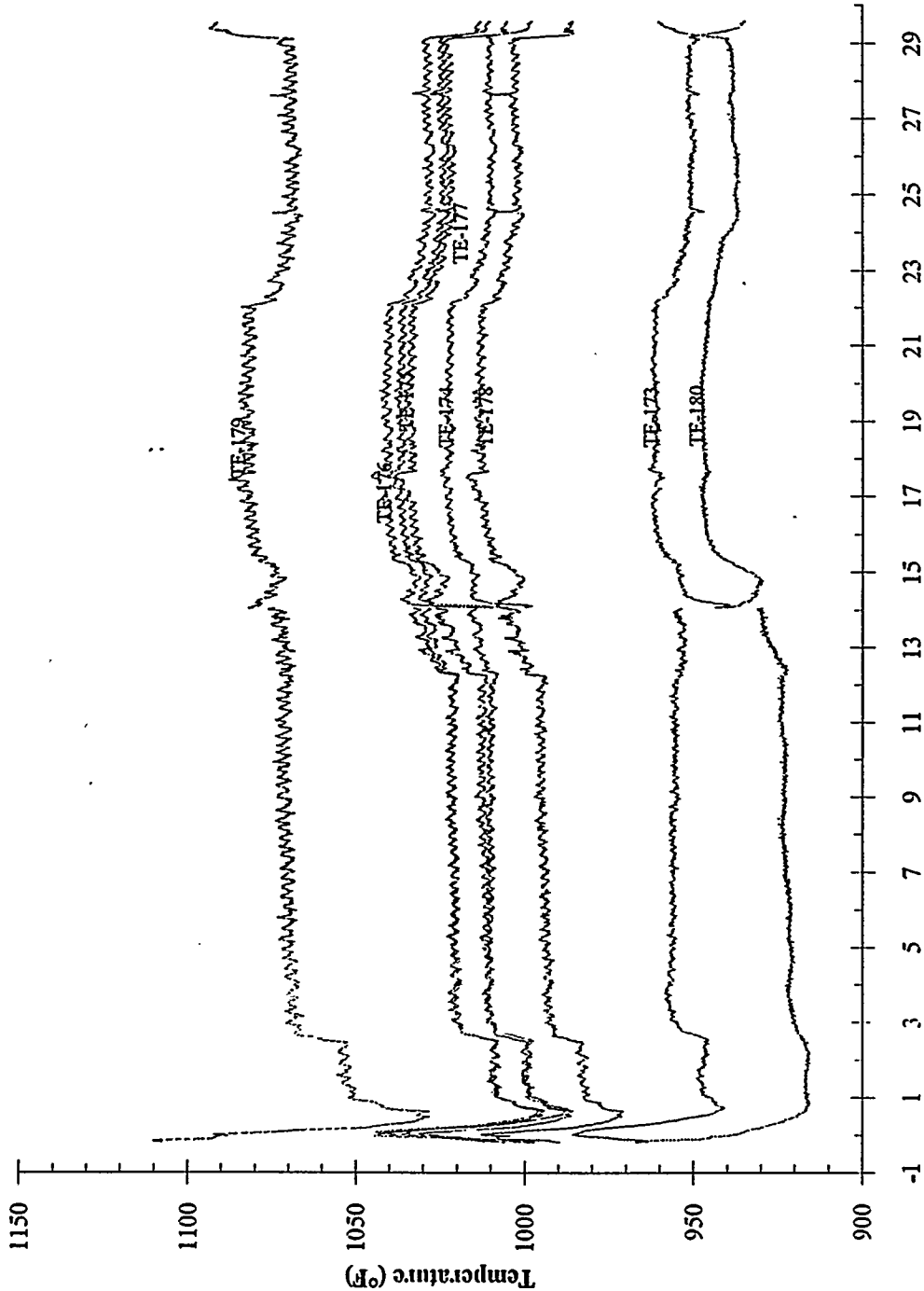

Test time: 8:30 - 22:33, 23:30 (January 21, 1993) - 14:32 (January 22, 1993)
Test duration: 29:05

L-3787Al Zinc Titanate
u=1.0 ft/sec T=1000 °F
H2S Inlet Conc. = 2000 ppm

Single Cycle Tests - ZTSC-08 Sulfidation 1

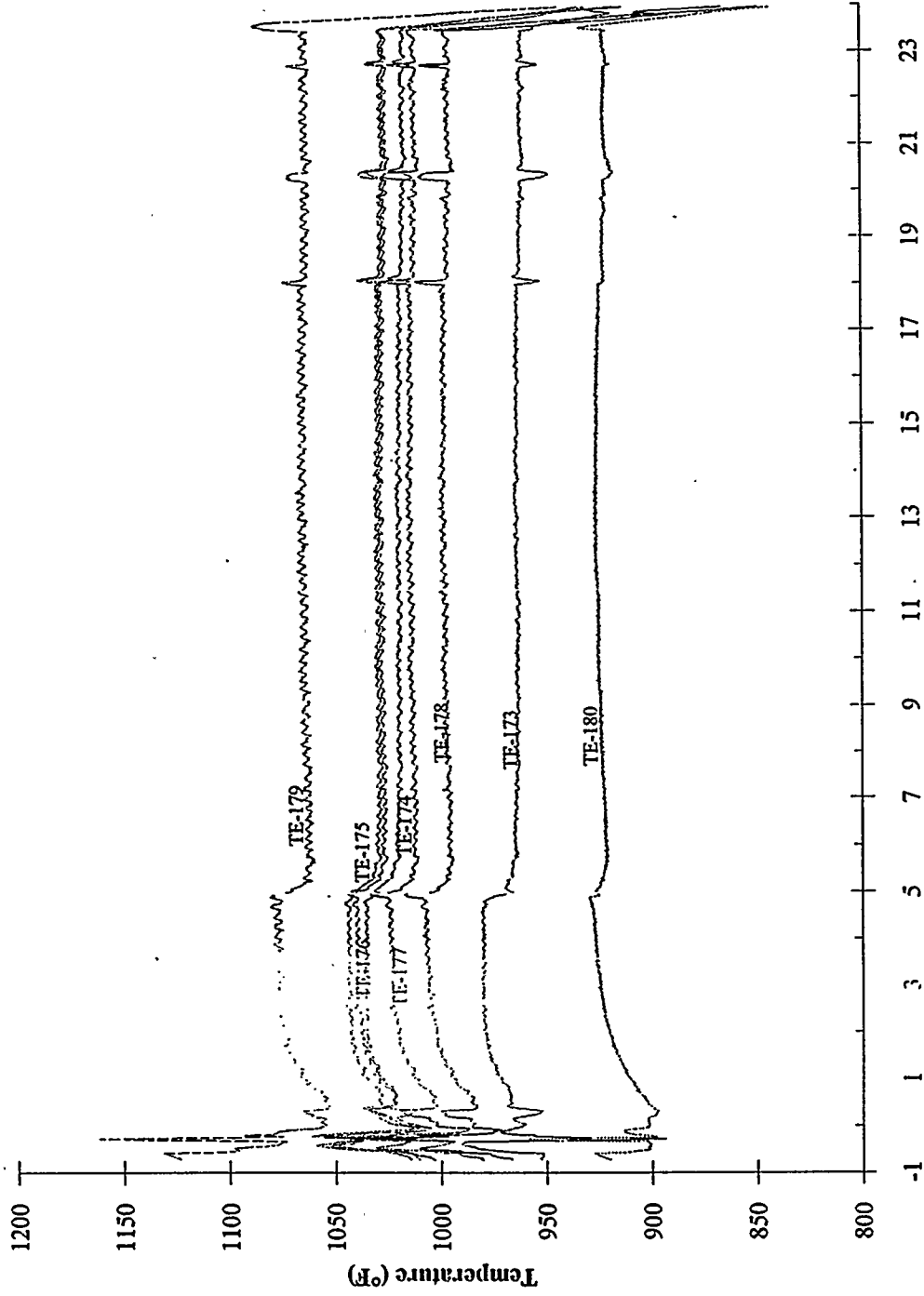

Test time: 10:00-14:57, 17:30 - (January 26, 1993) - 11:53 (January 27, 1993)
Test duration: 23:20

APPENDIX C
Data Acquisition Pressure Trends

System pressures are monitored by DDAS, a PC-based automatic data acquisition system. Trend plots for the Rosemount pressure transmitter readings are presented here. Data are from the reactor inlet, reactor outlet, and system exit pressure.

L-3787M Zinc Titanate
u=2.0 ft/sec T=1100 °F
H2S Inlet Conc. = 800 ppm

Single Cycle Tests - ZTSC-01 Sulfidation 1

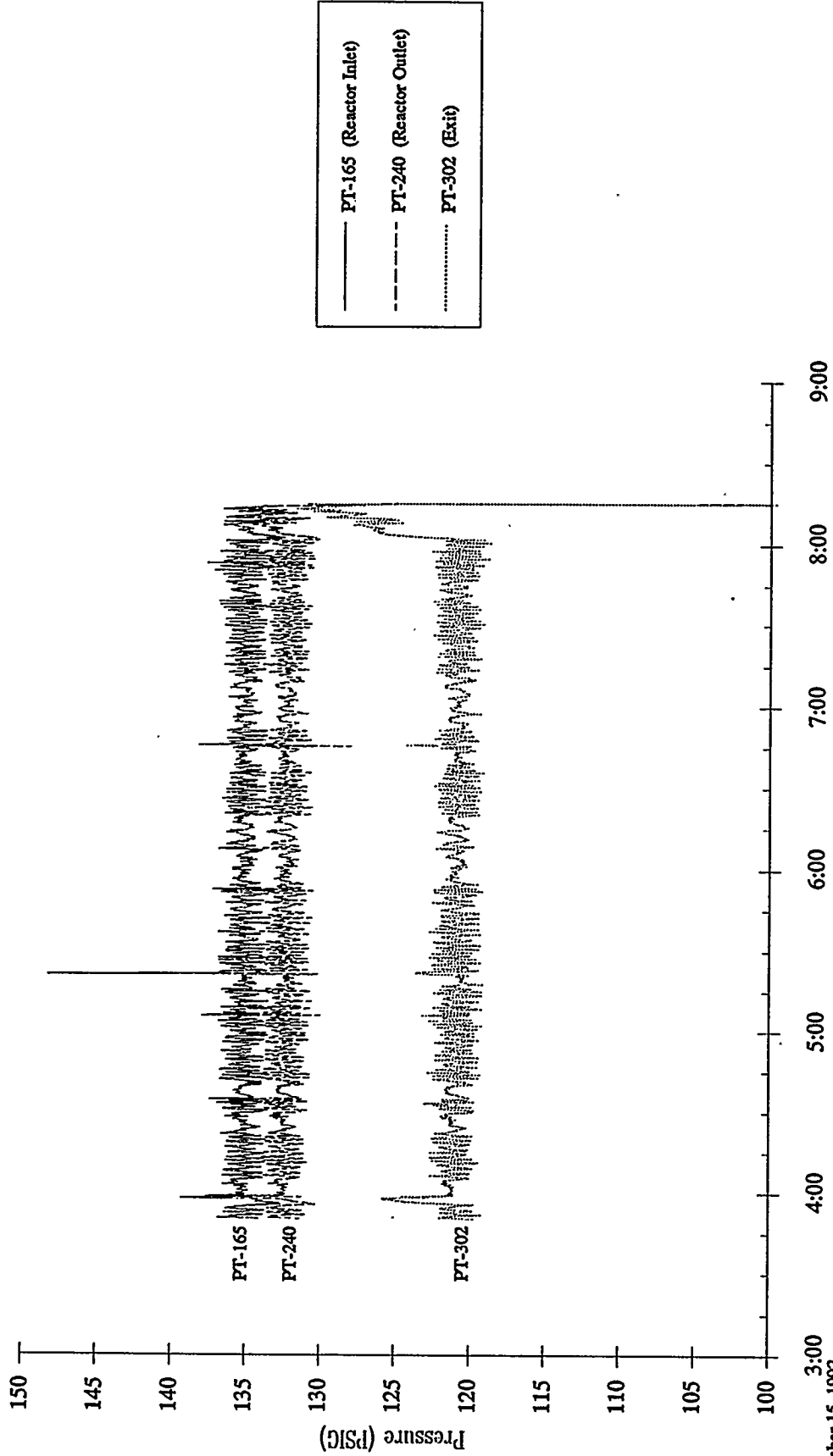

September 15, 1992
3:00 4:00 5:00 6:00 7:00 8:00 9:00
Test time: 4:35-8:08 (Test duration: 3:33)

L-3787M Zinc Titanate
u=1.0 ft/sec T=1100 °F
H2S Inlet Conc. = 800 ppm

Single Cycle Tests - ZTSC-02 Sulfidation 1

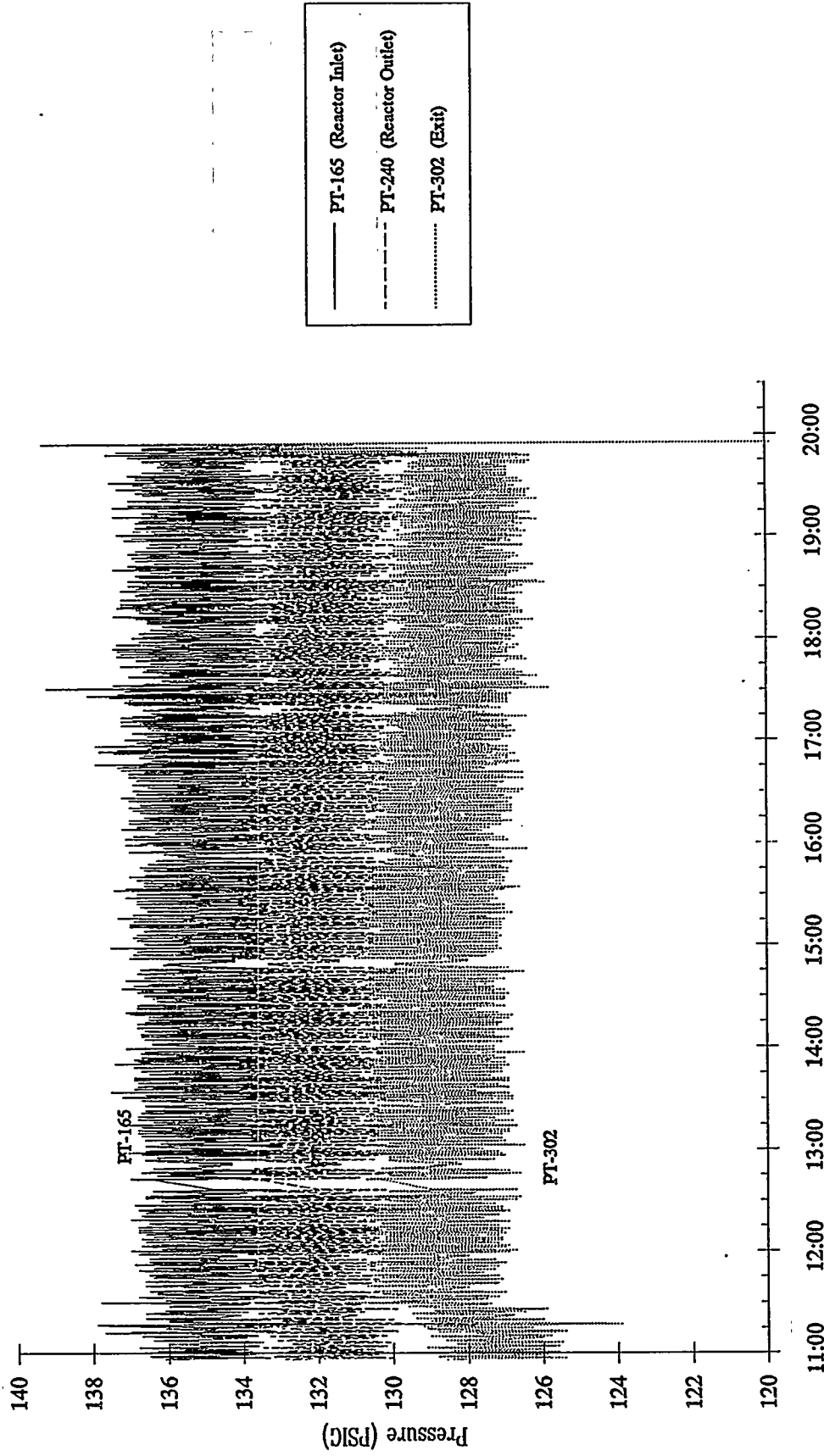

September 4, 1992
Test time: 11:30-19:45 (Test duration: 8:15)

L-3787M Zinc Titanate
u=1.0 ft/sec T=1100 °F
H2S Inlet Conc. = 800 ppm

Single Cycle Tests - ZTSC-03 Sulfidation 1

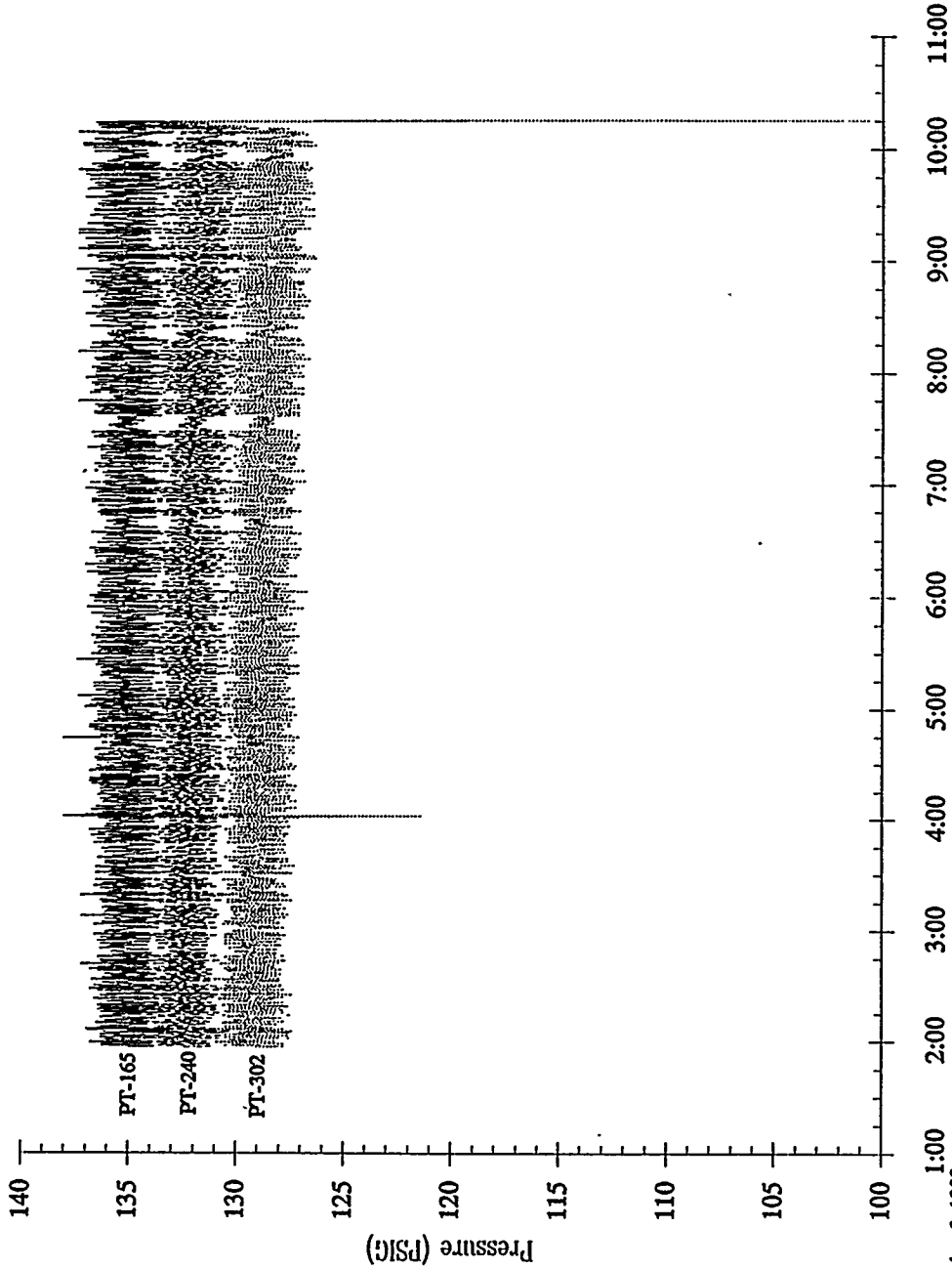

— PT-165 (Reactor Inlet)
- - - PT-240 (Reactor Outlet)
..... PT-302 (Exit)

September 9, 1992
Test time: 1:00-10:05 (Test duration: 9:05)

L-3787M Zinc Titanate
u=1.0 ft/sec T=1000 °F
H2S Inlet Conc. = 800 ppm

Single Cycle Tests - ZTSC-04 Sulfidation 1

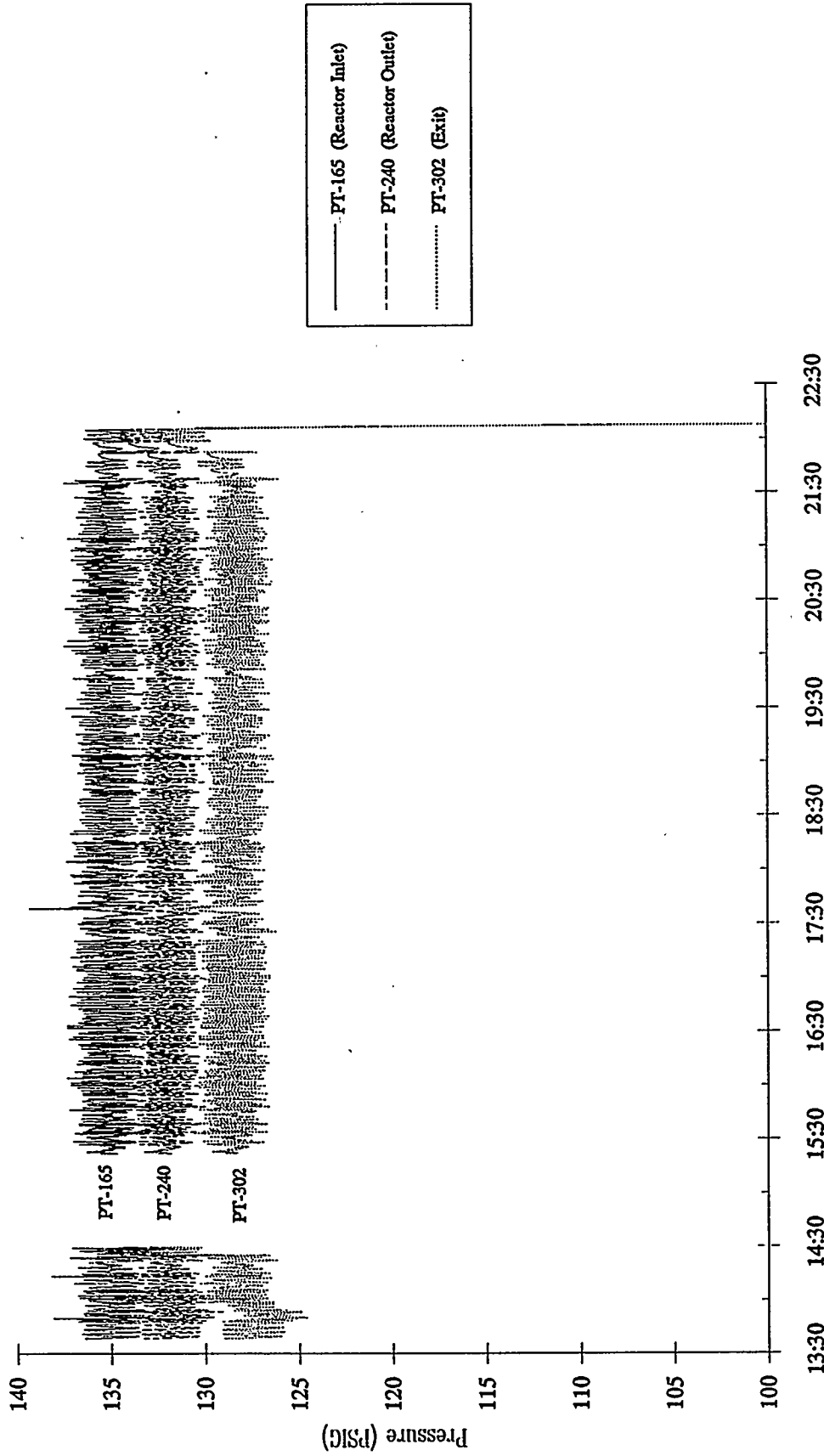

September 10, 1992
Test time: 14:00-14:23, 15:00-21:33 (Test duration: 6:56)

L-3787M Zinc Titanate
u=1.0 ft/sec T=1200 °F
H2S Inlet Conc. = 800 ppm

Single Cycle Tests - ZTSC-05 Sulfidation 1

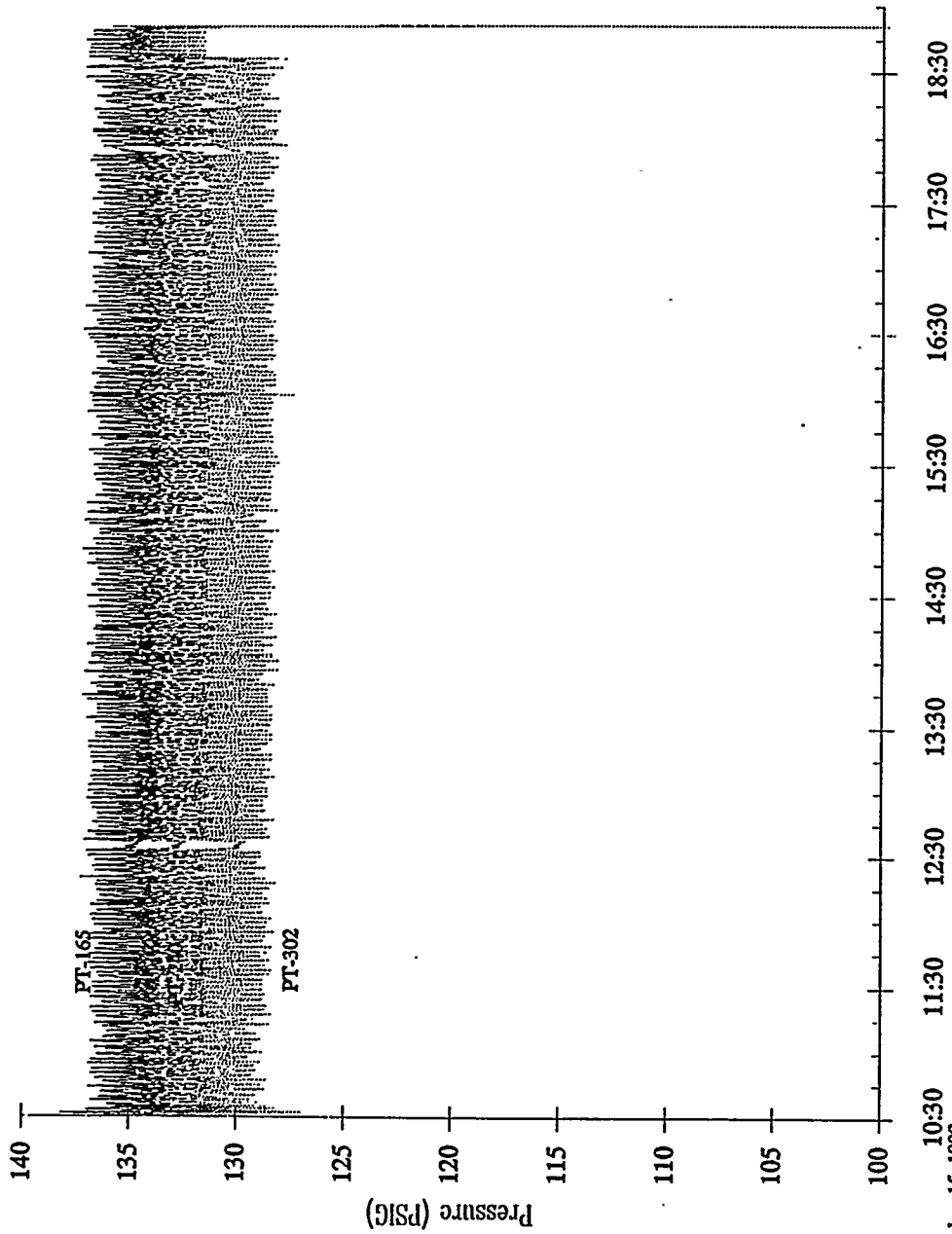

September 15, 1992
Test time: 11:00-18:34 (Test duration: 7:34)

L-3787M Zinc Titanate
u=0.5 ft/sec T=1200 °F
H2S Inlet Conc. = 800 ppm

Single Cycle Tests - ZTSC-06 Sulfidation 1

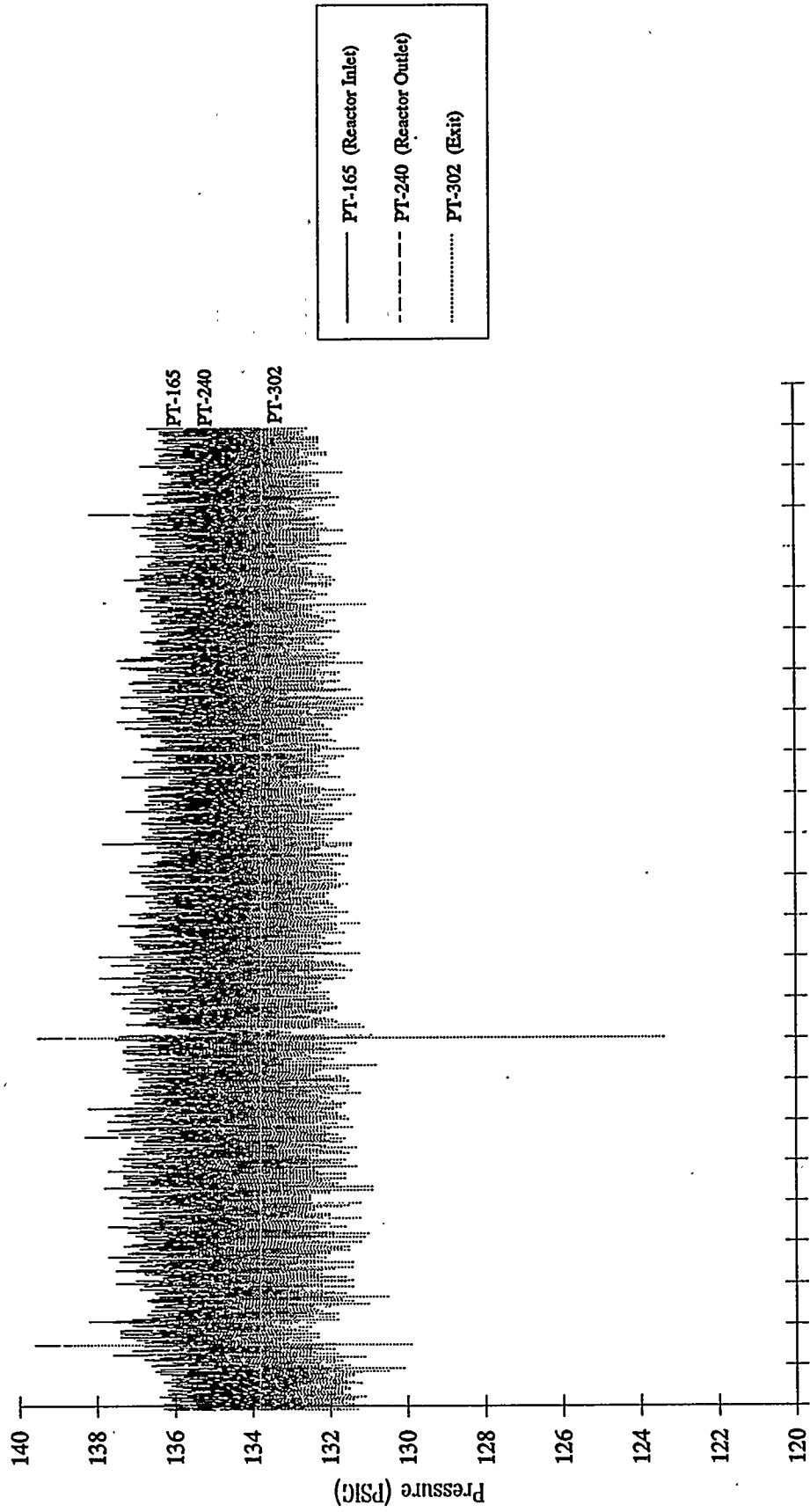

Test time: 9:00 (September 17, 1992) - 6:05 (September 19, 1992)
Test duration: 45:05

L-3787M Zinc Titanate
v=0.5 ft/sec T=1200 °F
H2S Inlet Conc. = 800 ppm

Single Cycle Tests - ZTSC-06 Sulfidation 1

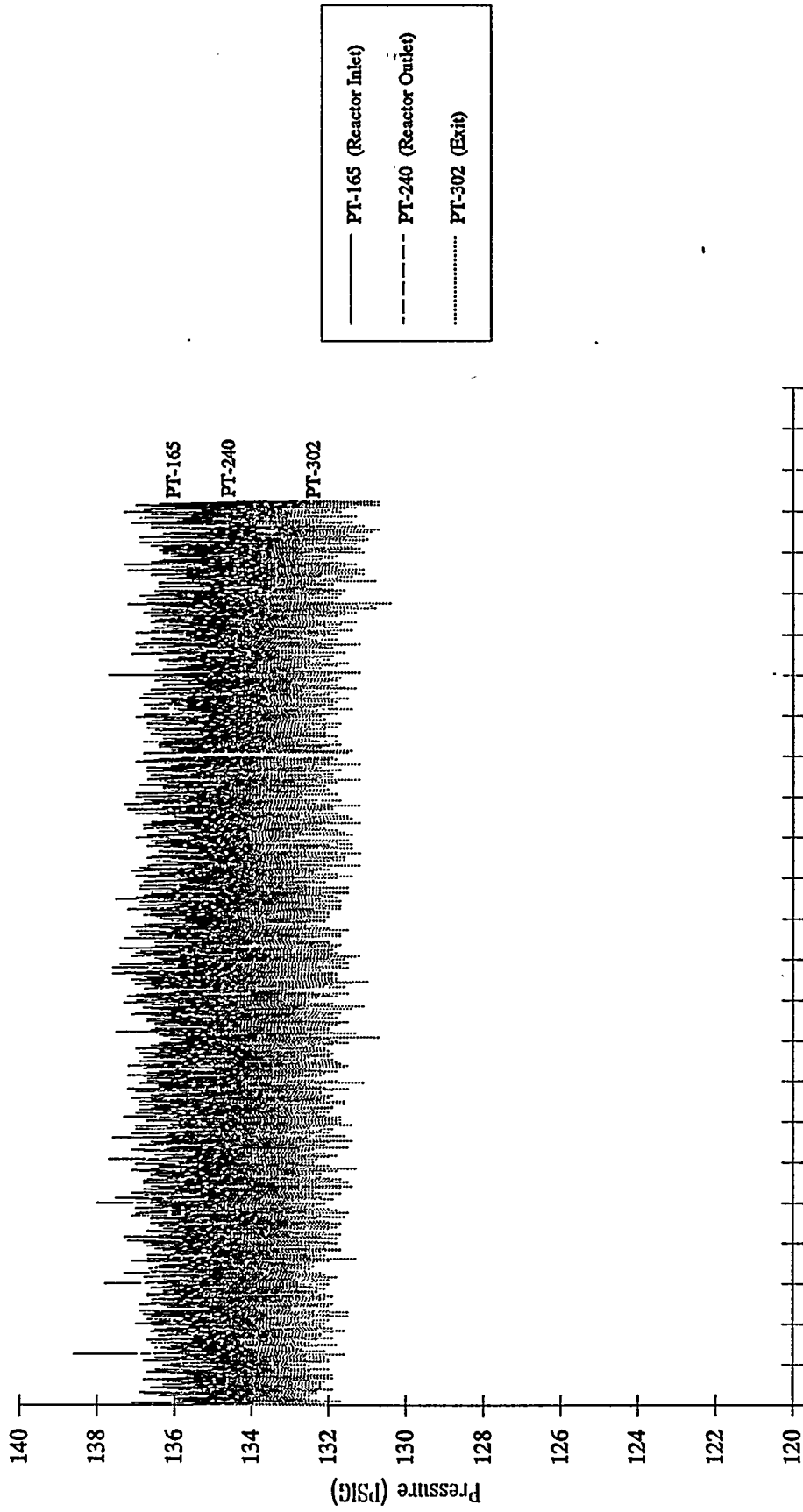

Test time: 9:00 (September 17, 1992) - 6:05 (September 19, 1992)
Test duration: 45:05

L-3787M Zinc Titanate
u=0.5 ft/sec T=1000 °F
H2S Inlet Conc. = 800 ppm

Single Cycle Tests - ZTSC-07 Sulfidation 1

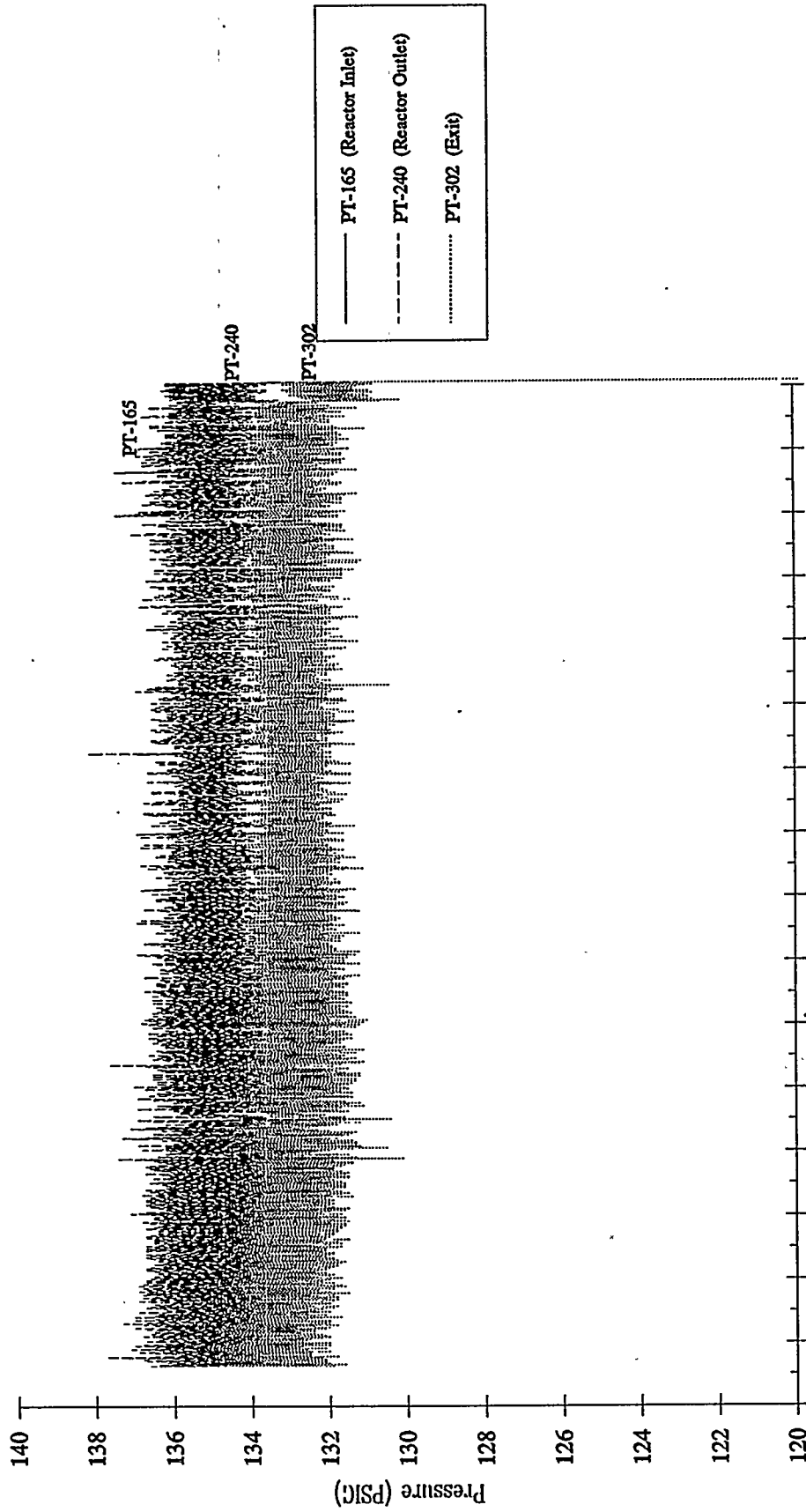

Test time: 12:45 (September 22, 1992) - 18:20 (September 23, 1992)
Test duration: 29:35

L-3787M Zinc Titanate
u=0.5 ft/sec Tmax=1400 F
O2 Inlet Conc. = 2.5 %

Single Cycle Tests - ZTSC-07 Regeneration 1

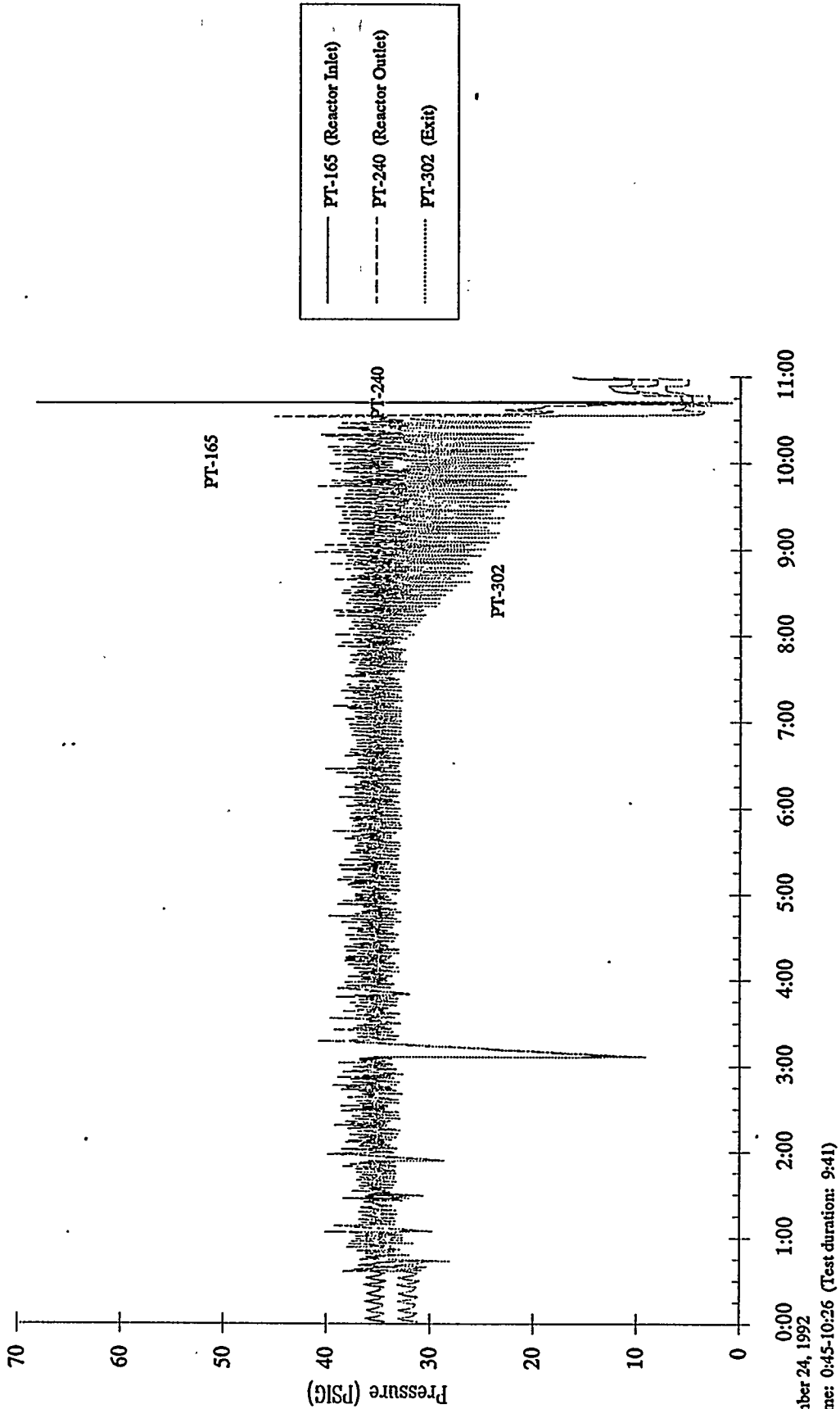

September 24, 1992
Test time: 0:45-10:26 (Test duration: 9:41)

L-3787M Zinc Titanate
u=0.5 ft/sec T=1000 F
H2S Inlet Conc. = 800 ppm

Single Cycle Tests - ZTSC-07 Sulfidation 2

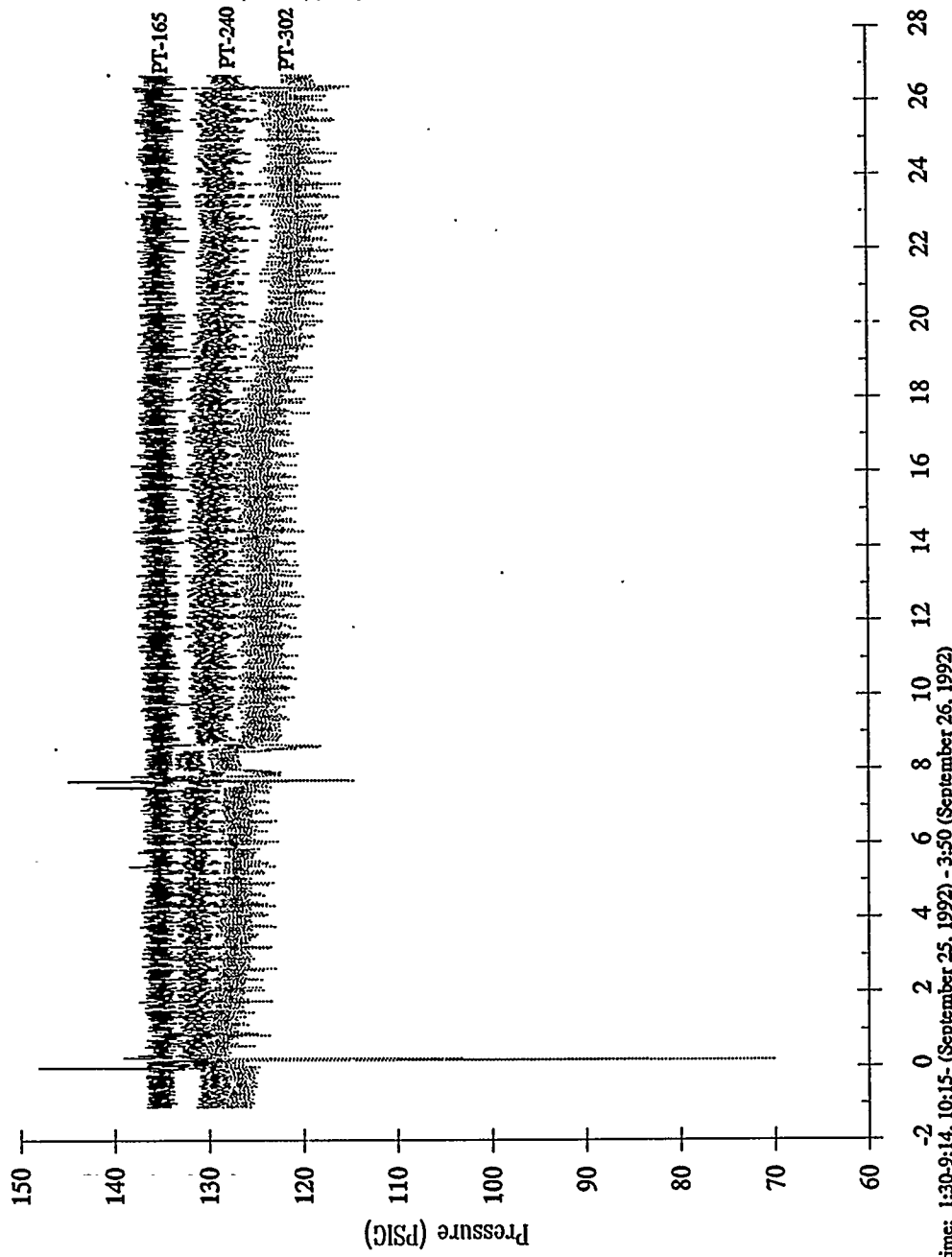

Test time: 1:30-9:14, 10:15- (September 25, 1992) - 3:50 (September 26, 1992)
Test duration: 25:19

L-3787M Zinc Titanate
u=1.0 ft/sec Tmax=1400 °F
O2 Inlet Conc. = 2.5 %

Single Cycle Tests - ZTSC-07 Regeneration 2

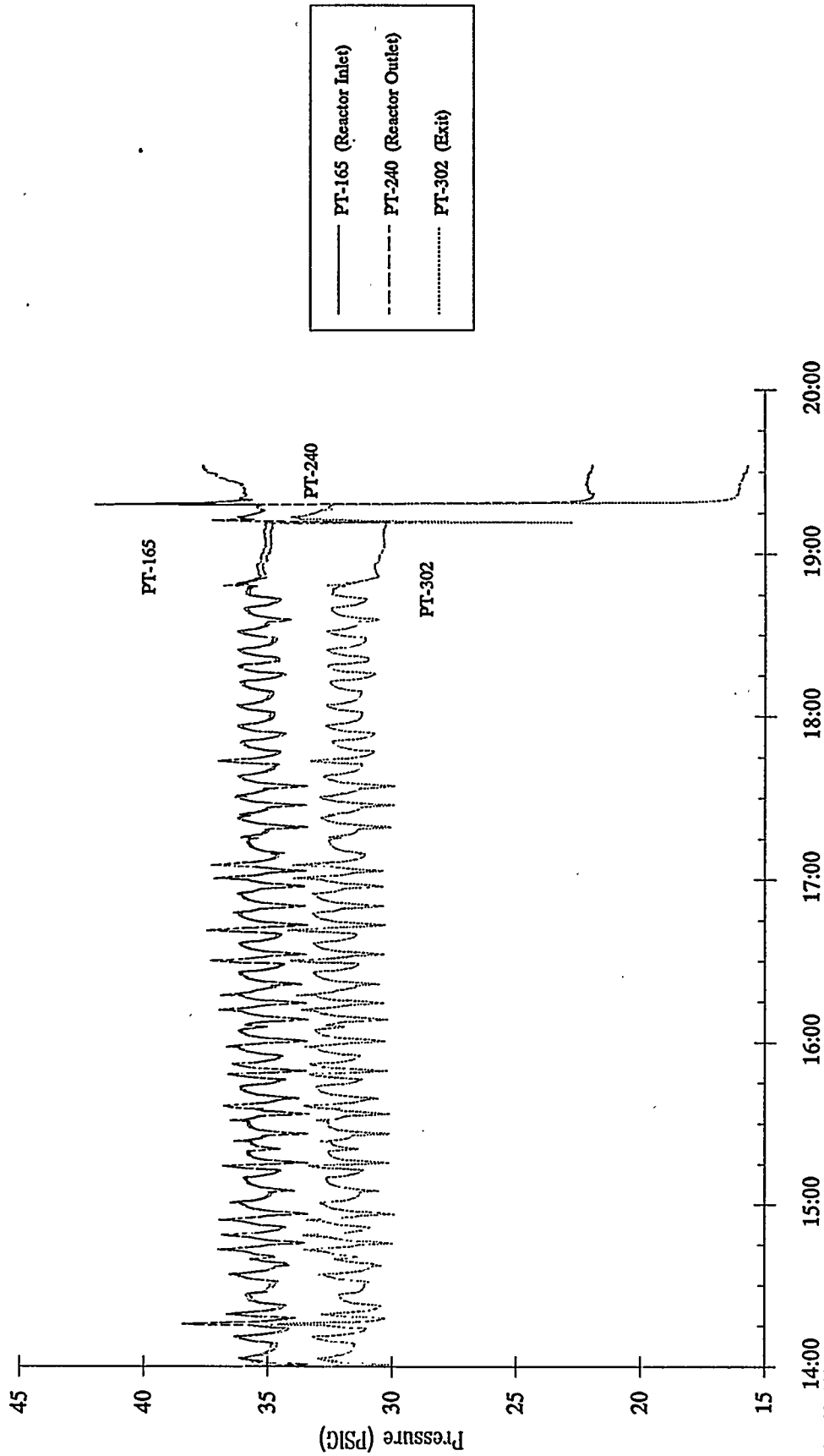

September 28, 1992
14:00 15:00 16:00 17:00 18:00 19:00 20:00
Test time: 14:15 - 18:49 (Test duration: 4:34)

L-3787M Zinc Titanate
u=2.0 ft/sec T=1200 °F
H2S Inlet Conc. = 800 ppm

Single Cycle Tests - ZTSC-07 Sulfidation 3

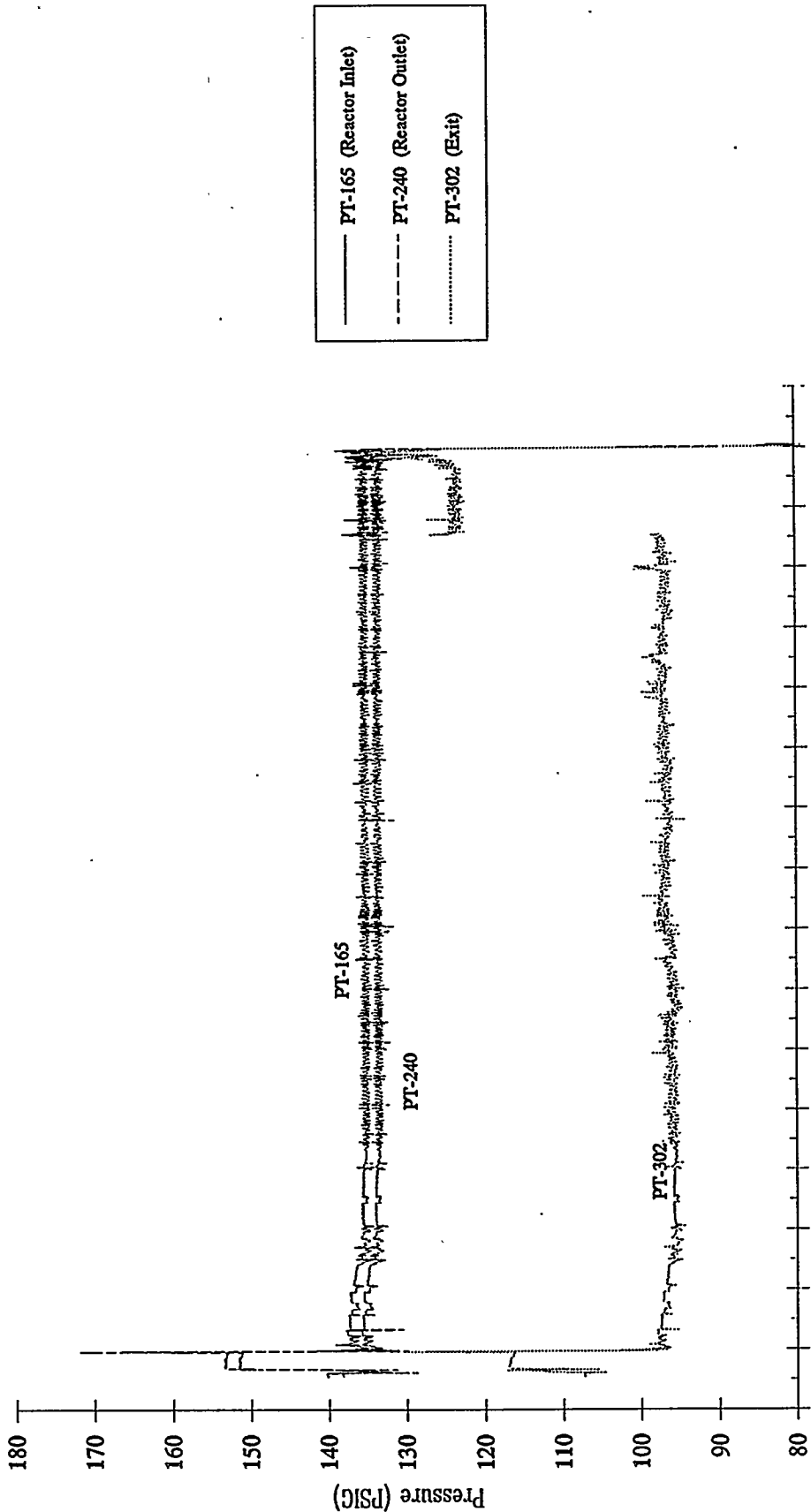

Test time: 1:00 (September 29, 1992) - 4:05 (September 30, 1992); 10:00-12:50 (October 1, 1992)
Test duration: 29:55

L-3787M Zinc Titanate
u=0.33 ft/sec Tmax=1400 °F
O2 Inlet Conc. = 1.5 %

Single Cycle Tests - ZTSC-07 Regeneration 3

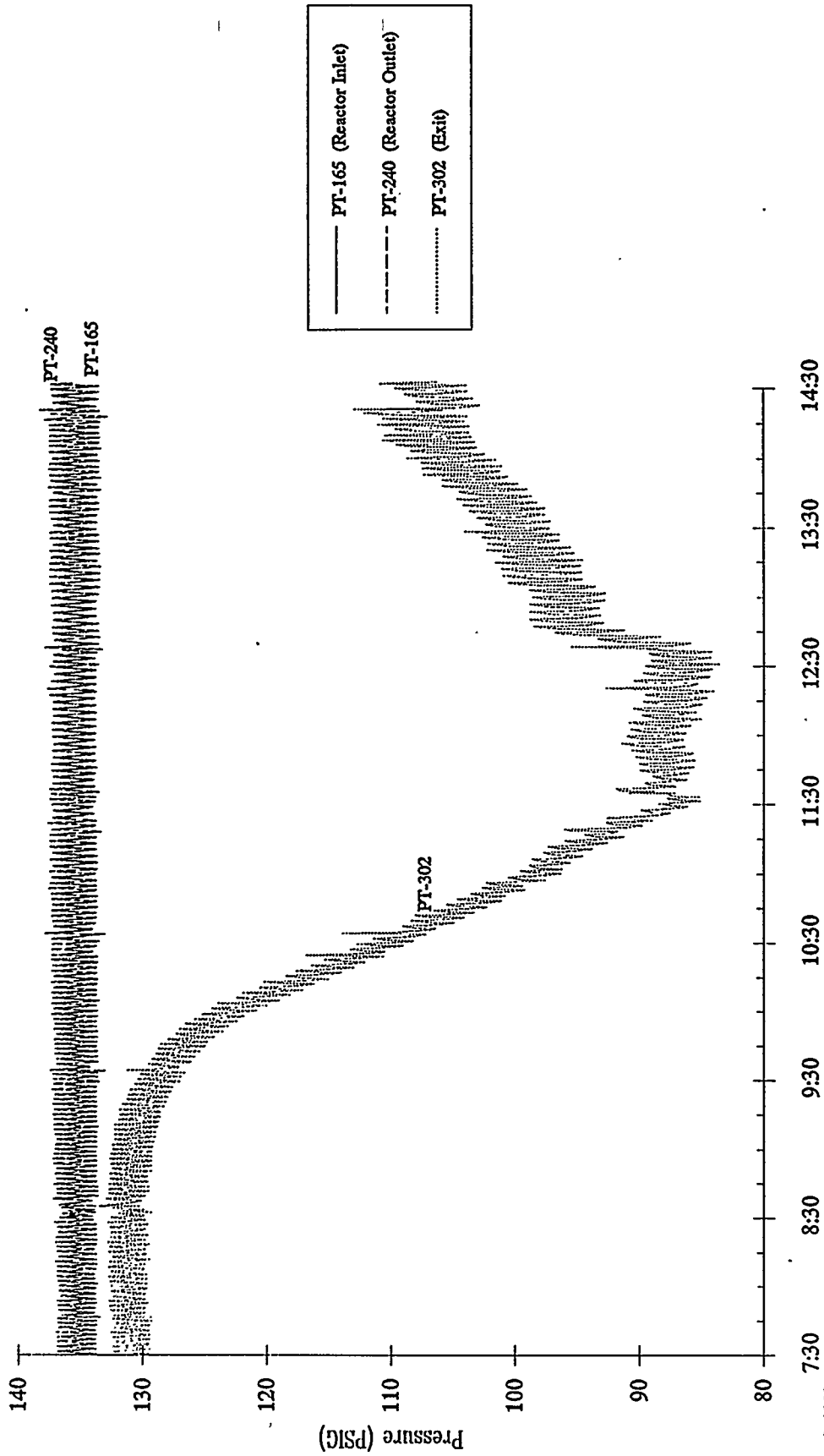

October 2, 1992
Test time: 8:30-14:18 (Test duration: 5:48)

L-3787M Zinc Titanate
u=0.5 ft/sec T=1200 °F
H2S Inlet Conc. = 300 ppm

Multi-Cycle Tests - ZTMC-01 Sulfidation 1

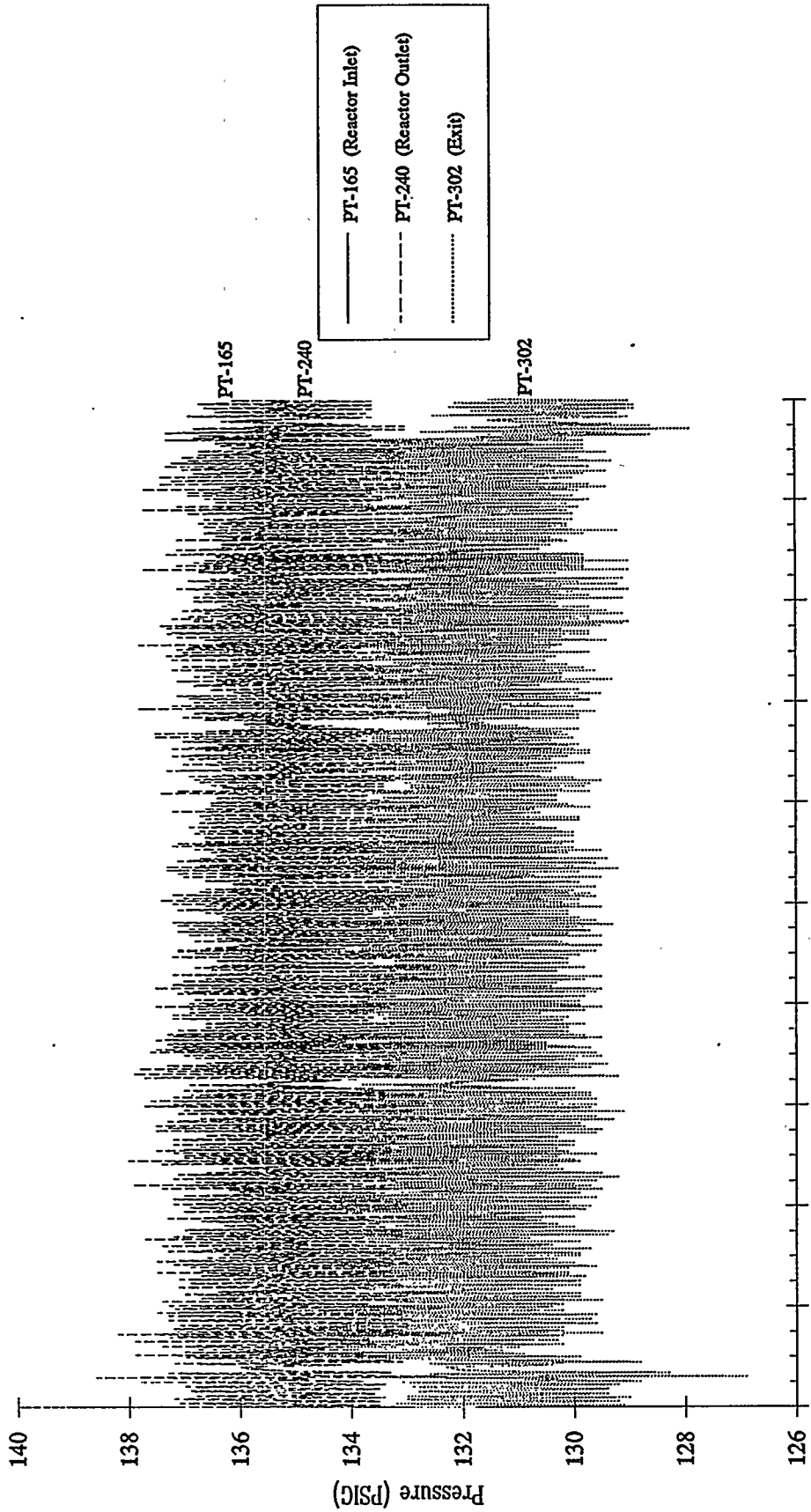

October 6, 1992

Test time: 9:00-18:05 (Test duration: 9:05)

L-3787M Zinc Titanate
u=1.0 ft/sec Tmax=1400 F
O2 Inlet Conc. = 1.5 %

Multi-Cycle Tests - ZTMC-01 Regeneration 1

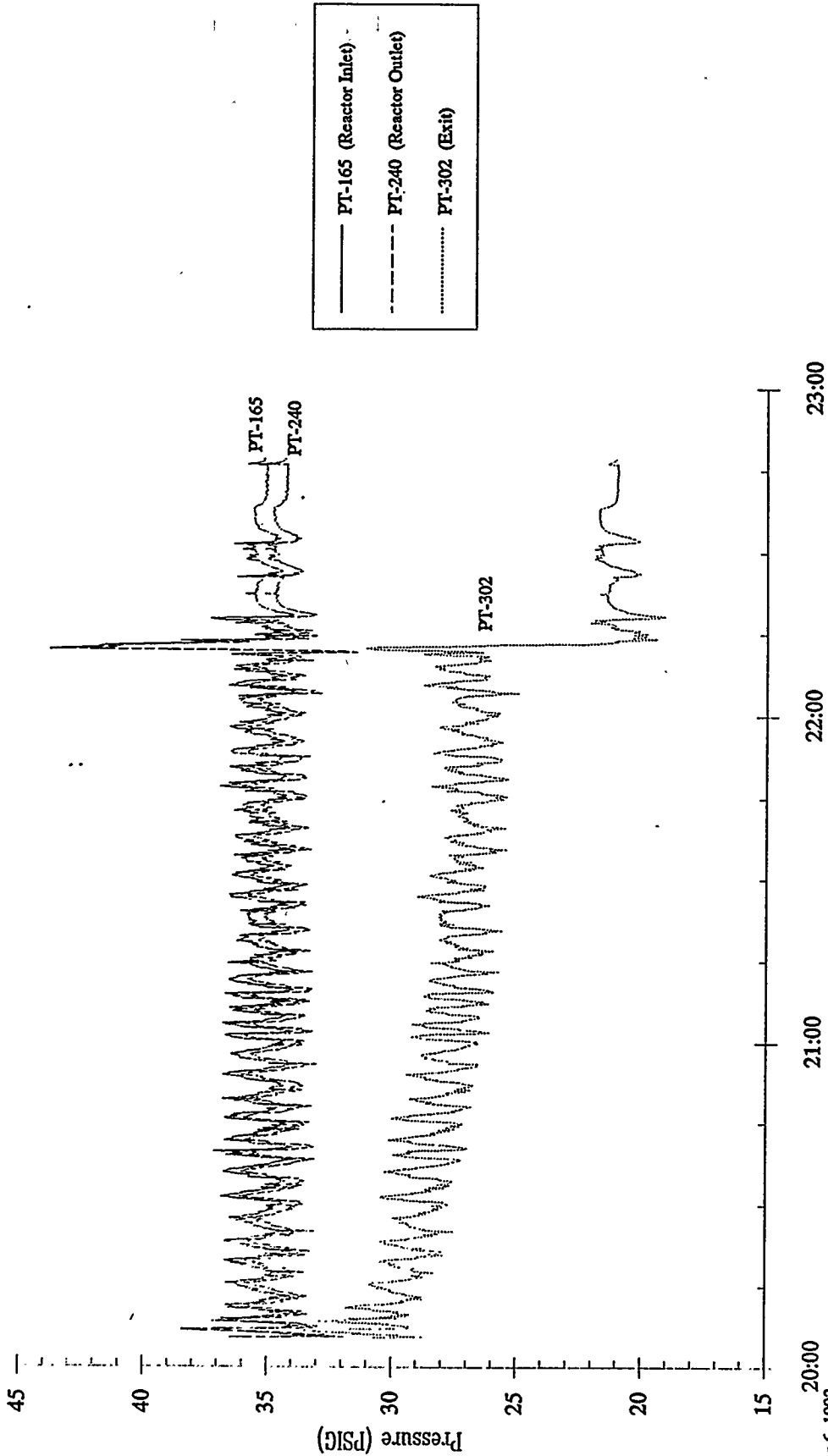

October 6, 1992
Test time: 20:00-22:12 (Test duration: 2:12)

L-3787M Zinc Titanate
u=0.5 ft/sec T=1200 °F
H2S Inlet Conc. = 300 ppm

Multi-Cycle Tests - ZTMC-01 Sulfidation 2

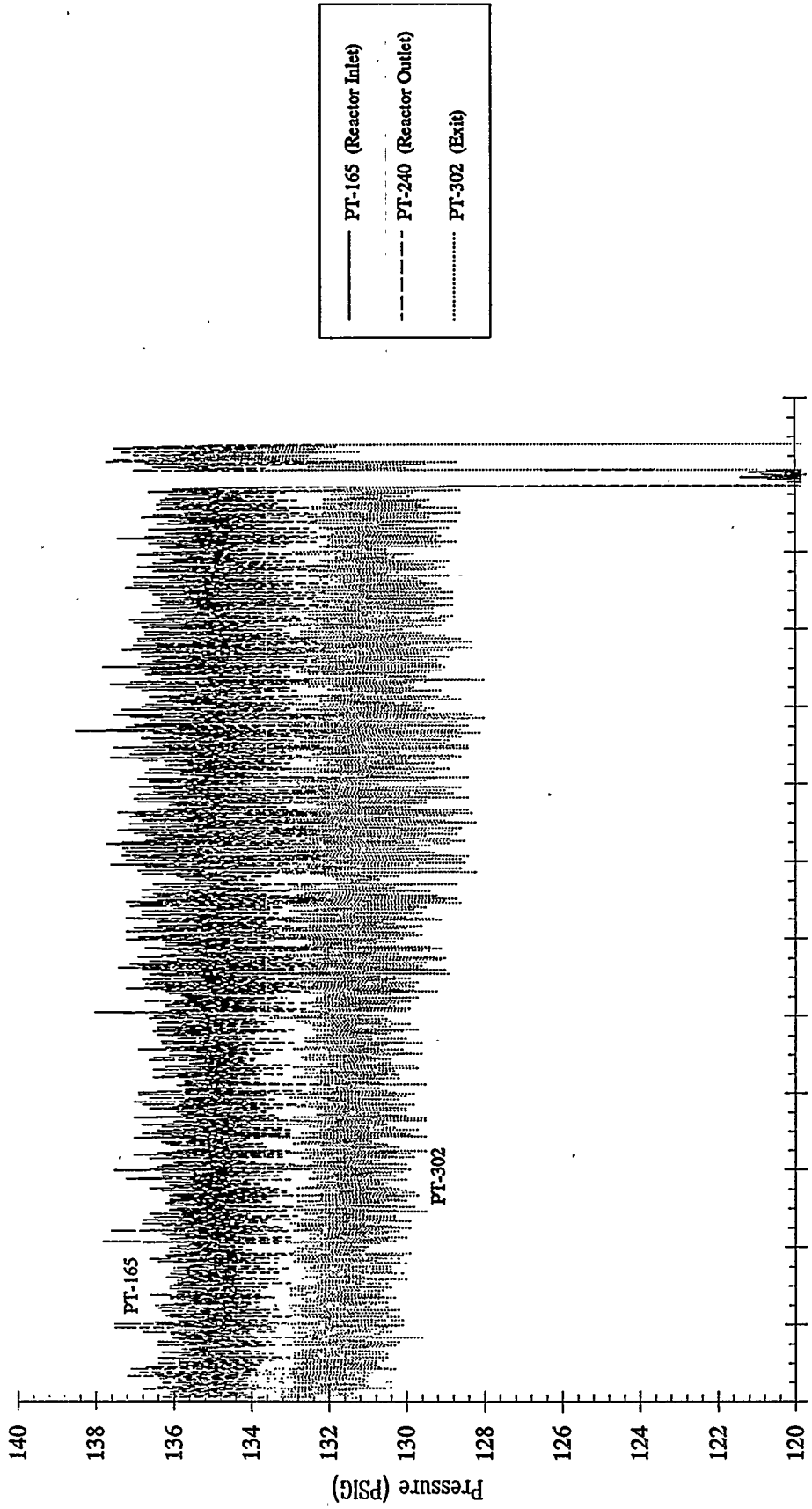

October 7, 1992
Test time: 1:00-13:10 (Test duration: 12:10)

L-3787M Zinc Titanate
v=1.0 f/sec Tmax=1300 °F
O2 Inlet Conc. = 0.75 %

Multi-Cycle Tests - ZTMC-01 Regeneration 2

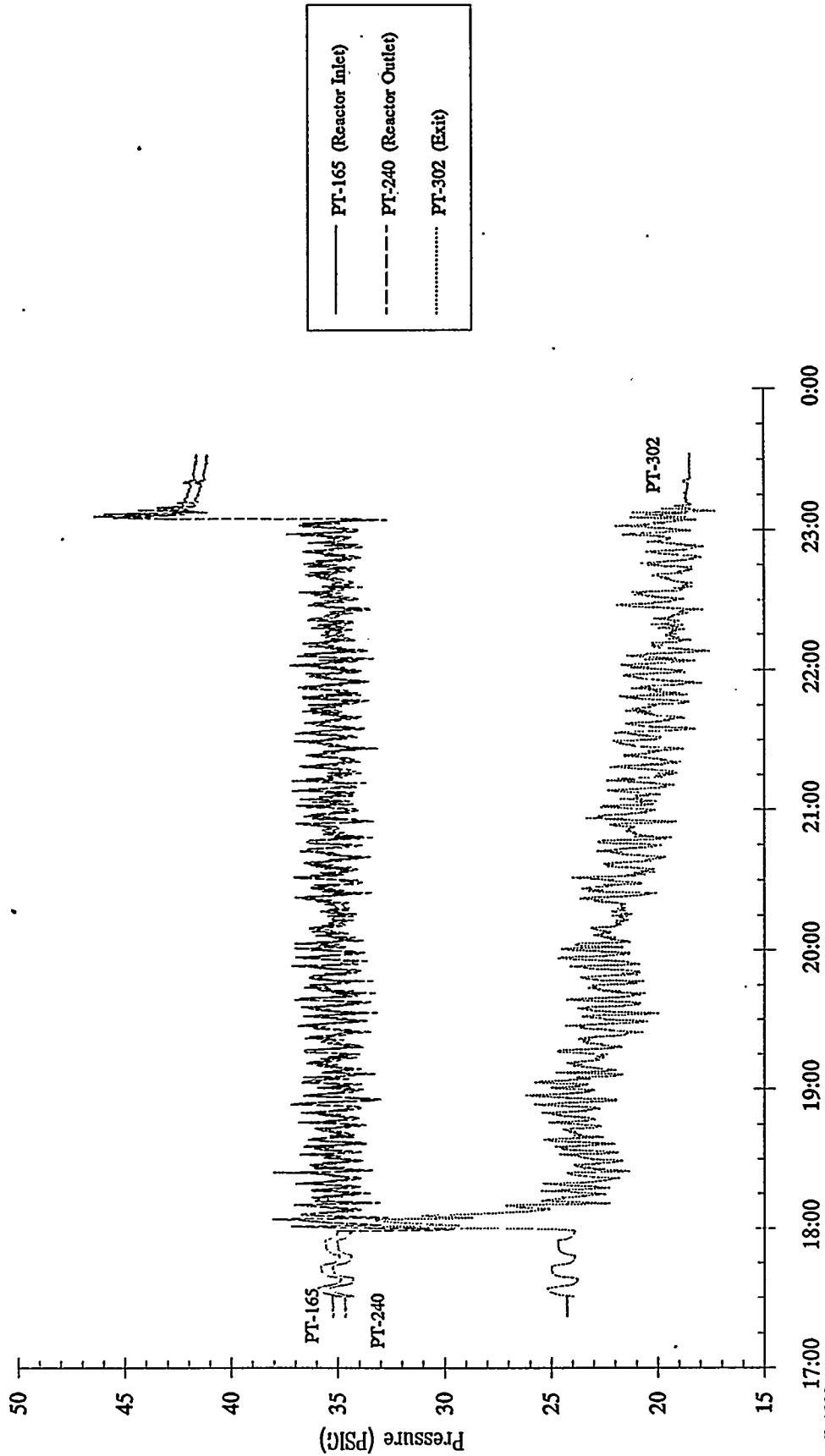

— PT-165 (Reactor Inlet)
- - - PT-240 (Reactor Outlet)
..... PT-302 (Exit)

October 7, 1992
Test time: 18:00-23:05 (Test duration: 5:05)

L-3787M Zinc Titanate
u=0.5 ft/sec T=1100 °F
H2S Inlet Conc. = 800 ppm

Multi-Cycle Tests - ZTMC-01 Sulfidation 3

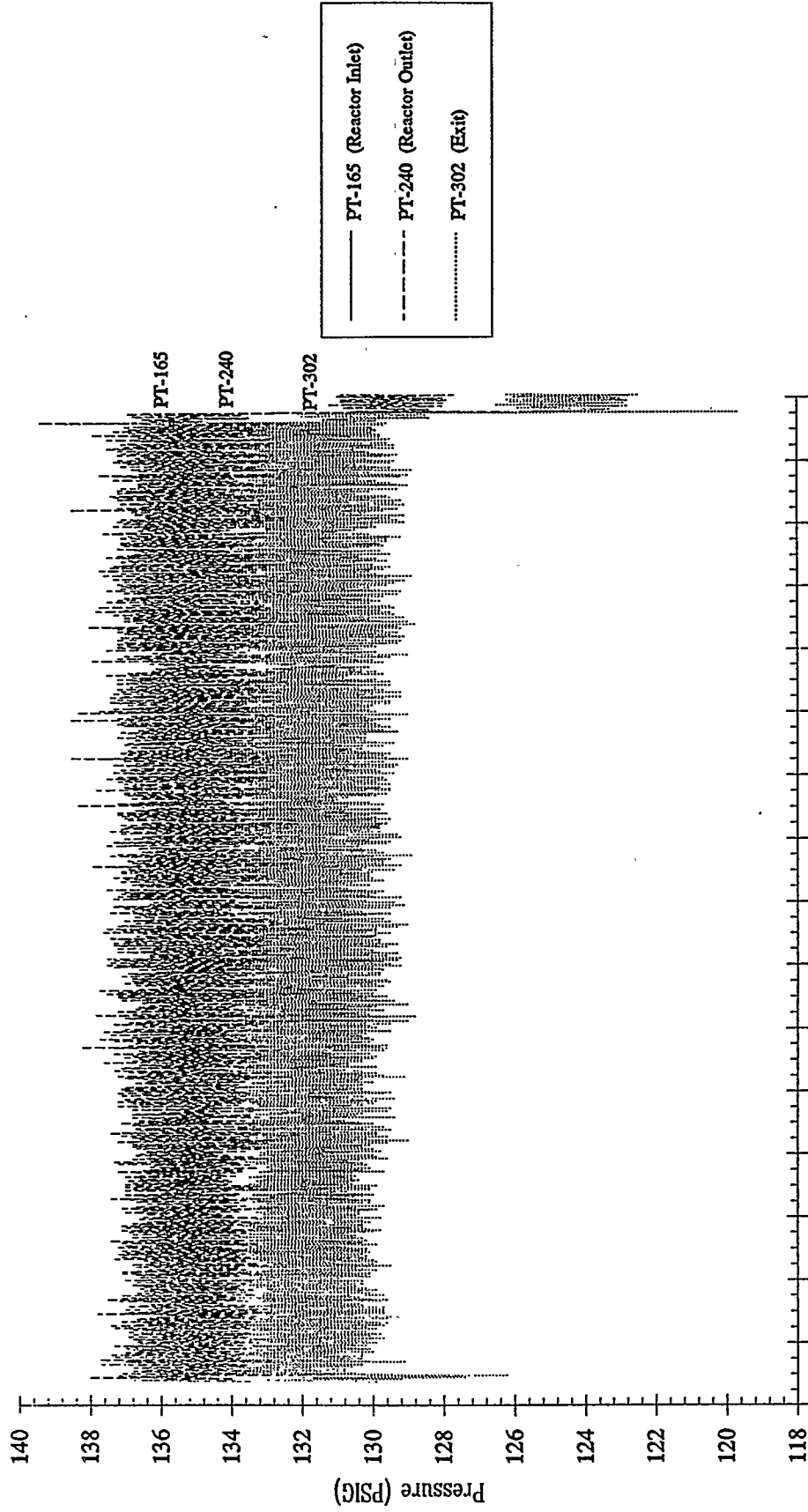

October 8, 1992
Test time: 3:00-18:03 (Test duration: 15:03)

L-3787M Zinc Titanate
u=1.0 ft/sec T_{max}=1300 °F
O₂ Inlet Conc. = 0.75 %

Multi-Cycle Tests - ZTMC-01 Regeneration 3

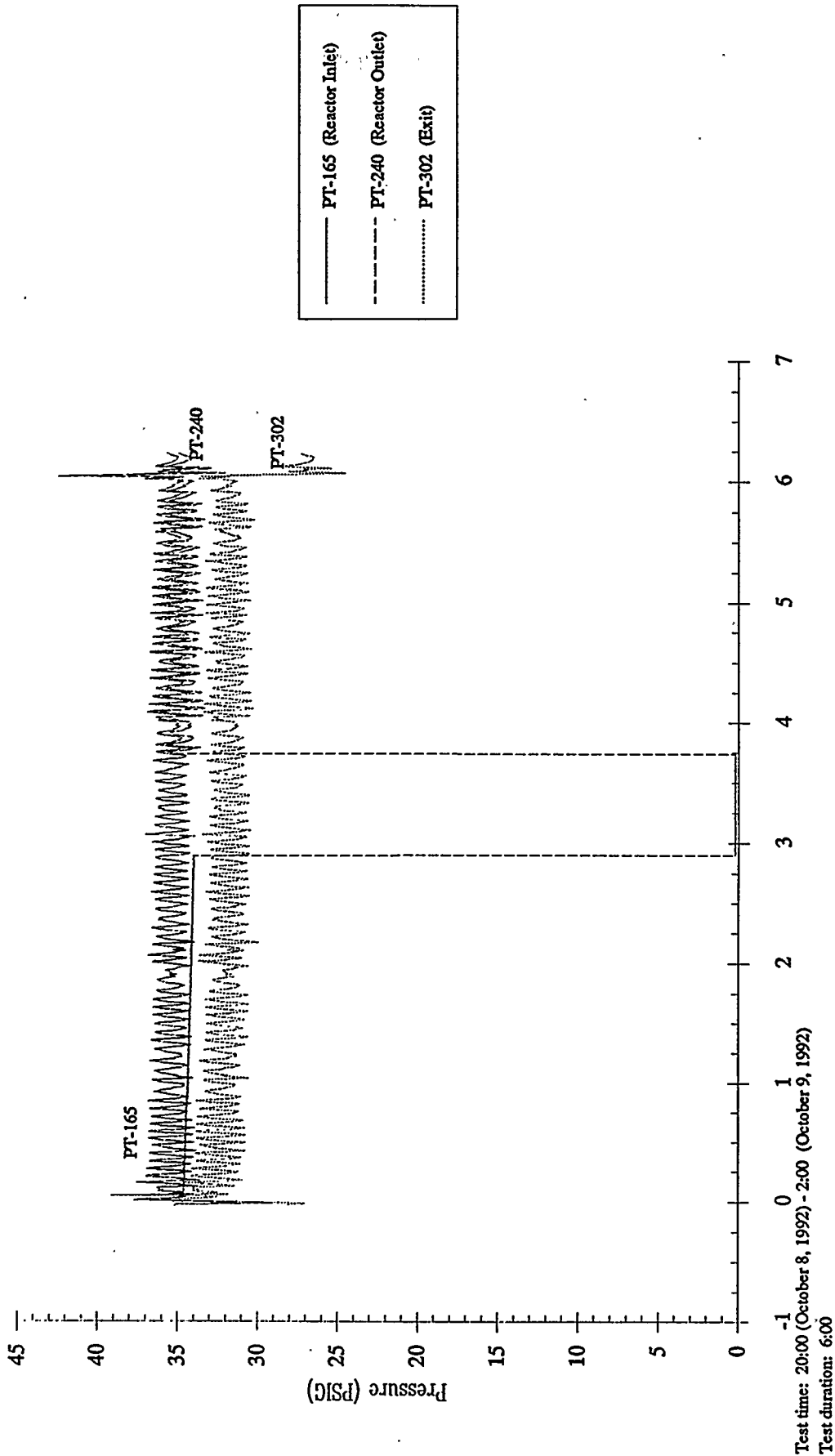

Multi-Cycle Tests - ZTMC-01 Sulfidation 4

L-3787M Zinc Titanate
u=0.5 ft/sec T=1100 °F
H2S Inlet Conc. = 800 ppm

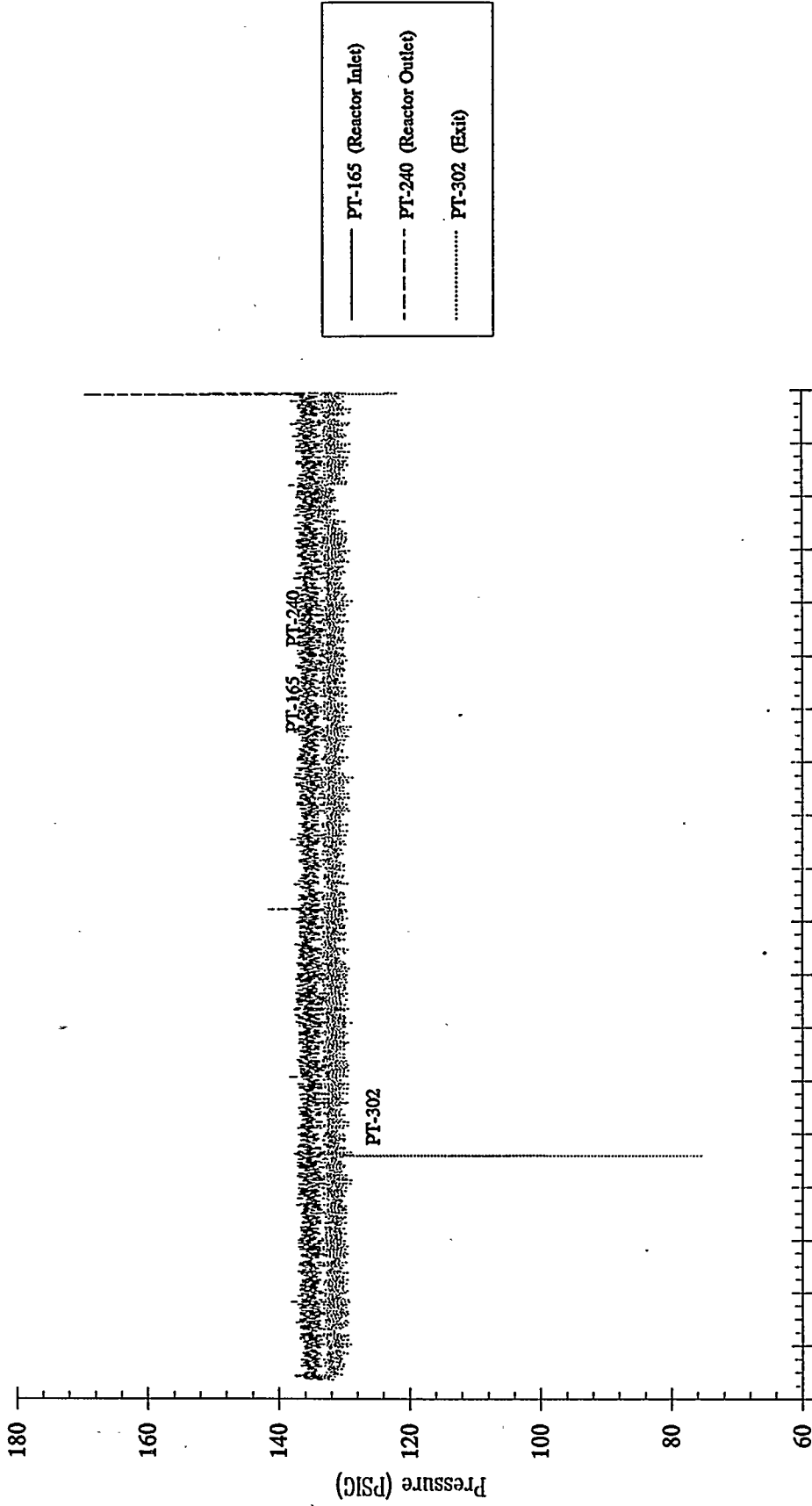

October 9, 1992 3:30 4:30 5:30 6:30 7:30 8:30 9:30 10:30 11:30 12:30 13:30 14:30 15:30 16:30 17:30 18:30 19:30 20:30 21:30 22:30
Test time: 4:00-22:16 (Test duration: 18:16)

L-3787M Zinc Titanate
u=0.5 ft/sec T=1000 °F
H2S Inlet Conc. = 300 ppm

Multi-Cycle Tests - ZTMC-02 Sulfidation 1

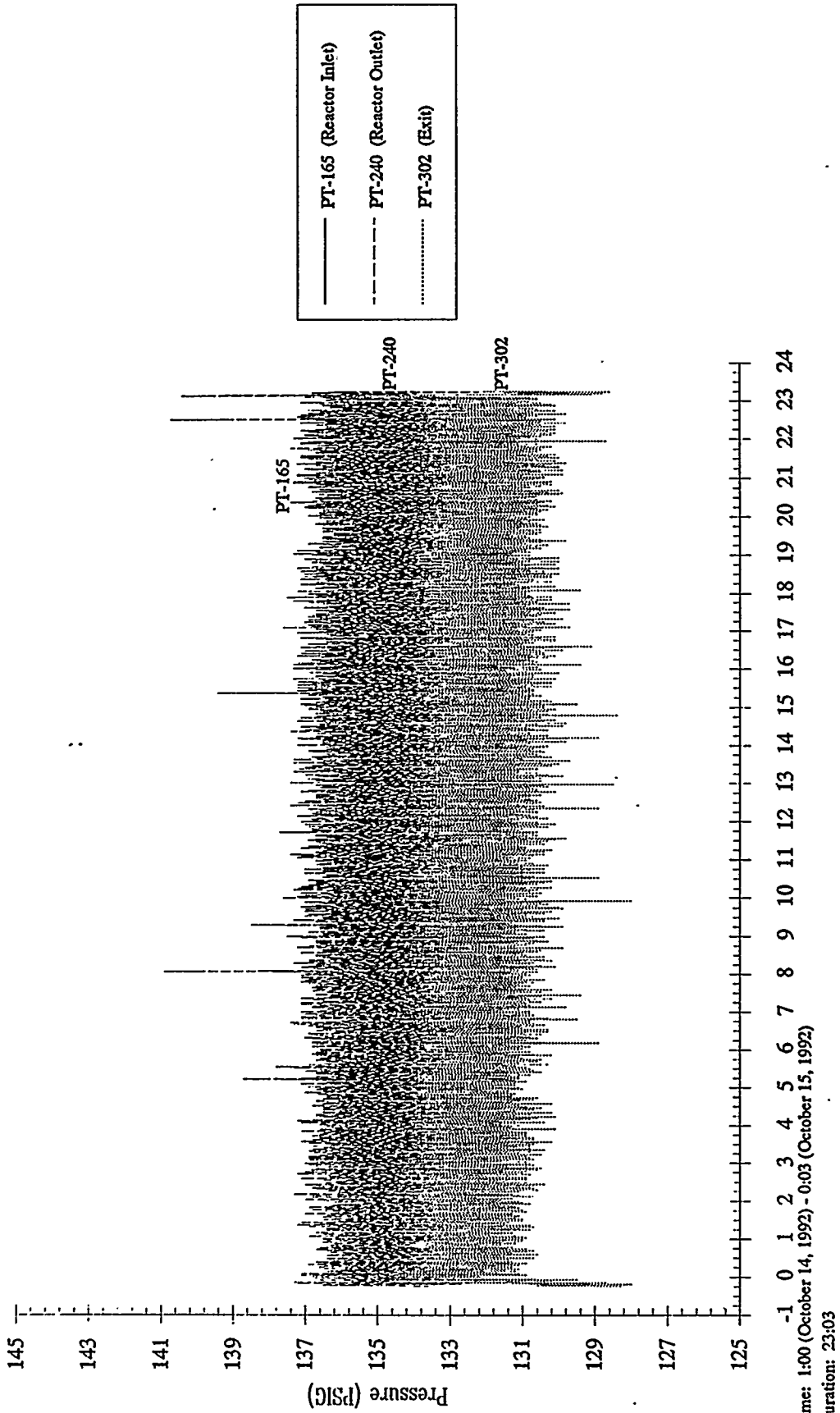

L-3787M Zinc Titanate
u=0.5 ft/sec Tmax=1400 °F
O2 Inlet Conc. = 2.5 %

Multi-Cycle Tests - ZTMC-02 Regeneration 1

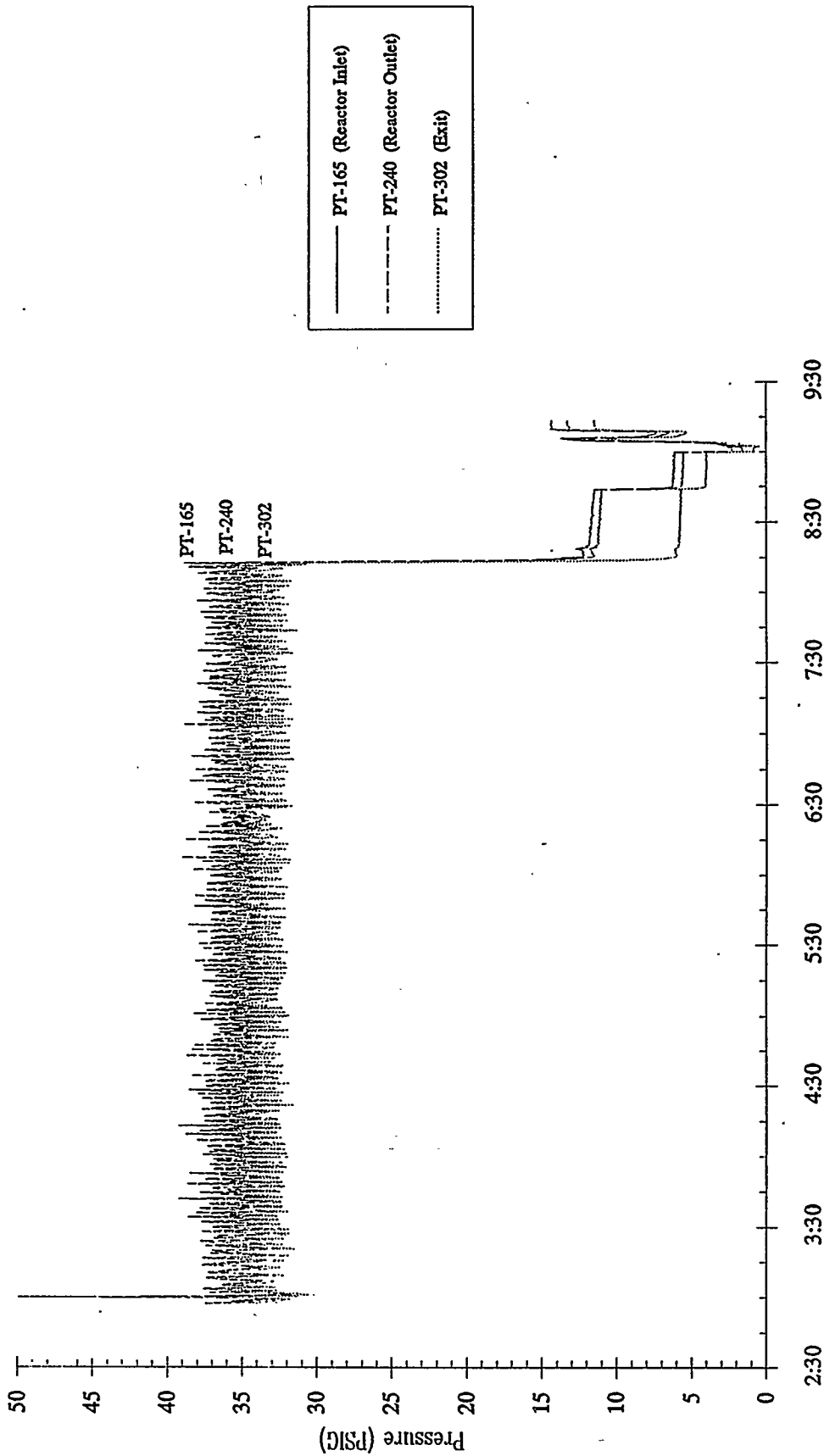

October 15, 1992
Test time: 3:00-8:13 (Test duration: 5:13)

L-3787M Zinc Titanate
u=0.5 ft/sec T=1000 °F
H2S Inlet Conc. = 300 ppm

Multi-Cycle Tests - ZTMC-02 Sulfidation 2

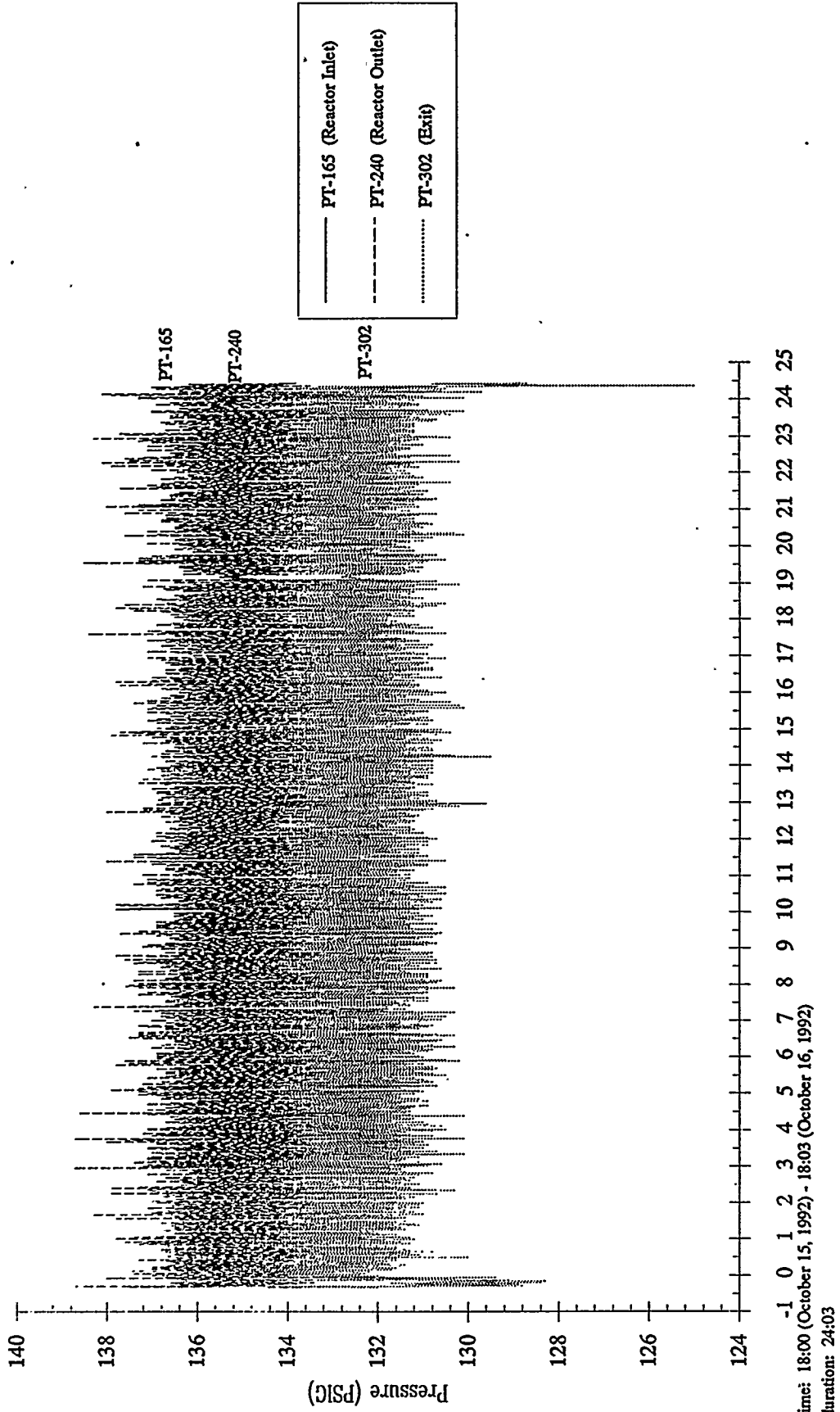

L-3787M Zinc Titanate
u=1.0 ft/sec Tmax=1400 °F
O2 Inlet Conc. = 2.5 %

Multi-Cycle Tests - ZTMC-02 Regeneration 2

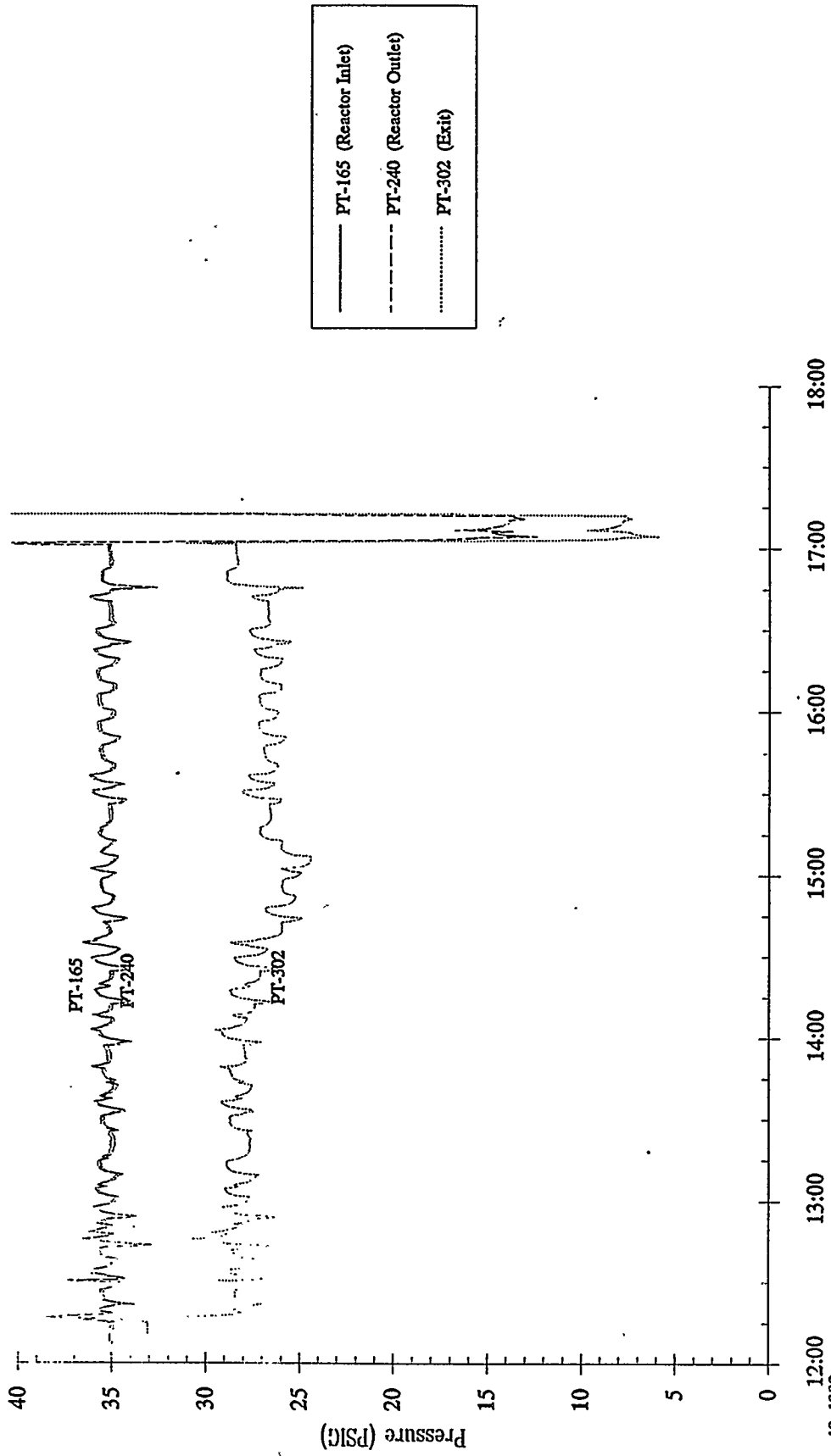

October 19, 1992
Test time: 12:30 - 16:45 (Test duration: 4:15)

L-3787M Zinc Titanate
u=2.0 ft/sec T=1200 °F
H2S Inlet Conc. = 800 ppm

Multi-Cycle Tests - ZTMC-02 Sulfidation 3

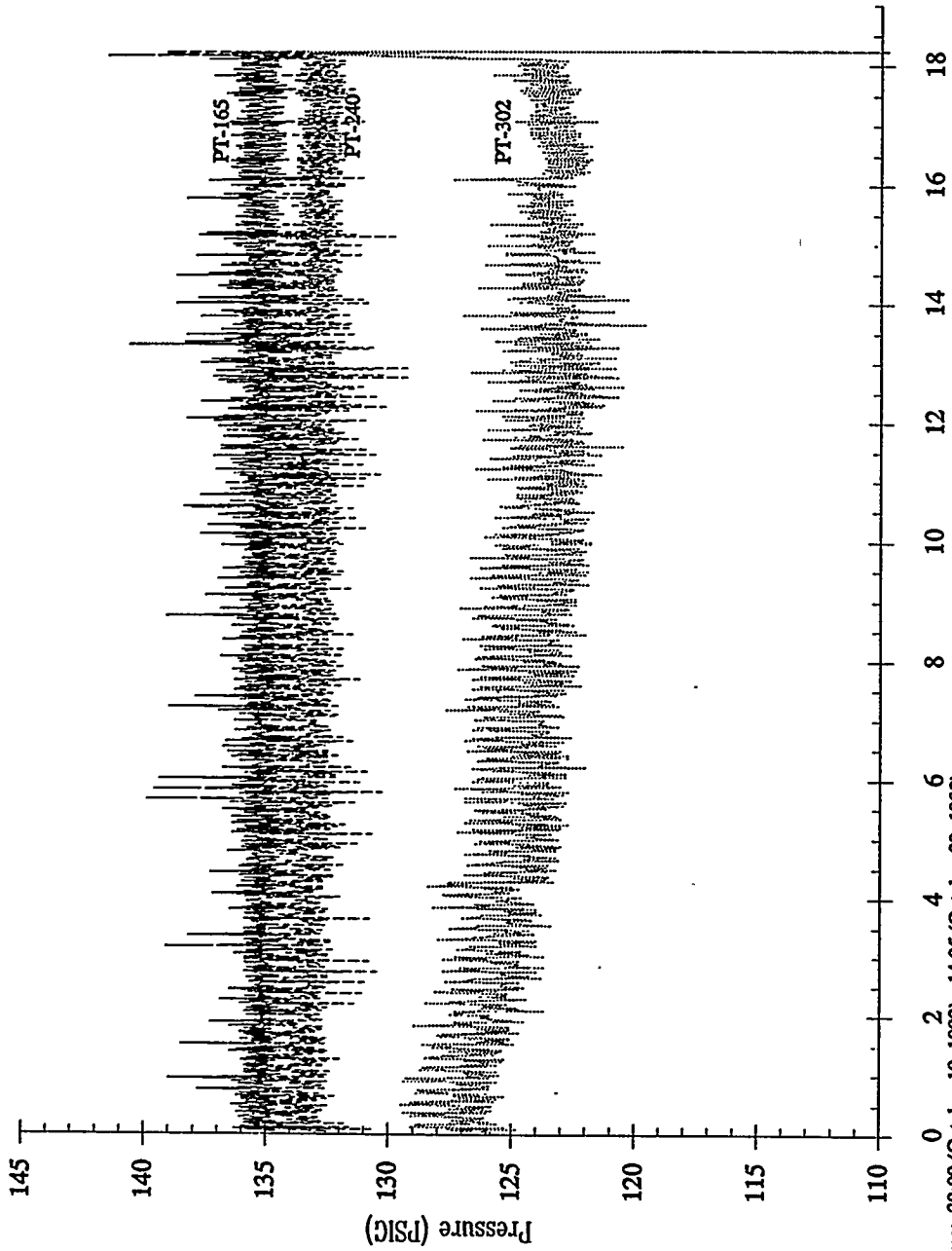

Test time: 20:00 (October 19, 1992) - 14:05 (October 20, 1992)
Test duration: 18:05

L-3787M Zinc Titanate

u=0.33 ft/sec T_{max}=1400 °F

O₂ Inlet Conc. = 1.5 %

Multi-Cycle Tests - ZTMC-02 Regeneration 3

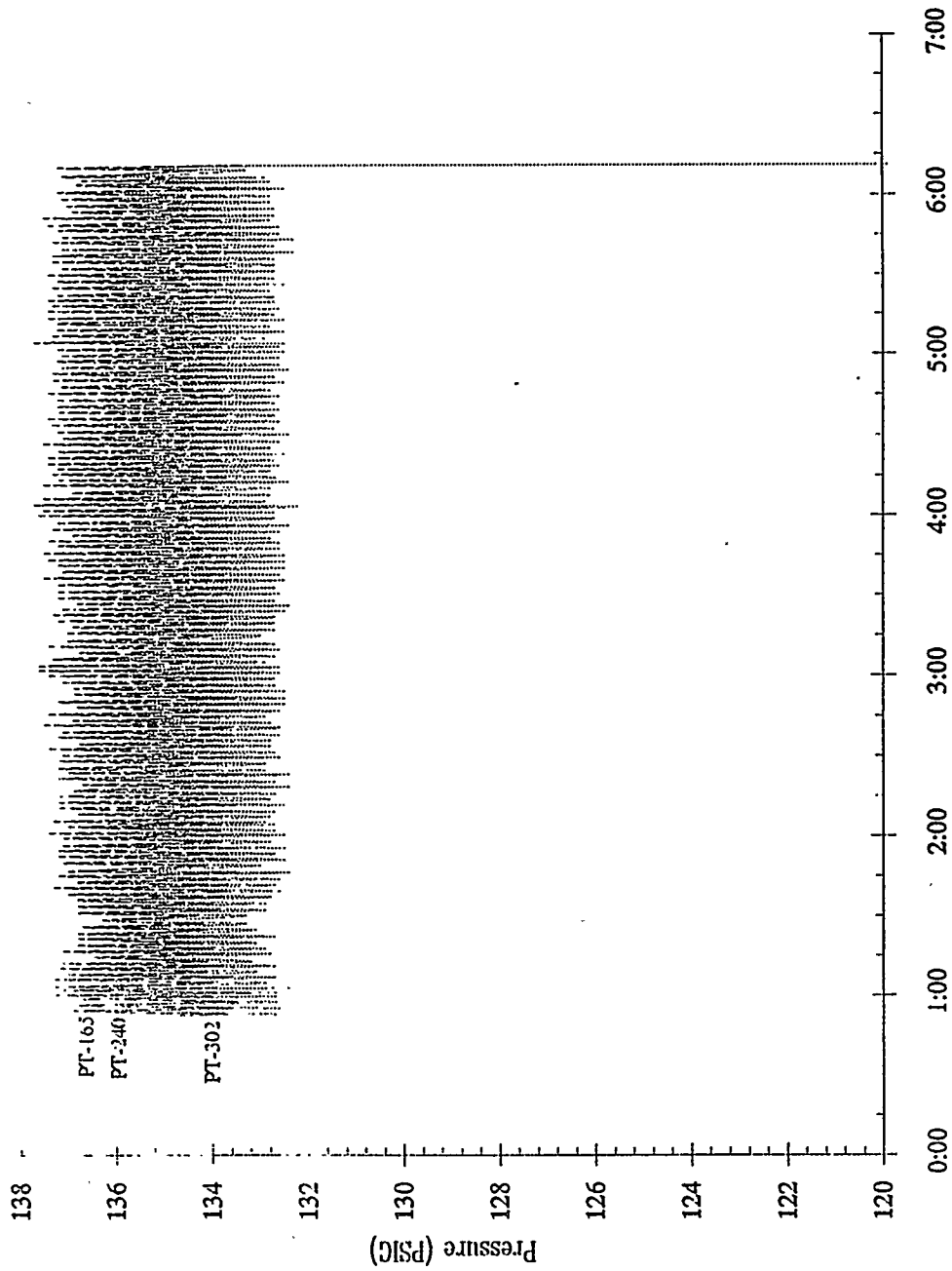

— PT-165 (Reactor Inlet)
- - - PT-240 (Reactor Outlet)
..... PT-302 (Exit)

October 21, 1992
Test time: 1:00 - 6:03 (Test duration: 5:03)

L-3787M Zinc Titanate
u=1.0 ft/sec T=1200 °F
E2S Inlet Conc. = 0 ppm

Multi-Cycle Tests - ZTMC-03 Sulfidation 1

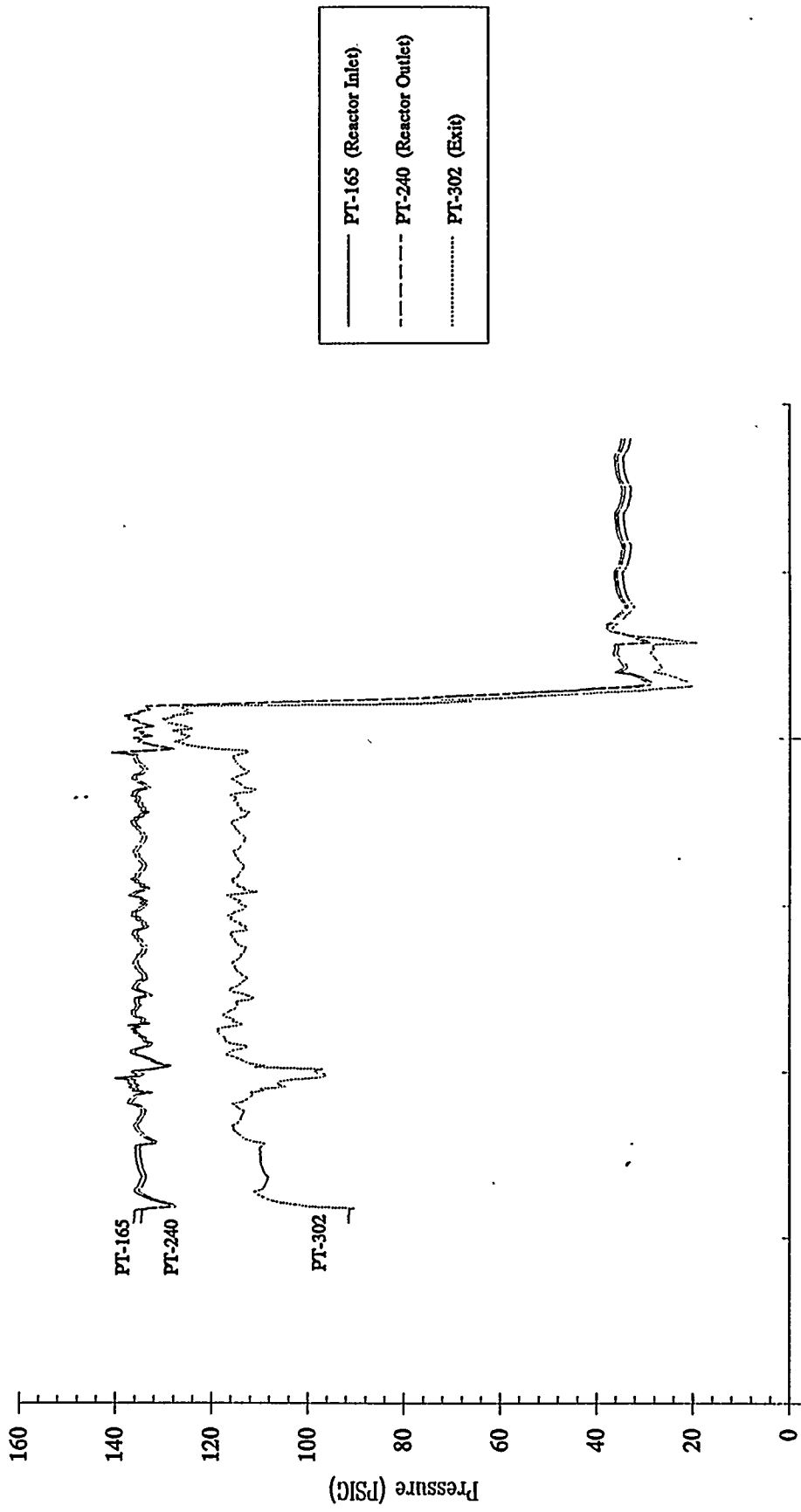

13:00
November 4, 1992
Test time: 13:30-14:00 (Test duration: 0:30)

14:00

L-3787M Zinc Titanate
u=1.0 ft/sec Tmax=1400 F
O2 Inlet Conc. = 0.75 %

Multi-Cycle Tests - ZTMC-03 Regeneration 1

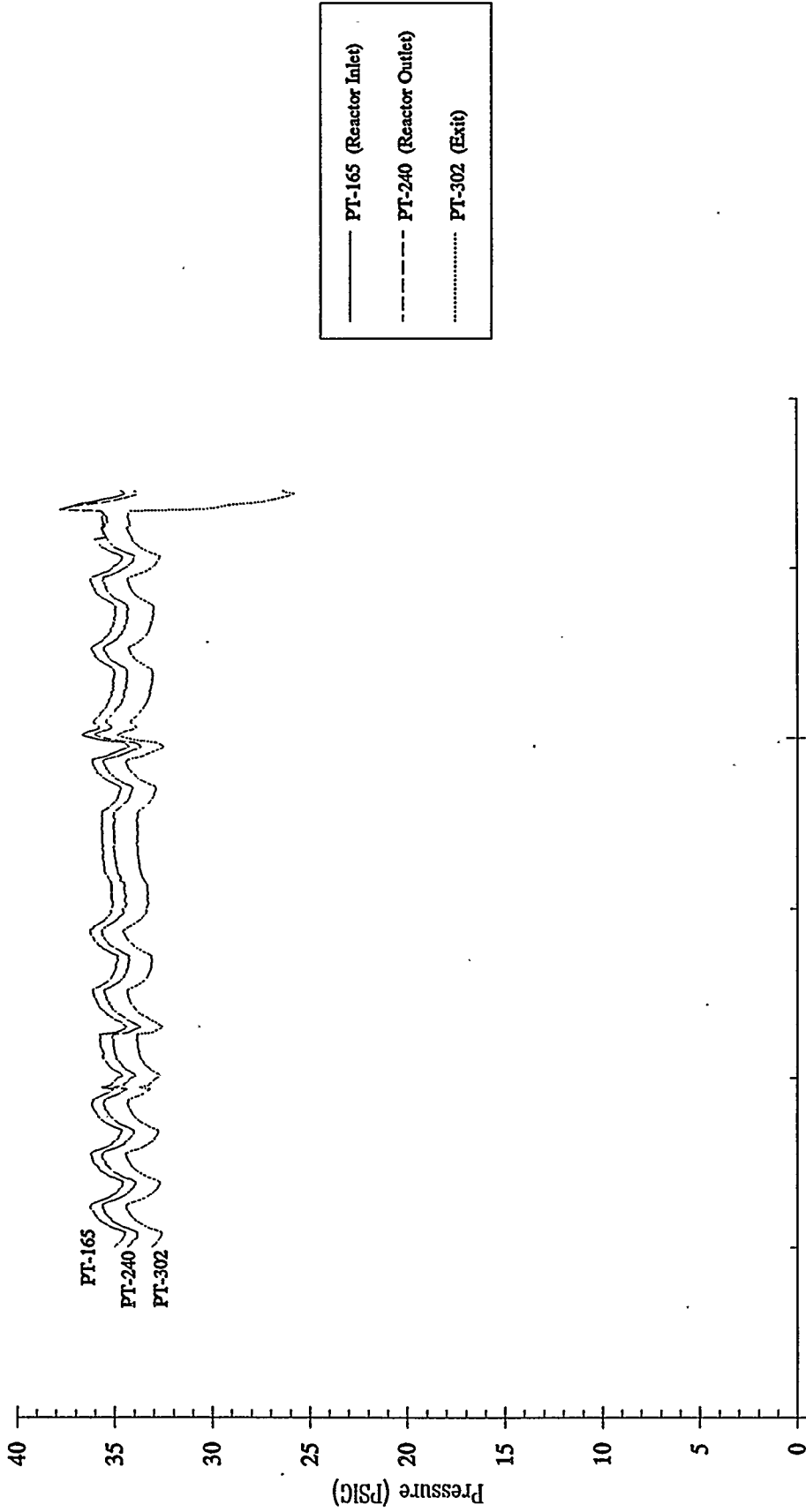

November 4, 1992
Test time: 15:30-16:00 (Test duration: 0:30)

L-3787M Zinc Titanate
u=1.0 ft/sec T=1200 °F
H2S Inlet Conc. = 0 ppm

Multi-Cycle Tests - ZTMC-03 Sulfidation 2

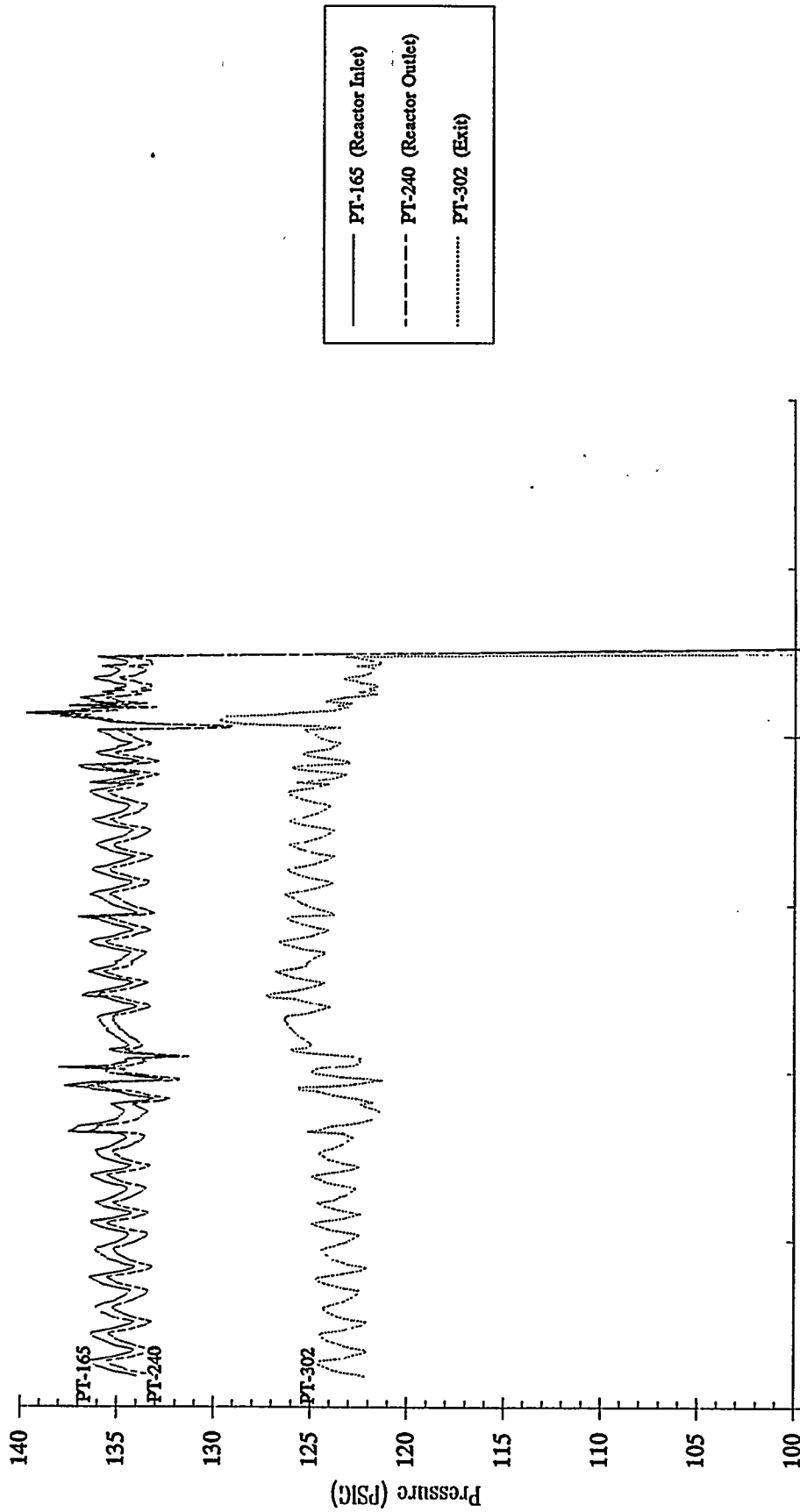

November 5, 1992
8:00

Test time: 8:30-9:00 (Test duration: 0:30)

9:00

L-3787M Zinc Titanate
u=1.0 ft/sec Tmax=1400 °F
O2 Inlet Conc. = 0.75 %

Multi-Cycle Tests - ZTMC-03 Regeneration 2

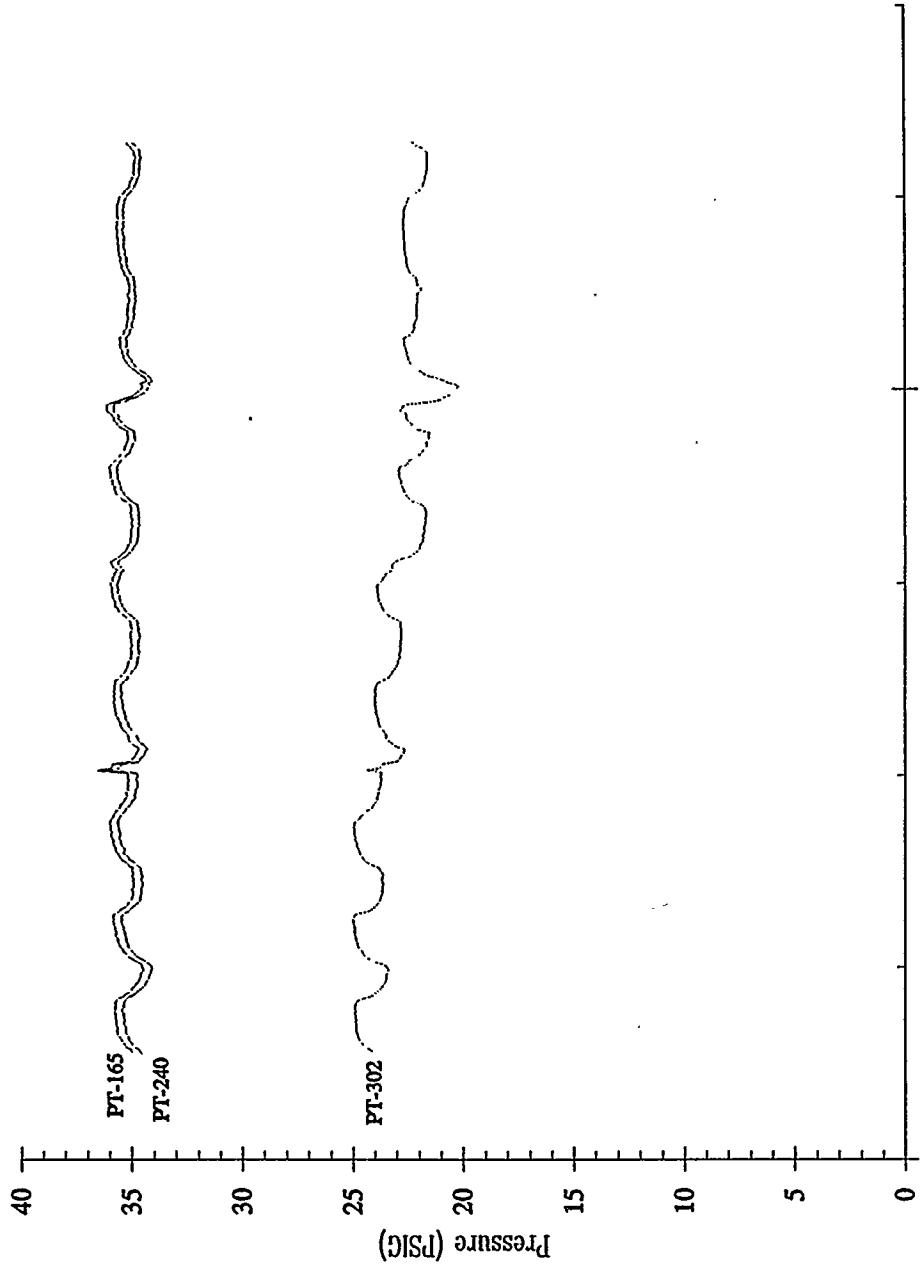

— PT-165 (Reactor Inlet)
- - - PT-240 (Reactor Outlet)
..... PT-302 (Exit)

11:30
November 5, 1992
Test time: 12:00-12:30 (Test duration: 0:30)

12:30

L-3787M Zinc Titanate
u=1.0 ft/sec T=1200 °F
H2S Inlet Conc. = 0 ppm

Multi-Cycle Tests - ZTMC-03 Sulfidation 3

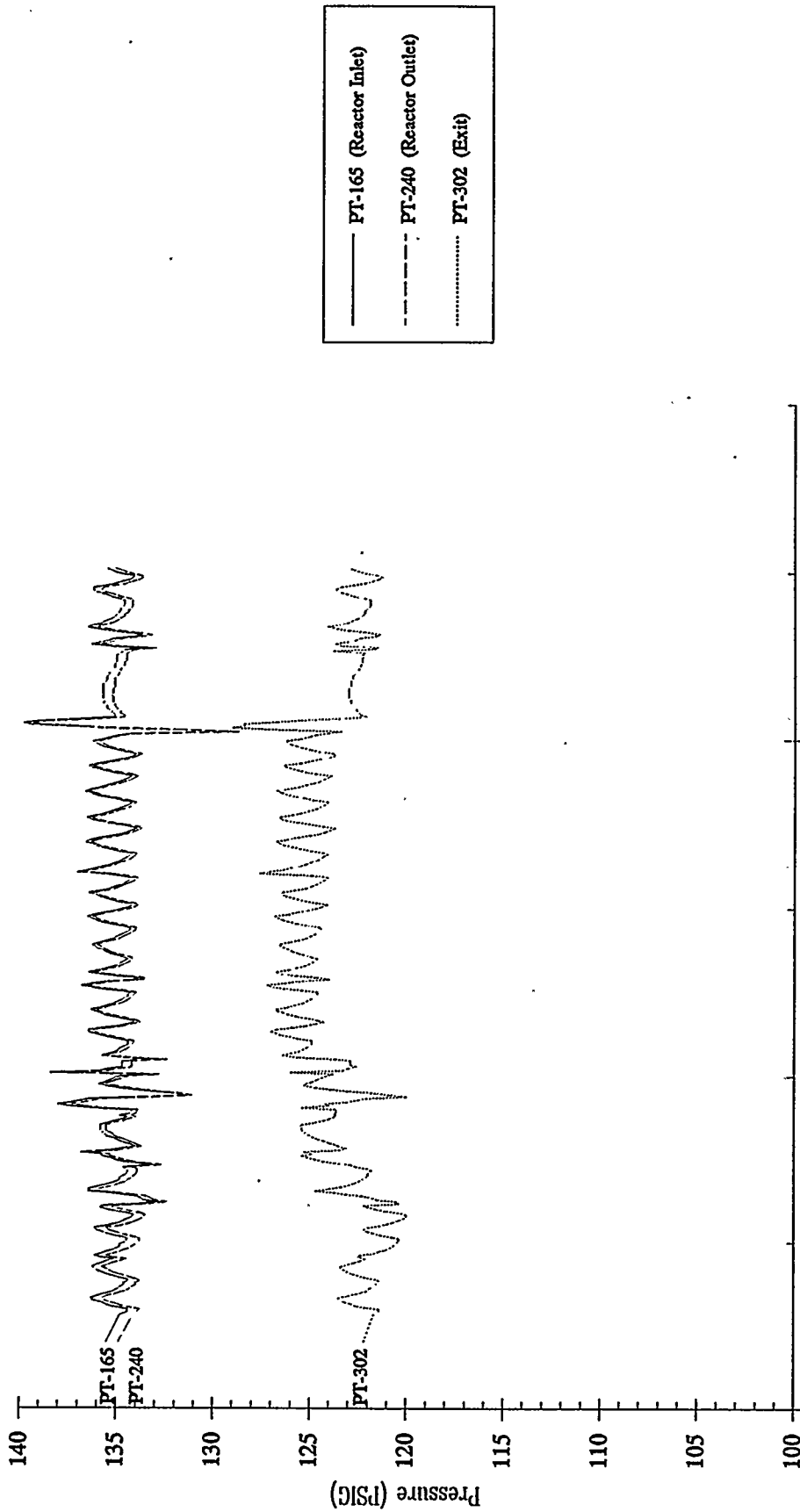

14:00
November 5, 1992
Test time: 14:30-15:00 (Test duration: 0:30)

L-3787M Zinc Titanate
u=1.0 ft/sec Tmax=1400 F
O2 Inlet Conc. = 0.75 %

Multi-Cycle Tests - ZTMC-03 Regeneration 3

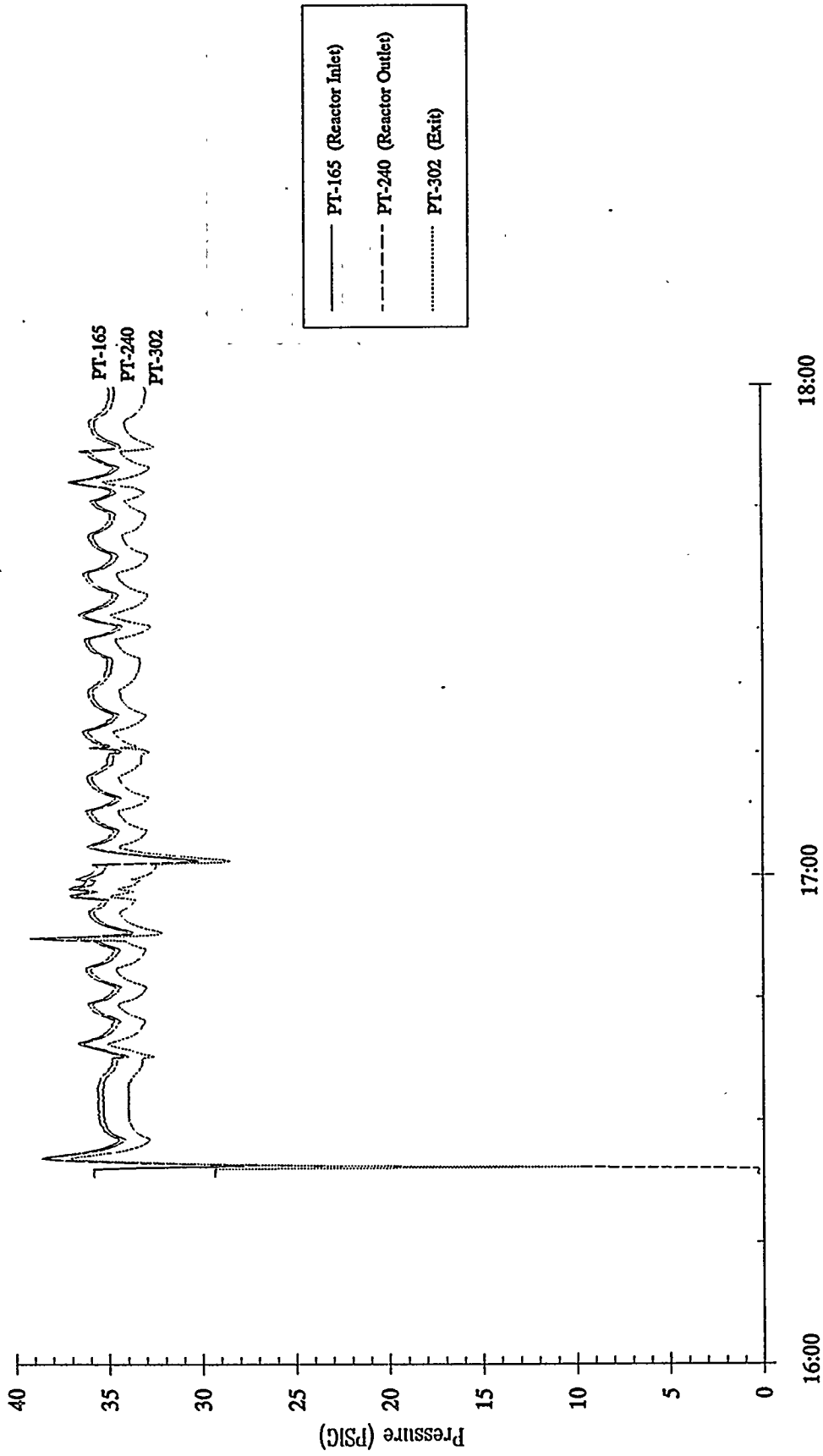

November 5, 1992
Test time: 17:15-17:45 (Test duration: 0:30)

L-3787M Zinc Titanate
u=1.0 ft/sec T=1200 F
H2S Inlet Conc. = 0 ppm

Multi-Cycle Tests - ZTMC-03 Sulfidation 4

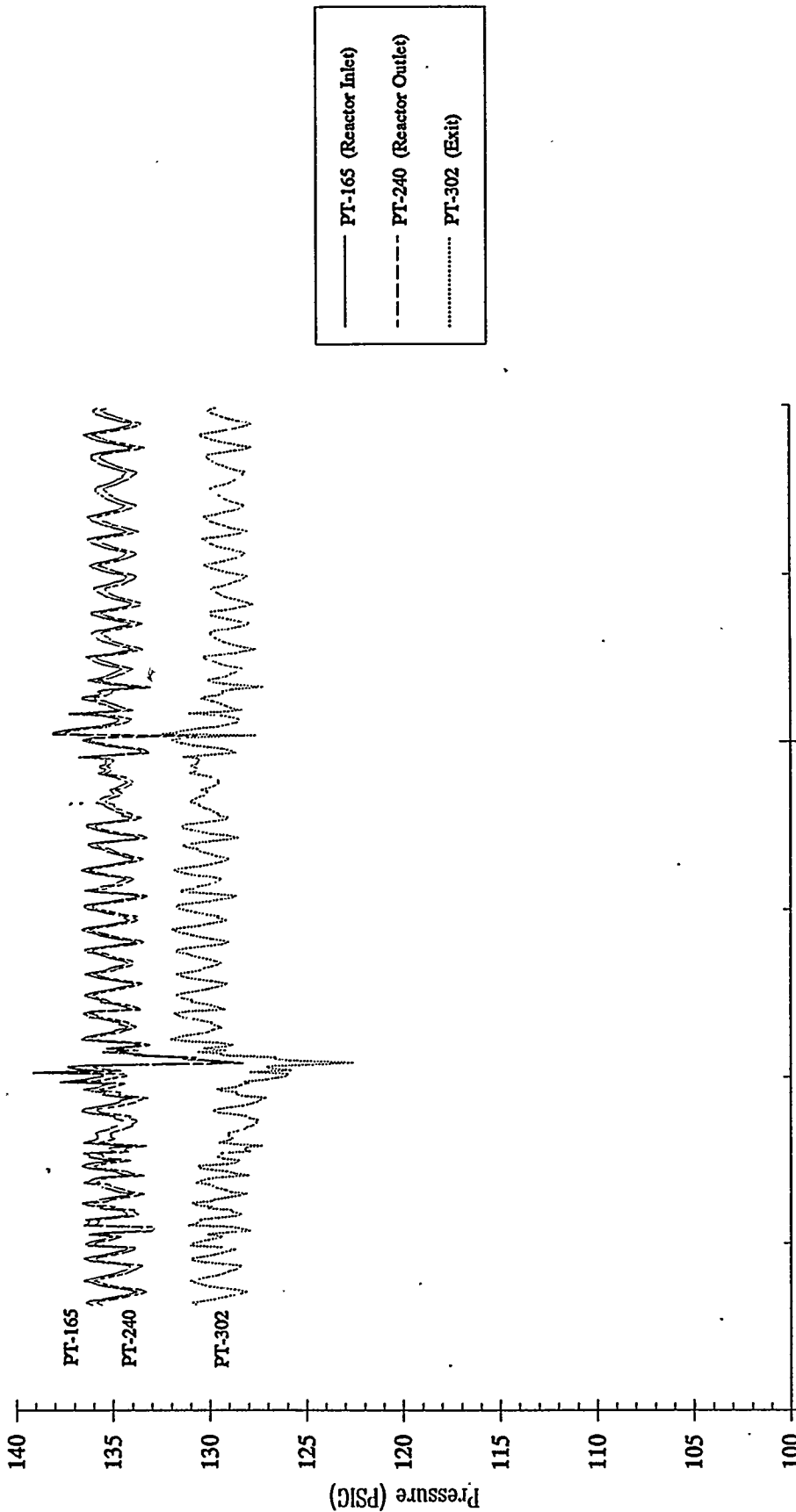

8:30
November 6, 1992
Test time: 9:00-9:30 (Test duration: 0:30)

L-3787M Zinc Titanate
u=1.0 ft/sec T_{max}=1400 °F
O₂ Inlet Conc. = 0.75 %

Multi-Cycle Tests - ZTMC-03 Regeneration 4

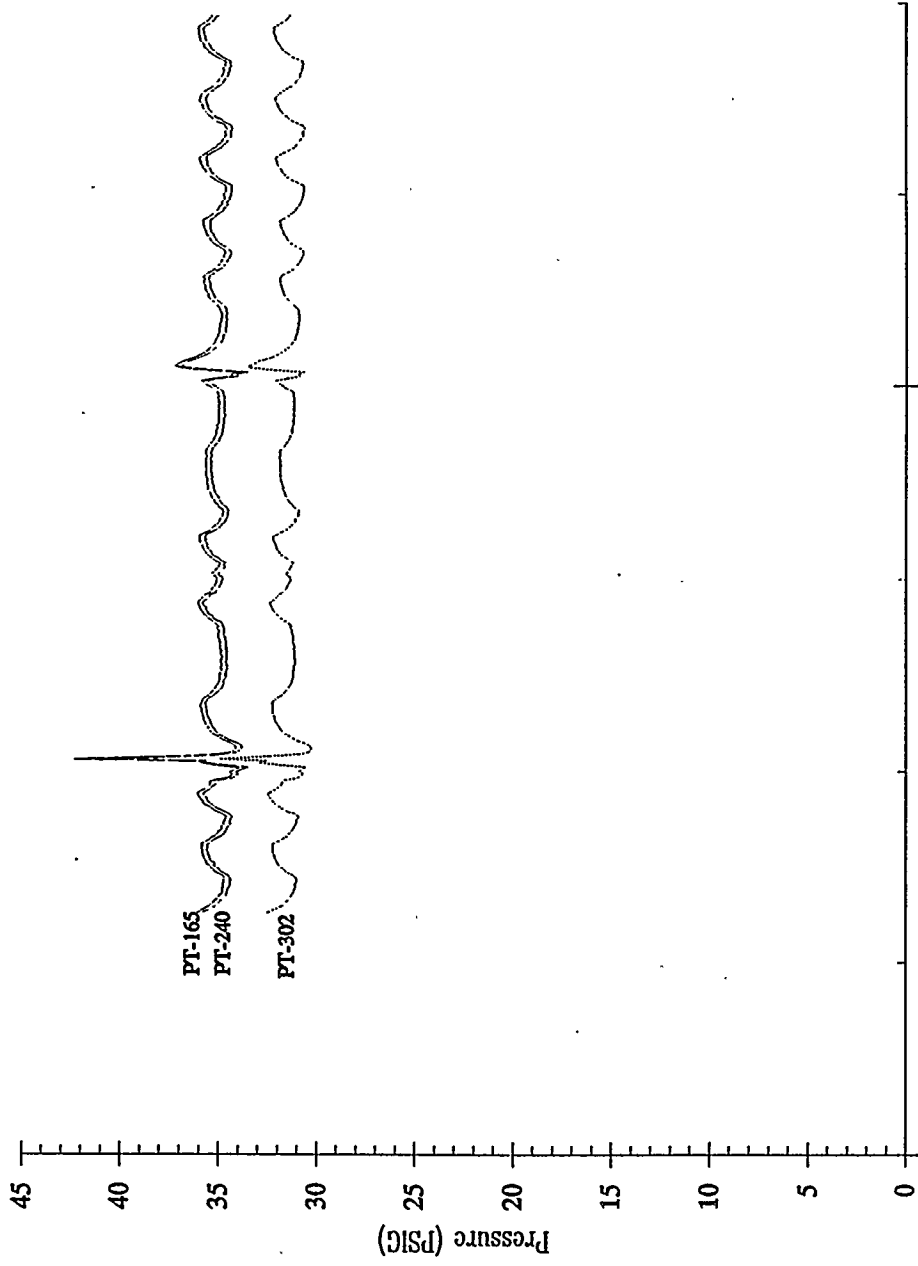

— PT-165 (Reactor Inlet)
- - - PT-240 (Reactor Outlet)
..... PT-302 (Exit)

11:30
November 6, 1992
Test time: 12:00-12:30 (Test duration: 0:30)

12:30

L-3787M Zinc Titanate
u=1.0 ft/sec T=1000 F
H2S Inlet Conc. = 800 ppm

Multi-Cycle Tests - ZTMC-04 Sulfidation 1

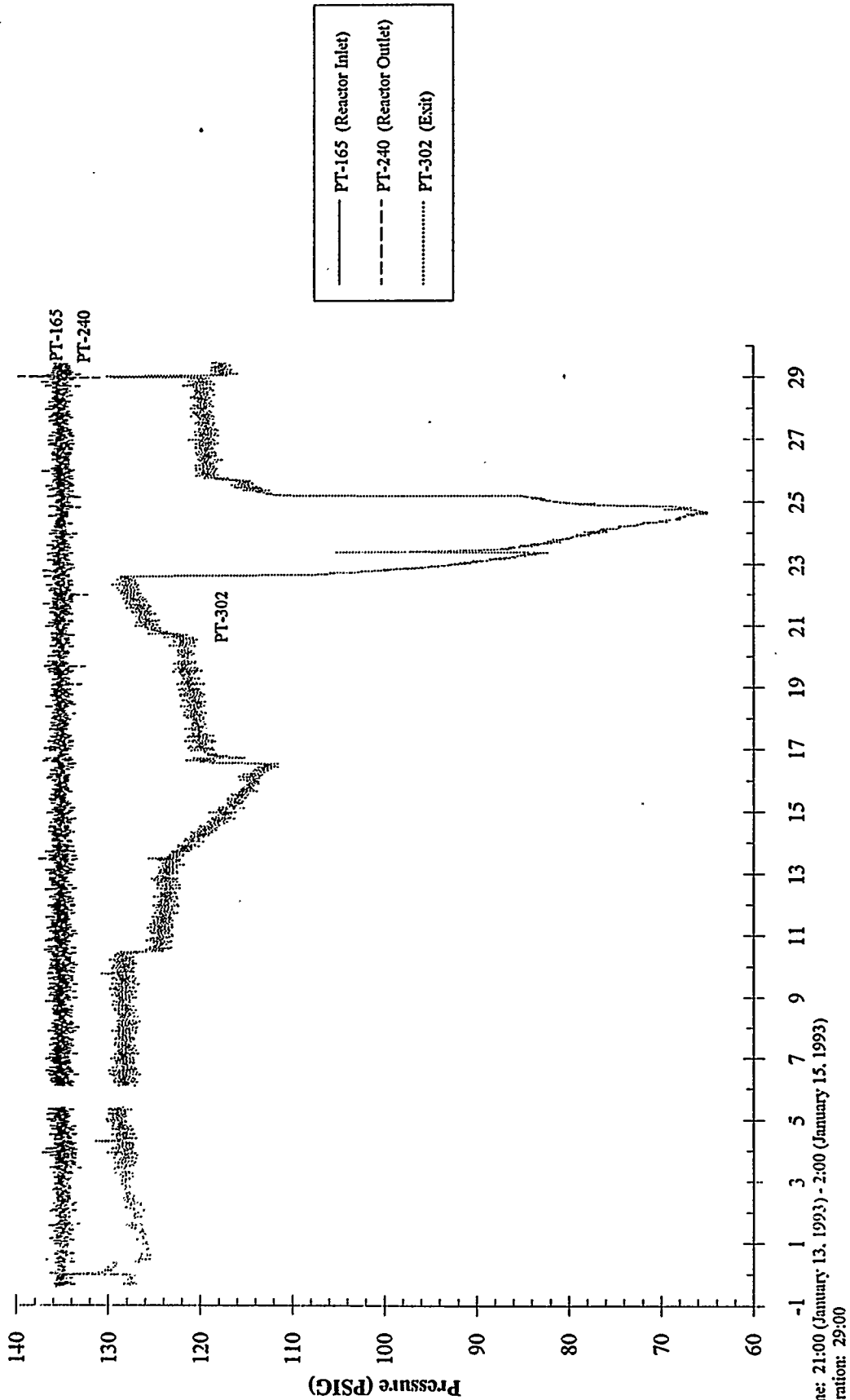

L-3787M Zinc Titanate
u=1.0 ft/sec T = 1000-1400 F
O2 Inlet Conc. = 0.5 - 21 %

Multi-Cycle Tests - ZTMC-04 Regeneration 1

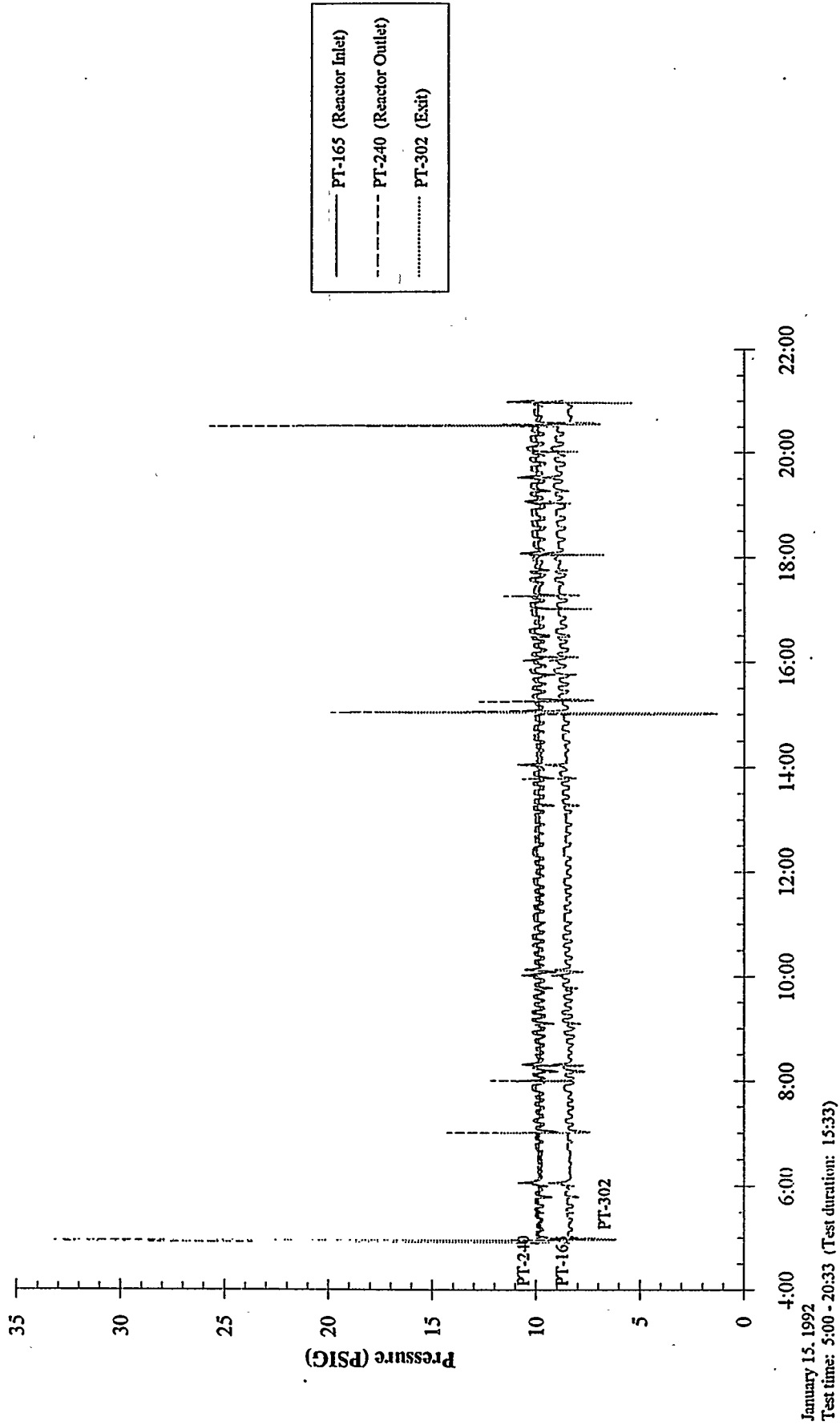

January 15, 1992
Test time: 5:00 - 20:33 (Test duration: 15:33)

L-3787M Zinc Titanate
u=1.0 ft/sec T=1000 F
H2S Inlet Conc. = 800 ppm

Multi-Cycle Tests - ZTMC-04 Sulfidation 2

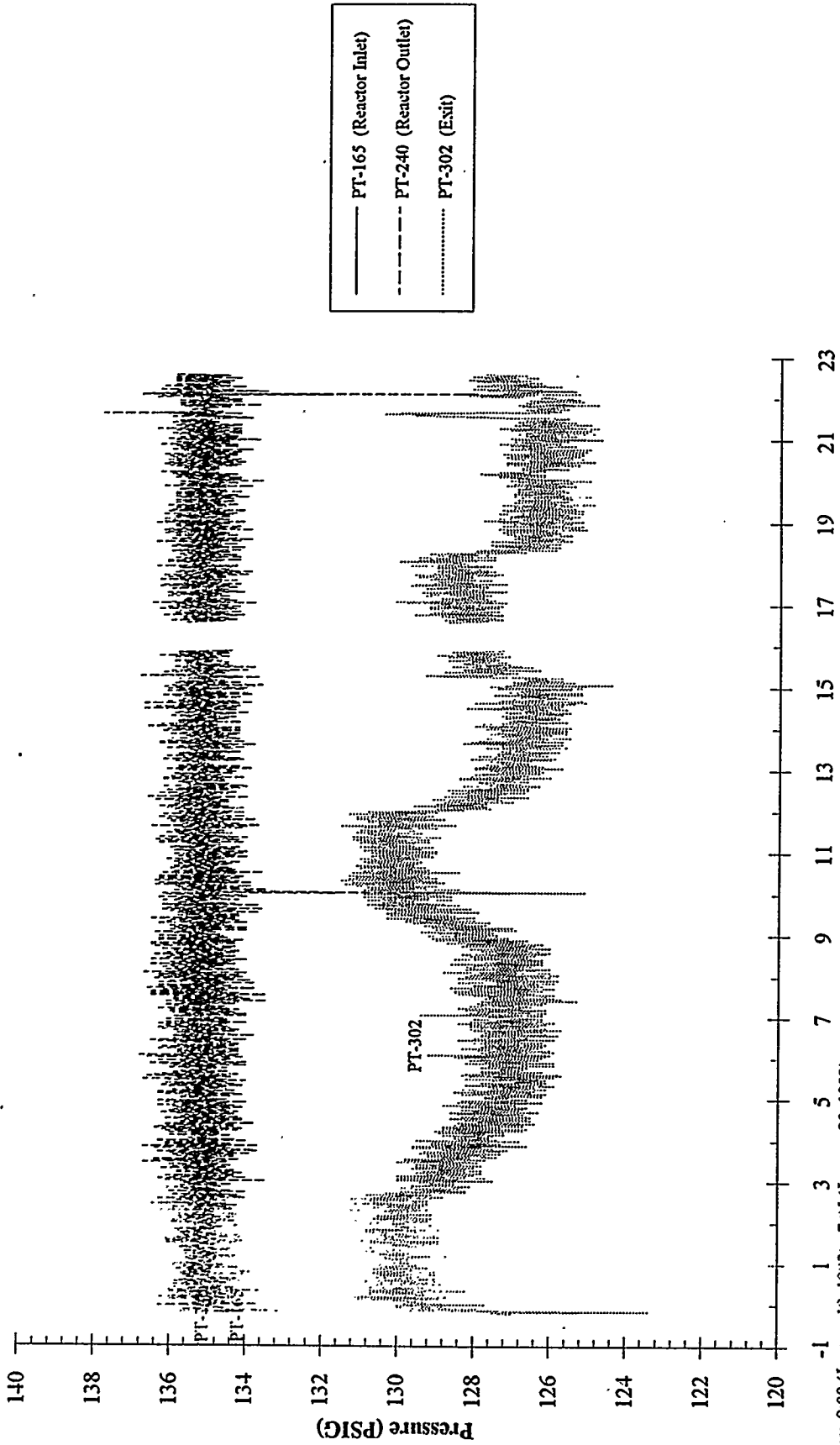

Test time: 9:00 (January 19, 1993) - 7:05 (January 20, 1993)
Test duration: 22:05

L-3787M Zinc Titanate
u=1.0 ft/sec T = 1000-1400 F
O2 Inlet Conc. = 0.5 - 21 %

Multi-Cycle Tests - ZTMC-04 Regeneration 2

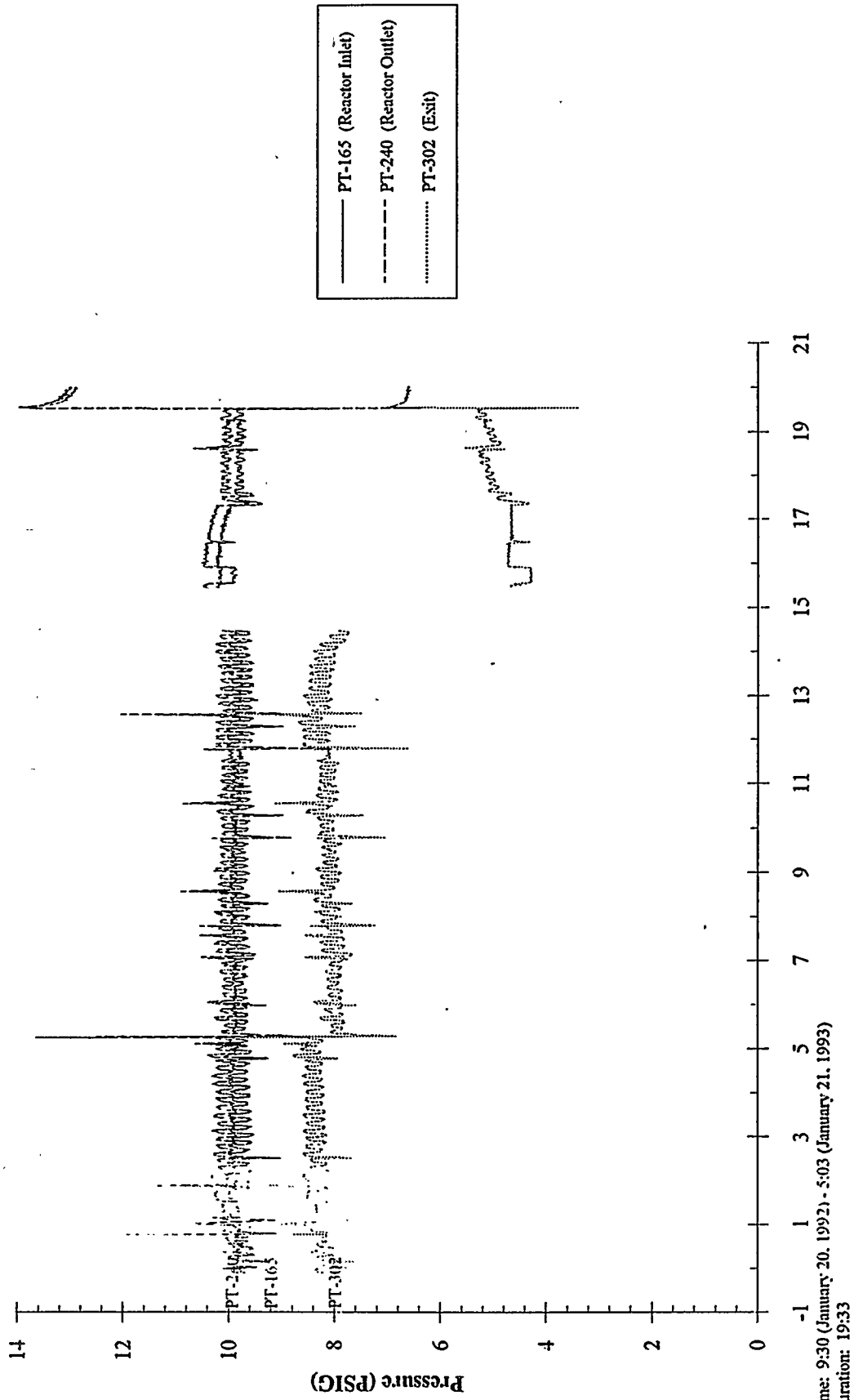

L-3787M Zinc Titanate
u=1.0 ft/sec T=1000 F
H2S Inlet Conc. = 800 ppm

Multi-Cycle Tests - ZTMC-04 Sulfidation 3

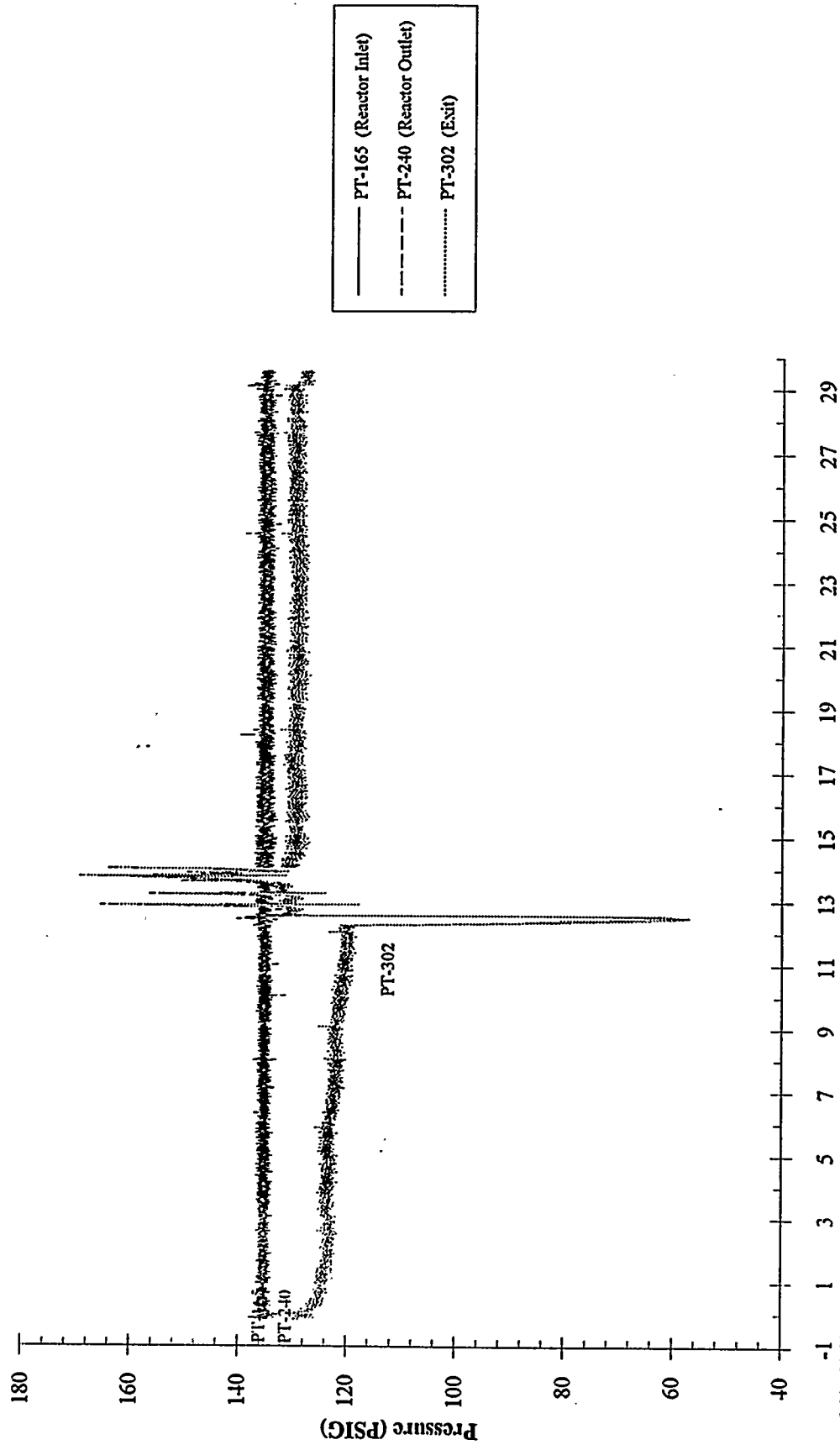

Test time: 8:30 - 22:33. 23:30 (January 21, 1993) - 14:32 (January 22, 1993)
Test duration: 29:05

Single Cycle Tests - ZTSC-08 Sulfidation 1

L-3787M Zinc Titanate
u=1.0 ft/sec T=1000 F
H2S Inlet Conc. = 2000 ppm

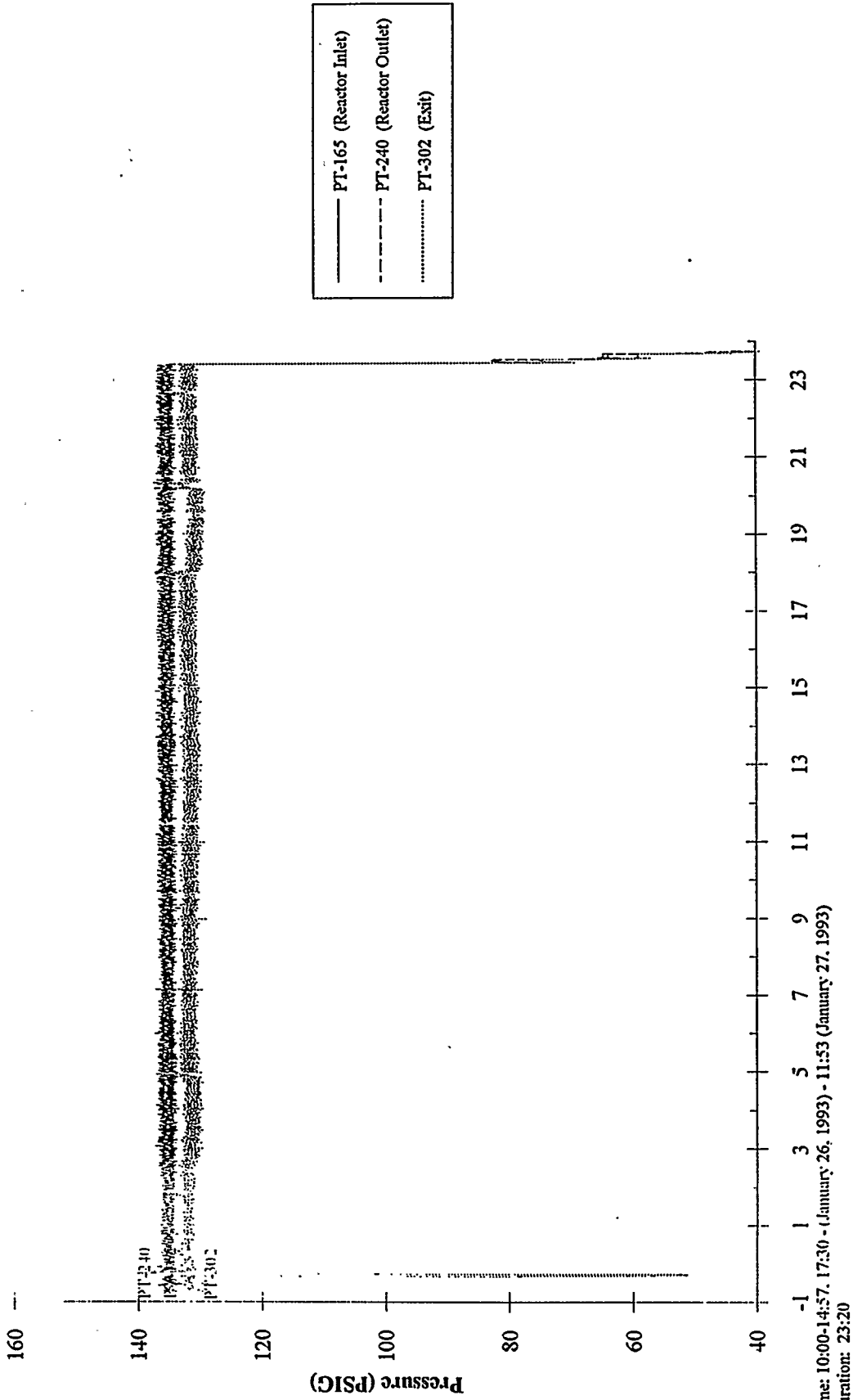

Test time: 10:00-14:57, 17:30 - (January 26, 1993) - 11:53 (January 27, 1993)
Test duration: 23:20

APPENDIX D
Data Acquisition Differential Pressure Trends

Differential pressure across the reactor was monitored by DDAS, a PC-based automatic data acquisition system. Trend plots for the Precision Digital differential pressure transmitter readings are presented here. Pressure taps are located upstream and downstream of the entire reactor and do not measure the pressure drop across the sorbent bed only. The pressure drop measured is the sum total of all of the pressure drops between the two pressure taps. These pressure drops are caused by valves and fittings, distributor plates, ceramic balls, Fiberfrax, etc., in addition to the sorbent bed itself. Thus, any attempt to use these values as any more than a rough approximation of the actual pressure drop across the sorbent bed only should be met with caution.

L-3787M Zinc Titanate
u=2.0 ft/sec T=1100 °F
H2S Inlet Conc. = 800 ppm

Single Cycle Tests - ZTSC-01 Sulfidation 1

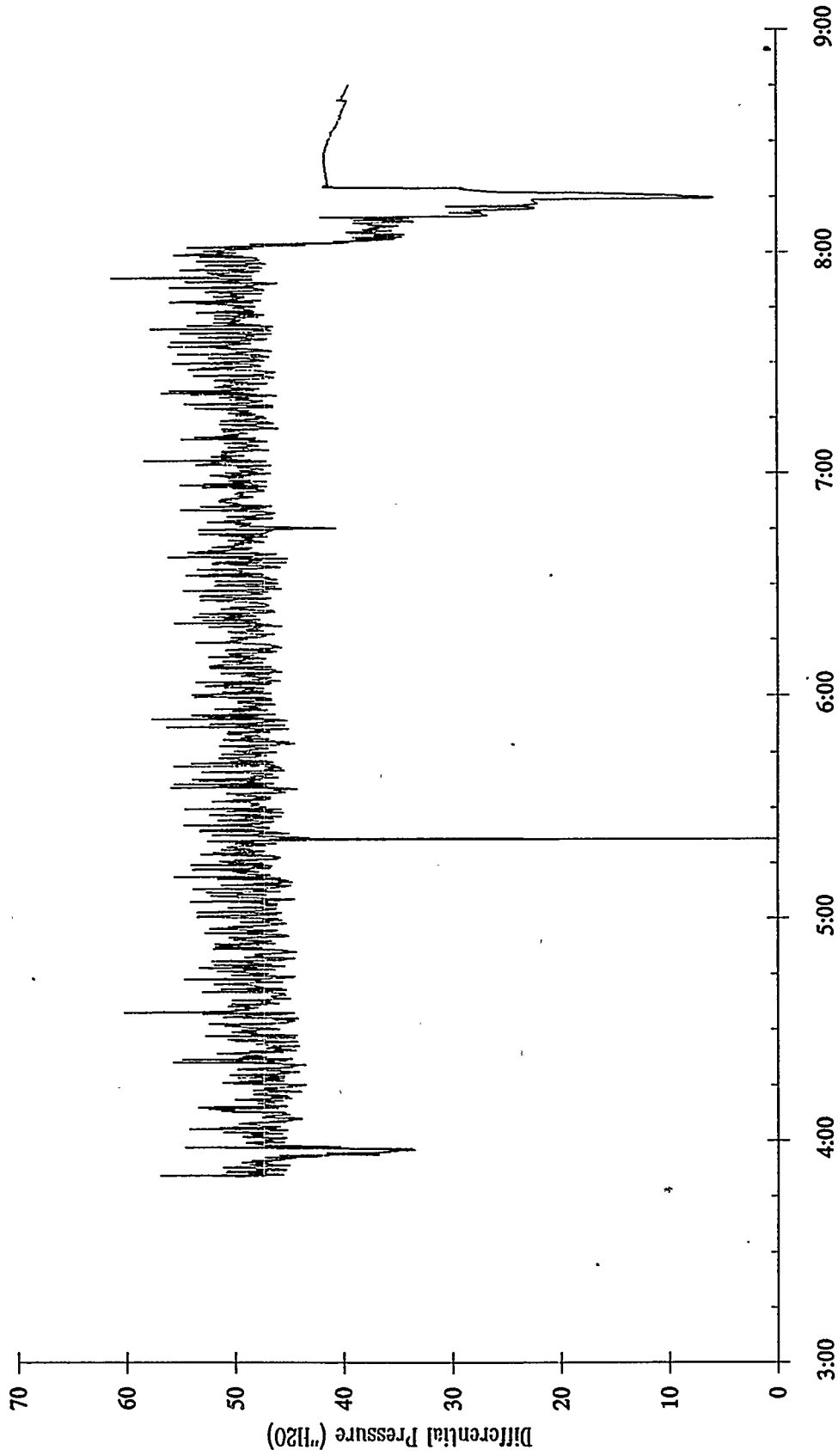

September 15, 1992
3:00

Test time: 4:35-8:08 (Test duration: 3:33)

L-3787M Zinc Titanate
u=1.0 ft/sec T=1100 °F
H2S Inlet Conc. = 800 ppm

Single Cycle Tests - ZTSC-02 Sulfidation 1

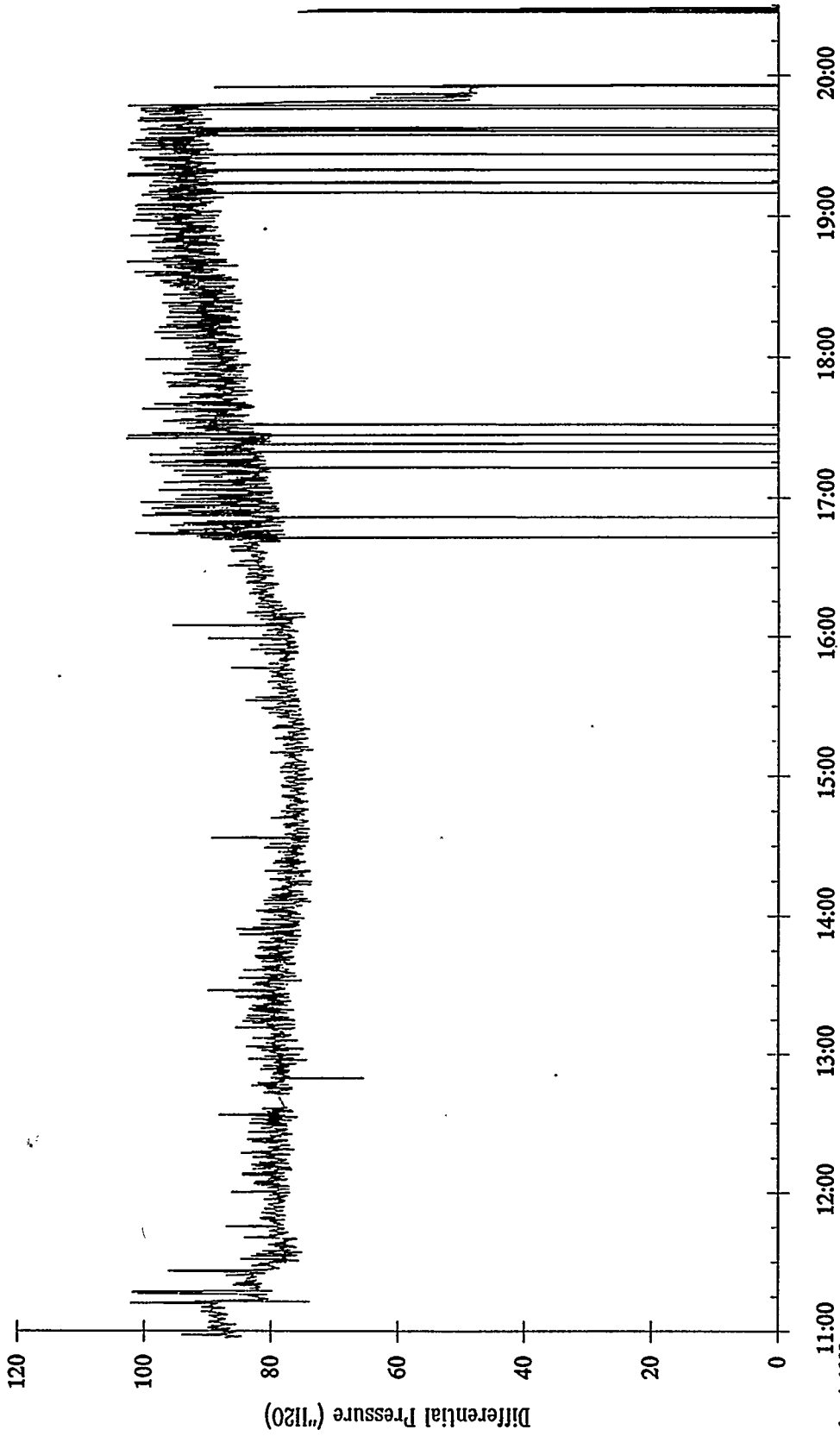

September 4, 1992
Test time: 11:30-19:45 (Test duration: 8:15)

L-3787M Zinc Titanate
u=1.0 f/sec T=1100 F
H2S Inlet Conc. = 800 ppm

Single Cycle Tests - ZTSC-03 Sulfidation 1

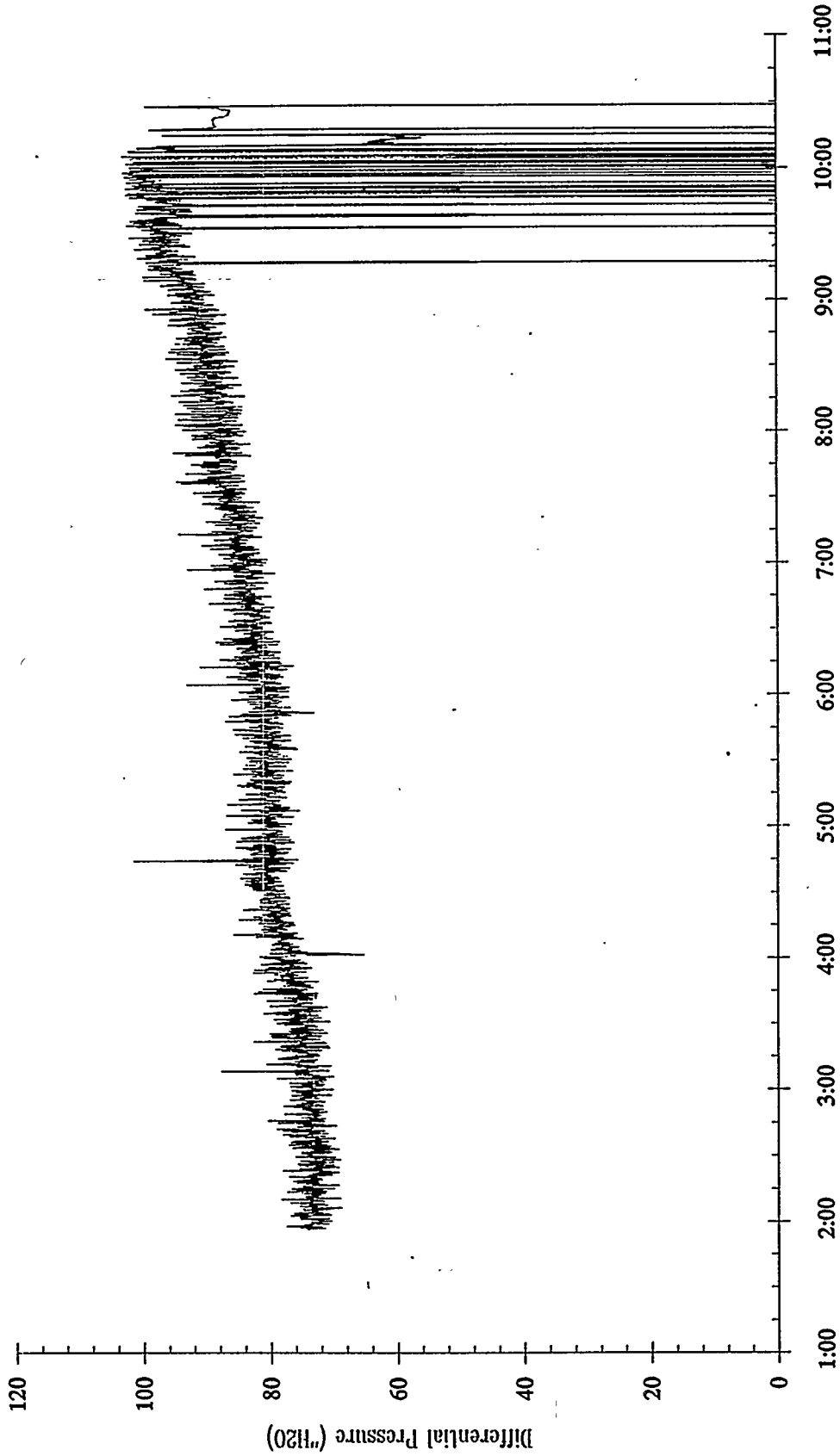

September 9, 1992
Test time: 1:00-10:05 (Test duration: 9:05)

L-3787M Zinc Titanate
u=1.0 ft/sec T=1000 °F
H2S Inlet Conc. = 800 ppm

Single Cycle Tests - ZTSC-04 Sulfidation 1

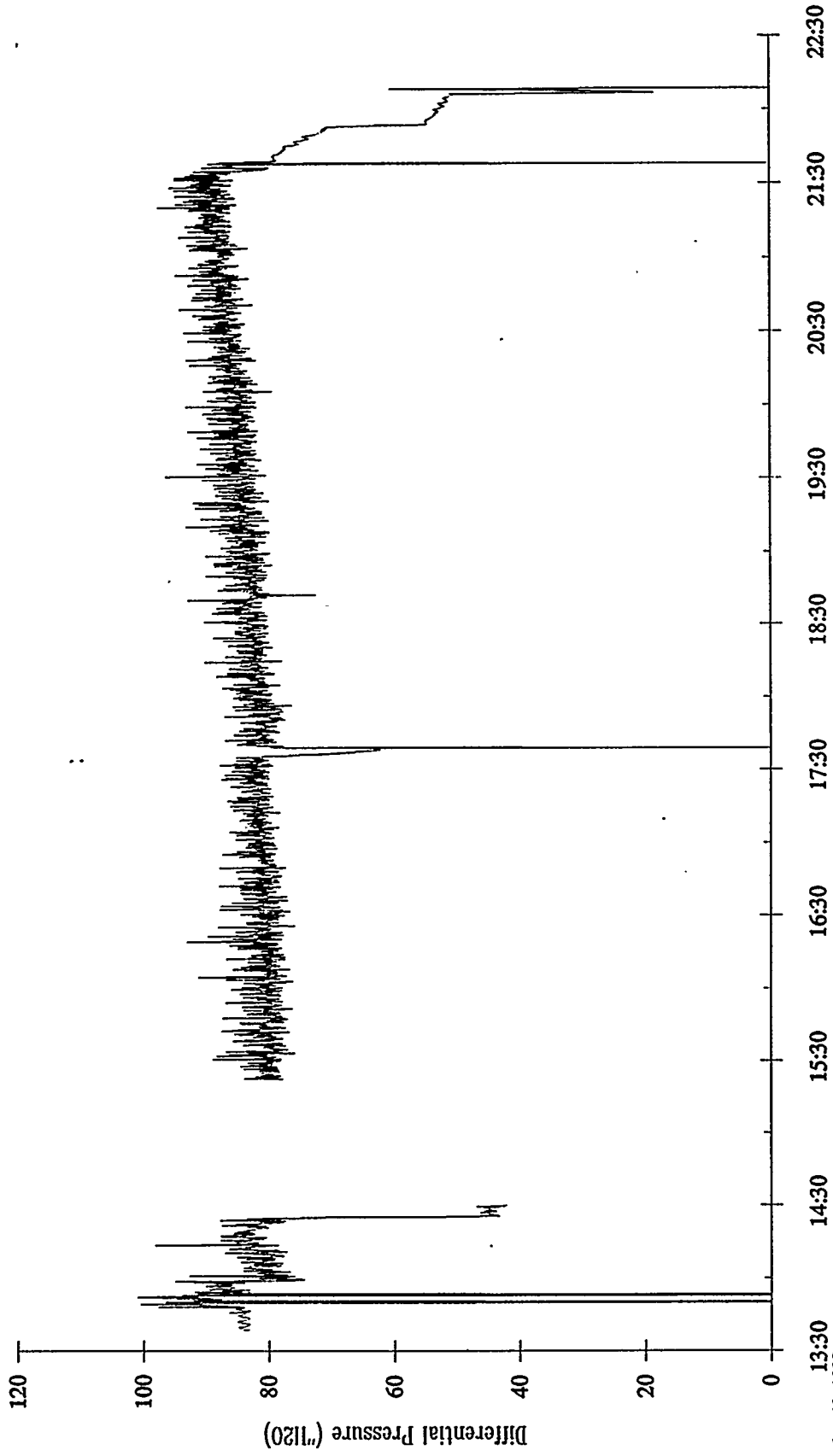

September 10, 1992
Test time: 14:00-14:23, 15:00-21:33 (Test duration: 6:56)

L-3787M Zinc Titanate
u=1.0 ft/sec T=1200 F
H2S Inlet Conc. = 800 ppm

Single Cycle Tests - ZTSC-05 Sulfidation 1

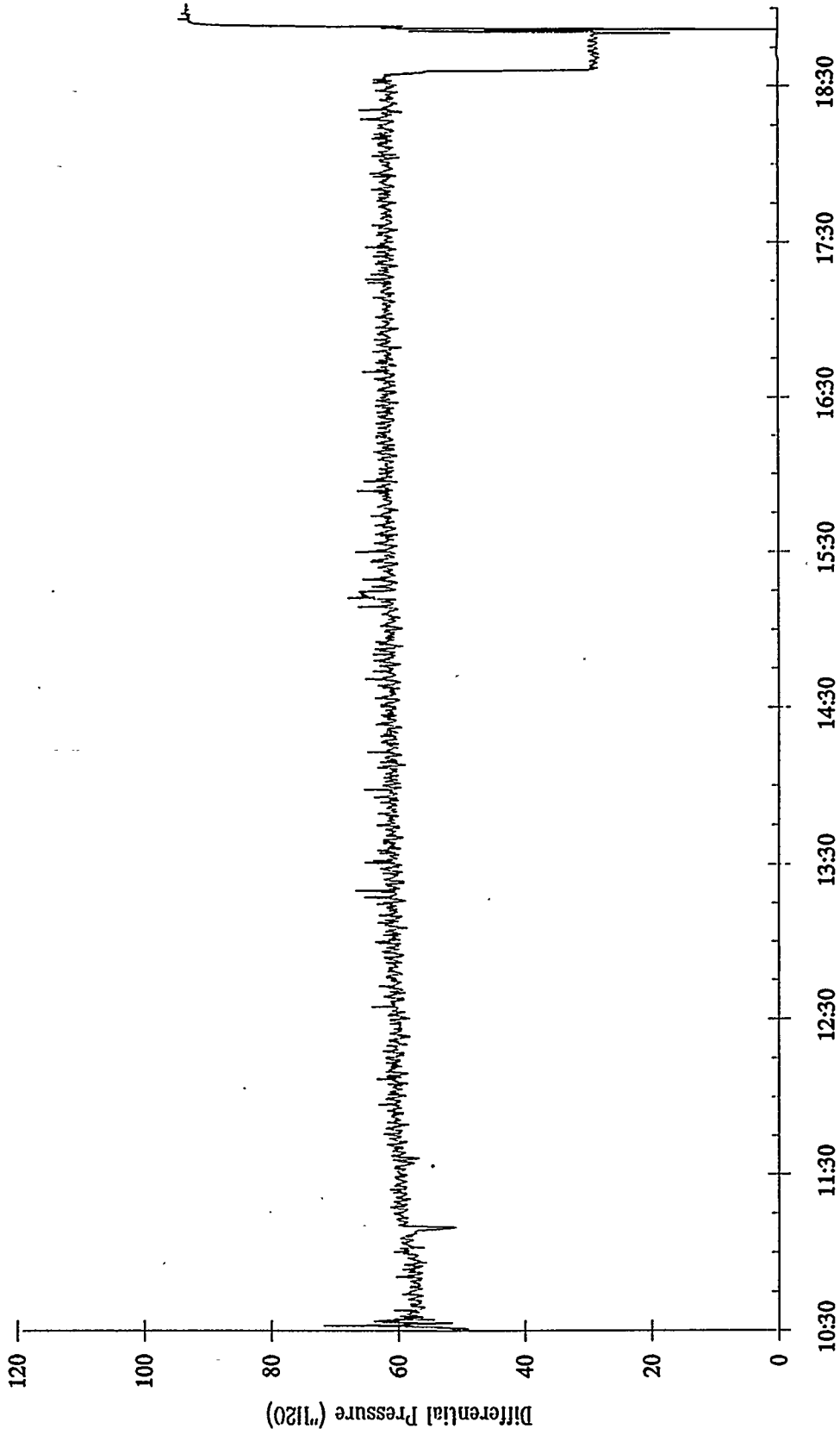

September 15, 1992
Test time: 11:00-18:34 (Test duration: 7:34)

L-3787M Zinc Titanate
u=0.5 ft/sec T=1200 °F
H2S Inlet Conc. = 800 ppm

Single Cycle Tests - ZTSC-06 Sulfidation 1

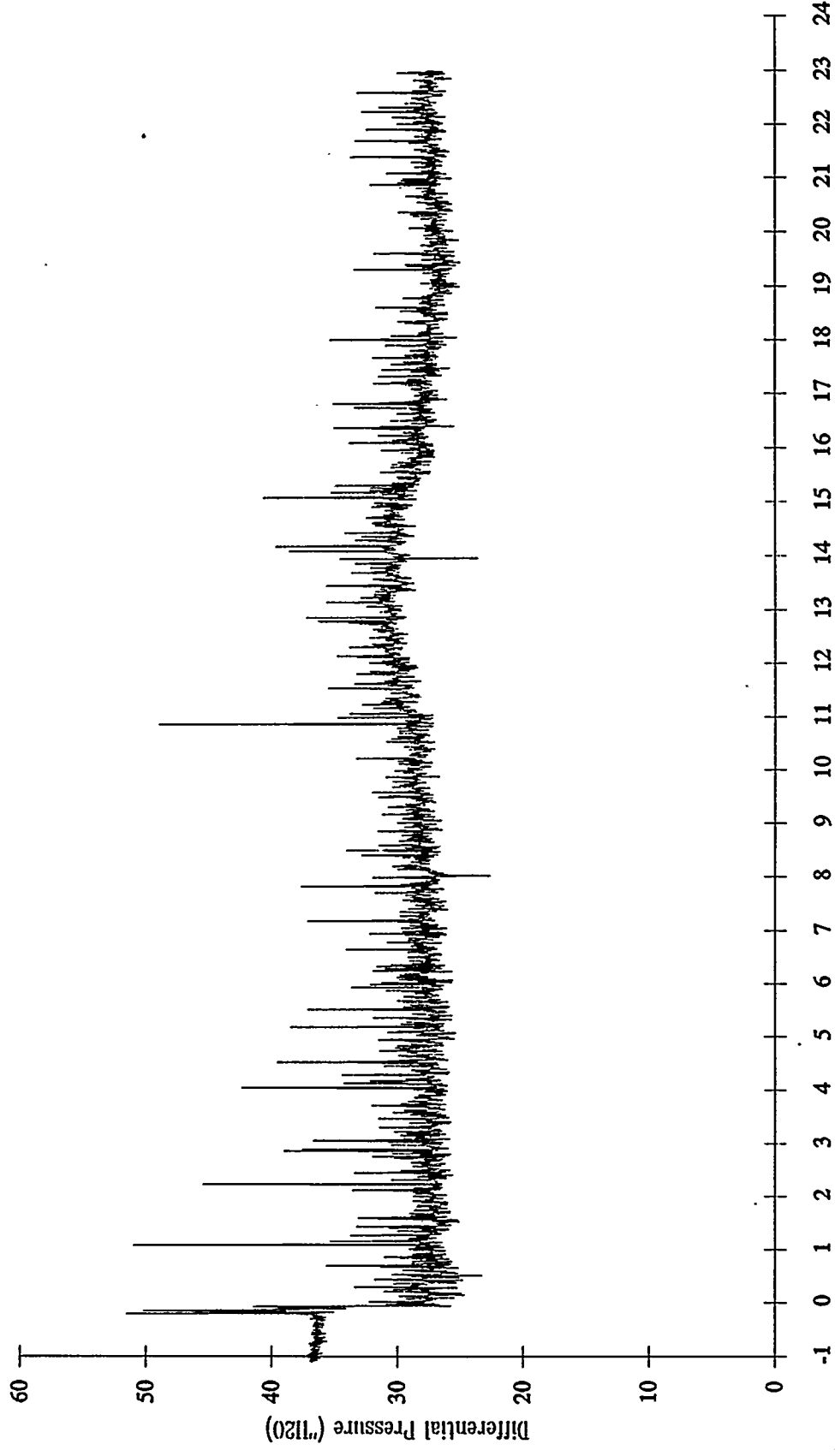

-1 0 1 2 3 4 5 6 7 8 9 10 11 12 13 14 15 16 17 18 19 20 21 22 23 24
Test time: 9:00 (September 17, 1992) - 6:05 (September 19, 1992)
Test duration: 45:05

L-3787M Zinc Titanate
u=0.5 ft/sec T=1200 °F
H2S Inlet Conc. = 800 ppm

Single Cycle Tests - ZTSC-06 Sulfidation 1

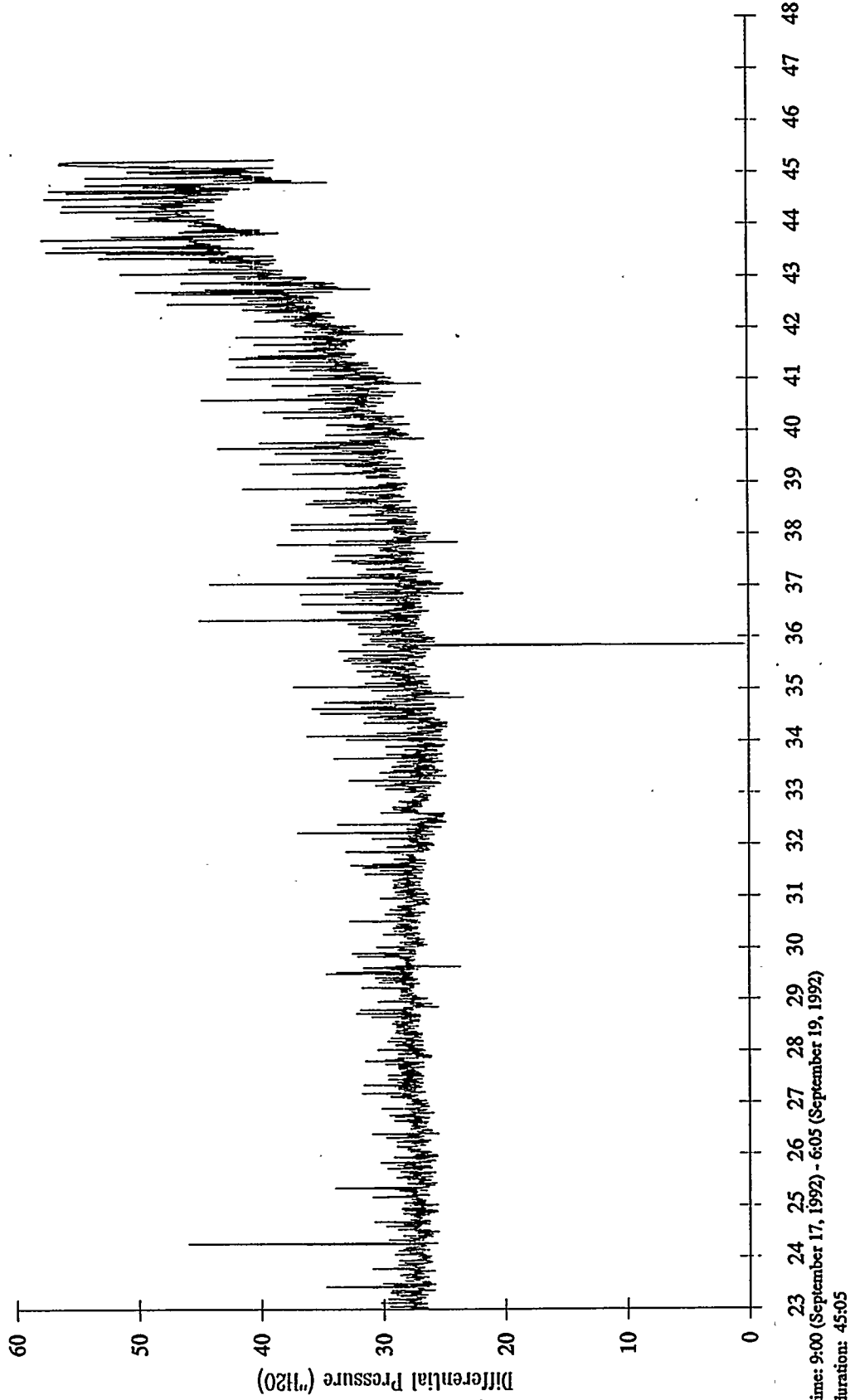

L-3787M Zinc Titanate
u=0.5 ft/sec T=1000 F
H2S Inlet Conc. = 800 ppm

Single Cycle Tests - ZTSC-07 Sulfidation 1

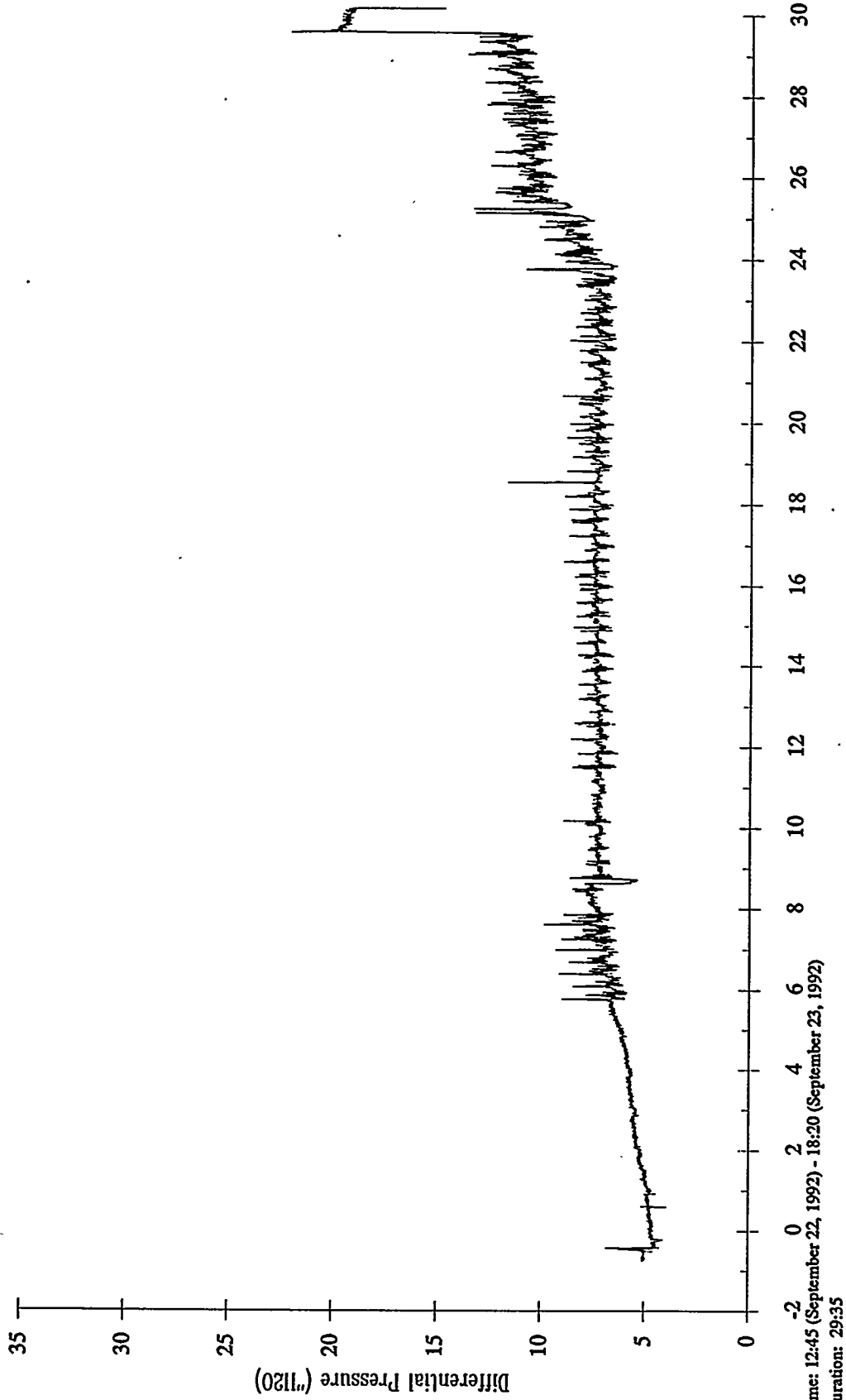

Test time: 12:45 (September 22, 1992) - 18:20 (September 23, 1992)
Test duration: 29:35

L-3787M Zinc Titanate
u=0.5 ft/sec T_{max}=1400 °F
O₂ Inlet Conc. = 2.5 %

Single Cycle Tests - ZTSC-07 Regeneration 1

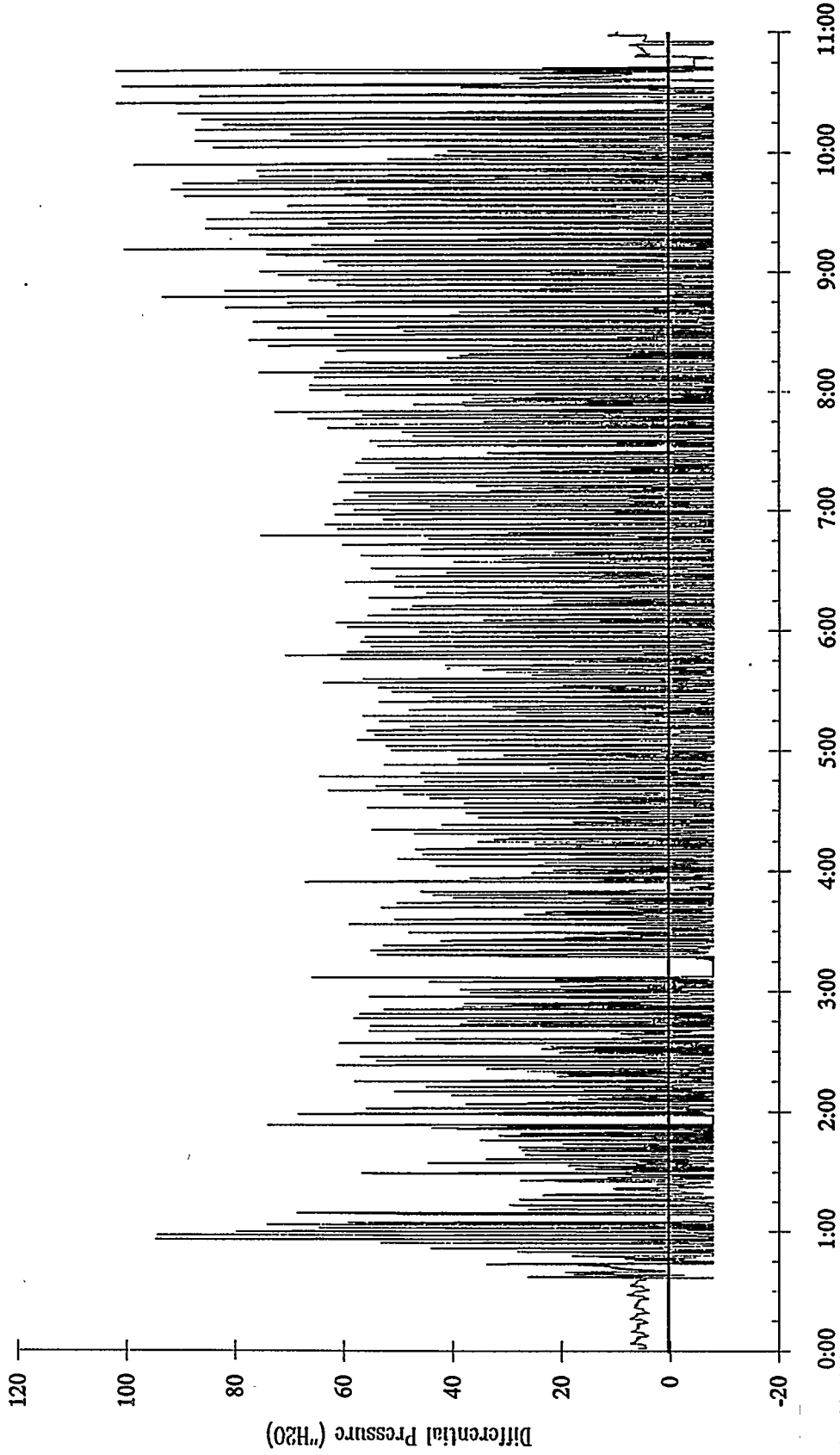

September 24, 1992
Test time: 0:45-10:26 (Test duration: 9:41)

L-3787M Zinc Titanate
u=0.5 ft/sec T=1000 F
H2S Inlet Conc. = 800 ppm

Single Cycle Tests - ZTSC-07 Sulfidation 2

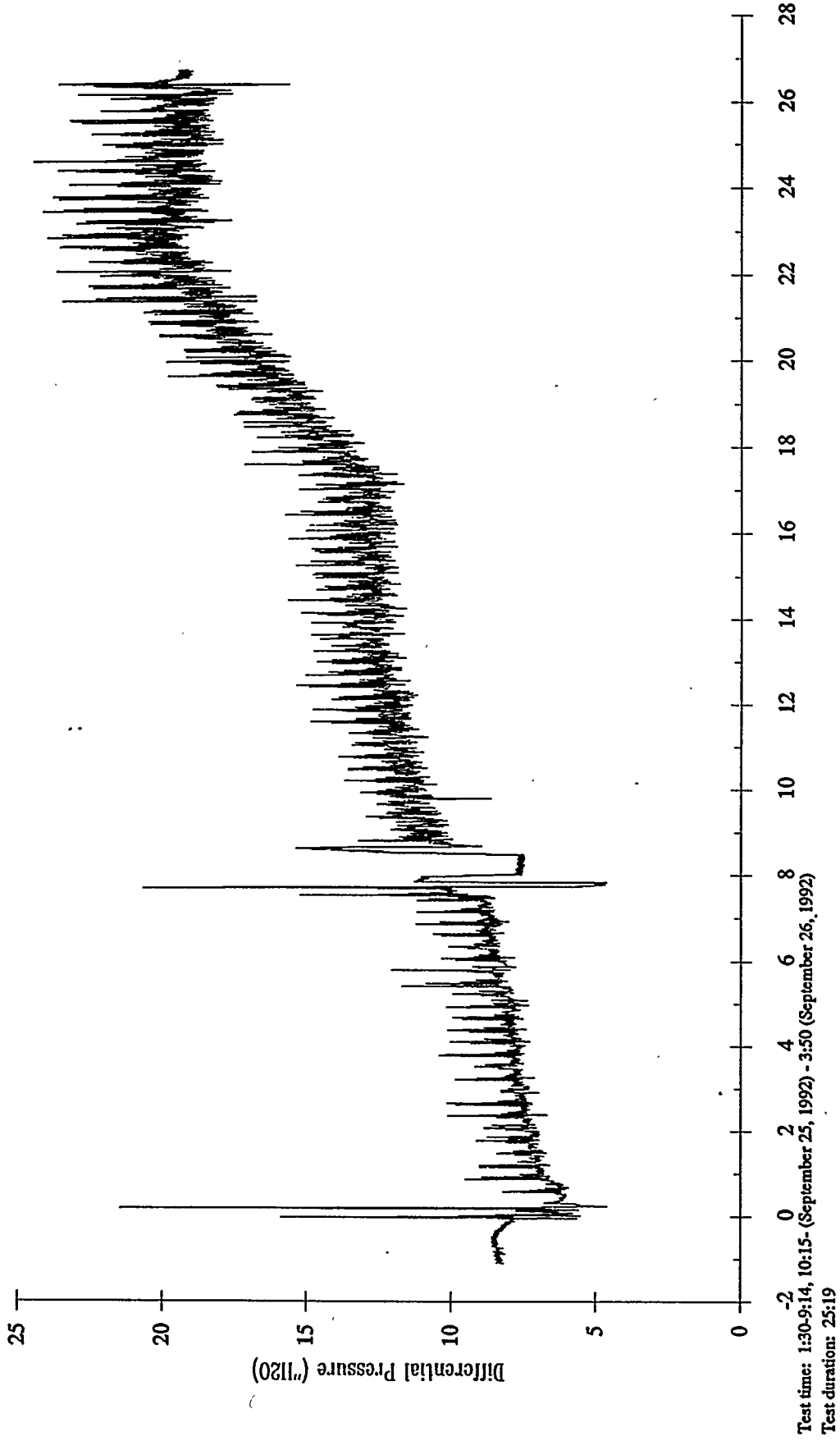

L-3787M Zinc Titanate
u=1.0 ft/sec Tmax=1400 °F
O2 Inlet Conc. = 2.5 %

Single Cycle Tests - ZTSC-07 Regeneration 2

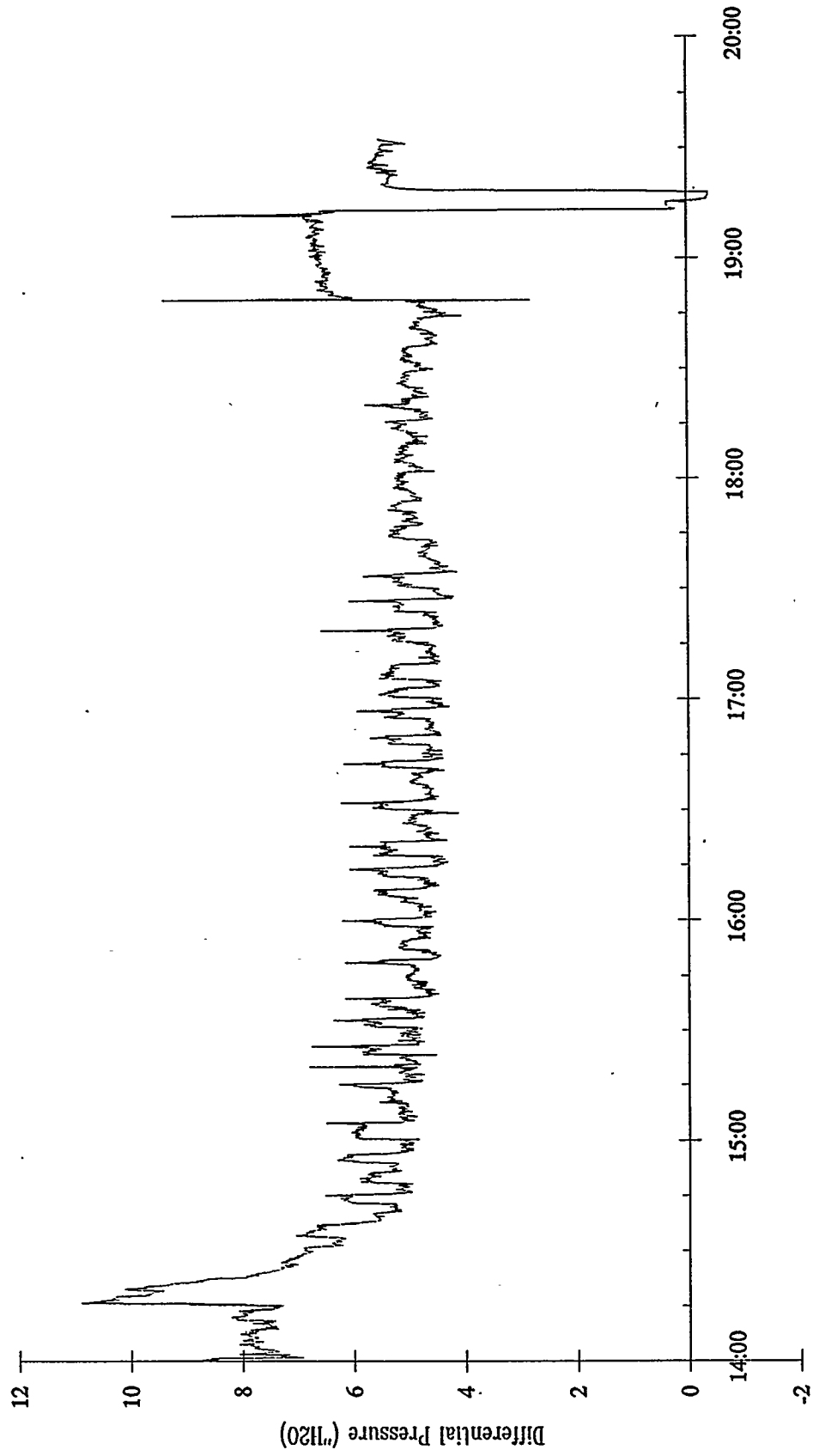

September 28, 1992
Test time: 14:15 - 18:49 (Test duration: 4:34)

L-3787M Zinc Titanate
u=2.0 ft/sec T=1200 °F
H2S Inlet Conc. = 800 ppm

Single Cycle Tests - ZTSC-07 Sulfidation 3

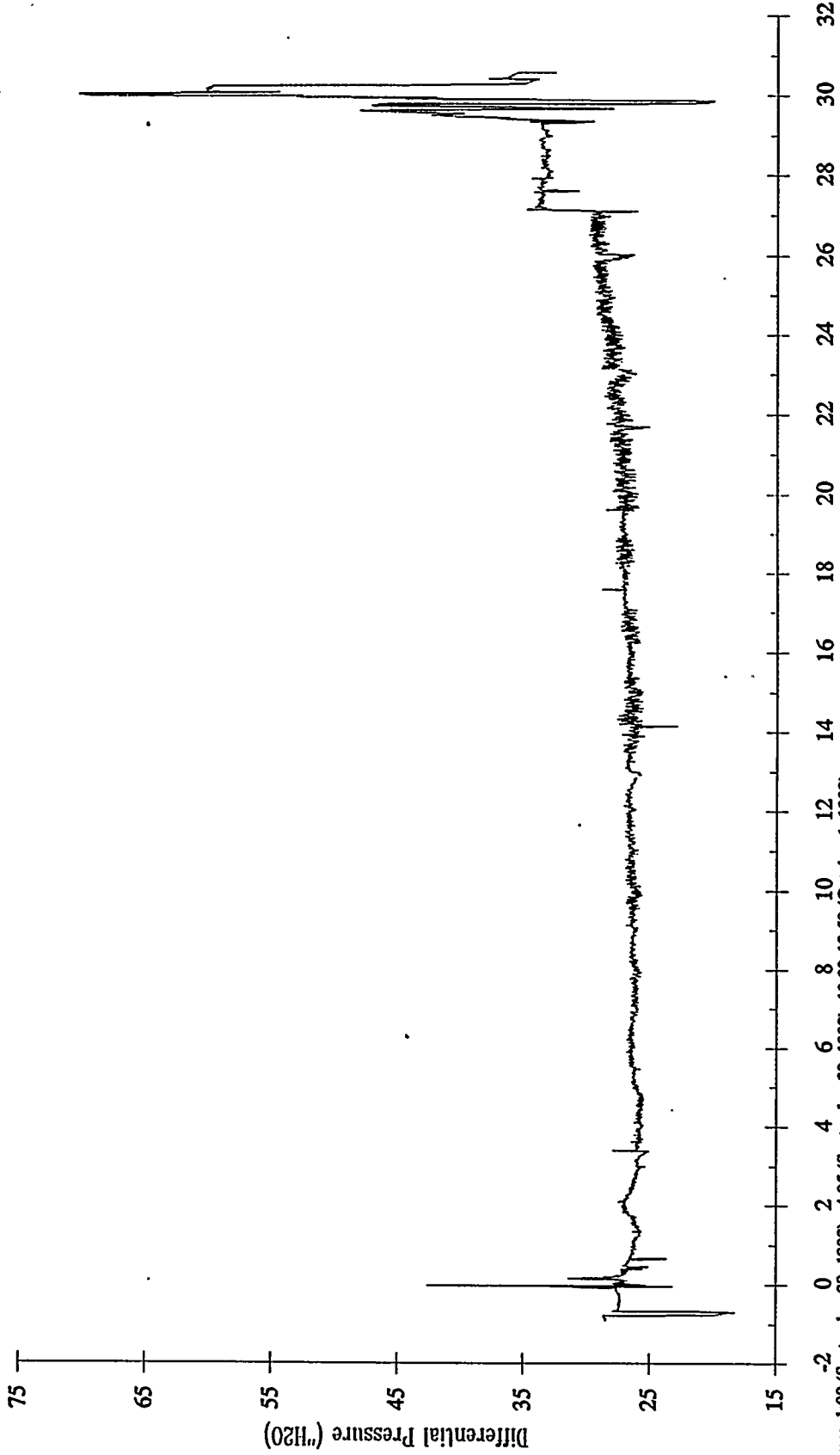

-2 0 2 4 6 8 10 12 14 16 18 20 22 24 26 28 30 32
Test time: 1:00 (September 29, 1992) - 4:05 (September 30, 1992); 10:00-12:50 (October 1, 1992)
Test duration: 29:55

L-3787M Zinc Titanate
u=0.33 ft/sec T_{max}=1400 °F
O₂ Inlet Conc. = 1.5 %

Single Cycle Tests - ZTSC-07 Regeneration 3

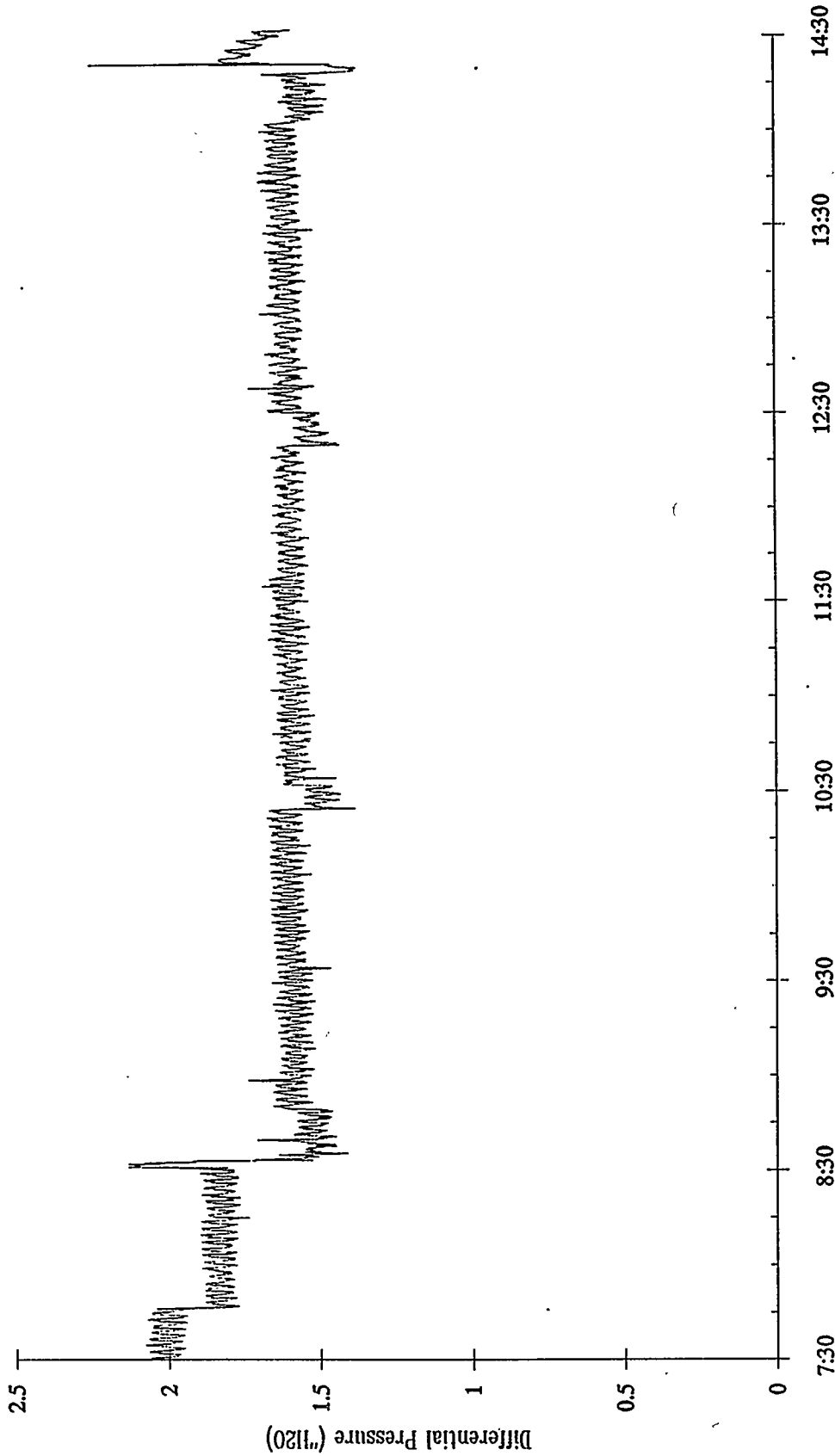

October 2, 1992
Test time: 8:30-14:18 (Test duration: 5:48)

L-3787M Zinc Titanate
u=0.5 ft/sec T=1200 °F
H2S Inlet Conc. = 800 ppm

Multi-Cycle Tests - ZTMC-01 Sulfidation 1

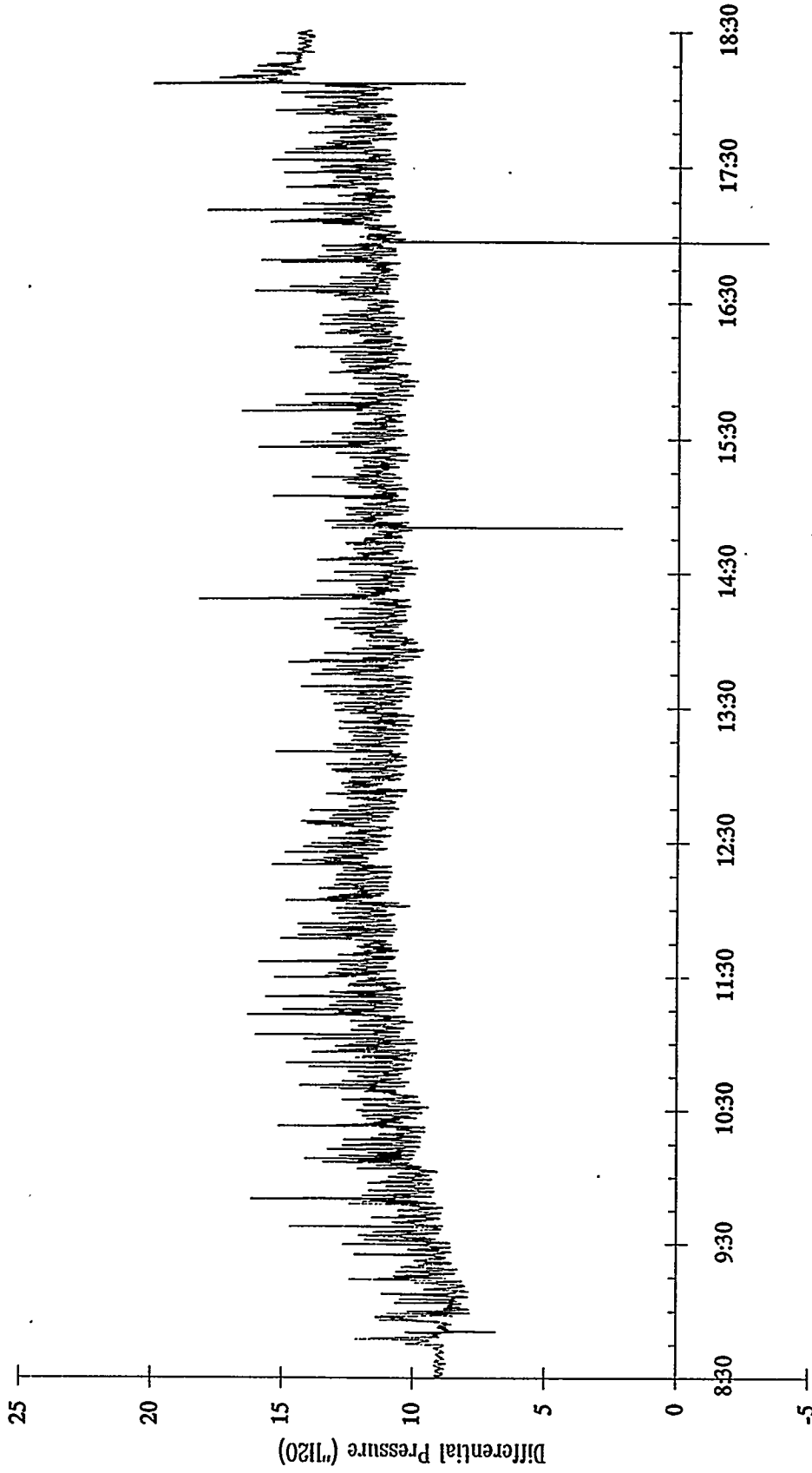

October 6, 1992
Test time: 9:00-18:05 (Test duration: 9:05)

L-3787M Zinc Titanate
u=1.0 ft/sec Tmax=1400 °F
O2 Inlet Conc. = 1.5 %

Multi-Cycle Tests - ZTMC-01 Regeneration 1

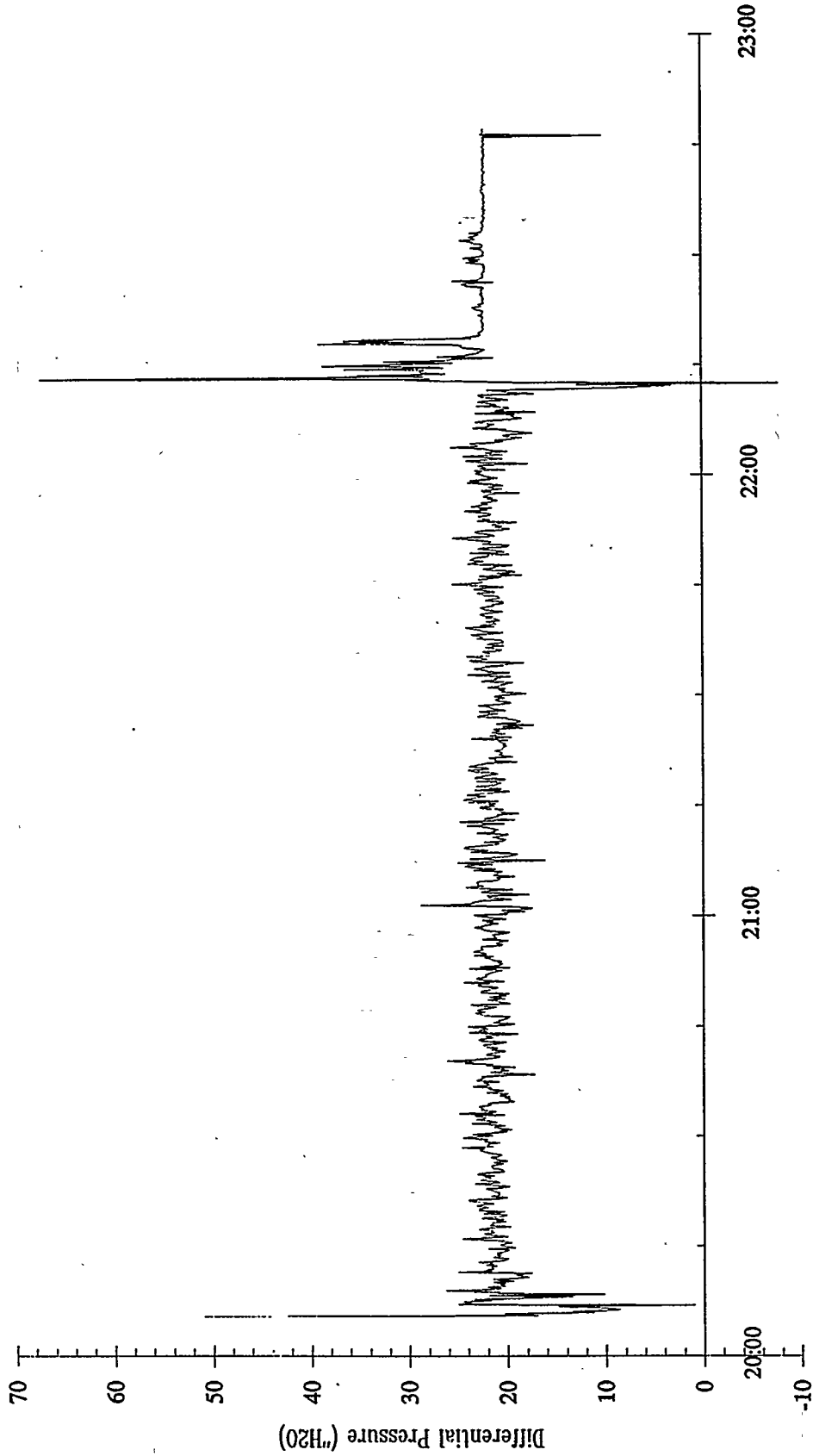

October 6, 1992
Test time: 20:00-22:12 (Test duration: 2:12)

L-3787M Zinc Titanate
u=0.5 ft/sec T=1200 °F
H2S Inlet Conc. = 300 ppm

Multi-Cycle Tests - ZTMC-01 Sulfidation 2

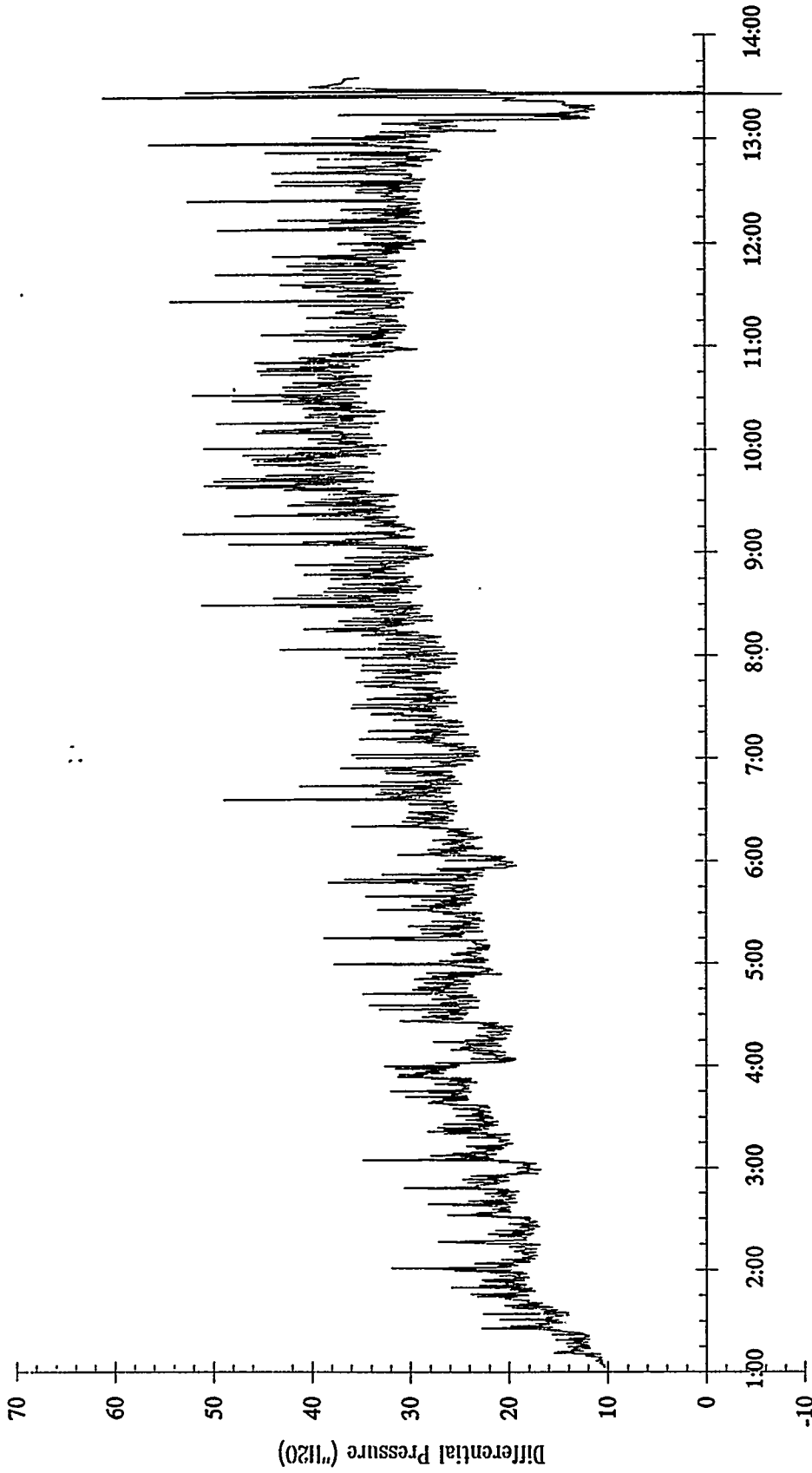

October 7, 1992
Test time: 1:00-13:10 (Test duration: 12:10)

L-3787M Zinc Titanate
u=1.0 ft/sec Tmax=1300 °F
O2 Inlet Conc. = 0.75 %

Multi-Cycle Tests - ZTMC-01 Regeneration 2

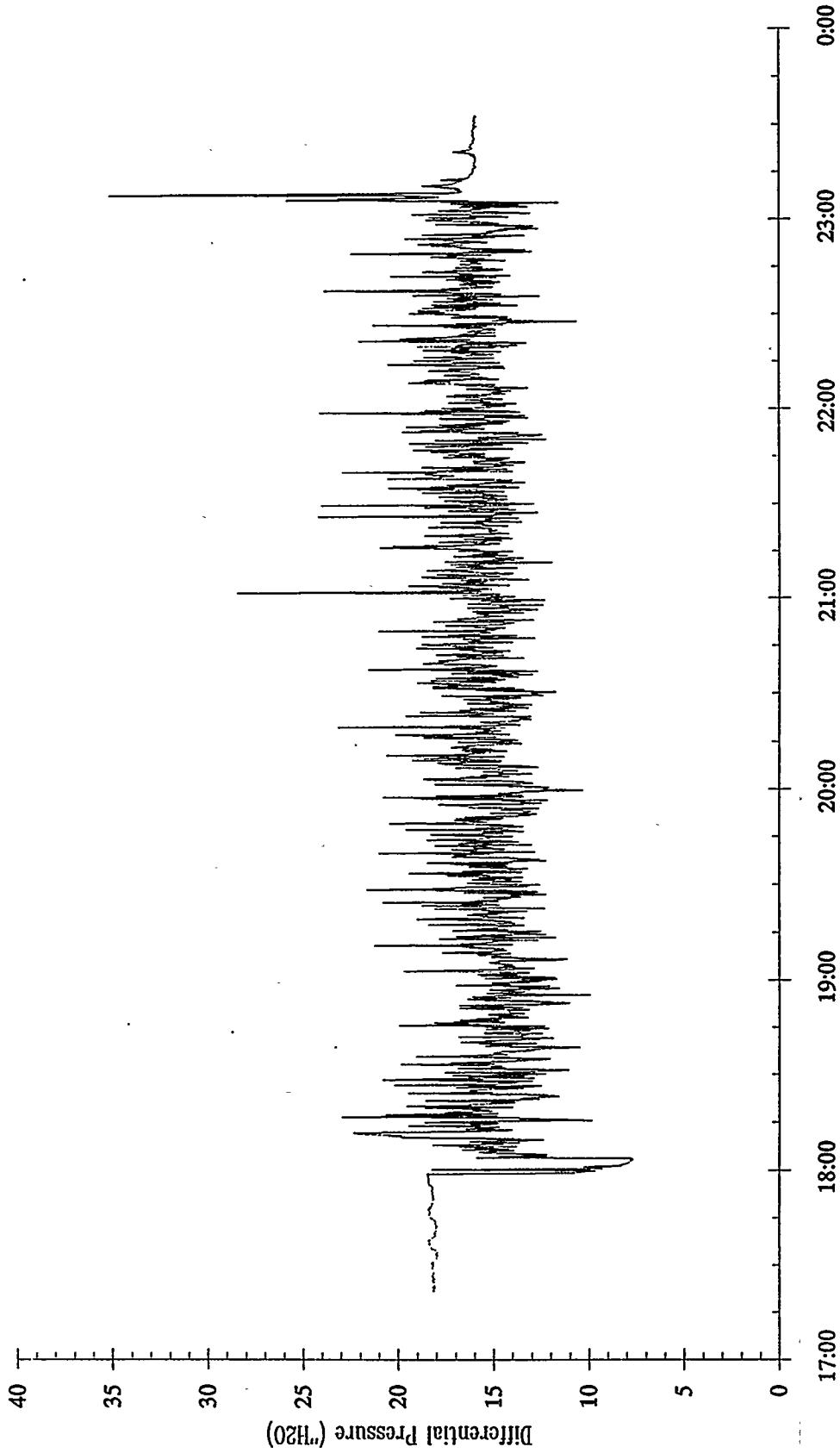

October 7, 1992
17:00 18:00 19:00 20:00 21:00 22:00 23:00 0:00

Test time: 18:00-23:05 (Test duration: 5:05)

L-3787M Zinc Titanate
v=0.5 ft/sec T=1100 °F
H2S Inlet Conc. = 800 ppm

Multi-Cycle Tests - ZTMC-01 Sulfidation 3

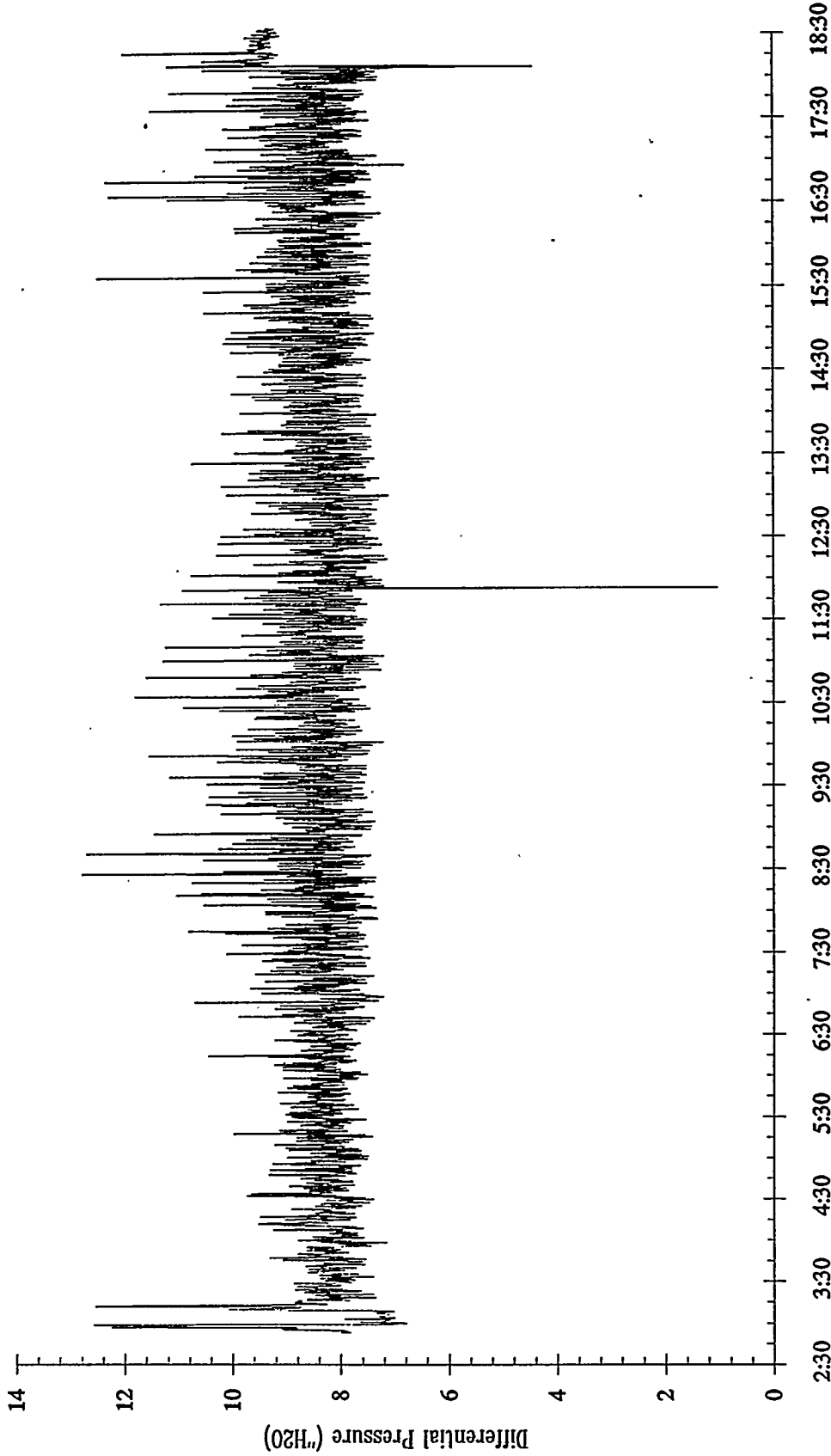

October 8, 1992
Test time: 3:00-18:03 (Test duration: 15:03)

L-3787M Zinc Titanate
u=1.0 ft/sec T_{max}=1300 °F
O₂ Inlet Conc. = 0.75 %

Multi-Cycle Tests - ZTMC-01 Regeneration 3

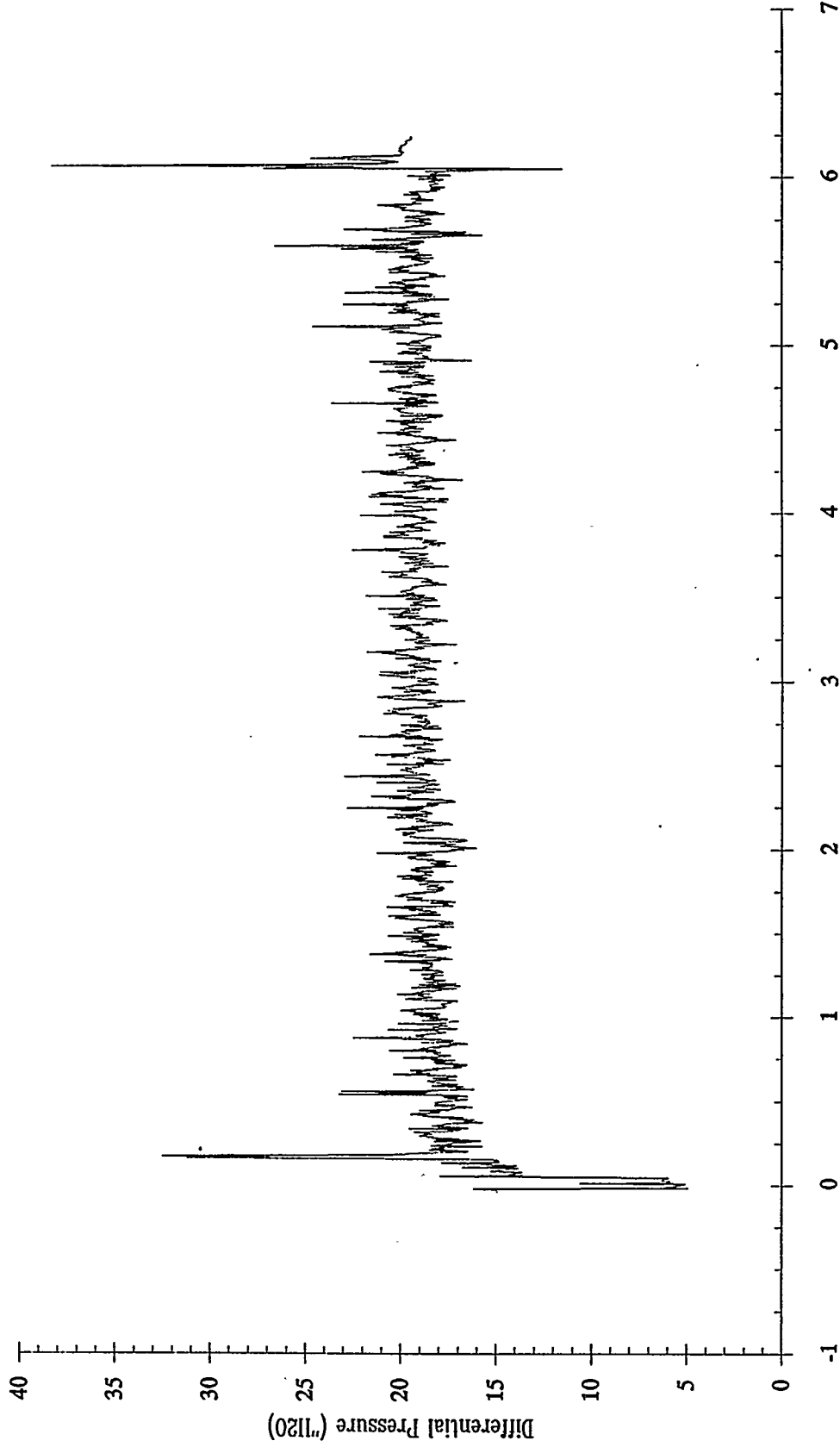

Test time: 20:00 (October 8, 1992) - 2:00 (October 9, 1992)
Test duration: 6:00

L-3787M Zinc Titanate
u=0.5 ft/sec T=1100 °F
H2S Inlet Conc. = 800 ppm

Multi-Cycle Tests - ZTMC-01 Sulfidation 4

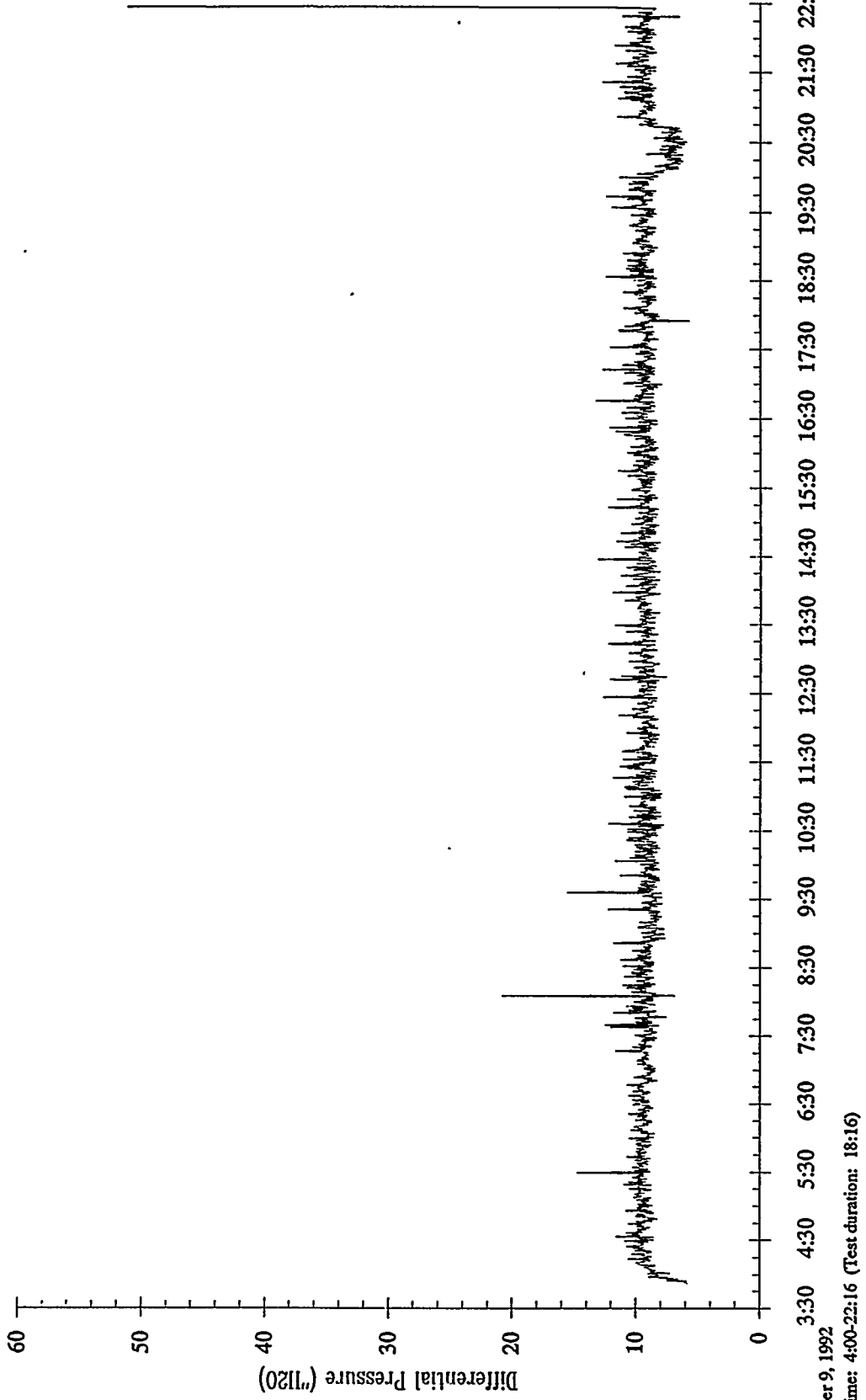

L-3787M Zinc Titanate
u=0.5 ft/sec T=1000 °F
H2S Inlet Conc. = 800 ppm

Multi-Cycle Tests - ZTMC-02 Sulfidation 1

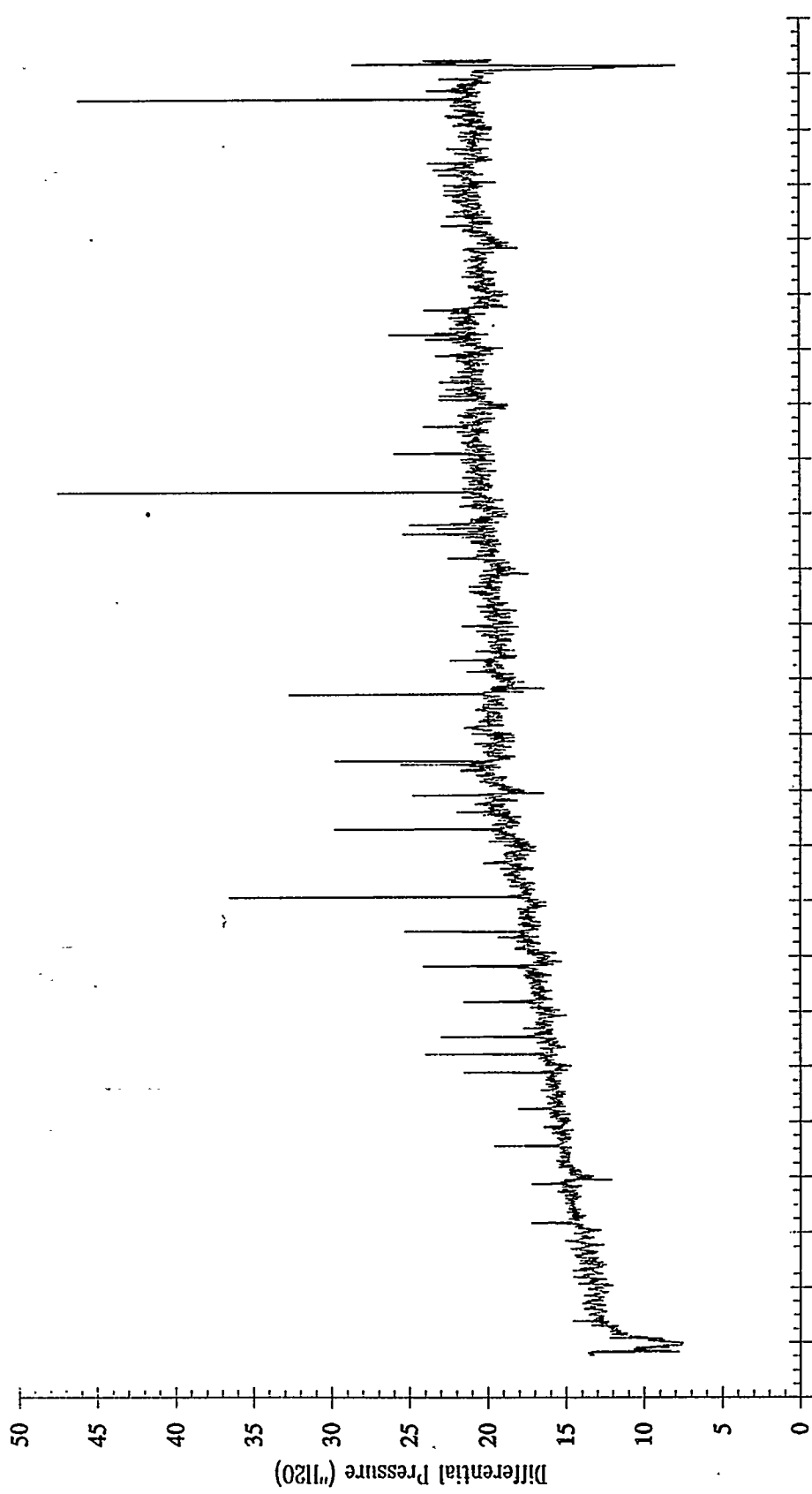

-1 0 1 2 3 4 5 6 7 8 9 10 11 12 13 14 15 16 17 18 19 20 21 22 23 24
Test time: 1:00 (October 14, 1992) - 0:03 (October 15, 1992)
Test duration: 23:03

L-3787M Zinc Titanate
u=0.5 ft/sec Tmax=1400 °F
O2 Inlet Conc. = 2.5 %

Multi-Cycle Tests - ZTMC-02 Regeneration 1

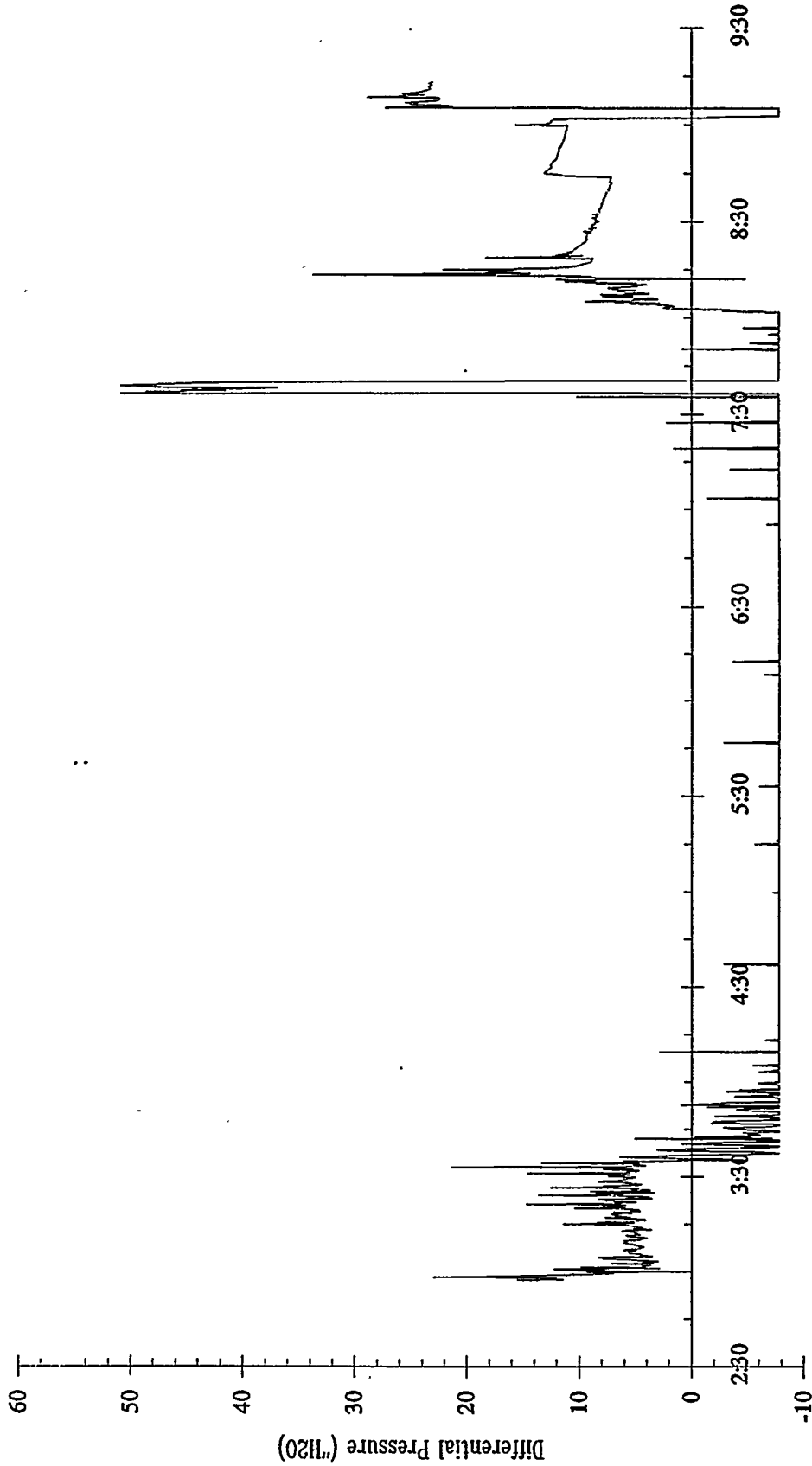

October 15, 1992
Test time: 3:00-8:13 (Test duration: 5:13)

L-3787M Zinc Titanate
u=0.5 ft/sec T=1000 °F
H2S Inlet Conc. = 800 ppm

Multi-Cycle Tests - ZTMC-02 Sulfidation 2

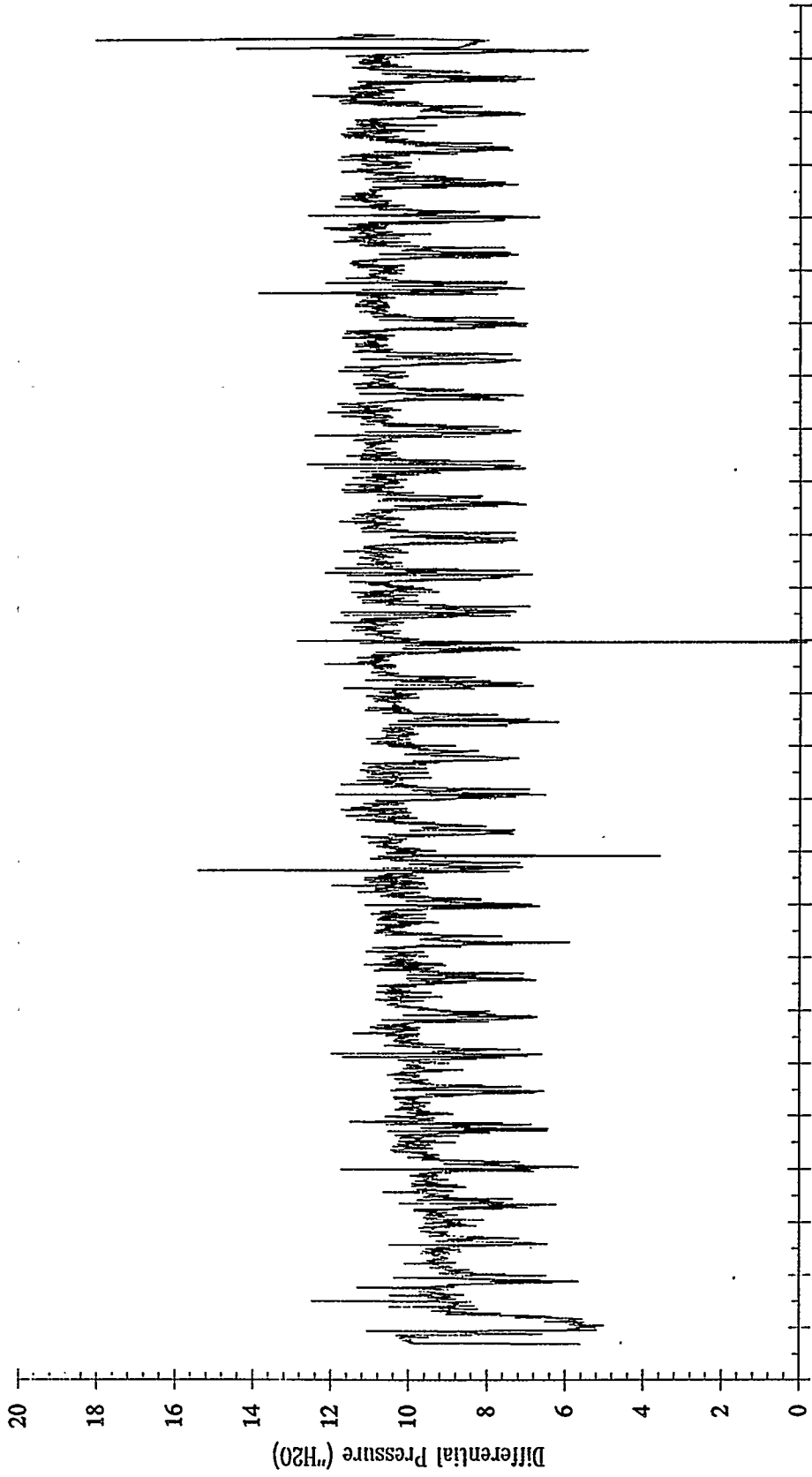

-1 0 1 2 3 4 5 6 7 8 9 10 11 12 13 14 15 16 17 18 19 20 21 22 23 24 25
Test time: 18:00 (October 15, 1992) - 18:03 (October 16, 1992)
Test duration: 24:03

L-3787M Zinc Titanate
u=1.0 ft/sec Tmax=1400 °F
O2 Inlet Conc. = 2.5 %

Multi-Cycle Tests - ZTMC-02 Regeneration 2

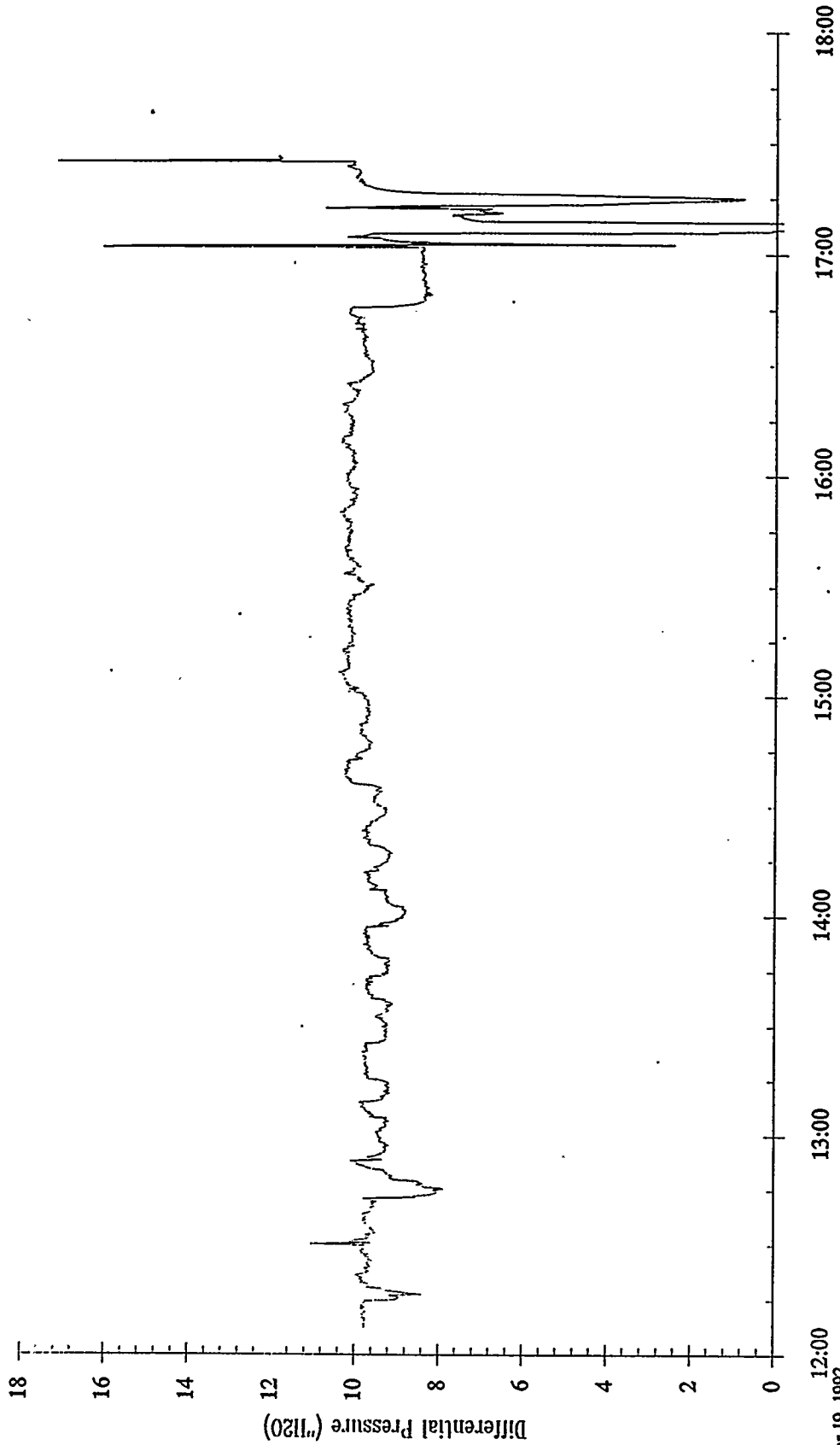

October 19, 1992
Test time: 12:30 - 16:45 (Test duration: 4:15)

L-3787M Zinc Titanate
u=2.0 ft/sec T=1200 °F
H2S Inlet Conc. = 800 ppm

Multi-Cycle Tests - ZTMC-02 Sulfidation 3

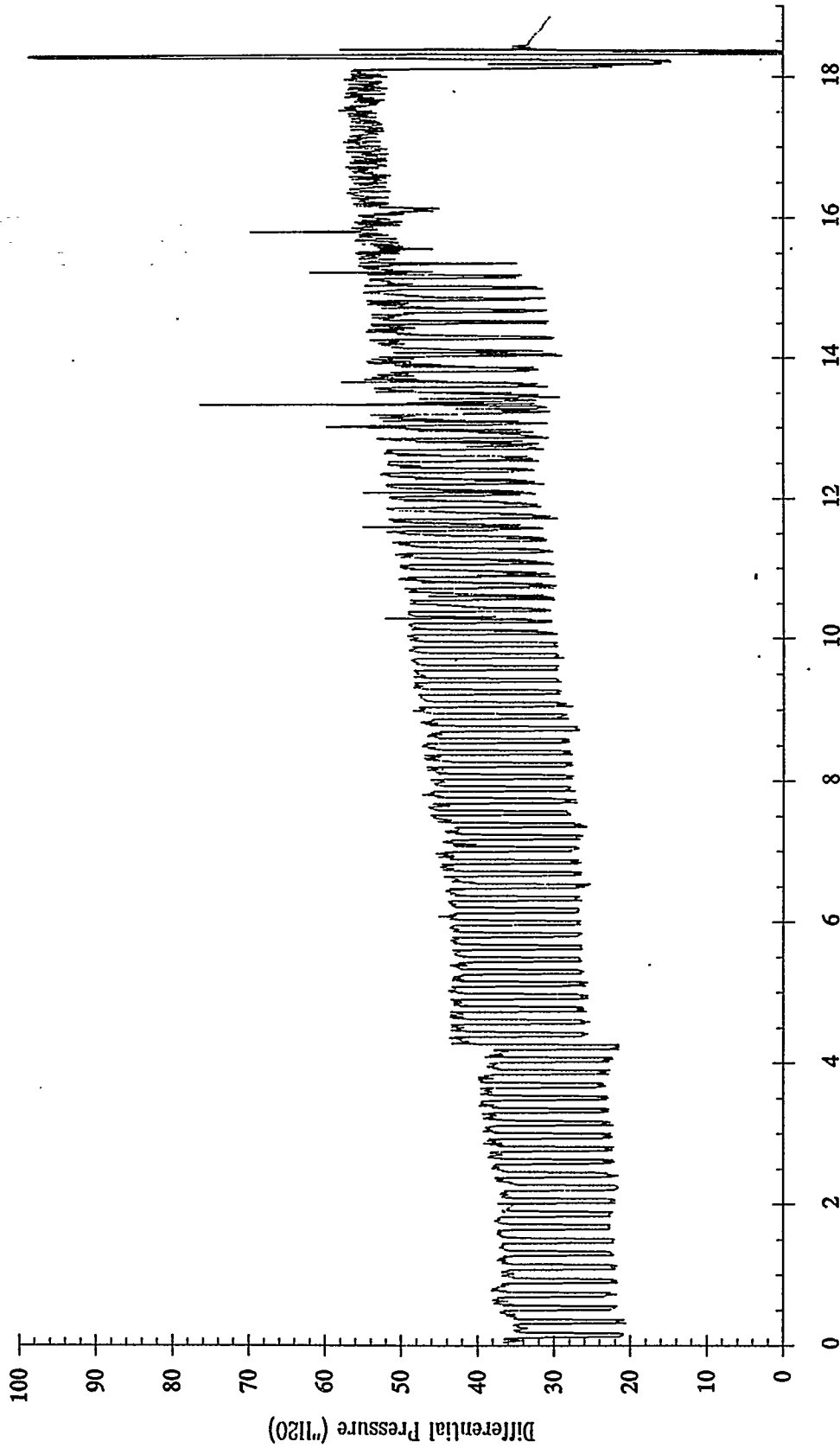

Test time: 20:00 (October 19, 1992) - 14:05 (October 20, 1992)
Test duration: 18:05

L-3787M Zinc Titanate
u=0.33 ft/sec Tmax=1400 F
O2 Inlet Conc. = 1.5 %

Multi-Cycle Tests - ZTMC-02 Regeneration 3

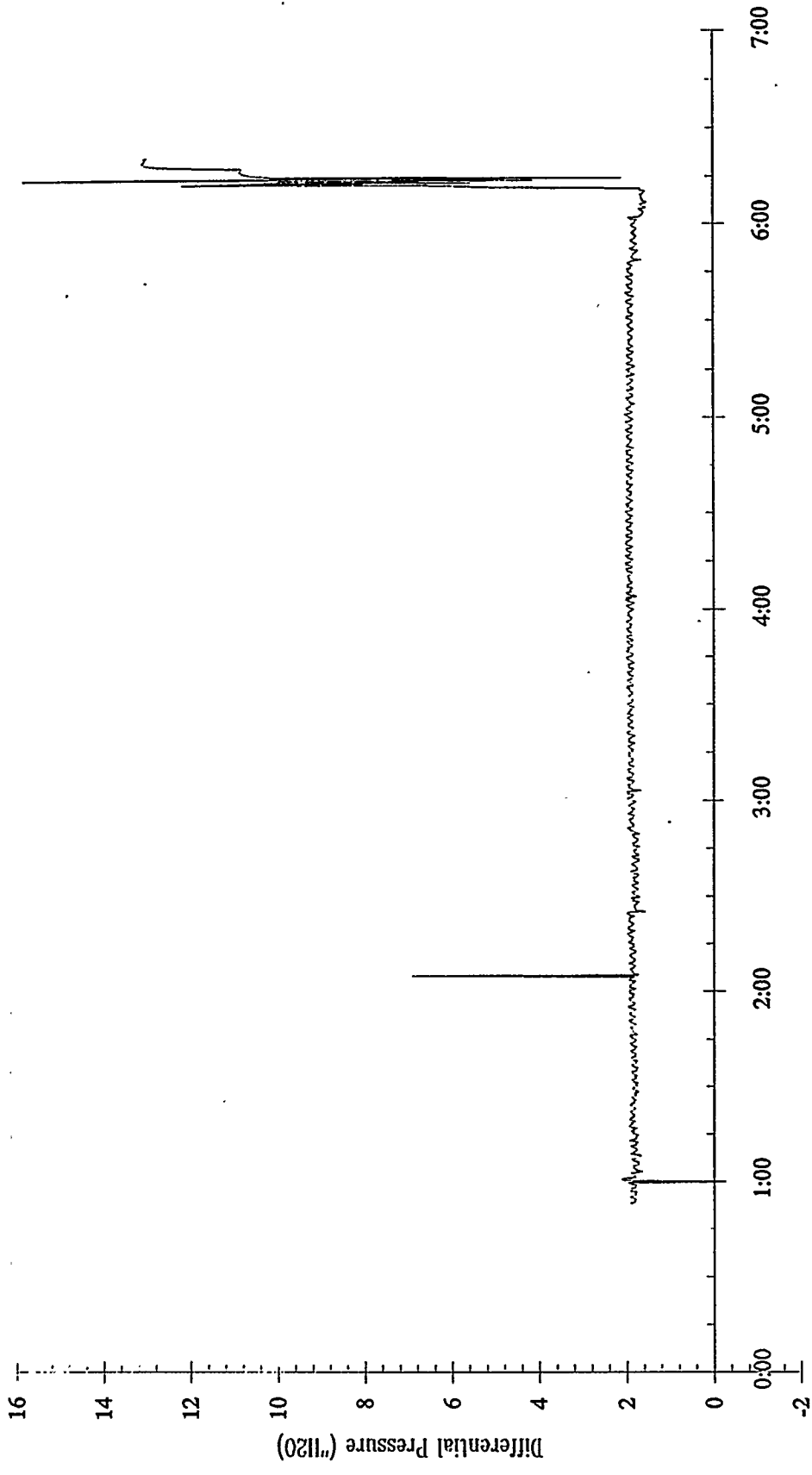

October 21, 1992
Test time: 1:00 - 6:03 (Test duration: 5:03)

L-3787M Zinc Titanate
u=1.0 ft/sec T=1200 °F
H2S Inlet Conc. = 0 ppm

Multi-Cycle Tests - ZTMC-03 Sulfidation 1

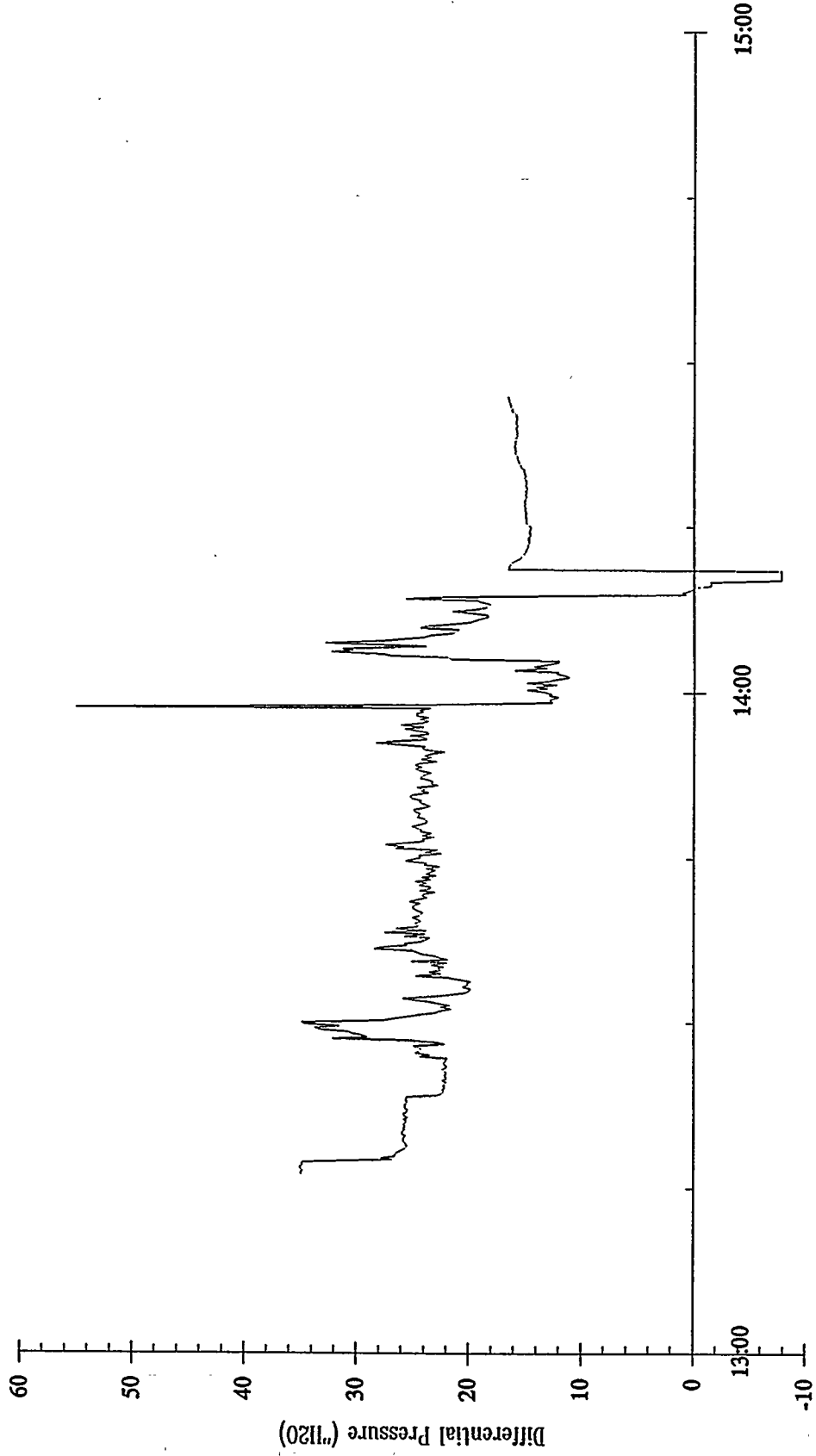

November 4, 1992
Test time: 13:30-14:00 (Test duration: 0:30)

L-3787M Zinc Titanate
u=1.0 ft/sec Tmax=1400 F
O2 Inlet Conc. = 0.75 %

Multi-Cycle Tests - ZTMC-03 Regeneration 1

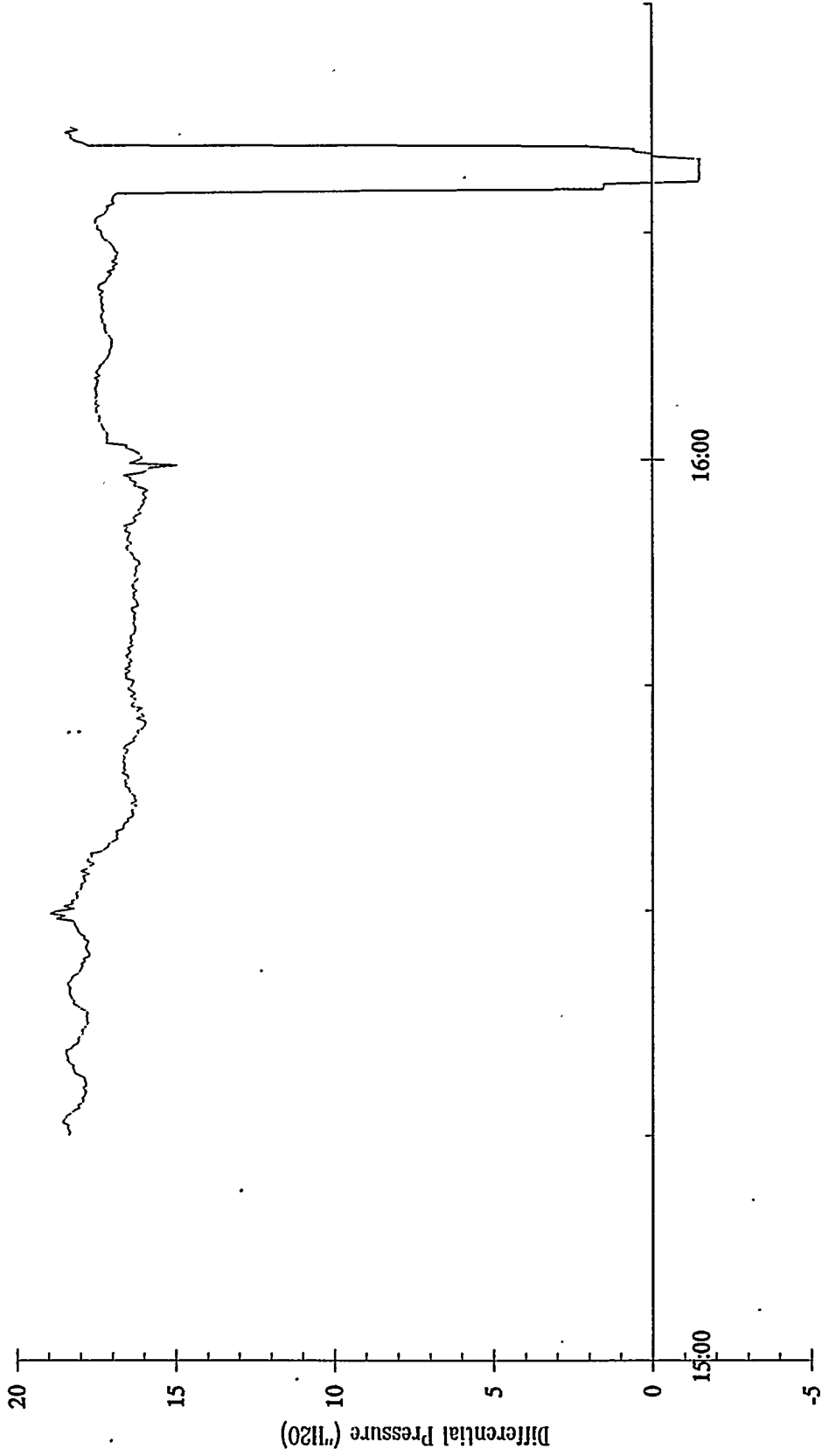

November 4, 1992
Test time: 15:30-16:00 (Test duration: 0:30)

L-3787M Zinc Titanate
u=1.0 ft/sec T=1200 °F
H2S Inlet Conc. = 0 ppm

Multi-Cycle Tests - ZTMC-03 Sulfidation 2

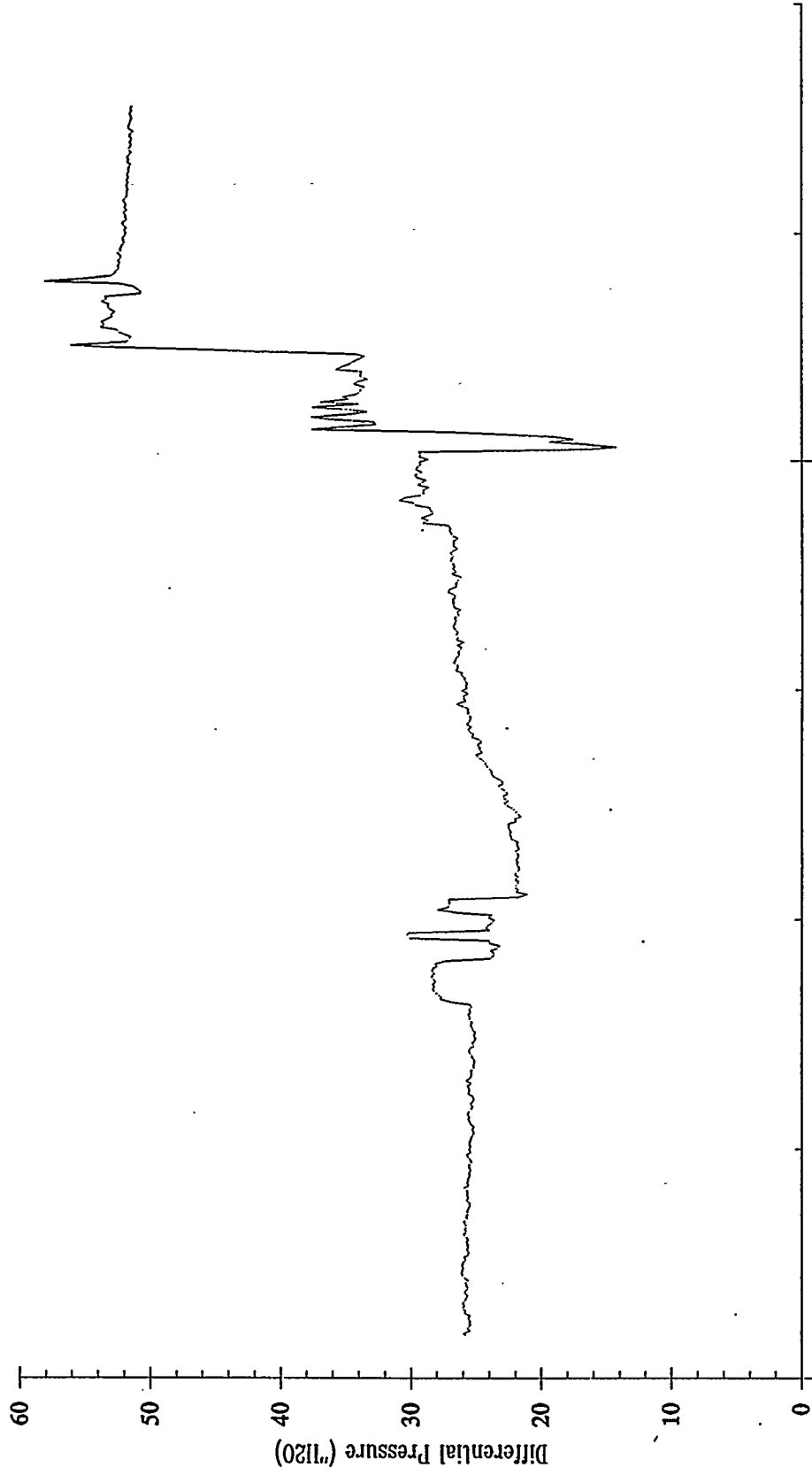

8:00
November 5, 1992
Test time: 8:30-9:00 (Test duration: 0:30)

9:00

L-3787M Zinc Titanate
u=1.0 ft/sec Tmax=1400 °F
O2 Inlet Conc. = 0.75 %

Multi-Cycle Tests - ZTMC-03 Regeneration 2

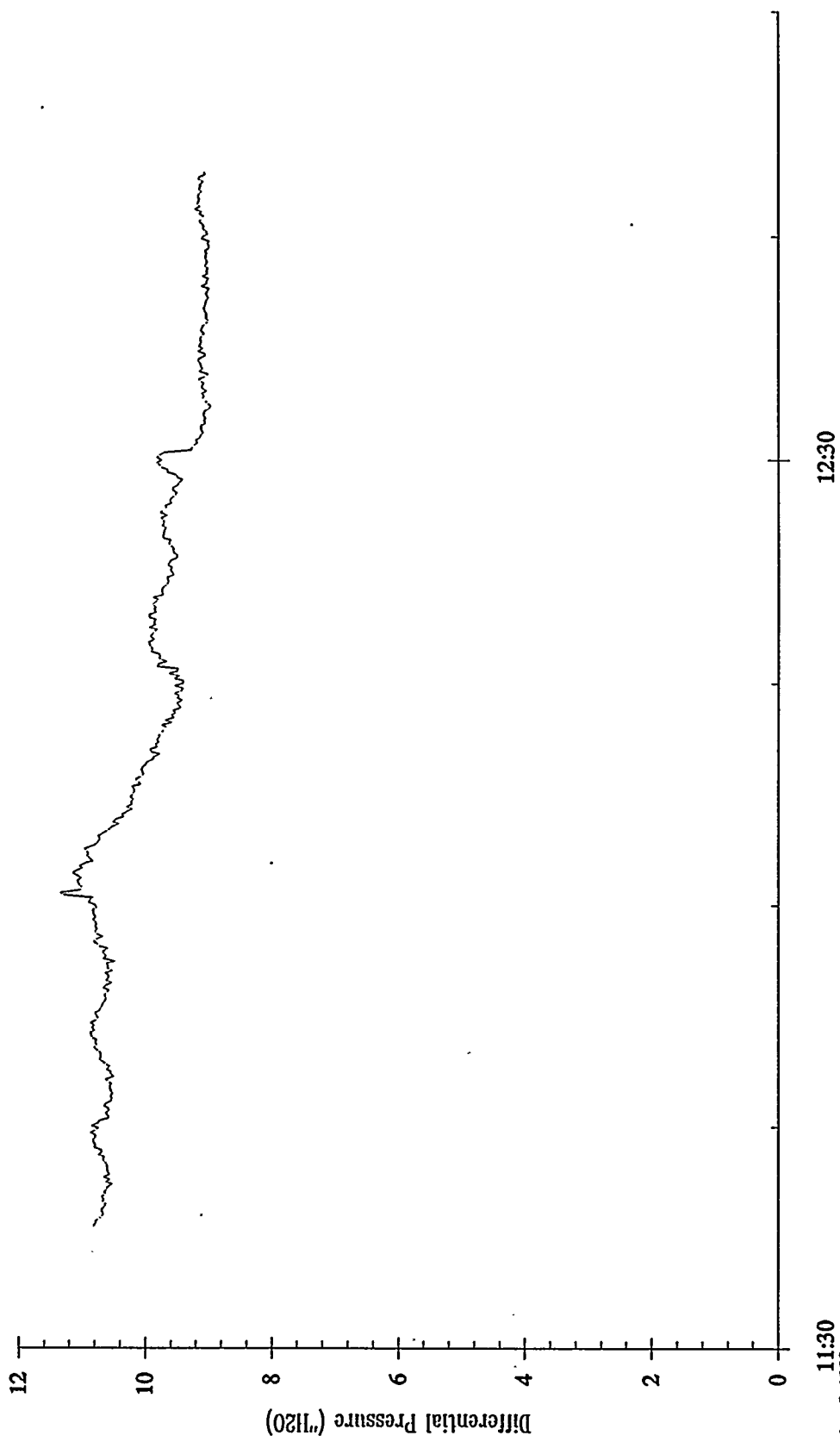

11:30
November 5, 1992
Test time: 12:00-12:30 (Test duration: 0:30)

L-3787M Zinc Titanate
u=1.0 ft/sec T=1200 °F
H2S Inlet Conc. = 0 ppm

Multi-Cycle Tests - ZTMC-03 Sulfidation 3

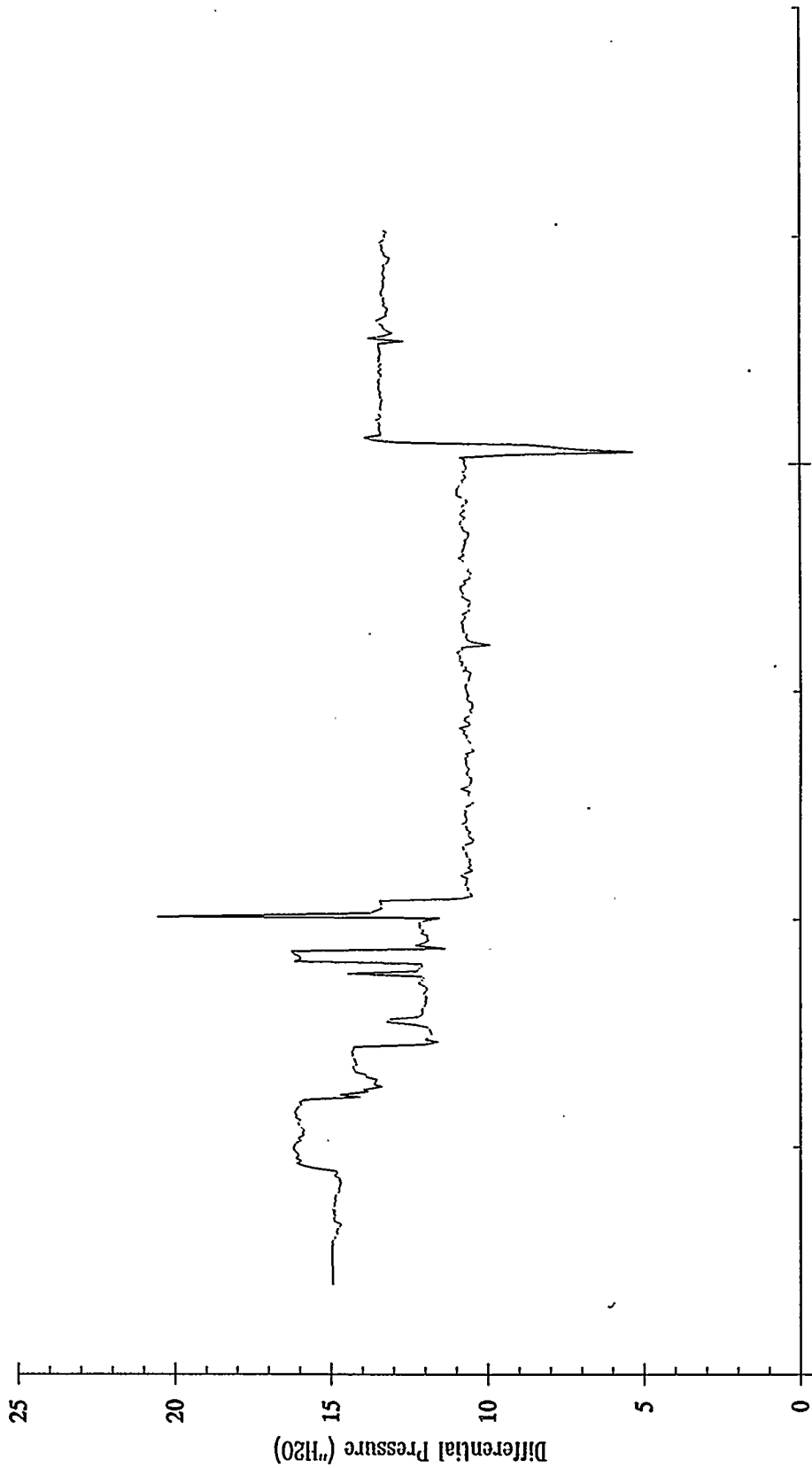

14:00

15:00

November 5, 1992
Test time: 14:30-15:00 (Test duration: 0:30)

L-3787M Zinc Titanate
u=1.0 ft/sec T_{max}=1400 °F
O₂ Inlet Conc. = 0.75 %

Multi-Cycle Tests - ZTMC-03 Regeneration 3

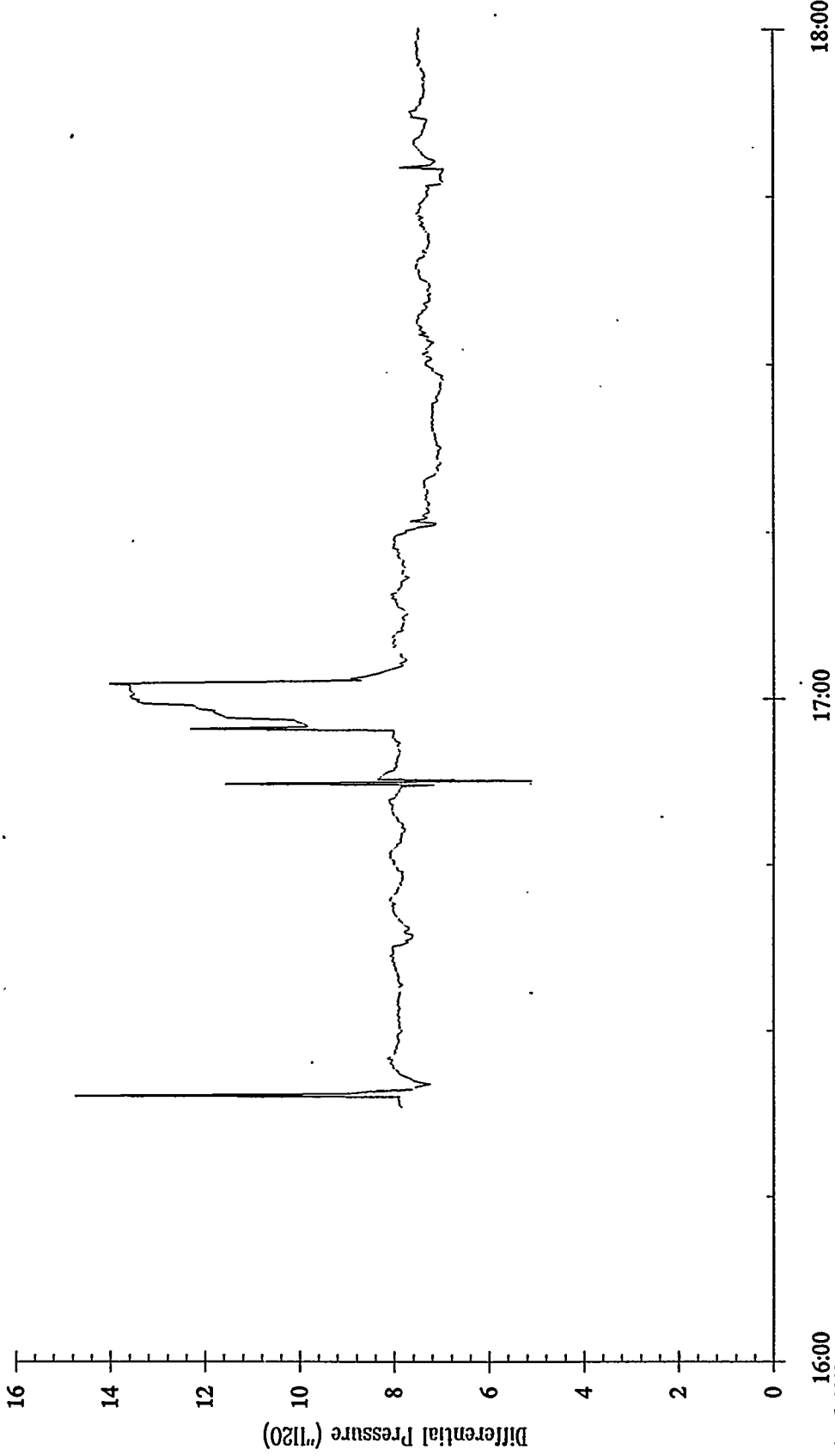

16:00
November 5, 1992
Test time: 17:15-17:45 (Test duration: 0:30)

L-3787M Zinc Titanate
u=1.0 ft/sec T=1200 °F
H2S Inlet Conc. = 0 ppm

Multi-Cycle Tests - ZTMC-03 Sulfidation 4

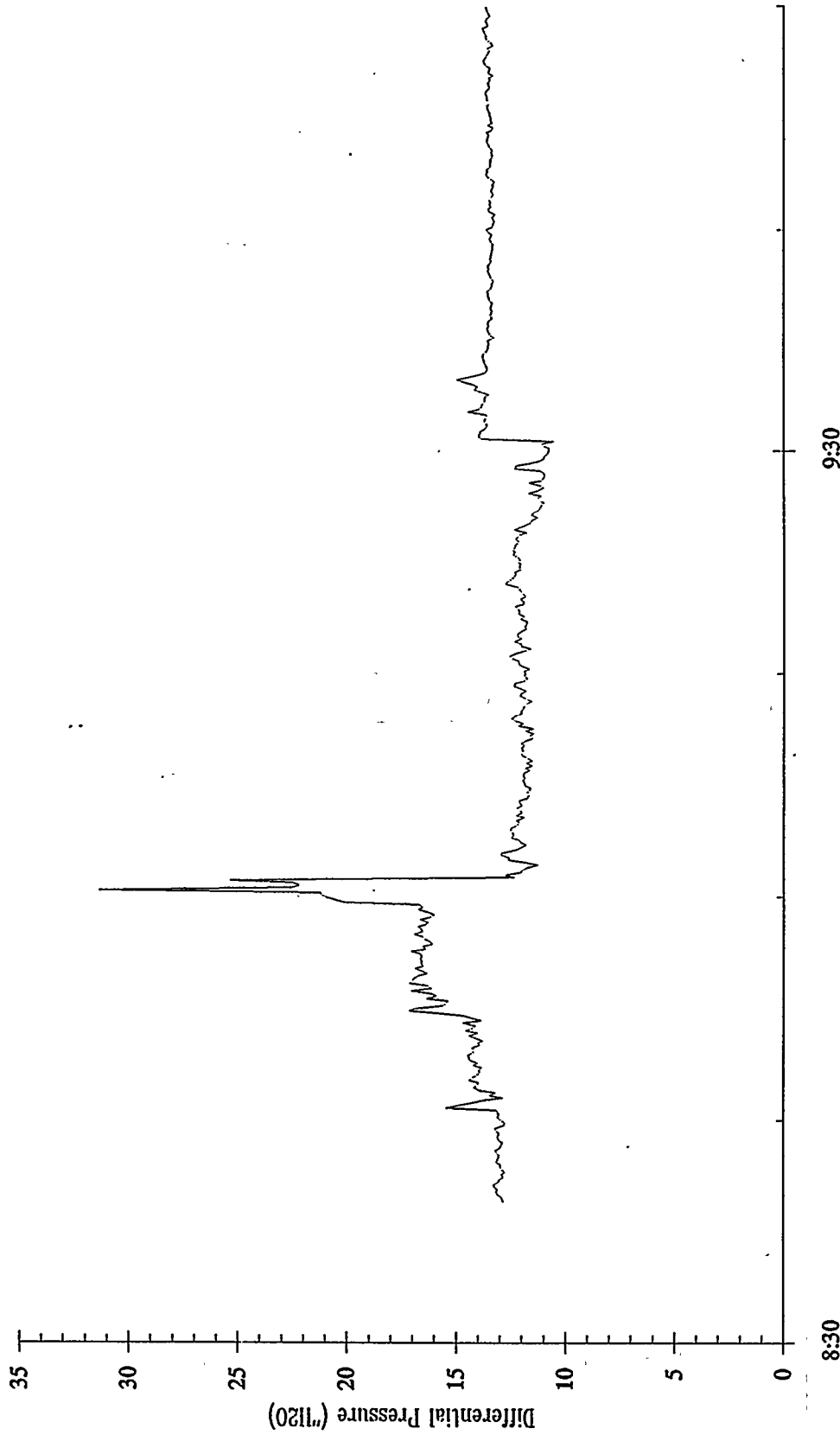

8:30
November 6, 1992
Test time: 9:00-9:30 (Test duration: 0:30)

L-3787M Zinc Titanate
u=1.0 ft/sec Tmax=1400 °F
O2 Inlet Conc. = 0.75 %

Multi-Cycle Tests - ZTMC-03 Regeneration 4

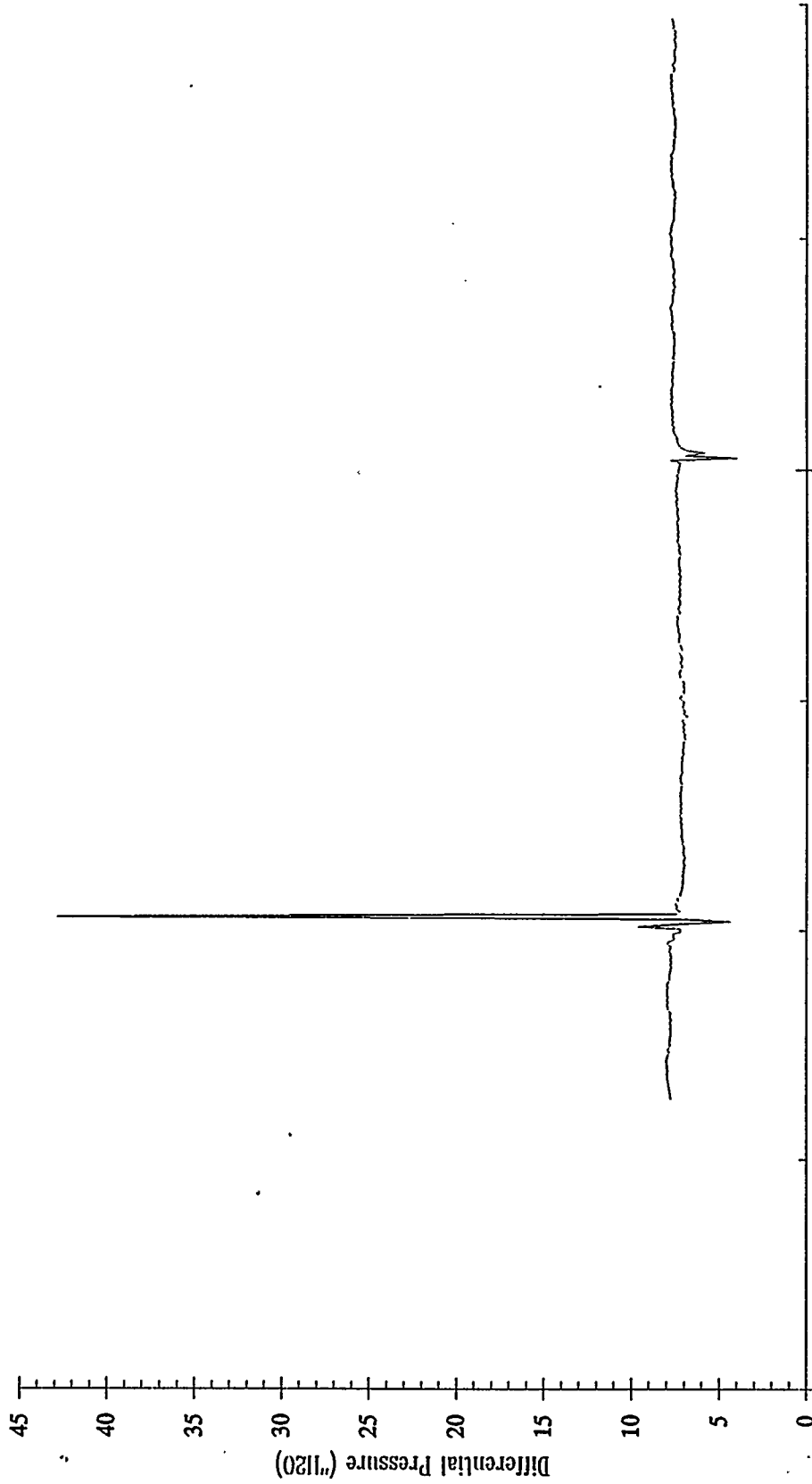

November 6, 1992
Test time: 12:00-12:30 (Test duration: 0:30)

L-3787M Zinc Titanate
u=1.0 ft/sec T=1000 F
H2S Inlet Conc. = 800 ppm

Multi-Cycle Tests - ZTMC-04 Sulfidation 1

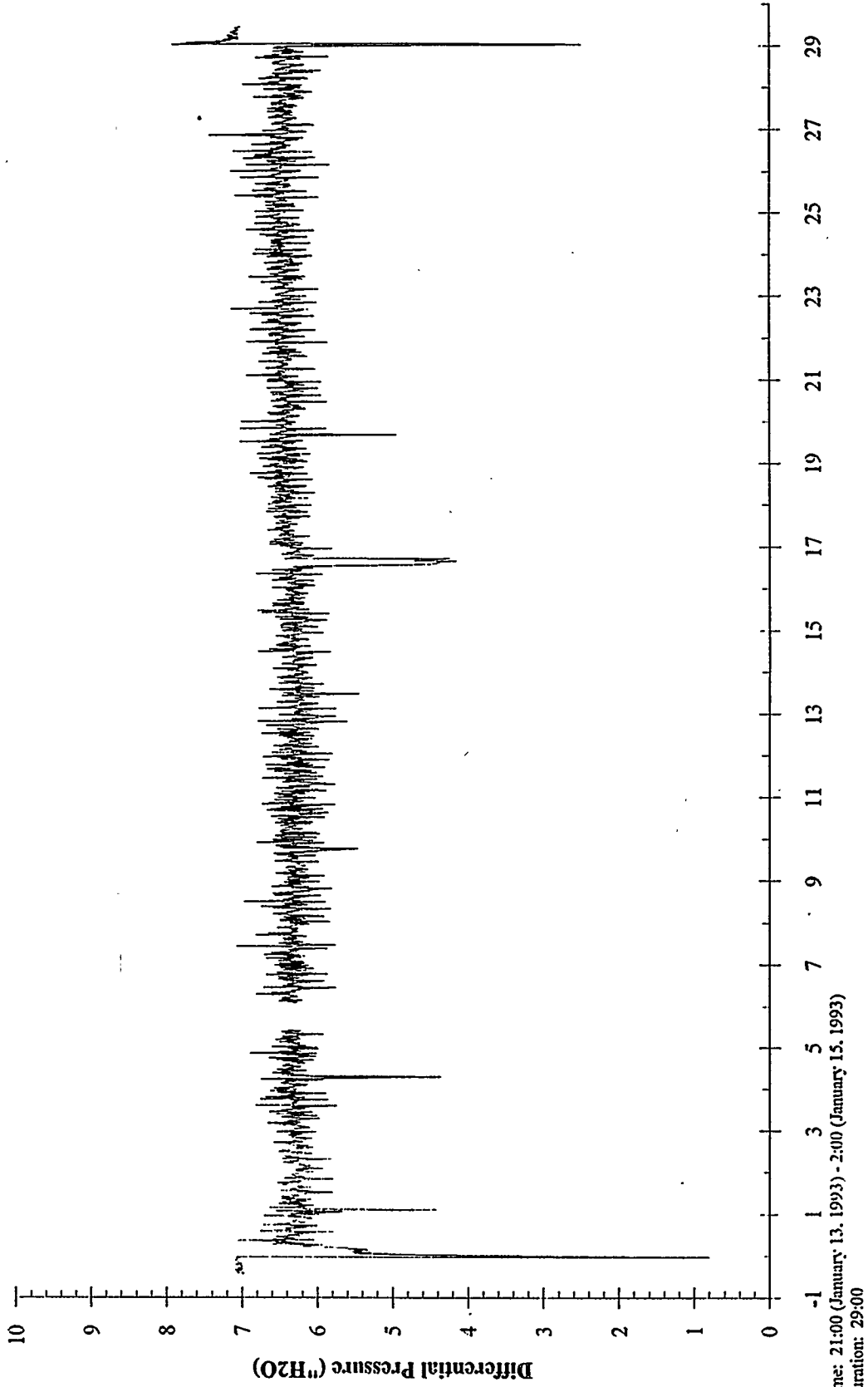

L-3787M Zinc Titanate
u=1.0 ft/sec T = 1000-1400 F
O2 Inlet Conc. = 0.5 - 21 %

Multi-Cycle Tests - ZTMC-04 Regeneration 1

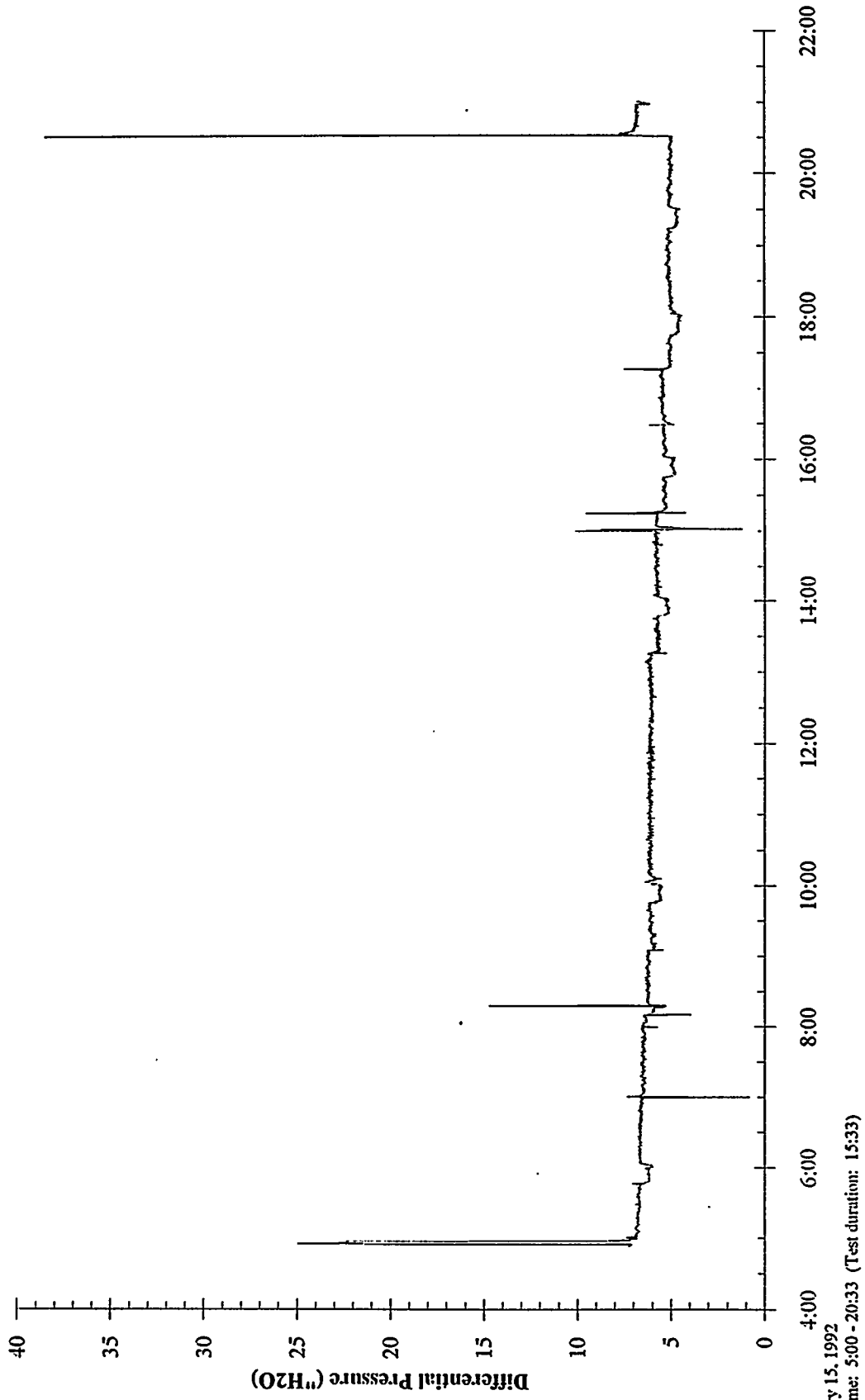

January 15, 1992
Test time: 5:00 - 20:33 (Test duration: 15:33)

L-3787M Zinc Titanate
u=1.0 ft/sec T=1000 F
H2S Inlet Conc. = 800 ppm

Multi-Cycle Tests - ZTMC-04 Sulfidation 2

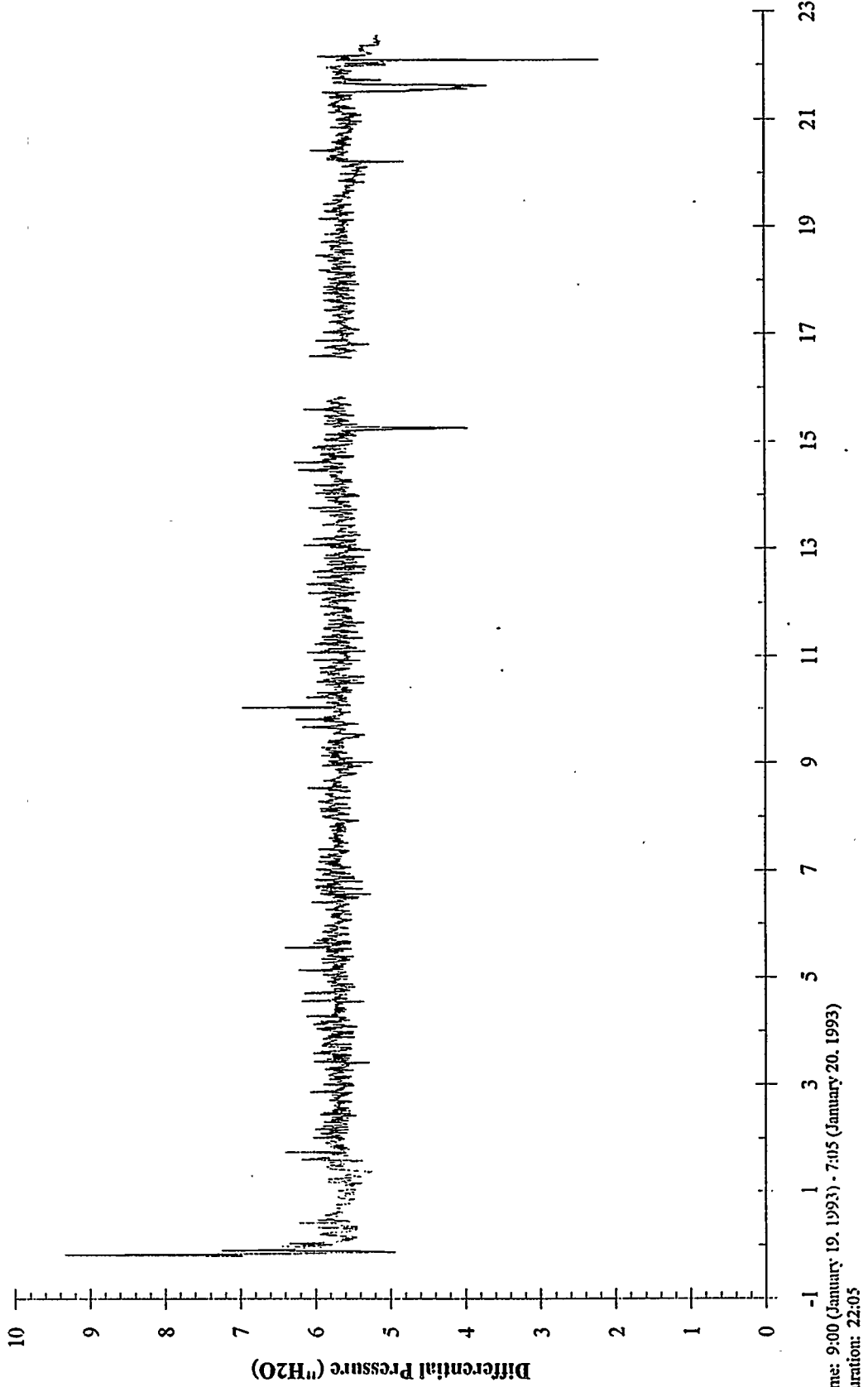

L-3787M Zinc Titanate
u = 1.0 ft/sec T = 1000-1400 F
0.2 inlet Conc. = 0.5 - 21 "

Multi-Cycle Tests - ZTMC-04 Regeneration 2

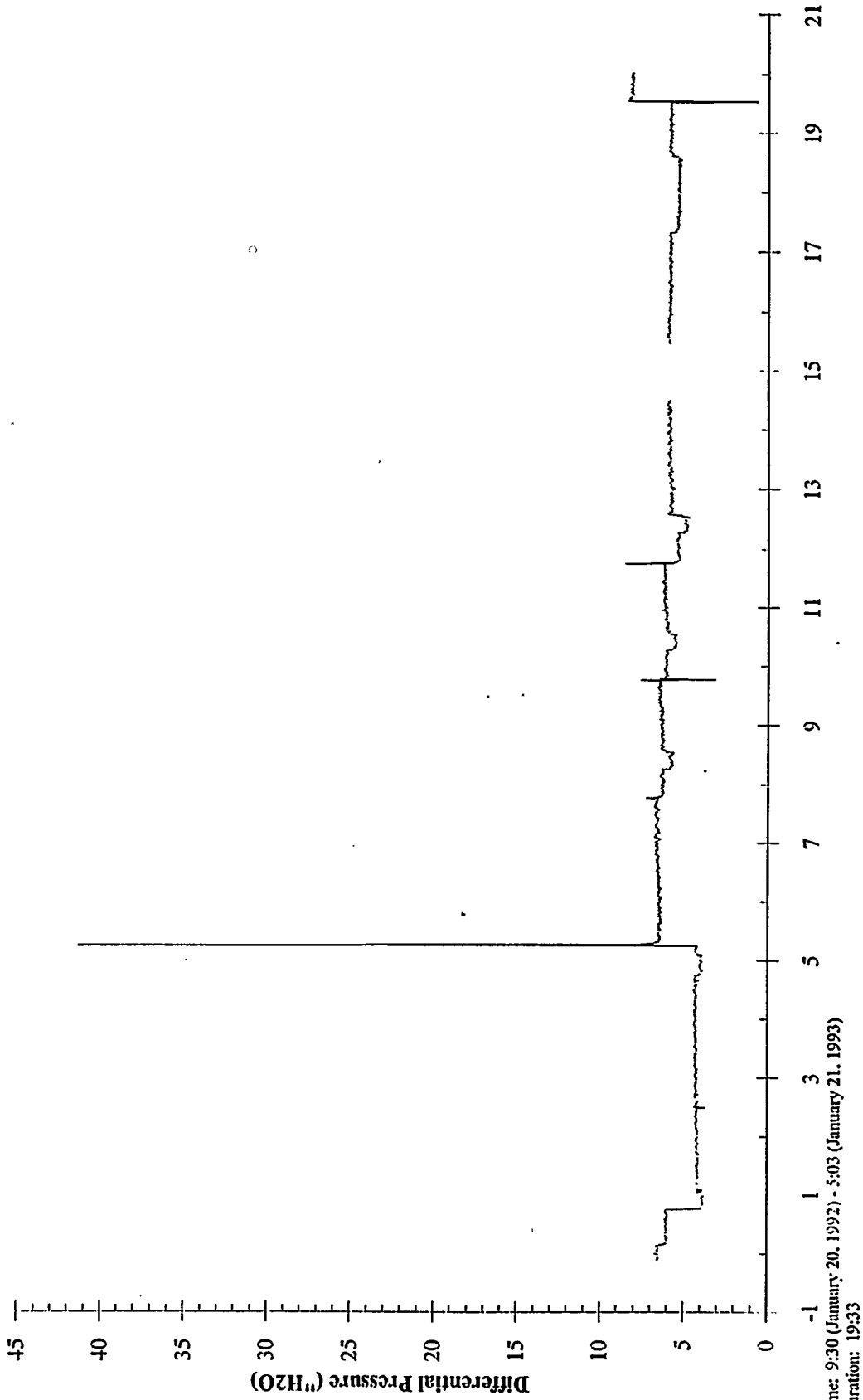

Test time: 9:30 (January 20, 1992) - 5:03 (January 21, 1993)
Test duration: 19:33

Multi-Cycle Tests - ZTMC-04 Sulfidation 3

L-3787M Zinc Titanate
u=1.0 ft/sec T=1000 F
H2S Inlet Conc. = 800 ppm

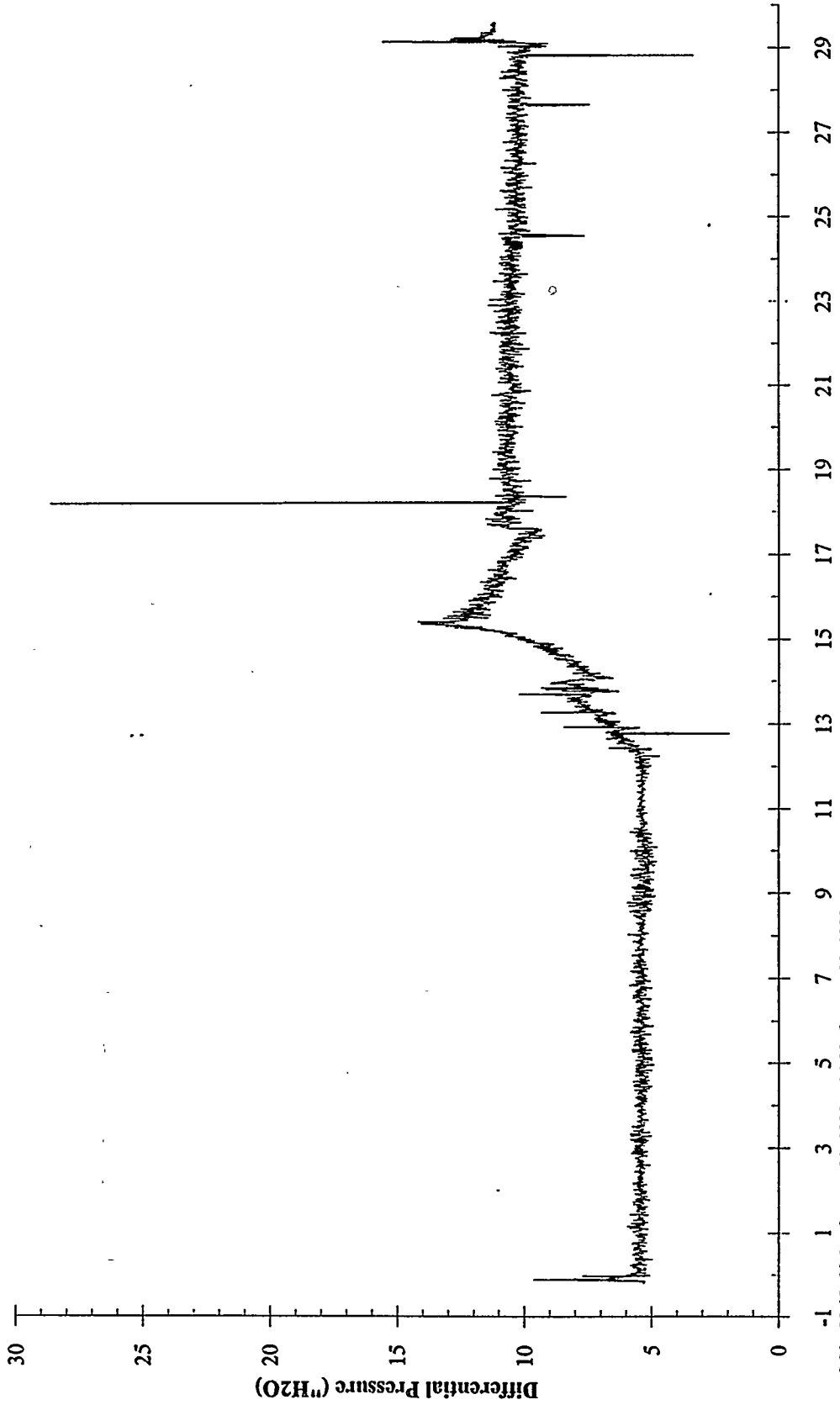

Test time: 8:30 - 22:33, 23:30 (January 21, 1993) - 14:32 (January 22, 1993)
Test duration: 29:05

L-3787M Zinc Titanate
u=1.0 ft/sec T=1000 F
H2S Inlet Conc. = 2000 ppm

Single Cycle Tests - ZTSC-08 Sulfidation 1

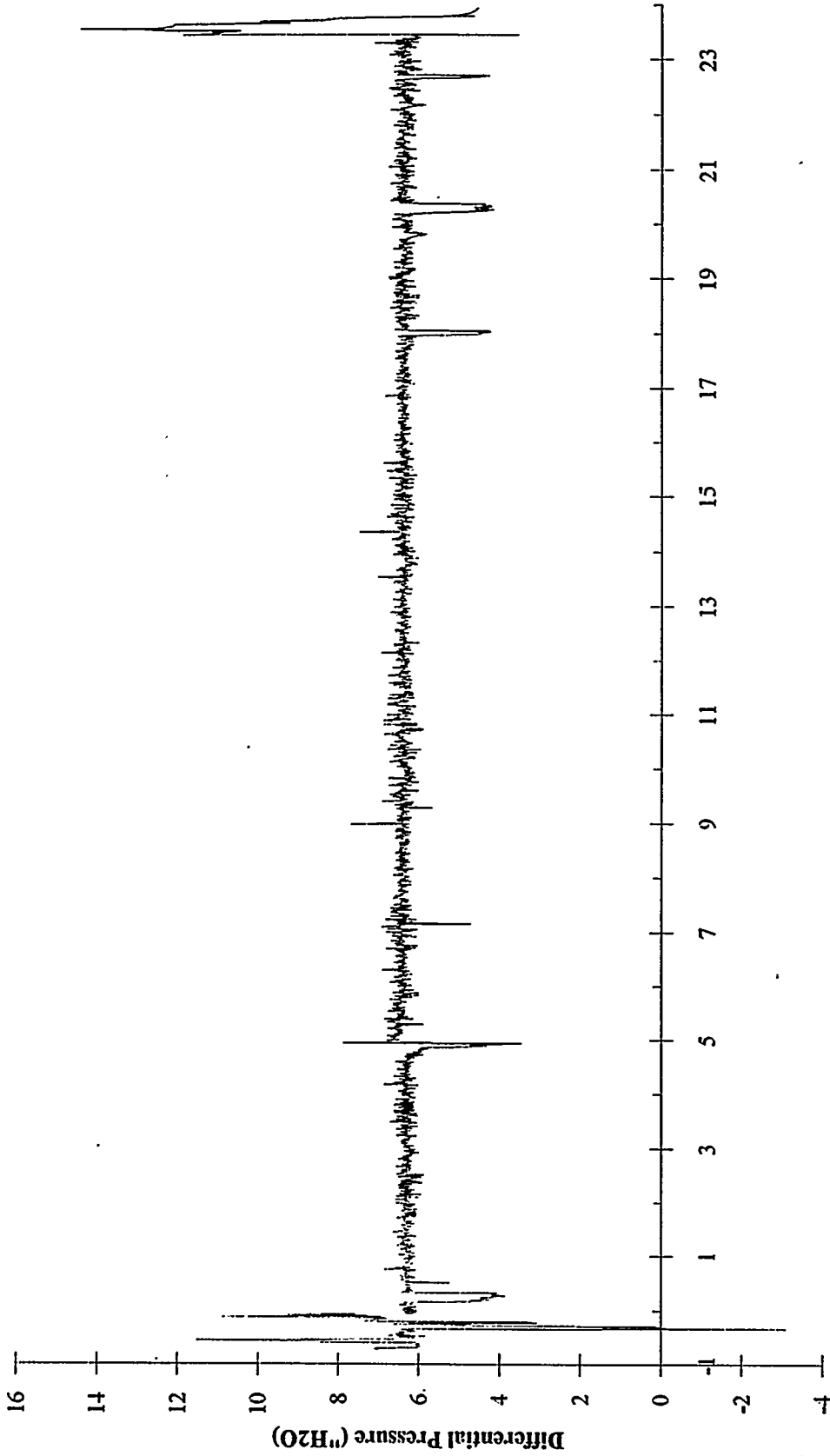

Test time: 10:00-14:57, 17:30 - (January 26, 1993) - 11:53 (January 27, 1993)
Test duration: 23:20

APPENDIX E
Laboratory Gas Chromatograph Results

Grab samples of the exit gas stream were collected at specific intervals throughout the tests. The analyses for each sample are provided on a dry gas basis.

Some of the gas chromatograph data sheets have a "H₂S Recalculated" heading. After a number of tests for the CRADA had been performed, it was determined that the H₂S level in a standard used to calibrate the gas chromatographs was decaying and causing inaccuracies in the GC data. The H₂S was apparently being adsorbed onto the cylinder walls and thus the actual H₂S concentration in the cylinder gas was slowly dropping over time. The daily calibration records, along with the beginning and ending actual values of H₂S in the bottle, were used to recalculate and thus correct the H₂S values for tests which were affected.

Outlet samples were taken using a slipstream of the process gas after the pressure control valves, while inlet samples were taken using another slipstream located between the gas preheater and the reactor vessel. Occasional samples were also taken using a sample port located after the final absorber to determine the effectiveness of the zinc oxide sorbent in the absorber.

The major, or fixed, gases (H₂, O₂, N₂, CH₄, CO, and CO₂) were analyzed using two separate gas chromatographs due to the different columns and oven temperatures required. H₂, O₂, N₂, CH₄, and CO were separated using a stainless steel 1/8" X 10' column packed with Molecular Sieve 13X. The gas chromatograph used with the molecular sieve column was a Hewlett Packard 5710A equipped with a Thermal Conductivity Detector (TCD). The detector and injector were held at 150 °C. Helium carrier flow was 25 mL/min and the oven was operated isothermally at 50 °C. CO₂ was separated using a Teflon 1/8" X 6' column packed with Poropak Q 80/100 mesh (Waters Associates Inc.). The Poropak column was used in a Perkin Elmer 8500 gas chromatograph equipped with a TCD. The detector and injector were held at 125 °C. The helium carrier flow was 25 mL/min and the oven was operated isothermally at 40 °C. A 200 µL aliquot of each sample was injected into the gas chromatograph using a gas tight syringe.

The sulfur gases H₂S, COS, and SO₂ were analyzed using four separate gas chromatographs. Low concentrations of H₂S, zero to approximately 150 ppmv, were analyzed using a glass column 1/8" x 6' packed with (40/60 mesh) Carbopack BHT 100. The column was used in a Perkin Elmer Sigma 300 gas chromatograph equipped with a Flame Photometric Detector (FPD). The detector and injector were held at 125 °C. The oven was temperature programmed as follows: 35° for 3 min.; ramped to 125°C at 10 °C/min. and held for 3 min. Helium at 17 mL/min was used as the carrier gas. 50 to 500 µL aliquots of the samples were injected into the gas chromatographs. Medium concentrations of H₂S, 150 to 3000 ppmv, COS, and SO₂ (below one percent) were separated using a 1/8" X

30" Teflon column packed with 18" of Supelcopak S (Supelco, Inc.). The column was used in a Perkin Elmer Sigma 1 gas chromatograph equipped with a Flame Photometric Detector (FPD). The detector and injector were held at 250 °C. The helium carrier gas flow was maintained at 25 mL/min. The oven was temperature programmed as follows: 40 °C for 2 min.; ramped at 10 °C/min to 130 °C and held for 1 min.; ramped at 40 °C/min. to 200 °F and held for 2 min. A 50 to 500 µL aliquot of each sample was injected into the gas chromatograph using a gas tight syringe. SO₂ concentrations greater than one percent were analyzed using a 1/8" X 30" Teflon column packed with 18" of Supelcopak S. The column was used in a Perkin Elmer Sigma 1 gas chromatograph equipped with a Thermal Conductivity Detector. The detector and injector were held at 125 °C while the oven was a constant 65 °C. Helium was used as the carrier gas at a flow rate of 25 mL/min. 100 µL of the samples were injected for this analysis.

High Pressure Hot Gas Desulfurization Lab Gas Analysis

ZTSC-01-S1 September 3, 1992

Normalized to 100

H2S Recalculated

Time	Loca.	H2 %	O2 %	N2 %	CH4 %	CO %	CO2 %	H2S PPM	COS PPM	SO2 PPM
440	Inlet	14.17	0.10	55.36	ND	22.44	7.85	741.1	72.8	2.6
440	Outlet	14.80	0.10	55.30	ND	21.19	8.61	9.9	0.2	ND
455	Outlet	15.54	0.10	54.51	ND	21.04	8.80	26.4	0.3	ND
510	Outlet	14.83	0.10	54.85	ND	21.57	8.65	29.0	0.5	ND
525	Outlet	15.00	0.09	54.84	ND	21.37	8.69	47.0	0.8	ND
535	Inlet	14.21	0.10	55.25	ND	22.53	7.84	752.7	72.6	3.1
535	Outlet	14.94	0.10	54.86	ND	21.81	8.29	45.5	1.1	ND
605	Inlet	14.26	0.09	55.20	ND	22.51	*7.86	713.3	69.8	2.8
605	Outlet	15.03	0.09	54.70	ND	21.58	8.60	83.2	5.2	ND
635	Outlet	14.67	0.10	54.85	ND	22.06	8.30	162.1	11.4	ND
650	Outlet	14.92	0.09	54.76	ND	21.93	8.27	205.4	14.3	ND
705	Outlet	15.37	0.09	54.42	ND	21.47	8.62	278.6	17.4	1.4
720	Outlet	14.92	0.09	54.77	ND	21.87	8.32	306.7	20.4	1.4
735	Outlet	15.08	0.09	54.68	ND	21.64	8.48	346.5	22.9	3.1
750	Outlet	14.86	0.09	54.71	ND	22.01	8.30	355.0	25.5	1.7
805	Inlet	16.96	0.10	68.91	ND	4.63	9.30	898.3	66.3	4.1
805	Outlet	17.26	0.10	71.86	ND	1.41	9.33	420.6	1.9	1.4

High Pressure Hot Gas Desulfurization Lab Gas Analysis

ZTSC-02-S1 September 4, 1992 Normalized to 100 H2S Recalculated

Time	Loca.	H2 %	O2 %	N2 %	CH4 %	CO %	CO2 %	H2S PPM	COS PPM	SO2 PPM
1140	Inlet	15.21	0.08	54.46	ND	21.43	8.75	675.5	42.4	2.3
1135	Outlet	16.54	0.09	53.70	ND	19.06	10.60	50.2	0.7	0.5
1145	Outlet	16.29	0.10	53.88	ND	19.28	10.45	37.2	0.5	ND
1200	Outlet	15.83	0.10	54.24	ND	19.64	10.18	18.1	0.2	ND
1215	Outlet	16.19	0.10	53.97	ND	19.43	10.31	21.1	0.3	ND
1230	Outlet	16.50	0.10	53.80	ND	18.99	10.61	21.1	0.3	ND
1300	Outlet	16.41	0.10	54.14	ND	18.97	10.38	19.9	0.3	ND
1300	Inlet	14.94	0.09	54.99	ND	21.56	8.34	742.3	46.8	2.0
1331	Outlet	16.23	0.09	54.22	ND	19.16	10.29	19.1	0.1	ND
1400	Outlet	16.19	0.09	54.18	ND	19.48	10.06	32.8	0.4	ND
1430	Outlet	15.94	0.10	54.44	ND	19.74	9.78	34.0	0.4	ND
1500	Outlet	15.69	0.09	54.55	ND	19.88	9.78	46.9	0.5	ND
1530	Outlet	15.78	0.10	54.50	ND	19.61	10.00	63.9	1.0	ND
1600	Outlet	15.41	0.08	54.78	ND	20.43	9.29	63.5	1.4	ND
1630	Outlet	15.66	0.09	54.61	ND	19.91	9.72	77.5	3.9	ND
1700	Outlet	16.20	0.09	54.33	ND	19.16	10.21	139.8	6.7	ND
1730	Outlet	15.86	0.09	54.44	ND	20.02	9.57	190.0	10.7	ND
1800	Outlet	15.28	0.09	54.87	ND	20.59	9.14	255.3	15.7	ND
1830	Outlet	15.90	0.10	54.62	ND	19.81	9.54	344.9	18.1	ND
1900	Outlet	15.59	0.10	54.61	ND	19.97	9.69	384.0	20.6	ND
1930	Outlet	15.82	0.10	54.44	ND	19.91	9.69	425.8	21.1	ND
1930	Inlet	15.06	0.09	54.91	ND	21.06	8.80	746.9	29.4	2.2

High Pressure Hot Gas Desulfurization Lab Gas Analysis

ZTSC-03-S1 September 9, 1992

Normalized to 100 H2S Recalculated

Time	Loca.	H2 %	O2 %	N2 %	CH4 %	CO %	CO2 %	H2S PPM	COS PPM	SO2 PPM
105	Inlet	15.01	0.08	55.30	ND	21.93	7.60	748.5	44.1	1.3
105	Outlet	15.79	0.16	54.65	ND	20.25	9.16	19.7	0.5	0.9
115	Outlet	15.83	0.09	54.68	ND	20.41	8.99	21.7	0.4	ND
130	Outlet	15.79	0.08	54.56	ND	20.70	8.86	19.2	0.2	ND
145	Outlet	15.51	0.09	54.62	ND	20.84	8.93	13.6	0.2	ND
200	Outlet	15.60	0.08	54.69	ND	20.59	9.04	18.3	0.2	ND
230	Inlet	14.75	0.08	55.14	ND	22.03	7.91	860.6	40.5	2.1
230	Outlet	15.51	0.10	54.79	ND	20.67	8.92	22.4	0.4	ND
300	Outlet	15.54	0.09	54.74	ND	20.73	8.90	29.0	0.5	ND
330	Outlet	14.56	0.10	55.23	ND	21.19	8.92	33.0	0.8	ND
400	Outlet	15.40	0.10	54.85	ND	20.92	8.72	41.7	1.1	ND
430	Outlet	15.50	0.09	54.83	ND	20.78	8.80	53.1	1.8	ND
500	Outlet	15.57	0.08	54.68	ND	20.83	8.83	65.7	4.6	27.9
530	Outlet	15.58	0.09	54.76	ND	20.83	8.73	89.9	2.8	2.4
600	Outlet	15.37	0.10	54.78	ND	21.02	8.72	143.3	4.2	ND
630	Outlet	15.46	0.09	54.66	ND	21.04	8.73	190.1	8.2	ND
700	Outlet	15.35	0.09	54.60	ND	21.19	8.74	219.4	9.6	ND
730	Outlet	15.27	0.09	54.71	ND	21.23	8.67	271.3	11.4	ND
800	Outlet	15.43	0.09	54.68	ND	21.11	8.66	309.7	13.0	ND
830	Outlet	15.30	0.09	54.81	ND	21.14	8.62	350.2	14.8	ND
900	Outlet	15.32	0.10	54.80	ND	21.38	8.36	405.8	16.4	ND
930	Outlet	15.42	0.09	54.71	ND	21.34	8.39	420.3	17.4	ND
1000	Inlet	14.65	0.09	55.14	ND	22.20	7.81	885.6	42.4	2.5
1000	Outlet	15.42	0.09	54.76	ND	21.05	8.63	445.0	17.8	1.5

High Pressure Hot Gas Desulfurization Lab Gas Analysis

ZTSC-04-S1 September 10, 1992 Normalized to 100 H2S Recalculated

Time	Loca.	H2 %	O2 %	N2 %	CH4 %	CO %	CO2 %	H2S PPM	COS PPM	SO2 PPM
1410	Outlet	14.97	0.08	53.26	ND	22.23	9.46	8.7	0.4	ND
1410	Inlet	14.14	0.09	53.62	ND	23.70	8.25	1940.0	146.5	5.3
1505	Outlet	16.22	0.08	52.21	ND	21.18	10.31	11.9	0.3	ND
1505	Inlet	15.32	0.08	52.63	ND	22.65	9.22	864.6	43.4	3.0
1515	Outlet	15.73	0.08	52.56	ND	21.78	9.85	10.2	0.2	ND
1530	Outlet	15.63	0.09	52.71	ND	22.10	9.47	19.0	0.4	ND
1545	Outlet	15.54	0.09	52.90	ND	22.26	9.20	28.7	0.6	ND
1600	Outlet	15.46	0.08	52.91	ND	22.37	9.18	43.5	0.8	ND
1630	Outlet	21.31	0.26	53.35	ND	18.40	6.62	564.8	32.3	2.0
1630	Inlet	14.68	0.08	53.30	ND	23.50	8.34	886.7	43.6	2.6
1700	Outlet	15.41	0.06	53.05	ND	22.45	9.01	80.8	2.8	ND
1730	Outlet	15.30	0.09	53.03	ND	22.51	9.05	122.8	5.6	ND
1800	Outlet	15.05	0.08	53.19	ND	22.76	8.91	186.2	8.9	ND
1830	Outlet	15.27	0.09	53.06	ND	22.62	8.94	225.3	10.9	ND
1900	Outlet	15.05	0.09	53.12	ND	22.71	9.00	263.4	12.8	ND
1930	Outlet	15.14	0.09	53.05	ND	22.76	8.93	291.2	14.3	ND
2000	Outlet	15.15	0.12	53.16	ND	22.69	8.84	330.9	15.3	1.2
2030	Outlet	15.12	0.10	52.97	ND	22.86	8.90	360.0	18.1	3.2
2100	Outlet	14.79	0.12	54.05	ND	22.27	8.74	333.7	18.4	1.8
2130	Outlet	15.16	0.11	52.98	ND	22.90	8.81	372.0	20.7	0.5
2130	Inlet	14.64	0.10	53.25	ND	23.67	8.26	828.6	41.5	1.4

High Pressure Hot Gas Desulfurization Lab Gas Analysis

ZTSC-05-S1 September 15, 1992

Normalized to 100 H2S Recalculated

Loca.	Time	H2 %	O2 %	N2 %	CH4 %	CO %	CO2 %	H2S PPM	COS PPM	SO2 PPM
Inlet	1105	15.32	0.11	53.20	ND	23.06	8.27	252.2	80.5	ND
Outlet	1105	17.00	0.11	52.17	ND	20.07	10.65	11.8	0.2	ND
Outlet	1115	17.08	0.10	52.16	ND	19.98	10.67	13.7	0.2	ND
Outlet	1130	17.03	0.09	52.03	ND	20.10	10.75	15.0	0.2	ND
Outlet	1145	17.08	0.09	52.11	ND	20.06	10.66	15.4	0.2	ND
Outlet	1200	16.91	0.09	52.19	ND	20.29	10.52	14.6	ND	ND
Inlet	1230	15.46	0.09	53.12	ND	22.88	8.37	785.6	51.5	2.1
Outlet	1230	16.83	0.08	52.22	ND	20.30	10.57	16.9	0.2	ND
Outlet	1300	16.88	0.09	52.26	ND	20.14	10.64	20.9	0.3	ND
Outlet	1330	16.64	0.09	52.43	ND	20.52	10.32	23.1	0.4	ND
Stack	1340	16.41	0.68	53.06	ND	19.86	9.99	<0.3	ND	ND
Outlet	1400	16.78	0.09	52.51	ND	20.39	10.22	33.6	0.3	ND
Outlet	1430	16.60	0.09	52.46	ND	20.75	10.10	45.2	0.2	ND
Outlet	1500	16.57	0.10	52.57	ND	20.68	10.08	53.3	0.7	ND
Outlet	1530	16.62	0.09	52.42	ND	20.98	9.88	73.6	1.5	ND
Outlet	1600	16.46	0.09	52.62	ND	20.90	9.92	91.5	4.8	ND
Outlet	1630	16.46	0.09	52.55	ND	20.99	9.90	194.1	10.1	ND
Outlet	1700	16.23	0.09	52.69	ND	21.24	9.72	280.7	15.7	1.1
Outlet	1730	16.22	0.10	52.72	ND	21.16	9.76	374.3	19.6	ND
Stack	1740	15.78	0.72	53.53	ND	20.48	9.49	<0.3	1.8	ND
Outlet	1800	16.04	0.08	52.79	ND	21.40	9.65	424.5	11.5	1.3
Inlet	1830	15.29	0.08	53.21	ND	22.93	8.40	892.9	37.6	1.9
Outlet	1831	16.16	0.09	52.79	ND	21.29	9.63	431.6	25.1	ND

High Pressure Hot Gas Desulfurization Lab Gas Analysis

ZTSC-06-S1 September 17, 1992 Normalized to 100 H2S Recalculated

Loca.	Time	H2 %	O2 %	N2 %	CH4 %	CO %	CO2 %	H2S PPM	COS PPM	SO2 PPM
Inlet	905	17.91	0.10	49.40	ND	23.18	9.39	110.9	101.0	ND
Outlet	905	20.20	0.08	48.04	ND	18.89	12.79	4.4	2.9	9.3
Outlet	915	19.29	0.08	48.38	ND	21.03	11.22	5.1	1.2	1.7
Outlet	930	19.97	0.08	48.14	ND	19.43	12.38	5.7	0.5	1.6
Outlet	945	20.02	0.08	48.10	ND	19.40	12.40	6.6	0.4	ND
Outlet	1000	19.96	0.08	47.83	ND	19.48	12.65	7.1	0.3	ND
Inlet	1030	17.90	0.09	48.95	ND	23.45	9.57	455.9	37.3	4.6
Outlet	1030	19.93	0.08	47.79	ND	19.57	12.63	6.9	0.2	ND
Outlet	1100	19.34	0.09	48.33	ND	20.40	11.84	6.0	ND	ND
Outlet	1130	20.12	0.08	47.98	ND	18.64	13.18	10.4	ND	ND
Outlet	1200	19.39	0.08	48.51	ND	19.97	12.05	<0.3	0.2	ND
Outlet	1230	19.73	0.09	48.52	ND	19.38	12.27	10.9	ND	ND
Inlet	1230	17.84	0.08	49.40	ND	23.16	9.47	516.4	29.4	1.8
Outlet	1300	20.01	0.08	48.26	ND	19.09	12.56	11.8	ND	ND
Outlet	1330	19.73	0.08	48.49	ND	19.62	12.08	11.1	ND	ND
Outlet	1400	19.42	0.09	48.46	ND	20.12	11.91	11.4	ND	ND
Outlet	1440	19.64	0.08	48.36	ND	19.65	12.26	13.4	ND	ND
Outlet	1500	19.04	0.09	48.88	ND	20.17	11.82	13.0	ND	1.1
Outlet	1530	19.53	0.08	48.40	ND	19.84	12.15	14.3	ND	ND
Outlet	1600	19.92	0.08	48.27	ND	18.98	12.74	<0.3	0.1	ND
Inlet	1630	17.71	0.09	49.33	ND	23.51	9.30	613.8	28.9	2.4
Outlet	1630	19.37	0.09	48.36	ND	20.04	12.14	15.0	ND	ND
Outlet	1730	19.53	0.08	48.39	ND	19.74	12.26	15.8	ND	ND
Outlet	1830	19.76	0.08	48.49	ND	19.41	12.27	16.4	0.1	ND
Outlet	1930	19.93	0.08	48.36	ND	18.86	12.77	12.5	0.1	ND
Outlet	2030	19.97	0.11	47.94	ND	18.91	13.07	14.4	0.3	ND
Outlet	2130	19.33	0.32	48.40	ND	19.49	12.46	14.5	0.3	ND
Outlet	2230	19.39	0.14	48.18	ND	19.88	12.41	15.7	0.1	ND
Outlet	2330	19.22	0.09	48.65	ND	20.09	11.94	16.1	ND	ND

High Pressure Hot Gas Desulfurization Lab Gas Analysis

ZTSC-06-S1 cont. September 18, 1992

Normalized to 100 H2S Recalculated

Loca.	Time	H2 %	O2 %	N2 %	CH4 %	CO %	CO2 %	H2S PPM	COS PPM	SO2 PPM
Outlet	30	19.47	0.09	48.51	ND	19.90	12.02	19.4	0.1	ND
Outlet	130	19.01	0.09	48.75	ND	20.60	11.55	20.1	0.2	ND
Outlet	200	19.54	0.09	48.53	ND	19.54	12.29	26.8	0.1	ND
Outlet	330	19.40	0.09	48.69	ND	19.66	12.15	26.2	0.4	ND
Outlet	430	19.17	0.08	48.41	ND	20.65	11.69	29.2	0.6	ND
Outlet	530	19.62	0.08	48.25	ND	19.87	12.18	46.3	0.6	ND
Outlet	630	19.12	0.08	48.41	ND	20.73	11.66	48.6	0.7	ND
Inlet	630	17.76	0.08	49.04	ND	23.53	9.53	471.0	33.5	2.2
Outlet	730	19.54	0.08	47.89	ND	20.54	11.94	75.9	1.3	ND
Outlet	830	19.29	0.08	48.09	ND	20.81	11.72	75.7	1.4	ND
Outlet	930	19.10	0.08	48.41	ND	20.79	11.61	61.8	2.3	ND
Outlet	1030	19.57	0.08	48.87	ND	20.47	11.00	86.9	4.1	ND
Outlet	1130	18.97	0.09	48.48	ND	20.63	11.81	116.3	3.4	ND
Outlet	1230	18.84	0.09	48.63	ND	20.77	11.65	135.5	4.0	ND
Outlet	1330	18.85	0.09	48.82	ND	20.66	11.57	161.1	7.5	ND
Outlet	1430	18.98	0.09	48.41	ND	20.87	11.63	186.4	9.0	ND
Outlet	1530	18.88	0.09	48.34	ND	21.10	11.56	198.8	9.6	ND
Outlet	1630	18.98	0.08	48.55	ND	20.63	11.73	229.1	11.3	ND
Outlet	1730	20.79	0.10	51.23	ND	21.40	6.46	229.4	12.5	ND
Outlet	1830	18.14	0.11	49.52	ND	22.00	10.21	199.6	13.7	ND
Stack	1845	18.57	0.67	49.34	ND	20.45	10.97	ND	ND	ND
Outlet	1930	18.92	0.12	48.76	ND	20.92	11.25	257.8	15.6	ND
Outlet	2030	18.91	0.10	48.54	ND	21.18	11.24	261.5	16.5	ND
Outlet	2130	19.05	0.15	48.45	ND	21.15	11.17	268.0	16.6	ND
Outlet	2230	19.14	0.11	48.38	ND	21.12	11.22	288.0	17.3	ND
Outlet	2330	19.24	0.09	48.24	0.01	21.19	11.19	294.2	17.6	ND

High Pressure Hot Gas Desulfurization Lab Gas Analysis

ZTSC-06-S1 cont. September 19, 1992 Normalized to 100 H2S Recalculated

Loca.	Time	H2 %	O2 %	N2 %	CH4 %	CO %	CO2 %	H2S PPM	COS PPM	SO2 PPM
Outlet	30	18.67	0.09	48.55	0.01	21.52	11.13	298.3	17.7	ND
Outlet	130	19.08	0.09	48.19	0.01	21.21	11.38	306.6	17.9	ND
Outlet	230	18.88	0.09	48.66	0.02	21.14	11.17	318.4	18.3	ND
Outlet	330	19.01	0.09	48.60	0.02	21.04	11.22	321.9	19.1	ND
Inlet	400	18.16	0.10	48.91	0.03	22.67	10.06	557.4	30.1	ND
Outlet	430	19.20	0.10	48.37	0.03	21.05	11.21	321.4	19.2	ND
Outlet	530	19.10	0.10	48.19	0.02	21.40	11.15	319.8	19.1	ND
Outlet	600	Broke Bottle								

High Pressure Hot Gas Desulfurization Lab Gas Analysis

ZTSC-07-S1 September 22, 1992

Normalized to 100 H2S Recalculated

Loca.	Time	H2 %	O2 %	N2 %	CH4 %	CO %	CO2 %	H2S PPM	COS PPM	SO2 PPM
Outlet	1250	14.47	0.08	57.10	0.01	18.50	9.84	2.2	ND	ND
Outlet	1300	14.66	0.08	57.14	ND	18.13	10.00	2.4	ND	ND
Inlet	1300	14.13	0.08	57.33	0.01	19.15	9.23	662.9	21.8	0.5
Outlet	1315	14.69	0.09	57.08	0.01	18.17	9.97	2.7	ND	ND
Outlet	1330	14.81	0.07	57.09	ND	18.12	9.91	3.5	ND	ND
Outlet	1345	14.90	0.08	56.98	ND	18.00	10.04	3.8	ND	ND
Inlet	1415	14.38	0.08	57.26	ND	18.75	9.46	702.3	24.5	ND
Outlet	1445	15.11	0.07	56.96	0.01	17.42	10.43	6.0	ND	ND
Outlet	1545	15.36	0.07	56.72	0.01	17.24	10.60	3.4	ND	ND
Outlet	1645	15.28	0.08	56.68	0.01	17.13	10.81	4.7	ND	ND
Outlet	1745	15.60	0.10	56.58	0.01	16.79	10.91	7.0	ND	ND
Inlet	1745	15.22	0.10	56.61	0.02	17.45	10.53	605.7	27.4	1.0
Outlet	1845	14.94	0.09	56.91	0.02	17.76	10.27	4.9	ND	ND
Outlet	1945	15.10	0.10	56.89	ND	17.59	10.32	18.8	ND	ND
Outlet	2045	15.26	0.10	56.64	0.01	17.22	10.77	11.8	ND	ND
Outlet	2145	15.51	0.10	56.50	0.01	16.76	11.12	19.7	0.1	ND
Inlet	2145	15.23	0.09	56.54	0.02	17.42	10.63	614.2	31.0	ND
Outlet	2245	14.88	0.32	56.89	0.01	16.97	10.92	23.1	0.3	ND
Outlet	2345	15.54	0.08	56.53	0.01	16.91	10.93	17.9	0.3	ND

High Pressure Hot Gas Desulfurization Lab Gas Analysis

ZTSC-07-S1 cont.		September 23, 1992		Normalized to 100				H2S Recalculated			
Loca.	Time	H2 %	O2 %	N2 %	CH4 %	CO %	CO2 %	H2S PPM	COS PPM	SO2 PPM	
Outlet	45	15.62	0.07	56.30	0.01	17.02	10.98	28.8	1.2	ND	
Outlet	145	15.62	0.08	56.30	0.01	17.18	10.80	38.9	1.8	ND	
Inlet	145	15.36	0.08	56.34	0.01	17.70	10.46	487.2	30.4	ND	
Outlet	245	15.28	0.08	56.49	0.02	17.81	10.31	51.2	2.0	ND	
Outlet	345	14.07	0.08	57.42	0.02	19.21	9.20	67.3	2.6	ND	
Outlet	445	14.44	0.08	57.15	0.02	18.77	9.53	87.8	4.3	ND	
Outlet	545	14.28	0.09	57.27	0.02	18.95	9.38	116.9	5.4	ND	
Inlet	545	13.74	0.07	57.33	0.02	19.97	8.80	618.4	25.1	ND	
Outlet	645	14.48	0.10	56.93	0.01	18.96	9.50	147.8	6.2	ND	
Outlet	745	14.40	0.09	56.85	0.01	19.12	9.51	166.2	7.4	ND	
Outlet	845	14.60	0.09	56.85	0.01	18.72	9.70	186.4	8.3	ND	
Outlet	945	15.22	0.10	56.35	0.01	17.87	10.42	200.1	8.6	0.8	
Inlet	945	14.59	0.09	56.61	0.01	18.61	10.03	613.3	20.1	0.8	
Outlet	1045	15.71	0.08	55.94	ND	17.27	10.97	245.9	12.7	0.3	
Outlet	1145	15.27	0.08	56.39	0.01	17.88	10.34	254.0	10.1	ND	
Outlet	1245	15.20	0.08	56.47	0.02	17.82	10.38	265.2	10.5	0.7	
Outlet	1347	12.10	0.09	59.36	0.06	20.61	7.76	232.3	16.0	ND	
Inlet	1347	11.88	0.09	59.40	0.06	20.99	7.52	628.2	33.0	ND	
Outlet	1445	15.27	0.09	56.43	0.01	17.83	10.33	317.0	12.3	0.7	
Outlet	1545	15.00	0.09	56.63	0.01	18.16	10.09	313.6	13.3	ND	
Outlet	1645	14.63	0.08	57.07	0.03	18.60	9.56	297.0	15.4	ND	
Outlet	1745	15.47	0.09	56.42	0.01	17.45	10.53	336.4	13.3	0.7	
Inlet	1745	15.25	0.09	56.53	0.01	17.76	10.30	626.8	17.5	1.0	
Outlet	1813	13.33	0.16	58.04	0.03	19.71	8.69	299.5	16.5	1.0	
Inlet	1813	13.87	0.09	57.46	0.01	19.75	8.76	623.6	20.9	ND	

High Pressure Hot Gas Desulfurization Lab Gas Analysis

ZTSC-07-R1 September 24, 1992 Normalized to 100 H2S Recalculated

Loca.	Time	H2 %	O2 %	N2 %	CH4 %	CO %	CO2 %	H2S PPM	COS PPM	SO2 PPM
Outlet	50	0.99	0.14	97.98	ND	0.09	0.77	393.4	0.6	1.1
Outlet	100	2.42	0.12	81.33	ND	1.48	14.47	1709.4	18.4	21.4
Outlet	115	0.36	0.15	84.76	ND	0.55	12.52	50.5	38.2	1.65%
Outlet	130	1.57	0.08	85.07	ND	0.75	10.80	161.9	24.7	1.79%
Outlet	145	0.21	0.08	84.33	ND	0.27	10.77	5.5	21.5	4.33%
Outlet	215	0.24	0.20	89.18	ND	0.17	4.61	0.7	13.2	5.61%
Outlet	245	0.19	0.11	89.21	ND	0.12	4.04	0.3	10.7	6.34%
Outlet	315	0.36	0.14	90.63	ND	0.15	2.54	0.3	10.7	6.19%
Inlet	330	ND	20.69	79.31	ND	ND	ND	<0.3	ND	5.8
Outlet	345	0.38	0.08	92.35	ND	0.06	1.36	0.8	5.5	5.77%
Outlet	400	0.29	0.20	91.87	ND	0.03	0.83	<0.3	3.5	6.78%
Outlet	445	0.43	0.14	91.45	ND	0.03	1.07	0.3	2.8	6.88%
Outlet	515	0.38	0.47	91.68	ND	0.02	0.38	<0.3	1.9	7.08%
Outlet	545	0.44	1.79	91.18	ND	0.03	0.49	<0.3	1.9	6.08%
Outlet	615	30.72	1.06	67.93	ND	0.02	0.06	0.4	ND	0.21%
Outlet	645	ND	17.06	81.84	ND	0.04	0.38	<0.3	0.2	0.68%
Stack	710	ND	21.90	78.07	ND	ND	0.03	<0.3	ND	1.0
Outlet	715	ND	18.50	80.89	ND	0.02	0.22	0.3	0.3	0.36%
Inlet	730	ND	20.72	79.28	ND	ND	ND	<0.3	ND	0.9
Outlet	745	ND	19.05	80.44	ND	0.02	0.23	<0.3	ND	0.26%
Outlet	815	ND	18.71	80.87	ND	0.01	0.16	24.7	ND	0.25%
Outlet	845	ND	19.50	80.16	ND	0.01	0.16	12.9	ND	0.18%
Outlet	915	ND	18.98	80.73	ND	0.01	0.11	12.7	ND	0.17%
Outlet	945	ND	19.82	79.99	ND	0.01	0.12	6.6	ND	627.5
Stack	953	ND	21.90	78.05	ND	ND	0.05	<0.3	ND	ND
Outlet	1015	30.65	1.04	68.11	ND	0.10	0.10	<0.3	ND	31.1
Inlet	1021	ND	20.72	79.28	ND	ND	ND	<0.3	ND	ND

High Pressure Hot Gas Desulfurization Lab Gas Analysis

ZTSC-07-S2 September 25, 1992 Normalized to 100 H2S Recalculated

Loca.	Time	H2 %	O2 %	N2 %	CH4 %	CO %	CO2 %	H2S PPM	COS PPM	SO2 PPM
Outlet	135	14.59	0.11	56.73	ND	17.51	11.05	26.5	11.3	12.5
Outlet	145	12.21	0.11	59.14	0.11	19.07	9.36	4.8	3.2	32.8
Inlet	145	12.02	0.12	59.25	0.14	19.59	8.84	317.0	27.3	2.8
Outlet	200	15.56	0.08	55.77	0.07	16.60	11.92	3.4	0.5	20.7
Outlet	215	15.97	0.09	55.55	0.04	16.01	12.34	5.5	0.3	ND
Inlet	215	15.52	0.08	56.03	0.04	16.86	11.42	467.0	19.2	1.1
Outlet	230	16.08	0.09	55.22	0.01	15.63	12.96	10.9	0.4	ND
Outlet	245	16.43	0.08	55.64	0.02	15.26	12.58	6.8	0.4	ND
Outlet	300	15.18	0.10	56.23	0.04	16.64	11.80	7.1	0.3	2.2
Inlet	300	14.42	0.09	56.04	0.03	17.80	11.56	544.5	20.3	3.7
Outlet	330	15.96	0.08	56.04	0.01	16.14	11.77	4.3	0.2	ND
Outlet	430	15.82	0.08	55.62	ND	15.83	12.66	7.3	0.1	3.6
Outlet	530	16.12	0.08	55.97	0.01	15.95	11.88	2.8	ND	8.6
Outlet	630	16.22	0.09	55.84	ND	15.79	12.07	3.7	ND	4.8
Inlet	635	14.68	0.09	56.77	ND	18.36	10.05	555.4	15.7	ND
Outlet	730	16.05	0.09	55.79	0.01	16.04	12.02	2.3	ND	ND
Outlet	830	16.14	0.09	55.90	0.01	16.12	11.73	2.8	ND	ND
Outlet	1045	14.40	0.09	54.17	0.02	18.80	12.53	2.4	ND	ND
Inlet	1045	13.86	0.10	54.55	0.03	19.72	11.69	531.9	20.6	ND
Outlet	1145	14.23	0.09	53.91	ND	19.16	12.62	3.9	ND	5.6
Outlet	1245	13.14	0.08	53.80	0.02	20.40	12.57	3.5	ND	ND
Outlet	1345	14.47	0.09	54.09	ND	19.04	12.32	4.6	ND	ND
Outlet	1445	13.93	0.08	54.61	0.01	20.11	11.26	4.9	ND	ND
Inlet	1445	13.95	0.08	54.09	0.01	19.71	12.11	512.9	18.7	ND
Outlet	1545	13.60	0.09	54.84	0.01	20.40	11.06	12.6	ND	ND
Outlet	1645	13.46	0.09	54.77	0.02	20.51	11.16	13.3	0.3	ND
Outlet	1745	14.13	0.09	54.23	0.01	19.24	12.29	36.9	0.6	ND

High Pressure Hot Gas Desulfurization . Lab Gas Analysis

ZTSC-07-S2 cont.		September 25, 1992				Normalized to 100				H2S Recalculated			
Loca.	Time	H2 %	O2 %	N2 %	CH4 %	CO %	CO2 %	H2S PPM	COS PPM	SO2 PPM			
Outlet	1845	13.91	0.09	53.89	0.01	19.55	12.54	58.5	0.9	0.9			
Inlet	1845	13.76	0.09	54.21	0.01	19.69	12.19	535.4	18.7	ND			
Outlet	1945	13.32	0.09	53.70	ND	20.00	12.89	72.7	1.9	ND			
Outlet	2045	14.18	0.11	54.68	0.01	19.44	11.57	63.8	4.3	ND			
Outlet	2155	14.29	0.10	54.74	0.01	19.53	11.32	81.5	3.6	ND			
Outlet	2245	13.80	0.12	54.76	0.01	20.05	11.25	98.6	4.2	2.0			
Inlet	2245	13.99	0.10	54.65	0.01	20.05	11.13	616.6	19.8	7.3			
Outlet	2345	13.76	0.11	54.97	0.02	20.12	11.02	105.5	5.6	4.2			
September 26, 1992													
Outlet	45	13.85	0.11	55.27	0.01	19.72	11.03	157.6	6.4	2.9			
Outlet	145	14.17	0.13	54.49	0.01	20.00	11.18	154.3	7.2	ND			
Outlet	245	13.77	0.12	54.78	0.01	20.33	10.98	162.7	8.3	9.1			
Inlet	245	13.52	0.10	55.03	ND	20.86	10.42	595.9	20.6	5.4			
Outlet	345	14.04	0.10	54.55	0.02	20.18	11.09	177.0	9.0	3.7			
Inlet	345	14.11	0.10	54.59	0.01	19.99	11.14	587.6	20.1	0.8			

High Pressure Hot Gas Desulfurization Lab Gas Analysis

ZTSC-07-R2 September 28, 1992 Normalized to 100

Loca.	Time	H2 %	O2 %	N2 %	CH4 %	CO %	CO2 %	H2S PPM	COS PPM	SO2 PPM
Outlet	1420	ND	0.14	97.33	ND	0.25	2.09	1.3	42.8	0.20%
Outlet	1430	ND	0.13	97.64	ND	0.10	1.15	2.1	31.9	0.97%
Inlet	1430	ND	2.49	97.40	ND	0.01	0.10	<0.3	0.5	ND
Outlet	1445	ND	0.13	97.93	ND	0.04	0.52	<0.3	14.3	1.39%
Outlet	1500	ND	0.13	98.81	ND	0.01	0.20	0.3	5.4	0.85%
Stack	1510	ND	21.89	78.08	ND	ND	0.03	<0.3	ND	ND
Outlet	1515	ND	0.14	98.51	ND	0.01	0.18	<0.3	4.6	1.16%
Outlet	1545	ND	0.13	98.79	ND	0.01	0.14	<0.3	4.0	0.93%
Inlet	1545	ND	1.43	98.57	ND	ND	ND	<0.3	ND	ND
Outlet	1615	ND	0.13	98.76	ND	ND	0.08	<0.3	3.0	1.03%
Outlet	1715	ND	0.18	98.80	ND	ND	0.07	<0.3	1.7	0.95%
Outlet	1745	ND	1.06	97.69	ND	0.01	0.10	<0.3	ND	1.14%
Outlet	1815	ND	2.43	97.40	ND	ND	0.04	<0.3	ND	0.13%
Outlet	1845	ND	2.60	97.35	ND	ND	0.05	<0.3	ND	62.4
Inlet	1845	ND	2.62	97.38	ND	ND	ND	<0.3	ND	ND

Randy D. Barnes
10/2/92

High Pressure Hot Gas Desulfurization Lab Gas Analysis

ZTSC-07-S3 September 29, 1992 Normalized to 100 H2S Recalculated

Loca.	Time	H2 %	O2 %	N2 %	CH4 %	CO %	CO2 %	H2S PPM	COS PPM	SO2 PPM
Outlet	105	15.95	0.09	53.29	ND	20.73	9.94	64.1	1.6	1.6
Outlet	115	15.69	0.09	53.43	ND	20.94	9.84	35.7	1.7	ND
Inlet	115	14.28	0.09	54.28	ND	23.10	8.20	357.4	30.7	1.5
Outlet	130	15.77	0.09	53.38	ND	20.83	9.93	12.9	0.2	ND
Outlet	145	15.65	0.09	53.52	ND	21.02	9.73	9.7	ND	ND
Outlet	200	15.82	0.09	53.79	ND	21.24	9.06	11.3	0.1	ND
Outlet	230	15.46	0.10	53.61	ND	21.24	9.59	18.4	0.2	ND
Inlet	230	14.33	0.11	54.31	ND	23.07	8.11	665.6	13.9	2.3
Outlet	300	15.36	0.10	53.78	ND	21.30	9.45	30.9	1.6	ND
Outlet	400	15.47	0.10	53.58	ND	21.72	9.12	111.5	4.1	ND
Outlet	500	15.18	0.09	53.83	ND	21.96	8.91	239.4	9.6	ND
Outlet	600	15.03	0.10	53.93	ND	22.01	8.90	346.9	13.0	ND
Inlet	600	14.46	0.09	54.25	ND	23.03	8.10	738.8	30.8	ND
Outlet	700	15.14	0.10	53.74	0.01	22.04	8.93	360.0	16.1	ND
Outlet	800	15.08	0.08	53.76	ND	22.16	8.87	470.2	18.3	ND
Outlet	900	14.93	0.09	53.84	ND	22.23	8.85	537.1	20.2	ND
Outlet	1000	14.97	0.09	53.85	ND	22.24	8.80	519.5	22.0	1.0
Inlet	1000	14.42	0.09	54.20	ND	23.16	8.05	800.2	23.4	3.6
Outlet	1100	15.04	0.08	53.97	ND	22.36	8.50	483.3	23.6	1.4
Stack	1118	ND	21.88	78.07	ND	ND	0.05	ND	ND	1.5
Outlet	1200	15.11	0.09	53.81	ND	22.32	8.60	648.1	24.9	ND
Outlet	1300	14.85	0.09	53.97	ND	22.36	8.67	584.9	26.2	ND
Outlet	1400	14.99	0.09	53.86	ND	22.31	8.68	540.5	26.4	ND
Inlet	1400	14.74	0.09	54.99	ND	23.45	6.64	882.8	23.3	ND
Outlet	1500	15.11	0.09	53.64	ND	22.46	8.61	812.9	28.9	ND
Outlet	1600	15.46	0.09	54.17	ND	21.39	8.83	613.2	26.1	ND
Outlet	1700	15.32	0.08	53.86	ND	21.90	8.76	692.2	27.7	3.9

High Pressure Hot Gas Desulfurization Lab Gas Analysis.

ZTSC-07-S3 cont.		September 29, 1992		Normalized to 100				H2S Recalculated			
Loca.	Time	H2 %	O2 %	N2 %	CH4 %	CO %	CO2 %	H2S PPM	COS PPM	SO2 PPM	
Outlet	1800	15.39	0.09	54.25	0.01	21.34	8.83	768.7	28.5	1.3	
Inlet	1805	15.18	0.08	54.34	0.01	21.96	8.33	941.6	23.8	23.9	
Outlet	1900	15.56	0.09	53.76	0.01	21.66	8.86	604.8	29.4	5.3	
Outlet	2000	15.38	0.09	53.85	0.01	21.77	8.84	559.9	29.7	1.3	
Outlet	2100	15.55	0.10	54.34	0.01	21.35	8.57	682.5	28.4	ND	
Outlet	2200	15.52	0.09	54.12	0.01	21.43	8.75	777.9	28.2	1.8	
Inlet	2200	15.11	0.10	54.33	0.01	22.05	8.30	956.5	25.9	ND	
Outlet	2300	15.52	0.10	54.23	0.01	21.46	8.61	736.3	28.5	2.1	
September 30, 1992											
Outlet	0000	15.71	0.10	55.14	0.01	21.82	7.13	819.4	30.0	9.5	
Outlet	0100	15.45	0.10	54.34	0.01	21.52	8.50	804.9	29.9	12.4	
Outlet	0200	15.40	0.10	54.16	0.01	21.59	8.66	767.0	30.2	0.8	
Inlet	0200	15.14	0.09	54.33	0.01	22.20	8.14	886.0	26.8	ND	
Outlet	0300	9.14	0.10	58.23	ND	22.75	9.69	802.5	49.5	5.4	
Stack	0323	15.02	0.73	54.60	0.01	21.31	8.31	191.8	33.6	2.2	
Outlet	0400	15.55	0.09	53.94	0.01	21.62	8.70	776.4	30.9	4.9	
Outlet	1015	14.55	0.08	54.49	ND	21.56	9.29	329.2	20.9	0.7	
Inlet	1015	14.47	0.07	54.69	0.01	22.35	8.34	679.1	44.1	ND	
Outlet	1030	15.14	0.08	54.91	ND	20.98	8.83	538.3	25.8	ND	
Outlet	1100	15.08	0.10	54.77	ND	21.67	8.31	639.7	28.4	1.2	
Outlet	1130	15.13	0.09	54.91	0.01	21.60	8.20	522.7	27.3	ND	
Inlet	1130	14.60	0.12	55.25	0.01	22.34	7.60	749.2	32.9	ND	
Outlet	1200	14.99	0.11	55.08	ND	21.57	8.19	582.4	29.3	ND	
Outlet	1230	13.62	0.08	54.97	0.18	24.01	7.08	577.8	42.8	ND	

High Pressure Hot Gas Desulfurization Lab Gas Analysis

ZTSC-07-R3 October 2, 1992

Normalized to 100

Loca.	Time	H2 %	O2 %	N2 %	CH4 %	CO %	CO2 %	H2S PPM	COS PPM	SO2 PPM
Outlet	0835	ND	0.12	98.81	ND	ND	0.52	1.3	2.9	0.56%
Outlet	0845	ND	0.13	98.80	ND	ND	0.06	2.1	0.5	1.02%
Inlet	0845	ND	1.69	98.30	ND	ND	0.01	<0.3	1.0	ND
Outlet	0900	ND	0.13	98.95	ND	ND	0.02	<0.3	0.2	0.91%
Outlet	0915	ND	0.12	99.00	ND	ND	0.01	0.3	ND	0.88%
Outlet	0930	ND	0.12	98.98	ND	ND	0.01	<0.3	ND	0.90%
Outlet	1030	ND	0.12	99.04	ND	ND	0.01	<0.3	ND	0.84%
Inlet	1030	ND	1.36	98.64	ND	ND	ND	<0.3	0.4	1.8
Outlet	1130	ND	0.14	99.02	ND	ND	0.01	<0.3	ND	0.84%
Outlet	1230	ND	0.24	98.98	ND	ND	ND	<0.3	ND	0.80%
Inlet	1230	ND	1.35	98.65	ND	ND	ND	<0.3	ND	1.3
Outlet	1330	ND	1.23	98.69	ND	ND	ND	<0.3	ND	866.0
Outlet	1430	ND	1.34	98.65	ND	ND	ND	<0.3	ND	75.0
Inlet	1415	ND	1.37	98.63	ND	ND	ND	<0.3	ND	ND

High Pressure Hot Gas Desulfurization Lab Gas Analysis

ZTMC-01-S1 October 6, 1992

Normalized to 100 H2S Recalculated

Loca.	Time	H2 %	O2 %	N2 %	CH4 %	CO %	CO2 %	H2S PPM	COS PPM	SO2 PPM
Outlet	0905	15.84	0.09	53.47	0.01	18.93	11.66	0.4	7.4	ND
Outlet	0915	16.39	0.19	53.47	0.01	17.77	12.16	ND	3.0	ND
Inlet	0915	14.63	0.08	54.18	ND	21.11	9.93	647.4	73.2	ND
Outlet	0930	15.26	0.08	54.08	ND	19.89	10.69	ND	1.8	ND
Outlet	0945	15.16	0.08	54.26	0.01	20.06	10.44	ND	0.6	ND
Outlet	1000	14.93	0.09	54.30	0.02	20.37	10.28	ND	0.7	ND
Inlet	1030	14.46	0.08	54.55	0.01	21.29	9.54	644.3	70.4	ND
Outlet	1100	16.31	0.08	53.54	ND	18.19	11.88	1.2	0.5	3.2
Outlet	1200	15.51	0.09	53.89	0.01	19.61	10.89	2.5	0.2	ND
Outlet	1300	14.80	0.07	54.10	0.02	20.78	10.22	3.6	0.4	ND
Outlet	1400	14.84	0.08	54.26	0.02	20.64	10.16	5.2	0.4	ND
Inlet	1400	14.68	0.07	54.14	0.02	21.09	9.91	776.8	64.1	ND
Outlet	1500	15.36	0.08	54.18	0.01	19.74	10.62	12.9	0.6	ND
Outlet	1600	15.70	0.08	54.23	ND	19.56	10.43	35.2	2.8	ND
Outlet	1700	14.72	0.07	54.14	0.03	20.60	10.42	83.4	4.8	ND
Outlet	1800	15.03	0.10	54.05	0.03	20.41	10.36	173.9	15.6	ND
Inlet	1800	14.24	0.10	54.50	0.05	21.26	9.77	716.8	66.6	ND

High Pressure Hot Gas Desulfurization Lab Gas Analysis

ZTMC-01-R1 October 6, 1992

Normalized to 100 H2S Recalculated

Loca.	Time	H2 %	O2 %	N2 %	CH4 %	CO %	CO2 %	H2S PPM	COS PPM	SO2 PPM
Inlet	2010	ND	2.82	97.09	ND	0.03	0.06	9.9	2.7	9.1
Outlet	2015	ND	0.13	98.82	ND	ND	0.11	351.4	ND	0.91%
Outlet	2030	ND	0.14	98.24	ND	ND	0.06	197.4	ND	1.53%
Outlet	2047	ND	3.96	94.72	ND	0.01	0.03	145.0	ND	1.26%
Outlet	2104	ND	5.30	93.55	ND	ND	0.04	126.5	ND	1.09%
Inlet	2130	ND	2.55	97.44	ND	ND	0.01	0.6	ND	22.5
Outlet	2200	ND	2.50	97.44	ND	ND	0.02	1.6	ND	399.8
Inlet	2210	ND	2.55	97.44	ND	ND	0.01	<0.3	ND	7.0

High Pressure Hot Gas Desulfurization Lab Gas Analysis

ZTMC-01-S2		October 7, 1992		Normalized to 100				H ₂ S Recalculated			
Loca.	Time	H ₂ %	O ₂ %	N ₂ %	CH ₄ %	CO %	CO ₂ %	H ₂ S PPM	COS PPM	SO ₂ PPM	
Outlet	0105	4.09	12.19*	71.72	0.04	8.27	3.67	73.6	8.7	140.1	
Outlet	0115	16.17	0.09	52.92	0.02	18.50	12.30	22.7	3.3	5.3	
Inlet	0130	16.42	0.09	52.92	0.01	18.09	12.46	28.2	1.9	1.3	
Outlet	0145	17.27	0.09	52.44	ND	16.68	13.51	25.0	1.1	1.7	
Outlet	0200	17.66	0.08	52.23	ND	16.69	13.34	15.1	0.6	0.7	
Inlet	0230	14.09	0.10	54.59	0.01	21.96	9.19	568.3	109.0	ND	
Outlet	0400	15.78	0.08	53.53	0.01	19.38	11.21	17.8	1.3	ND	
Outlet	0500	16.09	0.09	53.45	ND	18.93	11.44	20.0	0.9	ND	
Inlet	0510	14.39	0.09	54.39	0.02	21.54	9.48	733.8	96.4	ND	
Outlet	0600	14.69	0.10	54.06	0.05	21.14	9.97	11.1	0.5	ND	
Outlet	0700	15.61	0.10	54.00	0.02	19.62	10.64	20.9	2.1	ND	
Outlet	0800	15.69	0.09	54.19	ND	19.25	10.78	29.6	1.8	ND	
Outlet	0900	14.20	0.10	55.61	0.09	20.31	9.68	16.8	1.6	0.7	
Inlet	0910	13.94	0.09	55.65	0.06	21.03	9.16	735.3	72.4	ND	
Outlet	1000	14.93	0.09	55.34	0.02	19.40	10.21	37.5	4.1	0.8	
Outlet	1100	14.11	0.09	55.64	0.11	20.32	9.73	30.9	3.1	ND	
Outlet	1200	14.96	0.09	54.80	0.05	19.84	10.26	57.4	5.1	ND	
Outlet	1300	15.05	0.08	54.29	0.02	20.09	10.46	66.9	7.2	ND	
Inlet	1307	14.38	0.09	54.93	0.08	20.87	9.57	780.4	74.3	ND	

* Possible Air in sample *SJM*

High Pressure Hot Gas Desulfurization

Lab Gas Analysis

ZTMC-01-R2 October 7, 1992

Normalized to 100 H2S Recalculated

Loca.	Time	H2 %	O2 %	N2 %	CH4 %	CO %	CO2 %	H2S PPM	COS PPM	SO2 PPM
Inlet	1810	ND	1.50	98.48	ND	ND	0.02	<0.3	ND	ND
Outlet	1815	0.11	0.13	98.16	ND	0.19	1.25	338.7	22.2	1223.0
Outlet	1830	ND	0.14	98.66	ND	0.07	0.64	245.3	19.1	0.47%
Outlet	1845	ND	0.13	98.78	ND	0.03	0.38	233.5	15.8	0.66%
Outlet	1900	ND	0.14	98.78	ND	0.02	0.24	228.4	16.7	0.79%
Inlet	1900	ND	1.57	98.43	ND	ND	ND	<0.3	ND	1.4
Outlet	1930	ND	0.18	98.76	ND	ND	0.15	159.2	7.6	0.89%
Outlet	2000	ND	0.13	98.87	ND	ND	0.07	93.8	5.8	0.92%
Outlet	2030	ND	0.15	98.85	ND	ND	0.05	16.4	1.7	0.94%
Outlet	2100	ND	0.29	98.80	ND	0.01	0.06	0.8	0.4	0.83%
Outlet	2130	ND	0.72	98.71	ND	0.01	0.08	<0.3	0.7	0.47%
Outlet	2200	ND	1.29	98.46	ND	ND	0.04	<0.3	ND	0.21%
Outlet	2230	ND	1.58	98.37	ND	ND	0.02	<0.3	ND	336.7
Outlet	2300	ND	1.62	98.36	ND	ND	0.02	<0.3	ND	25.2
Inlet	2300	ND	1.64	98.36	ND	ND	ND	<0.3	ND	2.0

High Pressure Hot Gas Desulfurization Lab Gas Analysis

ZTMC-01-S3 October 8, 1992

Normalized to 100 H2S Recalculated

Loca.	Time	H2 %	O2 %	N2 %	CH4 %	CO %	CO2 %	H2S PPM	COS PPM	SO2 PPM
Outlet	0305	12.28	0.09	55.84	0.01	23.63	8.14	1.9	19.4	9.1
Outlet	0315	17.22	0.16	52.87	ND	16.30	13.45	17.7	8.5	10.0
Inlet	0315	13.67	0.10	55.10	ND	22.15	8.96	133.6	83.2	1.1
Outlet	0330	15.82	0.09	53.74	ND	18.84	11.51	5.9	1.1	1.4
Outlet	0345	15.51	0.09	54.19	ND	19.36	10.85	4.8	0.7	ND
Outlet	0400	15.65	0.09	54.20	ND	19.01	11.06	5.6	0.5	ND
Inlet	0430	14.17	0.08	55.10	ND	21.72	8.86	590.3	78.5	ND
Outlet	0500	15.73	0.09	54.19	ND	19.20	10.78	5.5	0.4	ND
Outlet	0600	15.33	0.10	54.46	ND	19.84	10.27	5.8	0.1	ND
Outlet	0700	15.40	0.10	54.44	ND	19.69	10.38	5.8	0.4	ND
Inlet	0700	14.01	0.09	55.21	ND	21.97	8.65	627.5	73.2	ND
Outlet	0800	15.49	0.10	54.35	ND	19.58	10.49	7.3	0.2	ND
Outlet	0900	14.30	0.08	55.27	ND	21.13	9.22	4.8	0.6	ND
Outlet	1000	14.26	0.10	55.47	0.01	21.24	8.92	4.9	0.2	ND
Outlet	1100	14.77	0.09	54.82	ND	20.65	9.67	8.0	0.2	ND
Inlet	1100	13.91	0.08	55.20	ND	21.86	8.87	614.9	61.5	1.2
Outlet	1200	14.22	0.08	55.14	0.01	21.42	9.12	7.8	1.1	ND
Outlet	1300	13.97	0.08	55.28	0.01	21.59	9.08	9.8	0.1	ND
Outlet	1400	14.98	0.08	54.73	ND	20.43	9.78	26.6	1.3	ND
Inlet	1500	14.53	0.08	54.89	ND	20.99	9.44	645.9	51.5	ND
Outlet	1600	14.57	0.12	55.03	ND	20.41	9.86	59.2	3.5	0.4
Stack	1610	13.70	1.84	57.07	ND	18.30	9.09	<0.3	0.4	19.2
Outlet	1700	14.79	0.08	54.84	ND	20.39	9.89	76.6	4.8	0.7
Outlet	1800	14.50	0.09	55.03	0.01	20.77	9.60	61.5	7.7	0.5
Inlet	1800	13.89	0.09	55.23	0.01	21.75	8.95	649.9	65.6	ND

High Pressure Hot Gas Desulfurization Lab Gas Analysis

ZTMC-01-R3 October 8, 1992

Normalized to 100 H2S Recalculated

Loca.	Time	H2 %	O2 %	N2 %	CH4 %	CO %	CO2 %	H2S PPM	COS PPM	SO2 PPM
Inlet	2010	ND	1.30	98.63	ND	ND	0.07	<0.3	0.6	ND
Outlet	2015	ND	0.14	98.89	ND	0.02	0.25	521.8	27.9	0.64%
Outlet	2030	ND	0.15	98.86	ND	0.01	0.11	314.2	ND	0.84%
Outlet	2045	ND	0.13	98.96	ND	ND	0.06	241.1	ND	0.82%
Outlet	2100	ND	0.14	98.99	ND	ND	0.03	203.4	ND	0.82%
Outlet	2130	ND	0.13	98.95	ND	ND	0.03	170.2	ND	0.88%
Outlet	2200	ND	0.13	98.96	ND	ND	0.02	90.6	ND	0.88%
Inlet	2203	ND	1.46	98.53	ND	ND	0.01	<0.3	0.4	15.0
Outlet	2230	ND	0.14	98.94	ND	ND	0.01	63.2	ND	0.90%
Outlet	2300	ND	0.16	98.96	ND	ND	0.01	9.8	ND	0.87%
Outlet	2330	ND	0.29	98.91	ND	ND	0.01	1.2	ND	0.79%

October 9, 1992

Outlet	0000	ND	0.55	98.79	ND	ND	0.02	0.3	ND	0.64%
Outlet	0030	ND	0.91	98.74	ND	ND	0.01	<0.3	ND	0.34%
Outlet	0100	ND	1.23	98.62	ND	ND	0.01	<0.3	ND	0.14%
Outlet	0130	ND	1.43	98.48	ND	ND	0.02	<0.3	ND	719.5
Outlet	0200	ND	1.48	98.50	ND	ND	0.01	<0.3	ND	71.3
Inlet	0200	ND	1.47	98.53	ND	ND	ND	<0.3	ND	4.2

High Pressure Hot Gas Desulfurization Lab Gas Analysis

ZTMC-01-S4 October 9, 1992

Normalized to 100 H2S Recalculated

Loca.	Time	H2 %	O2 %	N2 %	CH4 %	CO %	CO2 %	H2S PPM	COS PPM	SO2 PPM
Outlet	0405	15.63	0.08	53.81	ND	19.70	10.77	5.0	7.8	2.0
Outlet	0415	16.22	0.09	53.27	ND	18.89	11.52	6.6	3.4	2.8
Inlet	0415	13.86	0.09	54.71	ND	22.56	8.77	80.3	71.4	4.5
Outlet	0430	15.49	0.59	54.09	ND	18.93	10.90	6.7	1.3	2.2
Outlet	0445	15.64	0.15	53.75	ND	19.54	10.92	6.4	0.4	4.3
Outlet	0500	15.22	1.07	54.89	ND	18.12	10.70	15.1	0.8	6.1
Inlet	0530	13.70	0.09	55.20	ND	22.34	8.59	608.8	75.6	ND
Outlet	0600	15.33	0.10	54.19	ND	19.53	10.86	5.6	0.3	1.5
Outlet	0700	15.43	0.08	53.08	ND	20.65	10.76	3.9	0.2	0.9
Outlet	0800	14.81	0.08	54.49	ND	20.44	10.18	3.9	0.1	0.8
Outlet	0900	13.73	2.06	56.60	ND	18.74	8.87	3.9	0.1	2.8
Inlet	0900	13.88	0.08	54.99	ND	22.36	8.62	686.9	71.0	ND
Outlet	1000	14.42	0.09	54.84	ND	21.13	9.53	3.8	0.2	1.1
Outlet	1100	14.24	0.08	55.26	ND	21.13	9.28	4.9	0.1	ND
Outlet	1200	14.35	0.09	54.83	ND	21.07	9.65	6.3	0.4	ND
Outlet	1300	14.61	0.09	54.88	ND	21.13	9.29	7.8	0.1	ND
Inlet	1300	13.75	0.09	54.97	ND	22.32	8.78	801.7	76.1	ND
Outlet	1400	14.44	0.10	54.75	ND	21.30	9.41	9.7	0.3	ND
Outlet	1500	14.32	0.09	54.74	ND	21.58	9.27	9.6	0.3	ND
Outlet	1600	14.22	0.10	54.79	ND	21.65	9.24	10.6	0.7	ND
Outlet	1701	14.28	0.10	54.71	ND	21.79	9.12	14.5	0.5	ND
Inlet	1701	13.56	0.10	55.06	ND	22.67	8.54	627.6	69.7	ND
Outlet	1800	13.77	0.10	55.04	ND	22.09	9.00	18.1	0.5	ND
Outlet	1900	14.07	0.09	55.14	ND	21.56	9.13	29.7	1.5	ND
Outlet	2000	14.23	0.09	54.75	ND	21.37	9.55	64.9	3.4	ND
Outlet	2100	15.17	0.11	54.14	0.01	19.49	11.07	103.1	3.8	ND
Inlet	2100	14.69	0.18	54.46	0.01	19.97	10.61	720.8	58.7	ND
Outlet	2200	15.40	0.12	53.96	0.01	19.34	11.15	165.5	6.5	ND
Outlet	2215	14.97	0.19	54.29	0.01	19.53	10.99	174.9	8.2	ND

High Pressure Hot Gas Desulfurization Lab Gas Analysis

ZTMC-02-S1 October 14, 1992

Normalized to 100 H2S Recalculated

Loca.	Time	H2 %	O2 %	N2 %	CH4 %	CO %	CO2 %	H2S PPM	COS PPM	SO2 PPM
Outlet	0105	18.45	0.10	53.56	ND	10.13	17.76	6.8	18.7	1.5
Outlet	0115	18.70	0.16	53.65	ND	9.70	17.79	41.7	7.8	1.6
Inlet	0115	18.26	0.09	53.66	ND	10.73	17.18	791.8	54.0	6.4
Outlet	0130	18.74	0.10	53.58	ND	9.84	17.74	41.2	3.8	2.5
Outlet	0145	18.76	0.09	53.78	ND	9.78	17.59	27.4	2.1	1.5
Outlet	0200	18.92	0.09	53.55	ND	9.77	17.66	23.8	1.8	1.4
Inlet	0230	18.30	0.08	53.82	ND	10.76	16.94	983.0	40.6	2.1
Outlet	0300	18.90	0.08	53.72	ND	9.87	17.43	17.8	1.2	2.6
Outlet	0400	18.67	0.08	53.64	ND	9.99	17.62	32.9	0.9	2.7
Outlet	0500	18.72	0.09	53.80	ND	9.99	17.40	34.7	0.9	2.2
Inlet	0500	18.30	0.08	53.92	ND	10.73	16.87	1006.4	48.2	14.9
Outlet	0600	18.68	0.08	53.87	ND	10.06	17.30	38.9	1.0	5.0
Outlet	0700	18.63	0.09	53.86	ND	10.10	17.32	31.0	1.1	4.0
Outlet	0800	18.62	0.08	54.29	ND	10.21	16.79	39.3	1.9	4.6
Outlet	0900	18.48	0.09	54.36	ND	10.23	16.83	47.9	2.0	1.7
Inlet	0900	18.15	0.09	54.30	ND	10.67	16.68	993.5	40.3	0.8
Outlet	1000	18.49	0.10	54.20	ND	10.10	17.10	64.1	1.8	1.3
Outlet	1100	18.25	0.10	54.54	ND	10.18	16.92	62.0	2.8	0.9
Outlet	1200	18.46	0.08	54.09	ND	10.12	17.24	74.8	2.8	ND
Outlet	1300	18.41	0.08	54.25	ND	10.20	17.06	96.8	3.9	0.8
Inlet	1300	18.40	0.08	54.13	ND	10.54	16.77	894.2	42.2	ND
Outlet	1400	18.41	0.09	54.23	ND	10.22	17.04	136.8	6.5	1.2
Outlet	1505	17.90	0.39	55.17	ND	9.86	16.66	145.2	5.5	2.4
Outlet	1600	18.19	0.09	54.21	ND	10.22	17.26	185.9	9.5	1.9
Outlet	1700	18.17	0.08	54.14	ND	10.20	17.38	241.5	12.5	2.0
Inlet	1700	18.02	0.08	53.94	ND	10.55	17.30	1054.4	37.8	ND
Outlet	1800	17.43	0.69	55.31	ND	10.10	16.44	252.3	14.8	3.2

High Pressure Hot Gas Desulfurization Lab Gas Analysis

ZTMC-02-S1 cont.		October 14, 1992		Normalized to 100									
Loca.	Time	H2° %	O2 %	N2 %	CH4 %	CO %	CO2 %	H2S PPM	COS PPM	SO2 PPM	H2S Recalculated		
Outlet	1900	18.29	0.09	54.49	ND	10.33	16.78	296.6	11.5	2.1			
Outlet	2000	18.26	0.11	54.22	ND	10.24	17.13	315.5	16.0	1.7			
Outlet	2100	18.43	0.09	53.96	ND	10.31	17.17	349.2	16.4	1.2			
Inlet	2100	18.58	0.09	53.83	ND	10.52	16.88	1000.0	43.5	11.1			
Outlet	2200	18.61	0.09	55.30	ND	10.89	15.06	414.9	18.1	2.6			
Outlet	2300	18.24	0.08	53.99	ND	10.57	17.07	439.8	24.7	4.7			
October 15, 1992													
Outlet	0000	18.31	0.08	53.76	ND	10.55	17.26	452.2	15.3	1.6			
Inlet	0000	18.24	0.08	53.72	ND	10.66	17.20	962.9	44.0	9.6			

High Pressure Hot Gas Desulfurization Lab Gas Analysis

Loca.	Time	October 15, 1992									
		H2 %	O2 %	N2 %	CH4 %	CO %	CO2 %	H2S PPM	COS PPM	SO2 PPM	H2S Recalculated
Outlet	0305	0.45	3.81	93.03	ND	0.32	2.15	156.6	17.0	0.23%	
Outlet	0315	0.13	11.85	84.77	ND	0.47	1.52	27.1	2.5	1.26%	
Inlet	0315	ND	7.85	92.10	ND	ND	0.05	<0.3	ND	ND	
Outlet	0330	0.09	0.16	96.15	ND	0.01	0.18	93.0	3.4	3.40%	
Outlet	0345	0.09	0.42	95.76	ND	0.01	0.13	65.0	1.4	3.58%	
Outlet	0400	0.10	0.21	96.09	ND	0.01	0.10	80.3	1.7	3.49%	
Inlet	0430	ND	8.04	91.96	ND	ND	ND	<0.3	ND	ND	
Outlet	0500	0.11	0.14	96.42	ND	ND	0.05	87.3	ND	3.28%	
Outlet	0600	0.14	0.16	95.67	ND	ND	0.06	21.8	0.8	3.97%	
Outlet	0700	ND	4.34	93.66	ND	ND	0.07	<0.3	ND	1.93%	
Outlet	0800	ND	7.93	92.00	ND	ND	0.05	<0.3	ND	147.8	
Inlet	0810	ND	8.02	91.98	ND	ND	ND	<0.3	ND	ND	

High Pressure Hot Gas Desulfurization Lab Gas Analysis

ZTMC-02-S2		October 15, 1992				Normalized to 100				H2S Recalculated			
Loca.	Time	H2 %	O2 %	N2 %	CH4 %	CO %	CO2 %	H2S PPM	COS PPM	SO2 PPM	H2S PPM	COS PPM	SO2 PPM
	Inlet	1810	17.77	0.08	53.28	0.01	10.87	17.99	<0.3	75.1	ND	ND	ND
	Outlet	1815	12.36	7.41	62.71	ND	5.70	11.81	5.6	3.2	108.5	3.2	108.5
	Outlet	1830	18.70	0.10	52.65	ND	8.96	19.59	30.7	5.7	13.1	5.7	13.1
	Outlet	1846	18.55	0.09	52.80	ND	9.13	19.43	30.6	2.8	7.5	2.8	7.5
	Outlet	1900	18.75	0.09	52.76	ND	9.17	19.22	22.1	1.5	5.1	1.5	5.1
	Inlet	1905	17.97	0.09	53.06	ND	10.59	18.25	396.8	49.9	1.7	49.9	1.7
	Outlet	2000	6.56	14.92	69.82	ND	2.86	5.84	3.2	0.1	69.2	0.1	69.2
	Outlet	2100	18.80	0.09	54.71	ND	9.99	16.40	13.1	0.2	3.1	0.2	3.1
	Outlet	2200	18.23	0.09	53.48	ND	9.66	18.55	11.6	0.1	3.7	0.1	3.7
	Outlet	2300	18.19	0.09	53.74	ND	9.66	18.31	14.9	0.2	9.4	0.2	9.4
	Inlet	2300	18.01	0.09	53.35	ND	10.53	17.92	837.3	56.1	12.3	56.1	12.3
October 16, 1992													
	Outlet	0000	18.13	0.08	53.44	ND	9.90	18.45	8.9	0.2	1.2	0.2	1.2
	Outlet	0100	18.17	0.10	53.31	ND	9.89	18.52	14.9	0.1	61.5	0.1	61.5
	Outlet	0200	17.97	0.09	53.82	ND	10.18	17.95	11.2	0.2	3.6	0.2	3.6
	Outlet	0300	17.33	0.09	53.98	ND	10.09	18.50	24.3	0.6	1.9	0.6	1.9
	Inlet	0300	16.51	0.10	54.31	ND	10.80	18.18	858.0	21.2	4.8	21.2	4.8
	Outlet	0400	17.98	0.09	53.40	ND	10.11	18.41	29.5	1.0	4.7	1.0	4.7
	Outlet	0500	18.23	0.10	53.24	ND	10.07	18.36	32.1	1.4	0.7	1.4	0.7
	Outlet	0600	18.18	0.11	53.24	ND	10.16	18.30	73.3	1.6	1.7	1.6	1.7
	Outlet	0700	18.02	0.08	53.48	ND	10.28	18.14	46.4	0.7	9.0	0.7	9.0
	Inlet	0700	17.89	0.08	53.45	ND	10.73	17.73	1036.2	47.9	32.2	47.9	32.2
	Outlet	0800	17.99	0.08	53.57	ND	10.24	18.12	63.4	2.4	1.3	2.4	1.3
	Outlet	0900	17.92	0.08	53.55	ND	10.40	18.05	51.2	2.8	2.3	2.8	2.3
	Outlet	1000	18.10	0.08	53.23	ND	10.35	18.22	141.4	8.0	1.5	8.0	1.5
	Outlet	1100	17.57	0.08	53.48	ND	10.85	18.02	82.7	4.4	1.1	4.4	1.1

* Possible Air in sample *JJM*

High Pressure Hot Gas Desulfurization Lab Gas Analysis

ZTMC-02-S2 cont. October 16, 1992 Normalized to 100

Loca.	Time	H2 %	O2 %	N2 %	CH4 %	CO %	CO2 %	H2S PPM	COS PPM	SO2 PPM
Inlet	1100	17.75	0.07	53.20	ND	10.59	18.27	1064.1	47.8	1.1
Outlet	1200	17.93	0.08	53.35	ND	10.49	18.13	222.2	9.8	1.9
Outlet	1301	17.95	0.09	53.31	ND	11.03	17.60	123.7	8.3	0.9
Outlet	1400	18.18	0.08	53.07	ND	10.53	18.10	296.0	8.6	1.0
Outlet	1500	17.89	0.08	53.23	ND	10.82	17.95	177.9	6.5	1.9
Inlet	1500	17.89	0.07	53.05	ND	11.03	17.87	948.0	40.5	ND
Outlet	1600	17.97	0.08	53.53	ND	10.55	17.83	337.2	18.3	1.5
Outlet	1700	17.88	0.07	53.40	ND	10.73	17.88	254.4	12.9	0.9
Outlet	1800	17.98	0.08	53.30	ND	10.47	18.13	429.2	14.0	0.1
Inlet	1800	17.96	0.08	53.19	ND	10.61	18.04	1080.6	53.8	ND

High Pressure Hot Gas Desulfurization Lab Gas Analysis

ZTMC-02-R2 October 19, 1992 Normalized to 100

Loca.	Time	H2 %	O2 %	N2 %	CH4 %	CO %	CO2 %	H2S PPM	COS PPM	SO2 PPM
Outlet	1245	ND	0.11	98.76	ND	ND	0.05	0.8	0.4	1.07%
Inlet	1245	ND	0.17	99.64	ND	ND	0.09	<0.3	ND	0.10%
Outlet	1300	ND	0.13	99.03	ND	ND	0.05	0.8	ND	0.78%
Outlet	1315	ND	0.11	99.09	ND	ND	ND	<0.3	ND	0.80%
Outlet	1330	ND	1.03	98.19	ND	ND	0.05	<0.3	ND	0.73%
Outlet	1400	ND	1.24	98.62	ND	0.02	0.11	<0.3	ND	93.6
Outlet	1430	ND	0.14	98.74	ND	ND	ND	<0.3	ND	1.12%
Outlet	1530	ND	3.06	96.65	ND	ND	ND	<0.3	ND	0.29%
Outlet	1630	ND	2.40	97.60	ND	ND	ND	<0.3	ND	15.8
Inlet	1640	ND	2.41	97.52	ND	ND	0.06	<0.3	ND	124.3

High Pressure Hot Gas Desulfurization Lab Gas Analysis

ZTMC-02-S3 October 19, 1992

Normalized to 100 H2S Recalculated

Loca.	Time	H2 %	O2 %	N2 %	CH4 %	CO %	CO2 %	H2S PPM	COS PPM	SO2 PPM
Outlet	2015	20.25	0.07	51.91	ND	10.43	17.33	95.2	3.9	1.0
Inlet	2015	19.42	0.08	52.32	ND	11.65	16.45	595.6	66.2	58.7
Outlet	2030	20.34	0.08	51.97	ND	10.14	17.46	108.3	3.6	1.6
Outlet	2045	17.61	0.09	53.67	ND	14.53	14.10	31.1	0.9	1.4
Outlet	2100	19.95	0.07	52.12	ND	10.67	17.18	70.3	2.2	1.2
Inlet	2130	19.36	0.07	51.76	ND	11.77	16.97	603.1	44.2	28.5
Outlet	2200	17.46	0.10	54.21	ND	10.82	17.39	83.4	4.4	1.3
Outlet	2300	17.86	0.11	53.82	ND	14.48	13.71	46.9	1.4	0.8
October 20, 1992										
Outlet	0000	18.20	0.09	53.43	ND	10.76	17.50	237.7	6.7	1.6
Inlet	0000	17.52	0.08	53.85	ND	12.03	16.43	836.0	32.9	7.4
Outlet	0100	18.17	0.08	53.33	ND	13.99	14.41	176.6	9.5	5.5
Outlet	0200	18.31	0.11	52.81	ND	12.95	15.78	320.4	14.8	3.7
Outlet	0300	19.96	0.09	52.44	ND	10.95	16.50	600.8	18.6	4.9
Outlet	0400	19.89	0.08	52.80	ND	11.11	16.05	595.5	17.5	7.3
Inlet	0400	19.44	0.08	52.67	ND	11.67	16.05	856.6	31.6	1.4
Outlet	0500	19.67	0.08	52.04	ND	11.02	17.12	596.8	17.0	11.0
Outlet	0600	19.45	0.13	52.09	ND	11.42	16.84	642.6	23.2	2.7
Outlet	0700	19.39	0.17	52.74	ND	11.40	16.23	617.8	18.6	3.1
Outlet	0800	18.82	1.27	53.90	ND	10.56	15.39	589.8	20.7	5.8
Inlet	0800	19.54	0.07	52.59	ND	11.58	16.12	861.4	31.4	0.8
Outlet	0900	19.78	0.12	53.01	ND	11.62	15.40	612.9	24.4	2.4
Outlet	1000	20.04	0.08	53.37	ND	11.24	15.19	772.8	24.3	2.2
Outlet	1100	19.55	0.61	54.02	ND	10.91	14.83	688.0	25.0	2.7
Outlet	1200	19.77	0.08	53.27	ND	11.24	15.57	770.6	25.5	1.7
Inlet	1200	19.67	0.07	53.41	ND	11.73	15.02	894.7	22.3	1.2

High Pressure Hot Gas Desulfurization Lab Gas Analysis

ZTMC-02-S3 cont. October 20, 1992

Normalized to 100

Loca.	Time	H2 %	O2 %	N2 %	CH4 %	CO %	CO2 %	H2S PPM	COS PPM	SO2 PPM
Stack	1245	18.56	1.72	55.12	ND	10.24	14.34	101.2	32.4	3.3
Outlet	1300	19.83	0.13	53.25	ND	11.16	15.56	743.3	22.4	3.6
Outlet	1400	19.98	0.12	53.04	ND	11.13	15.65	738.4	24.6	3.0
Inlet	1400	20.07	0.07	52.93	ND	11.58	15.25	876.2	25.4	1.1

High Pressure Hot Gas Desulfurization Lab Gas Analysis

ZTMC-02-R3 October 21, 1992 Normalized to 100

Loca.	Time	H2 %	O2 %	N2 %	CH4 %	CO %	CO2 %	H2S PPM	COS PPM	SO2 PPM
Outlet	0115	ND	0.13	98.91	ND	ND	0.11	0.7	ND	0.85%
Inlet	0115	ND	1.41	98.54	ND	ND	0.05	<0.3	ND	ND
Outlet	0130	ND	0.12	98.96	ND	ND	0.06	<0.3	ND	0.86%
Outlet	0145	ND	0.13	98.90	ND	ND	0.06	<0.3	ND	0.91%
Outlet	0200	ND	0.12	98.88	ND	ND	ND	<0.3	ND	0.99%
Inlet	0230	ND	1.47	98.51	ND	0.02	ND	<0.3	ND	ND
Outlet	0300	ND	0.13	98.93	ND	ND	ND	<0.3	ND	0.94%
Outlet	0400	ND	0.13	98.93	ND	ND	ND	<0.3	ND	0.94%
Outlet	0500	ND	1.12	98.55	ND	ND	ND	<0.3	ND	0.33%
Outlet	0530	ND	1.48	98.44	ND	ND	ND	<0.3	ND	858.0
Outlet	0600	ND	1.50	98.49	ND	ND	ND	<0.3	ND	42.1
Inlet	0600	ND	1.49	98.51	ND	ND	ND	<0.3	ND	ND

High Pressure Hot Gas Desulfurization Lab Gas Analysis

ZTMC-03-S1 November 4, 1992

Normalized to 100

Loca.	Time	H2 %	O2 %	N2 %	CH4 %	CO %	CO2 %	H2S PPM	COS PPM	SO2 PPM
Outlet	1335	17.04	0.17	57.01	0.01	21.41	4.36	10.2	3.1	3.8
Outlet	1340	16.36	0.10	52.01	ND	19.98	11.55	8.5	0.8	1.4
Inlet	1345	15.45	0.10	53.49	ND	22.52	8.44	<0.3	14.3	ND
Outlet	1345	16.12	0.16	53.05	ND	20.46	10.21	6.7	0.4	0.7
Outlet	1400	16.64	0.10	52.87	ND	20.42	9.97	4.2	0.3	ND

ZTMC-03-R1

Outlet		ND	0.14	99.80	ND	ND	0.05	<0.3	ND	65.1
Outlet	1545	ND	0.83	99.14	ND	ND	0.03	<0.3	ND	68.3
Inlet	1545	ND	0.97	98.99	ND	ND	0.04	<0.3	ND	ND
Outlet	1600	ND	0.94	99.06	ND	ND	ND	<0.3	ND	19.8

High Pressure Hot Gas Desulfurization Lab Gas Analysis

ZTMC-03-S2 November 5, 1992

Normalized to 100

Loca.	Time	H2 %	O2 %	N2 %	CH4 %	CO %	CO2 %	H2S PPM	COS PPM	SO2 PPM
Outlet	0835	12.83	0.08	54.47	0.03	24.73	7.86	1.9	1.6	1.5
Outlet	0845	12.63	0.08	54.82	0.04	24.56	7.86	2.5	0.5	1.1
Inlet	0845	13.49	0.08	54.10	0.01	23.71	8.61	<0.3	30.9	ND
Outlet	0900	15.72	0.09	52.73	0.01	20.85	10.61	3.6	0.2	ND

ZTMC-03-R2

Outlet	1205	ND	0.13	99.07	ND	0.10	0.70	<0.3	ND	ND
Outlet	1215	Stopcock was open								
Inlet	1215	ND	0.77	99.14	ND	0.01	0.08	<0.3	ND	ND
Outlet	1230	ND	0.60	99.39	ND	0.01	ND	<0.3	ND	29.2

High Pressure Hot Gas Desulfurization Lab Gas Analysis

ZTMC-03-S3 November 5, 1992 Normalized to 100

Loca.	Time	H2 %	O2 %	N2 %	CH4 %	CO %	CO2 %	H2S PPM	COS PPM	SO2 PPM
Outlet	1435	12.88	0.10	54.79	0.01	24.78	7.44	2.6	1.3	5.5
Outlet	1445	12.70	0.10	55.14	0.01	24.73	7.31	2.3	0.2	3.6
Inlet	1445	13.93	0.08	54.32	0.01	23.37	8.90	<0.3	21.3	1.2
Outlet	1500	12.64	0.11	55.21	0.01	24.76	7.27	0.9	ND	1.9

ZTMC-03-R3

Outlet	1720	ND	0.14	99.47	ND	0.07	0.32	<0.3	ND	ND
Outlet	1730	ND	0.18	99.62	ND	0.01	0.19	<0.3	ND	ND
Inlet	1730	ND	0.62	99.22	ND	ND	0.16	<0.3	ND	ND
Outlet	1745	ND	0.87	99.04	ND	ND	0.09	<0.3	ND	3.4

High Pressure Hot Gas Desulfurization Lab Gas Analysis

ZTMC-03-S4 November 6, 1992

Normalized to 100

Loca.	Time	H2 %	O2 %	N2 %	CH4 %	CO %	CO2 %	H2S PPM	COS PPM	SO2 PPM
Outlet	0905	15.66	0.08	52.98	ND	20.67	10.61	7.0	6.8	2.7
Outlet	0915	15.35	0.13	53.42	ND	20.77	10.34	5.1	0.2	1.3
Inlet	0915	14.99	0.10	53.58	ND	22.04	9.29	<0.3	25.4	ND
Outlet	0930	13.97	0.08	54.46	0.02	23.01	8.45	1.5	0.1	1.6

ZTMC-03-R4

Outlet	1205	ND	0.12	99.79	ND	ND	0.09	<0.3	ND	1.3
Outlet	1215	ND	0.82	99.13	ND	ND	0.05	<0.3	ND	5.5
Inlet	1215	ND	0.81	99.12	ND	ND	0.07	<0.3	ND	ND
Outlet	1230	ND	0.86	99.11	ND	ND	0.03	<0.3	ND	3.5

High Pressure Hot Gas Desulfurization Lab Gas Analysis

ZTMC-04-S1 January 13, 1993 Normalized to 100

Loca.	Time	H2 %	O2 %	N2 %	CH4 %	CO %	CO2 %	H2S PPM	COS PPM	SO2 PPM
Outlet	2115	16.49	0.10	53.14	0.04	20.50	9.72	2.4	0.9	3.1
Outlet	2130	17.96	0.44	52.35	0.01	18.00	11.24	8.0	0.6	ND
Outlet	2200	18.38	0.14	51.93	0.01	18.45	11.08	15.2	7.4	ND
Inlet	2200	17.77	0.14	52.46	0.01	18.91	10.67	105.1	243.1	1.9
Outlet	2300	18.20	0.09	52.15	0.01	18.95	10.59	52.2	3.6	ND
Outlet	0000	18.50	0.09	51.77	0.01	18.62	11.00	82.6	7.6	ND
Outlet	0100	18.22	0.08	52.05	ND	18.70	10.94	138.2	13.7	0.7
Outlet	0200	18.19	0.09	52.04	0.01	18.88	10.77	186.3	16.0	1.1
Inlet	0200	17.73	0.12	52.26	0.01	19.13	10.70	473.4	96.2	3.1
Outlet	0300	18.27	0.08	52.11	0.01	18.60	10.90	223.1	19.4	1.2
Outlet	0400	18.11	0.10	52.17	0.01	18.91	10.66	288.1	25.5	1.0
Outlet	0500	18.11	0.09	52.16	ND	18.89	10.72	313.1	21.5	0.9
Outlet	0600	18.03	0.09	52.21	0.01	18.93	10.70	353.9	29.3	1.4
Inlet	0600	17.77	0.08	52.29	0.01	19.27	10.51	533.6	74.7	1.9
Outlet	0700	17.99	0.11	52.48	0.01	18.85	10.51	384.5	28.3	1.1
Outlet	0800	17.87	0.10	52.66	0.01	19.01	10.31	419.9	34.8	ND
Outlet	0900	18.07	0.09	52.41	0.01	18.84	10.53	467.7	33.4	1.1
Outlet	1000	15.34	3.78 *	56.90	ND	15.39	8.55	362.9	24.8	4.2
Inlet	1000	17.36	0.10	52.68	0.01	19.47	10.31	582.5	74.2	1.4
Outlet	1100	18.15	0.10	52.21	0.01	18.99	10.49	485.9	36.4	1.4
Outlet	1200	17.93	0.09	52.20	ND	19.17	10.56	514.4	29.8	0.8
Outlet	1300	17.92	0.09	52.32	ND	18.94	10.69	445.5	23.4	ND
Outlet	1400	18.38	0.18	51.83	0.01	17.98	11.58	452.4	30.3	ND
Inlet	1400	18.08	0.09	52.02	0.02	18.85	10.89	492.8	66.2	1.7
Outlet	1500	18.10	0.10	52.05	0.01	18.51	11.19	453.2	36.5	1.5
Outlet	1600	17.90	0.11	52.24	0.01	18.92	10.76	475.0	34.2	1.3
Outlet	1700	16.52	8.35 *	47.86	0.01	17.36	9.86	444.4	29.9	1.3

* Possible Air in Sample *3/11/93*

Loca.	Time	H2 %	O2 %	N2 %	CH4 %	CO %	CO2 %	H2S PPM	COS PPM	SO2 PPM
Inlet	1800	17.79	0.08	52.27	0.01	19.39	10.40	538.2	71.1	ND
Outlet	1800	17.76	0.11	52.31	0.01	19.26	10.50	498.7	36.9	1.1
Outlet	1900	17.89	0.10	52.25	ND	19.02	10.69	439.0	38.7	1.5
Outlet	2000	16.50	0.11	53.06	ND	21.29	9.00	433.9	35.5	ND
Inlet	2100	16.48	0.11	53.14	ND	21.42	8.79	535.4	61.7	1.7
Outlet	2100	16.66	0.10	53.05	ND	21.28	8.86	520.2	35.5	ND
Outlet	2200	16.66	0.09	53.03	ND	21.23	8.94	480.9	45.6	1.2
Outlet	2300	17.82	0.10	52.25	ND	20.29	9.50	462.2	41.0	1.1
Outlet	0000	17.68	0.11	52.39	ND	19.66	10.12	451.5	43.8	2.3
Outlet	0100	17.60	0.28	52.51	ND	19.14	10.42	480.0	34.8	3.5
Inlet	0100	17.89	0.08	52.19	ND	19.33	10.45	514.1	66.9	1.1
Outlet	0200	18.03	0.09	52.10	ND	19.22	10.51	486.0	39.1	2.8

High Pressure Hot Gas Desulfurization Lab Gas Analysis

ZTMC-04-R1 January 15, 1993 Normalized to 100

Loca.	Time	H2 %	O2 %	N2 %	GH4 %	CO %	CO2 %	H2S PPM	COS PPM	SO2 PPM
Outlet	0515	ND	0.13	99.74	ND	ND	0.11	<0.3	0.6	160.6
Outlet	0530	ND	0.12	99.75	ND	ND	0.10	<0.3	0.6	304.4
Inlet	0600	ND	0.27	99.69	ND	ND	0.03	54.5	ND	2.3
Outlet	0600	ND	0.13	99.75	ND	ND	0.07	0.3	2.0	527.1
Outlet	0700	ND	0.12	99.73	ND	ND	0.04	0.4	2.8	1109.3
Outlet	0800	ND	0.23	99.59	ND	ND	0.03	<0.3	1.7	1473.8
Outlet	0900	ND	0.13	99.67	ND	ND	0.05	<0.3	1.7	1558.8
Outlet	1000	ND	0.12	98.51	ND	ND	0.07	<0.3	3.4	1.30%
Inlet	1000	ND	1.75	98.07	ND	ND	0.03	<0.3	0.3	1492.6
Outlet	1100	ND	0.13	98.49	ND	ND	0.06	<0.3	1.8	1.32%
Outlet	1200	ND	0.50	98.41	ND	ND	0.05	<0.3	0.9	1.04%
Outlet	1300	ND	1.60	97.92	ND	ND	0.01	<0.3	ND	4711.6
Outlet	1400	ND	3.37	96.61	ND	ND	0.01	<0.3	ND	128.1
Inlet	1400	ND	3.26	96.71	ND	ND	0.01	<0.3	ND	192.5
Outlet	1500	ND	3.42	96.57	ND	ND	0.01	<0.3	ND	58.4
Outlet	1600	ND	13.93	86.05	ND	ND	0.02	<0.3	ND	27.0
Inlet	1600	ND	13.81	86.18	ND	ND	0.01	<0.3	ND	57.5
Outlet	1700	ND	13.92	86.06	ND	ND	0.01	<0.3	ND	51.0
Inlet	1800	ND	20.76	79.23	ND	ND	0.01	<0.3	ND	21.3
Outlet	1800	ND	20.80	79.19	ND	ND	0.01	<0.3	ND	38.3
Outlet	1900	ND	20.80	79.18	ND	ND	0.01	<0.3	ND	121.3
Inlet	1930	ND	20.79	79.20	ND	ND	0.01	<0.3	ND	9.7
Outlet	2000	ND	20.82	79.16	ND	ND	0.01	<0.3	ND	110.0
Outlet	2030	ND	20.95	79.03	ND	ND	0.01	<0.3	ND	92.9

High Pressure Hot Gas Desulfurization Lab Gas Analysis

ZTMC-04-S2 January 19, 1993

Normalized to 100

Loca.	Time	H2 %	O2 %	N2 %	CH4 %	CO %	CO2 %	H2S PPM	COS PPM	SO2 PPM
Outlet	0915	17.07	0.09	52.41	ND	20.79	9.64	3.8	2.2	ND
Outlet	0930	17.02	0.10	52.42	ND	20.72	9.74	13.0	2.0	ND
Outlet	1000	17.45	0.08	52.17	ND	20.56	9.73	30.5	3.6	ND
Inlet	1000	17.08	0.09	52.36	ND	21.06	9.36	240.1	216.2	ND
Outlet	1100	17.09	0.08	52.51	ND	20.80	9.51	111.9	8.5	ND
Outlet	1200	17.20	0.09	52.42	ND	20.84	9.44	178.0	15.1	ND
Outlet	1300	17.00	0.08	52.58	ND	20.85	9.46	201.2	24.4	ND
Outlet	1400	17.23	0.08	52.39	ND	20.78	9.50	242.1	30.5	ND
Inlet	1400	16.90	0.08	52.52	ND	21.11	9.33	480.1	145.0	ND
Outlet	1500	17.13	0.07	52.41	ND	20.82	9.54	271.7	32.4	ND
Outlet	1600	17.13	0.08	52.45	ND	20.83	9.47	297.7	35.7	ND
Outlet	1700	16.61	0.12	52.83	ND	20.83	9.57	316.0	30.1	2.7
Inlet	1800	16.23	0.20	53.04	ND	21.00	9.46	516.4	103.6	3.0
Outlet	1800	16.91	0.07	52.59	ND	20.83	9.56	371.7	34.9	ND
Outlet	1900	17.11	0.07	52.46	ND	20.77	9.55	376.6	32.2	1.1
Outlet	2000	17.15	0.08	52.57	ND	20.87	9.29	398.5	35.6	2.4
Outlet	2100	17.07	0.07	52.65	ND	20.93	9.24	425.8	40.3	0.6
Inlet	2200	16.90	0.07	52.78	ND	20.92	9.29	438.8	38.2	2.1
Inlet	2200	16.79	0.07	52.83	ND	21.05	9.20	536.8	90.0	2.0
Outlet	2300	17.05	0.07	52.65	ND	20.84	9.34	438.2	40.4	2.4
Outlet	0000	16.83	0.07	52.59	ND	20.90	9.56	456.0	38.8	1.1
Outlet	0100	17.13	0.07	52.53	ND	20.86	9.35	464.0	46.4	1.1
Outlet	0200	17.06	0.07	52.46	ND	20.81	9.54	488.1	46.9	1.8
Inlet	0300	16.89	0.08	52.54	ND	20.97	9.45	588.8	77.0	1.6
Outlet	0300	16.91	0.08	52.57	ND	20.83	9.56	504.6	48.1	0.8
Outlet	0400	17.09	0.07	52.44	ND	20.88	9.46	499.6	44.9	1.8
Outlet	0500	13.47	0.09	54.71	ND	22.10	9.57	526.8	52.9	1.9

Loca.	Time	H2 %	O2 %	N2 %	CH4 %	CO %	CO2 %	H2S PPM	COS PPM	SO2 PPM
Outlet	0600	15.54	0.07	56.99	ND	18.97	8.38	460.6	39.1	2.5
Inlet	0600	17.08	0.08	52.64	ND	20.98	9.16	553.8	83.8	1.0
Outlet	0700	15.14	0.10	53.83	0.02	22.77	8.08	475.3	65.4	1.1

High Pressure Hot Gas Desulfurization Lab Gas Analysis

ZTMC-04-R2 January 20, 1993

Normalized to 100

Loca.	Time	H2 %	O2 %	N2 %	CH4 %	CO %	CO2 %	H2S PPM	COS PPM	SO2 PPM
Outlet	0945	ND	0.10	99.76	ND	0.01	0.13	0.4	ND	ND
Outlet	1000	ND	1.87	97.71	ND	0.19	0.22	1.6	ND	131.7
Outlet	1030	ND	0.10	99.86	ND	ND	0.01	ND	ND	251.1
Inlet	1030	ND	0.10	99.85	ND	ND	0.05	10.5	ND	ND
Outlet	1130	ND	0.10	99.75	ND	ND	0.01	ND	ND	1437.9
Outlet	1230	ND	0.11	98.51	ND	ND	0.02	ND	0.7	1.36%
Outlet	1330	ND	0.17	98.47	ND	ND	0.01	ND	ND	1.35%
Outlet	1430	ND	0.39	98.55	ND	ND	ND	ND	ND	1.06%
Inlet	1430	ND	0.11	98.41	ND	ND	0.07	ND	2.7	1.41%
Outlet	1530	ND	1.90	97.49	ND	0.09	0.07	3.5	0.8	0.44%
Outlet	1630	ND	1.82	98.00	ND	ND	ND	ND	ND	1831.6
Outlet	1730	ND	3.28	96.71	ND	ND	ND	ND	ND	95.9
Inlet	1800	ND	3.17	96.78	ND	ND	0.01	ND	ND	393.4
Outlet	1800	ND	3.30	96.70	ND	ND	ND	ND	ND	68.2
Outlet	1900	ND	3.58	96.41	ND	ND	ND	ND	ND	48.4
Inlet	2000	ND	5.76	94.21	ND	ND	0.01	ND	ND	188.4
Outlet	2000	ND	5.87	94.13	ND	ND	ND	ND	ND	21.4
Outlet	2100	ND	5.80	94.20	ND	ND	ND	ND	ND	28.5
Outlet	2200	ND	20.69	79.30	ND	ND	0.01	ND	ND	22.1
Inlet	2200	ND	20.64	79.35	ND	ND	0.01	ND	ND	18.9
Outlet	2300	ND	20.71	79.27	ND	ND	0.01	ND	ND	96.1
Outlet	0060	ND	20.72	79.26	ND	ND	0.01	ND	ND	76.3
Outlet	0100	ND	20.83	79.15	ND	ND	0.01	ND	ND	69.4
Outlet	0200	ND	20.84	79.16	ND	ND	ND	ND	ND	67.8
Inlet	0300	ND	20.83	79.17	ND	ND	ND	ND	ND	4.1
Outlet	0300	ND	20.84	79.16	ND	ND	ND	ND	ND	62.2
Outlet	0400	ND	20.72	79.27	ND	ND	0.01	ND	ND	58.9

Loca.	Time	H2 %	O2 %	N2 %	CH4 %	CO %	CO2 %	H2S PPM	COS PPM	SO2 PPM
Outlet	0500	ND	20.80	79.19	ND	ND	ND	ND	ND	79.9

High Pressure Hot Gas Desulfurization Lab Gas Analysis

ZTMC-04-S3 January 21, 1993

Normalized to 100

Loca.	Time	H2 %	O2 %	N2 %	CH4 %	CO %	CO2 %	H2S PPM	COS PPM	SO2 PPM
Outlet	0845	16.42	0.07	52.86	ND	21.30	9.35	29.8	6.1	2.1
Outlet	0900	16.38	0.09	52.98	ND	21.29	9.24	119.9	11.2	2.8
Outlet	0930	16.54	0.08	52.90	ND	21.19	9.28	153.0	12.9	2.5
Inlet	0930	16.37	0.10	52.99	ND	21.48	9.00	415.7	155.5	15.6
Outlet	1030	16.51	0.09	52.87	ND	21.23	9.27	221.4	17.9	1.4
Outlet	1130	16.55	0.08	52.92	ND	21.21	9.21	254.9	19.8	ND
Outlet	1230	16.67	0.08	53.00	ND	21.21	9.02	256.0	21.0	1.4
Outlet	1330	16.59	0.07	53.16	ND	21.29	8.86	280.4	25.1	3.0
Inlet	1330	16.42	0.08	53.20	ND	21.52	8.71	542.7	99.1	4.2
Outlet	1430	16.49	0.08	53.18	ND	21.34	8.87	333.7	31.4	3.5
Outlet	1530	16.40	0.08	53.06	ND	21.37	9.05	374.4	32.6	6.4
Outlet	1630	16.80	0.07	52.84	ND	21.27	8.98	396.7	30.3	1.9
Inlet	1730	16.72	0.08	53.36	ND	21.49	8.29	566.1	81.4	3.9
Outlet	1730	16.86	0.09	53.29	ND	21.34	8.38	405.2	29.5	1.7
Outlet	1830	16.63	0.08	53.43	ND	21.40	8.41	438.7	36.6	2.1
Outlet	1930	16.62	0.08	53.04	ND	21.27	8.94	460.2	30.6	1.9
Outlet	2030	16.80	0.07	52.98	ND	21.20	8.90	471.9	30.6	1.0
Inlet	2130	15.48	0.31	54.13	ND	21.90	8.12	597.8	69.2	4.8
Outlet	2130	16.22	0.07	53.49	ND	21.90	8.27	412.7	38.5	3.1
Outlet	2230	16.12	0.07	53.31	ND	22.08	8.37	449.5	46.4	2.9
Outlet	0030	15.98	0.07	53.02	ND	22.67	8.22	475.0	49.8	1.3
Outlet	0130	15.77	0.09	52.88	ND	22.73	8.48	514.6	57.3	ND
Outlet	0230	16.39	0.08	53.72	ND	23.12	6.64	488.9	49.5	2.1
Inlet	0230	16.34	0.08	53.54	ND	23.22	6.74	626.1	80.0	2.6
Outlet	0330	15.86	0.07	52.82	ND	22.88	8.31	519.7	46.3	ND
Outlet	0430	15.85	0.07	52.70	ND	22.92	8.41	484.9	55.5	1.4
Outlet	0530	15.87	0.07	52.68	ND	22.89	8.43	470.5	51.8	1.2

Loca.	Time	H2 %	O2 %	N2 %	CH4 %	CO %	CO2 %	H2S PPM	COS PPM	SO2 PPM
Outlet	0630	15.76	0.11	52.75	ND	22.86	8.47	518.8	52.2	2.7
Inlet	0630	16.05	0.09	52.52	ND	22.90	8.38	648.7	78.1	2.3
Outlet	0730	15.88	0.08	52.60	ND	22.92	8.47	501.8	43.0	ND
Outlet	0830	15.87	0.08	52.68	ND	22.85	8.46	510.6	48.8	1.6
Outlet	0930	16.07	0.08	52.59	ND	22.75	8.45	554.5	55.8	1.3
Outlet	1030	15.96	0.07	52.59	ND	22.85	8.47	552.1	56.4	1.6
Inlet	1030	16.03	0.08	52.47	ND	22.96	8.39	616.3	78.4	1.2
Outlet	1130	15.96	0.12	52.75	ND	22.90	8.21	554.8	53.1	2.1
Outlet	1230	16.12	0.07	52.49	ND	22.90	8.37	548.7	56.3	1.9
Outlet	1330	16.03	0.06	52.58	ND	22.84	8.43	588.1	62.2	1.1
Outlet	1430	15.82	0.07	52.81	ND	22.88	8.36	590.3	60.6	1.8
Inlet	1430	15.80	0.07	52.76	ND	22.97	8.32	668.4	75.4	2.1

High Pressure Hot Gas Desulfurization Lab Gas Analysis

ZTSC-08-S1 January 26, 1993

Normalized to 100

Loca.	Time	H2 %	O2 %	N2 %	CH4 %	CO %	CO2 %	H2S PPM	COS PPM	SO2 PPM
Outlet	1015	19.23	0.08	67.98	ND	2.35	10.37	29.9	ND	ND
Outlet	1030	16.65	0.08	51.89	ND	22.24	9.13	57.2	6.9	ND
Outlet	1100	15.95	1.12	53.08	ND	21.11	8.73	124.1	12.5	2.2
Inlet	1100	16.09	0.09	52.12	ND	22.86	8.67	1515.7	154.1	2.8
Outlet	1200	16.37	0.08	51.97	ND	22.41	9.13	385.0	34.0	2.1
Outlet	1300	16.08	0.08	52.10	ND	22.53	9.14	624.3	63.8	ND
Outlet	1400	16.33	0.07	52.05	ND	22.51	8.94	815.1	72.9	1.3
Outlet	1830	16.24	0.09	52.13	ND	22.81	8.61	1135.8	81.4	1.3
Inlet	1830	15.92	0.07	52.48	ND	22.92	8.44	1504.3	118.3	1.7
Outlet	1930	16.14	0.08	52.23	ND	22.67	8.74	1217.8	79.9	2.4
Outlet	2030	16.35	0.10	52.21	ND	22.65	8.56	1267.1	77.7	1.7
Outlet	2130	16.28	0.09	52.24	ND	22.60	8.65	1287.2	71.3	1.4
Outlet	2230	16.30	0.08	52.19	ND	22.62	8.67	1358.8	77.9	1.9
Inlet	2230	16.09	0.09	52.27	ND	22.87	8.50	1686.5	93.0	2.5
Outlet	2330	16.18	0.08	52.29	ND	22.73	8.59	1258.3	82.4	2.2
Outlet	0030	16.27	0.08	52.16	ND	22.69	8.66	1338.7	82.6	1.5
Outlet	0130	16.26	0.08	52.20	ND	22.68	8.65	1366.7	86.6	2.0
Outlet	0230	16.27	0.09	52.15	ND	22.75	8.59	1356.0	87.6	1.3
Inlet	0230	15.86	0.55	52.75	ND	22.38	8.29	1609.9	108.6	2.7
Outlet	0330	15.94	0.08	52.31	ND	22.85	8.68	1425.1	88.5	1.4
Outlet	0430	16.15	0.08	52.15	ND	22.84	8.61	1495.3	83.4	1.6
Outlet	0530	16.17	0.07	52.12	ND	22.86	8.62	1489.4	98.9	1.8
Outlet	0630	16.25	0.07	52.09	ND	22.83	8.60	1578.1	99.1	1.9
Inlet	0630	16.18	0.08	52.07	ND	22.98	8.50	1693.5	88.1	1.7
Outlet	0730	15.95	0.07	52.43	ND	22.85	8.53	1595.8	87.4	1.3
Outlet	0830	16.46	0.08	51.95	ND	22.68	8.65	1645.5	107.9	1.8
Outlet	0930	16.13	0.08	52.09	ND	22.87	8.66	1623.3	93.9	1.4

Loca.	Time	H2 %	O2 %	N2 %	CH4 %	CO %	CO2 %	H2S PPM	COS PPM	SO2 PPM
Outlet	1030	16.28	0.08	52.08	ND	22.88	8.51	1621.8	109.5	3.3
Inlet	1033	16.04	0.08	52.19	ND	23.07	8.44	1723.8	93.9	ND
Outlet	1130	15.98	0.08	52.30	ND	22.95	8.48	2042.3	114.2	1.4
Outlet	1200	15.94	0.17	52.39	ND	22.91	8.40	1843.2	108.4	2.6
Inlet	1200	12.13	5.54 R	59.09	ND	16.83	6.27	1296.6	106.0	12.8

A Possible Air in sample *off M*

APPENDIX F
Detector Tube Results

During testing, detector tubes were utilized as a quick indicator of hydrogen sulfide and sulfur dioxide concentration in the exit gas stream. These determinations are only estimates of the actual concentrations and are used primarily as an indicator for the completion of a test phase. It is noted that Gastec detector tubes have a reported precision of $\pm 25\%$ full scale. The analyses for each sample are provided on a dry gas basis.

Single Cycle Tests - ZTSC-01 Sulfidation 1

September 15, 1992 Test time: 4:35-8:08 (Test duration: 3:33)

Detector Tube Readings - ppm Hydrogen Sulfide

Test start time: 4:35

Time	Elapsed Time	Inlet ppm	Time	Elapsed Time	Outlet ppm
4:42	0:07	1000	4:42	0:07	10
5:36	1:01	1150	4:55	0:20	18
6:05	1:30	1000	5:11	0:36	21
7:52	3:17	1050	5:26	0:51	47
8:06	3:31	690	5:36	1:01	46
			5:50	1:15	88
			6:06	1:31	110
			6:20	1:45	190
			6:36	2:01	250
			6:51	2:16	310
			7:06	2:31	390
			7:21	2:46	410
			7:36	3:01	500
			7:51	3:16	550
			8:06	3:31	690

Single Cycle Tests - ZTSC-02 Sulfidation 1

September 4, 1992 Test time: 11:30-19:45 (Test duration: 8:15)

Detector Tube Readings - ppm Hydrogen Sulfide

Test start time: 11:30

Time	Elapsed Time	Inlet ppm	Time	Elapsed Time	Outlet ppm
11:36	0.10	1000	11:36	0.10	35
13:01	1.52	1000	11:47	0.28	28
19:41	8.18	950	12:01	0.52	22
			12:16	0.77	20
			12:31	1.02	19
			13:01	1.52	17
			13:31	2.02	18
			14:01	2.52	25
			14:31	3.02	25
			15:01	3.52	32
			15:31	4.02	47
			16:01	4.52	56
			16:31	5.02	90
			17:01	5.52	150
			17:31	6.02	250
			17:45	6.25	350
			18:01	6.52	375
			18:15	6.75	400
			18:31	7.02	450
			18:45	7.25	475
			19:03	7.55	525
			19:21	7.85	550
			19:31	8.02	600
			19:42	8.20	600

Single Cycle Tests - ZTSC-03 Sulfidation 1

September 9, 1992 Test time: 1:00-10:05 (Test duration: 9:05)

Detector Tube Readings - ppm Hydrogen Sulfide

Test start time: 1:00

Time	Elapsed Time	Inlet ppm
1:36	0.60	950
2:31	1.52	1050
10:04	9.07	1100

Time	Elapsed Time	Outlet ppm
1:07	0.12	15
1:16	0.27	18
1:31	0.52	18
1:46	0.77	18
2:01	1.02	18
2:32	1.53	20
3:01	2.02	25
3:31	2.52	38
4:01	3.02	55
4:31	3.52	55
5:01	4.02	95
5:33	4.55	140
6:01	5.02	185
6:32	5.53	230
7:02	6.03	310
7:32	6.53	400
8:01	7.02	425
8:32	7.53	500
9:01	8.02	550
9:32	8.53	575
10:01	9.02	610

Single Cycle Tests - ZTSC-04 Sulfidation 1

September 10, 1992 Test time: 14:00-14:23, 15:00-21:33 (Test duration: 6:56)

Detector Tube Readings - ppm Hydrogen Sulfide

Test start time: 14:00

Time	Elapsed Time	Inlet ppm	Time	Elapsed Time	Outlet ppm
14:12	0.20	1600	14:11	0.18	18
14:15	0.25	3200	15:06	0.48	14
14:18	0.30	3200	15:21	0.73	15
14:21	0.35	3200	15:31	0.90	21
15:07	0.50	1050	15:46	1.15	27
16:32	1.92	1150	16:01	1.40	36
21:33	6.93	1100	17:01	2.40	104
			17:31	2.90	160
			18:01	3.40	230
			18:31	3.90	375
			18:45	4.13	375
			19:01	4.40	400
			19:31	4.90	400
			20:01	5.40	500
			20:16	5.65	500
			20:31	5.90	500
			20:45	6.13	500
			21:01	6.40	550
			21:15	6.63	575
			21:32	6.92	600

Single Cycle Tests - ZTSC-05 Sulfidation 1

September 15, 1992 Test time: 11:00-18:34 (Test duration: 7:34)

Detector Tube Readings - ppm Hydrogen Sulfide

Test start time: 11:00

Time	Elapsed Time	Inlet ppm	Time	Elapsed Time	Outlet ppm
11:07	0.12	425	11:08	0.13	11
11:09	0.15	750	11:15	0.25	11
12:32	1.53	1100	11:31	0.52	13
18:32	7.53	1100	11:46	0.77	13
			12:01	1.02	13
			12:33	1.55	15
			13:01	2.02	17
			14:01	3.02	24
			14:31	3.52	32
			15:01	4.02	47
			15:33	4.55	62
			16:01	5.02	115
			16:31	5.52	240
			17:01	6.02	400
			17:15	6.25	425
			17:31	6.52	475
			17:45	6.75	525
			18:01	7.02	575
			18:15	7.25	600
			18:33	7.55	650

Single Cycle Tests - ZTSC-06 Sulfidation 1

Test time: 9:00 (September 17, 1992) - 6:05 (September 19, 1992) Test duration: 45:05

Detector Tube Readings - ppm Hydrogen Sulfide

Test start time: 9:00

Time	Elapsed Time	Inlet ppm	Time	Elapsed Time	Outlet ppm
9:06	0.10	300	9:07	0.12	1
9:08	0.13	700	9:16	0.27	5
10:31	1.52	625	9:31	0.52	5
12:31	3.52	800	9:46	0.77	7
14:02	5.03	750	10:01	1.02	9
14:31	5.52	850	10:32	1.53	10
15:03	6.05	850	11:02	2.03	10
15:33	6.55	800	11:31	2.52	10
16:03	7.05	800	12:01	3.02	18
16:33	7.55	800	12:32	3.53	12
17:02	8.03	850	13:01	4.02	12
17:33	8.55	850	13:31	4.52	12
18:02	9.03	850	14:01	5.02	14
18:33	9.55	850	14:33	5.55	14
19:03	10.05	800	15:01	6.02	15
19:33	10.55	850	15:31	6.52	14
20:03	11.05	850	16:01	7.02	13
20:33	11.55	800	16:32	7.53	14
21:03	12.05	850	17:01	8.02	18
21:33	12.55	900	17:31	8.52	14
22:03	13.05	850	18:00	9.00	14
22:33	13.55	1100	18:31	9.52	15
22:37	13.62	850	19:01	10.02	13
23:03	14.05	900	19:31	10.52	15
23:33	14.55	800	20:01	11.02	16
0:03	15.05	800	20:31	11.52	18
1:03	16.05	800	21:01	12.02	16
1:33	16.55	800	21:31	12.52	16
2:01	17.02	800	22:01	13.02	16
2:33	17.55	825	22:31	13.52	16
3:02	18.03	800	23:01	14.02	16
3:33	18.55	825	23:31	14.52	18
4:02	19.03	800	0:01	15.02	20
4:33	19.55	775	0:31	15.52	20
5:02	20.03	775	1:01	16.02	22
5:33	20.55	800	1:31	16.52	24
6:03	21.05	800	2:00	17.00	24

Single Cycle Tests - ZTSC-06 Sulfidation 1

Test time: 9:00 (September 17, 1992) - 6:05 (September 19, 1992) Test duration: 45:05

Detector Tube Readings - ppm Hydrogen Sulfide

Test start time: 9:00

Time	Elapsed Time	Inlet ppm	Time	Elapsed Time	Outlet ppm
6:33	21.55	800	2:31	17.52	25
7:03	22.05	750	3:01	18.02	27
7:33	22.55	800	3:31	18.52	29
8:02	23.03	750	4:01	19.02	32
8:33	23.55	750	4:31	19.52	34
9:03	24.05	750	5:00	20.00	34
9:33	24.55	750	5:31	20.52	39
10:03	25.05	750	6:01	21.02	43
10:33	25.55	825	6:31	21.52	46
11:04	26.07	800	7:01	22.02	50
11:33	26.55	800	7:31	22.52	55
12:03	27.05	800	8:01	23.02	65
13:03	28.05	750	8:31	23.52	68
14:03	29.05	750	9:01	24.02	80
15:10	30.17	850	9:31	24.52	100
16:03	31.05	775	10:01	25.02	115
17:03	32.05	800	10:31	25.52	125
18:03	33.05	775	11:02	26.03	145
19:03	34.05	800	11:31	26.52	155
20:03	35.05	775	12:01	27.02	170
21:03	36.05	750	12:31	27.52	180
22:05	37.08	775	13:01	28.02	190
23:03	38.05	800	13:31	28.52	210
0:03	39.05	775	14:01	29.02	220
1:03	40.05	775	14:31	29.52	230
2:03	41.05	775	15:01	30.02	230
3:03	42.05	775	15:31	30.52	250
4:03	43.05	750	16:01	31.02	260
5:03	44.05	750	16:31	31.52	290
6:02	45.03	800	17:01	32.02	290
			17:31	32.52	280
			18:01	33.02	290
			18:31	33.52	350
			19:01	34.02	320
			19:31	34.52	340
			20:01	35.02	340
			20:31	35.52	350

Single Cycle Tests - ZTSC-06 Sulfidation 1

Test time: 9:00 (September 17, 1992) - 6:05 (September 19, 1992) Test duration: 45:05

Detector Tube Readings - ppm Hydrogen Sulfide

Test start time: 9:00

Time	Elapsed Time	Inlet ppm	Time	Elapsed Time	Outlet ppm
			21:01	36.02	340
			21:31	36.52	370
			22:01	37.02	350
			22:31	37.52	380
			23:01	38.02	360
			23:31	38.52	380
			0:01	39.02	380
			0:31	39.52	380
			1:01	40.02	380
			1:31	40.52	390
			2:01	41.02	400
			2:31	41.52	400
			3:01	42.02	410
			3:31	42.52	420
			4:01	43.02	400
			4:31	43.52	430
			5:01	44.02	420
			5:31	44.52	440
			6:01	45.02	440

Single Cycle Tests - ZTSC-07 Sulfidation 1

Test time: 12:45 (September 22, 1992) - 18:20 (September 23, 1992) Test duration: 29:35

Detector Tube Readings - ppm Hydrogen Sulfide

Test start time: 12:45

Time	Elapsed Time	Inlet ppm	Time	Elapsed Time	Outlet ppm
13:03	0.30	950	12:51	0.10	5
13:50	1.08	900	13:01	0.27	5
14:16	1.52	875	13:16	0.52	5
14:48	2.05	850	13:31	0.77	5
15:48	3.05	875	14:46	2.02	7
16:48	4.05	875	15:46	3.02	7
17:48	5.05	875	16:46	4.02	8
18:48	6.05	900	17:46	5.02	10
19:48	7.05	850	18:46	6.02	10
20:48	8.05	850	19:46	7.02	22
21:48	9.05	875	20:46	8.02	17
22:48	10.05	875	21:46	9.02	23
23:48	11.05	875	22:46	10.02	29
0:48	12.05	850	23:46	11.02	40
1:48	13.05	850	0:46	12.02	50
2:48	14.05	825	1:46	13.02	65
3:48	15.05	850	2:46	14.02	90
4:48	16.05	800	3:46	15.02	100
5:48	17.05	825	4:46	16.02	135
6:48	18.05	825	5:46	17.02	150
7:48	19.05	850	6:46	18.02	175
8:48	20.05	825	7:46	19.02	210
9:48	21.05	800	8:46	20.02	245
10:48	22.05	850	9:47	21.03	290
11:48	23.05	875	10:47	22.03	340
12:48	24.05	875	11:47	23.03	350
13:50	25.08	875	12:46	24.02	350
14:48	26.05	875	13:48	25.05	350
15:48	27.05	875	14:46	26.02	475
16:48	28.05	875	15:46	27.02	450
17:48	29.05	850	16:46	28.02	425
18:16	29.52	875	17:46	29.02	500
			18:14	29.48	450

Single Cycle Tests - ZTSC-07 Regeneration 1

September 24, 1992 Test time: 0:45-10:26 (Test duration: 9:41)

Detector Tube Readings - % Sulfur Dioxide

Test start time: 0:45

Time	Elapsed Time	Outlet %
	0:52	0.12
	1:06	0.35
	1:17	0.53
	1:32	0.78
	1:48	1.05
	2:17	1.53
	2:31	1.77
	2:47	2.03
	3:01	2.27
	3:16	2.52
	3:31	2.77
	3:46	3.02
	4:00	3.25
	4:16	3.52
	4:31	3.77
	4:46	4.02
	5:02	4.28
	5:17	4.53
	5:30	4.75
	5:47	5.03
	6:00	5.25
	6:16	5.52
	6:30	5.75
	6:46	6.02
	7:01	6.27
	7:16	6.52
	7:31	6.77
	7:46	7.02
	8:02	7.28
	8:16	7.52
	8:30	7.75
	8:47	8.03
	9:00	8.25
	9:16	8.52
	9:46	9.02
	10:01	9.27
	10:16	9.52
	10:17	9.53

Single Cycle Tests - ZTSC-07 Sulfidation 2

Test time: 1:30-9:14, 10:15- (September 25, 1992) - 3:50 (September 26, 1992) Duration: 25:19

Detector Tube Readings - ppm Hydrogen Sulfide

Test start time: 1:30

Time	Elapsed Time	Inlet ppm	Time	Elapsed Time	Outlet ppm
			1:36	0.10	20
1:48	0.30	575	1:46	0.27	7
2:18	0.80	842	2:01	0.52	7
3:03	1.55	800	2:16	0.77	7
3:33	2.05	775	2:31	1.02	7
4:33	3.05	850	2:46	1.27	11
5:33	4.05	800	3:01	1.52	8
6:33	5.05	800	3:31	2.02	5
7:33	6.05	825	4:31	3.02	7
8:33	7.05	800	5:31	4.02	5
10:48	8.28	775	6:31	5.02	5
11:48	9.28	825	7:31	6.02	5
12:50	10.32	775	8:32	7.03	5
13:49	11.30	850	10:46	8.25	5
14:48	12.28	800	11:46	9.25	6
15:49	13.30	825	12:46	10.25	5
16:48	14.28	800	13:46	11.25	5
17:48	15.28	800	14:46	12.25	9
18:49	16.30	850	15:47	13.27	10
19:48	17.28	875	16:46	14.25	18
20:49	18.30	875	17:46	15.25	47
21:49	19.30	850	18:46	16.25	48
22:48	20.28	925	19:48	17.28	96
23:48	21.28	825	20:46	18.25	84
0:48	22.28	825	21:48	19.28	150
1:47	23.27	825	22:46	20.25	140
2:48	24.28	800	23:46	21.25	180
3:48	25.28	825	0:46	22.25	195
			1:51	23.33	300
			2:46	24.25	375
			3:46	25.25	325

Single Cycle Tests - ZTSC-07 Regeneration 2

September 28, 1992 Test time: 14:15 - 18:49 (Test duration: 4:34)

Detector Tube Readings - % Sulfur Dioxide

Test start time: 14:15

Time	Elapsed Time	Outlet %
14:25	0.17	0.275
14:31	0.27	1.2
14:46	0.52	1.1
15:02	0.78	1.3
15:17	1.03	0.9
15:48	1.55	1.3
16:17	2.03	1
17:17	3.03	1.4
17:47	3.53	1
18:17	4.03	0.0795
18:31	4.27	0.0225
18:46	4.52	0.01

Single Cycle Tests - ZTSC-07 Regeneration 3

October 2, 1992 Test time: 8:30-14:18 (Test duration: 5:48)

Detector Tube Readings - % Sulfur Dioxide

Time	Elapsed Time	Outlet (%)
		8:30
8:36	0.10	1
8:46	0.27	1.2
9:01	0.52	1
9:16	0.77	1
9:31	1.02	1
10:31	2.02	1.1
11:30	3.00	1.1
12:30	4.00	0.9
13:32	5.03	0.0625
14:02	5.53	0.0075
14:15	5.75	0.002

Multi-Cycle Tests - ZTMC-01 Sulfidation 1

October 6, 1992 Test time: 9:00-18:05 (Test duration: 9:05)

Detector Tube Readings - ppm Hydrogen Sulfide

Test start time: 9:00

Time	Elapsed Time	Inlet ppm	Time	Elapsed Time	Outlet ppm
9:18	0.30	1000	9:06	0.10	0
10:03	1.05	1050	9:16	0.27	0
10:32	1.53	1150	9:31	0.52	0
11:03	2.05	1100	9:46	0.77	0
12:03	3.05	1150	10:01	1.02	0
13:03	4.05	1200	11:01	2.02	0
14:04	5.07	1250	12:01	3.02	0
15:03	6.05	1150	13:01	4.02	5
16:03	7.05	1125	14:02	5.03	7
17:03	8.05	1175	15:01	6.02	10
18:05	9.08	1150	16:01	7.02	33
18:05	9.08	1150	17:02	8.03	50
			18:03	9.05	170

Multi-Cycle Tests - ZTMC-01 Regeneration 1

October 6, 1992 Test time: 20:00-22:12 (Test duration: 2:12)

Detector Tube Readings - % Sulfur Dioxide

Test start time: 20:00

Time	Elapsed Time	Outlet (%)
20:16	0.27	1.2
20:31	0.52	1.9
20:48	0.80	1.7
21:05	1.08	1.7
21:31	1.52	1.2
22:03	2.05	0.01

Multi-Cycle Tests - ZTMC-01 Sulfidation 2

October 7, 1992 Test time: 1:00-13:10 (Test duration: 12:10)

Detector Tube Readings - ppm Hydrogen Sulfide

Test start time: 1:00

Time	Elapsed Time	Inlet ppm	Time	Elapsed Time	Outlet ppm
2:32	1.53	850	1:06	0.10	5
3:03	2.05	1000	1:16	0.27	30
4:03	3.05	1050	1:31	0.52	25
5:03	4.05	1050	1:46	0.77	20
6:03	5.05	1100	2:01	1.02	21
7:03	6.05	1100	2:33	1.55	18
8:03	7.05	1050	3:01	2.02	12
9:03	8.05	1050	3:30	2.50	12
10:03	9.05	1100	4:01	3.02	15
11:03	10.05	1100	4:30	3.50	15
12:03	11.05	1150	5:01	4.02	21
13:08	12.13	1175	5:30	4.50	19
13:08	12.13	1175	6:01	5.02	15
			6:34	5.57	18
			7:01	6.02	15
			7:30	6.50	23
			8:01	7.02	28
			8:30	7.50	18
			9:01	8.02	22
			9:30	8.50	28
			10:01	9.02	28
			10:30	9.50	42
			11:01	10.02	39
			11:30	10.50	51
			12:01	11.02	60
			12:31	11.52	72
			13:01	12.02	116

Multi-Cycle Tests - ZTMC-01 Regeneration 2

October 7, 1992 Test time: 18:00-23:05 (Test duration: 5:05)

Detector Tube Readings - % Sulfur Dioxide

Time	Elapsed Time	Outlet (%)
		18:00
18:16	0.27	0.2
18:31	0.52	0.7
18:46	0.77	0.8
19:02	1.03	1
19:31	1.52	1.1
20:01	2.02	1
20:31	2.52	1
21:02	3.03	0.8
22:02	4.03	0.17
22:32	4.53	0.0225
23:01	5.02	0.0032

Multi-Cycle Tests - ZTMC-01 Sulfidation 3

October 8, 1992 Test time: 3:00-18:03 (Test duration: 15:03)

Detector Tube Readings - ppm Hydrogen Sulfide

Test start time: 3:00

Time	Elapsed Time	Inlet ppm	Time	Elapsed Time	Outlet ppm
3:18	0.30	400	3:06	0.10	0
4:03	1.05	800	3:16	0.27	11
4:31	1.52	850	3:31	0.52	7
5:03	2.05	900	3:46	0.77	7
6:03	3.05	950	4:01	1.02	7
7:03	4.05	950	4:33	1.55	7
8:03	5.05	1000	5:01	2.02	7
9:03	6.05	950	5:30	2.50	7
10:03	7.05	950	6:01	3.02	7
11:03	8.05	1000	6:35	3.58	7
12:03	9.05	1000	7:01	4.02	9
13:03	10.05	1125	7:30	4.50	9
14:02	11.03	1125	8:01	5.02	7
15:03	12.05	1125	8:30	5.50	7
16:02	13.03	975	9:01	6.02	7
17:03	14.05	975	9:33	6.55	7
18:03	15.05	1000	10:01	7.02	7
			10:30	7.50	7
			11:01	8.02	9
			11:31	8.52	7
			12:01	9.02	11
			13:02	10.03	10
			14:01	11.02	23
			15:02	12.03	32
			15:43	12.72	45
			16:01	13.02	48
			16:30	13.50	62
			17:01	14.02	72
			17:30	14.50	92
			18:02	15.03	104

Multi-Cycle Tests - ZTMC-01 Regeneration 3

Test time: 20:00 (October 8, 1992) - 2:00 (October 9, 1992) Test duration: 6:00

Detector Tube Readings - % Sulfur Dioxide

Test start time: 20:00

Time	Elapsed Time	Outlet (%)
20:12	0.20	0
20:16	0.27	1
20:31	0.52	1
20:46	0.77	1.1
21:00	1.00	1.2
21:31	1.52	1.1
22:01	2.02	1.1
22:31	2.52	1.1
23:01	3.02	1.1
23:32	3.53	0.9
0:01	4.02	0.7
0:31	4.52	0.5
1:01	5.02	0.14
1:31	5.52	0.04
2:02	6.03	0.004

Multi-Cycle Tests - ZTMC-01 Sulfidation 4

October 9, 1992 Test time: 4:00-22:16 (Test duration: 18:16)

Detector Tube Readings - ppm Hydrogen Sulfide

Test start time: 4:00

Time	Elapsed Time	Inlet ppm	Time	Elapsed Time	Outlet ppm
4:18	0.30	200	4:06	0.10	5
5:03	1.05	700	4:16	0.27	5
5:31	1.52	800	4:31	0.52	7
6:03	2.05	900	4:46	0.77	7
7:03	3.05	1050	5:01	1.02	7
8:03	4.05	1200	6:01	2.02	5
9:03	5.05	1000	7:01	3.02	5
10:03	6.05	1000	8:01	4.02	5
11:03	7.05	950	9:01	5.02	5
12:02	8.03	1050	10:01	6.02	4
13:03	9.05	1025	11:01	7.02	4
14:03	10.05	1025	12:01	8.02	6
15:03	11.05	1025	13:02	9.03	8
16:03	12.05	1100	14:02	10.03	9
17:04	13.07	1025	15:01	11.02	11
18:04	14.07	1125	16:02	12.03	15
19:03	15.05	1025	17:03	13.05	25
20:05	16.08	1100	18:01	14.02	19
21:03	17.05	1050	19:02	15.03	34
22:03	18.05	1175	20:03	16.05	42
			20:30	16.50	61
			21:02	17.03	52
			21:30	17.50	84
			22:01	18.02	98
			22:16	18.27	120
			22:16	18.27	120

Multi-Cycle Tests - ZTMC-02 Sulfidation 1

Test time: 1:00 (October 14, 1992) - 0:03 (October 15, 1992) Test duration: 23:03

Detector Tube Readings - ppm Hydrogen Sulfide

Test start time: 1:00

Time	Elapsed Time	Inlet ppm	Time	Elapsed Time	Outlet ppm
1:18	0.30	1200	1:06	0.10	18
2:03	1.05	1300	1:16	0.27	44
2:31	1.52	1300	1:31	0.52	37
3:03	2.05	1300	1:46	0.77	35
4:03	3.05	1400	2:01	1.02	30
5:03	4.05	1300	2:33	1.55	28
6:03	5.05	1300	3:01	2.02	28
7:03	6.05	1300	4:01	3.02	25
8:03	7.05	1400	5:01	4.02	28
9:03	8.05	1300	6:01	5.02	30
10:03	9.05	1300	7:01	6.02	31
11:03	10.05	1300	8:01	7.02	43
12:04	11.07	1300	9:01	8.02	55
13:02	12.03	1350	10:01	9.02	70
14:03	13.05	1350	11:01	10.02	90
15:08	14.13	1300	12:02	11.03	110
16:03	15.05	1450	13:01	12.02	122
17:03	16.05	1575	14:01	13.02	165
18:03	17.05	1300	15:06	14.10	205
19:03	18.05	1275	16:02	15.03	230
20:03	19.05	1325	17:02	16.03	350
21:03	20.05	1300	18:01	17.02	375
0:03	23.05	1225	19:02	18.03	400
			20:02	19.03	475
			21:02	20.03	525
			21:31	20.52	540
			22:03	21.05	550
			21:31	20.52	540
			22:03	21.05	550
			22:31	21.52	550
			23:30	22.50	590
			0:01	23.02	600

Multi-Cycle Tests - ZTMC-02 Regeneration 1

October 15, 1992 Test time: 3:00-8:13 (Test duration: 5:13)

Detector Tube Readings - % Sulfur Dioxide

Test start time: 3:00

Time	Elapsed Time	Outlet (%)
3:06	0.10	2.1
3:16	0.27	4.2
3:31	0.52	3.5
3:46	0.77	4
4:01	1.02	3.8
5:01	2.02	3.9
6:01	3.02	4.2
7:01	4.02	1.6
7:30	4.50	0.19
8:01	5.02	0.01
8:03	5.05	0.005

Multi-Cycle Tests - ZTMC-02 Sulfidation 2

Test time: 18:00 (October 15, 1992) - 18:03 (October 16, 1992) Test duration: 24:03

Detector Tube Readings - ppm Hydrogen Sulfide

Test start time: 18:00

Time	Elapsed Time	Inlet ppm	Time	Elapsed Time	Outlet ppm
18:12	0.20	0	18:17	0.28	17
18:33	0.55	0	18:31	0.52	36
18:51	0.85	0	18:47	0.78	30
19:07	1.12	775	19:01	1.02	19
20:03	2.05	1100	20:02	2.03	20
21:03	3.05	1125	21:01	3.02	14
22:03	4.05	1525	22:02	4.03	17
23:03	5.05	1200	23:02	5.03	17
0:03	6.05	1200	0:02	6.03	13
1:03	7.05	850	1:01	7.02	20
2:03	8.05	1200	2:02	8.03	12
3:03	9.05	1200	3:02	9.03	27
4:03	10.05	1300	4:01	10.02	31
5:03	11.05	1300	5:01	11.02	40
6:03	12.05	1200	6:02	12.03	65
7:03	13.05	1250	7:02	13.03	65
8:03	14.05	1250	8:02	14.03	98
9:03	15.05	1200	9:02	15.03	105
10:03	16.05	1250	10:02	16.03	175
11:03	17.05	1250	11:02	17.03	175
12:03	18.05	1275	12:02	18.03	275
13:04	19.07	1275	13:02	19.03	200
14:03	20.05	1375	14:02	20.03	400
15:05	21.08	1400	15:03	21.05	258
16:03	22.05	1350	16:02	22.03	475
17:04	23.07	1350	17:03	23.05	450
18:03	24.05	1350	17:30	23.50	575
			18:01	24.02	600

Multi-Cycle Tests - ZTMC-02 Regeneration

October 19, 1992 Test time: 12:30 - 16:45

Detector Tube Readings - % Sulfur Dioxide

Test start time: 12:30

Time	Elapsed Time	Outlet (%)
12:47	0.28	0.5
13:01	0.52	1
13:16	0.77	1.1
13:31	1.02	1.1
14:32	2.03	1.4
15:32	3.03	0.5
16:32	4.03	0.001

Multi-Cycle Tests - ZTMC-02 Sulfidation 3

20:00 (October 19, 1992) - 14:05 (October 20, 1992) Test duration: 18:05

Detector Tube Readings- ppm Hydrogen Sulfide

Test start time: 20:00

Time	Elapsed Time	Inlet ppm	Time	Elapsed Time	Outlet ppm
20:18	0.30	875	20:17	0.28	120
21:31	1.52	1050	20:31	0.52	140
0:04	4.07	1175	20:46	0.77	30
4:03	8.05	1250	21:01	1.02	85
8:03	12.05	1250	22:01	2.02	130
12:03	16.05	1300	23:01	3.02	40
14:03	18.05	1075	0:03	4.05	250
			1:02	5.03	600
			2:01	6.02	350
			3:01	7.02	375
			4:02	8.03	500
			5:02	9.03	700
			6:02	10.03	850
			7:02	11.03	1000
			8:02	12.03	1000
			9:02	13.03	950
			10:02	14.03	1050
			11:02	15.03	850
			12:02	16.03	1100
			13:01	17.02	1075
			14:03	18.05	1075
			14:03	18.05	1075

Multi-Cycle Tests - ZTMC-04 Sulfidation 1

Test time: 21:00 (January 13, 1993) - 2:00 (January 15, 1993) Test duration: 29:00

Detector Tube Readings - ppm Hydrogen Sulfide

Test start time: 21:00

Time	Elapsed Time	Inlet ppm	Time	Elapsed Time	Outlet ppm
22:00	1.00	375	21:15	0.25	2
2:00	5.00	800	21:30	0.50	5
6:00	9.00	800	22:00	1.00	19
10:00	13.00	800	23:00	2.00	58
13:00	16.00	800	0:00	3.00	120
14:01	17.02	875	1:00	4.00	165
18:01	21.02	710	2:00	5.00	210
21:02	24.03	750	3:00	6.00	350
1:00	28.00	750	4:00	7.00	400
			5:00	8.00	450
			6:00	9.00	500
			7:00	10.00	550
			8:00	11.00	575
			9:00	12.00	600
			10:00	13.00	600
			11:00	14.00	645
			12:00	15.00	700
			13:00	16.00	650
			14:00	17.00	610
			15:00	18.00	675
			16:00	19.00	610
			17:00	20.00	600
			18:00	21.00	600
			18:03	21.05	600
			19:00	22.00	600
			20:00	23.00	600
			21:00	24.00	700
			22:00	25.00	600
			23:00	26.00	600
			0:00	27.00	625
			1:00	28.00	625
			2:00	29.00	625

Multi-Cycle Tests - ZTMC-04 Regeneration I

January 15, 1992 Test time: 5:00 - 20:33 (Test duration: 15:33)

Outlet Detector Tube Readings - % Sulfur Dioxide

Test start time: 5:00

Time	Elapsed Time	Outlet (%)
5:15	0:15	0.02
5:30	0:30	0.025
6:00	1:00	0.055
7:00	2:00	0.08
8:00	3:00	0.095
9:00	4:00	0.105
10:00	5:00	1.6
11:00	6:00	1.5
12:00	7:00	1.1
13:00	8:00	0.185
14:00	9:00	0.01
15:00	10:00	0.02
16:04	11:04	0.0017
17:00	12:00	0.002
18:00	13:00	0.0019
18:30	13:30	0.0034
19:00	14:00	0.0078
19:15	14:15	0.008
19:45	14:45	0.0063
20:00	15:00	0.0062
20:15	15:15	0.006
20:30	15:30	0.006

Multi-Cycle Tests - ZTMC-04 Sulfidation 2

Test time: 9:00 (January 19, 1993) - 7:05 (January 20, 1993) Test duration: 22:05

Detector Tube Readings - ppm Hydrogen Sulfide

Test start time:	9:00				
Time Elapsed	Time	Inlet	Time Elapsed	Time	Outlet
10:00	1.00	210	9:15	0.25	4
14:01	5.02	760	9:30	0.50	14
18:01	9.02	800	10:00	1.00	45
22:00	13.00	800	11:00	2.00	160
2:00	17.00	850	12:00	3.00	200
6:00	21.00	900	13:00	4.00	280
			14:00	5.00	350
			15:00	6.00	400
			16:00	7.00	490
			17:00	8.00	500
			18:00	9.00	520
			19:00	10.00	550
			20:00	11.00	600
			21:00	12.00	600
			22:00	13.00	600
			23:00	14.00	600
			0:00	15.00	600
			1:00	16.00	650
			2:00	17.00	650
			3:00	18.00	700
			4:00	19.00	750
			5:00	20.00	800
			6:00	21.00	800
			7:00	22.00	1200

Multi-Cycle Tests - ZTMC-04 Regeneration 2

Test time: 9:30 (January 20, 1992) - 5:03 (January 21, 1993) Test duration: 19:33

Outlet Detector Tube Readings - % Sulfur Dioxide

Test start time: 9:30

Time	Elapsed Time	Outlet (%)
9:45	0:15	0
10:00	0:30	0.0325
10:30	1:00	0.041
11:30	2:00	0.13
12:30	3:00	1.7
13:30	4:00	1.5
14:30	5:00	1.3
15:30	6:00	0.4
16:30	7:00	0.09
17:32	8:02	0.0055
18:00	8:30	0.0055
19:00	9:30	0.002
20:00	10:30	0.0006
21:00	11:30	0.0014
22:00	12:30	0.001
23:00	13:30	0.0065
0:00	14:30	0.006
1:00	15:30	0.0055
2:00	16:30	0.0055
3:00	17:30	0.0045
4:00	18:30	0.004
5:00	19:30	0.004

Multi-Cycle Tests - ZTMC-04 Sulfidation 3

Test time: 8:30 - 22:33, 23:30 (January 21, 1993) - 14:32 (January 22, 1993) Test duration: 29:05

Detector Tube Readings - ppm Hydrogen Sulfide

Test start time:	8:30				
Time Elapsed	Time	Inlet	Time Elapsed	Time	Outlet
9:30	1.00	500	8:45	0.25	47
13:45	5.25	780	9:00	0.50	130
17:31	9.02	850	9:30	1.00	200
21:34	13.07	800	10:30	2.00	300
2:30	17.05	850	11:30	3.00	350
6:30	21.05	800	12:30	4.00	400
10:30	25.05	775	13:30	5.00	400
14:31	29.07	750	14:30	6.00	480
			15:30	7.00	500
			16:30	8.00	450
			17:30	9.00	525
			18:30	10.00	600
			19:30	11.00	620
			20:30	12.00	610
			21:30	13.00	600
			22:30	14.00	600
			0:30	15.05	600
			1:30	16.05	650
			2:30	17.05	675
			3:30	18.05	750
			4:30	19.05	750
			5:30	20.05	775
			6:30	21.05	775
			7:30	22.05	780
			8:30	23.05	665
			9:30	24.05	700
			10:30	25.05	700
			11:30	26.05	700
			12:30	27.05	685
			13:30	28.05	700
			14:30	29.05	650

Single Cycle Tests - ZTSC-08 Sulfidation 1

Test time: 10:00-14:57, 17:30 - (January 26, 1993) - 11:53 (January 27, 1993) Test duration: 23:20

Detector Tube Readings - ppm Hydrogen Sulfide

Test start time:	10:00				
	Time Elapsed Time	Inlet	Time Elapsed Time	Outlet	
11:00	1.00	1300	10:15	0.25	25
			10:30	0.50	50
18:32	5.98	2000	11:00	1.00	80
18:34	6.02	1550	12:00	2.00	380
22:30	9.95	1400	13:00	3.00	700
2:30	13.95	1400	14:00	4.00	825
6:30	17.95	1400			
8:05	19.53	1500	18:30	5.95	1100
10:33	22.00	1500	19:30	6.95	1100
11:30	22.95	1725	20:30	7.95	1200
12:00	23.45	1700	21:30	8.95	1200
			22:30	9.95	1250
			23:30	10.95	1250
			0:30	11.95	1250
			1:30	12.95	1300
			2:30	13.95	1200
			3:30	14.95	1275
			4:30	15.95	1300
			5:30	16.95	1390
			6:30	17.95	1500
			7:30	18.95	1350
			8:30	19.95	1400
			9:30	20.95	1400
			10:30	21.95	1375
			11:30	22.95	1635
			12:00	23.45	1625

Multi-Cycle Tests - ZTMC-02 Regeneration 3

October 21, 1992 Test time: 1:00 - 6:03 (Test duration: 5:03)

Detector Tube Readings - % Sulfur Dioxide

Time	Elapsed Time	Outlet (%)
		1:00
1:18	0.30	1
1:31	0.52	1
1:46	0.77	1.1
2:02	1.03	1.1
3:01	2.02	1.1
4:01	3.02	1.1
4:30	3.50	0.8
5:01	4.02	0.2
5:15	4.25	0.08
5:31	4.52	0.025
5:45	4.75	0.011
6:02	5.03	0.0035

APPENDIX G
Porosity Plots

Cumulative percent porosity versus pore diameter plots are presented for the fresh and the reacted zinc titanate sorbent. Raw mercury porosimetry and nitrogen adsorption data have been retained in the project file.

Fresh L-3787M Zinc Titanate

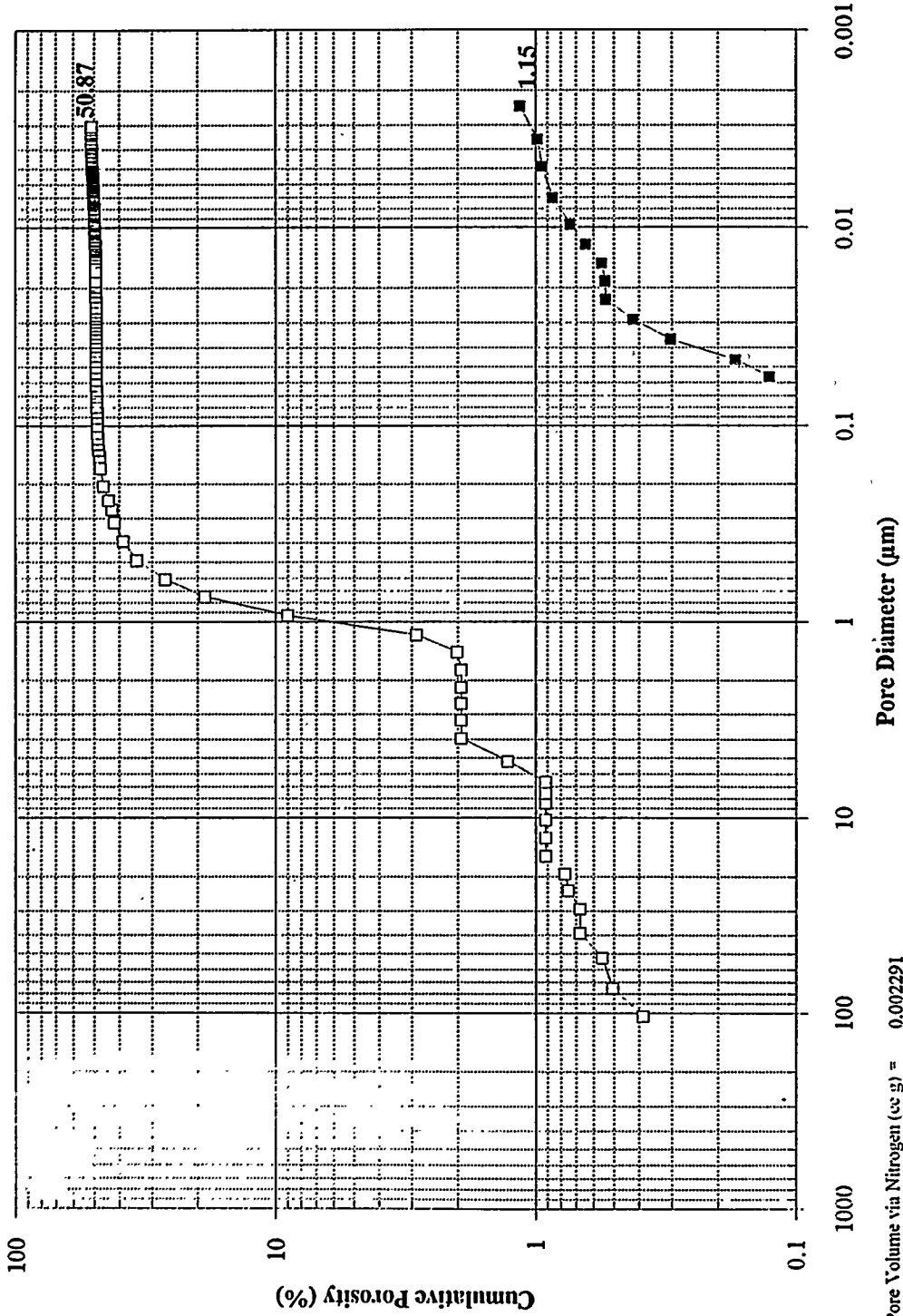

Total Pore Volume via Nitrogen (cc/g) = 0.002291

Total Pore Volume via Mercury (ml/g) = 0.2108

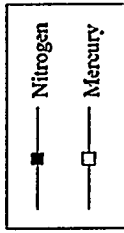

ZTSC-01-S1-B1
Top of Bed

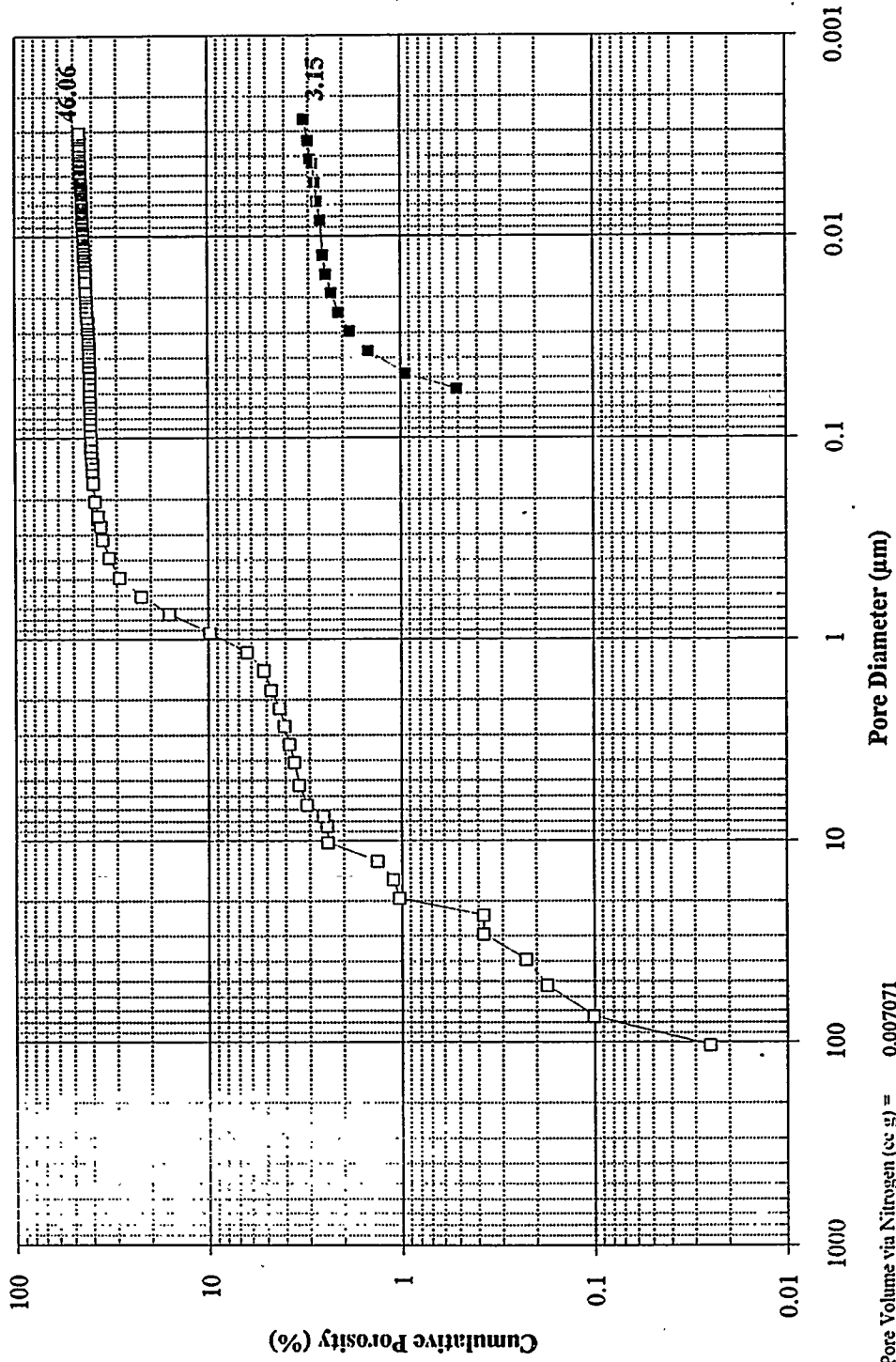

—■— Nitrogen
 —□— Mercury

Total Pore Volume via Nitrogen (cc/g) = 0.007071
 Total Pore Volume via Mercury (ml/g) = 0.1836

ZTSC-01-S1-B5
Middle of Bed

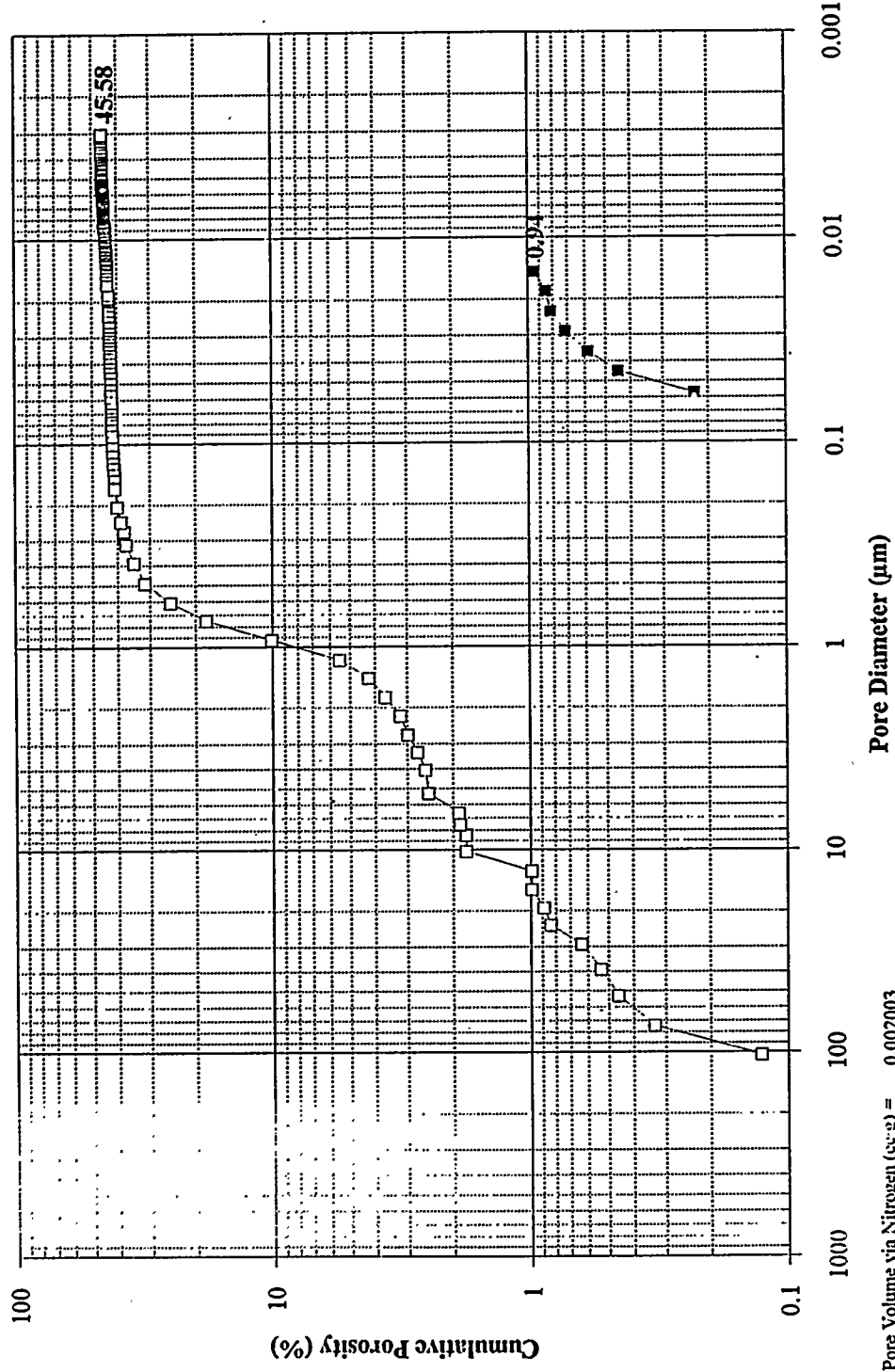

Total Pore Volume via Nitrogen (cc/g) = 0.002003

Total Pore Volume via Mercury (ml/g) = 0.1799

ZTSC-01-S1-B8
Bottom of Bed

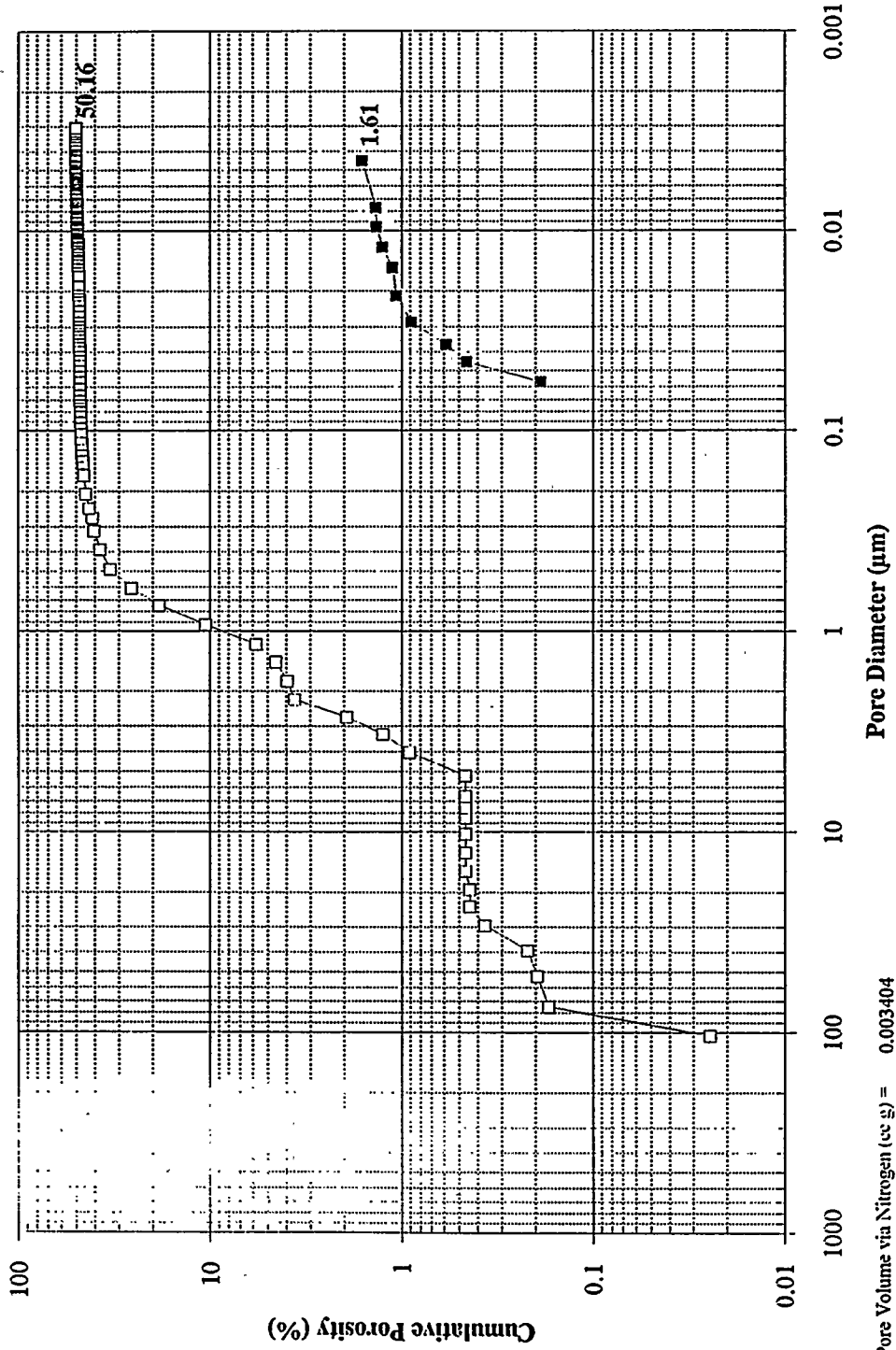

Total Pore Volume via Nitrogen (cc/g) = 0.003404

Total Pore Volume via Mercury (ml/g) = 0.2050

ZTSC-02-S1-B1
Top of Bed

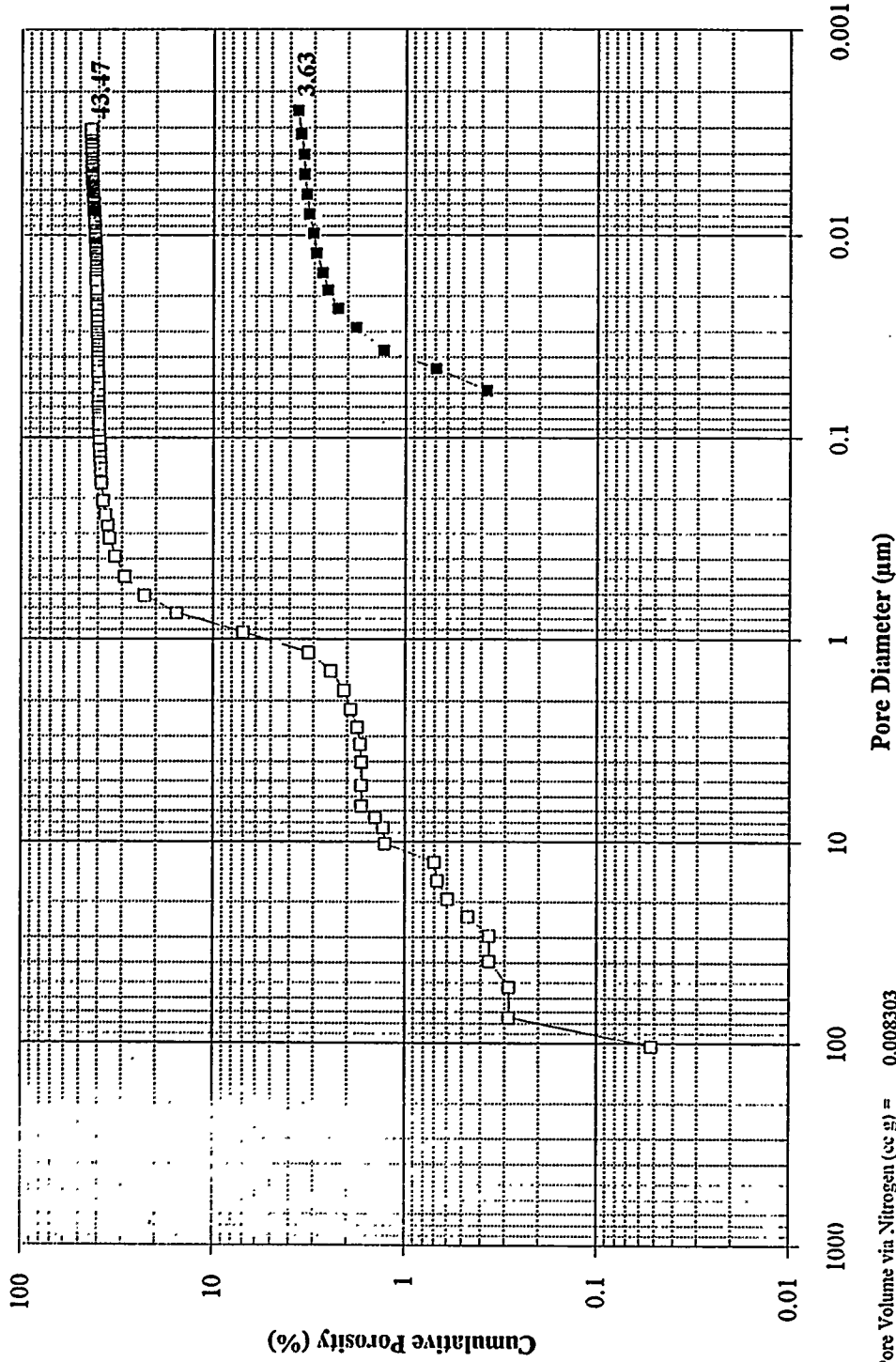

Total Pore Volume via Nitrogen (cc g) = 0.008303
 Total Pore Volume via Mercury (ml g) = 0.1679

ZTSC-02-S1-B5
Middle of Bed

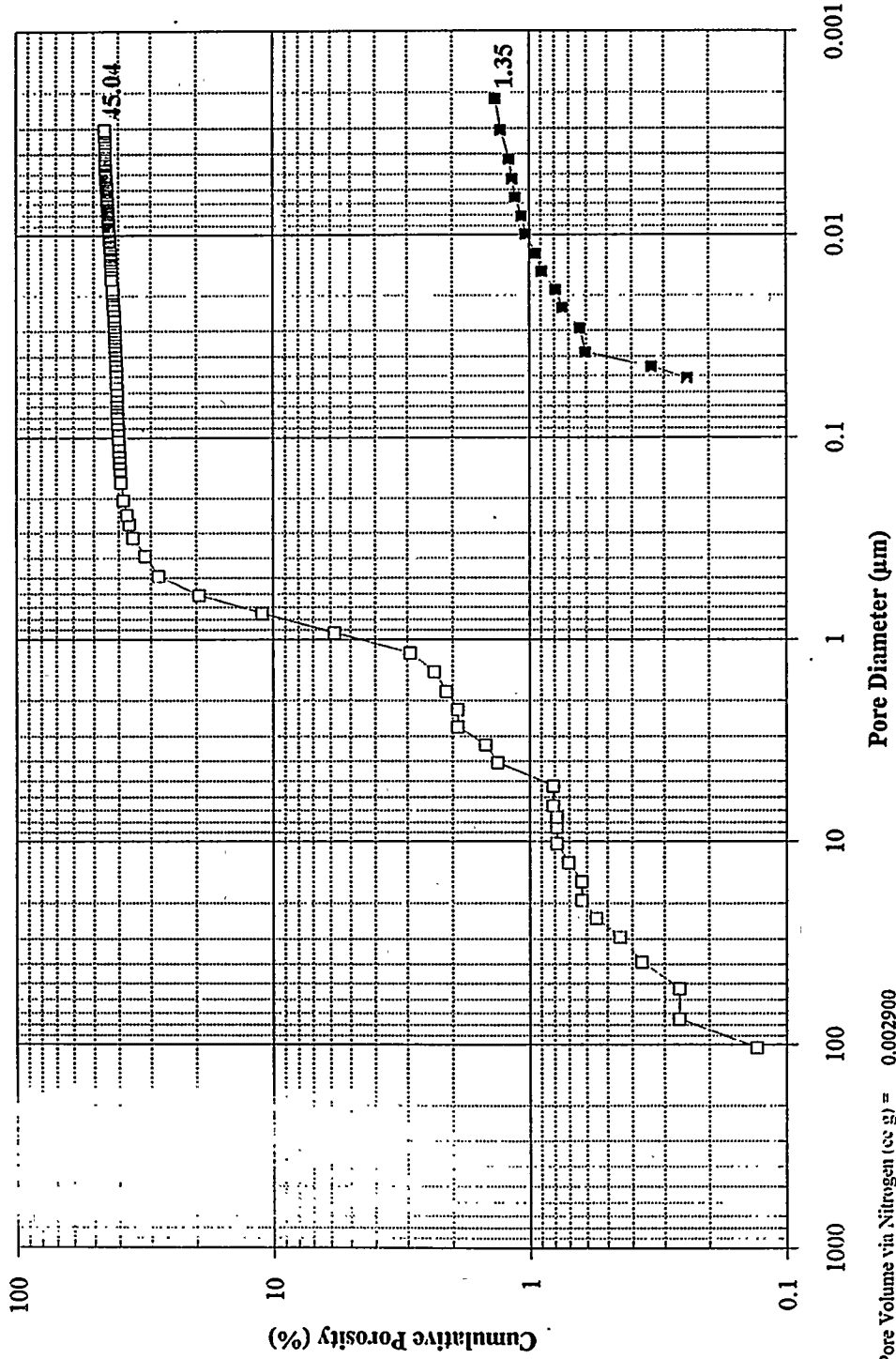

Total Pore Volume via Nitrogen (cc g) = 0.002900

Total Pore Volume via Mercury (ml g) = 0.1725

ZTSC-02-S1-B8
Bottom of Bed

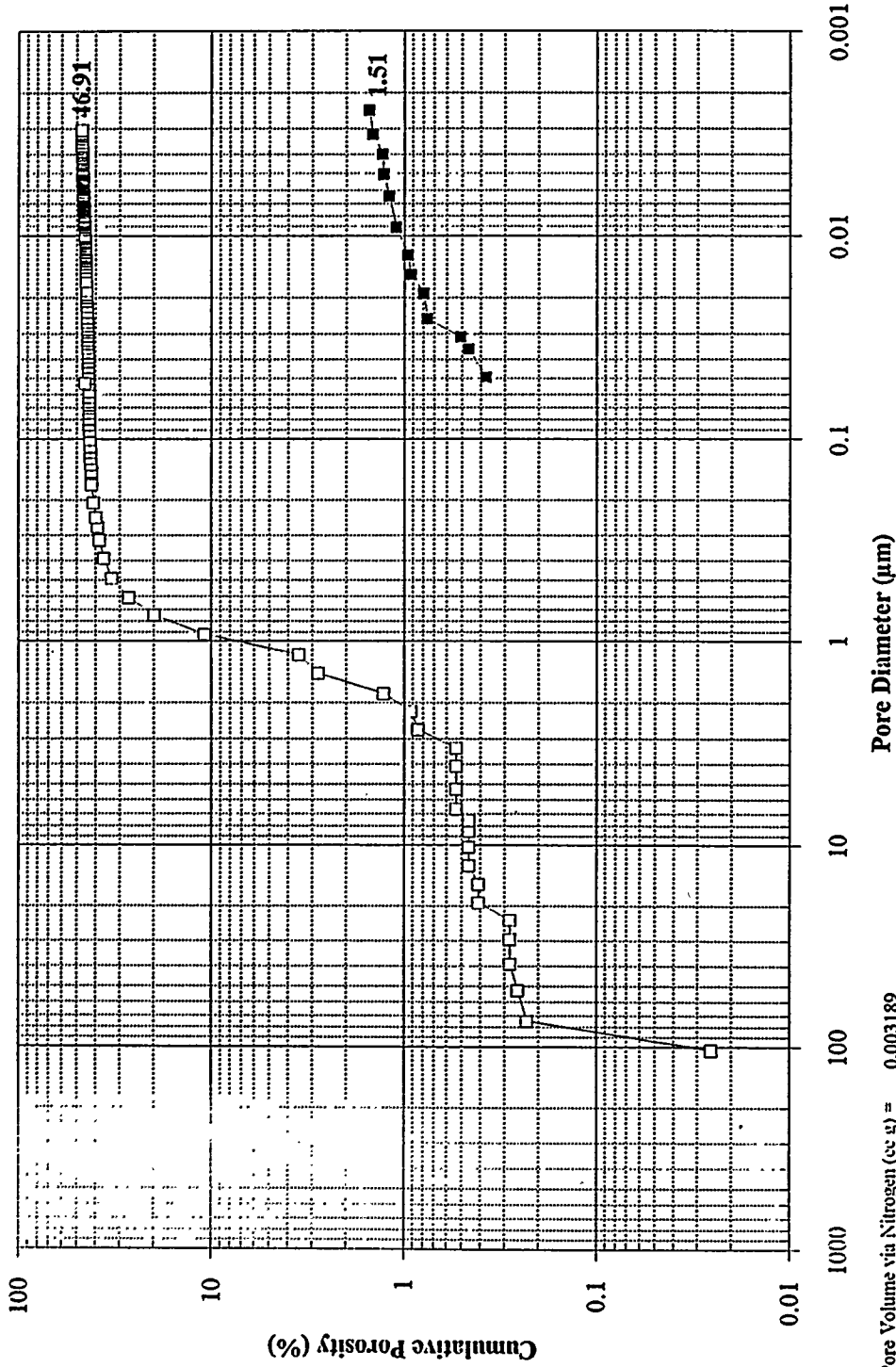

Total Pore Volume via Nitrogen (cc/g) = 0.003189

Total Pore Volume via Mercury (ml/g) = 0.1837

ZTSC-03-S1-B1
Top of Bed

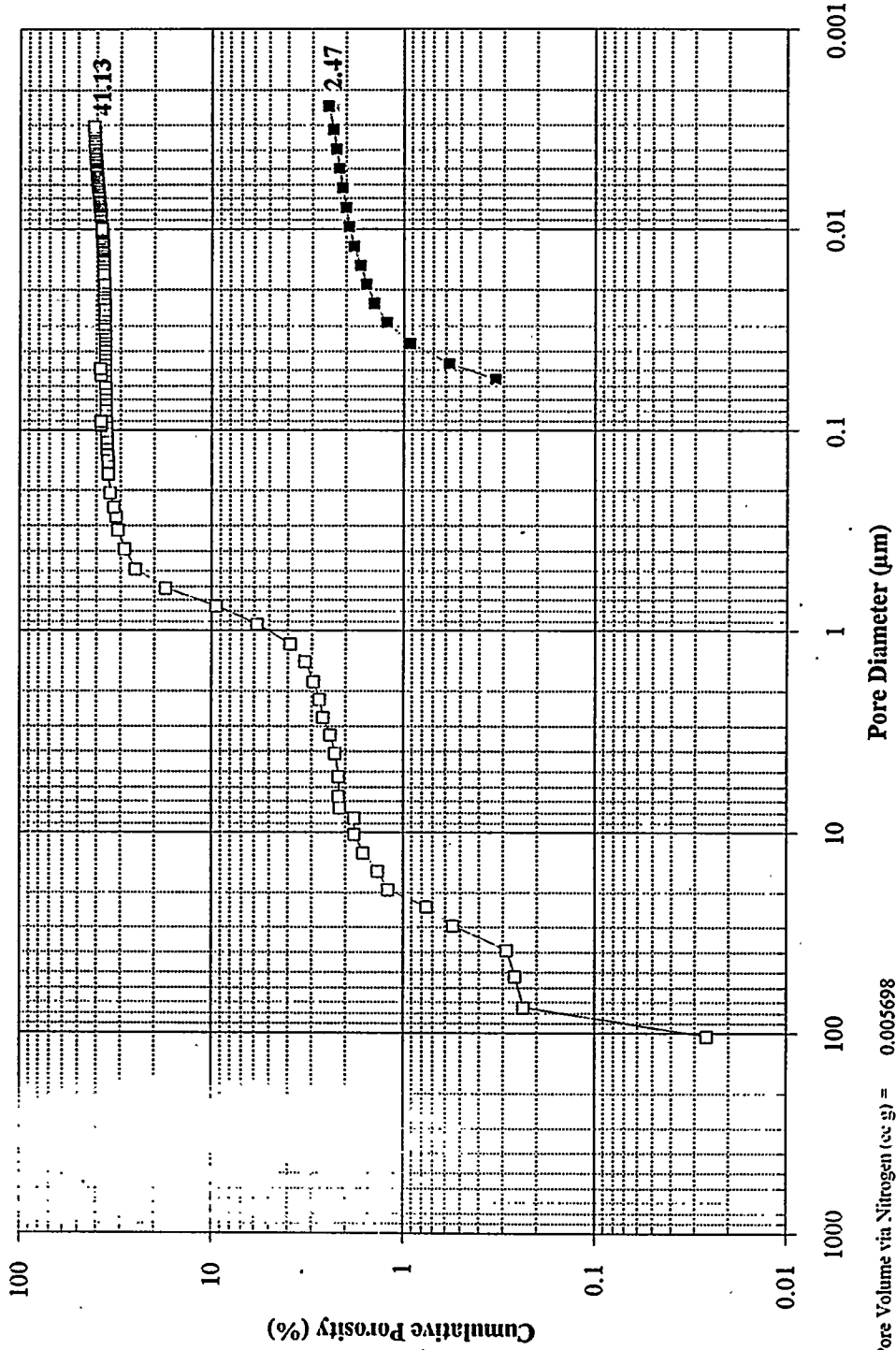

Total Pore Volume via Nitrogen (cc g) = 0.005698

Total Pore Volume via Mercury (ml g) = 0.1580

ZTSC-03-S1-B5
Middle of Bed

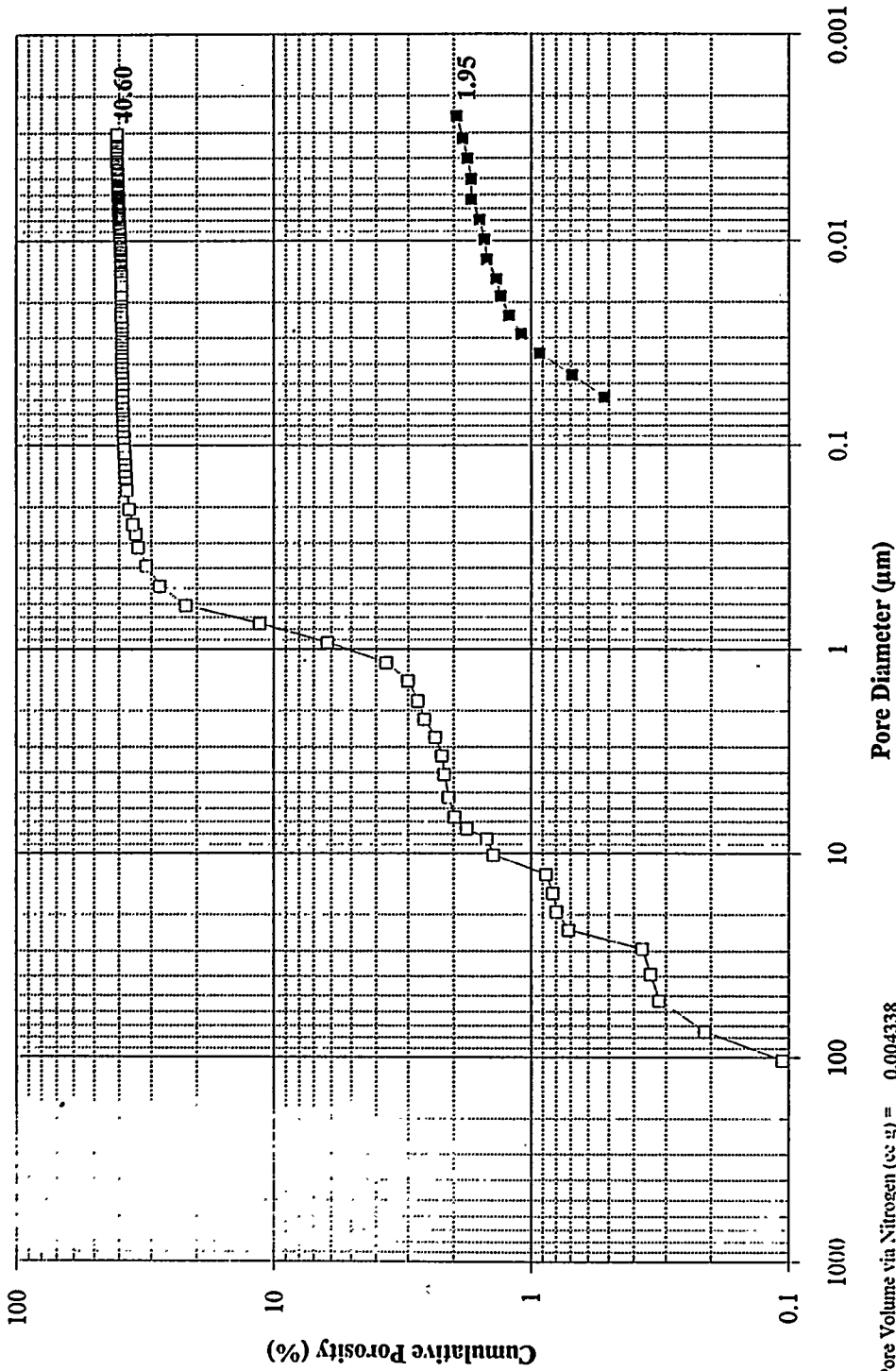

Total Pore Volume via Nitrogen (cc/g) = 0.004338

Total Pore Volume via Mercury (ml/g) = 0.1535

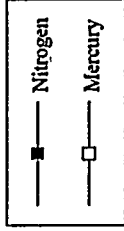

ZTSC-03-S1-B8
Bottom of Bed

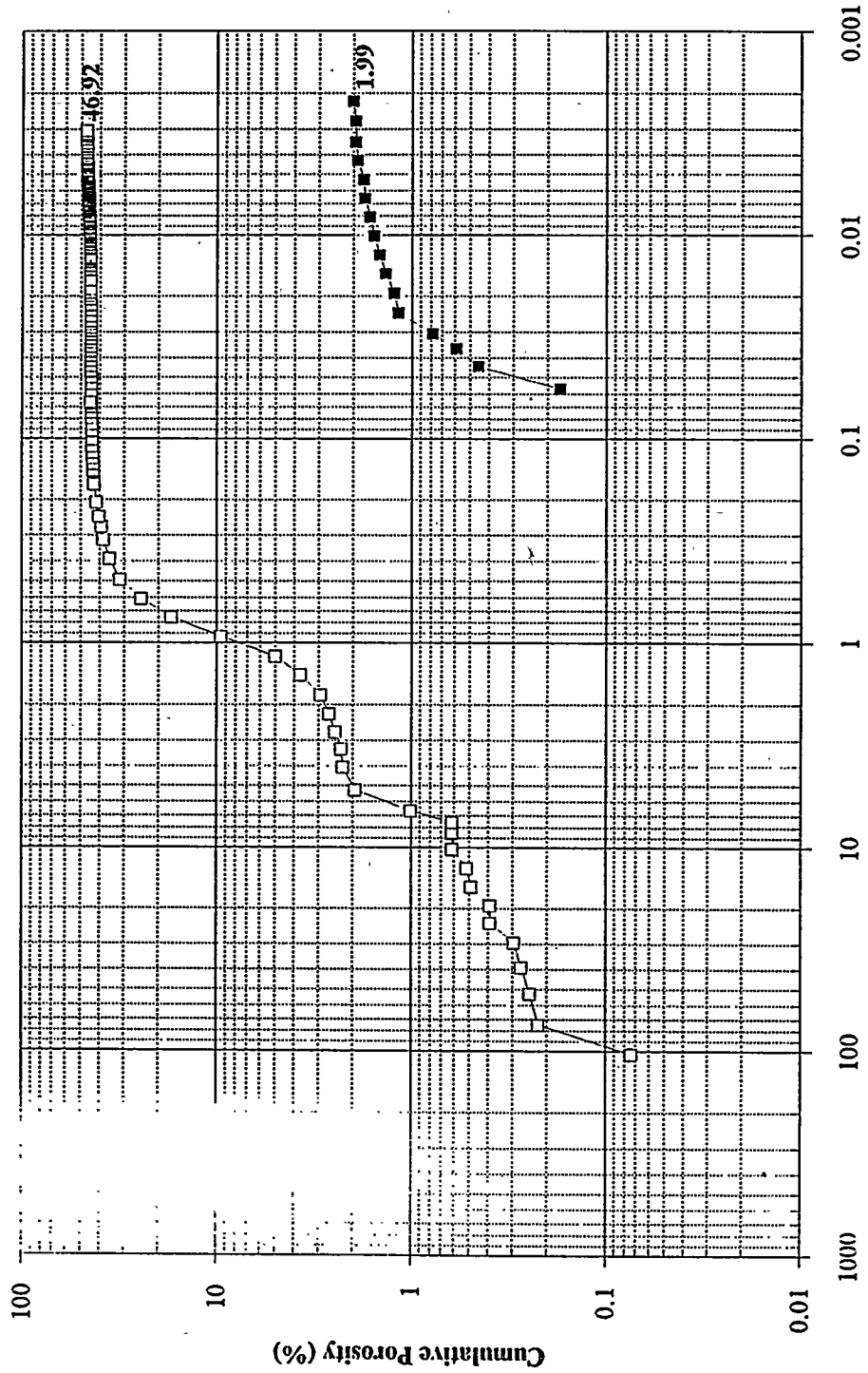

Total Pore Volume via Nitrogen (cc/g) = 0.004380

Total Pore Volume via Mercury (ml/g) = 0.1907

ZTSC-04-S1-B1
Top of Bed

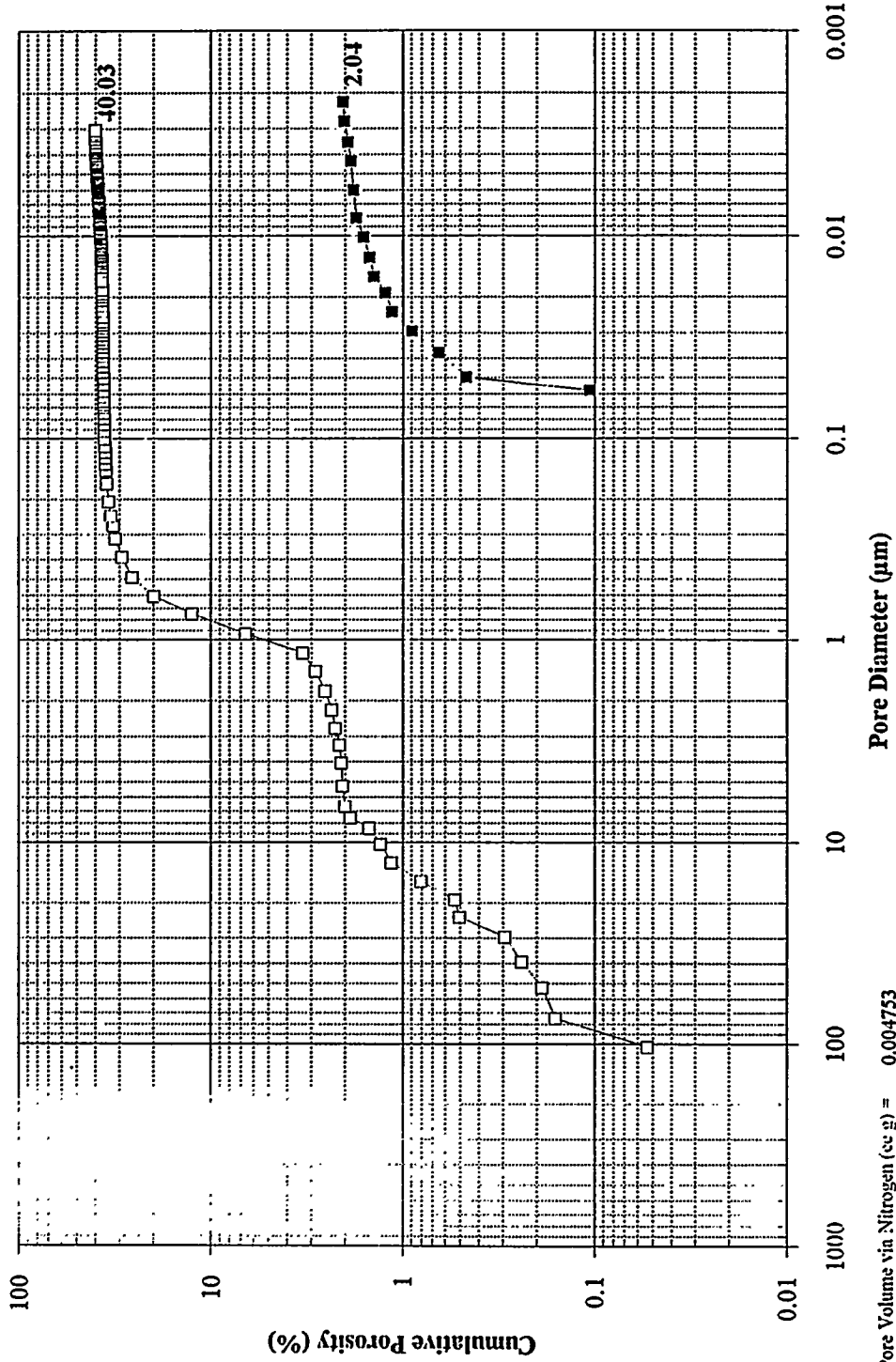

Total Pore Volume via Nitrogen (cc/g) = 0.004753

Total Pore Volume via Mercury (ml/g) = 0.1500

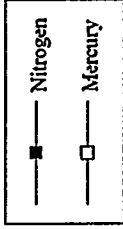

ZTSC-04-S1-B5
Middle of Bed

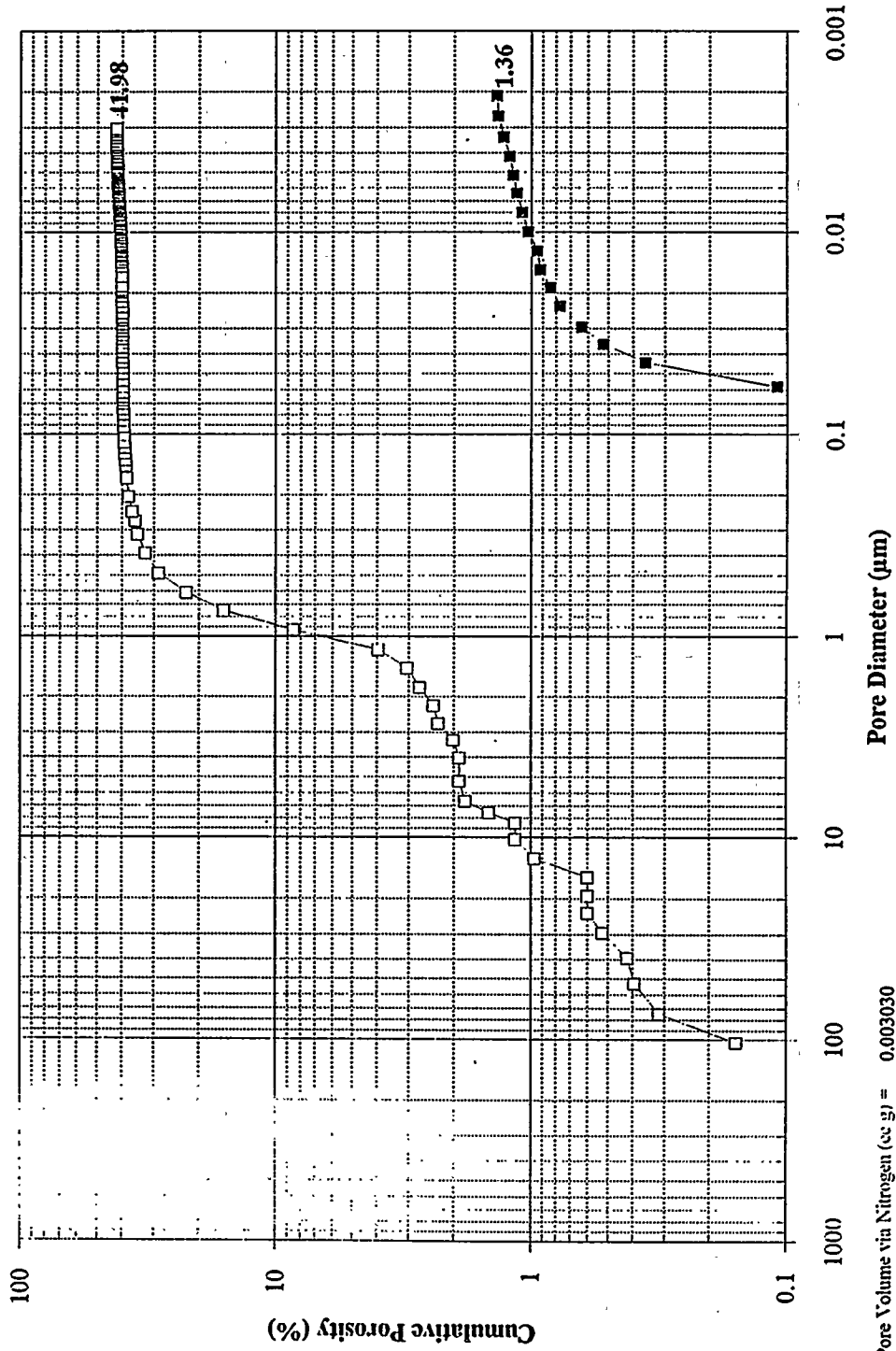

Total Pore Volume via Nitrogen (cc/g) = 0.003030

Total Pore Volume via Mercury (ml/g) = 0.1606

**ZTSC-04-S1-B8
Bottom of Bed**

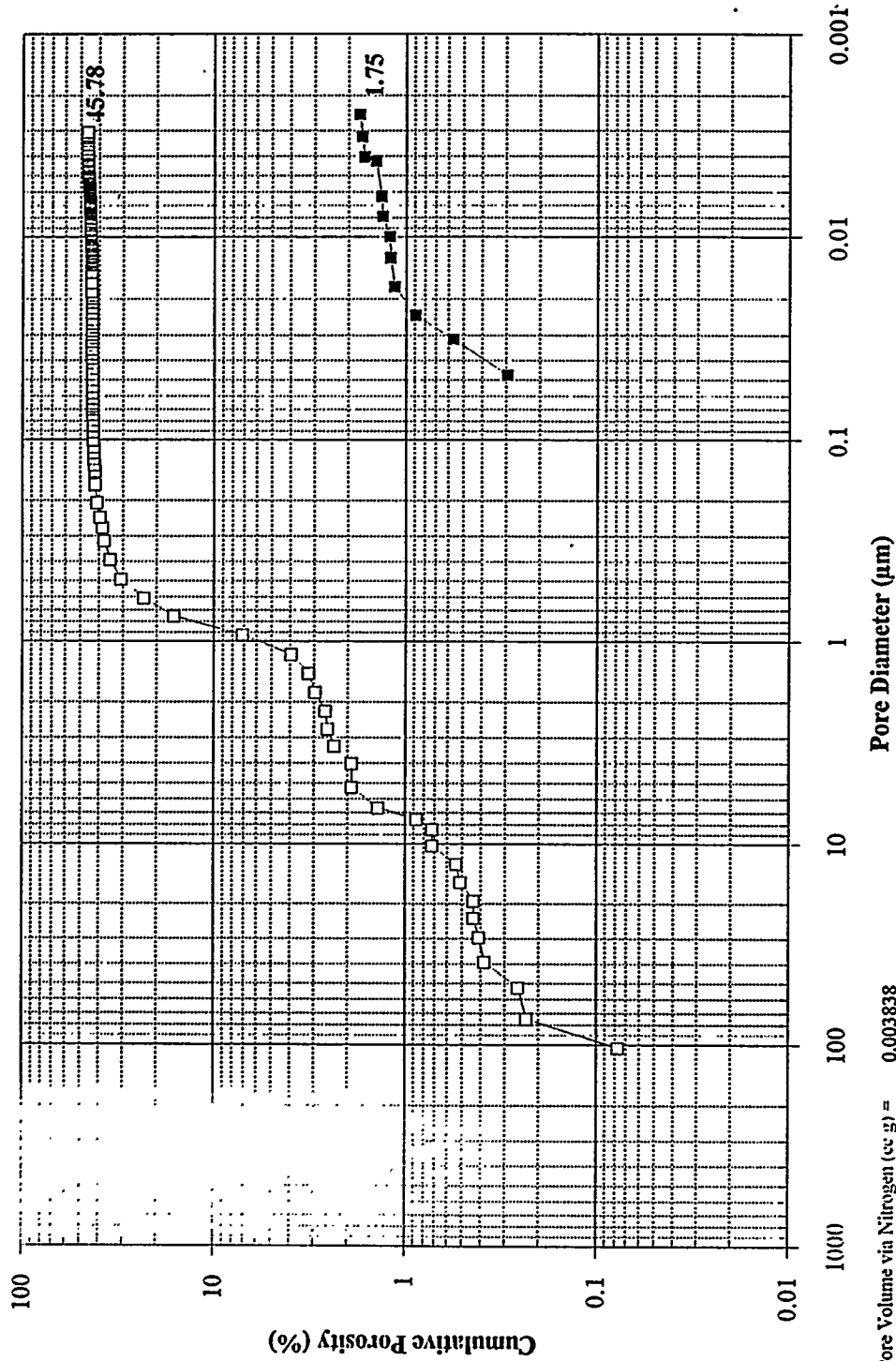

Total Pore Volume via Nitrogen (cc/g) = 0.003838

Total Pore Volume via Mercury (ml/g) = 0.1785

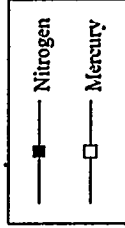

ZTSC-05-S1-B1
Top of Bed

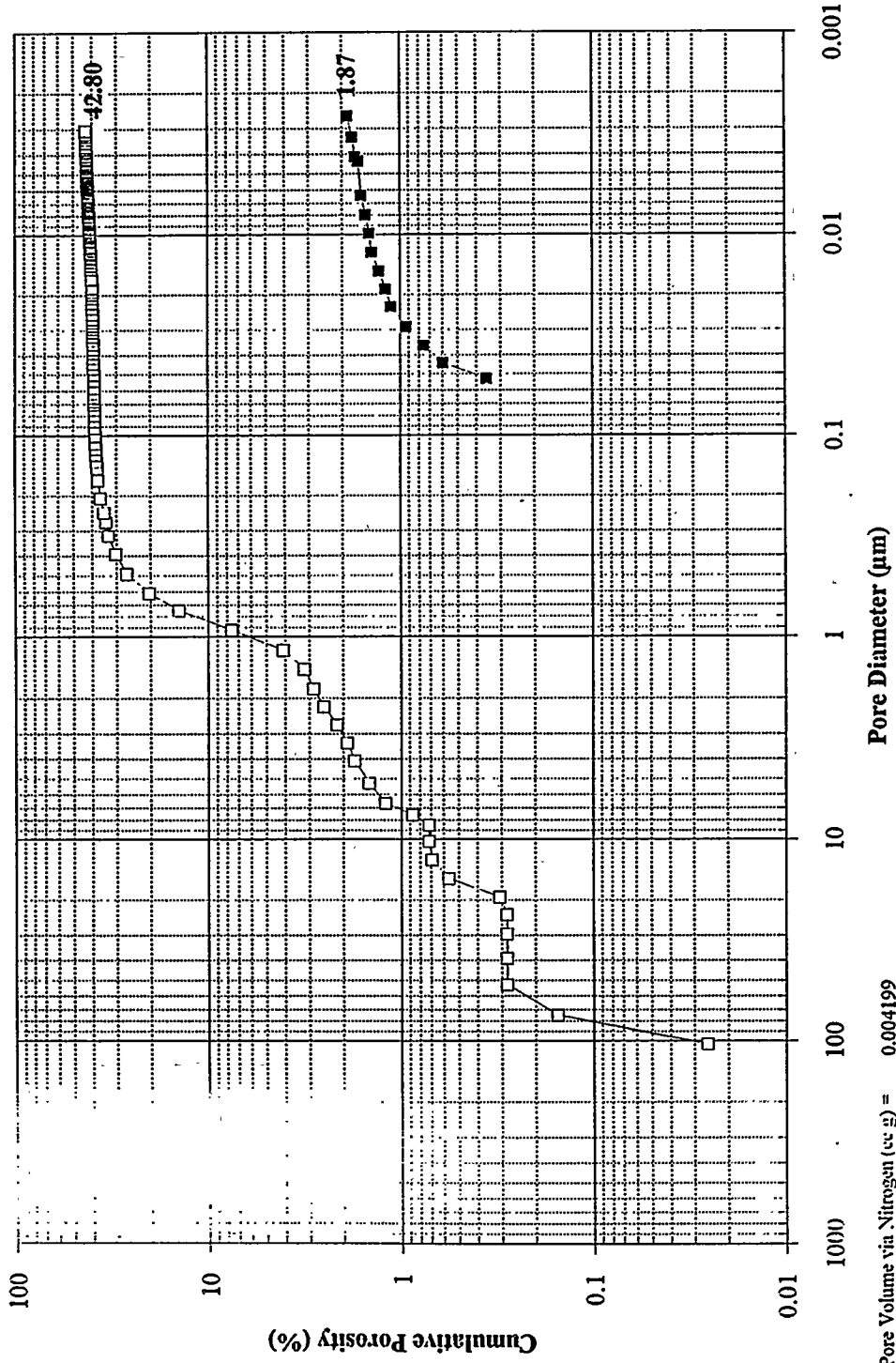

Total Pore Volume via Nitrogen (cc g) = 0.004199

Total Pore Volume via Mercury (ml g) = 0.1672

ZTSC-05-S1-B5
Middle of Bed

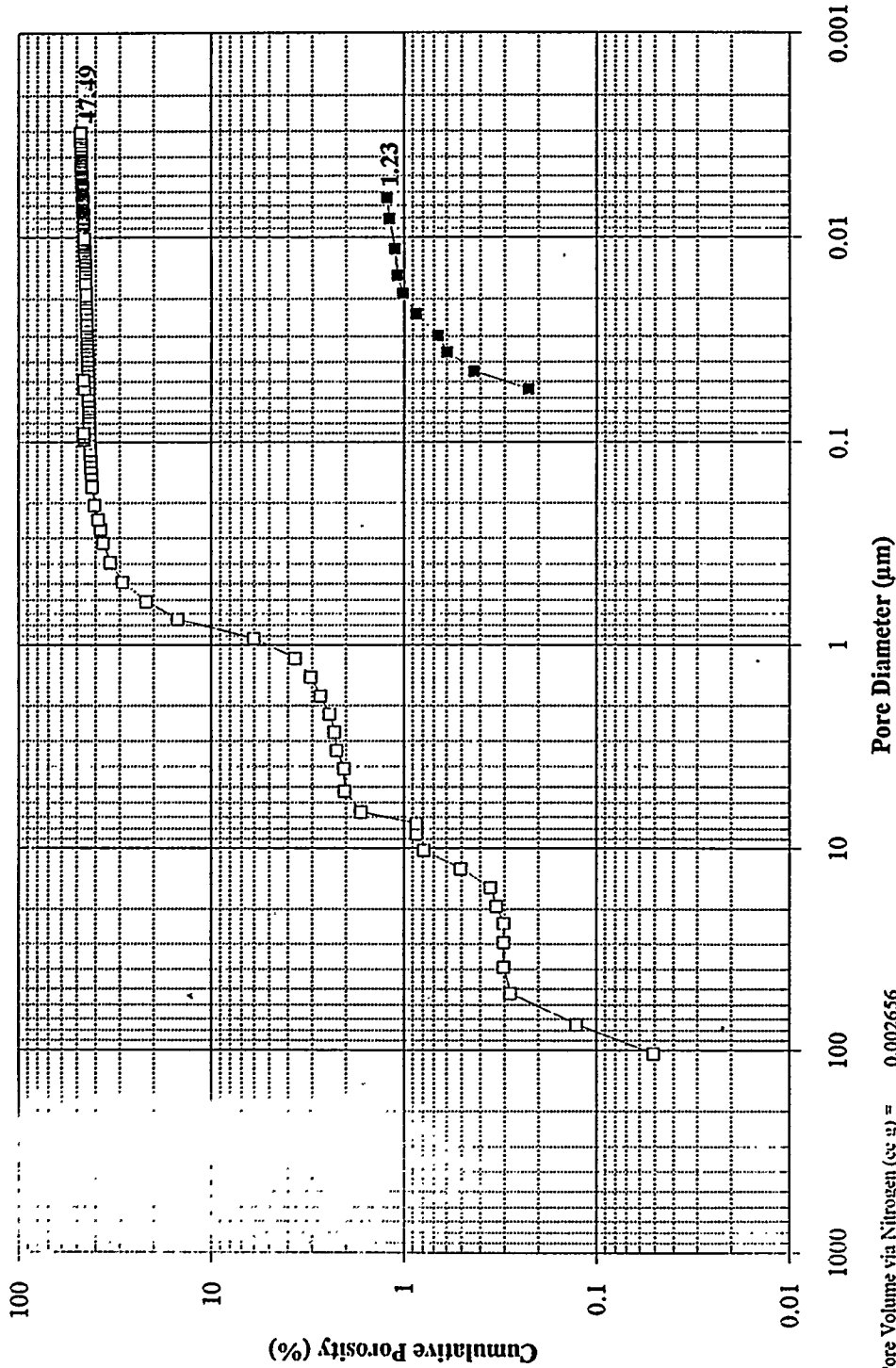

Total Pore Volume via Nitrogen (cc/g) = 0.002656

Total Pore Volume via Mercury (ml/g) = 0.1878

ZTSC-05-S1-B8
Bottom of Bed

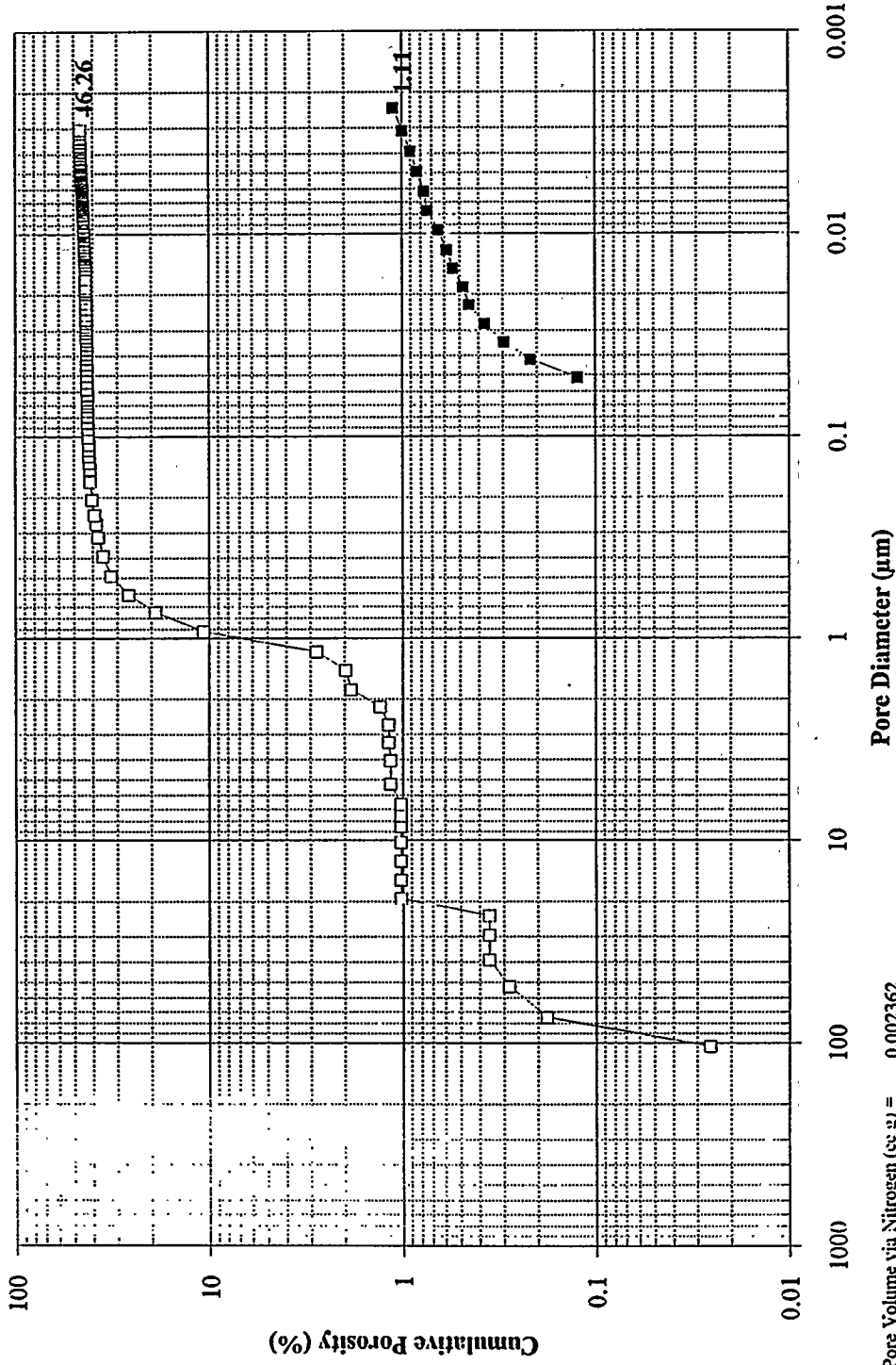

Total Pore Volume via Nitrogen (cc g) = 0.002362

Total Pore Volume via Mercury (ml g) = 0.1811

ZTSC-06-S1-B1
Top of Bed

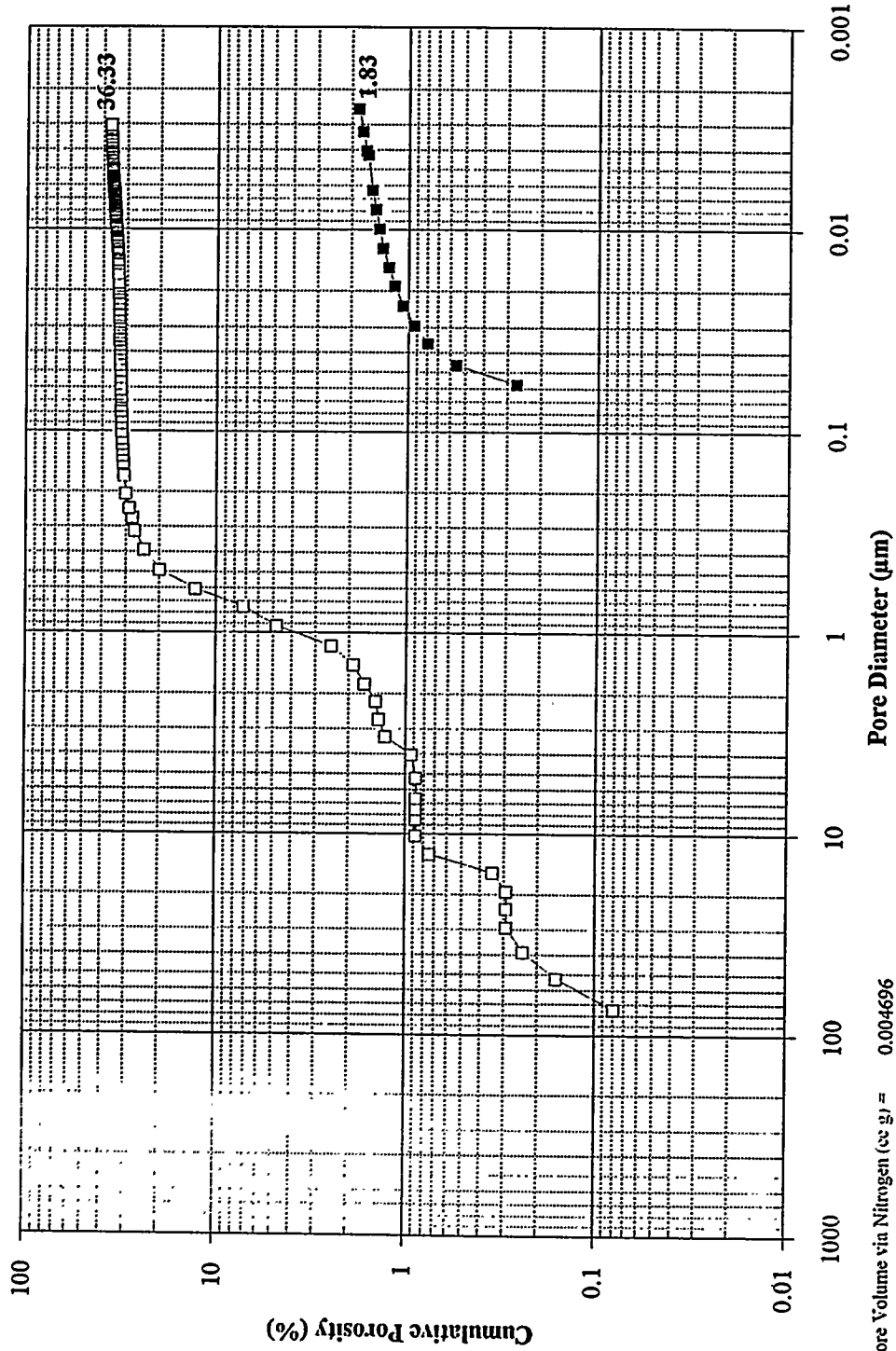

■ Nitrogen
□ Mercury

Total Pore Volume via Nitrogen (cc g) = 0.004696

Total Pore Volume via Mercury (ml g) = 0.1372

ZTSC-06-S1-B5
Middle of Bed

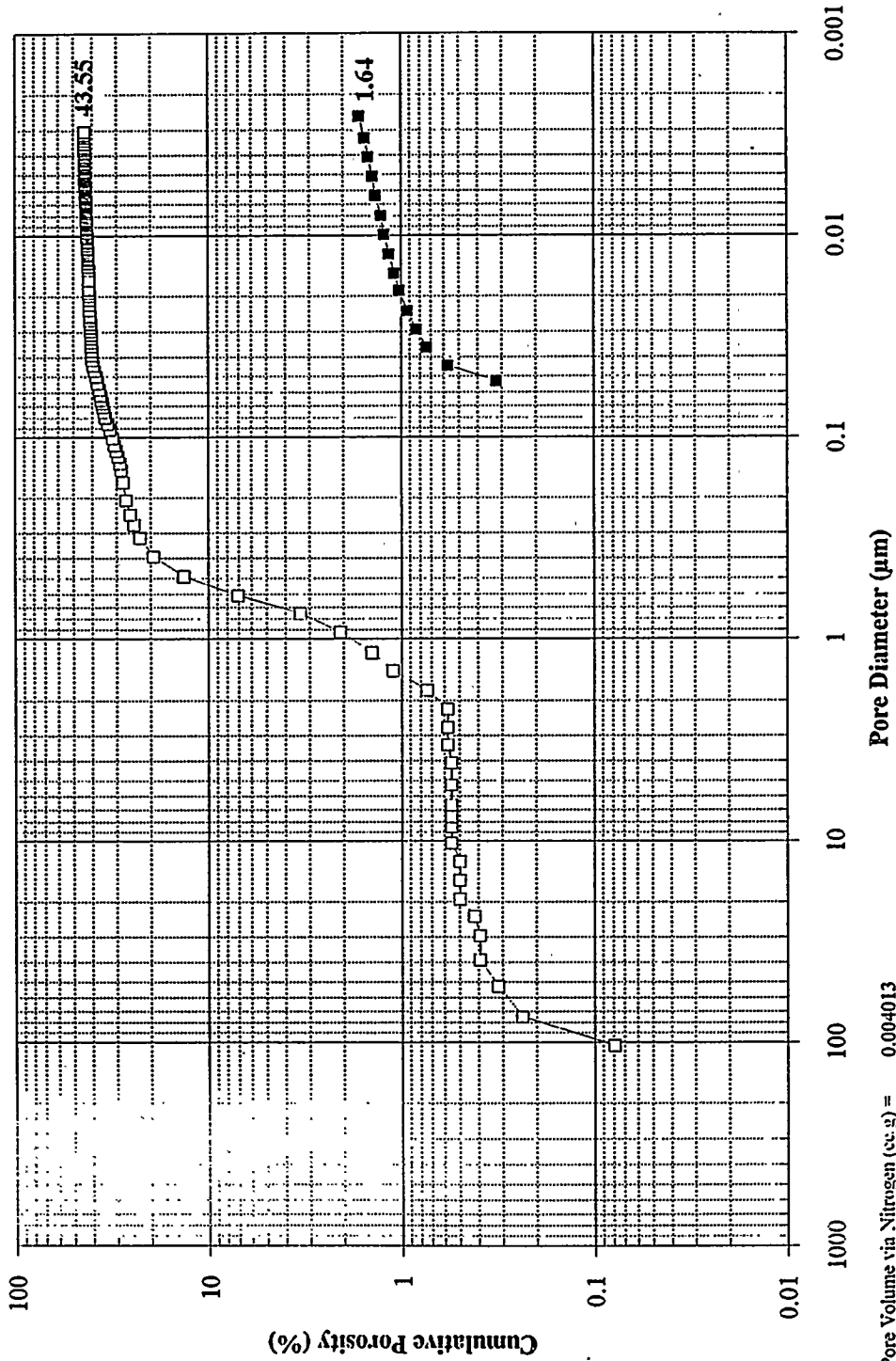

Total Pore Volume via Nitrogen (cc/g) = 0.004013

Total Pore Volume via Mercury (ml/g) = 0.1660

ZTSC-06-S1-B8
Bottom of Bed

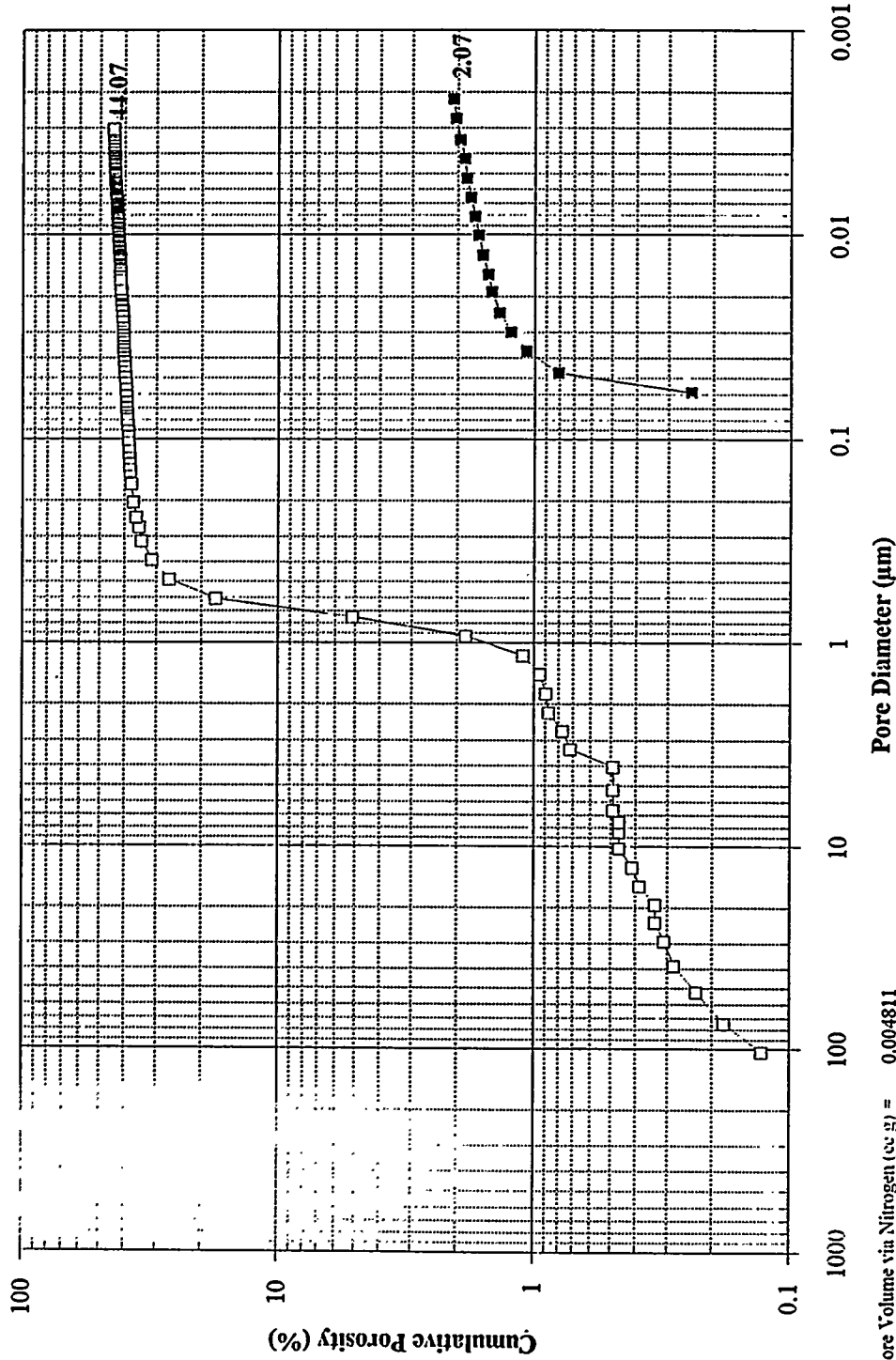

Total Pore Volume via Nitrogen (cc/g) = 0.004811

Total Pore Volume via Mercury (ml/g) = 0.1719

ZTSC-07-S3-B1
Top of Bed

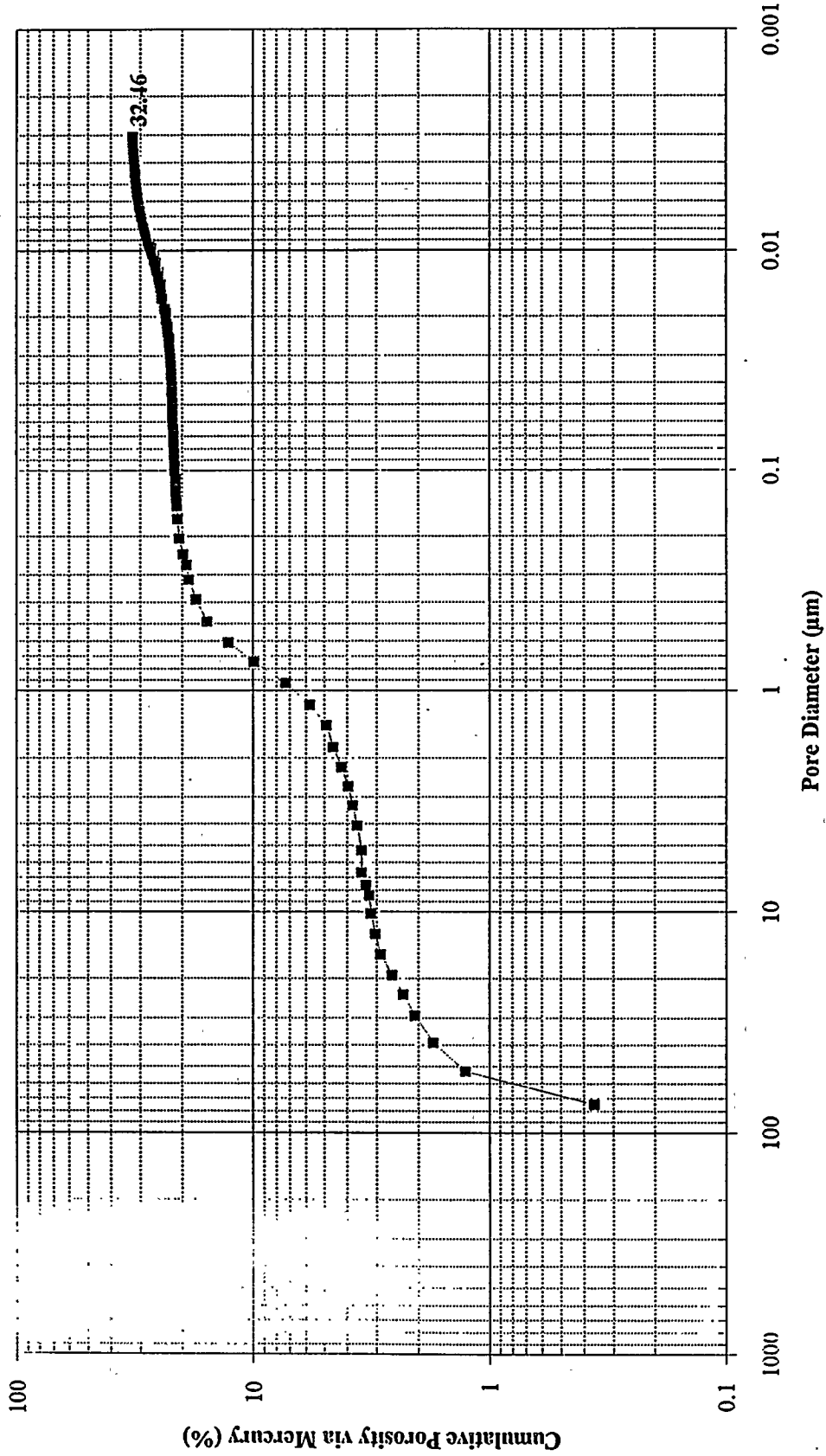

Total Pore Volume via Mercury (ml/g) = 0.1258

ZTSC-07-S3-B2
Middle of Bed

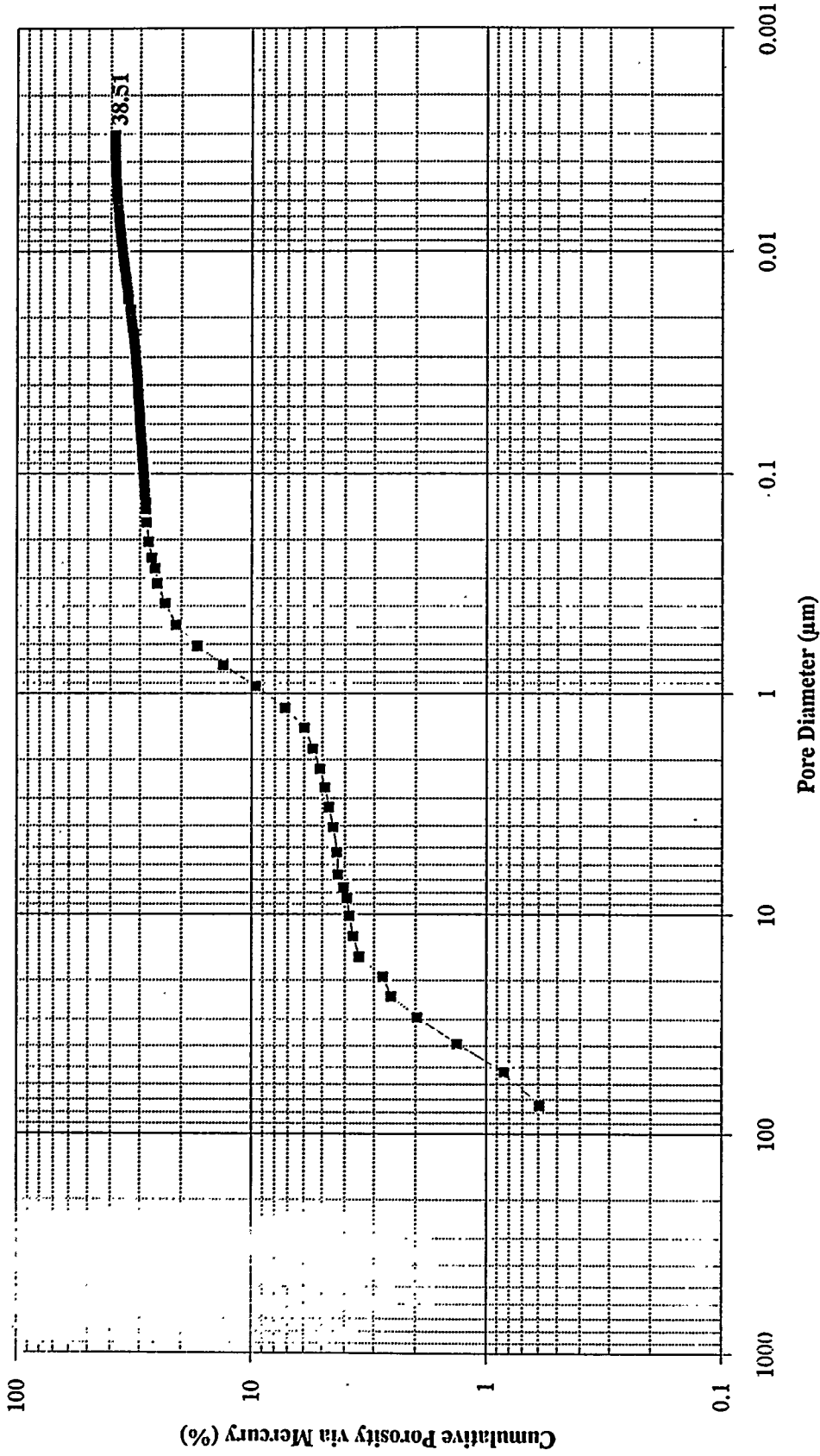

Total Pore Volume via Mercury (ml g) = 0.1561

ZTSC-07-S3-B3
Bottom of Bed

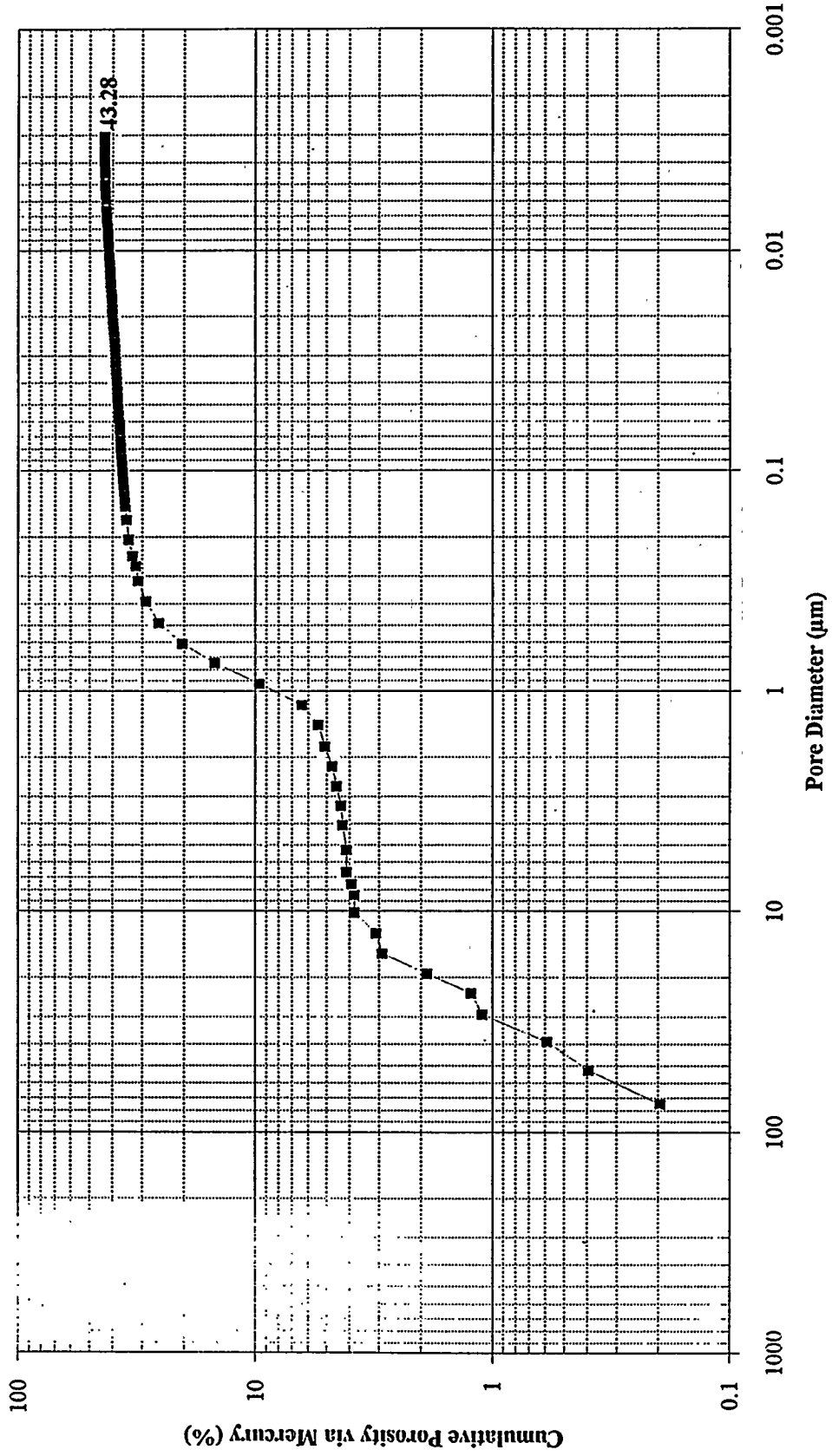

Total Pore Volume via Mercury (ml/g) = 0.1765

ZTSC-07-R3-B1
Top of Bed

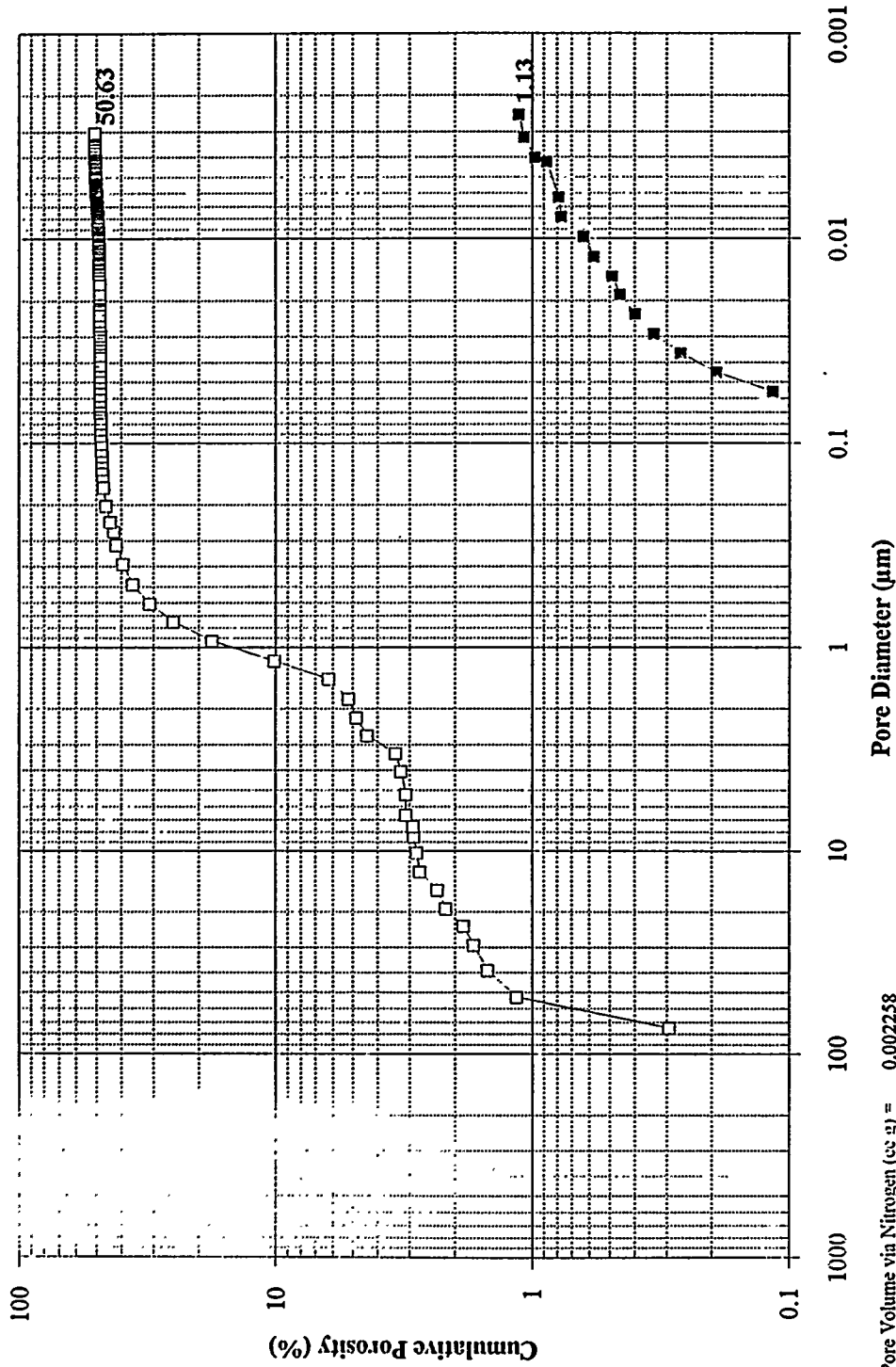

Total Pore Volume via Nitrogen (cc/g) = 0.002258

Total Pore Volume via Mercury (ml/g) = 0.2070

■ Nitrogen
□ Mercury

ZTSC-07-R3-B4
Middle of Bed

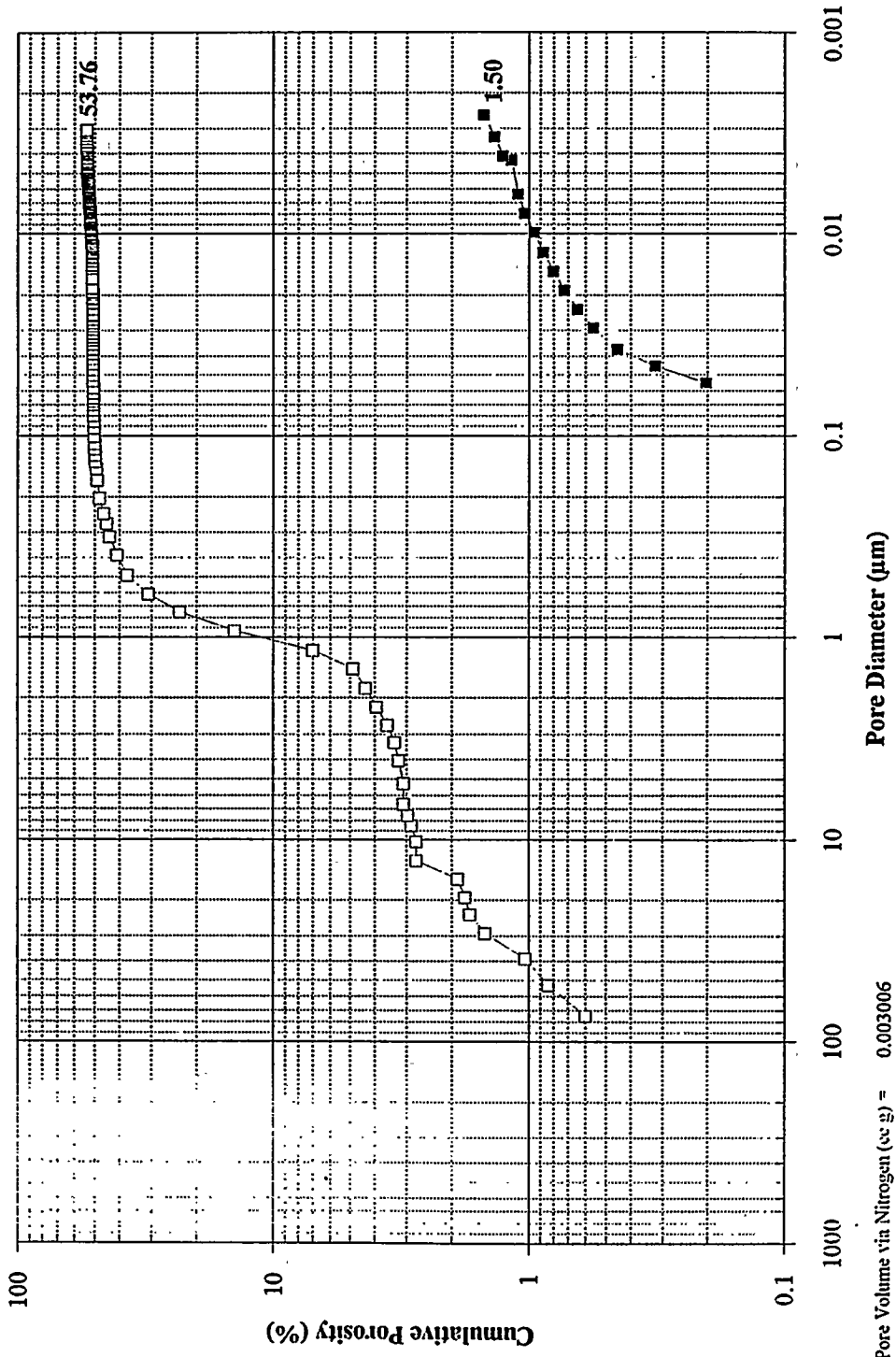

Total Pore Volume via Nitrogen (cc g) = 0.003006
 Total Pore Volume via Mercury (ml g) = 0.2246

ZTSC-07-R3-B7
Bottom of Bed

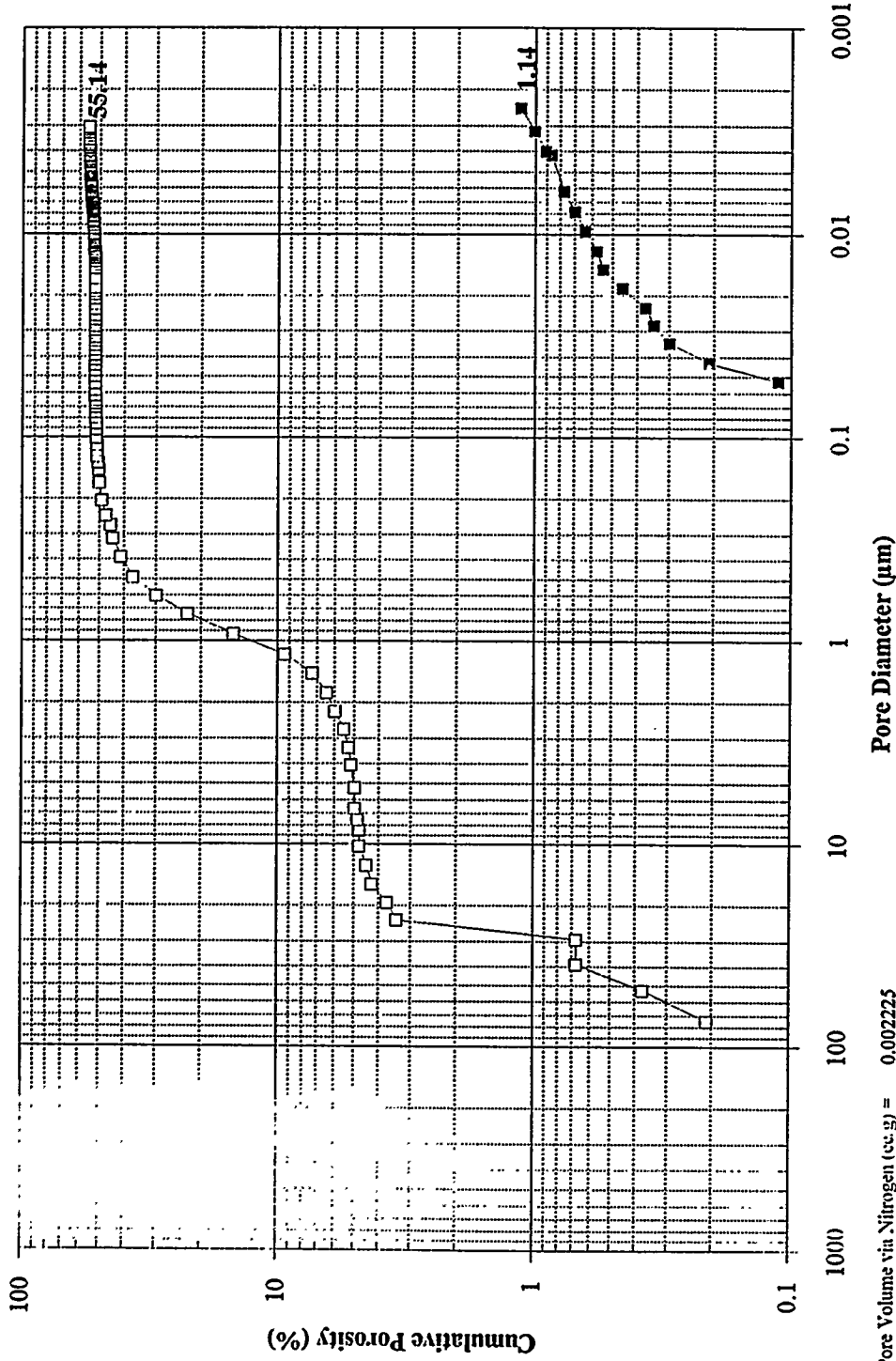

■ Nitrogen
□ Mercury

Total Pore Volume via Nitrogen (cc/g) = 0.002225

Total Pore Volume via Mercury (ml/g) = 0.2364

ZTMC-01-S4-B1
Top of Bed

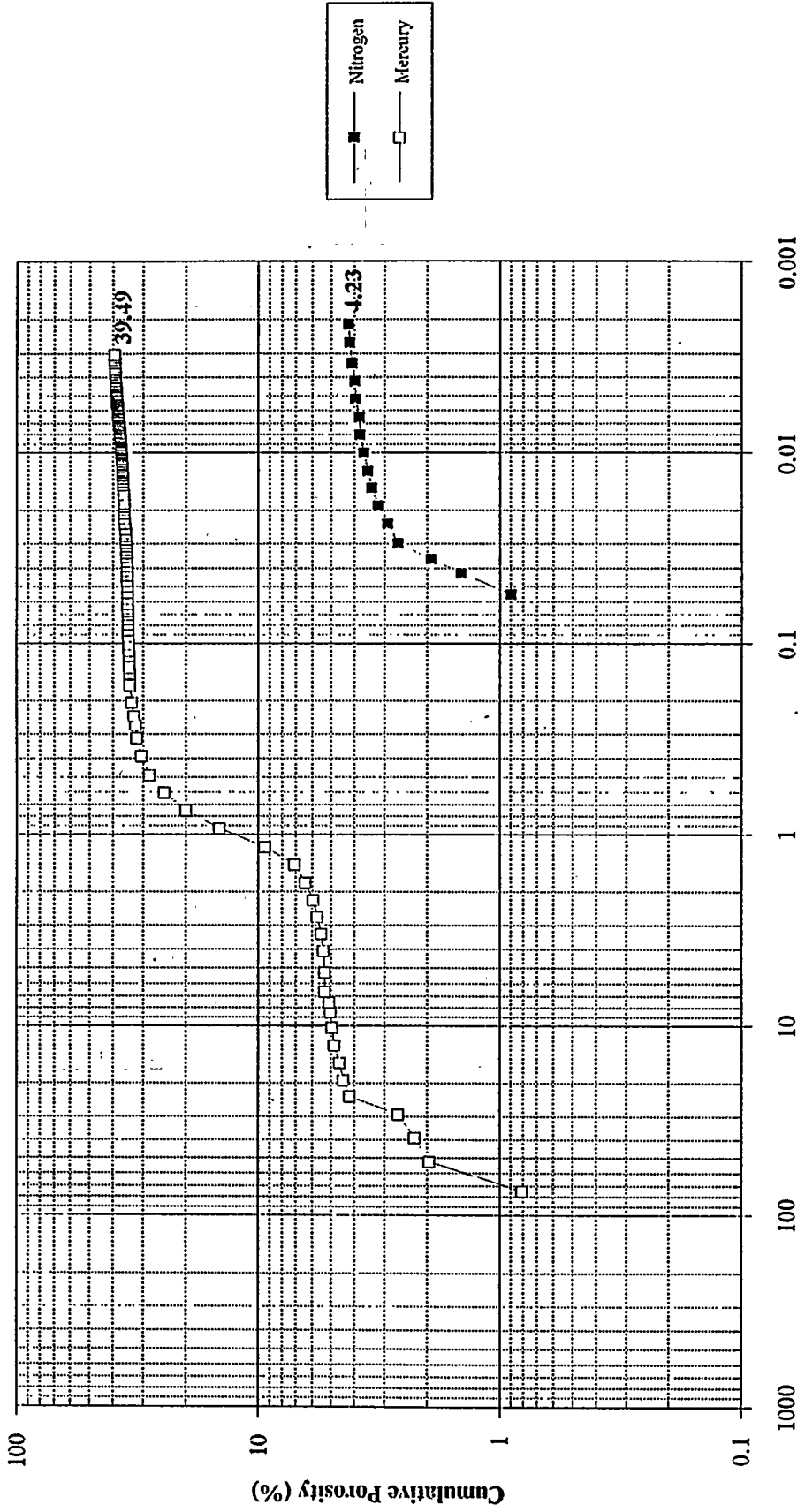

Total Pore Volume via Nitrogen (cc/g) = 0.010496

Total Pore Volume via Mercury (ml/g) = 0.1615

ZTMC-01-S4-B2
2nd Fraction

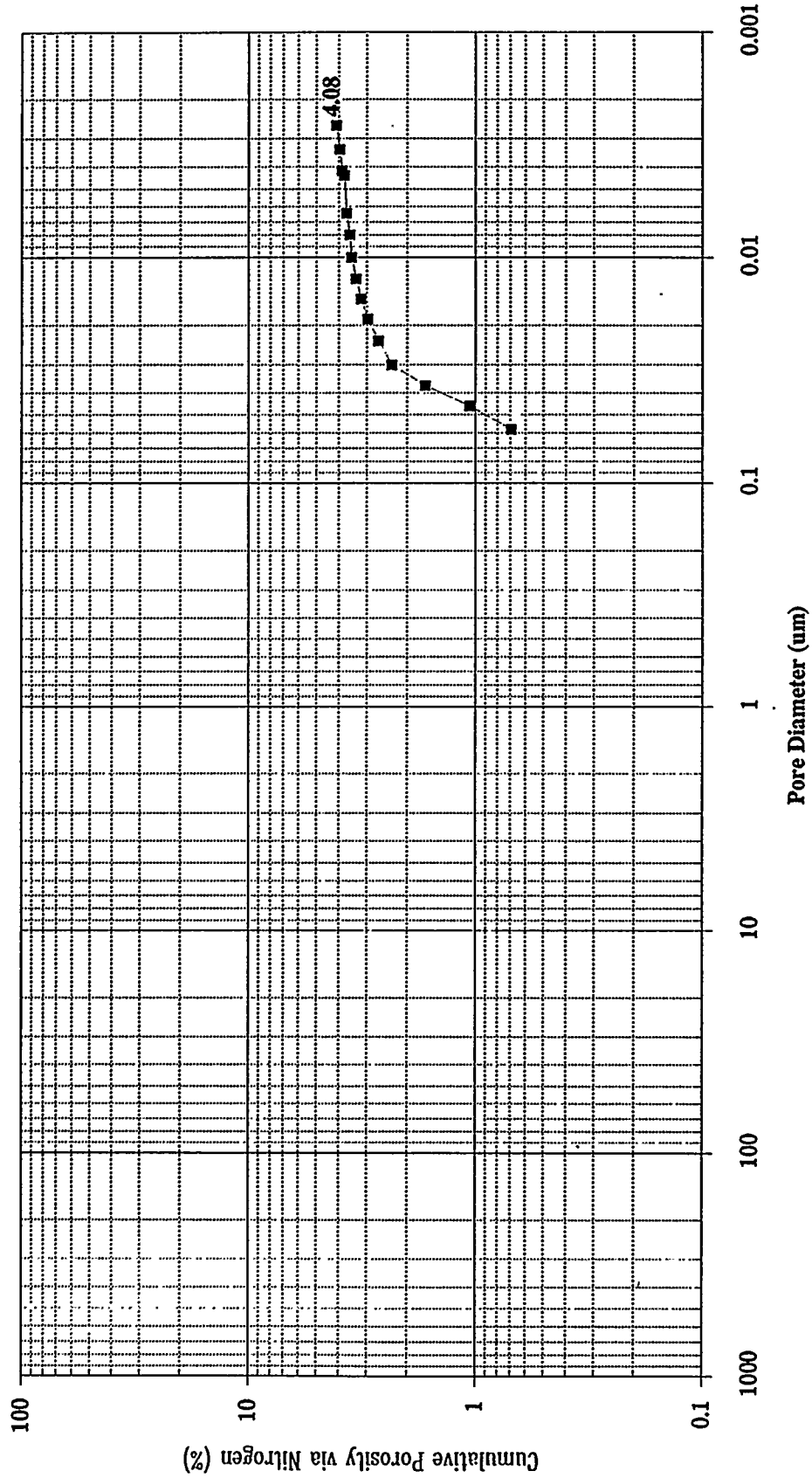

Total Pore Volume via Nitrogen (cc/g) = 0.010129

ZTMC-01-S4-B3
3rd Fraction

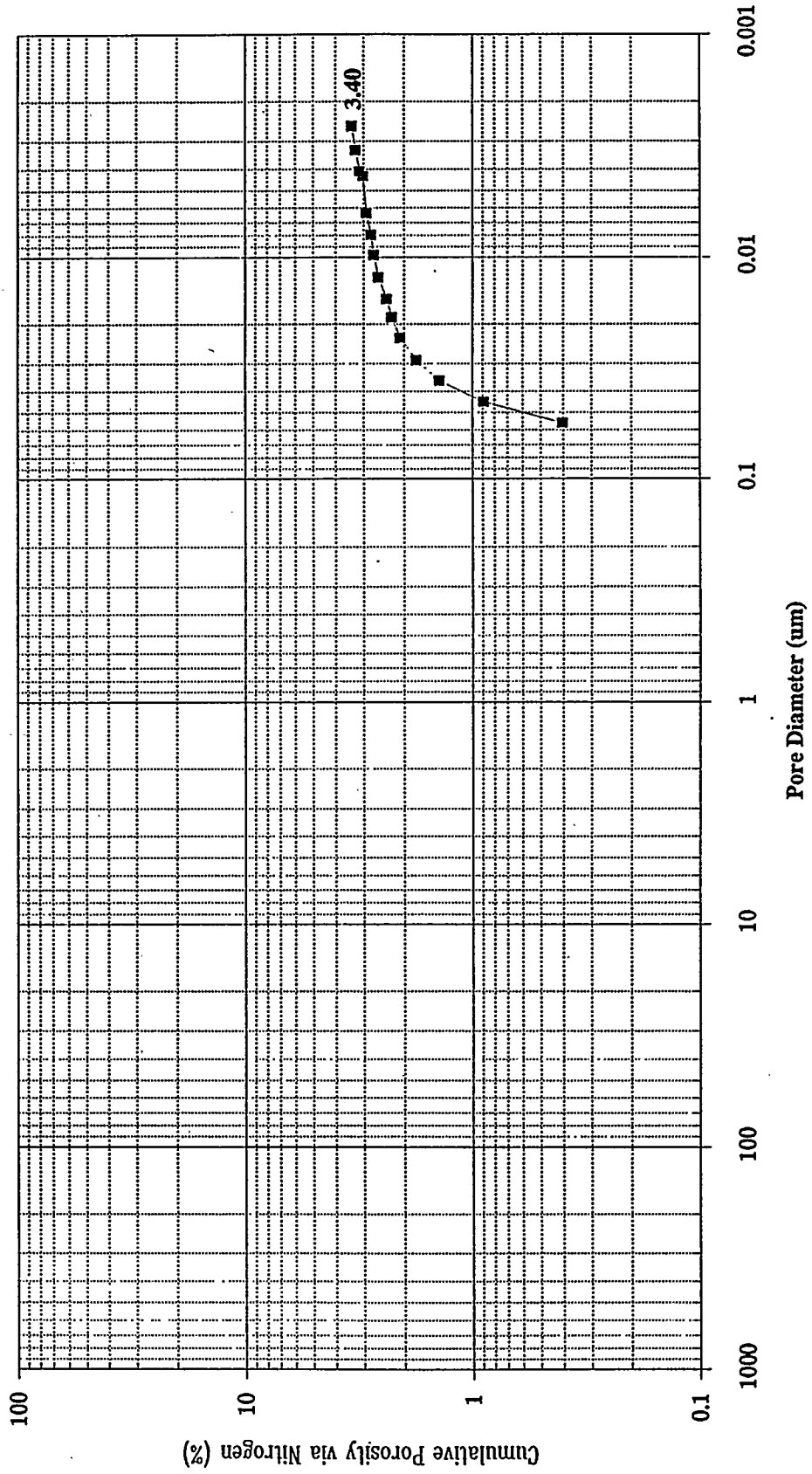

Total Pore Volume via Nitrogen (cc/g) = 0.008119

ZTMC-01-S4-B4
4th Fraction

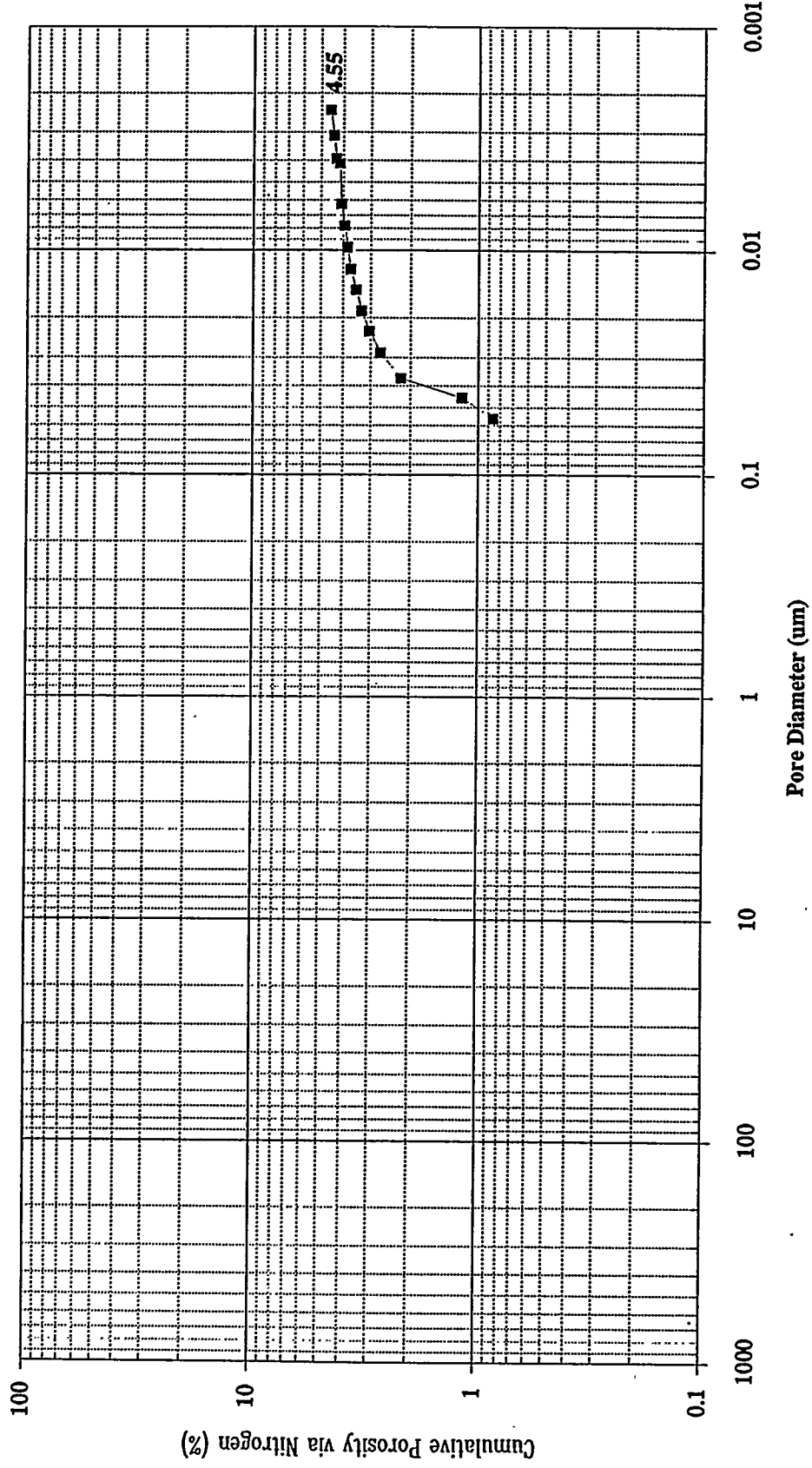

Total Pore Volume via Nitrogen (cc/g) = 0.010815

ZTMC-01-S4-B5
5th Fraction

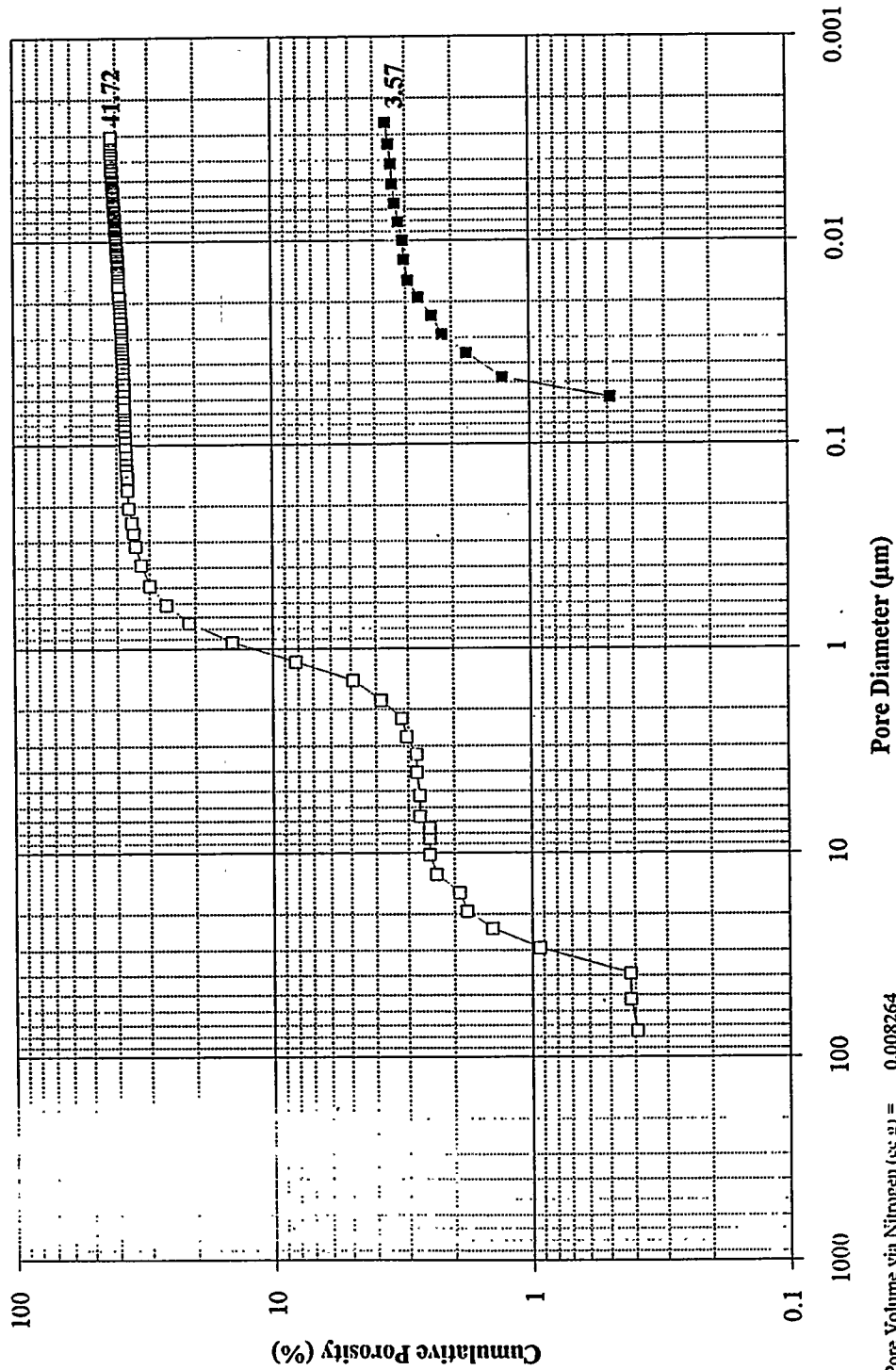

Total Pore Volume via Nitrogen (cc/g) = 0.008264

Total Pore Volume via Mercury (ml/g) = 0.1707

ZTMC-01-S4-B6
6th Fraction

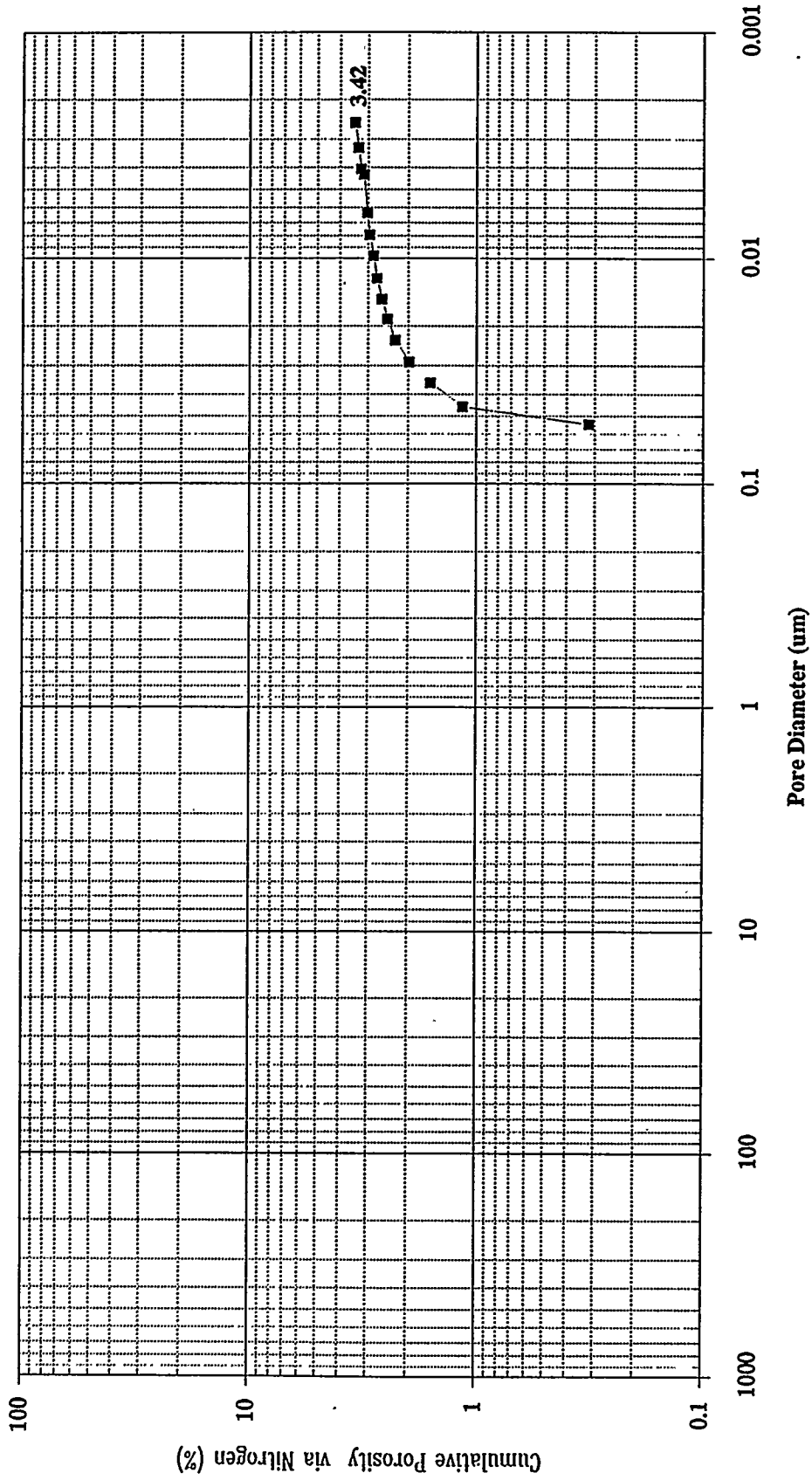

Total Pore Volume via Nitrogen (cc/g) = 0.007775

ZTMC-01-S4-B7
7th Fraction

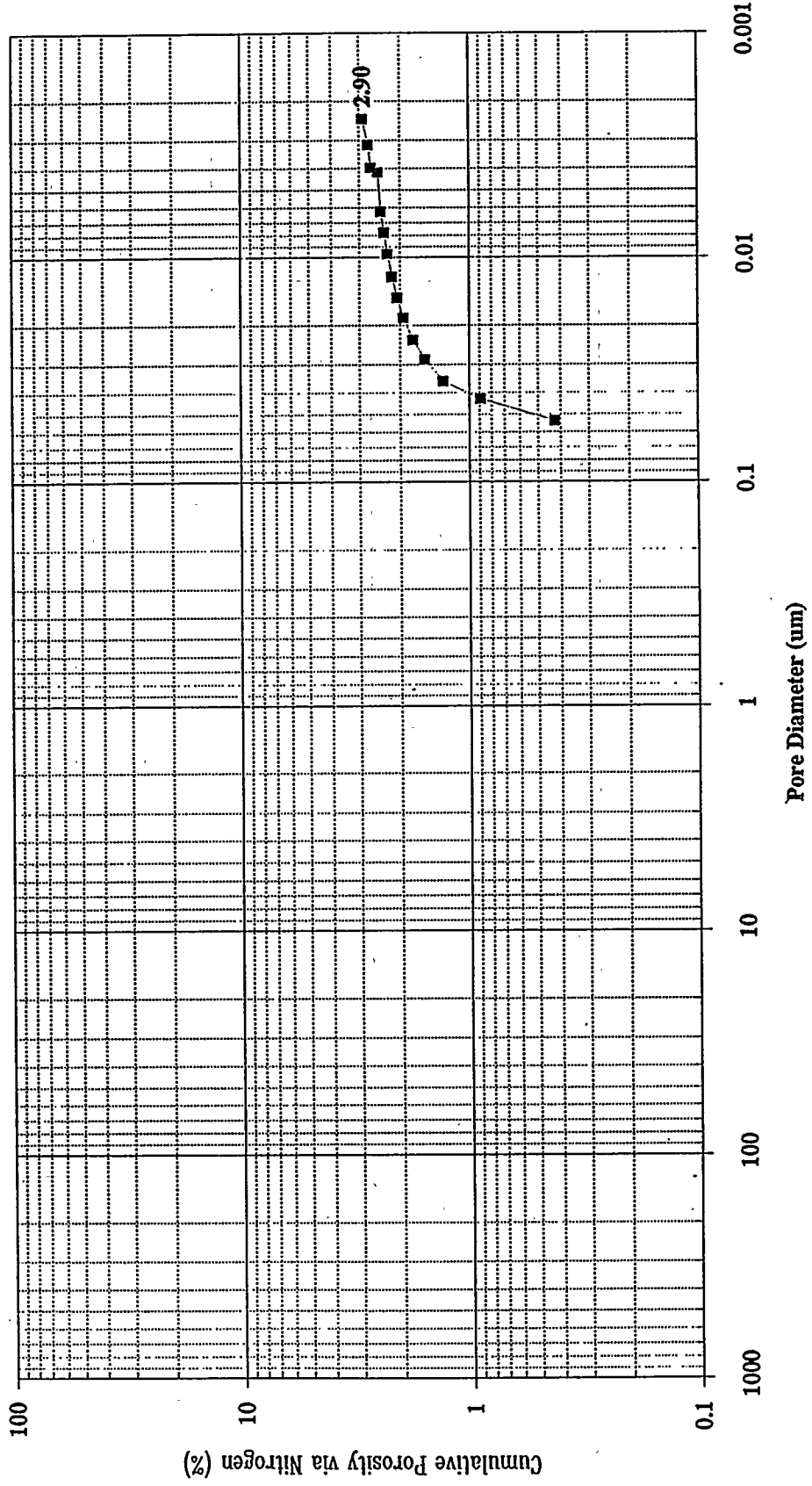

Total Pore Volume via Nitrogen (cc/g) = 0.006458

ZTMC-01-S4-B8
8th Fraction

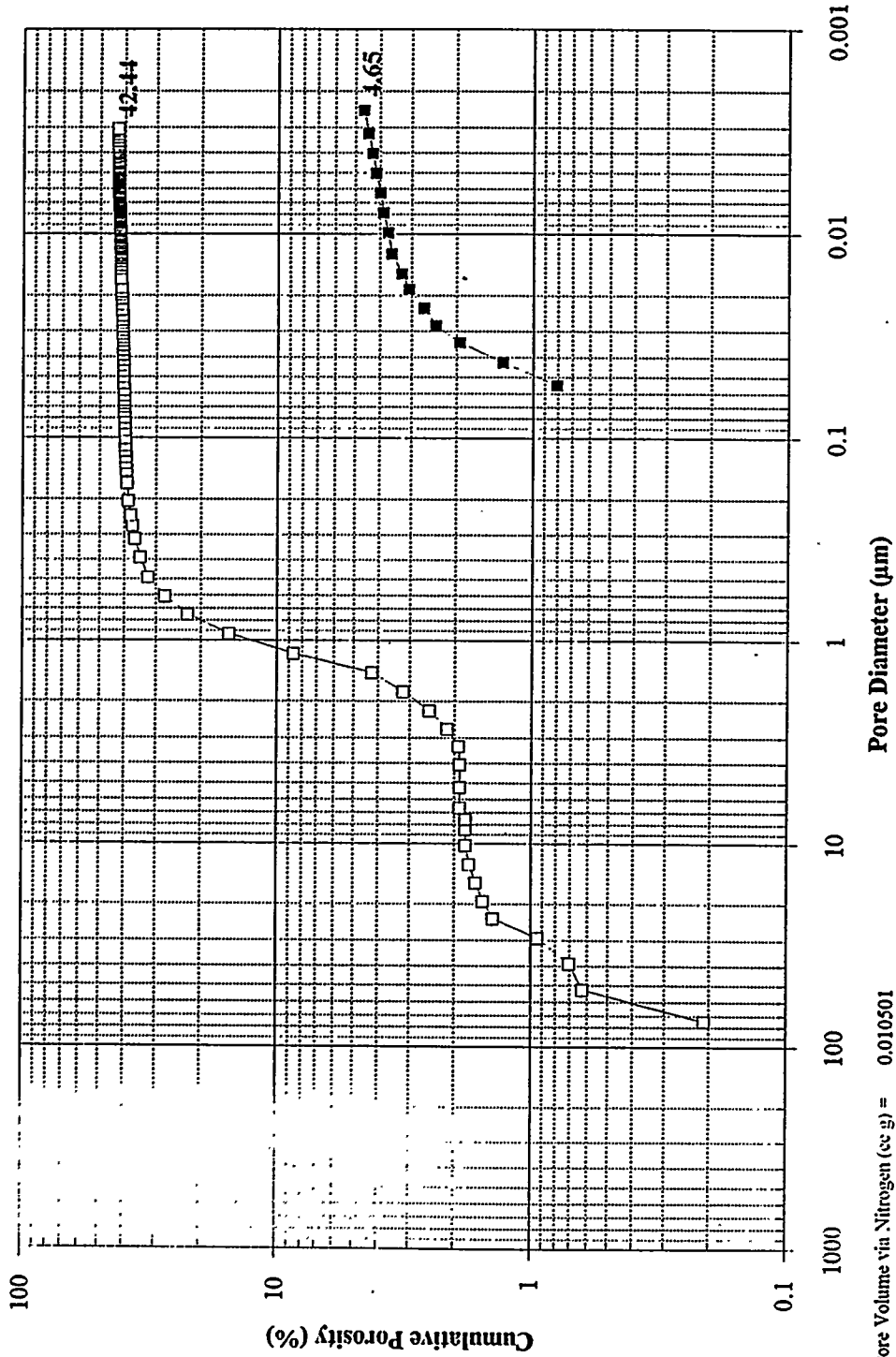

■ Nitrogen
□ Mercury

Total Pore Volume via Nitrogen (cc/g) = 0.010501

Total Pore Volume via Mercury (ml/g) = 0.1626

ZTMC-02-S3-B1
Top of Bed

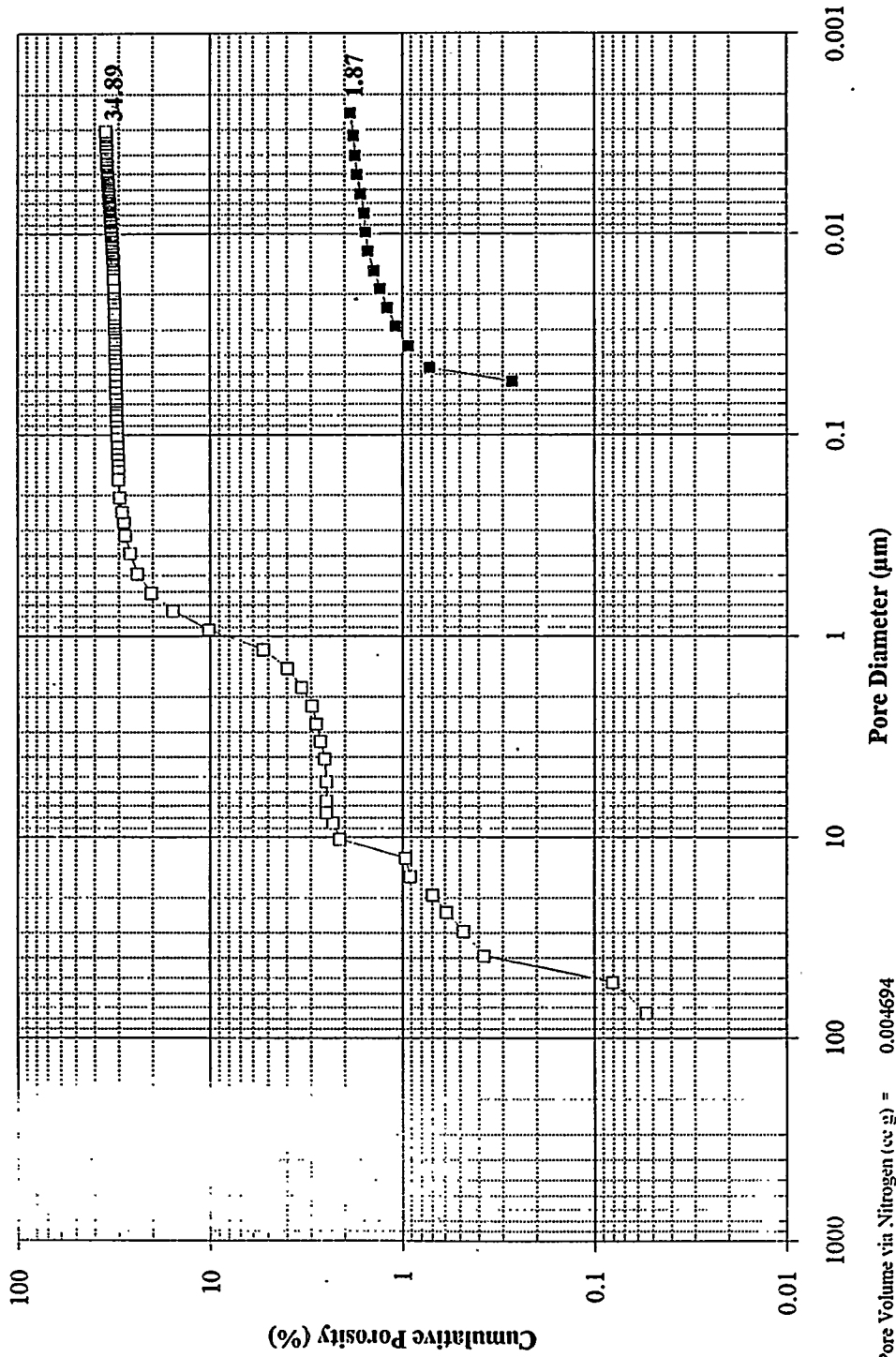

Total Pore Volume via Nitrogen (cc g) = 0.004694

Total Pore Volume via Mercury (ml g) = 0.1304

ZTMC-02-S3-B2
Middle of Bed

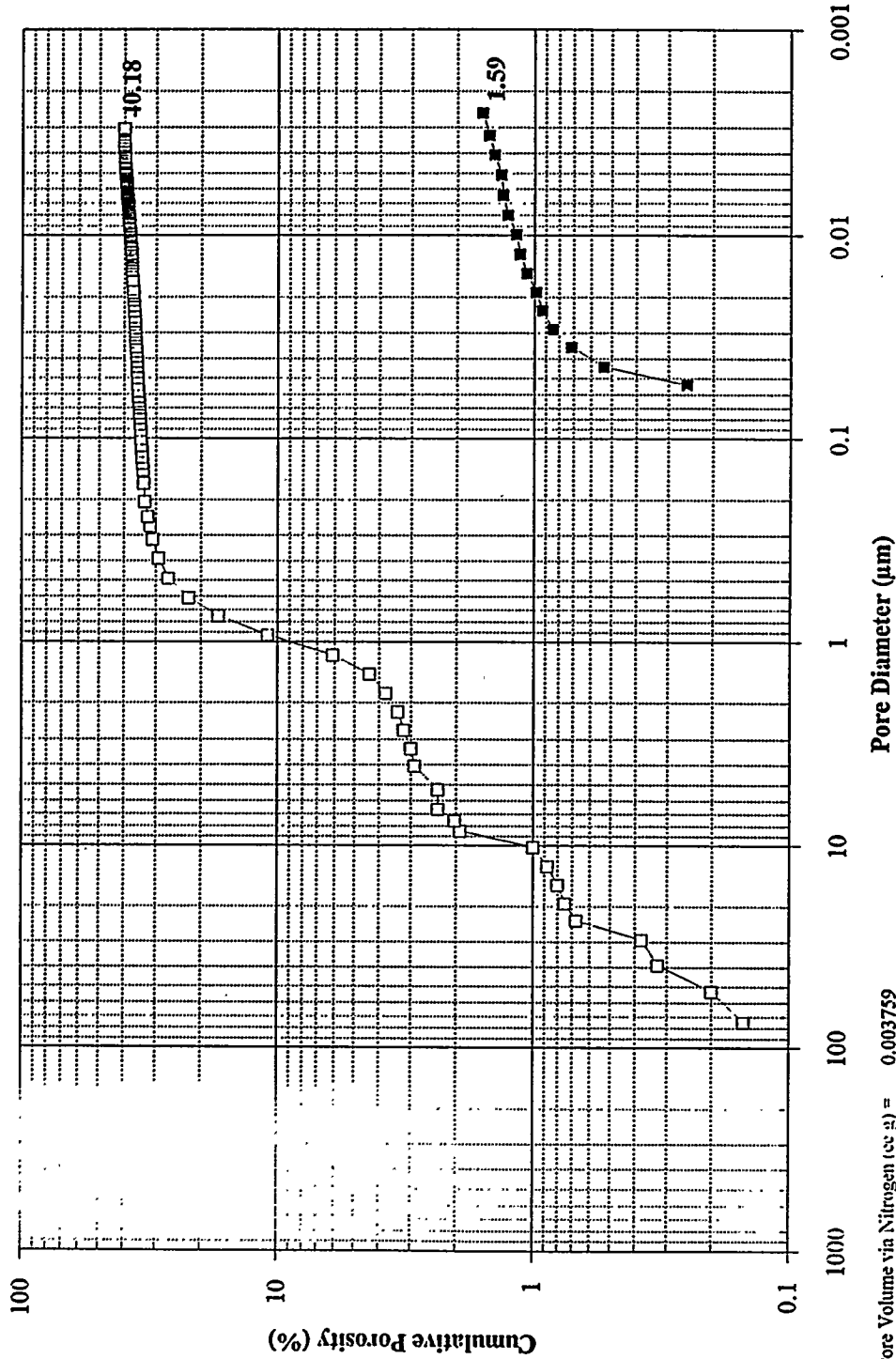

Total Pore Volume via Nitrogen (cc g) = 0.003759

Total Pore Volume via Mercury (ml g) = 0.1606

ZTMC-02-S3-B3
Bottom of Bed

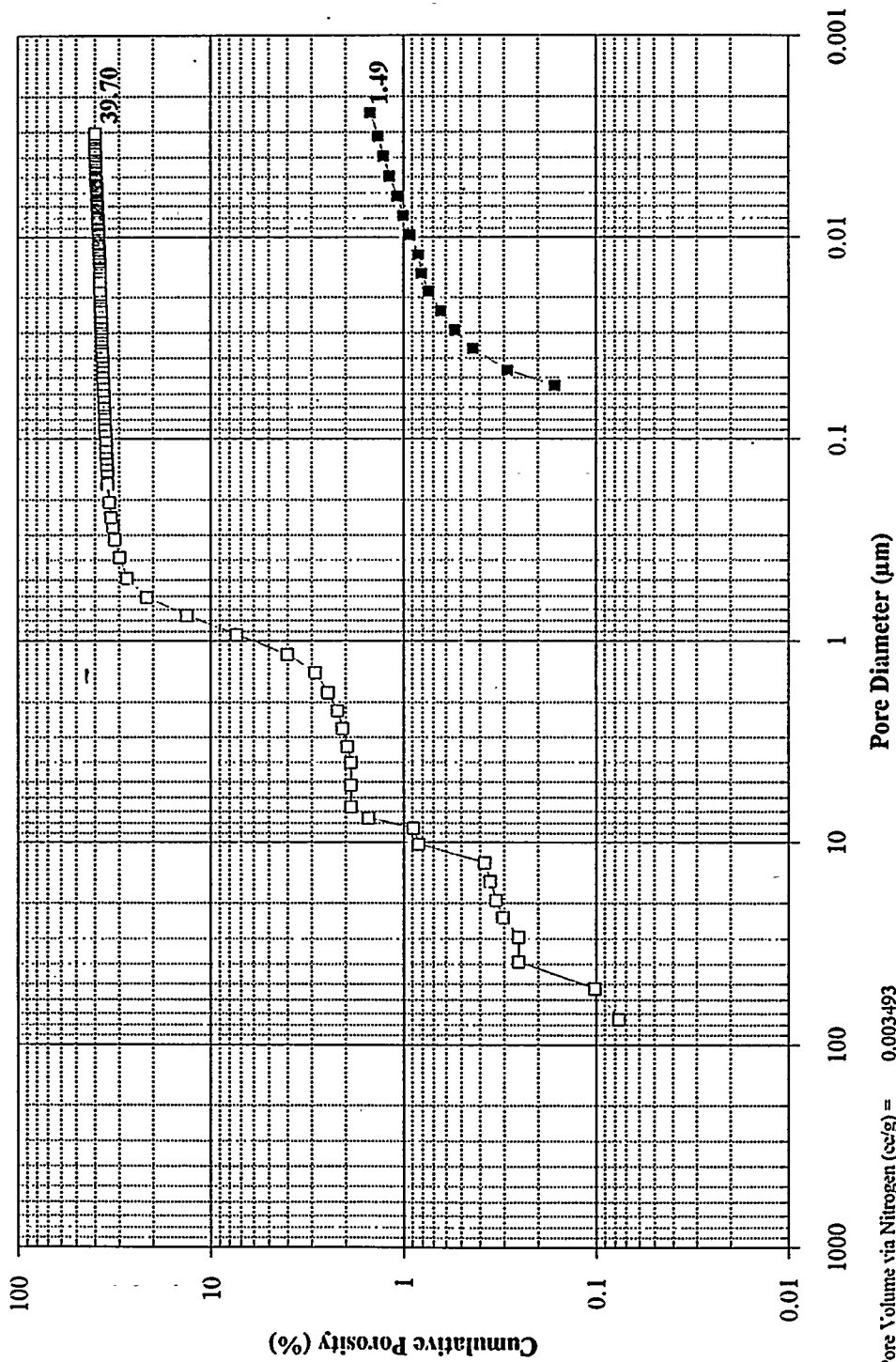

Total Pore Volume via Nitrogen (cc/g) = 0.003493

Total Pore Volume via Mercury (ml/g) = 0.1568

■ Nitrogen
□ Mercury

ZTMC-02-R3-B1
Top of Bed

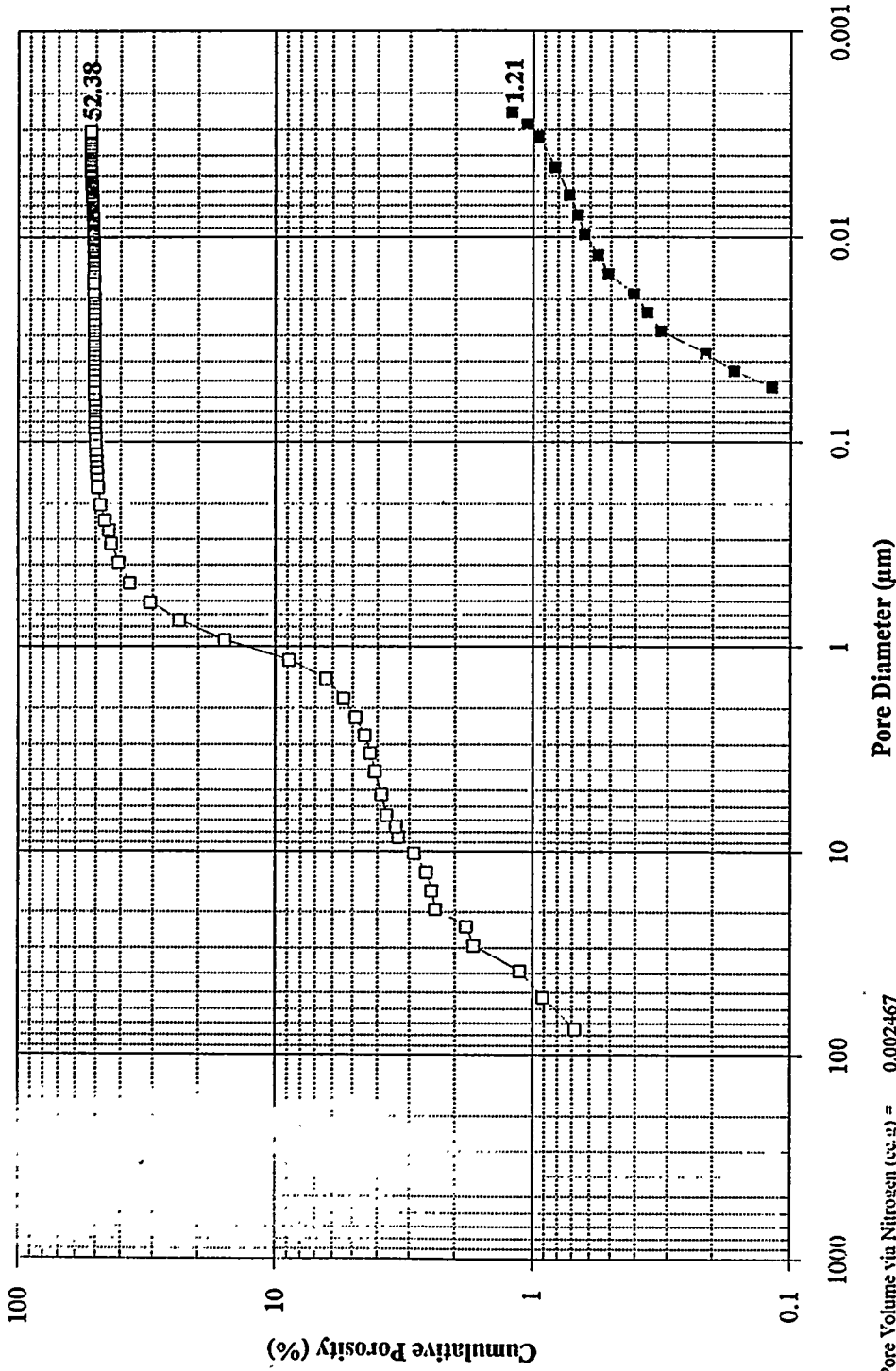

—■— Nitrogen
 —□— Mercury

Total Pore Volume via Nitrogen (cc/g) = 0.002467
 Total Pore Volume via Mercury (ml/g) = 0.2295

ZTMC-02-R3-B5
Middle of Bed

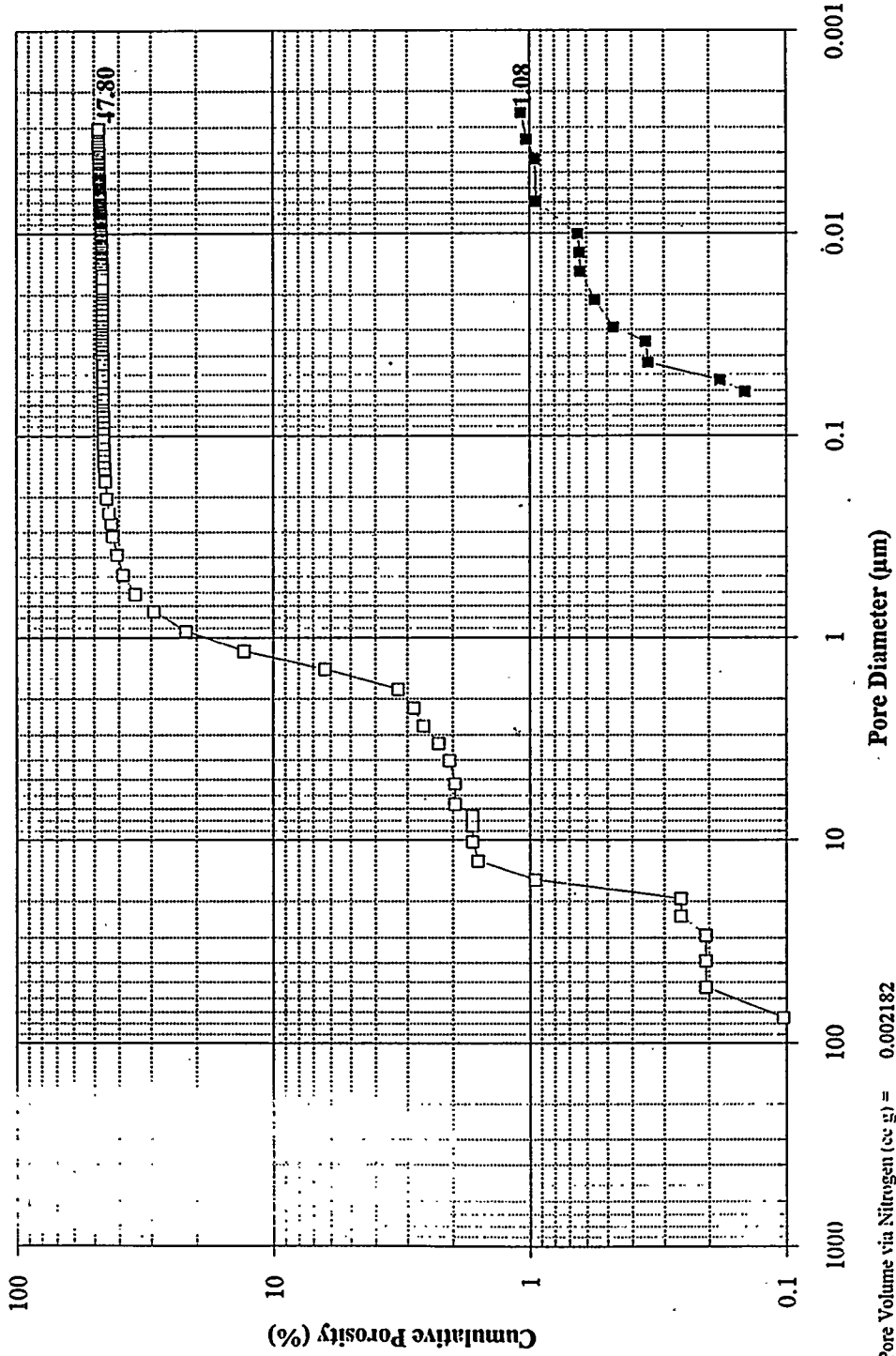

Total Pore Volume via Nitrogen (cc/g) = 0.002182

Total Pore Volume via Mercury (ml/g) = 0.1859

ZTMC-02-R3-B8
Bottom of Bed

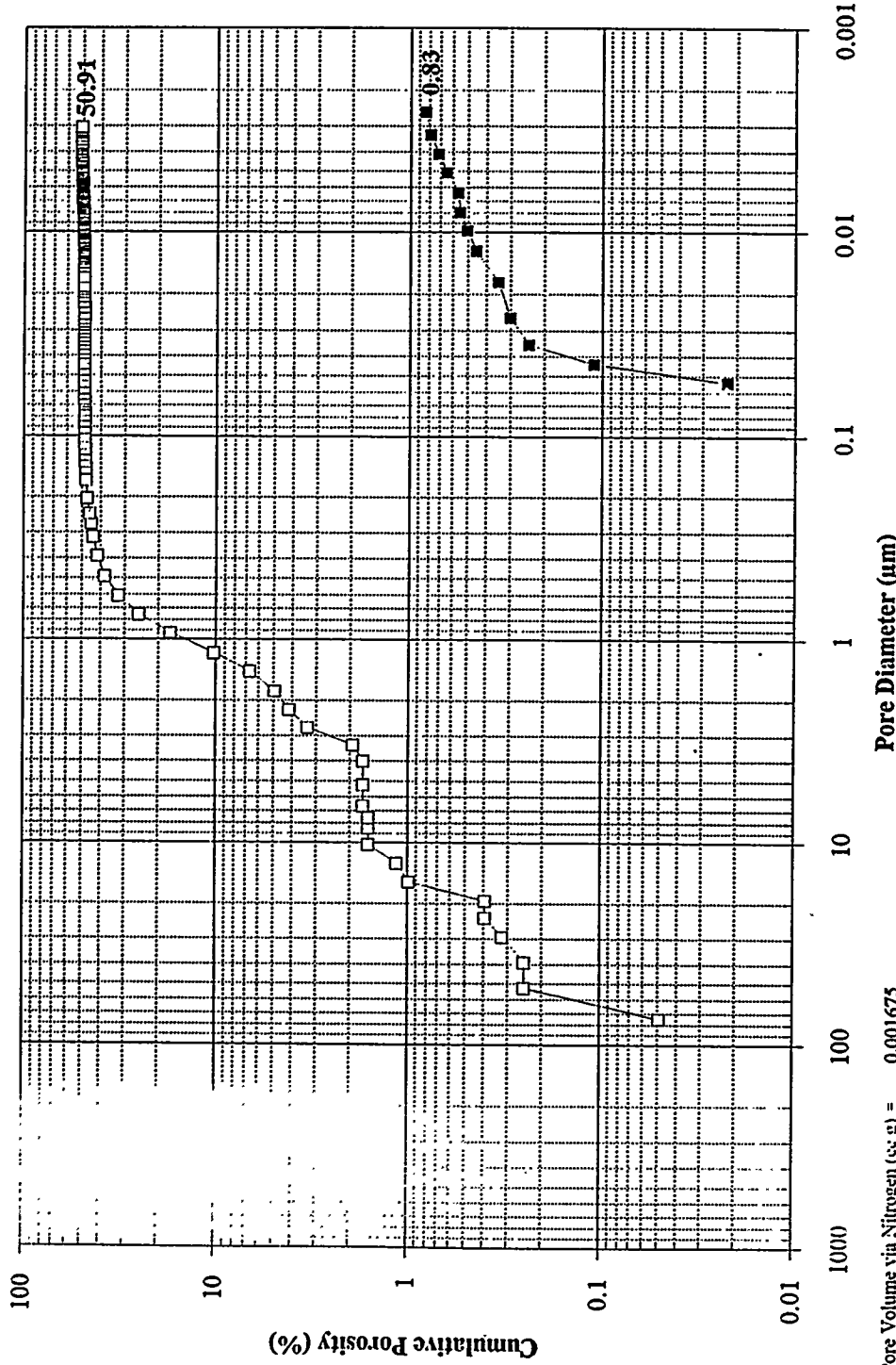

Total Pore Volume via Nitrogen (cc/g) = 0.001675
 Total Pore Volume via Mercury (ml/g) = 0.2065