

FC027
1/17/69



NATIONAL AERONAUTICS AND SPACE ADMINISTRATION

*LUNAR MODULE
SYSTEMS HANDBOOK
LM-5 THROUGH LM-9 VEHICLES*

JANUARY 17, 1969

NOTE

No further major revision to the handbook will be issued. Small revisions to individual drawings, figures, tables, or notes will be published as drawing change notices (DCN's) and/or page change notices (PCN's) as required.

*PREPARED BY
FLIGHT CONTROL DIVISION*

MANNED SPACECRAFT CENTER
HOUSTON, TEXAS

This cover revised by Change 4, dated June 2, 1969.

1 INTRODUCTION

2 STRUCTURES

3 CREW SYSTEMS

4 SEQUENTIAL AND
PYROTECHNICS

5 ELECTRICAL

6 ENVIRONMENTAL
CONTROL

7 EMU

8 COMMUNICATIONS

9 INSTRUMENT-
TATION

10 GUIDANCE AND
CONTROL

11 PROPULSION

12 REACTION
CONTROL

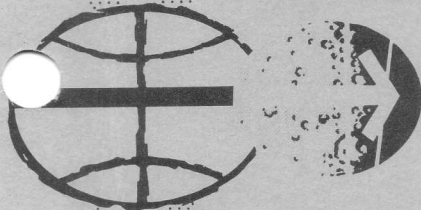

G AND C UNIVERSAL DRAWING TREE

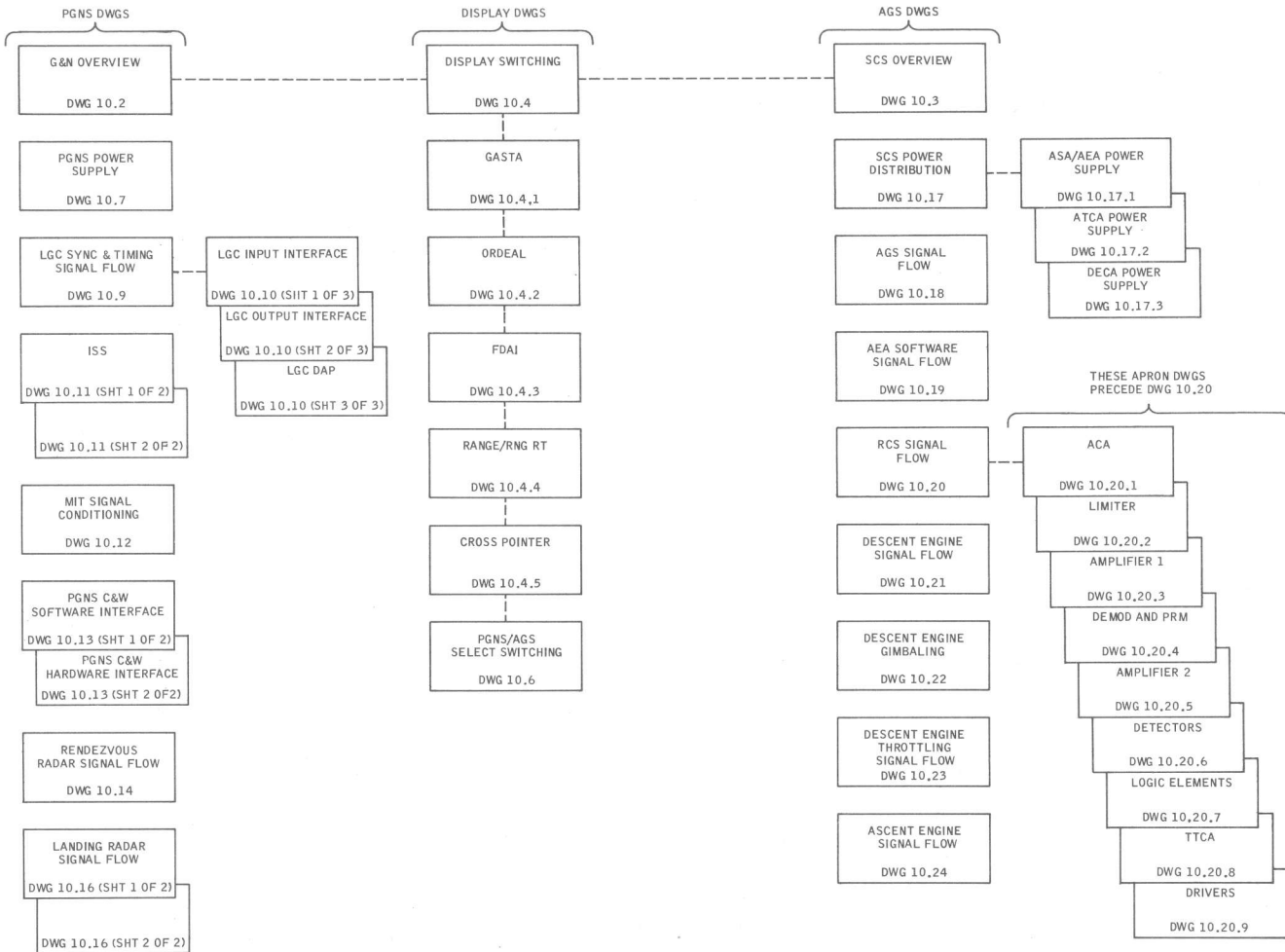

10-1

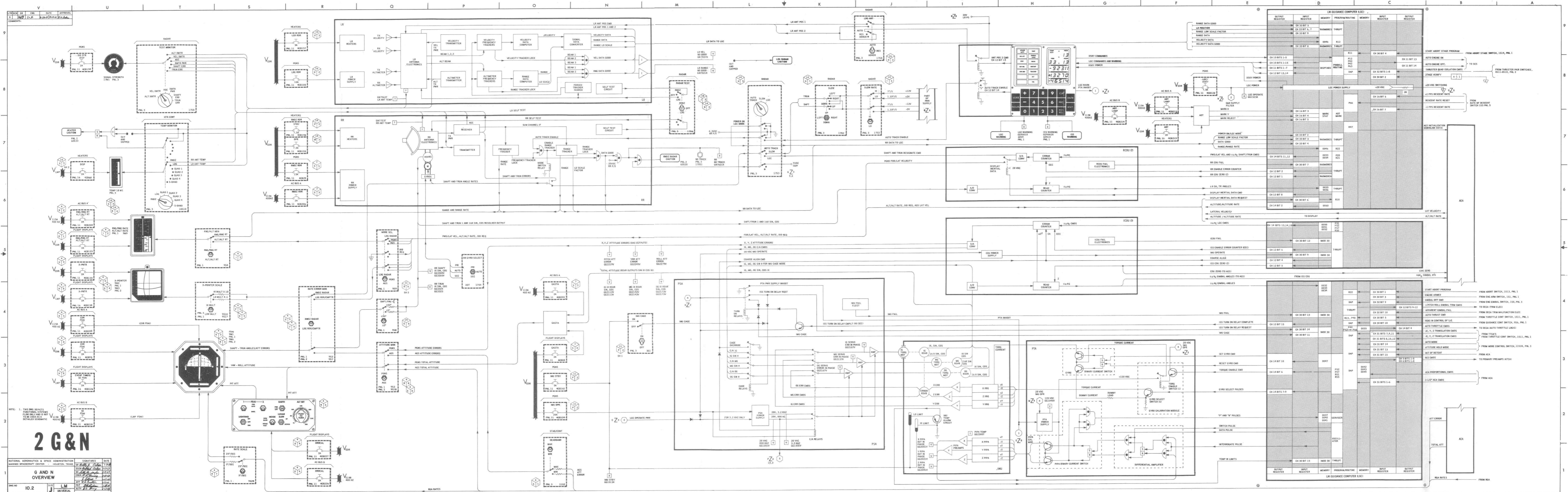

LT	CD	EN	DATE	APPROVAL
C		10/10/77	10/10/77	
COMMENTS:				

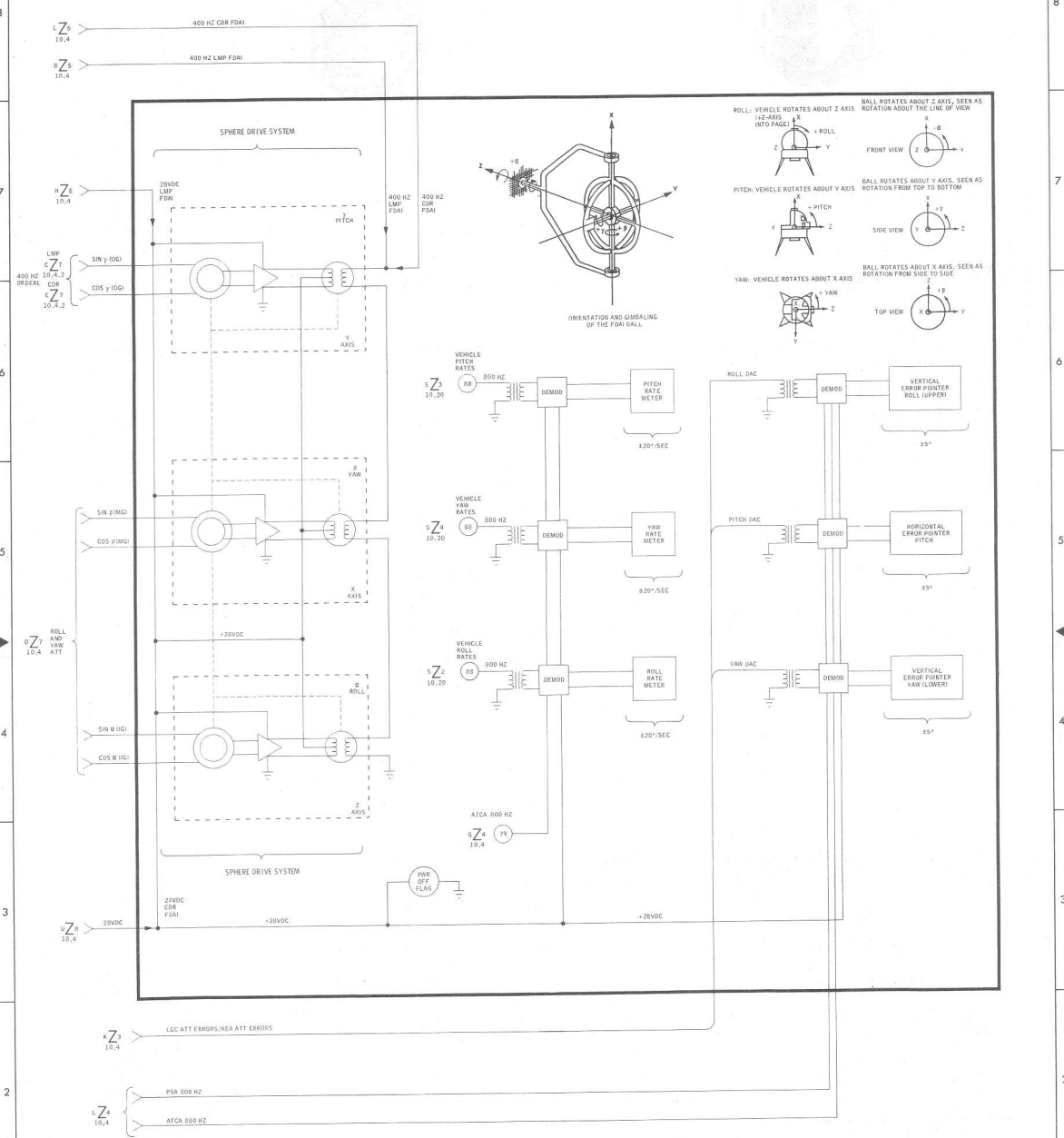

4.3 FDAI

NATIONAL AERONAUTICS & SPACE ADMINISTRATION MANNED SPACECRAFT CENTER - HOUSTON, TEXAS		SIGNATURES		DATE
FDAI		DR		11/21
		DCSR		11/21
		ENG		11/21
		APP		11/21
		PEC		11/21
		AUTH		11/21
DWG NO	10.4.3	LM		
		UNIVERSAL		
SHEET	OF	PAGE	10-7	30 X 40

- 3 FOR FSAI PARTWORK REFERENCE: $\frac{9M1}{10.1}$ $\frac{9M6}{10.1}$ $\frac{7A}{10.1}$ $\frac{7B}{10.1}$
- 2 FOR ELECTROLUMINESCENT DISPLAY LIGHTS, REFERENCE: $\frac{QZ1}{3.1}$
- NOTES: 1 DWG IS REPRESENTATIVE OF BOTH FSAIS (FM3-196)

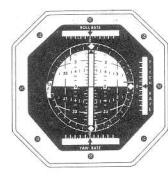

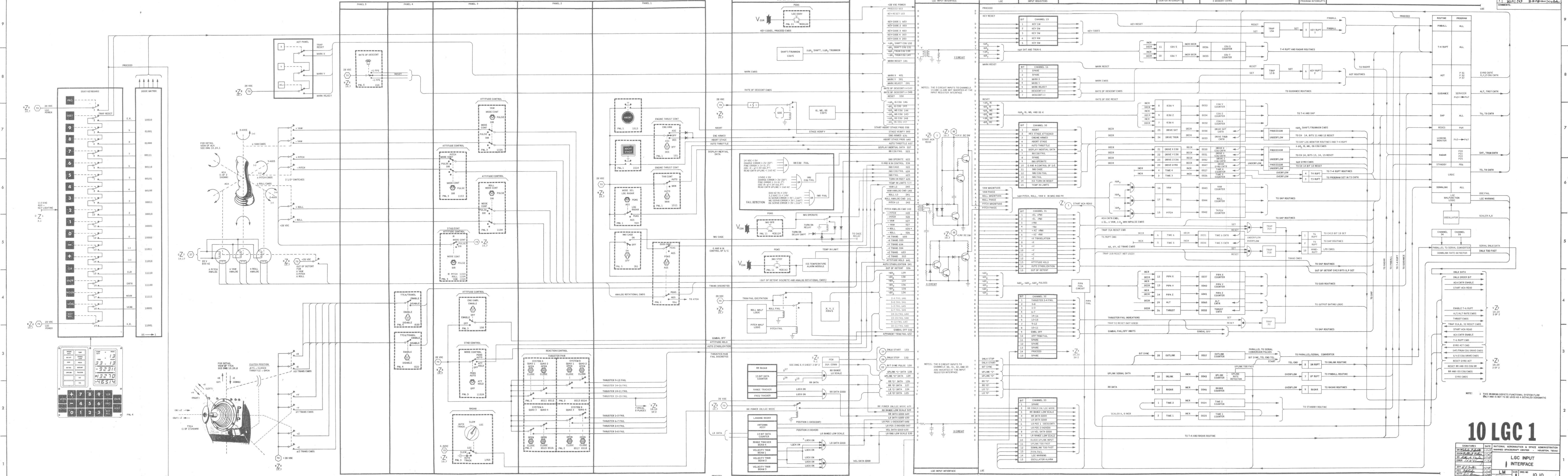

10 LGC 1

DATE	11/27/57
DESIGNED BY	W. J. ...
CHECKED BY	...
APP. BY	...
DATE	11/27/57
DESIGNED BY	...
CHECKED BY	...
APP. BY	...

NATIONAL AERONAUTICS & SPACE ADMINISTRATION
 WASHINGTON, TEXAS
 LGC INPUT
 INTERFACE
 10.10
 24.6 PERCENT
 UNIVERSAL
 J
 10-14
 1 OF 2

NOTE: 1. THIS DRAWING DEPICTS FUNCTIONAL SYSTEM FLOW ONLY AND IS NOT TO BE USED AS A DETAILED SCHEMATIC.

Table with columns: NAME, NO, FROM, TO. Lists various channels and registers.

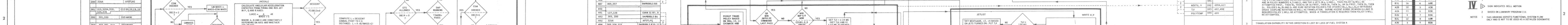
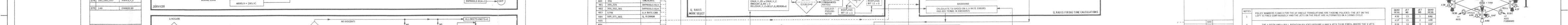
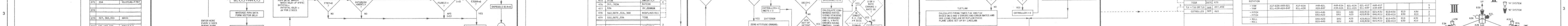
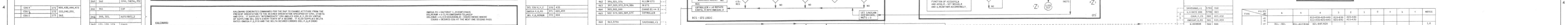
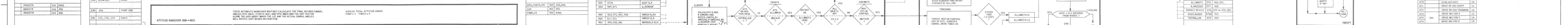
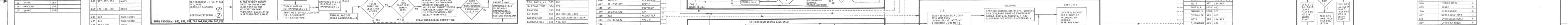
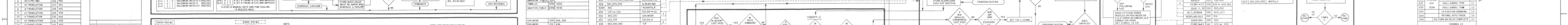
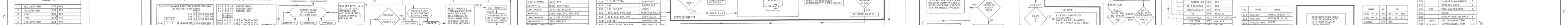
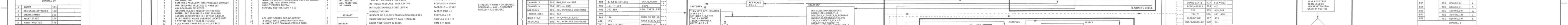

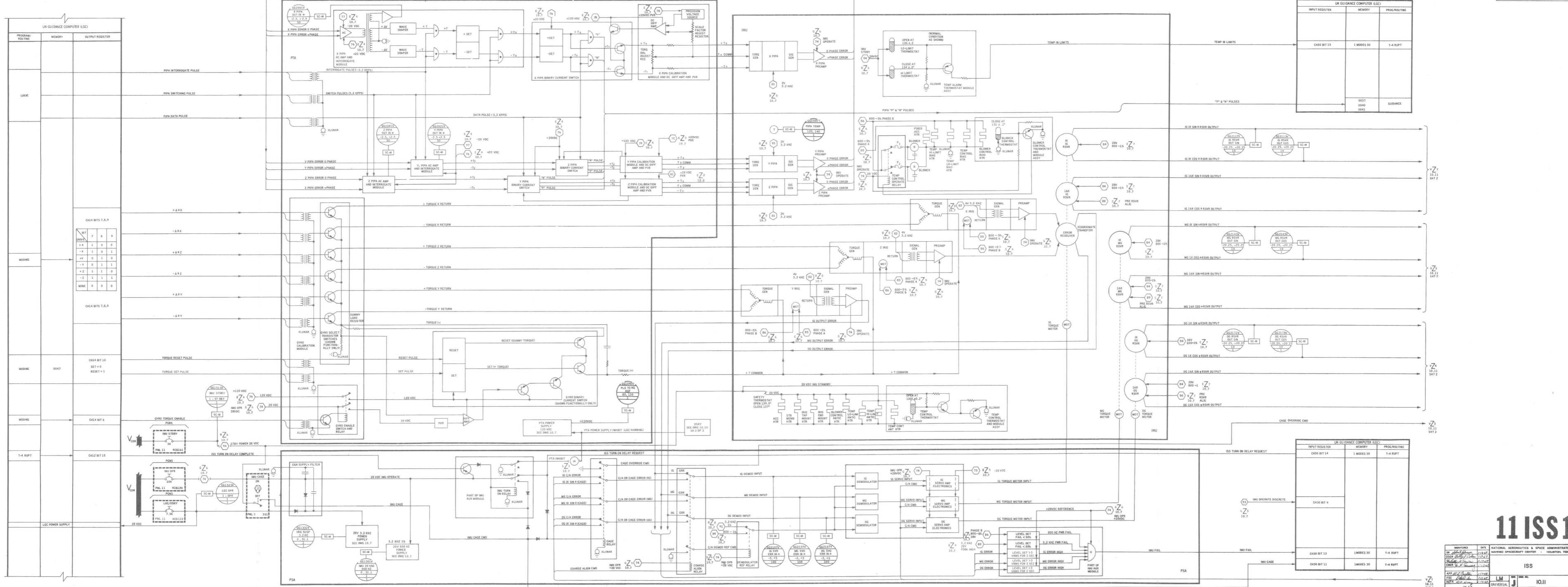

11 ISS1

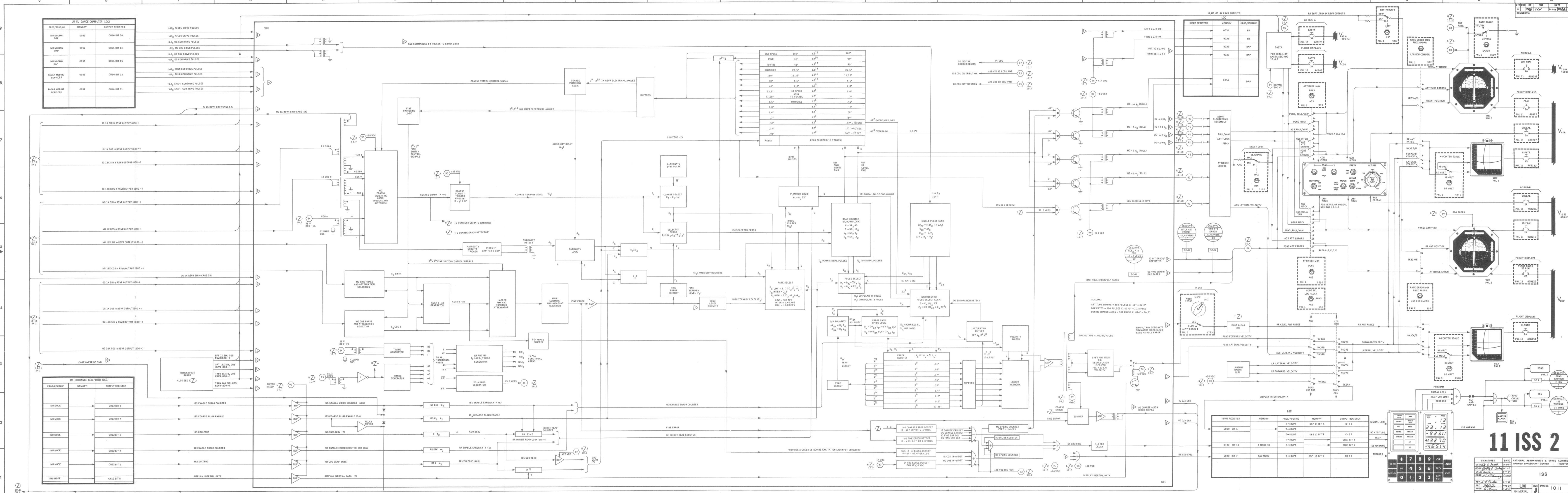

- 7 WHEN READ CTR IS WITHIN ≈ 0.1 DEG HIGH SCHMITT STOPS, FINE TAKES OVER. F_1 GETS ψ WITHIN TWO BITS OF θ .
- 6 RR CDU DRIVE PULSES REPRESENT (1) RR SHAFT AND TRUNNION DESIGNATE CMDS OR (2) FORWARD AND LATERAL VELOCITY (IF CH12B8 IS SET, DISPLAY INERTIAL DATA)
- 5 ISS CDU DRIVE PULSES REPRESENT (1) COARSE ALIGN CMDS, (2) MODE 1 DAP ERRORS, (3) MODE 2 DAP ERRORS, OR (4) DAP BODY RATES
- 4 GIMBAL DRIVE RATE IS LIMITED TO EITHER 35.5°/SEC (READ CTR AT 800 KPPS)
- 3 PROVIDES A GROUND PATH TO THE COARSE ALIGN RELAYS AND INHIBITS THE ERROR COUNTER ENABLE DISCRETE
- 2 THE RR CDU FAIL CIRCUITRY IS IDENTICAL TO THE ISS CDU FAIL CIRCUITRY WITH THE EXCEPTION OF POWER INPUT AS SHOWN
- 1 THE MIDDLE GIMBAL (MG) CDU SHOWN IN THIS DRAWING IS REPRESENTATIVE OF THE INNER GIMBAL (IG), OUTER GIMBAL (OG) RENDEZVOUS RADAR SHAFT AND RENDEZVOUS RADAR TRUNNION CDU'S

NOTES

11 ISS 2

ISS

LM UNIVERSAL

DATE: 10-11-68
REV: 10-11-68
PAGE: 10-11
SHEET: 2 OF 2

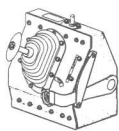
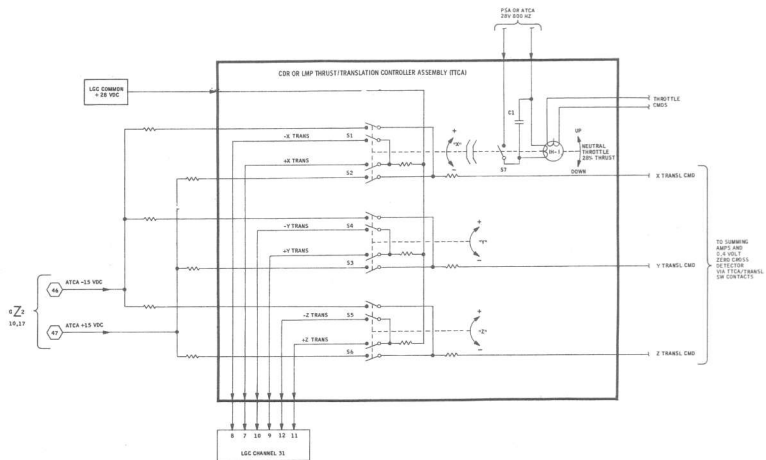

20.8 TTCA

SIGNATURES		DATE	NATIONAL AERONAUTICS & SPACE ADMINISTRATION
DR. Ron W. Moore		10-21-80	MANAGED SPACECRAFT CDP DR - HOUSTON, TEXAS
ENGR. J. J. ...		10-21-80	
ENGR. ...		10-21-80	
ENGR. ...		10-21-80	
DR. ...		10-21-80	
ENGR. ...		10-21-80	
ENGR. ...		10-21-80	
		LM	DWG. NO. 10.20.8
		UNIVERSAL	
30.8.40	PAGE 10-39	SHEET 1 OF 1	