



**CALCULATION SUMMARY SHEET (CSS)**

**FRAMATOME ANP**

Document Identifier 32 - 5020244 - 01

Title Point Beach 1 CRDM Temperbead Bore Weld Analysis

**PREPARED BY:**

**REVIEWED BY:**

METHOD:  DETAILED CHECK  INDEPENDENT CALCULATION

NAME JIRI KREJCIRIK

NAME JOHN F. SHEPARD

SIGNATURE *Jiri Krejcirik*

SIGNATURE *John F. Shepard*

TITLE ENGINEER DATE 2/28/03

TITLE ADVISORY ENGINEER DATE 2/28/03

COST CENTER 41020 REF. PAGE(S) 40 - 41

TM STATEMENT: REVIEWER INDEPENDENCE *ADM*

This document including the information contained herein and any associated drawings, is the property of Framatome ANP, Inc. It contains confidential information and may not be reproduced or copied in whole or in part nor may it be furnished to others without the expressed written permission of Framatome ANP, Inc., nor may any use be made of it that is or may be injurious to Framatome ANP, Inc. This document and any associated drawings and any copies that may have been made must be returned upon request.

**PURPOSE AND SUMMARY OF RESULTS:**

**Purpose:**

The purpose of Revision 1 is to provide a Non-Proprietary revision.

The purpose of this calculation is to analyze the Point Beach Unit 1 CRDM nozzle temperbead weld repair design. This repair consists of cutting the CRDM housing above the original attachment weld, removing the lower portion of the housing and welding the remaining housing to the RV head with a temperbead weld.

This calculation will demonstrate that the design meets the applicable requirements of the ASME Code, Section III, 1989 Edition with no Addenda.

**Conclusion:**

The calculations herein demonstrate that the Point Beach Unit 1 CRDM nozzle temperbead weld repair design meets the stress and fatigue requirements of the Design Code (ASME Code, Section III, 1989 Edition with no Addenda - Ref. 4)

Based on the loads and cycles specified in Reference 12, the conservative fatigue analysis indicates that the life of the CRDM Nozzle is approximately ( ) years.

THE FOLLOWING COMPUTER CODES HAVE BEEN USED IN THIS DOCUMENT:

CODE/VERSION/REV	CODE/VERSION/REV
_____	_____
_____	_____
_____	_____

THE DOCUMENT CONTAINS ASSUMPTIONS THAT MUST BE VERIFIED PRIOR TO USE ON SAFETY-RELATED WORK

YES  NO

## Table of Contents

1.0 Purpose.....	4
2.0 Background.....	4
3.0 Finite Element Model .....	5
4.0 Analytical Model.....	7
4.1 Model Geometry.....	7
4.2 Model Material.....	8
4.3 Model Boundary Condition .....	10
4.4 Overall 3D Finite Element Model.....	12
5.0 Applicable Loads .....	15
5.1 Design Conditions .....	15
5.2 Operating Transient Loads.....	15
5.3 External Loads .....	19
6.0 Thermal Results.....	20
7.0 Stress Results.....	27
7.1 ASME Code Criteria .....	29
7.2 ASME Code Primary Stress (SI) Intensity Criteria.....	30
7.2.1 Primary Stress Intensities for Design Conditions (Design Pressure @ Design Temperature).....	30
7.2.2 Primary Stress Intensities for Emergency (Level C) Conditions.....	32
7.2.3 Primary Stress Intensities for Faulted (Level D) Conditions.....	32
7.2.4 Primary Stress Intensities for Test Conditions .....	33
7.3 ASME Code Primary+Secondary SI Range and Fatigue Usage Criteria.....	34
8.0 Consideration of Corrosion of RV Head Low-Alloy Material.....	38
9.0 Conclusions .....	39
10.0 References.....	40
11.0 Computer Files.....	42
APPENDIX A .....	44

 <b>FRAMATOME ANP</b>	CRDM Temperbead Bore Weld Analysis		<b>NON-PROPRIETARY</b>
	DOCUMENT NUMBER 32-5020244-01	PLANT POINT BEACH 1	CONTRACT NUMBER 4160094

RECORD OF REVISIONS		
REVISION	DESCRIPTION	DATE
00	ORIGINAL RELEASE	9/02
01	NON-PROPRIETARY REVISION	2/03

 <b>FRAMATOME ANP</b>	CRDM Temperbead Bore Weld Analysis		NON-PROPRIETARY
	DOCUMENT NUMBER 32-5020244-01	PLANT POINT BEACH 1	CONTRACT NUMBER 4160094

## 1.0 Purpose

The purpose of this calculation is to analyze the Point Beach Unit 1 CRDM nozzle temperbead weld repair design described in Reference 2. This repair consists of cutting the CRDM housing above the original attachment weld, removing the lower portion of the housing and welding the remaining housing to the RV head with a temperbead weld.

As required by Ref. 7, this calculation will demonstrate that the design meets the applicable requirements of the ASME Code, Section III (Ref. 4). Installation of this repair may result in a given closure head assembly having CRDMs with both the repair design and the original design. Therefore, this document (an analysis of the repair design) is considered as a supplemental analysis to the original stress report (an analysis of the original design).

Additional results (stresses) are tabulated for the remnants of the original welds and the repair welds for potential use in flaw evaluations.

## 2.0 Background

In December 2000, inspection of the Alloy 600 Control Rod Drive Mechanism (CRDM) nozzle penetrations in the RV closure head (RVH) at Oconee Unit 1 identified leakage in the region of the partial penetration attachment weld between the RVH and the CRDM nozzle. This leakage, identified as the result of Primary Water Stress Corrosion Cracking (PWSCC), was repaired using manual grinding and welding. In February 2001, the manual repair of several CRDM nozzles at Oconee Unit 3 with similar defects resulted in extensive radiation dose to the personnel due to the location and access limitations. Consequently, the B&W Owner's Group (BWOOG) commissioned Framatome ANP (FRA-ANP) to design and demonstrate an automated repair that was ultimately implemented at Oconee Unit 2 and other plants.

Due to concerns that similar Control Rod Drive Mechanism (CRDM) nozzle degradation may have occurred at Pressurized Water Reactors (PWRs), Nuclear Management Company (NMC) has contracted FRA-ANP to adapt this repair for its Point Beach Unit 1&2 (PB1&2) with modifications as required to meet ASME Code.

	CRDM Temperbead Bore Weld Analysis		NON-PROPRIETARY
	DOCUMENT NUMBER 32-5020244-01	PLANT POINT BEACH 1	CONTRACT NUMBER 4160094

### 3.0 Finite Element Model

There are a total of 49 CRDM nozzle-to-head connections on the RV Closure Head. Each of the nozzles is aligned vertically. They are located at various radial distances from the vertical centerline of the hemisphere. Based on the distance from the center of the hemispherical head, the relative angle of the nozzle vertical centerline and the plane of the head curvature varies. This angle is referred to herein as the 'hillside angle'. Experience (with analyses for nozzles located at various hillside angles) indicates that the larger the hillside angle, the more severe the effect on stress levels in the connecting weld region. Based on this experience, the model herein represents the largest hillside angle of any of the CRDM Housing nozzle locations. This model is considered to produce results that are conservatively bounding all nozzle locations that have a smaller hillside angle.

The finite element model is a 3-dimensional model of a 180-degree segment of a CRDM tube with the adjacent head region and interconnecting weld. Symmetry boundary conditions are used to represent the un-modeled portions of the head and nozzle. The model is shown in Figure 1. The dimensions and material properties are documented in Section 4.0.

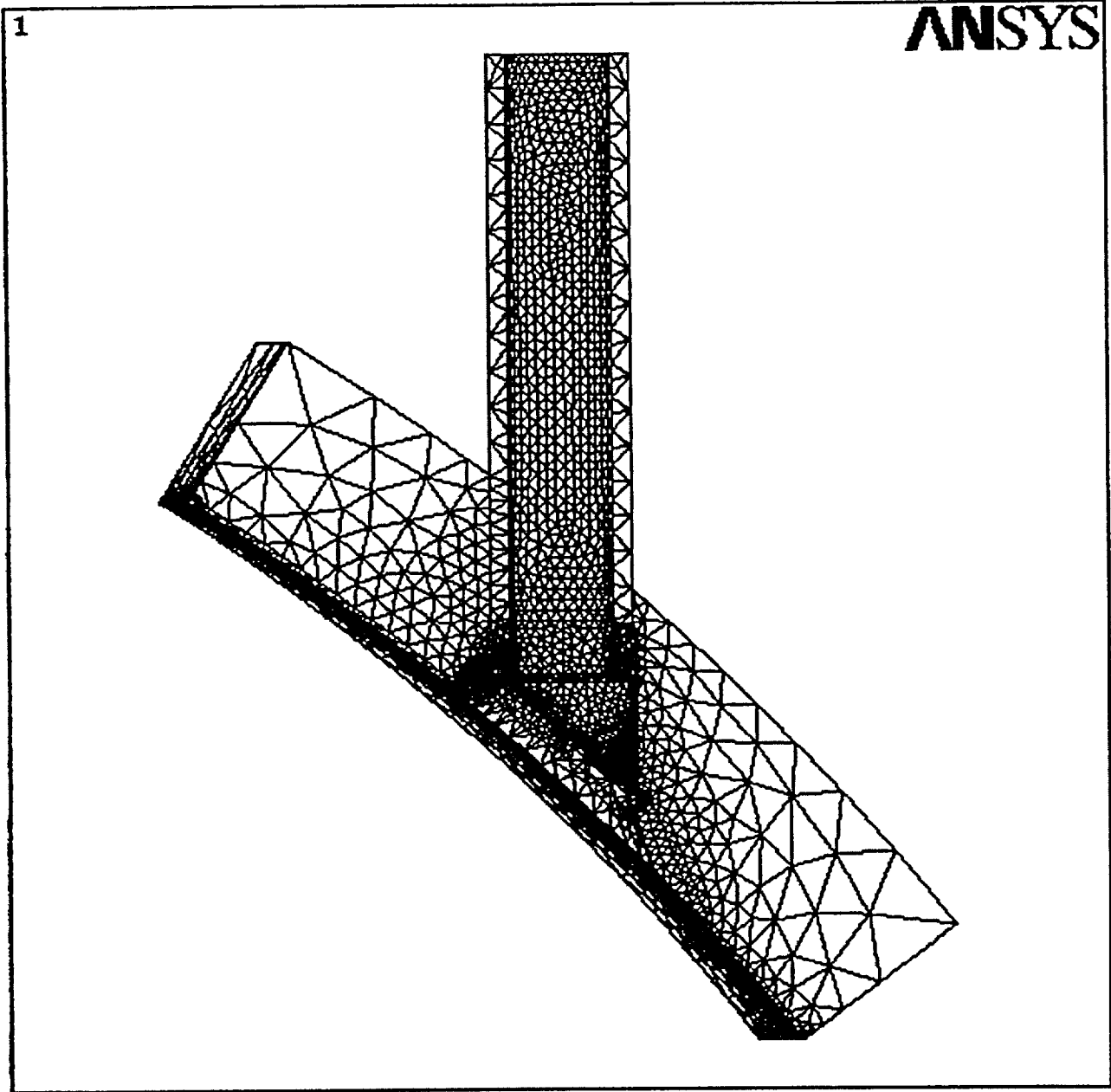

**Figure 1 Finite Element Mesh**

The figure above is not pertinent to this document.

*[Signature]* 2/28/03  
 \_\_\_\_\_  
 (for legibility concerns)

 <b>FRAMATOME ANP</b>	CRDM Temperbead Bore Weld Analysis		<b>NON-PROPRIETARY</b>
	DOCUMENT NUMBER 32-5020244-01	PLANT POINT BEACH 1	CONTRACT NUMBER 4160094

#### 4.0 Analytical Model

To provide the needed stress field refinement, the CRDM Housing nozzle-to-RV Head connection is modeled in three dimensions. This permits detailed accounting for the effects of the hillside orientation. The analysis software program ANSYS (Reference 3) is used for solid modeling, meshing, solution and post-processing of the model. This large 'general purpose' program utilizes the 'finite element' technique as its basis.

The model consists of 'geometry', 'materials' and 'boundary conditions'. Each of these items is discussed in more detail in the following sections.

#### 4.1 Model Geometry

The geometry of the model is based on References 2 and 15. Due to the spacing of the CRDM Housing nozzles and the attenuation of the stress effects, no appreciable overlap of stress fields occurs between adjacent nozzles. Therefore, only a single CRDM Housing nozzle is modeled.

As mentioned in Section 3.0, the model is based on the nozzle having the largest hillside angle (i.e., outermost nozzle). This produces stress results that are bounding of all other locations of CRDM Housing nozzles.

Some of the key dimensions are:

RV Head inside radius to base metal	=	66.3125"	(Ref. 15a)
RV Head thickness	=	5.375"	(Ref. 2)
RV Head cladding thickness	=	5/32"	(Ref. 15b)
CRDM Housing nozzle OD	=	4.000"	(Ref. 2)
CRDM Housing nozzle ID	=	2.75"	(Ref. 2)
Weld buttering layer thickness	=	0.25"	(Ref. 15b)
CRDM Penetration Bore	=	4.25"	(Ref. 2)
Max. machining diameter (Repair Weld)	=	2.818"	(See Note)

The RV Head is modeled a sufficient distance away (both in the uphill/downhill and circumferential directions) from the local weld region to assure that the stress effects have effectively attenuated. *(The adequacy of these distances is verified by review of solution runs for operational transients.)*

Note: To account for a possible future implementation of Waterjet Remediation at CRDM temperbead repair weld area, the diameter of 2.964" is assumed and used in this analysis. Comparing to Max. Grinding/Machining Diameter of 2.818", using the Waterjet Remediation Diameter is conservative.

 <b>FRAMATOME ANP</b>	CRDM Temperbead Bore Weld Analysis		<b>NON-PROPRIETARY</b>
	DOCUMENT NUMBER 32-5020244-01	PLANT POINT BEACH 1	CONTRACT NUMBER 4160094

## 4.2 Model Material

The material designations and their properties for the original design are documented in References 7 and 12. Per Reference 7, the material designation for the repair weld is ERNiCrFe-7, UNS N06052. Based on the Chemical Composition in Test Report (Ref. 17), the Alloy 690 material is assumed to be representative of the repair weld material properties.

The material designations of the sub-components are:

- RV Head = SA-302, Gr. B (Ref. 7)
- Original CRDM Housing nozzle = SB-167 (Alloy 600) (Ref. 7)
- Cladding = Type 304 SS (Use SA 240) (Ref. 12, Par. 4.3.1.2, use SA 240)
- J-Groove buttering = Alloy 600 (Ref. 12, Par. 4.1.1.9)
- J-Groove filler = Alloy 600 (Ref. 12, Par. 4.1.1.9)
- Repair weld = Alloy 690 (Ref. 7 and Ref. 17)

The pertinent properties (thermal & structural) for these materials are listed in the following tables.

The analysis herein uses the thermal properties – mean coefficient of thermal expansion ( $\alpha$ ), specific heat (C), thermal conductivity (k) and the mechanical properties – modulus of elasticity (E), Poisson’s ratio ( $\mu$ ), density ( $\rho$ ). Additionally, the structural/stress values of the yield stress ( $S_y$ ), ultimate strength ( $S_u$ ) and allowable stress ( $S_m$ ) are included.

The units of the quantity below are:

- E = psi ( $\times 10^6$ )
- $\mu$  = ratio (unitless)
- $\rho$  = pounds/ cubic inch
- $\alpha$  = inch/inch/ $^{\circ}$ F ( $\times 10^{-6}$ )
- k = BTU/hr-in- $^{\circ}$ F
- C = BTU/(lb- $^{\circ}$ F) [C is a calculated value based on  $C = k/(\rho \times \text{Thermal Diffusivity})$  where thermal diffusivity is taken from the same source as ‘k’]

- $S_m$  = ksi
- $S_y$  = ksi
- $S_u$  = ksi



**Table 4.1 Closure Head Base Material**

Low-Alloy Steel - SA-302, GR. B (Mn - 1/2Mo)

TEMP	E	μ	ρ	α	k	C	Sm	Sy	Su
100	29.00	0.29	0.2839	7.06	1.9667	0.1067	26.7	50.0	80.0
200	28.50	0.29	0.2831	7.25	2.0333	0.1141	26.7	47.5	80.0
300	28.00	0.29	0.2823	7.43	2.0583	0.1206	26.7	46.1	80.0
400	27.40	0.29	0.2817	7.58	2.0500	0.1270	26.7	45.1	80.0
500	27.00	0.29	0.2809	7.70	2.0167	0.1322	26.7	44.5	80.0
600	26.40	0.29	0.2802	7.83	1.9583	0.1375	26.7	43.8	80.0
700	25.30	0.29	0.2794	7.94	1.9000	0.1440	26.7	43.1	80.0
Ref.	5	Assumed	8	5	5	Calc.	5	5	5

**Table 4.2 Original CRDM Housing Nozzle, J-Groove Weld, Buttering**

ALLOY 600 (SB-167, UNS N06600) / Sy = 35 ksi (Alloy 182) Weld

TEMP	E	μ	ρ	α	K	C	Sm	Sy	Su
100	30.81	0.3	0.3060	6.90	0.7250	0.1068	23.3	35.0	80.0
200	30.20	0.3	0.3053	7.20	0.7583	0.1106	23.3	32.7	80.0
300	29.90	0.3	0.3045	7.40	0.8000	0.1140	23.3	31.0	80.0
400	29.50	0.3	0.3038	7.57	0.8417	0.1166	23.3	29.8	80.0
500	29.00	0.3	0.3030	7.70	0.8833	0.1184	23.3	28.8	80.0
600	28.70	0.3	0.3023	7.82	0.9250	0.1221	23.3	27.9	80.0
700	28.20	0.3	0.3016	7.94	0.9667	0.1244	23.3	27.0	80.0
Ref.	5	8	8	5	5	Calc.	5	5	5

**Table 4.3 Cladding (Stainless Steel)**

SA 240 Type 304 (18Cr - 8Ni)

TEMP	E	μ	ρ	α	K	C	Sm	Sy	Su
100	28.14	0.3	0.2862	8.55	0.7250	0.1157	Not used in analysis		
200	27.60	0.3	0.2853	8.79	0.7750	0.1209			
300	27.00	0.3	0.2844	9.00	0.8167	0.1246			
400	26.50	0.3	0.2836	9.19	0.8667	0.1286			
500	25.80	0.3	0.2827	9.37	0.9083	0.1313			
600	25.30	0.3	0.2818	9.53	0.9417	0.1334			
700	24.80	0.3	0.2810	9.69	0.9833	0.1358			
Ref.	5	8	8	5	5	Calc.	n.a.	n.a.	n.a.

Table 4.4 CRDM Housing Nozzle, Repair Weld									
ALLOY 690 (UNS N06690)									
TEMP	E	$\mu$	$\rho$	$\alpha$	K	C	$S_m$	$S_y$	$S_u$
100	30.1	0.29	0.3060	7.76	0.5833	0.1034	23.3	35.0	80.0
200	29.5	0.29	0.3053	7.85	0.6333	0.1075	23.3	31.6	80.0
300	29.1	0.29	0.3045	7.93	0.6833	0.1113	23.3	29.8	80.0
400	28.8	0.29	0.3038	8.02	0.7333	0.1140	23.3	28.7	80.0
500	28.3	0.29	0.3030	8.09	0.7833	0.1173	23.3	27.8	80.0
600	28.1	0.29	0.3023	8.16	0.8333	0.1189	23.3	27.6	80.0
700	27.6	0.29	0.3016	8.25	0.8833	0.1218	23.3	27.6	80.0
Ref.	6	Assumed	6	6	6	Calc.	6	6	6

### 4.3 Model Boundary Condition

The analytical model is a three-dimensional model of a 180-degree section of the cylindrical portion of the CRDM Housing nozzle body. Therefore, the model has a mirror plane of symmetry that contains the vertical centerline of the CRDM Housing nozzle and the center of curvature of the RV Head (i.e., this is a vertical plane). The thermal and structural boundary conditions are reflective in this plane.

As for Structural behavior of the closure head model, the model vertical plane boundaries are allowed to deflect in the direction that is radial and meridional to the head center of curvature.

For thermal transient type loads (heat transfer coefficient and bulk fluid temperature), the appropriate surfaces are loaded. Consistent with Reference 11 (see Design Analysis No. 9, Stress Analysis of Control Rod Mechanism Housing), a film coefficient of ( ) Btu/hr-ft<sup>2</sup>-F is used in this analysis for all wetted surfaces. At the RV Head exterior surface, a relatively small film coefficient (representing heat loss through the insulation) is applied in conjunction with the estimated ambient temperature above the head. The small air gap between the remaining CRDM Housing nozzle OD and penetration bore is modeled as 'coupled temperatures' to best represent the actual condition.

During operation, the inside of the RV Closure Head (and the inside bore of the CRDM Housing nozzle) are filled with Reactor Coolant fluid. The temperature and pressure of this fluid corresponds to those of the Reactor Coolant outlet. The fluid temperatures versus time are applied as loads to the model in conjunction with heat transfer coefficients (HTC). The following figure (Figure 2) depicts typical surfaces of the model that are loaded thermally.

For pressure, those surfaces in contact with primary coolant water (i.e., wetted) are loaded. These include the RV Head/J-groove weld, repair weld, enlarged bore, and the CRDM Housing nozzle inside diameter. The exteriors of the RV Head (and the air-filled interface

gap between the CRDM Housing nozzle and penetration bore) are not loaded by pressure. The upper end of the CRDM Housing nozzle cylinder has a pressure applied to represent the hydrostatic end load from the CRDM closure.

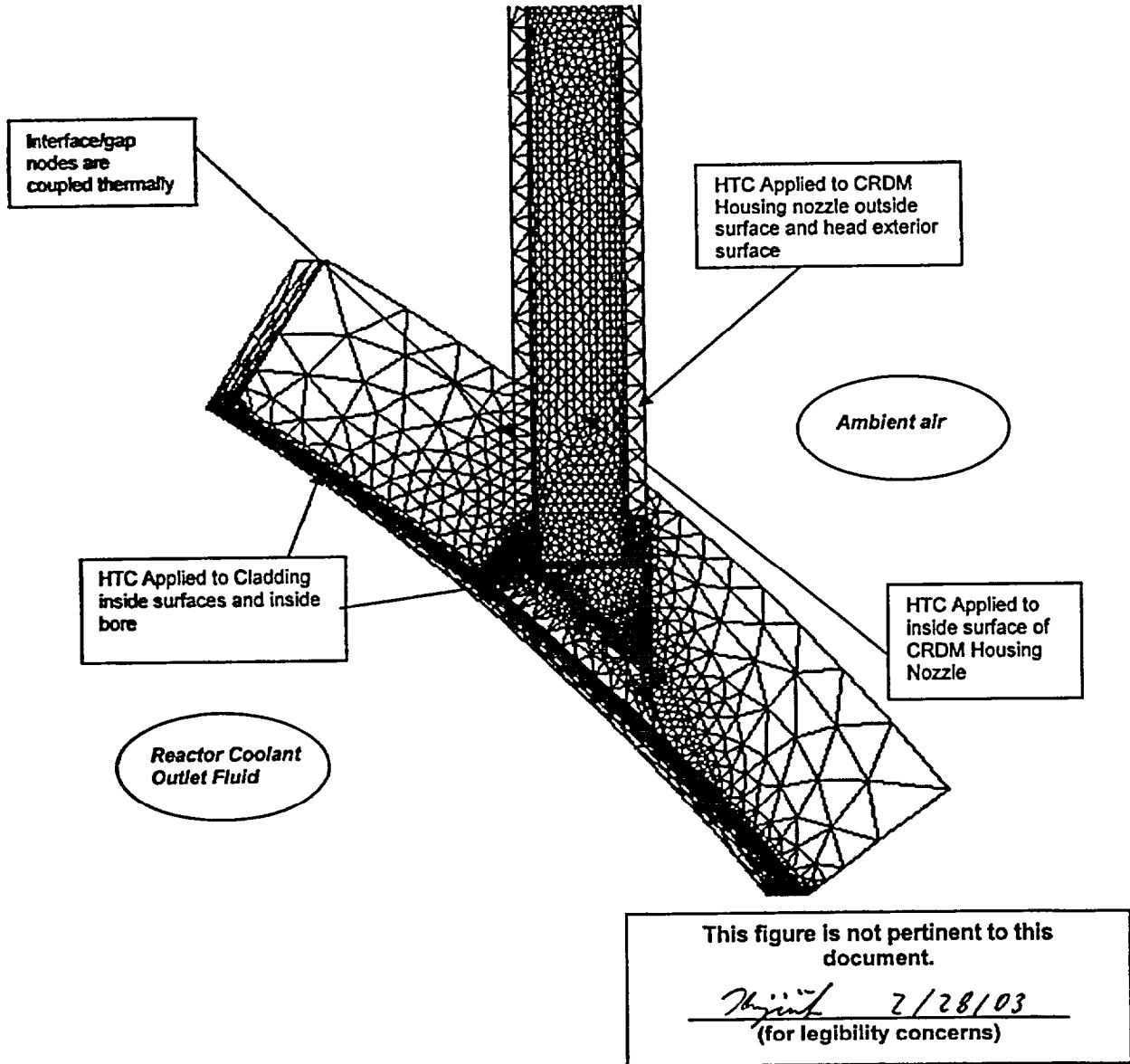

**Figure 2 Heat Transfer Regions of Thermal Analysis Model**

 <b>FRAMATOME ANP</b>	CRDM Temperbead Bore Weld Analysis		<b>NON-PROPRIETARY</b>
	DOCUMENT NUMBER 32-5020244-01	PLANT POINT BEACH 1	CONTRACT NUMBER 4160094

A portion of the remaining CRDM Housing nozzle is roll-expanded to the wall of the adjacent penetration bore (see Reference 2). This roll-expansion fit limits the relative motions of the CRDM nozzle body and the RV Head as the shrink fit (i.e., interference fit) did for the original fabrication. By limiting the relative motions, the thermal and pressure induced stresses in the interconnecting temperbead weld are limited. The typical shrink fit effect for such a nozzle/head configuration is demonstrated analytically by comparing the results of runs 'LWDesign2.out' (w/ interference restraint) and 'LWDesign3.out (w/o interference restraint) from Ref. 9. *[The geometry of the Reference 9 analysis is slightly different than Point Beach 1. But, the subject's general behavior is the same. Thus, the results of Reference 9 are applicable to Point Beach 1].* To assure conservative results, no credit is taken for this effect in this model – the restraint provided by the roll-expansion is omitted.

#### 4.4 Overall 3D Finite Element Model

Using the above items as parameters, the CRDM Connection 3D FE model is developed. The resulting overall model is depicted in Figure 1. The model is comprised of approximately 83,000 nodes and 57,000 elements. The element type chosen is the ANSYS SOLID87 (3D 10-Node Tetrahedral Thermal Solid) for the thermal analysis. This element is converted to element type SOLID92 (3D 10-Node Tetrahedral Structural Solid) for the structural solutions. These elements have the capability of having surface loads applied (such as heat transfer or pressure) and having structural boundary conditions applied (such as guided displacements, constraints, etc.).

As an example of the behavior of the model, a run has been made for the Design Condition loading of 2500 psia @ isothermal temperature = 650F (w/ no differential thermal growth –  $T_{unif} = T_{ref}$ ) [Run ID = 'PB1\_DES.out']. Figure 3 contains a deformed shape plot with an outline of the un-deformed shape. Such plots are used to confirm the correct modeling of the structural (displacement) boundary conditions. Figure 4 shows the stress contours associated with the Design Condition parameters. Assessment of this type of plot is used to confirm the general stress response of the model (such as spherical head stresses and nozzle cylinder stresses – remote from discontinuities).

Based on a review of the model behavior, it is concluded that the model is responding correctly. More specifically, the model is suitable for use in analyzing the CRDM Housing nozzle connection to the RV Head when subjected to the pressure and thermal loading associated with operating transients.

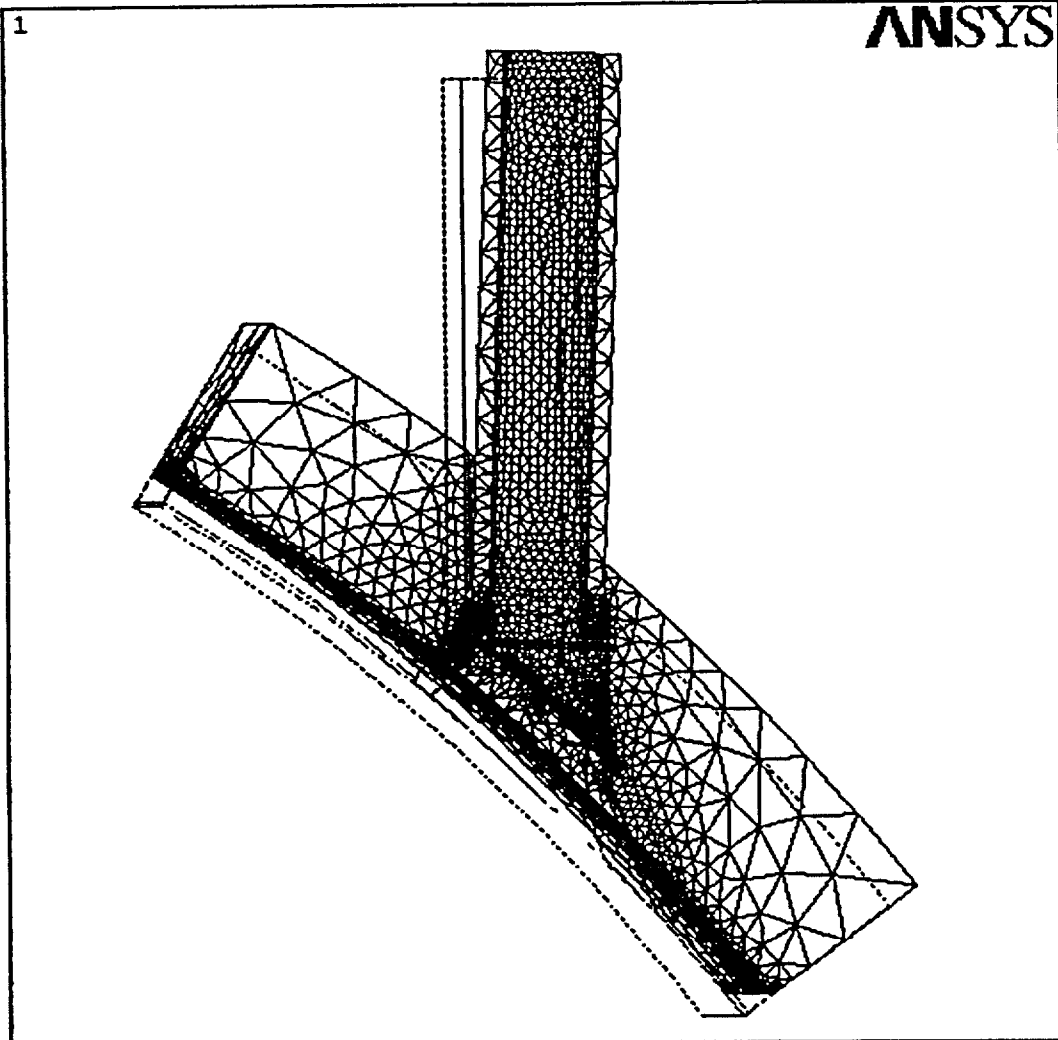

SEP 6 2002  
 10:45:21  
 DISPLACEMENT  
 STEP=1  
 SUB =7  
 TIME=.1  
 PowerGraphics  
 EFACET=1  
 AVRES=Mat  
 DMX =.053403

This figure is not pertinent to this document.

*Hynd* 2/28/03  
 \_\_\_\_\_  
 (for legibility concerns)

**Figure 3 Deformed Shape with Undeformed edge at Design Pressure**

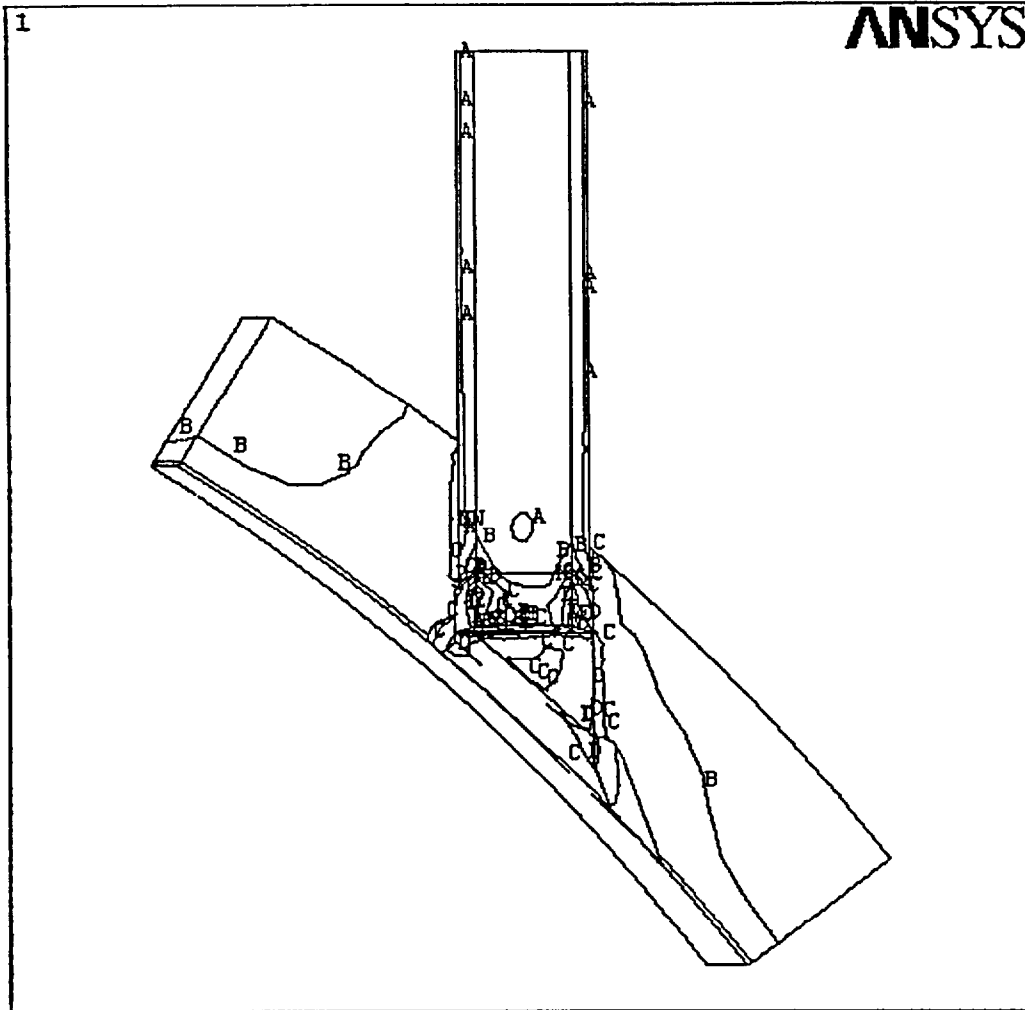

```

SEP  6 2002
10:46:59
NODAL SOLUTION
STEP=1
SUB  =7
TIME=.1
SINT      (AVG)
PowerGraphics
EFACET=1
AVRES=Mat
DMX  =.053403
SMN  =1131
SMX  =102550
A    =6765
B    =18034
C    =29303
D    =40572
E    =51841
F    =63109
G    =74378
H    =85647
I    =96916

```

This figure is not pertinent to this document.

*J. Krejcirik* 2/28/03  

---

(for legibility concerns)

**Figure 4 Stress Intensity Contour at Design Pressure**

## 5.0 Applicable Loads

The following sections address the types of loading that are applicable (or potentially applicable) to the thermal/stress analysis of the 3D model of the CRDM Housing to RV Head weld connection region.

### 5.1 Design Conditions

The RV Closure Head assembly (includes CRDM Housing nozzles and attachment welds) is designed to meet ASME Code stress criteria for maximum temperature and internal pressure. As a typical example, per Reference 12, the Design Temperature = 650F and the Design Pressure = 2500 psia are used.

As part of the developmental process for the subject FE model of the CRDM Housing nozzle attachment weld region, a run is made for the design conditions. The results of this run are used to assess the overall behavior of the model (i.e., displacements, deformations, stresses, etc.). Run 'PB1\_DES.out' contains a stress/displacement solution for the design conditions (note – per ASME Code, no thermal growth effects are included).

The Results of this run are used in evaluating the Primary Stresses to ASME Code Criteria.

### 5.2 Operating Transient Loads

The ANSYS model is subjected to the Reactor Coolant outlet thermal and pressure conditions versus time. Per Reference 12, the operating transients and their number of cycles are listed in Table 5.1.

Table 5.1 Transients

Transient	Abbreviation	Cycles
Heatup/Cooldown	HUCD	200
Plant Loading/Unloading	PLUL	14500
10% Step Load Increase/Decrease	SL10	2000
50% Step Load Decrease	SL50	200
Reactor Trip	RT	400
Loss of Flow	LF	80
Loss of Load	LL	80
*Hydro Test (3125 psia)		5
**Hydro Test (2500 psia)		5

Note: \* Hydrostatic test cycles occur only during pre-service and are not permitted once fuel has been loaded in the vessel. Therefore, Hydrostatic test (5 cycles) is not considered in fatigue evaluation.

\*\* The number of cycles for Hydro Test is added to HUCD in fatigue evaluation.

The temperature and pressure values for the key points of above transients are taken from Reference 12 and are shown below on time scales that are used for the analysis herein.

Table 5.2 HUCD Transient

HUCD		
Time (hrs)	Temperature (°F)	Pressure (psia)
0	100	450
2	300	450
4.4	540	2500*
6	540	2500*
6.001	540	2250
8.6	275	450
10.4	100	450
12	100	450

Table 5.3 PLUL Transient

Plant Loading/Unloading		
Time (hrs)	Temperature (°F)	Pressure (psia)
0	547	2250
0.3333	612	2250
3.0	612	2250
3.3333	547	2250
6	547	2250

\* This pressure includes 'operating pressure + 10% of operating pressure' for Hydro test.



Table 5.4 SL10 Transient

10% Step Load Increase/Decrease		
Time (hrs)	Temperature (°F)	Pressure (psia)
0	590	2250
0.0278	577	2140
0.0625	587	2275
0.0833	592	2260
1.0	590	2250
1.0111	598	2320
1.025	602	2275
1.0694	591	2140
2.0	591	2140

Table 5.5 SL50 Transient

50% Step Load Reduction		
Time (hrs)	Temperature (°F)	Pressure (psia)
0	575	2250
0.0333	587	2370
0.05	590	2350
0.1833	555	2150
0.2333	548	2200

Table 5.6 RT Transient

Reactor Trip Transient		
Time (hrs)	Temperature (°F)	Pressure (psia)
0	612	2250
0.0083	567	2050
0.0167	550	1925
0.025	547	1950
0.25	547	1950

Table 5.7 LF Transient

Loss of Flow		
Time (hrs)	Temperature (°F)	Pressure (psia)
0	612	2250
0.0033	612	2250
0.0053	520	2250
0.0067	528	2250
0.25	528	2250

Table 5.8 LL Transient

Loss of Load		
Time (hrs)	Temperature (°F)	Pressure (psia)
0	612	2250
0.0028	655	2750
0.0111	605	1850
0.0389	550	1475
0.0444	550	1450
0.25	550	1450

 <b>FRAMATOME ANP</b>	CRDM Temperbead Bore Weld Analysis		NON-PROPRIETARY
	DOCUMENT NUMBER 32-5020244-01	PLANT POINT BEACH 1	CONTRACT NUMBER 4160094

### 5.3 External Loads

The CRDM Housing nozzles function as mechanical mounts for the Control Rod Drive Mechanisms. The Control Rod Drive Mechanisms are relatively tall slender structures that may be subjected to loads from seismic or other motions. Any movement of the Control Rod Drive Mechanisms may produce loads in the CRDM Housing nozzles (essentially cantilevered from the RV Head). However, the design of the CRDM Housing nozzle connection to the RV Head includes a roll-expansion fit feature (also, applicable to repair process). This fit is located above the 'CRDM Housing-to-RV Head connection' weld. Therefore, mechanical loads from the Control Rod Drive Mechanisms are transmitted to the RV Head through the roll-expansion fit region. This design feature effectively shields the 'CRDM Housing-to-RV Head connection' repair weld from being subjected to external mechanical loads. Note that the mechanical loads applied to the original configuration were determined to have a negligible effect on the original welds (See Ref. 11, Report #9, Page A-1). Since the repair weld is also below the roll-expanded region, this conclusion remains valid. Therefore, no external mechanical loads are considered in the analysis of the 'CRDM Housing-to-RV Head connection' repair weld.

As for the closure head boltup load, it is considered to be insignificant with regard to the overall stress levels resulting from other loadings on CRDM nozzle and its repair weld. Therefore, the effects of Closure Head boltup load are not used in this document.

 <b>FRAMATOME ANP</b>	CRDM Temperbead Bore Weld Analysis		NON-PROPRIETARY
	DOCUMENT NUMBER 32-5020244-01	PLANT POINT BEACH 1	CONTRACT NUMBER 4160094

## 6.0 Thermal Results

Using thermal transients from Section 5.2, each thermal transient run is made. The results of the heat transfer analysis are contained in the output files:

HUCDPBth.out  
 PLULPBth.out  
 SL10PBth.out  
 SL50PBth.out  
 RTPBth.out  
 LFPBth.out  
 LLPBth.out

The relevant transient results are summarized in the graphs in Figure 5 and Figure 6. These figures depict the 'temperature versus time' and 'temperature difference versus time'. The text listings of the values for these curves are contained in the following files:

HUCDPBDelta.txt  
 PLULPBDelta.txt  
 SL10PBDelta.txt  
 SL50PBDelta.txt  
 RTPBDelta.txt  
 LFPBDelta.txt  
 LLPBDelta.txt

The resulting 'temperature differences' vs. time history illustrates at which transient time points the maximum thermal gradients (and associated maximum thermal stresses) occur. These time points are then chosen for detailed stress analysis in Section 7.0.

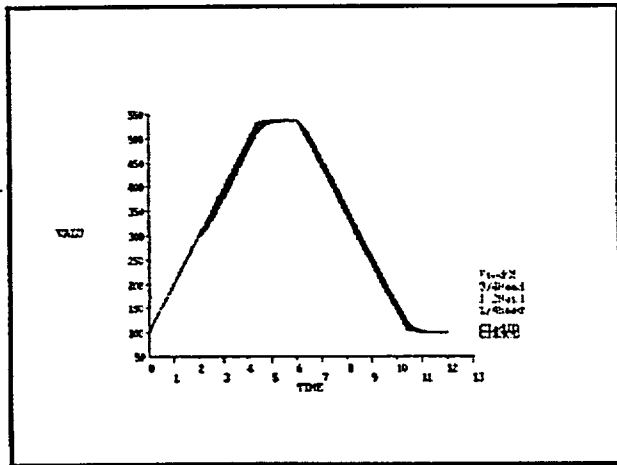

a) HUCD

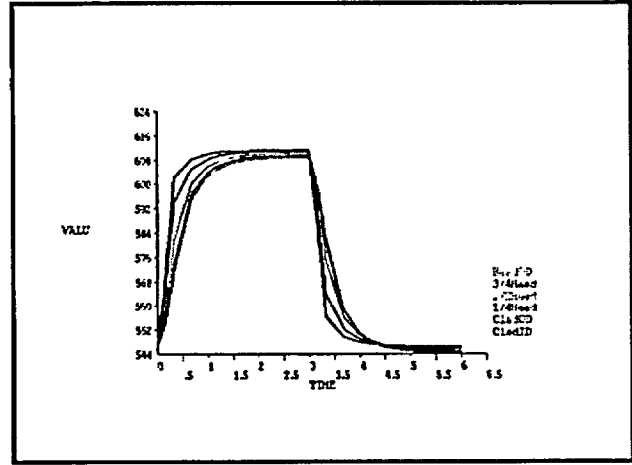

b) Plant Loading/Unloading

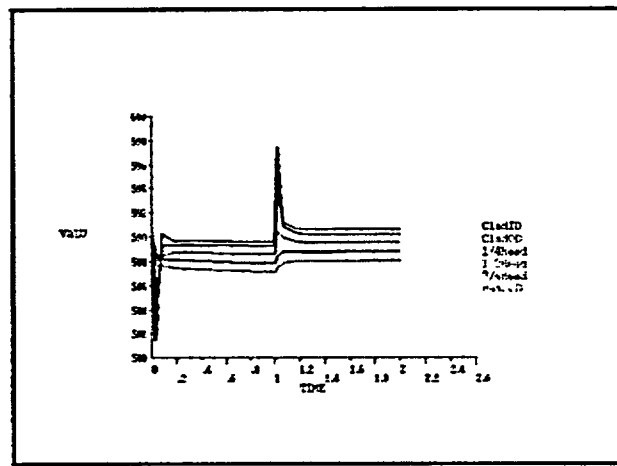

c) 10% Step Load

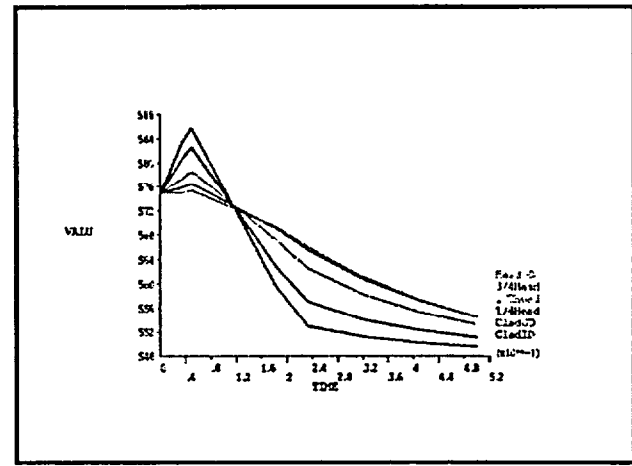

d) 50% Step Load

These figures are not pertinent to this document.

*Thyrist* 2/28/03

(for legibility concerns)

**Figure 5 Temp. Plots of Selected Model Locations for Transients Groups**

Note: Figures indicate that all Nodes start from the same temperature. Temperatures on the inside and outside surface of the RV Head should indicate about 5°F difference. Since this discrepancy happening at the beginning of transients only, the impact on the results is insignificant.

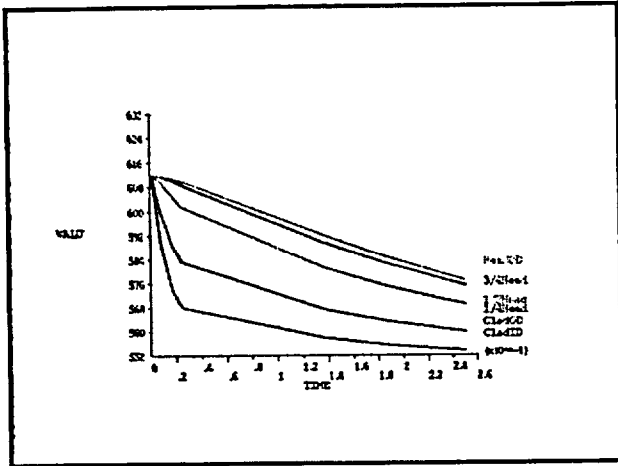

e) Reactor Trip

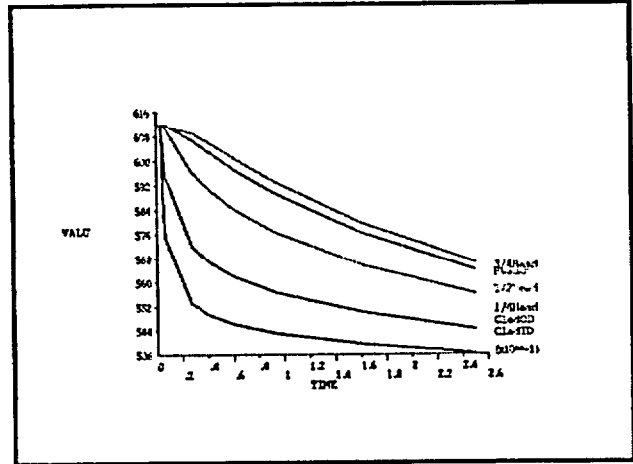

f) Loss of Flow

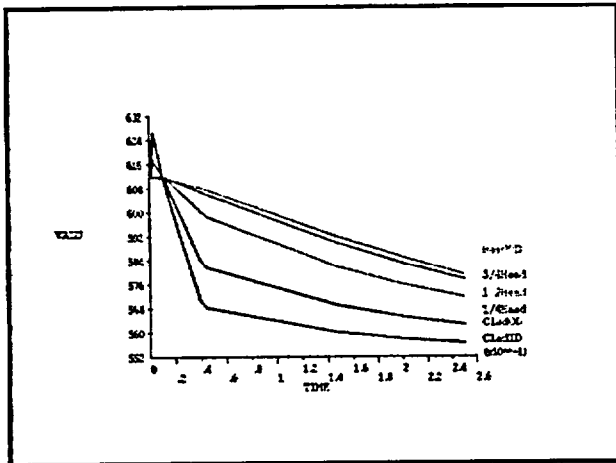

g) Loss of Load

These figures are not pertinent to this document.

*[Signature]* 2/28/03  
(for legibility concerns)

Figure 5 - Cont. Temp. Plots of Selected Model Locations for Transients Groups

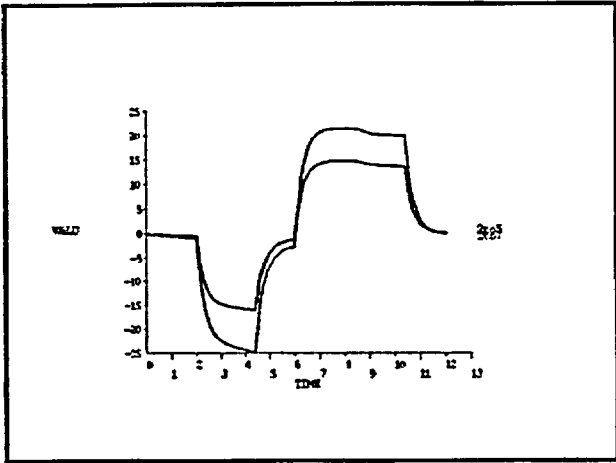

a) HUCD

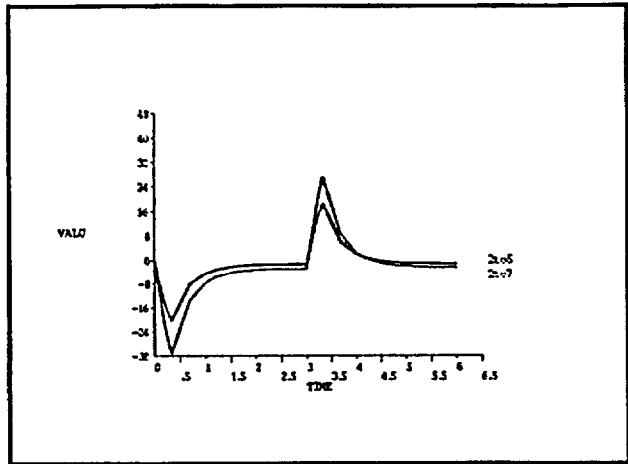

b) Plant Loading/Unloading

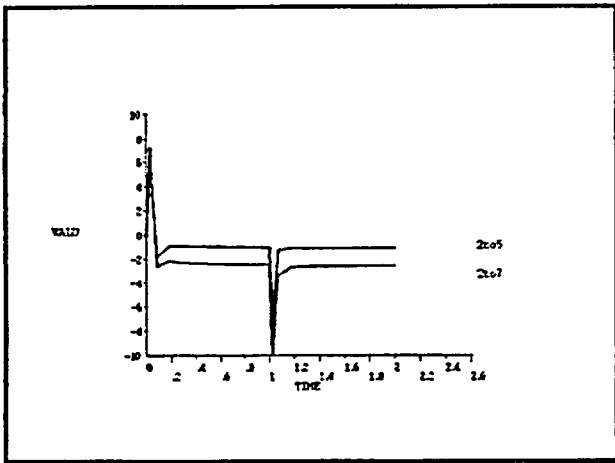

c) 10% Step Load

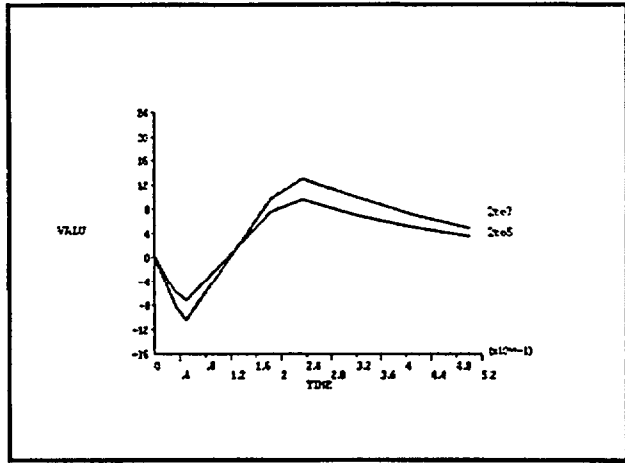

d) 50% Step Load

These figures are not pertinent to this document.

*Revised* 2/28/03  
 \_\_\_\_\_  
 (for legibility concerns)

**Figure 6 Delta-T Plots of Selected Model Locations for Transient Groups**

Note: '2' is a node on cladding, '5' is a node on middle of the closure head, and '7' is a node on outside of the closure head.

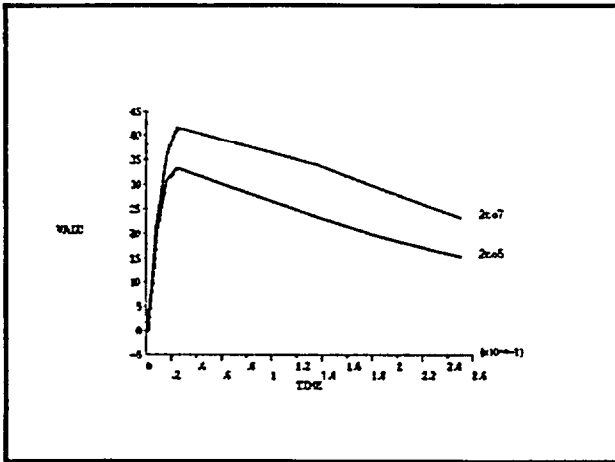

e) Reactor Trip

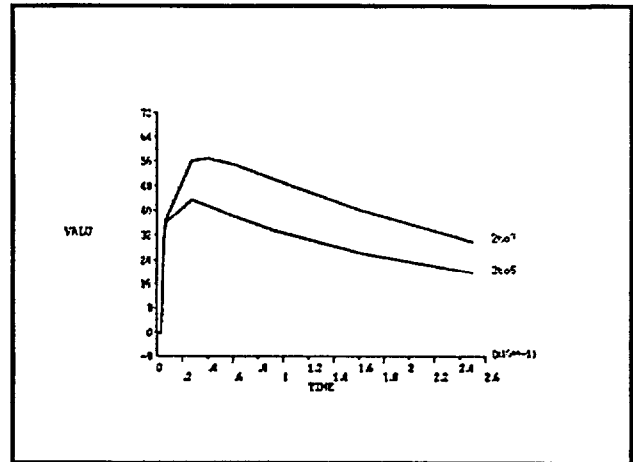

f) Loss of Flow

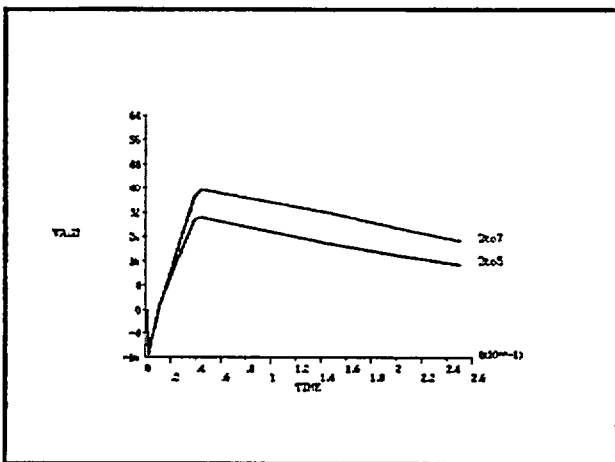

g) Loss of Load

These figures are not pertinent to this document.

*Thy...* 2/28/03  
(for legibility concerns)

Figure 6 – Cont. Delta-T Plots of Selected Model Locations for Transient Groups



Based on the delta-T values depicted above (and pressure variations along with steady-state conditions), stress calculations are performed at the following time points in the transients:

Load case	Time (Hr)	Temp (°F)	Pressure (psia)	Description
1	0.001	100	450	Initial condition
2	2.0	300	450	Higher Pres. Starts
3	4.4	540	2500	Max. Delta-T in HU, End of Heatup
4	6.0	540	2500	End of Steady State
5	7.8549	367	1110	2nd Max. Delta-T in CD
6	8.6	275	450	Pres. Drops to 450
7	10.4	100	450	End of Cooldown

Load case	TIME(Hr)	Temp (°F)	Pressure (psia)	Description
1	0.001	547	2250	Initial condition (SS)
2	0.3333	612	2250	End of Plant Loading
3	3.0	612	2250	Steady State
4	3.3333	547	2250	End of Plant Unloading

Load case	TIME(Hr)	Temp (°F)	Pressure (psia)	Description
1	0.001	590	2250	Initial condition (SS)
2	0.027778	577	2140	Max. Delta-T
3	0.0625	587	2275	Max. Pressure
4	1.0	590	2250	SS
5	1.025	602	2275	Min Delta-T

<b>Table 6.4 50% Step Load Reduction Time Points</b>				
Load case	Time (Hr)	Temp (°F)	Pressure (psia)	Description
1	0.001	575	2250	Initial condition (SS)
2	0.05	590	2350	Max Press/ Min. Delta-T
3	0.23333	548	2200	Max. Delta-T

<b>Table 6.5 Reactor Trip Time Points</b>				
Load case	TIME(Hr)	Temp (°F)	Pressure (psia)	Description
1	0.001	612	2250	Initial condition (SS)
2	0.016667	550	1925	Min. Press
3	0.025	547	1950	Max. Delta-T

<b>Table 6.6 Loss of Flow Time Points</b>				
Load case	TIME(Hr)	Temp (°F)	Pressure (psia)	Description
1	0.001	612	2250	Initial condition (SS)
2	0.006667	528	2250	End of Temp. change
3	0.04034	528	2250	Max. Delta-T

<b>Table 6.7 Loss of Load Time Points</b>				
Load case	TIME(Hr)	Temp (°F)	Pressure (psia)	Description
1	0.001	612	2250	Initial condition (SS)
2	0.002778	655	2750	Max. Press
3	0.04444	550	1450	Max. Delta-T

### 7.0 Stress Results

Stress analysis is performed at each of the previously listed time points. The model is loaded by nodal temperatures (thermal gradients) and internal pressure (see Tables 6.1 through 6.7 for applicable values). The results of the stress analyses are contained in the output files: HUCDPBst.out, PLULPBst.out, SL10PBst.out, SL50PBst.out, RTPBst.out, LFPBst.out and LLPBst.out. The ANSYS (Ref. 3) post-processor was used to tabulate the stresses along paths through the weld and head and classify them in accordance with ASME Code criteria. The locations of the paths are shown in Figure 7 and Figure 8. A review of the stress results indicates that these paths include the highest stressed (limiting) locations for the assembly (including RV head, CRDM nozzle and connecting repair weld).

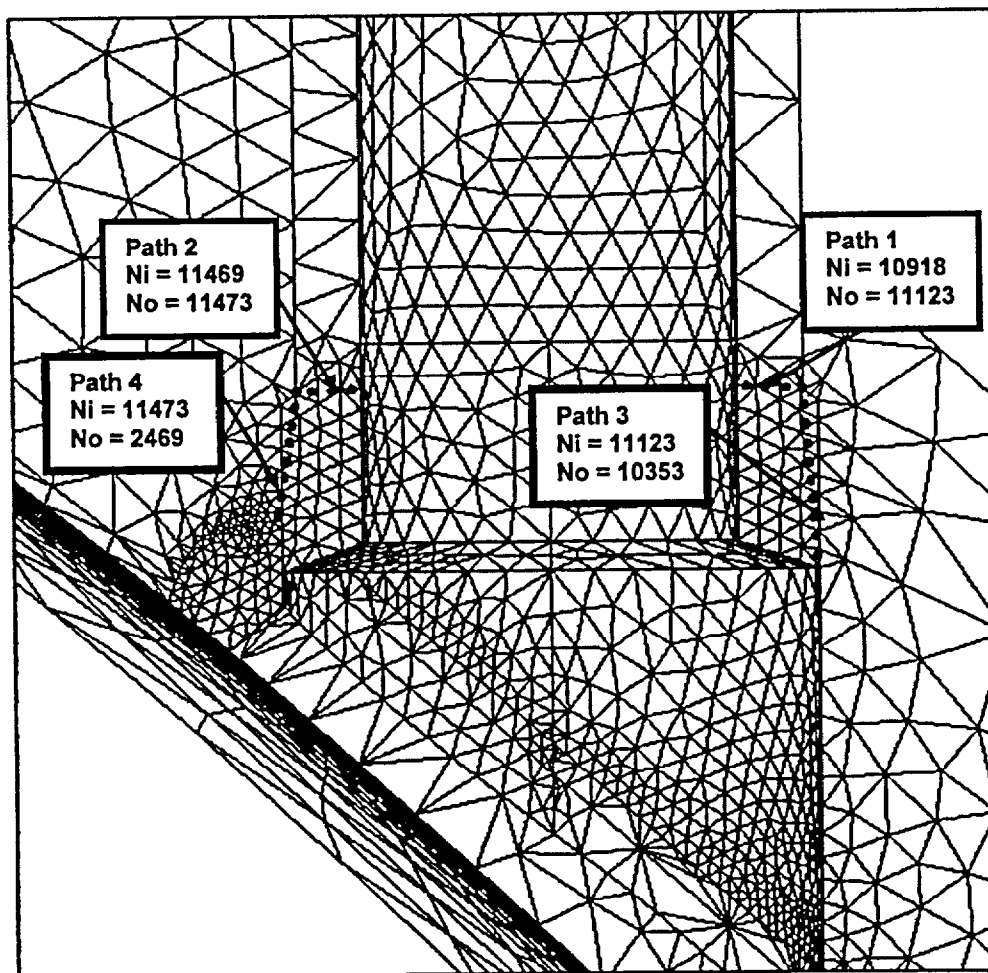

The figure above is not pertinent to this document.

*Hyjint* 2/28/03  
 (for legibility concerns)

**Figure 7 Stress Paths Through Weld**

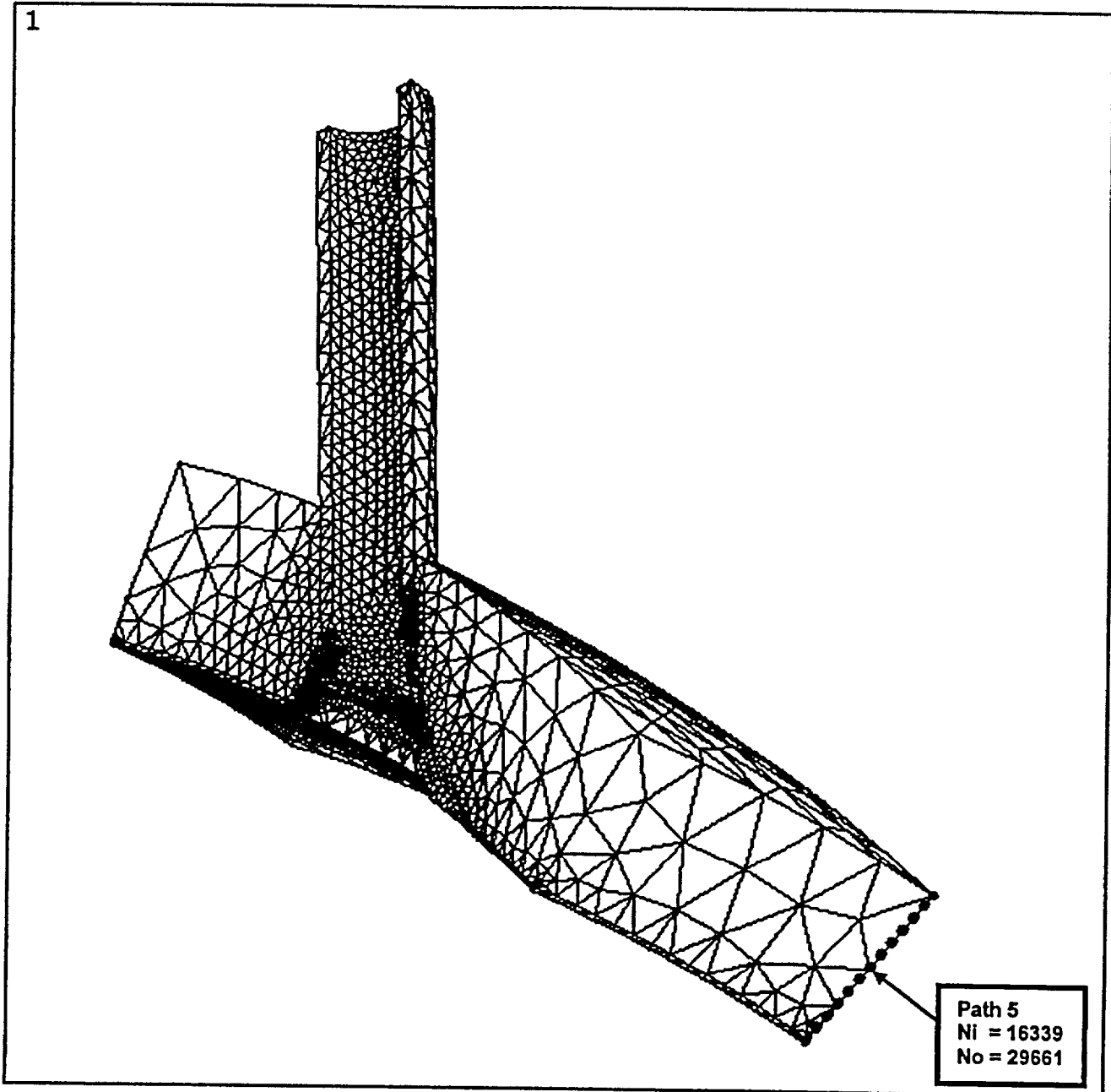

The figure above is not pertinent to this document.

*J. Krejcirik* 2/28/03  
(for legibility concerns)

**Figure 8 Stress Paths Through Head**

 <b>FRAMATOME ANP</b>	CRDM Temperbead Bore Weld Analysis		<b>NON-PROPRIETARY</b>
	DOCUMENT NUMBER 32-5020244-01	PLANT POINT BEACH 1	CONTRACT NUMBER 4160094

The results from the stress classification post-processing runs are contained in the files:

HUCDPBrw.out  
 PLULPBrw.out  
 SL10PBrw.out  
 SL50PBrw.out  
 RTPBrw.out  
 LFPBrw.out  
 LLPBrw.out

These runs calculate the classified stress components (membrane, bending and peak) for each of the stress paths shown in Figure 7 and Figure 8, at each of the time points analyzed in the stress analysis. Another post-processing program uses the data from those previously mentioned output files to calculate stress intensity ranges for use in fatigue calculations by following the method prescribed by the ASME Code in Paragraph NB-3216.2. The cycles associated with the calculated stresses are defined in Reference 12 (also, see Table 5.1).

The stresses resulting from the thermal/pressure transients represent the dominant contribution to total stresses for the repaired configuration of the RV Head, CRDM Nozzle and connecting repair weld. It is acknowledged that there are mechanical loads applied at the CRDM Nozzle flanged connection (outboard of the RV Head) and potentially some small load from the bolting-up of the RV Head Closure. These are considered to be negligible as addressed in Section 5.3.

### 7.1 ASME Code Criteria

The ASME Code stress analysis involves two basic sets of criteria – 1) assure that failure does not occur due to application of the design loads and 2) assure that failure does not occur due to repetitive loadings.

In general, the Primary Stress Intensity criteria of the ASME Code (Ref. 4) demonstrates that the design is adequate for application of design loads.

Also, the ASME Code criteria for cumulative fatigue usage factor assures that the design is adequate for repetitive loadings.

 <b>FRAMATOME ANP</b>	CRDM Temperbead Bore Weld Analysis		<b>NON-PROPRIETARY</b>
	DOCUMENT NUMBER 32-5020244-01	PLANT POINT BEACH 1	CONTRACT NUMBER 4160094

## 7.2 ASME Code Primary Stress (SI) Intensity Criteria

The analysis of primary stress intensities for Design Conditions is made to satisfy the requirements for application of design loads in accordance with Reference 4, par. NB-3221.

Other related criteria include the design limits for minimum required pressure thickness (see NB-3324) and reinforcement area (see NB-3330). The requirement for reinforcement area is effectively addressed by meeting NB-3221.1, NB-3221.2 and NB-3221.3.

### 7.2.1 Primary Stress Intensities for Design Conditions (Design Pressure @ Design Temperature)

Per Reference 12, Design Pressure = 2500 psia; Design Temperature = 650F

Computer run "PB1\_DES.out" contains the stress solution for the design conditions. The post-processing run "PB1DESrw.out" contains the classification of stresses into categories that are comparable to the categories used in the criteria of the ASME Code as discussed below:

#### NB-3221.1 – General Primary Membrane Stress Intensity ( $P_m \leq 1.0 S_m$ )

The applicable value occurs remote from discontinuities and includes no local effects. From Figure 8, Path 5 depicts an appropriate location for the RV Head. From "PB1DESrw.out", the membrane stress intensity of Path 5 is ( ) ksi. For the RV Head material,  $S_m = 26.7$  ksi (Table 4.1). Therefore, the requirement is met for the RV Head.

For the CRDM Nozzle (the portion affected by the repair), the membrane stress intensity is maximum at the thinned section (maximum machining diameter; see Section 4.1). This value is calculated as  $P_m = ((P_r/t) + (P/2)) = ( ) + ( ) = ( )$  ksi (Ref. 4, NB-3324.1). This is less than  $1.0 S_m$  for SB-167 (Alloy 600) =  $23.3$  ksi (Table 4.2). Therefore, the requirement is met for the CRDM Nozzle wall (as well as the corresponding section of the A690 weld).

#### NB-3221.2 – Local Membrane Stress Intensity ( $P_l \leq 1.5 S_m$ )

A conservative local membrane stress can be obtained by using the approach from Reference 13 (pg. 208). Considering a ligament between two adjacent penetrations, two stress concentration profiles from each penetration are accounted on the ligament and they are superimposed to simulate local effect from both penetrations. The average stress from the ligament is conservatively regarded as a local membrane stress. With approx. 11" of pitch length (between two penetrations' centerlines; see Ref. 15a) and  $P_m = ( )$  ksi, the local membrane stress is approximately ( ) ksi. For the RV Head material,  $1.5 S_m = 40.1$  ksi. Therefore, the requirement is conservatively met for the RV Head.

For the CRDM Nozzle wall section, the membrane SI values at the lower end (at the elevation of the crevice bottom) are classified as 'secondary' per NB-3337.3(b) of Reference 4. This 'secondary stress' classification is dependent on the weld dimensions fulfilling the requirements of Figure NB-4244(d)-1 and par. NB-3352.4(d). Figure 9 herein depicts the designer's concept of the repair weld enveloping the Code required weld. It is concluded, then, that the repair weld is larger (and stronger) than the minimum size required by the Code. Thus, there are no loads that generate Primary Local Membrane SI in the CRDM Nozzle wall. Therefore, for the CRDM Nozzle wall – PI includes the Pm contribution; therefore,  $PI = ( ) \text{ ksi} \leq 1.5 S_m = 35.0 \text{ ksi}$  for SB-167 & A690 and the requirement is met.

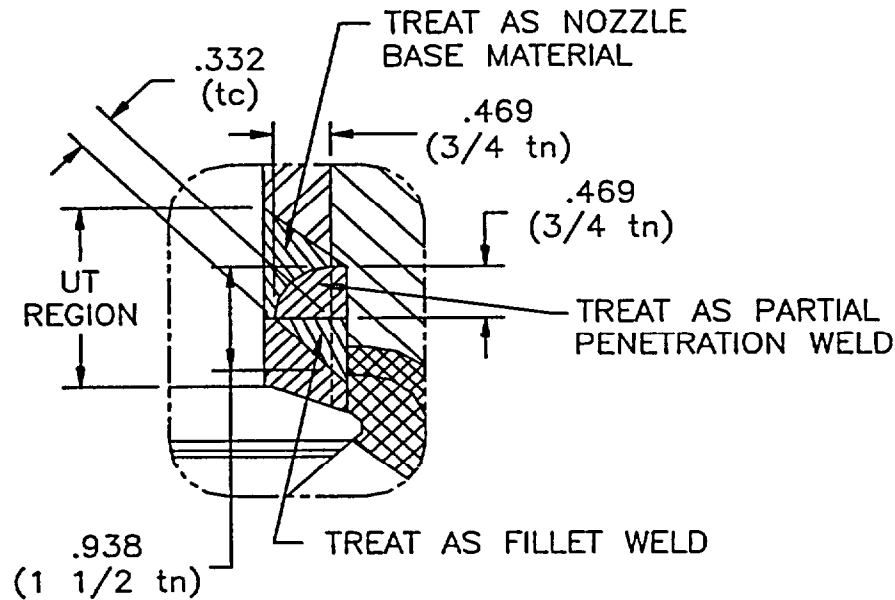

NB-4244(d)-1(c)

**Figure 9 Design Concept of the Repair Weld**

**NB-3221.3 – Primary Membrane + Primary Bending SI ( $PI+P_b \leq 1.5 S_m$ )**

For the head, the primary bending stress intensity ( $P_b$ ) is ( ) ksi from PB1DESrw.out. Thus, the Primary Membrane + Primary Bending SI for the RV head material = ( ) + ( ) = ( ) ksi. For the RV Head material,  $1.5S_m = 40.1 \text{ ksi}$ . Therefore, the requirement is met for the RV Head.

Per Ref. 4, Table NB-3217-1, since lateral external loads on the CRDM do not result in a bending stress at the lower part of the nozzle, there is no Primary Bending at that location. Therefore,  $PI+P_b = PI = ( ) \text{ ksi}$  (same as  $P_m$ )  $\leq 1.5 S_m = 35.0 \text{ ksi}$  for SB-167 & A690 and the requirement is met.

 <b>FRAMATOME ANP</b>	CRDM Temperbead Bore Weld Analysis		<b>NON-PROPRIETARY</b>
	DOCUMENT NUMBER 32-5020244-01	PLANT POINT BEACH 1	CONTRACT NUMBER 4160094

### 7.2.2 Primary Stress Intensities for Emergency (Level C) Conditions

There is no Emergency condition specified in Reference 12.

### 7.2.3 Primary Stress Intensities for Faulted (Level D) Conditions

Reference 14 specifies two 'faulted' category transients – Reactor Coolant Pipe Break and Steam Line Break. It is suggested that the maximum Faulted Condition transient pressure (2500 psia) be used. Therefore, the Primary Stresses for these Faulted Condition transients are well represented by those previously determined for the Design Conditions. The summary below lists the Primary Stresses compared to Level D (Faulted Condition) allowables.

#### RV Head (max. values considering all regions of low-alloy material):

Max. Primary General Membrane SI = ( ) ksi < 0.7 Su = **56.0 ksi**  
 (SA302, Gr. B @650F)  
*[Ref. 4, Par. NB-3225, F-1331.1(a)]* (computer run – 'PB1DESrw.out, Path 5)

Max. Primary Local Membrane SI = ( ) ksi < 1.05 Su = **84.0 ksi**  
 (SA302, Gr. B @650F)  
*[Ref. 4, Par. NB-3225, F-1331.1(b)]* (computer run – 'PB1DESrw.out, Path 5)

Max. Primary Membrane + Primary Bending SI = ( ) ksi < 1.05 Su = **84.0 ksi**  
 (SA302, Gr. B @650F)  
*[Ref. 4, Par. NB-3225, F-1331.1(c)]* (computer run – 'PB1DESrw.out, Path 5)

#### CRDMH Nozzle/Weld (max. values considering all regions of high-alloy material):

Max. Primary General Membrane SI = ( ) ksi < 2.4 Sm = **55.9 ksi**  
 (A600/A690 @650F)  
*[Ref. 4, Par. NB-3225, F-1331.1(a)]* (hand-calculated)

Max. Primary Local Membrane SI = ( ) ksi < 3.6 Sm = **83.8 ksi**  
 (A600/A690 @650F)  
*[Ref. 4, Par. NB-3225, F-1331.1(b)]* (no local membrane effects; only general membrane)

Max. Primary Membrane + Primary Bending SI = ( ) ksi < 3.6 Sm = **83.8 ksi**  
 (A600/A690 @650F)  
*[Ref. 4, Par. NB-3225, F-1331.1(c)]* (The repaired configuration generates no 'Primary Bending' stresses in the CRDMH Nozzle or Weld)



 <b>FRAMATOME ANP</b>	CRDM Temperbead Bore Weld Analysis		<b>NON-PROPRIETARY</b>
	DOCUMENT NUMBER 32-5020244-01	PLANT POINT BEACH 1	CONTRACT NUMBER 4160094

#### 7.2.4 Primary Stress Intensities for Test Conditions

Reference 14 specifies only one 'test' condition that is significant to the stress levels in the Closure Head (includes CRDMH Nozzle repair region) – Hydrostatic test @ 3125 psia. This transient results in a pressure of 3125 psia. Thus, the pressure induced Primary Stresses due to these transients are greater than those calculated for the Design Condition. To quantify the Primary Stresses due to the Hydrotest Condition, the stresses of the Design Conditions are multiplied by the ratio of the respective pressure values ( $3125/2500 \approx 1.25$ ). To account for the differences in temperatures, the stresses are again multiplied by the maximum 'ratio of moduli of elasticity at hydrotest temperature (70F) to those at Design temperature (650F)' for the materials involved (1.12). Therefore, the Primary Stresses for the Testing Condition transient summarized below and compared to Testing Condition allowables.

#### RV Head (max. values considering all regions of low-alloy material):

Max. Primary General Membrane SI = ( ) ksi < 0.9 Sy = **45.0 ksi**  
(SA302, Gr. B @100F)

[Ref. 4, Par. NB-3226(a)] (computer run – PB1DESrw.out, Path 5 x1.25x1.12)

Max. Primary Membrane + Primary Bending SI = ( ) ksi < 1.35 Sy = **67.5 ksi**  
(SA302, Gr. B @100F)

[Ref. 4, Par. NB-3226(b)] (computer run – PB1DESrw.out, Path 5 x1.25x1.12)

#### CRDMH Nozzle/Weld (max. values considering all regions of high-alloy material):

Max. Primary General Membrane SI = ( ) ksi < 0.9 Sy = **31.5 ksi**  
(A600/A690 @100F)

[Ref. 4, Par. NB-3226(a)] (Hand-calculated x 1.25 x 1.12)

Max. Primary Membrane + Primary Bending SI = ( ) ksi < 1.35Sy = **47.3 ksi**  
(A600/A690 @100F)

[Ref. 4, Par. NB-3226(b)] (The repaired configuration generates no 'Primary Local' or 'Primary Bending' stresses in the CRDMH Nozzle or Weld; therefore, same as 'Pm')

 <b>FRAMATOME ANP</b>	CRDM Temperbead Bore Weld Analysis		NON-PROPRIETARY
	DOCUMENT NUMBER 32-5020244-01	PLANT POINT BEACH 1	CONTRACT NUMBER 4160094

### 7.3 ASME Code Primary+Secondary SI Range and Fatigue Usage Criteria

As stated previously, the analysis of stresses for transient conditions is required to satisfy the requirements for repetitive (or cyclic) loadings. The following discussion describes the fatigue analysis process employed herein for the repair design.

As described in Section 7.0, the stresses for each transient time point chosen for stress analysis are determined in the ANSYS solution runs:

HUCDPBst.out  
 PLULPBst.out  
 SL10PBst.out  
 SL50PBst.out  
 RTPBst.out  
 LFPBst.out  
 LLPBst.out

Overall stress levels are reviewed and assessed to determine which model locations require detailed stress/fatigue analysis. The objective is to assure that 1) the most severely stressed locations are evaluated and 2) that the repair region is quantitatively qualified.

Once the specific locations for detailed stress evaluation are established, the ANSYS *'paths'* (sometimes called *'stress classification lines'*, SCL) are defined. Post-processing runs for these paths are made to convert the raw component stresses along these paths into Stress Intensity (SI) categories that correlate to the criteria of the ASME Code (i.e., *'membrane'*, *'linearized membrane+bending'* & *'total'*).

The transient analysis of the repair configuration indicates that the location of prime importance is at both the top and bottom crevices between the nozzle OD and the penetration bore diameter. These locations include the maximum peak stresses (due to the applicable SCF of 4.0) and include the low-alloy RV Head base metal (has lower fatigue properties compared to the high-alloy material). To assure that the maximum stress values are obtained, paths are taken through the weld in a radial direction (relative to the nozzle) and through the weld in a vertical direction along the *'weld-to-RV Head'* interface. These sectional locations are analyzed at the *'downhill'* and *'uphill'* side of the model (see Figure 7). Review of the stress results and experience with analyses of similar hillside configurations indicates that these sections (4 total) include the location of maximum stress/usage. The stress linearization for these paths (1 – 4) are contained in computer files:

HUCDPBrw.out  
 PLULPBrw.out  
 SL10PBrw.out

 <b>FRAMATOME ANP</b>	CRDM Temperbead Bore Weld Analysis		<b>NON-PROPRIETARY</b>
	DOCUMENT NUMBER 32-5020244-01	PLANT POINT BEACH 1	CONTRACT NUMBER 4160094

SL50PBw.out  
RTPBw.out  
LFPBw.out  
LLPBw.out

However, because this is a 3-D analysis and the directions of the principal stresses may vary during the transient, the 'range' of 'linearized membrane+bending' is determined by the method prescribed by Paragraph NB-3216.2 of the ASME Code (Ref. 4). The computer run containing the results of the application of this method is:

ALL\_PBw.Class\_Line\_Summary

The maximum SI range values (of linearized 'Membrane + Bending') as determined in this run are compared directly to the Primary + Secondary Stress Intensity Range criteria of the ASME Code.

As documented in Reference 12, the transients that have a potential impact on fatigue usage and their cycles (based on a 40-year plant life) are:

HUCD = 205 cycles (see note)  
Plant Loading/Unloading = 14500 cycles  
10% Step Load Increase/Decrease = 2000 cycles  
50% Step Load Decrease = 200 cycles  
Reactor Trip = 400 cycles  
Loss of Flow = 80 cycles  
Loss of Load = 80 cycles

NOTE: 5 cycles of Hydrotest @2500psia are added to HUCD.

For consideration of fatigue usage, the 'Peak Stress Intensity Ranges' are calculated. These values must include the 'total' localized stresses. As mentioned above, the geometry of the repair design results in a crevice-like configuration a) between the nozzle OD and the penetration bore diameter and b) between the repair weld and the original weld as-modeled at the uphill side. Therefore, the 'linearized membrane+bending' stress intensity range at these locations (Paths 1-2, outside and Paths 3-4, inside and outside) is multiplied by a factor of 4.0 (Ref. 4, Par. NB-3352.4(d)(5)) to represent the 'Peak Stress Intensity Range'.  
*[Note: The resulting values are confirmed to be greater than the 'total' stress intensities calculated directly from the model.]*

	CRDM Temperbead Bore Weld Analysis		NON-PROPRIETARY
	DOCUMENT NUMBER 32-5020244-01	PLANT POINT BEACH 1	CONTRACT NUMBER 4160094

For conservative approach, RV Head Base metal is analyzed for cumulative Fatigue Usage Factor calculation because of its lower fatigue properties as compared to high alloy material. Upon reviewing the stress range results from 'ALL\_PBw.Class\_Line\_Summary', it is determined that Path 4 – Outside (i.e., top of crevice between overlap of repair weld and original weld at uphill side) represents the limiting location for fatigue. Therefore, Path 4 – Outside node case (corresponds to bottom of the repair weld in Figure 7) is shown in this document.

Maximum Primary + Secondary SI Range for Low-alloy Material

Max. P+S SI Range = ( ) ksi (from Path2 inside, between HUCD and LL)

This is less than the maximum allowed by the design code, (3 Sm = 80.1 ksi)

[Ref. 4, Par. NB-3222.4]

Using the ranges/cycles described above, the corresponding cumulative usage is calculated on the following pages.

For demonstration purposes, the design cycles associated (by linear prorate) with 15 years are used in the following calculations.

Because design cycle usage is taken to vary linearly with time, the maximum number of projected years of life for the repair configuration is also provided.

**EVALUATION TITLE:** Point Beach 1 CRDM Temperbead Weld Analysis (Path4-outside crevice at uphill side 'repair weld-to-original weld' overlap)

**REFERENCE:** ALL\_PBw.Class\_Line\_Summary

**MATERIAL:** SA 302, Gr. B (both high and low-alloy steels are present at this crevice region)

**TYPE:** Low-alloy steel

**UTS (psi) =** 80000

**E matl (psi) =** 2.59E+07 (at T = 650F)

**E ratio = ('E curve' / 'E analysis')**

	RANGE NUMBER	TRANSIENTS WITH RANGE EXTREMES	REQ'D CYCLES 15 years	PEAK SI RANGE	E mat	S alt	(E ratio) x S alt	ALLOWABLE CYCLES "N"	USAGE FACTOR "U"
RV Head	1	LF - ZSS	30	( )	2.59E+07	( )	( )	( )	( )
RV Head	2	LL - ZSS	30	( )	2.59E+07	( )	( )	( )	( )
RV Head	3	PLUL - ZSS	17	( )	2.59E+07	( )	( )	( )	( )
RV Head	4	HUCD - PLUL	77	( )	2.59E+07	( )	( )	( )	( )
RV Head	5	PLUL - PLUL	5344	( )	2.59E+07	( )	( )	( )	( )
RV Head	6	PLUL - RT	94	( )	2.59E+07	( )	( )	( )	( )
RV Head	7	SL50 - LL	30	( )	2.59E+07	( )	( )	( )	( )
<b>Total Low-Alloy Usage =</b>									( )

**Note:** The 'Peak SI Range' = 'Linearized Membrane + Bending' x Fatigue Strength Reduction Factor (FSRF)

For Range 1, 'Linearized Memb + Bending' SI Range =	( )	ksi;	FSR=	4.0
For Range 2, 'Linearized Memb + Bending' SI Range =	( )	ksi;	FSR=	4.0
For Range 3, 'Linearized Memb + Bending' SI Range =	( )	ksi;	FSR=	4.0
For Range 4, 'Linearized Memb + Bending' SI Range =	( )	ksi;	FSR=	4.0
For Range 5, 'Linearized Memb + Bending' SI Range =	( )	ksi;	FSR=	4.0
For Range 6, 'Linearized Memb + Bending' SI Range =	( )	ksi;	FSR=	4.0
For Range 7, 'Linearized Memb + Bending' SI Range =	( )	ksi;	FSR=	4.0

 <b>FRAMATOME ANP</b>	CRDM Temperbead Bore Weld Analysis		<b>NON-PROPRIETARY</b>
	DOCUMENT NUMBER 32-5020244-01	PLANT POINT BEACH 1	CONTRACT NUMBER 4160094

### **8.0 Consideration of Corrosion of RV Head Low-Alloy Material**

The design configuration of the CRDM Nozzle Temperbead repair results in an area of RV Head base material (low alloy; SA302 Gr. B) being exposed to continuous contact with Reactor Coolant water. The chemistry of the Reactor Coolant combined with the properties of the RV Head material result in corrosion of the wetted surface.

The amount of corrosion rate has been determined to be ( ) inch per year (Reference 1). At this rate, the total surface corrosion for a repair life of ( ) years of plant life (see Section 7.0 and Section 9.0) is ( ) inch. This small amount of corrosion volume loss will not affect the thermal/structural integrity of RV Head Base metal.

In conclusion, the corrosion of the exposed low-alloy material has a negligible impact on the thermal/structural response of the CRDMH Nozzle assembly with temperbead repair and is, therefore, acceptable.

 <b>FRAMATOME ANP</b>	CRDM Temperbead Bore Weld Analysis		<b>NON-PROPRIETARY</b>
	DOCUMENT NUMBER 32-5020244-01	PLANT POINT BEACH 1	CONTRACT NUMBER 4160094

## 9.0 Conclusions

The preceding calculations demonstrate that the PB1 CRDM Nozzle temperbead repair design meets the stress and fatigue requirements of the Design Code (Reference 4, ASME Boiler and Pressure Vessel Code, Section III, 1989 Edition with no Addenda.) and Reference 7.

Based on the general specification of the Point Beach Unit 1&2 loads and cycles (Reference 12), and CRDM Nozzle ID Temper Bed Weld Repair Requirements (Reference 7), the fatigue analysis evaluation indicates that the usage factor for 15 years of operation is ( ). Furthermore, by allowing the cumulative fatigue usage factor to the maximum ASME Code allowable of 1.0, the life of the repair is approximately ( ) years.

 <b>FRAMATOME ANP</b>	<b>CRDM Temperbead Bore Weld Analysis</b>		<b>NON-PROPRIETARY</b>
	<small>DOCUMENT NUMBER</small> <b>32-5020244-01</b>	<small>PLANT</small> <b>POINT BEACH 1</b>	<small>CONTRACT NUMBER</small> <b>4160094</b>

## 10.0 References

1. FRA-ANP Document 51-5019941-00, "Corrosion Evaluation of Point Beach-1 CRDM IDTB Weld Repair"
2. FRA-ANP Dwg. 02-5019702E-02, "PB1 – CRDM Nozzle ID Temperbead Weld Repair"
3. "ANSYS" Finite Element Computer Code, Version 5.7, ANSYS, Inc., Canonsburg, Pa.
4. ASME Boiler and Pressure Vessel Code, Section III, 1989 Edition with no Addenda.
5. ASME Boiler and Pressure Vessel Code, Section II, Part D, 1989 Edition with no Addenda.
6. FRA-ANP Doc. 51-1176533-00, "Alloy 690 Material Properties"
7. FRA-ANP Doc. 51-5017195-05, "POINT BEACH 1 & 2 CRDM NOZZLE ID TEMPER BEAD WELD REPAIR REQUIREMENTS"
8. FRA-ANP Document NPGD-TM-500 rev D, "NPGMAT", NPGD Material Properties Program, User's Manual, dated March 1985
9. FRA-ANP Document 32-5012424-01, "CRDM Temperbead Bore Weld Analysis"
10. \* Point Beach Document, "Point Beach RSG Program – Reactor Vessel Evaluation, REE-95-0064", 8/95.
11. FRA-ANP Document "Design Report for Westinghouse", BW Contract No. 610-0115-51/52 [FRA-ANP Microfilm Roll No. 80-80].
12. \* Point Beach Document, "Equipment Specification #676243", Rev. 0, 5/5/66.
13. "Pressure Vessel Design: Nuclear and Chemical Applications", John F. Harvey, D. Van Nostrand Company, Inc., Princeton, NJ.
14. \* Point Beach Document, "Point Beach RSG Program – Transient Review, REE-95-0027", 3/95.
15. \* Point Beach Drawings
  - a. FRA-ANP DWG. 02-117847E, Rev. 5, "Closure Head Assembly"
  - b. FRA-ANP DWG. 02-117848E, Rev. 2, "Closure Head Sub-Assembly".
16. \* Point Beach Document, "Point Beach RSG RV/RI Interface Loads Evaluation, REE-95-0033", 4/95.



 <b>FRAMATOME ANP</b>	CRDM Temperbead Bore Weld Analysis		<b>NON-PROPRIETARY</b>
	DOCUMENT NUMBER 32-5020244-01	PLANT POINT BEACH 1	CONTRACT NUMBER 4160094

17. FRA-ANP Document 23-5017869-00, "Welding Consumables Material For NMC, LLC Point Beach Unit 2, 04/02

\* This document is not available for retrieval from Framatome-ANP Document Control System. This document is available from the Point Beach Document Control System. Therefore, this is an acceptable reference for use on this contract per Framatome-ANP Procedure FRA-ANP 0402-01, Rev. 32 Appendix 2.

 2/28/03  

---

 Project Manager

### 11.0 Computer Files

The finite element analyses done in this calculation were made using the ANSYS computer program (Ref. 3). Test cases verifying the suitability and accuracy of this program for this analysis were analyzed and the results of that analysis are included in files VM96.OUT and VM187.OUT.

### Computer Output Files (See page 61)

<u>File Name</u>	<u>Description</u>
HUCDPBth.out	HUCD thermal transient heat transfer analysis
PLULPBth.out	PLUL thermal transient heat transfer analysis
SL10PBth.out	SL10 thermal transient heat transfer analysis
SL50PBth.out	SL50 thermal transient heat transfer analysis
RTPBth.out	RT thermal transient heat transfer analysis
LFPBth.out	LF thermal transient heat transfer analysis
LLPBth.out	LL thermal transient heat transfer analysis
HUCDPBst.out	HUCD stress analysis
PLULPBst.out	PLUL stress analysis
SL10PBst.out	SL10 stress analysis
SL50PBst.out	SL50 stress analysis
RTPBst.out	RT stress analysis
LFPBst.out	LF stress analysis
LLPBst.out	LL stress analysis
HUCDPBdt.out	HUCD thermal post-processing
PLULPBdt.out	PLUL thermal post-processing
SL10PBdt.out	SL10 thermal post-processing
SL50PBdt.out	SL50 thermal post-processing
RTPBdt.out	RT thermal post-processing
LFPBdt.out	LF thermal post-processing
LLPBdt.out	LL thermal post-processing



 <b>FRAMATOME ANP</b>	<b>CRDM Temperbead Bore Weld Analysis</b>		<b>NON-PROPRIETARY</b>
	DOCUMENT NUMBER 32-5020244-01	PLANT POINT BEACH 1	CONTRACT NUMBER 4160094

## APPENDIX A

### Stresses used for Flaw Assessments

**Purpose**

The purpose of this appendix is to provide supplemental stress results of the transient analysis for flaw assessments. Two areas are selected for this study: original J-groove weld and new temperbead weld (See Figure 7). The original J-groove locations include paths through the remnant portion of the original J-groove welds and adjacent RV head base metal in planes at 0 degree and 180 degree around the CRDM opening bore (See Figure A-1). The stresses tabulated herein are to be used as input to flaw growth assessments.

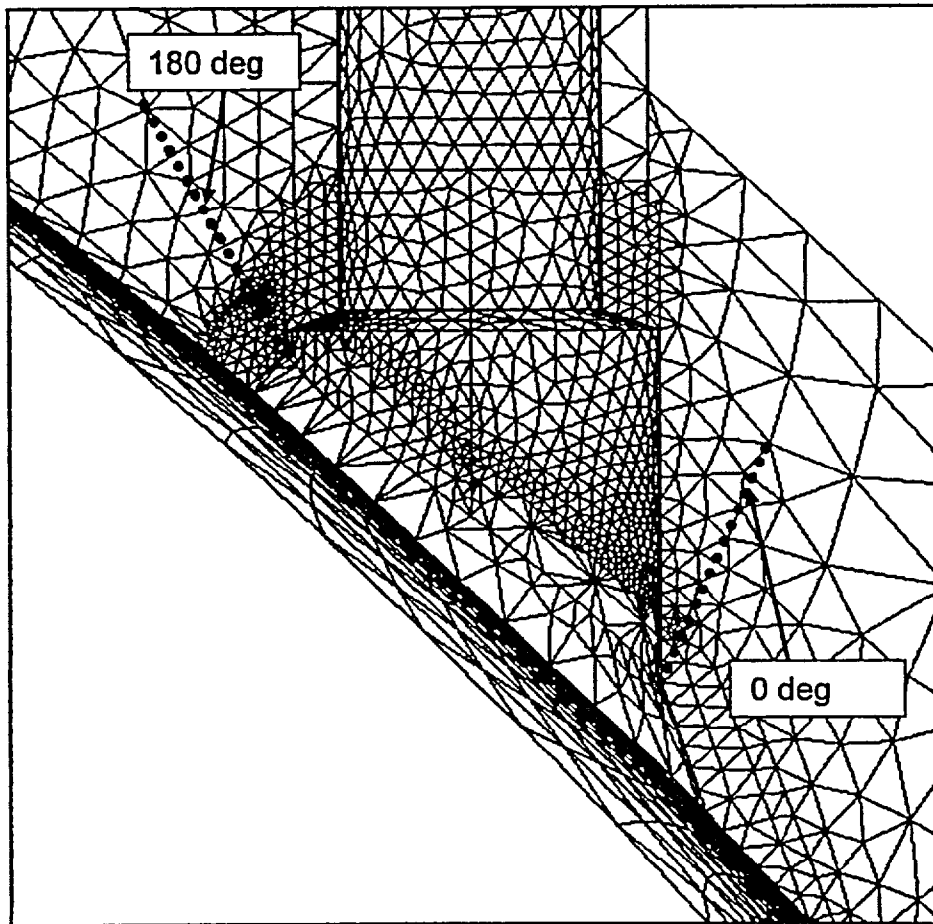

**Figure A-1 Close-up of Paths Through Original Welds/Head**

This figure is not pertinent to this document.  
*Amint* 2/28/03  
 (for legibility concerns)

 <b>FRAMATOME ANP</b>	CRDM Temperbead Bore Weld Analysis		<b>NON-PROPRIETARY</b>
	DOCUMENT NUMBER 32-5020244-01	PLANT POINT BEACH 1	CONTRACT NUMBER 4160094

For the J-groove weld, there are two line segments in each path: 1) from upper corner of chamfer to buttering weld (W1) and 2) from buttering weld to the middle of head thickness (W2). Each of these segments has five tabulation points equally spaced along its length.

The stress results are in cylindrical coordinate system.  
 SX = radial to CRDM Nozzle; SY = hoop; SZ = axial

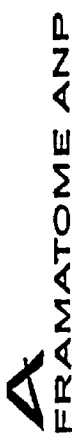
	CRDM Temperbead Bore Weld Analysis		NON-PROPRIETARY
	DOCUMENT NUMBER 32-5020244-01	PLANT POINT BEACH 1	CONTRACT NUMBER 4160094

Path Summary from file: C:\PointBeach\FB1\CRDM\Stress\Stress Outputs\Fracture Outputs\HUCDPBW1.out

Path Summary from file: C:\PointBeach\FB1\CRDM\Stress\Stress Outputs\Fracture Outputs\HUCDPBW2.out

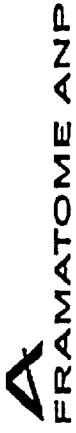
	CRDM Temperbead Bore Weld Analysis		NON-PROPRIETARY
	DOCUMENT NUMBER 32-5020244-01	PLANT POINT BEACH 1	CONTRACT NUMBER 4160094

Path Summary from file: C:\PointBeach\PBI\CRDM\Stress Outputs\Fracture Outputs\PLJLFBW1.out

Path Summary from file: C:\PointBeach\PBI\CRDM\Stress Outputs\Fracture Outputs\PLJLFBW2.out

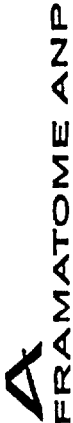

	CRDM Temperbead Bore Weld Analysis		NON-PROPRIETARY
	DOCUMENT NUMBER 32-5020244-01	PLANT POINT BEACH 1	CONTRACT NUMBER 4160094

Path Summary from file: C:\PointBeach\PB1\CRDM\Stress Outputs\Fracture Outputs\SLI0PBW1.out

Path Summary from file: C:\PointBeach\PB1\CRDM\Stress Outputs\Fracture Outputs\SLI0PBW2.out

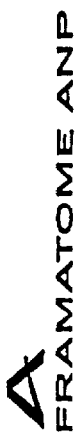
	CRDM Temperbead Bore Weld Analysis		NON-PROPRIETARY
	DOCUMENT NUMBER 32-5020244-01	PLANT POINT BEACH 1	CONTRACT NUMBER 4160094

Path Summary from file: C:\PointBeach\FB1\CRDM\Stress Outputs\Fracture Outputs\SL50PBW1.out

Path Summary from file: C:\PointBeach\FB1\CRDM\Stress Outputs\Fracture Outputs\SL50PBW2.out

 <b>FRAMATOME ANP</b>	<b>CRDM Temperbead Bore Weld Analysis</b>		<b>NON-PROPRIETARY</b>
	DOCUMENT NUMBER <b>32-5020244-01</b>	PLANT <b>POINT BEACH 1</b>	CONTRACT NUMBER <b>4160094</b>

Path Summary from file: C:\PointBeach\PB1\CRDM\Stress\Stress Outputs\Fracture Outputs\RTPBW1.out

Path Summary from file: C:\PointBeach\PB1\CRDM\Stress\Stress Outputs\Fracture Outputs\RTPBW2.out

	CRDM Temperbead Bore Weld Analysis		NON-PROPRIETARY
	DOCUMENT NUMBER 32-5020244-01	PLANT POINT BEACH 1	CONTRACT NUMBER 4160094

Path Summary from file: C:\PointBeach\FBI\CRDM\Stress\Stress Outputs\Fracture Outputs\LFPBW1.out

Path Summary from file: C:\PointBeach\FBI\CRDM\Stress\Stress Outputs\Fracture Outputs\LFPBW2.out

	CRDM Temperbead Bore Weld Analysis		NON-PROPRIETARY
	DOCUMENT NUMBER 32-5020244-01	PLANT POINT BEACH 1	CONTRACT NUMBER 4160094

Path Summary from file: C:\PointBeach\PB1\CRDM\Stress\Stress Outputs\Fracture Outputs\LLPBW1.out

Path Summary from file: C:\PointBeach\PB1\CRDM\Stress\Stress Outputs\Fracture Outputs\LLPBW2.out

 <b>FRAMATOME ANP</b>	<b>CRDM Temperbead Bore Weld Analysis</b>		<b>NON-PROPRIETARY</b>
	DOCUMENT NUMBER <b>32-5020244-01</b>	PLANT <b>POINT BEACH 1</b>	CONTRACT NUMBER <b>4160094</b>

Path Summary from file: C:\PointBeach\pbi\CRDM\Stress\Stress Outputs\Fracture Outputs\HUCDP5fr.out

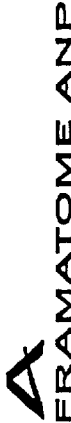
	CRDM Temperbead Bore Weld Analysis		NON-PROPRIETARY
	DOCUMENT NUMBER 32-5020244-01	PLANT POINT BEACH 1	CONTRACT NUMBER 4160094

Path Summary from file: C:\PointBeach\PBI\CRDM\Stress Outputs\Fracture Outputs\PLULPBfr.out



**FRAMATOME ANP**

**CRDM Temperbead Bore Weld Analysis** **NON-PROPRIETARY**

DOCUMENT NUMBER  
32-5020244-01

PLANT  
POINT BEACH 1

CONTRACT NUMBER  
4160094

Path Summary from file: C:\PointBeach\PB1\CRDM\Stress Outputs\Fracture Outputs\SL10PBfr.out



	CRDM Temperbead Bore Weld Analysis		NON-PROPRIETARY
	DOCUMENT NUMBER 32-5020244-01	PLANT POINT BEACH 1	CONTRACT NUMBER 4160094

Path Summary from file: C:\PointBeach\FBI\CRDM\Stress\Stress Outputs\Fracture Outputs\SL50PBfr.out

 <b>FRAMATOME ANP</b>	<b>CRDM Temperbead Bore Weld Analysis</b>		<b>NON-PROPRIETARY</b>
	DOCUMENT NUMBER <b>32-5020244-01</b>	PLANT <b>POINT BEACH 1</b>	CONTRACT NUMBER <b>4160094</b>

Path Summary from file: C:\PointBeach\PB1\CRDM\Stress\Stress Outputs\Fracture Outputs\RTPBfr.out

 <b>FRAMATOME ANP</b>	CRDM Temperbead Bore Weld Analysis		NON-PROPRIETARY
	DOCUMENT NUMBER 32-5020244-01	PLANT POINT BEACH 1	CONTRACT NUMBER 4160094

Path Summary from file: C:\PointBeach\PB1\CRDM\Stress Outputs\Fracture Outputs\LEPBfr.out

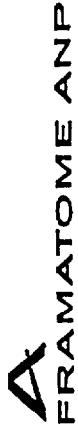
	CRDM Temperbead Bore Weld Analysis		NON-PROPRIETARY
	DOCUMENT NUMBER 32-5020244-01	PLANT POINT BEACH 1	CONTRACT NUMBER 4160094

Path Summary from file: C:\PointBeach\PB1\CRDM\Stress\Stress Outputs\Fracture Outputs\LLPBfr.out

## Computer Files

The ANSYS computer files used for the Appendix A are following:

### Computer Output Files (See page 42)

<u>File Name</u>	<u>Description</u>
<b>A) Original J-groove Weld</b>	
HUCDPBW1.out	HUCD old weld stress post-processing
HUCDPBW2.out	HUCD old weld stress post-processing
PLULPBW1.out	PLUL old weld stress post-processing
PLULPBW2.out	PLUL old weld stress post-processing
SL10PBW1.out	SL10 old weld stress post-processing
SL10PBW2.out	SL10 old weld stress post-processing
SL50PBW1.out	SL50 old weld stress post-processing
SL50PBW2.out	SL50 old weld stress post-processing
RTPBW1.out	RT old weld stress post-processing
RTPBW2.out	RT old weld stress post-processing
LFPBW1.out	LF old weld stress post-processing
LFPBW2.out	LF old weld stress post-processing
LLPBW1.out	- LL old weld stress post-processing
LLPBW2.out	LL old weld stress post-processing
<b>B) Temperbead Repair Weld</b>	
HUCDPBfr.out	HUCD rep. weld stress post-processing
PLULPBfr.out	PLUL rep. weld stress post-processing
SL10PBfr.out	SL10 rep. weld stress post-processing
SL50PBfr.out	SL50 rep. weld stress post-processing
RTPBfr.out	RT rep. weld stress post-processing
LFPBfr.out	LF rep. weld stress post-processing
LLPBfr.out	LL rep. weld stress post-processing