

National Aeronautics and Space Administration

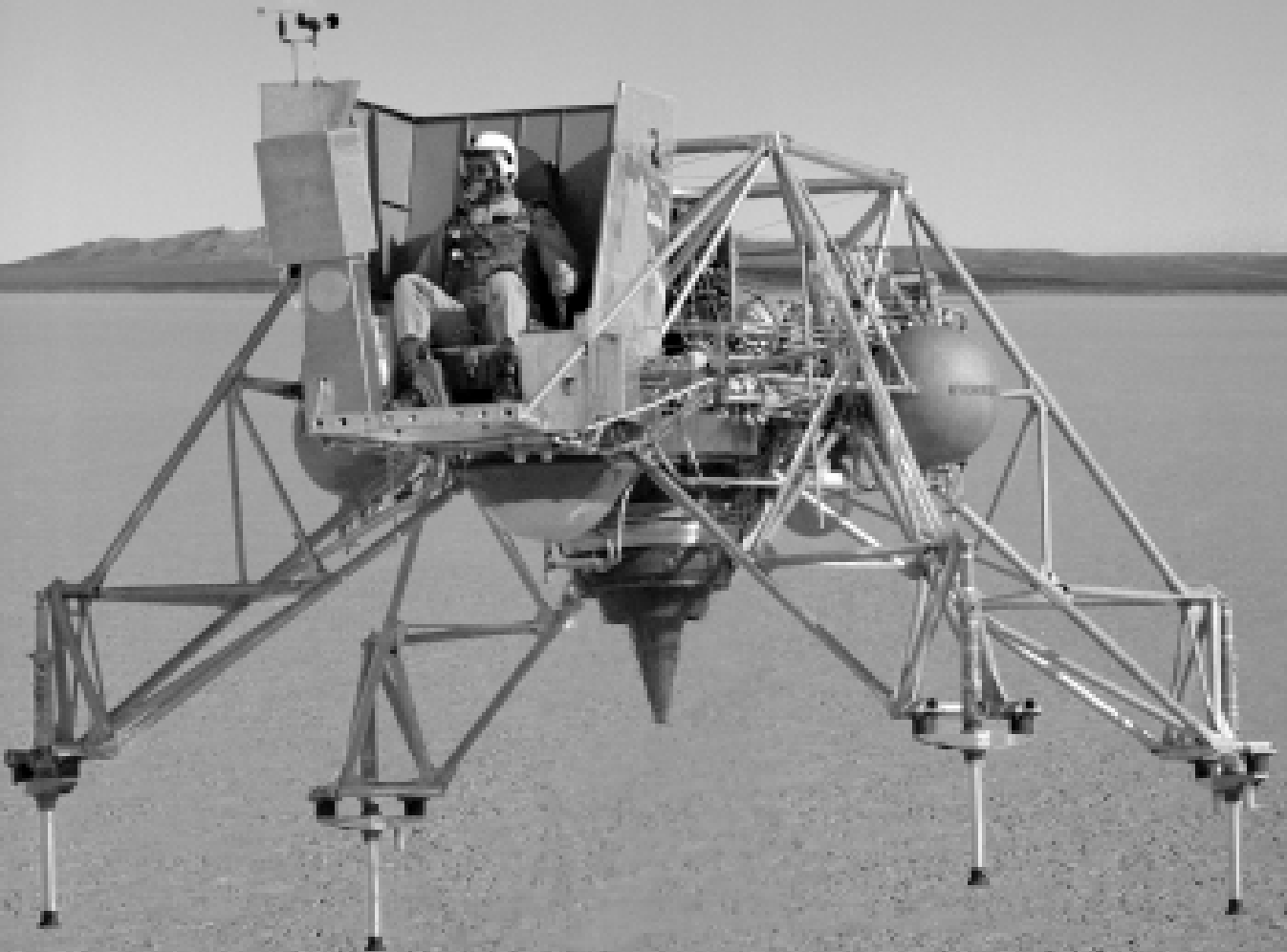

Unconventional, Contrary, and Ugly:

The Lunar Landing Research Vehicle



**Gene J. Matranga
C. Wayne Ottinger
Calvin R. Jarvis**

with D. Christian Gelzer

Monographs In Aerospace History #35
NASA SP-2004-4535

NASA SP-2004-4535

**Unconventional, Contrary, and Ugly:
The Lunar Landing Research Vehicle**

**Gene J. Matranga
C. Wayne Ottinger
Calvin R. Jarvis**

With D. Christian Gelzer

**NASA History Division
Office of External Affairs
Washington, D.C. 20546**

**Monographs in
Aerospace History
Number 35
2005**

Cover and book design by Steve Lighthill, NASA Dryden Flight Research Center.

Front cover: Composite image

Rear cover: Detail image

Library of Congress Cataloging-in-Publication Data

Matranga, Gene J.

Unconventional, contrary, and ugly : the Lunar Landing Research Vehicle / by Gene J. Matranga, C. Wayne Ottinger, Calvin R. Jarvis ; with D. Christian Gelzer.

p. cm. — (Monographs in aerospace history ; no. 35)

Includes bibliographical references and index.

"SP-2004-4535."

1. Lunar excursion module. 2. Project Apollo (U.S.)—History. I. Ottinger, Wayne. II. Jarvis, Calvin R. III. Title. IV. Series.

TL789.8.U6A55534 2004

629.44--dc22

2004022958

Table of Contents

Foreword by Neil A. Armstrong	v
Dedication	vii
Acknowledgements	viii
Introduction	ix
I. Development	1
Chapter 1: Conception	3
Chapter 2: A Proposal	16
Chapter 3: The NASA-Bell Collaboration	24
Chapter 4: A Vehicle Takes Shape	40
II. Flight Research	57
Chapter 5: Preparing for Flight	59
Chapter 6: Flying “Off the Books”	82
Chapter 7: Flight Research	106
III. Training for the Moon	123
Chapter 8: From LLRV to LLTV	125
Chapter 9: Houston	138
Epilogue	153
Appendices	157
Appendix A	159
Appendix B	165
Appendix C	167
Appendix D	172
Appendix E	179
Appendix F	183
Appendix G	194
Appendix H	197
Appendix I	202
Sources	209
Glossary	216
Index	219
NASA History Publications	221

Foreword

When the United States began considering a piloted voyage to the moon, an enormous number of unknowns about strategies, techniques, and equipment existed. Some people began wondering how a landing maneuver might be performed on the lunar surface.

From the beginning of the age of flight, landing has been among the most challenging of flight maneuvers. Touching down smoothly has been the aim of pilots throughout the first century of flight. Designers have sought the optimum aircraft configuration for landing. Engineers have sought the optimum sensors and instruments for best providing the pilot with the information needed to perform the maneuver efficiently and safely. Pilots also have sought the optimum trajectory and control techniques to complete the approach and touchdown reliably and repeatably.

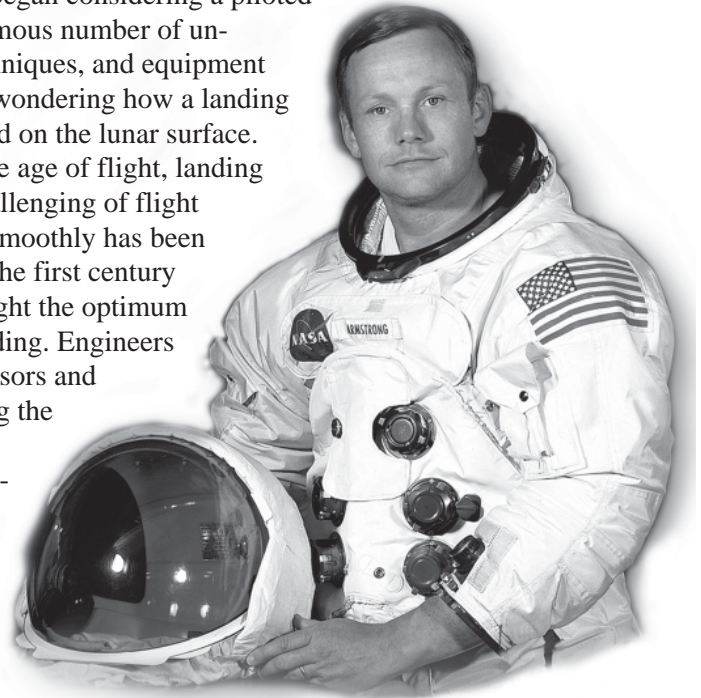

Landing a craft on the moon was, in a number of ways, quite different from landing on Earth. The lunar gravitational field is much weaker than Earth's. There were no runways, lights, radio beacons, or navigational aids of any kind. The moon had no atmosphere. Airplane wings or helicopter rotors would not support the craft. The type of controls used conventionally on Earth-based aircraft could not be used. The lack of an atmosphere also meant that conventional flying instrumentation reflecting airspeed and altitude, and rate of climb and descent, would be useless because it relied on static and dynamic air pressure to measure changes, something lacking on the moon's surface.

Lift could be provided by a rocket engine, and small rocket engines could be arranged to control the attitude of the craft. But what trajectories should be selected? What type of steering, speed, and rate-of-descent controls should be provided? What kind of sensors could be used? What kind of instruments would provide helpful information to the pilot? Should the landing be performed horizontally on wheels or skids, or vertically? How accurately would the craft need to be positioned for landing? What visibility would the pilot need, and how could it be provided?

Some flight-test engineers at NASA's Flight Research Center were convinced that the best way to gain insight regarding these unknowns would be the use of a free-flying test vehicle. Aircraft designers at the Bell Aircraft (Aerosystems) Company believed they could build a craft that would duplicate lunar flying conditions.

The two groups collaborated to build the machine. It was unlike any flying machine ever built before or since. The Lunar Landing Research Vehicle (LLRV) was unconventional, sometimes contrary, and always ugly.

Many who have seen video clips of the LLRV in flight believe it was designed and built to permit astronauts to practice landing the Apollo Lunar Module (LM). Actually, the LLRV project was begun before NASA had selected the strategy that would use the Lunar Module!

Fortunately, when the Lunar Module was designed somewhat later, its characteris-

tics were sufficiently similar to the LLRV that the LLRV could be used for LM simulation. A later version of the LLRV, the Lunar Landing Training Vehicle (LLTV), provided an even more accurate simulation following considerable modification to better represent the final descent stage.

Unconventional, Contrary, & Ugly: The Lunar Landing Research Vehicle tells the complete story of this remarkable machine, the Lunar Landing Research Vehicle, including its difficulties, its successes, and its substantial contribution to the Apollo program. The authors are engineers who were at the heart of the effort. They tell the tale that they alone know and can describe.

Six crews landed their Lunar Modules on the moon. They landed on the dusty sands of the Sea of Tranquility and the Ocean of Storms. They landed in the lunar highlands at Fra Mauro and on the Cayley Plains. They landed near the Apennine and Taurus Mountains. Each landing, in widely different topography, was performed safely under the manual piloting of the flight commander. During no flight did pilots come close to sticking a landing pad in a crater or tipping the craft over. That success is due, in no small measure, to the experience and confidence gained in the defining research studies and in the pilot experience and training provided by the LLRV and LLTV.

Someday men will return to the moon. When they do, they are quite likely to need the knowledge, the techniques, and the machine described in this volume.

NEIL A. ARMSTRONG
Lebanon, Ohio

Dedication

The authors wish to pay tribute to key people whose contributions to the LLRV program were invaluable but who did not survive to contribute or participate in this publication. They include:

- Don Bellman, the NASA FRC LLRV Project Manager, who with his insight, technical skills, and leadership put together an outstanding flight research team.
- Paul Bikle, the NASA FRC Director whose leadership, vision, and management style fostered the environment for successful programs including the X-15, LLRV, lifting bodies, and fly-by-wire.
- Leroy Frost, the NASA FRC inspector in flight operations whose dedication, knowledge, and ability to inspire teamwork helped ensure safe operations.
- Ken Levin, LLRV Technical Director for Bell Aerosystems, the key inventor, motivator, and technical manager at Bell Aerosystems, who conceived and implemented the free-flight, Earth-bound simulation of lunar landings.
- Joe Walker, chief research pilot for NASA FRC and the LLRV project pilot who made the first eight flights, and a total of 35 flights, for the program before he left to fly the XB-70. Joe had flown the X-15 with reaction controls but had never flown a helicopter before his assignment to the LLRV, yet he mastered the challenge.
- Leon Zwink, a Bell Aerosystems avionics engineer. Although able to participate in the early development of this publication, he did not survive for the completion of it. Leon was instrumental in helping the project overcome the numerous difficulties in the early flight tests of the LLRV, and later in the LLTV program.

The authors also thank Dill Hunley for his patience, expertise, and counsel in this project. The extraordinary time and effort needed to create and produce this work by the three authors really tested his dedication to professional collaboration. He passed this test with flying colors.

Other contributors to this work who deserve a big thanks include Joe Algranti, Bill Bascom, Bill Clark, Norm DeMar, Art Gorbaty, Dean Grimm, Ray Kellog, Alan King, Jack Kluever, Don Mallick, Warren North, Bruce Peterson, Don Reisert, Walt Rusnak, John Ryken, Glen Swanson, Rich Van Ripper, Ray White, Bill Wilson, and Ray Young.

Acknowledgements

The authors began the story of the Lunar Landing Research Vehicle under the tutelage of Dill Hunley when he was Chief Historian at NASA's Dryden Flight Research Center. It continued under the guidance of Michael H. Gorn, Dill's successor as Chief Historian. Without Mike's support of this project, and his belief in its importance, it would not have seen the light of day.

A number of people read the text along the way, offering comments that improved the story. The list includes Dill Hunley, Mike Gorn, Darlene Lister, Dean Grimm, Beth Hagenaur, Gray Creech, Peter Merlin, Curtis Peebles, and the Dryden *X-Press*' Sarah Merlin. The book enjoys its readability in large measure because Sarah labored over repeated versions of the manuscript, and she always found ways to improve it.

Carla Thomas had the arduous task of scanning and correcting the unusually large selection of images, and her long effort did a great deal to bring the story to life. Steve Lighthill laid out the text and imagery, and created the front and back covers, all to striking effect. Bell Helicopter Textron and Weber Aircraft LP kindly granted permission to use images dating from each company's involvement with the LLRV.

My pleasure in editing this book has been to work with all these people, as well as the three authors.

Christian Gelzer
Deputy Chief Historian
NASA Dryden Flight Research Center
Edwards, California

Introduction

Although the development of horizontal flight may be the dominant theme in the history of American aeronautics, the vertical dimension constitutes an important subplot in the narrative. From Igor Sikorsky's early helicopter designs and production vehicles to the U.S. Marine Corps' V-22 Osprey, from the British Harrier jet to the National Aeronautics and Space Administration's (NASA) XV-15 tilt-rotor vehicle, there have been many reasons to pursue vertical flight. Carrying firepower and troops to inaccessible areas in times of war, conducting search and rescue missions in unforgiving terrain, assisting large-scale construction projects, and serving as a commuter vehicle in dense urban areas all are contexts in which these machines either have given, or may one day give, service. But in the annals of vertical flight one machine stands alone in both design and purpose. NASA's Lunar Landing Research Vehicle (LLRV) arose from one of the greatest engineering challenges of the twentieth century: to land, as Neil Armstrong wrote in the foreword to this book, "reliably and repeatably" in a place with no atmosphere and one-sixth the gravity of Earth. Conceiving and producing this unprecedented vertical flyer reflects a singular achievement in the history of aeronautical engineering. Flying a vehicle capable of simulating the lunar gravity and atmosphere—and accomplishing this feat on Earth—represents an equally significant chapter in the history of flight research. The dual achievement of building and flight testing these remarkable machines is the story told in this book.¹

The path to Apollo and the LLRV could not have been traversed without two of the great technological breakthroughs nurtured during World War II, computer technology and rocketry.² Yet the American space program remained in the planning stages until the world heard the "beep, beep" of Sputnik 1 on 4 October 1957—followed less than a month later by Sputnik 2. By orbiting both of the world's first two man-made satellites—and doing so in less than a month—the Soviets took the lead in the race into space.

The U.S. answered early the following year with the launch of the Explorer 1 satellite into orbit on 31 January 1958, followed by the launch of Vanguard 1 on 17 March 1958. The first successful U.S. satellite weighed a mere 34 pounds, while Sputnik 1 weighed 183 pounds and Sputnik 2 a whopping 1,100 pounds. Nevertheless, the tiny Explorer 1 satellite—developed in a joint program by the Army Ballistic Missile Agency (ABMA) and NASA's Jet Propulsion Laboratory (JPL)—led to the discovery of a radiation belt surrounding the Earth (later named for astrophysicist James Van Allen).

The Soviets stretched their lead on 12 April 1961, when Cosmonaut Yuri Gagarin launched into orbit on Vostok 1 and completed the first full orbit of the Earth. Less than a month later, on 5 May, astronaut Alan B. Shepard, Jr., in the Mercury *Freedom 7* space capsule, became the first American to be launched into space, albeit in suborbital flight. With its successful launches over the next nine months, Project Mercury showed that the U.S. was a serious contender in the space race. Indeed, the U.S. closed the gap on 20 February 1962, when astronaut John H. Glenn, Jr., became the first American to orbit Earth in space, circling it three times in the Mercury *Friendship 7* capsule. As a result of a problem with the autopilot, Glenn flew portions of the final two rotations manually.

Circumlunar piloted flight had been under study in the U.S. since 1958. By 1960, NASA had undertaken a series of detailed studies on the requirements for landing a human on the moon. These reports concluded that sending individuals to the moon's surface and bringing them safely home to Earth did not await any major technological or scientific discoveries, but rather required careful planning to solve some operational unknowns.³

The U.S. Congress appeared ready to support this endeavor. In 1960, the House Committee on Science and Astronautics recommended that "a high priority program

should be undertaken to place a manned expedition on the moon” by the end of the decade.⁴ NASA’s first 10-year plan (presented to Congress in February 1960) called for broadly based research of piloted and unpiloted space flight, including scientific satellites to study the near-space environment, lunar probes to study and photograph the moon’s environment, weather satellites to improve understanding of Earth’s broad weather patterns, and the development of larger launch vehicles for lifting heavier payloads.

Speaking before a joint session of Congress on 25 May 1961, newly elected President John F. Kennedy forged these various strands into a single national policy when he committed the United States to pursuing the lunar mission. “Now it is time . . . for this nation to take a clearly leading role in space achievement, which in many ways may hold the key to our future on Earth,” he said. “I believe that this nation should commit itself to achieving the goal, before this decade is out, of landing a man on the moon and returning him safely to the Earth. No single space project in this period will be more impressive to mankind, or more important to long-range exploration of space; and none will be so difficult or expensive to accomplish.”⁵

Project Gemini represented a technological bridge between Mercury and Apollo. Gemini’s twelve flights (made between April 1964 and November 1966) provided many of the answers needed to advance from orbiting Earth to landing on the moon. Among other things, the Gemini program demonstrated that astronauts could remain in space long enough to endure a round-trip lunar voyage without suffering lasting ill effects from prolonged weightlessness. These flights also proved the rendezvous and docking maneuvers crucial to the success of the Apollo lunar flights. Moreover, Gemini served as the testbed for extravehicular activity (EVA), demonstrating in a series of experiments that astronauts could do useful work outside the spacecraft, whether on the moon or in orbit.

As walks in space became more routine, NASA concentrated on the Apollo launch vehicles. When the agency gained the Army Ballistic Missile Agency’s (ABMA) Development Operations Division in March 1960, it also gained the division’s head, Wernher von Braun, as well as the ABMA’s Saturn booster project. The Saturn rocket held the greatest promise of meeting the Apollo program’s need for a launch vehicle capable of lifting almost 300,000 pounds into Earth’s orbit and about 100,000 pounds into orbit around the moon. The successful launches of Saturn I and Saturn IB between 25 April 1962 and 25 August 1966 greatly increased NASA’s confidence in the entire propulsion system.⁶

Similarly, NASA’s confidence in finding a place for the astronauts to land on the moon increased with each successful landing of the three unpiloted lunar probes, which had been dubbed Ranger. Launched between July 1964 and March 1965, these provided close-up photos of the lunar surface that far exceeded the best telescopic detail possible from Earth. Between August 1966 and August 1967, the five lunar orbiters—state-of-the-art mapping satellites—photographed more than 99 percent of the moon’s surface, including potential landing sites, and transmitted data on the moon’s gravitational field and environment. Between June 1966 and January 1968, unpiloted Surveyor lunar landers soft-landed on the moon, transmitting detailed images from the moon’s surface and providing test results on soil samples, including chemical analysis.⁷

Finally, the event on which the hopes of the entire mission rested—the first test launch of the gigantic Saturn V rocket—occurred 9 November 1967 during Apollo 4, a successful developmental flight carrying the unpiloted Apollo command/service modules. Subsequent firings led finally to the first piloted Saturn V flight as well as to the first piloted lunar-orbit mission. On 21 December 1968 the rocket propelled Apollo 8 into Earth’s orbit, after which the third stage fired again, pushing the spacecraft away from Earth’s gravitational field and on a trajectory to the moon. With astronauts Frank Borman, James A. Lovell, Jr., and William A. Anders aboard, Apollo 8’s weeklong,

147-hour flight provided a close-up look at the moon during ten lunar orbits. At close range, the astronauts were able to verify the feasibility of potential landing sites on the moon's surface. The piloted Apollo 9 and Apollo 10 missions in early 1969 completed the final steps needed before landing on the moon.

As the U.S. progressed toward the goal of a lunar landing, each NASA center began addressing technical issues specific to its area of expertise. Landings have long been among the most challenging aspects of flight, but all that had been attempted heretofore paled in comparison to this undertaking. Specifically, since the moon had no atmosphere and its gravitational field was considerably weaker than Earth's, NASA engineers and scientists faced a dilemma: how to train astronauts for the complexities of a lunar landing without their actually touching down on the moon?

The drama unfolded in California's Mojave Desert at NASA's Flight Research Center (FRC), later designated the Hugh L. Dryden Flight Research Center (DFRC). This facility already had a long history in researching the landing behavior of high-performance aircraft.⁸ In the X-15 program, for example, the FRC used an F-104 to simulate X-15 behavior and assure safe landing characteristics under a wide range of flight conditions. And so it seemed the natural choice for conducting a Lunar Landing Research Vehicle flight research program.

Through a fortunate set of circumstances, in December 1961, Bell Aerosystems proposed to NASA headquarters a design for just such a flying simulator.⁹ The Bell plan merged its own design with concepts popular among FRC engineers. This approach won approval at NASA Headquarters as well as at the NASA Manned Spacecraft Center (MSC) in Texas, later known as the Lyndon B. Johnson Space Center. The space agency funded the design and construction of two LLRVs, expecting to collect sufficient flight research data to master the variables inherent in a moon landing. Moreover, by flying a variety of control conditions and trajectories, and with one or two pieces of the hardware of the actual Lunar Module (LM), Bell and NASA engineers hoped to achieve accurate simulations for the astronaut corps.

Most members of the Apollo team realized the importance of developing not merely a robotic lunar lander, but a free-flying, pilot-actuated vehicle capable of training astronauts to take the controls of the LM. Although some argued strongly for a fully automated landing system, they were outnumbered by those who felt that, at a minimum, a manual override was required so pilots could fly the machine if necessary, as Glenn did when the autopilot failed in the Mercury *Friendship 7*.

The supporters of pilot control were soon to be vindicated. As he attempted to land during the first mission to the moon in Apollo 11, Neil Armstrong found himself in a dangerous situation only human intervention could correct. Low on fuel and beset by computer overflow warnings, the LM was headed toward a rocky site unsuitable for a touchdown. Armstrong disengaged the automatic landing system and flew the final seconds under manual control, in all likelihood saving the mission. Had it not been for the training he had received with the LLRV—and with subsequent vehicles, including the Lunar Landing Training Vehicle (LLTV)—this option probably would not have been possible. As it turned out, all six Apollo lunar landings were flown manually. Although the autopilot could perform fully automatic touchdowns, according to Armstrong, “its primary disadvantage was its inability to pick a good landing spot. In a few flights, very large attitude changes, at low altitudes, were required to maneuver to the landing site, particularly Apollo 12 when it was attempting to land in close proximity to the unmanned Surveyor spacecraft, which had been resting on the lunar surface unattended for the previous two years.”¹⁰

Valuable as these trainer vehicles proved to be, they were not without flaws. Fragile and subject to limited operational margins (due to weight, jet-engine thrust, and limited fuel capacity), three of the vehicles crashed during the astronaut training program at Houston. The first vehicle to be lost was the Number One LLRV, followed by the first

two of the three LLTVs (updated versions of the LLRVs with improved capabilities for LM simulation). Fortunately, because of inherent flight-safety features, the LLRVs and LLTVs did not cost any astronaut his life, either during these accidents or during the program.

Despite these mishaps and the vehicles' vulnerabilities, MSC Apollo managers and the astronauts who had already landed on the moon considered these machines to be essential ingredients of Apollo training. "The LLTV proved to be an excellent simulator and was highly regarded by the astronauts as necessary to lunar landing preparation," Armstrong later recalled.¹¹

Moreover, the LLRV and LLTV contributed to the evolution of a pivotal advance in modern aeronautics: the first unstable flying vehicles entirely dependent on computers for flight control. These strange-looking machines left a lasting impression on FRC engineers. In part due to the success of these two vehicles and their analog fly-by-wire computer systems, a fully digital fly-by-wire control system was finally realized during the 1970s in the F-8 Digital Fly-By-Wire flight research project conducted at Dryden Flight Research Center.¹²

¹ Roger E. Bilstein, *Flight in America: From the Wrights to the Astronauts* (Baltimore and London: Johns Hopkins University Press, 1984), p. 117-118; Roger E. Bilstein, *Orders of Magnitude: A History of the NACA and NASA, 1915-1990* (Washington, D.C., NASA SP-4406, 1989), p. 143. See also Michael H. Gorn, *Expanding the Envelope: Flight Research at NACA and NASA* (Lexington: The University Press of Kentucky, 2001), chapter 7, for a discussion of the development and flight test of the XV-15 tilt-rotor.

² Except as noted otherwise, information in this chapter about the early history of the space program is drawn from Bilstein, *Orders of Magnitude*, p. 42-71.

³ All of the initial astronauts were males.

⁴ Neil A. Armstrong in "Wingless on Luna," 25th Wings Club General Harold R. Harris 'Sight' Lecture, presented at Grand Hyatt Hotel, New York, 18 May 1988.

⁵ Bilstein, *Orders of Magnitude*, p. 59.

⁶ "NASA Major Launch Record," NASA Pocket Statistics (Washington, D.C.: NASA, 1997), B-92 to B-98.

⁷ "Lunar Exploration," NASA Pocket Statistics, 1997 Edition, B-78 to B-82.

⁸ Many research publications reflect this area of expertise, including: Wendell H. Stillwell, "Results of Measurements Made During the Approach and Landing of Seven High-Speed Research Planes" (Washington, D.C.: NACA RM H54K24, 1955); Gene Matranga and Neil A. Armstrong, "Approach and Landing Investigation at Lift-Drag Ratios of 2 to 4 Utilizing a Straight-Wing Fighter Airplane" (Washington, D.C.: NASA TM X-31, 1959); Gene J. Matranga and Joseph A. Menard, "Approach and Landing Investigation at Lift-Drag Ratios of 3 to 4 Utilizing a Delta-Wing Interceptor Airplane" (Washington, D.C.: NASA TM X-125, 1959); Gene J. Matranga, William H. Dana, and Neil A. Armstrong, "Flight Simulated Off-the-Pad Escape and Landing Maneuvers for a Vertically Launched Hypersonic Glider" (Washington, D.C.: NASA-TM X-637, 1962).

¹⁰ Armstrong, "Wingless on Luna," p. 19.

¹¹ *Ibid.*, p. 15.

¹² See especially James E. Tomayko, *Computers Take Flight: A History of NASA's Pioneering Digital Fly-By-Wire Project* (Washington, D.C.: NASA SP 2000-4224, 2000).

I

Development

Chapter 1: Conception

Like most groundbreaking ideas, the concept of a free-flying lunar landing simulator did not materialize fully conceived from any one mind or institution. Rather, it evolved simultaneously with other technical elements that together constituted the architecture of Project Apollo. Planning for a lunar voyage began as early as 1959, when NASA Headquarters and Langley Research Center both assembled moon-mission work groups. But individuals inside NASA still reacted with shock—and perhaps a little panic—when, in 1961, President John F. Kennedy committed the nation to landing on the moon. Historian James R. Hansen recounted the feeling inside the agency after the president’s speech:

At first no one at Langley could quite believe it. If President Kennedy had in fact just dedicated the country to a manned lunar landing, he could not be serious about doing it in less than nine years. NASA...had never dreamed of a manned mission that included landing on and returning from the surface of the moon by the end of the 1960s. Not even Bob Gilruth, the leader of the [Langley Space Task Group] was prepared for the sensational announcement. He heard the news in a NASA airplane somewhere over the Midwest on his way to a meeting in Tulsa. He knew that Kennedy planned to say something dramatic about the space program in his speech, and so he asked the pilot to patch it through on the radio. Looking out the window over the passing clouds, he heard every incredible word. Only one word described Gilruth’s feelings at that moment: “aghast.”¹

Thus the entire lunar rendezvous concept began its long passage toward reality in the charged atmosphere occasioned by Kennedy’s address. Fortunately, stunned disbelief soon yielded to intense activity, in part because many of the elements essential to fulfilling the president’s objective had been under discussion in NASA conference rooms, hallways, and lunchrooms for some time.

At the time of the speech, debate already had been swirling inside the agency over three alternatives for reaching the moon: direct ascent, the most popular choice; Earth-orbit rendezvous (EOR), favored by the powerful Wernher von Braun; and lunar-orbit rendezvous (LOR), considered the least likely candidate. Direct ascent required an all-new, battleship-sized rocket dubbed Nova, capable of sufficient thrust to boost a payload to the moon with no intermediate steps. Von Braun and the EOR proponents wanted the Saturn to carry several parts essential for the mission into Earth orbit, mate them there, and send the assembled vehicle toward the moon. Dr. John C. Houbolt, a relatively obscure assistant chief in Langley Research Center’s Dynamics Loads Division, initiated and campaigned fervently for the concept of the LOR. Houbolt dismissed direct ascent as risky, impractical, and fraught with delay, and he regarded EOR as suspect because of the size and weight of the vehicle expected to fly from Earth orbit and make a soft landing on the lunar landscape. In place of these proposals, Houbolt championed a two-part vehicle: a command ship carrying crew and the lunar landing vehicle together into lunar orbit. The landing vehicle would separate from the command vehicle during lunar orbit and descend to the lunar surface. On completion of the mission, only a portion of the landing vehicle would lift off, leaving the base behind on the moon. It would ascend and dock with the orbiting command module, and the reunited crew would then return to Earth. Despite intense opposition, and partly due to intense personal persistence, Houbolt slowly won converts to his position, most notably Von Braun and NASA Administrator James E. Webb (who originally favored direct ascent). Not until July 1962 did the fog of combat lift and allow Webb to announce the

LOR concept as the winner.²

The development of lunar landing techniques—distinct from, but still part and parcel of, lunar-rendezvous planning—preceded Webb’s decision by some time, even while the direct ascent/EOR/LOR debate raged. The NASA Flight Research Center (FRC) on Edwards Air Force Base, Calif., assumed a leading role in the lunar landing decision-making process. Hubert M. “Jake” Drake, chief of the FRC’s newly established Advanced Planning Office, took charge of the initiative. Drake had been at the FRC since 1947, arriving on the heels of Walt Williams and the X-1 flight research team coming to California from the NACA Langley Memorial Aeronautical Laboratory in Hampton, Va.³ As an engineer in the 1950s, and with an extensive background at Langley in flight stability and control, Drake played a major role in rocket research planes. Together with Donald Bellman and Gene Matranga, two other FRC engineers, he contributed work on the first X-planes, especially the X-1E and the X-15. Drake also served as an advanced planner under Walt Williams—the first chief of the flight research organization that became the FRC in 1959—and helped associate the FRC with cutting-edge technological development, especially in his later advocacy of the X-15.⁴ Moreover, Drake’s close ties to Langley enabled him to foster cooperation across the continent, between the theorists and wind tunnel researchers working in Hampton and the flight research practitioners toiling in the Mojave Desert.

Lunar-Landing Study Begins

Drake wasted no time establishing the FRC as a mainstay in the evolution of lunar landing. As early as May 1960 he proposed to NASA Headquarters that the FRC conduct research on pilot control during entry into the lunar gravitational field and subsequent vehicle recovery or landing. Later in the decade he represented the FRC on two prestigious committees, one headed by Air Force Col. Donald H. Heaton that studied rendezvous as a technique for accomplishing the lunar mission and another chaired by John C. Houbolt of Langley that studied spacecraft rendezvous.⁵

Meanwhile, the month after President Kennedy’s momentous speech before Congress, Drake invited five talented young FRC engineers to join him on a lunar-landing study committee. He hoped their youth and relative inexperience might free them from preconceived ideas. His recruits included Jim Adkins, Gene Matranga, Charles Richard, John W. Smith, and Joseph Washko.⁶ A former Air Force F-86 pilot, Adkins specialized in the advanced control systems then being demonstrated on the X-15. Matranga’s low lift/drag landing research later proved successful on the X-15.⁷ Richard had a background in loads and structures. Smith, whose expertise concerned analog simulation, had been assigned to NASA as a lieutenant in the U.S. Army and he joined NASA after his military commitment ended. Finally, Lt. Washko, with a degree in aeronautics, had been detailed to NASA.

The committee soon found this project to be full of technical challenges, and one with more than its share of blind alleys. To begin with, the committee proposed using an off-the-shelf visual simulator, with which they hoped to create an extensive analog simulation of the lunar landing. Although this machine could replicate some of the less complicated factors of lunar landings (such as descent trajectories, fuel consumption, and visual requirements at altitudes from 10,000 to 100,000 feet above the moon’s surface), the committee realized that more sophisticated simulators would be needed to examine specific problems in greater depth. One possible alternative involved the high-speed sled facility at the Air Force Flight Test Center (AFFTC) at Edwards Air Force Base, which was potentially capable of adding motion cues to the simulation while retaining a high degree of pilot safety. Faced with very limited development time for simulating terminal lunar landing, the committee ruled out tethered devices in favor of helicopters, vertical takeoff and landing (VTOL) vehicles, or short takeoff and landing (STOL) vehicles.

Drake's engineers also conducted an extensive literature search. This revealed that the Naval Ordnance Test Station (NOTS) at Inyokern, Calif., had been conducting simulated unpowered lunar landings since 1959, according to NOTS project engineer Felton Williamson, Jr.⁸ Members of Drake's committee visited NOTS in early August 1961 and learned that station engineers had tested a 700-pound flying simulator late in the previous year.⁹ Fabricated from available hardware, the vehicle consisted of four fuel tanks, one oxidizer tank, one pressurizing tank, one variable-thrust rocket engine, four landing shock absorbers, and control hardware. The machine used a storable hypergolic fuel—unsymmetric dimethyl hydrazine—and relied on red fuming nitric acid as an oxidizer. The primary controlling device consisted of an optical altitude/velocity sensor at the top of the vehicle.

During testing, the vehicle was constrained by four cables suspended from the top of a 150-foot tower. Controlled entirely from the ground, the vehicle's first test successfully demonstrated only the rocket system. The second test successfully verified that both the engine vibration and the dust created by the engine had only negligible effect on the optical scanner. The NOTS project planned more tests for demonstrating the closed-loop operation of the optical sensor and control algorithms under a variety of conditions and surfaces. Members of the FRC committee decided to stay abreast of the NOTS research since it involved critical control parameters essential to their project.

Back at Edwards Air Force Base, Washko pursued the use of the AFFTC high-speed sled facility assisted by Ernest Coleal, chief of the engineering section of the Experimental Track Branch, and others.¹⁰ AFFTC engineers wanted to support the NASA research, but they expressed two concerns. First, using a human pilot in the test would probably require the approval of Air Force Headquarters. Second, since no existing sled satisfied NASA requirements, a new sled would need to be built. Faced with an estimated cost of fabrication and test of roughly \$20,000, Drake and his team decided to forego use of the AFFTC facility.

Casting about for a satisfactory replacement, in August 1961 Matranga met with Bill Swope of the U.S. Army Flight Test Group at Edwards to discuss the feasibility of using a helicopter to simulate lunar landing. A senior flight-test engineer with extensive helicopter experience, Swope gave more than a few reasons why helicopters would be unsuitable. Above all, he warned, thrust vector created by the rotor blades precluded the large attitude excursions needed for lunar simulation; it also created a coupling between lift and attitude control that would be hard to mask. Instead, Swope recommended the development of a specially designed VTOL vehicle.¹¹

This advice prompted Drake to conduct a wide survey. His committee contacted VTOL experts at NASA Ames Research Center and at Langley. At Ames, Drake approached research pilot Fred Drinkwater and research engineer Seth Anderson. At Langley, he contacted research pilot Jack Reeder and John Campbell; the latter was chief of the dynamic stability branch. All agreed with Swope: VTOL vehicles had many of the limitations already identified in helicopters. Moreover, VTOL flight duration lasted only minutes at a time. Therefore, these individuals recommended a non-aerodynamic platform such as the Rolls Royce "Flying Bedstead" as the basic lunar landing simulator design.¹² They cautioned that, to be effective, the simulator required an innovative system capable of maintaining a vertical thrust vector as the vehicle went through attitude changes. At the FRC, Smith conducted preliminary analog simulations that seemed to bear out the suggestions of the Ames and Langley pilots and engineers; simulated lunar landing seemed feasible with a free-flight, jet-supported vehicle.¹³

A Free-Flying Lunar Landing Simulator

Armed with this information, Drake pressed his case with higher NASA authorities. He spoke with Ray Bohling at NASA Headquarters on 19 September 1961 about the studies underway at the FRC and the desire to develop a free-flying vehicle to simulate



An artist's conception of the free-flight lunar landing simulator. During the first stages of planning, designers positioned the pilot directly above the jet engine intake to simplify center-of-gravity issues, but this led to distortion of the engine's intake flow. (ECN-8227)

lunar landing.¹⁴ Interested, Bohling suggested further development of the concept for presentation to NASA Headquarters later that fall. A few weeks later, Drake and Matranga raised the issue of a free-flying lunar landing simulator during a review of Apollo control, guidance, and navigation at Ames on 5 October of that year. Again, Bohling—along with E. O. Pearson of NASA Headquarters—urged them to pursue the concept. Encouraged by the expression of interest, Drake cast a wider net. He solicited support for the project from Walt Williams at an X-15 conference held at the FRC on 20 November 1961. By now director of space flight operations for Project Mercury, Williams believed the proposal had merit and agreed to do whatever he could to promote it.

On 7 December 1961, word reached the FRC that NASA Headquarters had received an unsolicited proposal from Bell Aerosystems of Niagara Falls, N.Y., for a free-flight lunar landing simulator. John Disher, one of Bohling's colleagues at Headquarters, had mentioned the Bell initiative to Wesley Messing, employed in the FRC flight mechanics branch. Disher apparently suggested combining the FRC and Bell ideas in order to draw the best from both sources.

Then another opportunity to advance the lunar simulator concept presented itself. At the Manned Lunar Symposium in December 1961, Matranga and Messing spoke

with George M. Low about the FRC's proposed free-flight lunar landing simulator. Low had joined the National Advisory Committee for Aeronautics (NACA) with a degree in aeronautical engineering from Rensselaer Polytechnic Institute in New York. After working in experimental and theoretical research at the NACA's Lewis Flight Propulsion Laboratory near Cleveland, Ohio, he became program chief of manned space flight at NASA Headquarters in 1958, a position NASA Deputy Administrator Robert Seamans described as "virtually the most important job in all of NASA."¹⁵

When Matranga and Messing mentioned the free-flight lunar landing simulator proposed by the FRC, Low said he was already familiar with the idea; evidently, both Walt Williams and Langley's Bob Gilruth had mentioned it to him. Low agreed to hear an informal briefing on the subject in late January 1962. He also expressed an interest in funding the program in 1963, provided the Langley's Space Task Group agreed.

Bell Aerosystems' Proposal

Toward the end of 1961, Bell Aerosystems joined a team of companies assembled by General Electric to study lunar landing. Ken Levin, a Bell engineer in charge of the preliminary LLRV design team, pinpointed one of the most problematic aspects of the conceptual vehicle. "We were impressed," he later said, "with the difficulty of trying to extrapolate Earth landing experience to lunar gravity."¹⁶ Since no one had ever landed on the moon, no one could be sure what the impact of the lower lunar gravity would be. While the effects on machinery could be determined from analysis, the same could not be said of effects on humans. According to Levin, he and others at Bell saw that "some device was needed with a human being in the loop for simulating lunar landing." The Bell concept evolved after Levin and others at Bell did a preliminary study "of all the different ways we could think of simulating lunar gravity..." They concluded that "ultimately, you would have to have something that would allow a man to fly free of the surface."

At this juncture, Bell managers selected a cadre of engineers for the project. Although Levin is sometimes referred to as the originator of Bell's LLRV concept, he and other Bell employees describe a collaborative creative process. According to Walt Rusnak (later the LLRV project manager for Bell's Avionics division), the LLRV emerged from a brainstorming session by a systems design group in Bell's structures division.¹⁷ Levin credited various people on the LLRV roster with contributing many of the projects' pivotal technical facets.

In any event, during November 1961, the company sent its lunar landing simulator ideas to Bob Voas at Langley, then the NASA center most involved with the Apollo project. According to Levin, Voas embraced the Bell concept but felt it was about five years premature since NASA had not yet developed a launch vehicle, let alone an accompanying trainer.

The next day, Levin took a phone call from Messing telling him he had heard from Voas about the Bell proposals. Messing expressed interest, and Levin and other Bell representatives traveled to the FRC to present their ideas for an LLRV. The Bell LLRV was remarkably similar to the approach envisioned at the FRC. Accordingly, Levin and his cohorts "whipped out [a] proposal to do a feasibility study" and submitted it to the FRC on 19 December 1961.

The similarity between the Bell and FRC positions was not surprising. Originally founded in 1935 by Lawrence D. Bell as the Bell Aircraft Corporation, Bell Aerosystems knew the FRC's objectives and personnel well. The company had built three of the early X-planes with which the FRC had been associated—the X-1, X-2, and X-5—and had extensive experience in aeronautics, rocketry, and VTOL aircraft.

Levin had been part of the Bell team for many years. He arrived at the firm's Niagara Falls facility in 1948 with a degree in electrical engineering, then worked seven years in New Mexico on the Air Force RASCAL missile. He developed a reputa-

tion for listening patiently to technical differences of opinion and then arriving at workable compromises.

Among the many difficulties faced by Levin's team, reduced lunar gravity and lack of atmosphere posed perhaps the greatest challenges to vehicular behavior. The Bell contingent, for example, suggested tilting the vehicle in flight in order to control "translation," or horizontal movement, as well as to conserve propellant. On the moon, however, tilt angles needed to be much greater than those used on Earth because of differences in gravity between the two.¹⁸ Levin and his associates proposed a neat solution for simulating lunar conditions: a double gimbal that would allow the outer vehicle to duplicate the moon's motions while a lift-supporting propulsion device maintained vertical orientation.

The Bell study recognized four fundamentals for successful simulation. First, the simulator must react as if it were flying in a vacuum like that found on the moon. Second, the simulator needed the same ratio of control torque to polar moment of inertia as that of the lunar landing vehicle. Third, the simulator must have the same thrust-to-mass ratio as the lunar landing vehicle. Fourth, and most important, the simulator had to duplicate a lunar gravity field, only one-sixth that of Earth.¹⁹

As it turned out, Bell and the FRC both explored the same range of possibilities for meeting these requirements. Bell ruled out use of a helicopter for the same reasons Swope had. (Bell initially considered using a gimballed vehicle supported by a helicopter, only to discard that idea due to the time and expense required to counteract aerodynamic and pendulum effects.)

Levin's engineers had only three viable propulsion options: a ducted fan, a rocket engine, and a jet engine. Individually, each lacked the desired qualities necessary to meet efficiency and response requirements for powering the craft. Therefore, the Bell group decided on an ingenious combination. Rockets mounted on the outer gimbal frame could produce the deceleration response needed while not consuming a prohibi-

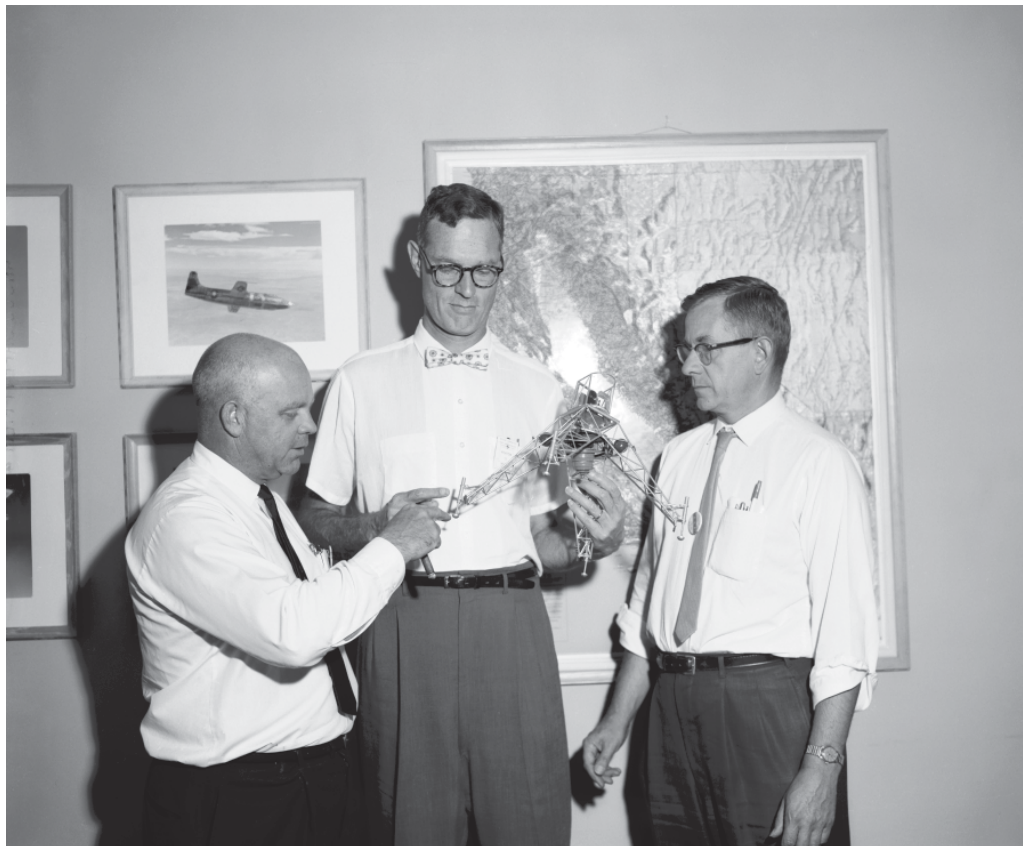

Don Bellman (right) is shown with Flight Research Center director Paul Bikle (left) and Bell Aerosystems' Ken Levin. In Levin's hand is a model of Bell's proposed simulator. (E-8679)

tive quantity of rocket propellant. Simultaneously, a ducted-fan or jet engine within the gimbal arrangement could provide efficient thrust for simulating lunar gravity.²⁰

Fortunately, a powerplant capable of giving continuous vertical operations already existed—the General Electric J85 jet engine. This engine enabled Levin’s team to envision a specific engine-thruster combination. For planning purposes, the group assumed a flight duration of ten to fifteen minutes and a rocket thruster operation of at least three minutes. Finally, a brief mission analysis pointed to not one but two different simulators: a simple, one-pilot vehicle used as an early research tool to help design the lunar vehicles, and a larger vehicle to simulate the Apollo lunar lander with a crew of two.

This drawing illustrates the hovering tilt angle capabilities of the SH-2 helicopter and LLRV compared to the Lunar Module (LM). The LLRV, with its gimbaled engine, was able to more accurately simulate the performance of the LM by approximating lunar gravity, which is 1/6 that of Earth.

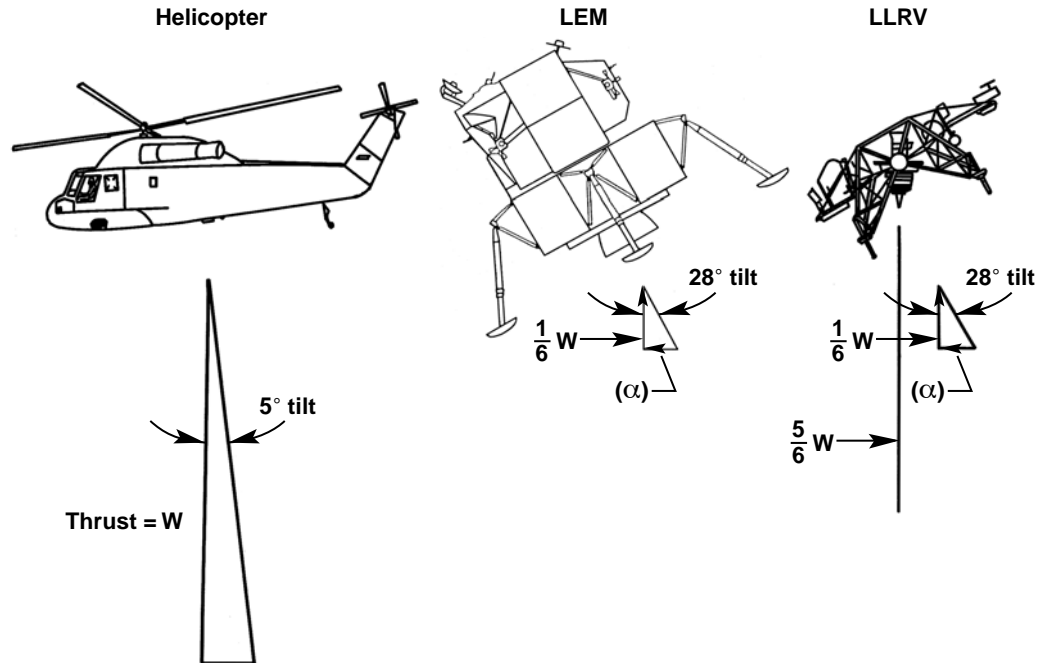

Bell proposed three phases for the program. The first involved preliminary design study and mission analysis. The second centered on designing, fabricating, and conducting a flight research program with the one-pilot vehicle. The third phase encompassed the design, fabrication, and flight simulation of the lunar lander. For the first phase, Levin and his group proposed six areas of study:

1. Establish the required characteristics in performance, stability and control, and configuration of a piloted and free-flying lunar landing simulator to be used for research.
2. Evaluate the free-flight vehicle’s ability to simulate landings adequately in the actual lunar environment, emphasizing dynamic response.
3. Compare the proposed configuration’s advantages and disadvantages with those of other types of simulators, such as fixed-base and tethered.
4. Compare various methods for providing five-sixths of the basic lift to simulate lunar weight and determine the optimum method for providing a free-flight vehicle.
5. Prepare a preliminary design of the proposed vehicle consistent with state-of-the-art technology that meets or exceeds these minimums in performance: pilot control, 200-pound payload capability, capability to descend safely from 2,000-foot altitude, capability for 1,000-foot translation at hovering altitude, 10-minute hovering time on the jet engine only, and two minutes of continuous

retro-rocket operation.

6. Investigate the configuration, performance capabilities and limitations, flight dynamics, jet and/or rocket installation, stabilization requirements, variable stability, vehicle and structural design, emergency escape system, and schedule and cost.

Again, FRC engineers found the concepts in the Bell paper remarkably similar to their own. Moreover, they were convinced that Apollo program managers and senior NASA leadership would find the ideas acceptable, especially since the proposed vehicle would be fabricated entirely from existing hardware. In fact, Bell's approach guided Drake and the FRC team as they prepared their own work statement for a study on LLRV feasibility and preliminary design. They sent the resulting document to Bell on 22 December 1961 and a fixed-price contract followed in January 1962. Not surprisingly, the Niagara Falls company assigned Levin as chief engineer for the project.²¹

Launch of the LLRV Program

Paul Bikle, the popular FRC director, named Bellman, then head of the propulsion branch, to be Levin's counterpart at the FRC. The down-to-earth and highly capable Bellman became LLRV program manager in January 1962. A native of Toledo, Ohio, Bellman's expertise lay in engine combustion processes, and in 1950 he transferred from the NACA's Lewis Flight Propulsion Laboratory to the High-Speed Flight Research Station (as the FRC was then called) to supervise propulsion research. Matranga became the assistant program manager and chief engineer. Matranga had worked for the FRC since 1954, specializing in stability and control on the X-1A, X-1B, and F-100A research planes. Later, he worked with pilots Joe Walker and Neil Armstrong in developing successful pilot techniques for landing the X-15.²²

Bellman began his tenure as LLRV program manager by visiting Bell Aerosystems to acquaint himself with the company's progress. He found Bell engineers making minor design changes in the vehicle's center of gravity (cg), and conducting structural-stress and aerodynamic analyses. But of greatest concern, he noticed, was the J85 engine. Closer investigation of the manufacturer's data indicated that the engine would generate only marginally enough thrust for the LLRV's operation. Compromises followed, entailing early-morning flights and restricted flights on hot summer days. Despite these challenges, Bellman left Bell's New York facility with a favorable impression.

After returning to California, Bellman found that the LLRV jet engine problem again needed attention. Levin conceded that the CJ610 version of the J85 lacked sufficient thrust for the project, as Bellman was aware. He and Levin therefore agreed upon a new requirement for LLRV thrust: 105 percent of takeoff weight on a warm day. The thruster rocket specifications also underwent modification. Bell engineers had planned to use only two 315-pound-thrust rockets, but the NASA group felt this was inadequate and instead recommended two 1,200-pound rockets. Recognizing the need for further analytical work, Bell's management agreed to fund additional research, clearing the way for analog studies and possibly a wind tunnel test. Meanwhile, Bellman suggested the contractor explore the Litton inertial navigation system for altitude and velocity measurement, a navigational instrument requiring no additional reference data once it had been powered up and its global position had been encoded. He also agreed to ask Langley's aerodynamicists to schedule some wind tunnel time for the LLRV.²³

Gradually, the LLRV propulsion system took shape. General Electric proposed that a fan version of the J85 engine be used, one that would increase thrust from 2,850 to 4,200 pounds at routine temperatures yet simultaneously reduce Specific Fuel Consumption from 0.99 to 0.70. (SFC is a ratio of pounds of fuel consumed per pounds of

thrust generated.) Although this change increased the weight of the bare engine by 283 pounds, and the weight of the overall vehicle by 480 pounds due to cg considerations, it represented a satisfactory solution, and GE said it could have four engines ready in nine months. As to the rocket thrusters, they narrowed the choices to two options: either six 50-pound, or twelve 25-pound thrusters. Levin and Bell Aerosystems preferred the twelve-rocket option because of redundancy. Bell also suggested that rocket operation be on/off—rather than possessing gradations of thrust—for greater reliability. While bleed air jets received considerable attention and were at first adopted in the design of the LLRV, planners ultimately discarded the idea. Used on the Bell X-14 VTOL research airplane, these jets provided stabilization. When the aerodynamic controls proved ineffective on the X-14, air bleed from the jet engine had been carried to the nose and wingtip of the vehicle and exhausted through control nozzles during low-speed flight.

The all-important jet engine decision came in February 1962, when Bellman and Matranga visited Bell to evaluate the program's progress. Levin and his team wanted to use the fan version of the J85 jet engine, the CF700-2B (later designated the CF700-2V), even though the engine had only completed its 150-hour qualification test in May 1961 and had not yet been produced in commercial quantities. It also cost \$130,000, twice the price of a standard J85 jet engine. But with this new powerplant, Bell engineers estimated that in a 14-minute flight, the LLRV could achieve an altitude of 2,000 feet, a forward velocity of 100 feet per second, and a vertical velocity of 200 feet per second. To accommodate the heavier fan model of the J85, the engine frame was beefed up, resulting in an increase in the vehicle's gross takeoff weight to 3,325 pounds.²⁴

Bell engineers also announced their solution to the rocket thruster question. They requested sixteen 80-pound hydrogen-peroxide rockets on a 12-foot arm—the same rockets used for reaction controls on the X-15. The rockets would operate as pairs of redundant systems to produce pure moments. Differences remained about whether to use a two-axis, side-arm controller and foot pedals for control, as Bell advocated, or a three-axis, side-arm controller favored by NASA. The parties also disagreed on how best to compensate for angular accelerations produced by altitude controls. NASA recommended control powers of two radians per second, squared, with Bell's representatives countering that large control accelerations required large thrusters. Bell noted that its own experiences showed that large control accelerations were unnecessary. Both agreed to await the upcoming analog simulation, which would shed more light on the subject.²⁵

Bellman and Matranga felt the design work at Bell was going reasonably well. A few weeks later, Matranga returned to participate in a weeklong analog simulation study of lunar landing.²⁶ Bell's John Gaul had mechanized (programmed) the simulation, using simplified equations of motion with no aerodynamic influence. The simulation display was rudimentary. Round dials showed longitudinal and lateral velocity, rate of climb and descent, altitude, and vehicle attitudes. An X-Y plotter tracked forward and lateral positions. A center stick with no force centering or gradient (that is, with no resistance to movement by the pilot) controlled yaw. The pilot's task was to descend from an altitude of 1,000 feet while translating forward 200 feet to the point of touchdown.

Dave Howe, a Bell test pilot with extensive VTOL and helicopter experience, flew the simulated landing. Successful simulated landings, it became clear, required the pilot's full attention as well as considerable practice. A short hover at an altitude of 100 feet seemed to help the pilot get the craft properly positioned for touchdown. Howe said that during the simulation study he concentrated first on optimizing the hover, and examined other aspects in more detail later.

The best balance seemed to be offered by control powers producing angular

accelerations of 0.25 to 0.5 radians per second, squared, in roll; 0.25 radians per second, squared, in pitch; and 0.1 radians per second, squared, in yaw. This particular balance provided rapid response without excessive tendency to over-control. These were considerably lower values than those generally used on existing VTOL vehicles. However, the FRC's three-axis, side-arm controller used in the Bell simulation became fatiguing for Howe when he used it without force gradient or centering. Even when light centering forces were applied to ease the task, Howe still preferred the center stick.

NASA's Joe Walker joined Howe in February 1962 to take part in the simulation. Walker had had a distinguished and varied career. After flying P-38 fighters in North Africa during World War II with the U.S. Army Air Forces, he logged many wintertime hours above the Great Lakes flying icing research missions for the NASA Lewis Flight Propulsion Laboratory. He also had piloted a number of NACA experimental aircraft, including the X-3, X-4, and X-5 research airplanes for the HSFRS. Walker flew most of the 60-degree wing sweep flights on the X-5, managing to avoid the serious stall/spin problems others had experienced. He also encountered roll coupling in the X-3 about the time it surfaced in the F-100A. When Scott Crossfield left the NACA in 1955 to help design and then fly the X-15 for North American Aviation, Walker became chief test pilot at the FRC.²⁷ Meticulous in all of his flight preparations, Walker planned and trained no less carefully for his first time aloft in the LLRV.

On 26 February 1962, FRC deputy director De Beeler, chief of research Thomas Toll, and Hubert Drake went to Langley to discuss how Langley's Lunar Landing Research Facility (LLRF) and the FRC's LLRV would coordinate support for the Apollo program.²⁸ Final arrangements also were made at that time for wind tunnel tests of Bell's LLRV configuration. A tethered craft supported within a large bridge structure, Langley's LLRF would simulate the final 50 feet of a lunar descent to touchdown. While there would be areas of overlap between the LLRF and the LLRV efforts, the LLRF would emphasize final touchdown dynamics and control while the LLRV would concentrate on terminal control and positioning.

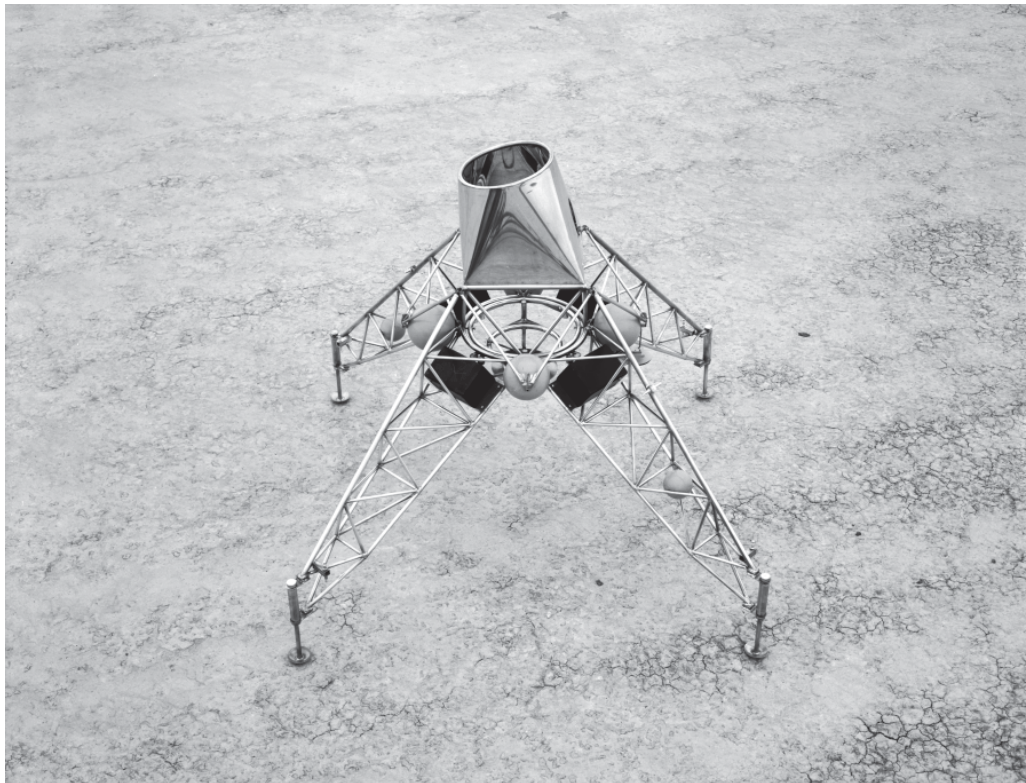

The Bell-proposed simulator photographed on the lakebed at Edwards Air Force Base, California. The canted aluminum shape at the top of the structure represents the cockpit for the pilot. (E-9636)

The project received not one but three “birth certificates” in March 1962. One took the form of a project development plan that officially gave the Lunar Landing Research Vehicle its name.²⁹ The second resulted from a crucial meeting attended by FRC dignitaries at the MSC in Houston, Texas. The members arrived to brief Gilruth, Williams, five of the Mercury astronauts, and an assembly of interested MSC engineers about the proposed LLRV as well as the paraglider spacecraft recovery project. The ensuing discussions went extraordinarily well, with the MSC agreeing to provide \$700,000 of current fiscal-year money to initiate the LLRV program. And finally, later that month, officials from Bell Aerosystems made a comprehensive presentation of Bell’s preliminary LLRV research.³⁰ The company issued a study report to the FRC in addition to a technical proposal (including cost) for designing and fabricating two vehicles.³¹ Just a few days earlier, the FRC project team had finished its own first draft of a statement of work for designing and fabricating the LLRV.

Between the submission of the Bell proposal and the go-ahead to fabricate the LLRVs, Levin found himself besieged by the press, with unintended consequences. During this period he had presented a paper at the annual meeting of the American Institute of Aeronautics and Astronautics (AIAA) in which he described the LLRV concept to date. He was subsequently interviewed by reporters, some of whom wanted to know how much progress had been made in building the LLRVs. Levin replied that Bell had done a study and was waiting for NASA to provide funding before construction could begin. “Well, lo and behold,” Levin said, “the newspaper came out that night, stating that NASA had provided the funds to build these vehicles.” Levin and his team expected to be “bawled out” in Houston for this, but discovered upon their return that a Houston newspaper had printed a similar front-page article. “Isn’t it great?” said a delighted MSC counterpart, evidently grateful for the publicity. “I’ll be darned if that wasn’t the thing that [drew] attention to it,” Levin said, adding that shortly thereafter the program got its start-up funding.³² The next hurdles proved to be even more formidable: getting all parties to agree on the technical details and identify the monies required to build the actual flight vehicles.

¹ James R. Hansen, *Spaceflight Revolution: NASA Langley Research Center From Sputnik to Apollo* (Washington, D.C.: NASA SP-4308, 1995), 222. Chapter 8, “Enchanted Rendezvous: The Lunar-Orbit Rendezvous Concept,” contains a fascinating account of the internal competition among NASA engineers and scientists to devise a means of reaching and landing on the moon, and returning to Earth. p. 221-268.

² Hansen, *Spaceflight Revolution*, p. 230-265.

³ Hubert M. Drake and Gerald Truszynski, interview by Gary Krier and Dill Hunley, NASA Dryden Flight Research Center, Edwards, CA, 15 November, 1996.

⁴ Richard P. Hallion, *On the Frontier: Flight Research at Dryden, 1946-1981* (Washington, D.C.: NASA SP-4303, 1984), pp. 76, 80, and 107. Williams came to the area where the FRC was later located in 1946 and left in 1959. It was initially called the NACA Muroc Unit, and went through five name changes before it became the FRC in 1959, shortly after Williams left.

⁵ Courtney G. Brooks, James M. Grimwood, and Lloyd S. Swenson, Jr., *Chariots for Apollo: A History of Manned Lunar Spacecraft* (Washington, D.C.: NASA SP-4205, 1979), p. 15; see also Hubert M. Drake, interview by Dill Hunley, NASA Ames Research Center, Moffett Field, CA, 16 April, 1997.

⁶ Gene J. Matranga, memo to research division chief on FRC research relating to lunar landings, 12 July, 1961. Copies of this and all other original material cited in this manuscript are part of the NASA Dryden Flight Research Center research library.

⁷ Gene J. Matranga and Neil A. Armstrong, *Approach and Landing Investigation at Lift-Drag Ratios of 2 to 4 Utilizing a Straight-Wing Fighter Airplane* (Washington, D.C.: NASA TM X-31, 1959).

- ⁸ Project 1055, Proposal for the Development of a Soft Landing Vehicle, U.S. Naval Ordnance Test Station, China Lake, CA, 5 October 1961.
- ⁹ Elmore J. Adkins, memo to research division chief on visit to naval ordnance test station concerning lunar landings, 7 August 1961.
- ¹⁰ Joseph T. Washko, memo to research division chief on meeting with experimental track branch, AFFTC, concerning possible track program in support of the lunar landing vehicle study, 7 August 1961; Washko, memo to research division chief on meeting with experimental track branch, AFFTC, concerning possible track program in support of the lunar landing vehicle study, 28 August 1961.
- ¹¹ Matranga, unpublished notes of the meeting with Bill Swope, August 1961.
- ¹² John P. Campbell, *Vertical Take Off and Landing Aircraft* (New York: Macmillan Co., 1962), p. 129-130. This vehicle was sometimes called the flying bedstead because of its resemblance to its namesake rather than an airplane. Built in 1953, the Thrust Measurement Rig, as it was officially designated, was a stepping stone to the first true vertical takeoff jet, the Kestrel (which evolved into the better-known Harrier). Like the later Lunar Landing Research Vehicle, the flying bedstead stayed in the air solely with the thrust of its engines and not by any aerodynamic structure providing lift.
- ¹³ John W. Smith, memo to research division chief on proposal 'analog study simulating lunar landing,' 6 November, 1962.
- ¹⁴ Except where otherwise noted, information here and below is from the FRC Lunar Landing Simulation Program Chronology.
- ¹⁵ Low became deputy director of the Manned Spacecraft Center in 1964. In 1969, he became deputy administrator of NASA and served as acting administrator 1970-1971. He retired from NASA in 1976 to become president of his alma mater, Rensselaer Polytechnic Institute, a post he still held when he died in 1984. In 1990, NASA renamed its quality and excellence award after him. See T. Keith Glennan, *The Birth of NASA: The Diary of T. Keith Glennan*, ed. J.D. Hunley (Washington, D.C.: NASA SP-4105, 1993), p. 36, 98, 160, 198, 214, 300, and 343. The quotation in the text is from Robert C. Seamans, Jr., *Aiming at Targets: The Autobiography of Robert C. Seamans, Jr.* (Washington, D.C.: NASA SP-4106, 1996), p. 73.
- ¹⁶ "Working Notes from an Interview of Ken Levin," by Ivan D. Ertel, Manned Space Center Historian (Houston, TX), 8 June 1971. All information regarding Ken Levin, including quotations, is from this unpublished source.
- ¹⁷ Walt Rusnak, "LLRV Reminiscences," 15 March 2000.
- ¹⁸ Proposal for a Free Flight Lunar Landing Simulator Study Bell Aerosystems Report D7161-953001, December 1961, p. 2-3.
- ¹⁹ Proposal for a Free Flight Lunar Landing Simulator, p. 6-8, 13-15.
- ²⁰ A jet engine ejects a jet or stream of gas or fluid to provide thrust. A rocket engine does the same, but instead of using the oxygen in the atmosphere to combine with the fuel to provide combustion, it includes its own oxidizer. A ducted-fan engine includes a fan or propeller enclosed in a duct; it can be a jet engine in which a ducted fan or ducted propeller augments the gases of combustion in the jet stream. See also Proposal for a Free Flight Lunar Landing Simulator, p. 15-22.
- ²¹ Proposal for a Free Flight Lunar Landing Simulator, p. 23-24.
- ²² Donald R. Bellman, briefing charts, Proposed Free-Flight Lunar-Landing Simulator Program, 9 January 1962, p.1.
- ²³ Bellman, memo to FRC personnel concerned with lunar landing simulator program on telephone conversation with Ken Levin, Bell Aerosystems, 18-19 January 1962. Bellman contacted Laurence K. Loftin, Jr., an aerodynamicist who had become Langley's assistant director in 1961, inquiring about the availability of wind tunnel test time. Loftin said that although Langley's 7-by-10-foot and full-scale tunnels were fully booked he felt the test could be squeezed in. Due to scaling concerns with the non-aerodynamic configuration, Loftin recommended that the model be as large as possible. Donald R. Bellman, memo to

those concerned with lunar landing simulator program on telephone conversation with Ken Levin of Bell Aerosystems Co. and with Laurence Loftin of Langley Research Center 24-5 January 1962.

²⁴ Donald R. Bellman and Gene J. Matranga, memo to those concerned with the lunar landing simulator project on information received during second visit to Bell 1 and 5 February 1962.

²⁵ During this visit by Bellman and Matranga, Bell engineers also indicated that they were studying ways to save the craft in case a jet engine failed. Using just the lift rockets would require too much propellant, they decided. However, the combination of a parachute 55 feet in diameter with two rockets having 2,800 pounds of thrust would work, they said, adding only 280 pounds in weight. The parachute would stabilize the craft's descent at 32 feet per second, and the lift rockets would reduce vertical velocity further to below the 10-feet-per-second limit as the craft neared the ground. A third possibility for saving the craft was for the pilot to flare a parawing near the ground, keeping the impact within design limits. But NASA engineers were skeptical about using a parawing, due to problems experienced only a few months earlier during parafoil testing at the FRC. An inflatable lifting surface, the parafoil was a concept first conceived by Francis M. Rogallo, a NASA engineer at Langley Research Center. NASA engineer R. Dale Reed had initiated small-scale testing of the parafoil at the FRC, the expectation being that it could be used in the Gemini program with the space capsule for soft touchdowns on land rather than the ocean splashdown method used in the Mercury program. The FRC and North American Aviation then conducted full-scale testing of the parafoil, but it was unsuccessful for the purpose intended. A fourth alternative for saving the craft in case of engine failure was to use two 130-foot parachutes, but that idea was dropped because the parachutes would add 900 pounds to the vehicle's weight. The final alternative suggested—a deployable two-bladed rotor weighing 380 pounds—would produce intolerable aerodynamic effects. It was also too complex.

²⁶ Matranga, memo to those concerned with the lunar landing simulator project on visit to Bell Aerosystems Company 19 to 27 February 1962.

²⁷ Milton O. Thompson, *At the Edge of Space: The X-15 Flight Program* (Washington, D.C.: Smithsonian Institution Press, 1992), p. 4-5; Hallion, *On the Frontier*, p. 52, 58-59.

²⁸ Bellman, memo for those concerned with FRC lunar landing simulator on visit to the Langley Research Center to discuss lunar landing simulators 26-27 February 1962.

²⁹ Project development plan for a free-flight lunar landing and takeoff simulator, NASA FRC, 6 March 1962.

³⁰ Bellman, memo to those concerned with the lunar landing and takeoff simulator program on oral presentation of results of Bell study contract, 15 March 1962.

³¹ Like Howe, Walker found he preferred the center stick to the side-stick. Moreover, he found the best control resulted from a technique called dithering—that is, making small, rapid movements of the stick. Walker then made several important observations for project engineers. He noted that the collective engine control “seemed to be out of directional sense with the motion the vehicle derived from it.” He expressed a preference for a thrust-to-weight ratio of 1.2 for the flare and landing, and he felt that rate stabilization in all three rotational axes would improve control immensely. Finally, Walker said of the entire experience, that he “found the simulation to be extremely interesting not only for acquainting one with the handling and control of the type of vehicle and for varying parameters of interest, but also for stimulating ideas for improving the capabilities and usefulness of the actual vehicle.” Joseph A. Walker, Evaluation of Bell Fixed Base Lunar Landing Simulation, 27 February 1962. See also Feasibility Study for a Lunar Landing Flight Research Vehicle Bell Aerosystems Report 7161-950001, 8 March 1962.

³² Working notes from an interview of Ken Levin, by Ivan D. Ertel, MSC Historian, 8 June 1971.

Chapter 2: A Proposal

With the completion of the LLRV proposal in March 1962, Bell Aerosystems sent a delegation of engineers to the FRC to summarize the proposal's findings and field questions. The technical aspects differed only slightly from the December 1961 report.¹ But the company's representatives made an audacious offer, proposing to design and fabricate a small research vehicle within one calendar year.² In return, they asked the space agency to allocate nearly two million dollars (\$1,946,000) for the effort, the bulk of the funds to be designated for engineering and manufacturing as well as for component and system testing. The NASA group, in turn, presented the Bell team with a statement of work for design and fabrication of two research vehicles.³

At this stage in the design process, Bell engineers envisioned an LLRV in which the pilot sat atop a four-legged truss structure. Its jet engine was positioned at the vehicle's center of gravity within a double gimbal. The legs spanned 21 feet at the shock struts. The proposed vehicle measured 19.8 feet in height at the top of the cockpit and weighed an estimated 3,420 pounds (gross). Walt Rusnak, Bell's avionics project engineer for the LLRV, said the vehicle "looked more like a water tower...than the aircraft shape with oversized legs that finally emerged as the LLRV."⁴

Nevertheless, this early incarnation contained many of the features adopted in the final design. Each of the vehicle's four legs consisted of a tapered triangular truss of welded aluminum tubing equipped with pin-joint fittings that attached the legs to the platform structure. (The ultimate design of the legs relied on use of an IBM 704 digital computer to optimize structural elements for the least weight).⁵ To absorb lateral energy during landing, each leg had a shock absorber attached with two rubber shear mounts. Engineers conceived the structure to withstand vertical velocities of ten feet per second (fps) with no side drift, or six fps with a side drift of three fps. Critical structural elements were designed to withstand a crash impact of 40g.⁶

The ring housing the jet engine was to be a formed steel tube containing four sets of gimbal bearings in hubs; two sets attached to the platform structure formed the outer gimbal and the other two attached to the engine mount formed the inner gimbal. The mechanism allowed the turbofan engine to tilt 40 degrees in any direction from the vertical axis. A device consisting of two pairs of nitrogen-actuated cylinders on the inner and outer gimbal rings locked the gimbals for takeoff and would protect them if the engine stabilization system failed.⁷ Supported within the gimbal frame and modified to operate vertically was the vehicle's main lift force, a General Electric CF700-2B axial-flow, aft-fan jet engine.

Rocket-propulsion systems typically require both fuel and an oxidizer—bipropellants—such as hydrazine and nitrogen tetroxide. An alternative is to use a monopropellant, as in the case with hydrogen peroxide, which, when passed through a catalyst, decomposes into steam and free oxygen, generating thrust. Although Bell designed the rocket system to use hydrogen peroxide as the primary propellant, an alternate design used hydrazine and nitrogen tetroxide. Despite the fact that the bipropellant system was lighter, Bell selected a peroxide-only system because the hardware required for the latter already had been qualified during the X-15 and Mercury programs as reaction motors. It was also less dangerous. The LLRV's lift thrust originated from two rocket motors capable of being throttled from 100 to 500 pounds thrust. Designers provided sixteen 80-pound rocket motors for attitude control, each operating in on/off mode only (that is, without throttle adjustment) and installed as two identical subsystems of eight motors each for redundancy, or backup capability.⁸

Propellants for the lift and attitude rockets were fed by a common source divided between two spheres, each containing 400 pounds of hydrogen peroxide and located fore and aft of the cockpit structure. Fuel from the tanks flowed through valves capable

of isolating either side of the system. Apart from the tanks containing the 90 percent strength hydrogen-peroxide propellant—made from 6061-T6 spun-aluminum shells—all other hardware in the rocket system, such as tubes, valves, and fittings, was fabricated from stainless steel.⁹

Bell planned an attitude-control system designed to provide adequate control of the vehicle for all likely maneuvering tasks. The system also would correct jet-thrust misalignment, drag moments created aerodynamically, dynamic unbalance resulting from asymmetrical configurations, and unbalanced thrust from the lift rockets. Bell's solution involved firing the attitude rockets to produce instantaneous angular accelerations of nominally 0.9 radians per second, squared, in each axis with both sets of rockets operating, half of that acceleration with only one set of rockets firing. Angular rate and attitude feedback gave the pilot the option of selecting angular rate commands or vehicle attitude control, as previously described.¹⁰

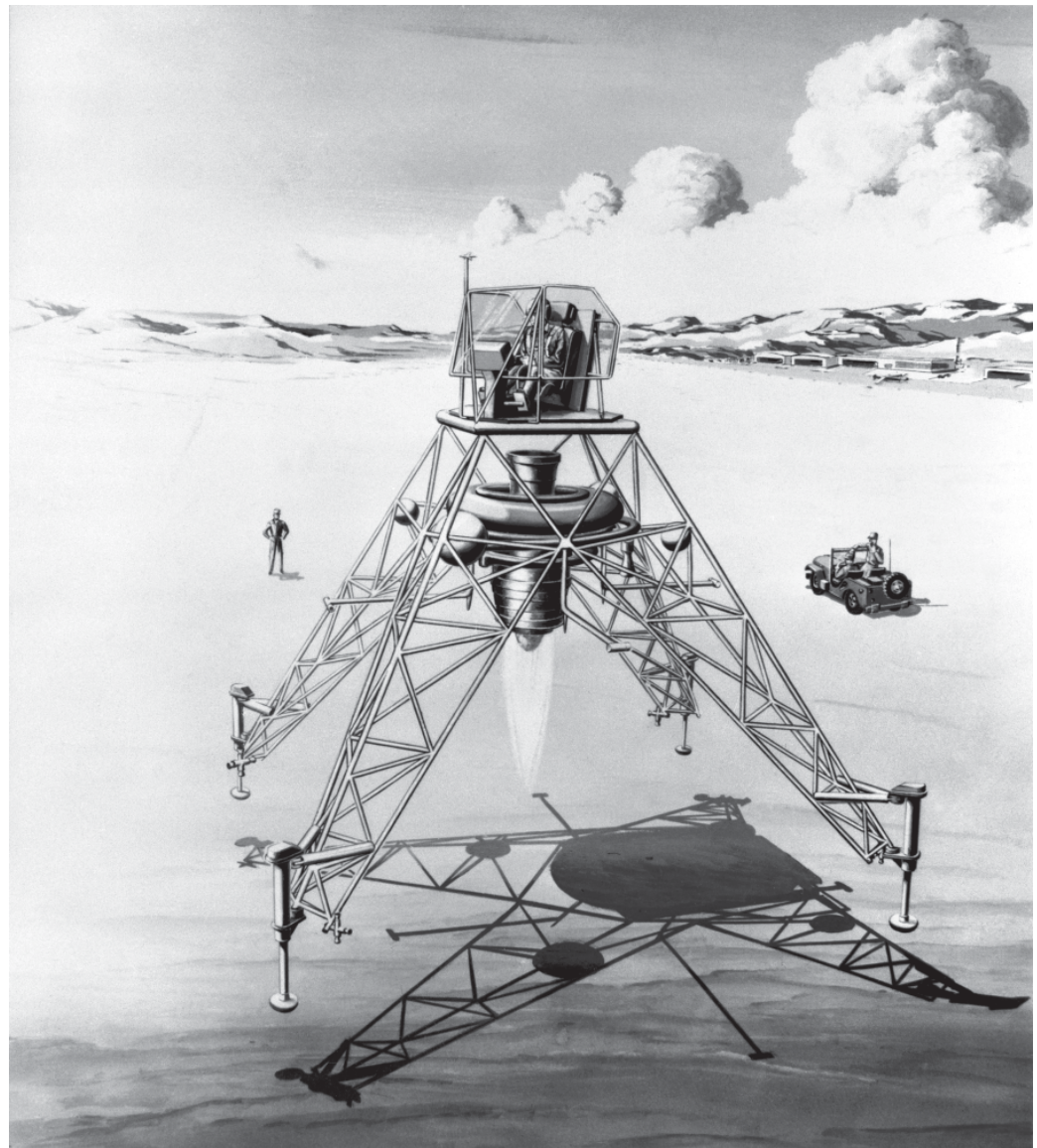

An artist's early conception of the LLRV design. (E-8228)

Bell's proposed engine attitude-control system and gimbal arrangement generated considerable discussion during the follow-up meeting at the Bell plant in Buffalo. NASA representatives voiced their discomfort with Bell's plan for an attitude-control system using engine bleed air and suggested using servo actuators instead. While the contractor did not like the suggestion (because of the added weight), Bell agreed to

evaluate the idea in greater detail.

But attitude control was not the only complicated technical issue. The engine attitude-stabilization system, for example, countered moments and disturbances produced by engine-thrust misalignment, drag moments accompanying airflow into the engine inlet, and engine gyroscopic moments resulting from engine rotation, as well as dynamic unbalances created by the gimbal mechanism. The engine throttle-control system gave the pilot direct control of engine thrust. It also provided the means to automatically position the throttle in response to commands from the vehicle weight programmer, thus creating the effect of simulated lunar gravity while correcting for vertical drag forces.¹¹ Yet, unlike the attitude-control system's double set of sensors, wiring, and rocket hardware—which provided complete redundancy—the jet engine-control system did not have a backup but relied instead on the pilot to detect malfunctions and provide manual control in the event of failure.¹²

The company's engineers proposed a cockpit arrangement that accommodated a single-pilot station with displays and controls. The proposal included space for installing a second pilot station later.¹³ Semi-enclosed with Mylar® sheeting, the cockpit area included minimum instrumentation for flight safety and hovering flight—which is to say, an altimeter, rate-of-climb indicator, pitch-and-roll attitude indicator, drift meter, airspeed indicator, and clock. System operating parameters were indicated by engine thrust, engine rpm, oil pressure, oil temperature, fuel level, fuel pressure gages, and DC and AC voltmeters. Annunciator lights warned the pilot about locked gimbals, low hydrogen-peroxide level, and maximum-tilt angle for the jet engine.

Pilot control consisted of conventional pitch-and-roll center stick and yaw pedals. The center stick controlled movement in pitch (nose up or down) and roll (around an axis from the rear to the front of the vehicle) while foot pedals controlled nose movement left to right and right to left (yaw). The stick and pedals were mechanically linked to the systems each controlled. There also was a parallel electrical link to the controls as well as throttles for the jet engine and lift rockets. Engineers included a zero-zero ejection seat for the pilot, providing safe ejection in the event of jet engine failure or loss of attitude control. Such a seat allows a pilot to safely eject from a vehicle at zero altitude and with zero air speed. Oxygen for the pilot would come from a bottle of compressed oxygen.

At this stage of conceptualization, the Bell team relied on relatively simple analytical methods. They estimated aerodynamic forces for the vehicle by using an elementary theory of cross-flow over the circular tubing of the basic components.¹⁴ Experimental wind tunnel test results on wires, cables, and cylinders generally confirmed the estimated values. No interference drag was factored into the aerodynamic estimates since the engineers expected the aerodynamic data to be upgraded at a later date, after wind tunnel testing. Similarly, results from Bell's earlier analog simulations were included in the March 1962 report and formed the basis for the design of the control-system elements.¹⁵ Designers recognized that more sophisticated simulations would be required before the design of the control system could be finalized.

The March report also addressed the all-important question of vehicle operation.¹⁶ Concerned that it might seriously degrade performance, Bell engineers studied the possibility of the jet engine ingesting its own exhaust fumes. A variety of experimental VTOL studies indicated ingestion would not be a cause for concern. Ground effect proved to be no impediment to the project. After examining debris caused by jet impingement, the Bell team concluded it would not be a problem as long as flights took place over conventional hard surfaces. The team also conducted a detailed reliability analysis of individual systems and subsystems, generating what was almost certainly an overly optimistic 99.11 percent mission-reliability estimate.¹⁷

With the essentials of the Bell proposals in hand, NASA's Don Bellman contacted various suppliers to determine whether some crucial modifications might be possible,

particularly in the LLRV's rocketry. He first contacted the Marquardt and Rocketdyne corporations about availability and cost of a bipropellant rocket system for the proposed vehicle.¹⁸ Although both corporations had extensive experience with such systems and said one could be finished in about a year, tailoring them to the LLRV application would cost millions of dollars, which Bellman found unacceptable. He also contacted the Walter Kidde Company regarding a 98 percent hydrogen peroxide solution as rocket propellant. The Kidde representative told Bellman that the company was experimenting with such a concentration, but was reluctant at that time to commit to its use. The 90 percent concentrations of hydrogen peroxide then used frequently as rocket propellant were considered highly volatile; an even higher concentration would be that much more dangerous. Abandoning all efforts along these lines of inquiry, the FRC team accepted the decisions made by Bell Aerosystems regarding the LLRV's rocket system.

Meanwhile, NASA engineers and scientists began to apply rigorous analysis to some of the admittedly "quick and dirty" requirements imposed on Bell by constraints of time and money.¹⁹ In order to validate the aerodynamics of the LLRV, the FRC team sent copies of the third work statement, CF700 engine performance curves, and three-view drawings of the vehicle to engineer Francis Rogallo at Langley. Rogallo needed the data to plan the test of an LLRV model in Langley's 7-by-10-foot wind tunnel. Bell Aerosystems engineers supplemented these documents with their own wind tunnel test requirements. Significantly, contractor drawings no longer showed the toroidal (donut-shaped) jet fuel tank. Instead, the drawings showed spherical tanks outside the gimbals, fore and aft of the engine.

Program Approval and Funding

The technical aspects of LLRV development took time to master. But getting agency approval for the program, a slow and torturous process under the best of circumstances, made the planning stage seem brief by comparison. Indeed, little progress on approving anything had been made since early January 1962. Hoping to gain some momentum, Drake, Bellman, and Matranga flew to Houston on 10 May 1962. There, at the MSC, the trio met Walter Williams, Maxime Faget, Charles Frick, Charles Mathews, John Eggleston, Richard Day, Warren North, and others, and succeeded in resolving the remaining differences about the free-flying simulator.

The MSC officials who helped cut the Gordian knot that day comprised a distinguished group. Williams was the founding director of the NACA Muroc Flight Test Unit. After much success, Williams left California in 1959 to become operations director for Project Mercury. Faget had played a major role in designing crewed spacecraft beginning with Project Mercury. By 1962, he was assistant director (and later director) for Engineering and Development at the MSC. Frick managed the Apollo project office at the MSC, and Mathews directed the Gemini project office. Eggleston was an MSC engineer, an assistant to Faget, and had previously been with Langley's Manned Space Laboratory Group. Dick Day, a former pilot with the Royal Canadian Air Force and the U.S. Army Air Corps, acted as the chief astronaut training officer at the MSC and was a member of the astronaut selection panel. (Williams had recruited Day from the FRC and persuaded him to come to Houston.) Warren North served as chief of the Flight Crew Support division in Houston, responsible for astronaut training. Earlier, he had been chief of Manned Satellites at NASA Headquarters.²⁰

As a direct consequence of this meeting, MSC Director Bob Gilruth informed Dr. D. Brainerd Holmes, director of the Office of Manned Space Flight at NASA Headquarters, that he had conditionally approved the LLRV concept and that the MSC would allocate \$300,000 to initiate qualification of the CF700 engine. Gilruth had been a consistent supporter of the LLRV program. An early advocate of human space flight, he had been part of the group that completed basic planning for Project Mercury in the

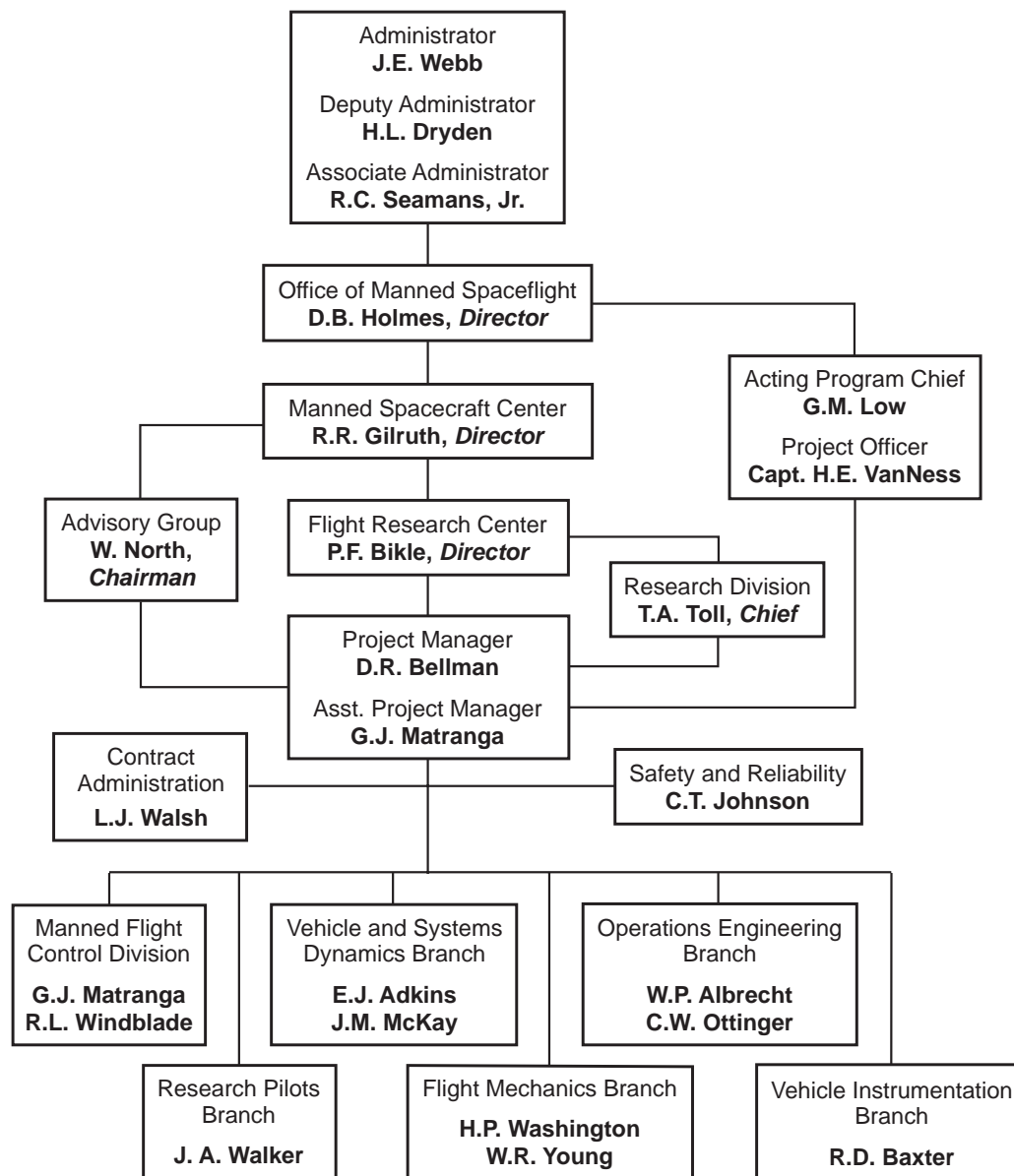

The NASA organization chart for the Free-Flight Lunar Landing Simulator program.

summer of 1958. By November of that year he was in charge of Project Mercury and the Space Task Group then was assigned to Langley, which was later moved to Houston with the founding of the MSC.²¹

Yet despite Gilruth's intercession, the wheels of bureaucracy moved as slowly as before. The technical and financial management channels of authority and responsibility seemed of particular concern to NASA Headquarters. Bernard Maggin and Bill Fleming, from the office of NASA Associate Administrator Dr. Robert Seamans, wanted additional information about the LLRV, specifically about the estimated delivery date of the jet engine—a date they considered unduly optimistic. Maggin was well known at the FRC from the NACA era, so Bellman and Drake telephoned him in late May 1962 and provided him with additional information on the project. The two FRC engineers followed up with a revised project development plan and the fourth draft of a work statement to NASA Headquarters and to Dick Day at the MSC.

At this juncture, the plain-spoken Paul Bikle wrote to Williams, expressing concern about the delays in formalizing the LLRV program. Bikle and Williams shared more than just a background in flight-testing fighters and bombers during World War II. As the first and second directors of the FRC, the two had developed similar no-nonsense

management styles geared toward producing results. Bikle proposed a meeting at the MSC to resolve remaining management concerns about the LLRV program, and Williams arranged the meeting.

After waiting, and hearing nothing further, Bikle telephoned Williams on June 20 to prod him toward a resolution of management disagreements at the MSC, only to find that prodding wasn't necessary. Williams told Bikle that an agreement had been reached and that Gilruth had approved the plan and sent it to NASA Headquarters. Williams added that he was satisfied with the plan and felt sure the FRC would be satisfied with it as well. Under the agreement as it had been approved, Warren North would be responsible for the program at the MSC, assisted by Dick Day.

Another month passed before the initiative received the approval of Associate Administrator Seamans. Ultimately, the project development plan, procurement plan, and work statement that had been finalized in May were not formally approved until mid-August.²² The management plan kept decision-making at NASA Headquarters while vesting the FRC with operational control. Under North, the MSC would follow the LLRV program to assure that it met the needs of the Apollo program, and provide funding in a timely manner.

Projected funding called for \$350,000 in fiscal year 1962, primarily for developing the jet engine, another \$3,600,000 in fiscal year 1963 for completing the purchase of the engine and fabricating the two LLRVs, and \$500,000 each in fiscal years 1964 and 1965 for operating the vehicles. Though funding for engine development became available in fiscal year 1962, funds for vehicle design and fabrication did not materialize until well into the next fiscal year. Meanwhile, back in California, FRC engineer Wayne Ottinger had been chosen to act as NASA's plant representative at Bell during the 14-month contract, and relocated to Bell's Niagara Falls facility in January 1963.

The contract between the FRC and Bell Aerosystems specified \$3,365,632, to which an added fixed fee of \$245,000 raised the total to \$3,610,632. The 14-month schedule called for the first vehicle to be delivered within twelve months, the second two months later. As part of the contractual agreement between the FRC and Bell, Bell agreed to buy the jet engines from General Electric and the FRC promised to furnish the ejection seats as well as the velocity and altitude sensors. The money appeared at the FRC in increments: \$1,050,000 in the first installment (which was then sent to Bell), and additional payments later in the year.²³ With the signing of the agreement between the FRC and Bell Aerosystems, the tower-like profile of the Lunar Landing Research Vehicle began to rise from the floor of the Bell plant.

¹ Fourteen months later, in May 1963, the configuration looked significantly different. The description of the initial design of the LLRV given in this chapter is from the Bell study report, Feasibility Study for a Lunar Landing Research Vehicle Bell Aerosystems Report 7161-950001, 8 March 1962. Hereafter, this report is referred to as Feasibility Study.

² Feasibility Study, p. 211-215.

³ Donald R. Bellman, memo for those concerned with lunar landing and takeoff simulator program on visit to Bell Aerosystems Co., Buffalo, NY, to discuss provisions of lunar landing and takeoff simulator work statement, 3 April 1962.

⁴ Walt Rusnak, "LLRV Reminiscences," 15 March 2000. Rusnak provided the authors with a copy of this unpublished document.

⁵ Feasibility Study, p. 33-35.

⁶ That is, acceleration 40 times that produced at sea level by normal Earth gravity.

⁷ Feasibility Study, p. 20.

⁸ Duct, nozzle, and valve components of the air-bleed engine stabilization system would be secured to and supported by the engine-mount structure attached to the mating flanges of the fan front and rear frames of the engine. A toroidal tank with a capacity for 500 pounds of JP-4 jet fuel—enough for ten minutes of flight—surrounded the engine in the plane of the compressor case. Ibid, p. 152-153, 161.

⁹ The T6 designation reflects the heat treatment of the aluminum. The rocket propellant tanks would be pressurized with gaseous nitrogen. Two titanium spheres on both sides of the craft, each having an inside diameter of 16.5 inches, would store the nitrogen at 3,000 psi. Nitrogen would pass from these tanks through five-micron filters and regulators to the peroxide tanks. The whole system was designed to provide ten minutes of attitude-rocket operation and two minutes of lift-rocket operation. It should be noted that weight problems plagued the LLRV design. Several possible solutions were discussed, including off-loading propellants to reduce thrust margin and flight duration, reducing the 200-pound instrumentation payload, using aluminum rather than stainless steel in the rocket system, using 98-percent hydrogen peroxide rather than a 90-percent concentration, and using a bipropellant system. Bell finally considered only two options: off-loading propellants or reducing the instrumentation payload. Although reducing weight through either of these means required more flights than originally planned, neither would significantly affect the desired research. Bell and FRC representatives also discussed using common basic sensors for research data, pilot display, and control. Feasibility Study, p. 58-59, 153, 155-156.

¹⁰ Ibid, p. 58-59. In the absence of aerodynamic resistance and system feedback, the firing of an attitude rocket produced an angular acceleration—measured in radians per second, squared—that varied directly with rocket thrust, creating an ever-increasing angular velocity measured in radians per second. Rockets fired in the opposite direction could preclude the unlimited increase in angular velocity. Since controlling motion in this way is a very exacting task, one alternative would be to use angular-rate feedback so the firing creates an angular rate rather than an angular acceleration, resulting in an increasing attitude angle at the angular rate commanded. When the desired attitude is reached, the pilot would center the control stick to stabilize the attitude angle. Most pilots prefer such control. Another mode of control would be to use both angular rate and attitude angular feedback so the pilot's stick becomes proportional to attitude. While this mode gives the pilot direct control of attitude, it also requires the stick to be held at the desired attitude. After a short time, most pilots object to having to hold the stick at any position other than neutral.

¹¹ Feasibility Study, p. 61, 65-70.

¹² Ibid., p. 171-174.

¹³ The electrical system proposed by the contractor consisted of a turbine air impingement start duct, AC generator, three-phase rectifier (for converting alternating to direct current), associated controls, and power distribution. Bell designers had selected an eight-pole synchronous AC generator capable of supplying 400-cycle, three-phase power at 6,000 revolutions per minute (rpm). For this, the Leland Company could provide an off-the-shelf unit delivering five kilovolt amps (kva) power, and a three-phase solid-state rectifier made by Westinghouse would provide 35 amps of DC power at 28 volts. Ibid., p. 168-169.

¹⁴ Ibid., p. 81-94.

¹⁵ Ibid., p. 118-132.

¹⁶ Ibid., p. 175-177.

¹⁷ Ibid., p. 177-189.

¹⁸ Bellman, memo for those concerned with the lunar landing and takeoff simulator on findings on visits to Marquardt Corporation and Walter Kidde Company, 10, 13 April 1962.

¹⁹ FRC Lunar Landing Simulation Program Chronology. Unless otherwise noted, information that follows is taken from this chronology.

²⁰ Sources for biographical details include: NASA News Release 95-179, "NASA Pioneer Walter C. Williams Dies," 11 October 1995; NASA Biographical Sketch, "Paul Bikle," March 1966; "W.C. Williams Named to Project Mercury Team; Bikle Takes over Direction of High-Speed Flight Station," NASA High-Speed Flight Station, X-Press, Extra, 28 August 1959; Bilstein, *Orders of Magnitude*, p. 50, 69; Hansen,

Spaceflight Revolution, p. 52, 54, 55, 63, 65, 226, 232-233, 263, 387; Henry C. Dethloff, *Suddenly Tomorrow Came . . . History of the Johnson Space Center, 1957-1990* (Washington, D.C.: NASA SP-4307, 1993), p. 62-67; and R. Dale Reed with Darlene Lister, *Wingless Flight: The Lifting Body Story* (Washington, D.C.: NASA SP-4220, 1997), p. 142, 159.

²¹ FRC Lunar Landing Simulation Program Chronology, 11 May 1962.

²² NASA Contract No. NASA-234, 16 January 1963; also Paul Bikle, memo to Jack C. Heberlig, 4 December 1963.

²³ The major vendors and the items they supplied to Bell for the LLRV included Airtek Dynamics, Inc. (Compton, CA): hydrogen peroxide tank assembly; Bendix Products Division, Bendix Corporation (South Bend, IN): landing-gear shock struts; Benson Manufacturing Company (Kansas City, MO): JP-4 fuel tanks; Small Aircraft Engine Department, General Electric Company (West Lynn, MA): CF700 turbofan engine; Hydraulic Research and Manufacturing Company (Burbank, CA): hydraulic actuators; and Menasco Manufacturing Company (Burbank, CA): helium pressure tanks. The Weber ejection seat used in the LLRV was government-furnished.

Chapter 3: The NASA-Bell Collaboration

The process of fabricating a flying machine that was without precedent could have been a cause for concern both at the FRC and at Bell. Instead, in 1963 engineers at both places seemed preoccupied with a far less cosmic quest: finding a jet engine that could fulfill the vehicle's requirements. Although Bell Aerosystems' manufacturing schedule called for the use of General Electric's CF700 turbofan—an aft-fan version of the J85 engine—alternative engines were being explored as well.

On 21 January, Gene Matranga arrived in England to canvas British engine makers. He visited Bristol-Siddley Engines, Ltd., and found that the company's BS-59 powerplant had advantages in thrust and weight over the GE candidate.¹ But the BS-59 would not be available for another three to five years. Matranga next went to Derby to explore what Rolls Royce, Ltd., had to offer.² He concluded that if GE encountered serious problems with the CF700, Rolls Royce's RB-162 engine offered a short-term alternative. The more advanced RB-175 seemed more promising because of its composite components and its significantly reduced weight, but Rolls Royce had the RB-175 in long-term development. None of the alternative engines from either British firm proved to be compatible with the LLRV manufacturing schedule. As Dean Grimm, LLRV project manager at the MSC, recalled in April 1971, NASA "got lots of offers from Rolls Royce and a lot of other people to spend about \$20 million to develop the engine we wanted, but of course we weren't too interested in that."³

On the other hand, members of the GE group at Edwards Air Force Base realized that if the CF700 were used in the LLRV, they would need to provide the FRC with technical support once the engines arrived in California. And so, on 10 April 1963, Wally Runner and three associates from GE at Edwards Air Force Base met with Bellman and Matranga to unveil the company's plan for technical support.⁴ Proposed support included a test engineer for the 50-hour qualification testing of the engines in the fall of 1963 at the GE plant in Lynn, Mass. GE also offered to send a test engineer to Bell when the engines were installed, to assign an engineer at the FRC once the vehicles had been delivered to Edwards, and to provide special tooling, spare parts, overhauls, and hot-section testing.

But pledges of support belied formidable difficulties. Runner and his GE associates acknowledged that while GE had tooling for the basic J85 engine, it didn't have the fan tooling needed for the CF700-2V, the vertical version of the J85 used in the LLRV. At the GE facility in Lynn, the proper tooling had yet to be identified. Nor was there an available supply of spare parts. This raised concerns at NASA. In addition, GE's refusal of NASA 200 Series inspection requirements in the fabrication of the jet engine gas generator was holding up final assembly.

Ottinger, NASA's resident LLRV technical representative at Bell, and Andy Syposs, quality-control specialist in the Air Force contracting office at Bell, discussed the qualification of the jet engine parts with Matranga and Richard Cox of the FRC's inspection group on 16 April.⁵ Since GE used the Mil Q 9558 inspection standard on its production line, the company wanted to use that procedure in parts production rather than use the NASA 200 Series. In the jet engine core, there were 800 military-certified parts, 180 Federal Aviation Agency-certified parts, and 20 non-certified parts. Moreover, there were 100 other non-certified parts in the fan alone; at issue were these 120 non-certified parts. An additional concern was that, in the rush to meet the delivery schedule, GE was building the first engine with used parts. To keep final assembly of the engine on schedule, NASA and GE reached a compromise. The space agency agreed that GE could call the quality control what it liked so long as NASA was satisfied with the inspections and engine paperwork. In effect, this enabled GE to use its own inspection procedures as it moved ahead with the final assembly of the engine.

Nonetheless, Matranga became increasingly concerned that the CF700 might be

unable to meet the thrust requirements for the LLRV.⁶ On 17 April, he contacted Ottinger at Bell, asking him about the costs of stopping GE's assembly if NASA sourced the LLRV engines elsewhere. Rather than see NASA take that course, Ottinger recommended that Ken Levin of Bell be instructed that if necessary, GE should be directed to upgrade engine thrust at the expense of engine life.⁷

Testing of the first CF700-2V engine began at GE's Lynn plant in mid-August 1963, with the engine operating horizontally in initial runs for a more accurate test. Maximum thrust was 4,432 pounds. Initial tests were made with a non-optimized nozzle; the nozzle was to be improved later, after additional data had been gathered.⁸

But engine thrust remained all-important. Indeed, the critical design challenge throughout the LLRV program was the need to obtain the maximum thrust possible with the selected jet engine in order to minimize three factors: first, the impact of weight-reduction initiatives on cost and schedule; second, the operational constraints for warm-weather takeoff performance, and third, any possible loss in the value of research or training. Therefore, project personnel kept a weather eye on the jet engine performance testing throughout the program.

Developing the Ejection Seat

Planning for pilot safety also was crucial. After issuing a Request For Proposal (RFP) during the summer of 1963 for development of a lightweight zero-speed and zero-altitude ejection seat, the FRC held discussions with the Lockheed California Company, Stanley Aviation, Weber Aircraft Corporation, and the El Segundo, Calif., division of the Douglas Aircraft Company. NASA requested that Lockheed representatives not bid on the project upon learning that their proposal claimed a pilot ejection system could not be built successfully with a weight under 1,000 pounds.⁹

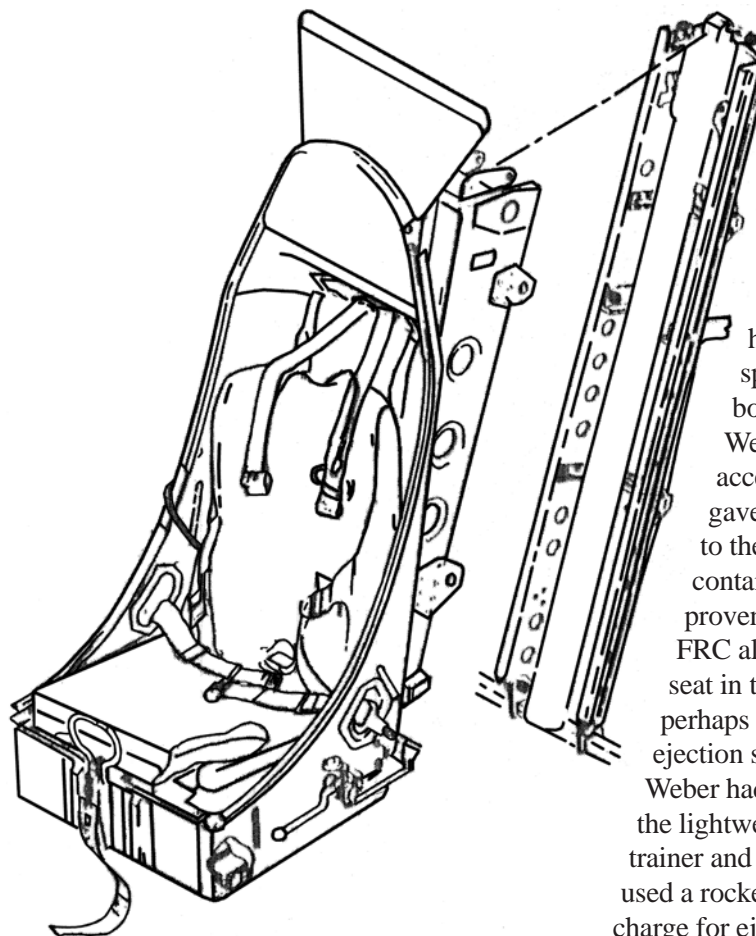

A diagram of the ejection seat chosen for the LLRV, showing the various elements of the system.

The seat proposed by Stanley was not only the heaviest of the three but it also had features that NASA found objectionable. The seats proposed by Douglas and Weber, on the other hand, met NASA's specifications. Although both the Douglas and Weber models were acceptable, the committee gave the highest evaluation to the Douglas seat because it contained a greater number of proven components. But the FRC already was using a Weber seat in the M2-F1 lifting body, perhaps one of the first zero-zero ejection seats in an aircraft. Weber had developed it by taking the lightweight seat in the T-37 jet trainer and modifying it so that it used a rocket rather than a ballistic charge for ejection.¹⁰ The company's

proposed seat for the LLRV involved an updated version of the M2-F1 seat that had been successfully demonstrated in the lifting body aircraft. With the potential cost savings inherent in this approach, the committee selected the Weber seat for the LLRV.

In the Weber seat, an explosive cartridge in the rocket system supplied hot gases for catapulting the seat to the top of the seat rails. The solid-propellant rocket motor attached to the seat structure would then ignite hot gases at the top of the stroke of the catapult, burning just long enough to take the seat away from the LLRV. Given the VTOL nature of the LLRV and the need to accommodate a range of vehicle-attitude angles at ejection, the Weber design called for a rotation of the seat and rocket assembly through an approximate 45-degree angle during rocket burn. The rotation provided the best statistical probability that, on ejection, the seat would achieve maximum vertical height above the ground. To achieve this rotation with optimum trajectory performance, the rocket motor thrust had to be precisely offset from the cg, the mass of the seat, and pilot by a few inches.

The FRC group executed three ground tests to verify the performance of the ejection seat in March 1963. The first two tests—with level pitch and roll attitude, and with a 30 degree nose-down attitude—ended successfully, achieving maximum altitudes of over 180 feet with full parachute inflation above 100 feet. But the third test—with both a 30 degree nose-down attitude and a 30 degree roll attitude—was only marginally successful, reaching an altitude of only 72 feet and with full parachute inflation at just 14 feet above ground.¹¹ The third test showed that the cg for the pilot/seat combination was critical, the weight of the pilot usually being almost double that of the seat alone. As a result, weight and cg had to be determined for each pilot, and a custom seat cushion made for each pilot. The pilots accepted the requirement gracefully, even when a flight had to be put on hold while a pilot's cushion was located.

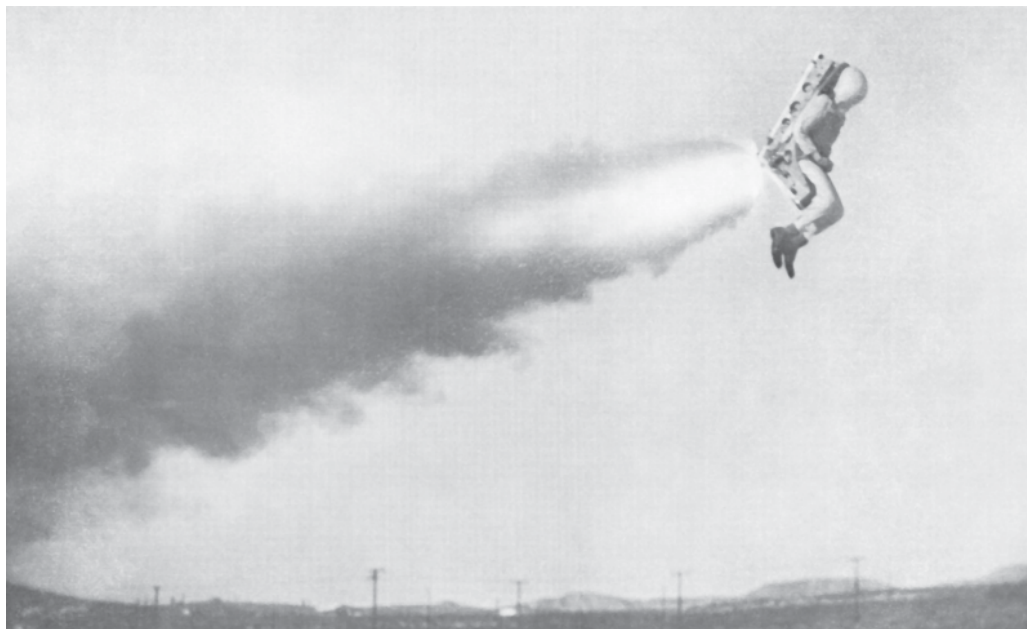

A successful firing of the LLRV's Weber ejection seat. Adapted from an ejection seat already used in another NASA FRC aircraft (the M2-F1 lifting body), only minor changes were necessary for the LLRV. (Weber Aircraft Company)

According to Donald L. Mallick, one of the LLRV project pilots, the Weber “was even better than a zero-zero seat. A zero-zero seat is one that will eject the pilot safely from the aircraft sitting on the ground at zero speed and zero altitude. The Weber seat would actually get the pilot clear of the vehicle very close to the ground with a 400-foot-per-minute rate of descent and with limited pitch and roll attitude relative to the local vertical.” The pilot's cushion was critical to this, explained Mallick, because the cushion “was of a height that complemented his body weight and density to allow the rocket motor to propel the pilot high enough above the vehicle or ground for a safe parachute deployment.”

Measuring the pilot for the specialized seat cushion involved putting him in a type of swing, with the pilot's cg determined from readings taken at various angles while the swing moved. To establish the necessary data, the LLRV pilots visited the Weber facility for measurements. "The measurements were rather time-consuming," added Mallick. "As Joe [Walker, the chief project pilot] and I each took our turn in the swing, we noticed an unusual number of very good-looking ladies were passing the doors to the Weber laboratory that we were in; most were turning and smiling as they went by." Later, Mallick recalled, after the tests were finished, both he and Walker told the Weber engineers that they hadn't minded the amount of time the tests took since they had enjoyed the "girl watching." The engineers laughed, telling Mallick and Walker that they weren't the ones doing the watching but, instead, were the ones being watched. "We hardly ever see them on a normal working day," the engineers said. "Those gals heard that we had two test pilots in for cg measurement, and they were down here to get a look at you."

The Weber ejection seat would be instrumental in saving the lives of one astronaut and two pilots at Houston during emergencies that transpired with the LLRVs and LLTVs. "On a major failure," Mallick explained, "there were few steps on the emergency checklist that came before PULL THE EJECTION HANDLE." Admitting he'd never had to use the ejection handle, Mallick added, "fortunately for those who did, in the LLRV and LLTV operations, the Weber ejection seat performed as advertised and in the life of the total program, saved three pilots."¹²

Changing the Configuration

During the spring of 1963, events beyond the LLRV's development prompted a change in the vehicle's fabrication.¹³ In a move resulting from the Apollo program's adoption of the Lunar Excursion Module (LEM)—later simply called the Lunar Module (LM)—Ken Levin recommended reducing the size of the LLRV and moving the cockpit so that it straddled the legs of the vehicle. This change, Levin argued, would reduce the height of the LLRV by about one-third and help solve problems related to weight, cg, and jet engine inlet distortion, all of which stemmed from the earlier placement of the cockpit cab over the jet engine. A few days later, on 7 May, Levin elaborated on configuration changes in a meeting at the FRC also attended by Dick Day from the MSC.¹⁴

During these discussions, the advantages of Levin's proposal became apparent. The changes would make the LLRV more like the LEM, reduce its weight by at least 60 pounds, make the structure less complicated, reduce engine inlet flow distortion, give the pilot better downward visibility, and increase payload flexibility. There were, admittedly, a few disadvantages. The changes would make the LLRV less symmetrical, for one. For another, implementing the structural redesign would require an additional 1,400 hours, delaying the production schedule by about two weeks. In spite of these drawbacks, the group agreed, believing the advantages of the new design far outweighed the disadvantages. Fortunately, the changes entailed no amendments to the contract since both designs seemed to satisfy the contract's Statement of Work.

Bell was urged to proceed at once with the new design. However, concerned about the impact the design changes would have on the delivery schedule, the FRC asked Bell to provide more detailed production information so that the schedule and costs could be tracked on a monthly basis. Reluctantly, Bell representatives agreed to provide this information, even though doing so would add costs they believed unwarranted.

Analog Simulation and Pilot Training

To ready pilots for flight in an unprecedented machine like the LLRV, simulation and training assumed paramount importance. Recognizing this, FRC management made appointments on 22 October 1963 to key positions in the LLRV's analog simulations.¹⁵ Joe LaPierre, an engineer who had worked on the X-15, took charge of the overall cockpit configuration. Jon Ball, a data systems specialist, assumed responsibility for design and

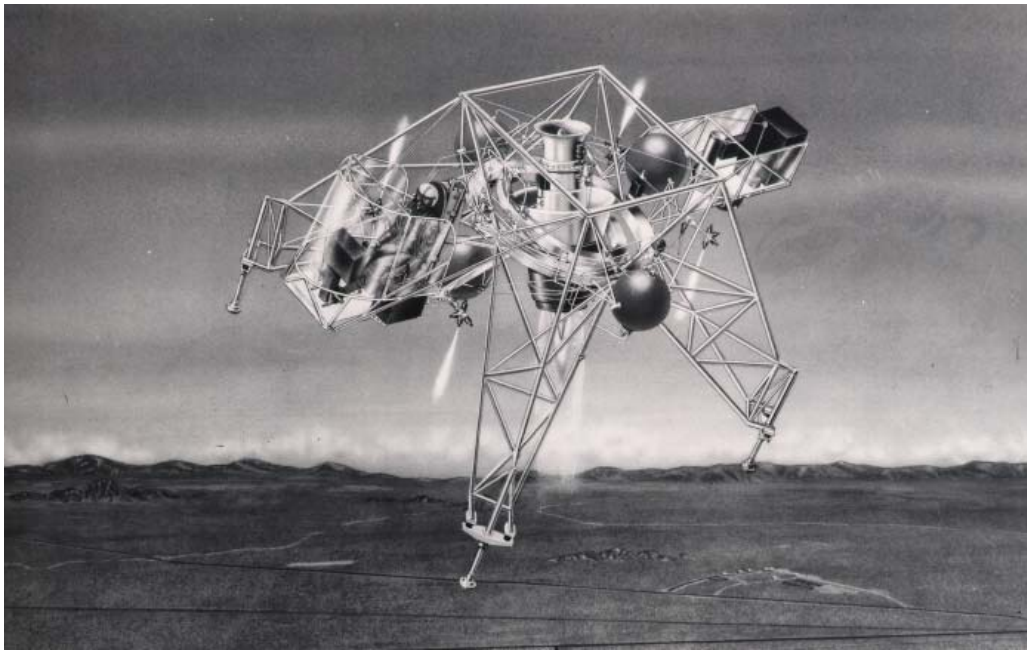

This revised illustration of the newly configured LLRV was largely faithful to the final planform. It shows the cockpit in front of the vehicle, the avionics at the aft end, and the true location of the maneuvering rockets. In the background is the Flight Research Center and Rogers Dry Lake. (Bell artist's conception)

fabrication of the pilot's cockpit display instruments, which later were also used in the flight vehicles. Flight-simulation technician Dick Musick supervised all interfaces for the display instruments in the simulator cockpit as well as the interfaces between the simulator cockpit and the analog computer (on which the equations of motion for the LLRV would be mechanized). Flight-simulation programmer Larry Caw assumed responsibility for programming the analog computer that would simulate the LLRV's operation and performance. Caw's main engineering points of contact were Gene Matranga (aerodynamic and performance data), and Cal Jarvis (control-system data).¹⁶ The analog simulation became operational barely one month later.

To duplicate the performance and response characteristics of the flight vehicle as closely as possible, the actual control-system hardware breadboard assemblies acquired for developing the LLRV jet engine and attitude control systems were used in the simulator. Consequently, control-stick forces and other operating features matched those of the actual vehicle quite well. (Engineers also went so far as to simulate attitude and lift rocket thruster noise until the pilots decided it had no particular benefit.) The analog system offered other benefits as well, especially in familiarizing pilots with the vehicle's control systems, handling qualities, and response characteristics. Through the simulator's use, various control-system parametric values were selected for the first flight.

Yet in other ways use of the simulator offered little advantage, particularly for pilots wanting to practice takeoff, climb-to-altitude, and trajectory maneuvering. While they felt that the analog simulator did familiarize them with new display or controller configurations before flight, as well as determine vehicle response and flying qualities, it was not much use in providing a realistic feel for maneuvering within lunar gravity or for trajectory optimization. These limitations stemmed from the simulator's lack of motion cues, since it did not move at all.

Joe Walker spent several hundred hours in the simulator. "Of course they had so much trouble with it and it was so damned terrible," Grimm recalled, "they figured if (Walker) could fly that simulator, he could fly anything." After Walker's first flight in the actual LLRV, Grimm recalls him saying, "Man, this thing is a pleasure to fly compared to that simulator."¹⁷

In early 1963, Matranga, FRC research pilot William H. Dana, and Maj. Emil E. "Jack" Kluever, then the chief engineering test pilot for the U.S. Army Aviation Test Facility at Edwards, went to investigate a training device for helicopter pilots at Del Mar

Engineering Laboratories in Los Angeles. What they saw at Del Mar was a helicopter mounted on a ground-effect machine by means of an articulated pylon that allowed limited pitch, roll, and vertical movement. By contrast, LLRV tethered flight would require three or more such machines to achieve realistic simulation. Kluever, a 1960 U.S. Air Force Test Pilot School graduate who had spent a year in Korea commanding a helicopter unit, actually flew the device. He agreed with Matranga and Dana that its lack of simulation fidelity, as well as the high costs involved, made it unacceptable as a training device for the LLRV. A better way to prepare pilots for the LLRV, Kluever said, would be conventional helicopter training in the Ames Research Center's variable-stability X-14. Instead, arrangements were made with Bell Helicopter a little over a month later to train LLRV pilots in rotorcraft operations using a Bell 47G.¹⁸

Early in the program, and while playing squash at the Edwards gym, Kluever asked Walker if he thought helicopter flight training might lower the flight risk on the first LLRV flights.¹⁹ "Being the professional pilot that he was," Kluever later recalled, "he accepted my offer to demonstrate the hovering flight regime to him so he could experience flight without the normal motion cues found in fixed-wing flight. So we used a U.S. Army helicopter and I demonstrated how a hover looked and felt and showed him how the helicopter would follow the rotor system tip path plane." Walker tried the maneuver himself several times, but "his performance did not agree with his expectations," Kluever recalled, and the two then returned to the FRC. "This occurred on a Thursday, and on the Monday following Mr. Bikle told me Joe was in Pensacola getting helicopter qualification with the Navy." When Walker returned, the FRC leased a Bell 47G, used thereafter as chase on LLRV flights, to improve pilot proficiency. Kluever recalls that qualification in a helicopter "was also required of moon-landing astronauts."²⁰

Instrumentation

For flight research, the LLRV needed a sophisticated instrumentation system for recording flight—both control and operational—performance parameters. At the same time, vehicle weight had to be minimized because of the performance margins.

The LLRV team found the solution to this dilemma by using the primary flight control system sensors to also collect parametric information for the flight instrumentation system, saving considerable instrumentation weight. But this practice deviated from traditional FRC design philosophy. Historically, FRC engineers did not collect instrumentation and flight control signals through the same sensors so as to prevent interference between systems that could affect vehicle control in flight. Bell, however, found a way to isolate the various sensors from the data system. The design allowed primary flight-control gyros, accelerometers, and position transducers to provide flight data to the onboard instrumentation system, all at real weight savings. After a careful review, the FRC accepted Bell's design.

To reduce weight even further a pulse-code modulation (PCM) telemetry system (rather than NASA's conventional onboard film recording) would relay research data to a ground station. Innovative for its time, the PCM system has since become standard for flight instrumentation systems, providing data in a convenient format for automatic data processing after each flight. Use of PCM telemetry allowed greater flight frequency during testing and considerably reduced turnaround time on data reduction. At one point, the team completed five LLRV flights in a single day, a virtual impossibility with the use of conventional data systems of the era. The PCM system transmitted 80 channels of data, recording each channel 200 times per second. The results were accurate to one percent except in altitude and yaw angle. The altimeter system had an accuracy of five percent above an altitude of 40 feet, two percent accuracy below that. The directional gyro had a drift rate of 0.25 degrees per minute, so yaw attitude varied with time. But since LLRV flights lasted less than 20 minutes, the maximum error in yaw attitude never exceeded five degrees.

And yet, some doubted the validity of pressure-sensed altitude or velocity data because of the unpredictability of airflow characteristics as the vehicle flew. Consequently, designers decided to augment the PCM system with a radar altimeter for height and vertical velocity information, and a helicopter Doppler radar for forward and lateral velocity.

Wind Tunnel Tests

In May 1963, a model of the original LLRV underwent tests in Langley's 17-foot section of the 7-by-10-foot wind tunnel. The FRC's Ray Young and Norm Paul from Bell participated in the wind tunnel tests, which were run by T.R. Turner and R. Vogler of Langley. The 30 percent scale model included a fan driven by compressed air to simulate jet engine operation. The fan produced airflow of 4.5 pounds per second, representing 45 percent of the scaled mass flow of jet exhaust from an actual CF700 engine.

Tunnel velocities varied between 15 and 100 feet per second, and the engineers subjected the model to a range of angles of attack, sideslip, velocities, and simulated power settings. Aerodynamic moments acting on the vehicle due to drag effects were lower than Bell had estimated; normal and axial forces, however, were higher. Variations in aerodynamic moments and forces with angle of attack differed from Bell's predictions, and definite jet engine thrust effects were noted in the force data.

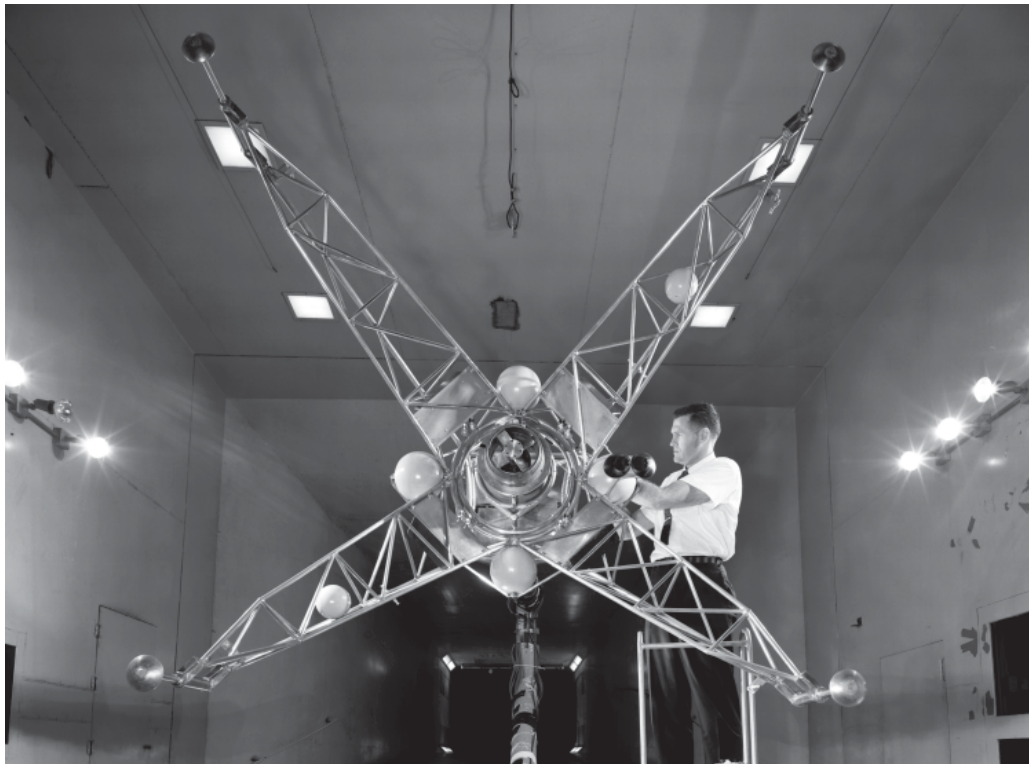

NASA Langley engineers tested this early LLRV design in the center's 7-by-10-foot wind tunnel. This model pre-dates the revised configuration and positions the cockpit directly over the engine intake. Note the dish-shaped pods on the landing gear, a feature designers would return to after wheels proved troublesome. (L-63-3535)

The tests indicated that the effects of aerodynamic forces acting on the LLRV during maneuvering flight and gusting winds would be significant.²¹ These aerodynamic forces, it turned out, contributed to the loss of an LLTV at Houston during an initial checkout flight. In that instance, large yawing moments during a lunar-simulation maneuver in high winds caused the vehicle to yaw, then roll out of control, and crash. Fortunately, and thanks to the Weber ejection seat, MSC chief pilot Joe Algranti escaped safely.

Design Reviews

After the May 1963 design review at Bell, Ottinger gathered up the resulting sketches, drawings, specifications, and system layouts and took them to the FRC for review. There,

teams of FRC personnel with various areas of expertise reviewed and evaluated the Bell design over the course of several weeks.²²

Team representatives collected and correlated questions and concerns from the review. On 6 and 7 June, Jim Adkins, Jon Ball, Don Bellman, Tom Lynch, Gene Matranga, Ben Mayrbat, Jim McKay, Wayne Ottinger, and Joe Walker of the FRC—along with Joe Algranti, Louis Allen, Dick Day, Warren North, and Larry Williams of the MSC—met with Bell team members at the Bell plant to try to complete the approval process.²³

As is common with a vehicle as complex as the LLRV, the review process identified a number of problems and concerns. Most were resolved satisfactorily, but a few remained. One concern was the weight computer, a concept originally conceived by Bell's avionics engineering manager, Walt Rusnak. Earlier in Rusnak's career, he had designed the artificial feel and trim system and stability augmentation system for the X-22A, an experimental VTOL and hovering aircraft. The weight computer—designed to automatically determine the initial weight of the LLRV as a baseline for the 5/6g weight command signal to the jet engine—seemed overly complex. There also were several issues regarding the engine attitude-control system, which continued to generate safety and reliability concerns.

In addition, Bell had yet to formulate an overall checkout of the combined operational systems, though theoretical and simulated-system operational assessments at the subsystem level had been performed. For instance, the vehicle attitude system and the jet engine attitude system had been evaluated separately. Any effect one system might have on the operational characteristics of the other, as a result, had not been determined. This was of particular concern since the LLRV was essentially a flying systems platform: its survivability depended entirely on the reliable interaction of all systems. Unlike an airplane, the LLRV had no wings it could use to glide to an emergency landing. As Dean Grimm explained, "If your electronics or avionics fail on that thing, that's just like your wings falling off" in a conventional airplane.²⁴

Another source of concern arose over the issue of relocating the cockpit from atop the LLRV to the front of the vehicle, a move that rendered obsolete Bell's structural analysis. Despite a new analysis by Bell, the FRC team raised several issues. The fuel tanks, for instance, were designed for a 4g load, while the cockpit had been designed for 20g. The lower g-loading for the tanks indicated that they could be damaged in a hard landing, possibly resulting in fire and explosion. With so many issues left unresolved, it became clear that the design approval process would take weeks in some cases and months in others, as various systems matured and completed functional testing. Final approval would be granted only when the designs were frozen and test data was in hand.

Structural engineer Jim McKay—X-15 pilot Jack McKay's twin brother—met over three days in mid-September 1963 with Bell's Richard Gallager, Jim Quinn, and Tom Rees for a comprehensive review of the LLRV's modified structural design.²⁵ After examining the computer model that Bell used for the structural analysis, McKay waded through the detailed results for the primary structural elements. The completed analysis showed that the new structure was 17 percent more rigid than the original, and the load limit for the fuel tanks had increased from 4g to 8.5g. McKay also reviewed the design of the Bendix landing shock struts and Bell's proposed testing of them. He recommended that the footpad material be changed from aluminum to something such as 4130 steel in order to reduce dig-in and pitch-over tendencies with horizontal velocities.

Jack Cates, Larry Caw, Cal Jarvis, and Gene Matranga from the FRC also were at Bell, reviewing the status of the control-system design with Bill Bascom, John Ryken, Walt Rusnak, Leon Zwink, Robert Kaiser, Myron Gump, and Charles Kay, all of Bell.²⁶ The FRC team requested vendor component characteristics, a written test plan covering recommended system-checkout procedures, and additional checkout test points. Bell's team agreed to this and a request to provide circuitry to monitor all rockets for any "stuck" condition.

The two teams also discussed the need for circuitry that would disengage the auto-

throttle at touchdown, and circuitry for resetting the vehicle's attitude-control system if it failed and dropped into backup mode. In turn, the FRC team agreed to reassess the warning-light requirements, ultimately deciding that onboard directional gyro erection indication was unnecessary. The team also conceded that vehicle attitude-mode control and combined-system influence did not need to be studied at Bell, but were issues to be addressed later by NASA.

After evaluating the Bell-designed instrument panel in the FRC simulator, Joe Walker expressed concern on finding that the installation obstructed too much of the pilot's downward visibility. Since design changes were causing contract costs to escalate, the FRC team decided that the instrument panel would be revised at the FRC and installed in the LLRV when Bell delivered it, a decision passed along to Bell in mid-November.²⁷ Ottinger estimated that this arrangement alone would save Bell 450 hours, greatly reducing the growing cost overruns.

Program Management

After Bell signed the original contract with the FRC in January 1963, some changes were made to the Bell project team. For six months, Albert E. Beaufore replaced John A. Mullen as program manager. Mullen then resumed management of Bell's LLRV program when Beaufore was assigned elsewhere. Ken Levin, technical director, gained two assistant technical directors, John Ryken and Bill Jackson.

Ryken, who headed up a systems analysis group for Bell, had been a member of the team at Bell that originally proposed the LLRV concept. Ryken handled the vehicle's control system, pilot interface, and avionics for Levin and would later serve as Bell's program manager for the LLTV. A former executive with Ford Motor Company, Jackson had an extensive technical and managerial background in program development and jet engine production. He would handle propulsion systems and manufacturing for Levin.

Ottinger continued as the FRC's on-site manager at Bell in Buffalo, N.Y., facilitating decision-making and keeping FRC program management apprised of progress and problems at the Bell plant. He eventually became the FRC's project engineer for LLRV flight operations due to his background in propulsion testing, including working in flight operations as a rocket-propulsion engineer for the X-15 program. On several occasions during meetings with Bell management Ottinger would excuse himself briefly to talk privately with FRC management for guidance. On these occasions, Bell had him use an adjacent office belonging to Bell Vice President of Research, Walter R. Dornberger. Ottinger remembers a large artist's painting of the Dyna-Soar entering the atmosphere from Earth orbit hanging on the wall in Dornberger's office, given to him by Boeing, with an engraved plaque in the frame. The words on the engraving were, as Ottinger remembers, "Dyna-Soar, Born 1954, Walter Dornberger; Died 1963, Mac the Knife." Robert MacNamara, then Secretary of Defense under President Kennedy, had just cancelled a number of programs, including the Dyna-Soar, and was referred to as "Mac the Knife," the name of a song popular then. Apparently Boeing, lead contractor for the project, chose to give credit to Dornberger for the Dyna-Soar concept as a derivative of a very early concept of a "boost-glide vehicle" conceived by Eugen Sänger, a German engineer in the 1930s.

While viewing the painting, Ottinger had an uneasy premonition about the big stakes world of aerospace R&D financing and was not a little concerned regarding the total development costs that were going to be required for the LLRV. The Dyna-Soar painting reminded him that FRC was playing in an ocean with some very big fish.²⁸

Ottinger was first given an on-site office at Bell's plant within the Defense Contracts Administration Services (DCAS), the designated government contracting agency. This office was some distance from the main engineering offices, which were adjacent to the manufacturing and laboratory facilities. Two months after he arrived, Ottinger arranged with Bell to move to an office closer to the engineering staff, a move that improved liaison activities considerably over the 14 months of the project. Despite Bell's periodic disagree-

ment with the FRC on a number of technical issues, there was general agreement with Ottinger and the FRC in meeting the challenge of the LLRV program's highly complex design goals.

While relations between the FRC and Bell's program and contract managers had been upbeat and nonconfrontational in the beginning, they became increasingly strained as difficulties eroded profit margins during development. As the program advanced, Bell's increasing overhead aggravated the cost situation. Most of the strain between Bell and the FRC stemmed from the costs required to develop a vehicle as complex as the LLRV, costs that quickly exceeded Bell's original estimate.

Although Bell originally had envisioned the LLRV as a low-risk program that would utilize many off-the-shelf components, company managers came to see that the program essentially constituted research and development. Consequently, Bell felt unduly penalized for having to work with a fixed development cost while project requirements were not well defined. In fairness, the FRC had been forced into a fixed-budget scenario as a result of disagreements with the Apollo program office regarding the need for the LLRV to play a role in training astronauts. The result was something of a shotgun wedding between the FRC and Bell teams, with each side working hard to develop the best vehicle possible while Bell managers tried hard not to lose their shirts in the process.

Dean Grimm later said he believed Bell had underestimated the job.²⁹ Ken Levin recalled that "technical problems" had driven costs above Bell's original estimate, piling on "contingencies" that couldn't be included in the contract Bell had with the FRC. "It really wiped out any profit we might have made on the program," Levin added, "although I don't think we sustained any big loss either."³⁰

One important requirement in developing the LLRV was that the final configuration should perform or conform as closely as possible to the actual LM being developed by Grumman Aerospace. To facilitate this requirement, Gene Matranga met on 12 April 1963 with Don Cheatham, Dick Day, Joe Loftus, Owen Maynard, Sig Sjoberg, and Larry Williams of the MSC.³¹ The upshot of the meeting was a request by Apollo management that Grumman coordinate its work as much as possible with the FRC and Langley. The object was to ensure that the LLRV and LTV vehicles supported Grumman's ongoing development of the LM. For the LLRV program, this request was significant since it opened a window on the possibility of funds being allocated from the Apollo program that would ensure the LLRV development schedule. The sentiment on the aeronautics side of NASA had been made abundantly clear: it would provide no additional funding for LLRV development without some indication that Apollo program management was willing to share the costs. The link with Grumman, then, meant there might be more funding to finish this crucial part of the program.

By mid-July, Bellman raised the issue of the program's rising costs with program managers and others at Bell.³² He told them he was very worried about Bell's lack of progress, and especially about the cost increases constantly being tacked on to the contract for minor changes that were well within the contract's scope. Conceding that many of these changes were in fact for items covered by the contract, Bell management agreed to provide a detailed breakdown of work they considered to be outside the contract's scope so that those cost increases could be negotiated into contract language.

Satisfied, Bellman accepted Bell finance officer Robert Lapsley's next two detailed schedule and cost reports, even though they projected a cost overrun of \$150,000. In doing so, Bellman said he wanted to see several more runs before predicting the trend in the contract's costs. However, he predicted—correctly, as it turned out—that additional action would be needed by early September regarding the cost overruns.

Indeed, in August Bell project management informed the FRC that existing LLRV funding would run out by mid-September; by then, Bell would need additional monies in order for development to remain on schedule. While the FRC agreed to additional funding, officials there warned the contractor that Bell would also be required to provide more

detailed information on actual costs in the future.

And so, with all these things in mind, Matranga aggressively pursued additional funding directly with Tom Baker of the Apollo project office, asking specifically for funding from Apollo to keep the LLRV project moving along. Baker, who had previously worked at the FRC, said that he thought additional funding could be provided if the FRC submitted a formal request. And so, on 24 April 1963, FRC funding officer Thomas Finch presented a formal request for funding to support LLRV development.³³ MSC management accepted the request, agreeing to provide Bell with \$350,000 in May and an additional \$140,000 by June. The funds from the MSC proved an enormous help to the LLRV, breathing life into a program whose costs already had far exceeded Bell's original estimates.

When he went to Bell in early October to check program progress and costs, Bellman took the newly designated LLRV crew chief, Ray White, with him.³⁴ A World War II Navy veteran, White had developed a knack for precision mechanical work during his X-plane experience at the FRC, work that made him well qualified to oversee the LLRV final assembly and test programs.

While White discussed interfaces between the vehicle and ground-support equipment with Bell technicians, Bellman and Ottinger discussed costs and schedule status with Bell's vice-president for engineering, Bill Smith, program manager John Mullen, and the technical director, Ken Levin. Bell's most current progress report showed an expected cost overrun of \$350,000 and a schedule delay of six weeks. Bellman and Ottinger discussed several options with Bell officials for reducing costs, including having NASA assemble the second vehicle and conduct all testing. Smith, Mullen, and Levin were not in favor of any of the options, pointing out that none of them affected ongoing work at the Bell facility. In the end, Bellman noted that the FRC would be watching the growth in costs very carefully, and that if the increases continued, some type of action would need to be taken by NASA.

In November 1963, as the final design neared completion, NASA asked Bell to provide a revised estimate of costs required for completion of the remaining development work. To the astonishment of FRC project managers, Bell's reply projected an overrun of more than a half million dollars—\$200,000 more than Bell had projected only a month earlier. Bikle, the FRC director, balked, making it clear to all concerned that he would not endure such overruns; the parties would have to find some way for Bell to reduce its project costs. Bell project managers then suggested abandoning construction of the second LLRV but NASA management rejected this option, urging Bell instead to accept a cost ceiling for the remainder of the program. Bell managers refused, reiterating their conviction that the LLRV was too experimental to justify commitment to a fixed development cost. And so it went.

In spite of such grave differences, FRC and Bell management gradually worked their way toward common ground. Two days later, they reached an agreement. Using the financial report of 25 October as the basis for negotiations, Bell agreed to a cost ceiling—provided NASA would allow a contingency amounting to 10 to 15 percent of funds yet to be expended. Meanwhile, existing discrepancies between Air Force plant auditors—NASA's designated governmental auditing group at Bell—and Bell's prices were trimmed from \$88,000 to about \$20,000, yielding a projected cost overrun of \$356,000.³⁵

NASA and Bell also agreed that the first LLRV would be delivered unassembled. Beyond this, the FRC would itself install the wiring and carry out final assembly and testing. In turn, Bell agreed to deliver a complete set of parts for the second LLRV, and Bell's engineering support at the FRC would be provided under a separate contract. All these changes, it was estimated, would save at least \$300,000.

Although the agreement was not finalized at that time—delayed to allow Air Force auditors and Bell to examine the numbers more closely—it was decided that a final estimate would be submitted on 8 November, with formal execution shortly thereafter. Both sides accepted a final revised contract cost on 12 November 1963, with delivery of the first LLRV projected for 20 March 1964. The contract price had been reduced from \$3,723,000 to \$3,405,000, with \$227,000 of that being Bell's fee. Above that amount, Bell agreed not to

receive any fee. That is, Bell's fee would be deducted as a means of sharing with NASA any additional overruns. Bell also agreed to an absolute ceiling of \$3,950,000.³⁶

Not long afterward, New York Sen. Jacob Javits telephoned Bikle and chided him for the contract change Bikle had forced Bell to accept. Not easily intimidated, Bikle explained that he had taken action he believed was necessary, adding that if Javits—through Congress—wanted to provide additional funding to Bell, NASA would be only too glad to add the increased costs to the contract. No one at the FRC heard from Sen. Javits again on the matter. In early December 1963, Bikle detailed the adjustments made in the Bell contract to Jack Heberlig, a member of Gilruth's MSC staff. Bikle also reminded Heberlig of the schedule of funding expected from the MSC through the end of fiscal year 1964 to ensure that the LLRV could provide timely support in the development of the LM.³⁷

No sooner did the dust settle than problems surfaced late that month, once again affecting costs and schedule and further taxing the shaky relationship between the FRC and Bell teams. From the Bell plant, Ottinger told Matranga that problems were turning up in the vibration testing of the boxes housing the vehicle's avionics (aviation electronics). For FRC managers, this was an especially alarming development because the operation of the LLRV depended entirely on the reliability and performance of the fly-by-wire systems. Without these systems functioning properly, there *was* no LLRV. For Bell, this new setback created even more concern since they had just agreed to a cost ceiling. Additional funding would now be necessary for every change in engineering.

At first, Bell's position on this new twist was that NASA had caused the problem by imposing drastic control over vehicle weight. The structural failures, Bell officials claimed, resulted from a lack of box stiffness. Reworking the boxes would cost \$150,000. Since Bell was limited by the contract ceiling, its management refused to pay for the fix. Project management at the FRC, in return, pointed out that the vibration specification had been in the contract from the start, and that Bell should have designed the boxes to meet requirements regardless of the weight issue.

Bell proposed shock-mounting the entire avionics rack assembly containing all electronic box assemblies, but FRC project management rejected that idea, pointing to documentation from the MSC and the FAA showing that shock-mounting primary flight-control electronic boxes to mask structural vibration was unacceptable. After considerable discussion, Bell managers finally agreed to test the boxes to the same specifications used in Project Mercury, guidelines less restrictive than those of either Bell or FRC specifications. But Bell steadfastly refused to modify the boxes structurally in the event of test failure. In the end, both sides agreed that if modifications to the boxes were necessary, the FRC would do them for the sake of safety and reliability. NASA also would accept the vehicles at the Bell plant on the basis of detailed drawings and parts-breakdown lists. Concerned that the life of the assemblies was being compromised by the severity of the vibrating testing, both management teams also agreed that the actual flight boxes would be tested to only one-third of the vibration levels required for qualification. Engineers feared that the boxes might pass the vibration tests only to emerge so weakened that they might fail in actual flight.

With this problem resolved, at least temporarily, Bellman and Matranga left the FRC in February 1964 to brief a group of about 20 astronauts at the MSC in Houston on the program's status. Under the direction of Neil Armstrong and Wally Schirra, the meeting was part of the astronaut training program. The group showed considerable interest in the LLRV, a free-flying vehicle for actual flight training in simulated lunar gravity.

Following the briefing, Bellman and Matranga then met with various individuals at the MSC—including Dick Day, Dean Grimm, Jim Brickley, Warren North, and Don Cheatham—to receive status updates on the LM and Apollo. In the process, Bellman and Matranga discovered that a major disagreement had broken out within MSC management over the final phase of landing the LM on the moon. One side favored "black-box," or autonomous control, while the other preferred hands-on control by an astronaut.

On one side stood George E. Mueller, Associate Administrator for Manned Space

Flight at NASA Headquarters, along with Joseph F. Shea, Apollo project manager at the MSC, and Maxime A. Faget, the MSC's assistant director of Engineering and Development, all of whom favored the black-box approach. Squaring off on the other side were the astronauts and Warren North, director of astronaut training at the MSC, all of whom preferred control by an astronaut during final descent and landing. North and the astronauts believed there still were too many unknowns about conditions on the lunar surface to rely on fully automated touchdown. The Apollo astronauts insisted that at least the first landing on the moon should be under the manual control of an astronaut, and they would eventually stand by that position for every landing made on the moon during Apollo.

The inability to commit to either automated or piloted landing until late in the Apollo development program had a significant impact on the LLRV project. MSC management was reluctant to provide additional vehicle funding if the final landing was to be automatic, since that approach would minimize the need for astronaut training. Eventually, however, all agreed that even with a fully automated landing, the manual landing option would be necessary as a backup in case the automated system failed. Consequently, astronaut training for manual landing would be required. Thereafter, all parties agreed on the need for a simulator such as the LLRV.

In May 1964, the Apollo project office established a panel to coordinate the development of the LLRV and the LM, particularly to ensure that all relevant LM inputs were included in planning LLRV research.³⁸ Chaired by Day, with Grimm designated as the project engineer, the panel included astronaut Armstrong and engineers Cheatham and Teagarden from the Apollo project office.

Grimm effectively coordinated the development of the LLRV and LM, being well qualified to serve as point of contact between the two programs. After being schooled as an aircraft and engine (A&E) mechanic by the Air Force on both airplanes and helicopters, Grimm had served as lead instructor in the Air Force helicopter A&E program. Upon completing a degree at the University of Kansas in aeronautical engineering, he worked as a B-58 flight-test engineer and aerodynamicist for Convair, Fort Worth, Texas. He moved to Boeing, in Seattle, Wash., working first as a flight-test engineer and aerodynamicist on the 707 and early 720 airplanes, and then as a jet-aircraft air-carrier-certification instructor for the FAA (in Oklahoma City, Okla.). Impressed with Grimm's diverse background, Warren North hired him to work for Dick Day in conducting Project Mercury simulations and developing astronaut flight procedures and techniques for the Mercury, Gemini, and Apollo programs. Grimm's role in the LLRV project progressed until he was ultimately responsible for defining Gemini and Apollo crew station configurations. North and Day had introduced Grimm early on to the LLRV program, and he ended up following the LLRV from design to fabrication and into flight testing, including astronaut training. Grimm eventually became the LLRV and LLTV program manager at Houston.

As the LLRV neared completion at Bell, the FRC decided it would be prudent to send crew chief Ray White and Leroy "Frosty" Frost—assigned to oversee the NASA inspection of the vehicle—to Bell during the final month of the vehicle's assembly and testing. Highly regarded at the FRC for his technical expertise and attention to detail, Frost had worked with Ottinger at Grumman in the mid-1950s.

At the Bell facility, Frost, Ottinger, and White worked closely, carefully scrutinizing all activities on the vehicle. They gleaned considerable knowledge of and experience with the LLRV that later proved invaluable, especially given that the final assembly and checkout would now take place at the FRC. Their presence onsite at Bell also improved communication between the FRC and Bell management teams regarding technical issues and acceptance of test results.

In the midst of all this activity, Frost and Ottinger conspired to play a joke on White, who had married only two weeks earlier. They arranged to include in a "TWX" (Teletypewriter Exchange Service message) sent 1 April from Bellman and Matranga a note to the effect that Bikle and Vensel wished White to remain behind at Bell until the avionics boxes

were ready. This implied a considerable stay. Frost and Ottinger, of course, would be returning to California soon, accompanying the first LLRV. White was devastated at hearing that he and his new bride would be separated even longer by this delay—until he learned that the TWX was only an April Fool’s joke.

Back at the FRC, Bellman was concerned that not enough thought was being put into identifying sites of operation and planning for the servicing and maintenance of the LLRV at Edwards. He asked Vensel, chief of flight operations for the FRC, to detail an operational plan and philosophy for LLRV flight support. Bellman suggested that the South Base at Edwards be considered as the operating site. With its vast concrete ramp area and virtually no activity, it seemed an ideal location if logistics could be resolved. Issues such as tie-down requirements, blast shields for the jet engine, vehicle hangars, the support of the Air Force fire department, and storage for hazardous materials needed to be addressed and resolved as quickly as possible. And time was running short.

A lesson in frugality came when the FRC attempted to acquire a device for moving the LLRV on the ground. As soon as NASA operation engineers created a design for the device, the FRC solicited open bids from industry to build it on a fixed-price basis. One aerospace ground-support company bid \$16,000. GE’s local site bid \$6,500, while a commercial trailer fabricator in Portland, Ore., bid only \$1,500. The contract office at the FRC contacted the trailer company, noted that the company’s bid was significantly lower than that of the next lowest bidder, and offered the company the opportunity to withdraw its bid. The owner of the trailer company responded, saying he would stand by his company’s bid. He said that his company had actually estimated it could build the hardware for \$750 but, as the customer was the government, he’d doubled the estimate. The Oregon company not only won the contract, but also delivered the device on schedule. The inherent lesson was that significant money could be saved if certified aerospace specifications were not required for hardware fabrication.

Various means for transporting the LLRV to the FRC were explored as the date for delivery approached. NASA asked to use Air Force transport airplanes at Edwards, but the request was denied since the job could not be justified as part of an Air Force test or training mission. Although the Apollo program was a major national commitment, it was not a joint NASA/Air Force program. NASA then turned to the Air National Guard C-130 squadron at Van Nuys, Calif., only to receive the same response. Neither could NASA’s “Guppy” transport airplanes be used since they already were committed to other missions for Apollo during the time needed for LLRV transport. And so arrangements were made to ship the LLRV by air-ride moving van.

Bell conducted a formal rollout ceremony at its plant in Niagara Falls on Wednesday, 8 April 1964. Afterward, the first vehicle was prepared for transport and loaded into the moving van, which then departed on its cross-country trip to Edwards. The moving van arrived on 14 April, only 50 hours after leaving the Bell plant. Two drivers had eliminated the need for all stops but those needed for refueling. Arriving a month later, also by air-ride moving van, the second LLRV went into storage at the FRC.

¹ Paul F. Bikle, letter to Dr. Stanley Hooker of Bristol-Siddley Engines, Ltd., regarding visit on 21 January 1963 of Gene J. Matranga, 3 April 1963.

² Bikle, letter to Arthur Geraghty of Rolls Royce, Ltd., regarding a visit by Gene J. Matranga on 22 January 1963, 3 April 1963.

³ Dean Grimm, as quoted in the unpublished working notes from an interview by Ivan D. Ertel, MSC Historian, 1 April 1971.

⁴ Bernard J. Mayrbat, memo for file documenting 10 April 1963 meeting with General Electric on service support, 10 April 1963.

⁵ Matranga, unpublished private notes of phone call from Ottinger and Syposs to Matranga and Cox, 16 April 1963. NASA 200 and Mil Q 9558 were inspection requirements used respectively by NASA and the U.S. military.

⁶ As listed in GE's fact summary sheet dated January 1964, general specifications for the unmodified CF700 engine were as follows: 4,200 lbs. takeoff thrust, .69 SFC (Specific Fuel Consumption), 4,000 lbs. max. continual thrust, .68 SFC 44.0 lbs/sec primary airflow, 84.0 lbs/sec fan airflow, 670 lbs. weight, 6.3 thrust/weight, 33.2" max. fan diameter, 74.0" length.

⁷ Matranga, unpublished private notes of phone calls concerning the qualification of jet engine parts from Mayrbat to Holmes of Bell contracts and from Matranga and Cox to Ottinger, 17 April 1963, and from Ottinger to Matranga, 18 and 19 April 1963.

⁸ Matranga, unpublished private notes of phone call from Ottinger concerning jet engine testing, 14 August 1963.

⁹ Bellman, Memo to Bernard J. Mayrbat on Technical Evaluation of Proposals Received on PR-88: Ejection Seat, Light Weight, Zero Speed, Zero Altitude Capability, 9 August 1963. Klein helped design and build portions of the M2-F1 lifting body, including the frame; he also worked on Parasev. Young later was a flight engineer on the Shuttle Carrier Aircraft.

¹⁰ Reed with Lister, *Wingless Flight*, p. 46-47.

¹¹ Weber Aircraft Corporation, NASA Edwards light weight ejection seat ground firing test plan, March 1963. Matranga, undated private notes of ejection seat test results.

¹² All quotations in the above three paragraphs from Donald L. Mallick, "Flying the LLRV," Appendix A. of this monograph.

¹³ Matranga, unpublished private notes of phone call to him from Levin, Ryken, and Ottinger concerning LLRV modifications, 3 May 1963.

¹⁴ Bellman, memo to those concerned with the LLRV on major change in the LLRV configuration, 10 May 1963.

¹⁵ John P. Smith, memo for all concerned on division of responsibility for the lunar landing research vehicle simulation program, 25 October 1963.

¹⁶ Caw was the flight-simulation programmer on the X-15. Jarvis worked on the reaction control and reaction augmentation systems in the X-15. Gene L. Waltman, *Black Magic and Gremlins: Analog Flight Simulations at NASA's Flight Research Center* (Washington, D.C.: NASA SP-2000-4520, 2000), p. 101, 124-125.

¹⁷ Grimm, interview by Ivan D. Ertel, MSC Historian, 1 April 1971.

¹⁸ Matranga, unpublished private notes of negotiations with Bell Helicopter concerning helicopter training and rental, 18 March 1963.

¹⁹ Matranga and William H. Dana, memo for file on evaluation of Del Mar ground effects device, 7 February 1963.

²⁰ Emil E. Kluever, "The LLRV Program Flight Experience," unpublished. Kluever retired from the U.S. Army as a colonel. According to Kluever, his work with the FRC began with supporting NASA research pilot Milt Thompson by towing Parasev with an Army L-19 Bird Dog. Then, he used a heavy twin-engine helicopter to drop quarter-scale models of the Rogallo Wing Gemini-capsule recovery system. He also recalls missing the first LLRV flights by Joe Walker and Donald Mallick because the Army sent him to Command and General Staff College at Ft. Leavenworth, KS.

²¹ Nelson A. Paul, memo to Ken Levin on LLRV wind tunnel test trip report, 354:63:0510-1:NAP, 10 May 1963.

²² Bellman, memo to those concerned with the LLRV on report on LLRV design review, 16 May 1963.

- ²³ Bellman, memo to those concerned with the LLRV on report on LLRV design review, 24 June 1963. Adkins had headed the X-15 project office. As mentioned in the first chapter, Adkins was an engineer (formerly a USAF pilot) who also had served on the FRC's original lunar landing research committee. McKay was a structural engineer, and Ball and Lynch worked with data systems at the FRC.
- ²⁴ Grimm, interview by Ivan D. Ertel, MSC Historian, 1 April 1971.
- ²⁵ James M. McKay, memo for vehicle and systems dynamics branch head on results of the lunar landing research vehicle structural and design analysis meeting at Bell Aerosystems, NY, 17-19, 25 September 1963.
- ²⁶ Matranga, memo to LLRV project manager on visit to Bell Aerosystems Company, 17-19 September 1963, 7 October 1963. According to Bell's LLRV project engineer Walt Rusnak in his unpublished "LLRV Reminiscences," Ryken became Bell's program manager on the LLTV and Bascom, a mechanical engineer, later managed Bell's avionics on the LLTV at the MSC in Houston. On the LLRV, according to Rusnak, Bascom took charge of the packaging and other mechanical designs necessary to implement the hardware, later assuming general responsibility for scheduling and following through on all activities connected with fabrication and procurement of the LLRV avionics. Rusnak identifies Leon Zwink as Bell's "finisher," the "getting it to work" engineer whose task was proving the design, saying Zwink later provided in-the-field support for the LLRV during flight tests and operations as well as support for the LLTV in Houston.
- ²⁷ Matranga, memo for LLRV contracting officer on deletion of instrument panel and supporting pedestal installation on LLRV, 18 November 1963.
- ²⁸ Walter Dornberger was a German Army ordnance officer and former commander of the Army portion of Nazi Germany's missile installation at Peenemünde. He came to the U.S. after World War II and became a missile design consultant for Bell. At his instigation, in 1952 the company inaugurated a boost-glide program featuring a bomber boosted into a flight trajectory by a missile—a concept designated BOMI. Out of this and other concepts, in 1957 the Air Force initiated Dyna-Soar, a reusable shuttle to be boosted into orbit by a Titan III launch vehicle. Policy considerations led to the cancellation of Dyna-Soar on 10 December 1963. On this issue see Roy F. Houchin II, "Hypersonic Technology and Aerospace Doctrine," *Air Power History* 46, No. 3 (Fall 1999): 4-17. On Sänger's boost-glide vehicle, see the account by his wife and co-worker, Irene Sänger-Bredt, "The Silver Bird Story: A Memoir," *History of Rocketry and Astronautics*, R. Cargill Hall, ed., *AAS History Series*, vol. 7, part 1 (San Diego: Univelt, 1986), pp. 195-228. See also Michael J. Neufeld, *The Rocket and the Reich: Peenemünde and the Coming of the Ballistic Missile Era* (New York: The Free Press, 1995).
- ²⁹ Grimm, interview by Ivan D. Ertel, MSC Historian, 1 April 1971.
- ³⁰ Unpublished working notes from an interview of Ken Levin 8 June 1971 by MSC Historian Ivan D. Ertel.
- ³¹ Matranga, memo for LLRV project manager on trip report on visit to MSC on 12-22 April 1963.
- ³² Bellman, memo for director on visit to Bell Aerosystems Company to discuss management relations between Bell and the FRC, 15 July 1963.
- ³³ Matranga, private notes on the visit of Thomas Finch to the MSC, 24 April 1963.
- ³⁴ Bellman, memo for file on visit to Bell to discuss LLRV program status and problems, 15 October 1963.
- ³⁵ Meeting notes regarding contract NASA-234, Amendment 11, 4 November 1963.
- ³⁶ Bellman, memo about visit to Bell Aerosystems regarding cost overruns and work cutbacks, 8 November 1963.
- ³⁷ Bikle, letter to Jack C. Heberlig at the MSC on revised funding plan for the LLRV, 4 December 1963.
- ³⁸ George M. Low, memo to distribution on formation of lunar lander research vehicle coordination panel, 26 May 1964.

Chapter 4: A Vehicle Takes Shape

The LLRV's unique requirements created a number of equally unique design challenges, particularly with respect to flight control. Not only was it important that the vehicle be able to simulate operation in the moon's gravity and atmosphere, it was equally important for the LLRV to operate in a conventional VTOL mode. VTOL mode eased takeoff and transition to the start of a lunar simulation since the craft could not actually fly in the conventional sense of the word. It also enabled recovery in the event it became necessary to abort a lunar landing maneuver, or if the attitude-control or jet-stabilization systems failed. Flight-control design was all the more difficult because the characteristics of flight qualities for VTOL and lunar landing vehicles had yet to be well-defined or validated. Consequently, the LLRV's flight-control systems would need to be designed with considerable flexibility so they could be adjusted and modified as task requirements later became better defined and understood.

Achieving a realistic simulation of the lunar free-flight environment clearly would require innovative control techniques. Among the challenges awaiting LLRV engineers was to create a simulation that would allow control requirements, pilot workload, and fuel consumption for the piloted lunar landing task to be established and validated. At that time, conventional state-of-the-art flight-control technology for piloted flight could not achieve these complex requirements. Combining conventional VTOL operation with simulated lunar-environment operation and research-system flexibility into one operational vehicle would be accomplished only with the application and incorporation of the very latest cutting-edge flight-control technology.

A number of flight-control research vehicles with elements that had possible application to the LLRV program were in development during the 1960s. The variable-stability X-14—a VTOL vehicle used to evaluate flight-control requirements for VTOL aircraft—and the Jetstar Variable Stability Aircraft used by NASA to investigate flight-control requirements for conventional landing aircraft are two examples.¹ All these vehicles, however, incorporated some type of mechanical backup for use when the research flight-control system was not in use or had failed during flight. In fact, at this stage in the evolution and development of piloted aircraft controls, no vehicle with electronic flight controls had been developed or flown without some kind of mechanical backup system. The requirements for reliability had not been fully developed, much less proven, for rating fly-by-wire flight controls during piloted flight.

The LLRV team chose analog fly-by-wire technology as its basic approach to systems design, as there was no other way to meet the vehicle's wide range of control requirements. In the early 1960s digital control technology still lay over the horizon. At the same time, team members opted to forego the complexities that accompanied a mechanical systems approach so as to avoid the weight such systems would add to the LLRV. And since weight was a critical issue, every possible weight-saving option had to be considered in order to attain acceptable vehicle thrust-to-weight margins for both VTOL and lunar-simulation operation. Analog fly-by-wire technology also would provide the great degree of flexibility needed to allow for design modifications that would later be required on the vehicle. Developmental testing for final verification of operation and performance would replace the usual exhaustive design analysis. This approach, accommodated by the fly-by-wire configuration, would be less costly and aligned with FRC test philosophy so long as changes could be made easily in the field.

Yet another benefit the fly-by-wire option offered was that the analog system could be configured to maximize the number of control parameters that could be varied during flight-testing. This would have been extremely difficult, if not impossible, for engineers to do using a conventional mechanical system if they were to remain within the weight constraints of the LLRV design. The redundancy levels, the degree of failure

The LLRV was essentially symmetrical, with the cockpit and electronics cantilevered on opposite sides of the vehicle. The locations of the spherical JP-4 and peroxide tanks presented challenges in maintaining a balanced center of gravity. The cockpit shown here still has the center-mounted instrument pedestal.

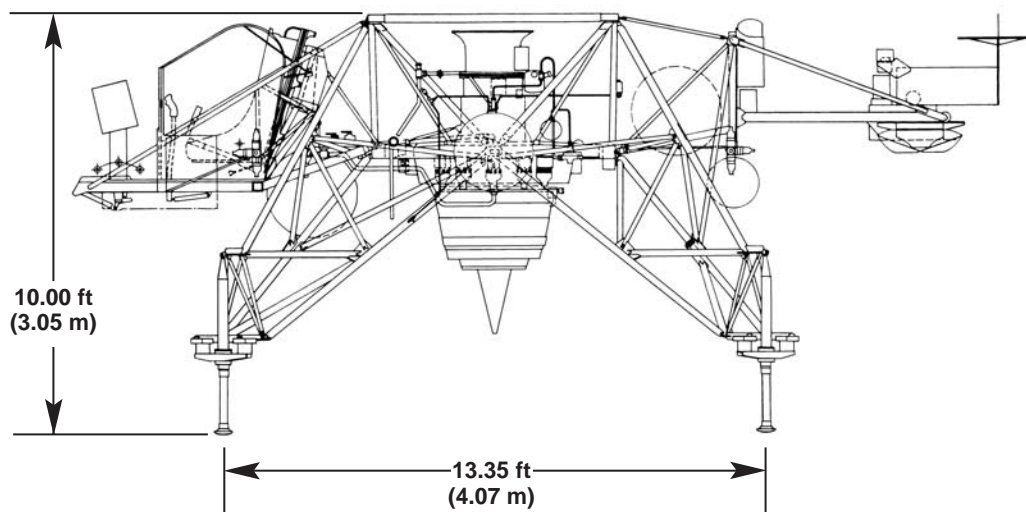
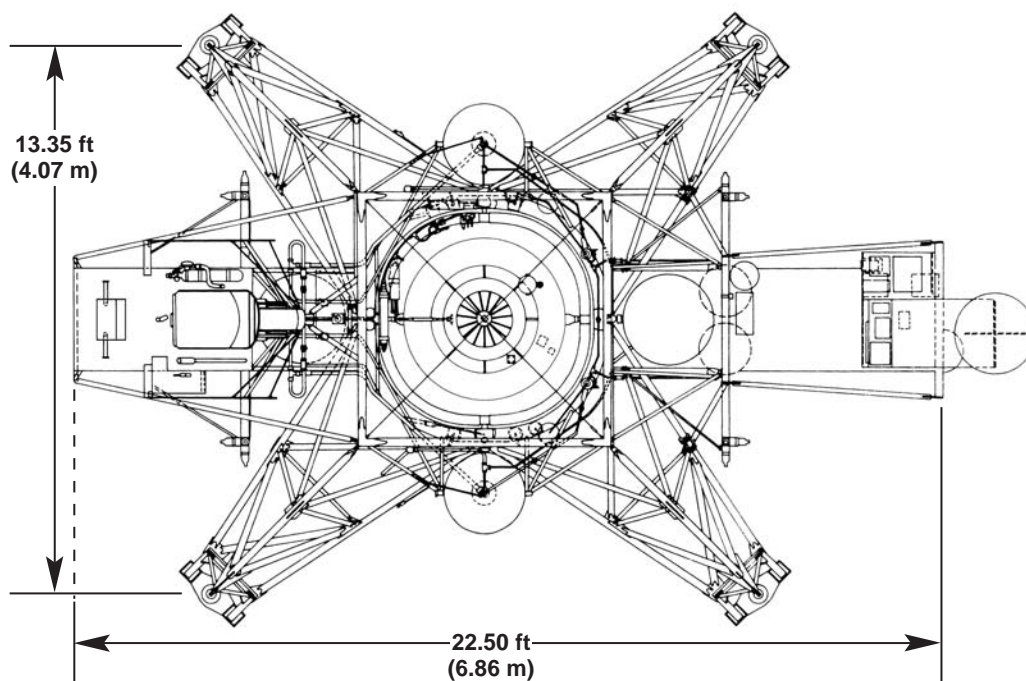

detection and, consequently, the reliability incorporated into the system was unprecedented, charting new territory in flight controls rated for piloted aircraft.

The flight controls in the LLRV consisted of two main systems: the vehicle attitude-control system and the jet engine stabilization system. The pilot utilized the vehicle attitude-control system for maneuvering during conventional VTOL, or lunar-simulation operation. During either operational mode, the jet engine stabilization system controlled the engine's attitude, which sat in a gimbal structure. Separate electronics assemblies, or boxes, housed each electronic component system. These boxes were mounted in an electronics rack on a shelf that extended from the rear of the vehicle. Made of aluminum, the boxes used printed circuit boards with components initially attached by conventional soldering. Some of the manufacturing methods and specifications were later modified, after problems arose during early qualification and functional tests. The two systems operated in several modes, described in the following sections.

- | | |
|---|---|
| 1. Oxygen tank | 8. Right helium tank |
| 2. Pilot's ejection seat | 9. Left helium tank |
| 3. Landing gear shock strut (4) | 10. Turbofan engine oil tank |
| 4. Forward JP4 tank | 11. Left helium plenum tank |
| 5. Right H ₂ O ₂ tank | 12. Hydraulic system reservoir |
| 6. Right helium plenum tank | 13. Left H ₂ O ₂ tank |
| 7. Aft JP4 tank | 14. Flight control electronics |

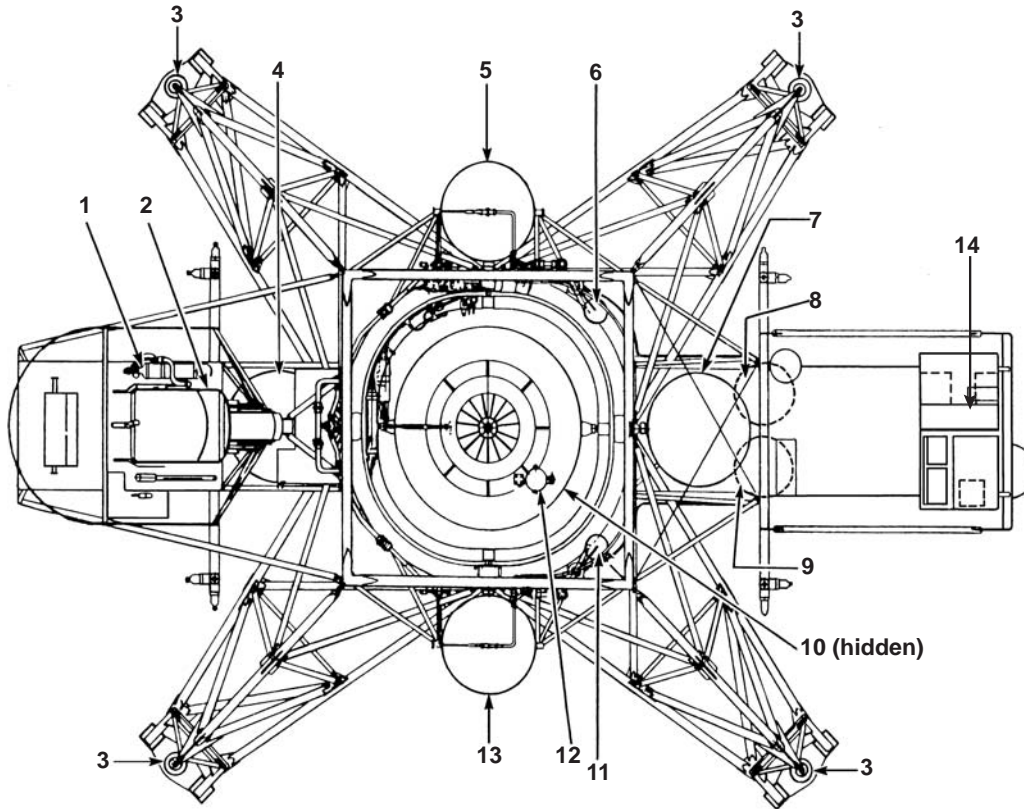

This overhead diagram identifies the LLRV's major components.

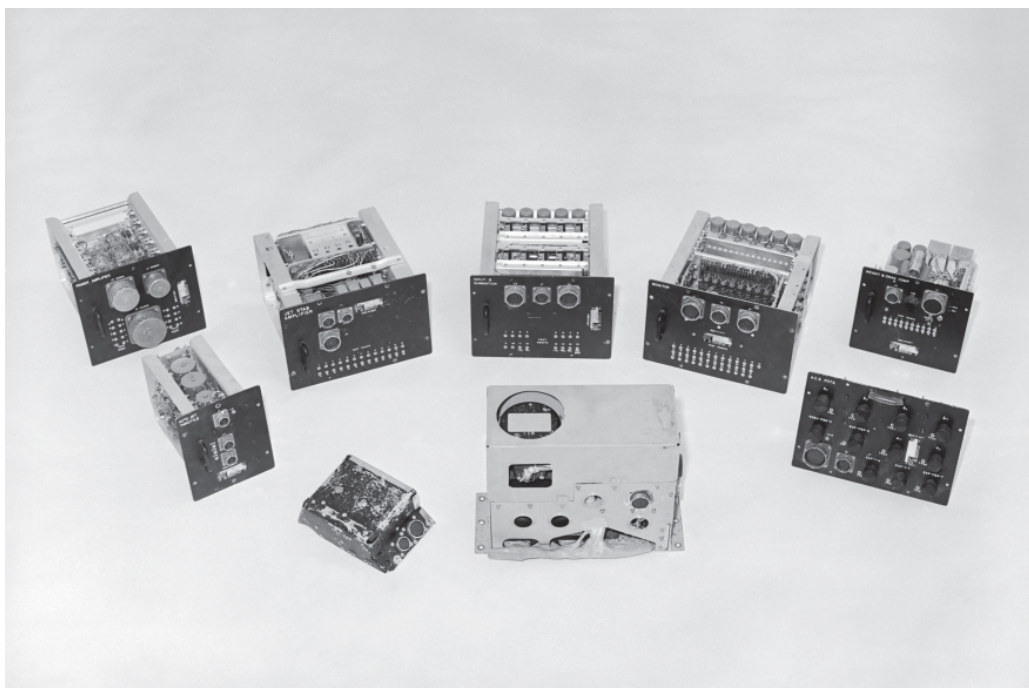

The lightweight construction of these assemblies rendered them unreliable during early stages of the flight program. (E-14322)

Vehicle Attitude-Control System

The LLRV's attitude-control system consisted of three separate components: an attitude-rocket system for generating control moments, primary and backup electronic systems for controlling operation of the attitude-control rockets, and a monitoring system containing failure-detection circuitry for monitoring system performance and reconfiguring systems when they failed.² Engineers separated the redundant electronic systems to boost reliability, housing all three independently in assemblies at the rear of the vehicle.

The vehicle attitude rockets were on-off thrusters, using a helium-pressurized, hydrogen-peroxide monopropellant system. The designers opted to use on-off rockets for overall simplicity of operation as well as to retain similarity between the control-system configurations of the LM and the LLRV. The attitude and lift rockets in the LLRV drew from the same hydrogen-peroxide propellant supply system.

The vehicle had two entirely separate but identical attitude rocket systems, one designated the "standard" set of rockets and the other the "test" set. Each set had eight attitude rockets, for a total of 16 rockets to control pitch, roll, and yaw. To help the pilot evaluate various control-authority levels, each rocket's thrust level could be adjusted from 18 to 90 pounds while on the ground. The thrusters were positioned in clusters of four at each corner of the vehicle, allowing proper distancing from the cg for generating sufficient control moments. The rockets typically operated in pairs, each pair firing in opposite directions and from opposite ends of the LLRV to generate control moments around a control axis.³

The pilot could select either the standard or the test set of rockets separately, or both sets simultaneously, using a three-position switch located on the left console. Normally, he would select the standard rocket set for VTOL operation during liftoff and transition to the beginning of lunar simulation.

During flight, the pilot usually selected the test set of rockets only after establishing a stable hover at a comfortable altitude. The test rockets were adjusted on the ground to provide the experimental levels of control authority needed to evaluate lunar-simula-

A cutaway diagram of the LLRV's lift and attitude rockets. Hydrogen-peroxide enters the rocket chamber through the piping at the top of the motor. As the nearly pure hydrogen-peroxide solution passed through the silver screen, it decomposed and turned into steam, which vented under pressure and served as a propulsion system.

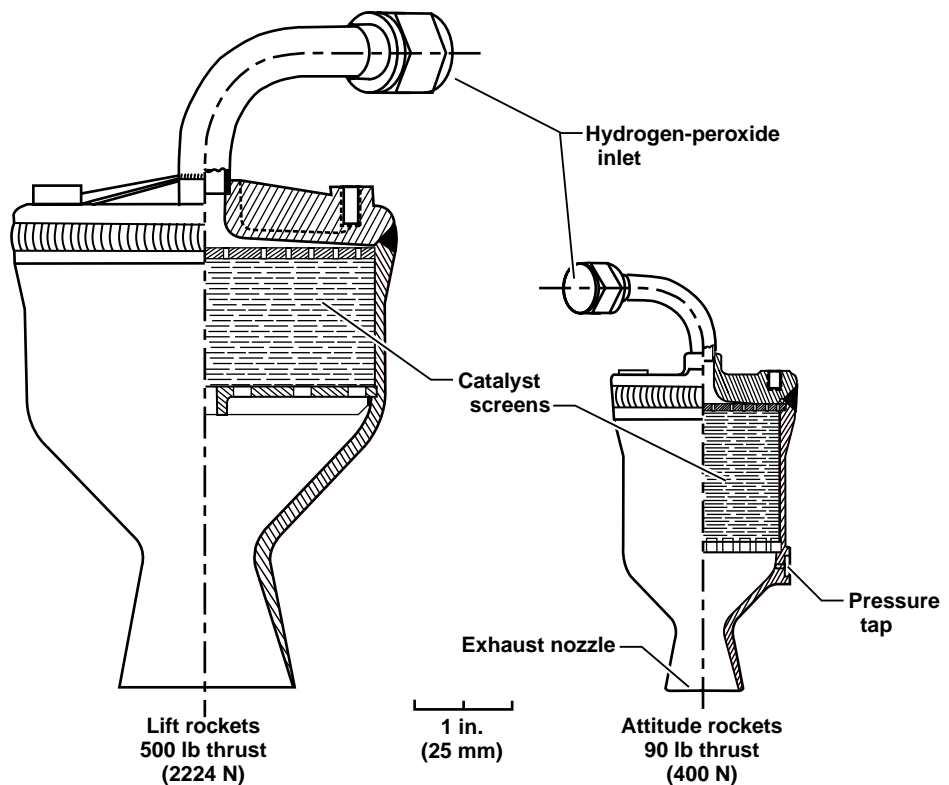

tion test maneuvering and landing. The pilot also could select simultaneous use of both rocket systems whenever more control authority was needed to recover from certain failures or from trim conditions caused by asymmetrical fuel use or buildup of aerodynamic moments. And in some failure modes, failure-detection circuitry would select both sets automatically.

The primary control system provided the normal mode of attitude control in all three control axes during VTOL as well as in lunar-simulation maneuvers and operation. This system housed the electronics for controlling the attitude thrusters in response to the pilot's input commands, providing control and maneuverability of the vehicle during flight.

The pilot used rudder pedals to control yaw and a conventional center stick to control pitch and roll. To provide the pilot with acceptable sensory characteristics, artificial force gradients had been added to the stick and rudder pedals. A breakout force of 0.5 pounds for the center stick and 0.25 pounds for the rudder pedals prevented inadvertent operation of the attitude thrusters. A side stick was added later for use in evaluations as well as to allow the LLRVs to more closely resemble the controller configuration in the LM.⁴

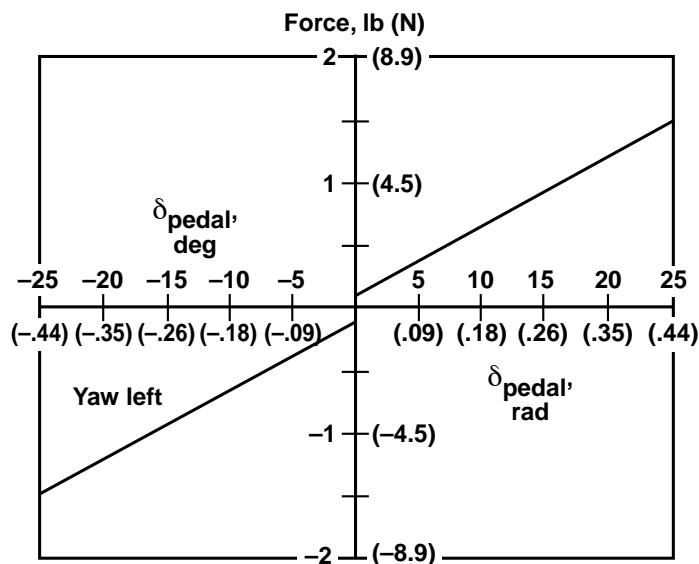
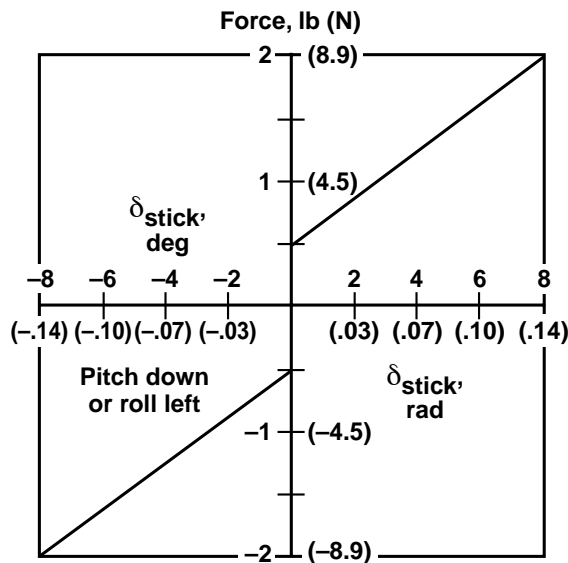

The LLRV center-stick and yaw pedal force gradients.

The pilot could adjust controller sensitivity during flight, using the individual pitch, roll, and yaw pilot sensitivity gain potentiometers on the left console. The rocket-firing threshold, or deadband setting, also could be adjusted using a threshold adjustment gain potentiometer. The ability to vary this threshold setting was important, since the rate of propellant use was a significant function of threshold value as well as of the pilot's ability to accurately control vehicle attitudes. The power-amplifier assembly housed the driver circuitry gating the open-closed solenoid valves. In the open position, the valves allowed helium-pressurized hydrogen peroxide to flow through the catalyst beds and fire the attitude thrusters.

One of the four rocket clusters of hydrogen-peroxide attitude thrusters. NASA first used this form of reaction control engine in the nose and wings of the X-15. (EC-93-1221-4)

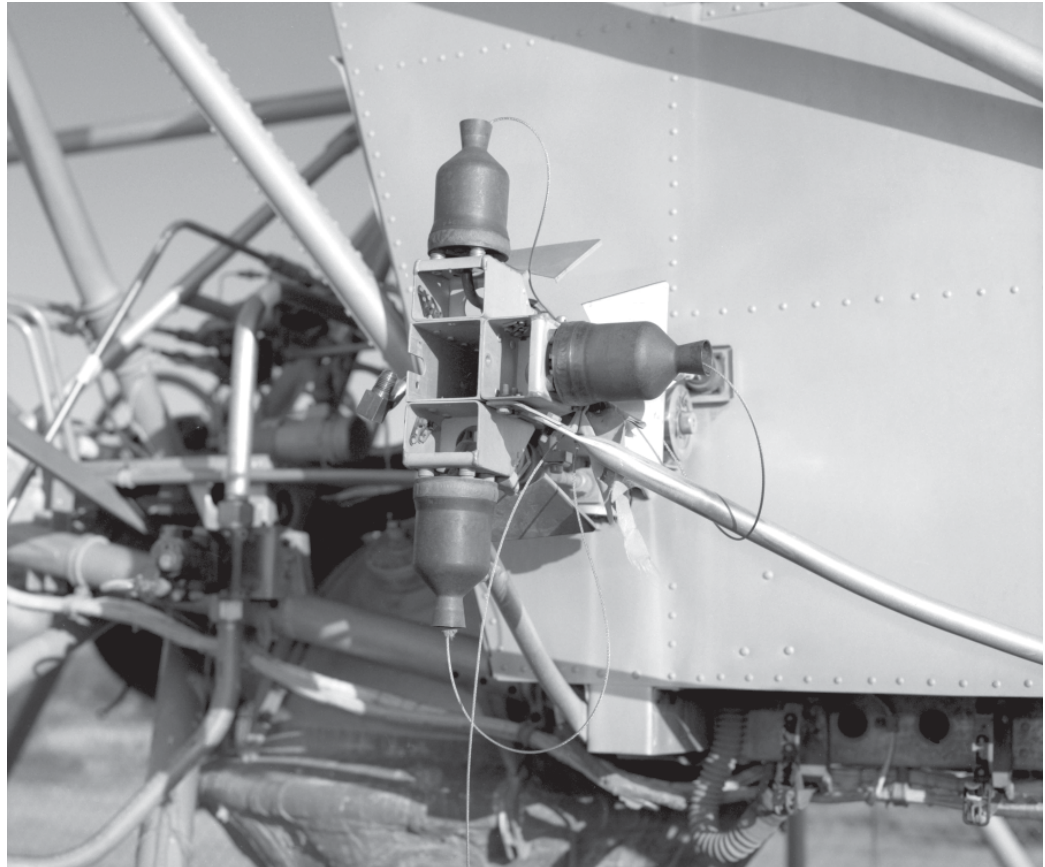

Parameters for the vehicle angular rate feedback came from the rate gyro assembly mounted between the LLRV's two rear legs where these joined the structural truss assembly. Because this area of the structure was reasonably rigid and experienced minimal levels of low-frequency vibration, it allowed low-pass filtering of the rate-gyro output signals, eliminating excitation of structural resonance from the attitude rockets. Rate gyros mounted in a three-axis triad arrangement would detect angular rates in pitch, roll, and yaw. The level of rate feedback could be adjusted through potentiometers for rate gyro gain located in the rear equipment rack.

Also housed on the rear equipment platform—and as close to the truss structure as possible for the sake of rigidity—was a pair of gyros, one for pitch and roll, and another for yaw or heading. These provided feedback on the vehicle's attitude. Both of these gyros used synchro output devices, allowing the units to be slewed from their null positions for testing during preflight or other checkout procedures on the ground. The pilot would use a nulling synchro, located on the left console, to reduce the directional gyro output to zero after gyro erection, regardless of the vehicle's heading angle. Displacement of the vehicle in yaw from this initial position would result in a yaw angle referenced to the initial vehicle heading.

Primary Attitude-Control System

The primary attitude-control system was operable in three modes: acceleration, rate, and attitude command. The mode of operation itself was determined by the comparison of parameter feedback with the pilot's input signal. No provision was made to allow the pilot to select one command mode over another. Modes were determined instead by adjustments of the rate and attitude feedback gain potentiometers located—together with potentiometers for threshold and hysteresis adjustment—on the rear equipment platform. The pilot could adjust stick and pedal sensitivity, but not threshold, hysteresis, or feedback gains that were made on the ground before each flight. Nor were there any status or warning lights indicating which command mode had been established by those pre-flight adjustments to the potentiometers.

Setting the rate and attitude feedback gain potentiometers to zero would select acceleration command mode. The system would then operate in an open-loop manner, the pilot using the center stick and rudder pedals to control the on-off thrust of the various attitude rockets. No system damping existed in this mode, and to stop angular accelerations, the pilot had to apply opposite input commands. In terms of fuel con-



Two clusters of four rockets, designed to arrest the vehicle's descent, were attached to the LLRV's gimbal frame. These were later eliminated after tests determined they were unnecessary.

sumption, the acceleration command mode was—at least in theory—the most efficient. However, it also required a great deal of work by a highly skilled pilot with a knack for on-the-spot learning in order to be effective and accurate in a six-degree-of-freedom environment.

Increasing the rate gyro gain potentiometer above zero while maintaining zero attitude feedback would result in selection of the rate command mode. In this mode, the vehicle's angular rates, measured by the frame-mounted rate gyros, were proportional to the deflection of the pilot's center stick and rudder pedals. Sensitivity and threshold settings determined the deadband through which the pilot had to move the controller before a firing signal would be sent to the attitude rocket. The vehicle angular rate continued until the pilot returned the controller to the neutral position.

Angular acceleration and the time required to reach the commanded rate depended on thrust levels set for the attitude rockets during preflight. Rate feedback and threshold

settings also determined how much the actual vehicle rate could deviate from the commanded rate before an attitude rocket fired to correct it. Rate-gyro and hysteresis settings determined how closely the actual rate had to match the commanded rate before the attitude rocket would be shut off. The angular rate motion stopped when the pilot returned the controller to the neutral position. The vehicle would assume an attitude that corresponded to the commanded rate, the length of time for maintaining that rate, and the direction of the controller's deflection.

In the attitude command mode, information about vehicle attitude was fed back from the vertical gyros and compared with the rate gyro's feedback signals and the deflections of the pilot's control stick and rudder pedals. In this mode, vehicle-attitude angles were directly proportional to the amount of deflection of the two controllers, the pilot's center stick, and rudder pedals. For a given amount of controller deflection, control sensitivity and the attitude gyro's gain settings would determine the commanded vehicle attitude. Response time for attaining a new attitude depended on the levels of attitude-rocket thrust, settings for threshold and hysteresis, and rate-gyro gain values. These settings also determined how much the actual vehicle attitude could deviate from the commanded attitude before an attitude rocket would be fired for correction. The pilot would return the controller to neutral position to initiate the commands to return the vehicle to a zero-attitude angle.

Backup Attitude-Control System

The backup flight-control system would engage automatically only when the primary system malfunctioned. The single-string system did not incorporate failure detection, and there was no provision for automatic return to the primary system if the backup system malfunctioned. The pilot could manually select the backup system during flight for evaluation or when an anomaly in the primary system did not trigger an automatic switch to the backup system. The pilot could select pitch, roll, or yaw backup control channels independently, using switches on the left console. The pilot could also reselect the primary system during flight, provided the failure causing the transfer to backup had been corrected.

Primarily to keep it as simple and reliable as possible, the backup system operated only in the rate command mode for pitch and roll control, and only in the acceleration command mode for yaw control. All elements of the backup system were completely independent of the primary system. Separate synchro transmitters on the center stick provided pitch and roll control, while microswitches on the rudder pedals provided on-off rocket control in yaw. The design included separate potentiometers for center-stick sensitivity and for threshold and hysteresis levels. Redundant rate gyros were used, as well, for pitch and roll, along with separate feedback gain potentiometers. All backup system potentiometers were contained in the potentiometer assembly in the rear electronics rack, and were accessible only from the ground.

The overall system had been designed so that no single failure would result in loss of the LLRV. Failure detection was designed to be as automatic as was practical; nevertheless, assessing certain failure modes and reconfiguring system elements required the pilot's intervention. In these cases, the vehicle's operational envelope, in terms of translational and angular velocities, would allow the pilot sufficient response time—at least in theory.

Failure Detection

The anomaly detection monitor operated in parallel with the primary control system in detecting inconsistencies between firing signals generated by the two systems' electronics. The monitor's electronic circuitry was identical to that of the primary system, including the switching amplifiers. A comparator circuit monitored the outputs of both systems' switching amplifiers. If a discrepancy longer than 150 milliseconds

existed between them, the system automatically switched to backup mode. Input and output signals of the primary system's power amplifiers also were compared and the backup system engaged if the same discrepancy occurred. Failures in the pitch-and-roll or yaw channels were detected separately. In such an event only the failed control axes transferred to backup mode, leaving the still fully functioning axes in the primary control mode. An indicator light on the front cockpit instrument panel notified the pilot whenever the automatic switch to backup occurred during flight, but the pilot was not told which control axes had actually transferred to backup. This he had to determine from changes in response around the vehicle's control axes.

Engineers developed a scheme for detecting excess use of roll-control authority in response to unbalanced conditions. Early simulation studies indicated that several events might occur within the vehicle's normal operational envelope that would result in rolling moments that exceeded the pilot's control authority. These included translational rates during lunar simulation at low-attitude thruster settings, asymmetric use of lift-rocket propellant from the storage tanks on either side of the vehicle, fluid shifts in cg, jet engine cg offset, or a stuck attitude-rocket solenoid valve. Since the automatic flight-control system would mask such a condition until the pilot's roll-control authority was exceeded, "roll left authority" and "roll right authority" warning lights were installed on the front instrument panel. When illuminated, these lights indicated to the pilot that the vehicle's control capability was being used excessively to counter one or more disturbing moments around the roll axes. The setting was adjustable on the ground. The level of control authority sufficient to illuminate a warning light was computed as the ratio of attitude-rocket "on" time to total averaged "on" time of the craft in that flight.

While the warning lights alerted the pilot to roll authority that was being expended to counter some type of imbalance, it fell to the pilot to determine its cause. For

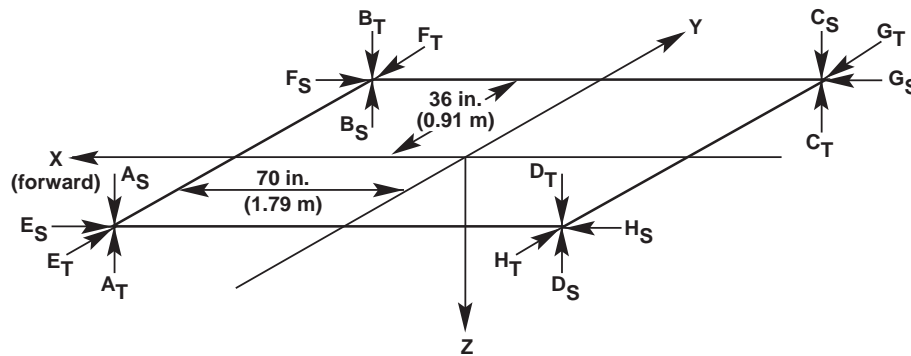

Rockets with subscript S denote standard rockets fire.
 Rockets with subscript T denote test rockets fire.
 For dual-system operation, both standard and test rockets fire.

Rocket	A _S	A _T	B _S	B _T	C _S	C _T	D _S	D _T	E _S	E _T	F _S	F _T	G _S	G _T	H _S	H _T
Pitch Up	✓	✓	✓	✓	✓	✓	✓	✓								
Pitch Down	✓	✓	✓	✓	✓	✓	✓	✓								
Roll Right	✓	✓	✓	✓	✓	✓	✓	✓								
Roll Left	✓	✓	✓	✓	✓	✓	✓	✓								
Yaw Right									✓	✓	✓	✓	✓	✓	✓	✓
Yaw Left									✓	✓	✓	✓	✓	✓	✓	✓
Pitch up and roll right		✓			✓											
Pitch up and roll left			✓				✓									
Pitch down and roll right				✓			✓									
Pitch down and roll left	✓				✓											

LLRV attitude rocket location's moment arms and firing logic.

The range of LLRV controller sensitivities for rate command mode.

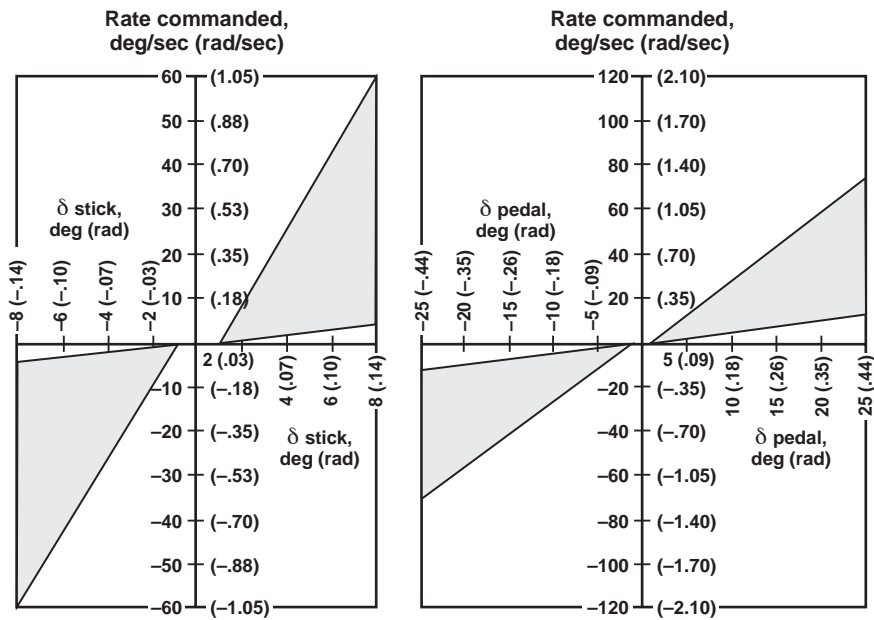

A simplified block diagram of the LLRVs lunar-simulation system.

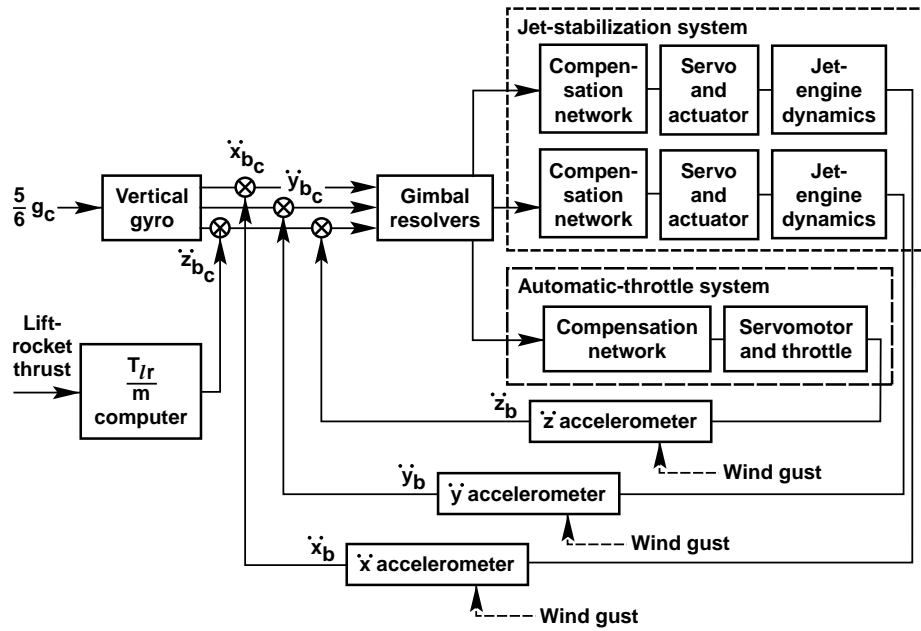

A block diagram of the lunar-gravity automatic throttle system.

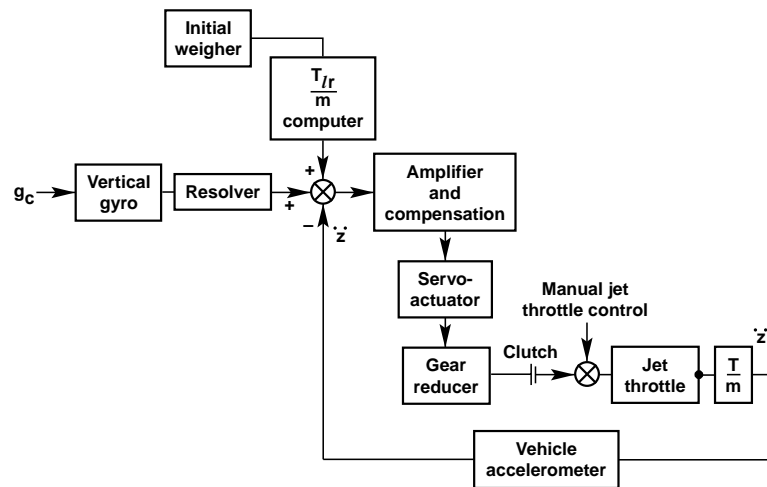

example, if the cause was a stuck rocket valve, the “valve stuck” light also would illuminate, and the pilot would select the set of rockets that did not include the stuck valve. If the loss of roll capability was due to weight imbalance, the pilot would use the roll-trim switch on the lift-rocket throttle handle to counter the disturbing moment. If aerodynamic forces were the culprit, the pilot could either decrease the vehicle’s translational velocities or select both sets of attitude rockets to increase available control authority.

The monitoring circuitry, however, could not detect hardover failures in the position sensors of the pilot’s control stick and rudder pedals or in the motion sensors of the vehicle’s attitude and rate gyros because these were single-string devices. For this reason, the on-board computer monitored the outputs of the primary system’s rate gyros. If a preset maximum level were exceeded during flight, the backup system engaged automatically, overriding the primary system. The rotational rate at which this transition would occur generally was set at around 40 degrees per second, the maximum output of the rate gyros. However, the vehicle did not need to reach this angular rate to trigger failure detection and transition to the backup system. Since the excessive rate circuitry was monitoring the electrical level of the rate gyro, a hardover signal level from the rate gyro would cause transition to backup, independent of actual vehicle motion. In the event of an actual hardover failure, the pilot’s usual opposing control inputs also would tend to minimize vehicle upset until transition to the backup system could occur.

While the monitor could detect failures in the electronic circuitry that provided firing signals to the on-off solenoid rocket-control valves, it could not detect a mechanical failure in the solenoid valves themselves. Since the automatic flight-control system would mask a stuck valve from the pilot, designers added a system for detecting a “stuck-open” solenoid valve, using attitude-rocket chamber-pressure transducers as sensing elements. Basically, the system checked for rocket-thrust combinations that would not occur unless a solenoid valve had failed in “on” status. It did this by applying pressure-transducer outputs of appropriate rocket combinations to AND-gate networks. If any of the combinations denoting valve failure occurred, a “stuck-valve” warning light would light up on the pilot’s instrument panel. The pilot then would take corrective action, usually selecting the opposite set of control rockets (standard or test) from the one being used when the failure occurred.

Jet Engine Stabilization System

The unique requirements of the LLRV’s jet engine stabilization system created a tremendous challenge for design engineers, given the state of flight-control technology for piloted vehicles in the early 1960s. At that time, it was difficult for system designers to conceive of putting a pilot at the mercy of electronic engine controls, especially amid the noise, vibration, and temperature extremes associated with the LLRV.

Analog stability augmentation systems providing mechanical reversion had advanced to the point that military applications of these systems were increasingly accepted for flight control in high-performance aircraft. The systems used in the Lockheed F-104 and the McDonnell Douglas F-4, for example, were just beginning to spill over into civil and commercial aircraft, including the Boeing 727 civil transport. These designs, however, could not begin to address the daunting problems of engine and vehicle control in the LLRV given the requirements for VTOL and lunar-simulation. Almost from the start, designers at NASA and Bell Aerosystems concluded that only a fully fly-by-wire system using advanced analog technology could meet the challenges inherent in the LLRV.⁵ Since the vehicle was free-flight in nature, certain approaches used in failure detection and reconfiguration by the attitude-control system could be carried over to the jet engine control system.

The basic configuration called for the engine to be mounted vertically, attached through an inner pitch gimbal and an outer roll gimbal. Free to rotate through 40 degrees

of deflection, the gimbals were positioned by linear hydraulic actuators supplied by an engine-driven, 3,000-psi hydraulic system. These hydraulic actuators were modifications of the steering actuators used in racing boats.⁶ At first, engine bleed air had been considered for stabilizing engine attitude, but this approach proved inadequate in terms of engine power and response.

For conventional VTOL operation, it was necessary for the jet engine to remain vertically aligned during takeoff and climb to an altitude and position above the ground where maneuvers in lunar simulation and landing were to begin. During takeoff and ascent, the jet engine would provide total lifting thrust for the vehicle. But once the pilot reached altitude and engaged the vehicle's lunar-simulation system, the jet engine had to compensate for only five-sixths of the Earth-referenced gravity vector of force in order for the vehicle to provide a realistic simulation of the lunar environment. Aerodynamic drag also acted on the vehicle during lunar-simulation maneuvers, for which the jet engine had to automatically compensate. Established at 0.005g, the design's requirement for maximum drag compensation error translated to 1.4 degrees of attitude at vehicle hover, a translational displacement of eight feet in 10 seconds if the pilot did not compensate for it.⁷ Studies by NASA and Bell suggested this degree of error was the outside limit for successful, valid simulation of lunar landing. Any unplanned departure—a failure or system anomaly—from the lunar simulation profile would require automatic reconfiguration in flight to re-establish a controllable engine mode while also maintaining vehicle stability.

Meeting these overall system requirements took four different engine attitude-control modes of operation: engine-centered, local-vertical, gimbal-locked, and lunar-simulation. In engine-centered mode, the engine would be slaved electronically to the vehicle's body axis (that is, a zero gimbal-angle position). In local-vertical mode, the engine would remain vertically aligned while the vehicle's cockpit and truss structure rotated around the engine through gimbal angle deflections. In gimbal-locked mode, the engine would be locked hydraulically to the vehicle's body axis. In lunar-simulation mode, the engine automatically provided 5/6g compensation in the vertical axis as well as aerodynamic drag compensation in all three Earth-referenced coordinate directions—forward, lateral, and vertical.⁸ Lunar-simulation mode was the heart of LLRV operations, containing the key characteristics for which the vehicle had been designed.

Engine-Centered and Local-Vertical Modes

Engine-centered and local-vertical modes of operation shared the same sensor and transducer components. A conventional vertical gyro from an aircraft autopilot with synchronous output signals provided vehicle-body-axis attitude angles for pitch and roll. Approximately one minute after initial power-up, a conventional gyro erection system would slave the gyro—that is, maintain its orientation—to its local vertical. The vertical gyro was housed in the attitude gyro's package assembly. Rotational potentiometers attached to the gimbal assemblies provided gimbal angle position. These rotational potentiometers were mounted between the pitch and roll gimbals to measure the roll gimbal angle, and between the pitch gimbal angle and the vehicle's truss structure to measure the pitch gimbal angle.

In local-vertical mode, vehicle pitch-and-roll body-axis angles from the vertical gyro were summed with the feedback signals from the gimbal-angle potentiometer; any error signal then commanded the hydraulic gimbal-angle actuators to corresponding angles. In this case the engine remained perpendicular to the Earth's surface while allowing the cockpit and truss assembly to rotate freely in pitch and roll—courtesy of the gimbal system—positioned by the attitude rocket system. When the pilot selected engine-centered mode, the actuation system slaved the engine to the truss structure. Unless the vehicle was on the ground, or the pilot had selected gimbal-locked or lunar-

simulation mode, the engine-centered mode was engaged automatically as the default mode, as there was no engage switch for it.

Microswitches mounted on each landing shock strut actuated the jet engine's local-vertical mode when the LLRV was on the ground, regardless of any configuration of engagement switches—except for the emergency gimbal-locked switch. Doing so prevented a large tip-over moment from occurring, should a hardover engine-attitude command occur during touchdown either from system failure or from large translational velocities.

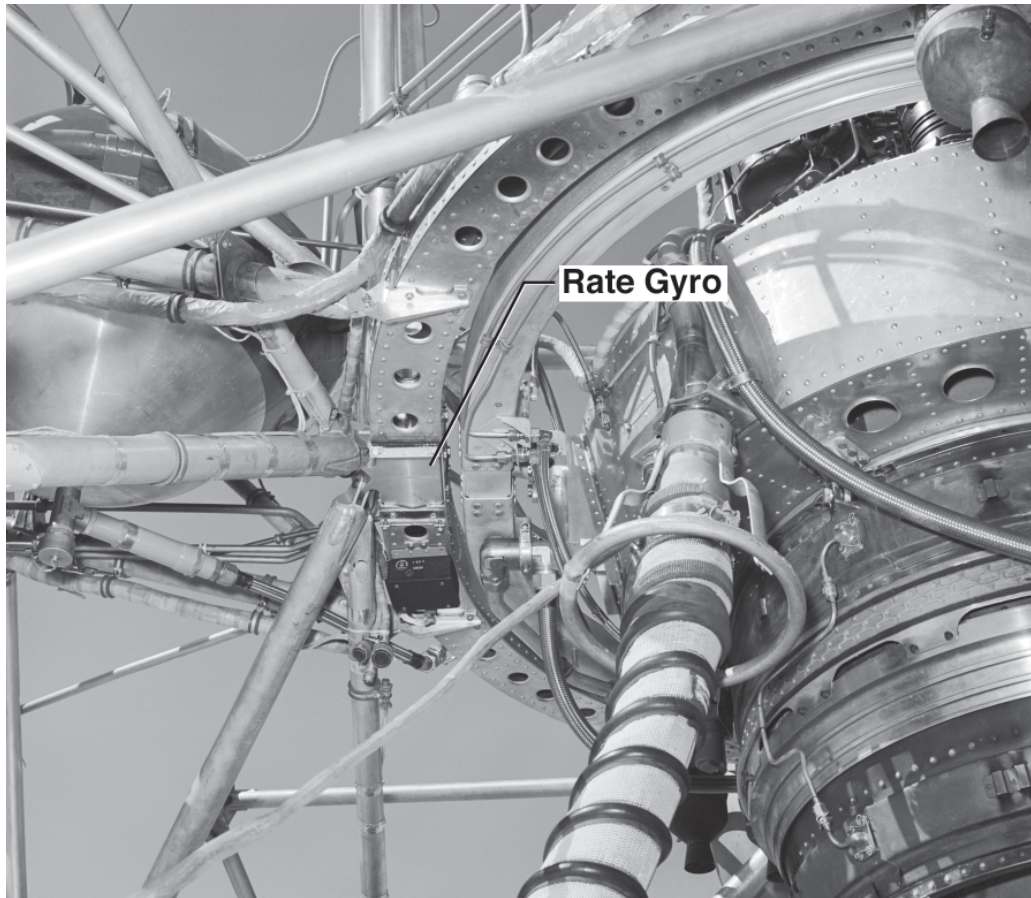

The rate gyro, located on the gimbal frame. (E-14480)

Lunar-Simulation Mode

The LLRV's purpose, of course, was lunar simulation. The basic design approach to the LLRV had been suggested initially by Walter Rusnak, chief of the Bell Aerosystems advanced systems design group.⁹ Preferring to think on his feet, Rusnak often solved complex engineering problems while walking around Bell's hangar facilities. Once aware of the physical laws involved, he was on the trail of a solution. Rusnak led a small LLRV systems design group that included Bascom, Zwink, and John Martin. The group had just completed successful development of the Artificial Feel and Trim System and the Stability Augmentation System for the X-22 VTOL research aircraft built by Bell, paving the way for their work on the LLRV.

The basic requirement of the lunar-simulation system was to reduce the influence of aerodynamic drag forces to a level not noticeable by the pilot while at the same time maintaining the jet engine's vertical thrust at 5/6 of the vehicle's weight. This was done by using the gimbals to vector the engine's thrust and by using the auto-throttle system to vary it.

The input command to the engine-attitude and auto-throttle systems was a constant 5/6g command signal during lunar simulation mode. A vertical gyro was used to

convert this command into coordinates for the vehicle's body axis. This conversion was necessary because the 5/6g command signal had to be compared with the actual vertical acceleration of the vehicle. The gyro output representing the 5/6g command in the vertical axis also was summed with the vehicle's acceleration resulting from lift rocket thrust, which was determined by the vehicle's thrust-to-weight computer.

If a discrepancy occurred between the value of the commanded 5/6g vertical acceleration and the actual acceleration during flight, the jet engine would tilt automatically forward or backward, or to the right or left, changing the engine thrust component's direction. As it did so, drag effects from translational velocities in the fore, aft, or side directions—the primary sources of such summing errors—were reduced automatically to zero. As a result, the vehicle's motion would be the same as if it were operating in a vacuum. The body-axis accelerometers were triad assemblies mounted in pairs opposite each other on the vehicle's truss structure.

Auto-Throttle System

In the lunar-simulation mode, the auto-throttle system automatically controlled jet engine thrust. Control input to the system was the sum of the difference between the vehicle's actual vertical acceleration and the vertical acceleration corresponding to lunar gravity. This error signal drove the jet engine throttle through a rotary servo actuator gear and an electrically activated electromagnetic clutch assembly. The clutch assembly, located between the automatic-throttle actuator and the jet engine throttle, was energized only when the auto-throttle was engaged. In this way, the auto-throttle system automatically positioned the jet throttle to compensate for vertical errors caused by vehicle drag resulting from sink rates or vertical wind gusts. To keep errors in vertical acceleration to within 0.005g, the engine's throttle control had to follow thrust commands that were accurate to within 15 pounds of the desired thrust.

The pilot engaged the auto-throttle system by electrically activating the electromagnetic clutch assembly that mechanically connected the servomotor output to the fuel-control and engine-throttle linkage. If a malfunction occurred in the auto-throttle, the pilot could override the clutch by applying 20 pounds of force to the handle of the manual jet-throttle control.

Limit switches in the throttle linkage ensured that the throttle would not exceed a preset maximum or minimum thrust setting. A maximum-limit switch was located at the 84-degree throttle setting, a minimum one at the 78-degree setting. If a malfunction occurred in the circuitry of the minimum-limit switch—allowing the minimum throttle position to be exceeded—a low-thrust switch activated, disengaging the auto-throttle clutch assembly and alerting the pilot with an annunciator on the instrument panel.

Thrust-to-Weight Computer

During lunar simulation, the thrust-to-weight computer used a motor-driven potentiometer arrangement to compute changes in the vehicle's weight. The biggest difficulty with this approach lay in accurately determining the weight of the vehicle when initiating lunar simulation, as the calculation had to be made during flight and after fuel burnoff had altered the weight considerably. To accomplish this, designers developed an innovative initial-weighing concept. This system summed the output of the vehicle's vertical accelerometer with the output of a nulling integrator, causing the signal at point C to be driven to zero when the lift-rocket throttle was at its bottom position and the micro-switch closed. Point C refers to the difference between commanded and actual vehicle translational acceleration. The pilot activated this micro-switch, which was attached to the lift-rocket handle, when he moved the handle to fire the rockets. Consequently, the signal at point C remained at zero despite the accelerometer output.

This made entry into the lunar-simulation mode possible from any attitude, with

translation in any direction, and with any amount of external drag. When the pilot moved the handle to fire the lift rockets, the micro-switch opened and the signal at C increased from zero due to the vehicle's increased acceleration from the lift-rocket thrust as measured along the vehicle's vertical axis. Therefore, the signal that appeared at C immediately after the micro-switch opened was a measure of the vehicle's accel-

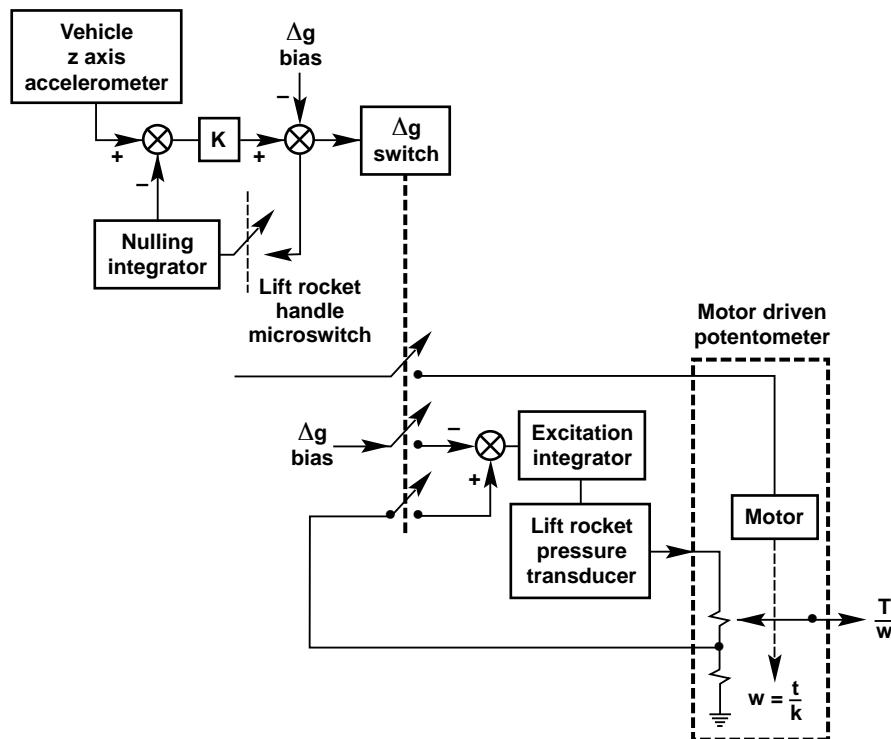

A diagram of the thrust-to-weight computer and initial weight determination system.

eration from lift-rocket thrust at the chosen scale factor.

When the signal at C matched a pre-selected acceleration level, the “delta-g” switch activated automatically. The delta-g value for activation was just high enough to prevent noise from activating the switch. Once the delta-g switch was activated, the weighing circuit played no further role in the simulation. The weighing operation was invisible to the pilot, who played no role in the operation and did not need to be aware it had taken place. The only indicator of weight adjustment the pilot would have was a small reduction of engine RPM as the system went into auto-throttle mode.

Prior to operation of the delta-g switch, the excitation integrator automatically set the signal at point z equal to delta-g at the chosen scale factor. Achieving this setting meant that the integrator had to drive its total input to zero to become stationary. Therefore, point z had to assume a signal equal to but opposite in sign to the delta-g being fed into the integrator through switch contact B. When the delta-g switch engaged, inputs to the excitation integrator were removed, clamping the output at the delta-g value. If no changes occurred in vehicle weight, the computation of acceleration by lift-rocket operation would be precise from that point on.

Yet simulation studies showed that the vehicle weight would drop approximately 17 percent during a two-minute simulation from the expenditure of propellants. Consequently, acceleration change resulting from fuel burnoff was programmed as a function of time by moving the arm of the motor-driven potentiometer, and was initiated by the delta-g switch. The computer continuously determined vehicle weight by calculating that the engine consumed 33 pounds of jet fuel per each minute of operation, while the lift rockets used 300 pounds of hydrogen peroxide per minute. System programming assumed that the lift rockets always gave an acceleration of 1/6 g. Since the jet engine in a lunar simulation supported five-sixths of the vehicle's weight—as long as fuel consump-

tion remained relatively constant—the resulting error was small.¹⁰ Based on Bell’s simulation studies, weight loss from the attitude rockets’ use of hydrogen peroxide was assumed to increase weight loss an additional five percent above that from lift-rocket usage.

Gimbal-Locked Mode

Gimbal-locked mode was primarily for emergencies. In the event of engine-stabilization system malfunction, gimbal-locked mode could either be automatically engaged or manually activated by the pilot. An independent hydraulic valve and pressure source within the gimbal-hydraulic-actuator assemblies aligned the engine with the vehicle’s centerline. Once hydraulically locked to this centerline, the engine required no electronics to remain in this position.

Typical Operation of the LLRV

Typically, a pilot flying the LLRV to the start of a lunar simulation used the engine-centered mode for engine-attitude control, and manual throttle for thrust control. The engage switches for local-vertical, auto-throttle, the jet-stabilization system, and gimbal-lock would be in the off position. The pilot established initial conditions—level flight at an altitude of 1,000 feet and a forward velocity of 70 feet per second at approximately 3,000 feet from a planned touchdown spot. Next, the pilot engaged the switches for the jet-stabilization and auto-throttle systems.

To initiate the lunar-simulation maneuvering, the pilot then moved the lift-rocket throttle handle, activating the lift rockets. The thrust-to-weight computer determined the vehicle’s initial weight, and the jet-stabilization and auto-throttle systems engaged automatically. The auto-throttle decreased jet thrust automatically to 5/6g, while the pilot increased lift-rocket thrust to control descent and initiate the landing trajectory. After translation and descent to the landing point, the pilot used the lift rockets to re-establish a hover then make the descent to touchdown. As the vehicle touched down, its landing struts compressed, activating the micro-switches that placed the engine-attitude system in local-vertical mode. Finally, the pilot manually disengaged the auto-throttle system.

Several pilot-override and emergency features were built into the engine-attitude systems. The local-vertical engage switch, located on the left console, overrode the engine-centered and jet-stabilization (lunar simulation) modes, but not the emergency gimbal-locked mode. When the vehicle was on the ground, the four micro-switches always placed the system in the local-vertical mode. At liftoff, as the landing struts extended and the strut micro-switches deactivated, the engine-centered mode engaged automatically. The jet-stabilization system did not have any override characteristics. To engage the lunar-simulation mode—which could only be fully done during flight—the pilot had to disengage the emergency gimbal lock and keep the local-vertical switch in the off position.

Rotating the engine attitude beyond 15 degrees from vertical was prohibited during any stage of operation because of limitations imposed by the lubrication set-up. And if engine attitude did deviate more than 15 degrees from the local-vertical, the local-vertical mode engaged automatically. Finally, if the local-vertical system did not return the engine to within 15 degrees of verticality in 0.5 seconds, the emergency gimbal-locked mode would be engaged automatically, aligning the engine with the vehicle’s centerline. Once it had been engaged automatically following excessive jet engine attitude displacement, the release button for local-vertical on the left console had to be depressed to re-establish either the engine-centered or the lunar-simulation mode.

The emergency gimbal-lock switch, located on the center stick, had complete override control in all of the jet engine attitude system operational modes. When activated, the emergency gimbal-locked mode took effect immediately, regardless of the position of the other mode control switches; to establish any other mode, the pilot first had to disengage the gimbal lock.

¹ L. Stewart Rolls, Fred J. Drinkwater III, and Robert C. Innis, Effects of Lateral Control Characteristics on Hovering a Jet Lift VTOL Aircraft (Washington, D.C.: NASA TN D-2788, 1965); JetStar Variable Stability Aircraft description.

² Calvin R. Jarvis, Flight-Test Evaluation of an On-Off Rate Command Attitude Control System of a Manned Lunar-Landing Research Vehicle (Washington, D.C.: NASA TN D-3903, April, 1967); Donald R. Bellman and Gene J. Matranga, Design and Operational Characteristics of a Lunar-Landing Research Vehicle (Washington, D.C.: NASA TN D-3023, 1965).

³ Through preflight adjustments of the thrusters and use of both rocket sets, attainable angular acceleration control authorities ranged from 0.086 to 0.86 radians per second (rps), squared, in pitch; from 0.11 to 1.1 rps, squared, in roll; and from 0.036 to 0.54 rps, squared, in yaw. NASA and Bell designers established these adjustable ranges on the basis of a number of VTOL and lunar-landing studies as well as research test results; J. A. Hill, "A Piloted Flight Simulation Study to Define the Handling Qualities Requirements for a Lunar Landing Vehicle," Report No. NA 62H-660, North American Aviation, Inc., 13 September 1962; John F. Garren Jr., James R. Kelly, and John P. Reeder, A Visual Flight Investigation of Hovering and Low-Speed VTOL Control Requirements (Washington, D.C.: NASA TN D-2788, 1965); H.M. Dathe, "Review of Hovering Control Requirements for VTOL Aircraft by a Flight Dynamics Analysis," AGARD Report 472, July 1963; Donald C. Cheatham and Clarke T. Hackler, "Handling Qualities for Pilot Control of Apollo Lunar-Landing Spacecraft," *Journal of Spacecraft and Rockets* 3, no. 5 (May 1966), p. 632-638; and Gene J. Matranga et al., Handling Qualities and Trajectory Requirements for Terminal Lunar Landing, as Determined from Analog Simulation (Washington, D.C.: NASA TN D-1921, 1963). A radian is a unit of plane angular measurement equal to roughly 57.29 degrees or almost one-sixth of a complete circle.

⁴ All controller-position transducers were synchro-transmitter devices for 400 cycles per second of alternating current. They enhanced reliability and resolution due to the inductive nature of their operation, as opposed to potentiometers that require mechanical wiper-arm connections for movable output signals. This feature was important, since the primary system input transducers required highly reliable components, no backups being used due to constraints of space, complexity, and weight

⁵ "Feasibility Study for a Lunar Landing Flight Research Vehicle," Bell Aerosystems Report No. 7161-950001 (8 March 1962), p. 118.

⁶ Working Notes from an Interview of Dean Grimm by Ivan D. Ertel, MSC Historian, 1 April 1971.

⁷ "Lunar Landing Research Vehicle Jet Engine Stabilization System," Bell Aerosystems interoffice memo No. 355:63:0421:JMR (22 April 1963), p. 6.

⁸ Donald R. Bellman and Gene J. Matranga, Design and Operational Characteristics of a Lunar-Landing Research Vehicle (Washington, D.C.: NASA TN D-3023, 1965).

⁹ "LLRV Jet engine Stabilization System," Bell Aerosystems interoffice memo (22 April 1963).

¹⁰ "Thrust/Weight Computer," Bell Aerosystems interoffice memo No. 325:63:0712:1-JR (12 July 1963).



Flight Research

Chapter 5: Preparing for Flight

In the spring of 1964, the first LLRV arrived unceremoniously at the FRC. The LLRV was delivered unassembled, in crates and shipping packages, all in keeping with cost reductions the FRC had negotiated with Bell. FRC employees—well informed about the significant research role the LLRV was set to play in the Apollo program—were understandably bewildered when they wandered out to the calibration hangar to catch a glimpse of the LLRV, for they saw what looked like a giant Erector® set. Even those assigned to the program felt as if a long road stretched ahead before the pieces would be assembled into a finely tuned research vehicle.

Due to Bell's cost overruns, most of the final acceptance and functional testing on the vehicle had been shifted from Bell to the FRC. Bell had done very limited testing—primarily of individual box assemblies and components of the rocket and other systems. Virtually no closed-loop, end-to-end testing had been done. Indeed, most of the final lengths of plumbing for the rocket system had been sent from Bell uncut. Shifting these tasks—including all cleaning and passivation of the hydrogen-peroxide components—from Bell to the FRC reduced the amount of the cost overruns. Much of the savings were later used to fund some remaining tasks at Bell. But to those at Edwards it

LLRV No. 1 is uncrated at the Flight Research Center. The vehicle's legs were not attached, and much work remained before it would be ready for flight. Examining the machine for the first time are Gene Matranga (left) and O. D. Cook. (E-11189)

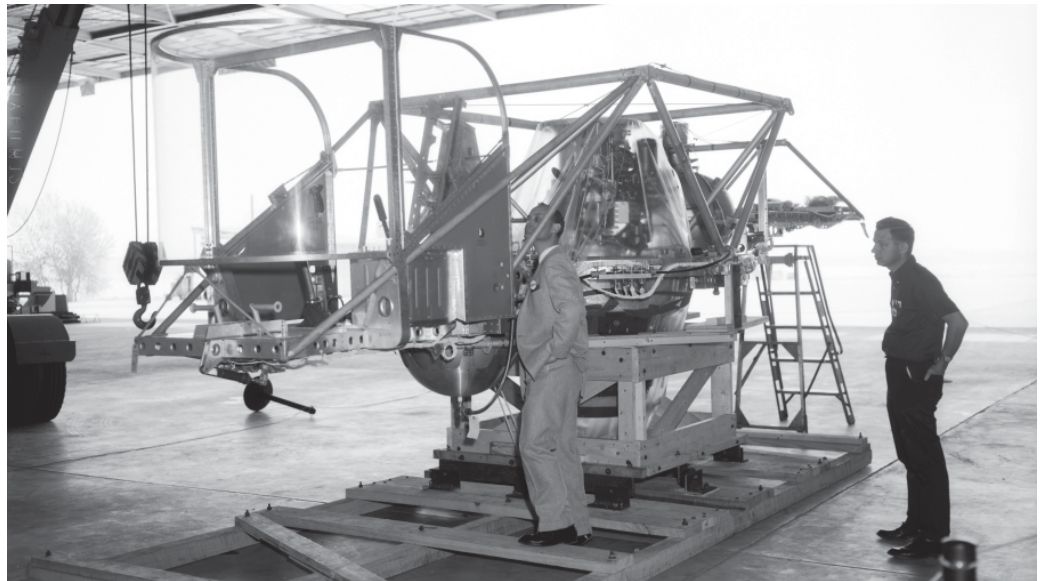

Unpacked from its crate on arrival at the FRC, the LLRV awaits assembly. The vehicle was shipped this way from the Bell plant as part of an agreement between Bell and NASA to arrest escalating costs; under the terms of the agreement, NASA would complete the final assembly. (E-11193)

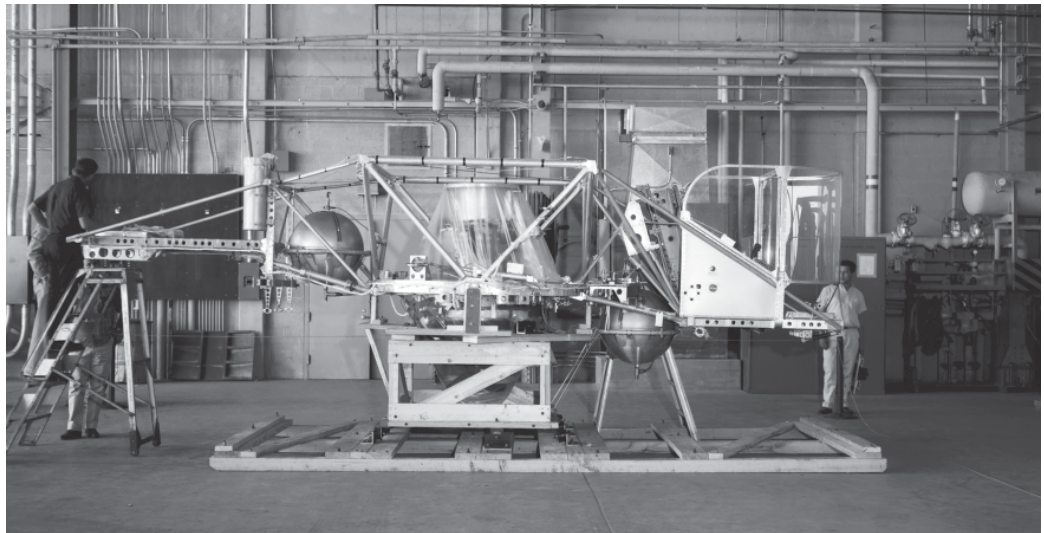

remained to be seen if this assembly of tubular structure, rocket and jet propulsion systems, and complex electronics would end up doing what it had been designed to do.

Installing and Testing Flight Controls

In March 1964, a team of four men at the FRC was assigned the critical task of installing and testing the flight controls. Led by systems engineer Cal Jarvis, the team included electronic and electrical technicians Ray Kellogg and Al Pendergraff, as well as Leon Zwink from Bell's LLRV design group.

Jarvis had been at the FRC since 1961, and worked as a research engineer on the primary and backup control systems of the X-15. Kellogg came to the FRC from the Air Force in 1960, bringing extensive training in avionics systems, and provided maintenance and operational support of flight controls for the X-15. Pendergraff, who gained technical experience with avionics while in the Army, also worked at the FRC in electrical support of the X-15 before being assigned to the LLRV. The experience these three team members had with the X-15 proved invaluable on the LLRV, especially in addressing problems caused by structural vibrations. Kellogg and Pendergraff had worked together at Convair Aircraft Company, solving problems with the flight-control systems of the F-102 and F-106 aircraft. FRC pilots soon dubbed them the "gold-dust twins" for their ability to work efficiently and quickly as a team in resolving routine problems with the LLRV flight controls during ground and flight tests.

At Bell, Leon Zwink had been part of Walt Rusnak's LLRV team that designed and developed the vehicle's avionics and flight control system. The FRC contracted with Bell to provide an on-site systems designer during the early phase of the flight test program to help with modifications. In May 1964, Zwink relocated to the Antelope Valley to work at the FRC. Zwink's earlier field-test experience with automatic landing systems for jet aircraft on Navy carriers turned out to be good preparation for his on-site LLRV work.

The Mojave's stark desert environment came as a shock to Zwink, a native of Buffalo accustomed to an abundance of trees and green grass. But he adjusted quickly, even to the regular pre-dawn flight test operations. He provided on-the-spot circuitry redesign and helped with other modifications. Having Zwink on site saved time by eliminating lengthy delays that would have been inevitable had it been necessary to ship the electronic assemblies to New York for changes.

It was not unusual for component changes to be made on the vehicle during testing, correcting operational discrepancies and fine-tuning overall system performance. While the vehicle was on the flight line, electronic box assemblies would be pulled out so components could be removed and resoldered on the spot, something which frustrated inspection personnel no end because of this seemingly haphazard approach. Fortunately, a procedure was soon worked out that provided proper inspection and quality control.

Of course, this way of doing things—though efficient and time saving—would be impossible in today's environment of extensive paperwork trails and highly structured quality-control procedures. Nor could it have happened then without a high level of cooperation among engineers, technicians, inspectors, and other personnel. These kinds of operational efficiencies were due in large part to the foresight of Bikle, who, along with other managers, established the LLRV as an independent project within the FRC.

The test team worked well together, blending Jarvis', Kellogg's, and Pendergraff's extensive test experience on the X-15 and other advanced flight-research vehicles with Zwink's design talent and skill as a "finisher"—the one who makes a design actually work. Together, they identified problems quickly, promptly devising and implementing changes; it was a method that proved extremely important under the program's cost and schedule constraints. As assembly of the vehicle began, final qualification tests of the electronic box assemblies took place at the FRC. A joint team of NASA and Bell

It was agreed that NASA would fabricate the pilot's instrument panel as part of the cost-saving effort. The pedestal originally was installed in the center of the cockpit, but would later be moved to the right side. The rudder pedals and yellow-and-black-striped ejection seat handle are visible. (E-12831)

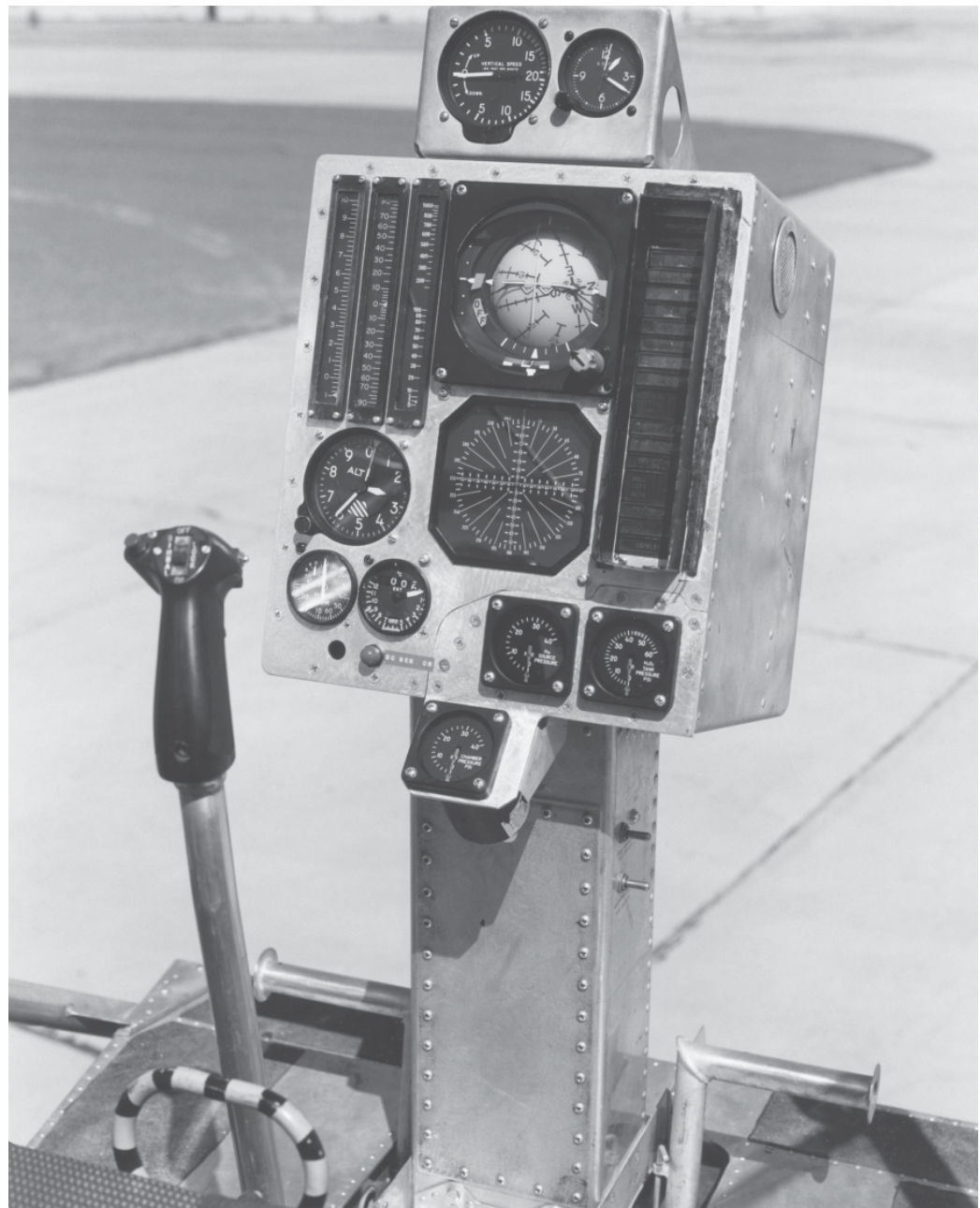

engineers and technicians conducted vibration tests to identify weak points in boxes and circuit boards. The boxes were reworked and stiffened.

Once mechanical assembly of the vehicle had progressed sufficiently, the flight-control team began the arduous task of installing electrical wiring. Although Bell had supplied wiring diagrams, these were used mainly to establish starting points since so many workarounds and modifications were required. In spite of the changes to the wiring paths, Kellogg, Pendergraff, and electrician Glen Angle completed the initial wiring of the LLRV in record time.

Enough assembly work had been completed within two weeks to enable the attitude-control system to be installed in the vehicle and powered up for the first time. For this momentous occasion, program managers Don Bellman and Gene Matranga, flight-operations engineer Wayne Ottinger, and other FRC managers were on hand to witness the first energizing of a major system. No sooner did the system come up than a problem surfaced. The vehicle's lightweight construction caused structural vibrations strong enough to be detected by the highly sensitive rate gyros of the rate-command

attitude-control system, which in turn caused the attitude-rocket solenoid valves to cycle on and off rapidly in response to the vibrations. Once excited, and with virtually no input to the control system, the solenoid valves simply cycled on and off with the structural vibration frequency. So severe was the structural motion that the instability became self-sustaining. Had the system been pressurized with the hydrogen-peroxide propellant, all attitude rockets would have been firing with no input from the pilot, rendering the system virtually ineffective. The first concern was how extensive the modifications would need to be in order to fix the problem, and how long this would take.

A similar problem had cropped up on the X-15 during early flight tests, when the flight-control system's sensitive rate gyros had detected a structural vibration in the plane's horizontal tail structure.¹ Resolving this problem led to a costly design modification of the flight-control system that affected the expansion of the X-15's flight envelope. But experience gleaned from the X-15 came to bear on the LLRV, minimizing the impact of modifications on both costs and schedule. Since team members knew the nature of the problem and the steps needed to alleviate it, they found it relatively straightforward to modify the LLRV flight controls so as to desensitize the system to the high-frequency vibrations while not detracting from the system's ability to control the LLRV during flight.

Immediately recognizing that the problem was of the same sort that had plagued the X-15, the team looked for methods that would isolate the vehicle's rate gyros from structural vibrations normally experienced during ground tests and in flight. Jarvis devised a simple method for simulating the firing of an attitude rocket by hanging a 90-pound weight from one of the attitude rocket cluster assemblies. Cutting the suspending wire caused an instantaneous 90-pound upward force to be applied to the vehicle's structure.

Jarvis' test revealed that the rate gyros were sensitive to a 20-cycle-per-second (cps) vibration, which occurred when the attitude rockets fired, and to vibrations of 4 and 8 cps from the platform assembly where the rate gyros were mounted. The ultralightweight construction of the LLRV's framework and gimbals was the obvious culprit. The lightness made the LLRV very "loose" structurally, a quality incompatible with the sensitive automatic flight-control system needed to control the normally unstable vehicle in flight.²

The fly-by-wire configuration of the LLRV's flight controls proved to be a tremendous advantage over the conventional mechanical augmentation systems used in the X-15, for this system could be modified in the field during testing; the X-15's could not. In the case of the X-15, the control system had to be shipped back to North American Aviation for modification, then reinstalled and re-tested in the field. And if the fix didn't work, the process had to be repeated until it did. While the X-15's control problems had taken months to correct, the LLRV's took only a matter of days.

Team members quickly examined the vehicle to see if there was a better location for the rate-gyro package that would reduce its susceptibility to vibrations. Bellman and Ottinger concluded that the stiffest area on the vehicle was probably the area where the rear leg assemblies joined the structural truss assembly. That spot, they reasoned, might be relatively immune to these vibrations. Mechanics made lightweight braces for the platform and rocket-cluster assemblies, further stiffening the structure. After working through the evening hours on the first day of testing, the team was able to resume operations the next day with the gyros mounted in the new location. Extending the workday into the evening was typical at the FRC then; managers, engineers, technicians, mechanics, and other employees worked together as a team to keep a project moving along with little regard for conventional work hours.

Additional testing after these modifications were installed showed that while the system was immune to the lower-frequency structural vibrations, it still was susceptible

to the 20-cps vibrations associated with the structural assemblies of the attitude-rocket clusters. So the team tried putting experimental electronic filters on the vehicle to desensitize the system to the 20-cps resonance. A simple filter with a breakpoint around 3 cps worked nicely, it turned out. The filter made the rate gyros unresponsive to vibrations above 3 to 4 cps while at the same time allowing the devices to respond sufficiently to vehicle motions for adequate control by the pilot. Within a matter of hours, the team had added a simple low-frequency bandpass filter to the fly-by-wire circuitry and evaluated it. The team then retested the entire system, finding it virtually immune to any vehicle structural modes or vibrations.

In less than a week, the team had remedied a major problem with the flight-control system on the LLRV. Not only had the team members' prior experience with the X-15 helped, so had the flexibility of the LLRV's analog fly-by-wire flight controls, which allowed modifications and design changes of this sort. Testing had just begun, but already the design approach of fly-by-wire systems was beginning to pay off.

Jet Engine Stabilization System

With the attitude flight-control system operational, the attention of the team turned to the jet engine stabilization system. Once the engine was attached to the vehicle's

The General Electric CF700 turbofan was unusual in having an aft-mounted fan section. The special -ZV variant of this engine, used in the LLRV/LLTV, was optimized for vertical installation. (E-12611)

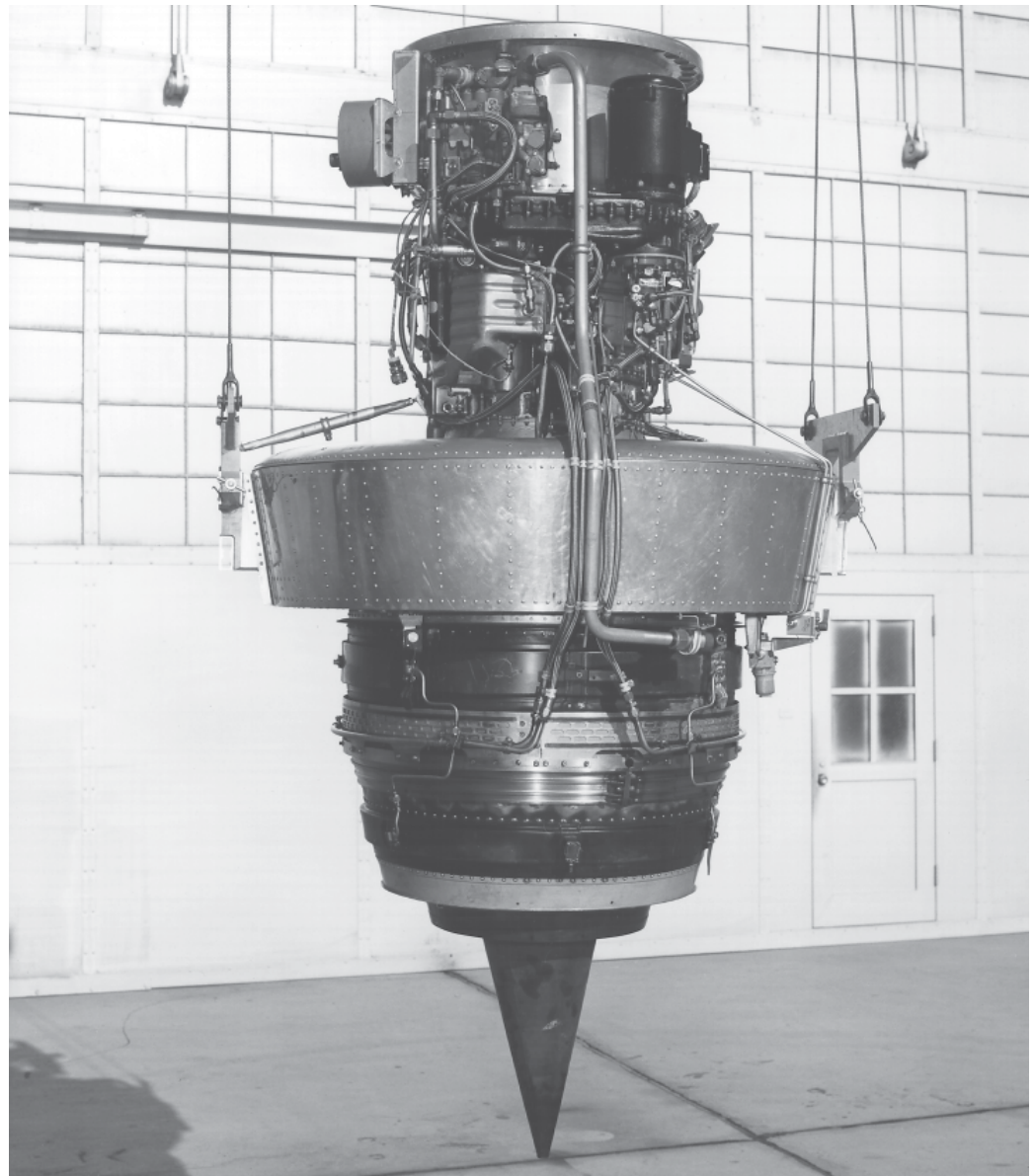

gimbal ring assembly, the hydraulic actuators used for gimbal positioning were installed and mated with the hydraulic system. Since the hydraulic pump was engine-driven, a ground cart supplied the vehicle with hydraulic pressure during engine-off ground tests.

When the system was initially powered up it was in gimbal-locked mode. Bypassing all of the electronics, this mode locked the jet engine hydraulically to the centerline of the vehicle. Because it was the simplest mode of operation, it was also the one most likely to function properly from the start. And, indeed, it did.

The engine-centered mode of operation was automatically engaged simply by disengaging gimbal-locked mode. In engine-centered mode, the engine was aligned electronically—rather than hydraulically—with the vehicle’s vertical centerline. Since engine-centered mode would be the normal mode of initial operation during flight, before the vehicle went into lunar-simulation mode, it was a critical system for engine-attitude control.

When first engaged in engine-centered mode, the engine began a rapid up-and-down oscillation at a frequency of 6.7 cps with a constant amplitude of about two inches, resembling a pogo stick with its extremely rapid vertical motion.³ The earlier modifications of the attitude-control system, it seemed, had not completely eliminated the problems with structural vibration and many of those watching the first engagement of the system found the sight disconcerting.

A quick survey of the engine gimbal system showed that both pitch and roll gimbal structures had natural frequencies on the order of 3 cps. Further, the entire gimbal assembly was vibrating vertically at a frequency of 6.7 cps in a highly undamped manner. This vibration, in effect, was causing the structure to act like a 6.7-cps tuning fork, vibrating in frequency whenever it was excited by structural input. This was the problem that had caused destabilization when operating in the engine-centered mode.⁴

Jarvis’ test team found that the structural oscillation was coupling with the system’s electronics through the complex arrangement of mechanical links that Bell had designed for attaching the gimbal-angle position transducers to the gimbal structure. The assembly exhibited a high degree of hysteresis and free play, preventing the gimbal-angle positions from being properly transmitted to the engine attitude-control system. Without this information, the system could not adequately stabilize the oscillatory motions.

And so Jarvis asked Ottinger and his team of mechanics and structural designers to stiffen the gimbal structural assembly to eliminate the oscillations reaching the jet engine stabilization system. They found it necessary to stiffen the main box beam outside of the gimbal system to provide the additional structural stiffness, and Charlie Linn, from the FRC machine shop, set about fabricating a thin-walled aluminum cap to fit over the existing box beam.

Meanwhile, Jarvis’ test team decided that instead of measuring gimbal position directly, they would measure the linear actuator position, using it to indicate gimbal-angle position. After all, gimbal-angle positions were directly proportional to the movement of the linear hydraulic actuators controlling them. They could then design a more rigid connection between the position transducers and the gimbal assemblies, entirely eliminating Bell’s complex mechanical links. After they had redesigned and modified the mechanisms, they retested the system to verify the elimination of unwanted oscillations. The LLRV’s overall response proved satisfactory.⁵

To ensure that the modifications had not compromised the structural integrity of the gimbal assembly, the test team reapplied test loads to the structural frame.⁶ At the Bell plant, an upward load of 2,000 pounds had been applied. The new test applied a load of 4,000 pounds. Bell tested a horizontal load of 2,000 pounds, so the new test at the FRC applied one of 3,000 pounds. These new tests revealed no deformations or failures.

Next, the test team evaluated the local-vertical mode of the engine-attitude system to determine the mode's response and bandwidth characteristics. In effect, this mode connected the pitch-and-roll attitude gyros to the input of the engine-attitude system. The attitude gyros provided the information needed to keep the jet engine aligned with an Earth-referenced vertical axis, which was independent of vehicle attitude motions.

For the tests, the team mounted the attitude gyro package on an external gyro test fixture, allowing the gyros to rotate in pitch and roll in order to verify that the engine tracked properly with the gyro motions. Since the same actuator-drive circuitry used in the engine-centered mode controlled jet engine attitude in the local-vertical mode, modifications correcting structural resonance in one mode also corrected those of the other mode. Subsequent testing revealed no destabilizing gimbal oscillations, and the engine attitude tracked the vertical gyro motions at satisfactory levels of response and accuracy.

Lunar-Simulation System

A difficult and unique problem confronted the test team during the initial integrated testing of the lunar-simulation system.⁷ This system relied on linear accelerometers to feed it information on the vehicle's actual motion. The system then compared this information to the input command set at a value corresponding to five-sixths of the acceleration acting on the vehicle due to Earth's gravity. Then, the jet engine would change its attitude position and thrust to compensate automatically for gravity, so that during lunar-simulation flight, only one-sixth of the Earth's gravity would be acting on the LLRV.

The problem was that the team could not evaluate total system operation on the ground, since they could not rotate the vehicle around its body axis and at the same time make it translate longitudinally and laterally across the Earth's surface. The puzzle was rooted in the feedback accelerometers, which had to be mounted to the vehicle's structural framework to provide the information on the acceleration needed for simulating lunar gravity. Mounted this way, the accelerometers responded to the vehicle's rotation and its horizontal and vertical motions while translating across the Earth's surface, providing the six-degrees-of-freedom information needed to resolve the gravitational force acting on the vehicle during flight. Try as they might, members of the test team could not devise a mounting device for the accelerometers that would allow for all six degrees of motion simultaneously in any controlled and coordinated manner short of actually flying the LLRV.

The team finally settled on use of an analog computer that would simulate flight operation of the LLRV's lunar-simulation system on the ground by computing vehicle acceleration motions based on values of jet engine attitude position and simulated thrust. These computed accelerations were then used as feedback information for comparison with the input command of the lunar-simulation system. The gimbal-angle potentiometers were used to provide information on engine attitude. The jet-throttle-position transducer was used in simulating jet thrust. Although this approach meant that the actual system accelerometers were not used for vehicle-motion feedback in these early tests, they were still left connected to the system to ensure that any existing problem in structural sensitivity would be detected.

When the system was first engaged, a 20-cps instability immediately became apparent, causing the engine to oscillate around both its pitch and roll axes at amplitudes large enough to destroy the engine. The team promptly ended the tests to hunt for the cause of the instability.⁸

By this time a natural suspect was an undetected structural vibration, and indeed, the team found a 20-cps mode associated with the outer gimbal ring to which the accelerometers were attached. Normally, a low-pass filter network added to these accelerometers would have solved the problem. But filtering the accelerometer signals

independently from the command signal required direct current, and the initial design of the lunar-simulation system was such that the command signal and the accelerometer feedback signals were compared before they were converted from AC to DC formats.

At this point, the FRC test team asked Bell to conduct a detailed analysis of system performance, and provide a compensation network and filter that would not unduly affect system performance and accuracy.⁹ Meanwhile, the FRC test team did its own analysis and came up with a compensation network, later verified by Bell's independent analysis, that successfully eliminated the instability while reducing overall bandwidth from 3 cps to 1.5 cps.¹⁰ The test team believed this change was sufficient for at least initial flight test evaluation and determination of system accuracy. Additional changes, if required, could be made during flight evaluation.



Bill Wilson holds a level sensor and anti-slosh feeder, which were located in each hydrogen-peroxide tank. Baffles prevented pressurized helium from entering the thrusters' transfer lines. (E-14558)

Propulsion Systems

While the flight-control systems were being checked out and modifications applied, others installed and integrated the rocket and jet propulsion. Major tasks included locating and mounting the system components, while accommodating the weight and balance constraints and fuel-management considerations. The rockets and jet engine each had two fuel tanks that had to be installed to facilitate even consumption of fuel from each tank. The JP-4 jet fuel for the jet engine came through a standard flow-divider, balancing the tanks well. But the rocket system had 24 rockets spread around the vehicle. Balanced fuel flow to all 24 during rocket operations required identical plumbing and component installations, and the extraordinarily narrow center of gravity permissible at this stage of testing—under low control authority (ranging from a 1/4-

inch sphere “dry” to 1/2-inch sphere “wet”)—dictated very precise fuel management.

Art Gorbaty of Bell worked closely with Ray White in assembling and checking out the LLRV’s rocket systems. Having been with Bell since the 1940s, Gorbaty had years of experience working as a rocket systems designer and project engineer, including on the attitude rockets for the X-15, and had been in charge of Bell’s work in developing the rocket systems for the LLRV. Assisting Gorbaty and White were Jack Russell and Dave Stoddard. By then head of the FRC’s rocket shop, Russell worked first as a mechanic for Bell on the XS-1 experimental rocket aircraft flown by Chuck Yeager and then as crew chief for the Air Force on the XS-1.¹¹ A master mechanic in the FRC’s rocket shop, Stoddard became head of the shop when Russell retired.

All pipes, tubes, clamps, valves, wiring harnesses, and other components had to be installed on the LLRV for proper fit. After this, all parts exposed to hydrogen-peroxide had to be properly cleaned and passivated. While the jet-fuel system was much simpler than the rocket system and not as sensitive, safety was a central concern in the design and operation of the LLRV. For example, hydrogen-peroxide rocket components, JP-4 jet fuel, the ejection seat’s solid rocket, hydraulic lines for the gimbal actuators, not to mention electrical harnesses and connectors, were located just behind the pilot’s seat. This whole area was open, with no fuselage panels to hide potential leaks. The few times when leaks did occur the pilot and ground crew were at risk of exposure to peroxide burns or other hazards. These safety issues were addressed diligently in maintenance and servicing practices as well as during systems checkout. Consequently, no serious injuries occurred during the entire program. According to Donald Mallick, he and Joe Walker soon took the further precaution of adding silk neck scarves to their flight gear “not to look fancy, but to protect our necks from the non-decomposed peroxide droplets that were everywhere around us...from the firing of the attitude rockets.”¹²

Preflight Testing

The fixed-base simulator used for planning flights, training pilots, and developing systems was modified periodically so it would reflect the latest configuration of the vehicle. An early emphasis was placed on developing and practicing recovery procedures using an emergency drogue chute and emergency lift rocket system, in case the jet engine should fail during flight. In these procedures, the pilot allowed the LLRV to

Before the first official flight took place, ground crewmembers performed a lengthy series of vehicle checks. Clad head-to-toe in white protective suits to prevent caustic hydrogen-peroxide burns, technicians fuel the LLRV. At right is the hydrogen-peroxide supply tank monitored by a crewmember, while the helium tanks are charged from a truck bed at far left. (ECN-446)



free-fall before carefully applying emergency lift rocket thrust to land. It became a tedious and challenging training task for pilots because a range of fuel-remaining conditions could accompany the emergency maneuver. These procedures were later eliminated, deemed too demanding for the pilots since it also became clear that, in such an emergency, it would be much safer for the pilot to use the ejection seat than the emergency rocket system.

Concerns about concrete spalling—that is, chipping—and flying chips being sucked into the LLRV’s engine inlet dictated the need for some form of protection. During initial jet engine testing, a four-foot-square steel plate was used as a blast shield. The LLRV’s engine was centered over the metal plate and the plate secured to tie-down bolts by specially designed cables installed in the concrete at each corner of the LLRV. The plate’s performance turned out to be less than desirable due to fluttering in the jet exhaust and concerns about the integrity of the cable system. The solution was a circular plate nearly two feet in diameter that was held by a single bolt sunk into the concrete.

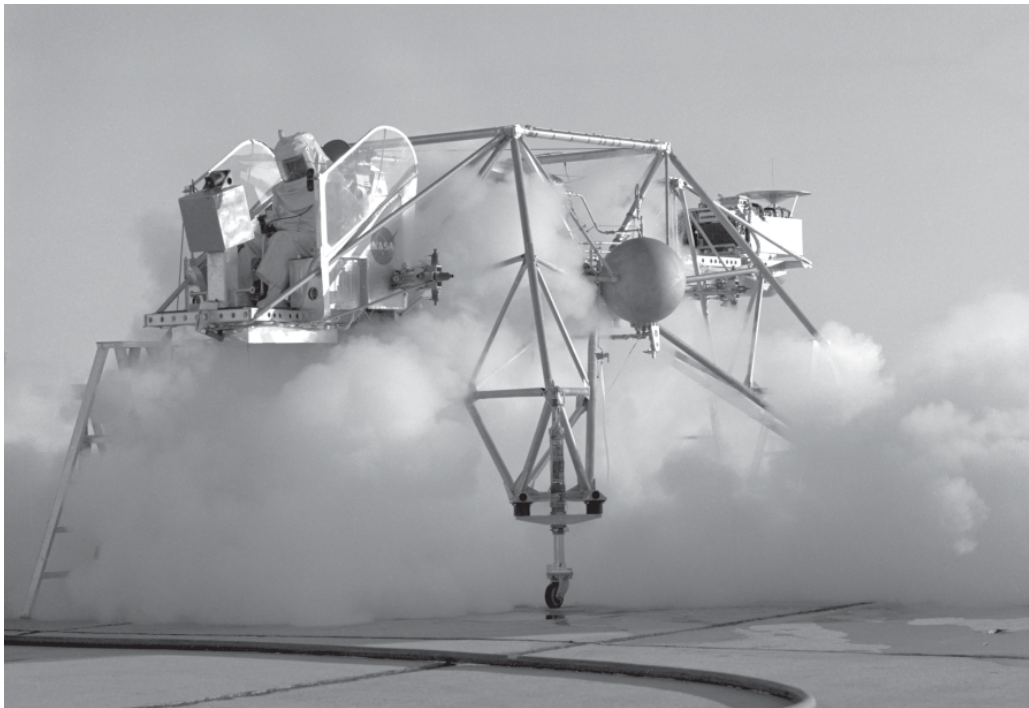

Shrouded in steam, the LLRV fires its lift-engines, located around the jet engine's gimbal ring. The individual in the cockpit, like the ground crew, wears a protective suit against the possibility of being burned by hydrogen-peroxide droplets. (EC-64-447)

The unofficial first flight of the LLRV occurred inadvertently in mid-1964 with Ray White at the controls. The rocket systems’ combined thrust was greater than White expected, lifting the LLRV about a foot off the ground before he could shut down the lift rockets. The lift rocket throttle system was designed to operate the two “normal” 500-pound-thrust lift rockets used for lunar simulation in the first part of the collective stick movement. Further throttle movement added the six emergency lift rockets gradually, bringing the total rocket thrust to about 4,000 pounds maximum. After White’s first flight in the LLRV, a vehicle tie-down system was used during further testing to keep him grounded.

On Friday, 19 June 1964, while these preflight tests were underway, President Lyndon Johnson arrived at Edwards for an official visit that included a review of flight-test aircraft and base facilities. As part of NASA’s involvement in the president’s visit, the LLRV was to be featured on static display. The plan involved mounting the LLRV in a simulated flight position with a combined pitch and roll attitude to demonstrate the gimbal action. To do this, supports of different heights were put under the LLRV’s landing gear struts, allowing the jet engine to stay vertically aligned while the

vehicle tipped as though in action.

Hoping the president would sit in the LLRV's cockpit, FRC Deputy Director De Beeler asked Ottinger to get a nonstandard liquid that could be used in the rocket system. Once pressurized, it would expel smoke from the attitude rockets when President Johnson moved the center control stick and yaw pedals. Considering the damage that could be done to the rockets, Ottinger cautioned against this. Instead, he wired up some red light bulbs in the rocket nozzles so they would light up in response to the control stick and yaw pedals, and the entire scheme worked as planned. But the Secret Service refused to allow President Johnson to sit in the LLRV's ejection seat, despite assurances that there was no risk to his safety.

In the midst of all this, Ottinger made plans for a practical joke on President Johnson during his visit. He arranged for Joe Walker to substitute a lens engraved with "AuH₂O" for the "H₂O₂" warning light (for low hydrogen-peroxide level) on the cockpit warning-light panel, since Walker was scheduled to stand with President Johnson at the cockpit on a platform. The plan was for Walker to make the exchange before President Johnson arrived. The light had been hooked up to a flasher, which then could be activated by a member of the ground crew standing at the electronic cart and who was also controlling the flashing red "engine" lights. "AuH₂O" happened to be a bumper sticker popular at the time with supporters of Barry Goldwater, Johnson's Republican opponent in the 1964 presidential election, "Au" being the chemical symbol for gold, "H₂O" for water.

In 1964 President Lyndon B. Johnson visited Edwards Air Force Base. While there he viewed an array of NASA project aircraft during his tour. Joe Walker (left), then chief test pilot at the FRC, explains the functions and controls of the LLRV, still outfitted with the curved Plexiglas® windscreen that was removed very early in the program. (E-11522)



The day before President Johnson's visit, Ottinger couldn't resist showing Bikle the new lens flashing on the LLRV's instrument panel as it sat in the NASA calibration hangar. Bikle looked at it, then asked, "What in the **** does 'AuH₂O' mean?" When Ottinger explained, Bikle had a good laugh, and went on with his own business. Early the next morning—on the day of the president's visit—Ottinger received a phone call from Deputy Director Beeler, who told him to bring the "AuH₂O" lens to his office immediately. Ottinger said he no longer had the lens; it was in Walker's pocket, and Walker had already left for the flight line. Ultimately, the joke never came off, and

nothing more was heard from anyone about it—a tribute to Walker’s good judgment, not to mention Ottinger’s good fortune in leaving the execution of the prank up to Walker.

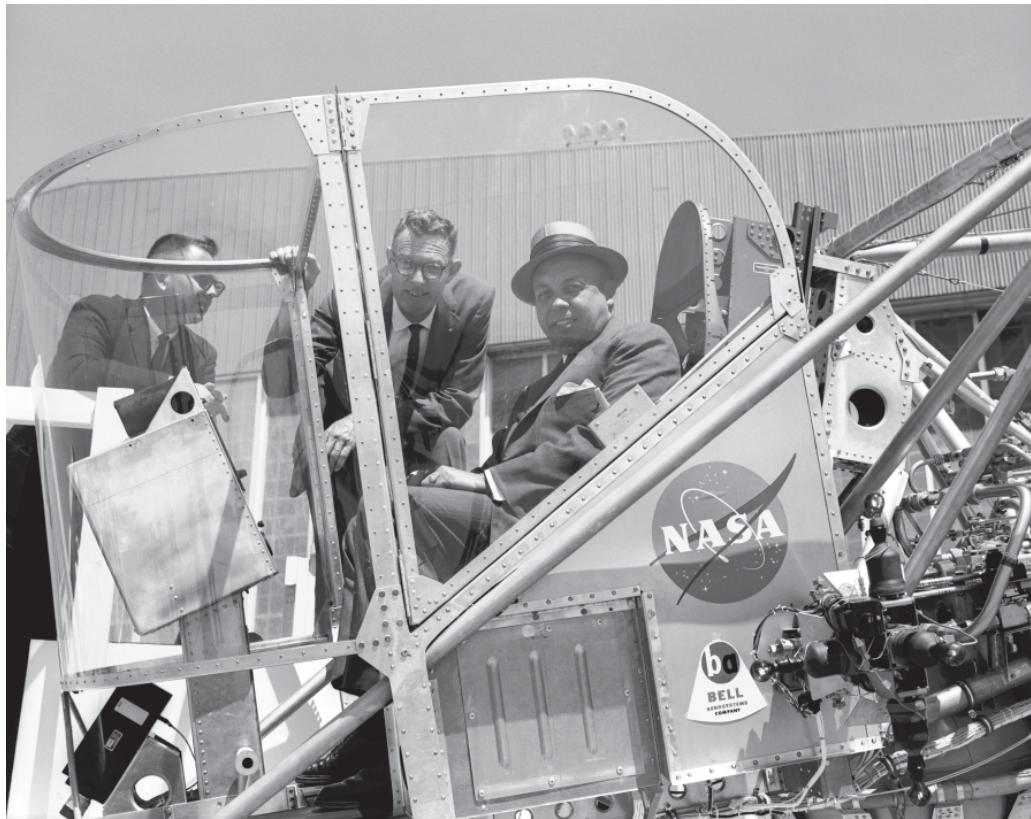

Following Johnson’s viewing, the LLRV was shown to Bill Gisel, president of Bell Aerospace, here seated in the cockpit. Leaning in to explain things is Bell’s technical director, Ken Levin (center), while NASA project engineer Wayne Ottinger looks on. (E-11497)

Closed Loop Fixture Tests

With President Johnson’s visit behind them and no national incident between NASA and the White House in his departure wake, work began in earnest in preparation for all-up testing of the LLRV systems. The FRC approach was to subject any new research aircraft to conditions that were as realistic as possible prior to its first flight. In this way, the Center ensured that every possible step had been taken to flush out latent system or operational anomalies that might otherwise be overlooked. The LLRV was no exception to this rule of operation.

After the LLRV’s functional tests had been completed in the calibration hangar, Bellman, Matranga, Jarvis, Ottinger, and Bell’s John Ryken discussed other tests that might be required to qualify the vehicle for flight. Although all these systems had been evaluated individually, there remained a good deal of concern regarding how they would interact when operating simultaneously, tied to the same vehicle and power-supply systems. Typical VTOL programs used tethered testing for closed-loop tests. Since tethered testing had proven to be extremely dangerous in many cases, the FRC team opted to avoid it in favor of a different approach.

Jarvis believed that the LLRV merited as much closed-loop testing as possible on all major systems. However, such extensive testing would require the construction of a unique test fixture that would allow for vehicle response to attitude-rocket operation and, if possible, independent operation of the jet engine’s attitude-control system. This would be an ambitious undertaking, just short of actually flying the vehicle.

After considerable discussion, Bellman, Matranga, Jarvis, Ottinger, and Ryken came up with a plan for using two special-purpose test fixtures for evaluating the vehicle’s attitude-control systems and jet engine. Ottinger and Ryken brought in Ray Manners from Bell to help with this task since Manners was responsible at both Bell

and the FRC for engineering support of the weight-and-balance fixture. Bell had designed the fixture to be a precision piece of tooling that met very stringent requirements. Ottinger, Ryken, and Manners needed to make sure that using this fixture in hot-rocket-system firings of the attitude-control system would not compromise its precision and purpose. After more study, the team decided to use the weight-and-balance fixture under tightly controlled conditions as a rocket test fixture providing combined pitch-and-roll closed-loop tests.

They renamed the entire contraption the “attitude-control-system test fixture.” Initial tests entailed anchoring the engine ring to the test structure, which allowed the vehicle to pitch and roll around its axes, as in lunar simulation mode. Without the jet engine running but with the attitude rockets operational, pilots could maneuver the LLRV as though in actual flight. This use of the weight-and-balance fixture extended beyond the phase of initial system checkout. It became a successful part of pilot familiarization throughout both the LLRV and the LLTV programs. The team’s second test device, an integrated-systems test fixture, would allow integrated operation of the vehicle’s and the jet engine’s attitude-control systems around a single control axis—either pitch or roll—but not around both simultaneously.

Attitude-Control System Test Fixture

The first full-up test of the vehicle’s control system occurred in the early morning hours of August 1964, with the vehicle attached to the attitude-control system test fixture. For Jarvis and his systems test team, this was a momentous occasion, the equivalent at the FRC of a final dress rehearsal for a new play opening on Broadway. Barring minor adjustments to feedback thresholds, rocket deadbands, and pilot gain settings, they expected no major anomalies. So confident were Jarvis and Zwink that the test would go well that morning that they had made reservations to play golf that afternoon.

Anchored to the Integrated System test fixture, the LLRV’s control rockets are fired in a preflight test sequence. The vehicle’s angle reveals the anticipated motions of the LLRV in flight. Once the hydrogen-peroxide rockets warmed up, the rockets’ exhaust was all but invisible. Water on the concrete is a combination of condensed steam—the result of decomposed hydrogen-peroxide – and water sprayed on the ground to dilute the concentrated hydrogen-peroxide. (E-11942)



It also was important from the pilot's perspective that the test should go well. The test would give the pilot his first real look at the vehicle and its control system. After all, this was a vehicle the pilot later would be taking 1,000 feet or more above the ground before simulating lunar landings. There were lots of things that had to work just right for this to happen, and this test was the first step in that direction. For Joe Walker, the LLRV project pilot, confirming systems integrity prior to first flight was a well-established process he understood after years of experience testing and flying experimental aircraft.

After the vehicle's hydrogen-peroxide propellant had been serviced, including the helium for pressurization, the test team and the pilot reviewed test procedures a final time. Then Walker climbed into the cockpit of the LLRV and spent the next 20 minutes on the checklist, verifying all systems as fully operational. The moment of truth had arrived.

As Walker slowly pulled back on the control stick, initiating the first pilot command to the attitude-control system, nothing happened. He paused, then continued pulling back on the control stick, increasing the command input. And still nothing happened. When he reached the point of 50-percent command with still no attitude-rocket response, Walker returned the stick to center position. Suddenly every pitch-attitude rocket on the vehicle fired with a deafening roar, startling everyone except those who had long since lost much of their hearing from exposure to flight-test. All faces turned to the test team for some logical explanation, but the team had none.

Trying not to fall out of the cockpit from laughing so hard, Walker could only comment over the intercom—in a classic understatement—that the time delay seemed a little long. Jarvis and Zwink, Kellogg and Pendergraff, meanwhile, were glancing around for a place to hide. Several more pilot inputs resulted in the same ear-splitting response, and the team unanimously decided to terminate the test.

After a short debriefing between the pilot and team members, the vehicle was turned over to Jarvis and the rest of the systems test team. By now it was well into the day; the sun beat down on the desert and shadows were lengthening. Jarvis and Zwink's hopes for a game of golf were quickly fading. Going over circuit diagrams as they sat in the control van, and trying to map out a test strategy, Kellogg—who along with Pendergraff had been removing power from the LLRV and running standard shutdown procedures—came in and sat down, a look of embarrassment on his face. Aloud, he wondered if an inadvertent switching of two connectors on the attitude-gyro box could possibly have had anything to do with the problem.

Jarvis and Zwink turned back to the drawings. They noticed that excitation voltage for demodulators converting input command signals from alternating to direct current had been wired through the attitude-gyro box for no apparent reason. This certainly could explain the problem. With no excitation voltage, filter capacitors on the demodulator outputs would charge to high voltage levels while the pilot held the control stick in a deflected position, only to rapidly discharge when the controller was moved to the center position, sending commands to fire to the attitude rockets.

When they examined the two adjacent connectors, they found that Bell's designers had anticipated the possibility of switching them accidentally. To help eliminate this possibility, the designers had used male and female connectors, then keyed them differently. Nevertheless, even with these precautions, it was still possible for the two connectors to have been reversed. Inspection revealed that when they were switched, the pins made no contact in either connector, and the demodulator excitation voltage was not supplied to the attitude-control system.

After the connectors were restored to the correct configuration, a test procedure verified that there had been no damage to the internal circuitry and that the system was, indeed, functioning properly. They decided to color-code the two connectors to prevent future occurrences of the problem. Jarvis and Zwink explained the situation to Ottinger

who, in turn, called Matranga with the good news. Matranga said he would explain what they had found to Walker and reschedule the test for the following morning. Jarvis and Zwink—at long last—left for the golf course.

The next morning the full-up operational tests were completed without a hitch. Walker spent some time getting a feel for the flight controls and the vehicle's response to several control-authority and pilot-gain settings. Jarvis and the test team selected combinations of attitude-rocket thrust levels, pilot gains, and rate-deadband settings as candidates for the first flight. Most important of all, the pilot and all members of the LLRV test team gained confidence in the operational characteristics of the attitude-control system.

The two initial full-up tests of the LLRV's attitude-control system demonstrated one of the anomalies associated with flight-testing of research aircraft: unsuccessful tests often reveal more than successful ones. That is, they often reveal what isn't known about a system and how that unknown can manifest itself in detrimental ways. A successful test, on the other hand, generally confirms what is already known about the vehicle, giving rise to the phrase that there are no unknown-unknowns—or, "unk-unks," as they are referred to in the flight-test community. Only intensive testing can flush out the unk-unks, minimizing in-flight risks. Over the years, this has led to the FRC's test approach of using extensive combined-systems testing on all new research vehicles to flush out things unknown or overlooked. It is always better for these elements to be discovered on the ground rather than during flight.

Integrated-Systems Test Fixture

Once tests with the attitude-control-system test fixture were complete, the team moved to the next level, using the integrated-systems test fixture. Constructed while the earlier full-up tests were underway, it was designed to evaluate combined operations of the vehicle's and jet engine's attitude-control systems, allowing angular motion around either the pitch or the roll axis, one axis at a time. Since the jet engine would be operating in this test along with other systems, the team could check out the integrated operation of the vehicle's hydraulic and electrical power systems. With the hydrogen-peroxide lift rocket system operating simultaneously with all other systems, this level of testing seemed as close as one could get to flying the LLRV while still remaining on the ground.

The LLRV was attached to the test structure through gimbal trunions that connected the engine to the vehicle's framework, allowing simultaneous and independent rotational motion of both the engine and the framework. Designing and fabricating the bracketry and bearings needed to mount the vehicle to the test structure were not simple tasks. Close tolerances were required, and the limited clearance between the gimbal ring and the main frame did not allow for much structural access. For the first test, the vehicle was connected to the integrated-systems test fixture to allow motions around the roll axis. Once again, Walker was in the cockpit. With the engine running the cockpit status lights and indicators, Walker found no system anomalies. With ground power disconnected, the LLRV began operating entirely under its own electrical power for the first time.

Meanwhile, the vehicle's systems were also being monitored from inside the control van. There, operations engineer Wayne Ottinger was working as test conductor. Key system parameters—such as voltage levels, controller positions, rocket-thrust levels, and jet engine performance parameters—were being telemetered to the NASA One telemetry station, where they appeared on various displays and strip-chart recorders. With the jet engine in gimbal-locked mode, Ottinger cleared Walker to begin cycling engine power up and back to verify that the electrical and hydraulic systems were operating properly. Walker then used the attitude rockets to rotate the vehicle around its roll axis. Locked hydraulically to the vehicle's centerline, the engine also

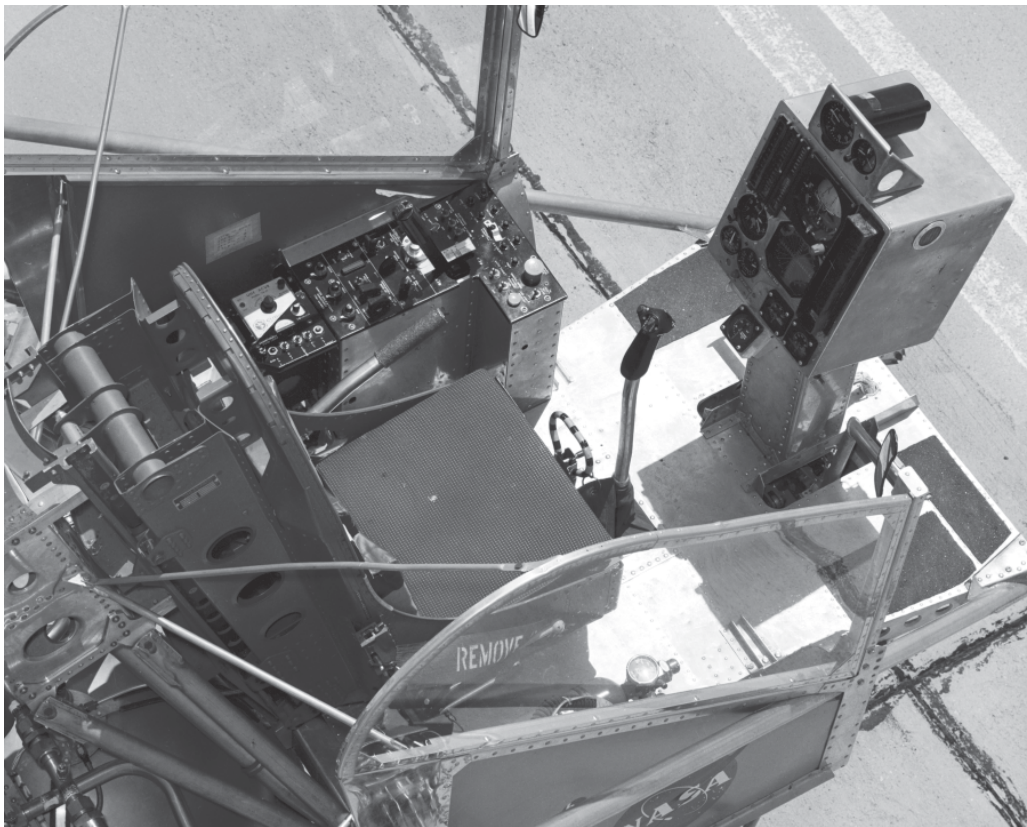

This is the original cockpit configuration of LLRV no. 1. The Plexiglas® side and front panels still are in place. The lightweight Weber ejector seat, center stick, lift-control handle, and rudder pedals are visible, as is the center-mounted instrument pedestal. (E-13115)

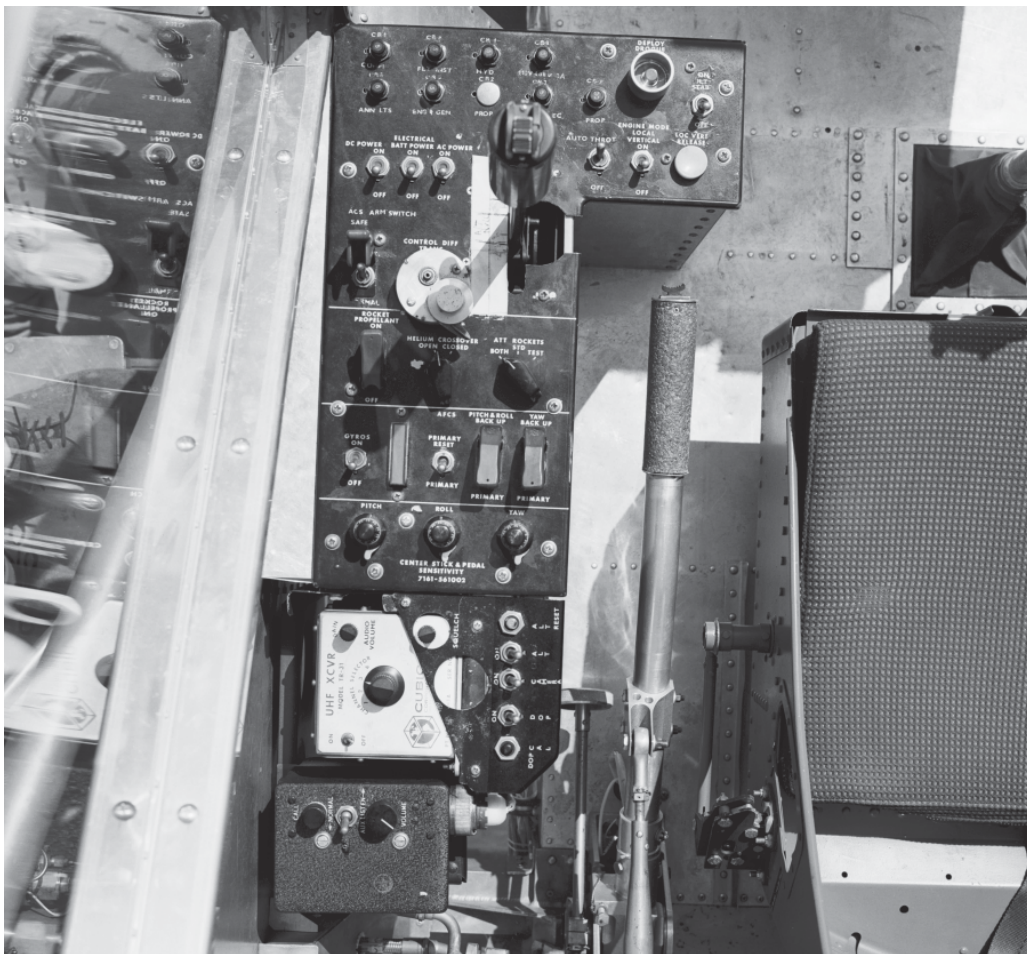

Most of the minor LLRV controls were initially located on the left console. The lift-control handle is visible next to the seat cushion. (E-12828)

rotated around the roll axis synchronously with the vehicle. No anomalies surfaced throughout these tests.

Finally, Ottinger cleared Walker to disengage the engine gimbal-locked mode that automatically activated the engine-centered mode, which he did using the thumb switch on the control stick. The engine-centered mode engaged with no noticeable transient in engine-attitude position. Walker rolled the vehicle clockwise, and the engine tracked with the vehicle just as planned. He carefully kept the roll angles under 15 degrees to keep from activating the engine-attitude limiting circuitry, which would automatically return the engine to a vertical position in less than one second at angles greater than 15 degrees.

Next, Walker manually engaged the engine local-vertical mode. The system made the switch without noticeable transience, and illuminated the status light on the pilot's instrument panel. As Walker rolled the vehicle from left to right, the engine remained perpendicular to the ground and test fixture, as designed. After the roll tests had been completed, the team remounted the vehicle on the test fixture in the pitch-axis configuration. Tests identical to those in the roll sequence were then done for pitch rotations, again without major anomalies.

The team also carried out frequency-response and transient-input tests, documenting the response characteristics of the engine-attitude system and comparing them with analytical predictions. All significant differences between the predicted and documented response characteristics had to be accounted for if the team wanted to avoid any latent performance characteristic surfacing unpredictably later in flight. Satisfied with the results, no further testing was done on the LLRVs or LLTVs with this fixture.

Auto-Throttle Testing

Since integrated testing of the lunar-simulation system was virtually impossible to do on the ground, the FRC had to allow the lunar-simulation system to engage with operational accelerometers for the first time during actual flight. This was a deviation from the normal test approach. And as a result, critical emphasis fell on end-to-end testing of the elements comprising that system.

A key component was the jet auto-throttle system that automatically controlled the engine throttle position and thrust while the vehicle operated in lunar-simulation mode. This system's response would be critical in minimizing errors associated with maintaining simulation of lunar gravity. Bell engineers had designed the system with a bandwidth on the order of seven cycles per second, which their analysis indicated was necessary to meet the requirements for simulating actual lunar gravity to within 0.005g.¹³ But this level of performance would require verification through testing.

The first tests of frequency response revealed a problem with the enclosed cable assembly (known as Teleflex cable) connecting the electromechanical auto-throttle actuator to the engine throttle linkage. Excessive cable friction and unacceptable response to rapid throttle commands resulted from the excessive amount of cable needed to allow large engine rotations around the gimbals without binding. After several attempts to make the cable system work, the test team opted to replace it entirely with a closed hydraulic system. From Charlie Lynn, chief of the FRC machine shop, Ottinger obtained a surplus hydraulic throttle system previously used in a World War II fighter. Technicians fabricated a new, closed hydraulic throttle system from this equipment and installed it on the LLRV—too quickly, as it turned out. Yet tests indicated the bandwidth characteristics were adequate; all that remained was to verify the proper system performance with the engine running.

The test team set up the LLRV for running auto-throttle response tests, using tie-downs to prevent an inadvertent liftoff. A signal generator connected to the auto-throttle input command circuit would be used to vary the frequency and amplitude of the input signal from a remote location. Jarvis would control the auto-throttle input signal while

monitoring actuator position on an instrumentation recorder in the control van. In the cockpit, Bill Wilson, lead mechanic on the LLRV, would operate the engine and monitor its performance. Wayne Ottinger, in the control van with the rest of the test team, would serve as test conductor. Due to the noise of the jet engine, intercom headsets were used for communication between test participants inside and outside the van.

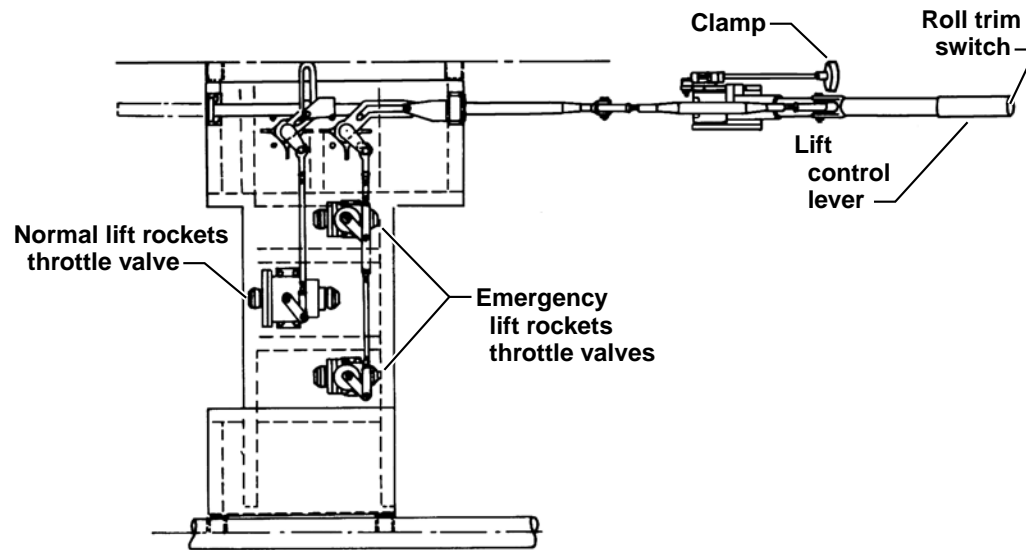

A diagram of the left-hand console's lift rocket control assembly.

Participants took their places after reviewing the test procedure. Wilson started the engine and placed it in idle. Jarvis began the frequency sweeps, slowly increasing the frequency and amplitude of the input signal while monitoring actuator position on the recorder. Engine thrust increased and decreased in concert with the signal inputs and actuator position. Everything seemed to be going well. And then the engine suddenly shut down at the low end of a throttle cycle.

Members of the team looked at one another, puzzled. Suddenly, Ottinger realized that although the engine had shut down, the throttle was continuing to increase in response to the auto throttle input signal, pumping fuel into the already heated combustion chamber. Excited, he began calling over the intercom to Wilson in the cockpit, directing him to terminate the test and disengage the auto-throttle system immediately. Realizing that the engine had shut down for no apparent reason and seeing that the throttle continued to increase the amount of fuel going into the combustion chamber, Wilson opted to override the electromechanical throttle-actuator himself by applying a force great enough to bring the handle back to the shut-off position. Wilson's quick action probably prevented a fire or explosion that would likely have occurred had the fuel not been stopped as swiftly as it was.

All systems were quickly powered down, and the test team set about determining what had caused the engine to shut off. A thorough analysis of the data revealed that the closed hydraulic system had been rigged at ambient temperature conditions. Changes in temperature affected the hydraulic fluid, and this in turn drove the engine throttle to its shut-off position, resulting in the sudden shutdown. Additional tests after the auto-throttle linkages were adjusted verified correct performance and response characteristics. However, problems with the auto-throttle system's sensitivity to temperature continued to plague operations until a major design flaw surfaced in an incident that occurred during engine start-up.

Emergency Parachute Recovery System

Early test flights of the LLRV employed a unique system designed specifically for

use in the event of complete jet engine failure. This system involved mortar deployment of a parachute assembly 55 feet in diameter and attached to the vehicle's framework that would allow the entire vehicle to descend safely to the ground.¹⁴ The parachute would lower the vehicle at a terminal velocity of 33.4 feet per second, reduced to zero at touchdown by pilot activation of the emergency lift rockets. With the 3,000-pound increment of lift rocket thrust, one second of full thrust would be enough to arrest the sink rate completely. The system was designed to save the vehicle in a free fall from an altitudes above 200 feet. At altitudes under 200 feet, the parachute could not be deployed in time to save the vehicle.

The system had two main disadvantages. First, the pilot had to remain with the vehicle to activate the lift rockets at touchdown. Second, once the recovery parachute was deployed, the ejection seat could not be fired due to clearance problems. For these and other reasons, the system was removed from the vehicles before they were transferred to Houston for actual use.

Since the emergency parachute system was to be used in the earliest flight tests, the system underwent qualification testing at the Naval Parachute Facility in El Centro, Calif. For the first test, a bomb mass simulating the LLRV was dropped from an altitude of 4,000 feet above sea level. The parachute system failed to deploy properly. The main recovery chute had become knotted, preventing extraction from the containment canister, even though the activating charge and drogue chute had deployed correctly.

During the second test, the drop helicopter was flying on autopilot when it yawed abruptly and began to descend just as the drop command was given. Lateral forces imparted to the drop model at launch caused the main parachute risers to separate during deployment, resulting in another failure. A successful deployment finally came on the fourth test, on 5 August 1964. Yet even after the system had been cleared for use in flight no one felt completely comfortable with its overall performance. Later, during flight-testing, a sigh of relief resonated throughout when the recovery system was removed from the LLRV. It had never been activated in an emergency.

Final Preflight Testing

By the early fall of 1964, basic functional testing of LLRV systems—including the making of design modifications and other changes necessary to resolve problems in operation and performance—was complete. All that remained was sufficient testing to certify that the overall reliability of systems was adequate for flight. The team accomplished this by verifying a satisfactory level of mean time between failures (MTBF) for the overall system during a period of intensive operation and testing.

The LLRV systems had been designed to operate for at least 1,000 hours before a failure rendered any of them inoperative. To verify this value, design changes were frozen in September 1964 and the systems were then subjected to rigorous qualification testing on the vehicle. In hindsight, the freeze point seemed premature, for the team continued to make changes after September 1964, indicating that the systems had not reached a satisfactory state of maturity before the rigorous control process began. Schedule demands clearly influenced the freeze date, the LLRV by then having become the key predecessor to vehicles later used to train astronauts for the final phase of the lunar-landing mission. As a result, the LLRV program had been subjected to steadily increasing levels of pressure and scrutiny.

Several problems emerged during operational verification tests, requiring changes to electronic components in assemblies. But with the configurations now frozen, changes required detailed procedures and work orders, greatly slowing the testing process. Failures in the control system generally fell into two categories. The first involved failures resulting from the technique Bell chose for summing and comparing the systems' various command and feedback signals. The second involved nuisance failures caused by structural vibrations and temperature effects on electronic compo-

nents and circuit-board assemblies, problems directly related to the weak structural integrity of the lightweight electronic boxes.

Bell's design had called for electronically summing all command and feedback signals in a 400-cps alternating-current format rather than a more straightforward direct-current format. Though the AC format required less circuitry, it proved less tolerant of small errors that occurred naturally during the operational summing process, generating errors large enough to activate various fault-detection circuits. This was especially true with the primary attitude-control system, which switched to the backup control system when the problem occurred.

Each problem required individual component changes in the electronic summing networks. As a result, Zwink became adept at real-time optimizing of input summing circuitry for the LLRV. Aggravating the problem, however, were temperature changes and structural vibrations during engine and lift rocket operation. Since the various assembly components had been encased in a potting compound to facilitate passing the vibration qualification tests, removing and replacing components turned out to be a major task.

In retrospect, these types of problems and their solutions illustrate the advantages of digital over analog fly-by-wire systems. The same tedious changes necessary in the hardware of an analog system could have been made with simple software changes in a digital system. Experience with the LLRV's analog systems led directly to the F-8 Digital Fly-by-Wire research program at the FRC, and this, in turn, helped encourage the acceptance of this technology in current applications for military and civilian aircraft.

Component changes in the LLRV became numerous enough to compromise the overall structural integrity of the lightweight electronic assemblies, leading to the second major cause of failures. From the outset, the weak structure of the lightweight electronic box assemblies created problems stemming from sensitivity to temperature changes and vibration levels. But the problems ballooned during the early flights as the electronic assemblies were subjected to even greater extremes in temperature and the vibration levels of normal flight operations.

As the reliability tests continued, the rigid process of configuration control became more and more time-consuming. Seeking to simplify the onerous process, the flight-controls test team and inspection personnel agreed on a procedure that reduced paperwork without compromising the integrity of testing and modification. In addition to calling for greater responsibility by inspection personnel for test performance, the process also obliged the flight-test team to write more detailed preflight test policies and procedures.¹⁵ In time, these policies and procedures became the baseline for the future of testing and validation of research flight-control systems developed at the FRC.

Because of the tight cg limitations, and to accommodate pilots of different weight and height, test team members devised a system of small ballast weights as an alternative to the time-consuming task of repositioning the rear equipment platform. The ballast consisted of small cylindrical metal cans with measured amounts of lead shot—between two and eight pounds—secured to selected leg braces. Ray White recalled carefully adding single bits of shot, one at a time, in an effort to achieve a true and finely balanced machine. And finally, in the original design the electronics equipment stood upright on the rear platform; in the final configuration, it lay on its side, lowering the center of gravity.

Pilot Preparation

As with all unique research aircraft, the question of pilot training remained. This was particularly ticklish since the LLRV had no match as an aircraft. The FRC's tradition of using a fixed-base simulator had worked well in experimental rocket

aircraft programs, including the X-15, and there was no reason to abandon the pattern with the LLRV.

Early in the design phase, Jack Kluever—the Army test pilot newly assigned to the FRC’s LLRV project—approached head project pilot Joe Walker about using a helicopter to train pilots for the LLRV. Walker, who had never flown a helicopter, opposed the idea. Leaning heavily on his X-15 and other rocket aircraft experience, he preferred to rely on the fixed-base simulator as the primary pilot-training device. But Kluever did not give up easily. He reminded Walker that X-15 research pilots had trained in F-104 aircraft to maintain the proficiency level required for X-15 missions. Kluever knew from his extensive Army aviation background that a helicopter offered a similar means for maintaining LLRV pilot proficiency since the VTOL capabilities of both vehicles required many of the same piloting techniques. He argued that the flying attitude of helicopters—which lack the motion cues available to a pilot in a jet fighter—would be excellent preparation for pilots training to fly the LLRV.

Eventually, Kluever persuaded Walker to take a ride in a small Bell helicopter, just to experience the unique piloting techniques involved in VTOL flight. Despite Kluever’s directions, Walker struggled to hover the helicopter over a point on the ground, failing to do so over several attempts. Walker persisted with a few more tries, certain there had never been an aircraft built that he could not fly and, probably, fly better than others did. Finally, he gave up, turned to Kluever, and told him to “fly the d***thing back and land.” On the ground, Walker got out of the helicopter without so much as a word, and Kluever assumed he had seen the end of any helicopter-training program for LLRV pilots.

But two days later, needing Walker’s signature on some paperwork, Kluever went to the pilots’ office, only to find that Walker wasn’t there. He asked Joe Vensel, then head of flight operations, where Walker was. Vensel told him to go see Bikle, who revealed that Walker was at the Naval Helicopter Training School in Pensacola, Fla., getting some helicopter flight training.

Not long after this the LLRV project office leased a Bell helicopter to use for safety chase in LLRV flights and as a pilot-proficiency training vehicle. Helicopter proficiency training remained a prerequisite throughout the LLRV and the LLTV programs, and all FRC and Houston pilots for both programs—as well as Apollo astronauts—underwent such training. Astronaut training for the trip to the moon began with flying helicopters on Earth, an investment in experience that paid huge dividends.

Preflight Readiness Review

With the first vehicle completely assembled, and with ground testing of systems underway, the FRC held a preflight readiness review on 13 and 14 August 1964, inviting representatives from the MSC in Houston as well as from the Ames, Langley, and Lewis research centers. Bellman gave an overall briefing on the LLRV, Matranga detailed the control systems, Ottinger discussed the propulsion systems, and Jon Ball described the displays and sensors. The team then demonstrated the LLRV, including firing the rockets, with the NASA 9 mobile communications van as a control center. The briefing concluded with those in attendance inspecting the LLRV personally.

For the review, representatives from the MSC and other research centers were assembled into committees representing key technical disciplines. Each committee then submitted critiques of the program from its area of expertise, which the LLRV team evaluated and incorporated into the project preflight review. Six months of final assembly, testing, modification, and re-testing finally drew to a close, and the preflight readiness review gave the green light. All systems were go; LLRV No. 1 was ready for flight.

Following the readiness review on 14 August, crewmembers towed the LLRV onto Rogers Dry Lake that afternoon for a series of photographs by Ralph Morse, a *Life*

magazine photographer, in a session arranged earlier through FRC director Paul Bikle. *Life* wanted to include the LLRV in a special issue on Apollo simulators planned for late 1964.

Morse arranged an elaborate system of strobe lights around the LLRV. At his request, LLRV crew chief Ray carefully swept out tire tracks left by the transporter. Having participated earlier in the readiness review, pilots Joe Walker and Neil Armstrong were on hand to take turns sitting in the cockpit of the LLRV for the photo shoot, the sinking desert sun in the background setting the dry lakebed ablaze. The strobe lights and special filters emphasized the effects of the sun's rays in the resulting set of photos. One of these photos, showing Armstrong in the cockpit, was used in a special issue of *Life*.

Less than two years later, and purely by chance, Ottinger again crossed paths with Morse during breakfast in a hotel across the street from the MSC. They talked about the recent midair collision in June 1966 between an XB-70A aircraft and an F-104N aircraft that had taken the lives of the copilot in the XB-70A, U.S. Air Force Maj. Carl Cross, and the pilot of the F-104N, Joe Walker.¹⁶ A few weeks later, Ottinger received a large color print in the mail of one of the unpublished photographs that Morse had taken. It showed Walker in the cockpit of the LLRV against a backdrop of desert sunset, a photograph Ottinger has cherished ever since.¹⁷

LLRV Preflight Readiness Review Committee Assignments

Category	Technical Area	Inspection Group	Information and Review
A	Pilot controls, displays and emergency devices	Neil Armstrong, MSC Roger Davidson, MSC Charles Bassett, MSC Fred Drinkwater, ARC Joseph Loftus, MSC Donald Mallick, FRC	Joseph Walker, FRC Roger Winblade, FRC Jon Ball, FRC John Ryken, Bell
B	Hydrogen-peroxide system	Vincent Capasso, FRC Jack Russell, FRC	Arthur Gorbaty, Bell Wayne Ottinger, FRC
C	Turbofan engine system	Ronald Waite, FRC Stewart Rolls, ARC Duane Rohde, LeRC	Norman DeMar, FRC William Kerr, GE
D	Control-system electronics and aircraft electrical systems	Donald Cheatham, MSC Keith Anderson, FRC John Drumm, FRC Harold Toy, MSC Frank Pauli, ARC	Calvin Jarvis, FRC Leon Zwink, Bell Andrew Cates, FRC O. D. Cook, FRC
E	Structures	Perry Row, FRC Richard Rosecrans, FRC	James McKay, FRC Ray Manners, Bell
F	Flight-worthiness	Richard Cox, FRC Charles Hamilton, FRC Dick Lucas, MSC	Leroy Frost, FRC Raymond White, FRC
G	Overall	Warren North, MSC James Chamberlin, MSC Richard Day, MSC Dean Grimm, MSC Norman McFadden, ARC	

¹ Dennis R. Jenkins, *Hypersonics Before the Shuttle: A Concise History of the X-15 Research Airplane* (Washington, D.C.: NASA SP-2000-4518, 2000).

² Notes and recollections of Cal Jarvis, flight systems engineer, LLRV.

³ Ibid.

⁴ Calvin R. Jarvis, *Operational Experience with the Electronic Flight Control Systems of a Lunar-Landing Research Vehicle* (Washington, D.C.: NASA TN D-3689, 1966), p. 8.

⁵ Ibid., p. 10.

⁶ Donald R. Bellman, memo for files on structural proof tests of the LLRV pitch stand with extended supports, 22 August 1964.

⁷ Closed loop operational tests of the LLRV jet engine attitude system, NASA memorandum for LLRV project manager, 17 March 1964.

⁸ Jarvis, *Operational Experience*, p. 12.

⁹ Bell Aerosystems interoffice memo No. 354:65:0604-1:JFM, 4 June 1965.

¹⁰ Jarvis, *Operational Experience*, p. 14.

¹¹ See, for example, the interview of John W. Russell by J. D. Hunley, 7 and 11 March 1997. Copy on file in the NASA Dryden Historical Reference Collection.

¹² Donald L. Mallick, "Flying the LLRV," an unpublished memoir (Appendix A of this monograph).

¹³ "Feasibility Study for a Lunar Landing Flight Research Vehicle," Bell Aerosystems Report No. 7161-950001, 8 March 1962.

¹⁴ In mortar deployment of a parachute assembly, a small cylinder of about one or two pounds is propelled by a pyrotechnic cartridge that produces hot gas, like that of a gun firing. The metal cylinder is connected to the parachute by a cable that drags the parachute out of the pack so it then can inflate in the air stream.

¹⁵ Calvin R. Jarvis, LLRV Flight Control Systems Test Program, memorandum for LLRV project manager, March 1964.

¹⁶ For accounts of this accident, see Hallion, *On the Frontier*, p. 182-184, and Lane E. Wallace, *Flights of Discovery: 50 Years at the NASA Dryden Flight Research Center* (Washington, D.C.: NASA SP-4309, 1996), p.73-74.

¹⁷ Recollections of Wayne Ottinger.

Chapter 6: Flying “Off the Books”

Faced with an aggressive Apollo program schedule, both FRC director Paul Bikle and Don Bellman felt that the only way for the LLRV to meet that schedule was to free it from the usual in-house procedures, including the bureaucratic process involved in overseeing and reporting on projects. Accordingly, Bellman persuaded Bikle that LLRV flight operations should be carried out at the remote South Base complex at Edwards. Bikle’s decision supporting this was a calculated gamble, since it deviated from normal practice and served to distance the entire program from literal oversight. But his actions reflected his confidence in Bellman and Ottinger and also were a measure of Bikle’s management style.

Line management at the FRC, however, was not so sure about the wisdom of this course of action. In effect, it meant that the operation would be “projectized,” that is, operating outside of line management’s oversight.¹ As the flight operations project engineer, Ottinger would report directly to Bellman, although Ottinger still would report through Perry Row of the operations engineering branch to Joe Vensel, director of flight operations. Ottinger would be independently responsible for conducting his end of the project within the FRC’s safety and operational guidelines.

In keeping with the traditional chain of command, Clyde Bailey, chief of the maintenance and manufacturing branch in the flight operations division, had already decided that the LLRV would be housed in the FRC hangar and towed to South Base for flights. As the time for the first flights drew near, others planned the logistics for transporting the vehicle, support equipment, and personnel to the test area for each mission. This was no easy task. South Base was about eight miles from the FRC facilities and on the opposite side of Edwards’ active runway.

Ottinger recalls that, in order to evaluate the logistics before the first flight was attempted, a caravan of 28 support vehicles (including trailers) accompanied the LLRV to South Base one morning for a planned ground-test operation.² The parade of vehicles made quite a spectacle as it proceeded down the taxiway toward the active runway.

But no one, it turned out, had notified personnel in the Edwards control tower about the LLRV operation. With over 20 unauthorized vehicles trundling toward the runway, tower personnel immediately contacted the air police with directions to intercept the invaders and stop them at all costs. Soon, a number of air police vehicles, red lights flashing, converged on the invaders, blocking the line of vehicles at the front and rear. In full battle dress complete with M-1 rifles, air policemen sprang from their vehicles and stood ready to stop any further attempts at movement by the line of interloping vehicles.

Bellman got out of the lead van to see what was going on. He was met at once by an air policeman wearing captain’s bars, who asked him for identification and an explanation for the appearance of so many unauthorized civilian vehicles on the flight line. When Bellman handed him his NASA identification badge, the captain found that he was dealing with a GS-15, the civilian equivalent to the rank of colonel in the Air Force. After Bellman explained why the vehicles were there and where they were going, the captain radioed the information, apologized to Bellman for the interruption, explained that the tower had not been notified about the crossing, and authorized the procession to proceed. He also told Bellman to be sure to contact the tower before trying in the future to cross the Air Force’s active runway.

“For the first day at South Base, we were not about to go back to the NASA facility, so we covered the vehicle with a canvas cover and, over that, a waterproof cover,” recalled Ottinger. “The next morning we had eight inches of snow.”³ It was obvious that routinely moving such a large caravan of vehicles the eight miles back and

forth from South Base was impractical. Bellman and Ottinger arranged with the Air Force to store the bulk of the support equipment in the compound of the rocket-test stand at South Base. They also arranged to store the LLRV in the hangar used by the Edwards Aero Club.

The eastern end of the large concrete ramp at South Base was designated the takeoff area since power and water were available there. The ramp was swept clean to minimize blowing debris that could potentially be sucked into the jet engine. Arrangements were made with the Air Force to have a fire engine and ambulance standing by during LLRV flight operations at South Base, a precaution that continued throughout the program. (Ground-test operations required only a fire truck.) At last, everything seemed ready for the first flight.

First Flight

The morning of 30 October 1964 was clear and cold, a beautiful autumn morning in the Mojave Desert.⁴ A slight breeze blew from the southwest, too light to pose a threat. The crew arrived in the early hours of the morning, and shortly after 3:30 a.m., they were positioning the LLRV over the blast shield. Then they began charging the vehicle with the helium pressurizing gas and hydrogen-peroxide propellant (the jet-fuel tanks were kept full at all times). All preflight tests were verified successfully, both on-site and in the NASA One control room at the FRC.

On 30 October 1964 the LLRV took to the air for its first official flight, with Joe Walker at the controls. (ECN-461)



Joe Walker and Don Mallick, the initial LLRV pilots, arrived at South Base in the leased Bell helicopter being used to maintain pilot proficiency for VTOL operations. Walker climbed into the LLRV cockpit wearing his orange flight suit. Crew Chief Ray

White helped strap him into the seat, making sure the personalized seat cushion was in place. Then, White left the cockpit, leaving Walker to execute his final checks.

Ottinger directed ground operations and acted as flight controller from a mobile control van equipped with radio communications and a public address system. He told Walker that all was ready. As one group of NASA and Bell engineers—along with the crew— anxiously watched the vehicle, another group in the FRC control room stared at the recorders. The jet engine started smoothly from the ground start-cart. Mechanic Bill “Willy” Wilson increased the engine rpm to speed, and the crew disconnected the external electrical cables and the start-cart air hose. The LLRV was now on its own, and after final preflight checks by Walker and the test team, Walker slowly advanced the throttle. It was 8:13:52 a.m.

As the gear oleos extended, the selected set of attitude rockets began making a rapid staccato noise, emitting puffs of steam until the rocket nozzles heated up. At 8:14:24, the gear oleo strut was fully extended. The LLRV slowly climbed to an altitude of about 10 feet. Gingerly, Walker performed small maneuvers for about 30 seconds. Then, he reduced thrust and made a soft landing. From beginning to end, the first liftoff had lasted only 56 seconds, although to everyone involved it had seemed much longer. By comparison, the longest flight made by the Wright brothers in December 1903 was 59 seconds. Everything seemed to work well and Walker lifted off a second time, conducting more maneuvers. The results were as good as on the first liftoff. The second flight also lasted 56 seconds. Walker lifted off a third time, but when the control electronics dropped into backup mode he landed after only 29 seconds.⁵

Although the flight was to be made with only one set of attitude-control rockets, a failure in the attitude-rocket selection relay occurred after the third liftoff, and both sets were engaged simultaneously, yielding twice the planned thrust levels and control effectiveness about each control axis. This increase in thrust levels then caused all 16 pitch-and-roll rockets to fire on and off rapidly, producing limit-cycle oscillations about the vehicle’s pitch-and-roll axes at a frequency of two cycles per second and at about six degrees in amplitude.

While the situation did not undermine control and stability, Walker, the test team, and other observers found the noise and the vibrations in the instrument panel from the rapidly firing attitude rockets to be extremely disconcerting. Jarvis and the flight-control team also found the situation strangely reminiscent of the first time they fired the attitude rockets while the LLRV sat on the center-of-gravity test stand, and they wanted nothing like that to happen during flight. The jet engine attitude-control system had been kept in the local-vertical mode during all three liftoffs, the lift rockets being unused. And so the first set of flight tests on the LLRV ended abruptly because of a relay failure. The failed relay was identified and replaced, and the problem never recurred.

Elation over the flight results mingled with concern about the electronics. The incident that had ended the third flight was merely the first of several problems occurring during the early LLRV flights that resulted in automatic transfers to the backup system. All were caused by the sensitivity of the lightweight electronic box assemblies to structural vibrations during flight.

During post-flight debriefing, Walker seemed generally satisfied with the vehicle’s performance, but he mentioned that the thrust of the jet engine had seemed on the low side despite the low ambient temperature. This did not bode well for the hot summer months to come, when higher air temperatures would mean even less air density and, consequently, even less mass flow, or thrust, available from the jet engine. Walker also mentioned that, while he had little difficulty maneuvering about the yaw axis, it seemed nearly impossible to prevent inadvertent inputs with the center stick in pitch and roll. As it turned out, he’d detected a major problem that proved endemic to virtually all flight-control systems in first-generation fly-by-wire aircraft, including the

Joseph A. Walker, in front of LLRV no. 1 after the 30 October 1964 first flight. Walker was chief pilot at the FRC and had flown nearly all the experimental aircraft at Edwards Air Force Base. In 1961 he had been awarded both the Collier Trophy and the Harmon International Trophy. (E-12217)



Air Force YF-16, NASA's Space Shuttle, and even the Swedish Air Force's Gripen fighter. Each of these vehicles experienced severe control disturbances during early flight testing. With the YF-16, the problem resulted in an inadvertent takeoff during initial taxi tests. The Space Shuttle suffered large pilot-induced oscillations (PIOs) during Approach and Landing Tests prior to first launch. And two Gripen fighters crashed during maiden flights as a result of control disturbances, destroying both fighters. The pilots ejected safely in each case.⁶

The problem resulted from excessive pilot controller sensitivity, which had not manifested itself during any of the numerous simulations carried out during the design and evaluation of the LLRV. It appeared only during critical flight-test maneuvers requiring high levels of pilot workload and concentration, such as takeoffs and landings, particularly during first flights. Since these situations are rarely evaluated during routine development simulations, the problem never occurred until first-flight conditions caused it to surface.

The team corrected the problem easily enough on the LLRV by reducing controller sensitivity, using variable adjustments inherent in the research system design. They also added a small mechanical dead zone around the control stick when the stick was in neutral position, increasing the distance the pilot had to move the controller in order to fire the attitude rockets. This lesson learned with the LLRV was not lost on the design of the Lunar Module. The final controller configuration on the LM was evaluated extensively for sensitivity during heavy workload conditions to prevent problems with over-sensitivity that otherwise might not manifest themselves until the first astronaut tried touching down on the lunar surface.

After the debriefing that followed the LLRV's first flight, the team formulated a tentative plan for troubleshooting anomalies in the electronic system, and then scheduled the next flight. The FRC notified the MSC and NASA Headquarters about the flight and issued a press release announcing the date. And during the traditional post-

flight party, all cares of the previous six months seemed to fade away, replaced by exuberance over the successful first flight.

Early Flights

Walker took the LLRV up again on 16 November shortly after noon, with a cool ambient temperature of 45 degrees F and a five-knot wind from the northeast.⁷ No limit cycle occurred, and Walker said he liked the feel of the modified control system. But during the flight the electronics once again reverted to backup mode. The day's big excitement came when the LLRV's jet blast lifted a manhole cover on the South Base ramp as the vehicle passed over it. The manhole cover flew up like a Frisbee®, nearly hitting the vehicle's leg struts; had the cover struck the leg struts, the results would likely have been catastrophic.

Once the LLRV was back on the ground, the team agreed that all South Base manhole covers would be welded shut to avoid a repeat. The team also decided to expedite delivery of the heavyweight electronic boxes, hoping these would eliminate the electronic-system failures causing transfer to the backup system. During the debrief Walker mentioned the wind effects on the LLRV, especially when the jet engine was in local-vertical mode. He noted that because of the drift caused by the wind, he had to continually correct to stay in the planned operating area. Given the surface wind, this situation had been expected when the LLRV was in local-vertical mode. Had it been in engine-centered, gimbal-locked, or lunar-simulation mode, the drift would not have been a problem.

The third day of flight, originally scheduled for the next day, 17 November, had to be postponed when a rare snowstorm swept the area. The LLRV finally lifted off again on 19 November, with Walker at the controls. The jet engine attitude system was in local-vertical mode during liftoff, and Walker maneuvered the vehicle in attitude while the engine remained vertical. Following several maneuvers in flight, he locked the engine gimbals and landed.

Another liftoff followed to validate the earlier results. The attitude controls reverted to backup mode as they had on previous flights, but Walker again reset the system to primary mode, as he had previously, and pressed on. He took great satisfaction in the feel of the aircraft in both local-vertical and gimbal-locked modes, and his confidence in flying the LLRV began to grow. Walker mentioned that the noise from the jet engine diminished significantly above an altitude of fifteen feet, a noise cue that became very useful to him in establishing his altitude as he descended for landing.⁸

Only days later, on 23 November, Walker flew the LLRV again. During this flight, he placed the jet engine in the local-vertical mode and, using the lift rockets for the first time during flight, maneuvered the LLRV in simulated lunar-landing configuration. The large tilt angles that were necessary to affect translation, he reported, felt quite strange. Before landing, he locked the gimbals and shut down the lift rockets, using only jet engine power from about 30 feet above the ground to touchdown. After the flight, Walker expressed great satisfaction with the smooth operation of the lift rockets and the vernier (finely adjusted) thrust they provided. This marked the first flight of the LLRV in which no failure of any kind occurred.⁹

After only four flights, confidence in the performance of the LLRV was beginning to build. Anxious to demonstrate its capabilities, Bikle invited the news media to Edwards Air Force Base for a flight demonstration on 25 November. Reporters gathered early for public affairs officer Ralph Jackson's preflight briefing before proceeding to South Base for the flight. However, with a strong wind blowing, prospects for the flight looked bleak. The weather forecast called for the wind to continue throughout the day, developing into a desert windstorm.

Over at South Base, the wind chill registered well below freezing. Members of the flight crew were servicing the LLRV for flight, but they knew there was little chance

the flight would occur, given the five-knot wind limit. Ottinger ignored their complaints about wasted effort, insisting that the servicing continue. A cardinal rule about flight planning had been burned into Ottinger's mind during his operations experience with the X-15: Never scrub a flight operation simply on the basis of "projected" weather. Weather people may be good, he realized, but rarely are they that good. Sure enough, right on time at 7 a.m., the LLRV was ready for its pilot, and suddenly there was dead calm as the wind dropped.

While Jackson was telling the press corps that the flight had been canceled due to high winds, Ottinger radioed flight operations at the FRC, asking that Jackson be informed that the pilot was in the cockpit, the winds were calm, and liftoff would take place in 20 minutes. Jackson immediately scrambled the reporters to the buses that would take them the eight miles to South Base.

Just as the buses rounded the curve to South Base, the LLRV lifted off. Reporters with their cameras and equipment came flying out of the buses to watch in amazement as the LLRV climbed to altitude, then performed a simulated lunar landing using the jet engine local-vertical mode and the vehicle's lift rockets for translation. At the controls, Walker climbed to 500 feet and accelerated to 20 knots forward velocity. There, he manually set the engine thrust to what he estimated to be five-sixths of the vehicle's weight, and executed a smooth simulation of a lunar landing.

Walker performed a second landing for the reporters and their cameras.¹⁰ Awed by the demonstration, the reporters rushed toward the LLRV as soon as it landed but had to be restrained by the crew and kept away from the misting vapors of hydrogen peroxide while Ray White helped Walker out of the cockpit. Afterward, Walker and Bellman patiently answered reporters' questions for nearly an hour. No sooner had the LLRV landed than the winds picked up and began blowing wildly again as the storm passed over South Base. After this experience, the flight crew never again questioned a decision by Ottinger to ready the LLRV for flight.

While the flight, obviously, had seemed impressive to the press corps, not everything had been quite as rosy as it had appeared. At the post-flight briefing with the test team, Walker reported that the vehicle's electronics had dropped into backup mode as he detected a yawing moment that he believed was caused by the jet engine. Jarvis and his test team had observed the same phenomenon on the telemetry. Using the duty cycle of the yaw rockets, they calculated the torque to be about 80 foot-pounds. Analyzing the data, they concluded that the inertial forces of airflow through the engine were producing this relatively constant torque to the LLRV, causing the firing of the yaw rockets to compensate for the unwanted gyroscopic effect. Since the extra rocket fuel required for this compensation was excessive, a solution was needed that would eliminate the torque without adding significant weight to the vehicle.

It was Bellman who came up with a solution: use thin-walled aluminum tubing to port jet engine bleed-air through an orifice with a moment arm and direction selected to cancel the gyroscopic force. Calculations indicated that a ten-foot moment arm with the orifice located at the rear equipment bay would provide the necessary compensation. The weight added by this device was insignificant, and the small amount of bleed-air from the fan-jet compressor had no real impact on its performance. The device was promptly built and installed, and it provided excellent compensation throughout the remainder of the LLRV flight program.

Walker flew the LLRV again that afternoon. On this flight, he rotated to 30-degree angles in pitch and roll, with the gimbals unlocked in local-vertical mode. Once again, he said it felt very strange to be tipped to the large angles without translating, descending, or turning. He was beginning to experience the unusual sensations of operating in the lunar environment, with gravity only one-sixth that on Earth. To everyone's relief on the ground, the flight was failure-free, without a single transfer to the backup control system.¹¹

Five days later, on 30 November, Walker piloted the LLRV in another demonstration flight—this time, for NASA Administrator Jim Webb and *Life* magazine. Walker put on a spectacular show. He set the engine thrust at what he estimated to be about five-sixths of the vehicle's weight and engaged the local-vertical mode, then simulated a lunar landing using large tilt maneuvers and the lift rockets, translating extensively over the terrain. Bringing the LLRV into a hover over the predetermined landing spot, Walker slowly set the vehicle down, using the lift rockets to control sink rate. It was a perfect performance and another failure-free flight.¹²

With everything working so well, the team grew confident about the reliability of the LLRV's flight control system. Overconfidence, however, can be dangerous in flight research, as the LLRV team found on 8 December 1964 during the eighth flight.

That day, as Walker made a rapid ascent in the LLRV during liftoff, the radar altimeter locked up, causing a loss of information about altitude. As he climbed higher, Walker encountered a large wind shear that made the LLRV translate rapidly away from the planned landing area. It took large tilt angles for him to finally get the translational velocities under control, but by then the vehicle was some distance from the landing site. Several times while maneuvering, Walker found that aerodynamic moments building up on the vehicle as a result of wind gusts exceeded the control authority of the yaw attitude rockets. He also had to reset the yaw primary attitude-control system several times, for it kept transferring into backup, indicating a hard failure. To everyone's relief on the ground, Walker finally got the LLRV down, albeit 200 yards from the planned landing area and with only a few minutes of fuel remaining.¹³

This flight got everyone's attention, bringing the team quickly back to reality. The unexpected wind shear Walker encountered focused the team's attention on the importance of knowing, before a flight, what the winds would be at altitude as well as on the ground. After this flight, the team used tethered weather balloons before all flights to determine wind velocities at an altitude of 1,000 feet. The pilot in the chase helicopter escorting all LLRV flights also helped, reporting on conditions up to that altitude before the LLRV lifted off and, if necessary, during flight.

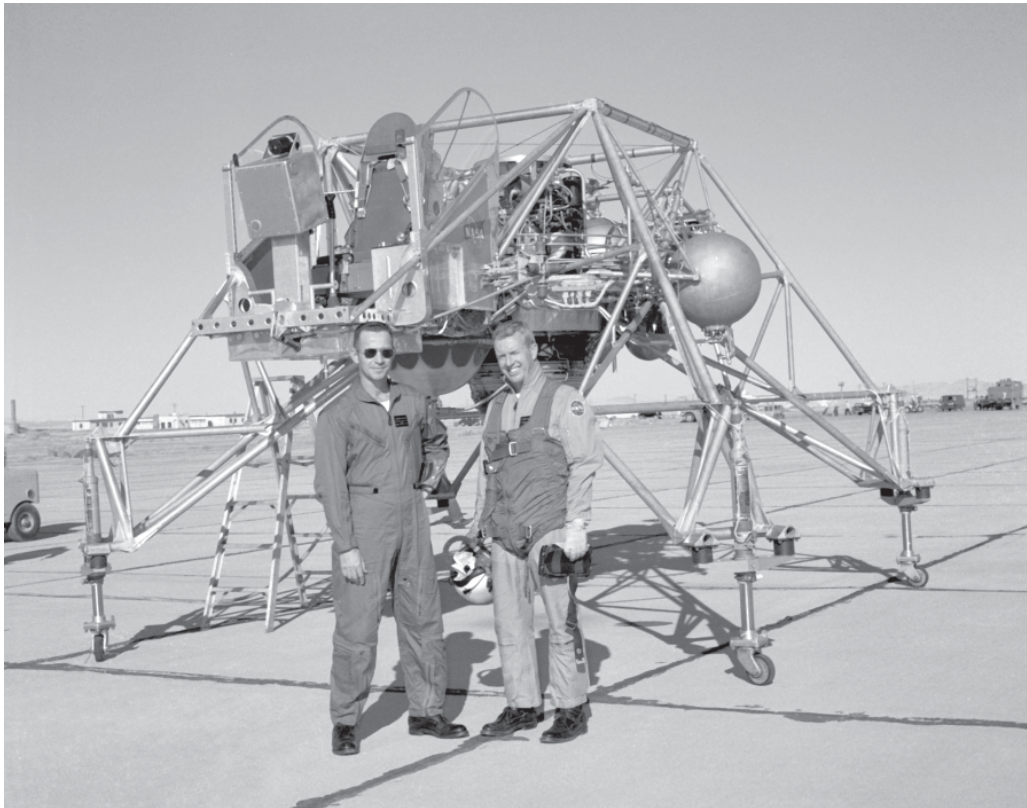

Don Mallick (left) and Joe Walker shared duties as pilots of the LLRV. Both had extensive experience in a variety of aircraft, although only Mallick had previous helicopter experience. Mallick transferred to the FRC from NASA Langley, where he had been involved in vertical flight research. (ECN-636)

Flights nine and ten, both occurring the next day, were checkout flights for Walker's backup pilot, Don Mallick. Mallick arrived at the FRC from Langley in 1963, where, as a research pilot, he had accumulated over 3,500 hours of flight time. Three hundred and fifty hours of that had been in helicopters and other VTOL aircraft, making him a natural choice as a research pilot for the LLRV. Though easygoing by nature, Mallick was nonetheless exceptionally thorough in everything he did. His two checkout flights were routine, and he encountered no failures.¹⁴

On a subsequent flight, however, something happened that made Mallick only too aware of the complexity of the overall operation, as well as of how quickly things could become critical. It happened when Mallick was performing normal preflight checks in the LLRV cockpit before engine start-up. The air start-cart for the jet engine and the ground cart supplying electrical power were connected to the LLRV. Rocket and jet fuel systems were topped off. Once the air start-cart brought engine rpm up to speed, the ground crew signaled Mallick to activate the ignition sequence. During a normal ignition sequence, the engine rpm increases to an idle speed of around 50 percent, equivalent to about half the maximum thrust. But in this ignition sequence the rpm increased rapidly to 95 percent—almost maximum thrust—and it began to raise the LLRV up on its oleo struts while it was still connected to the ground-support equipment. Mallick tried desperately to shut the jet engine off with the throttle lever, but there was no response. Fearing the LLRV was about to become airborne with the support equipment still attached, Ottinger told the ground crew to shut the engine down immediately, even though he was not at all sure how they were going to do this.

Fortunately, mechanic Willy Wilson—fully dressed in the rubber suit used by crewmembers as protection against the rocket system's hydrogen-peroxide—moved in and quickly stopped what was fast becoming a disaster. By this time the jet engine was emitting an enormous blast of hot gasses reflecting up from the ground. Moving in on the engine, Wilson used a pair of wire cutters to remove the safety wire from the engine throttle assembly. Then, he manually shut the engine down, using the lever on the main fuel control.

The cause of the problem was identified as the sizeable increase in ambient temperature that occurred between the time the hydraulic throttle system had been calibrated for flight and the time of actual flight. The temperature change caused the hydraulic fluid to expand, altering the operational characteristics of the throttle. In response to this, Bellman designed a thermal compensator device that FRC technicians fabricated and installed in the vehicle. The amended hydraulic throttle system served the jet engine well throughout the remainder of the LLRV and LLTV programs.

Assessment of Flight-Test Results

During the early LLRV flight tests, it became obvious that certain expectations about operational modes were invalid. Piloted analog simulation studies at both NASA and Bell suggested that the vehicle would be extremely sensitive to small changes in attitude while it translated across the ground with the engine's attitude system in gimbal-locked mode. These studies showed that as the pilot tilted the engine, and the vehicle's attitude changed in pitch or roll, the large thrust of the engine would cause this level of sensitivity. However, studies indicated that much larger changes in the vehicle's attitude were needed in order for it to translate across the ground in local-vertical mode, using the lower-thrust lift rockets.¹⁵ These indicators, derived from simulations, formed the basis for the decision to make the first flight tests of the LLRV with the engine's attitude system in local-vertical rather than gimbal-locked mode. In the simulations, pilots preferred local-vertical over gimbal-locked mode because of this difference in sensitivity between the two modes during translation.

But in actual flight, there was no such marked contrast between the two modes in performing control tasks. During flight, pilots found that motion and environmental

cues—not available during the fixed-based ground simulations—were invaluable to them during translation maneuvering in either of the two modes. They also found that flying the LLRV in either mode was very similar to their pilot training in the Bell helicopter. Because of the much larger tilt angles required for translating across the ground, the pilots did not at first find actual flight in the local-vertical mode—or, later, in the lunar-simulation mode—very appealing. As such, when flying the LLRV, pilots much preferred the gimbal-locked, or VTOL, mode of operation.¹⁶

The larger tilt angles resulted in significantly different motion cues that pilots at first found uncomfortable and unnatural, since these bore only passing resemblance to those of their experience in helicopter training. The effect was rather like flying in slow motion, requiring much greater anticipation from the pilot in order to maneuver the vehicle during translation. The pilots had to make significant adjustments to their flying styles in order to achieve a reasonable comfort zone with translation in the vertical-locked or lunar-simulation mode—a process that required patience, Kluever stressed. Indeed, the LLRV required a 30-degree angle in lunar-simulation mode to achieve the same acceleration that a helicopter achieved with a 5-degree rotor tilt. With this large angle, the LLRV achieved attitude and acceleration immediately, but the change in velocity came more slowly. That flight-test results were dramatically different from the ground-based simulation studies only underscored the importance of actual flight-test to create a lunar landing simulation. From the early flight tests alone, the importance of the LLRV—not only as a research tool but also, when modified, as a training device for lunar-landing astronauts—was already becoming apparent to astronauts and, most significant of all, to Apollo management.

Downtime for Modifications

With the approaching holiday season came the decision to stand down from flight operations on 9 December 1964, after the tenth flight, giving the research team a much-needed break and allowing four weeks for completion of modifications stemming from the earlier flights.

During this time, the program purchased a large motor home for conversion to a mobile control center for operations, making ground monitoring possible from South Base. Team members installed a full complement of telemetry equipment capable of displaying all critical parameters during flight. A valuable asset to the program, the converted van provided the equivalent of a full telemetry station at the flight line during all operations. The control van, equipped with radio communications, also included strip-chart recorders for real-time displays of critical system information.



Because virtually all LLRV activity was located on Edwards' South Base, far removed from the FRC's regular control room, the FRC purchased a motor home to use as the mobile control center for the LLRV. (E-14860)

An interior view of the mobile control center, showing the console from which LLRV flights were monitored. (E-15539)



The new equipment in the van also gave the test conductor the tools necessary for predicting when the LLRV was running low on fuel, one of his prime responsibilities. It was imperative that the test conductor know exactly how much flight time was left on the vehicle at all times, since depleting the fuel for either the engine or the rockets would mean pilot ejection and loss of the vehicle. Fuel depletion ultimately proved a major reason for the loss of LLRV No. 1 during a training mission at Houston with Neil Armstrong at the controls. Armstrong was able to safely eject, but it was a very close call, and it emphasized the risks associated with the LLRV.

Though the ability to conduct flight operations at South Base had proven an asset for the LLRV program, working out of the Aero Club's hangar was becoming problematic. The Air Force's high-altitude reconnaissance U-2s had moved in, making things rather crowded. So NASA built a small hangar of its own at South Base to house the LLRV and associated equipment. Office trailers were set up next to the small hangar. These were occupied by General Electric and Bell Aerosystems flight-test personnel who were updating drawings and the configuration of LLRV No. 2 as well as incorporating into drawings the changes made to LLRV No. 1 during the earlier flights. For the rest of the LLRV program, nearly 40 people worked in these facilities, not including a contingent of about 15 flight-operations personnel from the MSC who occupied the office trailers during a six-month training assignment originally scheduled to last only half that long.

During the holiday season downtime, engineers and mechanics also addressed an annoying problem that had cropped up in landings. Wheel casters on the landing gear oleo struts allowed the LLRV to roll and drift across the landing apron at touchdown, regardless of how smooth the landing had been. The vehicle did not have brakes, and there always seemed to be just enough side force during touchdown to keep the vehicle

from stopping at the desired point on the ramp. Replacing the wheel casters with dish-like footpads solved the problem. What is more, the LLRV now more closely resembled the LM, a fact not overlooked by the numerous members of the media who were following the test program closely. The heavier-gauge avionics boxes also were delivered, installed, and checked out. Everyone hoped that the heavier boxes would end the switching into backup that had plagued the earlier flights. And in February 1965, an awards program recognized the 112 people at the FRC who had contributed to the early success of the LLRV flight program.¹⁷

Preparations for renewed flight activity accelerated with the new year. The normal and anticipated anomalies turned up during the checkout of the new avionics boxes, and completely debugging the new assemblies took nine total-system ground operations. Once these were completed, the LLRV was ready to fly again.



During the holiday break between 1964 and 1965 the crew took the opportunity to perform a number of modifications to the LLRV. They replaced the castering wheels on the vehicle's legs with dish-like footpads, and moved the pilot's instrument console from the center to the right side of the cockpit. (E-14317)

Walker took the LLRV up on 19 February to continue expanding its flight envelope as well as to evaluate the modifications that had been made over the holiday season. During the flight, the nagging problem of dropping into the backup system occurred again, but Walker simply reset the primary system and completed the flight, and the problem did not recur during that flight. The team never determined why the problem popped up on the first flight after the heavier avionics boxes had been installed, as it did not recur during the next 30 flights. Although the team may not have realized it at the time, the system was beginning to mature.

Lunar-Simulation Flight Tests

Finally, it was time to begin flight evaluation of the jet auto-throttle and the aero-

dynamic drag compensation subsystems. These unique and complex subsystems were the very heart of the LLRV. They had to function perfectly in order for the craft to successfully simulate the dynamics of a piloted landing on the lunar surface.

Diagram of the initial jet engine thrust (automatically selected by the auto-throttle) and simulated lunar gravity environment as a function of error in computed vehicle weight at the point of lunar simulation system engagement.

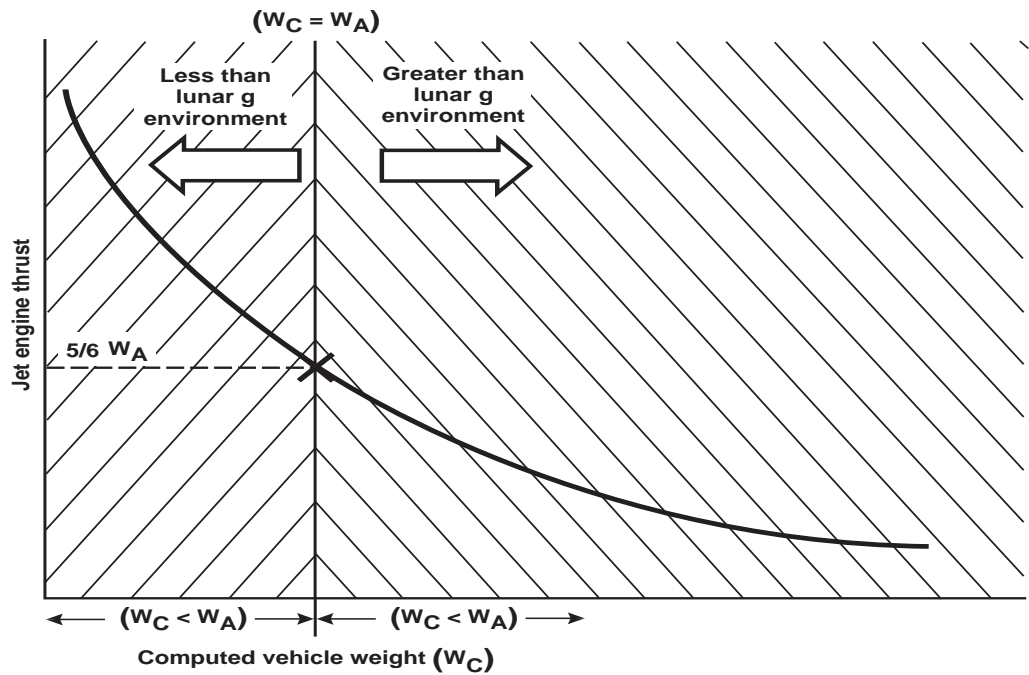
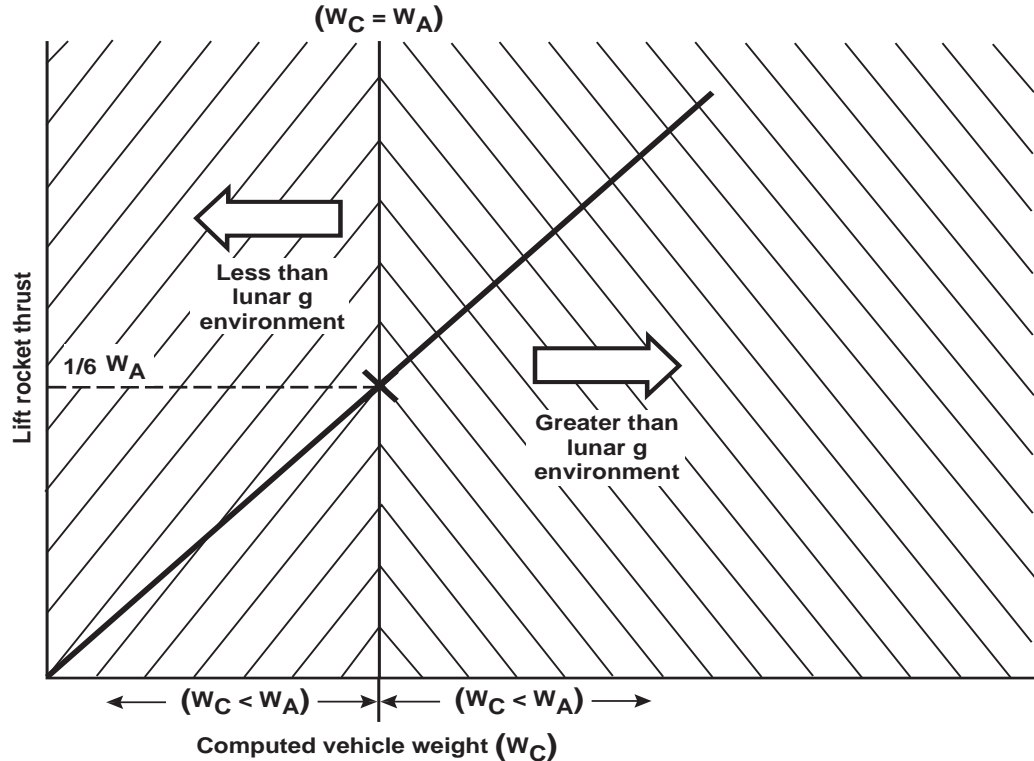

Illustration of the effect of in-flight initial vehicle weight computation on lift-rocket thrust required to hover, and on simulated lunar gravity environment.



An important feature of the auto-throttle subsystem was that it could be operated independently of the jet engine attitude-stabilization system during flight. This feature allowed the auto-throttle to be assessed without engaging the automatic aerodynamic

lift-and-drag compensation features of the jet stabilization. In effect, the feature greatly simplified the initial testing of the overall lunar-simulation system during flight. As previously noted, the system could not be tested thoroughly in a closed-loop manner on the ground due to the accelerometer mechanization.

On the twelfth flight, in late February, Walker engaged the auto-throttle subsystem for the first time. He had lifted off using engine thrust with the engine-attitude system in gimbal-locked mode and established a hover at an altitude of 150 feet. After arming the auto-throttle subsystem, Walker initiated a rapid upward acceleration, firing the lift rockets. In turn, this activated the vehicle's initial weighing system, which had been set to engage the auto-throttle automatically when the upward acceleration reached a predetermined value—in this case, .05g. This value had been preset at a relatively high level for the first in-flight test to prevent the auto-throttle from being engaged prematurely.

Later analysis of test data showed that when the auto-throttle engaged, the computed value of the vehicle's acceleration from lift-rocket thrust was less than the actual acceleration imparted to the LLRV, starting something of a chain reaction. For when the auto-throttle actually engaged, an erroneous command caused the engine to provide less thrust than necessary to support five-sixths of the vehicle's weight for a lunar simulation. As a result, the vehicle simulated a gravitational environment greater than the moon's, and in the end, much higher levels of lift-rocket thrust were needed for the vehicle to hover and maneuver in the simulated lunar environment. Walker repeated the auto-throttle engagement sequence several times during the flight, each time with the same results: large errors in the measured weight of the vehicle when the auto-throttle engaged led to incorrect gravity compensation, and much higher fuel consumption. After the flight, the flight-systems team hunted the cause of the unacceptable errors. In reviewing the test data, they found that when the lift rockets activated, the noise on the output of the accelerometer's sensor (used to measure acceleration from the lift rockets) became severe. That noise was caused by vibrations that accompanied the initial jolt of the firing lift rockets in the lightweight portion of the vehicle's structure where the accelerometer was mounted.

Jarvis and the systems test team came up with a solution. The problem could be alleviated, they found, by electrically filtering the accelerometer's output, a solution that would render it unresponsive to the higher frequencies of the structural vibrations. Zwink set about devising an adequate filter network, which the team then installed on the accelerometer's output.

The system was engaged in the same manner on the next flight. But this time, when the lift rockets were activated, the computed value of acceleration at the point of engagement was greater than the actual vehicle acceleration from the lift rockets. The fix had overcorrected the problem. Now, the erroneous command to the auto-throttle increased jet thrust to a level greater than that needed to compensate for five-sixths of the vehicle's weight. Consequently, hovering and maneuvering the vehicle took less lift-rocket thrust, which the pilot saw as providing more effective control than would be possible if operating in actual lunar gravity. This problem was considerably less critical since there was little danger of running out of effective thrust from the lift rockets while trying to control the vehicle's sink rate, even if it resulted in an inaccurate lunar simulation.¹⁸

After several more engagements in flight, the team noticed that the computed value of the vehicle's initial weight varied according to the manner in which Walker moved the handle to fire the lift rockets. Moving the handle faster resulted in larger errors in weight computations than when the handle was moved more slowly. Indeed, Walker once moved the handle so fast that the vehicle's downward acceleration could not be arrested even with maximum thrust from the lift rockets and he had to use jet engine thrust to halt the LLRV's sink rate

Obviously, there was a point at which downward acceleration would be so great that even maximum thrust from both the jet engine and the lift rockets would not be enough to arrest the sink rate before the vehicle struck the ground. The potential for this emphasized the need to test the system only while the vehicle was at altitudes sufficient to minimize the possibility. The ultimate checkpoint, however, became the pilot's ability to sense the approach of this danger, terminate the test, and arrest the vehicle's sink rate with jet engine thrust.

Considerably more testing and work to optimize the accelerometer filter followed. In the end, the team found a satisfactory combination of accelerometer response and pilot technique with the lift-rocket handle. At that point, typical operation of the auto-throttle subsystem resulted in acceleration errors (the difference between commanded and actual vertical accelerations) of less than .02g—that is, an error of less than three percent in simulating lunar gravity.¹⁹ Simulation studies showed that this error rate was well within the requirements for a valid in-flight simulator for piloted lunar-landing evaluations. Yet there remained concern that the solution to this problem might depend too much on piloting technique, leaving the door open in the future for erroneous weighing of the vehicle during engagement of lunar landing simulation that could lead to disaster. This happened, in fact, during a demonstration flight in October 1965 with Walker at the controls, and he narrowly avoided a catastrophe.

A diagram of an optimal lunar landing trajectory, which the LLRV was capable of simulating.

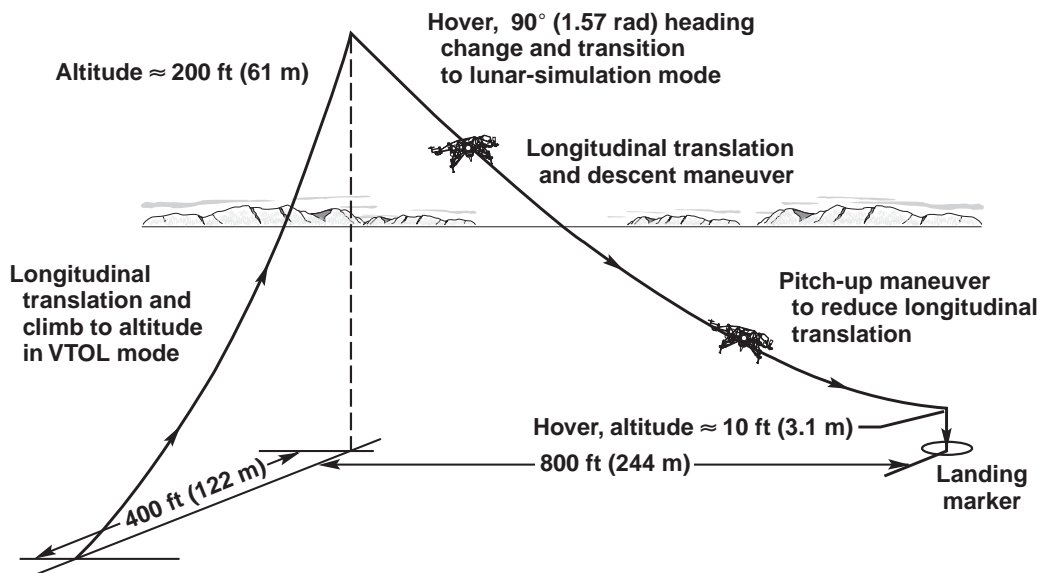

By the time the team was ready to evaluate the LLRV's drag-compensation subsystem during flight, most of the problems with it already had been identified and resolved during the testing of other systems. What remained was to operate the subsystem, determine its response and accuracy, and verify its overall performance. The design of the lunar-simulation system did not allow the vehicle's drag-compensation subsystem to operate independently of the auto-throttle subsystem. The auto-throttle had to be engaged before transferring into drag-compensation mode, which then placed the vehicle in full lunar-simulation mode.

For the fourteenth flight of the LLRV, in March 1965, Walker climbed to an altitude of just under 150 feet. From a hover, with engine in gimbal-locked mode, he armed and activated the auto-throttle subsystem, moving the lift-rocket handle and firing the hydrogen-peroxide landing rockets. The engine's throttle automatically reduced the thrust, and Walker established a hover, using lift-rocket thrust. He then disengaged the engine gimbal-locked mode, placing the vehicle in full lunar-simulation mode for the very first time.

Walker observed no noticeable transients, even though the vehicle had been at a two-degree left-bank angle when the transition took place. With the aircraft in this configuration, he performed longitudinal and lateral translations, tilting the LLRV about the pitch and roll axes and modulating the lift-rocket thrust level, reaching vehicle attitudes on the order of 10 to 20 degrees from the vertical. For attitude angles less than 10 degrees, vehicle accelerations were accurate to within .01g of the commanded values. The longitudinal acceleration error increased to approximately .02g, with pitch attitudes greater than 10 degrees although still within the desired acceleration-error limits for the system.²⁰

Fine-tuning the lunar-simulation system continued during the next few flights with Mallick in the cockpit. During Mallick's third flight in early May, he engaged the auto-throttle more abruptly than usual, resulting in a .09g error being introduced into the weighing circuitry. Consequently, engine thrust was insufficient to compensate for five-sixths of the vehicle's weight. Sensing the problem, Mallick disengaged the auto-throttle. During a second attempt, he activated the auto-throttle even more abruptly, causing an even greater acceleration error, after which Mallick again disengaged the auto-throttle and landed.

The engineering analysis after the flight identified the timing problem as a difference between the actual and the measured acceleration of the LLRV when the auto-throttle was engaged.²¹ As they found earlier with Walker, the problem was a function of how the pilot engaged the auto-throttle, and the group decided it could be resolved if Mallick was simply less abrupt. And indeed, he successfully engaged and operated the auto-throttle system over the next two flights for a total of 80 seconds.²²

Changes in Management and Operations

Satisfied that the LLRV systems checkout was proceeding well, in May 1965 Bikle allowed Bellman to return to his post as head of the propulsion branch at the FRC, promoting Gene Matranga to LLRV project manager.

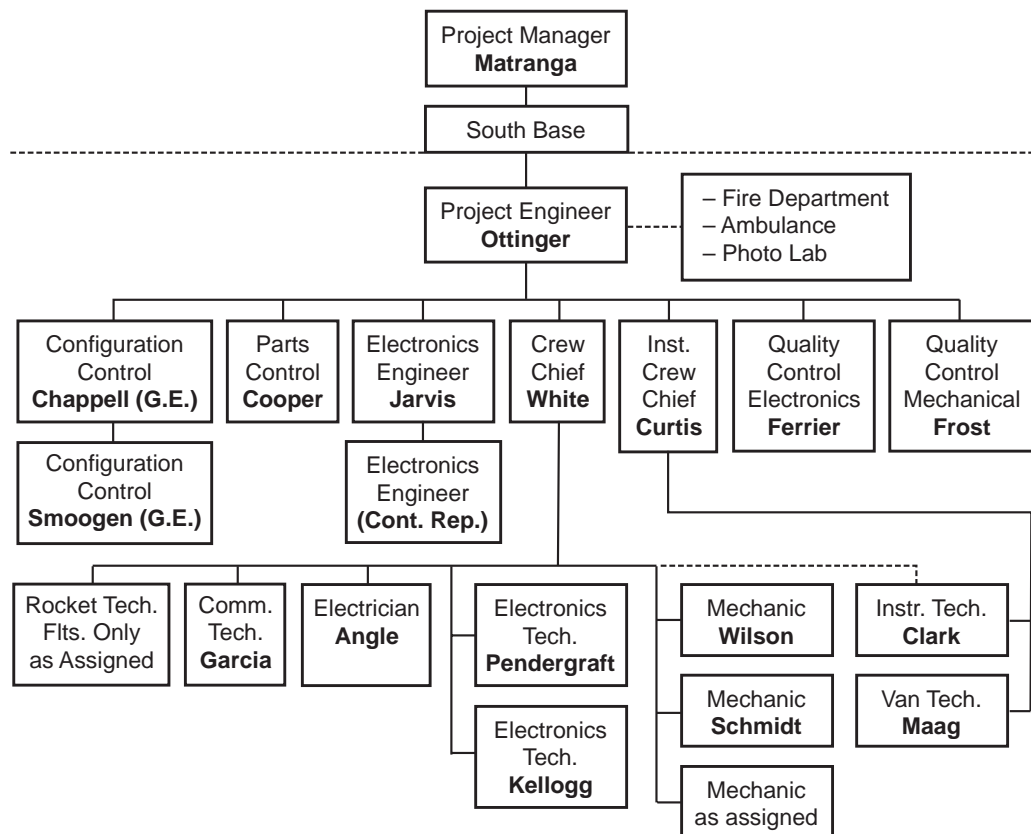

The LLRV program's new organizational chart as of May 1965.

Summer's high temperatures were only weeks away, and Matranga was concerned about how the LLRV's engine would perform during the hot ambient conditions in the desert. His first action as project manager was to change the start of the summer workday from 7:30 a.m. to 6 a.m. to allow more time for operations in the cool hours of the morning.²³ Of course, that required crewmembers to be at work even earlier on days when flights were scheduled. Matranga also took several other steps to facilitate operations during hot weather, including streamlining preflight procedures to minimize preparation time and cooling the helium tanks during the fill process to carry away the heat generated from the high pressurization of the gas.²⁴

Furthermore, the LLRV liftoff site was moved to the loading pit that had been used for the X-1 rocket-powered research aircraft, still in place at the South Base complex. The pit was about 100 square feet in area with a depth of about eight feet, covered by a steel grating with 25 percent porosity. Before flights, as the LLRV rested on the grating with the engine running, the porous surface directed the exhaust gases downward and away from the engine compressor inlet, allowing more thrust at takeoff.

A Menacing Roll-Control Problem

Joe Walker returned to the LLRV on 24 June 1965. The vehicle's twenty-first flight was intended as continuing checkout and fine-tuning of the lunar-simulation system. But shortly after takeoff, the roll-right authority light on the instrument panel lit up, indicating a significant reduction in the pilot's ability to control the vehicle about the roll axis. Walker landed immediately.

The systems test team set about uncovering the problem. Team members found that the attitude rockets for right roll had been firing automatically about 45 percent of the time, increasing to 53 percent a few minutes later as Walker was landing. This indicated that a large disturbing moment had acted on the vehicle in flight, resulting in a tendency for the vehicle to roll left and requiring that the roll-right attitude rockets fire over 50 percent of the time to compensate. (Since these rockets functioned only in an on-off basis, and were not throttleable, control authority came only through the firing's duration. Control was then as much a measure of firing time as of the rocket's actual thrust.) The concern, of course (in addition to excessive rocket propellant consumption), was that the out-of-balance condition could increase to such a point that continuous firing of the roll-right rockets would be required just to keep the vehicle from rolling, leaving no thrust left for maneuvering and leading to a loss of control about the roll axis. Suspicion fell on the hydrogen-peroxide tanks located on each side of the vehicle, for unequal propellant usage from the tanks could cause roll imbalance. The team measured the residual propellant in each tank and, sure enough, the propellant in the left tank was 15 pounds heavier than that in the right tank.²⁵

Review of previous flight data showed that the roll-right authority light had lit up on six earlier flights of the LLRV. Looking more closely at the data, team members discovered that on virtually every flight lasting at least one minute, a reduction in roll control authority had occurred, slowly increasing in magnitude as the flight progressed. Left unchecked, the total roll-right control authority would eventually be exhausted, leaving the pilot unable to rotate the LLRV in that direction.

The team found that two other factors significantly decreased roll control in the LLRV during flight. The first was wind blowing on the sides of the vehicle. The second was a yaw-left rolling moment imparted to the vehicle due to the location of the yaw-swirl compensation nozzle that used engine bleed-air. But the most significant cause of the problem was the asymmetric use of propellant from the side-mounted hydrogen-peroxide tanks; that usage varied according to lift rocket and attitude-rocket operations. All the contributing factors underscored one point: the total unbalancing force could be significant, as it was on the twenty-first flight, and could, under certain conditions, be catastrophic.

Team members also discovered that by monitoring the roll-attitude-rocket duty cycle on the ground, they could determine any imbalance about a given axis. An unequal attitude-rocket duty cycle in one direction indicated imbalance in the opposite direction. By monitoring this for several seconds, ground personnel could estimate both the magnitude and the direction of the imbalance then transmit that information to the pilot. By manually shutting off fuel usage from a tank, the pilot could rebalance the vehicle during flight.



LLRV no. 1 in lunar simulation mode. The center-mounted jet engine is perpendicular to the Earth despite the LLRV's tilt angle. The jet engine supported 5/6 of the LLRV's weight, effectively simulating lunar gravity. The puff of steam aft of the jet engine indicates the rear lift rockets are firing to correct the tilt angle. (E-14570)

Badly needing a way to trim the vehicle around the roll-control axis during flight, team members found they could achieve this by periodically shutting off propellant usage from one or the other of the side-mounted tanks, allowing the rolling moment to be shifted from right to left, or vice versa. Subsequently, team members attached a thumb-activated switch to the top of the lift-rocket throttle handle. The switch was wired to shut off the tank in whichever direction it had been thrown, left or right. Pilots established a satisfactory level of roll trim when they activated the switch during lift rocket operation. Although the pilot could achieve some trim effect by activating the trim switch while operating only the attitude rockets, the trim rate was significantly slower due to the lower rate of propellant usage. Roll control was never again a problem during the flight-research program once the thumb-activated switch was installed.

As the pace of flight-testing increased, team members made even more adjustments to the auto-throttle circuitry for initial weighing. They were trying to fine-tune the engagement sequence to make it less sensitive to pilot technique, but this turned out to be extremely difficult and was never accomplished to everyone's satisfaction. The possibility of error in initial weighing remained, depending on how rapidly or slowly the pilot activated the lift rockets to engage the system.

Nevertheless, a combination of filtering and pilot experience eventually produced what seemed to be a satisfactory solution, allowing the subsystem to be engaged with a minimum of acceleration error. Walker and Mallick successfully engaged the sub-

system during several flights that included normal operation of the full lunar-simulation system. After the team considered the problem sufficiently resolved, they moved to the final task of actually landing the LLRV with the lunar-simulation system fully engaged.

First Simulated Lunar Landing

The first simulated lunar landing in the LLRV came during the 34th flight, on 8 September 1965, with Mallick at the controls. After taking off and climbing to altitude, he engaged the lunar-simulation system and established a hover at 800 feet using the lift rockets. Once the ground controller confirmed that everything seemed to be working as designed, he initiated a nose-down pitch attitude, establishing a forward translational velocity of about 10 feet per second with a simultaneous descent rate to touchdown at a point about 1,000 feet in front of the vehicle. As the vehicle translated forward and downward, the pitch gimbal itself automatically rotated, tilting the top of the jet engine forward four degrees from vertical—the angle that the drag-compensation system had determined necessary.²⁶

After translating to the landing point, Mallick landed the LLRV in full lunar-simulation mode 78 seconds after initial engagement. During the flight, acceleration errors never exceeded three percent of the lunar-gravity-command value, not even at the larger vehicle-attitude angles and forward translational velocities. The flight led to elation over how well the systems performed; all of the systems, including subsystems, tubing, and state-of-the-art electronics, worked as designed. At last, the LLRV was performing the task of a simulated lunar landing for which it had been developed. Walt Rusnak, Bell's chief designer, deserves much credit for the LLRV because his creative genius generated the concept and development of this unique system. Many did not believe the LLRV would ever meet the demanding in-flight requirements for simulating lunar gravity within the Earth's environment, but they became believers after this flight.

Murphy's Law Strikes Again

After flight 34, Bikle was eager to demonstrate the LLRV's full capability to the engineering and flight-test community. That opportunity presented itself at the FRC a month later, during an AIAA conference held in conjunction with the X-15 meeting and attended by several hundred engineers, test pilots, and members of the news media.

To take advantage of the cooler temperatures and calmer air, the demonstration flight was scheduled to take place early in the morning on 8 October 1965. Since it was considerably easier to transport the LLRV to the FRC than it was to transport several hundred people from the FRC to South Base, the craft and its support equipment were moved from the South Base complex to a test pad in the aircraft run-up area south of the FRC's Building 4800 a week before the demonstration flight. The three-story Building 4800 was the main office and laboratory complex at the FRC, housing the entire research engineering staff and most of the support personnel and equipment, with hangars for research aircraft adjoining it. Technicians removed light standards to reduce hazards for VTOL flight.

Walker made two practice flights on 5 and 6 October. The flight plan was designed for optimal viewing by observers on the ground near the landing site as well as on the roof of Building 4800. The plan called for Walker to take off and climb to an altitude of about 200 feet above the taxi ramp. There, he would establish a hover and yaw the LLRV 90 degrees to the right so the vehicle would be headed due east and parallel to the rear of Building 4800. He would fire the lift rockets, the full lunar-simulation mode being automatically engaged after the weight-and-drag computer determined the vehicle's initial weight. Finally, Walker would set up a typical lunar-landing trajectory, simultaneously descending in altitude and translating forward about 800 feet to the predetermined landing point about 500 feet from the rear of Building 4800. He would

bring the LLRV to a hover about 30 feet above the ground, then gradually descend and land.

LLRV team members reviewed the flight plan on the evening before and again on the morning of the demonstration. They discussed at length the abort procedures to be used in case of an anomaly that would require the landing to be terminated. They were particularly concerned with the operation of the initial weighing circuitry since its performance was not completely predictable.

Some members of the flight-research team raised concerns about the process involved in disengaging the lunar-simulation system. To disengage the system, the pilot had to activate the auto-throttle switch and the local-vertical mode switch by hand, and both were located on the pilot's left-hand console. To do this, the pilot had to remove his hand from either the lift-rocket or jet engine throttle, activate the switches on the console, then move his hand back to the throttle control. Actual system disengagement would take place as the pilot was moving his hand from the switches back to the manual throttle. Normally, this was not a problem. But any anomaly would require that the pilot rapidly disengage the systems, and some team members were very concerned about exactly how fast this manual switching process could be done.

Part of this came in reaction to a recent fatal crash, in April 1965, of another VTOL aircraft at Edwards—the Ryan XV-5A—during a similar demonstration flight for industry representatives and the press. The investigation of that crash revealed that a major contributing cause lay in the fact that the pilot had had to reach behind his seat to push a critical switch needed for transitional flight control. In so doing, the pilot either activated the wrong switch unintentionally or had activated it by catching it on the sleeve of his flight suit, causing the aircraft to transition to a hover during a low pass over Rogers Dry Lake. The aircraft lost airspeed and crashed, killing the pilot, all in full view of spectators on the ground.²⁷

Jarvis and his systems test team considered moving the auto-throttle disengage switch to the attitude-control stick, allowing the pilot to disengage the lunar-simulation system simply by moving a switch, without having to take his left hand off the throttle handle. Jarvis believed this would shorten the time needed to disengage the lunar-simulation system manually as well as simplify the task for the pilot. But Walker disagreed. He felt strongly that the modification was unnecessary and that any emergency could be handled satisfactorily in the current configuration. Walker's basic philosophy—which had served him well during many years of flight research—was, "If it ain't broke, don't fix it." He had confidence in the system, especially since no anomalies had occurred during his two practice flights.

On the morning of the demonstration flight, weather conditions were perfect. A cold temperature meant maximum engine performance, and there was no wind. A large crowd gathered on the roof of Building 4800, as well as on the ground near the landing area. Members of the news media were there with cameras and recorders, a number of them having interviewed Walker and some project managers earlier that morning.

As anticipation mounted before the flight, members of the test team began thinking of all the things that could go wrong and which would terminate the flight, disappointing the large crowd that had gathered to witness the flight of the truly unusual research vehicle. Although none of them wanted to see the flight aborted, safety came first, as it did in all flight research operations, including demonstration flights.

After a brief meeting and the final review of the flight plan with the LLRV team, Walker climbed into the cockpit and began going down his preflight checklist. Ground crew started the engine and all systems were ready for liftoff. After takeoff, Walker climbed to an altitude of 200 feet, hovered, and rotated 90 degrees to the right, pointing the LLRV parallel to Building 4800 and the large gathering of observers. Looks of astonishment darted across the faces of observers as the strange machine defied the laws of gravity. It hung in the air, and the roar from the jet engine and the attitude

rockets exploding on and off was deafening, shrouding the vehicle in rising clouds of white steam in the cold morning air.

In the control van, team members quickly assessed the status of all systems, then gave Walker the okay to engage the lunar-simulation system and proceed with the landing trajectory. He fired the lift rockets, sending the vehicle upward a short distance during the initial weighing sequence that automatically engaged the lunar-simulation system. As the jet engine throttle began to lower automatically to the level five-sixths of Earth's gravity, Walker "nosed" the vehicle over in a pitch-down attitude and began his forward and downward trajectory toward the landing site.²⁸

The LLRV's jet engine exhaust pointed directly downward, causing concern among team members about the ingestion of exhaust and debris into the jet's intake. Hoping to deflect at least some of this blast, the crew positioned the LLRV above a grate with about 25 percent porosity. (E-15038)



This proved inadequate and the crew installed a new grate with nearly 80 percent porosity, which solved the problem. (E-15560)



About halfway down the landing trajectory, he began to slow his sink rate and forward velocity by rotating the “nose” of the vehicle upward and increasing the lift rocket thrust. At this point he began to suspect that something was wrong. To his dismay, increasing lift-rocket thrust produced only a small reduction in the sink rate. Quickly, he went to maximum throttle on the lift-rocket handle and began to feel the sink rate decreasing. He was rightly concerned that the sink rate would not be arrested completely by the time the LLRV arrived at the landing site. By this time, the nose-up attitude was at about 45 degrees since Walker was also trying to arrest the forward velocity as he neared the landing site, but the forward velocity was not slowing as rapidly as it should have.

At this juncture, Walker had two options: abort the trajectory immediately by disengaging the lunar-simulation system, or continue with the landing maneuver and hope the sink rate and forward velocities decreased enough for a safe landing. It's difficult to know how much the presence of a few hundred spectators figured in the decision Walker made. In most test pilots, there is a strong inclination not to disappoint the people and test teams who worked to bring the test vehicles into operation. Whatever his reasons, Walker opted to stay with the trajectory a while longer, still feeling he could recover the vehicle at the last moment, if necessary.

Meanwhile, the members of the research team monitoring the flight from the control van began to suspect there was a problem. The large nose-up pitch attitude and sink rate told them the velocities were not going to be arrested completely by the time the LLRV arrived at the landing site. Ottinger envisioned the LLRV missing the landing site, overshooting the ramp, and landing on the lakebed amid great clouds of dust—much better, of course, than having the LLRV crash through the rear of Building 4800. That fear brought to mind an incident that had occurred a few years earlier. Scott Crossfield was accustomed to taxiing his F-100 chase aircraft directly into the hangar of Building 4800 after landing on the lakebed. During one particular flight he had an engine fire warning in his F-100. Erring on the side of caution, he shut down the engine, executed a dead-stick landing on the lakebed, and rolled up the ramp toward hangar 4802. By the time he reached the hangar his brakes were no longer useful—the hydraulics reservoir was exhausted from minor braking—and the F-100's nose punched through the hangar wall. From then on, Crossfield was known as the pilot who had broken the hangar barrier, as opposed to the sound barrier.²⁹

By this time, Walker realized he was not going to be able to land successfully with the LLRV in lunar-simulation mode. He also had no desire to break the hangar barrier, as it were. He opted to remain in the lunar-simulation mode to the last possible second, even though he realized he would have only one shot at disengaging the lunar-simulation system and recovering the vehicle before it slammed into the lakebed or Building 4800. And it was at about this point, he later said, that he realized it wasn't such a bad idea after all to have a switch on the center stick for disengaging the lunar-simulation system.

As the LLRV descended toward the landing site, Walker disengaged the auto-throttle and jet-stabilization systems and moved his hand quickly back to the jet throttle, increasing it rapidly to its maximum setting. The engine-attitude system automatically reverted to the local-vertical mode with very little gimbal-angle change, even though the vehicle attitude was still at about 45 degrees. The sink rate rapidly diminished due to the increased engine thrust, and the forward velocity bled off because the lift rockets were still firing.

Then, Walker lowered the nose to a level attitude and decreased the lift-rocket thrust to zero, simultaneously engaging the engine gimbal-locked mode. As the vehicle went into a hover, to his amazement Walker found himself about 30 feet directly above the designated landing spot. He proceeded to complete the landing, using jet thrust with the engine gimbals locked. A review of the flight data showed that several cycles of the

switching and reconfiguration sequence took place in less than two seconds. That no crash ensued was testimony to Walker's uncanny ability to do exactly the right thing at exactly the right time in as short a time as humanly possible, and then repeat the action several times to make sure it had been done correctly.

To observers outside the control van, the LLRV most likely appeared to be in a perfect lunar-landing trajectory all the way to touchdown. The rapid changes in pitch attitude and throttle in the final two seconds before touchdown impressed everyone watching. As Walker shut down the jet engine and started to step out of the cockpit, the crowd applauded. Ottinger climbed the ladder to shake Walker's hand as he exited the cockpit. The first thing Walker said was, "Change the d*** switch location."

Upon review, they found that the problem had started with the weight-and-drag computer, which made an error in the initial weight computation of the vehicle as the lunar-simulation system engaged. The computed weight was lighter than it should have been, which called for less jet thrust and more lift-rocket thrust than needed for a true replication of the moon's gravitational field.

More work on the response time and accuracy of the weighing circuitry came over the course of the next several test flights. The solution involved both system response time and pilot technique in engaging the system, which proved satisfactory for the rest of the flight research program. In all, it had taken a year to debug the system before the LLRV could begin the research program.

Near the end of that year, a minor accident quickly escalated into a major incident, threatening the LLRV program's continued use of the South Base complex. One of many emergencies with the landing gear on the XB-70 halted rocket fuel servicing on the LLRV while the required Air Force fire truck stationed with the LLRV moved off to join other fire trucks at the landing area for the troubled XB-70. After a long delay, the fire truck returned, and servicing of the LLRV resumed. Meanwhile, a young NASA operations engineer was asked to drive an avionics technician over to the main hangar in the NASA station wagon to get a pilot's seat cushion that had been left behind. The engineer—who, it turns out, was just learning how to drive—accidentally put the station wagon into reverse. Stepping on the accelerator, the car shot backward and barely missed several NASA pilots. It did not, however, miss the Air Force fire truck that had just pulled into position beside the LLRV.

As fire-retardant foam spilled over the ramp from the fire truck, members of the vehicle's crew radioed the control tower that a NASA vehicle had attacked them. The Air Force investigation of the accident revealed that the young man driving the station wagon lacked not only a government driver's license, but a California driver's license as well. From there the incident escalated. Managers at Edwards were understandably irate. FRC director Bikle assigned NASA security chief George Blackwell—a retired Air Force colonel—to handle the problem, and Blackwell resolved the matter with Col. Donald Ewing, the base commander. Bikle, meanwhile, had Ottinger in the proverbial "Bikle barrel" for the first and last time.³⁰ He told Ottinger that while he had done very well early on with South Base operations, he was "winding Ottinger back to zero" because of the fire truck mishap. No more such incidents occurred during LLRV operations at South Base.³¹

¹ Projectized organization is a matrix form of operation. In effect, it is a form of organization in which people from different line organizations—such as different branches of flight operations, research engineering, and research projects—work together on a project under a project manager. They do not work for their line supervisor for the portion of their time devoted to the project. Matrix, or projectized, organization is the norm at Dryden today, but it began slowly. In the 1940s, some people—the "computers," for example,

mostly women who worked with Frieden calculating machines to reduce data—worked on more than one project at a time. This became less the norm in the 1950s, but the matrix form of organization began to be revived in the 1960s with people working part of the time on the LLRV, the lifting bodies, and/or the X-15, and part of the time for their line bosses. For a detailed view of how projectized organization worked in developing the first lifting body, see chapter two of Reed and Lister, *Wingless Flight*.

² Interview with Wayne Ottinger by MSC Historian Ivan D. Ertel, 27 and 28 July 1971.

³ Ibid.

⁴ Paul F. Bikle, memo to NASA headquarters on LLRV progress, report #16 for the period ending 30 October 1964, 10 November 1964.

⁵ Joe Walker, pilot flight notes, 10 October 1964.

⁶ The Shuttle pilot-induced oscillation (PIO) problem during astronaut Fred Haise's landing of the prototype Enterprise during the Approach and Landing Tests (ALT) at Edwards Air Force Base in 1977 is described, among other places, in Chapter 7 of James E. Tomayko, *Computers Take Flight: A History of NASA's Pioneering Digital Fly-By-Wire Project* (Washington, D.C.: NASA SP-4222, 2000).

⁷ Bikle, memo to NASA headquarters on LLRV progress, report #17 for the period ending 30 November 1964, 8 December 1964. LLRV flight 1-2-26 Notes, 16 November 1964.

⁸ LLRV flight 1-3-28 Notes, 19 November 1964.

⁹ Ibid., 1-4-29 Notes, 23 November 1964.

¹⁰ Ibid., 1-5-30 Notes, 25 November 1964.

¹¹ Ibid., 1-6-31 Notes, 25 November 1964.

¹² Ibid., 1-7-32 Notes, 30 November 1964.

¹³ Bikle, memo to NASA headquarters on LLRV progress, report #18 for the period ending 31 December 1964, 12 January 1965. LLRV flight 1-8-33 Notes, 8 December 1964.

¹⁴ LLRV flight 1-9-34 notes, 9 December 1964; Donald L. Mallick, Flight Log. LLRV flight 1-10-35 notes, 9 December 1964; Mallick, "Flying the LLRV."

¹⁵ See Lawrence Caw, "Personal Accounts of FRC Simulation Laboratory Personnel," in Gene L. Waltman, *Black Magic and Gremlin: Analog Flight Simulations at NASA's Flight Research Center* (Washington, D.C.: NASA Monographs in Aerospace History No. 20, 2000), 124-129.

¹⁶ Calvin R. Jarvis, "Operational Experience with the Electronic Flight Control Systems of a Lunar Landing Research Vehicle" (Washington, D.C.: NASA TN D-3689, October 1966).

¹⁷ Bikle, memo to those concerned on LLRV awards presentation, 17 February 1965.

¹⁸ Bikle, memo to NASA headquarters on LLRV progress, report #20 for the period ending 28 February 1965, 8 March 1965.

¹⁹ Jarvis, Operational Experience.

²⁰ Ibid.

²¹ Jarvis, memo to LLRV project manager on LLRV flight 1-17 automatic throttle evaluation, 3 May 1965.

²² Bikle, memo to NASA headquarters on LLRV progress, report #23 for the period ending 31 May 1965, 9 June 1965.

²³ Matranga, memo to LLRV personnel on reassignment of working hours, 11 June 1965.

²⁴ Matranga, memo for files on LLRV pre-flight procedures, 2 June 1965.

²⁵ Bikle, memo to NASA headquarters on LLRV progress, report #24 for the Period Ending 30 June 1965, 13 July 1965.

²⁶ Progress Report No. 27, 14 October 1965.

²⁷ The crash is discussed in Seth B. Anderson, *Memoirs of an Aeronautical Engineer: Flight Tests at Ames Research Center, 1940-1970* (Washington, D.C.: NASA Monographs in Aerospace History No. 26, 2002), p. 34-35.

²⁸ The use of the term “nose” here is metaphoric since the LLRV didn’t have a nose in the way that one is present in a normal airplane. It actually refers to the front of the vehicle where the pilot and cockpit were located.

²⁹ For a fuller account of this event see Hallion, *On the Frontier*, p. 97.

³⁰ See Reed and Lister, *Wingless Flight*, p. xv, 121. Bikle used to expose individual mistakes of some magnitude during regularly scheduled weekly meetings or at gatherings in his office, discouraging the individuals from repeating the error. An effective management tool, the procedure eventually was dubbed by those subjected to it as “being in the Bikle Barrel.”

³¹ The project management philosophy and practices instilled by FRC director Paul Bikle in the LLRV and the lifting body programs were essential to the success of both. Bikle had an uncommon ability to identify both strengths and weaknesses in the people doing the work and in the technologies involved in these advanced flight research projects. He was able to inspire the technical staff, pilots, mechanics, and technicians to find the right balance between risk taking and flight safety. Bikle was a stickler for detail; woe unto the subordinate who failed to be equally well versed. He was known for his ability to sit through long meetings involving complex technical problems at which he often acted like he was asleep. After the issues were well developed, he would offer his solution, usually a straightforward approach that resolved the differences in opinion. Despite his decisiveness, however, Bikle refused to compromise flight safety for the sake of schedules and he frequently admonished those around him not to “be on time for an accident.”

Chapter 7: Flight Research

Following a year of experimental flights, by late 1965 the LLRV was ready to begin actual flight research. Outside of the FRC, a growing understanding within NASA of the LLRV's value led Robert C. Duncan, chief of the Guidance and Control Division at the MSC, to suggest that the LLRV support the Apollo program in five crucial areas. The LLRV, Duncan said, could verify in-flight handling qualities of the LM during lunar landing and approach maneuvers, develop and verify the landing approach procedures, verify in-flight LM-type attitude and throttle controllers and partially verify displays, provide flight experience and training for pilots in a LM-type flight vehicle, and flight-check the operating envelope for landing and touchdown.¹

Officials at the FRC and MSC agreed on an ambitious one-year research program of 148 flights, an optimistic goal considering it had taken a year to complete the first 51 experimental flights and work yet remained. The flight research program was geared to evaluating the vehicle's aerodynamics, testing the performance of its attitude-control system, verifying its requirements for displays and control mechanisms, and further developing or verifying lunar trajectories and landings on sloped surfaces. The Apollo program office also wanted to use the LLRV for evaluating potential LM cockpit displays and pilot's controllers to get a clearer idea of how they would perform in an operational environment.²

Rate-Command System

Due to the mounting pressure to finalize the LM's vehicle control system, the first priority in the flight research program was to evaluate the LLRV's rate-command control system. The objective was to determine optimum values for control-system parameters that would give the pilot satisfactory control of the vehicle while using the lowest level of attitude-rocket propellant. Since increasing the level of vehicular control and stability generally required greater attitude-rocket fuel use, the LLRV team wanted to determine an optimum trade-off between these two requirements. And since the craft had to be landed on the moon, far from any source of fuel and oxidizer, propellant usage was a major concern with the LM, then under construction by the Grumman Aerospace Company.

The LLRV provided the first opportunity to obtain flight data for comparison with the design parameters that had been selected for the LM and which were based solely on analysis and computerized simulation studies. The MSC in Houston and Grumman's system designers were anxious for the real-life test results that the LLRV could provide since these design parameters could not otherwise be tested operationally until the LM actually landed on the moon.³

When Neil Armstrong had to fly the LM manually on the final leg of mankind's first journey to the surface of the moon, it became apparent that optimizing each pilot's control of the LM with flight training in the LLRV had been a program of extraordinary foresight. For as the LM approached the surface of the moon during Apollo 11, Armstrong found that the vehicle's automatic landing system was directing it to land in a boulder-strewn area. He not only had to maneuver the LM manually to a better landing site, he also had to do so while the navigation computer and low-propellant alarms were going off. But Armstrong had trained extensively in the LLRV for precisely this sort of situation, and this training paid off handsomely. Of course, it did so only because the LLRV and the LLTV used in Armstrong's training operated very much like the LM.

Flight 52 on 2 November 1965 was the first of 20 research flights evaluating the LLRV's rate-command system. The plan called for a pilot to evaluate the system for various control-system parameter settings while performing a simulated lunar landing.

The objective was to fly the LLRV in gimbal-locked mode to an altitude of 200 feet, transition into the lunar-simulation mode, then translate and descend to a landing site 800 feet in front of the LLRV. In some cases, the landing point was moved to the left or to the right, requiring the pilot to make lateral as well as forward translations.⁴ Pilots rated their ability to control the vehicle during the test maneuver according to a numerical scale of 1 to 10, with 1 as “easy to control” and 10 as “uncontrollable.”⁵ Walker was the evaluation pilot for the first five flights, Mallick for the remaining fifteen flights, ending with flight 71 on 8 December 1965.⁶

The six-degrees-of-freedom, fixed-base analog simulator for the LLRV was used at the FRC to establish an initial set of control-system parameters for operating in both a lunar and an Earth-gravity environment. Use of the simulator greatly reduced the chance of choosing an initial set of parameters that would render the vehicle uncontrollable in flight. It also reduced the number of actual flights necessary to establish and verify an optimum range of control-parameter values for satisfactory control by the pilot with a minimal use of propellant.⁷

Generally, test-flight results showed that pilots could achieve satisfactory vehicular control at much lower rate control authorities, higher dead-band settings, and lower values of controller sensitivity in lunar gravity than they could in Earth gravity.⁸ This meant that lunar operations would require less rocket propellant and, consequently, the vehicle could weigh less—an extremely important factor for the LM. Yet even though these settings were much less critical during simulated lunar-gravity operation, pilots tended to prefer flying the LLRV in VTOL mode. At first, pilots with conventional VTOL and helicopter experience found disconcerting the larger attitude angles needed to vector lift-rocket thrust while translating in the lunar-simulation mode, as much smaller angles were typically required for VTOL operations. This initial preference isn’t difficult to understand; pilots lacking experience with the LLRV would prefer

A Bell 47G helicopter was used as a chase for the LLRV. The two vehicles appear closer than they were due to the compression of a telephoto lens. (ECN-653)

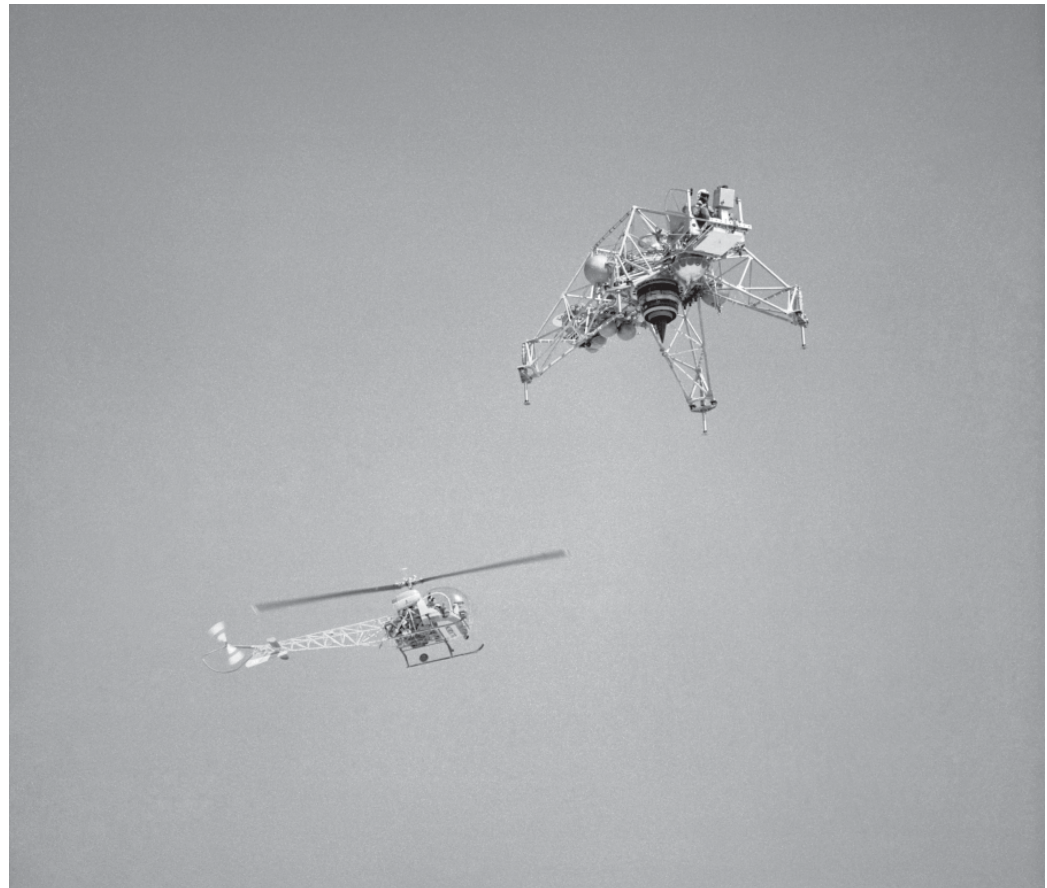

flight within the 1g Earth-gravity conditions they knew rather than within the 1/6-g lunar conditions they did not. But once pilots became more familiar with lunar-simulation operations in the LLRV, their preference began to change.

One item that remained problematic throughout the test program was maintaining lateral balance of the LLRV during flight. A weight imbalance around the roll axis would affect both control harmony and pilot ratings, especially when operating in lunar-simulation mode at low control authorities. Since the pilot used the same rockets to correct for unbalanced moments that were used for maneuvering the vehicle, large imbalances could, and did, reduce the pilot's control authority in normal attitude maneuvering.

Another persistent and significant problem derived from how the firing logic was arranged in the LLRV's attitude-control system. Two rockets operated simultaneously about a given axis to provide control, albeit from opposite ends of the craft. Pitch and roll rockets formed an additional pair about an axis, one firing upward and the other downward in concert. But when a pilot applied combined pitch and roll, only one rocket fired, causing motion about both the pitch and the roll axes at half the normal control authority. The very low control authorities gave the pilot a false sense of the response to his control input. Additionally, an attitude rocket correcting an imbalance about one axis could be overridden by a pilot command about the other axis, which the pilot would see as the vehicle rolling in response to pitch inputs, or vice versa, both being equally unacceptable situations.

This problem may be difficult to comprehend in the abstract, but just such a situation occurred on 18 November 1965 during flight 59. The authority values for pitch and roll control had been set very low—at 7.5 and 10 degrees per second squared, respectively. During the flight, unequal fuel and propellant usage from the supply tanks by both the jet engine and the lift rockets caused large vehicle imbalances in both pitch and roll, causing the LLRV to pitch nose down and roll to the left. A single rocket commanded automatically by the rate-command system fired continuously, providing pitch and roll moments to compensate for the imbalance and holding the vehicle level in attitude. But when Mallick applied pitch command inputs, the firing of the two pitch attitude rockets negated the counterbalancing moment the single attitude rocket had been providing about the roll axis. Mallick perceived the vehicle as rolling in response to his commands in pitch, an experience he found very disconcerting.

The same sort of situation occurred when roll command inputs voided the counterbalancing moment in pitch while the LLRV appeared to respond in pitch to his commands in roll. During flight 59, Mallick tried for several seconds to control the vehicle's attitude. He was able to do so only after manually selecting both sets of attitude thrusters and increasing control authority in both pitch and roll. Yet the problem was never encountered at pitch-and-roll control authorities above 10 degrees per second squared, even with large imbalances. It seemed that the higher angular accelerations masked the undesirable vehicle characteristics.⁹

All of this suggested that any externally applied disturbing moment could result in a dynamically unstable vehicle at low values of control authority. At the time, the Grumman team designing the flight controls for the LM had been considering use of very low levels of control authority out of concern for fuel usage, believing that on the moon there would be no aerodynamic forces to cause large unbalancing moments. The results of flight 59, however, were passed on to Houston and to the systems designers at Grumman, influencing the final design configuration. The result was that the firing logic of the attitude rockets and the control authorities on the LM were such that the problem that had been encountered on the LLRV would not be encountered on the LM.

Members of the test team also measured the amount of attitude-rocket propellant used during lunar-simulation landings with the rate-command system. They found that for all control authorities and controller sensitivities evaluated, the minimum propellant

consumption in either VTOL or lunar-simulation operations always occurred at approximately the same rate of dead-band settings: that is, 1.5 to 2.5 degrees per second. Extensive fixed-base simulation studies further evaluated this finding, which greatly simplified the design of dead-band settings for this type of control system.¹⁰

Pilot Checkout and Vehicle Modification

As Walker became involved with the XB-70A program in late 1965, he had less time for the LLRV. To restock the program's pilot complement, U.S. Army Lt. Col. Emil E. Kluever, known as Jack to his friends, joined Mallick as LLRV co-project pilot. Bickle asked the U. S. Army to assign Kluever, an honors graduate of the U.S. Air Force Test Pilot School in 1960, to the FRC because of his substantial experience with fixed- and rotary-wing aircraft. Kluever's background in flying the X-14 and XV-3 VTOL aircraft was an asset to a number of programs at the FRC, including those for high-speed drag devices, the heavyweight lifting bodies, and the LLRV. Besides flying the LLRV, Kluever performed flight safety reviews for the pilot's office.

As Joe Walker became more involved in the XB-70A program, NASA added Emil "Jack" Kluever to the roster of LLRV pilots. Kluever's extensive helicopter experience was a key factor in the addition of a Bell 47G as a chase vehicle. The helicopter also was used for introductory and recurrent training for all LLRV and LLTV pilots. (ECN-1182)

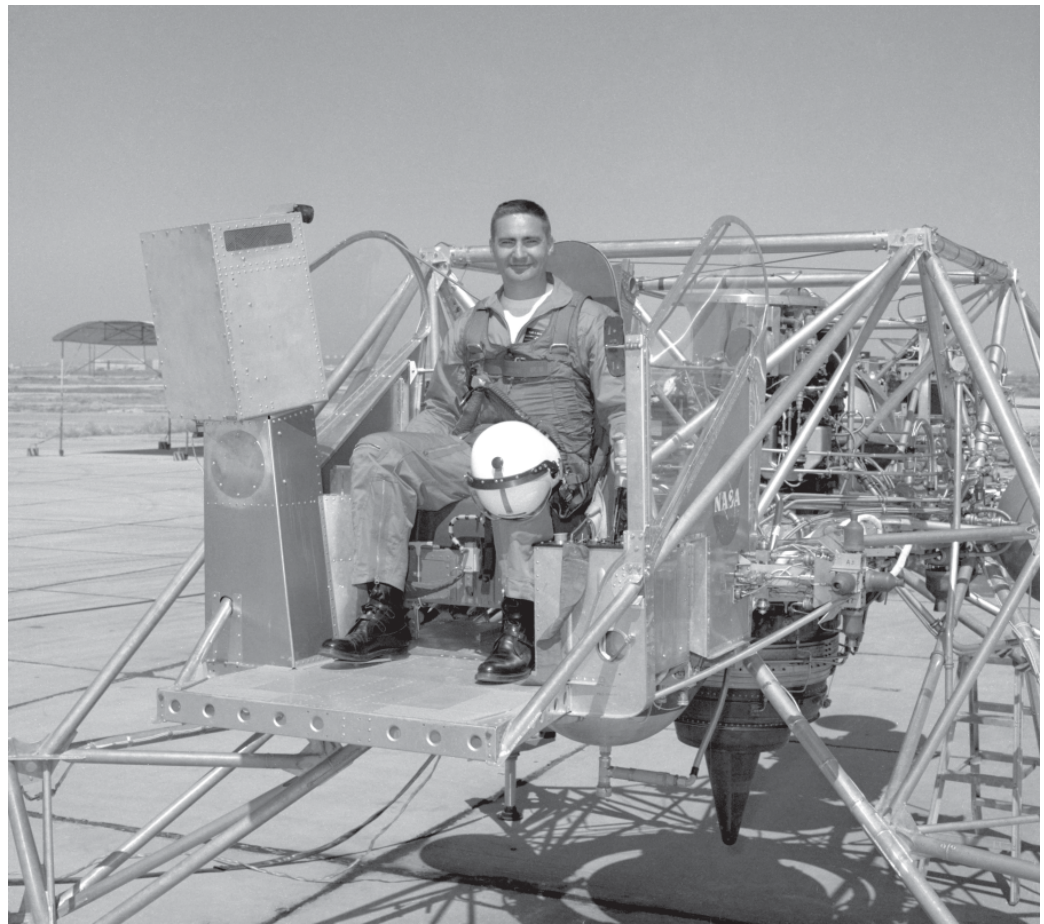

Before Kluever could begin flying the LLRV he needed to bring his weight down to 200 pounds to stay within the weight criteria established to ensure adequate thrust margin for the LLRV during takeoff. Ottinger wanted to lose some weight himself, so he challenged Kluever to a weight-loss contest. The two had time to interact daily as they competed, since Ottinger was briefing Kluever on LLRV systems during the early-morning LLRV operations. Together they drew up a chart for mapping their progress over ten weeks, with weigh-ins set for Monday mornings. While the goal was to lose an agreed-upon amount of weight, they also settled on a penalty of a dollar per pound above their projected weekly weights, and an equal credit for each pound under pro-

jected weekly weight. Early in the competition Ottinger led by as much as \$15 or \$20, primarily because he tempted Kluever with luscious desserts while traveling together on visits to contractors. But by the end of the ten weeks, both men had met their weight-loss goals and Kluever had pulled to within \$1 or \$2 of Ottinger.

It was during this time that a thief broke into the LLRV hangar at South Base on a Friday night. The following morning, Ottinger and the crew found equipment and numerous tools missing, much of it the personal property of crewmembers. Everyone was disgusted by the break-in, but members of the crew noticed that Ottinger's disgust grew considerably when he found his own stockpile of luncheon steaks—part of his diet—missing from the freezer. Thereafter, security at the facility was noticeably increased.

Kluever made his first flight in the LLRV—flight 73 in the project schedule—on 13 December 1965. This flight was carried out in gimbal-locked mode. During a second flight that day the gimbals were unlocked and Kluever flew the vehicle in local-vertical mode. Over the next two days he flew the LLRV three more times, gaining experience in full lunar-simulation mode. It took just five flights for him to successfully complete his checkout.¹¹

With Christmas approaching, flight activity ended for the year. During the downtime, crewmembers installed a LM-like instrument panel in the LLRV and checked it out, and conducted a thorough inspection of the vehicle. As promised, Ron Blilie of MSC operations engineering and Clif Rogillio from the quality assurance office arrived in December with a crew of eight Dynelectron mechanics to assist the LLRV team. Flying resumed on 4 February 1966 with Mallick evaluating the LLRV and its new instruments.¹² Even though the LLRV had been sitting idle for nearly two months, everything on the vehicle performed perfectly. Kluever also assessed the new instruments on the next flight—flight 79—on 11 February. Both Mallick and Kluever found the new instrumentation an improvement to the LLRV.

Next, the LLRV's center stick and pedal controllers were replaced with a right-hand three-axis controller like the one designed for the LM. Beginning with flight 86 on 11 March, Mallick completed a preliminary, seven-flight evaluation of the new controller. Kluever then evaluated the new controller over several flights, which included full lunar simulation to landing. Mallick and Kluever rated flying the LLRV with the new side stick comparable to flying it with the center stick and rudder pedals, and experienced no coupling between control axis inputs on these flights.¹³

Aerodynamic Evaluation

The LLRV's aerodynamic characteristics were measured during flights 102 through 112 during the first 20 days of April 1966. The crew installed an anemometer-type airspeed system on the vehicle to supplement the onboard Doppler radar system for measuring wind speed. Both instruments measured the airspeed across the LLRV's 2,000-foot horizontal flight path during flight 123 on 19 May, with Mallick at the controls. External radar measured the average speed at 43.6 feet per second, while the two onboard systems measured it at 39.2 and 43.4 feet per second, respectively. Data gathered on flights 102 through 112 was corrected based on data from the two on-board computers. The corrected data essentially agreed with Bell's predictions of the aerodynamic characteristics of the LLRV and formed the basis of the design requirements for the drag-compensation system.

Landing Trajectories for the LM

In the spring of 1966 the FRC team began evaluating the final landing-to-touch-down trajectory that the Apollo program office had selected for the LM, conducting the tests during the course of 26 flights in the LLRV. The team worked closely with flight planners at Grumman and in Houston to keep the trajectory characteristics aligned as

The LLRV above the South Base ramp. The B-47 and B-58 parked beneath the LLRV were used for various test programs. The B-58 Hustler had an extended nose containing the radar and fire control system from a YF-12 interceptor. Its large black radome won the B-58 the nickname "Snoopy." (ECN-688)



closely as possible with those in the projected LM profiles. The main purpose for these flights was to demonstrate that the LLRV could perform the LM syllabus of flights adequately and realistically in astronaut training.¹⁴ Mallick flew 11 of the 26 flights and Kluever, 15.

In his last two outings of this test sequence, Kluever made 180-degree turns on final approach to landing. Both pilots initiated the trajectories by engaging the lunar-simulation system at an altitude of 370 feet, a forward velocity of 45 feet per second, and a downward velocity of 7.5 feet per second. The task was to fly over a horizontal distance of 1,400 feet with the LLRV in a nose-up pitch attitude of 7 degrees and a thrust-to-weight ratio of 1.05, come to a hover at an altitude of 100 feet, and then descend to the landing point, all within 30 seconds. The flights gave both men a realistic feel for the dynamic characteristics of the landing trajectory.¹⁵ They found that the steeper descents, which required larger pitch attitudes in order to slow and arrest forward velocity, obscured the landing point during much of the descent. Since it was difficult to come to a hover immediately above the landing spot, it usually took longer than planned for pilots to maneuver from hover to touchdown, and this loss of time usually negated the expected savings in time from the steeper descents. Yet the shallower descents took longer still, further reducing fuel margins at touchdown. In spite of all this, after achieving the initial hover, neither pilot had any problem with translating laterally across the landing area.

But both Mallick and Kluever remarked on several difficulties in reading the cockpit instruments that were replicas of the displays designed for the LM. For ex-

ample, the markings on the thrust-to-weight meter at 0.2g intervals made it very difficult to establish the 1.05 point. Likewise, markings on the attitude indicator at 10-degree intervals made it difficult to set the desired 7-degree value. They passed these findings on to LM program managers who, by this time, were monitoring LLRV flight results quite closely.



True to a long-standing FRC tradition, the entire LLRV team assembled for a group portrait after the 100th flight, on 31 March 1966. (E-14754)

On 13 May 1966, MSC director Robert Gilruth came to South Base to observe the LLRV in operation and see for himself the vehicle's performance capabilities. Impressed with the full lunar-simulation trajectory and landing (flown by Kluever) that he witnessed, he wrote a letter to Matranga calling the LLRV "a key building block in the Apollo program."¹⁶ Even the Apollo program office now gradually conceded that the LLRV was the only means of providing astronauts with a realistic simulation of the final phase of the moon mission. Eventually, it would provide the best available operational training for the primary and backup mission commanders of all six successful landings as well as the aborted Apollo 13 mission. On 19 and 20 May, Matranga and Ottinger traveled to the MSC to help finalize specifications for the LLTV. At Edwards, the LLRV project moved into summer scheduling, with the workday starting at 5 a.m. to take advantage of the desert's cooler early-morning temperatures and lack of wind.¹⁷

Attitude-Command Mode

Mallick and Kluever evaluated the attitude-command mode of the attitude-control system on 15 flights—numbered 124 to 138—between 23 May and 15 June 1966. In this mode, the pilot's controller deflection determined the vehicle's attitude, rather than its angular rate, in direct proportion to how far he moved the control stick. Mallick and Kluever performed the same simulated lunar-landing maneuver as they had in evaluating the rate-command mode the previous November and December. For these flights, all test attitude rockets used for pitch and roll control were set at 40, 60, and 90 pounds of thrust. Yaw test rockets were always set at 60 pounds.

In pitch and roll, the two pilots evaluated rate dead-bands of one, two, and three

degrees per second of vehicle rate, and attitude dead-bands of one and two degrees of the vehicle's attitude. For all 15 of these flights, control-stick sensitivity was set at four degrees of vehicle attitude for each degree of controller. If the pilot moved the control stick to 10 degrees, the vehicle rotated 40 degrees in attitude, and the craft remained in this attitude until the pilot moved the control stick to neutral, at which point the vehicle returned to zero attitude.

Both pilots rated the simulated lunar landings made with the attitude-command mode as equally good or better than those made with the rate-command system. Both also indicated that while a pilot would need to adapt to the attitude-command mode of control, its use reduced a pilot's workload and made the vehicle easier to fly.¹⁸

By the time this series of 15 flights ended, in mid-June 1966, the flight-research program had been going so well that most of the team and crew assumed they had put the earlier harsh realities of system failures and concerns about reliability behind them. But flight 139 gave team members another wake-up call. The flight had to be terminated prematurely when a "stuck valve" indicator came on about halfway through the mission. Although the telemetered data did not confirm the failure, as a precaution Kluever was instructed to land the LLRV as soon as possible. The culprit turned out to be a broken wire, the first system failure in 90 flights.

A new set of ejection-seat tests had to be conducted after the cockpit was redesigned in late 1965 to more closely resemble the LM. Here, the Styrofoam® cover and small window aperture are visible on the mock-up. The test results bolstered Ottinger and Kluever's argument for the removal of the drogue chute and lift-rocket recovery system originally mounted on the LLRV.
(E-15318)

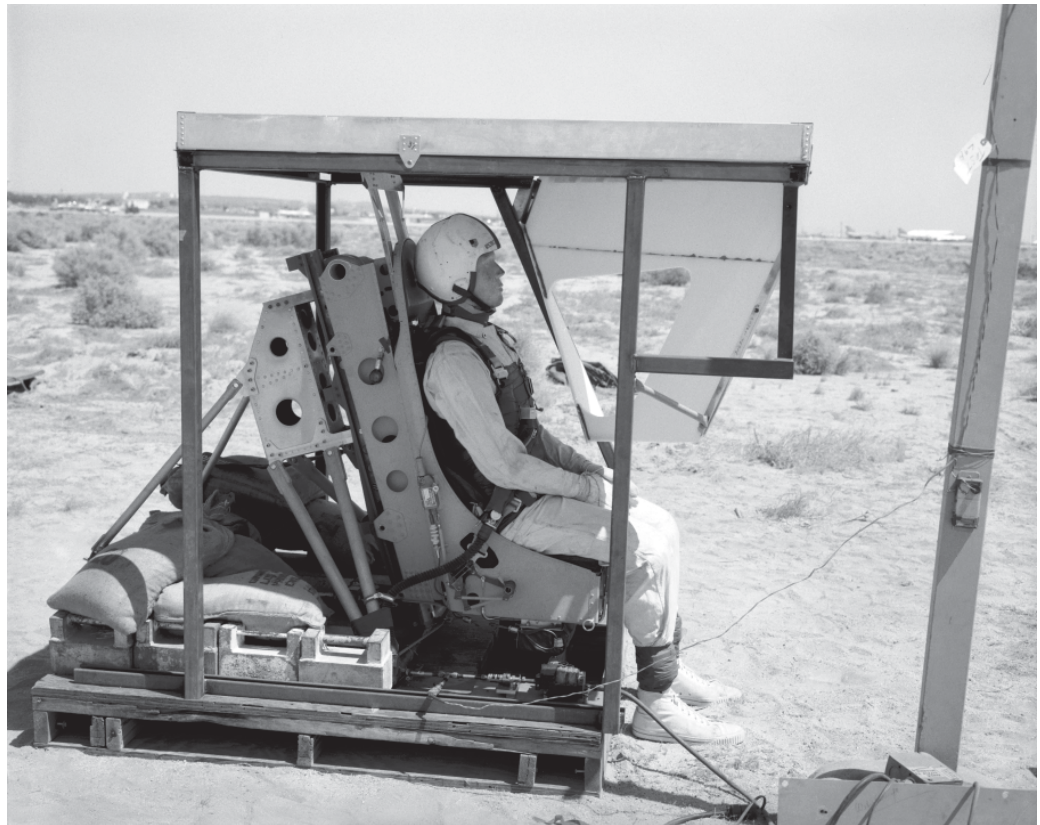

Removing the Emergency Recovery System

Earlier that spring, the LLRV team heard from the Weber Aircraft Company that the firm now offered a rocket with higher thrust for the ejection seat, and Weber recommended that the new rocket be used in the LLRV. The only drawback was that this new rocket would add 15 pounds of weight. The rocket itself was 10 pounds heavier than the original one, so the team would need to add 5 additional pounds of ballast to correct a change in the center of gravity. In the end, the idea of adding the 15 pounds led the team to reassess the overall weight of the vehicle, including the need for the emergency recovery system itself.¹⁹

Debate swirled over the latter item since the arrangement already in use nicely addressed two needs: saving the pilot in an emergency, and rescuing a unique test vehicle. Kluever and Ottinger were convinced of the benefit of trading the vehicle rescue system for useable weight in the LLRV, and they took on the unpopular task of trying to convince others involved with the project of their position. They would need to convince a large group of people at the FRC, the MSC, and Bell, many of whom felt that the emergency recovery system for the vehicle should not be abandoned. Yet the two persisted; it would be more important to save the pilot than the vehicle, they pointed out. At any rate, using the emergency recovery system would be “iffy” depending on how much rocket fuel remained on board at the time of a potential crisis. Fixed-base simulation studies, they reminded the others, had shown only about a 50-percent chance of successful vehicle recovery with the current system. And this was an insufficient margin to justify training astronauts in a procedure not directly related to lunar landing. It would be safer, they added, to upgrade the ejection seat with the new rocket and allow the pilot to abandon the vehicle in the event of a catastrophic failure during flight.

The two men emphasized the reliability of the vehicle, especially its jet engine, proven in more than 139 flights, as well as the difficulty facing any pilot who sought to precisely use the drogue chute and rockets in an emergency with low rocket-fuel remaining. It made no sense, they argued, to require astronauts to spend valuable training time learning how to use a system to save the vehicle that involved putting their own lives at great risk, especially since the system had little chance of actually saving the vehicle.

After carefully reviewing the issue, everyone ultimately agreed that the drogue and emergency rockets should be removed from the LLRV, something that dropped its weight by 60 pounds. Another 20 pounds was shed from the vehicle by removing the drogue chute used for emergency attitude stabilization, an integral part of the emergency rocket-recovery system. In an emergency caused by loss of control or engine thrust, the pilot would simply eject and sacrifice the vehicle.²⁰

NASA insisted on a live demonstration of the modified seat before it was installed in the LLRV. For the demonstration, a Styrofoam® enclosure was built around a cockpit configuration, providing the pilot with a window equivalent to the one in the LM. To withstand the flight velocities of the LLRV, the panels in the Styrofoam® enclosure were two inches thick. A cutting edge was designed and added to the top of the seat to facilitate ejecting through the Styrofoam® canopy roof. The roof panel was scored as well to reduce the force needed to penetrate it. The live demonstration took place at Edwards on 28 June 1966. Armstrong, who was well into his astronaut training by this time, was present for the demonstration, as was Ottinger, who by then was working as Bell’s LLTV technical director.

An emergency ejection is in fact a carefully timed chain of events, a ballistically charged ballet. The normal sequence of an ejection from the LLRV began with the pilot pulling the “D” ring on the ejection seat, firing a zero-time-delay M-27 catapult initiator. The ballistic charge of the rocket assembly propelled the seat up its guide rails. According to the plan, first the pilot’s hands and then his knees would contact the Styrofoam® front panel, shattering it. Next, the cutting edge atop the ejection seat would penetrate the Styrofoam® canopy. The seat riding up the guide rails would initiate (but not complete) the next step: mechanically firing the one-second-delay M-32 initiator meant to separate the pilot from the seat. A mere 0.155 seconds into this process, and just before the pilot-and-seat assembly left the guide rails, the rocket’s motor was to ignite. It would burn for less than half a second, long enough to provide up to 4,500 pounds of thrust directed through the waist of the seated pilot and at an angle of 53.1 degrees from the centerline of the guide rails. During the one-second delay of the M-32 initiator, the rocket’s motor would burn out. After this, gas pressure

supplied to a rotary actuator and release system cylinder would separate the pilot from the ejection seat. This, in turn, would automatically pull the drogue gun cable, activating another one-second-delay cartridge in the parachute drogue gun. During this last delay, the pilot separated from the seat, after which the drogue gun fired, deploying the pilot's chute and main canopy and safely lowering the pilot to the ground.²¹

But the demonstration did not quite adhere to the expected sequence of events. When the new rocket fired, it boosted the seat to an altitude of 300 feet, more than 100 feet higher than with the original rocket. The seat then went through dramatic gyrations in all three axes of rotation before the seat and the dummy separated.²² Ottinger noted Armstrong's somewhat alarmed expression as this happened, and Armstrong promptly left the scene. As it turned out, he would be the pilot the next time the LLRV's ejection seat fired, just two years later, during the first of three safe ejections from the fleet of LLRVs and LLTVs at the MSC training site on Ellington Air Force Base, near Houston.

While on a visit to the Weber Aircraft Co., the makers of the LLRV ejection seat, Wayne Ottinger (left) presented Jack Kluever with a photograph of the test dummy lying in the sand after a series of ejection seat tests. In the photograph witnesses can be seen walking away from the scene, and the photograph was captioned: "Oh well, he's just an Army pilot," a reference to Kluever's temporary detachment from the Army to NASA. (Weber Aircraft Co. no. P-143)



The team's concern over this unfortunate turn of events was somewhat relieved when analysis after the demonstration revealed what had caused the dramatic gyrations. The dummy's foot caught a corner of the instrument panel as the seat went up the rails. A pilot's heels, cautioned a note that soon appeared in the pilot's manual, should be held against the seat when ejecting. After flight 149, the new ejection seat was installed in LLRV No. 1 and the emergency lift rockets and drogue parachute were removed. The team breathed a sigh of relief that it had never been necessary to use the drogue chute to recover the vehicle in an emergency. Perhaps luck would have prevailed and the system would have worked, perhaps not, but there was never a need to find out.

More Lunar Trajectory Flights

In July 1966 Bikle received a request from Dean Grimm, the MSC project engineer

coordinating development of the LLRV and the LM, to conduct 14 additional lunar trajectory flights with the LLRV. The new trajectories involved starting from a hover 100 feet higher than in previous flights—that is, from an altitude of 500 feet—and extending by 400 feet the forward translation to the landing site. After engaging the lunar-simulation system, the pilot was to nose the vehicle down 10 degrees in order to generate the forward velocity and sink rate required to reach the preset landing point. The LM development team at the MSC hoped that the new trajectory would provide an optimum trade-off between the fuel burn and the time needed to transition from approach to landing. It was clear that the LM team still remained deeply concerned about the amount of fuel needed for this final maneuver, for there was no margin of error on the moon; there, the final maneuver had to be perfect. The problem lay in anticipating the unknown in order to decide how much fuel to reserve for contingencies. In the end, the additional trajectory flights of the LLRV at the FRC generated invaluable data for making these critical decisions.²³

Mallick and Kluever encountered no problems flying the new trajectories. Transit times ranged between 60 and 69 seconds. Horizontal velocities essentially were zero. All vertical velocities were below two feet per second at touchdown. The FRC team gave the results to the LM development team at the MSC, which, in turn, used the information in establishing the profile of the LM's landing trajectory on the surface of the moon.²⁴

MSC Pilot Checkout

Joe Algranti and H. E. “Bud” Ream—the two MSC pilots who would head LTV astronaut training operations at Houston—were eager to fly the LLRV and get checked out in flight. Mallick by then had phased out of the LLRV flight program, having become involved in the investigation of the midair collision of an XB-70A and F-104N



Posing in front of the LLRV following Joe Algranti's successful check-out flight were, from left, Joe Schneider, Bob Baron, Jack Kluever, Joe Algranti, Gene Matranga, and Ron Blilie. The vehicle soon was transferred to Houston, where Algranti oversaw aircraft operations and astronaut readiness training. (E-15559)

that took the lives of Joe Walker and Maj. Carl Cross.²⁵ Kluever was well qualified to check out the MSC pilots, with over 3,000 hours of experience as a flight instructor, including 2,507 in fixed-wing aircraft and 500 in helicopters.

Algranti, a World War II naval aviator whose career at the NACA and NASA spanned four decades, had been assigned to the new MSC in Houston during the summer of 1962, following three years at the Langley Research Center in Virginia and eight at the Lewis Research Center in Ohio. At Langley, he had been a pilot for NASA's first administrator, T. Keith Glennan, and had been involved in the Vertical Take Off and Landing program. In September 1962, he was appointed chief of aircraft operations at the MSC. During the 1960s, Algranti oversaw several major programs including the astronaut readiness-training program, flown in T-38s, as well as operation and testing of the LLTV. Later, during the early stages of NASA's Shuttle program, Algranti headed the development, modification, and maintenance of the Shuttle Training Aircraft and the Shuttle Carrier Aircraft.

Flight planners at the FRC and Houston developed a syllabus of 11 flights for checking out Algranti and Ream in the LLRV, flights that would later serve as a training syllabus for the astronauts. The first three were familiarization flights in gimbal-locked mode—one using the standard rockets, a second the test rockets, and a third using both—followed by a fourth flight in local-vertical mode using the lift rockets in landing. The remaining seven flights were in lunar-simulation mode. The fifth flight was a practice entry into lunar-simulation mode with a conventional landing, the sixth a longitudinal translation in that mode, the seventh a lateral translation in it, and the eighth a practice entrance and exit from lunar simulation. The ninth and tenth flights involved entering lunar simulation from a hover. The eleventh flight included entering lunar simulation with initial velocities.

After being briefed on the vehicle's systems as well as on normal flight and emergency procedures, Algranti made his first two flights, flights 155 and 156 of the LLRV, on 3 August 1966. The first time Algranti engaged the lunar-simulation system, the slow actuation of the lift rockets resulted in a considerable altitude increase without triggering the auto-throttle. Since Algranti had been briefed on earlier difficulties with engaging the system, he opted to lock the gimbals and land, using the jet engine. After Kluever flew the LLRV to ensure that the systems were functioning properly, Algranti successfully engaged the system on his next flight, completing a full simulation maneuver to touchdown. The rest of Algranti's checkout proceeded normally.²⁶

Bud Reams' checkout began with flight 176 on 22 August. He had to repeat his fourth flight after a switch failure kept the vehicle from going into local-vertical mode. The seal on the attitude-rocket select valve also failed after the screws holding the valve body together backed out during flight, spraying hydrogen peroxide over the rocket deck and into the cockpit. He landed the LLRV safely without significant damage to the vehicle. The LLRV was ready to fly again the next day. Ream completed his checkout on flight 191 on 1 September.²⁷

Making comparisons with their prior flight experience with VTOL and helicopters, Algranti and Ream took note of the larger angles required in the LLRV for control and translation in the lunar-simulation mode as well as the greater anticipation needed for maneuvering. After checking out in the LLRV, the two pilots were excited about the vehicle's capabilities for use in training astronauts to land on the moon and were eager to get the training operation underway at Houston.

Final Flights at South Base

August 1966 was, by far, the most productive month in LLRV activity at the FRC. By month's end, LLRV No. 1 was grounded so it could be updated to match the latest LM configuration before being prepped for shipment to the MSC. The LLRV jigs would be sent back to Bell, the ground support equipment, fixtures, tools, and spares

would later be sent to the MSC, and the LLRV simulator and cockpit would be packaged to go to Houston by moving van.²⁸

On 27 and 28 September, Bell engineers visited the FRC to collect the information they needed to construct the LLTVs. They picked up current drawings of the LLRV as well as approximately 100 detailed photographs taken by a NASA photographer to supplement the drawings. They also examined the LLRV's ground support equipment, and Jarvis made numerous suggestions on how to improve failure detection and flight safety with the electronic systems. The attitude-control system's hydrogen-peroxide shutoff valves had posed a safety problem during the program, a problem serious enough that it threatened to shut down the project. The electrical leads to the valve motor had become so chafed during normal operation that an electrical short could have ignited a fire or set off an explosion. Realizing it would take six months or longer for design and installation of a new valve that would eliminate the problem, LLRV crew chief Ray White came up with a field fix, using spacers to solve the problem.

That November, White's modification to the shutoff valves was approved. What is more, the White House and the U.S. Civil Service Commission recognized his suggestion as a distinguished accomplishment. Earlier, White had solved another safety problem by adding jet engine bleed-air deflector ducts to the LLRV to keep engine oil spray from mixing with hydrogen-peroxide exhaust from the rockets. By mid-November, modifications to LLRV No. 1 were complete. Kluever flew seven checkout flights on the modified LLRV—the last one at Edwards on 30 November—bringing the total number of flights on vehicle No. 1 to 198. The LLRV was then prepared for its trip to Houston by moving van.

By January 1967, LLRV No. 2 was ready for flight, using the avionics boxes from LLRV No. 1, the only flight-worthy set available. Kluever flew LLRV No. 2 six times—three flights on 11 January and three on 13 January—to validate that the No. 2 met specifications and was ready to be shipped to Houston. For these flights, the vehicle had the Styrofoam® cockpit that gave Kluever an outside view like that of the LM. The vehicle also had a T-handle lift controller akin to that in the LM replacing the collective stick for control of the lift rockets. Kluever had no problems with any of the modifications. He noted, however, that the T-handle was more sensitive for control at low-thrust settings than the stick it replaced.

The only problem encountered at Edwards in flying LLRV No. 2 occurred during the third flight, on 11 January. As soon as the vehicle became airborne, it was obvious to those in the control van that the attitude-rocket operation was quite different from anything seen previously with either LLRV. Bob Baron, the ground controller for the flight, radioed Kluever, suggesting he land. Kluever replied that there was no gyro feedback, and he wanted to evaluate the vehicle under these unique circumstances. Permission to continue the flight came after Kluever assured the ground controller that the LLRV was flyable, although flying it required much more effort, as in a conventional helicopter. Kluever finally gave the LLRV in that configuration a pilot rating of 4.5—only marginally acceptable.

Analysis after the flight showed that the pitch and yaw connectors from the rate gyros, improperly secured, had vibrated loose. The new Houston and contractor support personnel watching this flight witnessed an excellent real-life lesson regarding the critical nature of each component of a system, and how easily things could go awry. After the sixth flight, two days later, LLRV No. 2 was also ready to be shipped to Houston.²⁹

From the Mojave to Houston

A team of eight engineers and technicians from the FRC left the Mojave Desert on 27 September to support the checkout of LLRV No. 1 at the new LLRV operations site in Houston. The team included Bob Baron, Bill Bastow, Bill Clark, Leroy Frost, Ray

Kellogg, Gene Matranga, Al Pendergraff, and Ray White.

Although the U.S. Army had by this time reassigned Kluever to the Pentagon as program manager on the Cheyenne attack helicopter project, he was able to join the team from the FRC to make the checkout flights of the No. 1 LLRV at the MSC. As soon as the FRC contingent arrived, the LLRV was quickly prepared for a flight scheduled to take place the next morning. On 28 September, Kluever's first flight of No. 1 at Houston went perfectly. He flew once more in the morning and again, all was satisfactory. Kluever felt that the vehicle behaved as it should and Algranti, the MSC pilot, agreed. Thereupon, two LLRVs were formally turned over to Algranti.

The second flight of LLRV No. 2 on 1 January 1967 was also the 200th flight of the LLRV program. The LLTV would closely resemble this configuration of the LLRV. (E-16268)



The MSC staff threw a party for the FRC contingent to celebrate the transition. Near the party's end, a group of MSC mechanics grabbed Bob Baron and snipped his pant legs off above the knee. Baron had a reputation for snipping off ties at FRC parties, so the tables had been turned. (During one party at the Baron house a guest snatched one of Baron's ties without his knowledge and handed it to a latecomer to wear as he joined the festivities. Before he realized it, Baron had "shortened" his own tie, to the delight of the guests.) Following the party Baron, resplendent in his new shorts, with garter belt and high socks for all to see, happily sailed off to the airport without changing. Reaction at the Houston airport was mixed, although the clerk at the Continental Airlines desk admitted she'd like to be on the Los Angeles flight as it looked to be an interesting one.

Pilot	Number of Flights	Time (Hours:Mins.:Secs.)
Walker	35	2:22:59
Mallick	79	6:08:37
Kluever	65	6:08:59
Algranti	13	1:06:31
Ream	12	0:58:50

Task	Number of Flights
LM trajectories	26
Rate-command evaluation	31
Attitude-command evaluation	16
Aerodynamic measurement	10
LM panel evaluation	6
Three-axis controller evaluation	12
Pilot familiarization	43
Auto-throttle checkout	8
Jet-stabilization checkout	15
Operational check flights	37

The 204 flights break down accordingly, with 58 of them being LM simulations:³¹

So ended the LLRV program at the FRC. During two years of flight operations, there had been 198 flights in vehicle No. 1 and six more in No. 2, for a total of 204 flights.³⁰ In all, five different pilots flew the LLRVs.

MSC director Gilruth congratulated Bikle upon the completion of LLRV flights at the FRC. In his letter, Gilruth mentioned that the flights had yielded important technical results on handling qualities, piloting techniques, and procedures necessary for a successful lunar landing. And he complimented the FRC on having completed the program without injury to personnel or damage to the equipment, an outstanding safety record.³²

With the LLRV program complete at the FRC, Bikle and Matranga reflected on the program. Bikle admitted he'd had no faith in the LLRV's electronics, fully expecting one of the vehicles to be lost during testing. He was, of course, pleased that he had been wrong. And he admitted that he expected the LLRV results would benefit other fly-by-wire programs already being planned at the FRC. He hoped, added Bikle, that as LLRV program manager, Matranga appreciated the freedom he'd been given to operate the program, as well as the miniscule interference from either the FRC or the MSC. A program like that happened only once in a lifetime—if he was lucky, he reminded Matranga.

In turn, Matranga mentioned his concern about the operating rules the MSC had set for the LLRVs and LLTVs at Houston, particularly the 30-knot wind limit, which was twice the limit used with the LLRVs at the FRC. Not wanting to put his concerns in writing, Bikle passed this on to Gilruth during a telephone conversation and he was disappointed that no one at the MSC considered it a problem. Later events would show that Matranga's concern was well founded.

Taken from the chase helicopter, this aerial view shows LLRV operations at South Base. In the foreground is the vehicle astride the deflection grate; to the left is the trailer used to move the LLRV in and out of the storage hangar, which is at top left of the picture. Next to the hangar are the two support trailers used by NASA and Bell personnel. Water on the ramp is caused by condensed steam and also results from diluting the hydrogen-peroxide solution. (ECN-1406)



¹ See especially Courtney G. Brooks, James M. Grimwood, and Lloyd S. Swenson, *Chariots for Apollo: A History of Manned Lunar Spacecraft* (Washington, D.C.: NASA SP-4205, 1979), Chapter 14.

² Dean Grimm, interview by Wayne Ottinger, 5 August 2000.

³ Calvin R. Jarvis, "Flight Test Evaluation of an On-Off Rate Command Attitude Control System of a Manned Lunar Landing Research Vehicle" (Washington, D.C.: NASA TND-3903, 1967).

⁴ Jarvis, "Flight Test Evaluation," table II, p. 37.

⁵ On all LLRV flights, pilot-rating data complemented the rate-command system's evaluation database. Although these ratings generally were for unconstrained piloting tasks, the additional data helped in arriving at trends and conclusions involving overall vehicle controllability and propellant usage. Paul B. Bikle, Memo to NASA Headquarters on LLRV progress, report #29 for the period ending 30 November 1965, 14 December 1965.

⁶ LLRV Flight Log, Appendix I

⁷ Jarvis, "Flight Test Evaluation," p. 11-14.

⁸ Ibid

⁹ Joe Walker, "Summary account of visit to Grumman," 15 December 1966.

¹⁰ Jarvis, "Flight Test Evaluation," p. 14.

¹¹ Bikle, memo to NASA headquarters on LLRV progress, report #30 for the period ending 31 December 1965, January 1966.

- ¹² Bikle, memo to NASA headquarters on LLRV progress, report #32 for the period ending 28 February 1966.
- ¹³ Bikle, memo to NASA headquarters on LLRV progress, report #33 for the period ending 31 March 1966, 18 April 1966.
- ¹⁴ Ibid.
- ¹⁵ Bikle, memo to NASA headquarters on LLRV progress, report #34 for the period ending 1 June 1966.
- ¹⁶ Robert R. Gilruth, letter to Gene J. Matranga commenting on his impression of the LLRV demonstration flight, 18 May 1966.
- ¹⁷ S. Richard Simmons, memo to LLRV personnel concerned on tour of duty, 20 May 1966.
- ¹⁸ Jarvis, "Flight Test Evaluation."
- ¹⁹ Bikle, memo to NASA headquarters on LLRV progress, report #36 for the period ending 10 August 1966; Weber Aircraft Company interdepartmental communication No. SP251/ARJ/ES0004, 25 February 1966.
- ²⁰ J. Ryken, Study of Modification of a Lunar Landing Research Vehicle to a Lunar Landing Training Vehicle, Bell Report 7260-945001, Contract NAS 4-981, 26 January 1966, p. 14.
- ²¹ Bikle, memo to NASA headquarters on LLRV progress, report #36 for the period ending 31 July 1966, 10 August 1966.
- ²² J. D. Searcy, "Qualification Testing of LLRV Ejection System," Weber Aircraft TR-344, Burbank, Calif., 23 September 1966; Weber Aircraft Company interdepartmental communication No. SP251/ARJ/ES0004, 25 February 1966.
- ²³ Lunar Landing Research Vehicle and Lunar Landing Training Vehicle Program Plan, 18 March 1966, NASA MSC Houston; see also Den Grimm, interview by Wayne Ottinger, 5 August 2000.
- ²⁴ Searcy, "Qualification Testing of LLRV Ejection System."
- ²⁵ For an account of this accident see Hallion, *On the Frontier*, p. 182-184.
- ²⁶ Searcy, "Qualification Testing of LLRV Ejection System."
- ²⁷ Ibid.
- ²⁸ E. H. Mortensen, Letter to J. C. McCollom at NASA on transportation of LLRVs, 24 August 1966.
- ²⁹ According to Dean Grimm in the unpublished interview with him by MSC Historian Ivan D. Ertel, 1 April 1971. Donald K. (Deke) Slayton, LLRV/LLTV Monthly Progress Report, MSC, 19 January 1967.
- ³⁰ Bikle, memo to NASA headquarters on LLRV progress, report #40 for the period ending 31 January 1967, 6 February 1967; LLRV Flight Log, Appendix I.
- ³¹ LLRV Flight Log, Appendix I; Lunar Landing Simulation Program Chronology.
- ³² Gilruth, letter to Paul F. Bikle on completion of LLRV program at FRC, 28 February 1967. Gilruth obviously does not count the incident in which a young engineer hit a fire truck with a Dryden vehicle.



Training for the Moon

Chapter 8: From LLRV to LLTV

The original plan for reaching the lunar surface entailed a direct ascent to the moon. This concept presumed that whatever excursion vehicle was used to reach the moon's surface, that vehicle along with the command and service modules all would travel to the moon and nearly all of the assembly would return to Earth. But late in the summer of 1962, and only after considerable and contentious internal debate, NASA redesigned the Apollo system as a lunar orbit rendezvous. In this scenario, only the command module and lunar excursion vehicle would reach lunar orbit, and only the excursion vehicle would descend to the moon's surface. On completion of its mission, a portion of the lander would ascend, dock with the orbiting command module, and then only the latter would return to Earth. Once NASA reached this decision the planners knew they needed a smaller module for the actual lunar landing.¹

At the time, according to Bell's LLRV technical director, Ken Levin, the LM (or LEM, as it was called initially) had not been designed, nor had NASA issued any specific plan guidelines. "Our attitude," said Levin, "was, 'nobody knows what the LEM [is] going to look like so we won't make any attempt to outguess what [it is] going to look like. We'll just make the simplest research vehicle we know how to make,' and [the original LLRV design with the pilot sitting above the jet engine] looked like the simplest way to do it." Levin continued:

As we progressed we began to get into difficulties; it's very important for the cg of the entire mass of the vehicle to be located right at the gimbal axis which mounted the jet engine. We were having great difficulty in keeping the cg correct. It tended to be too high, and in order to lower it we had to lengthen the legs, and the vehicle became very large and ungainly. Also, putting the platform directly above the jet engine inlet was causing inlet distortion problems, so during the course of the design of the vehicle, quite a radical change was made. The pilot was moved from on top of the jet engine to a cabin out in front. And to balance his weight, all of the electronic gear was put into a sort of trailer portion in the back. Lo and behold, just by accident, we ended up with a configuration that was very much like the LEM. Unintentionally. But it did come out that way.²

From that point, the development of systems needed to train astronauts for the lunar-landing maneuver drove the evolution of the final LLRV design—and the subsequent LLTV design as well. Test results from the LLRV research flights regarding pilot controls, displays, and flight-control system parameters meshed with the emerging LM design. By late 1965, and supported by on-site General Electric technicians and engineers, personnel at the FRC were deep into documenting the changes being made to the configuration of LLRV No. 1. A parallel effort underway at the same time involved planning how to integrate the LLRV flight-test program with the MSC-specified requirements for developing the LLTV.

MSC planned for the free-flight training of astronauts in landing simulations to occur primarily at Ellington, where the MSC's aircraft operations were based. Final astronaut training—proficiency and maintenance—would occur at Kennedy Space Center Apollo launch site, right up until a day or two before launch. With Kennedy Space Center needing at least two training vehicles, the plan called for three new LLTVs. The two LLRVs would be modified and upgraded for use in training as well. According to prevailing opinion at the MSC from late 1965 until 1967, this five-vehicle fleet would be enough to support simultaneous operations at both Ellington and Kennedy Space Center.³

A trail of memos and meetings between the MSC and NASA Headquarters documents the request for construction of facilities at Cape Kennedy for LLTV flight training.⁴ As early as March 1966, Edwards had been considered for an astronaut-training site, but NASA dropped this option because of the travel burden it would impose on the astronauts. There was also the potential for interference in Edwards' airspace. At one point in 1967, George E. Mueller, NASA Headquarters' Associate Administrator for Manned Space Flight, told MSC director Gilruth to close down LLTV astronaut training at Ellington and do all the training at Cape Kennedy. But this order was quickly rescinded after Gilruth determined that training operations should remain at Ellington. Never used for LLTV flight operations, space reserved at the Cape Kennedy facilities was finally released by Chief Astronaut and Director of Flight Crew Operations Donald K. "Deke" Slayton on 8 November 1969.⁵

From Research to Training

On 19 October 1965 at a meeting held at the FRC, Dean Grimm, program manager for the LLTVs at Houston, emphasized the time-sensitive importance of training the astronauts as soon as possible for the final phase of the lunar landing if the Apollo program was to stay on schedule.⁶ Realizing that the LLTVs would probably not be available in time for the start of that phase of astronaut training, FRC and MSC representatives agreed that the LLRVs would be used. The schedule for LLRV No. 1 was reviewed, and the assembly of LLRV No. 2 was to begin at once. Just how the assembly of No. 2 was to proceed, however, was not apparent since the FRC did not have the personnel needed to simultaneously conduct an ambitious flight program with No. 1 while expediting the assembly and checkout of No. 2.

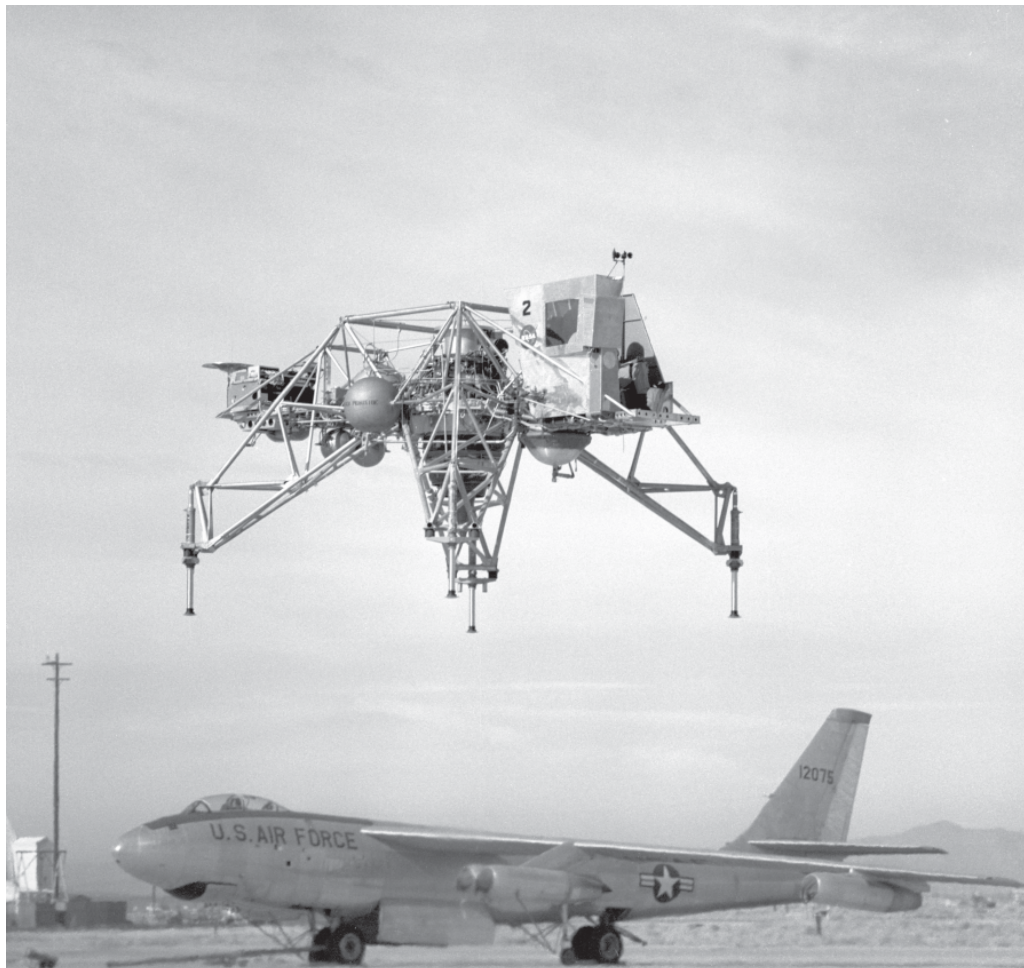

In January 1967 the FRC modified LLRV No. 2 to better simulate the enclosed cockpit of the LM. The vehicle now had walls on three sides of the cockpit and a roof. Only the front remained exposed. (ECN-1613)

At about this time, Bell advanced an informal proposal for assembling No. 2, but both the FRC and Houston considered Bell's proposal too costly. The search was on to find another, more affordable solution. Together with Grimm, Warren North, chief of astronaut training and division chief for crew flight support at the MSC, spoke with Bikle about the urgency of beginning the astronaut training if all was to stay on schedule for the first Apollo lunar landing, set for late 1969. Bikle suggested expediting the assembly of LLRV No. 2 by using additional personnel from the support contract that the FRC had with GE. Even though this suggestion would involve additional costs, Bikle said that the costs would be considerably less than those of Bell's proposal. Furthermore, Bikle pointed out, assembly could take place at the FRC's South Base, allowing for interaction with the LLRV flight research team. The whole effort could even be set up as a training operation for MSC personnel who later would be involved with LLTV operations at Houston. North and Grimm liked this idea. Bikle telephoned Virgil Weaver, the local GE site manager, to see if Weaver could provide the people needed. Weaver was interested, and he cleared the plan with GE's corporate management and legal office.

Under the new agreement, GE would continue to assemble LLRV No. 2, but work on that vehicle, it was emphasized, was not to interfere with the flight activity of LLRV No. 1. Additional parts would have to be purchased to fulfill any need for spares. The MSC would send a maintenance crew to the FRC that would help assemble the No. 2 vehicle; they also would learn how to operate LLRV No. 1 by actually working on it. On 4 November 1965, Gilruth concurred with the plans regarding vehicle No. 2.⁷

Once these plans were in place, at Grimm's request Matranga and Ottinger began working on the detailed LLTV model specification needed for the MSC's final contractual agreement with Bell for fabricating the LLTVs. The FRC provided Bell with documentation, including a complete set of LLRV drawings and engineering orders. Other information followed over the next six months as configuration documents were updated by comparing "as built" drawings with LLRV No. 1. The GE crew switched to a second shift so that work on LLRV No. 1 and the crew's assistance in assembling No. 2 would not interfere with flight research operations. The schedule called for both LLRVs to be operational by the summer of 1966 with delivery to Houston set for the first day of September.

Given the priority of safety concerns, particularly when dealing with hydrogen peroxide, the LLRV team developed an integrated crew approach, with the FRC technicians in the lead until the MSC crew had mastered operations. Because of his experience in assembling LLRV No. 1, Ray White became crew chief for No. 2, and lead mechanic Bill Wilson replaced White as crew chief on No. 1.

Fresh out of college, Bob Baron was assigned to assist Ottinger with the increased engineering workload in flight operations that involved frequent travel to Bell and Houston facilities. Concerned about the continuity of operations at South Base for both LLRVs, Bikle placed Ottinger in charge of operations for both vehicles. Research engineer Ray Young of the LLRV project office would assist in gathering information the MSC and Bell needed to design the LLTVs. Baron and Young ably proved themselves under the trying pressures of the program.

Once the management structure for South Base operations was in place, contract arrangements for assembling LLRV No. 2 were finalized with GE. Bob Humphries would manage GE's LLRV activities. Maurice D. "Doc" Jenks became GE's on-site engineer. Bob Chappell would maintain the drawings to an "as built" configuration under the direction of Bert Adams, the on-site Bell design engineering representative who had been Bell's chief design draftsman on the LLRV project. And an extra office trailer, added to the South Base complex, would accommodate additional staff and support personnel.

Conforming the LLRV to the LM

Major modifications to LLRV No. 1 helped bring it into closer conformity with the LM configuration. The center console housing the main instrument panel already had been moved to the right side of the cockpit in February 1966. A few months later, a three-axis, side-arm controller mounted to the pilot's right, just aft of the console, replaced the center stick and yaw pedals. In July, the vehicle's emergency recovery system—including the emergency lift rockets and the drogue chute—had been removed, a weight reduction that helped with operations during hot weather. These modifications were incorporated into LLRV No. 2 as it was being assembled and checked out for its first six flights on 11 and 13 January 1967. As it turned out, LLRV No. 2 never flew again after those six flights. LLRV No. 1 was the only LLRV to fly at Houston.

Other systems—such as avionics, electrical, hydraulic, jet propulsion, rocket, data, and structures—were configured for Houston, the latest changes being made during the initial vehicle checkouts and flight research program. Two more major changes were made to both LLRVs in 1966. First, LLRV No. 1 gained the improved ejection seat with the uprated rocket catapult when the vehicle's emergency recovery system was removed in July. Second, a cockpit enclosure with a Styrofoam® roof and simulated LM window opening was added to the LLRV, a prototype of the cockpit enclosure for the LLTV.

On to the LLTV: Major Changes

In early 1966, a serious discrepancy emerged between Bell's schedule for manufacturing the LLTV and Houston's schedule for training the astronauts for the Apollo program. NASA Headquarters informed William G. Gisel, president of Bell Aerosystems, that there would be no LLTV program if the astronaut-training schedule could not be met. Consequently, before the detailed LLTV design activity was complete, and a good seven months before NASA Headquarters approved the LLTV contract with Bell in early March 1967, Gisel committed nearly \$1 million to keep the LLTV program alive. He did this by ordering items for the LLTV that required long lead times, including the forgings for the jet-fuel, rocket-propellant, and helium tanks.⁸ Bell went on to produce the ascent engine for the LM as well as a number of components for the Apollo service module, including fuel tanks and valves.

The basic design and integration of the LLTV systems included no major modifications of the electronic systems used in the LLRV. For the most part, the basic system designs and concepts for the LLTV were identical to those in the LLRV, taking maximum advantage of the operational experience gleaned from the LLRV research and development program.

The most significant changes between the LLRV and the LLTV stemmed from advances made during the 1960s in the miniaturization of electronic circuitry and in packaging technologies. The availability of lighter-weight solid-state power supplies, integrated operational amplifiers, and other modular circuitry components greatly reduced the overall weight of the LLTV. In turn, the reduced weight allowed the structural housing assemblies to be beefed up, reducing the units' sensitivity to the extreme vibrations experienced in early LLRV flights. Not surprisingly, the reduction in this sensitivity decreased the number of nuisance attitude-control failures and transfers to the backup system that had plagued the early phases of LLRV flight operations.

Made possible because of these technological advances, the redesign included modifications that would simplify troubleshooting and repair during operation, such as plug-in circuitry cards instead of hardwired circuit boards. This provided access to the circuitry while the cards were still operating in the system. The change to the plug-in cards not only allowed problems to be identified quickly; it minimized the impact of repair on flight operations since spare cards could be used while others were in a shop for repair.

Except for the weight-and-drag computer, the LLTV's basic functional design incorporated the LLRV's electronic systems. Fuel consumption and in-flight weight changes for the LLTVs were reasonably predictable because astronaut-training flights in them were designed to duplicate the LLRV flight profiles. Consequently, the variable-control feature and weight-computation circuitry installed for research in the LLRV could be eliminated in the LLTV, greatly simplifying operation of the latter and eliminating the source of many difficulties experienced with the former, especially during the early phases of the program and with new pilots. One of these modifications enabled the LLTV to operate in a rate-command mode with an attitude-hold feature. In the LLRV, the vehicle could pitch or roll at a prescribed rate, depending on the pilot's movement of the attitude controller. When the control stick returned to neutral, the vehicle could drift at a small angular rate within the threshold setting without the rate gyros sending a correction signal. To correct for the drift rate, the pilot would have to recognize the situation, then make a small input in the opposite direction.

However, with the LLTV's attitude-hold feature, information from the attitude gyros caused the appropriate attitude rocket to fire automatically to correct for the drift whenever the vehicle rotated beyond a prescribed pitch or roll angle. This feature relieved the pilot of the need to correct for drift, reducing his overall workload. The attitude-hold feature also was used on the LM, so its inclusion on the LLTV was one more way the vehicle resembled the actual LM.

Another modification to the attitude-control system changed the firing logic to more closely resemble that in the LM. Sensors and transducers in the LLTV were much the same as in the LLRV, except for vertical and rate gyro assemblies. The vertical gyros used in the LLRV were replaced in the LLTV by more reliable units, eliminating the source of many of the failures experienced during LLRV operations. In the LLTV, newer devices were smaller and offered improved accuracy. To more closely simulate flying characteristics and performance in the LM, the Gemini side-arm hand controller used in the LLRV was replaced in the LLTV by the hand controller used in the LM.⁹

After the Failure Modes Effects and Analysis (FMEA) review, the avionics systems in the LLTVs underwent a number of changes before the vehicles were delivered to Houston. Included were additional fuses, failure-detection circuitry, relays, circuit breakers, and power supplies for correcting potential failure modes identified in the review.¹⁰ A late addition to the LLTV was an airborne computer used for calculating variations in the vehicle's weight due to the expenditure of hydrogen-peroxide fuel, an effort to refine the measurement method in the LLRV.

Nine modes were added to the attitude-control system in the LLTV's basic systems, backup modes, and malfunction detection circuits. The four modes added to basic systems were rate command and attitude hold, rate command with model (moment compensation) and attitude hold, direct, and direct with aerodynamic model. The two modes added to backup were rate command-pitch, roll, and yaw (the LLRV was direct command in yaw)-and single-axis primary (moment compensation). And finally, three modes were added to malfunction detection circuits; these were hand controller-malfunction detection, backup excess-rate detection, and stuck valve switches to both.

In the LLTV cockpit, the upgraded ejection seat included a larger rocket catapult, a parachute, and modifications to the deployment gun (mortar), harness, and canopy cutter. The FRC had built the horizontal and vertical velocity indicators and the thrust/weight indicator for the cockpit display in the LLRV; the Ryan Aeronautical Company built them for the LLTV. Ryan also built the hydrogen-peroxide-remaining indicator for the LLTV, an indicator that had not been included on the LLRV cockpit display. Displays for engine oil pressure, jet-fuel tank pressure, anemometer, and wind direction for the LLTV were incorporated into Bell specification control drawings to facilitate the procurement office's choice of vendors for these subassemblies.

The LLRV's roll authority lights were removed in the LLTV, and backup rate gyro failure and radar altimeter reliability indicators were added. The radio basic transceiver was changed from the tube model used in the LLRV to a transistor model in the LLTV.¹¹ When the LM was in an upright attitude, the pilot could look through a canted triangular window and see almost straight down. But if a window simulating the one in the LM were placed in the LLRV, the forward cockpit floor would have limited the pilot's downward view to an angle of about 45 degrees from the vertical. To maintain as much commonality with the LM as possible without compromising pilot control, they lopped 14 inches off the front of the floor, and removed an additional section at the front left corner of the cockpit. They also added a foot well to lower the pilot's knees and keep his legs firmly against the forward portion of the seat pad.¹²

To improve the pilot's field of view even further, the left console in the cockpit was shifted three inches aft and a 2.3-inch segment was removed from the forward end. Circuit breakers were relocated from this area to a sloping auxiliary panel on the left wall above the console.¹³ The cockpit was fully enclosed on the top, rear, and sides with polystyrene, a frangible material.

Originally, the plan had been to enclose the front as well except for a triangular opening to simulate the window in the LM. The idea was to place the window close to the pilot's face to replicate conditions in the LM, with the pilot standing and leaning slightly forward. However, in the LLTV, the pilot was restrained by a shoulder harness and seated in an ejection seat that sloped back 13 degrees. With the window in its planned location, the pilot's view of the left console was restricted and remained so even after the console was moved as far aft as possible. Furthermore, with an enclosure covering his knees, the pilot's downward view was restricted to a degree deemed intolerable for flight safety. There was only so much that could be done to replicate conditions in the LM, and in the end everything that could be done was done.

The compromise chosen eliminated the enclosure of the lower front of the cockpit, and moved the window and adjacent front wall approximately three inches forward, increasing the size of the window slightly to maintain the pilot's field of vision. The forward wall and window outline were removable for pilot access, and the pilot could break either in an emergency when use of the ejection seat was not warranted. Air-conditioning the cockpit was not necessary with the enclosure. A window or cutout covered by a panel held in place with Velcro permitted the pilot to see through the right wall in an emergency.¹⁴ Telemetry channels added to the LLTV provided the pilot with information regarding pressure in each of the aft and forward jet-fuel tanks, engine-oil pressure, remaining hydrogen peroxide, wind direction and velocity, and low hydraulic pressure.¹⁵

Improving the reliability of the primary DC electrical system in the LLTV involved eliminating a reverse-current relay, providing over/under voltage circuitry, and adding switch-type circuit breakers for units actuated during daily preflight checks. A solid-state inverter—rather than the rotary type used in the LLRV—was used in the LLTV's emergency AC electrical system. Over/under voltage circuitry also was added to the LLTV's primary AC electrical system. The vehicle's emergency DC system gained a battery-charge circuit, and the battery connector was eliminated. A double feeder was added to the forward emergency bus with redundant relay contacts. Equal-area actuators—rather than the unequal-area ones used in the LLRV—were used in the LLTV's jet throttle hydraulic controls. The dump valve for transfer to emergency mode (electrical actuator) used in the LLRV was eliminated in the LLTV. GE ran an abbreviated 30-hour preliminary flight-rating test confirming improvements in engine thrust for the LLTV.¹⁶ All in all, the result was greater reliability.¹⁷

The improvements in jet engine performance from the LLRV to the LLTV are summarized below. Though there was no increase in guaranteed takeoff thrust, Ottinger believes that takeoff thrust in hot-day performance improved 50 to 100 pounds.

Parameter	LLRV	LLTV
Takeoff #s thrust	4,200 pound	4,200 pound (plus 50 to 100)
Exhaust gas temp.	710°C (1300°F)	729°C (1345°F) (takeoff)
Gas generator speed	16,500 rpm	16,700 (101.2%) rpm
Fan speed	9,300 rpm	9,300 rpm
Max continuous thrust	4,000 pounds ¹⁸	4,000 pounds ¹⁹

Burning off jet fuel on hot days achieved about a 1.05/1.00 thrust-to-weight ratio for takeoff. This meant that five percent of the thrust would be available for accelerating the LLTV upward for liftoff. Immediately after takeoff the thrust-to-weight ratio increased because of jet and rocket fuel consumption as well as the increasing distance of the engine inlet from the region of hot-air ingestion close to the ground. Rarely did there need to be an extended period of burnoff, however, since preflight checks of all flight systems before takeoff consumed a great deal of fuel.²⁰

Further insight regarding engine performance came from data on engine thrust that the FRC compiled from a test, performed at Edwards Air Force Base, of an LLRV in vertical position. As the table indicates, when ambient air temperatures climbed, the air density dropped and jet engine thrust decreased. Engine inlet air temperatures increased along with the ambient temperatures and the actual mass of air flowing declined, leading to a drop in available power.²¹

Thrust (lbs.)	Inlet Air Temp. (degrees F)
4370	65
4335	70
4300	75
4260	80
4220	85
4175	90
4120	95
4060	100
3990	105
3920	110

According to this thrust data, the LLTV would be able to take off at sea level with a thrust-to-weight ratio of 1.05/1.00 at ambient temperatures up to approximately 92 degrees F. Summer temperatures at Ellington ranged into the 90s and 100s in degrees F. Pilots could extend the takeoff temperature to 98 degrees F by excluding 60 pounds of jet fuel. For example, in June 1969, the mission plans for Armstrong's training flights showed the fully serviced LLTV weighing just less than 4,200 pounds. Allowing for the burnoff of jet and rocket fuel in preflight checks, a clear need to offload jet fuel is evident, thereby reducing total flight time during certain hot-weather conditions due to limitations in engine thrust.²²

Cockpit display and telemetering of the jet fuel tank pressures were added for the

LLTV. The charging valve was relocated on the LLTV to facilitate servicing. On both the LLRV and the LLTV, the improved jet fuel (JP-4) proportioner filtration kept fuel imbalance in the tanks to a minimum. A relief valve, added to the aft jet fuel tank, increased safety. To improve operational flexibility for the LLTV, the tank design was changed to provide incremental filling and draining. To enhance reliability, the aluminum plumbing used in the gimbal hydraulic system on the LLRV was replaced with stainless steel in the LLTV on the return side of the system. A direct reading gauge on pump discharge was added to the LLTV for the convenience of maintenance crews. A new design of the system would prevent a single-point hydraulic leak from causing loss of control. The pre-charge pressure in an accumulator was changed to optimize system capability in handling internal leakage rates on the LLTV.

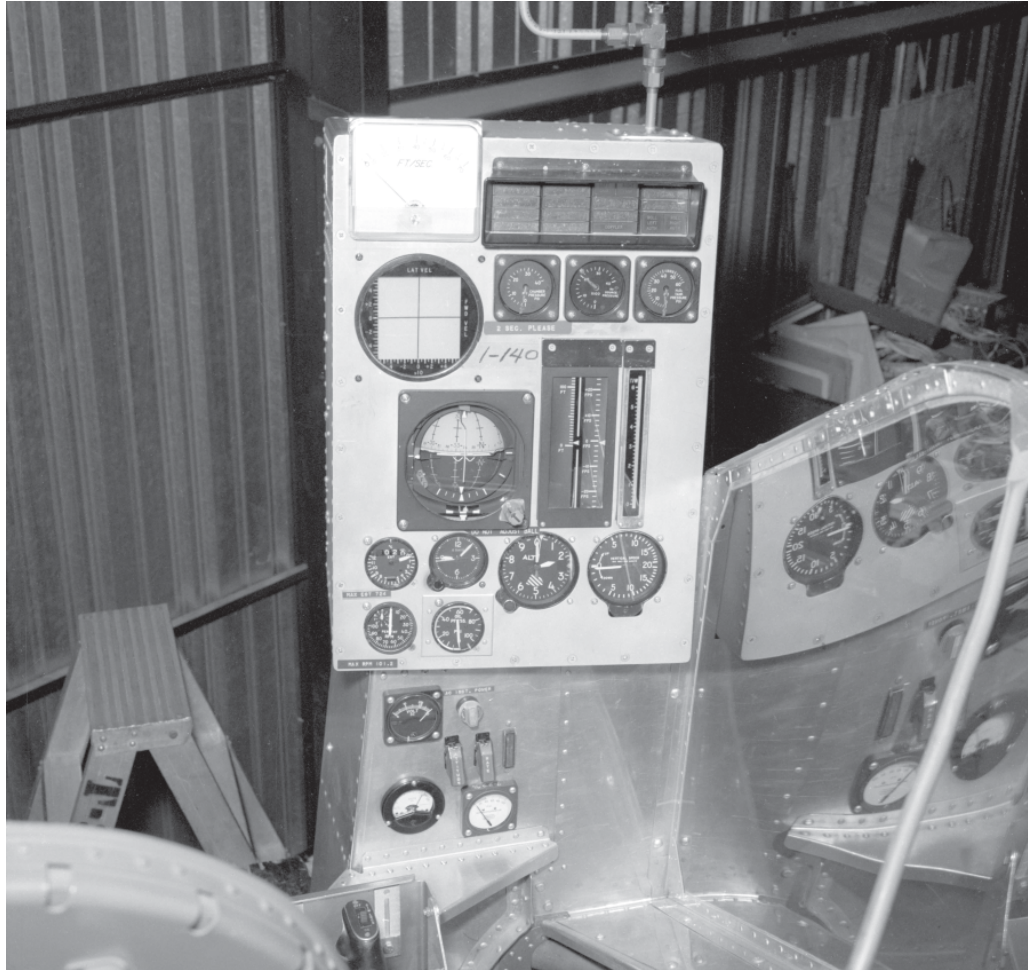

In late 1965, during seasonal down time, technicians again reworked the cockpit, this time to better replicate the LM configuration. Now, the instrument panel on the right was organized in the same way as the LM's would be, and a new side-mounted three-axis stick replaced the center-mounted joystick. On the left console the "T" handle replaced the lift-throttle rocket handle, more accurately approximating LM controls. (ECN-1578)

To accommodate the increased volume of hydrogen peroxide, helium tanks on the LLTV were uprated from 3,750 psi to 4,000 psi. Orifices on the regulator inlet matched the capacity of the new relief valve. Because of these changes, the pressure switch was adjusted to a higher pressure. The LLTV also gained a new helium crossover valve. To increase lunar-simulation time, the hydrogen-peroxide tanks on the LLTV were two inches larger in diameter, providing 20 percent greater volume. The LLTV's lift-rocket system included improved lift-throttle-valve dead-band characteristics and shaft seals. The LM "T" handle servo controller replaced the collective lift stick used on the LLRV, and the emergency lift-rocket system used on the LLRV was never included on the LLTV. A new shut-off valve in the LLTV's attitude-control system improved the reliability of its thrusters. And an improved variable orifice valve in the attitude-control system reduced hysteresis and increased adjustment resolution on the LLTV.²³

During the 1965 modifications a new three-axis side stick, on the right side, replaced the center-mounted joystick that had been used. (ECN-1295)

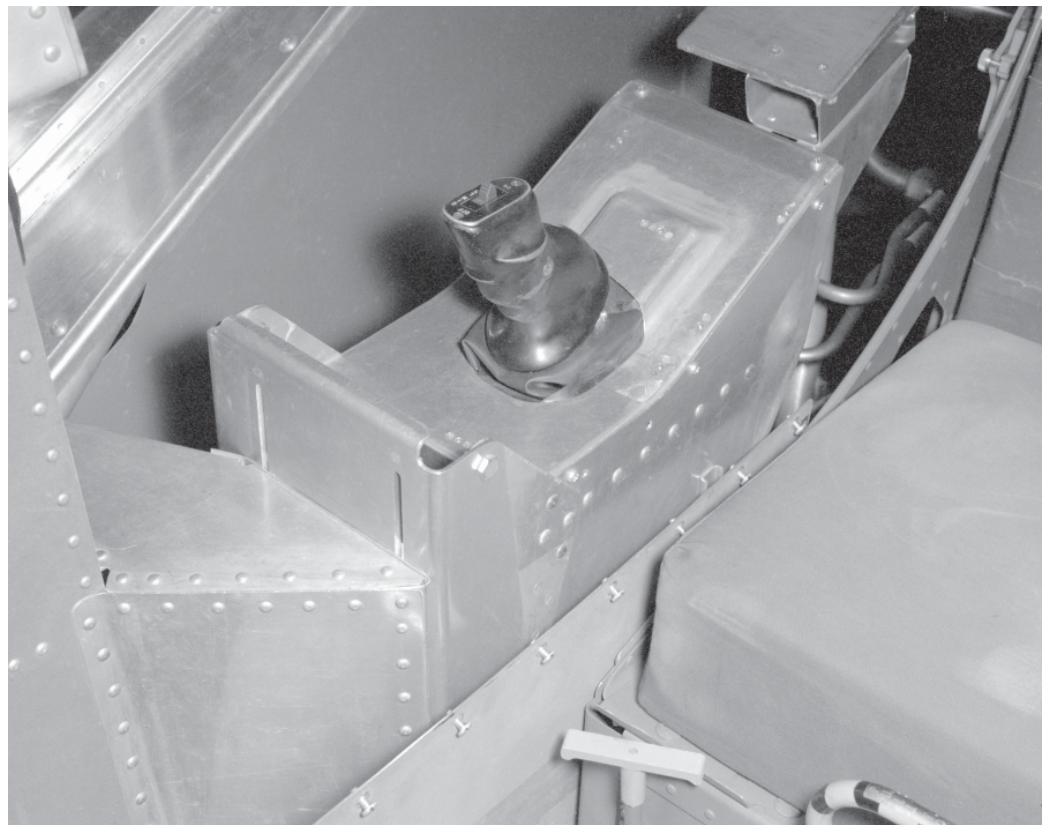

On the left console, a “T” handle replaced the lift-control handle, more accurately duplicating the LM controls. The T-handle proved to be more sensitive and better replicated the LM responses. (ECN-1294)

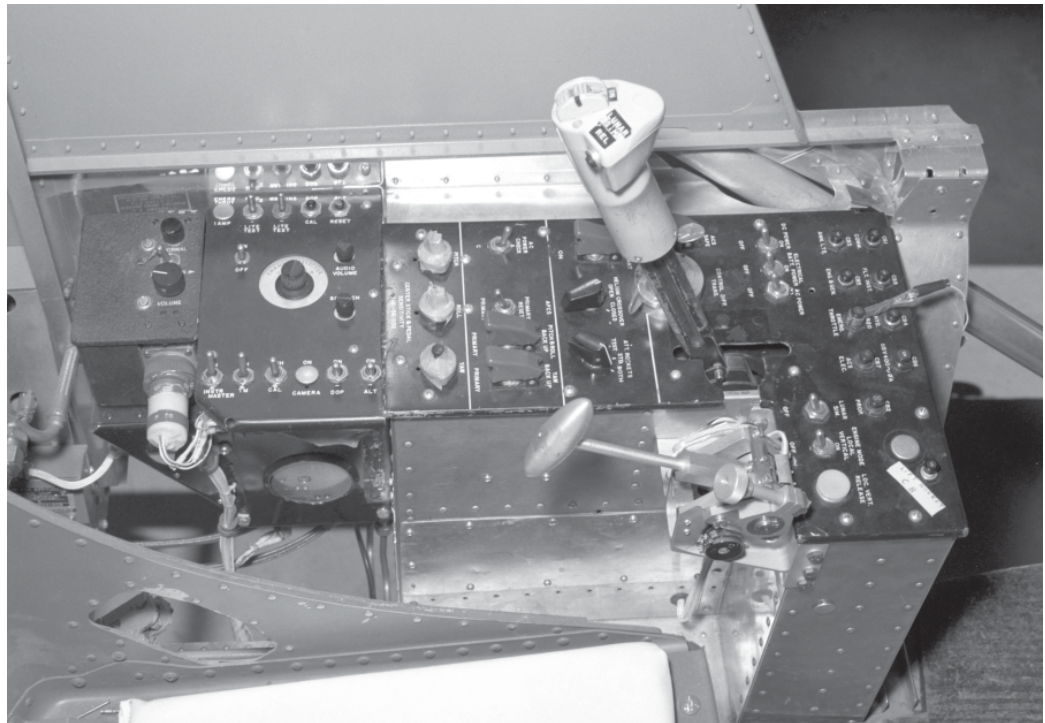

Adding an extension to the aft equipment structure on the LLTV corrected the shift in center of gravity caused by the cockpit's increased weight. The gimbal ring was redesigned in the LLTV to minimize deflections. To reduce corrosion, the ends of structural tubing were closed and sealed. The secondary structure was redesigned in the cockpit area to accommodate the new enclosure and console. The seat-support structure in the LLTV also was redesigned, correcting a problem that emerged during the heat-

treatment process.²⁴ In addition, Bendix changed the landing-gear strut on the LLTV, strengthening one element of the strut assembly.²⁵

Due to the critical takeoff weights of the LLRVs, in the original design of June 1963 the dry weight of the vehicle was 2,340 pounds and the maximum takeoff weight was projected at 3,657 pounds. Actual maximum takeoff weights for the LLRV, however, were on the order of 3,800 pounds. By January 1967, the nominal takeoff weight for the LLTV had been projected to be 4,051 pounds. This weight included 120 more pounds of hydrogen-peroxide fuel than the LLRV had carried, for the purpose of increasing flight time. By November 1967, nominal takeoff weight had become 4,114 pounds. In June 1969, Armstrong's training flights recorded a maximum takeoff weight of 4,186 pounds. By contrast, Bell's study on modifying an LLRV into an LLTV, done in early 1966, projected only a 119-pound increase in gross weight in going from the LLRV to the LLTV.²⁶

The LLRV, LLTV, and the LM Design

Grumman had partially defined basic handling qualities for the LM early in the design phase. By then, the FRC had studied handling qualities with the LLRV, and the MSC had used engineering simulators to conduct more such studies. Using Cooper-Harper ratings, NASA and Grumman assessed the characteristics of control qualities in the LM in terms of handling qualities. The results from the FRC study with the LLRV allowed the MSC and Grumman to size the attitude-control rockets on the LM with a great deal of confidence. Different modes and values—such as attitude hold, rate command, limit switches, dead-bands, and breakout forces in each axis of the hand controller—provided the designers of the LM control system with well-defined pilot preferences.

This information contributed to the way Grumman designed the jet logic, implemented electronic handling qualities, and set up the hand control characteristics for astronauts. In the design of its electronic circuitry, the LLTV jet logic was set up to simulate that of the LM. The rockets on the LLRV were positioned on the four corners of its frame. Engineers optimized the jet logic in order to maximize the moment capability of the vehicle since, at the time, adequate control needed to be ensured while Grumman studied handling quality. To establish the requirements for the attitude-control propellant on the LM, both the MSC and Grumman carefully examined the duty cycle on the LLRV and the LLTV. All of these parameters were then set up for evaluation in the fixed-base simulator. Later, astronauts Armstrong and Conrad said that the handling qualities of the LLTV established by the LLRV flights were very similar to the actual handling qualities of the LM during the lunar landings.²⁷

In the original LLRV configuration established before the LM was defined, the cockpit had a center console, rudder pedals, collective stick, and center stick that operated similarly to their counterparts in a helicopter. Given the number of uncertainties in the program, the FRC and Bell tried to build enough variability into the control system to cover the range of possibilities that might be encountered with the control system on the LM. As soon as the LM design was on paper, a three-axis side stick replaced the center stick and rudder pedals in the LLRV. The side-arm hand controllers used in the two LLRVs were Gemini flight hand controllers that the FRC modified to duplicate LM forces and motion, adding dual potentiometers for redundancy in all three axes. The actual LM controller, made by Honeywell, was installed on each of the three LLTVs so that the astronauts could familiarize themselves with the exact characteristics they would experience on the LM during lunar landing. The only differences between the hand controllers on the LM and on the LLTVs were the handgrips needed to accommodate the LLTVs' gimbal-lock capability.

To more closely resemble the LM, the collective stick on the LLRV was replaced with a "T" handle controller, allowing the pilot to use the lift rockets to provide transla-

New electronics also were added to the LLTV, taking advantage of faster and more reliable components. When Bell constructed the original LLRV, each of the three avionics boxes – including the contents – cost \$50,000. (Bell Aerosystems 204110, 204112)

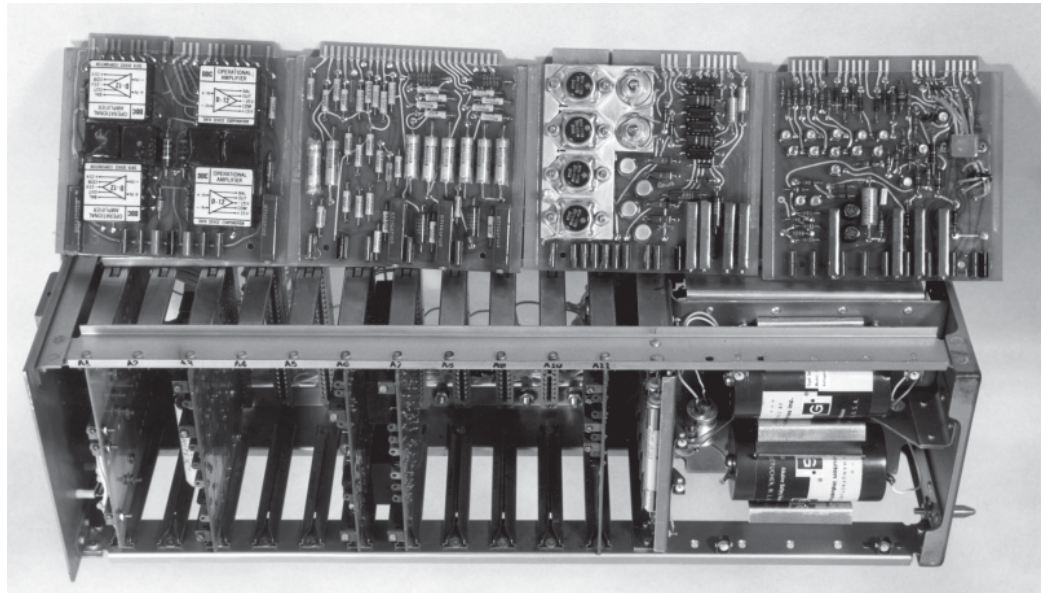
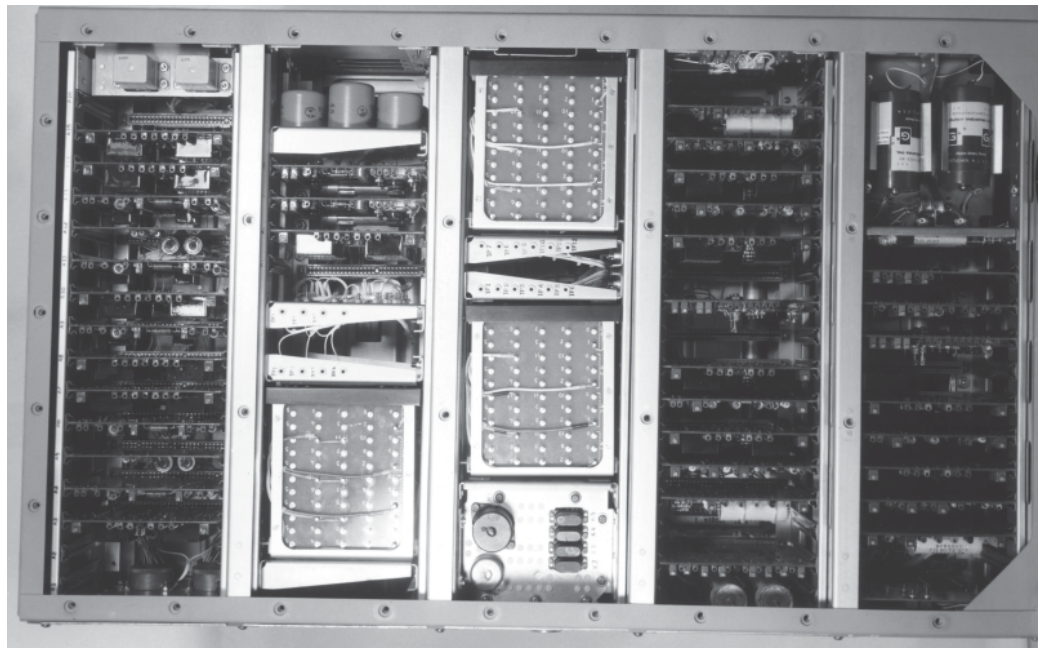

tional capability to simulate control of the LM's descent engine. Pilot evaluation of these control devices in the LLRV validated the LM design. So as to achieve a combined pitch and roll response from the LLRV, the jet logic had been set up to use three attitude rockets. To save fuel, only one rocket fired to achieve the same pitch and roll response on the LLTV and the LM. When this suggested modification first came up at the MSC, it generated considerable discussion, since it also compromised the amount of moment capability available with the attitude-control system. The jet logic on the LLTV was designed to simulate that of the LM, even though the LM had thrusters fore and aft, left and right. The fore and aft thrusters were in front of and behind the cockpit, unlike the LLRV and the LLTV where the rockets were located near the front at left and right of the cockpit and at the rear.

Other changes made at the FRC included replacing the analog gauges on the LLRV with simulated vertical tape instruments made in the instrument lab to represent those on the LM. The instruments were larger than those on the LM so that the astronaut, sitting in the LLTV's ejection seat, would have the same perspective as when standing

at the LM window and looking at the instruments. In building these instruments for the LLTV and the LM, Ryan upgraded the radar altimeter and the Doppler radar system for the velocity measurements. A pitot tube with a wind vane was added to provide data for an airspeed display and relative wind direction to the pilot, and an anemometer was installed on each vehicle's roof, enabling the pilot to determine actual wind speed and direction.

The variety of flights made in the LLRV to duplicate LM trajectories showed that the nominal trajectories could be accomplished easily, demonstrating adequate forward visibility even at large nose-up pitch attitudes. LLRV pilots found they had no significant difficulty in adjusting trajectories in the event of an alternate touchdown point, such as might occur in avoiding rough or soft terrain while landing on the moon. All such adjustments were executed successfully with good fuel-remaining margins.

This research successfully validated various design features of the LM, highlighted some potential improvements, and gave the astronauts confidence in the overall LM design, an extraordinary compliment to the engineers and pilots who labored to replicate conditions of an unknown environment.

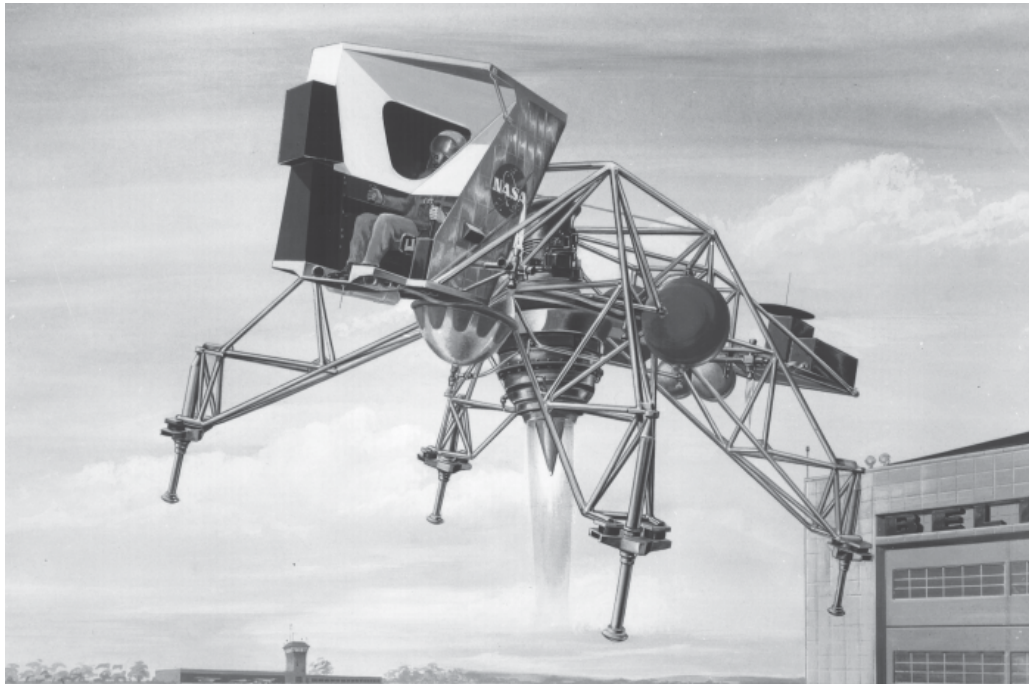

Transforming the LLRV into the LLTV involved a long series of changes. This artist's conception shows the LLTV with the addition of another window, positioned to replicate the LM's layout and the pilot's limited view. Although a roof was installed in the LLTV, the proposed window in front of the pilot was never added. (Bell Aerosystems C25321)

¹ Brooks, Grimwood, and Swenson, *Chariots for Apollo*, p. 62.

² Ken Levin, unpublished working notes from an interview of Ken Levin by MSC Historian Ivan D. Ertel, 8 June 1971.

³ Lunar Landing Research Vehicle and Lunar Landing Training Vehicle Program Plan, 18 March 1966, NASA MSC Houston, p. 8.

⁴ See, for example, Chris Kraft, memo to NASA headquarters requesting LLTV operations to begin at Cape Kennedy in the 3rd quarter of 1968, 17 January 1967.

⁵ "Report of Lunar Landing training program conducted by Apollo program office and mission operations directorate," NASA MSC, 31 March 1966; George E. Mueller, memo to Robert R. Gilruth, 9 November 1967; Donald K. "Deke" Slayton, memo to Kennedy Space Center, 8 October 1969.

⁶ Gene J. Matranga, memo to those concerned on meeting held during the week of 17 October relating to the LLRV, 26 October 1965.

⁷ Robert R. Gilruth, letter to Paul Bikle, 4 November 1965.

⁸ Interview of Cal Jarvis by MSC Historian Ivan D. Ertel, 28 July 1971; interview of Dean Grimm by MSC Historian Ivan D. Ertel, 1 Apr. 1971; Donald K. "Deke" Slayton, MSC LLRV/LLTV Monthly Progress Report, 27 April 1967.

⁹ Richard Van Riper, unpublished summary of LLRV to LLTV avionics changes, 3 August 2000.

¹⁰ LLTV B-1 Flight Readiness Review, Section B, FMEA Review, 25 July 1968.

¹¹ Ibid.

¹² J. Ryken, "Study of Modification of a Lunar Landing Research Vehicle to a Lunar Landing Training Vehicle," Bell Report 7260-945001, Contract NAS 4-981, 26 January 1966.

¹³ Ibid.

¹⁴ Ibid.

¹⁵ LLTV B-1 Flight Readiness Review.

¹⁶ Ibid.

¹⁷ Ibid.

¹⁸ CF700 Facts Summary, General Electric, January 1964. On the LLRV, the SFC at maximum continuous thrust was 0.68, the primary airflow was 44.0 lbs/sec, the fan airflow was 84.0 lbs/sec, the thrust-to-weight ratio was 6.3, the max fan diameter was 33.2 inches, and the length was 74.0 inches. Comparable data for these parameters has not been available for the LLTV.

¹⁹ Bell Aerosystems Lunar Landing Training Vehicle Flight Manual, Revision B, 1 September 1969.

²⁰ Wayne Ottinger, telephone conversations with MSC pilot Joe Algranti and MSC operations engineer Don Reisert, 25 August 2000.

²¹ Ryken, "Study of Modification of a Lunar Landing Research Vehicle."

²² CF700 Facts Summary, General Electric, January 1964.

²³ LLTV B-1 Flight Readiness Review, Section B, FMEA Review, 25 July 1968.

²⁴ Ibid.

²⁵ "Analytical Study of LLRV/LLTV Structure," Bendix Products Aerospace Division, Final, 9 March 1966.

²⁶ Ryken, "Study of Modification of a Lunar Landing Research Vehicle."

²⁷ Dean Grimm, interview by Wayne Ottinger, 5 August 2000.

Chapter 9: Houston

The mission of the Manned Spacecraft Center (MSC) detachment at Ellington Field, near Houston, Texas, involved training astronauts as well as providing other support and research for the Apollo program. Under the direction of Joe Algranti, Chief of Aircraft Operations, a staff of pilots checked out aircraft that—in addition to the LLRVs and LLTVs—included T-38s, two civil Bell 47G training helicopters, the NC-130B, two B-57s, and a P-3 aircraft flying Earth resources sensing equipment, in addition to a C-135 zero-g astronaut training aircraft. Algranti also was in charge of aircraft maintenance that involved civil service personnel as well as a number of contractors and subcontractors. The arrival of the LLRVs and LLTVs—with their extensive needs for specialized facilities, ground-support equipment, and technical personnel—added considerably to already-extensive MSC flight operations and maintenance activities.

The schedules for the Apollo program were extremely complex, involving six prime contractors and more than 20,000 subcontractors and suppliers, for a total of about 400,000 people.¹ Activities supporting the primary requirements of astronaut training were under intense scrutiny as a result of both general curiosity and congressional budget concerns. Research and training are different, of course. Research of the sort conducted at the FRC with the LLRV is exploratory, involving unexpected outcomes, and scheduling is of secondary importance. Astronaut training of the prime and backup crews for Apollo, on the other hand, involved tight scheduling and a rigorous set of often-repeatable procedures with expected outcomes. Consequently, the expectations and capabilities for facilities, equipment, and personnel were very different at the MSC than they had been at the FRC.

Predicting vehicle readiness and the reliability of training, for example, were more important at the MSC than they had been during earlier research phases at the FRC. Presumably to save time and money, Bell's ground and flight testing of the LLTVs was moved during contract negotiations from Bell's plant at Niagara Falls, N.Y., to the MSC facility at Ellington. Nevertheless, events caused extensive delays at the MSC that jeopardized the astronaut-training schedule. In turn, these events became the main reason for the change in plans that shifted the entire training mission to Ellington, dropping Kennedy Space Center altogether as an LLTV training center.²

Overview

The remote area at Ellington's northeast corner selected by the Aircraft Operations Division (AOD) for the site of LLRV and LLTV operations needed appropriate facilities and infrastructures, including roads, utilities, and buildings. For example, the ramp area would need jet blast shields and facilities to accommodate a control van, rocket-fuel servicing, and vehicle tie-down. Tooling and shop equipment would be needed for assembly and maintenance. The MSC also was adding an LLRV/LLTV fixed-base simulator on the first floor of Building 4, which housed offices for astronauts and the astronaut training division. Although planning had begun well in advance, completing this work was delayed for a number of months due, among other things, to a late recognition of the need for special power utilities and the difficulty in finding qualified ground crews.

LLRV No. 1 was delivered to Ellington in December 1966. Kluever made the first flight there on 3 March 1967. Thirteen more flights followed in March—two by Armstrong, three by Algranti, and eight by Bud Ream.³ However, a nine-month delay followed these flights, with LLRV flight operations starting up again only in January 1968. All Apollo schedules and plans were set back with the AS-204 (Apollo 1) accident on the launch pad at Cape Canaveral on 27 January 1967 that claimed the lives of

Ellington Field,
outside Houston,
site of the LLTV
program.
(S-68-50849)

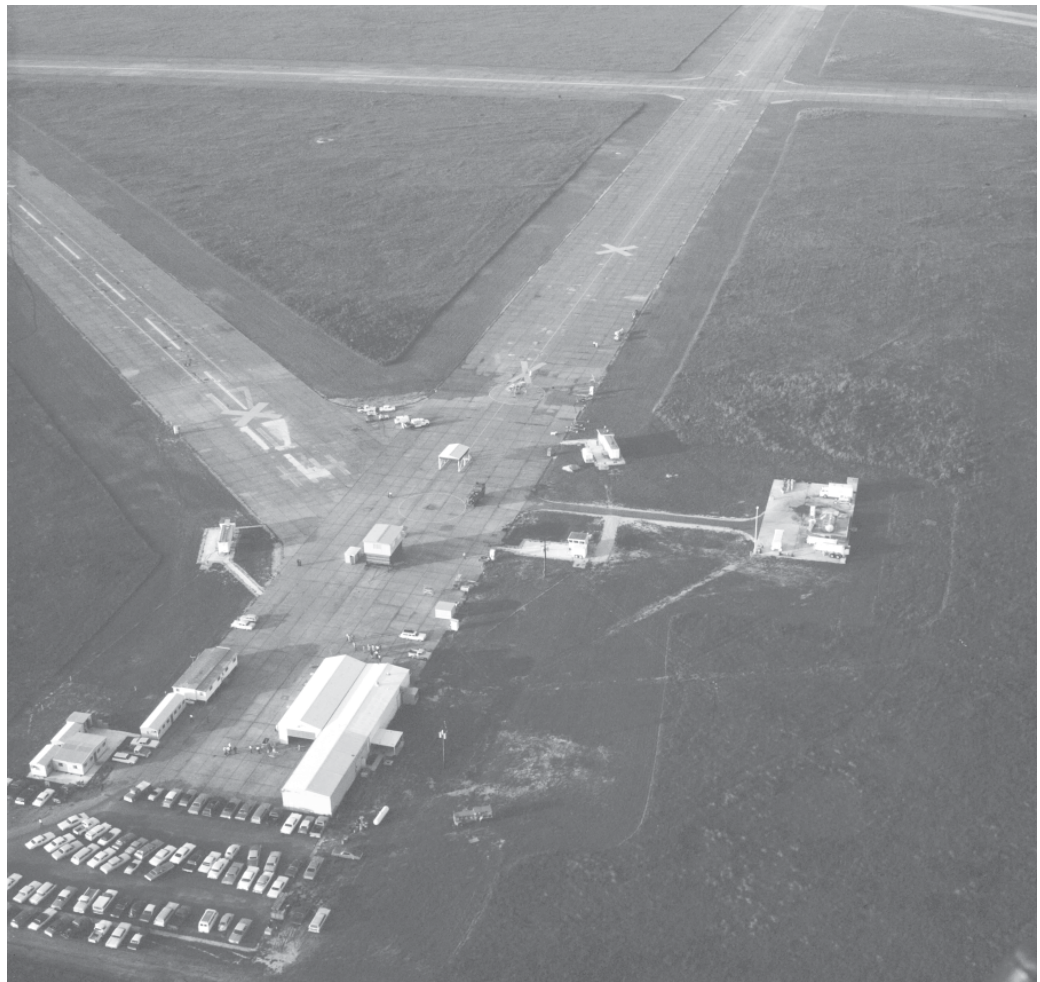

three Apollo astronauts—Lt. Comdr. Roger B. Chaffee, Lt. Col. Virgil I. Grissom, and Lt. Col. Edward H. White, Jr. Intended to be the first manned Earth-orbital Apollo flight, it became instead the first fatal accident in the American space flight program.⁴

Algranti remembered the incident vividly. “This event,” he said, “rippled throughout the Center, and morale was very poor—a bad atmosphere to start a critical free-flight vehicle training effort.”⁵ The tragic accident placed a heavy burden on key people in the Apollo program, accenting safety issues for all operations involving astronaut training. During the delay that followed, all problems with facilities, ground-support equipment, LLRV flight hardware, and ground-crew training were resolved.

As the Apollo schedule resumed with the launch of Apollo 7 on 11 October 1968, pressure mounted to get LLRV training underway again at Ellington as well. By this time, the LLTVs were starting to arrive at Ellington; Ottinger also arrived, in his capacity as Bell’s technical director on the vehicles. The influx of approximately 50 personnel from Bell—later to grow to over 100—added to the already high level of stress. As Algranti later recalled about this period at Ellington:

We had three different fatal T-38 accidents, and each investigation took a significant toll on Aircraft Operations Division resources. These were followed by another three accidents, starting with Joe Engle, astronaut pilot representative on the C.C. Williams (T-38 NASA 922) accident board, who had a training helicopter accident (late in 1967)—out of gas at night!—with no injury, but which totaled the OH-13H Army chopper (NASA 931). The Center assigned Neil Armstrong to head up the Engle helicopter accident board—then he (Armstrong)

had his LLRV accident on 8 May 1968. MSC management then had Joe Algranti head up the Armstrong LLRV Accident and Algranti had his LLTV (NASA 950) accident on 8 December 1968. Evidently, an assignment to an MSC aviation accident board was not good for a career resumé.⁶

Initial ground-test operations for the LLTVs were set up in NASA hangar facilities near the flight operations hangars—not at the remote site selected earlier. Checking out the avionics of LLTV flight hardware and integrating the avionics ground-checkout cart with the flight hardware turned out to be much larger tasks than either Bell or NASA had anticipated. Getting the operations to run smoothly took a great deal of time, given the need for various facilities and ground-support equipment and the support of Bell and MSC personnel. The seven-day-a-week workload—with two 12-hour shifts running daily—challenged the ground-crew engineers, technicians, and mechanics. While avionics was the main focus, testing generally needed the support of the entire crew since hydraulics, the rocket systems, data, and other systems would be involved as integrated testing progressed.

Ottinger recalls the first time the weight-and-balance fixture was used at the MSC for hot firing the LLTV's attitude-control rocket systems. To allow rocket testing even during rainy weather (rain was a rare occurrence at the FRC), the crew built a tall shed to shield the LLTV while it was mounted on the weight-and-balance fixture. The shed was used for the first time in a rocket test during an evening shift with a young Bell rocket engineer named Tom Stafford (who was not related to the astronaut of the same name) in the cockpit. The cold start, or initial firing, of peroxide rockets usually caused small droplets of liquid peroxide to form in the exhaust. On this soggy evening droplets collected on the underside of the shed's sheet-metal roof and dripped down onto the LLTV, setting off small areas of combustion—producing smoke but no flame—wherever residual contaminants lay on the vehicle.

The presence of both fuels created a volatile combination. Later, after the crashes of LLRV No. 1 and LLTV No. 1, Deke Slayton—director of flight crew operations at the MSC—changed the policy regarding the role of firemen and other personnel. His comments are revealing:

Hydrogen peroxide [H_2O_2] and JP-4 [jet fuel] make an extremely hazardous combination that has proven to be not only inflammable and self-igniting, but also shock sensitive, i.e., it will explode, releasing energy equivalent of dynamite. We have had two incidents where just a few ounces of 90 percent H_2O_2 was sprayed on a JP-4-soaked rag during a demonstration and it detonated of its own accord, rattling nearby windows. Besides the H_2O_2 /JP-4 hazard, the vehicle has 4000 psi He [helium] pressure and lesser pressures that are just as dangerous as explosives when their containers have been subjected to structural and heat damage.⁷

By the next day the rumor mill at the MSC had embellished the incident, saying that astronaut Tom Stafford had flown the LLRV through the hangar, setting fires with the rocket system. It took some time to dispel the story, and the incident pretty well ended the effort to save time in the schedule by conducting rocket tests even when it rained.⁸ Rocket testing was a dry-weather activity after that.

Fortuitous Decisions

A major part of the operational success of the LLRVs and the LLTVs was the exceptional reliability of the General Electric CF700-2V jet engine, which performed flawlessly. In the past, a number of VTOL aircraft—such as the Lockheed XV-4 Hummingbird, the Ryan VZ-3 and XV-5, and the German VJ-101—had been destroyed due to

failure of the propulsion system. This was why engineers saddled the LLRV, at first, with the weight penalty of a drogue chute and extra lift rockets.

In retrospect, the decision to reduce weight by removing the emergency recovery system of drogue chute and lift rockets was fortuitous, even though at the time it was a difficult and even questionable one. As it turned out, all three vehicle crashes at the MSC occurred after loss of attitude control at low altitudes for reasons other than flight-control system failure—and all with the jet engine still fully operational. Had the initial emergency recovery system not been removed, and had all three pilots relied on that system for recovery, it is very likely that all three pilots would have lost their lives.

Loss of vehicle control at low altitudes simply wasn't considered during initial discussions of emergency recovery and pilot egress methods. Even the decision to scrap the emergency recovery system in favor of relying on the ejection seat to save the pilot while sacrificing the vehicle was based on the assumption that emergencies would arise strictly from the loss of jet engine power. Strange as it may seem in retrospect, no one considered that an emergency might result from loss of vehicle attitude control. It was a

The LLTV ground crew posing with Neil Armstrong (wearing helmet and vest). (S69-37593)



case of making the right decision for the wrong reasons, but it was a fortuitous one nonetheless.

Another and central decision that contributed significantly to the program's success was the requirement that all pilots and astronauts receive helicopter training before flying the LLRVs and LLTVs. The motion cues and instinctive reactions necessary for successful hover flight were foreign to most pilots and astronauts who generally flew conventional winged aircraft. Helicopter training honed their instincts in what was, to them, a new realm of flight, and training in the LLRVs and LLTVs taught them how flight in this regime differed from flight within the reduced lunar gravity field.

As training for later Apollo missions progressed, accidents reduced the inventory of training vehicles from four to one. Had a fourth accident occurred due to pilot unfamiliarity with VTOL operations or some other cause, it likely would have caused the

Apollo astronaut-training operation to be shut down.

LLRV and LLTV Flight Histories

Cluever was the first to fly LLRV No. 1 at the MSC, on 3 March 1967. Armstrong made 21 flights in it, and Conrad another 13, in addition to the checkout flights by Algranti and Ream. Yet while the LLRV provided basic lunar simulation, the quality of the simulation was less representative of the LM than that provided by the LLTVs. LLRV No. 1 made a total of 84 flights at Ellington—46 of them by various astronauts—for a total of 282 flights including the earlier 198 flights at the FRC. No. 1 met its end on 6 May 1968, when Armstrong successfully ejected from the vehicle. The crash came as a result of hydrogen peroxide depletion followed by loss of helium pressure for the reserve attitude-rockets. The vehicle's instrumentation did not provide him adequate warning about the adverse conditions.

LLRV No. 2 never flew at the MSC. Cluever was at the controls for its six flights at the FRC. Parts from it were used to support LLRV No. 1. But the crash of LLRV No. 1 and the general LLTV upgrades, as well as program constraints of time and resources, precluded use of LLRV No. 2 in flight. For some time it was on display for public tours at the FRC.

LLTV No. 1 first flew at the MSC on 3 October 1968 with Algranti as pilot. In its lifetime, the vehicle accumulated a total of 2 hours, 8 minutes, and 35 seconds of flying time. This vehicle, with Algranti at the controls, crashed on its fifteenth flight on 8 December 1968, just before Armstrong was to begin astronaut training for Apollo 11. Algranti successfully ejected before the vehicle crashed, an event brought on when undetected wind shear exceeded aerodynamic control limits. As a result of the crash of LLTV No. 1, the three-airman mobile crew of the 6th Weather Squadron from Tinker Air Force Base, Okla., was added to all flight operations to provide theodolite wind data.

LLTV No. 2 was first flown at the MSC on 5 December 1968 by Ream and was later used to train Armstrong for Apollo 11. LLTV No. 2 flew a total of 24 hours, 2 minutes, and 26 seconds, until it crashed after flight no. 206 on 29 January 1970 after the primary DC electrical system failed. An unanticipated residual magnetic field prevented the vehicle from switching to backup. MSC staff pilot Stu Present successfully ejected from the vehicle before it crashed.

LLTV No. 3 flew a total of 33 hours, 18 minutes, and 51 seconds. Astronaut Gene Cernan was at the controls for the last flight on 13 November 1972, three weeks before the launch of Apollo 17. LLTV No. 3 flew a total of 286 flights and is the only surviving Lunar Landing Training Vehicle; it is presently on display in the lobby of Teague Auditorium at Johnson Space Center in Houston, formerly the MSC.

Crash of LLRV No. 1

On 17 October 1968, NASA released a summary of the combined findings of NASA investigation and review boards regarding the accident at Ellington on 6 May that resulted in the destruction of LLRV No. 1.

A large quantity of data on operation of the vehicle, collected by telemetry, furnished complete information on the LLRV's complicated control system and components. It showed that the helium was inadvertently depleted earlier than normal.

Both boards noted that the source of trouble was the loss of helium pressure, vented through the hydrogen peroxide propellant tanks and out the lift rockets and the small thrusters.

Normally the LLRV could be flown and landed safely with its gimbal mounted jet engine and attitude control thrusters even after the propellant supply to the lift rockets was depleted, but this called for quick action by the pilot as soon as the warning came.

The MSC Board said this action amounted to a "critical pilot task during the heavy

workload period which developed on this flight.” It laid the basic difficulty on a design deficiency: the helium pressurization for attitude control was not protected against loss through the lift rocket system.⁹

Although a standpipe system provided reserve hydrogen peroxide for the attitude control system, the board said there was no automatic backup pressurization, which is necessary to force the propellant into the control thrusters.

As set up in the LLRV, the helium could escape through the standpipe outlet into the lift engines when the propellant level fell below the top of the standpipe. Due to circumstances on this flight, helium was being lost one second before the pilot’s warning light came on steadily. The MSC report noted that the LLRV pilot handbook indicated the pilot had enough propellant for about six seconds of normal flight time

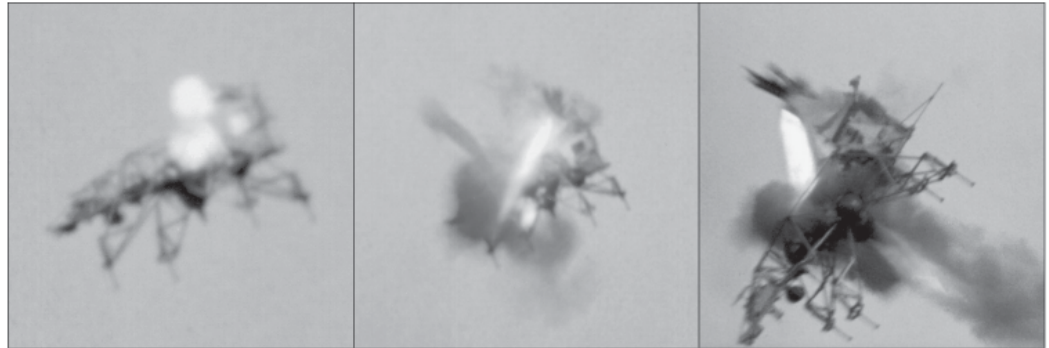

On 6 May 1968 Neil Armstrong ejected safely from LLRV No.1 as it began listing beyond recovery, becoming the first pilot forced to exit the vehicle while in flight. The accident stemmed in part from a sensor that failed to detect and warn the pilot of a fuel imbalance, which was exacerbated by gusting winds. Armstrong emerged uninjured, but the LLRV was destroyed. (Composite image)



after the “propellant low” warning came on and stayed on.

A fraction of a second before the pilot’s warning light came on, the control van crew noted a flicker of the “propellant low” warning light and directed the pilot to end his simulated lunar landing and transfer lift control to his jet engine.

“By the time the pilot could react and check his corresponding light,” the report said, “the helium pressurization gas was already venting overboard and rocket lift was beginning to decay. The early onset of a problem with no warning caught the pilot by surprise and undoubtedly added some confusion to a most time-critical situation in the control van.”

Among contributing causes, the MSC Board concluded that the sensing system in one propellant tank failed to warn the pilot of a low level of propellant, so that he could revert safely to normal Earth operation.

It also said the operating crew in the ground control van had inadequate warning of the abnormally low propellant supply, and that the crew failed to diagnose the loss of pressure in the tanks; that the pilot failed to shift one control handle at a critical point, and that the high and gusty winds prevailing had an adverse effect on propellant consumption.¹⁰

The Board also asserted the pilot’s handbook contained confusing and contradictory information on the subject of control rocket propellant, and said the LLRV’s double attitude control system was used excessively, resulting in abnormally high propellant consumption.

In its report on the case, the Review Board criticized the design of the control system because it failed to protect against loss of helium pressurization through the lift rocket system. The combination of circumstances produced the rapid and complete loss of helium pressurization.

The Review Board also found the LLRV’s warning system too small and poorly placed to be adequate. It said the ground crew had not perfected and practiced for such contingencies.

The Review Board recommended improved organization and management of the LLRV project, because of its importance to the Apollo program. The MSC Board listed 16 recommendations—six of them directly concerned with improvements in the LLRV and its systems—and called for a safety review of the entire LLRV program; operational criteria for wind conditions and for use of the two attitude control systems in combination; for control van crew and operations; for a computer and other improvements in the control van; for review of pilot training; modification of the pilot’s handbook; addition of fire and rescue equipment and added manpower, particularly for use on the control van team.

The Review Board said additional sensing probes to measure propellant level—one of the most important items in the cause of this accident—should be installed before any more flights of either the LLRV or its advanced version, the LLTV. Instead, MSC engineers followed the FRC’s real-time measurement method.¹¹

That Board also called for a master warning light in better position for pilot vision, for safety wind criteria for all such flights, and for establishment of better communications, responsibilities and emergency procedures in the astronaut training program.

In addition, the Review Board said all critical vehicle systems in the program should be examined, and criteria set up clearly for their operation, including “red-lines” and “go-no go” limits.

Because the LLTV had the same rocket fuel systems as the LLRV, the Review Board recommended it be corrected in similar ways.

Following a comprehensive study of the Lunar Module, and in light of the accident, the Review Board said it could find “no significant problems as a result of the LLRV accident,” and recommended no changes to the LM. On the contrary, it suggested that the ascent propellant level detector on the LM’s propulsion system be examined for

possible use on the simulators.

“Generally,” the Review Board concluded, “technical rigor has been instilled into the Apollo Program to a remarkable degree. Hardware, design, test and operation procedures for normal and emergency events, provision for reliability and safety, and training of ground and flight crews are specified in detail by formal documentation and are closely controlled by program personnel.

In its follow-up action, NASA initiated or completed work on all recommendations raised by the two boards. To carry out a comprehensive review of the safety of the lunar flight simulators, a flight readiness evaluation board was formed in the Office of Manned Space Flight, at Headquarters. The review was conducted by the Manned Spacecraft Center, with all actions monitored by the Headquarters Director of Safety.”¹²

Results of the Investigation

The Findings and Conclusions section of the accident report noted “the particular care and attention” that LLRV program personnel had devoted to the emergency ejection system that saved Armstrong’s life:

One additional finding that is worthy of note is the value of the particular care and attention that was devoted to the emergency pilot eject system of the vehicle. All personnel involved in the LLRV program fully appreciated the importance of this emergency system. Considerable attention to both engineering excellence and to operational rigor was given to this system. The vehicle was kept out of service for several months in order to update the pyrotechnic elements of the ejection system and to assure its proper operation in the unusual flight modes it may be required to cope with. While in no way relevant to avoiding the accident, this particular care and rigor may possibly have contributed to saving the life of pilot-astronaut Armstrong.

This portion of the accident report included additional commentary on the accident’s cause as well as the helpfulness of “comprehensive telemetering” in accurately reconstructing the sequence of events leading up to the accident to show “several contributing causes” for the accident:

The single, ultimate cause of the accident was a loss of attitude control due to the inadvertent depletion of helium pressurant for the propellant supply system. Leading up to this ultimate cause was a set of circumstances or contributory causes which, in combination, produced the inevitable result. In contrast with many accidents, in which a single initiating, or primary cause may be identified, the sequence of events and combination of circumstances producing the end result was particularly complex. Fortunately, the comprehensive telemetering allows a very accurate reconstruction of a sequence of events, the majority of which took place within a 30-second time period. From these telemetered flight data, the televised tape, and the color movie film that is tied to the voice transmission sequence, cause and effect can be closely related. From this information it is evident that there were several contributing causes to the accident.¹³

After the accident, as a crane removed the wreckage of LLRV No. 1, Ottinger saw a snake crawl out from under the wreck. He admitted imagining the befuddled snake looking up and asking, “What the hell was that?”

Astronaut Training in the LLTV

Nine months after LLRV No. 1 crashed, George E. Mueller, NASA Associate

Administrator for Manned Space Flight, described in a letter to Gilruth his understanding of the LLTV's role in training astronauts for completing a lunar landing:

The LLTV provides the capability for evaluation of the landing flight path from 500 feet to touchdown in one of the control modes of the LM although it does not simulate the LM as such. The speed-altitude relationship in flight, together with the handling qualities of the LLTV combine to give the astronaut the perception and anticipation training required for development of confidence in his ability to complete the lunar landing. Although no control mode transition point has been determined, the LLTV flight envelope will permit flying skill development covering the last 400-500 feet of descent.¹⁴

The control-mode transition that Mueller mentions undoubtedly refers to the controversy over automatic versus manual control by the LM commander during the lunar landing.

Nine months after this, Charles W. Mathews, Deputy Associate Administrator for Manned Space Flight, wrote Gilruth, detailing the main issue regarding use of the LLTV in training the Apollo astronauts:

The LLTV support for the first two lunar landing crews has just been adequate for training the prime Commanders. However, LLTV availability left little or no flexibility in the scheduling of this training and prevented full training of the backup Commanders. Since this training involves a unique combination of high value and high risk it must be conducted to a level and at a pace required by valid training considerations rather than dictated solely by LLTV availability.¹⁵

And two months later, Gilruth summarized and evaluated the MSC's LLTV program in a letter to Dale Myers, Mueller's successor as NASA Associate Administrator for Manned Space Flight:

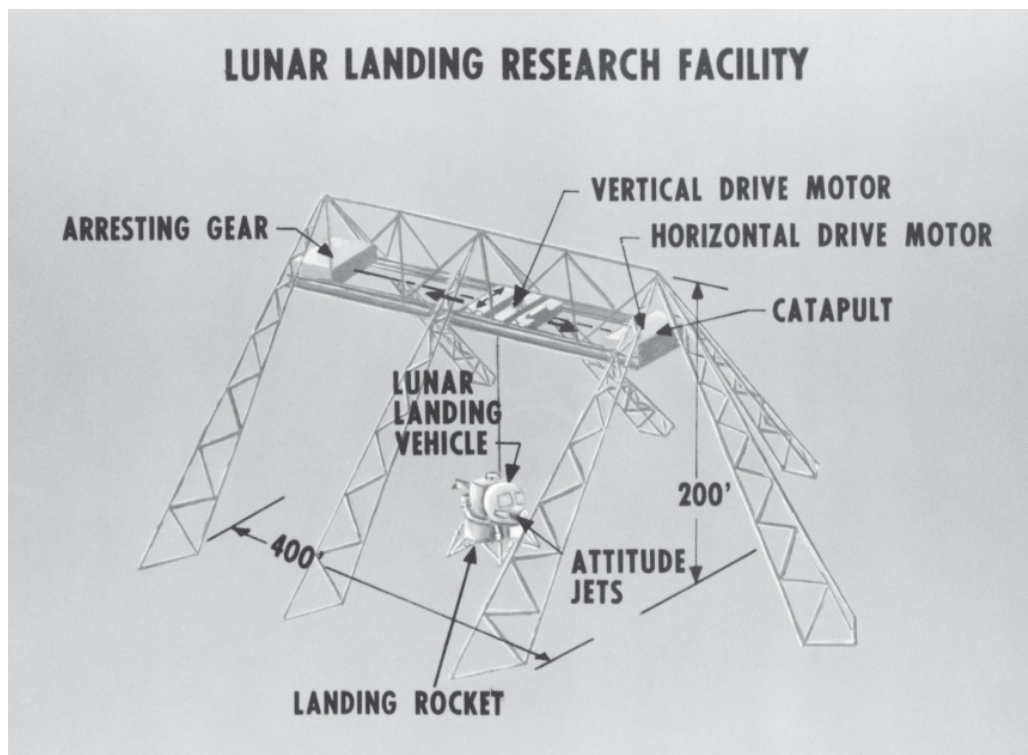

NASA Langley officials initially proposed training for the moon landing by using the Lunar Landing Research Facility. The structure measured 400 feet long and 200 feet high. Note the LM suspended from the structure. (S-64-01389)

During this past month we have again reviewed the requirement of use of the Lunar Landing Training Vehicle (LLTV) for crew training. Based on the experiences of Neil Armstrong and Pete Conrad, we have concluded that we must continue LLTV training for lunar landing missions.

The present plans call for a minimum of 22 flights for each Commander and backup Commander assigned to lunar landing missions. This includes 11 flights for initial qualification and 11 additional full lunar simulation trajectories for proficiency. We do not intend to train any Lunar Module pilots in the LLTV. These requirements are based on our LLTV flight experience to date and on the experience of the Apollo 11 and 12 crews. They give the optimum balance between risk, investment of crew time, and proficiency. Our ultimate plans call for completing qualification (or re-currency) 3 months prior to the subject mission, with proficiency flights up to 2 to 4 weeks from launch...

Our current assessment of LLTV support for Apollo 13 shows adequate capability to provide proper training for the Commander, with marginal capability to support the backup Commander. As of this date Jim Lovell has 14 flights remaining, while John Young must accomplish the full 22 flights.¹⁶

Unlike LM commanders, who trained in the LLRV/LLTV, LM pilots received training in the Lunar Landing Research Facility (LLRF) at Langley. Training in this enormous outdoor structure was considered sufficient since the likelihood was remote that an emergency might develop during a lunar mission that would require the LM pilot to take over from the commander (who actually flew the LM) during the final 500 feet of the lunar-landing trajectory. Due to the extensive maintenance requirements on the LLTV and the shortage of skilled crews for operations, training of backup commanders was a low priority. In February 1970, when Gilruth wrote Myers, there were two LLTVs available for astronaut training. A year later, only one LLTV was available to train the commanders and backup commanders for Apollo 15, 16, and 17.

EMI and LLTV No. 2

In May 1969—five months after the crash of LLTV No. 1 and less than two months before the scheduled launch of Apollo 11—LLTV No. 2 experienced its first serious problem with electromagnetic interference (EMI) just as Armstrong was slated to begin his training flights. Dean Grimm, LLTV program director, described the situation in his typically colorful manner, when MSC historian Ivan D. Ertel interviewed him nearly two years later:

On the second flight-test program after the accident, the thing was sitting out there and going to fly one more time. We were going to get Neil in there. He had been waiting in the wings like an expectant bride all along, and the mission was getting close. Headquarters was breathing down our necks, and congressional committees and everybody else were really sweating about this funny vehicle down here. All of a sudden, they [presumably, some LLTV team members] told me I had a problem on the vehicle.

I asked them, “What kind of a problem?”

They told me the thing had gone into backup in all three axes.

I said, “Hell, that can’t happen. We’ve got something designed so it won’t do that. Not only that, we’ve got the capability to fly it in two axes, because if you went into backup in all three axes, it was bang! bang!—sudden death.”

So we went and checked. Son-of-a-gun! We found that, sure enough, it had done just that. Well, we did everything but turn that vehicle loose, but we couldn’t make it duplicate that again. We tried for one week solid. We knew

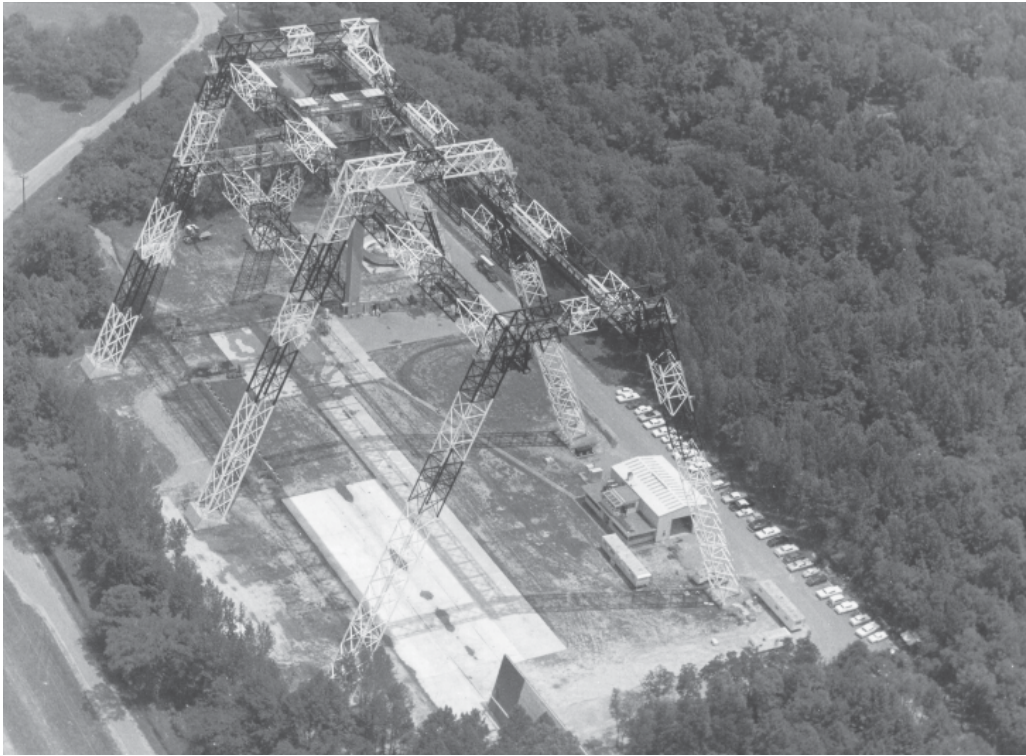

Two views of the Lunar Landing Research Facility at Langley. The first underscores its size; the second illustrates the facility's limitations because the lander remained tethered to the structure. (S66-4243, 65H-1161)

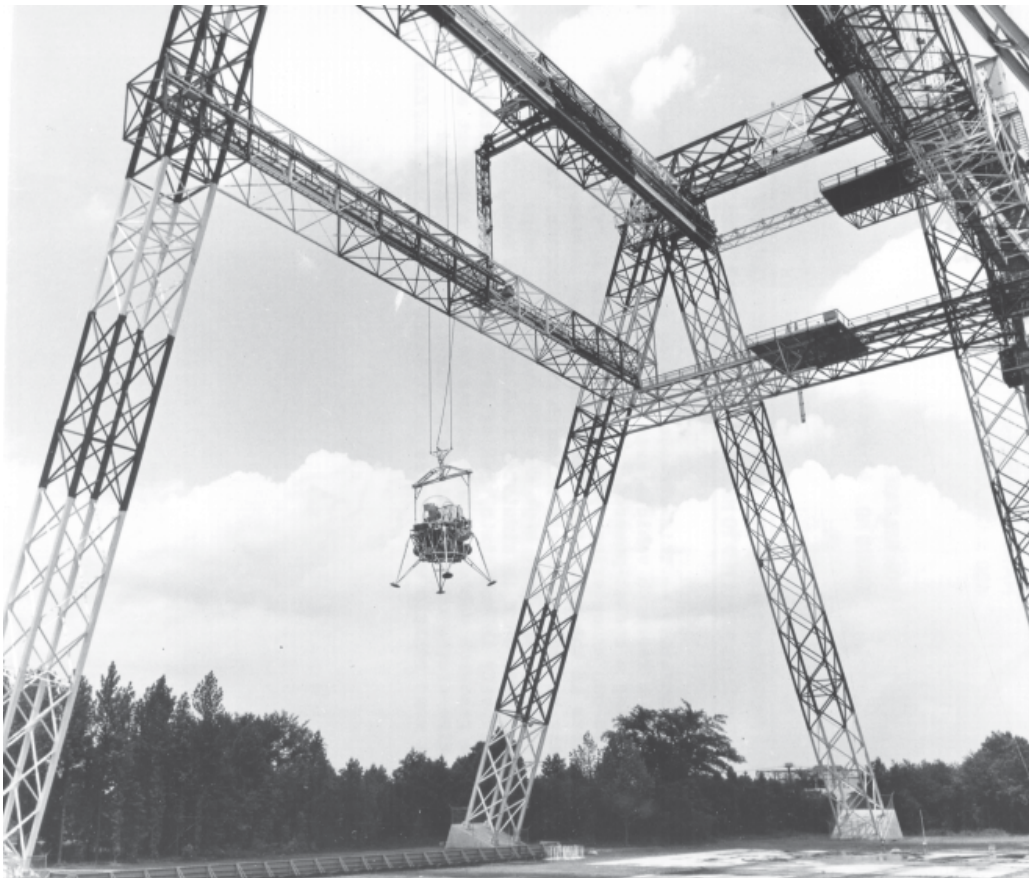

that we had some EMI problem, but we didn't know how bad because we never had run an EMI test on it. We knew that when we flew in a certain direction, we got dropouts on our radar and some of the other gear we had onboard, but

we really hadn't thought about it.

So we had the Telecommunications Systems Division come out and check the Air Force radar with [its] EMI equipment. [The Air Force] had a classified radar system for Ellington—an about 200- or 250-mile radar system. We found out that thing was strong enough to make you sterile on the spot—if you believed the readings.

It was the EMI expert's considered opinion that there wasn't anything outside of a lead vault that would keep us from getting EMI on that vehicle, with all the surrounding stuff we had out there. Plus the LLTV generated quite a little bit of its own EMI.

So we were in a quandary about what to do. We had all sorts of good advice about what to do, but none of it was very palatable. The Bell manager and I put our heads together and said, 'well, what do we have to do to make this vehicle safe in case this happens again?' Within one night, the Bell people designed a mod[ification] to that vehicle, and they put it in within another night [within 24 hours], which was damned near an impossible thing to do.¹⁷

The following month, the LLTV No. 2 flight readiness review board found that “in the LLTV [operating] area the radiation level is approximately forty times greater than the maximum allowed in the Apollo specification, and it was highly unlikely that the source [DoD equipment at Ellington] could be altered to produce a better EMI environ-

Following the crash and loss of LLTV No. 1, JSC shipped LLTV No. 3 to Langley for testing in the full-scale wind tunnel. (L-69-670)

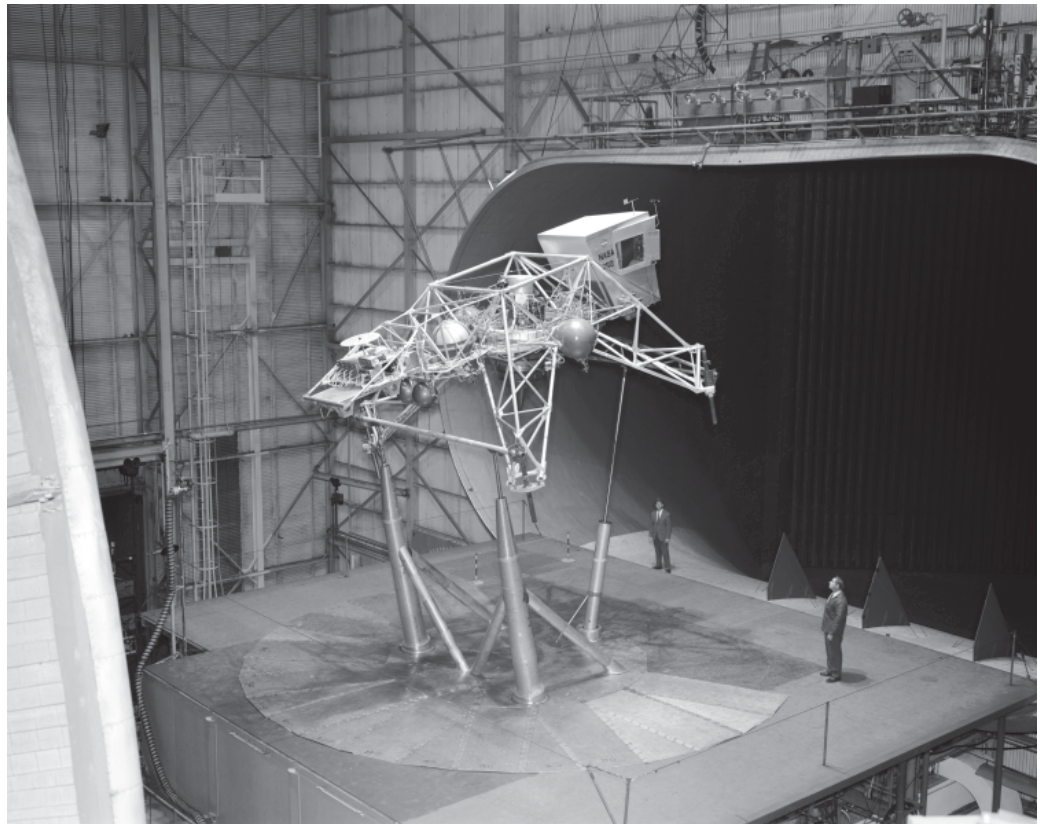

ment.”¹⁸ Grimm recalls negotiating an arrangement with the Ellington search radar facility to solve the EMI problem. The NASA crew would give the radar crew a call five minutes prior to lift-off then again at lift-off, and the radar installation would then ensure that its equipment was pointed away from the LLTV while in operation. This effectively solved the problem.

The LLRV program was essential in the quest for reaching the moon, as it was to

each Apollo commander's hands-on landing of a LM on the surface of the moon. The LLTV that evolved from the earlier research vehicle proved a realistic simulator of flight and landing in the unique lunar environment, and it successfully prepared the Apollo astronauts for the unknowns they encountered during the final phase of the approach and landing on the moon.

All six piloted landings on the lunar surface during the Apollo program were done manually, a choice made possible by use of the LLRV and LLTV for astronaut training. Each Apollo commander, it turned out, considered the final approach and landing on the moon to be too complex and precarious to be left to a fully automated system. None of them wanted to stand by idle, watching out the window as the LM descended slowly through a cloud of dust onto the rock-strewn lunar surface and landed itself automatically, hopefully without tipping over. Said Armstrong nearly two decades later, in 1988:

A 1968 study combined the autopilot characteristics with the expected lunar-surface conditions and concluded the LM would overturn on 7% of automatic landings. The autopilot's primary disadvantage was its inability to pick a good landing spot. In a few flights, very large attitude changes, at low altitudes, were required to maneuver to the landing site; particularly Apollo 12 when it was attempting to land in close proximity to the unmanned surveyor spacecraft, which had been resting on the lunar surface unattended for the previous two years.¹⁹

By about the middle of January 1970, while LLTV No. 3 was being cleared for use in flight-training of astronauts for the Apollo 13 mission, astronauts Armstrong and Conrad already had completed visual landings on the lunar surface. At the flight readiness review board meeting held for LLTV No. 3 on 12 January, Armstrong and Conrad testified that they were convinced it was absolutely necessary to use the LLTV in training other Apollo astronauts for lunar missions to provide the best simulation of lunar conditions.²¹

"If I were going to go again [to the moon]," said Conrad, "I would fly the LLTV as close to flight [time] as practical, and I would stretch it out a little bit, too. It will be a long time before we send somebody up there again that's already been there once, and each time you bring a new guy along, you are putting him in a more difficult landing site. We are banking our whole program on a fellow not making a mistake on his first landing," he concluded. "To build that confidence, I feel we should continue to fly the LLTV...[I]t is a dynamic vehicle, and there is no replacement for that type of training."

Agreeing with Conrad's points, Armstrong added, "I'm probably a little more reluctant to accept an instrument landing than Pete was...because we never did it before and never saw how the instruments operated...[W]hen you are first doing something, you think there might be something like flight data problems somewhere...[O]ne thing [that] is really important in setting yourself up for a possible instrument landing is that you really have to assure yourself that the instruments you are operating on are correct." The difficulty for Apollo 11, Armstrong said, "was getting into a small area. I felt that we would never find a spot that was good enough to land in. That's a kind of problem that's impossible to duplicate in the LMS [Lunar Module Simulator], or in the LLRF [Lunar Landing Research Facility]."

It was difficult to do in the LLTV as well, he admitted, "unless you sort of play the game to yourself, as you fly into a touchdown area and you say, 'no, I don't want to land there—I want to land over there.' As you get a little closer [to that spot] you [again] say, 'no, I really want to land over there.'" Of the relationship between his own training in the LLTV and his manual landing on the moon, Armstrong added:

I did pick up an unwanted horizontal velocity to the left during final phase and got

a lot closer to that little double crater than I wanted to, and I really can't account for that. Although I will admit in my case I was a little spastic in final approach, and you see a lot more attitude changes and throttle changes than you would like to see; still, all in all, I felt very comfortable—I felt at home. I felt like I was flying something I was used to, and it was doing the things that it ought to be doing.

Returning to the question of whether it was a good idea to continue using the LLTV (“buying this insurance policy,” as he called it) in training commanders for future Apollo landings on the moon, Armstrong continued:

What we all have to ask ourselves is, do we want to keep buying this insurance policy? We've paid a lot of money to buy this insurance policy to improve our ability to do the landing job, and...a couple of times, we've had to pay excess premiums. And now we are at the point where we say maybe, at this point in time, we don't need to buy the policy at all. Discontinue the premiums on it and avoid the possibility of these excess premiums that might burden us in the future with another crash or something like that. My own conclusion is that we still can't afford not to insure against . . . a catastrophe of one sort or another on final approach at the moon, and I think we should continue to buy the policy.

“I guess I agree with you,” Gilruth responded. “I can see why it gives you the feeling of confidence because you know that you have flown something that is as close to a [lunar] landing...as anybody can devise.”

“It is the only device we've had,” replied Armstrong, adding that “the LLTV is the only simulation at all where you can allow the process to take place...a closed-loop process where you infer the velocities from attitude, velocities over the ground, and the actual vertical velocities coming into the picture at the appropriate velocity. I'm talking of 50 feet per second over the ground, which is the transition phase, that phase...where you are essentially just watching out the window and...doing those things to come into a hover. That's the 150 feet-per-second to 10 feet-per-second region where you really have a lot of flying.

Conrad agreed, saying, “You do get yourself in situations in the LLTV that you can't get in any place else except at the moon.”

Six Apollo flights landed on the moon, and each flight commander manually piloted the LM safely and expertly onto the lunar surface. And not one of them, to quote Armstrong again, “came close to sticking a landing pad in a crater or tipping over. That success is due, in no small measure, to the experience and confidence gained in the defining research studies and the pilot experience and training by the LLRV and the LLTV.”

As research and training vehicles, the LLRV and LLTV performed the tasks they were designed for, and did so superbly. But training is always potentially hazardous, something underscored by the loss of three of the vehicles—LLRV No. 1, LLTV No. 1 and No. 3—during the MSC's astronaut-training program at Ellington. In spite of this, after the first Apollo landing on the moon, the training program was considered essential for preparing Apollo commanders for the final mission phase of lunar landing to touchdown. By then, it was obvious that the astronauts and managers at the MSC felt the training program not only was worth the risk of another accident occurring during training but also was indispensable in helping to prevent an accident from occurring during an actual lunar landing.

In retrospect, it is clear how essential the LLRV and the LLTV were to the Apollo program. It is impossible to say, considering the difficulty Armstrong encountered on the first moon landing, whether that landing would have been successful without the training he received in the LLRV and LLTV. But with a program such as Apollo, involving national commitment, there were few arguments against being on the safe side in training and research.

¹ Hansen, *Spaceflight Revolution*, p. 355.

² Dean Grimm, interview by Wayne Ottinger, 5 August 2000.

³ Minutes of Flight Readiness Review Board, Lunar Landing Training Vehicles, MSC, 12 January 1970; Joe Algranti, flight log notes and letter to Wayne Ottinger, 28 August 2000.

⁴ Bilstein, *Orders of Magnitude*, p. 80.

⁵ Joe Algranti, notes, 4 July 2000.

⁶ Ibid.

⁷ Donald K. Slayton, memo to MSC manager of reliability and quality assurance, 15 August 1969. If the project had been operating by today's standards, many of the safety issues would have been handled at the start of the program with an impact on accompanying schedule and cost.

⁸ Recollections of Wayne Ottinger.

⁹ Further examination determined that the original design was preferred and that protection from helium loss to the attitude-control system could be accomplished with improved monitoring by the control van and the pilot's warning system as well as by tightened procedures for flight operations. Donald K. Slayton, Director of Flight Crew Operations, NASA MSC, memo to acting manager of flight safety office, 23 September 1968.

¹⁰ LLRV operations at the FRC had established successful monitoring techniques that were available at Ellington but were not used by the flight controller.

¹¹ None were added due to the negative impacts of this suggestion—especially in terms of tank redesign, lead time, and cost. The marginal reliability of sensing probes in the hydrogen-peroxide environment dictated reliance on real-time fuel management using telemetered data in lieu of adding redundant sensing probe systems. Slayton, memo to acting manager of flight safety office, 23 September 1968. LLRV Accident Report, 12 July 1968.

¹² NASA Headquarters Release No. 68-182, 17 October 1968; LLRV Accident Report and Report by the NASA Accident Review Board on the Flight Accident with LLRV No. 1 on 6 May 1968, 12 July 1968.

¹³ LLRV Accident Report, 12 July 1968.

¹⁴ George E. Mueller, letter to Robert R. Gilruth, 19 February 1969.

¹⁵ Charles W. Mathews, letter to Robert R. Gilruth, 17 November 1969.

¹⁶ Robert R. Gilruth, letter to Dale Myers, 27 February 1970. The commander was the person who actually flew the LM for the landing on the moon. The backup commander was there to replace him if he could not go on the mission for reasons of health or other problems. The LM pilot was the second astronaut in the LM who was there to land the LM if for some reason the commander could not do so.

¹⁷ Unpublished working notes from an interview of Dean Grimm on 1 April 1971 by MSC Historian Ivan D. Ertel. The quoted portions have been lightly edited.

¹⁸ Minutes of the LLTV No. 2 Flight Readiness Review Board, 13 June 1969. Although we include the entire draft of the news release, rather than the actual release (which has not been available), the information in the draft matches the information on the accident given in other available sources.

¹⁹ Neil A. Armstrong, "Wingless on Luna," 25th Wings Club General Harold R. Harris 'Sight' Lecture, Grand Hyatt Hotel, New York, NY, 18 May 1988.

²⁰ Minutes of the meeting of the Flight Readiness Review Board for Lunar Landing Training Vehicles, NASA MSC (Houston, TX), 12 January 1970.

Epilogue

An element of serendipity exists in all flight research. During the planning phase, and even in the operational stage of a program, it is rarely apparent what findings and contributions will have application beyond the immediate program. Often enough, things emerge that no one knew would surface during the testing, let alone become major contributions down the road. The LLRV program was no exception. Several major contributions to the aerospace community—beyond supporting the Apollo mission—stemmed directly from the LLRV program, and radiated out to the larger community. Two specific examples linger in aviation history and technology.

The first is fly-by-wire flight control systems, which led to major advances in both commercial and military aircraft. Neither the LLRV nor the LLTV would have flown successfully without fly-by-wire flight controls. Even if the vehicles' unique performance requirements were achievable with then-conventional mechanical or hydraulic systems, weight requirements would have driven costs far beyond the acceptable. Initially, the management of the Apollo program was unwilling to admit the need for a free-flight research or training vehicle for the final phase of the lunar landing, which made selling the LLRV program difficult. Happily, the initially cool reception the idea received sent program designers and managers in a new direction, obliging them to develop unproven technology in flight controls.

Ultimately, two forces led the designers into uncharted waters: the need to keep the vehicle's weight and the program's costs down. The result was the analog fly-by-wire flight controls in the LLRV. At that time, the central concern about fly-by-wire systems in piloted aircraft was a lack of confidence in the overall reliability of such systems. Technologies simply hadn't been developed, let alone demonstrated, that provided the levels of reliability essential for aircraft flight controls. Without wings as a means of generating lift, the LLRV required a very high level of reliability because its very survival depended entirely on the flight-control system. Loss of flight control, even for seconds, would result in loss of the vehicle, as Armstrong and others found out. Yet concerns associated with a nascent technology were set aside in the face of both need and advantage associated with the new technology.

Extensive experience with the X-15 and other experimental aircraft led the flight-controls research community at the FRC to conclude that conventional hydromechanical systems could not provide the automation and rapid control-surface motions required by higher-performance aircraft. But getting the aerospace community and NASA management to accept this conclusion and fund a research program for developing and demonstrating the technology base needed for practical fly-by-wire development was a different matter entirely.

Flight control research engineers at the FRC viewed the LLRV as a program of opportunity for assessing the performance and characteristics of fly-by-wire technology in a critical application. And over the course of the LLRV program, the performance and reliability of the system proved to be extremely good. Indeed, at no time did the fly-by-wire flight-control system in the LLRV fail completely, and the LLRV pilots' acceptance of, and confidence in, the system's overall reliability helped convince FRC management that fly-by-wire technology was a viable flight-control discipline with applications to future aircraft development.

In 1969, while the LLTV was still being used to train Apollo commanders at the MSC, Bikle approved a proposal forwarded to NASA Headquarters for a major fly-by-wire flight research program. A renowned world-class glider pilot and holder of several world titles, including the maximum altitude record for glider aircraft, Bikle was an old-school stick-and-rudder pilot who did not take easily to replacing tried-and-proven methods with unproven new concepts, particularly for something as critical as flight

controls. But he also was a visionary who quickly grasped the significance of the LLRV flight-controls experience, and he became a strong advocate for major flight research and development of fly-by-wire controls. One measure of this lay in the fact that the proposal for a research program presented to NASA Headquarters for funding had been prepared at Bikle's urging. The program would involve an F-8 testbed aircraft retrofitted with a fly-by-wire flight-control system, using surplus hardware and software from the Apollo program to provide full fly-by-wire control with no mechanical or hydraulic backup system. Control of the aircraft would depend entirely on the primary fly-by-wire system.

But the program might soon have died had it not been for a fortuitous change at NASA Headquarters. Not long after returning from his trip to the moon, Neil Armstrong had been selected to head up all NASA aeronautical research and development programs. Perhaps better than anyone else at the time, he understood how important fly-by-wire had been to the LLRV. He was also aware of the feasibility, the value, and perhaps even the necessity of applying this technology in future aircraft. And he understood the magnitude of the task of developing the technology to the point where it would become acceptable to the aircraft design community and, especially, to pilots. Armstrong approved the program—with the strong recommendation that they employ a digital rather than an analog system. His endorsement reflected his experiences with the X-15, with the LLRV and LLTV, and with the total reliability of the Apollo system hardware and software that had taken him to the moon and back. From the confluence of all this came support and funding for the F-8 Digital Fly-by-Wire research program that laid the groundwork in the early 1970s for the acceptance by and application of fly-by-wire technology to modern-day commercial and military aircraft.¹ Had it not been for the LLRV's contribution, it is highly unlikely that the development and acceptance of fly-by-wire technology would have occurred as soon as it did.

The second long-term impact stemmed from Bikle's decision to "projectize" the LLRV program.² Neither easily done nor popular with managers, in retrospect his decision marked the beginning of a new way of operating at the FRC. It evolved into the way many complex flight research projects would be carried out in future. For much of the 1950s and early 1960s the FRC essentially had operated as a single-program facility supporting flight research with each successive X-plane.³ Nearly the entire facility was dedicated to the care and feeding of the three research vehicles that comprised the X-15 program, for instance. As X-15 program activity began winding down, it was replaced over a period of time with a number of smaller flight-research projects that competed within the facility for limited resources and workers.

The success of the LLRV program demonstrated that an independent and discrete project could be carried out with a dedicated workforce and resources while not having to compete continually with other organizations for priority and support. Crucial to the success of this approach, of course, was the dedication and resourcefulness of each project manager and technical leader. Another element central to that success was Bikle's delegation of operational responsibility to the program and site managers, whom he considered responsible for the success of the LLRV mission. The result was a freedom of operation in which each individual's talents and ingenuity could be utilized immediately in resolving the complex and critical problems that always seem to arise during the flight-testing of new vehicles.

From the start, Bikle realized that the only way the FRC would have a chance of meeting the schedule requirements set by the Apollo program was to select good people, delegate the appropriate responsibility and resources to them, and then stay out of their way. Bikle's decision to "projectize" the LLRV program ushered in a revised project management and organizational structure that remains a central element of the Dryden Flight Research Center.

Since the LLRV program, the same "projectized" manner of organization has been

used in carrying out numerous other flight research projects and activities at the facility. Within this structure, individuals dedicated to a specific project retain their supervisory ties with line managers. This organizational model allows the project team to focus entirely on the technical aspects of system development and flight-test operations without having to deal simultaneously with normal day-to-day supervisory routines and issues.

The process has not only served the Dryden FRC but has been the pattern for other NASA centers beginning in the early 1990s, perhaps when new methods of doing business were being explored as a means of surviving major budget cuts then taking place within the aeronautics community. As it turned out, NASA's new way of doing business is actually the FRC's old way of doing business, dating from the LLRV program at Edwards' South Base.

Drawing on its experience with the LLRV and LLTV, Bell proposed this single-pilot vehicle as a competitor to the Lunar Rover eventually selected by NASA for the final three missions to the moon.
(Bell Aerosystems)

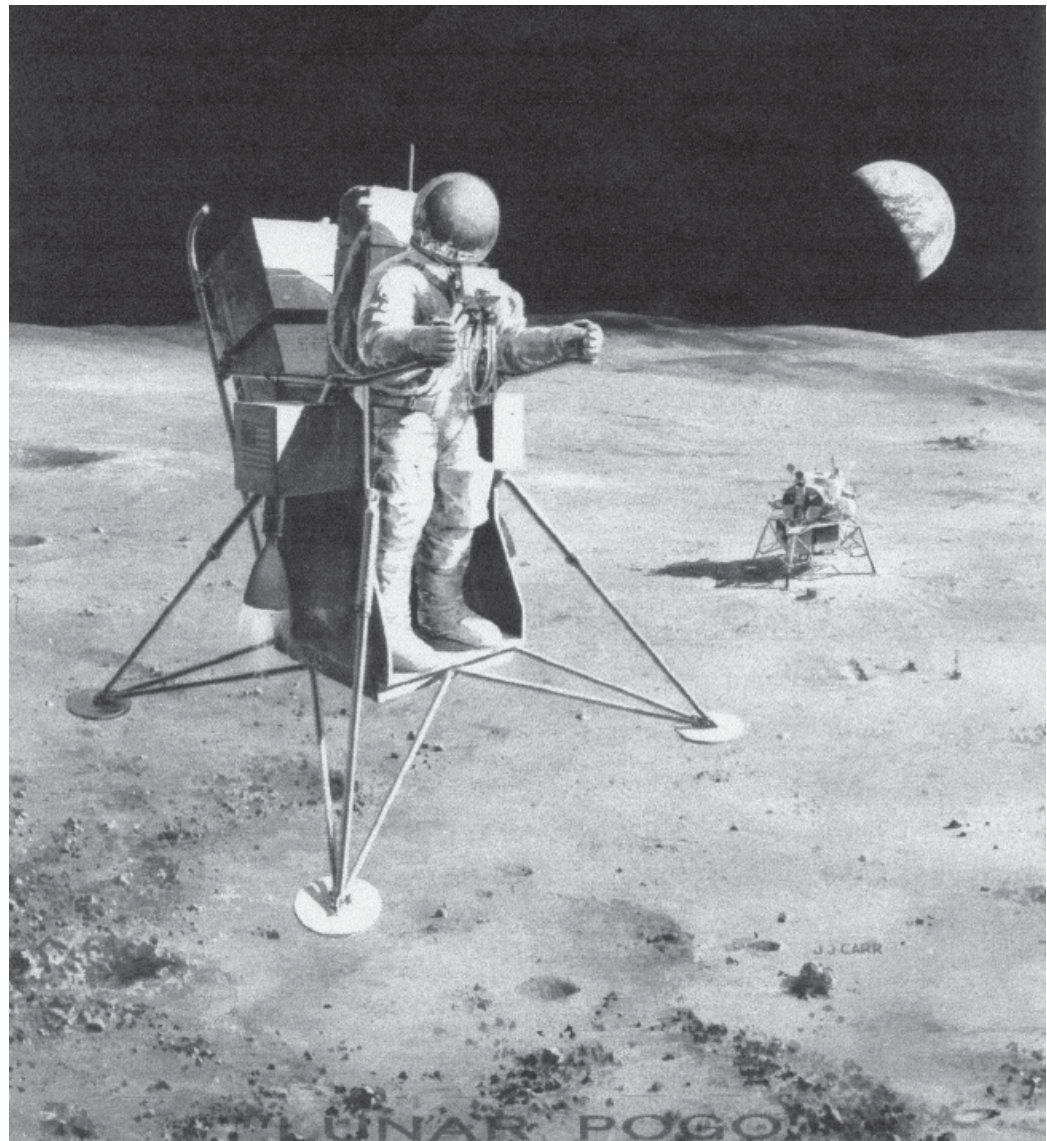

From the Past to the Future

In 1988, near the end of a symposium titled “Wingless on Luna,” Neil Armstrong spoke of the future he saw for mankind on the moon.⁴ Tongue-in-cheek, he briefly sketched the outlines of what the future might be like with a community of humans on the moon, sharing the environment with rocket-powered flying machines:

Compact flying machines should have good usability. Cruising altitudes above 200

feet should minimize visibility problems due to dust, but higher altitudes may be required to avoid irritating joggers below. Rocket exhausts are noiseless on Luna, so rocketports should be immune from noise abatement [law]suits. As soon as the plaintiff's bar has a Lunar section, however, they can be expected to find some basis for complaint.⁵

Once mankind is living in space, the moon will be a valuable source of raw materials—metals, oxygen, and residues from the solar wind. While “the rocket will carry the brunt of the load” in lunar flying machines, “low gravity and the consequent low divergence rates should make rocket belts more easily flyable than on Earth.”

Flying on the moon in the twenty-first century will require the use of rocket attitude controls perhaps different in some design details from those used in the twentieth century, but the applicable laws of physics will be the same. Future designers of flying machines will then benefit from the twentieth century's extensive experience with rocket attitude-control and lift systems. And the LLRV's groundbreaking accomplishments led the way.

This work is an attempt to preserve a small portion of this technical legacy. As Armstrong wrote, “Some day men will return to the moon. When they do, they are quite likely to need the knowledge, the techniques, and the machine described in this volume.”

¹ Tomayko, *Computers Take Flight*, p. 30-31. As Tomayko relates, FRC engineers Mel Burke and Cal Jarvis went to Washington to encourage NASA Headquarters to fund the program.

² See note 1 in Chapter 6 for the definition of “projectized” organizations.

³ “The one single individual responsible for the success of the X-15 flight program was Paul Bikle,” wrote veteran X-15 pilot Milton O. Thompson in his book *At the Edge of Space: The X-15 Flight Program* (Washington, D.C.: Smithsonian Institution Press, 1992), p. 271.

⁴ Armstrong, “Wingless on Luna.”

⁵ *Ibid.*

Appendices

Appendix A

“Flying the LLRV,” Donald L. Mallick

When I transferred from NASA Langley to the NASA FRC in 1963, I had about 3,500 hours total flight time, with 350 hours of that in helicopters and VTOL [vertical takeoff and landing]-type aircraft. These were flight-test aircraft with modified flight control systems. I suspect that this background made me a natural selection to fly the LLRV. I joined FRC chief pilot Joe Walker as the co-project pilot on the program. It had been in a planning stage for a number of years. Although some people assumed the actual lunar landing would be fully automatic, wise managers realized that there was the strong probability that the pilots or astronauts would be required to fly the final touchdown. It turned out that they were correct for all lunar landings.

For all of my experience with VTOL and VSTOL [vertical/short take-off and landing] at Langley, this LLRV struck me as being a most unusual vehicle. The operator's [pilot's] seat sat way out front in the open air and you almost had the feeling that you were out there in space [alone] with nothing behind you. Of course, that wasn't true. There was a lot behind you—the jet engine, lift rockets, attitude-control rockets, computer flight-control system, fuel and hydrogen peroxide tanks, plumbing, and all the aluminum pipes in the world to hold it together. It was a most unusual machine and I was proud to have the privilege of flying it. It was state-of-the-art or beyond in its technology and it was designed to support a very important NASA mission

Test Flight

A typical test flight was conducted as follows: The LLRV was powered up electrically several hours before the pilot got into the cockpit—or, front seat, which more aptly describes his position. A very complete set of electronic system checks would be made and the computers actually allowed to function for several hours to provide confidence that they were on and stabilized. The pilot then entered and went through his pre-start and pre-flight checks by starting the jet engine and checking out the attitude-control rockets. The systems of the LLRV were highly instrumented and the data was monitored in real time by ground personnel who could see lots of information, some of which was not available to the pilot on his cockpit gages. Therefore the ground monitors could sometimes detect problems before the pilot was aware of these. These ground systems monitors were critical to the program and on a number of occasions, they picked up deviations in systems that required a termination of flight and early landing. After all of these ground monitors and the pilot were satisfied that this machine was on the line and operating properly, a takeoff was made in the VTOL mode.

The fly-by-wire control system allowed the pilot to operate the LLRV in two primary flight control modes, VTOL and lunar simulation.

VTOL consisted of the engine gimbals being centered and lift provided by the fan-jet engine. Attitude control was provided through the hydrogen peroxide attitude control rockets.

Lunar simulation mode consisted of the jet engine being throttled back to 5/6 of the vehicle's weight and being continuously adjusted by the computer to stay at 5/6 of the total vehicle weight even as fuel [jet and hydrogen peroxide] was burned off. The vehicle's attitude control was not changed over that of the VTOL mode. The jet engine gimbals were unlocked in this mode, and computer-controlled engine angle allowed the pilot to maneuver the LLRV while adjusting the lift-rocket engines to fly in the simulated lunar gravity field to a landing at a designated spot. The sensors and computer were able to measure and cancel atmospheric drag on the vehicle. There were some

undesired aerodynamic pitching moments on the aircraft as a result of its speed through the air. The flight-control system would increase the firing rate or thrusting of the attitude rockets to cancel any angular rate that the aerodynamic moments were trying to generate. Thus the lunar simulation was complete, drag cancelled out, attitude or pitching moment with increasing speed cancelled and the jet engine only lifting 5/6 of the LLRV's weight. It was a very good simulation of the final approach and touchdown in a lunar environment.

How It Felt to Fly This Strange Machine

The initial pilot controls were as follows: A conventional center stick that provided pitch and roll control, and conventional rudder pedals that provided yaw control. The jet engine throttle was on the pilot's left, a conventional throttle that was moved forward and aft with the pilot's left hand as in a fighter plane. The lift rockets were controlled by a lift stick very similar to the collective stick in a helicopter, and it was attached to the floor on the pilot's left side. An up-and-down motion was used to control thrust from the two large lift rockets.

The liftoff in the VTOL mode was made by advancing the jet throttle until the LLRV rose on its oleo struts. There was a lot of noise and vibration as the throttle approached 100 percent. The thrust-to-weight ratio was hardly over 1.0 and the liftoff and separation from the ground were slow. As the oleo struts extended, some rudder inputs were usually required to prevent the LLRV from rotating in heading. The attitude-control rockets on the front corners of the vehicle could be heard popping [firing]. The reflection of the jet exhaust from the launch pad was swirling around the vehicle with its sounds and smell. If the morning was cool, the attitude rockets formed steam clouds around the vehicle. It was a sight and sound spectacular. On my first few flights, I felt like a train engineer trying to coax his big locomotive into flight rather than start it down the tracks. After a few flights, I became a little more accustomed to all the "show," but it never ceased to impress me.

As the pilot sitting out front, I had a front row seat to all the action. Joe and I quickly added silk scarves to our flight gear—not to look fancy, but to protect our necks from the non-decomposed hydrogen peroxide droplets that were everywhere around us. This was from the firing of the attitude rockets. It was a relief as the LLRV gained altitude and departed the high noise and vibration area that was experienced near the ground. As the LLRV gained altitude, it seemed to pick up a little more thrust [i.e., out of the re-circulation area]. The vehicle was tilted forward in pitch, similar to a helicopter, and flown in a climb to a position in space to prepare for the lunar simulation. This was about 1,000 feet above the ground and about 3,000 feet horizontally from the touchdown point. The speed was around 50 mph. A low-speed pitot tube airspeed indicator was used. Speeds much above 60 mph would result in the pitch attitude rockets firing almost full time to counter the aerodynamic pitching moment. This was not a desirable situation in that it left very little pitch control for damping or pilot control inputs. The pilot had no direct way of knowing precisely how often the attitude rockets were firing, and would rely on his ground monitors [co-pilots] to alert him by radio when he was approaching 80 percent of the pitch control capability. The warning told the pilot to watch the airspeed and not go faster.

The flying of the LLRV in this VTOL mode was very much like a helicopter but with limits on airspeed. In this mode, the LLRV was responsive and quite controllable within these limits. When the LLRV was stabilized at 1,000 feet above the ground and around 50 miles per hour, the lunar simulation mode was entered by selecting a switch and lifting the hydrogen peroxide lift [collective] stick to a point where the lift rockets fired. The computer automatically weighed the LLRV at this point and reduced the jet engine throttle to 5/6 of the vehicle's existing weight [via a throttle servo]. At the same time, it unlocked the engine gimbals and controlled the angle of the jet engine near the

vertical to allow the LLRV frame and lift rockets to maneuver without causing unwanted linear translations from the jet engine.

Lunar Simulation

This was a different world to fly in. The attitude control was similar as far as response, but very large pitch and roll attitudes were required along with what seemed to be long waiting periods to begin or arrest any translational motion, either along or to the left or right of the flight path. It took some getting used to, and a different amount of anticipation to fly and bring the LLRV to a hover and landing over a desired spot. It was possible and like all tasks, the more you did it the better you became. The control of the vertical descent with the lift rockets was different, too, in that it took a longer time to arrest a given vertical velocity as you approached the ground. It was apparent that a pilot or astronaut could fly a vehicle in the lunar environment of 1/6 the Earth's gravity and no atmosphere. It did require some adaptation by the pilot.

Our major evaluations were in the area of control power, or just how little control moment could we live with and still safely control this machine, which extrapolated to safely landing on the moon. The "test" set of attitude control rockets would be adjusted prior to flight to lower and lower levels as we probed the minimum level that we would accept. Joe Walker and I would then fly the standard lunar landing profile and evaluate the acceptability of the control power level. We always had the second set of attitude controls and a known nominal control power that could be selected if a control problem occurred. If we entered a dangerous control situation, we would rotate a switch located on the left-hand side panel to basic control or both, in order to restore a more powerful attitude control and allow us to recover the LLRV safely. Joe and I would each fly the various control powers settings and make qualitative pilot ratings on the Cooper-Harper rating scale. The ground personnel and engineers also had extensive recorded quantitative data to verify our feelings about a particular control setting. They could tell by pilot input and vehicle responses just how well the pilot and control system were doing. (There was one occasion I will discuss a little later that convinced me the selector switch for the different attitude control systems—1,2, or both—should have been on the control stick and not the side console.)

Joe was the chief pilot and my boss. This was the first program that I had the opportunity to share with him and fly as a co-project pilot; unfortunately, it was the only program. Joe, being the senior pilot, flew the first flight on the LLRV on 30 October 1964. After he had flown several flights, I made my first flight on 9 December 1964. I felt honored and enjoyed flying on the LLRV program with him. He was a world-renowned pilot, recognized and honored by the aeronautic community. He had been presented with the Collier Trophy by no less than the president of the United States for his work on the X-15. With all of the accomplishments and recognition that he had received, he was a real down-to-earth person and one with whom I got along very well. I should add that he was very professional and would not tolerate any of his pilots not being the same; he was not reluctant to provide guidance as the leader.

When I Joined the Program (July 1964)

Joe and I attended almost all of the planning and formulating meetings on the LLRV prior to the first flight. We were involved in final cockpit design and instrument layout. The LLRV had a rocket-powered seat designed and built by the Weber Company in Los Angeles. It was a very lightweight system and an excellent design. One of the features of the seat was that it was even better than a zero-zero seat. A zero-zero seat is one that will eject the pilot safely from the aircraft sitting on the ground at zero-speed and zero-altitude. The Weber seat would actually get the pilot clear of the vehicle very close to the ground with a 400-foot-per-minute rate of descent, and with limited pitch and roll attitude relative to the local vertical. To accomplish this, the center of

gravity of the pilot-seat combination was critical, and each pilot was fitted with seat cushion that was of a height that complemented his body weight and density, to allow the seat rocket motor to propel the pilot high enough above the vehicle or ground for a safe parachute deployment.

The measurement for the special seat cushion was an unusual one in that the pilot was placed in a type of swing and his individual body center of gravity (cg) was determined by taking readings at various angles of this swing. Depending on the pilot's weight and mass distribution, his personal cg was at a unique location, usually somewhere deep in the stomach behind his navel. The measurements were rather time-consuming, and as Joe and I each took our turn in the swing, we noticed that an unusual number of very good-looking ladies were passing the doors to the Weber laboratory that we were in; most were turning and smiling as they went by. After the tests were finished, Joe and I confessed to the Weber engineers that we hadn't minded the long time required for the tests, in that we enjoyed the "girl watching." We also commented on their savvy in locating their laboratory in such a strategic location to observe the normal work traffic. They laughed and informed us, "Fellows, you weren't the ones watching, you were victims of the 'boy watchers.' Those gals heard that we had two test pilots in for cg measurement, and they were down here to get a look at you. We hardly ever see them on a normal working day." I think that it was the first time that I was a victim of that phenomenon; I don't know about Joe.

Test flying is a profession that seems to run along smoothly for a long time, and then something completely unexpected jumps out of the woodwork to remind you it can be a risky business. I know that every test pilot has had an experience or two in a new aircraft or system that gives him a good scare, gets his attention, or "waters his eyes." My most memorable experience in the LLRV occurred during a test approach with limited attitude control power. As I arrested my forward motion into a hover and added more collective lift stick, the LLRV entered an uncontrolled roll to the left within about 30 feet of the ground. I immediately scrambled for the attitude-selector control on the left console and switched into both attitude control systems. The response was immediate, but with the full right roll that I was calling for, I entered a high rate roll to the right about 20 feet off the ground. This was actually an over-control situation (called a pilot-induced oscillation, or PIO) and after several large oscillations back and forth, I damped out the motion and safely landed the aircraft. This one "watered my eyes;" it was very close to a crash scenario. The ground engineers were equally as stunned, and it started a search for what caused the initial roll to the left in the landing maneuver. A look at the recorded data revealed that I had inadvertently pressed down a hydrogen peroxide trim switch shortly after entering the lunar simulation mode. The purpose of the switch was to control a lateral-trim problem between the hydrogen peroxide fuel tanks mounted left and right of the vehicle's centerline. This incident occurred after I had about 25 flights and I was at a loss as to why I had accidentally actuated this switch. After some thought and soul-searching, I came up with an explanation; it really didn't make what had happened any better. I had luckily dodged a bullet as one sometimes does, but I could now explain to myself how I had made a trim input inadvertently that usually took a deliberate motion or action:

Just prior to this test flight, I had been issued another ejection seat cushion from the Weber Company. Apparently the company's carry-on testing indicated that a thicker cushion was in order for me. The cushion was about two inches thicker than the previous one and raised my body position relative to the collective stick. Where once my left hand had naturally rested several inches from the top of the collective, it now was right near the top. My clumsy thumb curled right over the end of the collective where the lateral-trim switch was located. The trim switch had a very light, spring-loaded center position and in the "heat" of the flight, I had allowed thumb pressure to inadvertently activate the lateral-trim switch, driving the LLRV into a lateral miss-trim

condition. This knowledge restored my confidence, and from that flight on, I kept the heavy thumb away from the trim switch that was seldom used anyway. The spring force in this trim switch was also increased to prevent inadvertent actuation. It is always interesting, after the fact, to discover how something so simple could lead to such a dangerous situation.

One of the hallmarks of the NASA flight research experience was to share all information that was available. If a pilot had a problem or incident, it was analyzed with the idea that someone else could benefit from the experience and perhaps avoid a problem. Joe Walker had an experience with the LLRV that provided me with some background. The background helped me later on.

After we were into flying the LLRV for about a year, Joe was asked by management to fly a lunar simulation profile as a demonstration along the NASA taxiway near our main building at the northern part of the base. We had been conducting all of our research flights on the South Base area for convenience and safety. This request was one that pilots referred to as a “show and tell.” Once a program was underway and doing well, it was not unusual to put on a demonstration flight for visiting headquarters directors and managers or other VIPs. I was never really impressed with the idea of these demonstration flights, but I knew they were necessary. Over the years in my testing career, I had personally observed several test pilots killed in the process of demonstrating their machines. Some of the causes were mechanical failures that could have happened at any time, and some were over-extension of the test pilot’s skill in trying to make the vehicle impressive. In any event, I wasn’t too fond of these demonstrations.

The planned profile for Joe’s flight was for the LLRV to fly north along the NASA taxiway toward the hangar complex. The LLRV was to come into a hover and land in the NASA aircraft parking area not far from the main building. Joe entered his lunar simulation mode and started his approach to the landing spot. It was obvious to me as a ground observer and LLRV pilot that he was going to overshoot the landing spot. At our normal test area of South Base this was not a problem, as adequate space was available for the overshoot. In this case, there was very little room on the planned flight profile. Joe realized his problem in plenty of time, and switched the LLRV out of the lunar simulation mode into the VTOL mode, which enabled the jet engine to arrest the translation. He brought the LLRV to an uneventful hover and landed on the planned spot or slightly beyond it. A short time later, after Joe had left the LLRV program, I was asked to fly a similar demonstration, which I did, but I made the touchdown point about 100 yards further out from the hangars and people. It went off well. We had learned from Joe’s experience.

LLRV Program Flying

It was obvious early on in the planning stage that the LLRV was going to be limited in the area of thrust-to-weight ratio and endurance. Taking these problems into consideration, it was decided that the program was still worthwhile and would provide much-needed test data. To compensate for the limited thrust, the test flights were scheduled early in the morning. The cool desert air temperatures and low winds of morning made it a most desirable time to fly. After some flight experience was gained, it was not unusual to make several flights on the same morning. On several mornings, my first takeoff was made when adequate daylight to see was available, even before sunrise.

Because the LLRV was so new, with a computerized fly-by-wire flight control system, the engineers and ground crew would turn the electrical power on in the aircraft several hours before the actual flight [sometimes around 2 a.m.]. This would allow the system to warm up and function for a few hours to ensure its reliability. At this point, the operations engineer, Bob Baron, would call me at home [about 4 a.m.]. Bob would tell me that the system was on and running and they would be ready for me when I got there.

Bob's call was my alarm clock. If the support crew had experienced a delay or problem, Bob would not call and I would get an extra two hours' sleep and awake to my normal alarm clock, which was set about 6 a.m. It was a good plan and it worked well; it gave this test pilot as much sleep as possible. On many occasions, I would complete several LLRV flights at South Base and then proceed to the NASA FRC's main area and fly several other programs that day.

Flying the LLRV was not without risk. Any major failure in flight of the propulsion or flight control system required an immediate bailout or ejection. This was a known fact that was accepted and planned for. On a major failure, there were few steps on the emergency checklist that came before PULL THE EJECTION HANDLE. I had a great confidence in the Weber ejection seat discussed earlier. I also built a great confidence in the basic LLRV. The engineering, planning, and flight operations were conducted by a talented, dedicated group of NASA and other support personnel. When my LLRV crew chief and inspector reported the LLRV [as being] ready to fly to me, I was ready to fly it.

Fortunately for me, I never had to use the ejection handle. Fortunately for those who did, later in LLRV and LLTV operations, the Weber ejection seat performed as advertised and in the life of the total program, saved three pilots.

I flew 79 test flights over the 19 months that I flew on the program. It was a good program and I always had the feeling that this most unusual machine was gathering some most important flight-test data.

My Departure

In July 1966, I was phasing out of the LLRV program. U.S. Army assignee to NASA Dryden Maj. Jack Kluever was checked out in the LLRV beginning in December of 1965. Jack was a fine U.S. Army test pilot with an excellent flight background in helicopters. His checkout went quickly and smoothly. Jack was up to speed in the LLRV by the time I departed in July of 1966. In addition, two NASA Houston pilots, Joe Algranti and Bud Ream, were being prepared to fly the LLRVs and the follow-on LLTVs as instructor pilots. The LLTVs were to be used as flight simulators to train the Apollo astronauts.

I had enjoyed flying this test program. It was a machine that you had to pay attention to, flying it all the time. The mission time was short and the pilot was busy. The LLRV ground support was excellent and flight monitors and directors were like co-pilots backing you up on every flight. I had special feelings in July 1969, when Neil Armstrong and Buzz Aldrin touched down safely on the moon. It was mostly of pride for having been a part of the LLRV program.

Donald L. Mallick
NASA

Appendix B

“The LLRV Program Flight Experience,” Col. Emil E. “Jack” Kluever, (USA Ret.)

To be asked by Paul Bikle and Joe Walker to participate in the LLRV as a co-project pilot was the high point of my aviation career in 1963 while serving as the chief engineering test pilot with the U.S. Army Aviation Test Activity at Edwards Air Force Base.

My association with FRC started with supporting NASA research pilot Milt Thompson by towing the Parasev with an Army L-19 Bird Dog. This was followed by using a twin-engine heavy helicopter to drop quarter-scale models of the Rogallo Wing Gemini capsule recovery system. North American won the contract. The Army used a YHC-1A twin tandem rotor jet-powered helicopter to support the NASA program.

I joined the FRC in March 1964 after a year in Korea commanding a helicopter unit. Upon joining FRC, I found myself organizing a flight safety group in the pilots' office with Vic Horton supporting the effort. I also enjoyed checking out in various FRC aircraft such as the C-47 and T-33 and was especially thrilled to have Joe Walker and Bill Dana check me out in the FRC F-104s.

The Army saw fit to send me to the Command and General Staff College at Ft. Leavenworth, Kansas, from September to December 1964, so I missed Joe's first LLRV flight and Mallick's initial LLRV flights.

Prior to my departure, Joe and I were playing squash at the base gym and I asked if his getting helicopter flight training would lower the flight risk of the first LLRV flights. Being the professional pilot that he was, he accepted my offer to demonstrate the hovering flight regime to him so he could experience flight without the normal motion “Qs” found in fixed-wing flight. So we used a U.S. Army helicopter and I demonstrated how a hover looked and felt and showed him how the helicopter would follow the rotor system tip path plane. Joe tried it several times and his performance did not agree with his expectations so he asked to go back to FRC, which I did. This occurred on a Thursday and on the Monday following, Mr. Bikle told me Joe was in Pensacola getting helicopter qualification with the Navy. When Joe returned, FRC leased a Bell 47G3B, which we all three used for proficiency and for chase on LLRV flights. This qualification was also required of moon-landing astronauts.

When my day came to fly the LLRV, I was thrilled to be at the controls and making my first liftoff with gimbals locked. The noise level from the jet thrust made radio contact with the ground-based flight controller impossible until five to 10 feet altitude was achieved. I had checked control responses just prior to liftoff and found them very responsive and almost instantaneous in function.

Gimbals-locked flight was straightforward and responsive with small attitude changes required for easy maneuvering. Hearing the attitude rockets pop off [when making] an attitude adjustment or control input was very comforting.

My first time into lunar simulation I remember very well, as it seemed to get quieter and flight was like a balloon floating along. Attitude changes were greater but response to those changes was less since the lift vector was effectively shortened by 5/6.

Landing the LLRV was quite easy and straightforward, using the jet throttle for height control. This was the same as my X-14 flight experience. Landing in lunar simulation was easier since changes in lift-rocket response were instantaneous; [it allowed] small increments of change enabling to set it down as though it was landing on eggs.

Proceeding into evaluating and rating the control system was straightforward. The new tape displays installed were a step in the right direction. As with most new cockpit displays, they too involved a re-learning process.

My next flights were with the new attitude control system using large angles and

then using a side-arm controller in which each controller position matched a vehicle attitude. This feature made use of the neutral stability to rapidly move to the newly desired attitude and hold without apparent overshooting or undershooting the desired attitude. The side-arm controller evolved into one that did not physically move but electronically sensed pressure by the pilot [known as a force stick].

A series of jet stabilization and drag flights were next followed by LEM trajectory flights, which were straight-ahead flights, initially. We worked up until a 180-degree turn before landing was incorporated in the approach to landing.

The attitude control system was great to fly and so easy to learn and confidence in its use was readily accepted. One of the highlights of the program for me was to check out Joe Algranti and Bud Ream from MSC for their first LLRV flights at the South Base. They would be checking out the astronauts in the LLTVs at Houston.

An eleven-flight syllabus was prepared. My background in flight instruction [2,507 hours, with 500 hours in helicopters] made the job easier. The checkouts went very well, with Algranti and Ream accomplishing their flights with the highest professional standards; it was a highlight of my flight instruction experience.

Other highlights of the LLRV No. 1 and No. 2 experiences included a demonstration flight for the MSC Director Robert R. Gilruth at South Base on May 13, 1966. I flew six flights in one day, and was the only pilot who ever flew LLRV No.2. (LLRV No. 2 flew on two successive days at the South Base, was shipped to Houston, and never flown there. It is now on static display at the NASA Dryden FRC.)

All in all it was a great experience, working with dedicated people whom I will always remember. Thanks to one and all who together made this program a total success and timely for Neil Armstrong's moon landing.

Appendix C

LLRV Reminiscences by Walt Rusnak of Bell Aerosystems; 15 March 2000

When the LLRV was conceived, Bell Aerosystems Co. was organized into three divisions: Avionics, Rockets, and Aerospace Structures. All three played important roles in the development, fabrication, and follow-on support of the LLRV and, later, the LLTV. A brief description of the activities of these divisions is helpful towards understanding the climate at Bell at the time of the LLRV's creation.

Avionics' principal business was in automatic landing systems. The SPN10 and SPN42 were specifically designed for the Navy, while the GSN5 was tailored for Air Force requirements. These were radar-based systems, which tracked and then computed commands, which were transmitted to the aircraft. When coupled to the autopilot, these commands controlled the aircraft to the touchdown point on a safe flight profile. Other activities at that time were the development of inertial guidance systems and components. Among these, the Bell accelerometer was notable for its long history. This precision instrument served in its many incarnations from the time of the Rascal missile, in the late 1940s, to the present, in gradiometer systems. Efforts were also underway to penetrate the communications field, particularly in secure communications for the military

Rockets developed a number of rocket engines and attitude thrusters. Among them was the lift rocket on the LLRV, which simulated the LEM descent engine; the lunar ascent engine, which lifted the astronauts from the moon's surface; and the Agena engine, which was a most reliable workhorse used to inject a large number of satellites into orbit. The Agena was believed to be the first rocket engine with a restart-in-flight capability, and was possibly the most reliable rocket engine in use in that era.

Structures was responsible for the development of many experimental aircraft. The X-1, the first supersonic aircraft, is probably the best known. Another spectacular aircraft engineered by Structures was the X-22 airplane. This VSTOL used four swiveling, ducted rotor fans, which enabled it to simulate the handling characteristics of any other aircraft. It was used for many years as a flight research vehicle by Calspan, another Buffalo-based research company, and now sits in the aerospace museum at the Summit Park Mall in close proximity to the former Bell plant where it was born. NASA Ames did VTOL research for many years with the Bell-built X-14 jet-powered VTOL. Other vehicles, each with its own unique characteristics, included the P-59, X-5, X-16, and the Bell Model 30 helicopter. Such vehicles as these, and particularly the LLRV/LLTV group, led one European aviation magazine to label Bell as 'maker of grotesque airframes.' I don't remember at this distance in time the name of the publication but I do remember that a photograph of the LLRV illustrated the article. However the descriptor 'grotesque' may have been intended, we at Bell were proud.

Within Structures there was a Systems group, which was charged with responding to requests for proposals. This often entailed preliminary designs of aerospace vehicles for these proposals. Ken Levin was a member of the Systems group and, as I remember those days, was credited with being the principal LLRV innovator. Others were involved, since the concept apparently emerged from a brainstorming session within the Systems group. These activities were remote and behind the scenes for us in Avionics, and we were not particularly aware of the other participants or their relative contributions. There was a Configuration Patent issued on the LLRV that lists those credited, with Ken as one of the inventors. In my memory-of-long-ago quick glance at the patent, the configuration looked more like a water tower than the aircraft shape with oversized legs that finally emerged as the LLRV.

A history of the LLRV will no doubt document Levin's role, but I find it interesting to add a few of my remembered sidelights. Ken Levin passed away a few years ago. His

obituary in the Buffalo News was extensive and prominently credited his accomplishments as creator of the LLRV/LLTV. Ken was an interesting personality. His father was said to be the first psychiatrist in western New York and was said to have studied under Sigmund Freud. Ken's father was head of the Buffalo State Hospital, a mental institution. Ken was raised on the grounds of the hospital, where the senior staff members had private cottages separated from the main buildings. He enjoyed working with his hands and worked with his son in a building renovation business. I had the pleasure of his company on a number of business trips, and they were always made pleasurable by his stimulating conversation.

Avionics was assigned the responsibility for the design and fabrication of the electronics for the lunar simulation and attitude control system for the LLRV. I was designated project engineer. This task, in fact, assigned a significant portion of the system engineering to Avionics. The electronics tied together the cockpit control functions, the attitude control thrusters, and the rocket engine which simulated the LEM descent engine—the jet engine which provided the thrust in magnitude and direction to cancel Earth's gravity and aerodynamic drag—and performed the computations for control of these devices.

At the outset, I found myself flying solo in the implementation of both the system concepts and the preliminary circuit designs necessary for the lunar simulation and attitude control systems. The primary reason for this was the weak staffing available at the beginning. Avionics had to free people from other groups. Group leaders from these other groups typically and naturally freed their junior or less productive people first. There were no systems engineers in the initial assignments. Their major strength was overseeing the building, testing, and evaluation of mock-ups of circuits from rough schematics.

A strong secondary reason for my undertaking sole control and responsibility for the initial designs of the avionics package was that I thoroughly enjoyed the challenge, an engineer's dream. It was simultaneously exhausting and exhilarating. However, the workload was building up rapidly and I was in danger of violating the good management practice of delegating the work responsibly. While still engaged with design details, it was necessary to move the preliminary schematics into mockup and test, printed circuit board design and packaging. There were additional tasks, too, such as creating finished drawings, writing specifications for purchased components, ordering and acceptance testing of parts, creating and maintaining schedules. At this point Bill Bascom joined the group, affecting the much-needed distribution of responsibility.

Bascom was a mechanical engineer and initially took charge of the packaging and other mechanical designs necessary to implement the hardware. Very quickly, however, Bill assumed more general responsibilities. He took on the task of scheduling and following through on all activities connected with fabrication and procurement of the LLRV avionics. His initiative and self direction were impressive and I felt then, and now, that it was on the LLRV program that Bill matured as an engineer and manager. He later went on to manage the avionic effort on the LLTV at the Manned Space Flight Center in Houston.

Bascom and I were both originally from New York City. We both graduated from CCNY [now the City University of New York] and from Stuyvesant High School. However, we did not know each other in our NYC years. My stomping grounds were in the Bronx and his were in Harlem. Though our high school and college were the same, we never met there due to difference in ages. We did not attend at the same time. A mutually agreeable and pleasant division of labor fostered our first-rate working relationship at Bell, but it did seem to me that our joint NYC backgrounds added an extra feeling of 'we're in this thing together' to our cooperation.

Some months after Bill joined the LLRV group, the team was further strengthened by the addition of Leon Zwink. After completion of systems engineering, designing,

and building comes the all-important project phase of getting everything to work. Proving the design is most important, but much more is involved in this process. Troubleshooting a malfunctioning TV set fixes hardware that is known to have worked well previously. Debugging a new electronic system asks the question, ‘Is the design sound in the first place or are the problems due to incidental, unfortunate but fixable component and fabrication problems?’ Manufacturing processes may be faulty [example: cold-soldered joints]. Occasionally, components, though new, may be faulty. Unexpected cross-coupling of signals and power line hum between circuits can be discovered only after final assembly. Similarly, the insidious problem of ground loops, another form of false signal coupling, is revealed only after final assembly. Clearing up these kinds of problems is essential to finishing the job. In my experience, most engineers range between doing somewhat well to excellent in bringing systems to final assembly but stumble badly in this getting-it-to-work phase. It requires a finisher whose attributes are attention to gritty detail, ability to analyze problems, and ability to separate problems due to basic design from those due to errors. Common sense and persistence are also needed. Zwink had these talents and became the team’s finisher, the getting-it-to-work engineer. Leon later went into the field to support the flight tests and operations of the LLRV. Subsequently, he played a major role in support of the LLTV effort in Houston. In these and other programs Leon was invaluable not only because he could master the hardware problems but also because he had the ability to sell himself to the customer [in the case of the LLRV, NASA] and to generate confidence.

The avionics effort on the LLRV program proceeded in what now seems to me to have been a remarkably smooth operation. Though there were the usual and to-be-expected problems, there were no major difficulties from or changes to the original conceptions. Unusually, no design reviews were held. This seems to have been due in part to program management residing in the Structures group. Avionics LLRV was essentially loaned out to Structures. The Avionics leaders were more interested in those projects which they had brought into house, and for which they were the prime managers. Because of the exotic nature of the LLRV—outside of any conventional expertise—Avionics management was content, possibly even anxious for review and approval of the LLRV Avionics effort to be the responsibility of Structures. Information between Structures and the Avionics LLRV group proceeded via memos, drawings, and pedestrian face-to-face talks but there was never a presentation for formal review of Avionics LLRV concepts or designs. We in the Avionics LLRV group enjoyed this freedom to be creative, but couldn’t help being aware that this freedom also increased our burden of responsibility.

In a program such as the LLRV, the high excitement obviously occurs in the field where and when the vehicle is actually flown. Of course even in the field, there are many days spent on a lot of routine and prosaic detailed activities. Back in the shop, from initial design to final assembly, the activities are primarily in the latter category. There is never anything as spectacular as a successful flight (especially first flight) or as disastrous as a crash (thankfully). The kinds of things that I remember that went on “back at the shop” typically did not have high drama, if intellectual excitement is excluded. Our work required attention to detail and flexibility in addressing problems, which ranged from purely technical to personnel management with vendor headaches in between. A few examples of remembered events illustrate the variety of the activities and perhaps depict the working atmosphere.

The system utilized sets of accelerometers as described in the accompanying write-up. A problem developed with these accelerometers. The source of these units was a small start-up company located in a storefront resembling a hardware store. It was a spin-off from Cornell Aeronautical Laboratory, which was a non-profit organization controlled by Cornell University. It was the lab’s policy to spin off of products

they developed—encouraging their employees to become entrepreneurs—since the lab’s nonprofit status prohibited them from commercial exploitation of such products. The accelerometers cleverly used galvanometer movements purchased from manufacturers of multimeters (volt-amp-ohm meters). These movements were modified by unbalancing their masses, which resulted in a torque in the presence of a gravity component or acceleration along their sensitive axis. Current through the galvanometer coil countered this torque and the movement remained centered. The current magnitude was then a measure of the acceleration or component of gravity. The specifications called for a minimum threshold of sensitivity. The units were also subjected to vibration testing prior to acceptance. The first units passed both the threshold sensitivity and vibration tests satisfactorily. Later units, however, failed, becoming sluggish and insensitive to threshold accelerations. The vendor’s proximity to Bell facilitated the investigation of the problem because frequent visits were possible. In the course of the investigation, it was discovered that the vendor had begun adding a lubricant to the jewel pivot of the galvanometer to reduce contact friction and thereby increase the instrument’s sensitivity. This it did. However, the acceptance test vibration churned the lubricant and turned it into a thick “goo,” rather like churning milk into butter. So after an initial improvement in sensitivity, the units became stuck and unresponsive. The builder did not suspect this outcome, obviously. Discontinuing the “improvement” solved the problem.

An example of the flexibility and “out of the box” thinking needed to get things done occurred when problems developed with the manufacture of the printed circuit (PC) boards. The signals from these boards were erratic and noisy. Leon stayed after hours to pinpoint the problem. He ascertained that the problems were due to random, cold-soldered joints. But fixing the boards by reheating the bad joints would not be enough because there was reluctance on the part of some management levels to believe that the soldering processes were at fault. Anticipating this, Leon separated the fibers of some hook-up wire to get segments of the fine strands. He carefully soldered a single strand as a jumper around each of the suspected cold-soldered joints. With this bypass, the boards no longer exhibited their former erratic behavior. Now since the problems were random, many of the boards were sound to begin with and it was possible for a skeptic to insist that the board was one of the good ones and, therefore, to declare the demonstration to be inconclusive. The ingenuity of Leon’s stratagem then followed. By cutting the jumpers, the problem immediately reappeared, proving that the solder joints, which had been bypassed and were now again activated, were the problem.

Sometimes we just got lucky. After determining the power requirements for the electronics, we looked for the lightest power supply that would satisfy. Minimizing weight is always important for a flying vehicle. The best course seemed to be to specify and order a custom design, because the power required fell between the sizes that were ‘off-the-shelf’ available. We would have had to accept a higher-than-required capacity unit and accept the increased weight penalty. We proceeded with the procurement of a supply to be designed to our specifications and stipulated a delivery date. Before that date, changes were made which increased the required power. This now put the power required into the range of the higher capacity off-the-shelf units and the added weight could be justified. We ordered the off-the-shelf power supplies and wondered what we would do with the custom-built supplies when they came—possibly incorporate them into some lab test rigs at some time. As fate would have it, the vendor of the custom-built units did not meet the schedule stipulated. When their field representative showed up at the plant with the first unit, we took the hard line and refused acceptance on the grounds of their failure to meet the agreed-upon schedule. The program was saved the costs of the now-unneeded hardware, using the loophole provided by the vendor’s slip. As agents of the company required to maximize the company’s interests, this was a correct stance. Stonewalling the vendor’s representative

was inherently confrontational. Bill Bascom had this job and as I now remember my impression of that time, Bill was enjoying it.

To finish these reminiscences, the story of a minor but colorful and humorous incident serves as a graceful (hopefully) exit. Ron Decrevel and John Ryken were important figures in the history of the LLRV/LLTV programs. In this incident they became inadvertent players in an improbable episode. Briefly, Ron was a principal in the Structures group that germinated the LLTV program and John reported to Ron. The company at that time was engaged in upgrading the office spaces. The furnishing and decor of each office was based on the occupant's position in the company organization chart—the higher on the chart, the more elaborate the office. When the contract was received, John was designated as program manager. The company, in its arcane wisdom, rated this position higher than it did Ron's. In the office upgrading, the offices being constructed for them were next to each other, separated by a common interior wall. But John, as program manager, rated ornate wooden furniture, a rug on the floor, a paneled back wall, and paneled sidewalls. Ron's office rated art metal furniture, a bare floor, and only a back wall panel.

As the legend has it, this is what followed: The two agreed to exchange offices based on their understanding that John would again report to Ron after the LLTV was delivered—in effect, a private rectification of the organization chart. They notified the office planners to reverse their names on the floor plan blueprints. Over the next weekend a startling change took place. The workmen had reworked both offices so that the upscale features of John's old office had been reinstalled in his new office and the lower-prestige decor of Ron's old office had been reinstalled in his new office. Rugs, furniture, and wall panels had all been reversed. The principle of the decor following the organization chart had been preserved. As usual in these kinds of events, this provided merry material for the idlers around the coffee machines as well as some shallow philosophizing about the futility of hubris and the mindlessness of bureaucracies. The incident certainly did not affect work on the LLTV. Ron subsequently progressed in his career to become president of Textron's New Orleans facility, which produced surface effect ships and hovercraft. John continued to serve in varied capacities on other programs, including New Orleans assignments.

Final personal thoughts: The LLRV/LLTV programs were my career favorite projects. I was delighted when Neil Armstrong took over manual control in the first lunar landing and when later astronauts reported that the LEM handled just like the LLTV, derived from the LLRV. The attitude control and lunar simulation systems worked perfectly as conceived. I have fond recollections of the people I worked with then and of the creative atmosphere that existed in our Avionics group and at Bell Aerospace. In short, I am delighted that it all happened and that I was part of it.

Walter J. Rusnak
13 March 2000

Appendix D

NASA MSC Minutes of Meeting of Flight Readiness Review Board, Lunar Landing Training Vehicle, Houston, Texas, 12 January 1970

Capt. Pete Conrad: I guess I don't have a formal presentation, but I guess the question is, one, that after we made some lunar landings, is the vehicle a requirement for training for subsequent crews? And I have to preface my remarks by saying: were I to go back to the moon again on another flight, I personally would want to fly the LLTV again as close to flight time as practical.

Now, for the following reasons, I look at the vehicle myself in terms of our Gemini docking trainer and simulator devices like that and felt, I think as many people did, that we would have made some landings before we determined whether we really needed this kind of training or not, and as you know, I think that our simulators do an adequate job on formation flying around other vehicles so that we don't need the dynamic docking simulators.

I do feel that we need the LLTV and for the following reasons. I think the LMS [lunar mission simulator, a fixed-base simulator with no dynamic motion simulation] does an outstanding job for sight recognition and basic flying of the vehicle down to an altitude of 200 feet. At that time, and in the transition time, the visual and the LMS simulators do not come into the real world that well.

The LMS is certainly an adequate vehicle to do your instrument training necessary to land, to go all the way down and land. I'm not sure that everybody is aware of the fact that the probes on the L&A normally shuts you off visually at an altitude of about 100 feet and so you don't get the last part of it, nor do you get the transition part of flying. It doesn't do the job of flying safe velocities of 80 feet per/sec on down into this area of going into a hover.

The Langley vehicle No. 1, flying it at night—the night lighting does not even come close to what the moon looks like from my opinion. So it doesn't make any difference whether you are flying the Langley A-frame simulator at nighttime or in the daytime. The other thing that the Langley simulator cannot do is restrain laterally to plus or minus 25 feet, and the maximum horizontal velocity that I have ever been able to achieve in the Langley simulator are 10 feet per/sec and that's nothing. The problem, I feel, is in this flying regime from 500 feet down until the time to get in a hover, and you decide either that you are going to land visually or you are going to land on the gauges.

The problem of determining proper pitch attitude is one that I feel I got most benefit out of the LLTV, and if you will look at the films very closely of my landing, you will see some pretty healthy pitch attitude excursions or changes right down in the area of the heavy dust and this was strictly when I was going from outside the cockpit to inside the cockpit. If you will look at my LLTV landing summary, you will find I went into backup autopilot on several lunar sim landings for the plain and simple reasons [that] I stayed out of the cockpit and landed on the rear skids.

Now, one of the things that I learned that really helped me on the moon was, to build the confidence in the actual flight vehicle, to put my head back in the cockpit again.

One of the recommendations that I would make on the LLTV, if we continue to fly, is that we really put the LM instrumentation, as it is properly arranged in the LM, in the LLTV as much as possible. Because the more you fly lunar landings in the LLTV, the more you will fly them in the cockpit and the better landings you will make because you cannot determine pitch either in the LLTV or in the LM. Pitch is too easy to determine, I think, in the A-frame at Langley; that's another drawback of Langley.

MSC Director Robert Gilruth: You mean you can't determine by looking out the window?

Conrad: You can't determine by looking out the window. You've got to have this confidence, you don't care what you are doing in the LMS. The last 100 feet, you can sit there and fly it all the way down looking in the cockpit and land. In the LMS you don't have enough visual simulation to determine pitch anyhow, so you do it all on gauges in the LMS and that's not real world.

I guess the next thing that I feel, as we continue on the program, is that we are asking pilots to go into tougher and tougher sites. There will be smaller areas to land in and I feel that to get the most benefit out of learning how to translate with the little fuel that you have, both laterally and horizontally, the LLTV does the job. Now that sounds a little strange and I'm going to have to qualify that. We are constrained to fly the LLTV down the runway, and you normally don't make large lateral translations with the LLTV. However, with the wind situation you normally don't get into the lunar sim mode going down the runway properly and you wind up having to make these translational corrections laterally to stay on the runway. I think that all of us formerly have wound up over the grass somewhere and had to fly it back into the runway.

One of the comfortable things of my landings was to make that lateral translation. If you will listen to the tapes, even Al Bean remarked that we were 'doodling around in the sky,' because he had not flown in a real vehicle. He is not used to those kind of physiological feelings and sensations that you get by flying the LLTV, and it's probably one of the more uncomfortable vehicles to be rolled about 10 or 15 degrees and pitched up about 20 degrees and you don't get that in a Langley simulator either, because you are at low horizontal velocities and you make a very quick transition to a hover and come down.

The fact that we are going to get to more difficult sites and the fact we are taking people continually that have not been there before, and you look at the number of touch-and-go landings that anybody treats in any kind of airplane that they are checking out, we are banking our whole program on a fellow not making a mistake on his first landing. To build that confidence, I feel we should continue to fly the LLTV. As I said earlier, I would want to fly it myself if I were to go again. The more difficult the landing site, the more confidence a man has to have in being able to drive this vehicle. I can't assign a number to a confidence factor, but the reason I took over initially was that I thought I was going to overfly the target, and I maintained a pretty healthy pitch attitude coming into our landing site and made a rather steep descent. I guess it's on the order of 40 degrees, which looked straight down, and these all looked perfectly normal to me and caused me no concern up there, and I base all that on my LLTV experience and I can't base it on anything else.

That is just about all I can say and that pretty well pointed out the drawbacks of other simulators, and I don't feel that we can drop it in the same manner that we dropped the docking simulator. I think that it is a dynamic vehicle, and there is no replacement for that type of training.

Gilruth: Pete, one of the things you said I think is pretty significant. That is, that with a vehicle like the LM or the LLTV it's very difficult to determine pitch attitude because you don't have anything up in front of you to line up with the horizon or anything. In reality, I guess you might get used to having some horizontal lines you could line up.

Conrad: [Using] the upper part of the window and camera horizon, the roll is relatively easy to keep points level.

Gilruth: So I guess that I would like to ask you if there is anything that could be done in providing a reference to make it easier to fly? Is there something that you have thought about?

Conrad: I don't think adding a piece of structure to the vehicle would do that for the other reason and I didn't discuss the dust. I guess when everybody went back and engineered out our tapes, all concluded that the dust really wasn't that bad until we

were in the neighborhood of 30 feet. I was calling this in the area of 50 feet, and all of my altitude callouts were based on what the LMP called in my ear, and we were reading some 19 feet on the lunar surface on our inertial platform, and so I was off quite a considerable factor at the end, percentage-wise, on saying where the dust was.

As I said in our debriefing, I see no need to change anything in our procedures. I was extremely well satisfied with our training in all vehicles as far as landing on the moon went, and I had all the confidence in the world in the inertial guidance system, which made it very easy to put my head in the cockpit when I thought I had to do it. And I would have kept it there the whole time at the end had I thought that one gauge was working. That is the only recommended change I can see to our procedures.

I felt that I could leave the Langley simulator out of it completely. If I were going to go again tomorrow, I would fly the LLTV as close to flight as practical and I would stretch it out a little bit, too. I think it's good to come back and fly the vehicle for a certain number of flights in a row. You are thinking about landing on the moon and this is a complex vehicle. The LLTV should be as up to speed on its system as possible and not to interfere with proper training on the LM. It's not that difficult a vehicle that you can't do it. But I began to run out of gas on that Sunday; I'd flown nine flights in a row, four of them one day, three the next day, and two the next day, and we were going to fly again but the wind was up and I was tired, and I just felt that I was beating myself to death, with two vehicles and a little less sweat. I would like to have been able to come home a couple of weekends later and maybe flown two or three more flights.

I don't know what Neil's feelings are. I think that we are pretty much in agreement on this though. I understand the problem of flying close to flight, but you only get one chance. It will be a long time before we send somebody up there again that's already been there once and each time you bring a new guy along, you are putting him in a more difficult landing site and I don't think there is anything unsafe with our training. I got the decided impression we might abort out of a possible landing situation that could be avoided by a man having a little bit more confidence than you would get out of Langley and the LMS but not having had the LLTV.

Neil Armstrong: Actually, Pete's covered most of the factors and I agree with everything on all the points that Pete's made. I'm probably a little more reluctant to accept an instrument landing than Pete was. One, because we never did it before and never saw how the instruments operated, and the second reason is that I've flown a Doppler radar in a Ryan helicopter which had the following interesting characteristics. [Mr. Armstrong illustrated his point by drawing an altitude-versus-velocity bias diagram on the blackboard.] Plot altitude versus velocity bias, horizontal velocity. So say you came straight down vertically—this is zero. At 25 feet you were 0-0, horizontal velocity and as you came below, your indicators suddenly said that you had one foot per sec, two feet per sec, three feet per sec, finally six feet per sec, at zero altitude. And then, if you were flying 0-0 on the cross pointers—saying if you were flying zero at instrument landing, you would actually be touching down at six feet per sec, horizontal velocity.

McDivitt: Now, Neil, is that a function of altitude, purely, or altitude rate?

Armstrong: I'm not really sure, Jim. But the important thing is that it is probably an effect of rotor interference by the helicopter rotor and engine. Interference into the reflection of the Doppler waves somehow puts this bias in there. But it probably would not exist in the LM. I wouldn't be concerned about it, but when you are first doing something you think there might be something like flight data problems somewhere. But I've been exposed to it one time and I knew that it would be a terrible thing, like in Pete's case. If he ended up flying 0-0-0 and putting it right on the moon, and you ended up with seven feet per sec, or something like that, going sideways.

McDivitt: I think if he had those velocities, dust or not, he would see it.

Armstrong: Yes, but I was just verifying his point that one thing is really impor-

tant in setting yourself up for a possible instrument landing—is that you really have to assure yourself that the instruments you are operating on are correct, without any significant bias, and that they don't do something like this to you at the last minute. I believe Pete had a worse case than I did. I had a little less dust, I think—a significant amount—a little less problem than Pete had. I felt that by looking at a few rocks and protrusions and craters through the moving sheet, I could.

Gilruth: You are looking out the window during the last hundred feet of descent?

Armstrong: Yes, I cross-checked back and forth but I was pretty well convinced that my instruments seemed to be correct, but I was still looking for, maybe, something like this to go wrong.

Gilruth: When you are looking out the window, how do you keep—what do you use for a reference?

Armstrong: I agree with Pete. The roll is really fairly easy. Pitch is always somewhat more difficult. This is something I think that we all found early in the simulation game—that this was, in fact, true. It's true in the LLRF. Even though it's to a less extent because intuitively you would have a lot more with an A-frame around you and all that stuff, and a little more information coming into you whether you want it or not.

Conrad: Yes, and in the LLRF you also get that big boom sticking out in front.

Armstrong: Yes, that's right—with trim rockets on it. But still and all, I did pick up an unwanted horizontal velocity to the left during final phase and got a lot closer to that little double crater than I wanted to and I really can't account for that. Although I will admit, in my case, I was a little spastic in final approach and you see a lot more attitude changes and throttle changes than you would like to see. Still, all-in-all, I felt very comfortable—I felt at home. I felt like I was flying something I was used to and it was doing the things that it ought to be doing.

Gilruth: You must be controlling the attitude by keeping your drift low, rather than by the...

Armstrong: Yes, you infer it, particularly if you are flying at a constant pitch angle. You can tell your horizontal velocity and vertical velocity are related if you are flying along—they are proportionate to each other as you are flying along at a constant pitch angle so you infer in a closed-loop fashion vertical velocities from horizontal velocities that you see over the ground, and later on your horizontal velocity becomes your vertical velocity as you know you had. It's a closed-loop thing; it's probably more a specific way to gather some of this information but I don't really have a hold on it. I don't really think it's worthwhile having that additional information—it's not necessary; however, it may be useful. But I don't think it would help as much as having the confidence as in your own knowledge that you can fly the job in. Our own problem was getting into a small area. I felt that we would never find a spot that was good enough to land in. That's a kind of problem that's impossible to duplicate in the LMS, or in the LLRF. It's even that difficult to do in the LLTV unless you sort of play the game to yourself, as you fly into a touchdown area and you say, 'no, I don't want to land there—I want to land over there.' As you get a little closer you say, 'no, I really want to land over there,' and make yourself do that. So you have to force yourself to do that problem.

In general, I guess what we all have to ask ourselves is, do we want to keep buying this insurance policy? We've paid a lot of money to buy this insurance policy to improve our ability to do the landing job, and in a couple of times, we've had to pay excess premiums—premiums that we felt that we were really unwilling to pay or at least to continue paying. And now we are at the point where we say maybe, at this point in time, we don't need to buy the policy at all. Discontinue the premiums on it and avoid the possibility of these excess premiums that might burden us in the future with another crash or something like that. My own conclusion is that we still can't afford not to

insure against this particular catastrophe—a catastrophe of one sort or another on final approach at the moon, and I think we should continue to buy the policy.

Gilruth: I guess I agree with you. I've been trying to understand—from a point of view, trying to understand the mechanics of flight in this kind of vehicle and why the flying of an LLTV gives—I can see why it gives you the feeling of confidence, because you know that you have flown something that is as close to a landing—a lunar landing vehicle as anybody can devise and so from that point of view alone, it would give a real feeling of confidence.

Armstrong: It is the only device we've had. The only simulation at all where you can allow the process to take place—of a closed-loop process where you infer the velocities from attitude, velocities over the ground, and the actual vertical velocities coming into the picture at the appropriate velocity—I'm talking of 50 feet per sec over the ground, which is the transition phase—that phase from breaking where you are essentially just watching out the window and pre-designating and doing those things, to come into a hover. That's the 150-feet-per-sec to 10-feet-per-sec region—that's where you really have a lot of flying.

Conrad: In my case, a couple of times I had to fly off the short runway. And there were a couple of times, at the end there, I nearly landed on the axis but I had to get it stopped and I only had 60 seconds to do it, and it's not a question of saying, 'reset the simulator.' I blew that one. If I landed that LLTV on the grass, I'm in deep yogurt, and there is no way you can get that confidence—and you do get yourself in situations in the LLTV that you can't get in any place else except at the moon.

Gilruth: Yes.

Armstrong: The forcing function of a limited time is in many respects quite radical. Still, it didn't really worry me because I knew just what 10 seconds or 20 seconds were in terms of a flight situation.

Gilruth: Any of the group here have any questions or further discussions? Jim?

McDivitt: Yes, I have a couple of questions. What is your opinion of the number of flights needed?

Conrad: I think Charlie's charts pretty well show that. If you want to, scan some of Neil's flights and my flights that show how long it takes us to lunar sim mode—to really start flying the vehicle smoothly from when you first go into lunar sim and go in the thing we...and these have a very definite tendency to begin to level out after about five or six flights in lunar sim mode. Now, one problem here is Neil and I have been in and out of...Neil more than I have—but Neil and I have been in and out of the LLRV program, and so when we came into the LLTV we went through a five-flight job or two, and I suspected the schedules that they have laid out now, which was what—thirteen flights do you have, for guys that have never flown before?

Charles Haines: Eleven.

Conrad: What?

Haines: Eleven.

Conrad: Eleven flights and then he goes into...You have them all the way up to 40 before you add that last fully lunar sim mode. At that point in time, the guy starts training in the lunar sim mode. This is a problem in the vehicle, there is no doubt about it. You've got two different vehicles here, flying gimbal lock versus lunar sim. And you've got a guy that's never flown before. He needs those 10 flights. I agree with that, and I agree with the wind restrictions and everything else. Once you get the lunar sim mode, you get that proficiency. I feel that a guy should fly about...if he's never flown the vehicle before, I feel that he should fly at least eight lunar sim flights at some reasonable time period—like a week, two a day; or two one day and one the next or something, because you've got to get the hang of that vehicle in lunar sim. And I don't mean the aerodynamic hang of it either; I mean getting that baby back and landing it in front of the spot. I don't think that I have the capability of parking in lunar sim mode

from 300 feet, where we started—right exactly where I wanted to put it. I'd put it within 50 feet or 100 feet but I don't really know about our future landing sites; but I'm sure that we are getting into more and more difficult places to get into, maybe not dust-wise, but the guys are going to have smaller and smaller spots that they are not going to be able to overfly 1,000 feet or 2,000 feet—just go and land it.

Armstrong: Yes, you are always going to have to have the capability of landing within a specified area.

Conrad: That's pretty hard to do with the LLTV until you fly it quite a bit, I think.

Armstrong: I think both Joe and Bud have watched a lot of guys fly up there...point out that everyone's experience is probably about the same as Pete's and myself. That is to say, you have to fly about a half-dozen lunar sims before you have really seen everything that's happening. You are flying through it but it's flying you for awhile; by the time you fly half-dozen flights, you're flying the vehicle, going where you want to go and with the instruments.

Gilruth: How much of that is because [it's] a very complicated bunch of machinery? How much of that goes into actually learning the control of that kind of a vehicle?

Armstrong: About half and half, in my view. Although it's really a simple vehicle, it's nontrivial. You feel the pressure of trying to keep track of as many things as you can. And the other half is the fact that it is such a cotton-picking unusual environment—so different from anything you've ever been in before—that you are continually amazed at how machines can fly like that.

Conrad: That's what prompted Al's remark. He'd never been in a vehicle like that, and he didn't look out the window. He probably looked at the eight ball when I started the left translation, and I venture to say I don't think we had more than 10°, at the most, roll in there. But we were sitting in the neighborhood of 20° or 25° pitch. I didn't want to go by the crater and it upset him, you know. He made the remark that 'you really leaned on it,' and I told him that 'it's O.K., I felt fine.' But that's the weirdest feeling in the whole world, flying down that runway in that vehicle with it all pitched up and rolled over a little bit trying to get it back off the grass. You can't get that in a Langley simulator. You're not transitioning out of those kind of velocities. You're not coming from that kind of altitude. You can't even get a good lateral velocity going in the Langley simulator—you will be into the stops.

McDivitt: Dr. Gilruth, you asked a question about how much of that time is cut just because you are looking at that kind of machinery. I can't speak for the LLTV, because I have not flown it. But if you will, look at airplanes. The Air Force and the Navy have standardized their airplanes on the inside very much. The Air Force flies almost universally VH and stick grips and they have the same kind of air speed indicators and things like that. Most airplanes have dials and handles and things like that that are very familiar to pilots when they check out in new airplanes. It may be a little farther away, but every time you check out a new airplane it's a very unfamiliar thing. Not because the gauges and handles look different, but because it flies different. I wouldn't be a bit surprised if that wasn't what you find here.

Conrad: First, let me...if I go out here and fly a Cessna 310 which I have never flown before—now, I'm an experienced pilot and I'm behind that airplane or least equal to it. The first couple of times you go to do that and here—stick a guy up there at the moon and expect him to come down there. I was extremely surprised at the fact that I stayed as far in front of the LM as I did on the way down. I fully expected to be further behind on what was going on. And I attribute that to the total training program—to the LMS, to the LLTV, and I included in there Langley—because I was in auto mode and I came in about the right time and we do have a good simulation. They can't beat that L&A for LTV and getting used to starting over where you want to go, but that L&A falls apart about 200 feet, there is no doubt about it. But it does an outstanding job.

Gilruth: O.K., Chris?

Chris Kraft: I guess the only problem I have is—I think—some kind of automatic mode, in that period, might make you think a little differently about it. But even at that, you've still got to be prepared.

Conrad: May I comment on that? I went over the simulator in the program and, granted, it is not the optimized way in going back into this auto...and I think Gene Cernan and some of the rest of the boys have spent a lot more time on this little fix right now. You know, they had two different authorities. And I think their conclusion is that the auto mode kills the horizontal and lateral velocities very good. But their vehicle gets pretty spastic since you have large ones in there. And they all agree, at the end, [that] whether you are on the gauges or at the window, you had better have things in relatively good shape before you go back to the auto mode.

Kraft: But I still think even, you know—if when you have this auto mode, I think it's going to make you feel a lot more comfortable about landing sites.

Conrad: Well, I agree with what you're saying, but I would go back tomorrow with what I had.

Kraft: Oh, sure you would. But I think once you are given that mode that you are going to do precisely what you just described. You are going to kill off all those velocities and get it going where you want to go, and you will put that thing into auto and then monitor it down. I just think that would change your feeling about the LLTV, but even at that you have got to be prepared.

McDivitt: Chris, that auto mode is not doing us much good. These guys just got through discussing those auto modes and the complications in flying straight down with it.

Kraft: It's not going to do that at a higher altitude as a result of having the auto mode.

McDivitt: Yes, I know there are a number of phases to this thing. Auto mode only takes care of the lunar phase and hardly takes care of the landing part at all.

William Lee: That probably works fine in a simulator, but if this bias you were talking about happened to get in there—it could cut the auto.

Kraft: I don't deny that, but I don't buy that bias bit.

Conrad: I think our photographs show that we really have it as about as close to zero in any direction you can get or at least I didn't see any indications of skidding in any direction. And I understand that the inertial system was showing a 1.7-feet-per-sec forward. And I don't believe that we had that. I believe that that bias was really the inertial system.

Kraft: Yes, it is and you can expect that. It's going to be around two or three feet per sec. Did that come in?

Conrad: I don't remember any numbers over two feet per sec. I looked at a paper, just before we went, that went through all the phases that were manual, that were a fallout of P65 and what you can expect. You could expect to stay within the landing envelope, and all of them showed you could, and I didn't remember any number over two feet per sec. I also did understand that we did, right at the end, get some false radar data. But that is going to be taken care of, I understand. The radar goes off at 50 feet, is that right? And that will probably improve it.

Appendix E

Ken Levin–Working Notes by MSC Historian Ivan D. Ertel, 8 June 1971 interview with Levin

Levin: I have in front of me—to refresh my memory, and I’ll refer to them—a proposal which Bell submitted to NASA in December 1961 for a “Free Flight Lunar Landing Simulator Study,” Report No. D7161 – 953001, December 1961. At that time Bell was part of the GE team studying the lunar landing problem. And it was Bell’s responsibility to look at how the Apollo Three manned space module would be landed on the moon, and we were impressed with the difficulty of trying to extrapolate Earth landing experience to lunar gravity. Since no one had ever landed on the moon at this time, and we weren’t quite sure what the effects would be of the lower lunar gravity (other than analytically, that is; we could analyze and know what the effects are on a mechanism but say how would a human being respond to this?), we came to the conclusion that not only as a design tool but eventually as a trainer, some device was needed with a human being in the loop for simulating lunar landing. What we thought at that time was that a trainer was needed and we conceived of a trainer being an Apollo command module on top of a long, four-legged trusswork stand and that was supported by eight jet engines. This would be capable of supporting 5/6 of the entire Apollo Lunar Module plus the supporting trusswork. The whole thing could then fly and this ring of engines, gimballed, [could] be capable of simulating lunar gravity. Our feeling was that a three-man crew could actually be in this full-size capsule and go flying here on Earth.

This was the concept we had at the time and it looked good enough that we went to NASA LaRC [Space Task Group], which was heading up the Apollo study at that time and the trip there was in November 1961 to discuss the idea of a lunar landing simulator for training purposes. We talked to Bob Voas and the response that we got from Bob was that this was a great idea; it certainly was going to be needed, but we were probably five years too early. They didn’t know what the vehicle was going to look like yet, so they weren’t really ready to go into a trainer yet. So, we went back home and the next day I got a telephone call from Wes Messing at FRC and he said he had been talking to Bob Voas and found out that we had been talking about a lunar lander simulator for training. He said they were interested in simulating lunar landings for research work and they’d be very interested in knowing what our ideas were. So immediately we went out to FRC—I’m guessing that was about November—and described this concept of a vehicle, 5/6 of which was supported by a gimbal-mounted engine or cluster of jet engines in order to simulate the dynamics of lunar gravity. Well, it turned out that the people over at FRC had been thinking about a very similar idea in-house and were very, very much interested and wanted to know what Bell would propose to do. We came back home and whipped out this proposal to do a feasibility study and we submitted this proposal and, as I recall, within about two weeks from the time we submitted the proposal, we had a \$50,000 study contract and this was awarded in December. The purpose of the study was to establish the characteristics and conduct a preliminary design of a free flight lunar landing research test vehicle. We then conducted this study and came up with a smaller vehicle. As I said, the original idea was to carry the three-man Lunar Module. But during the study we got a little more realistic and ended up with a much smaller, one-man vehicle, supported by a single jet engine and at the same time we submitted the study results on March 8, we also handed them our proposal to build such a vehicle.

At this time LEM had not been designed yet, although by this time the concept of a separate lunar lander [existed]. It hadn’t been designed and our attitude was nobody knows what the LEM was going to look like so we won’t make any attempt to out-

guess what LEM was going to look like—we'll simply make the most simple research vehicle we know how to make—and this looked like the simplest way to do it. However, as we progressed, we began to get into difficulties—it's very important for the cg of the entire mass of the vehicle to be located right at the gimbal axis which mounted the jet engine.

We were having great difficulty in keeping the cg correct, so during the course of the design of the vehicle quite a radical change was made. The man was moved from on top of the jet engine to a cabin out in front. And to balance his weight all of the electronic gear was put into a sort of trailer portion in the back. Just by accident we ended up with a configuration that was very much like the LEM. Unintentionally, but it did come out that way.

Ertel: How did this thing happen? What was the philosophy and who had the forethought?

Levin: First of all, I had the idea myself that there was a need for some way of simulating lunar gravity and I'm sure lots of other people had the same idea, and we did go through a preliminary study of all the different ways we could think of simulating lunar gravity—from fixed-base simulators where maybe you'd have a computer, maybe, wiggling a slot around and things like that, and came to the conclusion that ultimately you would have to have something that would allow a man to fly free of the surface—not be hanging on a tether or mounted on gimbals. He had to have, I guess people call it, the 'pucker factor,' really flying—and I zeroed in pretty early on the fact that we had to have a free-flying vehicle with a man in it. From that point on it was my idea to use a jet engine, but, again, that was pretty obvious—to use a jet engine to supply 5/6 of the lift and rockets to the part the LEM itself would provide. Here at Bell a designer by the name of John Allen did most of the original layout work on the vehicle. Then when we made the big change of moving the man from the top of the vehicle down to the front and making it look more like its present configuration, that layout was done by John Trotter, another designer at Bell. I think GE should get some credit here for the engine. What we used was the only engine then available that had the right thrust range—was the GE CF-700. An aft fan engine was about 4200 lbs. thrust, but that engine had never been run in a vertical position and GE, in a relatively short time, reworked the lubrication system to make the engine amenable to vertical operation, did a preliminary flight rating test on it, and this proved to be a pretty good engine. That's what's been used in the RVs and TVs. In record time, we developed rocket engines for this vehicle there at Bell and they worked very well. Again, that was done by a fairly large team of rocket designers under the leadership of Art Gorbaty. And I think that probably we made something of a first. We'd had quite a background of building rockets for Mercury, which used hydrogen peroxide rockets...so we had quite a background in hydrogen peroxide rockets. We designed these rockets for the vehicle and built the first one of each.

Ertel: What part did you play?

Levin: During the feasibility studies I was the technical director and program manager. Now, when it came to the hardware contract—and that was in the neighborhood of \$4.5 million for 2 vehicles—I was the technical director and a man by the name of John Mullen was the program manager. I stayed with the program until they were delivered to the FRC, at which time I got off of the LLRV program and other people picked up on the LLTV.

We originally bid the thing at approximately \$3 million as a CPFF contract. It got to the point, due to technical problems—which I won't say were unforeseen, but you know in CPFF contracts you can't put contingencies in, so due to these problems it was evident that we were going to go over the \$3.5 million. So Bill Smith went to FRC, to Paul Bikle, and the two of them negotiated a change in the contract. It was still CPFF up to a ceiling and then beyond the ceiling either we paid all or it was cost sharing. It

ended up costing somewhere in the neighborhood of \$4.5 million, of which Bell put in enough of that that it really wiped out any profit we might have made on the program—although I don't think we sustained any big loss, either.

Ertel: Was an RV ever actually put together here?

Levin: Oh yes, that was another thing. The contract called for our building and ground testing two RVs. We were never to flight test. FRC was always to do that but we were to build and deliver two ground tested RVs. Another thing that was done to conserve NASA funds was that we built and completely assembled but did not ground test the first vehicle. That first vehicle went to FRC, where NASA people in conjunction with a Bell team that was out to FRC did the ground testing at FRC. Now on the second vehicle we built all the parts, but they were sent out as parts and the vehicle was to be assembled by FRC personnel. There were considerable changes between the RV and the TV. From outward appearances they look quite similar but a lot of improvements went into the TV based on RV experience, so to try to take an RV and build it up to a TV would probably cost almost as much as building a new TV.

Ertel: What was your experience when you first came up with the idea? Who did you have to sell and how hard was it to sell them?

Levin: That's interesting. The first thing was a problem right here in the company. I had no authorization to even work on the idea. I was working on a contract from GE, which did not include simulation of lunar landing. It was to design the lunar lander. I could not interest my own boss or people here in Bell that there was any point in looking at a vehicle this early in the program. So I bootlegged the work and did it myself on my own time whenever I could squeeze a few minutes. I spent maybe a month of my own time analyzing and drawing—proving the idea for a flying simulator. It was based on this bootleg work that we went to Langley and of course Langley confirmed what our own management had said, you know—"you're too early. You shouldn't be working on it." But when I got the call from FRC the next day, the company went along with it and paid my trip out to Edwards and immediately put up some bidding and proposal money to enable us to do a little more work and write this proposal for the feasibility study. We had no difficulty selling NASA at that point because FRC people were very receptive to the idea. They didn't have to be sold. First of all, because they had also had the idea and thought about it. They were willing to accept it. They had thought about it enough to know they wanted it and then we didn't have any great difficulty with Bell getting the contract because they knew, from past association, we built the X-1, which was flown out there, and the X-2 and the X-5 and the X-14—which was not flown there, but was at Ames. They knew we were qualified to build a research vehicle, so we didn't have any trouble justifying a sole source award. It was not a real tough selling job. I'd say, internally, Wes Messing probably did whatever selling needed and another man, Don Bellman, was very helpful.

Ertel: Do you recall any incidents, problems, etc.?

Levin: The first problem that came up was that we were battling to get the cg down. It kept wanting to go up on us and we finally solved it by taking the man off the top of the vehicle and putting him out in front. That occurred at about two months and required a complete redesign of the vehicle. From there on things went fairly smoothly. Now when it came to the testing, things went slowly, but in general everything worked as designed. There were some problems in flying, I think might come better from other people. There were a lot of operational problems for awhile—ironing out how to fly, what to monitor on the ground, how to communicate with the pilot. That is, how much you leave to him, and how much you leave to the people on the ground. There was never any fear on our part that the thing was going to turn upside down as long as the control system was working, and as long as the pilot didn't try to deliberately loop it or something. With the autopilot, it was a stable vehicle. Without the autopilot, the vehicle is inherently neutral stability—it doesn't have any tendency to tip over nor does it have

any tendency to right itself. What it does do is have a tendency to stay wherever you put it. Basically it is neutrally stable, but we put an autopilot in, which created an artificial stability which made it easier to fly. That was adjustable because we didn't want to cheat, we didn't want to make it easier than the LEM would be to fly, but it was a variable stability autopilot which could be set up.

In essence we could simulate not only lunar gravity, we could have done so much as simulate Mars gravity or zero-g—any kind of a vehicle they come up with that goes from zero-g to Earth-g. The term “flying bedstead” was also used for a British VTOL. One mechanic at FRC used to call the LLRV the “flying pipe rack.”

I will tell you an amusing story that's part of history. I gave a paper in 1962. If you recall, we finished the study in March 1962, but we didn't get a contract to build the vehicle until some time in 1963. There was a period of about a year in there when the funding was not available for building the hardware and it was really nip and tuck whether there ever would be any hardware. I went out to L.A. and gave a paper before an annual AIAA meeting in which I described the LLRV, which we hadn't built yet. After the talk, some reporters came up and interviewed me and they asked me what the status of building them was, and I told them we had done a contractually paid study and we were waiting for NASA to provide the funds to start building the hardware. Well, lo and behold, the paper came out that night stating that NASA had provided the funds to build these vehicles. The funny thing is that this appeared in the Houston papers and by this time *they* [the MSC] were the ones to provide the funds. So, the Houston paper came out with a front-page article saying NASA had provided the funds to build two LLRVs. We went to Houston expecting to be bawled out and everybody was asking everybody else, ‘Who approved it? Who approved it? Isn't it great?’ I'll be darned if that wasn't the thing that got attention to it and shortly after, the funds were approved. It was that newspaper article that did it. All I can say is that that was the thing that got it off dead center. We did some other things on our own money because we had confidence in the program. While we were doing the feasibility study, under contract to NASA, on our own funds we set up an analog simulation of the RV, and put a man in the loop to help convince ourselves that the vehicle would be flyable and controllable. The paid study was \$50,000 and I would say we put in an equal number of man hours on our own doing this manned simulation, which turned out to be very valuable because we got a lot of good design parameters from it. There's a patent on the basic idea by myself and John Allen.

Appendix F

Interview with Dean Grimm 1 April 1971, LLTV and LLRV–Working Notes by MSC Historian Ivan D. Ertel

Grimm: The program really started in the 1961 framework when Bell had a concept of a vehicle that would train the crews for a lunar-type landing environment. Some people at Bell—who were looking pretty far ahead to come up with this idea on the 1/6g environment—put together an unsolicited proposal and sent it to (NASA) headquarters. Headquarters didn't know what to do with a weird-looking vehicle like this and determined that FRC played games with things like this so 'we'll send it out to Paul Bikle and see what he thinks about it.' Paul and his people, along with Don Bellman and Gene Matranga, looked at it. They thought the proposal had some merit and it was something they had an interest in. They were always interested in something that didn't have wings on it and had some variable characteristics, and it was something unique and probably an advancement in the state of the art at that time. They looked over the proposal and went back to OART [NASA's Office of Advanced Research and Technology] but they couldn't get funding. OART said, 'if you really want to get this funded, it looks like an MSC-type of thing.' In late 1961 or 1962, Paul Bikle got together with Gilruth and Warren North and they thought it had some merit. Gilruth and North sponsored it at Headquarters and got approval for funding a development study for the vehicle. FRC would do the detailed hardware management for the development and MSC would provide the overall program management and funding. They believed that if it had any merit other than handling qualities, once MSC decided how they were going to get on the lunar surface, they would probably want such a training vehicle. Late in 1961 a contract to go ahead with Bell for preliminary design was implemented. FRC, followed by MSC, contracted with Bell to design and build vehicles called LLRVs. Contract go-ahead on the LLRVs came in February 1962. Unique features of the concept were pilot on top, and over-the-engine bellmouth.

The preliminary design showed it was unstable. When it was figured out where the cg and thrust vector were, it flew better upside down than right-side up. Midway through design, FRC re-designed and came up with cockpit-in-front, like in the present design. That delayed the effort somewhat. The original hardware delivery date was April 1964; Bell underestimated the job and Paul contracted for fixed price with cost sharing on escalation up to a certain point, and after that Bell had to absorb all costs. There was no profit left at that time and FRC, with our concurrence, went to Bell, put all the parts in a basket, and took them to FRC. FRC continued the build-up of the vehicle. Through their analysis during about a six-month ground checkout on the systems, it was discovered that a lot of modifications would be necessary. First flight was 30 October 30 1964. They had parts strung all over the place. FRC was a typical research center in that the place was pretty relaxed compared to [the MSC]. Occasionally some of the parts for the vehicle would end up on a lifting body or something else. The telemetry van, which we were also funding, would be up at Ames doing a telemetry test on some other research program.

I came on board in October 1963 with a flight test experimental background. The day I walked in the door, they slapped that program on me and said, 'It's yours, lock, stock, and barrel, and what comes out the other end is your responsibility. Whatever you do, just do it. Don't bother us with it at all.' I watched what FRC was doing and worked out a flight test program in terms of trajectories we thought we could fly based on a simulation study we had gotten from Martin. We gave that to FRC and they had some other requirements. They wanted to run a basic variable stability and handling qualities program on it. This was their basic aim to start with. They weren't too concerned with what we got or what we were interested in. We had a fairly good number

of discussions about what should be done with the vehicle while they had it and how soon they should be through with it. There were a number of problems—structure, engineering, avionics, vibrating, printed circuit boards coming apart, etc. We didn't have any engine for this vehicle, initially. FRC contracted with GE, along with [the Air Force], to take some standard J85s and modify them for vertical operation, put a fan on them and up-rate them from 2600 lbs. of thrust to 4200 lbs. to get off the ground [GE had already qualified and produced the fan version of the J85 for commercial use, the CF700]. The machine started with a goal [takeoff weight] of 3,200 [pounds] then grew to about 3,700 [pounds] but there was no engine in the U.S. to do the job for us. GE was in the process at the time of doing some prototype work and they were able to come out with a fan version of that old J85 engine. We got lots of offers from Rolls Royce and a lot of other people to spend about \$20 million to develop the engine we wanted but of course we weren't too interested in that. As I recall, we bought three engines. There were nine originally, of which the Air Force took six and we took three. [The Air Force] used theirs to power the big wind tunnel they had at [Wright Patterson Air Force Base]. So what we had was some old J85 engines that had been used where we took modified compressor sections, modified the bearing sections, etc., and slapped a fan on it and put a truss around it so we could hold it in the vehicle, and slapped it in the vehicle. If I can recall correctly, they cost us in the neighborhood of \$200K apiece when the basic J85 engine cost \$86K a piece. In the process of our working with them, the modifications cost us about as much as the engines did but we eventually got it into the configuration. When we procured the later engines for the TVs they were the same version as what GE was selling to Dassault for the Falcon airplanes at Pan Am. We ended up buying one of the FAA-certificated engines, which NASA paid a good chunk of the development cost on.

There are a lot of odd things on this vehicle. Some of the actuators that were originally used were modified actuators that were used on racing boats for steering. We had a Weber seat in the thing, which was an extreme modification of the old Gemini [T-37] seat. The catapult systems on that Weber ejection seat were something that was pulled out of a T-37. The Gemini seat weighed about 150 lbs. but we stripped it down to weigh about 95 lbs. Then we took the Ryan 97 Doppler radar altimeter system and used it with pretty good modifications to give us attitude, altitude rate, and horizontal velocity. So you see, we were kind of dredging around here, there, and yonder to get pieces and parts for this vehicle. Here was a case of having Bell build the basic avionics and structure and NASA finished the [Bell] engines and the ejection seat while FRC built [Air Force] standard controls. We also finished the radar systems. Over a two-year period I believe we ran 196 flights. FRC had a lot of problems and a lot of bugs to work out of a vehicle like that and they took it slow and easy. Joe Walker was the first pilot and Don Mallick was the second one. Then we ended up with Col. [Emil E. "Jack"] Kluever. All in all, the program was fairly successful. We sort of shortcut their program. I guess it was in 1966 that we were presumably going to be landing on the moon. That only gave us about one year and Bell was really beating the old drumsticks. They came down here to Gilruth, with everybody they could think of, and wrote letters to their congressmen and beat on headquarters, etc. Finally [Donald K. "Deke"] Slayton called me over and said, 'What are you doing about a program to provide some test vehicles for us?' I said, 'I'm not doing anything.' He said, 'Well, you'd better get busy.' I said, 'Why?' He said, 'Because we need something to train these crews in.' And he said, 'I want to buy some Chinese copies of the RV.' I told him that I didn't feel like buying Chinese copies of anything, especially when FRC hadn't gotten around to operating that LLRV in the mode that we'd expect the crews to fly in. Hell, they were operating it in the research mode. They were doing a lot of other things that weren't applicable to what we were trying to do, and they really hadn't flown a typical lunar trajectory at that time. To make a long story short, he gave me direction to procure

three vehicles. Well, he started out with two vehicles and I convinced him three was a good number because if you lost one you still have two, and if you start with two and lose one you don't have much left in terms of redundancy. He wanted a Chinese copy, and I told him there wasn't any way we would build a vehicle like that thing we were flying out there, and that there were all sorts of things that we wanted to change on it. We'd learned a little bit. That learning comes hard, but we did learn. So with that direction, I started off on a program to buy three more vehicles of an undefined type. In the meantime, at FRC we started out with stick and rudder pedals on the vehicle with a helicopter console in the center. I felt reasonably certain that we weren't going to fly that type of a helicopter approach with stick and rudder pedals and that we weren't going to have all that glass expanse, etc.

I directed FRC to go to a different cockpit approach, which would eliminate the center stick, the old cyclic stick and the collective stick. It was kind of like a plumber's nightmare—what you grabbed ahold of and working your feet and everything else to fly the rascal. It worked okay, but there are better ways to do things than that. The other thing is that we knew we weren't going to remotely resemble the controls that the crew had to work with on what was now called a lunar module. As a result of my direction to FRC, we had them design a new cockpit section and we took the cyclic stick out, the collective stick out, the rudder pedals out, and put in a side-arm controller. It moved the console over to the side and I had them seated, of course, instead of standing. At that time, they hadn't decided whether the men would be seated or standing in the LEM. I had them move the console so that the perspective, as we knew it, was where the controls and displays were going to be, and I had them scale up the displays so they would look the same to the crew. They had the same angle but were further away, so I had them scaled up so they would look the same. I had them build a cockpit enclosure to represent the final version—at that time—of what the viewing area would be out the window, put in a T-handle that simulated the T-handle that throttled the descent engine, and I took Gemini 7's hand controller after it had flown its mission and gave it to FRC. They chopped that rascal up and put it in the vehicle and that's what we flew with. Well, I'll take that back. The first vehicle that we flew out there we used an engineering model that I got from McDonnell that was mounted to a chair that we used in the lab to do simulations. I had FRC take that old thing off the chair and modify it and we flew the vehicle with that.

About three months later, I was able to convince people that I had a requirement for a flight-type qualified hand-controller that had a little more quality built into it. Right after [Frank] Borman's [GT-7] flight, we sent it out to them and they modified it. Then we swapped that out as quickly as possible. Subsequently, for the second vehicle, I got the hand-controller out of GT-8. That hand controller we still have. Those are some of the gyrations we went through. They put on the new cockpit, got rid of the cyclic stick and the collective stick and the rudder pedals and we got vertical instruments rather than tape drives in the [instrument panel]. FRC actually built them in their instrument lab and got rid of the old analog meters, etc. Then they flew, if I recall, about 20 flights in our configuration. I told them that was it, that I was convinced! I had business to get on with and we'd take it. I just chopped it off and we took delivery. We brought them in here in December 1966 if I'm not mistaken. So we brought it in here and set up business out on a corner at Ellington. Of course, I was responsible and worked with [Joe] Algranti on getting a crew together. I had sent the crew out to FRC to get trained on the thing by the FRC people so that when we brought it here we'd be able to operate it.

During the same time period I was playing games getting the facilities built out here. We picked that spot out there on the end of the runway. We played games with the [Air Force] Engineering Division, etc., to get that original building built. At the same time, I was buying engines and playing games with radars and doing designs on lunar instruments and contracting for the new vehicles. I was now the only guy on the

program doing all of this. As soon as the vehicles got here—I have to regress again because there are a lot of bits and pieces here—I was a little bit concerned about the fact that we hadn't done anything with that second vehicle. It was in bits and pieces and strung out across the hanger floor out there at FRC. I finally gave FRC direction and the money to put together the second vehicle. Now that I knew we were going to use these vehicles for training I was quite concerned that if we lost one, we lost the whole ball game. We had committed ourselves by saying it was required and then if we were to lose one, we've got one in baskets. It takes six months to put it together and another three to four months to check it out. Then we would have lost nine months and we couldn't afford that. So we directed them to put the vehicle together, which they did. Just barely before delivery, we got that rascal put together and had bad trouble with the avionics boxes. After we flew the one about 20 flights in the new configuration with the new cockpit and everything, we took the avionics boxes off the vehicle we had been flying all along and put them on the second vehicle. It was the only good set we had and we flew it to get it checked out.

Ertel: Was there was any problem in getting Joe and Bud [Ream] to fly this unlikely-looking machine?

Grimm: Well, I think—as anybody does—you have reservations the first time you look at that thing because you know it's not like an airplane; it doesn't have wings on it, and if your electronics or avionics fails, that's just like your wings falling off. In avionics, we've actually got three analog computers that actually drive all the systems on it. A closed-loop analog system with the pilot making the input—the analog computer processes it, fires thrusters, or gimbals the engine or does something that you expect or don't expect. So, if a computer happens to blow a tube or a card or a resistor or something or other, you have a problem. Of course, we have backup systems. We have a monitor system. The monitor system was always checking the primary system and the backup system. If it saw a discrepancy in what it was checking, it would switch you over to the backup system and then that told you to get home.

Ertel: Were the pilots hesitant to fly it?

Grimm: I don't think so. It would challenge any good old dyed-in-the-wool pilot who thinks that he can straddle any...thing that is made to get in the air and some that are not, and fly it better than anybody else. I think that applied to Joe and Bud as well as Joe Walker and Don Mallick and [Emil E. "Jack"] Kluever. I think a lot of pilots are that way. I have a pilot's background myself, but the more you learn about vehicles like this—intimately learn about them—the more cautious you are about what you're willing to do with them. I think the old thing that 'ignorance is bliss' is really true because I can recall that when I was a cadet, I did things with airplanes that when I went back to school and got my degree and found out what I'd been doing, I was shocked. I found out it was impossible—you can't do those things with an airplane! But to give them the confidence that they knew what the vehicle was going to do, FRC also built an analog fixed-base simulator. This is one of the few times in our area when we built a fixed-base simulator to simulate a vehicle that was simulating a vehicle that we're finding out how to fly. You know—as a simulator simulator, that's what it boils down to be.

So they built a simulator out there out of bits and pieces, etc. As a matter of fact, that's when the first hand-controller went. When we had the second hand controller, the first one went in the simulator and the other went into the vehicle. Joe Walker, I expect, spent a couple of hundred hours in the simulator. Of course, they had so much trouble with it and it was so damned terrible, they figured if he could fly that simulator he could fly anything. That was probably pretty true and of course Joe was a good pilot. After he got to flying the [LLRV], I think the first flight I was out there watching him, he said, 'Man, this thing is a pleasure to fly compared to that simulator. I'll fly this any day compared to that simulator.' He said, 'That thing is so bad you can't imagine what a relief it is to find out that this vehicle flies like it does.' He found out that the vehicle

was inherently stable. This is something that you really can't say for helicopters, as an example, that you can actually fly it hands-off. I've got some pictures of Kluever on some of his flights where he has his hands up in the air and it was flying by itself. This gave everybody a good deal of confidence with the way it performed, even from the first flight on. I think we never had any qualms about the basic vehicle design but it was with the maintainability, the reliability, and the parts where we had a lot of problems—on that vehicle as well as the other one. Anyhow, we brought the vehicles [to the MSC] and we had the maintenance people trained. Joe and I had a project engineer to handle the project out there, which I interviewed, and when they came here I turned them all over to Joe. I said, 'Okay Joe, these two vehicles are yours. You're checked out and you've got your facilities built for you and got spares that I bought for you and you've got the flight manual and the documents and the rest of it. You go train crews and I'm going to be off buying three more vehicles.' That's effectively what happened.

Then, of course, Bell and I didn't quite see eye to eye on what the new vehicle should be. I had them do a trade-off study in terms of, 'if we had to build another vehicle, what wouldn't we do like we did the first time?' There were a bunch of things that we wouldn't do like we did the first time and these came out in the trade study, which we subsequently turned into a [Statement of Work, or SOW] that we gave to Bell. Just so there wasn't any misunderstanding we had Bell write, in conjunction with us, a SOW that ended up about three inches thick that detailed precisely what they were to do and how each individual part on that thing was to perform. By the time we got that thing done and negotiated all the ifs and buts, it was January of 1967 and it looked like we might just have to train the initial part of the crew's training with the RV and finish the last three months with the TV, because that's about the time my schedule said that I could have it operational for them to fly—the last three months before the lunar mission, which was scheduled for 1968. Since we were having all the difficulty with the contract and how much it was going to cost, etc., I told Bell if they intended to build anything for us, they'd better [start now]. They started buying parts in August of 1966 without a contract and they had all their parts bought and in fabrication when we got the contract bought and signed in February 1967. We negotiated that basic contract for \$6 million for the three vehicles, plus some automatic ground checkout equipment, which I felt we ought to have.

We had another little thing. Because of the uniqueness of the vehicle it took FRC initially something on the order of ten hours to preflight it for a six-minute flight. Then it took them something like two to three hours to do a turnaround between flights. When we did a periodic [maintenance] it would take us in the neighborhood of two weeks, but yet we had a requirement to do a periodic once a month. So if you went by those rules and figured that what I was building was going to be an order of magnitude more sophisticated in a lot of the areas because of what I put in—effectively a LM-type control system, which was something we didn't have in the old vehicle. I wasn't sure that we'd ever get the thing off the ground. We'd be continually checking the thing out on the ground. I told Bell to design [an automatic] checkout system where I could run this cart out behind a vehicle and hook up a couple of plugs and punch a button and it says 'go,' 'do not stop,' 'proceed,' etc., and it spits out a number here that says I can't proceed past this point because something is wrong. Now you take the patch panel and punch a few buttons and it tells you what's wrong and you fix it and you continue through the system that way. That was a pretty good philosophy. We'd had a hard time doing that but we finally arrived, in our operations out here—that we were able to hook up this cart and do a complete preflight on the vehicle in something like two hours versus our original hand method that we started out with, which was sixteen hours getting through it on a preflight. This tells you it was almost an order of magnitude more sophisticated in terms of our checkout procedures than the old RV. So that was basically it. They would build us three vehicles, plus two ground checkout carts and

spares for \$6 million, and we were to do the 15-week ground checkout program in about the same length of time for the flight test program before we'd be ready to fly it. We were about as bad a guesser as anyone else on the second time around on how long it took to build vehicles.

Of course we contributed to it with changes, but it took them about seven to eight months longer to build the vehicle than they had anticipated. We brought them down here and we started going through the ground checkout. We were hard up for bucks then, and everybody said we couldn't have dollars and we couldn't do this and couldn't do that, so to cut all sorts of corners—such as doing the ground test and flight tests at Bell— we said we'd do it here. We'd use our facilities and we'd furnish all the crap that goes with it—typewriters, desk space, supplies, all the GSA stuff. We'd provide the pilots and we'd provide the [telemetry] van and we'd do all these good things. Well, we did them, but we finally accomplished about the last one, what we said we'd do, about the time Bell finished up on the contract, although we weren't entirely blameless on our good support of the program. We underestimated how long it was going to take to check that vehicle out. We estimated fifteen weeks. In fact, it took us from October through the following October to get the first one checked out. Instead of fifteen weeks it took us fifty-two weeks. We had a few problems along the way because we had what I call design deficiencies—design goofs and some just regular old problems where we hadn't anticipated what was going to happen. I guess we were a little more confident when we should have been a little more conservative about how sophisticated a vehicle we'd built for ourselves. It knew a lot of things that we couldn't explain. It took us awhile to figure out why it was doing all those things. Then we finally got into flight tests and went zinging through a beautiful flight test program.

The acceptance flight was when we lost the LLTV. I sort of skipped when we lost the RV but that was, like, a year after it was here and we'd had about 20 flights in it [84 total flights, including 46 for astronauts and 38 functional check flights]. When we lost it, I think that witch had about 200 [282] flights on it counting the FRC flights, if I recall correctly. We lost that LLTV on the acceptance flight and had a big turmoil then to find out what the problems were. We took the No. 3 vehicle to Langley and put it in the wind tunnel and ran it at a bunch of angles and velocities, etc. As we suspected—but not knowing exactly—we had known previously that the vehicle was aerodynamically limited and that our cockpit and the structure, etc., acted as airfoils and were drag surfaces, and the thrusters had to put out so much thrust that you get the vehicle at an angle where you're trying to control its attitude and the drag is greater than the capability of the thrusters to control that attitude. You've got a problem when it tries to turn upside down and a few other things.

We found out that our culprit was that odd-shaped cockpit because one side of it was closed in and one side of it was open. The aerodynamic limit of the vehicle on a straight and level flight, going straight ahead, was about what we anticipated. But when the vehicle yawed off to the right, the speed limit came way down on it. We hadn't anticipated that when you flew with a fairly good yaw the flight envelope was reduced drastically. That basically is what happened. We exceeded the aerodynamic envelope of the vehicle where the thrusters could no longer control it and the thrusters were going full thrust and the drag kept pulling the thing over until we reached a null point. By that time Joe [Algranti] was in a pretty hairy attitude. Actually, he was putting the controls to the opposite direction to keep it from doing that, when it finally went the opposite direction. It went so fast that he couldn't reverse fast enough to catch it. It went from a roll 90 degrees to the right to a roll 90 degrees to the left. We finally had the control in there, but by that time the vertical thrust was so low on the thing that it went in and he got out three-tenths of a second before impact.

Too close for comfort.

The vehicle was trying its damndest to fly the whole time—fly right, but it just had

a little more than it could handle. As a result, we put severe restrictions on the direction that we always flew it—downwind. We got better meteorological data by having [Air Force] balloon guys come in. We ran balloon checks with theodolite and they tracked it to tell us what the wind was at 50-foot intervals and on up to a thousand feet. It took them an hour before the flight, a half-hour before the flight, and five minutes right after the flight. I think we know more about wind shears than anybody else in this part of the country. That [Air Force] group that we had here was really a good group. Really did a good job for us. Then in addition, we've got towers out there where we get winds at five feet and 10 feet and 15 feet, and we have a 50-foot wind tower out there now. We finally got through ground tests and the flight tests. Then we had the accident. After that, we put the No. 3 vehicle in the wind tunnel and found out our problems. We came back with our basic modification, which was to saw a hole in the top of the cockpit to let some of that air out that was getting trapped in there. If you look at the vehicle we have now, 90% of the top is missing. That good Styrofoam® top that I had designed so that the crew could eject through it is gone. But that basically solved the problem, along with a lot of operational changes and procedures and how we controlled mission rules and revamping of the van with operational procedures.

We finally got back into the air when we convinced Dr. Gilruth that we knew what we were doing. He let us start continuing the flight test program. We ran into a real strenuous flight test program. We flew this vehicle in sideslips up to 60 degrees and had some pretty good velocities and descent rates and the thing flew pretty good. The day before, both vehicles were out there and we were going to fly two of them on the same day and break a record. We never flew the second vehicle [that day]! We completed the flight test program and on the last flight, on the second flight test program after the accident, the thing was sitting out there and going to fly one more time. We were going to get Neil in there. He had been waiting in the wings like the expectant bride all along here and the mission was getting close and headquarters was breathing down our necks and congressional committees and everybody else was really sweating this funny vehicle down here and Deke has committed us to have Neil fly it. I was in the building and all of a sudden they told me I had a problem on the vehicle. I asked them, 'What kind of a problem?' They told me that the thing had gone into backup in all three axes and I said, 'Hell, that can't happen. We've got something designed so it won't do that and not only that, we have the capability to fly it in two axes because when you went into backup in all three axes it was bang- bang—sudden death. You could probably do it in two [axes] but not in three.' So we went and checked and, son-of-a-gun, we found out—sure enough—that it had done that. Well, we did everything but turn that vehicle loose and we couldn't make it duplicate that again. We tried for one week solid to make that vehicle duplicate it.

We knew that we had some EMI [electromagnetic interference] problem and we didn't know how bad an EMI problem because we never had run an EMI test on it. We knew that when we flew in a certain direction that we got dropouts on our radar and some of the other gear we had on board but we really hadn't thought about it. We had TCSD [Telecommunications System Division, of the Air Force] come out and, with their EMI equipment, check the [Air Force] radar. They have a classified radar system there for Ellington and about 200- or 250-mile radar and we found out that thing is strong enough to make you sterile on the spot, if you believed the readings. It was the EMI experts' considered opinion that there wasn't anything outside of a lead vault that would keep us from getting EMI.

We were in a quandary about what to do, and we had all sorts of good advice about what to do and none of it was very palatable. The Bell manager and I got our heads together and said, 'Well, what do we have to do to make this vehicle safe if this happens again?' Overnight, the Bell people designed a mod to that vehicle and they put it in within another night [24 hours], which was damned near an impossible thing to do.

We spent a day convincing people we were ready to fly again, including Gilruth; and headquarters of course, being the weird ducks that they are, sent a TWX [Teletype-writer Exchange Service message] down to Gilruth saying, 'If you fly this thing in this configuration and this condition, it's at your own risk.' My comment back to headquarters was, 'Tell us something we don't already know. Because no matter what happens, it's going to be our problem.' We wrote a TWX for Gilruth's signature and he, in effect, sent a TWX back, saying, 'don't sweat the small stuff, we've got responsibility for it and we accept that responsibility.' Which was a nice way, I think, of telling us that he still had confidence in us. Of course there was a hell of a lot of pressure because in a week-see, this was the month before the [Apollo 11] flight; it was five weeks before when we had the problem and were down-and Deke says, 'When are we going to be able to fly? Are we going to be able to fly?' I said, 'I don't know Deke, but we'll give it a hell of a go.' And he says, 'Well, we're going to have the FRR [flight readiness review] in a week and if you say it's mandatory for Neil to fly this vehicle before we make the first lunar landing, then we're going to have to slip the first lunar launch by a month in order to get Neil trained if you're going to get that vehicle fixed and get in his flight time.' And these were some of those 25-hour days.

I was working at that time and I was getting calls by the hour from Gilruth or [MSC Deputy Director George] Trimble or [Apollo Program Deputy Director Samuel] Phillips and his assistants about every hour. Every once in awhile in between times, I'd hear from some congressional liaison committee member. I think one time somebody called me from Senator [Clinton P.] Anderson's office. There were a lot of people interested in it. Anyhow, Dr. G[ilruth] gave us the go and I talked to Neil at the Cape [Canaveral] and said, 'Neil, I think we've got our problems licked. Come on up in the morning.' This was on a Friday night. I said, 'We've got Saturday, Sunday, and Monday lined out for you if you can work your schedule and the people at the Cape can rearrange things so that you can get down there. We're going to support you around the clock and, the good Lord willing, we'll get everything in here that you'll need to get all the training that you want.' Because we were going to let him be the judge of when he felt comfortable enough to quit. He came up Friday night and we got a late start that morning because he had never done a sim run in the vehicle on the ground.

Well, we had to do a sim run and then re-service the thing and fly. Of course, we had the weather problems too. We'd never been able to fly it more than twice a day without some problem hitting us. Between the problems and the weather, and then the damn press, I got pressured by G and then through Slayton to set up a press showing. This I guess was for the second day, if I recall correctly. I was about cuckoo by this time, worrying about the press. There was quite a bit of wind. We got the ground sim run off okay and we turned it around in an hour. When we flew Neil, the limit we had on his first flight was five feet per second, I believe. We sat there awhile and we said, 'Okay Neil, we're there.' So we hopped off the ground. We were legal all the way. I've got the records to show that and then we get him down. After he flew the first one, he did pretty good, and fueled up; within an hour we were ready to go again. He hopped in that rascal again and in between time we're doing data reduction on how well he was doing and the systems were doing and we got a status from the TM van and a status from the systems and from him and the whole bit. So we got the second flight off and now we can go to a little bit higher wind level. We sat there and we just make it on the second wind speed level and that's another good flight. We service it up and we get the third one off that day. Then he had a press conference that afternoon, but we could have flown him two more times. This was killing our soul because there that vehicle was, ready and it was just sitting there. We couldn't do anything about it and of course everybody was worried that it was just getting ready to crap out. So we flew three that day and then the press conference. The next morning was when we had the soiree of all the press out there. I believe it was on the fifth flight. We started out the same way-the

wind was just marginal again and he got off the ground and did fairly well.

He was under a lot of pressure. He was quite nervous about it and he hadn't had the time. We were spoon-feeding him every step of the way. In between flights we were going over the data with him and telling him what he was doing wrong and what he was doing right and what he ought to do, etc. Of course, he'd been under a hell of a lot of pressure, with his training and the hours he'd been putting in. Neil wasn't in the best condition to be doing this under that kind of pressure, either. Also he wasn't any different than the rest of us about that time. So the next morning everything went well and we got that flight off and turned around in an hour and got another flight off and turned around in an hour and got another flight off and everything just went like clockwork. We flew four flights that day. I can't remember whether we flew two or three days now. I think we flew the third day. The last flight I remember flying was four o'clock in the P.M. I know it was the night that Phillips and [NASA Associate Administrator George] Mueller and that whole soiree from headquarters was in NASA One [an official NASA aircraft]. They were en route to the Cape for the FRR the next morning and Phillips called through the aircraft radio to the Andrews [Air Force Base] ham operator, who put through a telephone patch to me. He wanted to know if it was okay to go ahead with the FRR in the morning and had Neil completed his flights or how were things going? When I told him over the phone that Neil was through and that he was happy and satisfied and that everybody was gone, I think I could hear the yell all the way through. I think—if I can recall the comment—they said if I could get Neil trained in that thing under the circumstances that we did, that they didn't think they'd have any problems with anything else on the lunar mission. I think this was about six o'clock when they called me because I know that everybody had gone and I had just sat down in my chair and I was just sitting there unwinding after all of that! That was the little bit of drama that led up to training Neil. We put the vehicle in the shed then for the next two weeks because we were just a tad overdue on some of our periodics [periodic maintenances] that I had stretched out a little bit in order to get that training in for Neil.

I guess the rest is history because they had that good landing. Neil came back and said he 'felt the training was invaluable' in the vehicle and the main thing he learned from flying the vehicle was the slow response that you get in a 1/6-g field, and that you just have to wait for things to happen and if you're not prepared to wait then you can very easily misjudge things that you're planning out ahead of you. So from that standpoint, the fact that the pitch attitude, the slow deceleration, the slow turn, the slow everything—everything is going to happen in slow motion. The fact that we did have an actual LEM hand controller (we actually took flight controls off the line for the LEM) and modified those hand controllers and put them in the vehicle so he'd have identical characteristics of the hand controller...I modified the T-handle to simulate it for his descent engine. It had the same throttling characteristics on it for the rocket engines that we had. We had some new instruments that gave him the same look at his altitude and altitude rate and thrust-to-weight ratio, etc. We tried to make it as representative a look [view] angle out the cockpit window as what he had. We felt that we'd done as much as we could to make him feel reasonably at home in the vehicle, relative to the LEM configuration.

Ertel: I don't think in those early years you would have found many people who would say it would fly, etc.

Grimm: Well, like I told a lot of people, a lot of features on that vehicle were sort of a figment of my imagination in terms of what we did, like modifying the ejection seat and the actuators. I had new electronics built in it, new radar system, new Doppler, and new instruments and modified the hand controller and different structure. We modified this and that and the other and I really never had any advice or help for much of anything from anybody except for a couple of people at FRC [Gene Matranga and

Cal Jarvis] on the guidance control. It was kind of a solo-type project. I, of course, at the end had two people working for me that I assigned the project-engineer responsibility, Jim Bigham and the other was Sam Nassiff. Incidentally, we took part of what FRC had as far as the simulator and rebuilt the whole thing and it's down here [at the MSC] now. In the simulator that we built, we took parts of old 231-R computer surplus and hooked them up. I had Sam rebuild the whole cockpit section and a lot of the equipment. Then we went out and salvaged an old B-52 visual system that they [Air Force personnel] used for their simulation which had a runway picture, video cameras, etc., and he tied that in with the simulator and closed the loop on it. When the [pilot] made an input, he looked out here and he saw the runway tilt and he saw [himself] flying down the runway or flying backwards. We got that for free. We got it out of the depot up at Ogden [U.S. Air Force Ogden Air Logistics Center, Utah]. So for around \$300K we put together what I'd consider a pretty damned good fixed-base simulator here, which we use and still fly a lot. That was one of the areas that we spent a lot of time on here, trying to get a fairly high-fidelity simulator because we knew that we couldn't expect the guys to spend 200 hours in a simulator like Joe Walker did. Our schedule was something like 10 hours in that simulator before [the pilot] flew the first flight.

And there are a lot of other things I haven't mentioned. The fact that we had swing guides and the fact that we went through the same gyrations on the new vehicle that we did on the old. We had built different engines and different radars, and different instruments, and converted to the hand controls. We put in all the logic that the LEM had—or to simulate the LEM, I should say—in terms of its four jet logic and two jet logic and controller logic and breakout logic and hard stop logic. All that stuff, half of which went away by the time we flew. So I naturally built a lot more sophistication into the vehicle. Of course, the other thing I built was a wide range of adjustability in the avionics, because at that time I didn't know what the LEM was going to do in terms of handling qualities. One of the reasons that we wanted the vehicle to start with was that we wanted to find out if a guy could physically fly something like this or not. Were the handling qualities what we thought the lunar module was going to have? So that the end result was that once we zeroed in on the LEM handling qualities, on the real LEM handling qualities, we would just go up there and tweak the knobs and set the characteristics of the real LEM into this vehicle. Although the vehicle had a lot more capability than the lunar module did, we were able to make it fly just like the lunar module when it was in the lunar simulation mode. Anytime the pilot was flying it, it flew like the lunar module and when he wasn't flying it, when it was doing something itself, it had its own capability, so was kind of a unique vehicle in that sense. We were able, in the final analysis, to tweak in all the characteristics that were thought to be of interest as far as the pilot was concerned in the actual flight vehicle. It has a lot of flexibility if someone ever wanted to use it for another research program.

Ertel: Do you think the accident board dragged out their investigation too long?

Grimm: Well, the accident was December 8, 1968, and we finally got permission to fly in mid-April, so the accident board had to complete its investigation by the first of April. I think basically they were pretty much on schedule. We came in with a presentation about what we were going to do. Actually, [through] a combination of goofs...we actually presented some erroneous information to Gilruth. I had to go back and retract that information and then show him the good information and then show him we knew what we were talking about the second time around. That last go-around, we had flown flight tests during the six weeks and we were five weeks from scheduled launch when we had the last problem. We had to fix it practically overnight. We flew a couple of test hops and validated it just in time to get Neil in and give him his eight or nine rides and call it quits [Armstrong had two flights on 14 June 1969, three on 15 June 1969, and three on 16 June 1969].

I don't think they've ever flown that vehicle or any subsequent vehicle that many

times in a day since then. If I can recall correctly, we'd never done it before, even at FRC [Bud Ream flew LLRV #1 at FRC five times on September 1, 1966, and Jack Kluever also flew it one time that same day for a record total of six flights in one day]. That was just one of those mysteries that you wonder how you did it. But we did. But it was a lot of hard work and effort by a lot of people through that whole program. Of course there weren't too many on the NASA side because the most ever working on that program from MSC at one time was two. I don't want to ever get myself in that situation again. What really hurt us most was the fact that they put us on a stringent budget and said, 'Now look, this thing isn't any different than an airplane and when you get through with this thing, we want you to kick the tires and go fly it' type of thing. We couldn't convince a lot of people, including Deke, that this thing was near that sophisticated. Joe Algranti was the same way. He said there's nothing that sophisticated. It took a long time to get him convinced and I don't know if we ever convinced Deke that this thing was as sophisticated as we tried to tell him. As a result, if we had put more money into it and gotten high-reliability parts and a lot of the other things that you take on a high-risk program short fuse where you got national prestige, etc., riding on it, you'd never do what we did. Hell, we went with commercial parts. I think probably 90% of the parts on that vehicle—in terms of avionics parts—were commercial, or lesser-type parts, maybe I should say. We had mil-spec parts in there with a good deal of commercial parts, which isn't the ideal way to build a vehicle where you get a lot of risk and money and prestige, etc., riding on it.

Ertel: This is one of the most important training vehicles.

Grimm: All of the astronauts have given credit to the LLTV when they come back. It's, I guess, an oddity, though, that more people didn't recognize the importance that this vehicle might play at a time when it could have done us more good in terms of people, personnel support, engineering support, and financial support for the program. Not only here in the [MSC] but at headquarters as well, so that we'd have had a more reliable product. This was the thing that always concerned me, the thing that I always pointed out to people. You just imagine that you have \$20 million invested in the AMS [Apollo Mission Simulator] over here with all its visuals, etc., and that for \$2 million, which is what a LLTV cost, I did a lot of the same things, only it had to fly. There's a lot of difference in the risks and feelings you have for some programs that sit on the ground and use electricity and something that gets up and snorts and roars and takes off and flies through the air. I think probably that one of the most spectacular things to people is the first time they ever see that thing fly. Looking at it on the ground doesn't do it justice. On Neil's flight, he drove up there and shook hands with me and started talking to the press. I got so tickled about whoever that cat was—but he said that some blabbermouth PAO type was talking and nobody was interested in listening to him. That was me sitting there explaining what was going on. Of course I'd had a few tiffs with PAO. Boy, I had so much trouble, because, you know, if PAO had had their way we'd have had that thing right out there under the vehicle as it ran down the runway-type thing, and I had enough problems on my mind that I didn't want to have to worry about the safety of those people with all the other things I had to worry about at the same time. It was a very bad time, as far as I was concerned, to have a press showing.

Appendix G

Milestones

The following table provides an overview of the key events in LLRV and LLTV operations at Ellington Air Force Base, Texas. To put the LLRV and LLTV astronaut-training deadlines in perspective, the table includes Apollo launch dates.

Events	Date	Remarks
LLRV No. 1 Delivery	13 December 1966	
LLRV No.2 Delivery	25 January 1967	
LLRV No.1 First Flight	3 March 1967	FRC crew did the preflight. (Kluever)
Armstrong's First LLRV Flight	After 23 March 1967	First astronaut flight
LLTV No. 1 Delivery	9 October 1967	After extensive delay due to disputed interpretation of x-rays on structural aluminum welding
LLTV No. 2 Delivery	7 December 1967	
LLTV No. 3 Delivery	10 December 1967	
Crash of LLRV No. 1	8 May 1968	Loss of helium pressure. Neil Armstrong, pilot
LLTV No. 1 First Flight	3 October 1968	Joe Algranti, pilot
LLTV No.2 First Flight	5 December 1968	Bud Ream, pilot
Crash of LLTV No. 1	8 December 1968	Joe Algranti, pilot
LLTV Armstrong training	14–16 June 1969	
Launch of Apollo 11	16 July 1969	Armstrong, Aldrin, Collins
Launch of Apollo 12	14 November 1969	Conrad, Bean, Gordon
Launch of Apollo 13	11 April 1970	Lovell, Haise, Swigert
Launch of Apollo 14	29 January 1971	Shepard, Mitchell, Roosa
Crash of LLTV No. 2	31 January 1971	Stuart M. Present, pilot
Launch of Apollo 15	26 July 1971	Scott, Irwin, Worden
Launch of Apollo 16	16 April 1972	Young, Duke, Mattingly
Final LLTV Flight	13 November 1972	Gene Cernan, pilot
Launch of Apollo 17	7 December 1972	Cernan, Schmitt, Evans

Milestones for LLRV/LLTV Operations at Ellington AFB LLRV No. 1

Initial Astronaut-Training Plan

The initial LLTV astronaut training plan had seven requirements to be completed before the astronaut flew an LLTV for the first time:

- Complete 100 hours total helicopter time, with a minimum of five hours completed in the 30 days before LLTV checkout flights. (This requirement applied to all LLTV pilots.)
- Complete 10 training flights in the LLRF at NASA Langley.
- Complete 10 hours in the LLTV fixed-base simulator.
- Complete systems ground school on the LLTV.

- Use swing to determine ejection–seat cg at Weber Aircraft Company facilities in Burbank, Calif., to establish cushion thickness to optimize seat trajectory during ejection.
- Use LLTV cg fixture for attitude-rocket live firing closed loop attitude-control system hot firings in pitch and roll.
- Do LLTV tie-down combined systems run with jet engine and rocket systems

The initial LLTV transition syllabus required thirteen flights under the supervision of a staff instructor pilot. Later, the number of flights was lowered to eleven.

For pilots already checked out in the LLRV, the initial LLTV transition plan included three requirements:

- Complete systems ground school on the LLTV.
- Complete five hours in the LLTV fixed-base simulator.
- Do LLTV cg stand–closed loop attitude-control system hot firings in pitch and roll.

Five flights would be completed as a transition syllabus under the supervision of a staff instructor pilot, the syllabus defined after the LLTV No. 1 flight test. There were four post-checkout training requirements

- Eight flights, open cockpit front (no LM window) in full lunar simulation.
- Five plus flights with window in full lunar simulation.
- Currency flying, biweekly or two per month in full lunar simulation.
- Recurrency–helicopter currency; two flights minimum in vehicle with gimbal locked in first flight.

The following table summarizes the required training plus LLRV and LLTV flights of all Apollo astronauts, listed in numerical order of the Apollo missions. With the exception of Anders and Borman—who made LLRV flights before mission assignments were firm—only prime and backup LM commanders flew the LLRVs or LLTVs. However, Lovell, backup commander on Apollo 11, had no LLRV or LLTV training at all before Apollo 11 launched due to the crashes of LLRV No. 1 and LLTV No. 1.

LLRV and LLTV Training of Apollo Astronauts

Name	Role	LLRV Flights	Required	LLTV Flights
Armstrong (Launched 7/16/69)	Apollo 11 Commander	21	All available	6
Lovell	Apollo 11 Backup Commander	None	All available	None
Borman	Unassigned	1	[Too early]	None
Anders	Unassigned	11	[Too early]	None
Conrad (Launched 11/14/69)	Apollo 12 Commander	13	11	10
Scott	Apollo 12 Backup Commander	None	22	22
Lovell (Launched 4/11/70)	Apollo 13 Commander	None	22	22
Young	Apollo 13 Backup Commander	None	22	22
Shepard (Launched 1/31/71)	Apollo 14 Commander	None	22	22

Name	Role	LLRV Flights	Required	LLTV Flights
Cernan	Apollo 14 Backup Commander	None	22	22
Scott (Launched 7/26/71)	Apollo 15 Commander	None	11 or fewer	11 or fewer
Gordon	Apollo 15 Backup Commander	None	22	22
Young (Launched 4/16/72)	Apollo 16 Commander	None	11 or fewer	11 or fewer
Haise	Apollo 16 Backup Commander	None	22	22
Cernan (Launched 12/7/72)	Apollo 17 Commander	None	11 or fewer	11 or fewer
Young	Apollo 17 Backup Commander	None	11 or fewer	11 or fewer

The next table lists the five MSC Aircraft Operations Division and FRC pilots, their roles, and the number of LLRV and LLTV flights each made at the MSC.

MSC AOD Pilots

Name	Role	FRC Flights	LLRV Flights	LLTV Flights
Joe Algranti	MSC Staff Pilot	13	6	12
Bud Ream	MSC Staff Pilot	12	34	(unknown #)
Stu Present	MSC Staff Pilot	None	None	(unknown #)
Jerry Cobb	MSC Staff Pilot	None	None	(unknown #)
Jack Kluever	FRC Pilot	2	2	None

The following table gives the calculated vehicle flight log for the first LLRV (at the MSC only) and the three LLTVs. LLTV No. 1 flew 2 hours 8 minutes 35 seconds in 15 flight tests, an average of 8.56 minutes per flight. LLTV No. 2 flew 24 hours 2 minutes 26 seconds in a calculated 206 flights at an average of 7 minutes per flight. LLTV No. 3 flew 33 hours 18 minutes 51 seconds in a calculated 286 flights at an average of 7 minutes per flight. Total calculated flights for LLTV No. 2 and No. 3 are 492 and 216 respective training flights and 276 functional check flights.

Calculated Vehicle Flight Log

Vehicle	Total Flights	Total Training Check Flights	Total Functional Flights	Requirement
LLRV No. 1	84	50	46	38
LLTV No. 1	15	N/A	0	15
LLTV No. 2	206	264	216	116
LLTV No. 3	286	N/A	N/A	160
Totals:	591	N/A	N/A	329

N/A=Not available

Appendix H: Flight Logs

LLRV VEHICLE # 1 FLIGHT LOG

Flight number	Date	Pilot	Remarks
1-1-25	10/30/64	Walker	First Flight
1-2-26	11/16/64	Walker	Systems evaluation; local vertical
1-3-28	11/19/64	Walker	Local vertical to gimbal lock
1-4-29	11/23/64	Walker	Lift rocket operation
1-5-30	11/25/64	Walker	Press Demonstration
1-6-31	11/25/64	Walker	Large angle maneuvers
1-7-32	11/30/64	Walker	Demonstration for James E Webb, NASA Administrator
1-8-33	12/08/64	Walker	Systems evaluation
1-9-34	12/09/64	Mallick	Pilot Checkout
1-10-35	12/09/64	Mallick	Pilot Checkout
1-11-45	2/19/65	Walker	New electronic boxes
1-12-47	2/26/65	Walker	Auto throttle checkout; remove casters
1-13-48	3/02/65	Walker	Auto throttle checkout
1-14-52	3/19/65	Walker	Auto throttle checkout
1-15-55	3/29/65	Mallick	Weight/Drag computer checkout
1-16-61	4/28/65	Mallick	Weight/Drag computer checkout
1-17-62	4/30/65	Mallick	Weight/Drag computer checkout
1-18-65	5/10/65	Mallick	Pc(pressure transducer) failure of Lift Rocket
1-19-66	5/11/65	Mallick	Lunar simulation checkout
1-20-67	5/12/65	Mallick	Lunar simulation checkout
1-21-71	6/24/65	Walker	Large roll imbalance
1-22-73	6/29/65	Walker	Lunar simulation checkout
1-23-74	6/30/65	Walker	Lunar simulation checkout
1-24-76	7/09/65	Walker	Lunar simulation checkout
1-25-77	7/13/65	Walker	Lunar simulation checkout
1-26-80	8/3/65	Walker	Lunar simulation checkout; Uprated engine
1-27-85	8/6/65	Walker	Lunar simulation checkout
1-28-87	8/16/65	Mallick	Lunar simulation checkout
1-29-88	8/16/65	Mallick	Lunar simulation checkout
1-30-89	8/16/65	Mallick	Lunar simulation checkout
1-31-90	8/27/65	Mallick	Lunar simulation checkout
1-32-91	9/2/65	Mallick	Lunar simulation checkout
1-33-92	9/03/65	Mallick	Lunar simulation checkout
1-34-94	9/08/65	Mallick	Lunar simulation checkout
1-35-95	9/08/65	Mallick	Lunar simulation checkout; 1 st Landing in Lunar simulation
1-36-96	9/09/65	Mallick	Lunar simulation checkout
1-37-97	9/10/65	Mallick	Rate command checkout
1-38-98	9/10/65	Mallick	Rate command checkout
1-39-100	9/15/65	Mallick	Rate command checkout
1-40-101	9/15/65	Walker	Rate command checkout
1-41-104	9/23/65	Walker	Rate command checkout
1-42-105	9/23/65	Walker	Rate command checkout
1-43-106	9/24/65	Walker	Rate command checkout
1-44-107	9/29/65	Walker	Rate command checkout

1-45-110	10/05/65	Walker	Practice Demonstration for X-15 Conference
1-46-111	10/06/65	Walker	Practice Demonstration for X-15 Conference
1-47-112	10/08/65	Walker	X-15 Conference Demonstration; Light weight-lock-up
1-48-118	10/26/65	Walker	Rate command checkout
1-49-119	10/27/65	Walker	Rate command checkout; Broken gyro wire
1-50-120	10/29/65	Walker	Rate command checkout
1-51-121	10/29/65	Walker	Rate command checkout
1-52-122	11/02/65	Walker	Rate command evaluation
1-53-123	11/02/65	Walker	Rate command evaluation
1-54-124	11/05/65	Walker	Rate command evaluation
1-55-125	11/05/65	Walker	Rate command evaluation
1-56-128	11/09/65	Mallick	Rate command evaluation
1-57-129	11/09/65	Mallick	Rate command evaluation
1-58-130	11/10/65	Mallick	Rate command evaluation
1-59-132	11/18-65	Mallick	Large unbalance
1-60-134	11/30/65	Mallick	Rate command evaluation
1-61-135	11/30/65	Mallick	Rate command evaluation
1-62-136	12/01/65	Mallick	Rate command evaluation
1-63-137	12/01/65	Mallick	Rate command evaluation
1-64-138	12/02/65	Mallick	Rate command evaluation
1-65-139	12/02/65	Mallick	Rate command evaluation
1-66-140	12/03/65	Mallick	Rate command evaluation
1-67-141	12/06/65	Mallick	Rate command evaluation
1-68-143	12/06/65	Mallick	Large Pitch unbalance
1-69-146	12/07/65	Mallick	Rate command evaluation
1-70-147	12/08/65	Mallick	Rate command evaluation
1-71-148	12/08/65	Mallick	Rate command evaluation
1-72-149	12/10/65	Mallick	System checkout
1-73-150	12/13/65	Kluever	Pilot checkout
1-74-151	12/13/65	Kluever	Pilot checkout
1-75-152	12/14/65	Kluever	Pilot checkout
1-76-153	12/15/65	Kluever	Pilot checkout; Lunar simulation
1-77-154	12/15/65	Kluever	Pilot checkout; Lunar simulation
1-78-157	2/04/66	Mallick	New instrument panel evaluation
1-79-161	2/11/66	Mallick	New instrument panel evaluation
1-80-162	2/14/66	Kluever	New instrument panel evaluation
1-81-163	2/15/66	Kluever	Pilot checkout; Control evaluation
1-82-164	2/16/66	Kluever	Pilot checkout; Large angle maneuvers
1-83-165	2/16/66	Kluever	Pilot checkout; Lunar simulation
1-84-166	2/17/66	Mallick	Systems checkout
1-85-168	2/18/66	Kluever	Pilot checkout; Control evaluation
1-86-175	3/11/66	Mallick	Side arm controller checkout
1-87-176	3/11/66	Mallick	Side arm controller checkout; Lunar simulation
1-88-183	3/14/66	Mallick	Side arm controller checkout; Lunar simulation
1-89-184	3/15/66	Mallick	Side arm controller checkout; Lunar simulation
1-90-185	3/15/66	Mallick	Side arm controller checkout; Lunar simulation
1-91-188	3/17/66	Mallick	Side arm controller checkout; Lunar simulation
1-92-191	3/18/66	Mallick	Side arm controller checkout; Lunar simulation
1-93-192	3/18/66	Kluever	Side arm controller checkout; Lunar simulation
1-94-193	3/23/66	Kluever	Side arm controller checkout; Lunar simulation
1-95-194	3/24/66	Mallick	Side arm controller checkout; Lunar simulation
1-96-195	3/25/66	Mallick	Side arm controller checkout; Lunar simulation

1-97-196	3/28/66	Mallick	Side arm controller checkout; Lunar simulation
1-98-197	3/29/66	Mallick	Side arm controller checkout; Lunar simulation
1-99-198	3/30/66	Cluever	Side arm controller checkout; Lunar simulation
1-100-200	3/31/66	Cluever	Side arm controller checkout; Lunar simulation
1-101-201	3/31/66	Cluever	Side arm controller checkout; Lunar simulation
1-102-202	4/01/66	Cluever	Drag evaluation
1-103-203	4/06/66	Mallick	Drag evaluation
1-104-204	4/06/66	Mallick	Drag evaluation
1-105-205	4/07/66	Mallick	Drag evaluation
1-106-206	4/07/66	Mallick	Drag evaluation
1-107-207	4/13/66	Mallick	Systems checkout
1-108-208	4/13/66	Cluever	Drag evaluation
1-109-209	4/14/66	Cluever	Drag evaluation
1-110-211	4/15/66	Cluever	Drag evaluation
1-111-212	4/15/66	Mallick	Drag evaluation
1-112-214	4/20/66	Mallick	Drag evaluation
1-113-215	4/20/66	Mallick	Lunar module trajectories
1-114-216	4/20/66	Mallick	Lunar module trajectories
1-115-217	4/21/66	Mallick	Lunar module trajectories
1-116-218	4/22/66	Cluever	Lunar module trajectories
1-117-219	4/22/66	Cluever	Lunar module trajectories
1-118-223	5/12/66	Cluever	ACS Backup due to phase problem
1-119-224	5/13/66	Cluever	Lost telemetry
1-120-225	5/13/66	Cluever	Demonstration for Robert R. Gilruth, director of NASA's Space Task Group
1-121-227	5/18/66	Cluever	System checkout
1-122-228	5/19/66	Mallick	System checkout
1-123-230	5/19/66	Mallick	Anemometer evaluation
1-124-231	5/23/66	Mallick	Attitude command evaluation
1-125-232	5/24/66	Mallick	Attitude command evaluation
1-126-233	5/26/66	Cluever	Attitude command evaluation
1-127-234	5/26/66	Cluever	Attitude command evaluation
1-128-235	5/26/66	Mallick	Attitude command evaluation
1-129-236	5/26/66	Mallick	Attitude command evaluation
1-130-237	5/26/66	Mallick	Attitude command evaluation
1-131-238	5/27/66	Cluever	Attitude command evaluation
1-132-239	5/27/66	Cluever	Attitude command evaluation
1-133-241	6/01/66	Cluever	Attitude command evaluation
1-134-246	6/13/66	Cluever	Attitude command evaluation
1-135-248	6/14/66	Cluever	Attitude command evaluation
1-136-249	6/14/66	Cluever	Attitude command evaluation
1-137-251	6/15/66	Cluever	Attitude command evaluation
1-138-252	6/15/66	Cluever	Attitude command evaluation
1-139-255	6/16/66	Cluever	Stuck valve light on; Broken wire
1-140-261	7/18/66	Mallick	System checkout
1-141-262	7/18/66	Mallick	System checkout
1-142-265	7/19/66	Mallick	Lunar module trajectories
1-143-266	7/19/66	Mallick	Lunar module trajectories
1-144-267	7/19/66	Mallick	Valve stuck light on; Could not reproduce
1-145-269	7/21/66	Mallick	Lunar module trajectories
1-146-270	7/21/66	Mallick	Lunar module trajectories
1-147-271	7/22/66	Mallick	Lunar module trajectories
1-148-272	7/22/66	Mallick	Lunar module trajectories

1-149-273	7/22/66	Mallick	Lunar module trajectories
1-150-275	7/25/66	Kluever	Re-familiarization; Remove vehicle drogue
1-151-276	7/27/66	Kluever	Lunar module trajectories
1-152-277	8/01/66	Kluever	Lunar module trajectories
1-153-281	8/01/66	Kluever	Lunar module trajectories
1-154-282	8/01/66	Kluever	Lunar module trajectories
1-155-286	8/03/66	Algranti	Pilot checkout
1-156-287	8/03/66	Algranti	Pilot checkout
1-157-288	8/05/66	Mallick	Lunar module trajectories
1-158-293	8/08/66	Kluever	Check jet engine alignment
1-159-295	8/09/66	Kluever	Maintenance checkout
1-160-296	8/09/66	Kluever	Maintenance checkout
1-161-299	8/12/66	Algranti	Pilot checkout
1-162-300	8/16/66	Algranti	Pilot checkout
1-163/301	8/16/66	Algranti	Pilot checkout
1-164-302	8/16/66	Kluever	Lunar simulation checkout
1-165-303	8/17/66	Algranti	Pilot checkout
1-166-304	8/17/66	Algranti	Pilot checkout
1-167-305	8/17/66	Kluever	System checkout
1-168-306	8/18/66	Algranti	Pilot checkout
1-169-307	8/18/66	Algranti	Pilot checkout
1-170-308	8/18/66	Algranti	Pilot checkout
1-171-309	8/19/66	Algranti	Pilot checkout
1-172-310	8/19/66	Algranti	Pilot checkout
1-173-311	8/19/66	Algranti	Pilot checkout
1-174-313	8/19/66	Kluever	Lunar module trajectories; 180 degree turn
1-175-315	8/22/66	Ream	Pilot checkout
1-176-316	8/22/66	Ream	Pilot checkout
1-177-318	8/24/66	Kluever	Maintenance checkout
1-178-319	8/25/66	Kluever	Maintenance checkout
1-179-320	8/25/66	Ream	Pilot checkout
1-180-321	8/25/66	Ream	Pilot checkout
1-181-322	8/29/66	Kluever	Maintenance checkout
1-182-323	8/29/66	Ream	Pilot checkout
1-183-324	8/30/66	Ream	Pilot checkout
1-184-325	8/30/66	Kluever	Maintenance checkout
1-185-326	8/31/66	Ream	Pilot checkout
1-186-328	9/01/66	Ream	Pilot checkout
1-187-329	9/01/66	Ream	Pilot checkout
1-188-330	9/01/66	Ream	Pilot checkout
1-189-331	9/01/66	Kluever	Lunar module trajectories; 180 degree turn
1-190-332	9/01/66	Ream	Pilot checkout
1-191-333	9/01/66	Ream	Pilot checkout
1-192-336	11/18/66	Kluever	System checkout
1-193-337	11/18/66	Kluever	System checkout
1-194-340	11/23/66	Kluever	System checkout
1-195-341	11/29/66	Kluever	System checkout
1-196-343	11/29/66	Kluever	System checkout
1-197-344	11/30/66	Kluever	System checkout
1-198-345	11/30/66	Kluever	System checkout

LLRV VEHICLE # 2 FLIGHT LOG

2-1-17	1/11/67	Kluever	System checkout
2-2-18	1/11/67	Kluever	System checkout
2-3-19	1/11/67	Kluever	System checkout
2-4-20	1/13/67	Kluever	System checkout
2-5-21	1/13/67	Kluever	System checkout
2-6-22	1/13/67	Kluever	System checkout

Pilots

LLRV #1 1st Flight 10-30-64 – to Houston in December 1966

PILOTS: Joseph A. Walker, NASA FRC

Donald L. Mallick, NASA FRC

Emil “Jack” Kluever, Army Pilot assigned to NASA FRC

Joseph Algranti, NASA Manned Spacecraft Center

Harold E. “Bud” Ream, NASA Manned Spacecraft Center

LLRV #2 1st Flight 01-11-67 – to Houston January 1967

PILOT: Emil “Jack” Kluever, Army Pilot Assigned to NASA FRC

From the Pilot Office Log – “LLRV-Walker”

November 17, 1964 – Canceled due to snow

March 25, 1964 – Canceled due to wind

March 29, 1965 – Canceled–temp gage out

May 14, 1965 – Canceled due to wind

July 8, 1965 – Ground Run–Walker

August 5, 1965 – Scheduled and canceled

November 8, 1965 – Canceled due to wind

November 19, 1965 – Canceled due to wind

January 31, 1966 – Ground Run–Mallick

February 1, 1966 – Canceled due to wind and weather

February 4, 1966 – Flight delayed 1 hour

February 17, 1966 – 2nd Flight aborted

March 14, 1966 – Delayed to 11:00 AM from 9:30 AM (1 flt)

March 22, 1966 – Canceled due to wind

March 30, 1966 – Aborted 2nd mission

April 12, 1966 – Canceled due to wind

May 9, 1966 – Canceled due to wind

May 10, 1966 – Canceled due to wind

May 16, 1966 – No flights due to wind

May 17, 1966 – No LLRV flights

June 2, 1966 – Canceled due to wind

June 6, 1966 – Canceled due to wind

June 20, 1966 – Canceled

June 28, 1966 – Seat Firing

August 2, 1966 – Ground Runs

August 10, 1966 – Canceled due to wind

August 11, 1966 – Canceled due to wind

August 26, 1966 – Canceled due to wind

Late August 25 – Center says, “Ambulance and fire truck not available.”

December 6, 1966 – Canceled due to weather

Appendix I: Accidents

Crash of LLRV No. 1

On 17 October 1968, NASA released to the press a summary of the combined findings of NASA investigation and review boards regarding the accident at Ellington AFB on 6 May that resulted in the destruction of LLRV No. 1.

On May 6, 1968, at 2:38 p.m., EDT, while on a training flight, Lunar Landing Research Vehicle No. 1 crashed at Ellington Air Force Base, Tex. After losing control of the vehicle on a simulated lunar landing approach, the pilot, Astronaut Neil Armstrong, ejected from the vehicle and landed by parachute with only superficial injuries. The LLRV was damaged beyond repair.

Two investigation boards have cited a loss of attitude control as the cause of an accident that destroyed the National Aeronautics and Space Administration's experimental Moon landing trainer. One board was appointed to determine what caused the accident, the other to review and study its effects on the lunar landing program.

In the mishap last May 6, Astronaut Neil Armstrong escaped with minor injuries when he ejected just before the crash and landed by parachute. The Lunar Landing Research Vehicle (LLRV), a flying simulator built to train pilots for landing operations on the Moon, was a total loss.

An accident board appointed by Dr. Robert R. Gilruth, Director of NASA's Manned Spacecraft Center, Houston, found that the pilot was forced to escape a few seconds after the loss of helium pressure in the propellant tanks caused premature shutdown of the attitude control rocket system.

The other board, appointed by NASA Deputy Administrator Dr. T. O. Paine to review the mishap and study its possible impact on the Apollo program discovered no bad effects on the lunar landing project, particularly the Lunar Module which will be landed by two astronauts on the Moon.

The Review Board agreed with the Accident Board in calling for certain design improvements and operating practices in the LLRV, and urged more stringent control over such flying programs and greater attention to all of NASA's lunar landing simulators.

The accident at Ellington Air Force Base, near Houston, took place shortly after Armstrong began flying the LLRV in a simulated lunar landing. The wingless vertical flying vehicle has a conventional jet engine for normal use on Earth. When flying as a lunar vehicle, its jet engine compensates for 5/6 of the LLRV's weight, thereby simulating the Moon's gravity. Lift rockets propel the craft and 16 small rockets in clusters give the pilot control of attitude. The LLRV carries enough propellant to fly eight minutes on its jet engine and 80 seconds on its lift rockets.

The mishap occurred when the vehicle reached a hovering position about 30 feet above ground. Due to a loss of thrust from the lift rockets, the LLRV started to descend, but when the pilot shifted controls back to normal Earth flight operations, it began climbing. Then, apparently because the pilot was warned too late of running low on propellant for his attitude control rockets, he lost control of the vehicle. The pilot immediately ejected, when the craft was about 200 feet above ground and beginning to nose up and roll over.

A large quantity of data on operation of the vehicle, collected by telemetry, furnished complete information on the LLRV's complicated control system and components. It showed that the helium was inadvertently depleted earlier than normal.

Both boards noted that the source of trouble was the loss of helium pressure through the hydrogen peroxide propellant from the tanks to the lift rockets and the small thrusters operated by the pilot to control attitude.

Normally the LLRV can be flown and landed safely with its gimbal mounted jet engine and attitude control thrusters even after the propellant supply to the lift rockets is depleted, but this calls for quick action by the pilot as soon as warning comes.

The MSC Board said this action amounted to a “critical pilot task during the heavy workload period which developed on this flight.” It laid the basic difficulty on design deficiency because the helium pressurization for attitude control is not protected against loss through the lift rocket system.

Although a standpipe system provided reserve hydrogen peroxide for the attitude control system, the board said there was no automatic backup pressurization, which is necessary to force the propellant into the control engines.

As set up in the LLRV, the helium can escape through the standpipe outlet into the lift engines when the propellant level falls below the top of the standpipe. Because of circumstances on this flight, helium was being lost one second before the pilot’s warning light came on steadily. The MSC report noted that the LLRV pilot handbook indicates the pilot has enough propellant for about six seconds of normal flight time after the “propellant low” warning comes on.

A fraction of a second before the pilot’s warning light came on, the control van crew noted a flicker of the “propellant low” warning light and directed the pilot to end his simulated lunar landing and transfer lift control to his jet engine.

“By the time the pilot could react and check his corresponding light,” the report said, “the helium pressurization gas was already venting overboard and rocket lift was beginning to decay. The early onset of a problem with no warning caught the pilot by surprise and undoubtedly added some confusion to a most time-critical situation in the control van.”

Among contributing causes, the MSC board concluded that the sensing system in one propellant tank failed to warn the pilot of a low level of propellant, so that he could revert safely to normal Earth operation.

It also said the operating crew in the ground control van had inadequate warning of the abnormally low propellant supply, and that the crew failed to diagnose the loss of pressure in the tanks; that the pilot failed to shift one control handle at a critical point, and; that the high and gusty winds prevailing had an adverse effect on propellant consumption.

The Board also asserted the pilot’s handbook contained confusing and contradictory information on the subject of control rocket propellant, and said the LLRV’s double attitude control system was used excessively, resulting in abnormally high propellant consumption.

In its report on the case, the Review Board criticized the design of the control system because it failed to protect against loss of helium pressurization into the lift rocket system. The combination of circumstances produced the rapid and complete loss of helium pressurization.

The Review Board also found the LLRV’s warning system too small and poorly placed to be adequate. It said the ground crew had not perfected and practiced for such contingencies.

The Review Board recommended improved organization and management of the LLRV project, because of its importance to the Apollo program. The MSC Board listed 16 recommendations—six of them directly concerned with improvements in the LLRV and its systems—and called for a safety review of the entire LLRV program; operational criteria for wind conditions and for use of the two attitude control systems in combination; for control van crew and operations; for a computer and other improvements in the control van; for review of pilot training; modification of the pilot’s handbook; addition of fire and rescue equipment and added manpower, particularly for use on the control van team.

The Review Board said additional sensing probes to measure propellant level—one

of the most important items in the cause of this accident—should be installed before any more flights of either the LLRV or its advanced version, the Lunar Landing Training Vehicle (LLTV).

That Board also called for a master warning light in better position for pilot vision, for safety wind criteria for all such flights, and for establishment of better communications, responsibilities and emergency procedures in the astronaut training program.

In addition, the Review Board said all critical vehicle systems in the program should be examined, and criteria set up clearly for their operation, including “red-lines” and “go-no go” limits.

MSC management, the board said, should take whatever steps are necessary to improve the integration of the lunar landing simulator project into the Apollo program, in order to enhance its value in training astronauts for lunar landing operations, and to make sure adequate resources are applied.

Because the Lunar Landing Training Vehicle has the same rocket fuel systems as the LLRV, the Review Board recommended it be corrected in similar ways.

Following a comprehensive study of the Lunar Module, the Review Board said it could find “no significant problems as a result of the LLRV accident,” and recommended no changes to the LM. On the contrary, it suggested that the ascent propellant level detector on the LM’s propulsion system be examined for possible use on the simulators.

“Generally,” the Review Board concluded, “technical rigor has been instilled into the Apollo Program to a remarkable degree. Hardware, design, test and operation procedures for normal and emergency events, provision for reliability and safety, and training of ground and flight crews are specified in detail by formal documentation and are closely controlled by program personnel.”

In its follow-up action, NASA has initiated or completed work on all recommendations raised by the two boards. To carry out a comprehensive review of the safety of the lunar flight simulators, a flight readiness evaluation board has been formed in the Office of Manned Space Flight, at Headquarters. The review is being fully operated at the Manned Spacecraft Center. All actions are being monitored by the Headquarters Director of Safety.

Results of the Investigation

The findings and conclusions sections of the accident report noted “the particular care and attention” that LLRV program personnel had devoted to the emergency ejection system that saved the life of Neil Armstrong:

One additional finding that is worthy of note is the value of the particular care and attention that was devoted to the emergency pilot eject system of the vehicle. All personnel involved in the LLRV program fully appreciated the importance of this emergency system. Considerable attention to both engineering excellence and to operational rigor was given to this system. The vehicle was kept out of service for several months in order to update the pyrotechnic elements of the ejection system and to assure its proper operation in the unusual flight modes it may be required to cope with. While in no way relevant to avoiding the accident, this particular care and rigor may possibly have contributed to saving the life of pilot-astronaut Armstrong.

The single, ultimate cause of the accident was a loss of attitude control due to the inadvertent depletion of helium pressurant for the propellant supply system. Leading up to this ultimate cause was a set of circumstances or contributory causes which, in combination, produced the inevitable result. In contrast with many accidents, in which a single initiating, or primary cause may be identified, the sequence of events and combination of circumstances producing the end result was particularly complex. Fortunately, the comprehensive telemetering allows a very accurate reconstruction of a sequence of events, the majority of which took place within a 30-second time period.

From these telemetered flight data, the televised tape, and the color movie film that is tied to the voice transmission sequence, cause and effect can be closely related. From this information it is evident that there were several contributing causes to the accident.

The following chart shows the action taken with regard to each of the recommendations of the board investigating the crash of LLTV No. 1 on 8 December 1968.

Recommendation	Action Taken
Conduct wind-tunnel tests to provide sufficient aerodynamic data from which the aerodynamic operating limits of the LLTV can be established. Verification of this data should be accomplished during flight tests.	Accomplished.
Reconfigure control systems such that deflecting the attitude controller against the hard stops will cause the system to switch to sets of attitude thrusters.	Accomplished.
Provide the pilot with a cockpit display of (1) airflow speed and direction, and (2) control authority indications in all axes.	(1) Accomplished. (2) Hardware procured but not installed on vehicles.
Reconfigure the TM van monitor station locations and displays at each station to effectively implement the flight director concept. This should include the displays of yaw rocket authority and an X-Y plotter presentation of airspeed and direction.	Accomplished. X-Y plotter later discarded since same information is given on Dynamics panel meters.
Provide an effective yaw reference that is within the pilot's normal field of view while flying the LLTV.	Accomplished.
Increase the thrust output of the attitude rocket systems as much as is feasible.	Accomplished [rockets could be adjusted to 90 lbs., 60 lbs. selected].
Revise the LLTV Operations Manual so that it provides specific descriptions of the flight profiles to be used. All profiles shall depict allowable wind conditions.	Accomplished by adding profiles and wind restrictions to mission plans.
Implement a means of measuring the existing wind profile from the surface through an altitude of 700 feet.	AF team on duty March 1969 [at Ellington LLTV site].
Provide adequate crash/rescue protection.	AF helicopter unit on duty April 1969.
Investigate means of alleviating leg injury on ejection.	Not accomplished. Present system satisfactory.
Implement a system of data review to investigate detected or suspected anomalies.	Accomplished. Routine analysis performed before each flight.

LLTV No. 1 Accident–Draft News Release

DRAFT–News Release for LLTV No. 1 Accident Investigation Board Report

Aerodynamic forces overcame the vehicle's attitude control system and caused the December 8 crash of the Lunar Landing Training Vehicle (LLTV) No. 1 from which pilot Joseph Algranti safely ejected. The crash took place at Ellington near the NASA Manned Spacecraft Center during a lunar landing simulation flight of the wingless vehicle. A Board was appointed immediately after the crash by Manned Spacecraft Center Director Robert R. Gilruth, and was chaired by Captain Walter M. Schirra, Jr.

Through a reconstruction of the four-minute flight from telemetry tapes, motion pictures and videotapes, the Board determined that there had been no mechanical malfunction to cause the accident. The Board concluded:

1. That the primary cause of the accident was that the vehicle entered a region of flight where aerodynamic moments overpowered the control system in use such that attitude control was lost. The source of the control problem was not identified by either the pilot or the TM van in time to add a second control system which could have restored control capability.

2. That the adverse region of flight was entered because:

- (a) The aerodynamic limitations of the LLTV were not completely known by anyone.
- (b) The existing wind conditions were insufficiently accounted for in preflight and real-time flight planning.
- (c) The configuration of displays in both the LLTV and the supporting TM van inadequately defined the existing flight conditions.

Since the crash of LLTV No. 1, LLTV No. 3 has been tested in a Langley Research Center wind tunnel to measure the vehicle's responses to various wind conditions.

The crash occurred following a normal climb to 680 feet and positioning of the LLTV to begin the simulated lunar landing.

As the pilot began the simulated lunar landing run, the turbojet engine which subtracts five-sixths of the vehicle's weight was released from its fixed normal vertical thrust position (vertical relative to vehicle). Shortly after the lunar simulation run had begun, the LLTV attitude began to oscillate about all three axes. The pilot attempted to regain control of the vehicle by relocking the turbojet engine in its normal position.

The vehicle continued to oscillate (maximum 102 degrees bank) until it exceeded the point where the turbojet engine and the lift rockets could counteract gravity. The LLTV began a rapid descent, and at about 100 feet altitude the pilot ejected from the vehicle as it oscillated through the horizontal plan. Descent velocity has been estimated at 95 feet per second (64.8 mph) at the time of ejection.

The ejection seat propelled the pilot back to an altitude of 200 feet where the parachute opened. The parachute drifted well away from the LLTV impact and fireball, and the pilot was uninjured except for minor thigh bruises caused by the force of ejection. An earlier version of the LLTV, the Lunar Landing Research Vehicle, crashed May 6, 1968, when loss of helium rocket fuel pressurant caused loss of attitude control. Pilot Neil A. Armstrong ejected safely away from the vehicle.

In the report to the Manned Spacecraft Center Director, the LLTV Accident Investigation Board made 11 recommendations aimed toward improved flight safety in the future LLTV flight tests and astronaut lunar-landing training:

- Conduct wind tunnel tests to measure LLTV aerodynamic characteristics so that operating limits can be set.
- Redesign attitude control system to automatically select both sets of LLTV attitude thrusters when the pilot controller hits the hard stops.
- Provide an improved cockpit display of airflow velocity and direction as well as displays of attitude control ability in all directions.
- Revamp telemetry and ground control vans to include improved attitude control

displays and a real-time plotboard of vehicle airspeed and direction.

- Relocate into the pilot's field of view an improved yaw reference indicator.
- Increase thrust output of the attitude thrusters.
- Revise LLTV Operations Manual to spell out all details of various flight profiles to be flown, including wind condition tolerances.
- Measure the existing winds up to an altitude of 700 feet.
- Provide adequate crash rescue protection.
- Investigate ways to lessen pilot leg injuries in ejection.
- Review all flight data systematically to uncover any abnormal situations with flight hazard potential.

Crash of LLTV No. 2

Nearly nine months after the launch of Apollo 13, LLTV No. 2 crashed and burned on 29 January 1971, MSC staff pilot Stuart M. Present ejecting safely before the crash. The following two press releases issued on the incident—given here in their entirety—detail the incident and give the findings of the NASA board that investigated the accident.

MSC 71-05

29 January 1971

HOUSTON, TEXAS—Stuart M. Present, 40, an MSC staff pilot, ejected today from a lunar landing training vehicle at Ellington Air Force Base, Texas. He was not injured.

Preliminary investigation indicates that a loss of electrical power was the cause of the crash. Up to the time electrical power was lost, the attitude control system and the lunar module hand controller appeared to be functioning normally.

Christopher C. Kraft, Jr., MSC Deputy Director, said, "A complete investigation will be made of the accident. This accident should not affect Apollo 14. The only piece of hardware common to the LM and the LLTV is the hand controller, and that does not appear to have been the problem. The LLTV electrical system is totally different from the one in the lunar module."

Present was on a routine check flight when the accident occurred at 10:35 a.m., CST. He ejected moments before the vehicle crashed on a runway and burned. He had made 28 previous LLTV flights, beginning in April, 1970.

MSC 71-79

18 October 1971

HOUSTON, TEXAS—A NASA Investigation Board cited electrical system malfunction as the principal cause of the Lunar Landing Training Vehicle crash at Ellington AFB, Houston, Texas, on January 29, 1971. NASA Research Pilot Stuart Present, the sole occupant, ejected safely and received superficial cuts and bruises of the legs.

A five-man investigating board headed by Astronaut John Young concluded that the LTV [sic] Electrical Flight Control System lost its primary power source, the generator, and switching malfunctions prevented the battery from supplying emergency power. The LLTV, without its stabilizing control system, went out of control and crashed.

Before flight operations are resumed, the board recommended that the electrical system be modified to prevent these malfunctions, and ensure that the backup power is available to the flight control system.

[Years later, Dean Grimm said that the main cause of the electrical system's failure to switch over to the battery-powered emergency bus was an unknown high residual magnetic field present during its failure mode from the primary DC power source, the main DC generator on the jet engine's gearbox.]

GE replaced the original generator with an upgraded model intended to improve reliability, but the upgraded model prevented the switchover circuitry from engaging

the emergency bus. Data analysis from the accident showed that the exhaust from the ejection-seat rocket had caused the jet engine to flame out, causing the DC generator to spin down, removing the magnetic field and enabling the emergency bus to activate with battery power. At that point, the attitude rockets began firing as the vehicle crashed.

This obscure failure mode had been unidentified in Bell's formal Failure Mode and Effects Analysis (FMEA). The incident remains a good example of the need to be cautious about making product improvement changes in a system that works.

Sources

Armstrong, Neil A. "Wingless on Luna," 25th Wings Club Gen. Harold R. Harris 'Sight' Lecture, Grand Hyatt Hotel, New York, N.Y., 18 May 1988.

Bellman, Donald R. and Gene J. Matranga. *Design and Operational Characteristics of a Lunar-Landing Research Vehicle*. Washington, D.C.: NASA TN D-3023, 1965.

Bilstein, Roger E. *Orders of Magnitude: A History of the NACA and NASA, 1915-1990*. Washington, D.C.: NASA SP-4406.

Brooks, Courtney G. James M. Grimwood, and Lloyd S. Swenson. *Chariots for Apollo: A History of Manned Lunar Spacecraft*. Washington, D.C.: NASA-SP-4205, 1979.

Campbell, John P. *Vertical Take Off and Landing Aircraft*. New York: Macmillan Co., 1962.

Cheatham, Donald C., and Clarke T. Hackler. "Handling Qualities for Pilot Control of Apollo Lunar-Landing Spacecraft." *Journal of Spacecraft and Rockets* 3, no. 5 May 1966.

Dathe, H.M. "Review of Hovering Control Requirements for VTOL Aircraft by a Flight Dynamics Analysis." AGARD Report 472, July 1963.

Dethloff, Henry C. *Suddenly Tomorrow Came: A History of the Johnson Space Center, 1957-1990*. Washington, D.C.: NASA SP-4307, 1993.

Garren Jr., John F., James R. Kelly, and John P. Reeder. *A Visual Flight Investigation of Hovering and Low-Speed VTOL Control Requirements*. Washington, D.C.: NASA TN D-2788, 1965.

Glennan, T. Keith. *The Birth of NASA: The Diary of T. Keith Glennan*. ed. J.D. Hunley. Washington, D.C.: NASA SP-4105, 1993.

Hallion, Richard P. *On the Frontier: Flight Research at Dryden, 1946-1981*. Washington, D.C.: NASA STIB, 1984.

Hansen, James R. *Spaceflight Revolution: NASA Langley Research Center from Sputnik to Apollo*. Washington, D.C.: NASA SP-4308, 1995.

Jarvis, Calvin R. *Operational Experience with the Electronic Flight Control Systems of a Lunar-Landing Research Vehicle*. Washington, D.C.: NASA TN D-3689, 1966.

_____. *Flight-Test Evaluation of an On-Off Rate Command Attitude Control System of a Manned Lunar-Landing Research Vehicle*. Washington, D.C.: NASA TN D-3903, April, 1967.

Jenkins, Dennis R. *Hypersonics Before the Shuttle: A Concise History of the X-15 Research Airplane*. Washington, D.C.: NASA SP-2000-4518, 2000.

Matranga, Gene J. and Neil A. Armstrong. *Approach and Landing Investigation at Lift-*

Drag Ratios of 2 to 4 Utilizing a Straight-Wing Fighter Airplane. Washington, D.C.: NASA TM X-31, 1959.

Matranga, Gene J. et al. *Handling Qualities and Trajectory Requirements for Terminal Lunar Landing, as Determined from Analog Simulation.* Washington, D.C.: NASA TN D-1921, 1963.

Reed, R. Dale with Darlene Lister. *Wingless Flight: The Lifting Body Story.* Washington, D.C.: NASA SP-4220, 1997.

Rolls, L. Stewart, Fred J. Drinkwater III, and Robert C. Innis, "Effects of Lateral Control Characteristics on Hovering a Jet Lift VTOL Aircraft." Washington, D.C.: NASA TN D-2788, 1965.

Seamans, Robert C. Jr. *Aiming at Targets: The Autobiography of Robert C. Seamans, Jr.* Washington, D.C.: NASA SP-4106, 1996.

Thompson, Milton O. *At the Edge of Space: The X-15 Flight Program.* Washington, D.C.: Smithsonian Institution Press, 1992.

Tomayko, James E. *Computers Take Flight: A History of NASA's Pioneering Digital Fly-by-Wire Project.* Washington, DC: NASA SP-2000-4224, 2000.

Wallace, Lane E. *Flights of Discovery: 50 Years at the NASA Dryden Flight Research Center.* Washington, D.C.: NASA SP-4309, 1996.

Waltman, Gene L. *Black Magic and Gremlins: Analog Flight Simulations at NASA's Flight Research Center.* Washington, D.C.: NASA SP-2000-4520, 2000.

Unpublished Sources

Adkins, Elmore J. Memo to research division chief on visit to Naval Ordnance Test Station concerning lunar landings, 7 August 1961.

Algranti, Joe. Personal notes, 4 July 2000.

Bell Aerosystems "Thrust/Weight Computer." Interoffice memo No. 325:63:0712:1-JR, 12 July 1963.

Bell Aerosystems Lunar Landing Training Vehicle Flight Manual, Revision B, 1 September 1969.

Bellman, Donald R. Memo to those concerned with the lunar landing and takeoff simulator program on oral presentation of results of Bell study contract, 15 March 1962.

_____. Memo for those concerned with lunar landing and take off simulator program on visit to Bell Aerosystems Company, Buffalo, NY, to discuss provisions of lunar landing and take off simulator work statement, 3 April 1962.

_____. Memo for those concerned with the lunar landing and take-off simulator on findings on visits to Marquardt Corporation and Walter Kidde Company, 10, 13 April 1962.

_____. Memo to Bernard J. Mayrbat on Technical Evaluation of Proposals Received on PR-88: Ejection Seat, Light Weight, Zero Speed, Zero Altitude Capability, 9 August 1963.

_____. Memo to those concerned with the LLRV on report on LLRV design review, 24 June 1963.

_____. Memo for director on visit to Bell Aerosystems Company to discuss management relations between Bell and the FRC, 15 July 1963.

_____. Memo for file on visit to Bell to discuss LLRV program status and problems, 15 October 1963.

_____. Briefing charts, Proposed Free-Flight Lunar-Landing Simulator Program, 9 January 1962.

_____. Memo to FRC personnel concerned with lunar landing simulator program on telephone conversation with Mr. Ken Levin, Bell Aerosystems Company, 18-19 January 1962.

_____. Memo to concerned with lunar landing simulator program on telephone conversation with Mr. Ken Levin of Bell Aerosystems Company and with Mr. Laurence Loftin of Langley Research Center 24-25 January 1962.

_____. Memo for those concerned with FRC lunar landing simulator on visit to the Langley Research Center to discuss lunar landing simulators 26, 27 February 1962.

Bellman, Donald R. and Gene J. Matranga. Memo to those concerned with the lunar landing simulator project on information received during second visit to Bell Aerosystems Company 1-5 February 1962.

Bendix Products Aerospace Division. "Analytical Study of LLRV/LLTV Structure," Final, 9 March 1966.

Bikle, Paul F. Letter to Dr. Stanley Hooker of Bristol-Siddley Engines, Ltd., regarding visit on 21 January 1963 of Gene J. Matranga, 3 April 1963.

_____. Letter to Arthur Geraghty of Rolls Royce, Ltd., regarding a visit by Gene J. Matranga on 22 January 1963, 3 April 1963.

_____. Letter to Jack C. Heberlig at the MSC on revised funding plan for the LLRV, 4 December 1963.

_____. Memo to NASA headquarters on LLRV progress, report #16 for the period ending 30 October 1964, 10 November 1964.

_____. Memo to NASA headquarters on LLRV progress, report #17 for the period ending 30 November 1964, 8 December 1964. LLRV flight 1-2-26 Notes, 16 November 1964.

_____. Memo to NASA headquarters on LLRV progress, report #18 for the period ending 31 December 1964, 12 January 1965. LLRV flight 1-8-33 Notes, 8 December 1964.

_____. Memo to NASA headquarters on LLRV progress, report #20 for the period ending 28 February 1965, 8 March 1965.

_____. Memo to NASA headquarters on LLRV progress, report #23 for the period ending 31 May 1965, 9 June 1965.

_____. Memo to NASA headquarters on LLRV progress, report #24 for the Period Ending 30 June 1965, 13 July 1965.

_____. Memo to NASA Headquarters on LLRV progress, report #29 for the period ending 30 November 1965, 14 December 1965.

_____. Memo to NASA headquarters on LLRV progress, report #30 for the period ending 31 December 1965, and January 1966.

_____. Memo to NASA headquarters on LLRV progress, report #32 for the period ending 28 February 1966.

_____. Memo to NASA headquarters on LLRV progress, report #33 for the period ending 31 March 1966, 18 April 1966.

_____. Memo to NASA headquarters on LLRV progress, report #36 for the period ending 31 July 1966, 10 August 1966.

_____. Memo to NASA headquarters on LLRV progress, report #40 for the period ending 31 January 1967, 6 February 1967.

_____. Memo to those concerned on LLRV awards presentation, 17 February 1965.

Feasibility Study for a Lunar Landing Research Vehicle. Bell Aerosystems Report 7161-950001, 8 March 1962.

FRC Lunar Landing Simulation Program Chronology.

Gilruth, Robert R. Letter to Gene J. Matranga commenting on his impression of the LLRV demonstration flight, 18 May 1966.

_____. Letter to Paul F. Bikle, 4 November 1965.

_____. Letter to Paul F. Bikle on completion of LLRV program at FRC, 28 February 1967.

_____. Letter to Dale Myers, 27 February 1970.

_____. Letter to NASA Headquarters, 1 April 1969; Final Accident Investigation Board Report of the Lunar Landing Training Vehicle No. 1 Crash on 8 December 1968, 12 March 1969.

Jarvis, Calvin R. LLRV Flight Control Systems Test Program, memorandum for LLRV project manager, March 1964.

_____. Memo to LLRV project manager on LLRV flight 1-17 automatic throttle evaluation, 3 May 1965.

Kraft, Chris. Memo to NASA headquarters requesting LLTV operations to begin at Cape Kennedy in the 3rd Quarter of 1968, 17 January 1967.

LLRV Accident Report and Report by the NASA Accident Review Board on the Flight Accident with LLRV No. 1 on 6 May 1968, 12 July 1968.

LLRV flight 1-9-34 notes, 9 December 1964.

LLRV flight 1-10-35 notes, 9 December 1964.

“LLRV Jet engine Stabilization System,” Bell Aerosystems interoffice memo, 22 April 1963.

LLTV B-1 Flight Readiness Review, [Section] B, FMEA Review, 25 July 1968.

Low, George M. Memo to distribution on formation of lunar lander research vehicle coordination panel, 26 May 1964.

Matranga, Gene J. Memo to research division chief on FRC research relating to lunar landings, 12 July 1961.

_____. Memo to those concerned with the lunar landing simulator project on visit to Bell Aerosystems Company 19-27 February 1962.

_____. Memo for LLRV project manager on trip report on visit to MSC on 12, 22 April 1963.

_____. Memo to LLRV project manager on visit to Bell Aerosystems Company, NY, 17-19 September 1963, 7 October 1963.

_____. Memo for LLRV contracting officer on deletion of instrument panel and supporting pedestal installation on LLRV, 18 November 1963.

_____. Memo to LLRV personnel on reassignment of working hours, 11 June 1965.

_____. Memo for files on LLRV pre-flight procedures, 2 June 1965.

_____. Memo to those concerned on meeting held during the week of 17 October relating to the LLRV, 26 October 1965.

_____. Private notes on the visit of Thomas Finch to the MSC, 24 April 1963.

_____. Unpublished private notes of phone call from Ottinger concerning jet engine testing, 14 August 1963.

_____. Unpublished private notes of phone calls concerning the qualification of jet engine parts from Mayrbat to Holmes of Bell contracts and from Matranga and Cox to Ottinger, 17 April 1963, and from Ottinger to Matranga, 18-19 April 1963.

_____. Unpublished notes of the meeting with Bill Swope, August 1961.

_____. Unpublished private notes of phone call from Ottinger and Syposs to Matranga and Cox, 16 April 1963.

Mathews, Charles W. Letter to Robert R. Gilruth, 17 November 1969.

Mayrbat, Bernard J. Memo for file documenting 10 April 1963 meeting with General Electric on service support, 10 April 1963.

McKay, James M. Memo for vehicle and systems dynamics branch head on results of the lunar landing research vehicle structural and design analysis meeting at Bell Aerosystems Company, NY, 17-19, 25 September 1963.

Minutes of the meeting of the Flight Readiness Review Board for Lunar Landing Training Vehicles, NASA MSC, Houston, TX, 12 January 1970.

Minutes of Flight Readiness Review Board, Lunar Landing Training Vehicles, MSC, 12 January 1970; Joe Algranti, flight log notes and letter to Wayne Ottinger, 28 August 2000.

Minutes of the LLTV No. 2 Flight Readiness Review Board, 13 June 1969.

Mortensen, E. H. Letter to J. C. McCollom at NASA on transportation of LLRVs, 24 August 1966.

Mueller, George E. Letter to Robert R. Gilruth, 19 February 1969.

_____. Memo to Robert R. Gilruth, 9 November 1967.

NASA Headquarters Release No. 68-182, 17 October 1968.

Project 1055, Proposal for the Development of a Soft Landing Vehicle. U.S. Naval Ordnance Test Station, China Lake, CA, 5 October 1961.

Proposal for a Free Flight Lunar Landing Simulator Study. Bell Aerosystems Report D7161-953001.

“Report of Lunar Landing training program conducted by Apollo program office and mission operations directorate.” NASA MSC, 31 March 1966.

Riper, Richard Van. Unpublished summary of LLRV to LLTV avionics changes, 3 August 2000.

Ryken, J. *Study of Modification of a Lunar Landing Research Vehicle to a Lunar Landing Training Vehicle*, Bell Report 7260-945001, Contract NAS 4-981, 26 January 1966.

Searcy, J. D. “Qualification Testing of LLRV Ejection System.” Weber Aircraft TR-344, Burbank, CA, 23 September 1966.

Simmons S. Richard. Memo to LLRV personnel concerned on tour of duty, 20 May 1966.

Slayton, Donald K. (Deke). LLRV/LLTV Monthly Progress Report, MSC, 19 January 1967.

_____. MSC LLRV/LLTV Monthly Progress Report, 27 April 1967.

_____. Memo to Kennedy Space Center, 8 October 1969.

_____. Memo to acting manager of flight safety office, 23 September 1968.

_____. Memo to acting manager of flight safety office, 23 September 1968. LLRV Accident Report, 12 July 1968.

_____. Memo to MSC manager of reliability and quality assurance, 15 August 1969.

Smith, John W. Memo to research division chief on proposal 'analog study simulating lunar landing,' 6 November 1962.

Walker, Joseph A. Evaluation of Bell Fixed Base Lunar Landing Simulation, 27 February 1962.

Washko, Joseph T. Memo to research division chief on meeting with experimental track branch, AFFTC, 7 August 1961.

_____. Memo to research division chief on meeting with experimental track branch, AFFTC, 28 August 1961.

Interviews

Algranti, Joe. Interviewed by Wayne Ottinger.

Drake, Hubert M. and Gerald Truszynski. Interview by Gary Krier and John D. Hunley, NASA Dryden Flight Research Center, Edwards, CA, 15 November, 1996.

Drake, Hubert M. Interview by John D. Hunley, NASA Ames Research Center, Moffett Field, CA, 16 April, 1997.

Grimm, Dean. Interview by Ivan D. Ertel, MSC historian, 1 April 1971.

Grimm, Dean. Interview by Wayne Ottinger, 5 August 2000.

Jarvis, Cal. Interviewed by MSC Historian Ivan D. Ertel, 28 July 1971.

Cluever, Emil E. "The LLRV Program Flight Experience." Unpublished.

Levin, Ken. Notes from an interview by MSC Historian Ivan D. Ertel, 8 June 1971.

Rusnak, Walt. "LLRV Reminiscences," 15 March, 2000.

Glossary

Break-out force: The force a pilot must apply before the control lever, typically a joy stick, initiates a command. The force is small, measured in a few pounds. There also is a deadband in conjunction with the break-out force, an area of stick motion that results in no control input at all. This deadband allows a small range of motion to ensure that each small bit of movement does not translate into a command. The break-out force is the force necessary to go beyond the deadband, and initiate a command to the control surface.

Closed-loop: A system that employs a sensor that interprets the pilot's command and, through a feedback loop, electronically modifies the original input before it ever reaches the surface to be commanded. A *closed-loop* system ensures the pilot does not over-control or damage the aircraft. See also *open-loop*.

Cooper-Harper Handling Qualities Rating Scale: A system used by test pilots to assess the handling qualities of aircraft. Moving from one extreme to another, in which 1 represents "thorough control" and 10 represents "no control," the rating attempts to establish a uniform method of assessing aircraft handling.

Control torque: The distance from a force (H_2O_2 control rocket, in the case of the LLRV) to the center of gravity, times that force (rocket force measured in pounds of thrust).

Damping: The suppression of oscillations or disturbances in a control surface.

FRC: Flight Research Center, Edwards Air Force Base, CA. This Center underwent a number of name changes over the years and held this designation from 1959 to 1976. It is now the Hugh L. Dryden Flight Research Center (DFRC).

H_2O_2 : Hydrogen Peroxide, a molecule with two atoms of oxygen and two atoms of hydrogen. In concentrations of 90% or more, H_2O_2 can serve as a mono propellant. Passed over a catalyst, the molecule decomposes into steam, easily powering a turbine or serving as rocket thrust. Decomposition leaves only oxygen and water, nearly ideal in any environment.

Hysteresis: The slack that exists in a mechanical control system after the controls have been fully deflected in one direction and are then moved in the opposite direction. A train that has come to a complete stop, for instance, tends to compress all the physical links between cars. When the locomotive begins pulling again it travels a negligible—but real—distance before the caboose itself moves. That lag is hysteresis. Early computer-controlled flight controls, even though electronic, suffered hysteresis from the slow translation of input commands to the control surfaces themselves, often resulting in dramatic Pilot Induced Oscillations (PIO). Rocket motors powered by H_2O_2 are merely another form of control surface.

Jet logic: The manner or sequence in which the attitude rockets are fired to achieve the desired response in vehicle control.

JSC: Johnson Space Center, in Houston, TX. Formerly the Manned Spacecraft Center, it was renamed in honor of President Lyndon B. Johnson.

KSC: Kennedy Space Center, named for President John F. Kennedy. Located on the eastern coast of Florida, it serves as the primary facility for U.S. human space flight launches.

LLRV and *LLTV*: Lunar Landing Research Vehicle and Lunar Landing Training Vehicle.

MSC: Manned Spacecraft Center, located in Houston, TX; established in 1961 and later renamed Johnson Space Center.

Moment arm: In its most familiar example, a moment arm is a lever. For a given weight, the farther from the fulcrum, the less force necessary to lift the weight. In an aircraft, the farther a force is located from the center of gravity (point of rotation)—the small control rockets on the LLRV, for instance—the less force necessary to produce control.

Monopropellant: Many rocket motors rely on two components that are combined to form a chemical reaction, generating thrust. This is known as a bi-propellant. One such example is hydrazine and nitrogen tetroxide. By contrast, for the LLRV NASA employed hydrogen peroxide as a monopropellant in the rocket motors, a system derived from experience with reaction motors used on the X-15.

Open Loop: A control system with no feedback; a direct link such as the cables and pushrods in a small airplane. Its opposite, a *closed-loop* system, employs a sensor that interprets the pilot's action and, through a feedback system, electronically modifies the original input before it reaches the surface. The faster airplanes flew, the more a *closed-loop* system was needed to ensure the pilot did not over-control or damage the aircraft.

Parallax: The difference in the apparent direction or position of an object when viewed from different points in space around the object itself; expressed as an angle.

Passivation: The cleansing of a surface to make it chemically less reactive. This process was necessary because of the highly corrosive nature of hydrogen peroxide used as rocket fuel on the LLRV. Passivation involved treating all parts exposed to the propellant to minimize uncontrolled decomposition, which could also cause an explosion.

Polar moment of inertia: The product of mass times the square of the distance from the axis of rotation. Take, for instance, the drive shaft, or central axis, of a gyroscope, around which the wheel spins; the greater the distance from wheel to central shaft (the larger the wheel's diameter), the greater the *polar moment of inertia*.

Potentiometers: A method of measuring voltage differences by comparing them to a known voltage. The voltage in question is usually quite low.

Potting compound: A compound such as room-temperature vulcanizing rubber used to separate objects. Adaptive in odd spaces, solid and non-conductive yet not rigid, the material was ideal for isolating avionics boxes from LLRV vibrations.

Radians: An engineering method of expressing angles of a circle, or degrees. One radian equals 57.2958 degrees. In this case it was a method of calculating the roll rate of the LLRV as "radians per second."

Rocket duty cycle: The ratio or percentage of the time a rocket spends firing versus the time it is shut off. If a rocket fires for one second and is off for one second, its duty cycle would be 1:1, or 50%.

SFC: Specific Fuel Consumption is the amount of fuel, measured in pounds per hour, consumed by an engine for each pound of thrust developed.

Servo mechanisms: Control systems in which input forces by a pilot are routed through a mechanism that multiplies the force, and then activates the object being controlled in a manner proportional to the pilot's input. For the LLRV, NASA engineers sought a mechanical link rather than bleed-air from the engine when controlling the jet engine's alignment.

Single string: A single electronic connection between the pilot and the object being commanded, such as rocket motor. Such a system contains no redundancy and the entire system is subject to failure. By contrast, a multi-channel string, such as a three-channel string, routes the same control command over three paths, or strings, providing redundancy. An electronic system monitors the three strings in case one transmits a reading different from the other two. In the event of such an incident, a pre-programmed logic will vote the failing system out of the loop, leaving the other two to transmit the command.

Telemetry: Data generated by sensors placed on a vehicle, which is sent electronically to a control station monitoring the vehicle in operation. This data might be simply recorded, but more typically it also is analyzed in real time, allowing those in the control room to observe parameters of the vehicle and its flight while the flight occurs. The pilot may have some of this data displayed in the cockpit, but the bulk of the information is directed at engineers on the ground.

Transducers: A mechanism that translates a signal from one form of energy into another form of energy. One familiar example is a stereo speaker that translates electronic energy into sound.

'*Qs:*' Informal expression for 'cues;' should not be confused with "q," the engineering symbol used to represent dynamic pressure.

Six-degree-of-freedom: A reference to vehicular motion along six planes. The first three are longitudinal, lateral, and vertical motion relative to the Earth's surface, while the second three, pitch, roll and yaw motion, are relative to the vehicle's body-axis reference.

Threshold: The minimum signal level required to initiate an action, such as firing an attitude rocket.

Index

Algranti, Joseph: 31, 116-117, 138-139, 142, 147
Apollo: ix, xi, 35, 90, 106, 112, 125, 138, 141-2, 154
Armstrong, Neil A.: v, vi, 80, 106, 115, 139, 142, 150-151, 154-156
Auto throttle: 53, 55, 94
Baron, Robert: 118-127
Beeler, De: 12, 69,
Bell Aerosystems Corporation: 6-7, 10, 16, 18, 21, 29, 31-35, 51, 59, 61, 64, 66, 70-72, 74, 89, 91,
114, 118, 125, 128, 138
Bellman, Donald: 8, 11, 17, 19, 30, 33, 35-37, 62, 70, 79, 82, 89
Bikle, Paul: 8, 10, 20, 21, 29, 35, 60, 69, 82, 99, 103, 120, 127, 153-154
Caw, Lawrence: 28, 31
Control van: 90-91
Crossfield, A. Scott: 102
Day, Richard: 19, 31, 35-36
Dorenberger, Walter: 32
Drake, Hubert M.: 4-5, 12, 19-20
Dyna-Soar: 32
Ejection Seat: 25-7, 113-115, 135, 141
Ellington Air Force Base: 115, 125, 138-139, 149, 151
EOR/LOR: 4, 125
F-104: xi, 50, 116
Faget, Maxim: 19, 36
Flying Bedstead: 5
Fly-by-wire: 40, 50, 84, 153-154
Frost, Laurence: 36, 118
Gemini: ix
General Electric CF-700: 9-11, 16, 19, 21, 24-25, 29, 37, 68, 91, 127-131, 134, 140
Gilruth, Robert: 12, 21, 112, 120, 126, 145-146, 151
Gimbal-locked mode: 55
Gobarty, Arthur: 67
Grimm, Dean: 28, 31, 33, 35-6, 126-127, 147
H₂O₂ (Hydrogen Peroxide): 16, 43, 69, 142
Helicopter: 29, 79, 88, 107, 109, 117, 119, 134, 139, 141
Houbolt, John C: 3-4
Jarvis, Calvin: 28, 60, 62, 64, 70-72, 74, 94
Johnson, Lyndon B: 67-70
Kellogg, Raymond: 60-61, 118
Kennedy Space Center (KSC): 125-126
Kennedy, John F: ix, 3, 32
Kluever, Emil "Jack": 28-9, 79, 90, 109, 111-116, 118-119, 142
Langley Research Center (LaRC): 3-4, 7, 19-20-79, 117
Levin, Ken: 7-9, 13, 24, 27, 33, 125
Low, George: 7

Lunar Landing Research Facility: 12, 147
Lunar Module (LM): 27, 91, 106, 108, 110-11, 114, 125, 128-130, 132, 134-136, 149-150
Lunar simulation mode: 52-53, 65, 92-96, 99, 100-103, 115-117
M2-F1: 25
MacNamara, Robert: 32
Mallick, Donald: 26-7, 67, 89, 96, 98, 107, 110-2
Manned Spacecraft Center (MSC): 13, 29, 35-36, 79, 85, 106, 111-112, 114-115, 117, 119-120, 126-127, 138-140, 142-143
Matranga, Gene: 4-5, 7, 11, 19, 24, 28, 31, 34-35, 53, 70, 79, 96-97, 112, 120, 127
McKay, John: 31
Mercury: ix, xi, 12, 19, 35
Naval Ordnance Test Station (NOTS): 5
Ottinger, Wayne: 24, 31-2, 36-37, 61, 64, 69, 74-76, 79-80, 82, 103, 112, 115, 140
Pendegraff, Al: 60-61, 118
Rate gyro: 45-47
Ream, H. C. "Bud": 116-117
Rogallo, Francis: 19
Rolls Royce: 5
Rusnak, Walter: 7, 31, 52, 99
Seamans, Robert: 20
Slayton, Donald K. "Deke": 126, 140
South Base: 82, 81, 99-100, 103, 112, 127, 155
Sputnik: ix
Thrust-to-weight computer: 53-55
Vensel Joseph: 37, 79, 82
Von Braun, Wernher: 3
Walker, Joseph: 12, 27-28, 30, 67, 69, 72-74, 77, 80, 84-89, 91, 94, 97-103, 107, 116
Webb, James: 3, 88
Weber Corporation: 24-25, 113
White, Raymond: 67, 76, 83-4, 118-9
Williams, Walter: 7, 12, 19-21
Wilson, William: 75-6
Wind tunnel: 30
X-1: 67
X-14: 6, 11, 40
X-15: 11, 16, 31-2, 60, 62, 77, 87, 116, 153-154
X-3: 12
XB-70: 80, 103, 109
Zwink, Leon: 31, 52, 60, 71-2, 94

Reference Works, NASA SP-4000

Grimwood, James M. *Project Mercury: A Chronology*. NASA SP-4001, 1963.

Grimwood, James M., and Barton C. Hacker, with Peter J. Vorzimmer. *Project Gemini Technology and Operations: A Chronology*. NASA SP-4002, 1969.

Link, Mae Mills. *Space Medicine in Project Mercury*. NASA SP-4003, 1965.

Astronautics and Aeronautics, 1963: Chronology of Science, Technology, and Policy. NASA SP-4004, 1964.

Astronautics and Aeronautics, 1964: Chronology of Science, Technology, and Policy. NASA SP-4005, 1965.

Astronautics and Aeronautics, 1965: Chronology of Science, Technology, and Policy. NASA SP-4006, 1966.

Astronautics and Aeronautics, 1966: Chronology of Science, Technology, and Policy. NASA SP-4007, 1967.

Astronautics and Aeronautics, 1967: Chronology of Science, Technology, and Policy. NASA SP-4008, 1968.

Ertel, Ivan D., and Mary Louise Morse. *The Apollo Spacecraft: A Chronology, Volume I, Through November 7, 1962*. NASA SP-4009, 1969.

Morse, Mary Louise, and Jean Kernahan Bays. *The Apollo Spacecraft: A Chronology, Volume II, November 8, 1962-September 30, 1964*. NASA SP-4009, 1973.

Brooks, Courtney G., and Ivan D. Ertel. *The Apollo Spacecraft: A Chronology, Volume III, October 1, 1964-January 20, 1966*. NASA SP-4009, 1973.

Ertel, Ivan D., and Roland W. Newkirk, with Courtney G. Brooks, *The Apollo Spacecraft: A Chronology, Volume IV, January 21, 1966-July 13, 1974*. NASA SP-4009, 1978.

Astronautics and Aeronautics, 1968: Chronology of Science, Technology, and Policy. NASA SP-4010, 1969.

Newkirk, Roland W., and Ivan D. Ertel, with Courtney G. Brooks, *Skylab: A Chronology*. NASA SP-4011, 1977.

Van Nimmen, Jane, and Leonard C. Bruno, with Robert L. Rosholt. *NASA Historical Data Book, Volume I: NASA Resources, 1958-1968*. NASA SP-4012, 1976, reprinted 1988.

Ezell, Linda Neuman. *NASA Historical Data Book, Volume II: Programs and Projects, 1958-1968*. NASA SP-4012, 1988.

Ezell, Linda Neuman. *NASA Historical Data Book, Volume III: Programs and Projects, 1969-1978*. NASA SP-4012, 1988.

Gawdiak, Ihor, with Helen Fedor. *NASA Historical Data Book, Volume IV: NASA Resources, 1969-1978*. NASA SP-4012, 1994.

- Rumerman, Judy A. *NASA Historical Data Book, Volume V: NASA Launch Systems, Space Transportation, Human Spaceflight, and Space Science, 1979-1988*. NASA SP-4012, 1999.
- Rumerman, Judy A. *NASA Historical Data Book, Volume VI:† Space Applications, Aeronautics, and other topics, 1979-1988*. NASA SP-4012, 1999.
- Astronautics and Aeronautics, 1969: Chronology of Science, Technology, and Policy*. NASA SP-4014, 1970.
- Astronautics and Aeronautics, 1970: Chronology of Science, Technology, and Policy*. NASA SP-4015, 1972.
- Astronautics and Aeronautics, 1971: Chronology of Science, Technology, and Policy*. NASA SP-4016, 1972.
- Astronautics and Aeronautics, 1972: Chronology of Science, Technology, and Policy*. NASA SP-4017, 1974.
- Astronautics and Aeronautics, 1973: Chronology of Science, Technology, and Policy*. NASA SP-4018, 1975.
- Astronautics and Aeronautics, 1974: Chronology of Science, Technology, and Policy*. NASA SP-4019, 1977.
- Astronautics and Aeronautics, 1975: Chronology of Science, Technology, and Policy*. NASA SP-4020, 1979.
- Astronautics and Aeronautics, 1976: Chronology of Science, Technology, and Policy*. NASA SP-4021, 1984.
- Astronautics and Aeronautics, 1977: Chronology of Science, Technology, and Policy*. NASA SP-4022, 1986.
- Astronautics and Aeronautics, 1978: Chronology of Science, Technology, and Policy*. NASA SP-4023, 1986.
- Astronautics and Aeronautics, 1979-1984: Chronology of Science, Technology, and Policy*. NASA SP-4024, 1988.
- Astronautics and Aeronautics, 1985: Chronology of Science, Technology, and Policy*. NASA SP-4025, 1990.
- Noordung, Hermann. *The Problem of Space Travel: The Rocket Motor*. Edited by Ernst Stuhlinger and J.D. Hunley, with Jennifer Garland. NASA SP-4026, 1995.
- Gawdiak, Ihor Y., Ramon J. Miro, and Sam Stueland, compilers. *Astronautics and Aeronautics, 1986-1990: A Chronology*. NASA SP-4027, 1997.
- Gawdiak, Ihor Y. and Shetland, Charles. *Astronautics and Aeronautics, 1990-1995: A Chronology*. NASA SP-2000-4028, 2000.
- Orloff, Richard W. *Apollo by the Numbers: A Statistical Reference*. NASA SP-2000-4029, 2000.

Management Histories, NASA SP-4100

- Rosholt, Robert L. *An Administrative History of NASA, 1958-1963*. NASA SP-4101, 1966.
- Levine, Arnold S. *Managing NASA in the Apollo Era*. NASA SP-4102, 1982.
- Roland, Alex. *Model Research: The National Advisory Committee for Aeronautics, 1915-1958*. NASA SP-4103, 1985.
- Fries, Sylvia D. *NASA Engineers and the Age of Apollo*. NASA SP-4104, 1992.

Glennan, T. Keith. *The Birth of NASA: The Diary of T. Keith Glennan*. Edited by J.D. Hunley. NASA SP-4105, 1993.

Seamans, Robert C. *Aiming at Targets: The Autobiography of Robert C. Seamans*. NASA SP-4106, 1996.

Garber, Stephen J., editor. *Looking Backward, Looking Forward: Forty Years of Human Spaceflight Symposium*. NASA SP-2002-4107, 2002.

Mallick, Donald L. with Peter W. Merlin. *The Smell of Kerosene: A Test Pilot's Odyssey*. NASA SP-4108, 2003.

Iloff, Kenneth W. and Curtis L. Peebles. *From Runway to Orbit: Reflections of a NASA Engineer*. NASA SP-2004-4109, 2004.

Chertok, Boris. *Rockets and People, Volume 1*. NASA SP-2005-4110, 2005.

Laufer, Alexander, Post, Todd, and Hoffman, Edward. *Shared Voyage: Learning and Unlearning from Remarkable Projects*. NASA SP-2005-4111, 2005.

Dawson, Virginia P. and Bowles, Mark D., *Realizing the Dream of Flight: Biographical Essays in Honor of the Centennial of Flight, 1903-2003*. NASA SP-2005-4112.

Project Histories, NASA SP-4200

Swenson, Loyd S., Jr., James M. Grimwood, and Charles C. Alexander. *This New Ocean: A History of Project Mercury*. NASA SP-4201, 1966, reprinted 1999.

Green, Constance McLaughlin, and Milton Lomask. *Vanguard: A History*. NASA SP-4202, 1970; reprinted edition by Smithsonian Institution Press, 1971.

Hacker, Barton C., and James M. Grimwood. *On Shoulders of Titans: A History of Project Gemini*. NASA SP-4203, 1977, reprinted 2002.

Benson, Charles D. and William Barnaby Faherty, *Moonport: A History of Apollo Launch Facilities and Operations*. NASA SP-4204, 1978.

Brooks, Courtney G., James M. Grimwood, and Loyd S. Swenson, Jr. *Chariots for Apollo: A History of Manned Lunar Spacecraft*. NASA SP-4205, 1979.

Bilstein, Roger E. *Stages to Saturn: A Technological History of the Apollo/Saturn Launch Vehicles*. NASA SP-4206, 1980 and 1996.

Compton, W. David, and Charles D. Benson. *Living and Working in Space: A History of Skylab*. NASA SP-4208, 1983.

Ezell, Edward Clinton, and Linda Neuman Ezell. *The Partnership: A History of the Apollo-Soyuz Test Project*. NASA SP-4209, 1978.

Hall, R. Cargill. *Lunar Impact: A History of Project Ranger*. NASA SP-4210, 1977.

Newell, Homer E. *Beyond the Atmosphere: Early Years of Space Science*. NASA SP-4211, 1980.

Ezell, Edward Clinton, and Linda Neuman Ezell. *On Mars: Exploration of the Red Planet, 1958-1978*.

NASA SP-4212, 1984.

Pitts, John A. *The Human Factor: Biomedicine in the Manned Space Program to 1980*.

NASA SP-4213, 1985.

Compton, W. David. *Where No Man Has Gone Before: A History of Apollo Lunar Exploration Missions*.

NASA SP-4214, 1989.

Naugle, John E. *First Among Equals: The Selection of NASA Space Science Experiments* NASA SP-4215, 1991.

Wallace, Lane E. *Airborne Trailblazer: Two Decades with NASA Langley's 737 Flying Laboratory*.

NASA SP-4216, 1994.

Butrica, Andrew J. *Beyond the Ionosphere: Fifty Years of Satellite Communications*. NASA SP-4217, 1997.

Butrica, Andrew J. *To See the Unseen: A History of Planetary Radar Astronomy*. NASA SP-4218, 1996.

Mack, Pamela E., ed. *From Engineering Science to Big Science: The NACA and NASA Collier Trophy Research Project Winners*. NASA SP-4219, 1998.

Reed, R. Dale, with Darlene Lister. *Wingless Flight: The Lifting Body Story*. NASA SP-4220, 1998.

Heppenheimer, T. A. *The Space Shuttle Decision: NASA's Search for a Reusable Space Vehicle*. NASA SP-4221, 1999.

Hunley, J. D., ed. *Toward Mach 2: The Douglas D-558 Program*. NASA SP-4222, 1999.

Swanson, Glen E., ed. "Before This Decade is Out..." *Personal Reflections on the Apollo Program*. NASA SP-4223, 1999.

Tomayko, James E. *Computers Take Flight: A History of NASA's Pioneering Digital Fly-By-Wire Project*. NASA SP-4224, 2000.

Morgan, Clay. *Shuttle-Mir: The United States and Russia Share History's Highest Stage*. SP-2001-4225.

Leary, William M. *We Freeze to Please: A History of NASA's Icing Research Tunnel and the Quest for Safety*. NASA SP-2002-4226, 2002.

Mudgway, Douglas J. *Uplink-Downlink: A History of the Deep Space Network, 1957-1997*. NASA SP-2001-4227, 2001.

Dawson, Virginia P. and Mark D. Bowles. *Taming Liquid Hydrogen: The Centaur Upper Stage Rocket, 1958-2002*. NASA SP-2004-4230, 2004.

Center Histories, NASA SP-4300

Rosenthal, Alfred. *Venture into Space: Early Years of Goddard Space Flight Center*. NASA SP-4301, 1985.

Hartman, Edwin, P. *Adventures in Research: A History of Ames Research Center, 1940-1965*. NASA SP-4302, 1970.

Hallion, Richard P. *On the Frontier: Flight Research at Dryden, 1946-1981*. NASA SP-4303, 1984.

Muenger, Elizabeth A. *Searching the Horizon: A History of Ames Research Center, 1940-1976*. NASA SP-4304, 1985.†

Hansen, James R. *Engineer in Charge: A History of the Langley Aeronautical Laboratory, 1917-1958*. NASA SP-4305, 1987

Dawson, Virginia P. *Engines and Innovation: Lewis Laboratory and American Propulsion Technology*. NASA SP-4306, 1991.

Dethloff, Henry C. “*Suddenly Tomorrow Came...*”: *A History of the Johnson Space Center, 1957-1990*. NASA SP-4307, 1993.

Hansen, James R. *Spaceflight Revolution: NASA Langley Research Center from Sputnik to Apollo*. NASA SP-4308, 1995.

Wallace, Lane E. *Flights of Discovery: An Illustrated History of the Dryden Flight Research Center*. NASA SP-4309, 1996.

Herring, Mack R. *Way Station to Space: A History of the John C. Stennis Space Center*. NASA SP-4310, 1997.

Wallace, Harold D., Jr. *Wallops Station and the Creation of an American Space Program*. NASA SP-4311, 1997.

Wallace, Lane E. *Dreams, Hopes, Realities:† NASA’s Goddard Space Flight Center, The First Forty Years*. NASA SP-4312, 1999.

Dunar, Andrew J. and Stephen P. Waring. *Power to Explore: A History of Marshall Space Flight Center, 1960-1990*. NASA SP-4313, 1999.

Bugos, Glenn E. *Atmosphere of Freedom: Sixty years at the NASA Ames Research Center*. NASA SP-2000-4314, 2000.

Schultz, James. *Crafting Flight: Aircraft Pioneers and the Contributions of the Men and Women of NASA Langley Research Center*. NASA SP-2003-4316, 2003.

General Histories, NASA SP-4400

Corliss, William R. *NASA Sounding Rockets, 1958-1968: A Historical Summary*. NASA SP-4401, 1971.

Wells, Helen T., Susan H. Whiteley, and Carrie Karegeannes. *Origins of NASA Names*. NASA SP-4402, 1976.

Anderson, Frank W., Jr. *Orders of Magnitude: A History of NACA and NASA, 1915-1980*. NASA SP-4403, 1981.

Sloop, John L. *Liquid Hydrogen as a Propulsion Fuel, 1945-1959*. NASA SP-4404, 1978.

Roland, Alex. *A Spacefaring People: Perspectives on Early Spaceflight*. NASA SP-4405, 1985.

Bilstein, Roger E. *Orders of Magnitude: A History of the NACA and NASA, 1915-1990*. NASA SP-4406, 1989.

Logsdon, John M., ed., with Linda J. Lear, Janelle Warren Findley, Ray A. Williamson, and Dwayne A. Day. *Exploring the Unknown: Selected Documents in the History of the U.S. Civil Space Program, Volume I, Organizing for Exploration*. NASA SP-4407, 1995.

Logsdon, John M., ed, with Dwayne A. Day, and Roger D. Launius. *Exploring the Unknown: Selected Documents in the History of the U.S. Civil Space Program, Volume II, External Relationships*. NASA SP-4407, 1996.

Logsdon, John M., ed., with Roger D. Launius, David H. Onkst, and Stephen J. Garber. *Exploring the Unknown: Selected Documents in the History of the U.S. Civil Space Program, Volume III, Using Space*. NASA SP-4407, 1998.

Logsdon, John M., ed., with Ray A. Williamson, Roger D. Launius, Russell J. Acker, Stephen J. Garber, and Jonathan L. Friedman. *Exploring the Unknown: Selected Documents in the History of the U.S. Civil Space Program, Volume IV, Accessing Space*. NASA SP-4407, 1999.

Logsdon, John M., ed., with Amy Paige Snyder, Roger D. Launius, Stephen J. Garber, and Regan Anne Newport. *Exploring the Unknown: Selected Documents in the History of the U.S. Civil Space Program, Volume V, Exploring the Cosmos*. NASA SP-4407, 2001.

Logsdon, John M., ed., with Stephen J. Garber, Roger D. Launius, and Ray A. Williamson. *Exploring the Unknown: Selected Documents in the History of the U.S. Civil Space Program, Volume VI: Space and Earth Science*. NASA SP-2004-4407, 2004.

Siddiqi, Asif A., *Challenge to Apollo: The Soviet Union and the Space Race, 1945-1974*. NASA SP-2000-4408, 2000.

Hansen, James R., editor. *The Wind and Beyond: Journey into the History of Aerodynamics in America, Volume 1, The Ascent of the Airplane*. NASA SP-2003-4409, 2003.

Monographs in Aerospace History, NASA SP-4500

Launius, Roger D. and Aaron K. Gillette, compilers. *Toward a History of the Space Shuttle: An Annotated Bibliography*. Monographs in Aerospace History, No. 1, 1992

Launius, Roger D. and J.D. Hunley, compilers. *An Annotated Bibliography of the Apollo Program*. Monographs in Aerospace History, No. 2, 1994.

Launius, Roger D. *Apollo: A Retrospective Analysis*. Monographs in Aerospace History, No. 3, 1994.

Hansen, James R. *Enchanted Rendezvous: John C. Houbolt and the Genesis of the Lunar-Orbit Rendezvous Concept*. Monographs in Aerospace History, No. 4, 1995.

Gorn, Michael H. *Hugh L. Dryden's Career in Aviation and Space*. Monographs in Aerospace History, No. 5, 1996.

Powers, Sheryll Goecke. *Women in Flight Research at NASA Dryden Flight Research Center from 1946 to 1995*. Monographs in Aerospace History, No. 6, 1997.

Portree, David S.F. and Robert C. Trevino. *Walking to Olympus: An EVA Chronology*. Monographs in Aerospace History, No. 7, 1997.

Logsdon, John M., moderator. *Legislative Origins of the National Aeronautics and Space Act of 1958: Proceedings of an Oral History Workshop*. Monographs in Aerospace History, No. 8, 1998.

Rurerman, Judy A., compiler. *U.S. Human Spaceflight, A Record of Achievement 1961-1998*. Monographs in Aerospace History, No. 9, 1998.

- Portree, David S. F. *NASA's Origins and the Dawn of the Space Age*. Monographs in Aerospace History, No. 10, 1998.
- Logsdon, John M. *Together in Orbit: The Origins of International Cooperation in the Space Station*. Monographs in Aerospace History, No. 11, 1998.
- Phillips, W. Hewitt. *Journey in Aeronautical Research: A Career at NASA Langley Research Center*. Monographs in Aerospace History, No. 12, 1998.
- Braslow, Albert L. *A History of Suction-Type Laminar-Flow Control with Emphasis on Flight Research*. Monographs in Aerospace History, No. 13, 1999.
- Logsdon, John M., moderator. *Managing the Moon Program: Lessons Learned From Apollo. Proceedings of an Oral History Workshop Conducted July 21, 1989*. Monographs in Aerospace History, No. 14, 1999.
- Perminov, V.G. *The Difficult Road to Mars: A Brief History of Mars Exploration in the Soviet Union*. Monographs in Aerospace History, No. 15, 1999.
- Maisel, Martin, Demo J. Giulanetti, and Daniel C. Dugan. *The History of the XV-15 Tilt Rotor Research Aircraft: From Concept to Flight*. Monographs in Aerospace History, No. 17. NASA SP-2000-4517, 2000.
- Jenkins, Dennis R. *Hypersonics Before the Shuttle: A Concise History of the X-15 Research Airplane*. Monographs in Aerospace History, No. 18. NASA SP-2000-4518, 2000.
- Chambers, Joseph R. *Partners in Freedom: Contributions of the Langley Research Center to U.S. Military Aircraft of the 1990s*. Monographs in Aerospace History, No. 19. NASA SP-2000-4519, 2000.
- Waltman, Gene L. *Black Magic and Gremlins: Analog Flight Simulations at NASA's Flight Research Center*. Monographs in Aerospace History, No. 20. NASA SP-2000-4520, 2000.
- Portree, David S.F. *Humans to Mars: Fifty Years of Mission Planning, 1950-2000*. Monographs in Aerospace History, No. 21. NASA SP-2001-4521, 2001.
- Thompson, Milton O. with J.D. Hunley. *Flight Research: Problems Encountered and What They Should Teach Us*. Monographs in Aerospace History, No. 22. NASA SP-2001-4522, 2001.
- Tucker, Tom. *The Eclipse Project*. Monographs in Aerospace History, No. 23. NASA SP-2001-4523, 2001.
- Siddiqi, Asif A. *Deep Space Chronicle: A Chronology of Deep Space and Planetary Probes 1958-2000*. Monographs in Aerospace History, No. 24. NASA SP-2002-4524, 2002.
- Merlin, Peter W. *Mach 3+: NASA/USAF YF-12 Flight Research, 1969-1979*. Monographs in Aerospace History, No. 25. NASA SP-2001-4525, 2001.
- Anderson, Seth B. *Memoirs of an Aeronautical Engineer: Flight Tests at Ames Research Center: 1940-1970*. Monographs in Aerospace History, No. 26. NASA SP-2002-4526, 2002.
- Renstrom, Arthur G. *Wilbur and Orville Wright: A Bibliography Commemorating the One-Hundredth Anniversary of the First Powered Flight on December 17, 1903*. Monographs in Aerospace History, No. 27. NASA SP-2002-4527, 2002.
- No Monograph No. 28.

Chambers, Joseph R. *Concept to Reality: Contributions of the NASA Langley Research Center to U.S. Civil Aircraft of the 1990s*. Monographs in Aerospace History, No. 29. NASA SP-2003-4529, 2003.

Peebles, Curtis, editor. *The Spoken Word: Recollections of Dryden History, The Early Years*. Monographs in Aerospace History, No. 30. NASA SP-2003-4530, 2003.

Jenkins, Dennis R., Tony Landis, and Jay Miller. *American X-Vehicles: An Inventory- X-1 to X-50*. Monographs in Aerospace History, No. 31. NASA SP-2003-4531, 2003.

Renstrom, Arthur G., compiler, with Roberta W. Goldblatt, Carl Minkus, and Karen L. Berube. *Wilbur and Orville Wright: A Chronology Commemorating the One-Hundredth Anniversary of the First Powered Flight on December 17, 1903*. Monographs in Aerospace History, No. 32. NASA SP-2003-4532, 2002.

Bowles, Mark D. and Arrighi, Robert S. *NASA's Nuclear Frontier: The Plum Brook Research Reactor*. Monographs in Aerospace History, No. 33. NASA SP-2004-4533, 2003.

McCurdy, Howard E. *Low Cost Innovation in Spaceflight: The History of the Near Earth Asteroid Rendezvous (NEAR) Mission*. NASA SP-2005-4536.

Lambright, W. Henry. *NASA and the Environment: The Case of Ozone Depletion*. NASA SP-2005-4538.

Seamans, Robert C. Jr. *Project Apollo: The Tough Decisions*. NASA SP-2005-4537.

Dryden Historical Studies

Tomayko, James E., Christian Gelzer, editor. *The Story of Self-Repairing Flight Control Systems*. Dryden Historical Study #1, 2003.

Electronic Media, SP-4600

Remembering Apollo 11: The 30th Anniversary Data Archive. (CD-ROM) NASA SP-4601, 1999.

The Mission Transcript Collection: U.S. Human Spaceflight Missions from Mercury Redstone 3 to Apollo 17. NASA SP-2000-4602, 2001.

Shuttle-Mir: the United States and Russia Share History's Highest Stage. NASA SP-2001-4603, 2002.

U.S. Centennial of Flight Commission presents Born of Dreams ~ Inspired by Freedom. NASA SP-2004-4604, 2004.

Of Ashes and Atoms: A Documentary on the NASA Plum Brook Reactor Facility. NASA SP-2005-4605.

Taming Liquid Hydrogen: The Centaur Upper Stage Rocket. (CD-ROM) NASA SP-2004-4606, 2004.

Fueling Space Exploration: The History of NASA's Rocket Engine Test Facility. (DVD) NASA SP-2005-4607.

