

**COMMERCIAL-SCALE DEMONSTRATION OF THE  
LIQUID PHASE METHANOL (LPMEOH™) PROCESS**

**FINAL REPORT  
(Volume 2: Project Performance and Economics)  
for the period 16 October 1992 – 30 June 2003**

**Prepared by:**

**E. C. Heydorn and B. W. Diamond  
Air Products and Chemicals, Inc.  
Allentown, PA**

**and**

**R. D. Lilly  
Eastman Chemical Company  
Kingsport, TN**

**for the  
Air Products Liquid Phase Conversion Company, L.P.  
7201 Hamilton Blvd.  
Allentown, PA 18195-1501**

**June 2003**

**Prepared for the United States Department of Energy  
National Energy Technology Laboratory  
Under Cooperative Agreement No. DE-FC22-92PC90543  
R. M. Kornosky, Contracting Officer's Representative**

## DISCLAIMER

This report was prepared by Air Products & Chemicals, Inc. and Eastman Chemical Company for the Air Products Liquid Phase Conversion Company, L.P., pursuant to a Cooperative Agreement partially funded by the U.S. Department of Energy, and neither Air Products & Chemicals, Inc., Eastman Chemical Company, the Air Products Liquid Phase Conversion Company, L.P., nor any of their subcontractors nor the U.S. Department of Energy, nor any person acting on behalf of either:

- (A) Makes any warranty or representation, express or implied, with respect to the accuracy, completeness, or usefulness of the information contained in this report, or that the use of any information, apparatus, method, or process disclosed in this report may not infringe privately owned rights; or
- (B) Assumes any liabilities with respect to the use of, or for damages resulting from the use of, any information, apparatus, method, or process disclosed in this report.

Reference herein to any specific commercial product, process, or service by trade name, trademark, manufacturer, or otherwise, does not necessarily constitute its endorsement, recommendation, or favoring by the U.S. Department of Energy. The views and opinions of authors expressed herein does not necessarily state or reflect those of the U.S. Department of Energy.

## ABSTRACT

This project, which was sponsored by the U.S. Department of Energy (DOE) under the Clean Coal Technology Program to demonstrate the production of methanol from coal-derived synthesis gas (syngas), has completed the 69-month operating phase of the program. The purpose of this Final Report for the “Commercial-Scale Demonstration of the Liquid Phase Methanol (LPMEOH™) Process” is to provide the public with details on the performance and economics of the technology. The LPMEOH™ Demonstration Project was a \$213.7 million cooperative agreement between the DOE and Air Products Liquid Phase Conversion Company, L.P. (the Partnership). The DOE’s cost share was \$92,708,370 with the remaining funds coming from the Partnership. The LPMEOH™ demonstration unit is located at the Eastman Chemical Company (Eastman) chemicals-from-coal complex in Kingsport, Tennessee.

The technology was the product of a cooperative development effort by Air Products and Chemicals, Inc. (Air Products) and DOE in a program that started in 1981. Developed to enhance electric power generation using integrated gasification combined cycle (IGCC) technology, the LPMEOH™ Process is ideally suited for directly processing gases produced by modern coal gasifiers. Originally tested at the Alternative Fuels Development Unit (AFDU), a small, DOE-owned process development facility in LaPorte, Texas, the technology provides several improvements essential for the economic coproduction of methanol and electricity directly from gasified coal. This liquid phase process suspends fine catalyst particles in an inert liquid, forming a slurry. The slurry dissipates the heat of the chemical reaction away from the catalyst surface, protecting the catalyst, and allowing the methanol synthesis reaction to proceed at higher rates.

The LPMEOH™ Demonstration Project accomplished the objectives set out in the Cooperative Agreement with DOE for this Clean Coal Technology project. Overall plant availability (defined as the percentage of time that the LPMEOH™ demonstration unit was able to operate, with the exclusion of scheduled outages) was 97.5%, and the longest operating run without interruption of any kind was 94 days. Over 103.9 million gallons of methanol was produced; Eastman accepted all of the available methanol for use in the production of methyl acetate, and ultimately cellulose acetate and acetic acid.

The slurry bubble column reactor was successfully scaled from the 10 short tons-per-day (sT/D) LaPorte AFDU to the 260 sT/D or 80,000 gallons-per-day LPMEOH™ demonstration unit. Over the first 4 years of operation, the catalyst deactivation rate averaged 0.6 to 0.7% per day, which was higher than the basis for the design of the LPMEOH™ demonstration unit obtained from the LaPorte AFDU (0.4% per day). Engineering and laboratory efforts focused on the removal of trace contaminants in coal-derived synthesis gas (syngas), and the development of a procedure to activate a full charge of catalyst in the LPMEOH™ reactor (in-situ activation) followed by temperature programming (the increase of reactor temperature as necessary to maintain the desired methanol production rate) could reduce the capital cost by as much as 10 percent. Over the last 6 months of operation, these improvements demonstrated the potential to reduce the design basis for catalyst deactivation rate by 50%. Because the impact of catalyst cost on the economics of methanol production is significant (reducing the rate of catalyst deactivation to 0.2% per day can realize a 25 percent reduction in variable cost), this

performance demonstrated the potential of the LPMEOH™ process to meet the targets for catalyst consumption utilizing coal-derived syngas. Over the demonstration period, tests were successfully performed at a variety of conditions anticipated in IGCC/ coproduction applications (catalyst withdrawal and addition to maintain the desired methanol production rate, operation on a carbon monoxide (CO)-rich syngas feed, ramping, and on-off operation).

Methanol from the LPMEOH™ Demonstration Project was also used to conduct product-use testing to demonstrate how a centrally located clean coal electric power plant with methanol coproduct could provide energy services to local communities. Product-use testing proved that coal-derived methanol, free of sulfur and other impurities, could be used one day as a replacement for petroleum in transportation, a peaking fuel in combustion turbines IGCC power plants, a hydrogen (H<sub>2</sub>) source for small fuel cells, or as a chemical feedstock.

As a secondary objective to the LPMEOH™ Demonstration Project, design verification testing was completed to evaluate capability of the slurry bubble column reactor to produce dimethyl ether (DME) as a coproduct with methanol using the Liquid Phase Dimethyl Ether (LPDME™) Process. The LPDME™ Process uses a physical mixture of a commercial methanol catalyst and a commercial dehydration catalyst in a single slurry reactor. During a 25-day design verification test at the LaPorte AFDU in 1999, the rate of catalyst deactivation for both the methanol synthesis and dehydration catalysts were slightly higher than the results for the LPMEOH™ Process from the first 3 weeks of the 4-month proof-of-concept run at the LaPorte AFDU in 1988/89. Follow-up economic analysis showed that attractive economics for DME can likely be achieved at plant sizes approaching 1,100 sT/D. The program participants agreed that additional work on DME should be deferred so that all resources could be directed toward improving the catalyst performance for the LPMEOH™ Process during the remaining time within the operating program.

In evaluating the economics for the technology, studies showed that methanol from the LPMEOH™ Process can be coproduced with IGCC power at less than \$0.50 per gallon. If the improvement in catalyst performance from the last 6 months of operation can be extrapolated, the variable cost of production of methanol can be reduced by 25% over the current basis for future plants. Together, IGCC and LPMEOH™ technologies will be able to fill local needs for electric power, transportation fuels, and manufactured chemical products.

## ACKNOWLEDGEMENTS

We would like to acknowledge the contributions made to the project by the following individuals during the operating phase of the project:

### Air Products and Chemicals, Inc.

Edward Heydorn  
Barry Diamond  
VanEric Stein  
Bharat Bhatt  
Bernard Toseland  
Robert Quinn  
Xiang-Dong Peng  
Fred Lucrezi  
The Laboratory and Analytical Teams at Air Products

### Eastman Chemical Company

William Jones  
Ronnie Lilly  
Barry Street  
Travis Smith  
Chuck Crawford  
Richard Ramsey  
The Operations and Maintenance Teams for Plant 29

### U.S. Department of Energy

Robert Kornosky  
William O'Dowd  
Richard Hargis  
Edward Schmetz  
John Shen

## POINT OF CONTACT

Air Products and Chemicals, Inc., is the licensor of the LPMEOH™ technology. Listed below are two individuals to contact for more information on commercial applications:

Name	Department	Phone No.	E-mail
Robert J. Kirkland	Worldwide Hydrocarbon Equipment - Services	610-481-4866	<a href="mailto:kirklarj@apci.com">kirklarj@apci.com</a>
Zoltan S. Pukanecz	Intellectual Asset Management & Licensing	610-481-3639	<a href="mailto:pukaneczs@apci.com">pukaneczs@apci.com</a>

Address for both:

Air Products and Chemicals, Inc.  
7201 Hamilton Blvd.  
Allentown, PA 18195-1501

## TABLE OF CONTENTS

	<u>Page</u>
Abstract .....	ii
Acknowledgments .....	iv
Point of Contact .....	v
List of Tables .....	x
List of Figures .....	xii
List of Abbreviations .....	xiv
List of Units .....	xvi
Glossary of Terms .....	xvii
Executive Summary .....	xix
1.0 Introduction .....	1-1
1.1 Purpose of the Project Performance and Economics Report .....	1-1
1.2 Overview of the Project .....	1-1
1.2.1 Background and History of the Project .....	1-1
1.2.2 Project Organization .....	1-3
1.2.3 Project Description .....	1-4
1.2.4 Site .....	1-4
1.2.5 Project Schedule .....	1-6
1.3 Objectives of the Project .....	1-8
1.3.1 Primary Objective .....	1-8
1.3.2 Secondary Objective .....	1-8
1.4 Significance of the Project .....	1-10
1.5 DOE's Role in the Project .....	1-11
1.5.1 Clean Coal Technology Program .....	1-11
1.5.2 Management Plan .....	1-11
1.5.2.1 DOE .....	1-12
1.5.2.2 The Partnership .....	1-12
2.0 Technology Description .....	2-1
2.1 Description of the Demonstrated Technology .....	2-1
2.2 Description of the Demonstration Facility .....	2-3
2.3 Proprietary Information .....	2-3
2.4 Simplified Process Flow Diagram .....	2-4
2.5 Stream Data .....	2-4
2.6 Process and Instrumentation Diagrams .....	2-4
3.0 Update of the Public Design Report .....	3-1
3.1 Design and Equipment Changes .....	3-1
3.1.1 Condensed Oil (29G-01) and Oil Makeup (29G-03) Pumps .....	3-2
3.1.2 Slurry Return Pump (29G-02) .....	3-3
3.1.3 Availability of Hydrogen Gas (H <sub>2</sub> Gas) .....	3-3
3.1.4 Gas Sparger .....	3-4
3.2 Demonstration Plant Equipment Cost Update .....	3-4
3.3 Demonstration Plant Operating Cost Update .....	3-5
4.0 Demonstration Program .....	4-1
4.1 Test Plans .....	4-1
4.2 Operating Procedures .....	4-2
4.2.1 Instrumentation and Data Acquisition .....	4-8

## TABLE OF CONTENTS (cont'd)

	<u>Page</u>
4.2.2	Test Methods..... 4-8
4.3	Analysis of Feedstocks, Products and Reagents ..... 4-8
4.4	Data Analysis Methodology..... 4-9
4.5	Data Summary..... 4-9
4.6	Operability and Reliability..... 4-10
4.7	Section 4 Bibliography..... 4-12
5.0	Technical Performance..... 5-1
5.1	Catalyst Performance ..... 5-1
5.1.1	Catalyst Performance: Catalyst Campaign 1..... 5-2
5.1.2	Catalyst Performance: Catalyst Campaign 2..... 5-4
5.1.3	Catalyst Performance: Catalyst Campaign 3..... 5-8
5.1.4	Catalyst Performance: Catalyst Campaign 4..... 5-10
5.1.5	Summary ..... 5-11
5.2	Identification and Removal of Trace Contaminants in Coal-Derived..... 5-13
	Syngas
5.2.1	Kingsport Catalyst Campaign 1 ..... 5-15
5.2.2	Kingsport Catalyst Campaign 2 ..... 5-15
5.2.3	Kingsport Catalyst Campaign 3 ..... 5-20
5.2.4	Kingsport Catalyst Campaign 4 ..... 5-23
5.2.5	Summary ..... 5-24
5.3	Gas Sparger Performance..... 5-25
5.3.1	Initial Sparger Design (April – November 1997)..... 5-25
5.3.2	Second Sparger Design (December 1997 – February 1999)..... 5-28
5.3.3	Current Sparger Design (March 1999 – Present)..... 5-29
5.3.4	Summary ..... 5-32
5.4	Process Variable Tests: H <sub>2</sub> :CO Ratio..... 5-33
5.5	Ramping and On/Off Testing..... 5-35
5.6	In-Situ Activation and Temperature Programming..... 5-37
5.6.1	Preparatory Engineering and Laboratory Work..... 5-37
5.6.2	In-situ Activation Procedure and Results - August 2001 ..... 5-38
5.6.3	Temperature Programming (August 2001 – March 2002)..... 5-40
5.6.4	Second In-situ Activation Procedure and Results (June 2002)..... 5-40
5.6.5	Summary ..... 5-42
5.7	Section 5 Bibliography..... 5-42
6.0	Environmental Performance..... 6-1
6.1	Introduction..... 6-1
6.2	Waste Streams and Their Disposal..... 6-1
6.2.1	Spent Catalyst Slurry..... 6-1
6.2.2	10C-30 Catalyst Guard Bed ..... 6-3
6.2.3	29C-40 Carbonyl Guard Bed ..... 6-3
6.2.4	Waste Oil..... 6-4
6.2.5	Recovered Distillation Liquids..... 6-5
6.2.6	Waste Water..... 6-6
6.3	Potential Environmental Concerns..... 6-6
6.4	Section 6 Bibliography..... 6-6



## TABLE OF CONTENTS (cont'd)

		<u>Page</u>
7.0	Methanol Product-Use Testing.....	7-1
7.1	Introduction.....	7-1
7.2	On-Site Testing of Methanol.....	7-2
7.3	Off-Site Testing of Methanol.....	7-4
	7.3.1 Transportation Systems.....	7-5
	7.3.1.1 Florida Institute of Technology Bus & Light Vehicles....	7-5
	7.3.1.2 ARCADIS Geraghty & Miller Flexible Fuel Vehicle.....	7-5
	7.3.1.3 West Virginia University Study of Stabilized Methanol in Transit Bus.....	7-7
	7.3.2 Power Generation Systems.....	7-8
	7.3.2.1 West Virginia University Stationary Gas Turbine.....	7-8
	7.3.2.2 Aircraft Ground Support Equipment.....	7-10
	7.3.2.3 Low-NO <sub>x</sub> Stationary Microturbine Combustor.....	7-12
	7.3.2.4 University of Florida Fuel Cell.....	7-14
	7.4 Summary.....	7-15
	7.5 Section 7 Bibliography.....	7-16
8.0	Liquid Phase Dimethyl Ether (LPDME™) Design Verification Testing (DVT).....	8-1
	8.1 Introduction.....	8-1
	8.2 DME Market Studies.....	8-2
	8.3 DVT Economic Studies.....	8-2
	8.4 DVT Catalyst Studies.....	8-3
	8.5 1999 LPDME™ Process Design Verification Test Run.....	8-4
	8.6 DME DVT Conclusions.....	8-8
	8.7 Section 8 Bibliography.....	8-10
9.0	Economics.....	9-1
	9.1 Introduction.....	9-1
	9.2 Estimated Process Capital Costs.....	9-3
	9.3 Projected Operating and Maintenance Costs.....	9-5
	9.4 Summary of Performance and Economics.....	9-6
	9.5 Effect of Variables on Economics.....	9-6
	9.5.1 Plant Size.....	9-6
	9.5.2 Sulfur Content.....	9-7
	9.5.3 Inert Content.....	9-8
	9.5.4 Capacity Factor.....	9-9
	9.6 Section 9 Bibliography.....	9-10
10.0	Commercialization Potential and Plans.....	10-1
	10.1 Market Analysis.....	10-1
	10.1.1 Applicability of the Technology.....	10-1
	10.1.2 Market Size and Barriers.....	10-3
	10.1.3 Economics Comparison with Competing Technologies.....	10-4
	10.2 Commercialization Plans.....	10-5
	10.3 Section 10 Bibliography.....	10-6
11.0	Conclusions and Recommendations.....	11-1
12.0	Other Project Reports and Publications.....	12-1

## APPENDICES

- Appendix A Analytical Measurements for LPMEOH™ Demonstration Unit
- Appendix B Sample Material Balances from LPMEOH™ Demonstration Unit
- Appendix C Details on Data Analysis Methodology
- Appendix D Data Summary Tables

## LIST OF TABLES

<u>Table</u>	<u>Title</u>	<u>Page</u>
2.5-1	Heat and Material Balance Summary	2-6
3.2-1	Kingsport LPMEOH™ Demonstration Unit - Update of Equipment Cost Summary	3-5
3.3-1	Kingsport LPMEOH™ Demonstration Unit - Update of Operating Costs	3-6
4.1-1	Test Conditions at LPMEOH™ Demonstration Unit	4-3
4.6-1	LPMEOH™ Demonstration Unit Availability and Causes of Unplanned Outages	4-10
5.1-1	Kingsport LPMEOH™ Operating Program Campaigns	5-1
5.2.1-1	Kingsport Catalyst Campaign 1 – Elemental Composition of Solids from Slurry Samples	5-15
5.2.2-1	Elemental Analysis Results for Spent Activated Carbon from 29C-40 Carbonyl Guard Bed (June 1999)	5-17
5.2.2-2	Analysis of Fresh and Spent Manganese Dioxide from 29C-40 Carbonyl Guard Bed (11 August 1999)	5-18
5.2.2-3	Analysis of Fresh and Spent Activated Carbon from 29C-40 Carbonyl Guard Bed (11 August 1999)	5-18
5.2.3-1	Analysis of Fresh and Spent Cu/C Adsorbent from 29C-40 Carbonyl Guard Bed (20 February 2002)	5-22
5.2.4-1	Kingsport Catalyst Campaign 4 - Elemental Composition of Solids from Slurry Samples	5-23
5.4-1	Kingsport LPMEOH™ Process - H <sub>2</sub> :CO Ratio Testing	5-34
6.2-1	Spent Catalyst Slurry from LPMEOH™ Demonstration Unit	6-2
6.2-2	10C-30 Catalyst Guard Bed - Adsorbents Used during Operation of LPMEOH™ Demonstration Unit	6-3
6.2-3	29C-40 Carbonyl Guard Bed - Adsorbents Used during Operation of LPMEOH™ Demonstration Unit	6-4
6.2-4	Waste Oil from LPMEOH™ Demonstration Unit	6-5
6.2-5	Oil Collected in Distillation Equipment from LPMEOH™ Process	6-5
7.2-1	Refined-Grade Methanol from LPMEOH™ Demonstration Unit - Quality and Fitness for Use (1997)	7-3
7.3-1	Stabilized Methanol Composition - CO-rich Feed Gas (H <sub>2</sub> :CO = 0.7)	7-4
7.3.1-1	ARCADIS Geraghty & Miller FFV Fuel Economy Results	7-6
7.3.1-2	ARCADIS Geraghty & Miller FFV Emissions Results	7-6
7.3.1-3	West Virginia University - Tri-Boro Coach Emissions Results	7-8
8.6-1	LPDME™ Goals and Performance Results (Laboratory and AFDU)	8-9
9.2-1	Estimated Facility Investment Summary for Once-Through 500 sT/D LPMEOH™ Plant	9-4
9.3-1	Projected Operating and Maintenance Costs for Once-Through 500 sT/D LPMEOH™ Plant	9-5
10.1.2-1	Market Forecast for Methanol	10-3
10.1.3-1	Baseload Coproduction, 500 sT/D, Fuel Grade Methanol	10-5

## LIST OF TABLES (cont'd)

<u>Table</u>	<u>Title</u>	<u>Page</u>
A-1	Summary of Streams to be Analyzed for Material Balance Calculations	A-2
C-1	Summary of Data for Typical Material and Energy Balance and Reactor Performance Assessment	C-2
D-1	Data Summary for Kingsport Catalyst Campaign 1	D-2
D-2	Data Summary for Kingsport Catalyst Campaign 2	D-5
D-3	Data Summary for Kingsport Catalyst Campaign 3	D-26
D-4	Data Summary for Kingsport Catalyst Campaign 4	D-30

## LIST OF FIGURES

<u>Figure</u>	<u>Title</u>	<u>Page</u>
1.2.2-1	LPMEOH™ Demonstration Project Organization	1-3
1.2.3-1	Integration of Existing Facilities with LPMEOH™ Demonstration Unit	1-5
1.2.4-1	Photograph of Eastman Chemical Company's Chemicals-from-Coal Complex	1-6
1.2.5-1	LPMEOH™ Demonstration Project Schedule	1-9
1.5.2-1	Kingsport LPMEOH™ Demonstration Project Operating Phase Organization Chart	1-13
2.1-1	Gas-Phase Methanol Reactors	2-2
2.1-2	LPMEOH™ Reactor Schematic	2-2
2.4-1	LPMEOH™ Demonstration Unit Simplified Process Flow Diagram	2-5
4.1-1	LPMEOH™ Demonstration Test Plan Schedule of Tests	4-4
5.1.1-1	Kingsport LPMEOH™ Catalyst Life (Catalyst Campaign 1)	5-2
5.1.2-1	Kingsport LPMEOH™ Catalyst Life (Catalyst Campaign 2: 1997-1998)	5-4
5.1.2-2	Kingsport LPMEOH™ Catalyst Life (Catalyst Campaign 2: 1999)	5-6
5.1.2-3	Kingsport LPMEOH™ Catalyst Life (Catalyst Campaign 2: 2000-2001)	5-7
5.1.3-1	Kingsport LPMEOH™ Catalyst Life (Catalyst Campaign 3)	5-9
5.1.4-1	Kingsport LPMEOH™ Catalyst Life (Catalyst Campaign 4)	5-10
5.2-1	Photograph of Alternative Fuels Field Test Unit (AFFTU)	5-14
5.2.2-1	Kingsport Catalyst Campaign 2 - Trace Contaminant Concentrations on Slurry Samples	5-16
5.2.2-2	Effect of Arsenic Concentration on Methanol Catalyst Deactivation Rate in Autoclave	5-17
5.2.3-1	Kingsport Catalyst Campaign 3 - Trace Contaminant Concentrations on Slurry Samples	5-20
5.3.1-1	Sparger Resistance Coefficient – Sparger Design #1 (April - November 1997)	5-26
5.3.2-1	Sparger Resistance Coefficient – Sparger Design #2 (December 1997 - February 1999)	5-29
5.3.3-1	Sparger Resistance Coefficient – Sparger Design #3 (March 1999 - August 2001)	5-30
5.3.3-2	Sparger Resistance Coefficient – Sparger Design #3 (August 2001 - June 2002)	5-31
5.3.3-3	Sparger Resistance Coefficient – Sparger Design #3 (June 2002 - 31 December 2002)	5-32
5.5-1	Ramping Study at LPMEOH™ Demonstration Unit (13 June 2000)	5-36
5.5-2	Ramping Study at LPMEOH™ Demonstration Unit (13 March 2001)	5-36
5.6-1	Reduction Gas Uptake vs. Temperature – In-Situ Catalyst Activation (22-24 August 2001)	5-39

## LIST OF FIGURES (cont'd)

<u>Figure</u>	<u>Title</u>	<u>Page</u>
5.6-2	Reduction Gas Uptake vs. Temperature – In-Situ Catalyst Activation (25-27 June 2002)	5-41
7.1-1	Once-through Methanol Coproduction with IGCC Electric Power	7-1
7.3.1-1	West Virginia University Transportable Heavy Duty Emissions Testing Laboratory	7-7
7.3.2-1	West Virginia University Stationary Gas Turbine Emissions Test Results – 1998 Testing	7-9
7.3.2-2	West Virginia University Stationary Gas Turbine Emissions Test Results – 2000 Testing	7-10
7.3.2-3	Aircraft Ground Support Equipment Average NO <sub>x</sub> Emissions Reduction with WIF vs. JP-8	7-12
7.3.2-4	Low-NO <sub>x</sub> Microturbine NO <sub>x</sub> Emissions with Stabilized Methanol vs. Natural Gas	7-14
8.5-1	LaPorte Alternative Fuels Development Unit (AFDU)	8-5
8.5-2	1999 LPDME™ Operating Run at LaPorte AFDU – Estimated Catalyst Activity	8-6
8.5-3	1999 LPDME™ Operating Run at LaPorte AFDU – Production Results	8-7
8.6-1	LPDME™ Process Economics	8-10
9.5-1	Effect of Methanol Plant Size on Methanol Conversion Cost	9-7
9.5-2	Effect of Syngas Conversion on Methanol Conversion Cost	9-8
9.5-3	Effect of Inerts Concentration on Methanol Conversion Cost	9-9
10.1-1	LPMEOH™ Process Flow Diagram – Design Options for IGCC Applications	10-2
A-1	Syngas Sampling Apparatus	A-8

## LIST OF ABBREVIATIONS

AFB	-	Air Force Base
AFDU	-	Alternative Fuels Development Unit
AFFTU	-	Alternative Fuels Field Test Unit
AGSE	-	Aircraft Ground Support Equipment
Al/P	-	Aluminum to Phosphate
Air Products	-	Air Products and Chemicals, Inc.
APCI	-	Air Products and Chemicals, Inc.
AsH <sub>3</sub>	-	Arsine
CO	-	Carbon Monoxide
CO <sub>2</sub>	-	Carbon Dioxide
COS	-	Carbonyl Sulfide
COTR	-	Contracting Officer's Technical Representative
Cu/C	-	Copper-impregnated Activated Carbon (following reduction of copper oxide)
CuO/C	-	Copper Oxide-impregnated Activated Carbon
DME	-	Dimethyl Ether
DOE	-	United States Department of Energy
DVT	-	Design Verification Testing
EA	-	Environmental Assessment
Eastman	-	Eastman Chemical Company
EIV	-	Environmental Information Volume
EMP	-	Environmental Monitoring Plan
EPA	-	United States Environmental Protection Agency
FFV	-	Flexible-Fuel Vehicle
FONSI	-	Finding of No Significant Impact
H <sub>2</sub>	-	Hydrogen
H <sub>2</sub> S	-	Hydrogen Sulfide
IGCC	-	Integrated Gasification Combined Cycle
ISO	-	International Organization for Standardization
LHV	-	Lower Heating Value
LPMEOH™	-	Liquid Phase Methanol
LPDME™	-	Liquid Phase Dimethyl Ether
LPG	-	Liquefied Petroleum Gas
MeOH	-	Methanol
MTBE	-	Methyl Tertiary Butyl Ether
N <sub>2</sub>	-	Nitrogen
NEPA	-	National Environmental Policy Act
NO <sub>x</sub>	-	Nitrogen Oxides
NPDES	-	National Pollutant Discharge Elimination System
O <sub>2</sub>	-	Oxygen
Partnership	-	Air Products Liquid Phase Conversion Company, L.P.
PFD	-	Process Flow Diagram(s)
PON	-	Program Opportunity Notice
Project	-	Production of Methanol/DME Using the LPMEOH™ Process at an Integrated Coal Gasification Facility
P&ID(s)	-	Piping and Instrumentation Diagram(s)
RCRA	-	Resource and Conservation Recovery Act
ROI	-	Return on Investment
SO <sub>2</sub>	-	Sulfur Dioxide
Syngas	-	Synthesis Gas
TCLP	-	Toxicity Characteristic Leaching Procedure
TPD or sT/D	-	Short Ton(s) per Day (2,000 lbs/ton)
UHC	-	Unburned Hydrocarbons

## LIST OF ABBREVIATIONS (cont'd)

VOC	-	Volatile Organic Compounds
vol	-	Volume
vol%	-	Volume %
WIF	-	Water-in-Fuel
wt	-	Weight
wt%	-	Weight %
WVU	-	West Virginia University



## LIST OF UNITS

Btu	-	British Thermal Units
Btu/hr	-	British Thermal Units per hour
Btu/lb	-	British Thermal Units per pound
Btu/SCF	-	British Thermal Units per standard cubic foot
°C	-	Degrees Centigrade
Ft	-	Foot
°F	-	Degrees Fahrenheit
g	-	Grams
Gal or gal	-	Gallons
gmol	-	Gram-mole
gpm	-	Gallons per minute
Hp	-	Horsepower
hr	-	Hour
KCAL	-	Kilocalories
KSCFH	-	Acronym for 1,000 standard cubic feet per hour; for this term, standard conditions are 14.7 psia and 60°F
kWh	-	Kilowatt-hour
l	-	Liter
lb	-	Pound
lb mole	-	Pound mole
lbs	-	Pounds
mg	-	Milligrams
mpg	-	Miles per gallon
MM or mm	-	Million
ppbv	-	Parts per billion (volume basis)
ppm	-	Parts per million
ppmw	-	Parts per million (weight basis)
psi	-	Pounds per square inch
psia	-	Pounds per square inch (Absolute)
psig	-	Pounds per square inch (Gauge)
SCF	-	Standard cubic feet (60°F, 14.7 psia)
SCFM	-	Standard cubic feet per minute
SCFH	-	Standard cubic feet per hour
SCFD	-	Standard cubic feet per day
Sl/hr-kg	-	Standard Liter(s) per Hour per Kilogram of Catalyst (oxide basis)
x' -y''	-	x feet - y inches

## GLOSSARY OF TERMS

Availability	-	The percentage of time that the LPMEOH™ demonstration unit was able to operate, with the exclusion of scheduled outages
Balanced Gas	-	A syngas with a composition of hydrogen (H <sub>2</sub> ), carbon monoxide (CO), and carbon dioxide (CO <sub>2</sub> ) in stoichiometric balance ( $[\text{H}_2 - \text{CO}_2]/[\text{CO} + \text{CO}_2] = 2.05$ ) for the production of methanol
Carbon Monoxide Gas	-	A syngas containing primarily carbon monoxide (CO); also called CO Gas
Catalyst Activity	-	the rate at which the catalyst promotes the desired chemical reaction to proceed within the limitations of chemical equilibrium
Catalyst Age ( $\eta$ -eta)	-	The ratio of the rate constant at any point in time to the rate constant for a freshly reduced catalyst (as determined in the laboratory autoclave)
Catalyst Concentration	-	Synonym for Slurry Concentration
Catalyst Loading	-	Synonym for Slurry Concentration
CO Conversion	-	The percentage of CO consumed across the reactor
Crude-Grade Methanol	-	Underflow from rectifier column (29C-20), defined as 80 wt% minimum purity; requires further distillation in existing Eastman equipment prior to use
DOE-NETL	-	The DOE's National Energy Technology Laboratory (Project Team)
DOE-HQ	-	The DOE's Headquarters - Coal Fuels and Industrial Systems (Project Team)
Fresh Feed	-	Sum of Balanced Gas, H <sub>2</sub> Gas, and CO Gas
Gas Holdup	-	The percentage of reactor volume up to the Gassed Slurry Height which is gas
Gassed Slurry Height	-	Height of gassed slurry in the reactor
Hydrogen Gas	-	A syngas containing an excess of hydrogen (H <sub>2</sub> ) over the stoichiometric balance for the production of methanol; also called H <sub>2</sub> Gas
IGCC/OTM	-	An IGCC plant with a "Once-Thru Methanol" plant (the LPMEOH™ Process) added-on
Inlet Superficial Velocity	-	The ratio of the actual cubic feet of gas at the reactor inlet (calculated at the reactor temperature and pressure) to the reactor cross-sectional area (excluding the area contribution by the internal heat exchanger); typical units are feet per second
K	-	Sparger resistance coefficient (term used in calculation of pressure drop)
M85	-	A fuel blend of 85 volume percent methanol and 15 volume percent unleaded gasoline
Methanol Productivity	-	The gram-moles of methanol produced per hour per kilogram catalyst (on an oxide basis)
MW	-	Molecular weight, pound per pound mole
$\rho$	-	Density, pounds per cubic foot
Project	-	Production of Methanol/DME Using the LPMEOH™ Process at an Integrated Coal Gasification Facility
Raw Methanol	-	The sum of Refined-Grade Methanol and Crude-Grade Methanol; represents total methanol which is produced after stabilization
Reactor Feed	-	The sum of Fresh Feed and Recycle Gas
Reactor O-T-M Conversion	-	Percentage of energy (on a lower heating value basis) in the Reactor Feed converted to methanol (Once-Through-Methanol basis)
Reactor Volumetric Productivity	-	The quantity of Raw Methanol produced (tons per day) per cubic foot of reactor volume up to the Gassed Slurry Level
Recycle Gas	-	The portion of unreacted syngas effluent from the reactor "recycled" as a feed gas
Refined-Grade Methanol	-	Distilled methanol, defined as 99.8 wt% minimum purity; used directly in downstream Eastman processes
Slurry Concentration	-	Percentage of weight of slurry (solid plus liquid) which is catalyst (on an oxide basis)
Syngas Utilization	-	Defined as the number of standard cubic feet of Balanced Gas plus CO Gas to the LPMEOH™ demonstration unit required to produce one pound of Raw Methanol

## GLOSSARY OF TERMS (cont'd)

- Synthesis Gas - A gas containing primarily H<sub>2</sub> and CO, or mixtures of H<sub>2</sub> and CO; intended for "synthesis" in a reactor to form methanol and/or other hydrocarbons (synthesis gas may also contain CO<sub>2</sub>, water, and other gases)
- Temperature Programming - The increase of reactor temperature as necessary to control the reactor purge flowrate and maintain reactor volumetric productivity
- Tie-in(s) - The interconnection(s) between the LPMEOH™ demonstration unit and the Eastman Facility
- V - Volumetric flowrate, thousand standard cubic feet per hour

## EXECUTIVE SUMMARY

This project, which was sponsored by the U.S. Department of Energy (DOE) under the Clean Coal Technology Program to demonstrate the production of methanol from coal-derived synthesis gas (syngas), has completed the 69-month operating phase of the program. The purpose of this Final Report for the “Commercial-Scale Demonstration of the Liquid Phase Methanol (LPMEOH™) Process” is to provide the public with details on the performance and economics of the technology. The LPMEOH™ Demonstration Project was a \$213.7 million cooperative agreement between the DOE and Air Products Liquid Phase Conversion Company, L.P. (the Partnership). The DOE’s cost share was \$92,708,370 with the remaining funds coming from the Partnership. The LPMEOH™ demonstration unit is located at the Eastman Chemical Company (Eastman) chemicals-from-coal complex in Kingsport, Tennessee.

The technology was the product of a cooperative development effort by Air Products and Chemicals, Inc. (Air Products) and DOE in a program that started in 1981. Developed to enhance electric power generation using integrated gasification combined cycle (IGCC) technology, the LPMEOH™ Process is ideally suited for directly processing gases produced by modern coal gasifiers. Originally tested at the Alternative Fuels Development Unit (AFDU), a small, DOE-owned process development facility in LaPorte, Texas, the technology provides several improvements essential for the economic coproduction of methanol and electricity directly from gasified coal. This liquid phase process suspends fine catalyst particles in an inert liquid, forming a slurry. The slurry dissipates the heat of the chemical reaction away from the catalyst surface, protecting the catalyst, and allowing the methanol synthesis reaction to proceed at higher rates.

The LPMEOH™ Demonstration Project accomplished the objectives set out in the Cooperative Agreement with DOE for this Clean Coal Technology project. Methanol operation began on 02 April 1997, and startup was completed in two days. Nameplate production of 80,000 gallons per day (260 short tons per day [sT/D]) was achieved within four days, and production rates exceeding 115% of design were achieved within six days. Overall plant availability (defined as the percentage of time that the LPMEOH™ demonstration unit was able to operate, with the exclusion of scheduled outages) was 97.5%, and the longest operating period without interruption of any kind was 94 days. Over 103.9 million gallons of methanol was produced, including a one-month maximum of 2.5 million gallons. Eastman accepted all of the available methanol for use in the production of methyl acetate, and ultimately cellulose acetate and acetic acid.

The slurry bubble column reactor was successfully scaled from the 10 sT/D LaPorte AFDU to the 260 sT/D LPMEOH™ demonstration unit. The LPMEOH™ reactor did not exhibit any hydrodynamic instability, and the maximum catalyst loading of 151% of the design value of about 40,000 pounds (corresponding to a slurry concentration of greater than 49 weight % [wt%]) was achieved. The gas sparger at the inlet to the LPMEOH™ reactor was replaced with two modified units (using the same design principles as the original device), and stable performance was realized when a continuous flush of condensed process oil (in this case, by gravity) was utilized.

Catalyst performance (as determined by the rate of catalyst deactivation using an in-house kinetic model) improved during the demonstration test period. Initially, deactivation rates of greater than 1% per day were calculated at the design operating temperature of 250°C. As a basis of comparison, the calculated deactivation rate from the 4-month proof-of-concept run at the LaPorte AFDU in 1988/89 was 0.4% per day. (This run was performed on carbon monoxide [CO]-rich syngas derived from natural gas.) The high deactivation rates were attributed to the presence of post-construction debris in the reactor system. During the second catalyst campaign that began in December of 1997, the rate of catalyst deactivation was calculated to be 0.6 to 0.7% per day at a reactor temperature of 235°C. The practice of catalyst withdrawal and addition (removing a portion of the spent catalyst from the LPMEOH™ reactor and adding fresh catalyst in 2,000 pound batches) to maintain the desired methanol production rate was successfully demonstrated.

In determining the reasons for the higher rate of catalyst deactivation, the presence of certain elements (in particular, arsenic and sulfur) was identified from samples of spent catalyst, spent adsorbent materials from catalyst guard beds, and syngas entering the LPMEOH™ demonstration unit. A commercially available copper oxide-impregnated activated carbon was identified as having capacity to remove arsenic (in the form of arsine) within an existing catalyst guard bed that was originally designed for removal of metal carbonyls at ambient temperature.

In parallel, laboratory testing was performed to develop a procedure to activate (or reduce) a full charge of methanol synthesis catalyst within the LPMEOH™ reactor (so-called in-situ activation). The in-situ activation procedure prepared fresh methanol synthesis catalyst for production of methanol by reacting metal oxides (for example, copper oxide) with a reductant such as CO or hydrogen (H<sub>2</sub>) to produce the base metal plus either carbon dioxide (CO<sub>2</sub>) or water (H<sub>2</sub>O). During the operating program, this feature was identified as having significant commercial interest, as capital cost savings of about 10% could be realized by elimination of the separate processing equipment for the catalyst withdrawal/addition procedure. Also, operating the LPMEOH™ reactor at low temperatures at the outset and slowly increasing temperature with time to maintain a constant production of methanol (called temperature programming) was believed to have the potential to extend the life of the methanol synthesis catalyst. Following the first in-situ activation of methanol synthesis catalyst in August of 2001 (during which initial performance of the catalyst was about 70% of the value expected from the laboratory testing), the concept of temperature programming was demonstrated (temperature was gradually raised from 216°C to 250°C in order to maintain the desired methanol production rate). Following changes to the storage conditions of the catalyst slurry prior to reduction, the in-situ activation procedure was successfully practiced in June of 2002, resulting in the catalyst meeting the initial performance targets.

During the final six months of operation under the demonstration test plan, the average rate of catalyst deactivation was calculated to be 0.17% per day, which was ½ of the design basis for the LPMEOH™ demonstration unit. The reactor was maintained at a constant low temperature of 215°C during this period, and the adsorbent used in the catalyst guard bed within the LPMEOH™ demonstration unit (copper oxide-impregnated activated carbon) was replaced with fresh material after 3 months of operation (including a novel thermal treatment that was applied after two months to extend the useful life of the adsorbent). Because the impact of catalyst cost

on the economics of methanol production is significant (reducing the rate of catalyst deactivation by up to ½ of the current basis can realize a 25 percent reduction in variable cost), this performance demonstrated the potential of the LPMEOH™ process to meet the targets for catalyst consumption utilizing coal-derived syngas.

Although the host site for the LPMEOH™ demonstration unit was a chemical production facility, testing was able to be performed to simulate the performance of the LPMEOH™ Process in an IGCC power plant. A total of 78 days of testing at a variety of H<sub>2</sub>:CO ratios were performed to evaluate the effect of syngas compositions expected from coal-based IGCC units on the performance of the LPMEOH™ Process. All of the results met the expectations for methanol production rate based upon earlier studies in the laboratory. Catalyst performance for the LPMEOH™ reactor with lower H<sub>2</sub>:CO ratios were not significantly impacted based on the calculated rate of catalyst deactivation. On/off and ramping studies were also completed, and the LPMEOH™ demonstration unit was capable of meeting the ramping requirements for an IGCC system by achieving the goal of a minimum 5% change in design flow per minute. Tests of the ability of the LPMEOH™ reactor to operate in a load-following environment were also successful.

Stabilized (degassed) methanol produced from CO-rich syngas in the LPMEOH™ Process can have less than 1 wt% H<sub>2</sub>O, and has the potential to be used directly in transportation and power generation applications. The cost of distillation from stabilized methanol to chemical-grade purity has been estimated to be \$0.02 to \$0.04 per gallon. Stabilized methanol from the LPMEOH™ Demonstration Project was made available to seven test locations to study the feasibility of its use these systems. Successful demonstration of the use of stabilized methanol in these applications can enhance the flexibility of and revenue from IGCC plants. In bus and flexible fuel vehicle (FFV) trials, stabilized methanol provided the same environmental benefits as chemical-grade methanol with no penalty on performance or fuel economy. Tests in a gas turbine and a diesel generator showed that levels of nitrogen oxides (NO<sub>x</sub>) in the exhaust air were lowered when stabilized methanol or methanol emulsions are used instead of conventional oil fuels. As with chemical-grade methanol, lubrication additives will likely be required when stabilized methanol is fed to a gas turbine. Testing of stabilized methanol as the source of H<sub>2</sub> to a phosphoric acid fuel cell has shown that conventional steam reforming catalysts are not compatible with the trace mineral oil present in the stabilized methanol; when auto-thermal reforming or partial oxidation reforming are used, the stabilized methanol would possibly be acceptable as a fuel. Methanol from the LPMEOH™ Process that is purified to chemical-grade specifications should be suitable for use in this application. Product-use testing proved that coal-derived methanol, free of sulfur and other impurities, could be used one day as a replacement for petroleum in transportation, a peaking fuel in combustion turbines IGCC power plants, a source of H<sub>2</sub> for small fuel cells, or as a chemical feedstock.

As a secondary objective to the LPMEOH™ Demonstration Project, design verification testing was completed to evaluate capability of the slurry bubble column reactor to produce dimethyl ether (DME) as a coproduct with methanol using the Liquid Phase Dimethyl Ether (LPDME™) Process. The LPDME™ Process uses a physical mixture of a commercial methanol catalyst and a commercial dehydration catalyst in a single slurry reactor. In addition to its current uses, DME has potential applications as a chemical building block. Also, since the physical properties of

DME are similar to those of liquefied petroleum gas (LPG), it has been speculated that DME could be used in large-scale power production, in home heating, in replacement of LPG for automobiles, and as a diesel fuel substitute or combustion supplement. Economic targets on the production cost of DME from the LPDME™ Process were established, and a 25-day design verification test was performed at the LaPorte AFDU in 1999. The rate of catalyst deactivation for both the methanol synthesis and dehydration catalysts was calculated to be 0.7% per day, which was a large improvement over the 4% per day rate of deactivation which was calculated from autoclave studies prior to the initial test of the LPDME™ Process at the LaPorte AFDU in 1991; these results were slightly higher than the results (0.5% per day) for the LPMEOH™ Process from the first 3 weeks of the 4-month proof-of-concept run at the LaPorte AFDU in 1988/89. Follow-up economic analysis showed that the target DME cost of \$7 to \$8 per MMBtu (equivalent to costs for LPG in China) can likely be achieved at plant sizes approaching 1,100 sT/D. The program participants agreed that additional work on DME should be deferred so that all resources could be directed toward improving the catalyst performance for the LPMEOH™ Process during the remaining time within the operating program.

In evaluating the economics for the technology, parametric studies were also performed to determine the production cost of methanol from the LPMEOH™ Process in an IGCC power plant. The process can be designed to operate in a continuous, baseload manner, converting syngas from oversized gasifiers or from a spare gasifier. The process can also be designed to operate only during periods of off-peak electric power demand to consume a portion of the excess syngas and allow the electricity output from the combined-cycle power unit to be reduced. In this latter circumstance, the gasifiers continue to operate at full baseload capacity, so the IGCC facility's major capital asset is fully utilized. In either baseload or cycling operation, partial conversion of between 20% and 40% of the volume of H<sub>2</sub> and CO in the IGCC power plant's syngas is optimal on an economic basis, and conversion of up to 50% is feasible. Methanol conversion costs of about \$0.15 per gallon were determined for a coal-based IGCC plant using the once-through configuration; when the cost of syngas is added, the price of methanol is less than \$0.50 per gallon. As the economics for IGCC systems improve, the economics for coproduction of methanol will continue to look attractive in local markets when compared with methanol that is produced in off-shore locations from natural gas.

## **1.0 INTRODUCTION**

### **1.1 PURPOSE OF THE PROJECT PERFORMANCE AND ECONOMICS REPORT**

The purpose of the Project Performance and Economics Report for the “Commercial-Scale Demonstration of the Liquid Phase Methanol (LPMEOH™) Process” project is to consolidate for public use all relevant nonproprietary information on the project, other than that already included in the Public Design Report (Final Report - Volume 1).

The scope of the report is limited to nonproprietary information. Therefore, although its content is insufficient to provide a complete tool for designing a LPMEOH™ unit, it will serve as a reference for the design considerations involved in developing a commercial-scale facility.

### **1.2 OVERVIEW OF THE PROJECT**

#### **1.2.1 Background and History of the Project**

The purpose of this project was to demonstrate the commercial viability of the LPMEOH™ Process using coal-derived synthesis gas (syngas). This project was conducted pursuant to the U.S. Department of Energy (DOE) Clean Coal Technology Program.

The United States needs future sources of alternative liquid fuels. With domestic oil production declining and imports increasing, the potential of producing affordable liquid fuels from non-petroleum sources could one day prove both strategically and economically important. The LPMEOH™ Process offers an extremely attractive route to supplementing our liquid fuel supplies with methanol made from the abundant coal reserves of the United States.

Methanol also has a broad range of commercial applications. It can be substituted for or blended with gasoline to power vehicles. It is an excellent fuel for the rapid-start combustion turbines used by utilities to meet peak electricity demands. It contains no sulfur and has exceptionally low nitrogen oxide (NO<sub>x</sub>) characteristics when burned. Methanol may be an economical source of hydrogen (H<sub>2</sub>) for fuel cells. It can also be used as a chemical feedstock.

Air Products and Chemicals, Inc. (Air Products) and Eastman Chemical Company (Eastman) entered into a partnership known as Air Products Liquid Phase Conversion Company, L.P. (the Partnership). The Partnership and the DOE participated in the Clean Coal Technology Program demonstration of LPMEOH™ technology. The Partnership designed, built, owned, and operated a nominal 80,000 gallons-per-day (260 short tons-per-day [sT/D]) LPMEOH™ demonstration unit at Eastman’s chemicals-from-coal complex in Kingsport, Tennessee. The program objectives were to demonstrate the scaleup and operability of the LPMEOH™ Process under various coal-based syngas feed compositions and to gain operating experience for future syngas conversion projects.

The technology is the product of a cooperative development effort by Air Products and DOE in a program that started in 1981. Developed to enhance electric power generation using integrated gasification combined cycle (IGCC) technology, the LPMEOH™ Process is ideally suited for



directly processing gases produced by modern day coal gasifiers. Originally tested at the Alternative Fuels Development Unit (AFDU), a small, DOE-owned experimental unit in LaPorte, Texas, the technology offers significant potential, compared to conventional gas-phase methanol production technologies, to reduce electric power generation costs at coal-based IGCC facilities with the coproduction of chemical feedstocks and alternative liquid fuels. The domestically developed LPMEOH™ technology can use domestic coal reserves to produce clean, storable, liquid fuels and chemical feedstocks. Eventual commercialization of the LPMEOH™ Process would provide chemical feedstock and electric power cost savings, lower sulfur dioxide (SO<sub>2</sub>) and NO<sub>x</sub> emissions, and could reduce the use of imported liquid fuels.

The LPMEOH™ technology could someday be used as an adjunct to an IGCC power plant—one of the cleanest and most efficient of the 21st century power generating options. When the IGCC power plant is not generating electricity at its full capacity, excess syngas can be diverted to make methanol in a fast ramping LPMEOH™ plant. The methanol could be stored on-site and used in peaking turbines or sold as a commercial fuel or a chemical feedstock. In this configuration, the cost of making methanol from coal is likely to be competitive with stand alone natural gas-to-methanol facilities. A discussion of the process options and economics is provided in Section 9 of this report.

The LPMEOH™ demonstration unit was integrated with Eastman's chemicals-from-coal complex, accepting syngas and converting it to methanol, for use as a chemical feedstock within the Eastman facility. A portion of the methanol product was evaluated as a zero sulfur, low-NO<sub>x</sub> combustion fuel for testing in stationary power applications and mobile transportation use (buses, flexible-fuel vehicles [FFV's], etc.).

These fuel-use tests provided a basis for the comparison of the product methanol with conventionally accepted fuels with regard to emission levels and economic viability. The program goal of demonstrating methanol as a fuel can lead to the potential for greater use of oxygenated fuels, which burn cleaner than conventional fuels, thereby reducing air emissions from mobile (e.g., buses and vanpools) and stationary (e.g., engines, turbines, and fuel cells) sources.

The DOE, under the Clean Coal Technology Program, provided cost-shared financial assistance for the design, construction, and operation of the commercial-scale LPMEOH™ demonstration unit by The Partnership. Air Products designed and constructed the LPMEOH™ demonstration unit and Eastman operated it. The demonstration unit is a nominal 260 ton-per-day (or 80,000 gallon per day) unit situated on a 0.6 acre plot within the existing Eastman chemicals-from-coal complex in Kingsport, Tennessee.

The Eastman coal gasification facility has operated commercially since 1983. Eastman currently both produces and purchases methanol for use at the site. At this site, it was possible to perform studies that demonstrate the unique load-following flexibility of the LPMEOH™ demonstration unit for application to coal-based IGCC electric power generation facilities.

This project has also completed design verification testing (DVT), including laboratory- and pilot-scale research and market verification studies, to evaluate whether to include a

demonstration of the production of dimethyl ether (DME) as a mixed coproduct with methanol. DME has several commercial uses. In a storable blend with methanol, the mixture can be used as a peaking fuel in gasification-based electric power generating facilities, or as a diesel engine fuel. Blends of methanol and DME can be used as chemical feedstocks for synthesizing chemicals, including new oxygenated fuel additives.

### 1.2.2 Project Organization

As noted above, Air Products and Eastman formed the Partnership to execute the LPMEOH™ Demonstration Project. The Partnership subcontracted with Air Products to provide the overall management of the project, and to act as the primary interface with DOE. As subcontractor to the Partnership, Air Products provided the engineering design, procurement, construction, and commissioning of the LPMEOH™ demonstration unit, and provided the technical and engineering supervision needed to conduct the operational testing program required as part of the project. As subcontractor to Air Products, Eastman was responsible for operation of the LPMEOH™ demonstration unit, and for the interconnection and supply of syngas, utilities, product storage, and other needed services. Air Products also issued subcontracts for and managed the projects within the off-site testing of methanol from the LPMEOH™ Process. These roles and responsibilities are summarized in Figure 1.2.2-1.

**Figure 1.2.2-1  
LPMEOH™ Demonstration Project Organization**

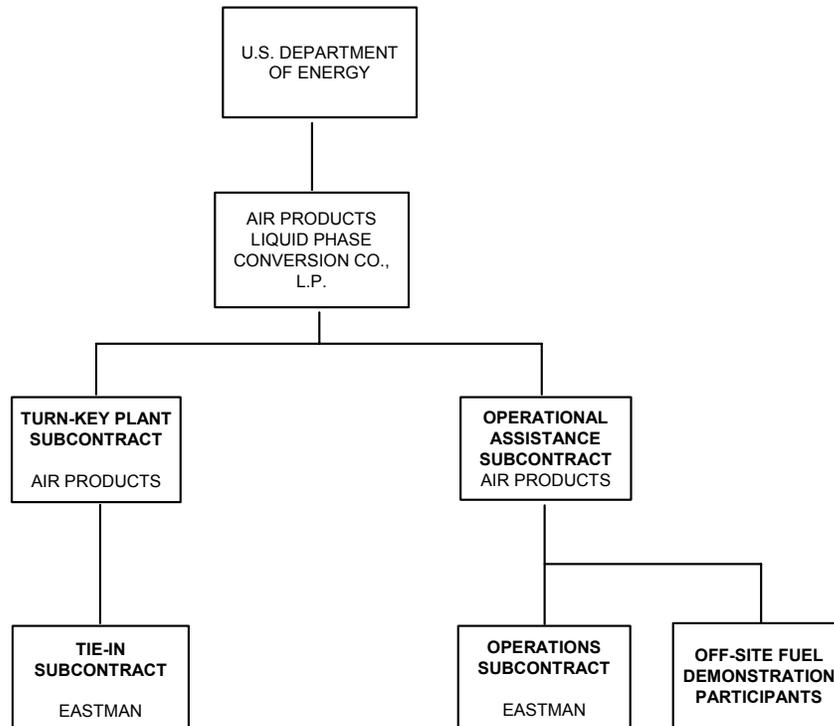

### **1.2.3 Project Description**

Air Products developed the two technologies that were demonstrated at various engineering scales during this demonstration project with the financial support of the DOE. The LPMEOH™ Process uses a slurry bubble column reactor to convert coal-derived syngas to methanol. Because of its superior heat management, the process can directly utilize the carbon monoxide (CO)-rich syngas characteristic of the gasification of coal, petroleum coke, residual oil, wastes, or other hydrocarbon feedstock. When added to a high-efficiency IGCC power plant, the LPMEOH™ Process converts a portion of the CO-rich syngas produced by the gasifier to methanol, and the unconverted gas is used to fuel the gas turbine combined-cycle power plant. The LPMEOH™ Process can also be applied to the conversion of syngas derived from natural gas. A block diagram showing the integration of the LPMEOH™ demonstration unit within the Eastman chemicals-from-coal complex is provided in Figure 1.2.3-1.

The Liquid Phase Dimethyl Ether (LPDME™) Process uses a physical mixture of a commercial methanol catalyst and a commercial dehydration catalyst in a single slurry reactor to coproduce DME with methanol. This process provides high syngas conversion, efficient heat transfer, and directly converts a variety of syngas compositions.

### **1.2.4 Site**

The demonstration unit, which occupies an area of 0.6 acre, is integrated into the existing 4,000-acre Eastman chemicals-from-complex located in Kingsport, Tennessee. The Eastman complex employs approximately 8,600 people. In 1983, Eastman constructed a coal gasification facility utilizing Texaco technology. The syngas generated by this gasification facility is used to produce carbon monoxide and methanol. Both of these products are used to produce methyl acetate and ultimately cellulose acetate and acetic acid. The availability of this highly reliable coal gasification facility was the major factor in selecting this location for the LPMEOH™ demonstration unit. An aerial photograph of Eastman's chemicals-from-coal complex is provided in Figure 1.2.4-1.

Three different feed gas streams (H<sub>2</sub> Gas, CO Gas, and the primary syngas feed known as Balanced Gas) are available from existing operations to the LPMEOH™ demonstration unit, thus providing the range of coal-derived syngas ratios (H<sub>2</sub> to CO) needed to meet the technical objectives of the demonstration project.

**Figure 1.2.3-1  
Integration of Existing Facilities with LPMEOH™ Demonstration Unit**

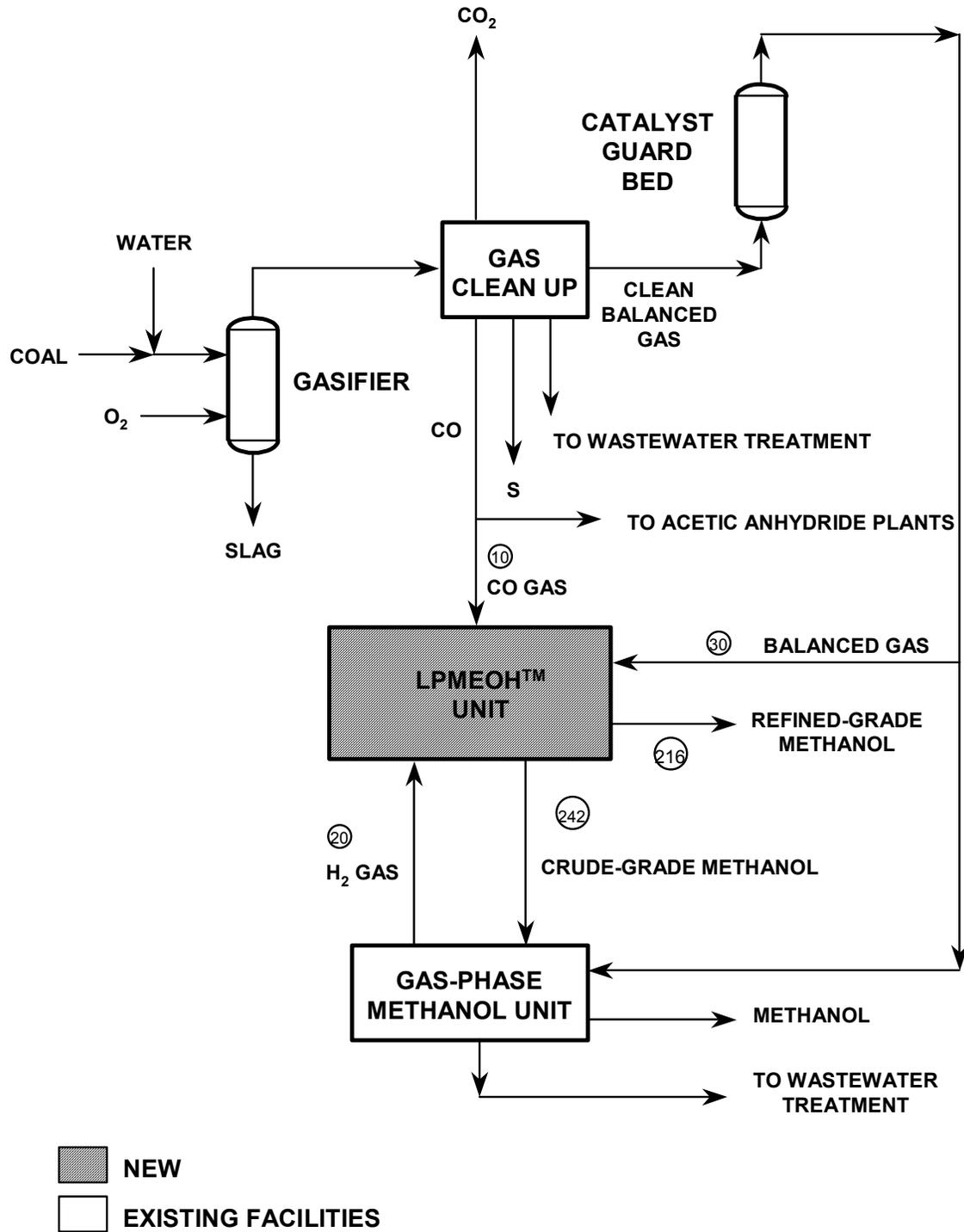

Note: Material Balance Points correspond to Stream Numbers on Table 2.5-1.

**Figure 1.2.4-1**  
**Photograph of Eastman Chemical Company's Chemicals-from-Coal Complex**

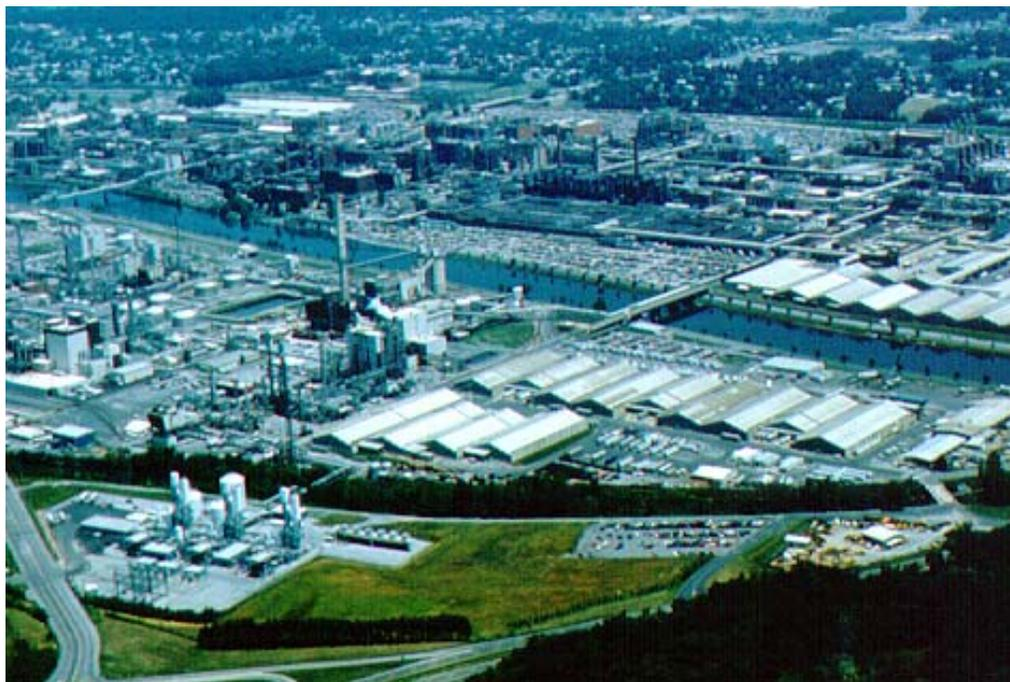

### **1.2.5 Project Schedule**

The project was divided into the following three phases:

- Design
- Construction
- Operation

The design phase included all of the engineering needed to construct the demonstration unit. This activity started in October of 1993 and was completed in early 1996. The construction phase started in October of 1995 and included the fabrication of the equipment and the field construction tasks (foundations, steel erection, etc.). The demonstration unit was commissioned in March of 1997. The startup was extremely smooth, as demonstrated by the rapid progression from first introduction of syngas (02 April 1997) to stable operation at design conditions (06 April 1997) to a test at 115% of the design production rate of methanol (10 April 1997). The startup also proceeded without injury or environmental incidents.

Based upon the original timetable for the project, the four-year demonstration test period was scheduled to be completed on 31 March 2001, with project close-out to be concluded by 31 December 2001. However, operational issues were encountered with the gas sparger within the LPMEOH™ reactor and with the impact of trace contaminants present in the coal-derived syngas on the long-term performance and life of the methanol synthesis catalyst. Additional information on these items is provided in Section 3.1 of this report. The time required to study

and develop solutions to these technical challenges adversely impacted the ability to execute the Demonstration Test Plan according to the original schedule.

During the project execution, an update on the economics of the coproduction of methanol with electric power via the LPMEOH™ Process was performed. During these studies, modes of operation that had not been anticipated during the development of the original Demonstration Test Plan were identified. One example was the development of a procedure to activate the methanol synthesis catalyst within the LPMEOH™ reactor by using syngas which is diluted with nitrogen (N<sub>2</sub>) (known as in-situ activation). If the separate processing equipment to activate catalyst on a batch-wise basis could be eliminated, a capital cost savings of about 10% would be realized. Also, operating the LPMEOH™ reactor at low temperatures at the outset and slowly increasing temperature with time to maintain a constant production of methanol can extend the life of the methanol synthesis catalyst.

Based upon these results, Air Products, on behalf of the Partnership, requested a 15-month no-cost time extension on 25 February 2000. This extension was necessary to complete some of the key tests which were originally defined in the September 1996 Demonstration Test Plan, and to allow the opportunity to perform the new tests of significant commercial interest. The extension was approved by DOE on 24 April 2000 and accepted by Air Products on behalf of the Partnership on 08 May 2000. Air Products submitted the first draft for the update to the Demonstration Test Plan on 15 May 2000; the final version was approved by DOE on 15 February 2001.

Over the next year, significant progress was made toward achieving the objectives for operation of the LPMEOH™ demonstration unit during the 15-month period of extended operation. A new commercially available adsorbent material was charged into the catalyst guard bed within the LPMEOH™ demonstration unit, pretreated to remove oxygen (O<sub>2</sub>), and brought on stream; initial results for the removal of arsenic from the Balanced Gas feed met performance expectations. Tests on operation in load-following and on-off modes, which are expected to occur in an IGCC complex where both methanol and electric power are produced, were successfully completed. Additional test campaigns on CO-rich syngas were performed. In August of 2001, the first test of the in-situ activation procedure was performed. Initial catalyst performance was less than the value expected from experiments in the laboratory.

Based upon this continued progress, Air Products, on behalf of the Partnership, requested an in-scope technical redirection of funds on 01 February 2002. Pending results from a laboratory assessment, the Partnership was considering a recommendation to DOE that a second attempt to perform the in-situ catalyst activation procedure may be warranted. Based upon the redirection of the available project funds and the time necessary to complete the laboratory studies, implement changes, perform the in-situ activation, and assess the results, it was expected that demonstration operations could be supported through December of 2002. Project closeout activities would be completed by the project end date of 31 March 2003 (the project was extended to 30 June 2003 to allow for completion of all technical reports). DOE approved this in-scope technical redirection on 08 March 2002. Based upon this redirection, the list and schedule of tests within the Demonstration Test Plan was updated; these changes are discussed in Section 4.1. As detailed in Section 5.6.4, the performance following the second in-situ

activation of catalyst matched the performance expected with properly activated catalyst from the laboratory autoclave.

The operating phase for the LPMEOH™ Demonstration Project was concluded on 31 December 2002. The final schedule, including activities associated with Design Verification Testing (DVT) of DME and the off-site fuel use testing program for stabilized methanol, is provided in Figure 1.2.5-1.

### **1.3 OBJECTIVES OF THE PROJECT**

#### **1.3.1 Primary Objective**

The LPMEOH™ Process technology is expected to be commercialized as part of an IGCC electric power generation system. Therefore, the project incorporates the commercially important aspects of the operation of the LPMEOH™ Process which would enhance IGCC power generation. These include the following:

- The coproduction of electric power and of high value liquid transportation fuels and/or chemical feedstocks from coal. This coproduction requires that the partial conversion of syngas to storable liquid products be demonstrated.
- Using an energy load-following operating concept which allows conversion of off-peak energy, at attendant low value, into peak energy commanding a higher value. The load-following concept makes use of gasifier capacity that is under utilized during low-demand periods by using the LPMEOH™ Process to convert the excess syngas to a storable liquid fuel for use in electric power generation during the peak energy periods. This operating concept requires that on/off and electrical load following capabilities be demonstrated.

During operation, the instrumentation system allowed for the collection of engineering data, analysis, and reporting which was done by technical personnel. Typical reporting included on-stream factors, material and energy balances, reactor and equipment performance, comparison with laboratory and AFDU results, conversion efficiencies, and catalyst activity. The resulting database will be used to quantitatively evaluate the LPMEOH™ Process technology compared to other commercially available methanol synthesis process technologies.

#### **1.3.2 Secondary Objective**

A secondary objective of the project was to demonstrate the production of DME as a mixed coproduct with methanol.

Subject to successful DVT, the Partnership proposed to enhance the project by including the demonstration of the slurry reactor's capability to produce DME as a mixed coproduct with methanol. DVT was required to address issues such as catalyst activity and stability and to provide data for engineering design and demonstration decision making.

**Figure 1.2.5-1  
LPMEOH™ Demonstration Project Schedule**

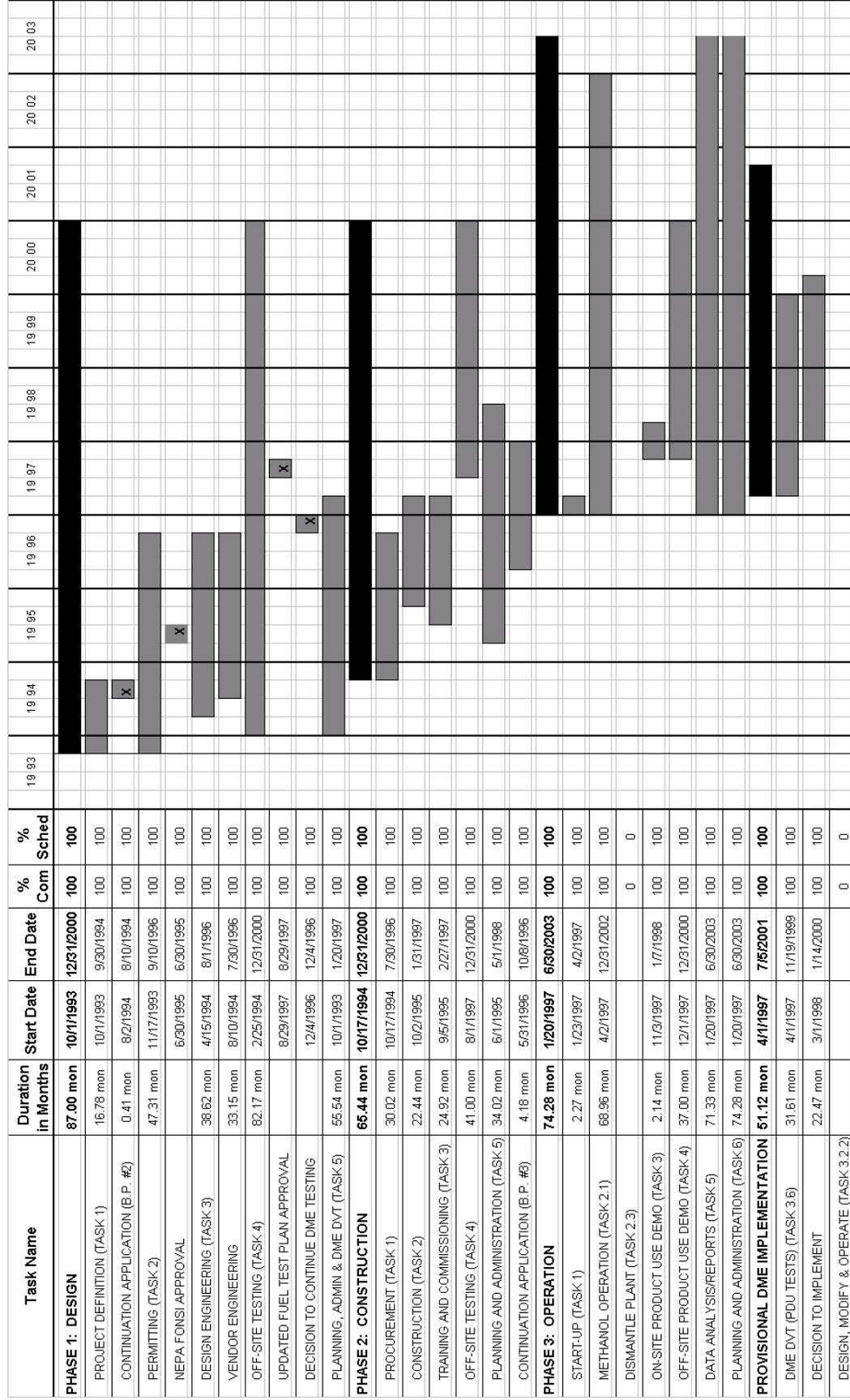



## **1.4 SIGNIFICANCE OF THE PROJECT**

This project demonstrated the commercial viability of Air Products' LPMEOH™ Process using coal-derived syngas, a mixture of H<sub>2</sub> and CO. The DOE's purpose for the demonstration project was to help fulfill the goals and objectives of the Clean Coal Technology Program by demonstrating the potential of a more efficient, liquid-phase reaction process as a preferred alternative to gas-phase reactions for methanol production.

The United States needs future sources of alternative liquid fuels. With domestic oil production declining and imports increasing, the potential of producing affordable liquid fuels from non-petroleum sources could one day prove both strategically and economically important. The LPMEOH™ Process offers an extremely attractive route to supplementing liquid fuel supplies with methanol made from abundant coal reserves in the United States.

Methanol has a broad range of commercial applications. It can be substituted for or blended with gasoline to power vehicles. It is an excellent fuel for the rapid-start combustion turbines used by utilities to meet peak electricity demands. It contains no sulfur and has exceptionally low NO<sub>x</sub> characteristics when burned. It is also used as a chemical feedstock.

The technology that has now completed the demonstration operations phase is ideally suited as an adjunct to a coal-based IGCC power plant - one of the cleanest and most efficient of the 21st century power generating options. When the power plant is not generating at its full capacity, excess syngas can be diverted to make methanol. The methanol could be stored on-site and used in peaking turbines or sold as a commercial fuel or chemical feedstock. In this configuration, the cost of making methanol from coal is likely to be competitive with stand-alone natural gas-to-methanol facilities.

The project objectives were to demonstrate the scaleup and operability of the LPMEOH™ Process under various coal-based feed gas compositions and to gain operating experience for future syngas conversion projects. DVT was also performed to evaluate the potential demonstration of the production of DME from syngas as a mixed coproduct with methanol.

The LPMEOH™ Process offers significant potential to economically produce methanol (using a technology developed in the United States over conventional technologies) and to reduce electric power generation costs with the production of alternative liquid fuels. The domestically developed LPMEOH™ technology can utilize the abundant coal reserves of the United States to produce clean, storable, liquid fuels and chemical feedstocks. Eventual commercialization of the LPMEOH™ Process in IGCC power plants would provide low priced chemical feedstocks and fuel leading to electric power generation cost savings, lower SO<sub>2</sub> and NO<sub>x</sub> emissions, and the reduced use of imported liquid fuels.

## **1.5 DOE'S ROLE IN THE PROJECT**

### **1.5.1 Clean Coal Technology Program**

The DOE's Clean Coal Technology Program has been implemented through five competitive solicitations. Congress set the basic goals for the program and for each solicitation in the enabling legislation and accompanying report language. DOE subsequently translated the guidance into performance-oriented solicitations. For each solicitation, evaluation criteria were defined and weighted to reflect specific congressional guidance and the current program objectives. This process enabled industry to set the technical agenda by allowing companies to propose their own technologies as qualifying projects. This had the significant benefit of attracting higher levels of private-sector cost-sharing and increasing the likelihood of realizing commercialization objectives.

An important attribute to the solicitation approach used to implement the program was the use of multiple solicitations spread over a number of years. Allowing time between solicitations made it possible to adjust program objectives. At the end of each solicitation, Congress provided the flexibility as needed to effectively implement the program.

Each solicitation was issued as a Program Opportunity Notice (PON). Proposals for demonstration projects consistent with the objectives of each PON were submitted to DOE by a specific deadline. DOE evaluated the proposals and announced those projects selected for negotiation.

The objective of the Round III was to solicit cost-shared clean coal technology projects to demonstrate innovative, energy-efficient technologies capable of being commercialized in the 1990's. These technologies were to be capable of (1) achieving significant reductions in emissions of SO<sub>2</sub> and/or NO<sub>x</sub> from existing facilities to minimize environmental impacts, such as transboundary and interstate pollution, and/or (2) providing for future energy needs in an environmentally acceptable manner. DOE received 48 proposals and selected 13 projects as best furthering the goals and objectives of the PON.

The LPMEOH™ Demonstration Project was selected in December of 1989 under Round III of the Clean Coal Technology Program.

### **1.5.2 Management Plan**

The DOE entered into a Cooperative Agreement with Air Products and Chemicals, Inc., which was later novated to the Partnership (between Air Products and Eastman) to conduct the project. The DOE monitored the project through the Contracting Officer and the Contracting Officer's Technical Representative (COTR). The Partnership managed the project through an Air Products Program Manager, who was assisted by a team of technical and managerial personnel from Air Products and from Eastman.

The organizational chart for the design and construction phases is included in the Public Design Report (Final Report - Volume 1). The organizational chart for the operating phase is shown in Figure 1.5.2-1.

### **1.5.2.1 DOE**

The DOE was responsible for monitoring all aspects of the project and for granting or denying approvals required by the Cooperative Agreement. The DOE Contracting Officer was the authorized representative of the DOE for all matters related to the Cooperative Agreement.

The DOE Contracting Officer appointed a COTR, who was the authorized representative for all technical matters and had the authority to issue “Technical Advice.” The COTR also approved those reports, plans, and technical information required under the Cooperative Agreement. The DOE COTR did not have the authority to issue any technical advice that assigned additional work outside the Statement of Work, increased or decreased the total estimated cost or time required for performance of the Cooperative Agreement, changed any of the terms, conditions, or specifications of the Agreement, or interfered with The Partnership’s right to perform the terms and conditions of the Agreement. All Technical Advice was issued in writing by the DOE COTR.

### **1.5.2.2 The Partnership**

The Air Products Program Manager coordinated the overall project and was responsible for all communication with the DOE and for interfacing with the DOE COTR.

The Air Products Program Manager was the primary focal point for this project having responsibility and authority for direction of the project subsequent to the signing of the Cooperative Agreement. The Air Products Program Manager was the principal representative between the Partnership and the DOE.

The Program Manager’s responsibilities encompassed both technical and fiscal considerations, including the following:

- Overall technical coordination of the program
- Monitoring of program cost
- Monitoring of program planning
- Monitoring of program schedule
- Commitment of resources to optimize performance under the Cooperative Agreement
- Reporting requirements
- Final review of all contract deliverables

Throughout the course of this project, reports dealing with technical, cost, and environmental aspects of the project were prepared by the Partnership and provided to DOE.

**Figure 1.5.2-1  
Kingsport LPMEOH™ Demonstration Project  
Operating Phase Organization Chart**

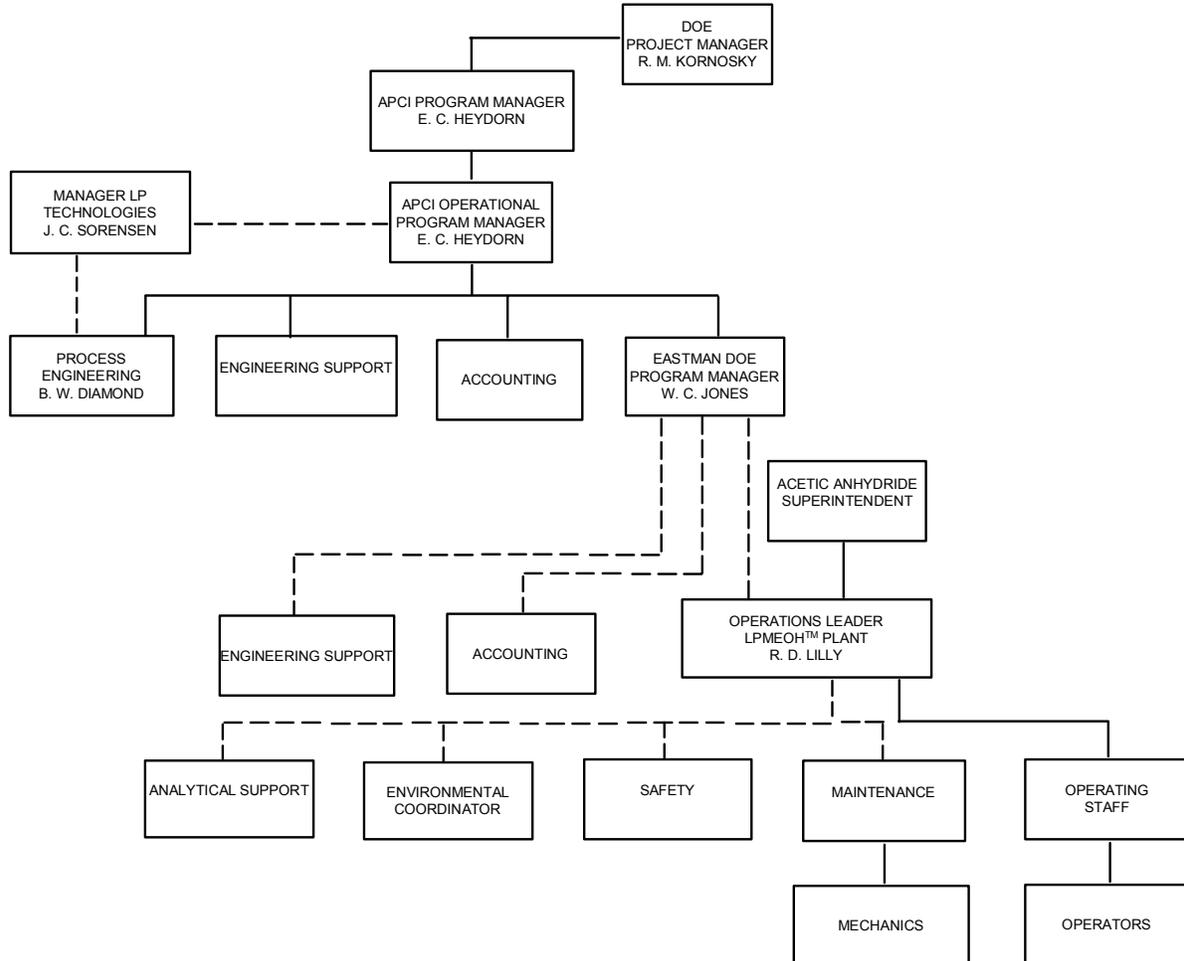

## 2.0 TECHNOLOGY DESCRIPTION

### 2.1 DESCRIPTION OF THE DEMONSTRATED TECHNOLOGY

Methanol is a versatile commodity chemical with applications ranging from fuels to feedstocks for higher valued chemicals such as methyl methacrylate and methyl tertiary-butyl ether (MTBE, an octane booster). Many applications have evolved for methanol as a fuel including methanol as a gasoline extender, the methanol to gasoline process, methanol as a feedstock to fuel cell systems, and IGCC technology for the coproduction of methanol and electricity.

The LPMEOH™ Process represents a major departure from traditional gas-phase routes to methanol in the method of removing the heat of reaction. The reactions of H<sub>2</sub> and CO and carbon dioxide (CO<sub>2</sub>) to form methanol are highly exothermic.

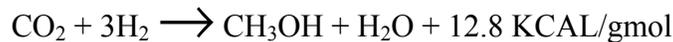

#### TYPICAL REACTION CONDITIONS:

1,000 psig  
440°–520°F

One of the most difficult design problems of the methanol synthesis process is removing the heat of reaction while maintaining precise temperature control to achieve optimum catalyst life and reaction rate. Catalyst life is seriously reduced by excessive temperatures.

Reactor schematics for conventional gas-phase reactors are shown in Figure 2.1-1. The catalyst is in the form of pellets. In these conventional gas-phase reactors, either cool unreacted gas is injected at stages in the catalyst bed, or internal cooling surfaces are used to provide temperature control. These schemes, however, were developed for diluted syngas which yields low conversion per pass. The LPMEOH™ Process (Figure 2.1-2) uses fine catalyst particles entrained in an inert hydrocarbon liquid, usually a mineral oil. The mineral oil acts as a temperature moderator and a heat removal medium, transferring the heat of reaction from the catalyst surface via the liquid slurry to boiling water in an internal tubular heat exchanger. As a result of this capability to remove heat and maintain a constant, highly uniform temperature through the entire length of the reactor, the slurry reactor can achieve much higher syngas conversion per pass than its gas-phase counterparts.

In addition, the LPMEOH™ Process is particularly well suited to coal-derived syngas which is rich in CO. These capabilities make the LPMEOH™ Process a potentially lower-cost conversion route to methanol, especially when methanol coproduction is added to a coal-based IGCC power plant. For a modest increase in complexity of an IGCC power plant, the methanol coproduction scheme produces a storable liquid fuel in parallel with electric power production, providing a significant turndown and peak-load capability for the IGCC power plant.

**Figure 2.1-1  
Gas-Phase Methanol Reactors**

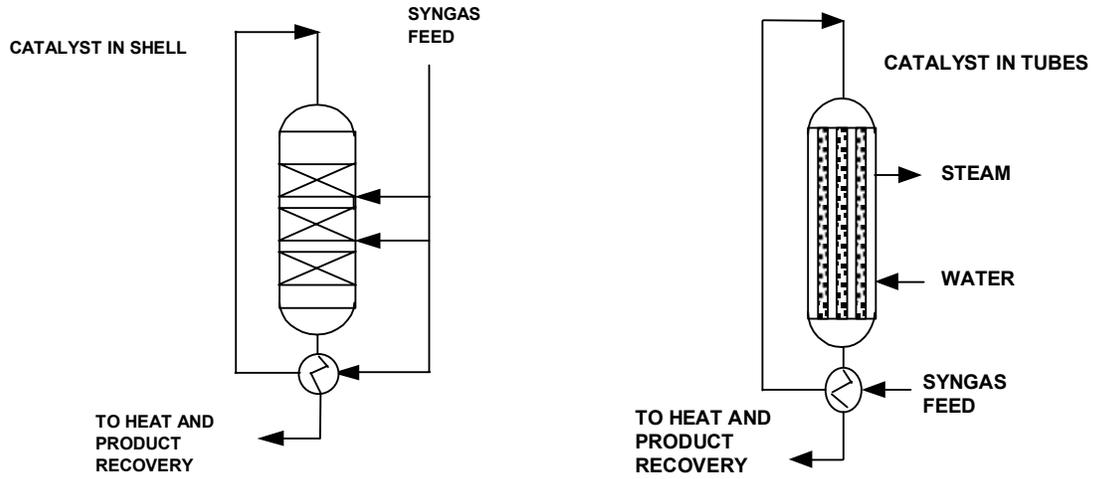

**Figure 2.1-2  
LPMEOH™ Reactor Schematic**

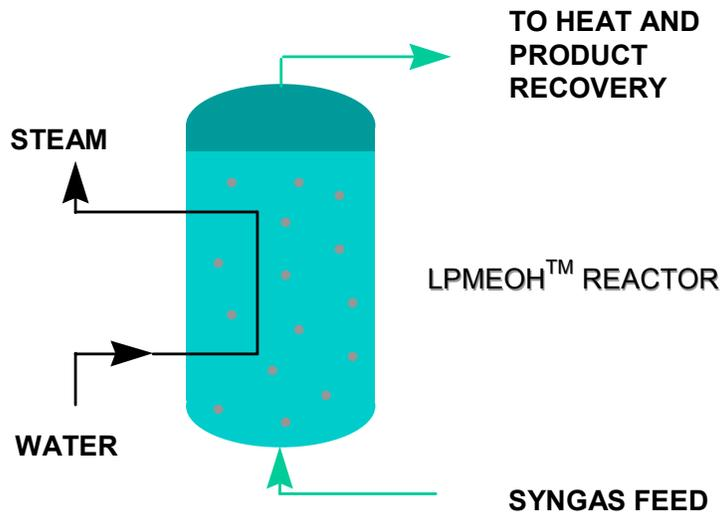

Information on the application of the LPMEOH™ Process to the IGCC power plant is provided in Section 9 of this report.

## **2.2 DESCRIPTION OF THE DEMONSTRATION FACILITY**

The reactor used in the LPMEOH™ Process is unlike conventional gas-phase reactors that use fixed beds of catalyst pellets and largely depend upon recycle diluent gas to both dilute the CO concentration and control the temperature rise caused by the heat of reaction. The LPMEOH™ reactor is a slurry reactor with small, powder-size catalyst particles suspended in inert mineral oil. The syngas bubbles up through the slurry where the H<sub>2</sub> and CO dissolve in the oil and diffuse to the catalyst surface where the methanol reaction occurs. The product methanol diffuses out of the slurry and exits as a vapor with the unreacted syngas. The inert oil acts as a heat sink and permits isothermal operation. The net heat of reaction is removed via an internal heat exchanger which produces steam. Unlike gas-phase reactors that limit per-pass conversion of syngas to methanol to accommodate the reaction exotherm, the LPMEOH™ reactor maintains isothermal operation. The methanol vapor leaves the reactor and is condensed to a liquid, sent to distillation columns for removal of higher alcohols, water (H<sub>2</sub>O), and other impurities, and is then stored in lot tanks for sampling prior to being sent to Eastman's methanol storage. A portion of the unreacted syngas is sent back to the reactor with the recycle compressor, improving cycle efficiency. The methanol is used for downstream feedstocks and for off-site fuel-use testing.

Unlike gas-phase reactors, the LPMEOH™ reactor is tolerant to CO-rich gas. Shift and CO<sub>2</sub> removal are not required. Low H<sub>2</sub>-to-CO ratios are acceptable as is any CO<sub>2</sub> content. Finally, in contrast to the gas-phase reactor in which the catalyst is sensitive to flow variations and changes from steady-state, the LPMEOH™ reactor is eminently suited for load-following and on/off operation in electrical generating applications.

The LPMEOH™ demonstration unit is integrated with Eastman's coal gasification facility and inserted in parallel with an existing gas-phase methanol unit.

No new equipment items were added to the LPMEOH™ demonstration unit during the operating phase; however, a different design for the pump used to add fresh mineral oil to the process was installed to replace the pumps from the original design. Also, Air Products developed two alternative designs for the gas sparger within the LPMEOH™ reactor, the last of which has been in service since March of 1999. The adsorbent material in the catalyst guard bed within the LPMEOH™ demonstration unit was also changed to remove arsine in addition to metal carbonyls, and changes were made to the piping and instrumentation system around this catalyst guard bed to allow for the new adsorbent to be pretreated prior to use in the process. Details on the changes can be found in Section 3.0 of this report.

## **2.3 PROPRIETARY INFORMATION**

As noted in Section 1.1, the scope of this report is limited to nonproprietary information. Therefore, although its content is insufficient to provide a complete tool for designing a LPMEOH™ unit, it will serve as a reference for the design considerations involved in developing a commercial-scale facility.

## **2.4 SIMPLIFIED PROCESS FLOW DIAGRAM**

The LPMEOH™ demonstration unit consists of five main process sections: Feed Gas Purification, Compression, Reactor Loop and Catalyst Reduction, Distillation, and Storage and Miscellaneous. The Feed Gas Purification area includes the feed gas supply tie-ins and a catalyst guard bed. The Compression area contains the recycle gas compressor and associated systems. The Reactor Loop and Catalyst Reduction area includes the reactor with its associated equipment and the slurry handling equipment and utility oil skid associated with catalyst preparation. The Distillation area includes two distillation columns and heat exchangers. The Storage and Miscellaneous area comprises oil storage and other process components. A detailed description of these sections is provided in Section 4.3 of the Public Design Report (Final Report - Volume 1). A block diagram for the LPMEOH™ demonstration unit is provided in Figure 2.4-1. A glossary of syngas terminology is provided in the beginning of this document.

## **2.5 STREAM DATA**

Table 2.5-1 shows the material balance for the points shown on Figures 1.2.3-1 and 2.4-1.

## **2.6 PROCESS AND INSTRUMENTATION DIAGRAMS**

A set of Process and Instrumentation Diagrams (P&ID's) can be found in Appendix A of the Public Design Report (Final Report - Volume 1).



**Figure 2.4-1  
LPMEOH™ Demonstration Unit Simplified Process Flow Diagram**

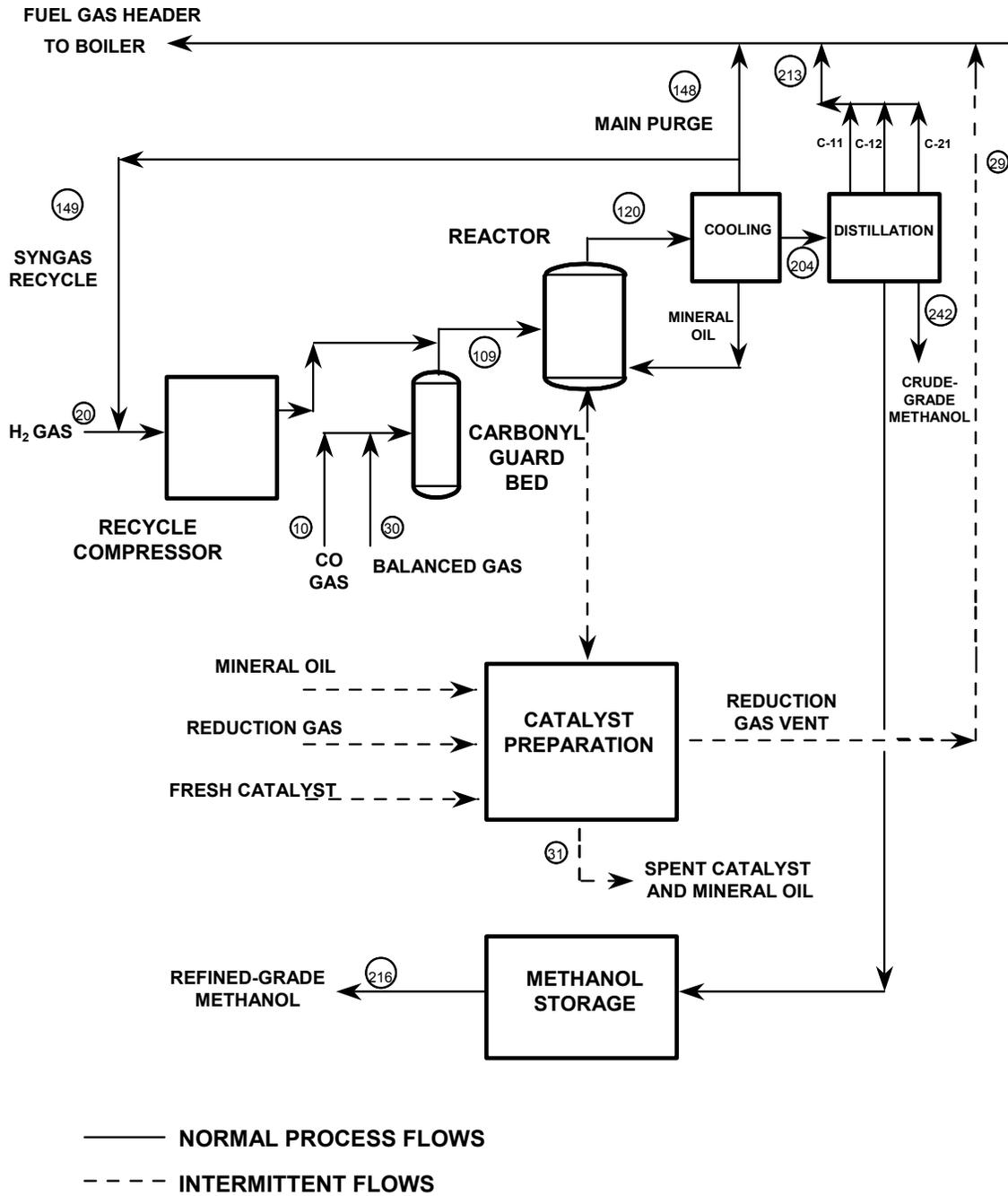

Note: Material Balance Points correspond to Stream Numbers on Table 2.5-1.

**Table 2.5-1  
Heat and Material Balance Summary**

CASE	L:\kingsprt\hmb\1feb95\ design							
Stream No.		10	109	120	148	149	20	204
Press	PSI	875.0	785.0	735.0	722.0	722.0	765.0	85.0
Temp	C	37.8	169.5	121.1	40.5	40.5	37.8	40.1
Temp	F	100.0	337.1	249.9	105.0	105.0	100.0	104.2
Lb mol/hr								
H2		2.636	4402.484	2967.899	252.163	2712.126	77.996	3.610
CO		127.846	1818.957	1121.754	95.167	1023.566	11.594	3.021
N2		1.318	293.947	294.054	24.922	268.047	12.648	1.084
CO2		0.000	654.744	635.137	51.831	557.470	3.162	25.836
MEOH		0.000	42.496	744.457	3.952	42.504	0.000	698.001
DME		0.000	3.790	5.057	0.353	3.796	0.000	0.909
H2O		0.000	0.448	21.642	0.042	0.448	0.000	21.152
ETOH		0.000	0.016	0.447	0.002	0.016	0.000	0.429
C3OH		0.000	0.001	0.065	0.000	0.001	0.000	0.063
C4OH		0.000	0.000	0.026	0.000	0.000	0.000	0.026
IBOH		0.000	0.001	0.087	0.000	0.001	0.000	0.086
C5OH		0.000	0.000	0.018	0.000	0.000	0.000	0.018
MEAC		0.000	0.065	0.242	0.006	0.065	0.000	0.171
MEFM		0.000	1.256	2.790	0.117	1.259	0.000	1.415
C1		0.000	12.228	13.449	1.137	12.234	0.000	0.077
C2		0.000	3.549	3.982	0.331	3.557	0.000	0.095
C3		0.000	1.007	1.171	0.094	1.010	0.000	0.067
OIL		0.000	0.000	0.032	0.000	0.000	0.000	0.032
Total molar flow		131.8	7235.0	5812.3	430.1	4626.1	105.4	756.1
Total massflow	lb/hr	3.623	98.846	98.686	6.337	68.154	975	24.195
Enthalpy	MMBtu/hr	-6.083	-188.288	-221.879	-13.674	-147.071	-1.066	-79.011
mol%								
H2		2.000	60.850	51.062	58.627	58.627	74.000	0.477
CO		97.000	25.141	19.300	22.126	22.126	11.000	0.400
N2		1.000	4.063	5.059	5.794	5.794	12.000	0.143
CO2		0.000	9.050	10.927	12.051	12.051	3.000	3.417
MEOH		0.000	0.587	12.808	0.919	0.919	0.000	92.317
DME		0.000	0.052	0.087	0.082	0.082	0.000	0.120
H2O		0.000	0.006	0.372	0.010	0.010	0.000	2.797
ETOH		0.000	0.000	0.008	0.000	0.000	0.000	0.057
C3OH		0.000	0.000	0.001	0.000	0.000	0.000	0.008
C4OH		0.000	0.000	0.000	0.000	0.000	0.000	0.003
IBOH		0.000	0.000	0.001	0.000	0.000	0.000	0.011
C5OH		0.000	0.000	0.000	0.000	0.000	0.000	0.002
MEAC		0.000	0.001	0.004	0.001	0.001	0.000	0.023
MEFM		0.000	0.017	0.048	0.027	0.027	0.000	0.187
C1		0.000	0.169	0.231	0.264	0.264	0.000	0.010
C2		0.000	0.049	0.069	0.077	0.077	0.000	0.013
C3		0.000	0.014	0.020	0.022	0.022	0.000	0.009
OIL		0.000	0.000	0.001	0.000	0.000	0.000	0.004
Total		100	100	100	100	100	100	100
Vapor Fraction		1.000	1.000	1.000	1.000	1.000	1.000	0.025
Liquid Fraction		0.000	0.000	0.000	0.000	0.000	0.000	0.975
Mol. Wt. Mix		27.490	13.662	16.979	14.733	14.733	9.255	32.000
Mol. Wt. Vapor		27.490	13.662	16.979	14.733	14.733	9.255	32.286
Mol. Wt. Liquid								31.992
Density	LB/ CUFT	4.092	1.206	1.621	1.701	1.701	1.114	13.386
Vapor Density	LB/ CUFT	4.092	1.206	1.621	1.701	1.701	1.114	0.461
Liquid Density	LB/ CUFT							48.981

**Table 2.5-1  
Heat and Material Balance Summary (cont'd)**

CASE	L:\kingsprt\hmb\1feb95\ design				
Stream No.		213	216	242	30
Press	PSI		40.0	80.0	790.0
Temp	C		40.7	100.8	37.8
Temp	F		105.3	213.4	100.0
Lbmol/hr					
H2		3.610	0.000	0.000	1608.013
CO		3.021	0.000	0.000	656.961
N2		1.084	0.000	0.000	11.859
CO2		25.836	0.000	0.000	94.868
MEOH		3.601	520.901	173.499	0.000
DME		0.909	0.000	0.000	0.000
H2O		0.013	0.054	21.084	0.000
ETOH		0.000	0.043	0.386	0.000
C3OH		0.000	0.000	0.063	0.000
C4OH		0.000	0.000	0.026	0.000
IBOH		0.000	0.000	0.085	0.000
C5OH		0.000	0.000	0.018	0.000
MEAC		0.170	0.002	0.000	0.000
MEFM		1.415	0.000	0.000	0.000
C1		0.077	0.000	0.000	0.000
C2		0.095	0.000	0.000	0.000
C3		0.067	0.000	0.000	0.000
OIL		0.000	0.000	0.032	0.000
Total molar flow		39.9	521.0	195.2	2371.7
Total mass flow	lb/hr	1,521	16,694	5,980	26,150
Enthalpy	MMBtu/hr	-5.147	-53.303	-19.938	-46.877
mol%					
H2		9.048	0.000	0.000	67.800
CO		7.572	0.000	0.000	27.700
N2		2.718	0.000	0.000	0.500
CO2		64.755	0.000	0.000	4.000
MEOH		9.026	99.981	88.885	0.000
DME		2.278	0.000	0.000	0.000
H2O		0.033	0.010	10.802	0.000
ETOH		0.001	0.008	0.198	0.000
C3OH		0.000	0.000	0.033	0.000
C4OH		0.000	0.000	0.013	0.000
IBOH		0.000	0.000	0.044	0.000
C5OH		0.000	0.000	0.009	0.000
MEAC		0.425	0.000	0.000	0.000
MEFM		3.546	0.000	0.000	0.000
C1		0.193	0.000	0.000	0.000
C2		0.237	0.000	0.000	0.000
C3		0.168	0.000	0.000	0.000
OIL		0.000	0.000	0.017	0.000
Total		100	100	100	100
Vapor Fraction		1.000	0.000	0.000	1.000
Liquid Fraction		0.000	1.000	1.000	0.000
Mol. Wt. Mix		38.132	32.042	30.634	11.026
Mol. Wt. Vapor		-0.003			11.026
Mol. Wt. Liquid			32.042	30.634	
Density	LB/ CUFT		48.306	45.200	1.377
Vapor Density	LB/ CUFT				1.377
Liquid Density	LB/ CUFT		48.306	45.200	

### 3.0 UPDATE OF THE PUBLIC DESIGN REPORT

#### 3.1 DESIGN AND EQUIPMENT CHANGES

Over the first three years of operation, the LPMEOH™ demonstration unit achieved an availability in excess of 97%. Engineering data was collected and analyzed so that the engineering tools that are necessary for the design of larger-scale LPMEOH™ plants could be improved. Much of the work associated with process optimization was completed, and ideas to reduce the number of rotating equipment items which simplify the process were successfully implemented.



Early performance of the proprietary gas sparger within the LPMEOH™ reactor (7.5' internal diameter) met expectations for gas distribution and reactor hydrodynamics, but the pressure drop across the device increased over time. Ultimately, the flow resistance across the sparger reached a value that severely limited the quantity of syngas that could be processed. After some proprietary studies conducted by Air Products, two updated spargers, designed by Air Products and fabricated by Eastman for the Partnership, were placed into service, the latest being in March of 1999. As detailed in Section 5.3, this device has shown excellent performance, with no increase in pressure drop over time.

Another technical challenge was the impact of trace contaminants present in the coal-derived syngas (which is the primary feedstock to the LPMEOH™ reactor) on the long-term performance and life of the methanol synthesis catalyst. These species, which are typically found in coal and are present in syngas streams in parts-per-billion levels, reduce the life of the catalyst, thus adversely affecting the economics of the LPMEOH™ Process. During the first year of operation, the rate of deactivation of the methanol synthesis catalyst was significantly higher than the target value which had been previously determined in a 4-month proof-of-concept test at the LaPorte AFDU. Significant progress was made in identifying both the species of catalyst poisons present in the syngas and the adsorbents which, when used upstream in the catalyst guard bed vessels, can effectively and economically remove these contaminants. Additional information is provided in Section 5.2.

### **3.1.1 Condensed Oil (29G-01) and Oil Makeup (29G-03) Pumps**

During plant commissioning activities, two sets of pumps required additional attention and impacted the mode of operation of the LPMEOH™ demonstration unit during startup.

The 29G-01 condensed oil pumps were designed to return condensed and entrained oil and catalyst from the 29C-05 secondary oil knock-out drum and 29C-06 cyclone to the 29C-01 LPMEOH™ reactor. A twin-screw design was selected due to the potential for high solids loadings at reactor temperatures and pressures. The 29G-03 oil make-up pumps were intended to provide seal flush to the condensed oil pumps, oil addition to the reactor loop, and high-pressure (1,100 psig) piping flush oil. The pumps also employed a twin-screw design with extremely tight clearances to generate high pressure differential, as the make-up oil was stored in the 29D-30 oil storage tank at low pressure (less than 10 psig). During initial commissioning activities in January of 1997, these pumps operated well during testing at the required discharge pressure of 700 to 900 psig. However, during subsequent testing, both oil make-up pumps exhibited difficulty in delivering oil at the required pressure. Notably, since the oil make-up pumps could not function at rated conditions to supply the necessary seal flush, the condensed oil pumps could not operate at full suction pressure.

During the plant design phase, in anticipation of operating problems with the condensed oil pumps, the elevation of the slurry collection equipment (secondary oil knock-out drum and cyclone) was raised high enough to permit any entrained or condensed material to gravity-drain back to the reactor. Because of the inability of the oil make-up pumps to provide seal flush for the condensed oil pumps, operation in the free-draining mode began at startup, and initial results were positive. Fresh make-up oil was added to the process by using the 29G-30 slurry transfer pump, which was designed to transfer catalyst slurry from the 29C-30 catalyst reduction vessel to the LPMEOH™ reactor. The slurry transfer pump packing also requires flush from the oil make-up pumps; however, it was determined that operation of the slurry transfer pump in clean-oil service without packing flush would not adversely affect the service life of the pump. Accordingly, make-up oil was batch-transferred from the oil storage tank to the catalyst reduction vessel, and then pumped to the reactor by the slurry transfer pump.

The gravity-drain line did exhibit intermittent plugging or vapor-locking during operation. Early in the operating campaign, blockages could be cleared by opening a utility line between the secondary oil knock-out drum and the catalyst reduction vessel and briefly blowing down to low pressure; piping connections to provide flush oil were rendered useless by the inoperable high-pressure oil make-up pumps. However, on 25 April 1997, a blockage occurred in the free-drain line that could not be removed by this method. Since the solids concentration of the condensed and entrained oil and catalyst slurry was relatively low, it was determined that the slurry transfer pump could pump this material without a packing flush on the pump. Condensed oil was batch-transferred from the secondary oil knock-out drum to the catalyst reduction vessel, and then pumped to the reactor. The frequency of the transfer to the catalyst reduction vessel was about once every three hours, and the catalyst reduction vessel was pumped to the reactor about once every 10 hours. The calculated accumulation rate of condensed and entrained slurry (1.5 to 2.0 gpm) matched the expected liquid traffic within the oil/catalyst collection equipment. This early

operating experience confirmed that the ability to flush piping systems in slurry service was an important operability requirement.

After an engineering review by Air Products and Eastman, a new 29G-03 oil make-up pump was specified with a simpler design than the original twin-screw configuration. Only one of these new pumps was purchased and installed to develop operational experience at minimum capital cost. The new pump, priced at \$7,900, was brought online in October of 1997 and met all operational requirements. The availability of this pump to flush out periodic blockages in the gravity-drain line established the viability of that concept to return condensed and entrained slurry to the LPMEOH™ reactor, and as a result, the condensed oil pumps were not put into service under operating conditions. The potential benefits are tremendous for future designs, including: significant capital cost savings from the elimination of two slurry pumps and their ancillaries (and perhaps the redundant oil make-up pump); increased operating flexibility; and lower maintenance costs by eliminating the seal system for the slurry pumps.

The long-term success of the gravity-draining system to return entrained slurry and condensed oil to the LPMEOH™ reactor eliminated the need for the condensed oil pumps and their continuous seal flush requirement. As a result, the single oil make-up pump has continued to operate in batch mode only. In this mode, the pump has added oil to the LPMEOH™ Process to provide flush oil to piping and instrumentation associated with the LPMEOH™ reactor and cyclone; the amount of flush oil can be optimized to match the required amount of make-up oil that is necessary to overcome the average oil loss rate with the methanol product (nominally 0.1 to 0.2 gpm). The new pump has operated well in over five years of operation in this batch mode.

### **3.1.2 Slurry Return Pump (29G-02)**

During the initial startup of the LPMEOH™ demonstration unit, individual batches of methanol catalyst slurry were activated in the 29C-30 catalyst reduction vessel and then pressure-transferred into the 29D-02 slurry tank. After activation of the ninth and final batch, the entire charge was to be pumped from the slurry storage tank to the reactor using the 29G-02 slurry return pump. This pump included a packing design which required a continuous flush of clean oil from the oil storage tank using the 29G-34 oil feed pump. During the transfer operation, seal oil leaked through the packing at a significantly higher rate than expected. If this condition had continued throughout the transfer, the oil would have diluted the slurry considerably, perhaps to the point of overflowing the reactor vessel. The operations team decided to apply N<sub>2</sub> at 45-50 psig to the slurry tank and pressure-transfer the remaining slurry to the reactor. This procedure was accomplished successfully, and the technique was used for all remaining slurry transfer steps when the slurry tank was utilized. This pump will be eliminated in future designs, providing an opportunity for capital savings and improved operability.

### **3.1.3 Availability of Hydrogen Gas (H<sub>2</sub> Gas)**

During the design phase for the LPMEOH™ demonstration unit, one of the feed syngas streams was the purge stream from the existing gas-phase methanol unit (called hydrogen gas or H<sub>2</sub> Gas). This stream contained an excess of H<sub>2</sub> over the stoichiometric balance for the production of methanol, and was expected to be used to adjust the H<sub>2</sub>:CO ratio during several of the tests

within the demonstration test plan. However, due to pressure control issues in the Eastman chemicals-from-coal complex, the operating pressure for H<sub>2</sub> Gas had to be reduced to less than the operating pressure of the LPMEOH™ demonstration unit. As a consequence, H<sub>2</sub> Gas was not available as a feed gas. The impact of this change from the plant design basis on the ability to meet the technical objectives for the LPMEOH™ Demonstration Project was minimal; details are provided in Section 4.1.

#### **3.1.4 Gas Sparger**

Because the performance of a slurry bubble column reactor depends heavily on the method of introduction of feed gas, the gas sparger design is a key feature of the overall LPMEOH™ reactor design. The gas sparger design for the LPMEOH™ demonstration unit was based on the device used during the successful 4-month proof-of-concept run at the LaPorte AFDU in 1988/89. In general, the process scaleup from the LaPorte AFDU to commercial scale was a significant objective for the LPMEOH™ Demonstration Project, and the gas sparger was one of the key components in this area.

Three different gas sparger designs were utilized during the operation of the LPMEOH™ demonstration unit. The original gas sparger design was used from startup in April of 1997 until November of 1997. The second gas sparger design was a modification of the first sparger using similar design principles and was installed in December of 1997. This design was used until March of 1999. A modified sparger design, again using the same design principles as the original device, was installed in March of 1999 and was used for the remainder of the demonstration test program. Details on the performance of the three devices are provided in Section 5.3.

### **3.2 DEMONSTRATION PLANT EQUIPMENT COST UPDATE**

The updated equipment cost summary for the LPMEOH™ demonstration unit is provided in Table 3.2-1. The only additional equipment that was purchased during the demonstration period was the replacement for the 29G-03 oil makeup pump (described in Section 3.1.1). It should be noted that, if the pumps and associated equipment described in Section 3.1 had not been installed, the equipment cost of the LPMEOH™ demonstration unit would have been reduced by almost 5% (\$210,000 out of \$4.4 million).

**Table 3.2-1**  
**Kingsport LPMEOH™ Demonstration Unit - Update of Equipment Cost Summary**  
(Dollars in Thousands)

Area	Item Description	Total	Subtotal
A	<b>Feed Gas Purification</b>	<b>\$77.0</b>	\$77.0
B	<b>Compression</b>	<b>\$776.8</b>	
	Compression		\$699.6
	Exchangers		\$37.6
	Separators		\$39.6
C	<b>Reactor Loop and Catalyst Reduction</b>	<b>\$2,202.1</b>	
	Equipment		\$1,487.8
	Exchangers		\$332.3
	Pumps		\$382.0
D	<b>Distillation</b>	<b>\$703.4</b>	
	Equipment		\$309.5
	Exchangers		\$214.7
	Tanks		\$131.3
	Pumps and Misc.		\$47.9
E	<b>Storage and Miscellaneous</b>	<b>\$648.6</b>	<b>\$648.6</b>
<b>Total</b>		<b>\$4,407.9</b>	<b>\$4,407.9</b>

### **3.3 DEMONSTRATION PLANT OPERATING COST UPDATE**

Table 3.3-1 summarizes the updated operating costs for the LPMEOH™ demonstration unit. A new category of costs was added to cover the changeout and disposal of the adsorbent from the 29C-40 carbonyl guard bed (the costs and consumption utilized at the end of the demonstration period are used in the tabulation of costs). The costs were developed using the performance following the successful demonstration of the in-situ activation procedure and temperature programming (details are provided in Section 5.6) to extend the life of the methanol synthesis catalyst.



**Table 3.3-1**  
**Kingsport LPMEOH™ Demonstration Unit - Update of Operating Costs**  
 Base Year 2002

**ANNUAL FIXED OPERATING COST**

Number of Operators per Shift	1.5
Number of Shifts per Week	4.2
Operating and Technical Support Labor Rate, \$/hr	\$76.71
Total Annual Operating and Technical Support Labor Cost	\$671,971
Total Annual Maintenance Labor Cost	\$510,440
Total Annual Maintenance Material Cost	\$249,999
Total Annual Administration and Support Labor Cost	\$1,925,670
<b>TOTAL ANNUAL FIXED O&amp;M COST</b>	<b>\$3,358,081</b>

**VARIABLE OPERATING COST**

Commodity	Unit	\$/Unit <sup>(1)</sup>	Quantity/hr	\$/hr
Compressed Air	1,000 SCF	0.22	18.00	3.95
Demineralized Water	1,000 Lb	0.66	2,500.00	1.65
Electricity	kWh	0.04	770.00	33.82
Filtered Water	1,000 Gal	0.49	0.30	0.15
High Pressure Steam	1,000 Lb	5.49	6.00	32.94
Low Pressure Steam	1,000 Lb	4.94	-1.00	-4.94
Medium Pressure Steam	1,000 Lb	4.39	12.50	54.90
Nitrogen	1,000 SCF	0.66	4.00	2.64
Synthesis Gas	1,000 SCF	4.48	850.00	3,805.62
Catalyst	1 Lb	10.29	5.21	53.58
Mineral Oil	1 Gal	3.03	7.18	21.78
Guard Bed Adsorbent (incl. disposal)	1 Lb	9.07	2.81	25.52
Waste Water	1 year	15,152.12		1.97
Slurry Reclaiming	1 Lb	0.38	7.81	2.95
Distillation of 29C-20 Underflow	1 Gal	0.05	781.25	42.89
Area Services (laboratory, general services)	1 month	86,985.60		135.92

**TOTAL VARIABLE OPERATING COST** 4,215.33

**TOTAL ANNUAL OPERATING HOURS FOR DEMONSTRATION** 7,680

<sup>(1)</sup> - These unit costs reflect the costs incurred by the Air Products Liquid Phase Conversion Company, L.P. (the Partnership) and are typical of published utility costs (for example, Process Economics Program Report 136A, "Plant Utility Costs", published by SRI International, Menlo Park, CA), and have been indexed for inflation from 1997 to 2002 using data from the Producer Price Index – Chemicals and Allied Products.

## 4.0 DEMONSTRATION PROGRAM

### 4.1 TEST PLANS

A Demonstration Test Plan<sup>(a)</sup> was prepared from the Technical Objectives set for the project. This original version was comprised of 37 specific tests. These are given in Table 3-2 of the Public Design Report (Final Report - Volume 1). The conditions imposed by each of these tests were incorporated in the process design of the LPMEOH™ demonstration unit.

Based upon the results from the initial three years of operation of the LPMEOH™ demonstration unit as well as the identification of new tests of significant commercial interest, an update to the Demonstration Test Plan was proposed by Air Products in 2000. The impact of catalyst poisons, both as post-construction debris and as present in the Balanced Gas feed, on the long-term performance of the catalyst altered the timeline for completing the objectives as stated in the Section 1.3.1 of this report. As a result, operating activities were focused upon studying the effects of catalyst concentration in the reactor (an important parameter in plant economics) on reactor hydrodynamics. As noted in Section 5.1, the weight of catalyst in the reactor reached a maximum of 151% of design during this step-wise approach to determining the operating limits for the slurry bubble column reactor.

Operation of the LPMEOH™ demonstration unit was different relative to the original design concept, thus eliminating either the ability or the need to complete several of the tests which had been included in the original Demonstration Test Plan (refer to Table 3.2 of the Public Design Report [Final Report - Volume 1] for the relevant test number and description):

- 1) In the original plant configuration, H<sub>2</sub> Gas was included as one of the feed syngas streams to the LPMEOH™ demonstration unit. However, as noted in Section 3.1, H<sub>2</sub> Gas was not available as a feed gas. This eliminated the ability to complete Test 12. Tests 13 and 14 also became redundant, as these conditions were covered in other tests.
- 2) Based upon the inspection of the cyclone separator and feed/product economizer at the vapor outlet of the LPMEOH™ reactor, it was concluded that some form of separation device which limits the flow of entrained slurry from the reactor to the tubes of the heat exchanger will be required in future designs. This eliminated the need to perform the portion of Test 19 during which the cyclone would be bypassed.
- 3) A consequence of increasing the catalyst slurry concentration in the LPMEOH™ reactor beyond the design value was that the extent of conversion of CO was increased. As the amount of CO is depleted in the reactor effluent and recycle gas streams, the H<sub>2</sub>:CO ratio at the reactor feed was increased. Adequate data had already been acquired at elevated H<sub>2</sub>:CO ratios such that a separate test for natural gas reformer-type syngas (Test 24) was no longer required.
- 4) Since the restart of the LPMEOH™ demonstration unit on the second charge of fresh catalyst in December of 1997, the majority of operating time was spent at a reactor

temperature of 235°C. This allowed for additional study of catalyst performance as a function of operating temperature, which has importance for the LPMEOH™ Process in applications regarding coal-derived syngas (effect of operating temperature on the impact of catalyst poisons) and natural gas systems (extending catalyst life in the absence of poisons).

- 5) The amount of time allocated in the original Demonstration Test Plan to the study of catalyst performance above the original design temperature of 250°C was overestimated. Also, it was not logical to return to lower temperature in the reactor following operation at elevated temperature; this eliminated the need to perform Test 29.
- 6) During the operating program for the LPMEOH™ demonstration unit, modes of operation which were not anticipated during the development of the original Demonstration Test Plan were identified. The ability to activate the methanol synthesis catalyst within the LPMEOH™ reactor by using syngas which is diluted with N<sub>2</sub> (so-called in-situ activation) can result in capital cost savings of about 10% by elimination of the separate processing equipment which is used at the demonstration unit. Also, the life of the methanol synthesis catalyst can be extended by operating the LPMEOH™ reactor at low temperatures at the outset and slowly increasing temperature with time to maintain a constant production of methanol (so-called temperature programming).

A tabulation of the conditions that were operated during the execution of the Demonstration Test Plan is provided in Table 4.1-1. This shows the test runs and the operating conditions. The time chart for execution of the Plan is provided in Figure 4.1-1. The changes to the Plan allowed for the satisfactory completion of the objectives from the Statement of Work while also providing the ability to perform new tests of significant commercial interest.

## **4.2 OPERATING PROCEDURES**

Summaries of the main procedures associated with the startup, operation, and shutdown of the LPMEOH™ demonstration unit are provided. The P&ID's, located in Appendix A of the Public Design Report (Final Report - Volume 1), contain references to equipment and instrumentation systems.

**Table 4.1-1  
Test Conditions at LPMEOH™ Demonstration Unit**

Run #	Test Run Description	Temp (Deg C)	Wt% Catalyst	Typical Conditions			Test Run Objective
				H <sub>2</sub> /CO Ratio at Inlet	Fresh Feed Rate (KSCFH)	MeOH Rate (TPD)	
<b>Task 2.1.1 - Process Shakedown and Catalyst Aging:</b>							
1	Initial Shakedown; and Design Production Tests	250	31	3.5	833	248	Initial facility start-up and shakedown
2	Gassed Slurry Level	Data during this period covered within other test runs.					Maximize reactor volumetric productivity
3	Reactor Feed: Texaco-Type Syngas	250	34	0.78	725	190	IGCC applications; Comparison with LaPorte AFDU and laboratory
5	Check @ Test 1 Conditions	250	28	3.5	700	200	Catalyst life; Comparison with LaPorte AFDU and laboratory
6	Catalyst Addition and Aging	235	36	4.1	750	225	Catalyst life
7	Free-Drain Entrained/ Condensed Oil to Reactor	Data during this period covered within other test runs.					Enhance system flexibility and economic benefit
8	Operation @ Design Feed Gas Rates	235	43	4.0	850	256	Confirmation of operation at design condition
9	Check for Limitation on Catalyst Slurry Concentration	235	49	3.7	750	207	Maximize reactor volumetric productivity
10	Catalyst Addition to Reach Maximum Productivity	235	44	3.5	700	196	Maximize reactor volumetric productivity
<b>Task 2.1.2 - Process Operational Test Phase:</b>							
11	Catalyst Withdrawal/ Addition Test	235	44	3.2	670	190	Catalyst life
21	Reactor Feed: Destec-Type Syngas	235	45	1.0	700	200	IGCC applications
2000-1	Catalyst Withdrawal/ Addition Tests	235	43	3.2	725	210	Catalyst life
2000-2	Turndown and Ramping Tests	5% of design syngas flow per minute ramp rate achieved.					IGCC applications
2000-3	Load-Following and On/Off Tests	Feed gas off for 10-14 hours, plant ramped to re-start.					IGCC applications
2000-4	Reactor Feed: H <sub>2</sub> /CO = 1.0	235	43	1.0	650	180	IGCC applications
2000-5	Reactor Feed: H <sub>2</sub> /CO = 0.7	235	39	0.67	500	130	IGCC applications
2000-6	Final Temperature Ramp of Methanol Synthesis Catalyst	235 -> 250	47	2.6	580	165	Catalyst life
2000-7	Reactor Inspection	Data during this period covered within other test runs.					Physical inspection of key system components
2000-8	In-situ Catalyst Activation 1, Temperature Programming	216 -> 250	40	3.0	500 -> 650	150 -> 200	Tests of recent commercial interest
2000-8	In-situ Catalyst Activation 2, Temperature Programming	215	40	3.6	500 -> 650	170 -> 180	Tests of recent commercial interest
2000-9	Heat/Mass Balance Check: Reactor Inlet H <sub>2</sub> /CO = 0.5	220	42	0.5	575	160	IGCC applications

**Figure 4.1-1  
 LPMEOH™ Demonstration Test Plan Schedule of Tests**

Task Name	Duration in Weeks	19 97	19 98	19 99	20 00	20 01	20 02	
<b>TASK 2.1.1 - PROCESS SHUTDOWN AND CATALYST AGING</b>	<b>110.57 wk</b>	[Solid black bar]						
TEST 1 - INITIAL SHUTDOWN AND DESIGN PRODUCTION TESTS	5.43 wk	[Grey bar]						
TEST 2 - GASSED SLURRY LEVEL	28.29 wk	[Grey bar]						
TEST 3 - REACTOR FEED: TEXACO-TYPE SYNGAS	0.71 wk		[X]					
TEST 5 - CHECK @ TEST 1 CONDITIONS	3.43 wk	[X]						
TEST 6 - CATALYST ADDITION AND AGING	32.57 wk		[Grey bar]					
TEST 7 - FREE-DRAIN ENTRAINED/CONDENSED OIL TO REACTOR	53.00 wk		[Grey bar]					
TEST 8 - OPERATION @ DESIGN FEED GAS RATES	2.00 wk		[X]					
TEST 9 - CHECK FOR LIMITATION ON CATALYST SLURRY CONCENTRATION	20.29 wk		[Grey bar]					
TEST 10 - CATALYST AGING TO REACH MAXIMUM PRODUCTIVITY	12.71 wk			[Grey bar]				
<b>TASK 2.1.2 - PROCESS OPERATIONAL TEST PHASE</b>	<b>189.29 wk</b>	[Solid black bar]						
TEST 11 - CATALYST ADDITION/WITHDRAWAL TEST	93.43 wk			[Grey bar]				
TEST 21 - REACTOR FEED: DESTEC-TYPE SYNGAS	3.00 wk			[X]				
TEST 2000-1: CATALYST ADDITION/WITHDRAWAL TESTS	64.86 wk				[Grey bar]			
TEST 2000-2: TURNDOWN AND RAMPING TESTS	1.00 wk				[X]			
TEST 2000-3: LOAD FOLLOWING AND ON/OFF TESTS	1.00 wk				[X]			
TEST 2000-5: REACTOR FEED COMPOSITION TEST - H <sub>2</sub> :CO RATIO =0.7	4.00 wk					[X]		
TEST 2000-6: FINAL TEMPERATURE RAMP OF METHANOL SYNTHESIS CATALYST	24.71 wk					[Grey bar]		
TEST 2000-7: REACTOR INSPECTION	3.00 wk					[Grey bar]		
TEST 2000-8: IN-SITU CATALYST ACTIVATION, TEMPERATURE PROGRAMMING	62.71 wk					[Grey bar]		
TEST 2000-9: MATERIAL BALANCE TEST - H <sub>2</sub> :CO RATIO =0.5	As Available					[X]	[X]	

### Startup Procedure:

The following procedure describes the startup of the LPMEOH™ reactor system. It is assumed that the reactor system has been properly purged with N<sub>2</sub> through the syngas loop and 29C-01 LPMEOH™ reactor. If this procedure is being implemented for the first time, or if the reactor was open to atmosphere for a significant period of time during a shutdown, a hot function test with syngas and mineral oil (in the absence of catalyst) to at least 200°C should be performed followed prior to the startup to minimize the production of metal carbonyls during normal operation. If this is a re-start procedure, it will not be necessary to perform this part of the procedure. The distillation system should be started on total recycle (see below).

The 29K-01 recycle compressor is started on total recycle (complete internal recycle operation). N<sub>2</sub> is introduced into the bottom of the reactor. The reduced catalyst slurry is then pressure transferred from the 29D-02 slurry tank to the LPMEOH™ reactor. If an in-situ activation was used to reduce the catalyst, or if the reactor was shutdown for only a brief period, the catalyst slurry would already be in the reactor.

The flow from the syngas recycle compressor is then introduced to the reactor by closing the recycle flow control valve. The increased gas flow from the recycle compressor will assist in heat transfer in the reactor during the heat-up phase. Once positive gas flow through the reactor has been observed on the flowmeter at the inlet to the reactor, the N<sub>2</sub> flow introduced at the bottom of reactor can be stopped.

Boiler feedwater flow to the 29C-02 steam drum (including the reactor tubes) is introduced to heat the catalyst slurry at a maximum rate of 30°C/hour. Startup steam, at 600 psig, is injected into the heat exchanger risers, as needed, to maintain this heat-up rate until the reaction initiation temperature (a maximum of 220°C) is reached.

Fresh feed gas is slowly started to the unit. The main valves upstream and downstream of the 29C-40 carbonyl guard bed are closed initially. A small manual valve is opened to slowly pressurize the carbonyl guard bed to avoid fluidization and damage of the adsorbent. Once the carbonyl guard bed has reached the syngas header pressure (nominally 750 psig), the main inlet and outlet valves to the carbonyl guard bed can be opened. The LPMEOH™ reactor, the carbonyl guard bed, and the syngas loop are then pressurized to syngas header pressure. Methanol product flow can then be taken to the distillation system (see below).

### Major LPMEOH™ Reactor Control Loops:

The reactor pressure is controlled using the 29PC-150 control loop which achieves a desired reactor pressure set-point by controlling the rate of flow of unreacted syngas through the purge gas valve, 29FV-157A. LPMEOH™ reactor bulk temperature is tightly controlled to the desired setpoint by using the 29TC-109 temperature control loop to adjust the steam drum pressure using control valve 29PV-109. The 29E-02 syngas feed / product economizer effluent temperature is controlled using the 29TC-101 control loop which achieves the desired economizer effluent

temperature set-point by controlling the rate of reactor feed flow through the 29TV-101 syngas feed / product economizer bypass valve.

#### Distillation System Startup Procedure:

The 29C-12 stabilizer feed drum, the 29C-10 stabilizer column, and the 29C-20 rectifier column are first purged with N<sub>2</sub>. The N<sub>2</sub> pressure is maintained until the syngas is started to the unit. Cooling water flow is then introduced to the 29E-11 stabilizer condenser and the 29E-22 stabilizer subcooler, and the fans on the 29E-21 rectifier air cooler are started. The stabilizer feed drum, stabilizer column, and rectifier column are filled with methanol from the methanol lot tanks (29D-20 or 29D-21). The stabilizer and rectifier columns are then heated using steam in their respective reboilers (29E-10 and 29E-20).

A recycle flow loop from the stabilizer feed drum through to the stabilizer and rectifier columns is then established. The methanol product takeoff from the 29C-21 methanol rectifier reflux drum and the underflow from the rectifier column are returned to the stabilizer feed drum until syngas flow is started to reactor. The rectifier column is set on total reflux during this time. Once methanol is available from the process at the 29C-03 high-pressure methanol separator, the distillation system is taken off of total recycle operation and the crude-grade methanol is sent to distillation capacity within the Eastman chemicals-from-coal complex for further processing. Raw methanol is then introduced from the high-pressure methanol separator into the stabilizer feed drum.

#### Batch-wise Slurry Withdrawal and Catalyst Activation Procedure:

The 29C-30 catalyst reduction vessel is designed to replace a portion (in 2,000 pound increments) of spent methanol catalyst slurry in the reactor with an equal amount of freshly activated catalyst. Spent catalyst slurry is pressure-transferred from the reactor to the catalyst reduction vessel through the control valve (29PV-424) at the discharge of the 29G-30 slurry transfer pump. The slurry is then cooled to less than 45°C using the 29E-33 utility oil cooler, at which temperature it can be safely drained into drums.

Mineral oil is charged to the vessel from the 29D-30 fresh oil tank. This mineral oil is pre-heated and catalyst is added. The slurry is agitated using the 29Y-30 agitator, and a reducing gas (consisting of a dilute mixture of CO Gas in N<sub>2</sub>) is introduced at the bottom of the catalyst reduction vessel. The agitator is stopped once gas flow has been established. The catalyst is then activated using a series of temperature steps which are programmed into the distributed control system logic. The heat of reduction is released to the slurry and is removed via an external heat exchanger jacket on the catalyst reduction vessel. Bulk temperature control is accomplished by varying the temperature of utility oil, which flows through the heat exchanger jacket and which is controlled at the outlet of the 29E-32 utility oil heater. The operating pressure for the catalyst activation procedure is controlled at the vapor outlet of the 29C-31 catalyst reduction vessel separator. Once the catalyst reduction procedure has been completed, the reduced catalyst is pumped to the reactor using the slurry transfer pump.

### In-situ Activation Procedure:

In-situ activation is the reduction of an entire charge (nominally 40,000 to 50,000 pounds) of fresh catalyst within the reactor vessel. Following the removal and drumming of the spent catalyst from the reactor, batches of fresh catalyst and mineral oil are mixed in the catalyst reduction vessel and pressure transferred (without reducing or activating the batches) into the reactor. During the loading procedure, N<sub>2</sub> is introduced into the bottom of the reactor to assist in mixing and heat transfer. Once a full charge of fresh catalyst is added to the reactor, the recycle compressor is started to further mix the catalyst slurry. The catalyst slurry is then activated using a series of temperature program steps. A dilute mixture of Balanced Gas in N<sub>2</sub> is used as the reducing gas and enters the reactor at the bottom of the vessel. Once positive gas flow from the recycle compressor through the reactor has been observed on the flowmeter at the inlet to the reactor, the N<sub>2</sub> flow introduced at the bottom of reactor can be stopped. The heat of reaction is released to the slurry and is removed via the internal heat exchanger. Bulk temperature control is accomplished by initially manually varying the steam drum pressure. Once the steam drum pressure exceeds the steam header pressure sufficiently, the temperature ramp can be automatically controlled through the distributed control system. The operating pressure for the in-situ activation is controlled using the 29PC-150 control loop which achieves a desired reactor pressure set-point by controlling the rate of flow of unreacted syngas through the purge gas valve, 29FV-157A. Once the in-situ catalyst reduction procedure has been completed, the reactor is started up normally using the procedure described above.

### Stand-by Conditions Procedure:

Following a shutdown of the LPMEOH™ demonstration unit, a standby condition is used to maintain conditions for subsequent re-start. The reactor temperature is held at 180°C during this stand-by condition, using 600 psig startup steam, as required. The recycle compressor is generally kept in operation during stand-by to assist in heat transfer and to allow for gas flow to continue through the reactor system. Generally, a reactor pressure of 95 psig is maintained with the recycle compressor in operation. N<sub>2</sub> makeup can be introduced to the system once the N<sub>2</sub> header pressure exceeds the compressor suction pressure of approximately 75 psig. The distillation system is placed in recycle operation. If the recycle compressor is not available, N<sub>2</sub> is introduced into the bottom of the reactor.

### Shutdown Procedure:

To shutdown the LPMEOH™ demonstration unit, the fresh feed gas valves controlling the flow of Balanced Gas and CO Gas are closed. If this is expected to be a short-term shutdown, the stand-by conditions are established (see above).

If this is a longer-term shutdown, for instance a maintenance inspection, the catalyst slurry in the LPMEOH™ reactor is pressure transferred to the slurry tank. The reactor can be depressurized very quickly to 95 psig. Once this pressure is reached, the recycle compressor can be put into internal recycle operation and subsequently shutdown, if required. N<sub>2</sub> can then be introduced into the bottom of the reactor to maintain mixing of the slurry while it is cooling. The slurry is



cooled in the reactor at a rate of 30-35°C per hour to a final temperature of 150°C. The slurry is then transferred either to the slurry tank for storage or to the catalyst activation vessel for further cooling using the utility oil cooler and subsequent draining into drums.

If the catalyst is to be reused after the shutdown, the catalyst will be pressure transferred from the slurry tank back to the reactor at the conclusion of the maintenance outage. The 29Y-02 agitator is used to maintain the slurry in suspension, and a steam jacket is used to minimize heat losses from the slurry tank. If the catalyst is to be replaced with freshly reduced catalyst, batches of spent catalyst are then pressure transferred with N<sub>2</sub> from the slurry tank to the catalyst reduction vessel for cooling to less than 45°C and drumming. Alternatively, these batches of spent catalyst can be directly transferred from the reactor to the catalyst reduction vessel for cooling and drumming, if desired.

#### **4.2.1 Instrumentation and Data Acquisition**

Within the LPMEOH™ Process, measurement of the flow and pressure of the catalyst slurry or the three-phase reactor fluid was required in order to assess the performance of the technology at the commercial demonstration of 260 sT/D. Transmitters with diaphragm seal(s) and oil flush connections were used to provide accurate readings in this difficult environment. In addition, nuclear density gauges were used on the LPMEOH™ reactor (to determine the expanded slurry height) and the 29C-30 catalyst preparation vessel (to measure the three-phase density and expanded slurry height). No other specialty instrumentation systems were required.

The LPMEOH™ demonstration unit utilized an existing computer network that controlled operating plants at the Eastman chemicals-from-coal complex. A distributed control system was used for automatic control, monitoring, and non-critical process and equipment shutdowns. A data acquisition was tied into the data highway for the control system so that real-time plant data could be accessed both at a office trailer (separate from the operating control room) at the LPMEOH™ demonstration unit as well as at Air Products' corporate headquarters in Allentown, PA. A dedicated programmable logic controller was used so that critical process shutdowns could be initiated independent of the control system hardware.

#### **4.2.2 Test Methods**

Appendix A, Table A-1 provides the streams, component lists and frequency of sampling for the routine analytical measurements. Appendix A also contains a description of the sampling and analytical methods used to quantify the concentration of arsenic (reported as arsine) and iron carbonyl in the fresh feed gas to the LPMEOH™ demonstration unit. The simplified process flow diagram, Figure 2.4-1, shows the measurement points.

### **4.3 ANALYSIS OF FEEDSTOCKS, PRODUCTS AND REAGENTS**

In order to perform the routine material balance calculations, gas chromatographs were used to analyze the syngas feed streams, the streams entering and exiting the LPMEOH™ reactor, and the purge streams leaving both the main reactor loop and the distillation section. Analysis of the two methanol streams (Crude-Grade Methanol and Refined-Grade Methanol) was also

performed. Appendix B contains samples of material balance calculation sheets that include the typical analysis of these streams for two operating scenarios: Appendices B-1 and B-2 provides data when Balanced Gas is fed to the LPMEOH™ demonstration unit, and Appendices B-3 and B-4 provide data during operation when CO-rich syngas is fed to the LPMEOH™ reactor.

In addition, syngas sampling was performed to determine the levels of trace components within the various syngas streams that may be poisons to methanol synthesis catalysts. A summary of these results is provided in Section 5.2.

Throughout the operating program, samples were taken of catalyst slurry from the LPMEOH™ reactor on a routine basis to analyze for the presence of known catalyst poisons and to track some of the key physical properties of the methanol synthesis catalyst. Section 5.2 contains the results of these analyses for the four different catalyst campaigns that were completed during the performance period.

#### **4.4 DATA ANALYSIS METHODOLOGY**

Appendix C, Table 1 contains the major field instrumentation signals, analytical measurements, and calculations which were used in determining the material and energy balance and LPMEOH™ reactor performance. The simplified process flow diagram, Figure 2.4-1, also shows the measurement points. Two sets of material balances were performed:

- Across the LPMEOH™ reactor, using the Reactor Feed Flowrate (Stream 109) and Reactor Effluent Flowrate (Stream 120); and
- Around the LPMEOH™ demonstration unit, using the major plant feeds and product streams as noted in Appendix C, Table 1.

Part of the process of data reduction is the elimination of those operating periods when one or more key inputs to the material balance calculation is invalid (for example, a failure of a key process flowmeter or an upset of the analytical system). If the material balance cannot be closed due to such an instrument failure, a portion of a data period will be eliminated from the material balance calculation. This analysis will be performed at the spreadsheet level, so that the historian files will always contain the raw data from field instruments and analytical equipment.

A comprehensive set of the formulas used to calculate the parameters listed in Appendix C, Table 1 is provided in Appendix C-2. These calculations were based upon actual measurements from the LPMEOH™ demonstration unit.

#### **4.5 DATA SUMMARY**

The operating program for the LPMEOH™ demonstration unit can be broken into four operating campaigns based upon the use of a fresh charge (full or partial) of methanol synthesis catalyst in the LPMEOH™ reactor. Kingsport Catalyst Campaign 1 was conducted between April of 1997 and November of 1997. This campaign was concluded on 03 November 1997 after 171 days of operation. Kingsport Catalyst Campaign 2 was conducted between December of 1997 and

August of 2001. The campaign was concluded on 06 August 2001 after 1,325 days of operation. Kingsport Catalyst Campaign 3 was conducted between August of 2001 and June of 2002. The campaign was concluded on 04 June 2002 after 284 days of operation. The fourth Kingsport Catalyst Campaign began on 28 June 2002 and included process and analytical data until the end of the operating program on 31 December 2002 (a total of 187 days of operation).

Appendix D, Tables D-1 through D-4 provide the results from the operation of the LPMEOH™ demonstration unit during the 69-month operating phase. These data represent daily averages, typically from a 24-hour material balance period, and those days with less than 12 hours of stable operation are omitted. Since startup, about 103.9 million gallons of methanol was produced. Eastman accepted all of the available methanol for use in the production of methyl acetate, and ultimately cellulose acetate and acetic acid. The analysis of the key results is provided in Section 5.

#### 4.6 OPERABILITY AND RELIABILITY

Table 4.6-1 contains the availability of the LPMEOH™ demonstration unit during the 69-month demonstration test program (availability is defined as the percentage of time that the LPMEOH™ demonstration unit was available to operate, with the exclusion of scheduled outages). The overall availability was 97.5%.

The causes of unplanned outages are also provided in Table 4.6-1. Startup was completed in two days, and nameplate production of 80,000 gallons per day (260 sT/D) was achieved within four days, and production rates exceeding 115% of design were achieved within six days.

Unexpected poisoning of the catalyst due to the presence of iron contamination in 1997 led to the

**Table 4.6-1  
LPMEOH™ Demonstration Unit Availability and Causes of Unplanned Outages**

Operating Year <sup>a</sup>	1997	1998	1999	2000	2001	2002 <sup>b</sup>
Availability (%)	94.9	99.54	99.4	96.3	97.7	94.1
<b>Total Hours of Unplanned Outages</b>	<b>325.6</b>	<b>45.1</b>	<b>52.8</b>	<b>311.4</b>	<b>166.3</b>	<b>198.9</b>
Catalyst	149.3	0.0	0.0	0.0	38.7	0.0
Carbonyl Guard Bed	0.0	0.0	0.0	118.9	120.6	198.9
Electrical	20.7	24.6	0.0	42.3	0.0	0.0
Instrumentation	12.8	1.3	0.0	4.7	7.0	0.0
Mechanical	142.8	19.2	52.8	145.5	0.0	0.0

a. Operating year defined as April-March.

b. Through 31 December 2002.

only unexpected outage related to catalyst performance. Given the very high level of catalyst poisoning present, the team felt that the full replacement of the catalyst charge, and the outage that would result, was necessary to achieve overall program goals. During operation of the system, it was found that some of the oil return lines to the reactor were plugging and one heat exchanger developed a leak at a flange connection. Redesign and replacement were undertaken in 1997, creating a permanent solution.

In 1998, non-routine maintenance related to instrumentation tubing around the recycle compressor caused a portion of the reported unplanned outages. Also, electrical transients resulted in two additional short outages. The longest continuous operating run without interruption of any kind was 94 days (July-October of 1998); an earlier campaign of 65 days of continuous operation was completed in April of 1998.

In 1999, an unexpected leak developed in the boiler feed water piping system and two heat exchangers, causing the need to make repairs.

In 2000, a leak in the tubing associated with a flow transmitter in the boiler feed water system and an unrelated failure of a solenoid valve controlling boiler water feed to the steam drum resulted in downtime. An electrical outage outside of the LPMEOH™ demonstration unit caused the failure of rupture discs for the cooling water system.

As noted in Section 5.2, plant activities associated with the changeout of the adsorbent in the 29C-40 carbonyl guard bed began. The philosophy associated with the design of this equipment was that the adsorbent would not need to be changed during the demonstration test period; as a consequence, the ability to isolate the vessel from the remainder of the LPMEOH™ demonstration unit for maintenance was not included in the engineering design. In future designs, the required isolation valves would be installed, so that the outages that were taken in 2000 through 2002 would be eliminated.

In 2001, a controls signal error caused the unit to drop off line for a very short period of time. Also, operation could not be continued during a catalyst withdrawal/addition operation; the LPMEOH™ reactor was restarted following the addition of a batch (2,000 pounds) of fresh catalyst from the catalyst preparation vessel.

A monthly production record of 2,500,000 gallons of methanol was reached during October of 2002. For a 23-day period, production of nameplate capacity (80,000 gallons per day) or higher was achieved. The October monthly average production was 101% of nameplate capacity. Production rates as high as 117% of nameplate capacity were also achieved for shorter periods.

In addition to producing syngas for the LPMEOH™ demonstration unit, the Eastman's coal gasification facility produces raw material for a gas-phase methanol production plant and a carbon monoxide facility. The fluctuating needs of the impurities removal facility causes some variance in the quantity of syngas produced. Given the ability of the LPMEOH™ demonstration unit to tolerate changes in the composition and flow of syngas, this facility is used as the swing facility to manage changes in syngas production. Through all of this fluctuation, the

LPMEOH™ demonstration unit produced methanol to its full projected capacity based on the composition and flow of syngas available.

#### **4.7 SECTION 4 BIBLIOGRAPHY**

- a. “Commercial Demonstration of the Liquid Phase Methanol (LPMEOH™) Process – Demonstration Test Plan”, Prepared by Air Products Liquid Phase Conversion Co., L.P., DOE Cooperative Agreement No. DE-FC22-95PC93052, September 1996.

## 5.0 TECHNICAL PERFORMANCE

### 5.1 CATALYST PERFORMANCE

As indicated in Section 4.5, there were four catalyst campaigns which characterize the operating program of the LPMEOH™ demonstration unit. A comparison of the catalyst campaigns is given in Table 5.1-1. The first campaign involved batch-wise catalyst activation along with the addition of fresh slurry to maintain catalyst productivity. The second campaign involved batch-wise catalyst activation along with withdrawal of spent catalyst slurry and addition of fresh slurry to maintain catalyst productivity. The third and fourth campaigns used an in-situ activation procedure to prepare a full charge of methanol synthesis catalyst. Temperature programming was used in the third campaign to maintain productivity. During the fourth catalyst campaign, productivity was essentially maintained by virtue of the very low catalyst deactivation rates and, therefore, temperature programming was not used during the period of performance. Methanol synthesis catalyst (baseline and alternative) from two different suppliers was used during the operating program.

As shown in Figures 1.2.3-1 and 2.4-1, two catalyst guard beds were available to limit the levels of trace contaminants entering the LPMEOH™ demonstration unit. The long-term performance of the methanol synthesis catalyst was adversely impacted by the presence of species such as arsenic (detected in the Balanced Gas stream) and iron (apparently generated during certain operating periods within the LPMEOH™ demonstration unit). A review of the work on the adsorbents used during the period of performance of the LPMEOH™ Demonstration Project is provided in Section 5.2.

**Table 5.1-1  
Kingsport LPMEOH™ Operating Program Campaigns**

Kingsport Campaign #	Run Start Date	Run End Date	Days Onstream	Catalyst Type Used	Starting Catalyst Charge (lbs)	Activation Method	Productivity Control Method	Operating Temperature (°C)
1	4/6/97	11/3/97	171	Baseline	20,300	Batch	Catalyst Addition Only	250 to 260
2	12/20/97	8/6/01	1,325	Baseline + Alternative	19,500	Batch	Catalyst Withdrawal / Addition	235 <sup>a</sup>
3	8/24/01	6/4/02	284	Alternative	41,580	In-situ	Temperature Programming	216 to 242
4	6/28/02	Ongoing <sup>b</sup>	Ongoing <sup>b</sup>	Alternative	40,040	In-situ	-	215

a. Primarily 235°C with brief operation at other temperatures.

b. The LPMEOH™ demonstration unit operating program ended 12/31/02 with 187 days onstream in Catalyst Campaign 4.

### 5.1.1 Catalyst Performance: Catalyst Campaign 1

An in-house kinetic model was used to assess the performance of the methanol synthesis catalyst and to eliminate the effects of varying feed composition or operating conditions. This model can be used to study changes in catalyst performance over stable periods of operation (typically two weeks or more); results over shorter durations must be considered in light of the influence of operating conditions (for example, variations in the bulk syngas composition). The “age” of the catalyst can be expressed in terms of a dimensionless variable eta ( $\eta$ ), which is defined as the ratio of the rate constant at any time to the rate constant for freshly reduced catalyst (as determined in the laboratory autoclave). Figure 5.1.1-1 shows performance results from the LPMEOH™ reactor during Catalyst Campaign 1. Typical exponential decay appeared as a straight line on a semi-log-plot, as shown. The curve fit to data from a 4-month test at the LaPorte AFDU in 1988/89 (this run was performed on CO-rich syngas derived from natural gas at a reactor temperature of 250°C) and laboratory autoclave data from 1996 are included for reference. During this catalyst campaign, the LPMEOH™ reactor operated at 250°C, except for brief operation at 260°C at the very end of the campaign. Catalyst additions are noted on the figure.

A partial charge (20,300 pounds out of a design of 40,000 pounds) of fresh catalyst was activated in 9 batches within the 29C-30 catalyst preparation vessel and added to the LPMEOH™ reactor

**Figure 5.1.1-1  
Kingsport LPMEOH™ Catalyst Life (Catalyst Campaign 1)**

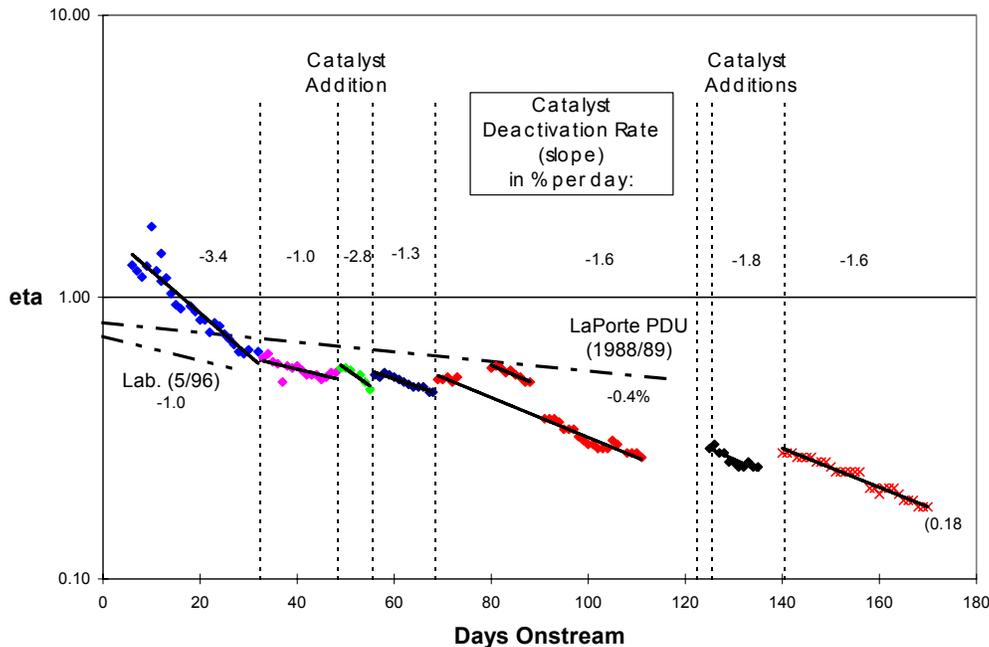

in early April of 1997. The initial performance of the catalyst was equivalent to the results from the laboratory autoclave, indicating that the catalyst activation was successful. The highest methanol production rate over a 24-hour period occurred on 19 April 1997 (89,900 gallons per day, or 292.2 sT/D); for shorter balance periods (approximately 12 hours), methanol production rates of 92,900 to 94,500 gallons per day (302 to 307 sT/D) were measured.

Over the next several weeks, the catalyst life data indicated that an accelerated negative change in performance occurred. During the April/May of 1997 operating period, it was not immediately apparent whether this decline in  $\eta$  was a result of a decline in catalyst activity or hydrodynamic effects related to an increase in pressure drop across the gas sparger at the inlet to the LPMEOH™ reactor. However, upon restarting the LPMEOH™ demonstration unit following a planned outage in June of 1997, the value of  $\eta$  was determined to be unaffected by the performance of the sparger. Therefore, it was concluded that the catalyst activity was declining more rapidly than expected. The catalyst deactivation rate for the first 30 days of operation was 3.4% per day; the higher catalyst deactivation during this period was later linked to high concentrations of iron on the reactor catalyst samples. These higher iron concentrations were most likely due to construction debris (refer to Section 5.2 for additional information).

Following the initial operating period, the catalyst performance continued to decline more rapidly than expected; however, as noted on Figure 5.1.1-1, the rate of change was slower than during the April/May operation. During the remaining period of operation during Catalyst Campaign 1 from June through November of 1997, deactivation rates were higher than expected based on experience from the LaPorte AFDU (catalyst deactivation rate of 0.4% per day). In fact, the catalyst life was similar to the baseline deactivation results obtained during laboratory autoclave testing (catalyst deactivation rate of 1.0% per day). Eliminating the catalyst performance results for the first month due to catalyst hyperactivity and the presence of iron construction debris, the average deactivation rate for the entire campaign was 1.3% per day.

Fresh catalyst was activated and added to the LPMEOH™ reactor on six occasions during this first catalyst campaign to maintain catalyst productivity and increase catalyst loading. On 04 July 1997, the first catalyst batch of 2,300 pounds of fresh catalyst activated and added to the LPMEOH™ reactor. This same quantity of catalyst was activated and added to the reactor on 11 July, 23 July, 12 September, 17 September, and 03 October 1997.

Based upon the results of unit operation and catalyst performance, DOE accepted a recommendation by Air Products and Eastman in October of 1997 to drain the initial charge of catalyst from the reactor and replace the charge with fresh catalyst. Prior to this catalyst turnaround, the operating temperature of the LPMEOH™ reactor was raised from 250°C to 260°C for about one week of operation.



### 5.1.2 Catalyst Performance: Catalyst Campaign 2

Catalyst Campaign 2 was the longest of the operating program at 1,325 days. During most of this catalyst campaign, the operating temperature in the LPMEOH™ reactor was lowered to 235°C. By using the lowest possible temperature necessary to achieve the required methanol production rate, the life of the methanol synthesis catalyst was potentially extended. Catalyst life data during the first portion of Catalyst Campaign 2 (covering operations in 1997 and 1998) is shown in Figure 5.1.2-1. At the start of this campaign in December of 1997, only a partial charge (19,500 pounds) of fresh catalyst was activated in the catalyst preparation vessel and added to the reactor system; this limited the amount of material exposed to poisons at the outset. During this first portion of the campaign, fresh catalyst was activated and added to the LPMEOH™ reactor on a periodic basis (as noted on the figure) to achieve the desired reactor performance and to determine if hydrodynamic limitations could be reached at high slurry concentrations (the design value was 40 weight % [wt%]). The rate of catalyst deactivation for periods of stable operations (typically 2 weeks or longer) are indicated on the figure.

At a reactor temperature of 235°C, the decrease in  $\eta$  with time from the starting date of 20 December 1997 through Day 38 was calculated to be 1.0% per day, which represented a significant improvement over the 3.4% per day decline measured during the initial six weeks of operation of Catalyst Campaign 1. The deactivation rate also improved from the longer-term rate of 1.6% per day calculated throughout the summer and autumn of 1997.

**Figure 5.1.2-1  
Kingsport LPMEOH™ Catalyst Life (Catalyst Campaign 2: 1997-1998)**

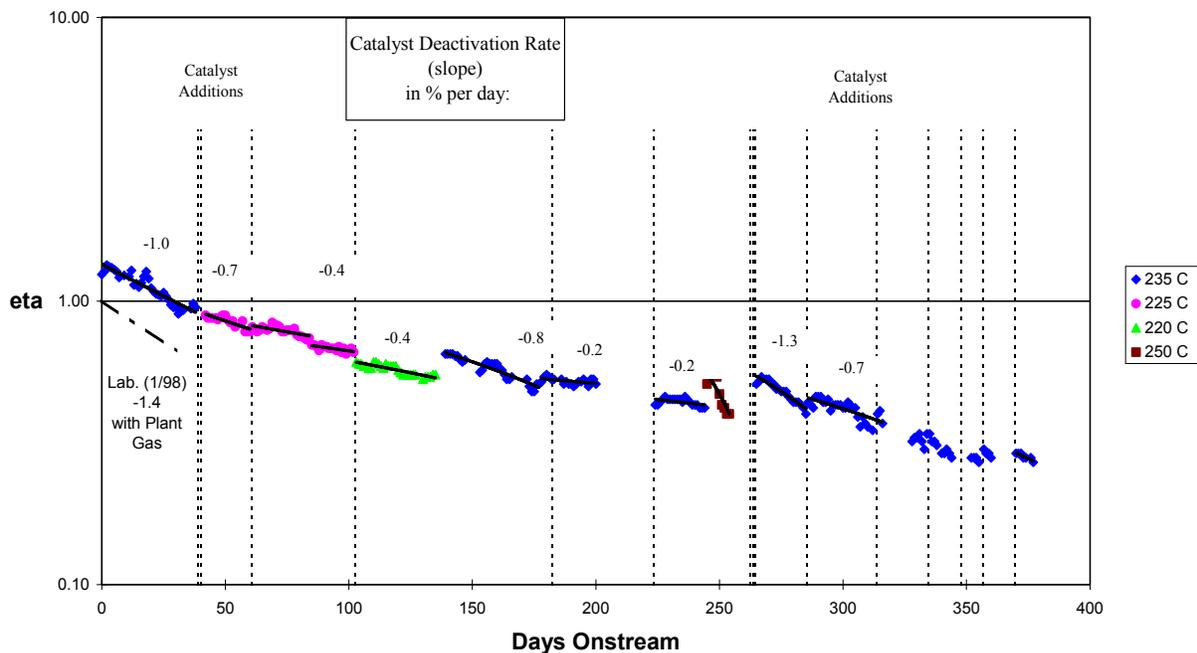

Based on this improvement, DOE accepted a recommendation by Air Products and Eastman to further decrease the reactor temperature to 225°C. The initial operation at this temperature (from Day 42 through Day 60) showed a modest improvement in the deactivation rate to 0.7% per day. During two additional stable operating periods between Day 61 and Day 101, deactivation rates of 0.27% and 0.36% per day were calculated. These results compare favorably with the performance from the 4-month proof-of-concept run at the LaPorte AFDU in 1988/89.

The reactor temperature was then lowered further to 220°C between Day 104 and Day 135. During a one-month test at a reactor temperature of 220°C and a Balanced Gas flowrate of 550-600 KSCFH, the rate of decline of  $\eta$  was 0.4% per day, which matched the performance at 225°C. Beginning on Day 139, the temperature of the LPMEOH™ reactor was increased to 235°C, which was the operating temperature after the December 1997 restart. After the catalyst addition on Day 182, the weight of catalyst in the LPMEOH™ reactor had reached 80% of the design value of 40,000 pounds.

The LPMEOH™ demonstration unit completed a 24-day stable period of operation on Day 206 at a reactor temperature of 235°C and a flowrate of Balanced Gas of approximately 700 KSCFH. Over this period, the rate of decline of  $\eta$  was 0.2% per day. This performance was superior to the original target from the 4-month proof-of-concept run at the LaPorte AFDU in 1988/89 (0.4% per day).

On Day 244, a test at a reactor temperature of 250°C was initiated. The test at the higher reactor temperature was completed on Day 254 when accelerated changes in the calculated value for  $\eta$  were observed. From Day 261 to Day 267, three batches of fresh catalyst were activated and added to the LPMEOH™ reactor, which brought the catalyst loading to slightly above the design value of 40,000 pounds.

Six additional batches of fresh catalyst were activated and added to the LPMEOH™ reactor between Day 285 and Day 376. At this point, the catalyst loading in the LPMEOH™ reactor had been increased to about 140% of design. No hydrodynamic instability was detected as the catalyst slurry concentration in the reactor ranged from 46 to 48 wt%.

For the first year of operation under Catalyst Campaign 2, the average rate of catalyst deactivation was calculated to be 0.65% per day. This result was a significant improvement over the catalyst performance during Catalyst Campaign 1 (1.3% per day).

Catalyst life data during the second portion of Catalyst Campaign 2 (covering operations in 1999) is shown in Figure 5.1.2-2. The use of catalyst withdrawal and addition (as noted on the figure) was first practiced during this portion of the campaign in order to achieve the desired performance of the LPMEOH™ reactor.

**Figure 5.1.2-2  
Kingsport LPMEOH™ Catalyst Life (Catalyst Campaign 2: 1999)**

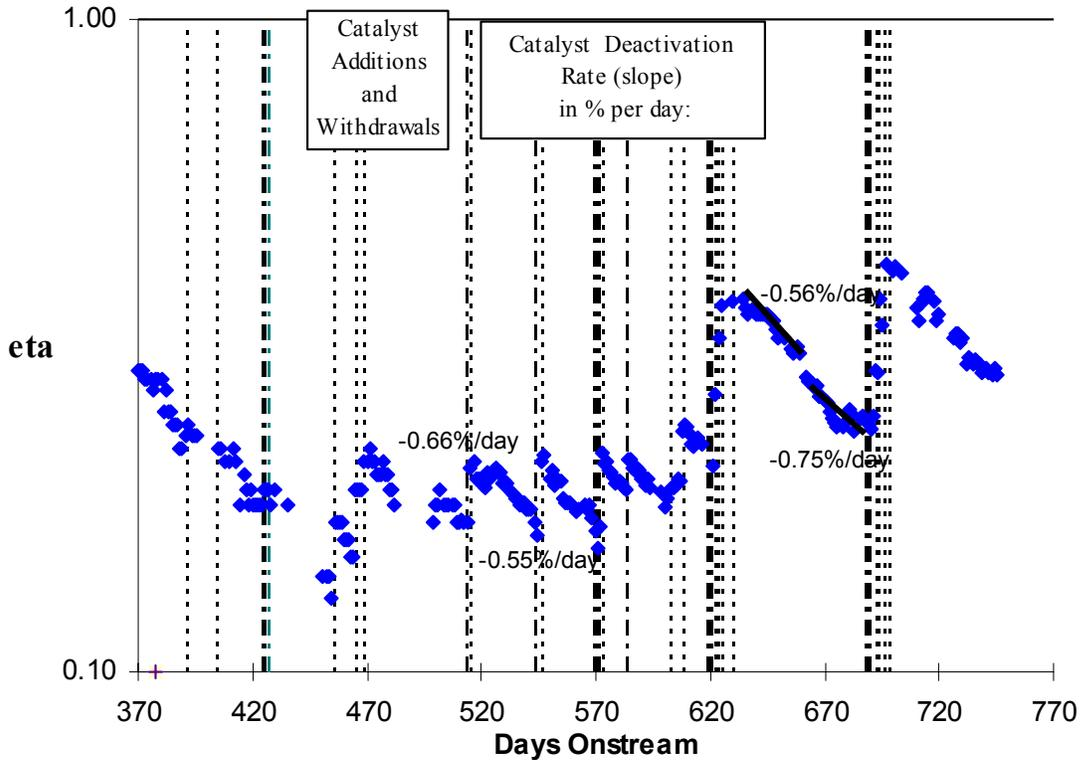

Between Day 377 and Day 466, the LPMEOH™ demonstration unit continued to perform well with high slurry concentrations in the LPMEOH™ reactor. Slurry concentrations greater than 48 wt% were achieved during this period with no apparent hydrodynamic instability. Three batches of fresh catalyst were activated and added during this time, bringing the catalyst loading to 151% of design, which was the maximum value achieved during the entire operating program.

Starting on Day 424, three separate transfers of catalyst slurry from the reactor were conducted in order to dilute the slurry concentration in anticipation of an upcoming outage in March of 1999.

These steps reduced the calculated slurry concentration in the reactor from in excess of 48 wt% to approximately 40 wt%. Reactor conditions were held at 235°C except for a brief production test, between Days 431 through Day 435, when reactor temperature was increased to 240°C.

The

LPMEOH™ demonstration unit was shutdown between Day 437 through Day 449 in order to complete the planned outage. A second planned Eastman complex outage was taken between Day 483 and Day 494.

The average catalyst deactivation rate for calendar year 1999 was calculated to be 0.58% per day. This result was equivalent to the performance in 1998 and was slightly greater than the baseline

deactivation rate from the 4-month proof-of-concept run at the LaPorte AFDU in 1988/89 (0.4% per day).

The catalyst life performance during the final portion of Catalyst Campaign 2 is provided in Figure 5.1.2-3. Catalyst withdrawals and additions are indicated as dotted vertical lines in the figure. A schedule for catalyst withdrawal and addition was developed that allowed for the desired methanol production rate to be maintained with minimum disruption to the operations staff. The overall schedule for catalyst withdrawals and additions was generally undertaken every two months, and the typical amount of catalyst that was exchanged was about 11,000 pounds.

A comparison of the performance of the methanol synthesis catalyst with different syngas compositions was able to be made. Between Day 825 and Day 844, during which a feed gas with a H<sub>2</sub>/CO ratio of 1:1 was fed to the LPMEOH™ reactor, a catalyst deactivation rate of 1.24% per day was calculated. Shortly after that test, a catalyst deactivation rate of 0.89% per day was calculated for the period from Day 875 to Day 903, during which Balanced Gas alone was used as feed to the LPMEOH™ demonstration unit. An analysis of these results determined that the two data sets were statistically similar, given the scatter in the calculated values for the catalyst rate constant.

**Figure 5.1.2-3  
Kingsport LPMEOH™ Catalyst Life (Catalyst Campaign 2: 2000-2001)**

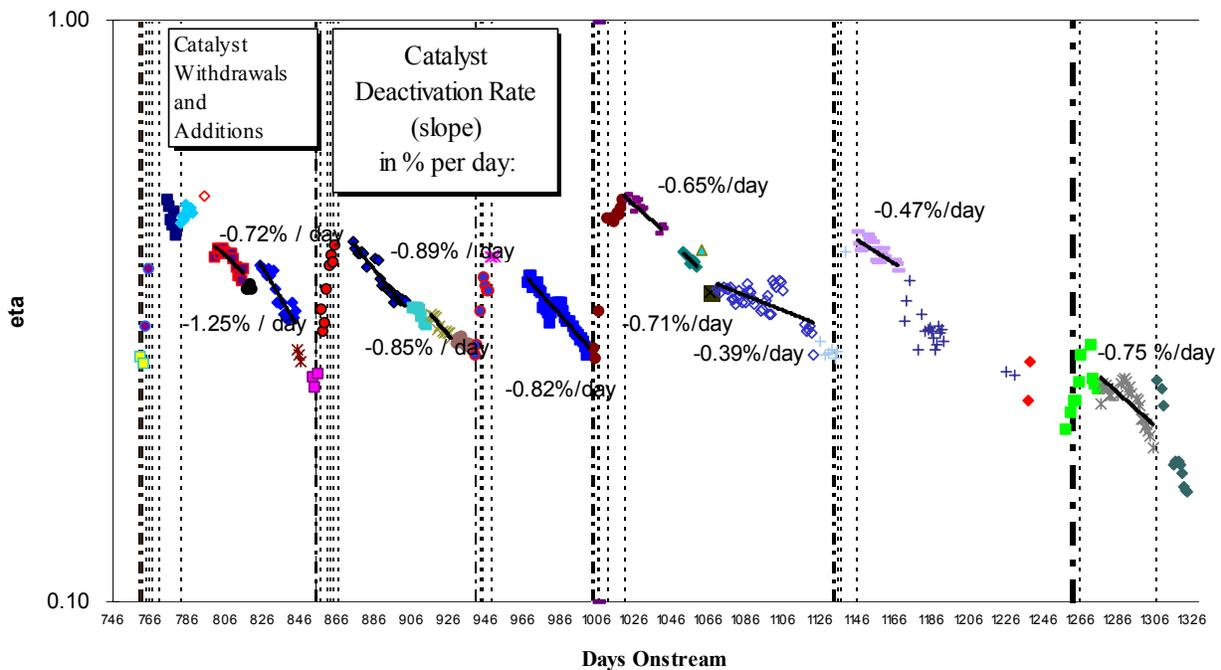

The catalyst performance was also used during this operating period to gauge the effectiveness of the 29C-40 carbonyl guard bed. As described in Section 5.2, the carbonyl guard bed was charged with manganese dioxide (targeting arsenic) and activated carbon (targeting iron and nickel) during this time. When the carbonyl guard bed was in service with aged adsorbents (approximately one year of service), a catalyst deactivation rate of 0.85% per day was calculated over a 12-day period (Days 917 through 928). When the carbonyl guard bed was bypassed over a 33-day period from Day 969 to Day 1002, a catalyst deactivation rate of 0.82% per day was calculated. These results were statistically the same and indicated that the aged adsorbents in the carbonyl guard bed were no longer effective in removing trace contaminants. Note that the carbonyl guard bed was bypassed for the remainder of Catalyst Campaign 2. The results for catalyst deactivation rates shown on Figure 5.1.2-3 varied from 0.4% to 0.7% per day over this operating period, which could indicate that the levels of trace contaminants entering the LPMEOH™ demonstration unit were likely varying in concentration during this time.

The average rate of catalyst deactivation during the final portion of Catalyst Campaign 2 was calculated to be 0.64% per day. For the entire campaign, the catalyst deactivation rate was determined to be 0.63% per day, which was greater than the value calculated from the 4-month proof-of-concept run at the LaPorte AFDU in 1988/89 (0.4% per day change in catalyst activity).

### **5.1.3 Catalyst Performance: Catalyst Campaign 3**

Catalyst Campaign 3 involved a demonstration of in-situ activation procedure. A full charge (greater than 40,000 pounds) of fresh methanol synthesis catalyst was placed into the LPMEOH™ reactor and activated at one time. This was in contrast to the batch-wise activation of smaller catalyst quantities (approximately 2,000 pounds each) used earlier in the demonstration.

As shown in Figure 5.1.3-1, the initial activity of the methanol synthesis catalyst for Catalyst Campaign 3 ( $\eta \cong 0.7$ ) was less than expected when compared with data from the laboratory ( $\eta = 1.0$ ). Information on the analysis of these initial performance results is provided in Section 5.6. Following the completion of the in-situ catalyst activation procedure, conditions were selected to deal with the hyperactivity that typically occurs when fresh methanol synthesis catalyst is initially exposed to syngas. During the first few weeks of operation, conditions were varying between a reactor pressure of 550-600 psig, reactor temperature of 212-220°C, and flowrate of Balanced Gas of 500-525 KSCFH. Once the test had proceeded beyond the period of hyperactivity, operating conditions were set at 218°C reactor temperature, 685 psig reactor pressure, and 600-650 KSCFH of Balanced Gas.

**Figure 5.1.3-1  
Kingsport LPMEOH™ Catalyst Life (Catalyst Campaign 3)**

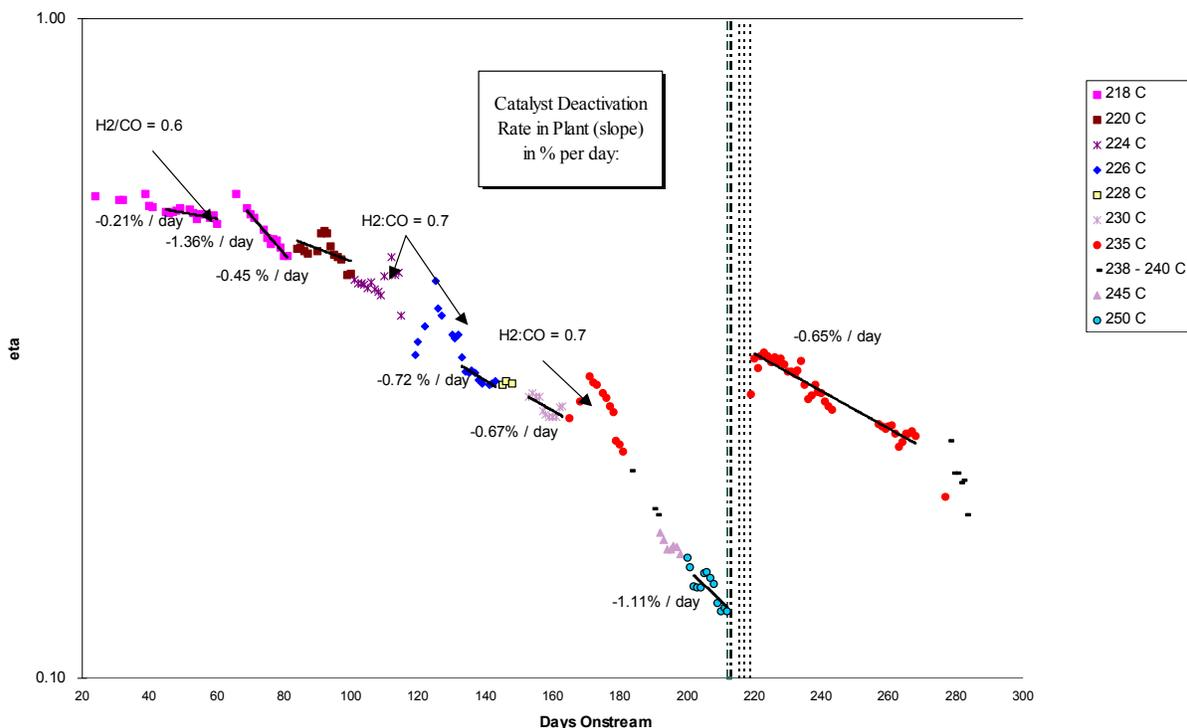

As noted in Table 5.1-1, temperature programming (as opposed to catalyst withdrawal and addition) was used as a productivity control method during Catalyst Campaign 3. The reactor temperature was gradually increased as necessary to control reactor purge flowrate and maintain catalyst productivity as the operating campaign progressed. Temperature changes were managed such that sufficient performance data could be achieved at each temperature (minimum of two weeks of operation at each condition to determine catalyst life performance data). Over the entire period of Catalyst Campaign 3, the reactor temperature ranged from 216°C to 242°C.

The rates of catalyst deactivation that were computed during this period are indicated in Figure 5.1.3-1. Note that, for two performance periods during the first 100 days onstream, the calculated rate of catalyst deactivation was significantly lower than the average results during Catalyst Campaign 2 (0.63% per day), and was equivalent to or better than the results from the 4-month proof-of-concept run at the LaPorte AFDU in 1988/89 (0.4% per day). Following the two periods of improved catalyst performance, the catalyst deactivation rates for Catalyst Campaign 3 approached historical values of 0.6 to 0.7% per day.

The first operating test using methanol synthesis catalyst activated in-situ (within the LPMEOH™ reactor as opposed to the 29C-30 catalyst preparation vessel) and temperature programming was completed on Day 213 when a catalyst withdrawal and addition campaign was undertaken to increase catalyst activity. A series of three withdrawals was conducted on Day 213 to Day 214. Four batches of fresh catalyst were activated and added to the reactor between

Day 215 and Day 220. At the conclusion of the catalyst withdrawal/addition catalyst campaign, the LPMEOH™ demonstration unit was operated at a constant reactor temperature of 235°C and a reactor pressure of 700 psig.

#### 5.1.4 Catalyst Performance: Catalyst Campaign 4

Based on the lower than expected activity achieved during the first in-situ activation, a decision was made to perform a second in-situ activation using a revised procedure. As detailed in Section 5.6.3, this revised procedure was developed to eliminate the step that resulted in the storage of the fresh slurry at elevated temperatures prior to activation.

The second in-situ activation was undertaken in late June of 2002. Performance results for the methanol synthesis catalyst following the second in-situ activation are presented in Figure 5.1.4-1. The initial catalyst activity was excellent, and matched the performance expected with properly activated catalyst from the laboratory autoclave. The initial operating conditions (reactor temperature of 214°C, reactor pressure of 450 psig, Balanced Gas flowrate of 500-600 KSCFH) were selected to deal with the hyperactivity that is typical of freshly activated methanol

**Figure 5.1.4-1  
Kingsport LPMEOH™ Catalyst Life (Catalyst Campaign 4)**

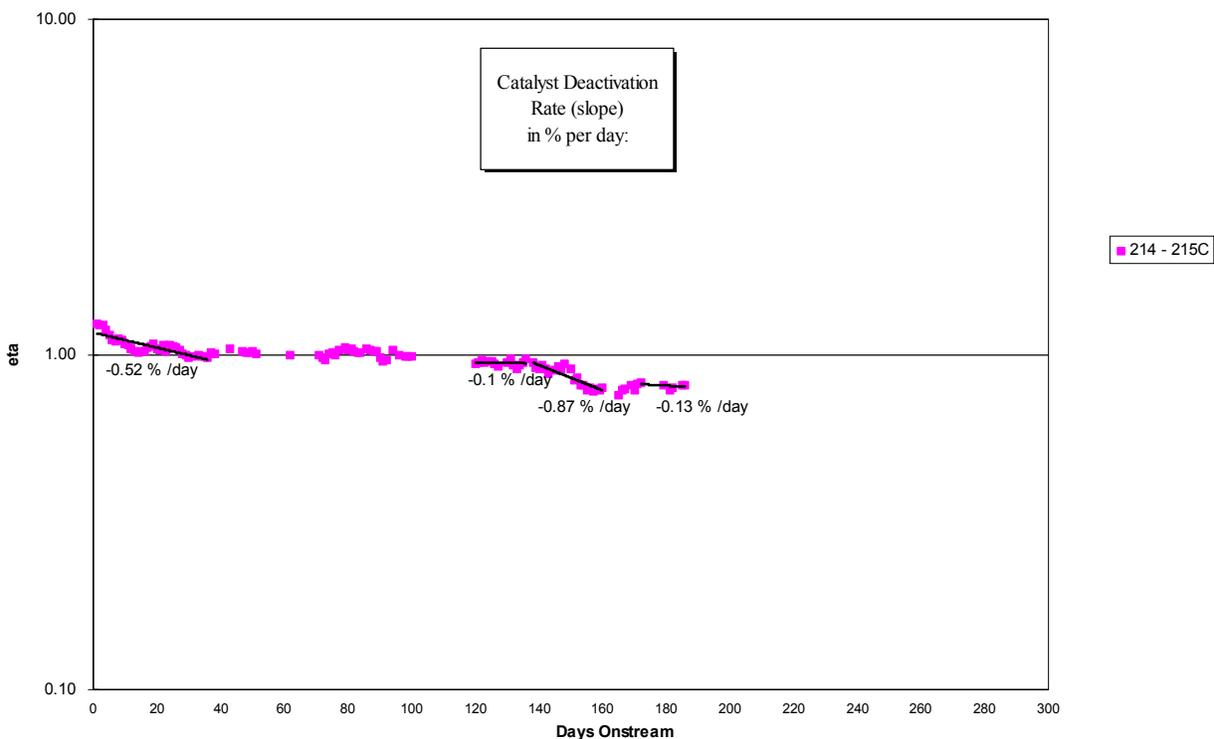

synthesis catalysts. Including the initial period of hyperactivity (approximately 3 weeks) that is typical of methanol synthesis catalysts, the catalyst deactivation rate over the first 52 days of operation was 0.52% per day; if the hyperactivity period is excluded, the rate of change of  $\eta$  over the first six months of this catalyst campaign was calculated to be in the range of 0.1 to 0.2% per day. These results were a significant improvement over the historical average of 0.6 to 0.7% per day and the results from the proof-of-concept run at the LaPorte AFDU in 1988/89 (0.4% per day), and may have been related to the performance of the adsorbent in the carbonyl guard bed, the removal of carbon steel components from the reactor internals (refer to Section 5.2), and the use of temperature programming to control the production rate across the LPMEOH™ reactor. Due to the low rate of catalyst deactivation, the reactor temperature was not increased during the 6-month operating period for this campaign (the operating program of the LPMEOH™ Demonstration Project ended on 31 December 2002). Reactor pressure was raised from 450 psig to 500 psig on 11 November 2002 to improve the conversion efficiency of the process.

The change in the rate of catalyst deactivation at Day 140 may have been caused by a breakthrough in arsenic (reported as arsine) through the adsorbent in the carbonyl guard bed. A thermal treatment of the adsorbent in the carbonyl guard bed (described in Section 5.2) may have resulted in the improvement in performance beginning on Day 160, and provides evidence of the impact of the presence of trace contaminants in coal-derived syngas on the life of methanol synthesis catalyst.

For the entire campaign (including the period of hyperactivity), the average rate of catalyst deactivation was calculated to be 0.17% per day, which was significantly lower than performance results from the laboratory, the LaPorte AFDU, or the earlier portions of the operating program for the LPMEOH™ Demonstration Project.

### **5.1.5 Summary**

Catalyst performance was tracked throughout the 69-month operating program at the LPMEOH™ demonstration unit. The design for the project used the performance during the 4-month proof-of-concept run at the LaPorte AFDU (0.4% per day on CO-rich syngas derived from natural gas at a reactor temperature of 250°C) as the basis. One of the key objectives of the commercial demonstration was to determine the long-term performance of the methanol synthesis catalyst on coal-derived syngas, and to quantify the rate of catalyst deactivation for use in any future projects. An in-house kinetic model was used to calculate the ratio of the rate constant at any time to the rate constant for freshly reduced catalyst (as determined in the laboratory autoclave). The rate of change of this parameter ( $\eta$ ) improved over the demonstration program. Following an accelerated rate of catalyst deactivation that was linked to the presence of post-construction debris in the system, the initial results at the design operating temperature of 250°C (averaging 1.3% per day) were significantly higher than the design basis.

The project team and DOE agreed that a second catalyst campaign be undertaken using a lower reactor temperature. During this 3+ year operating test, a long-term program of catalyst withdrawal and addition was demonstrated as an effective means to maintain catalyst



productivity. Most of the data during Catalyst Campaign 2 was taken at a reactor temperature of 235°C, and the rate of catalyst deactivation improved to 0.6% per day.

During the execution of the operating program for the LPMEOH™ Demonstration Project, modes of operation that were not anticipated during the development of the original Demonstration Test Plan were identified. The ability to activate the methanol synthesis catalyst within the LPMEOH™ reactor by using syngas that is diluted with N<sub>2</sub> (so-called in-situ activation) can result in lower capital cost. Also, the life of the methanol synthesis catalyst can be extended by operating the LPMEOH™ reactor at low temperatures at the outset and slowly increasing temperature with time to maintain a constant production of methanol (so-called temperature programming). The third catalyst campaign used this in-situ activation procedure to activate a full charge (in excess of 40,000 pounds) of fresh catalyst slurry inside the reactor. The catalyst did not reach proper initial activity compared to the results from the laboratory autoclave. The selection of operating conditions not associated with the activation was identified as the cause of the lower initial catalyst activity (refer to Section 5.6). Temperature programming was first practiced during Catalyst Campaign 3 to minimize the operating temperature and increase as necessary to maintain catalyst productivity. Levels of iron, arsenic, and sulfur were increasing on the catalyst during this campaign. The average catalyst deactivation rate for Catalyst Campaign 3 was similar to the result for Catalyst Campaign 2 (0.6% per day).

Catalyst Campaign 4 also involved an in-situ activation with an improved procedure to avoid high temperature storage of fresh catalyst slurry prior to activation. The activation resulted in the proper initial activity of the methanol synthesis catalyst. The average rate of catalyst deactivation during the 6-month duration of this campaign was 0.17% per day, which was ½ of the design basis for the LPMEOH™ demonstration unit. The reactor was operated at a constant low temperature of 215°C during this campaign.

The improvement in the long-term performance of the methanol synthesis catalyst can likely be attributed to several factors that were investigated as part of the operating program for the LPMEOH™ Demonstration Project. The negative effects of certain trace contaminants in coal-derived syngas may have had the most significant impact on catalyst life; Section 5.2 provides details on the results of analyses of catalyst samples from the LPMEOH™ reactor, laboratory work on trace contaminant removal, and the change of adsorbent materials within the existing catalyst guard bed system at the LPMEOH™ demonstration unit. The ability to maintain the desired rate of methanol production using the concept of temperature programming was likely another factor, and the development of the in-situ activation procedure allowed for the minimum operating temperature to be utilized; Section 5.6 provides additional details on the work in this area.

## **5.2 IDENTIFICATION AND REMOVAL OF TRACE CONTAMINANTS IN COAL-DERIVED SYNGAS**

One of the major technical risks associated with the design of the LPMEOH™ demonstration unit was the magnitude of the impact of trace contaminants in coal-derived syngas on the long-term performance of the methanol synthesis catalyst. Catalyst consumption is a major component in the variable cost of operation of methanol production plants, and the results from the 4-month proof-of-concept test at the LaPorte AFDU were obtained using CO-rich syngas produced from natural gas. During the operation of the LPMEOH™ demonstration unit, attempts were made to determine the impact of trace contaminants on the performance of the methanol synthesis catalyst. The presence of certain elements was identified from samples of spent catalyst, spent adsorbent materials from catalyst guard beds, and syngas entering the LPMEOH™ demonstration unit. The effects of certain elements were identified in laboratory studies, and the adsorbents in the catalyst guard bed system were changed based upon these results.<sup>(a)</sup>

A description of the Eastman upstream gas cleanup systems was provided in a topical report.<sup>(b)</sup> These systems include a Rectisol gas clean-up plant located downstream of the Texaco coal gasification system and a catalyst guard bed (equipment number 10C-30), which was installed by Eastman upstream of the fixed-bed methanol plant. Figure 1.2.3-1 shows the location of this equipment in relation to the syngas generation system and to both the fixed-bed methanol plant and the LPMEOH™ demonstration unit. The Rectisol unit was primarily designed to remove sulfur compounds from the syngas stream. The Eastman catalyst guard bed was installed to remove trace contaminants (in particular, compounds of sulfur and arsenic) which adversely impact the long-term performance of methanol synthesis catalysts.

The 29C-40 carbonyl guard bed (as shown in Figure 2.4-1) is a fixed adsorbent guard bed that protects methanol synthesis catalyst in the LPMEOH™ reactor against possible upsets of contaminants from the upstream gas cleanup units. The unit is four feet in diameter with an active bed length of 12 feet. Normal process flow is downward; the design also included a thermal regeneration system to reclaim performance of the adsorbent following saturation with metal carbonyls.

During the design phase of the LPMEOH™ Demonstration Project, the basis for the rate of catalyst deactivation (0.4% per day) was selected based upon the results from the 4-month test at the LaPorte AFDU. The experiences at the pilot unit had identified iron and nickel carbonyl as significant poisons to methanol synthesis catalyst. In addition, a field test was performed at the Kingsport chemicals-from-coal complex in 1996 using autoclaves housed in a transportable laboratory, the Alternative Fuels Field Development Unit (AFFTU); a photograph is provided in Figure 5.2.1-1. As documented in a topical report,<sup>(c)</sup> the performance of the methanol synthesis catalyst in the autoclave was not impacted by the presence of trace quantities of iron, nickel, sulfur, arsenic (expected to be in the form of arsine [AsH<sub>3</sub>]), and chloride that were detected on spent catalyst, even with no catalyst guard adsorbent materials in service.

Based upon these results, the basis for the design of the equipment to protect the methanol synthesis catalyst from trace contaminants in the coal-derived syngas was to utilize the existing

10C-30 catalyst guard bed within the Eastman chemicals-from-coal complex, which was charged with zinc oxide (targeting sulfur) and manganese dioxide on alumina (targeting arsenic), and to install the 29C-40 carbonyl guard bed utilizing activated carbon for removal of iron and nickel carbonyl. Both vessels were designed to operate at system pressure (nominally 750 psig) and ambient temperature.

**Figure 5.2-1**  
**Photograph of Alternative Fuels Field Test Unit (AFFTU)**



### 5.2.1 Kingsport Catalyst Campaign 1

Although there were no spent catalyst withdrawals during the campaign, freshly reduced catalyst was added to the LPMEOH™ reactor to maintain productivity starting in July of 1997. Analyses of early samples from Kingsport Catalyst Campaign 1 indicated a step-change increase in the concentration of iron on the catalyst surface during the initial six weeks, which could not be correlated to the presence of iron carbonyl in the feed gas streams. This finding was most likely related to the detection of post-construction debris within various parts of the facility. During this period, higher than expected levels of arsenic were also found on the catalyst samples. Table 5.2.1-1 lists elemental composition of freshly reduced and spent catalyst samples from Kingsport Catalyst Campaign 1. The presence of arsenic in sample K0597-2 indicated that the manganese dioxide in the Eastman catalyst guard bed was no longer effective in removing arsenic from the Balanced Gas feed. Given this result, Eastman replaced both adsorbents (zinc oxide and manganese dioxide) with fresh material in October of 1997.

### 5.2.2 Kingsport Catalyst Campaign 2

Fresh methanol catalyst was activated and transferred to the LPMEOH™ reactor in December of 1997 in preparation for this operating campaign. Given that the adsorbents in the Eastman catalyst guard bed had recently been replaced with fresh material, it was decided to replace the activated carbon in the carbonyl guard bed with fresh adsorbent. At the same time, the AFFTU was returned to the Eastman chemicals-from-coal complex to obtain real-time laboratory data in parallel with the unit operation.<sup>(d)</sup> At the baseline operating conditions for laboratory testing (including a reactor temperature of 250°C), the rate of catalyst deactivation in the autoclave in the AFFTU was statistically similar to the results using contaminant-free syngas. During the parallel test for the LPMEOH™ reactor (at a reactor temperature of 235°C), the catalyst deactivation in the LPMEOH™ demonstration unit was about 1% per day (as noted in Section 5.1-2), which was still higher than the results from the 4-month proof-of-concept test at the LaPorte AFDU in 1988/89 (0.4% per day at a reactor temperature of 250°C). Analytical results

**Table 5.2.1-1**  
**Kingsport Catalyst Campaign 1 - Elemental Composition of Solids from Slurry Samples**

	Time Onstream, days	Concentration, parts per million (weight basis) (ppmw)				
		As	S	Fe	Ni	Cl
Several	0	<25	100	47	25	-
K0597-2	31	446	190	281	61	< 200
K0897-1	93	601	235	169	< 20	-
K0997-1	110	779	575	261	37	-
K1097-	136	711	330	189	28	-
K9711-1b	173	699	340	194	37	-

also detected the presence of arsenic in the Balanced Gas feed (> 31 parts per billion by volume [ppbv]), carbonyl sulfide (COS) (10-20 ppbv), and an average total sulfur concentration of about 37 ppbv.

During the test period, there were numerous withdrawals of aged catalyst slurry and additions of freshly activated catalyst to the reactor resulting in a mixture of aged and fresh catalyst as the run proceeded. This complicated the interpretation of analytical data. Catalyst slurry samples for analysis at Air Products were taken at least monthly and were routinely monitored for expected trace contaminants including arsenic, sulfur, chlorine, iron, and nickel. As shown in Figure 5.2.2-1, arsenic, sulfur, and iron were detected on the catalyst in significant concentrations and, of these, arsenic was by far the most abundant. Catalyst additions and withdrawals caused periodic decreases in arsenic concentration but these values subsequently increase with time on stream.

Given that arsenic was the largest species detected on the samples of spent catalyst, laboratory studies were performed to determine its impact on catalyst life. The results showed that arsenic (in the form of arsine) was a strong catalyst poison, and that its effects were not determined during earlier autoclave testing in the AFFTU due to the high background rate of catalyst deactivation that is inherent to the laboratory setting (around 0.05% per hour or 1.2% per day vs. 0.4% per day at the LaPorte AFDU) and the low concentration of arsenic in the Balanced Gas feed (measured at 39 ppbv in a sample taken upstream of the Eastman catalyst guard bed in June of 1999). Figure 5.2.2-2 shows the fit of autoclave data for the impact of arsine on the life of methanol synthesis catalyst.

**Figure 5.2.2-1**  
**Kingsport Catalyst Campaign 2 - Trace Contaminant Concentrations on Slurry Samples**

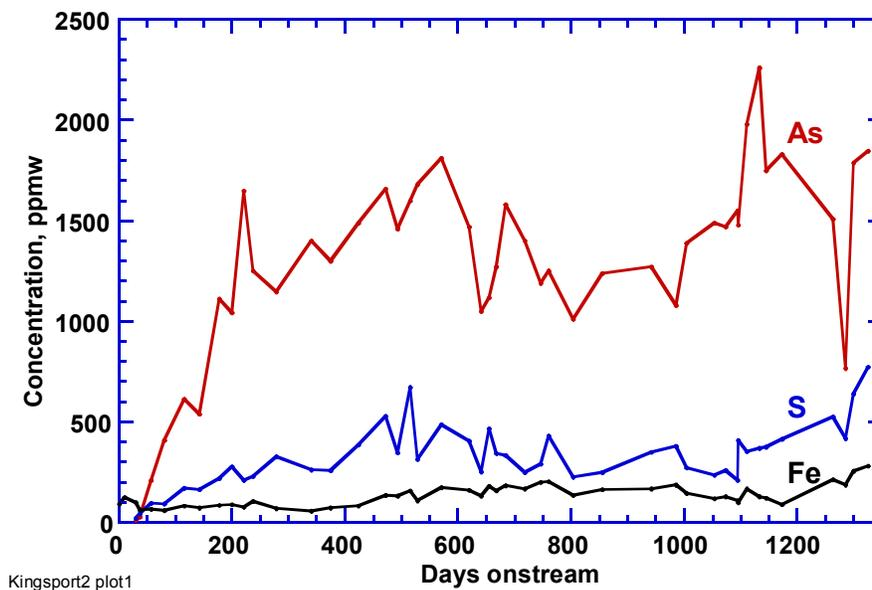

**Figure 5.2.2-2**  
**Effect of Arsine Concentration on Methanol Catalyst Deactivation Rate in Autoclave**

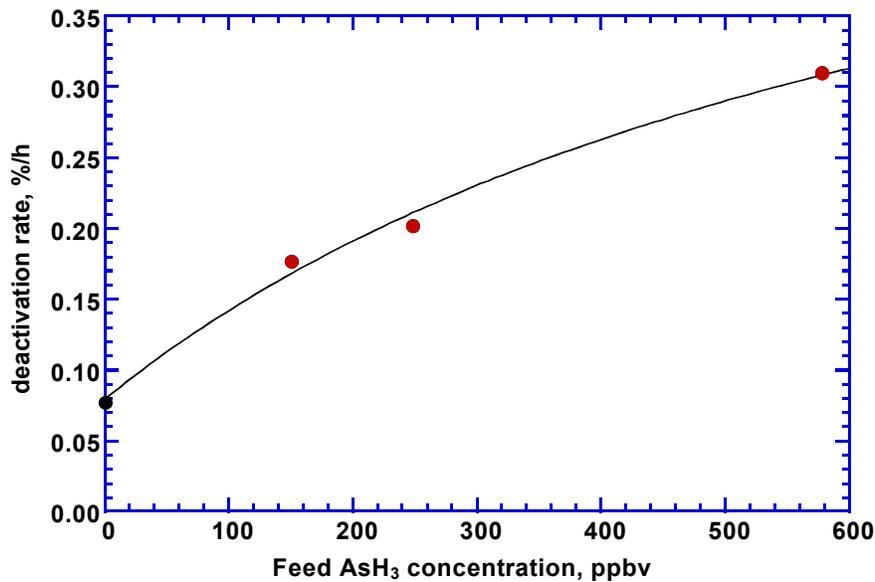

Given the increasing concentration of arsenic on the samples of spent catalyst, the adsorbents in both the Eastman catalyst guard bed and the carbonyl guard bed were changed. In June of 1999, the Eastman catalyst guard bed was charged with only manganese dioxide for arsine removal, and the carbonyl guard bed was split between manganese dioxide and activated carbon (as the carbon may have affinity for other species beyond iron and nickel carbonyl). The spent activated carbon was analyzed for presence of trace contaminants; the results are provided in Table 5.2.2-1. The fresh adsorbent contained substantial concentrations of sulfur, N<sub>2</sub>, and iron and thus an accurate accounting of these elements in the spent samples was difficult. In particular, the fresh adsorbent sulfur concentration was too high to obtain meaningful sulfur loadings on the bed. The results indicated a fairly uniform arsenic concentration throughout the bed implying that activated carbon was largely ineffective for removal of arsenic-containing contaminants.

**Table 5.2.2-1**  
**Elemental Analysis Results for Spent Activated Carbon from 29C-40 Carbonyl Guard Bed (June 1999)**

Sample No.	Description	Elemental Concentrations, ppmw, vs. Fresh Adsorbent <sup>a</sup>								
		As	S	N	Zn	Mn	Fe	Ni	Cr	Cu
AGB-57	fresh adsorbent	6.0	5,930	5,000	2.6	10.7	2,010	39.6	5.0	18.6
AGB-42	bed inlet	1,630	≤360	2,400	225	141	nd	nd	nd	nd
AGB-46	5' from bed inlet	1,570	≤330	-	213	135	nd	nd	nd	nd
AGB-50	12' from bed inlet	1,990	≤430	3,400	122	79	nd	nd	nd	nd

a. for spent adsorbent, elemental concentrations were corrected for concentrations on fresh adsorbent; nd = none detected.

During the first two months of service, the pressure drop across the carbonyl guard bed began to increase gradually. By the end of July of 1999, the pressure drop was measured at over 20 psi; the expected pressure drop was less than 1 psi. During a vessel inspection on 12 August 1999, changes to the bottom support screen and its support were made. During this maintenance, samples of the two adsorbents were analyzed. The results for the manganese dioxide are provided in Table 5.2.2-2. Arsenic was found throughout the manganese dioxide, but sulfur above that on the fresh adsorbent was found only on the inlet sample. For the activated carbon portion of the bed, arsenic concentrations were determined to be greater than that of the fresh adsorbent throughout the bed with a gradient from inlet to outlet (Table 5.2.2-3). This implied that arsine had broken through the bed.

Based upon these results, a laboratory screening program was initiated to identify alternate adsorbent materials with affinity for arsine that could be utilized in the Eastman catalyst guard bed and/or the carbonyl guard bed within the LPMEOH™ demonstration unit. Of the adsorbents examined, an activated carbon impregnated with copper oxide (CuO/C) was viewed as the material most likely to remove AsH<sub>3</sub> and other contaminants from the Balanced Gas feed. It was reasoned that the CuO portion would remove AsH<sub>3</sub>, COS, and hydrogen sulfide (H<sub>2</sub>S) while the carbon portion would function as it did previously to remove contaminants such as iron and nickel carbonyl as well as trace organics. The carbonyl guard bed was determined to provide adequate contact time and mixing length of the CuO/C adsorbent.

**Table 5.2.2-2  
Analysis of Fresh and Spent Manganese Dioxide from 29C-40 Carbonyl Guard Bed  
(11 August 1999)**

Sample	description	conc., wt%		Concentration, ppmw								
		Al	Mn	As	As <sup>a</sup>	S	S <sup>a</sup>	Mg	Zn	Mo	Ga	Ba
	fresh adsorbent	36.2	24.4	<46	6.3	150	210	180	nd	nd	nd	nd
AGB81199-1	Top	34.2	22.2	940	200	280	410	270	90	40	nd	nd
AGB81199-3	2 ft down	34.6	21.7	800	130	80	260	<300	nd	nd	30	nd
AGB81199-6	5 ft down	34.4	21.9	580	66	90	250	240	40	nd	nd	120

a. Concentration determined by elemental analysis; nd = not detected.

**Table 5.2.2-3  
Analysis of Fresh and Spent Activated Carbon from 29C-40 Carbonyl Guard Bed  
(11 August 1999)**

Sample	Description	Concentration, ppmw								
		S	S <sup>a</sup>	As	As <sup>a</sup>	Na	Mn	Mo	Ba	Zr
	fresh adsorbent	11,400	370 <sup>b</sup>	<16	2.1	400	12	nd	nd	nd
AGB 81199-9	8' down, top C	10,700	400 <sup>b</sup>	1,000	1,000	700	40	10	130	40
AGB 81199-11	10' down, middle C	9,800	330 <sup>b</sup>	240	260	800	30	10	130	30
AGB 81199-13	12' down, bottom C	8,300	320 <sup>b</sup>	320	410	300	50	10	80	nd

a. Concentration determined by elemental analysis.

b. Large errors because of high background S; nd = not detected.

Laboratory testing was performed to determine any safety implications of using this material at ambient temperature. Exposure of CuO/C adsorbent to Balanced Gas at 750 psig and 30°C resulted in temperature increases of 4.5°C or less, implying that no significant reduction (in this case, the reaction of the copper oxide with a reductant such as CO or H<sub>2</sub> to copper metal and either CO<sub>2</sub> or H<sub>2</sub>O) to metallic copper occurred at near ambient temperature. No methanol or other organics were observed in the bed exit gases, implying that the adsorbent had no methanol synthesis catalytic activity. Following reduction to a copper-impregnated carbon (Cu/C) adsorbent using dilute H<sub>2</sub> in N<sub>2</sub>, temperature increases upon syngas exposure were almost the same as for the unreduced material. Again, the bed outlet showed no sign of methanol or other organics meaning that the Cu/C material had negligible catalytic activity at near ambient temperatures. Additional testing at temperatures up to 250°C resulted in little to no formation of methanol or other organics.

The new adsorbent material was loaded into the carbonyl guard bed, and the vessel was operationally tested on 03 August 2000. Within 30 minutes of the introduction of Balanced Gas, temperatures in the carbonyl guard bed began to rise beyond the expected values based upon the results of the laboratory testing. The Eastman operations team moved quickly to depressurize the carbonyl guard bed by venting the syngas to the Eastman purge gas header. No environmental issues were experienced due to this incident. The carbonyl guard bed was then isolated from the feed syngas streams so that the LPMEOH™ demonstration unit could continue to operate.

The results of additional laboratory testing indicated that the probable cause of this temperature excursion was the reduction of copper oxide to copper metal. A procedure was then developed to reduce the copper oxide on the adsorbent to copper metal at 100°C using a dilute stream of Balanced Gas in N<sub>2</sub> over a 2-day period. The existing charge of adsorbent was subjected to the reduction procedure on 17-19 April 2001. Little uptake of H<sub>2</sub> or CO was measured, indicating that the adsorbent material had been essentially reduced during the initial operations in August of 2000. The carbonyl guard bed vessel was brought onstream on 26 April 2001. The carbonyl guard bed internal temperatures increased by about 30-40°C and then stabilized following the introduction of syngas. This was consistent with the temperature rise that would be expected due to the adsorption of CO on the guard bed material. However, sampling of the syngas entering and leaving the carbonyl guard bed indicated that breakthrough of arsine through the adsorbent had occurred within the first 6 days of operation versus an expected life of 1 to 2 months. Samples of spent material from the carbonyl guard bed indicated that the exposure to elevated temperatures during the upset in August of 2000 may have damaged the adsorbent.

Air Products and Eastman decided to replace the used adsorbent with fresh material. On 24 July 2001, the carbonyl guard bed was emptied and refilled with the same commercially available adsorbent. During this reduction procedure, a dilute stream of Balanced Gas in N<sub>2</sub> was preheated and used to reduce the copper oxide to copper metal in a temperature controlled manner. The temperature control during the procedure was excellent, and the uptake of CO and H<sub>2</sub> approached the theoretical value based upon the concentration of copper oxide on the adsorbent. The reduction was completed on 28 July 2001. After cooling with N<sub>2</sub>, a pressure check to full supply pressure with Balanced Gas was conducted. The adsorbent temperatures increased by about 25°C and stabilized during this examination. The carbonyl guard bed was



bypassed after the pressure check, and was brought onstream at the start of the third catalyst campaign.

### 5.2.3 Kingsport Catalyst Campaign 3

Unlike previous campaigns, the third Kingsport campaign involved an in-situ activation of a full charge (greater than 40,000 pounds) of catalyst. Methanol synthesis catalyst in the oxide form and mineral oil were loaded into the LPMEOH™ reactor without prior activation. The entire contents of the reactor were then reduced, or activated, using dilute Balanced Gas in N<sub>2</sub>. In previous campaigns at the LPMEOH™ demonstration unit, catalyst had been reduced with dilute CO in N<sub>2</sub> in smaller batches (approximately 2,000 pounds per batch) in the catalyst preparation system and transferred into the LPMEOH™ reactor. The initial performance of the catalyst was less than expected when compared with data from the laboratory. Additional information on this procedure is provided in Section 5.3.

Over the entire campaign, only two contaminants (iron and arsenic) were found on the catalyst. As shown in Figure 5.2.3-1, iron concentrations increased at a substantial rate while the increase in arsenic was much more modest. The final sample contained 534 ppmw iron. Arsenic concentrations reached a maximum of only 318 ppmw and 203 ppmw for the final sample analyzed (213 days). Sulfur was below its limit of detection (160 ppmw or lower) throughout the campaign. Although a direct comparison of data from Campaigns 2 and 3 is complicated by

**Figure 5.2.3-1**  
**Kingsport Catalyst Campaign 3 - Trace Contaminant Concentrations on Slurry Samples**

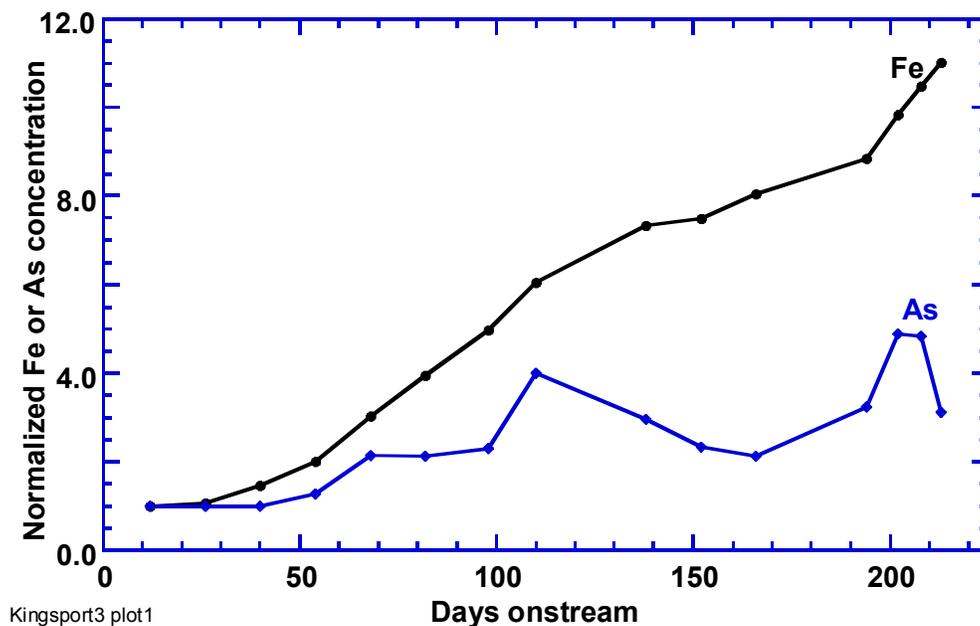

differences in total syngas exposure, some conclusions can be drawn. The arsenic loading on the Campaign 2 catalyst contained 277 ppmw sulfur while no sulfur was detected on the Campaign 3 catalyst. However, iron on the Campaign 2 catalyst was only 89 ppmw.

The use of the Cu/C adsorbent in the carbonyl guard bed was instrumental in lowering the quantity of arsine entering the LPMEOH™ demonstration unit. In order to confirm the observations during the laboratory evaluations, the effectiveness of the adsorbent was followed by monitoring AsH<sub>3</sub> concentrations in the carbonyl guard bed outlet. Samples were collected by passing syngas through an activated carbon trap followed by subsequent analysis for arsenic. During the first 27 days of service, the outlet AsH<sub>3</sub> concentration was less than 4 ppbv while the inlet arsine concentration was 52 ppbv (6 days) and 63 ppbv (28 days). Thus, the bed was effective for AsH<sub>3</sub> removal. The outlet concentration was next determined on the 68<sup>th</sup> day and found to be 5.6 ppbv, indicating that some breakthrough had occurred. The outlet concentration appeared to increase with time on stream and reached 30 ppbv by Day 102, indicating substantial breakthrough.

During the laboratory assessment of the Cu/C adsorbent, it was determined that the bond between copper and arsine was irreversible, and it was theorized that the rate limiting step in the reaction of Cu/C with AsH<sub>3</sub> was the diffusion of bound arsenic away from the Cu surface and into the bulk. It was reasoned that a “purge” of 120°C N<sub>2</sub> would warm the bed sufficiently to increase the rate of surface arsenic diffusion into the bulk and thus provide fresh copper surface for AsH<sub>3</sub> adsorption. During Catalyst Campaign 3, a thermal treatment was conducted in order to extend the useful life of the Cu/C adsorbent. The results of syngas sampling at the outlet of the carbonyl guard bed showed that the AsH<sub>3</sub> outlet concentration was below its limit of detection following both treatments. Thus, this thermal treatment extended the useful life of the adsorbent. Arsine was detected in the outlet of the carbonyl guard bed after 42 days on stream, which indicated that the performance of the adsorbent was beginning to degrade. A second thermal treatment was conducted, and once again arsine was not detected in the outlet from the carbonyl guard bed.

Based upon the decrease in the effective onstream time of the current charge of adsorbent, it was decided to replace the adsorbent in the carbonyl guard bed with fresh material. The spent Cu/C adsorbent was removed from the carbonyl guard bed and sampled; results of the analysis are provided in Table 5.2.3-1. The arsenic concentration varied in a regular fashion down the bed with 9,260 ppmw and 2,280 ppmw at the inlet and outlet, respectively. Sulfur concentrations were corrected for that of the fresh adsorbent and, because of high background sulfur concentration, the level of sulfur could be calculated only for the inlet sample. Similarly, high background iron precluded quantification of iron adsorption. No other contaminants were found on the spent adsorbent samples.

The fresh charge of CuO/C adsorbent was reduced and brought onstream on 08 March 2002. Initial performance following the replacement of the adsorbent was acceptable, as the average concentration of arsine was reduced from an inlet value of approximately 55 ppbv to 3 ppbv. The performance of the adsorbent began to degrade by late April of 2002, as the concentration of

**Table 5.2.3-1**  
**Analysis of Fresh and Spent Cu/C Adsorbent from 29C-40 Carbonyl Guard Bed**  
**(20 February 2002)**

Sample no.	Description	Concentration, ppmw						
		As	S <sup>a</sup>	Fe	Ni	P	Cr	Mo
18141-88-1	inlet	9,260	5,900	≤1,400	≤27	≤150	<8	≤140
18141-88-3	3 <sup>rd</sup> from inlet	8,720	nd	≤1,400	≤27	≤150	<8	≤140
18141-88-6	6 <sup>th</sup> from inlet	5,100	nd	≤1,400	≤27	≤150	<8	≤140
18141-88-9	9 <sup>th</sup> from inlet	4,250	nd	≤1,400	≤27	≤150	<8	≤140
18141-88-12	12 <sup>th</sup> from inlet	3,240	nd	≤1,400	≤27	≤150	<8	≤140
18141-88-16	16 <sup>th</sup> from inlet	3,150	nd	≤1,400	≤27	≤150	<8	≤140
18141-88-19	outlet	2,280	nd	≤1,400	≤27	≤150	<8	≤140

a. Concentration corrected for background on the fresh adsorbent; nd = none detected.

arsine at the outlet of the carbonyl guard bed had increased to 10 ppbv. This charge of adsorbent was used until the end of Catalyst Campaign 3 on 05 June 2002.

During this campaign, one result of note was the substantial increase in iron on the catalyst with time. The most likely and possibly the only source of iron contamination is iron carbonyl. The volatile carbonyl present in the syngas feed can enter the LPMEOH<sup>TM</sup> reactor if breakthrough of the adsorbent in the carbonyl guard bed occurred. A laboratory evaluation had earlier showed that the Cu/C adsorbent had a very high removal capacity for iron carbonyl. Furthermore, results from gas sampling performed on 23 April 2002 found < 8 ppbv iron carbonyl in the carbonyl guard bed inlet and outlet. Another possibility was that iron carbonyl was generated within the stainless steel metallurgy in the LPMEOH<sup>TM</sup> reactor or the associated recycle loop hardware. Based on laboratory experiments, this also seemed unlikely. Although the concentration of iron detected in slurry samples was likely sufficient to adversely impact the long-term catalyst activity during this campaign, its presence was not related to poor adsorbent performance in the carbonyl guard bed or to some problem with the in-situ activation procedure.

It was subsequently determined that the most likely source of the iron was the incorrect installation of carbon steel parts inside the reactor during a maintenance outage in April of 2001. The correct stainless steel parts were installed after the conclusion of Kingsport Catalyst Campaign 3 in June of 2002. A hot function test with a CO-rich syngas and mineral oil (in the absence of catalyst) showed low levels of iron carbonyl (approximately 30 ppbv) in the reactor feed gas stream after three days of testing.

#### 5.2.4 Kingsport Catalyst Campaign 4

The in-situ activation procedure was successfully demonstrated during the final Catalyst Campaign at the LPMEOH™ demonstration unit; details are provided in Section 5.3. The results of analysis of spent catalyst samples from this campaign are listed in Table 5.2.4-1. No significant quantities of any of the contaminants analyzed were found during the first three months of this catalyst campaign.

A fresh charge of CuO/C adsorbent was charged to the carbonyl guard bed, reduced, and brought onstream at the start of Catalyst Campaign 4. During the first week in service, gas sampling was performed to assess the initial performance of the adsorbent. The outlet concentration of arsine was determined to be less than the detection limit of the analysis (2 ppbv). These results provide evidence that the adsorbent in the carbonyl guard bed was performing well during the first week of operation.

Based upon results from Catalyst Campaign 3, an operating schedule for the adsorbent was developed. Fresh adsorbent can be used for about two months before breakthrough of arsine can be expected. A thermal treatment can then be performed on the adsorbent to provide increased capacity for arsine removal, and the material can be used for another month before the adsorbent needs to be replaced. Based upon this timetable, a thermal treatment was completed in late August of 2002. The spent adsorbent was removed after about 3 months of use, and fresh material was reduced and brought onstream in mid-October of 2002. (At the same time, Eastman replaced the manganese dioxide in the 10C-30 catalyst guard bed with fresh adsorbent.) The timing for the thermal treatment for this charge was accelerated by one week (to 06 December 2002) due to an observed increase in the rate of catalyst deactivation (as described in Section 5.1.4).

**Table 5.2.4-1**  
**Kingsport Catalyst Campaign 4 - Elemental Composition of Solids from Slurry Samples**

	Time Onstream days	Concentration, ppmw				
		As	S	Fe	Ni	Cl
K0206-1	0	< 20	< 40	< 23	< 10	< 100
K0109-1	12	< 2	< 19	28	< 7	na
K0109-3	26	4.2	< 25	44	< 7	na
K0110-1	40	5.4	< 39	40	< 6	na
K0110-2	54	19	< 47	58	< 7	na

a. K0206-1 is catalyst in oxide form; others are solids from reactor slurry samples;  
na = not available.

### 5.2.5 Summary

Significant progress was made during the operating phase of the LPMEOH™ Demonstration Project regarding the quantification of the impact of trace contaminants in coal-derived syngas on the performance of methanol synthesis catalyst and the study and use of adsorbents to remove targeted catalyst poisons. The 29C-40 carbonyl guard bed was originally designed for ambient temperature operation and to target the removal of carbonyl contaminants that could be present in coal-derived syngas. With the exception of two instances of the accidental introduction of iron to the system in Catalyst Campaign 1 (construction debris) and Catalyst Campaign 3 (incorrectly installed carbon steel parts in the LPMEOH™ reactor), iron and nickel carbonyls did not adversely impact the performance of the methanol synthesis catalyst at the LPMEOH™ demonstration unit.

Arsenic, and to a lesser degree sulfur, were the main contaminants that were detected on the samples of catalyst slurry taken from the LPMEOH™ reactor. Two adsorbents to target arsenic and sulfur were evaluated at the LPMEOH™ demonstration unit during Catalyst Campaigns 2 through 4. During Catalyst Campaign 2, the carbonyl guard bed was charged with 50% by volume manganese dioxide and 50% activated carbon. The manganese dioxide adsorbent displayed affinity for arsenic removal but the adsorbent bed broke through (based on gas-phase arsine analysis) after approximately one month of service. During Catalyst Campaigns 3 and 4, a copper oxide-impregnated activated carbon adsorbent was reduced and placed into service. This adsorbent was effective in arsine removal as determined by gas-phase analysis and catalyst sample results. The Cu/C adsorbent had a service life of about two months at the LPMEOH™ demonstration unit. An innovative thermal treatment was employed to extend the service life of the adsorbent for two additional months.

The improved performance of the catalyst guard system may have had a direct impact on the results for catalyst life during Catalyst Campaign 4 (catalyst deactivation rate of 0.1 to 0.2% per day versus an average of 0.6 to 0.7% per day during the previous 3 years of operation). By controlling the exposure of methanol synthesis catalyst to poisons, the targeted economics for coproduction of methanol in an IGCC power plant (as detailed in Section 9) can be achieved.

### **5.3 GAS SPARGER PERFORMANCE**

The sparger is a proprietary gas distribution device used to introduce the feed gas into the bottom of the LPMEOH™ reactor. The sparger was developed on a proprietary basis by Air Products and is intended to introduce the feed gas to the slurry bubble column reactor. It must also be able to withstand interruptions to gas flow without negative impact on operations. The principles for the design of the sparger at the LPMEOH™ demonstration unit were first utilized during the 4-month proof-of-concept test of the LPMEOH™ Process at the LaPorte AFDU, during which no sparger-related outages were encountered.

Pressure drop can be expressed by the following equation:

$$\Delta P = \frac{K * (V * MW)^2}{\rho}$$

where:

- $\Delta P$  = pressure drop across sparger (psi)
- $K$  = sparger resistance coefficient (dimensionless)
- $V$  = vapor volumetric flowrate (KSCFH)
- $MW$  = vapor molecular weight (lb/lb mole)
- $\rho$  = vapor density (lb/ft<sup>3</sup>)

This equation shows that changes in gas composition or flowrate can influence pressure drop measurements dramatically. Tracking the resistance coefficient ( $K$ ) over time can indicate any change in the gas flow path through the gas sparger. For a given gas volumetric flowrate and density, an increase in  $K$  (caused by a restriction in the flow path, for example), will cause an increase in pressure drop.

As noted in Section 3.1.3, three different gas sparger designs were utilized during the operation of the Kingsport LPMEOH™ demonstration unit. A review of the performance of the devices during the 69-month operating program is provided.

#### **5.3.1 Initial Sparger Design (April – November 1997)**

The LPMEOH™ demonstration unit was first brought onstream on 02 April 1997. Initial results indicated that the scaled-up gas sparger did provide the necessary distribution of syngas at the bottom of the reactor so that actual hydrodynamic behavior matched design expectations. In addition, the heat transfer coefficient of the internal heat exchanger exceeded the design value, further indicating good mixing. However, the measured pressure drop across the gas sparger increased considerably throughout the first few weeks onstream. As shown in Figure 5.3.1-1, the value for the resistance coefficient also reflected this trend, indicating the possibility that an obstruction of the flow path of the reactor feed gas was occurring. During this same time, periods of operation with no vapor flow through the gas sparger appeared to have no impact the rate of change of pressure drop.

**Figure 5.3.1-1  
Sparger Resistance Coefficient - Sparger Design #1 (April - November 1997)**

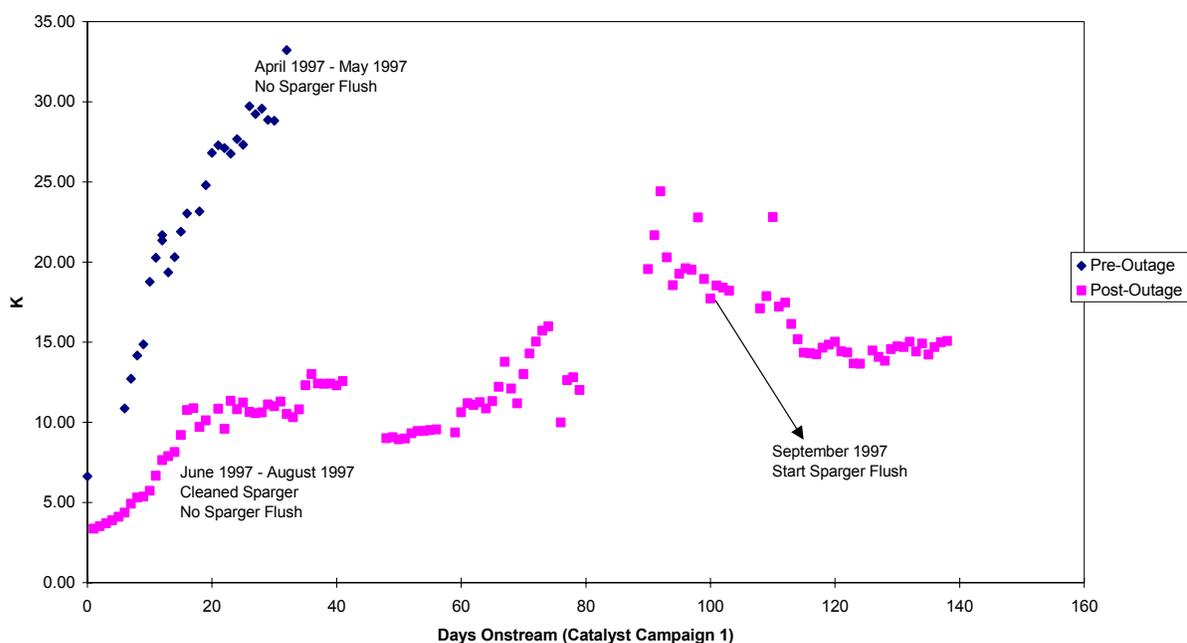

During a scheduled outage in May of 1997, an inspection of equipment associated with the reactor, particularly the gas sparger, was performed. About 800 pounds of residual catalyst was removed from the bottom head of the reactor during this exercise. A solid material (presumably methanol synthesis catalyst) appeared to block about 50% of the flow path through the sparger; a small amount of catalyst was found in the inlet piping to the sparger. There was no discernible pattern to the blockage by the catalyst, and no significant construction debris was found in the inlet piping or in the sparger. The sparger was removed from the reactor and cleaned. Structural modifications increased the maximum allowable pressure differential across the sparger, but no changes were made to its flow distribution characteristics. In addition to the inspection, a flush connection of fresh process oil from the 29D-30 oil storage tank via the 29G-30 slurry transfer pump to the gas inlet line to the reactor was added.

Upon restarting the LPMEOH™ demonstration unit on 17 June 1997, the pressure drop across the gas sparger returned to its design value. However, the gas sparger pressure drop and resistance coefficient did continue to increase with time onstream, although not as rapidly as the April/May operation (see Figure 5.3.1-1). A flush by fresh oil through the new connection at the gas inlet line yielded a decline in pressure drop through the gas sparger. However, the effects were temporary, and the flow resistance continued to increase. Additional flushing with fresh oil was limited, because fresh oil can only be added to the process at an average of 0.1 to 0.2 gpm to match the rate of oil loss with the methanol product.

The resistance coefficient experienced a significant step-change increase during a week-long shutdown in early September of 1997. A practice of flushing the gas sparger with entrained slurry from the 29C-06 cyclone and 29C-05 secondary oil knock-out drum was then initiated; this was supplied at the average rate of liquid flow in the secondary oil knock-out drum and cyclone (1 to 2 gpm). This flushing procedure was a batch-wise pumping process using the 29C-30 catalyst reduction vessel and the slurry transfer pump. Flow resistance through the gas sparger was stabilized at a manageable level by flushing in this manner (refer to Figure 5.3.1-1). The rate of addition of the flush was 30 gpm, and it was performed 2 to 3 times per day at the average rate of liquid flow through the cyclone and secondary oil knock-out drum.

On 09 October 1997 (Day 114), a new procedure was tested to gravity-drain the condensed oil and entrained slurry continuously to the flush connection at the average rate of liquid flow in the reactor loop, thus eliminating the batch-transfer operating steps. An inventory of condensed oil was collected in the secondary oil knock-out drum, and the gravity-drain line to the flush connection was then placed in service. Level in the secondary oil knock-out drum dropped and the temperature at the bottom of the reactor fell slightly, confirming the flowing path of oil to the reactor despite the already high pressure drop through the gas sparger.

During subsequent operation, the gravity-drain line became obstructed about twice per day. This blockage, either resulting from accumulation of catalyst or from vapor-locking within the piping system, cleared easily with a brief flush of clean oil from the oil storage tank via the 29G-03 oil makeup pump. At this frequency of operation, the amount of fresh oil added to the process during line flushing was less than the average oil loss rate with the methanol product (0.1 to 0.2 gpm). During the gravity-drain operation, the flow resistance coefficient across the gas sparger showed some modest improvement, compared to the period in September when the condensed oil and entrained slurry were pumped batch-wise via the slurry transfer pump.

On 03 November 1997, the LPMEOH™ demonstration unit was shut down in order to prepare a second batch of fresh catalyst slurry. After the system was drained of spent catalyst, the LPMEOH™ reactor was inspected by video camera. Dried catalyst slurry was observed in the bottom head and around the gas sparger.

Preparations were then made to restart the LPMEOH™ reactor with a second partial charge of fresh methanol synthesis catalyst. Batches of fresh catalyst slurry were activated in the catalyst reduction vessel and stored in the slurry tank. On 26 November 1997, the first seven batches of freshly reduced catalyst slurry were pressure-transferred from the slurry storage tank to the LPMEOH™ reactor. N<sub>2</sub> flow was introduced through the gas sparger prior to beginning the transfer operation, and the recycle compressor was started under N<sub>2</sub> at the completion of the transfer. While this was occurring, the activation of the eighth batch of catalyst was proceeding in the catalyst reduction vessel. Heat-up of the reactor using 600 psig steam on the internal heat exchanger proceeded smoothly; however, the pressure drop at the bottom of the reactor increased slowly, from 1.4 psi to 2.1 psi over a four-hour period. When the gas sparger was flushed at the gas inlet piping connection using fresh oil from the oil storage tank, the pressure drop across the sparger rose to about 7 psi. Then, when the eighth batch of slurry was transferred to the reactor using the slurry transfer pump, the pressure drop rose to 14 psi. After this transfer, the recycle compressor began to approach surge, indicating significant blockage at the sparger. Attempts to



clean the flow path were unsuccessful, and the contents of the reactor were pressure-transferred back to the slurry tank.

After completing the slurry transfer and securing the steam and syngas supplies, the manway on the bottom of the reactor was opened. The gas sparger was found to be plugged with fresh catalyst. In addition, a review of the data during the slurry transfer indicates that the N<sub>2</sub> flow to the reactor was quite low, and that there was evidence that the gas inlet piping to the reactor had filled with slurry during the transfer operation. Settling of the fresh catalyst appeared to have occurred in the reactor and gas inlet piping, which resulted in the plugging of the gas sparger.

### **5.3.2 Second Sparger Design (December 1997 – February 1999)**

Following the attempted restart of the LPMEOH<sup>TM</sup> demonstration unit in November of 1997, a modified sparger design was developed by Air Products and fabricated and installed by Eastman. Part of the reasoning for draining the initial charge of catalyst slurry from the process was to demonstrate that the operation of the gas sparger could be maintained at the design flow resistance coefficient by gravity-draining the condensed oil and entrained slurry to the flush connection at the gas inlet piping to the LPMEOH<sup>TM</sup> reactor. Within 24 hours of restarting the LPMEOH<sup>TM</sup> demonstration unit, the gravity-draining flow path for this material was placed in service. As shown in Figure 5.3.2-1, the flow resistance through the gas sparger of the LPMEOH<sup>TM</sup> reactor could be stabilized by use of this continuous flush. Performance of the second sparger design showed significant improvement over the operating results from 1997; however, a slight increase in resistance coefficient over time was still apparent.

On 15 October 1998 (Day 299), maintenance work was performed on the oil flush system that cleans the taps used to measure the pressure drop across the gas sparger. Upon completion of this work, the measured pressure drop increased by 2.0 psi. An analysis of other pressure readings around the reactor was performed to determine the rate of increase of this pressure drop. It appeared that the increase in pressure drop across the sparger occurred around the time of the maintenance work. Another step-change increase in pressure drop occurred after restarting from a complex-wide power outage in early November of 1998.

As a result of the greater sparger pressure drop, condensed oil and entrained slurry could not be gravity-drained to the flush connection at the gas inlet line to the reactor. In order to overcome the pressure drop, the streams were batch-transferred to the catalyst reduction vessel and returned to the reactor via the slurry transfer pump. This procedure was last used with the initial sparger design in October of 1997. During periods when the catalyst reduction vessel was otherwise in use, the condensed oil and entrained slurry streams were free-drained directly to a connection on the reactor where the pressure drop was not limiting.

**Figure 5.3.2-1  
Sparger Resistance Coefficient - Sparger Design #2 (December 1997 - February 1999)**

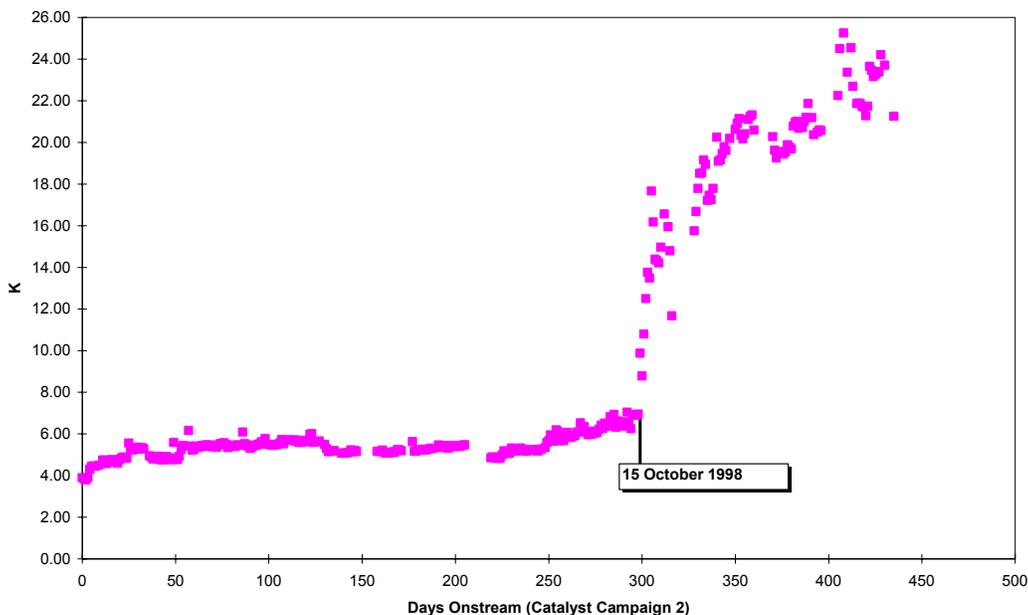

During January and February of 1999 (around Days 377-435), the sparger resistance coefficient across the LPMEOH™ reactor continued to increase beyond the step-change experienced in October of 1998 (refer to Figure 5.3.2-1). The associated higher pressure drop within the reactor loop limited the quantity of Balanced Gas that could be fed to the LPMEOH™ demonstration unit.

During a schedule outage in March of 1999, the second version of the gas sparger was removed from the LPMEOH™ reactor and inspected. It was estimated that the blockage in the sparger was consistent with the resistance coefficient that was calculated prior to shutdown.

### **5.3.3 Current Sparger Design (March 1999 – Present)**

During the outage in March of 1999, a modified gas sparger was installed in the reactor; Air Products developed this design using the same principles as the previous two devices. During that outage, a gravity drain line piping modification was also made to separate the condensed oil from the oil knockout vessel from the entrained slurry from the cyclone. The condensed oil stream is relatively clean and was used to continuously flush the sparger; the slurry from the cyclone was sent directly into the reactor. The separation of these streams reduced plugging and improved the overall reliability of the sparger flush and the oil return. Upon restarting on 14 March 1999, the performance of the new sparger met or exceeded the design expectations for pressure drop and reactor operation, and stable operation was maintained for over 500 days (refer to Figure 5.3.3-1).

**Figure 5.3.3-1**  
**Sparger Resistance Coefficient - Sparger Design #3 (March 1999 - August 2001)**

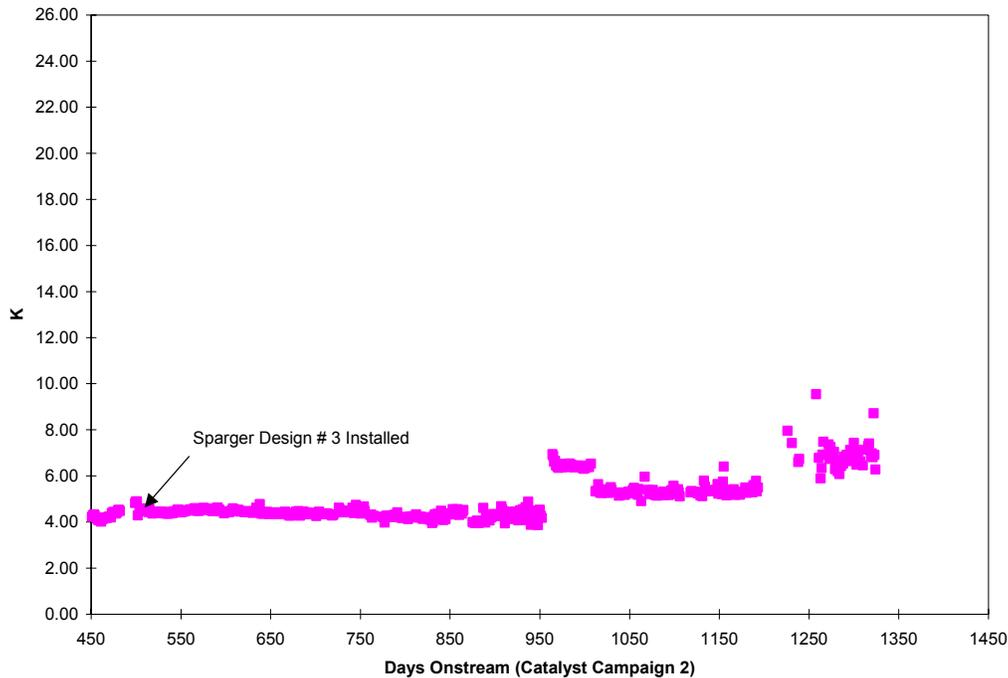

After the restart of the LPMEOH™ demonstration unit on 04 August 2000 (Day 958 of Catalyst Campaign 2), the resistance coefficient increased approximately 50% (from an average of about 4.3 to 6.6). Subsequent flushing of the sparger with clean oil resulted in a sizable reduction of the increased flow resistance (to an average of 5.3). During the operating period between March 2001 (Day 1193 of Catalyst Campaign 2), the resistance coefficient did not appear to be further increasing over time.

During this biennial outage, the sparger was removed from the LPMEOH™ reactor for inspection and cleaning. In addition, all differential pressure transmitters around the sparger and reactor were calibrated, and the pressure taps were cleaned. Following the restart of the unit (Day 1217 of Catalyst Campaign 2), the resistance coefficient was higher than the value that was calculated following the March 1999 outage. The most likely cause is that the recalibration of the differential pressure transmitters had experienced a shift in their baseline measurement. The sparger resistance continued to show no significant increase over time, which was consistent with the operating history with this device.

In August of 2001, Catalyst Campaign 3 was started, during which the catalyst inventory was removed and a new in-situ activation procedure was used to activate a full load of fresh catalyst inside the reactor vessel (refer to Section 5.1). Figure 5.3.3-2 shows the sparger performance for this operating period (August of 2001 to June of 2002). The sparger resistance showed no increase over time during this period.

**Figure 5.3.3-2**  
**Sparger Resistance Coefficient - Sparger Design #3 (August 2001 - June 2002)**

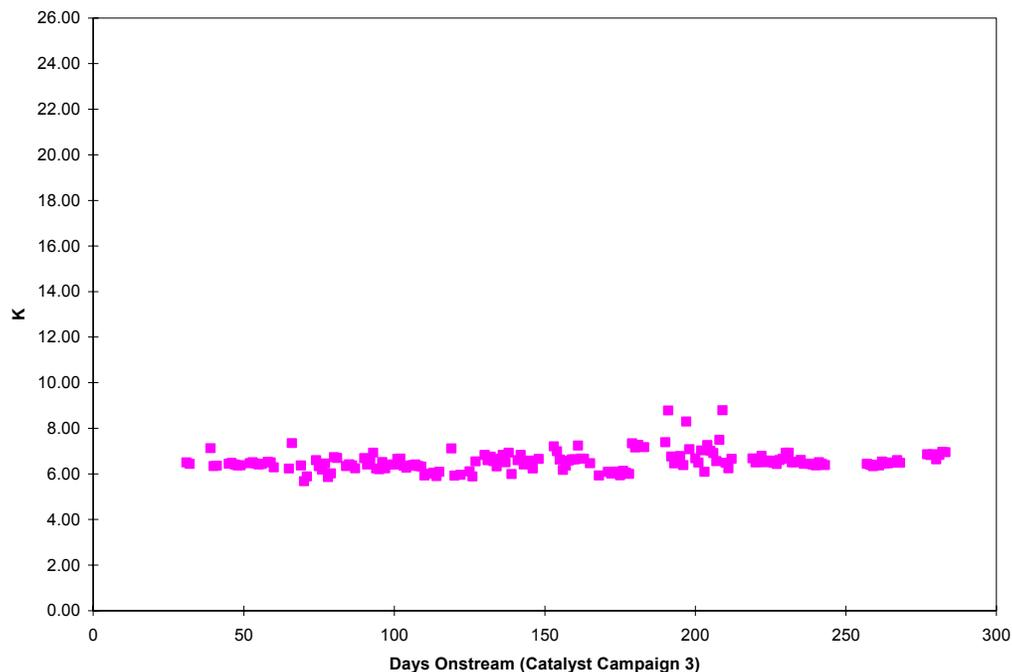

During the preparations for Catalyst Campaign 4 in June of 2002, the sparger was inspected and cleaned. As shown in Figure 5.3.3-3, the performance of the sparger showed no significant increase in resistance between following the restart on 27 June 2002 through to the end of the operating program on 31 December 2002.

**Figure 5.3.3-3**  
**Sparger Resistance Coefficient - Sparger Design #3 (June 2002 - 31 December 2002)**

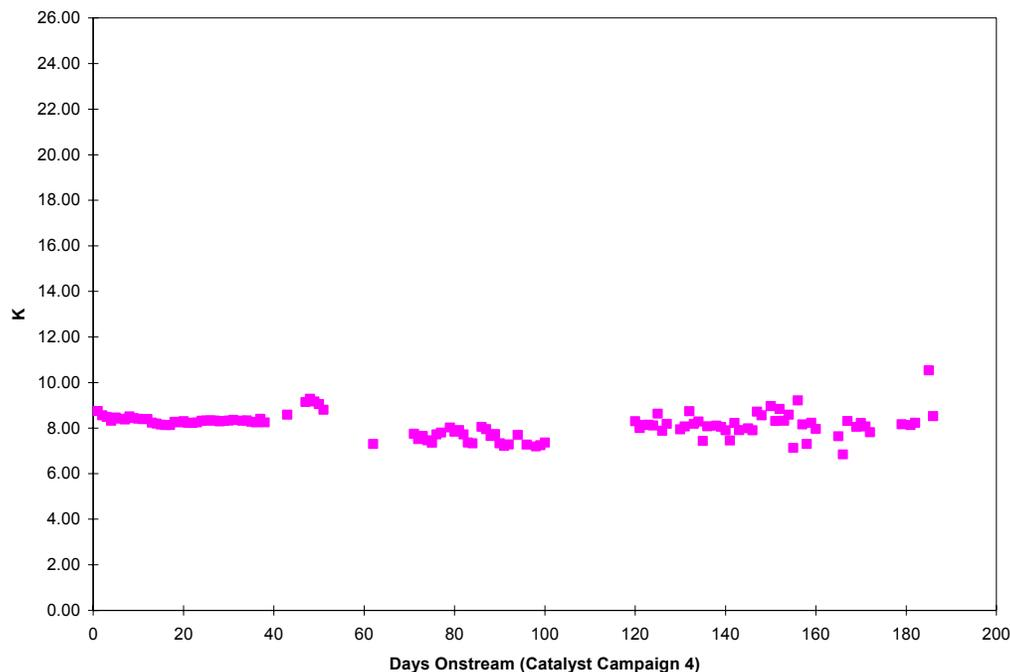

#### **5.3.4 Summary**

The current design of the gas sparger for the LPMEOH™ reactor has been demonstrated to meet the requirements for initial pressure drop and long-term performance. The device provides operating flexibility through all modes of operation. The use of condensed or entrained slurry, either by pump or by gravity draining, as a continuous or periodic flush through the sparger has contributed greatly to the reliability of the sparger operation. This flushing system and procedure is now a standard part of the design package for the LPMEOH™ Process.

## 5.4 PROCESS VARIABLE TESTS: H<sub>2</sub>:CO RATIO

Syngas ratios will vary with the type of gasifier and feed used in an IGCC power plant application. A key commercialization goal of the LPMEOH™ Demonstration Project was to operate the LPMEOH™ reactor utilizing a wide variety of syngas feed ratios. Three different feed gas streams were diverted from existing operations to the LPMEOH™ demonstration unit:

- 1) H<sub>2</sub> Gas, containing an excess of H<sub>2</sub> over the stoichiometric balance for the production of methanol (as noted in Section 3.1, this stream was not used during the demonstration test program);
- 2) CO Gas, a syngas containing primarily CO; and
- 3) Balanced Gas, a syngas with a composition of H<sub>2</sub>, CO, and CO<sub>2</sub> in stoichiometric balance ( $[\text{H}_2 - \text{CO}_2]/[\text{CO} + \text{CO}_2] = 2.05$ ) for the production of methanol.

With the availability of these feed gas streams, a wide range of syngas feed ratios, including those from modern coal gasifiers, could be examined (subject to syngas availability). The H<sub>2</sub>:CO ratio at the reactor inlet was set to the desired value by adjusting the total quantity of fresh feed syngas and the Recycle Gas.

As noted in Section 2.1, the LPMEOH™ Process is particularly well suited to coal-derived syngas which is rich in CO. Unlike gas-phase reactors, shift and CO<sub>2</sub> removal are not required to adjust the composition to a particular requirement. Low H<sub>2</sub>-to-CO ratios are acceptable as is any CO<sub>2</sub> content. These capabilities make the LPMEOH™ Process a potentially lower-cost conversion route to methanol, especially when methanol coproduction is added to a coal-based IGCC power plant. As shown in Table 4.1-1, several test campaigns were undertaken to study the performance of the LPMEOH™ Process using CO-rich syngas. Three ranges of CO-rich feed gases were generally tested: a syngas with a H<sub>2</sub>:CO ratio at the reactor inlet of approximately 0.5, a syngas with a H<sub>2</sub>:CO ratio at the reactor inlet of about 0.7, and a syngas with a H<sub>2</sub>:CO ratio at the reactor inlet of approximately 1.0. A table detailing all of the CO-rich testing performed during the demonstration test program at the LPMEOH™ demonstration unit is given in Table 5.4-1.

A total of 4 days of testing with a CO-rich syngas at a H<sub>2</sub>:CO ratio of about 0.5 (around 57 volume % [vol%] in the reactor feed gas stream) was conducted during the operating program. The results for methanol production matched the performance based upon studies in the laboratory autoclave. Due to the short duration of these tests, the rate of catalyst deactivation could not be calculated.

**Table 5.4-1  
Kingsport LPMEOH™ Process - H<sub>2</sub>:CO Ratio Testing**

Date Started	Date Ended	Duration (days)	H <sub>2</sub> :CO Ratio @ Reactor Inlet	Reactor Temperature (°C)	Methanol Production (sT/D)	Catalyst Deactivation Rate (% per day)
5/7/97	5/8/97	2	0.43	250	70	na <sup>a</sup>
8/1/97	8/12/97	12	0.80	250	190	- 1.70
2/8/97	2/12/98	5	0.78	225	192	na
8/24/98	8/26/98	3	0.96	250	228	na
12/2/99	12/10/99	8	1.02	235	204	na
2/23/00	2/23/00	1	0.57	235	177	na
3/21/00	4/13/00	24	1.03	235	180	-1.24
5/9/00	5/10/00	1	~ 0.5	250	NA	na
11/15/00	11/18/00	4	1.08	235	220	na
5/9/01	5/13/01	5	0.65	235	117	na
10/29/01	10/29/01	1	0.64	218	156	na
12/12/01	12/17/01	6	0.68	224	142	na
12/24/01	12/29/01	6	0.76	226	143	na

a. na = operating campaigns were of insufficient length to calculate rate of catalyst deactivation.

A total of 35 days of testing with a CO-rich syngas at a H<sub>2</sub>:CO ratio of about 0.7 was conducted during the operating program. During a 12-day campaign that was undertaken during Catalyst Campaign 1 (early August of 1997), the rate of catalyst deactivation was calculated to be 1.7% per day. This result was statistically similar to the rates calculated during this campaign when Balanced Gas was used as the feed to the LPMEOH™ demonstration unit.

A total of 39 days of testing with a syngas at a H<sub>2</sub>:CO ratio of around 1.0 was conducted during the operating program. A 24-day test was performed from 21 March 2000 to 13 April 2000. The catalyst performance for this test period was calculated as a deactivation rate of 1.24% per day. This rate was also statistically similar to the rates calculated using Balanced Gas during this same period during Catalyst Campaign 2 (refer to Section 5.1.2).

In summary, a variety of H<sub>2</sub>:CO ratios were tested in the Kingsport LPMEOH™ demonstration unit to evaluate the effect of syngas compositions on the performance of the LPMEOH™ Process. All of the results met the expectations for methanol production rate based upon earlier studies in the laboratory. Catalyst performance for the LPMEOH™ reactor with lower H<sub>2</sub>:CO ratios were not significantly impacted based on the calculated rate of catalyst deactivation. These results provide additional confirmation (beyond the performance during the 4-month proof-of-concept test at the LaPorte AFDU in 1988/89 on CO-rich syngas) of the capability of the LPMEOH™ Process to process syngas directly from all modern syngas generation systems, including coal gasifiers.

## 5.5 RAMPING AND ON/OFF TESTING

The ability of the LPMEOH™ Process to start and stop rapidly is an important feature within an IGCC power plant application. In addition, the capability of the LPMEOH™ Process to perform in an electrical demand environment will be required for the technology to be successfully dispatched in these power generation applications. Although the host site for the LPMEOH™ demonstration unit was a chemical production facility, a test protocol was developed to evaluate the ability of the reactor to ramp up and shut down quickly, and cycle on and off. These ramping and on/off tests were conducted within the limitations of the rate of response of the existing Eastman complex, in particular the limits on rate-of-change on the parallel fixed-bed methanol plant and the impact of purge flow from the LPMEOH™ demonstration unit on the operation of the downstream boiler system.

Opportunities to test the ability of the LPMEOH™ process to stop quickly occurred throughout the operating program. Syngas could be stopped as quickly as the other systems within Eastman's chemicals-from-coal complex could handle the additional flow. It was also shown that the recycle compressor could continue to operate until the reactor pressure, which decreased either due to purge losses or continued consumption of H<sub>2</sub> and CO, reached the minimum flow based upon approach to surge (around 85 psig).

In designing the test for the restart of the LPMEOH™ demonstration unit, a goal of 5 to 10% change in design flow per minute, which meets the requirements for an IGCC system, was established. The first test of the ability to ramp the LPMEOH™ reactor from a standby condition to production rates was performed 13 June 2000. This test simulated the ramping that must be performed within the startup requirements of an IGCC facility. An average ramping rate of 3% of the design flow (990 KSCFH) per minute and a maximum ramp rate of 4% of the design flow per minute was achieved, which approached the minimum target rate of 5% per minute. Figure 5.5-1 shows the results of this initial ramping test.

Three additional ramping tests were performed between 04 and 13 March 2001. For the first two tests (on 04 and 06 March), the reactor standby temperature was 216°C and 212°C, respectively; from this starting point, a reasonable ramping rate could not be reached. During the third test on 13 March 2001, a standby reactor temperature of 227°C was used; for all of the tests performed in March of 2001, gas flow from the recycle compressor was maintained to the LPMEOH™ reactor. Balanced Gas was then introduced to the process as quickly as possible (within the limitations of other systems at the Eastman chemicals-from-coal complex). As shown in Figure 5.5-2, a maximum ramp rate of 5.7% full load per minute and an average ramp rate of 4.2% full load per minute were achieved during this testing. This ramp performance approached the minimum target ramp rate of 5% full load per minute. For each test, once Balanced Gas flowrate



**Figure 5.5-1  
Ramping Study at LPMEOH™ Demonstration Unit (13 June 2000)**

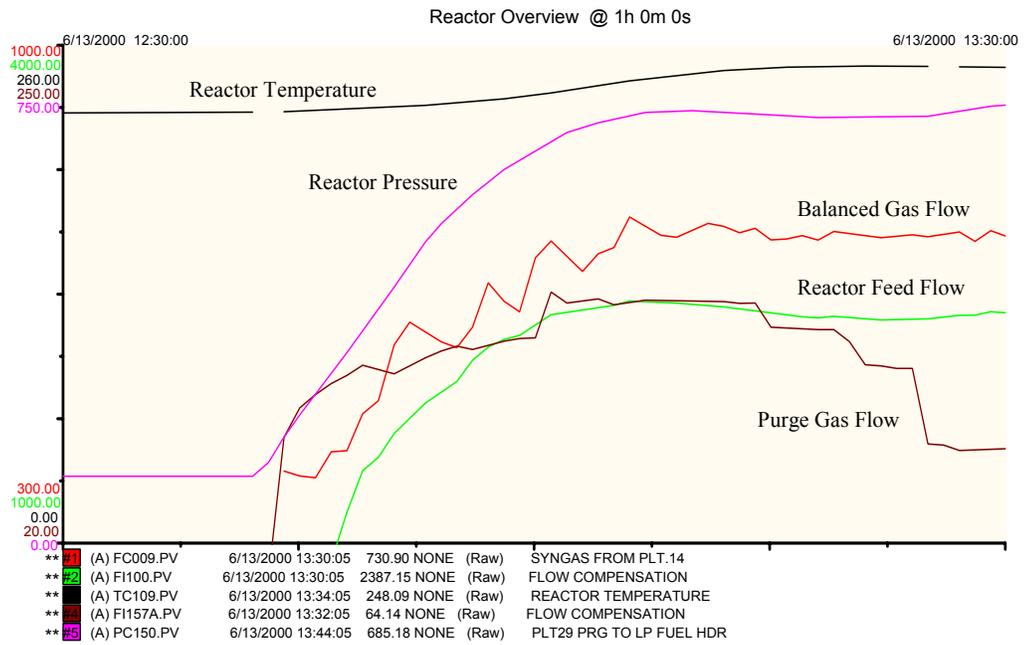

**Figure 5.5-2  
Ramping Study at LPMEOH™ Demonstration Unit (13 March 2001)**

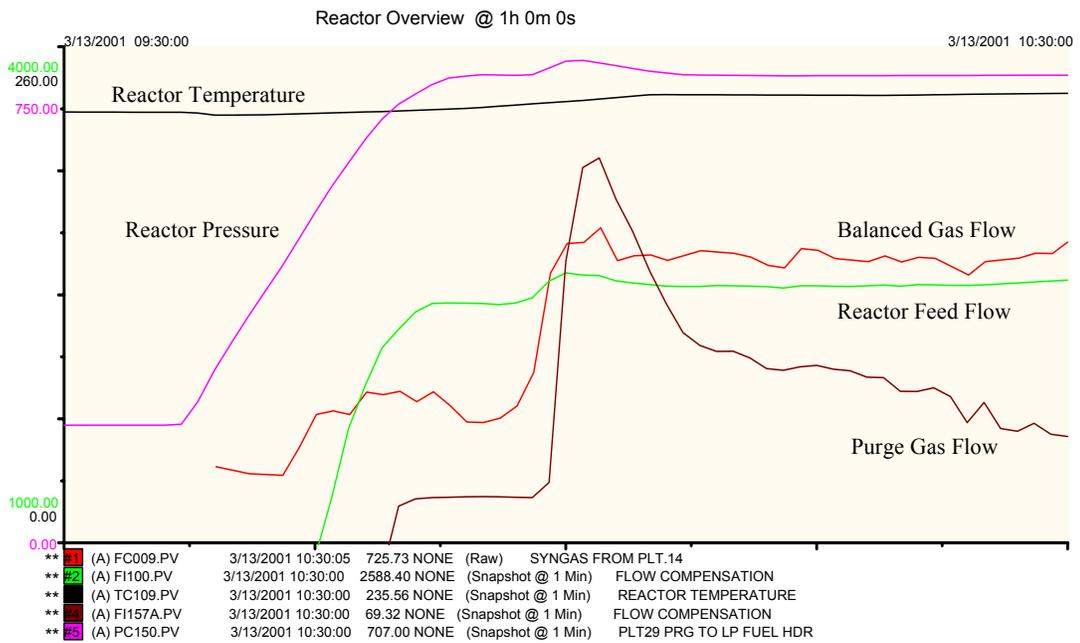

was reestablished and reactor temperature and pressure were placed into control, the performance of the LPMEOH™ demonstration unit was determined to have returned to the condition prior to the shutdown.

Two tests of the ability of the LPMEOH™ reactor to operate in a load-following environment were performed during the week of 15 January 2001. For two consecutive days, the reactor was taken offline for 12 hours, and then Balanced Gas was introduced to the process as quickly as possible (within the limitations of other systems at the Eastman chemicals-from-coal complex). The attempts to perform these ramping tests were hampered by the standby conditions that were selected, including the lack of flow to the reactor (which lowered the reactor heat transfer coefficient) and the reactor temperature (180°C). Once Balanced Gas flowrate was reestablished and reactor temperature and pressure were placed into control, the performance of the LPMEOH™ demonstration unit, including the gas sparger in the reactor, was determined to have returned to the condition prior to the shutdown.

During these tests, it was shown that the LPMEOH™ demonstration unit was capable of meeting the ramping requirements for an IGCC system by achieving the goal of a minimum 5% change in design flow per minute. Tests of the ability of the LPMEOH™ reactor to operate in a load-following environment were also successful; the performance of the LPMEOH™ demonstration unit, including the gas sparger in the reactor, was determined to have returned to the condition prior to the commencement of the on/off testing.

## **5.6 IN-SITU ACTIVATION AND TEMPERATURE PROGRAMMING**

Depending upon the H<sub>2</sub>:CO ratio and level of catalyst poisons in the fresh feed gas and site-specific requirements, it may be economical to operate the LPMEOH™ Process in the same manner as conventional gas-phase reactor systems - that is, charge the maximum amount of unreduced catalyst slurry to the LPMEOH™ reactor, perform the catalyst reduction (reacting metal oxides [for example, copper oxide] with a reductant such as CO or H<sub>2</sub> to produce the base metal plus either CO<sub>2</sub> or H<sub>2</sub>O) within the reactor vessel (so-called in-situ activation), and practice temperature programming (the increase of reactor temperature as necessary to control the reactor purge flowrate and maintain reactor volumetric productivity) to extend the catalyst life. In this scenario, eliminating the need for a separate catalyst activation vessel, slurry addition pump, and other subsystems can lower capital costs. There has been interest from potential customers for the LPMEOH™ Process to demonstrate in-situ catalyst activation at the LPMEOH™ demonstration unit; as a result, tests of both the activation procedure (a base case and an improved procedure) and the subsequent temperature programming were performed during the demonstration.

### **5.6.1 Preparatory Engineering and Laboratory Work**

Preliminary process simulation work was performed in January of 2000 in order to determine the operating conditions that could be used (based upon site-specific limitations) during a potential test of in-situ catalyst activation within the LPMEOH™ reactor. For example, the amount of purge gas flow from the LPMEOH™ demonstration unit (Stream 148 of Figure 2.4-1) was limited based upon the capacity of the downstream boiler system; this established the maximum

quantity of gas (dilute Balanced Gas in N<sub>2</sub>) that could be fed during the catalyst activation procedure. A test to determine the minimum operating pressure and corresponding flowrate of N<sub>2</sub> that could be generated by the recycle compressor was performed in March of 2000. This information was then used to modify the procedure and determine conditions for a confirmation test in the laboratory autoclave. Laboratory testing of the proposed procedure was then undertaken to verify the operating conditions.

In July of 2000, Air Products and Eastman initiated the engineering activities in support of the demonstration of the in-situ activation of methanol synthesis catalyst in the LPMEOH™ reactor. Piping and instrumentation changes were needed to allow for the introduction of the Balanced Gas and N<sub>2</sub> streams at the proper flowrates per the proposed procedure. Air Products released a process engineering specification for these changes in August of 2000. Eastman then developed a detailed design package that defined the necessary modifications to the piping and instrument systems. In order to minimize downtime, the field modifications were completed during a scheduled code biennial inspection of all pressure vessels within the LPMEOH™ demonstration unit in March of 2001. A detailed operating procedure was drafted by Air Products and reviewed by Eastman prior to the initiation of the first in-situ activation of methanol synthesis catalyst in August of 2001.

### **5.6.2 In-situ Activation Procedure and Results - August 2001**

The LPMEOH™ demonstration unit was shutdown on 06 August 2001 to prepare for the first test of the in-situ catalyst activation procedure. The slurry contents of the reactor from Catalyst Campaign 2 were drained from the system. Beginning on 13 August 2001, batches of fresh catalyst were mixed with mineral oil in the catalyst reduction vessel, heated to 150°C, and transferred, without being reduced (or activated), to the slurry tank. A total of ten batches of fresh catalyst slurry, each containing about 4,000 pounds of fresh catalyst, were prepared in this manner. After the final transfer, the total catalyst inventory in the slurry tank was 41,580 pounds of fresh catalyst, which was approximately the design catalyst inventory for the LPMEOH™ reactor. The catalyst loading and transfer operation to the slurry tank was completed on 21 August 2001.

The common inlet and outlet line of the slurry tank (2" diameter) developed a plug during the transfer of the tenth batch of fresh catalyst slurry from the catalyst reduction vessel. After modifications to the piping system were made, Eastman operations personnel were able to clear this obstruction, and the contents of the slurry tank were then successfully transferred into the LPMEOH™ reactor. The transfer of fresh catalyst slurry to the reactor was completed 22 August 2001.

Immediately upon completion of the slurry transfer, the recycle compressor was started on N<sub>2</sub> to begin to cool the reactor contents to less than 90°C, which was the desired initial temperature for catalyst activation. After this step was completed, the in-situ catalyst activation procedure was started at 2300 hrs on 22 August 2001. Make-up N<sub>2</sub> flow was controlled at 52 KSCFH, and a small quantity of Balanced Gas was introduced into the discharge of the recycle compressor to ensure that sufficient reductant was present at all times in the reactor inlet. Temperature control was a manual ramping operation using the steam drum pressure as a control point. A reactor

temperature ramp from 88°C to 215°C over a 27-hour period was used. The in-situ catalyst activation procedure ended at 0100 hrs on 24 August 2001.

The progress of the in-situ catalyst activation procedure was tracked by evaluating the uptake of reductant (H<sub>2</sub> and CO) by the catalyst. An uptake of 70% of the theoretical value was calculated based upon analytical data and measured flowrates. Figure 5.6-1 shows the uptake performance during the first in-situ activation as compared to the performance obtained in the laboratory autoclave during the testing in 2000. The LPMEOH™ demonstration unit was then restarted at 1200 hrs on 24 August 2001. As described in Section 5.1.3, the performance of the methanol synthesis catalyst was also lower than expected as calculated from an in-house kinetic model. Catalyst samples that were taken from the reactor following the in-situ catalyst activation did not provide conclusive results.

An assessment of the performance of the methanol synthesis catalyst following the completion of the in-situ activation procedure in August of 2001 was completed. Based on laboratory studies, it was found that storage of the fresh catalyst in the presence of mineral oil at elevated temperatures (the experiments were performed at approximately 200°C) prior to reduction was the cause of the lower than expected catalyst activity. During the initial demonstration of the in-situ activation procedure at the LPMEOH™ demonstration unit, the slurry was approached this temperature in the slurry tank, where batches of fresh catalyst slurry were stored during the catalyst loading procedure.

**Figure 5.6-1**  
**Reductant Gas Uptake vs. Temperature - In-Situ Catalyst Activation**  
**(22-24 August 2001)**

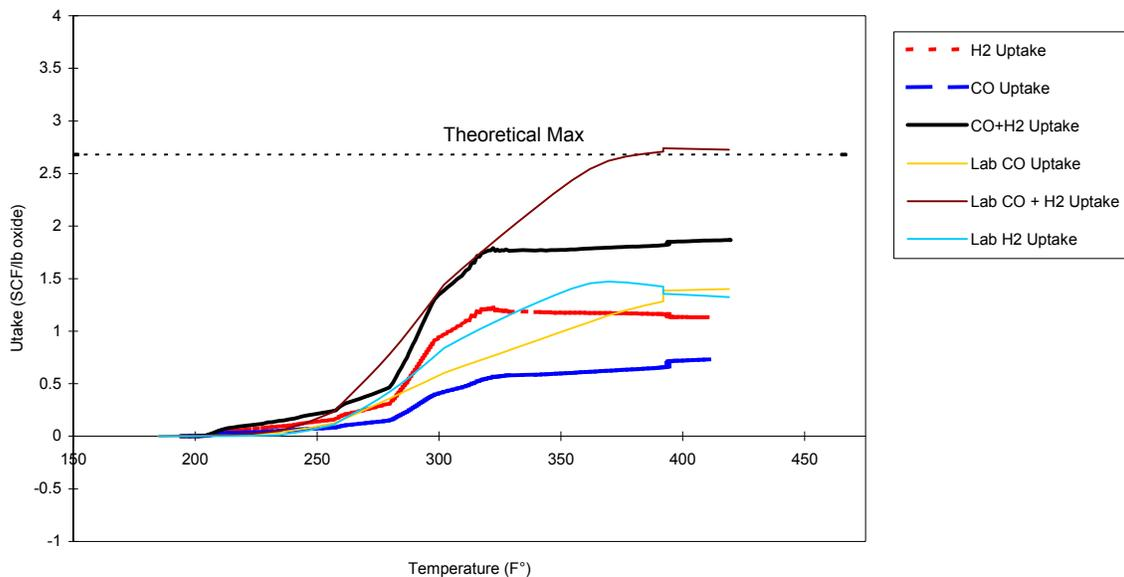

### **5.6.3 Temperature Programming (August 2001 – March 2002)**

Following the completion of the in-situ catalyst activation procedure, conditions were selected to deal with the hyperactivity that typically occurs when fresh methanol synthesis catalyst is initially exposed to syngas. During the first few weeks of operation, conditions were varying between a

reactor pressure of 550-600 psig, reactor temperature of 212-220°C, and flowrate of Balanced Gas of 500-525 KSCFH. Once the hyperactivity period had passed, operating conditions were set at 218°C reactor temperature, 685 psig reactor pressure, and 600-650 KSCFH of Balanced Gas.

As part of the operating protocol following the completion of the in-situ activation of methanol synthesis catalyst in the LPMEOH™ reactor, temperature programming continued during the operating period; this involved the increase of reactor temperature as necessary to control the reactor purge flowrate and maintain reactor productivity. Over the entire period spanning August of 2001 to March of 2002, the reactor temperature was increased from 218°C to the final temperature of 250°C (250°C was the design temperature for the LPMEOH™ demonstration unit). The reactor pressure was increased from 685 psig to 700 psig on 12 November 2001 and maintained at that level for the balance of the operating period. The flowrate of Balanced Gas was controlled at an average value of 630 KSCFH during this time.

The first operating test using methanol synthesis catalyst activated in-situ was completed on 25 March 2002 when a catalyst withdrawal and addition campaign was undertaken to increase catalyst activity.

### **5.6.4 Second In-situ Activation Procedure and Results (June 2002)**

Based upon the results of the laboratory assessment following the August 2001 in-situ catalyst activation, operating steps were modified so that the fresh methanol catalyst would not be exposed to temperatures in excess of 100°C prior to the introduction of dilute syngas. A recommendation to DOE to perform a second test of the in-situ catalyst activation procedure was accepted.

Beginning on 21 June 2002, batches of fresh catalyst were mixed with mineral oil in the catalyst reduction vessel, heated to 100°C, and transferred, without being reduced or activated, directly to the reactor. Since the slurry tank was not used to collect the batches, the process was greatly simplified and shortened (from 8 days to 3 days) compared with the first in-situ activation procedure in August of 2001. A total of eleven batches of fresh catalyst slurry, each containing about 3,700 pounds of fresh catalyst, was prepared in this manner. After the final transfer, the total amount of fresh catalyst in the reactor was 40,040 pounds, which is approximately the design catalyst inventory for the LPMEOH™ demonstration unit. N<sub>2</sub> was introduced in the bottom of the reactor during the entire loading procedure, and the unreduced catalyst in the reactor was maintained at 100°C by adding steam as necessary to the steam drum and internal heat exchanger. The catalyst loading and transfer operation was completed on 24 June 2002.

The reactor was cooled overnight to the desired initial temperature for catalyst activation; the recycle compressor was started on N<sub>2</sub> to assist in cooling the reactor contents. By 0800 hours on 25 June 2002, the reactor inlet flow was set at approximately 300 KSCFH, and 52 KSCFH of make-up N<sub>2</sub> was introduced at the compressor suction. Reactor pressure was set at 85 psig. Cooling was completed after the reactor temperature reached 86°C.

The in-situ catalyst activation procedure was started at 1200 hrs on 25 June 2002. In addition to the 52 KSCFH of N<sub>2</sub>, a small quantity of Balanced Gas was introduced into the discharge of the recycle compressor to ensure that sufficient reductant was present at all times in the reactor inlet. A temperature ramp from 87°C to 215°C was conducted over a period of 51 hours, which was a slower ramp rate than was used during the first in-situ activation. The in-situ catalyst activation procedure ended at 0200 hrs on 27 June 2002.

The progress of the in-situ catalyst activation procedure was tracked by evaluating the uptake of reductant by the catalyst. A reductant gas uptake of 98% of the theoretical value was calculated based upon analytical data and measured flowrates, which was an indication that the methanol synthesis catalyst was properly activated during the in-situ catalyst activation procedure. Figure 5.6-2 shows the excellent uptake performance of the second in-situ activation as compared to the performance obtained in the laboratory autoclave.

**Figure 5.6-2**  
**Reductant Gas Uptake vs. Temperature - In-Situ Catalyst Activation**  
**(25-27 June 2002)**

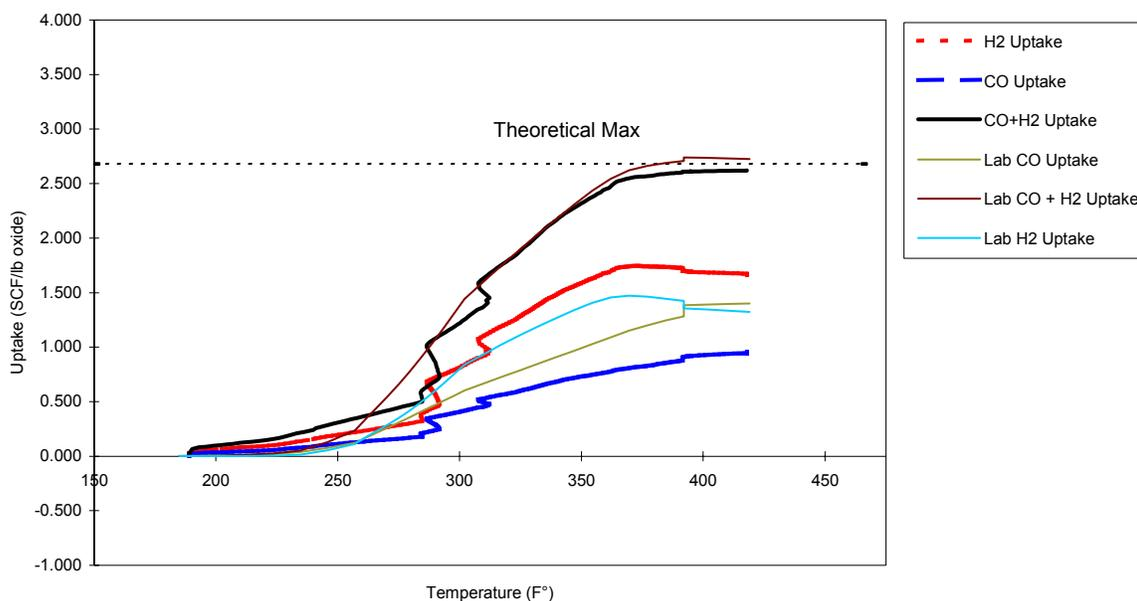

The LPMEOH™ demonstration unit was then re-started at 1500 hrs on 27 June 2002. In addition, the initial value for  $\eta$  (as defined in Section 5.1) was calculated to be 1.23, which was representative of a properly activated catalyst. In addition, the startup conditions for this charge of methanol synthesis catalyst were less severe (pressure of 450 psig and 214°C reactor temperature) than those following the first in-situ catalyst activation (550-600 psig, reactor temperature of 212-220°C) while processing a greater quantity of Balanced Gas (603 KSCFH vs. 500-525 KSCFH). These results showed a clear improvement when compared with the performance of the methanol synthesis catalyst following the first in-situ activation procedure. As noted in Section 5.1.4, due to the low catalyst deactivation rate experienced following the second in-situ activation, the practice of temperature programming was not required during the remainder of the operating program of the LPMEOH™ Demonstration Project.

### **5.6.5 Summary**

The in-situ activation procedure was successfully demonstrated at the LPMEOH™ demonstration unit. Following the initial trial in August of 2001, revisions to the activation procedure, including a limitation on the storage temperature for the fresh catalyst slurry and a much slower temperature ramp rate during the activation procedure, were made. Temperature programming was found to be a very practical approach to maintaining reactor productivity during the operating program following the first in-situ activation; although the reactor temperature did not have to be increased during Catalyst Campaign 4 (June-December of 2002), the selection of the minimum reactor temperature necessary to meet the desired methanol production rate may have been a factor in the low rate of catalyst deactivation that was calculated during this operating period (as described in Section 5.1.4).

## **5.7 SECTION 5 BIBLIOGRAPHY**

- a. "Removal of Trace Contaminants from Coal-Derived Synthesis Gas", Prepared by Air Products Liquid Phase Conversion Co., L.P., DOE Cooperative Agreement No. DE-FC22-95PC93052, March 2003.
- b. "Project Data on Eastman Chemical Company's Chemicals-from-Coal Complex in Kingsport, TN", Prepared by Air Products Liquid Phase Conversion Co., L.P., DOE Cooperative Agreement No. DE-FC22-95PC93052, March 2003.
- c. "Design and Construction of the Alternative Fuels Field Test Unit and Liquid Phase Methanol Feedstock and Catalyst Life Testing at Eastman Chemical Company (Kingsport, TN)", Topical Report Prepared by Air Products and Chemicals, Inc., DOE Cooperative Agreement No. DE-FC22-95PC93052, March 1997.
- d. "Alternative Fuels Field Test Unit Support to Kingsport LPMEOH™ Demonstration Unit Topical Report (December 1997 - January 1998)", Topical Report Prepared by Air Products Liquid Phase Conversion Co., L.P., DOE Cooperative Agreement No. DE-FC22-92PC90543, November 1998.

## 6.0 ENVIRONMENTAL PERFORMANCE

### 6.1 INTRODUCTION

As part of the requirements for DOE to fulfill its responsibility under the National Environmental Policy Act (NEPA) of 1969, the Partnership prepared a detailed Environmental Information Volume (EIV)<sup>(a)</sup> describing the environmental aspects and projected impacts of the LPMEOH™ Demonstration Project. DOE then prepared an Environmental Assessment (EA)<sup>(b)</sup> for the Project, and determined that an Environmental Impact Statement was not required. A Finding of No Significant Impact (FONSI) was issued on 30 June 1995.



The Partnership then prepared an Environmental Monitoring Plan (EMP)<sup>(c)</sup> which described in detail the environmental monitoring activities to be performed during the operation of the LPMEOH™ demonstration unit. In order to quantify the environmental performance of the LPMEOH™ demonstration unit, a comparison of the estimated quantities of emissions, effluents, and solids for disposal from the EA with the results from the LPMEOH™ demonstration unit is provided in this Section.

### 6.2 WASTE STREAMS AND THEIR DISPOSAL

#### 6.2.1 Spent Catalyst Slurry

The LPMEOH™ Process uses conventional low-temperature methanol synthesis catalyst (comprised primarily of oxides of copper and zinc) in powder form, slurried in a mineral oil that is inert at reaction conditions. Over time, these catalysts, whether used in conventional fixed-bed reactor systems or the LPMEOH™ Process, will show a decrease in catalytic activity. This aging phenomenon is caused by both the presence of the catalyst at the reaction conditions (most likely temperature) and by the chemical poisoning of the catalyst by trace contaminants within the system (for example: sulfur, iron, nickel, and arsenic are known catalyst poisons). In order to maintain the same level of production of methanol across the reactor, one of two methods can be used:

- 1) The process conditions can be altered to increase the rate of production of methanol (this is typically accomplished by slowly increasing the reactor temperature with time, and is the method that is used in the fixed-bed methanol processes)
- 2) A portion of the volume of catalyst slurry within the reactor can be removed and replaced with an equal volume of fresh catalyst slurry.

As noted in Section 5.1, the original design of the LPMEOH™ Process called for the use of catalyst withdrawal and addition to maintain the production rate of methanol. This method tends



to use larger quantities of methanol synthesis catalyst, as a portion of the catalyst that is removed from the LPMEOH™ reactor has greater activity than the average catalyst particle within the process.

However, the operating tests following the in-situ activation of methanol synthesis catalyst within the LPMEOH™ reactor have also demonstrated the ability to temperature program the reactor and maximize the on-stream time of the catalyst (refer to Section 5.6).

Table 6.2-1 provides the annual amount of spent catalyst slurry that was generated by the LPMEOH™ Process during the demonstration test period. The average annual generation rate is less than the projected rate as reported in the final EA for the LPMEOH™ Demonstration Project. During the period from April of 1997 through July of 2001, the catalyst withdrawal/addition method was used to maintain the rate of production of methanol across the LPMEOH™ reactor. In addition to this periodic transfer of a portion of the catalyst slurry from the process, the entire contents of the LPMEOH™ reactor were drained on two occasions (in November of 1997, following the initial accelerated rate of deactivation related to the presence of iron on the catalyst; and in July of 2001, in preparation for the first attempt to activate the methanol catalyst using the in-situ activation procedure). Between August of 2001 and March of 2002, temperature programming was used following the in-situ activation of the methanol synthesis catalyst within the LPMEOH™ reactor. A brief period of catalyst withdrawal and addition then followed until the contents of the reactor were drained in June of 2002 and the second attempt to demonstrate the in-situ activation procedure was successfully completed.

All of the spent catalyst slurry was shipped on a periodic basis from the LPMEOH™ demonstration unit to a company which reclaimed the metallic components (copper and zinc) from the catalyst.

**Table 6.2-1  
Spent Catalyst Slurry from LPMEOH™ Demonstration Unit**

<b>Year of Operation</b>	<b>Spent Catalyst Slurry to Reclaimer, pounds</b>	<b>Comments</b>
April 1997 – March 1998	91,100	Onstream 02 April 1997
April 1998 – March 1999	22,500	
April 1999 – March 2000	126,400	
April 2000 – March 2001	76,450	
April 2001 – March 2002	145,140	
April 2002 – December 2002	95,205	
<b>Annual Average</b>	92,800	Projected to March 2003
<b>Expected Value</b>	103,100 to 128,000	Refer to Final EA for Project <sup>(b)</sup>

### 6.2.2 10C-30 Catalyst Guard Bed

As shown in Figure 1.2.3-1, the 10C-30 catalyst guard bed is located within the Eastman chemicals-from-coal complex, upstream of both the LPMEOH™ demonstration unit and the existing gas-phase methanol reactor. Prior to the startup of the LPMEOH™ demonstration unit, this catalyst guard bed had been charged with both zinc oxide and manganese dioxide in order to remove trace quantities of sulfur and arsenic that are present in Balanced Gas. Table 6.2-2 shows the type and quantity of adsorbent materials that were used in this service during the demonstration period for the LPMEOH™ Process at Kingsport.

### 6.2.3 29C-40 Carbonyl Guard Bed

As shown in Figure 2.4-1, the 29C-40 carbonyl guard bed is located within the LPMEOH™ demonstration unit, and was designed to remove trace levels of metal carbonyls (iron and nickel) that could be present in either the Balanced Gas or CO Gas streams. Table 6.2-3 shows the type and quantity of adsorbent materials that were used in this service during the demonstration program for the LPMEOH™ Process at Kingsport. Details on the technical selection for the adsorbent materials used in the carbonyl guard bed are provided in Section 5.2. The expected quantity of adsorbent during the design phase of the project was a single charge of 10,000 pounds of activated carbon over a four-year period. Due to the adverse impact of trace contaminants (in particular arsenic) that are poisons to methanol synthesis catalysts, additional types and combinations of adsorbents were used in the carbonyl guard bed.

In Section 4.4.2 of the EMP, incineration was considered to be the means of disposal of the spent activated carbon. Given the change in the type of adsorbent and the presence of arsenic, Eastman performed the testing necessary to characterize the copper-impregnated activated carbon and determine the appropriate means of disposal. The Toxicity Characteristic Leaching Procedure

**Table 6.2-2**  
**10C-30 Catalyst Guard Bed**  
**Adsorbents Used during Operation of LPMEOH™ Demonstration Unit**

Adsorbent Material	Targeted Catalyst Poison	Time in Service
(1) Zinc Oxide (155 cubic feet) (2) Manganese Dioxide (75 cubic feet)	(1) Sulfur (2) Arsenic	1995 – September 1997
(1) Zinc Oxide (155 cubic feet) (2) Manganese Dioxide (75 cubic feet)	(1) Sulfur (2) Arsenic	October 1997 – June 1999
Manganese Dioxide (230 cubic feet)	Arsenic	June 1999 – October 2002
Manganese Dioxide (230 cubic feet)	Arsenic	October 2002 – 31 December 2002 (continuing)

**Table 6.2-3**  
**29C-40 Carbonyl Guard Bed**  
**Adsorbents Used during Operation of LPMEOH™ Demonstration Unit**

Adsorbent Material	Targeted Catalyst Poison	Time in Service
Activated Carbon (6,300 pounds)	Iron, Nickel	April 1997 – November 1997
Activated Carbon (6,553 pounds)	Iron, Nickel	December 1997 – June 1999
(1) Manganese Dioxide (2,900 pounds) (2) Activated Carbon (2,200 pounds)	(1) Arsenic (2) Iron, Nickel	June 1999 – July 2000
Copper Oxide-impregnated Activated Carbon (4,892 pounds)	Arsenic, Sulfur, Iron, Nickel	August 2000 – July 2001
Copper Oxide-impregnated Activated Carbon (5,336 pounds)	Arsenic, Sulfur, Iron, Nickel	August 2001 – February 2002
Copper Oxide-impregnated Activated Carbon (5,073 pounds)	Arsenic, Sulfur, Iron, Nickel	March 2002 – June 2002
Copper Oxide-impregnated Activated Carbon (5,810 pounds)	Arsenic, Sulfur, Iron, Nickel	June 2002 – October 2002
Copper Oxide-impregnated Activated Carbon (5,225 pounds)	Arsenic, Sulfur, Iron, Nickel	October 2002 – 31 December 2002 (continuing)

(TCLP) was used to determine the metals and total concentration for organics; the results from the testing for various samples are provided in Environmental Monitoring Report Nos. 14, 19, and 22 (References 36, 39, and 44 in Section 12). Only one of the three samples exceeded the regulatory limit for arsenic. Even though the other material could have been incinerated, Eastman decided to classify the material as hazardous for arsenic (U.S. Environmental Protection Agency (EPA) Hazardous Waste Code D004) under the Resource and Conservation Recovery Act (RCRA) due to the uncertainty associated with the detection limit for arsenic. However, the incinerator did not accept material with this waste code. This led to the selection of a permitted hazardous waste landfill as the site to dispose of this spent adsorbent. Prior to landfilling, this facility stabilized the material to ensure that the leachate contained less than 5 ppmw arsenic.

#### 6.2.4 Waste Oil

As part of the design of the LPMEOH™ demonstration unit, an oil-water separator was included to collect any spill of the process mineral oil during operation or maintenance. During the demonstration program, oil was collected on a periodic basis and sent to incinerator equipment within the Eastman chemicals-from-coal complex for energy recovery. Table 6.2-4 shows the quantity of waste oil that was collected in the oil-water separator during the demonstration program for the LPMEOH™ Process at Kingsport. During the design phase, the annual quantity of waste oil from the oil-water separator was expected to be 13,000 pounds; the average amount observed during the demonstration period should be used as the basis during the design of future plants.

**Table 6.2-4  
Waste Oil from LPMEOH™ Demonstration Unit**

<b>Year of Operation</b>	<b>Waste Oil, pounds</b>	<b>Comments</b>
April 1997 – March 1998	24,000	Onstream 02 April 1997
April 1998 – March 1999	24,000	
April 1999 – March 2000	42,000	
April 2000 – March 2001	6,000	
April 2001 – March 2002	0	
April 2002 – December 2002	48,000	
<b>Annual Average</b>	25,040	
<b>Expected Value</b>	13,000	Refer to Final EA for Project <sup>(b)</sup>

In addition, a one-time test was performed in June of 2002 to identify potential sources of iron contamination within the LPMEOH™ Process. Mineral oil (in the absence of methanol synthesis catalyst) was heated in the presence of syngas, and sampling of the syngas stream was performed to determine the concentration of iron carbonyl. This quantity of oil (35,600 pounds) was also incinerated for energy recovery.

### 6.2.5 Recovered Distillation Liquids

As shown in Figure 2.4-1, a Crude-Grade Methanol stream containing about 25% of the methanol that was produced in the LPMEOH™ reactor was sent to existing distillation equipment within the Eastman chemicals-from-coal complex for further distillation. This stream contained a small quantity of the mineral oil that is used in the preparation of the methanol catalyst slurry. Table 6.2-5 shows the quantity of oil that was collected in the Eastman

**Table 6.2-5  
Oil Collected in Distillation Equipment from LPMEOH™ Process**

<b>Year of Operation</b>	<b>Oil Collected, pounds</b>	<b>Comments</b>
April 1997 – March 1998	0	Onstream 02 April 1997
April 1998 – March 1999	178,269	
April 1999 – March 2000	34,100	
April 2000 – March 2001	116,533	
April 2001 – March 2002	221,855	
April 2002 – December 2002	110,557	
<b>Annual Average</b>	115,010	
<b>Expected Value</b>	324,000	Refer to Final EA for Project <sup>(b)</sup>

distillation equipment during the demonstration period for the LPMEOH™ Process at Kingsport. The average annual generation rate is less than the projected rate as reported in the final EA for the LPMEOH™ Demonstration Project.

### **6.2.6 Waste Water**

The chemistry for the production of methanol from syngas (refer to Section 2.1) also yields water as a byproduct. This water is separated from the Refined-Grade Methanol in the 29C-20 methanol rectifier column, and exits the LPMEOH™ demonstration unit with the Crude-Grade Methanol stream. After further distillation in existing equipment within the Eastman chemicals-from-coal complex, the water from the LPMEOH™ Process is combined with other streams and fed to the Eastman water treatment system. During the operation of the LPMEOH™ demonstration unit, Eastman provided reports on the samples taken at the discharge point from the water treatment system to the Holston River. As noted in the Environmental Monitoring Reports (referenced in Section 12), there were no excursions for any of the parameters that were tested as required by the National Pollutant Discharge Elimination System (NPDES) permit for the Eastman chemicals-from-coal complex.

## **6.3 POTENTIAL ENVIRONMENTAL CONCERNS**

Based upon the excellent environmental performance at the LPMEOH™ demonstration unit, the use of the technology in future applications should cause no significant impact on the local environment. Site-specific considerations should be made regarding the disposal options for the spent catalyst slurry (for example, the cost of and proximity to a catalyst reclaiming operation). In addition, the benefits of recovery and reuse of the oil streams from the oil-water separator and the distillation system (where used) should also be evaluated on a site-by-site basis.

## **6.4 SECTION 6 BIBLIOGRAPHY**

- a. "Commercial-Scale Demonstration of the Liquid-Phase Methanol (LPMEOH™) Process - Environmental Information Volume", Prepared by Air Products Liquid Phase Conversion Co., L.P., DOE Cooperative Agreement No. DE-FC22-95PC93052, May 1996.
- b. "Final Environmental Assessment for the Liquid Phase Methanol (LPMEOH™) Project", DOE/EA-1029, June 1995.
- c. "Commercial-Scale Demonstration of the Liquid-Phase Methanol (LPMEOH™) Process - Final Environmental Monitoring Plan", Prepared by Air Products Liquid Phase Conversion Co., L.P., DOE Cooperative Agreement No. DE-FC22-95PC93052, August 1996.

## 7.0 METHANOL PRODUCT-USE TESTING

### 7.1 INTRODUCTION

The LPMEOH™ Process is a very effective technology for converting a portion of an IGCC electric power plant's coal-derived syngas to methanol, as depicted in Figure 7.1-1. The process has the flexibility to handle wide variations in syngas composition. It can be designed to operate in a continuous, baseload manner, converting syngas from oversized gasifiers or from a spare gasifier. Alternatively, the process can be designed to operate only during periods of off-peak electric power demand, consuming a portion of the excess syngas and reducing the electricity output from the combined-cycle power unit. In this scenario, the gasification unit continues to operate at full baseload capacity, so that the IGCC facility's major capital asset is always fully utilized.

In either baseload or cycling operation, partial conversion of between 20% and 33% of the IGCC plant's syngas is optimal, and conversion of up to 50% is feasible. The required degree of conversion of syngas, or the quantity of methanol relative to the power plant size, determines the design configuration for the LPMEOH™ unit. In its simplest configuration, syngas at maximum available pressure from the IGCC power plant's gasifier system passes once-through the LPMEOH™ unit and is partially converted to methanol without recycle, water-gas shift, or CO<sub>2</sub>

**Figure 7.1-1**  
**Once-through Methanol Coproduction with IGCC Electric Power**

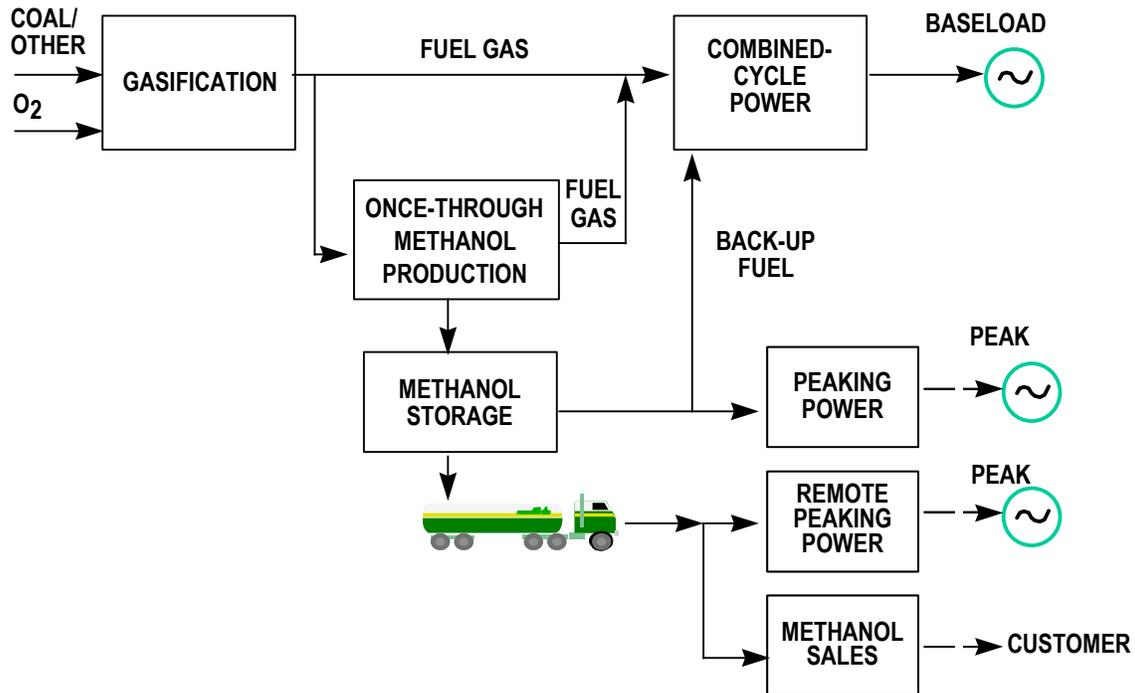

removal. The unreacted gas is returned to the IGCC power plant's combustion turbines. If greater syngas conversion is required, different design options are available.

Methanol which is produced directly from CO-rich syngas has only 1 wt% H<sub>2</sub>O in the condensed stream entering the first distillation column. Significant capital and operating costs (corresponding to a purification cost of \$0.02 to \$0.04 per gallon of methanol) can be avoided if stabilized methanol, which is produced via removal of dissolved gases such as CO<sub>2</sub> from the first column, can be directly used in some chemical and power systems. The Statement of Work from the Cooperative Agreement defines the scope of work for the studies associated with the testing of this as-produced methanol:

“The methanol product must be adequate for its intended use. Therefore, the economic upgrading of the methanol product will be demonstrated as part of Phase III, Task 2.1 (*LPMEOH™ Process Demonstration Facility Operation – Methanol Operation*), and the suitability of using the product will be demonstrated as part of Phase III, Tasks 3 (*On-site Testing (Product Use Demonstration)*) and 4 (*Off-site Testing (Product Use Demonstration)*). The product use demonstrations will include fuel use and chemical use product testing. The fuel use applications may include use in transit buses and car pools and for the generation of stationary power for public, industrial and electric utilities.”

## **7.2 ON-SITE TESTING OF METHANOL**

As noted in Section 1.2.4, the methanol that is produced at the LPMEOH™ demonstration unit was used by Eastman in the production of methyl acetate and, ultimately cellulose acetate and acetic acid. Beginning with the startup of the LPMEOH™ demonstration unit, Eastman monitored the quality of the Refined-Grade Methanol as determined by a set of in-house fitness-for-use criteria. These criteria, as well as a summary of the results of the analysis of over 7.19 million gallons of Refined-Grade Methanol produced in 1997, are provided in Table 7.2-1. Occasionally, a lot tank sample fell outside an internal manufacturing limit. Through 31 December 1997, a total of 24 samples of refined methanol failed to meet one of the analytical tests. Refined-Grade Methanol is pumped from the methanol lot tanks within the battery limits of the LPMEOH™ demonstration unit to a primary methanol storage tank elsewhere within the Eastman complex. When results of a sample of Refined-Grade Methanol fall outside the fitness-for-use criteria, Eastman evaluates the impact of this material on the contents of this primary storage tank. As long as the properties of the methanol in this tank stay within the methanol specification, the lot of Refined-Grade Methanol can be accepted. All 24 lots of Refined-Grade Methanol that have failed to meet all of the fitness-for-use criteria have been accepted in this manner. Over the entire 69-month operating program for the LPMEOH™ demonstration unit, over 103.9 million gallons of methanol was produced, and Eastman accepted all of the available methanol for use in the production of methyl acetate, and ultimately cellulose acetate and acetic acid.

An opportunity to demonstrate the use of methanol directly from the LPMEOH™ Process in the production of methyl acetate occurred on 08 February 1998. During a planned five-day outage in Eastman's shift reactor, operations continued in the LPMEOH™ demonstration unit with a H<sub>2</sub>:CO ratio in the reactor feed of 0.7, while Eastman's gas-phase methanol plant was forced to shut down. Furthermore, Eastman took the opportunity to shut down their methanol distillation

**Table 7.2-1  
Refined-Grade Methanol from LPMEOH™ Demonstration Unit  
Quality and Fitness for Use (1997)**

Property	1 LIML	2 UIML	3 # Obs.	4 Avg.	5 Min.	6 Max.	7 # Out IMLs
Acetone, ppm		125	207	11.217	10	30	0
Appearance	pass	pass	207				3
Color by pcs		5	207	5	5	5	0
Decane, ppm		12	207	10.642	10	76	5
Ethanol, ppm		500	207	101.01	100	220	0
Water, % by Coulemetric			170	0.0094	0.0023	0.0571	
Water, % by Titration		0.03	96	0.0127	0.0023	0.0581	5
Acetic Acid, %		0.003	207	0.0004	0.0002	0.003	0
Methanol, %	99.9		207	99.985	99.92	100	0
Alkalinity, ppm		0.8	51	0.596	0.1	2.3	11
Specific Gravity @ 20/20	0.792	0.793	96	0.7928	0.792	0.793	0

Notes:

1) Terms:

- Column 1 - Lower Internal Manufacturing Limit
- Column 2 - Upper Internal Manufacturing Limit
- Column 3 - Number of lot tank samples analyzed for this test
- Column 4 - Average value of analytical test for all lot tank samples
- Column 5 - Minimum value of analytical test for all lot tank samples
- Column 6 - Maximum value of analytical test for all lot tank samples
- Column 7 - Number of lot tank samples falling outside Internal Manufacturing Limit

2) Analysis is performed on each lot with the exception of:

- Alkalinity - every 4th lot
- Specific Gravity - every other lot

3) The Coulemetric water test was replaced by a water titration in August of 1997.

equipment for maintenance, leaving no flow path for the Crude-Grade Methanol underflow from the second, rectifier column in the LPMEOH™ demonstration unit. However, because of the CO-rich feed, the rectifier column could be shut down for the production of stabilized methanol (98+ wt% methanol, <1 wt% H<sub>2</sub>O). Approximately 12,000 gallons of stabilized methanol was loaded into trailers and shipped off-site for future product-use testing. During the remainder of this operating period, approximately 181,800 gallons (600 short tons) of stabilized methanol (99.3 wt% methanol, 0.3 wt% H<sub>2</sub>O) was pumped directly from the LPMEOH™ demonstration unit to Eastman's methyl acetate plant, bypassing the normal route through the distillation equipment.

This methanol was considered acceptable by Eastman because of the low levels of all impurities. In particular, the H<sub>2</sub>O concentration of the stabilized methanol was significantly lower than what is produced during operation on the normal Balanced Gas supply (typically 3-4 wt% H<sub>2</sub>O). This is a result of operation on a CO-rich syngas with a relatively low CO<sub>2</sub> concentration. This test



was the first attempt to feed a stabilized methanol stream with low water content directly into one of Eastman's downstream chemical processes, providing another indication of the flexibility of the LPMEOH™ Process. Eastman's only alternative was to flare the syngas stream, which was undesirable both environmentally and economically.

### **7.3 OFF-SITE PRODUCT-USE TESTING OF METHANOL**

The product-use test program attempted to develop broader market applications and commercial fuels comparisons by evaluating new utility dispersed electric power developments, and possibly new mobile transport engine developments. The objective of the product-use test program was to demonstrate commercial market applications for the stabilized methanol as a replacement fuel and as a fuel supplement. During the program definition phase, attempts were made to develop sites to test stabilized methanol in municipal, industrial, and utility applications and as fuel supplements for gasoline, diesel, and natural gas. These tests were envisioned based upon the U.S. energy market needs projected through the 2018 time period when the LPMEOH™ technology is expected to be commercialized.

Because the generation of electric power is not a feature of the demonstration project at Kingsport, the coproduction of methanol with electric power could not be demonstrated. However, the product-use test program was developed to provide data on potential applications of stabilized methanol in order to enhance the early commercial acceptance of central clean coal technology processing facilities, coproducing electricity and methanol to meet the needs of the local community. These applications required testing of the product to confirm its suitability.

A limited quantity of the stabilized methanol from the demonstration unit was made available for product-use tests. Product-use tests commenced during the first year of demonstration operations. As noted in Section 7.2, an initial inventory of approximately 12,000 gallons of stabilized methanol was produced at LPMEOH™ demonstration unit to supply the needs of the product-use test program. Analysis of the stabilized methanol from tests conducted using a CO-rich feed gas is shown in Table 7.3-1. Results from two Kingsport tests are quite comparable with results from a test campaign at the LaPorte AFDU. The difference in the concentrations of H<sub>2</sub>O and higher alcohols of the two Kingsport samples is related to the age or activity of the catalyst and the amount of CO<sub>2</sub> in the reactor feed gas.

**Table 7.3-1  
Stabilized Methanol Composition - CO-rich Feed Gas (H<sub>2</sub>:CO = 0.7)**

	Kingsport Sample #1	Kingsport Sample #2	LaPorte AFDU Sample
Methanol	98.08	99.26	98.40
Ethanol	0.31	0.25	0.60
C3+	0.40	0.18	0.46
Water	1.22	0.31	0.54

The status of the seven projects which have been defined within the product-use test program is reviewed. Two categories of potential applications of stabilized methanol were under investigation, transportation systems and power generation systems.

### **7.3.1 Transportation Systems**

A total of five vehicles have been tested on fuel blends made from stabilized methanol from the LPMEOH™ Demonstration Project. These tests, which have been performed at three different locations, were designed to determine if there are any differences in fuel economy, maintenance, or exhaust emissions when compared to the performance with fuels made with chemical-grade methanol.

#### **7.3.1.1 Florida Institute of Technology Bus & Light Vehicles**

Three of the vehicles are located at the Florida Institute of Technology, and all were tested on stabilized methanol from the LPMEOH™ Demonstration Project. A 1988 Chevrolet Corsica flexible-fuel vehicle (FFV) was driven a total of 4,455 miles on M-85 (85 vol% methanol/15 vol% gasoline) and M-100 (100 vol% methanol) fuel blends. Repairs were of a routine nature and independent of the type of methanol used or the fuel blend. A total of 32 refuelings were performed under the sponsorship of the product-use program, with an average fuel economy of 10.88 miles per gallon (mpg). When compared with the EPA rated gasoline mileage of 19.0 mpg, the methanol blends are less efficient on an energy density basis (methanol has a lower energy content per gallon than gasoline). Additional data on the base gasoline performance is necessary in order to complete this analysis.

The second vehicle is a 1993 Ford Taurus FFV which was acquired during the project. During the project, a total of 7,648 miles were accumulated on fuel blends with stabilized methanol content ranging from M-85 to M-15. Since the car was acquired in July of 1998, the car operated well; the fuel pump was replaced due to routine wear not related to the use of either stabilized methanol or chemical-grade methanol fuel blends. The fuel economy ranged from 14.68 mpg on M-85 to 19.81 mpg for M-15. This latter figure matched both the measured fuel economy with pure gasoline and the EPA rated gasoline mileage.

A bus which had been operated by the Jacksonville Transportation Authority was driven a total of 937 miles on M-100 during the project. Due to the costs associated with hiring a driver for this vehicle, no further tests beyond the initial shakedown of the bus were conducted.

#### **7.3.1.2 ARCADIS Geraghty & Miller Flexible Fuel Vehicle**

A second set of FFV trials was performed at ARCADIS Geraghty & Miller in a 1996 Ford Taurus FFV. During sponsorship by the product-use program, the FFV was driven a total of 3,206 miles on a M-85 fuel blended from chemical-grade methanol, and 3,479 miles were accumulated on M-85 produced from stabilized methanol. The fuel economy of about 16 mpg was the same for both fuel blends (Table 7.3.1-1).

**Table 7.3.1-1  
ARCADIS Geraghty & Miller FFV  
Fuel Economy Results**

	Fuel Economy, mpg	
	Chemical -Grade M-85	M-85 w/ LPMEOH™ Stabilized Methanol
In-use	16.2	16.4
Emission Test on Dynamometer	16.9	16.3

Results of emissions testing on a dynamometer are presented in Table 7.3.1-2. The FFV exhibited higher emissions for total hydrocarbons, CO, CO<sub>2</sub>, and methane for the stabilized methanol fuel blend; emissions of non-methane hydrocarbons and NO<sub>x</sub> were higher for the M-85 fuel blended with chemical-grade methanol. For each of these parameters, emissions for both fuels were within the standards established by the State of California. Emissions of methanol and formaldehyde were greater for the stabilized methanol blend, and the readings for formaldehyde were above the California standard for both fuel blends (there is no standard for methanol emissions). It was concluded that further engine tuning would bring the formaldehyde emissions into compliance for both fuel blends.

Overall, the FFV operated by ARCADIS Geraghty & Miller exhibited similar performance characteristics for both fuel economy and emissions when the vehicle was operated on fuel blends from either stabilized methanol or chemical-grade methanol.

**Table 7.3.1-2  
ARCADIS Geraghty & Miller FFV  
Emissions Results**

	Constituent Emission Rate, grams/mile		California Emission Standard, grams/mile
	Chemical -Grade M-85	M-85 w/ LPMEOH™ Stabilized Methanol	
Carbon Dioxide	334	346	No Standard
Carbon Monoxide	0.867	0.923	3.4
Nitrogen Oxides	0.138	0.121	0.4
Total Hydrocarbons	0.093	0.132	No Standard
Methane	<0.001	0.011	No Standard
Non-methane Hydrocarbons	0.120	0.118	0.25
Methanol	0.143	0.252	No Standard
Formaldehyde	0.0194	0.0337	0.015

### 7.3.1.3 West Virginia University Study of Stabilized Methanol in Transit Bus

West Virginia University (WVU) has developed a transportable laboratory facility which specializes in the measurement of emissions from heavy-duty vehicles. Figure 7.3.1-1 is a photograph of the laboratory, and one of the pieces of test equipment.

Under this effort, three buses operated on M-100 by Tri-Boro Coach in New York were tested. The buses were manufactured in 1993 and 1994 by Transit Motor Corp. The Detroit Diesel 6V92 methanol engines in the buses are rated at 253 horsepower. All buses were operated on the Central Bus District Cycle, which is intended to simulate the use of a transit bus in city service and is also used to rate the performance of new buses. One bus was also tested using a 5-mile cycle, which uses five different segments of acceleration, cruise, and deceleration.

The results from the average vehicle emissions for this product-use test are presented in Table 7.3.1-3. On average, emissions of hydrocarbons (primarily unburned methanol and aldehydes)

**Figure 7.3.1-1  
West Virginia University  
Transportable Heavy Duty Emissions Testing Laboratory**



WVU mobile emissions laboratory

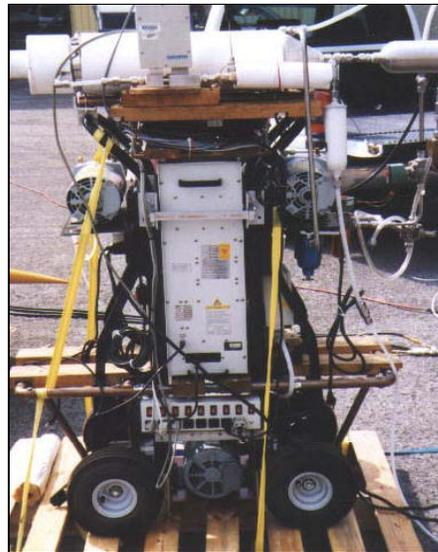

WVU mobile testing equipment

**Table 7.3.1-3  
West Virginia University - Tri-Boro Coach  
Emissions Results**

	Constituent Emission Rate, grams/mile		
	Chemical -Grade M-85	M-85 w/ LPMEOH™ Stabilized Methanol	New Diesel Engine w/ Diesel Fuel
Carbon Dioxide	2,773	2,811	2,611
Carbon Monoxide	10.41	9.60	4.9
Nitrogen Oxides	5.60	5.11	30.1
Total Hydrocarbons	5.39	6.88	0.13
Particulate Matter	0.21	0.24	0.24

and particulate matter were increased slightly when stabilized methanol is used as the fuel. Also shown for reference are recent test results as reported by the laboratory for a new diesel engine; methanol fuels offer substantial advantages in lower emissions of NO<sub>x</sub> with minor changes in other components when compared with diesel fuel.

### **7.3.2 Power Generation Systems**

As indicated in Figure 7.1-1, one of the primary applications for stabilized methanol derived from syngas streams rich in CO is in the generation of electric power. The more classical approach is to generate electricity in a methanol-fired gas turbine at the power plant during periods of peak power demand. In recent years, changes in the power generation and transmission industry and technological improvements in smaller turbine and fuel cell systems have spawned the concept of distributed power. A local power producing system will be able to provide the electricity for a small number of users (for example, the heating and air conditioning needs of an office complex or shopping center). Methanol, produced at a centrally located coal-fired IGCC plant, can be produced at prices which are competitive in these distributed power applications.

The product-use test program was designed to study the uses of stabilized methanol in a variety of power generation systems (turbines, fuel cells, generators).

#### **7.3.2.1 West Virginia University Stationary Gas Turbine**

This program was designed to compare the emissions and operational aspects of gas turbine operation on stabilized methanol compared with conventional liquid fuel. At WVU, a research aircraft was built using a GTC-85-72 gas turbine as the power source. This unit, which is rated at 235 horsepower in the form of compressor bleed air, was used in this study. Several of the turbine subsystems (fuel tank and pumps, speed and fuel flow controller, ignition system, bleed air load controller) had to be modified to accommodate the stabilized methanol fuel.

Testing has shown that the present configuration of the gas turbine does not allow operation on methanol at startup. Conventional fuel (in the form of Jet A) was used for initial turbine firing,

and a fuel emulsifier was added to assure a smooth transition from Jet A to stabilized methanol. At low power loads, flameout occurred during the transition to methanol; this appears to be the result of the higher heat of vaporization of methanol when compared with Jet A. Two glow plugs were added to overcome this problem. Initial testing was also performed without any additives in order to determine if the trace amounts of the inert oil from the LPMEOH™ Process were sufficient to provide the necessary lubrication for the fuel pump and controller. It was determined that the mineral oil levels in the stabilized methanol did not adequately lubricate these systems.

Testing was performed by the WVU Transportable Heavy Duty Emissions Testing Laboratory in order to compare the emissions generated from Jet A and stabilized methanol fuels. The results are provided in Figure 7.3.2-1, and demonstrate the capability of stabilized methanol to significantly reduce the levels of NO<sub>x</sub> in gas turbine exhausts.

Following this work, a second set of performance tests and emissions measurements were performed with stabilized methanol and the selected lubricant to determine if any differences from the earlier testing could be determined. Figure 7.3.2-2 contains a representative set of results for a 2% mixture of the lubricant in methanol; emissions of NO<sub>x</sub> were again substantially lower than for a kerosene fuel, and levels of CO, hydrocarbons, and particulates were also reduced.

The investigators recommend that additional work could be focused on optimizing the selection and concentration of the lubricant and solving the problems with operation at low power load.

**Figure 7.3.2-1  
West Virginia University Stationary Gas Turbine  
Emissions Test Results – 1998 Testing**

**Emissions during fuel type change over from Jet-A to  
Methanol at t=5 minutes and back to Jet A at t=11 minutes at  
45% power level, August 18, 1998**

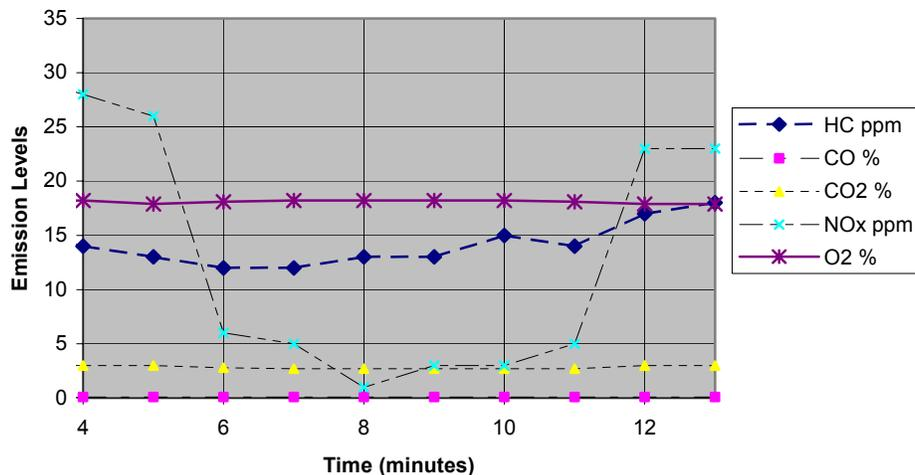

**Figure 7.3.2-2  
West Virginia University Stationary Gas Turbine  
Emissions Test Results – 2000 Testing**

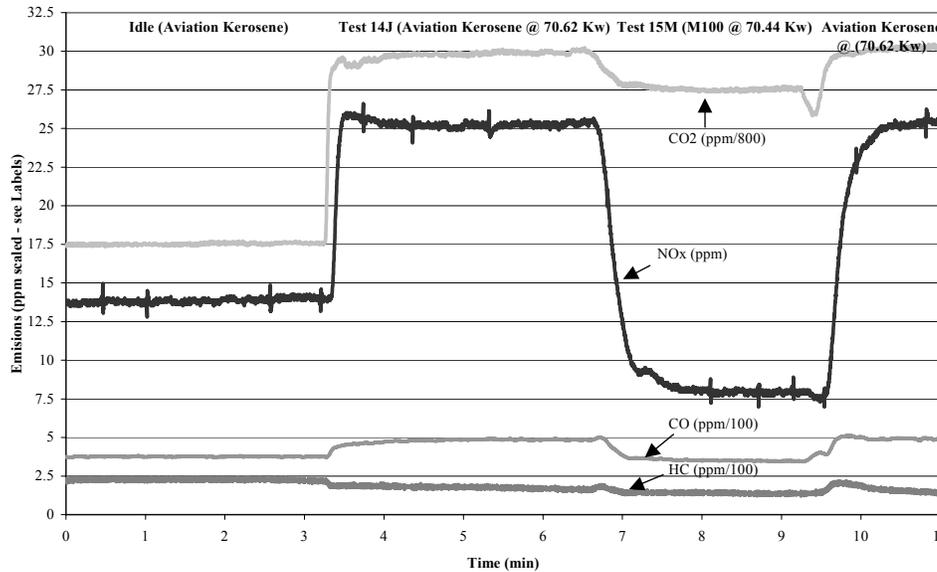

Emissions During Fuel Type Change Over From Aviation Kerosene To Methanol, 3/14/00 Tests - Idle, Test 14J (Aviation Kerosene @ 70.62 Kw), 15M (70.44 Kw) And Back To Aviation Kerosene @ 70.62 Kw

### 7.3.2.2 Aircraft Ground Support Equipment

In preparation for the possibility that combustion sources at U.S. Air Force bases may be required to reduce their emissions of NO<sub>x</sub>, the Air Force had become interested in the evaluation of possible approaches to controlling NO<sub>x</sub> emissions from aircraft ground support equipment (AGSE) diesel generators (part of a class of off-road power generation systems). These generators are very high NO<sub>x</sub> emitters. It has been determined that the AGSE accounts for nearly 40 to 60 percent of a typical base's emissions of NO<sub>x</sub> and the diesel generator accounts for 70 to 90 percent of the AGSE emissions. Replacement of these systems is expensive, and other alternative fuels (such as liquefied or compressed natural gas or liquefied petroleum gas) are not feasible. One NO<sub>x</sub> control approach applicable to these engines is the use of a diesel/water emulsion fuel in place of standard diesel fuel.

The use of diesel/water emulsions containing nominally 5-percent methanol have been shown to be effective in achieving nominally 40-percent NO<sub>x</sub> reductions from some engines. However, the diesel/water emulsion experience base is quite limited, and the long-term effects of such emulsions on engine performance were unknown. Thus, there was a need to evaluate the effectiveness and the long-term performance of this NO<sub>x</sub> control approach when applied to AGSE.

ARCADIS Geraghty & Miller developed a project to perform an extended evaluation of the use of a diesel/water/methanol emulsion, prepared using stabilized methanol from the LPMEOH™

Demonstration Project as the methanol component. Testing was planned on an Air Force flight line generator at Tyndall Air Force Base (AFB), Florida. Previous work supported by the Air Force Green AGSE Program developed an additive package that is effective in both stabilizing a diesel/water emulsion and preventing engine part corrosion. Two of these generators at Tyndall AFB were made available to this project. Of these, one was to be operated on the emulsion fuel during the evaluation, and the other was to be run on a military jet fuel (specification JP-8). JP-8 jet fuel is used in the mobility applications of the generators, and the Air Force has standardized the use of JP-8 in diesel engines to reduce the need to manage and maintain two fuel types and fueling systems. Engine performance and emissions testing were planned to be conducted before the start and after the end of this 6-month period to quantify emission reductions and performance impacts. Engine inspections were also planned, to address durability and corrosion issues.

The water-in-fuel (WIF) emulsion containing the stabilized methanol and additives was the emulsion fuel that was evaluated in these tests. The WIF emulsion was prepared to contain nominally 30 percent water, 5 percent methanol, and 1 percent additives, with the balance being JP-8.

When this project was originally planned, substantial support of the effort was offered by several Air Force and contractor organizations at Tyndall AFB. As the project proceeded, however, mission priorities of all the Air Force organizations supporting the evaluation changed to the point that further support of the project was not possible. As a result of these changes, support for the project could no longer be offered after May of 1999, and the project needed to be concluded. Up to that point, a series of initial performance and emissions tests had been completed.

In the initial performance and emissions tests that were completed, engine emissions of O<sub>2</sub>, CO, CO<sub>2</sub>, NO<sub>x</sub>, and unburned hydrocarbons (UHC) were measured from engines fueled with both WIF and JP-8. Particulate emissions measurements were also performed using a dilution tunnel measurement technique. However, the 30-minute sampling time at each test load was not long enough to allow collecting measurable quantities of particulate on the sampling train filters.

Results of the tests were as follows:

- As shown in Figure 7.3.2-3, the use of the WIF emulsion reduced engine NO<sub>x</sub> emissions by 21 to 57% over the engine load range, with the greater emission reductions achieved at lower engine loads. The International Organization for Standardization (ISO) cycle weighted average NO<sub>x</sub> emissions were reduced 34% from 1,550 ppm at 15% O<sub>2</sub> with JP-8 fuel to 1,030 ppm at 15% O<sub>2</sub> with the emulsion.
- CO emissions from the engine did not vary significantly with load for the JP-8 fuel, and were nominally 500 ppm at 15% O<sub>2</sub>. With the WIF emulsion, CO emissions were relatively constant at engine loads from full load to 50 percent load, but increased substantially at lower engine loads.



**Figure 7.3.2-3**  
**Aircraft Ground Support Equipment**  
**Average NO<sub>x</sub> Emissions Reduction with WIF vs. JP-8**

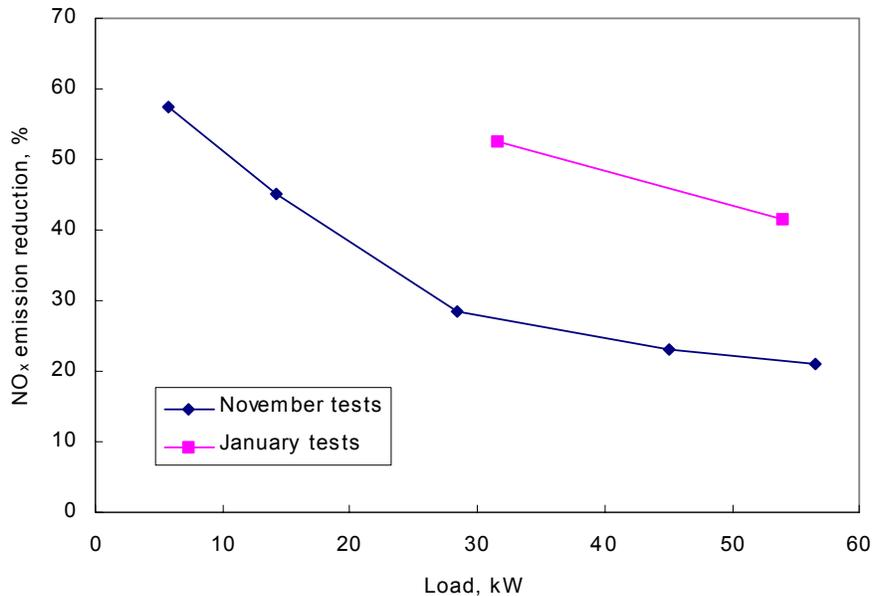

- Relative CO emissions for the two test fuels showed inconsistent behavior. For one series of tests, CO emissions with the WIF emulsion were lower than with JP-8 at engines loads of 50% or greater, but were higher at lower engine loads. ISO-cycle weighted average emissions for this test series were comparable for both fuels. For a second test series, CO emissions were substantially higher with the WIF emulsion than with JP-8 at all engine loads tested.

Stabilized methanol from the LPMEOH™ Demonstration Project was successfully used to produce the WIF emulsion which was used in this project. Although NO<sub>x</sub> emissions reduction with the WIF were impressive, severe problems with cold starting and operation at low ambient temperatures were experienced. A few approaches to solve these problems were tried during this abbreviated project, but without success. Until the cold start problem is solved, WIF use in Air Force applications was not recommended.

### 7.3.2.3 Low-NO<sub>x</sub> Stationary Microturbine Combustor

As originally proposed by ARCADIS Geraghty & Miller, the objective of the subject project was to demonstrate cost-effective volatile organic compound (VOC) destruction by a small gas turbine operating in a distributed power generation application fired with stabilized methanol from the LPMEOH™ Demonstration Project. However, after an exhaustive search, no host site willing to participate in the project was identified.

At this point, a decision was made to shift the environmental focus of the project. California, as well as the EPA, regulates NO<sub>x</sub> as an ozone precursor. As a consequence, California continues to pursue very aggressive NO<sub>x</sub> control strategies to facilitate bringing California ozone nonattainment regions into attainment. Moreover, such strategies will become more commonplace in the Midwestern and Northeastern states in response to EPA's decision to implement a NO<sub>x</sub> cap and trade program in both the Northeastern states as well as the Midwestern states that contribute to the ozone nonattainment status of regions of the Northeast via transported ozone.

Given these mandates, it was clear that any new distributed generation capacity will need to be low NO<sub>x</sub> emitting units. In response to this need, Alzeta Corporation, with support from the California Energy Commission, the DOE's National Energy Technology Laboratory, and a number of gas turbine manufacturers, has been developing an advanced low NO<sub>x</sub> surface stabilized combustor technology for stationary microturbines in distributed generation applications. The opportunity arose for the LPMEOH™ Demonstration Project to participate in this program and extend demonstration testing to stabilized methanol. Accordingly, a decision was made to redirect the project on VOC control to focus on completing a series of tests using stabilized methanol as a fuel for a low NO<sub>x</sub> microturbine combustor targeted for use in a distributed generation application. In testing performed with natural gas fuel, it was possible to achieve combustor NO<sub>x</sub>, CO, and UHC emissions approaching 2 ppm at 15 percent O<sub>2</sub>. Parallel testing with stabilized methanol was performed in these tests to evaluate whether comparable performance could be achieved.

As shown in Figure 7.3.2-4, NO<sub>x</sub> emissions with stabilized methanol from the LPMEOH™ Demonstration Project were comparable to and, for several conditions, lower than those with natural gas fuel. Results of the tests showed that combustor NO<sub>x</sub> emissions could be held below 6 ppm at 15 percent O<sub>2</sub> over the range of combustor firing rates corresponding to turbine idle to full load. Emissions as low as 1 ppm at 15 percent O<sub>2</sub> were achieved at a number of test conditions, and were 3 ppm at 15 percent O<sub>2</sub> or lower for all but the highest load tested. The low NO<sub>x</sub> emissions were achieved with CO emissions at 20 ppm (at 15 percent O<sub>2</sub>) or lower. CO emissions when stabilized methanol was used as fuel were also comparable to those with natural gas fuel. In fact, CO emissions were 4 ppm at 15 percent O<sub>2</sub> or lower at all but low load (firing rate) and high load.

In summary, stabilized methanol from the LPMEOH™ Process would seem to represent an acceptable liquid fuel for advanced low emission microturbines using the Alzeta combustor technology, offering emissions performance at or slightly better than the levels achieved with natural gas fuel.

**Figure 7.3.2-4**  
**Low-NO<sub>x</sub> Microturbine**  
**NO<sub>x</sub> Emissions with Stabilized Methanol vs. Natural Gas**

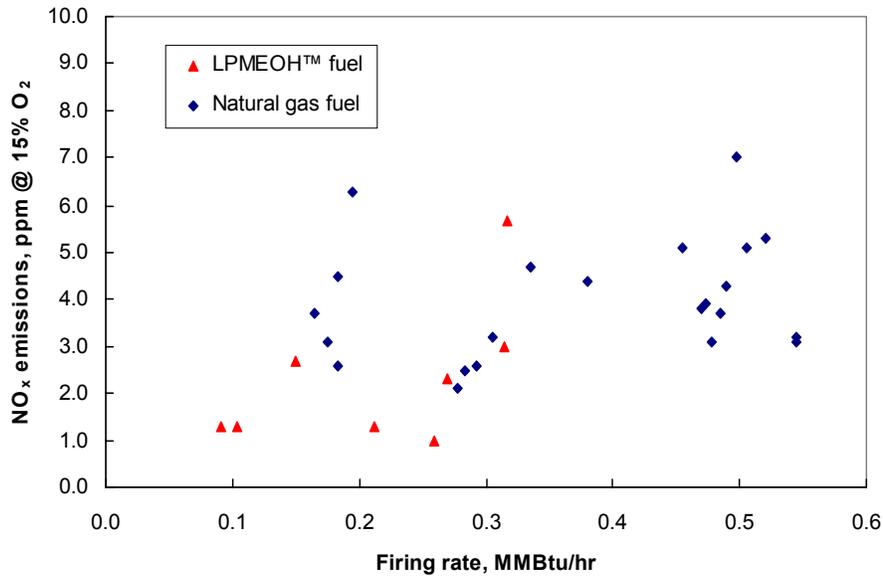

#### 7.3.2.4 University of Florida Fuel Cell

Over the past few years, progress has continued in the development of fuel cells, which can be used in either transportation or power applications.

While pure gaseous H<sub>2</sub> is the ideal fuel for fuel cell power systems, it is also relatively expensive, difficult to transport, and difficult to store for onboard transportation systems. Consequently, there has been, and is, considerable interest in utilizing liquid hydrocarbon fuels for transportation fuel cell applications. For a liquid fuel to be a feasible alternative to H<sub>2</sub>, it must be possible and practical to utilize a fuel processing system to transform the liquid fuel into a H<sub>2</sub>-rich gas. More specifically, the H<sub>2</sub>-rich gas must be compatible with long-term operation of the fuel cell system within which it would be utilized, with little or no degradation in performance. In earlier demonstrations with phosphoric acid fuel cells, chemical-grade methanol has been used successfully as the source of H<sub>2</sub>.

Clearly, the implication is that a suitable fuel-fuel processor combination must maintain the ability to provide almost complete conversion of the liquid fuel feedstock into an acceptable H<sub>2</sub>-rich gas over a long period of time and many cycles of operation. “Acceptable” H<sub>2</sub>-rich gas in this case means a maximum concentration of H<sub>2</sub> and virtually zero concentration of contaminants (primarily unreacted components from the liquid fuel) which would degrade the life and/or performance of the fuel cell stack. To meet this acceptability requirement, the fuel processor must also not undergo any significant decrease in its ability to convert the liquid fuel in a continuing and consistent manner. A prime mechanism for the fuel processor to experience a

significant decrease in conversion ability would be through a deactivation of the catalyst in a catalyst-driven processor such as the steam reformer.

Catalyst deactivation can occur for many reasons including excess temperature, rapid temperature transients, or the introduction of O<sub>2</sub>. However, with the introduction of a new liquid fuel such as stabilized methanol, it is obvious that deactivation can occur as a result of one or more contaminants (such as higher alcohols or the trace quantity of mineral oil from the LPMEOH™ Process) contained in the liquid fuel. Given the cost of distillation (\$0.02 to \$0.04 per gallon) of stabilized methanol to chemical-grade purity, a fuel cell test site of this potential source of H<sub>2</sub> was sought. The University of Florida had facilities and equipment in the Fuel Cell Research and Training Laboratory to perform this type of research, as well as two operational methanol-fueled fuel cell engines. As a result, an agreement was reached for the University of Florida to undertake the evaluation of the stabilized methanol as a suitable fuel for steam-reformed methanol/phosphoric acid fuel cell systems.

Since it was obviously important not to damage the operational fuel cell engines, the procedure was to fabricate small steam reformers using catalyst pellets of the type (copper oxide-zinc oxide) typically used for methanol steam reformation. The apparatus was designed so as to allow determination of areas of deactivation if they occurred as a result of the stabilized methanol fuel. A parallel reformer operating simultaneously with chemical-grade methanol was used as a control.

Initial results showed very rapid degradation of the catalyst exposed to the stabilized methanol. Analysis of the results indicated that a likely cause of the deactivation was the presence of high boiling point components in the stabilized methanol feedstock. A potential scenario for this deactivation was a probable coating of the catalyst with trace quantities of the mineral oil which is used as the liquid medium in the LPMEOH™ reactor. Subsequent tests and modifications to the reformer unit were performed as well as the utilization of a higher temperature reformer catalyst to avoid rapid catalyst degradation. Higher temperatures did, as expected, result in less effect due to the mineral oil, but it also resulted in a more unfavorable balance among H<sub>2</sub>, methane, CO<sub>2</sub>, and CO in the reformat.

The results to date indicate that for the relatively low-temperature steam reforming of stabilized methanol, the trace mineral oil in the stabilized methanol would most likely have to be removed in order for it to be a suitable fuel. On the other hand, the limited higher temperature results indicate that possibly for auto-thermal reforming and probably for partial oxidation reforming, the stabilized methanol would be acceptable as a fuel. Methanol from the LPMEOH™ Process that is purified to chemical-grade specifications should be suitable for use in this application.

## **7.4 SUMMARY**

Methanol from the LPMEOH™ demonstration unit was tested in a variety of chemical and fuel applications. A test methodology was developed by Eastman to satisfy the criteria for use of methanol in their chemicals-from-coal complex. Over the entire 69-month operating program for the LPMEOH™ demonstration unit, over 103.9 million gallons of methanol was produced,

and Eastman accepted all of the available methanol for use in the production of methyl acetate, and ultimately cellulose acetate and acetic acid.

Stabilized methanol from the project was also made available to seven test locations to study its feasibility as feedstock in transportation and power generation applications. Use in these applications is expected to enhance the flexibility of and revenue from IGCC electric power plants. In bus and FFV trials, stabilized methanol provided the same environmental benefits as chemical-grade methanol with no penalty on performance or fuel economy. Tests in a gas turbine and a diesel generator showed that levels of NO<sub>x</sub> in the exhaust air can be lowered when stabilized methanol or methanol emulsions are used instead of conventional oil fuels. As with the chemical-grade methanol, lubrication additives will likely be required when stabilized methanol is fed to a gas turbine. Testing of stabilized methanol as the source of H<sub>2</sub> to a phosphoric acid fuel cell showed that conventional steam reforming catalysts are not compatible with the trace mineral oil present in the stabilized methanol; when auto-thermal reforming or partial oxidation reforming are used, the stabilized methanol would possibly be acceptable as a fuel. Methanol from the LPMEOH™ Process that is purified to chemical-grade specifications should be suitable for use in this application.

Product-use testing proved that coal-derived methanol, free of sulfur and other impurities, could be used one day as a replacement for petroleum in transportation, a peaking fuel in combustion turbines IGCC power plants, a H<sub>2</sub> source for small fuel cells, or as a chemical feedstock. Implementation of the LPMEOH™ technology and the use of stabilized methanol in transportation and power systems will add significant flexibility and dispatch benefits to IGCC electric power plants, which traditionally have been viewed as strictly a baseload power generation technology. Now, central clean coal technology processing plants, making coproducts of electricity and methanol, can meet the needs of local communities for dispersed power and transportation fuel. Methanol coproduction studies show that methanol can be produced at economically competitive levels from an abundant, non-inflationary local fuel source, such as coal. The coproduced methanol may be an economical H<sub>2</sub> source for small fuel cells, as a transportation fuel, and an environmentally advantaged fuel for dispersed electric power.

## **7.5 SECTION 7 BIBLIOGRAPHY**

- a. "Off-site Testing of Stabilized Methanol from the Liquid Phase Methanol (LPMEOH™) Process", Topical Report Prepared by Air Products Liquid Phase Conversion Co., L.P., DOE Cooperative Agreement No. DE-FC22-92PC90543, February 2002.
- b. "Off-site Testing of Stabilized Methanol from the Liquid Phase Methanol (LPMEOH™) Process, Volume 1 - Transportation Systems", Topical Report Prepared by Air Products Liquid Phase Conversion Co., L.P., DOE Cooperative Agreement No. DE-FC22-92PC90543, February 2002.
- c. "Fleet Trials for Fuel Grade Methanol Under USDOE Cooperative Agreement No. DE-FC22-92PC90543", Prepared by Florida Institute of Technology for Air Products and Chemicals, Inc., August 1999).
- d. "Final Report: Liquid-Phase Methanol (LPMEOH™) Demonstration Project - Light-Duty Flexible-Fueled Vehicle Demonstration", Prepared by ARCADIS Geraghty & Miller for Air Products and Chemicals, Inc., April 1999.

- e. "Exhaust Emissions Testing Performed for Air Products Corporation on Transit Buses Fueled by Air Products Brand Methanol Fuel", Prepared by West Virginia University for Air Products and Chemicals, Inc., August 1998.
- f. "Off-site Testing of Stabilized Methanol from the Liquid Phase Methanol (LPMEOH™) Process, Volume 2 - Power Generation Systems", Topical Report Prepared by Air Products Liquid Phase Conversion Co., L.P., DOE Cooperative Agreement No. DE-FC22-92PC90543, February 2002.
- g. "Emissions and Operational Aspects of Methanol as an Alternative Fuel in a Stationary Gas Turbine", Prepared by West Virginia University for Air Products and Chemicals, Inc., August 2000.
- h. "Evaluation of a Water Emulsion Fuel in Air Force Aircraft Ground Support Equipment Diesel Generator Sets", Prepared by ARCADIS Geraghty & Miller for Air Products and Chemicals, Inc., January 2000.
- i. "Evaluation of Liquid-Phase Methanol (LPMEOH™) in a Low-NOx Stationary Gas Turbine Combustor", Prepared by Arthur D. Little, Inc. for Air Products and Chemicals, Inc., February 2001.
- j. "An Investigation Into the Acceptability of Stabilized Methanol as a Fuel for Phosphoric-Acid Fuel Cell Power Systems", Prepared by the University of Florida for Air Products and Chemicals, Inc., February 2001.

## 8.0 LIQUID PHASE DIMETHYL ETHER (LPDME™) DESIGN VERIFICATION TESTING (DVT)

### 8.1 INTRODUCTION

The Statement of Work from the Cooperative Agreement defined a Secondary Objective for the LPMEOH™ Demonstration Project regarding the demonstration of Air Products' Liquid Phase Dimethyl Ether (LPDME™) Process:

"Subject to Design Verification Testing (DVT), the Partnership proposes to enhance the Project by including the demonstration of the slurry reactor's capability to produce DME as a mixed co-product with methanol. The production of DME from synthesis gas is a natural extension of the LPMEOH™ Process in that three reactions occur concurrently in a single liquid phase reactor, methanol synthesis, methanol dehydration and water-gas shift. This process enhancement can significantly improve the overall conversion of coal derived synthesis gas to a storable blend of methanol and DME...

"The enhanced (DME production) demonstration is complementary to ongoing studies being sponsored by DOE's Liquid Fuels Program... the enhancement will expand DOE's liquid fuels technology data base and will demonstrate the versatility of liquid phase synthesis.

"DVT is required to address issues such as catalyst activity and stability and to provide data for engineering design and demonstration decision making. The DVT plan will be coordinated with and utilize the resources of the DOE's Liquid Fuels Program as technology experts. The essential steps required for Project decision making regarding the methanol/DME co-product enhancement are:

- "DVT, including laboratory R&D to develop engineering data and to verify the market through engine tests and through market and economic study. (Phase I, Task 5).
- "DVT, including Process Development Unit Verification Testing utilizing the LaPorte AFDU for proof of concept tests. (Phase III, Task 6).
- "Final decision making to implement the full-scale methanol/DME co-product demonstration. (Phase III, Task 2.2).

"At the conclusion of each of the DVT steps, a joint Partnership/DOE decision will be made regarding continuation of methanol/DME demonstration."

The LPDME™ Process uses a physical mixture of a commercial methanol catalyst and a commercial dehydration catalyst in a single slurry reactor to coproduce DME with methanol. This process provides high syngas conversion, efficient heat transfer, and directly converts a variety of feed gas compositions. There are three simultaneous reactions in this system, namely,

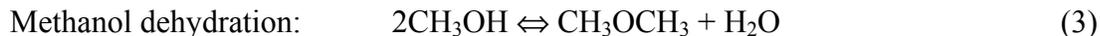
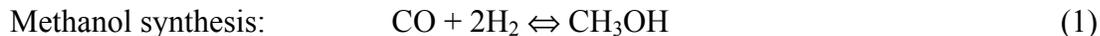

The methanol synthesis catalyst promotes Reactions 1 and 2, and the dehydration catalyst promotes Reaction 3. Both catalysts are micron-sized powders suspended in an inert hydrocarbon liquid, usually a mineral oil. The mineral oil acts as a temperature moderator and a

heat removal medium, transferring the heat of reaction from the catalyst surface via the liquid slurry to boiling water in an internal tubular heat exchanger. As a result of this capability to remove heat and maintain a constant, highly uniform temperature through the entire length of the reactor, the slurry reactor can manage the high syngas conversion per pass that can be achieved in the LPDME™ Process.

These capabilities make the LPDME™ Process a potentially lower-cost conversion route to DME, especially when DME coproduction is added to a coal-based IGCC power plant. In this application, the overall reaction of syngas to DME is:

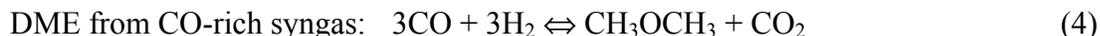

This is the "once-through" CO-rich syngas concept for the LPDME™ Process utilizing a single slurry reactor. Conversion per pass, with CO-rich syngas, can be higher than for the LPMEOH™ Process. Methanol may also be produced, as a mixed coproduct with the DME, and can easily be separated and recovered. The separation of DME from CO<sub>2</sub> will be necessary for certain market applications.

## **8.2 DME MARKET STUDIES**

A topical report<sup>(a)</sup> provided information on the status of the current market for DME and an outlook on potential market developments through 2006. Over 50% of the demand for DME worldwide (currently between 100,000 and 150,000 metric tons per year) is for use as a projectile agent. DME is also being used as a methylating agent, and as a cleaning material for laboratory systems and some high precision, high value added applications, such as in electronics.

DME has potential applications as a chemical building block. In addition, since the physical properties of DME are similar to those of liquefied petroleum gas (LPG), it has been speculated that DME could be used in large scale power production, in home heating, in replacement of LPG for automobiles, and as a diesel fuel substitute or combustion supplement. In these applications, the specification for the purity of DME has been reported to be lower than the 99 wt% requirement for current uses, which may provide an opportunity for savings in capital and operating costs for product distillation. If these markets are developed, production capacity for DME will need to increase by an order of magnitude over current levels of about 143,000 metric tons per year. Projects to meet this future market are under development, including two large natural gas-based opportunities serving markets in India and Japan and a coal-based opportunity in China.

## **8.3 DVT ECONOMIC STUDIES**

The economics studies, for once-through coproduction (with an IGCC power plant, for example) on syngas rich in carbon oxides, show that the LPDME™ Process will have an economic advantage greater than the LPMEOH™ Process. A once-through LPDME™ reactor is able to convert greater than 50% of such a syngas, whereas a once-through LPMEOH™ reactor can convert only about 30%. The economics, of course, depend upon the end-use (purity) of the



DME and upon the gasification plant's coproduct mix (amount of power, methanol, DME, etc.). The same liquid phase reactor design options to increase syngas conversion, such as feed gas compression and/or CO-rich gas recycle; are also applicable for the LPDME™ Process. So, the LPDME™ technology has the potential to improve on the \$0.05 to \$0.10 per gallon (methanol equivalent) advantage over the LPMEOH™ Process for the coproduction of DME to serve local markets.

As with the LPMEOH™ Process, gas-phase process technology must be considered as the economic competitor. The gas-phase DME process<sup>(b)</sup> must run with H<sub>2</sub>-rich syngas. In the IGCC coproduction flow sheet (shown in Figure 7.1-1), gas-phase technology is at an economic disadvantage, since separate shift and CO<sub>2</sub> removal are required. As is the case for methanol, inexpensive remote natural gas would therefore be the economic plant site choice for gas-phase technology. A comparison of coproduction of DME in an IGCC facility using the LPDME™ Process compared with DME imported from remote gas facilities, shows an advantage of 20-30% for locally produced DME relative to imported DME. The transportation cost to import DME is much higher than for methanol, and the LPDME™ coproduction advantage is even greater than that for the LPMEOH™ Process (vs. methanol import). Dehydration of imported methanol to make DME is not competitive. Therefore, for DME in local markets, coproduction using the LPDME™ Process should have a clear economic advantage over imported DME.

With H<sub>2</sub>-rich syngas, the LPDME™ Process loses its (once-through, high conversion per pass) economic advantage. The overall reaction, with (> 2:1) H<sub>2</sub>-rich syngas is:

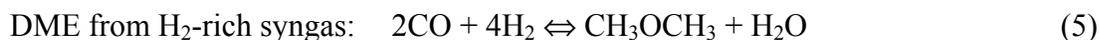

Since water inhibits the methanol dehydration reaction, the slurry reactor must be staged, with water removal between stages. Staging could be by high ratio gas recycle, and/or with multiple reactors; but the once-through simplicity is lost. Therefore, it is unlikely that the LPDME™ Process would be developed for use in H<sub>2</sub>-rich syngas applications.

A cost estimate of commercial-scale LPDME™ plants has been performed. This work has helped quantify the targets for the laboratory research and development program (summarized below). From these studies, a commercially successful LPDME™ system was defined for a Texaco-type syngas (35 vol% H<sub>2</sub>, 51 vol% CO, 13 vol% CO<sub>2</sub>) available at 500 psig. At a reactor operating pressure of 950 psig and a space velocity of 4,000 liters/hr-kg catalyst, the LPDME™ catalyst system must have a methanol equivalent productivity of 14 mol/kg catalyst-hr after 6 months of operation, producing at least 75% (by heating value) DME and 25% methanol.

#### **8.4 DVT CATALYST STUDIES**

A research and development program was initiated by Air Products in 1994, with DOE's sponsorship under the Liquid Fuels Program, to develop a catalyst system for the LPDME™ Process that met the economic targets. This work resulted in an invention of aluminum phosphate as the dehydration catalyst.<sup>(c)</sup> The aluminum phosphate provided an active and stable catalyst system. The system met the program targets under standard test process conditions of an initial methanol equivalent productivity of 28 gmole per kg catalyst - hr, a CO<sub>2</sub>-free, carbon

selectivity of 80% to DME, and stability of both catalysts equivalent to that of the methanol catalyst in the absence of the aluminum phosphate. Because the aluminum phosphate catalyst was not commercially available, a scaleup project was initiated with a commercial catalyst vendor to prepare a total of 800 pounds of aluminum phosphate to provide for two reactor charges and some additional material for testing.<sup>(d)</sup> Eight 160 pound pilot batches of uncalcined catalyst were prepared. The reproducibility of the aluminum to phosphate (Al/P) ratio, an important physical property of the catalyst, from batch to batch was poor. Of these eight lots, two were qualified as yielding acceptable performance under the proposed LaPorte AFDU trial life test conditions. One of the batches was tested under conditions which allow direct comparison to the lab benchmark aluminum phosphate. This batch gave faster deactivation of the methanol catalyst than did the lab material, showing it to be of inferior quality. Two additional batches were prepared at half-dilution to alleviate any mixing problems which might have caused the poor reproducibility in the original eight batches. However, the Al/P ratio of both of these batches was high. One was tested, and shown to give unacceptable performance. All scaleup work on aluminum phosphate was suspended in November of 1998, as a commercially-available catalyst discussed below was identified which performed equivalently.

The deactivation rates of the methanol and the dehydration catalyst were correlated to reaction conditions. The correlations suggested a dependence of the deactivation rates on reaction conditions. The trends suggested by the correlations were confirmed by additional experiments. Better stability was obtained using the aluminum phosphate catalyst system by operating at favorable process conditions. The same improvement was also demonstrated with the gamma alumina catalyst system. However, there was a 10-20% trade-off in the productivity when shifting from the optimal conditions to the stable conditions for both the catalyst systems. As the gamma alumina was off-the-shelf commercial material, it was chosen for the LaPorte AFDU test. A methanol catalyst to gamma alumina ratio of 95:5 by weight was found to be optimum for catalyst stability.

## **8.5 1999 LPDME™ PROCESS DESIGN VERIFICATION TEST RUN**

A demonstration of the production of DME by the LPDME™ Process was successfully completed at the LaPorte AFDU in October-November of 1999. A photograph of the LaPorte AFDU is provided in Figure 8.5-1. The demonstration was conducted at a pilot scale of 10 sT/D to evaluate the commercial viability of the LPDME™ Process. Based upon the improvement in the life of the catalyst system at the laboratory scale, the participants in the LPMEOH™ Demonstration Project agreed that a trial at the LaPorte AFDU was the appropriate step to demonstrate these improvements. This run was co-funded by the LPMEOH™ Demonstration Project and the DOE's Liquid Fuels program. The objectives of the run were to demonstrate the operation of the LPDME™ Process with improved catalyst life at a 10 sT/D scale, using commercially produced catalysts, obtain information to correlate the scaleup of catalyst aging from autoclave to bubble column, conduct process variable testing, and perform experiments to better understand the reactor fluid dynamics. A topical report<sup>(e)</sup> was written detailing the testing at the LaPorte AFDU.

**Figure 8.5-1**  
**LaPorte Alternative Fuels Development Unit (AFDU)**



The methanol catalyst was successfully activated at the beginning of operations with dilute H<sub>2</sub>, resulting in an expected H<sub>2</sub> uptake. The reduction was conducted with 3 vol% H<sub>2</sub> in N<sub>2</sub> at 67 psig reactor pressure. The heat-up proceeded from 200 to 464°F, as planned. The reduction appeared normal, and a cumulative uptake very close to the theoretical maximum value of 2.68 SCF H<sub>2</sub>/lb oxide was obtained. The reduction was essentially complete at 390°F or 17 hours onstream. Nuclear Density Gauge measurements indicated an average gas holdup of 36.8 vol%, with a catalyst concentration of 40.1 wt% at 392°F during the reduction. The catalysts appeared to have good initial activity, with DME and methanol productivity slightly exceeding expectations. This confirmed that the catalyst activation was proper. The initial DME production rate was 5.1 sT/D compared to an expectation of 4.8 sT/D, while the methanol production rate was 3.6 sT/D vs 3.5 sT/D expected.

The LaPorte AFDU was operated for 25 days to compare catalyst aging in a pilot-scale slurry bubble column reactor with that in a laboratory autoclave. The proportion of two catalysts corresponded to a 95:5 methanol to dehydration catalyst ratio by weight. The methanol and dehydration catalyst activities, expressed as the ratio of the rate constant at any point in time to the rate constant for a freshly reduced catalyst (as determined in the laboratory autoclave), are plotted in Figure 8.5-2. These normalized rate constants were estimated based on a reaction model developed from laboratory data. After the expected initial aging, the catalysts appeared to be stabilizing, but there was significant scatter in the data. Gas chromatographic as well as sampling problems were discovered with methanol analysis that required use of liquid balance

**Figure 8.5-2**  
**1999 LPDME™ Operating Run at LaPorte AFDU – Estimated Catalyst Activity**

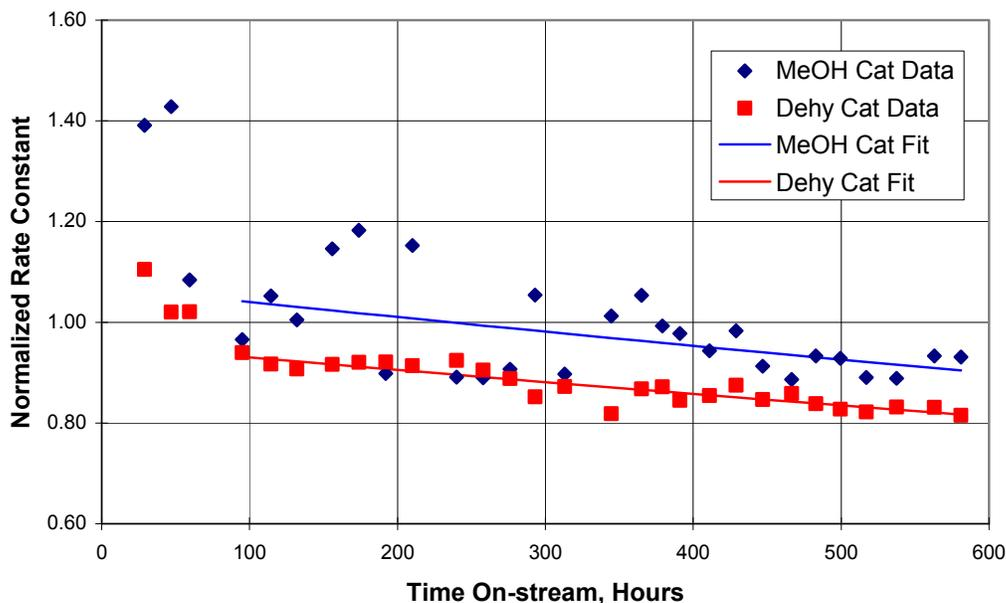

for calculations, contributing to the scatter. The problems were corrected in two days. The initial deactivation rate appeared high: 0.08% per hour (2% per day) for methanol catalyst with a 0.05% per hour standard error and 0.03% per hour (0.6% per day) for dehydration catalyst with a 0.009% per hour standard error. It was decided to extend the aging test to get a better estimate on catalyst deactivation rate, which was the main objective.

The LaPorte AFDU data appeared to follow the autoclave trends, with somewhat higher conversions than the autoclave throughout the test period. The methanol productivity level remained relatively constant, while the DME productivity showed a slight decline. The DME and methanol production rates through the run are shown in Figure 8.5-3. The DME production rate declined from 5.1 sT/D to 4.1 sT/D in 25 days onstream, while methanol production showed a scatter within the 3.1 to 3.8 sT/D range through the run. The scatter in data decreased significantly after the gas chromatograph and sampling problems were resolved (350 hours onstream). The performance also met the productivity and selectivity targets. The initial methanol equivalent productivity exceeded the target of 28 gmole/hr-kg catalyst, and the DME selectivity was at the target of 65% on a carbon basis. The reactor operated in a hydrodynamically stable manner, with uniform temperature profile and gas holdups. Differential pressure measurements indicated about 42 vol% gas holdup and 36 wt% catalyst concentration. Gas-, liquid-, and solid-phase mixing was studied using radioactive tracer injections. Washington University in St. Louis analyzed the tracer data as part of a DOE program on hydrodynamics of slurry bubble column reactors.

**Figure 8.5-3**  
**1999 LPDME™ Operating Run at LaPorte AFDU – Production Results**

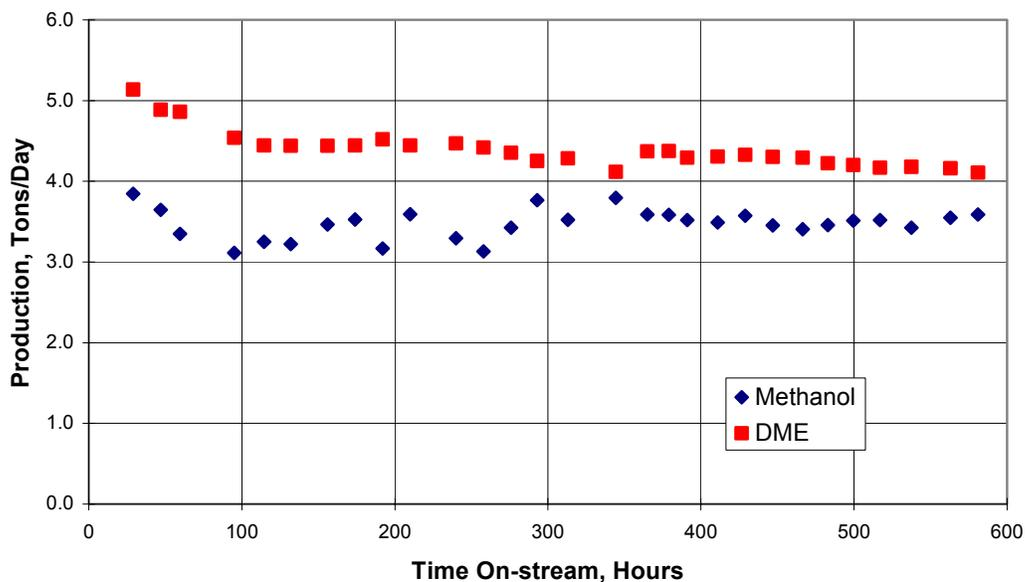

The equipment for this test was operated for the first time following a 4-year hiatus; the operations were smooth. The initial startup was very quick, with the baseline condition reached in 12 hours after the introduction of syngas. A re-start after a syngas outage took only 4 hours. The speed of the startup and re-start demonstrates the ease and flexibility of the slurry technology in response to changes.

The major accomplishments of this run are summarized below:

- Commercial viability of the LPDME™ Process was successfully evaluated on a 10 sT/D scale, using commercially produced catalysts. The LaPorte AFDU was operated for 25 days to compare catalyst aging in a pilot scale slurry bubble column with that in a laboratory autoclave. The catalyst life study was extended in favor of a planned process variable study to obtain additional data on catalyst aging. Hydrodynamic information was obtained at the baseline conditions by conducting a detailed survey of the reactor with radioactive tracer injections.
- The deactivation rate for both the catalysts was calculated to be 0.7% per day. This result was lower than the 1.2% per day which had been calculated for both the methanol synthesis and dehydration catalysts during experiments in the autoclave. The rate of deactivation was slightly higher than 0.5% per day rate which was achieved for the LPMEOH™ Process after 3 weeks of operation at the LaPorte AFDU in 1988/89. The methanol productivity remained relatively constant throughout the test period, while the DME productivity showed a slight decline. These trends were consistent with observations from the laboratory. The standard error for the methanol catalyst deactivation rate was high (0.25% per day) due to initial scatter in the data. The scatter decreased significantly after problems in the sampling and

analytical system were discovered and resolved at 350 hours on stream. The dehydration catalyst activity data have better statistics, with a standard error of 0.06% per day.

- The 1999 design verification test of the LPDME™ Process at the LaPorte AFDU represented a significant step forward in the development of the technology. The 0.7% per day rate of catalyst deactivation which was achieved during this campaign is a large improvement over the 4% per day rate of deactivation which was calculated from autoclave studies prior to the initial test of the LPDME™ Process at the LaPorte AFDU in 1991.

## **8.6 DME DVT CONCLUSIONS**

During a Project Review Meeting on 12-13 January 2000, the preliminary results from the LPDME™ DVT were presented. A table which compared the performance of the LPDME™ catalyst system during the DVT with results from the recent work in the laboratory autoclave and the economic targets for the LPDME™ Process was presented (Table 8.6-1). The results from the laboratory work had indicated that the targets for catalyst productivity and life can be met at lower selectivity to DME. The results from the DVT were applied to a cost estimate for a commercial-scale LPDME™ plant (Figure 8.6-1). The case that was considered was the retrofit of an existing Texaco gasifier in China which is currently used in the production of ammonia. The results of this initial work were that, for this syngas (35 vol% H<sub>2</sub>, 51 vol% CO, 13 vol% CO<sub>2</sub>) available at 500 psig, the DME costs are competitive with LPG in China (\$7 to \$8 per MMBtu). The cost of syngas assumes constant utilization for each plant size, and economies of scale are indicated by changes in the conversion and separation costs. The target DME cost can likely be achieved at larger plant sizes by extrapolating the costs to the 1,100 sT/D production rates. The sensitivity of the cost of production of DME to the life of the LPDME™ catalyst system was shown for the results from LaPorte (0.7% per day deactivation), as well as the impact of changes to the value for catalyst life on the process economics.

As stated in the 30 July 1997 letter which transmitted Air Products' recommendation to proceed with LPDME™ DVT, the basis for commercialization of the technology must come from:

- 1) the results from testing of the LPDME™ catalyst system at the LaPorte AFDU; and
- 2) the reactor performance (methanol catalyst activity and life, hydrodynamics, and heat transfer) from the LPMEOH™ demonstration unit.

After discussing the results from the LPDME™ DVT activities and the ongoing performance results from Kingsport, the meeting participants agreed that the available resources should be directed toward improving the catalyst performance for the LPMEOH™ Process during the remaining time within the operating program. The results of this economic analysis were forwarded to the DOE's Liquid Fuels Program in order to provide direction to the ongoing catalyst development efforts.

**Table 8.6-1  
LPDME™ Goals and Performance Results (Laboratory and AFDU)**

	<b>Liquid Fuels Program Goals</b>	<b>Commercial Targets</b>	<b>Laboratory Results (July 1997)</b>	<b>Laboratory Results (June 1999)</b>	<b>AFDU Results (Oct./Nov. 1999)</b>
<b>Catalyst Productivity, mol/kg catalyst-hr (MeOH-equivalent)</b>	> 28 (Initial Productivity)	> 14 (productivity for aged catalyst)	28 (Initial Productivity)	28 (Initial Productivity)	30.5 (Initial Productivity)
<b>Catalyst Selectivity</b>	DME Selectivity > 80% (% Carbon, CO <sub>2</sub> -free)	DME = 75%, Methanol = 25% (heating value basis)	DME Selectivity = 79% (% Carbon, CO <sub>2</sub> -free)	DME Selectivity = 65% (% Carbon, CO <sub>2</sub> -free)	DME Selectivity = 66 (start) - 61 (end)% (% Carbon, CO <sub>2</sub> -free)
<b>Catalyst Life</b>	> 50% Initial Productivity after 1000 hours	Target Productivity after 6 months of operation	57% of Initial Productivity after 1000 hours	61% of Initial Productivity after 1000 hours	Calculated Target Productivity after 3-1/3 months of operation

**Figure 8.6-1  
LPDME™ Process Economics**

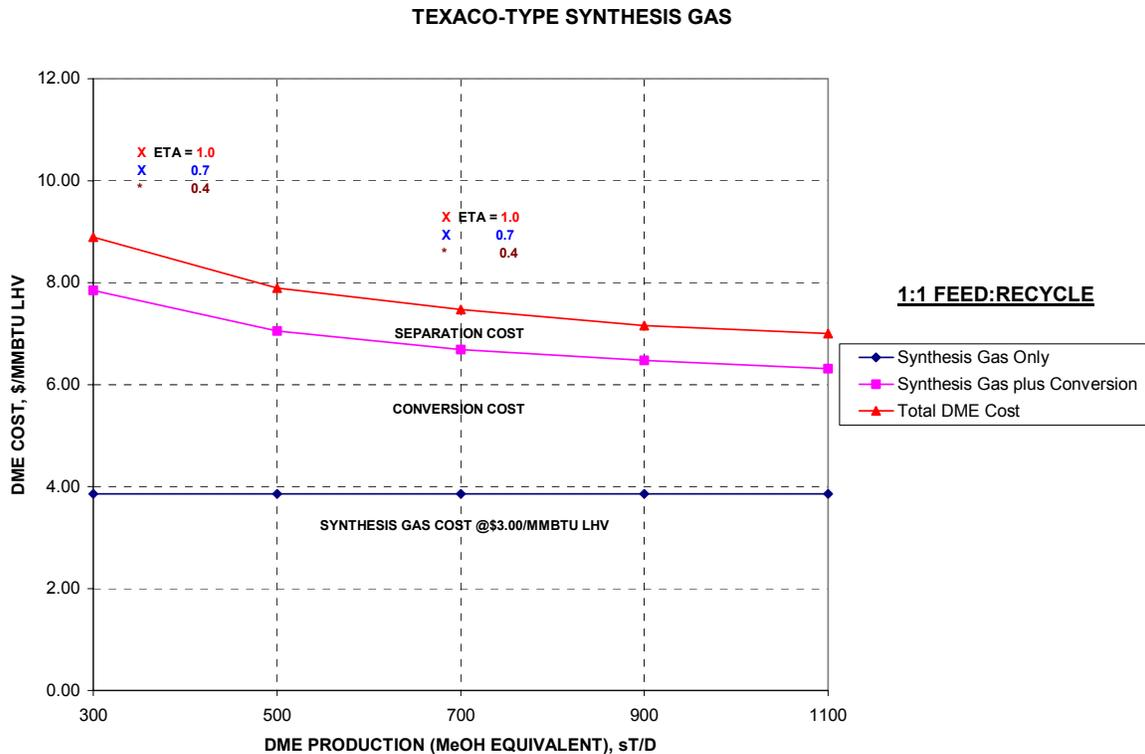

## **8.7 SECTION 8 BIBLIOGRAPHY**

- “Market Outlook for Dimethyl Ether (DME)”, Topical Report Prepared by Air Products Liquid Phase Conversion Co., L.P., DOE Cooperative Agreement No. DE-FC22-92PC90543, April 2002.
- Haldor Topsoe AS, “Preparation of Fuel Grade Dimethyl Ether”, International Publication Number WO9623755, World International Property Organization, 08 August 1996.
- “Catalyst Activity Maintenance for the Liquid Phase Synthesis Gas-to-Dimethyl Ether Process, Part I: An Investigation of the Cause and Mechanism of Catalyst Deactivation”, Topical Report Prepared by Air Products and Chemicals, DOE Cooperative Agreement No. DE-FC22-95PC93052, February 2000.
- X. D. Peng, G. E. Parris, B. A. Toseland, and P. J. Battavio (Air Products and Chemicals, Inc.), “Use of Aluminum Phosphate as the Dehydration Catalyst in Single Step Dimethyl Ether Process”, U.S. Patent No. 5,753,716, 19 May 1998.
- “Liquid Phase Dimethyl Ether Demonstration in the LaPorte Alternative Fuels Development Unit”, Topical Report Prepared by Air Products Liquid Phase Conversion Co., L.P., DOE Cooperative Agreement No. DE-FC22-92PC90543, January 2001.



## 9.0 ECONOMICS

### 9.1 INTRODUCTION

A topical report on the economics of coproduction of methanol in an IGCC power plant was published as part of the LPMEOH™ Demonstration Project.<sup>(a)</sup> This study was used as the basis for the capital and operating costs for the LPMEOH™ Process that are published within this report. The assumptions for key economic parameters are provided:

Capital costs for equipment, valves, and instrumentation are calculated using costs from the 260 sT/D LPMEOH™ demonstration unit as the basis (calendar year 1995). Different multipliers are used to scale the costs. For example, costs associated with methanol distillation to the desired grade of methanol might scale directly with methanol production rates, while some of the costs within the LPMEOH™ reactor system may depend upon the volumetric gas flowrate.

Construction costs assume the same schedule (15 months) and site preparation as the LPMEOH™ Demonstration Unit.

Freight and Miscellaneous refer to project execution costs, again based upon the costs from the LPMEOH™ Demonstration Project.

Air Products Process Studies refer to initial process evaluations which need to be performed in order to optimize the process cycle selected for a particular IGCC application. For example, optimization of feed and recycle compression and an evaluation of the need for water injection are performed during these studies.

Air Products Technical Package refers to the final process design package for a site-specific application. This includes all heat and material balances, detailed equipment specifications for the LPMEOH™ reactor, and process specifications for other equipment items.

Project Engineering refers to the overall management of the engineering, design, and construction work, based upon the costs from the LPMEOH™ Demonstration Project.

Design Engineering refers to the detailed design work (civil, mechanical, instrument and electrical), again based upon the costs from the LPMEOH™ Demonstration Project.

Field Engineering refers to all field engineering services, including construction management at the site. These costs are again based upon the costs from the LPMEOH™ Demonstration Project.

Travel and Living costs are included as a line item.

Reserve is provided as a line item, but is not included in these evaluations.

License Fee is provided as a line item, but is not included in these evaluations.

Once these items are computed, an allowance for Owner's Cost (25% of the equipment cost for the evaluated system) is provided. This is a nominal cost of project execution which includes costs for:

- a) Initial charge of catalyst
- b) Initial supply of chemicals and lubricants
- c) Any applicable taxes and insurance
- d) Cost of land
- e) Legal and other overhead costs

Costs associated with Methanol Storage and CO<sub>2</sub> Removal (if required) are separated from other equipment items, since the costs are site-specific and are highlighted in this manner to provide a potential customer with the opportunity to optimize the required storage.

The sum of these items is the Capital Cost for the LPMEOH™ Facility. The costs are also tabulated by process area (excluding Owner's Cost, Methanol Storage Cost, and CO<sub>2</sub> Removal Costs) to provide information on the relative costs of the different process steps, including all valves, instruments, and associated construction costs.

A calculation of the Plot Area Required, based upon the layout from the LPMEOH™ demonstration unit, is also given.

Operating costs are evaluated as annual costs (\$/Year) and as the cost per gallon of methanol. The annual cost is computed from the cost per unit time and the annual capacity factor. The final cost of methanol is computed as follows:

$$\$/\text{Gallon Methanol} = \frac{\text{Annual Costs } (\$/\text{Year})}{365 * \text{LF} * 303 * X}$$

where:

LF = Annual Capacity Factor

X = Methanol Production Rate, short Tons per Day

The conversion factor 303 gallons per short ton of methanol is used in this equation.

The following is a summary of the components of the Operating Costs:

Syngas refers to the value (lower heating value [LHV] basis) of the syngas produced in the IGCC facility. When a specific application is defined, the cost (\$ per MMBtu) can be specified.

Unreacted Gas refers to the value (LHV basis) of the syngas returned from the LPMEOH™ plant to the IGCC facility. When a specific application is defined, the cost (\$ per MMBtu) can be specified.

Power used by the LPMEOH™ Process is evaluated at \$0.04/kWh, which is assumed to be the electricity costs from the adjacent IGCC facility. Categories of power consumers (compressors, pumps, etc.) are tabulated separately.

Steam is a credit from the LPMEOH™ Plant; a typical value of \$4.00/1,000 pounds of steam production (including the cost for boiler feed water and the credit for condensate return) is used for the 200 psig steam produced by the LPMEOH™ Reactor.

Cooling Water is evaluated at a 20°F temperature rise across all cooling water heat exchangers. A cost of \$0.12/1,000 gallons of cooling water is used in this study.

Other Miscellaneous Utilities (such as instrument air and N<sub>2</sub>) are calculated based upon the costs from the LPMEOH™ Demonstration Project.

Catalyst, Chemicals and Lubes refers to the estimated costs for the methanol synthesis catalyst, process mineral oil, and other lubricants. These values are based upon the costs from the LPMEOH™ Demonstration Project.

Zinc Oxide is used as the absorbent for the H<sub>2</sub>S which is present with the fresh feed syngas or is produced by the COS (carbonyl sulfide) Hydrolysis catalyst within the LPMEOH™ Process. Each of these consumables is evaluated based upon present costs for each material.

Operating Labor is calculated from the original budgetary forecast for the LPMEOH™ Demonstration Project (which was met during the operating program).

Maintenance costs are evaluated based upon an annual budget of 2% of the total capital cost for the evaluated LPMEOH™ Facility.

Property Taxes and Insurance are estimated at an annual budget of 1.5% of the total capital cost for the evaluated LPMEOH™ Facility.

Overhead is computed at a nominal rate of 15% of the operating costs (not including the costs for syngas or the credit for the unreacted gas).

Recovery of Capital Cost, Depreciation, and ROI (Return on Investment) are computed based upon a 15 year depreciation and a ROI of about 14%, which results in a total charge of 20% of the investment per year.

## **9.2 ESTIMATED PROCESS CAPITAL COSTS**

Table 9.2-1 provides a summary of the estimated capital costs for a 500 sT/D LPMEOH™ plant that coproduces a fuel-grade methanol (a minimum of 97 wt% methanol, a maximum of 1 wt% water, 1.5 wt% higher alcohols, and 0.5 wt% mineral oil from the LPMEOH™ Process) from CO-rich syngas (H<sub>2</sub>:CO = 0.68) in a coal-based IGCC power plant. These costs were originally

**Table 9.2-1  
Estimated Facility Investment Summary for Once-Through 500 sT/D LPMEOH™ Plant**

<u>INVESTMENT BREAKDOWN</u>			<u>MM-\$</u>
COMPRESSION			\$0.00
LPMEOH™ EQUIPMENT			\$5.09
VALVES & INSTRUMENTS			\$3.35
CONSTRUCTION			\$10.40
FREIGHT & MISCELLANEOUS			\$0.37
AIR PRODUCTS PROCESS STUDIES			\$0.22
AIR PRODUCTS TECHNICAL PACKAGE			\$0.97
PROJECT ENGINEERING			\$1.63
DESIGN ENGINEERING			\$3.88
FIELD ENGINEERING			\$1.15
TRAVEL & LIVING			\$0.29
RESERVE			\$0.00
LICENSE FEE			not incl
		Sub-total Turnkey Plant	\$27.35
OWNER'S COST	25% of Equipment		\$1.27
METHANOL STORAGE	30 days	5.0 MM Gallons	\$2.46
CO2 REMOVAL			\$0.00
		TOTAL CAPITAL	\$31.08

**PLOT AREA REQUIRED, ACRES**

LPMEOH™ = 0.11	Storage = 5.13	TOTAL	5.24
----------------	----------------	-------	------

**INVESTMENT BY AREA**

<u>AREA</u>	<u>INVESTMENT</u>	<u>DESIGN BASIS</u>	<u>MM-\$</u>
A	REACTOR LOOP & CATALYST REDUCTION	500 sT/D	\$18.60
B	FEED COMPRESSION	0 BHP	\$0.00
C	RECYCLE COMPRESSION	0 BHP	\$0.00
D	FRONT-END GAS CLEANUP	14552 LB-MOL/HR	\$3.00
E	COMMON EQUIPMENT	500 sT/D	\$1.85
F	SATURATOR		\$0.00
G	DISTILLATION	500 sT/D	\$2.71
	RESERVE	0.0 %	\$0.00
	AIR PRODUCTS PROCESS STUDIES		\$0.22
	AIR PRODUCTS TECHNICAL PACKAGE		\$0.97
	LICENSE FEE		not incl
		Sub-total Turnkey Plant	\$27.35

- Notes: 1) Syngas (H<sub>2</sub>:CO = 0.68) containing 5 ppmv COS is available at 1,000 psig.  
2) Equipment from LPMEOH™ demonstration unit, escalated to 2002\$, was used as basis.

published in the topical report on economics (referenced above). The capital cost of the LPMEOH™ demonstration unit, excluding the equipment items that were not used during the demonstration period (as described in Section 3.1), was used as a basis.

### 9.3 PROJECTED OPERATING AND MAINTANANCE COSTS

Table 9.3-1 provides a summary of the projected operating and maintenance costs for a 500 sT/D LPMEOH™ plant in the IGCC plant location. The operating and maintenance costs for the distillation system can be separated from the other conversion costs to yield a methanol conversion cost (in this case, a methanol conversion cost of \$0.155 per gallon, including capital recovery, was calculated); this terminology will be used in developing the impact of changes in operating parameters on costs in Section 9.5.

**Table 9.3-1**  
**Projected Operating and Maintenance Costs for Once-Through 500 sT/D LPMEOH™ Plant**

MeOH Production	500 sT/D				
Annual Load Factor	90 %				
Distillation to Fuel Grade Methanol					
Syngas H <sub>2</sub> :CO = 0.68					
				<b>M-\$/Yr</b>	<b>\$/Gal</b>
Syngas (LHV)	1434 MMBTU/hr	\$0.00 /MMBTU		\$0	\$0.000
Unreacted Gas (LHV)	(995) MMBTU/hr	\$0.00 /MMBTU		\$0	\$0.000
Power					
Feed Compressor	0 kW	\$0.04 /kWh		\$0	\$0.000
Recycle Compressor	0 kW	\$0.04 /kWh		\$0	\$0.000
Pumps, Heaters, etc.	382 kW	\$0.04 /kWh		\$121	\$0.002
Distillation	43 kW	\$0.04 /kWh		\$13	\$0.000
CO <sub>2</sub> Removal	0 kW	\$0.04 /kWh		\$0	\$0.000
LP Steam, 100 psig	3515 lb/hr	\$3.00 /M-lb		\$83	\$0.002
MP Steam, 200 psig	(49300) lb/hr	\$4.00 /M-lb		(\$1,555)	(\$0.031)
C Water, 20oF Delta T	652 gpm	\$0.12 /M-gal		\$37	\$0.001
Misc Utilities				\$240	\$0.005
Catalyst, Chemicals & Lubes				\$989	\$0.020
Sulfur Removal, Zinc Oxide	104 M-lb/yr	\$3.58 /lb		\$337	\$0.007
COS Hydrolysis Catalyst	6 M-lb/yr	\$3.63 /lb		\$18	\$0.000
Operating Labor				\$733	\$0.015
Maintenance	2% of Investment/yr			\$622	\$0.012
				<hr/>	<hr/>
			Sub-Total	\$1,638	\$0.033
Property Taxes, Insurance	1.5% of Investment/yr			\$466	\$0.009
Overhead	15% of Oper Costs (Less Feed)			\$252	\$0.005
				<hr/>	<hr/>
Capital Costs, Depr & ROI	20% of Investment/yr			\$6,212	\$0.125
				<hr/>	<hr/>
			Methanol Conversion Cost, Total	\$8,569	\$0.172

Notes: 1) Syngas (H<sub>2</sub>:CO = 0.68) containing 5 ppmv COS is available at 1,000 psig.  
2) Costs from LPMEOH™ demonstration unit, escalated to 2002\$, were used as basis.

## **9.4 SUMMARY OF PERFORMANCE AND ECONOMICS**

The capital cost summary for a 500 sT/D LPMEOH™ plant (Table 9.2-1) was developed based upon the design of and operating results from the LPMEOH™ demonstration unit. The scaleup of the size of the LPMEOH™ reactor (7.5' internal diameter, 260 sT/D design, greater than 300 sT/D demonstrated performance) can be managed; a topical report was issued on the construction of the reactor at the LPMEOH™ demonstration unit and the lessons learned that can be applied to the fabrication of larger diameter vessels.<sup>(b)</sup>

The operating cost summary (Table 9.3-1) was developed using the results from the 69-month operating program at the LPMEOH™ demonstration unit as the basis. Given the excellent on-stream performance (availability of 97.5%), a highly reliable system can be designed for future plants. In particular, the elimination of the slurry return pumps within the LPMEOH™ Process (refer to Section 3.1-1) was a key factor in achieving high on-stream time and lower maintenance costs. The basis for catalyst consumption is a catalyst deactivation rate of 0.4% per day, which was readily achieved during Kingsport Catalyst Campaign 4 (refer to Section 5.1.4). All other parameters (such as steam production from the LPMEOH™ reactor and steam consumption for distillation) were demonstrated during the operating phase of the LPMEOH™ Demonstration Project.

## **9.5 EFFECT OF VARIABLES ON ECONOMICS**

Cases were developed to illustrate the impact of key operating variables on the methanol conversion cost (as defined in Section 9.3). The space velocity in the LPMEOH™ reactor was selected based upon an analysis contained in the topical report on the economics of coproduction of methanol with electric power. To illustrate the sensitivity, two syngas supply pressures (500 psig and 1,000 psig) were used.

### **9.5.1 Plant Size**

Figure 9.5-1 shows the impact of methanol plant size on the methanol conversion cost for coal-derived syngas available at 1,000 psig. The once-through process yields the lowest conversion cost; the case at 500 sT/D was used as the basis for the capital and operating costs that were provided in Sections 9.2 and 9.3.

**Figure 9.5-1  
Effect of Methanol Plant Size on Methanol Conversion Cost**

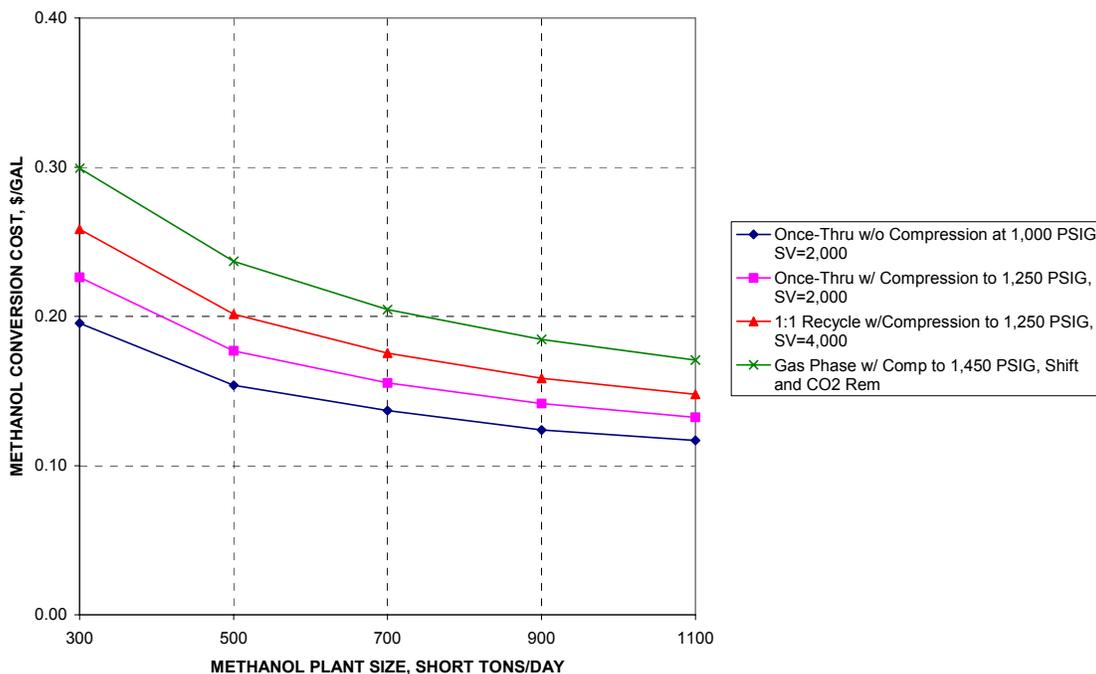

### 9.5.2 Sulfur Content

In this analysis, the fresh syngas was assumed to contain 5 ppmv of COS. To remove this catalyst poison the COS is first hydrolyzed over a metal oxide catalyst and then the H<sub>2</sub>S produced is removed with a zinc oxide bed. COS was selected to represent sulfur species in the syngas instead of H<sub>2</sub>S because of the higher capital cost associated with the hydrolysis step (operating costs for absorption of H<sub>2</sub>S and COS after hydrolysis are the same on a sulfur weight basis). Figure 9.5-2 shows the effect of an increase to 20 ppmv of COS in the syngas feed on the methanol conversion cost at 1,000 psig syngas supply pressure. There is an increase of \$0.05 to \$0.08/gal in the methanol conversion cost at lower syngas conversion, as a large amount of gas must be treated. As the amount of conversion is increased (independent of the methanol conversion technology), the effect on cost becomes more modest.

**Figure 9.5-2**  
**Effect of Syngas Conversion on Methanol Conversion Cost**

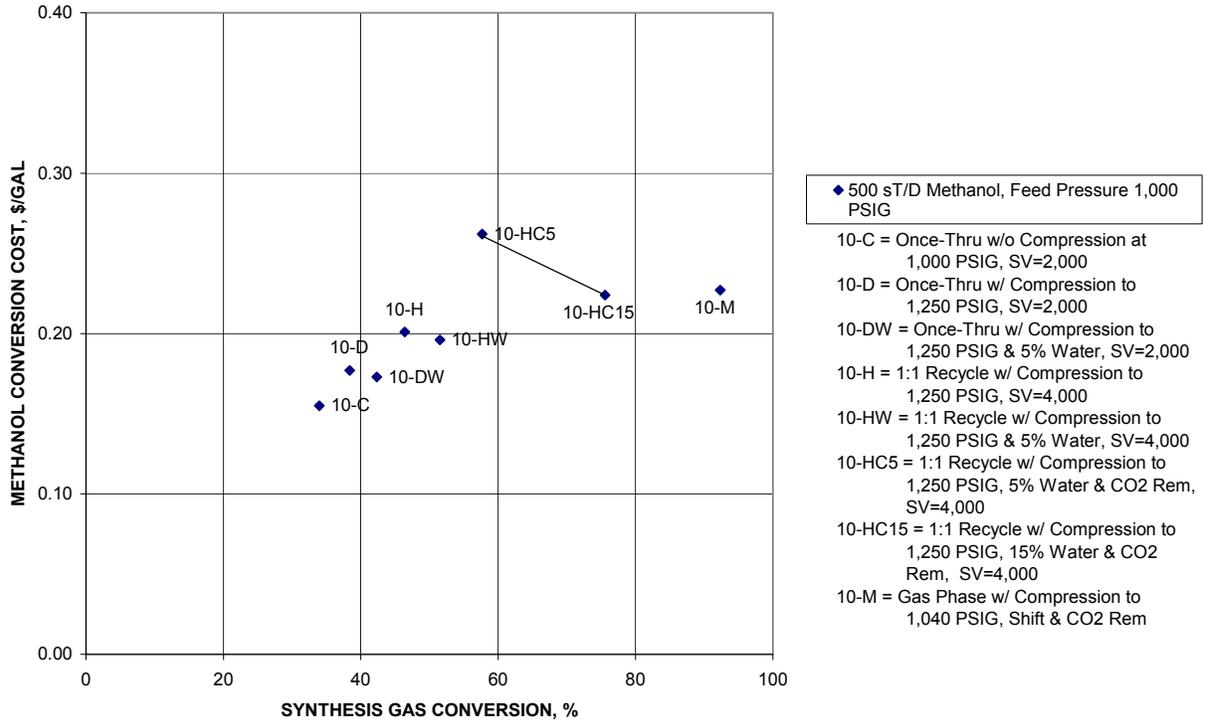

**9.5.3 Inert Content**

In this analysis, the fresh syngas was assumed to contain 1 vol% inerts. Increased levels of inerts can result from such parameters as the O<sub>2</sub> purity from the air separation unit feeding the coal gasifier. The greater the syngas conversion, the greater becomes the cost penalty of inert build up in the synthesis loop. Figure 9.5-3 shows the effect of an increase to 10% inerts in the feed syngas on the methanol conversion cost at 500 psig syngas supply pressure. For the once-through case (Case 5-A) there is a \$0.044/gal increase in cost along with a small reduction in conversion. With a 1:1 recycle at 1,250 psig (Case 5-H), the cost increase becomes less, \$0.015/gal. For the gas-phase process, the effect is much greater. In the case shown the inerts in the synthesis loop were limited to 35% to limit the impact on conversion due to lower partial pressure of reactants; this increases the methanol conversion cost by \$0.027/gal and greatly reduced the syngas conversion to 77%.



**Figure 9.5-3**  
**Effect of Inerts Concentration on Methanol Conversion Cost**

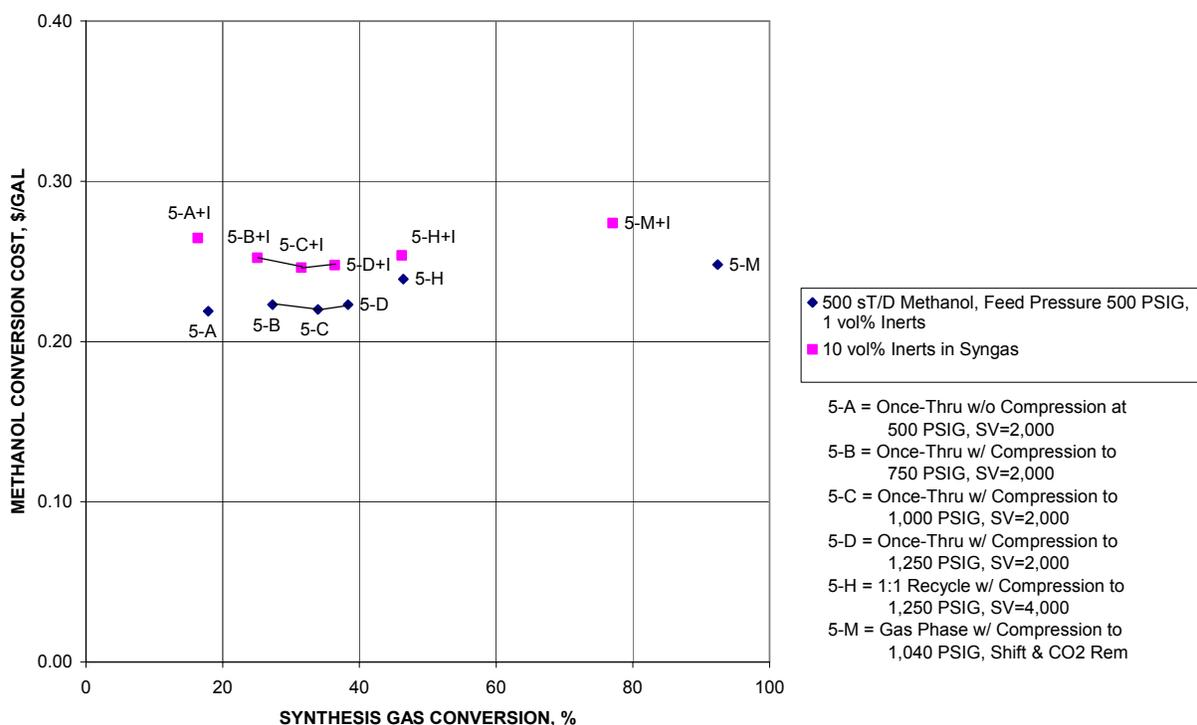

### 9.5.4 Capacity Factor

The depreciation and return on investment have a significant impact on the methanol conversion cost. These are magnified by the capacity factor, as this term is inversely related to the unit cost of methanol (\$ per gallon). All of the figures and tables presented to this point in this Section have used a capacity factor of 90%. An analysis was performed to determine the change in methanol conversion cost when the capacity factor is lowered to 70%. This is more representative of the coproduction of methanol with electric power in an IGCC load-following application. When syngas is available at 500 psig, the effect of lowering the capacity factor from 90% to 70% is to increase the methanol conversion cost by \$0.05 to \$0.06 per gallon of methanol. When the feed syngas is available at 1,000 psig, the methanol conversion cost increases by \$0.04 to \$0.05 per gallon of methanol when the capacity factor is lowered from 90% to 70%.

## **9.6 SECTION 9 BIBLIOGRAPHY**

- a. "LPMEOH™ Process as an Add-On to Integrated Gasification Combined Cycle (IGCC) for Coproduction - Economic Analysis", Topical Report Prepared by Air Products Liquid Phase Conversion Co., L.P., DOE Cooperative Agreement No. DE-FC22-92PC90543, October 1998.
- b. "Design and Fabrication of the First Commercial-Scale Liquid Phase Methanol (LPMEOH™) Reactor", Topical Report Prepared by Air Products Liquid Phase Conversion Co., L.P., DOE Cooperative Agreement No. DE-FC22-92PC90543, October 1998.

## 10.0 COMMERCIALIZATION POTENTIAL AND PLANS

### 10.1 MARKET ANALYSIS

#### 10.1.1 Applicability of the Technology

The LPMEOH™ Process is a very effective technology for converting a portion of the H<sub>2</sub> and CO in an IGCC electric power plant's coal-derived syngas to methanol. The process is very flexible in being able to process many variations in syngas composition. The LPMEOH™ Process can be used with an IGCC power plant to provide the once-through methanol production as depicted in Figure 7.1-1. The process can be designed to operate in a continuous, baseload manner, converting syngas from oversized gasifiers or from a spare gasifier. The process can also be designed to operate only during periods of off-peak electric power demand to consume a portion of the excess syngas and allow the electricity output from the combined-cycle power unit to be reduced. In this latter circumstance, the gasifiers continue to operate at full baseload capacity, so the IGCC facility's major capital asset is fully utilized. In either baseload or cycling operation, partial conversion of between 20% and 40% of the volume of H<sub>2</sub> and CO in the IGCC power plant's syngas is optimal on an economic basis, and conversion of up to 50% is feasible.

A simplified process flow diagram for the LPMEOH™ Process design options is shown in Figure 10.1-1. This shows several once-through LPMEOH™ Process design options, as described more fully in the Public Design Report (Final Report - Volume 1) and in a topical report on the economics of methanol coproduction as an add-on to an IGCC power plant.

In its simplest configuration, part or all of the CO-rich syngas at its maximum available pressure from the IGCC power plant (Stream 1) is passed once, without recycle, through the LPMEOH™ reactor. The unreacted syngas (Stream 3) is returned to the IGCC power plant's combustion turbines.

If greater amounts of syngas conversion are required, different design options are available:

- a) Use of Gas Recycle;
- b) Once-Through, with Feed Gas Compression;
- c) Once-Through, with Water Addition;
- d) Once-Through, with Water Addition and CO<sub>2</sub> Removal; and
- e) Staged Liquid Phase Reactors.

With any of these options, there is still no need for upstream stoichiometric adjustment of the feed gas by the water-gas shift reaction and CO<sub>2</sub> removal, so the simplicity of once-through CO-rich gas processing is retained.

The design configuration for the LPMEOH™ Process depends upon the degree of conversion of syngas (or the quantity of methanol produced relative to the power plant size).

**Figure 10.1-1**  
**LPMEOH™ Process Flow Diagram – Design Options for IGCC Applications**

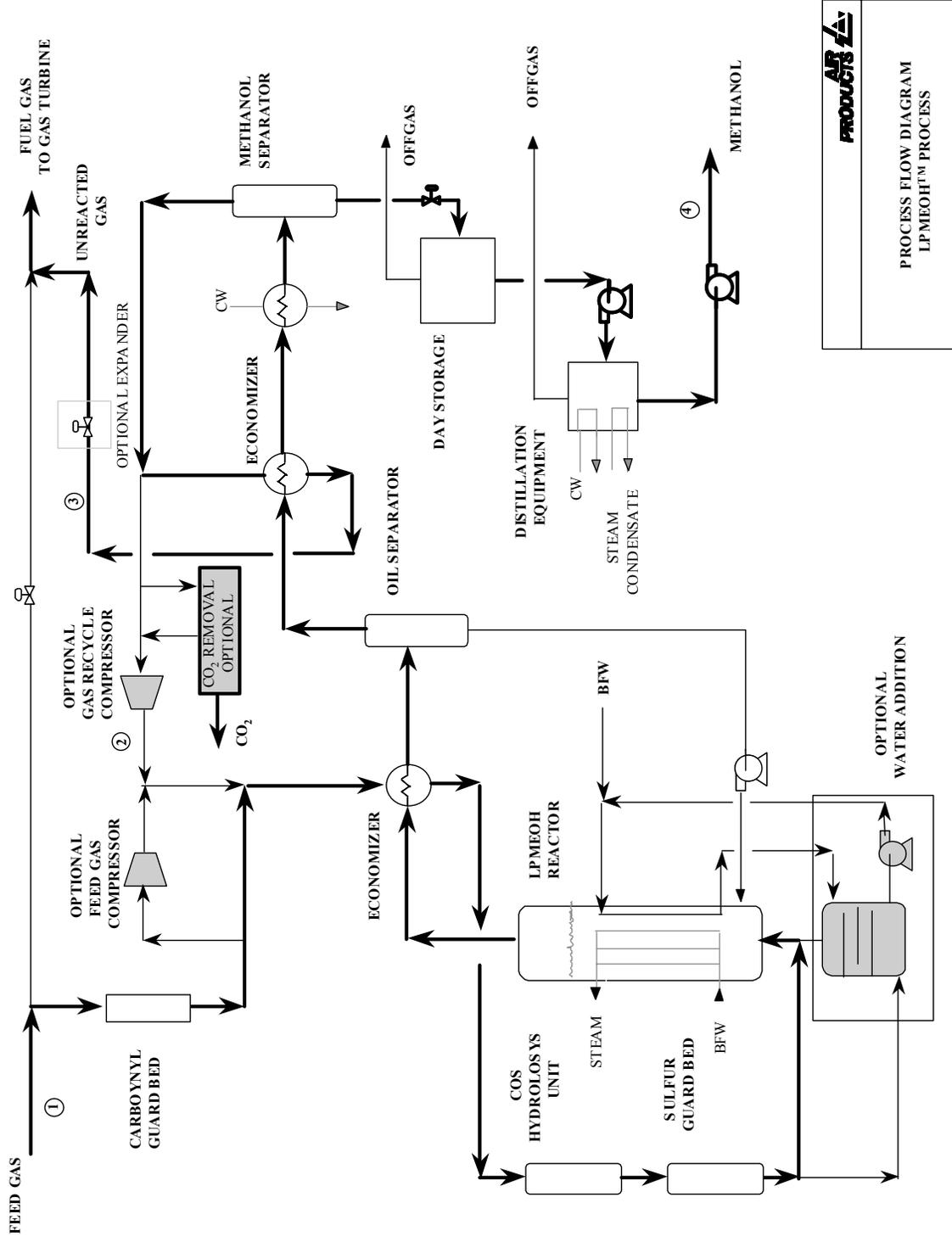

The features of the LPMEOH™ Process that satisfy the requirements in the coproduction application can also be applied to other carbon-rich feedstocks such as petroleum coke and other environmentally disadvantaged fuels. The LPMEOH™ Process has also shown the potential to meet the economic requirements for large, natural gas-based methanol production plants.<sup>(a)</sup>

### 10.1.2 Market Size and Barriers

Table 10.1.2-1 provides an assessment by the Methanol Institute of the forecast of the market for methanol through 2007.<sup>(b)</sup> The decrease in demand for methanol to produce MTBE is expected to be offset by increases in other basic chemicals such as formaldehyde and methyl methacrylate. Beyond this analysis, the potential exists for future market growth for methanol as a source of H<sub>2</sub> for fuel cell systems.

As noted in Section 10.1.1, a key market for the LPMEOH™ Process is the coproduction of methanol with electric power in an IGCC power plant. Using the DOE's High Fossil Electricity Technology Case that relates to the output of DOE's Fossil Energy program, the potential market for IGCC power plants in the United States could exceed 60 GW by 2020.<sup>(c)</sup> Assuming that coproduction could be a candidate for 10-20% of this total, the opportunity can exist for significant market participation for the LPMEOH™ Process.

The methanol marketplace is currently undergoing a period of transition due to the planned elimination of MTBE by several states in the United States as well as the development of large (greater than 5,000 metric tons per day), off-shore methanol plants utilizing low-cost natural gas as feedstock.

Future markets will depend on such factors as the rate of growth of the IGCC power generation

**Table 10.1.2-1**  
**Market Forecast for Methanol**  
(Thousands of Metric Tons; Source: Methanol Institute)

<b>SUPPLY</b>	2003	2004	2005	2006	2007
Capacity Available	35,680	38,617	40,692	39,944	40,910
Production	30,427	31,016	31,774	31,885	32,196
Excess Capacity	5,253	7,601	8,918	8,059	8,714
Operating Rate	85%	80%	78%	80%	79%
<b>DEMAND</b>					
Formaldehyde	11,000	11,390	11,708	12,029	12,386
MTBE	7,506	7,428	7,197	6,598	6,207
Acetic Acid	3,339	3,374	3,649	3,735	3,826
Dimethyl Terephthalate	590	590	603	618	632
Methyl Methacrylate	892	923	979	1,004	1,030
Gas/Fuels	859	867	896	946	988
Solvents	1,285	1,313	1,342	1,379	1,411
Others	4,956	5,131	5,401	5,577	5,716
<b>TOTAL DEMAND</b>	<b>30,427</b>	<b>31,016</b>	<b>31,774</b>	<b>31,885</b>	<b>32,196</b>

business, global methanol market prices, and government incentives aimed at encouraging IGCC and/or IGCC coproduction projects, consistent with DOE's Vision 21. Methanol coproduction with IGCC power generation, using the LPMEOH™ Process, will continue to benefit from the economies of scale provided by the gasification plant, and result in lower methanol costs than for a standalone methanol plant with the same methanol production capacity. Methanol transport economies, compared with imported methanol based on low cost stranded natural gas, can also be achieved by serving local inland markets. Outside the United States, most of the current interest in LPMEOH™ technology has come from China, because of China's abundance of coal, historic dependence on domestic chemical production, and the amenability of the LPMEOH™ Process to coal-based syngas. In the longer term, the development of clean coal projects in China utilizing IGCC technology would provide a platform for additional interest in the LPMEOH™ Process. In the U.S., interest in LPMEOH™ technology will also depend on the development and timing of the IGCC industry, which in turn will depend on a number of factors, notably, natural gas price and availability, further improvement in IGCC economics, new environmental regulations further affecting coal-based power generation, and government incentives.

### **10.1.3 Economic Comparison with Competing Technologies**

As noted in Section 9, a topical report was written during the performance period that compared the cost of methanol as produced from the LPMEOH™ Process and from a conventional gas-phase process as applied to a generic 500 sT/D methanol plant as part of an IGCC coproduction facility. The cost of methanol was calculated as the sum of three terms: the methanol conversion cost (which includes the fixed and operating costs for the methanol unit), the distillation cost, and the syngas cost from the IGCC facility. A proprietary cost estimation screening program was used to calculate the methanol conversion cost and the distillation cost from the LPMEOH™ Process and the gas-phase process for various syngas supply pressures and on-stream factors. The methanol conversion cost from the LPMEOH™ Process was \$0.02 to \$0.07 per gallon lower than from the gas-phase methanol process.

A major component of the methanol conversion cost in an IGCC complex is the cost to distill the as-produced methanol product in order to meet the final specification. It is typical for methanol to be stabilized (either by distillation or by deep flashing) to remove volatile components (such as CO<sub>2</sub>) and permit shipment and transport in atmospheric vessels. Beyond stabilization, other distillation may be necessary so that the final methanol product meets the specification for the designated end-use. There are two grades of methanol product (Chemical-Grade AA and Fuel-Grade) that could be used in downstream chemical or power applications. These grades of methanol differ in the amounts of water and higher alcohols that are present in the final product. In particular, the Fuel-Grade product has a water specification of 1 wt%, while the Chemical-Grade AA methanol has a maximum water content of 0.1 wt%.

The LPMEOH™ Process, which can directly process coal-derived syngas which is rich in CO, produces a methanol product with nominally about 1 wt% water. Whereas, gas-phase methanol synthesis results in as-produced methanol stream with 2-20 wt% water, depending on the amount of CO<sub>2</sub> in the syngas which is converted to methanol and water. This resulted in lower purification cost for the LPMEOH™ Process for the Fuel-Grade product. By applying the same

cost estimation screening program, the distillation cost to produce Fuel-Grade methanol from the LPMEOH™ Process which directly utilizes CO-rich syngas was about \$0.02 per gallon less than from the gas-phase methanol process.

Sensitivity studies performed as part of this Report indicated that the magnitude of the advantage in the methanol conversion cost for the LPMEOH™ Process when compared with the conventional gas-phase process is increased when:

- a) the syngas is rich in CO,
- b) syngas is available at higher pressures,
- c) only modest syngas conversion to methanol is required,
- d) syngas is available with low H<sub>2</sub>S and COS content,
- e) inerts in the syngas (such as N<sub>2</sub> in the O<sub>2</sub> from the air separation unit feeding the gasifier) are relatively high, and
- f) Fuel-Grade Methanol is required.

Table 10.1.3-1 summarizes several operating scenarios for a baseload 500 sT/D LPMEOH™ Facility, when compared with the more complex 500 sT/D gas-phase methanol facility. As in the prior discussion, the baseload coproduction assumes that the syngas is normally available 90% of the time and syngas is charged at \$4.50 per MMBtu. Cost advantages of \$0.04 to \$0.11 per gallon of methanol can be realized by utilizing the LPMEOH™ Process.

## 10.2 COMMERCIALIZATION PLAN

During the development phase for the LPMEOH™ technology, a team within Air Products was assembled to manage the various programs needed to achieve commercial readiness. With the conclusion of the LPMEOH™ Demonstration Project, these efforts have achieved this goal. Future commercial activities will be managed from the Worldwide Hydrocarbon Equipment business unit.

Any future offerings will be based on the results from both the 4-month proof-of-concept run at the LaPorte AFDU and the operation at the LPMEOH™ demonstration unit. Future process flow

**Table 10.1.3-1**  
**Baseload Coproduction, 500 sT/D, Fuel Grade Methanol**  
 CO-rich Syngas (H<sub>2</sub>:CO = 0.68) @ \$4.50 per MMBtu

Syngas Feed Pressure, psig	<u>500</u>	<u>500</u>	<u>1,000</u>	<u>1,000</u>
Flow Scheme	Once-Through	1:1 Recycle	Once-Through	1:1 Recycle
Syngas Conversion, %	34	46	34	46
Methanol Cost, \$/Gal	0.548	0.567	0.483	0.529
LPMEOH™ Advantage over gas-phase, \$/Gal	0.055	0.036	0.109	0.063

diagrams will derive from the as-built flowsheet from the LPMEOH™ demonstration unit. Catalyst performance has improved since the completion of the second in-situ catalyst activation in June of 2002, and provides an indication of the potential for improved economics for the LPMEOH™ Process. Future project opportunities will likely be based on coal-derived syngas in either IGCC facilities or standalone coal-to-chemicals complexes, or syngas that is produced from environmentally disadvantaged feedstocks (such as petroleum coke). Facility availability at the LPMEOH™ demonstration unit has been excellent since initial startup, and consistent with the high demands that accompany these capital-intensive projects.

### **10.3 SECTION 10 BIBLIOGRAPHY**

- a. D. E. Benedict, E. C. Heydorn, and T. R. Tsao (Air Products and Chemicals, Inc.), “Economics of Methanol Production from Natural Gas Using Liquid Phase Methanol Synthesis”, Paper Presented at 2001 World Methanol Conference, 05-07 November 2001.
- b. “World Methanol Supply and Demand”, Methanol Institute Fact Sheet, published at [www.methanol.org](http://www.methanol.org).
- c. “Forecasting the Benefits of DOE Programs for Advanced Fossil-Fuel Electricity Generating Technologies: The EIA High Fossil Electricity Technology Case”, U.S. DOE Office of Fossil Energy, National Energy Technology Laboratory, Office of Systems and Policy Support, October 2002.



## 11.0 CONCLUSIONS AND RECOMMENDATIONS

The LPMEOH™ Demonstration Project accomplished the objectives set out in the Cooperative Agreement with DOE for this Clean Coal Technology project. Methanol operation began on 02 April 1997, and startup was completed in two days. Nameplate production of 80,000 gallons per day (260 sT/D) was achieved within four days, and production rates exceeding 115% of design were achieved within six days. Overall availability of the LPMEOH™ demonstration unit was 97.5%, and the longest operating period without interruption of any kind was 94 days. Over 103.9 million gallons of methanol was produced, including a one-month maximum of 2.5 million gallons. Eastman accepted all of the available methanol for use in the production of methyl acetate, and ultimately cellulose acetate and acetic acid.

The slurry bubble column reactor was successfully scaled from the 10 sT/D LaPorte AFDU to the 260 sT/D LPMEOH™ demonstration unit. The LPMEOH™ reactor did not exhibit any hydrodynamic instability, and the maximum catalyst loading of 151% of the design value of about 40,000 pounds (corresponding to a slurry concentration of greater than 49 wt%) was achieved. The gas sparger at the inlet to the LPMEOH™ reactor was replaced with two modified units (using the same design principles as the original device), and stable performance was realized when a continuous flush of condensed process oil (in this case, by gravity) was utilized.

Catalyst performance (as determined by the rate of catalyst deactivation using an in-house kinetic model) improved during the demonstration test period. Initially high deactivation rates using Balanced Gas (greater than 1% per day vs. the design basis of 0.4% per day from a 4-month proof-of-concept run on CO-rich syngas derived from natural gas at the LaPorte AFDU [1988/89]) at the design operating temperature of 250°C were attributed to the presence of post-construction debris in the reactor system. During the second catalyst campaign that began in December of 1997, the rate of catalyst deactivation was calculated to be 0.6 to 0.7% per day at a reactor temperature of 235°C. The practice of catalyst withdrawal and addition (removing a portion of the spent catalyst from the LPMEOH™ reactor and adding fresh catalyst in 2,000 pound batches) to maintain the desired methanol production rate was successfully demonstrated.

In determining the reasons for the higher rate of catalyst deactivation, the presence of certain elements (in particular, arsenic and sulfur) was identified from samples of spent catalyst, spent adsorbent materials from catalyst guard beds, and syngas entering the LPMEOH™ demonstration unit. A commercially available copper oxide-impregnated activated carbon was identified as having capacity to remove arsenic (in the form of arsine) within the existing carbonyl guard bed that was originally designed for removal of metal carbonyls at ambient temperature.

In parallel, laboratory testing was performed to develop a procedure to activate (or reduce) a full charge of methanol synthesis catalyst within the LPMEOH™ reactor (so-called in-situ activation). During the operating program, this feature was identified as having significant commercial interest, as capital cost savings of about 10% could be realized by elimination of the separate processing equipment for the catalyst withdrawal/addition procedure. Also, operating the LPMEOH™ reactor at low temperatures at the outset and slowly increasing temperature with

time to maintain a constant production of methanol (called temperature programming) was believed to have the potential to extend the life of the methanol synthesis catalyst. Following the first in-situ activation of methanol synthesis catalyst in August of 2001 (during which initial performance of the catalyst was about 70% of the value expected from the laboratory testing), the concept of temperature programming was demonstrated (temperature was gradually raised from 216°C to 250°C in order to maintain the desired methanol production rate). Following changes to the storage conditions of the catalyst slurry prior to reduction, the in-situ activation procedure was successfully practiced in June of 2002, resulting in the catalyst meeting the initial performance targets.

During the final six months of operation under the demonstration test plan, the average rate of catalyst deactivation was calculated to be 0.17% per day, which was ½ of the design basis for the LPMEOH™ demonstration unit. The reactor was maintained at a constant low temperature of 215°C during this period, and the carbonyl guard bed adsorbent (copper oxide-impregnated activated carbon) was replaced with fresh material after 3 months of operation (including a novel thermal treatment that was applied after two months to extend the useful life of the adsorbent). Because the impact of catalyst cost on the economics of methanol production is significant (reducing the rate of catalyst deactivation by up to ½ of the current basis can realize a 25 percent reduction in variable cost), this performance demonstrated the potential of the LPMEOH™ process to meet the targets for catalyst consumption utilizing coal-derived syngas.

Although the host site for the LPMEOH™ demonstration unit was a chemical production facility, testing was able to be performed to simulate the performance of the LPMEOH™ Process in an IGCC power plant. A total of 78 days of testing at a variety of H<sub>2</sub>:CO ratios were performed to evaluate the effect of syngas compositions expected from coal-based IGCC units on the performance of the LPMEOH™ Process. All of the results met the expectations for methanol production rate based upon earlier studies in the laboratory. Catalyst performance for the LPMEOH™ reactor with lower H<sub>2</sub>:CO ratios were not significantly impacted based on the calculated rate of catalyst deactivation. On/off and ramping studies were also completed, and the LPMEOH™ demonstration unit was capable of meeting the ramping requirements for an IGCC system by achieving the goal of a minimum 5% change in design flow per minute. Tests of the ability of the LPMEOH™ reactor to operate in an electrical load-following environment were also successful.

An off-site, fuel-use test program was conducted to demonstrate the suitability of stabilized (degassed) methanol product as a transportation fuel and as a fuel for stationary applications for small modular electric power generators for distributed power. Stabilized (degassed) methanol produced from CO-rich syngas in the LPMEOH™ Process can have less than 1 wt% water, and has the potential to be used directly in these applications. Stabilized methanol from the LPMEOH™ Demonstration Project was made available to seven test locations. Successful demonstration of the use of stabilized methanol in these applications can enhance the flexibility of and revenue from IGCC plants. In bus and FFV trials, stabilized methanol provided the same environmental benefits as chemical-grade methanol with no penalty on performance or fuel economy. Tests in a gas turbine and a diesel generator showed that levels of NO<sub>x</sub> in the exhaust air were lowered when stabilized methanol or methanol emulsions are used instead of conventional oil fuels. As with chemical-grade methanol, lubrication additives will likely be

required when stabilized methanol is fed to a gas turbine. Testing of stabilized methanol as the source of H<sub>2</sub> to a phosphoric acid fuel cell has shown that conventional steam reforming catalysts are not compatible with the trace mineral oil present in the stabilized methanol; when auto-thermal reforming or partial oxidation reforming are used, the stabilized methanol would possibly be acceptable as a fuel. Methanol from the LPMEOH™ Process that is purified to chemical-grade specifications should be suitable for use in this application.

As a secondary objective to the LPMEOH™ Demonstration Project, design verification testing was completed to evaluate capability of the slurry bubble column reactor to produce DME as a mixed coproduct with methanol using the LPDME™ Process. In addition to its current uses, DME has potential applications as a chemical building block. Also, since the physical properties of DME are similar to those of LPG, it has been speculated that DME could be used in large scale power production, in home heating, in replacement of LPG for automobiles, and as a diesel fuel substitute or combustion supplement. Economic targets on the production cost of DME from the LPDME™ Process were established, and a 25-day design verification test was performed at the LaPorte AFDU in 1999. The rate of catalyst deactivation for both the methanol synthesis and dehydration catalysts was calculated to be 0.7% per day, which was a large improvement over the 4% per day rate of deactivation which was calculated from autoclave studies prior to the initial test of the LPDME™ Process at the LaPorte AFDU in 1991; these results were slightly higher than the results (0.5% per day) for the LPMEOH™ Process from the first 3 weeks of the 4-month proof-of-concept run at the LaPorte AFDU in 1988/89. Follow-up economic analysis showed that the target DME cost of \$7 to \$8 per MMBtu (equivalent to costs for LPG in China) can likely be achieved at plant sizes approaching 1,100 sT/D. The program participants agreed that additional work on DME should be deferred so that all resources could be directed toward improving the catalyst performance for the LPMEOH™ Process during the remaining time within the operating program.

The commercial application of the LPMEOH™ technology with the greatest long-term potential continues to be the coproduction of methanol within an IGCC power plant. The ability of the slurry reactor to ramp rapidly and to start/stop easily makes it amenable to peak shaving scenarios in an IGCC power plant. Of significant interest is that relatively small quantities (30,000 gallons per day) of methanol can be coproduced from coal at world scale (greater than 600,000 gallons per day) economics. Parametric studies were performed to determine the production cost of methanol from the LPMEOH™ Process in an IGCC power plant. The process can be designed to operate in a continuous, baseload manner, converting syngas from oversized gasifiers or from a spare gasifier. The process can also be designed to operate only during periods of off-peak electric power demand to consume a portion of the excess syngas and allow the electricity output from the combined-cycle power unit to be reduced. In this latter circumstance, the gasifiers continue to operate at full baseload capacity, so the IGCC facility's major capital asset is fully utilized. In either baseload or cycling operation, partial conversion of between 20% and 40% of the volume of H<sub>2</sub> and CO in the IGCC power plant's syngas is optimal on an economic basis, and conversion of up to 50% is feasible. Methanol conversion costs of about \$0.15 per gallon were determined for a coal-based IGCC plant using the once-through configuration; when the cost of syngas is added, the price of methanol is less than \$0.50 per gallon. As the economics for IGCC systems improve, the economics for coproduction of

methanol will continue to look attractive in local markets when compared with methanol that is produced in off-shore locations from natural gas.

Further reductions to the cost of syngas from a modern coal gasification system will increase the market opportunities for coproduction of chemicals such as methanol from the LPMEOH™ Process. Developments of and advancements in the processes for the removal of trace contaminants in coal-derived syngas will extend catalyst life and lead to lower methanol conversion costs. Continued studies of the hydrodynamics of slurry bubble column reactors would facilitate the use of larger diameter reactors, which will improve the economies of scale for all potential feedstocks (coal, natural gas, environmentally disadvantaged fuels).

## 12.0 OTHER PROJECT REPORTS AND PUBLICATIONS

(since the Public Design Report [Final Report - Volume 1])

Note: Reports or publications on specific topics are included in individual chapters where appropriate.

1. Technical Progress Report No. 34, October - December 2002.
2. Technical Progress Report No. 33, July - September 2002.
3. Technical Progress Report No. 32, April - June 2002.
4. Technical Progress Report No. 31, January - March 2002.
5. Technical Progress Report No. 30, October - December 2001.
6. Technical Progress Report No. 29, July - September 2001.
7. Technical Progress Report No. 28, April - June 2001.
8. Technical Progress Report No. 27, January - March 2001.
9. Technical Progress Report No. 26, October - December 2000.
10. Technical Progress Report No. 25, July - September 2000.
11. Technical Progress Report No. 24, April - June 2000.
12. Technical Progress Report No. 23, January - March 2000.
13. Technical Progress Report No. 22, October - December 1999.
14. Technical Progress Report No. 21, July - September 1999.
15. Technical Progress Report No. 20, April - June 1999.
16. Technical Progress Report No. 19, January - March 1999.
17. Technical Progress Report No. 18, October - December 1998.
18. Technical Progress Report No. 17, July - September 1998.
19. Technical Progress Report No. 16, April - June 1998.
20. Technical Progress Report No. 15, January - March 1998.
21. Technical Progress Report No. 14, October - December 1997.
22. Technical Progress Report No. 13, July - September 1997.
23. Technical Progress Report No. 12, April - June 1997.
24. Technical Progress Report No. 11, January - March 1997.
25. Technical Progress Report No. 10, October - December 1996.
26. Technical Progress Report No. 9, July - September 1996.
27. Technical Progress Report No. 8, April - June 1996.
28. Technical Progress Report No. 7, January - March 1996.
29. Technical Progress Report No. 6, October - December 1995.
30. Technical Progress Report No. 5, July - September 1995.
31. Technical Progress Report No. 4, April - June 1995.
32. Technical Progress Report No. 3, October 1994 - March 1995.
33. Technical Progress Report No. 2, July - September 1994.
34. Technical Progress Report No. 1, October 1993 - June 1994.
35. Environmental Monitoring Report No. 23, October - December 2002.
36. Environmental Monitoring Report No. 22, July - September 2002.
37. Environmental Monitoring Report No. 21, April - June 2002.
38. Environmental Monitoring Report No. 20, January - March 2002.
39. Environmental Monitoring Report No. 19, October - December 2001.
40. Environmental Monitoring Report No. 18, July - September 2001.
41. Environmental Monitoring Report No. 17, April - June 2001.
42. Environmental Monitoring Report No. 16, January - March 2001.
43. Environmental Monitoring Report No. 15, October - December 2000.
44. Environmental Monitoring Report No. 14, July - September 2000.

45. Environmental Monitoring Report No. 13, April - June 2000.
46. Environmental Monitoring Report No. 12, January - March 2000.
47. Environmental Monitoring Report No. 11, October - December 1999.
48. Environmental Monitoring Report No. 10, July - September 1999.
49. Environmental Monitoring Report No. 9, April - June 1999.
50. Environmental Monitoring Report No. 8, January - March 1999.
51. Environmental Monitoring Report No. 7, October - December 1998.
52. Environmental Monitoring Report No. 6, July - September 1998.
53. Environmental Monitoring Report No. 5, April - June 1998.
54. Environmental Monitoring Report No. 4, January - March 1998.
55. Environmental Monitoring Report No. 3, October - December 1997.
56. Environmental Monitoring Report No. 2, July - September 1997.
57. Environmental Monitoring Report No. 1, April - June 1997.
58. "Commercial-Scale Demonstration of the Liquid Phase Methanol (LPMEOH™) Process", Public Design Report (Final Design Report, Volume 1: Public Design)", Prepared by Air Products Liquid Phase Conversion Co., L.P., DOE Cooperative Agreement No. DE-FC22-92PC90543, January 2000.
59. "Commercial-Scale Demonstration of the Liquid Phase Methanol (LPMEOH™) Process", Demonstration Technology Startup Report", Prepared by Air Products Liquid Phase Conversion Co., L.P., DOE Cooperative Agreement No. DE-FC22-92PC90543, September 1998.
60. "Peroxide Formation of Dimethyl Ether in Methanol Mixtures", Topical Report Prepared by Air Products Liquid Phase Conversion Co., L.P., DOE Cooperative Agreement No. DE-FC22-92PC90543, November 1997.
61. "Liquid Phase Methanol (LPMEOH™) Process Development", E. C. Heydorn, B. W. Diamond (Air Products and Chemicals, Inc.), R. D. Lilly (Eastman Chemical Co.), and R. M. Kornosky (U.S. Department of Energy), 2001 Pittsburgh Coal Conference, 04-07 December 2001.
62. "Liquid Phase Methanol (LPMEOH™) Process Development Demonstration Plant Availability", D. E. Benedict, E. C. Heydorn (Air Products and Chemicals, Inc.), R. D. Lilly (Eastman Chemical Co.), and R. M. Kornosky (U.S. Department of Energy), 2001 Gasification Technologies Conference, 07-10 October 2001.
63. "Lubricity Problems and Solutions in a Methanol Fueled Gas Turbine", R. E. Bond, J. L. Loth, R. W. Guiler, N. N. Clark (West Virginia University), E. C. Heydorn, P. J. A. Tijm (Air Products and Chemicals, Inc), 2000 International Mechanical Engineering Congress and Exposition, 05-10 November 2000.
64. "Liquid Phase Methanol (LPMEOH™) Process Development", E. C. Heydorn, P. J. A. Tijm, B. L. Bhatt (Air Products and Chemicals, Inc.), B. T. Smith (Eastman Chemical Co.), and R. M. Kornosky (U.S. Department of Energy), Energex 2000 – The 8<sup>th</sup> International Energy Forum, 23-28 July 2000.
65. "Catalyst and Process Development for Liquid Phase DME Synthesis", B. L. Bhatt, B. A. Toseland, X. D. Peng, E. C. Heydorn, (Air Products and Chemicals, Inc.), 2000 Pittsburgh Coal Conference, 11-15 September 2000.
66. "Liquid Phase Methanol (LPMEOH™) Project: Operating Experience Update", P. J. A. Tijm, E. C. Heydorn, B. W. Diamond (Air Products and Chemicals, Inc.), B. T. Street (Eastman Chemical Co.), and R. M. Kornosky (U.S. Department of Energy), 1999 Gasification Technologies Conference, 17-20 October 1999.
67. "Commercial-Scale Demonstration of the Liquid Phase Methanol (LPMEOH™) Process, Clean Coal Technology Topical Report No. 11, April 1999.
68. "Commercial-Scale Demonstration of the Liquid Phase Methanol (LPMEOH™) Process: Initial Operating Experience", E. C. Heydorn, V. E. Stein, P. J. A. Tijm (Air Products and Chemicals Inc.), B. T. Street (Eastman Chemical Co.), and R. M. Kornosky (U.S. Department of Energy), Sixth Clean Coal Technology Conference, May 1998.

## **APPENDIX A**

### **ANALYTICAL MEASUREMENTS FOR LPMEOH™ DEMONSTRATION UNIT**

**Table A-1**  
**Summary of Streams to be Analyzed for Material Balance Calculations**

Stream No.	10	19
Description	CO Gas to LPMEOH™ Demonstration Unit	Distillation Fuel Gas
PFD Material Balance Point No.	10	--
Gas Chromatograph Point No.	2	8
Reported in:		
EMRs (Compliance)		
EMRs (Supplemental)	X (Summary Data)	
Technical Progress Reports	X	X
Test Series Report (one time)		
Temperature	X	X
Pressure	X	X
Flow Rate	X	X
Composition		
<b>LPMEOH™ Gas Analysis (vol%)</b>	X	X
Hydrogen		
Carbon Monoxide		
Nitrogen		
Carbon Dioxide		
Methanol		
Dimethyl Ether		
Methane		
Oxygen (Argon)		
Trace (by difference)		
Analysis Frequency	Continuous	Continuous
Sampling Technique	Piped to GC	Piped to GC
Analytical Method	GC	GC



**Table A-1**  
**Summary of Streams to be Analyzed for Material Balance Calculations (cont'd)**

Stream No.	20	30
Description	H <sub>2</sub> Gas to LPMEOH™ Demonstration Unit	Balanced Gas to LPMEOH™ Demonstration Unit
PFD Material Balance Point No.	20	30
Gas Chromatograph Point No.	3	1
Reported in:		
EMRs (Compliance)		
EMRs (Supplemental)	X (Summary Data)	X (Summary Data)
Technical Progress Reports	X	X
Test Series Report (one time)		
Temperature	X	X
Pressure	X	X
Flow Rate	X	X
Composition		
<b>LPMEOH™ Gas Analysis (vol%)</b>	X	X
Hydrogen		
Carbon Monoxide		
Nitrogen		
Carbon Dioxide		
Methanol		
Dimethyl Ether		
Methane		
Oxygen (Argon)		
Trace (by difference)		
Analysis Frequency	Continuous	Continuous
Sampling Technique	Piped to GC	Piped to GC
Analytical Method	GC	GC

Notes:

- a. Stream 20 was not available during operation of the LPMEOH™ demonstration unit (refer to Section 3.1.3).

**Table A-1**  
**Summary of Streams to be Analyzed for Material Balance Calculations (cont'd)**

Stream No.	109	120
Description	Reactor Feed Gas	Reactor Section Effluent Gas
PFD Material Balance Point No.	109	120
Gas Chromatograph Point No.	5	6
Reported in:		
EMRs (Compliance)		
EMRs (Supplemental)	X (Summary Data)	
Technical Progress Reports	X	X
Test Series Report (one time)		
Temperature	X	X
Pressure	X	X
Flow Rate	X	X
Composition		
<b>LPMEOH™ Gas Analysis (vol%)</b>	X	X
Hydrogen		
Carbon Monoxide		
Nitrogen		
Carbon Dioxide		
Methanol		
Dimethyl Ether		
Methane		
Oxygen (Argon)		
"Other" (by difference)		
Analysis Frequency	Continuous	Continuous
Sampling Technique	Piped to GC	Piped to GC
Analytical Method	GC	GC

**Table A-1**  
**Summary of Streams to be Analyzed for Material Balance Calculations (cont'd)**

Stream No.	148	149
Description	Main (Plant) Purge	Recycle Gas
PFD Material Balance Point No.	148	149
Gas Chromatograph Point No.	7	7
Reported in:		
EMRs (Compliance)		
EMRs (Supplemental)	X (Summary Data)	
Technical Progress Reports	X	X
Test Series Report (one time)		
Temperature	X	X
Pressure	X	X
Flow Rate	X	X
Composition		
<b>LPMEOH™ Gas Analysis (vol%)</b>	X	X
Hydrogen		
Carbon Monoxide		
Nitrogen		
Carbon Dioxide		
Methanol		
Dimethyl Ether		
Methane		
Oxygen (Argon)		
"Other" (by difference)		
Analysis Frequency	Continuous	Continuous
Sampling Technique	Piped to GC	Piped to GC
Analytical Method	GC	GC

**Table A-1**  
**Summary of Streams to be Analyzed for Material Balance Calculations (cont'd)**

Stream No.	204	216
Description	Methanol to Distillation	Refined-Grade Methanol
PFD Material Balance Point No.	204	216
Gas Chromatograph Point No.	N/A	N/A
Reported in:		
EMRs (Compliance)		
EMRs (Supplemental)		X (Summary Data)
Technical Progress Reports	X	X
Test Series Report (one time)		
Temperature	X	X
Pressure	X	X
Flow Rate	X	X
Composition		
<b>Methanol Analysis (wt%)</b>	X	X
Acetic Acid		
Water		
Decane		
Methanol		
Acetone		
Ethanol		
Analysis Frequency	Weekly	Daily
Sampling Technique	Grab	Grab
Analytical Method	GC/IR/TC	GC/IR/TC

**Table A-1**  
**Summary of Streams to be Analyzed for Material Balance Calculations (cont'd)**

Stream No.	242
Description	Crude-Grade Methanol to Lurgi (Methanol) Unit
PFD Material Balance Point No.	242
Gas Chromatograph Point No.	N/A
Reported in:	
EMRs (Compliance)	
EMRs (Supplemental)	X (Summary Data)
Technical Progress Reports	X
Test Series Report (one time)	
Temperature	X
Pressure	X
Flow Rate	X
Composition	
<b>Methanol Analysis (wt%)</b>	X
Acetic Acid Water Decane Methanol Acetone Ethanol	
Analysis Frequency	Weekly
Sampling Technique	Grab
Analytical Method	GC/IR/TC

## Test Methods for Sampling of Syngas

Test methods were developed to determine the average concentration of arsenic (reported as arsine), iron, and nickel in syngas streams; these techniques were typically applied to the fresh feed gas entering the LPMEOH™ demonstration unit.

Gas-phase arsenic concentrations in a syngas feed were determined using a modified version of the National Institute for Occupational Safety and Health (NIOSH) Method 6001 for “Arsine” in which arsenic was trapped on a column of activated carbon. A diagram of the sampling set-up is given in Figure A.1. Sample gas was purged through a charcoal packed into a stainless steel tube for a predetermined length of time and flow. The sampling flow was set with the fine metering valve as illustrated. The charcoal was then washed with dilute nitric acid and arsenic was determined by Inductively Coupled Plasma Atomic Emission Spectroscopy (ICP-AES). The limit of detection was 1-5 ppbv arsenic (as arsine).

Gas-phase iron carbonyl concentrations in a syngas feed were determined using a modified NIOSH method 6007 for “Nickel Carbonyl,” which is similar to the method for arsine previously described. Sample gas was purged through a packed bed of charcoal in a stainless steel tube for a predetermined length of time and flow. The charcoal was then washed with dilute nitric acid and the iron content was determined by ICP-AES. The limit of detection was relatively high due to the baseline presence of iron in charcoal, with a typical limit of 10 ppbv iron (as iron carbonyl).

**Figure A-1**  
**Syngas Sampling Apparatus**

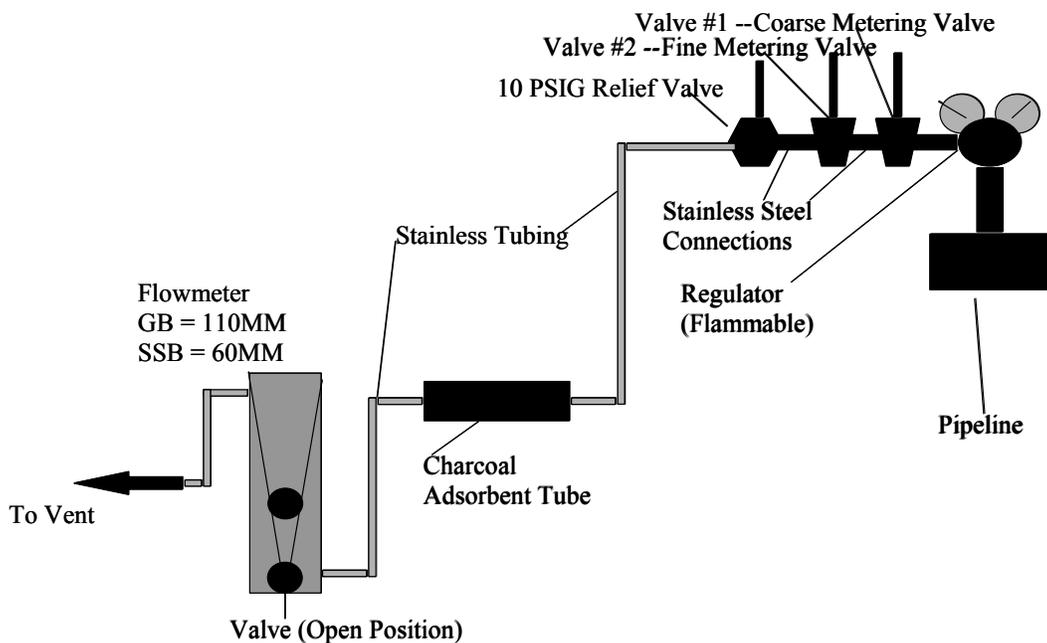

A gas scrubbing technique, using concentrated nitric acid as the scrubbing solution, was also utilized for determination of the concentration of iron carbonyl. Sample gas was purged through a set of bubbling impingers containing nitric acid scrubbing solutions for a predetermined length of time and flow. The nitric acid solution was then analyzed and the iron content was determined by ICP-AES. The limit of detection was generally in the range of 3-5 ppbv iron (as iron carbonyl).

## **APPENDIX B**

### **SAMPLE MATERIAL BALANCES FROM LPMEOH™ DEMONSTRATION UNIT**



**APPENDIX B-1**  
**SAMPLE MATERIAL BALANCE – BALANCED GAS CASE (02 JULY 1997)**

**RUN NO:** K5-7/2      **TITLE:** Recheck Test 1 Conditions

**Balance Period:**  
 Start Date      02jul97 07:00:00  
 End Date        03jul97 07:00:00

**Time From Start of Run (days)**  
 Start  
 End

86.7  
87.7

**Reaction Conditions**

Temperature (°F)	481	<b>Slurry Data</b>	Catalyst Weight (lb oxide)	19,500
Pressure (psig)	707		Slurry Concentration (wt %)	26.5
Space Velocity (sL/kg-hr)	8827		Slurry Level (ft)	58.4
Vg (inlet)	0.70		Gas Holdup (vol %)	45.4
			Gassed Slurry Volume (ft3)	2459

**Performance Results**

Raw MeOH Production (ton/day)	195.9	(gas measurements)	<b>Energy Balance</b>	12027
Raw MeOH Production (ton/day)	195.9	(liquid measurements)	Steam Production (lb/hr)	373
Syngas Utilization (SCF/lb MeOH)	41.9		Steam Drum Pressure (psig)	1446
Catalyst Life (eta)	0.54		Steam Import/Export (lb/hr)	19.6
CO Conversion (total) (%)	30.7		Reactor O-T-M Conversion (% LHV)	54.7
CO Conversion to MeOH (%)	32.5		Wetted Tube Length (ft)	2120
CO Conversion to H2 (%)	-1.95		Heat Transfer Area (ft2)	166
			Reactor Overall U (BTU/hr-ft2-F)	

**Atom/Mass Balance Closure (% of reactor inlet)**

Syngas Conversion (% LHV)	77.4	<b>C</b>	99.14
Syngas Usage (BTU/gallon MeOH)	69,808	<b>H</b>	98.92
Recycle Ratio	3.22	<b>O</b>	100.75
MeOH Productivity (gmol/kg-hr)	25.39	<b>N</b>	99.65
Rxr Volumetric Productivity (ton/day-ft3)	0.080	<b>Total Mass</b>	100.60
Sparger "K"-value	9.21		

**Liquid Product Analysis (wt%)**

Methanol	99.92	7/2	7/3	<b>REFINED PRODUCT</b>	<b>CRUDE PRODUCT</b>
Ethanol	0.01	19:00	7:00		
Water	0.08				
Oil	0.00				
<b>Total</b>	<b>100.01</b>			<b>100.04</b>	<b>100.06</b>

**CRUDE PRODUCT**

7/2	7/3
19:00	7:00
85.62	86.58
0.25	0.25
14.02	13.08
0.15	0.15
<b>100.04</b>	<b>100.06</b>

**APPENDIX B-1**  
**SAMPLE MATERIAL BALANCE – BALANCED GAS CASE (02 JULY 1997) (cont'd)**

RUN NO: K5-7/2		TITLE: Recheck Test 1 Conditions									
	FRESH FEED	CO MAKEUP	H2 MAKEUP	K-01 OUTLET	REACTOR FEED	C-05 OUTLET	MAIN PURGE	DISTILL. PURGE	CRUDE PRODUCT	REFINED PRODUCT	
F	95	82	84	117	334	249	100	74	222	84	
psig	754	864	486	742	733	699	686	9	185	139	
H2	67.14	1.93	77.66	69.27	68.72	63.64	69.27	8.00	0.00	0.00	
CO	29.89	97.05	9.12	18.27	19.85	15.82	18.27	7.00	0.00	0.00	
N2	0.46	0.97	6.50	4.09	3.18	3.66	4.09	2.00	0.00	0.00	
CH4	0.03	0.05	0.92	0.34	0.26	0.30	0.34	0.00	0.00	0.00	
CO2	2.48	0.00	3.76	5.07	4.31	4.51	5.07	62.00	0.00	0.00	
DME	0.00	0.00	0.01	0.00	0.00	0.01	0.00	4.00	0.00	0.00	
MeOH	0.00	0.00	0.06	0.55	0.65	8.15	0.55	10.00	78.00	99.90	
EtOH	0.00	0.00	0.00	0.00	0.00	0.00	0.00	0.00	0.16	0.01	
H2O	0.00	0.00	0.00	0.00	0.00	0.46	0.00	0.00	21.83	0.09	
others	0.00	0.00	1.97	2.40	3.03	3.44	2.40	7.00	0.01	0.00	
TOTAL	100.00	100.00	100.00	100.00	100.00	100.00	100.00	100.00	100.00	100.00	
lb/lbmol	10.953	27.501	7.770	10.849	10.897	12.096	10.849	39.217	29.048	32.028	
MMBTU/hr	191.6	0.0	0.0	562.6	754.6	735.9	18.4	1.6	33.3	114.9	
MMBTU/hr	-32.98	0.00	0.00	-104.51	-123.21	-149.39	-3.44	-2.98	-15.25	-40.68	
SCFH	684.799	0	0	2,202.625	2,913.449	2,535,117	71,933	8,736	55,532	150,156	
lbmol/hr	1,805.2	0.0	0.0	5,806.4	7,680.2	6,682.9	189.6	23.0	146.4	395.8	
lb/hr	19,772	0	0	62,993	83,688	80,838	2,057	903	4,252	12,678	

**APPENDIX B-2**  
**SAMPLE MATERIAL BALANCE – BALANCED GAS CASE (13 SEPTEMBER 1998)**

**RUN NO:** K6-09/13

**TITLE:** Catalyst Addition and Aging

**Balance Period:**

Start Date 13sep98 07:00:00  
 End Date 14sep98 07:00:00

**Time From Start of Run (days)**

Start 267.3  
 End 268.3

**Reaction Conditions**

Temperature (°F) 454  
 Pressure (psig) 710  
 Space Velocity (sL/kg-hr) 3811  
 Vg (inlet) 0.64

**Slurry Data**

Catalyst Weight (lb oxide) 42,900  
 Slurry Concentration (wt %) 43.4  
 Slurry Level (ft) 56.0  
 Gas Holdup (vol %) 40.0  
 Gassed Slurry Volume (ft3) 2355

**Performance Results**

Raw MeOH Production (ton/day) 262.6 (gas measurements)  
 Raw MeOH Production (ton/day) 256.4 (liquid measurements)  
 Syngas Utilization (SCF/lb MeOH) 39.8  
 Catalyst Life (eta) 0.54  
 CO Conversion (total) (%) 48.0  
 CO Conversion to MeOH (%) 50.7  
 CO Conversion to H2 (%) -2.74

**Energy Balance**

Steam Production (lb/hr) 21624  
 Steam Drum Pressure (psig) 240  
 Steam Import/Export (lb/hr) 12853  
 Reactor O-T-M Conversion (% LHV) 26.8  
 Wetted Tube Length (ft) 52.2  
 Heat Transfer Area (ft2) 2026  
 Reactor Overall U (BTU/hr-ft2-F) 199

**Atom/Mass Balance Closure (% of reactor inlet)**

C 100.60  
 H 100.17  
 O 100.23  
 N 101.50  
 Total Mass 100.53

**Liquid Product Analysis (wt%)**

	9/13	9/14
	19:00	7:00
Methanol	99.99	99.99
Ethanol	0.01	0.01
Water	0.01	0.01
Oil	0.00	0.00
Total	100.01	100.00

**REFINED PRODUCT**

**CRUDE PRODUCT**

	9/13	9/14
	19:00	7:00
	91.10	91.29
	0.09	0.09
	8.80	8.53
	0.06	0.06
Total Mass	100.05	99.97

**APPENDIX B-2**  
**SAMPLE MATERIAL BALANCE – BALANCED GAS CASE (13 SEPTEMBER 1998) (cont'd)**

RUN NO: K6-09/13		TITLE: Catalyst Addition and Aging									
T	F	FRESH FEED	CO MAKEUP	H2 MAKEUP	K-01 OUTLET	REACTOR FEED	C-05 OUTLET	MAIN PURGE	DISTILL. PURGE	CRUDE PRODUCT	REFINED PRODUCT
P	psig	101 754	80 866	82 560	269 743	316 734	240 701	99 691	76 7	220 185	72 133
Comp (mol %)	H2	67.63	1.93	77.66	72.47	70.75	63.65	72.47	8.00	0.00	0.00
	CO	29.23	97.05	9.12	13.38	18.10	11.54	13.38	7.00	0.00	0.00
	N2	0.40	0.97	6.50	4.71	3.44	4.22	4.71	2.00	0.00	0.00
	CH4	0.05	0.05	0.92	0.83	0.59	0.73	0.83	0.00	0.00	0.00
	CO2	2.70	0.00	3.76	7.18	5.76	6.46	7.18	62.00	0.00	0.00
	DME	0.00	0.00	0.01	0.00	0.00	0.01	0.00	4.00	0.00	0.00
	MeOH	0.00	0.00	0.06	0.60	0.64	12.03	0.60	10.00	85.49	99.98
	EtOH	0.00	0.00	0.00	0.00	0.00	0.00	0.00	0.00	0.06	0.01
	H2O	0.00	0.00	0.00	0.00	0.00	0.62	0.00	0.00	14.45	0.01
	others	0.00	0.00	1.97	0.82	0.73	0.74	0.82	7.00	0.01	0.00
	TOTAL	100.00	100.00	100.00	100.00	100.00	100.00	100.00	100.00	100.00	100.00
Mole Wt	lb/lbmol	10.860	27.501	7.770	10.266	10.513	12.765	10.266	39.217	30.041	32.039
LHV	MMBTU/hr	237.6	0.0	0.0	486.6	724.8	699.6	18.2	0.9	65.8	128.1
Enthalpy	MMBTU/hr	-41.05	0.00	0.00	-91.37	-127.52	-159.02	-3.66	-1.61	-27.16	-45.39
Flow	SCFH	851,389	0	0	1,920,286	2,767,621	2,255,511	71,868	4,732	100,354	167,205
	lbmol/hr	2,244.4	0.0	0.0	5,062.1	7,295.8	5,945.8	189.5	12.5	264.5	440.8
	lb/hr	24,374	0	0	51,967	76,702	75,898	1,945	489	7,947	14,122

**APPENDIX B-3**  
**SAMPLE MATERIAL BALANCE – H<sub>2</sub>:CO = 0.77 (06 AUGUST 1997)**

**RUN NO:** K3-8/06

**TITLE:** Texaco-type Syngas

**Balance Period:**

Start Date  
End Date

06aug97 07:00:00  
07aug97 07:00:00

**Time From Start of Run (days)**

Start  
End

121.7  
122.7

**Reaction Conditions**

Temperature (°F)  
Pressure (psig)  
Space Velocity (sL/kg-hr)  
Vg (inlet)

481  
701  
6507  
0.70

**Slurry Data**

Catalyst Weight (lb oxide)  
Slurry Concentration (wt %)  
Slurry Level (ft)  
Gas Holdup (vol %)  
Gassed Slurry Volume (ft3)

26,400  
33.8  
56.5  
45.4  
2377

**Performance Results**

Raw MeOH Production (ton/day)  
Raw MeOH Production (ton/day)  
Syngas Utilization (SCF/lb MeOH)  
Catalyst Life (eta)

193.0  
193.0  
45.5  
0.56

(gas measurements)  
(liquid measurements)

**Energy Balance**

Steam Production (lb/hr)  
Steam Drum Pressure (psig)  
Steam Import/Export (lb/hr)  
Reactor O-T-M Conversion (% LHV)  
Wetted Tube Length (ft)  
Heat Transfer Area (ft2)  
Reactor Overall U (BTU/hr-ft2-F)

13520  
332  
1341  
18.5  
52.7  
2045  
139

Syngas Conversion (% LHV)  
Syngas Usage (BTU/gallon MeOH)  
Recycle Ratio  
MeOH Productivity (gmol/kg-hr)  
Rxx Volumetric Productivity (ton/day-ft3)  
Sparger "K"-value

70.9  
68,968  
2.98  
18.56  
0.081  
8.95

**Atom/Mass Balance Closure (% of reactor inlet)**

C  
H  
O  
N  
Total Mass

98.60  
101.83  
98.16  
99.56  
98.77

**Liquid Product Analysis (wt%)**

Methanol  
Ethanol  
Water  
Oil  
Total

8/6  
19:00  
99.98  
0.01  
0.02  
0.00  
100.01

**REFINED PRODUCT**

**CRUDE PRODUCT**

8/6  
19:00  
95.11  
1.32  
2.42  
1.15  
100.00

8/7  
7:00  
95.61  
0.97  
2.56  
0.65  
99.79

**APPENDIX B-3**  
**SAMPLE MATERIAL BALANCE – H<sub>2</sub>:CO = 0.77 (06 AUGUST 1997) (cont'd)**

RUN NO: K3-8/06 TITLE: Texaco-type Syngas

	FRESH FEED	CO MAKEUP	H <sub>2</sub> MAKEUP	K-01 OUTLET	REACTOR FEED	C-05 OUTLET	MAIN PURGE	DISTILL. PURGE	CRUDE PRODUCT	REFINED PRODUCT
T	90	77	74	122	336	243	89	66	217	76
P	755	861	455	753	738	688	669	9	185	140
Comp (mol %)										
H <sub>2</sub>	67.35	1.93	77.66	31.81	38.27	28.96	31.67	3.00	0.00	0.00
CO	28.98	97.05	9.12	54.09	50.02	49.91	53.97	15.00	0.00	0.00
N <sub>2</sub>	0.45	0.97	6.50	2.57	2.05	2.35	2.56	2.00	0.00	0.00
CH <sub>4</sub>	0.06	0.05	0.92	0.45	0.36	0.41	0.45	0.00	0.00	0.00
CO <sub>2</sub>	3.16	0.00	3.76	10.27	8.36	9.49	10.25	59.00	0.00	0.00
DME	0.00	0.00	0.01	0.01	0.01	0.01	0.01	3.00	0.00	0.00
MeOH	0.00	0.00	0.06	0.51	0.60	8.00	0.82	11.00	94.71	99.97
EtOH	0.00	0.00	0.00	0.00	0.00	0.02	0.00	0.00	0.79	0.01
H <sub>2</sub> O	0.00	0.00	0.00	0.00	0.00	0.10	0.00	0.00	4.40	0.02
others	0.00	0.00	1.97	0.30	0.33	0.75	0.26	7.00	0.10	0.00
TOTAL	100.00	100.00	100.00	100.00	100.00	100.00	100.00	100.00	100.00	100.00
Mole Wt	11.004	27.501	7.770	21.360	19.391	22.197	21.405	39.897	31.853	32.038
LHV	176.7	30.0	0.0	585.3	792.9	773.9	38.7	1.0	51.1	95.6
Enthalpy	-31.93	-11.62	0.00	-250.85	-282.41	-309.74	-16.62	-1.90	-18.41	-33.86
Flow										
SCFH	636,302	95,064	0	2,182,407	2,907,469	2,542,142	143,266	5,609	69,317	124,830
lbmol/hr	1,677.4	250.6	0.0	5,753.1	7,664.4	6,701.4	377.7	14.8	182.7	329.1
lb/hr	18,457	6,892	0	122,886	148,619	148,750	8,084	590	5,820	10,543

**APPENDIX B-4**  
**SAMPLE MATERIAL BALANCE – H<sub>2</sub>:CO = 0.96 (27 MARCH 2000)**

**RUN NO:** K21-03/27

**TITLE:** Reactor Feed: Destec Type Syngas

**Balance Period:**

Start Date	27mar00 07:00:00
End Date	28mar00 07:00:00

**Time From Start of Run (days)**

Start	828.3
End	829.3

**Reaction Conditions**

Temperature (°F)	454
Pressure (psig)	700
Space Velocity (sL/kg-hr)	3720
Vg (inlet)	0.66

**Slurry Data**

Catalyst Weight (lb oxide)	44,687
Slurry Concentration (wt %)	42.2
Slurry Level (ft)	49.0
Gas Holdup (vol %)	25.1
Gassed Slurry Volume (ft3)	2057

**Performance Results**

Raw MeOH Production (ton/day)	187.3	(gas measurements)
Raw MeOH Production (ton/day)	187.2	(liquid measurements)
Syngas Utilization (SCF/lb MeOH)	42.5	
Catalyst Life (eta)	0.370	

**Energy Balance**

Steam Production (lb/hr)	14609
Steam Drum Pressure (psig)	248
Steam Import/Export (lb/hr)	6697
Reactor O-T-M Conversion (% LHV)	19.1
Wetted Tube Length (ft)	45.2
Heat Transfer Area (ft2)	1754
Reactor Overall U (BTU/hr-ft2-F)	158

**Atom/Mass Balance Closure (% of reactor inlet)**

C	99.50
H	100.39
O	99.73
N	102.33
Total Mass	100.83

**Liquid Product Analysis (wt%)**

Methanol	99.99
Ethanol	0.01
Water	0.01
Oil	0.00
Total	100.01

**CRUDE PRODUCT**

3/27	3/28
19:00	7:00
96.60	96.48
0.29	0.33
3.00	3.07
0.06	0.06
99.95	99.94

**REFINED PRODUCT**

3/27	3/28
19:00	7:00
99.99	99.99
0.01	0.01
0.01	0.01
0.00	0.00
100.01	100.01

**APPENDIX B-4**  
**SAMPLE MATERIAL BALANCE – H<sub>2</sub>:CO = 0.96 (27 MARCH 2000) (cont'd)**

RUN NO: K21-03/27		TITLE: Reactor Feed: Destec Type Syngas									
T	F	FRESH FEED	CO MAKEUP	H <sub>2</sub> MAKEUP	K-01 OUTLET	REACTOR FEED	C-05 OUTLET	MAIN PURGE	DISTILL. PURGE	CRUDE PRODUCT	REFINED PRODUCT
P	psig	66 753	57 859	52 5	269 742	302 728	247 679	90 658	78 8	216 185	87 145
Comp (mol %)	H <sub>2</sub>	65.86	1.93	77.66	35.54	42.04	33.21	35.54	8.00	0.00	0.00
	CO	30.96	97.05	9.12	47.34	44.01	43.37	47.34	7.00	0.00	0.00
	N <sub>2</sub>	0.47	0.97	6.50	2.93	2.27	2.63	2.93	2.00	0.00	0.00
	CH <sub>4</sub>	0.16	0.05	0.92	0.91	0.71	0.82	0.91	0.00	0.00	0.00
	CO <sub>2</sub>	2.55	0.00	3.76	9.98	7.96	9.10	9.98	62.00	0.00	0.00
	DME	0.00	0.00	0.01	0.02	0.01	0.02	0.02	4.00	0.00	0.00
	MeOH	0.00	0.00	0.06	0.24	0.19	7.85	0.24	10.00	94.50	99.98
	EtOH	0.00	0.00	0.00	0.00	0.00	0.01	0.00	0.00	0.21	0.01
	H <sub>2</sub> O	0.00	0.00	0.00	0.00	0.00	0.13	0.00	0.00	5.28	0.01
	others	0.00	0.00	1.97	3.04	2.80	2.86	3.04	7.00	0.01	0.00
	TOTAL	100.00	100.00	100.00	100.00	100.00	100.00	100.00	100.00	100.00	100.00
Mole Wt	lb/lbmol	11.282	27.501	7.770	20.337	18.339	20.758	20.337	39.217	31.349	32.039
LHV	MMBTU/hr	174.9	12.7	0.0	551.7	742.7	723.9	25.7	1.0	50.5	91.2
Enthalpy	MMBTU/hr	-31.46	-4.93	0.00	-223.49	-253.61	-277.87	-10.75	-1.79	-18.48	-32.23
Flow	SCFH	622,767	40,204	0	2,129,278	2,813,381	2,431,800	99,014	5,244	69,500	119,058
	lbmol/hr	1,641.7	106.0	0.0	5,613.0	7,416.4	6,410.5	261.0	13.8	183.2	313.9
	lb/hr	18,522	2,915	0	114,150	136,008	133,070	5,308	542	5,743	10,056



## **APPENDIX C**

### **DETAILS ON DATA ANALYSIS METHODOLOGY**

**Table C-1  
Summary of Data for Typical Material and Energy Balance and Reactor Performance Assessment**

Signal or Computed Value	Process Flow Diagram Sht.	Mass Balance Point	Analytical Measurement	Comments
CO Gas Flowrate	1	10	Yes - On-Line GC	Used in Overall Material and Energy Balance
H2 Gas Flowrate	1	20	Yes - On-Line GC	Used in Overall Material and Energy Balance
Balanced Gas Flowrate	1	30	Yes - On-Line GC	Used in Overall Material and Energy Balance
Reactor Feed Flowrate	2	109	Yes - On-Line GC	Used in Material and Energy Balance Across Reactor
Reactor Effluent Flowrate	2	120	Yes - On-Line GC	Used in Material and Energy Balance Across Reactor
Plant Purge Flowrate	3	148	Yes - On-Line GC	Used in Overall Material and Energy Balance
Recycle Gas Flowrate	1	149	Yes - On-Line GC	Used in Overall Material and Energy Balance
Refined Grade Methanol Flowrate	3	216	Yes - Batch Sample	Total Transfer from 29D-20 and 29D-21 Used in Overall Material and Energy Balance
Crude Grade Methanol Flowrate	3	242	Yes - Batch Sample	Used in Overall Material and Energy Balance
Distillation Fuel Gas Flowrate	3	See Comment	Yes - On-Line GC	Sum of Vapor Flows from 29C-11, 29C-12, and 29C-21; Used in Overall Material and Energy Balance
Total Methanol Production	3	204	No	Sum of Mass Balance Points 216 and 242
Steam Production Flowrate	5	409	No	Steam Produced at 29C-02 Steam Drum
Steam Import/Export Flowrate	5	430	No	As Required from Eastman Steam System
Reactor O-TM Conversion	n/a	n/a	No	
Reactor Temperature	2	n/a	No	Specified for each Case
Reactor Pressure	2	n/a	No	Specified for each Case
Gas Holdup	n/a	n/a	No	Calculated from Reactor Pressure-Drop Measurements
Slurry Concentration	n/a	n/a	No	Calculated from Catalyst Addition/Withdrawal Amounts
Gassed Slurry Level	2	n/a	No	From 29C-01 Nuclear Density Gauge
Space Velocity	n/a	n/a	No	From Reactor Feed Flowrate and Slurry Concentration
Inlet Superficial Velocity	n/a	n/a	No	From Reactor Feed Flowrate
Catalyst Age	n/a	n/a	No	Estimated Average Catalyst Age vs. Fresh Catalyst
Reactor Volumetric Productivity	n/a	n/a	No	Tons per Day Methanol per Cubic Foot Reactor Volume
% CO Conversion	n/a	n/a	No	CO Consumption across 29C-01 Reactor
Catalyst Methanol Productivity	n/a	n/a	No	Defined as gm-mole Methanol/hr-kg Catalyst Oxide
Syngas Utilization	n/a	n/a	No	

**Energy Balance:**

**Reactor Data:**

## APPENDIX C-2

### METHODS OF CALCULATION FOR KEY PROCESS PARAMETERS

$$\text{Catalyst Age } (\eta) = k_0/k_0(t=0)$$

where:  $k_0$  = the pre-exponential kinetic rate constant for the methanol synthesis reaction at any time

$k_0(t=0)$  = the pre-exponential kinetic rate constant for the methanol synthesis reaction for fresh catalyst

The rate constants are determined using a proprietary model which computes the kinetic rate constant for the methanol synthesis reaction.

$$\text{CO Conversion to Methanol [\%]} = \frac{(\text{Raw Methanol Flow} + \text{Methanol in Main Plant Purge} + \text{Methanol in Distillation Purge [all lbmol/hr]})}{\text{Carbon Monoxide in Reactor Feed [lbmol/hr]} * 0.01}$$

where: Methanol in Main Plant Purge [lbmol/hr] = *Main Plant Purge Flow* [lbmol/hr] \* *Methanol Concentration in Main Plant Purge* [mol%]

Methanol in Distillation Purge [lbmol/hr] = *Distillation Purge Flow* [lbmol/hr] \* *Methanol Concentration in Distillation Purge* [mol%]

Carbon Monoxide in Reactor Feed [lbmol/hr] = *Reactor Feed Flow* [lbmol/hr] \* *Carbon Monoxide Concentration in Reactor Feed* [mol%]

$$\text{Gas Holdup (vol\%)} = \frac{(\text{Liquid-Solid Density [lb/ft}^3\text{]} - \text{3-Phase Density [lb/ft}^3\text{]}) * 100}{(\text{Liquid-Solid Density [lb/ft}^3\text{]} - \text{Vapor Density [lb/ft}^3\text{]})}$$

where: Vapor Density [lb/ft<sup>3</sup>] is calculated using the composition at the Reactor Effluent, and at the measured temperature and pressure of the Reactor

$$\text{3-Phase Density [lb/ft}^3\text{]} = \frac{\text{Pressure Drop [psi]} * 144 \text{ [in}^2\text{/ft}^2\text{]}}{\text{Span between Taps of Pressure Drop Measurement [ft]}}$$

Liquid-Solid Phase Density [lb/ft<sup>3</sup>] is a function of the catalyst concentration [wt%], which is iterated until the calculated weight of catalyst matches the catalyst weight in the Reactor.

General Notes:

- All terms in *Italics* refer to measured variables, either by field instruments or gas chromatographs.

## APPENDIX C-2

### METHODS OF CALCULATION FOR KEY PROCESS PARAMETERS (cont'd)

$$\text{Gassed Slurry Volume [ft}^3\text{]} = \text{Reactor Cylindrical Volume [ft}^3\text{]} + \text{Reactor Head Volume [ft}^3\text{]}$$

where: Reactor Cylindrical Volume [ft<sup>3</sup>] = A [ft<sup>2</sup>] \* Cylindrical Height [ft]

$$A \text{ [ft}^2\text{]} = \frac{\pi}{4} * (\text{Reactor ID [ft]})^2 * (\text{Fraction Open Area})$$

$$\text{Reactor ID} = \text{Reactor Inside Diameter} = 7.5 \text{ ft}$$

Fraction Open Area = 0.9652 (3.48% of the cross-sectional area of the Reactor is occupied by the tubes of the internal heat exchanger)

$$\text{Cylindrical Height [ft]} = \text{Gassed Slurry Height [ft]} - \frac{(\text{Reactor ID [ft]})}{4}$$

Note: The term “(Reactor ID)/4” is the depth of the bottom head of the Reactor.

$$\text{Reactor Head Volume [ft}^3\text{]} = \frac{\pi * (\text{Reactor ID [ft]})^3}{24} - 8 \text{ [ft}^3\text{]}$$

Note: 8 cubic feet is subtracted from the Reactor Head Volume to account for the displacement of the gas sparger and the header piping for the internal heat exchanger.

$$\text{Inlet Superficial Velocity [ft/s]} = \frac{\text{Reactor Feed Flow [lbmol/hr]} * V \text{ [ft}^3\text{/lbmol]}}{3,600 \text{ [s/hr]} * A \text{ [ft}^2\text{]}}$$

$$\text{where: } V \text{ [ft}^3\text{/lbmol]} = \frac{10.73 * (\text{Reactor Temperature [}^\circ\text{F]} + 459.67)}{(\text{Reactor Pressure [psig]} + 14.1)}$$

$$A \text{ [ft}^2\text{]} = \frac{\pi}{4} * (\text{Reactor ID [ft]})^2 * (\text{Fraction Open Area})$$

$$\text{Reactor ID} = \text{Reactor Inside Diameter} = 7.5 \text{ ft}$$

Fraction Open Area = 0.9652 (3.48% of the cross-sectional area of the Reactor is occupied by the tubes of the internal heat exchanger)

General Notes:

- a. All terms in *Italics* refer to measured variables, either by field instruments or gas chromatographs.

## APPENDIX C-2

### METHODS OF CALCULATION FOR KEY PROCESS PARAMETERS (cont'd)

$$\text{Methanol Productivity [gmol/kg-hr]} = \frac{(\text{Methanol in Reactor Effluent [lbmol/hr]} - \text{Methanol in Reactor Feed [lbmol/hr]}) * 1,000 \text{ [g/kg]}}{\text{Catalyst Weight (lb oxide)}}$$

where: Methanol in Reactor Effluent [lbmol/hr] = *Reactor Effluent Flow* [lbmol/hr] \*  
*Methanol Concentration in Reactor Effluent Stream* [mol%]

$$\text{Methanol in Reactor Feed [lbmol/hr]} = \text{Reactor Feed Flow [lbmol/hr]} * \text{Methanol Concentration in Reactor Feed Stream [mol\%]}$$

$$\text{Reactor O-T-M Conversion [\%]} = \frac{\text{LHV of Raw Methanol} * 100}{\text{LHV of Reactor Feed}}$$

Note: Lower heating values (LHV's) for Raw Methanol and Reactor Feed are calculated from compositions of each stream, in units of million Btu per hour.

$$\text{Reactor Volumetric Productivity [TPD/ft}^3\text{]} = \frac{\text{Raw Methanol Flow [TPD]}}{\text{Gassed Slurry Volume [ft}^3\text{]}}$$

$$\text{Space Velocity [sL/kg-hr]} = \frac{\text{Reactor Feed Flow [lbmol/hr]} * 10,175 \text{ [sL/lbmol @ 0}^\circ\text{C]}}{\text{Catalyst Weight [lb oxide]} * 0.454 \text{ [kg/lb]}}$$

$$\text{Sparger Resistance Coefficient "K"} = \frac{\text{Sparger Pressure Drop [psi]} * \text{Reactor Feed Density [lb/ft}^3\text{]} * \text{constant}}{(\text{Reactor Feed Flow [KSCFH]} * \text{Reactor Feed Molecular Weight [lb/lbmol]})^2}$$

$$\text{Syngas Usage [Btu/gallon Methanol]} = \frac{\text{Syngas LHV to Methanol [Btu/hr]} * 24 \text{ [hr/day]} * 6.642 \text{ [lb/gallon Methanol]}}{\text{Raw Methanol Flow [TPD]} * 2,000 \text{ [lb/ton]}}$$

where: Syngas LHV to Methanol [Btu/hr] = the difference between the Lower Heating Value of the three feed gas streams (Balanced Gas, CO Gas, H<sub>2</sub> Gas) and the two purge gas streams (Main Plant Purge, Distillation Purge). Lower heating values are calculated from the compositions of each stream.

General Notes:

- a. All terms in *Italics* refer to measured variables, either by field instruments or gas chromatographs.

## APPENDIX C-2

### METHODS OF CALCULATION FOR KEY PROCESS PARAMETERS (cont'd)

$$\text{Syngas Utilization [SCF/lb Methanol]} = \frac{(\text{Balanced Gas Flow [SCFH]} + \text{CO Gas Flow [SCFH]}) * 24 \text{ [hr/day]}}{\text{Raw Methanol Flow [TPD]} * 2,000 \text{ [lb/ton]}}$$

General Notes:

- a. All terms in *Italics* refer to measured variables, either by field instruments or gas chromatographs.

## **APPENDIX D**

### **DATA SUMMARY TABLES**

### Table D-1 – Data Summary Table for Kingsport Catalyst Campaign 1

Case	Date	Days On Stream	Gas Type	Temp (Deg.C)	Pres. (psig)	Fresh Feed (KSCFH)	Recycle Gas (KSCFH)	Reactor Feed (H <sub>2</sub> CO)	Purge Gas (KSCFH)	Inlet Sup. Velocity (ft/sec)	Space Velocity (lhr-lb)	Slurry Conc. (wt% ox)	Holdup (vol%)	Gas Hgt (ft)	Catalyst Inventory (lb)	Catalyst Age (eta)	CO Conv. (%)	O-T-M Conv. (%)	Syngas Util. (SCE/lb)	Raw MeOH Prod. (TPD)	Catalyst MeOH Prod. (gmol/hr-kg)	Reactor Vol. Prod. (TPD/#3)	Overall (Btu/hr ft <sup>2</sup> F)	Sparger dP (psi)	Sparger Resist. ("K")																		
																										18-Apr-97	19-Apr-97	20-Apr-97	21-Apr-97	22-Apr-97	23-Apr-97	24-Apr-97	25-Apr-97	26-Apr-97	27-Apr-97	28-Apr-97	29-Apr-97	30-Apr-97	1-May-97	2-May-97	3-May-97	4-May-97	5-May-97
1	12-Apr-97	6	Balanced	248	719	758	1,375	NA	33.7	0.50	6,203	30.5	50.2	54.9	20,300	1.30	54.8	33.1	37.6	242.3	30.74	0.105	181	6.23	10.87																		
1	13-Apr-97	7	Balanced	249	716	792	1,536	NA	30.1	0.55	6,783	30.8	50.6	54.9	20,300	1.24	52.5	31.7	37.5	253.8	32.19	0.110	184	8.69	12.72																		
1	14-Apr-97	8	Balanced	249	705	789	1,619	NA	29.1	0.58	7,014	30.9	52.0	56.1	20,300	1.18	50.5	30.5	37.5	252.4	32.00	0.107	172	10.50	14.17																		
1	15-Apr-97	9	Balanced	249	705	818	1,601	NA	36.5	0.58	7,019	30.8	50.9	55.1	20,300	1.29	51.7	31.2	37.9	258.9	32.84	0.112	170	11.05	14.88																		
1	16-Apr-97	10	Balanced	248	705	904	1,527	NA	61.9	0.59	7,094	30.9	50.7	54.5	20,300	1.78	55.8	33.6	38.5	281.9	35.82	0.123	168	14.17	18.78																		
1	17-Apr-97	11	Balanced	249	704	887	1,746	NA	57.5	0.63	7,629	32.1	53.0	54.3	20,300	1.24	49.8	30.0	39.4	270.5	34.35	0.119	171	17.61	20.28																		
1	18-Apr-97	12	Balanced	249	705	841	1,843	NA	37.3	0.64	7,762	32.0	51.9	53.4	20,300	1.14	48.2	29.1	37.8	267.0	33.86	0.119	173	19.17	21.35																		
1	18-Apr-97	12	Balanced	249	703	964	1,779	NA	116.3	0.66	7,970	32.0	52.2	53.8	20,300	1.43	51.1	30.7	40.0	288.8	36.80	0.128	153	20.47	21.69																		
1	19-Apr-97	13	Balanced	249	709	958	1,994	3.47	76.9	0.70	8,562	32.2	51.5	52.4	20,300	1.17	48.3	29.2	39.4	292.2	36.60	0.133	158	21.59	19.36																		
1	20-Apr-97	14	Balanced	249	708	913	2,114	3.78	73.6	0.72	8,771	30.3	50.5	55.8	20,300	1.03	47.1	26.4	39.8	275.5	34.77	0.117	172	21.64	20.31																		
1	21-Apr-97	15	Balanced	249	709	859	2,108	4.00	59.8	0.71	8,635	30.2	47.5	53.0	20,300	0.94	47.5	25.6	39.5	261.1	32.83	0.117	176	22.29	21.90																		
1	22-Apr-97	16	Balanced	249	709	793	2,086	4.32	52.1	0.69	8,376	29.5	45.2	52.5	20,300	0.91	49.0	24.6	39.2	242.7	30.65	0.110	175	21.59	23.04																		
1	24-Apr-97	18	Balanced	249	702	865	2,028	3.52	61.4	0.70	8,419	29.9	43.1	49.5	20,300	0.93	44.6	26.2	39.8	261.0	33.17	0.126	186	24.25	23.16																		
1	25-Apr-97	19	Balanced	248	700	835	1,921	3.52	65.7	0.67	8,019	31.8	44.9	47.0	20,300	0.89	44.6	26.2	40.4	248.2	31.58	0.126	164	23.48	24.80																		
1	26-Apr-97	20	Balanced	246	694	864	1,878	3.27	103.1	0.67	7,980	32.8	45.6	45.5	20,300	0.83	41.6	26.0	41.9	247.8	31.38	0.130	147	25.38	26.81																		
1	27-Apr-97	21	Balanced	247	690	902	1,793	2.95	129.1	0.66	7,842	32.8	44.9	45.0	20,300	0.83	39.7	26.9	42.9	252.2	31.87	0.134	154	26.18	27.29																		
1	28-Apr-97	22	Balanced	247	696	783	1,903	3.70	86.4	0.65	7,817	30.9	43.3	47.5	20,300	0.75	42.7	24.4	41.9	224.4	28.35	0.113	157	24.49	27.11																		
1	29-Apr-97	23	Balanced	249	700	810	1,922	3.40	76.7	0.66	7,951	29.3	45.2	53.0	20,300	0.81	42.1	25.6	40.9	238.0	30.05	0.107	161	26.26	26.76																		
1	30-Apr-97	24	Balanced	249	699	794	1,912	3.58	78.7	0.66	7,872	29.1	43.6	49.5	20,300	0.79	43.0	25.1	41.3	230.8	29.24	0.106	163	26.13	27.67																		
1	1-May-97	25	Balanced	249	699	798	1,932	3.49	95.0	0.66	7,945	29.9	44.0	50.5	20,300	0.74	41.1	24.5	42.0	228.0	28.85	0.108	162	26.26	27.32																		
1	2-May-97	26	Balanced	249	700	757	1,898	3.82	85.0	0.64	7,728	29.7	43.0	50.0	20,300	0.71	42.8	23.7	42.2	215.4	27.32	0.103	162	25.91	29.24																		
1	3-May-97	27	Balanced	249	699	782	1,886	3.55	98.2	0.65	7,767	30.4	43.1	48.5	20,300	0.68	40.5	23.9	42.8	219.5	27.66	0.108	162	26.05	29.25																		
1	4-May-97	28	Balanced	249	700	789	1,901	3.48	110.9	0.65	7,831	30.5	44.0	49.0	20,300	0.64	38.9	23.4	43.4	218.1	27.43	0.106	156	26.24	29.58																		
1	5-May-97	29	Balanced	249	699	798	1,901	3.29	115.8	0.66	7,856	30.1	43.6	49.5	20,300	0.63	37.5	23.4	43.7	218.9	27.76	0.105	157	26.26	28.88																		
1	6-May-97	30	Balanced	249	700	776	1,923	3.32	99.8	0.65	7,835	30.4	42.5	48.5	20,300	0.65	38.1	23.3	42.8	217.3	27.85	0.108	161	26.26	28.83																		
1	8-May-97	32	CO-rich	249	700	255	1,051	0.43	30.2	0.32	3,813	30.8	36.9	43.0	20,300	0.64	8.6	15.1	44.4	69.0	8.83	0.038	128	14.81	33.22																		
5	18-Jun-97	73	Balanced	248	724	718	1,938	3.69	82.5	0.62	8,062	25.6	45.3	61.4	19,500	0.61	39.3	22.5	42.0	205.3	26.95	0.079	161	2.99	3.37																		
5	19-Jun-97	74	Balanced	249	711	638	1,938	4.34	58.6	0.62	7,905	26.6	45.3	57.8	19,500	0.63	42.6	21.4	40.7	188.3	24.77	0.077	175	3.05	3.52																		
5	20-Jun-97	75	Balanced	249	707	651	2,079	4.15	62.1	0.66	8,294	27.1	44.9	56.0	19,500	0.59	39.2	20.2	41.3	189.4	24.99	0.080	171	3.45	3.71																		
5	21-Jun-97	76	Balanced	249	707	687	2,109	3.55	74.2	0.67	8,465	27.6	45.2	55.0	19,500	0.58	35.5	20.8	41.4	198.9	26.14	0.086	170	4.00	3.90																		
5	22-Jun-97	77	Balanced	249	707	625	2,097	3.55	59.7	0.65	8,203	28.2	44.2	52.7	19,500	0.50	33.4	19.5	41.3	181.5	23.85	0.082	168	3.96	4.11																		
5	23-Jun-97	78	Balanced	249	707	762	2,021	3.19	119.3	0.67	8,456	28.4	43.6	51.6	19,500	0.57	33.6	21.5	43.8	208.8	27.35	0.096	171	4.51	4.38																		
5	24-Jun-97	79	Balanced	249	708	781	1,991	3.19	146.5	0.67	8,412	29.0	44.5	50.9	19,500	0.56	33.2	21.2	45.6	205.4	26.90	0.096	154	5.04	4.93																		
5	25-Jun-97	80	Balanced	248	707	737	2,003	3.26	117.7	0.66	8,338	29.2	43.3	49.4	19,500	0.57	33.7	21.0	44.0	201.5	26.62	0.097	160	5.33	5.31																		
5	26-Jun-97	81	Balanced	249	706	736	2,326	3.12	90.8	0.74	9,252	26.7	46.6	59.0	19,500	0.55	33.0	20.7	43.4	203.5	26.65	0.088	163	5.64	5.38																		
5	27-Jun-97	82	Balanced	249	707	691	2,307	3.33	74.9	0.72	9,079	27.5	45.8	56.0	19,500	0.53	31.0	19.3	41.5	199.6	25.84	0.085	168	8.12	6.67																		
5	28-Jun-97	83	Balanced	249	706	719	2,267	3.13	92.3	0.72	9,042	27.7	43.9	53.5	19,500	0.53	30.0	19.5	42.6	202.3	26.24	0.090	170	9.33	7.65																		
5	29-Jun-97	84	Balanced	249	706	711	2,263	3.22	91.5	0.72	9,019	28.1	43.9	52.5	19,500	0.51	29.9	19.1	43.0	198.4	25.77	0.090	168	9.29	7.90																		
5	30-Jun-97	85	Balanced	249	707	676	2,251	3.54	70.0	0.71	8,944	26.1	43.3	58.4	19,500	0.52	31.5	19.0	42.0	193.2	24.68	0.077	163	9.47	8.15																		
5	1-Jul-97	86	Balanced	249	707	685	2,203	3.46	71.9	0.70	8,827	26.5	45.4	59.4	19,500	0.54	32.5	19.6	41.9	195.9	25.39	0.080	166	10.66	9.21																		
5	2-Jul-97	87	Balanced	249	707	664	2,218	3.48	59.6	0.70	8,794	27.5	43.9	54.0	19,500	0.54	32.8	19.4	41.1	193.9	25.48	0.085	168	12.10	10.78																		
5	3-Jul-97	88	Balanced	249	707	705	2,231	3.83	54.5	0.70	7,939	30.0	44.1	54.0	21,800	0.56	37.3	21.0	40.6	208.4	23.96	0.092	162	12.21	10.89																		
6	4-Jul-97	89	Balanced	249	706	761	2,203	3.59	82.4	0.72	8,060	30.7	43.1	51.5	21,800	0.56	35.8	21.1	42.3	216.0	25.11	0.100	159	11.09	9.73																		
6	5-Jul-97	90	Balanced	249	705	755	2,198	3.66	89.8	0.71	8,031	30.2	42.5	52.0	21,800	0.55	36.2	20.9	42.6	212.8	24.85	0.097	163	11.49	10.12																		



**Table D-1 – Data Summary Table for Kingsport Catalyst Campaign 1 (cont'd)**

Case	Date	Days On Stream	Gas Type	Temp (Deg.C)	Pres. (psig)	Fresh Feed (KSCFH)	Recycle Gas (KSCFH)	Reactor Feed (H <sub>2</sub> CO)	Purge Gas (KSCFH)	Inlet Sup. Velocity (ft/sec)	Space Velocity (l/hr-kg)	Slurry Conc. (wt% ox)	Gas Holdup (vol%)	Gassed Slurry Hgt (ft)	Catalyst Inventory (lb)	Catalyst Age (eta)	CO Conv. (%)	O-T-M Conv. (%)	Syngas Util. (SCE/lb)	Raw MeOH Prod. (TPD)	Catalyst MeOH Prod. (g/mol/hr-kg)	Reactor Vol. Prod. (TPD/ft <sup>3</sup> )	Overall (Btu/hr ft <sup>2</sup> F)	Sparger dP (psi)	Sparger Resist. ("K")
6	8-Jul-97	93	Balanced	249	706	761	2,161	3,62	103.0	0.70	7926	31.1	41.9	49.5	21,800	0.53	35.4	20.5	44.2	206.5	24.25	0.099	161	11.94	10.85
6	9-Jul-97	94	Balanced	248	695	610	2,277	3,83	49.7	0.70	7788	31.3	42.0	49.0	21,800	0.50	34.3	19.0	40.2	182.1	21.28	0.089	166	11.02	9.60
6	10-Jul-97	95	Balanced	249	694	632	2,235	3,87	60.0	0.69	7705	29.9	42.3	52.5	21,800	0.47	33.9	18.5	41.9	181.1	21.09	0.082	161	12.05	11.35
6	11-Jul-97	96	Balanced	249	695	748	2,118	4.12	100.1	0.70	7013	32.0	42.4	53.0	24,100	0.53	39.8	21.0	43.4	206.6	21.54	0.093	157	11.34	10.83
6	12-Jul-97	97	Balanced	249	699	805	2,063	4.12	145.4	0.70	7036	31.5	41.8	53.5	24,100	0.52	40.0	21.0	46.0	209.8	22.17	0.093	157	11.30	11.24
6	13-Jul-97	98	Balanced	249	701	800	2,125	3.60	116.5	0.70	7177	32.0	41.4	52.0	24,100	0.54	37.7	21.8	43.4	221.2	23.42	0.101	157	12.00	10.65
6	14-Jul-97	99	Balanced	249	702	801	2,139	3.56	116.0	0.71	7209	32.6	41.3	50.5	24,100	0.53	36.8	21.5	43.8	219.6	23.24	0.104	151	11.89	10.57
6	15-Jul-97	100	Balanced	249	703	781	2,170	3.48	101.0	0.71	7228	32.3	42.1	52.0	24,100	0.52	36.1	21.4	42.8	218.9	23.17	0.100	155	12.27	10.63
6	16-Jul-97	101	Balanced	249	704	788	2,154	3.49	108.2	0.71	7217	32.3	41.6	51.5	24,100	0.51	35.9	21.4	43.2	219.1	23.07	0.101	153	12.53	11.13
6	17-Jul-97	102	Balanced	249	703	763	2,189	3.42	96.7	0.71	7231	32.5	41.6	51.0	24,100	0.50	35.0	21.1	42.5	215.6	22.71	0.101	152	12.80	11.01
6	18-Jul-97	103	Balanced	249	702	770	2,124	3.70	125.2	0.70	7102	33.2	40.3	48.5	24,100	0.49	36.1	20.5	44.6	207.3	21.92	0.102	152	11.99	11.30
6	19-Jul-97	104	Balanced	249	702	767	2,173	3.41	115.9	0.71	7213	33.4	40.2	48.0	24,100	0.48	34.1	20.5	43.8	210.2	22.25	0.104	153	12.05	10.52
6	20-Jul-97	105	Balanced	249	702	768	2,187	3.19	108.8	0.71	7240	33.2	40.9	49.0	24,100	0.48	32.7	20.6	43.5	212.0	22.50	0.103	152	12.26	10.33
6	21-Jul-97	106	Balanced	249	702	746	2,137	3.54	103.4	0.70	7067	31.6	42.1	53.5	24,100	0.48	35.4	20.8	42.8	209.1	22.15	0.093	160	11.61	10.81
6	22-Jul-97	107	Balanced	249	702	755	2,160	3.47	111.9	0.70	7083	31.1	40.6	53.5	24,100	0.46	34.0	20.5	43.9	206.6	21.67	0.092	159	13.32	12.33
6	23-Jul-97	108	Balanced	250	702	706	2,197	3.30	74.5	0.70	7058	31.1	42.5	55.0	24,100	0.46	32.8	20.4	41.6	203.5	21.30	0.088	152	14.71	13.01
6	24-Jul-97	109	Balanced	249	700	796	2,090	3.62	98.9	0.70	6460	33.7	39.8	51.5	26,400	0.51	37.3	22.4	42.6	224.3	21.64	0.104	156	13.17	12.43
6	25-Jul-97	110	Balanced	249	700	781	2,062	3.45	92.3	0.69	6361	33.6	39.6	51.5	26,400	0.52	38.1	22.7	41.9	223.9	21.62	0.103	152	13.32	12.43
6	26-Jul-97	111	Balanced	249	700	748	2,082	3.61	78.2	0.69	6334	33.6	39.4	51.5	26,400	0.50	37.9	22.1	41.6	215.7	20.58	0.100	146	13.02	12.31
6	27-Jul-97	112	Balanced	249	700	790	2,048	3.46	99.5	0.69	6354	33.1	39.5	52.5	26,400	0.52	38.3	22.8	42.1	225.3	21.71	0.102	154	13.45	12.58
3	4-Aug-97	120	Texaco	249	702	722	2,233	0.73	138.9	0.71	6600	33.5	47.5	59.5	26,400	0.37	31.9	18.1	45.0	192.4	18.11	0.077	139	17.86	9.01
3	5-Aug-97	121	Texaco	249	702	721	2,238	0.74	137.3	0.71	6600	33.7	46.2	57.7	26,400	0.37	31.4	18.2	45.1	192.0	18.25	0.079	140	18.10	9.08
3	6-Aug-97	122	Texaco	249	701	731	2,182	0.77	143.3	0.70	6507	33.8	45.4	56.5	26,400	0.36	29.7	18.9	45.5	193.0	18.56	0.081	139	17.07	8.95
3	7-Aug-97	123	Texaco	249	701	743	2,148	0.82	144.2	0.70	6459	34.4	45.4	55.0	26,400	0.34	29.4	18.8	45.8	194.8	18.75	0.084	138	16.52	9.00
3	8-Aug-97	124	Texaco	249	702	724	2,129	0.78	145.9	0.69	6376	33.4	45.1	57.0	26,400	0.34	28.7	17.9	45.7	190.2	18.36	0.079	140	17.05	9.33
3	9-Aug-97	125	Texaco	249	703	722	2,130	0.78	147.5	0.69	6383	33.4	45.4	57.5	26,400	0.33	28.8	18.4	46.1	187.9	18.08	0.078	138	17.30	9.46
3	10-Aug-97	126	Texaco	249	702	719	2,118	0.82	151.5	0.69	6364	33.8	45.9	57.0	26,400	0.32	28.2	18.6	46.0	187.7	17.98	0.078	136	17.25	9.47
3	11-Aug-97	127	Texaco	249	702	717	2,101	0.81	154.3	0.68	6320	34.9	45.9	54.5	26,400	0.30	27.9	18.3	46.3	186.0	17.89	0.081	137	16.94	9.52
3	12-Aug-97	128	Texaco	249	702	711	2,088	0.80	155.6	0.68	6284	34.0	42.4	53.0	26,400	0.30	27.9	18.2	46.0	185.6	17.95	0.083	139	16.71	9.56
6	15-Aug-97	131	Balanced	249	700	642	2,303	3.73	79.9	0.72	6602	34.0	39.4	50.5	26,400	0.37	31.9	18.1	45.0	185.5	17.82	0.087	151	10.37	9.38
6	16-Aug-97	132	Balanced	249	700	701	2,203	3.52	121.4	0.70	6491	34.1	39.0	50.0	26,400	0.37	31.4	18.6	44.1	190.8	18.46	0.091	151	11.05	10.64
6	17-Aug-97	133	Balanced	249	700	693	2,227	3.21	103.8	0.71	6537	34.2	40.4	51.0	26,400	0.37	29.7	18.9	42.6	195.5	18.78	0.091	150	12.19	11.20
6	18-Aug-97	134	Balanced	249	700	633	2,278	3.26	65.3	0.71	6508	34.7	41.1	50.5	26,400	0.36	29.4	18.5	40.4	188.0	18.03	0.089	152	12.29	11.09
6	19-Aug-97	135	Balanced	249	698	632	2,244	3.28	82.3	0.70	6454	34.8	40.3	49.5	26,400	0.34	28.7	17.9	41.8	181.6	17.56	0.087	151	12.04	11.26
6	20-Aug-97	136	Balanced	249	700	636	2,296	3.08	77.2	0.71	6554	35.3	43.2	51.0	26,400	0.34	27.7	18.2	41.0	186.3	17.89	0.087	157	12.40	10.87
6	21-Aug-97	137	Balanced	249	700	636	2,224	3.48	101.1	0.69	6383	36.4	41.7	47.5	26,400	0.34	29.5	17.7	42.8	178.3	17.20	0.089	154	11.34	11.33
6	22-Aug-97	138	Balanced	249	701	666	2,283	3.10	107.3	0.71	6567	35.7	45.8	52.5	26,400	0.32	26.7	17.8	43.6	183.1	17.36	0.083	148	13.77	12.23
6	23-Aug-97	139	Balanced	249	702	652	2,205	3.43	125.8	0.69	6368	35.5	41.2	49.0	26,400	0.31	28.1	17.2	45.1	173.8	16.59	0.084	148	17.38	13.78
6	24-Aug-97	140	Balanced	249	702	653	2,204	3.43	129.7	0.69	6381	35.8	40.1	47.5	26,400	0.30	27.4	16.8	45.7	171.3	16.36	0.086	146	11.79	12.11
6	25-Aug-97	141	Balanced	249	702	623	2,287	2.94	99.2	0.70	6469	36.3	40.7	47.0	26,400	0.30	25.3	17.0	42.7	175.0	16.65	0.089	147	12.09	11.19
6	26-Aug-97	142	Balanced	249	702	629	2,176	3.47	124.1	0.68	6275	35.1	39.0	48.0	26,400	0.29	27.6	16.8	45.0	167.7	16.40	0.083	148	12.21	13.01
6	27-Aug-97	143	Balanced	249	702	625	2,185	3.21	121.1	0.68	6291	35.7	39.3	47.0	26,400	0.29	26.4	16.7	44.9	167.1	16.13	0.085	149	14.31	14.30
6	28-Aug-97	144	Balanced	249	708	709	2,117	2.99	186.5	0.68	6331	35.5	39.3	47.5	26,400	0.29	25.3	17.0	49.5	172.1	16.61	0.086	145	15.22	15.04
6	29-Aug-97	145	Balanced	249	711	742	2,112	3.10	212.0	0.68	6403	36.4	40.3	46.5	26,400	0.31	25.7	16.8	51.1	174.2	16.88	0.089	140	15.16	15.72

**Table D-1 – Data Summary Table for Kingsport Catalyst Campaign 1 (cont'd)**

Case	Date	Days On Stream	Gas Type	Temp (Deg C)	Pres. (psig)	Fresh Feed (KSCFH)	Recycle Gas (KSCFH)	Reactor Feed (H2:CO)	Purge Gas (KSCFH)	Inlet Sup. Velocity (ft/sec)	Space Velocity (1/hr-kg)	Slurry Conc. (wt% ox)	Holdup (vol%)	Gas Holdup (vol%)	Gassed Slurry Hgt (ft)	Catalyst Inventory (lb)	Catalyst Age (eta)	CO Conv. (%)	O-T-M Conv. (%)	Syngas Util. (SFCF/lb)	MeOH Prod. (TPD)	Raw MeOH Prod. (TPD)	Catalyst MeOH Prod. (gmol/hr-kg)	Reactor Vol. Prod. (TPD/lb)	U Overall (Btu/hr ft2 ft)	Sparger dp (psi)	Sparger Resist. ("K")
6	30-Aug-97	146	Balanced	249	701	644	2,184	2.86	127.5	0.68	6311	36.5	39.3	45.5	45.5	26,400	0.30	24.6	17.0	45.3	170.8	16.52	0.090	146	16.66	15.99	
6	1-Sep-97	148	Balanced	249	705	644	2,204	3.02	145.4	0.70	6499	35.1	38.5	47.5	47.5	26,400	0.28	23.7	15.8	46.9	164.7	15.84	0.083	149	10.65	10.00	
6	2-Sep-97	149	Balanced	249	705	668	2,205	2.87	164.3	0.69	6418	35.1	38.9	46.0	46.0	26,400	0.28	23.4	16.1	48.1	166.9	16.14	0.087	147	13.24	12.64	
6	3-Sep-97	150	Balanced	249	705	665	2,211	2.92	165.9	0.69	6419	39.3	46.4	46.0	46.0	26,400	0.28	23.3	16.0	48.2	165.6	15.93	0.086	142	13.01	12.81	
6	4-Sep-97	151	Balanced	249	706	669	2,246	2.89	173.7	0.70	6516	37.9	42.8	45.5	45.5	26,400	0.27	22.8	15.7	49.0	163.6	15.62	0.086	143	12.77	12.02	
6	15-Sep-97	162	Balanced	250	675	473	2,020	3.94	48.9	0.63	5147	36.4	38.6	49.0	49.0	28,700	0.24	28.3	15.7	41.6	136.4	12.07	0.066	166	14.82	19.56	
6	16-Sep-97	163	Balanced	251	675	473	2,002	3.68	53.3	0.62	5093	35.4	39.0	51.5	51.5	28,700	0.23	27.1	15.7	42.2	134.5	11.99	0.062	151	16.90	21.67	
6	17-Sep-97	164	Balanced	251	676	473	2,001	3.20	52.0	0.62	5075	35.1	39.5	52.5	52.5	28,700	0.23	25.2	16.0	41.4	137.1	12.26	0.062	147	20.28	24.41	
6	18-Sep-97	165	Balanced	251	675	536	2,025	4.42	57.1	0.64	4872	37.5	38.5	50.5	50.5	31,000	0.29	35.6	17.6	41.3	155.8	12.91	0.073	140	15.76	20.30	
6	19-Sep-97	166	Balanced	251	675	577	2,119	3.95	65.5	0.67	5047	37.3	38.6	51.0	51.0	31,000	0.30	33.3	18.0	41.7	165.9	13.78	0.077	155	16.11	18.56	
6	20-Sep-97	167	Balanced	251	675	578	2,058	3.81	79.6	0.67	5054	38.1	40.5	51.0	51.0	31,000	0.28	31.6	17.7	42.4	163.5	13.51	0.076	148	16.80	19.28	
6	21-Sep-97	168	Balanced	251	675	577	2,112	3.46	71.6	0.68	5115	38.8	39.2	48.5	48.5	31,000	0.28	29.4	17.7	42.0	164.7	13.64	0.081	151	18.24	19.61	
6	22-Sep-97	169	Balanced	251	675	572	2,012	3.71	86.9	0.65	4922	36.7	38.3	52.0	52.0	31,000	0.26	30.3	17.5	43.5	157.8	12.94	0.072	148	16.17	19.52	
6	23-Sep-97	170	Balanced	249	675	577	2,026	3.57	91.3	0.66	4971	39.1	41.1	49.5	49.5	31,000	0.26	29.5	17.2	43.1	160.8	13.15	0.077	143	19.31	22.79	
6	24-Sep-97	171	Balanced	249	676	578	2,082	3.43	89.6	0.67	5076	39.6	39.2	47.0	47.0	31,000	0.25	27.7	17.2	43.6	159.1	12.96	0.081	140	17.14	18.95	
6	25-Sep-97	172	Balanced	249	675	578	2,057	3.45	97.0	0.66	5031	38.8	36.6	46.5	46.5	31,000	0.25	28.1	17.2	43.9	157.8	13.00	0.081	147	15.76	17.72	
6	26-Sep-97	173	Balanced	249	680	579	2,081	3.33	95.6	0.66	5065	37.6	37.5	49.5	49.5	31,000	0.26	28.0	17.2	43.6	159.4	13.35	0.077	153	16.91	18.54	
6	27-Sep-97	174	Balanced	249	690	573	2,118	3.22	83.1	0.66	5120	37.2	36.9	50.0	50.0	31,000	0.25	27.5	17.3	42.8	160.7	13.51	0.077	154	17.50	18.41	
6	28-Sep-97	175	Balanced	249	681	555	2,115	3.17	78.0	0.66	5085	40.1	40.8	47.5	47.5	31,000	0.25	26.8	17.0	42.3	157.5	13.25	0.079	155	17.24	18.21	
6	3-Oct-97	180	Balanced	249	676	552	2,161	4.12	49.0	0.69	4847	41.0	40.7	49.0	49.0	33,300	0.28	34.1	17.6	39.8	166.4	13.02	0.081	143	15.23	17.11	
6	4-Oct-97	181	Balanced	249	675	497	2,125	4.37	23.1	0.66	4671	39.2	39.5	51.5	51.5	33,300	0.28	35.1	17.2	38.4	155.2	12.15	0.072	146	15.08	17.88	
6	5-Oct-97	182	Balanced	249	675	548	2,017	4.01	51.1	0.65	4584	40.1	38.0	48.5	48.5	33,300	0.28	34.4	18.2	40.2	163.6	12.80	0.080	141	17.92	22.81	
6	6-Oct-97	183	Balanced	249	675	578	2,098	3.59	64.4	0.67	4749	40.0	38.2	49.0	49.0	33,300	0.27	31.5	18.2	40.8	170.0	13.31	0.083	139	15.37	17.23	
6	7-Oct-97	184	Balanced	249	675	577	2,098	3.34	62.8	0.68	4766	40.2	38.0	48.5	48.5	33,300	0.27	29.9	18.2	40.6	170.5	13.35	0.084	140	16.12	17.47	
6	8-Oct-97	185	Balanced	249	675	578	2,093	3.42	65.3	0.67	4763	40.9	37.1	46.5	46.5	33,300	0.27	30.0	18.0	40.9	169.3	13.25	0.087	142	14.49	16.14	
6	9-Oct-97	186	Balanced	250	675	577	2,092	3.37	64.5	0.67	4753	37.0	40.9	57.5	57.5	33,300	0.27	30.2	18.3	40.6	170.6	13.36	0.071	135	13.97	15.19	
6	10-Oct-97	187	Balanced	250	674	577	2,098	3.35	66.9	0.68	4768	37.0	40.9	57.5	57.5	33,300	0.26	29.7	18.1	40.9	169.3	13.25	0.070	136	13.37	14.35	
6	11-Oct-97	188	Balanced	250	675	578	2,082	3.38	71.2	0.67	4743	38.1	39.8	54.0	54.0	33,300	0.26	29.7	18.0	41.1	168.6	13.20	0.074	140	13.01	14.31	
6	12-Oct-97	189	Balanced	249	674	578	2,089	3.26	72.6	0.67	4750	38.2	40.5	54.5	54.5	33,300	0.26	28.9	18.0	41.2	168.1	13.16	0.073	143	13.28	14.25	
6	13-Oct-97	190	Balanced	249	674	577	2,067	3.47	88.0	0.67	4698	38.2	39.4	53.5	53.5	33,300	0.25	29.3	17.5	42.8	161.7	12.66	0.072	142	12.83	14.66	
6	14-Oct-97	191	Balanced	249	672	522	2,145	3.31	55.0	0.68	4760	40.5	42.0	51.0	51.0	33,300	0.24	27.2	16.7	40.4	154.8	12.12	0.072	154	14.08	14.85	
6	15-Oct-97	192	Balanced	250	674	578	2,107	3.14	87.3	0.68	4785	39.0	39.6	52.0	52.0	33,300	0.24	26.7	17.1	43.2	160.7	12.58	0.074	144	14.45	15.03	
6	16-Oct-97	193	Balanced	249	675	577	2,084	3.23	95.7	0.67	4747	38.7	39.4	52.5	52.5	33,300	0.24	27.6	17.2	42.7	162.1	12.69	0.073	147	13.34	14.44	
6	17-Oct-97	194	Balanced	249	675	578	2,075	3.36	95.3	0.67	4717	39.5	39.0	50.5	50.5	33,300	0.24	28.1	17.3	43.1	160.9	12.59	0.076	146	12.54	14.36	
6	18-Oct-97	195	Balanced	249	674	577	2,081	3.13	88.7	0.67	4742	39.5	38.9	50.5	50.5	33,300	0.24	27.1	17.4	42.5	163.2	12.78	0.077	146	12.72	13.68	
6	19-Oct-97	196	Balanced	249	673	578	2,071	3.08	92.4	0.67	4733	39.9	38.6	48.0	48.0	33,300	0.24	26.6	17.3	42.8	161.8	12.67	0.077	149	12.79	13.66	
6	21-Oct-97	198	Balanced	250	675	560	2,070	3.43	116.4	0.67	4692	40.7	38.6	48.0	48.0	33,300	0.21	26.5	15.9	45.6	147.2	11.53	0.073	149	12.73	14.49	
6	22-Oct-97	199	Balanced	250	675	515	2,115	3.28	77.9	0.66	4687	41.5	39.8	47.5	47.5	33,300	0.21	25.4	15.8	42.7	144.7	11.33	0.073	152	12.88	14.09	
6	23-Oct-97	200	Balanced	249	675	508	2,104	3.25	82.4	0.66	4662	41.6	38.9	46.5	46.5	33,300	0.20	24.9	15.5	43.1	141.6	11.09	0.073	150	12.61	13.85	
6	24-Oct-97	201	Balanced	250	675	513	2,062	3.14	81.0	0.65	4596	40.2	39.4	48.0	48.0	33,300	0.21	24.8	15.9	43.0	143.2	11.22	0.069	150	12.98	14.58	
28	25-Oct-97	202	Balanced	259	675	499	2,043	3.68	54.5	0.66	4540	40.2	37.2	48.0	48.0	33,300	0.21	29.6	16.7	40.2	149.0	11.67	0.074	145	12.12	14.74	
28	26-Oct-97	203	Balanced	259	676	499	2,064	3.50	50.5	0.66	4583	39.7	38.3	50.0	50.0	33,300	0.21	28.7	16.8	39.7	150.9	11.81	0.072	150	12.77	14.70	
28	27-Oct-97	204	Balanced	258	674	513	2,075	3.49	66.3	0.66	4598	41.7	42.4	49.5	49.5	33,300	0.20	28.0	16.5	41.6	148.0	11.59	0.071	159	13.15	15.03	
28	28-Oct-97	205	Balanced	259	674	513	2,041	3.56	72.6	0.66	4550	40.8	39.1	48.5	48.5	33,300	0.19	28.0	16.2	42.5	144.8	11.34	0.071	157	14.42	14.93	
28	29-Oct-97	206	Balanced	259	674	501	2,069	3.36	63.9	0.66	4568	41.6	38.4	46.5	46.5	33,300	0.19	26.9	16.1	41.3	145.4	11.38	0.075	156	13.12	14.93	
28	30-Oct-97	207	Balanced	259	675	508	2,017	3.59	76.8	0.65	4501	40.2	38.2	49.0	49.0	33,300	0.19	28.0	16.0	42.8	142.7	11.17	0.069	153	11.66	14.24	
28	31-Oct-97	208	Balanced	259	675	508	2,042	3.59	81.6	0.66	4534	40.4	36.8	47.5	47.5	33,300	0.18	27.2	15.6	43.5	140.2	10.97	0.070	152	12.16	14.70	
28	1-Nov-97	209	Balanced	259	674	508	2,030	3.55	85.9	0.65	4512	41.4	38.4	47.0	47.0	33,300	0.18	27.1	15.7	43.5	140.4	10.99	0.071	155	12.27	14.99	
28	2-Nov-97	210																									

**Table D-2 – Data Summary Table for Kingsport Catalyst Campaign 2**

Case	Date	Days On Stream	Gas Type	Temp (Deg C)	Press (psig)	Fresh Feed (KSCFH)	Recycle Gas (KSCFH)	Reactor Feed (H2CO)	Purge Gas (KSCFH)	Inlet Sup. Velocity (ft/sec)	Space Velocity (l/hr-kg)	Slurry Conc. (wt%-ox)	Gas Holdup (vol%)	Gassed Slurry Hgt (ft)	Catalyst Inventory (lb)	Catalyst Age (eta)	CO Conv. (%)	O-T-M Conv. (%)	Reactor Util. (SCT/lb)	Synygas Prod. (TPD)	Raw MeOH Prod. (gmol/hr-kg)	Reactor Vol. Prod. (TPD/B3)	Overall (Btu/hr (2-F))	Sparger dP (psf)	Sparger Resist. ("K")
6	20-Dec-97	0	Balanced	225	680	772	2,193	4.11	66.1	0.71	8,994	27.3	49.3	59.0	19,500	1.24	44.4	23.3	39.3	236.0	31.53	0.095	171	3.98	3.90
6	21-Dec-97	1	Balanced	233	680	907	2,276	4.16	74.4	0.77	9,688	26.2	44.6	57.5	19,500	1.27	48.2	25.1	39.9	272.8	36.45	0.113	144	4.67	3.84
6	22-Dec-97	2	Balanced	235	680	908	2,250	4.27	71.6	0.77	9,587	29.0	51.6	57.6	19,500	1.34	50.9	25.9	39.5	275.8	36.85	0.114	146	4.67	3.79
6	23-Dec-97	3	Balanced	235	680	920	2,259	4.29	78.0	0.77	9,657	27.7	49.8	59.0	19,500	1.32	50.7	25.7	39.8	277.5	37.08	0.112	162	4.76	3.90
6	24-Dec-97	4	Balanced	235	680	921	2,288	4.02	82.0	0.77	9,558	27.5	49.8	59.5	19,500	1.31	48.6	25.6	39.8	277.7	37.10	0.111	166	5.21	4.31
6	25-Dec-97	5	Balanced	235	680	918	2,255	4.05	72.9	0.77	9,625	28.1	49.8	58.0	19,500	1.29	48.5	25.5	39.4	279.5	37.35	0.115	164	5.27	4.45
6	26-Dec-97	6	Balanced	235	680	929	2,276	4.05	84.4	0.77	9,664	28.9	50.0	56.0	19,500	1.27	48.2	25.4	39.9	279.0	37.28	0.118	163	5.32	4.46
6	27-Dec-97	7	Balanced	235	679	914	2,280	3.79	81.7	0.78	9,714	30.0	50.8	54.0	19,500	1.21	45.4	25.4	39.3	279.3	37.32	0.123	163	5.42	4.44
6	29-Dec-97	9	Balanced	235	680	919	2,199	4.20	94.6	0.76	9,462	30.7	51.9	53.5	19,500	1.23	48.7	24.9	40.8	270.7	36.18	0.120	159	4.93	4.51
6	31-Dec-97	11	Balanced	234	681	733	2,303	5.61	46.8	0.73	9,111	32.1	51.2	49.0	19,500	1.22	54.2	21.7	38.8	226.8	30.35	0.110	154	4.17	4.75
6	1-Jan-98	12	Balanced	235	680	804	2,211	5.34	59.5	0.73	9,069	32.1	50.6	49.0	19,500	1.28	55.4	23.2	39.9	241.9	32.33	0.118	164	4.22	4.75
6	2-Jan-98	13	Balanced	235	680	906	2,264	3.70	92.0	0.77	9,601	31.0	52.5	53.5	19,500	1.14	43.2	24.2	40.7	267.2	35.73	0.119	153	5.54	4.58
6	3-Jan-98	14	Balanced	235	680	918	2,181	3.99	119.3	0.76	9,434	30.5	51.0	53.0	19,500	1.15	45.9	24.3	41.4	265.9	35.57	0.119	155	5.12	4.66
6	4-Jan-98	15	Balanced	235	680	772	2,289	4.43	49.7	0.74	9,222	30.5	50.4	52.5	19,500	1.12	47.4	22.9	39.1	236.8	31.66	0.107	166	5.27	4.73
6	5-Jan-98	16	Balanced	234	680	735	2,223	5.28	53.5	0.72	8,939	29.9	47.7	51.0	19,500	1.16	52.5	22.1	39.3	224.8	30.05	0.105	169	4.43	4.77
6	6-Jan-98	17	Balanced	235	681	734	2,191	5.37	50.1	0.71	8,843	28.1	50.6	58.8	19,500	1.22	54.6	22.7	39.1	225.5	30.21	0.091	161	4.43	4.72
6	7-Jan-98	18	Balanced	235	680	732	2,168	5.55	53.3	0.70	8,748	26.4	47.7	60.5	19,500	1.27	56.4	22.9	39.2	224.1	30.00	0.088	165	4.32	4.65
6	8-Jan-98	19	Balanced	235	680	727	2,253	4.77	39.8	0.72	8,989	26.6	49.7	62.0	19,500	1.20	50.8	23.2	38.4	227.4	30.42	0.087	170	5.17	4.60
6	9-Jan-98	20	Balanced	235	681	727	2,252	5.08	47.5	0.72	9,065	27.9	50.0	58.5	19,500	1.11	50.8	22.1	39.2	222.7	29.76	0.090	166	4.79	4.77
6	10-Jan-98	21	Balanced	235	680	735	2,221	5.14	52.9	0.72	8,964	28.4	49.8	57.0	19,500	1.08	50.9	22.0	39.5	223.4	29.86	0.093	166	4.87	4.89
6	11-Jan-98	22	Balanced	235	680	735	2,239	4.75	48.2	0.72	8,960	28.4	50.3	57.5	19,500	1.06	48.4	22.2	39.3	224.6	30.03	0.093	166	4.87	4.89
6	12-Jan-98	23	Balanced	235	681	725	2,264	4.55	44.5	0.72	8,991	28.0	49.8	58.0	19,500	1.05	46.9	22.3	38.8	224.5	30.01	0.092	165	5.04	4.83
6	13-Jan-98	24	Balanced	235	680	728	2,273	4.41	43.7	0.73	9,071	28.5	49.9	57.0	19,500	1.04	45.8	22.3	38.7	225.9	30.20	0.094	163	5.18	4.85
6	14-Jan-98	25	Balanced	235	680	728	2,289	5.07	50.3	0.73	9,174	28.5	48.7	55.5	19,500	1.07	49.2	21.4	39.2	223.0	29.81	0.096	167	5.56	5.36
6	15-Jan-98	26	Balanced	235	696	732	2,375	5.06	43.7	0.73	9,388	29.0	49.5	55.0	19,500	1.04	48.7	21.2	39.4	223.1	29.82	0.096	170	5.69	5.30
6	16-Jan-98	27	Balanced	235	700	727	2,360	4.88	45.3	0.73	9,320	29.1	49.2	54.5	19,500	1.01	47.8	21.4	39.0	223.6	29.89	0.098	171	5.63	5.24
6	17-Jan-98	28	Balanced	235	701	731	2,360	4.87	51.9	0.73	9,345	29.5	50.0	54.5	19,500	0.97	46.8	21.1	39.5	221.9	29.67	0.097	172	5.54	5.29
6	18-Jan-98	29	Balanced	235	700	728	2,342	4.84	53.4	0.72	9,278	29.5	49.6	54.0	19,500	0.95	46.2	21.0	39.8	219.7	29.38	0.097	167	5.46	5.34
6	19-Jan-98	30	Balanced	235	700	729	2,336	5.24	67.5	0.72	9,254	30.1	48.5	51.5	19,500	0.95	48.5	20.6	40.0	218.5	29.22	0.101	168	5.03	5.36
6	20-Jan-98	31	Balanced	235	700	729	2,402	4.37	57.9	0.73	9,422	30.4	50.3	52.5	19,500	0.90	42.3	20.8	39.7	220.3	29.45	0.100	163	5.93	5.27
6	21-Jan-98	32	Balanced	235	700	725	2,312	4.75	60.6	0.71	9,185	30.1	48.0	51.0	19,500	0.92	45.2	20.8	39.8	218.6	29.22	0.102	167	5.19	5.34
6	22-Jan-98	33	Balanced	234	710	726	2,397	4.62	50.2	0.72	9,387	30.8	49.7	51.0	19,500	0.93	44.4	20.8	39.1	222.6	29.76	0.104	170	5.45	5.29
6	23-Jan-98	36	Balanced	235	710	729	2,382	4.83	52.2	0.72	9,436	30.7	51.8	53.5	19,500	0.94	45.3	20.5	39.4	221.9	29.65	0.099	155	4.94	4.96
6	26-Jan-98	37	Balanced	234	709	734	2,367	4.81	50.1	0.72	9,391	29.6	49.4	53.5	19,500	0.98	46.1	20.9	39.0	226.0	30.20	0.100	164	4.81	4.89
6	27-Jan-98	38	Balanced	235	711	727	2,385	4.99	54.3	0.72	9,450	30.1	48.6	51.5	19,500	0.95	45.8	20.3	39.6	220.2	29.43	0.102	165	4.59	4.79
6	30-Jan-98	41	Balanced	226	700	735	2,217	5.31	53.7	0.68	7,030	31.1	48.2	61.5	24,800	1.00	52.2	21.7	39.3	224.4	23.63	0.087	160	4.18	4.93
6	31-Jan-98	42	Balanced	225	701	728	2,338	4.34	50.7	0.70	7,250	31.0	47.2	60.5	24,800	0.89	43.3	21.0	39.4	221.7	23.38	0.087	155	4.93	4.76
6	1-Feb-98	43	Balanced	225	700	726	2,315	4.35	55.4	0.70	7,171	31.7	48.2	60.0	24,800	0.87	43.0	20.9	39.9	218.7	22.99	0.087	151	4.82	4.76
6	4-Feb-98	44	Balanced	225	700	732	2,271	4.51	65.6	0.69	7,112	32.0	47.6	58.5	24,800	0.87	44.4	21.2	39.9	220.2	23.16	0.089	154	4.59	4.79
6	3-Feb-98	45	Balanced	225	700	734	2,256	4.42	62.4	0.69	7,118	32.2	47.7	58.0	24,800	0.87	43.5	21.3	40.1	219.5	23.07	0.090	154	4.72	4.92
6	4-Feb-98	46	Balanced	225	700	723	2,337	4.03	51.2	0.70	7,243	31.9	47.0	58.0	24,800	0.87	40.8	21.4	39.2	221.3	23.26	0.091	162	5.18	4.76
6	5-Feb-98	47	Balanced	225	700	732	2,323	3.99	56.1	0.70	7,203	32.9	49.7	58.5	24,800	0.86	40.4	21.4	39.6	221.9	23.32	0.090	159	5.07	4.84
6	6-Feb-98	48	Balanced	225	700	727	2,307	4.18	56.5	0.69	7,148	33.3	49.3	57.0	24,800	0.88	41.7	21.3	39.5	221.0	23.24	0.092	154	4.76	4.85
6	7-Feb-98	49	Balanced	225	702	721	2,307	4.77	65.3	0.63	6,532	33.3	47.8	55.5	24,800	0.89	47.6	21.9	41.0	210.9	22.17	0.090	162	4.11	5.59
3	8-Feb-98	50	Texaco	225	710	735	2,295	0.74	133.6	0.69	7,216	33.7	54.2	62.0	24,800	0.89	12.4	17.8	44.2	199.7	21.15	0.076	147	8.96	4.78

**Table D-2 – Data Summary Table for Kingsport Catalyst Campaign 2 (cont'd)**

Case	Date	Days On Stream	Gas Type	Temp (Deg C)	Press (psig)	Fresh Feed (KSCFH)	Recycle Gas (KSCFH)	Reactor Feed (H <sub>2</sub> CO)	Purge Gas (KSCFH)	Inlet Sup. Velocity (ft/sec)	Space Velocity (1/hr-kg)	Slurry Conc. (wt%-ox)	Gas Holdup (vol%)	Gassed Slurry Hgt (ft)	Catalyst Inventory (lb)	Catalyst Age (eta)	CO Conv. (%)	O-T-M Conv. (%)	Syngas Util. (SCF/lb)	Raw		U			
																				MeOH Prod. (TPD)	MeOH Prod. (gmol/hr-kg)	Reactor Vol. Prod. (TPD/B3)	Overall (Btu/hr (2-F))	Sparger dP (psf)	Sparger Resist. ("K")
3	9-Feb-98	51	Texaco	225	711	724	2,320	0.76	128.4	0.70	7,286	35.1	53.0	57.0	24,800	0.86	12.2	17.3	44.3	196.0	20.77	0.082	139	9.03	4.78
3	10-Feb-98	52	Texaco	224	710	708	2,343	0.84	123.7	0.70	7,283	37.0	49.4	49.0	24,800	0.84	12.5	16.9	44.2	192.4	20.39	0.094	136	8.87	4.93
3	11-Feb-98	53	Texaco	224	710	700	2,343	0.81	131.1	0.70	7,287	38.8	49.8	46.0	24,800	0.85	12.2	16.8	44.0	190.8	20.25	0.099	135	9.57	5.25
3	12-Feb-98	54	Texaco	224	710	700	2,348	0.74	152.5	0.70	7,314	40.7	46.9	40.5	24,800	0.81	10.9	15.7	46.4	181.0	19.08	0.107	127	10.13	5.45
6	15-Feb-98	57	Balanced	223	710	726	2,218	5.86	133.6	0.67	7,020	38.5	40.6	39.5	24,800	0.85	49.0	18.7	44.7	197.6	20.80	0.120	159	4.64	6.16
6	16-Feb-98	58	Balanced	224	710	728	2,479	3.92	89.9	0.73	7,603	37.9	43.0	42.0	24,800	0.78	35.5	18.6	41.5	210.6	22.15	0.120	149	6.12	5.42
6	17-Feb-98	59	Balanced	224	710	721	2,437	3.49	76.3	0.72	7,519	37.8	45.2	44.0	24,800	0.78	33.7	19.3	40.5	213.6	22.47	0.116	151	6.28	5.23
6	18-Feb-98	60	Balanced	225	710	728	2,413	3.93	83.4	0.71	7,450	37.0	45.3	45.5	24,800	0.78	36.4	19.1	41.2	211.9	22.29	0.111	147	5.63	5.27
6	19-Feb-98	61	Balanced	225	710	728	2,349	4.46	54.7	0.70	6,616	37.1	45.2	50.0	27,450	0.81	43.8	20.4	39.4	221.8	21.07	0.106	148	5.54	5.42
6	20-Feb-98	62	Balanced	225	711	728	2,344	4.11	53.4	0.70	6,613	37.6	46.3	50.0	27,450	0.79	41.2	20.6	39.3	222.5	21.13	0.106	148	5.67	5.36
6	21-Feb-98	63	Balanced	225	710	712	2,328	4.43	54.9	0.69	6,528	37.4	44.2	48.5	27,450	0.78	43.1	20.2	39.4	217.1	20.62	0.107	146	5.32	5.38
6	22-Feb-98	64	Balanced	224	710	710	2,292	4.84	66.5	0.68	6,441	37.2	44.9	49.5	27,450	0.79	45.3	19.9	40.2	212.2	20.16	0.102	142	4.89	5.44
6	23-Feb-98	65	Balanced	225	710	728	2,304	4.46	62.0	0.69	6,524	38.0	47.8	50.5	27,450	0.81	44.1	20.5	39.7	220.0	21.11	0.104	153	5.31	5.42
6	24-Feb-98	66	Balanced	225	710	728	2,261	4.52	61.1	0.68	6,427	37.4	47.0	51.0	27,450	0.80	44.8	20.4	39.8	219.3	20.84	0.102	155	5.47	5.42
6	25-Feb-98	67	Balanced	225	710	726	2,256	4.47	61.8	0.68	6,409	38.0	47.3	50.0	27,450	0.79	44.6	20.6	39.7	219.7	20.87	0.105	156	5.16	5.47
6	26-Feb-98	68	Balanced	225	710	724	2,249	4.49	65.2	0.68	6,387	36.5	43.4	49.5	27,450	0.80	44.6	20.7	39.8	218.0	20.72	0.105	152	5.12	5.39
6	27-Feb-98	69	Balanced	225	710	734	2,184	4.83	69.1	0.67	6,275	34.9	47.6	57.0	27,450	0.84	48.3	21.3	40.1	219.4	20.85	0.091	148	4.87	5.46
6	28-Feb-98	70	Balanced	225	711	727	2,234	4.59	61.5	0.68	6,372	34.5	48.5	59.0	27,450	0.82	46.4	21.2	39.5	221.3	21.03	0.089	146	5.13	5.39
6	1-Mar-98	71	Balanced	225	710	727	2,223	4.60	59.5	0.67	6,333	33.5	48.8	62.0	27,450	0.82	46.5	21.3	39.6	220.6	20.95	0.084	146	5.20	5.41
6	2-Mar-98	72	Balanced	225	710	721	2,267	4.21	50.7	0.68	6,421	35.1	51.0	60.5	27,450	0.81	43.7	21.6	38.8	223.4	21.22	0.088	146	5.39	5.36
6	3-Mar-98	73	Balanced	225	710	722	2,268	4.21	53.0	0.68	6,427	34.6	48.3	58.5	27,450	0.78	42.8	21.2	39.1	221.4	21.03	0.090	146	5.32	5.46
6	4-Mar-98	74	Balanced	225	710	729	2,234	4.25	56.6	0.67	6,364	32.8	47.2	62.0	27,450	0.78	43.2	21.2	39.7	220.4	20.93	0.084	144	5.26	5.53
6	5-Mar-98	75	Balanced	225	710	728	2,217	4.44	61.0	0.67	6,334	32.3	47.0	63.0	27,450	0.79	44.8	21.4	39.5	221.3	21.02	0.083	145	5.07	5.55
6	6-Mar-98	76	Balanced	225	710	726	2,194	4.53	61.7	0.66	6,262	32.3	46.2	62.0	27,450	0.79	45.4	21.3	39.8	219.0	20.80	0.084	143	4.90	5.58
6	7-Mar-98	77	Balanced	225	710	728	2,212	4.32	61.9	0.67	6,295	33.5	45.8	58.5	27,450	0.79	44.1	21.4	39.7	220.3	20.93	0.089	144	5.09	5.50
6	8-Mar-98	78	Balanced	225	710	731	2,202	4.33	64.7	0.66	6,261	33.8	44.4	56.5	27,450	0.80	44.5	21.6	39.9	219.9	20.90	0.093	148	5.05	5.34
6	9-Mar-98	79	Balanced	225	710	728	2,250	4.02	59.2	0.68	6,411	36.4	49.4	55.5	27,450	0.76	41.1	21.2	39.5	221.4	21.03	0.095	150	5.29	5.39
6	10-Mar-98	80	Balanced	225	710	720	2,260	4.37	63.3	0.68	6,401	36.2	50.8	57.5	27,450	0.75	42.6	20.5	40.0	215.9	20.50	0.089	145	5.01	5.46
6	11-Mar-98	81	Balanced	225	709	742	2,257	4.13	73.9	0.68	6,436	35.8	48.9	56.5	27,450	0.75	41.4	20.8	40.6	219.6	20.86	0.092	148	5.26	5.45
6	12-Mar-98	82	Balanced	225	710	756	2,244	3.88	75.9	0.68	6,441	35.9	49.2	56.5	27,450	0.74	39.7	21.0	41.0	221.1	21.01	0.093	151	5.40	5.40
6	13-Mar-98	83	Balanced	225	710	741	2,215	4.15	84.3	0.67	6,347	35.7	47.8	55.5	27,450	0.73	41.0	20.7	41.2	215.9	20.51	0.093	154	5.06	5.45
6	14-Mar-98	84	Balanced	225	709	735	2,226	4.11	85.5	0.67	6,343	35.4	46.2	54.5	27,450	0.74	40.8	20.7	40.7	216.9	20.61	0.095	159	5.06	5.48
6	15-Mar-98	85	Balanced	225	709	733	2,319	3.27	67.5	0.70	6,569	35.9	46.4	53.5	27,450	0.70	33.6	20.1	40.6	217.0	20.62	0.097	156	6.16	5.45
6	16-Mar-98	86	Balanced	225	710	715	2,139	4.08	82.9	0.65	6,113	36.0	45.4	52.5	27,450	0.70	40.3	20.4	41.5	206.5	19.62	0.094	158	5.23	6.09
6	17-Mar-98	87	Balanced	225	709	726	2,283	3.91	83.8	0.69	6,474	36.8	45.2	50.5	27,450	0.69	37.4	19.8	41.5	209.7	19.93	0.099	152	5.51	5.53
6	18-Mar-98	88	Balanced	225	711	727	2,271	3.38	82.0	0.68	6,462	37.3	46.7	51.0	27,450	0.67	34.0	20.2	41.1	212.1	20.16	0.099	148	5.90	5.48
6	19-Mar-98	89	Balanced	225	709	733	2,242	3.48	85.5	0.68	6,396	37.0	45.5	50.5	27,450	0.70	35.2	20.4	41.3	212.9	20.24	0.100	151	5.65	5.41
6	20-Mar-98	90	Balanced	225	710	733	2,268	3.24	82.2	0.68	6,444	38.7	47.1	48.5	27,450	0.69	33.3	20.4	41.2	213.3	20.27	0.105	154	5.81	5.31
6	21-Mar-98	91	Balanced	224	710	730	2,274	3.33	82.6	0.68	6,447	40.0	47.0	46.0	27,450	0.69	33.6	20.3	41.1	213.2	20.26	0.111	159	5.64	5.37
6	22-Mar-98	92	Balanced	224	710	729	2,247	3.40	85.5	0.68	6,413	40.3	46.5	45.0	27,450	0.68	34.0	20.1	41.3	211.8	20.12	0.112	156	5.55	5.43
6	23-Mar-98	93	Balanced	224	710	728	2,219	3.63	96.5	0.67	6,358	36.7	43.9	49.5	27,450	0.68	35.4	19.9	41.9	208.4	19.88	0.100	138	5.27	5.46
6	24-Mar-98	94	Balanced	224	710	715	2,223	3.88	98.5	0.67	6,298	38.1	43.4	46.5	27,450	0.68	36.5	19.6	42.2	203.2	19.32	0.104	143	5.04	5.49
6	25-Mar-98	95	Balanced	224	710	674	2,235	4.02	74.0	0.66	6,231	38.8	42.4	44.5	27,450	0.67	37.2	19.3	40.9	197.9	18.81	0.106	148	4.96	5.52
6	26-Mar-98	96	Balanced	224	710	685	2,187	4.12	80.5	0.65	6,169	37.4	41.8	46.5	27,450	0.69	38.7	19.7	41.0	200.7	19.08	0.103	149	4.87	5.62
6	27-Mar-98	97	Balanced	224	710	675	2,225	3.56	68.1	0.66	6,243	37.3	41.7	46.5	27,450	0.66	34.3	19.5	40.6	199.6	18.98	0.102	146	5.47	5.60

**Table D-2 – Data Summary Table for Kingsport Catalyst Campaign 2 (cont'd)**

Case	Date	Days On Stream	Gas Type	Temp (Deg C)	Press (psig)	Fresh Feed (KSCFH)	Recycle Gas (KSCFH)	Reactor Feed (H <sub>2</sub> CO)	Purge Gas (KSCFH)	Inlet Sup. Velocity (ft/sec)	Space Velocity (1/hr-kg)	Slurry Conc. (wt%-ox)	Gas Holdup (vol%)	Gassed Slurry Hgt (ft)	Catalyst Inventory (lb)	Catalyst Age (eta)	CO Conv. (%)	O-T-M Conv. (%)	Synogas Util. (SCF/lb)	Raw		U		
																				MeOH Prod. (TPD)	Sparger dP (ps)	Reactor Vol. Prod. (TPD/ft <sup>3</sup> )	Overall (Btu/hr (2-F))	Sparger Resist. ("K")
6	28-Mar-98	98	Balanced	224	710	674	2,111	4,57	90.0	0.63	6,003	37.8	40.2	44.5	27,450	0.68	41.3	19.5	41.9	192.9	18.35	150	4.47	5.78
6	29-Mar-98	99	Balanced	224	710	682	2,223	3.63	80.6	0.66	6,242	39.2	41.6	43.0	27,450	0.65	34.4	19.3	41.2	198.6	18.89	150	5.23	5.51
6	30-Mar-98	100	Balanced	224	710	681	2,175	3.96	84.7	0.65	6,153	38.8	41.2	43.5	27,450	0.67	36.9	19.4	41.5	196.8	18.72	148	4.88	5.51
6	31-Mar-98	101	Balanced	224	709	681	2,176	3.93	79.4	0.65	6,152	38.4	41.6	44.5	27,450	0.68	37.2	19.4	41.5	199.4	18.96	147	4.91	5.48
6	1-Apr-98	102	Balanced	224	709	682	2,247	3.46	71.9	0.66	6,268	39.2	42.9	44.0	27,450	0.66	33.9	19.7	40.5	202.1	19.20	152	5.44	5.46
6	2-Apr-98	103	Balanced	221	710	684	2,234	3.51	91.6	0.66	5,696	40.7	43.1	45.5	30,050	0.61	32.8	19.0	42.2	194.6	16.90	152	5.28	5.49
6	3-Apr-98	104	Balanced	221	710	641	2,240	3.51	82.1	0.65	5,615	39.2	41.6	47.0	30,050	0.60	31.9	18.4	41.6	185.0	16.07	145	5.19	5.48
6	4-Apr-98	105	Balanced	219	710	630	2,267	3.39	79.4	0.65	5,646	40.8	42.1	44.5	30,050	0.60	30.2	17.9	41.6	181.8	15.79	149	5.24	5.51
6	5-Apr-98	106	Balanced	219	709	630	2,261	3.33	85.8	0.64	5,620	41.2	40.9	43.0	30,050	0.59	29.5	17.8	42.0	179.9	15.63	148	5.25	5.73
6	6-Apr-98	107	Balanced	218	709	605	2,269	3.47	75.6	0.64	5,605	41.9	39.0	40.5	30,050	0.59	30.0	17.4	41.2	176.2	15.31	150	5.28	5.70
6	7-Apr-98	108	Balanced	218	710	593	2,252	3.44	65.3	0.64	5,578	42.2	37.3	39.0	30,050	0.58	29.8	17.3	40.9	173.8	15.10	147	5.19	5.53
6	8-Apr-98	109	Balanced	218	710	587	2,264	3.30	66.2	0.64	5,604	43.0	36.8	37.5	30,050	0.58	28.6	17.2	40.6	173.6	15.09	143	5.43	5.70
6	9-Apr-98	110	Balanced	219	709	583	2,227	3.61	50.2	0.63	5,519	37.6	42.1	50.5	30,050	0.61	32.1	17.9	39.7	176.4	15.31	143	5.26	5.71
6	10-Apr-98	111	Balanced	220	710	578	2,195	4.03	45.0	0.63	5,462	37.5	44.8	53.0	30,050	0.61	35.4	18.0	39.2	177.1	15.40	152	4.83	5.70
6	11-Apr-98	112	Balanced	220	710	582	2,185	4.05	50.0	0.63	5,447	37.9	43.9	51.5	30,050	0.60	35.2	17.9	39.7	176.0	15.28	151	4.75	5.70
6	12-Apr-98	113	Balanced	220	711	582	2,192	3.80	52.0	0.63	5,451	38.1	42.7	50.0	30,050	0.59	33.5	17.9	39.7	176.0	15.28	150	4.91	5.69
6	13-Apr-98	114	Balanced	219	710	576	2,208	3.61	49.3	0.63	5,468	37.4	41.8	50.0	30,050	0.58	31.8	17.8	39.6	174.4	15.14	146	5.07	5.71
6	14-Apr-98	115	Balanced	220	710	580	2,189	3.68	46.4	0.62	5,436	36.9	43.9	53.5	30,050	0.60	33.1	18.3	39.4	176.9	15.36	152	5.02	5.64
6	15-Apr-98	116	Balanced	220	710	578	2,227	3.65	46.5	0.62	5,426	36.3	44.5	55.5	30,050	0.59	32.7	18.2	39.5	175.5	15.24	146	5.01	5.60
6	16-Apr-98	117	Balanced	219	709	578	2,227	3.57	48.1	0.63	5,506	37.1	44.8	54.0	30,050	0.59	31.7	18.0	39.5	175.5	15.24	151	5.15	5.59
6	17-Apr-98	118	Balanced	220	710	573	2,258	3.58	46.5	0.64	5,570	37.2	45.0	54.0	30,050	0.59	31.4	17.7	39.2	175.7	15.25	151	5.30	5.70
6	18-Apr-98	119	Balanced	220	710	567	2,267	3.54	39.3	0.64	5,550	36.5	44.9	55.5	30,050	0.59	31.3	17.8	39.0	174.5	15.17	149	5.33	5.63
6	19-Apr-98	120	Balanced	220	710	577	2,229	3.57	50.4	0.63	5,505	37.6	44.4	52.5	30,050	0.57	31.3	17.7	40.0	173.0	15.06	148	5.19	5.67
6	20-Apr-98	121	Balanced	220	710	583	2,198	3.52	61.0	0.63	5,473	37.5	44.3	52.0	30,050	0.56	30.8	17.7	40.6	172.5	14.98	142	5.11	5.63
6	21-Apr-98	122	Balanced	219	710	583	2,240	3.55	65.0	0.64	5,543	38.4	41.0	48.0	30,050	0.55	28.7	17.2	41.0	170.9	14.84	144	5.60	5.98
6	22-Apr-98	123	Balanced	219	711	583	2,229	3.38	70.2	0.63	5,535	39.2	42.3	47.5	30,050	0.55	28.5	17.1	41.2	169.9	14.76	141	5.54	6.01
6	23-Apr-98	124	Balanced	220	710	583	2,230	3.34	63.3	0.63	5,517	36.7	43.5	53.5	30,050	0.55	29.4	17.5	40.7	172.1	14.94	146	5.23	5.60
6	24-Apr-98	125	Balanced	220	710	583	2,201	3.55	67.3	0.63	5,473	37.1	42.0	51.5	30,050	0.55	30.3	17.4	41.2	170.0	14.76	145	5.00	5.62
6	25-Apr-98	126	Balanced	219	709	583	2,193	3.53	69.7	0.63	5,459	37.4	41.7	50.5	30,050	0.55	30.0	17.3	41.4	168.9	14.68	144	4.96	5.64
6	26-Apr-98	127	Balanced	219	708	583	2,182	3.47	70.2	0.63	5,440	37.7	40.7	49.0	30,050	0.55	29.7	17.3	41.3	169.4	14.72	149	4.94	5.66
6	29-Apr-98	130	Balanced	220	709	554	2,292	3.80	63.3	0.64	5,555	37.2	43.5	52.5	30,050	0.53	30.0	16.0	41.0	162.0	14.08	145	4.87	5.49
6	30-Apr-98	131	Balanced	220	709	552	2,259	3.98	63.1	0.63	5,487	36.7	41.1	51.5	30,050	0.54	31.1	16.0	41.4	159.9	13.89	147	4.53	5.29
6	1-May-98	132	Balanced	219	710	549	2,249	3.96	62.7	0.63	5,481	37.4	41.2	50.0	30,050	0.54	30.8	15.9	41.6	158.2	13.74	149	4.46	5.15
6	2-May-98	133	Balanced	219	710	554	2,233	3.93	67.3	0.63	5,455	38.4	39.7	47.0	30,050	0.54	30.5	15.9	42.2	157.7	13.70	150	4.40	5.17
6	3-May-98	134	Balanced	219	709	554	2,206	4.15	67.9	0.62	5,413	37.1	40.5	50.0	30,050	0.55	32.2	16.1	42.1	158.0	13.73	151	4.25	5.18
6	4-May-98	135	Balanced	220	710	555	2,289	4.16	59.8	0.64	5,554	37.7	41.2	49.5	30,050	0.55	31.8	15.9	41.7	159.9	13.89	150	4.41	5.20
6	8-May-98	139	Balanced	234	709	735	2,145	4.45	54.8	0.67	5,619	37.3	41.7	51.5	30,050	0.65	47.3	22.4	40.2	219.5	19.05	147	5.01	5.08
6	9-May-98	140	Balanced	235	707	738	2,176	4.20	49.5	0.67	5,683	36.9	42.0	52.5	30,050	0.65	45.7	22.6	39.5	224.1	19.45	148	5.24	5.07
6	10-May-98	141	Balanced	234	707	738	2,130	4.41	55.2	0.66	5,601	37.6	41.4	50.5	30,050	0.65	47.1	22.6	40.1	221.1	19.19	149	4.90	5.08
6	11-May-98	142	Balanced	235	710	729	2,139	4.48	52.0	0.66	5,615	36.8	42.4	53.0	30,050	0.65	47.6	22.5	39.7	220.0	19.09	148	4.94	5.09
6	12-May-98	143	Balanced	235	710	738	2,139	4.55	60.1	0.67	5,625	36.5	42.1	53.5	30,050	0.64	47.7	22.5	40.4	219.4	19.05	147	4.89	5.12
6	13-May-98	144	Balanced	234	710	733	2,096	4.73	67.2	0.65	5,537	37.1	40.2	50.5	30,050	0.64	48.9	22.3	40.5	216.8	18.83	148	4.64	5.24
6	14-May-98	145	Balanced	234	710	713	2,138	4.40	53.2	0.66	5,584	37.1	40.2	50.0	30,050	0.62	46.2	22.4	39.6	215.9	18.75	145	4.97	5.14
6	15-May-98	146	Balanced	235	710	732	2,107	4.13	54.6	0.66	5,577	35.9	41.4	54.0	30,050	0.61	44.6	22.1	40.1	218.8	19.00	143	5.19	5.21
6	16-May-98	147	Balanced	235	710	732	2,087	4.34	59.3	0.65	5,516	36.5	40.5	52.0	30,050	0.62	46.5	22.6	40.0	219.6	19.07	144	4.78	5.16

**Table D-2 – Data Summary Table for Kingsport Catalyst Campaign 2 (cont'd)**

Case	Date	Days On Stream	Gas Type	Temp (Deg C)	Press (psig)	Fresh Feed (KSCFH)	Recycle Gas (KSCFH)	Reactor Feed (H2CO)	Purge Gas (KSCFH)	Inlet Sup. Velocity (ft/sec)	Space Velocity (1/hr-kg)	Slurry Conc. (wt%-ox)	Gas Holdup (vol%)	Gassed Slurry Hgt (ft)	Catalyst Inventory (lb)	Catalyst Age (eta)	CO Conv. (%)	O-T-M Conv. (%)	Reactor		Raw		U		
																			Vol. Prod. (TPD/B3)	Catalyst (gmol/hr-kg)	MeOH Prod. (TPD)	Syngas Util. (SCF/lb)	MeOH Prod. (TPD)	Overall (Btu/hr (2-F))	Sparger dP (ps)
6	27-May-98	158	Balanced	234	710	733	2,115	3.99	80.4	0.66	5,584	37.2	40.4	50.5	30,050	0.56	41.7	21.6	0.101	18.54	213.5	41.2	144	5.07	5.16
6	28-May-98	159	Balanced	235	710	731	2,078	4.01	71.5	0.65	5,507	37.1	40.3	50.5	30,050	0.57	42.5	21.9	0.102	18.77	161.1	40.6	142	4.76	5.16
6	29-May-98	160	Balanced	234	710	731	2,050	4.08	68.8	0.65	5,456	36.5	40.4	52.0	30,050	0.60	44.3	22.6	0.100	19.06	219.5	39.9	144	4.63	5.16
6	30-May-98	161	Balanced	234	710	732	2,023	4.25	68.8	0.64	5,412	37.1	39.5	50.0	30,050	0.61	45.6	22.7	0.104	18.91	217.8	40.3	144	4.83	5.23
6	31-May-98	162	Balanced	234	710	726	2,054	3.88	57.3	0.65	5,469	37.7	39.8	49.0	30,050	0.60	42.9	22.9	0.107	19.09	219.9	39.6	144	4.83	5.10
6	1-Jun-98	163	Balanced	235	710	721	2,085	3.88	56.1	0.65	5,498	38.3	39.9	48.0	30,050	0.60	42.8	22.7	0.109	19.06	219.6	39.4	144	4.88	5.08
6	2-Jun-98	164	Balanced	234	710	705	2,064	3.94	49.3	0.64	5,442	37.4	37.9	48.4	30,050	0.60	43.3	22.6	0.107	18.73	215.8	39.2	148	4.82	5.08
6	3-Jun-98	165	Balanced	235	710	730	2,013	4.13	66.4	0.64	5,388	37.2	39.7	50.0	30,050	0.60	45.2	22.9	0.104	18.98	218.6	40.1	144	4.51	5.12
6	4-Jun-98	166	Balanced	234	710	725	2,029	4.28	75.2	0.64	5,412	37.8	39.4	48.5	30,050	0.58	45.1	22.4	0.105	18.52	213.4	40.8	145	4.51	5.13
6	5-Jun-98	167	Balanced	234	709	736	2,050	3.97	79.9	0.65	5,460	37.5	39.9	49.5	30,050	0.57	42.5	22.4	0.104	18.70	215.4	41.0	145	4.75	5.10
6	6-Jun-98	168	Balanced	235	710	735	2,072	3.98	81.3	0.65	5,504	37.5	40.4	50.0	30,050	0.55	41.9	22.0	0.102	18.61	214.4	41.1	146	4.72	5.17
6	7-Jun-98	169	Balanced	234	710	719	2,064	4.05	79.8	0.65	5,461	38.0	39.9	48.5	30,050	0.53	41.4	21.4	0.102	18.04	207.8	41.5	144	4.61	5.25
6	8-Jun-98	170	Balanced	234	710	734	2,047	3.94	89.1	0.64	5,447	37.4	40.3	50.0	30,050	0.53	41.0	21.7	0.100	18.32	210.9	41.8	143	4.61	5.24
6	9-Jun-98	171	Balanced	234	709	733	2,058	3.76	80.5	0.64	5,444	36.3	41.2	53.0	30,050	0.54	40.1	21.9	0.095	18.44	212.4	41.4	144	4.78	5.19
6	15-Jun-98	177	Balanced	234	709	732	2,032	4.58	112.2	0.64	5,420	38.7	42.7	49.5	30,050	0.53	44.3	20.8	0.097	17.51	201.4	43.6	146	4.70	5.63
6	16-Jun-98	178	Balanced	230	711	497	2,212	5.24	27.6	0.62	5,304	37.4	41.1	50.5	30,050	0.50	40.4	16.7	0.072	13.18	151.7	39.3	142	4.32	5.17
6	17-Jun-98	179	Balanced	230	710	497	2,246	4.94	26.2	0.63	5,359	36.7	39.0	50.0	30,050	0.48	38.5	16.7	0.073	13.24	152.5	40.2	140	4.56	5.18
6	18-Jun-98	180	Balanced	230	707	487	2,178	5.08	26.6	0.62	5,229	37.6	38.6	48.0	30,050	0.48	39.6	16.7	0.074	13.01	149.7	39.1	143	4.38	5.22
6	19-Jun-98	181	Balanced	235	709	733	2,084	3.74	96.2	0.65	5,482	38.1	40.2	48.5	30,050	0.51	38.4	21.1	0.102	18.01	207.2	42.4	141	4.81	5.23
6	20-Jun-98	182	Balanced	235	709	732	2,080	3.83	100.5	0.65	5,470	38.2	38.5	47.0	30,050	0.51	39.2	21.2	0.105	17.98	206.7	42.5	142	4.81	5.23
6	21-Jun-98	183	Balanced	235	709	732	2,062	4.00	69.5	0.65	5,003	38.4	41.2	53.0	32,700	0.52	43.3	22.5	0.097	17.20	215.4	40.8	137	4.91	5.26
6	22-Jun-98	184	Balanced	235	709	734	2,061	4.05	59.8	0.65	5,013	37.9	41.2	54.0	32,700	0.54	44.3	22.8	0.096	17.48	219.0	40.2	135	4.85	5.24
6	23-Jun-98	185	Balanced	235	709	733	2,035	4.17	62.4	0.64	4,953	37.9	39.4	52.5	32,700	0.55	45.6	22.9	0.099	17.44	218.5	40.2	137	4.63	5.25
6	24-Jun-98	186	Balanced	235	709	721	2,031	4.29	64.8	0.64	4,942	39.4	40.7	50.5	32,700	0.54	45.7	22.5	0.101	17.04	213.6	40.5	137	4.59	5.28
6	25-Jun-98	187	Balanced	235	709	739	1,982	4.30	84.0	0.63	4,882	39.3	38.6	49.0	32,700	0.53	45.6	22.5	0.103	16.95	212.3	41.8	134	4.44	5.32
6	26-Jun-98	188	Balanced	234	709	740	1,949	4.36	87.2	0.62	4,826	38.0	38.0	51.0	32,700	0.53	46.4	22.6	0.098	16.84	210.7	42.2	133	4.34	5.31
6	29-Jun-98	191	Balanced	234	710	722	1,927	4.43	77.8	0.62	4,780	36.0	33.9	52.0	32,700	0.53	46.9	22.6	0.096	16.77	210.1	41.3	179	4.20	5.47
6	30-Jun-98	192	Balanced	235	710	631	1,978	4.72	41.5	0.61	4,707	34.7	28.7	51.0	32,700	0.51	47.2	21.3	0.089	15.28	191.6	39.6	190	4.18	5.34
6	1-Jul-98	193	Balanced	234	710	728	2,018	3.61	65.0	0.63	4,925	35.3	28.6	49.5	32,700	0.52	40.8	22.6	0.105	17.34	217.3	40.2	206	4.94	5.37
6	2-Jul-98	194	Balanced	234	710	730	2,004	3.66	65.4	0.63	4,919	34.5	29.7	52.0	32,700	0.51	40.9	22.5	0.099	17.24	216.0	40.6	201	4.92	5.44
6	3-Jul-98	195	Balanced	235	710	707	2,008	3.69	55.8	0.63	4,877	34.9	29.4	51.0	32,700	0.51	41.2	22.5	0.099	16.98	212.8	39.9	202	4.84	5.36
6	4-Jul-98	196	Balanced	235	710	679	2,002	3.90	48.5	0.62	4,817	35.2	28.9	50.0	32,700	0.50	42.2	22.0	0.097	16.33	204.7	39.8	200	4.66	5.32
6	5-Jul-98	197	Balanced	235	711	680	1,986	4.07	51.8	0.62	4,801	35.9	30.2	49.5	32,700	0.51	43.8	22.1	0.099	16.42	205.8	39.6	204	4.52	5.37
6	6-Jul-98	198	Balanced	234	710	730	1,964	3.80	70.9	0.62	4,845	36.0	30.4	49.5	32,700	0.52	42.3	22.6	0.103	17.10	214.2	40.9	207	4.68	5.45
6	7-Jul-98	199	Balanced	234	710	731	1,946	3.81	71.7	0.62	4,815	35.6	31.3	51.0	32,700	0.52	42.8	23.0	0.100	17.18	215.2	40.8	204	4.62	5.42
6	8-Jul-98	200	Balanced	234	710	732	1,921	3.86	74.2	0.61	4,772	35.4	32.4	52.0	32,700	0.53	43.5	23.2	0.098	17.18	215.2	40.8	207	4.48	5.39
6	9-Jul-98	201	Balanced	234	710	678	1,935	4.33	53.7	0.60	4,693	36.2	33.9	51.5	32,700	0.52	45.8	22.3	0.094	16.17	202.6	40.1	200	4.18	5.43
6	10-Jul-98	202	Balanced	235	710	675	1,958	4.13	55.1	0.61	4,762	36.7	34.4	51.0	32,700	0.50	43.5	21.9	0.094	16.02	200.7	40.4	201	4.46	5.40
6	11-Jul-98	203	Balanced	234	710	673	1,950	4.26	49.9	0.61	4,737	36.8	34.0	50.5	32,700	0.53	45.3	22.3	0.096	16.31	204.4	39.5	210	4.30	5.46
6	12-Jul-98	204	Balanced	234	710	676	1,935	4.25	54.0	0.61	4,705	37.3	34.1	49.5	32,700	0.53	45.6	22.5	0.098	16.32	204.5	39.7	204	4.31	5.46
6	13-Jul-98	205	Balanced	234	706	666	1,944	4.13	52.5	0.61	4,702	38.0	34.5	48.5	32,700	0.51	43.6	22.0	0.098	15.91	199.4	40.1	204	4.38	5.48
6	27-Jul-98	219	Balanced	234	710	635	1,990	3.53	100.3	0.61	4,738	39.5	35.7	46.5	32,700	0.37	32.9	18.9	0.090	13.96	174.7	43.6	208	4.02	4.86
6	28-Jul-98	220	Balanced	234	710	631	1,964	3.55	90.4	0.60	4,688	37.8	36.8	50.5	32,700	0.38	33.8	19.4	0.083	14.14	176.9	42.8	213	4.00	4.87
6	29-Jul-98	221	Balanced	234	710	633	1,969	3.39	89.1	0.60	4,700	37.0	38.3	53.5	32,700	0.38	32.7	19.4	0.079	14.17	177.3	41.2	214	4.17	4.90
6	30-Jul-98	222	Balanced	234	710	634	2,113	3.60	88.7	0.64	4,949	37.2	38.4	53.0	32,700	0.38	32.9	18.6	0.081	14.36	179.8	42.3	213	4.41	4.85

**Table D-2 – Data Summary Table for Kingsport Catalyst Campaign 2 (cont'd)**

Case	Date	Days On Stream	Gas Type	Temp (Deg C)	Press (psig)	Fresh Feed (KSCFH)	Recycle Gas (KSCFH)	Reactor Feed (H <sub>2</sub> CO)	Purge Gas (KSCFH)	Inlet Sup. Velocity (ft/sec)	Space Velocity (1/hr-kg)	Slurry Conc. (wt%-ox)	Gas Holdup (vol%)	Gassed Slurry Hgt (ft)	Catalyst Inventory (lb)	Catalyst Age (eta)	CO Conv. (%)	O-T-M Conv. (%)	Reactor		Raw		U		Sparger Resist. ("K")
																			Vol. Prod. (TPD/ft <sup>3</sup> )	Reactor Vol. Prod. (TPD/ft <sup>3</sup> )	Syngas Util. (SCF/lb)	MeOH Prod. (TPD)	Overall (ftu)	Sparger dP (ps)	
6	31-Jul-98	223	Balanced	234	710	634	2,158	3,37	84.4	0.65	5034	37.7	38.4	52.0	32,700	0.37	30.8	18.3	42.3	1800	14.38	0.082	218	4.64	4.82
6	1-Aug-98	224	Balanced	234	710	733	2,119	3.70	88.4	0.66	4770	40.0	38.0	51.0	35,350	0.43	37.4	20.8	42.0	209.5	15.47	0.098	210	4.59	4.85
6	2-Aug-98	225	Balanced	234	710	696	2,118	4.10	76.6	0.65	4688	40.5	37.4	49.5	35,350	0.43	40.0	20.5	41.0	203.6	15.03	0.098	217	4.31	4.99
6	3-Aug-98	226	Balanced	234	710	722	2,145	3.54	69.9	0.66	4760	40.9	37.0	48.5	35,350	0.44	37.0	21.1	41.0	211.2	15.60	0.104	214	5.04	5.19
6	4-Aug-98	227	Balanced	235	710	741	2,121	3.47	70.2	0.66	4761	40.1	37.5	50.5	35,350	0.45	37.2	21.6	41.0	216.7	16.00	0.102	205	5.03	5.11
6	5-Aug-98	228	Balanced	234	710	739	2,090	3.61	73.6	0.66	4722	40.3	36.8	49.5	35,350	0.46	39.0	21.9	40.8	217.5	16.07	0.105	210	4.91	5.06
6	6-Aug-98	229	Balanced	234	710	740	2,098	3.38	77.7	0.66	4726	40.7	36.6	48.5	35,350	0.45	36.8	21.8	41.0	216.5	15.99	0.106	211	5.07	5.08
6	7-Aug-98	230	Balanced	234	710	727	2,100	3.60	81.1	0.65	4692	41.9	36.7	46.5	35,350	0.45	38.0	21.4	41.0	212.6	15.70	0.109	211	5.00	5.33
6	8-Aug-98	231	Balanced	235	710	737	2,054	3.58	78.0	0.65	4654	39.5	38.6	52.5	35,350	0.45	38.6	21.9	41.1	215.1	15.89	0.098	204	4.90	5.24
6	9-Aug-98	232	Balanced	235	709	739	2,059	3.56	78.6	0.65	4639	39.9	38.3	51.5	35,350	0.45	38.5	21.9	41.1	215.8	15.93	0.100	204	4.78	5.18
6	10-Aug-98	233	Balanced	234	709	740	2,062	3.56	81.5	0.65	4649	40.9	38.3	49.5	35,350	0.45	38.5	21.9	41.2	215.8	15.94	0.104	210	4.79	5.18
6	11-Aug-98	234	Balanced	235	710	706	2,064	3.80	71.4	0.64	4606	41.2	37.7	48.5	35,350	0.45	39.8	21.5	40.4	209.7	15.48	0.103	208	4.61	5.22
6	12-Aug-98	235	Balanced	234	710	714	2,045	3.84	75.3	0.64	4590	40.5	37.9	50.0	35,350	0.44	39.8	21.3	41.3	207.2	15.31	0.099	204	4.66	5.33
6	13-Aug-98	236	Balanced	234	710	710	2,006	4.07	80.8	0.63	4548	41.2	36.5	47.5	35,350	0.46	42.0	21.6	40.9	208.4	15.40	0.105	212	4.34	5.26
6	14-Aug-98	237	Balanced	234	710	716	2,042	3.67	73.7	0.64	4600	40.1	39.4	52.0	35,350	0.45	39.3	21.8	40.6	211.8	15.64	0.097	213	4.73	5.21
6	15-Aug-98	238	Balanced	235	709	715	2,055	3.54	72.5	0.64	4611	40.1	38.9	51.5	35,350	0.44	38.1	21.7	40.6	211.3	15.60	0.098	210	4.82	5.17
6	16-Aug-98	239	Balanced	235	710	710	2,036	3.75	77.9	0.64	4587	40.8	38.7	50.0	35,350	0.43	39.1	21.3	41.1	207.5	15.32	0.099	209	4.57	5.22
6	17-Aug-98	240	Balanced	235	710	703	2,054	3.61	70.1	0.64	4607	41.3	38.5	49.0	35,350	0.43	37.8	21.2	40.6	207.9	15.35	0.101	208	4.70	5.25
6	18-Aug-98	241	Balanced	234	710	714	2,049	3.50	75.7	0.64	4610	41.5	37.8	48.0	35,350	0.43	37.3	21.4	40.9	209.7	15.49	0.104	212	4.74	5.20
6	19-Aug-98	242	Balanced	235	710	704	2,071	3.46	72.2	0.65	4642	42.0	38.3	47.5	35,350	0.42	36.4	21.1	40.6	208.1	15.37	0.104	210	4.85	5.24
6	20-Aug-98	243	Balanced	234	710	717	2,091	3.12	73.2	0.65	4695	42.7	38.6	46.5	35,350	0.42	33.7	21.1	40.7	211.7	15.64	0.109	209	5.12	5.26
6	21-Aug-98	244	Balanced	235	710	711	2,077	3.37	78.8	0.65	4656	42.6	37.0	45.5	35,350	0.42	35.2	20.9	40.8	209.0	15.44	0.110	204	4.67	5.18
6	22-Aug-98	245	Balanced	249	710	741	2,009	4.04	45.9	0.66	4599	41.0	40.0	51.5	35,350	0.51	46.7	23.5	38.7	229.8	16.96	0.106	208	4.71	5.25
6	23-Aug-98	246	Balanced	249	711	731	1,981	4.33	48.3	0.65	4526	41.6	39.1	49.5	35,350	0.53	49.2	23.5	39.0	225.1	16.61	0.108	209	4.50	5.26
6	25-Aug-98	248	1:1	249	711	764	2,244	0.98	66.8	0.72	5028	44.3	43.4	48.0	35,350	0.56	17.5	21.6	39.9	229.9	16.99	0.114	209	10.35	5.34
6	26-Aug-98	249	1:1	249	711	770	2,238	0.95	75.3	0.71	5005	44.9	43.4	47.0	35,350	0.54	17.0	21.4	40.8	226.6	16.76	0.115	202	10.77	5.59
6	27-Aug-98	250	Balanced	249	710	775	2,087	3.93	69.1	0.68	4772	42.0	40.0	49.5	35,350	0.47	44.9	23.4	39.9	233.0	17.21	0.112	216	5.80	5.68
6	28-Aug-98	251	Balanced	249	710	755	2,045	4.22	79.0	0.67	4672	43.5	41.7	48.0	35,350	0.43	45.6	22.5	41.0	221.0	16.33	0.110	206	5.55	5.96
6	29-Aug-98	252	Balanced	249	710	734	2,070	4.11	69.1	0.67	4672	44.0	40.1	46.0	35,350	0.42	44.2	22.2	40.4	217.9	16.09	0.113	211	5.38	5.65
6	30-Aug-98	253	Balanced	249	710	735	2,074	3.77	64.2	0.67	4698	45.0	41.8	45.5	35,350	0.40	41.5	22.4	40.3	219.1	16.18	0.115	206	5.66	5.67
6	31-Aug-98	254	Balanced	249	710	742	2,040	3.90	70.8	0.67	4646	43.0	39.9	47.5	35,350	0.40	42.6	22.4	40.6	219.0	16.17	0.110	215	5.85	6.20
6	1-Sep-98	255	Balanced	235	709	686	2,098	3.10	119.9	0.65	4650	43.0	41.9	48.5	35,350	0.34	29.5	18.6	44.7	184.3	13.68	0.091	204	5.95	6.12
6	2-Sep-98	256	Balanced	234	710	681	2,079	3.32	123.6	0.64	4605	43.3	40.6	47.0	35,350	0.35	30.9	18.6	44.8	182.2	13.48	0.092	210	5.25	5.68
6	3-Sep-98	257	Balanced	235	709	620	2,098	3.39	79.0	0.63	4536	41.2	39.1	46.0	35,350	0.34	31.3	18.5	41.9	177.3	13.10	0.085	211	5.25	5.77
6	4-Sep-98	258	Balanced	234	709	591	2,077	3.84	72.2	0.62	4468	42.1	39.2	48.0	35,350	0.33	33.2	17.8	42.0	168.7	12.47	0.084	208	4.68	5.68
6	5-Sep-98	259	Balanced	234	709	588	2,081	3.86	77.8	0.62	4466	43.1	39.7	46.5	35,350	0.33	33.2	17.4	41.9	168.4	12.45	0.086	209	4.81	5.89
6	6-Sep-98	260	Balanced	234	709	588	2,087	3.80	72.2	0.62	4480	44.7	38.5	43.0	35,350	0.33	32.2	17.4	42.6	165.7	12.25	0.092	217	5.00	6.07
6	7-Sep-98	261	Balanced	234	709	587	2,059	3.44	70.3	0.62	4472	44.8	37.8	42.5	35,350	0.33	30.4	17.7	42.0	167.5	12.38	0.094	205	5.15	5.83
6	8-Sep-98	262	Balanced	235	711	587	2,061	3.73	74.1	0.65	4491	44.0	38.9	44.5	35,350	0.32	32.0	17.7	42.1	167.6	12.38	0.090	206	4.93	5.85
6	9-Sep-98	263	Balanced	235	710	692	2,085	3.75	71.5	0.65	4320	43.6	39.4	49.0	38,000	0.39	37.9	20.7	41.0	202.6	13.91	0.099	202	5.30	5.89
6	10-Sep-98	264	Balanced	235	713	783	2,043	3.88	74.8	0.65	4093	44.6	41.9	52.5	40,650	0.44	43.9	23.4	40.7	231.1	14.83	0.105	200	5.48	5.93
6	11-Sep-98	265	Balanced	235	711	796	2,003	4.29	57.6	0.65	3834	45.2	41.8	54.0	42,900	0.51	51.1	25.0	39.7	240.8	14.64	0.106	206	5.56	6.08
6	12-Sep-98	266	Balanced	235	710	837	1,950	4.00	69.6	0.65	3837	44.3	40.4	54.5	42,900	0.52	50.2	25.9	40.1	250.6	15.24	0.109	202	5.71	6.09
6	13-Sep-98	267	Balanced	235	710	851	1,920	3.91	71.9	0.64	3811	44.3	40.0	56.0	42,900	0.54	50.7	26.8	39.8	256.4	15.60	0.109	199	6.16	6.53
6	15-Sep-98	269	Balanced	235	710	853	1,884	4.04	81.6	0.64	3767	42.8	39.6	57.0	42,900	0.53	51.4	26.5	40.4	253.2	15.41	0.106	198	5.60	6.35

**Table D-2 – Data Summary Table for Kingsport Catalyst Campaign 2 (cont'd)**

Case	Date	Days On Stream	Gas Type	Temp (Deg C)	Press (psig)	Fresh Feed (KSCFH)	Recycle Gas (KSCFH)	Reactor Feed (H <sub>2</sub> CO)	Purge Gas (KSCFH)	Inlet Sup. Velocity (ft/sec)	Space Velocity (1/hr-kg)	Slurry Conc. (wt%-ox)	Gas Holdup (vol%)	Gassed Slurry Hgt (ft)	Catalyst Inventory (lb)	Catalyst Age (eta)	CO Conv. (%)	O-T-M Conv. (%)	Syngas Util. (SCF/lb)	Raw MeOH Prod. (TPD)	Catalyst MeOH Prod. (gmol/hr-kg)	Reactor Vol. Prod. (TPD/B3)	Overall (Btu/hr (2-F))	Sparger dP (psi)	Sparger Resist. ("K")
6	16-Sep-98	270	Balanced	235	710	848	1,857	4.25	89.6	0.63	3730	40.9	39.3	61.0	42,900	0.53	53.0	26.4	40.9	248.8	15.14	0.097	193	5.20	6.11
6	17-Sep-98	271	Balanced	235	710	834	1,868	4.07	83.3	0.63	3720	40.8	39.6	61.5	42,900	0.51	50.8	26.2	41.0	244.4	14.87	0.094	191	5.33	5.97
6	18-Sep-98	272	Balanced	235	710	849	1,851	4.00	91.6	0.63	3728	41.9	40.3	59.5	42,900	0.51	50.6	26.4	41.1	247.8	15.09	0.099	195	5.37	6.03
6	19-Sep-98	273	Balanced	235	710	835	1,865	3.87	90.1	0.63	3733	42.9	39.8	57.0	42,900	0.49	48.7	26.1	41.0	244.5	14.88	0.102	196	5.42	5.98
6	20-Sep-98	274	Balanced	235	710	837	1,855	3.92	89.9	0.63	3702	42.0	39.3	58.5	42,900	0.49	49.7	26.3	41.0	244.8	14.90	0.099	193	5.43	6.14
6	21-Sep-98	275	Balanced	235	710	840	1,905	3.84	92.8	0.64	3775	43.5	40.7	56.5	42,900	0.48	47.9	25.8	41.0	245.9	14.96	0.103	196	5.50	6.04
6	22-Sep-98	276	Balanced	235	710	845	1,901	3.77	93.8	0.64	3779	44.1	40.5	55.0	42,900	0.48	47.2	25.8	41.2	246.5	15.00	0.107	201	5.57	6.08
6	23-Sep-98	277	Balanced	235	710	847	1,913	3.80	96.3	0.64	3798	42.1	41.2	60.0	42,900	0.48	47.3	25.7	41.1	247.3	15.05	0.098	197	5.66	6.23
6	24-Sep-98	278	Balanced	235	710	850	1,900	3.78	108.8	0.64	3764	41.5	41.2	61.5	42,900	0.46	46.5	25.4	42.0	242.6	14.77	0.094	195	5.71	6.42
6	25-Sep-98	279	Balanced	235	710	828	1,897	3.78	99.1	0.63	3747	42.3	40.5	59.0	42,900	0.45	45.9	25.1	41.8	237.7	14.47	0.096	197	5.61	6.27
6	26-Sep-98	280	Balanced	235	710	818	1,883	3.74	99.3	0.63	3721	43.2	40.6	57.0	42,900	0.44	45.5	25.0	41.8	234.7	14.29	0.098	195	5.83	6.52
6	27-Sep-98	281	Balanced	234	710	814	1,872	3.78	103.5	0.62	3698	43.8	38.1	53.5	42,900	0.44	45.7	24.9	42.0	232.9	14.18	0.104	205	5.59	6.36
6	28-Sep-98	282	Balanced	235	710	813	1,841	3.86	101.4	0.62	3661	43.0	40.1	57.0	42,900	0.44	46.8	25.1	42.2	231.5	14.10	0.097	193	5.54	6.42
6	29-Sep-98	283	Balanced	234	710	811	1,871	3.74	104.4	0.62	3685	44.8	39.9	53.0	42,900	0.43	44.9	24.7	42.4	229.5	13.97	0.103	199	6.00	6.82
6	30-Sep-98	284	Balanced	235	710	815	1,871	3.69	112.0	0.62	3691	43.2	41.0	57.5	42,900	0.42	44.0	24.5	42.6	229.6	13.98	0.095	199	5.80	6.68
6	1-Oct-98	285	Balanced	235	710	765	1,913	3.79	84.7	0.62	3663	44.1	42.6	60.5	45,200	0.40	43.6	23.7	41.6	220.4	13.41	0.092	198	5.84	6.94
6	2-Oct-98	286	Balanced	235	710	768	1,873	4.27	73.3	0.61	3451	42.8	40.2	60.5	45,200	0.42	50.2	24.8	40.5	227.3	13.12	0.089	195	5.13	6.33
6	3-Oct-98	287	Balanced	235	709	795	1,880	4.05	89.6	0.62	3485	44.3	40.4	57.5	45,200	0.43	48.0	24.7	41.5	230.2	13.29	0.095	198	5.51	6.62
6	4-Oct-98	288	Balanced	235	710	806	1,875	4.09	92.4	0.62	3491	45.0	39.8	55.5	45,200	0.42	48.3	24.7	40.9	232.0	13.40	0.099	196	5.31	6.56
6	5-Oct-98	289	Balanced	235	710	809	1,837	4.26	81.0	0.61	3447	41.8	37.9	60.5	45,200	0.46	51.7	25.6	41.7	237.1	13.69	0.093	195	4.99	6.38
6	6-Oct-98	290	Balanced	235	709	817	1,859	4.01	76.7	0.62	3480	41.8	39.8	62.5	45,200	0.46	49.9	25.9	40.6	241.3	13.93	0.092	195	5.42	6.58
6	7-Oct-98	291	Balanced	235	710	795	1,879	4.07	69.7	0.62	3470	42.5	40.5	61.5	45,200	0.46	50.2	25.7	40.3	236.8	13.67	0.091	197	5.30	6.40
6	8-Oct-98	292	Balanced	235	709	815	1,888	4.14	88.7	0.63	3518	45.7	43.5	57.5	45,200	0.44	49.4	25.1	41.2	237.4	13.70	0.098	195	5.65	7.05
6	9-Oct-98	293	Balanced	235	710	821	1,910	3.80	81.9	0.63	3563	45.7	40.8	55.0	45,200	0.44	46.9	25.4	40.6	242.5	13.99	0.105	204	5.69	6.55
6	10-Oct-98	294	Balanced	235	711	797	1,897	3.91	74.8	0.62	3505	44.5	40.4	57.0	45,200	0.45	48.2	25.5	40.2	238.1	13.74	0.099	205	5.30	6.25
6	11-Oct-98	295	Balanced	235	710	779	1,873	4.09	81.9	0.62	3464	45.2	39.8	55.0	45,200	0.41	47.8	24.4	41.0	227.6	13.14	0.098	198	5.47	6.90
6	12-Oct-98	296	Balanced	235	710	817	1,879	3.78	92.7	0.62	3503	45.2	41.5	56.5	45,200	0.43	46.5	25.3	41.2	238.2	13.75	0.100	199	5.86	6.93
6	13-Oct-98	297	Balanced	235	709	825	1,858	3.75	93.8	0.62	3492	44.1	41.6	59.0	45,200	0.43	46.6	25.5	41.3	239.9	13.85	0.097	196	5.76	6.89
6	14-Oct-98	298	Balanced	235	710	822	1,836	3.82	93.4	0.62	3466	44.4	41.8	58.5	45,200	0.43	47.5	25.8	41.0	240.5	13.88	0.098	200	5.61	6.96
6	15-Oct-98	299	Balanced	235	710	826	1,853	3.78	96.1	0.62	3490	44.6	41.6	58.0	45,200	0.43	46.9	25.6	41.2	240.7	13.90	0.099	197	8.10	9.88
6	16-Oct-98	300	Balanced	235	710	825	1,855	3.70	95.0	0.62	3483	43.8	40.4	58.5	45,200	0.42	46.0	25.5	41.4	239.0	13.80	0.097	192	7.31	8.79
6	17-Oct-98	301	Balanced	235	712	758	1,808	4.13	72.3	0.59	3348	44.2	40.1	57.5	45,200	0.42	49.3	25.1	40.2	226.3	13.07	0.094	196	7.75	10.80
6	18-Oct-98	302	Balanced	235	710	824	1,931	2.75	53.1	0.64	3591	43.7	40.6	59.0	45,200	0.44	38.8	26.7	38.8	254.6	14.69	0.103	186	12.84	12.50
6	19-Oct-98	303	Balanced	235	709	828	1,889	2.85	66.3	0.63	3541	44.4	39.5	56.5	45,200	0.43	39.4	26.5	39.5	251.5	14.52	0.106	186	13.14	13.77
6	20-Oct-98	304	Balanced	235	711	828	1,841	3.18	79.5	0.62	3488	45.0	38.8	54.5	45,200	0.42	42.1	26.3	40.1	248.1	13.49	0.108	190	11.52	13.49
10	21-Oct-98	305	Balanced	235	709	660	1,649	5.14	52.1	0.54	3006	44.8	36.5	53.0	45,200	0.42	55.6	23.6	41.7	190.2	11.00	0.085	195	9.18	17.66
10	22-Oct-98	306	Balanced	235	707	609	1,867	5.30	38.9	0.58	3222	44.6	37.3	54.0	45,200	0.39	52.9	21.8	39.7	184.2	10.64	0.081	192	10.25	16.18
10	23-Oct-98	307	Balanced	235	710	743	1,864	3.85	91.7	0.60	3371	45.6	39.0	53.5	45,200	0.36	43.5	23.5	42.5	209.9	12.16	0.093	191	11.09	14.39
10	24-Oct-98	308	Balanced	235	710	760	1,820	3.76	88.2	0.60	3356	44.3	39.5	56.5	45,200	0.39	45.0	24.7	41.5	220.1	12.75	0.093	194	12.09	14.32
10	25-Oct-98	309	Balanced	235	710	759	1,804	3.62	91.5	0.60	3343	44.8	38.2	54.5	45,200	0.37	43.3	24.2	42.0	216.8	12.62	0.095	194	11.00	14.21
10	26-Oct-98	310	Balanced	235	710	740	1,800	3.70	94.3	0.59	3309	44.5	37.0	54.0	45,200	0.36	42.9	23.8	42.1	210.6	12.23	0.093	186	11.14	14.97
10	28-Oct-98	312	Balanced	235	710	734	1,777	3.50	93.1	0.58	3226	43.7	38.6	57.0	45,200	0.35	41.7	24.0	42.5	207.2	12.02	0.086	178	12.05	16.56
10	30-Oct-98	314	Balanced	235	710	723	1,760	4.17	62.6	0.58	3085	43.0	36.7	59.5	47,400	0.40	50.2	25.3	39.9	217.3	11.96	0.087	173	11.05	15.95
10	31-Oct-98	315	Balanced	235	710	734	1,723	4.33	68.8	0.57	3056	41.6	36.2	62.5	47,400	0.41	52.0	25.5	40.4	218.1	12.00	0.083	179	9.77	14.80
10	1-Nov-98	316	Balanced	235	710	734	1,988	4.13	65.2	0.63	3369	43.5	37.8	59.5	47,400	0.37	46.0	23.4	40.0	220.0	12.08	0.088	175	9.65	11.67



**Table D-2 – Data Summary Table for Kingsport Catalyst Campaign 2 (cont'd)**

Case	Date	Days On Stream	Gas Type	Temp (Deg C)	Press (psig)	Fresh Feed (KSCFH)	Recycle Gas (KSCFH)	Reactor Feed (H2CO)	Purge Gas (KSCFH)	Inlet Sup. Velocity (ft/sec)	Space Velocity (1/hr-kg)	Slurry Conc. (wt%-ox)	Gas Holdup (vol%)	Gassed Slurry Hgt (ft)	Catalyst Inventory (lb)	Catalyst Age (eta)	CO Conv. (%)	O-T-M Conv. (%)	Reactor Vol. Prod. (TPD/ft3)	Catalyst MeOH Prod. (g/mol-hr-kg)	Reactor Overall (hr 12.F)	Sparger dP (psi)	Sparger Resist. (K")
10	13-Nov-98	328	Balanced	235	701	735	2,028	4,43	101.0	0.65	3443	44.6	35.2	55.0	47,400	0.32	38.5	21.7	0.091	11.58	182	14.05	15.75
10	14-Nov-98	329	Balanced	235	695	761	2,134	1,888	91.4	0.68	3590	44.8	40.7	59.5	47,400	0.33	24.7	21.9	0.087	12.06	162	22.13	16.68
10	15-Nov-98	330	Balanced	235	694	770	2,075	1,888	100.1	0.68	3540	45.3	40.3	58.0	47,400	0.33	25.4	22.4	0.091	12.25	167	22.85	17.79
10	16-Nov-98	331	Balanced	235	692	768	1,980	1,888	101.5	0.65	3393	46.1	38.9	55.0	47,400	0.34	26.2	23.1	0.095	12.11	169	21.92	18.51
10	17-Nov-98	332	Balanced	235	693	760	2,031	1,91	110.1	0.66	3466	45.6	37.8	55.0	47,400	0.32	24.9	21.9	0.092	11.78	164	22.28	18.53
10	18-Nov-98	333	Balanced	235	692	730	1,967	1,91	98.3	0.65	3336	45.7	36.8	54.0	47,400	0.30	24.8	21.7	0.091	11.38	160	22.51	19.16
10	19-Nov-98	334	Balanced	235	695	693	2,111	1,94	52.6	0.66	3326	44.2	37.5	60.5	49,600	0.34	25.4	21.8	0.080	10.76	147	24.56	18.94
10	20-Nov-98	335	Balanced	235	695	769	2,066	1,89	77.3	0.67	3363	44.7	37.8	59.5	49,600	0.34	26.8	23.8	0.092	12.09	163	25.56	17.21
10	21-Nov-98	336	Balanced	235	699	707	2,135	2,04	56.1	0.67	3370	46.3	35.2	54.0	49,600	0.32	26.8	22.5	0.095	11.36	165	21.80	17.46
10	22-Nov-98	337	Balanced	235	708	745	2,060	2,15	66.5	0.65	3311	45.3	36.9	57.5	49,600	0.32	28.8	23.4	0.092	11.68	166	20.05	17.25
10	23-Nov-98	338	Balanced	235	705	753	2,055	2,20	87.1	0.66	3327	45.3	34.0	55.0	49,600	0.31	29.0	22.5	0.095	11.54	164	19.76	17.79
10	25-Nov-98	340	Balanced	235	709	655	1,895	3,92	63.2	0.59	3035	45.7	33.1	53.5	49,600	0.29	40.5	21.3	0.074	10.15	181	14.01	20.25
10	26-Nov-98	341	Balanced	235	709	728	1,956	3,31	95.2	0.62	3185	44.9	32.9	55.0	49,600	0.29	36.3	21.8	0.090	10.95	167	15.52	19.10
10	27-Nov-98	342	Balanced	235	695	764	1,997	2,10	109.4	0.65	3268	45.9	34.3	54.0	49,600	0.30	26.7	22.1	0.095	11.37	164	20.46	19.16
10	28-Nov-98	343	Balanced	235	695	753	1,990	2,07	111.7	0.65	3248	46.1	34.2	53.5	49,600	0.29	26.0	21.7	0.094	11.12	160	20.64	19.46
10	29-Nov-98	344	Balanced	235	695	750	1,969	2,06	118.8	0.64	3223	46.1	35.6	53.0	49,600	0.28	25.5	21.4	0.093	10.92	156	20.62	19.79
10	30-Nov-98	345	Balanced	230	696	520	2,117	2,08	27.1	0.61	3116	46.1	31.2	58.5	49,600	0.27	22.7	18.3	0.076	8.55	181	15.59	19.61
10	2-Dec-98	347	Balanced	230	695	501	2,027	3,73	51.0	0.58	2959	46.0	27.4	48.5	49,600	0.24	31.2	17.0	0.074	7.92	166	13.57	20.20
10	5-Dec-98	350	Balanced	231	700	515	1,850	4,75	28.0	0.55	2702	45.6	32.1	51.8	51,800	0.33	41.8	18.7	0.069	7.98	161	10.96	20.63
10	6-Dec-98	351	Balanced	232	700	696	1,883	3,32	86.5	0.60	2921	45.6	32.1	55.0	51,800	0.29	36.4	21.7	0.086	10.10	161	15.47	20.91
10	7-Dec-98	352	Balanced	235	703	735	1,851	3,43	113.2	0.60	2932	46.2	33.9	55.5	51,800	0.28	37.6	22.1	0.087	10.26	151	15.45	21.14
10	8-Dec-98	353	Balanced	235	710	728	1,906	3,39	103.7	0.61	2987	45.8	28.4	52.0	51,800	0.28	37.0	22.0	0.093	10.32	170	15.55	20.34
10	9-Dec-98	354	Balanced	235	709	741	1,935	3,27	112.6	0.62	3018	45.7	28.9	52.5	51,800	0.28	35.9	21.9	0.093	10.42	176	15.96	20.17
10	10-Dec-98	355	Balanced	234	710	712	1,920	3,40	102.6	0.61	2974	45.5	29.8	53.5	51,800	0.27	36.6	21.6	0.089	10.14	177	15.47	20.41
10	12-Dec-98	357	Balanced	235	710	732	1,882	3,84	88.2	0.61	2850	45.4	30.4	56.5	54,000	0.30	42.0	23.0	0.088	10.37	171	15.69	21.11
10	13-Dec-98	358	Balanced	235	710	732	1,882	3,84	84.8	0.60	2826	45.1	30.3	57.0	54,000	0.29	42.7	22.9	0.087	10.15	171	15.17	21.26
10	14-Dec-98	359	Balanced	235	709	727	1,900	3,77	84.6	0.61	2843	46.1	30.4	55.0	54,000	0.29	41.4	22.7	0.089	10.04	176	15.60	21.32
10	15-Dec-98	360	Balanced	235	710	688	1,899	3,87	84.4	0.60	2815	46.1	28.3	53.5	54,000	0.28	41.2	22.0	0.088	9.66	181	14.74	20.59
10	25-Dec-98	370	Balanced	235	705	760	1,995	3,58	89.3	0.64	2890	47.8	29.9	53.5	56,200	0.29	39.8	22.3	0.096	10.17	180	17.08	20.28
10	26-Dec-98	371	Balanced	235	705	753	1,962	3,81	95.6	0.63	2844	47.2	28.9	54.0	56,200	0.29	41.6	22.4	0.094	10.03	177	15.38	19.63
10	27-Dec-98	372	Balanced	235	709	746	1,937	4,09	92.5	0.62	2817	45.7	29.2	57.2	56,200	0.29	43.8	22.4	0.088	9.93	175	15.38	19.25
10	28-Dec-98	373	Balanced	235	710	752	1,926	4,06	104.6	0.62	2802	45.3	25.7	55.5	56,200	0.28	43.2	22.4	0.090	9.83	177	14.23	19.56
10	29-Dec-98	374	Balanced	235	709	753	1,901	4,06	113.9	0.62	2791	45.8	26.5	55.0	56,200	0.28	42.7	22.1	0.089	9.68	179	14.08	19.52
10	31-Dec-98	376	Balanced	235	710	760	1,940	4,73	108.3	0.63	2828	45.1	29.7	59.0	56,200	0.28	41.6	22.4	0.085	9.93	179	14.67	19.45
10	1-Jan-99	377	Balanced	235	710	756	1,964	3,64	111.1	0.63	2842	45.6	29.9	58.0	56,200	0.27	39.1	22.0	0.086	9.82	176	15.36	19.56
10	2-Jan-99	378	Balanced	235	710	766	1,924	3,48	102.3	0.62	2819	46.1	31.2	58.0	56,200	0.28	39.1	22.6	0.088	10.10	179	15.50	19.88
10	3-Jan-99	379	Balanced	235	710	778	1,915	3,52	107.5	0.63	2835	47.6	31.8	55.5	56,200	0.28	39.5	22.8	0.094	10.23	184	15.16	19.77
10	4-Jan-99	380	Balanced	235	710	770	1,952	3,47	107.5	0.64	2867	48.6	34.3	55.5	56,200	0.28	38.8	22.3	0.092	10.24	180	15.53	19.68
10	5-Jan-99	381	Balanced	235	710	735	1,909	3,97	132.1	0.61	2767	49.0	35.4	55.5	56,200	0.25	39.4	21.0	0.085	9.18	165	14.01	20.78
10	6-Jan-99	382	Balanced	235	710	775	1,848	3,88	137.5	0.61	2745	47.5	31.6	55.5	56,200	0.27	41.1	22.2	0.089	9.67	186	13.97	20.97
10	7-Jan-99	383	Balanced	235	710	752	1,949	3,43	116.1	0.63	2837	47.2	30.9	55.5	56,200	0.25	36.6	21.6	0.089	9.66	172	16.52	21.02
10	8-Jan-99	384	Balanced	235	710	749	1,949	3,38	124.2	0.62	2822	45.9	29.4	57.0	56,200	0.25	35.9	21.3	0.085	9.51	167	16.30	20.67
10	9-Jan-99	385	Balanced	235	710	741	1,972	3,47	123.9	0.63	2851	45.6	27.3	56.0	56,200	0.24	35.5	20.9	0.086	9.40	170	16.06	20.79
10	10-Jan-99	386	Balanced	235	710	741	1,983	3,32	131.6	0.63	2865	46.7	30.8	56.5	56,200	0.24	33.9	20.7	0.084	9.31	165	16.61	20.71
10	11-Jan-99	387	Balanced	235	709	663	1,970	3,88	98.1	0.61	2766	47.0	27.1	53.0	56,200	0.24	37.3	19.8	0.083	8.71	190	15.50	21.00

**Table D-2 – Data Summary Table for Kingsport Catalyst Campaign 2 (cont'd)**

Case	Date	Days On Stream	Gas Type	Temp (Deg C)	Press (psig)	Fresh Feed (KSCFH)	Recycle Gas (KSCFH)	Reactor Feed (H <sub>2</sub> CO)	Purge Gas (KSCFH)	Inlet Sup. Velocity (ft/sec)	Space Velocity (1/hr-kg)	Slurry Conc. (wt%-ox)	Gas Holdup (vol%)	Gassed Slurry Hgt (ft)	Catalyst Inventory (lb)	Catalyst Age (eta)	CO Conv. (%)	O-T-M Conv. (%)	Reactor Util. (SCF/lb)	Syngas Prod. (TPD)	Raw MeOH Prod. (gmol/hr-kg)	Catalyst Vol. Prod. (TPD/ft <sup>3</sup> )	Reactor Vol. Prod. (TPD/ft <sup>3</sup> )	Overall (ft <sup>3</sup> /hr)	Sparger dP (psi)	Sparger Resist. (°K)																	
																											388	389	391	392	394	395	396	405	406	408	410	412	413	415	416	417	418
10	12-Jan-99	388	Balanced	235	710	632	1,982	3.81	91.8	0.61	2743	46.5	24.9	52.5	56,200	0.22	35.6	19.2	42.5	178.3	8.37	0.081	0.081	175	14.95	21.21																	
10	13-Jan-99	389	Balanced	235	710	642	1,994	3.83	103.2	0.60	2722	46.4	28.2	55.0	56,200	0.22	35.6	19.1	43.8	175.8	8.23	0.076	0.076	169	15.29	21.86																	
10	15-Jan-99	391	Balanced	235	710	626	1,950	4.42	71.7	0.60	2605	45.8	28.4	58.5	58,400	0.23	41.5	20.0	41.9	179.4	8.10	0.073	0.073	168	14.27	21.19																	
10	16-Jan-99	392	Balanced	235	710	639	1,940	4.43	78.6	0.60	2604	44.8	29.3	61.5	58,400	0.24	43.7	20.5	43.3	184.8	8.53	0.073	0.073	182	13.58	20.37																	
10	18-Jan-99	394	Balanced	235	709	691	1,948	3.77	100.4	0.61	2659	44.5	28.5	61.5	58,400	0.23	37.7	20.5	43.7	189.9	8.56	0.073	0.073	164	15.22	20.49																	
10	19-Jan-99	395	Balanced	235	710	685	1,935	3.86	103.5	0.61	2636	44.8	29.2	61.5	58,400	0.23	38.3	20.5	43.6	188.8	8.50	0.073	0.073	161	14.74	20.60																	
10	20-Jan-99	396	Balanced	235	709	694	1,923	3.77	113.5	0.61	2635	44.5	26.7	60.0	58,400	0.23	37.6	20.5	44.2	188.5	8.49	0.073	0.073	166	14.92	20.57																	
10	29-Jan-99	405	Balanced	235	711	539	1,931	4.64	30.5	0.57	2397	42.9	24.7	64.5	60,600	0.22	42.0	19.3	39.7	163.2	7.02	0.060	0.060	171	14.27	22.25																	
10	30-Jan-99	406	Balanced	235	710	538	1,802	4.60	33.6	0.54	2275	45.1	23.7	58.5	60,600	0.22	43.7	20.2	39.7	162.7	7.00	0.066	0.066	171	14.21	24.50																	
10	1-Feb-99	408	Balanced	235	710	529	1,648	3.78	33.0	0.51	2118	45.4	25.0	59.0	60,600	0.21	38.8	21.1	38.9	163.4	7.02	0.066	0.066	171	12.18	25.25																	
10	3-Feb-99	410	Balanced	235	709	515	1,926	4.02	24.5	0.56	2356	46.1	25.8	58.0	60,600	0.21	36.4	18.6	38.7	159.9	6.87	0.066	0.066	160	13.84	23.37																	
10	5-Feb-99	412	Balanced	235	710	521	1,542	4.82	34.8	0.48	2013	46.4	21.7	54.5	60,600	0.22	46.8	20.9	40.9	152.8	6.58	0.067	0.067	179	9.93	24.54																	
10	6-Feb-99	413	Balanced	235	711	504	1,663	4.63	29.3	0.50	2111	46.0	23.3	56.5	60,600	0.21	44.7	20.5	39.5	153.1	6.59	0.064	0.064	182	11.26	22.69																	
10	8-Feb-99	415	Balanced	235	709	561	2,079	4.30	82.1	0.58	2439	47.1	22.2	53.5	60,600	0.18	36.3	17.7	43.4	155.2	6.68	0.069	0.069	148	14.59	21.86																	
10	9-Feb-99	416	Balanced	235	710	565	1,940	3.75	51.5	0.58	2447	47.3	24.2	54.5	60,600	0.20	35.4	19.1	40.3	168.4	7.24	0.073	0.073	164	15.65	21.89																	
10	10-Feb-99	417	Balanced	235	710	542	1,985	4.20	52.7	0.59	2456	47.4	22.6	53.0	60,600	0.19	36.1	17.7	41.2	158.1	6.80	0.071	0.071	172	14.59	21.86																	
10	11-Feb-99	418	Balanced	235	710	532	1,994	4.02	51.0	0.59	2455	48.6	21.4	52.0	60,600	0.18	34.4	17.4	41.2	154.8	6.67	0.074	0.074	172	15.12	21.72																	
10	13-Feb-99	420	Balanced	235	710	558	2,062	3.75	64.0	0.61	2566	48.4	24.4	52.0	60,600	0.18	30.9	16.8	42.3	159.2	6.85	0.072	0.072	164	15.19	21.78																	
10	14-Feb-99	421	Balanced	235	709	581	2,039	3.76	71.2	0.61	2560	48.7	24.6	52.0	60,600	0.18	31.5	17.0	42.9	162.3	6.98	0.074	0.074	173	15.06	21.84																	
10	15-Feb-99	422	Balanced	235	710	541	1,976	4.01	58.1	0.58	2451	48.3	24.2	52.5	60,600	0.18	33.4	17.0	41.9	154.9	6.67	0.070	0.070	173	14.99	23.65																	
10	16-Feb-99	423	Balanced	235	710	581	1,904	3.87	80.5	0.58	2415	47.8	22.2	52.0	60,600	0.18	33.9	18.0	43.5	160.3	6.90	0.073	0.073	172	14.81	23.46																	
11	17-Feb-99	424	Balanced	235	710	585	1,926	3.72	103.2	0.58	2579	48.1	25.7	51.0	57,303	0.18	31.3	17.2	45.6	153.8	7.01	0.072	0.072	165	15.43	23.16																	
11	18-Feb-99	425	Balanced	235	710	594	1,939	3.58	113.6	0.58	2744	47.5	24.7	48.5	53,951	0.19	30.1	17.0	46.3	153.7	7.43	0.076	0.076	179	15.43	23.26																	
11	19-Feb-99	426	Balanced	235	709	582	1,956	3.50	109.8	0.59	2773	48.5	25.2	47.0	53,951	0.19	28.7	16.6	46.4	151.3	7.32	0.077	0.077	174	15.76	23.36																	
11	20-Feb-99	427	Balanced	237	709	557	1,942	3.88	105.6	0.58	2904	46.6	25.8	48.0	50,676	0.19	30.6	16.3	45.7	146.9	7.56	0.073	0.073	175	14.49	23.40																	
11	21-Feb-99	428	Balanced	237	709	546	1,923	3.01	112.6	0.58	2870	46.7	25.5	47.5	50,676	0.18	30.3	15.8	46.9	140.6	7.24	0.071	0.071	168	14.23	24.21																	
11	23-Feb-99	430	Balanced	235	710	572	1,783	4.43	156.3	0.55	2775	45.8	25.5	49.0	50,676	0.19	31.6	15.3	52.0	132.6	6.83	0.064	0.064	177	12.04	23.71																	
11	28-Feb-99	435	Balanced	240	709	583	2,010	3.35	100.0	0.61	3008	44.9	26.4	51.5	50,676	0.18	28.8	17.2	44.4	157.4	8.10	0.073	0.073	168	16.20	21.26																	
10	16-Mar-99	451	Balanced	235	710	488	2,066	3.02	123.0	0.59	3019	39.8	31.1	65.5	49,988	0.14	19.3	12.6	50.3	116.5	6.09	0.042	0.042	190	3.17	4.23																	
10	17-Mar-99	452	Balanced	235	710	487	2,029	2.99	122.9	0.59	2985	40.6	30.5	63.0	49,988	0.14	19.6	12.9	49.5	118.1	6.17	0.044	0.044	193	3.15	4.29																	
10	18-Mar-99	453	Balanced	235	710	495	2,061	3.04	131.3	0.59	3008	41.1	31.4	62.5	49,988	0.14	19.2	12.4	51.7	115.0	6.01	0.044	0.044	193	3.20	4.33																	
10	19-Mar-99	454	Balanced	235	710	493	2,005	3.02	146.0	0.58	2955	41.0	29.8	61.5	49,988	0.13	19.1	12.4	53.0	111.7	5.91	0.043	0.043	185	3.07	4.29																	
10	21-Mar-99	456	Balanced	235	711	521	2,291	3.63	84.9	0.65	3163	42.0	30.6	62.5	52,188	0.17	24.5	13.9	44.9	139.2	6.96	0.053	0.053	176	3.56	4.19																	
10	22-Mar-99	457	Balanced	235	710	530	2,401	3.36	93.5	0.68	3296	43.1	30.1	59.5	52,188	0.17	22.4	13.5	45.1	141.0	7.05	0.056	0.056	180	3.96	4.14																	
10	23-Mar-99	458	Balanced	235	710	623	2,370	2.92	173.7	0.70	3390	44.6	30.5	56.5	52,188	0.17	20.2	13.5	51.3	145.9	7.30	0.061	0.061	175	4.33	4.07																	
10	24-Mar-99	459	Balanced	235	710	630	2,370	2.94	175.2	0.69	3381	44.6	30.4	56.5	52,188	0.17	20.5	13.7	51.3	147.3	7.37	0.062	0.062	187	4.39	4.15																	
10	25-Mar-99	460	Balanced	235	710	614	2,379	2.94	172.7	0.70	3387	45.6	31.9	55.5	52,188	0.16	20.0	13.3	51.3	143.7	7.19	0.062	0.062	171	4.34	4.12																	
10	26-Mar-99	461	Balanced	235	710	621	2,385	2.78	170.6	0.70	3397	43.5	31.8	60.0	52,188	0.16	19.5	13.5	50.9	146.3	7.32	0.058	0.058	182	4.39	4.02																	
10	27-Mar-99	462	Balanced	235	710	618	2,393	2.76	174.9	0.70	3421	43.5	31.9	60.0	52,188	0.16	18.9	13.1	51.7	143.6	7.19	0.057	0.057	184	4.56	4.13																	
10	28-Mar-99	463	Balanced	235	711	628	2,331	2.96	199.0	0.69	3348	44.7	30.2	56.0	52,188	0.15	19.5	12.9	54.5	138.4	6.92	0.059	0.059	178	4.26	4.14																	
10	29-Mar-99	464	Balanced	235	711	625	2,310	3.10	205.3	0.68	3323	44.9	28.7	53.5	52,188	0.15	19.9	12.8	55.4	135.3	6.78	0.060	0.060	181	4.09	4.15																	
10	30-Mar-99	465	Balanced	235	711	615	2,322	3.60	105.2	0.68	3187	44.6	28.7	57.5	54,388	0.19	27.4	15.5	45.6	161.8	7.81	0.067	0.067	160	4.04	4.18																	
10	31-Mar-99	466	Balanced	235	711	620	2,302	3.56	119.7	0.67	3153	45.3	26.2	54.0	54,388	0.19	27.3	15.6	46.0	161.7	7.79	0.071	0.071	174	3.98	4.19																	
10	1-Apr-99	467	Balanced	235	709	632	2,282	3.67	131.4	0.68	3148	45.3	26.0	54.0	54,388	0.19	27.8	15.6	47.0	161.5	7.77	0.071	0.071	175	3.90	4.18																	

**Table D-2 – Data Summary Table for Kingsport Catalyst Campaign 2 (cont'd)**

Case	Date	Days On Stream	Gas Type	Temp (Deg C)	Press (psig)	Fresh Feed (KSCFH)	Recycle Gas (KSCFH)	Reactor Feed (H <sub>2</sub> CO)	Purge Gas (KSCFH)	Inlet Sup. Velocity (ft/sec)	Space Velocity (1/hr-kg)	Slurry Conc. (wt%-ox)	Gas Holdup (vol%)	Gassed Slurry Hgt (ft)	Catalyst Inventory (lb)	Catalyst Age (eta)	CO Conv. (%)	O-T-M Conv. (%)	Syn gas Util. (SCF/lb)	Raw MeOH Prod. (TPD)	Catalyst MeOH Prod. (gmol/hr-kg)	Reactor Vol. Prod. (TPD/B3)	Overall (Btu/hr (2-F))	Sparger dP (psf)	Sparger Resist. ("K")
10	2-Apr-99	468	Balanced	235	710	650	2,261	3,57	137.8	0.67	3147	45.3	26.1	54.0	54,388	0.19	27.5	15.8	47.9	162.9	7.84	0.072	175	3.97	4.19
10	3-Apr-99	469	Balanced	235	710	606	2,236	4.28	84.5	0.66	2953	44.0	27.3	61.0	56,588	0.21	35.2	16.9	43.3	167.8	7.74	0.065	161	3.67	4.22
10	4-Apr-99	470	Balanced	235	710	653	2,201	4.24	108.1	0.66	2960	44.1	26.6	59.0	56,588	0.21	35.2	17.6	44.6	175.8	8.11	0.071	176	3.73	4.23
10	5-Apr-99	471	Balanced	235	710	653	2,217	4.09	100.1	0.66	3101	45.3	25.3	53.5	56,588	0.22	34.0	17.5	44.5	176.1	8.47	0.078	191	3.80	4.22
10	6-Apr-99	472	Balanced	235	710	651	2,218	4.09	103.9	0.66	2985	44.8	26.5	56.5	56,588	0.21	33.6	17.3	44.7	174.9	8.06	0.074	181	3.75	4.20
10	7-Apr-99	473	Balanced	235	710	654	2,225	4.07	109.3	0.67	2990	45.6	29.2	58.0	56,588	0.21	33.3	17.2	45.0	174.2	8.04	0.071	177	3.93	4.38
10	8-Apr-99	474	Balanced	235	710	652	2,188	4.07	120.8	0.66	2900	45.5	29.0	57.2	56,588	0.20	33.0	17.1	46.2	169.6	7.82	0.069	171	3.88	4.41
10	9-Apr-99	475	Balanced	235	710	645	2,149	3.93	122.2	0.65	2902	45.9	30.1	58.0	56,588	0.20	32.6	17.4	45.6	169.9	7.84	0.070	181	3.90	4.44
10	10-Apr-99	476	Balanced	235	710	641	2,181	3.98	117.8	0.65	2914	47.0	29.8	55.5	56,588	0.20	32.4	17.0	45.7	168.5	7.82	0.072	176	3.75	4.41
10	11-Apr-99	477	Balanced	235	709	653	2,199	3.72	104.0	0.66	2954	47.5	31.0	55.5	56,588	0.21	32.1	17.8	43.9	178.6	8.24	0.077	185	3.92	4.37
10	12-Apr-99	478	Balanced	235	709	651	2,249	3.80	116.0	0.67	3001	47.8	31.9	55.5	56,588	0.20	30.7	16.8	45.5	171.7	7.92	0.074	179	3.91	4.38
10	13-Apr-99	479	Balanced	234	709	651	2,263	3.48	108.6	0.67	3025	47.6	30.7	55.0	56,588	0.20	29.1	17.0	44.7	174.9	8.06	0.076	184	4.24	4.43
10	14-Apr-99	480	Balanced	235	710	535	2,304	3.89	45.5	0.66	2954	47.1	27.4	53.5	56,588	0.19	30.3	16.0	40.4	158.8	7.32	0.071	191	4.13	4.51
10	15-Apr-99	481	Balanced	235	711	535	2,303	3.80	44.2	0.65	2943	46.7	27.7	54.5	56,588	0.19	28.4	16.2	39.9	160.8	7.41	0.070	191	4.21	4.53
10	16-Apr-99	482	Balanced	235	710	510	2,313	3.90	48.4	0.65	2942	47.1	28.2	54.0	56,588	0.18	28.2	15.0	41.0	149.4	6.88	0.066	178	3.83	4.48
10	3-May-99	499	Balanced	235	711	554	2,234	3.39	69.7	0.65	2898	45.7	29.4	58.0	56,588	0.17	26.7	15.7	42.7	155.8	7.19	0.064	184	4.38	4.83
10	4-May-99	500	Balanced	235	711	601	2,156	3.21	106.7	0.64	2874	46.2	30.9	58.0	56,588	0.18	26.2	16.2	45.2	159.5	7.36	0.065	188	4.43	4.89
10	5-May-99	501	Balanced	235	710	607	2,122	3.34	110.1	0.63	2844	45.1	27.9	58.0	56,588	0.18	27.2	16.4	45.3	160.6	7.41	0.066	191	4.16	4.90
10	6-May-99	502	Balanced	235	710	610	2,308	3.20	102.7	0.68	3041	46.0	25.1	54.5	56,588	0.19	25.2	15.6	44.7	163.9	7.36	0.072	201	4.23	4.59
10	8-May-99	504	Balanced	235	710	587	2,219	2.87	88.4	0.65	2934	46.3	29.3	56.5	56,588	0.18	23.7	15.8	43.7	161.0	7.43	0.068	185	4.78	4.29
10	9-May-99	505	Balanced	235	710	587	2,198	2.97	87.6	0.65	2916	46.7	28.3	55.0	56,588	0.18	24.7	16.0	43.4	162.2	7.48	0.070	194	4.25	4.53
10	10-May-99	506	Balanced	235	710	593	2,176	3.13	103.1	0.64	2884	47.0	27.0	53.5	56,588	0.18	25.3	15.8	44.8	158.9	7.34	0.071	192	4.32	4.56
10	11-May-99	507	Balanced	235	710	596	2,121	3.09	99.6	0.63	2846	46.2	27.7	55.5	56,588	0.18	25.6	16.2	44.8	159.5	7.37	0.068	193	4.06	4.59
10	12-May-99	508	Balanced	235	709	592	2,143	3.01	99.2	0.64	2858	46.6	27.4	54.5	56,588	0.18	24.9	16.1	44.8	158.9	7.33	0.069	193	4.07	4.52
10	13-May-99	509	Balanced	235	709	581	2,177	2.92	99.2	0.64	2873	46.6	27.4	54.5	56,588	0.17	23.8	15.8	44.2	157.6	7.27	0.069	187	4.07	4.52
10	14-May-99	510	Balanced	235	710	585	2,161	2.82	104.7	0.64	2891	47.4	27.6	53.0	56,588	0.17	23.3	15.7	44.5	157.7	7.32	0.071	193	4.15	4.47
10	15-May-99	511	Balanced	235	709	588	2,179	2.73	107.1	0.64	2889	47.5	27.7	53.5	56,588	0.171	22.5	15.7	45.0	157.0	7.25	0.071	184	4.21	4.46
10	16-May-99	512	Balanced	235	709	588	2,177	2.74	111.0	0.65	2890	47.8	27.2	52.0	56,588	0.169	22.4	15.6	45.2	155.9	7.20	0.071	183	4.20	4.46
11	18-May-99	514	Balanced	235	709	546	2,191	2.69	107.0	0.64	3048	47.9	26.3	48.5	53,494	0.170	21.1	14.9	44.5	149.3	7.30	0.073	188	4.16	4.44
11	19-May-99	515	Balanced	235	710	566	2,193	3.72	63.8	0.64	2907	47.9	27.4	53.0	55,694	0.206	30.7	16.9	41.1	165.5	7.75	0.074	186	3.75	4.57
11	21-May-99	517	Balanced	235	710	575	2,173	3.65	57.4	0.63	2896	47.2	27.4	52.5	55,694	0.210	30.9	17.0	41.1	167.7	7.86	0.076	194	3.72	4.43
11	22-May-99	518	Balanced	235	710	554	2,228	3.17	63.8	0.64	2940	47.2	27.1	52.0	55,694	0.198	27.3	16.6	40.3	164.8	7.72	0.075	186	4.15	4.37
11	23-May-99	519	Balanced	234	710	558	2,207	3.10	48.6	0.64	2921	47.5	28.0	52.0	55,694	0.198	26.9	16.7	40.8	164.1	7.69	0.075	190	4.20	4.38
11	24-May-99	520	Balanced	235	709	560	2,208	3.06	52.0	0.64	2927	46.8	28.8	54.0	55,694	0.197	26.9	16.8	40.5	165.8	7.77	0.073	194	4.26	4.44
11	25-May-99	521	Balanced	235	710	564	2,182	3.24	63.5	0.63	2896	46.8	28.2	53.5	55,694	0.193	27.4	16.6	41.8	162.3	7.60	0.072	190	4.01	4.45
11	26-May-99	522	Balanced	235	710	566	2,187	3.21	68.3	0.64	2909	47.3	28.0	52.5	55,694	0.192	26.8	16.4	42.1	161.3	7.56	0.073	188	3.98	4.45
11	27-May-99	523	Balanced	235	710	569	2,195	3.24	51.0	0.64	2907	46.5	29.3	55.0	55,694	0.202	28.0	16.9	40.9	166.9	7.82	0.072	191	3.96	4.44
11	28-May-99	524	Balanced	235	710	561	2,204	3.19	50.3	0.64	2922	46.3	28.1	54.5	55,694	0.198	27.3	16.7	40.7	165.4	7.75	0.072	190	3.97	4.40
11	29-May-99	525	Balanced	235	710	565	2,155	3.32	55.5	0.63	2878	46.2	27.3	53.5	55,694	0.203	28.3	16.8	41.2	164.5	7.73	0.072	192	3.78	4.43
11	30-May-99	526	Balanced	234	710	562	2,178	3.25	55.9	0.63	2883	46.5	27.3	53.5	55,694	0.205	27.3	16.7	41.3	164.4	7.72	0.073	195	3.84	4.43
11	31-May-99	527	Balanced	234	710	562	2,172	3.11	54.4	0.63	2888	46.9	27.1	52.5	55,694	0.202	26.9	16.7	41.2	163.9	7.68	0.074	198	3.95	4.40
11	1-Jun-99	528	Balanced	234	710	566	2,142	3.41	68.0	0.63	2854	46.9	26.4	52.0	55,694	0.202	28.4	16.3	42.1	161.2	7.55	0.074	193	3.65	4.41
11	2-Jun-99	529	Balanced	235	710	562	2,129	3.43	72.4	0.62	2839	47.0	27.3	52.5	55,694	0.195	28.0	16.3	42.8	157.5	7.38	0.071	181	3.65	4.45
11	3-Jun-99	530	Balanced	235	710	565	2,141	3.26	65.9	0.63	2858	46.9	27.6	53.0	55,694	0.196	27.6	16.6	42.1	160.9	7.54	0.072	187	3.79	4.41
11	4-Jun-99	531	Balanced	235	710	567	2,153	3.12	67.8	0.63	2877	46.8	26.1	51.0	55,694	0.194	26.4	16.5	42.3	161.0	7.55	0.075	191	3.90	4.41

**Table D-2 – Data Summary Table for Kingsport Catalyst Campaign 2 (cont'd)**

Case	Date	Days On Stream	Gas Type	Temp (Deg C)	Press (psig)	Fresh Feed (KSCFH)	Recycle Gas (KSCFH)	Reactor Feed (H <sub>2</sub> CO)	Purge Gas (KSCFH)	Inlet Sup. Velocity (ft/sec)	Space Velocity (1/hr-kg)	Slurry Conc. (wt%-ox)	Gas Holdup (vol%)	Gassed Slurry Hgt (ft)	Catalyst Inventory (lb)	Catalyst Age (eta)	CO Conv. (%)	O-T-M Conv. (%)	Synogas Util. (SCF/lb)	Raw		U			
																				MeOH Prod. (TPD)	Syngas Prod. (TPD)	Reactor Vol. Prod. (TPD/B3)	Overall (Btu/hr (2-F))	Sparger dP (ps)	Sparger Resist. ("K")
11	5-Jun-99	532	Balanced	235	710	565	2,162	2.93	65.2	0.63	2885	47.5	26.6	51.0	55,694	0.190	25.2	16.4	42.1	161.1	7.55	0.075	186	4.02	4.37
11	6-Jun-99	533	Balanced	235	711	560	2,147	3.03	67.3	0.63	2870	47.5	26.5	51.0	55,694	0.189	25.6	16.3	42.1	159.7	7.49	0.075	189	3.93	4.42
11	7-Jun-99	534	Balanced	235	711	560	2,146	2.97	69.8	0.63	2866	47.8	26.6	50.5	55,694	0.187	25.4	16.4	42.1	159.5	7.48	0.075	197	3.99	4.40
11	8-Jun-99	535	Balanced	235	710	561	2,154	2.89	69.4	0.63	2868	48.2	27.9	51.5	55,694	0.185	24.9	16.4	42.2	159.4	7.47	0.074	189	4.06	4.36
11	10-Jun-99	536	Balanced	235	710	550	2,141	2.75	67.0	0.63	2865	46.2	25.2	52.5	55,694	0.185	24.2	16.4	42.1	160.1	7.51	0.073	196	4.17	4.38
11	11-Jun-99	537	Balanced	235	710	550	2,151	2.70	66.9	0.63	2863	46.4	26.5	53.0	55,694	0.180	23.2	16.0	42.4	155.6	7.30	0.070	191	4.22	4.37
11	11-Jun-99	538	Balanced	235	705	559	2,112	2.91	77.9	0.62	2823	47.2	27.1	52.0	55,694	0.181	24.5	16.1	43.5	154.2	7.23	0.071	186	3.94	4.38
11	12-Jun-99	539	Balanced	235	704	554	2,093	3.51	86.8	0.62	2799	47.0	26.7	52.0	55,694	0.181	25.3	15.8	44.1	150.7	7.07	0.069	181	3.72	4.43
11	13-Jun-99	540	Balanced	235	706	559	2,140	2.75	82.0	0.63	2847	47.2	27.1	52.0	55,694	0.178	23.2	15.9	43.6	154.1	7.23	0.071	189	4.07	4.39
11	14-Jun-99	541	Balanced	235	705	554	2,109	3.01	87.5	0.62	2816	47.3	27.2	54.5	55,274	0.177	24.3	15.7	44.2	150.5	7.07	0.069	189	3.77	4.40
11	15-Jun-99	542	Balanced	235	705	507	2,130	3.21	56.6	0.62	2789	47.3	26.8	51.5	55,694	0.177	25.4	15.2	41.7	145.9	6.84	0.067	196	3.71	4.46
11	16-Jun-99	543	Balanced	235	705	497	2,160	3.18	68.0	0.62	2953	48.0	27.8	48.5	53,074	0.169	23.0	14.4	43.2	138.1	6.80	0.068	192	3.72	4.41
11	17-Jun-99	544	Balanced	235	705	478	2,172	3.28	69.7	0.62	2943	48.3	25.3	46.5	53,074	0.162	22.5	13.6	44.1	130.1	6.40	0.064	177	3.58	4.44
11	19-Jun-99	546	Balanced	235	700	499	2,109	4.17	32.1	0.60	2715	45.7	27.2	54.5	55,274	0.210	32.2	16.0	41.0	145.8	6.89	0.067	190	3.16	4.52
11	20-Jun-99	547	Balanced	235	700	497	2,109	4.13	31.4	0.60	2716	45.7	27.2	54.5	55,274	0.215	32.5	16.3	40.2	148.4	7.01	0.065	200	3.16	4.54
11	23-Jun-99	550	Balanced	235	697	569	2,091	3.17	70.0	0.63	2828	46.5	27.3	53.0	55,274	0.197	27.7	17.1	42.5	160.7	7.59	0.072	185	3.94	4.41
11	24-Jun-99	551	Balanced	234	695	565	2,128	3.11	64.3	0.64	2871	47.0	27.3	52.0	55,274	0.203	27.6	16.1	42.0	161.6	7.63	0.074	184	4.07	4.43
11	25-Jun-99	552	Balanced	235	693	577	2,061	3.07	73.3	0.63	2816	46.9	27.0	52.0	55,274	0.193	26.9	17.1	43.0	161.0	7.61	0.074	191	3.90	4.49
11	26-Jun-99	553	Balanced	234	692	575	2,045	3.11	76.5	0.62	2788	46.6	26.7	52.5	55,274	0.198	27.6	17.4	42.7	161.6	7.64	0.073	205	3.86	4.45
11	28-Jun-99	555	Balanced	235	705	569	2,081	3.47	81.5	0.62	2817	47.7	27.0	50.5	55,274	0.196	28.2	16.4	43.6	156.7	7.41	0.074	196	3.45	4.47
11	29-Jun-99	556	Balanced	235	702	547	2,108	3.01	62.0	0.62	2835	47.2	27.6	52.0	55,274	0.185	25.5	16.3	42.0	156.2	7.38	0.072	189	3.92	4.51
11	30-Jun-99	557	Balanced	235	696	540	2,074	3.05	66.5	0.62	2797	46.8	25.8	51.5	55,274	0.182	25.8	16.4	42.0	154.4	7.30	0.071	194	3.84	4.50
11	1-Jul-99	558	Balanced	234	694	536	2,059	3.25	74.2	0.61	2763	46.9	24.6	50.5	55,274	0.182	26.6	16.1	42.8	150.3	7.10	0.071	202	3.64	4.50
11	2-Jul-99	559	Balanced	234	692	550	2,050	3.12	86.9	0.62	2771	47.0	27.1	52.0	55,274	0.182	25.5	16.0	44.0	150.1	7.10	0.069	198	3.68	4.51
11	4-Jul-99	561	Balanced	235	692	497	2,070	3.21	57.7	0.61	2729	46.6	24.7	51.0	55,274	0.176	25.5	15.5	41.4	144.2	6.81	0.067	193	3.56	4.55
11	5-Jul-99	562	Balanced	234	690	527	2,064	2.90	72.3	0.62	2754	47.0	25.8	51.0	55,274	0.178	23.9	15.8	42.7	148.1	7.01	0.069	194	3.77	4.54
11	8-Jul-99	565	Balanced	235	689	536	2,036	3.37	93.3	0.61	2744	46.1	26.8	53.5	55,274	0.180	26.1	15.4	44.3	145.1	7.01	0.065	190	3.44	4.60
11	9-Jul-99	566	Balanced	235	689	536	2,037	3.10	95.5	0.62	2747	46.7	26.3	52.0	55,274	0.177	24.2	15.2	45.1	142.7	6.76	0.065	189	3.56	4.56
11	10-Jul-99	567	Balanced	235	690	543	2,066	3.01	99.6	0.62	2782	47.0	27.2	52.0	55,274	0.180	23.4	15.1	45.5	143.2	6.77	0.066	192	3.61	4.49
11	11-Jul-99	568	Balanced	234	691	528	2,068	2.99	92.0	0.62	2771	47.4	26.0	50.5	55,274	0.172	23.2	15.1	44.4	142.7	6.75	0.067	198	3.60	4.53
11	13-Jul-99	570	Balanced	235	691	462	2,145	2.55	85.2	0.62	3256	46.8	29.7	46.5	47,338	0.165	17.7	12.9	44.9	123.5	6.82	0.063	199	3.91	4.48
11	14-Jul-99	571	Balanced	234	690	452	2,123	2.63	90.9	0.62	3223	48.2	32.4	46.0	47,338	0.155	17.9	12.7	45.4	119.5	6.61	0.062	182	3.89	4.51
11	15-Jul-99	572	Balanced	235	690	457	2,125	2.75	99.1	0.62	3237	47.6	30.9	46.0	47,338	0.167	18.3	12.5	46.8	119.5	6.65	0.062	181	3.76	4.52
11	16-Jul-99	573	Balanced	235	690	505	2,027	3.67	43.6	0.61	3020	46.1	29.1	49.5	49,538	0.216	30.0	16.4	40.7	149.0	7.86	0.072	192	3.43	4.58
11	17-Jul-99	574	Balanced	234	691	495	2,042	3.73	46.3	0.60	3020	46.2	28.9	49.0	49,538	0.208	29.5	16.0	40.8	145.4	7.66	0.071	189	3.39	4.58
11	18-Jul-99	575	Balanced	234	690	500	2,020	3.93	53.6	0.60	2988	46.2	29.2	49.5	49,538	0.210	30.7	16.1	41.3	145.2	7.65	0.070	193	3.21	4.61
11	19-Jul-99	576	Balanced	235	690	493	1,981	3.83	53.6	0.59	2935	46.3	29.5	49.5	49,538	0.204	30.8	16.4	41.0	144.2	7.60	0.069	189	3.25	4.60
11	20-Jul-99	577	Balanced	235	690	492	2,057	3.59	47.0	0.61	3041	46.7	29.1	48.5	49,538	0.202	28.3	15.8	40.8	144.7	7.63	0.071	189	3.49	4.57
11	21-Jul-99	578	Balanced	235	690	493	2,085	3.46	47.6	0.61	3064	46.7	29.3	48.5	49,538	0.199	27.3	15.7	40.9	144.7	7.62	0.071	192	3.61	4.56
11	22-Jul-99	579	Balanced	234	690	488	2,070	3.34	47.5	0.61	3050	47.1	28.7	47.5	49,538	0.195	26.2	15.5	41.3	141.8	7.48	0.071	190	3.66	4.55
11	23-Jul-99	580	Balanced	235	689	495	2,026	3.30	61.7	0.60	3002	46.2	28.6	49.0	49,538	0.196	25.6	15.4	42.3	140.3	7.40	0.068	190	3.44	4.57
11	24-Jul-99	581	Balanced	234	690	505	2,054	3.26	70.7	0.61	3056	46.9	29.1	48.0	49,538	0.194	25.0	15.3	42.7	141.8	7.47	0.070	195	3.51	4.57
11	25-Jul-99	582	Balanced	234	690	500	2,072	3.13	64.7	0.61	3059	46.3	28.8	49.0	49,538	0.192	24.4	15.2	42.4	141.5	7.46	0.069	194	3.59	4.53
11	26-Jul-99	583	Balanced	234	690	476	2,090	3.14	50.2	0.61	3041	46.1	29.2	49.5	49,538	0.190	24.1	14.9	41.6	141.7	7.45	0.066	196	3.67	4.51
11	27-Jul-99	584	Balanced	234	689	518	2,069	3.28	115.1	0.62	3468	46.9	27.8	42.0	43,980	0.211	22.3	13.6	48.3	128.7	7.66	0.073	198	3.42	4.54

**Table D-2 – Data Summary Table for Kingsport Catalyst Campaign 2 (cont'd)**

Case	Date	Days On Stream	Gas Type	Temp (Deg C)	Press (psig)	Fresh Feed (KSCFH)	Recycle Gas (KSCFH)	Reactor Feed (H2CO)	Purge Gas (KSCFH)	Inlet Sup. Velocity (ft/sec)	Space Velocity (1/hr-kg)	Slurry Conc. (wt%-ox)	Gas Holdup (vol%)	Gassed Slurry Hgt (ft)	Catalyst Inventory (lb)	Catalyst Age (eta)	CO Conv. (%)	O-T-M Conv. (%)	Synygas Util. (SCF/lb)	Raw		U			
																				MeOH Prod. (TPD)	MeOH Prod. (gmol/hr-kg)	Reactor Vol. Prod. (TPD/B3)	Overall (Btu/hr (H2-F))	Sparger dP (psi)	Sparger Resist. ("K")
11	28-Jul-99	585	Balanced	234	685	501	2,026	3,05	106.0	0.60	3362	45.9	29.3	44.5	43,980	0.211	22.1	14.2	46.8	128.6	7.65	0.069	205	3.46	4.47
11	29-Jul-99	586	Balanced	234	681	475	2,011	2.81	80.3	0.60	3327	45.5	29.2	45.5	43,980	0.206	21.1	14.4	44.1	129.3	7.69	0.069	201	3.60	4.58
11	30-Jul-99	587	Balanced	235	684	483	2,024	2.71	81.9	0.60	3353	44.8	29.5	46.5	43,980	0.204	20.8	14.5	44.1	131.4	7.82	0.067	192	3.68	4.52
11	31-Jul-99	588	Balanced	234	684	474	2,019	2.73	85.8	0.60	3340	45.2	29.7	46.0	43,980	0.206	20.5	14.2	44.0	129.1	7.69	0.067	195	3.62	4.57
11	1-Aug-99	589	Balanced	234	685	480	2,040	2.61	81.1	0.60	3366	44.4	27.0	45.5	43,980	0.203	20.0	14.4	43.8	131.5	7.79	0.069	194	3.77	4.59
11	2-Aug-99	590	Balanced	234	685	476	2,047	2.44	81.5	0.61	3418	45.8	31.5	46.0	43,980	0.197	18.6	14.1	43.6	131.0	7.79	0.068	190	3.89	4.57
11	3-Aug-99	591	Balanced	235	685	491	2,067	2.61	98.7	0.61	3396	46.0	27.2	46.0	43,980	0.199	19.4	14.1	45.2	130.3	7.76	0.068	195	3.70	4.63
11	4-Aug-99	592	Balanced	235	687	486	1,987	2.55	99.5	0.59	3314	43.8	29.2	48.0	43,980	0.193	19.4	14.2	45.4	128.4	7.64	0.064	199	3.55	4.56
11	5-Aug-99	593	Balanced	235	685	490	2,015	2.69	96.1	0.60	3360	44.2	30.2	48.0	43,980	0.197	20.1	14.1	45.4	129.5	7.72	0.064	200	3.55	4.52
11	6-Aug-99	594	Balanced	234	686	460	2,031	3.12	106.1	0.60	3350	44.8	29.5	46.5	43,980	0.191	20.9	13.3	46.8	119.7	7.12	0.061	204	3.36	4.47
11	10-Aug-99	598	Balanced	235	705	405	2,196	3.07	41.7	0.61	3472	46.4	33.0	46.0	43,980	0.188	20.3	12.8	41.4	117.3	6.97	0.061	195	3.76	4.38
11	12-Aug-99	600	Balanced	235	705	408	2,158	3.26	56.1	0.59	3413	46.1	32.2	46.0	43,980	0.179	20.8	12.6	43.1	113.5	6.75	0.059	190	3.58	4.41
11	13-Aug-99	601	Balanced	235	704	418	2,149	3.30	59.3	0.60	3429	44.0	29.6	48.0	43,980	0.184	21.1	12.7	43.4	115.6	6.87	0.057	182	3.54	4.43
11	15-Aug-99	603	Balanced	235	696	468	2,094	3.20	68.1	0.60	3260	44.8	29.2	48.5	46,180	0.191	22.6	13.9	44.1	127.1	7.20	0.062	193	3.55	4.42
11	16-Aug-99	604	Balanced	235	700	458	2,109	3.23	60.0	0.60	3259	44.7	28.1	48.0	46,180	0.191	22.9	14.0	43.1	127.6	7.22	0.063	196	3.56	4.44
11	17-Aug-99	605	Balanced	235	702	462	2,082	3.46	69.0	0.59	3228	44.5	28.2	48.5	46,180	0.193	24.0	14.0	43.9	126.2	7.15	0.062	192	3.39	4.46
11	18-Aug-99	606	Balanced	235	702	464	2,059	3.49	65.6	0.59	3224	44.3	27.8	48.5	46,180	0.197	24.7	14.2	43.6	127.7	7.23	0.063	194	3.42	4.47
11	19-Aug-99	607	Balanced	235	700	461	2,054	3.59	70.1	0.59	3199	43.7	28.2	50.0	46,180	0.196	25.0	14.2	43.8	126.4	7.16	0.060	192	3.34	4.51
11	20-Aug-99	608	Balanced	235	700	499	2,031	4.12	49.8	0.59	3072	42.8	28.1	54.5	48,380	0.234	32.7	16.5	40.8	146.6	7.91	0.065	185	3.34	4.59
11	21-Aug-99	609	Balanced	235	700	504	2,007	4.19	50.9	0.59	3046	42.8	28.7	54.5	48,380	0.240	33.8	16.9	40.7	148.4	8.01	0.065	199	3.22	4.53
11	22-Aug-99	610	Balanced	235	700	492	2,033	4.12	46.0	0.59	3049	42.8	28.0	54.0	48,380	0.237	33.1	16.7	40.4	146.4	7.89	0.064	207	3.27	4.47
11	23-Aug-99	611	Balanced	235	700	490	1,985	4.28	52.4	0.58	3012	43.1	27.6	53.0	48,380	0.232	33.5	16.5	41.1	143.2	8.36	0.070	195	3.31	4.48
11	24-Aug-99	612	Balanced	235	710	536	2,065	3.57	63.1	0.60	3156	43.4	27.8	52.5	48,380	0.224	29.8	16.9	41.5	154.9	8.36	0.070	195	3.58	4.48
11	25-Aug-99	613	Balanced	235	710	530	2,112	3.57	62.8	0.61	3160	44.2	28.4	51.0	48,380	0.221	29.0	16.5	41.4	153.7	8.30	0.071	191	3.71	4.47
11	26-Aug-99	614	Balanced	235	710	541	2,058	3.57	69.1	0.60	3160	44.3	28.0	51.0	48,380	0.225	29.6	16.8	42.0	154.7	8.35	0.072	201	3.55	4.53
11	27-Aug-99	615	Balanced	235	710	528	2,071	3.63	60.7	0.60	3159	44.4	27.6	50.5	48,380	0.228	30.0	16.9	41.3	153.5	8.28	0.072	212	3.55	4.50
11	28-Aug-99	616	Balanced	235	710	546	2,063	3.45	75.6	0.61	3180	43.8	28.1	52.0	48,380	0.224	28.4	16.7	42.6	153.8	8.30	0.070	200	3.54	4.45
11	2-Sep-99	621	Balanced	235	710	460	2,173	2.60	95.9	0.62	4151	43.9	36.9	46.0	37,688	0.207	17.9	12.9	45.3	123.6	8.58	0.064	182	3.59	4.43
11	3-Sep-99	622	Balanced	235	711	522	2,133	3.26	57.1	0.62	3923	43.8	33.0	46.0	39,888	0.266	26.7	16.2	41.1	152.3	9.97	0.079	201	3.79	4.44
11	5-Sep-99	624	Balanced	235	710	620	2,083	3.50	54.7	0.63	3772	43.2	30.7	48.0	42,088	0.325	34.3	19.7	40.3	184.7	11.45	0.092	208	4.04	4.48
11	6-Sep-99	625	Balanced	235	710	676	2,051	3.59	49.3	0.63	3617	42.1	26.2	49.5	44,288	0.365	39.4	22.1	39.4	206.2	12.15	0.099	202	4.08	4.43
11	11-Sep-99	630	Balanced	235	710	793	2,042	3.43	85.3	0.66	3587	42.4	32.5	56.0	46,488	0.371	39.8	23.4	41.0	231.9	13.02	0.098	176	4.25	4.40
11	15-Sep-99	634	Balanced	235	695	622	1,948	4.54	44.0	0.60	3237	43.3	28.8	51.5	46,488	0.374	44.4	20.7	39.5	188.9	10.60	0.087	192	3.08	4.62
11	16-Sep-99	635	Balanced	235	695	620	2,066	4.12	32.3	0.63	3374	43.7	30.7	52.0	46,488	0.361	41.6	20.6	38.4	193.8	10.87	0.089	191	3.62	4.48
11	17-Sep-99	636	Balanced	235	695	615	2,023	4.34	37.4	0.62	3340	44.0	30.1	51.0	46,488	0.352	43.1	20.6	38.8	189.9	10.65	0.089	195	3.53	4.46
11	19-Sep-99	638	Balanced	235	695	643	1,814	4.64	87.6	0.57	3026	43.9	26.9	49.0	46,488	0.359	46.4	21.6	46.4	186.4	10.47	0.091	209	2.61	4.78
11	20-Sep-99	639	Balanced	235	710	819	1,997	2.98	112.8	0.65	3563	44.6	30.3	50.0	46,488	0.356	35.6	23.2	42.4	231.9	13.03	0.110	187	4.33	4.39
11	21-Sep-99	640	Balanced	235	711	832	2,034	2.73	116.7	0.67	3641	45.1	30.8	49.5	46,488	0.353	33.3	23.2	42.4	235.8	13.24	0.113	189	4.66	4.36
11	22-Sep-99	641	Balanced	234	710	858	1,950	3.18	165.2	0.65	3539	45.3	30.0	48.5	46,488	0.352	36.9	23.2	44.8	230.0	12.92	0.113	195	4.05	4.41
11	23-Sep-99	642	Balanced	234	707	831	1,994	2.94	132.0	0.66	3577	45.2	30.5	49.0	46,488	0.354	35.2	23.3	42.8	232.9	13.08	0.113	189	4.33	4.36
11	24-Sep-99	643	Balanced	235	706	831	1,953	3.11	136.0	0.65	3523	44.0	29.3	50.5	46,488	0.354	36.8	23.4	43.3	230.3	12.94	0.109	191	4.13	4.38
11	25-Sep-99	644	Balanced	235	706	821	1,987	3.21	123.4	0.65	3505	43.0	28.0	51.5	46,488	0.354	37.6	23.3	43.0	228.8	12.86	0.106	190	4.05	4.41
11	26-Sep-99	645	Balanced	235	708	793	1,980	3.28	103.0	0.64	3494	42.6	29.0	53.0	46,488	0.354	38.1	23.2	42.0	226.9	12.74	0.102	190	4.02	4.42
11	27-Sep-99	646	Balanced	235	708	794	1,936	3.13	104.9	0.63	3463	42.6	28.3	52.5	46,488	0.351	37.2	23.5	42.0	227.0	12.75	0.103	192	4.02	4.44
11	28-Sep-99	647	Balanced	235	710	789	2,013	2.89	95.8	0.65	3557	43.0	30.1	53.0	46,488	0.345	34.5	23.0	41.4	228.9	12.85	0.103	188	4.43	4.40

**Table D-2 – Data Summary Table for Kingsport Catalyst Campaign 2 (cont'd)**

Case	Date	Days On Stream	Gas Type	Temp (Deg C)	Press (psig)	Fresh Feed (KSCFH)	Recycle Gas (KSCFH)	Reactor Feed (H2CO)	Purge Gas (KSCFH)	Inlet Sup. Velocity (ft/sec)	Space Velocity (1/hr-kg)	Slurry Conc. (wt%-ox)	Gas Holdup (vol%)	Gassed Slurry Hgt (ft)	Catalyst Inventory (lb)	Catalyst Age (eta)	CO Conv. (%)	O-T-M Conv. (%)	Synegas Util. (SCF/lb)	Raw		U			
																				MeOH Prod. (TPD)	MeOH (gmol/hr-kg)	Reactor Vol. Prod. (TPD/B3)	Overall (Btu/hr (2-F))	Sparger dP (psf)	Sparger Resist. ("K")
11	29-Sep-99	648	Balanced	235	710	803	2,003	2.81	105.1	0.65	3565	42.9	31.8	54.5	46,488	0.346	34.2	23.3	41.7	230.8	12.96	0.101	186	4.52	4.36
11	30-Sep-99	649	Balanced	235	710	795	2,016	2.89	113.2	0.65	3558	43.3	31.5	53.5	46,488	0.334	34.0	22.8	42.3	225.8	12.68	0.100	185	4.35	4.35
11	1-Oct-99	650	Balanced	235	710	771	2,031	2.90	103.1	0.65	3559	43.3	30.9	53.0	46,488	0.326	33.4	22.2	42.0	220.5	12.38	0.099	184	4.39	4.39
11	2-Oct-99	651	Balanced	234	710	767	2,019	3.06	103.0	0.64	3515	43.2	30.8	53.0	46,488	0.328	34.7	22.2	42.1	218.9	12.29	0.098	187	4.14	4.40
11	3-Oct-99	652	Balanced	234	710	763	2,025	2.97	104.0	0.64	3522	43.5	30.2	52.0	46,488	0.325	33.5	21.9	42.1	217.3	12.21	0.099	186	4.18	4.40
11	6-Oct-99	655	Balanced	235	710	699	2,065	3.21	72.6	0.64	3495	42.7	30.6	54.0	46,488	0.313	34.4	21.2	40.5	206.9	11.61	0.091	184	3.98	4.34
11	7-Oct-99	656	Balanced	235	710	745	2,039	2.92	98.0	0.65	3528	42.6	30.4	54.0	46,488	0.309	32.3	21.4	42.1	212.4	11.93	0.094	180	4.20	4.37
11	8-Oct-99	657	Balanced	235	711	765	1,991	3.05	122.6	0.64	3484	43.4	33.5	54.5	46,488	0.311	33.5	21.5	43.4	211.5	11.88	0.092	180	4.01	4.42
11	9-Oct-99	658	Balanced	235	711	770	1,996	3.00	125.1	0.64	3488	43.3	30.1	53.5	46,488	0.314	33.3	21.7	43.3	213.3	11.98	0.095	185	4.05	4.40
11	10-Oct-99	659	Balanced	234	710	766	2,021	2.76	118.5	0.64	3526	43.3	30.3	52.5	46,488	0.309	31.1	21.5	43.2	212.6	11.94	0.096	186	4.35	4.38
11	13-Oct-99	662	Balanced	235	710	646	2,097	3.08	64.2	0.63	3465	44.2	30.0	50.5	46,488	0.284	31.4	19.9	40.4	191.7	10.76	0.090	189	4.08	4.37
11	14-Oct-99	663	Balanced	235	711	669	2,092	3.10	80.6	0.64	3480	43.9	30.5	51.5	46,488	0.279	31.3	19.9	41.6	193.2	10.80	0.089	184	4.04	4.38
11	16-Oct-99	665	Balanced	235	710	663	2,049	3.18	85.9	0.63	3423	43.3	29.5	52.0	46,488	0.276	31.7	19.7	42.1	189.1	10.62	0.087	180	3.82	4.34
11	17-Oct-99	666	Balanced	235	710	654	2,034	3.04	79.3	0.62	3407	43.6	29.1	51.0	46,488	0.273	30.7	19.8	41.4	189.5	10.64	0.088	185	3.84	4.45
11	18-Oct-99	667	Balanced	234	711	675	2,037	3.36	110.0	0.63	3417	44.1	29.5	50.5	46,488	0.275	32.3	19.4	43.4	186.5	10.47	0.088	189	3.59	4.34
11	19-Oct-99	668	Balanced	234	710	665	2,088	2.88	95.4	0.64	3486	45.0	30.6	49.5	46,488	0.264	28.5	19.1	42.6	187.5	10.53	0.090	183	4.02	4.33
11	20-Oct-99	669	Balanced	234	710	682	2,063	3.27	122.8	0.63	3442	44.9	29.7	49.0	46,488	0.264	30.9	19.0	44.4	184.4	10.35	0.090	189	3.64	4.36
11	21-Oct-99	670	Balanced	234	710	682	2,066	3.15	122.8	0.63	3461	45.4	29.4	48.0	46,488	0.261	30.0	19.0	44.3	184.8	10.37	0.092	195	3.76	4.33
11	22-Oct-99	671	Balanced	234	710	674	2,050	3.01	120.3	0.63	3478	45.5	29.7	48.0	46,488	0.259	29.1	18.6	44.3	182.6	10.26	0.091	193	3.87	4.28
11	23-Oct-99	672	Balanced	234	710	675	2,078	2.91	125.6	0.64	3478	46.2	30.0	47.0	46,488	0.251	27.7	18.6	44.8	180.9	10.16	0.092	188	3.95	4.29
11	24-Oct-99	673	Balanced	234	710	683	2,093	2.89	139.0	0.64	3507	46.5	29.3	46.0	46,488	0.245	27.1	18.2	45.4	180.4	10.13	0.094	191	3.92	4.29
11	25-Oct-99	674	Balanced	235	710	684	2,059	2.88	139.8	0.64	3494	45.9	30.2	47.5	46,488	0.241	26.8	18.1	45.9	178.7	10.04	0.090	185	3.98	4.37
11	26-Oct-99	675	Balanced	235	710	659	2,066	3.06	129.9	0.63	3438	45.9	28.5	46.5	46,488	0.237	27.8	18.0	45.9	174.1	9.78	0.089	187	3.78	4.38
11	27-Oct-99	676	Balanced	234	710	659	2,042	3.13	133.8	0.63	3420	45.4	28.8	47.5	46,488	0.239	28.0	17.8	45.9	172.2	9.68	0.086	186	3.66	4.38
11	29-Oct-99	678	Balanced	235	711	648	2,035	2.95	116.8	0.62	3387	43.1	30.4	53.0	46,488	0.238	27.3	18.1	44.6	174.5	9.80	0.078	187	3.66	4.45
11	31-Oct-99	680	Balanced	235	711	660	2,019	2.76	123.3	0.62	3387	43.4	30.0	52.0	46,488	0.243	26.2	18.1	45.0	175.9	9.89	0.081	184	3.81	4.45
11	1-Nov-99	681	Balanced	235	710	567	2,042	2.97	61.7	0.61	3312	43.8	28.8	50.5	46,488	0.253	26.9	17.7	40.7	167.1	9.38	0.079	182	3.51	4.48
11	2-Nov-99	682	Balanced	235	711	566	2,136	2.98	49.2	0.63	3419	45.3	30.8	49.0	46,488	0.248	27.2	18.0	39.8	170.0	9.56	0.083	199	3.79	4.29
11	3-Nov-99	683	Balanced	234	710	537	2,175	3.02	38.1	0.63	3470	43.9	31.8	52.5	46,488	0.233	26.7	17.4	39.2	164.8	9.24	0.075	207	3.99	4.28
11	6-Nov-99	686	Balanced	235	710	624	2,027	3.11	112.1	0.61	3353	42.9	30.0	53.0	46,488	0.244	27.0	17.3	45.1	166.3	9.35	0.075	187	3.43	4.45
11	7-Nov-99	687	Balanced	235	710	616	2,060	2.92	101.1	0.62	3386	43.2	30.1	52.5	46,488	0.246	25.9	17.4	43.8	168.7	9.48	0.076	185	3.61	4.44
11	9-Nov-99	689	Balanced	234	711	529	2,171	2.57	112.6	0.63	4407	42.0	31.2	43.5	36,124	0.240	18.9	13.9	46.4	136.8	9.89	0.075	195	3.87	4.41
11	10-Nov-99	690	Balanced	234	711	529	2,144	2.52	114.9	0.62	4375	42.4	30.4	42.5	36,124	0.236	18.5	13.8	47.1	134.7	9.75	0.076	192	3.89	4.41
11	11-Nov-99	691	Balanced	234	712	557	2,140	2.51	128.3	0.62	4411	43.6	29.4	40.0	36,124	0.247	19.0	14.1	47.9	139.6	10.10	0.083	215	3.91	4.38
11	12-Nov-99	692	Balanced	235	712	594	2,140	2.98	73.6	0.63	4215	41.9	32.2	47.0	38,324	0.290	26.7	17.6	41.8	172.0	11.71	0.087	185	3.89	4.39
11	13-Nov-99	693	Balanced	235	712	596	2,130	2.90	75.8	0.63	4200	41.9	32.8	47.5	38,324	0.288	26.2	17.6	42.0	171.9	11.71	0.086	186	3.94	4.40
11	14-Nov-99	694	Balanced	235	711	672	2,022	3.74	65.6	0.62	3290	40.8	32.9	52.5	40,524	0.373	0.4	21.4	40.5	195.7	12.89	0.091	187	3.50	4.33
11	15-Nov-99	695	Balanced	235	711	667	2,091	3.37	68.2	0.64	3992	41.7	38.9	55.5	40,524	0.340	34.1	20.6	40.4	197.9	12.73	0.085	163	3.80	4.33
11	17-Nov-99	697	Balanced	235	705	784	2,161	1.44	68.8	0.70	4115	42.4	36.2	54.5	42,724	0.413	21.3	22.5	40.2	233.9	14.27	0.102	177	6.75	4.34
11	20-Nov-99	700	Balanced	235	710	807	2,050	3.31	77.6	0.66	3727	41.0	32.8	57.5	44,924	0.413	40.6	24.7	40.1	241.7	14.03	0.100	172	4.45	4.38
11	21-Nov-99	701	Balanced	235	710	808	1,994	3.61	78.2	0.65	3660	40.1	27.1	55.0	44,924	0.417	43.4	24.8	40.1	241.8	14.04	0.105	177	3.83	4.26
11	24-Nov-99	704	Balanced	225	700	577	2,157	2.86	24.7	0.61	3488	40.8	30.4	55.5	44,924	0.408	29.9	20.0	38.2	181.1	10.50	0.078	165	4.05	4.45
11	30-Nov-99	710	Balanced	235	710	756	2,104	3.40	86.1	0.65	3688	43.7	30.2	50.0	44,924	0.362	38.5	23.0	40.8	220.5	12.91	0.106	164	4.20	4.35
11	1-Dec-99	711	Balanced	235	710	755	2,092	3.27	78.9	0.66	3739	43.5	31.7	51.5	44,924	0.346	36.2	22.5	41.1	220.7	12.81	0.102	165	4.36	4.36
21	2-Dec-99	712	Destace	235	695	722	2,157	1.06	96.9	0.69	3816	45.5	33.6	45.5	44,924	0.368	15.9	19.8	42.6	203.4	11.81	0.099	158	7.28	4.38

**Table D-2 – Data Summary Table for Kingsport Catalyst Campaign 2 (cont'd)**

Case	Date	Days On Stream	Gas Type	Temp (Deg C)	Press (psig)	Fresh Feed (KSCFH)	Recycle Gas (KSCFH)	Reactor Feed (H2CO)	Purge Gas (KSCFH)	Inlet Sup. Velocity (ft/sec)	Space Velocity (1/hr-kg)	Slurry Conc. (wt%-ox)	Gas Holdup (vol%)	Gassed Slurry Hgt (ft)	Catalyst Inventory (lb)	Catalyst Age (eta)	CO Conv. (%)	O-T-M Conv. (%)	Reactor O-T-M Conv. (%)	Syngas Util. (SCF/lb)	Raw MeOH Prod. (TPD)	Catalyst MeOH Prod. (gmol/hr-kg)	Reactor Vol. Prod. (TPD/B3)	Overall (Btu/hr (2-F))	Sparger dP (psi)	Sparger Resist. ("K")
11	3-Dec-99	713	Destac	235	695	722	2,140	1,000	99.1	0.69	3802	44.8	33.3	50.0	44,924	0.372	15.4	19.5	0.096	42.9	202.1	11.75	0.096	153	7.26	4.35
21	4-Dec-99	714	Destac	234	695	723	2,115	1,066	98.0	0.68	3783	45.4	31.2	47.5	44,924	0.382	16.5	20.3	0.104	41.8	208.0	12.09	0.104	166	7.08	4.35
21	5-Dec-99	715	Destac	235	695	715	2,121	1,000	97.0	0.68	3770	44.0	33.0	51.0	44,924	0.381	15.8	20.0	0.095	41.9	204.7	11.90	0.095	160	7.18	4.33
21	8-Dec-99	718	Destac	235	695	730	2,112	1,033	120.6	0.69	3813	44.7	32.9	50.0	44,924	0.370	15.5	19.5	0.097	43.1	203.2	11.81	0.097	184	7.05	4.29
21	9-Dec-99	719	Destac	234	696	703	2,127	1,020	107.5	0.68	3797	45.2	32.0	48.5	44,924	0.346	14.9	18.7	0.096	43.3	194.9	11.34	0.096	148	7.06	4.29
21	10-Dec-99	720	Destac	234	697	703	2,127	1,000	112.5	0.68	3766	46.0	32.6	47.5	44,924	0.353	15.0	18.9	0.098	43.2	195.7	11.37	0.098	151	6.92	4.32
11	16-Dec-99	726	Balanced	235	710	662	1,925	4,444	107.7	0.59	3323	40.5	25.7	53.0	44,924	0.325	41.3	20.4	0.082	43.4	183.2	10.63	0.082	170	2.80	4.62
11	17-Dec-99	727	Balanced	235	710	659	1,942	4,088	76.3	0.60	3398	37.5	24.3	58.5	44,924	0.329	40.3	21.1	0.083	41.1	192.2	11.16	0.083	179	3.18	4.54
11	18-Dec-99	728	Balanced	235	710	665	1,933	3,988	77.6	0.60	3390	38.1	23.3	56.5	44,924	0.329	40.1	21.3	0.081	41.3	193.0	11.21	0.081	176	3.24	4.48
11	19-Dec-99	729	Balanced	235	710	658	1,936	3,866	75.3	0.60	3389	40.0	28.9	56.5	44,924	0.321	38.9	21.1	0.080	41.4	190.7	11.08	0.080	170	3.32	4.47
11	20-Dec-99	730	Balanced	235	710	731	1,953	3,244	94.6	0.62	3511	39.9	25.3	54.0	44,924	0.326	35.4	22.0	0.091	42.3	207.3	12.04	0.091	177	3.75	4.41
11	22-Dec-99	732	Balanced	235	710	698	2,060	3,022	81.2	0.64	3622	41.6	32.1	55.5	44,924	0.297	31.6	20.9	0.087	41.5	202.1	11.72	0.087	172	4.11	4.47
11	23-Dec-99	733	Balanced	235	710	724	1,992	3,244	104.9	0.63	3566	41.7	30.4	54.0	44,924	0.303	33.8	21.2	0.089	42.8	202.8	11.77	0.089	177	3.79	4.46
11	24-Dec-99	734	Balanced	235	710	721	1,996	3,188	102.8	0.63	3572	42.3	31.4	53.5	44,924	0.300	33.1	21.1	0.090	42.8	202.2	11.73	0.090	177	3.80	4.46
11	25-Dec-99	735	Balanced	235	710	727	2,005	3,011	103.4	0.64	3604	43.0	33.2	53.5	44,924	0.297	31.8	21.1	0.091	42.5	205.2	11.90	0.091	177	3.92	4.47
11	26-Dec-99	736	Balanced	235	710	738	1,946	3,311	135.4	0.62	3508	43.0	30.7	51.5	44,924	0.300	33.2	20.6	0.091	44.8	196.7	11.42	0.091	173	3.47	4.49
11	27-Dec-99	737	Balanced	235	710	719	1,981	3,299	117.0	0.63	3538	42.5	30.0	52.0	44,924	0.296	33.5	20.8	0.091	43.6	198.0	11.49	0.091	177	3.65	4.44
11	28-Dec-99	738	Balanced	235	710	742	1,964	3,055	125.6	0.63	3561	42.0	35.5	57.5	44,924	0.297	32.3	21.3	0.084	43.8	203.2	11.79	0.084	168	3.87	4.42
11	29-Dec-99	739	Balanced	235	710	695	2,017	3,166	96.6	0.63	3569	42.7	30.3	52.0	44,924	0.288	32.1	20.6	0.090	42.6	196.0	11.37	0.090	180	3.88	4.41
11	31-Dec-99	741	Balanced	235	710	723	1,999	3,014	114.1	0.63	3567	42.0	28.5	52.0	44,924	0.291	31.6	20.8	0.091	43.6	192.2	11.56	0.091	174	4.04	4.62
11	1-Jan-00	742	Balanced	235	710	721	1,979	2,991	112.6	0.63	3539	41.5	30.5	54.5	44,924	0.287	30.8	20.8	0.086	43.7	198.1	11.50	0.086	163	3.95	4.43
11	2-Jan-00	743	Balanced	235	710	717	1,952	3,055	124.8	0.62	3501	41.4	27.6	52.5	44,924	0.286	31.5	20.5	0.088	44.2	194.5	11.31	0.088	165	3.71	4.39
11	3-Jan-00	744	Balanced	235	710	692	1,946	2,933	98.6	0.61	3462	41.4	26.8	52.0	44,924	0.292	31.2	20.8	0.089	42.8	193.8	11.26	0.089	163	3.85	4.42
11	4-Jan-00	745	Balanced	235	710	694	1,991	2,821	97.6	0.62	3532	42.6	26.5	49.5	44,924	0.286	29.8	20.6	0.094	42.6	195.4	11.35	0.094	179	4.29	4.75
11	5-Jan-00	746	Balanced	235	710	694	2,009	3,066	113.2	0.63	3567	43.0	26.9	49.0	44,924	0.273	29.9	19.6	0.092	43.8	190.1	11.03	0.092	172	3.57	4.43
11	6-Jan-00	747	Balanced	235	710	700	1,986	3,225	123.8	0.62	3504	42.5	29.8	52.0	44,924	0.279	31.6	19.8	0.087	44.4	189.4	10.99	0.087	169	3.49	4.50
11	7-Jan-00	748	Balanced	235	710	697	1,985	3,022	116.7	0.62	3535	42.9	32.8	53.5	44,924	0.276	29.9	19.8	0.085	43.9	190.6	11.07	0.085	160	3.69	4.48
11	8-Jan-00	749	Balanced	235	710	697	2,014	2,821	109.1	0.63	3549	42.9	35.5	55.5	44,924	0.271	28.6	19.9	0.082	43.8	191.1	11.09	0.082	153	3.87	4.41
11	9-Jan-00	750	Balanced	235	710	695	2,005	2,655	107.7	0.63	3555	43.3	35.7	55.0	44,924	0.271	27.4	20.0	0.083	43.6	191.4	11.10	0.083	152	4.03	4.37
11	10-Jan-00	751	Balanced	235	710	697	1,996	2,655	112.1	0.63	3538	42.9	32.2	53.0	44,924	0.276	27.9	20.1	0.086	43.5	192.2	11.16	0.086	157	4.04	4.38
11	11-Jan-00	752	Balanced	235	710	701	2,027	2,799	118.9	0.64	3592	42.9	32.1	53.0	44,924	0.273	28.2	19.7	0.086	43.9	191.6	11.13	0.086	154	4.04	4.41
11	12-Jan-00	753	Balanced	235	710	701	1,996	2,711	122.2	0.63	3535	42.5	33.8	55.0	44,924	0.271	27.8	19.7	0.082	44.3	189.9	11.03	0.082	149	3.92	4.40
11	13-Jan-00	754	Balanced	235	710	700	2,015	2,633	120.7	0.63	3576	44.2	31.0	49.5	44,924	0.269	26.9	19.5	0.092	44.0	190.7	11.08	0.092	165	4.24	4.67
11	14-Jan-00	755	Balanced	235	710	697	2,054	2,688	120.8	0.64	3593	43.2	26.6	48.5	44,924	0.263	26.6	19.2	0.093	44.4	188.3	10.93	0.093	165	4.01	4.48
11	20-Jan-00	761	Balanced	235	710	563	2,134	2,422	113.5	0.63	4721	35.9	21.6	45.5	33,687	0.264	19.8	15.2	0.077	45.8	147.4	11.41	0.077	164	3.96	4.31
11	21-Jan-00	762	Balanced	235	710	555	2,117	2,433	115.5	0.62	4680	35.7	21.2	45.5	33,687	0.257	19.4	14.9	0.075	46.4	143.5	11.11	0.075	144	3.88	4.32
11	22-Jan-00	763	Balanced	234	710	548	2,089	3,133	62.6	0.61	4328	37.3	25.4	48.0	35,887	0.297	27.7	17.5	0.080	40.8	161.2	11.71	0.080	135	3.59	4.19
11	24-Jan-00	765	Balanced	234	710	646	2,004	3,995	76.8	0.61	4057	39.0	22.7	46.0	38,087	0.374	38.2	20.4	0.097	41.3	187.7	12.85	0.097	162	3.13	4.27
11	3-Feb-00	775	Balanced	235	710	863	1,885	4,211	82.1	0.63	3795	38.7	32.8	56.5	42,487	0.491	44.8	27.4	0.109	40.1	258.1	15.83	0.109	157	4.02	4.23
11	4-Feb-00	776	Balanced	235	710	859	1,960	3,929	81.6	0.65	3905	41.3	31.8	53.0	42,487	0.479	43.5	26.5	0.115	40.1	256.8	15.75	0.115	167	4.21	4.21
11	5-Feb-00	777	Balanced	235	710	854	1,921	3,277	85.8	0.64	3842	41.0	31.0	53.0	42,487	0.454	42.4	26.1	0.113	40.8	251.3	15.41	0.113	157	4.27	3.97
11	6-Feb-00	778	Balanced	235	710	825	1,946	3,311	78.8	0.64	3830	40.8	30.4	53.0	42,487	0.445	42.1	25.6	0.110	40.4	245.3	15.04	0.110	147	3.93	4.24
11	7-Feb-00	779	Balanced	234	710	855	1,915	3,116	82.3	0.64	3832	40.8	27.7	51.0	42,487	0.470	42.3	26.5	0.119	40.2	255.6	15.68	0.119	160	4.03	4.27
11	8-Feb-00	780	Balanced	234	710	824	1,998	3,277	88.5	0.65	3895	40.8	27.6	51.0	42,487	0.427	40.1	24.8	0.113	40.2	241.6	14.82	0.113	150	4.03	4.27
11	9-Feb-00	781	Balanced	234	710	840	1,917	3,299	99.1	0.64	3802	42.7	26.0	46.5	42,487	0.442	41.9	25.7	0.126	41.2	244.4	14.99	0.126	169	3.92	4.25

**Table D-2 – Data Summary Table for Kingsport Catalyst Campaign 2 (cont'd)**

Case	Date	Days On Stream	Gas Type	Temp (Deg C)	Press (psig)	Fresh Feed (KSCFH)	Recycle Gas (KSCFH)	Reactor Feed (H <sub>2</sub> CO)	Purge Gas (KSCFH)	Inlet Sup. Velocity (ft/sec)	Space Velocity (l/hr-kg)	Slurry Conc. (wt%-ox)	Gas Holdup (vol%)	Gassed Slurry Hgt (ft)	Catalyst Inventory (lb)	Catalyst Age (eta)	CO Conv. (%)	O-T-M Conv. (%)	Reactor		Raw		U		
																			Vol. Prod (TPD/B3)	Catalyst MeOH Prod (gmol/hr-kg)	Syngas Util. (SCF/lb)	MeOH Prod. (TPD)	Overall (Btu/hr (2-F))	Sparger dP (psf)	Sparger Resist. ("K")
11	10-Feb-00	782	Balanced	234	710	884	1,870	3.14	94.7	0.64	3620	41.7	23.2	50.0	44,687	0.475	43.8	27.5	40.6	261.5	15.25	0.125	152	4.12	4.23
11	11-Feb-00	783	Balanced	233	710	899	1,857	3.10	113.0	0.64	3627	43.1	30.5	51.0	44,687	0.468	42.8	27.3	41.4	260.9	15.19	0.122	140	4.09	4.23
11	12-Feb-00	784	Balanced	233	710	894	1,884	3.11	116.0	0.64	3653	41.4	23.4	49.5	44,687	0.449	41.7	26.7	41.9	256.1	14.93	0.123	139	4.12	4.22
11	13-Feb-00	785	Balanced	233	710	905	1,864	2.96	123.1	0.64	3645	43.2	32.3	52.0	44,687	0.460	41.0	27.1	41.9	259.3	15.14	0.119	132	4.22	4.23
11	14-Feb-00	786	Balanced	235	710	896	1,877	3.02	119.5	0.64	3646	45.6	32.9	48.0	44,687	0.453	41.2	26.8	41.6	258.1	15.06	0.128	147	4.19	4.29
11	15-Feb-00	787	Balanced	235	710	900	1,819	3.48	111.6	0.63	3563	41.7	29.3	53.0	44,687	0.482	47.5	27.9	41.3	261.1	15.23	0.117	159	3.81	4.29
11	16-Feb-00	788	Balanced	235	710	908	1,841	3.39	109.8	0.63	3573	41.2	26.0	51.5	44,687	0.472	46.1	27.5	42.0	259.1	15.12	0.120	159	3.91	4.31
11	17-Feb-00	789	Balanced	235	710	900	1,857	3.12	101.5	0.64	3630	41.3	23.9	50.0	44,687	0.468	43.7	27.6	40.8	264.8	15.45	0.126	168	4.15	4.30
11	18-Feb-00	790	Balanced	235	710	916	1,806	3.29	122.7	0.63	3649	40.9	24.4	51.0	44,687	0.475	45.7	27.9	41.8	262.9	15.29	0.123	166	3.95	4.28
11	19-Feb-00	791	Balanced	235	710	908.7	1,862	3.12	112.2	0.64	3649	42.4	24.9	48.5	44,687	0.467	43.4	24.9	41.2	264.6	15.44	0.130	174	4.30	4.42
25	23-Feb-00	795	Shell	235	710	624	2,237	0.57	85.1	0.66	3760	42.4	35.6	56.5	44,687	0.500	11.4	17.9	42.4	176.6	10.28	0.074	164	8.28	4.19
11	25-Feb-00	797	Balanced	234	700	570	2,041	4.74	26.7	0.61	3423	42.2	27.7	47.5	44,687	0.402	46.3	20.1	38.1	179.2	10.45	0.090	160	3.42	4.17
11	27-Feb-00	799	Balanced	234	710	854	1,949	3.17	129.5	0.65	3689	42.3	26.1	49.5	44,687	0.400	39.3	24.6	43.4	238.4	13.92	0.115	152	4.27	4.21
11	28-Feb-00	800	Balanced	234	710	860	1,956	3.15	135.6	0.65	3726	42.8	26.1	48.5	44,687	0.392	38.5	24.2	43.8	239.3	13.97	0.118	151	4.17	4.19
11	29-Feb-00	801	Balanced	234	710	852	1,942	3.16	133.8	0.65	3689	42.8	26.0	48.5	44,687	0.393	38.8	24.3	43.0	237.9	13.89	0.117	153	4.15	4.22
11	1-Mar-00	802	Balanced	234	710	861	1,944	3.00	125.5	0.65	3688	42.6	25.9	48.5	44,687	0.404	38.2	24.8	42.5	242.9	14.19	0.119	155	4.22	4.17
11	2-Mar-00	803	Balanced	234	710	850	1,974	2.90	118.6	0.65	3724	43.0	26.6	48.5	44,687	0.396	36.8	24.5	42.2	241.9	14.13	0.119	151	4.31	4.13
11	3-Mar-00	804	Balanced	234	710	854	1,919	3.03	121.4	0.64	3644	42.4	26.4	49.5	44,687	0.404	38.7	25.1	42.3	242.1	14.13	0.117	156	4.11	4.19
11	4-Mar-00	805	Balanced	234	710	854	1,933	3.02	120.7	0.64	3656	42.3	26.2	49.5	44,687	0.401	38.7	25.1	42.2	242.9	14.18	0.116	157	4.24	4.22
11	5-Mar-00	806	Balanced	234	710	852	1,931	2.96	118.1	0.64	3661	42.4	27.3	50.0	44,687	0.400	38.0	24.9	42.2	242.6	14.16	0.116	153	4.20	4.23
11	6-Mar-00	807	Balanced	234	712	855	1,955	3.05	126.2	0.65	3692	42.8	26.1	48.5	44,687	0.398	38.0	24.4	42.5	241.2	14.09	0.119	153	4.11	4.21
11	8-Mar-00	809	Balanced	234	710	825	1,928	3.09	114.3	0.64	3615	42.7	25.0	48.0	44,687	0.398	38.8	24.5	42.1	235.5	13.76	0.117	155	4.12	4.25
11	9-Mar-00	810	Balanced	234	710	836	1,940	2.87	112.2	0.64	3663	42.5	22.6	47.0	44,687	0.396	36.8	24.5	42.3	237.3	13.86	0.120	159	4.41	4.20
11	10-Mar-00	811	Balanced	234	710	816	1,952	2.91	112.4	0.64	3645	42.0	24.5	49.0	44,687	0.389	36.8	24.3	42.0	233.1	13.62	0.113	156	4.42	4.22
11	11-Mar-00	812	Balanced	234	710	808	1,932	3.05	118.2	0.63	3609	42.6	24.1	49.0	44,687	0.376	37.5	24.1	42.6	228.1	13.31	0.111	160	4.33	4.33
11	12-Mar-00	813	Balanced	234	710	818	1,995	3.08	124.0	0.65	3695	42.4	27.7	50.5	44,687	0.364	36.6	23.6	42.7	229.9	13.41	0.108	155	4.16	4.22
11	13-Mar-00	814	Balanced	234	710	824	1,981	2.92	124.2	0.65	3701	42.2	25.1	49.0	44,687	0.364	35.2	23.6	42.7	231.4	13.50	0.112	157	4.27	4.22
11	14-Mar-00	815	Balanced	234	710	818	1,966	2.92	130.4	0.65	3674	42.2	26.1	49.5	44,687	0.357	34.9	23.3	43.2	227.4	13.24	0.109	149	4.24	4.24
11	15-Mar-00	816	Balanced	234	710	835	1,921	2.97	137.0	0.64	3625	42.0	23.8	48.5	44,687	0.374	36.5	23.9	43.4	231.1	13.50	0.114	157	4.08	4.20
11	17-Mar-00	818	Balanced	234	710	783	2,026	2.91	109.0	0.65	3720	41.6	24.9	50.0	44,687	0.346	33.7	22.6	42.3	222.2	12.96	0.106	148	4.31	4.23
11	18-Mar-00	819	Balanced	234	710	746	1,997	3.16	131.0	0.64	3635	42.4	23.3	47.5	44,687	0.346	35.8	22.4	41.5	215.5	12.59	0.108	152	3.97	4.16
11	19-Mar-00	820	Balanced	234	710	808	1,974	2.93	133.6	0.64	3663	41.9	27.2	51.0	44,687	0.353	34.8	23.0	43.5	222.7	13.02	0.104	148	4.22	4.14
11	20-Mar-00	821	Balanced	234	710	804	1,952	3.03	147.0	0.64	3622	42.4	27.0	50.0	44,687	0.344	35.0	22.7	44.5	216.7	12.66	0.103	147	4.14	4.21
21	24-Mar-00	825	1:1	235	700	650	2,140	0.95	75.8	0.66	3722	41.0	19.7	48.0	44,687	0.378	15.1	19.1	41.3	189.0	11.04	0.094	167	7.05	4.19
21	25-Mar-00	826	1:1	235	700	662	2,121	0.93	94.4	0.66	3719	41.4	27.8	52.5	44,687	0.374	14.7	18.8	42.5	186.8	10.92	0.085	152	6.98	4.13
21	26-Mar-00	827	1:1	235	700	651	2,130	0.94	89.3	0.66	3713	41.4	27.8	52.5	44,687	0.370	14.9	19.0	41.9	186.3	10.89	0.084	150	6.98	4.12
21	27-Mar-00	828	1:1	234	700	663	2,130	0.96	99.0	0.66	3720	42.2	25.1	49.0	44,687	0.370	15.0	19.1	42.5	187.2	10.84	0.091	158	6.84	4.09
21	28-Mar-00	829	1:1	234	700	667	2,121	0.97	98.1	0.66	3713	42.5	23.2	48.5	44,687	0.365	15.0	19.0	42.8	187.0	10.93	0.092	149	6.83	4.14
21	29-Mar-00	830	1:1	234	700	656	2,132	1.05	94.7	0.66	3712	43.2	27.9	49.0	44,687	0.373	16.0	19.5	42.2	186.7	10.91	0.091	150	6.59	3.96
21	30-Mar-00	831	1:1	234	700	657	2,113	1.08	94.9	0.66	3697	42.7	28.1	50.0	44,687	0.364	16.2	16.2	46.2	186.2	10.88	0.089	143	6.52	4.01
21	31-Mar-00	832	1:1	234	700	675	2,069	0.96	105.3	0.65	3639	42.2	25.1	49.0	44,687	0.371	15.4	19.3	43.8	185.1	10.82	0.090	111	6.89	4.25
21	1-Apr-00	833	1:1	233	695	626	2,191	1.11	105.0	0.67	3740	42.1	31.8	54.0	44,687	0.346	15.8	18.4	43.6	183.0	10.70	0.081	108	7.00	4.33
21	2-Apr-00	834	1:1	234	700	638	2,246	1.08	119.5	0.70	3940	42.1	22.4	47.5	44,687	0.327	14.6	17.3	44.8	181.8	10.64	0.091	130	7.61	4.25
21	4-Apr-00	836	1:1	234	700	657	2,172	1.15	98.1	0.70	3934	46.6	31.0	45.0	44,687	0.325	15.2	17.7	43.0	183.4	10.71	0.097	122	7.62	4.36
21	5-Apr-00	837	1:1	234	700	640	2,255	1.11	95.4	0.69	3867	43.0	32.2	52.5	44,687	0.327	14.9	17.7	42.4	180.8	10.50	0.082	117	7.18	4.18



**Table D-2 – Data Summary Table for Kingsport Catalyst Campaign 2 (cont'd)**

Case	Date	Days On Stream	Gas Type	Temp (Deg C)	Press (psig)	Fresh Feed (KSCFH)	Recycle Gas (KSCFH)	Reactor Feed (H2CO)	Purge Gas (KSCFH)	Inlet Sup. Velocity (ft/sec)	Space Velocity (1/hr-kg)	Slurry Conc. (wt%-ox)	Gas Holdup (vol%)	Gassed Slurry Hgt (ft)	Catalyst Inventory (lb)	Catalyst Age (eta)	CO Conv. (%)	O-T-M Conv. (%)	Syngas Util. (SCF/lb)	Raw MeOH Prod. (TPD)	Catalyst MeOH Prod. (gmol/hr-kg)	Reactor Vol. Prod. (TPD/B3)	Overall (Btu/hr (2-F))	Sparger dP (psi)	Sparger Resist. ("K")
21	6-Apr-00	838	1-1	234	700	682	2,229	0.91	147.2	0.69	3849	42.7	31.5	52.5	44,687	0.312	12.5	16.5	46.8	174.9	10.26	0.079	113	7.24	4.29
21	7-Apr-00	839	1-1	234	700	692	2,225	0.86	160.4	0.68	3843	42.5	27.3	50.0	44,687	0.312	12.1	16.3	48.0	173.2	10.14	0.082	126	7.38	4.28
21	8-Apr-00	840	1-1	234	700	593	2,275	1.09	95.0	0.68	3842	45.3	26.6	44.5	44,687	0.305	13.9	16.6	43.5	163.8	9.57	0.088	135	7.90	4.49
21	9-Apr-00	841	1-1	233	700	622	2,288	1.12	97.2	0.69	3885	43.9	31.8	50.5	44,687	0.306	14.1	16.7	43.2	172.7	10.10	0.081	120	7.08	4.17
21	10-Apr-00	842	1-1	234	700	619	2,229	1.06	97.0	0.68	3802	44.1	33.0	51.0	44,687	0.327	14.3	17.2	42.8	173.2	10.13	0.081	131	6.90	4.09
21	11-Apr-00	843	1-1	233	700	640	2,245	1.14	104.9	0.68	3841	44.7	32.6	49.5	44,687	0.308	14.5	16.9	44.5	172.7	10.10	0.083	106	6.80	4.10
21	12-Apr-00	844	1-1	234	700	645	2,230	1.12	112.8	0.68	3813	44.7	34.7	51.0	44,687	0.316	13.7	17.0	45.0	172.0	10.06	0.080	99	6.98	4.12
11	13-Apr-00	845	Balanced	233	700	648	2,173	2.77	100.5	0.66	3739	42.8	22.9	46.5	44,687	0.271	26.0	17.8	43.2	180.1	10.52	0.092	130	4.19	4.13
11	14-Apr-00	846	Balanced	234	700	642	2,181	2.81	96.8	0.66	3697	43.0	29.6	50.5	44,687	0.266	26.5	17.8	42.9	179.6	10.50	0.085	122	4.20	4.37
11	15-Apr-00	847	Balanced	234	700	655	2,181	2.81	109.8	0.66	3723	42.8	24.4	47.5	44,687	0.258	25.5	17.5	44.3	177.4	10.37	0.089	122	4.20	4.38
11	21-Apr-00	853	Balanced	234	700	636	2,216	2.86	108.7	0.67	3750	43.6	28.8	49.0	44,687	0.244	24.9	16.9	44.5	171.5	10.02	0.083	124	4.53	4.56
11	22-Apr-00	854	Balanced	235	700	631	2,196	3.00	110.5	0.66	3717	43.0	33.9	54.0	44,687	0.234	25.8	16.9	44.8	169.0	9.88	0.074	113	4.18	4.32
11	24-Apr-00	856	Balanced	234	700	551	2,266	2.74	124.5	0.66	4851	38.0	23.7	43.5	34,207	0.247	19.1	13.6	47.9	137.9	10.54	0.076	139	4.28	4.40
11	26-Apr-00	858	Balanced	234	700	550	2,236	4.48	74.3	0.64	4418	38.2	30.4	47.5	36,407	0.319	32.7	15.8	42.8	154.0	11.04	0.077	139	3.28	4.56
11	27-Apr-00	859	Balanced	234	700	533	2,285	3.55	54.0	0.66	4555	40.7	33.2	47.5	36,407	0.291	27.2	15.6	41.1	155.5	11.15	0.078	132	3.97	4.40
11	28-Apr-00	860	Balanced	234	700	614	2,292	2.77	89.4	0.68	4710	40.3	32.0	46.5	36,407	0.301	23.8	16.4	43.1	171.0	12.26	0.088	131	4.57	4.31
11	29-Apr-00	861	Balanced	235	700	682	2,249	3.04	79.5	0.69	4465	40.3	28.0	47.5	38,607	0.345	29.4	19.0	41.7	196.1	13.26	0.098	125	4.65	4.40
11	30-Apr-00	862	Balanced	234	700	706	2,162	3.65	73.1	0.67	4126	38.5	20.2	48.5	40,807	0.380	37.0	20.9	40.6	209.0	13.36	0.103	135	4.23	4.47
11	1-May-00	863	Balanced	234	710	768	2,183	3.12	85.7	0.68	4245	38.8	21.0	48.5	40,807	0.395	34.6	21.9	41.4	224.3	14.35	0.110	135	4.74	4.36
11	2-May-00	864	Balanced	234	710	776	2,182	3.50	88.9	0.68	4013	40.1	20.8	48.5	43,007	0.384	37.5	21.9	41.4	224.6	13.63	0.110	129	4.45	4.47
11	3-May-00	865	Balanced	234	710	738	2,072	3.96	63.5	0.65	3830	40.3	18.2	46.5	43,007	0.411	42.6	22.4	40.3	218.7	13.27	0.112	149	3.97	4.52
11	13-May-00	875	Balanced	234	709	784	2,130	3.43	69.0	0.67	3780	43.1	26.7	49.0	45,207	0.415	40.5	23.9	39.9	236.0	13.62	0.115	141	4.33	4.00
11	14-May-00	876	Balanced	234	709	793	2,147	3.31	70.0	0.68	3833	45.5	29.6	46.5	45,207	0.405	38.8	23.5	40.2	236.8	13.67	0.121	142	4.43	3.97
11	16-May-00	878	Balanced	233	708	880	2,094	3.16	138.7	0.68	3833	45.5	28.8	46.5	45,207	0.397	37.5	23.6	43.4	243.1	14.05	0.125	130	243.1	3.96
11	17-May-00	879	Balanced	233	708	873	2,082	3.01	124.7	0.69	3864	41.2	20.4	48.5	45,207	0.397	26.2	23.6	43.0	243.6	14.08	0.120	119	4.49	3.95
11	18-May-00	880	Balanced	234	708	854	2,091	3.07	109.2	0.69	3846	41.1	18.3	47.5	45,207	0.399	37.1	23.8	42.4	241.8	13.97	0.121	131	4.68	4.06
11	19-May-00	881	Balanced	234	709	860	2,089	2.93	111.3	0.69	3850	43.8	27.2	48.0	45,207	0.397	36.0	23.9	42.4	243.7	14.08	0.121	128	4.70	4.00
11	20-May-00	882	Balanced	233	710	638	2,195	3.88	27.7	0.66	3701	43.8	27.5	48.0	45,207	0.377	40.0	21.2	38.3	199.9	11.53	0.099	132	4.16	3.96
11	25-May-00	887	Balanced	234	710	535	2,056	4.95	34.2	0.57	3204	42.9	23.0	47.0	45,207	0.390	41.9	18.7	39.6	162.1	9.35	0.082	138	2.62	4.61
11	27-May-00	889	Balanced	234	710	795	2,087	3.61	102.9	0.66	3706	41.2	25.2	51.5	45,207	0.387	40.8	22.7	42.6	223.9	12.94	0.104	142	4.08	3.97
11	28-May-00	890	Balanced	234	710	766	2,141	3.41	82.1	0.67	3792	44.2	25.9	46.5	45,207	0.360	37.3	21.7	41.0	223.8	12.92	0.115	151	4.3	4.22
11	29-May-00	891	Balanced	234	710	765	2,159	3.41	87.6	0.67	3792	42.3	28.8	52.0	45,207	0.349	36.7	21.4	41.5	221.4	12.76	0.101	126	4.19	4.15
11	30-May-00	892	Balanced	234	710	765	2,134	3.47	91.6	0.67	3752	41.6	22.4	49.0	45,207	0.347	37.1	21.4	41.7	220.0	12.70	0.107	131	3.96	4.11
11	31-May-00	893	Balanced	234	710	765	2,096	3.46	92.2	0.66	3739	41.0	19.9	48.5	45,207	0.344	36.9	21.4	42.0	218.6	12.63	0.107	131	3.95	4.11
11	1-Jun-00	894	Balanced	234	710	761	2,112	3.29	91.0	0.67	3758	40.9	23.4	51.0	45,207	0.346	35.7	21.4	41.5	219.8	12.70	0.103	123	4.07	4.06
11	2-Jun-00	895	Balanced	233	710	764	2,116	3.17	93.5	0.67	3770	40.3	18.6	49.0	45,207	0.342	34.3	21.2	41.0	220.1	12.71	0.107	119	220.1	4.29
11	3-Jun-00	896	Balanced	234	710	764	2,141	3.11	93.6	0.68	3807	41.0	18.8	48.0	45,207	0.337	33.5	21.1	41.7	219.6	12.68	0.109	122	4.33	4.20
11	4-Jun-00	897	Balanced	234	710	748	2,120	3.21	96.9	0.67	3747	43.5	23.2	46.0	45,207	0.326	33.7	20.7	42.2	212.9	12.30	0.110	125	4.17	4.26
11	5-Jun-00	898	Balanced	234	710	746	2,122	3.21	81.1	0.68	3752	44.0	25.2	46.5	45,207	0.333	34.5	21.2	41.2	217.2	12.55	0.111	138	4.29	4.34
11	6-Jun-00	899	Balanced	234	710	741	2,180	2.93	65.2	0.68	3842	45.6	26.4	44.5	45,207	0.336	32.4	21.2	40.1	221.7	12.79	0.119	146	4.71	4.33
11	8-Jun-00	901	Balanced	234	710	759	2,142	3.02	94.2	0.68	3800	43.7	24.6	46.5	45,207	0.329	32.4	21.0	41.8	218.0	12.59	0.112	127	4.39	4.27
11	9-Jun-00	902	Balanced	234	710	759	2,126	2.79	87.0	0.67	3775	45.0	25.6	44.0	45,207	0.332	31.4	21.3	41.4	220.0	12.70	0.119	138	4.63	4.33
11	10-Jun-00	903	Balanced	234	710	765	2,104	2.76	93.0	0.67	3763	45.6	24.0	44.0	45,207	0.329	30.9	21.2	42.1	218.1	12.60	0.117	135	4.54	4.26
11	14-Jun-00	907	Balanced	235	710	744	2,137	2.92	79.3	0.67	3760	43.4	26.0	48.0	45,207	0.320	32.0	20.9	41.3	216.1	12.48	0.107	120	4.86	4.68
11	15-Jun-00	908	Balanced	235	710	753	2,132	3.00	88.1	0.67	3783	43.3	25.8	48.0	45,207	0.320	32.4	20.9	41.7	216.7	12.52	0.108	122	4.73	4.56

**Table D-2 – Data Summary Table for Kingsport Catalyst Campaign 2 (cont'd)**

Case	Date	Days On Stream	Gas Type	Temp (Deg C)	Press (psig)	Fresh Feed (KSCFH)	Recycle Gas (KSCFH)	Reactor Feed (H <sub>2</sub> CO)	Purge Gas (KSCFH)	Inlet Sup. Velocity (ft/sec)	Space Velocity (1/hr-kg)	Slurry Conc. (wt%-ox)	Gas Holdup (vol%)	Gassed Slurry Hgt (ft)	Catalyst Inventory (lb)	Catalyst Age (eta)	CO Conv. (%)	O-T-M Conv. (%)	Reactor		Raw		U	
																			Vol. Prod. (TPD/ft <sup>3</sup> )	Catalyst MeOH Prod. (gmo/ht-kg)	Syngas Util. (SCF/lb)	MeOH Prod. (TPD)	Overall (Btu/hr (2-F))	Sparger dP (psf)
11	16-Jun-00	909	Balanced	236	710	755	2,148	3,04	86.8	0.68	3808	43.8	27.1	48.0	45,207	0.321	32.8	20.9	41.6	218.0	12.59	129	4.53	4.32
11	17-Jun-00	910	Balanced	236	710	758	2,156	3,02	87.6	0.68	3815	43.4	27.0	48.5	45,207	0.320	32.6	20.9	41.7	218.1	12.60	128	4.71	4.46
11	18-Jun-00	911	Balanced	236	710	758	2,163	3,02	90.3	0.68	3828	43.4	25.2	47.5	45,207	0.319	32.4	20.8	41.7	218.0	12.59	132	4.2	3.94
11	19-Jun-00	912	Balanced	236	710	680	2,192	3,25	56.1	0.67	3754	44.3	23.7	45.0	45,207	0.309	33.2	20.0	39.9	204.3	11.79	140	4.4	4.35
11	20-Jun-00	913	Balanced	236	710	672	2,193	3,16	56.1	0.67	3742	43.6	25.8	47.5	45,207	0.301	32.2	19.7	40.1	201.0	11.60	128	4.42	4.32
11	21-Jun-00	914	Balanced	235	710	676	2,195	3,08	60.2	0.67	3768	42.3	22.7	48.0	45,207	0.300	31.3	19.6	40.2	201.8	11.65	129	4.37	4.21
11	24-Jun-00	917	Balanced	234	710	682	2,136	3,35	71.5	0.65	3661	43.8	28.0	48.5	45,207	0.313	34.0	20.1	41.3	198.1	11.45	134	4.14	4.19
11	25-Jun-00	918	Balanced	234	710	681	2,141	3,27	71.9	0.65	3670	42.9	23.9	47.5	45,207	0.310	33.2	20.1	41.3	198.0	11.44	136	4.32	4.29
11	26-Jun-00	919	Balanced	234	710	681	2,141	3,27	74.4	0.65	3667	43.5	25.4	47.5	45,207	0.309	33.2	20.0	41.4	197.4	11.41	138	4.23	4.22
11	27-Jun-00	920	Balanced	234	710	678	2,137	3,30	71.4	0.65	3654	43.4	26.9	48.5	45,207	0.308	33.6	20.1	41.2	197.4	11.40	142	4.11	4.13
11	28-Jun-00	921	Balanced	234	710	668	2,136	3,28	74.3	0.65	3661	45.5	28.7	46.0	45,207	0.293	32.3	19.6	41.7	192.1	11.09	142	4.42	4.44
11	29-Jun-00	922	Balanced	234	710	691	2,136	3,24	91.1	0.65	3669	44.3	25.5	46.0	45,207	0.297	32.4	19.8	42.4	195.4	11.29	147	4.42	4.45
11	30-Jun-00	923	Balanced	234	710	683	2,150	3,17	89.2	0.66	3696	42.3	23.6	48.5	45,207	0.291	31.2	19.4	42.4	193.1	11.16	133	4.26	4.21
11	1-Jul-00	924	Balanced	234	710	684	2,158	3,11	90.5	0.66	3699	42.3	23.7	48.5	45,207	0.290	30.8	19.4	42.6	192.5	11.13	132	4.36	4.22
11	2-Jul-00	925	Balanced	234	710	685	2,135	3,10	88.3	0.65	3680	42.5	24.2	48.5	45,207	0.291	30.7	19.5	42.6	192.7	11.14	130	4.25	4.19
11	3-Jul-00	926	Balanced	234	710	687	2,127	3,06	94.5	0.65	3656	42.6	25.3	49.0	45,207	0.289	30.5	19.5	43.1	191.3	11.06	119	4.14	4.07
11	4-Jul-00	927	Balanced	234	710	663	2,124	3,05	76.5	0.65	3637	42.9	23.9	47.5	45,207	0.290	30.7	19.5	41.7	190.8	11.02	142	4.35	4.29
11	5-Jul-00	928	Balanced	234	710	667	2,116	3,31	84.8	0.65	3641	40.8	14.0	45.5	45,207	0.285	31.7	18.9	42.6	187.8	10.85	148	4.3	4.51
11	8-Jul-00	931	Balanced	234	710	670	2,174	3,01	82.8	0.66	3731	44.4	26.4	46.5	45,207	0.279	29.1	18.6	42.0	191.4	11.06	140	4.52	4.55
11	9-Jul-00	932	Balanced	234	710	683	2,156	3,08	89.5	0.66	3691	42.7	26.3	49.5	45,207	0.284	30.1	18.9	42.6	192.3	11.12	133	4.15	4.25
11	10-Jul-00	933	Balanced	234	710	677	2,143	3,04	89.5	0.66	3695	42.1	28.9	50.0	45,207	0.286	30.0	19.0	42.1	192.9	11.15	134	4.25	4.25
11	11-Jul-00	934	Balanced	234	710	682	2,174	2,82	89.3	0.66	3725	40.5	18.3	48.5	45,207	0.279	28.0	18.9	42.6	192.0	11.09	133	4.82	4.64
11	12-Jul-00	935	Balanced	234	710	675	2,169	2,85	88.1	0.66	3706	42.2	25.7	50.0	45,207	0.277	28.1	18.8	42.6	190.4	11.00	130	4.18	4.08
11	13-Jul-00	936	Balanced	234	710	668	2,164	2,88	84.8	0.66	3712	43.7	25.2	47.0	45,207	0.274	28.1	18.6	42.5	188.9	10.84	141	4.55	4.41
11	14-Jul-00	937	Balanced	234	710	679	2,057	3,24	69.9	0.64	3581	41.4	16.6	46.0	45,207	0.279	31.3	19.1	43.4	187.7	10.84	165	4.35	4.88
11	16-Jul-00	939	Balanced	234	710	681	2,158	2,81	90.3	0.66	3716	42.8	25.9	49.0	45,207	0.276	27.6	18.7	42.9	190.5	11.01	135	4.36	4.24
11	17-Jul-00	940	Balanced	234	710	669	2,150	2,94	88.0	0.66	3686	42.9	25.5	48.5	45,207	0.273	28.4	18.5	42.6	188.3	10.89	136	3.8	3.88
11	18-Jul-00	941	Balanced	233	710	643	2,214	2,69	105.0	0.66	3984	41.2	21.5	46.0	42,278	0.265	24.1	16.9	44.2	174.6	10.80	133	4.55	4.49
11	19-Jul-00	942	Balanced	233	710	614	2,220	2,82	95.3	0.65	4237	43.7	39.7	50.5	39,349	0.276	24.3	16.4	44.0	167.5	11.13	114	4.4	4.44
11	20-Jul-00	943	Balanced	234	710	655	2,215	3,07	63.6	0.67	4094	42.1	29.4	48.5	45,499	0.316	29.8	18.8	40.8	192.6	12.10	100	4.4	4.35
11	22-Jul-00	945	Balanced	235	710	676	2,169	3,53	40.7	0.66	3848	42.3	26.9	49.0	43,749	0.361	37.3	20.6	39.3	206.5	12.41	150	4.4	4.35
11	23-Jul-00	946	Balanced	234	710	676	2,171	3,46	42.6	0.67	3876	42.4	24.7	47.5	43,749	0.350	36.0	20.5	39.3	206.6	12.32	151	4.53	4.43
11	24-Jul-00	947	Balanced	234	710	684	2,172	3,34	47.8	0.67	3880	42.2	25.1	48.0	43,749	0.342	34.8	20.5	39.6	207.2	12.36	142	4.46	4.33
11	25-Jul-00	948	Balanced	234	710	713	2,165	3,28	64.6	0.67	3897	43.2	27.8	48.0	43,749	0.342	34.4	20.6	40.7	210.4	12.55	104	3.98	3.87
11	26-Jul-00	949	Balanced	234	710	787	2,122	3,34	57.2	0.68	3766	43.0	22.0	47.0	45,949	0.392	39.0	23.0	39.7	237.8	13.50	139	3.98	3.87
11	27-Jul-00	950	Balanced	234	705	808	2,091	3,24	66.3	0.68	3737	43.8	25.3	47.5	45,949	0.394	38.4	23.3	40.3	240.7	13.67	144	4.72	4.53
11	28-Jul-00	951	Balanced	234	705	812	2,096	3,16	70.6	0.68	3741	44.3	30.9	50.5	45,949	0.394	37.9	23.5	40.3	241.6	13.73	134	4.53	4.28
11	29-Jul-00	952	Balanced	234	705	816	2,098	3,14	79.5	0.68	3742	44.3	27.5	48.0	45,949	0.392	37.5	23.3	40.7	240.5	13.67	137	4.46	4.18
11	10-Aug-00	964	Balanced	234	706	622	2,147	4,69	48.3	0.64	3539	42.9	24.2	48.5	45,949	0.322	42.5	19.1	40.3	185.3	10.53	121	5.88	6.94
11	11-Aug-00	965	Balanced	234	709	618	2,177	4,63	46.3	0.65	3570	43.4	26.5	49.0	45,949	0.317	41.6	18.8	40.4	183.5	10.51	119	5.87	6.86
11	12-Aug-00	966	Balanced	234	701	641	2,177	4,32	47.1	0.65	3569	44.6	31.1	50.0	45,949	0.332	40.5	19.5	40.5	190.1	10.80	115	5.9	6.61
11	13-Aug-00	967	Balanced	235	709	668	2,177	4,34	54.2	0.66	3649	44.5	28.7	48.5	45,949	0.331	41.0	19.8	40.7	197.1	11.19	123	6.05	6.66
11	14-Aug-00	968	Balanced	235	705	708	2,229	3,62	52.9	0.69	3767	44.3	28.1	48.5	45,949	0.342	37.0	20.7	40.2	211.0	11.98	120	6.78	6.46
11	15-Aug-00	969	Balanced	235	705	750	2,271	3,41	67.4	0.69	3772	44.6	27.5	47.5	45,949	0.354	36.5	21.5	40.6	221.6	12.58	121	6.78	6.43
11	16-Aug-00	970	Balanced	234	705	760	2,176	3,34	74.0	0.68	3758	44.8	27.2	47.0	45,949	0.365	36.9	22.1	40.4	225.5	12.81	125	6.9	6.38

**Table D-2 – Data Summary Table for Kingsport Catalyst Campaign 2 (cont'd)**

Case	Date	Days On Stream	Gas Type	Temp (Deg C)	Press (psig)	Fresh Feed (KSCFH)	Recycle Gas (KSCFH)	Reactor Feed (H <sub>2</sub> CO)	Purge Gas (KSCFH)	Inlet Sup. Velocity (ft/sec)	Space Velocity (l/hr-kg)	Slurry Conc. (wt%-ox)	Gas Holdup (vol%)	Gassed Slurry Hgt (ft)	Catalyst Inventory (lb)	Catalyst Age (eta)	CO Conv. (%)	O-T-M Conv. (%)	Syngas Util. (SCF/lb)	Raw MeOH Prod. (TPD)	Catalyst MeOH Prod. (gmol/hr-kg)	Reactor Vol. Prod. (TPD/B3)	Overall (Btu/hr (2-F))	Sparger dP (psi)	Sparger Resist. ("K")
11	17-Aug-00	971	Balanced	234	705	760	2,138	3.49	78.9	0.68	3730	44.7	26.8	46.5	45,949	0.364	37.9	22.0	40.9	223.0	12.67	0.098	124	6.64	6.35
11	18-Aug-00	972	Balanced	234	705	735	2,137	3.50	78.4	0.67	3667	44.9	26.5	46.5	45,949	0.348	37.2	21.5	41.1	214.4	12.19	0.094	121	6.56	6.47
11	20-Aug-00	974	Balanced	234	705	743	2,194	3.14	64.5	0.69	3767	44.4	29.1	49.0	45,949	0.354	34.7	21.6	40.0	223.0	12.66	0.098	117	6.98	6.36
11	21-Aug-00	975	Balanced	234	705	739	2,190	3.29	76.9	0.68	3757	44.2	31.5	51.0	45,949	0.342	34.8	21.0	41.1	216.1	12.27	0.095	110	6.85	6.38
11	22-Aug-00	976	Balanced	234	705	735	2,168	3.33	79.6	0.68	3736	44.6	33.2	51.5	45,949	0.340	35.0	20.9	41.3	213.8	12.19	0.094	109	6.73	6.39
11	23-Aug-00	977	Balanced	234	708	727	2,172	3.09	76.7	0.68	3734	45.7	29.7	47.0	45,949	0.321	32.6	20.6	41.0	212.9	12.10	0.094	107	6.77	6.46
11	24-Aug-00	978	Balanced	234	710	670	2,168	3.68	44.1	0.66	3635	44.9	25.8	46.0	45,949	0.332	37.4	20.4	39.4	203.8	11.57	0.091	121	6.28	6.52
11	25-Aug-00	979	Balanced	234	710	656	2,188	3.70	46.6	0.66	3639	42.5	23.7	49.0	45,949	0.319	36.5	19.9	39.6	198.7	11.28	0.088	115	6.24	6.48
11	26-Aug-00	980	Balanced	234	710	655	2,173	3.55	46.1	0.66	3638	43.0	23.8	48.0	45,949	0.315	35.3	19.8	39.8	197.3	11.21	0.098	126	6.32	6.42
11	27-Aug-00	981	Balanced	234	710	655	2,168	3.45	49.0	0.66	3637	43.8	29.7	50.5	45,949	0.302	33.7	19.7	40.0	196.6	10.93	0.087	105	6.41	6.40
11	28-Aug-00	982	Balanced	234	707	692	2,166	3.12	63.4	0.66	3661	44.0	34.9	54.0	45,949	0.314	32.6	20.3	40.5	205.0	11.65	0.090	107	6.72	6.52
11	29-Aug-00	983	Balanced	234	706	732	2,131	3.10	82.8	0.66	3659	44.0	30.2	50.5	45,949	0.321	32.9	20.6	41.7	210.5	11.97	0.099	114	6.55	6.54
11	30-Aug-00	984	Balanced	234	706	738	2,116	3.16	84.0	0.66	3648	42.7	26.0	50.0	45,949	0.326	33.8	21.0	41.6	212.9	12.10	0.101	123	6.46	6.51
11	31-Aug-00	985	Balanced	235	706	730	2,111	3.20	77.6	0.66	3622	42.0	23.2	49.5	45,949	0.326	34.5	21.2	41.2	212.5	12.08	0.102	128	6.39	6.49
11	1-Sep-00	986	Balanced	235	706	726	2,123	3.19	76.5	0.66	3634	42.1	22.7	49.0	45,949	0.326	34.3	21.1	41.0	212.4	12.07	0.094	118	6.45	6.45
11	2-Sep-00	987	Balanced	235	706	725	2,123	3.09	75.7	0.66	3647	42.4	23.6	49.0	45,949	0.327	33.7	21.1	41.1	211.6	12.13	0.092	116	6.64	6.39
11	3-Sep-00	988	Balanced	234	706	726	2,138	3.13	85.2	0.66	3654	42.9	25.7	49.5	45,949	0.316	33.1	20.8	41.8	208.4	11.85	0.100	124	6.58	6.37
11	4-Sep-00	989	Balanced	234	706	726	2,127	3.17	96.6	0.66	3651	43.5	28.1	50.0	45,949	0.308	32.7	20.4	42.5	204.7	11.64	0.098	118	6.49	6.43
11	5-Sep-00	990	Balanced	234	706	735	2,147	3.12	104.6	0.67	3708	43.7	29.5	50.5	45,949	0.303	31.8	20.1	43.1	204.4	11.63	0.096	114	6.58	6.41
11	6-Sep-00	991	Balanced	235	709	705	2,169	3.27	77.0	0.67	3708	41.1	19.6	49.0	45,949	0.304	33.1	20.1	41.4	204.2	11.60	0.099	137	7.58	6.45
11	7-Sep-00	992	Balanced	235	707	705	2,156	3.17	81.0	0.67	3696	41.4	25.9	52.5	45,949	0.304	32.6	20.2	41.6	203.1	11.55	0.092	128	6.68	6.43
11	8-Sep-00	993	Balanced	235	707	697	2,156	3.15	79.4	0.67	3670	41.4	25.9	52.5	45,949	0.298	31.9	19.9	41.7	200.6	11.41	0.091	127	6.68	6.45
11	9-Sep-00	994	Balanced	235	707	696	2,140	3.13	84.5	0.66	3642	42.1	24.1	50.0	45,949	0.292	31.5	19.8	42.2	198.0	11.19	0.094	125	6.63	6.42
11	10-Sep-00	995	Balanced	235	707	692	2,151	3.11	88.1	0.66	3637	42.5	24.7	49.5	45,949	0.290	31.2	19.6	42.4	195.6	11.14	0.094	123	6.64	6.44
11	11-Sep-00	996	Balanced	235	707	688	2,156	3.06	89.7	0.66	3646	42.8	25.5	49.5	45,949	0.287	30.5	19.4	42.6	194.0	11.04	0.093	121	6.67	6.36
11	12-Sep-00	997	Balanced	234	708	684	2,157	3.01	91.7	0.66	3641	43.4	27.9	50.0	45,949	0.283	29.8	19.2	42.8	191.7	10.91	0.091	116	6.72	6.72
11	13-Sep-00	998	Balanced	234	708	687	2,149	2.98	91.7	0.66	3640	43.4	27.8	50.0	45,949	0.284	29.8	19.3	42.8	192.7	10.97	0.092	118	6.71	6.33
11	14-Sep-00	999	Balanced	234	708	683	2,148	3.03	97.1	0.66	3632	43.9	29.9	50.5	45,949	0.281	29.9	19.2	43.1	190.3	10.84	0.090	115	6.62	6.31
11	15-Sep-00	1000	Balanced	234	710	666	2,198	3.08	90.0	0.66	3675	44.5	32.1	51.0	45,949	0.274	29.4	18.7	42.6	187.5	10.67	0.088	113	6.65	6.34
11	16-Sep-00	1001	Balanced	234	710	661	2,229	3.08	91.7	0.67	3697	44.8	33.0	51.0	45,949	0.266	28.7	18.3	42.9	184.8	10.51	0.086	111	6.61	6.35
11	17-Sep-00	1002	Balanced	235	710	675	2,180	3.02	85.7	0.66	3669	42.4	25.8	50.5	45,949	0.271	29.2	18.9	42.6	190.1	10.81	0.090	124	6.60	6.39
11	19-Sep-00	1004	Balanced	234	710	599	2,240	2.87	111.9	0.66	4614	39.3	24.3	44.0	36,163	0.273	23.3	15.7	45.6	157.7	11.41	0.086	142	6.54	6.45
11	20-Sep-00	1005	Balanced	234	711	579	2,186	2.94	108.8	0.64	4504	39.4	26.3	45.0	36,163	0.263	23.7	15.7	45.3	153.4	11.03	0.081	126	6.34	6.39
11	22-Sep-00	1007	Balanced	235	710	634	2,140	3.09	86.4	0.64	4248	39.9	31.0	50.0	38,363	0.317	33.0	18.4	42.8	177.6	12.11	0.085	149	5.94	6.33
11	27-Sep-00	1012	Balanced	235	706	817	2,126	3.89	62.0	0.69	3859	42.2	33.8	55.0	44,963	0.458	45.7	24.3	40.4	242.8	14.10	0.105	174	5.89	5.34
11	28-Sep-00	1013	Balanced	235	706	851	2,195	3.52	65.7	0.69	3866	41.4	30.1	54.5	44,963	0.458	43.6	24.9	40.0	255.5	14.84	0.112	160	5.81	5.34
11	30-Sep-00	1015	Balanced	230	706	676	2,122	4.37	33.1	0.64	3636	41.8	26.8	51.0	44,963	0.431	47.8	21.8	39.0	208.2	12.30	0.097	167	4.86	5.64
11	2-Oct-00	1017	Balanced	235	706	811	2,422	3.51	46.8	0.68	3838	40.2	27.4	55.0	44,963	0.465	43.7	25.0	38.9	230.4	14.53	0.108	148	5.87	5.27
11	3-Oct-00	1018	Balanced	235	706	832	2,091	3.39	53.1	0.68	3845	42.2	27.5	51.0	44,963	0.464	42.9	25.1	39.2	234.6	14.77	0.119	155	5.90	5.30
11	4-Oct-00	1019	Balanced	235	706	856	2,088	3.48	59.7	0.69	3849	42.1	27.9	51.5	44,963	0.476	44.4	25.6	39.5	260.1	15.09	0.120	158	5.76	5.27
11	5-Oct-00	1020	Balanced	235	705	867	2,027	3.65	67.5	0.67	3780	39.4	29.0	54.0	44,963	0.491	46.9	26.2	39.7	262.5	15.23	0.116	156	5.52	5.40
11	6-Oct-00	1021	Balanced	235	705	911	2,071	3.49	67.8	0.70	3715	45.4	33.9	52.0	47,163	0.492	46.3	26.8	39.6	275.7	15.25	0.126	167	5.86	5.29
11	7-Oct-00	1022	Balanced	235	705	934	2,068	3.60	73.9	0.70	3726	44.3	31.0	51.0	47,163	0.501	47.7	27.0	39.9	281.3	15.55	0.131	172	5.63	5.30
11	8-Oct-00	1023	Balanced	235	705	925	2,057	3.55	80.2	0.69	3710	43.7	33.0	54.5	47,163	0.485	46.6	26.6	40.2	275.8	15.27	0.120	144	5.63	5.30
11	9-Oct-00	1024	Balanced	235	709	900	2,057	3.73	79.0	0.68	3680	43.9	33.5	54.5	47,163	0.468	47.1	26.0	40.1	269.0	14.88	0.117	137	5.37	5.42

**Table D-2 – Data Summary Table for Kingsport Catalyst Campaign 2 (cont'd)**

Case	Date	Days On Stream	Gas Type	Temp (Deg C)	Press (psig)	Fresh Feed (KSCF/HR)	Recycle Gas (KSCF/HR)	Reactor Feed (H2CO)	Purge Gas (KSCF/HR)	Inlet Sup. Velocity (ft/sec)	Space Velocity (1/hr-kg)	Slurry Conc. (wt%-ox)	Gas Holdup (vol%)	Gassed Slurry Hgt (ft)	Catalyst Inventory (lb)	Catalyst Age (eta)	CO Conv. (%)	O-T-M Conv. (%)	Reactor		Raw		U		
																			Vol. Prod. (TPD/ft3)	MeOH Prod. (gmol/hr-kg)	Syngas Util. (SCF/lb)	MeOH Prod. (TPD)	Overall (Btu/hr (12 F))	Sparger dP (psf)	Sparger Resist. ("K")
11	10-Oct-00	1025	Balanced	235	709	916	2,038	3.63	67.5	0.69	3682	44.5	33.8	53.5	47,163	0.494	47.8	26.8	39.6	277.6	15.36	0.123	151	5.42	5.35
11	11-Oct-00	1026	Balanced	235	707	911	2,053	3.46	64.9	0.69	3709	44.4	27.9	49.5	47,163	0.487	45.9	26.7	39.5	276.9	15.32	0.133	157	5.63	5.26
11	12-Oct-00	1027	Balanced	235	709	928	2,074	3.41	66.3	0.70	3742	44.8	31.8	51.5	47,163	0.491	45.6	26.8	39.6	281.1	15.55	0.130	155	5.85	5.41
11	13-Oct-00	1028	Balanced	235	707	918	2,085	3.31	68.3	0.70	3764	44.3	33.3	53.5	47,163	0.480	44.1	26.5	39.4	279.4	15.46	0.124	140	5.87	5.29
11	14-Oct-00	1029	Balanced	234	706	922	2,083	3.30	73.8	0.70	3745	44.3	33.2	53.5	47,163	0.474	43.9	26.6	39.6	279.2	15.44	0.124	136	6.05	5.51
11	15-Oct-00	1030	Balanced	234	708	920	2,070	3.43	81.3	0.69	3729	44.1	27.5	50.0	47,163	0.476	45.1	26.6	39.9	276.5	15.31	0.132	145	5.83	5.40
11	23-Oct-00	1038	Balanced	234	706	865	2,103	3.27	76.8	0.70	3717	44.1	30.1	51.5	47,163	0.430	41.0	24.9	40.1	259.0	14.30	0.120	124	5.89	5.14
11	25-Oct-00	1040	Balanced	238	711	993	1,906	3.35	140.8	0.68	3622	45.2	36.9	55.0	47,163	0.445	45.2	27.0	43.1	276.6	15.34	0.120	117	5.3	5.19
11	26-Oct-00	1041	Balanced	234	709	888	2,098	3.29	79.3	0.70	3742	44.4	26.5	48.5	47,163	0.439	41.9	25.4	40.2	265.1	14.68	0.130	148	5.92	5.28
11	30-Oct-00	1045	Balanced	234	710	792	2,248	3.31	54.9	0.71	3824	45.5	34.4	52.0	47,163	0.393	38.2	23.0	39.3	241.9	13.37	0.111	123	6.18	5.18
11	3-Nov-00	1049	Balanced	234	710	786	2,178	3.57	59.0	0.69	3703	42.1	24.4	51.5	47,163	0.385	40.4	23.1	39.9	236.3	13.08	0.109	127	5.67	5.32
11	4-Nov-00	1050	Balanced	234	710	788	2,189	3.49	59.8	0.69	3705	44.6	30.6	51.0	47,163	0.395	40.5	23.5	39.5	239.3	13.25	0.112	131	5.84	5.32
11	5-Nov-00	1051	Balanced	234	710	791	2,191	3.45	63.1	0.69	3712	45.6	33.3	51.0	47,163	0.393	39.9	23.4	39.7	238.9	13.22	0.112	127	5.81	5.26
11	7-Nov-00	1053	Balanced	234	710	786	2,146	3.56	60.1	0.68	3658	44.1	27.9	50.0	47,163	0.400	41.6	23.7	39.4	239.4	13.25	0.114	139	5.68	5.34
11	8-Nov-00	1054	Balanced	234	705	775	2,095	3.41	55.9	0.67	3605	44.2	28.8	50.5	47,163	0.394	40.3	23.7	39.5	235.2	13.02	0.111	134	5.80	5.41
11	9-Nov-00	1055	Balanced	234	705	782	2,118	3.61	65.0	0.68	3616	44.9	28.6	49.0	47,163	0.391	41.6	23.5	39.8	235.5	13.03	0.115	136	5.61	5.48
11	10-Nov-00	1056	Balanced	236	705	800	2,162	3.23	62.3	0.70	3726	45.6	33.2	51.0	47,163	0.381	38.2	23.4	39.7	241.6	13.37	0.113	126	241.6	5.26
11	11-Nov-00	1057	Balanced	234	705	792	2,148	3.21	61.8	0.69	3708	45.0	30.3	50.0	47,163	0.385	37.7	23.1	39.9	238.4	13.20	0.114	130	5.94	5.26
11	12-Nov-00	1058	Balanced	234	705	792	2,143	3.11	59.0	0.69	3698	44.6	28.5	49.5	47,163	0.387	37.1	23.3	39.6	240.0	13.28	0.116	129	6.02	5.31
11	13-Nov-00	1059	Balanced	234	705	790	2,152	3.06	63.6	0.69	3702	46.7	36.1	51.0	47,163	0.383	36.3	23.1	39.9	237.7	13.16	0.111	117	5.92	5.19
11	14-Nov-00	1060	Balanced	234	705	800	2,145	3.49	78.0	0.69	3683	43.3	27.2	51.0	47,163	0.376	39.3	23.0	40.7	236.2	13.06	0.110	123	5.53	5.44
21	17-Nov-00	1063	Balanced	235	704	726	2,250	1.08	62.4	0.74	3928	46.3	35.7	51.5	47,163	0.403	16.8	20.3	39.6	220.2	12.19	0.102	125	9.94	4.91
11	21-Nov-00	1067	Balanced	248	730	1019	1,902	4.23	252.7	0.66	3509	45.4	29.9	49.5	47,163	0.340	49.1	26.2	47.9	265.2	14.14	0.123	133	4.76	5.97
11	25-Nov-00	1071	Balanced	234	705	650	2,149	4.12	36.3	0.65	3471	44.5	31.0	51.5	47,163	0.345	41.3	21.0	38.8	200.9	11.11	0.093	134	4.85	5.39
11	26-Nov-00	1072	Balanced	235	705	650	2,169	3.88	31.6	0.65	3499	45.1	30.5	50.0	47,163	0.347	40.0	21.3	38.3	203.4	11.24	0.097	138	5.09	5.33
11	27-Nov-00	1073	Balanced	234	701	693	2,155	3.33	39.4	0.68	3599	43.3	28.7	50.0	47,163	0.340	35.9	21.5	38.9	213.9	11.83	0.102	129	5.45	5.21
11	28-Nov-00	1074	Balanced	234	701	704	2,141	3.52	47.8	0.67	3553	43.6	28.6	51.5	47,163	0.347	37.9	21.8	39.2	215.6	11.92	0.100	125	5.17	5.28
11	30-Nov-00	1076	Balanced	236	709	699	2,114	3.22	47.6	0.66	3556	41.4	21.6	51.0	47,163	0.346	41.1	21.7	38.9	215.7	11.93	0.101	123	5.07	5.39
11	1-Dec-00	1077	Balanced	236	710	698	2,182	3.68	37.7	0.67	3618	44.2	28.7	50.5	47,163	0.346	39.4	21.5	38.6	217.1	12.01	0.102	122	5.27	5.22
11	2-Dec-00	1078	Balanced	236	710	700	2,194	3.41	34.2	0.68	3642	44.3	28.3	50.0	47,163	0.348	37.6	21.7	38.3	219.3	12.12	0.104	124	5.6	5.19
11	3-Dec-00	1079	Balanced	236	710	701	2,232	3.37	39.3	0.69	3684	44.5	30.2	51.0	47,163	0.332	36.2	21.2	38.9	215.9	11.94	0.101	116	5.66	5.17
11	4-Dec-00	1080	Balanced	236	710	711	2,217	3.31	44.4	0.68	3671	44.9	29.9	50.0	47,163	0.332	35.9	21.4	39.1	218.1	12.07	0.104	118	5.63	5.19
11	5-Dec-00	1081	Balanced	234	710	686	2,231	3.28	43.8	0.68	3666	43.9	28.9	51.0	47,163	0.325	34.5	20.8	39.0	211.2	11.68	0.099	119	5.56	5.14
11	13-Dec-00	1082	Balanced	235	710	701	2,190	3.51	49.3	0.67	3629	43.1	30.1	53.5	47,163	0.333	37.0	21.2	39.3	214.0	11.84	0.095	122	5.3	5.17
11	7-Dec-00	1083	Balanced	235	710	714	2,121	3.59	51.0	0.66	3561	42.4	26.7	52.5	47,163	0.342	38.6	21.7	39.9	215.0	11.90	0.097	131	5.18	5.24
11	8-Dec-00	1084	Balanced	235	710	701	2,200	3.54	49.7	0.67	3631	42.8	27.3	52.0	47,163	0.328	36.8	21.1	39.3	213.8	11.82	0.098	125	5.38	5.27
11	9-Dec-00	1085	Balanced	234	710	701	2,139	3.43	49.3	0.66	3576	43.1	28.7	52.5	47,163	0.337	37.0	21.6	39.2	214.3	11.86	0.097	126	5.3	5.20
11	10-Dec-00	1086	Balanced	234	710	700	2,191	3.36	48.3	0.67	3616	43.1	27.3	51.5	47,163	0.326	35.6	21.0	39.6	212.4	11.75	0.098	123	5.36	5.18
11	11-Dec-00	1087	Balanced	235	710	741	2,108	3.37	60.7	0.66	3559	43.9	31.5	53.0	47,163	0.351	37.9	22.4	39.8	223.3	12.36	0.100	138	5.29	5.26
11	12-Dec-00	1088	Balanced	235	710	758	2,167	3.25	62.4	0.68	3657	44.3	33.7	54.0	47,163	0.340	36.2	22.1	40.0	227.5	12.58	0.100	133	5.47	5.32
11	13-Dec-00	1089	Balanced	235	710	750	2,167	3.10	62.4	0.67	3623	44.8	31.2	51.0	47,163	0.340	35.1	22.1	40.1	224.6	12.43	0.105	137	5.49	5.32
11	14-Dec-00	1090	Balanced	235	710	749	2,921	3.01	62.3	0.68	3659	45.5	31.7	50.0	47,163	0.332	33.6	21.7	40.4	222.7	12.32	0.106	135	5.66	5.22
11	15-Dec-00	1091	Balanced	235	710	735	2,195	3.06	60.6	0.68	3663	45.5	31.6	50.0	47,163	0.325	33.5	21.4	40.0	220.5	12.20	0.105	131	5.59	5.24
11	18-Dec-00	1094	Balanced	234	710	743	2,148	3.20	82.7	0.67	3620	44.7	31.5	51.5	47,163	0.316	33.8	21.1	41.3	215.8	11.94	0.100	115	5.12	5.17
11	19-Dec-00	1095	Balanced	234	710	743	2,158	3.04	79.0	0.67	3626	43.8	31.2	53.0	47,163	0.319	33.0	21.3	41.0	217.4	12.03	0.098	116	5.42	5.25



**Table D-2 – Data Summary Table for Kingsport Catalyst Campaign 2 (cont'd)**

Case	Date	Days On Stream	Gas Type	Temp (Deg C)	Press (psig)	Fresh Feed (KSCFH)	Recycle Gas (KSCFH)	Reactor Feed (H <sub>2</sub> CO)	Purge Gas (KSCFH)	Inlet Sup. Velocity (ft/sec)	Space Velocity (1/hr-kg)	Slurry Conc. (wt%-ox)	Gas Holdup (vol%)	Gassed Slurry Hgt (ft)	Catalyst Inventory (lb)	Catalyst Age (eta)	CO Conv. (%)	O-T-M Conv. (%)	Reactor		Raw		U		
																			Vol. Prod. (TPD/ft <sup>3</sup> )	Sparger dP (psi)	Syngas Util. (SCF/lb)	MeOH Prod. (TPD)	MeOH Prod. (gmol/hr-kg)	Reactor Vol. Prod. (TPD/ft <sup>3</sup> )	Overall (ft <sup>3</sup> /hr)
11	24-Mar-01	1190	Balanced	235	708	744	2,171	2,86	97.2	0.67	3585	43.5	24.9	49.0	47,160	0.297	30.7	20.9	42.4	210.5	11.65	0.102	132	6.02	5.46
11	25-Mar-01	1191	Balanced	234	710	739	2,201	2,88	91.6	0.68	3648	43.0	23.3	49.0	47,160	0.290	29.9	20.3	42.7	207.5	11.48	0.101	124	6.43	5.79
11	26-Mar-01	1192	Balanced	234	710	746	2,201	2,90	90.6	0.67	3630	42.8	24.3	48.0	47,160	0.293	30.4	20.5	42.8	208.8	11.55	0.104	130	5.81	5.33
11	27-Mar-01	1193	Balanced	234	710	732	2,226	2,87	100.1	0.68	3657	43.2	18.9	46.0	47,160	0.280	28.9	19.6	43.5	202.0	11.17	0.105	124	6.05	5.50
11	29-Apr-01	1226	Balanced	235	710	543	2,344	2,94	40.2	0.65	3577	43.4	29.2	51.5	46,716	0.249	24.5	16.2	40.5	161.7	10.67	0.075	108	8.20	7.96
11	4-May-01	1231	Balanced	235	710	621	2,238	2,88	65.6	0.66	3584	43.4	21.4	50.5	46,716	0.245	24.9	17.8	41.5	197.7	10.04	0.085	102	8.20	7.96
11	31-May-01	1258	Balanced	235	710	544	2,224	2,73	74.7	0.63	3420	43.4	21.1	46.5	46,716	0.198	22.0	15.3	44	148.5	8.31	0.076	105	9.3	7.43
11	3-Jun-01	1261	Balanced	234	710	603	2,063	2,70	115.8	0.61	3302	44.3	28.4	49.5	46,716	0.212	23.4	16.4	46.7	154.8	8.68	0.075	106	6.05	6.78
11	5-Jun-01	1263	Balanced	233	710	571	2,192	2,36	138.8	0.62	3859	39.5	14.4	44	41,216	0.222	18.1	14	49.4	138.6	8.82	0.075	107	5.62	5.89
11	6-Jun-01	1264	Balanced	234	710	572	2,178	2,30	131	0.62	3847	43.1	19.9	41	41,216	0.222	18.4	14.4	48.1	142.6	9.07	0.083	126	6.18	6.34
11	7-Jun-01	1265	Balanced	234	710	574	2,151	2,54	99	0.62	3680	45.5	25.9	42	42,866	0.238	21.2	15.6	45.4	151.6	9.3	0.086	124	6.39	6.93
11	8-Jun-01	1266	Balanced	234	710	612	2,110	2,50	46.4	0.62	3474	42.1	21.5	48	45,620	0.266	25.9	19	40.7	180.7	10.35	0.09	105	7.7	7.48
11	14-Jun-01	1272	Balanced	235	710	671	2,010	3.24	105.6	0.61	3372	41.2	22	50	45,620	0.276	31.4	19.2	44.7	179.9	10.33	0.086	118	6.19	7.37
11	15-Jun-01	1273	Balanced	235	710	608	2,127	2.60	68.7	0.63	3500	42.7	25.7	49.5	45,620	0.242	25.0	17.7	42.7	170.8	9.79	0.082	99	7.02	6.74
11	16-Jun-01	1274	Balanced	235	710	612	2,097	2.92	87.8	0.62	3446	43.0	25.1	48.5	45,620	0.237	26.5	17.5	44.1	166.5	9.55	0.082	103	6.77	7.26
11	17-Jun-01	1275	Balanced	235	710	614	2,116	2.93	95.4	0.62	3467	42.6	24.7	49.0	45,620	0.232	26.0	17.1	44.9	164.2	9.42	0.08	99	6.56	7.00
11	19-Jun-01	1277	Balanced	235	710	556	2,170	2.90	72.6	0.62	3462	44.6	32.4	50.5	45,620	0.219	24.0	15.8	43.4	153.5	8.8	0.072	104	6.43	6.98
11	20-Jun-01	1278	Balanced	235	710	583	2,121	3.19	83.4	0.61	3411	39.8	22.2	53.0	45,620	0.237	27.1	16.7	43.8	159.7	9.16	0.072	104	5.98	7.04
11	21-Jun-01	1279	Balanced	235	710	577	2,154	2.98	67.1	0.62	3468	39.7	19.6	51.5	45,620	0.233	25.6	16.5	43.3	159.8	9.16	0.074	105	5.84	6.30
11	22-Jun-01	1280	Balanced	235	710	584	2,161	2.78	68.9	0.63	3506	40.9	23.3	51.5	45,620	0.236	24.8	16.9	42.7	164.1	9.4	0.076	109	6.6	6.67
11	23-Jun-01	1281	Balanced	235	710	581	2,163	2.91	78.6	0.63	3478	40.6	22.5	51.5	45,620	0.233	25.0	16.5	43.6	159.9	9.16	0.074	103	5.99	6.44
11	24-Jun-01	1282	Balanced	235	710	579	2,210	2.76	78.4	0.63	3512	40.6	24.8	53.0	45,620	0.227	23.8	16.3	43.5	159.8	9.16	0.072	97	6.01	6.21
11	25-Jun-01	1283	Balanced	235	710	580	2,221	2.63	72.5	0.64	3551	40.9	22.7	51.0	45,620	0.227	23.2	16.5	42.8	162.7	9.32	0.076	103	6.67	6.59
11	26-Jun-01	1284	Balanced	235	710	592	2,175	2.61	73.1	0.63	3519	40.4	18.7	49.5	45,620	0.233	23.8	16.9	42.7	166.2	9.52	0.080	110	6.11	6.08
11	28-Jun-01	1286	Balanced	235	710	568	2,196	2.69	66.6	0.63	3500	43.4	20.2	45.0	45,620	0.227	23.8	16.5	42.5	160.4	9.19	0.085	114	6.41	6.43
11	30-Jun-01	1288	Balanced	235	710	573	2,160	2.58	62.5	0.63	3477	42.5	23.5	48.5	45,620	0.237	23.6	16.8	42.2	162.9	9.33	0.08	119	6.54	6.53
11	1-Jul-01	1289	Balanced	235	710	570	2,152	2.58	60.8	0.62	3469	41.7	21	48.5	45,620	0.241	23.7	16.9	41.8	163.5	9.36	0.08	121	6.8	6.84
11	2-Jul-01	1290	Balanced	235	710	573	2,163	2.81	64.3	0.63	3480	43	25	48.5	45,620	0.242	23.6	16.7	42.1	163.2	9.35	0.08	117	6.7	6.82
11	3-Jul-01	1291	Balanced	235	710	578	2,150	2.58	67.1	0.62	3477	44.4	25.6	46.5	45,620	0.238	23.5	16.8	42.4	163.4	9.36	0.08	118	6.7	6.74
11	4-Jul-01	1292	Balanced	235	710	572	2,168	2.57	71.9	0.63	3484	44.7	24.8	45.5	45,620	0.230	22.9	16.4	42.9	159.9	9.16	0.079	115	6.92	6.92
11	5-Jul-01	1293	Balanced	235	710	566	2,146	2.61	58.2	0.62	3458	45.2	29.5	47.5	45,620	0.234	24.0	16.8	42	161.9	9.28	0.073	122	6.68	6.67
11	6-Jul-01	1294	Balanced	235	710	560	2,171	2.61	62.1	0.63	3485	44.3	26.4	47.0	45,620	0.228	23.4	16.5	41.8	160.5	9.19	0.073	152	6.8	6.74
11	8-Jul-01	1296	Balanced	235	710	564	2,155	2.52	69.0	0.62	3461	45.1	26.8	46.0	45,620	0.223	22.6	16.4	42.8	158.1	9.06	0.072	118	7.17	7.12
11	9-Jul-01	1297	Balanced	235	710	549	2,145	2.80	62.0	0.63	3489	43.6	21.9	45.5	45,620	0.222	24.0	16.0	42.4	155.5	8.91	0.082	185	6.82	6.96
11	10-Jul-01	1298	Balanced	235	710	542	2,100	3.05	60	0.65	3593	42.8	20.2	46.0	45,620	0.218	24.2	15.2	42.3	153.5	8.80	0.070	195	6.49	6.64
11	11-Jul-01	1299	Balanced	235	710	524	2,181	2.55	73.2	0.62	3433	45.3	22.4	43.0	45,620	0.206	20.9	15.1	43.6	144.4	8.27	0.068	160	6.99	7.13
11	12-Jul-01	1300	Balanced	235	710	526	2,158	2.91	66.7	0.63	3530	45.8	25.6	44.0	45,620	0.206	22.6	14.7	43.1	146.4	8.40	0.070	203	7.01	7.44
11	13-Jul-01	1301	Balanced	235	710	524	2,181	2.54	72.7	0.62	3440	45.5	25.5	44.5	45,620	0.199	20.7	15.0	43.8	143.6	8.23	0.068	159	6.94	7.03
11	14-Jul-01	1302	Balanced	235	710	533	2,118	2.92	80.7	0.65	3589	44	20.3	44.0	45,620	0.202	21.6	14.2	44.5	143.6	8.23	0.068	185	6.54	6.90
11	15-Jul-01	1303	Balanced	235	710	529	2,154	2.71	80.2	0.64	3543	44	18.6	43.5	45,620	0.196	20.6	14.2	44.6	142.4	8.17	0.068	187	6.27	6.49
11	16-Jul-01	1304	Balanced	237	710	510	2,189	2.89	55.7	0.63	3477	43.7	18.2	43.5	45,620	0.193	22.5	14.6	42.5	142.3	8.16	0.069	190	6.32	6.66
11	17-Jul-01	1305	Balanced	237	710	495	2,162	2.86	59.7	0.63	3494	46	21.3	41.5	45,620	0.184	21.4	14.0	43.1	138.0	7.91	0.066	185	6.75	7.07
11	19-Jul-01	1307	Balanced	240	710	658	2,059	2.86	60.2	0.67	3516	42.4	23.3	51.0	47,820	0.240	28.0	18.4	41.4	190.8	10.42	0.087	146	7.1	6.64
11	22-Jul-01	1310	Balanced	240	710	655	2,102	2.72	89.6	0.63	3312	46.5	26.2	45.5	47,820	0.232	27.8	19.1	42.8	183.9	10.06	0.096	161	6.52	6.46
11	23-Jul-01	1311	Balanced	235	710	471	2,196	2.62	27.2	0.61	3219	46.4	25.4	45.0	47,820	0.217	26.3	15.3	40.1	141.0	7.70	0.075	147	7.13	7.13
11	28-Jul-01	1316	Balanced	250	710	566	2,179	2.67	47.3	0.65	3329	47.0	27.6	46.0	47,820	0.172	24.9	17.2	41.3	164.8	8.99	0.085	141	7.86	7.30

**Table D-2 – Data Summary Table for Kingsport Catalyst Campaign 2 (cont'd)**

Case	Date	Days On Stream	Gas Type	Temp (Deg C)	Press (psig)	Fresh Feed (KSCFH)	Recycle Gas (KSCFH)	Reactor Feed (H <sub>2</sub> CO)	Purge Gas (KSCFH)	Inlet Sup. Velocity (ft/sec)	Space Velocity (1/hr-kg)	Slurry Conc. (wt%ox)	Gas Holdup (vol%)	Gassed Slurry Hgt (ft)	Catalyst Inventory (lb)	Catalyst Age (eta)	CO Conv. (%)	O-T-M Conv. (%)	Syngas Util. (SCF/lb)	Raw MeOH Prod. (TPD)	Catalyst MeOH Prod. (gmol/hr-kg)	Reactor Vol. Prod. (TPD/ft <sup>3</sup> )	U Overall (ftu hr ft <sup>2</sup> F)	Sparger dP (psi)	Sparger Resist. ("K")
11	29-Jul-01	1317	Balanced	250	710	577	2,221	2.68	48.3	0.66	3393	48.7	33.5	47.0	47,820	0.174	24.9	17.2	41.4	167.4	9.14	0.085	148	8.36	7.41
11	31-Jul-01	1319	Balanced	251	710	619	2,144	2.47	70.6	0.65	3349	47.2	30.4	47.5	47,820	0.174	24.7	17.9	42.7	173.9	9.51	0.087	154	7.85	6.88
11	1-Aug-01	1320	Balanced	250	710	606	2,176	3.27	71.3	0.65	3356	46.6	26.6	46.0	47,820	0.172	24.2	17.4	42.4	171.2	9.46	0.089	160	6.69	6.98
11	2-Aug-01	1321	Balanced	250	710	600	2,156	2.48	75.4	0.65	3347	46	23.3	45.0	47,820	0.166	23.7	17.2	42.8	168.4	9.21	0.089	155	7.56	6.81
11	3-Aug-01	1322	Balanced	250	710	560	2,170	2.52	62.8	0.64	3322	46.4	22.7	44.0	47,820	0.158	23.2	16.6	42.1	159.5	8.72	0.087	156	8.47	8.72
11	4-Aug-01	1323	Balanced	250	710	556	2,169	2.53	61.7	0.64	3311	47.7	24.4	43.0	47,820	0.156	23.0	16.4	42.4	157.3	8.6	0.087	157	7.61	6.92
11	5-Aug-01	1324	Balanced	250	710	544	2,177	2.50	59.2	0.64	3299	46.6	18.8	42.5	47,820	0.154	22.5	16.1	42.3	154.5	8.45	0.087	152	6.94	6.28

### Table D-3 – Data Summary Table for Kingsport Catalyst Campaign 3

Case	Date	Days On Stream	Gas Type	Temp (Deg C)	Pres. (psig)	Fresh Feed (KSCFH)	Recycle Gas (KSCFH)	Reactor Feed (H <sub>2</sub> CO)	Purge Gas (KSCFH)	Inlet Sup. Velocity (ft/sec)	Space Velocity (1/hr-kg)	Slurry Conc. (wt%-ox)	Gas Holdup (vol%)	Gas Slurry Hgt (ft)	Caused Slurry (ft)	Catalyst Inventory (lb)	Catalyst Age (eta)	Catalyst Age (sta-corr)	CO Conv. (%)	O-T-M Conv. (%)	Reactor O-T-M Conv. (%)	Syngas Util. (SCFE/lb)	Raw MeOH Prod. (TPD)	Catalyst MeOH Prod. (gmol/hr-kg)	Reactor Vol. Prod. (TPD/H <sub>2</sub> )	Overall (Btu/hr ft <sup>2</sup> F)	Sparger dp (psi)	Sparger Resist. ("K")
2000-8	17-Sep-01	24	Balanced	216	573	580	1,798	3.33	71.8	0.65	3320	40.7	20.8	45.0	41,580	0.537	1,159	32.5	19.9	0.086	43.0	161.8	10.17	0.086	105	5.38	6.80	
2000-8	24-Sep-01	31	Balanced	218	666	649	2,080	3.53	54.9	0.64	3804	43.0	33.5	49.0	41,580	0.532	1,095	35.4	20.6	0.092	41.2	189.0	11.87	0.092	108	6.05	6.50	
2000-8	25-Sep-01	32	Balanced	218	663	663	2,100	3.64	58.5	0.64	3841	43.0	33.3	49.0	41,580	0.530	1,090	36.2	20.6	0.094	41.3	192.4	12.08	0.094	107	5.79	6.44	
2000-8	2-Oct-01	39	Balanced	217	685	634	2,096	4.55	60.0	0.62	3756	41.1	26.8	48.0	41,580	0.543	2,090	40.7	19.5	0.091	41.7	182.6	11.47	0.091	107	4.96	7.13	
2000-8	3-Oct-01	40	Balanced	218	658	658	2,244	3.09	38.4	0.66	4053	39.3	26.1	51.0	41,580	0.521	3,090	31.7	20.2	0.092	40.0	197.2	12.38	0.092	111	6.99	6.34	
2000-8	4-Oct-01	41	Balanced	219	685	657	2,217	3.20	39.9	0.66	4037	38.2	22.8	51.0	41,580	0.518	4,090	32.5	20.3	0.092	39.9	197.5	12.40	0.092	104	6.73	6.36	
2000-8	8-Oct-01	45	Balanced	218	685	675	2,213	3.15	52.3	0.66	4021	38.3	21.7	50.0	41,580	0.510	5,090	31.7	20.0	0.094	41.2	196.8	12.35	0.094	99	6.58	6.45	
2000-8	9-Oct-01	46	Balanced	218	685	658	2,201	3.24	50.0	0.66	3997	38.6	21.0	49.0	41,580	0.507	6,090	32.7	19.9	0.095	40.6	194.8	12.23	0.095	100	6.46	6.48	
2000-8	10-Oct-01	47	Balanced	220	685	651	2,215	3.39	38.9	0.66	4005	40.5	21.7	46.0	41,580	0.509	7,090	34.3	20.1	0.101	40.0	195.4	12.27	0.101	105	6.38	6.41	
2000-8	11-Oct-01	48	Balanced	219	683	660	2,159	3.12	46.5	0.65	3947	38.1	20.9	50.0	41,580	0.512	8,090	32.8	20.4	0.093	40.5	195.3	12.26	0.093	102	6.46	6.37	
2000-8	12-Oct-01	49	Balanced	218	685	627	2,191	3.30	37.2	0.64	3930	38.2	19.6	49.0	41,580	0.516	9,090	32.8	20.4	0.092	39.8	188.7	11.85	0.092	108	6.44	6.38	
2000-8	15-Oct-01	52	Balanced	218	685	677	2,154	3.09	57.6	0.65	3951	39.1	22.5	49.0	41,580	0.513	12,090	32.4	20.4	0.096	41.1	198.0	12.43	0.096	109	6.40	6.47	
2000-8	16-Oct-01	53	Balanced	218	685	677	2,177	3.09	62.2	0.65	3990	40.1	23.8	48.0	41,580	0.508	13,090	31.2	20.1	0.098	41.2	197.3	12.39	0.098	108	6.44	6.51	
2000-8	17-Oct-01	54	Balanced	218	685	677	2,198	3.00	67.2	0.66	4010	39.4	22.6	48.5	41,580	0.497	14,090	30.0	19.7	0.096	41.6	195.6	12.28	0.096	102	6.44	6.46	
2000-8	18-Oct-01	55	Balanced	218	685	684	2,166	3.02	59.5	0.65	3989	39.6	23.1	48.5	41,580	0.506	15,090	31.1	20.2	0.098	41.1	199.7	12.54	0.098	107	6.43	6.41	
2000-8	19-Oct-01	56	Balanced	218	685	684	2,159	3.01	64.8	0.65	3960	39.3	23.0	49.0	41,580	0.505	16,090	31.0	20.2	0.096	41.4	198.0	12.43	0.096	108	6.41	6.43	
2000-8	21-Oct-01	58	Balanced	218	685	669	2,173	3.06	65.7	0.65	3955	39.4	21.0	47.5	41,580	0.498	18,090	30.8	19.8	0.097	41.4	193.9	12.18	0.097	106	6.47	6.53	
2000-8	22-Oct-01	59	Balanced	218	685	657	2,140	3.13	55.9	0.64	3920	38.8	21.4	49.0	41,580	0.503	19,090	31.8	20.1	0.093	41.0	192.2	12.07	0.093	109	6.48	6.50	
2000-8	23-Oct-01	60	Balanced	218	685	645	2,129	3.10	52.9	0.64	3890	38.3	19.9	49.0	41,580	0.489	20,090	31.4	20.0	0.092	40.9	189.2	11.89	0.092	104	6.52	6.29	
2000-8	28-Oct-01	65	Balanced	218	685	643	2,234	2.62	61.2	0.66	4025	39.7	20.1	46.5	41,580	0.475	25,090	28.3	18.9	0.097	40.7	189.7	11.89	0.097	102	6.33	6.23	
2000-9	29-Oct-01	66	H <sub>2</sub> CO = 0.6	218	684	577	2,461	0.94	99.3	0.69	4220	41.5	25.5	46.5	41,580	0.542	26,090	9.3	14.1	0.080	44.5	155.5	9.76	0.080	128	7.58	7.35	
2000-8	1-Nov-01	69	Balanced	218	685	638	2,460	2.90	50.2	0.66	4026	37.5	25.1	54.0	41,580	0.515	29,090	30.4	20.2	0.087	40.2	196.4	12.31	0.087	111	7.32	6.37	
2000-8	2-Nov-01	70	Balanced	218	685	652	2,229	2.88	48.8	0.66	4016	38.1	20.8	50.0	41,580	0.505	30,090	29.9	20.0	0.093	40.2	194.4	12.19	0.093	114	6.49	5.68	
2000-8	3-Nov-01	71	Balanced	218	685	649	2,244	2.90	50.6	0.66	4030	38.0	22.1	51.0	41,580	0.498	31,090	29.6	19.8	0.090	40.3	193.3	12.12	0.090	113	6.67	5.89	
2000-8	6-Nov-01	74	Balanced	218	685	650	2,260	2.81	61.0	0.67	4067	40.2	27.2	50.0	41,580	0.478	32,090	27.7	19.0	0.091	40.9	190.8	11.96	0.091	114	7.28	6.60	
2000-8	7-Nov-01	75	Balanced	218	685	646	2,279	2.77	66.9	0.67	4061	38.3	21.5	50.0	41,580	0.465	33,090	26.7	18.5	0.089	41.6	186.4	11.69	0.089	102	6.94	6.33	
2000-8	8-Nov-01	76	Balanced	218	685	634	2,281	2.76	69.0	0.66	4055	39.4	21.7	48.0	41,580	0.456	34,090	26.0	18.2	0.090	41.8	182.2	11.43	0.090	104	6.79	6.19	
2000-8	9-Nov-01	77	Balanced	218	685	640	2,266	3.02	75.9	0.66	4036	38.9	24.1	50.5	41,580	0.463	35,090	28.2	18.5	0.086	41.9	183.0	11.48	0.086	106	6.81	6.46	
2000-8	10-Nov-01	78	Balanced	218	685	637	2,255	3.14	74.1	0.66	4024	37.2	20.5	51.5	41,580	0.460	36,090	29.2	18.6	0.084	42.0	182.1	11.42	0.084	108	6.17	5.86	
2000-8	11-Nov-01	79	Balanced	218	685	637	2,251	3.00	78.1	0.66	4016	38.3	20.9	49.5	41,580	0.449	37,090	27.7	18.2	0.087	42.5	179.8	11.28	0.087	106	6.33	6.02	
2000-8	12-Nov-01	80	Balanced	218	696	636	2,317	3.06	76.3	0.66	4108	39.8	24.6	49.0	41,580	0.436	38,090	27.1	17.6	0.085	42.5	179.5	11.25	0.085	105	7.00	6.73	
2000-8	13-Nov-01	81	Balanced	218	700	639	2,350	2.91	76.4	0.67	4151	38.6	24.2	51.0	41,580	0.437	39,090	26.2	17.7	0.085	42.3	181.5	11.38	0.085	101	6.70	6.20	
2000-8	16-Nov-01	84	Balanced	220	700	648	2,262	3.47	66.8	0.65	4044	38.1	25.3	53.0	41,580	0.448	40,090	32.0	18.9	0.084	41.4	187.8	11.78	0.084	110	6.27	6.34	
2000-8	17-Nov-01	85	Balanced	220	700	651	2,246	3.57	72.2	0.65	4011	37.7	24.2	53.0	41,580	0.449	41,090	32.7	18.9	0.084	41.8	186.7	11.71	0.084	108	6.12	6.42	
2000-8	18-Nov-01	86	Balanced	220	700	648	2,286	3.35	69.9	0.65	4053	37.8	24.6	53.0	41,580	0.444	42,090	31.1	18.8	0.084	41.5	187.3	11.74	0.084	108	6.45	6.37	
2000-8	19-Nov-01	87	Balanced	220	700	644	2,287	3.13	65.9	0.65	4043	37.9	24.8	53.0	41,580	0.440	43,090	29.8	19.0	0.084	41.3	186.9	11.72	0.084	110	6.65	6.24	
2000-8	22-Nov-01	90	Balanced	220	700	645	2,108	3.49	73.8	0.61	3813	38.7	27.2	53.0	41,580	0.444	44,090	33.3	19.6	0.082	42.2	183.3	11.49	0.082	118	5.84	6.69	
2000-8	23-Nov-01	91	Balanced	220	696	655	2,122	3.94	81.3	0.62	3849	38.1	24.0	52.0	41,580	0.472	45,090	36.5	19.6	0.085	42.4	185.5	11.63	0.085	130	5.42	6.41	
2000-8	24-Nov-01	92	Balanced	220	695	656	2,102	3.92	82.3	0.62	3830	36.5	25.4	56.5	41,580	0.476	46,090	36.8	19.8	0.078	42.3	186.1	11.67	0.078	119	5.60	6.55	
2000-8	25-Nov-01	93	Balanced	220	700	655	2,141	4.06	83.4	0.63	3880	37.2	26.1	55.5	41,580	0.473	47,090	36.6	19.2	0.079	42.7	184.2	11.55	0.079	117	5.75	6.93	
2000-8	27-Nov-01	94	Balanced	220	700	658	2,119	3.27	72.6	0.65	4009	37.9	24.7	53.0	41,580	0.452	48,090	31.3	19.3	0.085	41.6	190.0	11.41	0.085	121	6.84	6.23	
2000-8	28-Nov-01	95	Balanced	220	700	655	2,253	2.88	72.3	0.65	4039	37.6	24.4	53.5	41,580	0.439	49,090	28.3	19.1	0.084	41.6	188.9	11.85	0.084	115	6.81	6.20	
2000-8	29-Nov-01	96	Balanced	220	700	652	2,259	2.86	73.2	0.65	4049	37.6	26.0	53.5	41,580	0.435	50,090	27.8	18.9	0.083	41.7	187.7	11.87	0.083	117	7.15	6.52	
2000-8	29-Nov-01	97	Balanced	220	700	654	2,368	2.87	75.3	0.65	4000	36.8	24.0	53.0	41,580	0.431	51,090	28.1	19.0	0.085	41.7	187.4	11.63	0.085	123	6.84	6.24	
2000-8	1-Dec-01	99	Balanced	220	700	645	2,284	2.79	83.1	0.66	4081	38.2	25.7	53.0	41,580	0.409	52,090	26.0	18.0	0.081	42.7	181.3	11.37	0.081	112	7.01	6.40	



**Table D-3 – Data Summary Table for Kingsport Catalyst Campaign 3 (cont'd)**

Case	Date	Days On Stream	Gas Type	Temp (Deg C)	Pres. (psig)	Fresh Feed (KSCFH)	Recycle Gas (KSCFH)	Reactor Feed (H <sub>2</sub> CO)	Purge Gas (KSCFH)	Inlet Sup. Velocity (ft/sec)	Space Velocity (1/hr-kg)	Slurry Conc. (wt%-ox)	Gas Holdup (vol%)	Gassed Slurry Hgt (ft)	Catalyst Inventory (lb)	Catalyst Age (eta)	Catalyst Age (sta-corr)	CO Conv. (%)	O-T-M Conv. (%)	Syngas Util. (SCF/lb)	Raw MeOH Prod. (TPD)	Catalyst MeOH Prod. (gmol/hr-kg)	Reactor Vol. Prod. (TPD/H <sub>2</sub> )	Overall (Btu/hr ft <sup>2</sup> F)	Sparger dB (psi)	Sparger Resist. ("K")
2000-8	2-Dec-01	100	Balanced	220	700	654	2,265	2,85	900	0.66	4067	38.2	25.5	53.0	41,580	0.410	53,090	26.5	18.1	43.1	182.0	11.42	0.082	113	6.84	6.41
2000-8	3-Dec-01	101	Balanced	223	700	645	2,274	3,05	688	0.66	4084	39.2	26.1	51.5	41,580	0.402	54,090	28.8	18.7	41.4	187.1	11.73	0.086	109	7.12	6.65
2000-8	4-Dec-01	102	Balanced	224	700	654	2,296	2,89	710	0.67	4113	38.5	23.2	51.0	41,580	0.397	55,090	27.8	18.7	41.5	189.2	11.87	0.088	105	7.44	6.67
2000-8	5-Dec-01	103	Balanced	224	700	651	2,277	2,90	691	0.66	4083	38.5	23.5	51.0	41,580	0.397	56,090	28.2	18.9	41.4	188.7	11.84	0.088	110	7.05	6.36
2000-8	6-Dec-01	104	Balanced	224	700	650	2,258	2,83	73.5	0.66	4050	37.8	21.3	51.0	41,580	0.395	57,090	27.8	18.9	41.8	186.7	11.71	0.087	108	7.06	6.27
2000-8	7-Dec-01	105	Balanced	224	700	646	2,250	2,81	74.6	0.66	4038	38.9	23.0	50.0	41,580	0.391	58,090	27.5	18.8	41.9	184.8	11.59	0.088	110	7.19	6.36
2000-8	8-Dec-01	106	Balanced	224	700	651	2,240	2,83	71.6	0.65	4028	39.4	25.9	51.0	41,580	0.399	59,090	28.2	19.3	41.6	187.6	11.77	0.088	118	7.25	6.39
2000-8	9-Dec-01	107	Balanced	224	700	647	2,285	2,79	71.6	0.66	4082	38.9	26.0	52.0	41,580	0.388	60,090	27.1	18.8	41.7	186.2	11.68	0.085	114	7.24	6.41
2000-8	10-Dec-01	108	Balanced	224	700	651	2,273	2,75	77.1	0.66	4080	40.6	30.7	52.0	41,580	0.386	61,090	26.8	18.7	42.0	185.9	11.66	0.085	111	7.19	6.34
2000-8	11-Dec-01	109	Balanced	224	700	654	2,272	2,68	79.3	0.66	4084	39.1	25.7	51.5	41,580	0.381	62,090	26.1	18.5	42.3	185.4	11.63	0.086	111	7.19	6.32
2000-5	12-Dec-01	110	H <sub>2</sub> CO = 0.7	224	700	643	2,413	1.06	107.4	0.69	4220	38.0	29.2	54.0	41,580	0.407	63,090	13.3	16.3	44.9	171.6	10.78	0.076	83	10.51	5.93
2000-5	14-Dec-01	112	H <sub>2</sub> CO = 0.7	224	690	513	2,449	0.58	91.1	0.67	4084	37.6	27.7	56.0	41,580	0.435	65,090	8.7	13.7	44.2	139.4	8.76	0.059	142	12.14	6.01
2000-5	15-Dec-01	113	H <sub>2</sub> CO = 0.7	224	690	506	2,456	0.54	99.0	0.67	4072	38.9	25.2	51.5	41,580	0.408	66,090	7.9	12.7	45.3	134.0	8.42	0.062	150	11.91	6.05
2000-5	16-Dec-01	114	H <sub>2</sub> CO = 0.7	224	690	492	2,402	0.50	98.5	0.66	3999	39.1	29.5	51.5	41,580	0.412	67,090	7.5	12.3	45.8	128.9	8.09	0.076	144	11.43	5.90
2000-5	17-Dec-01	115	H <sub>2</sub> CO = 0.7	224	700	532	2,515	0.72	108.8	0.69	4218	42.7	30.8	48.0	41,580	0.354	68,090	8.5	12.4	47.1	135.6	8.51	0.067	114	11.70	6.09
2000-8	21-Dec-01	119	Balanced	226	700	560	2,455	2.75	48.8	0.68	4167	43.9	30.7	46.0	41,580	0.309	66,090	22.8	16.0	41.3	162.8	10.20	0.084	112	7.43	7.12
2000-8	22-Dec-01	120	Balanced	226	700	555	2,298	3.57	51.7	0.65	3995	38.5	19.8	49.0	41,580	0.323	57,090	28.3	16.4	41.2	161.7	10.14	0.079	116	5.40	5.92
2000-5	24-Dec-01	122	H <sub>2</sub> CO = 0.7	226	700	512	2,519	0.65	106.8	0.68	4183	42.0	28.8	48.0	41,580	0.341	63,090	8.2	11.6	47.2	130.2	8.17	0.065	106	13.03	5.96
2000-5	27-Dec-01	125	H <sub>2</sub> CO = 0.7	225	700	572	2,469	0.73	125.9	0.68	4195	43.2	26.0	44.0	41,580	0.400	64,090	8.9	12.9	47.5	144.3	9.05	0.078	164	11.23	6.14
2000-5	28-Dec-01	126	H <sub>2</sub> CO = 0.7	225	700	542	2,455	0.70	116.3	0.68	4164	43.1	25.5	44.0	41,580	0.363	65,090	8.6	12.6	46.5	139.9	8.78	0.076	139	10.87	5.89
2000-5	29-Dec-01	127	H <sub>2</sub> CO = 0.7	226	700	584	2,423	0.95	100.5	0.68	4147	39.0	27.5	53.0	41,580	0.354	66,090	11.3	14.7	44.3	158.1	9.91	0.071	106	11.85	6.55
2000-8	1-Jan-02	130	Balanced	226	700	629	2,233	2.72	87.4	0.65	4006	38.6	26.5	53.0	41,580	0.332	69,090	24.7	17.4	43.0	175.8	11.02	0.079	127	6.88	6.83
2000-8	2-Jan-02	131	Balanced	226	700	600	2,280	2.67	61.8	0.66	4039	38.8	25.6	52.0	41,580	0.327	70,090	24.3	17.2	41.3	174.5	10.94	0.080	127	7.02	6.60
2000-8	3-Jan-02	132	Balanced	226	700	605	2,276	2.68	63.4	0.66	4023	39.4	27.2	52.0	41,580	0.332	71,090	24.5	17.4	41.2	176.1	11.04	0.081	134	7.00	6.75
2000-8	4-Jan-02	133	Balanced	226	700	575	2,309	2.65	61.6	0.66	4033	39.2	26.7	52.0	41,580	0.306	72,090	22.8	16.3	41.8	165.1	10.35	0.076	120	6.91	6.56
2000-8	5-Jan-02	134	Balanced	226	700	550	2,334	2.65	58.8	0.65	4011	37.4	24.2	54.0	41,580	0.291	73,090	21.9	15.6	41.8	157.7	9.89	0.069	106	6.61	6.32
2000-8	6-Jan-02	135	Balanced	226	700	550	2,290	2.79	62.8	0.65	3982	37.7	25.0	54.0	41,580	0.290	74,090	22.3	15.4	42.4	155.6	9.76	0.069	107	6.55	6.66
2000-8	7-Jan-02	136	Balanced	226	700	549	2,295	2.84	63.4	0.65	3975	38.7	28.1	54.0	41,580	0.293	75,090	22.8	15.6	42.0	156.8	9.83	0.069	111	6.62	6.83
2000-8	8-Jan-02	137	Balanced	226	700	555	2,339	2.56	63.9	0.65	4020	38.5	26.1	54.0	41,580	0.290	76,090	21.3	15.6	42.0	158.7	9.95	0.070	110	6.84	6.51
2000-8	9-Jan-02	138	Balanced	226	700	550	2,317	2.56	68.5	0.65	4011	38.8	25.6	52.0	41,580	0.283	77,090	20.8	15.2	42.6	155.1	9.73	0.070	108	7.30	6.93
2000-8	10-Jan-02	139	Balanced	226	700	545	2,315	2.54	71.0	0.65	4003	37.3	21.8	52.5	41,580	0.280	78,090	20.7	15.2	42.4	154.2	9.67	0.071	102	6.31	5.99
2000-8	12-Jan-02	141	Balanced	226	700	547	2,311	2.52	74.1	0.65	3985	36.6	23.0	55.0	41,580	0.278	80,090	20.4	15.1	43.0	152.9	9.59	0.066	100	6.84	6.60
2000-8	13-Jan-02	142	Balanced	226	700	550	2,290	2.56	75.2	0.65	3975	38.8	25.7	52.0	41,580	0.280	81,090	20.7	15.2	43.0	153.5	9.63	0.070	108	6.99	6.83
2000-8	14-Jan-02	143	Balanced	226	700	550	2,283	2.68	73.7	0.65	3957	38.9	25.9	52.0	41,580	0.282	82,090	21.6	15.3	42.8	154.0	9.66	0.071	114	6.37	6.41
2000-8	16-Jan-02	145	Balanced	228	700	550	2,273	2.80	67.2	0.65	3948	37.4	25.5	55.0	41,580	0.278	83,090	23.0	15.8	42.0	157.3	9.86	0.072	115	6.51	6.58
2000-8	17-Jan-02	146	Balanced	228	700	555	2,263	2.81	61.1	0.64	3932	37.5	24.9	54.0	41,580	0.282	84,090	23.5	16.1	41.6	160.0	10.03	0.070	114	6.14	6.23
2000-8	19-Jan-02	148	Balanced	228	700	575	2,287	2.70	71.4	0.65	3967	38.7	25.9	52.5	41,580	0.280	85,090	22.7	16.2	42.9	160.8	10.08	0.073	118	6.75	6.65
2000-8	24-Jan-02	153	Balanced	230	700	555	2,205	3.24	69.6	0.63	3849	38.6	30.0	56.0	41,580	0.267	90,090	25.9	16.1	42.8	155.7	9.76	0.066	115	6.32	7.21
2000-8	25-Jan-02	154	Balanced	230	700	565	2,227	3.10	73.6	0.64	3893	37.7	26.9	55.5	41,580	0.270	91,090	25.2	16.2	42.8	158.5	9.94	0.068	115	6.38	6.99
2000-8	26-Jan-02	155	Balanced	230	700	558	2,240	3.07	72.2	0.64	3910	37.6	25.2	54.5	41,580	0.267	90,090	24.4	15.8	42.9	155.9	9.78	0.068	111	6.32	6.63
2000-8	27-Jan-02	156	Balanced	230	700	559	2,261	2.89	70.1	0.65	3929	36.4	20.8	54.0	41,580	0.267	93,090	23.6	16.0	42.4	158.2	9.92	0.070	113	5.95	6.17
2000-8	28-Jan-02	157	Balanced	230	700	548	2,287	2.66	72.5	0.65	3963	36.9	21.6	53.5	41,580	0.254	94,090	21.5	15.3	42.9	153.3	9.62	0.068	105	6.52	6.36
2000-8	29-Jan-02	158	Balanced	230	700	543	2,292	2.59	71.9	0.65	3961	38.0	23.7	52.5	41,580	0.251	95,090	20.9	15.2	42.9	151.9	9.53	0.069	105	6.84	6.58
2000-8	30-Jan-02	159	Balanced	231	700	550	2,288	2.61	77.4	0.65	3961	37.6	22.4	52.5	41,580	0.249	96,090	20.9	15.1	43.6	151.4	9.50	0.069	102	6.86	6.64
2000-8	31-Jan-02	160	Balanced	231	700	550	2,254	2.92	85.0	0.65	3922	37.6	20.9	51.5	41,580	0.249	97,090	21.7	15.0	44.2	149.3	9.37	0.069	97	6.46	6.64

**Table D-3 – Data Summary Table for Kingsport Catalyst Campaign 3 (cont'd)**

Case	Date	Days On Stream	Gas Type	Temp (Deg C)	Pres. (psig)	Fresh Feed (KSCFH)	Recycle Gas (KSCFH)	Reactor Feed (H <sub>2</sub> -CO) (KSCFH)	Purge Gas (KSCFH)	Inlet Sup. Velocity (ft/sec)	Space Velocity (1/hr-kg)	Slurry Conc. (wt% ox)	Gas Holdup (vol%)	Gassed Slurry Hgt (ft)	Catalyst Inventory (lb)	Catalyst Age (eta)	Catalyst Age (eta - corr)	CO Conv. (%)	O-T-M Conv. (%)	Reactor		Raw		U		Sparger Resist. (K <sup>2</sup> )
																				Vol. Prod. (TPPD/HR)	MeOH Prod. (gmol/hr-kg)	Syngas Util. (SCE/ft)	MeOH Prod. (TPD)	Overall (Bu/hr H <sub>2</sub> F)	Sparger dP (hrs)	
2000-8	1-Feb-02	161	Balanced	230	700	547	2,282	2,71	76.5	0.65	3948	39.7	28.6	52.5	41,580	0.249	98,090	21.2	15.0	43.7	150.3	9.43	0.068	108	7.11	7.24
2000-8	2-Feb-02	162	Balanced	230	700	550	2,263	2,98	82.7	0.65	3919	36.9	23.8	55.0	41,580	0.257	99,090	22.7	15.1	44.0	150.0	9.41	0.065	107	6.07	6.67
2000-8	3-Feb-02	163	Balanced	230	700	575	2,246	2,94	86.9	0.64	3916	37.8	24.6	53.5	41,580	0.258	100,090	22.5	15.1	45.9	150.2	9.42	0.067	110	6.06	6.66
2000-8	3-Feb-02	165	Balanced	235	700	548	2,171	3,31	64.7	0.64	3881	38.1	21.5	51.0	41,580	0.248	102,090	26.1	16.0	42.0	156.6	9.32	0.073	108	5.56	6.41
2000-5	8-Feb-02	168	H <sub>2</sub> -CO = 0.7	235	693	495	2,393	0.54	95.7	0.68	4043	39.7	27.5	52.0	41,580	0.263	108,090	8.0	12.1	45.7	130.2	8.17	0.060	98	10.89	5.93
2000-5	11-Feb-02	171	H <sub>2</sub> -CO = 0.7	235	695	501	2,425	0.66	101.7	0.68	4077	38.4	26.5	54.0	41,580	0.287	108,090	7.8	11.7	46.5	129.1	8.10	0.057	97	11.03	6.09
2000-5	12-Feb-02	172	H <sub>2</sub> -CO = 0.7	235	695	497	2,407	0.68	101.8	0.68	4056	39.2	23.8	50.5	41,580	0.281	109,090	7.7	11.4	47.7	125.0	7.85	0.057	88	10.73	6.01
2000-5	13-Feb-02	173	H <sub>2</sub> -CO = 0.7	235	699	494	2,406	0.69	105.4	0.67	4054	39.2	24.6	51.0	41,580	0.278	110,090	7.8	11.6	46.6	127.0	7.80	0.059	92	10.75	6.10
2000-5	15-Feb-02	175	H <sub>2</sub> -CO = 0.7	235	700	496	2,393	0.65	100.5	0.67	4037	38.1	21.3	51.0	41,580	0.270	110,090	8.3	12.1	46.2	128.8	8.09	0.060	97	10.64	5.94
2000-5	16-Feb-02	176	H <sub>2</sub> -CO = 0.7	236	700	495	2,377	0.70	99.4	0.67	4018	38.3	26.5	54.0	41,580	0.266	113,090	8.3	12.3	45.9	129.2	8.11	0.057	98	11.09	6.14
2000-5	17-Feb-02	177	H <sub>2</sub> -CO = 0.7	235	700	497	2,384	0.73	101.0	0.67	4025	39.0	22.6	50.0	41,580	0.258	114,090	8.4	12.2	46.5	128.2	8.05	0.061	96	10.70	6.05
2000-5	18-Feb-02	178	H <sub>2</sub> -CO = 0.7	235	700	485	2,371	0.71	99.8	0.67	4013	38.5	24.0	52.0	41,580	0.253	115,090	8.1	11.8	46.5	125.2	7.86	0.057	100	10.59	6.00
2000-8	19-Feb-02	179	Balanced	235	700	543	2,160	2,98	81.2	0.62	3755	39.0	22.5	50.0	41,580	0.229	96,090	24.0	15.8	43.8	149.0	9.34	0.071	112	6.67	7.34
2000-8	20-Feb-02	180	Balanced	235	700	547	2,139	2,88	88.9	0.62	3733	36.2	17.4	52.5	41,580	0.226	97,090	23.6	15.9	44.3	148.0	9.29	0.067	107	6.67	7.15
2000-8	21-Feb-02	181	Balanced	235	700	553	2,163	2,79	96.4	0.63	3768	37.0	17.8	51.0	41,580	0.221	98,090	22.5	15.5	45.2	146.7	9.21	0.069	112	6.82	7.27
2000-8	23-Feb-02	183	Balanced	238	700	550	2,202	2,91	87.4	0.63	3797	40.0	23.9	49.0	41,580	0.206	99,090	23.0	15.5	44.7	147.6	9.26	0.072	109	6.65	7.17
2000-8	2-Mar-02	190	Balanced	240	700	546	2,201	2,78	114.3	0.64	3811	40.0	27.5	51.5	41,580	0.181	102,090	21.2	14.7	46.9	139.7	8.77	0.065	117	7.29	7.39
2000-8	3-Mar-02	191	Balanced	240	700	544	2,219	2,72	115.8	0.65	3850	38.8	24.6	52.0	41,580	0.177	103,090	20.5	14.5	46.7	139.7	8.76	0.064	118	8.82	8.78
2000-8	4-Mar-02	192	Balanced	246	700	548	2,226	2,83	90.9	0.66	3880	39.4	26.0	52.0	41,580	0.166	104,090	21.8	15.0	45.2	145.3	9.11	0.067	110	6.76	6.76
2000-8	5-Mar-02	193	Balanced	246	700	545	2,221	2,76	97.8	0.66	3860	39.2	22.3	50.0	41,580	0.162	105,090	21.4	14.9	45.6	143.6	9.01	0.068	111	6.53	6.46
2000-8	6-Mar-02	194	Balanced	247	700	545	2,218	2,76	104.0	0.65	3841	36.6	23.8	56.5	41,580	0.157	106,090	21.2	14.8	46.2	141.5	8.88	0.060	95	6.70	6.59
2000-8	7-Mar-02	195	Balanced	247	700	547	2,200	2,80	110.3	0.65	3810	37.3	22.4	54.0	41,580	0.157	107,090	21.5	14.8	46.8	140.2	8.80	0.062	103	6.78	6.78
2000-8	8-Mar-02	196	Balanced	245	700	542	2,183	2,82	110.8	0.64	3773	36.6	18.6	53.0	41,580	0.159	108,090	21.3	14.6	47.4	137.0	8.61	0.062	110	6.31	6.39
2000-8	9-Mar-02	197	Balanced	245	700	543	2,198	2,66	113.3	0.65	3811	40.9	30.3	52.0	41,580	0.158	109,090	20.4	14.5	47.3	137.7	8.65	0.063	111	8.52	8.30
2000-8	10-Mar-02	198	Balanced	245	700	547	2,223	2,64	117.1	0.65	3855	39.5	25.0	51.0	41,580	0.154	110,090	19.7	14.2	47.9	137.2	8.61	0.064	112	7.00	7.08
2000-8	12-Mar-02	200	Balanced	250	700	551	2,198	2,67	103.1	0.65	3804	38.9	22.8	51.0	41,580	0.152	112,090	21.4	15.3	46.4	142.6	8.95	0.067	117	7.07	6.68
2000-8	13-Mar-02	201	Balanced	250	700	537	2,177	2,61	103.7	0.65	3770	38.9	21.2	51.0	41,580	0.147	107,090	20.6	14.9	46.4	138.8	8.74	0.066	112	6.80	6.49
2000-8	14-Mar-02	202	Balanced	250	700	547	2,260	2,85	133.2	0.66	3881	40.9	24.8	48.5	41,580	0.138	108,090	20.3	13.8	50.1	131.2	8.24	0.064	119	7.64	7.03
2000-8	15-Mar-02	203	Balanced	250	700	547	2,241	2,76	135.5	0.66	3849	39.8	18.1	46.5	41,580	0.137	109,090	19.8	13.7	50.6	129.9	8.17	0.067	117	6.68	6.09
2000-8	16-Mar-02	204	Balanced	250	700	546	2,250	2,73	140.2	0.66	3863	42.2	25.3	46.5	41,580	0.137	110,090	19.0	13.3	50.5	129.7	8.15	0.065	109	7.47	7.26
2000-8	17-Mar-02	205	Balanced	250	700	556	2,208	2,67	128.0	0.66	3854	39.8	24.0	50.0	41,580	0.144	111,090	19.9	14.2	49.0	136.2	8.56	0.067	115	7.21	7.01
2000-8	18-Mar-02	206	Balanced	250	700	559	1,916	2,65	139.5	0.59	3426	38.9	17.8	48.0	41,580	0.145	112,090	21.7	15.5	50.1	134.0	8.42	0.067	108	5.68	6.91
2000-8	19-Mar-02	207	Balanced	250	700	551	2,012	2,61	138.6	0.61	3558	40.3	18.7	46.0	41,580	0.142	113,090	20.6	14.8	50.0	132.2	8.31	0.069	109	5.95	6.56
2000-8	20-Mar-02	208	Balanced	250	700	553	2,179	2,62	136.7	0.65	3788	44.5	29.4	45.0	41,580	0.139	114,090	19.5	14.0	49.9	132.9	8.35	0.070	118	7.65	7.49
2000-8	21-Mar-02	209	Balanced	251	700	503	2,251	2,75	103.4	0.65	3816	48.3	38.8	45.0	41,580	0.130	115,090	19.2	13.4	47.1	128.1	8.04	0.068	111	8.74	8.79
2000-8	22-Mar-02	210	Balanced	251	700	505	2,556	2,72	108.0	0.66	3869	40.5	17.7	45.0	41,580	0.126	116,090	18.5	13.1	48.1	126.2	7.92	0.067	107	6.42	6.48
2000-8	23-Mar-02	211	Balanced	251	700	507	2,246	2,87	106.6	0.65	3814	40.2	19.2	44.5	41,580	0.128	117,090	18.4	13.3	47.8	127.2	7.98	0.068	112	6.33	6.24
2000-8	24-Mar-02	212	Balanced	250	700	506	2,224	2,62	120.6	0.65	3780	41.4	17.7	43.5	41,580	0.126	118,090	18.0	13.0	49.6	122.4	7.69	0.067	115	6.79	6.66
2000-8	31-Mar-02	219	Balanced	235	700	589	2,325	2,33	84.0	0.61	3926	39.1	20.9	45.5	38,704	0.269	110,090	22.3	17.5	43.4	162.8	10.97	0.083	129	6.22	6.68
2000-8	1-Apr-02	220	Balanced	235	700	658	2,209	2,32	60.1	0.66	4018	39.0	23.8	50.0	40,904	0.305	111,090	24.4	19.2	40.8	193.3	12.33	0.092	120	7.07	6.30
2000-8	2-Apr-02	221	Balanced	235	700	651	2,192	2,32	57.7	0.66	3970	37.2	19.9	52.0	40,904	0.295	110,090	24.0	18.9	40.9	190.9	11.97	0.087	115	7.20	6.53
2000-8	3-Apr-02	222	Balanced	235	700	659	2,239	2,58	60.8	0.67	4121	39.4	25.9	50.5	40,904	0.308	113,090	26.6	19.4	40.5	195.4	12.45	0.092	116	7.74	6.79
2000-8	235	700	657	2,244	2,72	61.7	2,44	2.72	61.7	0.67	4098	40.3	24.6	48.0	40,904	0.312	114,090	27.7	19.4	41.3	191.2	12.10	0.095	112	7.44	6.51
2000-8	5-Apr-02	224	Balanced	235	700	655	2,242	2,72	64.3	0.67	4098	38.9	20.9	48.5	40,904	0.308	115,090	27.4	19.2	41.5	189.7	12.10	0.093	106	7.47	6.58
2000-8	6-Apr-02	225	Balanced	235	700	643	2,252	2,72	63.2	0.67	4098	38.9	20.9	48.5	40,904	0.301	116,090	26.9	18.9	41.4	186.3	11.88	0.092	103	7.47	6.58

**Table D-3 – Data Summary Table for Kingsport Catalyst Campaign 3 (cont'd)**

Case	Date	Days On Stream	Gas Type	Temp (Deg C)	Pres. (psig)	Fresh Feed (KSCFH)	Recycle Gas (KSCFH)	Reactor Feed (H <sub>2</sub> CO)	Purge Gas (KSCFH)	Inlet Sup. Velocity (ft/sec)	Space Velocity (1/hr-kg)	Slurry Conc. (wt%-ox)	Gas Holdup (vol%)	Gassed Slurry Hgt (ft)	Catalyst Inventory (lb)	Catalyst Age (eta)	Catalyst Age (sta-corr)	CO Conv. (%)	O-T-M Conv. (%)	Syngas Util. (SCF/lb)	Raw MeOH Prod. (TPD)	Catalyst MeOH Prod. (gmol/hr-kg)	Reactor Vol. Prod. (TPD/H <sub>2</sub> )	U Overall (Btu/hr ft <sup>2</sup> F)	Sparger dp (psi)	Sparger Resist. ("K")
2000-8	7-Apr-02	226	Balanced	235	700	654	2,234	2.71	69.6	0.67	4075	40.1	23.2	47.5	40,904	0.306	117,090	27.2	19.1	41.7	188.4	12.02	0.095	108	7.28	6.48
2000-8	8-Apr-02	227	Balanced	235	700	654	2,220	2.67	76.8	0.66	4047	39.7	20.3	46.5	40,904	0.300	118,090	26.8	18.9	42.1	186.2	11.88	0.095	104	7.17	6.43
2000-8	9-Apr-02	228	Balanced	235	700	654	2,216	2.69	74.6	0.66	4047	41.5	26.4	47.0	40,904	0.305	119,090	27.4	19.3	41.8	187.8	11.98	0.095	111	7.44	6.61
2000-8	10-Apr-02	229	Balanced	235	700	655	2,233	2.71	77.2	0.66	4051	40.7	24.8	47.5	40,904	0.299	120,090	27.0	19.0	42.3	185.7	11.85	0.093	107	7.45	6.66
2000-8	11-Apr-02	230	Balanced	235	700	653	2,220	2.70	88.7	0.66	4029	40.6	22.9	46.5	40,904	0.291	121,090	26.4	18.5	43.2	181.4	11.58	0.093	104	7.68	6.93
2000-8	12-Apr-02	231	Balanced	235	700	650	2,209	2.66	89.1	0.66	4012	40.9	22.2	45.5	40,904	0.291	122,090	26.3	18.6	43.1	180.8	11.54	0.095	105	7.71	6.93
2000-8	13-Apr-02	232	Balanced	234	700	651	2,213	2.57	99.3	0.66	4014	39.5	17.0	45.0	40,904	0.289	123,090	25.3	18.4	43.6	179.2	11.43	0.095	103	7.36	6.50
2000-8	14-Apr-02	233	Balanced	235	700	659	2,195	2.57	100.4	0.65	4002	42.7	21.2	42.0	40,904	0.293	124,090	25.7	18.7	43.7	180.9	11.54	0.103	115	7.39	6.51
2000-8	15-Apr-02	234	Balanced	235	700	655	2,205	2.52	87.6	0.65	4007	40.7	18.9	44.0	40,904	0.303	125,090	26.0	19.1	42.6	184.7	11.79	0.100	114	7.53	6.52
2000-8	16-Apr-02	235	Balanced	234	700	589	2,245	2.57	66.3	0.65	3972	41.0	17.8	43.0	40,904	0.279	126,090	24.7	17.8	41.6	169.9	10.84	0.094	108	7.55	6.61
2000-8	17-Apr-02	236	Balanced	234	700	576	2,238	2.65	68.9	0.65	3955	41.2	16.6	42.0	40,904	0.265	127,090	24.2	17.2	42.2	163.6	10.44	0.093	105	7.12	6.44
2000-8	18-Apr-02	237	Balanced	235	700	574	2,214	2.89	63.4	0.64	3913	40.1	16.8	44.0	40,904	0.268	128,090	26.2	17.4	42.1	163.6	10.44	0.089	107	6.83	6.45
2000-8	19-Apr-02	238	Balanced	235	700	578	2,213	2.88	61.2	0.64	3914	39.6	20.0	46.5	40,904	0.279	129,090	27.1	18.0	41.1	168.7	10.76	0.087	109	6.85	6.44
2000-8	20-Apr-02	239	Balanced	235	700	577	2,213	2.85	62.1	0.64	3915	39.3	16.3	45.0	40,904	0.272	130,090	26.4	17.7	41.6	166.7	10.63	0.088	106	6.77	6.40
2000-8	21-Apr-02	240	Balanced	235	700	577	2,210	2.76	65.0	0.64	3923	40.6	17.4	43.5	40,904	0.270	131,090	25.6	17.6	41.7	165.9	10.59	0.091	108	6.86	6.37
2000-8	22-Apr-02	241	Balanced	235	700	581	2,252	2.72	69.2	0.64	3982	42.0	20.1	43.5	40,904	0.263	132,090	24.5	20.1	43.5	164.8	10.52	0.090	106	7.04	6.51
2000-8	23-Apr-02	242	Balanced	234	700	578	2,250	2.79	73.0	0.65	3974	40.5	16.3	43.0	40,904	0.258	133,090	24.5	16.9	42.7	162.5	10.37	0.090	106	6.75	6.44
2000-8	24-Apr-02	243	Balanced	234	700	569	2,237	2.46	69.5	0.64	3935	40.0	14.7	43.0	40,904	0.255	134,090	24.8	16.8	42.8	159.5	10.17	0.099	106	6.57	6.39
2000-8	8-May-02	257	Balanced	234	700	556	2,186	2.80	78.6	0.63	3858	40.3	14.6	42.5	40,904	0.243	135,090	24.0	16.5	43.4	153.7	9.81	0.086	110	6.46	6.44
2000-8	9-May-02	258	Balanced	235	700	545	2,218	2.69	65.0	0.64	3895	41.4	19.1	43.0	40,904	0.241	136,090	23.2	16.4	42.4	154.2	9.84	0.086	109	6.68	6.40
2000-8	10-May-02	259	Balanced	235	700	550	2,249	2.59	69.8	0.64	3935	39.7	15.5	44.0	40,904	0.239	137,090	22.2	16.2	42.9	154.1	9.83	0.084	103	6.76	6.33
2000-8	11-May-02	260	Balanced	235	700	550	2,232	2.59	71.9	0.64	3910	41.1	16.3	42.0	40,904	0.241	138,090	22.5	16.3	42.6	154.9	9.89	0.088	112	6.76	6.39
2000-8	12-May-02	261	Balanced	234	700	552	2,214	2.58	74.4	0.63	3882	40.0	14.5	43.0	40,904	0.242	139,090	22.4	16.3	42.8	154.6	9.87	0.086	107	6.58	6.37
2000-8	13-May-02	262	Balanced	234	700	556	2,277	2.64	74.7	0.65	3982	41.6	17.8	42.0	40,904	0.235	140,090	21.7	15.6	43.7	152.9	9.75	0.087	105	6.73	6.54
2000-8	14-May-02	263	Balanced	234	700	538	2,300	2.60	77.0	0.66	4026	40.7	13.9	41.5	40,904	0.224	141,090	20.3	14.8	43.7	147.5	9.41	0.085	97	6.70	6.46
2000-8	15-May-02	264	Balanced	234	700	553	2,292	2.62	87.6	0.65	4010	40.0	10.5	41.0	40,904	0.228	142,090	20.6	14.9	44.5	148.9	9.51	0.087	101	6.57	6.46
2000-8	16-May-02	265	Balanced	235	700	537	2,283	2.72	62.3	0.65	3992	39.4	14.6	44.0	40,904	0.235	143,090	22.1	14.6	42.3	152.5	9.73	0.083	101	6.59	6.49
2000-8	17-May-02	266	Balanced	235	700	541	2,258	2.68	65.5	0.65	3953	42.0	18.0	41.5	40,904	0.235	144,090	22.2	15.7	42.6	152.2	9.71	0.088	110	6.67	6.48
2000-8	18-May-02	267	Balanced	235	700	543	2,286	2.75	59.0	0.66	4012	40.1	21.4	46.5	40,904	0.237	145,090	22.6	15.8	41.9	155.5	9.91	0.080	101	6.69	6.60
2000-8	19-May-02	268	Balanced	235	700	543	2,296	2.71	63.9	0.66	4032	39.2	16.0	45.0	40,904	0.233	146,090	21.8	16.0	42.3	153.8	9.81	0.082	100	6.57	6.48
2000-8	28-May-02	277	Balanced	235	700	497	2,291	2.53	96.6	0.65	3964	42.1	20.3	42.5	40,904	0.188	143,090	17.5	13.0	46.5	128.2	8.19	0.072	81	7.03	6.86
2000-8	29-May-02	278	Balanced	240	700	569	2,214	2.78	60.8	0.65	3917	42.7	22.8	43.0	40,904	0.229	144,090	24.5	17.2	41.7	163.8	10.45	0.091	127	7.12	6.82
2000-8	30-May-02	279	Balanced	240	700	536	2,239	2.74	64.7	0.65	3921	40.7	20.4	45.0	40,904	0.205	145,090	22.6	16.6	42.7	150.7	9.62	0.080	102	7.04	6.86
2000-8	31-May-02	280	Balanced	240	700	541	2,225	2.64	72.6	0.64	3895	41.7	19.8	43.0	40,904	0.205	146,090	22.0	15.7	43.4	149.5	9.55	0.083	111	6.90	6.64
2000-8	1-Jun-02	281	Balanced	240	700	555	2,232	2.65	83.0	0.64	3911	41.9	19.5	42.5	40,904	0.198	147,090	21.3	15.2	45.4	146.5	9.36	0.082	99	7.00	6.83
2000-8	2-Jun-02	282	Balanced	240	700	540	2,233	2.67	74.6	0.65	3932	41.8	20.1	43.0	40,904	0.200	148,090	21.5	15.3	43.5	148.9	9.51	0.083	100	7.02	6.97
2000-8	3-Jun-02	283	Balanced	242	700	510	2,255	2.68	66.6	0.65	3928	42.3	19.5	42.0	40,904	0.177	149,090	20.6	14.6	43.4	141.0	9.01	0.080	88	7.12	6.95

### Table D-4 – Data Summary Table for Kingsport Catalyst Campaign 4

Case	Days On Stream	Temp (Deg C)	Gas Type	Pres. (psig)	Fresh Feed (KSCFH)	Reycle Gas (KSCFH)	Reactor Feed (HZ,CO)	Purge Gas (KSCFH)	Inlet Sup. Velocity (ft/sec)	Space Velocity (1/hr-kg)	Slurry Conc. (wt% ox)	Gas Holdup (vol% ox)	Gassed Slurry Hgt (ft)	Catalyst Inventory (lb)	Catalyst Age (eta)	Catalyst Age (eta - corr)	CO Conv. (%)	Reactor		Syngas Util. (SCEF/lb)	Raw MeOH Prod. (TPD)	Catalyst MeOH Prod. (gmol/ltr-kg)	Reactor Vol. Prod. (TPD/03)	Overall (Btu/hr ft2.F)	Sparger dp (psi)	Sparger Resist. ("K")
																		O-T-M Conv. (%)	U							
2000-8	28-Jun-02	214	Balanced	450	599	1,288	3.81	48.9	0.64	2723	39.0	25.9	49.5	40,040	1,231	1,159	52.4	28.5	40.4	177.9	11.60	0.086	132	5.78	8.75	
2000-8	29-Jun-02	214	Balanced	450	606	1,305	3.69	48.6	0.65	2744	37.3	24.0	51.5	40,040	1,226	1,095	51.1	28.4	40.6	179.0	11.68	0.083	126	5.83	8.36	
2000-8	30-Jun-02	214	Balanced	450	605	1,308	3.71	49.2	0.65	2750	37.7	23.6	50.5	40,040	1,220	1,095	51.1	28.2	40.6	178.8	11.66	0.084	127	5.76	8.49	
2000-8	1-Jul-02	214	Balanced	450	558	1,366	3.82	32.6	0.65	2764	37.8	23.2	50.0	40,040	1,181	2,090	50.3	27.1	39.7	168.7	11.00	0.080	126	5.93	8.32	
2000-8	2-Jul-02	214	Balanced	450	550	1,353	3.91	34.0	0.65	2747	38.5	23.1	48.5	40,040	1,141	3,090	50.5	26.8	39.6	166.7	10.87	0.082	125	5.78	8.46	
2000-8	3-Jul-02	214	Balanced	450	553	1,353	3.86	35.3	0.65	2755	38.7	22.7	48.0	40,040	1,107	4,090	49.8	26.7	39.7	167.0	10.89	0.083	119	5.77	8.41	
2000-8	4-Jul-02	214	Balanced	450	550	1,353	3.90	34.4	0.65	2739	38.4	23.1	49.0	40,040	1,093	5,090	50.2	26.7	39.9	165.6	10.80	0.081	113	5.72	8.37	
2000-8	5-Jul-02	215	Balanced	450	550	1,337	3.93	34.2	0.65	2735	38.9	24.0	48.5	40,040	1,115	6,090	50.9	26.8	39.7	166.2	10.83	0.082	119	5.81	8.51	
2000-8	6-Jul-02	215	Balanced	450	550	1,354	3.85	32.7	0.65	2751	38.2	22.7	49.0	40,040	1,102	7,090	50.0	26.8	39.4	167.3	10.91	0.081	113	5.81	8.43	
2000-8	7-Jul-02	214	Balanced	450	550	1,368	3.70	34.2	0.66	2765	38.5	22.0	48.0	40,040	1,074	8,090	48.0	26.5	39.6	166.5	10.86	0.083	118	5.92	8.41	
2000-8	8-Jul-02	214	Balanced	450	523	1,389	5.01	27.8	0.65	2763	38.7	21.9	47.5	40,040	1,067	9,090	47.8	26.0	39.0	161.0	10.49	0.081	117	6.02	8.39	
2000-8	9-Jul-02	214	Balanced	450	525	1,391	3.69	28.4	0.66	2766	39.4	22.2	46.5	40,040	1,043	10,090	47.0	25.9	39.2	160.8	10.48	0.082	117	6.08	8.40	
2000-8	10-Jul-02	215	Balanced	450	522	1,402	3.53	26.6	0.66	2782	39.7	23.1	46.5	40,040	1,023	11,090	45.5	25.9	39.1	160.3	10.45	0.082	115	6.28	8.24	
2000-8	11-Jul-02	215	Balanced	450	525	1,434	3.48	26.8	0.67	2828	39.1	22.2	47.0	40,040	1,015	12,090	44.5	25.6	39.1	161.3	10.52	0.082	115	6.41	8.19	
2000-8	12-Jul-02	215	Balanced	450	523	1,431	3.40	25.1	0.67	2822	38.8	22.9	48.0	40,040	1,021	13,090	44.2	25.9	38.8	161.6	10.52	0.080	114	6.52	8.15	
2000-8	13-Jul-02	215	Balanced	450	522	1,434	3.22	23.0	0.67	2831	39.6	24.5	47.5	40,040	1,020	14,090	42.6	26.0	38.4	163.2	10.62	0.082	115	6.60	8.13	
2000-8	14-Jul-02	215	Balanced	450	522	1,417	3.27	22.1	0.67	2814	38.6	23.8	49.0	40,040	1,045	15,090	43.4	26.1	38.6	162.2	10.56	0.079	117	6.58	8.13	
2000-8	15-Jul-02	215	Balanced	450	523	1,406	3.46	25.4	0.66	2809	39.1	23.1	47.5	40,040	1,057	16,090	44.8	25.8	38.9	161.4	10.51	0.081	125	6.26	8.27	
2000-8	16-Jul-02	215	Balanced	750	523	1,418	3.34	23.5	0.66	2806	37.8	23.1	50.0	40,040	1,073	17,090	44.1	26.1	38.6	162.6	10.58	0.077	124	6.52	8.25	
2000-8	17-Jul-02	215	Balanced	450	523	1,407	3.39	25.4	0.66	2791	37.7	21.9	49.5	40,040	1,039	18,090	44.0	25.8	38.9	161.1	10.49	0.078	118	6.36	8.30	
2000-8	18-Jul-02	215	Balanced	450	522	1,420	3.15	24.9	0.66	2805	38.8	23.1	48.0	40,040	1,027	19,090	44.1	26.2	38.8	161.7	10.53	0.080	122	6.65	8.23	
2000-8	19-Jul-02	215	Balanced	450	522	1,404	3.33	23.9	0.66	2793	39.0	25.2	49.0	40,040	1,067	20,090	44.1	26.2	38.8	161.7	10.53	0.079	130	6.48	8.22	
2000-8	20-Jul-02	215	Balanced	450	523	1,410	3.31	23.6	0.67	2793	38.5	25.0	50.0	40,040	1,020	21,090	43.9	26.2	38.7	161.9	10.54	0.077	112	6.53	8.25	
2000-8	21-Jul-02	215	Balanced	450	523	1,397	3.46	24.8	0.65	2769	37.5	23.0	50.5	40,040	1,063	22,090	45.1	26.0	38.9	161.3	10.50	0.076	123	6.26	8.32	
2000-8	22-Jul-02	215	Balanced	450	523	1,396	3.48	24.8	0.66	2771	37.9	23.4	50.0	40,040	1,055	23,090	45.1	25.9	38.9	161.1	10.49	0.077	124	6.24	8.33	
2000-8	23-Jul-02	215	Balanced	450	520	1,395	3.46	24.4	0.66	2773	38.5	24.6	50.5	40,040	1,044	24,090	44.8	25.9	38.9	160.6	10.46	0.076	125	6.28	8.34	
2000-8	24-Jul-02	215	Balanced	450	523	1,399	3.34	26.0	0.66	2782	38.2	23.5	49.5	40,040	1,027	25,090	43.6	25.9	38.9	161.3	10.51	0.078	124	6.34	8.33	
2000-8	25-Jul-02	215	Balanced	450	520	1,410	3.19	25.9	0.66	2790	38.6	23.1	48.5	40,040	1,005	26,090	41.8	25.7	38.9	160.5	10.45	0.079	122	6.42	8.29	
2000-8	26-Jul-02	215	Balanced	450	520	1,408	3.16	26.6	0.66	2785	38.8	22.1	47.5	40,040	0,996	27,090	41.4	25.6	38.9	160.5	10.45	0.081	121	6.36	8.31	
2000-8	27-Jul-02	214	Balanced	450	520	1,407	3.14	27.9	0.66	2774	39.0	21.9	47.0	40,040	0,980	28,090	40.9	25.4	39.1	159.6	10.39	0.081	119	6.32	8.33	
2000-8	28-Jul-02	215	Balanced	450	518	1,401	3.21	26.9	0.65	2767	38.7	21.8	47.5	40,040	0,988	29,090	41.7	25.5	39.0	159.4	10.38	0.080	120	6.25	8.35	
2000-8	29-Jul-02	215	Balanced	450	520	1,401	3.23	26.5	0.66	2772	38.2	22.8	49.0	40,040	0,999	31,090	42.0	25.6	39.1	159.5	10.39	0.080	121	6.29	8.32	
2000-8	30-Jul-02	215	Balanced	450	520	1,401	3.27	29.6	0.65	2766	37.7	21.2	49.0	40,040	0,984	32,090	42.2	21.2	39.3	158.8	10.34	0.077	117	6.24	8.34	
2000-8	31-Jul-02	215	Balanced	450	518	1,408	3.15	29.2	0.65	2771	38.9	24.0	48.5	40,040	0,986	33,090	41.4	25.6	39.1	159.0	10.36	0.078	124	6.43	8.27	
2000-8	1-Aug-02	215	Balanced	450	518	1,410	3.07	28.5	0.66	2780	38.2	23.6	49.5	40,040	0,976	34,090	40.5	25.6	39.1	158.9	10.35	0.076	122	6.55	8.25	
2000-8	3-Aug-02	215	Balanced	450	518	1,384	3.34	27.8	0.65	2742	37.3	22.5	50.5	40,040	1,011	35,090	43.5	25.8	38.7	160.4	10.45	0.076	121	6.06	8.41	
2000-8	4-Aug-02	215	Balanced	450	518	1,412	2.94	25.3	0.66	2788	37.7	22.9	50.0	40,040	1,002	36,090	39.8	25.8	38.5	161.6	10.52	0.077	122	6.56	8.25	
2000-8	5-Aug-02	215	Balanced	450	528	1,323	5.37	32.4	0.63	2664	37.9	22.7	49.5	40,040	1,037	37,090	48.8	26.3	39.4	160.8	10.48	0.077	124	5.35	8.59	
2000-8	6-Aug-02	214	Balanced	450	527	1,224	4.62	39.3	0.59	2518	38.1	20.1	47.5	40,040	1,018	38,090	54.9	25.7	41.5	152.4	9.94	0.076	123	4.42	9.14	
2000-8	7-Aug-02	214	Balanced	450	532	1,194	4.77	69.3	0.59	2484	36.8	18.5	49.0	40,040	1,015	39,090	56.0	25.6	42.5	150.3	9.81	0.073	117	4.27	9.28	
2000-8	8-Aug-02	215	Balanced	450	528	1,215	4.62	58.2	0.60	2520	37.8	20.7	48.5	40,040	1,014	40,090	54.9	25.7	41.6	152.2	9.92	0.073	119	4.46	9.17	
2000-8	9-Aug-02	215	Balanced	450	530	1,235	4.52	55.6	0.60	2546	38.0	21.4	48.5	40,040	1,019	41,090	54.2	25.8	41.3	154.0	10.04	0.076	123	4.58	9.05	
2000-8	10-Aug-02	215	Balanced	450	529	1,271	4.23	49.3	0.61	2595	37.7	21.3	49.0	40,040	1,007	42,090	51.5	25.8	40.8	155.7	10.15	0.076	123	4.90	8.80	
2000-8	11-Aug-02	215	Balanced	450	569	1,339	3.41	47.0	0.65	2766	38.3	21.5	48.0	40,040	0,999	43,090	44.5	26.4	40.5	168.8	11.00	0.084	118	5.04	7.30	
2000-8	12-Aug-02	215	Balanced	450	583	1,279	3.99	72.0	0.64	2695	38.3	21.4	48.0	40,040	0,992	44,090	49.2	25.9	42.3	165.3	10.79	0.082	119	4.44	7.75	

**Table D-4 – Data Summary Table for Kingsport Catalyst Campaign 4 (cont'd)**

Case	Date	Days On Stream	Gas Type	Temp (Deg C)	Pres. (psig)	Fresh Feed (KSCFH)	Recycle Gas (KSCFH)	Reactor Feed (HZ,CO)	Purge Gas (KSCFH)	Inlet Sup. Velocity (ft/sec)	Space Velocity (1/hr-kg)	Slurry Conc. (wt% ox)	Gas Holdup (vol%)	Gassed Slurry Hgt (ft)	Catalyst Inventory (lb)	Catalyst Age (eta)	Catalyst Age (eta - corr)	CO Conv. (%)	O-T-M Conv. (%)	Syngas Util. (SCF/lb)	Raw MeOH Prod. (TPD)	Catalyst MeOH Prod. (gmol/ltr-kg)	Reactor Vol. Prod. (TPD/H3)	Overall (Btu/hr ft2.F)	Sparger dp (psi)	Sparger Resist. (W")
2000-8	7-Sep-02	72	Balanced	215	450	583	1,306	3,68	66.6	0.65	2732	38.3	21.5	48.0	40,040	0.976	45,090	46.2	25.9	42.0	166.4	10.86	0.083	119	4.69	7.51
2000-8	8-Sep-02	73	Balanced	215	450	578	1,287	3,84	72.2	0.64	2702	38.8	21.3	47.0	40,040	0.960	46,090	47.2	26.3	42.4	163.7	10.69	0.083	119	4.51	7.65
2000-8	9-Sep-02	74	Balanced	215	450	588	1,309	3,66	68.4	0.65	2736	38.4	21.9	48.0	40,040	1.005	47,090	46.8	25.6	41.7	169.1	11.04	0.084	123	4.73	7.46
2000-8	10-Sep-02	75	Balanced	215	450	588	1,279	3.61	67.0	0.64	2726	38.8	22.3	47.5	40,040	1.011	48,090	46.7	26.6	41.7	169.2	11.04	0.085	125	4.72	7.35
2000-8	11-Sep-02	76	Balanced	214	450	586	1,223	4.05	80.6	0.62	2668	38.8	21.5	47.0	40,040	0.922	49,090	50.1	26.1	42.8	164.1	10.72	0.083	121	4.16	7.72
2000-8	12-Sep-02	77	Balanced	214	450	594	1,256	3.95	73.2	0.63	2666	38.9	21.7	47.0	40,040	1.027	50,090	50.2	26.8	41.9	169.9	11.08	0.086	125	4.28	7.80
2000-8	14-Sep-02	79	Balanced	215	450	593	1,189	4.19	77.0	0.62	2610	37.8	22.3	49.5	40,040	1.044	52,090	52.8	26.8	42.6	167.3	10.92	0.081	123	4.07	8.02
2000-8	15-Sep-02	80	Balanced	215	450	593	1,223	3.99	71.2	0.62	2643	38.0	23.0	49.5	40,040	1.031	53,090	50.9	26.9	42.1	169.0	11.03	0.081	123	4.25	7.84
2000-8	16-Sep-02	81	Balanced	215	450	593	1,206	4.26	76.7	0.62	2419	38.1	22.4	49.0	40,040	1.036	54,090	51.8	26.8	42.4	167.8	10.95	0.082	123	4.11	7.91
2000-8	17-Sep-02	82	Balanced	215	450	598	1,232	3.92	71.9	0.63	2656	38.1	22.4	49.0	40,040	1.020	55,090	50.2	26.8	42.4	169.4	11.05	0.082	121	4.28	7.72
2000-8	18-Sep-02	83	Balanced	215	450	591	1,295	3.33	58.3	0.65	2749	38.5	23.8	49.0	40,040	1.014	56,090	44.7	27.0	40.9	173.5	11.32	0.084	125	4.94	7.36
2000-8	19-Sep-02	84	Balanced	215	450	591	1,298	3.28	57.4	0.65	2738	38.4	23.4	49.0	40,040	1.012	57,090	44.3	27.1	44.3	173.1	11.30	0.084	124	4.93	7.33
2000-8	21-Sep-02	86	Balanced	215	450	591	1,182	4.37	90.8	0.61	2568	37.9	21.0	48.5	40,040	1.038	59,090	54.0	26.6	43.5	163.1	10.65	0.080	122	3.90	8.05
2000-8	22-Sep-02	87	Balanced	215	450	591	1,208	4.25	84.4	0.62	2607	37.9	21.7	49.0	40,040	1.027	59,090	52.7	26.6	42.9	165.1	10.78	0.080	122	4.03	7.95
2000-8	23-Sep-02	88	Balanced	215	450	591	1,264	3.90	67.1	0.64	2695	38.8	22.9	48.0	40,040	1.025	59,090	49.7	26.8	41.4	171.1	11.15	0.085	127	4.36	7.65
2000-8	24-Sep-02	89	Balanced	215	450	591	1,243	3.94	70.2	0.63	2664	38.5	22.8	48.5	40,040	1.020	59,090	50.1	26.8	41.8	169.7	11.07	0.083	125	4.25	7.74
2000-8	25-Sep-02	90	Balanced	215	450	588	1,334	3.47	58.5	0.66	2788	39.4	24.7	48.0	40,040	0.976	59,090	44.5	26.3	41.3	170.9	11.14	0.085	125	4.88	7.33
2000-8	26-Sep-02	91	Balanced	215	450	602	1,312	3.24	73.9	0.65	2759	38.9	24.3	48.5	40,040	0.956	59,090	42.7	26.4	42.4	170.3	11.11	0.084	121	4.92	7.22
2000-8	27-Sep-02	92	Balanced	215	450	602	1,303	3.24	76.8	0.65	2737	39.5	24.4	47.5	40,040	0.965	59,090	43.0	26.5	42.4	170.3	11.11	0.085	124	4.90	7.28
2000-8	29-Sep-02	94	Balanced	215	450	678	1,190	3.70	129.3	0.64	2692	37.8	23.1	50.0	40,040	1.031	59,090	48.9	27.4	45.7	177.8	11.63	0.085	124	4.30	7.70
2000-8	1-Oct-02	96	Balanced	215	450	616	1,322	3.09	69.2	0.66	2782	38.0	25.2	51.0	40,040	0.996	59,090	42.3	27.0	42.4	176.4	11.51	0.082	123	5.12	7.27
2000-8	3-Oct-02	98	Balanced	216	450	643	1,331	2.78	82.4	0.66	2808	37.8	23.9	50.5	40,040	0.989	59,090	39.8	27.4	42.4	181.9	11.88	0.086	121	5.32	7.19
2000-8	4-Oct-02	99	Balanced	215	450	645	1,276	2.89	88.8	0.65	2766	38.9	24.8	49.0	40,040	0.983	59,090	40.8	27.4	42.9	180.5	11.78	0.088	126	5.01	7.25
2000-8	5-Oct-02	100	Balanced	215	450	646	1,248	3.04	93.0	0.65	2741	38.6	24.0	49.0	40,040	0.986	59,090	42.3	27.4	43.0	180.1	11.76	0.088	125	4.78	7.36
2000-8	25-Oct-02	120	Balanced	215	450	555	1,343	3.28	49.8	0.65	2741	38.8	23.1	48.0	40,040	0.937	59,090	42.2	25.4	40.7	163.5	10.66	0.081	121	5.64	8.30
2000-8	26-Oct-02	121	Balanced	215	450	555	1,344	3.23	48.1	0.65	2753	40.5	29.4	49.0	40,040	0.945	59,090	41.9	25.5	40.4	164.8	10.74	0.080	120	5.51	8.00
2000-8	27-Oct-02	122	Balanced	215	450	555	1,344	3.28	46.3	0.65	2752	39.4	26.4	49.0	40,040	0.958	59,090	42.6	26.4	40.2	165.7	10.79	0.081	123	5.55	8.13
2000-8	28-Oct-02	123	Balanced	215	450	555	1,342	3.29	47.9	0.65	2747	39.9	26.3	48.0	40,040	0.949	59,090	42.6	26.3	40.4	164.7	10.73	0.082	123	5.54	8.15
2000-8	29-Oct-02	124	Balanced	215	450	556	1,349	3.18	45.4	0.65	2756	40.9	27.7	47.0	40,040	0.955	59,090	41.7	25.6	40.4	165.1	10.75	0.084	127	5.72	8.11
2000-8	30-Oct-02	125	Balanced	215	450	555	1,352	3.15	43.0	0.66	2775	40.4	30.8	50.0	40,040	0.957	59,090	41.5	25.6	40.0	166.4	10.84	0.079	124	6.16	8.63
2000-8	31-Oct-02	126	Balanced	215	450	560	1,333	3.42	50.7	0.65	2738	39.1	26.3	49.5	40,040	0.936	59,090	43.4	25.4	40.9	164.2	10.70	0.079	123	5.12	7.88
2000-8	1-Nov-02	127	Balanced	215	450	555	1,300	3.59	53.2	0.64	2709	40.5	27.3	47.5	40,040	0.919	59,090	44.4	25.2	41.3	161.3	10.51	0.081	125	5.03	8.18
2000-8	4-Nov-02	130	Balanced	215	450	576	1,304	3.50	60.5	0.64	2723	41.2	29.3	47.5	40,040	0.948	59,090	44.5	25.8	41.7	165.8	10.80	0.083	128	4.98	7.94
2000-8	5-Nov-02	131	Balanced	215	450	577	1,308	3.58	60.2	0.64	2715	41.3	30.2	48.0	40,040	0.970	59,090	44.2	26.3	41.5	166.8	10.87	0.083	128	5.28	8.07
2000-8	6-Nov-02	132	Balanced	215	450	563	1,371	3.19	53.6	0.66	2783	41.5	30.8	48.0	40,040	0.929	59,090	41.2	25.6	40.6	166.5	10.85	0.083	126	6.06	8.74
2000-8	7-Nov-02	133	Balanced	215	450	573	1,360	3.20	59.0	0.66	2782	39.4	26.9	47.5	40,040	0.907	59,090	40.7	25.2	40.7	165.4	10.77	0.083	123	5.57	8.18
2000-8	8-Nov-02	134	Balanced	215	450	570	1,342	3.18	55.1	0.65	2771	41.2	30.0	48.0	40,040	0.932	59,090	41.3	25.5	41.1	166.7	10.86	0.083	128	5.69	8.28
2000-8	9-Nov-02	135	Balanced	215	450	570	1,336	3.23	54.0	0.65	2750	37.4	21.1	49.5	40,040	0.949	59,090	42.3	25.8	41.1	166.7	10.87	0.080	127	5.06	7.43
2000-8	10-Nov-02	136	Balanced	215	450	569	1,318	3.27	57.8	0.64	2717	40.7	30.1	49.0	40,040	0.967	59,090	43.2	26.0	41.1	165.9	10.81	0.081	126	5.45	8.08
2000-8	12-Nov-02	138	Balanced	215	500	570	1,554	3.64	29.3	0.65	3068	40.9	30.6	49.0	40,040	0.942	59,090	45.3	24.8	39.1	174.8	11.38	0.085	132	6.34	8.10
2000-8	13-Nov-02	139	Balanced	215	500	570	1,569	3.47	29.0	0.66	3089	40.9	30.5	49.0	40,040	0.912	59,090	43.2	24.6	39.2	174.7	11.37	0.085	130	6.43	8.05
2000-8	14-Nov-02	140	Balanced	215	500	568	1,553	3.58	30.9	0.66	3076	40.8	29.6	48.5	40,040	0.902	59,090	43.8	24.3	39.4	172.9	11.26	0.085	129	6.15	7.90
2000-8	15-Nov-02	141	Balanced	215	500	565	1,546	3.53	30.9	0.65	3060	39.0	25.3	49.0	40,040	0.929	59,090	44.3	24.8	38.9	174.6	11.37	0.085	133	5.89	7.45
2000-8	16-Nov-02	142	Balanced	215	500	570	1,559	3.56	31.2	0.66	3076	39.5	25.1	48.0	40,040	0.902	59,090	42.3	24.7	39.4	173.6	11.30	0.086	132	6.72	8.22
2000-8	17-Nov-02	143	Balanced	215	500	568	1,556	3.54	34.8	0.66	3075	39.2	24.1	48.0	40,040	0.872	59,090	42.7	24.3	39.7	171.8	11.19	0.085	126	6.08	7.91

**Table D-4 – Data Summary Table for Kingsport Catalyst Campaign 4 (cont'd)**

Case	Date	Days On Stream	Gas Type	Temp (Deg C)	Pres. (psig)	Fresh Feed (KSCFH)	Recycle Gas (KSCFH)	Reactor Feed (HZ,CO)	Purge Gas (KSCFH)	Inlet Sup. Velocity (ft/sec)	Space Velocity (1/hr-kg)	Slurry Conc. (wt% ox)	Gas Holdup (vol%)	Gassed Slurry Hgt (ft)	Catalyst Inventory (lb)	Catalyst Age (eta)	Catalyst Age (eta - corr)	CO Conv. (%)	O-T-M Conv. (%)	Syngas Util. (SCEF/lb)	Raw MeOH Prod. (TPD)	Catalyst MeOH Prod. (gmol/ltr-kg)	Reactor Vol. Prod. (TPD/03)	Overall (Btu/hr ft2.F)	Sparger dp (psi)	Sparger Resist. ("C)
2000-8	19-Nov-02	145	Balanced	215	500	570	1,555	3,59	29.4	0.66	3071	38.8	26.3	50.0	40,040	0.900	59,090	43.9	24.6	39.3	174.2	11.34	0.083	130	6.08	7.99
2000-8	20-Nov-02	146	Balanced	215	500	570	1,535	3,48	31.0	0.65	3055	38.4	24.9	50.0	40,040	0.919	59,090	45.2	24.9	39.3	174.1	11.33	0.083	131	6.00	7.90
2000-8	21-Nov-02	147	Balanced	215	500	560	1,556	3,48	32.6	0.66	3076	40.1	28.4	49.0	40,040	0.897	59,090	43.0	24.7	39.1	171.9	11.19	0.084	132	7.03	8.72
2000-8	22-Nov-02	148	Balanced	215	500	585	1,537	3,59	35.3	0.65	3064	38.0	22.1	49.0	40,040	0.939	59,090	45.2	25.6	39.4	178.3	11.61	0.087	136	6.55	8.56
2000-8	24-Nov-02	150	Balanced	215	500	575	1,566	3,45	29.3	0.66	3098	40.3	28.3	48.5	40,040	0.904	59,090	43.0	24.8	38.9	177.5	11.56	0.087	134	6.97	8.96
2000-8	25-Nov-02	151	Balanced	215	500	550	1,529	3,89	32.5	0.64	3012	40.0	28.1	49.0	40,040	0.836	59,090	44.8	23.7	39.6	166.7	10.86	0.081	118	5.66	8.31
2000-8	26-Nov-02	152	Balanced	215	500	560	1,536	3,95	33.9	0.65	3027	38.4	23.3	49.0	40,040	0.852	59,090	45.5	23.3	39.6	169.6	11.04	0.082	121	5.94	8.84
2000-8	27-Nov-02	153	Balanced	215	500	550	1,582	3,57	30.6	0.66	3088	38.6	24.1	49.0	40,040	0.813	59,090	41.3	23.4	39.4	167.6	10.91	0.081	117	6.21	8.32
2000-8	28-Nov-02	154	Balanced	215	500	550	1,571	3,58	32.3	0.66	3077	40.5	29.5	49.0	40,040	0.809	59,090	41.3	23.4	39.4	167.4	10.90	0.081	116	6.32	8.59
2000-8	29-Nov-02	155	Balanced	215	500	535	1,581	3,26	32.0	0.66	3078	39.3	24.6	48.0	40,040	0.781	59,090	38.0	22.9	39.2	163.9	10.67	0.081	115	5.58	7.13
2000-8	30-Nov-02	156	Balanced	215	500	548	1,541	3,73	38.4	0.64	3020	42.4	30.1	46.0	40,040	0.794	59,090	42.3	23.2	39.9	164.5	10.71	0.085	120	6.30	9.21
2000-8	1-Dec-02	157	Balanced	215	500	538	1,594	3,35	32.7	0.66	3108	38.9	24.1	48.5	40,040	0.778	59,090	38.4	24.1	39.1	164.9	10.73	0.081	115	6.35	8.16
2000-8	2-Dec-02	158	Balanced	215	500	550	1,605	3.16	32.9	0.66	3108	38.9	24.1	48.5	40,040	0.791	59,090	37.5	23.3	39.3	167.8	10.93	0.082	116	5.82	7.30
2000-8	3-Dec-02	159	Balanced	215	500	548	1,584	3.16	30.6	0.66	3093	38.7	24.4	49.0	40,040	0.785	59,090	37.4	24.4	39.5	166.3	10.83	0.081	114	6.48	8.23
2000-8	4-Dec-02	160	Balanced	215	500	548	1,584	3.16	30.6	0.66	3106	38.3	23.2	49.0	40,040	0.799	59,090	37.9	23.3	39.0	168.6	10.97	0.082	118	6.31	7.96
2000-8	9-Dec-02	165	Balanced	215	500	535	1,596	3.32	32.8	0.66	3090	40.4	27.1	47.5	40,040	0.753	59,090	37.6	22.7	39.2	163.6	10.65	0.082	111	5.74	7.64
2000-8	10-Dec-02	166	Balanced	215	500	550	1,590	3.39	35.7	0.66	3092	37.3	20.0	49.0	40,040	0.782	59,090	39.0	23.1	39.4	167.7	10.92	0.082	112	5.08	6.84
2000-8	11-Dec-02	167	Balanced	215	500	548	1,584	3.15	29.6	0.66	3104	37.7	21.9	49.5	40,040	0.789	59,090	37.5	23.4	39.1	168.0	10.94	0.081	119	6.59	8.31
2000-8	13-Dec-02	169	Balanced	215	500	550	1,534	3.14	31.6	0.66	3079	37.9	20.3	48.0	40,040	0.807	59,090	38.1	23.7	38.9	169.6	11.04	0.084	123	6.36	8.05
2000-8	14-Dec-02	170	Balanced	215	500	548	1,578	3.28	31.7	0.66	3089	39.3	24.5	48.0	40,040	0.783	59,090	38.3	23.2	39.1	168.2	10.95	0.084	118	6.17	8.22
2000-8	15-Dec-02	171	Balanced	215	500	558	1,559	3.48	32.7	0.65	3059	38.4	23.3	49.0	40,040	0.814	59,090	41.1	23.8	39.3	170.4	11.09	0.083	121	5.80	8.07
2000-8	16-Dec-02	172	Balanced	215	500	560	1,544	3.66	36.2	0.65	3033	36.6	19.4	50.0	40,040	0.827	59,090	42.9	23.9	39.3	171.1	11.14	0.082	118	5.34	7.82
2000-8	23-Dec-02	179	Balanced	215	500	550	1,604	3.25	27.0	0.67	3122	37.6	24.8	51.5	40,040	0.808	59,090	38.4	23.3	39.2	168.3	10.96	0.078	115	6.43	8.17
2000-8	25-Dec-02	181	Balanced	215	500	551	1,569	3.57	35.3	0.65	3067	39.0	24.5	48.5	40,040	0.782	59,090	40.5	23.1	40.0	165.2	10.75	0.081	113	5.83	8.13
2000-8	26-Dec-02	182	Balanced	215	500	558	1,534	3.89	41.7	0.65	3045	37.7	19.5	48.0	40,040	0.797	59,090	43.3	23.3	40.3	166.1	10.81	0.082	113	5.47	8.23
2000-8	29-Dec-02	185	Balanced	215	500	545	1,526	4.02	36.7	0.65	3027	37.3	25.3	52.5	40,040	0.813	59,090	44.8	23.4	39.7	164.8	10.73	0.075	114	7.07	10.53
2000-8	30-Dec-02	186	Balanced	215	500	550	1,537	3.82	37.3	0.65	3025	37.2	24.2	52.0	40,040	0.813	59,090	43.6	23.7	39.6	167.0	10.87	0.076	115	5.81	8.52