

**Tidd PFBC Demonstration Project
Public Final Design Report**

Topical Report

October 1992

Work Performed Under Contract No. DE-AC22-89MC24132

**For
U.S. Department of Energy
Office of Fossil Energy
Morgantown Energy Technology Center
Morgantown, West Virginia**

**By
Ohio Power Company
Columbus, Ohio**

**Prepared by
American Electric Power Service Corporation
Columbus, Ohio**

TOPICAL

DISCLAIMER

This report was prepared as an account of work sponsored by an agency of the United States Government. Neither the United States Government nor any agency thereof, nor any of their employees, makes any warranty, express or implied, or assumes any liability or responsibility for the accuracy, completeness, or usefulness of any information, product, or process disclosed, or represents that its use would not infringe upon privately owned rights. Reference herein to any specific commercial product, process, or service by trade name, trademark, manufacturer, or otherwise does not necessarily constitute or imply its recommendation, endorsement, or favoring by the United States Government or any agency thereof. The views and opinions of the authors expressed herein do not necessarily state or reflect those of the United States Government or any agency thereof.

This report has been reproduced exactly as received. No available copy.

Available to DOE and DOE contractors from the Office of Scientific and Technical Information, P.O. Box 62, Oak Ridge, TN 37831; prices available from (615)576-8401.

Available to the public from the National Technical Information Service, U. S. Department of Commerce, 5285 Port Royal Rd., Springfield, VA 22161.

**Tidd PFBC Demonstration Project
Public Final Design Report**

Topical Report

Work Performed Under Contract No.: DE-FC21-87MC24132

**For
U.S. Department of Energy
Office of Fossil Energy
Morgantown Energy Technology Center
P.O. Box 880
Morgantown, West Virginia 26507-0880**

**By
Ohio Power Company
1 Riverside Plaza
Columbus, Ohio 43216-6631**

**Prepared by
American Electric Power Service Corporation
Columbus, Ohio 43215**

October 1992

TABLE OF CONTENTS

	<u>Page No.</u>
1.0 INTRODUCTION	1
2.0 PROGRAM BACKGROUND	1
3.0 TECHNOLOGY DESCRIPTION	3
4.0 PLANT DESCRIPTION	7
4.1 Site Description	7
4.2 Plant Layout	8
4.3 Cycle Description	11
4.3.1 Cycle Configuration	11
4.3.2 Air/Gas Cycle	11
4.3.3 Steam Cycle	15
5.0 PLANT SYSTEMS	16
5.1 Combustor Assembly	16
5.1.1 Boiler	16
5.1.2 Cyclones	18
5.1.3 Bed Ash Reinjection	20
5.1.4 Bed Preheating	20
5.2 Gas Turbine/Generator	22
5.3 Coal Systems	26
5.3.1 Coal Storage	26
5.3.2 Coal Conveyors	26
5.3.3 Coal Preparation	26
5.3.4 Coal Injection	28
5.4 Sorbent Systems	28
5.4.1 Sorbent Storage	28
5.4.2 Sorbent Conveyors	28
5.4.3 Sorbent Preparation	30
5.4.4 Sorbent Injection	30
5.5 Economizer	32
5.6 Electrostatic Precipitator	32

TABLE OF CONTENTS (Cont'd)

	<u>Page No.</u>
5.7 Ash Systems	35
5.7.1 Cyclone Ash Removal System	35
5.7.2 Fly Ash Removal System	35
5.7.3 Cyclone Ash Handling System	36
5.7.4 Bed Ash Removal System	36
5.7.5 Bed Ash Handling System	38
5.7.6 Ash Disposal	38
5.8 Balance of Plant Systems	38
5.8.1 Steam Turbine/Generator	38
5.8.2 Condenser	42
5.8.3 Condensate System	42
5.8.4 Feedwater System	43
5.8.5 LP Service Water System	43
5.8.6 HP Service Water System	43
5.8.7 Electrical System	44
5.9 Control System	44
5.9.1 Purpose	44
5.9.2 System Description	45
5.9.3 System Arrangement	45
5.9.4 Process Control Units	45
5.9.5 Safety System	47
5.9.6 Operator Interface	47
5.9.7 Simulator	47
5.9.8 Additional Equipment	47
6.0 PROJECT COSTS	48
7.0 HEAT BALANCE	48
8.0 GENERAL ARRANGEMENT DRAWINGS	53
8.1 Site Plan Drawings	53
8.2 Combustor Building Drawings	53
8.3 Existing Building Drawings	53
9.0 FIGURES	
1 Project Schedule	
2 Site Plan	
3 Flow Diagram Composite Cycle	
4 Combustor Vessel Assembly	
5 Boiler Circulation Schematic	
6 Bed Ash Reinjection System	
7 Schematic Arrangement of the GT 35P Gas Turbine	
8 Coal Preparation	
9 Coal Injection System	

TABLE OF CONTENTS (Cont'd.)

10	Sorbent Preparation	
11	Sorbent Injection System Diagram	
12	Electrostatic Precipitator Diagram	
13	Bed Ash Removal System	
14	Electrical One-Line Diagram	
15	Heat Balance	
16	Heat Balance	
17	1-5000-03	Gen. Arg't Construction Site Plan
18	1-5001-01	Gen. Arg't Combustor Building Plans @ El. 652' and 660'
19	1-5001-02	Gen. Arg't Combustor Building Plans @ El. 676' and 686'
20	1-5001-03	Gen. Arg't Combustor Building Plans @ El. 703' and 728'
21	1-5001-04	Gen. Arg't Precipitator and Economizer Plan
22	1-5001-05	Gen. Arg't Plan & Sections Precipitator 1A & 1B Duct Modifications
23	1-5001-06	Gen. Arg't Plan & Sections Precipitator 1A & 1B Duct Modifications
24	1-5001-07	Gen. Arg't Ash Handling Facility
25	1-5001-08	Gen. Arg't Combustor Building Sections
26	1-5001-09	Gen. Arg't Combustor Building Sections
27	1-5001-10	Gen. Arg't Combustor Building Sections
28	1-5001-11	Gen. Arg't Combustor Building Sections
29	1-5001-12	Gen. Arg't Waste Water Pumps Structure Plan & Sections
30	1-5001-13	Gen. Arg't Combustor Building Plans @ El. 744' and Roof
31	1-5010-01	General Cross Section of Plant, Unit #1
32	1-5010-02	General Cross Section of Plant, Unit #1
33	1-5010-03	Floor Plans of Turbine Room, Elev's @ 608', 624', and 636', Unit #1
34	1-5010-04	Basement Floor Plan of Plant Elev's @ 650' and 665', Unit #1
35	1-5010-05	Basement Floor Plan of Plant Elev. @ 650', Unit #1
36	1-5010-06	Main Floor Plan of Plant, Elev. 676', Unit #1
37	1-5010-07	Main Floor Plan of Plant, Elev. 676', Unit #1
38	1-5010-08	Floor Plans of Boiler Room & Heater Bay, Elev's @ 707', 708', 710', 727', 720', and 732', Unit #1
39	1-5010-09	Floor Plans of Boiler Room & Heater Bay, Elev's @ 741', 747', and 751'; Fan Floor, Elev. 766', Unit 1, 650', Unit #1
40	1-5010-10	Longitudinal Section Heater Bay and Turbine Room, Unit #1
41	1-5010-11	Screen House General Arrangement

1.0 INTRODUCTION

This Public Final Design Report describes the 70 MWe Tidd PFBC Demonstration Plant under construction in Brilliant, Ohio. This project is receiving cost-sharing from the U.S. Department of Energy (DOE), and is being administered by the Morgantown Energy Technology Center in accordance with DOE Cooperative Agreement No. DE-FC21-87 MC24132.000. The project is also receiving cost-sharing from the State of Ohio. This award is being administered by the Ohio Coal Development Office.

The Tidd PFBC Demonstration Project is the first utility-scale demonstration project in the U.S. Its objective is to demonstrate that the Pressurized Fluidized Bed Combustion (PFBC) combined-cycle technology is an economic, reliable, and environmentally superior alternative to conventional technology in using high-sulfur coal to generate electricity.

Detailed design of the plant began in May, 1987, leading to the start of construction in April, 1988. First coal fire occurred in November, 1990, and the three-year test program began in February, 1991.

2.0 PROGRAM BACKGROUND

Plant-scale investigation of pressurized fluidized bed combustion (PFBC) began in the late 1960's, with the completion of a combustor rig at the National Coal Board (NCB) Coal Utilization Research Laboratory (CURL) in Leatherhead, England. Later, expanded facilities, including a gas turbine blade cascade, were added at CURL. In the mid-70's to early 80's, a number of PFBC test facilities were built and tested. These were built by Exxon, Curtiss-Wright, General Electric, New York University, Argonne National Laboratory, NASA Lewis Laboratory, NCB (IEA Grimethorpe and CURL) and ASEA Brown Boveri (ABB) (Component Test Facility).

In late 1976, following theoretical studies and review of available PFBC test results, American Electric Power Service Corporation (AEPSC) and ABB Carbon (then STAL-LAVAL) of Sweden signed an agreement to perform a joint feasibility study to evaluate the merits of PFBC technology and the technical challenges to be overcome in proceeding with a development program. A conceptual design of a 170 MWe demonstration plant was prepared utilizing the deactivated Tidd Plant steam turbine.

The feasibility study addressed many technical issues which had to be resolved prior to embarking on a demonstration project. Combustion tests were initiated in 1977 at the Coal Utilization Research Laboratory in Leatherhead, England, using Ohio coal and dolomite to evaluate the process. The advantages of a tapered

bed and the environmental advantages of the PFBC process, including high-sulfur removal and low NO_x emissions, were demonstrated.

Encouraged by these developments, AEPSC and ABB Carbon agreed to proceed with the next phase of development in 1978. The development work continued with an extensive cold and hot physical model test program and analytical modeling to quantify crucial design parameters. Cold flow models were constructed primarily to further study the fluidization process. The primary effort in the hot test work was AEPSC and ABB Carbon participation in the U.S. DOE sponsored 1000-hour test program at CURL. Major objectives of this test program were to determine the operating life of gas turbine blades exposed to hot PFBC gases and in-bed tube erosion/corrosion potential. Results verified the extended life for both the gas turbine blades and steam generator tubes.

While the test program was proceeding, preliminary engineering and design of both the 170 MWe Tidd Commercial Demonstration Plant and a future larger commercial plant were performed. Part of this effort consisted of cost estimates of both plants and a comparison of the economics of a future PFBC commercial plant with a conventional pulverized coal plant using a Flue Gas Desulfurization (FGD) system.

Over 2000 hours of tests were completed at Leatherhead and, as a result, combustor and other component designs evolved considerably. The technical readiness of the process for major utility generation was proven, and the economic evaluation indicated a clear advantage for PFBC. At that time, ABB Carbon (then ASEA PFBC) decided to erect an integrated pilot plant to conduct more extensive tests on the PFBC process and PFBC-related systems.

The 15 MW (thermal) Component Test Facility (CTF) which incorporated all PFBC-related auxiliary systems and components required for operation in a commercial power station, was designed in 1980. Key design parameters (temperatures, pressures, velocities, bed geometry, tube arrangements, etc.) at the CTF were identical to the PFBC demonstration plant design.

In 1982, financial constraints dictated that the demonstration plant be scaled down from 170 MWe to 70 MWe. The 15 MWe ABB STAL GT-35P gas turbine was substituted for the 75 MWe GT-120P gas turbine. This scale-down allowed for the commercial viability of PFBC to be proven at reduced cost. The preliminary design and cost estimate for the 70 MWe plant were completed in 1984. In 1984, Babcock & Wilcox became involved in the PFBC demonstration plant project. After a careful review of the

design and concept by Babcock & Wilcox, a partnership was formed between ABB Carbon and Babcock & Wilcox (ASEA Babcock) to pursue the project and the ultimate commercialization of PFBC.

In May, 1986, AEPSC and ASEA Babcock began the detailed design of the 70 MWe Tidd PFBC Demonstration Plant. In February, 1987, Ohio Power Company, a subsidiary of American Electric Power, entered into an agreement with the U.S. Department of Energy for up to \$60.2 million in Federal cost-sharing under the Clean Coal Technology Program and with the Ohio Coal Development Office for \$10 million in state cost-sharing.

Construction on the Tidd Project began in April, 1988. Initial combined cycle operation was achieved in November, 1990. Start-up and plant checkout were completed and the 3-year demonstration period was initiated in March, 1991. A project schedule is provided in Figure 1.

3.0 TECHNOLOGY DESCRIPTION

A fluidized bed consists of a mass of granular particles with an air stream flowing upward through the particles. As the velocity of the air increases to about 3 feet per second, the particles are maintained in a highly turbulent suspended state. The bed in this state is said to be fluidized and, in general, behaves like a fluid.

This fluidized motion permits excellent surface contact between the air and the particles. If a combustible material, such as coal, is introduced into the bed, this mixing will permit almost isothermal conditions and efficient combustion. The operating temperature of the bed is determined by the amount of carbon in the bed, the excess air, and the rate of heat removal from the bed. The temperature range is established by the coal characteristics; the minimum temperature is set by the lowest temperature at which combustion is maintained, and the maximum temperature is set by the ash fusion temperature of the fuel. For Eastern coals, the bed temperature range is 1350°F to 1700°F.

In a general sense, sulfur in coal reacts with oxygen during combustion to form SO₂. In order to control the emission of SO₂, sulfur can be removed from the process by several means, including prior to combustion (coal cleaning), after combustion (flue gas desulfurization), or during combustion (fluidized bed).

In a fluidized bed, sulfur is removed during combustion by adding a sorbent, such as dolomite or limestone, to the bed. Dolomite was the design sorbent for the Tidd PFBC Demonstration Plant. Dolomite, composed primarily of calcium carbonate and magnesium carbonate (CaCO₃ - MgCO₃), when heated, dissociates to form the porous and reactive complex of magnesium oxide-calcium carbonate (MgO - CaCO₃) to react with sulfur dioxide.

At fluidized bed temperatures in the 1350°F to 1700°F range, the reaction of this complex with sulfur dioxide (SO₂) forms an inert magnesium oxide-calcium sulfate complex (MgO CaSO₄). This is expressed chemically as:

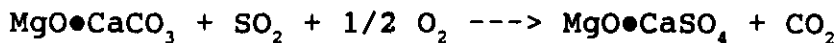
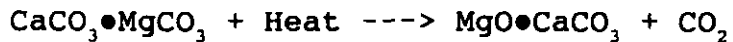

The magnesium oxide-calcium sulfate complex produced in these reactions is a dry granular by-product which, when removed from the bed, can be easily managed.

In addition to reduced SO₂ emissions, NO_x emissions from a fluidized bed are lower than from a conventional pulverized coal boiler. The lower combustion temperature in a fluidized bed minimizes thermal NO_x generation. A conventional pulverized coal fired unit, which operates at combustion temperatures of 3200°F, typically generates NO_x emissions of 0.6 to 0.7 lbm per million BTU; a fluidized bed which has a combustion temperature of typically less than 1600°F generates approximately 0.3 lbm of NO_x per million BTU.

During combustion, the fluidized bed will contain less than 1 percent combustible material. The balance consists of dolomite and inert material (reacted dolomite and ash). Because of this low percentage of combustibles and the low combustion temperature, the fluidized bed can burn a much wider range of fuels than conventional combustion processes. Fuels with very low or high heating value, low or high ash content, low or high sulfur content, and low or high ash fusion temperatures can be burned in a fluidized bed.

Boiler tubes submerged in a fluidized bed are used to generate steam to drive a steam turbine-generator. Because of the turbulent nature of the bed particles, overall heat transfer rates 4 to 5 times greater than in a conventional furnace are achieved in these tubes. Therefore, the total amount of boiler surface is significantly reduced compared with a conventional boiler, resulting in capital cost savings.

Fluidized beds can be operated under various conditions, the most distinguishing of which is pressure. Combustion in fluidized beds operating at pressures of about one atmosphere or less are referred to as Atmospheric Fluidized Bed Combustion (AFBC).

J F M A M J J A S O N D J F M A M J J A S O N D J F M A M J J A S O N D J F M A M J J A S O N D J F M A M J J A S O N D

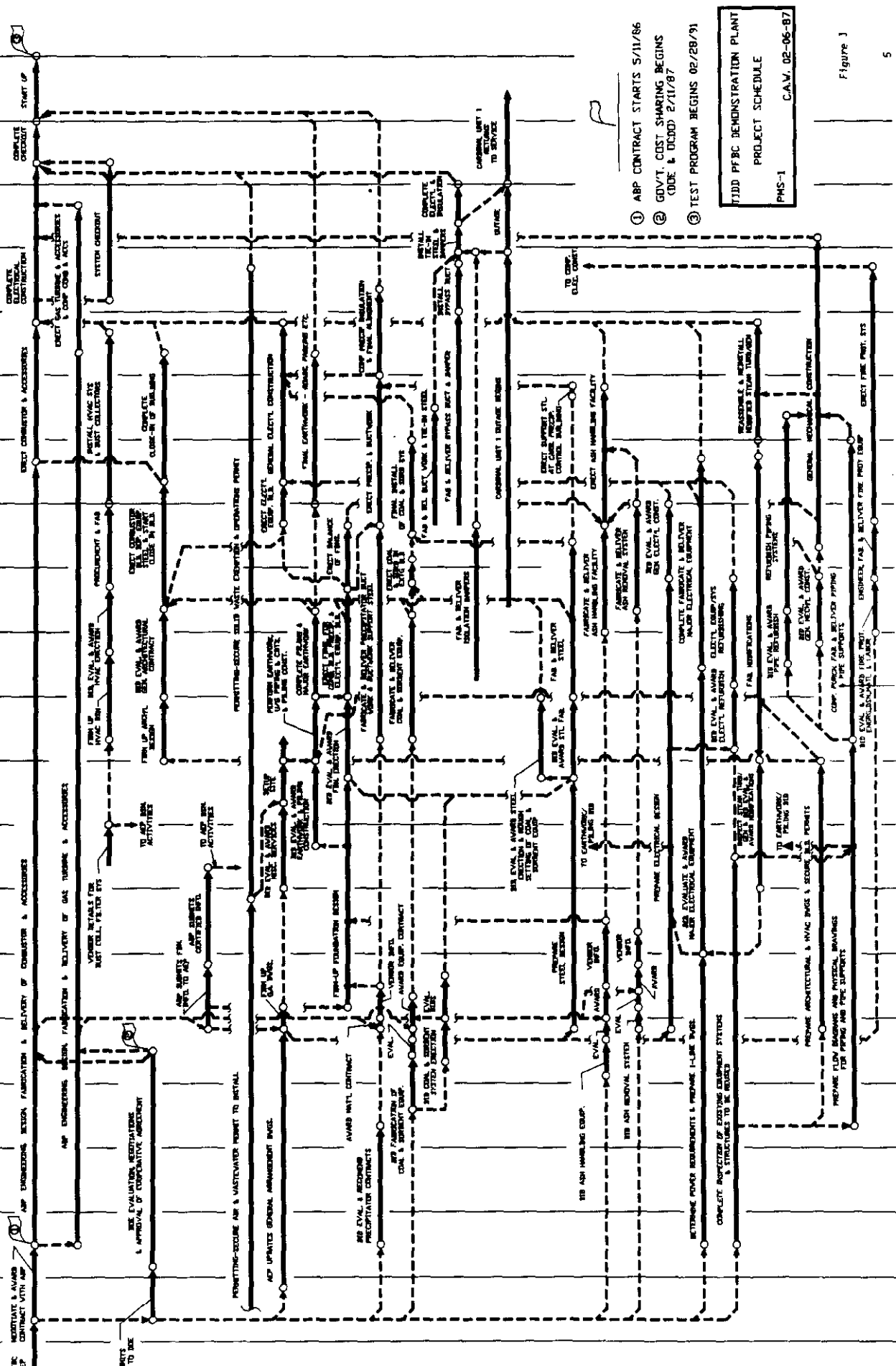

- ① ABP CONTRACT STARTS 5/11/86
- ② GOVT. COST SHARING BEGINS (OOE & ODD) 2/11/87
- ③ TEST PROGRAM BEGINS 02/28/91

T100 PFBC DEMONSTRATION PLANT
 PROJECT SCHEDULE
 PMS-1
 C.A.V. 02-06-87

Figure J

Fluidized bed combustion at much higher pressures is referred to as Pressurized Fluidized Bed Combustion (PFBC). At Tidd, PFBC is achieved by incorporating the fluidized bed within a pressure vessel. A compressor supplies the combustion and fluidizing air.

Because of the higher pressure, the exhaust gases from a PFBC have sufficient energy to drive a gas turbine while the steam generated in the in-bed boiler tubes drives a steam turbine. This combined cycle configuration allows a power plant design which is more economic and efficient than alternatives.

In PFBC, the higher operating pressure allows for the use of deep beds which result in a long residence time that yields high combustion efficiency and 90 percent sulfur removal with a calcium-to-sulfur molar ratio of 1.6. A PFBC power plant will permit burning a wide range of coals in an environmentally compatible manner. Intimate contact of the coal and dolomite enables a consistent, high degree of sulfur removal during combustion. Relatively low combustion temperatures result in low NO_x emissions. The waste products, both fly ash and bed ash, are dry, benign, and manageable. The high pressure and high in-bed heat transfer allow a reduction in plant size with corresponding material savings. The combined-cycle operation results in high generating efficiency.

4.0 PLANT DESCRIPTION

4.1 Site Description

The 70 MWe Tidd PFBC Demonstration Plant is located at the Ohio Power Company Tidd Plant on the Ohio River in Brilliant, Ohio. The PFBC module repowered Tidd Unit 1, a 110 MWe steam plant.

The Tidd Plant is a two-unit plant; each unit is rated at 110 MWe. Tidd Unit 1 was commissioned in September, 1945, deactivated in 1976, and retired in 1979. The plant was retired because it was not cost effective to retrofit the plant with electrostatic precipitators necessary to achieve U.S. Environmental Protection Agency particulate emission standards.

The Tidd Plant offered an ideal site for the PFBC Demonstration Plant for the following reasons:

- Existing plant equipment such as coal handling systems, plant services, and high voltage connection to the existing 138 KV switchyard could be utilized.

- The demonstration plant could be erected and placed in service in much less time than if a Greenfield site was selected.
- Cost savings could be realized in developing the combined cycle aspect of PFBC by utilizing the Unit 1 existing steam turbine-generator, condenser, and feedwater system.
- The open space adjacent to Unit 1 provided an unobstructed location for the PFBC plant.
- The site is adjacent to the Ohio River which is conducive to barge shipment of large modular pieces to the site.

The plant is located at Ohio River mile 76.6 measured downstream from Pittsburgh, Pennsylvania, in the section of the river named the Pike Island Pool. At this point, the flood plain is approximately 1500 feet wide. The site is bound on the north by a main line of the Norfolk and Western Railroad. The major road is nearby Ohio Route 7. The area is occupied primarily by industrial and power generation facilities: Cardinal Plant and Tidd Plant.

The normal river pool elevation is 644 feet and the ordinary high water is elevation 647.3 feet. The 1936 flood water level was at elevation 671.5 feet, the highest water level established for the site. The existing Tidd Power Plant grade elevation is 675 feet, equal to the final grade of the new plant. The new plant components are located in the area immediately north of the existing Tidd Plant.

4.2 Plant Layout

The new PFBC island, including the combustor and auxiliary systems, the gas turbine, and the coal and sorbent preparation and injection systems, are located in a new "combustor building" north of and adjoining the existing Tidd Unit 1 (See Figure 2). The economizer, precipitator, electrical equipment building, and ash silos are constructed west and north of this building. The majority of the remaining balance-of-plant (BOP) components are located in the existing Tidd Unit 1 building.

The close proximity of the Tidd Plant to the Cardinal complex affords the opportunity to share certain auxiliary systems and services with this complex. These include final disposal of waste water and dry ashes, the Cardinal 1 flue gas stack, and other facility support services such as potable water, filtered water, fire protection water, sewage treatment, guardhouse, and truck scales.

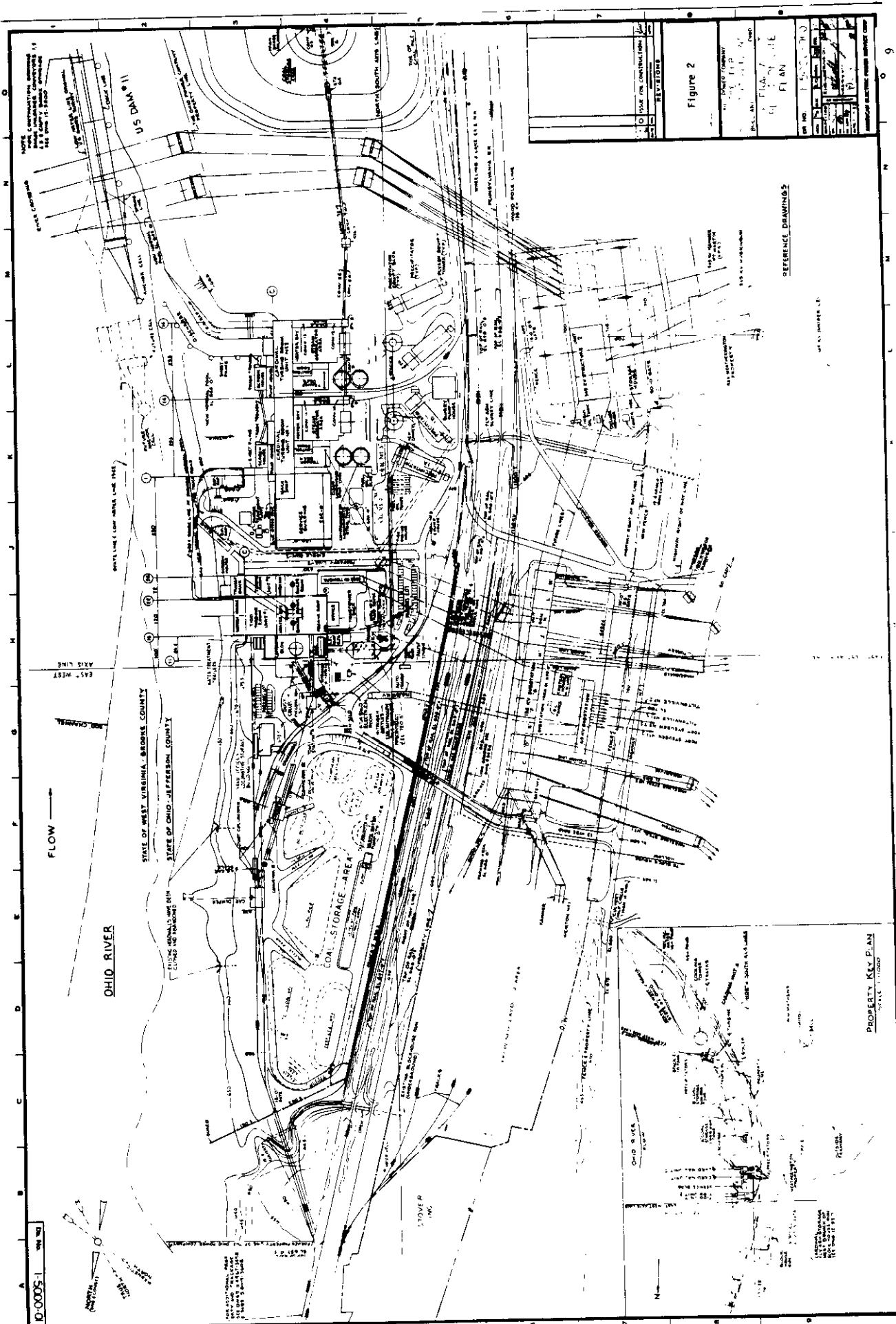

10-0005-1 1000 FT



OHIO RIVER

STATE OF WEST VIRGINIA - BERKLEY COUNTY
STATE OF OHIO - JEFFERSON COUNTY

645 WEST ARS LINE

645 WEST ARS LINE

COAL STORAGE AREA

PROPERTY KEY PLAN
SCALE: 1"=1000'

Figure 2

REFERENCE DRAWINGS

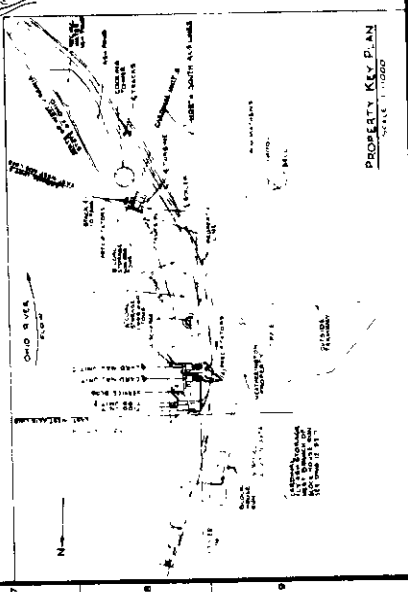

4.3 Cycle Description

4.3.1 Cycle Configuration

Figure 3 provides a composite cycle schematic which identifies how the PFBC island will be incorporated into the existing Tidd Unit 1 conventional steam cycle. The Tidd Unit 1 steam cycle is a 1940's vintage cycle, with original steam conditions of 900,000 #/hr steam flow at 1300 psia and 925°F with no reheat, which produced an electrical output of 110 MW at a cycle efficiency of 31%. As configured for PFBC operation, the plant has a steam flow of 439,560 #/hr at 1300 psia and 925°F, which will produce a gross electrical output of 57 MWe from the steam turbine and 17 MWe from the gas turbine with a net cycle efficiency of 34%. Table 1 provides the full load process values.

4.3.2 Air-Gas Cycle

Ambient air enters the low pressure compressor section of the gas turbine and is compressed to 56 psia. The compressed air is then cooled by condensate in the gas turbine intercooler. The air then enters the high pressure compressor where it is further compressed to 177 psia and 572°F.

The hot compressed air is then directed through the outer annulus of a coaxial air/gas pipe and then into the pressure vessel. Once inside the pressure vessel, the hot air is routed through a series of internal cyclone ash coolers where the air is further heated before it is directed into the fluidized bed via a system of sparger ducts.

In the fluidized bed, coal/water paste (25% nominal water content by weight) is burned at a temperature of 1580°F. The sorbent is injected into the bed via a pneumatic transport system. For the 3.4% sulfur Pittsburgh #8 design coal and 90% sulfur retention, the projected calcium/sulfur molar ratio is 1.6 when using dolomite as the sorbent.

After leaving the fluidized bed zone, the hot gases and entrained ash particles enter the freeboard zone where the excess air content is controlled to about 25%. The hot gases and entrained ash then pass into seven parallel sets of cyclones, each with two cyclones in series. The cyclones are designed to remove 98% of the entrained ash from the gas stream. The gas is cleaned sufficiently to pass through the gas turbine without deleterious erosion of the gas turbine components.

TABLE 1
DESIGN PROCESS VALUES
(FULL LOAD)

Feedwater/Steam Cycle

Feedwater Flow	424,110 lb/hr
Economizer Inlet Temperature	299°F
Final Feedwater Temperature	478°F
Final Feedwater Pressure	1880 psig
Main Steam Flow	439,560 lb/hr
Main Steam Temperature	925°F
Main Steam Pressure	1350 psig
Steam Turbine Output	56,757 kwg

Air/Gas Cycle

LP Compressor Outlet Pressure	71 psig
LP Compressor Outlet Temperature	326°F
HP Compressor Outlet Pressure	192 psig
HP Compressor Outlet Temperature	572°F
Air Flow	646,000 lb/hr
Bed Temperature	1580°F
HP Turbine Inlet Pressure	165 psig
HP Turbine Inlet Temperature	1525°F
LP Turbine Inlet Pressure	47 psig
LP Turbine Inlet Temperature	986°F
Economizer Inlet Temperature	766°F
Economizer Outlet Temperature	350°F
Gas Flow	724,100 lb/hr
Excess Air	25%
Gas Turbine Output	16,900 kwg

Solids

Coal Flow (Dry)	57,300 lb/hr
Coal Water Paste Flow	72,620 lb/hr
Sorbent Flow ⁽¹⁾	27,760 lb/hr
Bed Height ⁽²⁾	126 in
Cyclone Ash Flow	13,690 lb/hr
Bed Ash Flow	9,820 lb/hr

NOTES:

- (1) At calcium to sulfur molar ratio of 1.64 for 90% sulfur retention.
- (2) Bed height was increased to 144" in December, 1991.

GENERAL NOTES

- LEGEND**
- GAS
 - WATER
 - STEAM
 - AIR
 - VACUUM
 - VAPOR
 - LIQUID
 - HEAVY LIQUID
 - MOUNTAIN
- NOTES**
- 1) FOR STANDARD SYMBOLS, REFER TO GENERAL NOTES, PART 1 OF THIS DRAWING.
 - 2) ALL VALVES ARE FOR STEAM UNLESS OTHERWISE NOTED.
 - 3) ALL VALVES ARE FOR STEAM UNLESS OTHERWISE NOTED.
 - 4) MOTOR DRIVEN VALVES ARE INDICATED BY THE LETTER 'M'.
 - 5) ALL VALVES ARE FOR STEAM UNLESS OTHERWISE NOTED.
 - 6) ALL VALVES ARE FOR STEAM UNLESS OTHERWISE NOTED.
 - 7) EQUIPMENT LOCATIONS ON THIS DRAWING ARE INDICATED BY ELEVATIONS.
 - 8) ALL VALVES ARE FOR STEAM UNLESS OTHERWISE NOTED.
 - 9) ALL VALVES ARE FOR STEAM UNLESS OTHERWISE NOTED.

1) FOR STANDARD SYMBOLS, REFER TO GENERAL NOTES, PART 1 OF THIS DRAWING.

2) ALL VALVES ARE FOR STEAM UNLESS OTHERWISE NOTED.

3) ALL VALVES ARE FOR STEAM UNLESS OTHERWISE NOTED.

4) MOTOR DRIVEN VALVES ARE INDICATED BY THE LETTER 'M'.

5) ALL VALVES ARE FOR STEAM UNLESS OTHERWISE NOTED.

6) ALL VALVES ARE FOR STEAM UNLESS OTHERWISE NOTED.

7) EQUIPMENT LOCATIONS ON THIS DRAWING ARE INDICATED BY ELEVATIONS.

8) ALL VALVES ARE FOR STEAM UNLESS OTHERWISE NOTED.

9) ALL VALVES ARE FOR STEAM UNLESS OTHERWISE NOTED.

1) FOR STANDARD SYMBOLS, REFER TO GENERAL NOTES, PART 1 OF THIS DRAWING.

2) ALL VALVES ARE FOR STEAM UNLESS OTHERWISE NOTED.

3) ALL VALVES ARE FOR STEAM UNLESS OTHERWISE NOTED.

4) MOTOR DRIVEN VALVES ARE INDICATED BY THE LETTER 'M'.

5) ALL VALVES ARE FOR STEAM UNLESS OTHERWISE NOTED.

6) ALL VALVES ARE FOR STEAM UNLESS OTHERWISE NOTED.

7) EQUIPMENT LOCATIONS ON THIS DRAWING ARE INDICATED BY ELEVATIONS.

8) ALL VALVES ARE FOR STEAM UNLESS OTHERWISE NOTED.

9) ALL VALVES ARE FOR STEAM UNLESS OTHERWISE NOTED.

1) FOR STANDARD SYMBOLS, REFER TO GENERAL NOTES, PART 1 OF THIS DRAWING.

2) ALL VALVES ARE FOR STEAM UNLESS OTHERWISE NOTED.

3) ALL VALVES ARE FOR STEAM UNLESS OTHERWISE NOTED.

4) MOTOR DRIVEN VALVES ARE INDICATED BY THE LETTER 'M'.

5) ALL VALVES ARE FOR STEAM UNLESS OTHERWISE NOTED.

6) ALL VALVES ARE FOR STEAM UNLESS OTHERWISE NOTED.

7) EQUIPMENT LOCATIONS ON THIS DRAWING ARE INDICATED BY ELEVATIONS.

8) ALL VALVES ARE FOR STEAM UNLESS OTHERWISE NOTED.

9) ALL VALVES ARE FOR STEAM UNLESS OTHERWISE NOTED.

1) FOR STANDARD SYMBOLS, REFER TO GENERAL NOTES, PART 1 OF THIS DRAWING.

2) ALL VALVES ARE FOR STEAM UNLESS OTHERWISE NOTED.

3) ALL VALVES ARE FOR STEAM UNLESS OTHERWISE NOTED.

4) MOTOR DRIVEN VALVES ARE INDICATED BY THE LETTER 'M'.

5) ALL VALVES ARE FOR STEAM UNLESS OTHERWISE NOTED.

6) ALL VALVES ARE FOR STEAM UNLESS OTHERWISE NOTED.

7) EQUIPMENT LOCATIONS ON THIS DRAWING ARE INDICATED BY ELEVATIONS.

8) ALL VALVES ARE FOR STEAM UNLESS OTHERWISE NOTED.

9) ALL VALVES ARE FOR STEAM UNLESS OTHERWISE NOTED.

Figure 3

DESIGNATION PLANT

FLOW DIAGRAM

COMPOSITE CYCLE

DATE: 1-31-60-09-0

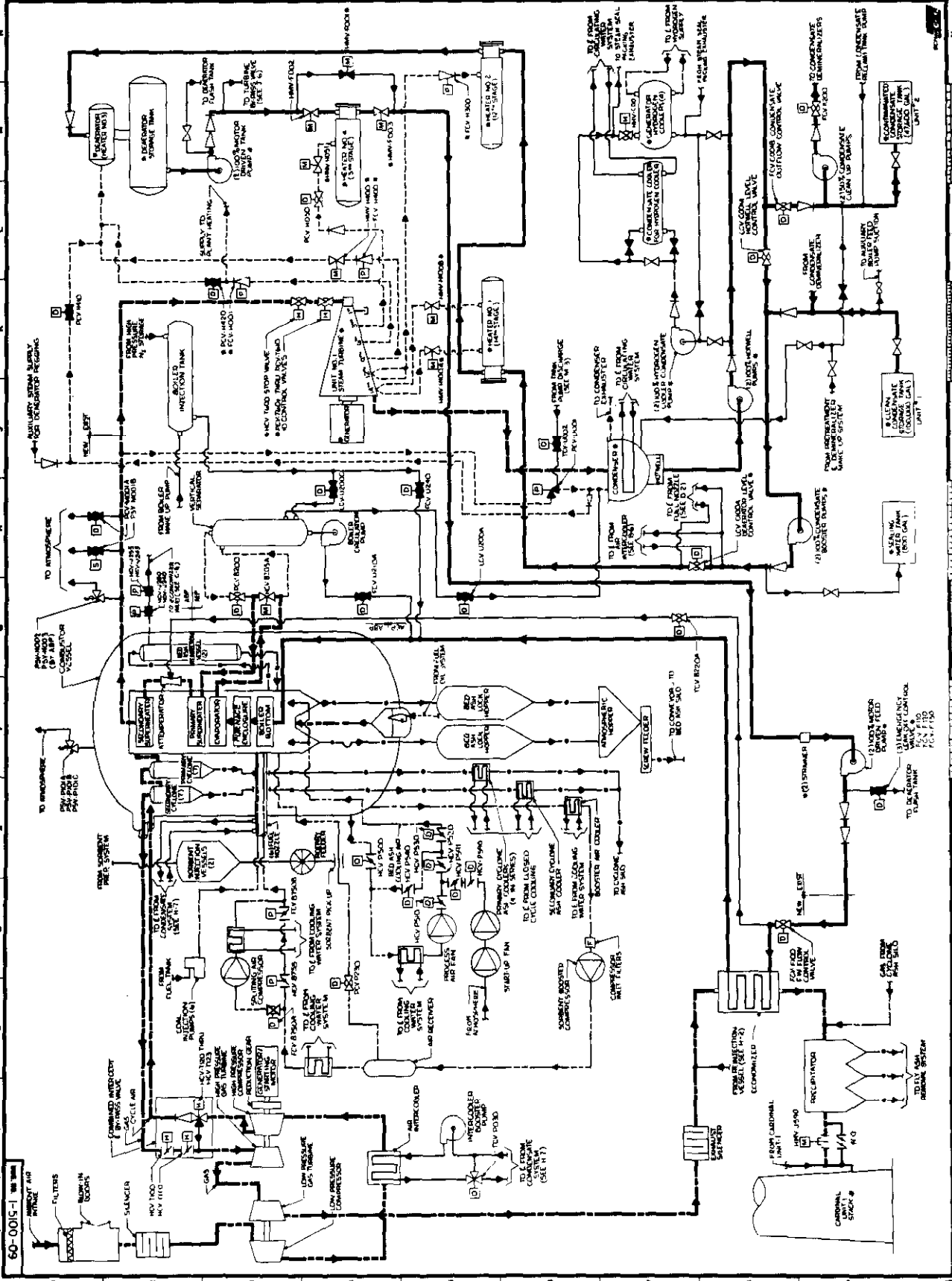

After exiting the cyclones, the gas is collected in a manifold and exits the pressure vessel at 153 psia. The gas is directed thru the inner pipe of the coaxial pipe, past the hot gas intercept valves and into the high pressure gas turbine at 1525°F and 149 psia.

There the hot gases are expanded through the high pressure turbine. The gas then enters the low pressure turbine where it is further expanded and is cooled to 350°F in the turbine exhaust gas economizer.

After the economizer, the gas enters the electrostatic precipitator where it is further cleaned to meet the New Source Performance Standards (NSPS) of 0.03 lbm/million BTU before being emitted to the atmosphere via the Cardinal Unit 1 flue gas stack.

4.3.3 Steam Cycle

The steam cycle is a Rankine cycle with a once through Benson type boiler. Condensate from the condenser is heated from 74°F to 259°F in three stages of low pressure heaters and the gas turbine intercooler as it is pumped to the deaerator by the hotwell and condensate booster pumps. From the deaerator, the feedwater is pressurized by the tank pumps to 817 psia and further heated to 295°F by the single high pressure heater before being fed to the suction of the feedwater pump. The flow is further pressurized to 2038 psia by the feedwater pump and directed to the economizer where heat in the gas exiting the gas turbine further preheats the feedwater to 478°F. From there the subcooled feedwater is routed to the pressure vessel and enters the boiler at 478°F and 1865 psia.

The feedwater enters the boiler bottom which is comprised of the walls of the two ash hoppers. After passing through the boiler bottom, fluidized bed and freeboard wall enclosures, it enters the in-bed evaporator surface where boiling occurs. Steam, which is two phase up to about 40% load and slightly superheated at full load, is conveyed to the vertical separator. At lower loads, the water from the separator is recirculated through the boiling surfaces with the assistance of a circulating pump. The steam from the separator then enters the in-bed primary superheater. From the primary superheater outlet, spray attemperation is used to control final steam temperature exiting the boiler. From the attemperator, steam is directed to the in-bed secondary superheater and then exits the boiler at 1335 psia and 925°F.

During start-up and in the event of a steam turbine trip, a 50% bypass system to the condenser and a pressure control valve to atmosphere serve to dispose of the excess steam while controlling

the boiler pressure/temperature decay and preserving as much of the treated water as practical. In the event of a loss of plant power or loss of the boiler feed pump during operation, a backup feedwater system is also provided to maintain water flow to the boiler circuits exposed to the heat contained in the slumped bed.

5.0 PLANT SYSTEMS

5.1 Combustor Assembly

The combustor assembly, shown in Figure 4, is the heart of the combined cycle system. It generates the hot gases to drive the gas turbine and the steam to drive the steam turbine. The combustor assembly contains the boiler, cyclones, cyclone ash coolers and bed ash reinjection vessels within a single cylindrical pressure vessel. This arrangement allows the components within it to be designed for a relatively low differential pressure even though the process pressure is relatively high in absolute terms.

The pressure vessel, which is externally insulated, is designed for internal operating conditions of 572°F at 168 psig. It consists of a vertical cylindrical shell approximately 44 feet in diameter with elliptical heads. The overall vessel height is approximately 70 feet. The vessel heads include removable service openings which allow for the removal of internal components. In addition, internal and external service platforms, lifting devices, and access doors are provided to permit maintenance and service of both internal and external systems.

5.1.1 Boiler

The PFBC boiler contains the combustion process and absorbs the heat necessary to generate steam and control bed temperature while maintaining the required gas temperature to the gas turbine.

The boiler enclosure is designed with membraned water wall construction. It is comprised of three major sections: the boiler bottom, the bed zone, and the freeboard.

The boiler bottom consists of fluidizing air ducts arranged on top of a pair of membraned water wall hoppers. The fluidizing air ducts direct the majority of the combustion air for fluidization of the bed material. The hoppers, which remain full of ash during operation, act to direct the spent bed ash to the bed ash removal system. The bed ash is cooled from bed temperature down to approximately 180°F by a portion of the combustion air. The cooling air is drawn off the combustor

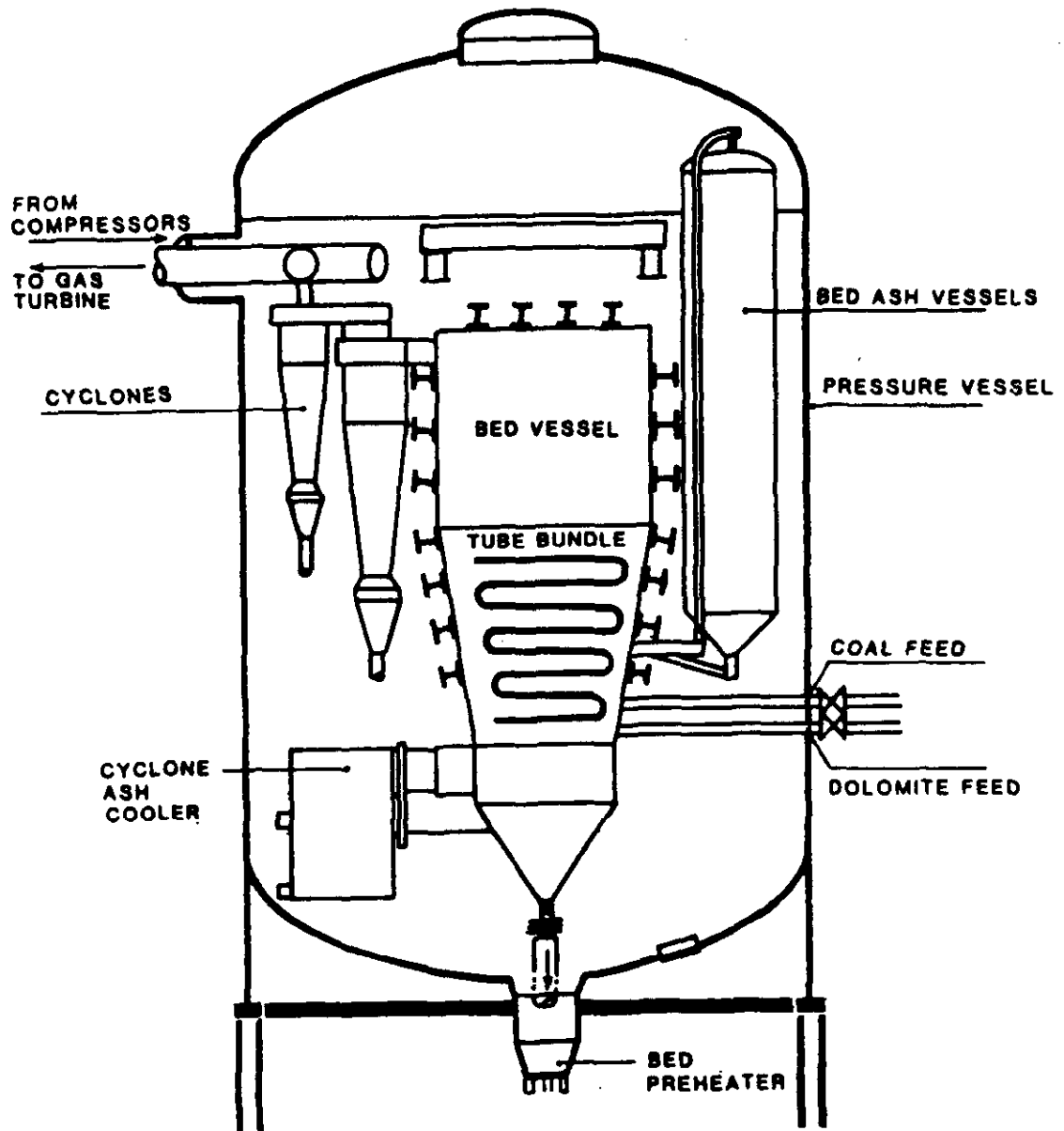

**PFBC TIDD DEMONSTRATION PLANT
COMBUSTOR VESSEL ASSEMBLY**

Figure 4

pressure vessel, cooled and readmitted through the vessel into proprietary bed ash cooling components located in the boiler bottom hoppers. The heat removed from the ash is recovered in the combustion air.

The bed zone is designed as a 10.5 ft deep tapered fluidized bed in which the superheater and evaporator sections are submerged. The coal is burned in the presence of sorbent within the bed zone at 1580°F. At full load, all of the evaporator and superheater surface is submerged within the fluidized bed. At reduced loads, the bed level is lower, thereby exposing portions of the evaporator and superheater surface. The surface above the bed acts to convectively cool the gases to the gas turbine, as well as reduce heat transfer to the steam side, since the convective heat transfer rates are significantly lower than those within the fluidized bed.

The boiler freeboard is sized to minimize elutriation of fly ash by the gas flow. It is internally insulated to reduce gas heat loss on the way to the gas turbine.

The boiler steam side circuitry is schematically depicted in Figure 5. The circuitry is arranged in the following order of flow: (1) enclosure, (2) evaporator, (3) moisture separator, (4) primary superheater, (5) attemperator and (6) secondary superheater. At normal operating loads, the boiler is a sub-critical once-through unit, with the moisture separator receiving dry steam. During start-up, shutdown, or any load below 40%, a circulation pump with suction from the bottom of the moisture separator acts to operate the boiler in a forced circulation mode.

5.1.2 Cyclones

The gas leaving the boiler will pass through two stages of cyclone separation. The cyclones reduce the particulate loading of the gas flow to preclude erosion of the gas turbine. The cyclones are arranged in seven parallel strings, with two stages per string.

The gas is conveyed from the upper part of the boiler freeboard to the first stage cyclones through connecting flues. The gas flows from the first stage cyclones to the second stage cyclones and into a common gas collecting pipe which discharges into the center portion of the coaxial pipe going to the gas turbine. The cyclones and gas collecting pipe are insulated to minimize gas temperature losses.

See Section 5.7.1 for an explanation of the cyclone ash removal system.

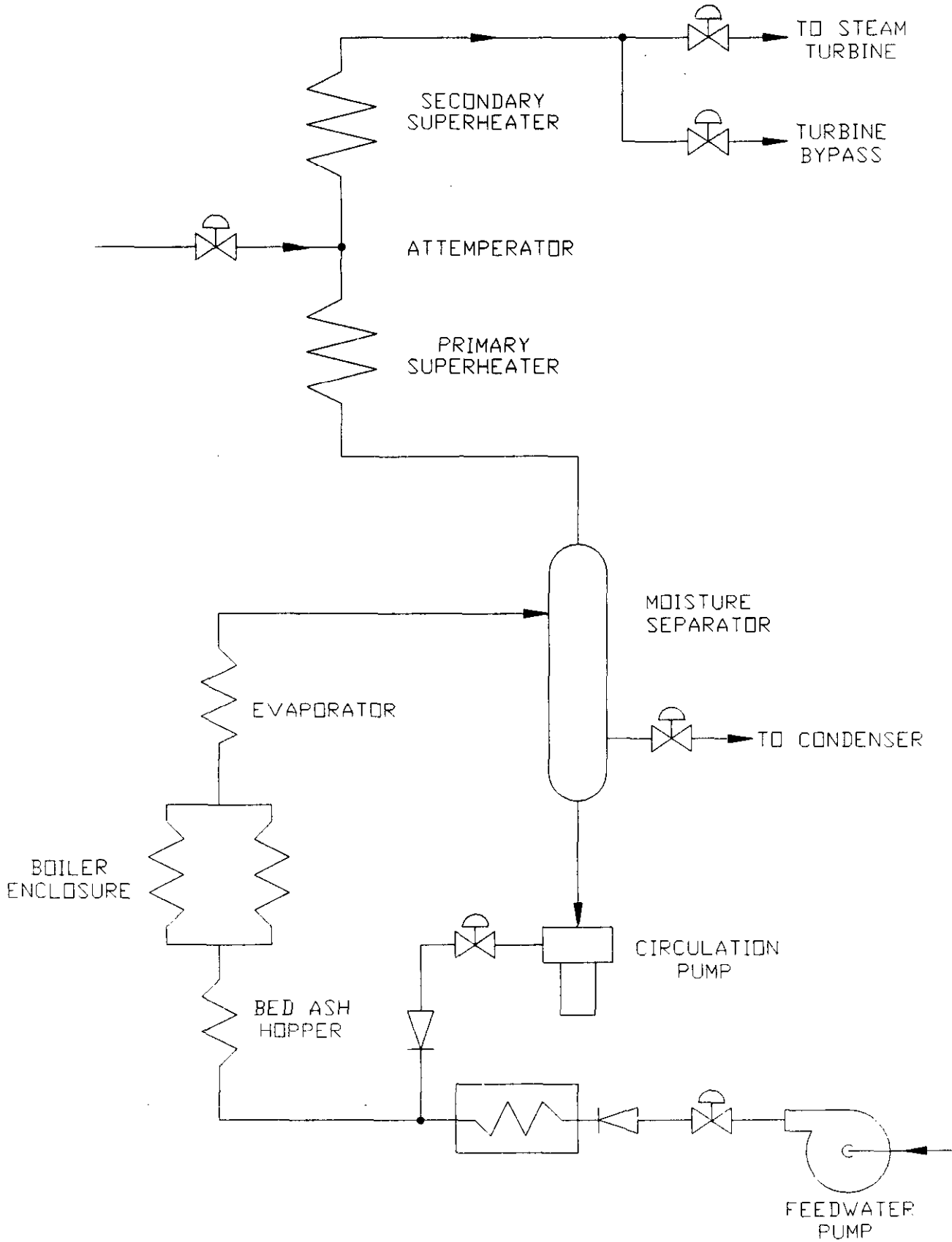

TIDD PFBC BOILER CIRCULATION SCHEMATIC
 Figure 5

5.1.3 Bed Ash Reinjection

Bed level is the primary load controlling parameter in the PFBC boiler. The Bed Ash Reinjection System permits rapid unit load change by transferring bed material to and from a pair of reinjection vessels located inside the combustor pressure vessel. A schematic of the system is shown in Figure 6.

To increase load, bed material stored in the reinjection vessels is admitted into the bed by means of an L-valve, an L-shaped material handling device which permits a uniform, high flow rate of material when compressed air is admitted at the bend in the valve and plugs to stop material flow when the air flow is stopped.

To decrease load, bed material is pneumatically transported from the bed to the reinjection vessels. Air from the combustor pressure vessel serves as the transport medium. The transport air flow is separated from the ash and vented outside the combustor into the main combustion gas flue. The reinjection vessels are normally at the same pressure as the boiler; however, during load decreases, they are at a slightly lower pressure.

The system is sized to store 103,000 lbs of bed ash, which is approximately 70 percent of the full load fluidized bed material and admit/remove bed ash to/from the boiler to change unit load at rates up to two percent of full load per minute. At start-up, additional bed material to achieve full load is accumulated during unit operation by not running the Bed Ash Removal System.

Bed Material Data

Particle size, inches	0.008 - 0.25
Particle density, lbs/cu ft	162.0
Bulk density, lbs/cu ft	81.0
Specific heat, BTU/lb	0.19 - 0.32

5.1.4 Bed Preheating

The bed preheating system is used during start-up to preheat the bed material to 1200°F, which is the minimum temperature for sustained coal combustion. This is accomplished by directing air flow from the gas turbine compressor through the bed preheating combustor. The air flow ranges from 260,000 lb/hr to 300,000 lb/hr. The bed preheating combustor is designed to burn No. 2 fuel oil with this air to generate combustion gases at 1560°F for warming the start-up bed.

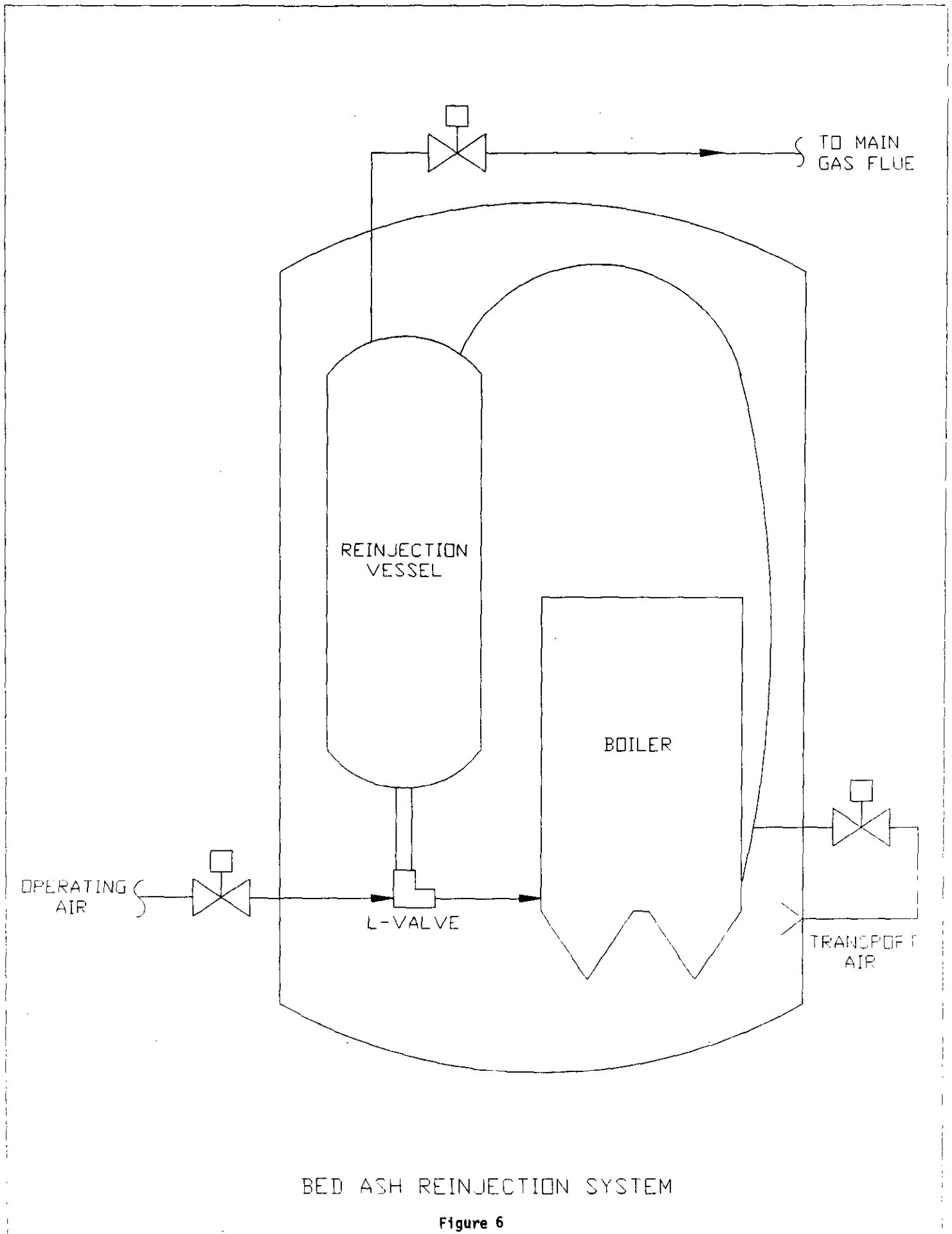

5.1.4.1 Bed Preheating Combustor

The bed preheating combustor incorporates five "spill flow" burners which receive oil flow from a bed preheating fuel oil pump. They are termed spill flow burners since throughout their operating range the oil chambers for the burners receive a constant flow of oil and the amount in excess of that fired is recirculated back to an 80 gallon receiver tank. Burner firing rate is controlled by regulation of the recirculation control valve which varies the fuel oil pressure at the fuel oil chambers, thereby modifying the flow of oil into the burners. Peak burner fuel oil usage will be approximately 13 gpm, which corresponds to the maximum bed preheating combustor heat input of 102 million BTU/hr. The burners are arranged in a pentagon inside the bed preheating combustor. Two of the burners are equipped with spark plugs, which are used to ignite the burners. A single UV flame scanner, located in one of the remaining three burners, is used to monitor the fuel oil ignition process.

5.1.4.2 Receiver Tank

This 80 gallon atmospherically vented tank acts as the fuel supply reservoir for the bed preheating fuel oil pump and as the burner recirculation flow receiver. Make-up flow to the receiver is supplied from the fuel oil supply subsystem.

The recirculation flow inlet to the tank incorporates a deaerator. The tank is vented to the outside through the deaerator. Internal baffling inside the receiver tank forms a separate reservoir for the fuel oil pump suction, thereby isolating the pump suction from return flow disturbances.

5.1.4.3 Fuel Oil Pump

This gear-type positive displacement pump delivers a continuous 28 gpm to the five bed preheating combustor burner oil chambers. Pump discharge pressure is a function of the position of the recirculation control valve, but is limited to 725 psig by a relief valve.

5.2 Gas Turbine/Generator

The GT-35P gas turbine/generator set is a modified ABB Carbon AB GT-35 for PFBC application. It is matched thermally to the P200 combustor.

SCHEMATIC ARRANGEMENT OF THE GT 35P GAS TURBINE

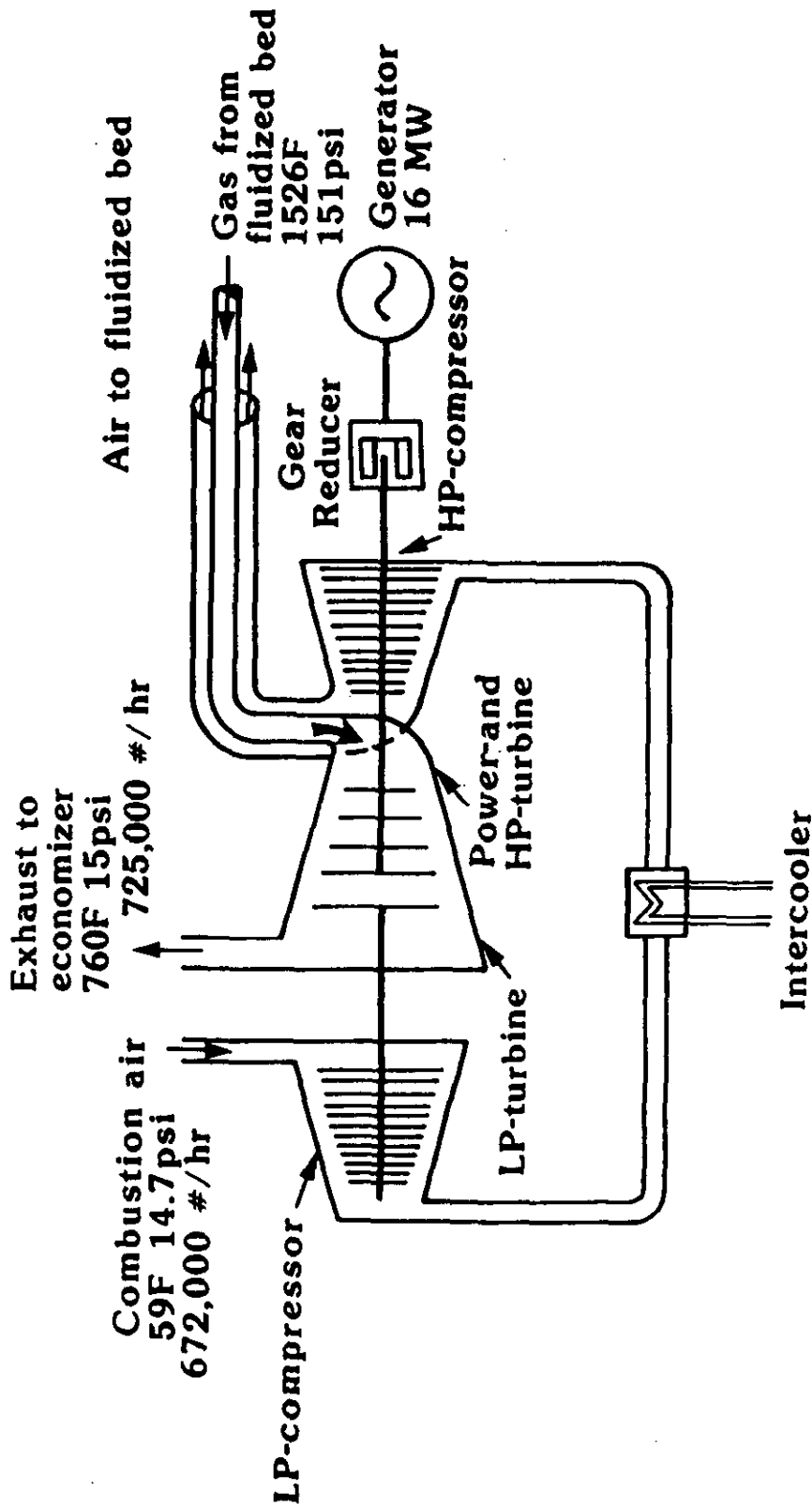

Figure 7

The major GT-35P gas turbine mechanical components are two compressors, an intercooler, and two gas turbines arranged in a classic Compressor-Intercooler-Compressor-Combustor-Turbine-Turbine (CICBTT) cycle (Figure 7). Air from the low pressure compressor is intercooled before entering the high pressure compressor stages. Intercooling serves to maintain combustion air temperature within required limits, and to increase overall cycle efficiency over the load and ambient air temperature ranges. Compressed air is then supplied to the combustor through the annulus of the coaxial combustor supply/delivery pipes. Gaseous combustion products are transported to the high pressure turbine through the inner coaxial pipe, and expanded through the high pressure and low pressure turbines to near atmospheric pressure at the low pressure turbine exhaust.

The electric generator is a synchronous 4-pole motor/generator with a salient pole type rotor. The stator windings are designed as a 3-phase diamond winding with two coil sides per coil pitch. The brushless exciter has eight poles and wire-wound coils in rotor and stator.

Physically, the rotating gas turbine equipment is arranged in-line on two shafts. The variable speed low pressure compressor is mechanically coupled to its driving low pressure turbine on one shaft. The high pressure turbine drives both the constant speed high pressure compressor, to which it is mechanically coupled, and the electric generator. An epicyclic reduction gear couples the electric generator to the high pressure shaft.

The functions of the gas turbine/generator set can be described in terms of its mechanical function as a PFB combustor system, and its thermodynamic function which contributes to the high efficiency of a PFBC combined cycle:

GT-35P Gas Turbine/Generator

Mechanical Function	Provide compressed air for combustion, for fluidization of a deep bed, and for ash cooling.
Thermodynamic Function	Produce useful work from the expansion of gaseous products of pressurized combustion.

The GT-35P was constructed and delivered in five modules. Modular design not only is an advantage in terms of delivery and installation, but it also contributes to high maintainability, including minimal down time for maintenance.

The two shaft design has considerable operating advantages. As unit load is reduced, for example, by decreasing bed height, combustion gas temperatures are lowered due to heat losses to newly exposed steam generator tubes. Reduced gas temperatures result in a reduction of LP shaft speed, and thus combustion air flow rate and pressure are also lowered. The free-spinning LP shaft thus allows for a less complicated control scheme than would be required for a single shaft machine.

Optimization of the cycle and cycle efficiency is enhanced by the GT-35P's two shaft design. Excess air quantity can be held constant over the entire ambient air temperature range. At partial loads, excess air levels can be optimized. Fluidizing velocity can be held constant over the operating range of the unit.

During start-up, the GT-35P is used to initially pressurize the vessel. In this mode, the electric generator acts as a motor for the HP compressor. Key operating and design parameters are shown in Table 2.

TABLE 2

GT-35P GAS TURBINE/GENERATOR SET
DESIGN AND OPERATING PARAMETERS

Number of Stages	Low Pressure Compressor	11
	Low Pressure Turbine	1
	High Pressure Compressor	12
	High Pressure Turbine	4
Speed	LP Shaft 5364 rpm	
	HP Shaft 6218 rpm	
Inlet Temperature	1526 F	
Pressure Ratio	12:1	
Output	16MWe nominal	
Motor/Generator	Output rating 22.5 MVA @ 13.8 KV, 0.8PF, & 60Hz	
	Rotor	Salient pole type
	Brushless Exciter	Eight poles, wire wound coils in rotor and stator 3-phase diamond winding with two coil sides per coil pitch Air/Water

5.3 Coal Systems

The Tidd PFBC Demonstration Plant utilizes coal/water paste (CWP) fuel which is injected into the fluidized bed. CWP is distinctively different from slurry type coal/water mixtures. Slurries typically have greater than 30% water content and rely upon chemical additives to reduce inter-particle friction and maintain their long-term stability for storage and shipment. CWP is prepared on site, thus shipment, long-term stability, and storage concerns are minimized. Pumpability is the main consideration with CWP, and adequate pumpability is achieved with a 25% water content by the use of a specific coal size distribution which results in virtually no inter-particle motion.

5.3.1 Coal Storage

Coal, delivered by truck, is weighed and sampled prior to placement in the existing storage area. A 30-day supply of coal is maintained in the storage area which has adequate space for storage of two smaller piles of test coals, each with a 7-day supply. Mobile equipment will be used to maintain the storage piles and to reclaim coal from storage.

5.3.2 Coal Conveyors

Coal, from storage, is loaded into existing rotary car dumper hoppers and delivered by a system of existing belt conveyors and transfer stations to three existing bunkers located in the main plant building. The conveyors, with a maximum capacity of 800 tons per hour, are totally enclosed and are provided with dust collection and fire protection systems. Weighing, crushing, screening and magnetic separation equipment are provided in the system. The three bunkers have a total storage capacity of 1350 tons of coal (28 hours at full load) and are filled by a conveyor equipped with a traveling tripper.

A new conveyor system was installed below the existing bunkers to convey coal to the coal preparation system, which is located in the new combustor building. The new conveyor system is equipped with weighing, sampling, magnetic separation and metal detection equipment.

5.3.3 Coal Preparation

Coal preparation, as depicted in Figure 8, involves crushing and mixing of coal with water to develop a coal-water paste (CWP) with a nominal water content of 25% by weight. Uncrushed coal, one inch or less in size, stored in a surge hopper with a storage capacity of 45 tons will be fed into a double roll crusher by a vibratory feeder. Crushed coal, all of which is 6 mm (1/4") or less in size, is transported by a system of conveyors onto a triple deck screen to eliminate undesirable oversized pieces over 10 mm (3/8") and then through a weigh feeder into a pugmill type mixer. Moisture content is measured from the coal on the weigh

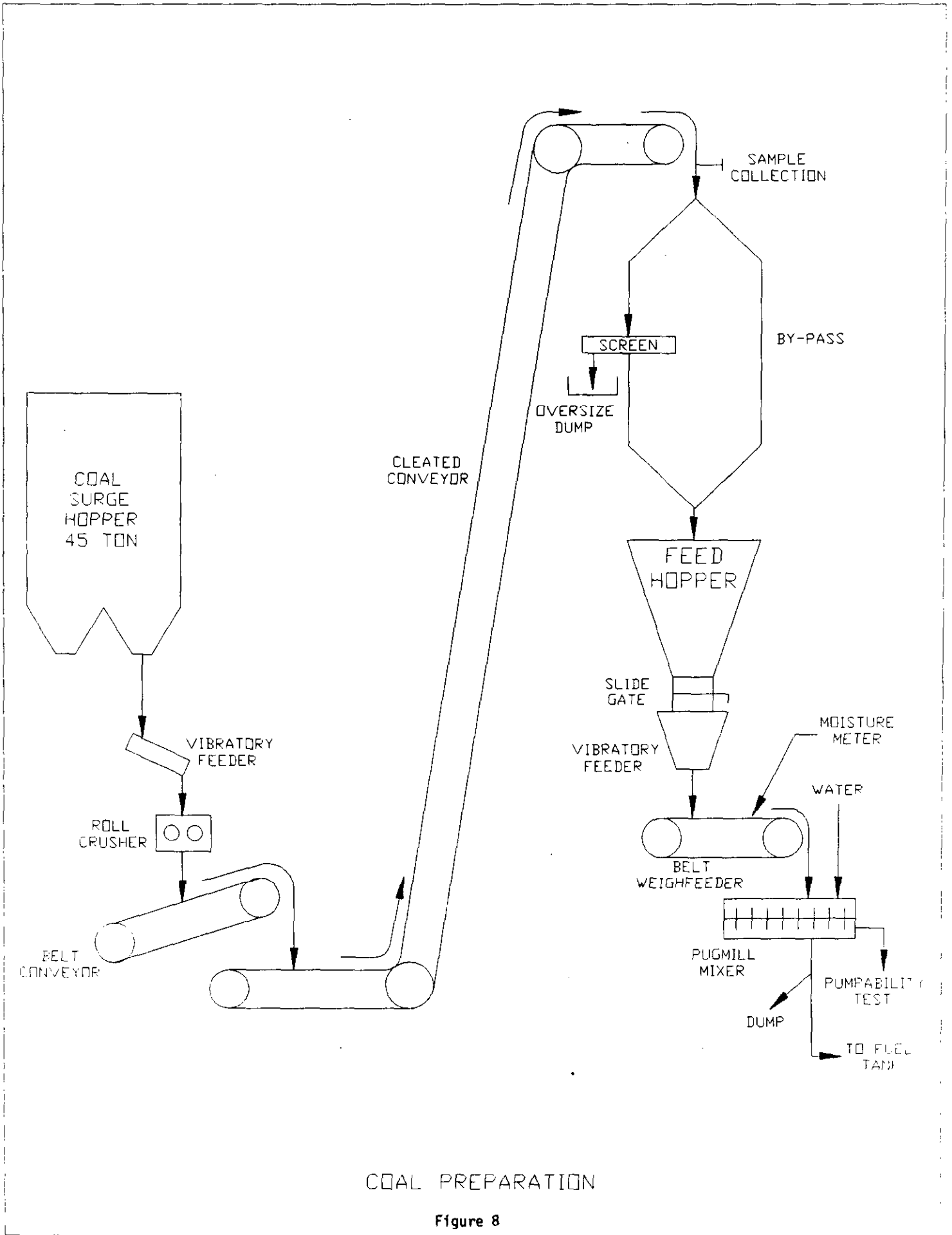

COAL PREPARATION

Figure 8

feeder and an appropriate amount of water is added to the coal in the mixer to prepare the CWP. Samples of paste are taken to determine its pumpability characteristics and unacceptable paste is dumped through a gate into a container. Acceptable paste is delivered directly into a fuel feed hopper that has sufficient capacity for one hour of storage. The fuel feed hopper is provided with agitators to maintain the pumpability characteristics.

5.3.4 Coal Injection

A schematic of the coal injection system is shown in Figure 9. Prepared coal-water paste (CWP) from the coal preparation system is continuously fed into a hopper from which the coal injection pumps draw CWP. The hopper provides a surge volume to compensate for upsets in the preparation system and ensures an even flow of CWP to each of the injection pumps.

The system utilizes six parallel coal injection pumps to deliver the CWP to the boiler. Each pump delivers the fuel flow into the boiler through a dedicated fuel nozzle. The nozzles penetrate the pressure vessel and boiler enclosure walls. High pressure compressed air is used to atomize the CWP at the discharge of the nozzles.

The coal injection pumps are hydraulically operated piston pumps. The fuel flow rate is controlled by varying the speed of the pumps.

5.4 Sorbent Systems

5.4.1 Sorbent Storage

Sorbent (dolomite or limestone) is delivered by truck or by barges and unloaded by a temporary conveying system to the existing coal storage area, separate from the coal piles. A 30-day supply of sorbent is maintained in the storage area which has adequate space for storage of two smaller piles of test sorbents, each with a 7-day supply. Mobile equipment is used to maintain the storage piles and to reclaim sorbent from storage.

5.4.2 Sorbent Conveyors

Sorbent, from storage, is loaded into an existing reclaim hopper, separate from the coal reclaim hoppers and delivered to an existing bunker by the same existing belt conveyors that will be used to convey coal to the existing bunkers. The sorbent bunker has a total storage capacity of 650 tons of sorbent, which is equivalent to 36 hours at full load consumption.

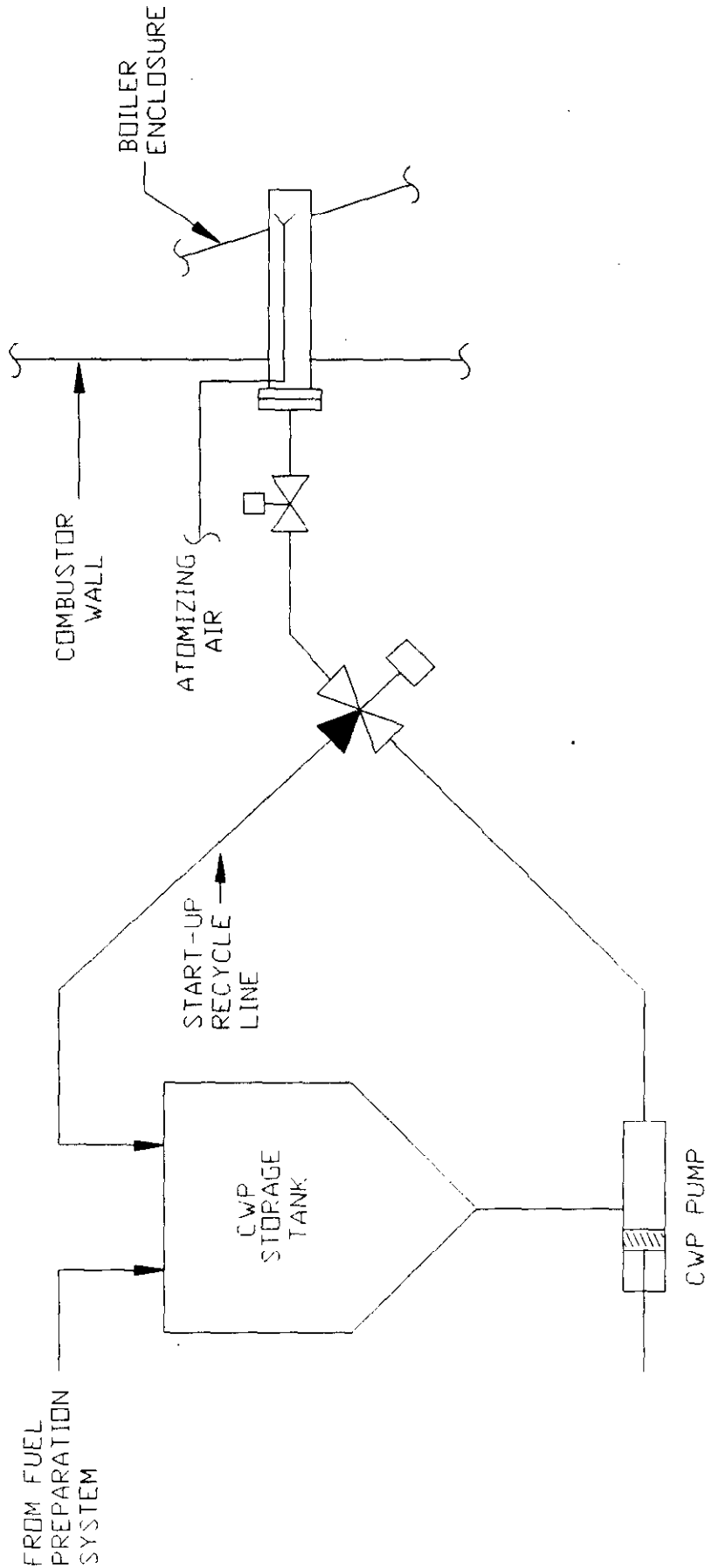

COAL INJECTION SYSTEM

Figure 9

A conveyor system was installed below the sorbent bunker to convey sorbent to the sorbent preparation system, which is located in the new combustor building. The sorbent conveyor system is equipped with weighing, sampling and magnetic separation equipment.

5.4.3 Sorbent Preparation

Sorbent preparation, as depicted in Figure 10, involves crushing and drying of sorbent. Uncrushed 3/4" x 0" sorbent, stored in a surge hopper with a capacity of 70 tons, is fed into an impact dryer mill by a vibratory feeder. The specific size of the sorbent is controlled by a vibratory screen and by controlling the air flow through the mill. The air flow is controlled by adjusting a Venturi or a velocity separator, both located above the mill. The air is heated by an oil-fired air heater prior to entering the mill. The sized material is swept from the mill by the hot air and is separated by a cyclone separator and a baghouse. A vibratory screen, located at the outlet to the cyclone separator, will divert oversized material back to the mill for recycling. The fines from the baghouse are mixed with the final product, but they can also be discharged outside for disposal. The final product is transported by a cleated belt conveyor into a 200 ton sorbent storage hopper which has two outlets to feed the sorbent injection system.

5.4.4 Sorbent Injection System

A schematic of the sorbent injection system is shown in Figure 11. Sorbent is pneumatically conveyed into the boiler from a pair of alternating lockhoppers. The lockhoppers are sequenced so that one is filling and pressurizing while the other is supplying sorbent to the fluidized bed, thus providing an essentially continuous flow of sorbent.

The lockhoppers receive prepared sorbent at atmospheric pressure from the common sorbent storage vessel. When a lockhopper is full, the sliding disk valve above the lockhopper, the ball valve below the lockhopper, and the vent valves are closed. The lockhopper is then pressurized to a higher pressure than the combustor with air from the booster compressor.

The lower isolation valve is then opened, and the sorbent is pneumatically conveyed to the two sorbent injection nozzles in the fluidized bed. The sorbent flow is controlled with variable-speed rotary feeders immediately below the lower isolation valves.

When the lockhopper is empty, it is isolated from the combustor vessel by closing the lower isolation valve, and then depressurized by opening vent valves which divert the air to bag filters. When completely depressurized, the lockhopper is ready to be refilled by opening the upper isolation valve.

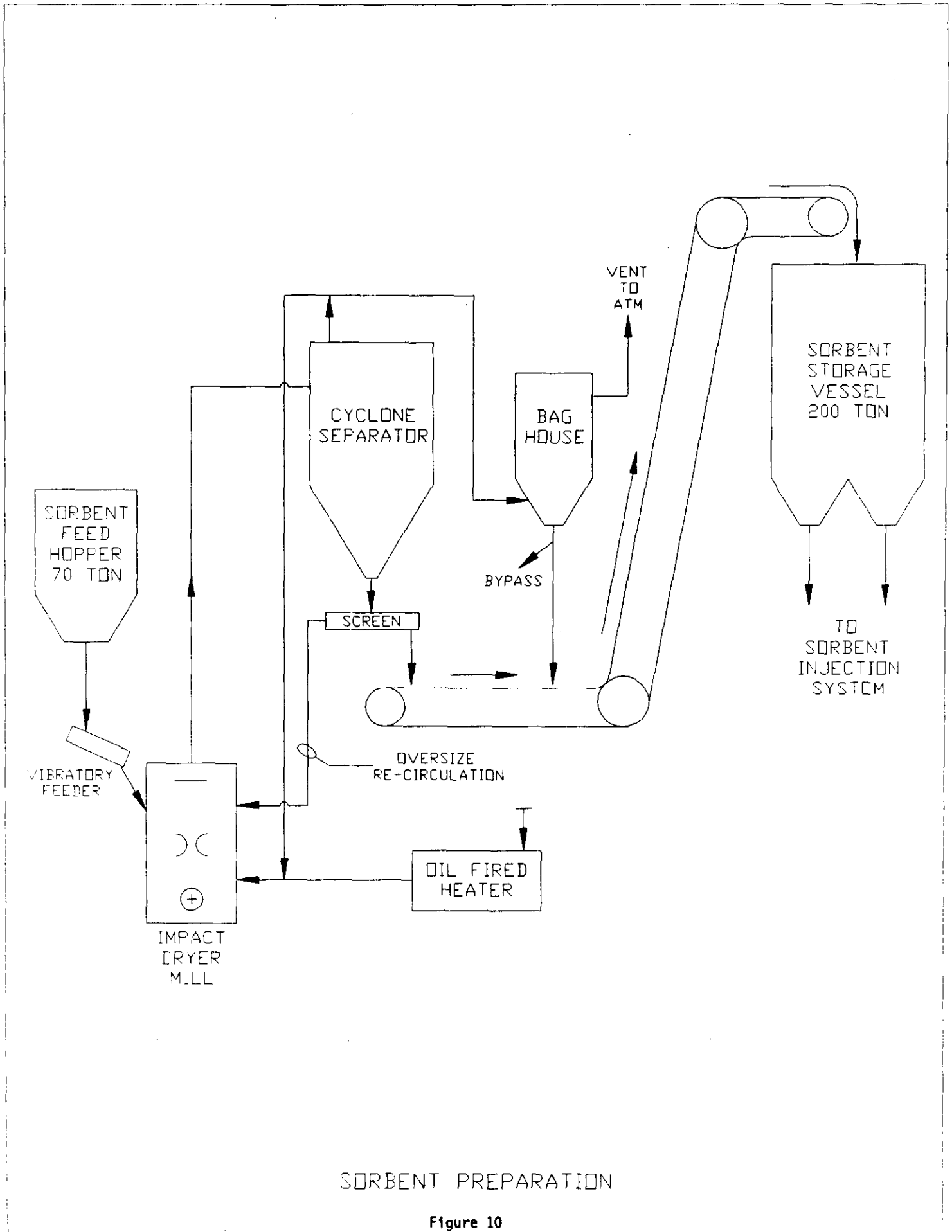

SORBENT PREPARATION

Figure 10

5.5 Economizer

A once through economizer is employed to recover heat from the gas turbine exhaust for preheating of feedwater. The economizer is of a modular design with the flue gas flowing horizontally across vertical in-line spirally finned water tubes.

Under full load design conditions, the economizer will raise the feedwater temperature to 478°F while reducing the gas turbine exhaust gas temperature to 350°F.

5.6 Electrostatic Precipitator (ESP)

The ESP, manufactured by Flakt, Inc., is designed to meet the new source standards for particulate emissions of 0.03 lbm/million BTU and an opacity not to exceed 20%. The ESP is designed for a removal efficiency of 96.5%. Approximately 400 lbm/hr of fly ash will be collected when the unit is operating at full load. The ESP is designed to treat a gas flow of 275,000 acfm at 350°F.

The ESP is located down stream of the economizer and is comprised of a single precipitator casing (see Figure 12). The ESP is approximately 64 feet high including hoppers and support steel, 39 feet wide and 72 feet long. The ESP has four electrical bus sections and four fields configured parallel to the gas flow. The 96.5% removal efficiency can be achieved with any three fields in service. The fourth field is a spare.

The first two fields have collecting plates spaced 11.75 inches apart providing 38 gas passages. The last two fields have collecting plates spaced 15.75 inches apart providing 28 gas passages. The total installed collecting surface is 106,575 sq ft to treat the 275,000 acfm of gas at full unit load. The installed specific collecting area (SCA) is 388 ft²/1000 acfm. Each field is 12.3 feet in length and the design gas velocity is 3.80 fps. The ESP is of European design using a rigid frame, a spiral wire corona electrode system and using an internal tumbling hammer rapping system for the discharge electrodes and collecting plates.

Four transformer rectifier (T/R) sets, one for each field, provide power to the ESP. Two are rated at 55 kV dc for use on the first two fields and two are rated at 80 kV dc for use on the last two fields. Eight hoppers are provided, two rows of four, parallel to gas flow to store the collected particulate for removal by the fly ash removal system (FARS). (See Section 5.7.2).

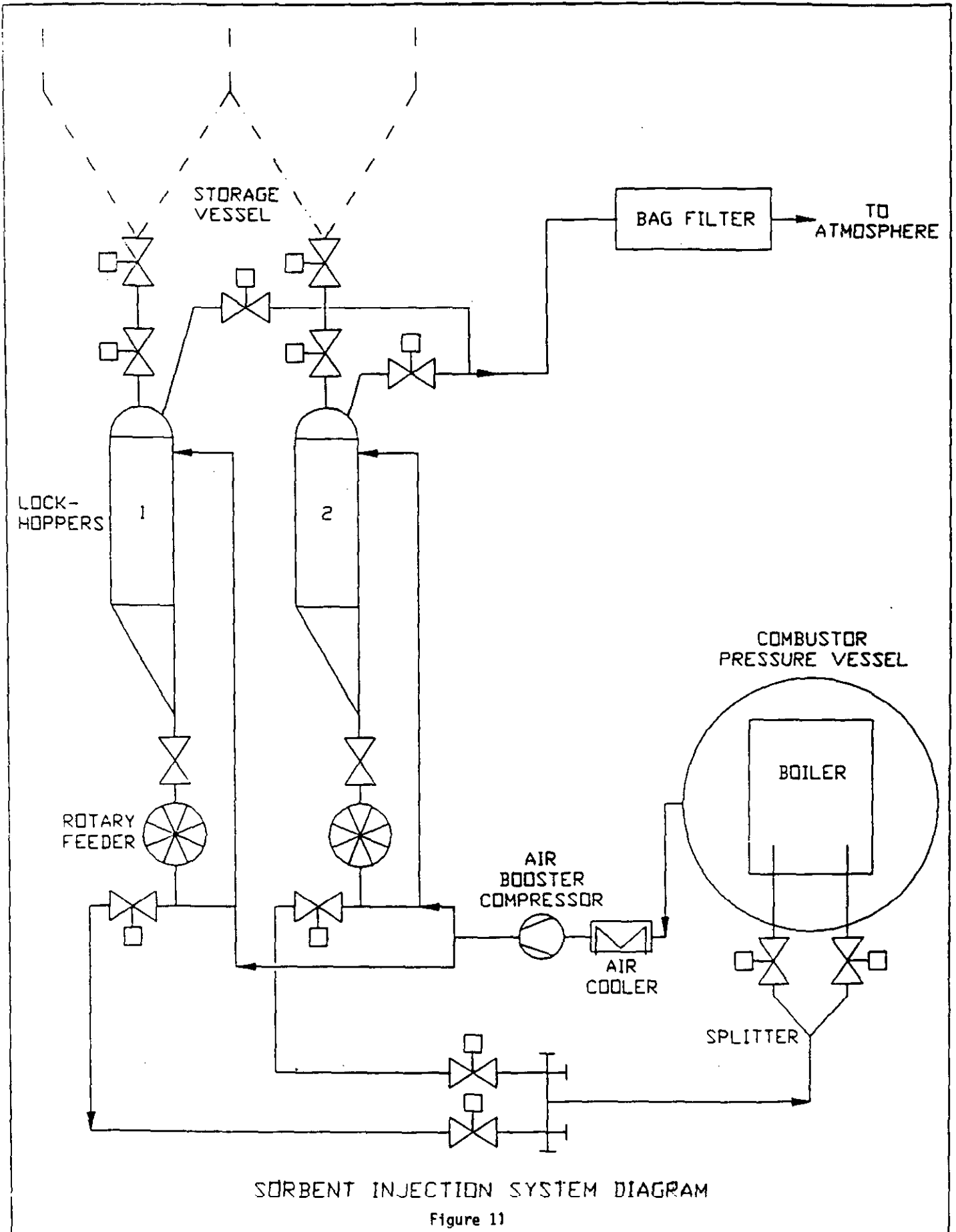

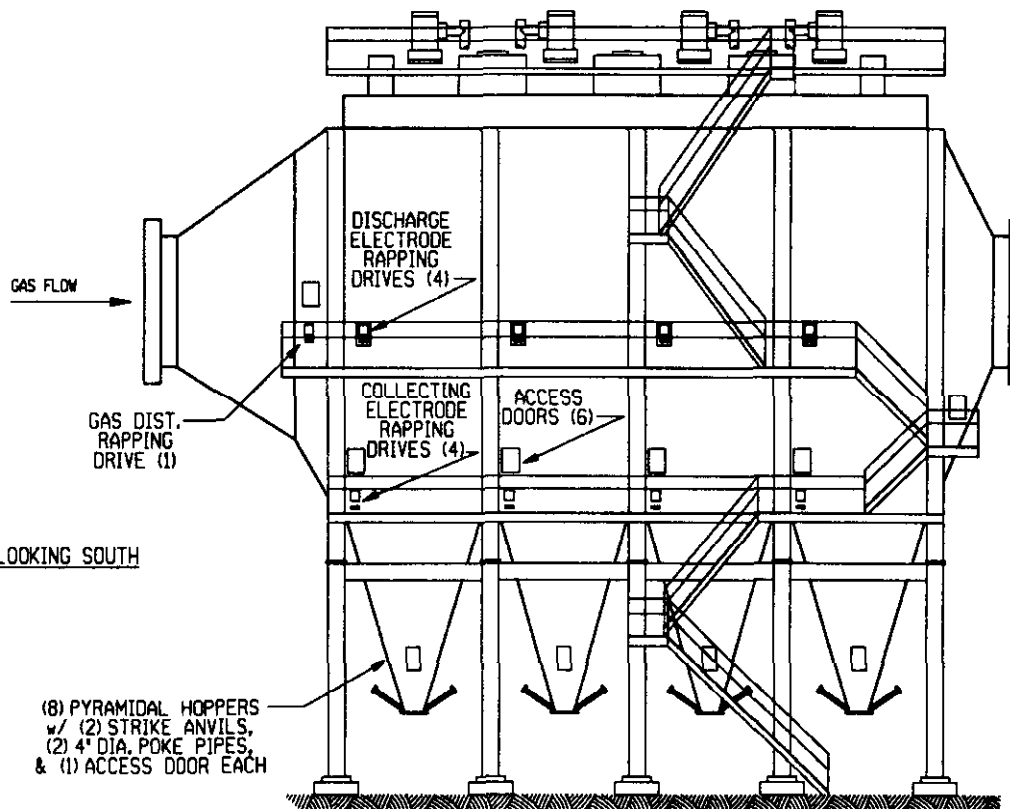
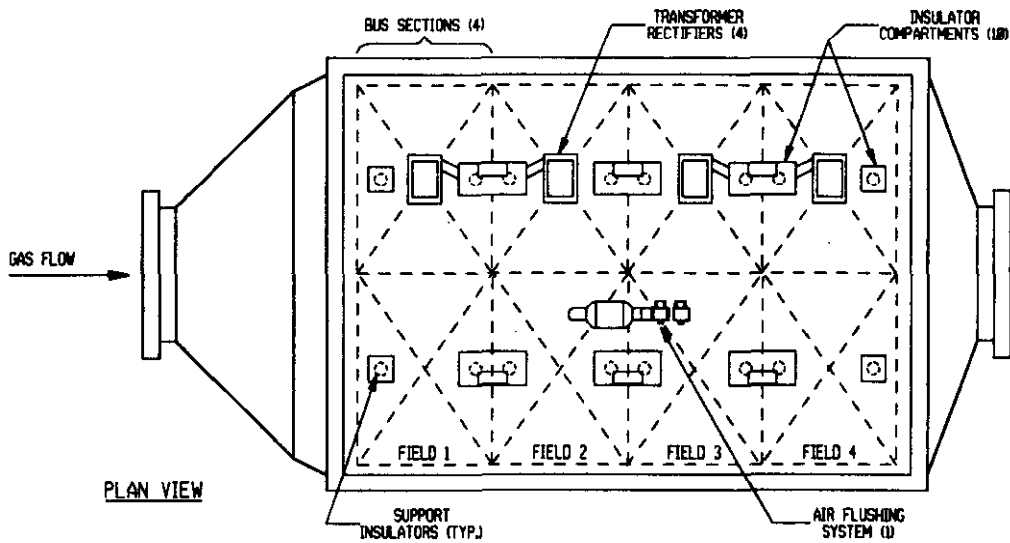

ELECTROSTATIC PRECIPITATOR
Figure 12

5.7 Ash Systems

5.7.1 Cyclone Ash Removal

Fine ash collected in the gas cleaning cyclones is continuously removed via a pneumatic transport system in which a small portion of the high-pressure gas from the cyclone conveys the ash to an atmospheric pressure silo. The ash/gas flow is cooled to an acceptable level with a portion of the heat being recovered in the combustion air. Depressurization of the gas/ash stream is achieved without lockhoppers or valves.

5.7.2 Fly Ash Removal System (FARS)

The FARS removes collected fly ash stored in the precipitator hoppers and pneumatically conveys the ash via vacuum to the cyclone ash silo.

The system is designed to convey fly ash at a rate of 5 tons per hour with a minimum pickup velocity of 3000 fpm. Fly ash is removed from each hopper in sequence until all eight hoppers have been unloaded. The system can then be shutdown or continue to unload hoppers until the cycling sequence is ordered to shut down.

The vacuum pump, manufactured by Nash, is used to create the conveying air flow and vacuum in the ash piping network. The pump, driven by a 50 HP motor, will produce a vacuum of 12.65 inches Hg when operating at the design flow rate of 725 acfm.

The fly ash intake valves, located below each hopper, are used to regulate the flow of ash into the ash conveying pipe. A fluidizing blower and heater provides heated fluidizing air to the fly ash intake valves to keep the ash free flowing above the valves.

The ash entrained in the conveying air is transported to the bag filter/separator, located above the cyclone ash silo, where ash is separated from the conveying air.

The bag filter contains 23 filter bags 4.5 inches diameter x 10 feet in length to provide a total bag filter area of 271 sq ft. The design air to cloth ratio is 2.9 acfm/ft².

The transfer lockhopper is located between the bag filter/separator and the cyclone ash silo. Its function is to transfer ash from the negatively pressurized bag filter to the silo which is at atmospheric pressure.

5.7.3 Cyclone Ash Handling System

Cyclone ash from the cyclones and fly ash from the precipitator hoppers will be pneumatically transported in a dry state via separate systems to a 22 foot diameter, flat-bottom, elevated storage silo with an active storage capacity of 260 tons, equivalent to 20 hours of full load operation. Conditioning equipment will be installed in the cyclone ash silo to remove cyclone ash from the storage bin, wet it to minimize fugitive dusting, and transfer it to open type dump trucks for disposal. Dry cyclone ash may also be loaded into dry bulk carrier trucks for sales or testing purposes.

5.7.4 Bed Ash Removal System

Granular bed ash must be continuously removed from the boiler bottom hoppers in order to maintain the desired fluidized bed level. To achieve this, bed ash flows by gravity from each of the two boiler bottom hoppers into dedicated lockhoppers. L-valves are used to meter the flow of bed ash. The two lockhoppers operate in parallel, but are independent from one another with respect to emptying and repressurization cycles.

When full, the lockhoppers are depressurized by venting and are emptied by gravity into a common atmospheric pressure hopper. From the hopper, the ash is fed by a screw feeder onto an enclosed conveyor system which transports the bed ash to the storage silo. A schematic of the Bed Ash Removal System is depicted in Figure 13.

The maximum bed ash discharge rate required is 22,000 lb/hr. The bed ash removal system is designed to discharge bed ash from the boiler at rates up to 25,000 lb/hr (14% margin over maximum required) with one of its two removal/depressurization trains out of service.

The screw conveyor for the lower bed ash hopper is designed to discharge ash from each side of that hopper at a rate of 25,000 lb/hr. As such, the downstream bed ash conveyors are designed to convey up to 50,000 lb/hr of bed ash for the situations when both sides of the lower bed ash hopper contain material at the same time. This will occur when ash from one lockhopper train is still within the lower hopper when the other lockhopper train is emptied into the lower hopper.

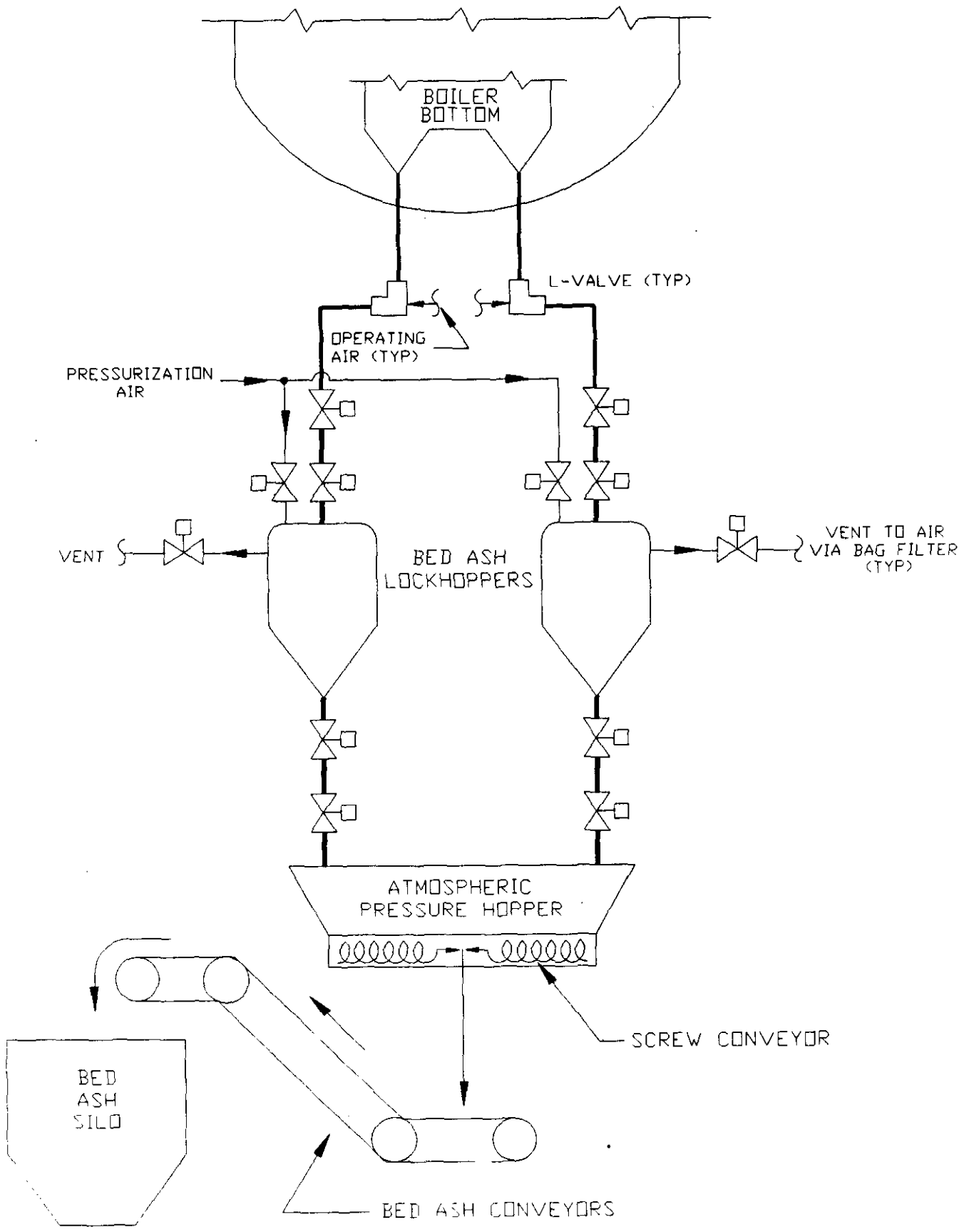

BED ASH REMOVAL SYSTEM

Figure 13

5.7.5 Bed Ash Handling System

Bed ash is transported by belt conveyor in a dry state to a 22 foot diameter, conical-bottom storage silo, adjacent to the cyclone ash silo. Active storage capacity is 220 tons, equivalent to 20 hours of full load operation. Equipment will be installed in the bed ash silo to remove the bed ash from the bin and transfer it to open type dump trucks for disposal. Because of the granular nature of bed ash, fugitive dusting is not anticipated to be a problem and, therefore, wetting of the ash is not necessary.

5.7.6 Ash Disposal

Both bed ash and cyclone ash, estimated at 58,000 tons each per year, will be disposed of in an Ohio EPA permitted area that has been used to dispose of over 8.5 million tons of fly ash from Cardinal Plant. From the storage silos located at the plant site, the ash will be loaded into dump trucks that will be covered and weighed prior to its departure for the disposal site. Spray curtains and truck washes will be provided at the silos to reduce dusting during loading operations and to remove ash which adheres to the vehicles during loading. The dump trucks will haul the ash to the Cardinal Plant fly ash Reservoir I. Once at the disposal site, the ash will be dumped from the trucks, spread, wetted to optimum moisture content, and finally compacted. The types of equipment that will be used to operate and maintain the disposal site include track-type dozers, track-type loaders, smooth-drum vibratory and sheepsfoot rollers, and watering trucks.

5.8 Balance of Plant Systems

5.8.1 Steam Turbine/Generator

The existing steam turbine at the Tidd Plant is a 110 MW, 1800 rpm condensing turbine/generator. It is contained in a single casing directly connected to a 0.9 pf, 111,111-kva, 3-phase, 60-cycle, 13,800-volt generator. The PFBC boiler produces less main steam flow than the original Tidd boilers; therefore, the steam turbine produces 57 MW at full load.

The turbine is equipped with an automatic low vacuum trip located within the forward turbine pedestal.

Although the chance of the vacuum trip failing to operate in an emergency is very slight, a further safeguard against condenser failure is provided in the form of a relief diaphragm mounted on the turbine exhaust. In addition, an initial pressure regulator is used which closes the steam admission valves to the turbine in case of a sudden drop in boiler pressure.

Details of the existing steam turbine are given in the following sections.

5.8.1.1 Turbine - Shells

The high pressure portion of this machine is of a single shell design. The casing is split on the horizontal center line. The shell and control valve casing are integral parts of the same casting and are of carbon molybdenum alloy steel. The casing is divided into two sections with upper and lower halves. The forward section is of cast alloy steel, and the rear section of carbon steel casting. All the parts in the shell which are subjected to steam temperatures greater than 750°F are of alloy steel.

5.8.1.2 Turbine - Rotor

The turbine rotor consists of an alloy steel shaft, upon which carbon steel forged wheels are keyed in position. The high pressure end wheels are pin bushed. There is a total of 17 stages.

5.8.1.3 Stop Valve and Steam Pipes

A quick closing, oil operated stop valve is used at the steam inlet. This stop valve can be closed either manually or by the emergency governor in the event of overspeed. It is also equipped with an internal steam strainer with removable screen grid.

Steam is admitted to the control valve chest on either half of the unit by alloy pipes designed with suitable flexibility from a stop valve in front of the turbine below the floor line. The stop valve is of alloy steel suitable for welding to the pipes which in turn are welded with the control valve chest. This stop valve is a two position valve, either open or fully closed. It has an internal bypass valve which can throttle steam flow up to 20% of full load. It is operated remotely by oil.

5.8.1.4 Operating Governor

The main operating governor of the unit is mounted on the high pressure end, and is of the centrifugal type with rotating pilot valve driven by the turbine shaft through a worm gear. It is provided with a suitable 250 volt DC motor operated synchronizing device for controlling the speed. It is also provided with a handwheel for instant control by hand, in the event the synchronizing motor becomes inoperative. The motor operated synchronizing mechanism is adequate to maintain rated frequency at all loads under steam conditions specified.

5.8.1.5 Emergency Governor

The turbine is also provided with an emergency overspeed governor of the oil-trip type. This governor is mounted at the head end of the turbine shaft and is normally set to operate at 110 percent rated speed.

5.8.1.6 Control Valves

There are ten control valves, five located in the upper half shell and five in the lower half shell. This arrangement provides for steam admission at both top and bottom, assuring equal distribution of the heat and resulting in minimum distortion of the shells. All ten valves admit steam to the first stage nozzles. All valves are under the control of the main operative governor. With the current arrangement of valves, the primary control valves open until full flow is passed by the machine.

5.8.1.7 Main Bearings and Couplings

The unit has four main bearings of the ball seated, self-aligning, pressure lubricated type. The bearings have cast iron shells and are lined with babbitt. Suitable means are provided to prevent oil or vapor in the bearing from creeping out around the shaft.

A solid type of coupling is used to connect the turbine rotor to the generator field.

5.8.1.8 Thrust Bearing

The axial thrust of both the turbine and the generator rotor is absorbed by a thrust bearing of the single runner type. This bearing is attached to the turbine end bearing and is enclosed in the bearing standard.

5.8.1.9 Lubricating Oil System

The unit is provided with a self-contained lubricating system. The oil tank is located in the basement under the front end of the unit, away from the hot steam parts. The main gear type oil pumps are located in this tank and driven by 550 volt AC motors. All oil delivered from these pumps passes through the oil cooler, which is also located in this oil tank.

The cooler is capable of maintaining the oil in a 110°F to 120°F range when supplied with cooling water at 90°F. The amount of 90°F cooling water required is 390 gallons per minute with a head loss of 4.6 ft. This system also contains a DC driven auxiliary pump which can supply oil in the event of a failure of the AC motor driven pumps.

5.8.1.10 Shaft Packings

The shaft packings on the high pressure end were originally of the combined labyrinth and water seal type. These are being converted to the more conventional steam seal type.

5.8.1.11 Buckets

The turbine buckets are made of corrosion resisting material throughout. All buckets were machined from bar stock and were buffed and highly polished before being inserted in the wheels.

There are 18 rows of chrome iron alloy impulse type buckets. All buckets are dovetailed to the wheel rims.

The stages of the low pressure end are arranged so as to extract heavier particles of moisture, which will reduce bucket wear to a minimum.

5.8.1.12 Generator

The generator is rated 110,000 kw, 0.9 pf, 111,111 kva, 3 phase, 60 cycle, 13,800 volts. It is hydrogen cooled. The generator is directly connected to a main and pilot exciter which is totally enclosed and provided with its own air cooling and ventilation system.

The generator and the hydrogen accessories are designed so that the generator can be operated at any hydrogen pressure up to 15 psi. Generator efficiency at 0.5 psi hydrogen pressure is approximately 99.2%.

5.8.1.13 Exciter

The main exciter is designed for 250 volts and is shunt wound with separately excited shunt field.

The pilot exciter is designed for 250 volts and is compound wound with self-excited shunt field. The pilot exciter has a minimum current rating of 1.5 times the normal load on the pilot exciter when the main exciter is operating at rated voltage and current.

5.8.1.14 Generator Coolers

The cooler consists of four sections mounted inside of the generator casing, with a total cooling surface of 10,000 sq ft.

The exciter cooler consists of one section, mounted in the exciter base, having a cooling surface of 590 sq ft.

5.8.2 Condenser

The Unit 1 main condenser at Tidd plant receives steam from the low pressure exhaust of the steam turbine. It uses cooling water from the Ohio River which is pumped to the condenser by two circulating water pumps. This condenser has three major functions:

- To produce a vacuum or desired back pressure at the turbine exhaust for the improvement of plant heat rate.
- To condense turbine exhaust steam for reuse in a closed cycle.
- To deaerate the condensate.

The condenser is designed so that the reversing of the circulating water flow is possible by operating the reversing valves. Its design internally consists of two (2) working water sides. Either of the two sides of this condenser can be cut out of service and opened up for cleaning or inspection while the other side remains in service. The condenser hotwell serves to collect the condensed turbine exhaust steam.

5.8.3 The Condensate System

After leaving the condenser hotwell, the condensate is heated through a slipstream, sent to the gas turbine intercooler where it absorbs the heat of air compression. It is then pumped to two (2) low pressure heaters and a deaerating heater where it absorbs heat from steam extracted from the steam turbine. Heater #1 uses the 14th stage extraction steam to heat the condensate. The condensed extraction steam is drained into the Heater #1 drain tank, and from the tank the drains go back to the condenser.

Heater #2 receives extraction steam from the 12th stage of the turbine. As in Heater #1, the condensed steam from the heater drains to its drain tank, and then back to the condenser. The 9th stage extraction steam is used in the deaerating heater to heat and deaerate the condensate.

The deaerator is a direct contact heater in which oxygen and other noncondensable gases are removed from the condensate. Directly below the deaerator is the deaerator storage tank, having a 22,000 gallon capacity. Both of these are at a high elevation to give sufficient suction head to the deaerator tank pumps.

5.8.4 The Feedwater System

The amount of feedwater circulating through the economizer and the combustor/boiler will be determined by a feedwater flow control valve located at the feedwater pump discharge. Full load feedwater flow will be 439,560 lb/hr. From the tank pumps, feedwater will pass through an intermediate pressure Heater #4 which utilizes 3rd stage extraction steam, and then to the boiler feed pump. The boiler feed pump adds additional head to the feedwater entering the economizer. The feedwater then flows through the economizer where heat will be extracted from the gas turbine exhaust gases. The feedwater temperature rises to 478°F in the economizer, cooling the exhaust gas to 350°F. The actual values are a function of gas turbine load and feedwater flow. Some of the flow will be used for attemperation, the rest will enter the combustor at 478°F.

5.8.5 LP Service Water System

Service water to the various coolers in the plant is provided by the Ohio River. The temperature of the incoming water from the river varies with weather conditions from 32°F to 90°F. Pressure in the system is maintained at 60 psig.

River water can be pumped through four (4) service water pumps depending on cooling water demand which varies with plant load and weather conditions. Each pump is rated for 1050 gpm at 160 ft head and is driven by a 50 HP motor, which is controlled from the plant control room.

Each pump has a single basket suction strainer which protects the pump and the system from contamination by debris from the river.

5.8.6 HP Service Water System

The high pressure service water system supplies river water to various services in the plant which require water at 120 psig or less.

Two (2) service water booster pumps each rated for 500 gpm at 150 ft head, take suction from the L.P. service water system and supply water to the H.P. service water system piping. The pumps are driven by 25 HP motors and controlled from the plant control room.

5.8.7 Electrical System

Auxiliary electrical loads for the PFBC steam and gas cycle will be powered from the existing Tidd Unit 1 and Unit 2 distribution systems. The existing generator step-up (GSU) transformer was replaced by two 37.5 MVA transformers, one connected to each winding of Generator No. 1. The main and reserve auxiliary transformer scheme, including connection to the 2.4 kV buses, is identical to the original Tidd design; operation is also similar. The unit will be started from the reserve source (69 kV to 2.4 kV transformers) and transferred to the main source for normal operation. The 2.4 kV buses will fast transfer to the reserve source on unit trip.

The PFBC auxiliary loads are served at 2.4 kV and 600 V and distributed between the "A" and "B" buses. Auxiliary power consumption is expected to be less than 10% of gross output. One main auxiliary transformer and most of the 2.4 kV to 600 V transformers have been replaced due to removal of existing Tidd transformers which contained Polychlorinated Biphenyls (PCB). The gas turbine generator/motor will be connected to the Tidd 138 kV bus No. 2 via a new 25 MVA GSU transformer, 13.8 kV switchgear and frequency converter. The frequency converter will be used to operate the gas turbine at variable speeds during start-up. The generator motor will require 4.8 MVA on start and approximately 10 MVA at synchronous speed. When the PFBC combustor begins producing power, the generator motor will gradually draw less current and then act as a generator. The generator/motor will produce up to 22 MVA at full power. There are no 13.8 kV auxiliary loads connected to the gas turbine-generator/motor bus. A schematic of the electrical system is provided in Figure 14.

5.9 Control System

The control system is a modular microprocessor based distributed process control system, featuring both analog and sequential control.

5.9.1 Purpose

The purpose of this system is to collect signals and measurements from the process for control, supervision, and protection. The system also provides for the operator process diagrams and information through the use of process displays, trends, alarms, event list, and archived data, through the use of a keyboard and monitor. The system provides for the operator the means of modifying the process.

5.9.2 System Description

The control system is a distributed programmable logic system, known as Bailey NET 90, based on:

- NET 90 PCU (process control unit)
- NET 90 MCS (management command system)

Configuration of the process control unit is rather simple, using function codes entered by a configuration tuning module (CTM) or via an engineering work station (EWS). Work with the EWS station is carried out in a graphic mode, where the engineer enters functions directly in the configuring drawing. The documentation can either be in the form of a graphic printout or a printed list.

Operator communication is performed via color CRTs (cathode ray tubes), functional keyboards and touch screens. Process diagrams and standard displays are presented at several levels on the CRT's. Function groups and objects can be controlled on the display by using a keyboard or a touch screen.

Events and alarms are listed, time tagged and printed out on a printer connected to the MSC. Two printers are provided in the control room connected to the NET 90 system. One is for the alarm and pertinent data. Acoustic and optical alarms are also produced by additional interfacing relays.

In addition to these two printers, a third is attached to the beta alarm system. The beta is a standard window box annunciator system used in addition to the NET 90 and in case of NET 90 problems.

5.9.3 System Arrangement

The process control is divided into function groups and objects. In some cases, there are safety concerns which must be addressed. This involves allowing a specific object to be controlled from both the PCU it belongs to and the safety PCU.

5.9.4 Process Control Units

There are eight PCU's to control the plant. These are divided into the following major parts called nodes.

- Gas Turbine
- Combustor (three PCU)
- Steam Turbine
- Balance of Plant (two PCU)
- Safety

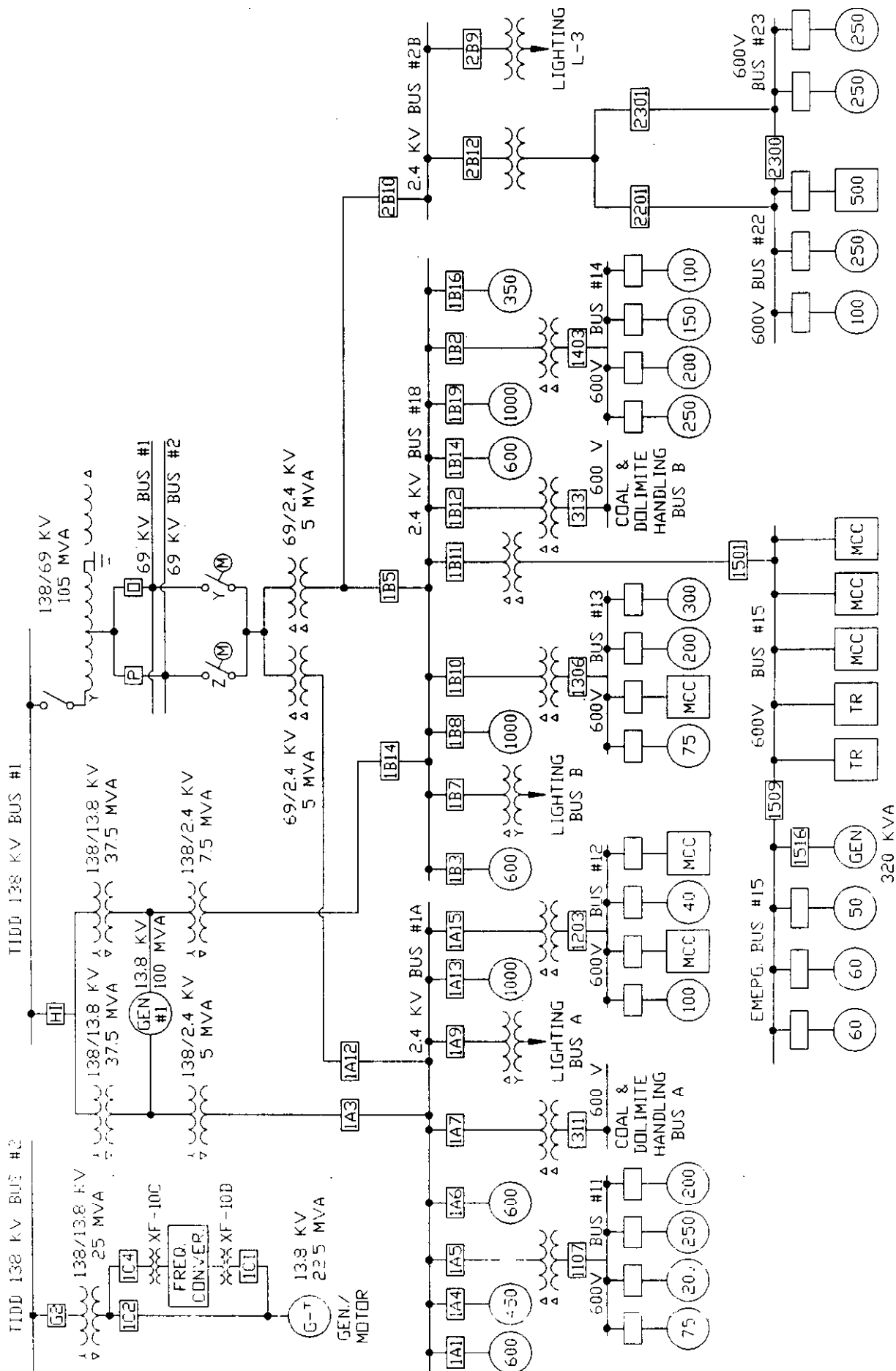

ELECTRICAL ONE-LINE DIAGRAM
Figure 14

The above units perform the control of individual plant items (object control) and also most of the coordinating control, interlocking, and automatic functions involving groups of related items.

5.9.5 Safety System

The safety system logic is handled by one NET 90 PCU. The safety function is two out of three for life threatening or equipment damage related processes and one out of two for all others. This is possible by using separate nodes to process the incoming data.

5.9.6 Operator Interface

The system arrangement includes two redundant management command system (MCS), with four CRT's and four keyboards. The CRT's are provided with touch screen functions. This means that four operators independent of each other can work individually and control their respective part of the plant. A printer is used for event and alarm hard copies. The MCS also provides displays for system status, e.g., node status.

5.9.7 Simulator

To educate and train the operators in this new technology, a simulator was developed. The simulator consists of one PCU, two MCS, and two personal computers (PC). One PC is used as a middle man to talk to the PC and the MCS and as an EWS. The other PC is the model for the simulator. Process parameters were developed from design data and expected operating conditions. After a lengthy debugging period, the simulator was delivered to the plant and has already proved its worth in operator training and indicating potential control problems.

5.9.8 Additional Equipment

Two additional MCS's are in use now. Both are in the trailer on the turbine deck. These will be used for observation of the plant operations only and not for control.

A plant operations computer (POC) will be installed in the control room. This was necessary to relieve the NET 90 from the logging and trending functions. With the amount of data that is expected to be requested by all the parties involved, it became evident that the NET 90 could become overloaded to the point of slowing the update of dynamic conditions. This was viewed as unacceptable, and thus the POC computer added.

6.0 PROJECT COSTS

The total program cost is currently estimated at \$224.1 million. A breakdown of the project cost is as follows:

	(\$ in Million)			<u>Total</u>
	<u>OPCo Share</u>	<u>DOE Share</u>	<u>OCDO Share</u>	
A - Preliminary Engineering, Design, Cost Estimate, Technical Support Program	7.7	-	-	7.7
B - Phase I (Design and Permitting)	18.7	7.0	5.0	30.7
Phase II (Construction and Start-up)	79.3	47.0	5.0	131.3
Phase III (Operation, Data Collection, Reporting and Disposition)	33.8	6.2	-	40.0
C - Allowance for Funds Used During Construction (AFUDC)	14.4	-	-	14.4
TOTAL	<u>153.9</u>	<u>60.2</u>	<u>10.0</u>	<u>224.1</u>

A summary of Phases I and II current forecast according to the type of equipment/system supplied and overheads are as follows:

	<u>Cost (\$ Million)</u>
● Combustor Vessel with appurtenances (major equipment include combustor assembly, controls, economizer, coal preparation system, coal and sorbent injection system)	54.8
● Gas Turbine	16.3
● Precipitator and flue gas	5.0
● Sorbent handling and preparation system	2.4
● Dust collection and ash removal	2.0
● Ash handling and ash disposal	1.5
● Other facilities and modifications	38.9
● Engineering, Design and Overheads	<u>41.2</u>
	162.0

7.0 HEAT BALANCE

The design full load heat balances for the steam side and the gas side of the combined cycle are shown in Figures 15 and 16, respectively. The figures show the expected performance of the unit at 100% load (i.e., 100% firing rate), 59°F ambient air temperature, and 60% ambient relative humidity.

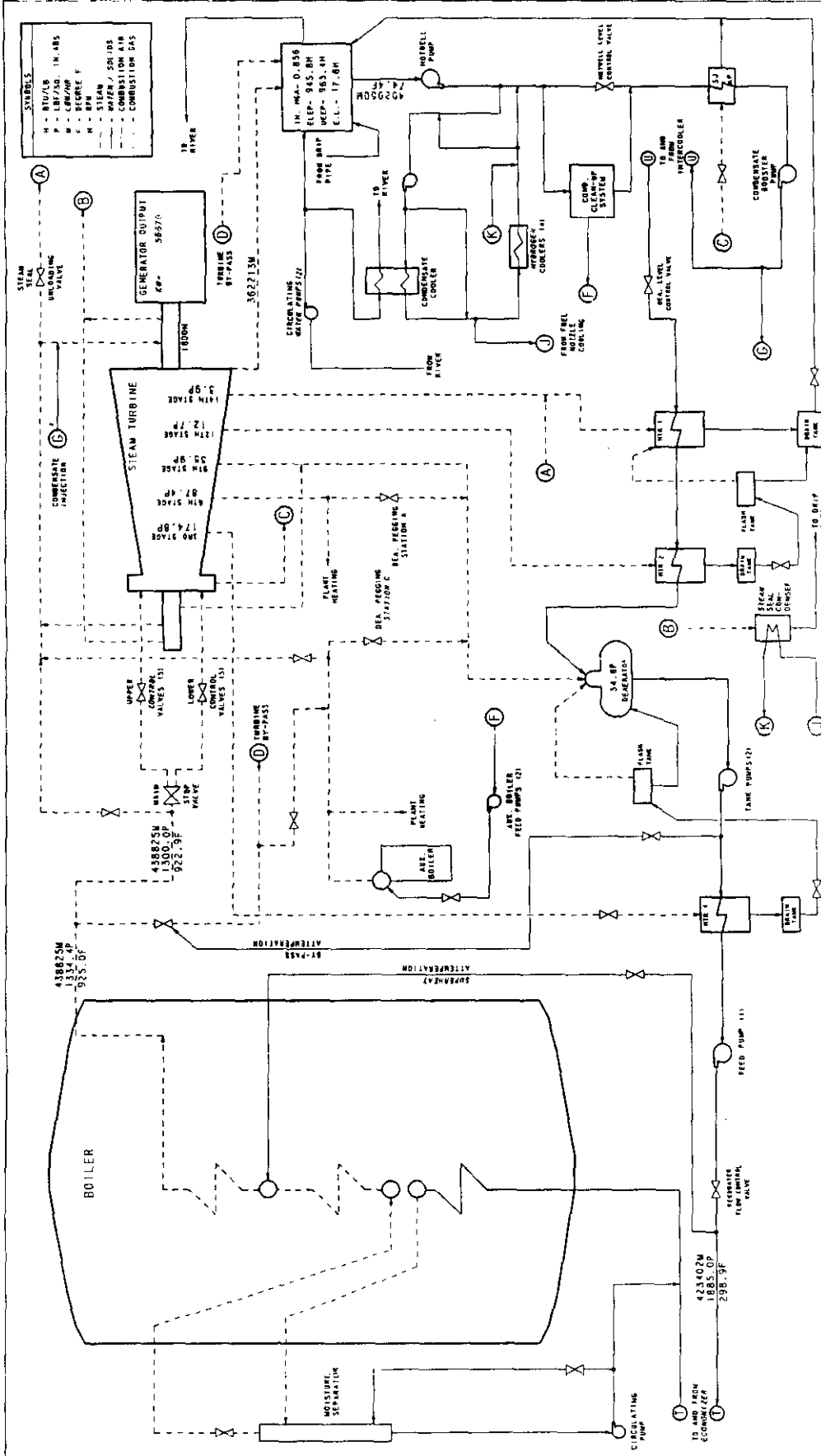

REFERENCE DATA AND NOTES DESIGN CASE - AMBIENT CONDITIONS - EXPECTED AVERAGE FOR SPRING/FALL - COAL TYPE - PERFORMANCE Similar to I-10000A Rev 1	STEAM CYCLE PERFORMANCE GROSS KW - 56670	TOTAL PLANT PERFORMANCE CPOSS KW - 73920 NET KW - 69815 CDR (BTU/KWH) - 9415 NET UNIT EFF - 34.23% GROSS UNIT EFF - 36.24% AIR TEMP - 59 OF REF. HUMIDITY - 60.00% CIRC. WATER TEMP - 59 OF	Figure 15 AMERICAN ELECTRIC POWER SERVICE CORP TURBINE CYCLE EVALUATION SECTION T-10000A Rev 1 DEMONSTRATION PLANT Page 1 of 2
	STEAM CYCLE PERFORMANCE GROSS KW - 56670	TOTAL PLANT PERFORMANCE CPOSS KW - 73920 NET KW - 69815 CDR (BTU/KWH) - 9415 NET UNIT EFF - 34.23% GROSS UNIT EFF - 36.24% AIR TEMP - 59 OF REF. HUMIDITY - 60.00% CIRC. WATER TEMP - 59 OF	Figure 15 AMERICAN ELECTRIC POWER SERVICE CORP TURBINE CYCLE EVALUATION SECTION T-10000A Rev 1 DEMONSTRATION PLANT Page 1 of 2

SORBENT ANALYSIS	
ID (LBS/TON)	
CALCIUM REACTIVITY	
CONSTITUENT MASS FRACTION	
CaCO ₃	0.3220
MgCO ₃	0.4400
MgO	0.0010
SiO ₂	0.0210
Al ₂ O ₃	0.0006
Fe ₂ O ₃	0.0034
Mn ₂ O ₃	0.0008
K ₂ O	0.0005
SO ₂	0.0006
CL	0.0005
TOTAL	1.0000

COMBUSTION CHEMISTRY	
36.86 C ₂ H ₅ + 124.00 H ₂ O + 98.7 M ₂ O + 145.98 N ₂ + 98.7 M ₂ O + 98.7 O ₂	
98.86 C ₂ H ₅ + 124.00 H ₂ O + 43.2 C ₂ H ₄ + 2.0 C ₂ H ₆ + 3.3 H ₂ O + 2.0 C ₂ H ₂	
53.7 C ₂ H ₅ + 58.4 SO ₂ + 26.8 O ₂	
53.7 C ₂ H ₅ + 58.4 SO ₂ + 26.8 O ₂ + 55.7 C ₂ H ₄ + 0.3 H ₂ O + 0.3 H ₂ O	
517.8 C + 1205.9 H ₂ + 59.03 + 4753.0 O ₂	
517.8 C + 1205.9 H ₂ + 59.03 + 4753.0 O ₂ + 1239.0 H ₂ O + 928.1 O ₂ + 48.0 C	

NOTE: CONSTITUENT DIMENSIONS - LBS/TON

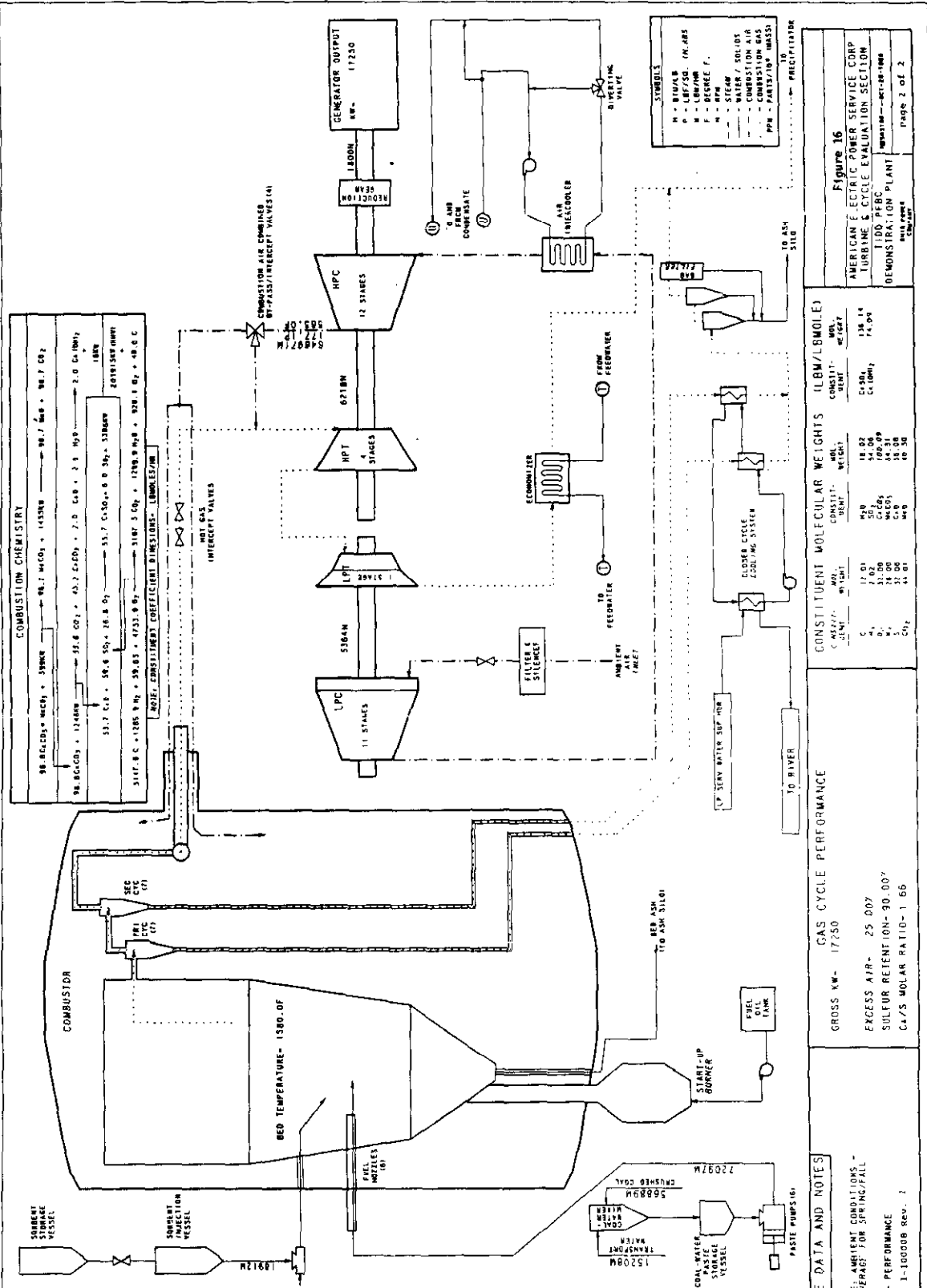

FUEL ANALYSIS	
COAL - PITTSBURGH #8	
ANALYSIS RECEIVED	
CONSTITUENT MASS FRACTION	
C	0.8545
H	0.0449
N	0.0145
O	0.0126
S	0.0136
ASH	0.1145
TOTAL	1.0000

REFERENCE DATA AND NOTES
 DESIGN CASE: AMBIENT CONDITIONS
 EXPECTED AVERAGE FOR SPRING/FALL
 COAL TYPE - PERFORMANCE
 Similar to 1-100008 Rev. 1

GAS CYCLE PERFORMANCE	
GROSS KW -	17,250
EXCESS AIR -	25.00%
SULFUR RETENTION -	90.00%
CA/S MOLAR RATIO -	1.65

CONSTITUENT MOLECULAR WEIGHTS (LBW/LBMOLE)	
CONSTITUENT	MOLECULAR WEIGHT
C	12.01
H	1.008
N	14.006
O	16.003
SO ₂	64.06

Figure 16	
AMERICAN ELECTRIC POWER SERVICE CORP	
TURBINE S. CYCLE EVALUATION SECTION	
1100 PERC	
DEMONSTRATION PLANT	
DESIGNED BY	AMERICAN ELECTRIC POWER SERVICE CORP
DATE	1964

8.0 GENERAL ARRANGEMENT DRAWINGS

Two groups of general arrangement drawings were developed for the project, one group for the existing plant and another for the new combustor building.

These drawings are enclosed and listed below.

8.1 Site Plan Drawings

<u>Figure #</u>	<u>Drawing #</u>	<u>Title</u>
2	1-5000-01	Gen. Arg't Plant On-Site Plan
17	1-5000-03	Gen. Arg't Construction Site Plan

8.2 Combustor Building Drawings

<u>Figure #</u>	<u>Drawing #</u>	<u>Title</u>
18	1-5001-01	Gen. Arg't Combustor Building Plans @ El. 652' and 660'
19	1-5001-02	Gen. Arg't Combustor Building Plans @ El. 676' and 686'
20	1-5001-03	Gen. Arg't Combustor Building Plans @ El. 703' and 728'
21	1-5001-04	Gen. Arg't Precipitator and Economizer Plan
22	1-5001-05	Gen. Arg't Plan & Sections Precipitator 1A & 1B Duct Modifications
23	1-5001-06	Gen. Arg't Plan & Sections Precipitator 1A & 1B Duct Modifications
24	1-5001-07	Gen. Arg't Ash Handling Facility
25	1-5001-08	Gen. Arg't Combustor Building Sections
26	1-5001-09	Gen. Arg't Combustor Building Sections
27	1-5001-10	Gen. Arg't Combustor Building Sections
28	1-5001-11	Gen. Arg't Combustor Building Sections
29	1-5001-12	Gen. Arg't Waste Water Pumps Structure Plan & Sections
30	1-5001-13	Gen. Arg't Combustor Building Plans @ El. 744' and roof

8.3 Existing Building Drawings

<u>Figure #</u>	<u>Drawing #</u>	<u>Title</u>
31	1-5010-01	General Cross Section of Plant Unit #1
32	1-5010-02	General Cross Section of Plant Unit #1
33	1-5010-03	Floor Plans of Turbine Room Elev's @ 608', 624', and 636', Unit #1

<u>Figure #</u>	<u>Drawing #</u>	<u>Title</u>
34	1-5010-04	Basement Floor Plan of Plant Elev's @ 650' and 665', Unit #1
35	1-5010-05	Basement Floor Plan of Plant Elev's @ 650', Unit #1
36	1-5010-06	Main Floor Plan of Plant Elev. 676', Unit #1
37	1-5010-07	Main Floor Plan of Plant Elev. 676', Unit #1
38	1-5010-08	Floor Plans of Boiler Room & Heater Bay Elev's @ 707', 708', 710', 727', 720', and 732', Unit #1
39	1-5010-09	Floor Plans of Boiler Room & Heater Bay Elev's @ 741', 747', & 751'' Fan floor Elev. 766', Unit #1, 650', Unit #1
40	1-5010-10	Longitudinal Section Heater Bay and Turbine Room Unit #1
41	1-5010-11	Screen House General Arrangement

60-0005-1

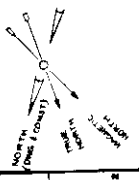

OHIO RIVER

FLOW

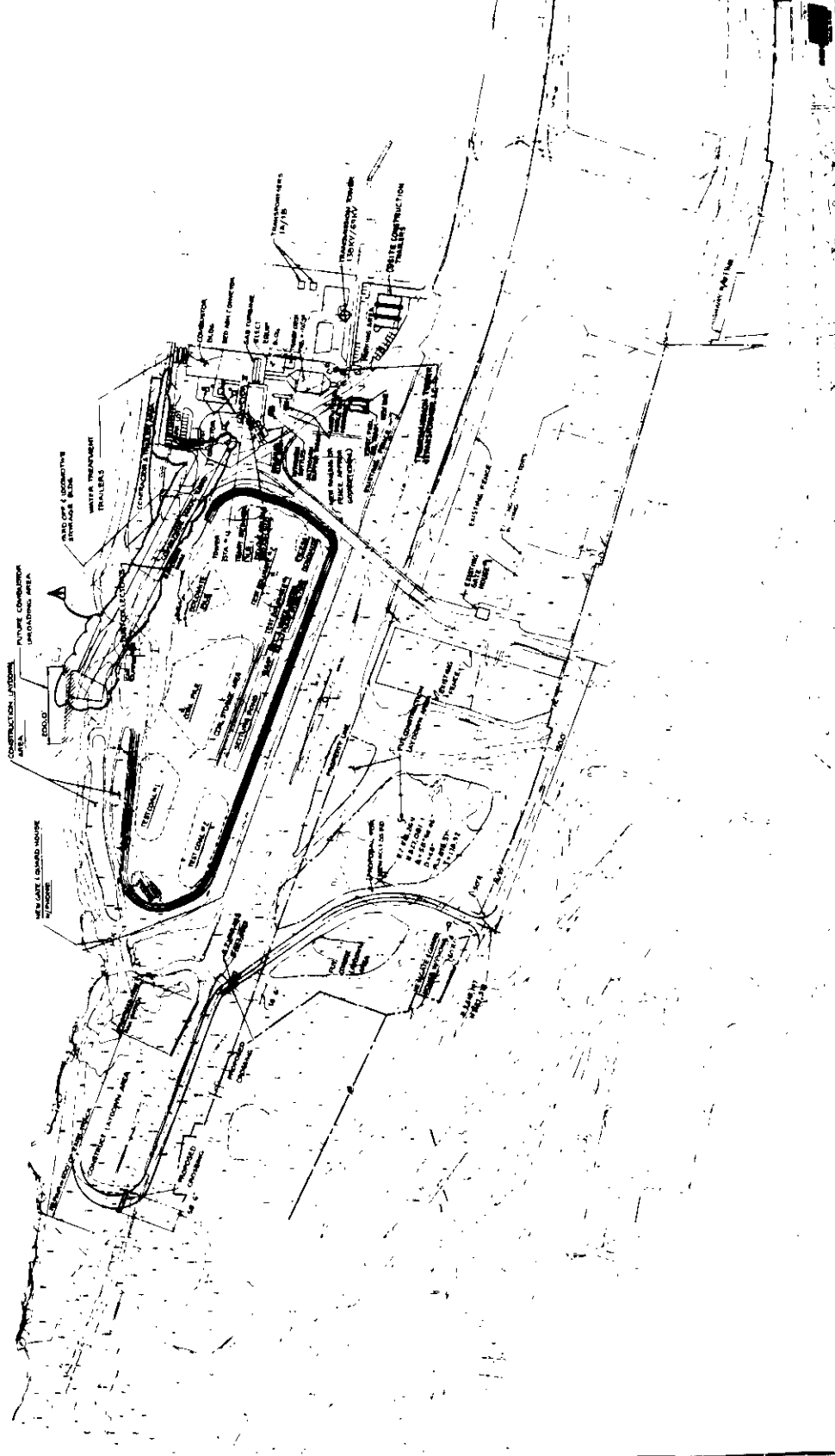

REVISIONS	
NO. 1	REVISIONS
NO. 2	REVISIONS

Figure 17

**GENERAL ARCT
CONSTRUCTION SITE
PLAN**
1-5000-03-1

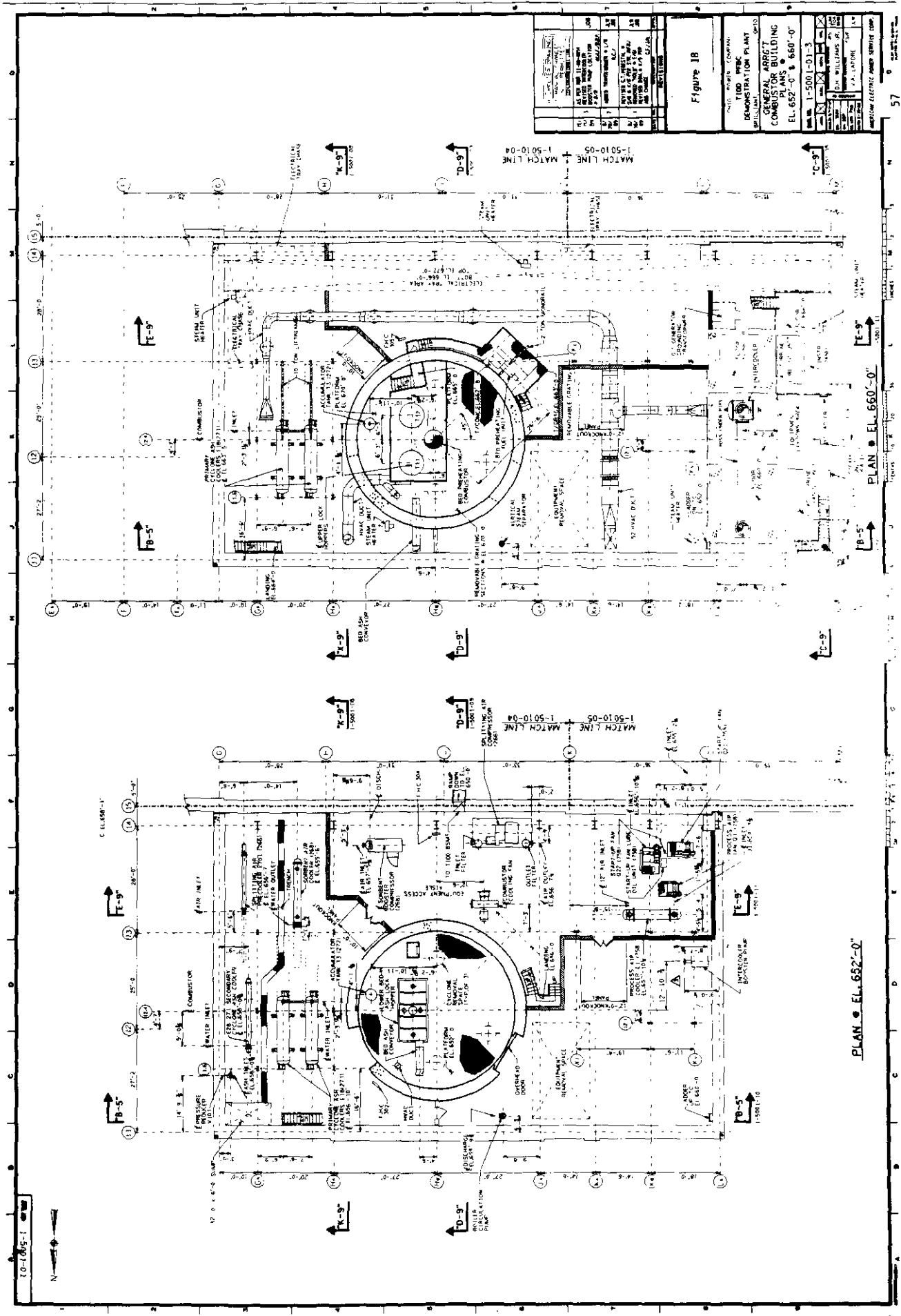

REVISIONS	
NO.	DESCRIPTION
1	ISSUED FOR PERMITS
2	REVISED PER COMMENTS
3	REVISED PER COMMENTS
4	REVISED PER COMMENTS
5	REVISED PER COMMENTS
6	REVISED PER COMMENTS
7	REVISED PER COMMENTS
8	REVISED PER COMMENTS
9	REVISED PER COMMENTS
10	REVISED PER COMMENTS
11	REVISED PER COMMENTS
12	REVISED PER COMMENTS
13	REVISED PER COMMENTS
14	REVISED PER COMMENTS
15	REVISED PER COMMENTS

Figure 1B

TIED POWER COMPANY
 DEMONSTRATION PLANT
 GENERAL ARRANGEMENT
 COMBUSTOR BUILDING
 PLANS
 EL. 652'-0" & 660'-0"

1-5001-01-3

DATE: 11/15/50
 DRAWN BY: J. W. WILLIAMS, JR.
 CHECKED BY: J. A. LARSON, SR.
 APPROVED BY: [Signature]

AMERICAN ELECTRIC POWER SERVICE CORP.

PLAN • EL. 652'-0"

PLAN • EL. 660'-0"

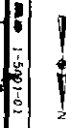

10-1065-1

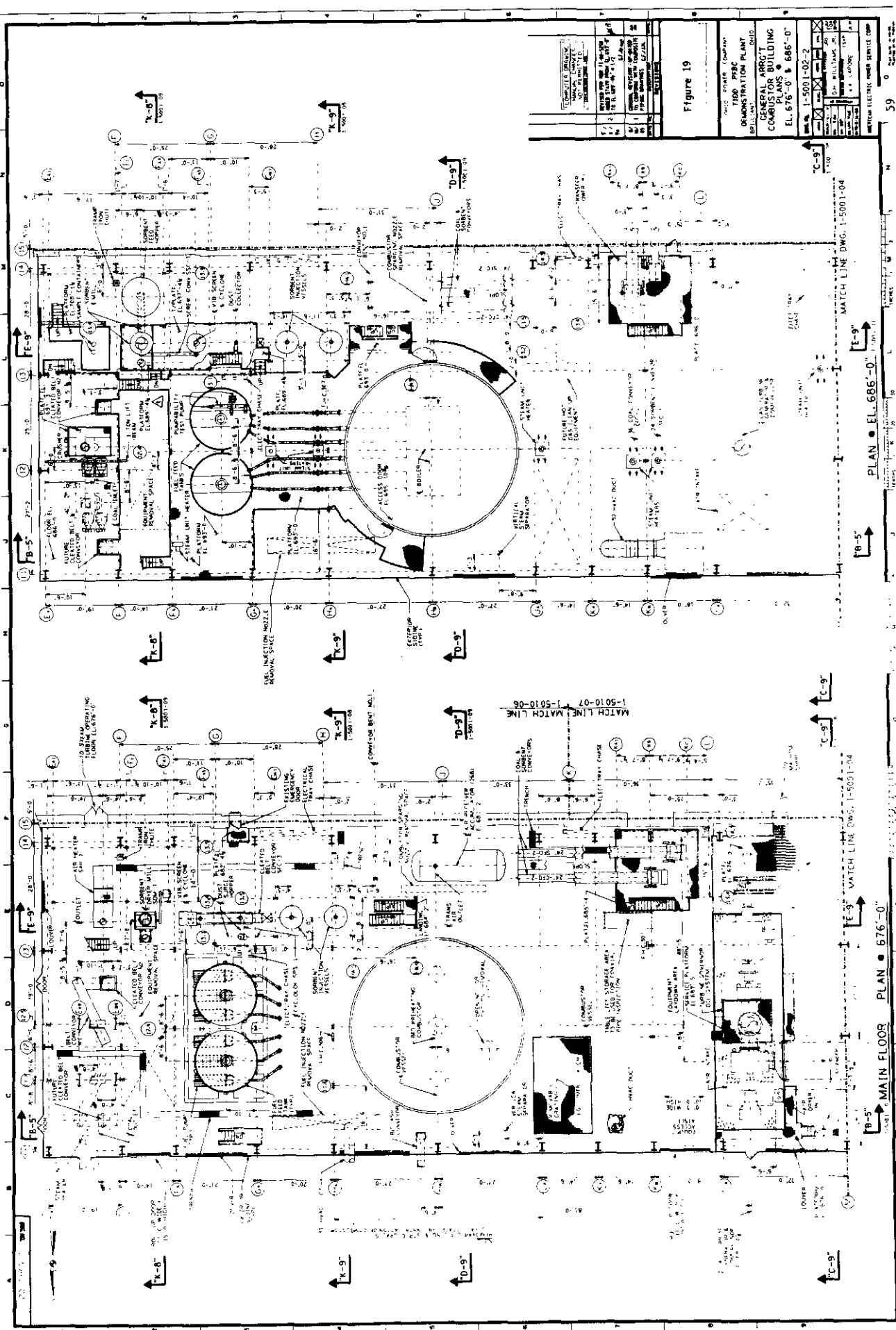

Figure 19

1	STAIR CASE
2	STAIR CASE
3	STAIR CASE
4	STAIR CASE
5	STAIR CASE
6	STAIR CASE
7	STAIR CASE
8	STAIR CASE
9	STAIR CASE
10	STAIR CASE
11	STAIR CASE
12	STAIR CASE
13	STAIR CASE
14	STAIR CASE
15	STAIR CASE
16	STAIR CASE
17	STAIR CASE
18	STAIR CASE
19	STAIR CASE
20	STAIR CASE
21	STAIR CASE
22	STAIR CASE
23	STAIR CASE
24	STAIR CASE
25	STAIR CASE
26	STAIR CASE
27	STAIR CASE
28	STAIR CASE
29	STAIR CASE
30	STAIR CASE
31	STAIR CASE
32	STAIR CASE
33	STAIR CASE
34	STAIR CASE
35	STAIR CASE
36	STAIR CASE
37	STAIR CASE
38	STAIR CASE
39	STAIR CASE
40	STAIR CASE
41	STAIR CASE
42	STAIR CASE
43	STAIR CASE
44	STAIR CASE
45	STAIR CASE
46	STAIR CASE
47	STAIR CASE
48	STAIR CASE
49	STAIR CASE
50	STAIR CASE
51	STAIR CASE
52	STAIR CASE
53	STAIR CASE
54	STAIR CASE
55	STAIR CASE
56	STAIR CASE
57	STAIR CASE
58	STAIR CASE
59	STAIR CASE
60	STAIR CASE
61	STAIR CASE
62	STAIR CASE
63	STAIR CASE
64	STAIR CASE
65	STAIR CASE
66	STAIR CASE
67	STAIR CASE
68	STAIR CASE
69	STAIR CASE
70	STAIR CASE
71	STAIR CASE
72	STAIR CASE
73	STAIR CASE
74	STAIR CASE
75	STAIR CASE
76	STAIR CASE
77	STAIR CASE
78	STAIR CASE
79	STAIR CASE
80	STAIR CASE
81	STAIR CASE
82	STAIR CASE
83	STAIR CASE
84	STAIR CASE
85	STAIR CASE
86	STAIR CASE
87	STAIR CASE
88	STAIR CASE
89	STAIR CASE
90	STAIR CASE
91	STAIR CASE
92	STAIR CASE
93	STAIR CASE
94	STAIR CASE
95	STAIR CASE
96	STAIR CASE
97	STAIR CASE
98	STAIR CASE
99	STAIR CASE
100	STAIR CASE

GENERAL ARR'GT
COMBUSTION BUILDING
EL. 676'-0" & 686'-0"

1-5001-02-2

59

PLAN • EL. 686'-0"

MAIN FLOOR PLAN • 676'-0"

PLAN • 676'-0"

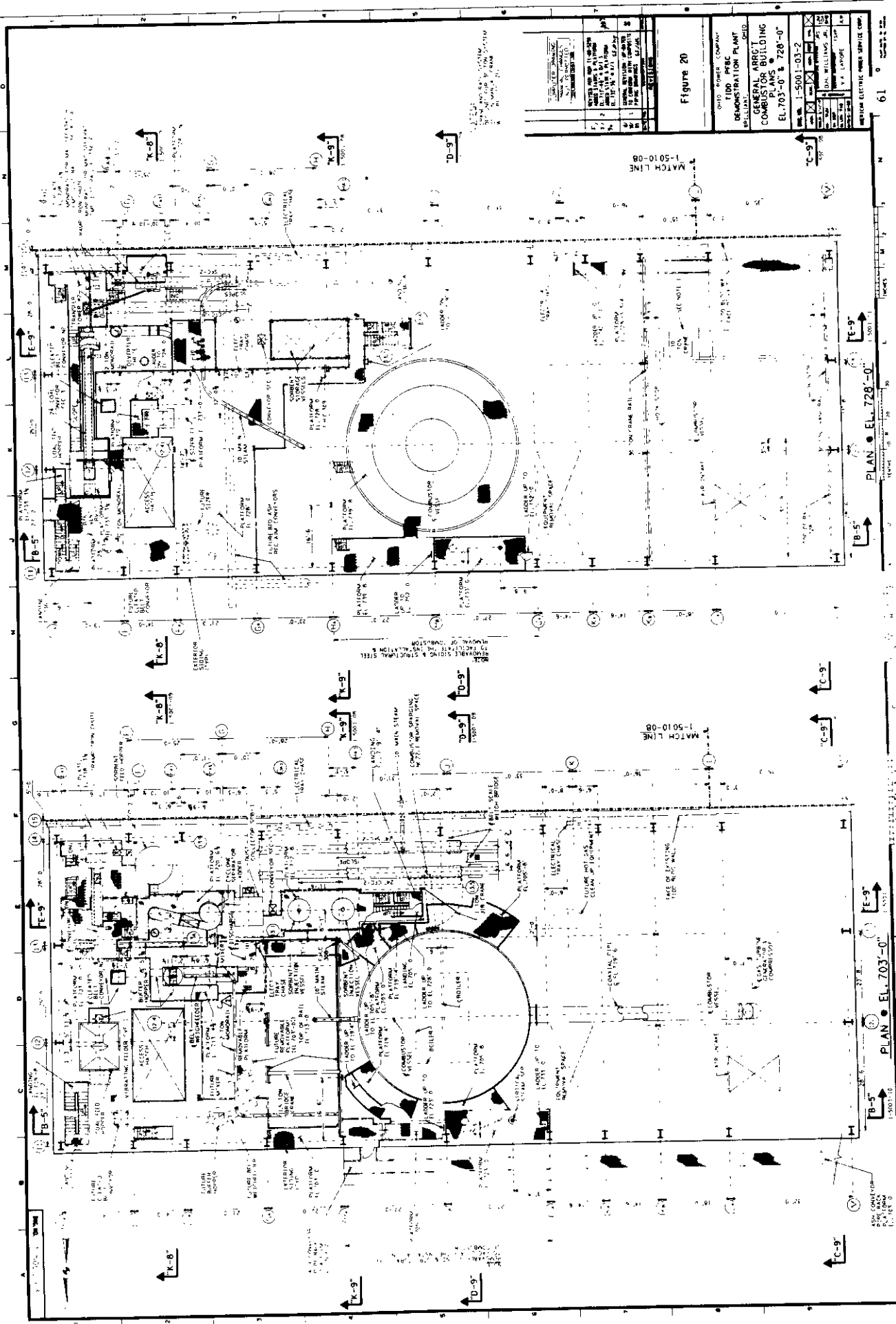

Figure 20

NO.	DESCRIPTION	DATE	BY	CHECKED
1	REVISED DRAWING	1-5010-08	J. J. HANCOCK	J. J. HANCOCK
2	REVISED DRAWING	1-5010-08	J. J. HANCOCK	J. J. HANCOCK
3	REVISED DRAWING	1-5010-08	J. J. HANCOCK	J. J. HANCOCK
4	REVISED DRAWING	1-5010-08	J. J. HANCOCK	J. J. HANCOCK
5	REVISED DRAWING	1-5010-08	J. J. HANCOCK	J. J. HANCOCK
6	REVISED DRAWING	1-5010-08	J. J. HANCOCK	J. J. HANCOCK
7	REVISED DRAWING	1-5010-08	J. J. HANCOCK	J. J. HANCOCK
8	REVISED DRAWING	1-5010-08	J. J. HANCOCK	J. J. HANCOCK
9	REVISED DRAWING	1-5010-08	J. J. HANCOCK	J. J. HANCOCK
10	REVISED DRAWING	1-5010-08	J. J. HANCOCK	J. J. HANCOCK
11	REVISED DRAWING	1-5010-08	J. J. HANCOCK	J. J. HANCOCK
12	REVISED DRAWING	1-5010-08	J. J. HANCOCK	J. J. HANCOCK
13	REVISED DRAWING	1-5010-08	J. J. HANCOCK	J. J. HANCOCK
14	REVISED DRAWING	1-5010-08	J. J. HANCOCK	J. J. HANCOCK
15	REVISED DRAWING	1-5010-08	J. J. HANCOCK	J. J. HANCOCK
16	REVISED DRAWING	1-5010-08	J. J. HANCOCK	J. J. HANCOCK
17	REVISED DRAWING	1-5010-08	J. J. HANCOCK	J. J. HANCOCK

GENERAL ARRANGEMENT
COMBUSTION BUILDING
EL. 703'-0" & 728'-0"
1-5001-03-2

PLAN - EL. 728'-0"

PLAN - EL. 703'-0"

MATCH LINE 1-5010-08

MATCH LINE 1-5010-08

MATCH LINE 1-5010-08

MATCH LINE 1-5010-08

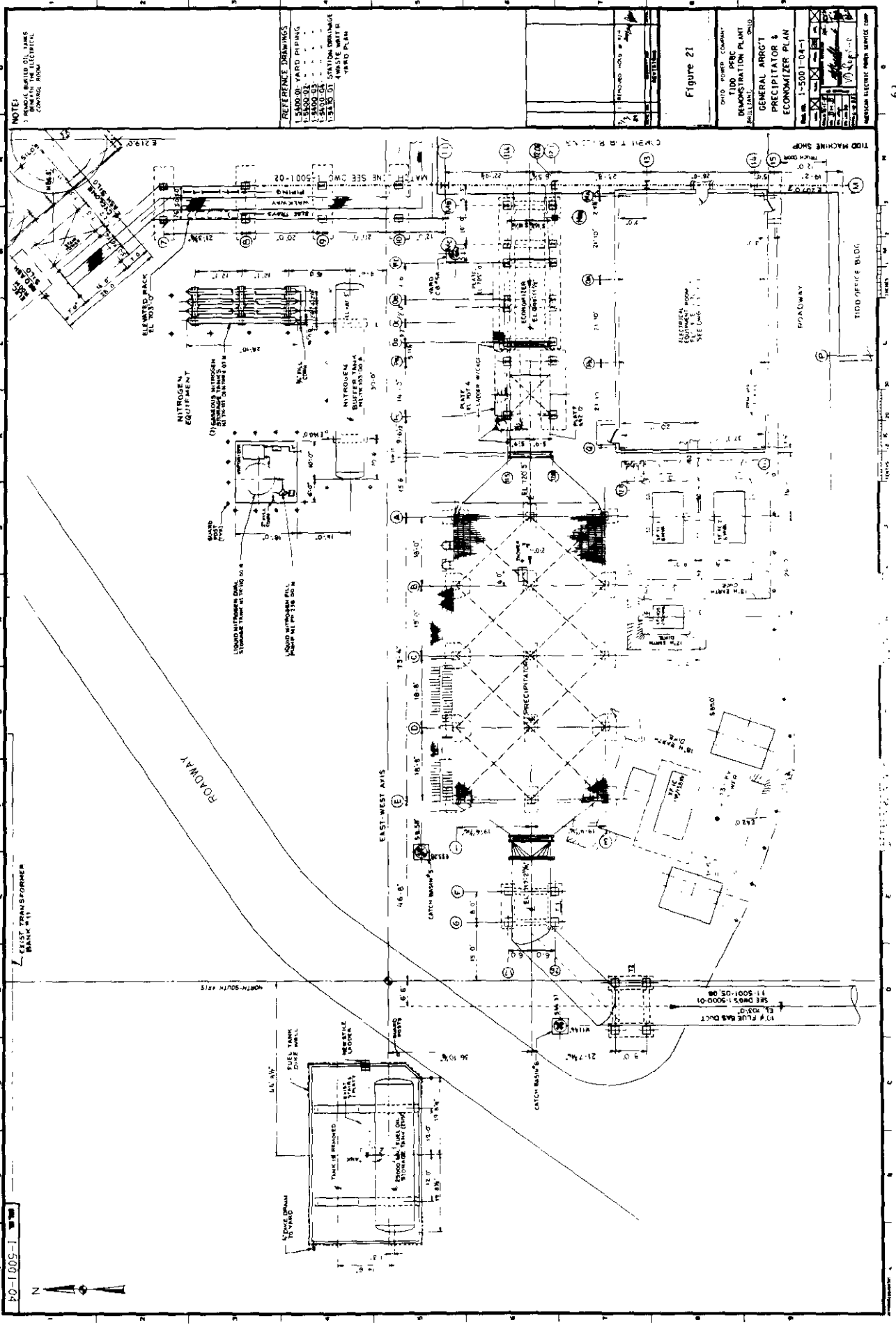

NOTES:
 1. FUEL TANK DISPOSE OF OIL TANKS
 2. BREAKER IN ELECTRICAL CONTROL ROOM

REFERENCE DRAWINGS

1-5000-01	GENERAL ARR'GT
1-5000-02	DEMONSTRATION PLANT
1-5000-03	ELECTRICAL CONTROL ROOM
1-5000-04	PRECIPITATOR & ECONOMIZER PLAN
1-5000-05	YARD PLAN

Figure 21

DMIR POWER COMPANY
 TIDD PRECIPITATOR PLANT
 MILLVILLE, MISSISSIPPI

GENERAL ARR'GT
 DEMONSTRATION PLANT
 ECONOMIZER PLAN
 1-5000-04-1

10/1/50
 10/1/50
 10/1/50

MICROTECH ELECTRIC SERVICE CORP.

1-5000-04

GENERAL NOTES

- REFERENCE DRAWINGS**
- CASUALTY PLANT (11113)
 - 1.2.1015 STACK PLATE AREA
 - 1.2.2025 STACK LINER AREA
 - 1.3.1015 KEY PLAN
 - 1.3.1015 SECT. A & B
 - 1.3.2025 SECT. C & D
 - 1.3.2025 SECT. E & F
 - 1.3.2025 SECT. G & H
 - 1.3.2025 SECT. I & J
 - 1.3.2025 SECT. K & L
 - 1.3.2025 SECT. M & N
 - 1.3.2025 SECT. O & P
 - 1.3.2025 SECT. Q & R
 - 1.3.2025 SECT. S & T
 - 1.3.2025 SECT. U & V
 - 1.3.2025 SECT. W & X
 - 1.3.2025 SECT. Y & Z
 - 1.3.2025 SECT. AA & BB
 - 1.3.2025 SECT. CC & DD
 - 1.3.2025 SECT. EE & FF
 - 1.3.2025 SECT. GG & HH
 - 1.3.2025 SECT. II & JJ
 - 1.3.2025 SECT. KK & LL
 - 1.3.2025 SECT. MM & NN
 - 1.3.2025 SECT. OO & PP
 - 1.3.2025 SECT. QQ & RR
 - 1.3.2025 SECT. SS & TT
 - 1.3.2025 SECT. UU & VV
 - 1.3.2025 SECT. WW & XX
 - 1.3.2025 SECT. YY & ZZ
 - 1.3.2025 SECT. AAA & BBB
 - 1.3.2025 SECT. CCC & DDD
 - 1.3.2025 SECT. EEE & FFF
 - 1.3.2025 SECT. GGG & HHH
 - 1.3.2025 SECT. III & JJJ
 - 1.3.2025 SECT. KKK & LLL
 - 1.3.2025 SECT. MMM & NNN
 - 1.3.2025 SECT. OOO & PPP
 - 1.3.2025 SECT. QQQ & RRR
 - 1.3.2025 SECT. SSS & TTT
 - 1.3.2025 SECT. UUU & VVV
 - 1.3.2025 SECT. WWW & XXX
 - 1.3.2025 SECT. YYY & ZZZ
 - 1.3.2025 SECT. AAAA & BBBB
 - 1.3.2025 SECT. CCCC & DDDD
 - 1.3.2025 SECT. EEEE & FFFF
 - 1.3.2025 SECT. GGGG & HHHH
 - 1.3.2025 SECT. IIII & JJJJ
 - 1.3.2025 SECT. KKKK & LLLL
 - 1.3.2025 SECT. MMMM & NNNN
 - 1.3.2025 SECT. OOOO & PPPP
 - 1.3.2025 SECT. QQQQ & RRRR
 - 1.3.2025 SECT. SSSS & TTTT
 - 1.3.2025 SECT. UUUU & VVVV
 - 1.3.2025 SECT. WWWW & XXXX
 - 1.3.2025 SECT. YYYYY & ZZZZ
 - 1.3.2025 SECT. AAAAA & BBBBB
 - 1.3.2025 SECT. CCCCC & DDDDD
 - 1.3.2025 SECT. EEEEE & FFFFF
 - 1.3.2025 SECT. GGGGG & HHHHH
 - 1.3.2025 SECT. IIIII & JJJJJ
 - 1.3.2025 SECT. KKKKK & LLLLL
 - 1.3.2025 SECT. MMMMM & NNNNN
 - 1.3.2025 SECT. OOOOO & PPPPP
 - 1.3.2025 SECT. QQQQQ & RRRRR
 - 1.3.2025 SECT. SSSSS & TTTTT
 - 1.3.2025 SECT. UUUUU & VVVVV
 - 1.3.2025 SECT. WWWWW & XXXXX
 - 1.3.2025 SECT. YYYYYY & ZZZZZ
 - 1.3.2025 SECT. AAAAAA & BBBBBB
 - 1.3.2025 SECT. CCCCCC & DDDDDD
 - 1.3.2025 SECT. EEEEEE & FFFFFF
 - 1.3.2025 SECT. GGGGGG & HHHHHH
 - 1.3.2025 SECT. IIIIII & JJJJJJ
 - 1.3.2025 SECT. KKKKKK & LLLLLL
 - 1.3.2025 SECT. MMMMMM & NNNNNN
 - 1.3.2025 SECT. OOOOOO & PPPPPP
 - 1.3.2025 SECT. QQQQQQ & RRRRRR
 - 1.3.2025 SECT. SSSSSS & TTTTTT
 - 1.3.2025 SECT. UUUUUU & VVVVVV
 - 1.3.2025 SECT. WWWWWW & XXXXXX
 - 1.3.2025 SECT. YYYYYY & ZZZZZZ
 - 1.3.2025 SECT. AAAAAA & BBBBBB
 - 1.3.2025 SECT. CCCCCC & DDDDDD
 - 1.3.2025 SECT. EEEEEE & FFFFFF
 - 1.3.2025 SECT. GGGGGG & HHHHHH
 - 1.3.2025 SECT. IIIIII & JJJJJJ
 - 1.3.2025 SECT. KKKKKK & LLLLLL
 - 1.3.2025 SECT. MMMMMM & NNNNNN
 - 1.3.2025 SECT. OOOOOO & PPPPPP
 - 1.3.2025 SECT. QQQQQQ & RRRRRR
 - 1.3.2025 SECT. SSSSSS & TTTTTT
 - 1.3.2025 SECT. UUUUUU & VVVVVV
 - 1.3.2025 SECT. WWWWWW & XXXXXX
 - 1.3.2025 SECT. YYYYYY & ZZZZZZ

LEGEND

- 1.5.0000 GENERAL AREA
- 1.5.0000 SITE PLAN
- 1.5.0000 DUCT MODIFICATIONS

Figure 22

GENERAL ARMY
 DEMONSTRATION PLANT
 PRECIPITATOR IA & IB
 DUCT MODIFICATIONS

DATE: 1-5-01
 DRAWN BY: [Name]
 CHECKED BY: [Name]
 APPROVED BY: [Name]

NO.	DATE	DESCRIPTION
1	1-5-01	ISSUED FOR CONSTRUCTION
2	1-5-01	REVISIONS
3	1-5-01	REVISIONS
4	1-5-01	REVISIONS
5	1-5-01	REVISIONS
6	1-5-01	REVISIONS
7	1-5-01	REVISIONS
8	1-5-01	REVISIONS
9	1-5-01	REVISIONS
10	1-5-01	REVISIONS
11	1-5-01	REVISIONS
12	1-5-01	REVISIONS
13	1-5-01	REVISIONS
14	1-5-01	REVISIONS
15	1-5-01	REVISIONS
16	1-5-01	REVISIONS
17	1-5-01	REVISIONS
18	1-5-01	REVISIONS
19	1-5-01	REVISIONS
20	1-5-01	REVISIONS
21	1-5-01	REVISIONS
22	1-5-01	REVISIONS
23	1-5-01	REVISIONS
24	1-5-01	REVISIONS
25	1-5-01	REVISIONS
26	1-5-01	REVISIONS
27	1-5-01	REVISIONS
28	1-5-01	REVISIONS
29	1-5-01	REVISIONS
30	1-5-01	REVISIONS
31	1-5-01	REVISIONS
32	1-5-01	REVISIONS
33	1-5-01	REVISIONS
34	1-5-01	REVISIONS
35	1-5-01	REVISIONS
36	1-5-01	REVISIONS
37	1-5-01	REVISIONS
38	1-5-01	REVISIONS
39	1-5-01	REVISIONS
40	1-5-01	REVISIONS
41	1-5-01	REVISIONS
42	1-5-01	REVISIONS
43	1-5-01	REVISIONS
44	1-5-01	REVISIONS
45	1-5-01	REVISIONS
46	1-5-01	REVISIONS
47	1-5-01	REVISIONS
48	1-5-01	REVISIONS
49	1-5-01	REVISIONS
50	1-5-01	REVISIONS

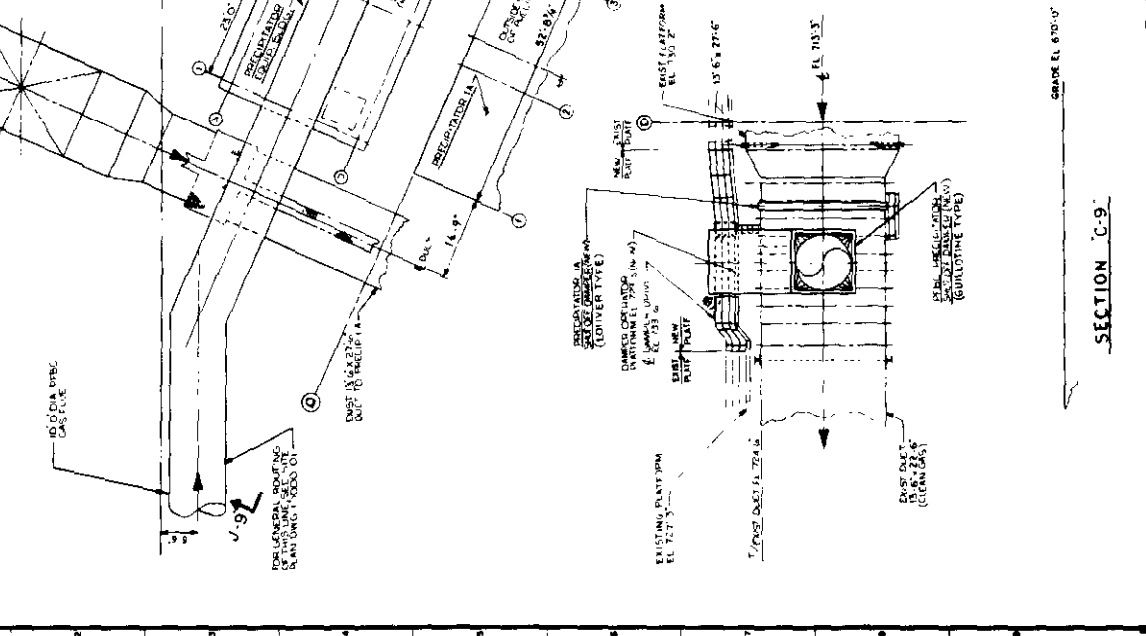
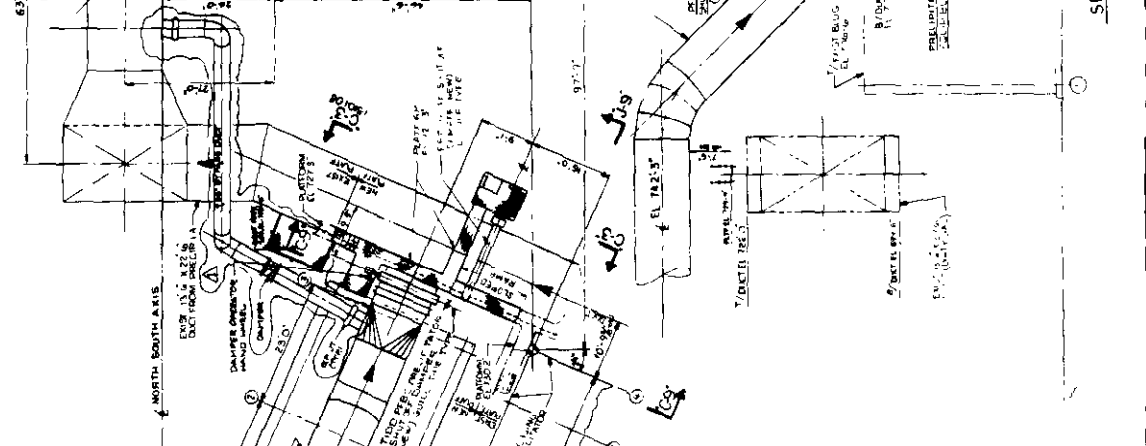
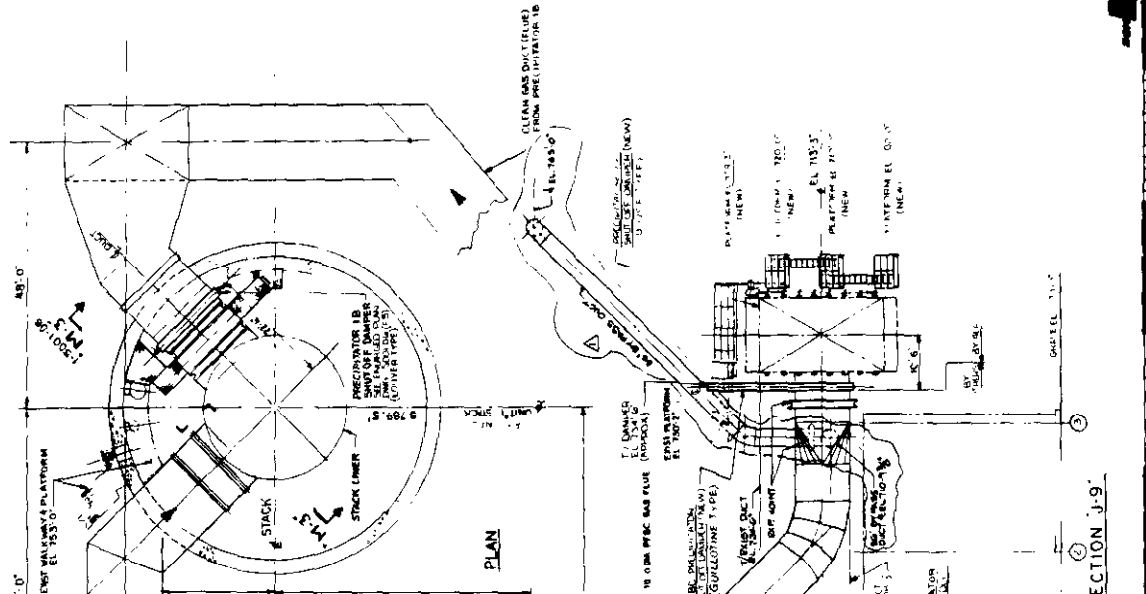

50-1005-1

90-1005-1

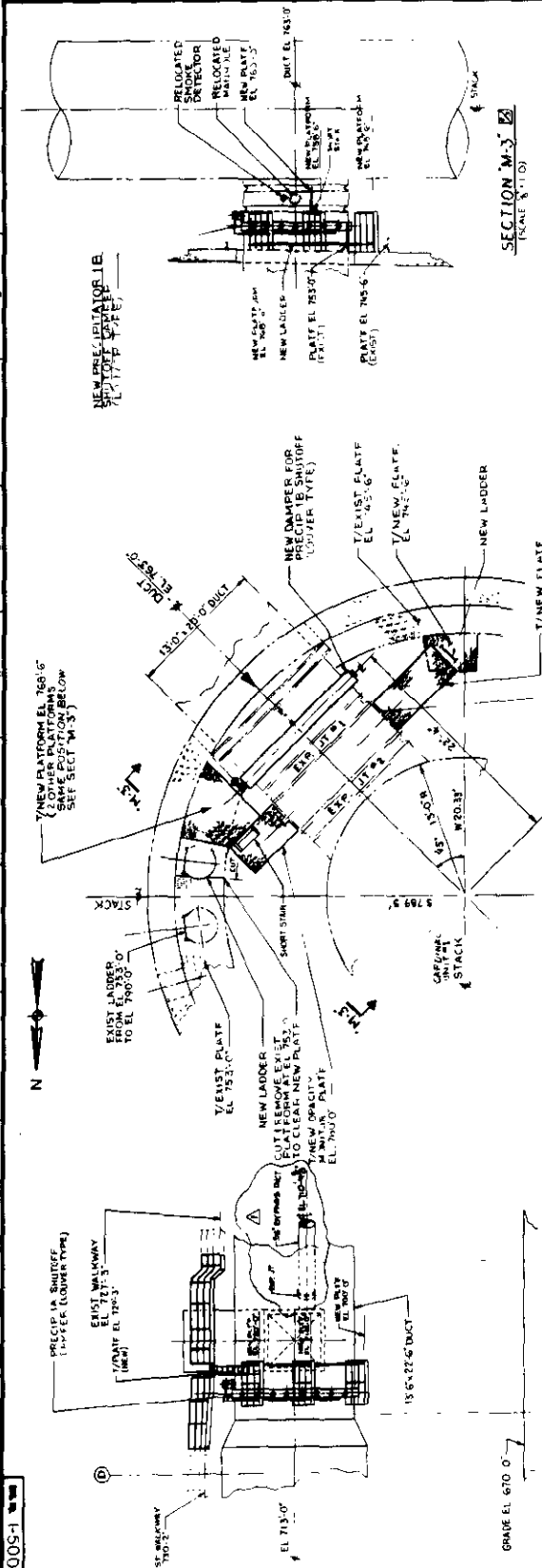

SECTION C-3'
 DWG. I-5001-05
 (SCALE 1/4"=1'-0")

**ENLARGED PLAN AT
 PRECIP. IB SHUTOFF
 DAMPER**
 DWG. I-5001-05
 (SCALE 1/4"=1'-0")

SECTION M-3'
 DWG. I-5001-05
 (SCALE 1/4"=1'-0")

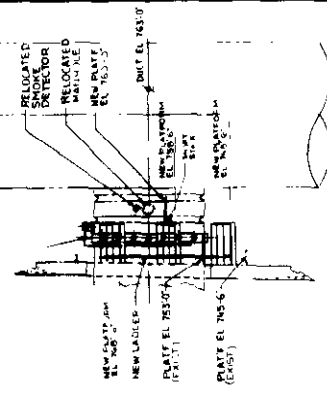

SECTION M-3'
 DWG. I-5001-05
 (SCALE 1/4"=1'-0")

GENERAL NOTES

REFERENCE DRAWINGS
 LISTED ON DWG. I-5001-03

Figure 23

THIS PROJECT	DISCONTINUATION PLANT
GENERAL ARRANGEMENT	PRECIPITATOR IA & IB
DUCT MODIFICATIONS	DWG. I-5001-06-1

REV. 10/6/61

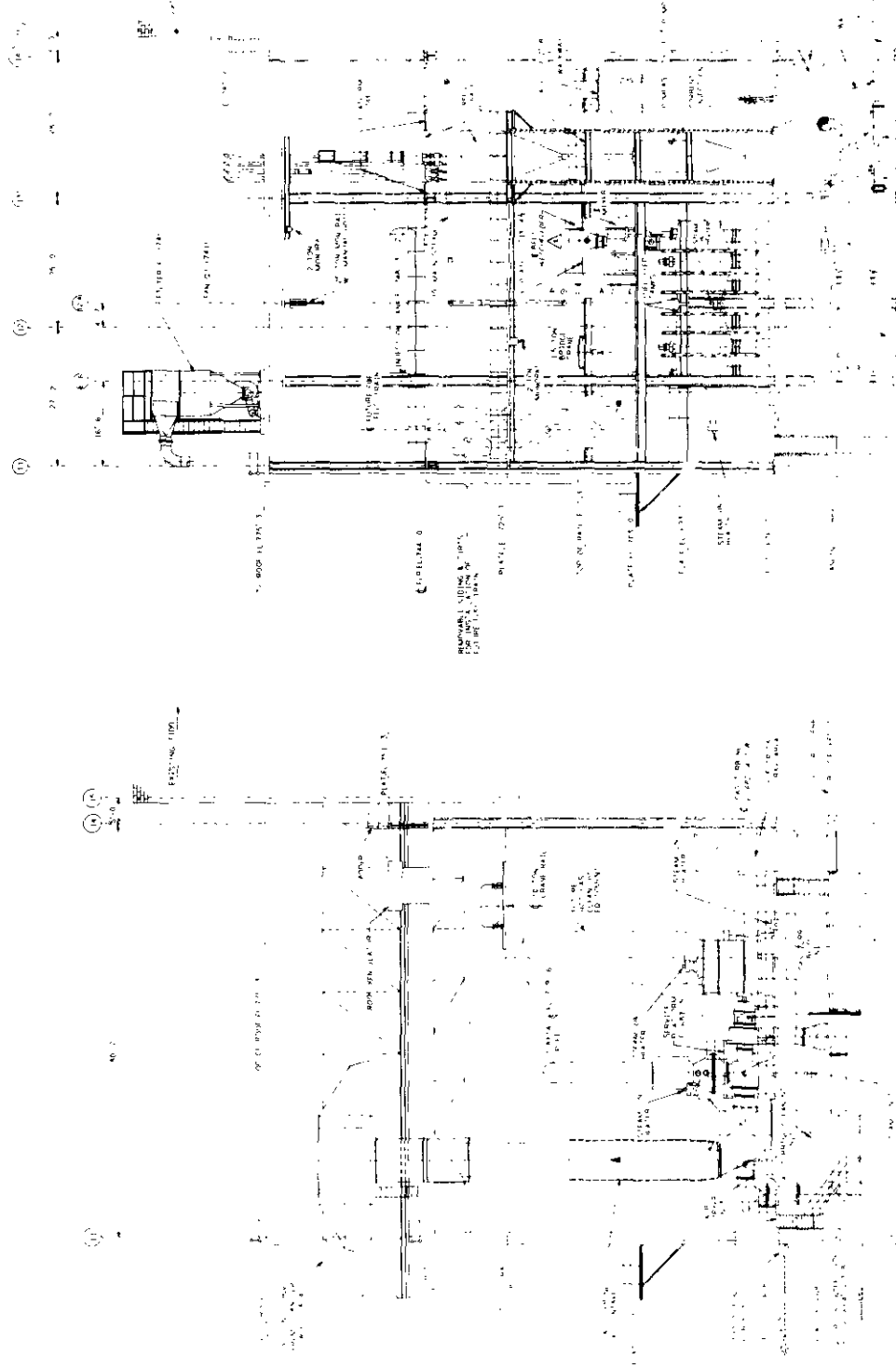
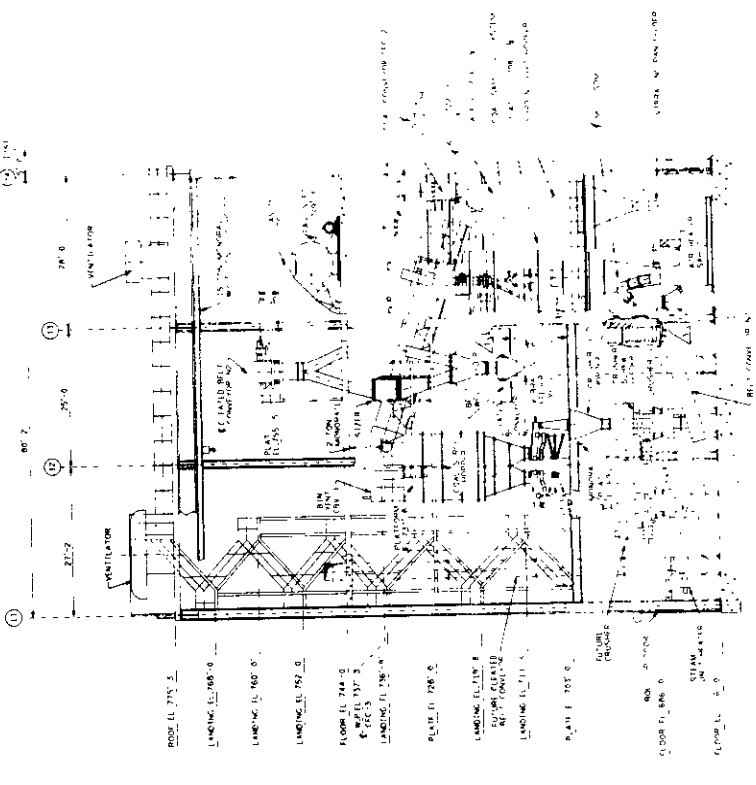
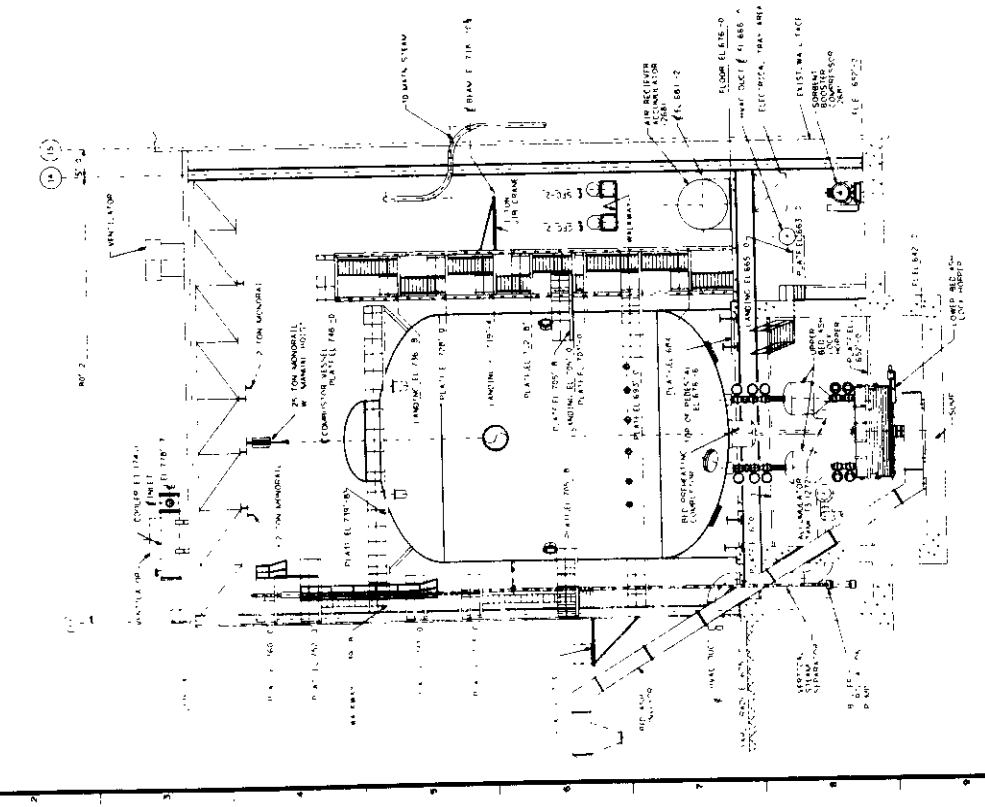

Figure 25

GENERAL INFORMATION	
PROJECT NO.	1-5001-08-2
DATE	10/6/61
SCALE	AS SHOWN
DESIGNER	AMERICAN GENERAL INVESTMENT CO.
CONTRACTOR	
ENGINEER	
ARCHITECT	
MECHANICAL	
ELECTRICAL	
PLUMBING	
HEATING	
VENTILATION	
AIR CONDITIONING	
FIRE PROTECTION	
SOUND ABSORPTION	
LIGHTING	
FURNITURE	
FIXTURES	
EQUIPMENT	
MATERIALS	
FINISHES	
DETAILS	
NOTES	
REFERENCES	
LEGEND	
SCALE	
DATE	
DRAWN BY	
CHECKED BY	
APPROVED BY	



SECTION "K-8"



SECTION "D-9"

CONSULTING ENGINEER WILLIAMS & BROWN 1500 W. BROADWAY HOUSTON, TEXAS	
DRAWN BY W. B. BROWN CHECKED BY W. B. BROWN DATE 1/25/50	TITLE SECTION "K-8" SECTION "D-9"
GENERAL CONTRACTOR TUDOR PEB DEMONSTRATION PLANT BRILLIANT GENERAL APPROX COMBUSTOR BUILDING SECTIONS	
DRAWING NO. 1-5001-09-1 SHEET NO. 73	
AMERICAN ELECTRIC POWER SERVICE COMPANY	

SECTION 'B-5'

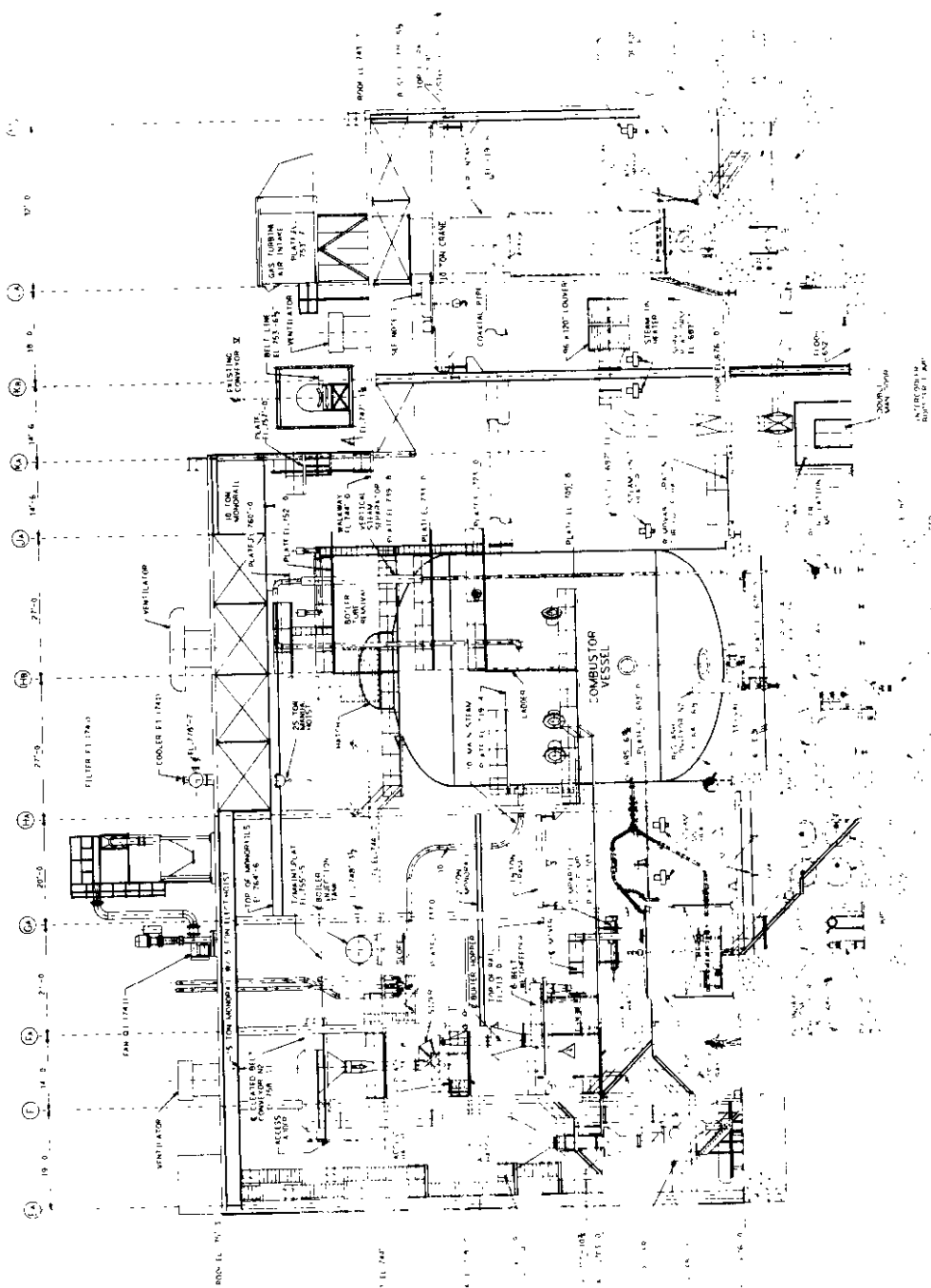

SECTION 'B-5'

REVISIONS	
NO.	DESCRIPTION
1	ISSUED FOR CONSTRUCTION
2	REVISIONS TO BE MADE TO THE DRAWING
3	REVISIONS TO BE MADE TO THE DRAWING
4	REVISIONS TO BE MADE TO THE DRAWING
5	REVISIONS TO BE MADE TO THE DRAWING
6	REVISIONS TO BE MADE TO THE DRAWING
7	REVISIONS TO BE MADE TO THE DRAWING
8	REVISIONS TO BE MADE TO THE DRAWING
9	REVISIONS TO BE MADE TO THE DRAWING
10	REVISIONS TO BE MADE TO THE DRAWING
11	REVISIONS TO BE MADE TO THE DRAWING
12	REVISIONS TO BE MADE TO THE DRAWING
13	REVISIONS TO BE MADE TO THE DRAWING
14	REVISIONS TO BE MADE TO THE DRAWING
15	REVISIONS TO BE MADE TO THE DRAWING

PROJECT	TIDCO PERC DEMONSTRATION PLANT
DATE	1961
GENERAL ARCHT	COMBUSTOR BUILDING SECTIONS
SECTION NO.	1 500 T-10-2
SCALE	
DRAWN BY	
CHECKED BY	
APPROVED BY	
DATE	
PROJECT NO.	
PROJECT NAME	AMERICAN ELECTRIC POWER SERVICE CORP.

Figure 27

1-1905 1-1905

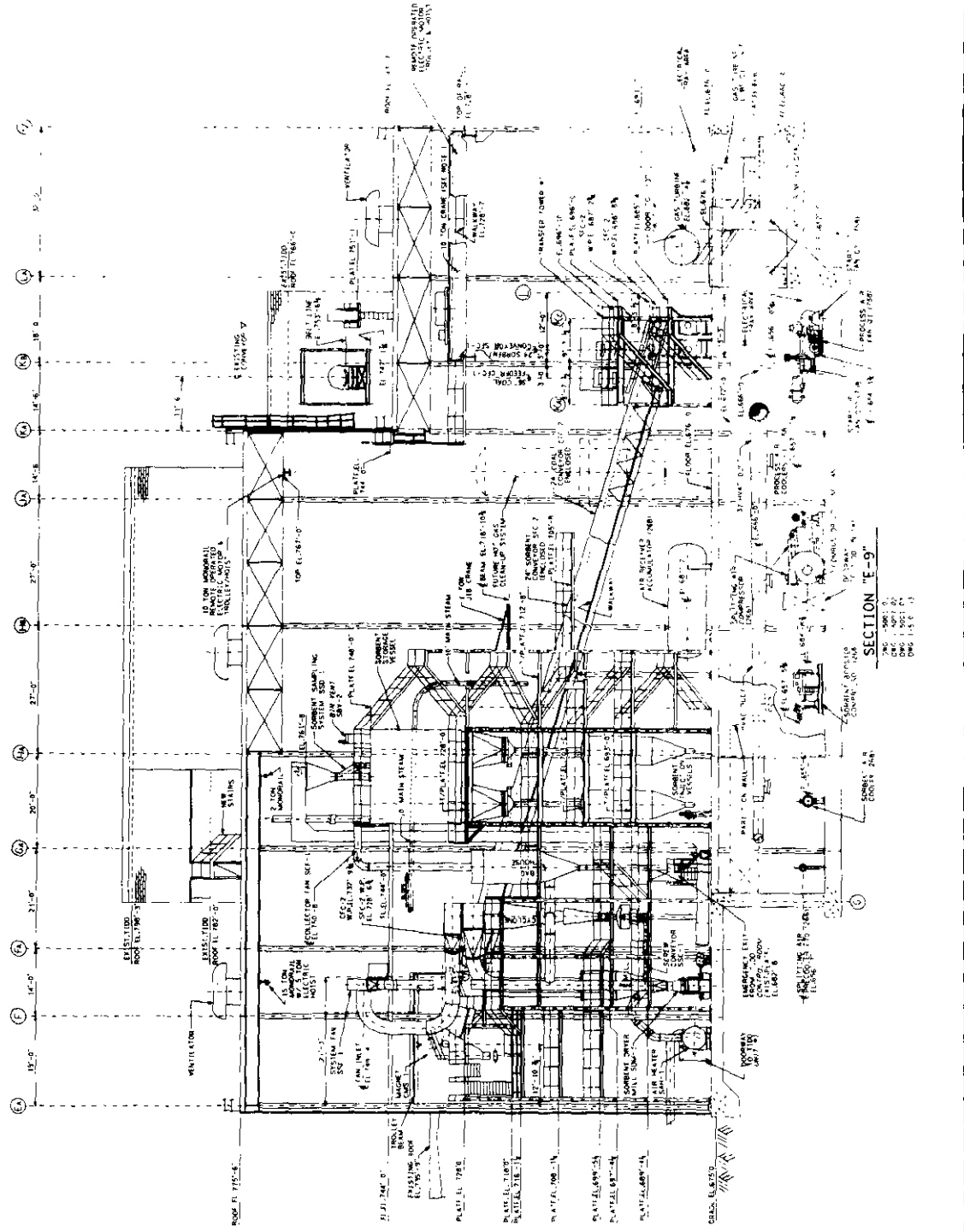

NOTES:
 1. SEE DRAWING 1-1905 1-1905
 2. SEE DRAWING 1-1905 1-1905
 3. SEE DRAWING 1-1905 1-1905
 4. SEE DRAWING 1-1905 1-1905

Figure 28

DUKE POWER COMPANY
 DEMONSTRATION PLANT
 BRILLIANT, OHIO
 GENERAL ARRIS 7
 SECTIONS

NO. 1-5001-1-0	DATE	BY	CHECKED

SECTION 'E-9'

21-1001-1



GENERAL NOTES

- REFERENCE DWGS**
- 1-5000-22 FLOOR PLAN
 - 1-5000-23 STARTING DRAWING
 - 1-5000-24 WASTE PUMP
 - 1-5000-25 WASTE WATER PUMP
 - 1-5000-26 WASTE WATER PUMP
 - 1-5000-27 WASTE WATER PUMP
 - 1-5000-28 WASTE WATER PUMP
 - 1-5000-29 WASTE WATER PUMP
 - 1-5000-30 WASTE WATER PUMP
 - 1-5000-31 WASTE WATER PUMP
 - 1-5000-32 WASTE WATER PUMP
 - 1-5000-33 WASTE WATER PUMP
 - 1-5000-34 WASTE WATER PUMP
 - 1-5000-35 WASTE WATER PUMP
 - 1-5000-36 WASTE WATER PUMP
 - 1-5000-37 WASTE WATER PUMP
 - 1-5000-38 WASTE WATER PUMP
 - 1-5000-39 WASTE WATER PUMP
 - 1-5000-40 WASTE WATER PUMP
 - 1-5000-41 WASTE WATER PUMP
 - 1-5000-42 WASTE WATER PUMP
 - 1-5000-43 WASTE WATER PUMP
 - 1-5000-44 WASTE WATER PUMP
 - 1-5000-45 WASTE WATER PUMP
 - 1-5000-46 WASTE WATER PUMP
 - 1-5000-47 WASTE WATER PUMP
 - 1-5000-48 WASTE WATER PUMP
 - 1-5000-49 WASTE WATER PUMP
 - 1-5000-50 WASTE WATER PUMP

Figure 29

1-5001-12

WASTE WATER PUMPS
STRUCTURE
PLAN & SECTIONS

1-5001-12

1-5001-13

1-5001-14

1-5001-15

1-5001-16

1-5001-17

1-5001-18

1-5001-19

1-5001-20

1-5001-21

1-5001-22

1-5001-23

1-5001-24

1-5001-25

1-5001-26

1-5001-27

1-5001-28

1-5001-29

1-5001-30

1-5001-31

1-5001-32

1-5001-33

1-5001-34

1-5001-35

1-5001-36

1-5001-37

1-5001-38

1-5001-39

1-5001-40

1-5001-41

1-5001-42

1-5001-43

1-5001-44

1-5001-45

1-5001-46

1-5001-47

1-5001-48

1-5001-49

1-5001-50

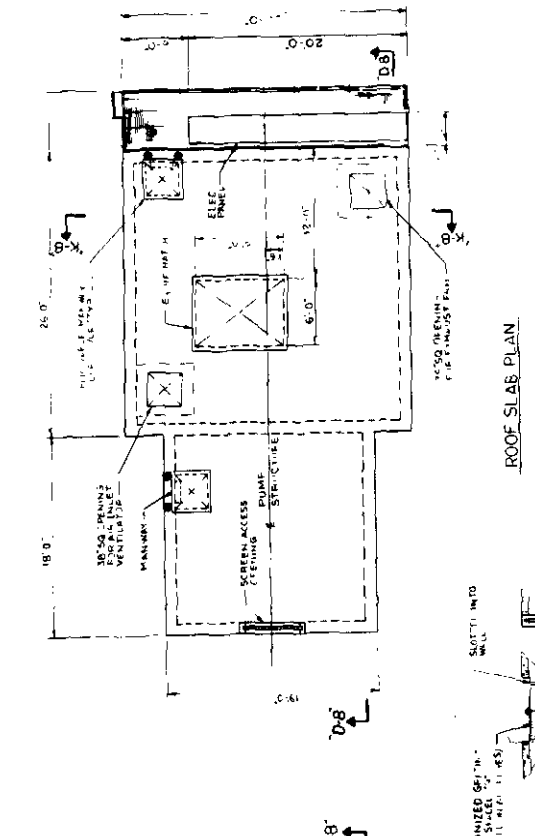
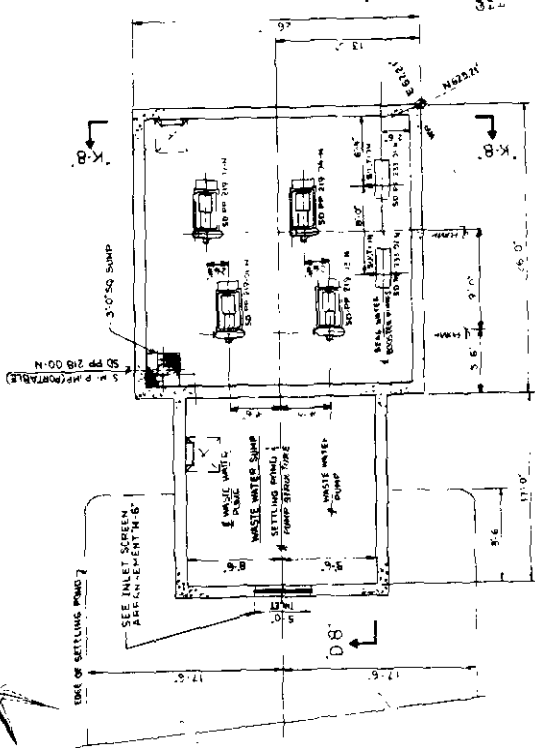

PLAN

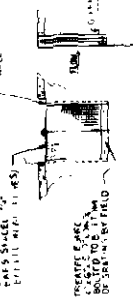

SECTION A-A

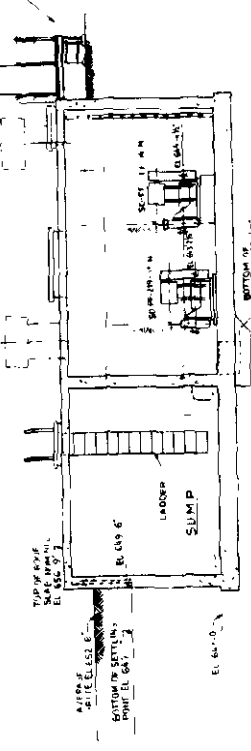

SECTION D-C

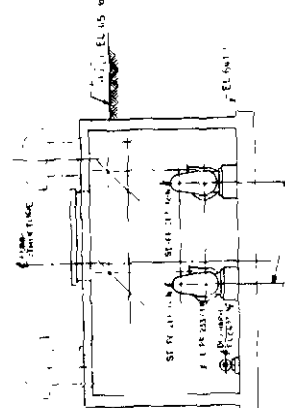

SECTION K-B

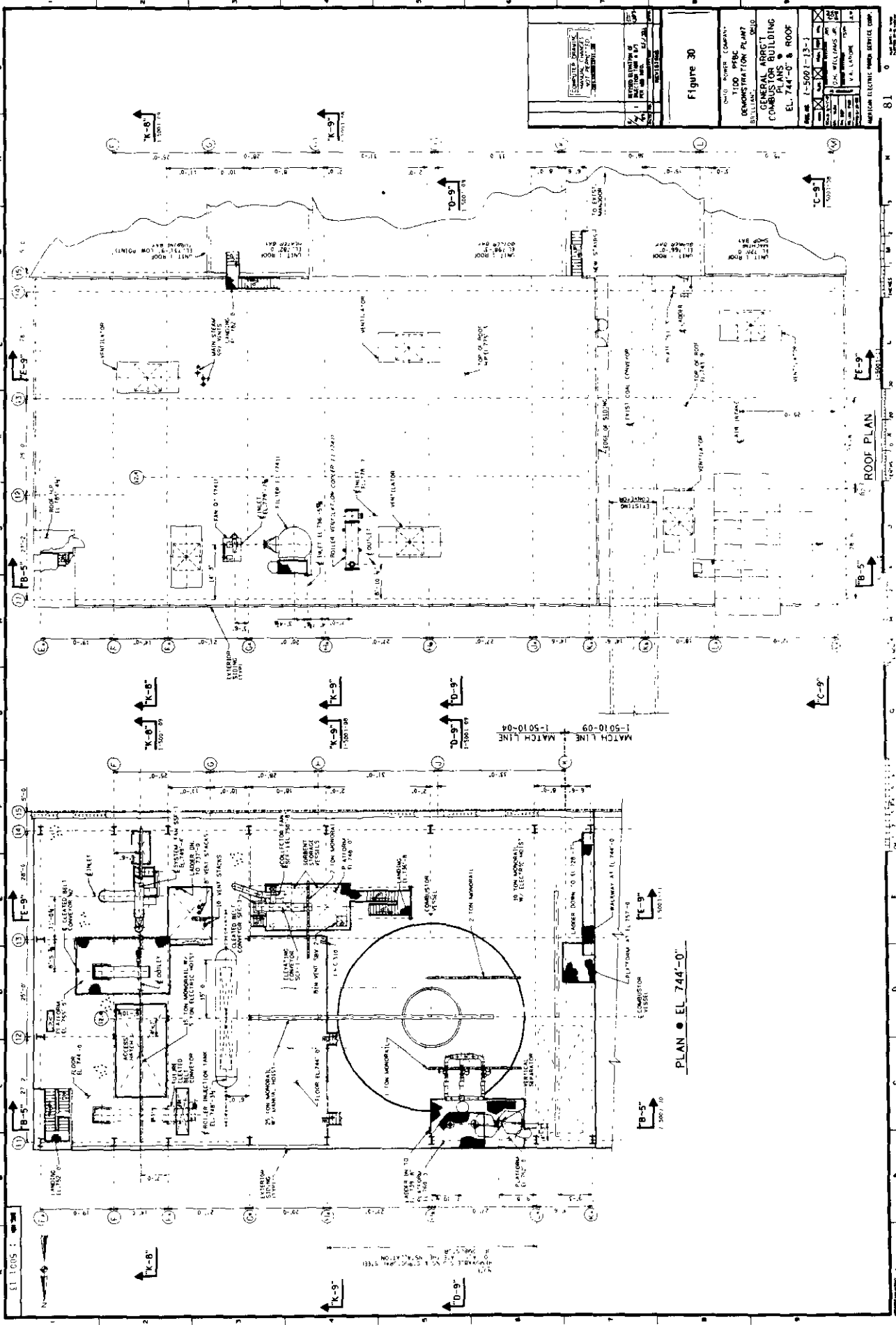

PLAN • EL. 744'-0"

ROOF PLAN

Figure 30

GENERAL CONTRACTOR		GENERAL CONTRACTOR	
1100 SPFC		1100 SPFC	
DEMONTREATION PLAN		DEMONTREATION PLAN	
BUILDING		BUILDING	
GENERAL CONTRACTOR		GENERAL CONTRACTOR	
COMBINATION PLAN & ROOF		COMBINATION PLAN & ROOF	
EL. 744'-0" & ROOF		EL. 744'-0" & ROOF	
L-5001-13-1		L-5001-13-1	
DATE: 11/15/70		DATE: 11/15/70	
DRAWN BY: J. L. LORR		DRAWN BY: J. L. LORR	
CHECKED BY: J. L. LORR		CHECKED BY: J. L. LORR	
APPROVED BY: J. L. LORR		APPROVED BY: J. L. LORR	
SCALE: AS SHOWN		SCALE: AS SHOWN	
PROJECT NO. 1100 SPFC		PROJECT NO. 1100 SPFC	
SHEET NO. 81		SHEET NO. 81	
TOTAL SHEETS: 81		TOTAL SHEETS: 81	
MOTION ELECTRIC SERVICE CORP.		MOTION ELECTRIC SERVICE CORP.	

GENERAL NOTES
 1. ALL WORK SHALL BE IN ACCORDANCE WITH THE LATEST EDITIONS OF THE BUILDING CODES AND SPECIFICATIONS.
 2. ALL MATERIALS SHALL BE OF THE BEST QUALITY AVAILABLE.
 3. ALL WORK SHALL BE SUBJECT TO INSPECTION AND APPROVAL BY THE CITY ENGINEER.

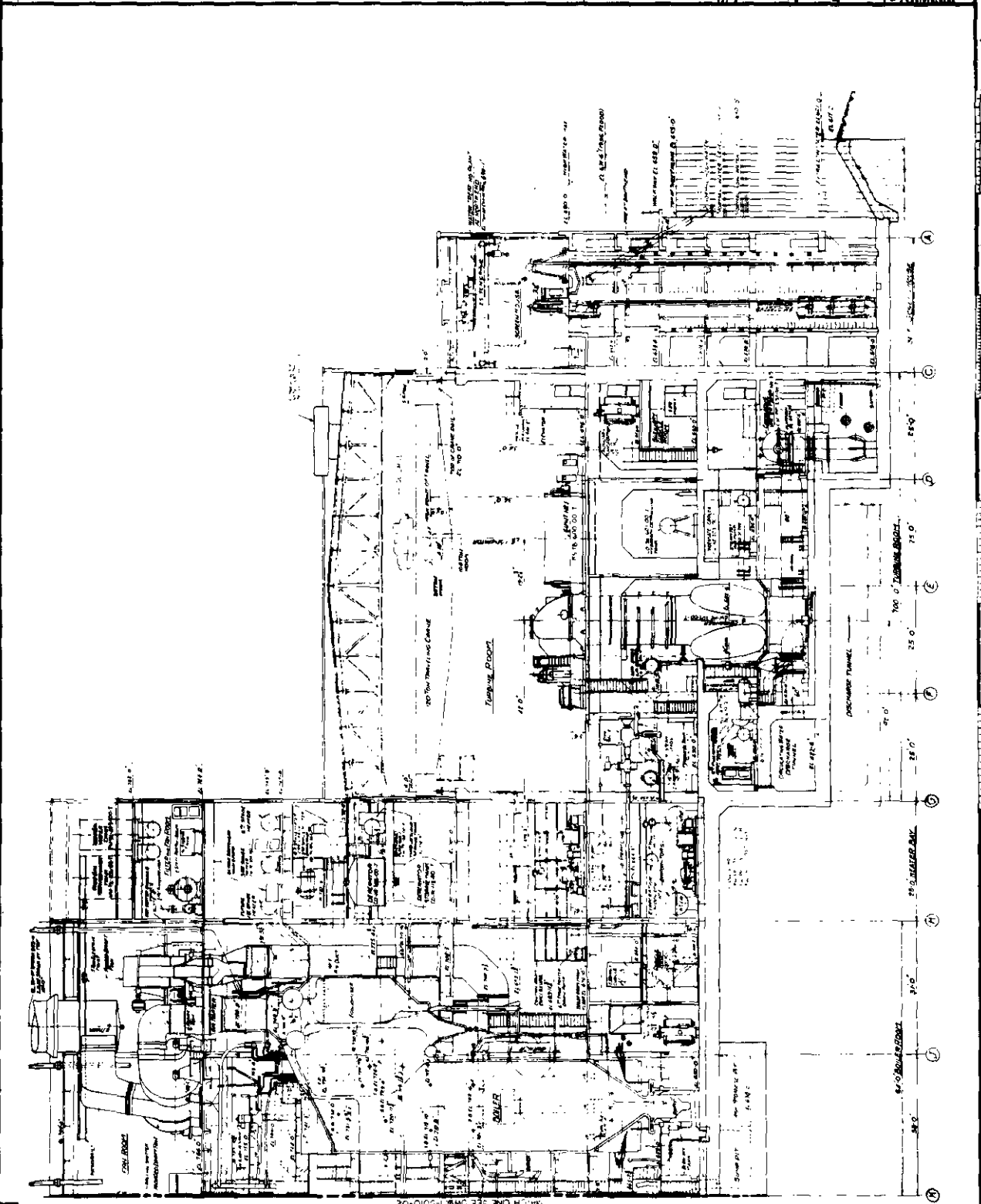

10 0005-1 see sheet

Figure 31

1000 CUBIC
 DEMONSTRATION PLANT
 GENERAL
 CROSS SECTION
 OF PLANT
 UNIT IN FT.
 SCALE: 1/8" = 1'-0"

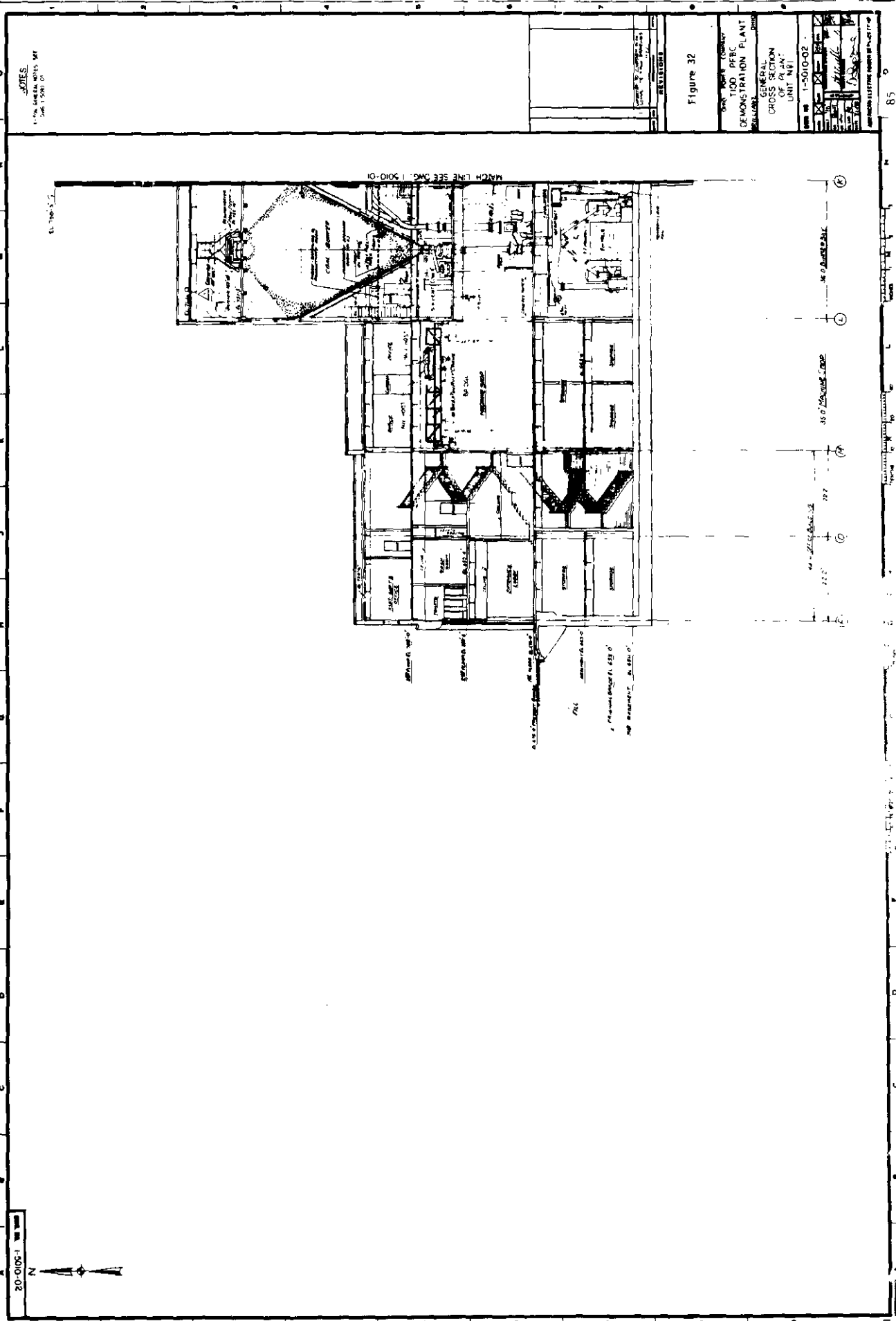

NOTES:
 1. FOR GENERAL NOTES SEE DWG. 1-5010-01

Figure 32

TODD PERC
 DEMONSTRATION PLANT

GENERAL
 CROSS SECTION
 OF PLANT
 UNIT N61

1-5010-02



20'-0"=1" 1/8"=1"

NOTES
SEE GENERAL NOTES 800

Figure 33

TODD PFBFC
DEMONSTRATION PLANT
FLOOR PLANS OF
TURBINE ROOM ELEV.
608'-0" 624'-0" 636'-0"
UNIT NO. 1
DATE: 1-20-03

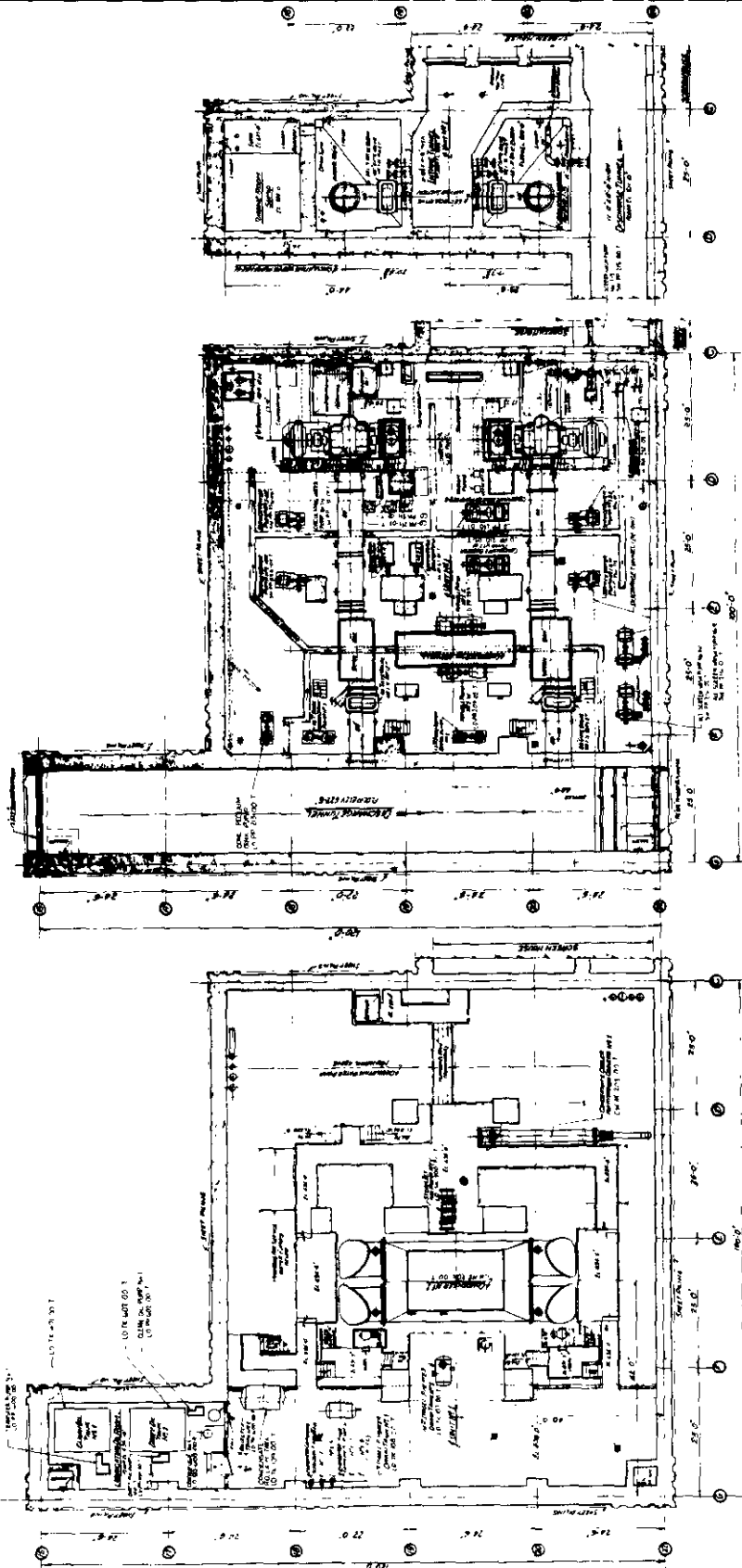

PLAN at ELEV. 608'-0"

PLAN at ELEV. 624'-0"

PLAN at ELEV. 636'-0"

EO 0105 1 - 000 000

NOTES
1. SEE DRAWING NOTES FOR
GENERAL NOTES.

Figure 34

UNIT NO. 15010-04-2
DEMOSNITION PLAN
BASEMENT FLOOR PLAN
OF PLANT
ELEV. 600' 0" (1969.0')
UNIT NO. 1

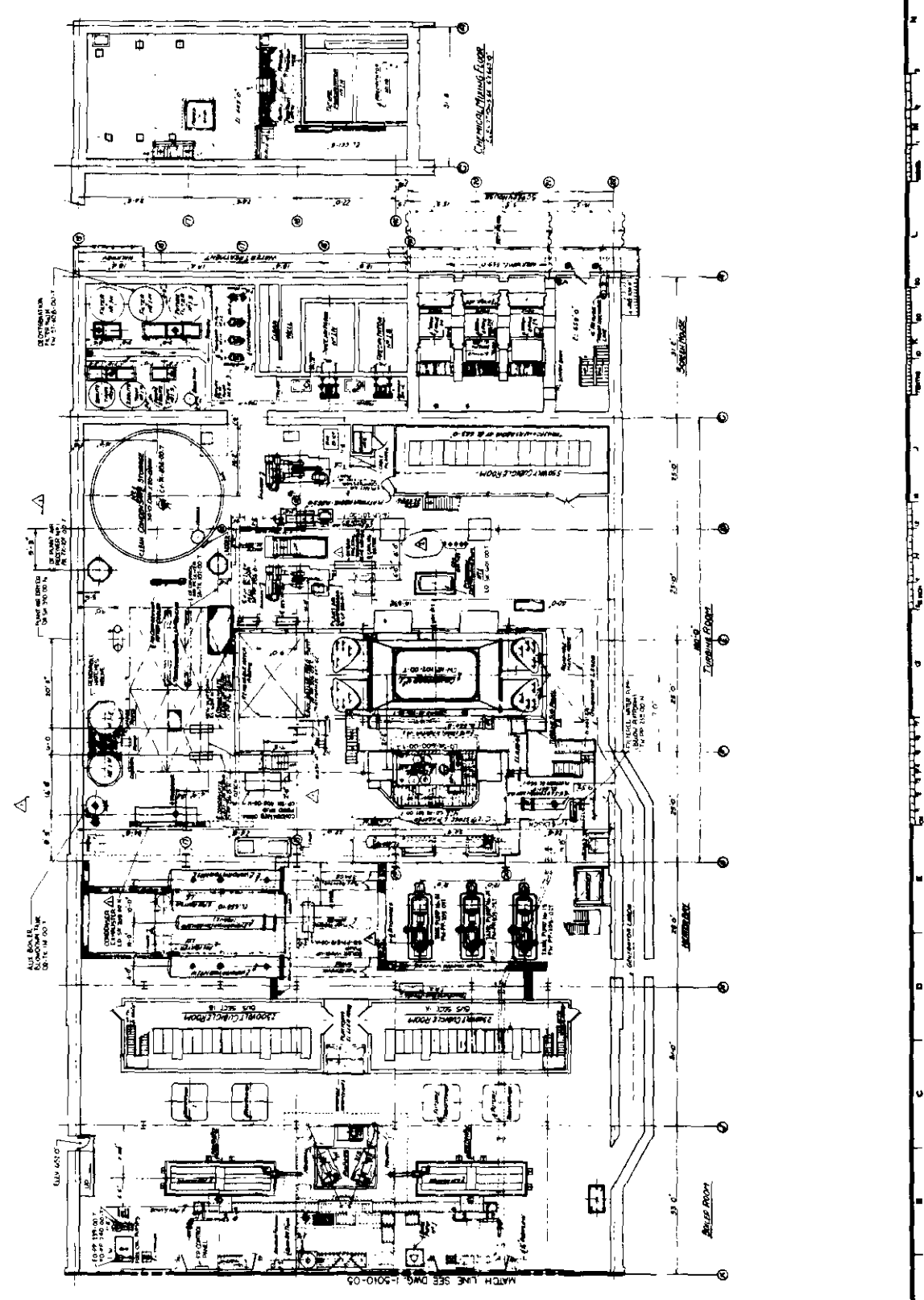

PC-0005-1

WORTH LINE SEE DWG. 1-5010-02

NOTES:
 1. FOR GENERAL NOTES SEE
 DWG. 1-5010-01

Figure 35

TIDD, JOHN COMPANY
 TIDD, P.F.B.C.
 DEMONSTRATION PLANT
 PLUMBING
 BASEMENT FLOOR PLAN
 OF PLANT
 ELEV. 100.0
 UNIT NO. 0

DATE	1-10-05	1
BY		
CHECKED		
APPROVED		
SCALE		
PROJECT		
DRAWING NO.		
REV.		

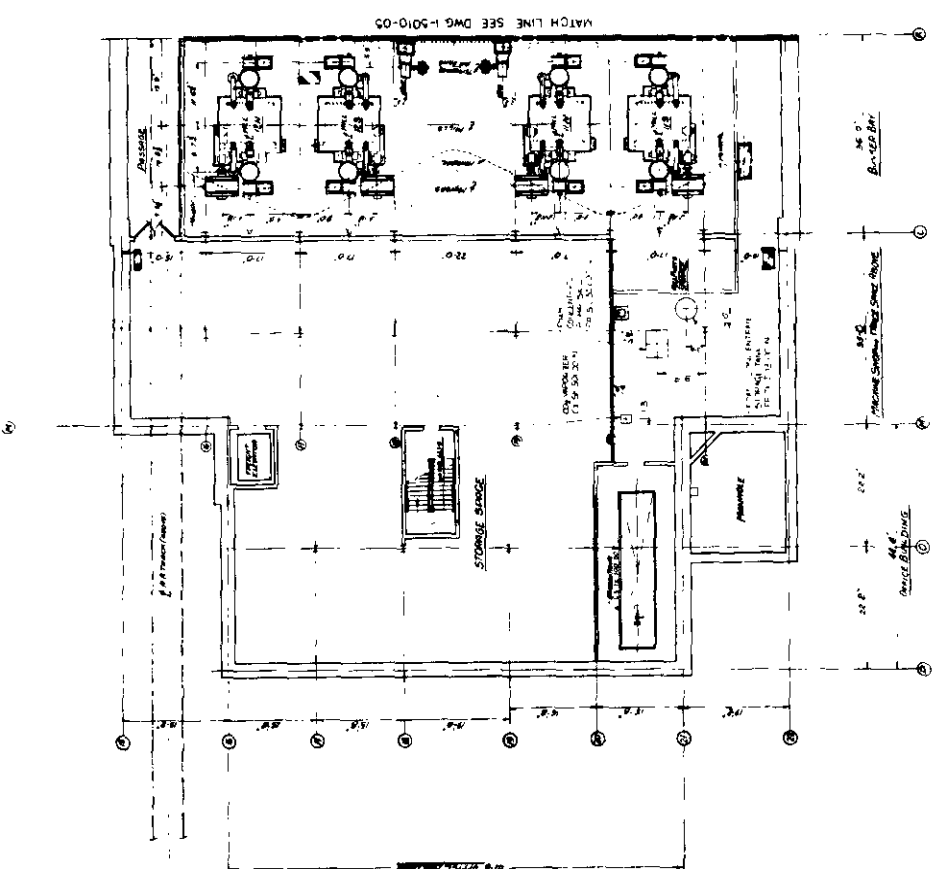

MATCH LINE SEE DWG 1-5010-05

STORAGE SPACE

NO. 0
 BUILT-UP BRK

NO. 0
 PLUMBING STORAGE SPACE ABOVE

NO. 0
 PLUMBING STORAGE SPACE ABOVE

STAIRS

STAIRS

STAIRS

STAIRS

STAIRS

STAIRS

STAIRS

STAIRS

STAIRS

STAIRS

STAIRS

STAIRS



50-0105-1

NOTES
1. GENERAL NOTES
2. SEE DWG. 1501207

Figure 36

1000 P.E.B.C. DEMONSTRATION PLANT	
MEET ROOM IN AN	
ELEV. 100.0	
DATE: 10/20/68	
DRAWN BY: [Signature]	
CHECKED BY: [Signature]	
SCALE: 1/8" = 1'-0"	
PROJECT NO. 1501207	
SHEET NO. 36	
TOTAL SHEETS: 36	
DRAWING TITLE: MEET ROOM	

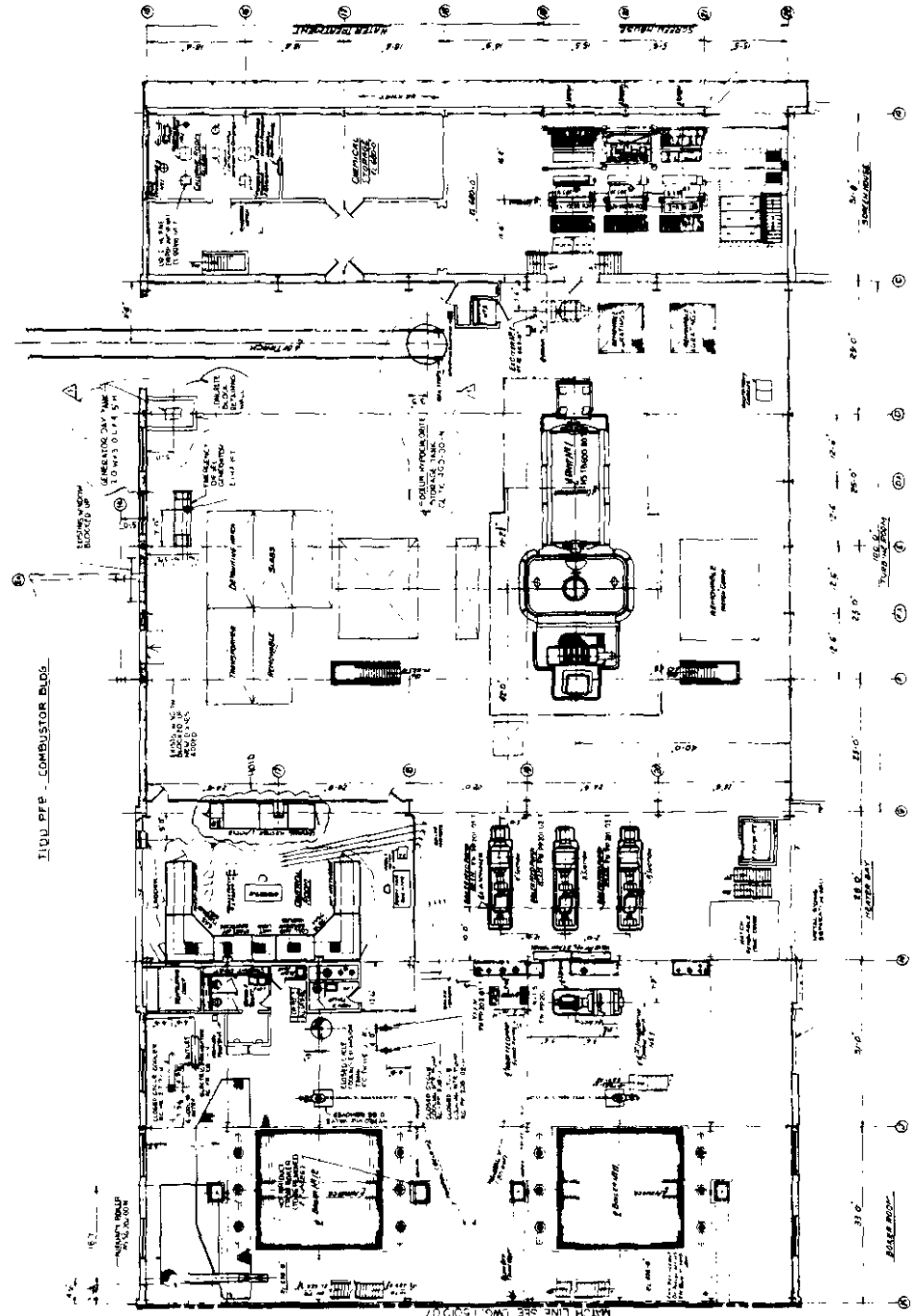

NOTES:
1. FOR GENERAL NOTES SEE
DWG. 1-BUILD-01

Figure 37

MARK FLOOR PLAN
OF PLANT
ELEV. 676'-0"
UNIT 07.1



TIDD PIBC COMBUSTOR BLDG.

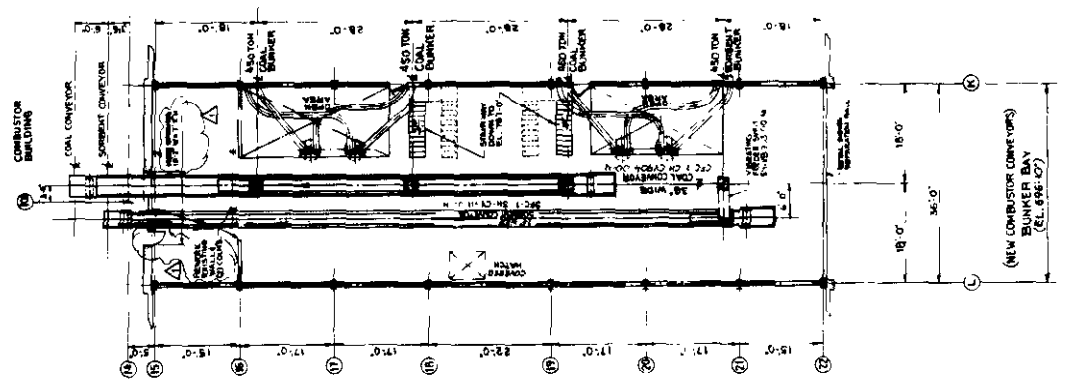
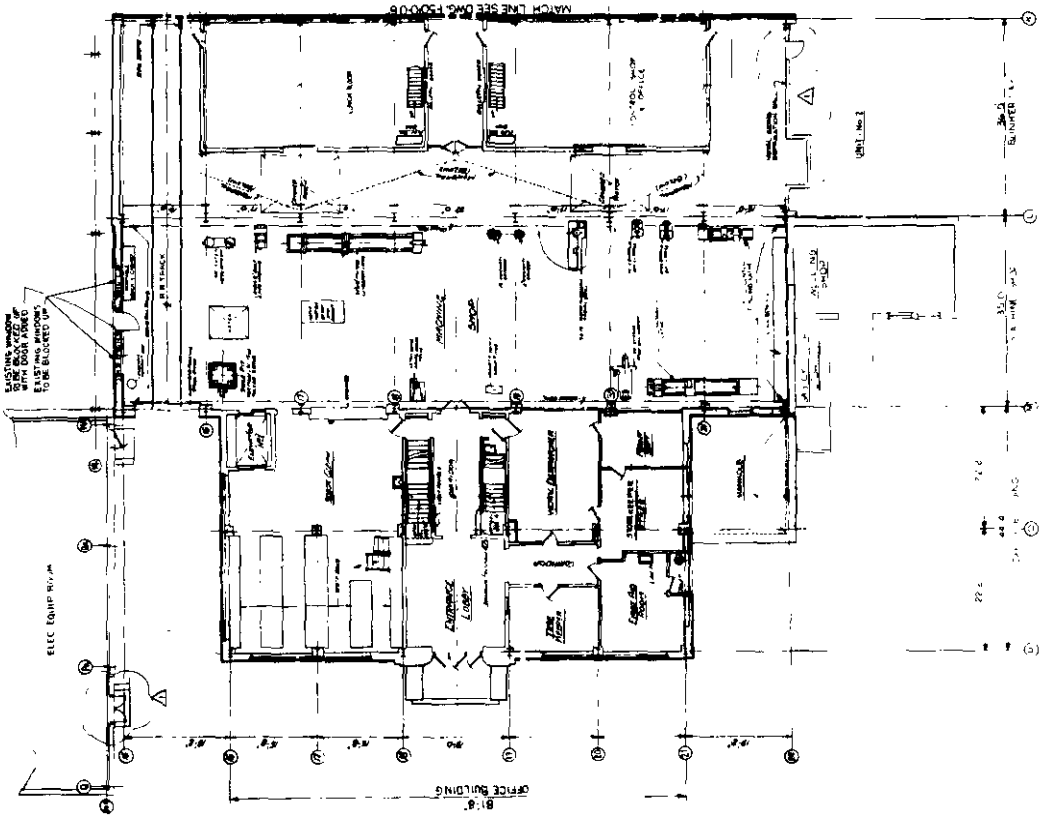

20 0000-1 1/8\"/>

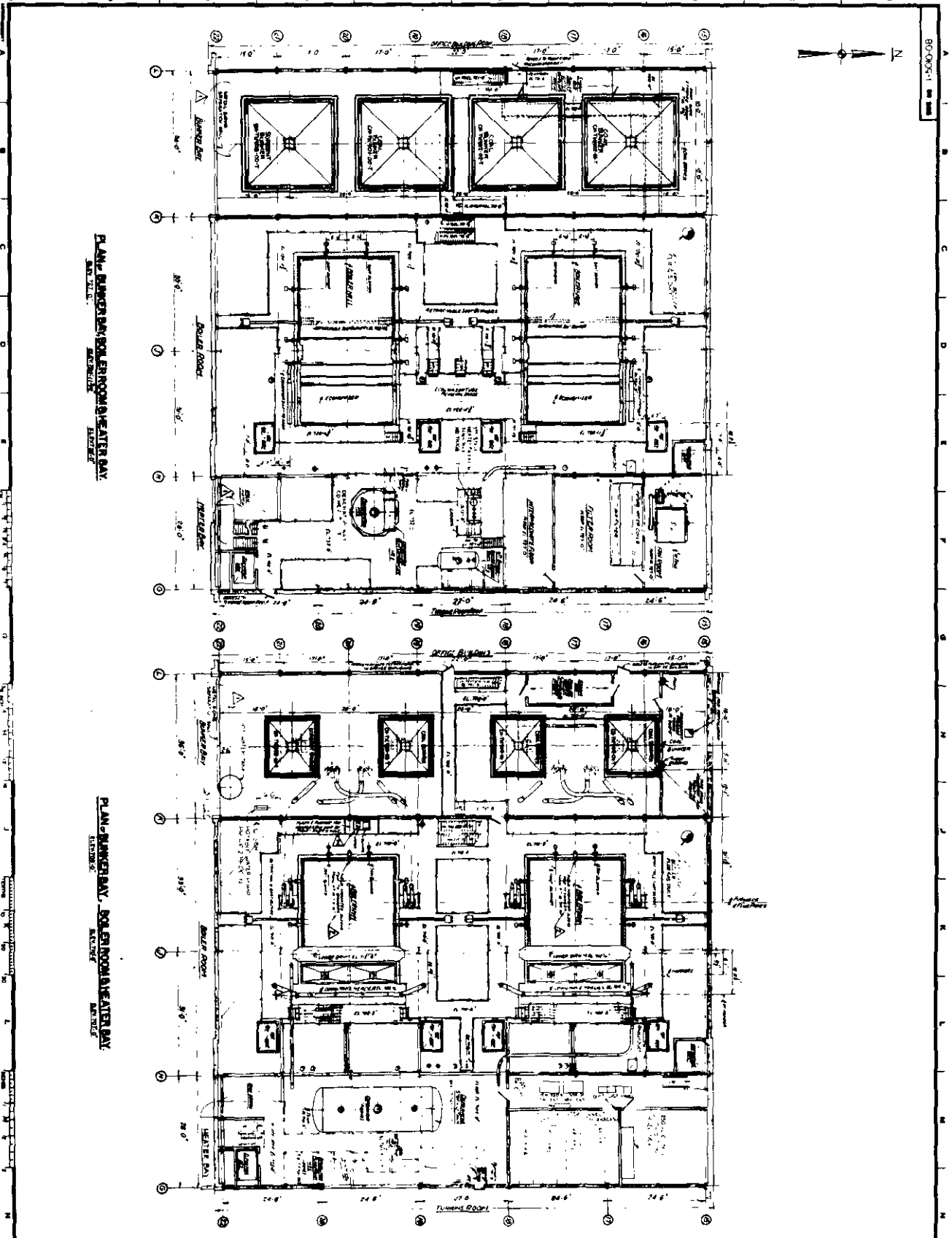

PLAN - BOILER BAY, BOILER ROOM & HEATER BAY
 SCALE: 1/8" = 1'-0"
 DATE: 11/15/50

PLAN - HEATER BAY, BOILER ROOM & HEATER BAY
 SCALE: 1/8" = 1'-0"
 DATE: 11/15/50

NOTES:
 1. SEE 80-000-11 FOR DETAILS

<p>DATE: 11/15/50 1000 P.B.C. DEMONSTRATION PLANT DRAWN BY: [Signature] CHECKED BY: [Signature] FLOOR PLANS OF BOILER ROOM & HEATER BAY ELEVATIONS AND DETAILS DRAWING NO. 80-000-11 PROJECT NO. 1-5000-08-1</p>	<p>Figure 38</p>
---	------------------

NOTES
 1. FOR GENERAL NOTES, SEE
 DRAWING 1-501-03-1

Figure 39

TIDD PFBC
 DEMONSTRATION PLANT
 FLOOR PLANS OF
 ROOMS 200, 201, 202, 203, 204, 205, 206, 207, 208, 209, 210, 211, 212, 213, 214, 215, 216, 217, 218, 219, 220, 221, 222, 223, 224, 225, 226, 227, 228, 229, 230, 231, 232, 233, 234, 235, 236, 237, 238, 239, 240, 241, 242, 243, 244, 245, 246, 247, 248, 249, 250, 251, 252, 253, 254, 255, 256, 257, 258, 259, 260, 261, 262, 263, 264, 265, 266, 267, 268, 269, 270, 271, 272, 273, 274, 275, 276, 277, 278, 279, 280, 281, 282, 283, 284, 285, 286, 287, 288, 289, 290, 291, 292, 293, 294, 295, 296, 297, 298, 299, 300, 301, 302, 303, 304, 305, 306, 307, 308, 309, 310, 311, 312, 313, 314, 315, 316, 317, 318, 319, 320, 321, 322, 323, 324, 325, 326, 327, 328, 329, 330, 331, 332, 333, 334, 335, 336, 337, 338, 339, 340, 341, 342, 343, 344, 345, 346, 347, 348, 349, 350, 351, 352, 353, 354, 355, 356, 357, 358, 359, 360, 361, 362, 363, 364, 365, 366, 367, 368, 369, 370, 371, 372, 373, 374, 375, 376, 377, 378, 379, 380, 381, 382, 383, 384, 385, 386, 387, 388, 389, 390, 391, 392, 393, 394, 395, 396, 397, 398, 399, 400, 401, 402, 403, 404, 405, 406, 407, 408, 409, 410, 411, 412, 413, 414, 415, 416, 417, 418, 419, 420, 421, 422, 423, 424, 425, 426, 427, 428, 429, 430, 431, 432, 433, 434, 435, 436, 437, 438, 439, 440, 441, 442, 443, 444, 445, 446, 447, 448, 449, 450, 451, 452, 453, 454, 455, 456, 457, 458, 459, 460, 461, 462, 463, 464, 465, 466, 467, 468, 469, 470, 471, 472, 473, 474, 475, 476, 477, 478, 479, 480, 481, 482, 483, 484, 485, 486, 487, 488, 489, 490, 491, 492, 493, 494, 495, 496, 497, 498, 499, 500, 501, 502, 503, 504, 505, 506, 507, 508, 509, 510, 511, 512, 513, 514, 515, 516, 517, 518, 519, 520, 521, 522, 523, 524, 525, 526, 527, 528, 529, 530, 531, 532, 533, 534, 535, 536, 537, 538, 539, 540, 541, 542, 543, 544, 545, 546, 547, 548, 549, 550, 551, 552, 553, 554, 555, 556, 557, 558, 559, 560, 561, 562, 563, 564, 565, 566, 567, 568, 569, 570, 571, 572, 573, 574, 575, 576, 577, 578, 579, 580, 581, 582, 583, 584, 585, 586, 587, 588, 589, 590, 591, 592, 593, 594, 595, 596, 597, 598, 599, 600, 601, 602, 603, 604, 605, 606, 607, 608, 609, 610, 611, 612, 613, 614, 615, 616, 617, 618, 619, 620, 621, 622, 623, 624, 625, 626, 627, 628, 629, 630, 631, 632, 633, 634, 635, 636, 637, 638, 639, 640, 641, 642, 643, 644, 645, 646, 647, 648, 649, 650, 651, 652, 653, 654, 655, 656, 657, 658, 659, 660, 661, 662, 663, 664, 665, 666, 667, 668, 669, 670, 671, 672, 673, 674, 675, 676, 677, 678, 679, 680, 681, 682, 683, 684, 685, 686, 687, 688, 689, 690, 691, 692, 693, 694, 695, 696, 697, 698, 699, 700, 701, 702, 703, 704, 705, 706, 707, 708, 709, 710, 711, 712, 713, 714, 715, 716, 717, 718, 719, 720, 721, 722, 723, 724, 725, 726, 727, 728, 729, 730, 731, 732, 733, 734, 735, 736, 737, 738, 739, 740, 741, 742, 743, 744, 745, 746, 747, 748, 749, 750, 751, 752, 753, 754, 755, 756, 757, 758, 759, 760, 761, 762, 763, 764, 765, 766, 767, 768, 769, 770, 771, 772, 773, 774, 775, 776, 777, 778, 779, 780, 781, 782, 783, 784, 785, 786, 787, 788, 789, 790, 791, 792, 793, 794, 795, 796, 797, 798, 799, 800, 801, 802, 803, 804, 805, 806, 807, 808, 809, 810, 811, 812, 813, 814, 815, 816, 817, 818, 819, 820, 821, 822, 823, 824, 825, 826, 827, 828, 829, 830, 831, 832, 833, 834, 835, 836, 837, 838, 839, 840, 841, 842, 843, 844, 845, 846, 847, 848, 849, 850, 851, 852, 853, 854, 855, 856, 857, 858, 859, 860, 861, 862, 863, 864, 865, 866, 867, 868, 869, 870, 871, 872, 873, 874, 875, 876, 877, 878, 879, 880, 881, 882, 883, 884, 885, 886, 887, 888, 889, 890, 891, 892, 893, 894, 895, 896, 897, 898, 899, 900, 901, 902, 903, 904, 905, 906, 907, 908, 909, 910, 911, 912, 913, 914, 915, 916, 917, 918, 919, 920, 921, 922, 923, 924, 925, 926, 927, 928, 929, 930, 931, 932, 933, 934, 935, 936, 937, 938, 939, 940, 941, 942, 943, 944, 945, 946, 947, 948, 949, 950, 951, 952, 953, 954, 955, 956, 957, 958, 959, 960, 961, 962, 963, 964, 965, 966, 967, 968, 969, 970, 971, 972, 973, 974, 975, 976, 977, 978, 979, 980, 981, 982, 983, 984, 985, 986, 987, 988, 989, 990, 991, 992, 993, 994, 995, 996, 997, 998, 999, 1000

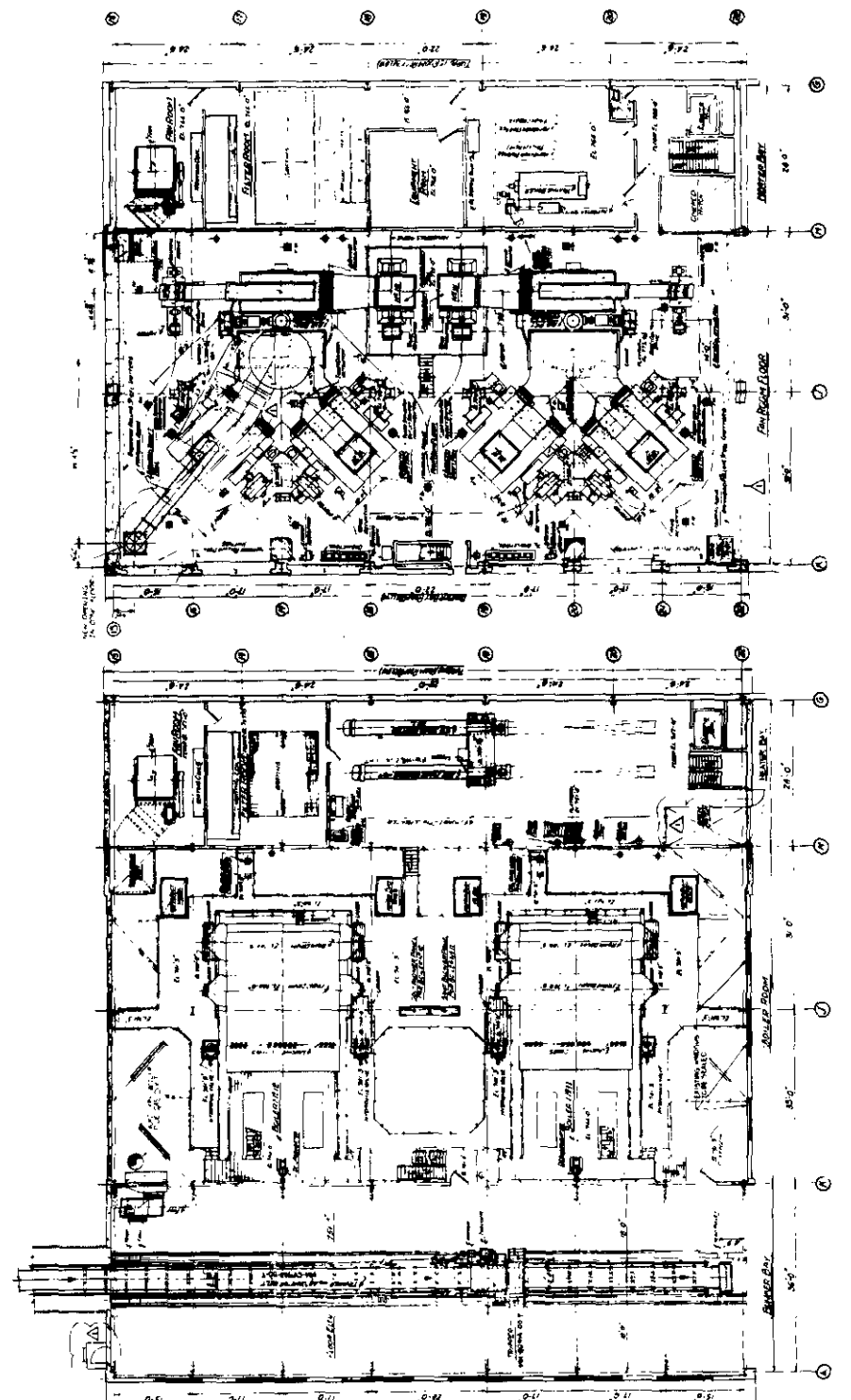

PLAN OF FAN FLOOR & HEATER BOX
 SERVICE

PLAN OF BUFFER ROOM & HEATER BOX
 SERVICE

60-0106-1 SEE SHEET

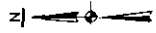

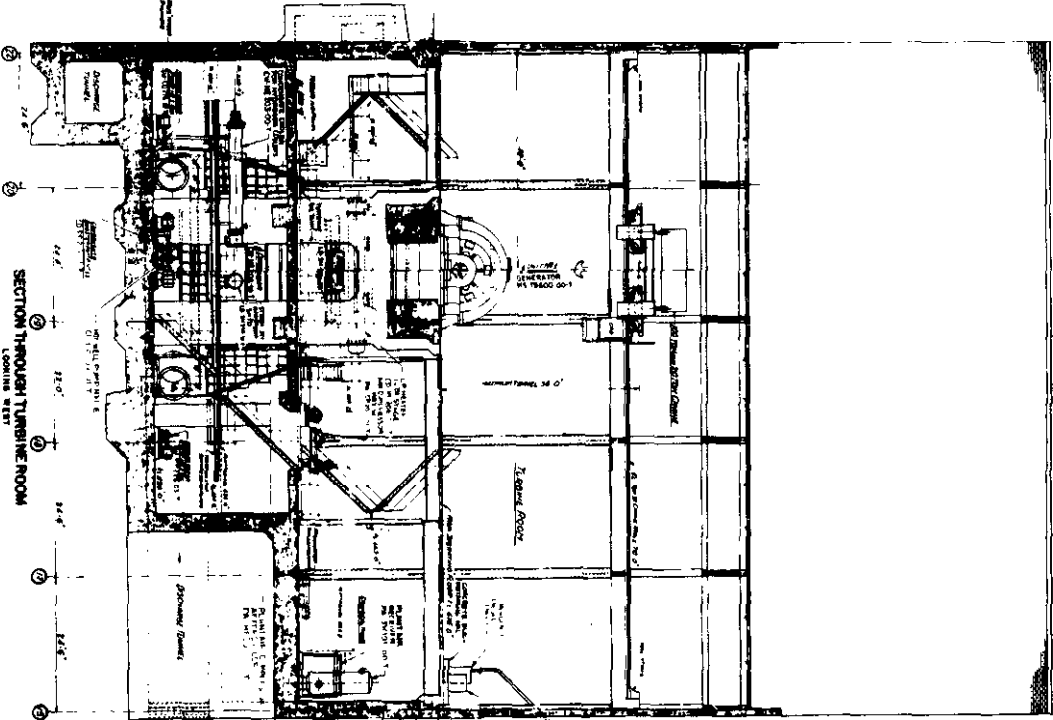
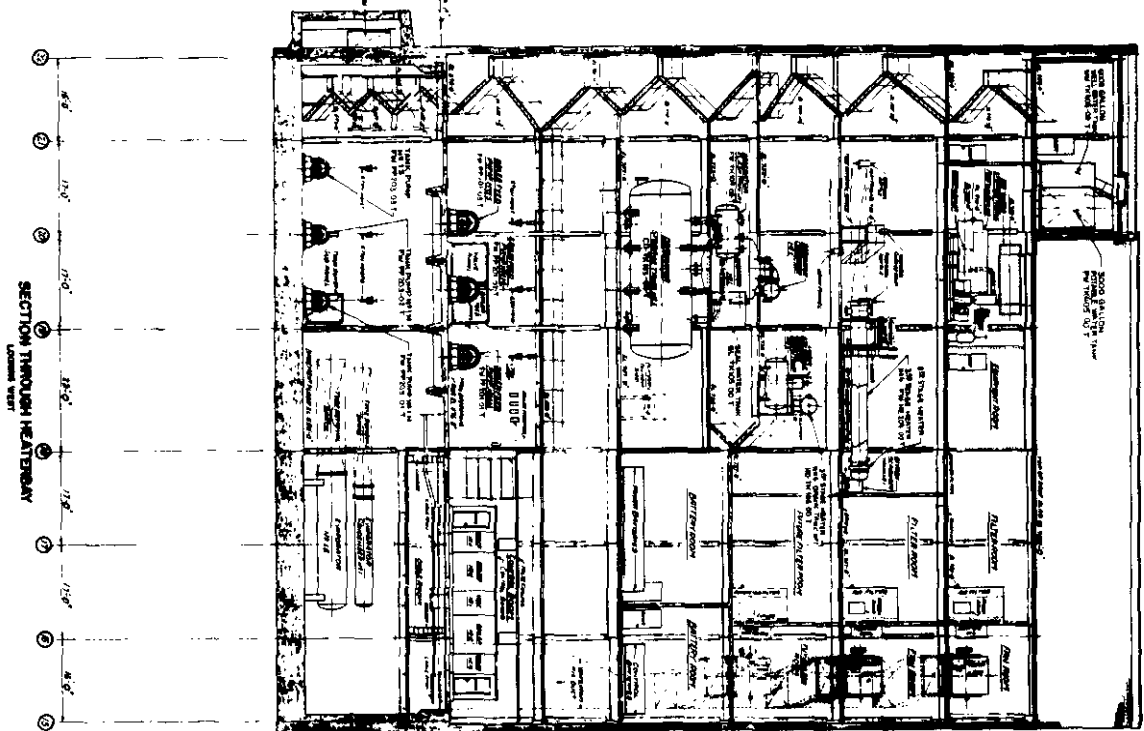

NOTES

1. SEE GENERAL NOTES 3 & 4

2. SEE SHEET 01-0005-2

Figure 40

THE POWER COMPANY
1100 P.P.C.
DEMONSTRATION PLANT
CONVENTIONAL SECTION
HEATER BAY
AND TURBINE ROOM
JOB NO. 1
REV. NO. 1 - 5010-10-1

NO.	REVISION	DATE
1	AS SHOWN	10/10/50

NOTES:
 FOR GENERAL NOTES, SEE
 DWG. 1-5010-11-1

11-0105-1

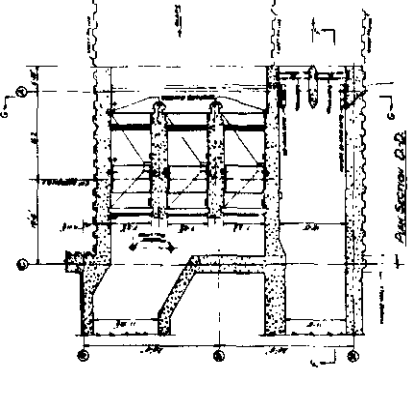
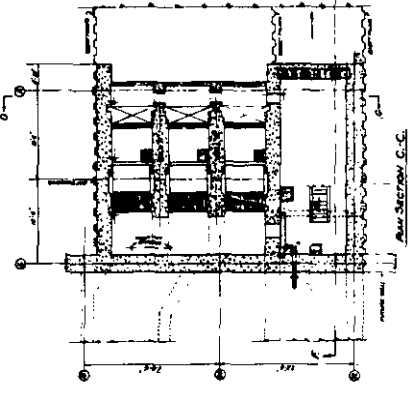
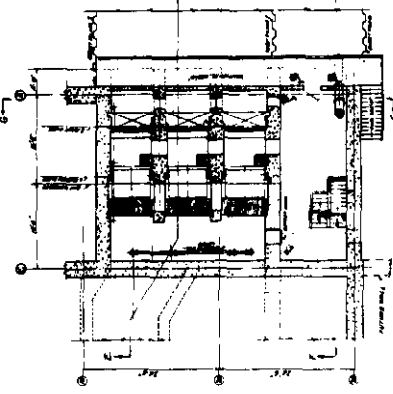
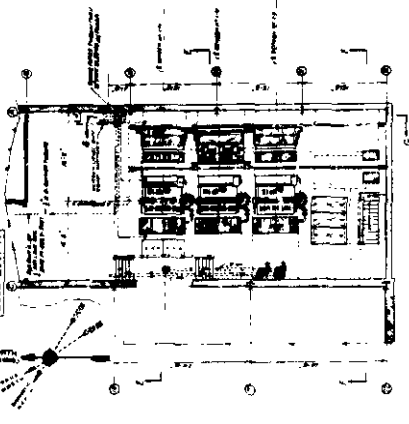

PLAN SECTION A.A.

PLAN SECTION B.B.

PLAN SECTION C.C.

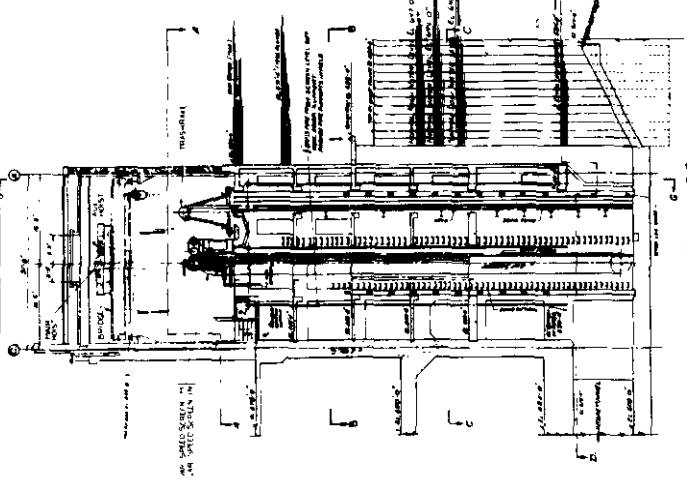

SECTIONAL ELEVATION E.E.

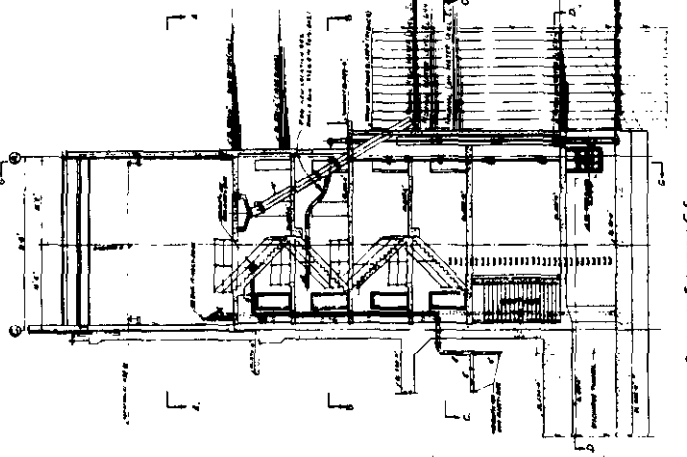

SECTIONAL ELEVATION F.F.

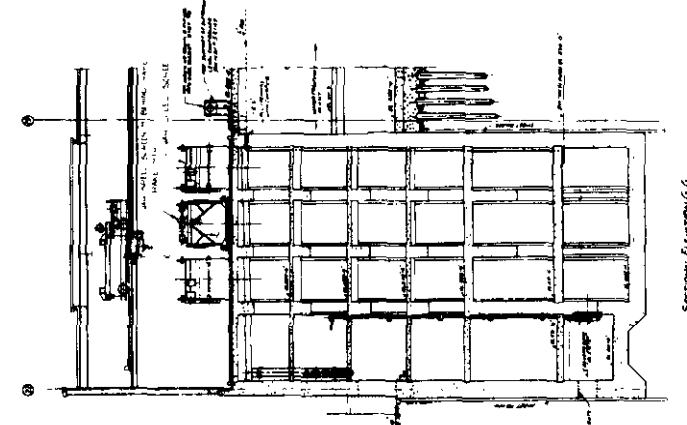

SECTIONAL ELEVATION G.G.

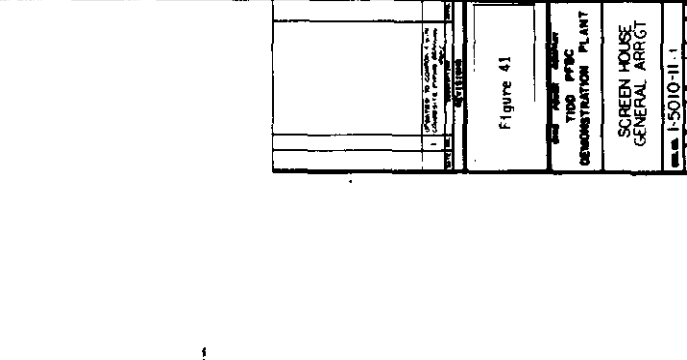

SECTIONAL ELEVATION H.H.

Figure 41

THOD PFBSC
 DEMONSTRATION PLANT

SCREEN HOUSE
 GENERAL ARRGT

NO. 1-5010-11-1	DATE	BY	CHECKED