

RECEIVED

JUN 19 1998

OSTI

**Electric Utility Engineer's FGD Manual
Volume I - FGD Process Design**

DOE/PC/94256--99.001.1

**Final Report
March 4, 1996**

Work Performed Under Contract No.: DE-FG22-95PC94256

For
U.S. Department of Energy
Office of Fossil Energy
Federal Energy Technology Center
P.O. Box 880
Morgantown, West Virginia 26507-0880

By
Radian International LLC
P.O. Box 201088
Austin, Texas 78720-1088

MASTER
Law

DISTRIBUTION OF THIS DOCUMENT IS UNLIMITED

DISCLAIMER

This report was prepared as an account of work sponsored by an agency of the United States Government. Neither the United States Government nor any agency thereof, nor any of their employees, makes any warranty, express or implied, or assumes any legal liability or responsibility for the accuracy, completeness, or usefulness of any information, apparatus, product, or process disclosed, or represents that its use would not infringe privately owned rights. Reference herein to any specific commercial product, process, or service by trade name, trademark, manufacturer, or otherwise does not necessarily constitute or imply its endorsement, recommendation, or favoring by the United States Government or any agency thereof. The views and opinions of authors expressed herein do not necessarily state or reflect those of the United States Government or any agency thereof.

DISCLAIMER

**Portions of this document may be illegible
electronic image products. Images are
produced from the best available original
document.**

FOREWORD

This *Electric Utility Engineer's Flue Gas Desulfurization (FGD) Manual* is a compilation of up-to-date technical information describing the application of lime- and limestone-based FGD processes to control sulfur dioxide (SO₂) emissions from coal-fired steam electric generating stations. It was written with two objectives in mind:

- To provide utility engineers with technical information needed to successfully **specify and procure** a lime- or limestone-based wet FGD system; and
- To provide utility engineers with process knowledge useful for **operating and optimizing** a lime- or limestone-based wet FGD system.

By meeting these objectives, utility engineers using the manual will gain the background information needed to procure and operate a cost-effective FGD system considering capital and operating costs, SO₂ removal efficiency, reliability, and byproduct solids disposal. Cost-effectiveness should be considered equal in importance to reliability and ability to meet the performance requirements.

This manual is not intended to be a step-by-step process or equipment design guide; qualified FGD system vendors and equipment suppliers are ultimately responsible for offering their best detailed designs on the basis of their specialized knowledge and experience. Instead, the manual highlights the various technical and economic decisions that must be made by utility engineers to ensure that they specify and procure an FGD system that is well suited to their specific application. The manual also provides technical details about FGD process design and performance variables and their interactions so that utility engineers can distinguish and evaluate the advantages and disadvantages of competing FGD system proposals. This same information will also prove useful for the engineers responsible for successfully operating the FGD system once it is placed into service.

The manual consists of five parts, each covering a different aspect of FGD design, purchase, or operation. As illustrated in Figure 1, these parts consist of the following:

- Part I--FGD Process Design;
- Part II--Major Mechanical Equipment;
- Part III--FGD Proposal Evaluations;
- Part IV--Use of FGDPRIISM™ in System Modification, Proposal Evaluation, and Design; and
- Part V--FGD System Case Study.

Part I--FGD Process Design. Part I opens with a simplified process description intended to orient the reader who has limited prior knowledge of lime- or limestone-based wet FGD systems. The arrangement and purpose of major equipment items are described, and key process design and performance variables are defined. This introductory material is followed by a detailed discussion of process FGD chemistry. Potential FGD process options are presented next, and the factors that must be considered in selecting the best process configuration for a specific application are discussed. This is followed by discussions of materials-of-construction options and factors that affect FGD system reliability. Requirements for chemical monitoring and laboratory facilities are described next, followed by discussions of lime and limestone reagents and various available chemical additives.

Part I concludes with sections on typical and recommended ranges of major FGD process design parameters, construction schedule, and performance guarantees and tests.

Part II--Major Mechanical Equipment. Part II of the manual provides more detailed technical information on the selection and design of individual pieces of equipment used in the FGD system. For each equipment item described, the manual presents the alternatives normally considered, the design considerations that affect the selection, available

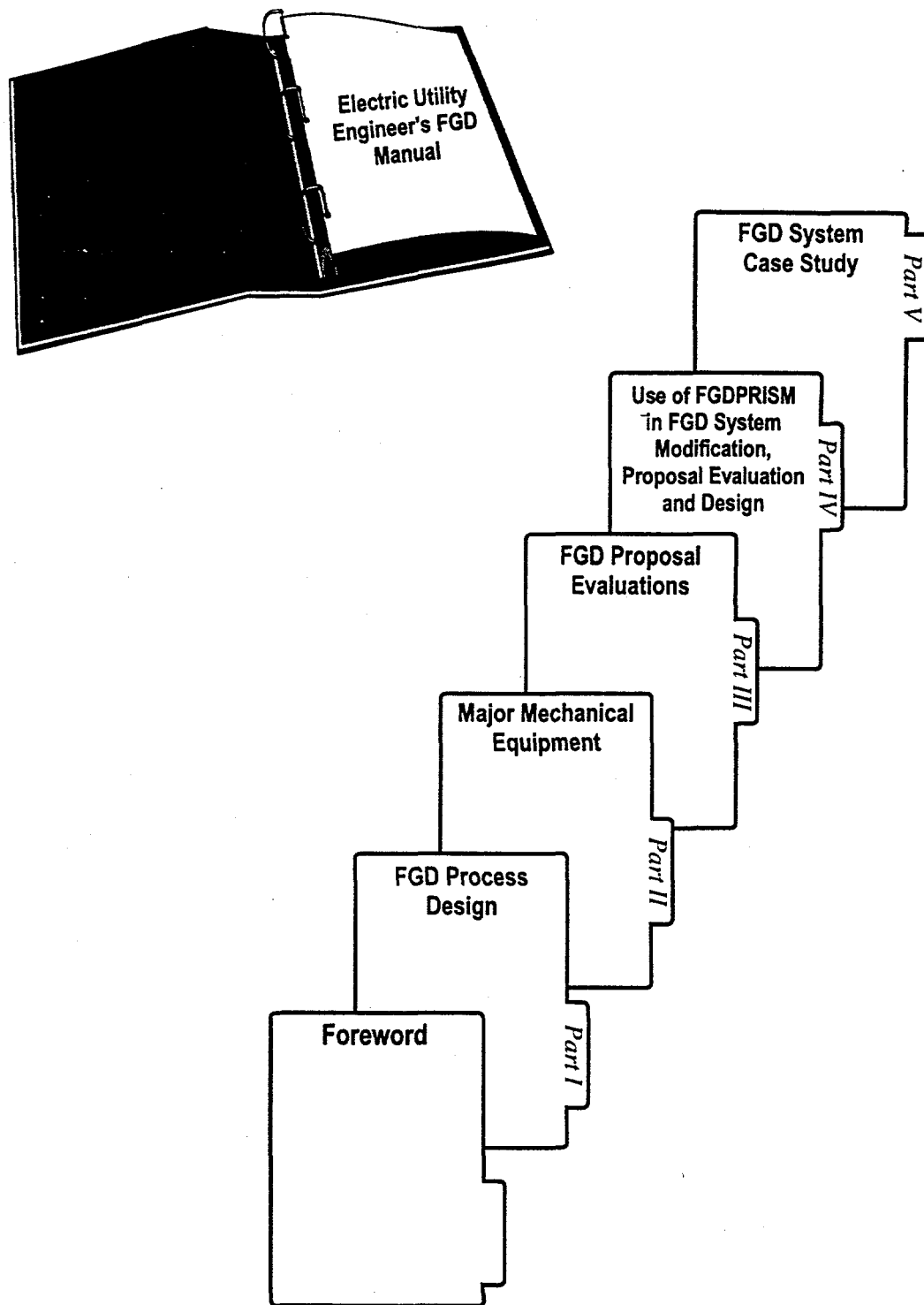

Figure 1. Electric Utility Engineer's FGD Manual Organization

materials of construction, and specific recommendations based on recent utility and vendor experience.

Part III--FGD Proposal Evaluations. This part of the manual describes procedures for evaluating competitive proposals received from FGD system vendors. A utility's proposal evaluation should include consideration of both technical and economic factors. A primary objective of the technical evaluation is to determine whether a proposal is likely to meet the specified performance guarantees. A procedure for assigning weighted scores to the various technical factors is described so that an overall technical rating can be developed for each vendor's proposal. The use of FGDPRISM in evaluating the relative degree of design conservatism among competing proposals is also introduced in this section. For the economic evaluation, a procedure is recommended for determining the lowest-cost proposal considering both initial installed capital cost and annual operating and maintenance costs.

Part IV--Use of FGDPRISM™ in FGD System Modification, Proposal Evaluation, and Design. The use of the Electric Power Research Institute's (EPRI's) FGDPRISM computer model is introduced at appropriate points in Parts I and III of this manual. In Part IV, more detailed descriptions of this model and its potential uses are given. These uses include evaluating process modifications, preparing system specifications, and contributing to proposal evaluations.

Part V--FGD System Case Study. In Part V of this manual, a case study is presented to illustrate the way in which the information presented earlier in the manual can be used in preparing an FGD system purchase specification and evaluating the responding proposals. A hypothetical design basis is introduced, and then, based on the information in Parts I and II of the manual, example procedures are given for developing design and performance parameters for inclusion in a specification. In the final section of Part V, two hypothetical responses to the example specification are evaluated using the procedures described in Parts III and IV of the manual.

TABLE OF CONTENTS

PART I--FGD PROCESS DESIGN

	Page
1.0 INTRODUCTION	I.1-1
1.1 Objectives	I.1-1
1.2 Organization and Content	I.1-1
2.0 PROCESS DESCRIPTION AND BASIC TERMINOLOGY	I.2-1
2.1 Process Description	I.2-1
2.2 Glossary of Terms	I.2-4
3.0 LIME- AND LIMESTONE-BASED WET SCRUBBING PROCESS CHEMISTRY	I.3-1
3.1 SO ₂ Removal	I.3-1
3.2 FGD Process Variables	I.3-6
3.2.1 Flue Gas Flow Rate (G)	I.3-9
3.2.2 Liquid-to-Gas Ratio (L/G)	I.3-11
3.2.3 Slurry Ph and Limestone Reagent Ratio	I.3-12
3.2.4 Flue Gas SO ₂ Concentration	I.3-15
3.2.5 Slurry Solids Concentration and Solids Retention Time	I.3-15
3.3 Sulfite/Sulfate Scaling Control	I.3-16
3.3.1 Inhibited Oxidation	I.3-17
3.3.2 Forced Oxidation	I.3-18
3.3.3 Natural Oxidation	I.3-19
3.4 Chemical Additives for SO ₂ Removal Enhancement	I.3-19
3.4.1 Magnesium	I.3-20
3.4.2 Dibasic Acid (DBA)/Adipic Acid	I.3-21
3.4.3 Formic Acid/Sodium Formate	I.3-23
3.4.4 Additive Consumption	I.3-27
3.5 Hazardous Air Pollutant Removal in FGD Systems	I.3-28
3.6 Lime- and Limestone-Based FGD Process Material Balance	I.3-30
3.6.1 FGD Process Water Management	I.3-34
3.6.2 Dissolved Solids (Chloride) Concentration	I.3-37
3.6.3 FGD Process Wastewater	I.3-41
3.6.4 FGD Byproduct Solids Management	I.3-42
4.0 FGD SYSTEM DESIGN CONSIDERATIONS	I.4.1-1
4.1 Design Basis Assumptions	I.4.1-1
4.1.1 Fuel Property Range	I.4.1-2
4.1.2 Flue Gas Property Range	I.4.1-5

TABLE OF CONTENTS (Continued)

		Page
	4.1.3 Regulatory Requirements	I.4.1-7
	4.1.4 Makeup Water Quality and Availability	I.4.1-8
	4.1.5 Site Conditions	I.4.1-10
	4.1.6 Regional Demand for Commercial-Quality Gypsum	I.4.1-14
	4.1.7 Wastewater Discharge Limitations	I.4.1-16
4.2	Absorber Module	I.4.2-1
	4.2.1 Absorber Design Alternatives	I.4.2-1
	4.2.2 Absorber Module Materials of Construction	I.4.2-20
4.3	Reaction Tank	I.4.3-1
	4.3.1 Reaction Tank Volume	I.4.3-1
	4.3.2 Recycle Slurry Solids Content	I.4.3-3
	4.3.3 Reaction Tank Configuration and Agitation	I.4.3-4
	4.3.4 Forced Oxidation	I.4.3-4
	4.3.5 Reaction Tank Materials of Construction	I.4.3-5
4.4	Mist Eliminator Systems	I.4.4-1
	4.4.1 ME Orientation	I.4.4-1
	4.4.2 Gas Flow Considerations	I.4.4-5
	4.4.3 ME Blade Design Considerations	I.4.4-7
	4.4.4 Number and Spacing of ME Stages	I.4.4-11
	4.4.5 Materials of Construction	I.4.4-12
	4.4.6 Wash System Design Issues	I.4.4-16
	4.4.7 ME System Instrumentation	I.4.4-22
4.5	Wet Stack Considerations	I.4.5-1
	4.5.1 Factors Affecting Use of a Wet Stack	I.4.5-1
	4.5.2 Condensate Formation	I.4.5-6
	4.5.3 Wet Stack Equipment Design	I.4.5-7
	4.5.4 Wet Stack Materials of Construction	I.4.5-13
4.6	Flue Gas Reheat	I.4.6-1
	4.6.1 Reasons for Flue Gas Reheat	I.4.6-1
	4.6.2 Process Alternatives	I.4.6-4
	4.6.3 Materials of Construction Considerations	I.4.6-14
	4.6.4 Energy and Cost Considerations	I.4.6-18
4.7	Reagent/Additive Preparation Equipment	I.4.7-1
	4.7.1 Lime Reagent Preparation Equipment	I.4.7-1
	4.7.2 Limestone Reagent Preparation Equipment	I.4.7-10
	4.7.3 Chemical Additive Preparation Equipment	I.4.7-16
	4.7.4 Materials-of-Construction Considerations	I.4.7-17
4.8	Byproduct Solids Handling Equipment	I.4.8-1
	4.8.1 Primary Dewatering	I.4.8-6
	4.8.2 Secondary Dewatering	I.4.8-8
	4.8.3 Tertiary Processing	I.4.8-12
	4.8.4 Ultimate Disposal	I.4.8-16
	4.8.5 Materials-of-Construction Considerations	I.4.8-24

TABLE OF CONTENTS (Continued)

		Page
	4.8.6 Other Gypsum Production Operating Considerations	I.4.8-25
4.9	Chloride Purge and Wastewater Treatment	I.4.9-1
	4.9.1 Reasons for Purging Chlorides	I.4.9-2
	4.9.2 Purge Alternatives	I.4.9-4
	4.9.3 Treatment Systems	I.4.9-9
4.10	Process Control and Instrumentation	I.4.10-1
	4.10.1 Major Process Control Loops	I.4.10-1
	4.10.2 Instrumentation Options	I.4.10-24
4.11	Equipment Arrangement Considerations	I.4.11-1
	4.11.1 New Versus Retrofit Installation	I.4.11-1
	4.11.2 Flue Gas Handling System Arrangement	I.4.11-2
	4.11.3 Absorber Module System Arrangement	I.4.11-6
	4.11.4 Reagent/Additive Preparation System Arrangement	I.4.11-11
	4.11.5 Byproduct Handling System Arrangement	I.4.11-12
4.12	References	I.12-1
5.0	MATERIALS-OF-CONSTRUCTION OPTIONS	I.5-1
5.1	The Importance of Corrosion Engineering of FGD Systems	I.5-1
5.2	The Corrosion Engineering Process	I.5-4
5.3	The Relationship Between Process Design and Materials Selection	I.5-4
	5.3.1 Corrosive Environment Zones	I.5-4
	5.3.2 Startup, Shutdown, Upset, and Maximum-Credible-Accident Conditions	I.5-13
5.4	Basic Design Philosophy Decisions	I.5-14
5.5	Sheet Elastomer and Reinforced Resin Linings	I.5-15
	5.5.1 Product Descriptions	I.5-17
	5.5.2 Installation Requirements	I.5-20
	5.5.3 Modes of Failure	I.5-21
5.6	Corrosion-Resistant Alloys	I.5-24
	5.6.1 Alloy Products and Corrosion Resistance	I.5-27
	5.6.2 Alloy Construction Options	I.5-32
	5.6.3 Alloy Verification and Weld Quality Control	I.5-41
5.7	Monolithic Mortars, Brick, Tile, and Block Systems	I.5-41
	5.7.1 Monolithic Gunited Mortars	I.5-42
	5.7.2 Acid Brick	I.5-42
	5.7.3 Vitreous Ceramic Tile and Brick	I.5-43
	5.7.4 Silicon Carbide Brick	I.5-48
	5.7.5 Foamed Borosilicate Glass Block	I.5-48
5.8	Fiber-Reinforced Plastic (FRP)	I.5-52
	5.8.1 FRP Pipe	I.5-54
	5.8.2 Free-Standing FRP Structures	I.5-55
5.9	Economics	I.5-59

TABLE OF CONTENTS (Continued)

	Page
5.10 References	I.5-60
6.0 SYSTEM RELIABILITY	I.6-1
6.1 General	I.6-1
6.2 Chemical Process Considerations	I.6-2
6.2.1 Degree of Calcium Sulfite Oxidation	I.6-2
6.2.2 Mist Eliminator Wash Water Quality	I.6-3
6.2.3 Slurry Chloride Level	I.6-3
6.3 FGD System Equipment Considerations	I.6-4
6.3.1 Flue Gas Handling Equipment	I.6-5
6.3.2 Absorber Module Equipment	I.6-7
6.3.3 Reagent/Additive Preparation Equipment	I.6-9
6.3.4 Byproduct Solids Handling Equipment	I.6-11
6.4 Glossary of Terms	I.6-14
6.5 References	I.6-17
7.0 CHEMICAL MONITORING PROGRAM	I.7-1
7.1 Reasons for Monitoring	I.7-1
7.1.1 Routine Analyses to Operate and Control the Process	I.7-2
7.1.2 Routine Analyses Performed to Monitor Performance	I.7-2
7.1.3 Analyses Performed to Evaluate and Characterize Scrubber Process	I.7-3
7.1.4 Analyses Performed to Demonstrate Compliance with Regulatory or Contractual Requirements	I.7-4
7.2 Required Elements of an FGD Laboratory	I.7-4
7.2.1 Physical Space and Utilities	I.7-4
7.2.2 Equipment and Instrumentation	I.7-5
7.2.3 Personnel Requirements	I.7-8
7.2.4 Quality Assurance and Quality Control	I.7-9
7.2.5 Safety	I.7-11
7.3 Overall Chemical Monitoring Program	I.7-11
7.4 References	I.7-12
8.0 LIME AND LIMESTONE REAGENT CONSIDERATIONS	I.8-1
8.1 Reagent Availability	I.8-2
8.1.1 Limestone Availability	I.8-2
8.1.2 Lime Availability	I.8-4
8.2 Reagent Composition	I.8-4
8.2.1 Limestone Composition	I.8-6

TABLE OF CONTENTS (Continued)

	Page
8.2.2 Lime Composition	I.8-9
8.3 Reagent Reactivity	I.8-11
8.3.1 Limestone Reactivity	I.8-11
8.3.2 Lime Reactivity	I.8-13
8.4 Particle Size Distribution Effect	I.8-14
8.4.1 Effect of Limestone Particle Size on FGD System Performance	I.8-15
8.4.2 Limestone Particle Size Measurements	I.8-16
8.4.3 Limestone Hardness	I.8-17
8.5 References	I.8-18
9.0 CHEMICAL ADDITIVE CONSIDERATIONS	I.9-1
9.1 Available Additives	I.9-1
9.2 Advantages and Disadvantages of Additive Use	I.9-2
9.2.1 Organic Acids	I.9-2
9.2.2 Thiosulfate (Sulfur)	I.9-8
10.0 FGD DESIGN PARAMETERS	I.10-1
10.1 Flue Gas Velocities	I.10-2
10.1.1 Ductwork Flue Gas Velocity	I.10-2
10.1.2 Absorber/Mist Eliminator Flue Gas Velocity	I.10-3
10.1.3 Stack Flue Gas Velocity	I.10-4
10.2 Absorber Liquid-to-Gas Ratio (L/G)	I.10-5
10.3 Reagent Utilization	I.10.8
10.4 Slurry Chloride Level	I.10-13
10.5 Chemical Additive Concentration	I.10-14
10.6 Optimization Using FGDPRISM™	I.10-18
10.6.1 Establishing FGD System Specification Requirements	I.10-21
10.6.2 Investigations of Process Modifications at an Existing Site	I.10-21
10.7 References	I.10-22
11.0 CONSTRUCTION CONSIDERATIONS	I.11-1
11.1 Construction Schedule	I.11-1
11.2 Equipment Field-Lining Considerations	I.11-5
11.3 Special QA/QC Testing and Inspections	I.11-7
11.4 Performance Testing	I.11-8
12.0 GUARANTEES AND WARRANTIES	I.12-1
12.1 Performance Gurarantees	I.12-1

TABLE OF CONTENTS (Continued)

	Page
12.1.1 Pollutant Emission and Environmental Guarantees	I.12-2
12.1.2 Economic and Reliability Guarantees	I.12-7
12.1.3 Performance Guarantees for Support Systems	I.12-11
12.2 Equipment and Material Warranties	I.12-11
12.3 Performance Testing	I.12-12
12.4 Reference	I.12-14

LIST OF FIGURES

PART I--FGD PROCESS DESIGN

	Page
1-1 Part I Organization	I.1-2
2-1 General Process Description	I.2-2
3-1 Typical Sulfite Equilibrium Curves	I.3-4
3-2 Two-Film Theory of Gas Absorption	I.3-7
3-3 Typical DBA Equilibrium Curves	I.3-22
3-4 Typical Performance Improvement with DBA Additive	I.3-24
3-5 Typical Formate Equilibrium Curves	I.3-26
3-6 Overall System Material Balance	I.3-31
3-7 Effects of Solids Dewatering and Makeup Water Chloride Content on Chloride in Process Liquid	I.3-40
4.1-1 Typical Generating Station Layout	I.4.1-11
4.2-1 Countercurrent and Cocurrent Absorber Configurations	I.4.2-2
4.2-2 Open Spray Absorber	I.4.2-5
4.2-3 Spray/Tray Absorber	I.4.2-10
4.2-4 Packed, Cocurrent Absorber	I.4.2-13
4.2-5 Dual-Loop Absorber	I.4.2-16
4.2-6 Jet Bubbling Reactor	I.4.2-18
4.4-1 Effect of Mist Eliminator Orientation on Liquid Drainage	I.4.4-3
4.4-2 Comparison of Flat and Peaked ME Designs	I.4.4-4
4.4-3 Carryover Performance of a Typical Vertical Gas Flow Mist Eliminator	I.4.4-6
4.4-4 Different Type of Chevron Blade Profiles	I.4.4-8
4.4-5 Effect of Chevron Exit Section on Gas Flow	I.4.4-10

LIST OF FIGURES (Continued)

	Page
4.4-6 Recommended Mist Eliminator Stage Spacing	I.4.4-13
4.5-1 Wet Stack	I.4.5-2
4.6-1 Bypass Reheat	I.4.6-6
4.6-2 Cyclic Reheat	I.4.6-9
4.6-3 In-Line Reheat	I.4.6-12
4.6-4 Indirect Hot Air Reheat	I.4.6-13
4.6-5 Direct-Firing Reheat	I.4.6-15
4.7-1 Lime Reagent Preparation System	I.4.7-2
4.7-2 Lime Transportation Truck Trailer	I.4.7-4
4.7-3 Lime Transportation Railcar	I.4.7-4
4.7-4 Barge Unloading Equipment	I.4.7-5
4.7-5 Lime Reagent Preparation Equipment Arrangement	I.4.7-9
4.7-6 Limestone Reagent Preparation System	I.4.7-11
4.7-7 Limestone Reagent Preparation Equipment Arrangement	I.4.7-14
4.8-1 Byproduct Solids Decision Alternatives	I.4.8-2
4.8-2 Typical Waste Byproduct Solids Handling System	I.4.8-3
4.8-3 Typical Commercial-Grade Gypsum Handling System	I.4.8-4
4.8-4 Pug Mill Mixer	I.4.8-13
4.8-5 Waste Byproduct Disposal Pond	I.4.8-19
4.8-6 Waste Byproduct Disposal Landfill	I.4.8-20

LIST OF FIGURES (Continued)

	Page
4.8-7 Gypsum Stack	I.4.8-22
4.9-1 FGD Liquor Chloride Concentration versus Coal Chloride Content and Liquor Purge Rate	I.4.9-6
4.9-2 FGD Purge Metals Precipitation Process	I.4.9-12
4.9-3 Two-Effect Evaporator	I.4.9-14
4.9-4 Vapor Compression Evaporator	I.4.9-15
4.10-1 Outlet SO ₂ Control Using Partial Bypass	I.4.10-7
4.10-2 Outlet SO ₂ Control Using Slurry pH Adjustments	I.4.10-9
4.10-3 Feedforward-Feedback Reagent Feed Control	I.4.10-15
4.10-4 Reaction Tank Level and Density Controls	I.4.10-19
4.11-1 Typical Flue Gas Handling System Arrangements	I.4.11-4
4.11-2 APS Harrison Station FGD System Arrangement	I.4.11-7
4.11-3 RWE Weisweiler Station FGD System Arrangement	I.4.11-8
4.11-4 Absorber Module Arrangements	I.4.11-9
4.11-5 Byproduct Dewatering Equipment Arrangement--Hydrocyclones	I.4.11-13
4.11-6 Byproduct Dewatering Equipment Arrangement--Thickeners	I.4.11-15
5-1 Corrosive Environment Zones Within a Single-Loop, Countercurrent Lime/Limestone FGD System	I.5-6
5-2 Illustration of Welded Joint Design in Mill-Clad Plate Construction	I.5-34
5-3 Mechanical Anchoring of Titanium Sheet Linings Within a Carbon Vessel ...	I.5-36
5-4 One Common Corner Trim Design for Alloy Wallpaper Construction	I.5-37
5-5 Metallic Composite Panel (MCP) and MCP Joint Design	I.5-40

LIST OF FIGURES (Continued)

	Page
5-6 Vitreous Ceramic Tile Lining of a Carbon Steel Shell	I.5-46
5-7 Free-Standing Vitreous Ceramic Brick and Tile Construction Options	I.5-47
5-8 Foamed Borosilicate Glass Block Lining of Carbon Steel	I.5-51
6-1 Graphical Definition of Reliability Concepts	I.6-15
7-1 Typical Layout For an FGD Laboratory	I.7-6
8-1 Distribution of Chalk and Limestone Deposits in the United States	I.8-3
8-2 Commercial Lime Plants in U.S. and Canada	I.8-5
10-1 SO ₂ Removal vs. Limestone Utilization for Different Full-Scale Absorbers . . .	I.10-10
11-1 Typical FGD System Design and Construction Schedule	I.11-2

LIST OF TABLES

PART I--FGD PROCESS DESIGN

	Page
3-1 Typical Terms in a Lime/Limestone FGD Process Water Balance	I.3-35
4.1-1 Commercial-Grade Gypsum Specifications	I.4.1-15
4.5-1 Critical Re-entrainment Velocity for Stack Liner Materials	I.4.5-11
4.5-2 Wet Stack Materials-of-Construction Characteristics	I.4.5-16
4.8-1 Byproduct Solids Handling Equipment Options	I.4.8-3
4.8-2 Dewatered FGD Waste Byproduct Characteristics	I.4.8-15
4.8-3 Advantages and Disadvantages of Alternative Waste Byproduct Solids Disposal Alternatives	I.4.8-17
4.10-1 Summary of SO ₂ Removal Control Strategies	I.4.10-4
4.10-2 Summary of Reagent Feed Rate Control Strategies	I.4.10-11
4.10-3 Summary of Reaction Tank Level and Density Control Strategies	I.4.10-18
4.10-4 Options for Level Sensors in Lime- and Limestone-Based FGD Systems	I.4.10-27
4.10-5 Options for Flow Measurements in Lime- and Limestone-Based FGD Systems	I.4.10-30
5-1 Causes of FGD Materials Failures, 1982 through 1993	I.5-3
5-2 Corrosion Environment Zones for a Single-Loop, Countercurrent, Open-Tower FGD System	I.5-7
5-3 Factors Affecting FGD Process Corrosivity	I.5-10
5-4 Summary of Advantages and Disadvantages of Rubber and Reinforced Resin Linings	I.5-16
5-5 Summary of Advantages and Disadvantages of Alloy Construction	I.5-25
5-6 Ranking of Alloys Commonly Considered for FGD Applications	I.5-30

LIST OF TABLES (Continued)

	Page
5-7 Summary of Advantages and Disadvantages of Vitreous Ceramic Tile and Brick	I.5-44
5-8 Summary of Advantages and Disadvantages of Foamed Borosilicate Glass Block	I.5-49
5-9 Summary of Advantages and Disadvantages of Fiber-Reinforced Plastic (FRP)	I.5-53
5-10 Relative Costs of Major Vessel Construction Options	I.5-58
5-11 Maintenance Assumptions for Economic Comparison	I.5-59
9-1 Example Recycle Pump Power Cost Savings with Organic Acid Additive Use ..	I.9-4
9-2 Example Limestone Cost Savings with Organic Acid Additive Use	I.9-6
9-3 Comparison of Inhibited-Oxidation versus Forced-Oxidation Limestone FGD Processes	I.9-10
10-1 Example Performance Data for Absorbers in Lime- and Limestone-Based FGD Service	I.10-6
10-2 Example Economic Tradeoffs Between L/G (Pump Power) and Reagent Utilization for a Spray Absorber	I.10-11
10-3 Example Economic Tradeoffs Among L/G (Pump Power), Reagent Utilization, and Additive Concentration for a Spray Absorber	I.10-16
10-4 FG DPRISM Calibration Parameters	I.10-23

PART I

FGD PROCESS DESIGN

1.0 INTRODUCTION

Part I of the *Electric Utility Engineer's Flue Gas Desulfurization (FGD) Manual* emphasizes the chemical and physical processes that form the basis for design and operation of lime- and limestone-based FGD systems applied to coal- or oil-fired steam electric generating stations. The objectives, organization, and content of this part of the manual are described below.

1.1 Objectives

The objectives of Part I are:

- To provide a description of the chemical and physical design basis for lime- and limestone-based wet FGD systems;
- To identify and discuss the various process design parameters and process options that must be considered in developing a specification for a new FGD system; and
- To provide utility engineers with process knowledge useful for operating and optimizing a lime- or limestone-based wet FGD system.

1.2 Organization and Content

The organization of Part I is illustrated in Figure 1-1. Following this introduction, Part I of the manual begins with a simplified process description (Section 2) intended to orient the reader who has limited prior knowledge of lime- or limestone-based wet FGD systems. The arrangement and purpose of major equipment items are described, and key process design and performance variables are defined.

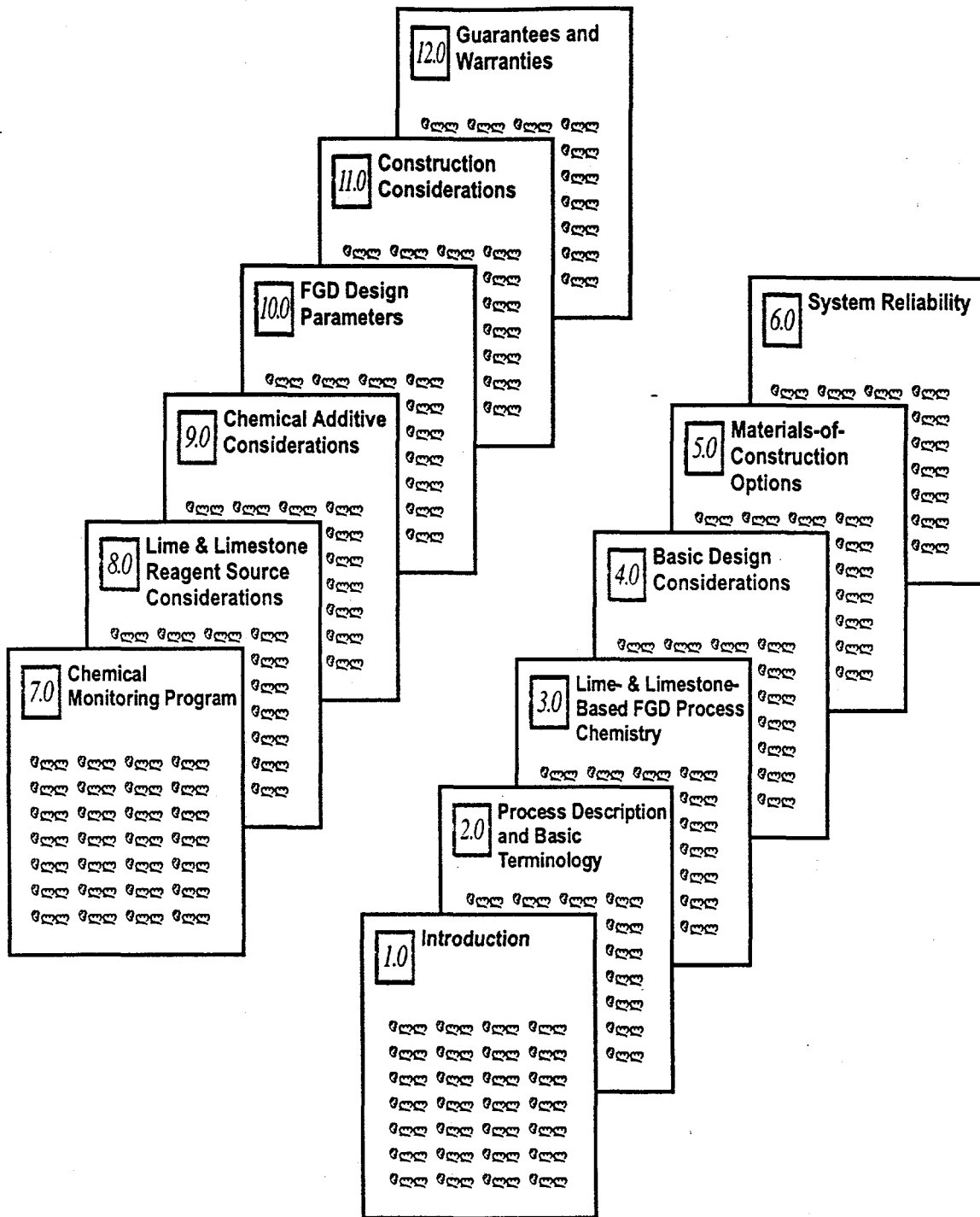

Figure 1-1. Part I Organization

This introductory material is followed by a detailed discussion of process chemistry in Section 3, which includes absorption of SO₂ from the flue gas, neutralization of acidic species by lime or limestone reagent, oxidation of some or all of the absorbed SO₂, and precipitation of the calcium sulfite and sulfate byproduct solids. The process material balance is also described. The process chemistry discussion introduces important process design and performance variables and provides a basis for the remaining sections of Part I.

Section 4 of Part I presents the major FGD process options that are available and discusses the factors that must be considered in selecting the best process configuration for a specific application. The section begins by explaining how the entire FGD process design basis is affected by boiler and fuel parameters, site conditions, and regulatory requirements. Then, process and equipment options in the following categories are discussed:

- Absorber;
- Reaction tank;
- Mist eliminators;
- Wet stack;
- Flue gas reheat;
- Reagent preparation;
- Byproduct solids handling;
- Wastewater treatment;
- Process controls and instruments; and
- Equipment arrangement.

Materials-of-construction options are discussed in Section 5 of Part I. The information in this section is based on more than 20 years of in-service experience with FGD materials. The discussion shows how different zones of the FGD process are subject to different requirements for corrosion-resistant materials, depending on factors such as temperature, pH, solids content, and chloride concentration. Major classes of materials meeting these requirements are identified. Installation and maintenance costs for various

materials are compared, and the concept of life-cycle costing is introduced as a means of comparing the total costs of materials that have different initial costs and service life. The close relationship between FGD process design decisions and materials selection is emphasized throughout this section.

Section 6 of Part I discusses FGD system reliability. High reliability is attained through careful attention to process chemistry and control and proper selection of redundant equipment items.

Requirements for chemical monitoring and laboratory facilities are described in Section 7. Chemical monitoring is an important element of process control and optimization of FGD systems.

Section 8 is a discussion of lime and limestone reagent source considerations. The relationships between reagent composition, reactivity, and particle size and process performance are explained. This section provides a basis for selecting the optimum lime or limestone reagent supply from available sources.

In Section 9, the use of chemical additives for improving process performance is addressed. Organic acid additives can be a cost-effective method of obtaining high SO₂ removal efficiency. Sulfur is used to inhibit sulfite oxidation as a means of scale control. The advantages and applications of these additives are discussed and some example data showing potential cost savings are presented.

Major FGD process design parameters such as flue gas velocity, absorber liquid-to-gas ratio, reagent ratio, chemical additive concentrations, and dissolved chloride level are discussed in Section 10. Example performance data are presented showing the interrelated effects of these parameters on process performance and operating costs. Typical design ranges for these parameters are given and different approaches for including design limits in a

specification are described. Potential uses of EPRI's Flue Gas Desulfurization Process Integration and Simulation Model (FGDPRISM™) are also introduced in this section.

Section 11 describes a typical construction schedule and performance test program for the completed system.

Section 12, the final section in Part I, discusses the FGD system performance guarantees and equipment/material warranties that should be included in the purchase specification. The discussion includes typical guarantee values and recommended compliance test procedures.

2.0 PROCESS DESCRIPTION AND BASIC TERMINOLOGY

The following description provides a brief introduction to lime- and limestone-based wet FGD systems for the reader who has limited previous knowledge of the operating principles and equipment used in these processes. The terms in **boldface** are those most critical to understanding the material presented in the remainder of Part I. These terms are defined in Section 2.2--Glossary of Terms.

2.1 Process Description

Figure 2-1 is a general process flow sheet showing some of the important elements of a lime- or limestone-based wet FGD system. The flue gas is processed in one or more **absorbers** where the SO_2 (along with some oxygen) is transferred from the flue gas to the **recycle slurry**. The hot flue gas is also cooled and saturated with water in the absorber. The absorber shown in the figure is a **countercurrent spray tower**. Countercurrent means that the flue gas and slurry flow in opposite directions in the absorber. Other absorber styles are discussed in Part I, Section 4.2--Absorber Module. The **recycle slurry** is pumped continuously from the **reaction tank** in the base of the absorber to one or more **spray headers** that penetrate the sides of the absorber. Each header has numerous individual **spray nozzles** that atomize the slurry into droplets. In some absorbers, a **perforated tray** or **packing** is placed below the spray headers. The tray improves gas distribution. Both the tray and packing enhance SO_2 removal.

Treated flue gas passes through a **mist eliminator** before exiting the absorber. The mist eliminator removes entrained slurry droplets. **Mist eliminator wash** is required to keep the passages free of solids.

Lime **reagent** is prepared by slaking, and limestone reagent is prepared by grinding. In both cases, the reagent is stored in a **reagent slurry tank**. Other **chemical additives** may be added to the reagent slurry tank or to the reaction tank to enhance SO_2

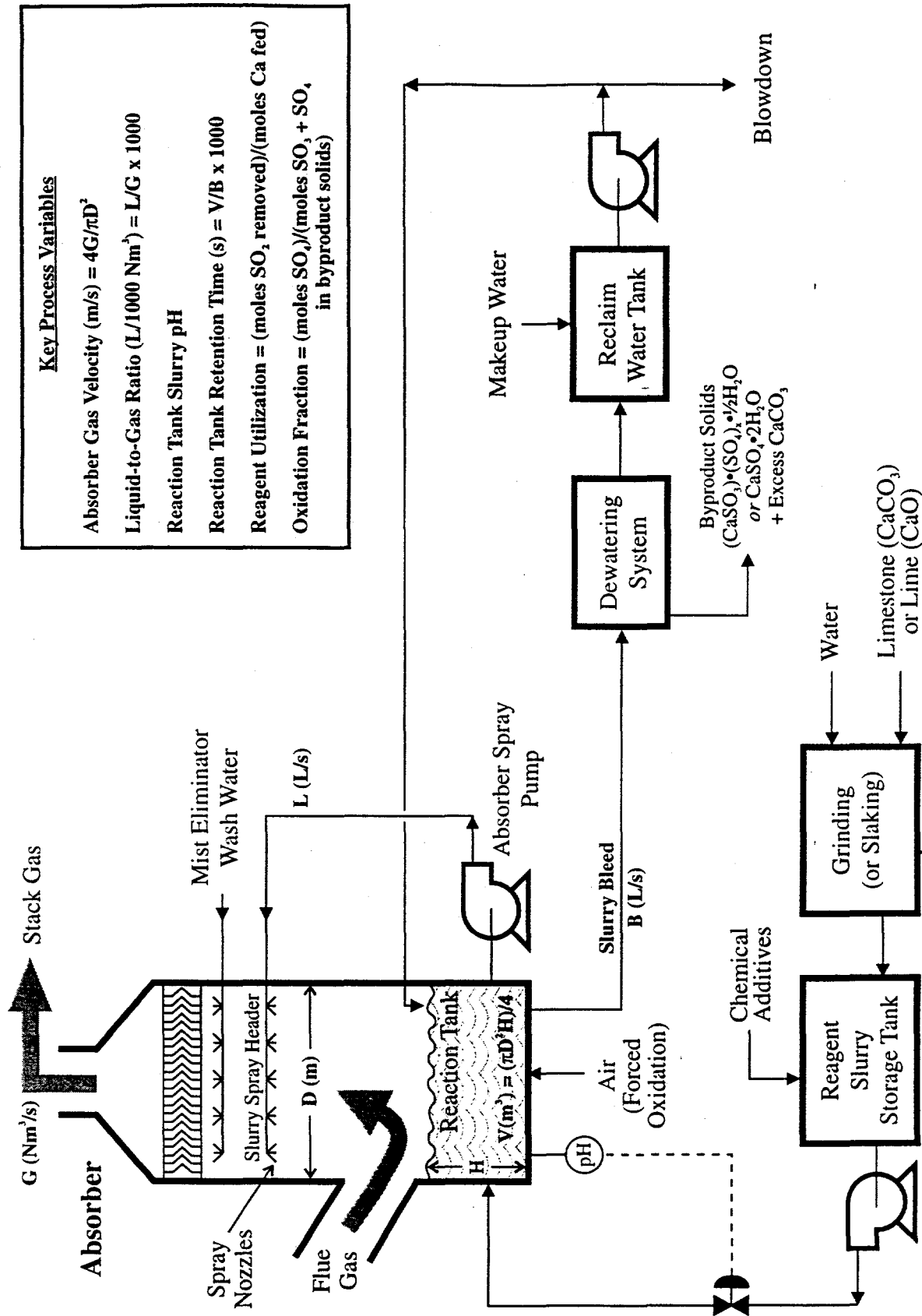

Figure 2-1. General Process Description

removal or to control **sulfite oxidation**. The reagent slurry is added to the reaction tank to neutralize absorbed SO_2 . The reagent slurry feed rate is regulated automatically to control the **reaction tank pH**.

As the reagent and SO_2 react, **byproduct solids** precipitate in the reaction tank. In the **forced oxidation** limestone process, compressed air is sparged into the reaction tank to convert absorbed SO_2 to sulfate and precipitate gypsum. In the **inhibited oxidation** process, the byproduct is a solid solution of calcium sulfite and sulfate.

A **slurry bleed** stream is pumped from the reaction tank to the **dewatering** system equipment. The slurry bleed stream contains the byproduct solids, which must be removed from the reaction tank as they precipitate. The dewatering system equipment for calcium sulfite waste byproduct usually includes a **thickener** followed by a **vacuum filter**. In the forced oxidation process, the thickener is often replaced by **hydrocyclones**. In the dewatering system, the byproduct solids are separated from the bleed slurry. The dewatered byproduct solids are either sold or sent to a **landfill**. In some cases, partially dewatered byproduct solids are pumped to a **disposal pond**. If commercial-grade gypsum is produced by the FGD system, the byproduct solids are sold by the utility to a third party for off-site use.

The liquid that is separated from the bleed slurry is stored in the **reclaim water** tank. **Makeup water** is also added to this tank to replace water that is evaporated by the flue gas in the absorber, and water that is lost with the byproduct solids. The combined makeup and reclaim water is returned to the absorber reaction tank or used as mist eliminator wash or to prepare reagent slurry. Separate fresh water makeup may also be used for these purposes and for supplying slurry **pump seal water**. The pump seal water is used to flush solids from the seal between the rotating shaft and the outer pump casing. In some processes a **blowdown** stream is discharged from the FGD system to control the level of total dissolved solids (especially chloride) in the process liquor.

Key process design and operating variables include the following:

- **Absorber Gas Velocity**--The average, superficial velocity of saturated flue gas in the absorber vessel is equal to the flue gas volumetric flow rate divided by the absorber cross-sectional area perpendicular to the gas flow. The area lost to support, spray headers, and other internal structures is not deducted from the cross-sectional area in this calculation.
- **Liquid-to-Gas Ratio (L/G)**--L/G is equal to the recycle slurry flow rate divided by the saturated flue gas flow rate.
- **Reaction Tank pH**--A key process control parameter is the pH of the mixed slurry in the reaction tank.
- **Solids Retention Time**--The solids retention time is equal to the reaction tank volume divided by the slurry bleed rate. It is also equal to the byproduct solids inventory in the reaction tank divided by the solids production rate.
- **Reagent Utilization**--Reagent utilization is equal to the total moles of SO_2 absorbed from the flue gas divided by the total moles of calcium in the reagent fed to the system.
- **Oxidation Fraction**--Oxidation fraction is equal to the total moles of sulfate leaving the process (less any sulfate added in the makeup water) divided by the total moles of SO_2 absorbed from the flue gas.

2.2

Glossary of Terms

Absorber--a process vessel designed to promote transfer of SO_2 from the flue gas to the lime or limestone slurry in the FGD process.

Blowdown--a liquid stream that is discharged from the FGD process to control the dissolved solids content in the process liquor.

Byproduct solids--a mixture of calcium sulfite, calcium sulfate, calcium carbonate, fly ash, and other inert solids that is the reaction product resulting from SO₂ removal with the wet lime- or limestone-based FGD process.

Chemical additives--chemical compounds that are added to the FGD process in relatively small quantities to improve the process performance.

Countercurrent spray tower--the most common absorber design used in the lime/limestone FGD process. In this absorber, the flue gas flows upward and is contacted with spray droplets flowing downward.

Dewatering system--a combination of process equipment designed to separate the byproduct solids from the process liquor. The recovered water can be returned to the process; the dewatered solids are removed from the system.

Disposal pond--a pond designed for partial dewatering and permanent storage of byproduct solids.

Forced oxidation--a process operating mode in which air is blown into the reaction tank to oxidize absorbed SO₂ to SO₄²⁻ (sulfate).

Hydrocyclones--dewatering devices that separate byproduct solids from process liquor using centrifugal force.

Inhibited oxidation--a process operating mode in which a chemical additive (usually, emulsified sulfur) is used to prevent oxidation of absorbed SO₂.

Landfill--an area in which dewatered byproduct solids are placed for permanent disposal.

Makeup water--water that is added to the FGD process to replace water lost by evaporation, by blowdown, and with the byproduct solids.

Mist eliminator--a device that separates entrained slurry droplets from the cleaned flue gas. The type most frequently seen in FGD systems uses parallel chevron blades to remove the entrained droplets by inertial forces.

Mist eliminator wash--water that is used to clean the mist eliminator.

Packing--material that is placed in an absorber to provide a surface over which the recycle slurry is distributed to promote gas/liquid contact and SO₂ absorption.

Perforated tray--a thin metal partition with small holes through which gas and slurry flow countercurrently in an absorber to promote gas/liquid contact and SO₂ absorption.

Pump seal water--clean water that is used to prevent abrasive slurry from entering the pump shaft packing gland.

Reaction tank--a process vessel in which the reaction between absorbed SO₂ and lime or limestone solids is completed. This tank may also be called a recirculation tank by some FGD system vendors.

Reaction tank pH--the pH of the slurry in the reaction tank. Reaction tank pH is a key process control variable.

Reagent--lime or limestone that is used to neutralize absorbed SO₂.

Reagent slurry tank--a process vessel in which a finely ground slurry of lime or limestone is stored before it is added to the process.

Reclaim water--water that is separated from the byproduct solids in the dewatering equipment for return to the process.

Reclaim water tank--a process vessel in which reclaim water and makeup water are held for return to the FGD process.

Recycle slurry--slurry that is contacted with the flue gas in the absorber.

Slurry bleed--a process stream by which byproduct solids are transferred from the reaction tank to the dewatering system.

Spray nozzles--devices that atomize the recycle slurry into droplets to promote gas/liquid contact and SO₂ absorption.

Spray header--piping that supports spray nozzles and distributes the recycle slurry among the nozzles.

Spray pump--the pump(s) that recirculates slurry from the reaction tank to the spray headers. Also called recirculation pump or recycle pump.

Sulfite oxidation--the reaction between absorbed SO₂ and absorbed O₂ to produce sulfate (SO₄²⁻).

Thickener--a process vessel in which byproduct solids are partially dewatered by settling.

Vacuum filter--dewatering equipment that removes the water from byproduct solids by applying a vacuum through a cloth-type filter medium.

3.0 LIME- AND LIMESTONE-BASED WET SCRUBBING PROCESS CHEMISTRY

The basic chemistry of lime- and limestone-based wet scrubbing processes for flue gas desulfurization is described in this section. This discussion provides background for the process design considerations that are addressed in Part I, Section 4.0--Basic Design Considerations. Utility engineers who are primarily concerned with the specification and purchase of FGD system equipment may not require a detailed understanding of process chemistry and may want to proceed to Section 4. The material in this section will be most useful for engineers who are concerned with making overall process design decisions (for example, forced-oxidation versus inhibited-oxidation) prior to issuing an FGD process specification for bids. Also, engineers or chemists who will be responsible for FGD operations should become familiar with the material in this section.

The overall chemistries of the lime- and limestone-based process options are quite similar. Each removes SO_2 from flue gas by absorption into an alkaline liquid, and each produces a byproduct consisting of calcium sulfite and sulfate solids. However, many of the detailed design and operating features are different for a lime-based versus a limestone-based process. In this section, as in the remainder of this manual, the general discussion is applicable to both processes, and the differences between the lime- and limestone-based systems are addressed where appropriate.

3.1 SO₂ Removal

The process by which SO_2 is removed from flue gas involves both gas-liquid reactions and liquid-solid reactions. Some of the individual steps in the overall process are summarized below:

Absorption of SO₂ into the Liquid Phase



Dissolution of Reagent and Neutralization Reactions

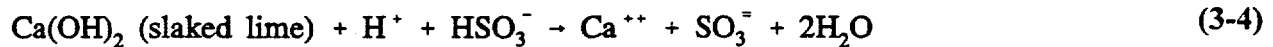
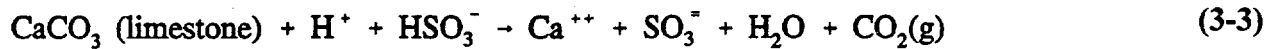

Oxidation Reactions



Precipitation Reactions

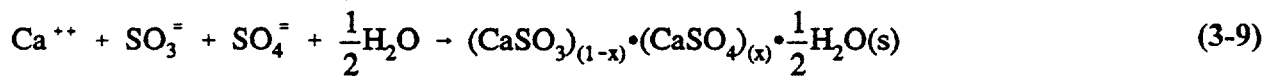

where x is the fraction of absorbed SO₂ that is fully oxidized to SO₄⁻.



In the initial absorption step (Reaction 3-1), SO₂, which is a fairly soluble and acidic gas, diffuses into the liquid phase and reacts with water to form sulfurous acid (H₂SO₃). Sulfurous acid rapidly dissociates to produce bisulfite (HSO₃⁻) ion and hydrogen ion (Reaction 3-2). For SO₂ absorption to continue, the acidity or H⁺ ions generated in this second reaction must be

neutralized; otherwise, the recycle slurry pH will decrease (i.e., the slurry acidity will increase) until the slurry can no longer absorb SO_2 .

This necessary neutralization is accomplished by dissolution of the solid limestone or lime reagent (Reaction 3-3 or Reaction 3-4). The dissolution of limestone generates CO_2 , which is normally evolved from the process. The sulfite ion (SO_3^-) formed by Reaction 3-3 or 3-4 can react further to neutralize an additional H^+ ion (Reaction 3-5). Ultimately, dissolution of one mole of lime or limestone reagent is required to neutralize one mole of absorbed SO_2 .

The role that sulfite plays in neutralizing H^+ , Reaction 3-5, depends primarily on the operating pH of the absorber recycle slurry. Figure 3-1 is a typical equilibrium relationship calculated for Reactions 3-2 and 3-5 showing how absorbed SO_2 is distributed among sulfurous acid, bisulfite ion, and sulfite ion as a function of slurry pH. At low pH (below 2.0), much of the absorbed SO_2 is in the form of sulfurous acid (H_2SO_3). As pH increases, sulfurous acid dissociates to form first bisulfite (HSO_3^-), between pH 4 and 5, then sulfite, at pH above 6.

Limestone-based processes are generally limited to operating pH's below about 6.2 in order to increase limestone solubility. At a more typical limestone operating pH of 5.5 to 6.0, most of the dissolved SO_2 in the recycle slurry is in the form of bisulfite ion and incapable of reacting with H^+ . The amount of sulfite available for Reaction 3-5 is very small compared to the amount of SO_2 that is absorbed per unit volume of slurry. Since lime is more soluble than limestone, a lime-based process can operate at a higher pH and still maximize reagent solubility. The lime process recycle slurry typically is controlled in the pH range from 6.5 to 7.5. In this pH range, the available liquid-phase alkalinity in the recycle slurry increases because much of the dissolved SO_2 is in the form of SO_3^- , which can neutralize H^+ by accepting a proton.

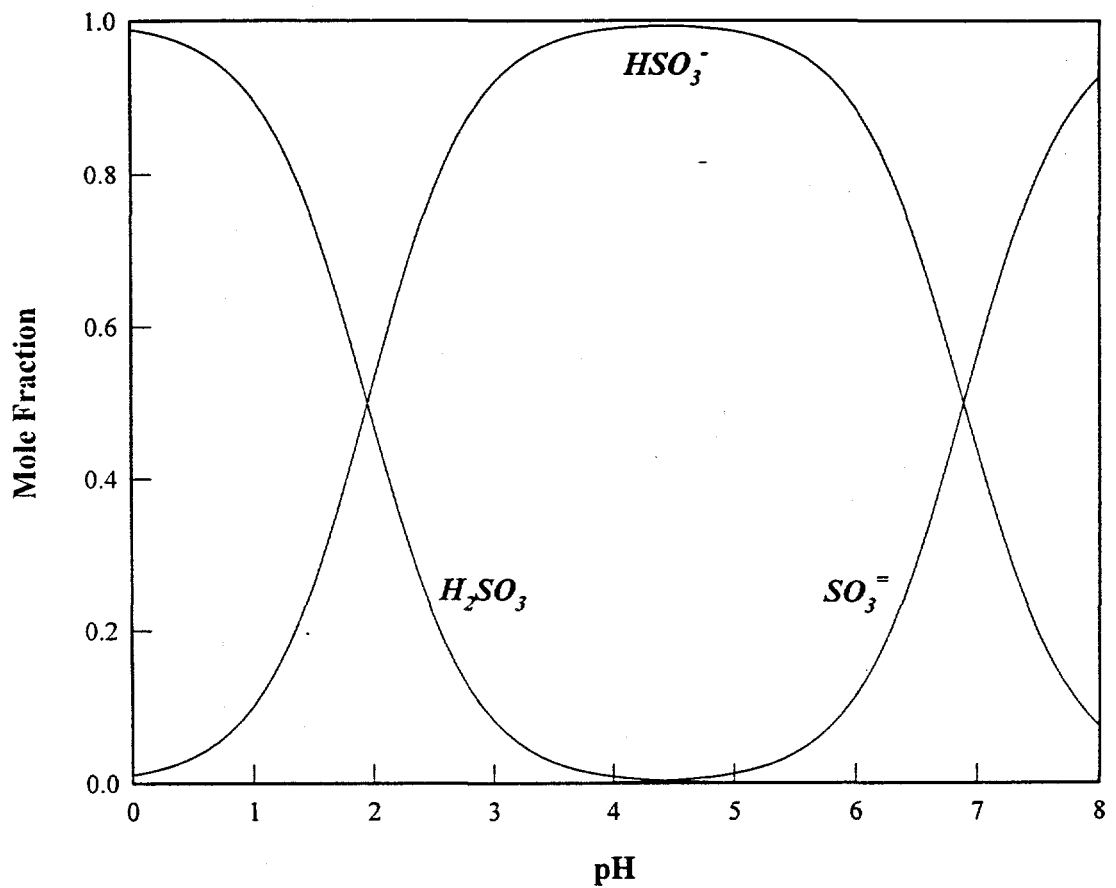

Figure 3-1. Typical Sulfite Equilibrium Curves

Reagent dissolution (Reaction 3-3 or 3-4) can occur both in the absorber and in the reaction tank. Under some conditions, especially in the forced-oxidation limestone process, there is a minimal amount of sulfite ion present in the liquid phase compared to the amount of SO_2 that must be neutralized. As a result, dissolution of limestone (Reaction 3-3) must occur in the absorber as the recycle slurry absorbs SO_2 . Under other conditions, usually in the inhibited-oxidation lime-based process, sufficient dissolved sulfite is present in the absorber recycle slurry to neutralize H^+ as SO_2 is absorbed (Reaction 3-5) so that nearly all of the lime reagent dissolution occurs in the reaction tank. In the lime-based process, soluble magnesium (in the form of dolomitic lime) is often added to the process to increase the solubility of sulfite by forming a MgSO_3 ion pair. The use of magnesium to improve lime process performance is described further in Part I, Section 3.4--Chemical Additives for SO_2 Removal Enhancement.

Another important FGD process reaction is the oxidation of sulfite (SO_3^-) and bisulfite (HSO_3^-) to sulfate (SO_4^-) as shown in Reactions 3-6 and 3-7. Oxidation is a result of metal-catalyzed, free radical, chain reactions involving sulfite and bisulfite free radicals and oxygen. The source of oxygen for these reactions is the flue gas and, in forced-oxidation processes, the oxidation air injected near the bottom of the reaction tank. The trace amounts of fly ash removed from the flue gas by the absorber are a significant source of metal ions.

Calcium sulfite and sulfate salts are only slightly soluble at typical operating pH levels, so precipitation of these salts occurs as the final step in the overall process. Depending on the extent of oxidation, the reaction product is either calcium sulfite hemihydrate (Reaction 3-8), a solid solution composed of calcium sulfite and calcium sulfate hemihydrate (Reaction 3-9), calcium sulfate dihydrate (gypsum) (Reaction 3-10), or a mixture of the solid solution and gypsum.

The phase diagram for the calcium sulfite/sulfate hemihydrate solid solution is known from laboratory experiments. When the fraction of absorbed SO_2 oxidized to sulfate (x in Reaction 3-9) exceeds about 0.15, the solid solution becomes saturated with sulfate, and

any additional sulfate formed by oxidation will precipitate as calcium sulfate dihydrate, gypsum, as shown in Reaction 3-10.

In practice, all of the reaction steps described above are occurring simultaneously, so that the overall rate of SO₂ absorption may be limited by the rates of one or more of the individual reaction steps. In limestone-based systems, the rate of dissolution of the limestone reagent (Reaction 3-3) is usually the slowest or "rate-limiting" step and can have a significant effect on the overall SO₂ removal rate. In lime-based systems, where the reagent is more soluble, the SO₂ absorption step (Reaction 3-1) is usually the slowest or "rate-limiting" step.

3.2 FGD Process Variables

A useful model for this type of gas absorption process can be developed using a simplified approach called the "two-film" theory, which can be found in many standard chemical engineering textbooks. The two-film model can be used to explain how several important FGD process variables affect SO₂ removal efficiency. The model assumes that the rate of SO₂ removal is governed by the rate at which SO₂ diffuses through thin stagnant films of gas and liquid on either side of the gas/liquid interface. The interface can be, for example, the surface of a spray droplet, or of a wetted packing. Figure 3-2 illustrates the two-film model for gas absorption and shows some of the simultaneous gas-liquid-solid reaction steps in the lime- and limestone-based FGD processes.

Using the two-film theory, absorber performance can be approximately described by the following expression:

$$NTU = \ln \left(\frac{SO_{2, \text{ in}}}{SO_{2, \text{ out}}} \right) = \frac{K \cdot A}{G} \quad (3-11)$$

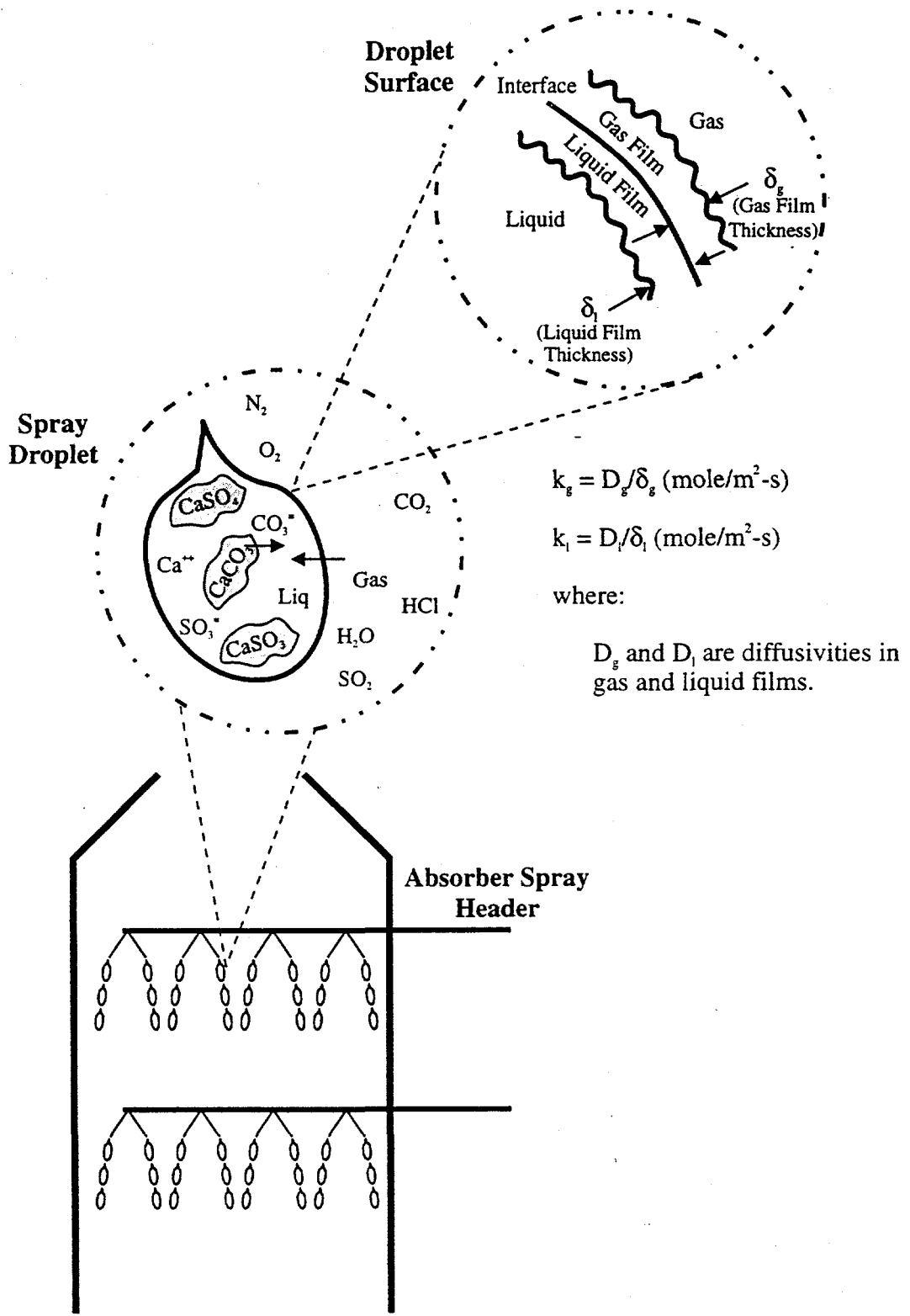

Figure 3-2. Two-Film Theory of Gas Absorption

where:

- NTU = Number of Transfer Units, dimensionless;
- $SO_{2, \text{in}}$ = Inlet SO_2 mole fraction;
- $SO_{2, \text{out}}$ = Outlet SO_2 mole fraction;
- K = Average overall gas-phase mass transfer coefficient, $kg/s\cdot m^2$;
- A = Total interfacial area for mass transfer, m^2 ; and
- G = Total gas flow rate, kg/s .

It is assumed in the above expression that the equilibrium partial pressure of SO_2 above the FGD liquor is small compared to the inlet and outlet concentrations. This is approximately true for most lime- and limestone-based FGD systems. This same equation could also be written in terms of η , the fractional SO_2 removal efficiency [$NTU = -\ln(1 - \eta)$], but the logarithmic expression in terms of NTU is more convenient when explaining the effects of different process variables on SO_2 removal.

Equation 3-11 shows that for a fixed gas flow rate (G), SO_2 removal will increase as the product of K and A increases. The A term in Equation 3-11 is straightforward. It is the total liquid surface area exposed to the flue gas in the absorber. In a spray tower, for example, A would be equal to the total surface area of all of the spray droplets. In a packed tower, A would be equal to the wetted surface area of the packing (plus any droplets that drain from the packing). In a tray tower, A includes both the droplet surface and the surface of gas bubbles that rise through the slurry held on the tray. Surface area is, therefore, a function of the mechanical design of the absorber. It can be increased, for example, by increasing the liquid spray rate in a spray or tray tower or the packing depth in a packed tower.

The K term is more complex. The overall coefficient K can be expressed as a function of two individual coefficients, k_g and k_l , that represent diffusion rates across the gas and liquid films, respectively:

$$\frac{1}{K} = \frac{1}{k_g} + \frac{H}{k_l\phi} \quad (3-12)$$

where H is a Henry's law constant, and ϕ is the liquid-film "enhancement factor." The constants k_g and k_l are a function of the diffusivity of SO₂ and physical variables, such as droplet size and relative velocity of the gas and liquid, that influence the film thicknesses. The enhancement factor is a function of the liquid composition or alkalinity. As the alkalinity of the liquid increases, ϕ increases. Therefore, the value of K (and the rate of SO₂ absorption) can be increased either by increasing the effectiveness of contact between the gas and liquid (e.g., decreasing the film thicknesses by increasing turbulence) or by increasing the alkalinity of the liquid.

The form of Equation 3-12 suggests that the effects of increasing liquid-phase alkalinity on the overall mass transfer coefficient (and therefore on NTU or SO₂ removal efficiency) will diminish at some point when $H/k_l\phi$ becomes small compared to $1/k_g$. This is referred to as "gas-film-limited" absorption. When this point is reached for a given absorber, there is no benefit to further increasing the liquid alkalinity.

Using the above model for SO₂ removal, FGD process variables that affect SO₂ removal efficiency can be described in terms of their effect on the product of K and A and the ratio of this product to G. The major process variables that affect SO₂ removal are discussed below.

3.2.1 Flue Gas Flow Rate (G)

Equation 3-11 shows that increasing flue gas flow rate (G in the denominator) will decrease NTU and, therefore, decrease SO₂ removal efficiency under otherwise constant conditions. That is, if the flue gas is exposed to the same absorber surface area for a shorter period of time, the relative fraction of SO₂ that is removed must decrease. On the other hand, treating more flue gas per unit of absorber vessel cross sectional area (resulting in a higher

flue gas velocity in the absorber module) will decrease the absorber module's capital cost. In practice, selection of the design flue gas flow rate is closely tied to the physical characteristics of the particular absorber type that will be used. Some general guidelines regarding flue gas flow rate and resulting flue gas velocity are given here. The different absorber design alternatives are described in more detail in Part I, Section 4.2--Absorber Module.

The absorber type most widely used in lime- and limestone-based FGD processes is the countercurrent spray tower. In this absorber, the flue gas flows upward while a slurry containing finely ground lime or limestone reagent is sprayed downward. SO_2 is absorbed by the spray droplets. In a spray tower, the design flue gas velocity normally ranges from about 3 to 5 m/s (10 to 15 ft/s). Increasing gas velocity increases K by decreasing the film thicknesses at the interface between the gas and spray droplets. However, if the velocity is too high, the spray droplets will be carried from the absorber along with the flue gas. The upper limit for flue gas velocity in a countercurrent spray tower is usually fixed by the capability of the mist eliminators, as described in Part I, Section 4.4--Mist Eliminator Systems.

Some vendors supply a countercurrent spray tower with a perforated tray added to improve SO_2 absorption. The flue gas bubbles through a layer of slurry held on the tray. In the spray/tray absorber, the optimum flue gas velocity is fixed by the hydraulic characteristics of the tray design. If the velocity is too low, all of the liquid will drain from the tray. If the velocity is too high, the slurry cannot drain from the tray and the tray will "flood," causing excess flue gas pressure loss.

A cocurrent packed absorber may be used in a limestone FGD process. In this absorber, the flue gas and recycle slurry flow in the same direction. The surface area for SO_2 absorption is provided by a wetted-film packing over which the recycle slurry is distributed. Because the packed absorber does not depend on small-diameter slurry droplets to provide the required mass transfer surface area, a higher flue gas velocity can be used with this absorber

type--typically 5 to 7 m/s (15 to 22 ft/s)--without overloading the mist eliminators and causing excessive droplet carryover.

3.2.2 Liquid-to-Gas Ratio (L/G)

The liquid-to-gas ratio (L/G) in lime- and limestone-based FGD processes describes the amount of alkaline slurry that is recirculated to the absorber per unit volume of flue gas. L/G is usually expressed by international FGD vendors as liters of slurry/1000 Nm³ of flue gas (1 atmosphere and 298 K). In the United States, L/G is most often expressed as gallons of slurry/1000 ft³ of flue gas at absorber temperature and pressure conditions.

L/G has some important effects in lime- and limestone-based FGD processes. First, in most absorber designs, the amount of recirculated liquid determines the amount of surface area (A in Equation 3-11) that is available for SO₂ absorption. This is especially true for spray and spray/tray absorbers. For a countercurrent spray absorber, the amount of spray droplet surface area is approximately proportional to the liquid spray rate (or L/G at a constant gas flow). After the optimum flue gas flow rate has been selected for a particular absorber, L/G becomes one of the most important design variables for obtaining the specified SO₂ removal efficiency. Because the total liquid recirculation rate is not the only variable that affects surface area, the required L/G will also vary with other absorber design aspects such as spray droplet size or packing depth. More details of absorber design features are described in Part I, Section 4.2--Absorber Module.

Another important effect of L/G occurs through its affect on ϕ , the liquid film enhancement factor (Equation 3-12). When L/G is increased, not only does surface area increase, but the amount of available alkalinity for neutralizing absorbed SO₂ increases, increasing ϕ . This increases the overall value of K in Equation 3-11.

The final effect of L/G is related to oxidation. Researchers have shown that the oxidation rate of sulfite and bisulfite (Reactions 3-6 and 3-7) in the absorber module is

very much dependent on the rate at which O_2 is absorbed. O_2 absorption, in turn, will depend primarily on two factors, the O_2 available (concentration) in the flue gas and the liquid recycle flow rate, the L factor in L/G. The oxidation rate increases with increases in either of these two factors. The oxidation rate in the absorber module is important because it can affect the tendency for scale to form in the absorber and can also affect the physical properties of the precipitating solids. These effects will be discussed further in subsequent sections of this manual.

3.2.3 Slurry pH and Limestone Reagent Ratio

Along with flue gas velocity and L/G, another process variable that has a significant effect on SO_2 removal efficiency is the pH of the recycle slurry. Slurry pH is also the primary control variable in lime- and limestone-based FGD processes. The slurry pH is normally measured in the reaction tank where spent recycle slurry from the absorber is mixed with fresh lime or limestone slurry. The amount of lime or limestone reagent that is added to the process is adjusted automatically to maintain a slurry pH setpoint (instrumentation and controls are described in more detail in Part I, Section 4.10--Process Controls and Instrumentation).

Slurry pH affects SO_2 removal through its effect on the liquid-film enhancement factor, ϕ , in Equation 3-12. The value of ϕ increases with increasing pH, thereby increasing K, the overall mass transfer coefficient. Slurry pH affects ϕ and therefore SO_2 removal efficiency in two ways. First, increasing slurry pH increases the concentration of soluble alkaline species such as sulfite ion that act to neutralize absorbed SO_2 . Second, increasing pH also increases the amount of undissolved lime or limestone reagent (reagent

ratio)* in the recycle slurry. When more solid reagent is circulated to the absorber, more reagent is available to dissolve as the liquid-phase alkalinity is depleted. However, too much excess reagent in the recycle slurry is not economical, so the slurry pH is usually controlled to maintain an optimum reagent ratio. The optimum is determined by the trade-off between higher reagent purchase costs versus higher capital and auxiliary power cost for increased L/G.

The optimum slurry pH (and reagent ratio) is substantially different for lime- and limestone-based FGD processes. In the limestone-based process, the typical pH setpoint is in the range of 5.0 to 6.0, depending on the cost of reagent and whether the process is operated to produce gypsum or calcium sulfite. A typical limestone reagent ratio for a process not designed to produce a commercial-quality gypsum byproduct is in the range of 1.05 to about 1.1. Processes which are designed to produce commercial-quality gypsum byproducts are usually operated at a lower reagent ratio (1.01-1.03) for two reasons. First, excess limestone must be minimized in order to achieve the required gypsum purity specification, normally >95%, in the final solid byproduct. Second, a lower operating pH generally improves the oxidation rate of sulfite to sulfate, minimizing the cost of the oxidation air supply.

A limestone process that produces commercial-quality gypsum will often be designed with a bank of hydrocyclones for the primary dewatering of the slurry (discussed in Part I, Section 4.8--Byproduct Solids Handling Equipment). Most of the gypsum crystals in the slurry are larger than the unreacted limestone particles. Therefore, the hydrocyclones enrich the concentration of limestone in the overflow stream, which is returned to the absorber reaction tanks, and deplete the concentration of limestone in the underflow slurry, which

* Reagent ratio, also termed stoichiometric ratio, is defined as the number of moles of calcium added per mole of SO₂ removed. This value is typically in the range of 1.01 to 1.10 and indicates the amount of excess reagent present in the slurry. Reagent ratio is also the numerical inverse of reagent utilization (i.e., 90% utilization is the same as a reagent ratio of 1.11).

contains the byproduct solids. This arrangement results in a higher reagent ratio (more excess limestone) measured in the recycle slurry than measured in the byproduct solids. The higher reagent ratio in the recycle slurry maintains a high SO₂ removal efficiency, while the lower overall reagent ratio in the byproduct keeps the limestone content of the byproduct below the maximum value permitted in commercial-quality gypsum.

Lime is more soluble and more alkaline than limestone; therefore, the operating pH for a lime-based process is higher than for a limestone-based process. In most cases, lime-based processes are designed to take advantage of soluble sulfite alkalinity to neutralize absorbed SO₂ (Reaction 3-5). The amount of sulfite in solution is often increased by adding soluble magnesium to the process (see Part I, Section 3.4--Chemical Additives for SO₂ Removal Enhancement).

The reaction tank pH in a lime-based process is usually maintained in the range from 6.5 to 7.0. The optimum slurry pH range for the lime-based process is determined on the basis of a trade-off between two competing reactions. When lime is dissolved in the reaction tank, the pH should be kept high enough to convert as much bisulfite to sulfite as possible (Reaction 3-4), so that the sulfite can neutralize absorbed SO₂ in the absorber (Reaction 3-5). However, if the pH is held high enough for complete conversion of bisulfite to sulfite, CO₂ is absorbed from the flue gas. The absorbed CO₂ then reacts with the lime to form insoluble CaCO₃. The precipitated CaCO₃ is removed from the FGD process with the byproduct solids. The result is an increased reagent use and byproduct solids production with no increase in SO₂ removal. Because lime reagent is usually much more expensive than limestone, a lime-based process is typically operated to maintain a reagent ratio in the range of 1.01 to 1.02. At the pH setpoint selected to maintain this low reagent ratio, only partial conversion of bisulfite to sulfite will occur in the reaction tank. (The effect of pH on bisulfite/sulfite conversion was described in more detail in Part I, Section 3.1.)

3.2.4 Flue Gas SO₂ Concentration

Increasing fuel sulfur content and, therefore, the flue gas SO₂ concentration will generally decrease SO₂ removal efficiency in limestone-based FGD systems at otherwise constant operating conditions. Higher inlet SO₂ depletes the available liquid-phase alkalinity more rapidly, causing the liquid-film resistance to absorption to increase. The effect of varying inlet SO₂ concentration on scrubbing efficiency of a lime-based FGD process is less significant because more liquid-phase alkalinity is available.

3.2.5 Slurry Solids Concentration and Solids Retention Time

In a properly designed process, the precipitation step (Reaction 3-8, 3-9, or 3-10) occurs continually on the surface of recirculating solids. Sufficient "seed" solids must be maintained and sufficient reaction time allowed to ensure that the process slurry does not become supersaturated resulting in the potential formation of scale on the surfaces of equipment within the absorber. Sufficient time must also be allowed for the lime or limestone reagent to dissolve (Reactions 3-2 and 3-3). The amount of "seed" solids maintained in the process is normally expressed as slurry density or slurry solids concentration. A minimum of 1 to 2 wt % solids is normally sufficient to ensure adequate seed material; however, it is more typical to operate a limestone-based process at a slurry density of 10 to 15 wt % solids. The slurry density in the reaction tank is controlled by removing a portion of the slurry in a "bleed" stream for dewatering and processing.

The length of time solids that remain in the reaction tank is usually expressed in terms of solids retention time. This is equal to the solids inventory in the reaction tank divided by the average solids production rate. It is also equal to the reaction tank volume divided by the average bleed rate of slurry to the dewatering equipment. Typical solids retention times in lime- and limestone-based FGD processes are in the 12- to 24-hour range. Retention times much longer than this can have a detrimental effect on the solids' physical,

dewatering, and handling properties as a result of crystal breakage and attrition from the shear forces and particle impacts applied by the large recirculation pumps and agitators.

3.3 Sulfite/Sulfate Scaling Control

Early installations of lime- and limestone-based FGD processes experienced operating problems caused by homogeneous nucleation and precipitation of the solid reaction products on equipment surfaces. This problem is usually referred to as "scaling." In modern systems, scaling generally can be avoided by proper design and operation.

The most significant process variable affecting scaling tendency is the extent of sulfite oxidation (Reactions 3-6 and 3-7). If the oxidation fraction (x) is less than 0.15, the reaction products will precipitate as a solid solution of calcium sulfite and calcium sulfate hemihydrate (Reaction 3-9). Under most conditions, this product will not form scale on equipment. If oxidation is nearly complete (0.9 or greater), the reaction product is primarily gypsum (Reaction 3-10) and scale will normally not form because gypsum precipitates preferentially on seed crystals that are maintained in the circulating slurry.

Experience has shown that gypsum scale formation is most likely to be a problem when the sulfite oxidation fraction is in the range from about 0.15 to 0.3. In this oxidation range, the calcium sulfite crystal lattice is saturated with respect to sulfate, so some of the sulfate must precipitate directly as gypsum. However, since oxidation of sulfite to sulfate is substantially incomplete in this range, only a small amount of gypsum is present in the reaction solids, and there is insufficient gypsum seed surface area to prevent homogeneous nucleation from occurring. This results in the formation of gypsum scale.

In practice, most lime- and limestone-based FGD processes are operated in either an "inhibited-oxidation" mode, to keep the system oxidation fraction below 0.15, or in a "forced-oxidation" mode, to keep the oxidation fraction above 0.95. The choice between the two process options depends primarily on the methods feasible for byproduct solids disposal

at a specific site (see Part I, Section 4.8--Byproduct Solids Handling). From the standpoint of SO₂ removal efficiency, the two processes are not substantially different.

3.3.1 Inhibited Oxidation

An inhibited-oxidation process is designed and operated so that the oxidation fraction of the absorbed SO₂ is less than 0.15. Below an oxidation fraction of 0.15, all of the sulfate that is formed by Reactions 3-6 and 3-7 precipitates as a solid solution of calcium sulfite and sulfate hemihydrate (Reaction 3-9). Oxidation is inhibited in lime- and limestone-based FGD systems by adding thiosulfate ion to the circulating slurry. Sodium thiosulfate was originally used for this purpose, but thiosulfate can be generated at lower cost by adding emulsified elemental sulfur to the slurry. Elemental sulfur reacts with sulfite, in situ, to form thiosulfate according to the reaction:



Typically, the net conversion of elemental sulfur to dissolved thiosulfate ion is about 50 percent. This conversion rate will increase with increases in pH, sulfite concentration, and temperature.

Sulfite oxidation is thought to be an autocatalytic, free radical, chain reaction involving a sequence of reaction steps including initiation reactions, propagation reactions, and termination reactions. Thiosulfate inhibits sulfite oxidation by reacting with the free radicals generated in the initiation and propagation steps. The products of these reactions are trithionate, S₃O₆⁻, and tetrathionate, S₄O₆⁻. In the presence of sulfite, tetrathionate is rapidly converted to trithionate. Trithionate will react with water to regenerate thiosulfate and sulfate according to the following reaction:

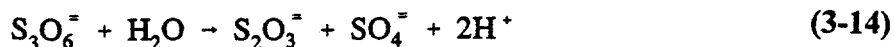

At sufficiently high concentrations of thiosulfate, the rate at which thiosulfate reacts with free radicals will be limited by their production in the initiation reactions in the free radical chain reaction. Under these conditions, the oxidation rate in the absorber module will be fixed by the rate of the initiation reactions and the rate of the trithionate hydrolysis reaction (3-14) that produces sulfate and regenerates thiosulfate. Researchers have estimated that this oxidation can be as low as 1 to 2 percent.

Process factors which determine the oxidation rate in the absorber module and, as a result, the concentration of thiosulfate that is required to inhibit oxidation include the soluble sulfite concentration, soluble trace metal concentration, temperature, and pH. In addition, the oxidation rate is very sensitive to the rate at which O_2 is absorbed in the absorber module, increasing at higher levels of O_2 absorption. Factors which determine the O_2 absorption rate in the absorber module, such as L/G and the O_2 concentration in the flue gas, can have a significant effect on the concentration of thiosulfate required to maintain the oxidation fraction below 0.15.

3.3.2 Forced Oxidation

Forced oxidation is obtained by sparging air into the slurry in the reaction tank, converting the dissolved sulfite and bisulfite to sulfate, and causing gypsum to precipitate. The extent of oxidation that can be obtained depends on the reaction tank depth and quantity of air. A typical design for complete (>99%) oxidation would supply about 1.5 moles of O_2 per mole of absorbed SO_2 . Nearly complete oxidation is required if commercial-quality byproduct gypsum will be produced. If the byproduct will be landfilled, complete oxidation is not required.

In situ forced oxidation (oxidation in the reaction tank) is usually applied only to the limestone-based process because the lime-based process depends on dissolved sulfite for liquid-phase alkalinity to neutralize absorbed SO_2 . However, this problem can be avoided by ex situ forced oxidation (oxidation in a separate tank as part of the byproduct dewatering system). While uncommon, ex situ oxidation of a lime-based FGD system has been conducted at an installation in Grand Haven, Michigan, for several years.

3.3.3 Natural Oxidation

Under "natural" oxidation conditions, the fraction of sulfite oxidized to sulfate is not deliberately controlled, but is instead determined by the inherent rates of the oxidation reactions in the system, and the ratio of SO_2 to O_2 that is absorbed from the flue gas. Some FGD processes can be operated without sulfur additive or thiosulfate while maintaining low oxidation if the coal sulfur content is high and the excess air in the flue gas is low. Under these conditions the oxidation fraction will be low because the ratio of absorbed SO_2 to absorbed O_2 will be high. Conversely, near-complete oxidation in an FGD process can be obtained, without forced air sparging, if the rate at which the sulfite is oxidized is nearly as great as the rate at which SO_2 is absorbed. Normally, this is possible only if the coal sulfur content is low and the slurry pH is controlled in the 5.0 to 5.5 range. For most applications it is beneficial to operate either in an inhibited-oxidation mode to control the oxidation fraction below 0.15, through the addition of sulfur additive, or in a forced-oxidation mode with air sparging.

3.4 Chemical Additives for SO_2 Removal Enhancement

SO_2 removal efficiency in lime- or limestone-based FGD systems can be increased by increasing the surface area in the absorber, either by increasing the L/G, adding a tray, or adding internal packing. However, these options to increase absorber surface area can be expensive. Experience has shown that much of the overall resistance to SO_2 absorption is accounted for by the liquid-film diffusion (that is, $1/k_g$ is much smaller than $H/k_l\phi$ in Equation

3-12). When SO₂ absorption is "liquid-film-limited," the cost-effectiveness of high-efficiency scrubbing can be greatly improved by the use of additives that enhance liquid-phase alkalinity. Additives may also be used to increase process flexibility. For example, in applications where fuel sulfur content is highly variable, it may be more cost-effective to design the absorber for average inlet SO₂ conditions and use a chemical additive to maintain desired SO₂ removal when higher-sulfur fuel is burned.

Three additives have been used in currently operating lime- or limestone-based FGD systems to improve SO₂ removal efficiency: magnesium, dibasic acid, and formic acid (or sodium formate). Effects of these additives on process performance are discussed below.

3.4.1 Magnesium

Several liquid-phase species capable of neutralizing absorbed SO₂ are generally present in both limestone and lime systems. The most important of these include SO₃⁻ and HCO₃⁻. The solubility of SO₃⁻ is low in the presence of dissolved calcium, but the use of supplemental soluble magnesium in the process, which can be introduced with the reagent limestone or lime, greatly increases the amount of sulfite alkalinity that can be provided by forming the soluble MgSO₃ ion pair. Supplemental magnesium is usually introduced by adding a small amount of slaked dolomitic lime [Ca(OH)₂•Mg(OH)₂] to the reagent slurry.

The use of magnesium additive is effective in an inhibited-oxidation process only because the sulfite ion provides essential supplemental alkalinity. The effectiveness of magnesium additive is also a strong function of slurry pH. As discussed earlier, at low pH much of the dissolved SO₂ will be in the form of HSO₃⁻, which cannot neutralize H⁺ (see Section 3-1). Although at least one full-scale limestone-based FGD system uses supplemental dolomitic lime, this additive is most commonly used in lime-based processes because it is more effective at the higher operating pH of a lime-based FGD process (6.5 to 7.5). Magnesium-enhanced lime FGD systems can operate with sufficient soluble sulfite alkalinity to approach gas-film-limited absorption efficiency.

Magnesium additive has some disadvantages. In the limestone-based process, high magnesium and sulfite concentrations decrease the limestone dissolution rate (Equation 3-3) and, consequently, increase the limestone reagent ratio required for a specific SO₂ removal efficiency. Magnesium ion also acts as a crystal contaminant or crystal modifier for the precipitating solids. The result can be a significant deterioration of the solids handling and dewatering properties.

3.4.2 Dibasic Acid (DBA)/Adipic Acid

Dicarboxylic acids have the general formula HOOC-(CH₂)_n-COOH. DBA is a mixture of three dicarboxylic acids: succinic (n=2), glutaric (n=3), and adipic acid (n=4). It is a byproduct of adipic acid manufacture. Like soluble sulfite, DBA improves SO₂ removal efficiency by providing supplemental liquid-phase alkalinity to neutralize absorbed SO₂. DBA acts by accepting protons (H⁺) as SO₂ is absorbed by the recycle slurry:

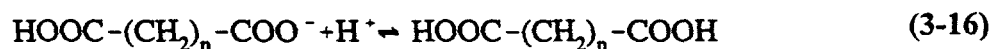

Reactions 3-15 and 3-16 are then reversed in the reaction tank as limestone dissolves to raise the pH.

DBA is more effective than sulfite in a limestone-based process because it can neutralize absorbed SO₂ and buffer the slurry over a pH range more favorable to limestone-based systems. Figure 3-3 is a typical equilibrium relationship calculated for Reactions 3-15 and 3-16 showing the distribution of DBA species as a function of pH. In this figure, the alkyl group, (CH₂)_n, is abbreviated by "R." At low pH, most of the DBA is in the undissociated (acid) form (HOOC-R-COOH). As the pH increases, the acid dissociates. The concentrations of the acid form and the singly deprotonated form (HOOC-R-COO⁻) are about equal at pH 4. With a further increase in pH, the second ionization step proceeds, and the

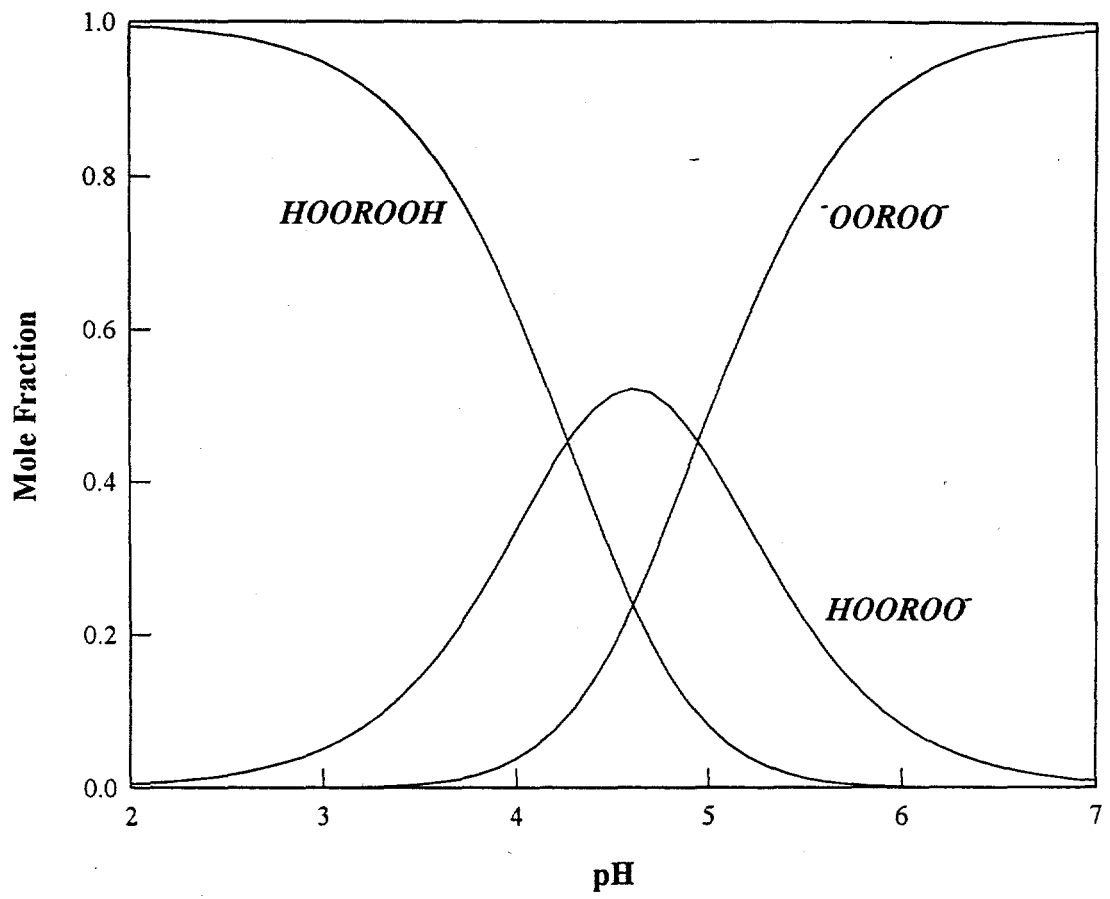

Figure 3-3. Typical DBA Equilibrium Curves

fully deprotonated form (OOC-R-COO^-) predominates above pH 6. Therefore, the DBA is essentially fully deprotonated in the limestone process reaction tank before it is recirculated to the absorber.

DBA is not consumed in the reversible Reactions 3-15 and 3-16, but is lost by two other mechanisms, oxidative degradation and precipitation with the calcium sulfite solids. DBA also leaves the FGD system in liquid lost with the byproduct solids.

DBA has been used in full-scale limestone FGD systems since 1981, when it was tested at Springfield (Missouri) City Utilities' Southwest Station Unit 1. Adipic acid can also be used, but the DBA byproduct is usually less expensive. The effect of DBA on SO_2 removal efficiency also has been measured in full-scale tests at several limestone FGD systems. Figures 3-4a and 3-4b show the typical extent of performance improvement that can be expected with DBA additive in a limestone-based FGD system.

A significant increase in removal efficiency occurs as the DBA concentration is increased over the range from 0 to 1000 mg/L DBA. At higher DBA concentrations, the improvement in terms of NTU (Figure 3-4a) is still significant, but as the SO_2 removal efficiency approaches the gas-film-limited maximum (Figure 3-4b) that can be obtained in a specific absorber, the marginal cost of additional SO_2 removal enhancement using DBA increases rapidly. Tests at full-scale FGD systems have shown that limestone-based absorbers designed for 85 to 90% SO_2 removal without DBA can achieve 95 to 97% removal with cost-effective amounts of DBA. Absorbers designed for 90 to 95% SO_2 removal without DBA can operate at 98 to 99% removal efficiency with DBA.

3.4.3 Formic Acid/Sodium Formate

Formic acid (HCOOH) is a carboxylic acid that has also been used to improve performance in limestone FGD systems. Formic acid can also be added to the FGD system in the form of sodium formate (NaCOOH), a dry powder that has important health and safety

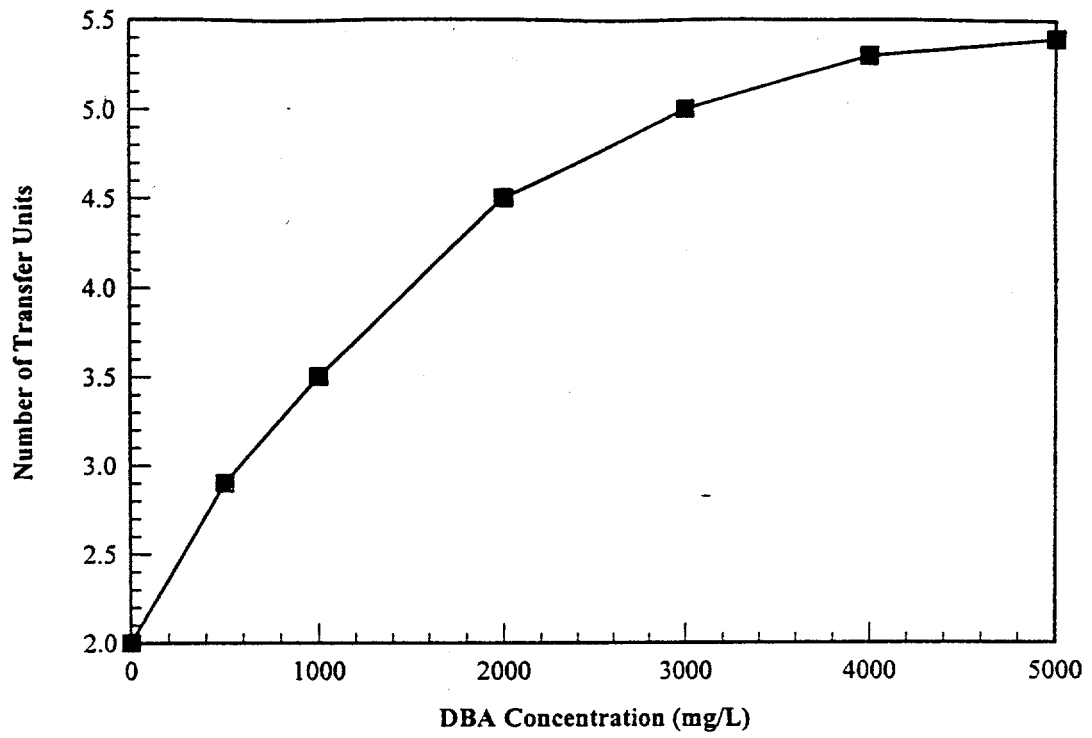

a. Effect on NTUs

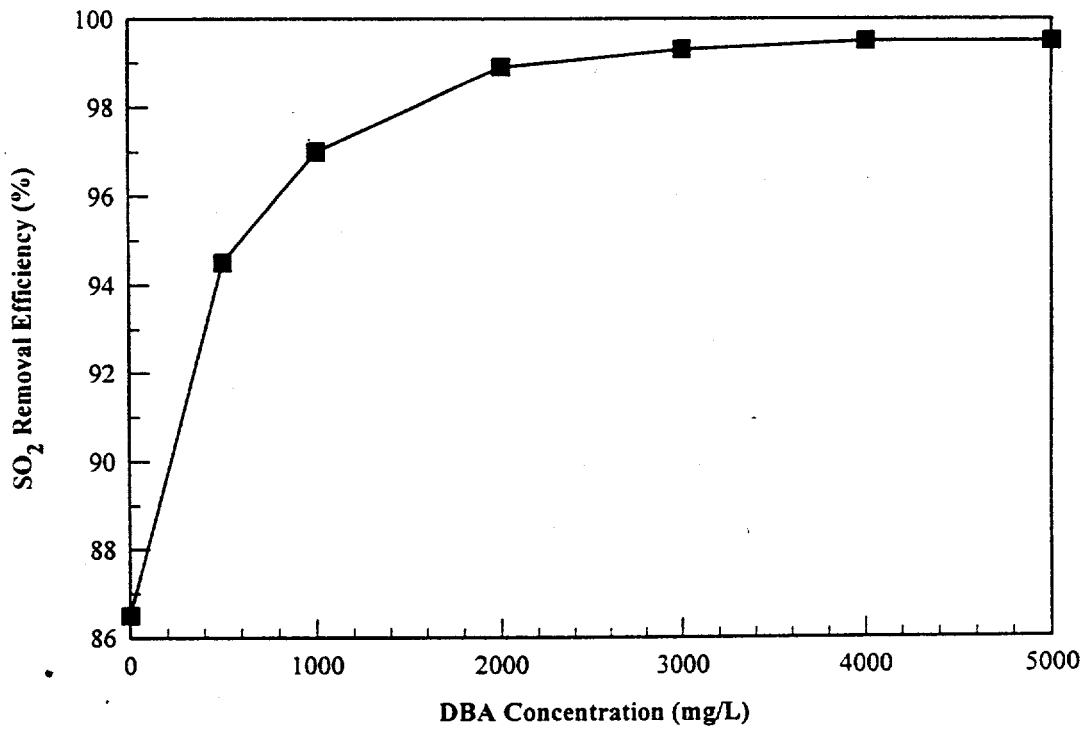

b. Effect on Removal Efficiency

Figure 3-4. Typical Performance Improvement with DBA Additive

advantages over formic acid. The neutralizing effect of either formic acid or sodium formate is similar to that of DBA, except that the formate ion accepts only one proton (H^+) per molecule:



Figure 3-5 is a typical equilibrium relationship calculated for Reaction 3-17 showing the distribution of formate ion ($HCOO^-$) and protonated formic acid ($HCOOH$) as a function of pH. Most of the formic acid remains in the deprotonated form until the pH is less than about 3.6.

Comparing the neutralizing capacity per mole, and the molecular weights of DBA (about 130 g/mole for the typical mixture of acids) and formic acid (46 g/mole), formic acid should have about 50% more neutralizing capacity on an equal weight basis (22 milli-equivalents per gram of formate versus 15 milli-equivalents per gram of DBA). However, the actual neutralizing capacity of both DBA and formic acid depends on the operating pH range for a specific FGD system. This can be seen by examining Figures 3-3 and 3-5.

Figure 3-3 shows that in order to use the full neutralizing capacity of DBA, the slurry pH would need to be above 6 in the reaction tank and below 3 at the absorber exit. Figure 3-5 shows that the corresponding pH range for full neutralization using formic acid would be above 5 in the reaction tank and less than 2 at the absorber exit. Therefore, lower-pH operation will tend to favor formic acid relative to DBA. However, most limestone FGD systems operate in a pH range that favors DBA. The relative performance of DBA and formic acid has been measured in several full-scale limestone FGD systems. At equal mass concentrations, formic acid usually provides slightly less performance enhancement compared to DBA, in spite of the theoretical advantage of formic acid. In practice, the choice between DBA and formic acid most likely will depend on the relative delivered costs of these two additives.

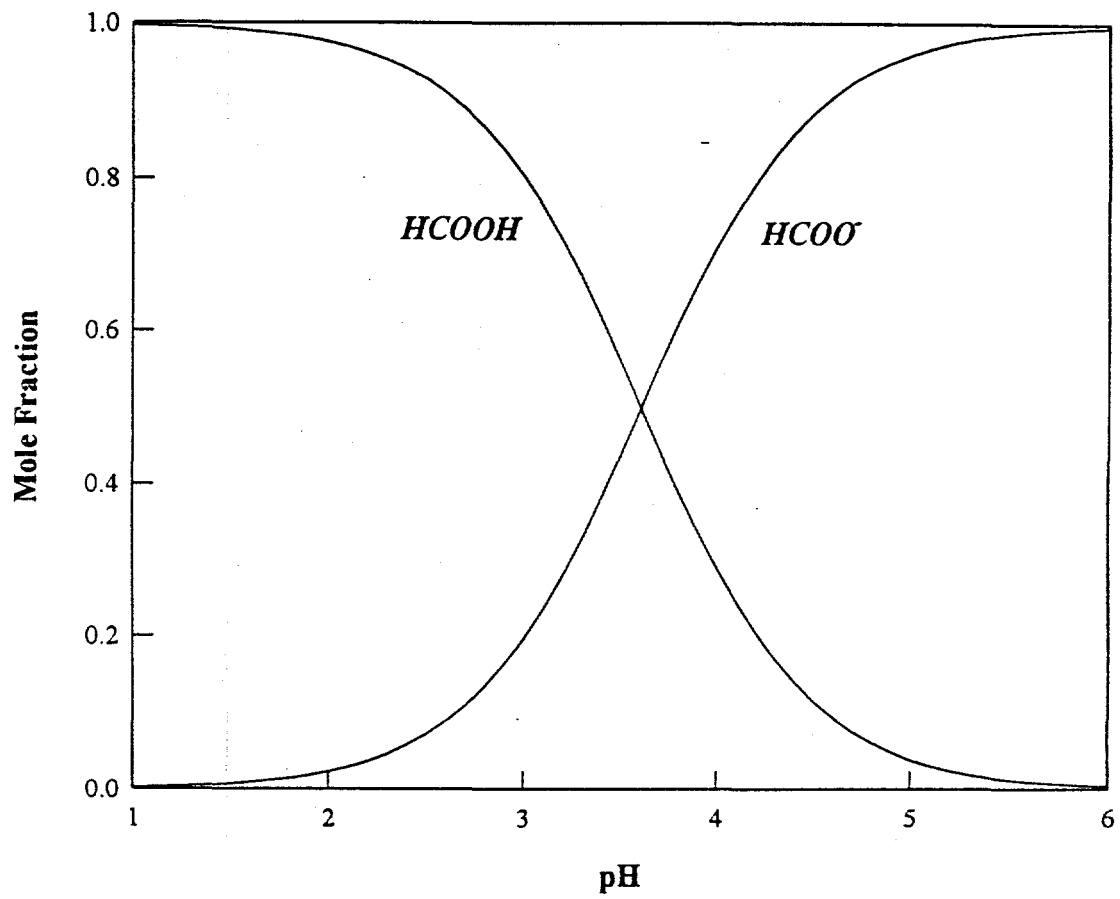

Figure 3-5. Typical Formate Equilibrium Curves

3.4.4 Additive Consumption

The cost-effectiveness of high-efficiency scrubbing using additives depends primarily on the cost and consumption rate of the additives. For this reason, additive consumption has been measured at a number of full-scale FGD systems.

In general, additive consumption in lime- or limestone-based FGD systems can be divided into "solution" and "non-solution" losses. Solution losses result from the presence of additive in liquor that is removed from the FGD system, either with the partially dewatered byproduct solids, or with a separate blowdown stream. This is the only loss mechanism for supplemental magnesium additive. Solution losses are easily estimated by material balance for any specific FGD system and additive. For example, additive solution losses at a concentration of 1000 mg/L would typically range from 0.5 to 2 kg/1000 kg of SO₂ removed, depending on the molecular weight and solids content of the FGD byproduct.

The organic acid additives can also be lost through chemical degradation, co-precipitation (inclusion of additive with the solid byproduct), and in the case of formic acid, by vaporization into the flue gas. DBA does not vaporize to any significant extent in FGD systems. The relative importance of degradation and precipitation is substantially different for forced-oxidation versus inhibited-oxidation systems. The relative importance of degradation and precipitation is also different for DBA and formic acid additives. Test results have shown that DBA and formate do not precipitate with the gypsum byproduct in forced-oxidation systems, but precipitation with calcium sulfite is the primary loss mechanism for organic acids in inhibited-oxidation systems. Test results have also shown the co-precipitation losses for DBA are higher than for formic acid under identical operating conditions. Chemical degradation of organic acid additives via oxidation occurs in both types of limestone FGD systems, although at a lesser rate in an inhibited-oxidation process.

A predictive correlation for additive consumption in limestone-based FGD systems has been developed on the basis of experimental pilot-scale data. For forced-

oxidation systems, oxidative degradation was correlated empirically as a function of additive concentration and chloride concentration. Test data suggested that high concentrations of chloride resulted in reduced oxidative degradation losses. The data also showed that the oxidative degradation rate for formic acid, under these conditions, was an order of magnitude higher than for DBA. For inhibited-oxidation systems, precipitation rates of additives were correlated as functions of the activity product of the calcium ion and the precipitating additive ion. For both systems, formate vaporization was correlated as a function of formate ion concentration. The resulting additive consumption models have been incorporated into EPRI's FGDPRIISM™ lime- or limestone-based scrubbing process simulator. The use of this process simulation model is discussed in Part IV of this manual--Use of FGDPRIISM in System Design and Proposal Evaluation.

3.5 Hazardous Air Pollutant Removal in FGD Systems

The Clean Air Act Amendments of 1990 (CAAA) [Title III, Section 112(b)(1)] address hazardous air pollutants (HAPs) and require major sources of HAPs to use the maximum achievable control technology (MACT), as defined in the amendments. Coal-fired electric power plant boilers are not identified as major HAP sources by the CAAA; however, the CAAA directs the U.S. Environmental Protection Agency (EPA) to conduct a study of mercury emissions from all sources and to make recommendations to Congress on whether there is a risk basis for requiring control of such emissions.

With the exception of mercury, a recent review of the available literature concluded that there is not sufficient meaningful information to allow HAP removal to be correlated to FGD system operating parameters (1). However, it is expected that the particulate removal efficiency of the FGD system can be used as a rough estimate of the system's removal efficiency of solid-phase HAPs. The particulate removal in a wet FGD system relies on impaction of the particulate with slurry droplets (1). Generally, the typical low-pressure-drop wet FGD absorber is not expected to be highly effective at removing the fine particulate matter (0.1 to 2 μm in diameter) that remains in the flue gas following an

electrostatic precipitator or fabric filter, but there are few published data. Measurements of FGD system fly ash removal efficiency are difficult because of low inlet and outlet loadings as well as potential generation of additional particulate matter due to penetration of fine mist droplets through the mist eliminator. In one recent publication, reported removal efficiencies for various solid-phase HAP across a wet FGD system ranged from 0 to nearly 98% (2).

Removal of vapor-phase HAPs would tend to be affected by the same process parameters that affect SO₂ removal efficiency, such as gas diffusivity, liquid-gas contact area, contact time, and solubility in water (1).

Prior to the passage of the CAAA, the Electric Power Research Institute (EPRI) initiated a power plant chemical emissions study entitled "Power Plant Integrated System: Chemical Emissions Studies (PISCES)." The data from PISCES and other studies show that, without modification, conventional wet FGD systems are capable of removing mercury from combustion gases (3-6). However, the extent of this reported removal efficiency varies widely, ranging from less than 10% to over 90 percent.

Mercury exists in coal combustion flue gas in two forms: elemental mercury (Hg⁰) and an oxidized state (Hg⁺⁺). Although very little data on mercury speciation are currently available, the limited results from existing studies indicate that 40 to 50% of the mercury is present in the oxidized form and that mercury speciation seems to be dependent on the type of coal (7).

The mercury removal efficiency obtained in a wet FGD system has been found to be strongly dependent on the speciated form of the mercury. Tests at EPRI's 4-MW Environmental Control Technology Center (ECTC)* have demonstrated that over 98% of the

* The ECTC is located at the New York State Electric and Gas Corporation's Kintigh Station and was formerly known as the High Sulfur Test Center (HSTC). This facility has been the site of research into the operation of various flue gas desulfurization processes and process modifications for many years.

oxidized mercury can be removed (7). Additional tests showed that the oxidized mercury removal efficiency was limited only by gas-film mass transfer. Elemental mercury vapor does not appear to be removed by an FGD system. This is not surprising since elemental mercury has a very low solubility in water. Other tests of mercury removal by FGD systems have shown similar results, with little or no removal of elemental mercury (1,8).

The testing at the ECTC determined that all of the mercury removed by the FGD system was incorporated into the byproduct solids, although the exact chemical form was not reported (7). No elevated levels of mercury were found in the process liquor or system blowdown stream.

3.6 Lime- and Limestone-Based FGD Process Material Balance

Figure 3-6 illustrates an overall material balance for a lime- or limestone-based FGD process. The primary inlet stream (in terms of mass flow rate) is the flue gas. In most cases, prior to entering the FGD system, the flue gas is treated by a particulate control device such as a high-efficiency electrostatic precipitator (ESP) or fabric filter. These devices are capable of removing over 99.5% of the fly ash in the flue gas. Although some lime- and limestone-based wet FGD systems are designed to remove fly ash from the flue gas or to use alkaline fly ash as a reagent, fly ash can have several detrimental effects on the process and is normally removed upstream of the FGD system. In any case, however, some fly ash passes through the particulate control device and enters the FGD process. Major components of the inlet flue gas include nitrogen, carbon dioxide, water vapor, and oxygen. Minor components include sulfur dioxide, nitrogen oxides, hydrogen chloride, hydrogen fluoride, and sulfuric acid vapor. Some additional soluble trace elements may be present in the flue gas or fly ash.

In the FGD system, SO_2 and some oxygen are removed from the flue gas. In the limestone-based process, about one mole of CO_2 is added to the flue gas per mole of SO_2 absorbed. In the lime-based process, a small amount of CO_2 may be removed from the flue gas (typically, < 0.1 mole CO_2 /mole SO_2). An FGD process that removes 95% of the SO_2

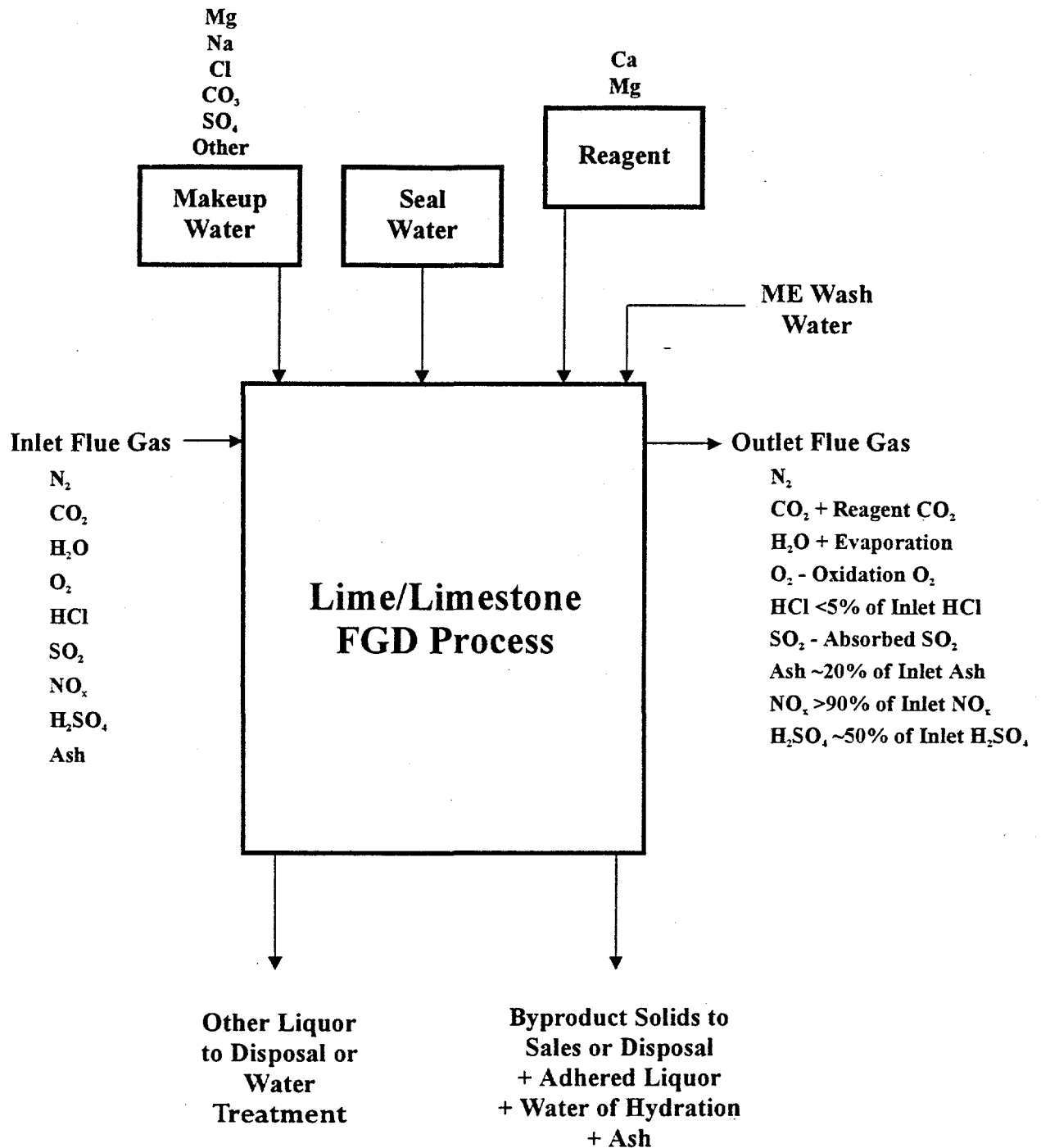

Figure 3-6. Overall System Material Balance

will also remove essentially all of the hydrogen chloride (HCl) from the flue gas because HCl is more readily absorbed than SO₂. Chloride introduced to the FGD system by the flue gas plays an important role in process chemistry. Nitric oxide (NO) that is present in the inlet flue gas typically passes through the FGD system. Although nitrogen dioxide (NO₂) may be absorbed, it is typically only a small fraction of the total nitrogen oxides in the flue gas.

Some vapor-phase sulfuric acid is typically present in the inlet flue gas. Although the H₂SO₄ (g) concentration is only about 1% of the SO₂ concentration, the presence of H₂SO₄ can have significant consequences. When the flue gas is first cooled at the absorber inlet, vapor-phase H₂SO₄ rapidly condenses to form a submicrometer-sized acid mist. Typically, less than about 50% of this mist is removed in the absorber. The remaining mist that penetrates the absorber module may cause a visible stack plume as a result of light scattering by the submicrometer-sized particles.

If the FGD system is downstream of a high-efficiency ESP, up to 80% of the residual fly ash that escapes the particulate control device may be removed in the FGD system. This fly ash typically accounts for only a small fraction of the total FGD byproduct solids, but trace chemical species introduced with the ash can affect process chemistry, especially if wastewater is to be discharged. Trace chemical species, such as iron and manganese, introduced with the ash can also act as oxidation catalysts, providing a benefit to forced-oxidation systems or a detriment to inhibited-oxidation processes.

In the absorber, the flue gas becomes saturated with water. Water evaporation in the absorber is an extremely important material balance term. The amount of water evaporated depends on coal composition, the inlet gas temperature, and inlet gas moisture content, but is usually about 0.06 to 0.07 L/s (1 to 1.2 gpm) for each megawatt of electrical power produced if all of the flue gas is treated.

Water also leaves the process as liquor that is lost with the dewatered byproduct solids. The amount of water that leaves with the solids is small compared to the

evaporation, but in some systems the liquor leaving with the byproduct solids can be the only purge for soluble species such as chloride from the FGD system. Therefore, the volume of water that leaves with the byproduct solids controls the concentration of dissolved species in the process liquor unless there is a separate liquid purge stream (blowdown) from the system. The amount of water that leaves with the byproduct solids is substantially different for the inhibited- and forced-oxidation process modes.

Water must be added to the process to replace water that is evaporated and water that leaves with the solids. Makeup water can be added in several locations, depending on the specific process design. In some cases, especially if the boiler is operated at partial load, the amount of water added to the FGD process can exceed the amount lost to evaporation and with the solid byproduct. Then, excess process liquor must be temporarily stored or discharged. FGD process water management is discussed in more detail later in this section.

The byproduct solids are produced in proportion to the amount of SO_2 removed. In the inhibited-oxidation process, the byproduct solids molecular weight is about 131 g/mole, and the theoretical dry calcium sulfite/sulfate solids production rate is therefore about 2.05 kg/kg of SO_2 removed. In the forced-oxidation process, the byproduct molecular weight is 172 g/mole and the theoretical dry solids production rate increases to 2.69 kg/kg SO_2 removed. In both process modes, the actual solids production rate is slightly higher due to the presence of inert material in the reagent lime or limestone, fly ash, and some excess reagent.

Calcium sulfite byproduct solids are usually disposed of in a pond or a landfill. If the solids are to be landfilled, additional processing is required to improve their handling properties. This processing usually consists of mixing the dewatered byproduct solids with fly ash (stabilization) or fly ash and lime (fixation) to improve its physical and chemical properties. Calcium sulfate may be ponded, landfilled without additional processing, or placed in a gypsum stack. Calcium sulfate also may be sold as a commercial gypsum

product. Byproduct solids management is also discussed in more detail in Part I, Section 4-8 --Byproduct Solids Handling.

3.6.1 FGD Process Water Management

Table 3-1 lists typical terms in the FGD process water balance for each of the three basic process options. Certain specific makeup water requirements are listed for the processes. The remainder of the makeup water ("other makeup" in the table) is added as required to maintain liquid levels in the system. At steady state, the amount of water entering the process must equal the amount leaving. In order to illustrate the relative magnitude of the terms, approximate flow rates are given for an FGD system treating flue gas from a 500-MW coal-fired boiler burning bituminous coal with a sulfur content of 2 percent.*

In the magnesium lime-based process, a total of about 42 L/s (666 gpm) of water leaves the example system. Most of this [37 L/s (587 gpm)] is evaporation to the flue gas, but water leaving with the byproduct solids is about 12% of the total. In the lime-based process, the byproduct solids are usually dewatered to about 50% moisture. A small amount of water is combined with the calcium sulfite as water of hydration.

Water entering the lime-based process includes water used to hydrate (slake) the lime and to produce a 35% slurry for use as reagent makeup to the absorber. Slaking water must be relatively low in dissolved solids and cannot be reclaimed process liquor. For this example process, about 7 L/s (111 gpm) makeup water is required for reagent preparation. Mist eliminator wash water in a magnesium lime-based process can be reclaimed process liquor and, therefore, represents no net addition of water to the system. Good-quality makeup water is also needed for pump seals and vacuum (filter) pump seals, and side-entry agitator seals. About 7 L/s (111 gpm) is required. Other makeup to the process is required

* This combination of unit size and coal sulfur content will be used throughout this manual as the basis for numerical examples.

**Table 3-1
Typical Terms in a Lime/Limestone FGD Process Water Balance***

Process Type	Inlet Water Streams	Flow Rate (L/s)	Outlet Water Streams	Flow Rate (L/s)
Magnesium lime	Lime slurry	7	Evaporation	37
	Mist eliminator wash	reclaim	Free water with solids	5
	Pump and filter seals	7	Water of hydration	<u>0.3</u>
	Other makeup	<u>28.3</u>	Total	42.3
	Total	42.3		
Limestone inhibited-oxidation	Limestone Slurry	reclaim	Evaporation	37
	Mist Eliminator Wash	reclaim	Free water with solids	3
	Pump and Filter Seals	10	Water of hydration	<u>0.3</u>
	Other Makeup	<u>30.3</u>	Total	40.3
	Total	40.3		
Limestone forced-oxidation	Limestone slurry (50% blend)**	4	Evaporation	42
	Mist eliminator wash (50% blend)	3	Free water with solids	0.8
	Pump and filter seals	10	Water of hydration	1.3
	Filter cake wash	2	Blowdown	<u>2</u>
	Other makeup	<u>27.1</u>	Total	46.1
Total	46.1			

* Based on a 500-MW Boiler, 2%-sulfur bituminous coal, full-load operation

** Denotes a blend of fresh makeup water and reclaim water.

(1 L/s = 15.9 gpm)

so that the amount of water added is equal to the amount leaving. By difference, the other makeup water rate is about 28 L/s (444 gpm).

In the limestone-based, inhibited-oxidation process, reclaimed process water can be used for preparing the limestone reagent slurry as well as for mist eliminator wash. The pump and filter seal water requirement [10 L/s (159 gpm)] is somewhat greater than that for the lime-based process because more absorber recycle pumps are used. This is the only water added to the system at a specific location, and the balance [about 30 L/s (476 gpm)] is added to maintain level. Note that the amount of water leaving with the limestone byproduct solids is only about half that leaving with the lime-based system's byproduct solids because the lime-based process solids are more difficult to dewater.

In the example limestone-based, forced-oxidation process, it is assumed that a commercial-quality gypsum byproduct is being produced. The evaporation is slightly higher in the forced-oxidation process because water is evaporated by the oxidation air supply. On the other hand, the free water leaving with the gypsum solids is quite low because gypsum is dewatered more effectively than the calcium sulfite byproduct. The forced-oxidation process also requires a separate "blowdown" or discharge stream to control the chloride concentration in the process liquor. This is done because the gypsum quality specification limits chloride to a maximum of about 200 mg/kg (dry weight) in the filter cake. The combined total water leaving the forced-oxidation process is about 46 L/s (729 gpm).

In the forced-oxidation process, the reclaimed process liquor is saturated with gypsum and is used primarily for reagent slurry preparation and adjusting reaction tank levels. Reclaim water must be blended with fresh water before use as mist eliminator wash. It is frequently recommended that, if possible, only fresh makeup water be used to wash the mist eliminators. In the example water balance, it is assumed that half of the reagent slurry preparation stream [4 L/s (63 gpm)] and mist eliminator wash stream [3 L/s (48 gpm)] are fresh makeup water. Fresh makeup water [2 L/s (32 gpm)] is also used in the forced-oxidation process to wash dissolved solids from the gypsum byproduct solids. The total

remaining makeup water requirement is about 27 L/s (428 gpm) for the forced-oxidation process.

The above examples do not include miscellaneous sources of water added to the process such as rainfall and runoff from adjacent pavement, and wash-down water. In practice, these sources of water can be significant terms in the water balance as well.

The above examples are also based on continuous high-load operation of the boiler. When the boiler operates at reduced load, the water lost through saturation of the flue gas and with the byproduct solids is reduced proportionately, but the pump shaft/vacuum pump seal water and the mist eliminator wash water requirements are often not reduced proportionately. In this case, more makeup water can sometimes be required than is lost. This is termed a "positive water balance." If the long-term average water balance remains negative, a short-term positive balance is often accommodated by using a surge pond. Water is discharged to this pond when necessary and reclaimed at some later time as makeup when the balance has become negative. If the long-term water balance is positive, water must either be discharged, or corrective measures taken to reduce the amount of water added to the process.

The use of mechanical seals instead of water gland seals for the slurry pumps is one important approach that can significantly improve an FGD system water balance. These seals are discussed in Part II, Section 5.0--Slurry Pumps.

3.6.2 Dissolved Solids (Chloride) Concentration

Another aspect of the FGD process material balance that is closely related to the water balance is the question of dissolved solids in the process liquor. Except for processes designed to produce commercial-quality gypsum, most lime- and limestone-based FGD processes are operated "closed-loop." That is, the only water discharged from the system is that associated with the byproduct solids. Because this is a small discharge,

compared to the amount of water that is evaporated, any soluble chemical species that enter the FGD system can become highly concentrated over time in the process liquor.

The most important soluble species that occur in lime- and limestone-based FGD processes include magnesium, sodium, and chloride. Magnesium enters the process along with the lime or limestone reagent, and is sometimes added deliberately in the lime-based process. Sodium enters the process primarily in the makeup water. Sodium is usually a minor species unless the makeup water is naturally brackish or is recycled from another plant source. For example, cooling tower blowdown is often-used as makeup water for FGD systems and can contain elevated levels of sodium. Chloride enters the system primarily from the flue gas. Of these three soluble species, chloride is most important because of its negative effects on process performance and its tendency to accelerate corrosion, especially with stainless steel components.

High concentrations of chloride decrease SO₂ removal efficiency in limestone FGD systems under otherwise constant conditions. The dissolved calcium concentration increases as chloride increases, because of the ion pairing between calcium and chloride. This can inhibit limestone dissolution and lower liquid-phase alkalinity. Tests have shown decreases in NTU of 10 to 40% at constant limestone utilization as chloride concentration was increased from 0 to 60,000 mg/L. The extent of reduction is dependent on operating conditions. In general, systems with higher SO₂ pickup per unit slurry volume will be more sensitive to higher chloride concentrations. Larger decreases in NTU were also seen with the inhibited-oxidation process than with the forced-oxidation process. The effect of dissolved chloride on SO₂ removal is not significant for chloride concentrations less than about 15,000 mg/L.

The effect of chloride concentration on corrosion of stainless steel is widely variable and depends on many other factors, especially temperature and pH, but in general, the least expensive alloys such as Type 316L stainless steel cannot be used for absorber construction if the process liquor chloride concentration exceeds about 3000 mg/L. Type

904L stainless steel is reported to be acceptable for chloride concentrations up to about 10,000 mg/L. Higher-nickel alloys such as alloy C-276 (or lined carbon steel) would be required for chloride concentrations exceeding about 20,000 mg/L. Materials selection for FGD systems is discussed in detail in Part I, Section 5.0--Materials-of-Construction Options.

Figure 3-7 illustrates how the chloride concentration in lime- and limestone-based FGD process liquor varies as a function of byproduct solids dewatering, makeup water quality, and coal composition. In this figure, the process liquor chloride concentration determined by material balance calculations is plotted versus the percent solids in the dewatered byproduct.

Two extremes of coal and makeup water composition have been used to develop these curves. The two lowest curves are for an FGD system applied to a boiler burning a relatively high-sulfur, low-chloride coal (4.0% S, 0.04% Cl). The two highest curves are for a medium-sulfur, medium-chloride coal (2.0% S, 0.10% Cl). Two different ranges for molecular weight and solids content in the dewatered byproduct have also been used to obtain these results. The results for solids contents less than 75% are calculated on the basis of a calcium sulfite/sulfate byproduct from an inhibited-oxidation process. The results for solids contents 75% or higher are based on a gypsum byproduct. The change in byproduct molecular weight accounts for the discontinuity in the curves.

The high-sulfur, low-chloride coal will result in relatively low chloride concentrations in the process liquor. The high sulfur content causes an increase in the amount of solids produced and, as a result, an increase in the amount of water leaving the system with the byproduct solids. The low chloride content decreases the amount of chloride entering the system with the flue gas. Conversely, the lower-sulfur, higher-chloride coal results in a higher chloride concentration in the process liquor.

The magnitude of change in chloride concentration with the assumed extent of solids dewatering is as great as the change with the coal quality. Of the three processes

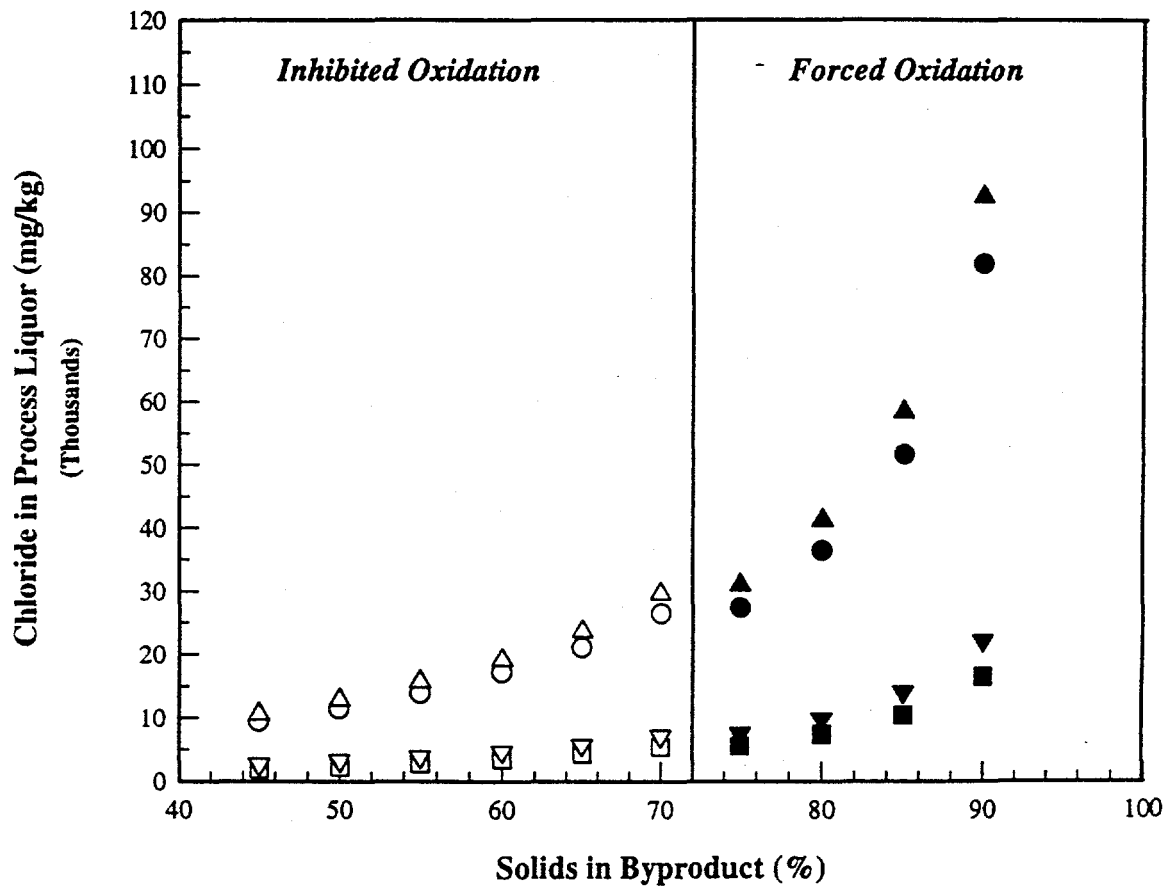
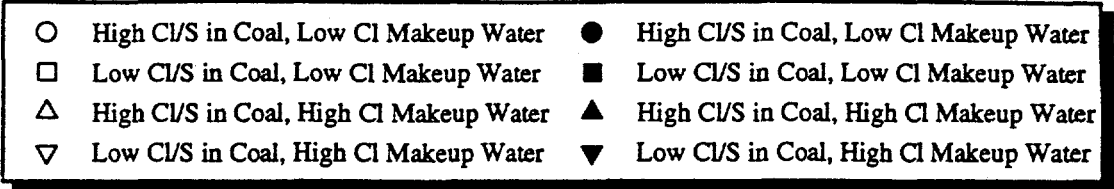

Figure 3-7. Effects of Solids Dewatering and Makeup Water Chloride Content on Chloride in Process Liquid

described in this manual, the magnesium-enhanced lime-based process produces solids that are the most difficult to dewater. The maximum solids content in the lime-based process byproduct is usually about 50 percent. Byproduct from a limestone inhibited-oxidation process can be dewatered to about 70% solids. The gypsum byproduct from the limestone forced-oxidation process can be dewatered to as high as 90% solids.

The small difference between the two curves for each coal type results from two different makeup water quality assumptions. The lower of the curves assumes 10 mg/L Cl⁻ in the makeup water and the higher assumes 200 mg/L Cl⁻ in the makeup water. These two chloride levels represent, for example, a typical surface water source and a concentrated source such as cooling tower blowdown. The results in Figure 3-7 show that the ratio of chloride to sulfur in the coal and the extent of solids dewatering usually are more important variables in the chloride material balance than makeup water quality.

3.6.3 FGD Process Wastewater

Generally, if the byproduct solids produced by a lime- or limestone-based FGD system will be disposed of, the system can be designed without a wastewater discharge. However, if commercial-quality gypsum is to be produced, the gypsum specification will not permit more than about 200 mg/kg (dry weight) total chloride in the solids. The gypsum crystals themselves contain no chloride, but the product is not completely dry, and some chloride is present in the adherent process liquor. For example, if the filtered gypsum contains 10% process liquor by weight, then 1 kg (dry basis) of gypsum will contain 0.11 kg of process liquor. Therefore, to meet the 200 mg/kg chloride limit, the liquor itself cannot contain more than about 1800 mg/kg chloride (200 mg/kg divided by 0.11 kg/kg).

Figure 3-7 shows that, without a wastewater discharge, the chloride content of the FGD system process liquor would be in the range of 15,000 to over 90,000 mg/kg. Therefore, a wastewater discharge would be required if commercial-quality gypsum is produced.

One method for purging chloride from the FGD system, when commercial-quality gypsum is produced, is to wash the gypsum filter cake with fresh water and discharge the vacuum filter filtrate. If the chloride-to-sulfur ratio in the coal is high, additional discharge may be necessary. Depending on regulations and on the size, quality, and use of the receiving stream, various levels of treatment may be required before discharging FGD process liquor. These could include lime/soda softening, metals removal by chemical precipitation, and chemical or biological oxidation. None of these treatment steps removes chloride, so other approaches may be necessary if the chloride-containing wastewater cannot be discharged. Concentration and conversion to a stabilized solid waste, for example, is one means of ultimate disposal. FGD wastewater treatment is discussed in more detail in Part I, Section 4.9--Chloride Purge Wastewater Treatment.

3.6.4 FGD Byproduct Solids Management

There are several options for managing the solid byproduct from lime- and limestone-based FGD systems. The two basic choices are disposal and sales. At this time, there is a market only for gypsum produced in the forced-oxidation process. Disposal is the only option for calcium sulfite byproduct solids from the lime-based process or inhibited oxidation, limestone-based process. Because this is a high-volume waste, disposal on or near the power plant site is most economical. If a suitable market for the gypsum byproduct cannot be found, disposal of this material is also required. Byproduct solids management is discussed in more detail in Part I, Section 4.8--Byproduct Solids Handling.

3.7 References

1. Peterson, J.R., O.W. Hargrove, Jr., D.M. Seegar, R.C. Skarupa, and R. E. Moser. "Mercury Emissions Control by Wet FGD Systems: EPRI Pilot-Scale Results." Proceedings of the 1995 SO₂ Control Symposium. Electric Power Research Institute, U.S. Department of Energy, and U.S. Environmental Protection Agency, Miami, Florida, 1995.

2. Wesnor, J.D. "Hazardous Air Pollutant Removal in FGD Systems." In: Proceedings of the 1995 SO₂ Control Symposium. Electric Power Research Institute, U.S. Department of Energy, and U.S. Environmental Protection Agency, Miami, Florida, 1995.
3. Krishnan, S.V., B.K. Gullet, and W. Jozewicz. "Sorption of Elemental Mercury by Activated Carbon." Environmental Science & Technology. 28(8): pp. 1506-1512, 1994.
4. U.S. Environmental Protection Agency. Field Test of Carbon Injection for Mercury Control at Camden County Municipal Waste Combustor. EPA-600/R-93-181. 1993.
5. Shendrikar, A.D., and D.S. Ensor. "Critical Review: Measurement of Mercury Combustion Aerosols in Emissions from Stationary Sources." Waste Management and Research. 4(75), 1986.
6. Meij, R. "Fate of Mercury in Coal-Fired Power Plants and the Influence of Wet Flue Gas Desulphurization." Journal of Water, Air, and Soil Pollution. 56(21), 1991.
7. Noblett, J.G., Jr., F.B. Messerole, D.M. Seegar, and D.R. Owens. "Control of Air Toxics from Coal-Fired Power Plants Using FGD Technology." In: Proceedings: Second International Conference on Air Pollutants, 1993. Washington D.C., 1993.
8. Peterson, J.R., D.M. Seegar, R.C. Skarupa, M. Stohs, O.W. Hargrove, Jr., and D.R. Owens. "Mercury Removal by Wet Limestone FGD Systems: EPRI HSTC Test Results." Presented at the Air & Waste Management Association's 87th Annual Meeting. Cincinnati, Ohio, 1994.

4.0 FGD SYSTEM DESIGN CONSIDERATIONS

This section of the manual discusses the basic considerations that govern the design of a lime- or limestone-based FGD system. Generally, an FGD system's basic design considerations are relatively unaffected by which of these reagents is used. Areas where the choice of reagent does affect the design are highlighted.

4.1 Design Basis Assumptions

Underlying the many FGD system design decisions that must be made is a foundation of basic design assumptions. These assumptions are typically site- and utility-specific, and consist of factors that determine how much flue gas must be treated, how efficient the FGD system must be, and what physical and process limitations are imposed by the site.

To a great extent, these basic design assumptions are governed by the utility's overall philosophy regarding design conservatism and operating flexibility. Design assumptions that are too conservative may unnecessarily increase capital and operating costs without compensating benefits. Conversely, assumptions that provide insufficient conservatism may result in a system that is unable to reliably attain the applicable regulatory requirements over the entire range of potential operating conditions. Marginal design assumptions also may reduce the ability of the system to respond to future changes in regulations or fuel characteristics. The goal of the utility design engineer is to select design assumptions that result in a reliable, flexible FGD system without unreasonable increases in the system's capital and operating costs.

The basic design assumptions that are discussed in this section include the following:

- Fuel property range;
- Flue gas property range;
- Regulatory requirements;
- Makeup water quality and availability;
- Site characteristics;
- Regional demand for commercial-quality gypsum; and
- Wastewater discharge limitations.

4.1.1 Fuel Property Range

The two fuel properties that most influence the design of the FGD system are the fuel's heating value and sulfur content. Unfortunately for the FGD system designer, even for a single coal seam, these values vary in every truck and railcar load of coal delivered to the site. Even more difficult is the common situation in which the coal supply may be supplied by more than one mine, providing coals with widely differing characteristics. In addition, the utility's fuel procurement staff may request the widest possible flexibility in future procurement activities, which can make establishing the design coal properties even more difficult.

The principal factor that directs every design aspect of an FGD system is the amount of SO₂ generated during combustion. This amount, normally expressed in nanograms of SO₂ per joule of heat input (ng/J) [or its equivalent in pounds per million Btu (lb/MMBtu)], is a function of the coal sulfur content and heating value. The amount of SO₂ generated can be calculated using the following formula:

$$SO_{2, \text{ gen}} = \frac{2 \cdot S \cdot 10^7}{HHV} \quad (4.1-1)$$

where: SO_{2, gen} = SO₂ generated, ng/J;
 S = Fuel sulfur content, %; and
 HHV = Fuel higher heating value, J/g.

$$1 \text{ ng/J} = 0.00233 \text{ lb/MMBtu}$$

This formula assumes that 100% of the coal sulfur is converted to SO_2 . As discussed earlier in Part I, Section 3.5--Lime- and Limestone-Based FGD Process Material Balance, during combustion a small fraction of the coal sulfur (approximately 1%) is converted to H_2SO_4 . Fractions of the coal sulfur are also present in the pyritic materials rejected by the coal pulverizers and in the bottom ash and fly ash. This may account for up to 3 to 4% of the total coal sulfur content. However, most designs assume 100% conversion of coal sulfur to SO_2 to provide a degree of design conservatism.

A balance must be struck in the selection of coal heating value and sulfur content used to calculate this critical FGD system design parameter. Assuming coal characteristics that produce too low an SO_2 generation value will limit the capacity of the system to respond to the normal variations in coal quality. Such a selection can also place restraints on future coal procurement activities by eliminating the potential to burn possibly lower cost, higher SO_2 generating fuels. Assuming characteristics that produce too high a value will eliminate these problems but will result in a system with excess capacity in the reagent preparation system, SO_2 absorbers, and byproduct solids handling system. This excess capacity unnecessarily increases the capital cost of the FGD system.

The design engineer should keep in mind that some degree of coal blending occurs naturally in the coal pile, damping out some of the fuel property variations. Active blending of higher and lower sulfur coals is also a possibility for reducing the design SO_2 generation.

The SO_2 generation design value must be established by closely examining all available data on the proposed and potential future coal sources and by selecting a value that represents a reasonable compromise. If sufficient fuel quality data are available, a statistical study of the correlation between fuel heating value and sulfur content should be conducted. The designer can then select a reasonable confidence limit for the SO_2 generation value. For example, the analysis may determine that 95% of the fuel delivered to the site has an SO_2 generation value of 1,000 ng/J or less and, considering the fuel blending in the coal pile, this

may be a reasonable design value. With an active fuel blending program, a lower SO₂ generation level could be reasonably selected. As discussed later, the use of chemical additives or spare equipment can also be considered in setting this design value. If necessary, economic studies can be conducted to quantify the effects of alternative coal quality characteristics on FGD system costs.

A second coal property that strongly affects the design of the FGD system is the coal's chlorine content. Coal chlorine content varies widely from less than 0.02% by weight to more than 0.5 percent. During combustion, over 80% of this chlorine is converted to HCl. As discussed in Part I, Section 3.5--Lime- and Limestone-Based FGD Process Material Balance, almost 100% of this HCl is removed by the FGD system, which can result in high levels of soluble chlorides in the recycle slurry. High levels of chloride affect both the alkalinity and corrosivity of the slurry. Slurry alkalinity can affect the L/G and reagent ratio required to meet the required SO₂ removal efficiency. Slurry corrosivity affects the selection of materials of construction and annual maintenance costs. In both cases, high levels of chlorides in the slurry are detrimental to the system. Systems with high slurry chloride levels require a larger L/G or reagent ratio; carefully selected, corrosion-resistant materials; and increased maintenance.

Like coal sulfur content, the chlorine content varies over time and among coal supplies. Because of the large volume of slurry in an FGD system, however, the chloride content of the recycle slurry does not change as rapidly. Generally, the normal day-to-day variations in coal chlorine content can be neglected and the average coal chlorine value of the highest chlorine coal (measured in ng Cl/J) can be used for design purposes. Experience has shown, however, that systems that depend on a blowdown stream to control slurry chloride level can experience rapid increases in chlorides (over 500 mg/L per day) if there is a disruption in the blowdown. This should be considered in establishing a margin of safety in the slurry chloride level.

The presence of fly ash and other trace materials can affect the FGD system in specific instances, but typically are much less important than the sulfur and chloride content. The degree to which these coal properties must be considered depends to a major extent on the efficiency of the upstream particulate control device.

4.1.2 Flue Gas Property Range

Following the amount of SO₂ generated, the physical characteristics of the flue gas to be treated are the most critical factors in the design of an FGD system. Important flue gas characteristics include the gas volume, temperature, and pressure. Of these characteristics, the gas volume has the greatest effect on the FGD system design.

Like the amount of SO₂ generated, the volume of flue gas can be a difficult value to quantify for the purpose of establishing an FGD system design condition. Not only does the amount of flue gas generated vary with the characteristics of the coal, it also is affected by the following:

- Unit load;
- Excess combustion air;
- Air heater outlet temperature;
- Air heater leakage; and
- Other air in-leakage.

It is customary practice in the electric utility industry to use the same design values and margins for the FGD system flue gas parameters that are used for the particulate control device (ESP or fabric filter) or induced draft (ID) fans. However, some utilities prefer to use a larger value such as the maximum output of the ID fans, which may include an additional 10 to 15% margin on the expected gas volume and pressure rise. Since the sizing of the inlet and outlet ductwork, isolation dampers, and absorbers are directly related to the volume of flue gas treated, the value selected has major cost consequences. As with the

SO₂ generation factor, capital cost increases with increasing conservatism in setting the volume of flue gas to be treated.

The flue gas temperature influences the water mass balance around the FGD system and the selection of materials of construction. A major consideration is the transient gas temperature that occurs upon loss of one or more steam generator air heaters. Typical inlet gas temperatures to the FGD system are 150°C (300°F) or less, but loss of an air heater can raise the temperature to over 370°C (700°F) for a short period of time. The FGD system must be designed to cope with such temperature excursions without damage to the equipment.

The flue gas pressure, in addition to affecting the volume of flue gas to be treated, is used in the structural design of the entire flue gas handling system: fans, ductwork, dampers, and absorbers. If the FGD system is located on the downstream side of the ID fans (or FGD booster fans, if employed), typical system inlet pressures are 200 to 400 pascals (Pa) [8 to 16 inches of water, gage (inwg)]. Often the FGD system is specified to withstand excursions to the deadhead pressure of the fans, which may exceed 1,000 Pa (40 inwg). This prevents structural damage to the system in the unlikely event that the gas path to the chimney is blocked. The equipment must also be able to withstand the maximum negative pressure resulting from the natural draft effect of the chimney. This is typically in the range of -100 to -200 Pa (-4 to -8 inwg).

Although much less frequently seen, the FGD system can be located upstream of the ID fans and operate under sub-atmospheric pressures of -500 Pa (-20 inwg) or greater. In this case, negative pressure excursions to pressures of less than -1,250 Pa (-50 inwg) must be considered in the structural design.

4.1.3 Regulatory Requirements

After the design flue gas composition and volume are established, the next step in establishing the FGD system design assumptions is to determine how much SO₂ may be emitted. This sets the FGD system's overall SO₂ removal efficiency.

The procedures for establishing the SO₂ emission limit at specific geographic locations are beyond the scope of this manual. The amount of SO₂ that may be emitted is determined by a complex set of governmental regulations: national, regional, state, and local. These regulations may set the following:

- A minimum SO₂ removal efficiency;
- A maximum SO₂ emission rate;
- A maximum ambient SO₂ concentration; or
- A combination of two or more of these limits.

As an example, U.S. New Source Performance Standards (NSPS) for utility steam generating stations built after September 18, 1978,* establish a multi-tier SO₂ emission regulation that uses a combination of minimum removal efficiencies and maximum emission rates. Under this regulation, the appropriate limit depends on the coal's SO₂ production in terms of ng/J (lb/MMBtu). For a new facility or a major generating facility renovation, these baseline limits are further modified by the requirement that the system employ best available control technology (BACT). The situation is further complicated by the need to maintain applicable regional ambient air quality standards for SO₂ and by the provisions of the Clean Air Act Amendments of 1990. The act also requires capping SO₂ emissions by the year 2000, which means zero net increase in emissions, and allows trading and sale of SO₂ emissions credits between facilities.

* 40 CFR 60.40a, Subpart Db--Standards of Performance for Electric Utility Steam Generating Units for Which Construction Is Commenced After September 18, 1978.

Because of the complexity of this topic, a study of the applicable site-specific regulations is usually required to set the FGD system's design SO₂ removal efficiency. In most cases, however, a utility burning a medium- to high-sulfur coal would expect a requirement to achieve a minimum of 90 to 95% SO₂ removal. With the potential to generate SO₂ emission credits that can be sold or used to offset emissions from other generating units, most recently designed U.S. installations have elected to design their FGD systems to achieve removal efficiencies of 95% or greater. This is well within the capabilities of modern lime- and limestone-based FGD systems.

Additional regulations governing the disposal of byproduct solids and FGD system wastewater must also be considered. Although FGD byproduct solids are classified by the Resource Conservation and Recovery Act (RCRA) as nonhazardous,* a disposal landfill must meet the regulatory requirements pertaining to disposal of nonhazardous industrial solid wastes. Depending upon these regulations and local geological and soil conditions, an impermeable liner and leachate collection system will be required. Disposal of leachate and FGD system blowdown to local streams will also be subject to government regulations and may involve adjustment of pH and treatment to control suspended solids, metals, and oxygen-consuming chemical species. These topics are discussed in more detail in Part I, Section 4.1.5--Site Conditions.

4.1.4 Makeup Water Quality and Availability

As discussed in Part I, Section 3.5--Lime- and Limestone-Based FGD Process Material Balance, an FGD system is a major consumer of water due to saturation of the treated flue gas and to water lost with the waste solids. Fortunately, most of the system's water demands can be met with relatively low-quality water. The following are typical sources of FGD system makeup water:

* 40 CFR 261.4(b)(4) classifies the following solid wastes as not hazardous: fly ash, bottom ash, slag waste, and flue gas emission control waste, generated primarily from the combustion of coal or other fossil fuels.

- Treated plant wastewater;
- Ash sluice water;
- Cooling tower blowdown;
- Once-through cooling water;
- Treated municipal wastewater;
- Raw plant makeup water;
- Stormwater runoff; and
- Plant service water.

The listed sources have widely differing qualities and availabilities, which are unique to each specific site. Each has been used extensively as makeup water in existing FGD systems. Also as discussed in Part I, Section 3.5, the various demands for makeup water have differing water quality requirements. Pump shaft seals and lime slakers require relatively high-quality water while mist eliminators can be washed with any source which has a calcium sulfate relative saturation of less than approximately 50% and is free of suspended solids and debris.

Because of the problems associated with the buildup of soluble chlorides in the FGD system, makeup water sources that are relatively low in chlorides are preferred. Other chemical species, such as iron and manganese, may also be of concern if the byproduct is to be sold as a commercial product. Water sources high in some species, such as magnesium and sodium carbonate, may be advantageous to the system as sources of alkalinity.

For these reasons, the FGD system must be integrated into the water and wastewater management plans of the site. In most cases, a study of plant water and wastewater management systems is required to identify the optimum sources of makeup water to the FGD system. An FGD system that is well integrated into the generating plant's water balance should not place a large demand on high-quality water sources and can help reduce the volume of wastewater discharges.

4.1.5 Site Conditions

A typical layout for a 500 MW coal-fired generating unit is presented in Figure 4.1-1. Unique site conditions related to SO₂ emission limits and makeup water supply have already been cited as design considerations. Other site-specific conditions may also influence the design of the FGD system. These conditions include the following:

- Available space for the FGD system;
- Regional availability of lime and limestone reagent;
- Available space for reagent storage; and
- Available land for disposal of byproducts.

Available Space for the FGD System

As shown in Figure 4.1-1, an FGD system requires a substantial amount of space at the rear of the steam generator. The absorber(s) alone require space comparable to that required by the particulate control device (ESP or fabric filters). Whether at a new or existing site, this area is relatively congested and limited by factors such as topography, access roads, coal handling and storage, ash handling, and cooling towers. These factors are critical at an existing facility, especially one that was not laid out with adequate provisions for the future addition of an FGD system.

The available space may influence the decision on the reagent used, the number of absorbers installed, and the general arrangement of the absorbers and FGD support systems. Lime-based systems typically require much more space than limestone-based systems for the byproduct dewatering equipment. Limited space can be more efficiently used by designing for fewer, larger-capacity absorbers, or absorbers located behind (and even inside) the chimney rather than the more typical location between the ID fans and the chimney. It may be necessary to locate the support systems, such as reagent preparation and byproduct dewatering systems, at a site remote from the absorbers. Additional discussion of FGD

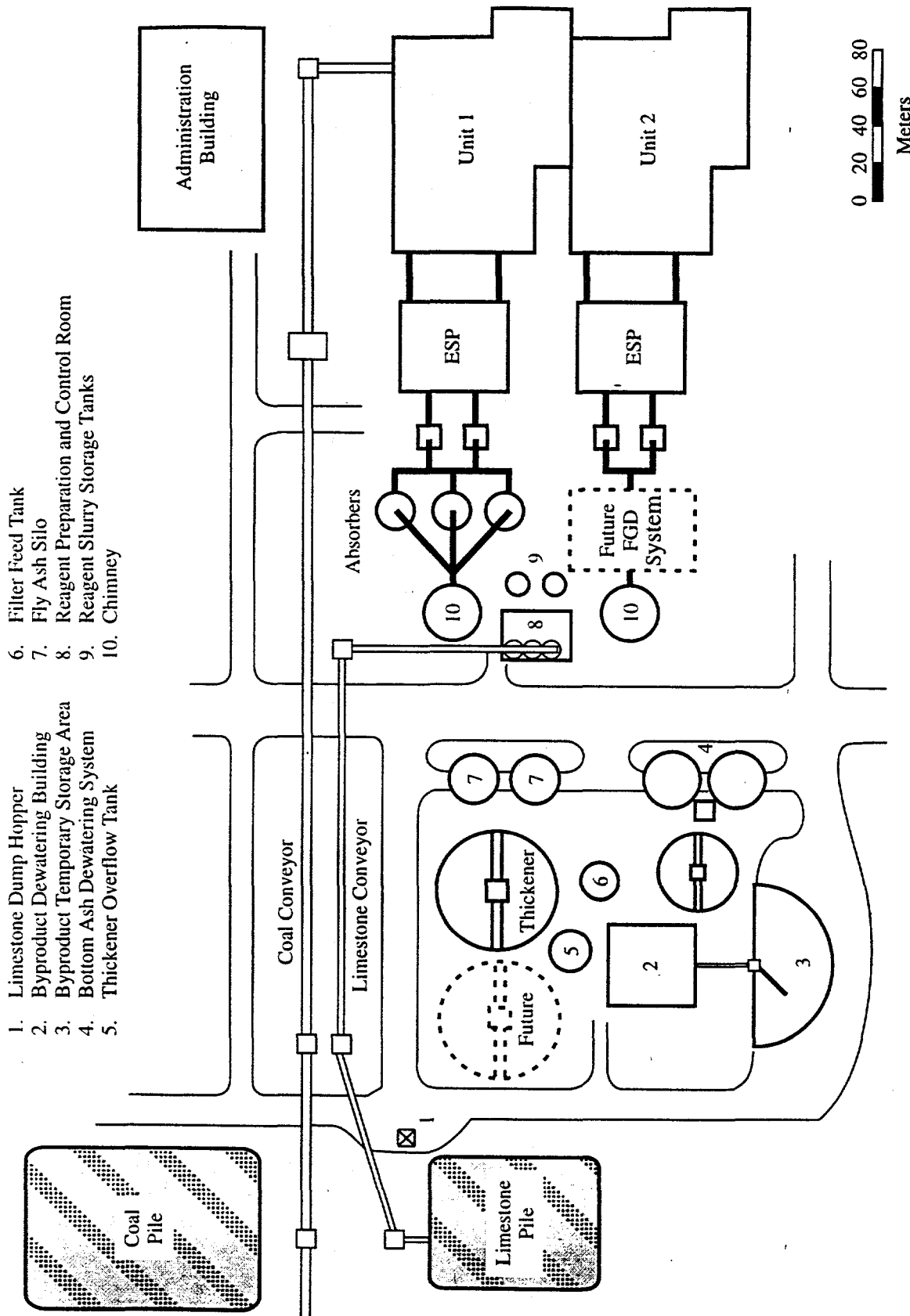

- 1. Limestone Dump Hopper
- 2. Byproduct Dewatering Building
- 3. Byproduct Temporary Storage Area
- 4. Bottom Ash Dewatering System
- 5. Thicker Overflow Tank
- 6. Filter Feed Tank
- 7. Fly Ash Silo
- 8. Reagent Preparation and Control Room
- 9. Reagent Slurry Storage Tanks
- 10. Chimney

Figure 4.1-1. Typical Generating Station Layout

system arrangement is provided in Part I, Section 4.11--Equipment Arrangement Considerations.

Regional Availability of Lime and Limestone

Limestone (CaCO_3) is a common mineral found throughout the world. Lime (CaO) is formed by calcining (heating) limestone in a kiln. A detailed discussion of the availability, composition, and other factors related to these reagents is presented in Part I, Section 8--Lime and Limestone Reagent Source Considerations. In determining whether lime or limestone is the preferable reagent at a specific site, the utility engineer must consider the regional availability and delivered cost of both reagents, and the ability of the local transportation network to handle deliveries to the site. The determination of which of these reagents is the more advantageous at a specific site is usually the subject of an engineering study.

Although both lime and limestone are readily available chemicals, their quality and delivered costs can vary dramatically from site to site. Also, an FGD system consumes large amounts of reagent, over one mole per mole of SO_2 removed. For a large utility FGD system, this can involve delivery of several hundred tons of reagent per day for the life of the system. This imposes a major new demand on the existing market for these materials. In some cases, the quantity required may be sufficiently large to justify new quarries or kilns based on serving the new demand.

The ability of the local transportation network (truck, rail, or barge) to support the delivery of large quantities of reagent on a daily basis also must be considered. Rail or barge delivery is preferable because of the large quantities to be handled. For a 500 MW boiler burning a 2% sulfur coal, the FGD reagent delivery system would be comparable in scale to the coal delivery system at a 50 MW plant. This could entail as many as 20 to 25 trucks per day or ten 100-ton railcars per week for limestone delivery.

Availability of Space for Reagent Storage

Another aspect of the reagent selection study mentioned earlier is the availability of space at the power plant site for bulk storage of the lime or limestone. In most cases, the factors that determine how much reagent should be stored at the site are identical to those used to size the generating station's reserve coal pile, primarily the likelihood and duration of disruption in deliveries. Such disruptions could occur for a number of reasons, including labor problems and inclement weather. These factors could justify a reserve storage containing 30 to 90 days' supply at full load operating conditions.

Limestone is usually stored in an open or covered pile similar to coal and is received and handled by the same types of equipment: conveyors and large mobile equipment. The limestone is placed in and removed from the reserve pile in the same manner as coal. The limestone pile, which may cover more than 4,050 m² (1 acre), may be located near the coal pile but is usually kept as close as practical to the reagent preparation equipment to minimize conveyor lengths. The location and size of a typical limestone storage pile are shown in Figure 4.1-1.

Lime must be stored in silos and is unloaded and handled pneumatically. The silos require less site area than a limestone pile and can be located closer to the FGD system's reagent preparation equipment. Two lime storage silos could provide the same storage capacity (in terms of hours of FGD system operation) as the limestone pile shown in Figure 4.1-1, while requiring less than one-half of the space and eliminating the need for the separate conveyor belt system. The smaller area requirements of lime silos is a factor favoring lime-based FGD systems at sites with limited available space near the absorbers.

Available Land for Disposal of Byproducts

An FGD system can produce up to 3 kg of dry byproduct solids per kg of SO₂ removed from the flue gas (3 lb solids/lb SO₂ removed). The moisture content of the

byproduct may range from 10% to over 40% depending on the reagent and sulfite oxidation level. Generally, lime-based systems produce byproduct solids with a higher moisture content than limestone-based systems. For a 2% sulfur coal, the total amount of byproduct solids produced is comparable to the total ash produced by combustion of the coal, and presents similar disposal problems. A 500 MW plant operating at a 65% annual capacity factor and burning coal that generates 1,720 ng SO₂/J (4 lb SO₂/MMBtu) would generate over 127,000 m³ (4.5 million ft³) of byproduct material per year. During the 30-year life of an electric utility generating plant, this would accumulate to approximately 3.8 million m³ (3,900 acre-feet). Depending upon the specific site location and topography, disposal of such quantities may pose a problem equal in magnitude to the disposal of bottom ash and fly ash.

Where sufficient land is not available for byproduct disposal either at the site or within an economical transportation distance, additional consideration must be given to the production of commercial-quality gypsum.

4.1.6 Regional Demand for Commercial-Quality Gypsum

Commercial-quality gypsum (calcium sulfate dihydrate) has a number of uses, such as a raw material for the production of wallboard, an ingredient in cement, and a soil conditioner for sulfur-poor soils. Although the specifications for gypsum vary by intended end use and user, typical vendor specifications are presented in Table 4.1-1. If a local demand for gypsum exists or can be developed, FGD system byproduct disposal costs can be greatly diminished.

Because the gypsum produced by an FGD system must compete in the marketplace with naturally occurring gypsum deposits, the economics of producing commercial-quality gypsum are highly site-specific. Like fly ash, the gypsum produced must be actively marketed by the utility to develop and maintain a demand for gypsum. Although it may be necessary to rely on the demand from a single byproduct gypsum consumer, marketing to several users may result in a better long-term demand for the material. Based on

Table 4.1-1
Commercial-Quality Gypsum Specifications

Constituent	Composition Limit				
	User A	User B	User C	User D	User E
Free water, weight %, maximum	1	10	10	10	10
Calcium sulfate, % dry weight, minimum	94	90	95	80-95*	95
Calcium sulfite, % dry weight, maximum	0.5	--	2	0.25	0.25
Inerts (fly ash, etc.), % dry weight, maximum	3	--	1	--	8
Chlorides, mg/kg, maximum	400	200	120	100	--
Sodium, mg/kg, maximum	250	200	75	600	100
Magnesium, mg/kg, maximum	250	--	50	1,000	130
Total water soluble salts, mg/kg, maximum	--	--	600	--	1,000
pH range	6.0-8.0	3.0-9.0	6.5-8.0	5.0-9.0	6.0-8.5

* Depending on end use.

the same set of operating assumptions previously used to illustrate the quantity of land required for disposal of byproduct, a 500 MW plant would produce over 155,000 metric tons (170,000 tons) per year of gypsum. The large volume of material produced emphasizes the benefits of developing multiple markets and long-term commitments for the gypsum. Dependence on a single user leaves the utility vulnerable to storage and disposal problems in the event of a disruption in the operations of that user or the demand for its products.

Limestone-based FGD systems can be designed to produce a commercial-quality gypsum with relatively few equipment and process modifications, and several have been installed in recent years in the United States and Germany. Lime-based systems producing commercial-quality gypsum are relatively rare, but such an installation is possible and has been in operation for several years in Grand Haven, Michigan. Regardless of the reagent used, the modifications are designed to ensure that the FGD byproduct is fully oxidized to calcium sulfate and contains relatively low levels of excess reagent, other inert material, and soluble salts (especially chlorides).

4.1.7 Wastewater Discharge Limitations

As discussed previously, the major consumptive use of water in an FGD system is saturation of the hot inlet flue gas. The soluble salts present in the FGD system makeup water remain and become concentrated in the system. Also, a significant quantity of soluble chlorides is added to the FGD system by the removal of HCl from the flue gas. Depending on the overall water and solids balance, soluble chlorides in the recirculating slurry may exceed 30,000 mg/L and total dissolved solids (TDS) values may exceed 100,000 mg/L. In order to limit the buildup of dissolved solids in the FGD slurry, a blowdown from the system may be required.

For FGD systems treating flue gas from the combustion of low-chlorine coal (less than 0.05%) and using makeup water with relatively low TDS content (less than 500 mg/L), sufficient dissolved solids may leave the FGD system through the byproduct solids.

For example, 1000 kg of FGD byproduct material dewatered to 80% solids contains 200 kg of entrained water (1 ton of byproduct contains 48 gallons of water). In such cases, no additional blowdown of wastewater may be required if the byproduct solids are placed in a disposal landfill.

For systems that treat flue gas from the combustion of high-chlorine coal (greater than 0.2%), that use relatively high-TDS makeup water sources (greater than 1,000 mg/L), or that wash the byproduct solids to remove soluble solids from commercial gypsum, a supplemental blowdown of wastewater is required.

Site-specific factors will determine whether such a wastewater stream can be discharged to local streams and how much treatment may be required prior to discharge. For plants located on large rivers, the discharge of a relatively low-volume, high-TDS wastewater stream may not be of concern in maintaining water quality; however, treatment to control the levels of suspended solids, metals, and oxygen-demanding compounds in the discharge may be required. In areas of high net evaporation, evaporation ponds may be a feasible method for disposal of blowdown. For plants located on small streams, however, the discharge of high-TDS wastewaters may be prohibited in order to preserve receiving stream water quality. In some cases, the dissolved solids can be concentrated by evaporators and the concentrated wastewater used to condition the fly ash for disposal. However, this can affect the marketability of the fly ash. In extreme cases, the blowdown stream must be completely evaporated and the salts produced must be placed in specially designed landfills.

4.2 Absorber Module

The absorber module is a key equipment item in the lime- and limestone-based FGD processes. The most important objective in absorber design is to create liquid surface area for SO₂ absorption at a minimum cost and with high reliability. There are a variety of vendor-specific absorber designs being used in lime- and limestone-based FGD applications. The discussion in this manual is intended to familiarize the reader with the design and operating features that affect performance for each of the major generic absorber types. It is not intended to recommend a specific absorber type for any specific application. This is best done by evaluation of actual vendor bids, performance guarantees, and the performance histories of existing installations. The combined capital and operating costs of alternative absorber designs should be compared at equivalent levels of SO₂ removal efficiency and reagent consumption. Evaluation of proposals that feature different absorber design alternatives is discussed in more detail in Part III--FGD System Proposal Evaluations.

4.2.1 Absorber Design Alternatives

The absorber types that are most widely used in lime- and limestone-based FGD processes can be divided into two major classes--countercurrent and cocurrent--on the basis of the relative direction of flow of the flue gas and recycle slurry through the absorber vessel. In the countercurrent configuration, the fresh recycle slurry from the reaction tank first contacts the flue gas at the absorber exit and the slurry flows in a direction opposite that of the flue gas flow. In the cocurrent configuration, the fresh recycle slurry first contacts the flue gas at the absorber inlet and the slurry and flue gas flow in the same direction. These two different absorber configurations are illustrated in Figure 4.2-1.

Most of the absorber designs offered by FGD vendors feature countercurrent flow. There is a slight theoretical advantage to this configuration with respect to absorption efficiency. In some circumstances, when the equilibrium partial pressure of SO₂ above the spent recycle slurry is not always zero (unlike the assumption that was made in deriving

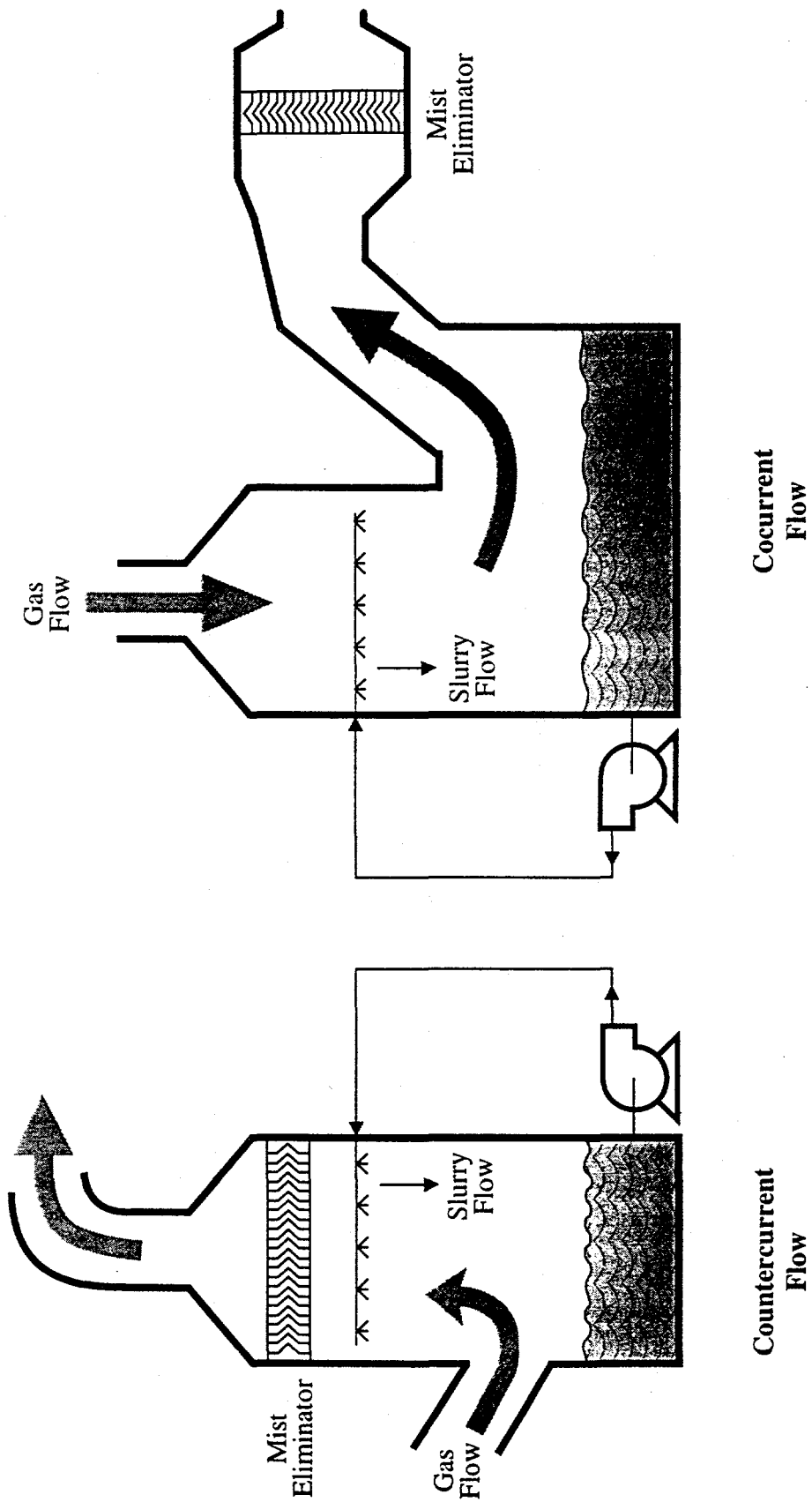

I.4.2-2

Figure 4.2-1. Counter-current and Cocurrent Absorber Configurations

Equation 3-9), it is advantageous to contact the fresh recycle slurry with the flue gas at the absorber exit so that the spent slurry can still absorb SO_2 from the inlet flue gas. In lime- and limestone-based FGD processes, this difference between the countercurrent and cocurrent absorber configurations is usually not significant, and either absorber type is capable of high SO_2 removal efficiency.

Other advantages to countercurrent operation apply to specific absorber types. In a spray absorber, for example, the mass transfer coefficient (see Equation 3-10) increases with increasing relative velocity between the spray droplets and the flue gas because of increased turbulence at the surface of the droplets. At the same time, each droplet remains in the absorber for a longer time when sprayed countercurrent to the flue gas, thus providing more surface area per unit volume of absorber. Therefore, the absorber will be more efficient at otherwise equivalent conditions if the droplets and flue gas are flowing countercurrently.

The cocurrent configuration has an important practical advantage compared to the countercurrent design in that a higher absorber gas velocity can be used. Higher velocity in the absorber means a smaller, less expensive absorber vessel. In the countercurrent configuration, the upper limit on flue gas velocity is fixed by the tendency for the flue gas to carry the recycle slurry from the top of the absorber before it has contacted the flue gas. This is especially true for the countercurrent spray absorber. For typical spray droplet sizes in the 1000 to 3000 μm range, the countercurrent absorber flue gas velocity must be less than about 5 m/s (16 ft/s) so that excessive amounts of recycle slurry are not carried out of the top of the absorber vessel. In a cocurrent absorber, the flue gas is usually directed downward toward the surface of the reaction tank at the bottom of the vessel and then sharply upward to the absorber exit. A large percentage of the slurry droplets carried with the gas is captured by inertial impaction on the surface of the reaction tank slurry. Cocurrent absorbers offered by one vendor are designed with a flue gas velocity of about 6 m/s (20 ft/s).

Other than the choice between the countercurrent and cocurrent configurations, absorber types differ primarily by the manner in which surface area is created to promote

transfer of SO₂ from the flue gas to the slurry. FGD system vendors currently offer the following types of absorbers for lime- and limestone-based FGD service: open spray tower, spray tower with tray, spray tower or flooded tower with packing, and jet bubbling reactor (JBR). The features of each of these absorber types are described below.

Open Spray Tower

The open spray tower has become one of the most widely used scrubber types in lime- and limestone-based FGD service. Figure 4.2-2 illustrates the major features of a typical open spray tower. Both circular and rectangular cross sections are offered. Flue gas usually enters at the bottom of the tower and flows upward. Turning vanes may be used to distribute the inlet flue gas across the tower. Lime or limestone slurry is sprayed downward from higher elevations in the tower. Surface area for SO₂ absorption is provided by spray droplets produced by nozzles. Spray nozzles are arranged on individual headers that penetrate the sides of the tower at various elevations. At each header elevation, there is a sufficient number of nozzles spaced such that the individual spray patterns overlap to obtain complete spray coverage over the cross section of the tower. Although other arrangements have been used, the most common practice is to dedicate a single spray pump to each of the spray header elevations. The number of operating pumps can then be adjusted as required to maintain the desired scrubbing efficiency with variations in unit load or coal sulfur content.

Most of the spray droplets fall through the tower and are either collected in an integral tank at the base of the tower or diverted to an external tank. Because the spray nozzles produce a range of droplet sizes, some of the smaller droplets are carried upward with the flue gas and must be removed by a mist eliminator. The mist eliminator is most commonly placed horizontally across the top of the tower, but can be placed vertically after the outlet ductwork has turned. Mist eliminator systems are described in more detail in Part I, Section 4.4--Mist Eliminator Systems.

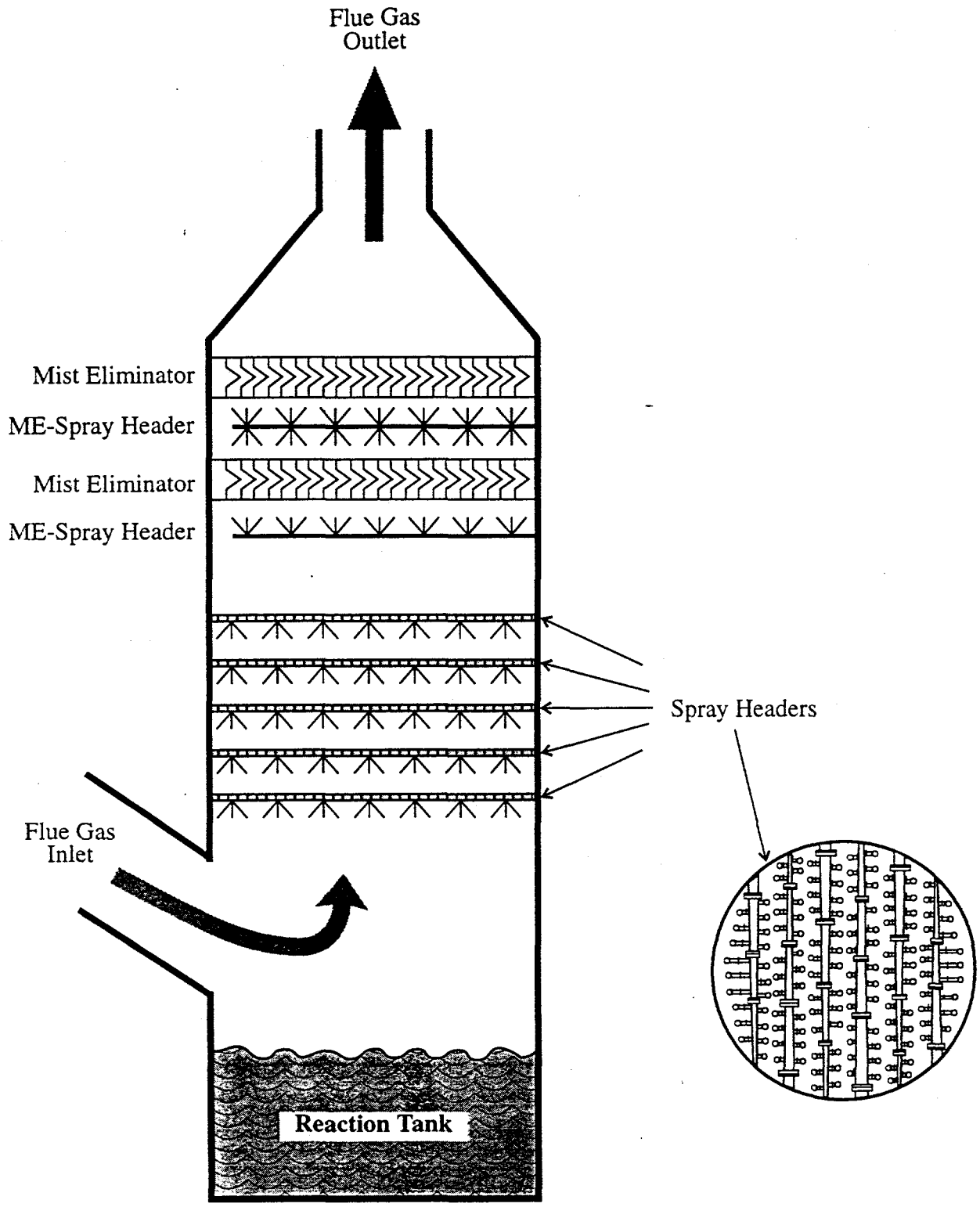

Figure 4.2-2. Open Spray Absorber

Spray Header Arrangement--The spray headers in an open spray tower are placed so that the absorber cross section is completely and evenly covered with spray droplets. The most important header design parameters are the number of header levels (elevations) and the vertical spacing between the header levels. These factors contribute to the total absorber height and are therefore a key cost component.

Typical open spray tower designs for the limestone-based process feature four to six spray header levels. Fewer headers are needed in the lime-based process because it operates at a lower L/G for the same SO₂ removal efficiency. As seen in Figure 4.2-2 (previously presented), at each level the slurry flow is distributed among a sufficient number of internal spray headers to supply the individual spray nozzles without excessive connection lengths to each of the nozzles. The first or lowest header level must be placed far enough above the top of the flue gas inlet duct so that the spray can effectively contact the incoming gas and so that excessive slurry is not sprayed into the inlet duct. The first header elevation might typically be about 2 to 3 m (6 to 10 ft) above the top of the gas inlet. Additional headers are typically spaced at intervals of about 1 to 2 m (3 to 6 ft). A sufficient distance must also be provided between the uppermost header and the bottom of the mist eliminator. This distance is typically at least 2 m (6 ft).

Spray Nozzle Characteristics and Placement--SO₂ removal efficiency in a spray tower obviously will depend on the number and size of droplets as well as on the gas velocity in the tower. The number and size of the droplets in turn depend on the total liquid flow rate and the nozzle characteristics. In gas absorption applications, spray droplet size is often expressed in terms of "Sauter mean diameter," which is the diameter of a droplet that has the same surface-to-volume ratio as the average for the entire droplet size distribution. Typical Sauter mean diameter droplet sizes in FGD applications are in the 1500 to 3000 μm range. Smaller droplets will yield a higher scrubbing efficiency per unit volume of recycle liquid, but there are some limitations that define the nozzle characteristics and drop size that are most suitable for FGD scrubbers.

The lower limit for drop size is primarily set by mist "carryover." At a typical flue gas velocity of 3 to 4 m/s (10 to 13 ft/s) in a countercurrent spray tower, droplets smaller than about 500 μm will be carried upward by the flue gas into the mist eliminator. If too large a portion of the droplets are carried over into the mist eliminator, it will not function properly, causing excess slurry to penetrate into the outlet ductwork and chimney. For a typical FGD application, no more than about 5% of the slurry droplets should be less than 500 μm in diameter. Nozzle vendors can provide detailed drop size distribution data for specific nozzles.

In general, smaller nozzles produce smaller droplets at the same operating pressure. However, nozzles must be large enough to pass debris such as pieces of scale without plugging. Nozzles must be spaced closely enough so that overlapping spray patterns eliminate "holes" where flue gas can flow without contacting droplets. A typical design for an open spray tower in lime- and limestone-based, wet FGD service might feature flow rates of 10 to 20 L/s per nozzle at operating pressures of 70,000 to 100,000 Pa [160 to 320 gpm at 10 to 15 pounds per square inch, gage (psig)]. With this size nozzle, typical spacing would be 1.0 to 1.5 m^2 (10 to 15 ft^2) of absorber cross section per single spray nozzle.

The importance of good spray pattern coverage and the effect of nozzle size has been demonstrated in tests of a full-scale spray tower (1). The original spray tower design featured 25 130-mm (5-inch) nozzles per spray header level, each with a flow rate of 31.5 L/s (500 gpm). This design was modified to include 60 to 84 50-mm (2-inch) nozzles per header level, each with a flow rate of 12.6 L/s (200 gpm) operating at about the same nozzle pressure. In addition to the nozzle change, perforated plates were added to improve gas distribution at the spray tower inlets. These changes increased SO_2 removal efficiency from about 80% to more than 96 percent. Most of this increase was attributed to the improvements in spray coverage and the significant decrease in mean droplet size with the smaller nozzles.

Effect of Flue Gas Velocity on SO₂ Removal--Flue gas velocity also has a major effect on SO₂ removal in an open spray tower. Equation 3-9 suggests that NTU will be inversely proportional to flue gas velocity if K and A are independent of gas velocity. In a counter-current spray tower, however, an increase in gas velocity will tend to increase K because increased relative velocity between the droplets and the flue gas will cause increased turbulence and should decrease the liquid and gas film thicknesses. An increase in gas velocity will also tend to increase A because the time for the spray droplets to pass through the scrubber will increase with increased gas velocity. Recent tests of a full-scale open spray tower in a limestone FGD process showed that NTU was proportional to $1/G^{0.3}$ (G = gas flow rate) (2).

It should be noted that the effect of gas velocity on inlet gas distribution in an open spray tower can also significantly affect SO₂ removal efficiency. This type of effect will be specific to a given scrubber and inlet duct configuration and can be established only by testing.

Effect of Total Spray Rate on SO₂ Removal--In a spray tower, the total spray rate can be increased or decreased by changing the number of operating recycle spray pumps. In most cases, each header level is supplied by a separate spray pump. With this configuration, the total droplet surface area in the absorber should be roughly proportional to total spray rate because all of the spray nozzles operate at constant pressure and the drop size distribution does not change with the number of operating pumps. The proportional relationship between total spray rate and total droplet surface area assumes that droplets are not lost by agglomeration or by collision with other headers or supports. Test data from one full-scale countercurrent spray tower using the limestone-based process showed that NTU was proportional to $L^{0.7}$ (L = liquid flow rate). Data from a cross-flow spray absorber showed that NTU was proportional to $L^{1.0}$ (2,3).

Effect of Header Elevation (Absorber Height) on SO₂ Removal--In a spray tower with multiple header levels, the amount of droplet surface area contributed by each

header increases with header elevation in the tower because droplets introduced at a higher elevation travel farther before leaving the tower. However, there are some additional effects that tend to minimize the effect of header elevation on SO₂ removal. As droplets travel farther from the nozzle exit, their velocity decreases and the gas and liquid film thicknesses increase. Also, the alkalinity at the surface of the droplet is depleted. Droplets may also agglomerate by collision with other droplets. The net result is that some of the droplet surface area contributed by the top headers to lower portions of the spray tower is less effective in terms of SO₂ removal than "fresh" surface area contributed by the lower headers. This means that the effect of header elevation on SO₂ removal is less than might be expected. For example, in tests at one full-scale spray absorber with four separate header elevations, SO₂ removal was 73% (NTU = 1.8) with the bottom two headers operating compared to 76% (NTU = 2.1) with the top two headers operating (4).

Effect of Inlet SO₂ Concentration on SO₂ Removal--Higher inlet SO₂ concentrations will generally decrease SO₂ removal efficiency in lime- and limestone-based FGD systems at otherwise constant operating conditions. The significance of this effect depends on the amount of liquid-phase alkalinity. In recent full-scale tests with an open spray tower in a limestone FGD process, NTU was proportional to $1/\text{SO}_{2,\text{in}}^{0.25}$ (2). In processes with high alkalinity such as the magnesium-enhanced lime-based process or a limestone-based process with organic acid additive, the effect of inlet SO₂ concentration on efficiency will be much less.

Spray/Tray Absorber

At least one lime- and limestone-based FGD system vendor offers an absorber that combines the countercurrent spray absorber configuration with a perforated-plate tray. Trays have also been installed in existing absorbers to improve performance. Figure 4.2-3 illustrates a typical spray/tray absorber arrangement for lime- and limestone-based FGD service. The usual tray placement is toward the bottom of the vessel, with two or more spray headers above the tray. Spray headers may also be located below the tray to ensure that the

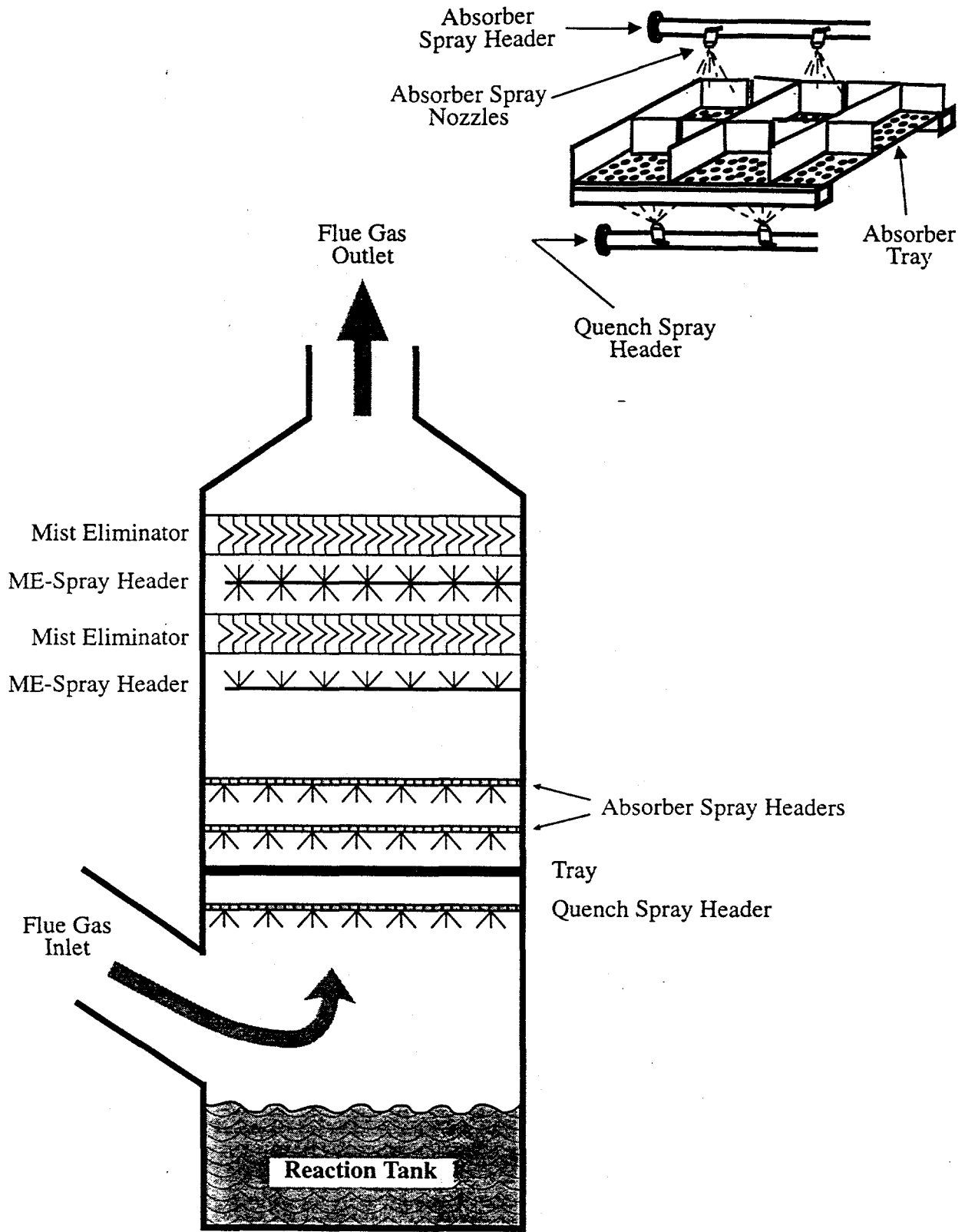

Figure 4.2-3. Spray/Tray Absorber

flue gas is completely saturated prior to contacting the tray. The tray itself is a perforated plate with typical hole sizes in the 25- to 40-mm (1 to 1.5 in.) range and open areas in the range of 25 to 40 percent. The tray is usually subdivided by partitions to improve liquid distribution. In operation, flue gas flows upward through a portion of the holes while slurry flows down through other holes. Gas and liquid generally flow alternately through any given hole due to turbulent motion of the liquid that is retained on the tray. The most common flow regime for this type of counterflow tray can be described as a continuous slurry phase held on the tray with jets or bubbles of gas passing through. A counterflow tray in FGD service typically adds 400 to 800 Pa (1.6 to 3.2 inwg) of flue gas pressure drop to the absorber.

Effect of a Tray on Spray Tower Performance--When used in a new absorber design, a counterflow tray has certain advantages compared to an open spray tower. One advantage is that the mass transfer surface area generated on a tray requires less vertical distance compared to a spray header. Therefore, when a tray is used, high-efficiency SO₂ removal may be obtained with a shorter tower as well as a lower total spray rate, providing some capital savings in absorber shell construction and in recycle pump capacity. Both of these effects reduce the required pumping power. These savings are offset by increased fan power due to added flue gas pressure drop. Therefore, total annualized costs at comparable guaranteed performance levels must be compared to evaluate the potential economic advantage of any specific absorber configuration.

Performance data reported for a full-scale spray tower where a tray was added to improve performance showed that adding a tray increased SO₂ removal efficiency from about 90% (NTU = 2.3) to 94% (NTU = 2.8) (1). Tray placement is important. If the tray is placed too close to the spray zone above the tray, the surface area lost from the spray zone can detract significantly from the area gained on the tray. Depending on the specific circumstances, a tray may improve performance beyond the level indicated above if the tray improves flue gas distribution in an existing spray tower. Single-module tests or scale modeling can be used to investigate the potential effect of a tray on flue gas distribution.

Increasing mass transfer by adding internal devices such as a tray to an open spray tower does increase the potential for plugging problems. However, advances in FGD chemistry and process control have greatly reduced this risk.

Effect of Gas Velocity on SO₂ Removal Across a Tray--Increasing gas velocity increases the liquid-phase hold-up and turbulence on a tray (and the pressure drop) sufficiently to increase the product of K and A proportionately to the increase in G (Equation 3-9). Performance data reported for a pilot-scale tray tower using magnesium-enhanced lime showed that SO₂ removal efficiency either remained the same or increased slightly with increasing gas velocity (5).

Effect of Total Liquid Rate on SO₂ Removal Across a Tray--Increasing the liquid rate in a tray absorber also increases the liquid-phase hold-up and the tray pressure drop. Pilot-scale tests with magnesium-enhanced lime showed that tray NTU increased roughly in proportion to liquid flooding rate (5).

Packed Absorber

Another method to increase the surface area for SO₂ absorption is to place packing in the absorber vessel. Packing of various types has long been used in gas absorbers, but its application in lime- and limestone-based FGD service has been limited because of the potential for plugging or scaling. Like the use of trays, packing has become a more feasible alternative as improvements in process chemistry and control have reduced the risk of plugging and scaling.

Figure 4.2-4 illustrates one type of cocurrent packed tower configuration for lime- and limestone-based FGD service. In lime- and limestone-based FGD absorbers, the packing structure is usually fairly open to reduce plugging and facilitate cleaning, when required. The packing is manufactured in structured modular sections for easy placement. A variety of materials can be used, with polypropylene being a typical choice. Because surface

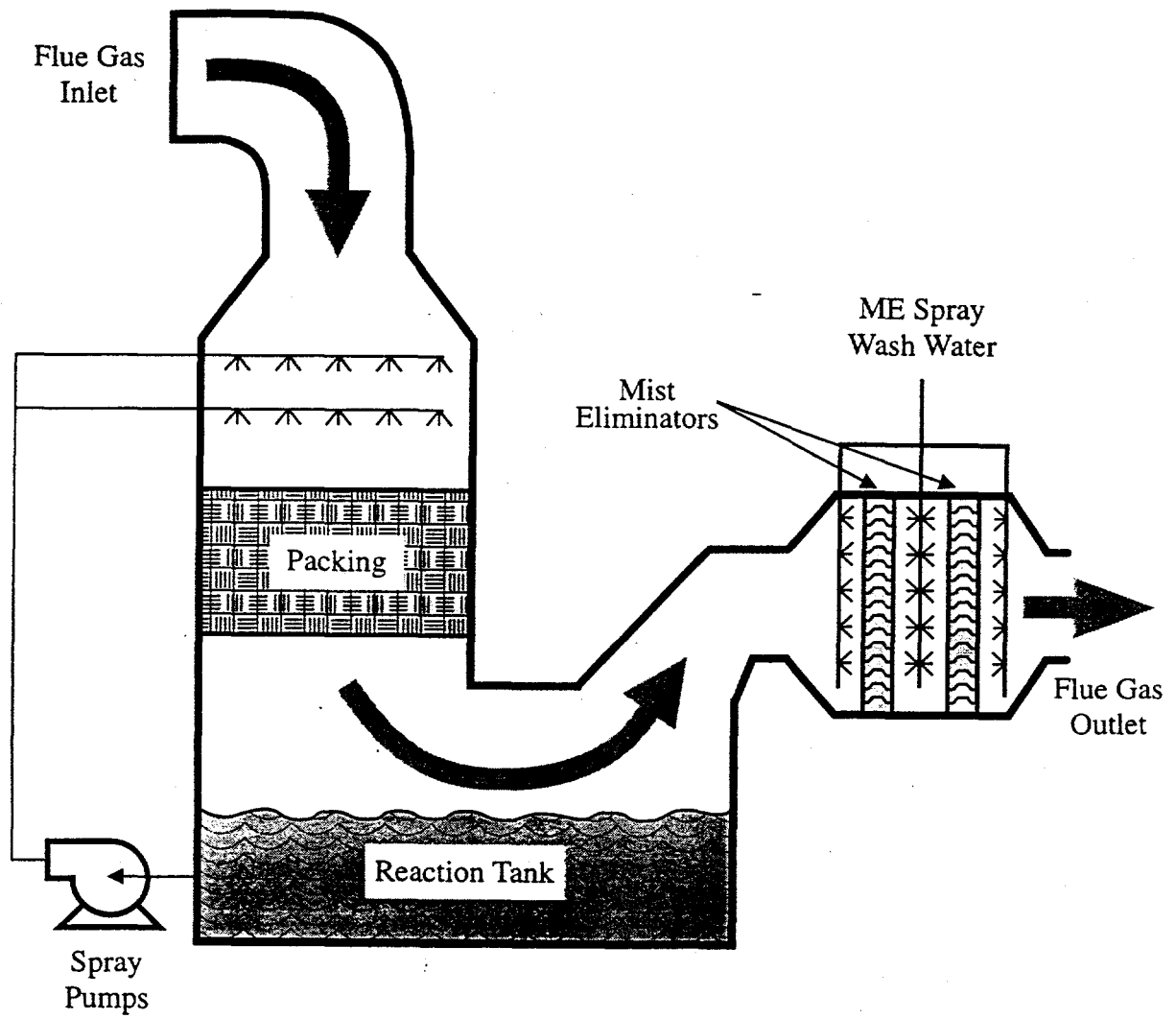

Figure 4.2-4. Packed, Cocurrent Absorber

area for SO₂ absorption is provided by the wetted surface of the packing instead of small droplets, the recycle slurry can be supplied by headers with a smaller number of larger, low-pressure nozzles.

Typical surface areas per unit volume of packing in FGD applications range from about 35 to 140 m²/m³. This is higher than the surface area per volume of absorber (10 to 15 m²/m³) estimated for open spray towers using the FGDPRISM™ computer model. Therefore, a packed tower, like a tray tower, can obtain high SO₂ removal efficiency with a shorter tower and lower total spray rate relative to an open spray tower. In some packed scrubbers, conventional spray headers are also installed below the packed section.

Effect of Flue Gas Velocity on SO₂ Removal Across Packing--In a packed tower, the relative velocity between the wetted surface and flue gas is equal to the flue gas velocity so that the film thicknesses decrease and mass transfer coefficients increase significantly as gas velocity increases. Various correlations for the effect of gas velocity on mass transfer in packed towers suggest that the overall mass transfer coefficient will increase with $G^{0.3}$ to $G^{0.4}$ (G = flue gas flow rate). The wetted surface area is not a strong function of gas velocity. As a result, NTU in a packed tower will be inversely proportional to $G^{0.6}$ to $G^{0.7}$. For example, at one full-scale, limestone-based FGD system with a cocurrent packed absorber, SO₂ removal in terms of NTU decreased by about 20% when boiler load was increased by 50 percent (6). These data show that, in this absorber, NTU was proportional to $1/G^{0.6}$.

Effect of Total Liquid Rate on SO₂ Removal Across Packing--Data from the same full-scale packed absorber show that NTU increases with $L^{0.8}$ (L = liquid flow rate) at constant gas velocity. This increase is comparable to that for an open spray absorber (6).

Dual-Loop Absorber

One FGD vendor offers an absorber configuration for use in the limestone-based FGD process that has two independent reaction tanks and slurry recycle loops. This absorber is illustrated in Figure 4.2-5. The lower-loop slurry is circulated from an integral reaction tank in the base of the absorber vessel to spray headers that are located in the lower portion of the absorber. The upper-loop slurry is circulated from a separate, external reaction tank to spray headers that are located in the upper portion of the absorber. Packing may also be used in the upper loop to enhance SO₂ removal efficiency. The two loops are separated by a bowl that directs the spent slurry from the upper loop back to the external reaction tank. The external reaction tank overflows to the lower loop tank, and a sidestream of lower-loop slurry is sent to the dewatering system. While the single-loop designs previously discussed are less complex, the dual-loop design offers several advantages that are obtained by optimizing process chemistry in the two different slurry recirculation loops.

As described earlier in this manual, the SO₂ removal efficiency in a limestone-based FGD absorber is a strong function of absorber liquid-to-gas ratio (L/G) and the amount of excess limestone in the recycle slurry (limestone utilization). In a single-loop absorber, for a given SO₂ removal efficiency, there is a cost trade-off between pumping power (L/G), and limestone reagent consumption. If little excess limestone is present (high utilization), then a higher L/G is required. Conversely, with a lower L/G, more excess limestone is required.

The dual-loop absorber, on the other hand, can obtain the same SO₂ removal efficiency as a comparable single-loop absorber while using both a lower L/G and less excess limestone. This is done by controlling the slurry pH at two different setpoints for the lower- and upper-loop reaction tanks. The upper loop is operated at a relatively high pH and with more excess limestone in the recycle slurry. This minimizes the L/G and pumping power necessary to obtain good SO₂ removal efficiency. The lower loop is operated at a lower pH, so that little excess limestone is present in the lower-loop recycle slurry. Much of the limestone used in the lower loop is provided by overflow from the upper-loop reaction tank.

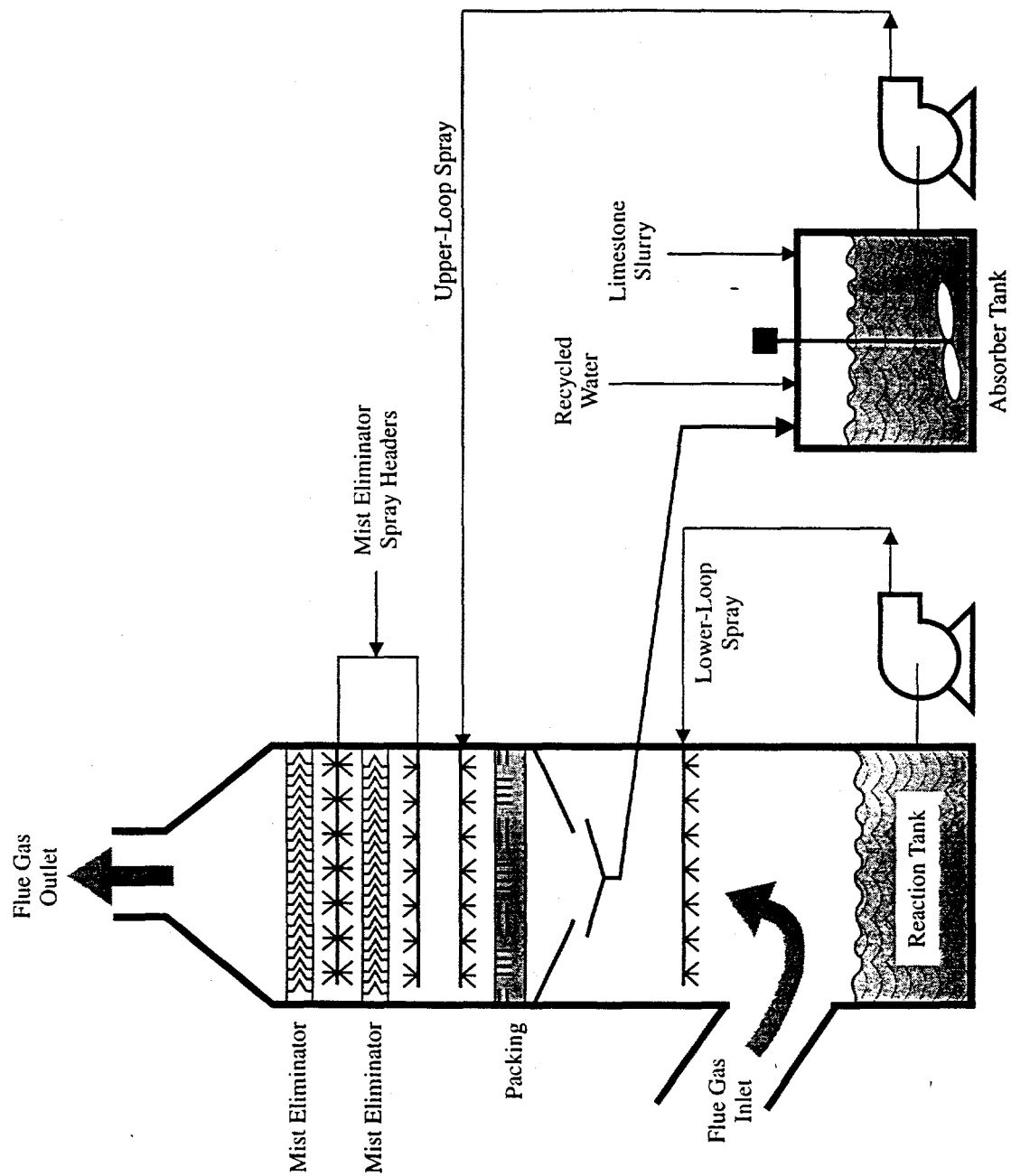

Figure 4.2-5. Dual-Loop Absorber

Because the byproduct solids are drawn off from the lower loop, less limestone is wasted than in the single-loop absorber.

The dual-loop absorber is especially advantageous when applied to a forced-oxidation limestone-based process that is producing high-purity gypsum for wallboard production. The allowable amount of excess limestone in the gypsum byproduct is very low, and the single-loop process requires a significantly higher L/G compared to the double-loop process.

Another advantage of the dual-loop absorber is related to chloride concentration in the slurry. Because HCl in the flue gas is much more soluble than SO₂, most of the HCl is removed in the lower loop, even though it is operated at a relatively low pH. As a result, only the lower-loop portion of the absorber is exposed to high dissolved chloride concentrations. This offers some savings in materials of construction because the upper portion of the absorber vessel can be constructed with a less expensive alloy than the lower portion.

As for any of the absorber configurations, the potential economic benefit of the double-loop absorber must be evaluated for each specific application by comparing the total operating costs, which include the annualized capital cost as well as power and reagent costs.

Jet Bubbling Reactor (JBR)

The JBR is a proprietary absorber design offered by Chiyoda Corporation. This contactor is unique in the FGD industry because surface area for absorption is created by bubbling the flue gas through a pool of slurry rather than recycling slurry through the flue gas as in the other absorber types. Figure 4.2-6 illustrates the essential features of the JBR. Flue gas is pre-cooled in a quench section prior to entering the JBR. The JBR consists of an enclosed plenum formed by upper and lower deck plates. The flue gas is forced through multiple sparger tube openings in the lower deck. These tubes are submerged beneath the

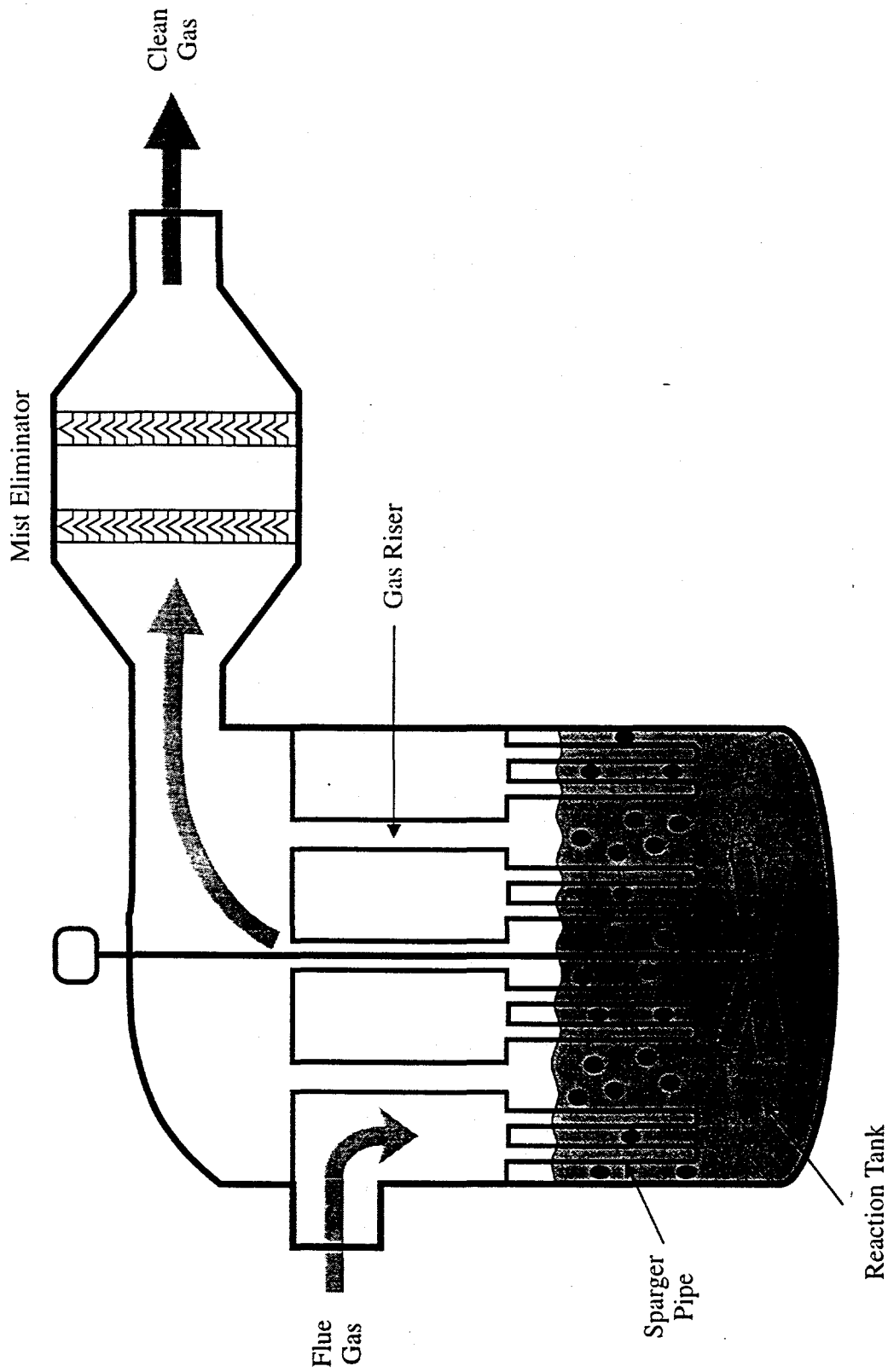

Figure 4.2-6. Jet Bubbling Reactor

level of agitated slurry contained in the integral reaction tank in the base of the JBR. The bubbling action of flue gas as it exits the sparger tubes and rises through the slurry promotes SO₂ absorption. The gas then leaves the JBR via gas risers that pass through both the lower and upper decks. An external mist eliminator removes residual mist carried over from the JBR. The liquid level above the bottom of the sparger tubes can be adjusted using an overflow weir to increase or decrease gas/liquid contacting area in the JBR. Liquid overflowing the weir drains to an external slurry tank where limestone is added before the liquid is returned to the JBR.

The JBR is reported to have several advantages compared to the other conventional contactors described in this section. Because SO₂ absorption is achieved by bubbling flue gas into the reaction tank, the JBR vessel is relatively compact compared to a conventional spray absorber. Gypsum crystals produced in the JBR have a relatively large size distribution since there is no attrition due to circulation through slurry recycle spray pumps. Measured particulate removal efficiencies in the JBR compare favorably with conventional spray absorbers. The total power consumption of the JBR is also reported to be relatively low. However, as with any of the absorber types, the advantages of the JBR, if any, must be evaluated on a site-specific basis by comparing total annualized costs at the same guaranteed performance levels with those of competing system proposals.

Effect of Flue Gas Velocity on SO₂ Removal in the JBR--Tests at Georgia Power Company's Plant Yates showed that when the JBR is operated at constant pH and constant flue gas pressure drop, NTU is approximately proportional to 1/G. For example, increasing boiler load from 75 MW to 100 MW at 3000 Pa (12 inwg) differential pressure decreased SO₂ removal from 93% (NTU = 2.7) to 86% (NTU = 2.0) (7).

Effect of Flue Gas Pressure Drop (ΔP) on SO₂ Removal in the JBR--Increased ΔP is usually the result of increasing the submergence of the sparger tubes in the slurry. At the same plant cited above, test results showed that NTU increased with JBR $\Delta P^{1.2-1.5}$, depending on the operating pH (7).

4.2.2 Absorber Module Materials of Construction

The absorber module environment may be moderately to severely corrosive depending primarily on the pH and chloride content of the circulating slurry. In addition to corrosion, components that are part of the recycle slurry system must be designed to resist erosive wear due to the abrasive nature of the slurries.

The materials choices for the absorber vessel usually include either lined carbon steel or alloy steel. Some non-metallic materials, including fiber-reinforced plastic (FRP) and ceramic tile, have also been used to construct absorber vessels. The material choices differ in terms of both initial cost and expected lifetime. For example, carbon steel lined with either rubber or reinforced organic resins may provide good corrosion resistance, but liners can be expected to have a shorter service life compared to a properly selected solid or clad alloy steel. Careful surface preparation and rigorous quality control are required to obtain good results with liners. Liners can also be easily damaged and spot repairs may be more difficult than welding patches onto an alloy vessel. Therefore, the cost of periodic repairs and replacement must be added to the initial cost of a lined carbon steel absorber to estimate its true cost for comparison with alloy construction. As a result, the life-cycle cost approach must be used to compare the overall cost of each materials option. The performance and expected service life of different absorber materials is discussed in more detail in Part I, Section 5--Materials-of-Construction Options. Economic comparison of different absorber materials using life-cycle costs is discussed in more detail in Part III, Section 3--Economic Evaluation.

Materials choices for absorber spray pumps usually include rubber-lined cast iron or hardened alloys. Spray piping and header materials include rubber-lined steel, alloy steel, and FRP. Spray nozzle materials include alloy steel and hard ceramics such as silicon carbide. Materials for these specific equipment items are discussed in more detail in Part II--Major Mechanical Equipment Information.

4.3 Reaction Tank

As described in Part I, Section 2--Process Description and Basic Terminology, the purpose of the reaction tank is to allow time for the lime or limestone reagent to dissolve and the calcium sulfite/sulfate byproduct solids to precipitate. The most important process design parameter for the reaction tank is total tank volume. As described in Section 2, tank volume is usually expressed in terms of solids retention time, which is calculated as the total solids inventory in the tank divided by the solids production rate. The use of solids retention time rather than tank volume itself allows the tank size to be-adjusted appropriately for differences in total SO₂ removal rate (which fixes the reagent dissolution and byproduct precipitation rates in the tank).

In addition to tank volume, reaction tank design considerations include the tank location (integral or external to the absorber vessel), the type and location of agitators, and the oxidation air supply (forced-oxidation systems only).

4.3.1 Reaction Tank Volume

Optimum reaction tank volumes differ substantially for lime- and limestone-based FGD processes. Reaction tank volumes for the two process options are discussed separately below. Because the reaction tank design for limestone-based processes is more critical to the performance of the FGD system, that process is discussed first.

Limestone-Based Process

Reaction tank volume or solids residence time can have several effects on process performance, but experience has shown that in the limestone-based process, the minimum reaction tank volume is usually that which is required to maintain good limestone utilization. Typically, in a limestone-based process, the reaction tank volume is designed to yield a solids residence time in the range of 12 to 24 hours. There is a trade-off between

reaction tank volume and limestone particle size or fineness of grind. If the limestone reagent is ground to a finer size, then a smaller reaction tank can be used to obtain the same limestone utilization. The finer grind, however, requires more grinding energy increasing capital and annual operating costs for the ball mills.

The byproduct precipitation step (Reaction 3-8 or 3-9) is also affected by reaction tank volume. At a constant SO_2 removal rate, the extent of supersaturation in the reaction tank slurry will increase as the reaction tank volume decreases. In the inhibited-oxidation process, this is usually not a problem, but in the forced-oxidation process, high gypsum supersaturation can contribute to scaling in the absorber. In most cases, a reaction tank volume that is sufficient to yield good limestone utilization will be large enough to prevent gypsum scaling. One exception to this might be the case in which a packed absorber is designed with a relatively low L/G compared to a spray absorber. In this case, a larger reaction tank volume might be beneficial in preventing scaling in the absorber packing.

Reaction tank volume can also affect the particle size and dewatering properties of the byproduct solids. In theory, a larger reaction tank volume should yield a larger byproduct solids size. However, in practice, there are other factors that have more important effects on byproduct solids properties. For example, in the inhibited-oxidation limestone-based process, the extent of oxidation has a much stronger effect on byproduct dewatering properties compared to the effect of reaction tank size. In tests at full-scale FGD systems, byproduct solids settling rates have decreased by a factor of 10 as the extent of oxidation varied from 2 or 3% to about 15%. Also, as byproduct solids are circulated through the agitated reaction tank and recycle pumps, fines are created by particle attrition. This mechanism tends to counteract the positive effect of a large reaction tank volume on byproduct size. As a result of these other factors, a large reaction tank volume will not necessarily result in more favorable byproduct solids properties.

Lime-Based Process

In the lime-based process, the reagent is much more soluble, and the reaction tank size is generally much smaller than in the limestone-based process. Solids residence times in the 1- to 4-hour range have proved to be adequate for the lime-based process reaction tank.

4.3.2 Recycle Slurry Solids Content

Reaction tank solids retention time is proportional to the recycle slurry solids content as well as the reaction tank volume. Like reaction tank volume, the design level of recycle slurry solids content is different for the limestone- and lime-based processes.

Limestone-Based Process

In the limestone-based process, the recycle slurry solids content is usually designed to be as high as can be tolerated without causing erosion or plugging problems in the recycle slurry system. Operation with higher slurry solids content makes more limestone solids available for dissolution in the absorber at the same level of limestone utilization. This can improve SO₂ removal efficiency at otherwise constant conditions. Higher recycle solids content in the limestone-based process can also result in better performance in the slurry dewatering equipment. Most limestone-based processes are designed for recycle slurry solids contents in the range of 10 to 15% by weight.

Lime-Based Process

In the lime-based process, where nearly all of the alkalinity for SO₂ removal is provided by liquid-phase sulfite species, there is no comparable performance advantage to high slurry recycle solids content. Therefore, in the lime-based process, the optimum slurry solids content is much lower than in the limestone-based process. In fact, experience has shown

that, in the lime-based process, attrition of the byproduct solids crystals can have a dominating effect on dewatering properties. As a result, low recycle solids contents provide the best overall performance. Most lime-based processes are designed for recycle slurry solids contents in the range of 4 to 10% by weight.

4.3.3 Reaction Tank Configuration and Agitation

There are two different reaction tank configurations that can be used in the lime- and limestone-based FGD processes. The tank can be constructed as an integral part of the absorber vessel, or it can be an independent vessel. Almost all of the current vendor designs include an integral reaction tank at the base of the absorber. If the design tank volume exceeds that which can be conveniently located in the base of the absorber vessel, then an additional independent tank is provided.

With either tank configuration, sufficient agitation must be provided to keep the slurry solids from settling in the tank bottom. When the tank is located in the base of the absorber vessel, multiple side-mounted agitators are provided. For the independent reaction tank, a single top-mounted agitator is usually adequate, but some very large reaction tanks may require multiple top-mounted agitators.

Tanks should be equipped with large access doors for maintenance and clean-out ports flush with the tank bottom. The access doors should be large enough to permit a small front-end loader to enter the tank to remove accumulated solids. These doors also facilitate the erection of internal scaffolding.

4.3.4 Forced Oxidation

In the forced-oxidation limestone-based process, equipment must be provided to promote complete oxidation of absorbed SO_2 . This is accomplished by sparging air into the reaction tank. The oxidation air is supplied by dedicated blowers. Most frequently, the air is

distributed into the reaction tanks through perforated pipes arranged across the bottom of the reaction tank. The air is discharged through multiple 20- to 30-mm (3/4 to 1-1/4 in.) openings in the bottom of the discharge pipes. Some vendors recommend injecting the oxidation air through single nozzles located below the side-mounted agitators.

Because the compression process heats the air, service water is injected into the oxidation air discharge header to cool and saturate the air before it is introduced to the bottom of the reaction tank. Experience has shown that this is necessary to prevent the air distribution nozzles from plugging.

The amount of oxidation air that must be supplied depends on the depth of the reaction tank, which fixes the air supply pressure, and on the SO₂ removal rate for the process. In a typical process design with a reaction tank depth of 10 m (30 ft), about 1.5 moles of air is supplied per mole of absorbed SO₂, if the sparger is located no more than 2 m (6 ft) above the tank floor. For smaller tank depths, the sparger depth is less, and relatively more air must be supplied to obtain the same results. To develop the most cost-effective forced-oxidation air supply, the designer must consider how the design pressure and volume of the air supply affect both the capital and operating costs of the blowers or compressors.

4.3.5 Reaction Tank Materials of Construction

The materials choices for the reaction tank include those used for the absorber vessel (eg., lined carbon steel, alloy steel, ceramic tile) and coated, reinforced concrete. In the reaction tank, the floor, walls, and roof may be constructed of different materials to accommodate their different service environments and structural requirements. For example, the tank floor may be covered with a durable surface such as tile or concrete so that the tank can be cleaned using mechanical equipment such as small front-end loaders without damaging the surface. The tank walls or roof may provide adequate corrosion resistance using a less durable and lighter coating such as a reinforced organic resin. Materials options are discussed in more detail in Part I, Section 5--Materials-of-Construction Options.

4.4 Mist Eliminator Systems

The purpose of the mist eliminators (MEs) in an FGD system is to remove the slurry mist entrained in the flue gas. If not removed, this mist can lead to the buildup of solids and liquid in the downstream ductwork and stack; corrosion of downstream equipment, ducts, and stack liner; and stack "rain" (emission of liquid, solids, or slurry) to the area surrounding the plant. The physical and chemical environments in which the MEs operate require that the system, including the wash system, be carefully designed to ensure the reliability of the FGD system. The importance of the MEs to overall FGD system reliability is discussed in detail in Part I, Section 6.0--System Reliability. The key ME system design parameters are discussed below.

4.4.1 ME Orientation

The orientation of an ME is defined in terms of the direction of gas flow through the ME section, either horizontal or vertical (upward). The ME blades are installed in panels oriented perpendicular to the gas flow direction. Thus, a vertical ME system has vertical gas flow through ME panels situated in a horizontal plane, as depicted earlier in Figure 4.2-2. Although an ME system can be designed for either vertical or horizontal orientation independent of the absorber configuration (countercurrent or cocurrent), the type of absorber generally dictates the ME orientation (see Figure 4.2-1). Countercurrent flow absorbers typically use vertical gas flow MEs, while cocurrent absorbers (Figure 4.2-4) and jet bubbling reactors (Figure 4.2-5) use horizontal MEs.

Both ME orientations have characteristic advantages and disadvantages. Horizontal gas flow MEs can successfully remove mist from gas flowing at a higher velocity than vertical MEs. Horizontal MEs studied at a test facility were shown to have very little or

no liquid carryover* at gas velocities as high as 8.5 m/s (28 ft/sec) and at inlet liquid loadings significantly higher than those expected in FGD systems. Most vertical MEs currently in FGD service were designed for gas velocities of 3.6 m/s (12 ft/s) or less; however, advanced vertical gas flow ME systems have been demonstrated to prevent liquid carryover at gas velocities of up to about 5.2 m/s (17 ft/s). Although vertical MEs have a lower maximum gas velocity limit than horizontal MEs, this limit is still at or above that for which most countercurrent absorbers are designed.

Horizontal gas flow MEs perform better than vertical designs at higher gas velocity because of the drainage path for mist removed from the flue gas. Figure 4.4-1 shows that in a horizontal ME the liquid droplets removed from the gas drain down the length of the ME blade, perpendicular to gas flow. This reduces the potential for re-entrainment of the droplets in the gas stream. The droplets removed by a vertical ME drain down the width of the ME blade, countercurrent to the gas stream. These droplets, especially if they are small, are more prone to being re-entrained into the gas flow even though the gas velocity is lower.

Some of the advantage of better liquid drainage in horizontal MEs can be incorporated into vertical gas flow MEs by "peaking" the ME blades. Figure 4.4-2 shows a flat vertical gas flow design and a peaked vertical gas flow design. Peaked MEs have been able to handle gas velocities up to about 7 m/s (23 ft/s) in pilot tests. Peaking the ME improves the liquid drainage and increases the surface area for mist removal. However, peaked designs require more space (absorber height) than flat designs, are more expensive, and require a more elaborate wash system.

The higher gas velocity capability of the horizontal MEs reduces the amount of ME materials required and allows them to be placed in a smaller duct compared to vertical MEs. However, these advantages are offset by the fact that vertical MEs can be placed in the

* Liquid carryover consists of liquid droplets in the flue gas stream downstream of the ME system that are either not removed by the ME or are re-entrained and is expressed as L/s-m² (gpm/ft²).

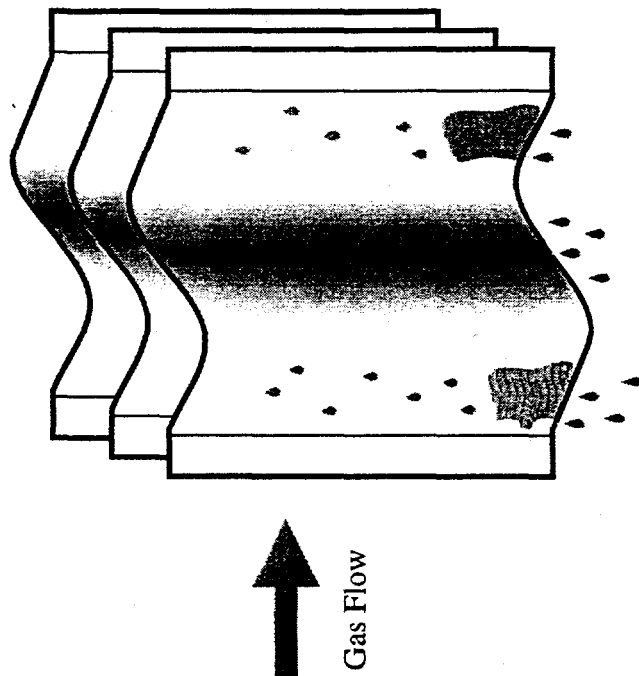

Horizontal Gas Flow Mist Eliminators

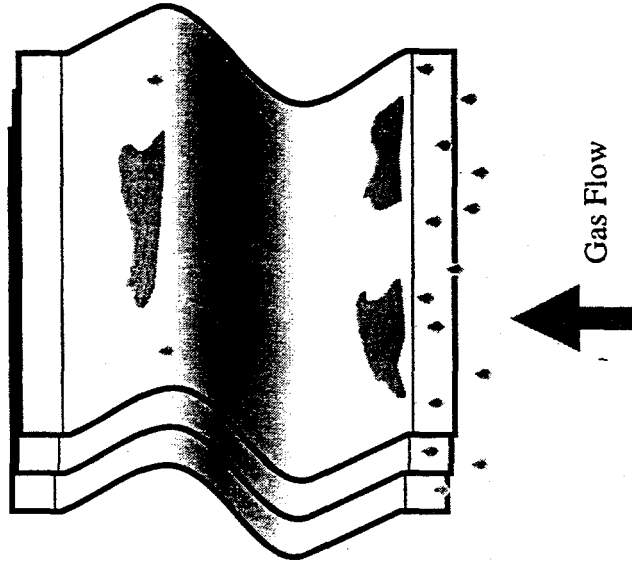

Vertical Gas Flow Mist Eliminators

Figure 4.4-1. Effect of Mist Eliminator Orientation on Liquid Drainage

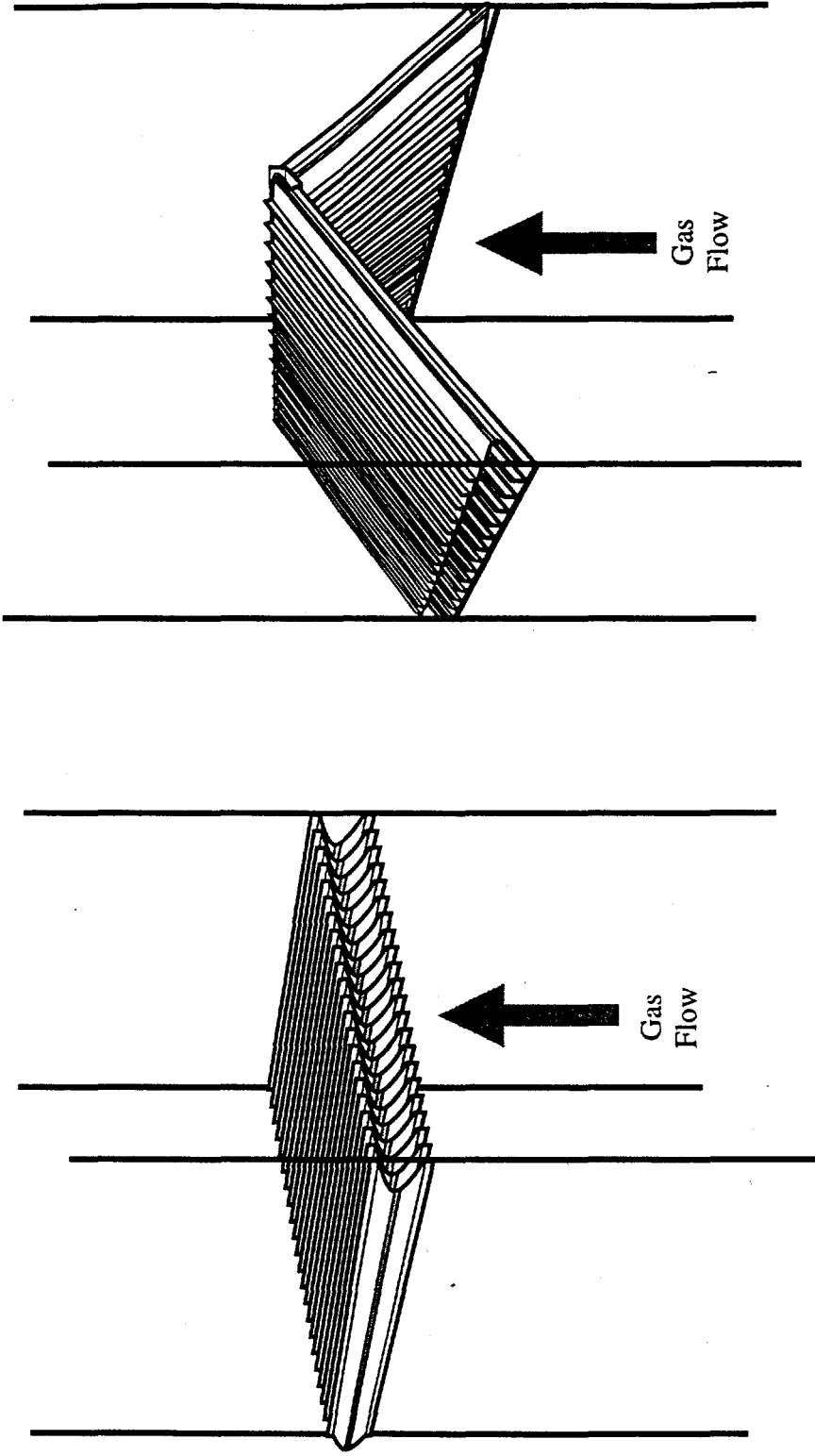

Flat Mist Eliminator Design

Peaked Mist Eliminator Design

Figure 4.4-2. Comparison of Flat and Peaked ME Designs

absorber module, while horizontal ME systems require a separate section of duct. Another advantage of horizontal MEs is that it is easier to replace ME sections because of easier access for blade removal and maintenance. The large panels of ME blades can be lifted through roof hatches and lowered to grade by a trolley hoist. Removal of vertical ME blade panels is more difficult and labor-intensive. Vertical ME blade panels are limited in size to a weight that can be lifted and carried from the module by two maintenance workers, typically 34 to 45 kg (75 to 100 lb).

One drawback of horizontal MEs is that the flue gas pressure drop across them is higher because of the higher gas velocity. At a typical design velocity for a two-stage horizontal ME system [6 m/s (20 ft/s)], the pressure drop will be about 250 Pa (1 inwg) compared to about 75 Pa (0.3 inwg) for a two-stage vertical ME system at a design velocity of 3.4 m/s (11 ft/s). This increases the performance requirements of the induced draft or booster fans. This can be of particular concern when retrofitting an FGD system to an existing plant where the total FGD system pressure drop may determine whether booster fans are required.

4.4.2 Gas Flow Considerations

In either horizontal or vertical MEs, it is extremely important for the gas distribution across the face of the MEs to be as uniform as possible. Once the flue gas velocity reaches the point at which liquid carryover begins, the amount of carryover is very sensitive to gas velocity. Figure 4.4-3 shows results from carryover testing for a typical vertical gas flow ME. The figure demonstrates that an increase of as little as 0.3 m/s (1 ft/s) can result in an order of magnitude increase in the amount of liquid carryover. This sensitivity can result in excessive liquid carryover, even if only a small part of the total ME is exposed to gas velocities that exceed the ME's limit. Therefore, it is recommended that the gas flow distribution to an ME not vary by more than $\pm 15\%$ from the average to prevent high gas flow areas.

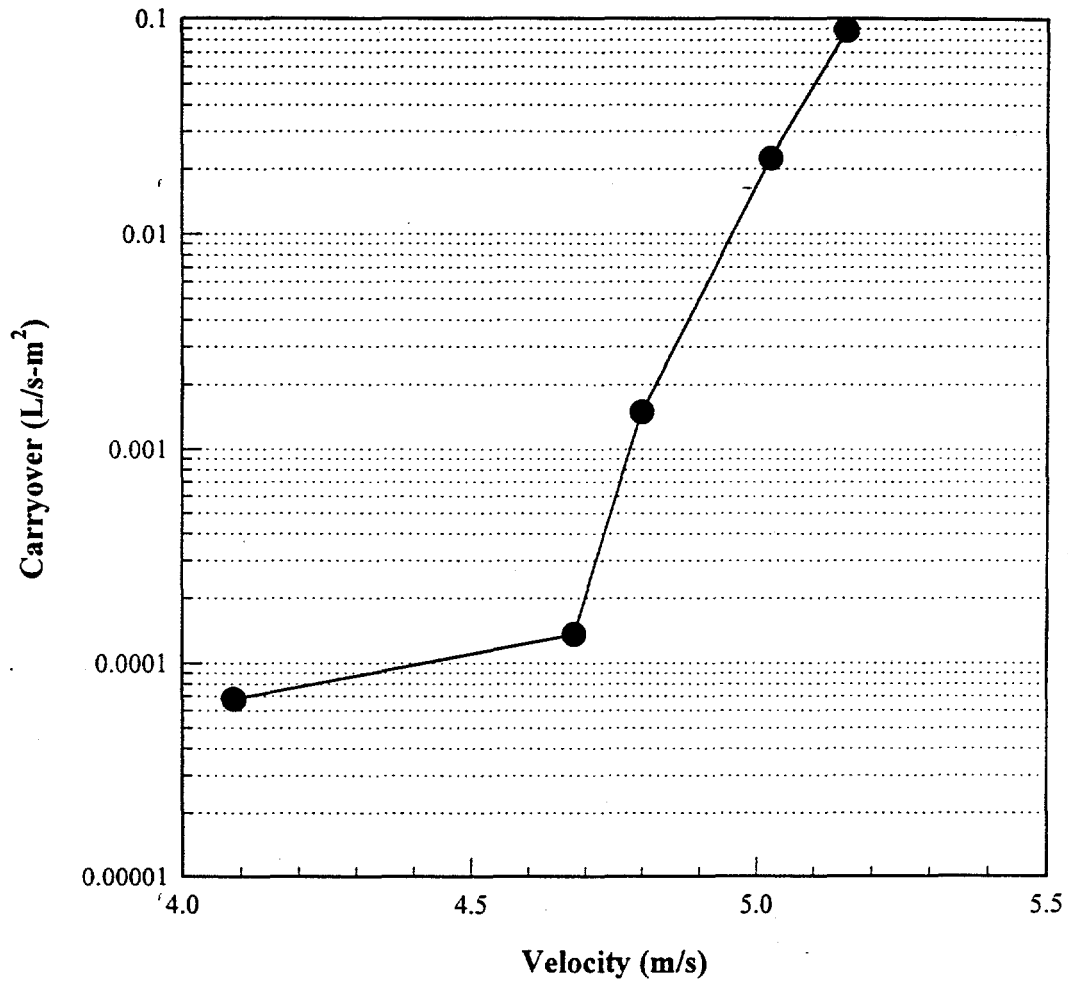

Figure 4.4-3. Carryover Performance of a Typical Vertical Gas Flow Mist Eliminator

4.4.3 ME Blade Design Considerations

A number of different types of mist elimination devices are available such as chevrons, mesh pads, centrifugal separators, rod banks, and baffles. However, the FGD system presents challenging physical and chemical environments where the liquid loading [$L/s\text{-m}^2$ (gpm/ft^2)] can be relatively high and can include a wide range of drop sizes from a few micrometers in diameter up to 2000 μm . The mist is also a chemically reactive slurry that can cause scaling and/or pluggage if the ME blades are not kept clean. On the basis of more than 20 years of operating experience worldwide, the chevron-style ME has proved to be the best device for mist removal in FGD systems.

Chevron MEs are capable of removing essentially all the drops that are 30 to 40 μm and larger. This constitutes the vast majority of the liquid loading volume in the flue gas. The chevrons drain well and are relatively open, which makes them easy to wash on line. Chevrons also produce a relatively low flue gas pressure drop, which is important when treating large volumes of gas. Other devices such as mesh pads are not easily washed and may, therefore, tend to accumulate solids due to scaling or pluggage. Rod banks and baffles are much less efficient than chevrons, and centrifugal separators have a higher flue gas pressure drop for the same mist removal efficiency.

Chevron MEs come in a wide range of styles in terms of the shape of the blades; the number of "passes" (changes in gas flow direction); drainage channels, hooks, or other surface features; spacing between blades; and exit gas straightener length. Figure 4.4-4 presents examples of several of the different blade profiles available, from zig-zag to sinusoidal. The figure also shows ME blades with 2 to 4 passes. The number of passes is an important design specification for MEs since it involves a trade-off between the removal efficiency and the ability to clean the MEs. In general, more passes provide better droplet removal efficiency, but increase the difficulty of adequately washing the deposits from the blades. Inspection of the ME blades can also be difficult if the chevrons have three or more

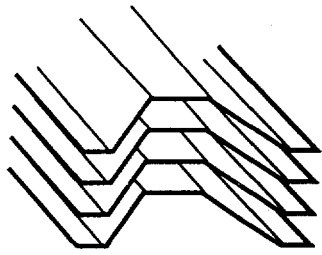

**2-Pass Modified
Zig-Zag**

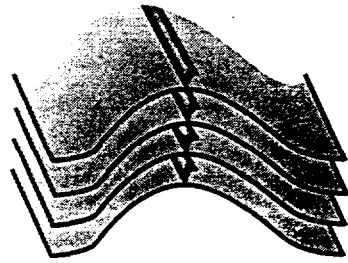

**2-Pass Sinusoidal
with Hook**

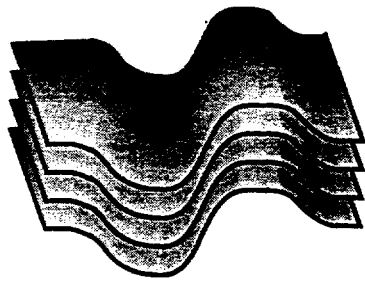

4-Pass Sinusoidal

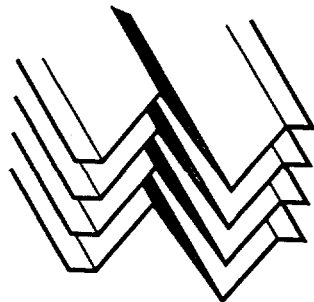

3-Pass Zig-Zag

Figure 4.4-4. Different Types of Chevron Blade Profiles

passes. It is recommended that chevrons used in FGD systems have at least two passes, but no more than four.

The spacing between blades also presents a trade-off between carryover and the ability to wash the MEs. Closer spacings make the MEs more efficient, but also make them more difficult to wash. Commercial MEs used for FGD systems generally have spacings ranging from about 20 to 75 mm (0.75 to 3 in.), with closer spacings used for the downstream stages of a multistage ME system (the number and purposes of multiple stages in mist elimination systems is discussed below). The initial stages usually have wider blade spacings [40 to 75 mm (1.5 to 3 in.)] since the liquid loading is higher and there will be more slurry to wash from the blades. The second stage will generally have a narrower blade spacing [20 to 40 mm (0.75 to 1.5 in.)] to increase efficiency and eliminate as much mist as possible.

Hooks and other surface features, such as grooves or slots, are placed on ME blades to enhance drainage of the liquid removed from the gas. Hooks appear to be effective on horizontal MEs; however, these types of features are not recommended for vertical ME applications. Experience at utility FGD systems has shown that these features provide locations for solids to accumulate and scaling to begin, possibly because the captured slurry does not drain well from these areas. Smooth-surfaced MEs are recommended for vertical ME applications.

One final important aspect of chevron blade design is the length of the exit gas straightener section. Gas is traveling at an angle relative to the duct or tower section in which the MEs are located as it flows through the last pass of the ME (see Figure 4.4-5). If the exit section on the first ME stage is not long enough to straighten out the gas, it can leave at an angle and cause a maldistribution of gas to the next ME section. Maldistribution of the flue gas can cause a high gas velocity in the next ME, which can seriously degrade its performance. This problem has been experienced at several full-scale FGD systems. The length of the exit section necessary to prevent this phenomenon depends on the spacing between the blades and the blade design.

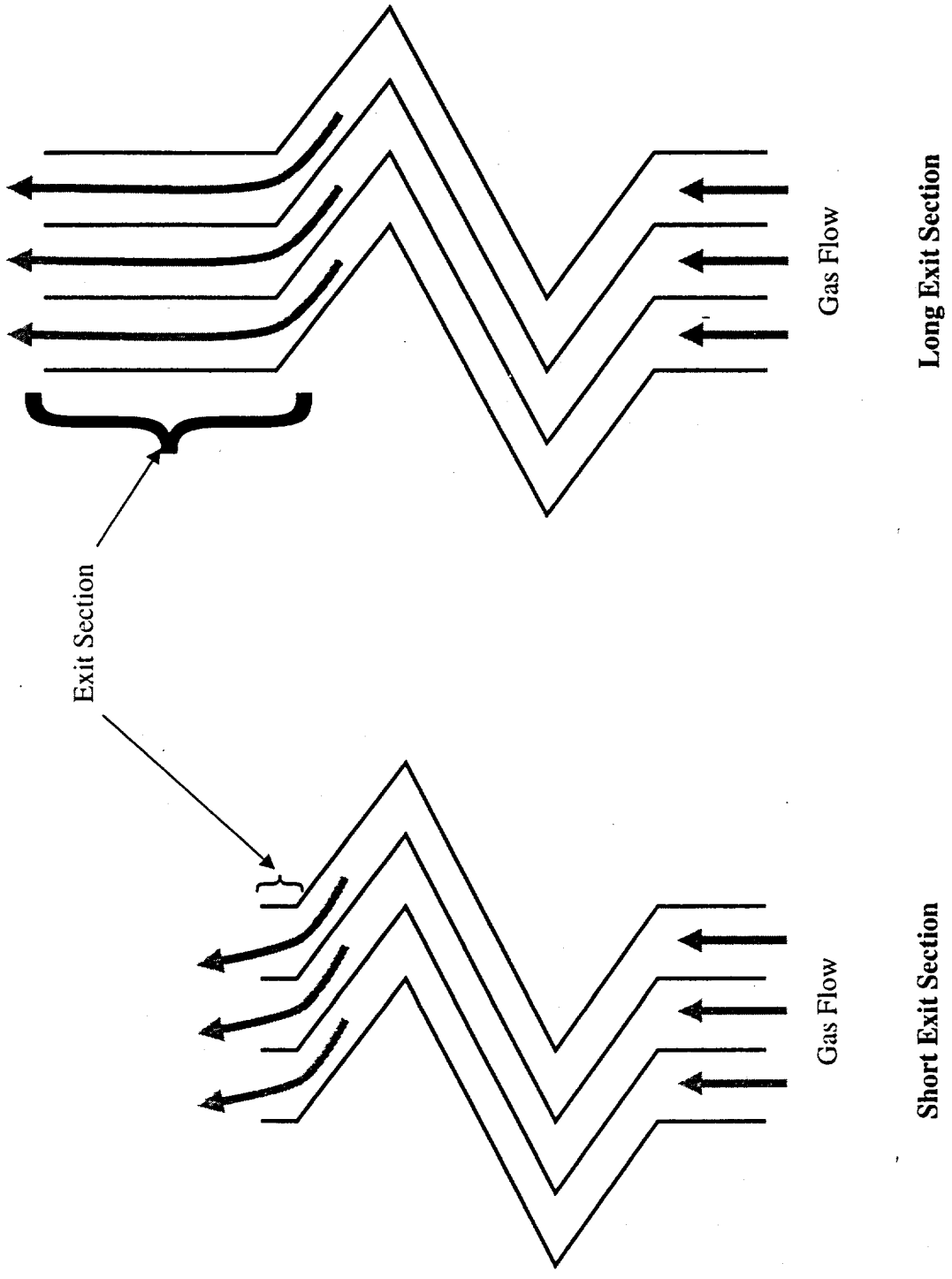

Figure 4.4-5. Effect of Chevron Exit Section on Gas Flow

4.4.4 Number and Spacing of ME Stages

Historically, removing slurry droplets from flue gas with a relatively high droplet content while keeping the ME blades clean has been a difficult challenge for FGD system designers and ME system suppliers. As mentioned above, trade-offs exist between removal efficiency and the ability to wash an ME with respect to the number of passes in a chevron and the spacing between chevron blades. Attempting to satisfy these competing demands has been tried in FGD systems with a single-stage ME, with limited success. As a result, two or three stages of MEs are used in most FGD systems, with two stages being more common. This allows the use of a first stage with wider blade spacing to remove the majority of the entrained mist droplets (over 95%), while allowing the ME to be easily washed. A more efficient second stage with a narrower blade spacing can then be used to provide final droplet removal. Washing is not as difficult for the second stage because the liquid loading of this stage is significantly lower than in the first stage. While this logic could be extended to a third stage of mist elimination, the small increase in droplet removal typically is not considered to outweigh the additional capital costs and flue gas pressure drop. As a result, a two-stage ME system is recommended for most FGD applications.

The spacing of the ME stages relative to each other and to other features in the absorber is important, especially in vertical gas flow applications where the MEs are located above the spray section of the absorber. The first ME stage needs to be far enough above the last absorber spray level to provide space for some of the larger entrained drops to disengage from the gas; this will reduce the ME liquid loading. There should also be sufficient room for the piping furnishing water to the ME wash nozzles. A minimum distance of about 1.2 to 1.5 m (4 to 5 ft) is recommended for vertical ME systems.

Providing sufficient space between the last stage of slurry nozzles and the first stage of the ME is generally not a problem for horizontal ME systems because the MEs are generally located in a horizontal duct separate from the absorber section (see Figures 4.2-2 and 4.2-3 presented earlier).

Sufficient spacing between stages is also necessary to provide room for disengagement of larger drops that have been re-entrained in the flue gas leaving the first-stage ME. Sufficient space between stages is also needed for installation of a wash system for both the back (downstream side) of the first stage and the front (upstream side) of the second stage, as well as access space to inspect, manually clean, and replace the ME blade panels. Typically, a minimum distance of 1.5 to 1.8 m (5 to 6 ft) between stages is necessary. This minimum distance applies to both vertical and horizontal ME systems.

The final distance that is important in vertical gas flow applications is the distance from the back of the second ME stage to a point where the absorber or duct cross-section begins to narrow and gas velocity increases. Liquid stripped from ME blades and re-entrained in the flue gas usually forms fairly large droplets compared to the droplet size that can be supported by the gas velocity. Providing space for these droplets to disengage from the gas and fall back to the ME will reduce the amount of carryover to downstream ductwork and equipment. A minimum distance of about 1 m (3 ft) is recommended for this spacing. Figure 4.4-6 graphically presents the recommended spacing for a two-stage ME system.

4.4.5 Materials of Construction

The factors that need to be considered when choosing materials of construction for the ME chevrons include the flue gas temperature and the ME material's flammability, durability, and resistance to chemical attack. Typical materials that are used for MEs are polypropylene, glass-coupled polypropylene, polysulfone, fiber-reinforced plastic (FRP), and various grades of stainless steel. The effect of the key factors on these materials is discussed below.

The temperature of the flue gas as it passes through the MEs is generally in the range of 49 to 60°C (120 to 140°F). All the materials noted above are capable of operating at these temperatures. However, if all of an absorber module's spray pumps shut down while the absorber module is in service (because of a power failure, for example), the flue gas

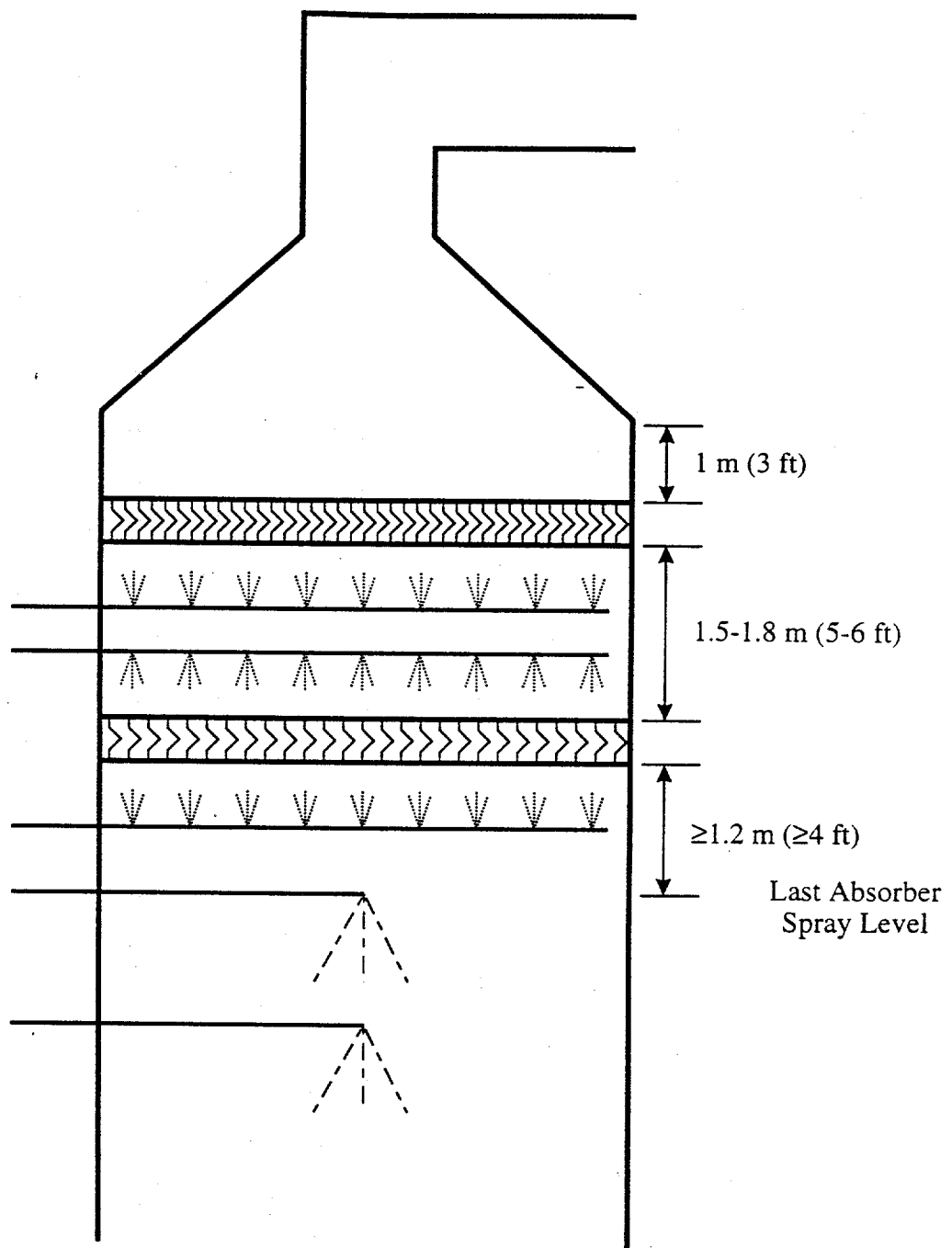

Figure 4.4-6. Recommended Mist Eliminator Stage Spacing

temperature would quickly climb to the FGD inlet gas temperature, which is typically about 150 to 175°C (300 to 350°F).^{*} The duration of exposure to high temperature flue gas could be just for the period needed for the absorber module to be isolated (3 to 10 minutes), or it could be longer, depending on the cause of the spray pump failure and the overall FGD system design.

Polypropylene and glass-coupled polypropylene will deform in a relatively short period of time at these temperatures. These materials are relatively inexpensive to replace compared with alternative materials with higher temperature tolerances, but are not recommended unless appropriate gas quenching safeguards are in place. The remaining materials should be able to handle the higher temperatures, although some of the organic resins used for FRP manufacture could have problems if the exposure is very long (over 5-10 minutes).

The chemical environment experienced by ME systems can vary from a fairly neutral pH to strongly acidic, and the chloride concentration of the slurry droplets can be over 10,000 mg/L. The majority of the materials listed above are resistant to this environment. The primary area of concern is corrosion of some of the lower grades of austenitic stainless steel by a low-pH/high-chloride environment. This will generally require a high-grade stainless steel such as Type 317L, 317LMN, or better, depending on the chloride concentration.

Flammability is obviously not a concern during typical FGD operation. However, there may be instances where welding is taking place during an outage to repair ducts or supports in the ME area. Protection from sparks and flames must be provided for polypropylene and glass-coupled polypropylene MEs in such a situation. This protection is typically in the form of temporary covers or shrouds over the blades and standby fire-fighting

* At many facilities, the FGD system has an emergency quench system installed in the module inlet duct to prevent flue gas above about 90°C (200°F) from reaching the MEs. This quench system is also used to control the maximum temperature to which the absorber module linings and spray piping are exposed.

equipment. FRP can be made fire-retardant, and polysulfone is naturally fire-retardant. Flammability is not a concern when stainless steels are used.

The final consideration with respect to ME materials of construction is the durability of the ME blades. This presents a trade-off between initial cost and service life. Although the service life of the MEs will vary to some extent, one factor influencing the life is the amount of scaling that occurs. Removal of the scale generally requires manual cleaning with a high-pressure wash that can damage the ME blades. Polypropylene and glass-coupled polypropylene tend to embrittle after several years of use, and high-pressure washing can break the blades. If walked on or otherwise subjected to high stresses, FRP can develop cracks in the outer surface that allow the FGD system process liquor to penetrate to the fibers. If the fibers have not been adequately saturated with resin, the process liquor will "wick" down the fibers. This causes the fibers to expand over time, resulting in delamination of the blades.

One item to note with respect to durability is that none of the ME materials mentioned are designed to be walked on by workers during maintenance. Temporary platforms and walking services should be installed during maintenance to the MEs to protect the blades. The use of temporary platforms and walking surfaces is applicable to all of the alternative materials; however, stainless steel and polysulfone are more resistant to maintenance damage than the other materials.

An average life for polypropylene, glass-coupled polypropylene, and FRP ME blades is five to eight years, although individual experience may vary significantly from this range. Polysulfone is a more flexible material that is homogenous like polypropylene, which means it is not subject to the cracking experienced by FRP. Polysulfone MEs have not been in service in commercial FGD systems long enough or at a sufficient number of installations to determine their average service life. Although polysulfone MEs have a higher initial capital cost than polypropylene and FRP MEs, they are expected to last longer. Stainless steel MEs are very durable (expected 10- to 20-year life) and are not generally affected by high-

pressure washing. The type of stainless steel used must consider the process liquor chloride concentrations. Stainless steel MEs also generally have the highest initial capital cost.

4.4.6 Wash System Design Issues

The importance of a well-designed and operated wash system to the reliable operation of MEs, and, therefore, the overall FGD system, cannot be overstated. An inadequately designed system can result in localized or general scaling or pluggage of the ME blades. Full-scale experience has shown that foregoing ME washing for as little as one day can cause scaling of the ME blades, and pilot tests have shown that the performance of MEs degrades significantly with even a light coating of scale on the ME surfaces. Scaling and pluggage tend to grow from the point of initiation once started. More extensive scaling results in higher gas velocities through the scaled ME sections and adjoining sections, further deteriorating the ME performance. Therefore, the design and operation of the ME wash system is critically important.

Mist Eliminator Faces Washed

At a minimum, an ME wash system should wash the front, or upstream side, of each ME stage. The majority of the slurry droplets are removed from the flue gas by the first pass of the chevron blades, and a front-side wash is most effective at reaching this area. In a two-stage ME configuration, it is also recommended that the back (downstream side) of the first stage be washed. As discussed earlier, over 95% of the slurry droplets are generally removed in the first stage. This can be a significant amount of slurry, and washing the first stage from the back side will help rinse the slurry through the ME to prevent the buildup of solids. The first-stage, back-side wash is especially needed if the first stage has more than two passes or has a fairly narrow blade spacing.

Washing the back of the last ME stage is not recommended. Pilot tests have shown that at gas velocities of 3.0 to 3.7 m/s (10 to 12 ft/s), 10 to 20% of the wash water is

entrained in the gas stream and carried directly to the downstream ductwork and stack. This can be a significant quantity of water and may result in stack rainout problems.

Wash System Spacing

The distance from the wash nozzles to the surface of the ME is a trade-off between the number of spray nozzles required and the potential for not achieving full wash coverage of the ME blades. Locating the wash nozzles too close to the ME surface decreases the diameter of nozzles spray pattern and increases the number of nozzles required. The nozzles' wash spray pattern may be deformed by the flue gas if the nozzles are located too far away from the ME surface, resulting in areas that are not adequately washed. Experience has shown that locating the nozzles from 0.6 to 0.9 m (2 to 3 ft) from the ME surface is a good compromise.

Wash System Coverage

As stated previously, ME scaling can occur quite rapidly if the ME is not adequately washed. Therefore, it is important that the wash system be designed to cover the entire ME area. Since wash nozzles typically have circular spray patterns (see discussion below on the common types of wash nozzles), it is necessary to overlap the spray patterns from adjacent wash nozzles. The wash coverage is frequently expressed by multiplying each nozzle's spray pattern area* by the total number of nozzles washing that face of the ME and dividing this product by the total surface area of the ME face washed; the result is reported as a percentage. This coverage value provides an indication of the degree of overlap of the spray patterns. If the nozzles are laid out on a square matrix, the minimum overlap of adjoining spray patterns to ensure full coverage will result in about 150% coverage. Systems are typically designed with closer to 180 to 200% coverage to provide a margin of safety.

* Note that a wash nozzle's spray pattern area increases as the distance between the nozzle and the ME surface increases. The spray pattern area per nozzle must be calculated at the distance between the nozzle and the ME surface.

Two other factors should be considered in laying out the wash nozzles to obtain full wash coverage. First, particular attention should be paid to the edges of the tower to make sure that all of the ME surface is washed. Scaling can begin in unwashed areas and spread to adjoining areas. The second factor is that the wash nozzle layout should take into account the location of support beams and other obstructions that could cause "shadowing" or blocking of the spray pattern. This could also result in unwashed areas of the ME.

Wash Nozzle Type

A wide array of wash nozzles are available that could be used for an ME wash system. However, experience has shown that there are some particular features to look for in the areas of basic nozzle type, free passage size, spray pattern, spray angle, and spray distribution. A detailed discussion of nozzle types and terminology is presented in Part II, Section 9.0--Spray Nozzles.

A fixed vane type of spray nozzle which produces a uniform full-cone spray pattern with a fairly coarse droplet size distribution is recommended for ME wash service. A nozzle which produces a large number of fine droplets (less than 30 to 40 μm) may result in carryover due to the penetration of the wash water through the MEs. Nozzles which use moving parts (internal spinners) are not recommended since long-term reliability is needed. The nozzle should also have a relatively large free passage to reduce the probability of nozzle pluggage.

It was mentioned earlier that the wash nozzles typically have a circular spray pattern, and this is the recommended pattern. Square spray pattern nozzles are also available, but the pattern is usually generated by squaring off a circular spray pattern by adjusting the shape of the nozzle orifice. This results in a higher spray intensity along the sides of the spray pattern with lower intensity at the corners, making the wash water application rate less uniform. If square spray patterns are used with very little overlap of adjoining areas, care must be taken to install the nozzles so the spray patterns are oriented correctly. In a large

wash header with numerous nozzles, maintaining the orientation of each nozzle is difficult. Also, the orientation of the square spray patterns with respect to the nozzle tends to vary if the wash water pressure changes.

Wash nozzles are commonly available with spray angles of 90 to 120°. For ME wash systems, the 90° spray angle nozzle should be used. Spray angles larger than 90° have a difficult time supplying sufficient wash to the blades at the outside edges of the spray pattern because of the shallow angle at which the water hits the ME. Unavoidably, the smaller spray angle increases the number of wash nozzles required since each nozzle produces a smaller spray pattern.

Finally, wash nozzles should have a relatively even liquid distribution throughout the spray pattern. Tests on some nozzles have found that the amount of liquid at the edge of the spray pattern was significantly higher than that in the middle (ratio of up to 3 to 1). In a layout where only the edges of the spray patterns overlap, the center of the spray pattern could provide inadequate wash, and the overlapped areas could provide too much wash water.

Wash Intensity, Duration, and Frequency

The instantaneous amount of wash water provided to the ME surface area is frequently termed the wash intensity and is expressed in units of $L/s\text{-m}^2$ (gpm/ft^2). The wash intensity is important since too low an intensity can result in scaling and too high an intensity can overwhelm the ME and cause carryover. The intensity, along with the wash duration and frequency, also needs to be considered in relation to the FGD system water balance, particularly if outside makeup water is used for all or part of the wash. For vertical MEs, experience has shown that the front of the first stage should be washed with an intensity of $1.0 L/s\text{-m}^2$ ($1.5 gpm/ft^2$). The back of the first stage and the front of the second stage (and subsequent stages, if applicable) should be washed at an intensity of $0.34 L/s\text{-m}^2$ ($0.5 gpm/ft^2$). Less FGD system experience is available for horizontal MEs, but current

recommended wash rates are 1.0 L/s-m^2 (1.5 gpm/ft^2) for the front of the first stage and 0.7 L/s-m^2 (1.0 gpm/ft^2) each for the back of the first stage and the front of the second stage.

The wash duration and frequency of the wash involve a trade-off between maintaining a clean ME and preventing FGD system water balance problems. Obviously, more frequent and longer washing would help keep the ME cleaner, but either would also introduce a larger volume of water into the absorber. If outside makeup water is used for all or part of the wash water, too much water could be introduced to the FGD system to maintain an overall negative water balance. With or without outside makeup water, a large amount of wash water could also result in difficulty controlling the solids content in the circulating scrubber slurry.

The purpose of the wash is to remove any collected slurry that has not drained from the ME surface before scaling can occur. The wash water dilutes the slurry (preventing it from becoming supersaturated and causing scaling) and provides additional volume to rinse off the slurry solids that have accumulated on the blades. A more frequent wash which reduces the time that the slurry remains on the MEs and become supersaturated is preferred. The wash duration just needs to be long enough to ensure that a sufficient volume of wash water is introduced to the ME. Washing at the intensities recommended above provides an almost instant rinsing of the entire ME blade. Therefore, the duration needs to be only long enough to allow time for opening of the wash water valve to achieve full wash flow and a short time to provide a rinsing action. Experience has shown that washing each ME face for about 45 seconds every 30 minutes is sufficient to keep MEs clean in most situations.

To minimize the wash water flow rate, each ME surface is washed in segments. The number of wash headers at each level depends to some extent on the module diameter, but typically four or more independent wash headers are provided. In this way, only 25% or less of the ME surface is washed at any one time. A programmable control sequentially opens and closes the wash header isolation valves. The sequence and duration of the washing is controllable by the FGD system operators and can be varied to address specific wash needs.

Wash Water Pressure

The wash water pressure has an impact on the size of the droplets produced and the nozzle spray pattern. High-pressure water can cause atomization of the water and subsequent penetration of small drops through the ME which contribute to carryover. Low-pressure water can result in incomplete formation of the spray pattern or deformation of the spray pattern by the gas flow. A pressure range of 140 to 280 kPa (20 to 40 psig) provides a good compromise.

Wash Water Quality

The wash water quality, specifically the water's gypsum relative saturation* and suspended solids content, is a factor which needs to be considered in designing a wash system. Some of the water that is used for washing will remain on the blades until the next wash cycle. In FGD systems that use forced-oxidation or natural-oxidation chemistry, this water will remove some SO₂, possibly increasing the gypsum relative saturation. If the water has a high relative saturation initially (e.g., only return water from the dewatering system is used), the water will become supersaturated, and scaling will result. Keeping the gypsum relative saturation of the wash water below 50% has proved to be successful in preventing scaling due to the wash water quality. This relative saturation level can be achieved either by using only an outside makeup water source with a low gypsum relative saturation, or by blending an outside water source with reclaim water from the dewatering system.

Experience with inhibited-oxidation FGD systems (systems with less than 15% sulfite oxidation) has shown that the gypsum relative saturation of the wash water is not a concern. The return water from inhibited oxidation systems generally has a lower gypsum relative saturation, and thiosulfate is present in the wash water to help inhibit further

* Relative saturation is the ratio of the actual concentration of an ion in a solution to the ion's theoretical saturation concentration considering the solution's chemical composition, pH, and temperature.

oxidation. In inhibited-oxidation systems, therefore, the wash water may consist solely of reclaim water.

The suspended solids content of the wash water is also important. One of the purposes of the wash is to remove solids from the MEs. Washing them with water that has a significant suspended solids content does not help achieve this goal. Suspended solids in the wash water can also eventually cause pluggage of the wash headers and nozzles, and plugged wash nozzles are one of the most common causes of ME pluggage problems. Therefore, it is recommended that the wash water be free of suspended solids. A strainer on the wash water supply header is also useful to prevent larger pieces of foreign matter from plugging the wash nozzles.

4.4.7 ME System Instrumentation

Instrumentation to monitor the MEs and associated wash system is important to maintaining a reliable system. The pressure drop across the MEs in each absorber should be continuously recorded. The pressure drop provides an excellent indication of how clean the MEs are; gradually increasing pressure drop can provide an early indication of potential problems.

The importance of the wash system has been noted several times in earlier discussions, and instrumentation to ensure that the system is operating as intended is an important consideration. This instrumentation should include local or remote indication of the water pressure at the elevation the spray headers enter the absorber tower. Since the wash water flow rate is set by the type of nozzle and the water pressure, maintaining an adequate pressure is important to obtaining the desired wash rate. An instantaneous readout of the wash flow rate through the headers during a wash cycle is also important to make sure that no headers or a significant number of wash nozzles are plugged. A flow totalizer on the wash water to each absorber will provide a check on nozzle or header pluggage. This information

can also be useful when troubleshooting the FGD system water balance and in locating leaking wash water valves.

4.5

Wet Stack Considerations

Electric utility flue gas stacks are composed of a stack shell and the stack liner (also called a flue), as shown in Figure 4.5-1, and are commonly over 200 m (600 ft) high. The area between the shell and the liner is termed the stack annulus. The stack shell provides structural support for the stack liner and protects it from wind loads. The stack liner carries the flue gas from the outlet ductwork to the elevated discharge point. The flue gas is directed from the absorber modules to the stack liner by the outlet ductwork.

The treated flue gas leaves the absorber modules at the gas's adiabatic saturation temperature [45 to 65°C (115 to 150°F)] and saturated with moisture. The gas may also contain fine liquid droplets that have passed through the mist eliminator. If no flue gas reheat system is employed to raise the flue gas temperature, the downstream ductwork and stack are said to be operating in a "wet" condition. The decision on whether to operate with a wet stack or to employ flue gas reheat is an important one, because it affects plume dispersion, plume visibility, and generating unit heat rate. These topics, as well as the design and materials selection for wet stack components, are discussed in this section. Flue gas reheat alternatives and design considerations are discussed in Part I, Section 4.6--Flue Gas Reheat.

4.5.1 Factors Affecting Selection of a Wet Stack

Although many FGD systems throughout the world have installed flue gas reheat systems, the majority of U.S. FGD systems designed since the mid-1980s have elected to operate with a wet stack. Generally, the most important factors affecting a utility's decision of whether to operate with a wet stack or to use flue gas reheat are the relative capital and operating costs. In most cases, the wet stack alternative offers the lowest total cost. However, other factors, including plume dispersion and opacity, may override the economic advantages of a wet stack. These considerations are discussed in the following sections.

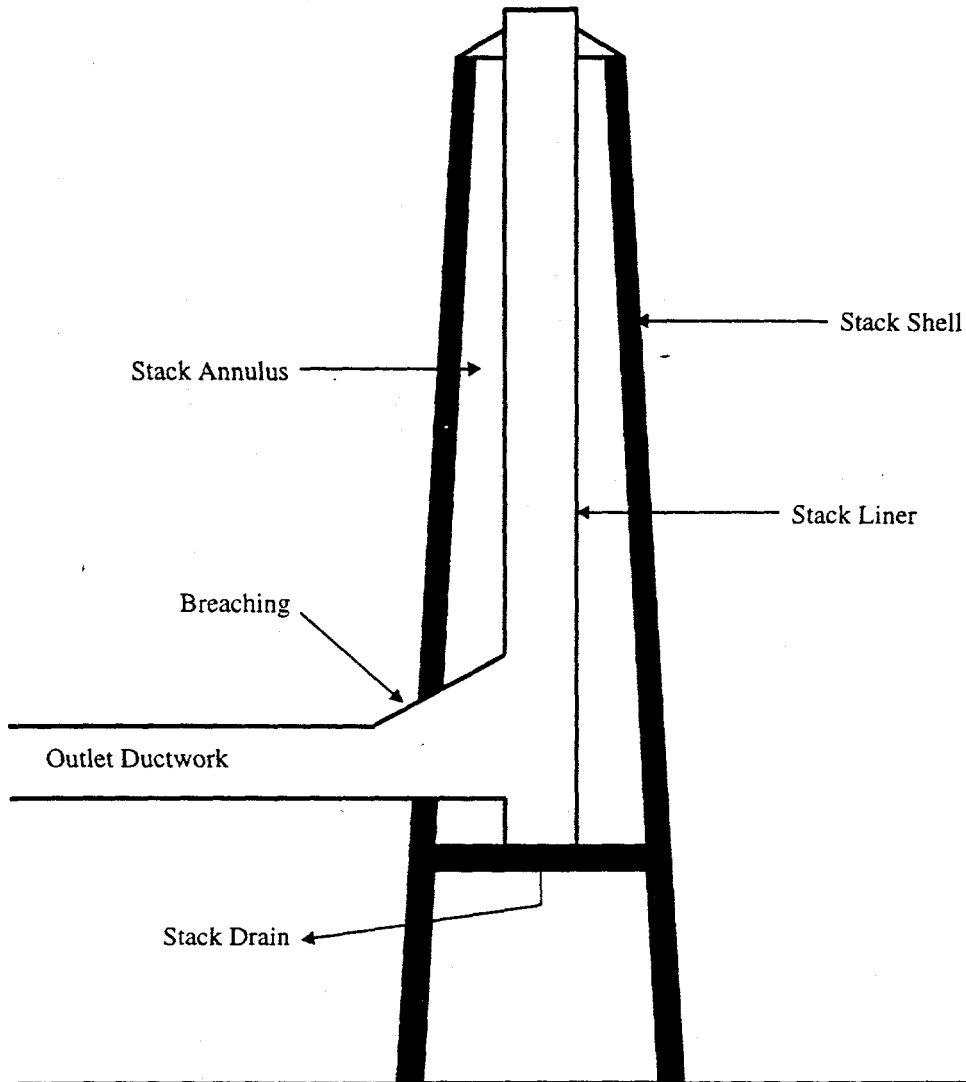

Figure 4.5-1. Wet Stack

Plume Dispersion

The flue gas leaving the stack forms a discrete plume that gradually disperses in the atmosphere. This plume dispersion can have effects both close to the stack and at longer distances downwind. A condition referred to as "plume downwash" occurs if the plume falls below the stack outlet elevation in the immediate vicinity of the stack. Wind blowing on the stack forms a low-pressure zone on the stack's downwind side. As the wind velocity increases, the size of this low-pressure zone increases and the pressure decreases. Plume downwash occurs if the flue gas leaves the stack with insufficient buoyancy or vertical velocity. The wind bends the plume horizontally so that the flue gas is drawn into the low-pressure area. Plume downwash causes deterioration of chimney component materials and reduces the rate of plume dispersion. Additionally, during sub-freezing weather, plume downwash causes ice formation on the stack. The potential for downwash problems is greater for a stack that contains multiple flues* than for one having a single flue because the large-diameter stack shell produces a larger low-pressure zone.

Because of reduced plume buoyancy and vertical dispersion rates, wet stacks produce maximum ground-level concentrations of SO₂ (and other pollutants) that are greater in magnitude and closer to the stack than stacks discharging reheated flue gas. These ground-level concentrations are sensitive to stack exit temperature because increasing the plume temperature increases its buoyancy. A more buoyant plume has a greater plume rise, which gives the emissions more time to disperse and to traverse downwind before the bottom of the plume reaches ground level.

Determination of the minimum stack height (with or without reheat) required to comply with applicable ambient air quality standards can be predicted by using any of a variety of standard dispersion modeling programs. The appropriate model for a specific

* If a stack serves more than one generating unit, a separate stack liner is typically installed within the stack shell for each unit, thus significantly increasing the diameter of the stack shell.

location is determined by area topography and the presence of any other emission sources in the area. These models also consider site-specific meteorological data; existing ground-level pollutant concentrations; and the distances to the local structures, populations, and other emission sources.

Stack liquid discharge (also called stack "rainout") is of concern to any generating unit that uses a wet FGD system. Rainout results from the discharge of liquid droplets entrained with the flue gas that are too large to evaporate before reaching the ground, and typically occurs within a few hundred feet downwind of the stack. Stack rainout problems are more likely to occur with a wet stack, but may occur even if the flue gas is reheated. Proper attention to the controllable design parameters of the FGD system, ducting, and stack can minimize liquid discharge problems. These parameters are discussed later in this section.

Opacity

Opacity is a measurement of the amount of light that is blocked as it passes through the flue gas plume leaving the stack. Plume opacity is caused by the interaction of light with particulate matter and certain liquids and gases in the flue gas. At power generating stations, the predominant interactions are with fly ash particles and sulfuric acid mist. The most significant opacity-producing gas is nitrogen dioxide.

As the warm, saturated flue gas leaves the stack, the plume temperature drops and water mist droplets form. While this water mist reduces the opacity of the plume, it is not typically included when the opacity of a plume is measured for regulatory purposes. However, a utility must consider the presence of the water mist in the plume since it obscures the opacity produced by other plume components and affects the location of opacity monitoring equipment.

An untrained observer is typically unable to distinguish between opacity caused by condensed water vapor from opacity caused by particulate matter in the plume. Individuals living near the generating station using a wet stack may believe the plume from the stack has a high opacity because of the presence of particulate matter when, in fact, it is due to moisture. This should be considered when contemplating the use of a wet stack. It should be noted that while flue gas reheat may delay or reduce the formation of water mist, most such systems are not designed to eliminate condensation of water vapor in the plume under all atmospheric conditions. During cool weather, a visible water mist plume will form even on systems employing flue gas reheat.

Economics

If a utility's evaluation of plume dispersion and opacity indicates that a wet stack is feasible based on technology, regulatory requirements, and public acceptance, then an economic evaluation should be undertaken to select the stack's most advantageous operating mode. This evaluation should include all differences between the non-reheat and reheat systems. In most cases, an FGD system with a well-designed wet stack will be much lower in total capital and operating costs than a system with flue gas reheat.

The total costs of the non-reheat and reheat systems must include capital and annual costs of the outlet ductwork, stack, and flue gas reheat system. The differential operating costs of a reheat system are especially important in this evaluation. Using turbine extraction steam as the energy source input to the flue gas reheater (a common practice) can increase the generating unit's heat rate (MW energy input per MWe output) by 5% or more. Use of a gas-gas heat exchanger to transfer heat from FGD inlet flue gas to the outlet flue gas has little effect on unit heat rate, but represents a large capital cost and an increase in the flue gas pressure drop across the FGD system. Discussions of these and other aspects of flue gas reheating are presented in Section 4.6.

4.5.2 Condensate Formation

Minimizing stack rainout is a major objective in the design of a wet stack. The water droplets may be present in the flue gas as a result of absorber module mist eliminator (ME) carryover, adiabatic expansion of the flue gas, and heat losses through the ductwork and stack liner walls. ME carryover can be highly variable, depending on the cleanliness of the ME and other factors. At some locations, carryover from an ME can be the predominant stack moisture source. These droplets are typically in the range of 100 to 1000 μm in diameter, with a few large droplets over 2000 μm .

As saturated flue gas rises up the stack, the flue gas pressure decreases, and adiabatic expansion causes the gas to cool, resulting in the formation of very small water droplets (typically less than 1 μm in diameter). Adiabatic expansion is thought to produce the greatest number of droplets in the stack. However, because these droplets are very small, they do not contribute significantly to the volume of stack liquid discharge. Although some of the condensed liquid will collect on the walls of the upper section of the stack, most will exit the stack. These droplets are small enough that most will be carried with the plume and evaporate before reaching ground level.

Another major source can be condensate formed as the warm, saturated gas contacts the cooler walls of the ductwork and stack liner. The amount of condensate formed by this mechanism varies with the length of the outlet ductwork, the ductwork insulation system used, the stack liner material, and the ambient temperature.

Some of the water droplets formed in the flue gas are carried to the ductwork and stack walls by inertial forces where they combine with the moisture formed by condensation on the walls. Most droplets from carryover from a well-designed and well-operated ME are thought to be large enough that they are collected in this manner by impingement on solid surfaces. The very fine droplets that do not impinge seldom present a major problem as they exit the stack. As the condensate volume on the walls increases, the

fine droplets coalesce into larger droplets that can be stripped from the walls by the flue gas. The amount of re-entrainment depends on the characteristics of the wall surface and the flue gas velocity. Rougher wall surfaces and higher gas velocities result in higher re-entrainment rates. These re-entrained droplets are typically much larger than droplets formed by either condensation in the gas or ME carryover. Re-entrained droplets are in the size range of 100 to 500 μm (1).

4.5.3 Wet Stack Equipment Design

This section discusses design provisions employed to collect condensate that is formed in the flue gas and to minimize stack liquid discharge:

- ME design and operation;
- Outlet ductwork design;
- Stack liner design; and
- Alternative stack designs.

Proper Mist Eliminator Design and Operation

In many FGD systems, the primary source of liquid in stacks is ME carryover from normal operation, abnormal operation, and ME washing. A detailed discussion of ME systems is presented in Part I, Section 4.4--Mist Elimination Systems. Although proper ME design and operation are important to any FGD system, these concerns are especially important to a system with a wet stack. The ME must be kept clean to maintain proper performance. Pluggage of passages between the ME blades causes high flue gas velocity through unplugged areas and increased moisture carryover. To maintain ME cleanliness, a wash system should spray clean water over all ME surfaces on a regular cycle. Pressure drop across the ME section of the absorber should be continuously monitored to ensure that pluggage is not occurring.

Outlet Ductwork Design

In a wet stack, liquid will be present on duct walls, flue gas turning vanes, and internal ductwork support stiffeners. Ideally, this liquid flows to the duct floor drains and is directed to the absorber reaction tank or a building sump. However, re-entrainment of the liquid that forms or collects on the ductwork can occur if the flue gas velocity is high enough. A discussion of the role of gas velocity in re-entrainment is presented in the following section on chimney design.

Each specific ductwork material of construction has a characteristic re-entrainment velocity above which collected liquid will be stripped from the wall surface by the flue gas. Re-entrainment of collected liquid can be minimized if the gas velocity is kept below the re-entrainment velocity for the material used. The gas velocity at which significant re-entrainment begins for most outlet ductwork materials is in the range of 12 to 30 m/s (40 to 100 ft/s). Velocities at the upper end of this range are acceptable for ducts with smoother surfaces and fewer discontinuities and internal structures.

Duct floors should be sloped toward one or more floor drains located between the absorber module outlets and the stack breeching. The design of duct floors and internals, such as turning vanes and internal stiffeners, should minimize pooling of liquids in order to prevent both re-entrainment and localized corrosion. In order to minimize re-entrainment problems, some FGD system specifications do not permit the use of internal duct stiffeners; all stiffeners must be outside the duct.

The stack breeching is the transition piece from the outlet duct to stack liner. This is the point where the duct penetrates the stack shell and where the flue gas flow begins to turn from horizontal to vertical. The use of internal stiffeners in the breeching should be avoided because they provide sites for liquid re-entrainment close to the stack. The above recommendations for outlet ductwork design apply to the breeching, as well. Also, the width and orientation of the breeching can affect droplet deposition at the base of the stack.

Maintaining the breeching width at half the stack liner diameter will promote swirling of the flue gas with the desirable consequence of liquid deposition on the stack walls (1).

Physical and computer gas flow modeling of the outlet ductwork/stack liner system is strongly recommended and is typically performed in the design of an FGD system to minimize flue gas pressure drop from the absorber module through stack outlet. This modeling involves the sizing and routing of the ductwork and the placement of turning vanes. Additionally, modeling also can help predict both the liquid deposition and re-entrainment characteristics and the optimum location of liquid collection devices. Normally, physical models are used to predict droplet trajectories, liquid film movement, and re-entrainment, while computer models are best suited to determine rates of vapor condensation and droplet evaporation.

Stack Liner Design

In a wet-stack system, the stack liner should be designed to minimize stack liquid discharge. This can be achieved through the collection of the larger droplets entering with the flue gas and the prevention of re-entrainment of droplets from the stack wall. As discussed earlier, the droplets formed by adiabatic expansion are small and not considered to be a problem. The design of the outlet ductwork, breeching, and stack, and the choice and placement of devices to prevent liquid discharge are critical factors in minimizing stack liquid discharge.

Although the amount of moisture entering the stack should be minimized, the larger drops that do pass through the breeching can usually be collected near the base of the stack liner. As the gas enters the stack, it typically makes a sharp turn from horizontal flow to vertical flow. Inertial forces will drive the larger drops into the stack liner wall opposite the breeching. Devices have been successfully installed at this location to collect droplets and prevent them from being re-entrained. Although modeling determines the required location of collection devices, the apparatus itself can be quite simple. For example, sections of fiber-

reinforced plastic grating have been used with success at the base of the stack on the wall opposite the breeching.

The base of the stack liner should extend below the bottom of the breeching to provide a reservoir for collected liquid. A stack drain, designed to prevent pluggage, must also be provided.

Over the past two decades, many wet stack systems have been commissioned in the United States. Operating experience with these stacks has broadened the knowledge base related to stack materials and the gas velocity limits needed to prevent re-entrainment. Model testing has been used to determine the critical re-entrainment velocities for various stack materials, as summarized in Table 4.5-1 (2). The critical re-entrainment velocity is defined as the lowest gas velocity at which liquid droplets are sheared off the liquid attached to the wall. As expected, the tabulated test results indicate that a smoother surface allows higher operating gas velocities. These results are conservative; higher velocities may be acceptable under conditions of low entrained liquid entering the stack and efficient moisture collection near the breeching. Full-scale operation of wet stacks that were designed using the results of model testing has shown that stack liquid discharge can be avoided completely.

In the past, most acid brick stack liners were tapered; now, most are a constant diameter for their entire length. As shown in Table 4.5-1, straight brick liners allow a much higher gas velocity before the onset of re-entrainment (i.e., 17 m/s for smooth brick liners versus 9 m/s for lines with a 3.2 mm offset). The offset lip between each brick level that results from brick liner taper creates a very large number of sites for re-entrainment. As moisture runs down the liner, it detaches from the wall at these lips, and the droplets are entrained in the flue gas.

Higher flue gas velocities can be tolerated in tapered brick liners if the offset dimension is reduced. One utility has operated a tapered, acid brick-lined, wet stack with flue gas velocities of 14 m/s (46 ft/s) at the entrance and 21 m/s (70 ft/s) velocity at the stack exit.

Table 4.5-1

Critical Re-entrainment Velocity for Stack Liner Materials

Stack Liner Material	Critical Re-entrainment Velocity, m/s*
Alloy	21
Plasite lining	21
Fiber-reinforced plastic	18
CXL-2000 lining	18
Acid brick, smooth	17
Acid brick, 3.2-mm offset	9

* 1 m/s = 3.28 ft/s

Source: Reference (2)

The reason that higher velocities can be tolerated in the upper region of the stack is that a boundary layer forms at the liner wall, and the velocity at the wall is considerably less than in the bulk gas (1).

A common method to increase flue gas velocity at the point of exit is to install a choke at the top of the stack. A choke is a large reduction in the stack liner diameter at the outlet that results in a large increase in gas velocity. This higher velocity may decrease the occurrence of plume downwash and improve plume dispersion. However, liquid droplets can collect and be released from the inner surface of the choke, causing an increase in stack liquid discharge. Therefore, the choke design should minimize droplet formation and discharge by avoiding sharp edges and using gradual changes in diameter.

An additional design option that applies to stacks with multiple liners is to extend the liner above the stack shell. Increasing the liner extension up to about two liner diameters will reduce the potential for plume downwash. For single-flue stacks, extending the liner has little effect on downwash because the liner and the shell are almost the same size.

An annulus pressurization system should be used if there is a possibility of the stack liner developing leaks. Annulus pressurization is standard with the use of brick liners and can be used for other liner types, as well. Maintaining the annulus at a slightly higher pressure than the flue gas reduces the potential for leakage and the resulting corrosion damage. However, if the liner has large cracks then an excessive amount of air will enter the flue gas, causing cooling and higher gas velocities. Both consequences can increase stack liquid discharge. The annulus pressurization air can also be heated to raise the temperature of the inside surface of the stack liner and, thereby, reduce moisture condensation.

Alternative Stack Designs

Another wet stack method that has been applied in Germany is to eliminate the flue gas stack and to discharge the flue gas in the plume of a hyperbolic cooling tower. The

air flow from cooling tower draft is approximately twenty times as great as the flue gas flow rate. Because the air flow is so much larger than the flue gas flow, the feasibility of eliminating flue gas reheat may be increased. Obviously, this option is available only to those units whose hyperbolic cooling towers are located within a reasonable distance of the FGD system. Although this technology has not been employed in the United States, more than 15 units in Germany discharge flue gas to hyperbolic cooling towers. Additional information on the use of a hyperbolic cooling tower as a stack for wet flue gas is provided in Part I, Section 4.11.2--Flue Gas Handling System Arrangement.

4.5.4 Wet Stack Materials of Construction

While wet operation will have little or no impact on the materials of construction of the stack shell, reliable performance of the materials for the ductwork and stack liner is essential. These critical components of the FGD system typically have no redundancy. Liner degradation far short of mechanical failure can cause serious problems with stack liquid or corrosive particle discharge. A more detailed discussion of the characteristics of the materials of construction mentioned in the following paragraphs is contained in Part I, Section 5.0--Materials-of-Construction Options.

In the case of an existing stack whose materials of construction are not suitable for operation as a wet stack, choices might include an alloy "wallpaper" or an organic coating (such as a reinforced resin liner) for the existing liner. For a new stack, a wider choice of materials can be considered. The most important consideration in materials selection (other than corrosion resistance and minimizing liquid discharge) will be flue gas bypass requirements and, for an existing stack, structural limitations imposed by the existing design. For example, some types and configurations of existing acid-resistant brick liners are more susceptible to "leaning" problems than others.

Power plant stacks are generally classified as either dry or wet. The wet stack classification includes stacks subjected to 1) wet scrubbed flue gas without reheat at all times,

2) partially reheated flue gas, and 3) occasional bypass of hot, untreated gas. The interior surfaces of the wet ductwork and stack liner are exposed to innately acidic condensates containing both sulfuric and sulfurous acids, in addition to chlorides and fluorides from the FGD process. If there is any mixing of treated and bypassed flue gas, or periodic full bypass of untreated gas, the wet ductwork and liner are also exposed to an elevated temperature that evaporates water and can create extremely high levels of acidity, fluorides, and chlorides. Conditions similar to these have been experienced in direct-bypass outlet ducts, and at some locations, have destroyed almost all available materials of construction (see discussion of Zone 5 operating conditions in Part I, Section 5.3.1--Corrosion Environment Zones).

Materials of construction for new or replacement wet flues will be selected from a small suite of candidate materials. Material selection is iterative with other aspects of the wet stack design, most notably exterior site constraints, the management of bypass gas, prevention of moisture re-entrainment, and overall economics. This interaction is bi-directional; certain FGD design decisions define material selection options, while certain material selection options can mandate certain design decisions. For example, the decision to allow partial bypass of untreated gas into the outlet ductwork, on either a continuous basis or at full bypass during startup/shutdown, will exclude some of the potential materials (e.g., fiber-reinforced plastic or organic, reinforced resin-lined steel) because of temperature limitations. However, cost or space limitations may preclude the use of a separate bypass flue.

To control stack liquid discharge, the designer must recognize that each duct/liner material has a critical velocity for moisture re-entrainment that must not be exceeded unless special liquid collection devices are installed. Thus, material selection affects duct and liner diameters, and the overall capital costs. Another important consideration is the estimated cost of maintenance over the life of the generating unit. Life-cycle cost modeling of other FGD components has repeatedly shown that some lower initial cost materials have the highest life-cycle and levelized costs. The topic of life-cycle economic evaluations of alternatives is discussed in detail in Part III--FGD System Proposal Evaluations.

Pertinent information describing materials that have been used or are being proposed for use in new or replacement wet stack liners is summarized in Table 4.5-2. Mainly because of cost considerations, acid-resistant brick liners have been the predominant liner material for coal-fired units in the United States. However, brick is not acceptable in some geographic areas because of seismic activity.

When technical constraints have been addressed, a preliminary economic analysis can be done to evaluate the costs of converting an existing stack or building a new wet stack. The suite of candidate materials might also be reduced at this stage, but final material selection would be done during the actual design and procurement stage.

In the majority of cases, new stacks or modifications to existing stacks are not completely designed by the utility or its architect engineer (A/E), if used. Instead, the design responsibility is split among the utility, its A/E, and a turnkey specialty contractor who designs and erects stacks. The design basis and materials options are established by the utility and A/E and a specification is issued for bids. In many cases, the final decision on materials of construction is not made until the bids are evaluated and a specialty contractor is selected. The selected contractor then completes a detailed design for review by the utility and A/E and finally constructs the stack according to the approved design.

**Table 4.5-2
Wet Stack Materials-of-Construction Characteristics**

Characteristic	Acid-Resistant Brick/Mortar	Alloy C-276	Borosilicate Glass Block on Steel	Fiber-Reinforced Plastic	Vitreous Ceramic Brick/Tile on Steel	Enhanced Organic Resin Liners
Suitable for partial reheat?	Yes	Yes	Yes	No	Yes	No
Suitable for 100% periodic bypass?	Yes	Yes	Yes	No	Yes	No
Suitable for totally non-reheated operation?	Yes	Yes	Yes	Yes	Yes	Yes
Suitable for active seismic zones?	No	Yes	Yes	Yes	Unknown	Yes
Retrofittable to existing steel liners?	No	Yes, as wallpaper	Yes	No	Sometimes	Yes
Supplemental moisture removal required above specified velocity	~18 m/s (smooth) ~9 m/s (typical)	~21 m/s	~14 m/s	~20 m/s	~18 m/s	~14-20 m/s
Demonstrated wet stack performance?	Yes	Yes	Yes	Yes, limited	No	No
Additional R&D needs	No	No	No	Additional testing	Additional testing	Additional testing
Additional comments	Requires pressurized annulus and corrosion-resistant reinforcing bands		Excellent insulator, reduces condensation, light weight		Performance prediction based on outlet duct experience	Exacting installation QA/QC

1 m/s = 3.28 ft/s

4.6 Flue Gas Reheat

"Flue gas reheat" describes the process of raising the temperature of the treated flue gas leaving the absorber modules before the gas is discharged from the stack. Reheating flue gas is a common procedure in many parts of the world, notably Japan and Germany. In the United States, although many existing utility FGD systems do use reheat, a large and growing number do not. Operation without flue gas reheat results in a wet stack, as described in the preceding section.

The temperature increase that the reheat system provides to the FGD outlet flue gas can vary, but depends mainly on environmental regulations. In the United States, the flue gas is typically reheated by 15 to 30°C (25 to 55°F); in Japan, the typical reheat range is 35 to 90°C (65 to 160°F); and in Europe, the amount of flue gas reheat can range from 25 to 90°C (45 to 160°F). Reheating the flue gas results in a significant increase in FGD capital and operating costs as the level of reheat increases. For that reason, a wet stack is typically the more economical choice unless environmental regulations require reheat.

4.6.1 Reasons for Flue Gas Reheat

Historically, four reasons have been cited by utilities to justify installing a flue gas reheat system:

- To improve the dispersion of pollutants;
- To reduce the visible plume;
- To avoid liquid droplet rainout from the stack; and
- To avoid corrosion problems on downstream materials.

The first two reasons listed above are valid in light of the current state of the art of FGD technology; however, progress in duct/stack design and in materials of

construction have minimized the latter two reasons. Flue gas reheat is an effective way to minimize condensate formation downstream of the absorber modules, but it is usually ineffective at evaporating the larger liquid droplets that are typically formed from re-entrainment. However, as discussed in Section 4.5.3--Wet Stack Equipment Design, liquid rainout can be avoided by proper stack design without reheat. Flue gas reheat has only a limited effect on reducing corrosion in the outlet ductwork and stack liner. In fact, corrosion can be a major problem in the reheater itself.

Improve Pollutant Dispersion

As discussed in Section 4.5.1--Factors Affecting Wet Stack Design, increasing the temperature of flue gas before it exits the stack increases the plume's buoyancy, resulting in a higher plume rise and better dispersion of the flue gas. In some parts of the world, particularly where power plants are located near populated areas, up to 90°C (160°F) of reheat may be required to adequately disperse emissions and to meet ground-level concentration limits. Also, at some power plant sites, a minimum stack outlet temperature may be written into the plant's operating permit based on enhanced flue gas dispersion considerations.

Reduce Visible Plume

The effect of reheat on plume opacity is also discussed in Section 4.5.1. If it is not sufficiently reheated, the flue gas discharged from a stack downstream of a wet FGD system appears as a large steam plume. The amount of reheat required to prevent the appearance of a steam plume depends, to some extent, on ambient temperature and wind conditions. With some small amounts of reheat, a steam plume may still appear; however, it will be detached a short distance from the stack. Under most weather conditions, 50 to 100°C (90 to 180°F) of reheat is required to prevent any visible steam plume from forming. Higher levels are required during cold weather.

As discussed in Section 4.5.1, opacity problems can also be caused by other flue gas constituents, including particulate matter (fly ash), H_2SO_4 , and NO_2 . Flue gas reheat has little or no effect on the opacity caused by these emissions other than increasing their rate of dispersion.

Prevent Liquid Droplet Rainout

As discussed in the preceding section on wet stacks, the saturated flue gas from a wet FGD system will contain some liquid droplets, with the amount depending on the efficiency of the mist eliminator (ME) and other factors. These droplets, and any additional liquid that condenses from the flue gas, contain sulfuric, sulfurous, and hydrochloric acids, and can have a pH of 1.5 or less. One reason used in the past as a justification for using flue gas reheat was to evaporate these droplets and to prevent their formation by condensation. Unfortunately, because of the short time the flue gas remains in the ductwork and stack, reheat is useful for evaporating only the very small droplets. Larger droplets, such as those from re-entrainment of liquid that collects on duct walls, are not evaporated before they exit the stack. However, reheat minimizes, and may eliminate, condensation on the duct walls, which, in turn, reduces the number of large droplets formed.

The amount of liquid the reheat system must evaporate depends largely on the effectiveness of the ME system. A properly designed and operated ME should discharge less than 0.05 g/m^3 (0.02 gr/ft^3)* of liquid. Many reheater problems experienced by early FGD systems appear to have been caused by poorly operating ME systems. Mist eliminator carry-over rates of up to 9 g/m^3 (4 gr/ft^3) have been documented from tests on these early systems.

As stated in Section 4.5--Wet Stack Considerations, heat is lost by the flue gas through the duct and stack liner walls, from adiabatic expansion of gas rising up the stack, and from the introduction into the stack of annulus pressurization air. This heat loss leads to condensation in the ductwork and stack liner. The rate of heat loss through duct and stack

* 1 grain (gr) = 1/7000 pound or 0.0648 gram.

liner walls depends mainly on equipment design, materials of construction, and ambient conditions. As such, these heat losses are site-specific. However, temperature loss from adiabatic expansion can be estimated from the stack height. As flue gas rises up a 150-m (500-ft) stack, the pressure decreases, decreasing the gas temperature by about 0.3°C (0.6°F). This temperature drop would produce approximately 18 mg of condensation per kg of dry flue gas. For a 500 MW unit, this could be as much as 1.2 L/s (20 gpm). Flue gas reheat is an effective method of offsetting this temperature drop and minimizing the formation of additional condensate.

Avoid Corrosion Problems

One of the primary justifications for the use of flue gas reheat in early FGD systems was the desire to avoid corrosion problems with the downstream ductwork and stack liner. Unfortunately, extensive corrosion was experienced downstream of many of these reheat systems. Corrosion problems were especially severe at facilities using bypass reheat. In some cases, the rate and degree of corrosion were actually worse downstream of the reheat system than in a wet stack using similar materials. These installations clearly demonstrated that if an acidic condensate is present, materials corrode more quickly at higher temperature.

Although refined reheater designs and improved materials of construction have reduced corrosion problems associated with flue gas reheat, flue gas reheat can seldom be justified by reduced material corrosion problems. Additional information on the effect of corrosion on the design of flue gas reheat systems is contained in Section 4.6.2--Process Alternatives and Section 4.6.3--Materials-of-Construction Considerations.

4.6.2 Process Alternatives

The design of a flue gas reheat system is based on the amount of heat that must be transferred to the gas stream. This total heating requirement is the sum of the heat added to aid plume rise and dispersion, the heat needed to eliminate (or reduce) the visible plume,

the heat added to evaporate liquid droplets, and the heat added to prevent condensation in the ductwork and stack. The five most common types of reheat are:

- Bypass reheat;
- Cyclic reheat;
- In-line reheat;
- Indirect hot air reheat; and
- Direct-firing reheat.

Materials of construction and energy and cost considerations are discussed in subsequent sections. Important additional information on the effect of the type of reheat used on the design of the absorber module outlet ductwork and outlet plenum is provided in Part II, Section 3--Ductwork and Expansion Joints.

Bypass Reheat

In an FGD system using bypass reheat, a portion of the hot, untreated gas at approximately 130 to 150°C (270 to 300°F) is mixed with the cooler, treated gas, 45 to 65°C (115 to 150°F), downstream of the absorber modules, as shown in Figure 4.6-1. Typically, the treated and untreated gas mix in the ductwork prior to entering the stack. In some designs, perforated plates or other devices are used to promote the mixing of the two gas streams; in others, no special devices are used. In the past, some systems routed the bypass and treated flue gas streams directly to the stack through separate breechings. The flue gas mixing in these systems occurred in the stack.

The temperature of the combined flue gas depends on the amount of flue gas bypassed and the relative flue gas temperatures. Bypassing 30% of the total flue gas around the absorber modules will increase the absorber outlet gas temperature by about 27°C (50°F), assuming complete mixing of the gas streams. In actual operation, it is very difficult to

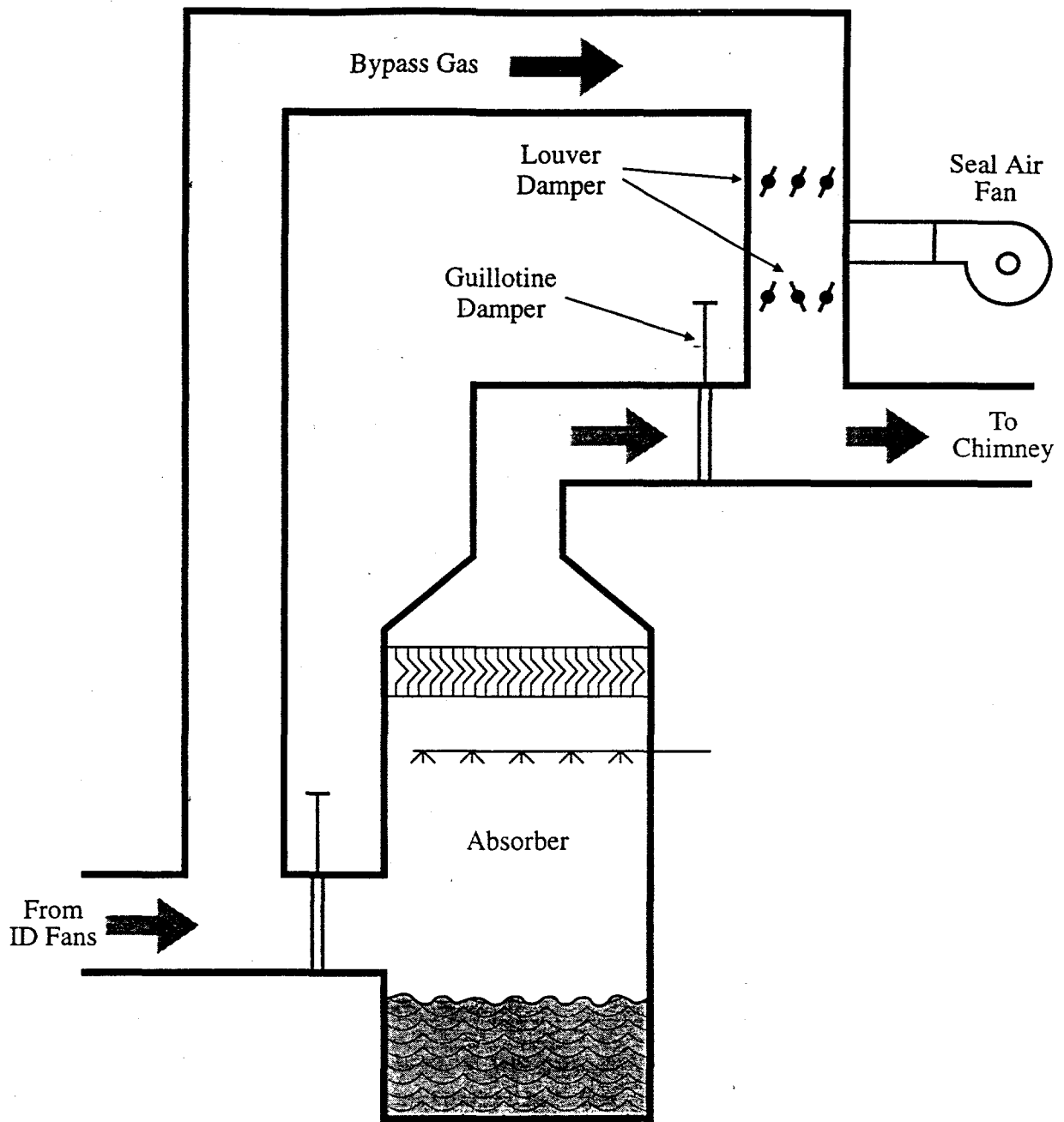

Figure 4.6-1. Bypass Reheat

achieve complete mixing, and stratified flows of significantly higher and lower temperatures are typically produced (see Figure 3-3 in Part II, Section 3 for an illustration of thermal stratification in an existing FGD system using bypass reheat). This is especially true where there is only a short time for mixing to occur prior to the stack and where no special mixing devices are used. The degree of reheat will also be affected by the amount of liquid entrainment in the treated flue gas. The more entrained moisture, the lower the temperature of the combined gases, because a large part of the thermal energy in the bypass gas will be used to evaporate the liquid droplets.

Figure 4.6-1 shows a typical bypass arrangement, with louver dampers in the bypass duct for isolation and flow control. Two dampers are shown, with the capability of injecting seal air between them. This design prevents any leakage through the dampers during periods when no bypass is desired. The downstream damper is shown as an opposed-blade louver damper because that design provides better control of gas flow than the parallel-blade type. The upstream parallel-blade damper is less costly and provides better sealing. Additional information on the characteristics of opposed-blade and parallel-blade louver dampers is provided in Part II, Section 4.0--Dampers.

A bypass reheat system is relatively inexpensive to install and operate. Usually, an automatic controller adjusts the position of the bypass damper blades to control the bypass flow rate on the basis of the desired stack temperature. Since most FGD systems have a bypass duct installed for startup or emergency use, the only additional design features needed are those for controlling the bypass flow rate and promoting the mixing of the hot and cool gases prior to entering the stack. However, a major limitation of bypass reheat is that bypassing untreated gas reduces the overall SO_2 removal efficiency of the FGD system. Therefore, the use of bypass reheat is limited to units that are required to meet relatively modest SO_2 removal rates (less than 80 percent). In the United States, the popularity of bypass reheat was greatest when the average SO_2 removal efficiency requirement was 70 percent.

Many of the reported cases of a leaning brick stack liner have occurred at sites where the hot and cool gases were mixed in the stack (separate breechings for saturated and bypass gases) (1,2). This leaning is the result of swelling of the brick and mortar on the side of the stack opposite the stack breechings. Also, as discussed later, bypass reheating creates a very corrosive operating environment in the gas mixing area (also see Part 1, Section 5.3.1--Corrosive Environment Zones). Because of these and other problems, bypass reheat is not recommended.

Cyclic Reheat

The cyclic reheat system removes sensible heat from the untreated flue gas upstream of absorber modules and transfers that energy to the treated flue gas, as shown in Figure 4.6-2. Cyclic reheat has been used on most of the coal-fired units in Germany and Japan, where more than 120 of these systems using rotary regenerative heaters (Figure 4.6-2a) have been installed since the early 1980s. Some shell-and-tube heat exchangers (Figure 4.6-2b) are also used. Although all cyclic reheat systems have relatively low operating costs, their capital costs are high. The equipment must be large (to handle all of the flue gas), and materials must withstand the harsh corrosive environment.

The plate-type regenerative system is similar to the Ljungstrom-type regenerative heaters used to preheat boiler combustion air. These systems can have either a rotating plate or a stationary plate with rotating hoods. The heaters can be oriented for horizontal or vertical gas flow. In conjunction with FGD systems, horizontal gas flow allows for a more compact system arrangement with less ductwork. A drawback of the plate-type reheater is that some flue gas leakage occurs from the high-pressure to the low-pressure gas stream. In most FGD systems, the ID fans (or booster fans) are located upstream of the absorbers, which results in the untreated flue gas being at the higher pressure. Leakage of inlet gas (up to 5%) to the outlet stream is, in effect, a bypass stream, and decreases the overall SO₂ removal efficiency of the FGD system. Installing improved radial seals and injecting treated gas near the seals can reportedly reduce total leakage to less than 0.5 percent.

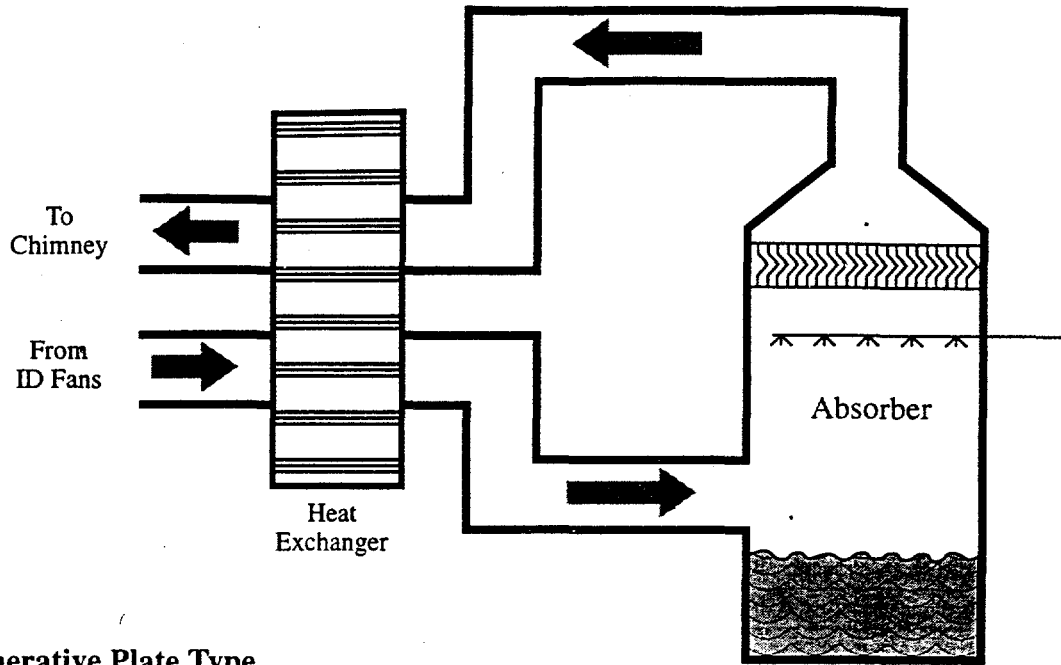

a. Regenerative Plate Type

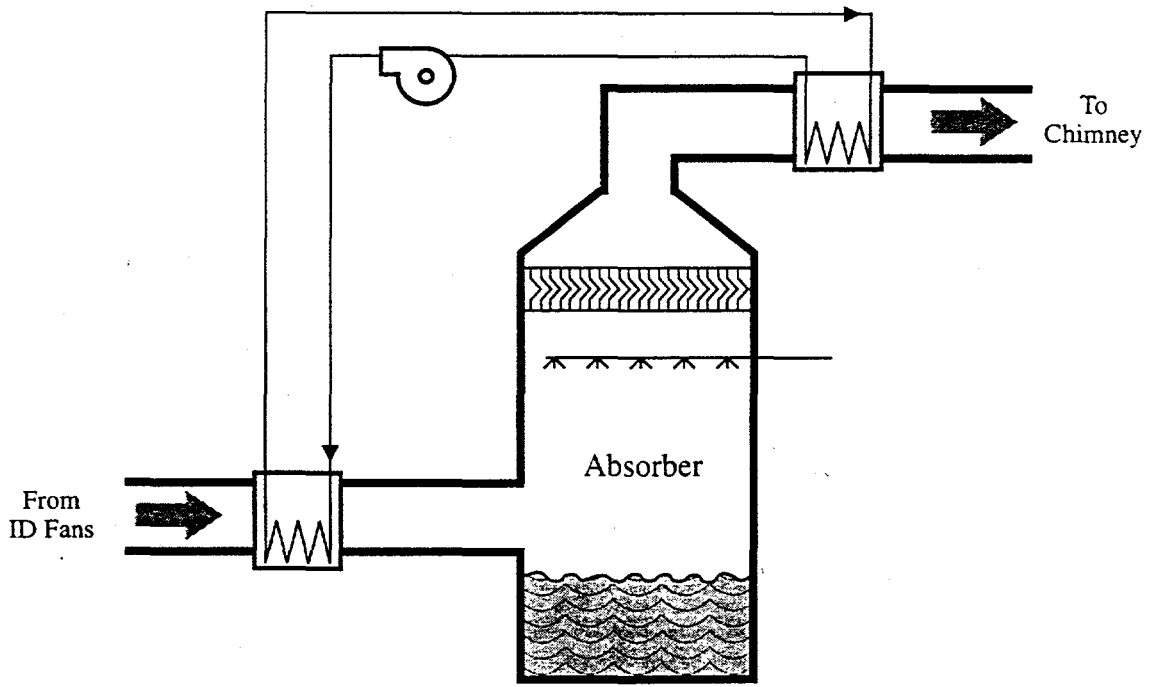

b. Shell-and-Tube Heat Exchangers

Figure 4.6-2. Cyclic Reheat

As an alternative, the ID fans (or booster fans) can be located between the absorber outlet and the reheater, which can reportedly reduce overall leakage to below 0.75 percent (3). This solves the problem of untreated gas bypassing the absorbers, but creates a far more corrosive environment for fan operation (See Part II, Section 2.0--Fans).

Shell-and-tube heat exchangers have two sets of exchangers, with a heat transfer fluid pumped through them. The fluid can be water, mineral oil, ethylene glycol, or another fluid. Because there is no direct connection between the inlet and outlet ductwork, there is no flue gas leakage around the absorber modules.

Heat pipes are a special form of shell-and-tube exchanger with no pumps or other moving mechanical parts. Density differences between the hot and cool fluids cause the fluid to move through inclined tubes between the two exchangers. Most heat pipe installations require that the inlet and outlet ducts be adjacent; however, a system using more widely separated heat pipes has been designed. Depending on the locations of the absorber modules' inlet and outlet ductwork and the stack, such a restriction in ductwork arrangement may or may not be a problem.

Cyclic reheat lowers the temperature of the flue gas entering the absorber modules, which reduces both the adiabatic saturation temperature of the flue gas and the rate of evaporation in the absorber. This has a major effect on the FGD system water and material balances, since most water is consumed by evaporation to the flue gas. With less water evaporated, the rate of makeup water addition must be carefully controlled. The lower absorber inlet temperature may be below the dew point of sulfuric acid (H_2SO_4), which can result in extremely corrosive conditions in the extraction reheater and ductwork to the absorber modules.

In-Line Reheat

An in-line reheater, Figure 4.6-3, is a relatively simple system, with energy from the unit's steam cycle transferred directly to the saturated gas by a shell-and-tube reheater. Turbine extraction steam or hot boiler feed water is passed through smooth or finned tubes located in the ductwork downstream of the absorber module. Although simple in design and operation, in-line reheaters are prone to corrosion and plugging problems. Proper operation and maintenance of the ME is critical because any carryover will lead to formation of deposits on the tubes, reducing heat transfer and increasing flue gas pressure drop through the reheater. Entrained moisture will also increase the reheater energy requirement to evaporate the droplets.

Indirect Hot Air Reheat

The indirect hot air reheat system, also referred to as ambient air reheat, is shown in Figure 4.6-4. This system is similar to in-line reheat, except that air instead of flue gas is passed over the finned tubes, which carry steam (boiler feed water is not hot enough for use in indirect hot air reheat). The air is heated to 175 to 200°C (350 to 400°F) and then injected into the saturated flue gas, which raises the flue gas temperature and increases its mass flow rate. The rate of hot air addition (at 200°C) would be about 12% of the flue gas rate to reheat the flue gas by 30°C (50°F), and the downstream ductwork and stack must be sized for the resulting larger gas volume.

The major advantage of hot air reheat is that locating the air heater tubes in an ambient air stream allows the tubes to be constructed of carbon steel. Another advantage of this reheat method is that the reheat air increases the total gas volume discharged from the stack, which (on a retrofit project) increases stack exit velocity and may improve plume dispersion. (If a new stack is being built, the stack velocity can be designed independently.) The additional air also reduces plume opacity by reducing the moisture content of the flue gas.

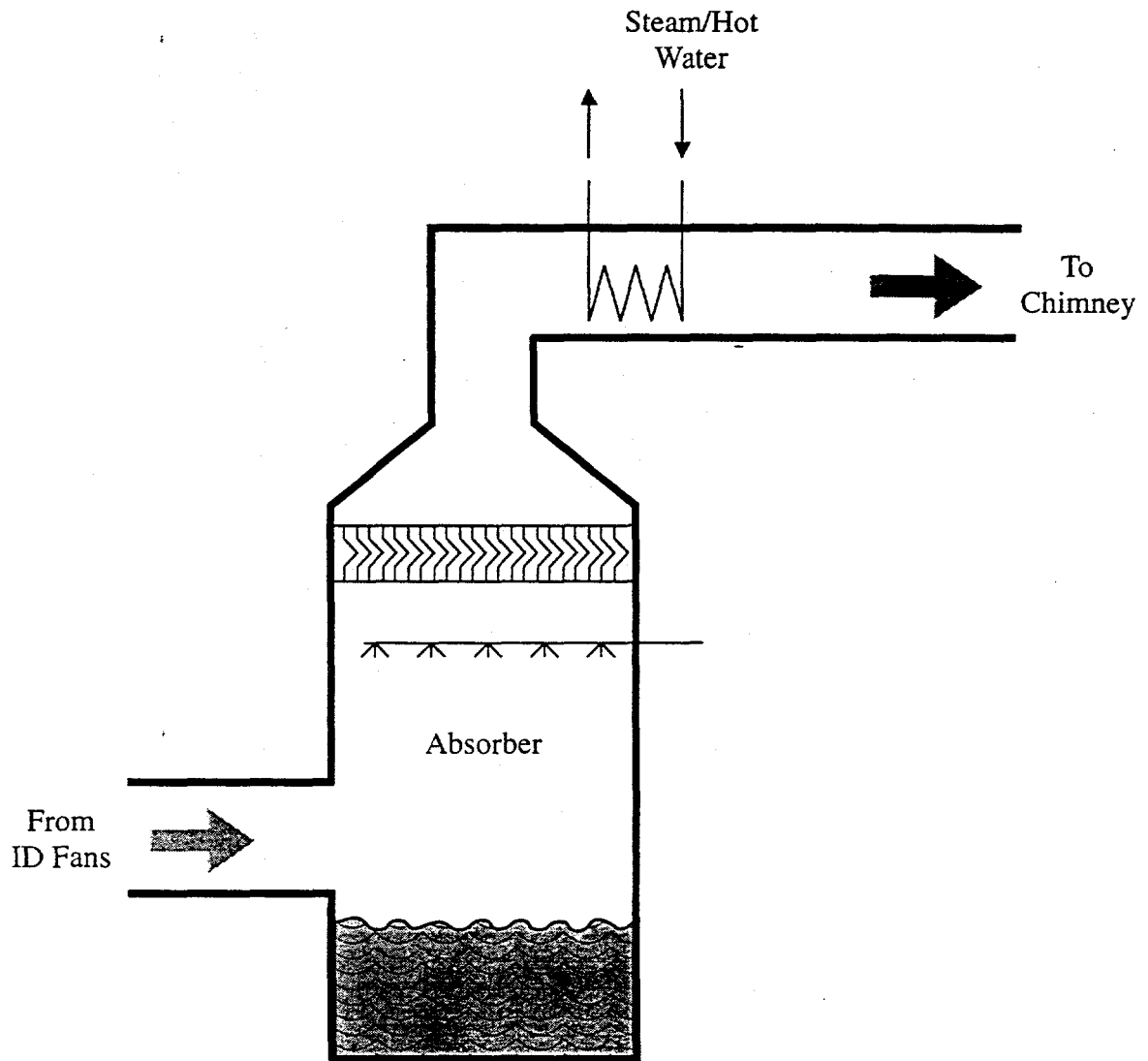

Figure 4.6-3. In-Line Reheat

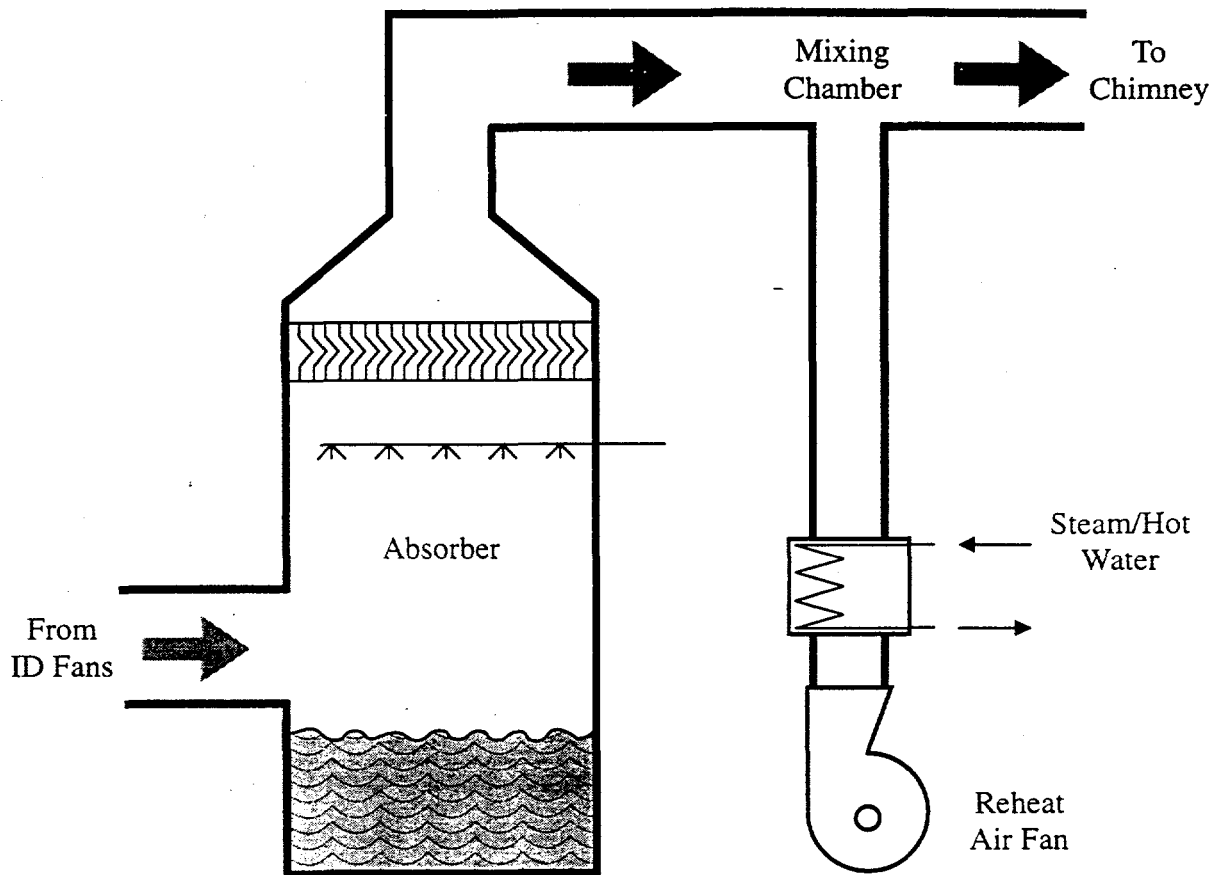

Figure 4.6-4. Indirect Hot Air Reheat

Although the reheater tubes are not exposed to the corrosive gases leaving the absorber modules, operating costs are significantly greater than for an in-line reheater because the total mass of air to be heated (flue gas plus reheat air) is greater. Also, the reheat fans are significant power consumers. Reheater tube leaks occur but are less frequent than for in-line reheat systems.

Direct-Firing Reheat

In a direct-firing reheat system, Figure 4.6-5, low-sulfur fuel oil or natural gas is burned in a combustion chamber near the outlet ductwork, and the hot combustion gas is injected into the treated flue gas. Since direct firing produces a hotter reheat gas stream than indirect hot air reheat does, a smaller volume of reheat gas is required. This reduces the size of the reheat air fan and the increase in the total volume of the flue gas handled by the ductwork and stack. This reheat method is common on oil-fired units in Japan, where the flue gas is reheated by 80 to 90°C (144 to 162°F).

4.6.3 Materials-of-Construction Considerations

This section covers the materials used to fabricate the components of a flue gas reheat system. The components include steam coils, air fans, ductwork, and the gas mixing chamber. In general, the choice of materials depends on the equipment's operating environment--hot inlet flue gas, wet (or wet-dry) outlet flue gas, or air. More complete discussion of FGD materials of construction is provided in Part I, Section 5.0--Materials-of-Construction Options and Part II, Section 3--Ductwork and Expansion Joints.

Bypass Reheat

The bypass duct can be constructed of carbon steel from the inlet duct to the downstream control damper. If two dampers are used, the upstream damper can be constructed of carbon steel. However, the downstream damper and ductwork to the absorber

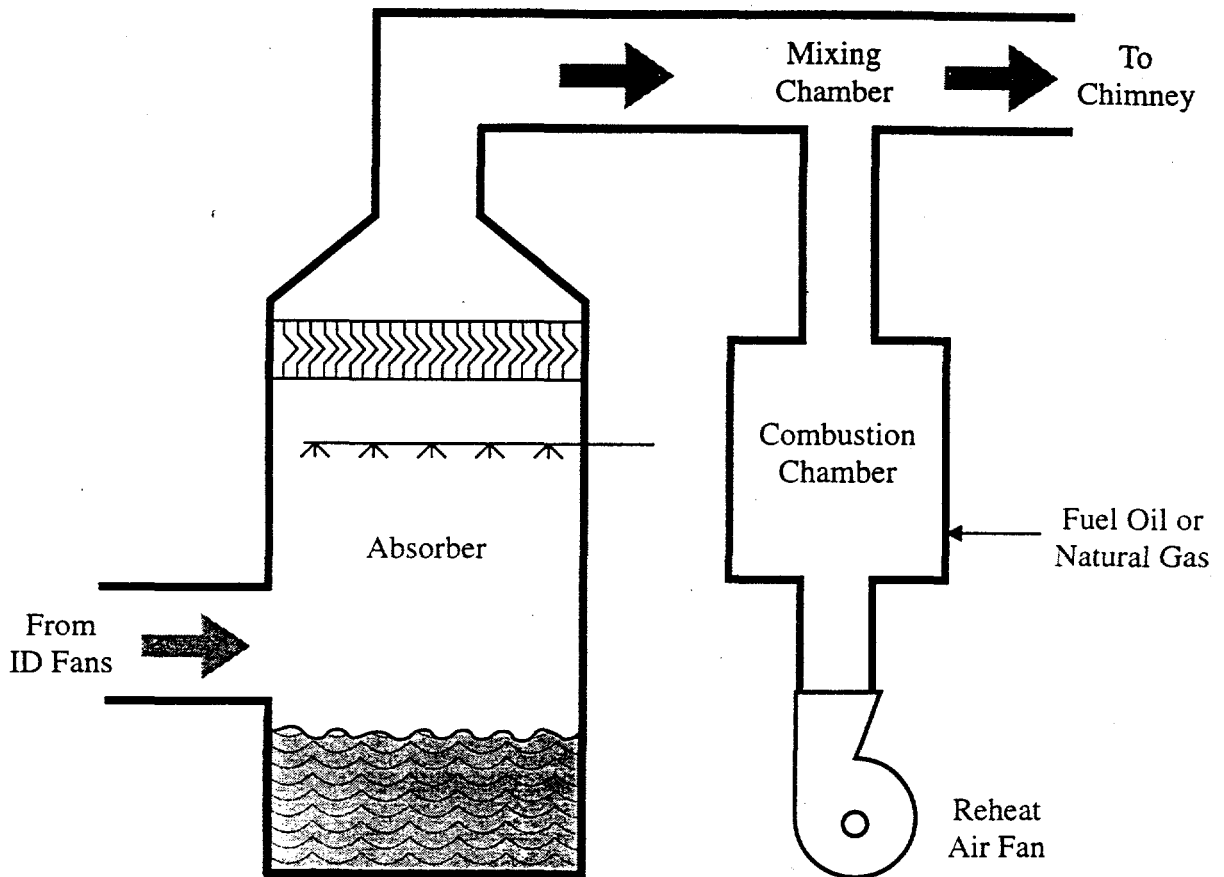

Figure 4.6-5. Direct-Firing Reheat

module outlet ductwork must be constructed of corrosion-resistant materials, typically a nickel alloy.

Corrosion problems with bypass reheat mixing areas are severe because of the mixing of hot, SO₂-laden bypass gas with the wet, treated flue gas from the absorber modules. The mixing zone should be designed for collection and drainage of condensate that may form. Also, it should have gas-side surfaces constructed of materials that can withstand a continuous operating temperature of 150°C (300°F), excursions to 315°C (600°F) during a combustion air heater failure, and an extremely acidic (pH of 1 or less), high-chloride (over 100,000 mg/L) condensate. Liners that exhibit any measurable permeability, such as gunite and organic linings, are not recommended. Nickel alloys, ceramic tile, and borosilicate glass block have given the best results. However, as stated in Part I, Section 5.3.1--Corrosive Environment Zones, even the most corrosion-resistant materials sometimes fail in the extreme conditions found in the bypass reheat mixing zone.

Cyclic Reheat

Plate-type reheaters handle both FGD system inlet and outlet flue gases, and, therefore, are subject to extremes in temperature and corrosive conditions. In Japan and Germany, where these systems are common, a variety of construction materials have been used. In combustion air preheater service, these systems are normally constructed of carbon steel. However, to withstand the corrosive effects of wet flue gas, enameled steel is typical. Thermoplastic materials have been successfully used for some of the cold-side heating elements (3). Although alloys may outperform coated steel, alloy use for the large surface area of the reheater baskets would be prohibitively expensive.

Shell-and-tube heat exchangers and heat pipes can be built to avoid corrosion problems more easily than plate-type exchangers can. The main advantage is that separate tubing is used in the inlet and outlet ducts, allowing for optimized materials at each location. The tubes in the hot inlet gas stream can be made of Type 316L or 317L stainless steel.

Carbon steel tubes are not likely to be successful in this service because the tube surface temperature will fall below the dew points of H_2SO_4 and HCl , and the tubes must withstand the low-pH condensation. The tubing in the outlet duct must withstand the corrosive effects of low-pH condensation and higher chlorides, and nickel-based alloy or coated carbon steel construction is used. However, some installations have successfully used carbon steel tubes by keeping them hot and not allowing condensate to form (4). Teflon[®]-covered tubes and tubesheets have also performed well in this wet environment (5). Heat pipes are typically made of carbon steel, including the fins. However, stainless steels and alloys can also be used.

In-Line Reheat

Many materials have been used for the tubes of in-line reheat systems and have produced mixed results. Two major factors that affect tube material performance have been identified. The first is ME performance. Since the reheat tubes are typically located just downstream of the MEs, any mist carryover will impinge on the tubes, evaporate, and form deposits. The second factor is tube temperature. Maintaining the tubes at a high temperature (avoiding temperature cycling) reduces the formation of corrosive liquid deposits. Although carbon steel has performed well at some stations, nickel-based alloys are generally recommended for this application.

Indirect Hot Air Reheat

The majority of the equipment in this reheat application can use low-grade alloys or carbon steel throughout, because the fans, ductwork, and tubes are all outside of the flue gas path. Also, finned tubes can be used to increase heat transfer, because there is less concern for solids buildup on tubes in the air stream than there is with the in-line reheater. The reheat mixing zone is a corrosive environment, although less corrosive than the mixing zone of a system using bypass reheat. Nevertheless, the material recommendations for the gas

mixing area with an indirect hot air reheat system are the same as those for bypass reheat systems.

Direct-Firing Reheat

The combustion chamber must be lined with a refractory material similar to that used in the boiler. The refractory material can be brick or mortar. Since the combustion chamber is typically outside the FGD flue gas outlet duct, temperature considerations are more important than corrosion considerations. Duct lining requirements for the reheat mixing area are similar to those for bypass reheat.

4.6.4 Energy and Cost Considerations

The energy for a reheat system comes from one of three basic sources--the hot, untreated flue gas, the unit's steam cycle, or a supplemental fuel. Transferring heat directly from the inlet to the outlet flue gas (cyclic and bypass reheat) makes effective use of waste heat and has little effect on unit heat rate. However, cyclic reheat has a high capital cost, and bypass reheat, while less expensive, is limited to FGD systems that are not required to achieve high SO₂ removal efficiencies. Extraction steam (or hot boiler feed water) and supplemental fuel are expensive sources of energy and affect unit heat rate. Each of these energy sources is discussed in the following paragraphs.

Use of Heat from Untreated Gas

Bypass and cyclic reheat are two methods that utilize energy from the inlet flue gas that would otherwise be wasted. The use of bypass reheat is limited to those FGD systems with SO₂ removal efficiencies below 80 percent. Since most new FGD systems are designed for higher removal efficiencies, bypass reheat is generally not an option. Cyclic reheat has been frequently applied in Europe and Japan. A relatively small amount of electrical power is required to operate the plate-type reheater drive motor or to operate the

fluid circulating pump between shell-and-tube heat exchangers. The greatest power requirement of cyclic reheaters is the power to the ID fans (or booster fans) to overcome the additional flue gas pressure drop.

Use of Steam or Boiler Feed Water

Steam and boiler feed water are readily available in power plants; however, the amount required to reheat flue gas has a significant effect on unit heat rate. In addition to the effects on efficiency, retrofitting a reheat system that uses steam could result in derating the unit's power output at a unit with a marginally sized steam generator. The amount of steam required to reheat flue gas depends on the type of reheat system. An in-line system is the most efficient, since only the flue gas is heated. The energy used for a 30°C (55°F) temperature increase for an in-line reheat system increases the total boiler heat input requirement by approximately 2 percent. Indirect hot air reheat requires about 10 to 15% more energy than an in-line reheat system because air also must be heated. As noted earlier, boiler feed water cannot be used in indirect hot air reheat systems because it is not hot enough to produce the required reheat air temperature.

Use of Supplemental Fuel

Supplemental fuel is the energy source for the direct-firing reheat system. The fuel is usually a low-sulfur oil, since this reheat method has been most often used on oil-fired units. However, natural gas can also be used if a source is available. The amount of fuel required depends, of course, on the reheat temperature increase. For example, to raise the gas temperature by 30°C (55°F), an amount of oil equivalent to about 1.5% of the boiler's fuel firing rate is required.

4.7 Reagent/Additive Preparation Equipment

Depending on the FGD process and options used, the reagent/additive preparation equipment may handle lime or limestone reagent, and a chemical additive such as emulsified sulfur, DBA, adipic acid, formic acid, or sodium formate. Detailed discussions of these reagents/additives can be found in Part I, Section 8.0--Lime and Limestone Reagent Source Considerations and Part I, Section 9.0--Chemical Additive Considerations. The reagent/additive preparation equipment for each of these materials can be grouped into three subcategories:

- Receiving and storage;
- Preparation; and
- Slurry storage.

4.7.1 Lime Reagent Preparation Equipment

Lime can be delivered to the generating station in one of several forms, but "pebble lime" is the form most frequently used at electric utility FGD systems. Pebble lime has a particle size range of 50 mm to 6 mm (2 in. to 1/4 in.). Although lime can be furnished in larger sizes (lump lime) and finer sizes (pulverized lime), these forms require special designs to prevent plugging and flooding of silos, hoppers, and feeders. Therefore, this discussion of lime reagent preparation equipment will focus on pebble lime. The overall lime reagent preparation system is depicted in Figure 4.7-1.

Lime Receiving and Storage Equipment

Lime can be delivered to the generating facility in one of three ways: truck, railcar, or barge. Each type of delivery has been used at an existing electric utility FGD system. The choice among them depends on site-specific factors such as annual lime consumption, availability of rail and barge deliveries to the site, and lime supplier capabilities.

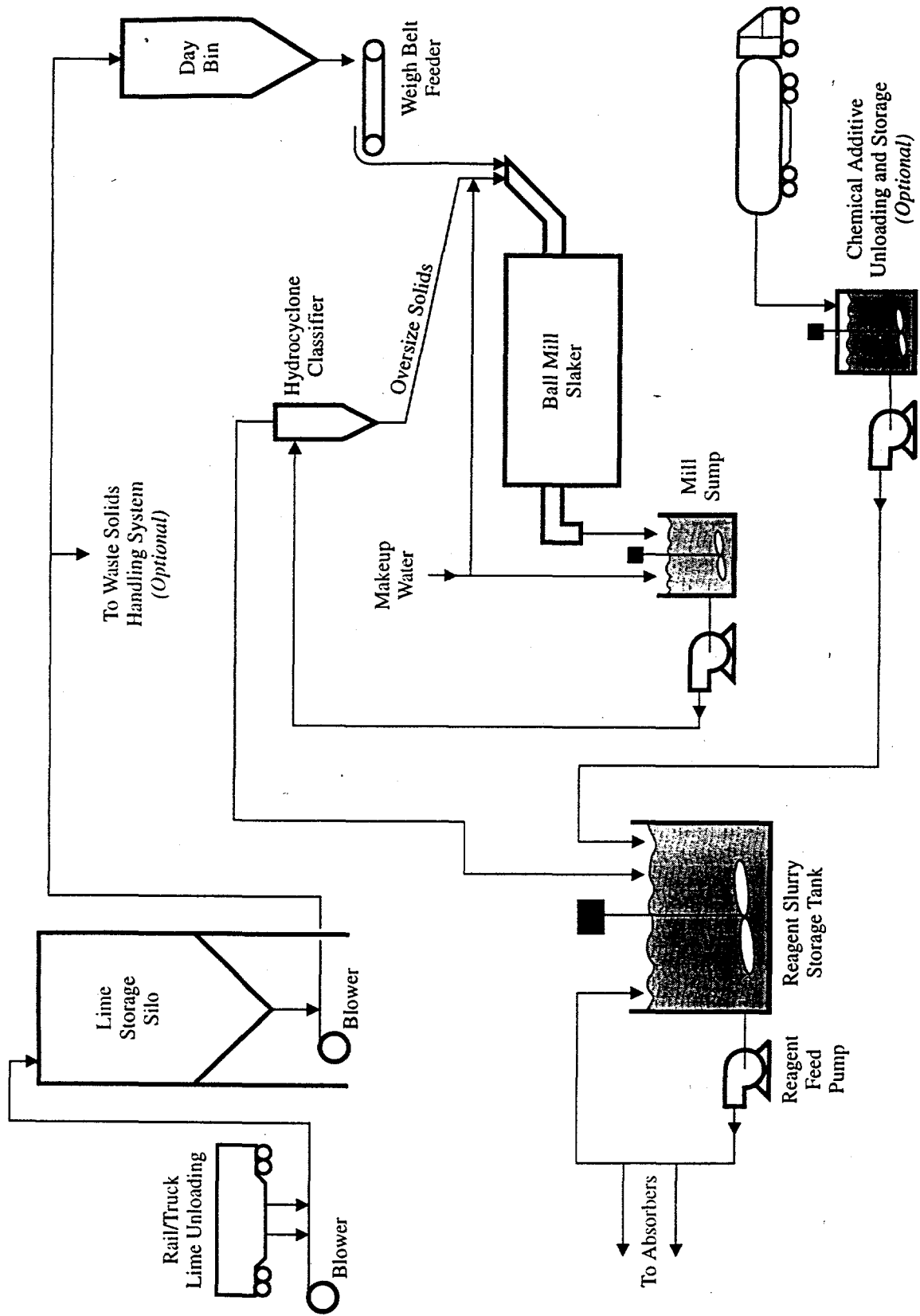

Figure 4.7-1. Lime Reagent Preparation System

Lime delivery trucks, such as the one shown in Figure 4.7-2, have a typical capacity of 10 to 23 tonnes* (11 to 25 tons) and usually are equipped with a pneumatic unloading system for transferring their contents directly to the lime storage silos. A truck can be unloaded by this system in one to two hours. A fixed pneumatic system capable of handling more than one truck at a time is also possible if the quantity of lime delivered per day is very large. Truck delivery is most common where the lime supplier is relatively close to the generating plant or where rail and barge deliveries are not possible. Virtually all lime suppliers have the capability of shipping lime by truck.

Railcars, such as the one shown in Figure 4.7-3, have a typical capacity of 90 tonnes (100 tons) and may be unloaded into a below-grade hopper or by a rail-side pneumatic transfer system. In either case, unloading railcars is relatively more difficult than unloading trucks and should be conducted in an enclosed, weather-proof building. Lime delivered by rail is usually less expensive per ton of lime than delivery by truck, but requires a separate rail siding at the plant and a railcar positioning system. Most lime suppliers have the ability to support railcar shipments of lime. At locations where direct rail access to the generating station is not available, lime can be shipped by rail for a portion of the total distance, then off-loaded and delivered to the site by truck.

Barge delivery is usually the most economical method of delivering large quantities of lime to the generating plant if the plant is located on a navigable stream and has the ability to receive barge shipments. Barges have capacities in the range of 725 to 1,800 tonnes (800 to 2000 tons). A typical barge delivery system, such as the one shown in Figure 4.7-4, can unload a barge using a combination of mechanical and pneumatic systems in a few hours. Several lime suppliers in the United States have the ability to support barge deliveries of lime.

The choice among these three methods of lime delivery is motivated by economics. The selection of the lowest-cost alternative is usually the subject of an economic

* 1 tonne = 1000 kg.

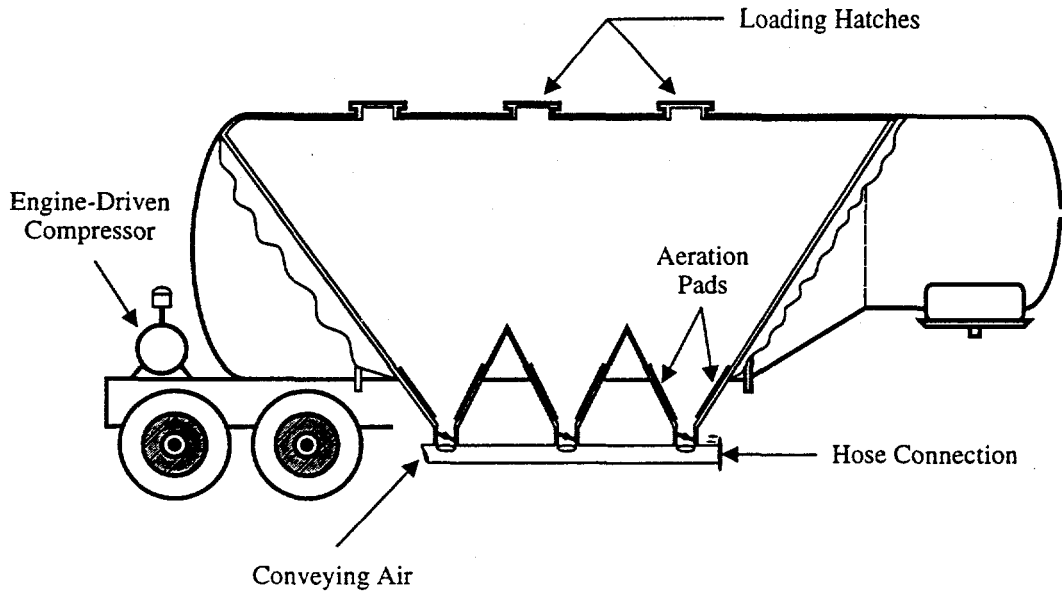

Figure 4.7-2. Lime Transportation Truck Trailer

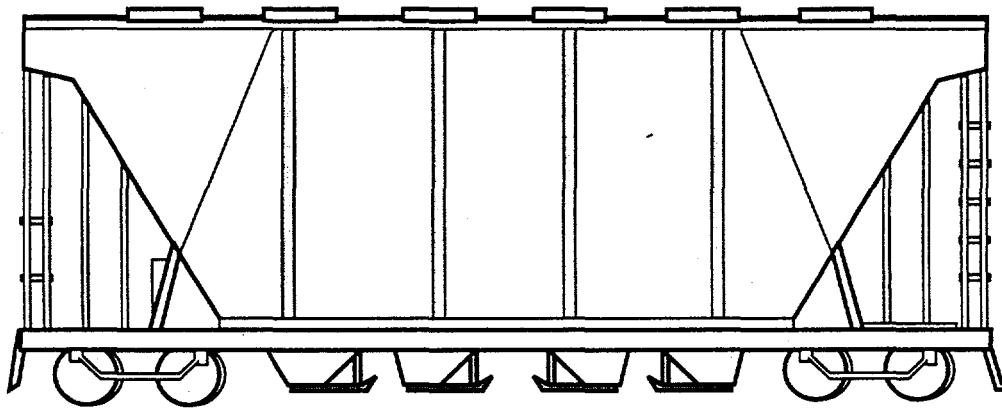

Figure 4.7-3. Lime Transportation Railcar

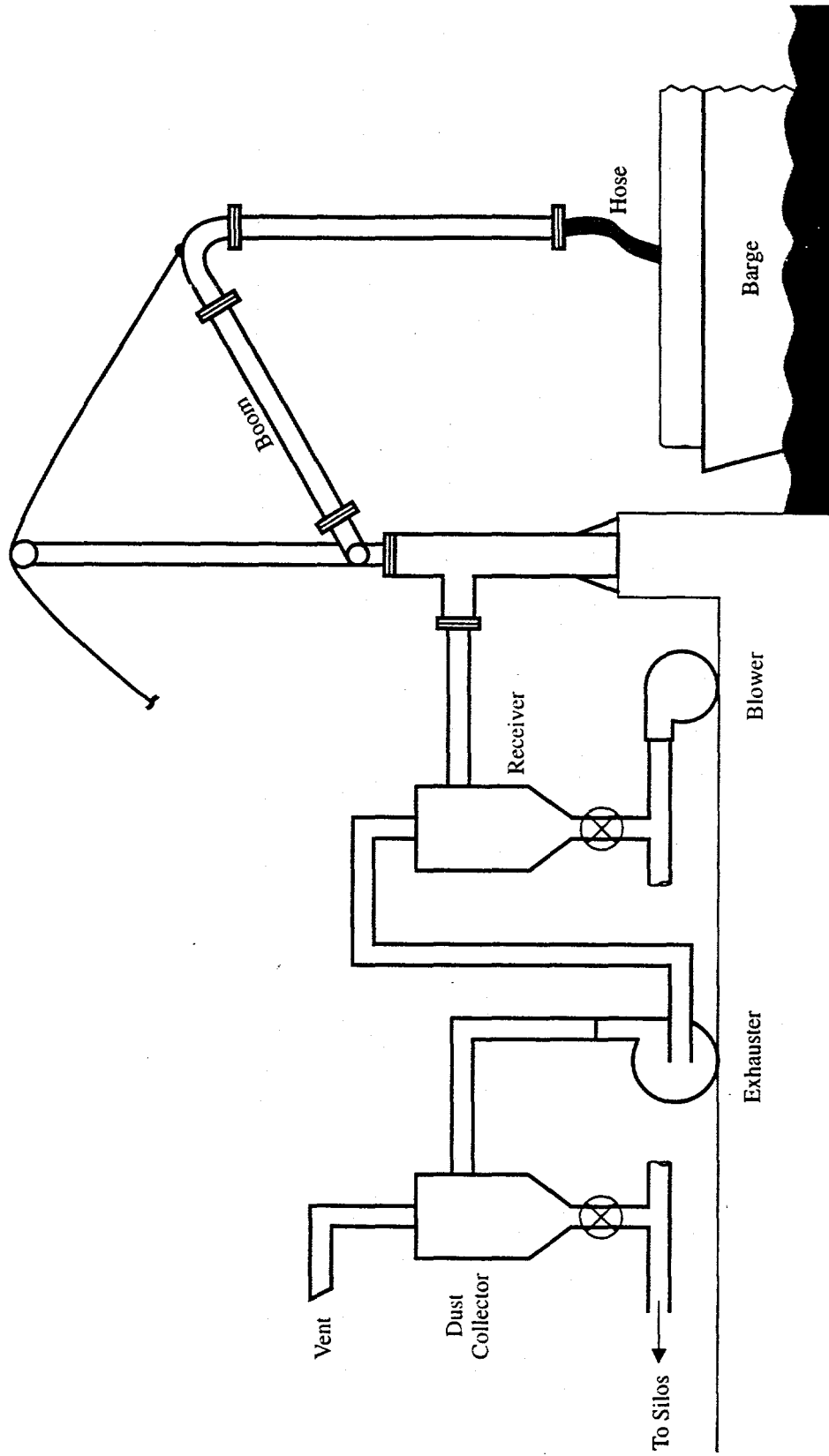

Figure 4.7-4. Barge Unloading Equipment

study prior to the development of the FGD system specification. Discussions with potential lime suppliers are required to determine their shipment capabilities and differential delivered price.

Regardless of the method of delivery to the plant, ultimately the lime is transferred to one or more storage silos. The number and capacity of silos are functions of the quantity of lime stored at the generating plant. The on-site storage capacity required depends on factors such as maximum daily lime consumption, lime delivery method, and the likelihood of disruptions in lime delivery. Lime is a relatively expensive material [approximately \$55 per tonne (\$50/ton)] and the cost of maintaining a large inventory of lime can be high. Although site-specific considerations such as those described above can result in smaller storage quantities, a 7- to 14-day supply of lime is a typical design value.

Lime is pneumatically transferred from the storage silos to day bins in the lime slurry preparation area. Typically, one bin is provided for each lime slaker. The bin capacity is determined by the slaker capacity and lime slaking frequency. Typically, the bins are sized such that lime is transferred from the storage silos once per day.

If the FGD byproduct solids are to be fixated (mixed with lime and fly ash) prior to disposal, lime from the storage silos will also be pneumatically transferred to a day bin in the byproduct solids handling equipment area. This is discussed further in Part I, Section 4.8--Byproduct Solids Handling.

Lime Slaking Equipment

The lime slaking equipment converts the dry quicklime (CaO) received at the plant into a hydrated lime [$\text{Ca}(\text{OH})_2$] slurry containing 20 to 25% solids. The slaking reaction results from the addition of water to the dry lime as shown in Equation 4.7-1:



As shown in this equation, the lime slaking reaction requires one mole of water for each mole of lime and is exothermic. Additional water must be added to produce a lime slurry of the desired solids content. The slaking reaction is more rapid and complete at high temperatures; however, the temperature in the slaker must be carefully controlled by regulating the ratio of lime and water to prevent steam explosions.

As shown in Figure 4.7-1, the lime from the day bins is fed to the lime slakers by weigh belt feeders. A signal from the feeder is used to control the volume of fresh water added to the slaker. The fresh water addition rate also is adjusted on the basis of slaker temperature and slurry density. Slaking water must be relatively low in dissolved solids to minimize undesirable chemical reactions in the slaker that reduce the slaking efficiency. Therefore, reclaim water from the dewatering equipment is not used for lime slaking.

In large utility FGD systems, two types of lime slakers have predominated: paste slakers and ball mill slakers. The two types of slakers use different approaches to the slaking procedure but produce approximately the same quality of slaked lime product. The principal difference between the two processes is that paste slakers remove unreacted, inert material (grit) present in the lime from the slurry while ball mill slakers do not. This grit material may be 1% to 2% of the lime by weight. If the grit is removed in the slaking process, it must be transported to disposal, usually to a landfill. Temporary storage of grit can be messy and transportation is an additional operating cost. Ball mill slakers grind the grit to a very fine particle size, and the grit remains with the slaked lime product. Since the grit is not removed during the slaking process, it leaves the FGD system in the byproduct solids. This eliminates the need for temporary grit storage and the cost for separated grit disposal; however, the presence of grit in the slaked lime increases the erosivity of the reagent slurry to piping and valves.

A typical large paste slaker has a capacity of approximately 3.6 tonnes per hour (4 tons/hr), while ball mill slakers are available with capacities in excess of 45 tonnes per hour (50 tons/hr). As a result, the use of a ball mill slaker can greatly reduce the number of slakers required.

Because of the paste slaker's need for grit handling and the ball mill slaker's ease of operation and much larger slaking capacity, the ball mill slaker has been the most frequently applied in recent electric utility FGD applications. A typical lime slaker equipment arrangement based on ball mill slakers is shown in Figure 4.7-5. A detailed discussion of ball mill slakers is contained in Part II, Section 10.0--Reagent Ball Mills.

Lime Slurry Storage

The slaked lime slurry leaving the slakers is directed to one or more lime slurry storage tanks. These agitated tanks provide the needed surge capacity in the reagent feed system. The total volume of lime slurry storage is dependent on the maximum lime demand and the operating frequency of the lime slaking equipment. Typically, lime slaking systems are operated for one shift per day, 7 days per week. The lime slurry storage tanks under these conditions would be sized to provide the maximum lime slurry demand for 24 hours.

The reagent feed pumps transfer the lime slurry to the absorber modules, as needed, to control the pH in the reaction tanks (See Part I, Section 4.10--Process Control and Instrumentation). The reagent slurry is pumped in a loop, with the unused portion returning to the storage tanks. The design of this piping must consider maintaining the slurry velocities in this line within the range of 2 to 3 m/s (6 to 10 ft/s) at conditions ranging from no reagent feed to the absorbers to the maximum reagent feed rate. At lower flow velocities, the solids may settle out and plug the pipelines. Higher velocities are excessively erosive of piping materials and valves. Because of the potential for line plugging, provisions are included in the design of this piping for automatic draining and flushing upon shutdown of the reagent feed pumps.

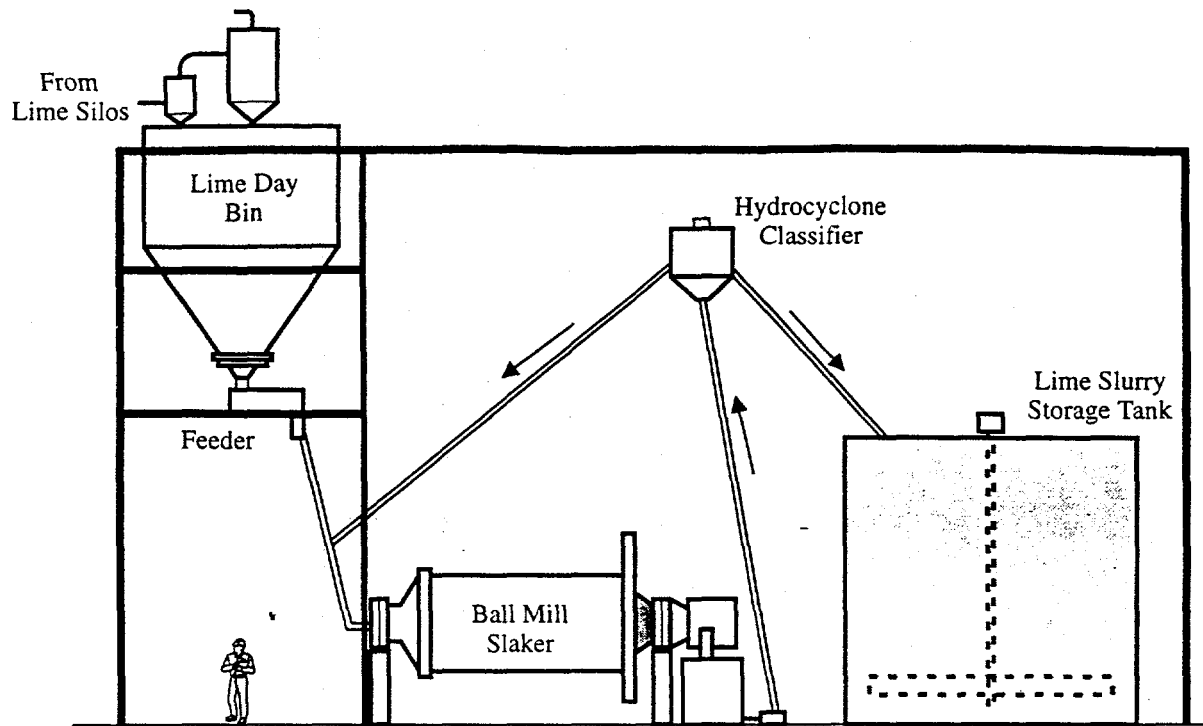

Elevation

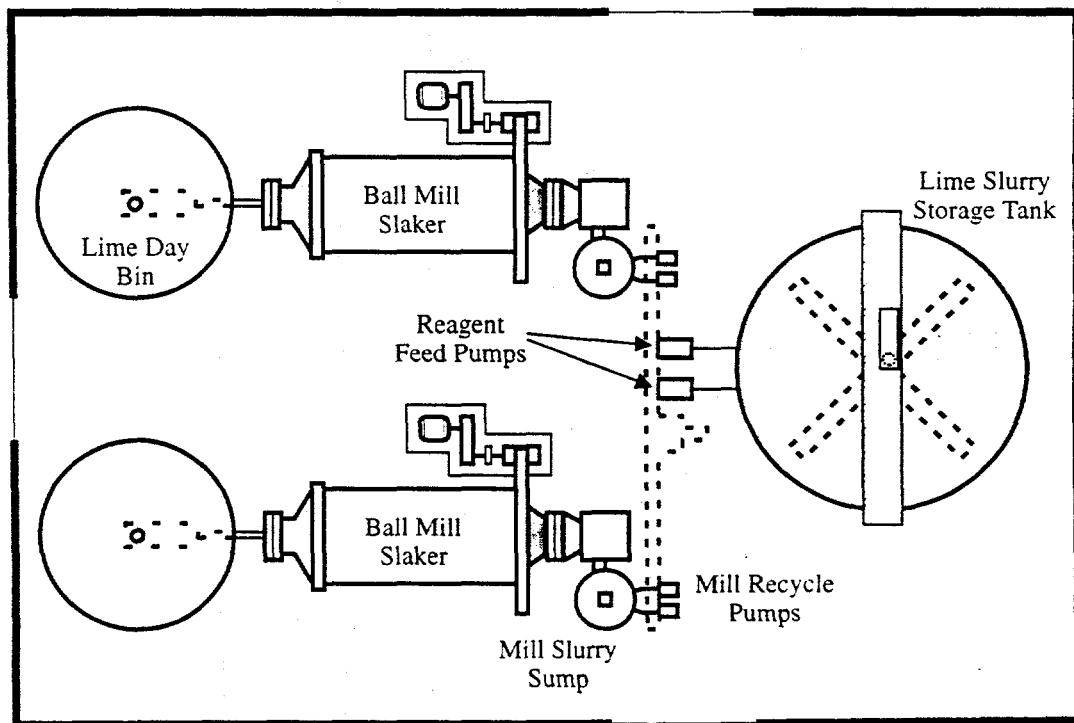

Plan View

Figure 4.7-5. Lime Reagent Preparation Equipment Arrangement

4.7.2 Limestone Reagent Preparation Equipment

Limestone can be delivered to the generating plant site in either crushed or powdered form. Crushed limestone, with a size range of 19 mm by 0 mm (3/4 in. to 0 in.), is used at all but a few installations because powdered limestone [typically 95% less than 44 μ m (325 mesh)] is more difficult to transport and store, and is usually more expensive. An exception to powdered limestone's higher cost may occur if limestone fines are available as a waste product at the quarry where fine material is removed from the crushed rock. Fine limestone particles can create fugitive dust problems and, if wetted, produce a thick, sticky mud that hampers the operation of reclaim equipment, bridges and plugs hoppers, and sticks to conveyor belts. Therefore, some utilities prefer to use a screened or washed limestone, which has the fine particles removed, or to place contract restrictions on the percentage of fine material that may be present in the limestone delivered to the station. Because most utilities use crushed limestone, with or without fines removal, the discussion of limestone reagent preparation equipment will concentrate on this form. The major components of the limestone reagent preparation system are shown in Figure 4.7-6.

Limestone Receiving and Storage

As is the case with lime, limestone can be delivered to the generating facility by truck, rail, or barge. Again, the choice between these alternatives is site-specific; however, because limestone deposits are so widely available in most locations, delivery by truck is the most prevalent. Because limestone is an inert mineral, it can be delivered and stored in a manner similar to coal. At some locations, coal and limestone are unloaded and conveyed to storage by the same equipment.

The trucks used to deliver limestone to the site are typically the same types used to deliver coal, and have a maximum capacity of 23 tonnes (25 tons) depending on local highway transportation regulations. Both rear-dump and hopper-type trucks are used. The rear-dump style trucks can unload either by the use of a dump hopper and stackout conveyor

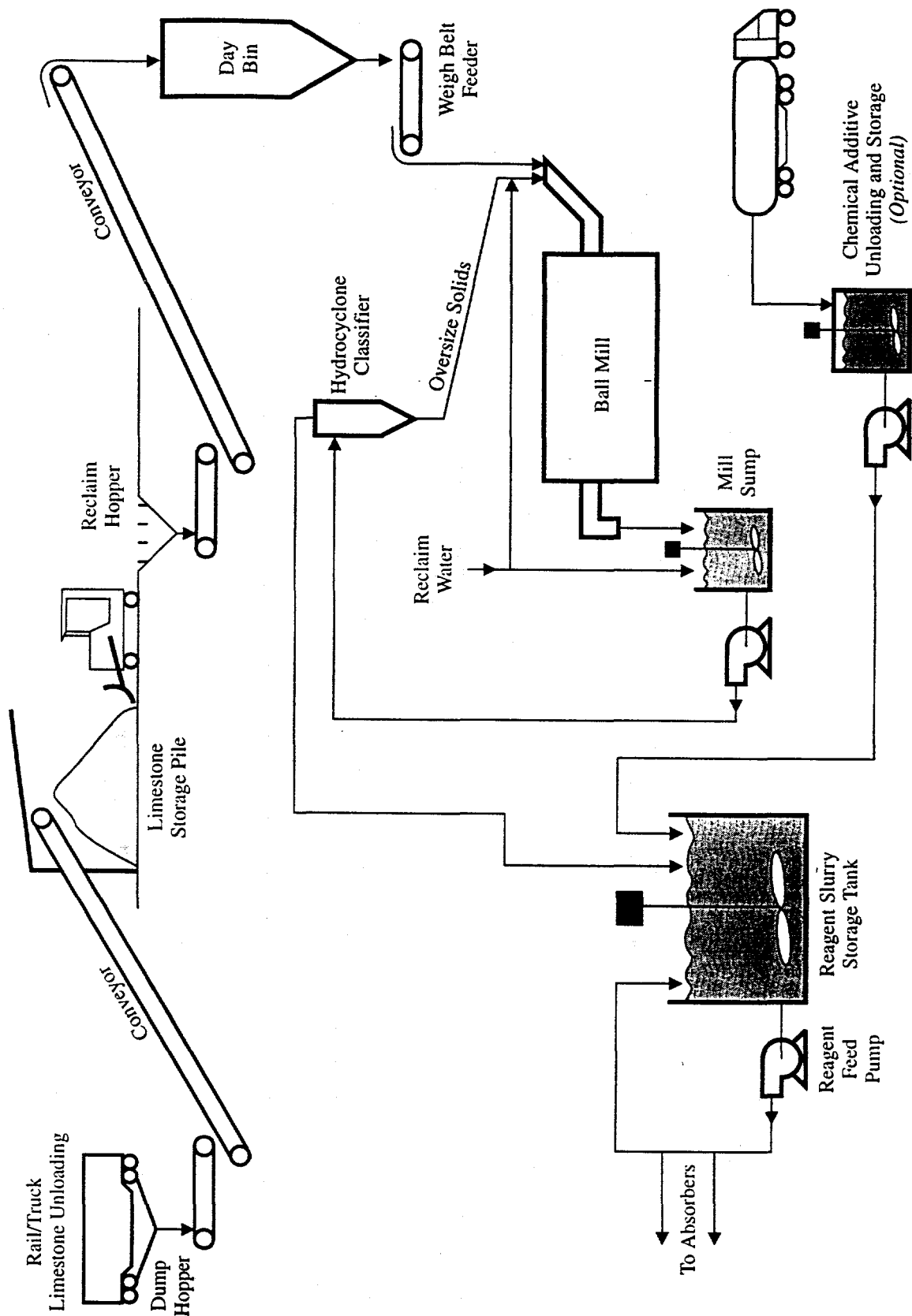

Figure 4.7-6. Limestone Reagent Preparation System

as shown in Figure 4.7-5 or by dumping directly on the ground next to the limestone storage pile. In both cases, mobile equipment, such as front-end loaders, is commonly used to place the limestone in the pile and to move the limestone to a reclaim hopper as it is needed. The use of mobile equipment has been minimized at some facilities by using stacker-reclaimers and under-pile reclaim hoppers.

The railcars used to transport limestone are of the same style as those used for coal, and both rotary-dump and hopper-type cars are used. These cars have a typical capacity of 90 tonnes (100 tons). The railcars are unloaded into a dump hopper and the limestone is conveyed to the storage pile.

Barge delivery of limestone is feasible, but is the least common of the three alternatives. If coal is delivered to the site by barge and there is no local supply of suitable limestone, then limestone delivery by barge may also be economically feasible. The same variety of barge unloading equipment used to unload coal can be used with limestone.

Limestone can be stored in either an open pile or in a weather-protected enclosure. Some facilities have opted for an enclosure to minimize fugitive dust problems or to prevent difficulties in reclaiming wet or frozen limestone in the winter. The on-site storage capacity required depends on the same set of factors identified for lime reagent. However, because limestone is a relatively low-cost material [typically \$5 to \$13 per tonne (\$5 to \$12/ton)], it is common to maintain a larger supply on site. Often the same criteria used for sizing the inactive coal reserve at the site are also used for sizing the limestone storage pile. Stockpiles of 30 days' supply and greater are common.

Limestone is transferred from the storage pile to the day bins in the limestone slurry preparation area by belt conveyor. The limestone may be moved to a reclaim hopper by front-end loaders as shown in Figure 4.7-6, or an under-pile reclaim system may be used. Typically, one day bin is provided for each limestone ball mill. The bins are sized such that the reclaim equipment operates just a few hours per day.

Powdered limestone, when used, is received and stored by equipment very similar to the equipment used to receive and store lime. Care must be taken to prevent the limestone from becoming wet, or removal from the storage silo and day bins will be very difficult.

Limestone Slurry Preparation Equipment

The limestone slurry preparation equipment consists of a wet ball mill and its support equipment that grinds the limestone to produce a 30 to 40% solids slurry with typically at least 90% of the particles passing a 44 μm screen (325 mesh) and a mean particle size in the 10 to 20 μm range. As shown in Figure 4.7-6, limestone is fed to the ball mills by weigh belt feeders. Reclaim water from the reclaim water tank is added on the basis of signals from the weigh belt feeder and from a density meter on the discharge line from the mill slurry sump to the hydrocyclone classifiers. Because no chemical reactions occur during the limestone grinding operation, reclaim water can be used to prepare the limestone reagent slurry without affecting the reactivity of the reagent.

Two principal types of ball mills have been used in the preparation of limestone as a FGD system reagent: horizontal ball mills and vertical ball mills. The equipment schematic diagram shown in Figure 4.7-5 is based on a horizontal ball mill. Although the horizontal mill is predominant in U.S. electric utility installations, the vertical mill may offer some advantages in arrangement flexibility and power consumption and has been successfully applied in recent installations. A detailed discussion of both types of ball mills is presented in Part II, Section 10.0--Reagent Ball Mills. A typical equipment layout based on a horizontal ball mill would be very similar to the ball mill slaker illustrated in Figure 4.7-5 (presented earlier). A typical vertical ball mill arrangement is presented in Figure 4.7-7.

The limestone slurry leaving the ball mill contains a fraction of particles that are larger than desired. As shown in Figure 4.7-6, in a horizontal ball mill the removal of

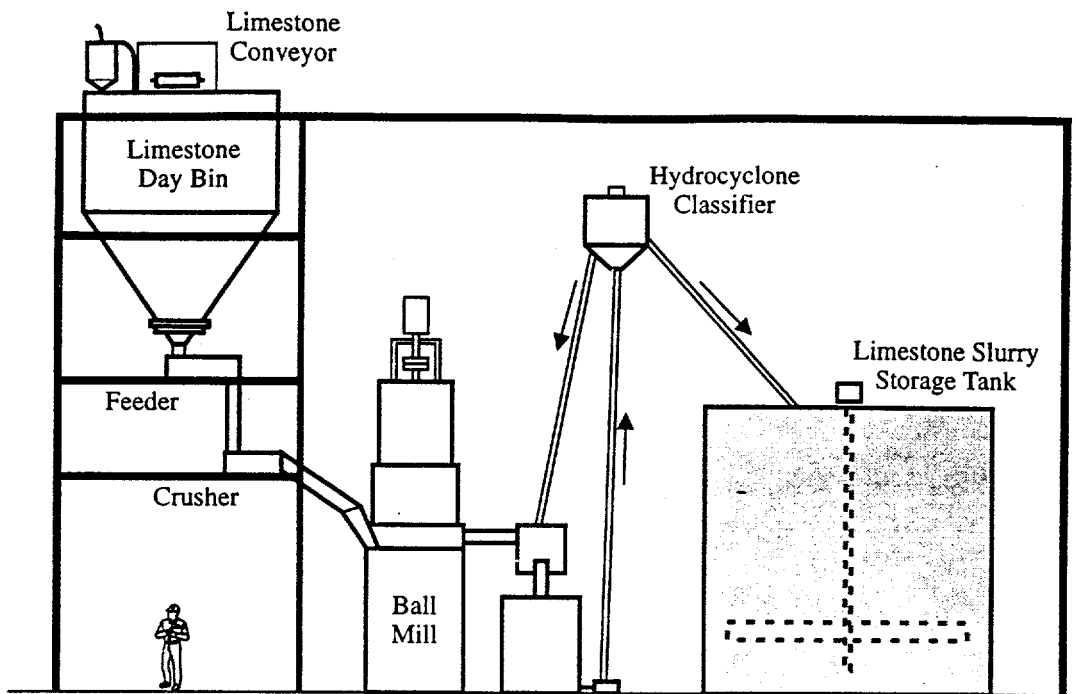

Elevation

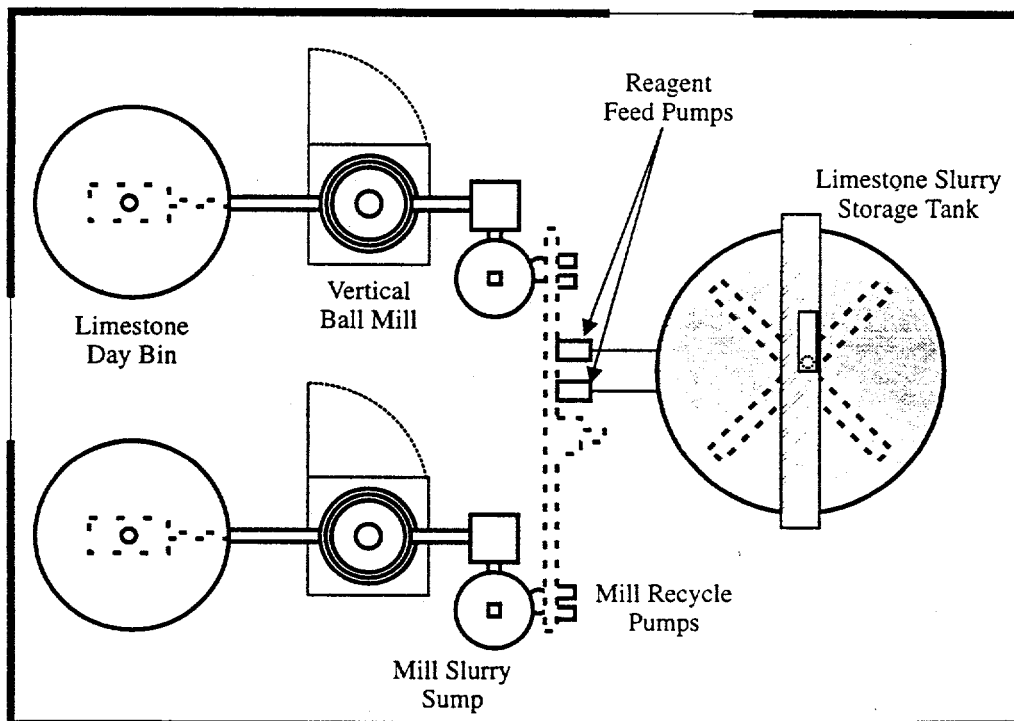

Plan View

Figure 4.7-7. Limestone Reagent Preparation Equipment Arrangement

oversized particles is performed by a hydrocyclone classifier. A vertical ball mill uses both a gravity settling tank and a hydrocyclone classifier. The hydrocyclone product consisting of a 30 to 40% solids slurry is directed to the limestone slurry storage tank. The oversized material removed by the hydrocyclones is directed to the feed end of the ball mill for additional grinding.

Limestone Slurry Storage

The limestone slurry storage tanks provide the needed surge capacity in the reagent preparation system. As with the lime slurry storage tanks discussed previously, the total volume of reagent storage is dependent on the maximum reagent demand and the operating frequency of the limestone reagent grinding equipment. One alternative is to operate the grinding equipment one shift per day, 7 days per week, and size the slurry storage tanks to provide 24 hours' storage at the maximum reagent consumption rate. To minimize the capital costs of the ball mills, the limestone reagent preparation systems can be designed to operate 24 hours per day, 7 days per week. The reagent storage capacity for such systems can be reduced to as little as 8 hours at maximum reagent consumption. This approach requires the selection of very reliable equipment and careful evaluation of required equipment redundancy. Part I, Section 6.0--System Reliability discusses the topic of reagent preparation equipment redundancy in more detail.

In a system identical to that described for the lime slurry reagent feed pumps, the limestone reagent slurry is transferred to the absorber modules as needed to control the pH in the reaction tanks. The same design slurry piping velocities and automatic slurry line drain and flush provisions apply.

4.7.3 Chemical Additive Preparation Equipment

Unlike the lime and limestone reagents, chemical additives for lime- and limestone-based FGD systems are usually delivered in a ready-to-use form. Therefore, the additive preparation equipment consists of only storage and delivery systems.

Emulsified Sulfur

Emulsified sulfur is added to FGD systems to produce thiosulfate for inhibiting sulfite oxidation. Sulfur is usually delivered as an emulsion of very fine particles suspended in water. A small amount of clay and surfactant is used to produce a stable suspension that contains about 70% solids by weight. This material is transported in tank trailers with a maximum capacity of about 23 tonnes (25 tons). The required sulfur feed rate for a 500 MW system burning a 2% sulfur coal is only about 6 to 12 kg/hr (assuming 50% conversion to thiosulfate), so that a sulfur tank that is sized to contain one or two tanker loads, about 40 tonnes (10,000 gallons), provides sufficient on-site storage for several months' supply.

Sulfur is usually pumped from the storage tank to the reagent slurry storage tank on an intermittent basis because the average delivery rate is so small [less than 0.06 L/s (1 gpm)]. Typically, sulfur addition on a once-per-week basis is sufficient to maintain a reasonably steady concentration in the FGD system liquor. A positive-displacement metering pump may be used so that the desired amount can be fed by operating this pump for a timed duration. For larger FGD systems, depending on the thiosulfate level that is being maintained, it may be possible to off-load a single tanker into the reagent slurry storage tank without intermediate storage. With this approach, the thiosulfate concentration in the process slurry rises rapidly, then slowly decreases until the next tanker is received.

DBA/Sodium Formate/Formic Acid

The storage and delivery system for DBA, sodium formate, or formic acid is similar to that for emulsified sulfur, except that with DBA, the storage tank must be heated. DBA is typically delivered in tank trailers as a 50% solution in water. This material must be maintained at about 50°C to prevent crystallization. Formic acid is supplied as an 85% solution in water, and does not require heating. A sodium formate storage tank should be heated and insulated unless it is located in a heated indoor location. Supplied as a 50% solution in water, sodium formate crystallizes at 25°C (77°F); a 40% solution crystallizes at 10°C (50°F).

The organic acid storage tank is sized to hold two tank trailers [about 40 tonnes (10,000 gallons)] so that a full tanker can be unloaded into storage before the tank is completely empty. For the example 500 MW station burning 2% sulfur coal, a typical DBA or formic acid feed rate might be about 50 kg/hr (100 kg/hr of 50% solution) so that a 40 tonne storage tank would provide at least two weeks' supply.

As with sulfur, DBA, sodium formate, and formic acid need not be metered continuously to the process, but can be added on an intermittent basis so that the delivery pump and line size are not so small that plugging becomes a problem. For example, DBA might be pumped into the reagent slurry storage tank over a period of one or two hours each day. Depending on ambient temperature and on the length of the DBA delivery line, the line might need to be heat-traced to prevent crystallization of DBA.

4.7.4 Materials-of-Construction Considerations

The materials of construction used for the reagent/additive preparation equipment are selected on the basis of the erosion and corrosion potential of the materials handled. In the lime and limestone reagent preparation equipment, the potential for erosive wear predominates the material selection. In the chemical additive preparation equipment the

principal concern is corrosion. Detailed information on each of the materials identified in this section is presented in Part I, Section 5.0--Materials-of-Construction Options.

Lime Slurry Preparation System Materials

The equipment in the lime slurry preparation system is subjected to slightly erosive conditions. The lime storage silos may be fabricated of either carbon steel or concrete. The day bins are constructed of carbon steel. The pneumatic transfer piping is fabricated of carbon steel, although erosion-resistant cast iron may be preferred for some areas of high erosive wear such as elbows and bends.

The 20 to 30% solids lime slurry leaving the slaker is slightly more abrasive if the grit has not been removed by the slaker. The reagent storage tank is typically an unlined carbon steel tank. An erosion-resistant, reinforced resin liner is frequently recommended for use on the tank floor to control the erosive wear in this area due to the tank agitator. The agitator shaft and paddle arms are rubber-coated carbon steel to withstand the more severe erosive wear they experience.

Lime slurry piping is almost exclusively fabricated of carbon steel pipe; however, erosion-resistant fiber-reinforced plastic (FRP) and high-density polyethylene (HDPE) piping would also be suitable. The slurry pumps in this system are fabricated of either rubber-lined cast iron or an erosion-resistant cast iron alloy.

Limestone Slurry Preparation System Materials

The limestone handling equipment uses the same materials that would be used for similar service in coal handling equipment. The limestone day bins are fabricated of carbon steel, although special erosion-resistant liners may be used in areas of high wear near the bins' outlets.

Limestone slurry is more erosive than lime slurry, and more erosion-resistant materials are used. The limestone slurry also has a higher chloride content (due to the use of reclaimed water to produce the slurry), and, therefore, corrosion is an additional concern. For these reasons, the reagent storage tank is typically fabricated of carbon steel with a reinforced resin liner. As in the case of a lime slurry storage tank, an erosion-resistant liner material is used on the tank floor to control erosive wear. The 30 to 40% solids slurry produced by the ball mills is too erosive for either unlined carbon steel pipe or erosion-resistant FRP pipe. Therefore, rubber-lined carbon steel piping is most often used for the limestone slurry feed piping. At least one existing FGD installation has replaced its rubber-lined piping with HDPE piping, which is less expensive and provides similar life in this service. Other facilities are having success with cast basalt-lined pipe. The slurry pumps in this system are fabricated of either rubber-lined cast iron or an erosion-resistant cast iron alloy.

Chemical Additive System Materials

The emulsified sulfur is neither erosive nor corrosive and can be handled by components fabricated of carbon steel, FRP, or plastic. All of the materials used in lines that are to be freeze-protected must be compatible with the temperatures produced by the heat-tracing equipment.

DBA, sodium formate, and formic acid are corrosive and the additive storage tank, piping, and pumps are typically constructed of Type 304 or Type 316 stainless steel. Valves should be either stainless steel or rubber-lined carbon steel.

4.8

Byproduct Solids Handling Equipment

Figure 4.8-1 illustrates the series of decisions that must be made regarding byproduct solids handling. Someone unfamiliar with FGD processes might assume that the choice of byproduct solids handling method would be one of the last decisions made in the course of an FGD system installation. Actually, it is one of the first, and ranks equal to the selection of the reagent type in its importance in establishing the overall FGD system design considerations. Generally, at the same time that the utility engineers are evaluating reagent supplies available to the site, an evaluation must also be made of whether the FGD process's byproduct solids will be disposed of as a waste material or whether all or a portion of the solids can be utilized off site as a saleable byproduct such as commercial-quality gypsum. The factors that influence this decision are discussed in Part I, Sections 3.5.4--FGD Byproduct Solids Management, 4.1.5--Site Conditions, and 4.1.6--Regional Demand for Byproduct Solids. This section of the manual is concerned with the design factors that must be considered after this critical decision has been made.

Byproduct solids handling can be divided into four general steps regardless of whether the solids will be treated as a waste material or as commercial-quality gypsum:

- Primary dewatering;
- Secondary dewatering;
- Tertiary processing to modify the physical or chemical characteristics of the solids; and
- Ultimate disposal of the solids.

As shown in Table 4.8-1, each of these steps presents additional equipment options that must be considered in specifying a complete byproduct solids handling system.

Typical waste byproduct solids handling systems are shown in Figures 4.8-2 and 4.8-3. The system shown in Figure 4.8-2 is typical of one that could process the

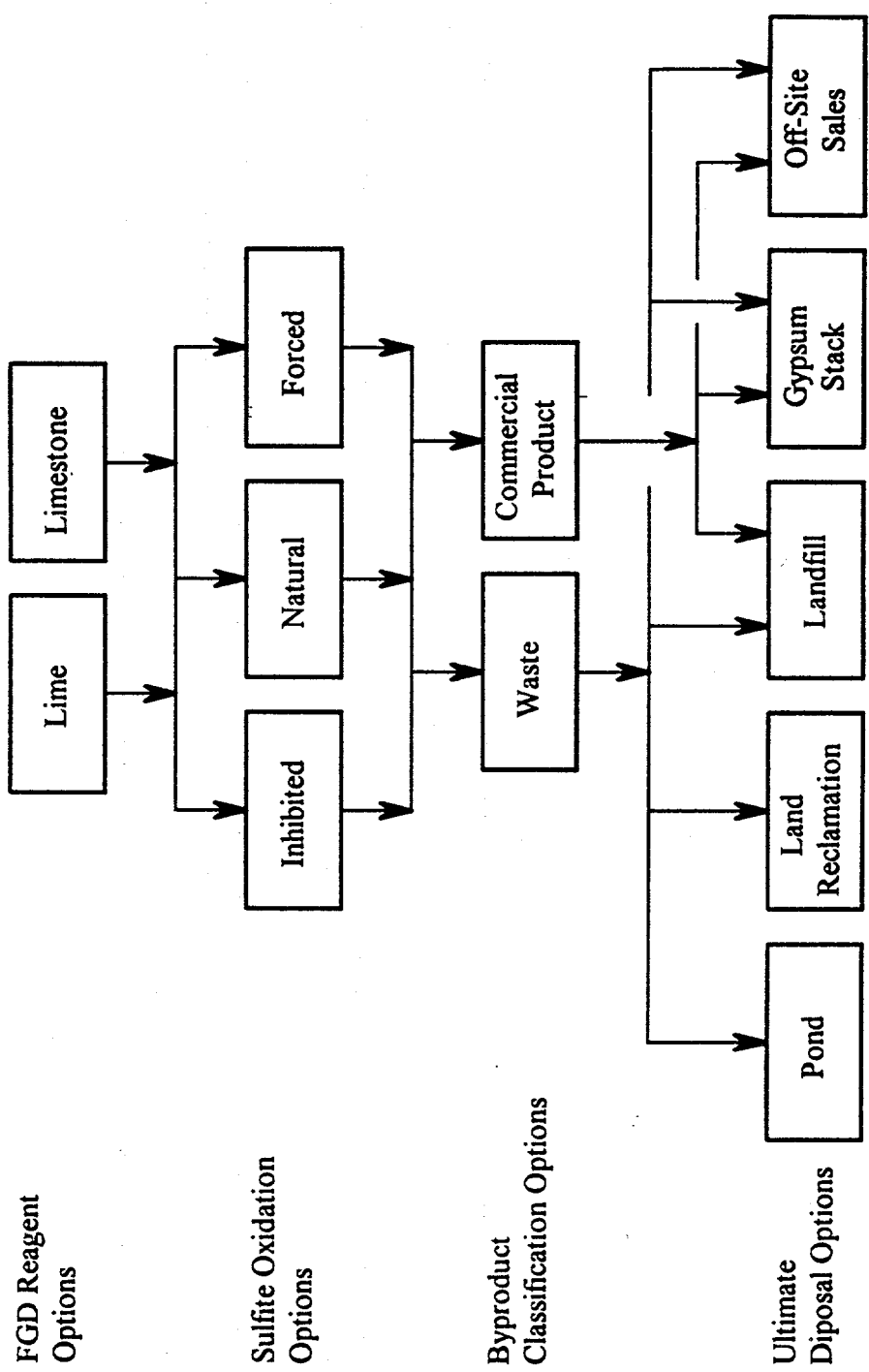

Figure 4.8.1. Byproduct Disposal Decision Alternatives

Table 4.8-1
Byproduct Solids Handling Equipment Options

Byproduct Handling Steps	Equipment Options	Byproduct*			Commercial-Quality Gypsum
		I	N	F	
Primary dewatering	Thickener	✓	✓	✓	✓
	Hydrocyclones			✓	✓
	None	✓	✓	✓	✓
Secondary dewatering	Horizontal vacuum filter	✓	✓	✓	✓
	Horizontal belt filter			✓	✓
	Centrifuge	✓	✓	✓	✓
	Other	✓	✓	✓	✓
	None	✓	✓	✓	
Tertiary processing	Stabilization	✓	✓		
	Fixation	✓	✓		
	Pelletizing				✓
	None	✓	✓	✓	✓
Ultimate disposal	Pond	✓	✓	✓	
	Landfill	✓	✓	✓	✓
	Gypsum stack			✓	✓
	Land reclamation	✓	✓	✓	
	Off-site sale	✓	✓	✓	✓

* Byproduct Solids: I = Inhibited-oxidation FGD process
 N = Natural-oxidation FGD process
 F = Forced-oxidation FGD process

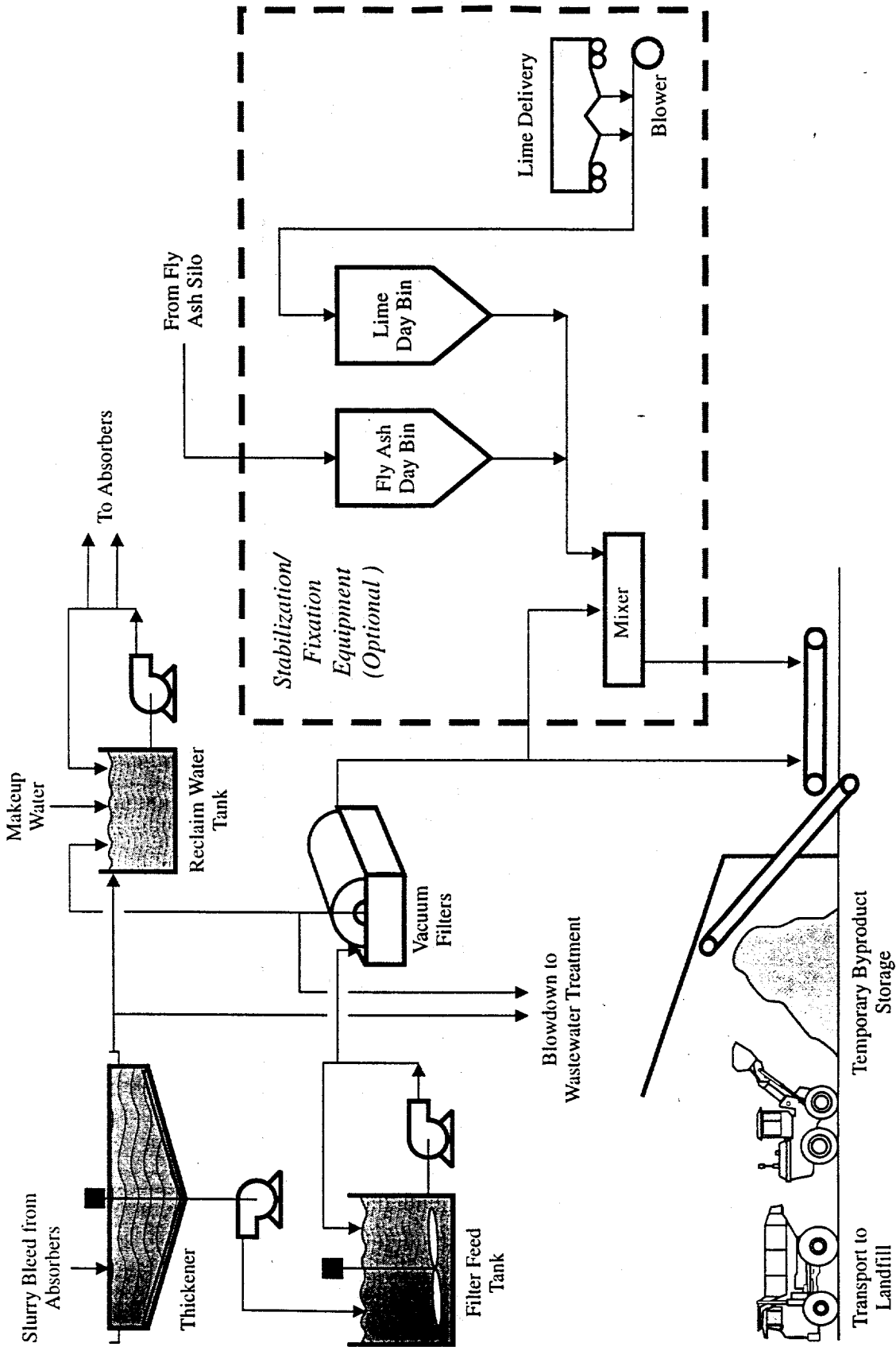

Figure 4.8-2. Typical Waste Byproduct Solids Handling System

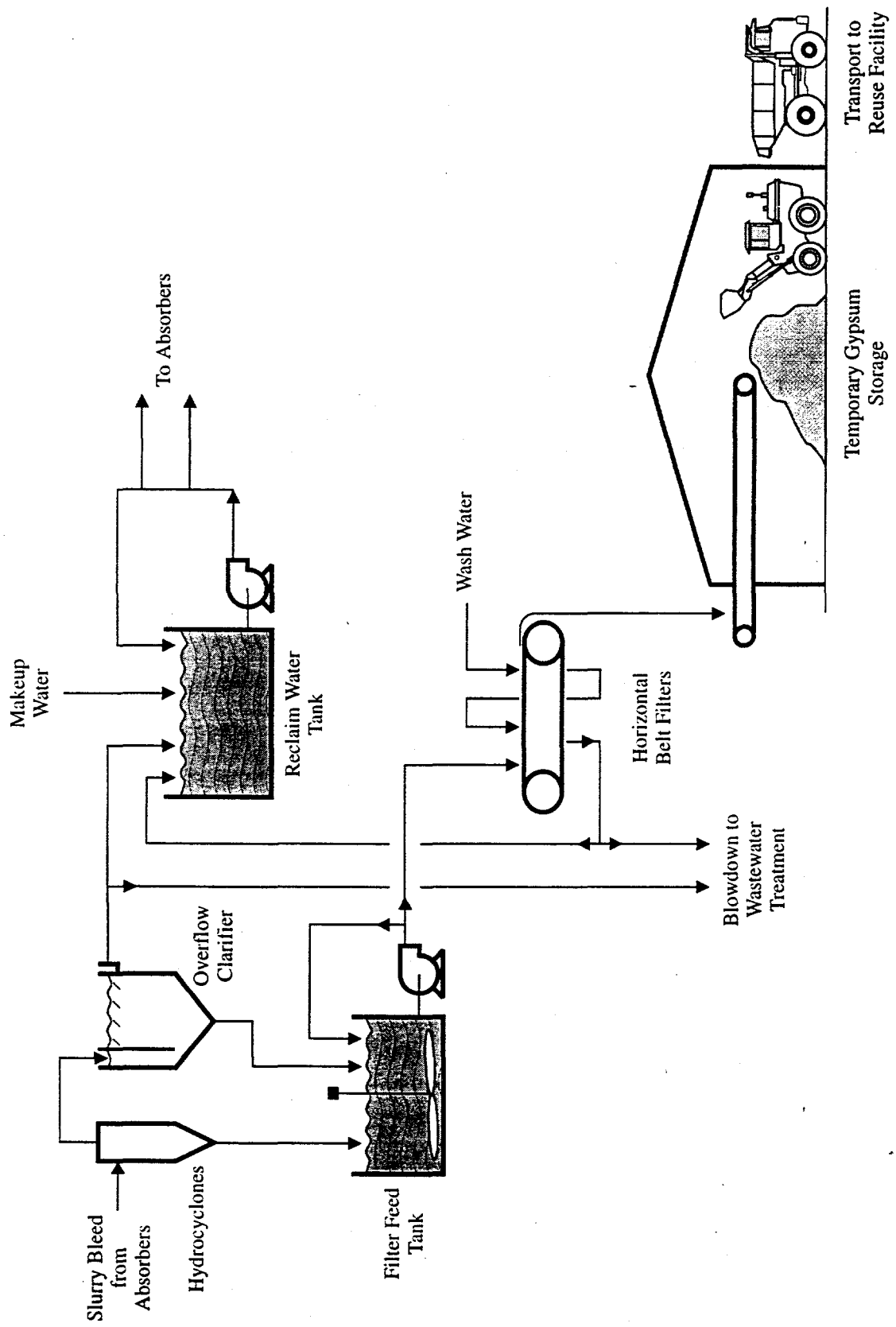

Figure 4.8-3. Typical Commercial-Grade Gypsum Handling System

byproduct solids produced by either a lime- or limestone-based FGD system using a natural-, inhibited-, or forced-oxidation process. The system presented in Figure 4.8-3 shows the process changes that can be implemented when a forced-oxidation process is used and a saleable byproduct is produced.

4.8.1 Primary Dewatering

The principal purpose of the primary dewatering equipment is to reduce the volume and increase the solids concentration of byproduct slurry processed by the secondary dewatering equipment. For most FGD systems, the bleed stream from the absorber modules is discharged to the primary dewatering system as a slurry containing approximately 10 to 15% solids (100 to 150 g solids per kg slurry). The primary dewatering equipment concentrates the slurry to between 30 and 50% solids. In Figure 4.8-2, primary dewatering is provided by a thickener. Although a single thickener is shown in the figure, more than one thickener is often installed to reduce the potential for the complete loss of byproduct solids processing ability as a result of an equipment failure. In Figure 4.8-3, a bank of hydrocyclones is provided for primary dewatering. Hydrocyclones are very effective at separating relatively large, dense particles from the slurry and, therefore, are well suited for concentrating the calcium sulfate (gypsum) solid produced by a forced-oxidation FGD process. Additional information on the design and operation of the primary dewatering equipment is provided in Part II, Sections 11.0--Thickeners and 12.0--Hydrocyclones.

Not all FGD systems require primary dewatering. Most systems that use ponds or gypsum stacks for ultimate disposal do not provide primary dewatering. The absorber slurry bleed stream is discharged directly to the disposal pond or stack, which combines the functions of primary and secondary dewatering and ultimate disposal. Also, one limestone-based FGD system using the forced-oxidation process and a cocurrent absorber operates with a reaction tank slurry solids level in the range of 20 to 30% and does not use any primary dewatering. For this process, the absorber bleed stream may be discharged directly to the secondary dewatering equipment. Theoretically, even a process with 10 to 15% reaction tank

slurry solids could omit the primary dewatering step. In this case, however, the larger required number and capacity of the secondary dewatering equipment usually results in overall capital costs being much greater than when primary dewatering is provided.

The process water recovered during primary dewatering is directed to the reclaim water tank for reuse in the FGD system. Overflow from a thickener can be sent directly to this tank. Because the overflow from the hydrocyclones may have a suspended solids level of 5% or more, an overflow clarifier or second set of hydrocyclones must process this flow prior to entering the reclaim water tank. The solids removed are directed to the underflow storage tank. If the FGD system must discharge a blowdown stream from the system to control the soluble chloride level in the system, the blowdown is normally taken from overflow from the primary dewatering equipment prior to the reclaim water tank. Depending on the FGD system's overall water management system, fresh FGD system makeup water may be added to the reclaim water tank.

Most of the reclaim water is returned to the absorber module reaction tanks for level control and, under certain conditions, for washing the mist eliminators. Limitation on the use of reclaim water for washing mist eliminators was discussed in Part I, Section 4.4--Mist Eliminator System. In limestone-based systems, reclaim water is also used to prepare the limestone reagent slurry.

The concentrated solids leaving the primary dewatering device are directed to an underflow storage tank (also called a filter or centrifuge feed tank). This agitated tank serves as a surge tank and allows independent operation of the primary and secondary dewatering systems. The primary dewatering equipment must operate 24 hours per day, 7 days per week; and throughout the operating day, the flow rate of concentrated solids discharged to the tank varies on the basis of factors such as the generating unit load and the coal sulfur level. The underflow storage tank is typically sized to permit the secondary dewatering equipment (rotary vacuum filters, for example) to operate at a constant feed rate and on a more limited schedule. For example, the utility may want to operate the secondary

dewatering equipment for 10 hours per day, 7 days per week to provide time for equipment cleanup and repair. Additionally, the utility may want to minimize operating adjustments to the secondary dewatering equipment by bringing equipment trains in and out of service on the basis of the level in the underflow storage tank. The storage tank also improves the reliability of the overall FGD system by reducing the occasions when a short-term outage of the secondary dewatering equipment or other downstream equipment could affect the operation of the absorbers or primary dewatering equipment.

4.8.2 Secondary Dewatering

The purpose of the secondary dewatering equipment is to reduce the moisture content of the byproduct solids to the point that they can be placed in a landfill, or in the case of commercial-quality gypsum, transported to the gypsum reuse facility. As discussed earlier, if the ultimate disposal of the waste byproduct solids is to be in a pond or gypsum stack, no secondary dewatering equipment is required. Depending on the degree of sulfite oxidation achieved in the FGD absorbers, the dewatered solids leaving the secondary dewatering equipment will have a solids content from as low as 45% to over 90 percent. The low end of this range is typical of inhibited- or natural-oxidation, lime-based FGD processes. The high end is typical of limestone-based processes producing commercial-quality gypsum.

Various types of secondary dewatering equipment have been used to process FGD byproduct solids. The types most frequently used are rotary drum vacuum filters, horizontal belt vacuum filters, and centrifuges. Additional information on these devices is provided in Part II, Sections 13.0--Vacuum Filters and 14.0--Centrifuges. Rotary drum vacuum filters and centrifuges can be used on all types of byproduct solids, regardless of the sulfite oxidation level. Horizontal belt filters are less widely applied unless commercial-quality gypsum is produced and the solids are to be washed to remove water-soluble salts.

The choice between vacuum filters and centrifuges is a complicated decision for the utility engineer. FGD specifications can take any of several approaches to making this choice. The specifications may:

- Specify a particular type of filter or centrifuge;
- Request that the FGD system proposal include alternative designs, so that price and guaranteed performance can influence the choice; or
- Allow the FGD vendor to base the design on equipment that (in their opinion) best meets the performance specifications.

Based on recent FGD installations worldwide, the only clear trend in using particular types of dewatering equipment is that decanter centrifuges dominate the inhibited-oxidation FGD segment. Among new forced-oxidation systems, both vacuum filters and centrifuges are used. Although most German systems have used horizontal belt filters and most U.S. systems have used rotary drum filters, vertical basket centrifuges have been selected for some recent major FGD projects. The Northern Indiana Public Service Company's Bailly Station in the United States and National Power's Drax Station in the United Kingdom both produce wallboard-quality gypsum using vertical centrifuges.

Choosing the optimum dewatering equipment for a specific facility mainly depends on the type of FGD process and the characteristics of the byproduct solids. Production of wallboard-quality gypsum requires that the gypsum be washed with fresh water to reduce soluble chlorides and dewatered to over 90% solids. Wallboard producers require a dry gypsum feed for their process, so cake moisture is an important consideration. With economic credits for dry cake (or penalties for not meeting the moisture specification), the utility can afford to pay a premium for equipment that achieves the minimum cake moisture. Capital costs of drum filters are considerably lower than those of belt filters or centrifuges, but drum filters provide less efficient cake washing and may have problems producing very dry filter cake (>85% solids). For a given gypsum dewatering process, the capital investment for a belt filter system and a vertical centrifuge system may be similar. Although filters are

often reported to require less power than centrifuges, the advantage is reduced when the comparison includes all auxiliary equipment.

Centrifuges have two major advantages over filters: they produce a drier product and they have a more compact and enclosed design. Filters require auxiliary equipment such as vacuum receiver tanks, vacuum pumps, and process sumps that centrifuges do not need. Other costs resulting from the auxiliary equipment include building space, installation, and maintenance costs. Filters have higher water requirements because of the seal water typically used for the vacuum pumps. Centrifuges may have lower maintenance costs than filters. The required periodic replacement of filter media is a major time-consuming operation.

Conversely, filters have some advantages over centrifuges. Aside from the low capital cost of drum filters, the major difference is that filters operate at much lower speeds. The lower speed of filters results in fewer problems related to abrasion and vibration. Another advantage is that operating problems with filters can be readily seen, whereas centrifuge problems may not be as apparent. Centrifuges typically allow more solids into the recovered liquid stream (centrate) than filters do. Although the centrate may contain up to 2% solids, this may not be a significant difference since centrate and filtrate are both typically returned to the thickener or to another point in the FGD process.

The Electric Power Research Institute (EPRI) supported a study comparing the secondary dewatering options of horizontal and drum filters and vertical and horizontal decanter centrifuges (1). In the tests, a gypsum slurry containing either 5,000 mg/L or 40,000 mg/L chloride was first dewatered by thickeners or hydrocyclones to within the range of 40 to 60% solids. The goals of secondary dewatering were to produce a cake with 85% solids and washed to 200 ppm (dry basis) chloride. Reported test results show that both vacuum filters and the vertical centrifuge met the goals for chlorides and solids. The best technical performance was achieved by the vertical centrifuge, which produced 90% solids. However, the drum filter had the lowest projected costs. The horizontal centrifuge, which had a solid

bowl section and a screen section for cake washing and final dewatering, was not able to meet the required 85% solids while producing a washed cake.

Regardless of the type used, secondary dewatering equipment is normally installed as a number of parallel components; for example, three 50%-capacity vacuum filters. The use of multiple components results from the following factors:

- The required solids dewatering rate (kg/h) may be greater than the capacity of the largest available dewatering device;
- The dewatering equipment normally performs better if the feed rate and solids content of the feed material to each component are relatively constant;
- Batch-type equipment (e.g., vertical basket centrifuges) can process the byproduct slurry almost continuously if multiple components are used and their operating sequences are coordinated (see Part II, Section 14.0--Centrifuges);
- Multiple components improve the reliability of the secondary dewatering process (see Part I, Section 6.0--System Reliability); and
- The equipment requires a significant amount of maintenance and cleanup.

The water recovered during secondary dewatering is normally routed to the reclaim water tank for reuse in the FGD system. If the recovered water contains a significant amount of byproduct solids, it may be returned to the primary dewatering equipment.

The dewatered solids are discharged onto a series of conveyors that transport them either to tertiary processing or to a stackout and temporary storage area. The stackout conveyor at the temporary storage area is often a radial stacker conveyor that can produce a pile with several days' storage capacity. In some cases, utilities have elected to cover the temporary storage area to facilitate truck loading operations in cold or wet weather. When commercial-quality gypsum is produced, the temporary storage is typically covered because the dewatered material generally must have a solids content of 90% or greater. Uncovered

temporary storage of commercial-quality gypsum is less necessary if the gypsum will be used for agricultural purposes, but would improve material handling conditions during wet weather.

4.8.3 Tertiary Processing

Tertiary processing is performed on the waste byproduct solids leaving the secondary dewatering equipment in order to improve their physical or chemical characteristics. There are a number of physical and chemical factors of interest in the disposal of waste byproduct solids, including the following:

- Handling characteristics--Do handling and transportation of the solids create any operating problems?
- Bearing strength--How much weight will the solids support when placed in a landfill?
- Leachate characteristics--How permeable are the solids placed in a landfill and what are the chemical characteristics of the leachate produced?

The most common tertiary processes for byproduct solids are stabilization and fixation. The stabilization process involves combining byproduct solids with fly ash to improve the mixture's handling characteristics and bearing strength (measured as unconfined compressive strength*) and to reduce the mixture's permeability. The weight ratio of fly ash to wet byproduct solids is typically in the range of 1:3 to 1:1. The fixation process is similar to stabilization except that lime is added to the byproduct solids/fly ash mixture (1 to 3% by weight) to increase the unconfined compressive strength and reduce the permeability of the compacted byproduct, and to improve leachate chemical characteristics. The mixing of the byproduct solids, fly ash, and lime (fixation only) is typically conducted in a pug mill mixer similar to the mixer illustrated in Figure 4.8-4. The mixture leaving the mixers is conveyed

* American Society for Testing and Materials (ASTM) Standard D-2166, Unconfined Compressive Strength, measures the load per unit area at which an unconfined cylindrical sample will fail because of an imposed compression load.

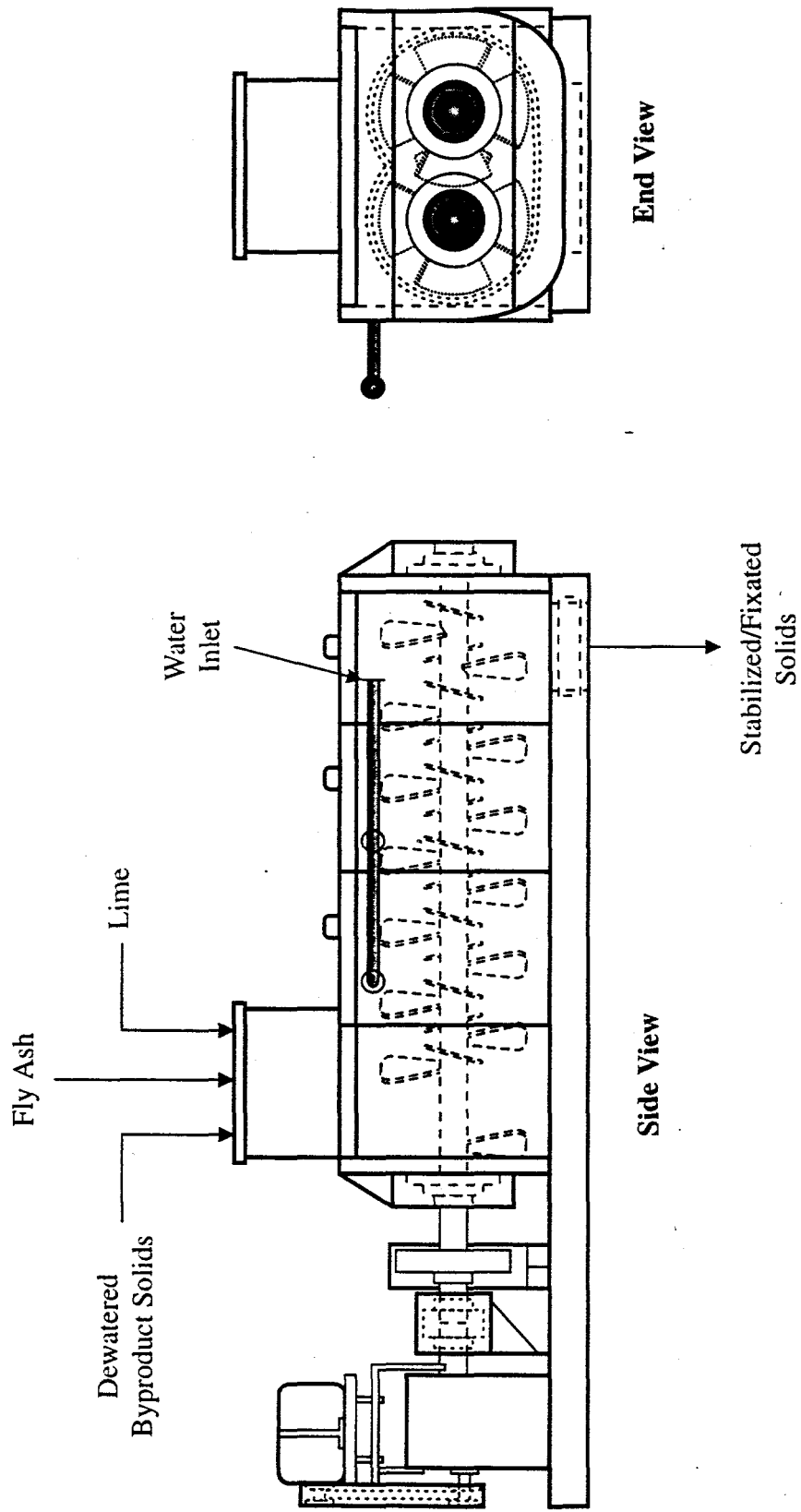

Figure 4.8-4. Pug Mill Mixer

to the temporary storage area for transport to the disposal landfill. When lime is added to the mixture, the solids should remain in the temporary storage area for several hours prior to transportation to allow some of the initial chemical reactions to occur prior to transportation to the landfill.

Some FGD byproduct solids, especially those from lime-based systems using natural oxidation, exhibit thixotropic behavior following secondary dewatering. Thixotropic solids appear to be solid as they leave the vacuum filter or centrifuge; however, when agitated or shaken, they become liquid. When left at rest, the liquefied material may partially resolidify. Thixotropic solids are very difficult to convey or transport since the motion experienced during the transfer operations is enough to liquefy the solids. Both stabilization and fixation are used to eliminate thixotropic behavior in byproduct solids.

The unconfined compressive strength and permeability of byproduct solids placed in a landfill vary with the degree of sulfite oxidation and the solid crystal form. Table 4.8-2 contains typical values of these characteristics as a function of sulfite oxidation level (2). As seen in this table, stabilization and fixation improve both characteristics. The reduced permeability and increased compressive strength obtained through fixation result from increasing the level of lime addition.

The degree of improvement in the physical and chemical characteristics of the byproduct solids is dependent on many factors, including the initial characteristics of the solids, the amounts of fly ash and lime added, and the design and operation of the byproduct solids landfill. The fixated material has been used as structural fill material and road-base material, and has been tested as a synthetic aggregate for concrete. The design of a stabilization/fixation system is a specialized expertise, and the use of an experienced consultant is recommended.

Although it is not usually necessary, tertiary processing in the form of solids pelletizing or thermal drying may be installed when commercial-quality gypsum is produced.

Table 4.8-2
Dewatered FGD Waste Byproduct Characteristics*

Waste Byproduct	Permeability, cm/s	Unconfined Compressive Strength, kg/m²
Inhibited-oxidation	Free draining	0
Natural-oxidation	Free draining	0
Forced-oxidation	1.0×10^{-5}	2.1×10^4
Stabilized**	1.0×10^{-6}	4.6×10^4
Fixated***	5.0×10^{-9}	9.5×10^5

Note: $1 \times 10^4 \text{ kg/m}^2 = 2048 \text{ lb/ft}^2$

- * Chemical and physical characteristics of coal combustion byproducts vary because of variations in fuel characteristics, reagent composition, and FGD system performance. Actual values may vary by a factor of 5 to 10.
- ** Blended with fly ash; compaction only, no pozzolanic activity.
- *** Blended with fly ash and lime, then compacted. Typical values are after 4 months of curing.

Source: Conversion Systems, Inc. (2)

Some users of byproduct gypsum prefer that the gypsum be pelletized or dried to improve its handling and storage characteristics, and pelletized or dried gypsum may bring a higher market price. In a pelletizing operation, the byproduct gypsum from the secondary dewatering equipment is conveyed to the pelletizer where the material is formed into hard pellets through the addition of binders and the application of pressure and heat. The uncured pellets are conveyed to a covered, temporary storage facility to cure (harden) prior to shipment. Various styles of commercial thermal dryers may be used to increase the moisture content of the gypsum product to less than 5% by weight.

4.8.4 Ultimate Disposal

Waste Byproduct Solids

The waste byproduct solids produced by the FGD system must be disposed of in an environmentally sound manner. There are three principal alternatives for ultimate disposal of waste byproduct solids: ponds, landfills, and gypsum stacks. In addition, fixated/stabilized materials can be used for land reclamation or production of a commercial product (3-6). The advantages and disadvantages of each alternative are presented in Table 4.8-3. The selection of alternatives is extremely site-specific, depending on topography, available land, groundwater depth, and similar factors. All of these factors must be considered to determine each alternative's physical, economic, and regulatory feasibility. In all cases, protection of the groundwater aquifer from contamination by leachate from the byproduct solids is a critical design consideration.

A detailed discussion of the design of an ultimate disposal area is beyond the scope of this manual. The determination of the best alternative for a specific facility is based on a detailed engineering and regulatory study. The following paragraphs provide brief overviews of each disposal alternative.

Table 4.8-3
Advantages and Disadvantages of Alternative Waste Byproduct Solids Disposal Alternatives

Disposal Method	Advantages	Disadvantages
Pond	<ul style="list-style-type: none"> ▶ Lowest operating cost. ▶ Eliminates the need for primary and secondary dewatering equipment. ▶ Byproduct transported by pipeline. ▶ Operation not affected by cold weather. ▶ Least affected by FGD process variations. 	<ul style="list-style-type: none"> ▶ Largest land area requirement. ▶ Highest potential for groundwater contamination. ▶ Very poor recovery of chemical additives. ▶ Very site-dependent. ▶ Not feasible in areas of high rainfall. ▶ Uses of land after closure are limited. ▶ Modular expansion more difficult.
Landfill	<ul style="list-style-type: none"> ▶ Smallest land area requirement. ▶ Least potential for groundwater contamination. ▶ Least site-dependent. ▶ Very good recovery of chemical additives. ▶ Greatest flexibility in land use after closure. ▶ Modular expansion of disposal area. 	<ul style="list-style-type: none"> ▶ Highest operating cost. ▶ Primary and secondary dewatering required. ▶ Byproducts from inhibited and natural oxidation FGD systems require stabilization or fixation. ▶ Operation difficult in cold and wet weather. ▶ Affected by FGD process variations.
Gypsum stack	<ul style="list-style-type: none"> ▶ Lower operating cost. ▶ Lower land area requirement. ▶ Eliminates the need for primary and secondary dewatering equipment. ▶ Byproduct transported by pipeline. ▶ Good flexibility in land use after closure. ▶ Operation less affected by cold weather. 	<ul style="list-style-type: none"> ▶ Applicable only for byproducts from a forced-oxidation FGD system. ▶ Greater potential for groundwater contamination. ▶ Poor chemical additive recovery. ▶ Relatively site-dependent. ▶ Affected by FGD process variations. ▶ Less feasible in areas of high rainfall. ▶ Uses of land after closure are limited.
Land reclamation and commercial uses	<ul style="list-style-type: none"> ▶ Reduces on site disposal requirements. ▶ Beneficial use of byproduct material. 	<ul style="list-style-type: none"> ▶ Relatively high operating cost. ▶ Primary and secondary dewatering required. ▶ Generally requires stabilization or fixation. ▶ Operation difficult in cold and wet weather. ▶ Affected by FGD process variations.

Ponds--The arrangement and cross section of a typical disposal pond are presented in Figure 4.8-5. Depending on the topography of the site, disposal ponds may be either a single cell or multiple cells. Because the byproduct solids tend to settle out very near the discharge point, the discharge point must be periodically moved in order to efficiently use the pond's volume. The outlet structure is designed to control the level of water in the pond. As the pond fills with solids, the overflow level is raised. An impervious lining (either clay or a man-made material) is required to prevent the contamination of groundwater. In some locations, the pond is underlain by an impervious clay layer and no additional lining is required. Where a man-made liner is installed, a leachate collection system must be installed to intercept the leachate before it enters the groundwater aquifer. Even with the use of an impervious liner and leachate collection system, a system of groundwater monitoring wells may be required by the state regulatory agency to monitor groundwater quality up- and down-gradient from the ponds. The recovered water is either returned to the pond or the FGD system for reuse. On closure of the pond, the free water is drained from the pond and an impervious cap and soil cover are installed. In most cases, the ponded solids have very poor unconfined compressive strength, so the completed site has few commercial or recreational uses.

Landfills--A landfill is a frequently applied method for disposal of FGD byproduct solids. The cross section of a typical byproduct landfill is presented in Figure 4.8-6. The byproduct solids in the temporary storage area are loaded onto trucks and transported to the landfill. At the landfill, the material is spread and compacted by earthmoving equipment.

A landfill is developed in modules or cells which are kept as small as possible to minimize the generation of rainfall runoff. Each cell is developed as a series of lifts with a thickness of 600 mm (2 ft) or less to permit thorough compaction. As soon as a cell is full, an impervious cap and soil cover are installed. The location of the landfill is more flexible than for ponds; if necessary, several locations on the site can be developed. Because the material placed in the landfill develops a significant unconfined compressive strength, the

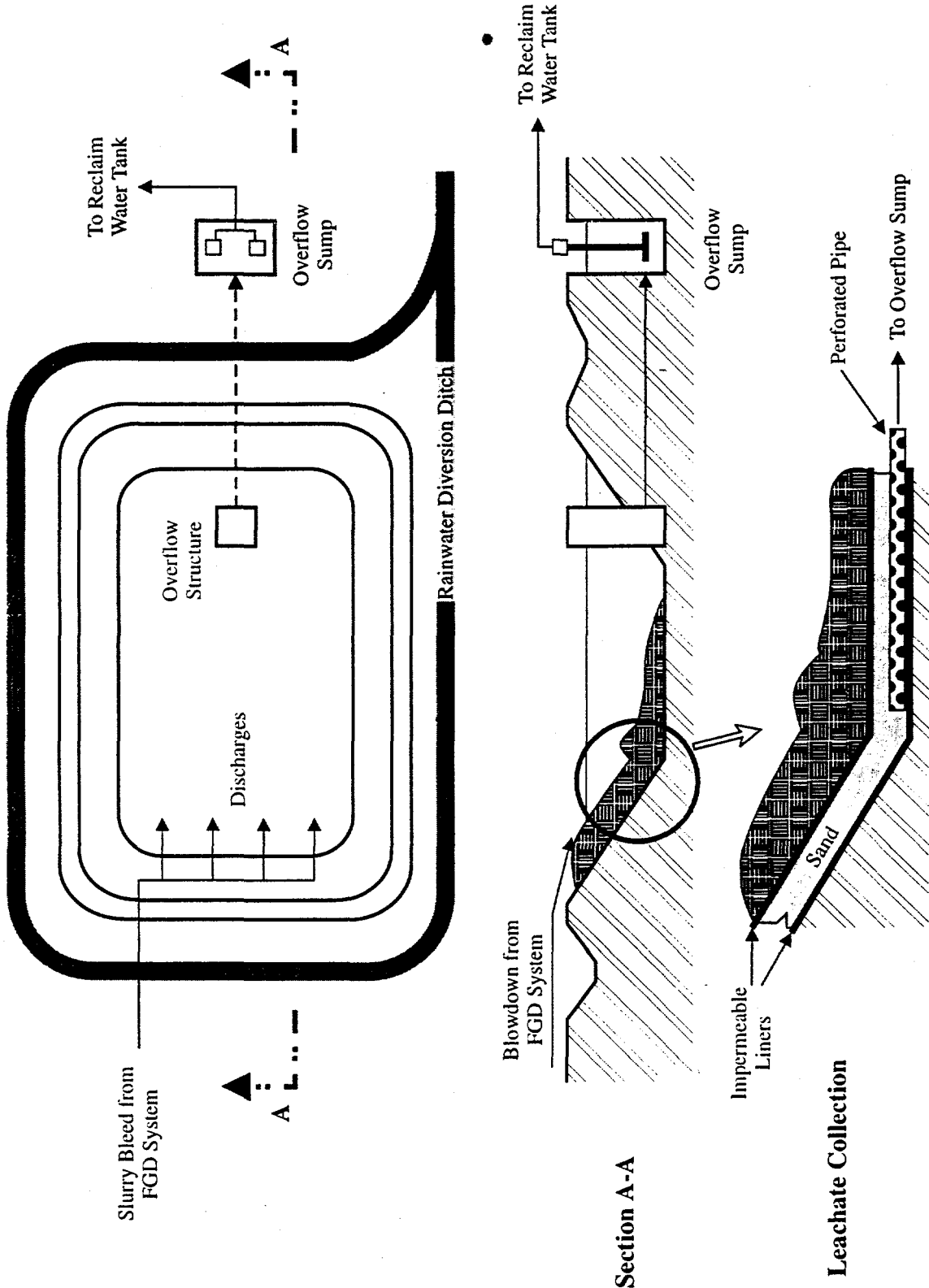

Figure 4.8-5. Waste Byproduct Disposal Pond

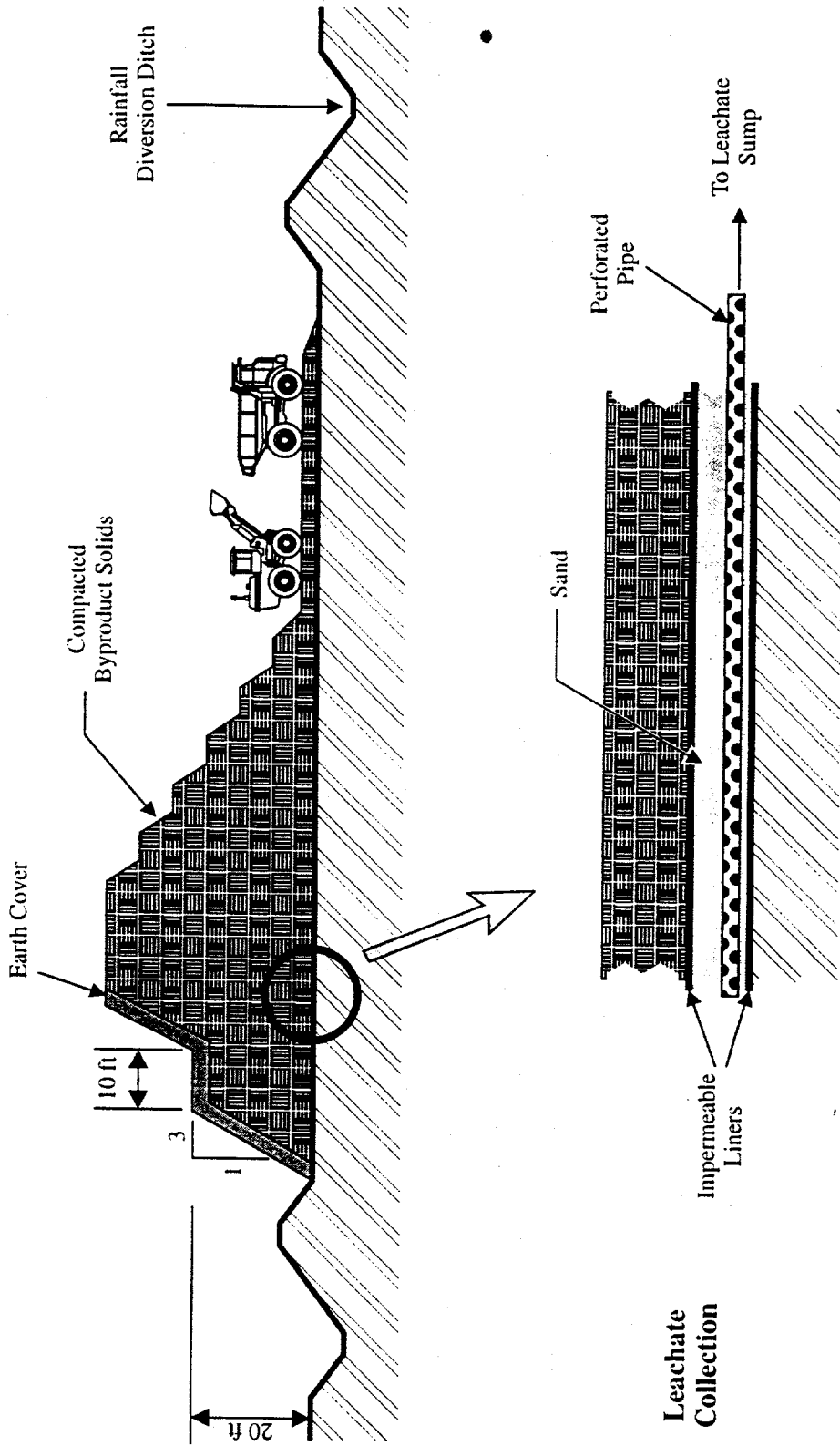

Figure 4.8-6. Waste Byproduct Disposal Landfill

disposal area has a variety of potential commercial and recreational uses after closure. For mine-mouth generating stations, the disposal of byproduct solids is often incorporated into the mine reclamation effort.

Like ponds, the landfill must be lined and a leachate collection system must be installed. In the case where the waste byproduct solids are fixated, the fixated material may be suitable for use as a lining material. At some facilities, layers of fixated solids are used to encapsulate stabilized solids or solids that have not received any tertiary processing. The leachate and rainwater runoff from the site must be collected. Often this wastewater is sprayed back onto the landfill to control fugitive dust or to facilitate solids compaction.

Landfill disposal presents both advantages and disadvantages, as listed in Table 4.8-3. Landfills can be developed at sites where the topography, groundwater depth, soil conditions, or other site-specific factors make the use of ponds infeasible. Because landfills have significant unconfined compressive strength, the completed landfill may have recreational or commercial uses. The dewatering of the solids by vacuum filters or centrifuges recovers a higher percentage of any chemical additives present in the process liquor. If the filter/centrifuge cake is washed during the dewatering process, an even greater percentage of chemical additives can be recovered. The greatest disadvantages of disposal in a landfill are the capital and operating costs of the necessary primary and secondary dewatering equipment and of the landfill operation.

Gypsum Stacking--Gypsum stacking is a relatively new method of disposing of FGD system byproduct solids but has been used on similar waste materials in the phosphate industry for many years. A typical arrangement and cross section of a gypsum stack are presented in Figure 4.8-7. In a gypsum stack, the bleed stream from the absorber modules is pumped to a settling area similar to operation in a disposal pond. The byproduct solids settle out and the clarified overflow water is directed to an overflow sump. Additional water flows through the gypsum stack walls and is collected in a peripheral ditch. This water is also directed to the overflow sump. The reclaimed water is returned to the FGD system for

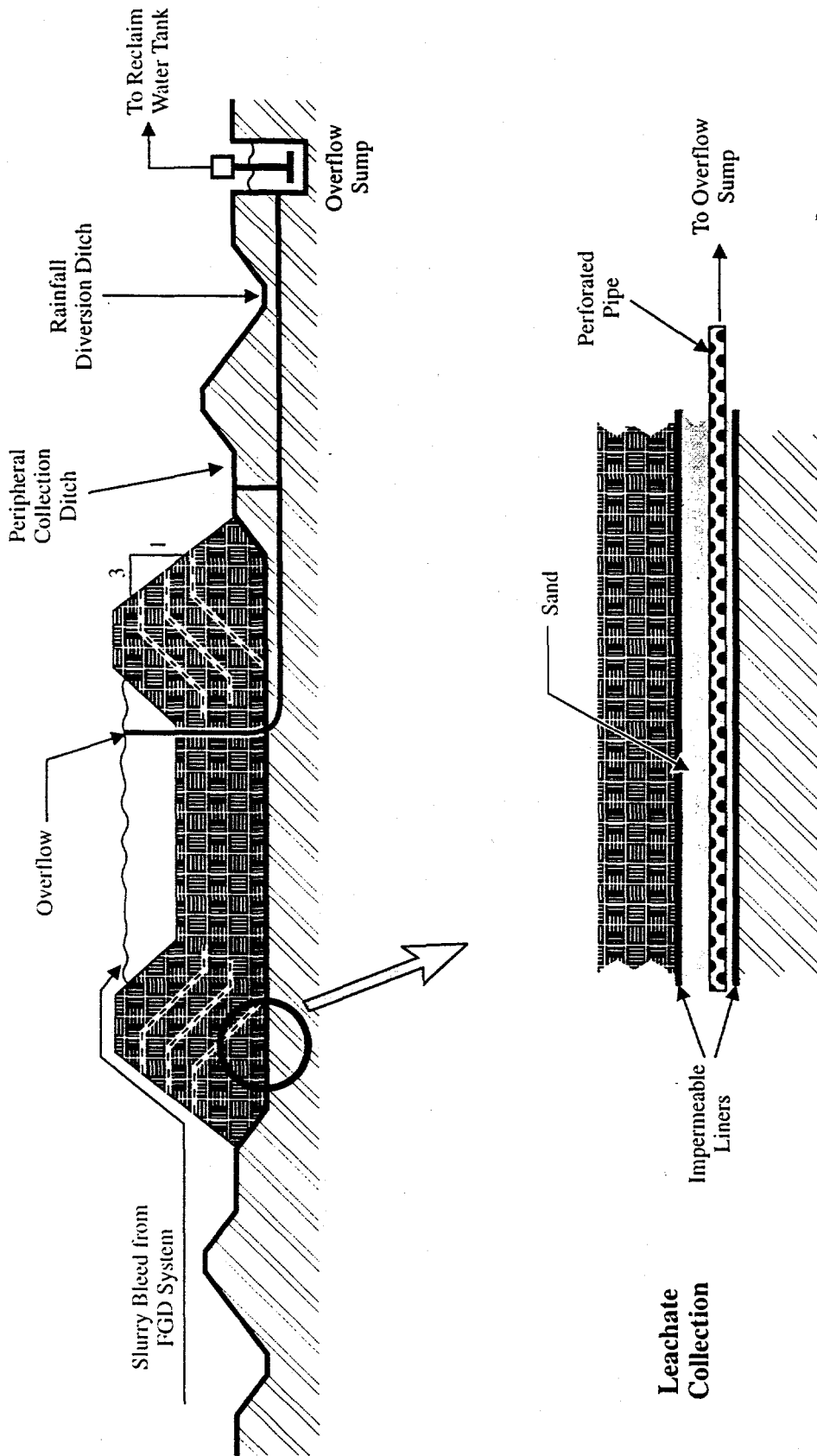

Figure 4.8-7. Gypsum Stack

reuse. Periodically, accumulated solids are dredged out and used to raise the height of the peripheral berms. Like ponds, gypsum stacks can be developed as a single cell or in multiple cells.

When the gypsum stack is closed, the free water is drained from the stack and an impervious cap and soil cover are installed. The stack has relatively poor unconfined compressive strength and has few commercial or recreational uses after closure.

Land Reclamation/Off-Site Commercial Uses--Fixated and stabilized FGD byproduct solids have been used for land reclamation for a number of years (3,4), and have recently been shown to be effective at reducing subsidence and acid drainage formation in underground mines (5). Additional uses such as production of artificial reefs and synthetic aggregate have been demonstrated on a pilot plant level (3). The economic feasibility of land reclamation and off-site commercial uses is very site-specific.

Commercial-Quality Gypsum

The commercial-quality gypsum in the temporary storage area is loaded onto trucks or rail cars and shipped to the end user. As discussed earlier, the loading area should be covered to prevent the rewetting of the gypsum.

Even if a market is found for all of the commercial-quality gypsum produced by the FGD system, a disposal landfill is still needed to dispose of byproduct solids that do not meet the commercial-quality gypsum requirements and to provide a disposal alternative during temporary disruptions in gypsum sales. Such disruptions may occur due to market changes, labor difficulties, or other problems. In this respect, the design and operating considerations are no different than for a facility that plans to sell its fly ash for off-site use.

While the emergency landfill can be much smaller than a landfill sized for the total byproduct production, the design requirements and operation are the same. It is difficult

to generalize about the recommended size of this landfill since the required storage capacity is dependent on projecting for the life of the generating unit such factors as the volume of "off-spec" material that may be produced and the cumulative duration of disruptions in off-site sales. A reasonable assumption would be that 10% of the byproduct produced over the life of the system would require disposal in the emergency landfill.

4.8.5 Materials-of-Construction Considerations

Detailed discussions of the characteristics of alternative materials of construction are presented in Part I, Section 5.0--Materials-of-Construction Options. The following sections present some of the more frequently used materials for the byproduct handling equipment.

Primary Dewatering Equipment

The materials of construction used in the primary dewatering equipment are selected on the basis of their ability to handle erosive and corrosive slurries. Both slurry piping and reclaim water piping are either rubber-lined carbon steel or fiber-reinforced plastic (FRP). Rubber-lined carbon steel piping is preferred for slurries with more than 25% solids. The thickener and underflow tank shells may be fabricated of concrete or carbon steel. In either case the shell should be lined with reinforced organic resins or coal-tar epoxy. Concrete lined with ceramic tile is also a suitable tank shell material. The thickener rake and other wetted equipment are rubber-covered carbon steel. The hydrocyclones have replaceable rubber linings.

The reclaim water tank does not handle any slurries, but the reclaim water can be corrosive because of the high chloride level. The most common material of construction for these tanks is carbon steel with a reinforced epoxy lining. Reclaim water piping can be fabricated of rubber-lined carbon steel or FRP.

Secondary Dewatering Equipment

The wetted parts of vacuum filters are fabricated of rubber-lined carbon steel, FRP, polyethylene, and nickel alloys. Centrifuges use a combination of stainless steels and nickel alloys with stellite (an abrasion-resistant cobalt alloy) bonded to the tips of the scroll. The materials of construction used in this equipment are selected by the equipment manufacturer on the basis of their experience with equipment in similar service.

Tertiary Processing

In the tertiary processing mixers and pelletizers, erosion considerations outweigh concerns over corrosion. Pug mill mixers are fabricated of erosion-resistant carbon steel with heat-treated carbon steel paddles. Pelletizers and associated equipment are fabricated of carbon steel. Erosion-resistant panels of ceramic materials or high-density plastic may be used in areas of high wear in conveyor chutes.

4.8.6 Other Gypsum Production Operating Considerations

A number of site-specific factors may lead the utility engineer toward the selection of an FGD system capable of producing commercial-quality gypsum:

- Lack of space for disposal of byproduct solids either on site or within an economical transportation distance;
- Desire to minimize the potential liability arising from disposal of a solid waste;
- Utility policy to maximize the reuse of byproduct materials; and
- Presence of a local demand for commercial-quality gypsum.

The local demand for gypsum is often the most critical of these factors.

Before committing to production of a commercial-quality gypsum byproduct, the utility should consider the repercussions on FGD system operation that result. These repercussions include the need to develop a sufficient demand for byproduct gypsum, to maintain gypsum quality, and to provide short-term/emergency storage of gypsum.

Market Demand for Gypsum

The most familiar analogy for marketing byproduct gypsum is the effort electric utilities have made to market fly ash and bottom ash. Like gypsum, there is a commercial demand for these materials and many utilities have been successful in disposing of all or a portion of their ash by this means. The most successful of these utilities have recognized that ash, like any other product, must be marketed. Marketing is especially important if several utilities install FGD systems capable of producing commercial-quality gypsum, and the potential supply is greater than the local demand. Potential users must be contacted and their needs must be considered. These needs could include the gypsum quality and the shipment size, frequency, and delivery method.

Several electric utilities have contacted potential users of large volumes of gypsum, such as wallboard producers, early in the FGD system selection and design phases to obtain long-term commitments to accept the gypsum produced. In some cases, these efforts have been successful and a continuing market for the gypsum has been assured. Tying the sale of byproduct gypsum to a single user has potential problems, however. For instance, if market conditions change, the user may be unwilling or unable to continue to accept gypsum shipments. A prolonged labor disruption at the user's plant would have similar consequences. Where possible, sales to several users of the byproduct gypsum would reduce this risk.

It should be noted that gypsum selling price is usually of less concern than obtaining a consistent demand. Again similar to the sale of ash, every ton not sold must be disposed of by the utility in another manner. It is very possible that the utility would find it

economically attractive to provide the gypsum to the user at little or no cost to avoid the higher cost of on-site disposal.

Quality Assurance

Byproduct solids destined for disposal in a pond or landfill have few chemical or physical limitations outside of those related to waste handling characteristics. A commercial-quality gypsum, however, must meet a quality specification. The result is that the composition of the byproduct material imposes operating limitations on the FGD system. Potentially, these limitations could limit the acceptable suppliers of coal and reagent, or the maximum SO₂ removal efficiency of the FGD system. Failure to consistently maintain the required gypsum quality would jeopardize the continued acceptance of the byproduct by the end user.

Meeting a specification requires an ongoing test program to confirm that the material produced meets the specification. Such a program must be incorporated into the design of the FGD system chemical monitoring program. Additional discussion of byproduct quality assurance is presented in Part I, Section 7.1--Objectives of Monitoring.

Short-Term and Emergency Storage

It is probably inevitable that the gypsum quality specification cannot be met at all times. If, for example, the FGD system must operate at a high reagent ratio in order to treat the flue gas from a coal with very high sulfur content, this would be reflected in a higher level of excess reagent in the byproduct solids. If the byproduct is a waste material, this is of little or no consequence to its disposal characteristics. If the byproduct is intended to be commercial-quality gypsum, however, this could result in byproduct that does not meet the specified composition. Such material must be handled as waste material.

Because of the potential for disruptions in off-site sales discussed above, the FGD system design must include provisions for some amount of on-site storage and an alternative disposal procedure. As discussed previously, the most frequently used method of handling short-term and emergency storage needs would be a small landfill area (either on site or off site) meeting the same design criteria as a disposal landfill.

4.9 Chloride Purge and Wastewater Treatment

A discussion of the FGD chloride balance was presented in Part I, Section 3.6.2--Dissolved Solids (Chloride) Concentration. As described in that section, the combustion process converts chlorides in the coal to hydrochloric acid (HCl). Hydrochloric acid is highly soluble in water and is absorbed into the absorber spray droplets along with the SO₂. In water, the hydrogen and chloride ions immediately and completely dissociate, and the hydrogen ion is neutralized by the lime or limestone reagent.

Dissociation



Neutralization (Lime)



Neutralization (Limestone)



Under FGD operating conditions, the chlorides do not form a precipitate, but instead can build up to very high levels, depending on the process operating conditions. Typically, the dissolved chloride concentration in the FGD system process liquor is in the range of 5,000 to 20,000 mg/L. At FGD systems with limited or no liquid blowdown, however, chloride concentrations in the range of 15,000 to 50,000 mg/L are common, and concentrations above 100,000 mg/L have been reached in some cases.

In a closed-loop (no separate liquid blowdown) FGD system, the only stream leaving the FGD process that contains chlorides is the waste byproduct stream. The amount of chloride associated with the byproduct depends on the byproduct's moisture content and the chloride concentration of the FGD process liquor. The byproduct moisture content depends on the FGD process and ultimate byproduct disposal method, and can range from more than

25% to less than 10 percent. For example, the dewatered gypsum byproduct material produced by a forced-oxidation FGD process typically contain 85 to 90% solids. The dissolved chloride is included in the 10 to 15% liquid fraction of the gypsum, which, unless the byproduct is washed during dewatering, has the same chloride concentration as the FGD process liquor.

High concentrations of chloride can have a detrimental effect on FGD system operation. "Chloride purge" is a phrase used to describe an FGD liquor stream employed to control the dissolved chloride concentration. This section addresses reasons for purging chlorides from the FGD system, various chloride purge methods, and options for treating the purge stream, if required.

4.9.1 Reasons for Purging Chloride

A high concentration of dissolved chloride in the FGD system process liquor can affect the operation of the system in three principal ways:

- Increased materials corrosion;
- Decreased reagent utilization or SO₂ removal efficiency; and
- Poor gypsum byproduct quality.

Increased Materials Corrosion

Increased corrosion of the absorber module materials of construction is often the main chloride-related concern of FGD system operators. This is especially true for older units that were designed for lower chloride concentrations. Generally accepted chloride limits for various types of materials are discussed in Part I, Section 5--Materials-of-Construction Options. Table 5-6 in that section lists common metal alloys and ranks them in terms of resistance to chloride corrosion. The performance of some materials, such as rubber linings and reinforced resin linings, is not affected by the slurry chloride concentration, and these

materials do not have maximum chloride limits. The corrosion rate of most metal alloys, however, can be directly related to chloride level, and maximum chloride limits are necessary.

There are no firm rules for selecting a metal alloy on the basis of the process liquor's chloride level. The following examples are indicative of typical maximum chloride concentration values for some of the most frequently used alloys:

- Type 316L stainless steel has performed well up to 3000 mg/L chloride;
- The limit for Type 317LM stainless steel is in the range of 6000 to 8000 mg/L chloride; and
- The upper chloride limit for C-Class alloys in FGD applications has not been determined, but Alloy C-276 has been specified for service at 50,000 mg/L chloride.

These concentration limits are based on the materials being located in absorbers where the surface is continually washed with slurry to avoid scaling and pit formation (1). It should be noted, however, that determining the chloride limits of stainless steel and nickel-based alloys is the subject of continuing materials research. The above-listed values should be considered as relative values only and may not be applicable in a specific installation.

Decreased Reagent Utilization and SO₂ Removal Efficiency

As discussed in Section 3.6.2, high chloride concentrations in the absorber slurry decrease the SO₂ removal efficiency in lime and limestone FGD systems under otherwise constant conditions. The dissolved calcium concentration increases as chloride increases, because of the ion pairing between calcium and chloride. This can inhibit limestone dissolution and lower liquid-phase alkalinity in both lime- and limestone-based systems. As a result, either the SO₂ removal efficiency will decrease or the same removal efficiency will be achieved at a lower reagent utilization rate (e.g., higher reagent consumption).

Poor Gypsum Byproduct Quality

FGD byproduct quality is a concern if the utility is selling gypsum for commercial uses. Commercial-quality gypsum must meet strict composition requirements that typically include a maximum chloride content. Typical commercial-quality gypsum specifications are listed in Table 4.1-1 (Part I, Section 4--Design Basis Considerations). In that table, the maximum chloride content allowed by four gypsum users ranges from 100 to 400 mg/kg (on a dry weight basis). The two options for controlling gypsum chloride are to reduce dissolved chloride in the FGD system through liquor blowdown and to wash the gypsum product. A combination of both options is typically used to produce an acceptable commercial-quality gypsum product.

4.9.2 Purge Alternatives

The chloride concentration in the FGD process liquor can be reduced through use of a FGD system purge stream (i.e., blowdown). Ideally, the FGD purge stream should be a stream that contains a high chloride concentration so that the purge stream volume is minimized. A clear liquor stream from either the primary or secondary dewatering equipment is selected (e.g., thickener/hydrocyclone overflow or vacuum filter filtrate). The following options for handling the chloride purge stream are available to the utility engineer:

- Discharge;
- Combination with fly ash;
- Duct injection;
- Evaporation ponds; and
- Dissolved solids removal.

The purge rate for all of the options listed above depends on the byproduct handling and disposal alternatives selected. As discussed earlier, very little chloride can leave

the FGD system with the commercial-quality gypsum because of the chloride limits set by gypsum users (see Table 4.1-1). Therefore, in systems producing commercial-quality gypsum, the chloride level must be controlled by a purge stream.

Figure 4.9-1 illustrates how the FGD process liquor chloride concentration is affected by coal chloride content and liquor purge rate. As the chloride content in the coal increases, the chloride level in the process liquor increases. As the purge rate increases, the process liquor chloride level decreases. In addition to the assumptions listed in the figure, the makeup water was assumed to contain 63 mg/L chloride and the byproduct was dewatered to 90% solids.

The effect of coal chloride concentration on process liquor chloride level is almost linear, reflecting the fact that most of the chloride enters the FGD system as HCl removed from the flue gas. At a purge rate of 6 L/s, doubling the coal chloride from 0.10% to 0.20% doubles the process liquor chloride level from approximately 10,000 mg/L to 20,000 mg/L. Other sources, such as the makeup water and reagent, add relatively little chloride to the FGD system.

The effect of purge rate on process liquor chloride concentration also is nearly linear, reflecting the fact that very little chloride leaves with the byproduct solids. Reducing the purge rate by half from 6 L/s to 3 L/s also approximately doubles the chloride level.

Discharge

A utility's ability to discharge FGD blowdown depends on site-specific environmental regulations. Each plant has its own wastewater discharge permit that specifies limits on contaminant concentrations. Federal and state water quality regulations typically require any wastewater discharge to meet certain quality limits. The most common restrictions relate to total suspended solids (TSS), pH, and oil and grease; but discharge permits may include limits on total dissolved solids (TDS) and specific dissolved metal

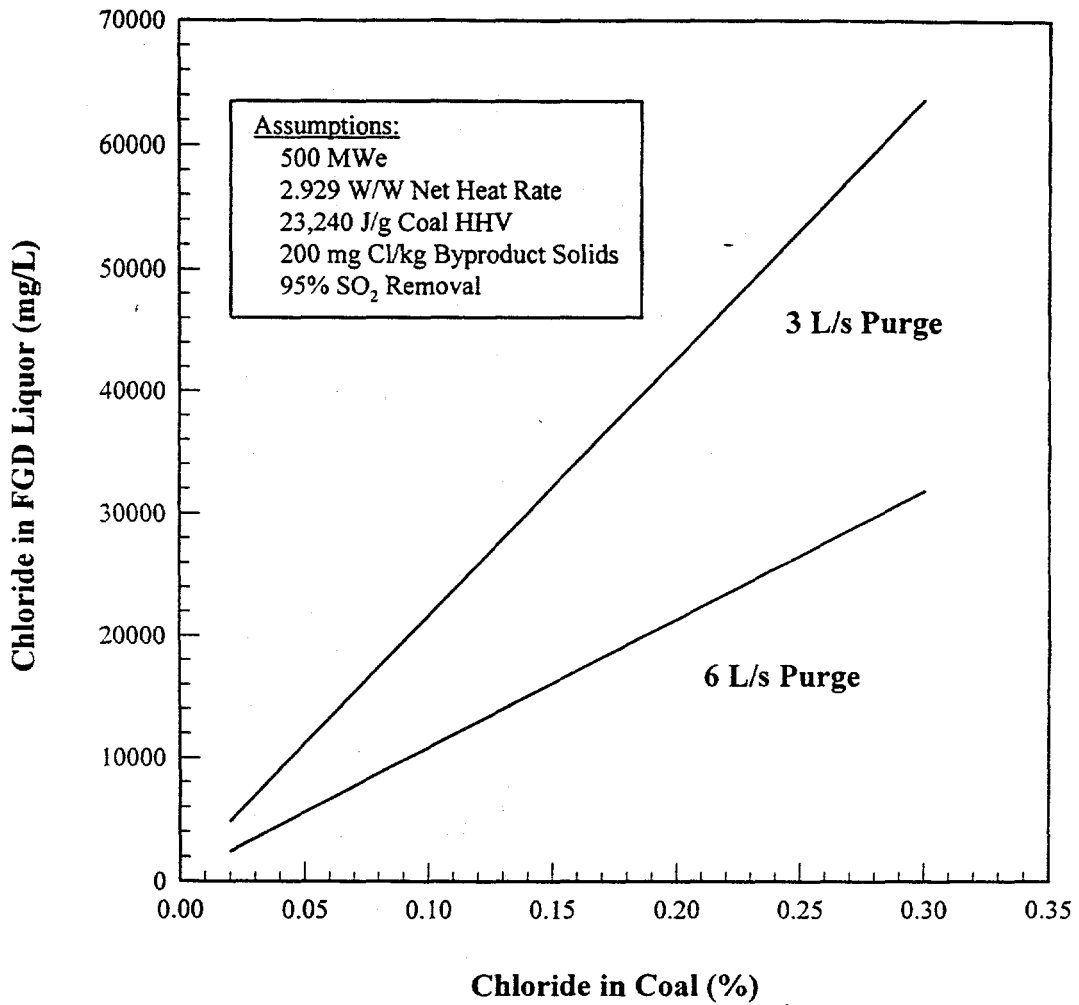

Figure 4.9-1. FGD Liquor Chloride Concentration versus Coal Chloride Content and Liquor Purge Rate

species, such as arsenic, cadmium, chromium, copper, lead, mercury, and selenium. Treatment processes to remove metals are discussed in Section 4.9.3, under "Metals Precipitation."

Besides metals, the purge stream may also be required to have other soluble contaminants removed. When discharging into an ocean, major river, or other large body of water, TDS level of the purge stream may not be a concern. However when the discharge is into a smaller, inland waterway, the TDS level (and the chloride level, in particular) often presents a problem. TDS and chloride removal prior to discharge is not an economically attractive option. Nonetheless, dissolved solids can be removed using the methods discussed in Section 4.9.3--Treatment Systems.

Combination with Fly Ash

One of the most economical methods for reducing FGD chloride is to use a purge stream to condition (wet) fly ash prior to transportation to disposal. Fly ash is normally wetted as it is unloaded from the storage silo into truck or rail cars to make the material easier to handle, reduce dusting, and improve compaction in a landfill. If the fly ash is used for commercial purposes, such as an ingredient in cement or asphalt, this is not an option since the ash is normally transported in a dry condition and quality restrictions may limit its acceptable chloride level. However, relatively few utilities are able to sell all of their fly ash, so many have the opportunity to mix a chloride purge with at least a fraction of their ash.

Duct Injection

The FGD purge stream also can be injected into the flue gas duct upstream of the particulate collection device [electrostatic precipitator (ESP) or fabric filter]. The hot [150°C (300°F)] flue gas evaporates the water from the purge stream, and the remaining solids are collected in the particulate control device along with the fly ash.

Besides being a disposal method for the purge stream, this option has another advantage: HCl from the flue gas is absorbed in the purge stream prior to evaporation, reducing the amount of chloride entering the FGD system. Lime, or possibly less-expensive limestone, can be added to neutralize the absorbed acids (primarily HCl and SO₃; very little SO₂ is absorbed under these conditions). The chloride and other salts from the FGD purge stream are disposed of with the fly ash. This option has several advantages, including process simplicity and relatively low capital cost. The quantity of FGD purge water that can be processed in this way is limited by the volume, temperature, and moisture content of the flue gas leaving the air heater. The temperature of the flue gas entering the particulate control device should be at least 10°C (20°F) above the flue gas adiabatic saturation temperature to prevent corrosive condensation.

Duct injection can both positively and negatively affect the performance of the particulate control device and ash handling equipment. The type and magnitude of these effects depend on site-specific factors. For example, humidification of the inlet flue gas has been shown to reduce the resistivity of the fly ash, which may increase the collection efficiency of an ESP. Alternatively, corrosion in the ductwork and the ESP/fabric filter may increase as a result of localized moisture condensation and higher chloride concentrations in the ash. The ash also may be more difficult to remove from the hoppers. The increase in fly ash chloride content may eliminate the potential for fly ash sales.

To date, full-scale utility experience with FGD purge stream disposal by duct injection is limited. Papers have described design of a purge stream injection system (without alkaline material addition) at Northern Indiana Public Service Company's Bailly Station (2,3); however, little information on its performance has been published.

Evaporation Ponds

Evaporation ponds are an option for power plants that cannot or may not discharge any wastewater (zero-discharge units) when these plants are located in arid climates.

Unfortunately, sites where evaporation rates significantly exceed precipitation rates are limited. As a result, evaporation ponds are possible for relatively few utilities.

Evaporation ponds concentrate the blowdown stream, leaving precipitated salts. The required number, size, and design of these ponds depend on the local climatic conditions. If the concentrated brine contains hazardous levels of metals, then the pond must be designed to meet hazardous waste storage requirements. This may require the use of costly double liners with leachate monitoring and collection. The ponds will eventually fill with solids, requiring either a new pond to be built or the existing pond to be emptied. Both of these options are expensive. Despite their high capital costs, evaporation ponds are solar-powered, so there are no energy-related operating costs.

Dissolved Solids Removal

The purge stream can be treated for removal of oxygen-demanding substances, pH, TSS, TDS, and specific dissolved species. For systems that remove (or concentrate) dissolved species, the treated water may then be suitable for recycle to the FGD system or other power plant systems. However, processes that can operate in a high scaling mode (i.e., supersaturation of gypsum or other salts) can be expensive in both capital and operating costs.

Because the chloride ion is highly soluble in water, no economically viable process can **selectively** remove it. Therefore, any treatment processes that removes chlorides (such as membrane separation and evaporation) also removes most other dissolved species.

4.9.3 Treatment Systems

The method used to treat FGD purge streams depends on the types of contaminants targeted for removal. If chloride levels are not a problem in the discharge stream, the utility may only need to adjust the stream's pH and remove TSS and specific

dissolved metals. For discharge to a high-quality or low-flow waterway, effluent regulations also may require a low TDS level in the wastewater discharge.

Treatment systems that can be applied to FGD system purge streams include the following:

- Metals precipitation;
- Activated carbon treatment;
- Biological treatment;
- Mechanical evaporation; and
- Membrane separation.

In each of these cases, a residual stream, such as a sludge or brine, is produced and requires disposal. In some cases, further treatment of these residual streams is required prior to disposal.

Metals Precipitation

Various heavy metals such as arsenic, cadmium, chromium, copper, lead, mercury, and selenium may be present in the purge stream. The sources of these metals in the FGD process liquor are the coal, lime or limestone reagent, and makeup water. Recirculation and evaporation of water in the FGD system concentrates the metals to levels that typically cannot be discharged under current effluent regulations. If wastewater discharge is an option, then a metals precipitation process is an obvious choice for heavy metals removal. It must be noted, however, that metals precipitation does not remove chlorides. At sites where discharge of high-chloride wastewater is not permitted, more extensive treatment is required, as discussed later.

There are several precipitation processes used for wastewater treatment by the metals fabricating industries. The most common ones precipitate the metals ions as insoluble

hydroxides, carbonates, sulfides, or a combination of these. A typical metals precipitation process for FGD purge stream treatment is shown in Figure 4.9-2. This process is used in over 20 installations in Germany and 4 in the United States (4). This illustration includes all of the main equipment items that could be required to treat FGD wastewater for metals removal.

There are four steps in this metals precipitation process:

- Oxidation of sulfite to sulfate;
- Neutralization and gypsum desupersaturation;
- Precipitation of heavy metals; and
- Separation of the suspended solids and precipitation products.

The oxidation step is not required if the FGD system is operating under force-oxidation conditions. Because of wastewater discharge limitations on oxygen-demanding substances, however, an oxidation step may be necessary to reduce chemical oxygen demand (COD) of the purge stream if the inlet sulfite concentration is greater than about 100 mg/L SO_3^- . In this step, air is injected into a well-mixed tank, and sufficient residence time is provided to allow full oxidation of any sulfite that is present.

The next step is to reduce gypsum saturation and neutralize the solution. The purge stream is usually supersaturated with gypsum, which must be precipitated early in the metals removal process to prevent scaling on downstream equipment. Therefore, some gypsum solids are recycled from the clarification step to provide gypsum seed crystals to reduce saturation levels. Lime or sodium hydroxide is added to the purge stream to reach a pH of 9.0 to 9.2. In this pH range heavy-metal hydroxides are formed, but magnesium hydroxide is not. FGD liquor (and, therefore, the purge stream) typically contains a large amount of dissolved magnesium. The objective is to leave the magnesium in solution to reduce the quantity of heavy-metal sludge produced. (The magnesium also increases

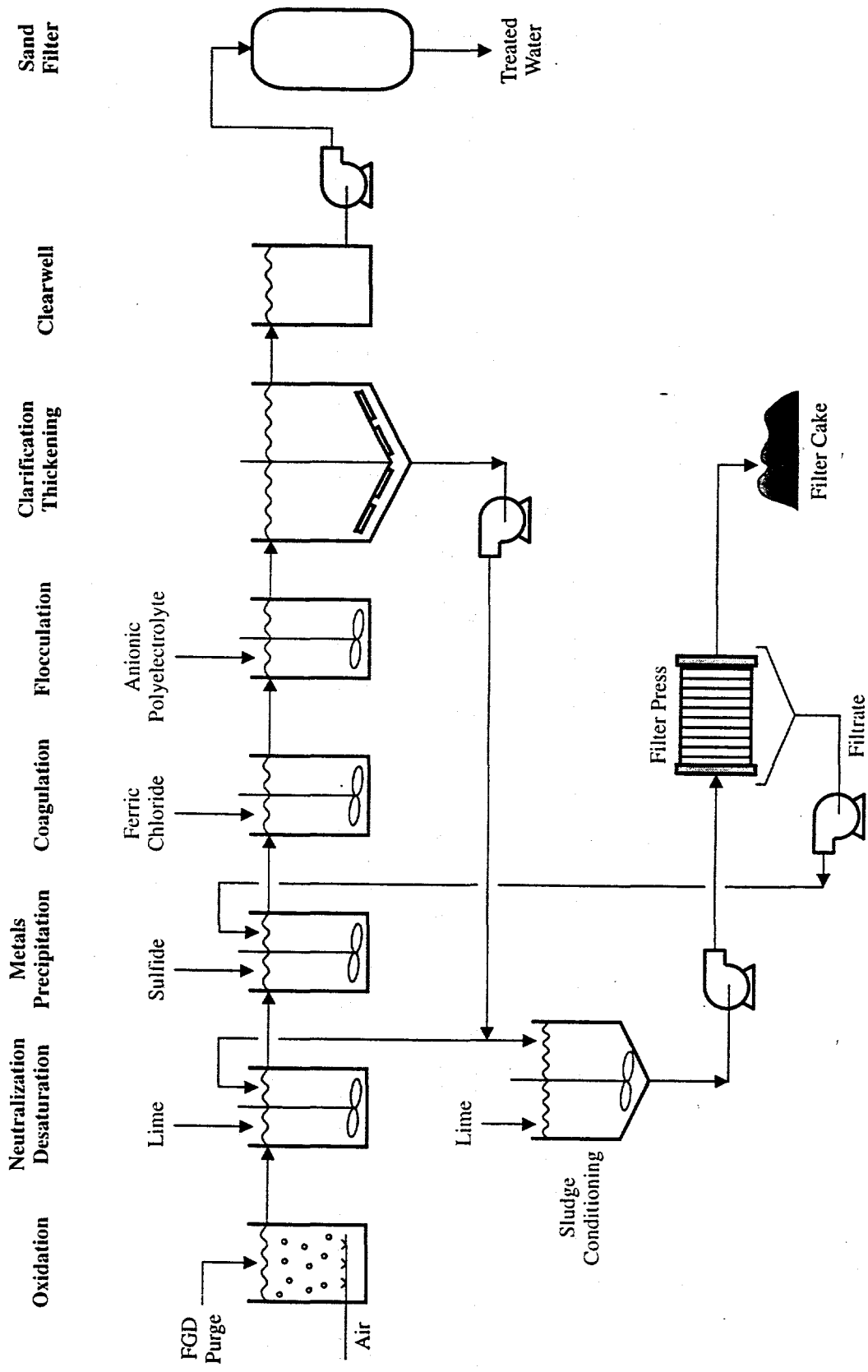

Figure 4.9-2. FGD Purge Metals Precipitation Process
 (Ref. Infilco Degremont Inc., Richmond, Virginia)

dissolved alkalinity, which improves SO₂ removal if the treated water is returned to the scrubber.)

Several chemicals are added to produce the desired metal ion precipitation. A sulfide-containing compound is added to convert metal hydroxides to metal sulfides, since metal sulfides are generally less soluble than metal hydroxides. Although the sulfide could be added as either sodium sulfide (Na₂S) or sodium hydrosulfide (NaHS), these compounds are toxic and require special care. A popular alternative is to use a non-toxic organosulfide. Ferric chloride is added as a coagulant to enhance settling, but it has the added benefit of forming iron oxyhydroxide and coprecipitating other metals, including selenate (Se⁶⁺) and chromate (Cr⁶⁺). These two metal ions are not efficiently removed by the hydroxide and sulfide precipitation steps. A weakly anionic polymer is typically added next to promote the solids flocculation rate.

A single vessel can be used to separate liquid and solids, with the vessel providing both clarification of the treated stream and thickening of the solids produced. A rake at the bottom of the vessel scrapes solids to the center, where they are withdrawn. Clarification of the overflow can be assisted by the use of inclined plate modules to trap any large particles that are carried over. Discharge from the clarifier is then sent to sand filters that remove most remaining suspended solids. The thickened sludge is pumped to a conditioning tank, and then to a plate-and-frame filter unit for dewatering prior to landfill disposal. Lime may be added in the conditioning tank to improve sludge dewatering characteristics.

Activated Carbon Treatment

Depending on the site-specific limitations on wastewater discharge quality, the FGD system purge stream may require treatment to reduce the level of COD or biochemical oxygen demand (BOD) prior to discharge. Chemical oxygen demand can result from trace organics or unoxidized sulfite ions. For systems with low COD removal requirements,

granular activated carbon (GAC) may be satisfactory to meet discharge requirements. However, environmental regulations at some locations also may require removal of the COD contributed by dithionate ($S_2O_6^{2-}$). GAC is ineffective in removing dithionate, and ion exchange on a special synthetic absorbent is required (5).

Biological Treatment

The purge stream from an FGD system usually exhibits a low level of BOD. However, the level of BOD will be higher if organic acid additives are used, and treatment to reduce BOD may be required at some sites. Organic acid additives are sometimes used to enhance the SO_2 removal performance of an FGD system (See Part I, Section 3.4--Chemical Additives for SO_2 Removal Enhancement). They are typically mono- or dibasic carboxylic acids such as formic, adipic, succinic, or glutaric acid. The amount of BOD caused by a given concentration of a carboxylic acid can be calculated. For example, formic acid has a BOD of 0.24 g BOD/g formic acid and the DBA mixture produced by DuPont has a BOD of about 1.1 g/g acid. Scrubbers that use an organic additive and discharge wastewater can treat the blowdown with a biological trickling filter or activated sludge sequencing batch reactors (SBRs). Detailed discussions of trickling filters and activated sludge systems are available in standard textbooks on wastewater treatment (6,7,8).

Tests of pilot- and full-scale treatment systems have shown formic acid removal rates greater than 90% using biological trickling filters. These results are based on inlet COD of 1000 mg/L and a chloride concentration of 9000 mg/L. However, at chloride levels above 10,000 mg/L biological processes may be inhibited (4). Bench-scale treatability tests using SBRs have demonstrated 92 to 96% BOD removal of a synthetic FGD purge stream containing approximately 15,000 mg/L chloride and 28,000 mg/L TDS (9).

Mechanical Evaporation

Mechanical evaporation is commonly referred to as brine concentration. This process is also referred to by the names of specific types of mechanical evaporation, including multiple-effect, vapor-compression, thin-film, and forced-circulation evaporation. In a simple flash distillation unit, one pound of steam will evaporate about one pound of feed water. Evaporators can be operated in a series of stages (termed "multiple-effect evaporators") to increase efficiency, with the vapor from one stage being condensed in the next, which operates at a lower pressure and temperature. Such multiple-effect units use steam in the first stage and cooling water in the last, and increase efficiency (i.e., reduce energy consumption per unit volume of purge water) by recycling the latent heat of evaporation through each stage. A two-stage evaporator system is illustrated in Figure 4.9-3.

Although each additional stage increases the process efficiency, it also adds equipment, which increases capital and maintenance costs. Therefore, the optimum number of effects is influenced by a trade-off between capital/maintenance costs and energy costs.

Another method of achieving energy efficiency is to recycle the evaporated vapor with a compressor, as shown in Figure 4.9-4. One stage of vapor-compression evaporation (VCE), also called mechanical vapor recompression, can be as efficient as a fifteen-stage evaporator system. In this system, the evaporated water vapor is compressed to a higher pressure to increase the saturation temperature and used to heat the recirculating wastewater. The compressed vapor condenses as it cools, releasing its latent heat of vaporization. Although steam may be required during startup, thereafter the major energy input to the equipment is the compressor electrical power. Compressors are typically centrifugal or axial machines operating at a 1.2 to 1.5 compression ratio. Although the VCE process may have just one or two stages, capital and operating costs of the compressor and recirculation pump are relatively high. Therefore, the cost effectiveness of choosing a VCE system over a multiple-effect evaporator depends to a large extent on the relative costs of steam and electricity.

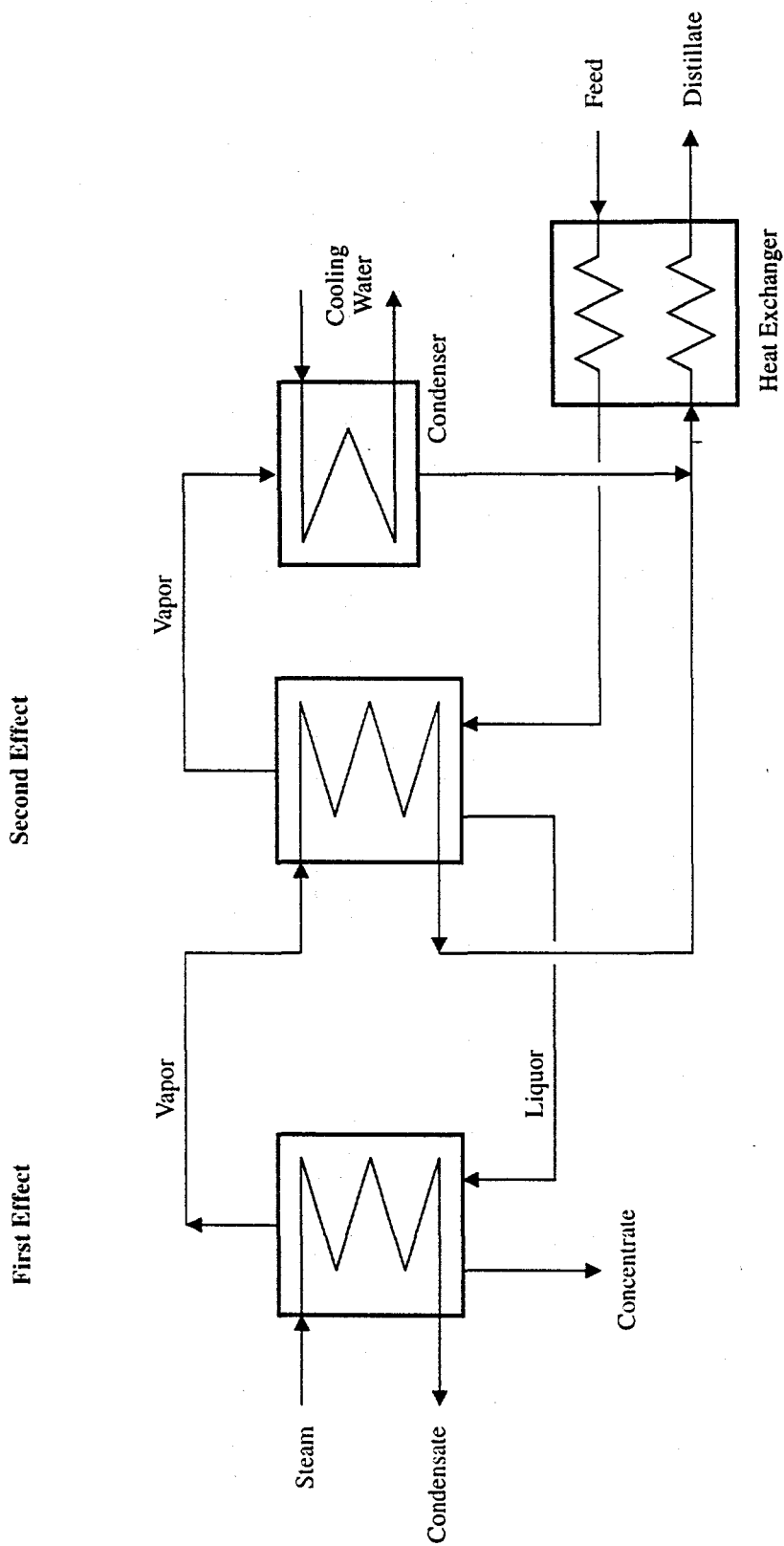

Figure 4.9-3. Two-Effect Evaporator

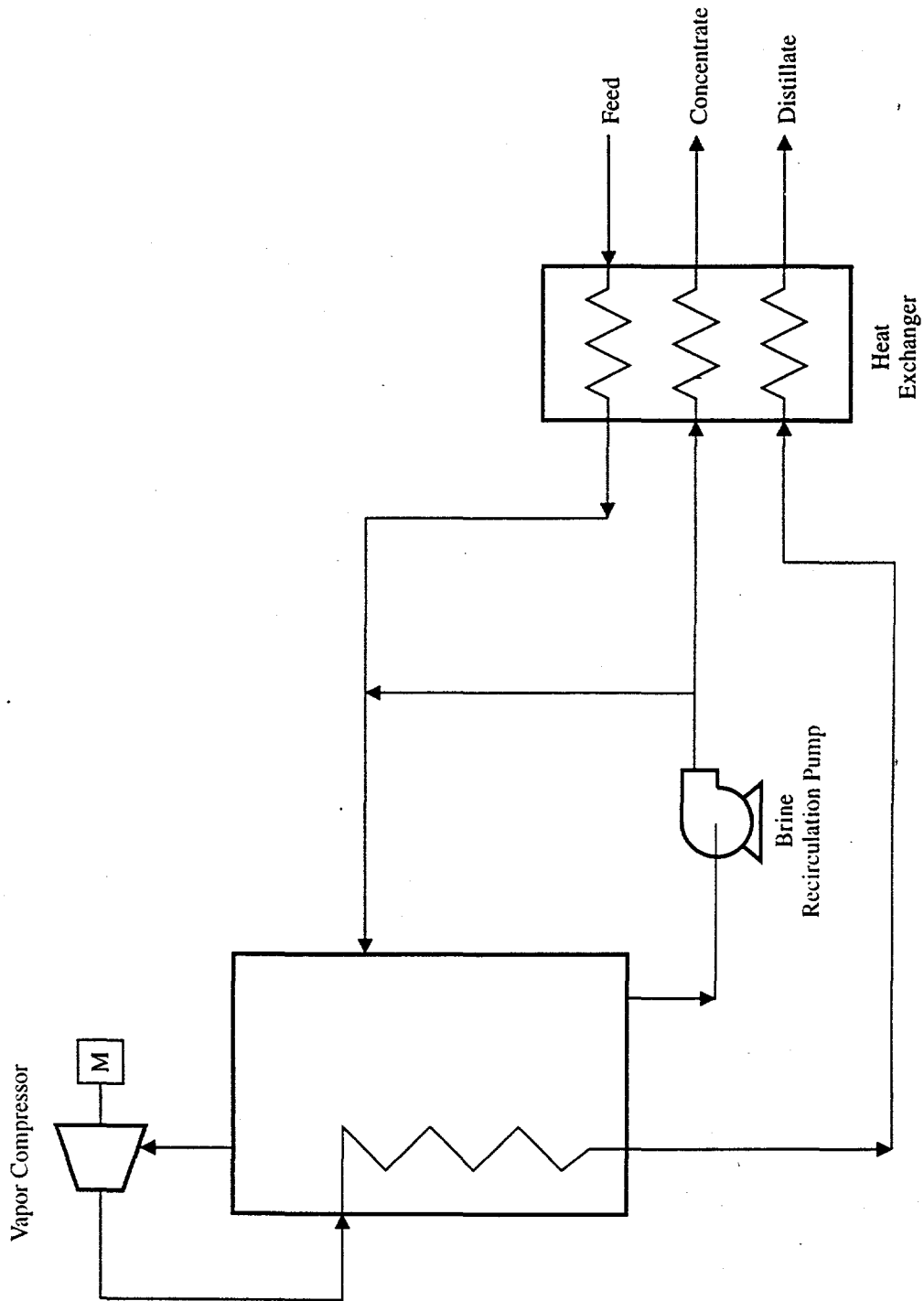

Figure 4.9-4. Vapor Compression Evaporator

Mechanical evaporators are in common use throughout the world, treating a variety of wastewaters. Although many power plants employ this technology, only a few use it to evaporate FGD blowdown. The major concern in concentrating FGD purge by evaporation is handling the precipitated solids. In the evaporator, gypsum is formed and encouraged to precipitate on recirculated crystals. Precipitation of sodium salts usually is not desired because these salts will form rapidly and scale over the heat transfer surfaces (decreasing their heat transfer efficiency). Also, the high concentration of dissolved solids can require a vapor pressure differential that is greater than the compressor can provide. The operating limit for dissolved sodium chloride concentration in the evaporator brine is about 33 percent. Therefore, some FGD purge evaporator systems produce a 33% NaCl solution, which may be a saleable byproduct. The maximum recovery rate (kg product flow per kg feed flow) from an evaporator is, therefore, limited by the inlet purge stream composition and the constraint of maintaining brine below the NaCl saturation level. Even with this limit, recovery is typically in the range of 90 to 95 percent. The product stream from evaporation typically has a TDS concentration of approximately 10 mg/L, allowing the water to be used in applications requiring very low TDS water.

Membrane Processes

Membrane processes for FGD purge treatment include reverse osmosis (RO) and electrodialysis reversal (EDR). Membrane processes can be used to concentrate wastewater, but they produce a larger-volume, less-concentrated waste stream than is typical of evaporation processes. In both processes, and particularly in RO, membrane scaling is a major concern. Therefore, membrane technologies have not commonly been used to treat FGD purge streams. On the other hand, membrane processes are quite common in a wide variety of industries throughout the world. In fact, utilities often use RO or EDR to treat boiler makeup water prior to ion exchange. The difference is that water used for boiler makeup is typically not saturated with gypsum and does not form precipitates during concentration by the membrane process. RO and EDR are also used for desalination, producing potable water from seawater. Although seawater typically has a higher

concentration of NaCl, its relative saturation of gypsum is much lower than in an FGD purge stream.

The RO and EDR processes each use semipermeable membranes to separate water molecules from dissolved species. However, their methods of performing this separation are quite different. In RO, high pressure is used to force water through the semipermeable membrane, leaving a concentrated salt solution behind. EDR, however, uses a direct current electrical charge to attract cations and anions through another type of membrane, leaving a clean water stream behind. The "reversal" term in EDR refers to the electrical field being periodically reversed to dissolve any salts that have precipitated on the membranes.

As a wastewater treatment device and TDS concentrator, RO is much more energy-efficient than evaporative processes since no phase change occurs. RO membranes are typically 90 to 99% efficient at removing dissolved solids from the feed water. This efficiency is termed the system rejection rate (i.e., 90% of the inlet stream's TDS is rejected from the product stream). The membranes have been manufactured in three general configurations: tubular, hollow fiber, and spiral wound. Tubular and hollow fiber membranes are somewhat similar, with the selective membrane on the inside and a stronger material on the outside. The major difference between the two is their size--tubular membranes are about 1 cm and hollow fibers are about 50 μm in diameter. Up to 4.5 million fibers can be grouped in a single pressure vessel, called a permeator. In the treatment of low-scaling feed water, a single permeator can recover up to half of the feed as product.

Spiral wound membranes consist of two flat sheets of membrane glued together on three edges and wound around a tube. Feed water is pumped axially through the vessel. Permeate flows radially through the membrane and then in a spiral path between the two sheets to the center tube, where it is collected. A single spiral wound element can recover only about 8 to 10% of the feed flow, so elements are connected in series.

All types of RO elements are very much susceptible to fouling and scaling. Therefore, using RO to treat an FGD purge stream saturated with gypsum would be particularly challenging. Antiscalants such as sodium hexametaphosphate, polyphosphoric acid, or polyacrylic acid can allow operation with a gypsum relative saturation (RS_{gyp}) up to about 1.8. However, concentrating the purge from $RS_{\text{gyp}} = 1.0$ to $RS_{\text{gyp}} = 1.8$ would only recover 40% of the feed stream, leaving 60% for further treatment or disposal. Purge from an inhibited-oxidation FGD system may be an acceptable RO feed, since RS_{gyp} may be only 0.5. However, water from a natural- or forced-oxidation scrubber would require softening prior to RO treatment. Although lime softening followed by RO appears feasible, it is not in commercial use. Softening also adds a significant cost to the wastewater treatment system.

EDR unit recovery rates can range from 50 to over 90% but salt rejection is typically 80 to 90%, which is slightly lower than with RO. However, EDR can operate at a significantly higher gypsum relative saturation than is acceptable with RO. The basic difference between EDR and RO is that with EDR, ions are attracted toward the membranes, whereas with RO, water is forced through the membranes. Tests on an EDR feedwater with low gypsum relative saturation ($RS_{\text{gyp}} = 0.27$) produced a concentrate stream with $RS_{\text{gyp}} = 4.4$ (10).

As described above in the section on metals removal, a large number of vessels and chemical feeds are required to remove heavy metals from an FGD purge stream. EDR can be used in combination with evaporation to treat the FGD purge stream and economically produce a small-volume concentrated waste stream. EDR treatment of FGD blowdown has recently been tested in the United States, Europe, and Japan. In tests in Japan, the process consisted of four main steps: filtration to remove suspended solids, EDR, evaporation, and solidification (11). With EDR pre-concentrating the evaporator feed, a smaller evaporator can be used, which results in capital and operating cost savings. The test feed rate was 0.39 L/s (6.2 gal/min) with a chloride concentration of 20,000 ppm. Evaporator concentrate was mixed with cement and fly ash in the ratio of 1.0 to 0.67 to 1.1, respectively. The EDR

system was operated successfully and a conclusion of the tests was that this hybrid process is more economical than a standard metals precipitation process.

Tertiary Treatment and Disposal

Recall that the main objective of FGD purge stream treatment is to remove contaminants, including chloride, from the FGD process. The treatment processes described above remove contaminants from wastewater, but they all produce two streams--a product stream that is relatively clean (and in some cases can be recycled) and a waste stream that has concentrated the contaminants and must be disposed of in an environmentally sound manner. The concentrated wastes may be liquid or wet sludge, depending on the process. In fact, sludge from a metals precipitation process may contain just 50% solids. Therefore, further processing may be required to produce the dry, non-leachable solid that is normally needed for landfill disposal.

Some stations may be able to avoid separate landfill disposal of this materials by combining this relatively small amount of metal-containing sludge with the coal in the coal pile. The sludge is sent to the boiler with the coal and the metal ions ultimately leave the process incorporated in the bottom ash and fly ash.

If the waste stream must be disposed of in a dry condition, there are two general methods for producing a dry product. One method is to remove the moisture and the other is to chemically bind the moisture.

Removal of the moisture can be accomplished by spray drying or crystallization. Spray drying is a common method of drying wastes. Liquid waste is sprayed into a large vessel that has hot gas passing through it. The result is a humidified gas stream and a dry waste stream. The waste solids produced are collected downstream in an ESP or fabric filter. Crystallization is another method for drying a concentrated salt stream. The main advantage of crystallization is that a relatively dry solid product is possible with the use

of a centrifuge. Because of its high cost, crystallization is not commonly used by utilities; however, crystallization may be advantageous if a pure saleable product is desired.

Stabilization, solidification, and fixation are terms that describe the process of mixing a wet waste with pozzolans,* such as lime, cement, and fly ash. The advantage of stabilizing wastes is that a nonhazardous waste is produced, thus reducing the disposal costs as compared with disposing of hazardous wastes. Also, both short- and long-term environmental liabilities are reduced. Tests should be conducted on the specific waste to determine which additives may be required to yield a stabilized product.

* Pozzolans are cementitious materials that harden into a solid mass when mixed with water.

4.10 Process Control and Instrumentation

Like any other process, the lime- and limestone-based FGD processes require certain chemical and physical parameters to be maintained in a favorable range to obtain reliable, cost-effective performance. In this section, the basic control requirements and the various approaches to meeting these requirements are described. The emphasis here is on process control strategy. Instrumentation options are also discussed, but specific control hardware is not addressed. Some additional information on process control hardware such as dampers, valves, and continuous emission monitors (CEMs) is presented in Part II--Major Mechanical Equipment Information.

4.10.1 Major Process Control Loops

A process control loop is a combination of hardware and software that acts to maintain certain process variables within a specified operating range. A process control loop consists of the following components:

- Sensor--A sensor measures the actual value of the process variable being controlled.
- Controller--A controller receives the sensor signals ("inputs") describing the actual value of the process variable to be controlled, in addition to other related information. This input is compared to the variable's desired value (the "setpoint"), and a signal called the controller output is generated.
- Control element--A control element receives the controller's output signal and manipulates a part of the process that causes the process variable to change so that it moves toward the desired setpoint.

A process control loop may be either "feedback," "feedforward," or a combination of these two types of control. In a feedback control loop, the control action is based on a measurement of the process variable that is to be controlled. This approach may not provide good performance if the response of the controlled variable is slow. In a

feedforward loop, the control action is based on changes in upstream process variables that have a predictable time-delayed effect on the process variable that is to be controlled.

The controller may be an analog or digital device, and the change in the output signal to a change in the input signal can be either automatic or manually initiated by an operator. In automated control loops the relationships between input and output signals are adjusted by "tuning" an analog controller or programming a digital controller.

Major control loops for the lime- and limestone-based FGD processes are described below. In most cases, there are several alternative strategies for each control loop. The selection of a specific strategy depends to some extent on the operating philosophy and experience of the process user and the FGD system vendor. Some approaches, for example, are more highly automated and require that instrumentation be frequently maintained. Other approaches require more decisions by human operators. The advantages and disadvantages of different control strategies are pointed out where appropriate.

SO₂ Removal Efficiency

SO₂ removal efficiency (or SO₂ emission rate) is usually the primary performance variable monitored for the FGD process. The control system for this variable must satisfy the regulatory constraints as the unit load and fuel sulfur content vary. At the same time, the control system should seek operating conditions that minimize the cost of compliance. The process variables that are available for manipulating SO₂ removal are limited in scope and are usually not controlled by an automatic control loop logic using process instrumentation. In addition, the types of process variables that can be monitored depend on the specific FGD process design.

Recalling the discussions in Part I, Sections 3.2--FGD Process Variables and 4.2--Absorber Module, the following process variables directly affect the SO₂ removal efficiency and may be manipulated to control the level of removal:

- Number of absorber modules in service;
- Amount of flue gas treated versus the amount bypassed;
- Absorber recycle slurry flow rate (number of absorber spray pumps in service);
- Absorber recycle slurry pH; and
- Absorber recycle slurry chemical additive concentration.

Table 4.10-1 summarizes strategies that are available to control FGD system SO₂ removal efficiency. All of the strategies use the outlet SO₂ concentration as a major input parameter and obtain the required data from a CEM located in the stack. Because of their importance in FGD applications, CEM systems are discussed in more detail in Part II, Section 15 of this manual.

Changing the number of absorber modules in service is normally not an automatic SO₂ emission control function. Rather, the FGD system operator determines the optimum number of operating absorber modules based on experience and vendor-recommended operating practices, and manually initiates module startup or shutdown. Although manually initiated, the actual module startup and shutdown sequences, however, are frequently automatically controlled. This sequence may include spray pump startup/shutdown, isolation damper opening/closing, and, as needed, slurry line drain and flushing. Automating the sequence ensures that each startup/shutdown step is taken in the correct sequence and at the correct time. Usually, changing the number of absorber modules in service is not done in response to minor variations in the SO₂ content of the flue gas; however, it may be desirable if the generating unit will experience a significant change in load (i.e., flue gas volume) lasting for several hours.

Another SO₂ control strategy is to vary the fraction of flue gas that is treated in the absorber module(s). With this approach, the FGD system is designed such that a portion of the flue gas from the boiler can bypass the FGD system and flow directly to the outlet duct

Table 4.10-1

Summary of SO₂ Removal Control Strategies

Control Objectives: Maintain SO₂ removal as required by regulations and minimize cost of SO₂ removal.
 Origin of Process Variations: Boiler load and fuel sulfur content.

Control Strategy	Sensors	Controlled Variables	Control Elements	Advantages	Disadvantages
Adjust absorber flue gas velocity by adjusting number of operating modules.	<ul style="list-style-type: none"> ▶ Stack CEM. ▶ Modules on/off. 	Number of modules in service.	Isolation dampers.	<ul style="list-style-type: none"> ▶ Optimum absorber gas velocity can be maintained over wide unit load range. ▶ Spare module can be cleaned/maintained while boiler operates. 	<ul style="list-style-type: none"> ▶ Multiple absorber modules increase cost and complexity of FGD system.
Adjust amount of flue gas treated using partial flue gas bypass.	<ul style="list-style-type: none"> ▶ Stack CEM. ▶ Bypass damper position. 	Bypass flow.	Bypass damper.	<ul style="list-style-type: none"> ▶ Good response time. ▶ Simple continuous response characteristics. ▶ Provides partial reheat. ▶ Does not affect process chemistry. 	<ul style="list-style-type: none"> ▶ Bypass mixing zone is corrosive environment. ▶ Damper leakage can limit maximum SO₂ removal.
Adjust absorber recycle slurry flow rate.	<ul style="list-style-type: none"> ▶ Stack CEM. ▶ Pumps on/off. 	Number of pumps in service.	Pump motor controls.	<ul style="list-style-type: none"> ▶ Good response time. ▶ Simple response characteristics. ▶ Does not affect process chemistry. 	<ul style="list-style-type: none"> ▶ Pump start/stop increases wear on motors and drives. ▶ Only a few discrete levels are available.
Adjust absorber recycle slurry pH.	<ul style="list-style-type: none"> ▶ Stack CEM. ▶ Slurry pH. 	Reagent feed rate.	Reagent feed valve.	<ul style="list-style-type: none"> ▶ Can be used to maximize reagent utilization. ▶ pH control loop is already required to control process chemistry. 	<ul style="list-style-type: none"> ▶ Slow response time. ▶ Non-linear response. ▶ Limited control range. ▶ Can affect other aspects of process chemistry (e.g., oxidation, dewatering).

**Table 4.10-1
(Continued)**

Control Strategy	Sensors	Controlled Variables	Control Elements	Advantages	Disadvantages
Adjust absorber recycle slurry additive concentration.	<ul style="list-style-type: none"> ▶ Stack CEM. ▶ Chemical analysis. 	Additive feed rate.	Additive pump speed or control valve.	<ul style="list-style-type: none"> ▶ Additive can be used to extend operating range of absorbers efficiency and reduce FGD system cost. 	<ul style="list-style-type: none"> ▶ Slow response time. ▶ Requires some additional equipment plus additive supply.

or stack. The absorber operating conditions are held approximately constant and the amount of bypass flue gas is continuously varied by changing the position of the bypass damper. This damper is typically a single- or double-louver design. The damper position is adjusted in response to the difference between the measured and desired SO_2 concentration in the stack gas. Partial bypass control is illustrated in Figure 4.10-1. This option is typically used only in conjunction with bypass reheating of the flue gas (see Part I, Section 4.6--Flue Gas Reheat). The hot bypass flue gas also provides some flue gas reheat, which can reduce condensation in the absorber outlet ducts and stack and improve stack plume buoyancy. This approach is possible only if the SO_2 removal efficiency achieved in the absorber modules is significantly greater than the required overall removal efficiency since this difference controls the volume of flue gas that can be bypassed. This approach has largely been discontinued due to the serious materials-of-construction problems associated with bypass reheat and the desire to achieve the maximum degree of SO_2 removal from the flue gas.

The next control option in the table is to adjust the absorber recycle slurry flow rate by adjusting the number of absorber spray pumps in service, which increases or decreases the liquid-to-gas (L/G) ratio (see Part I, Section 3.0--Process Chemistry). Most often, this option is used in response to an extended change in inlet flue gas volume and attempts to maintain the L/G ratio with a specific range. This approach is simple to implement and is usually initiated manually. The absorber SO_2 removal efficiency responds rapidly to changes in L/G ratio, and the process chemistry is not otherwise affected significantly. The most important disadvantage to this approach is that typically only three to five discrete levels of slurry flow rate are available with a single absorber module (one per spray level). Therefore, with this control strategy, the FGD system SO_2 removal would exceed the required level most of the time unless some other process variable is also controlled. Another disadvantage is additional wear on pump motors and drives caused by more frequent starts and stops. Like adjusting the number of absorber modules in service, adjusting the number of absorber spray pumps is normally done only in response to extended changes in flue gas volume.

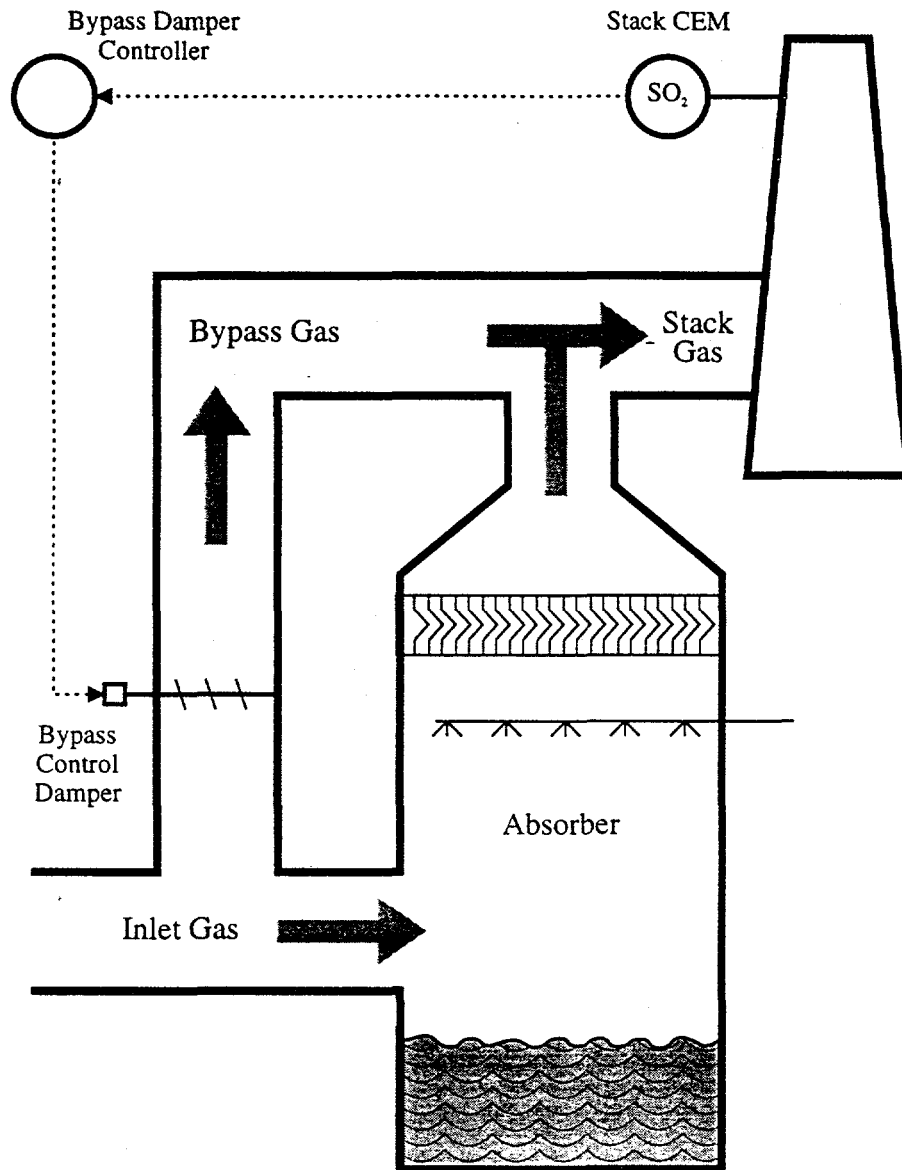

Figure 4.10-1. Outlet SO₂ Control Using Partial Bypass

The next SO₂ removal control option is to adjust the absorber recycle slurry pH. In most cases, changing the slurry pH will change the SO₂ removal efficiency.* In this control approach, the recycle slurry pH is measured directly by an immersed electrode, and the reagent slurry feed rate to the reaction tank is varied to increase or decrease the pH. The pH setpoint is adjusted (manually or automatically) to maintain the desired SO₂ removal during periods of more or less constant load after the appropriate number of absorber spray pumps in service has been set. In the automatic mode, the pH controller setpoint would be adjusted in response to a signal from another controller that compares the stack CEM SO₂ measurement to its desired value. This control strategy is illustrated in Figure 4.10-2. It should be noted that the pH control setpoint range is subject to certain high and low limits that are discussed later in this section. These limits override the requirements for SO₂ removal efficiency.

Unlike changing the number of absorber spray pumps in operation, the use of slurry pH for SO₂ removal control provides a continuous response and can be used to save reagent by operating close to the desired emission limit. However, slurry pH has a relatively slow response time. Therefore this approach will be most useful if boiler load and fuel sulfur content do not fluctuate widely over operating periods shorter than one or two hours.

The next entry in Table 4.10-1 involves the use of chemical additives to control SO₂ removal efficiency. The initial absorber design may or may not be based on the use of chemical additives. In either case, additives can be used to improve SO₂ removal efficiency while saving reagent and pumping costs. The use of chemical additives might be cost-effective under some or all operating conditions, depending on the additives' delivered costs and consumption rates. Changing the chemical additive concentration is a slow process compared to changing the absorber spray flow rate or slurry pH, because of the large volume of the reaction tanks and the very low additive consumption rate. Generally, the concentration can be increased much more quickly than decreased. As a result, the chemical

* The magnesium-enhanced lime FGD process is an exception to this rule because the SO₂ absorption rate may be gas-film limited.

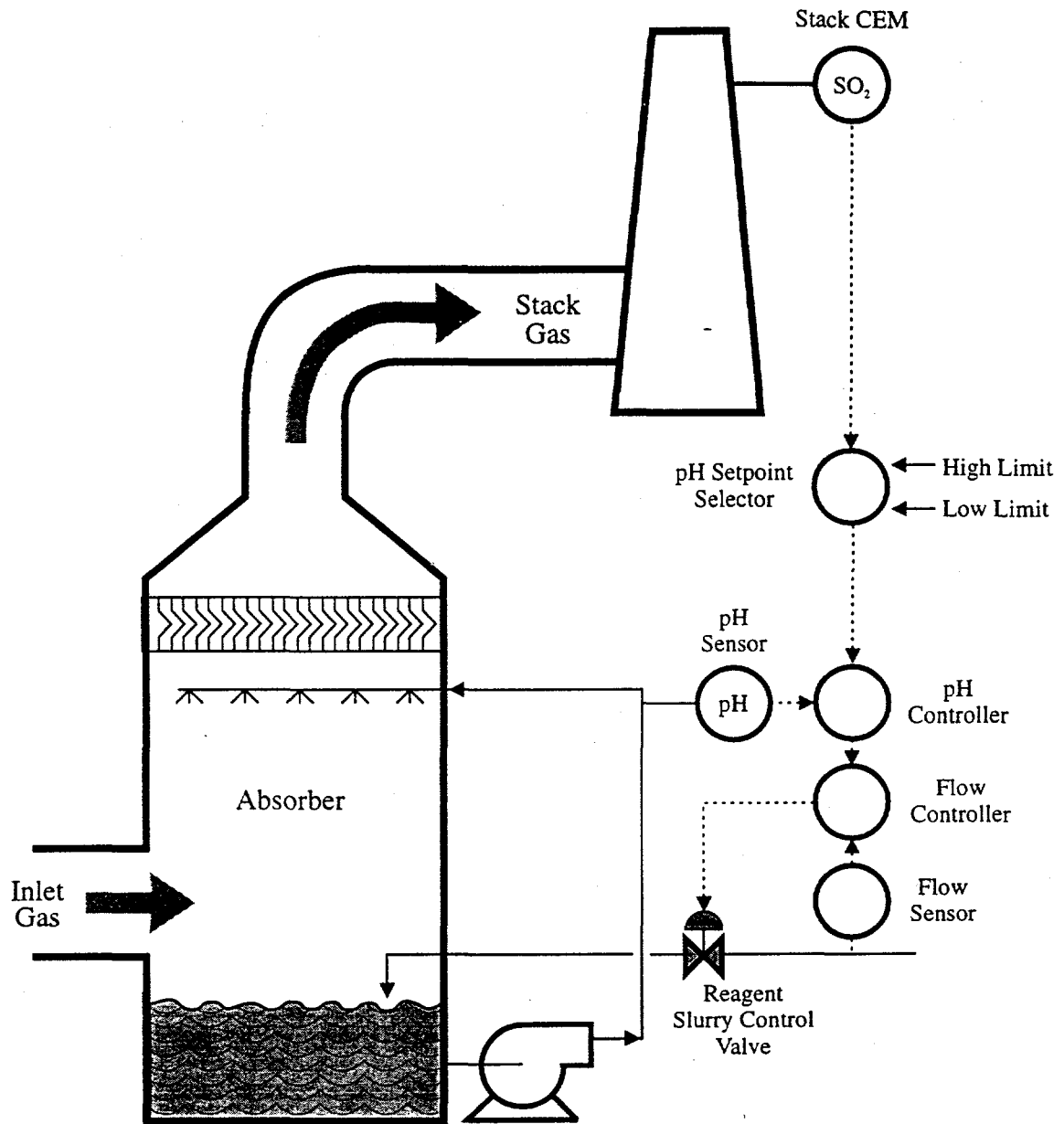

Figure 4.10-2. Outlet SO₂ Control Using Slurry pH Adjustment

additive concentration typically is not adjusted hourly or even daily. When an additive is used, the control objective is usually to maintain a preselected concentration range that yields the most cost-effective operation. This concentration would be changed only if relatively long-term changes in fuel sulfur content were expected or if the required SO₂ removal efficiency could not be met by the other control strategies.

Reagent Feed Control

Table 4.10-2 summarizes four potential reagent feed control strategies. The first entry in Table 4.10-2 is the pH control approach that was previously described for SO₂ removal control. The reagent feed rate is adjusted to maintain a specified recycle slurry pH setpoint. Because of the importance of reagent feed and pH control to successful operation of lime- and limestone-based FGD processes, some additional aspects of the reagent feed/pH control loop are discussed here.

The pH control loop in a lime- or limestone-based FGD process is required exclusive of its use in controlling SO₂ removal efficiency. Slurry pH in the reaction tank must be controlled in a range that yields optimum reagent utilization as well as the desired SO₂ removal efficiency. If the pH is too high, poor reagent utilization can cause scaling and plugging problems in the absorber and mist eliminator, affect the quality of the byproduct solids, and increase reagent consumption. If the pH is too low, SO₂ removal will be below the desired efficiency and the corrosiveness of the process liquor increases. Slurry pH may also have a significant effect on sulfite oxidation in some systems. The sulfite oxidation rate decreases with increasing pH and increases with decreasing pH. This effect can be important in an inhibited-oxidation process that is close to the 15% oxidation fraction required to prevent gypsum scaling (see Part I, Section 3.3--Sulfite/Sulfate Scaling Control). As described earlier in this section, slurry pH may be used to control SO₂ removal efficiency, but limits must be placed on the pH setpoint range. These operating pH limits are established by performance tests and operating experience with a given FGD system.

Table 4.10-2

Summary of Reagent Feed Rate Control Strategies

Control Objectives: Adjust reagent feed rate as required by SO₂ removal rate and minimize cost of SO₂ removal.
 Origin of Process Variations: Boiler load and fuel sulfur content.

Control Strategy	Sensors	Controlled Variables	Control Elements	Advantages	Disadvantages
Adjust reagent feed based on reaction tank slurry pH.	<ul style="list-style-type: none"> ▶ Slurry pH. ▶ Reagent slurry flow rate. 	Reagent slurry flow rate.	Reagent slurry feed valve.	<ul style="list-style-type: none"> ▶ Maintains process pH in favorable range. 	<ul style="list-style-type: none"> ▶ pH sensors require frequent maintenance and calibration. ▶ Slow response time and non-linear response. ▶ Optimum pH range may change with time.
Adjust reagent feed based on boiler load and inlet SO ₂ content, and trim reagent feed based on reaction tank pH.	<ul style="list-style-type: none"> ▶ Boiler load. ▶ Inlet CEM or fuel analyzer. ▶ Reagent slurry flow rate. ▶ Reagent slurry density. 	Reagent slurry flow rate.	Reagent slurry feed valve.	<ul style="list-style-type: none"> ▶ Better response time than simple pH control. ▶ Maintains process pH in favorable range. 	<ul style="list-style-type: none"> ▶ Requires inlet gas CEM or continuous fuel analyzer. ▶ pH sensors require frequent maintenance and calibration. ▶ Optimum pH range may change with time.
Adjust reagent feed based on reaction tank slurry pH, and trim pH setpoint based on outlet SO ₂ .	<ul style="list-style-type: none"> ▶ Slurry pH. ▶ Stack CEM. ▶ Reagent slurry flow rate. 	Reagent slurry flow rate.	Reagent slurry feed valve.	<ul style="list-style-type: none"> ▶ Can be used to maximize reagent utilization. ▶ Maintains process pH in favorable range. 	<ul style="list-style-type: none"> ▶ pH sensors require frequent maintenance and calibration. ▶ Slow response time and non-linear response. ▶ Optimum pH range may change with time.

**Table 4.10-2
(Continued)**

Control Strategy	Sensors	Controlled Variables	Control Elements	Advantages	Disadvantages
Adjust reagent feed based on continuous slurry analyzer.	<ul style="list-style-type: none"> ▶ Autotitrator. ▶ Reagent slurry flow rate. 	Reagent slurry flow rate.	Reagent slurry feed valve.	<ul style="list-style-type: none"> ▶ Can be used to maximize reagent utilization. ▶ Does not depend on a constant relationship between pH and reagent utilization. 	<ul style="list-style-type: none"> ▶ Continuous slurry analyzer is still under development.

It should be noted that the above control strategy assumes that the appropriate pH setpoint limits for a process do not change with time. In practice, other process variations, including changes in the limestone reagent particle size and changes in the slurry soluble species concentrations (especially magnesium), can result in gradual changes in the relationship between slurry pH and reagent utilization. For this reason, a chemical monitoring program is usually set up to monitor the process chemistry and to verify that the current pH control range is appropriate. Chemical monitoring is discussed in more detail in Part I, Section 7--Chemical Monitoring Program.

The pH control loop also requires a satisfactory means of regulating the reagent feed to the absorber module reaction tank. In the usual configuration, the prepared reagent slurry (about 30 to 40% solids content) is pumped from an agitated reagent storage tank through a continuous piping loop and back to the storage tank. The slurry velocity in this reagent supply loop is held constant to minimize settling and plugging problems. The reagent supply to individual reaction tanks is taken as a sidestream from this loop and regulated by some type of control valve.

The use of a simple feedback pH control system to regulate reagent feed has some disadvantages. In the limestone-based FGD process, the slurry in the reaction tanks normally contains a large inventory of unreacted limestone. Therefore, the response of the tank pH to changes in reagent feed rate can be slow (up to several hours' response time to a step change in reagent feed rate). The response of pH to reagent feed rate is also nonlinear. At the lower end of the normal operating pH range (5.2 to 5.5), changes in reagent feed rate yield a significant pH response, but at the high end of the operating range (6.0 to 6.2), large increases in reagent feed rate result in a very small increase in pH. In this range, a small error in pH measurement can lead to costly excess reagent feed.

In the lime-based FGD process, where most of the required alkalinity is supplied by soluble sulfite, the excess reagent inventory is small, and the response of reaction

tank pH to reagent feed is faster. The simple pH feedback control loop is usually adequate for the lime-based process.

The second approach in Table 4.10-2 uses some other measurements in a "feedforward" mode in addition to feedback control based on slurry pH to improve the response time and prevent large errors in limestone reagent feed rate due to pH measurement errors. In this control strategy, the reagent feed rate setpoint is made proportional to the product of a boiler load signal and an inlet SO₂ measurement. The inlet SO₂ may be measured by a CEM located in the FGD system inlet duct or by a continuous fuel sulfur analyzer located at a coal feeder. The reagent feed rate is then "trimmed" (increased or decreased over a smaller range) in response to the recycle slurry (reaction tank) pH. This arrangement yields better response to changes in boiler load and fuel sulfur content while still maintaining the recycle slurry pH in a favorable range. Figure 4.10-3 illustrates this control approach. If the slurry density varies significantly, a frequent addition to this alternative is to also include reagent slurry density as a control input.

The third approach in Table 4.10-2 is the same as one of those described for controlling SO₂ removal. A reaction tank pH control loop is used to maintain a pH setpoint, but the setpoint itself is controlled to maintain the desired SO₂ concentration in the stack gas. This approach has the advantage of maximizing reagent utilization, because only enough reagent is fed to maintain the required SO₂ removal.

The final reagent feed control option shown in Table 4.10-2 is based on the use of a continuous slurry analyzer that measures the amount of excess reagent in the recycle slurry. The reagent feed rate is then adjusted to maintain a pre-set level of excess reagent. With this approach, errors in pH measurement do not result in wasted reagent. Also, changes in the pH versus reagent utilization relationship also do not affect this control strategy. However, the continuous slurry analyzer is still under development.

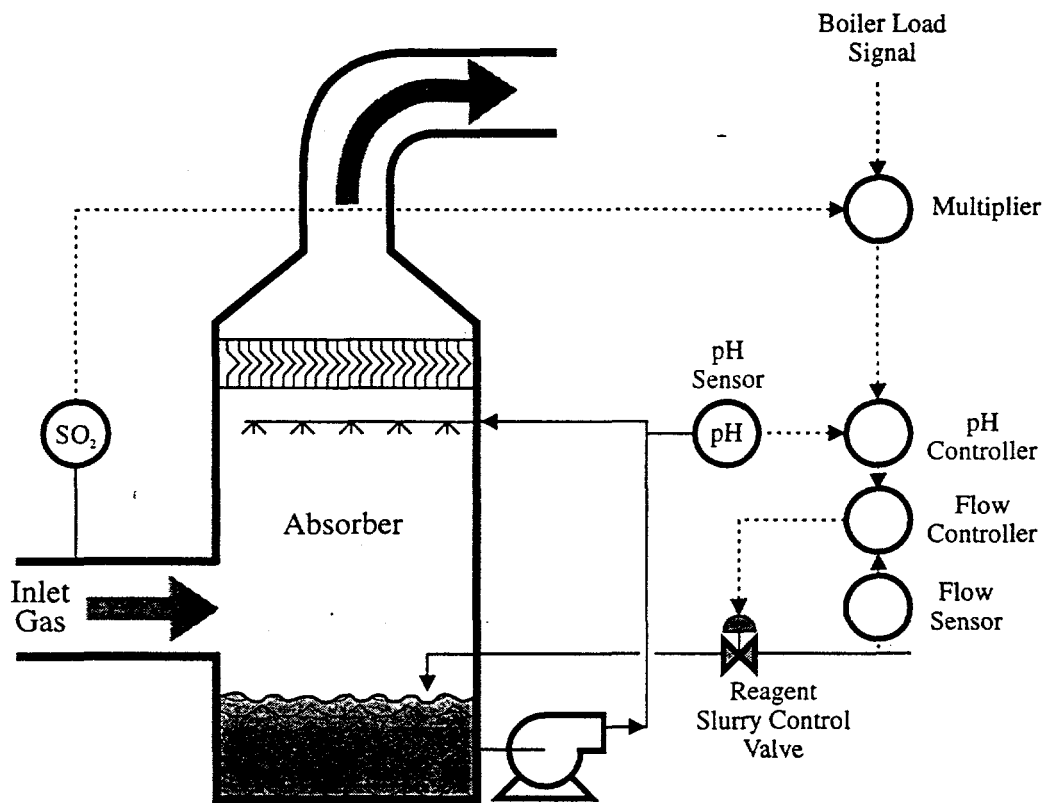

Figure 4.10-3. Feedforward-Feedback Reagent Feed Control

Note that all of the reagent feed control options include the use of a reagent feed rate flow sensor and flow rate controller. In practice, the pH controller may not actually open and close the reagent flow control valve directly. Instead, a "cascade" control arrangement is used in which the pH controller output provides a setpoint to a separate flow controller, which actually opens and closes the reagent feed valve based on a flow measurement. With cascade control, the control system response is improved because the flow controller rapidly compensates for fluctuations in the reagent feed rate caused by disturbances such as pressure variations or valve wear without waiting for the eventual change in reaction tank pH. The reagent flow rate sensor also provides information that is important for troubleshooting other control problems such as pH measurement errors and control valve failures.

Liquid Level and Slurry Density Control

Because large quantities of water are lost by evaporation in the absorber module, liquid level control is important in lime- and limestone-based FGD processes. Liquid level control is necessary to protect process pumps from running dry and to maintain proper process chemistry by regulating the reaction tank slurry solids inventory. Because liquid level and slurry density control loops are closely related in the absorber module, these control requirements are discussed together.

Reaction Tank Level and Density Control--The absorber module reaction tank must be maintained at its full operating level to provide proper solids retention time and to protect the absorber spray pumps from cavitation. Water is added to the module through pump and agitator seals, with reagent feed slurry, and through the mist eliminator wash system. Water is lost from the module by evaporation to the flue gas and with slurry that is bled to the byproduct solids dewatering system. In most FGD system designs, the absorber water balance is "negative." That is, the evaporation rate exceeds the sum of the other fixed-rate water inputs to the module. The balance of the water needed to maintain reaction tank

level is returned to the reaction tank from the reclaim water tank, which receives clarified overflow from the dewatering system.

Table 4.10-3 summarizes four strategies for reaction tank level/density control. These are illustrated in Figure 4.10-4, parts a, b, c, and d. The first option is to blow down slurry from the reaction tank by an overflow to a waste sump. With this approach, the tank level is maintained at the overflow elevation and the slurry density is controlled by varying the amount of reclaim water returned to the reaction tank. The required sensors include tank level (for alarm purposes only), slurry density, and reclaim water flow rate. The density controller adjusts the reclaim water flow rate setpoint. The flow rate controller then adjusts the flow rate by opening or closing a control valve in the return line to maintain a density setpoint. With the overflow configuration, the only control valve is on the clear reclaim water. This is an advantage because slurry control valves are high-maintenance components. Pumps are still required to transfer the bleed slurry from the waste sump to the dewatering system, however. One disadvantage of this approach is that relatively large solids can accumulate in the reaction tank because the tank is not perfectly mixed. Extending the overflow pipe deep into tank will minimize the accumulation of large slurry solids.

The second and third strategies in the table both use the reclaim water flow rate to control tank level, and the slurry density is controlled by adjusting the slurry bleed rate. In option two, the slurry bleed is a sidestream from one of the recycle pump discharge lines and the bleed rate is controlled by a density controller that adjusts a valve in this line. This arrangement requires no separate pump to bleed slurry from the reaction tank, but another intermediate pump may be required to transfer the slurry to the byproduct solids dewatering system. In this arrangement, the slurry bleed control valve can become a high-maintenance component. In option three, the density controller controls the slurry bleed rate by operating a variable-speed motor and pump. This pump can be sized to deliver the bleed slurry directly to the dewatering system. It also provides a continuous slurry flow, which can minimize plugging problems compared to the bleed valve approach.

Table 4.10-3

Summary of Reaction Tank Level and Density Control Strategies

Control Objectives: Maintain full level in reaction tank and optimum slurry density.
 Origin of Process Variations: Boiler load and fuel sulfur content.

Control Strategy	Sensors	Controlled Variables	Control Elements	Advantages	Disadvantages
Maintain tank level by slurry overflow.	<ul style="list-style-type: none"> ▶ Tank level. ▶ Slurry density. ▶ Reclaim water flow. 	<ul style="list-style-type: none"> ▶ Reclaim water flow rate. 	<ul style="list-style-type: none"> ▶ Reclaim water control valve. 	<ul style="list-style-type: none"> ▶ Reaction tank cannot be overfilled. ▶ Overflow bleed requires no pump or slurry control valve. 	<ul style="list-style-type: none"> ▶ Waste sump and pumps required.
Maintain slurry density by reclaim water flow rate.	<ul style="list-style-type: none"> ▶ Tank level. ▶ Slurry density. ▶ Reclaim water flow. 	<ul style="list-style-type: none"> ▶ Reclaim water flow rate. ▶ Slurry bleed flow rate. 	<ul style="list-style-type: none"> ▶ Reclaim water control valve. ▶ Slurry bleed control valve. 	<ul style="list-style-type: none"> ▶ Slurry bleed requires no separate pump. 	<ul style="list-style-type: none"> ▶ Bleed control valve is high-maintenance component. ▶ On/off control can cause plugging in bleed line.
Maintain tank level by reclaim water flow rate.	<ul style="list-style-type: none"> ▶ Tank level. ▶ Slurry density. ▶ Reclaim water flow. 	<ul style="list-style-type: none"> ▶ Reclaim water flow rate. ▶ Slurry bleed flow rate. 	<ul style="list-style-type: none"> ▶ Reclaim water control valve. ▶ Slurry bleed motor control. 	<ul style="list-style-type: none"> ▶ Bleed pump provides continuous flow to minimize plugging problems. 	<ul style="list-style-type: none"> ▶ Separate pump required.
Maintain slurry density by slurry bleed valve.	<ul style="list-style-type: none"> ▶ Tank level. ▶ Slurry density. ▶ Reclaim water flow. 	<ul style="list-style-type: none"> ▶ Reclaim water flow rate. ▶ Slurry bleed flow rate. 	<ul style="list-style-type: none"> ▶ Reclaim water control valve. ▶ Slurry bleed motor control. 	<ul style="list-style-type: none"> ▶ Bleed pump provides continuous flow to minimize plugging problems. 	<ul style="list-style-type: none"> ▶ Separate pump required.

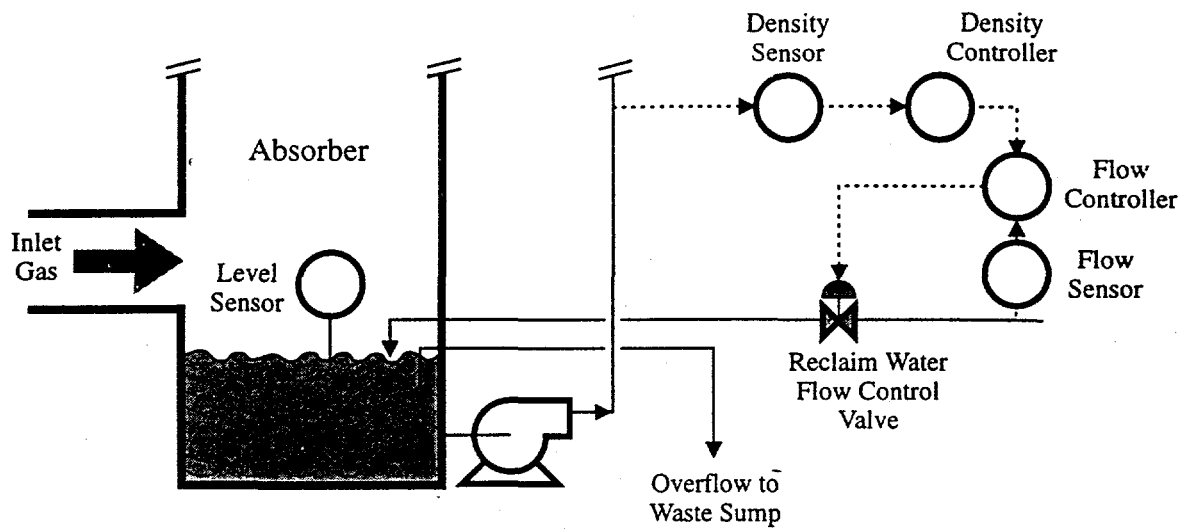

a. Reaction Tank Level Control by Overflow and Density Control by Reclaim Water

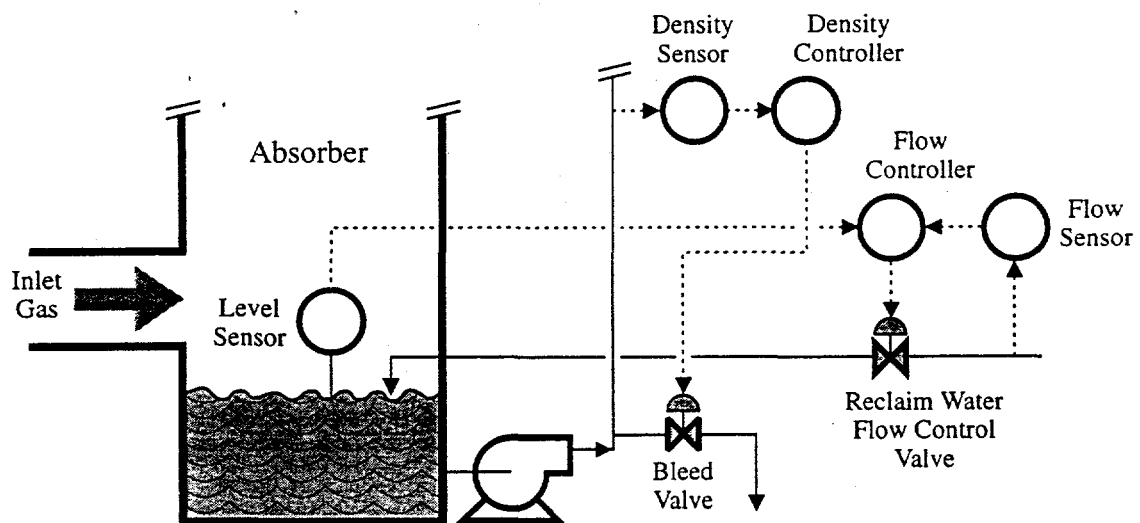

b. Reaction Tank Level Control by Reclaim Water and Density Control by Bleed Valve

Figure 4.10-4. Reaction Tank and Density Controls

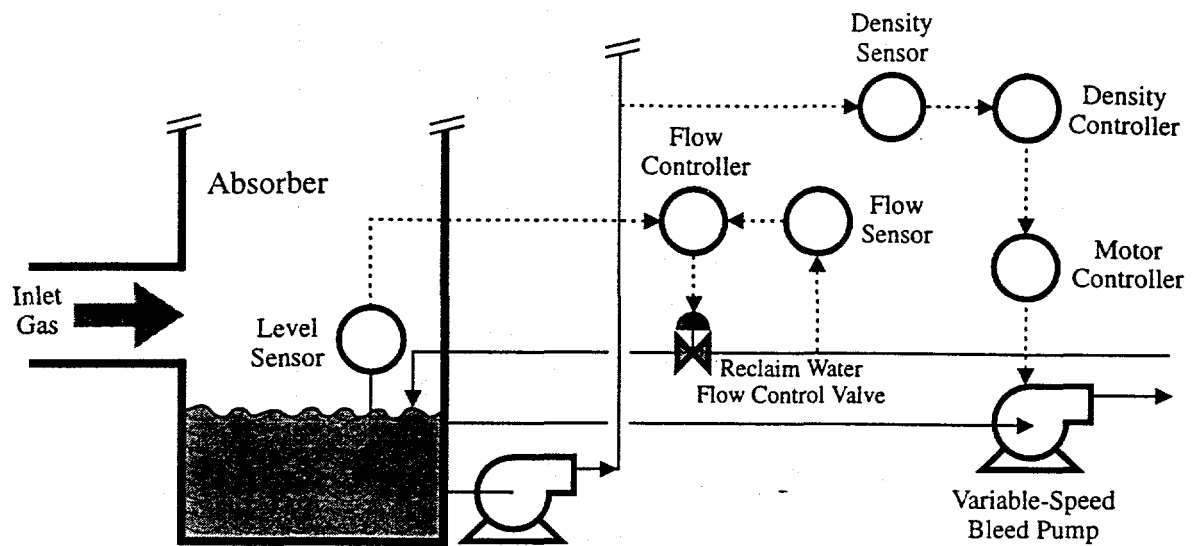

c. Reaction Tank Level Control by Reclaim Water and Density Control by Variable-Speed Bleed Pump

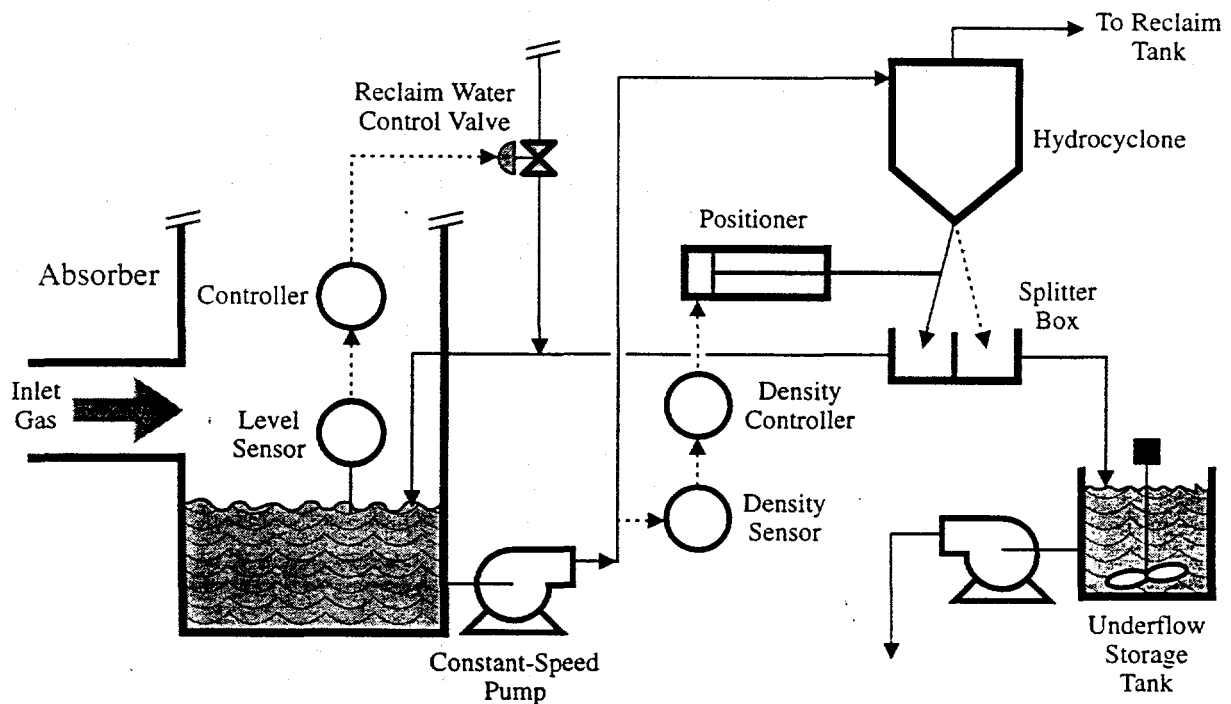

d. Reaction Tank Level Control by Reclaim Water and Density Control by Hydrocyclone Underflow Splitter Box

Figure 4.10-4. Reaction Tank and Density Controls (Continued)

The fourth strategy in the table again uses reclaim water flow to control the reaction tank level, but the bleed slurry is pumped at a constant rate to a process hydrocyclone. The hydrocyclone overflow flows to the reclaim water tank and the concentrated underflow is either returned to the reaction tank or diverted to a storage tank to control the slurry density in the reaction tank. The density controller actuates a positioner which moves a flow diverter to direct the hydrocyclone underflow to either side of a splitter box (see Part II, Figure 12-4). This arrangement is most likely to be used in the forced-oxidation limestone process where thickeners are not required for primary dewatering. This continuous flow arrangement minimizes plugging, but the hydrocyclone can increase crystal attrition in the process and create fines that can sometimes blind the vacuum filter medium.

The automatic slurry density control strategies described above can also be accomplished using a manual slurry density measurement. The rate of change of slurry density with time in most limestone-based FGD systems is slow because of the large inventory of solids in the reaction tank. The permissible control range for slurry density (10 to 15% by weight) is also broad compared to that for pH or tank level. In the manual method, the slurry density is measured once per shift by weighing a calibrated flask. The reclaim water flow rate or slurry bleed flow rate setpoint is then adjusted manually to increase or decrease the slurry density. This approach has proved to be adequate for some operating systems, especially where the boiler load and fuel sulfur content do not vary over a wide range.

A special level/density control case can arise during low-load operation, especially in a single-module FGD system. At low load, the absorber water balance can become "positive" as the evaporation rate decreases. This is especially true for systems with absorber spray pumps and side-mounted agitators that use gland seal water. In this case, the amount of slurry that is bled to control density may not be sufficient to control level. This situation may require that the density controller be manually overridden, or that the mist eliminator wash rate be adjusted as a function of load. Mist eliminator wash control is discussed later in this section.

Dewatering System Level/Density Control--Bleed slurry from the absorber reaction tanks is transferred to the byproduct solids dewatering system (see Part I, Section 4-8--Byproduct Solids Dewatering Equipment). If there is an intermediate waste slurry sump between the absorbers and the primary dewatering equipment, its level is controlled either by variable speed pumps or on/off pumps. For inhibited-oxidation FGD systems, the primary dewatering device is typically a thickener that often serves as a surge tank for solids in the FGD system. Normally, the thickener underflow slurry is pumped to an underflow storage tank from which it is fed to the final dewatering equipment. The overflow from the thickener flows by gravity to the reclaim water tank from which it is returned to the absorber reaction tanks as required. When additional underflow storage is required, however, the thickener underflow slurry can be recycled to the thickener inlet. The byproduct solids inventory in the thickener can be allowed to increase until the underflow solids depth reaches maximum allowable depth.

In the forced-oxidation process, the thickener is often replaced by hydrocyclones as the primary dewatering device. In this case, the waste slurry is pumped through the hydrocyclones either directly from the reaction tanks or from an intermediate sump. The hydrocyclone overflow is stored in the reclaim water tank and the underflow is stored in underflow storage tank before processing in the secondary dewatering step.

The secondary dewatering equipment may be either vacuum filters or centrifuges. Both of these devices work best with constant feed conditions (feed rate and solids concentration), so the secondary dewatering equipment may be operated only one or two shifts per day. The secondary dewatering is begun when the underflow storage tank is full and continues at a constant rate until the tank level reaches a low-level shut-off point. The number of vacuum filter/centrifuges in operation also is adjusted to control tank level and secondary dewatering equipment operating duration.

Mist Eliminator Wash Control

The absorber mist eliminators (MEs) must be washed to prevent buildup of slurry solids on the blades. As noted above, the ME wash system design and control approach must be compatible with the absorber module water level/density control strategy. Wash system design was described in detail in Part I, Section 4.4--Mist Eliminator Systems. The MEs are washed in segments to minimize total mist carryover from washing and to minimize the required wash pump flow rate. The wash control system opens and closes the control valves to each wash system segment according to a pre-set sequence. Each ME wash segment is operated for about one minute every 30 to 60 minutes. The wash controller is programmed to decrease the wash frequency during low-load operation so that the absorber density can still be controlled.

Overall FGD System Water Balance Control

Controlling the water inventory in an FGD system is complex and has been the source of operating problems at several existing installations. Water inventory control is typically the subject of an engineering study early in the design stage. This study evaluates water demands and consumption in the system under various operating conditions. The objective is to ensure that the FGD system remains a net consumer of water on both a short-term and long-term basis and to provide adequate surge capacity to accommodate transient conditions.

The total FGD system water inventory is controlled by adding makeup water to maintain the level in the reclaim water tank. During periods of low-load operation, the FGD system may not consume a sufficient quantity of water, causing the water balance to become "positive." In this case, excess water must be stored. Depending on the system load profile, more temporary storage volume may be needed than can be provided by the reclaim water tank. Many FGD systems include a storage pond or tank to which excess water can be pumped for additional, temporary storage when required. This pond or tank can also be used

to store water from reaction tanks or thickeners during system outages when these tanks are emptied for maintenance. Water from the surge pond must be returned to the system during periods of high-load operation. Storage tanks have the added benefit of returning the slurry solids to the FGD system, which minimizes absorber module restart problems.

4.10.2 Instrumentation Options

All of the control strategies described above ultimately depend on accurate, reliable measurements of process conditions. In lime- and limestone-based FGD service, the selection of proper instrumentation depends to a great extent on whether the process stream to be measured is a clear liquor or a slurry. Some options for the required process instrumentation are described below. CEMs for flue gas SO₂ measurements are discussed separately in Part II, Section 15 of this manual.

Slurry pH

Even though some type of pH control loop is used to control reagent feed rate in all lime- and limestone-based FGD processes, there are some persistent problems with this approach. The slurry pH sensor itself has proved to be one of the most maintenance-intensive components in FGD system control loops. The response of the pH electrode changes from day to day due to the interaction between the porous reference junction of the electrode and fine suspended and precipitating solids in the slurry. In most lime- and limestone-based FGD systems, two redundant pH sensors are used at each measurement location so that false readings are more readily detected. In addition to redundant sensors, daily sensor calibration using standard buffers or a calibrated portable pH meter is essential.

The placement of pH sensors is also important. The sensor must be located such that the slurry in contact with it represents "average" conditions in the recycle slurry (reaction tank). The electrode must be situated so that it is readily accessible and can be removed from the process stream for repair or replacement while the absorber is operating.

Several different electrode placement approaches have been successful. The electrodes can be inserted through a ball valve directly into the side of a reaction tank. In this case, the tank penetration should be at the same elevation as the absorber spray pump suction. Locations at the top and bottom of the reaction tank should be avoided because the tank is not likely to be completely mixed.

The pH electrode may also be mounted in a dedicated piping loop that extends from an absorber spray pump or slurry bleed pump discharge line. In this arrangement, the piping loop should be sized to maintain the proper flow velocity without throttling. Velocities in the 2 to 3 m/s (6 to 10 ft/s) range are typical to prevent solids from settling in the line. Sharp bends and restrictions should be avoided. High velocities in the pH measurement loop should also be avoided to minimize electrode erosion.

In some systems, the pH measurement slurry line discharges into a small open sink or tank into which the electrodes are placed. This tank overflows into a waste slurry sump or back to the reaction tank. This arrangement allows easier access to the electrodes and minimizes erosion. At the same time, a portable meter is easily used at the same location to check and calibrate the on-line meter reading.

Slurry Density (Solids Content)

The nuclear absorption density meter has become the most widely used process instrument for slurry density measurement in lime- and limestone-based wet FGD systems. This sensor measures the degree of absorption of gamma rays passing through the slurry in a process pipe. A radiation source is mounted on one side of the pipe and a detector on the opposite side. There are no parts of the instrument that are exposed to the process stream, which is an advantage for application to FGD slurry streams.

In practice, the nuclear density meter has proved to be reliable; however, it requires frequent calibration to maintain good accuracy. Another disadvantage of the nuclear

meter is that a trained, and in some cases, licensed person is needed to safely service this device.

In many cases, the manual method for measuring slurry density (weighing a known volume of slurry) can be used. This method is quick, simple, and requires no specific operator training. However, unlike the nuclear density meter, manual density testing cannot be incorporated into an automatic control loop. Even if not used as the primary density control method, manual testing is very useful for verifying and calibrating automated density monitoring techniques.

Other methods for measuring slurry density in lime- and limestone-based FGD systems include ultrasonic and photodetection systems. In ultrasonic density systems, an ultrasonic signal is sent from a transducer to a receiving transmitter, which converts the ultrasonic signal to an electronic signal. The slurry density affects the strength of the ultrasonic signal received. Photodetection density systems pass a slurry sample through a glass cell, which is illuminated by a laser light source. Scattered light is collected and then focused on a photodetector that provides a signal proportional to the volume of particles in the slurry. The system can differentiate between suspended and dissolved solids.

Tank Level

There are a number of instruments that can be used for measuring the level of liquor or slurry in process tanks. Table 4.10-4 describes the different level sensors and compares their advantages and disadvantages. For level measurement of slurry tanks (reagent storage tanks, reaction tanks, and underflow storage tanks), it is important to select a level indicator type that will not be adversely affected by scaling or plugging. For reaction tanks, it is also beneficial if the level sensor operation is not affected by the buildup of foam, because foaming has been experienced at a few facilities.

Table 4.10-4.

Options for Level Sensors in Lime- and Limestone-Based FGD Systems

Sensor Type	Measurement Principle	Advantages	Disadvantages
Float	Tank level is indicated through the action of a float on the surface of the liquor or slurry. Various mechanical, electrical, or magnetic linkages can be used.	<ul style="list-style-type: none"> ▶ Simple, direct measurement. 	<ul style="list-style-type: none"> ▶ Deposits can form on float in lime/limestone FGD service. ▶ Affected by foam.
Bubbler	A constant volume of air flows through a vertical tube immersed in the tank. Level is proportional to the back-pressure necessary to maintain the air flow.	<ul style="list-style-type: none"> ▶ Level signal is transmitted by a commonly used differential pressure device. 	<ul style="list-style-type: none"> ▶ Bubbler tubes are easily plugged in lime/limestone FGD service. ▶ Calibration is affected by changes in slurry density.
Displacement	A vertical sensor is suspended in the tank from a force measuring device. The weight of the sensor varies with the depth of liquid displaced by the sensor.	<ul style="list-style-type: none"> ▶ Simple, direct measurement. 	<ul style="list-style-type: none"> ▶ Deposits can form on sensor in lime/limestone FGD service. ▶ Most easily applied to open-top tanks. ▶ Calibration is affected by changes in slurry or liquid density.
Differential pressure	The hydraulic head of the liquid or slurry is measured by a differential pressure sensor.	<ul style="list-style-type: none"> ▶ Simple, direct measurement. 	<ul style="list-style-type: none"> ▶ Pressure taps are easily plugged in lime/limestone FGD service. ▶ Calibration is affected by changes in slurry or liquid density.
Ultrasonic	A sound signal is transmitted from the sensor to the surface of the liquid. The level is inversely proportional to the elapsed time for the reflected signal to return to the sensor.	<ul style="list-style-type: none"> ▶ Sensor is not in contact with process fluid. ▶ Calibration is not affected by changes in fluid density. 	<ul style="list-style-type: none"> ▶ This sensor may interpret a foam layer as the true liquid level.
Electrical capacitance	A plastic-coated rod electrode is positioned vertically in a tank and a differential voltage is maintained between the rod and the tank wall. The electrical capacitance between the rod and the wall is a measure of the height of liquid on the rod.	<ul style="list-style-type: none"> ▶ System is fairly simple. 	<ul style="list-style-type: none"> ▶ Scaling or solids deposition on the rod can give false readings.

Table 4.10-4
(Continued)

Sensor Type	Measurement Principle	Advantages	Disadvantages
Nuclear	A gamma ray source is mounted on the top or side of the tank, with a detector on the side, which provides either a point or continuous level measurement.	<ul style="list-style-type: none"> ▶ Sensors are not in contact with process fluid. ▶ Changing density or presence of foam does not affect accuracy. 	<ul style="list-style-type: none"> ▶ The system has high cost. ▶ Special training is required for maintenance.
Radar	Similar to ultrasonic system, but operates at lower frequencies.	<ul style="list-style-type: none"> ▶ Sensors are not in contact with process fluid. ▶ Changing density or presence of foam does not affect accuracy. 	<ul style="list-style-type: none"> ▶ Higher cost than ultrasonic.

Many instruments are intrusive to the process; that is, parts of the level system are located in the process tank. This can be a problem in agitated tanks if the wetted parts are not protected from excessive movement. Such protection can be achieved by placing the parts (e.g., float, sensor, or capacitance rod) in a perforated pipe that is attached to the tank.

Flow Rate

There are a variety of instrument types for flow measurement. Table 4.10-5 describes the different options for flow measurement and compares their advantages and disadvantages. Again, flow instruments that can operate without being affected by scaling, plugging, or erosion should be selected for service in slurry streams.

Many other types of flow measurement instruments are available and suitable for clear liquid streams, which includes water for makeup, ME wash, pump/agitator seals, and reagent dilution. Rotameters, paddle wheels, and turbine meters have proved to be reliable in these applications.

Table 4.10-5

Options for Flow Measurement in Lime- and Limestone-Based FGD Systems

Sensor Type	Measurement Principle	Advantages	Disadvantages
Differential pressure	The pressure difference across an orifice, flow nozzle, or venturi section in the pipe is measured. Flow is proportional to the square root of the pressure difference.	<ul style="list-style-type: none"> ▶ Measurement principle is well established and flow rate can be calculated from theory. ▶ The flow element itself is inexpensive and the differential pressure sensor and transmitter are commonly used instrumentation. 	<ul style="list-style-type: none"> ▶ This flow measurement option is primarily useful for clear liquids. ▶ The flow element is subject to erosion and the pressure taps will plug in slurry service. ▶ Calibration is affected by changes in slurry or liquid density.
Doppler ultrasonic	A sound signal is transmitted through the pipe. Sound is reflected from particles or bubbles in the flowing fluid. The fluid velocity is inferred from the reflected sound frequency.	<ul style="list-style-type: none"> ▶ Sensors can be applied to exterior surface of ordinary piping after installation. ▶ Less expensive than magnetic flow meter. 	<ul style="list-style-type: none"> ▶ Applied only to slurry streams or liquid streams with air bubbles. ▶ Signal cannot be transmitted through large-diameter FRP piping.
Magnetic	A magnetic field is established across the pipe. The fluid velocity is inferred from voltage induced by the fluid flowing through the field.	<ul style="list-style-type: none"> ▶ Accurate and dependable in slurry service. 	<ul style="list-style-type: none"> ▶ Applied only to slurry streams. ▶ Requires separate pipe spool piece as integral part of sensor.

4.11 Equipment Arrangement Considerations

This section provides information on the factors that influence the layout of the FGD system. The utility engineers will establish the locations on the site allotted for installation of the absorber modules and supporting subsystems, but the actual arrangement of the equipment within these areas is normally part of the FGD system supplier's scope of services. In addition to the information provided in this section, additional discussion of equipment arrangement evaluation factors is provided in Part III, Section 2.7--Evaluation of Equipment Arrangement.

4.11.1 New Versus Retrofit Installation

As discussed earlier in Section 4, the FGD system and its support subsystems require a substantial amount of space on the generating plant site. The FGD absorber modules require an area comparable to that needed for the particulate control device (ESPs or fabric filters) and should be located as close as possible to the particulate control device and stack to minimize ductwork lengths and flue gas pressure drop. The reagent preparation equipment and byproduct handling equipment also require significant space on the site. If possible, this equipment should be located relatively close to the absorber modules to minimize slurry piping lengths and pumping costs. Conveyor lengths are minimized if the reagent receiving and storage facilities are located near the slurry preparation equipment. Depending on the ultimate disposal method selected, the byproduct disposal area can easily exceed the space required by the entire power generation block. Regardless of whether the FGD system is being installed as part of a new generating plant or is being retrofit to an existing system, the arrangement of the required equipment in the available space may affect the overall operation and reliability of the system.

In arranging the FGD system, the utility engineer and FGD system supplier must consider the following factors:

- Integration and interfacing with existing equipment;
- Provisions for future plant construction activities;
- Provisions for maintenance access to all plant equipment; and
- Provisions for operation and supervision of the processes.

Subsequent subsections will discuss these factors as applicable to each of the major FGD subsystems. Obviously, when the FGD system will be installed as part of a new unit, especially a site with no existing units, the utility engineer and FGD system 'supplier's designers have the most flexibility in the arrangement of the equipment. Where future generating units are planned for the site, the initial equipment arrangements often reserve space for the future equipment and envision sharing of spare equipment.

The space limitations at an existing site can require very creative equipment arrangements. Inlet ducts can be very long; new ID booster fans or a new stack may be required; and the reagent preparation and byproduct handling equipment may be a kilometer (0.6 mile) or more from the absorber modules. How well these space limitations can be accommodated in the FGD system arrangement is a test of the ingenuity of the utility engineers and FGD system vendor.

4.11.2 Flue Gas Handling System Arrangement

The flue gas handling system includes the ID fans (and booster fans, if needed), inlet and outlet ductwork, bypass ductwork, module isolation dampers, bypass ductwork and damper (if provided), and stack. As mentioned previously, the best arrangement is one that minimizes ductwork lengths and flue gas pressure drop. Because the outlet ducts experience the most corrosive conditions, it is especially important to minimize their lengths to reduce capital and maintenance costs. At an existing site, the length of the outlet ductwork may be a major consideration in determining whether a new stack should be installed.

Three example FGD system arrangements are illustrated in Figure 4.11-1.

Although the example arrangements use only one or two absorber modules, arrangements for more than two modules would be similar. An arrangement with three absorber modules can be seen in Figure 4.1-1 (previously presented in Section 4.1.5). Some existing FGD systems use six or more absorber modules and their arrangements can be very complex. However, most FGD system vendors currently offer a single FGD module capable of treating more than 1200 Nm³/s (2.5 million acfm) of flue gas. This is approximately equivalent to the volume of flue gas generated by a 650 MW boiler. Each of the three absorber modules at the Allegheny Power System (APS) Harrison Station is capable of handling the flue gas generated by 640 MW of generating capacity on a continuous basis and by 940 MW during emergency situations. Also, because of demonstrated improvements in FGD system reliability, fewer systems are being installed with a spare absorber module. Considering these trends toward larger capacity modules and eliminating spare modules, arrangements with more than three modules are less likely to be installed than they were in the past.

Arrangement 4.11-1a is a common arrangement at a new site where the FGD system is integrated into the initial layout of the generating plant or at an existing site where space was reserved for the future installation of an FGD system. The absorbers are located between the ID fans and the stack, minimizing the inlet ductwork lengths. The example shows an ID fan dedicated to each absorber module; however, a crossover duct between the fans is preferred by some designers to permit one module to be shut down for maintenance while the other module handles flue gas from both ID fans at reduced unit load. Such a crossover duct would be common in an installation where each module is capable of handling more than 50% of the design gas flow rate. Additional discussion of the absorber module capacity and sparing is presented in Part I, Section 6.0--Reliability.

Utilities frequently require the FGD flue gas handling system to have the capability to bypass all or a portion of the untreated flue gas around the absorber modules to provide emergency operating conditions such as complete power loss to the FGD system. Arrangement 4.11-1a shows the bypass duct routed from the inlet crossover duct to the

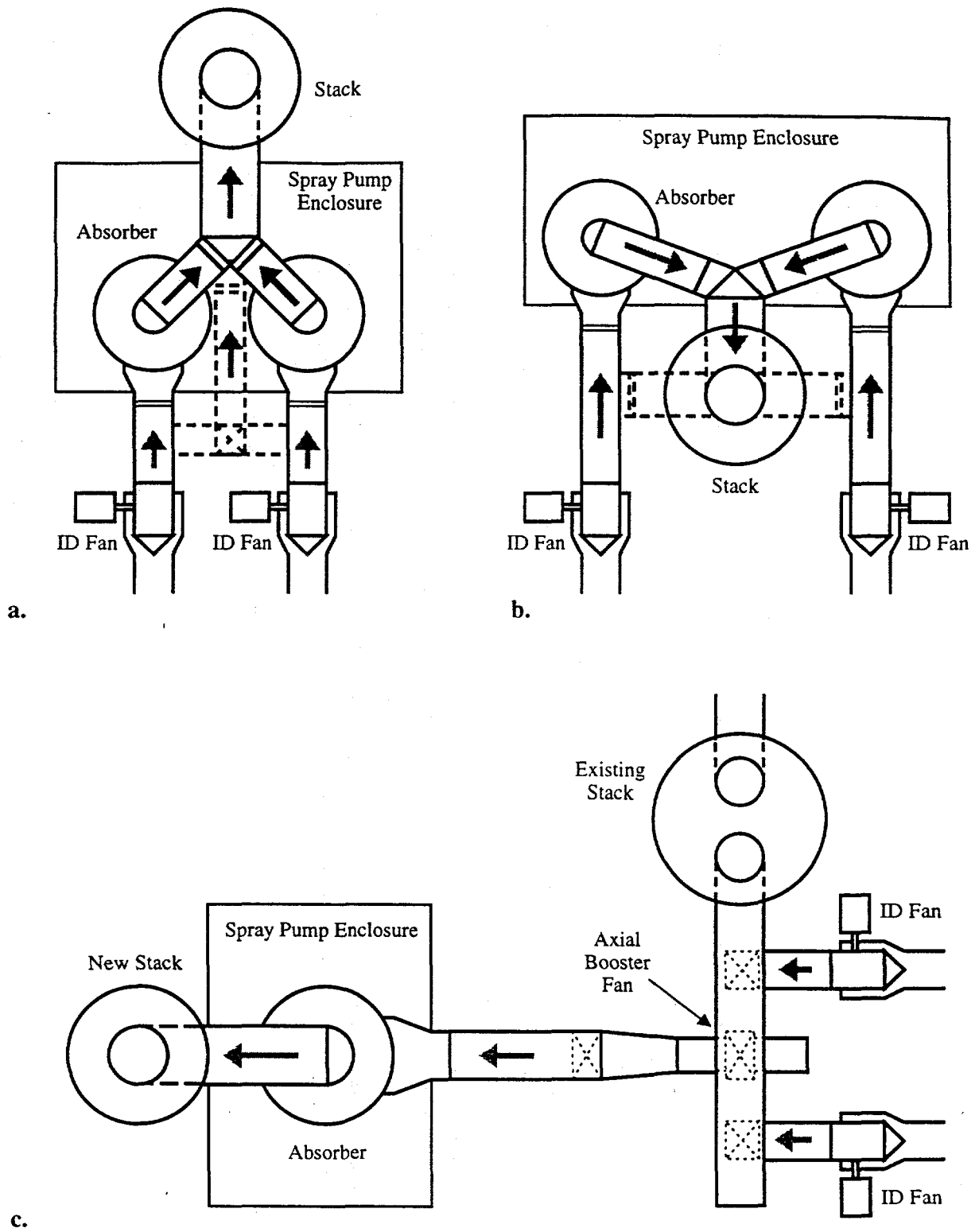

Figure 4.11-1. Typical Flue Gas Handling System Arrangements

common outlet duct. One or two multilouver-type flue gas dampers would be installed in this duct.

The absorber module inlet and outlet isolation dampers are typically top-entry guillotine-type dampers. The damper locations must be accessible by cranes or hoists in order to replace the damper blades or drive motors, if necessary. Although this is not a common occurrence, the arrangement of the ductwork and other structures should consider this possibility.

In this arrangement, maintenance access to the absorber spray pumps and the locations of the reagent preparation and byproduct handling subsystems are somewhat limited by the location of the stack. The arrangement also requires separate ductwork support steel for both the inlet and outlet ducts.

Arrangement 4.11-1b is common at new sites and at retrofit installations where there is insufficient room between the ID fans and the stack for installation of the absorber modules. The outlet ductwork remains relatively short, but the inlet ducts are much longer than in the previous arrangement, resulting in greater flue gas pressure drop. Access to the absorber pumps, however, is much improved and there is greater opportunity to locate the reagent preparation and byproduct handling equipment close to the absorber modules.

In the case shown, the module inlet and outlet ductwork are located on the chimney side of the absorbers. The general design of the ductwork is otherwise the same. Inlet crossover and bypass ductwork could be the same as shown in Arrangement 4.11-1a. Alternatively, as shown in Arrangement 4.11-1b, the bypass ducts could be routed directly to the stack. The location of all ductwork on the same side of the absorber modules reduces the number of structural steel columns to support the inlet and outlet ducts, reducing structural steel and foundation costs. Crane or hoist access to the isolation dampers must still be considered.

Arrangement 4.11-1c illustrates a possible arrangement proposed for a retrofit installation where there is no room for the FGD system near the existing stack and the existing ID fans have insufficient discharge pressure capacity. A similar duct arrangement could result if a new stack was required because of the wet outlet flue gas. In this arrangement, an axial booster fan provides the required flue gas pressure and a single absorber module discharges to a new stack suitable for wet flue gas. This arrangement highlights one of the potential benefits of using a single absorber module; no separate inlet or outlet isolation dampers are required under some design conditions.

Figures 4.11-2 and 4.11-3 illustrate two novel flue gas handling approaches. Figure 4.11-2 illustrates the arrangement of the FGD systems installed at APS Harrison Units 1, 2, and 3 (640 MW each). At this retrofit installation, each unit uses a single absorber module and discharges to a common stack with three separate stack liners. The Unit 2 absorber module is located inside the base of the stack and discharges directly to the Unit 2 chimney liner, which eliminates the module's outlet ductwork. Absorber spray pumps and reagent slurry storage tank are also located in the base of the stack. Figure 4.11-3 presents a flue gas handling arrangement that eliminates the need for a chimney by discharging the treated flue gas into the base of a hyperbolic cooling tower. Three retrofit FGD systems at RWE's Weisweiler Station in Germany (1500 MW total capacity) discharge flue gas from limestone-based FGD systems to three hyperbolic cooling towers. Untreated flue gas is directed to existing stacks. These units have been in service since the mid-1980s.

4.11.3 Absorber Module System Arrangement

The absorber module system consists of the absorber modules, reaction tanks, mist eliminators, slurry pumps, and absorber building enclosure. It is very difficult to generalize about the design considerations applicable to arrangement of the absorber modules because there are so many different types (see Part I, Sections 4.2--Absorber Module and 4.3--Reaction Tanks) and because each FGD system vendor has its own design characteristics and requirements. These vendor-specific design characteristics influence arrangement

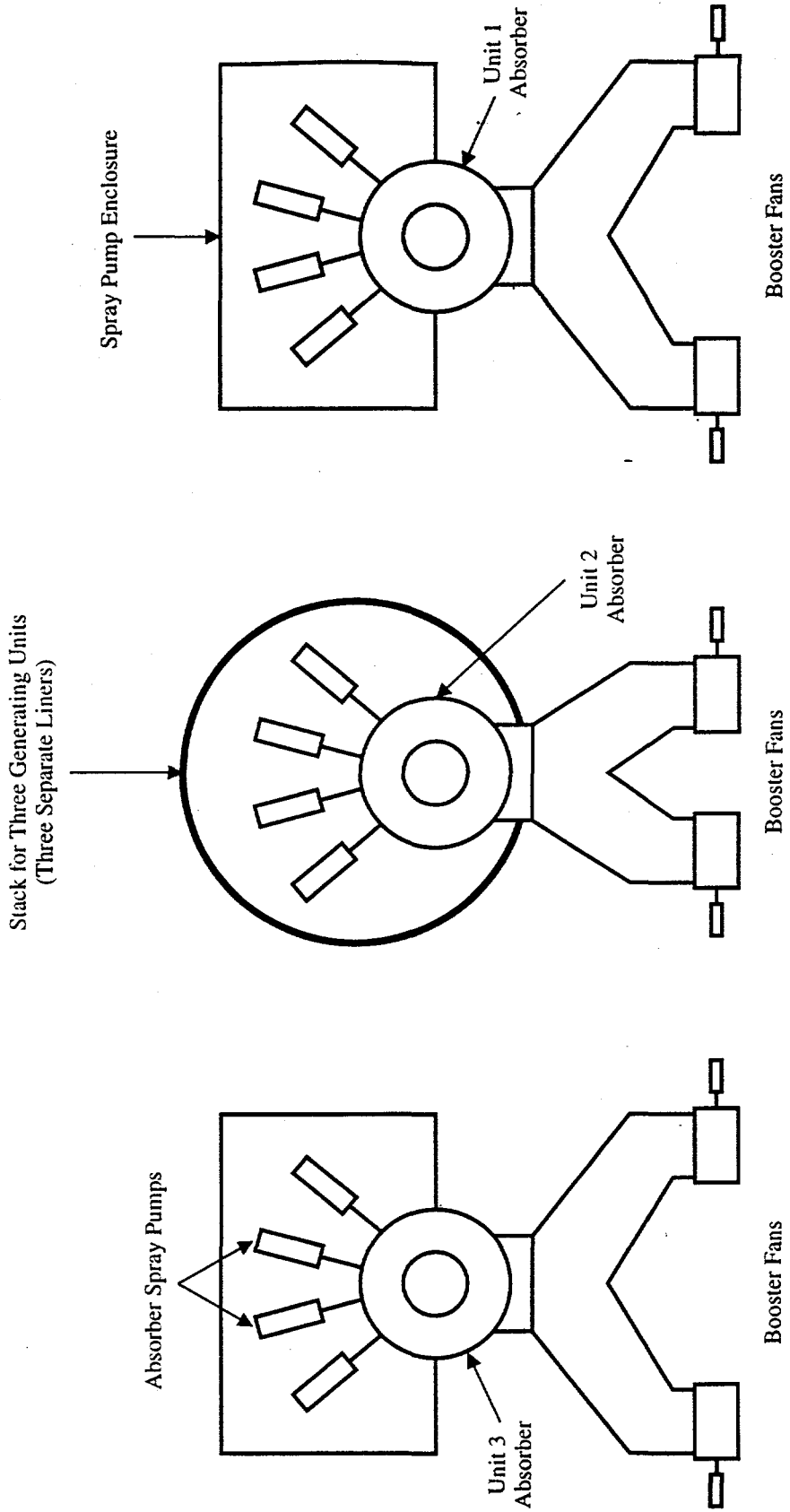

I.4.11-7

Figure 4.11-2. APS Harrison Station FGD System Arrangement

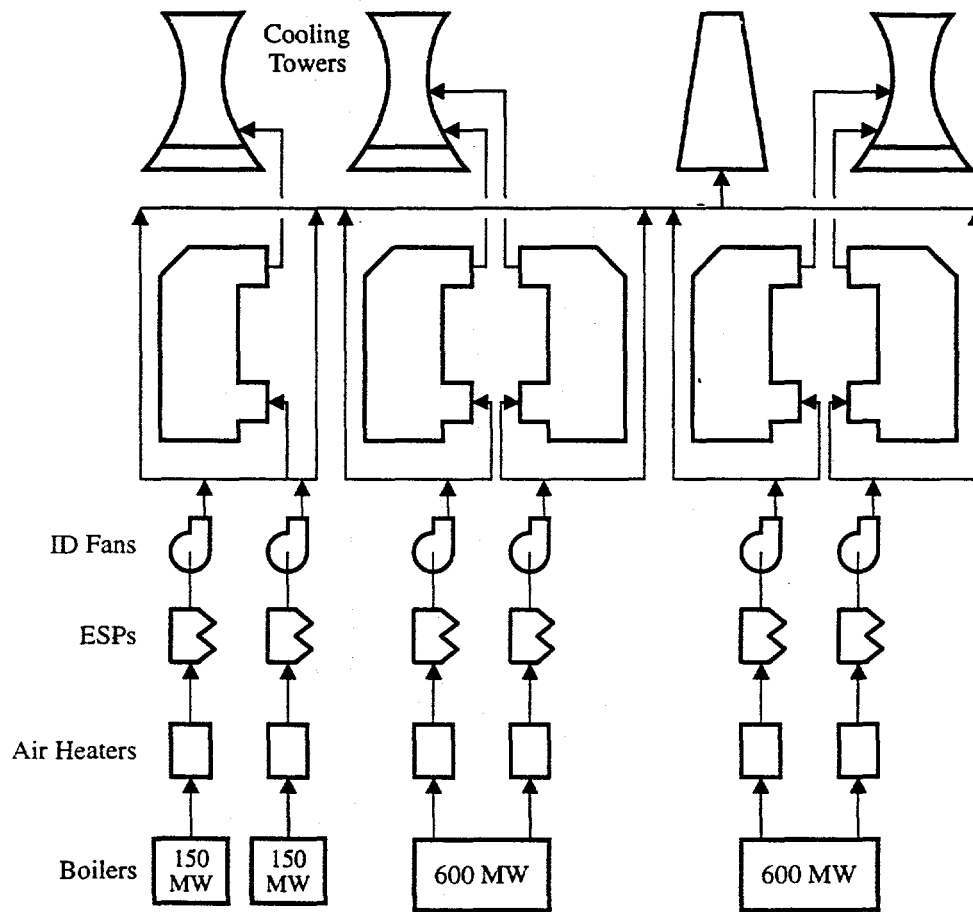

Figure 4.11-3. RWE Weisweiler Station FGD System Arrangement

considerations such as the use of integral versus independent reaction tanks, the number and location of reaction tanks, and the number and location of absorber spray pumps. Also, the arrangement of the flue gas handling system discussed in the preceding subsection imposes additional requirements on the arrangement of the absorber modules and support equipment.

Probably the most important absorber module system arrangement design consideration is the need to provide good maintenance access to the absorber, reaction tanks, mist eliminators, and absorber spray pumps. This involves the design of platforms, stairs, ladders, hoists, and maintenance access lanes. The large reaction tank access doors recommended to facilitate cleaning of the tanks should be mated with an access lane capable of handling a small front-end loader and waste dumpster. The mist eliminator removal hatches should be accessible to a drop area where ME sections can be lowered to grade during replacement.

As the maximum volume of flue gas treated by a single absorber module has increased over the years, the number and capacity of the absorber spray pumps have also risen. The design of these pumps is discussed in Part II, Section 5.0--Slurry Pumps. It is not uncommon for a large absorber module to require six or more spray pumps, each capable of pumping 2200 L/s (35,000 gpm) or more. Pump drive motors may be greater than 1000 kW (1200 hp). Because these pumps are very large and require periodic maintenance, their arrangement is critical. The front casing on a large absorber spray pump can weigh over 1 tonne (1.1 tons) and must be removed to replace the internal pump liner. A monorail or bridge crane system is extremely useful for both in-place maintenance and equipment removal for shop maintenance. The monorail or bridge crane drop area should be easily accessible by truck or fork lift.

Figure 4.11-4 presents three possible absorber spray pump arrangements. As seen in Arrangement 4.11-4a, as the number of spray pumps increases, it becomes difficult to arrange them along one side of the reaction tank. A minimum of 1 m (3 ft) should be maintained between spray pumps to allow sufficient maintenance access space. As a result,

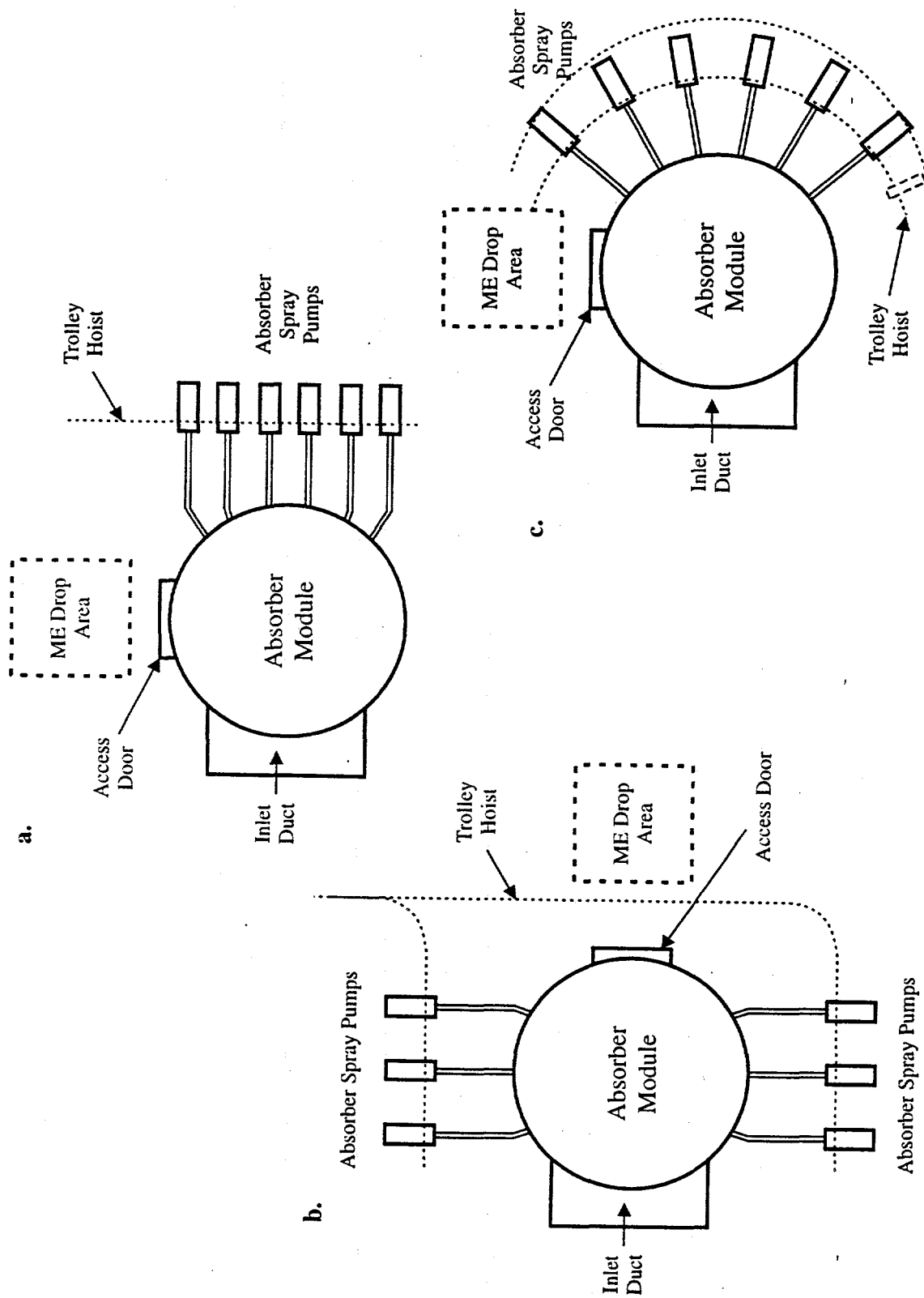

Figure 4.11-4. Absorber Module Arrangements

six large pumps arranged in a row would require a space 16 m by 4 m (48 ft by 12 ft). Also, this in-line arrangement results in the pump suction lines of the end pumps being long and difficult to route. Arrangements similar to 4.11-4b and 4.11-4c have been proposed by FGD vendors as alternatives to the in-line arrangement. In all of these alternatives, the location of reaction tank access doors, mist eliminator drop area, and pump removal monorail system must also be considered.

4.11.4 Reagent/Additive Preparation System Arrangement

The reagent/additive preparation system equipment consists of the reagent/additive receiving and storage equipment, slurry preparation equipment, and slurry storage tanks. The location of this equipment is typically a compromise between minimizing the reagent conveying costs and the reagent slurry pumping costs. The location of the reagent receiving and storage equipment is usually determined by the same factors that govern the location of the coal receiving and storage system. The equipment must be far enough away from the generating unit that the material deliveries do not interfere with other plant operations but close enough to permit reasonable conveying lengths. Often the result is that the limestone pile is located adjacent to the coal pile. There is usually more flexibility in the location of lime storage silos and additive storage tanks. A lime-based FGD system consumes over 43% less reagent (by weight) than a limestone-based system and smaller quantities are kept on site. A lime silo offers efficient use of plant space and presents fewer fugitive dust problems during unloading and storage than a limestone storage pile. Additive storage tanks seldom hold more than two truck-loads of chemical additive [38 m^3 (10,000 gallons)] and are usually located very near the reagent storage tanks.

The reagent preparation equipment (slakers or ball mills) should be located as close to the absorber modules as possible to minimize reagent slurry pumping costs. In some new systems, the reagent preparation equipment has been incorporated into the same building as the absorber modules. Typical arrangements of lime slakers and limestone ball mills are illustrated in Figure 4.8-5 and 4.8-7 (presented previously).

Maintenance access is important around the slakers and limestone ball mills. Although ball mills do not require frequent maintenance, maintenance access lanes and doors should be included in the arrangement to facilitate the removal of the mills and drive motors when required. A trolley hoist system is very useful for ball mill maintenance and for adding new balls to the mills.

4.11.5 Byproduct Handling System Arrangement

The byproduct handling system equipment consists of the primary and secondary dewatering equipment, reclaim water tank, and the temporary storage area. The driving force behind the arrangement of the byproduct handling system is the desire to minimize slurry pumping distances. This is especially important with the byproduct handling equipment because the solids level in the slurry leaving the primary dewatering equipment may be as high as 50 percent. For this reason, the primary and secondary dewatering equipment is normally grouped as close together as possible. If there is insufficient space near the absorber modules, the preference is usually for pumping the absorber blowdown to a location where there is sufficient room for both primary and secondary dewatering. A typical byproduct handling equipment arrangement for a forced-oxidation FGD system using thickeners and rotary vacuum filters is presented in Figure 4.11-5. The arrangement of equipment for byproduct solids from an inhibited-oxidation limestone-based FGD process or a lime-based FGD process would be similar, but the dimensions of the thickeners would be larger (see Part II, Section 11.0--Thickeners).

For alternatives using ponds or gypsum stacking as the ultimate disposal for waste byproduct solids, the arrangement of equipment near the absorber modules is greatly simplified. The equipment consists of a blowdown tank and a set of pumps to transfer the slurry to the disposal area. Conventional primary and secondary dewatering equipment is not required.

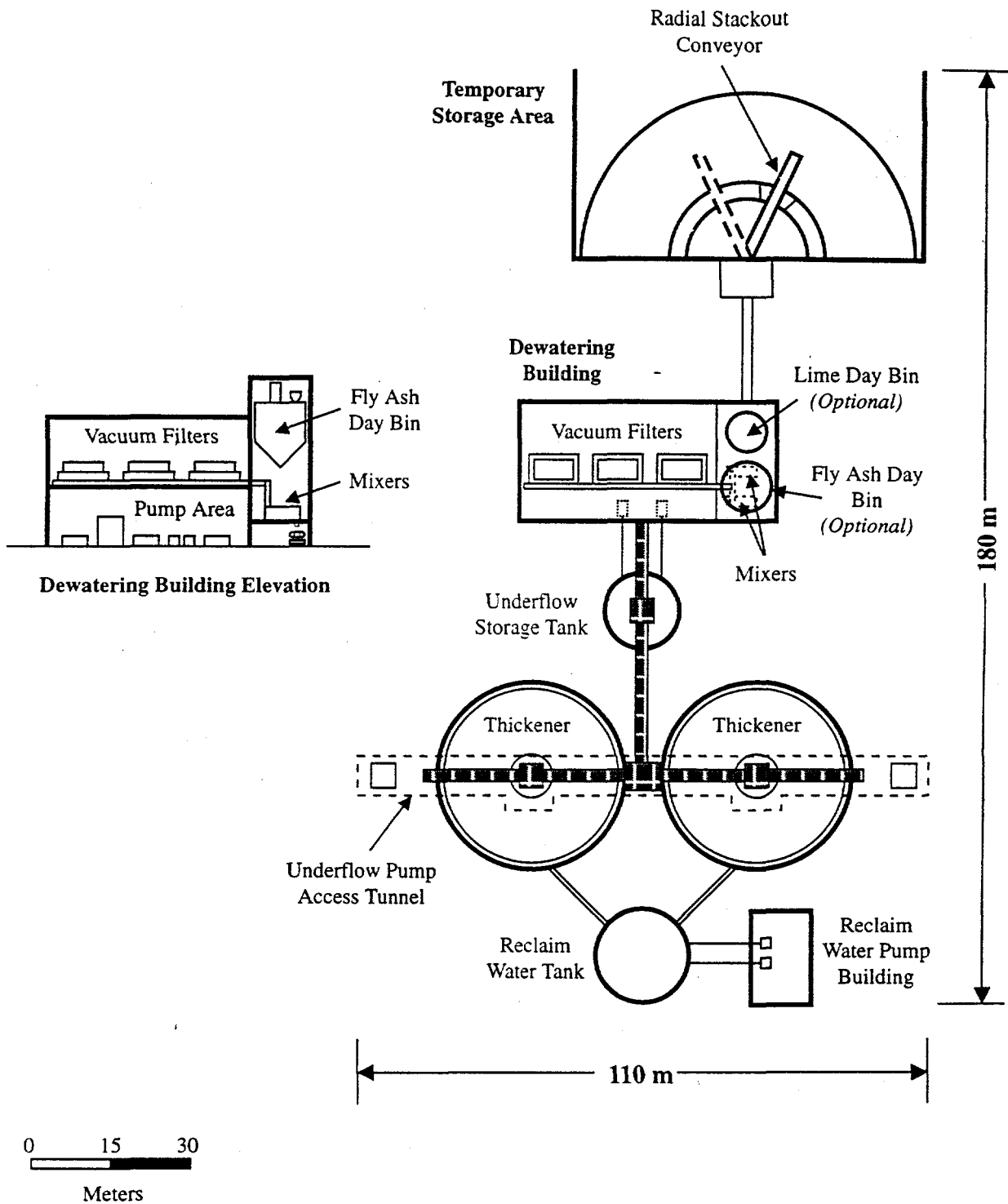

Figure 4.11-5. Byproduct Dewatering Equipment Arrangement--Thickeners

The trend toward the use of hydrocyclones for primary dewatering in forced-oxidation, limestone-based processes has offered the opportunity to install the primary and secondary dewatering equipment in the same building as the absorber modules. Hydrocyclones can be located above grade, with underflow storage tanks, and other equipment below. With hydrocyclones, an extremely compact and efficient FGD system arrangement such as the one shown in Figure 4.11-6 is possible. At Virginia Power's Mount Storm Station, the secondary dewatering vacuum filters are located above the temporary gypsum storage area. The dewatered solids fall directly from the vacuum filters to the storage area, eliminating the need for several byproduct conveyors.

The removal of the dewatered byproduct solids from the generating plant area can be another major concern. If the byproduct is to be sent to a landfill for disposal or taken off site for commercial use, the equipment arrangement must consider the movement of large trucks to and from the byproduct temporary storage area.

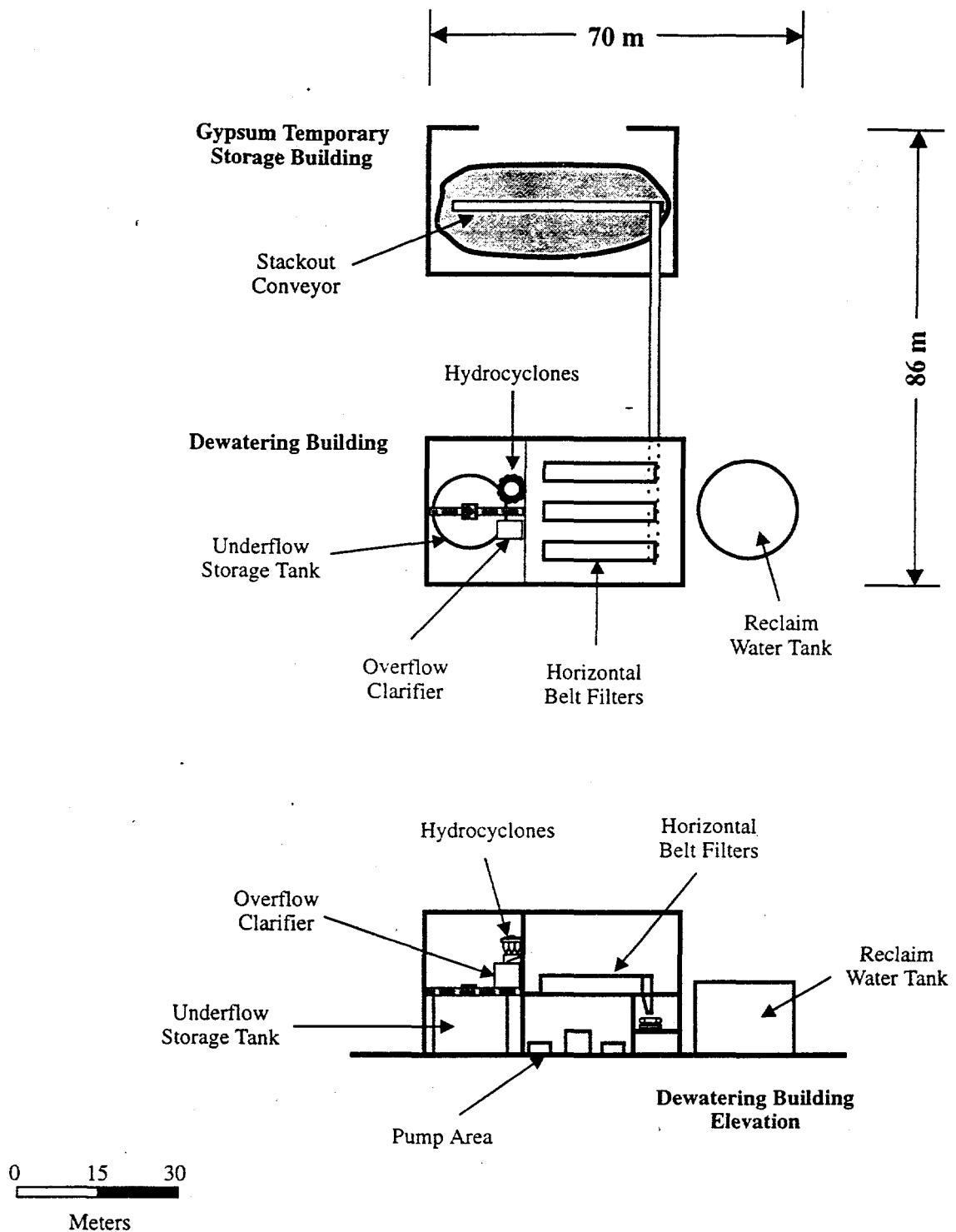

Figure 4.11-6. Byproduct Dewatering Equipment Arrangement--Hydrocyclones

5.0 MATERIALS-OF-CONSTRUCTION OPTIONS

This section will acquaint individuals involved in FGD system design with the issues related to materials selection and corrosion engineering of lime- and limestone-based wet FGD systems, dual alkali FGD systems, and sodium/magnesium throwaway FGD systems. The discussions of the major components of FGD systems in Part II each contain specific comments on materials of construction. The experienced FGD engineer may elect to proceed directly to those discussions. This section presents a broader, more tutorial discussion of the issues involved in material selection for the engineer with limited experience with corrosion in FGD systems. The discussions in Part II also frequently direct the reader to this section for additional background information.

This section makes extensive use of references to other available reports and literature on FGD system materials of construction.* These documents are listed in Section 5.10--References and are recommended to the reader who requires a more detailed treatment of this topic.

5.1 The Importance of Corrosion Engineering of FGD Systems

The selection of appropriate materials of construction is a critical aspect of the overall corrosion engineering of the FGD system. Experience has shown that lime- and limestone-based wet FGD processes can generate corrosive conditions which rapidly destroy most commonly used engineering materials. Cost-effective corrosion control is a complex interaction between plant design and materials selection in that certain plant design decisions can force specific materials selection decisions which may increase both initial and life-cycle

* Reference to specific products and manufacturers is unavoidable in a meaningful discussion of FGD materials of construction. Reference to a particular product or manufacturer is not an endorsement of that product or manufacturer over technically comparable products or manufacturers.

costs. Therefore, materials selection issues should be considered throughout the design process.

For example, one critical fundamental design decision is whether or not to reheat the flue gas, and how to achieve reheat if that option is selected. Many first- and second-generation FGD systems in the United States relied on direct-bypass reheat, in which a portion of the hot, untreated flue gas bypasses the scrubber and is re-combined with the cool, wet, treated gas downstream of the scrubber. This design option is extremely simple, compared to other reheat options, and imposes no parasitic power losses on the power plant. However, experience has shown that the gas mixing zones (where the untreated and treated gas recombine) of direct-bypass reheat systems generate environments so corrosive that even the most corrosion-resistant commercially available alloys sometimes fail. For this reason, direct-bypass reheat is rarely proposed for newer FGD systems (See Part I, Section 4.6--Flue Gas Reheat).

A survey of the causes of FGD system materials failures from 1982 through 1993 (1-3) showed that while the specific causes of failure were diverse, the failures fell into four broad categories, shown in Table 5-1. This table shows that 64% of the failures were attributable to poor materials selection (i.e., failure could have been anticipated based on the state of the knowledge at the time the system was constructed) and design, construction, and operational quality control problems. An additional 14.3% of the failures resulted from deliberate modification of the FGD process by the utility after construction such that the functional limits of the materials of construction were exceeded. The most common deliberate modification was tightening of the water cycle, resulting in elevation of slurry chlorides. Fewer than one-fourth of the failures resulted from inadequate material selection. Either the materials of construction available at that time were inadequate for the corrosive environment, or the experience to select adequate materials had not yet been disseminated. Most of these failures were related to one specific FGD design feature: direct-bypass reheating discussed above.

Table 5-1

Causes of FGD Materials Failures, 1982 through 1993

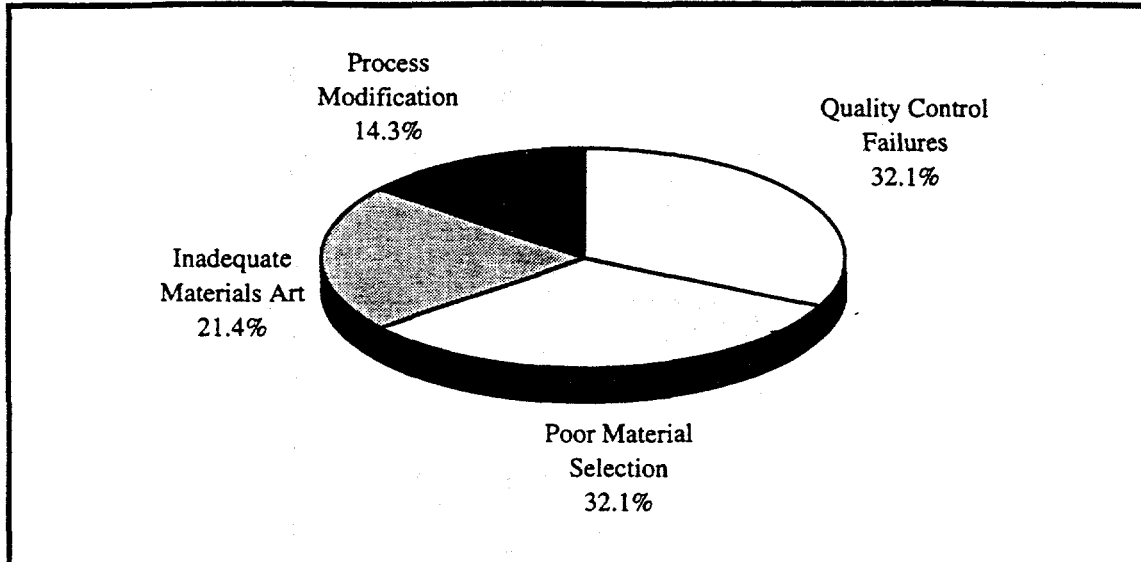

Failure Category	Discussion
Quality control	Design QC failures (7.4%) resulted from the failure to implement a consistent design and reflect design modifications throughout the system.
	Product QC failures (10.6%) resulted from inadequate materials specifications and/or verification checks of materials brought on site.
	Installation QC failures (7.4%) resulted from inadequate control during installation of the corrosion-resistant products.
	Process control QC failures (7.4%) resulted from failure to maintain adequate control of the process, resulting in operation outside the specified design limits.
Poor materials selection	Failures in this category resulted from materials selection contrary to conservative practices as understood at the time that the specifications were made. In other words, these material failures were predictable from consideration of the design service conditions and materials information available at the time the design was finalized.
Inadequate materials selection art	Certain FGD process designs create conditions which severely challenge all current engineering materials of construction. This failure category is avoidable by prudent process design.
Deliberate process modification	The root cause of component failure was the deliberate modification of the FGD process or process chemistry. The two most common modifications are 1) large increases in the chloride content of the absorber liquids resulting from conversion to zero discharge under changing environmental regulations and 2) addition of thiosulfate to suppress oxidation and control scale formation.

Table 5-1 illustrates that at least two-thirds of FGD materials problems can be avoided or minimized by good design, appropriate materials selection, and proper plant operation.

5.2 The Corrosion Engineering Process

The corrosion engineering process should be iterative, with the following broad steps:

- Step 1: Define the system operating parameters.
- Step 2: Prepare a technically ranked list of materials-of-construction options for each portion of the FGD system, considering normal operation, startup and shutdown conditions, and worst-case system upsets (probably simultaneous air preheater and absorber spray pump failure).
- Step 3: Fully consider the design and operational implications of each option, including possible demands for ancillary equipment such as emergency quench systems.
- Step 4: Perform economic evaluations, including the costs of any ancillary equipment added or eliminated by the particular materials selections.
- Step 5: Consider whether modification of the system operating parameters offers sufficient economic incentive to justify modification. If yes, revise system operating parameters and return to Step 2.
- Step 6: Specify materials.

5.3 The Relationship Between Process Design and Materials Selection

5.3.1 Corrosive Environment Zones

The interaction of the flue gas with the wet FGD scrubbing medium creates a variety of different corrosive environments as the gas passes through the system. These

differing corrosive environments are best described by dividing the wet portion of the FGD process into descriptive zones, as shown in Figure 5-1 and Table 5-2. Table 5-3 summarizes the principal effects of the process parameters that have the greatest impact on materials performance.

Note that the wet portion of the process begins at the point where moisture first occurs on the duct or vessel walls as the gas flows through the system. The wet portion of the process extends up the stack regardless of any provisions for gas reheat. Experience has shown that reheating rarely achieves complete dryness because the kinetics of droplet (mist) evaporation are slow in relationship to the flue gas residence time in the outlet duct and stack.

Zone 1, the inlet duct near the breeching to the absorber, is the transition between Zones 0 and 2. The gas in Zone 0 is above the acid dew point, and is hot and dry. Zone 1 contains the wet/dry interface where hot gas first contacts liquid from the absorber. This area represents a harsh environment characterized by concentrated acid films and concentration of dissolved salts through evaporation. If the FGD system uses a venturi for particulate removal, the venturi is a Zone 1 area also characterized by high abrasiveness. Depending on the configuration of the absorbers, the lower portion of the absorber, around the gas inlet, may contain a quench zone where temperatures are higher and pH is lower than elsewhere in the absorbers. This quench zone is also included in Zone 1.

The reaction tank (Zone 2) is the portion of the absorber which holds recirculating slurry. It may be integral to the absorber or it may be a separate tank. Like the absorber, the environment in the reaction tank is relatively mild because the liquid slurry prevents wall contact with hot gases and the pH is relatively mild. The floors of reaction tanks are subject to abrasion and mechanical damage from objects such as tools and nozzles dropped during construction or maintenance.

The absorber (Zone 3) typically represents one of the mildest environments. Gas temperatures are typically 52 to 60°C (125 to 140°F) after quenching, and there is

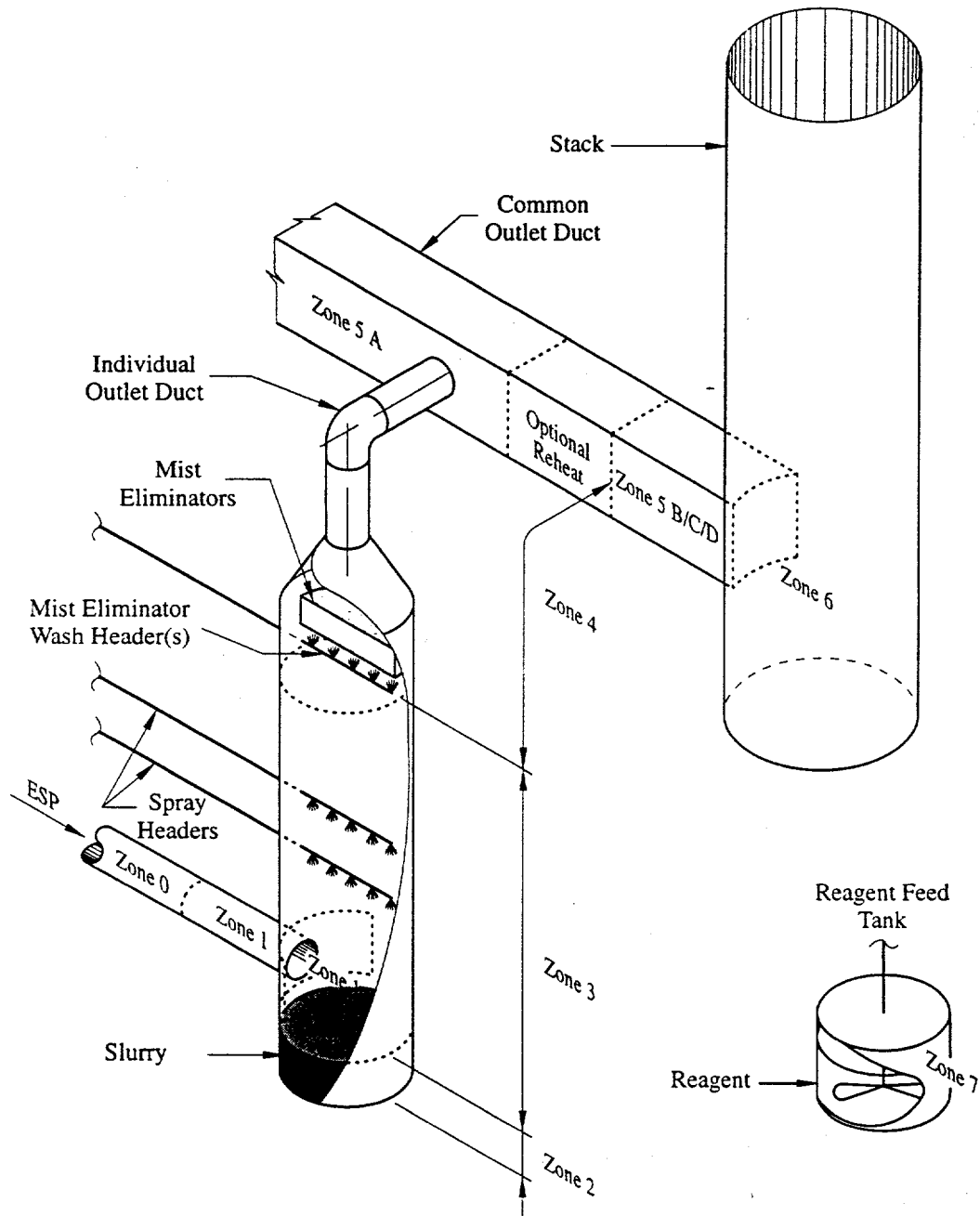

Figure 5-1. Corrosive Environment Zones Within a Single-Loop, Countercurrent Lime/Limestone FGD System

Table 5-2

Corrosion Environment Zones for a Single-Loop, Countercurrent, Open-Tower FGD System

Zone	Name/Description	Location	Environmental Factors	Preferred Materials
0	Gas inlet duct	The gas inlet duct upstream of the point where moisture first forms on the duct surfaces.	<ul style="list-style-type: none"> ▶ Dry gas with typical temperatures of 93 to 166°C (200 to 330°F). ▶ Excursions to 315°C (600°F) possible during air preheater failure. 	<ul style="list-style-type: none"> ▶ Unlined carbon steel.
1	Inlet breech and quench zone	The gas inlet duct from the point where moisture first forms on the duct surfaces until the gas is in moisture-saturated equilibrium with the slurry.	<ul style="list-style-type: none"> ▶ Fluctuating temperatures as gas quenches to adiabatic saturation, approximately 52 to 60°C (125 to 140°F). ▶ Potential severe thermal excursion during air preheater failure. ▶ Wet/dry zones, potential formation of extremely acidic condensates. 	<ul style="list-style-type: none"> ▶ Alloys. ▶ Ceramic tile/brick.
2	Reaction tank/sump	Extends from the bottom of the absorber to the liquid level in integral tank designs, includes the entire reaction tank in non-integral designs. Also includes slurry piping and slurry processing equipment.	<ul style="list-style-type: none"> ▶ Temperatures well modulated. ▶ Wall scouring by agitated slurry. ▶ pH typically 5.0 to 6.0. ▶ Floors subject to abrasion and mechanical damage by falling objects. 	<ul style="list-style-type: none"> ▶ Alloys. ▶ Reinforced resin linings on carbon steel. ▶ Rubber on carbon steel. ▶ Ceramic tile/brick (frequently applied to floors with other materials for walls). ▶ FRP with ceramic tile/brick floor.
3	Spray zone	The area between the top of Zone 1 and the inlet face of the mist eliminators which is not exposed to unquenched or partially quenched gas.	<ul style="list-style-type: none"> ▶ Moderate temperatures. ▶ pH typically 3.5 to 5.5. ▶ Walls washed with falling slurry. ▶ Abrasion only a problem if nozzle sprays directly against wall. ▶ Temperature excursions to 315°C (600°F) possible with loss of both air preheater and absorber sprays. 	<ul style="list-style-type: none"> ▶ Alloys. ▶ Reinforced resin linings on carbon steel. ▶ Rubber on carbon steel. ▶ Ceramic tile/brick.

**Table 5-2
(continued)**

Zone	Name/Description	Location	Environmental Factors	Preferred Materials
4	Individual outlet duct	Extends from the inlet side of the mist eliminators to the common outlet duct breeching.	<ul style="list-style-type: none"> ▶ Wet, saturated gas, moisture condensation on vessel walls. ▶ Continued sorption of acid gases produces low pH, on the order of 1.3 to 2. ▶ Temperature excursions to 315°C (600°F) possible with loss of both air preheater and absorber sprays. 	<ul style="list-style-type: none"> ▶ Alloys. ▶ Reinforced resin linings on carbon steel.
5A	Common outlet duct, unreheated	In systems without reheat, this zone extends throughout the common outlet duct to the stack.	<ul style="list-style-type: none"> ▶ Wet, saturated gas, moisture condensation on vessel walls ▶ Continued sorption of acid gases produces low pH. ▶ Acid condensate pooling on duct floors. ▶ Temperature excursions to 315°C (600°F) possible with loss of both air preheater and absorber sprays. 	<ul style="list-style-type: none"> ▶ Alloys. ▶ Ceramic tile/brick. ▶ Foamed borosilicate glass block. ▶ Reinforced resin linings on carbon steel. ▶ Fiber-reinforced plastic (FRP).
5B	Common outlet duct, indirect reheat	Zone 5B extends from just upstream of the reheat apparatus to the stack.	<ul style="list-style-type: none"> ▶ Reheating rarely achieves dryness in the stack due to inadequate residence time; concentrates aggressive ions through partial evaporation of moisture films. ▶ Temperature excursions to 315°C (600°F) possible with loss of both air preheater and absorber sprays. 	<ul style="list-style-type: none"> ▶ Alloys. ▶ Ceramic tile/brick. ▶ Foamed borosilicate glass block.

Table 5-2
(continued)

Zone	Name/Description	Location	Environmental Factors	Preferred Materials
5C	Common outlet duct, direct-bypass reheat	Extends from point of bypass gas injection to the stack.	<ul style="list-style-type: none"> ▶ Extremely aggressive, concentrated acid condensate films and wet/dry zones. ▶ Temperature excursions to 315°C (600°F) possible with loss of both air preheater and absorber sprays. 	<ul style="list-style-type: none"> ▶ Even the most corrosion-resistant materials of construction sometimes fail in this environment. ▶ Alloys, ceramic tile/brick, and foamed borosilicate glass block have given the best results.
6	Stack	Common outlet duct breaching to the discharge of the stack.	<ul style="list-style-type: none"> ▶ In systems without reheat, this environment is similar to Zone 5A. ▶ In systems with indirect reheat, expect large thermal gradients across the diameter of the stack due to gas stratification in the outlet duct. ▶ In systems with direct-bypass reheat, and systems with dual treated gas and bypass gas breeches, expect large thermal gradients across diameter of stack. 	<ul style="list-style-type: none"> ▶ Fire-clay or red shale acid brick. (pressurized annulus construction) ▶ Alloys. ▶ Reinforced resin lining on steel. ▶ Vitreous tile or brick. ▶ Foamed borosilicate glass block. ▶ Bare carbon steel (if gas is always dry).
7	Reagent tank(s)	Interiors of reagent preparation and storage tanks, and reagent, but not slurry, piping.	<ul style="list-style-type: none"> ▶ Near-ambient temperature, alkaline pH, approximately 8 for limestone and 12 for lime. 	<ul style="list-style-type: none"> ▶ Reinforced resin linings on carbon steel. ▶ Ceramic tile/brick floors common. ▶ Bare carbon steel (floors subject to erosion-corrosion, pitting in stagnant areas).

Table 5-3

Factors Affecting FGD Process Corrosivity

Property	Effects
Physical Properties	
Temperature	Rubber, reinforced resin, and FRP components have definite temperature limits. Corrosion-resistant alloys do not have a temperature limit within the range expected in FGD operations, but increasing temperature generally accelerates corrosion.
Wet/dry transitions	Wet/dry transitions are extremely corrosive due to the concentration of corrosive salts and precipitation of concentrated acids at these locations.
Particulate and slurry properties	Variations in slurry and particulate properties generally have relatively little effect on FGD materials performance except that erosion increases rapidly if particle size becomes too large or if the slurry contains excessive amounts of flint.
Velocity	Velocity is a critical factor in the design of slurry piping. Direct impingement of slurry sprays from nozzles can also cause severe erosion. The bottoms of agitated slurry tanks are subject to erosion due to locally high slurry velocities.
Geometry	Geometry is an important factor in velocity-related problems. Geometries that favor the pooling of condensates are detrimental and should be minimized to the fullest extent possible.
Chemical Properties	
Chloride	All of the alloys used in FGD applications have threshold chloride levels above which pitting will occur, so chloride level dictates alloy selection. The threshold chloride level depends on pH, temperature, and alloy composition. Rubber, reinforced resin liners, vitreous ceramic block, acid brick, foamed borosilicate glass block, and FRP are not sensitive to chloride concentration at least to 50,000 mg/L.
pH, acidity	Lowering pH (increasing acidity) reduces the concentration of chloride required to initiate pitting of stainless steels, nickel-based alloys, and titanium. Lower pH accelerates pit growth once started. The extremely concentrated acid films present in wet/dry transition zones attack not only alloys, but also rubber and reinforced resin liners.
Buffering capacity (residual alkalinity)	The buffering capacity or residual alkalinity of moisture films counters the increasing acidity resulting from continued sorption of acid gases. Condensate films downstream of the mist eliminators are acidic because the only source of residual alkalinity is carried-over absorber mist.

Table 5-3
(continued)

Property	Effects
Fluoride	Acidic fluoride salts can form in wet/dry zones, accelerating corrosion of nickel-based alloys and glass-based products. Most fluoride entering the system is precipitated by calcium or complexed by aluminum. With the exception of some wet/dry transition situations, fluoride is probably of little significance.
Polyvalent metal ions	The varying concentrations of trace levels of polyvalent metal ions such as copper, iron, manganese, and aluminum can significantly affect the corrosiveness of the process toward alloys, either beneficially or detrimentally.
Process enhancement amendments	The commonly used organic process additives, such as adipic and formic acids, are not known to adversely affect the materials of construction of FGD systems. Thiosulfate is known to promote the corrosion of certain stainless steels in paper-making processes, but the extent of the potential detrimental effect on the alloys used in FGD applications is not clear.

abundant alkalinity to neutralize the acid gases, so pHs are relatively mild. Abrasion is rarely a significant problem in Zone 3, unless the discharge of a slurry spray nozzle is aimed directly at a vessel wall or internal structural component.

The outlet duct (Zone 4) begins at the mist eliminators and extends to the common outlet plenum. Moisture forming on the absorber shell or duct walls downstream of the mist eliminators continues to absorb SO_2 from the flue gas. Because of the mist eliminators, there is no replenishment of alkalinity, and any residual alkalinity is rapidly consumed. The pH of the resulting moisture film is typically considerably lower than that encountered upstream of the mist eliminators, making the outlet duct a more aggressive environment, even in the absence of reheat.

The environment in the common outlet duct (Zone 5A) in the absence of, or upstream of, reheat is an extension of the environment of Zone 4, but geometry, in the form of duct drainage, plays a more significant role. Pooling of acidic condensates on the duct floor frequently causes severe corrosion. Ductwork should be designed to drain effectively.

Reheating the flue gas by indirect means (i.e., steam or hot water coils, hot air injection) (Zone 5B) raises the gas temperature and increases corrosiveness. Experience has shown that the reheated duct environment is rarely dry, and there is a very strong tendency for the gas stream to stratify with warm and cool layers. In addition, the cool layers frequently contain a fine mist of slurry particles carried over from the mist eliminators. Some of these droplets impact on the duct walls, and condensation may occur as well, creating a potentially corrosive moisture film and puddles. Adequate drainage can be even more important downstream of reheat than in Zone 5A.

Extremely harsh conditions, characterized by elevated temperatures and pHs less than 1, are created in and downstream of the mixing zones of direct-bypass reheat systems (Zone 5C). Excellent drainage is absolutely essential downstream of direct-bypass

reheat. The corrosive problems associated with direct-bypass reheat are so severe that this option should not be considered for new FGD construction.

The environment in the stack is an extension of the environment in the common outlet duct (Zone 5A, 5B, or 5C, depending on reheat options). Since the walls of the gas flue are vertical surfaces, they are not subjected to condensate pooling. This tends to make the stack environment less aggressive than the outlet duct environment. In reheated systems, a significant thermal gradient can be expected across the diameter of the stack, which can promote leaning of the flue. This effect can be severe in direct-bypass systems, or in systems in which treated gas and hot bypass gas enter a common flue through separate breeches. The latter geometry creates very severe thermal gradients across the flue, as well as zones where concentrated acids condense on the flue surfaces.

5.3.2 Startup, Shutdown, Upset, and Maximum-Credible-Accident Conditions

Consideration of the service environments to which materials will be subjected must address normal operating conditions, startup, shutdown, and upset conditions, including consideration of the "maximum credible accident" (a concept developed by the nuclear industry). For FGD systems, the maximum credible operational accident would probably be the simultaneous failure of the air preheater and absorber spray pumps, coupled with failure of the isolation dampers to close, resulting in thermal excursions to 315°C (600°F) throughout the absorbers and outlet ducts. This unlikely event actually occurred in an FGD system because of a lightning strike, which cut all internal and external power to the plant, including power to the emergency quench system. The accident destroyed the reinforced resin linings of the absorbers and outlet ducts, and melted the polypropylene mist eliminators. While most FGD plants have some form of emergency quench system, this incident shows that these systems can also fail.

5.4

Basic Design Philosophy Decisions

The FGD materials selections will have been successful if the performance of the materials meets *realistic* expectations. Within this context, several basic design philosophy decisions must be made, each of which can have profound impacts on the overall materials selection process.

The first critical question is whether the FGD system will always be operated within the design chloride limits, regardless of future changes in regulations and coal supply. The design chloride level determines alloy selection. If the system is constructed of alloys, once the design chloride level is established, it will be imperative that the design maximum chloride level not be exceeded. As discussed above, one of the significant underlying causes of FGD materials failure was the deliberate decision--in response to ever tightening water quality regulations--to reduce wastewater discharge from the process. This tightening of the water balance necessarily causes an increase in the process liquor chloride content, unless a chloride removal process is installed (see Part I, Section 4.9--Chloride Purge and Wastewater Treatment). Flexibility in future chloride levels can be obtained by selecting more corrosion-resistant alloys for the initial construction, or by electing alternative materials, such as reinforced resin or rubber linings, ceramic tile, or fiber-reinforced plastic (FRP), that do not have chloride limits.

The second basic philosophical decision is the trade-off between reduced initial capital expense versus increased annual maintenance. In many cases, selections can be made between alternatives having similar life-cycle costs but very different initial installed (capital) costs. Plainly, in such cases, the option with the lower installed cost requires significantly more maintenance than the option with the higher initial cost. The decision between such options is philosophical in nature, a question of paying now or paying later, provided that parties selecting the low-initial-cost/high-maintenance option are prepared to pay the higher annual maintenance costs as they occur. Additional discussion of this topic is presented in Part III, Section 3.3--Economic Evaluation of Total Cost.

Several categories or types of materials can be used to construct each of the zones of the FGD system, and those currently receiving significant consideration were highlighted in Table 5-2 and are discussed below. Sheet elastomer and reinforced resin linings offer relatively low installed costs with high annual maintenance, while corrosion-resistant alloys offer relatively higher installed costs with the potential for low annual maintenance costs. Vitreous ceramic brick and tile, foamed borosilicate glass block, and FRP each offer the potential for relatively low initial costs, coupled with low maintenance costs for specific applications within the FGD process.

5.5 Sheet Elastomer and Reinforced Resin Linings

Rubber and reinforced resin liners applied over carbon steel were utilized heavily in first- and second-generation FGD systems because of their low installed cost compared to other corrosion-resistant materials. These materials still offer some of the lowest installed costs, and their performance is not adversely affected by high chloride levels, but experience has shown that their life-cycle costs are relatively high due to large periodic repair costs (4). The advantages and disadvantages of sheet elastomers and reinforced resin liners are summarized in Table 5-4.

Rubber and reinforced resin liners have given their best performances in absorber modules and related services such as sumps and thickener vessels, where conditions are not too severe. Rubber and flaked glass polyester liners can be expected to provide roughly five years of relatively trouble-free service in uninsulated absorber modules, though annual or biannual repairs to a few percent of the surface area are commonly required. Large-scale maintenance or replacement of flaked glass or rubber linings is frequently necessary after five to ten years. Replacement can be extremely costly, often 1.5 to 2 times as costly as the original installation, because of the difficulty in removing the remains of the old liner. In almost all cases where they were used, reinforced resin liners functioned unsatisfactorily in the long term in outlet ducts (3,4), and are not generally recommended for new construction in these areas. Rubber has been only rarely used in this environment.

Table 5-4

Summary of Advantages and Disadvantages
of Rubber and Reinforced Resin Linings

	Reinforced Resin Linings	Rubber Linings
Product(s)	Multi-functional Novalac epoxies and Novalac epoxy/melamine/phenolic polymer alloys, bisphenolic epoxies, vinyl esters, and bisphenolic polyesters, reinforced with glass flake, glass fiber, alumina, silicon carbide, or other inert fillers.	Chlorobutyl rubber, either cured in place or applied as pre-cured sheet.
More common use area(s)	Reaction tank walls, absorber vessel walls.	Reaction tank walls, absorber vessel walls, absorber vessel top cones.
Less common use area(s)	Absorber vessel top cones, individual outlet ducts, unreheated common outlet ducts, unreheated stacks, reagent tanks.	
Major advantages	<ul style="list-style-type: none"> ▶ Low installed cost. ▶ Abrasion resistant formulations available where needed. ▶ No ceiling on chloride levels. 	<ul style="list-style-type: none"> ▶ Low installed cost. ▶ Good abrasion resistance. ▶ No ceiling on chloride levels.
Major disadvantages	<ul style="list-style-type: none"> ▶ Very exacting installation procedures. ▶ High maintenance--plan for major repair/replacement at 5-to-10 year intervals in absorbers, 3-to-6 year intervals in unreheated outlet ducts. ▶ Rapidly degraded by temperature excursions. ▶ Susceptible to impact damage. ▶ Ignitable by welding on outside of vessel. ▶ May be cracked by excessive flexing (oil-canning) of duct walls. 	<ul style="list-style-type: none"> ▶ Very exacting installation procedures. ▶ High maintenance; plan for major repair/replacement at 5-to 10-year intervals in absorbers. ▶ Rapidly degraded by temperature excursions. ▶ Moderately susceptible to impact damage. ▶ Ignitable by welding on outside of vessel.

Despite their higher maintenance costs compared to some other options, reinforced resin and sheet elastomer linings are still being specified at some sites for new construction of the milder portions of FGD processes, particularly absorbers, reaction tanks, and ancillary vessels, due to their lower initial cost.

The descriptions of elastomeric products and their installation requirements are discussed in Section 5.5.1, while reinforced resin products and their installation requirements are described in Section 5.5.2. Because the failure mechanisms of these dissimilar appearing materials are both similar and rather subtle, they are discussed together in Section 5.5.3.

5.5.1 Rubber and Other Sheet Elastomers

Product Description

Historically, three types of sheet elastomer have been used in FGD system applications: natural rubber, chlorobutyl rubber, and neoprene. Currently, however, the sheet elastomer most widely used in FGD applications is chlorobutyl rubber. A survey of the three major U.S. manufacturers of FGD rubber liners in 1985-1986 found that all three recommended specification of chlorobutyl rubber for the FGD absorber module and pipe lining. None of the three continued to endorse natural rubber or neoprene for this application (5).

Chlorobutyl rubber used in FGD service contains 80-85% chlorobutyl polymer blended with 15-20% isoprene (natural rubber). The sheet has a thin layer of natural rubber tie gum on one side for adhesion to steel substrates. The polymer blend is formulated (mixed) with a variety of additives such as carbon black, silica flour, and barium sulfate, to obtain the desired final properties upon curing. Only acid-resistant fillers, such as carbon black, barium sulfate, and silica flour, should be allowed. Acid-soluble fillers, such as calcium carbonate, should be avoided. The typical sheet thickness is 6.4 mm (0.25 in.). In U.S. FGD applications, the product is typically cured in place with atmospheric steam and

should have a final Shore Durometer hardness of at least 60A (5). Many European FGD applications in the early 1980s used a similar but factory pre-cured chlorobutyl system. It was thought that the more controlled curing available under factory conditions would yield a more durable product. While initial results appeared promising, longer-term experience suggests no great improvement compared to field-cured chlorobutyl (6).

Chlorobutyl rubber is inherently more resistant to moisture permeation than natural rubber, is naturally resistant to ozone and oil, and is more resistant to dibasic acids than either natural rubber or neoprene. It can operate continuously at 93°C (200°F).

Natural rubber requires large additions of anti-ozonants to prevent cracking, and such protection is essential to service in an FGD system (5,7). However, these anti-ozonants can impair adhesion of the elastomer to the substrate. Natural rubber is also susceptible to damage by oil carryover in the flue gas during startup, and has a maximum sustained operating temperature of 66°C (150°F). While natural rubber is no longer recommended for absorber linings, it is still widely used in molded form for pump impellers and volute linings.

Neoprene is much more difficult to install than either natural rubber or chlorobutyl, and is usually used only if institutional factors demand its fire-retardant properties. If neoprene must be used, *only lead-cured neoprene is acceptable for FGD service*. The lead curing is essential for adequate moisture permeation resistance (5). Zinc-cured or magnesium-cured neoprene is not acceptable.

Sheet fluoroelastomers have seen limited use as outlet duct liners. They have a thermal limit of about 82°C (180°F) in wet service, and up to 204°C (400°F) in dry service, and are probably more tolerant of thermal excursion than most other organic coatings (8,9). While they are resistant to acids, they can be degraded by exposure to wet unreacted lime or limestone reagent slurry. They are generally much more costly and difficult to install than the other organic coatings discussed in this report, and are not widely used, except as expansion joint seals.

Installation Requirements

One of the major drawbacks to the use of sheet elastomer linings is the exacting requirements for quality control during application, requirements which can be difficult to consistently maintain under field construction conditions. Manufacturer's specifications require that the metal surface over which they are applied be absolutely clean--free of rust, dust, and moisture--during installation. A white metal blast* with a specified blast profile** is required. This surface must remain absolutely dry throughout the application process. Many rubber and resin coating manufacturers require that the metal surface temperature be maintained at least 2.8 C° (5 F°) above the dew point temperature at all times to preclude condensation (5). When required, priming must occur within set times after the final grit blasting.

Rubber liners should be installed with 50-mm (2-in.) lap seams. Since slurry is flowing down the walls, seams on the walls should be made with the upper sheet overlapping the lower so that slurry drains away from the exposed edge. Once installed, the rubber liner must be cured by application of exhaust steam. Great care is necessary to ensure that all parts of the rubber lined structure are adequately cured (5).

As a practical matter, it can be extremely difficult to produce the clean, dry, dust-free surfaces required for optimum coating/rubber performance under the conditions typically present during the construction of a scrubber. Adhesive failure (debonding) or blistering can result if these conditions are not met.

* A "White Metal Blast Cleaned Surface Finish" is defined by NACE-International (under TM0170, No. 1) and by the Steel Structures Painting Council (under SSPC-SP 5-63) as an abrasive air-blasted "surface with a gray-white (uniform metallic) color, slightly roughened to form a suitable anchor pattern for coatings. This surface is free of all oil, grease, dirt, mill scale, rust, corrosion products, oxides, paint, and other foreign matter."

** The blast profile is the depth of a dense pattern of hook-like nicks created on the substrate surface by blasting with a specified grit at a specified angle and discharge pressure. The blast pattern anchors the lining to the substrate. Different linings require different depth profiles, specified by the manufacturer.

5.5.2 Reinforced Resin Liners

Product Description

Reinforced resins linings are slurries of catalyzed liquid resins and reinforcing material, applied over steel or other substrates in liquid form. They then spontaneously harden by cross-linking to produce a protective membrane barrier against the corrosive FGD environment. Commonly used resins include, in decreasing order of chemical and moisture permeation resistance: multi-functional Novalac epoxies and Novalac epoxy-melamine-phenolic polymer alloys, bisphenolic epoxies, vinylesters, and bisphenolic polyesters. Isophthalic polyesters have inadequate chemical resistance for use in FGD service. In general, aromatic-amine-cured systems are more resistant than aliphatic-amine-cured systems. Many of these formulations are crosslinked with styrene as an essential step in the curing process (3).

The most common reinforcing material is E-glass in the form of chopped glass fibers or glass flakes. If the product is flake-reinforced, glass flakes should be specified. A variety of other reinforcing or filler materials, such as woven glass matting, silicon carbide, and alumina, are also sometimes used, particularly in abrasion-resistant (AR) formulations. Fillers should be inert in sulfuric acid at 82°C (180°F), and should not themselves be porous. Mica flakes should be prohibited, because they react with sulfur oxides.

The thermal limit of resin-based liners is 82°C (180°F) in wet service. Dry service ceiling temperatures vary with resin: 121°C (250°F) for polyester and epoxy, and 182°C (360°F) for vinyl ester. However, all of these linings will fail rapidly if exposed to sharp wet/dry thermal excursions (8-10).

Installation Requirements

Reinforced resin linings have the same exacting requirements for surface preparation, cleanliness, and absolute dryness during application as the sheet elastomer linings.

In addition, the product specifications generally require a blast profile of a specified depth. Obtaining the necessary conditions for installation of resin linings is just as problematic as for sheet elastomer linings. Inability to maintain the required conditions during installation is probably the leading cause of early failure.

Glass-reinforced resin coatings should be trowel-applied, not sprayed, for best results, since trowelling reduces porosity from entrained air bubbles and results in layering of the flakes, apparently enhancing permeation resistance. Two coats, each a minimum of 1 mm (0.040 in.) thick should be specified. Commonly, the product comes in two colors so that the coats can be distinguished. The outer coat is frequently tan. If there is any possibility that brush blasting may later be used to remove deposits, then the outer coat should be brightly colored so the personnel cleaning the coated surface can more readily see that the lining has been reached during cleaning (3).

5.5.3 Modes of Failure of Sheet Elastomer and Reinforced Resin Linings

Premature Failure

Premature failure of sheet elastomer and reinforced resin linings can occur for several reasons, most notably the following:

- Improper specification;
- Product variation or substitution;
- Application problems; and
- In-service thermal or mechanical damage.

Aside from improper material selection, product variation is the most significant contributory factor in the failures of rubber liners. Historically, this problem was so prevalent that the Electric Power Research Institute (EPRI) sponsored development of the *Specification Guidelines For Flue Gas Desulfurization Rubber* (5). In some cases, the

problem was simply that the product specification was excessively broad. One investigation found that three distinct formulations, all reputedly the same rubber, had been installed in the same FGD module (11,12). Additionally, some manufacturers have varied formulations of their rubbers and resin products over time, sometimes with no change in designation or product name to alert the purchaser. Some of these product "modifications" resulted in inferior performance (7,13,14). In response to increasingly stringent environmental regulations, many resin products manufactured in the United States are being reformulated to reduce or eliminate the use of aromatic amine curing agents and styrene cross-linking agents. The effects of these reformulations on long-term performance in FGD service have not been demonstrated at this time (3). For these reasons, specifications for sheet elastomeric and reinforced resin liners should contain detailed product specifications.

As discussed previously, successful application of sheet elastomer and reinforced resin products requires exacting control of conditions during installation. Failure or inability to maintain the required environment can result in early adhesion failures of the linings.

Both resin liners and rubber liners are subject to premature failure by thermal shock or mechanical damage during service or outages. At one utility, masses of scale falling into drain cones of absorber modules ruptured the chlorobutyl liners (15). At another site, the maintenance crew removed deposits from a resin-lined venturi bowl by beating on the walls with sledge hammers (16)! Sheet elastomer and reinforced resin linings are also easily damaged by thermal upsets or excursions. Neither rubber nor resin liners are very tolerant of thermal excursions of the magnitude that can occur in FGD systems under some abnormal conditions. All of these materials have strict thermal limits, and damage is cumulative. Some means of effective, automatic, fail-safe, emergency cooling under severe system upsets or malfunctions should be provided to protect rubber or resin liners from severe thermal excursions.

The risk of fire can be very high during application because of the flammable nature of the solvents used, and special precautions must be taken to prevent accumulation of dangerous levels of fumes. In addition, most reinforced resin and elastomeric liners are combustible in the cured state. Several catastrophic fires have resulted from welding on the exteriors of lined absorbers. All lined absorbers should bear prominent "Do Not Weld" signs.

Ultimate Failure

Both sheet elastomer and reinforced resin liners are semipermeable membranes. They ultimately fail because of moisture permeation leading to debonding between the coating and steel substrate. This permeation is manifested as fluid-filled blisters between the coating or lining and the substrate. Failure occurs when the blisters rupture, allowing corrosion of the carbon steel substrate. Several factors affect the time required to blister. The most important factors are the natural moisture permeation resistance of the material, liner thickness, and the magnitude of the thermal gradient through the lining. The last effect is commonly referred to as the "cold wall" effect.

Although the mechanism is not clearly understood, the accelerating effect of a through-wall thermal gradient with the warmer temperature on the coated or lined surface is well documented and is the basis for the accelerated Atlas Cell test of rubbers and coatings. Both laboratory studies (17,18,19), and FGD experience (13,14) indicate that reduction of the through-wall thermal gradient by external insulation could easily result in a several-fold extension of the life of rubber or resin liners.

Despite the potential liner life-extending benefits of external insulation, the literature does not contain any rigorous study of the cold wall effect, its full implications on FGD liner life, or of any utility which has intentionally taken this approach to liner life extension.

Corrosion-resistant alloys (including austenitic stainless steels, duplex stainless steels, nickel-based Cr-Mo alloys, and titanium*) are the leading choices for inlet and outlet duct construction. They are also the main alternatives to sheet elastomer or reinforced resin lined steel for absorber construction.

A number of all-alloy systems have been built in the United States, trading higher initial capital cost for anticipated reduced annual maintenance expense in the long term. During the 1980s, there was a general shift from rubber-lined steel construction to all-alloy construction in Europe, coupled with a trend toward specification of more highly alloyed, more corrosion-resistant materials (6,20). In the United States, all-alloy systems utilizing C-Class nickel-base alloys** and titanium are increasingly being specified to cope with the anticipated very high chloride levels in FGD systems constructed after 1990.

Construction or lining with high-performance alloys (6-Mo superaustenitic stainless steels, C-Class alloys, and titanium) has become the generally accepted approach for the more severe regions of the FGD system, particularly in the wet/dry zone at the absorber inlets (Zone 1), and in the mixing zones of reheated outlet ducts (Zone 5). Well over 40 different alloy wallpaper installations were made during the 1980s. Most replaced reinforced resin liners in outlet ducts to solve ongoing corrosion problems (20). Many new FGD designs rely heavily on alloy wallpaper and other alloy construction.

Table 5-5 summarizes the advantages and disadvantages of corrosion-resistant alloy construction. Alloy construction offers several distinct advantages. In general, selection of the correct alloys is initially more expensive than rubber or resin liners, but the resulting

* Strictly speaking, Grade 2 titanium, the grade used in FGD construction, is a pure metal rather than an alloy, a distinction that will not be made elsewhere in this manual.

** Alloy C-276 and derivatives such as Alloys C-22™, 59™, 622™, 686™, and Allcorr™.

Table 5-5
Summary of Advantages and Disadvantages
of Alloy Construction

	Solid Plate Construction	Mill-Clad Plate Construction	Wallpaper and Metallic Composite Panel Construction
Product(s)	Type 316L, 4-Mo austenitic stainless steels, 6-Mo superaustenitic stainless steels, duplex stainless steels, 625-Class alloys, C-Class alloys, titanium.	6-Mo superaustenitic stainless steels, 625-Class alloys, C-Class alloys.	6-Mo superaustenitic stainless steels, 625-Class alloys, C-Class alloys, titanium.
More common use area(s)	All grades in reaction tank and absorber service, only 625-Class and C-Class alloys and titanium in inlet breechings and outlet ducts.	6-Mo superaustenitic stainless steels, 625-Class alloys and C-Class alloys in reaction tanks and absorbers, only 625-Class and C-Class alloys in inlet breechings and outlet ducts.	625-Class alloys, C-Class alloys, and titanium in inlet breechings and outlet ducts.
Less common use area(s)	None.	None.	6-Mo superaustenitic stainless steels, 625-Class and C-Class alloys, and titanium in reaction tank and absorber service (not generally recommended).
Major advantages	<ul style="list-style-type: none"> ▶ Low maintenance if correct alloys are selected. ▶ Repairs generally simple to make. ▶ Simple installation. ▶ Immune to thermal excursions. ▶ Resistant to mechanical damage. ▶ Abrasion problems rare. ▶ Load-bearing components can be attached directly to vessel walls. 	<ul style="list-style-type: none"> ▶ Low maintenance if correct alloys are selected. ▶ Repairs generally simple to make. ▶ Simple installation. ▶ Immune to thermal excursions. ▶ Resistant to mechanical damage. ▶ Abrasion problems rare. ▶ Load-bearing components can be attached directly to vessel walls. 	<ul style="list-style-type: none"> ▶ Low maintenance if correct alloys are selected. ▶ Repairs generally simple to make. ▶ Immune to thermal excursions. ▶ Resistant to mechanical damage. ▶ Abrasion problems rare.

**Table 5-5
(continued)**

	Solid Plate Construction	Mill-Clad Plate Construction	Wallpaper and Metallic Composite Panel Construction
Major disadvantages	<ul style="list-style-type: none"> ▶ Alloy selection fixes maximum allowable chloride for system. ▶ High initial cost. 	<ul style="list-style-type: none"> ▶ Alloy selection fixes maximum allowable chloride for system. ▶ High initial cost. 	<ul style="list-style-type: none"> ▶ Alloy selection fixes maximum allowable chloride for system. ▶ Medium initial cost. ▶ Obtaining 100% seal weld integrity can be problematic. ▶ Potential for flooding annular space between wallpaper sheets and substrate. ▶ Load-bearing components cannot be attached directly to vessel walls. ▶ Potential for fatigue failure under some circumstances.

systems tend to require much less maintenance. Alloys do not suffer the thermal sensitivities of rubber or resin liners, and are, therefore, much more resistant to damage during upset conditions. Emergency cooling provisions are not generally required for all-alloy systems. Alloy constructions are much easier to clean than coated surfaces, since there is no worry about damaging a coating. Alloy surfaces are also much easier to inspect. Finally, should repairs be required, repair of alloy construction is usually easier, provided that qualified welders are available.

The installation requirements are much less rigorous than for rubber and resin liners, thereby accommodating field installation under more adverse construction site conditions. Product variation of alloys is generally minor compared to product variation of rubbers and resins, and material verification is much simpler. Successful installation does, however, require welders qualified for the specified alloys and weld geometries.

In addition to their relatively high initial capital costs, the major disadvantage of alloy construction is that selection of the alloys forever fixes the upper limit for chlorides in the FGD process. Alloy selection must take into account anticipated "regulatory ratchet" of increasingly stringent environmental regulations. If evolving environmental regulations result in higher-than-design chloride levels in the FGD process liquor, the original alloy will have to be covered with a more chloride-resistant grade. Alternatively, some form of chloride removal system could be installed.

5.6.1 Alloy Products and Corrosion Resistance

All of these alloys, with the exception of titanium, owe their corrosion resistance to the spontaneous formation and regeneration of a passivation film, consisting of an invisibly thin layer of molybdenum-reinforced chromia, on the surface of the alloy.* As

* Titanium owes its corrosion resistance to the spontaneous formation of a titania film on the metal surface. While the nature of the film is different than that formed on stainless steels and nickel-based alloys, the concept of a passivation film is functionally applicable to titanium.

long as the passivation film remains intact, the corrosion rates of the alloys are extremely low, fractions of a mil (1 mil = 0.001 in. = 25.4 μm). The primary determinants of the stability of the passivation film on the stainless steels and nickel-based alloys are the alloy microstructure, the chromium, molybdenum, and nitrogen contents of the alloy, and the temperature, pH, and chloride levels of the environment. Other minor variables, such as varying trace metal ions in the environment, can also have a dramatic effect, either beneficial or detrimental.

These corrosion-resistant alloys exhibit an alloy- and environment-specific chloride threshold limit, above which the passivation film ruptures in small areas. If these ruptures occur at mechanical crevices or under deposits, crevice corrosion results. If the ruptures occur on the exposed surfaces of the alloy, the result is pitting. Pitting and crevice corrosion are the primary modes of degradation of the alloys in FGD service.

Increasing temperature or lowering pH reduces the chloride threshold limit of a particular alloy, and the transition from passive (good) behavior to serious pitting or crevice corrosion can be quite abrupt. This threshold behavior means that the behaviors of different grades of corrosion-resistant alloy are identical until the threshold limit of the less resistant alloy is exceeded.

The austenitic stainless steels and nickel-based alloys used in FGD construction form a homologous series with increasing pitting and crevice corrosion resistance which can be ranked according to the following formula:

$$\text{PREN}^* = \text{Cr} + 3.3\text{Mo} + 16\text{N} + 1.15\text{W} \quad (5-1)$$

where: Cr = chromium content, wt%;
N = nitrogen content, wt%; and
W = tungsten content, wt%.

* PREN is an extension of the Pitting Resistance Equivalent (PRE) concept, expanded to include the effects of nitrogen (N) and tungsten (W) alloying additions.

Table 5-6 provides a class ranking of the corrosion-resistant alloys most commonly promoted for FGD applications. The different classes of alloys are further partitioned into groups which are likely to have similar corrosion resistances in FGD applications. This table also contains the PRENW figure-of-merit range for each austenitic alloy (the PRENW figure-of-merit for an alloy is a range because of composition tolerances within the alloy specification). The duplex stainless steels and titanium have been inserted in this table on the basis of accelerated laboratory test data and general experience in FGD applications.

Unfortunately, while the PRENW figure-of-merit can be used to rank and compare alloys of different compositions, no quantitative correlation between alloy composition and acceptable chloride levels in FGD applications exists at this time (January 1995). Chloride tolerance levels cited in the literature for the same alloys may vary by two orders of magnitude (3,22). Part of the difficulty is that many factors other than chloride content and alloy composition affect resistance to chlorides. These factors include temperature, pH, flow, slurry scouring, specific design features, and trace level concentrations of polyvalent metal ions in the liquor. As of 1994, the Nickel Development Institute (NiDI) has a program underway to calibrate the PRENW figure of merit with environmental factors, but results of that effort lie in the future.

Over the years, some very general *ad hoc* rules-of-thumb have developed concerning chloride concentration limits in FGD service. These rules-of-thumb apply to absorber vessels and assume that surfaces are continually washed with slurry, which retards pit formation. While results have generally been good when chlorides remained below these limits, failures have been known to occur at much lower levels. Similarly, some successes have occurred at much high levels.

Type 316L stainless steel has provided good performance in lower (less than 2000 to 3000 mg/L) chloride absorbers and sumps. The chloride resistance of the alloy is quite sensitive to variation in the molybdenum content, and the market for Type 316L with a

Table 5-6

Ranking of Alloys Commonly Considered for FGD Applications

Alloy Class	Description	Example(s)	PRENW
2-3 Mo Austenitic Stainless Steels	Austenitic stainless steel containing 2 to 3% Mo.	Type 316L Type 316LM	23-28 26-28
4-Mo austenitic stainless steels	Austenitic stainless steels containing 4 to 5% Mo, some with nitrogen (N) additions.	Type 317LM Type 317LMN Alloy 904L	30-37 32-40 32-40
22-Cr duplex stainless steels	Duplex stainless steels containing nominally 22% Cr.	2205	PRENW not applicable. Chloride resistance probably comparable to the 4 Mo austenitic grades.
G-Class alloys	Cr-Mo-Fe-Ni alloys containing approximately 6% Mo.	Alloy G Alloy G-3 Alloy G-30	41-50 41-50 41-50
6-Mo superaustenitic stainless steels	Austenitic stainless steels containing nominally 6% Mo plus N.	6XN™ 254 SMO™ 1925hMo™	43-49 42-45 41-48
25-Cr duplex stainless steels	Duplex stainless steels containing nominally 25% Cr and 4% Mo.	Ferralium™ 255™ SAF 2507	PRENW not applicable. Chloride resistance probably comparable to the super-austenitic 6 Mo grades.
625-Class alloys	Cr-Mo-Fe-Ni alloys containing nominally 9% Mo.	Alloy 625 Alloy H-9M™	48-56 47-56
C-Class alloys	Cr-Mo-Ni alloys containing a minimum of 12% Mo and 15% Cr.	Alloy C-276 Alloy C-22™ Alloy 59™ Alloy 622™ Alloy 686™ Allcorr 41™	64-73 61-70 72-83 59-73
Titanium	Titanium grade 2.	Titanium grade 2	Does not have a PRENW, but chloride resistance similar to C-Class alloys.

* Allcorr actually contains 9-12% Mo, but its very high chromium content (29-33%) places it in the C-Class of alloys.

specified minimum molybdenum content of 2.75% has been so large that a separate grade, designated as Type 316LM, has come into existence.

The general trend has been toward higher grades of stainless steel, with Type 317LM and 904L probably being the most commonly used in absorbers and sumps. The NiDI suggests a conservative chloride limit of 6,000 to 8,000 mg/L for this class of alloys in absorber service (21).

Nickel-based G-Class alloys were developed to obtain molybdenum contents in the 6% range. Improvements in steel-making technology have subsequently allowed production of austenitic stainless steels containing these molybdenum contents, a family of alloys described collectively as "6-Mo superaustenitic stainless steels," which have essentially displaced the more costly G-Class alloys. These superaustenitic stainless steels are relatively recent developments and FGD experience with them is limited. The NiDI has indicated that these alloys may be suitable in FGD absorber service up to about 20,000 mg/L chloride (21).

The 625-Class and C-Class alloys, as well as titanium, are the alloys of choice for absorber service above 20,000 mg/L chloride. While the upper chloride limits of these alloys in FGD applications are not known, Alloy C-276 has been specified for service at 50,000 mg/L.

As discussed previously, the outlet duct environment is generally more severe than the absorber environment, even in the absence of reheat. Lower grades of stainless steel (i.e., Type 316L, Type 317LM) have repeatedly demonstrated unsatisfactory performance in outlet ducts and related environments. Alloy G, the lowest grade of nickel-base alloy commonly used in FGD applications, also experienced severe pitting in reheated outlet duct service, requiring retrofit lining (wallpapering) with Alloy C-276. Alloy 625, the next step up from Alloy G, is perhaps the minimum grade suitable for reheated outlet duct applications, though C-Class alloys and titanium are generally best suited for such applications (23-25)

unless high strength is required. If high strength is necessary, then Alloy 625 remains the optimum choice.

Infrequent failures of generally small areas of even these highly corrosion-resistant alloys have occurred in the wet/dry interfaces of FGD inlets and in the mixing zones of direct-bypass reheat outlet ducts. Conditions in these areas--the combination of wet/dry conditions, films and puddles of concentrated acid condensates, and elevated temperatures--have caused corrosion of Alloys C-22 and C-276 at rates of 100 to 250 $\mu\text{m}/\text{yr}$ (4 to 10 mil/yr) with broad shallow pitting (26,27). Titanium has suffered similar attacks in comparable locations. Usually, the attack is limited to a small fraction of the total duct surface, where conditions are severe enough to corrode these normally highly resistant alloys. Despite occasional problems, C-Class alloys and titanium may represent the best available materials technology for inlet wet/dry interfaces and reheated outlet ducts.

5.6.2 Alloy Construction Options

Construction with corrosion-resistant alloys has a higher initial capital cost compared most other options, and several forms of high performance metallic products have been developed to obtain the performance of the corrosion-resistant metal at reduced installed cost.

Solid Plate

Solid plate is the product form traditionally used in alloy construction, and will likely continue to be the form of choice for most stainless steels. Traditionally, shells are constructed of 6.4-mm (0.25-in.) butt-welded plate, though designs using 4.8-mm (0.1875-in.) plate are also common. While free-standing designs exist, an external carbon steel supporting structure typically provides much of the structural stiffness in the majority of systems. Solid plate construction is the simplest method. When highly alloyed nickel-base materials and titanium are considered, it is also the most expensive option.

Millclad Plate

This product consists of thin, typically 1.6-mm (0.0625-in.), corrosion-resistant alloy sheet that is essentially continuously bonded, by hot rolling or explosion bonding, to a thicker carbon steel backing plate. Because the alloy is continuously bonded to the steel backing plate, the full thickness of the plate is used in calculating structural properties, but the cost is significantly lower than solid plate when the clad is a C-Class alloy. On-site fabrication is similar to welded assembly of ordinary steel plate, except that the weld passes are made with high-alloy rod, as illustrated in Figure 5-2. Carbon steel millclad with Alloy C-276 has been used for stack retrofits, and has been specified for a number of new FGD projects (22).

Wallpapering (Field Installation of Thin Sheet Liners)

In wallpapering, thin (i.e., 1.6-mm or 0.0625-in.) sheets of corrosion-resistant alloy are field-installed over a substrate. The substrate is usually carbon steel, though retrofit wallpaper applications over stainless steel and Alloy G have been performed.

The requirements and procedures for installation of alloy wallpaper liners in FGD equipment are described in the National Association of Corrosion Engineers International (NACE-International) Recommended Practice RP0292-92 (28). Before an alloy liner can be installed, any previous liner must be removed. However, the requirements for cleanliness are not as stringent as when installing or replacing rubber or resin liners. Thorough brush blasting is usually sufficient. Any necessary repairs to the substrate should be made, and all substrate welds ground sufficiently flat (but not flush) such that they will not interfere with the fit-up of the lining sheets, which must be very close to permit successful seal-welding of the liner sheet.

The alloys which have most commonly been applied as wallpaper liners are Alloys C-276 and C-22. The usual approach is to skip-weld the perimeter of an alloy sheet to

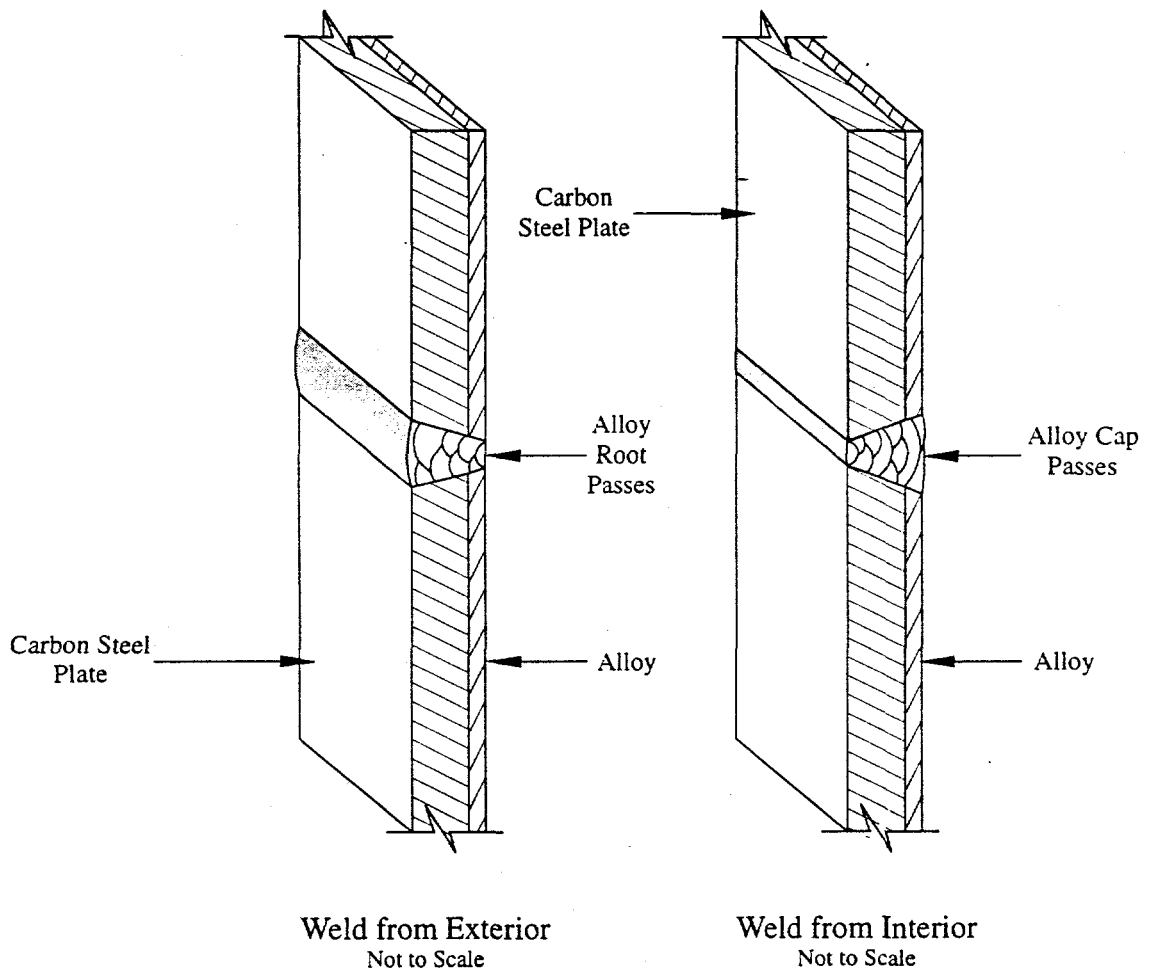

Figure 5-2. Illustration of Welded Joint Design in Mill-Clad Plate Construction

the substrate, using 25-mm (1-in.) beads with 1525-mm (6-in.) skips. The next sheet is then placed so that it laps the first by at least 50 mm (2 in.). The alloy-to-alloy edge is continuously seal-welded, while the alloy-to-substrate edge(s) are skip-welded. The process is repeated until the area to be lined is covered and all exposed welds are continuous seal welds. Mid-sheet attachments are made to the substrate by means of plug or arc-spot welds, if required by the design, to prevent fluttering or vibration of the alloy sheets, or possible damage should a vacuum be generated in the ductwork. This approach may be used with any alloy which can be welded directly to the substrate (28).

Because titanium cannot be directly welded to steel substrates, loose-sheet titanium liners must be mechanically attached to the substrate, as illustrated in Figure 5-3. Typically, titanium or steel bolts and washers are inserted through holes drilled through the liner and substrate so that the heads are visible when one looks at the liner. The holes in the substrate may be pre-tapped, or the bolts may be secured with nuts on the outside of the structure. Once installed, the bolt heads (if titanium bolts were used) are seal-welded to the titanium sheet, or small, pre-stamped titanium caps are fitted over the bolt heads (either titanium or steel), and seal-welded in place. The edges of the titanium sheets are lapped and continuously seal-welded like other alloy sheets (28).

Regardless of the material used, corners require special attention. Welding in corners should never be attempted. One common approach is to use preformed corner trim made of strips of the corrosion-resistant metal or alloy bent into an "L" with at least 50-mm (2-in.) legs. Other common trim designs have 50-mm (2-in.) radii, or a diagonal face which fits into the corner, illustrated in Figure 5-4. The latter designs can reduce the need to grind structural welds in the corners.

Because the substrate provides the necessary structural support, it is essential that all liner seal welds have 100% leak integrity. Otherwise, corrosive liquids can accumulate between the liner and substrate and continue to corrode the substrate. Vacuum box testing is the preferred weld-inspection method (28).

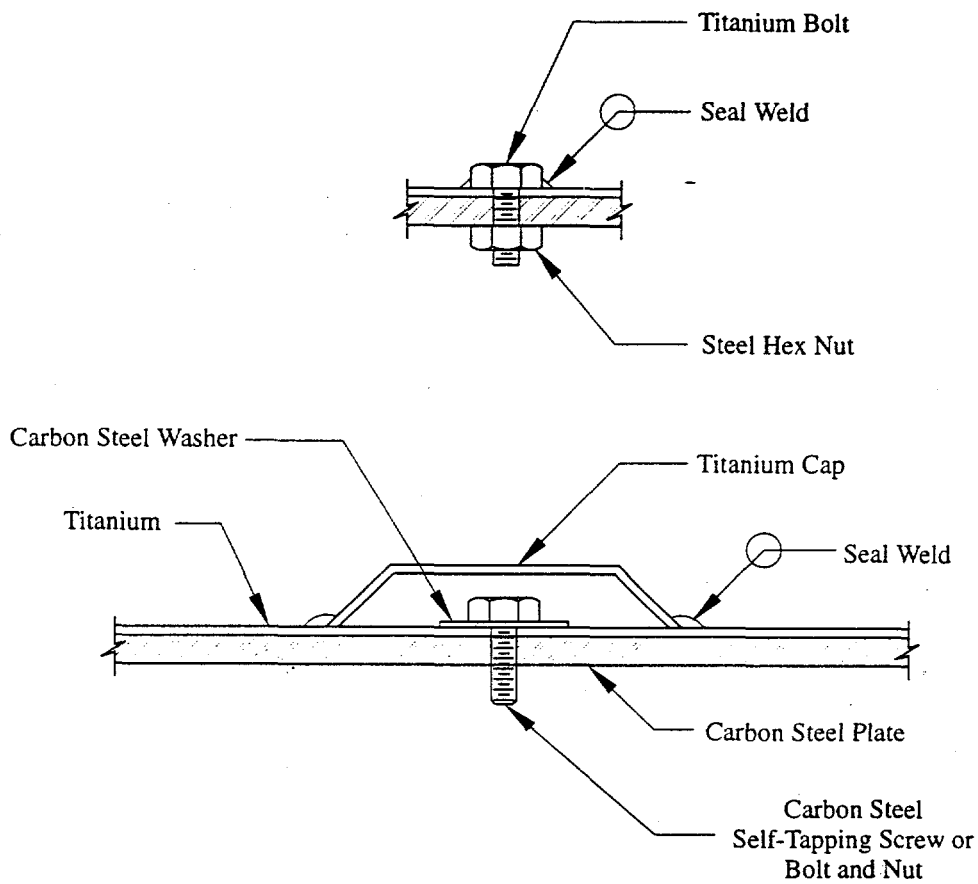

Figure 5-3. Mechanical Anchoring of Titanium Sheet Linings Within a Carbon Steel Vessel

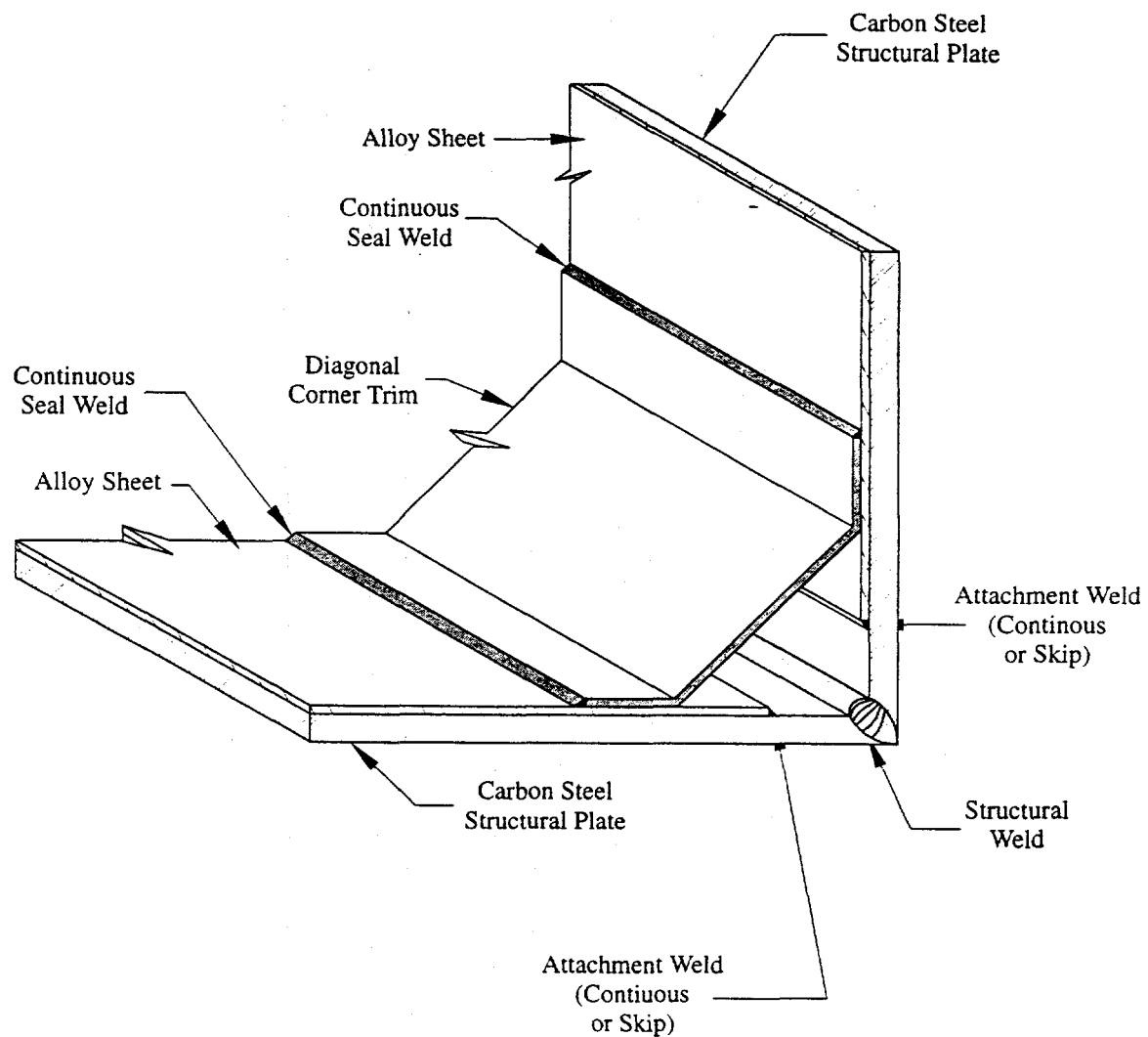

Figure 5-4. One Common Corner Trim Design for Alloy Wallpaper Construction
 [Alternatives are trim strips with a 5-cm (2-in.) radius bend, or L-shaped corner trim.]

One drawback to the use of intermittent alloy-to-substrate attachment welds is that, should a leak occur, liquids can migrate long distances, and it can be difficult to locate the leak for repair. Consequently, some utilities require 100% perimeter seal-welding of each alloy sheet, limiting liquid migration, and making it much easier to locate any leaks, should they occur. This option increases installation cost by about 5% and requires that the corrosion-resistant material be directly weldable to the substrate.

Most wallpaper applications have been in ductwork, and experience in absorber vessels and reaction tanks is limited. Because of the greater potential for flooding between the alloy and substrate should a liner perforation occur, 100% perimeter seal-welding, or at least segmenting the liner by perimeter seal-welding small groups of sheets, is vitally important when the wallpaper liner is to be used in absorber or reaction tank service. Also, the wallpaper liner is not a load-bearing structure, and nothing can be attached to it for support.

More closely spaced attachment welds may be needed if the wallpaper is installed where liquid impingement occurs, since the potential for vibration-induced failure is higher. For example, retrofit Type 317LM liners in the downcomer cones of one set of FGD absorbers failed by vibration-induced fracture (fatigue) after only a few hours of service. The root cause of failure was severe vibration resulting from poor fit of the alloy sheet and omission of a large percentage of the plug welds (29).

Metallic Composite Panels

Metallic composite panels (MCPs) are similar to mill-clad plate in that the corrosion-resistant metal or alloy is bonded to a steel substrate in the mill. However, the bonding uses some pattern of discontinuous attachment points. In the form most similar to mill-clad plate, the corrosion-resistant sheet and structural steel plate are essentially the same size, essentially a "pre-wallpapered" plate. The design is such that fit-up of the MCPs results in overlaps of the corrosion-resistant metal or alloy. During construction, the steel backing

sheets are butt-welded using standard carbon steel welding technologies. Overlapped corrosion-resistant metal joints are continuously seal-welded as in conventional wallpapering. MCP panel and overlapped joint design are shown in Figure 5-5. Corrosion-resistant alloy trim strip is used as necessary to cover exposed base-metal welds in spots where the corrosion-resistant alloy sheets do not overlap.

The bonding techniques used in the manufacture of MCP are applicable to nickel-base alloys, stainless steels, and titanium (as well as a number of other metals and alloys, such as zirconium and tantalum, not used in FGD construction). The solid-backing-plate configurations described above are primarily applicable to new constructions.

Metallic composite panels of titanium-steel have also been fabricated with only a narrow strip of thin carbon steel along two adjoining edges. These are used for wallpaper installations of titanium in pre-existing steel ductwork.

Corners are finished with pre-formed strip as in conventional wallpaper installations. If the corrosion-resistant alloy can be welded to the substrate, then the edges of the lined area are simply seal-welded. In most cases, when titanium-steel MCP is installed new or over pre-erected carbon steel, the titanium will be extended into regions where corrosion of bare steel is not a problem, allowing exposure of the steel backing at the edges of the lining. However, should transition from titanium to some other alloy (e.g., stainless steel or nickel alloy) be required, explosion-bonded strips of the two materials accommodate this transition.

Metallic composite panel applications require the same 100% seal-weld integrity as wallpaper linings, and should one of the seal welds leak, the same potential for migration of corrosive liquids exists. However, MCPs do not require plug welds, and the concerns for weld dilution associated with mill-clad plate are eliminated by the design of the MCPs.

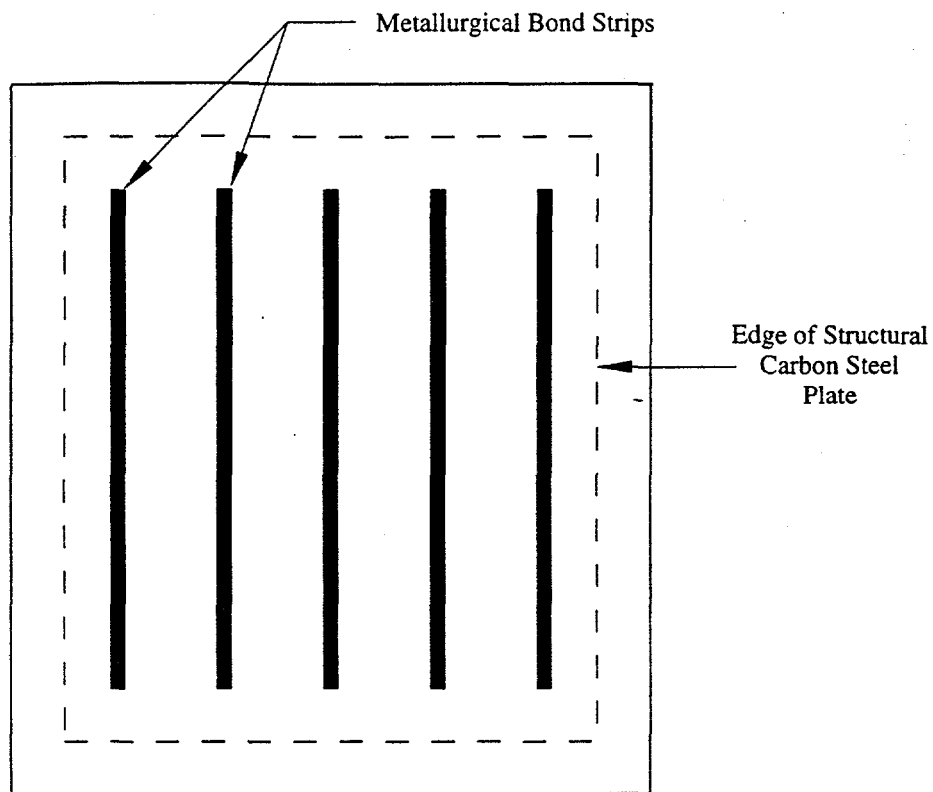

Top View of MCP

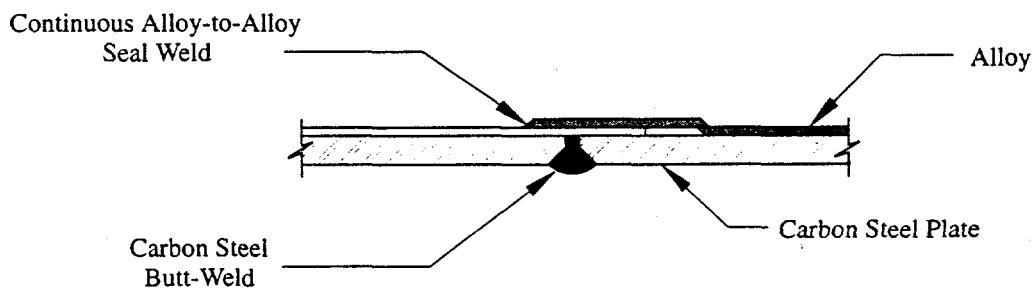

Figure 5-5. Metallic Composite Panel (MCP) and MCP Joint Design

5.6.3 Alloy Verification and Weld Quality Control

Although alloy products are clearly identified by inked markings when shipped to the construction site, it is extremely easy for these markings to be lost once the material is on site. Different alloys cannot be distinguished by their appearance. If more than one grade of alloy is being used during the construction, verification of each piece of alloy by use of a portable alloy analyzer is strongly recommended. Occasionally, emission-type portable analyzers can fail to identify a nickel-based alloy because the composition of the outer fraction of a mil of the sheet differs from the bulk composition. Should this occur, light grinding of a small test spot corrects the problem (the surface alteration is only rarely important in terms of materials performance). In addition, all welds should be inspected by the portable analyzer to verify that the correct filler metal has been used.

In addition to verification of the weld alloy composition, a rigorous program of weld quality control and inspection is very important to the overall success of the construction. Welders should be thoroughly qualified for the specific types and configurations of welds which they will be required to make. Qualification should be with the same alloys, filler metals, and type of welding equipment.

All welds should be examined for signs of slag, porosity, cracking, lack of fusion, and other defects. Defects should be ground out and repaired.

5.7 Monolithic Mortars, Brick, Tile, and Block Systems

This category of materials includes monolithic guniting mortars, acid-resistant brick, vitreous ceramic brick and tile, silicon carbide brick, and foamed borosilicate glass block. Each of these materials is discussed separately below.

5.7.1 Monolithic Gunited Mortars

These products consist of acid-resistant inorganic mortars, typically based on potassium silicate cements, spray-applied ("gunited") onto carbon steel surfaces to which mechanical anchor hooks have been attached. Various products of this type were widely used in early wet FGD systems, particularly in inlet and outlet duct applications and in high-wear areas. Performance was so consistently poor that these products are no longer proposed for FGD construction.

The greatest problem appears to have been that flexing of structures and/or thermal shock led to fracturing, which allowed corrosive liquids to infiltrate between the mortar and substrate, resulting in intolerable corrosion of the substrate.

5.7.2 Acid Brick

Fireclay and red shale refractory brick have both been very widely used for construction of brick flues within stacks. In such construction, there is a pressurized annular space between the stack shell and the brick flue. This pressurization is required to prevent flue gas from infiltrating into the annulus (see Part I, Section 4.5--Wet Stack Considerations).

Both fireclay and red shale brick undergo irreversible swelling in service. Fireclay bricks show greater moisture expansion than red shale brick. The expansion of fireclay brick is more dependent on moisture level than on temperature; red shale brick expansion is more dependent on temperature. Consequently, red shale brick is more suitable for flues that are prone to significant moisture gradients, whereas fireclay brick is more appropriate to stacks subjected to severe thermal gradients. Organic-gelled potassium silicate mortar may be the most appropriate choice for stack service.

Note that brick flues are prone to develop a significant lean over time, particularly if mixing of hot bypass gas and wet cool gas occurs in the stack. This situation

will occur in most systems using direct-bypass reheat, and in any case where treated gas and bypass gas enter the same stack through separate breechings. The stack leans because the magnitude of the irreversible swell of the brick is greatest on the side of the stack where the hot gas impinges (30,31).

5.7.3 Vitreous Ceramic Tile and Brick

These products are characterized by the presence of a hard, vitreous glaze on the surface exposed to the process. Table 5-7 summarizes the advantages and disadvantages of vitreous ceramic tile and brick.

The Stebbins Engineering and Manufacturing Company offers several engineered acid and wear-resistant SCI™ brick and Semplate™ (tile) systems suitable for selected FGD applications (32). The Stebbins systems were originally developed for extremely corrosive and abrasive processes such as acid leaching of mineral ores. The materials are extremely resistant to abrasion and incidental mechanical damage, such as from dropped tools and nozzles. Historically, their most common use in FGD systems has been to line the floors and lower walls of reaction tanks. The tile products have also been used to line the walls of reaction tanks, absorbers, and outlet ducts.

The materials are immune to the worst-case thermal upset scenario for FGD systems. Minnkota Power suffered a scaffold fire in an absorber tower lined with Stebbins tile. There was no detectable damage to the liner.

The two major disadvantages of the materials are weight and geometry limitations. Because of the weight of the material, steel supporting structures may have to be stronger. Except for foundation-supported floors, the tile or brick must be applied to slightly concave surfaces.

Table 5-7

**Summary of Advantages and Disadvantages
of Vitreous Ceramic Tile and Brick**

	Lining on Steel Shell	Self-Supporting Structure
Product(s)	Vitreous/ceramic tile or brick with acid-resistant grout and polyurethane membrane, applied to and supported by a steel shell.	Free-standing vitreous/ceramic tile or brick structure.
Most common use area(s)	Floor and wainscotting of reaction tanks.	None.
Less common use area(s)	Absorber liners, inlet and outlet duct liners, stack liners.	Integral reaction-tank, absorber shells.
Major advantages	<ul style="list-style-type: none"> ▶ Extremely abrasion resistant. ▶ Immune to thermal excursion. ▶ Immune to concentrated acid condensates. ▶ Very resistant to mechanical damage. ▶ Good thermal insulator, eliminates need for external insulation of duct work. 	<ul style="list-style-type: none"> ▶ Extremely abrasion resistant. ▶ Immune to thermal excursion. ▶ Immune to concentrated acid condensates. ▶ Very resistant to mechanical damage. ▶ Reduced cost.
Major disadvantages	<ul style="list-style-type: none"> ▶ Geometry limitation--all lined surfaces, except horizontal floors, must be slightly concave. ▶ High unit area weight may require more robust steel supporting structure. 	<ul style="list-style-type: none"> ▶ Geometry limitation--all lined surfaces, except horizontal floors, must be slightly concave. ▶ Limited to horizontal, foundation-supported floors and vertical walls.

Product Description

As manufactured by Stebbins, vitreous ceramic tile is supplied in a form designated as "Semplate™." The tiles have a hard glazed outer surface and dove-tail grooves on the reverse surface. Floor tiles are flat, and wall tiles are slightly concave.

The SCI brick is thicker and supplies more protection in extremely severe environments. Brick for walls and ductwork has a slight curvature.

Construction

Figure 5-6 illustrates the application of Semplate tile to a steel absorber or reaction tank wall. The polyurethane membrane is trowel-applied approximately 6.4-mm (0.25-in.) thick to the steel shell prior to erection of the liner, where it cures in place. The tiles are erected several courses at a time with furan mortar in the joints. No support forms are required. Once the furan mortar sets, portland cement grout is injected. This process is repeated until the entire vessel is lined. Brick, rather than tile, is used where conditions are very severe.

Free-standing reaction tanks and integral reaction tank-absorber towers have also been constructed without steel supporting shells. Figure 5-7 illustrates the method of construction. The Semplate-Semplate™ and Semplate-brick™ vessels can be erected without support forms. The courses of tile or brick are erected to predetermined heights with the reinforcement steel (rebar) in place, then grouted. The process is repeated until the entire module is erected. Support forms are required for the conical tops of the modules if these are tile lined. Free-standing Semplate-Semplate construction may be approximately 15% less costly than a comparable Semplate-lined steel shell.

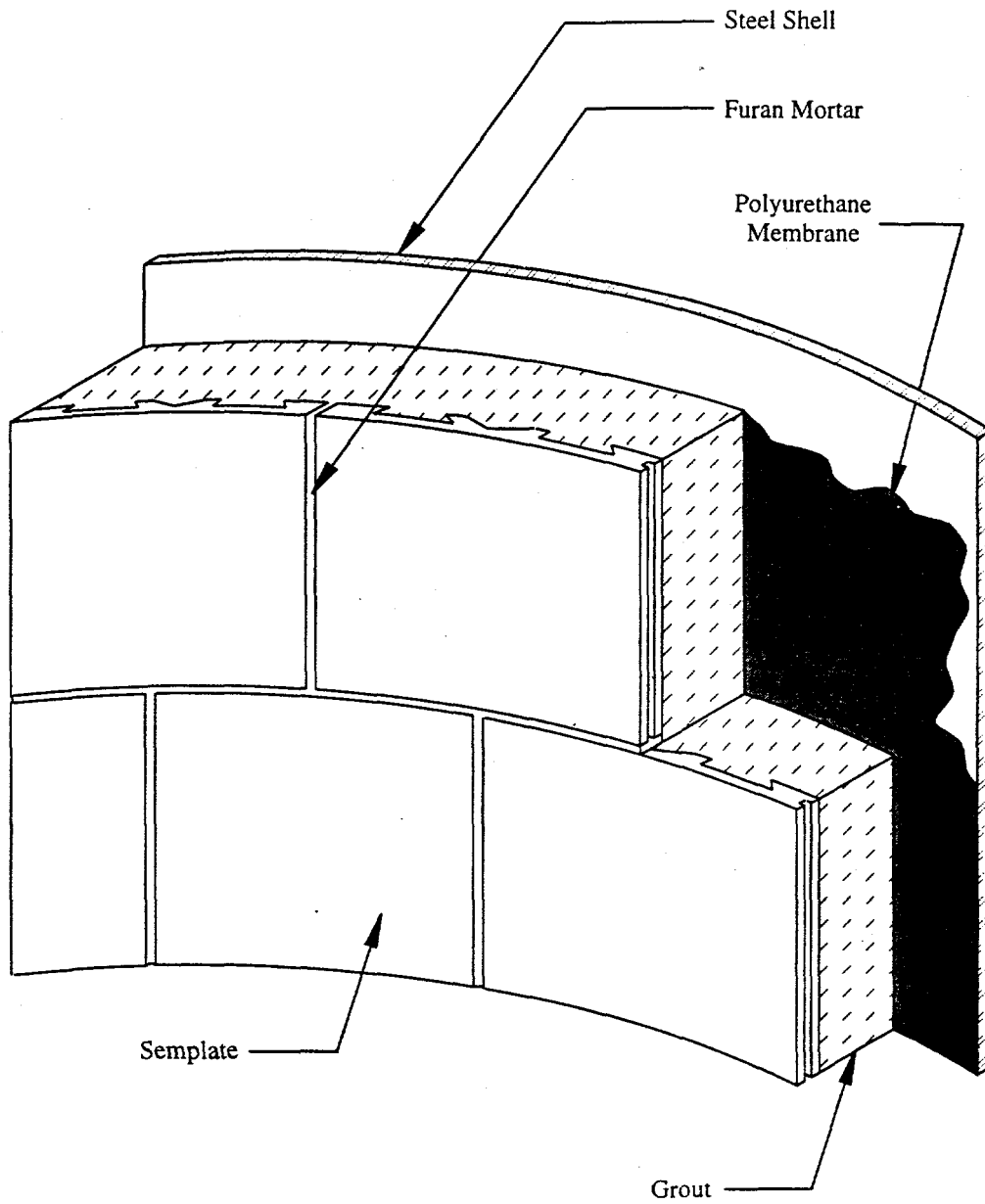

Semplate-Lined Steel

Figure 5-6. Vitreous Ceramic Tile Lining of a Carbon Steel Shell

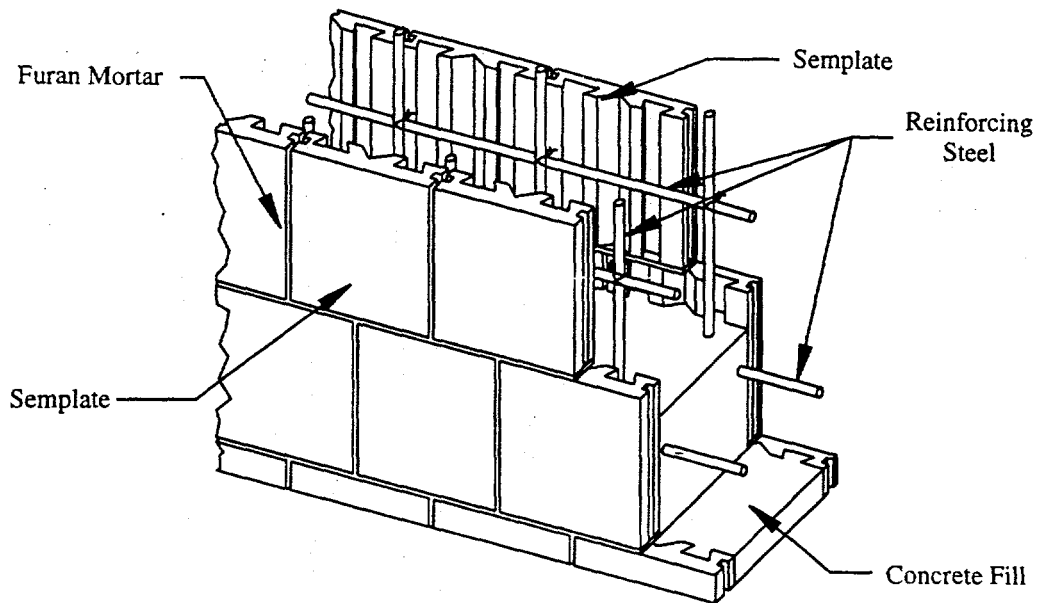

Free-Standing Semplate-Semplate Construction

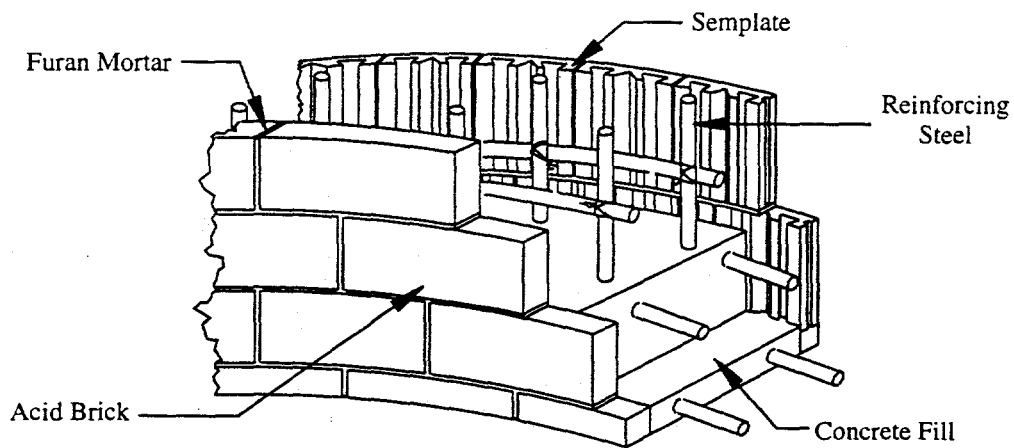

Free-Standing Brick-Semplate Construction

**Figure 5-7. Free-Standing Vitreous Ceramic Brick and Tile Construction Option
(Redrawn from Stebbins Product Literature)**

The requirement for application to curved surfaces means that ductwork lined with Stebbins tile or brick must be cylindrical or elliptical in cross-section. Brick is used more frequently than tile for outlet duct applications.

5.7.4 Silicon Carbide Brick

Silicon carbide brick has been fairly widely and successfully used as a wear lining in the throats of adjustable aperture venturi scrubbers. The brick is grouted with an organic resin-bonded silicon carbide mortar.

5.7.5 Foamed Borosilicate Glass Block

Use of foamed borosilicate block is limited to the protective lining of the walls of steel outlet ducts. Table 5-8 summarizes the advantages and disadvantages of foamed borosilicate glass block.

The foamed borosilicate glass block lining is an extremely efficient thermal insulator and eliminates the need for external insulation. The thermal stability and insulating properties of the block also render the system immune to even severe and repeated thermal excursions. The borosilicate glass is also essentially inert and is impermeable to acidic condensates (except hydrofluoric acid) and moisture.

Borosilicate glass block is light in weight and can usually be installed in steel ductwork without increased stiffening or bracing. The entire system is slightly flexible and can tolerate slight flexing (oil-canning) of the duct walls.

Foamed borosilicate glass block has one significant shortcoming that must be considered. The standard block is extremely friable. Block on the duct floor can be damaged by personnel walking in the duct or by wheelbarrows brought in to remove solids buildup. Walls can also be damaged by accidental ramming or scraping by wheelbarrows. Instances of

Table 5-8

Summary of Advantages and Disadvantages
of Foamed Borosilicate Glass Block

	Foamed Borosilicate Glass Block
Product	Sealed-cell foamed borosilicate glass block bonded to steel substrate by polyurethane mastic membrane.
More common use area	Outlet duct lining.
Less common use area	No other uses.
Major advantages	<ul style="list-style-type: none">▶ Light weight.▶ Easy to apply.▶ Immune to thermal excursions.▶ Highly resistant to acid condensates (except hydrofluoric acid).▶ Extremely good insulator, eliminates need for external insulation.
Major disadvantages	<ul style="list-style-type: none">▶ Friable, extremely susceptible to mechanical damage and impingement erosion (may be top-coated with thin layer of gunited potassium silicate cement for protection against mechanical damage).

severe erosion have been reported in outlet ducts with geometries creating impingement targets. The material cannot be hydroblasted or sandblasted to remove fly ash deposits.

Product Description

Figure 5-8 shows the components of a foamed borosilicate glass block lining on a carbon steel substrate. The foamed borosilicate glass block system consists of sealed-cell borosilicate glass blocks, typically 100 x 230 x 40 mm (4 x 9 x 1.5 in.) in dimension, attached to the steel substrate by a thick polyurethane asphaltic mastic applied to the back and sides of each block and to the steel substrate. The urethane mastic provides the ultimate barrier against corrosive moisture. Because it is sandwiched between the block and the steel substrate, the through-wall thermal gradient is eliminated, greatly reducing the driving forces for moisture permeation in any locations where moisture gets behind the glass block.

To compensate for the extreme friability of the block, some utilities have installed foamed borosilicate glass block, then installed approximately 12.7 mm (0.5 in.) of potassium silicate gunite over the floors and lower walls for protection against mechanical damage. In such applications, some cracking of the gunite is quite acceptable, since its only function is to dissipate point loads on the glass block.

Elf Atochem has produced a modified block product designed specifically to overcome the susceptibility to erosion (33). This block is provided with a skin of crushed borosilicate glass/silicate mortar on one side, providing a tough outer wear surface. The prevailing strategy is to apply regular block over the entire lined surface. If a local erosion problem appears, the affected area can be relined with the more expensive modified block.

Installation

Prior to installation of foamed borosilicate glass block, metal substrates should be sandblasted to a good commercial blast, but not the white metal blast required by organic

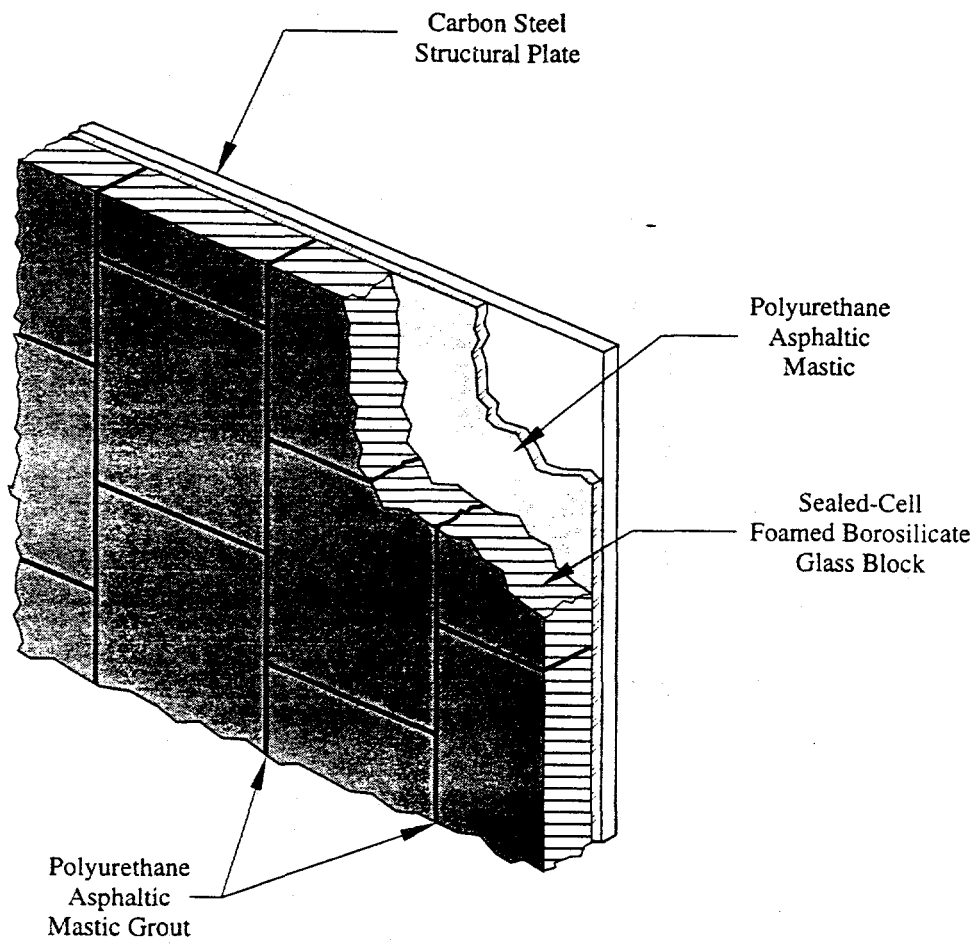

Figure 5-8. Foamed Borosilicate Glass Block Lining of Carbon Steel

resin coatings.* Other requirements (e.g., dust-free surfaces, control of humidity and surface temperatures) are important, but not as critical or as unforgiving as with reinforced resin or rubber liners.

The block can be readily cut by hand with a hacksaw and shaped with a pocket knife. Once the blocks are trimmed to size, the backs and edges are coated with trowel-applied mastic and the blocks are pressed into place. No support framing is required.

5.8 Fiber-Reinforced Plastic (FRP)

While the glass-reinforced resin liners applied over steel, discussed previously, are technically reinforced plastic components, this discussion focuses on resin laminate structures that are so reinforced there is no metallic support at all. Components in this category are referred to generically as FRP components. All are laminate structures that derive their structural properties from multiple plies of resin-impregnated glass fiber. Surfaces of the laminate that will contact hostile environments are coated with a resin-rich gel-coat, which serves as a corrosion and moisture barrier, preventing the wicking of moisture into the fiber plies. The gel coat is optional if the laminate surface will be exposed only to air (37).

FRP has been widely used for slurry piping and mist eliminators in FGD systems. In addition, there has been limited use of free-standing FRP structures. Table 5-9 summarizes the advantages and disadvantages of FRP pipe and free-standing FRP structures.

* A "Commercial Blast Cleaned Surface" is defined by NACE-International (under TM0175) and by the Steel Structures Painting Council (under SSPC-SP 6-63) as an abrasive air-blasted "surface from which all oil, grease, dirt, rust scale, and foreign matter have been completely removed and all rust, mill scale, and old paint have been removed except for slight shadows, streaks, or discolorations caused by rust stain or mill scale. At least two-thirds of the surface area shall be free of all visible residues, and the remainder shall be limited to light discoloration, slight staining, or light residues mentioned above. If the surface is pitted, slight residues of paint or rust are found at the bottoms of the pits."

Table 5-9

Summary of Advantages and Disadvantages
of Fiber Reinforced Plastic (FRP)

	Slurry Piping	Free-standing Vessels and Stack Liners
Product(s)	Glass fiber reinforced thermosetting resin, vinylester preferred, with abrasion resistant liner for service outside the absorbers, and abrasion resistant lining on both interior and exterior for service inside the absorbers.	Glass fiber reinforced thermosetting resin, vinylester, or brominated vinylester preferred.
Most common use area	Slurry piping.	Cylindrical tanks, duct work, stack liners.
Less common use area(s)	Other process piping.	Cylindrical absorber towers.
Major advantages	<ul style="list-style-type: none"> ▶ Light weight. ▶ Low cost compared to other options. ▶ Ease of fabrication. ▶ No chloride limits. ▶ Erosion failures are rare. ▶ Extremely wide use in FGD applications. 	<ul style="list-style-type: none"> ▶ Light weight. ▶ Resistant to chemical attack by slurry, and condensates, except concentrated acid condensates. ▶ Abrasion-resistant formulations available where required. ▶ Field-fabricated diameters of 3.7 to 27.4 m (12 to 90 ft) feasible.
Major disadvantages	<ul style="list-style-type: none"> ▶ Continuous operating temperature limit of 93°C (200°F), excursion limit of 149°C (300°F). ▶ Slurry velocity limit of 2.4 m/s (8 ft/s). ▶ Limited load-bearing strength. 	<ul style="list-style-type: none"> ▶ Immersion and spay zone temperature limit of 93°C (200°F), sustained gas temperature limit of 160°C (320°F). ▶ Some amount of periodic maintenance required. ▶ Extremely specialized engineering required, few sources available. ▶ Lack of standards for FGD applications. ▶ Limited FGD experience.

5.8.1 FRP Pipe

FRP pipe has been very widely used for slurry transport outside the absorber vessels, and to a lesser extent within the absorbers as spray headers, due to its low cost and generally good performance. Vinylester is the preferred resin. FRP pipe for service outside the absorbers must have an abrasion-resistant resin lining coat. Generic chemical service grades of FRP pipe are not routinely manufactured with this lining. FRP pipe for FGD service must be specified and rated for slurry service. FRP pipe used inside the absorbers should have an abrasion-resistant exterior coating, in addition to the abrasion-resistant liner (34,35).

Use of FRP pipe places certain restrictions on the process. FRP pipe has a continuous operating temperature limit of 93°C (200°F), but can withstand limited excursions to 149°C (300°F). The slurry particle size should not exceed 150 µm mean diameter (100 mesh), and the slurry solids content should not exceed 25 percent. Serious erosion can occur if local slurry velocity exceeds approximately 3.65 m/s (12 ft/s), and FRP slurry piping is typically designed for a nominal bulk velocity of 1.52 to 2.44 m/s (5 to 8 ft/s) to allow for local acceleration at elbows and similar features. Use of long-radius elbows and long reduction fittings also reduces the potential for erosion failure (34).

FRP pipe is light in weight compared to other piping materials (e.g., rubber-covered and rubber-lined carbon steel and alloy piping). FRP is relatively easy to install and modify as needed.

Care should be taken to prevent application of excessive mechanical loads during maintenance activities. In particular, scaffolding planks should never be laid over FRP pipe, and personnel should not walk on the pipe. Protection is best afforded by designing the supporting structure to preclude such actions during maintenance.

5.8.2 Free-Standing FRP Structures

In recent years, there has been increasing interest in the possibilities of FRP for major FGD components, including slurry, reagent, and thickener tanks; absorber vessels; duct work; and stack liners. On-site field fabrication of large diameter components is practical using field winding machinery. On-site fabrication of vessels with diameters ranging from 3.6 to 27 m (12 to 90 ft) is feasible. Potomac Electric Company has used 3.6 m (12-foot) diameter FRP ducting within the Dickerson Station's wet particulate scrubber system. Ershigs, Inc., fabricated an 8.5-m (28-foot) diameter by 208-m (682-foot) tall stack liner for the Delta Plant of the Intermountain Power Project. This stack was found to have a "shiny, near-new" appearance without surface cracking after 18 months of base-load operation. Major FRP components have also been used for a number of years in diverse, non-utility, FGD-like applications, particularly in the metal smelting and pulp and paper industries (34-36).

Between 1977 and 1992, 17 FRP stack liners based on temperature-resistant chlorendic anhydride polyester or brominated bis-phenol-A fumarate polyester resin were placed into service, and 15 were still operating as of 1992. Vinylester-based stacks are more durable (retain strength properties better than polyester-based stacks), and FRP outlet ducts based on vinylester have been in use in Germany since 1988 (35).

Brominated vinylester provides even better acid and temperature resistance than non-halogenated vinylester, and is self-extinguishing.* Brominated vinylester stack liners are generally able to operate unquenched at 163°C (325°F) during plant startups. One brominated vinylester stack liner was still in "excellent" condition after operating on bypass for nine months at 160°C (320°F). FRP quencher shells and stacks have been lined with acid brick as a thermal barrier, allowing service at gas temperatures of 260°C (500°F) (35).

* Both vinylester and brominated vinylester will burn if exposed to flame. Vinylester will continue to burn once the flame is removed, but the brominated vinylester will not continue to burn in the absence of contact with direct flame.

Temperature resistance can be increased further by amending the resin with conductive graphic filler, which minimizes the thermal gradient through the laminate. The internal stresses due to differential thermal expansion through the laminate structure are the principal causes of delamination failure of the composite. The graphite filler increases thermal conductivity, thus reducing internal stress. In France, the inlet duct of an absorber on a municipal waste incinerator was fabricated from graphite-filled vinylester. This duct handles flue gas at a continuous temperature between 200 and 250°C (392 and 482°F) (35).

In a waste combustion process in the United States, an FRP duct made of an unspecified resin was charred after nine months. It was replaced with an FRP duct made with vinylester resin containing 25 wt% graphite powder in the interior corrosion barrier and filament-wound glass in the structural layer. After two years, the graphite-filled duct showed no evidence of thermal oxidation. The addition of up to 25 wt% graphite powder to vinylester resin does not reduce the resistance to 75% sulfuric acid at 82°C (180°F).

Thus, vinylester appears to be the current resin of choice for free-standing FRP structures. Improved performance can be obtained from brominated vinylester resins, and these should probably be specified for future duct works and stack liners. Thermal tolerance can be further increased by the addition of powdered graphite filler to increase the thermal conductivity of the composite laminate.

Despite its potential, successful use of FRP in FGD applications has been hampered by a lack of clear standards for design and fabrication. The proper design of FRP equipment entails complexities beyond the typical issues confronting designers, and the special nature of FRP composites is easily overlooked, even by competent engineers. Consequently, large FRP structures are typically designed and fabricated as a package by a few highly specialized vendors. The very specialized engineering knowledge required for the design of large FRP structures can make it difficult for utilities to evaluate bid responses (36).

5.9

Economics

Numerous comparisons of the costs of different materials selections for FGD applications have been published over the years (4,34,38-41). All suffer from several inherent problems. One problem is that the costs of materials, particularly of stainless steels, nickel-based alloys, and titanium, fluctuate over time. Nickel-based alloy costs in particular have fluctuated widely over the last decade.

It is also important to compare the different options on a "like" basis. For example, if reinforced resin is being compared to alloy construction, the resin cost must include the steel substrate. The most useful comparative bases are probably the total erected cost and life-cycle cost.

Finally, economic comparisons that consider life-cycle costs are highly vulnerable to the specific maintenance and repair assumptions of the analysis, as well as the assumed cost-of-money and other economic variables.

The relative cost factors presented in Table 5-10 were derived from an economic evaluation in 1992, which considered different permutations of initial cost and maintenance assumptions to arrive at total erected cost and present-value-life-cycle (PVLC) cost ranges for each option (4). The study assumed an escalation rate of 5.0% per year for capital cost items, a present value rate of 11.5%, and a design life of 30 years. The absorber was assumed to be uninsulated. Costs for the outlet duct included an allowance for external insulation, except for the Stebbins tile/brick and foamed borosilicate glass block options, which are self-insulating and do not require external insulation. The maintenance assumptions are shown in Table 5-11.

Any generic economic comparison, including this one, can represent only general trends. A detailed, case-specific analysis would be required to resolve choices between technically competitive materials selections. Such analyses may even involve

Table 5-10

Relative Costs of Major Vessel Construction Options

	Absorbers		Outlet Duct	
	Initial Cost	PVLC Cost	Initial Cost	PVLC Cost
Rubber and Reinforced Resin Liners on Carbon Steel				
Flake glass-reinforced resin	1.0	1.0	1.0	1.0
0.25-in (6.4 mm) chlorobutyl rubber	1.4 ± 0.2	1.4 ± 0.4	Material not specified for outlet duct service.	
Vitreous (Hard) and Foamed Glass Brick and Tile				
Stebbins tile/brick on concrete	1.1 ± 0.1	0.5 ± 0.1	Construction not feasible.	
Stebbins tile/brick on carbon steel	1.3 ± 0.1	0.6 ± 0.2	1.1 ± 0.1	0.5 ± 0.2
Stebbins Semplate-Semplate construction	1.6 ± 0.2	0.8 ± 0.2	Construction not feasible.	
Foamed borosilicate block on carbon steel	Unsuitable for absorber service.		1.4 ± 0.1	0.7 ± 0.2
Metallic Wallpaper Liners on Carbon Steel				
Titanium-steel metallic composite panel lining on carbon steel	These options were not cost-modeled for absorbers.		1.5 ± 0.1	0.7 ± 0.2
H-9M			1.4 ± 0.1	0.7 ± 0.2
Bolted titanium			1.8 ± 0.2	0.7 ± 0.3
Alloy 625	1.7 ± 0.2	0.8 ± 0.2	1.6 ± 0.2	0.7 ± 0.3
C-Class alloy	1.7 ± 0.2	0.8 ± 0.2	1.6 ± 0.2	0.7 ± 0.3
Mill-Clad Plate [0.062-in (1.6 mm) alloy on 0.1875-in (4.8 mm) carbon steel plate]				
Alloy 625 clad	2.1 ± 0.2	1.0 ± 0.2	1.94 ± 0.16	0.9 ± 0.3
C-Class alloy clad	2.1 ± 0.2	1.0 ± 0.2	1.94 ± 0.16	0.9 ± 0.3
Solid Plate [0.25-in (6.4 mm) plate]				
6XN superaustenitic stainless steel	1.3 ± 0.1	0.6 ± 0.1	1.26 ± 0.09	0.6 ± 0.2
Alloy 625 plate	2.7 ± 0.3	1.3 ± 0.3	2.40 ± 0.21	1.1 ± 0.4
C-class alloy plate	2.7 ± 0.3	1.3 ± 0.3	2.40 ± 0.21	2.4 ± 0.4

Table 5-11

Maintenance Assumptions for Economic Comparison

Material	Absorber	Outlet Duct
Alloy options	No significant repairs.	No significant repairs.
Stebbins tile and brick options	No significant repairs.	No significant repairs.
Foamed borosilicate glass block	Not considered.	Replacement of 20% of the block lining at 10 year intervals due to erosion.
Chlorobutyl rubber-lined carbon steel--best case	100% replacement at 10-year intervals with repair of 5% of the liner per year in years without major repair.	Not considered.
Chlorobutyl rubber-lined carbon steel--worst case	50% replacement at 5-year intervals with repair of 5% of the liner per year in years without major repair.	Not considered.
Premium flake glass-reinforced resin on carbon steel--best case	100% replacement at 8-year intervals with repair of 5% of the liner per year in years without major repair.	100% replacement at 8-year intervals with repair of 5% of the liner per year in years without major repair.
Premium flake glass-reinforced resin on carbon steel--worst case	50% replacement at 4-year intervals with repair of 5% of the liner per year in years without major repair.	50% replacement at 2-year intervals with repair of 5% of the liner per year in years without major repair.

assuming different design variations and constraints on process operating conditions to arrive at the most cost-effective option.

5.10 References

1. Electric Power Research Institute. Causes of FGD Construction Materials Failures, Volume 1: September 1982--July 1985. GS-63961. Palo Alto, California, 1989.
2. Electric Power Research Institute. Causes of FGD Construction Materials Failures, Volume 2: August 1985--December 1986. GS-6396. Palo Alto, California, 1989.
3. Electric Power Research Institute. Causes of FGD Construction Materials Failures, Volume 2: January 1987--April 1992. GS-6396. Palo Alto, California, 1994.
4. R.L. Torstrick, and P.F. Ellis. "Materials Selection For Hypersaline FGD Systems: Economics." In: Proceedings of the 1992 Air Pollution Seminar (AirPol/92). NACE-International, Houston, Texas, 1992.
5. Electric Power Research Institute. Specification Guidelines for Flue Gas Desulfurization Rubber. CS-5528. Palo Alto, California, November 1987.
6. W.D.H. Plant. "Current FGD Materials Considerations in the United Kingdom and Europe." In: Proceeding of the 1990 Air Pollution Seminar (AirPol/90). NACE-International, Houston, Texas, 1990.
7. Causes of FGD Construction Materials Failures, Volume 3, Appendix A.
8. Electric Power Research Institute. Construction Materials for Wet Scrubbers: Update, Volume 1. CS-3350. Palo Alto, California, July 1984.
9. Electric Power Research Institute. Guidelines for FGD Materials Selection and Corrosion Protection, Volumes 1 and 2. TR-100680. Palo Alto, California, March 1993.
10. Causes of FGD Construction Materials Failures, Volume 1, Appendix F.
11. Causes of FGD Construction Materials Failures, Volume 1, Appendix A.
12. Causes of FGD Construction Materials Failures, Volume 1, Appendix B.

13. Causes of FGD Construction Materials Failures, Volume 1, Appendix C.
14. Causes of FGD Construction Materials Failures, Volume 3, Appendix B.
15. Causes of FGD Construction Materials Failures, Volume 2, Appendix B.
16. Causes of FGD Construction Materials Failures, Volume 3, Appendix D.
17. Zolin, B.I. "Protective Lining Performance." Chemical Engineering Progress. Volume 66, No. 8, August 1970.
18. Montle, J.F. "Unexplained Coating Phenomena with Some Partially Baked Answers." Presented at Corrosion/71. 1971. -
19. Schwenk, W. "Adhesion Loss of Organic Coatings, Causes and Consequences for Corrosion Protection." In: Corrosion Control By Organic Coatings. H. Leidheiser, ed. NACE, 1981
20. Nicholas, A.F., J.L. Nickerson, and A.I. Asphahani. "Field Experience with Nickel-base Alloys and Future Trends in Flue Gas Desulfurization Systems." In: Proceedings of the 1990 Air Pollution Control Seminar, Louisville, Kentucky, October 17-19, 1990.
21. P.F. Ellis, "Conclusions From a Decade of FGD Materials Failure Analysis," Session 3B, Proceedings of the 1993 SO₂ Control Symposium, Boston, Massachusetts, 24-27 August 1993.
22. Telephone conversation with Mr. Bill Mathay of the Nickel Development Institute, Toronto, Ontario (Canada).
23. Causes of FGD Construction Materials Failures, Volume 2, Appendix F.
24. Causes of FGD Construction Materials Failures, Volume 3, Appendix E.
25. Causes of FGD Construction Materials Failures, Volume 2, Appendix A.
26. Causes of FGD Construction Materials Failures, Volume 3, Appendix F.
27. Causes of FGD Construction Materials Failures, Volume 3, Appendix H.
28. NACE-International. Standard Recommended Practice (for) Installation of Thin Metallic Lining in Air Pollution Control and Other Process Equipment. RP0292. Houston, Texas, 1992.
29. Causes of FGD Construction Materials Failures, Volume 2, Appendix D.

30. Electric Power Research Institute. Flue Gas Desulfurization Gas Path Materials Reference Guide. Palo Alto, California, undated.
31. Electric Power Research Institute. Leaning Brick Stack Liners. GS-6520. Palo Alto, California, 1989.
32. Data provided by Stebbins Engineering Company.
33. Data provided by Elf Atochem (formerly Pennwalt).
34. Boucher, E.J. and R.D. Brady. "The Intelligence & Economics of F.R.P. (Fiberglass reinforced plastics) in F.G.D. Systems." In: Proceedings of the 1992 Air Pollution Seminar (AirPol/92), NACE-International, Houston, Texas, 1992.
35. Kelley, D.H. "Why Fiberglass-Reinforced Plastic (FRP) is Being Specified in Flue Gas Desulfurization (FGD) Applications." In: Proceedings of the 1993 SO₂ Control Symposium. Boston, Massachusetts, August 24-27, 1993.
36. Shelly, J. and J. Karmody. "High-Temperature Composites for Flue Gas Desulfurization Processes." In: Proceedings of the 1990 Air Pollution Seminar (AirPol/90). NACE-International, Houston, Texas 1990.
37. Renoud, W.J. and R.J. Rapoza. "Summary of Guidelines for the Use of FRP in Utility FGD Systems." In: Proceedings of the 1992 Air Pollution Seminar (AirPol/92). NACE-International, Houston, Texas, 1992.
38. Agarwal, D.C. "The Role, Economic Analysis and Performance Reliability of Metals and Non-Metals in FGD and Incineration Systems." In: Proceedings of the 1984 Air Pollution Seminar (AirPol/84). NACE-International, Houston, Texas, 1984.
39. Redmond, J.D., R.M. Davidson, and Y.M. Shah. "Life-Cycle Cost Comparison of Alternative Alloys for FGD Components." In: Proceedings of the 1987 Air Pollution Seminar (AirPol/87). NACE-International, Houston, Texas 1987.
40. Skabo, R.R., J.L. Sebesta, and P.F. Ellis. "Life Cycle Costs of FGD Lining Systems." In: Proceedings of the 1987 Air Pollution Seminar (AirPol/87). NACE-International, Houston, Texas 1987.
41. Richard, R.L. "Economics of a C-276 Outlet Duct Wallpaper Retrofit at Public Service Indiana Gibson #5." In: Proceedings of the 1987 Air Pollution Seminar (AirPol/87). NACE-International, Houston, Texas 1987.

6.0 SYSTEM RELIABILITY

6.1 General

The objective of this section is to present a discussion of the chemical and equipment factors that should be considered in designing an FGD system with a high degree of **reliability**. A discussion of reliability must use several specialized terms. These terms are printed in **boldface type** when first used in this section and are defined in Section 6.4--Glossary of Terms.

Historically, one of the most significant concerns regarding the installation of an FGD system was the perception that these systems were unreliable and would reduce the **availability** of the generating unit. This perception was the result of several factors, including the initially poor reliability of the first electric utility FGD system installations in the 1970s. Fortunately, the technical understanding of FGD systems continually advanced, and the chemical and equipment problems inherent in these early designs have largely been overcome. While some installations still experience operating problems, FGD systems in general do not significantly reduce the availability of the generating unit. Most FGD system vendors are now willing to provide a contract guarantee that, during the performance warranty period (typically the first 12 months of operation), the FGD system reliability will be 99% or greater and the **availability** will be in the high 90s.

The North American Electric Reliability Council (NERC) has analyzed reliability data from 111 FGD systems in the United States for the period of 1986 through 1991 (1,2). In addition to their conclusion that FGD systems had minimal effect on the generating units' **equivalent unavailability factor (EUF)** and **equivalent forced outage rate (EFOR)**, the NERC studies reached the following conclusions:

- Reduced FGD system reliability was mainly due to damage to the stack liners, plugged mist eliminators, and repairs to ductwork and absorber vessels;

- No statistically significant difference in reliability was found between FGD systems included as part of the original generating unit design and those retrofit at a later date;
- No statistically significant difference was found between the EUFs or EFORs of lime-based and limestone-based systems;
- During the period 1989 to 1991, the **median** EUF and EFOR for the 111 operating systems surveyed were 0.23% and 0.07%, respectively;
- Flue gas reheating produced a very slight reduction in EUF and EFOR;
- The use of a spare absorber module provided a small reduction in EUF and EFOR;
- The capability to bypass flue gas around the FGD system produced a small reduction in EUF and EFOR; and
- The determination of whether the reliability improvements gained by flue gas reheating, spare absorber modules, and bypass capability justified their additional capital and operating costs must be based on a site-specific economic evaluation.

6.2 Chemical Process Considerations

There are several chemical process considerations that can affect the reliability of the FGD system. Foremost among these are the following:

- Degree of calcium sulfite oxidation;
- Mist eliminator (ME) wash water quality; and
- Slurry chloride level.

6.2.1 Degree of Calcium Sulfite Oxidation

The importance of sulfite oxidation control is discussed several times in Part I of this manual, including Sections 3.3--Sulfite/Sulfate Scaling Control and 9.2.2--Thiosulfate (Sulfur). One of the major causes of reduced FGD system availability in the first generation

of FGD systems was the rapid formation of large volumes of hard, adherent calcium sulfite/sulfate scale on absorber module internals. Almost all of these systems were natural-oxidation processes where the sulfite oxidation level was between 15 and 90 percent. Although the implementation of inhibited- and forced-oxidation process modifications has brought scale formation under control, utility reservations on the use of gas/liquid contact trays and packing have historically stemmed from the scaling problems experienced by these early natural-oxidation processes. With the ability to control scaling, the successful use of internal gas/liquid contact enhancements, such as trays and packing, has expanded.

Although there are no published data on the relative availabilities of inhibited- and forced-oxidation processes, these two processes are generally considered to be equally reliable.

6.2.2 Mist Eliminator Wash Water Quality

The NERC data cited previously indicated that plugging of the mist eliminators (MEs) with calcium sulfite/sulfate scale was a major contributor to FGD system unavailability. The importance of the wash water quality to ME performance is discussed in Part I, Section 4.4--Mist Eliminator Systems. By ensuring that the relative saturation level of calcium sulfate in the wash water is less than 50%, the ME wash system can maintain the ME blades scale-free and greatly reduce the potential for an absorber module to be removed from service because of ME plugging. It should be emphasized, however, that even good-quality ME wash water will not be sufficient in maintaining clean ME surfaces unless adequate wash coverage, duration, and frequency are maintained.

6.2.3 Slurry Chloride Level

In the first generation of FGD systems, the corrosivity of the absorber slurry to absorber and inlet ductwork materials of construction was underestimated. One of the principal slurry components leading to corrosive failures was the slurry chloride level. As

discussed in Part I, Section 5.0--Materials-of-Construction Options, the higher the slurry chloride level, the greater the slurry corrosivity, and, therefore, the greater the chance for decreased FGD system availability because of materials failure.

As the knowledge of both slurry characteristics and materials performance in this environment has expanded, the problems associated with operating with a high chloride slurry have been identified. With proper selection of the materials of construction and the implementation of a good quality assurance program during erection, new FGD systems should see little, if any, reduction in system availability as a result of slurry chloride level.

6.3 FGD System Equipment Considerations

Many factors may influence the reliability of FGD system equipment. These factors include the following:

- Operating conditions;
- Equipment type;
- Number and capacity of equipment components; and
- Materials of construction.

The following subsections discuss the reliability considerations applicable to the major FGD system support systems. Part II--Major Mechanical Equipment Information--presents detailed information on many types of process equipment used in FGD systems. A discussion of the equipment reliability is included with this information. Part I, Section 5.0--Materials-of-Construction Options--provides additional information on the operating conditions in various zones in the FGD system and applicable materials of construction for each zone.

6.3.1 Flue Gas Handling Equipment

The flue gas handling equipment includes the ID (or booster) fans, inlet and outlet ductwork, inlet and outlet isolation dampers, and flue gas reheat system (if included in the design). The reliability of this equipment is directly related to its relative exposure to corrosive conditions.

ID and Booster Fans

A few first-generation FGD systems installed in the United States were equipped with flue gas fans downstream of the FGD system (wet-fan operation); however, the reliability of these fans in this very corrosive environment has been poor. As a result, in all recent U.S. designs, the fans have been located upstream of the FGD system where they experience the same operating conditions as the typical utility ID fan. In this location, the FGD system imposes no special reliability-based design requirements on these fans.

Ductwork

The inlet and outlet ductwork experiences very different operating conditions. The majority of the inlet ductwork is exposed to the hot, untreated flue gas and requires no special design considerations based on FGD system reliability. The portion of the inlet duct where the flue gas enters the absorber module, however, sees an extremely corrosive environment of high temperature, periodic wetting, surface deposits, and high chloride concentrations. The NERC data indicated that corrosive failure of ductwork materials was one of the major factors contributing to FGD system unreliability.

In order to prevent failure of the inlet duct due to corrosion, extremely corrosion-resistant materials, such as nickel-based alloys, are used in this area. Likewise, the corrosive conditions present in the outlet duct require the use of very corrosion-resistant materials of construction.

Many FGD systems include a bypass duct (or ducts) to permit untreated flue gas to be discharged directly to the stack. Although there are several reasons for installing a bypass duct, the major reliability-based justification is the ability to allow the generating unit to continue operation without derating (or to be gradually removed from service) following the loss of an absorber module or the entire FGD system. Not all FGD systems have bypass ducts, however. As the reliability of the FGD system has improved, the necessity for a bypass has diminished. Also, the desire for very high SO₂ removal efficiency has required that little or no leakage occur across the bypass control damper. Although many new FGD systems incorporate a bypass duct, some existing installations have removed (or permanently sealed) the bypass ducts that were originally installed because they were never used or were used so infrequently that the bypass control damper would not operate. As noted earlier, the NERC data indicated only a small reduction in EUF and EFOR for systems equipped with bypass ducts. Ultimately, the decision on whether to include a bypass duct in the FGD system design depends on the utility's planned response to an FGD system outage.

Dampers

With few exceptions, each absorber module is equipped with isolation dampers at the module inlet and outlet. The major reliability-based factor in the selection and design of the isolation dampers is the need to provide man-safe conditions inside an isolated absorber module while the generating unit remains in operation. Man-safe conditions are environmental conditions (temperature and gas composition) that would permit maintenance workers to safely enter the module and perform internal maintenance without the use of supplied breathing air.

If either isolation damper fails to close or fails to maintain man-safe conditions in an isolated absorber, no internal repair or preventive maintenance can be performed. For this reason, the guillotine-type dampers with a seal air system are most frequently selected for module isolation service. However, two-stage louver dampers with seal air provided between

stages have also been used. The design of module isolation dampers is discussed in Part II, Section 4.0--Flue Gas Dampers.

Flue Gas Reheaters

The NERC data indicated that for the 111 FGD systems in their survey group, flue gas reheat provided a small reduction in EUF and EFOR. However, few recent FGD systems in the United States have included any type of reheat in their design except where justified by a specific need to improve plume buoyancy and emissions dispersion. The materials-of-construction concerns that justified the use of flue gas reheat in earlier installations are now better addressed by selection of materials that can withstand the operating environment. The capital and operating costs of reheating usually outweigh any small improvement in system availability.

6.3.2 Absorber Module Equipment

One of the most significant decisions made in the design of an FGD system is the number and capacity of absorber modules. In conjunction with this decision, the designer must also determine if a spare absorber spray level is justified.

Existing FGD systems run a wide range of alternatives in the selection of the number and capacity of absorber modules, from six 25%-capacity modules to a single module treating flue gas from two generating units. Typically, a new or retrofit installation might consider two or more of the following alternatives:

- Three 50%-capacity absorbers;
- Two 67%-capacity absorbers;
- Two 50%-capacity absorbers; and
- One 100%-capacity absorber.

The above alternatives are listed 1) in order of decreasing equipment redundancy, space requirements, and capital cost and 2) in order of increasing effect on the generating unit in the event of the loss of an absorber module. At a multi-unit installation, a popular alternative is for the FGD system serving each unit to share a spare absorber. Any of these alternatives may also incorporate one or more spare spray levels in each absorber.

The selection of the number of absorber modules and spare spray levels is almost always the subject of an engineering study. This study must consider factors such as capital cost, available land area, possible equipment arrangements, maintenance access requirements, effects of FGD availability on the generating unit, coal sulfur variability, and a wide variety of site-specific regulatory factors. A detailed discussion of this complex study is beyond the scope of this manual. In general, however, this study should consider the following factors:

- Almost all FGD system suppliers are currently willing to guarantee greater than 99% system reliability with a single, 100%-capacity module;
- In the United States, some FGD systems can be bypassed during repairs without affecting the generating unit through the use of SO₂ emission credits;
- The use of a spare spray level permits maintenance to an absorber spray pump to be performed without affecting SO₂ removal efficiency;
- Chemical additives can be used to make up for a reduction in the number of operating absorber spray pumps;
- With proper selection of the materials of construction and design of the ME wash system, internal maintenance of the absorber module and

* In retrofit FGD systems installed under Title IV of the Clean Air Act Amendments of 1990 (so-called "Phase I acid rain systems"), SO₂ emission credits can be generated and banked by operating the FGD system at a higher than required efficiency, can be transferred from another generating unit in the utility's generating system, or can be purchased from another utility. All other systems in the United States are typically held to 3-hour or 30-day rolling averages that prevent bypassing except under emergency conditions (blizzard, flooding, or other natural disasters).

outlet ductwork may be extended to intervals of 12 months or longer;
and

- Single absorber vessels are capable of treating over 850 Nm³/s (2.5 million acfm).

The result of these considerations is that the trend in most recent FGD systems has been toward fewer, larger-capacity modules without a spare module (or with a spare shared between generating units). One spare spray level is typically included in each module.

6.3.3 Reagent/Additive Preparation Equipment

The reagent/additive preparation equipment may handle lime, limestone, or chemical additives, and consists of three subcategories: receiving and storage equipment, slurry preparation (or slaking) equipment, and slurry storage tank(s).

Reagent/Additive Receiving and Storage Equipment

The reagent/additive receiving and storage subsystem uses relatively reliable components, and redundancy is kept to a minimum. Although lime may be stored in more than one storage silo, this is primarily based on the economical sizing of the silos. The pneumatic lime transfer system between the storage silo and lime day bins may be equipped with a spare blower but a single transfer line. If the required transfer rate exceeds the capacity of a single pneumatic system, however, multiple transfer lines may be required. Limestone is usually transferred from the storage pile or building to the ball mill day bins by a single conveyor system that may employ belt, screw and elevating conveyors. Typically, a single day bin is provided for each lime slaker or limestone ball mill.

A single storage tank is typically provided for each chemical additive. As with most pumping systems, the chemical transfer line between the additive storage tank and the reagent storage tank would be equipped with two full-capacity pumps.

Slurry Preparation Equipment

The ball mills used to slake lime or to grind limestone are characterized by high capacity [up to 110 tonnes* of lime or limestone per hour (120 tons/hr) are available] and high reliability (**mean-time-between-failures** greater than 60,000 hours). Ball mill equipment vendors recommend that their equipment operate 24 hours per day because the greatest stresses on the equipment occur during starting and stopping the mill. In view of the large capacity available, common practice is to specify two reagent preparation trains, each consisting of a day bin, belt feeder, ball mill, and classification system. Each train is sized to produce the daily reagent slurry requirement at the FGD system design conditions within 24 hours. Alternatively, both mills could be operated 12 hours per day. Both operating procedures provide ample opportunity to perform preventive maintenance to the ball mill and support equipment without affecting the reliability of the reagent preparation system.

Often, where more than one generating unit at a site is equipped with an FGD system, the reagent requirements of all units are supplied by a single reagent preparation system. In this case, one or more ball mill trains may be provided for each unit and they may share a common spare mill train.

Paste slakers can also be used to slake lime, but have a maximum capacity of approximately 3.6 tonnes per hour (4 tons/hr). A typical design would divide the daily reagent requirement at design conditions between several slaker trains all operating 12 to 24 hours per day. Each equipment train would consist of a day bin, weigh feeder, and slaker. One or more spare slaker trains would be included in the design. A single grit collection and conveying system would serve all of the slakers.

* 1 tonne = 1000 kg.

Slurry Storage Tanks

Reagent slurry storage tanks are typically sized on the basis of the reagent consumption at design conditions. This tank is typically very reliable, and the number and capacity of reagent storage tanks are usually based on the cost of the tank(s) rather than reliability requirements. A typical design might provide 8 to 16 hours' storage in a single tank. If this tank becomes too large to agitate with a single top-entry agitator, two 50%-capacity tanks may be used.

6.3.4 Byproduct Solids Handling Equipment

The byproduct solids handling equipment may consist of primary dewatering equipment, secondary dewatering equipment, and tertiary processing equipment.

Primary Dewatering Equipment

Primary dewatering may use either thickeners or hydrocyclones, both of which are discussed in detail in Part II--Major Mechanical Equipment Information. Although primary dewatering can be interrupted for several hours without limiting the operation of the FGD system, this equipment generally must be operational 24 hours per day, 7 days per week.

Where thickeners are used for primary dewatering, a single full-capacity or two lower-capacity thickeners are typically used. There are several mechanisms for failure of a thickener that can result in the prolonged loss of this equipment. These mechanisms include plugging of the thickener outlet, embedding of the rake in dense solids, and mechanical failure of the rake drive mechanism. An outage of several days may be required to drain the thickener, remove the settled solids, and repair the problem. Since loss of primary dewatering capability would immediately affect the availability of the FGD system, systems using two 50%-capacity thickeners are common. At installations with more than one FGD system, a common spare thickener serving all units may be justified.

The use of hydrocyclones in forced-oxidation FGD processes was spurred by their lower capital costs and greater reliability in relation to thickeners. Individual hydrocyclones are installed in banks of multiple independent units, and one or more spare hydrocyclones can be included in the bank at very little additional cost. These devices have no moving parts and their primary failure mechanism is wear of the cyclone liner. An individual cyclone can be removed from service in a few minutes without affecting the overall operation of the primary dewatering system and returned to service after repair or replacement, usually in a very short period of time.

The underflow from the thickeners or hydrocyclones is directed to one or more underflow tanks. Thickeners use underflow pumps to transfer the solids from the thickener to the underflow tank, and an installed spare underflow pump must be provided. These pumps are usually located in a tunnel that runs beneath the thickener. In some arrangements with multiple thickeners, all underflow pumps are located in a central pump room and the spare underflow pump can be shared between thickeners. Flow from the hydrocyclones to the underflow tanks is by gravity using a single pipe. Often the hydrocyclone bank is located directly above the underflow tank and minimal piping is required.

One underflow tank per unit is usually provided. This tank stores a slurry with 30 to 50% solids and must be agitated. Failure of the agitator could result in the loss of the use of this tank; however, in most cases the tank could be returned to service in a few days. The use of emergency agitation methods, such as air lances, may reduce the need to remove the tank from service during agitator repair. The storage capacity required depends on the maximum daily byproduct solids production and the number of hours per day of operation of the secondary dewatering system. While reliability has some effect on the number of underflow storage tanks used, capital cost and the difficulty in agitating very large storage tanks are more influential factors. Also, some gypsum crystal degradation can occur in forced-oxidation systems if the underflow slurry is agitated or recirculated for too long a period of time. This can adversely affect the solids' filtering properties. For this reason, underflow storage tank retention time should be limited to no more than 12 hours.

In some newer designs using hydrocyclones for primary dewatering, the underflow tank is not required. A bank of hydrocyclones is associated with each secondary dewatering device (such as a horizontal belt filter) and the cyclone underflow is piped by gravity directly to the filter. This eliminates the underflow tank, tank agitator, filter feed pumps, and slurry piping and valves--all equipment handling a thick slurry.

One of the benefits of the use of ponds or a gypsum stack for ultimate disposal is that these alternatives eliminate the need for mechanical dewatering equipment altogether. In both alternatives, blowdown from the absorber modules is usually discharged to a single blowdown tank, then pumped to the pond or gypsum stack. Two full-capacity pumps are usually provided for pumping from the tank to disposal and for pumping the reclaimed water back to the FGD system.

Secondary Dewatering Equipment

Secondary dewatering equipment typically requires a significant amount of preventive maintenance and repair. Regardless of the type of equipment used and the number of dewatering equipment trains required to handle the design dewatering rate, a spare equipment train should be included in the design. The determination of whether this should result in two 100%-capacity trains, three 50%-capacity trains, or another combination is based on the maximum hourly byproduct solids dewatering rate, the number of hours per day of secondary dewatering system operation, and the available dewatering capacities of the equipment. The spare train may be shared between generating units, or a separate spare may be provided for each unit.

Normally, the secondary dewatering equipment discharges to a conveyor belt that transports the byproduct solids to tertiary processing equipment or to temporary storage. Most dewatering systems use a single conveyor for this service. The use of parallel conveyors usually requires the use of diverting hoppers or reversing conveyors, both of which add complexity to the system and increase the chance of mechanical failure. Hoppers and

conveyor transfer points are especially prone to plugging and should be minimized as much as possible.

Tertiary Byproduct Solids Processing Equipment

Pug mill mixers for combining waste byproduct solids with fly ash, or fly ash and lime, are available in capacities in excess of 180 tonnes per hour (200 tons/hr). Therefore, only one or two mixers would be required by most FGD systems. A spare mixer is recommended to allow for maintenance and cleaning. As with the previously discussed equipment, the spare mixer may be shared between generating units.

In systems where the byproduct solids are to be stabilized or fixated, a single fly ash day bin and a single lime day bin (if required) are provided.

6.4 Glossary of Terms

Availability--The period of time when the equipment is available for operation regardless of whether or not it is actually called on to operate, expressed as a percentage.

$$\text{Availability} = \frac{\text{Hours Available to Operate}}{\text{Total Hours in the Period}} \times 100\% \quad (6-1)$$

Equivalent Forced Outage Rate (EFOR)--As defined by NERC, the EFOR represents the random outage and derating failures occurring during periods when the equipment is expected to be in service (1). A graphical representation of EFOR is presented in Figure 6-1. Using this illustration, EFOR is defined as:

$$\text{EFOR} = \frac{A}{B} \times 100\% \quad (6-2)$$

Equivalent Availability Factor (EAF)--EAF is a complex indicator that uses forced, planned, maintenance, and seasonal outages and deratings in measuring the unit's

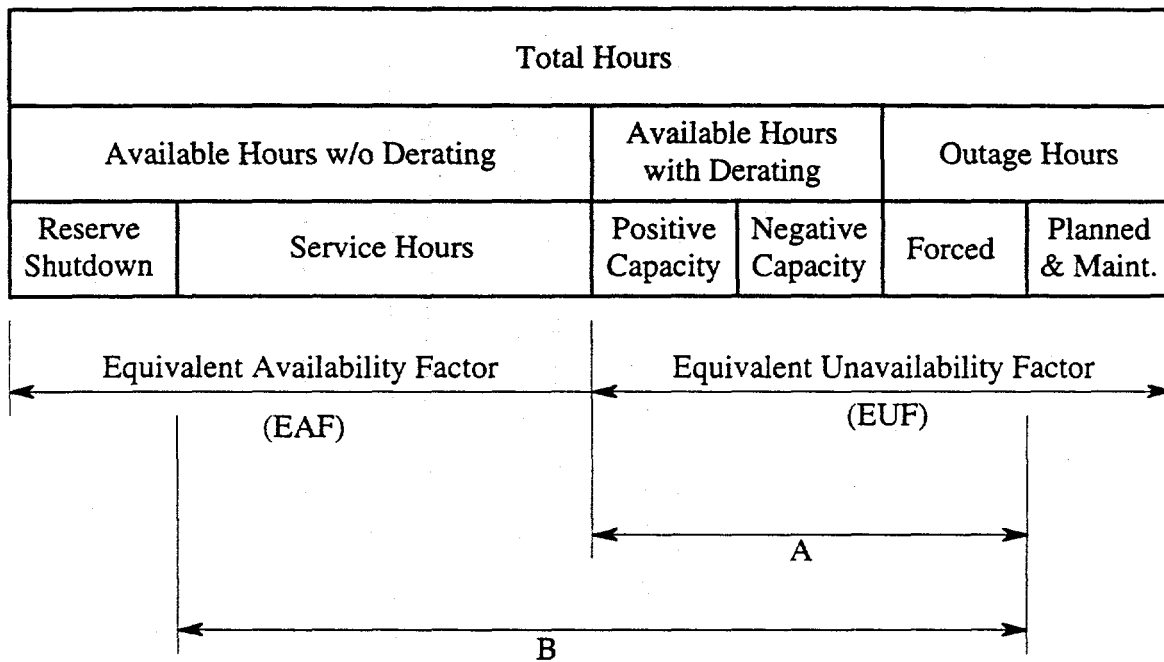

$$\text{Equivalent Forced Outage Rate (EFOR)} = \frac{A}{B} \times 100\%$$

Figure 6-1. Graphical Definition of Reliability Concepts (1)

ability to perform at full-load capacity (1). A graphical representation of EAF is presented in Figure 6-1.

Equivalent Unavailability Factor (EUF)--EUF is the complement of the EAF as shown in Figure 6-1 (1). In comparison to the EFOR, the EUF includes additional terms for planned and maintenance outages and reserve shutdown hours.

Mean-Time-Between-Failures (MTBF)--The average time between returning a repaired component to service and its next failure. This value is usually obtained from plant maintenance records for the component or for a similar component in similar service.

Median--The point in a population of data where there are as many observations greater than the point as there are lesser. The median is used in lieu of the average to reduce the effect of a few very high or very low values.

Reliability--The period of time when the equipment is available for operation when it is actually called on to operate, expressed as a percentage.

$$\text{Reliability} = \frac{\text{Hours Available to Operate}}{\text{Total Hours Called on to Operate}} \times 100\% \quad (6-3)$$

Unavailability--The complement of availability. The period of time when the equipment is not available for operation regardless of whether or not it is actually called on to operate, expressed as a percentage.

$$\text{Unavailability} = 100\% - \text{Availability} \quad (6-4)$$

Unreliability--The complement of reliability. The period of time when the equipment is not available for operation when it is actually called on to operate, expressed as a percentage.

$$\text{Unreliability} = 100\% - \text{Reliability} \quad (6-5)$$

6.5

References

1. North American Electric Reliability Council. Impact of FGD Systems-- Availability Losses Experienced by Flue Gas Desulfurization Systems. Princeton, New Jersey, 1991.
2. Curley, Michael G. Flue Gas Desulfurization System Impact on Availability-- 1989-1991 Performance Update. 92-JPGC-Pwr-14, American Society of Mechanical Engineers, New York, New York, 1992.

7.0 CHEMICAL MONITORING PROGRAM

A chemical monitoring program is established for an FGD system for a number of reasons. This section of the manual presents discussions of these reasons and the associated laboratory elements required to implement an FGD system chemical monitoring program.

7.1 Reasons for Chemical Monitoring

There are a number of reasons for establishing an FGD chemical monitoring program and performing analyses of FGD process streams. Depending on site-specific factors, these reasons may include the following:

- Calibration of on-line instrumentation;
- Routine process control and operation;
- Identification and characterization of process upsets and process problems;
- Evaluation and optimization of system performance;
- Initial system characterization and performance testing; and
- Demonstration of compliance with regulatory or contractual requirements for wastewater discharges or byproduct solids.

The specific objectives for performing chemical monitoring will determine which analyses or group of analyses are performed and their frequency. In general, however, the analytical requirements for an FGD chemical monitoring program fall into four categories:

- Routine analyses performed to operate and control the FGD process;
- Routine analyses performed to monitor FGD system performance;

- Analyses performed to evaluate, characterize, or optimize the FGD process; and
- Analyses performed to demonstrate compliance with regulatory or contractual requirements.

A discussion of each of these categories is presented in the paragraphs below.

7.1.1 Routine Analyses to Operate and Control the Process

Analyses in this category are conducted to calibrate on-line instrumentation, such as pH and density monitors, and to provide rapid feedback for process control and operation. Examples include pH measurements of absorber spray slurry and density and solids measurements of absorber or reagent slurry streams. If performance enhancing additives are being used, routine measurements of their concentrations in the process streams are made to provide data for adjusting their addition rates. Depending on the variability of the process and the specific parameter being measured, specific analyses in this category may be performed at frequencies ranging from several times per day to weekly.

7.1.2 Routine Analyses Performed to Monitor Performance

Another category of routine analyses consist of those conducted to monitor the performance of the absorber module and ancillary systems such as reagent preparation and byproduct handling. The objectives of these analyses are to monitor the performance of the system in order to verify that design performance levels are consistently met and to obtain an early indication of when the performance of the FGD system has changed or deteriorated. The following are examples of routine analyses that are performed on FGD system process streams:

- Solid-phase analyses to determine such performance indicators as reagent utilization and sulfite oxidation fraction;

- Liquid-phase analyses to determine relative saturation levels and scaling potentials of several key soluble species; and
- Liquid-phase analyses of soluble ions such as sulfite and chloride to evaluate liquid-phase SO₂ absorption capacity and corrosion potential.

Examples of analyses that may be performed to evaluate the performance of the FGD process's ancillary systems may include reagent particle size distribution, filter feed solids concentration, and filter cake solids concentration.

The exact analyses that are performed and their frequencies depend on the specific FGD system, process variability, and objectives of the monitoring program. The distinguishing feature of analyses in this category, however, is the fact that they are performed on a routine basis (e.g., daily, twice weekly, weekly, etc.) over the duration of the FGD system operating life.

7.1.3 Analyses Performed to Evaluate, Characterize, and Optimize the FGD Process

A third category of analyses consists of those required to provide a more detailed evaluation and characterization of the process. This is normally done during startup and the initial FGD system performance testing to provide baseline performance and process characterization information. Characterization analyses are also performed, on an as-needed basis, to help identify and solve process problems or to aid in the optimization of the FGD process. Depending on the specific reason for conducting a detailed characterization of the process, a wide variety of analytical and physical tests and measurements of any or all of the absorber, makeup water, reagent, byproduct solids process, or process liquor streams would be included.

7.1.4 Analyses Performed To Demonstrate Compliance with Regulatory or Contractual Requirements

This category of analyses consists of those required to demonstrate compliance with either regulatory or contractual requirements. Depending on the requirements of the regulation or contract, analyses of this type may be performed at frequencies that range from daily to quarterly to annually. Generally, regulatory or contractual compliance analyses are performed on liquid or solid discharges from the FGD process and on saleable byproduct solids, if applicable. Examples of analyses that may be included are pH, total suspended solids (TSS), total dissolved solids (TDS), and specific major ions (e.g., Ca^{++} , Mg^{++} , Na^+ , Cl^- , SO_4^-) in wastewater discharge stream. If the byproduct solids are sent off site for commercial use, analyses of byproduct quality parameters (e.g., Cl^- , total soluble ions, total moisture, etc.) are necessary. Some byproduct solids characterization analyses may be required even when the byproduct is disposed of as a waste material.

7.2 Required Elements of an FGD Laboratory

Analyses performed as part of a chemical monitoring system for an FGD process are normally done in a laboratory established at the plant site. This may be a separate facility located near the FGD system, or it may be combined with existing plant laboratory facilities that perform tests on boiler water, coal, and wastewater discharges. In either case, establishing an FGD laboratory requires that a number of laboratory elements be considered, including physical space, permanent fixtures and utilities, equipment and instrumentation, and personnel requirements. Written laboratory analysis and quality assurance/quality control (QA/QC) procedures are required to ensure that accurate and reliable data are safely obtained and reported. These laboratory elements are discussed in the paragraphs below.

7.2.1 Physical Space and Utilities

The physical space required for the FGD laboratory depends on the scope of the monitoring effort which, in turn, depends on the size and complexity of the FGD process;

the number, types, and frequencies of analyses required; the test methods used; and the objectives of the chemical monitoring program. Typically, FGD laboratories, whether they are a section of a main laboratory or a separate facility, have about 40 to 90 square meters (400 to 1000 square feet) of floor space. An FGD laboratory is normally equipped with a number of permanent fixtures and utilities including the following:

- Electrical power (several individual electrical circuits);
- Tap water plumbing, sink, and drain;
- Deionized water system;
- Heating and air conditioning system;
- Cabinets (floor and wall);
- Bench-top space;
- Fume hood(s);
- Safety shower;
- Emergency eye wash;
- Compressed air system;
- Vacuum system; and
- Storage area.

A typical layout for an FGD laboratory showing the location of cabinets, sinks and hoods is presented in Figure 7-1.

7.2.2 Equipment and Instrumentation

The equipment and instrumentation required for the laboratory can be divided into several categories, including support equipment, glassware, non-expendable supplies, expendable supplies, and analytical instrumentation. The selection of the specific equipment

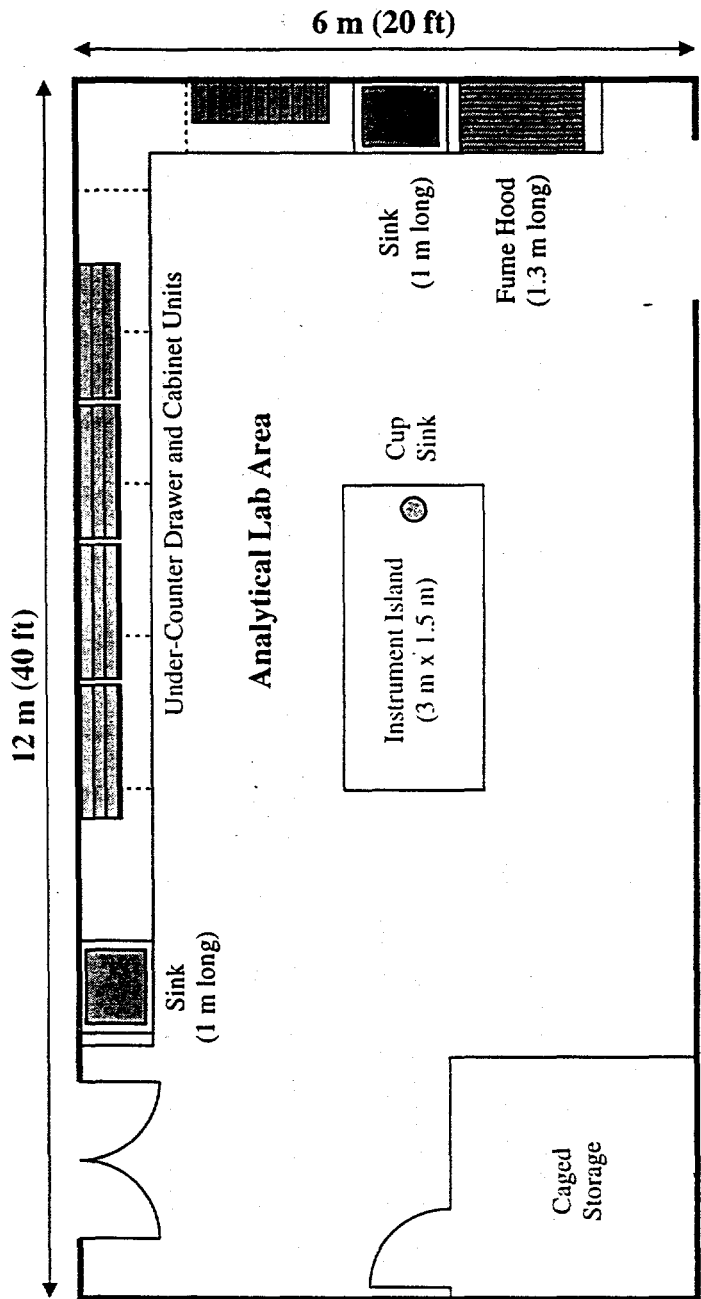

Figure 7-1. Typical Layout for an FGD Laboratory

and instrumentation will depend, to a large extent, on the analytical methods selected to perform the analyses. Often these decisions flow out of the basic decision of whether it is preferable to perform analyses using instrumental methods and techniques, or wet chemical (e.g., manual titrimetric, gravimetric) methods and techniques. Some of the guidelines that should be considered in making this decision are summarized below:

- Instrumental techniques are, in general, more efficient for analyzing a large number of samples. Modern instruments are normally supplied with computer control and equipment for automatic sample acquisition and data reduction. This allows a user to perform analyses of a large number of samples unattended. However, the time required for instrument setup and calibration often makes an instrumental technique less efficient than a wet chemical technique if only a few samples are analyzed.
- Instrumental techniques often offer the capability of measuring more than one chemical species. For example, an atomic absorption spectrophotometer (AAS) or an inductively coupled argon plasma spectrometer (ICAP) can determine a wide variety of cations, many of which are of interest when characterizing an FGD process. Ion chromatographs are capable of analyzing a number of key FGD anions. The ability to analyze multiple parameters often makes instrumental techniques more desirable and cost-effective than wet chemical techniques.
- Instrumental techniques have a high capital cost associated with the purchase of the analytical instrumentation. In addition, these techniques require a higher level of expertise and training for the analysts, and may require additional permanent fixtures in the laboratory, such as ventilation fans. As a result, establishing a laboratory using instrumental techniques will have greater initial setup costs than establishing a laboratory using wet chemical techniques. These added costs must be balanced against the possible time-saving advantages and increased analytical capabilities of the instrumental methods.
- Wet chemical techniques, in general, require less setup time than instrumental techniques. As a result they are probably more efficient to perform for a small number of samples. In addition, the costs associated with acquiring the equipment required to perform wet chemical analyses are much less than instrumental techniques. As a result, wet chemical techniques are probably the techniques of choice if the budget available to establish the laboratory is limited. Finally, the

level of expertise required to perform wet chemical techniques is not as great as required by instrumental techniques. This is a benefit in terms of technology transfer and training. Also the skills to troubleshoot, repair, and maintain the analytical instruments are not required.

There are some support, instrumental, and non-expendable equipment items that will be required regardless of which techniques are chosen for performing analyses. These items include refrigerators, analytical balances, pH meters, ovens, stir plates, hot plates, and sampling equipment. A desktop computer is very useful in maintaining data and preparing reports. A library of standard methods and procedures should be provided. Required glassware includes an assortment of various sized beakers, graduated cylinders, volumetric flasks, erlenmeyer flasks, and pipettes. Expendable supplies and equipment that will be required include chemicals, reagents, filters, desiccant, pH electrodes, and sample bottles.

7.2.3 Personnel Requirements

A key aspect of successfully establishing a chemical monitoring program is identifying and training a well-motivated laboratory staff. Laboratory staff members and supervisory personnel should have expertise and training in the following areas:

- Basic laboratory and analytical practices and principles;
- Principles and procedures associated with the analytical and instrumental methods that will be used to perform the FGD analyses;
- Procedures for calculating, tabulating, and summarizing analytical results and FGD performance indicators; and
- Basic concepts of FGD process chemistry in order to relate the laboratory data to system operation and performance.

The laboratory personnel will be responsible for some or all of the following activities:

- Collecting process samples and process data;
- Calibrating instrumentation;
- Performing chemical analyses;
- Troubleshooting analytical methods;
- Calculating, summarizing, and reporting analytical results and FGD performance indicators to appropriate plant and FGD system operating personnel;
- Evaluating FGD system operation and performance;
- Training other laboratory personnel;
- Interacting with appropriate plant and FGD system operating personnel as required to discuss results and discuss scrubber operation and performance; and
- Administering the laboratory QA/QC and safety programs.

7.2.4 Quality Assurance and Quality Control

A laboratory QA/QC program is necessary so that analysts and users know that the analytical data reported by the laboratory are accurate and reliable. An effective QA/QC program covers all aspects of the procedures and protocols associated with sample collection, sample handling, analysis, and data reporting and includes all activities carried out to ensure and maintain data quality. An effective QA/QC program also requires periodic, independent performance and system audits of the laboratory and an effective means of taking corrective action when problems arise.

A key aspect of a successful QA/QC program is the selection of appropriate methods and procedures for sample collection and analysis. The methods selected should ensure sample integrity from the time the sample is collected until analyses are complete, and should avoid or eliminate interferences from other chemical constituents that may be present.

Another important aspect of a successful QA/QC program is document control. Complete and permanent documentation should be recorded and maintained for every sample collected, for all intermediate and final data associated with an analysis, for final analytical results and calculated performance indicators, and for results of all QA/QC analyses. In addition, a program should be established to maintain complete records and documentation regarding laboratory procedures with respect to sample collection, handling and analysis, data reporting, instrument use and maintenance, and all other aspects of laboratory operation. Finally, a program should be established to record, summarize, and report QC data. This program is used to assess and document the performance of the laboratory and the quality of the analytical data.

A QA/QC program includes a number of routine procedures associated with each analysis to ensure that the results of the analysis meet specified limits with respect to data quality and data reliability. Depending on the analytical method, these QA/QC procedures can include instrument calibration, reagent standardization, blank analyses, duplicate analyses, quality control sample analyses, and spike analyses.

Chemical parameter-specific control limits are normally established for duplicate samples, quality control samples, and spiked samples. Control limits can also be established for blanks, and correlation coefficients can be computed for calibration curves. The control limits should be based on the historical performance of the laboratory, the inherent variability of the particular analytical procedure, and an assessment of the level of data quality required for the chemical monitoring program. The control limits should be used to determine if the particular analysis that has been performed has met the criteria established by the laboratory for data quality and reliability. If this is not the case, procedures also need to be established to ensure that the out-of-control data are not reported and that corrective actions are taken to bring subsequent analyses within the specified control limits. Being able to make this assessment requires that procedures be put in place to calculate and record the results of a QA/QC analysis prior to completing and reporting the sample analyses.

7.2.5 Safety

A laboratory safety program is another element that must be considered when establishing an FGD laboratory. Normally, a plant-wide safety program will already be established, and the specific details of the safety program for the FGD laboratory should be consistent with the plant program. Some of the important elements of a safety program that should be included are summarized below:

- General laboratory safety procedures and practices;
- Procedures for safe handling of chemicals and hazardous materials;
- Procedures for safe handling of compressed gases;
- General first aid procedures;
- Procedures for the use of eye protection, hearing protection, and protective clothing;
- Procedures for use of breathing devices;
- Electrical hazard avoidance procedures;
- Fire prevention and protection procedures; and
- Emergency response procedures.

Additional information on laboratory safety is available from the American Chemical Society (1) and the Manufacturing Chemists Association (2).

7.3 Overall Chemical Monitoring Program

Establishing a chemical monitoring program is a key requirement in the successful operation of an FGD system. It is difficult to imagine that an FGD system can be operated reliably and meet its SO₂ removal requirements without performing key analyses on a routine basis. The types and frequency of the analyses should be reviewed periodically to

ensure that the goals of the monitoring are being met. Analytical procedures specifically directed at operation of FGD systems have been developed by the Electric Power Research Institute (3). Standard methods of performing other analyses are also available (4,5).

Regardless of whether instrumented or wet chemical methods are used to perform the analyses, adequate equipment and facilities are critical to the quality of the data obtained by the chemical monitoring program. Documented QA/QC procedures are also vital. Without quality data, the FGD engineers and operating personnel have no way of knowing if the analytical data truly characterize the performance of the FGD system. Operating the system using on incorrect chemical monitoring data can lead to problems as severe as those resulting from operating insufficient data.

7.4 References

1. American Chemical Society, Committee on Chemical Safety. Safety in Academic Chemistry Laboratories. 3rd ed. Washington, D.C., 1979.
2. Manufacturing Chemists Association. Guide for Safety in the Chemical Laboratory. 2nd ed. Van Nostrand, New York, New York, 1972.
3. Electric Power Research Institute. FGD Chemistry and Analytical Methods Handbook, Volumes 1 and 2. EPRI CS-3612. Palo Alto, California, 1990.
4. American Public Health Association. Standard Methods for the Examination of Water and Wastewater. 19th ed. Washington, D.C. 1995.
5. U.S. Environmental Protection Agency, Environmental Monitoring and Support Laboratory. Methods for Chemical Analysis of Water and Waste. EPA-600/4/79-020. Cincinnati, Ohio, 1979.

8.0

LIME AND LIMESTONE REAGENT CONSIDERATIONS

FGD systems require a source of alkalinity to neutralize the SO_2 removed from boiler flue gas. This alkalinity is nearly always supplied by limestone or lime. Typically, limestone is delivered to the generating station as crushed rock. At the utility, the crushed rock is ground in a wet ball mill and fed to the FGD system as a slurry. This grinding is required to increase the surface area and reactivity of the relatively insoluble limestone. Lime is produced by calcining limestone. This process employs heat to convert calcium carbonate (CaCO_3) to calcium oxide (CaO), and the lime is delivered to the generating station in this form. The lime is slaked by mixing the lime with water. During the slaking process, reactions occur which convert calcium oxide to calcium hydroxide [$\text{Ca}(\text{OH})_2$]. Additional grinding is not required and the slaked lime is fed to the FGD system as a slurry. Detailed discussions of reagent delivery, storage, and slurry preparation are presented in Part I, Section 4.7--Reagent/Additive Preparation Equipment.

Limestone is a natural material and, therefore, its composition and performance characteristics can vary. The impurities found in limestone can affect the performance and reliability of both limestone- and lime-based FGD systems which, in turn, affect operating costs. Engineers responsible for the design of an FGD system or the selection of a reagent from a group of sources should understand how reagent characteristics affect FGD system performance.

This section begins with a discussion of the availability of limestone and lime within the United States. Although this discussion is limited mainly to the United States, similar considerations apply to the world market. Next, important limestone and lime characteristics are discussed along with their impact on process performance. These characteristics are composition, reactivity, particle size distribution, and hardness. The influence of these characteristics on process performance differs considerably for limestone and lime; therefore, separate discussions are provided for each reagent.

8.1 Reagent Availability

Transporting a reagent to the generating station represents a significant operating cost. In most cases, the reagent transportation cost exceeds the cost of the raw material itself. Consequently, the availability of suitable quality limestone and lime that are located relatively close to the plant or that can be delivered at a reasonable price is a prerequisite for minimizing the operating cost of an FGD system. This subsection presents an overview of the availability of limestone and lime. Information is presented to show the locations of limestone deposits within the United States, and the locations of lime producers who market commercial lime.

8.1.1 Limestone Availability

Limestone is an abundant, naturally occurring form of calcium carbonate. It is second in abundance only to silicate rock as a material composing the earth's crust. Limestone is used in the production of hundreds of industrial chemicals and in the construction of roads and buildings, and the use of limestone for environmental purposes (such as FGD) is increasing.

Limestone is mined from thousands of quarries throughout the United States and deposits are wide-spread. A map highlighting major limestone deposits is presented in Figure 8-1 (1). As illustrated on the map, the most extensive deposits (and the population of existing quarries) are located in the eastern United States. However, there are significant reserves in most western states as well.

As described later in Section 8.2, it is desirable, if possible, to employ relatively high-purity limestone in FGD systems. Limestones with modest quantities of magnesium may also be suitable for some systems. The Electric Power Research Institute (EPRI) has sponsored programs designed to develop detailed information on the locations of both high-calcium limestones (greater than 90% calcium carbonate) and limestones which may

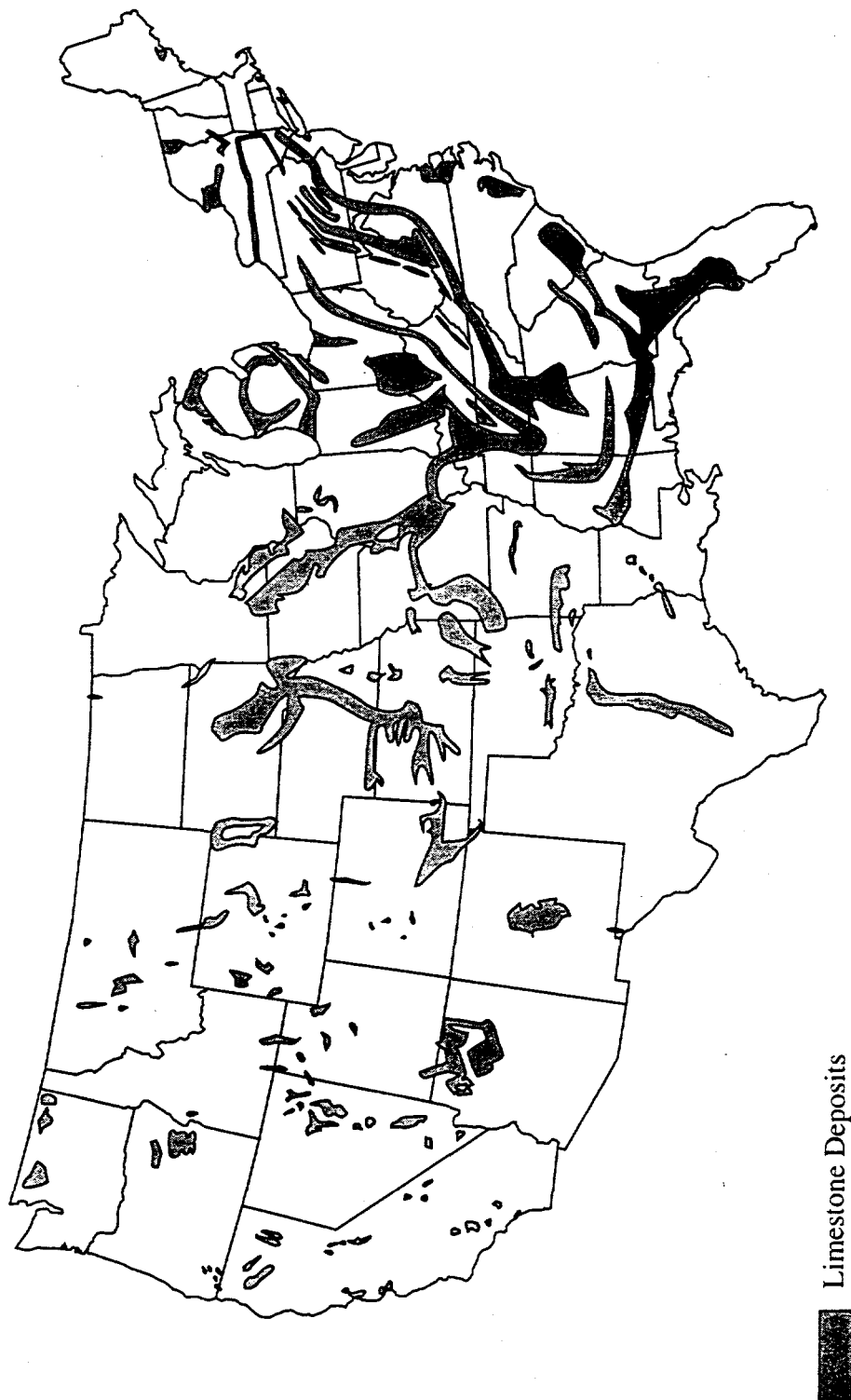

Figure 8-1. Distribution of Limestone Deposits in the United States

potentially contain significant quantities of soluble magnesium (magnesium carbonate concentrations ranging from 3 to 12 percent) (2,3).

8.1.2 Lime Availability

Lime is not found in nature and must be produced by calcining limestone for several hours at high temperatures [about 1100°C (2000°F)]. The calcining process converts calcium carbonate and magnesium carbonate to their respective oxides. Lime production has remained relatively stable at about 16 million metric tons per year (about 18 million tons per year) since 1970 (4). According to the National Lime Association, high-calcium and dolomitic (high-magnesium) limes are produced in over 70 commercial lime plants in the United States, and an additional 14 plants are operated in Canada. The locations of these plants are mapped in Figure 8-2 (5).

The steel industry is the largest single lime consumer and uses about a third of the total amount of lime consumed. This factor accounts for the relatively high concentration of lime producers in the industrial northeast (see Figure 8-2). Other industrial operations such as metals production, acid neutralization, paper production, and production of calcium carbide account for an additional third of the total consumption rate. About one quarter of total lime consumption is used for environmental purposes, including flue gas desulfurization, waste and waste water treatment, and water purification. The wide variety of uses for lime explains the fact that lime plants are distributed throughout the country (4).

8.2 Reagent Composition

The limestone used for wet FGD service and for production of FGD lime is composed primarily of calcium carbonate. However, there are impurities present in limestone which can affect the performance and reliability of both limestone and lime FGD systems. This section describes these effects and presents general guidelines for appropriate concentrations of calcium and various impurities in FGD-quality limestone and lime.

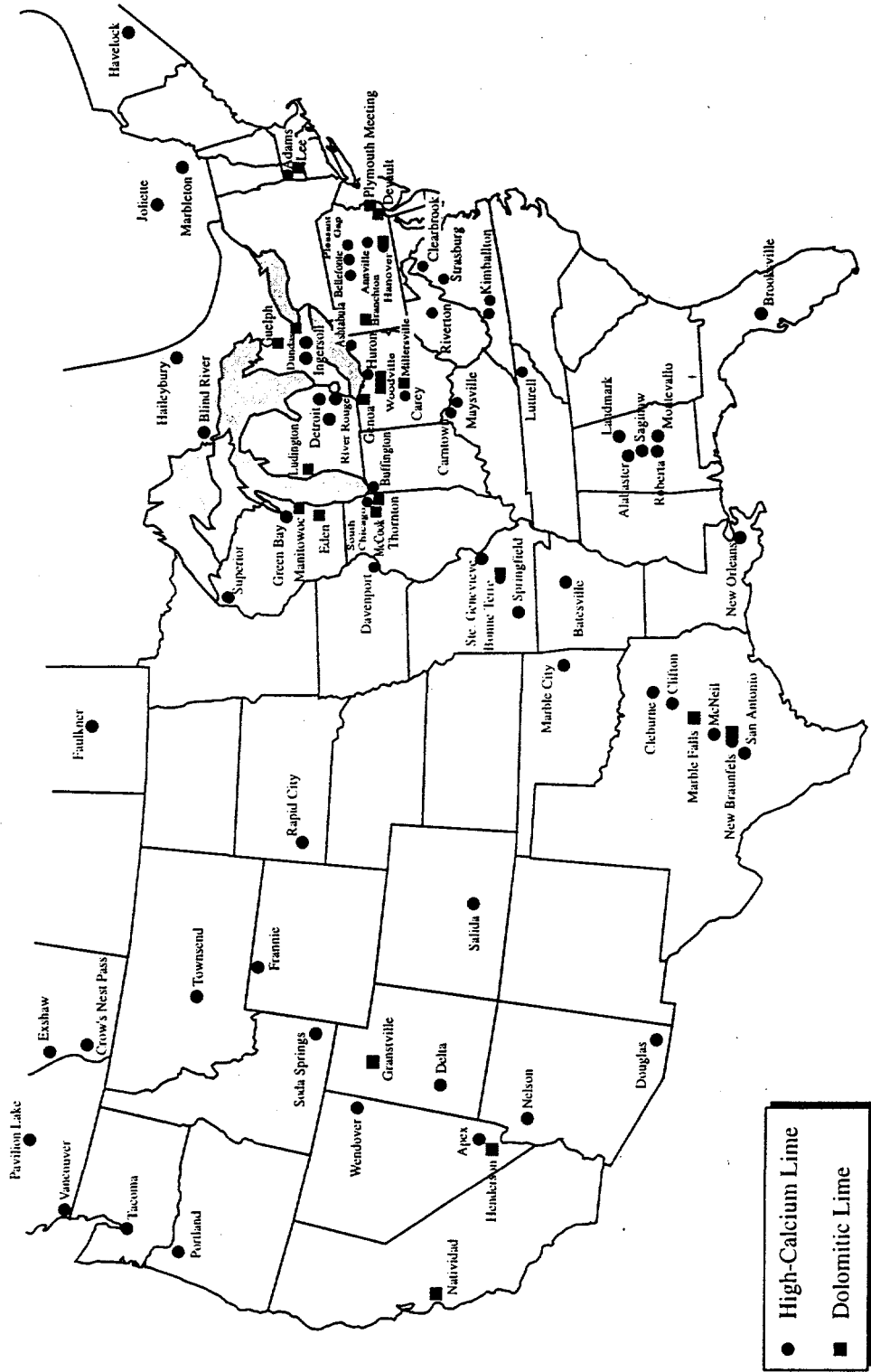

Figure 8-2. Commercial Lime Plants in the United States and Canada (1994)

8.2.1 Limestone Composition

The most common impurities in limestone include magnesium carbonate (MgCO_3) and the oxides of silicon, aluminum, and iron. A portion of the magnesium carbonate may be soluble at the conditions which exist in an FGD system, and this often has a significant effect on the performance of the system. The metal oxides are not very soluble even in strong acid, and these materials are often referred to as acid inerts.

Forms of Magnesium Carbonate

Magnesium carbonate in limestone can be found in two major forms: solid-solution magnesium carbonate and dolomite. Solid-solution magnesium carbonate refers to magnesium ions which have displaced calcium ions from the calcium carbonate crystal structure (calcite). The calcite crystal structure can accommodate up to about 5% magnesium carbonate in the solid solution form.

Solid-solution magnesium carbonate is soluble at FGD system conditions and contributes magnesium ions to the scrubbing slurry. As described in Section 3.4.1, dissolved magnesium ions can have both positive and negative effects on FGD system performance. Under many conditions, dissolved magnesium can improve SO_2 removal. On the other hand, too much dissolved magnesium can adversely affect the settling and dewatering characteristics of unoxidized waste solids, and may require cake washing for systems designed to produce commercial-grade gypsum. As a result of these competing factors, the level of soluble magnesium carbonate in the limestone should be treated as a design variable which can be specified to optimize system performance and minimize operating costs.

Magnesium carbonate may also be present as dolomite ($\text{CaCO}_3 \cdot \text{MgCO}_3$), a chemical compound containing equal amounts (on a molar basis) of calcium and magnesium carbonate. In comparison to solid-solution magnesium carbonate, dolomite is essentially insoluble at the conditions existing within FGD systems.

The amount of dolomite in a limestone is important for several reasons. Since dolomite is relatively insoluble, the calcium and magnesium carbonate which composes the dolomite is "unavailable" and will eventually leave the FGD system with the waste solids. This increases limestone consumption and decreases the purity of commercial-grade gypsum. In addition, the presence of dolomite impedes the dissolution of the reactive portion of the limestone matrix. Consequently, limestones with higher concentrations of dolomite tend to be less reactive.

Effects of Acid Inerts

Limestone often contains rock-like impurities, including sand, clay, and silt. These materials are composed primarily of silicon dioxide and lesser amounts of aluminum and iron oxides. The primary effects of these materials on FGD system performance include the following:

- Silicon dioxide is abrasive and causes increased wear in ball mills and slurry pumps, nozzles, and transport lines. The erosiveness of these particles can be reduced by grinding them to a smaller size. However, silicon dioxide is harder than calcite and there is a corresponding increase in the required grinding energy. This effectively reduces the capacity of the grinding circuit.
- The presence of acid inerts reduces gypsum purity and limestone reactivity in a manner similar to dolomite.
- Solubilized aluminum and iron may degrade the performance of the FGD system. Aluminum may contribute to so-called aluminum fluoride blinding which causes a reduction in the reaction tank pH and a loss of pH control (6). Iron catalyzes sulfite oxidation which may contribute to gypsum scaling in natural or inhibited oxidation systems.

Limestone Composition Guidelines

The allowable concentration levels of impurities in limestone can vary with the design and operating characteristics of the FGD system. However, it is possible to present guidelines based on decades of accumulated experience.

In general, the calcium carbonate concentration should be above 85% by weight. Lower levels of calcium carbonate lead to operating problems with impurities; they also lead to higher reagent consumption rates with increases in associated costs for transportation and disposal of unreactive material. Although a few systems operate with limestone having less than 85% calcium carbonate, the majority of systems operate with limestone having more than 90% calcium carbonate.

Magnesium carbonate concentrations typically range from 0 to 5 percent. At higher magnesium carbonate levels, a greater fraction of the magnesium carbonate is present as relatively insoluble dolomite. This occurs because the amount of magnesium which can be present in the solid solution form is limited by crystal matrix effects. The net effect is that any benefits associated with soluble magnesium are out-weighed by the consequences of higher levels of insoluble dolomite.

The concentration of acid inerts should be held below 10% to minimize problems associated with equipment wear. However, limestones containing more than 10% inerts have been used successfully in FGD systems. If lower purity limestones must be used, the ball mill circuit should be operated to achieve complete grinding of the inerts. A discussion of the operation of the ball mill circuit is presented in Part I, Section 4.7.2-- Limestone Reagent Preparation Equipment.

8.2.2 Lime Composition

As described in Section 4.7, lime is prepared by calcining limestone. Therefore, lime will contain the same types of impurities present in limestone. Calcination is typically conducted at temperatures of about 1100°C (2,000°F), and the process converts the calcium and magnesium carbonates to their respective oxides. Typically, lime with a top size of about 50 mm (2 in.) is produced and is referred to as pebble lime. The lime is shipped to the site in this form.

Lime must be slaked before it can be used in an FGD system. This process involves controlled mixing of the lime with water. Then, exothermic reactions essentially explode the lime pellets and convert calcium oxide to calcium hydroxide (MgO does not form the hydroxide unless pressure hydration is employed). Calcium hydroxide is highly reactive, increasing the solubility of both the calcium and magnesium portions of the lime. The acid inerts, along with unreacted calcium carbonate or oxide, form a residue called grit.

Magnesium in Lime

Lime-based wet FGD systems are operated with lower levels of solid-phase alkalinity. As a result, a greater portion of the alkalinity in the scrubbing slurry must be carried in the liquid phase. This is accomplished by utilizing lime containing magnesium, or alternatively, by using a mixture of high-calcium and dolomitic limes.

Accumulated operating experience indicates that the optimum amount of magnesium oxide in the slaked lime should fall between 4 and 7 percent. This type of lime is referred to as magnesian or thiosorbic™ lime. At these magnesium oxide levels, enough liquid-phase alkalinity is produced for good SO₂ removal even though a small portion of the magnesium oxide does not dissolve, and some of the dissolved magnesium precipitates from the scrubbing slurry. Higher levels of magnesium in the lime do not significantly improve the SO₂ removal capability and may further degrade the settling and dewatering properties of the

naturally oxidized waste solids (poor settling and dewatering properties are characteristic of lime FGD systems).

Lime-based wet FGD systems can also be operated with high-calcium lime containing lower quantities of magnesium. In this case, however, supplemental magnesium is required to increase the liquid-phase alkalinity and enhance SO₂ removal. This magnesium may be obtained in the form of dolomitic lime. Dolomitic lime is simply calcined dolomitic limestone which contains high levels of magnesium carbonate (up to a one-to-one molar ratio with calcium, or about 40% MgO). Calcining dolomitic limestone greatly increases its reactivity. However, dolomitic magnesium carbonate "calcines" at a lower temperature than calcium oxide, and care must be employed when "calcining" dolomite to avoid producing unreactive, "dead-burned" lime (4).

Effects of Acid Inerts

The concentration of acid inerts in lime is also important and can affect operating costs and system reliability. When lime is slaked, a material called grit, composed of the acid inerts and some unreacted calcium oxide and carbonate, is formed. Grit is abrasive and in the past was generally removed by either screening or grinding to avoid excessive wear of equipment exposed to the lime and absorber recycle slurries.

Since the average particle size of slaked lime is small [about 5 micrometers (μm)], screens can be used to remove the larger grit particles. However, the grit and the active lime reagent cannot be perfectly separated, and the result is a loss of active reagent and an increase in lime consumption. In addition, the amount of grit formed is significant (about 1 to 2% of the total lime consumed). This generates a waste material which must be disposed of.

As an alternative, most new lime-based FGD systems are being designed so that lime slaking is conducted within a ball mill. The objective is to reduce the size of the

grit so that it is less abrasive. Then, the grit passes through the FGD without harming process equipment, and it is disposed of along with the FGD system waste solids. There is usually an additional detention tank associated with ball mill systems to provide the full residence time needed to finish the slaking process. This is important since incomplete slaking can lead to calcium hydroxide scaling in the lime transfer lines.

8.3 Reagent Reactivity

The alkalinity in FGD systems is provided by dissolving solid-phase reagents (limestone or lime). The reagent reactivity affects the speed and extent to which these reagents dissolve which, in turn, affects the FGD system's performance and operating cost. Various tests are available to measure the reactivities of limestone and lime reagents. This section defines reactivity, and describes what reactivity tests measure and how reactivity affects the performance of the FGD system.

8.3.1 Limestone Reactivity

Limestone reactivity is an important factor in limestone-based wet FGD systems because a significant portion of the alkalinity in the absorber is derived from an inventory of dissolving limestone. Differences in reactivity between alternative limestones can affect the relationships between SO₂ removal, limestone utilization, and reaction tank pH. If all other factors are the same, a more reactive limestone will improve performance by providing higher SO₂ removal at a given utilization, or alternatively, higher utilization at a given SO₂ removal rate. These factors obviously affect operating costs in many ways. One of the more important considerations, for example, is the effect of reactivity on the purity of commercial-grade gypsum.

There is no universally accepted definition of limestone reactivity. To some, reactivity refers to the speed at which the limestone dissolves. This can affect, for example, the pH at which the reaction tank operates. To others, reactivity relates to the amount of

carbonate in a limestone which will not dissolve in the scrubber, a factor often related to the amount of dolomite and other impurities in the limestone. Clearly, both factors are important, and a variety of tests have been developed by FGD system vendors and others to quantify these factors and provide an indication of how a given limestone will perform in an FGD system.

Research shows that certain dissolved chemical species can affect the rate at which limestone dissolves. Perhaps the most important of these are dissolved sulfite, magnesium, and aluminum fluoride complexes (6,7). The characteristics of each of these inhibitors are summarized in the following paragraphs.

Dissolved sulfite is present to some extent in the recirculating slurry of all FGD systems. One effect of sulfite is to provide dissolved alkalinity, which can improve SO_2 removal performance. However, another effect of dissolved sulfite is to inhibit the dissolution of limestone. In most cases, the consequences of sulfite inhibition are minor, and FGD systems can function properly even though this effect is occurring. However, severe sulfite inhibition (or "blinding") is fairly common and occurs in systems where the sulfite relative saturation is high and the concentration of calcium sulfite seed crystals in the recirculating slurry is low (i.e., the slurry is composed primarily of gypsum). This combination of conditions can occur in natural-oxidation systems treating flue gas from lower-sulfur coal, and in forced-oxidation systems in which the oxidation air rate is insufficient to depress the dissolved sulfite concentration. The symptoms of sulfite blinding include a reduced operating pH and a reduction in SO_2 removal efficiency. There may also be a loss of pH control (i.e., an inability to maintain the desired limestone utilization by operating at a specified pH setpoint).

Dissolved magnesium can also inhibit the dissolution of limestone. In this case, inhibition is observed as a reduction in operating pH with increasing levels of dissolved magnesium. In many FGD system designs, dissolved magnesium will improve system performance by increasing liquid-phase alkalinity. That is, the alkalinity provided by

dissolved magnesium is more important than its inhibiting effect on limestone dissolution. However, there is an optimum point beyond which further increases in dissolved magnesium will not improve SO₂ removal. Then, the inhibiting effect of further increases in magnesium may cause SO₂ removal to fall.

The formation of aluminum fluoride complexes in the recirculating slurry can lead to "blinding" which ranges in severity from slight to severe (5). Severe aluminum fluoride blinding is rare. When it occurs, however, the reaction tank pH plummets and cannot be raised regardless of how much excess limestone is added. - The sources of fluoride and aluminum ions are hydrofluoric acid and fly ash, respectively, removed from the flue gas in the absorber. It appears that relatively high concentrations of fly ash are required to trigger aluminum fluoride blinding. This is one reason that episodes of aluminum fluoride blinding are often associated with upsets in the particulate removal equipment upstream of the FGD system. Even though aluminum fluoride blinding has not been encountered very often, FGD engineers operating systems with inefficient or erratic particulate removal equipment, or alternatively, systems in which particulate removal occurs within the absorber itself, should be aware of this potentially serious operating problem.

8.3.2 Lime Reactivity

The reactivity of calcium hydroxide (slaked calcium oxide) is much higher than the reactivity of calcium carbonate in limestone. In addition, the calcination process converts insoluble dolomitic magnesium carbonate to magnesium oxide, which is capable of dissolving at the conditions present in typical lime-based wet FGD systems. Consequently, reactivity is a less important issue for lime-based FGD systems. There are, however, several aspects related to lime reactivity which can affect process performance and should be considered.

Lime must be slaked prior to its addition to the FGD system reaction tank. This is normally accomplished in a paste or ball mill slaker (see Part I, Section 4.7--Reagent and Additive Preparation Equipment). In either case, it is important to provide enough

residence time in the slaking system to allow the slaking reactions to go to completion. Insufficient residence time can lead to formation of calcium hydroxide scale in downstream equipment and piping. Therefore, the lime must be reactive enough to react within the given residence time of the slaking equipment.

Lime reactivity tests can be conducted to measure the temperature rise (which is directly related to the rate of slaking) over a specified time interval. The test is essentially a quality control check on the calcination process although the reaction rate also decreases with increasing amounts of magnesium oxide. With these considerations in mind, the temperature rise reactivity test could be used to ensure that sufficient residence time exists for complete conversion within the slaking system.

An alternative reactivity test has been developed to measure the reactivity (or availability) of calcium hydroxide and magnesium oxide in slaked lime (8). The test consists of dissolving a measured quantity of slaked lime at a constant pH of 6.0. Then, the amount of available alkalinity in the lime is determined on the basis of the amount of acid added, and the amount of available magnesium oxide is determined from an analysis of the liquid phase for dissolved magnesium. This test may be more useful as a quality control check than the temperature rise test, and the test also provides a prediction of the relatively small amount of magnesium oxide in the slaked lime that does not dissolve in the FGD system.

8.4 Particle Size Distribution Effect

Limestone is generally supplied and transported to the generating station as crushed rock. There, ball mills or other types of equipment are used to grind the crushed rock to produce a slurry containing fine limestone particles. The limestone particle size distribution (PSD) in this slurry is an important design and operating variable. Because limestone is relatively slow-reacting, the limestone PSD controls the surface area of the dissolving limestone and influences the relationship between reaction tank pH and limestone utilization.

This section discusses several aspects related to limestone PSD. First, an overview is presented to describe how limestone PSD can affect process performance. This includes information on the typical PSD ranges used in existing FGD systems. Then, methods are presented for monitoring the limestone PSD to ensure that the grinding circuit is operating properly and that reagent is not being wasted. Finally, information on limestone hardness is presented because limestone hardness directly affects the limestone PSD.

As described in previous subsections, lime is much more reactive than limestone. Except for the aspect of grit removal described previously in Section 8.2, the lime PSD does not affect the performance of the process and is not an important design variable. Consequently, the remaining discussion in this section focuses on limestone.

8.4.1 Effect of Limestone Particle Size on FGD System Performance

The total surface area of the dissolving limestone in an FGD system directly affects the pH of the recycle slurry and the amount of limestone that dissolves in the absorber. These variables, in turn, control the SO₂ removal rate. One way to change the total limestone surface area is to increase or decrease the fineness of the grind (more finely ground limestone, for example, has a higher surface area per unit mass). Alternatively, the total limestone surface area can be changed by increasing or decreasing the limestone utilization (or more specifically, the mass of excess limestone per unit volume of scrubbing slurry). These two factors are essentially interchangeable. For example, if a finer limestone grind is employed, the FGD system can be operated at a higher utilization and still maintain the same reaction tank pH and SO₂ removal rate. Therefore, the optimum limestone PSD represents a tradeoff between grinding equipment capital and operating costs and costs associated with changes in limestone utilization. For example, to produce a finer limestone grind, a larger ball mill would be required, and it would need a higher energy input per unit mass of limestone product. However, the resulting higher utilization would reduce reagent consumption and the volume of waste solids produced, or allow a gypsum purity specification to be achieved.

In general, more recent FGD system designs have tended toward a relatively fine limestone grind. A typical specification, for example, requires 90 to 95% of the ground limestone product to pass through a 325-mesh screen (having openings of about 44 μm). However, some existing system designs, particularly older system designs, were configured to operate with considerably coarser limestone (for example, 60% passing a 200-mesh having openings of 74 μm). These distributions probably represent the practical extremes for FGD system operation.

8.4.2 Limestone Particle Size Measurements

Periodic monitoring of the limestone PSD produced by the grinding/classification circuit is recommended to ensure the proper function of this equipment. There are several ways to accomplish this, including wire mesh screens, various instrumental methods, and on-line PSD monitors.

Wire mesh screens are widely used by FGD system laboratory personnel to monitor PSD. A sample is taken and analyzed to determine the mass of limestone passing through either a 325- or 200-mesh screen (the choice depends on the fineness of the grind). This procedure characterizes the PSD at a single point (i.e., the size of the screen opening), and this point is typically at the large end of the PSD range (for example, if the grind is 90% passing 325 mesh, only 10% of the limestone is larger than the screen opening). This is appropriate because the larger particles in a limestone grind have the greatest influence on limestone utilization.

Instrumental methods for measuring PSD are becoming more readily available. These methods offer the advantage of measuring the entire PSD (not just the fraction passing a single size). The available instruments use a variety of principles, with the instruments varying considerably in cost. A utility can purchase such instruments if desired, or send samples to an outside laboratory.

Neither the screening nor the instrumental methods provide real-time feedback on the PSD, and the result of a given measurement is not known for several hours. Since a considerable amount of off-specification material could be produced during this time interval, there has been a growing interest in the use of on-line PSD analyzers. These analyzers can help FGD system operators establish optimum grinding conditions and can identify when the grinding and classification equipment is not functioning correctly (9).

8.4.3 Limestone Hardness

Limestone hardness is an important limestone characteristic which has a significant impact on the limestone PSD. Hardness is normally expressed as the Bond Work Index (BWI), although other conventions such as the grindability index are also utilized. The BWI can be measured in the laboratory and typically ranges between 4 and 14 (harder limestones have higher BWIs). The energy required to produce a given limestone grind varies in proportion to the BWI. For example, if the BWI doubles, twice the energy input is required to produce a given limestone grind. In practice, changes in the BWI affect the fineness of the PSD that can be produced, or alternatively, affect the maximum capacity of the grinding/classification system for a given fineness.

Ball mill/classification equipment vendors utilize design equations to estimate the PSD which will result from a given limestone/grinding circuit combination. The important design variables include the type of grinding and classification equipment, the particle size distributions of the feed and product materials, and the hardness of the limestone. These relationships are somewhat empirical and direct experience with a wide variety of limestones is helpful. Therefore, grinding circuit equipment vendors should be consulted regarding specific effects of changes in these variables.

FGD system engineers should be aware, however, of the effect of the feed size distribution on the ultimate product size distribution. As an example, scalped feed materials [e.g., a 19 mm x 6 mm (3/4 in. x 1/4 in.) distribution in which the fines have been removed]

are sometimes specified to simplify material handling and minimize freezing problems in colder climates. However, the use of a scalped feed can significantly increase the specific grinding energy required to produce a given limestone grind.

8.5 References

1. U.S. Bureau of Mines Bulletin No. 395.
2. Electric Power Research Institute. Flue Gas Desulfurization Chemistry Studies: Limestone Grindability, Volume 1: FGD Reagent Mapping. CS-3618. Palo Alto, California, July 1984.
3. Electric Power Research Institute. The Distribution and Analysis of High Purity Magnesian Limestones in the United States. CS-2783. Palo Alto, California, December 1982.
4. Benson, L.B. "Production and Uses of Lime in the U.S." Presented at the 6th Annual Canadian Conference on Markets for Industrial Minerals. Toronto, Ontario, Canada, October 1994.
5. "Commercial Lime Plants in the U.S. and Canada." Supplied courtesy of the National Lime Association, Arlington, Virginia, 1994.
6. Farmer, W.R., and J.B. Jarvis. "Effects of Aluminum/Fluoride Chemistry on Wet Limestone Flue Gas Desulfurization." Presented at the 1987 Spring National AIChE Meeting. Houston, Texas, March 1987.
7. Jarvis, J.B., et al. "Development of a Predictive Model for Limestone Dissolution in Wet FGD Systems." Presented at the EPA/EPRI First Combined FGD and Dry SO₂ Control Symposium. St. Louis, Missouri, October 1988.
8. Personal communication with Lewis Benson, Dravo Lime Company, February 1995.
9. Maybach, G. B., et al. "Pilot Plant and Full-Scale Experiences with On-line Particle Size Measurement for Controlling Limestone Grind for Wet FGD Systems." Presented at the EPRI/EPA/DOE 1993 SO₂ Control Symposium. Boston, Massachusetts, August, 1993.

9.0

CHEMICAL ADDITIVE CONSIDERATIONS

The process chemistry of additives to control scaling and to improve SO₂ removal efficiency in wet lime-and limestone-based FGD systems was described in Part I, Sections 3.3 and 3.4 of this manual. Chemical additive storage and delivery equipment was described in Part I, Section 4.7--Reagent/Additive Preparation Equipment. The following sections provide additional details on the use of chemical additives in FGD process design and operation.

9.1

Available Chemical Additives

As described in Section 3.4--Chemicals for SO₂ Removal Enhancement, various organic acids have been used as buffering agents to improve SO₂ removal efficiency. In the United States, most utility FGD systems that use organic acid buffers have used either formic acid (also supplied as sodium formate) or dibasic acid (DBA), which is a mixture of succinic, glutaric, and adipic acids. DBA, which is a byproduct of adipic acid manufacture, is used in preference to pure adipic acid because it is less expensive. In practice, any weak organic acid that can buffer in the pH range from about 3 to 6 could be used to improve limestone FGD system performance. For example, acetic and benzoic acid have also been used in pilot-scale tests.

Thiosulfate is used to inhibit sulfite oxidation. It can be added as a sodium salt, but in the United States, emulsified sulfur is used to generate thiosulfate in lime- and limestone-based FGD systems because it is much less expensive than sodium thiosulfate. Either mined or byproduct sulfur may be used.

Several other chemical additive types are commonly used in lime- and limestone-based FGD systems. These may include flocculents to improve solids settling properties in thickeners, biocides to prevent the growth of undesirable sulfate-reducing bacteria that can produce H₂S gas, and anti-foaming agents to prevent excessive foaming in

agitated tanks. Most of these low-volume additives are proprietary formulas supplied by water treatment specialists, and will not be discussed further.

9.2 Advantages and Disadvantages of Chemical Additive Use

9.2.1 Organic Acids

In the United States, organic acids have historically been used to improve the performance of wet limestone-based FGD systems not meeting their required SO₂ removal efficiencies. However, experience with these chemical additives has shown additional advantages to their use. For example:

- The required liquid/gas contacting area to obtain a specified SO₂ removal efficiency can be reduced in the design stage of the project. This translates into lower capital and operating costs for the absorber. Depending on the cost and consumption rate of the chemical additive, its use will often result in a substantial net savings.
- Because of the buffering ability of the chemical additives, the reagent utilization needed to obtain a specified SO₂ removal efficiency can be increased by operating at a lower pH. This can be an important advantage in a forced-oxidation system producing a commercial-quality gypsum in which excess CaCO₃ is limited by the end-user specification. A net savings can also result if the chemical additive cost is less than the savings in reagent consumption.
- Increased flexibility in fuel procurement can be gained. The FGD system can be designed for a lower average fuel sulfur content with good performance maintained at higher sulfur levels by intermittent use of a chemical additive.
- Increased operating flexibility is possible. For example, recycle pumps and absorber modules may be taken off line for maintenance and a chemical additive used to maintain overall system performance at an acceptable level.

Unless an existing FGD system has failed to meet its performance guarantee, the potential for using an organic acid additive would be based on an economic evaluation.

In this evaluation, the annualized cost for chemical additive use would be compared to the annualized savings in absorber capital and operating costs. Obviously, the economic benefits of organic acid additive use will be site-specific and will depend on the relative costs of power, reagent, and chemical additive. The cost for chemical additive use depends primarily on the consumption rate and the delivered price. The consumption rate is determined primarily by the additive concentration in the recycle slurry, but the FGD system wastewater discharge rate and the byproduct cake washing efficiency are also factors to be considered.

It is not possible to predict chemical additive consumption with complete accuracy for a given FGD system, but consumption rates have recently been measured for a variety of systems in the United States. Based on these data, for a nominal additive concentration of 1000 mg/L, a consumption rate of 4 to 6 kg DBA or formate per tonne of SO₂ removed (8 to 12 lb/ton) can be used for preliminary economic evaluations. The additive consumption rate can be assumed to be approximately proportional to concentration. Example economic comparisons based on actual performance data from some U.S. FGD systems are given in Tables 9-1 and 9-2 to illustrate the magnitude of savings that might be expected.

In Table 9-1, a spray absorber is operated with either 5, 4, or 3 spray levels, and performance is maintained at a constant level of 91% SO₂ removal efficiency at the reduced spray rates by using organic acid additive. For example, operation with 4 spray levels and 150 mg/L formate additive or 3 spray levels and 350 mg/L formate additive yields the same performance as operation with 5 spray levels and no additive. The design basis is the same as that used throughout this manual (500 MW, 2% S in coal), and 9.1 tonne/hr (10.0 ton/hr) of SO₂ entering the FGD system. The measured chemical additive consumption rate for this system was 5.1 kg/tonne (10.2 lb/ton) of SO₂ removed at 1000 mg/L additive.

The economic calculation in Table 9-1 shows that, for this example, the savings in pump power exceeds the chemical additive cost by as much as \$20/hr. If the design and procurement of the FGD system were based on the use of additive, additional savings would be realized because of the reduction in the number of spray pumps. Also, fewer spray levels

Table 9-1
Example Recycle Pump Power Cost Savings
with Organic Acid Additive Use*

Description	5 Pumps	4 Pumps	3 Pumps
Technical Data			
SO ₂ removal efficiency, %	91	91	91
L/G, L/Nm ³	15	12	9
No. of absorber spray levels	5	4	3
Total spray pump power, MW	4	3.2	2.4
Power cost, \$/kWh	\$0.02	\$0.02	\$0.02
Formate concentration, mg/L	0	150	350
Formate cost, \$/kg	NA	\$0.80	\$0.80
Formate consumption, kg/tonne SO ₂ removed**	NA	5.1	5.1
Formate consumption, kg/hr	0	6.3	14.7
Operating Costs			
Pumping power costs, \$/hr	80.00	64.00	48.00
Sodium formate cost, \$/hr	<u>0.00</u>	<u>5.04</u>	<u>11.76</u>
Subtotal, \$/hr	80.00	69.04	59.76
Net savings			
\$/hr	base	10.96	20.24
\$/yr	base	62,400	115,200

* Based on actual test data, adjusted to 500 MW and 2% sulfur in coal. Annual costs assume 65% annual capacity factor.

** Sodium formate consumption, kg/tonne SO₂ removed at 1000 mg/L (as formate ion). Consumption proportional to concentration.

would permit a shorter absorber vessel. The capital savings might be as much as \$2 or \$3 million even after the cost of the chemical additive storage and delivery system is included. Depending on the financial accounting method, on an annualized basis, this savings is even greater than the operating cost savings.

Table 9-2 shows how savings can also be obtained by using an organic acid additive to reduce limestone consumption. In Case 1, the FGD system SO₂ removal efficiency is 93.5% with no chemical additive and with 81% limestone utilization. When 650 mg/L DBA is used, the system can be operated with a lower pH set point, increasing limestone utilization to 93% while maintaining the same SO₂ removal efficiency. For this case, the savings in limestone consumption exceeds the cost of the chemical additive by more than \$15/hr. As in the case with fewer spray pumps, the actual annualized savings may be greater than the operating cost savings because the capacity of the reagent preparation equipment can also be reduced. Case 2 in Table 9-2 shows a similar evaluation for another FGD system. In this case, the savings is less because the cost of limestone reagent is much less for this system.

There are some potential disadvantages to the use of organic acid additives. The following are the most important:

- If the FGD system has a separate wastewater discharge to control dissolved solids concentration or to satisfy a positive water balance, this stream may require treatment to reduce the chemical and biochemical oxygen demand (COD and BOD) contributed by the organic acid additive.*
- If sodium formate or formic acid is used, some formic acid will be emitted from the FGD system in the flue gas. Measured formate concentrations in flue gas at U.S. FGD systems where formate has been

* Discharge of an organic acid in wastewater depletes oxygen in the receiving stream as the acid is metabolized by biological agents. The amount of oxygen in mg/L that is used by naturally occurring agents is termed BOD. The total amount of oxygen in mg/L needed to completely oxidize the acid to CO₂ and H₂O is termed COD. These quantities are measured by standard test procedures.

Table 9-2
Example Limestone Cost Savings
with Organic Acid Additive Use*

Description	Packed Absorber		Spray/Packed Absorber	
	Case 1A	Case 1B	Case 2A	Case 2B
Technical Data				
SO ₂ removal efficiency, %	93.5	93.5	96.0	96.0
pH setpoint	6.1	5.6	6.1	5.8
Reagent utilization, %	81.0	93.0	85.0	92.0
Reagent consumption, tonne/hr	17.5	15.3	16.7	15.5
Reagent cost, \$/tonne	\$11.00	\$11.00	\$8.60	\$8.60
DBA concentration, mg/L	0	650	0	200
DBA cost, \$/kg	NA	\$0.44	NA	\$0.46
DBA consumption, kg/tonne SO ₂ removed**	NA	3.5	NA	7.1
DBA consumption, kg/hr	0	19.3	0	12.3
Operating Costs				
Reagent cost, \$/hr	192.50	168.30	143.62	133.30
DBA cost, \$/hr	<u>0.00</u>	<u>8.49</u>	<u>0.00</u>	<u>5.66</u>
Subtotal, \$/hr	192.50	176.79	143.62	138.96
Net savings				
\$/hr	base	15.71	base	4.66
\$/yr	base	89,500	base	26,500

* Based on actual test data, adjusted to 500 MW and 2% sulfur in coal. Annual costs assume 65% annual capacity factor.

** DBA consumption, kg/tonne SO₂ removed at 1000 mg/L. Consumption proportional to concentration.

tested ranged from less than 1 to as high as 12 parts per million by volume (ppmv). DBA has a much lower vapor pressure and does not vaporize in the absorber.

- If the FGD system is designed to use organic acid additive to meet its performance guarantee, then disruption in the additive supply or increases in additive price could significantly affect FGD system operation.

It should be noted that the potential for disruptions in organic acid deliveries can be greatly diminished by the fact that all of the possible organic acids are relatively interchangeable. For example, if a disruption occurs in the supply of DBA, adipic acid or formic acid could be substituted with little or no equipment modifications. Only the chemical feed rate would be changed to provide the appropriate chemical concentration for the substitute chemical.

Treatment of FGD blowdown to remove BOD due to organic acids has been done at several European FGD systems using formic acid and has been installed at a new installation using DBA. For low concentrations of formic acid, treatment by trickling filter has been effective. For higher concentrations of formic acid or DBA, an activated sludge process or sequencing batch reactors (SBRs) can be used. In either case, pretreatment by physical and chemical processes to remove toxic metals may also be required. The cost of these treatment processes can be significant and must be included in an economic evaluation of chemical additive use. Even considering these costs, the use of organic acids frequently has been shown to be economically attractive.

Loss of formic acid to the flue gas cannot be controlled. For the 500 MW base case design used in this manual, a concentration of only 1 ppmv formic acid in the flue gas corresponds to an emission rate of about 5 kg/hr (11 lb/hr), or about 44 tonnes per year (48 tons/yr) at 100% capacity, and the actual rate could be as much as 10 times as high. This formic acid emission source may have to be considered in the permitting process, depending on local regulations.

A dependable chemical additive supply at a reasonable cost will be needed if the FGD system is designed so that additive is required to meet emission regulations. The interchangeability of the available organic acids is expected to have a stabilizing effect on their delivered prices. In addition, an examination of Tables 9-1 and 9-2 shows that chemical additive use remains economical in most cases even at costs that are twice those used in the examples.

One additional effect of organic acid additives should be considered when they are proposed for use in an existing FGD system. These compounds, especially succinic acid can change the size and shape of the byproduct solid crystals, and, therefore, change the settling and filtration properties of the slurry solids. Depending on the initial sulfite oxidation fraction in the FGD system, organic acids have been observed to both increase and decrease settling rates. These changes can usually be accommodated by the dewatering equipment, but may require changes in equipment operating conditions.

9.2.2 Thiosulfate (Sulfur)

As discussed in Section 3.3, there is a significant advantage in reliability when lime- and limestone-based FGD systems are operated either with <15% sulfite oxidation or with nearly 100% oxidation to control gypsum scaling. In limestone-based systems, thiosulfate or sulfur additive is usually required to maintain low oxidation, while lime-based systems can often be operated with low oxidation without the use of additive. Both inhibited- and forced-oxidation processes have a record of reliable operation. However, there are some site-specific technical factors that can limit successful application of the inhibited-oxidation process.

Low oxidation is favored by high SO₂ content and low oxygen content in the flue gas. Because oxidation increases with the amount of oxygen absorbed from the flue gas, low oxidation is also favored in less-efficient absorbers (typically systems with lower L/Gs). For example, an absorber designed for 95% SO₂ removal (NTU = 3.0) requires about 60%

more mass-transfer surface area than an absorber designed for 85% removal ($NTU = 1.9$) and will absorb 60% more oxygen, but only about 12% more SO_2 . The ratio of absorbed oxygen to absorbed SO_2 increases with higher L/G and, therefore, tends to increase oxidation. Because of the importance of the absorbed O_2/SO_2 ratio, the most difficult application for inhibited-oxidation will be with low-sulfur (<1% S) coal and high absorber L/G. Unusually high air in-leakage and/or frequent low-load (high excess combustion air) boiler operation also make inhibited-oxidation difficult. Therefore, for applications with some or all of these characteristics, a forced-oxidation process may be more technically prudent.

For applications where there are no technical barriers, selection of an inhibited-versus a forced-oxidation limestone FGD process is primarily an economic choice. Table 9-3 summarizes some factors that must be considered in making this choice. The comparisons made in the table are discussed below.

Test data show that the forced-oxidation process has a slight advantage over the inhibited-oxidation process with respect to SO_2 removal efficiency. Therefore, there may be a small cost savings with the forced-oxidation absorber, which can be designed with less mass transfer capability. However, this difference would not be expected to affect the process choice to any great extent.

Both process versions have proved to be reliable from the standpoint of scale control. The inhibited-oxidation process (when operated at less than 0.15 sulfate oxidation fraction) may be slightly more scale-free because the process liquor is always subsaturated with respect to gypsum. The inhibited-oxidation process has an additional advantage over the forced-oxidation process if the absorber design is based on a packed tower with a low L/G. In this case, the forced-oxidation process is more likely to experience scaling in the packing because the fresh recycle slurry is always saturated with gypsum. With a low L/G and forced-oxidation, the gypsum saturation may exceed the scaling threshold as SO_2 is absorbed and oxidized and as reagent calcium dissolves in the absorber.

Table 9-3

Comparison of Inhibited-Oxidation versus Forced-Oxidation Limestone FGD Processes

Performance Indicator	Inhibited-Oxidation Process	Forced-Oxidation Process
SO ₂ removal efficiency	May require slightly higher reagent ratio or higher L/G to obtain the same SO ₂ removal efficiency at otherwise equivalent conditions.	Forced-oxidation process has a slight advantage; higher SO ₂ removal can be obtained at equivalent reagent utilization and lower L/G, or higher utilization can be obtained at equivalent SO ₂ removal efficiency.
Scale control	Inhibited oxidation process has a slight advantage because the process slurry is not saturated with gypsum.	Good scale control is possible with complete oxidation; however, the minimum absorber L/G may be limited by scale control requirements instead of SO ₂ removal requirements.
Byproduct solids dewatering	Calcium sulfite solids can be relatively difficult to dewater. Large thickeners are required for primary dewatering. This can be a problem in applications where site area is limited.	Gypsum is more easily dewatered. Hydrocyclones can be used for primary dewatering. Vacuum filter throughput is higher than for sulfite byproduct solids.
Byproduct solids disposal	For landfill disposal, calcium sulfite solids must be mixed with fly ash or fly ash plus lime to develop unconfined compressive strength and permeability limits.	Gypsum can be stacked or landfilled without stabilization.
Byproduct solids sales	Markets for calcium sulfite/fly ash blends are under development, but fly ash that might otherwise be sold is usually used to stabilize sulfite solids for disposal.	Byproduct gypsum can be used for wallboard and cement manufacture and as a soil conditioner. Fly ash can also be sold because it is not needed for stabilization of gypsum.
FGD system water balance	More water is retained by landfilled solids so that dissolved chloride concentration is lower, permitting less expensive alloys for absorber construction. Lower quality water can be used for makeup because reclaimed process water can be used for mist eliminator washing.	If gypsum is sold, specifications may require low chloride content, making a separate wastewater stream necessary. If gypsum is landfilled, less water is retained compared to sulfite solids, and higher chloride concentrations will result compared to the inhibited-oxidation process. Process water cannot be used to wash the mist eliminators.

The forced-oxidation process may be advantageous in applications where space is limited. The forced-oxidation byproduct solids are much more easily dewatered than the sulfite byproduct, and primary dewatering may be accomplished using hydrocyclones, which require much less area than the large thickeners that are used to concentrate the sulfite byproduct solids (see Part I, Section 4.8--Byproduct Handling Equipment).

Differences in the disposal characteristics of the inhibited- versus forced-oxidation byproduct solids may also influence an economic comparison of these two options. Unlike gypsum from the forced-oxidation process, sulfite byproduct solids must be blended with fly ash (stabilization), and in many cases, with fly ash and lime (fixation), to develop sufficient compressive strength for placement in a landfill (see Part I, Section 4.8.3--Tertiary Processing). If the byproduct must meet permeability requirements, fixation will be necessary. If the fly ash required for stabilization or fixation could otherwise be sold, this would strongly favor the selection of the forced-oxidation process.

The question of byproduct sales may be the most important factor in choosing between the inhibited- and forced-oxidation process options. In either process, the cost of solids disposal represents a significant portion of the total operating cost and future disposal regulations may further increase these costs for utilities. If some or all of the byproduct solids can be sold, then the avoided disposal cost plus the sales revenue would be a dominating factor in the economic comparison. The forced-oxidation process is much more likely to produce a marketable byproduct. FGD gypsum has been used in wallboard and cement manufacture and as a soil conditioner. Markets for calcium sulfite byproduct solids are under development, but few, if any, existing inhibited-oxidation systems are currently selling their byproduct solids. One potential use for the sulfite byproduct (blended with fly ash) is as a flowable fill material that can be pumped at high solids content because of its special thixotropic property. Because transportation costs will be important in any byproduct sales situation, the economic benefit for most uses of FGD byproduct solids will be site-specific.

The final comparison made in Table 9-3 is the difference in the FGD system water balance for the inhibited- and forced-oxidation processes. This was discussed in detail in Part I, Section 3.5.2--Dissolved Solids (Chloride) Concentration. The sulfite byproduct solids retain more moisture so that (without a wastewater blowdown) the steady-state chloride concentration in the FGD slurry will be lower than for the forced-oxidation process. This can have a significant effect on the performance and cost of corrosion-resistant alloys used in absorber construction, and on the sizing of a wastewater blowdown treatment system.

10.0 FGD DESIGN PARAMETERS

Many individual aspects of wet lime- and limestone-based FGD process design have been introduced and discussed in previous sections of this manual. This section provides some examples of how the most important FGD design parameters affect process performance and gives typical design ranges for these variables. Different approaches for including these design variables in an FGD system specification are also described. The approach used to include these design variables in the specification can vary, depending on the utility's knowledge of the FGD process and experience with FGD vendors.

Some utilities have elected to give the FGD vendors complete freedom to select optimum design parameters for their system. This approach is a "performance specification," which relies on the performance guarantees to ensure that the FGD system will meet the required SO₂ removal efficiency. This approach takes advantage of the vendors' proprietary data and experience, and may result in the lowest proposal costs. However, this approach may also result in the smallest design margins. If a performance specification is used, the utility's engineer or project manager should at least be aware of typical ranges of design variables applied to other FGD systems so that vendors' proposals that deviate significantly from typical practice can be identified. More detailed supporting data or experience can then be requested to verify the reasonableness of design practices that vary from those typically used.

Other utilities have attempted to ensure a minimum design margin by preparing an "equipment specification" for certain parts of the process, especially the absorber. When minimum or maximum design parameters are specified, the vendors will not be tempted to provide insufficient design margin as a means of submitting the lowest bid. This approach may increase proposal costs, but will ensure that proposals can be compared on an economic basis that is not complicated by varying degrees of technical risk. In order to prepare an equipment specification, however, the utility (or its consultant) must have knowledge and experience pertaining to the FGD process.

10.1 Flue Gas Velocities

The ranges of flue gas velocities in lime- and limestone-based FGD systems will vary with location in the process. The FGD process can be divided into three zones for which the optimum velocities differ. These are the ductwork, the absorber/mist eliminator, and the stack. Design ranges for velocities in these locations are discussed below. An FGD process specification would normally allow the project engineer or the FGD vendor to set these velocities. In the case of absorber gas velocity, the utility might specify a maximum design velocity to assure some degree of conservatism in the design, but restricting the maximum absorber gas velocity might result in a more expensive absorber than is necessary. As mentioned in Part I, Section 4.1.2--Flue Gas Property Range, some conservatism may already be introduced into the system design when the flue gas volume is specified for the overall design basis.

10.1.1 Ductwork Flue Gas Velocity

The design flue gas velocity for the FGD system inlet and outlet ductwork is based on an economic tradeoff between the cost of materials (duct size) and the cost of fan power to overcome pressure losses. This aspect of FGD system design is normally within the scope of the overall project engineer, who may or may not be the FGD system vendor. Inlet and outlet ductwork is typically sized so that the design full-load velocity is about 20 m/s (60 ft/s).

A special case pertains to the duct transition at the absorber inlet. This portion of the inlet ductwork design is within the scope of the absorber vendor and is closely related to absorber performance. Depending on the absorber cross section, the inlet duct profile may provide a flue gas velocity that is higher or lower than the velocity upstream of the absorber. Proper design of the absorber inlet is required to obtain good distribution of flue gas over the absorber cross section. Because good inlet gas distribution is essential for proper absorber and mist eliminator performance, the absorber inlet design is usually based on modeling

studies. Appropriate geometric factors are derived from these studies, relating the optimum inlet duct dimensions to the absorber dimensions.

10.1.2 Absorber/Mist Eliminator Flue Gas Velocity

The effect of absorber flue gas velocity on performance was described in Part I, Sections 3.2--FGD Process Variables and 4.2--Absorber Module. For fixed absorber dimensions and constant recycle slurry spray rate, SO₂ removal efficiency generally decreases with increasing flue gas velocity because the gas is contacted with the recycle slurry for a shorter period of time. However, the effectiveness of gas-liquid contact in the absorber also changes with gas velocity so that the quantitative relationship between absorber gas velocity and SO₂ removal efficiency varies with absorber type. The reader is referred to Section 4.2 for more details of how performance varies with flue gas velocity for different absorber types.

Typical design velocities for countercurrent absorbers in FGD service range from about 2.5 to 5 m/s (8 to 16 ft/s). Many installations have used a design velocity of 3 m/s (10 ft/s). The most recent design trend, however, is toward the higher end of this range, especially for open spray towers. Experience has shown that, at constant SO₂ removal efficiency, the required L/G for an open spray tower decreases with increasing absorber flue gas velocity. With higher absorber flue gas velocity, the savings in pump power is partially offset by the increase in fan power as a result of increased absorber pressure drop, but the capital cost savings due to a smaller absorber cross section and lower-capacity recycle pumps results in a net benefit for higher flue gas velocity in the absorber.

The most critical limitation on flue gas velocity in the absorber is actually related to mist eliminator performance, which was discussed in Part I, Section 4.4--Mist Eliminator Systems. At high velocity, slurry droplets that are captured by the mist eliminator are stripped off (re-entrained) by the flue gas before they can drain from the blades. For vertical-gas-flow mist eliminators, which are placed in the top of the absorber vessel, the latest designs have an upper gas velocity limit of about 6 m/s (20 ft/s) before re-entrainment

of slurry becomes a problem (1). After allowing for the space taken up by the mist eliminator support structure and for local variations in the average flue gas velocity, the actual maximum design flue gas velocity will be about 5 m/s (16 ft/s). If the absorber gas velocity is greater than this, then the absorber vessel cross section must be increased at the location of the mist eliminator.

Horizontal-gas-flow mist eliminators can be used to extend the practical range of absorber/mist eliminator velocities to 7 or 8 m/s (23 to 26 ft/s) (1). In this ME configuration, the re-entrainment velocity is higher because the collected droplets are not draining against the gas flow as they are in the vertical-gas-flow design. The horizontal-gas-flow design requires more space, however.

Absorber/mist eliminator flue gas velocities are normally set by the FGD vendor. However, some process specifications place a limit on the maximum deviation from the average absorber velocity that is allowed at any point in the absorber cross section in order to prevent performance problems associated with poor gas distribution. Close attention to flue gas distribution across the absorber can be especially important for high-velocity designs where the average absorber flue gas velocity is close to the operating limit for the mist eliminator.

10.1.3 Stack Flue Gas Velocity

Current wet FGD design practice favors "wet stack" operation. Wet stack design was discussed in Part I, Section 4.5. The design flue gas velocity in a wet stack is restricted by the tendency for condensate to be stripped from the stack wall and carried out of the stack with the flue gas. Experience has shown that the upper limit for flue gas velocity in a wet stack is a function of the roughness of the stack liner material. The highest design velocities [about 20 to 23 m/s (65 to 75 ft/s)] can be used for smooth liner material such as metal alloys. For acid brick liners, the design velocity limit can range from as low as 6 m/s

(20 ft/s) to as high as 20 m/s (65 ft/s), depending on the tolerance for radial offset between successive courses of brick.

10.2 Absorber Liquid-to-Gas Ratio (L/G)

Like absorber gas velocity, absorber L/G is an important design parameter that affects SO₂ removal efficiency. As discussed in Part I, Section 3.2.2--Liquid-to-Gas Ratio and Section 4.2.1--Absorber Design Alternatives, absorber performance in terms of NTU increases with increasing L/G at constant gas velocity. Because recycle pump power is a significant operating cost in a typical wet limestone FGD system, the FGD vendor will strive to offer an absorber design that offers the lowest L/G that meets the required performance. In a performance-type specification, the FGD vendor is allowed to choose the optimum L/G, but the utility engineer should be familiar enough with absorber performance to recognize whether or not the vendor's design L/G is reasonable. Unfortunately, the design L/G required to obtain a given SO₂ removal efficiency varies not only with the absorber design, but also with reagent consumption and (for limestone) reagent particle size, inlet SO₂ concentration, and process liquor composition. Therefore, there is no simple relationship between efficiency and L/G.

Some examples of actual performance data from full-scale lime-and limestone-based FGD systems are given in Table 10-1 to illustrate expected design ranges for L/G (2 through 7). Later in this section, the use of the FGDPRISM™ computer model is introduced. This model, which includes the effects of major design variables, is helpful for evaluating performance tradeoffs among these various FGD design parameters.

The first entry in Table 10-1 shows performance for an open spray absorber. This particular FGD system uses limestone reagent ground to 56% less than 200 mesh (74 μm) and operates with a reagent utilization of 87 percent. The inlet SO₂ concentration is 1600 parts per million by volume (ppmv), the absorber gas velocity is 2.7 m/s (9 ft/s), and the L/G is 14 L/Nm³ (104 gal/1000 ft³) to obtain 90% SO₂ removal efficiency. This L/G is

Table 10-1

Example Performance Data for Absorbers in
Lime- and Limestone-Based FGD Service

Absorber Type	Reagent	Reagent Grind Size (% <74 μm)	Reagent Utilization (%)	Inlet SO ₂ (ppmv dry)	Gas Velocity (m/s)	L/G (L/Nm ³)	SO ₂ Removal Efficiency (%)
Spray tower (2)	Limestone	56	87	1600	2.7	14	90
Spray/Tray (3)	Limestone	87	93	1500	2.4	9	90
Spray/Packed (4)	Limestone	77	95	2800	2.3	11	90
Spray/Packed (5)	Limestone	NR	NR	2600	2.7	12	90
Packed (6)	Limestone	95	92	2100	4.0*	11	90
Spray/Tray (7)	Mg-Lime	NA	NR	2100	NR	3	96

NR = Not Reported NA = Not Applicable * Cocurrent gas flow

1 m/s = 3.28 ft/s

1 L/Nm³ = 7.48 gal/ft³ (corrected to actual flue gas temperature and pressure)

typical for a spray absorber in limestone-based FGD service. As discussed in Section 8--Lime and Limestone Reagent Considerations, the limestone grind for this FGD system is relatively coarse, and the same SO₂ removal efficiency could probably be obtained with higher limestone utilization if a finer grind were used. However, the L/G for this spray absorber is representative of typical design practice for 90% removal in applications with moderate fuel sulfur content. For higher sulfur coals or higher SO₂ removal efficiencies, higher L/Gs would be used in a spray absorber.

The next four entries in the table are for absorbers that have enhanced mass transfer area provided by trays or packing. For the same 90% SO₂ removal efficiency, these absorbers can operate at higher limestone utilization and/or lower L/G compared to the open spray tower. Note that the lowest L/G in this group of absorbers is also for the case with the lowest inlet SO₂ concentration.

Some caution must be used in designing a low-L/G absorber for a forced-oxidation process, especially with high-sulfur fuel. In that application, it is possible that the L/G required for preventing scaling might be greater than that required for SO₂ removal efficiency. In that situation, the FGDPRISM computer model, which is discussed later in this section, is useful for estimating the effect of L/G on gypsum saturation in the absorber effluent slurry. Based on this type of calculation, a utility might include a minimum L/G as part of an absorber equipment specification.

The final entry in Table 10-1 is for a spray/tray absorber using a magnesium lime reagent. With the magnesium lime reagent, the liquid-phase alkalinity is so high that comparable SO₂ removal can be obtained at very high reagent utilization (98%) and very low L/G--only 3 L/Nm³ (22 gal/1000 ft³)--compared to 9 to 14 L/Nm³ (67 to 104 gal/1000 ft³) for the limestone-based absorbers.

10.3 Reagent Utilization

Reagent characteristics were discussed in detail in Section 8.0 of the manual. For both lime- and limestone-based FGD systems, reagent composition must be addressed when potential reagent supplies are evaluated. With both lime and limestone, one objective is to obtain a reagent supply with a relatively low content of inert substances that add to the cost of transportation and can increase erosion in the FGD process piping and equipment. With lime, the proper amount of magnesium must also be obtained in the reagent supply. This may require blending of two separate lime supplies. Potential reagent sources, compositions, and costs are usually included in the process specification for a new FGD system so that the bidders can design accordingly.

After a suitable reagent supply is identified, the most important process design parameter related to the reagent is the amount of excess reagent in the recycle slurry. Reagent utilization was quantitatively defined in Section 2 of the manual as the molar ratio of SO_2 removed in the FGD process to the amount of reactive calcium added to the process. Reagent ratio, which is the inverse of reagent utilization, is another expression of the amount of excess reagent that is present in the absorber recycle slurry. Reagent utilization is a design and performance parameter that has a significant economic impact on both lime- and limestone-based wet FGD processes. A process specification would typically allow the FGD vendor to select the optimum reagent utilization for their absorber configuration unless this parameter is constrained by the end user of the FGD byproduct solids.

As explained in Section 8, the effect of reagent utilization on performance and the appropriate design range for utilization are different for lime and limestone processes. In the lime process, most of the alkalinity for neutralizing absorbed SO_2 is provided by soluble sulfite species (see Section 3.4). The solubility of lime is relatively high compared to limestone, and little excess solid-phase lime is typically present in the absorber recycle slurry. High SO_2 removal can be obtained with very high (>98%) lime utilization.

In the limestone process, most of the alkalinity for neutralizing SO_2 is provided by dissolution of solid limestone in the absorber itself. Therefore, limestone process performance is sensitive to the total surface area of limestone solids in the recycle slurry. From a process design standpoint, the limestone surface area can be adjusted by changing either the amount or the particle size of reagent in the recycle slurry. The optimum reagent particle size and utilization are based on the trade-off between the cost of reagent, the cost of grinding, and the costs of absorber fan and pumping power for a particular absorber configuration.

Figure 10-1 illustrates performance relationships between limestone utilization and SO_2 removal efficiency for four of the absorbers included in Table 10-1. It should be emphasized that the relative positions of the curves on this plot depend on many process design parameters that are specific to each of these existing FGD systems. Therefore, the data cannot be used for any general comparison of the relative performance of these different absorber types. The shape of the performance curves, however, is typical for most limestone-based FGD systems. At the high end of the utilization range for each absorber, SO_2 removal efficiency increases rapidly with increasing excess reagent (decreasing limestone utilization). As more excess reagent is used, SO_2 removal efficiency becomes less sensitive to the amount of excess reagent. Because SO_2 removal efficiency is a function of both limestone utilization and L/G, for most FGD systems there will be an optimum reagent utilization for which the combined cost of recycle pump power and reagent is minimized.

Table 10-2 gives an example of the trade-off between reagent cost and pump power cost based on the spray absorber performance data that were used to develop Figure 10-1. This absorber can be operated with three different combinations of L/G and limestone utilization to obtain the same SO_2 removal efficiency (85% in this example). With three recycle pumps operating, a pH of 5.7 and a limestone utilization of 80% will yield 85% SO_2 removal efficiency. With four pumps, limestone utilization can be increased to 87% at a pH of 5.5, and with five pumps, limestone utilization can be increased to 89% at a pH of 5.3.

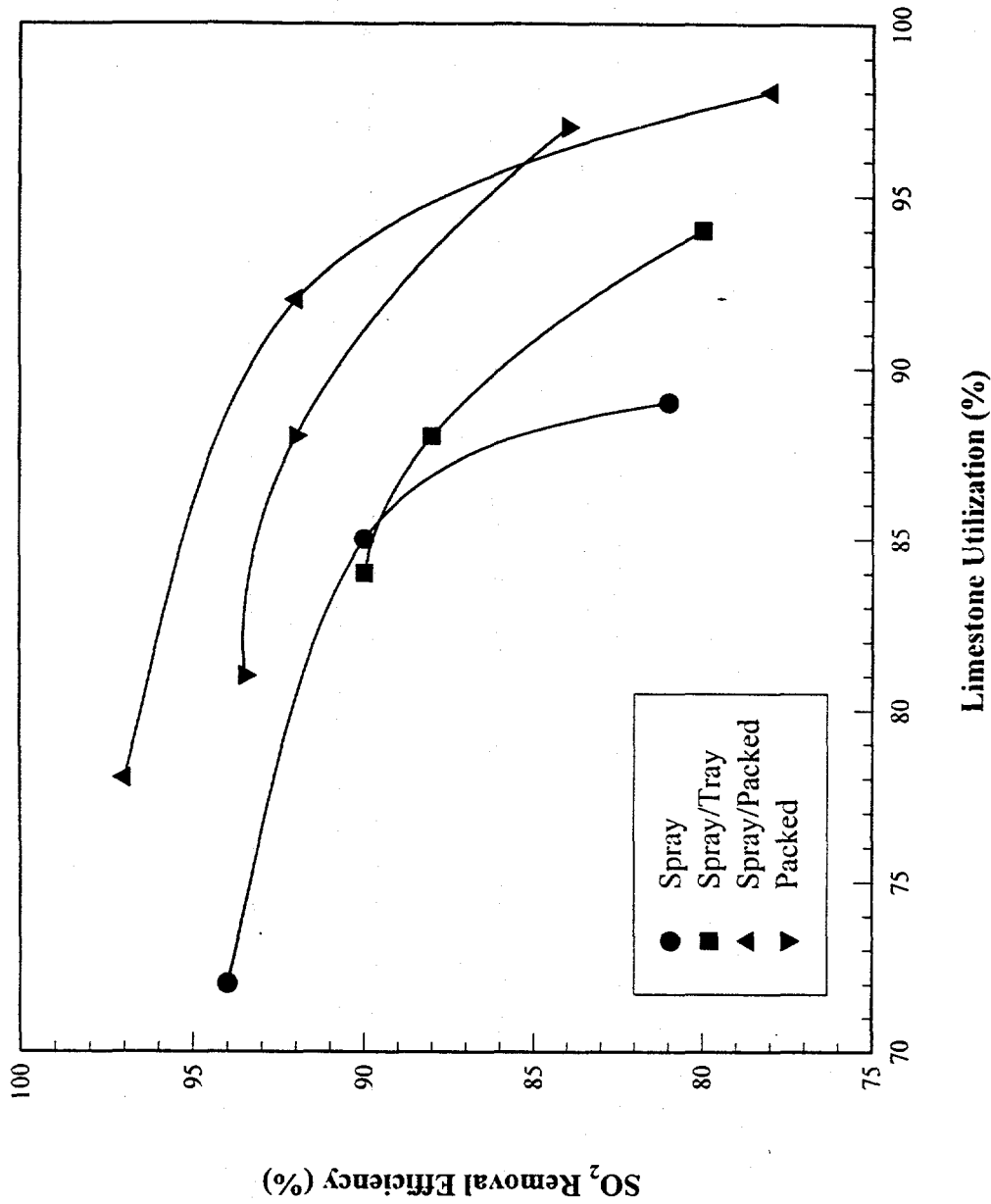

Figure 10-1. SO₂ Removal vs. Limestone Utilization for Different Full-Scale Absorbers

Table 10-2

Example Economic Trade-offs Between L/G (Pump Power) and Reagent Utilization for a Spray Absorber (Adjusted to the 500 MW, 2% S design basis)

SO ₂ Removal Efficiency (%)	L/G (L/Nm ³)	pH	Reagent Utilization (%)	Reagent Feed Rate (tonne/h)	Reagent Cost (\$/h)	Recycle Slurry (L/s)	Pump Power Cost (\$/h)	Total Cost (\$/h)
Case 1--Power Cost = \$0.015/kWh, Limestone Cost = \$15/tonne								
85	8.4	5.7	80	17.8	267	5800	36	303
85	11.3	5.5	87	16.3	245	7900	49	294
85	14.1	5.3	89	16.0	240	9800	61	301
Case 2--Power Cost = \$0.05/kWh, Limestone Cost = \$8/tonne								
85	8.4	5.7	80	17.8	142	5800	120	262
85	11.3	5.5	87	16.3	130	7900	163	294
85	14.1	5.3	89	16.0	128	9800	203	331

1 L/Nm³ = 7.46 gal/ft³ (corrected to actual flue gas temperature and pressure)

1 tonne = 1.1 tons

1 L/s = 15.7 gpm

Two cases are shown in Table 10-2. For the first case, it was assumed that the cost of power is relatively low and the cost of reagent is high. The total pump power plus reagent cost for the three-pump case with 80% limestone utilization is \$303/h. With four pumps operating and 87% limestone utilization, the savings in limestone exceeds the increased power cost, and the total cost falls to \$294/h. With five pumps operating, however, the combined cost increases because the savings in limestone is small and the decrease in SO₂ removal (at constant L/G) is large when operating on the "steep" portion of the removal-versus-utilization performance curve.

The optimum reagent utilization will obviously depend on the unit costs assigned to power and reagent. For the second case, it was assumed that the cost of power is relatively high and the reagent cost is lower. For this case, the results show that the optimum operation is with three recycle pumps at a limestone utilization of only 80 percent. The cost of operating another recycle pump exceeds the additional limestone savings.

It should be noted that one other constraint is important in selecting the optimum limestone utilization. Experience has shown that mist eliminator plugging can be a serious operating problem when limestone utilization is less than about 85 percent. Slurry containing large amounts of excess limestone promotes the formation of scale on mist eliminator blades. Therefore, a prudent process specification would require that limestone utilization be maintained above 85% even if the cost evaluation indicated that lower utilization would result in a net savings.

In a more detailed analysis, the effect of reagent particle size on performance would also be considered. If reagent is expensive and power is cheap, then a finer grind and higher L/G would be used to obtain higher limestone utilization at the required SO₂ removal efficiency. Conversely, if reagent is cheap and power is expensive, more excess reagent could be used to save pump and grinding power. The annualized capital costs of the recycle pumps and reagent preparation equipment would also be considered in this type of evaluation. For other absorber types, such as packed absorbers, the performance trade-off would also include

the cost of different amounts or types of packing and the cost of fan power for different absorber flue gas pressure drop.

10.4 Slurry Chloride Level

An important aspect of an FGD process specification is the amount of chlorine in the fuel. As discussed in Section 3.5--FGD Material Balance, chlorine in the fuel is converted to HCl in the flue gas. Essentially all of this HCl is captured by the FGD absorber and accumulates as soluble chloride salts in the FGD slurry. The steady-state concentration of chloride in the process slurry is fixed by the amounts of HCl entering with the flue gas and the chloride entering with the makeup water, and the amount of process liquor leaving with the byproduct solids and in any separate blowdown stream. The chloride concentration has a strong effect on the selection of materials of construction (see Section 5.0--Materials-of-Construction Options), and can also affect SO₂ removal efficiency and limestone utilization.

The slurry chloride level may be included in a process specification in one of several ways:

- The utility may specify only the chlorine content of the fuel and the chloride content of the makeup water and allow the FGD vendor to fix the design chloride level according to their material balance calculations.
- The utility may specify a minimum and maximum design chloride concentration for the process slurry.
- In the case where gypsum byproduct will be sold, the utility may specify a maximum chloride content in the byproduct solids.

In any case, the utility must also specify whether or not a separate wastewater discharge from the process will be permitted and, if so, what volume and water quality restrictions will apply to this discharge.

Design chloride concentrations for recent wet lime- and limestone-based FGD systems installed in the United States range from less than 10,000 to as high as 50,000 mg/L. Generally, lime-based systems operate in the lower end of this range because of the difficulties that may arise when dewatering the byproduct solids. Limestone-based systems, especially those using forced-oxidation, are in the higher end of this range.

Test data from limestone-based FGD processes have shown that absorber mass transfer capability (in terms of NTU) can decrease by as much as 30 to 40% with increasing chloride concentration over the above-listed range of chlorides. Therefore, an absorber operating with higher chloride concentrations will require higher L/G, more excess limestone, or other changes to counteract the effect of chloride on SO₂ removal efficiency. If a wastewater discharge is not permitted, the FGD vendor must design for whatever chloride content is fixed by the process material balance. If a discharge is allowed, then the cost of treating the discharge to meet applicable water quality standards must be compared to the alternative of designing for a higher chloride concentration.

Similar high-chloride operating data are not available from lime-based FGD systems; however, lime-based systems have much greater liquid-phase alkalinity than limestone-based systems, and the effect of chlorides on the absorber mass transfer capability should be much less.

10.5 Chemical Additive Concentration

The use and benefits of chemical additives were discussed in Section 9-- Chemical Additive Considerations. The two primary additive types are thiosulfate (produced in situ from sulfur), which is used to inhibit oxidation, and organic acids, which are used to enhance SO₂ removal.

The choice of an inhibited- versus a forced-oxidation process is normally made by the utility on the basis of the factors listed in Table 9-3 and will not be discussed here. This choice would normally be made before issuing an FGD process specification.

The option of using organic acid may be encouraged or prohibited by the utility or left to the FGD vendor to evaluate. If a chemical additive is to be considered in the process design stage, the utility should specify the additive type that will be used, the form in which it can be delivered, and the approximate cost range for use in evaluations conducted by the FGD vendors. It should be noted that only a few FGD specifications to date have been written allowing chemical additive use for meeting base-case performance guarantees. Instead, most utilities are including the use of additives only as a means of increasing process flexibility to accommodate a wider range of potential fuel sulfur contents. This results in an absorber design that is more conservative, and also more expensive since the benefits of the chemical additive are not incorporated into the base design.

As with the other design parameters discussed above, the selection and use of organic acid additives to enhance SO₂ removal in a lime- or limestone-based FGD system must be evaluated in terms of cost trade-offs. Some examples of the effect of organic acid additives on process operating costs were given in Section 9. Some further examples of how the optimum additive concentration would be selected in the process design stage are given here.

Table 10-3 illustrates a spreadsheet calculation that evaluates combined cost trade-offs for L/G, reagent utilization, and formate additive concentration in a limestone-based FGD system with a spray absorber. The design and cost basis is summarized at the bottom of the table. The performance relationships among SO₂ removal efficiency, reagent utilization, and formate additive concentration are based on actual test data for the spray tower referenced in Table 10-1.

Table 10-3

Example Economic Trade-offs Among L/G, Reagent Utilization, and Chemical Additive Concentration for a Spray Absorber (Adjusted to 500 MW and 2% Sulfur Coal)

Formate (mg/L)	Number of Spray Levels	Formate Feed (kg/hr)	Formate Capital (\$1000/yr)	Formate Chemical (\$1000/yr)	Fan Power (\$1000/yr)	Pump Power (\$1000/yr)	Spray Pump Capital (\$1000/yr)	Limestone Reagent (\$1000/yr)	Solids Disposal (\$1000/yr)	Total Annual Cost (\$1000)	Average Cost (\$/tonne SO ₂)
Case 1—pH=5.6, Utilization = 85%											
0	5	0	0	0	293	447	750	1,401	1,036	3,927	64
150	4	10	32	53	283	357	600	1,401	1,036	3,763	62
325	3	22	36	115	273	268	450	1,401	1,036	3,580	59
800	2	54	41	283	263	179	300	1,401	1,036	3,504	57
Case 2—pH = 5.2, Utilization = 90%											
250	5	17	34	89	293	447	750	1,323	1,000	3,936	65
400	4	27	37	142	283	357	600	1,323	1,000	3,743	61
800	3	54	41	283	273	268	450	1,323	1,000	3,640	60
2,000	2	136	47	709	263	179	300	1,323	1,000	3,822	63
Case 3—pH = 5.8, Utilization = 75%											
0	4	0	0	0	283	357	600	1,588	1,108	3,936	65
200	3	13	33	71	273	268	450	1,588	1,108	3,791	62
500	2	34	38	177	263	179	300	1,588	1,108	3,653	60

Basis:

Annual capacity factor 0.85
 Flue gas flow (total at 500 MW) 870 kg/s
 Inlet flue gas pressure (5 spray levels) 1.5 kPa
 SO₂ Removal efficiency 90%
 SO₂ Removal rate 8.2 tonne/h
 Cost of station service power \$0.02/kWh
 Additive system capital cost at 50 kg/h \$300,000
 Sodium formate \$0.70/kg
 Sodium formate loss rate at 1000 mg/L 8.3 kg/tonne SO₂
 Limestone reagent \$13/tonne
 Byproduct solids disposal \$8/tonne
 Flue gas pressure loss per spray level 50 Pa
 Pump power/spray level, L/G = 3 L/Nm³ 200 kW
 Pump-piping-nozzle cost per spray level \$1,000,000
 Annual capital recovery factor 0.15

The same SO₂ removal efficiency (90% for this example) can be obtained with a number of different combinations of formate additive, limestone utilization, and number of spray levels in the absorber. For each option, the formate consumption and annual formate purchase cost is evaluated. The annualized cost for construction of the formate storage and delivery system is also included, based on a capital recovery factor of 0.15. The cost of this equipment was assumed to be \$300,000 for a 50 kg/h capacity and is adjusted as a function of capacity for other required feed rates.

The annual costs also include fan power and pump power. Fan power decreases slightly as the number of spray levels decreases because the absorber pressure drop decreases. No savings in fan capital cost was included because this change is small. Pump power is directly proportional to the number of spray levels. A capital recovery charge is also included for the cost of each spray level. The installed capital cost of each spray level (pumps, headers, and nozzles) was assumed to be \$1,000,000. In the example cited, capital savings were not estimated for a shorter absorber tower; however, this could result in appreciable capital cost reduction depending on the absorber design.

The final contributions to the annual costs in the table are for reagent and for byproduct solids disposal. These costs both vary as a function of reagent utilization.

For the first case in Table 10-3, the slurry pH is 5.6 and the limestone utilization is 85 percent. Total operating costs are evaluated for a spray absorber with 5, 4, 3, and 2 spray levels. The results show that the savings in pump power and capital cost exceed the cost of formate additive as the number of spray levels decreases. The annualized savings is about \$400,000 for operation with only 2 spray levels and 800 mg/L formate compared to operation with 5 spray levels without formate additive.

For the second case in Table 10-3, the operating pH is decreased to increase limestone utilization to 90 percent. For this case, more formate additive is required to obtain the same 90% SO₂ removal efficiency. At this pH and limestone utilization, the least-cost

operation is obtained with 3 spray levels and 800 mg/L formate additive. However, the total annualized cost for 3-spray-level operation with 90% limestone utilization is greater than the first case (2 spray levels with 85% limestone utilization) by about \$130,000.

For the third case in Table 10-3, the pH setpoint is higher and only 75% limestone utilization is obtained. At this pH, the formate requirements are less than for the other cases, but the total annualized cost remains greater than for the other cases because of higher costs for reagent and for solids disposal. Even if this case were cost-effective, operation with 75% limestone utilization would not be recommended because of the potential for mist eliminator scaling and the inability to meet commercial-quality gypsum byproduct specifications.

The example cost trade-offs shown in Table 10-3 suggest that most of the cost advantage of using additives to obtain 90% SO₂ removal efficiency is contributed by the capital cost savings because of fewer recycle pumps and headers. However, data from the full-scale tests referenced in Table 10-1 have shown that when higher SO₂ removal efficiency (>95%) is required, substantial savings in operating costs alone can be obtained with the use of additives, compared to using more reagent or operating more recycle pumps. Therefore, the potential economic incentive for organic acid additive use will increase with increasing SO₂ removal efficiency.

10.6 Optimization Using FGDPRISM™

The examples given above show that many interrelated design parameters must be evaluated to obtain an optimum FGD process design. Actual test data from full-scale FGD systems were used to illustrate some of the key cost trade-offs that must be considered. To help meet this need for predicting the performance of this complex process and selecting optimum design and operating parameters, the Electric Power Research Institute (EPRI) has developed the Flue Gas Desulfurization Process Integration and Simulation Model (FGDPRISM™).

FGDPRISM simulates the lime- or limestone-based FGD processes as a series of unit operations or equipment modules connected by process streams. The model uses iterative gas-liquid and liquid-solid mass transfer calculations along with ionic equilibrium reactions in the liquid to describe: 1) absorption of SO_2 , 2) dissolution of lime or limestone, and 3) precipitation of byproduct solids. The performance of a variety of absorber configurations can be modeled. In addition to modeling mass transfer rates and predicting system performance parameters such as SO_2 removal and reagent utilization, the model can also be used for overall material balance calculations based on assumed input values for process performance.

A detailed description of the FGDPRISM computer model and its use in evaluating design trade-offs for a new FGD system or for modifying an existing system is presented in Part IV, Section 2.0--Use of FGDPRISM in System Design and Specification Preparation. A brief explanation of how the model can be used for this purpose is given below.

The most basic use of the model is for overall material balance calculations. With this option, the effects of alternative fuels, water sources, and reagents on the composition of the process liquor and on the amount and composition of byproduct solids can be evaluated. The system performance parameters (SO_2 removal and reagent utilization) are not predicted, but instead are fixed as inputs. Some typical uses for the material balance model might be the following:

- Determining overall flow rates and/or compositions of flue gas, reagent, byproduct solids, and makeup water;
- Estimating reagent and additive consumption rates;
- Estimating the concentrations of chemical species (for example, chloride) in the process liquor;
- Evaluating effects of alternative fuel and reagent compositions on process liquor composition; and

- Evaluating effects of alternative dewatering and blowdown assumptions on process liquor composition.

A more sophisticated use of the model is in predicting how process performance will change as a function of design and operating parameters. In the full system performance simulation, the same system material balance input parameters are used to define the overall process, but SO₂ removal and reagent utilization are predicted instead of being fixed by input. Some uses for the full system simulation may include the following:

- Evaluating the effects of alternative fuels (sulfur and chloride content) on SO₂ removal efficiency;
- Evaluating the process effects of alternative makeup water sources and water balance changes;
- Evaluating the effect of alternative chemical additives and concentrations on SO₂ removal efficiency;
- Evaluating performance and cost trade-offs among the interrelated design parameters of reagent utilization, reagent particle size, L/G, and additive concentration;
- Evaluating the effects of installing trays or packing to enhance liquid/gas contact and mass transfer coefficients;
- Estimating the relative saturations of calcium sulfite and calcium sulfate in the recirculating slurry; and
- Evaluating the effects of alternative blowdown and dewatering assumptions on system performance.

The procedure for evaluating cost trade-offs would be similar to that illustrated by Table 10-3, except that performance test data for the different operating conditions would be replaced by FGDPRIISM performance predictions.

10.6.1 Establishing FGD System Specification Requirements

The results of FGDPRISM studies such as those listed above may be useful in setting the requirements of an FGD system specification in many areas. These areas include the following:

- Establishing a minimum L/G to control the maximum calcium sulfate relative saturation level and prevent scaling in the absorber;
- Determining the minimum number of operating spray levels;
- Determining if a wastewater blowdown will be required to control slurry chloride level;
- Determining the slurry chloride level to specify the correct materials of construction; and
- Determining if chemical additives should be allowed or required.

It must be emphasized that FGDPRISM is not a detailed design tool that will permit the utility engineer to set all FGD system process parameters. The design of an FGD system is based on years of experience, and the system vendors are best qualified to optimize all of the interrelated operating parameters for their specific equipment design.

10.6.2 Investigations of Process Modifications at an Existing Site

The FGDPRISM program is an excellent tool for predicting how process performance of an existing FGD system would change as a result of modifying a design or operating parameter.

In the full system performance simulation, the same system material balance input parameters are used to define the overall process, but SO₂ removal and reagent utilization are predicted instead of being fixed by input. Accurate performance predictions using FGDPRISM require a "calibrated" version of the model to be developed using test data

from a particular absorber type and FGD system configuration. The model is calibrated by adjusting certain input parameters until predicted performance matches actual performance for the initial cases being simulated. After the model is calibrated, it can be used to predict performance for conditions other than those used in the calibration.

Table 10-4 lists the most important FGDPRIISM calibration parameters and describes how they are adjusted to calibrate the model. Calibrating the FGDPRIISM model is an iterative process. A perfect fit to all of the performance parameters cannot be obtained over the entire operating range of a given FGD system. Therefore, the proposed use of the calibrated model should be considered as part of the calibration process. For example, suppose that the model will be used to evaluate the use of organic acid additive to obtain high SO₂ removal efficiency. In this case, it will be important to use film thicknesses that give the best fit for predicted versus observed SO₂ removal efficiency at the highest efficiency that was tested. Another example might be evaluating a cost trade-off between L/G and reagent utilization. If power is relatively cheap and reagent is expensive, then the optimum operation will be at relatively high utilization, and the model calibration procedure should emphasize obtaining the best fit for the highest level of reagent utilization that was tested.

10.7 References

1. Jones, A.F., K.E. McIntush, J.E. Lundeen, R.G. Rhudy, and C.F.P. Bowen. "Mist Elimination System Design and Specification for FGD Systems." Presented at the EPRI/EPA/DOE SO₂ Control Symposium. Boston, Massachusetts, August 1993.
2. Phillips, J.L., G.M. Blythe, and J.R. White. "Results of High SO₂ Removal Testing at New York State Electric and Gas Corporation's Kintigh Station." Presented at the EPRI/EPA/DOE SO₂ Control Symposium. Miami, Florida, March 1995.
3. Blythe, G.M., J.L. Phillips, and T. Slater. "Results of High Efficiency SO₂ Removal Tests at Southwestern Electric Power Company's Henry W. Pirkey Station." Presented at the EPRI/EPA/DOE SO₂ Control Symposium. Boston, Massachusetts, August 1993.

Table 10-4
FGDPRISM Calibration Parameters

Parameters	Effect on Modeled Results	Calibration Approach
System Material Balance Inputs ▶ Boiler ▶ Fuel ▶ Reagent ▶ Makeup Water ▶ Dewatering ▶ Blowdown	These parameters define the overall system material balance.	Reagent and makeup water compositions along with fuel chloride content, percent solids in dewatered byproduct and blowdown flow rate are adjusted to match the observed soluble species (Mg, Na, Cl) concentrations in the process liquor. The material balance option can also be used to predict these concentrations for a new system.
Gas and Liquid Film Thicknesses	These parameters change the absorber SO ₂ removal efficiency under otherwise constant conditions.	Absorber is operated over a wide range of SO ₂ removal efficiencies. Film thicknesses are adjusted to obtain the best fit for these performance data.
Limestone Reactivity and Surface Area Factor	These parameters change the rate of limestone dissolution in the process.	FGD process is operated over a wide range of slurry pH and limestone utilization. Limestone reactivity constant is adjusted to obtain the best fit for utilization versus operating pH.
Calcium Sulfite/Sulfate Precipitation Rate Constants and Oxidation Fraction	These parameters change the rate of byproduct precipitation in the process.	Rate constants and oxidation fraction are adjusted to match the observed concentrations of sulfite and sulfate in the process liquid and solids.

4. Smolenski, J., J.L. Phillips, A.P. Espenscheid, and T.M. Shires. "High-Efficiency SO₂ Removal Tests at Tampa Electric Company's Big Bend Unit 4." Presented at the EPRI/EPA/DOE SO₂ Control Symposium. Boston, Massachusetts, August 1993.
5. Dhargalkar, P.H. and T. Tsui. "Recent Operating Experience of Double-Loop® Limestone FGD Systems on High-Sulfur Coal." Presented at the EPRI/EPA/DOE SO₂ Control Symposium. New Orleans, Louisiana, May 1990.
6. Reynolds, P., J.G. Noblett, Jr., and D.R. Owens. "Options for Increasing SO₂ Removal and Improving the Water Balance at Hoosier Energy's Merom Station." Presented at the EPRI/EPA/DOE SO₂ Control Symposium. Boston, Massachusetts, August 1993.
7. Brockman, W.D., M.G. Milobowski, R.W. Telesz, and G.K. VanBuskirk. "Operation and Maintenance Update of the Wm. H. Zimmer Generating Station FGD System." Presented at the EPRI/EPA/DOE SO₂ Control Symposium. Boston, Massachusetts, August 1993.

11.0 CONSTRUCTION CONSIDERATIONS

The installation of an FGD system, whether installed along with a new unit or retrofit to an existing unit, is a major construction project and usually involves the FGD vendor and several contractors. The management of the construction may be provided by the utility, the utility's architect/engineer, or a general contractor. Among the many factors that should be considered in the construction of an FGD system are the following:

- The construction schedule;
- The special environmental conditions required for installation of internal linings in the absorber module, process tanks, and ductwork;
- Special quality assurance/quality control (QA/QC) testing and inspections; and
- Performance tests.

11.1 Construction Schedule

The interval between the date the FGD system contract is awarded and the date the system is placed into commercial operation is typically 36 to 48 months, depending on the complexity of the design and construction efforts. Figure 11-1 is a simplified Gantt chart schedule based on the actual construction schedule proposed for an FGD system installed on an existing 650 MW unit. In this example, the construction period from date of contract award to the completion of the initial performance test was 43 months. The example FGD system's contract scope of supply covered the flue gas handling system from the outlet of existing ID fans to the breeching of a new stack (furnished and installed under another contract), the absorber modules, reagent preparation equipment, and byproduct handling equipment. The contract also covered the structural support steel, the electrical equipment, the controls and instruments, and enclosure buildings for all equipment. Foundations for all equipment were furnished under another contract.

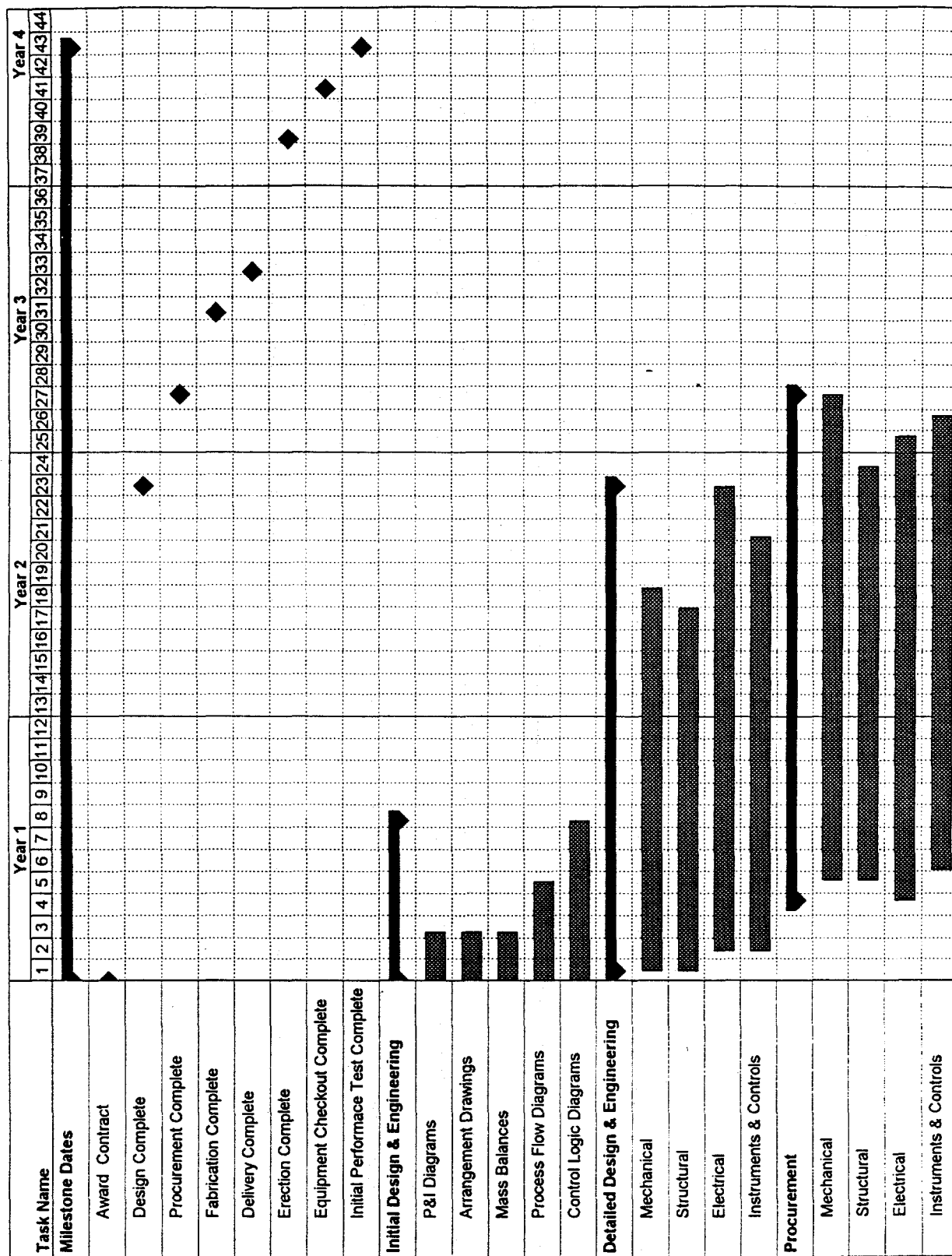

Figure 11-1. Typical FGD System Design and Construction Schedule

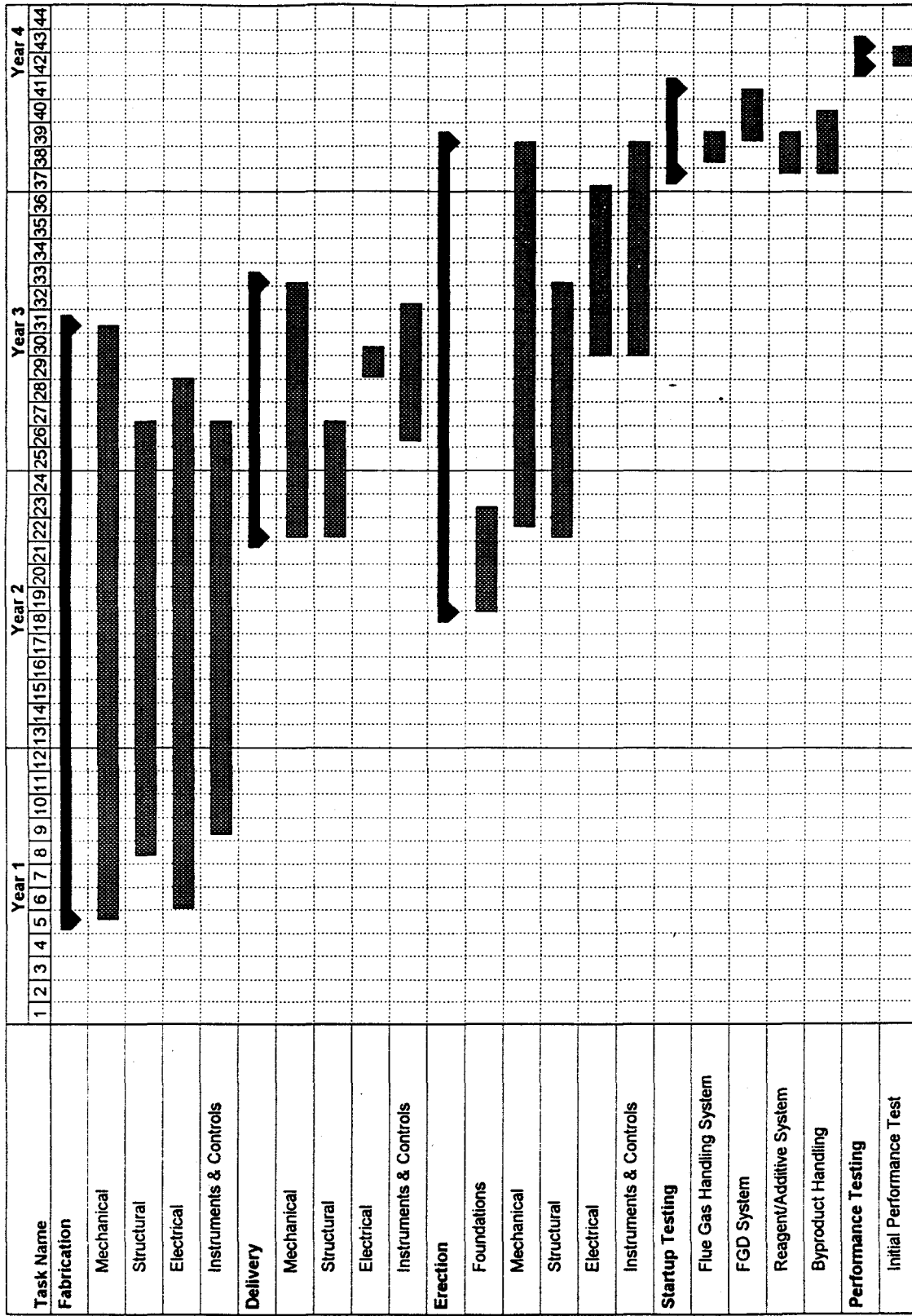

Figure 11-1. (Continued)

This example schedule contains the following major design and construction activities:

- Initial design and engineering;
- Detailed design and engineering;
- Procurement;
- Fabrication;
- Delivery;
- Erection;
- Startup testing; and
- Performance testing.

The initial design and engineering phase of the project starts with the award of the contract and, in the example schedule, lasted approximately eight months. This phase consists of the production of piping and instrument (P&I) diagrams, general arrangement drawings, mass balances, process flow diagrams, and control logic diagrams. As this information is completed, it is submitted to the utility (and its architect/engineer/consultants, if applicable) for approval. The approved information then is used in the detailed design of the equipment.

The detailed design of the FGD system also begins with the award of the contract and, in the example, lasts for nearly two years. In the example schedule, the detailed design phase has been broken out into mechanical, structural, electrical, and instrument and controls design activities. These activities are, of course, interactive and data from each area are required at specific dates to support design activities in another area. For example, the mechanical design of the absorber module and reaction tank is needed by the structural designer for design of the support steel. In the example case, the structural foundation design loads imposed by the absorber module, process tanks, pumps, and support steel were needed by the contractor responsible for foundation design.

As soon as the detailed design of each major FGD system component is completed and approved by the utility, equipment procurement can begin. In the example, work on procurement began approximately four months after award of the contract and was completed two years later. Fabrication of the first equipment purchased began within approximately five months of contract award. Fabrication of all equipment was scheduled to be complete 31 months after contract award.

Foundations and site work began approximately 18 months after contract award. The first FGD system components scheduled for delivery were the reagent preparation ball mills, structural steel, and steel plate for the absorber modules and tanks, which arrived four months later. The last shipments were scheduled for delivery 33 months after contract award.

Actual erection of the FGD system was scheduled to begin 22 months after contract award and to be completed approximately 17 months later. As each major subsystem was completed, it was subjected to startup testing. The entire system was scheduled to be ready for commercial operation 41 months after contract award.

The initial performance test was scheduled to occur approximately one month after commercial operation of the FGD system. A second performance test (not shown on the schedule) was scheduled for 12 months after successful completion of the first test. A reliability/availability demonstration test, also not shown on the schedule, was scheduled for the period between the two performance tests.

11.2 Equipment Field-Lining Considerations

As discussed in the preceding sections of this manual, the absorber vessel, reaction tanks, slurry storage tanks, and outlet ductwork may be constructed with field-applied elastomer (rubber) or reinforced resin linings. When these linings are used, the environmental conditions during application and curing are critical to the performance of the materials (see

Part I, Section 5.5.2--Installation Requirements). These conditions include limits on substrate temperature and on atmospheric temperature and relative humidity. For instance, reinforced resin linings have a minimum atmospheric temperature requirement in the range of 13 to 15°C (55 to 60°F), depending on the supplier. Maximum allowable substrate temperatures throughout the application and curing periods are in the range of 27° to 38°C (80° to 100°F). The allowable metal temperature range for application of rubber linings is 15° to 32°C (59° to 90°F).

If the absorber modules, process tanks, or ductwork are to be lined with a rubber or reinforced resin, the equipment erection schedule must consider whether and how these required ambient and substrate temperature conditions can be met. The effect on the erection schedule can be significant, because much of the absorber module's internal equipment (e.g., spray headers and mist eliminators) must be installed after the absorber module linings. Depending on the geographic location and the season of the year when the linings are scheduled to be applied, the required environmental conditions may occur naturally. This is, however, an exception to the typical experience. Generally, provisions are required to ensure that the temperature and relative humidity of the air in the vessels and the substrate temperature are controlled within the required ranges. Since maintaining a safe breathing air condition for the lining applicators is also necessary, this generally requires relatively large volumes of air to be handled. Natural gas- or propane-fired heaters are often required to warm the air and reduce its relative humidity. Oil-fired heaters are prohibited because they can deposit films of oil on the surfaces to be lined, preventing proper adhesion. In other situations, dehumidification and air chillers may be required. In some geographic locations, application of linings is simply not feasible in some seasons.

With the exception of the outlet ductwork, most of the lined equipment is un-insulated. Maintaining the correct steel substrate temperature during application and curing may be difficult, especially in the winter. In the summer months, the steel should be shielded from the sun to prevent it from becoming too hot. Obviously, these problems are reduced if the vessels to be lined are located inside an enclosed, heated building where ambient

conditions can be better controlled. However, when a building is relied upon for this purpose, the schedule must consider the building's stage of erection completion at the time when lining needs to occur. For example, the building roof and siding must have been installed and (as required) the heating and ventilation equipment must be functional.

A few installations have elected to minimize the on-site environmental problems with field-applied linings by shipping the components to the site with factory-applied linings. This concept has been applied to vessels as large as absorber modules, which were fabricated in segments with shop-applied rubber linings and were field-assembled into complete modules.

11.3 Special QA/QC Testing and Inspections

QA/QC testing and inspections are a critical aspect of all construction projects. The critical importance of the performance of the materials of construction used in fabrication of the FGD system, however, requires that special QA/QC procedures be employed. These tests may involve testing the material as it is delivered to the site and inspections during erection.

The need for inspection and testing of alloy materials delivered to the plant site was discussed in Part I, Section 5.6.3--Alloy Verification and Weld Quality Control. The recommendations of that section should be incorporated into the erection specifications for all field-erected alloy equipment, which may include the absorber modules, reaction tanks, and ductwork. Weld quality is vital to the performance of any corrosion-resistant alloy. A rigorous program of weld quality control and inspection is important to the overall success of the construction.

Testing is required throughout the process of installing rubber and glass-reinforced resin liners. Testing must be conducted to ensure that the required ambient conditions discussed above are maintained. The test results should be maintained as vital

documentation records that could be used in support of damage claims if the linings fail during the warranty period. As noted in Part I, Section 5.5.3--Modes of Failure, product variation or substitution has been the cause of liner failures at several installations. QA/QC procedures should be implemented to identify any materials delivered to the site that do not meet the specification.

Application problems are another frequent mode of material failure. The QA/QC procedures recommended by the liner material manufacturers should be identified in the specification and rigorously enforced during installation. For rubber and resin linings, this will involve spark-testing of all surface areas and, possibly, destructive testing of lined test coupons.

11.4 Performance Testing

The actual performance of the completed FGD system is compared against the system's guaranteed performance by conducting performance tests. In order to confirm that the initial performance of the system is sustainable, two tests are frequently conducted: the first upon completion of the system, the second after one year or more of operation.

The FGD system supplier's contract contains a number of performance guarantees, which may include the following:

- SO₂ removal efficiency (outlet SO₂ emission rate);
- Outlet particulate emission rate;
- Mist eliminator performance (water droplet emission rate);
- Byproduct solids composition and moisture content;
- Wastewater composition and volume;
- Electrical power consumption;

- Flue gas pressure drop (overall and across specific components);
- Flue gas reheater performance and energy consumption;
- Reagent utilization (reagent consumption);
- Water consumption for each source of makeup water; and
- Overall FGD system reliability and availability.

With the exception of overall reliability and availability, these guarantees are evaluated during the initial performance test. This test is usually conducted by an independent third party who may be paid by the utility or the FGD vendor. The generating unit is operated as close to design conditions as possible during this test. The utility may stockpile a supply of high-sulfur coal for use during the test to raise the flue gas SO₂ content as close to the design level as possible. In addition, the utility and vendor may agree on a set of correction curves that project the FGD system performance under actual conditions to the estimated performance under design conditions.

The subsequent activities depend on whether the FGD system meets all guarantees during the initial performance test. If the test results demonstrate that the system has successfully met all of its performance guarantees, the testing program progresses to a reliability and availability test and to a second performance test, if required by the contract. If the system does not meet one or more of these guarantees, the contract usually requires one of the following actions.

In most cases, the vendor is required to modify the equipment as needed to meet the performance guarantee at no cost to the utility. Following the modification, the initial performance test would then be repeated to verify the modified system's performance.

If the system modifications are unsuccessful in meeting performance guarantees, the contract usually contains liquidated damage clauses that establish a monetary penalty that varies with the difference between the guaranteed and actual performance. As an

example, if the system power consumption is greater than guaranteed, the vendor's payment may be reduced by the present value of the additional power over the projected life of the system.* The FGD vendor's contract will specify a maximum total value of liquidated damages.

Following the successful completion of the initial performance test, the contract may require one or more tests of the FGD system's availability and reliability. This test is conducted over a prolonged period of time, usually several weeks or months. During reliability/availability tests, the generating unit is operated in its normal mode (base-loaded, load-following, peaking, etc.). Scheduled and unscheduled maintenance to the FGD equipment is permitted during the test and the spare equipment may be used to compensate for equipment outages. The availability and reliability of the system** during the test period are compared against the contract guarantees.

If the system fails to meet the required availability or reliability guarantee, the system is modified by the vendor at no additional cost to the utility. Similar to the initial performance test, the reliability/availability demonstration test would be restarted to verify the performance of the modified system, and liquidated damages could be assessed if the system is unable to meet the guarantees after modifications.

In many cases, a final performance test is specified in order to verify that the FGD system can meet the performance guarantees after it has been in operation for some period of time and the equipment is no longer in new condition. This test is most often scheduled for one year after successful completion of the initial performance test. The same remedies for failure to meet performance guarantees used in the initial performance test also apply to the final performance test.

* For a discussion of the concept of "present value" and the economic assessment of annual costs, see Part III, Section 3.0--Economic Evaluations.

** Reliability and availability are defined in Part I, Section 6.0--System Reliability.

Section 4.2--Absorber Module

1. Hendry, D.W., et al. "FGD Performance Improvements at Plains-Escalante Generating Station." Presented at the EPRI/EPA/DOE 1990 SO₂ Control Symposium, New Orleans, Louisiana, May 1990.
2. Phillips, J.L., et al. "Results of High SO₂ Removal Testing at New York State Electric and Gas Corporation's Kintigh Station." Presented at the EPRI/EPA/DOE 1995 SO₂ Control Symposium, Miami, Florida, March 1995.
3. Gray, S.M., et al. "Results of High Efficiency SO₂ Removal Testing at PSI Energy's Gibson Station." Presented at the EPRI/EPA/DOE 1995 SO₂ Control Symposium, Miami, Florida, March 1995.
4. Noblett, J.G., et al. "Update On EPRI's FGDPRIISM Process Simulation Model (Version 2.0)." Presented at the EPRI/EPA/DOE 1993 SO₂ Control Symposium, Boston, Massachusetts, August 1993.
5. Benson, L., et al. "Advanced Mg-Enhanced Lime SO₂ and NO_x Control Pilot Plant." Presented at the EPRI/EPA/DOE 1990 SO₂ Control Symposium, New Orleans, Louisiana, May 1990.
6. Reynolds, P., et al. "Options for Increasing SO₂ Removal and Improving the Water Balance at Hoosier Energy's Merom Station." Presented at the EPRI/EPA/DOE 1993 SO₂ Control Symposium, Boston, Massachusetts, August 1993.
7. Burford, D.P., et al. "Plant Yates ICCT CT-121 Demonstration: Results of Parametric Testing." Presented at the EPRI/EPA/DOE 1993 SO₂ Control Symposium, Boston, Massachusetts, August 1993.

Section 4.5--Wet Stack Considerations

1. Smigelski, J.E. and L.A. Maroti. "Design and Operation of a Wet Process Based Flue Gas Desulfurization System Without Reheat." Presented at the Tenth Symposium on Flue Gas Desulfurization, Atlanta, Georgia, November 17-21, 1986.
2. Froelich, D. A. and G.M. Graves. "Eliminating Reheat from Existing FGD Systems." Journal of the Air Pollution Control Association, Vol. 37, No. 3, March 1987.

Section 4.6--Flue Gas Reheat

1. Electric Power Research Institute. Leaning Brick Stack Liners. GS-6520. Palo Alto, California, 1989.
2. Rosenberg, H.S., C.W. Kistler, Jr., and E.R. Dille. "Laboratory and Field Studies on Leaning Brick Stack Liners." In: Proceedings of the 1987 Air Pollution Seminar. National Association of Corrosion Engineers, Houston, Texas, 1987.
3. Collins, S. "What to Look for in Heat Pipes, Gas-to-Gas Heat Exchangers." Power. 136(5):102-106, 1992.
4. Ando, J. and C.B. Sedman. "Status of Acid Rain and SO₂ and NO_x Abatement Technology in Japan." Presented at the Tenth Symposium on Flue Gas Desulfurization, Atlanta, Georgia, November 17-21, 1986.
5. Johnson, D.W., D.R. Rowley, K.H. Schulze, and J.F. Carrigan. "Integrated Flue Gas Treatment and Heat Recovery Using a Condensing Heat Exchanger." Presented at the American Power Conference, Chicago, Illinois, April 25-27, 1994.

Section 4.8--Byproduct Solids Handling Equipment

1. Colley, J.D., S.M. Gray, D.A. Stewart, and J.A. Wilhelm. "Evaluation of Washing Alternatives for FGD Byproduct Gypsum Production." Presented at the EPRI/EPA/DOE SO₂ Control Symposium, Atlanta, Georgia, November 17-21, 1986.
2. Telephone conversation with Mr. Craig H. Fleming of Conversion Systems, Inc., Horsham, Pennsylvania, March 17, 1995.
3. Smith, C.L. "Case Histories in Full Scale Utilization of Fly Ash-Fixated FGD Sludge." Conversion Systems, Inc., Horsham, Pennsylvania.
4. Smith, C.L. "Stabilized FGD Compositions Yield Environmentally Positive Mine Reclamation." Conversion Systems, Inc., Horsham, Pennsylvania.
5. Fleming, C.H. "Reducing Mine Subsidence with FGD Sludge." Presented at the EPRI/EPA/DOE 1995 SO₂ Control Symposium, Miami, Florida, March 1995.

6. Buckner, J.H., I.S. Brodsky, and L.R. Burnham. "Limestone Forced Oxidation FGD System for TVA's Cumberland Units 1 & 2." Presented at the EPRI/EPA/DOE 1993 SO₂ Control Symposium, Boston, Massachusetts, August 1993.

Section 4.9--Chloride Purge and Wastewater Treatment

1. Phillips, J.L, W.M. Horton, D.R. Owens, and J.G. Patterson. "Economic Impact of Chloride Removal from Wet Limestone FGD Systems." Presented at the EPRI/EPA/DOE SO₂ Control Symposium, Boston, Massachusetts, August 1993.
2. Vymazal, D.C, B.A. Wrobel, and T. Sarkus. "Project Update: Advanced FGD Design for Northern Indiana Public Service Company's Bailly Generating Station." Presented at the EPRI/EPA/DOE SO₂ Control Symposium, Boston, Massachusetts, August 1993.
3. FGD & DeNO_x Newsletter, "99.99% Availability at NIPSCO." The McIlvaine Company, No. 201, January 1995.
4. Mierzejewski, M.K. "The Elimination of Pollutants from FGD Wastewaters." Presented at the EPRI/EPA/DOE SO₂ Control Symposium, Washington, D.C., December 1991.
5. Mierzejewski, M.K, D.C. Ciszewski, and K.R. Minnich. "When the Regulations Get Tough: Advanced Treatment of FGD Blowdowns." Presented at the EPRI/EPA/DOE SO₂ Control Symposium, Boston, Massachusetts, August 1993.
6. Metcalf & Eddy, Inc. Wastewater Engineering: Treatment, Disposal, & Reuse, 3rd Edition. McGraw-Hill, Inc., New York, New York, 1991.
7. American Society of Civil Engineers. Wastewater Treatment Plant Design. No. 36. New York, New York, 1982.
8. Water Pollution Control Federation. Wastewater Treatment Plant Design. No. M0008. New York, New York, 1982.
9. Telephone conversation with Mr. Richard Osantowski, Radian Corporation, May 9, 1995.
10. Elyanow, D., E. Sieveka, and J. Mahoney. "The Determination of Supersaturation Limits in an EDR Unit with Aliphatic Anion Membranes." Presented at the Ninth Annual Conference of the National Water Supply Improvement Association, Washington, D.C., May 1981.

11. Tsubouchi, S., T. Miwada, S. Kotake, and N. Ukawa. "Development of Waste Water Concentration & Solidification System for Wet Flue Gas Desulfurization Plant." Presented at the EPRI/EPA/DOE SO₂ Control Symposium, Boston, Massachusetts, August 1993.