

# Isolated Perfused Rabbit Lung: A Critical Appraisal

by Richard W. Niemeier\*

The isolated perfused lung (IPL), when compared to available *in vitro* and *in vivo* pulmonary systems, is a preparation that fulfills a majority of the ideal criteria for studying metabolism, binding and/or physiological response to xenobiotics. The IPL is an exceptionally useful method when there is a need for concurrent administration of multiple agents in different physical forms. Various details such as physiological and biochemical parameters and the construction of a small animal tracheal valve system are discussed.

Our general interest in the lung originated from the fact that the respiratory tract is the main portal of entry and one of the first surfaces contacted by airborne contaminants. The main reason for our interest in pulmonary disposition of pollutants is the potential importance in the ultimate toxicity of some of these agents. Of interest, also, are the agents, drugs, or pollutants reaching the lung via the circulatory system. It has been well established that the lungs are capable of binding and/or metabolizing several such agents (1-12).

There is no way to study the pulmonary metabolic activity *in vivo* because of the influence of other organs. *In vitro* tissue preparations such as slices and homogenates compromise the integrity of an investigation (13), especially when considering concurrent administration of multiple agents in different physical forms or when determining distribution or binding of compounds throughout the pulmonary system. Therefore, the obvious choice in our opinion was the isolated perfused lung (IPL).

A number of criteria were chosen and considered mandatory in order to provide an isolated perfused lung preparation that was sufficiently stable to permit evaluation of metabolic activity, distribution, and uptake of compounds (14). In addition, we thought that monitoring of physiological and biological indices would better define the stability of the system. A summary of the major features of our isolated perfused rabbit lung preparation is presented in Table 1.

Table 1. Major features of isolated perfused lung preparation.

- 
1. Perfusate: recirculation of undiluted, heparinized, autologous whole blood.
  2. Constant blood pressure and blood flow
  3. Chemically and biochemically inert
  4. Normothermic conditions
  5. Ventilation
    - Subatmospheric pressure (-3 to -13 cm H<sub>2</sub>O)
    - Net subatmospheric end respiratory pressure
    - Sighing (-30 cm H<sub>2</sub>O)
    - Fresh filtered gas, humidified and warmed
  6. Monitoring of biochemical and physiological conditions
  7. Controlled pH
  8. Materials available for analyses
    - Blood
    - Lung washings
    - Pulmonary tissues
    - Ventilating gases
- 

\*Kettering Laboratory, Department of Environmental Health, University of Cincinnati, College of Medicine, Cincinnati, Ohio 45267.

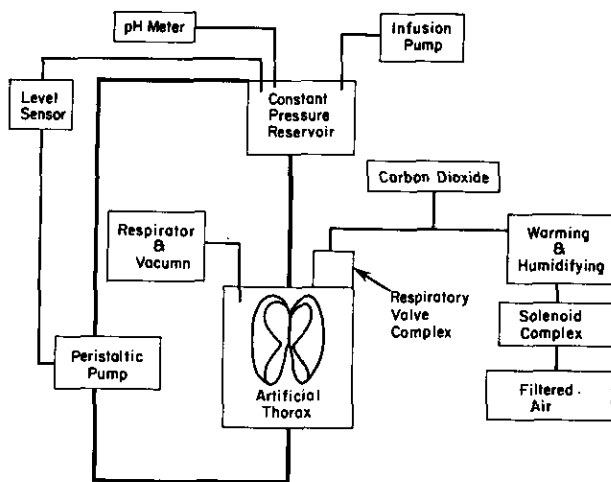

FIGURE 1. Simplified schematic of isolated perfused rabbit lung system.

Undiluted, heparinized, autologous whole blood was chosen as the perfusate for a number of reasons. The principal reason is that this perfusate is perhaps the best physiological and biochemical medium available, i.e., the essential cofactors, trace metals, and autologous proteins are present.

Investigations of benzo[a]pyrene metabolism have indicated that the metabolites are distributed differentially when comparing plasma to red cells (15). This observation reflects the importance of using whole blood when possible, since distribution, absorption, and excretion kinetics are important parameters in estimating total toxicity of a chemical. The possibility exists where significant factors may be overlooked when organs are perfused with artificial media. However, the design of the experiment may dic-

Table 2. Physiological values in the isolated perfused rabbit lung preparation.

Parameter	Value
Hematocrit, %	
Mean	35.0 ± 5.0
Mean change per hr	-1.6 ± 0.3
Weight gain, %/hr	2.81 ± 1.36
Blood flow, ml/min	160-240 (constant in each experiment)
$P_{O_2}$ , mm Hg	118 ± 6, 121 ± 10*
$P_{CO_2}$ , mm Hg	39 ± 4, 32 ± 4*
pH range	7.38-7.42
Tidal volume, ml	11.7 ± 0.3, 11.0 ± 0.4*

\* Typical values.

tate the use of artificial media as for example in the study of lipid metabolism.

Constant blood pressure and flow are essential for kinetic studies. The system is essentially chemically and biochemically inert utilizing silicone rubber tubing and silicone coated glass. The system is operated at 37°C, and ventilation is accomplished through subatmospheric alternating pressures. The pH of the blood is controlled through infusion of  $NaHCO_3$  (0.3 meq/hr) and titrating to pH 7.40 with carbon dioxide added to the ventilating gas. The materials that are available for analysis include blood, lung washings, alveolar macrophages, trachea-bronchi, peripheral lung tissue, and ventilating gases.

Figure 1 is a simplified schematic of our isolated perfused lung preparation (14) showing the lungs suspended in the artificial thorax. A peristaltic pump maintains the constant pressure of blood through an electronic feedback-level sensing device. Filtered air is warmed and humidified prior to passing the respiratory valve complex.

A summary of the biochemical changes found in the plasma of eight control isolated perfused rabbit lungs has been reported previously (14). One of the most notable changes is the glucose concen-

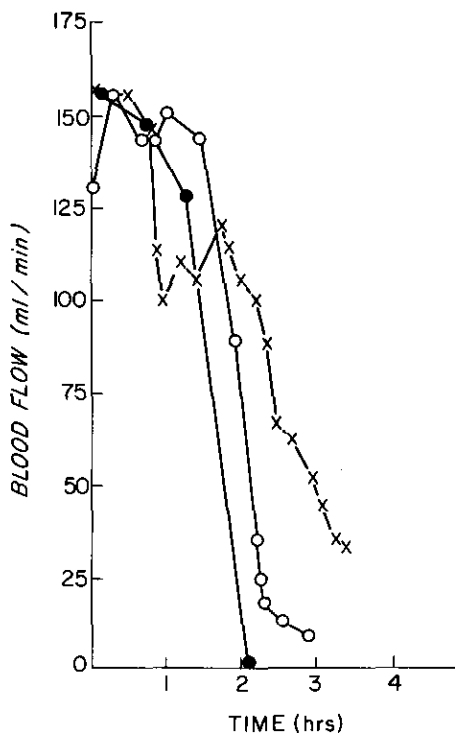

FIGURE 2. Unsatisfactory blood flow rates in the IPL, measured before addition of heparin and epinephrine.

tration. The average disappearance rate was approximately 35 mg-%/hr. Infusion of this amount resulted in no net change throughout the perfusion. Lactate dehydrogenase, glutamic oxalacetic transaminase (GOT), and lactic acid were found to increase quite substantially. The increases in LDH and GOT and the increases in plasma hemoglobin were attributed to hemolysis.

Typical physiological values obtained from control lungs are shown in Table 2. Historically, edema has been a problem in the IPL. We feel that we have minimized or at least delayed its appearance with this system, as is evident by the small increases in weight of the lungs measured before and after perfusion.

Cervical dislocation is used to kill the animal since anesthesia is undesirable for metabolic studies. The location of the strike must be precise, since brain trauma results in massive hemorrhage and edema in the lungs. We have also noted that in experiments in which the blood flow decreases with time in the IPL, edema and hemorrhage usually follows. Therefore, we sought to correct the blood flow problems that normally are found with the IPL hoping that these corrections might also influence edema formation.

Figure 2 shows typical blood flow values which we considered inadequate for metabolic studies before the corrective measures were made. It was evident that in 1-2 hr a consistent phenomenon was occurring. Areas of hemorrhage and low perfusion were very evident in these lungs. Administration of regular maintenance doses of heparin (200-500 IU) as well as epinephrine

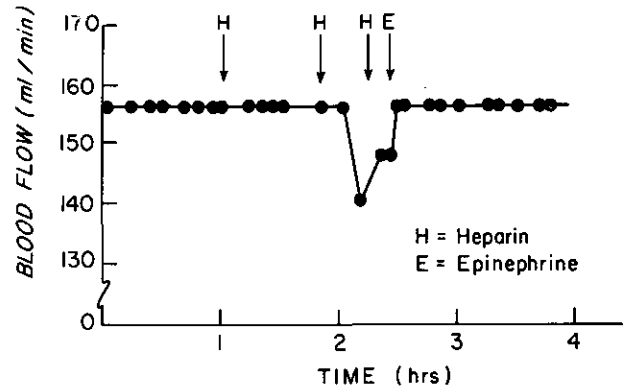

FIGURE 3. Typical blood flow rate after addition of heparin and epinephrine.

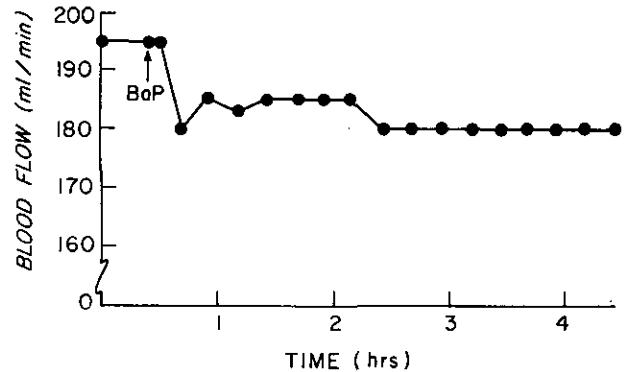

FIGURE 4. Typical blood flow rate with addition of BaP, heparin and epinephrine.

(40-100  $\mu$ g) were found necessary to maintain constant blood flow in the isolated perfused rabbit lung (Fig. 3). Figure 4 illustrates the effects of

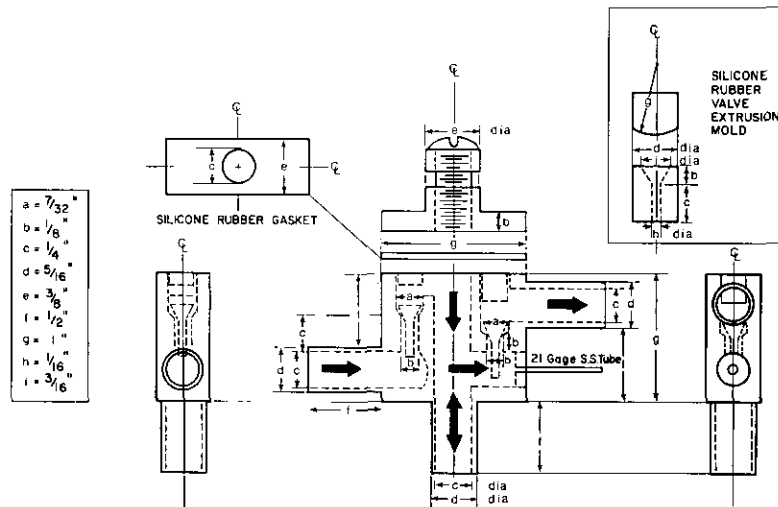

FIGURE 5. Tracheal valve system. Inset is a diagram of the silicone rubber valve extrusion mold.

blood flow of benzo[a]pyrene (BaP) in an ethanol saline (1:1, v/v) suspension administered intratracheally to the IPL. The initial decrease in flow is due to the ethanol administration. Histopathological examination of control lungs revealed no edema and excellent maintenance of pulmonary structures after 4 hr of perfusion.

We are primarily interested in the pulmonary metabolism of the ubiquitous carcinogen benzo[a]pyrene. One of our aims was to study this compound when coadministered intratracheally with ferric oxide or SO<sub>2</sub>. A development which arose from this need was the tracheal valve system which is shown in Figure 5. The valve is fabricated with Teflon and has an extratracheal dead air space of approximately 6 cm<sup>3</sup>. Silicone rubber stem valves permit unidirectional flow. The offset diagram in Figure 5 gives the dimensions of the valve extension mold which is also fabricated with Teflon. Intratracheal pressures can be

measured and intratracheal instillations are made through a port at the top of the valve. Spirometric measurements are also possible, therefore, adding another dimension to metabolic and acute toxicity investigations.

Table 4. Perturbations with IPL.

Perturbations prior to perfusion	
Enzyme-inducing agents (IP) Pb, 3-MC, B(a)P, PCBs	
Inhalation exposure SO <sub>2</sub> , <i>n</i> -dodecane, coal dust, metals	
Dietary manipulations	
Intratracheal instillations	
BaP, crystalline quartz, papain, asbestos	
ferric oxide, with or without BaP	
crude air particulate (CAP), with or without BaP	
Concurrent administration of multiple agents to IPL	
CAP + BaP ± SO <sub>2</sub>	
Ferric oxide + BaP	
Ethanol + trichloroethylene	

Table 3. Metabolites of BaP found in the IPL.

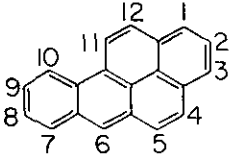
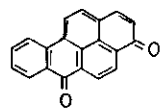
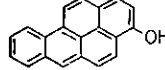
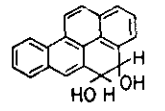
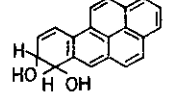
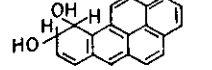
Structure	Compound	R <sub>f</sub> value
	BaP	0.88
	BaP-3,6-dione	0.78
	BaP-3-hydroxy	0.48
	BaP-4,5-dihydrodiol (P <sub>2</sub> ) <sup>a</sup>	0.24
	BaP-7,8-dihydrodiol (P <sub>1</sub> ) <sup>a</sup>	0.16
	BaP-9,10-dihydrodiol (baseline) <sup>a</sup>	0.03
	polar (conjugates) <sup>a</sup>	—

<sup>a</sup> Tentative identification.

The R<sub>f</sub> values of the metabolites of benzo[a]pyrene found in isolated perfused rabbit lung preparation after intratracheal administration of <sup>14</sup>C-BaP in ethanolic saline are listed in Table 3. The benene-reconstituted extracts were chromatographed on silica gel thin layer plates using benzene:ethanol (19:1). The Mylar-backed chromatograms were cut in 1-cm strips and placed in scintillation vials for subsequent counting.

Blood samples taken at various times during the perfusion were analyzed for their metabolite content. Typical values found in control lungs and those pretreated 24 hr prior to perfusion with 3-methylcholanthrene (3-MC) in corn oil (IP, 20 mg/kg) are shown in Figure 6. The rates of metabolic appearance are linear for 60 min or longer, and pretreatment with 3-MC was found to increase the total rate approximately sevenfold.

A summary of the perturbations that we have completed or are planning are presented in Table 4. This table reflects some of the potential uses of the IPL in characterizing the effects of many environmental contaminants on pulmonary metabolic activity. In addition, concurrent administration of multiple agents are made possible with this system for the purpose of investigating combined effects of agents in different physical forms.

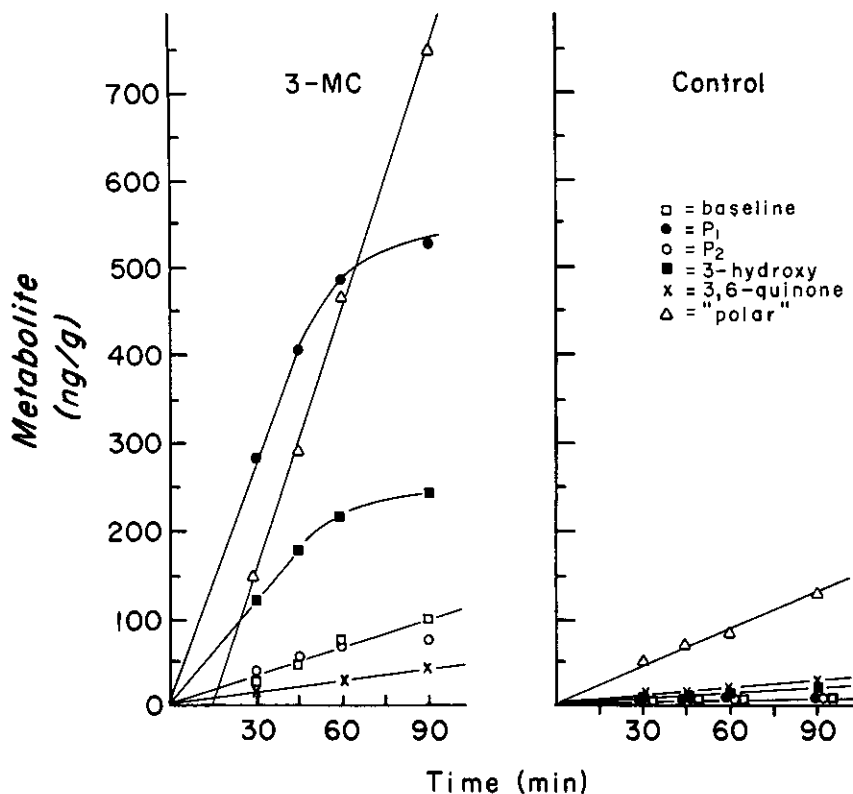

FIGURE 6. Metabolite appearance in blood from IPL after BaP intratracheal administration.

The author wishes to acknowledge support from a NCI grant CA 15344-02, and EPA contract EPA 68-02-1678, and a grant from the Ohio Thoracic Society.

#### REFERENCES

- Dingell, J. V., and Sanders, E. Methylation of desmethylimipramine by rabbit lung *in vitro*. *Biochem. Pharmacol.* 15: 599 (1966).
- Fouts, J. R. Some studies and comments on hepatic and extrahepatic microsomal toxication-detoxication systems. *Environ. Health Perspect.* 1: 55 (1972).
- Oppelt, W. W., et al. Comparison of microsomal drug hydroxylation in lung and liver of various species. *Res. Commun. Chem. Pathol. Pharmacol.* 1: 43 (1970).
- Orton, T. C., et al. Xenobiotic accumulation and metabolism by isolated perfused rabbit lungs. *J. Pharmacol. Exptl. Therap.* 186: 482 (1973).
- Rosenbloom, P. M., and Bass, A. D. A lung perfusion preparation for the study of drug metabolism. *J. Appl. Physiol.* 29: 138 (1970).
- Ryrfelt, A., Ramsay, C. H., and Appelgren, L. E. The distribution and fate of  $^{14}\text{C}$ -clofexin in the lung of the rat. *Acta Pharmacol. Toxicol.* 33: 317 (1973).
- Uehleke, H. Extrahepatic microsomal drug metabolism. *Proc. Europ. Soc. Study Drug Toxicity* 10: 94 (1968).
- Whitnack, E., et al. Demethylation of nortriptyline by the dog lung. *J. Pharmacol. Exptl. Therap.* 181: 288 (1972).
- Grover, P. L. K-region epoxides of polycyclic hydrocarbons: formation and further metabolism by rat lung preparations. *Biochem. Pharmacol.* 23: 333 (1974).
- Toft, D. O., and Spelsberg, T. C. Brief communication: Binding of chemical carcinogens in the lung. *J. Natl. Cancer Inst.* 52: 1351 (1974).
- Grover, P. L., Hewer, A., and Sims, P. Metabolism of polycyclic hydrocarbons by rat lung preparations. *Biochem. Pharmacol.* 23: 323 (1974).
- Law, F.C.P., et al. Metabolism of xenobiotics by the isolated perfused lung. *Drug Metab. Disposition* 2: 422 (1974).
- Ross, B. D. *Perfusion Techniques in Biochemistry*. Clarendon Press, Oxford (1972).
- Niemeier, R. W., and Bingham, E. An isolated perfused lung preparation for metabolic studies. *Life Sci.* 11: 807 (1972).
- Bingham, E., Niemeier, R., and Dalbey, W. Metabolism of environmental pollutants by the isolated perfused lung. *Fed. Proc.* 35: 81 (1976).