

# CHAPTER 7

## OVERHEAD AND GANTRY CRANES

This chapter specifies operation, inspection, maintenance, and testing requirements for the use of overhead and gantry cranes and implements the requirements of ASME B30.2 [“Overhead and Gantry Cranes (Top-Running Bridge, Single or Multiple Girder, Top-Running Trolley Hoist)”], B30.11 (“Monorail Systems and Underhung Cranes”), and B30.17 [“Overhead and Gantry Cranes (Top-Running Bridge, Single Girder, Underhung Hoist)”]. Only equipment built to the appropriate design standards shall be used in DOE installations.

7.1	GENERAL.....	7-1
7.1.1	Operator Training/Qualification .....	7-1
7.1.2	Rated-Load Marking.....	7-1
7.1.3	Modification.....	7-1
7.1.4	Egress.....	7-1
7.1.5	Hoist Brakes.....	7-1
7.1.6	Power Shutoff.....	7-1
7.1.7	Hoist-Limit Switch .....	7-5
7.1.8	Load Limits.....	7-5
7.1.9	Maintenance History.....	7-5
7.2	INSPECTIONS .....	7-6
7.2.1	General.....	7-6
7.2.2	Crane Service.....	7-6
7.2.3	Initial Inspection .....	7-6
7.2.4	Daily Preoperational Check .....	7-6
7.2.5	Monthly Rope, Chain and Hook Inspection.....	7-6
7.2.6	Frequent Inspection.....	7-7
7.2.7	Periodic Inspection .....	7-7
7.2.7.1	Cranes .....	7-7
7.2.7.2	Wire Rope.....	7-8
7.2.7.3	Chain (Welded Link) .....	7-9
7.2.7.4	Chain (Roller) .....	7-10
7.2.8	Cranes Not in Regular Service.....	7-11
7.3	TESTING.....	7-12
7.3.1	Operational Tests .....	7-12
7.3.2	Rated Load Test.....	7-12
7.4	MAINTENANCE .....	7-14
7.4.1	Operating Equipment.....	7-14
7.4.2	Wire-Rope Maintenance .....	7-14
7.5	OPERATION .....	7-15
7.5.1	Conduct of Operator .....	7-15
7.5.2	Hoist-Limit Switch/Device .....	7-15
7.5.3	Standard Hand Signals.....	7-16
7.5.4	Identification of Signalers.....	7-16
7.5.5	Size of Load.....	7-16
7.5.6	Attaching the Load.....	7-16
7.5.7	Moving the Load.....	7-16
7.5.8	Ordinary Lifts .....	7-18
7.5.9	Critical Lifts.....	7-18

EXHIBIT I	Bridge, Wall, Gantry Crane Load Test .....	7-21
EXHIBIT II	Overhead Crane Pre-Operational Checklist .....	7-25
EXHIBIT III	Overhead Crane Periodic Inspection Report (Mechanical).....	7-27
EXHIBIT IV	Overhead Crane Periodic Inspection Report (Electrical).....	7-29

---

## 7.1 GENERAL

---

Overhead and gantry cranes include top-running single- or multiple-girder bridge with top-running trolley hoists (Figure 7-1), top-running single-girder bridge with underhung trolley hoists (Figure 7-2), and monorails/underhung cranes (Figure 7-3).

### 7.1.1 OPERATOR TRAINING/QUALIFICATION

Operators of overhead cranes shall be trained and qualified as required in Chapter 6, "Personnel Qualification and Training."

### 7.1.2 RATED-LOAD MARKING

The rated capacity shall be marked on each side of the crane. If the crane has more than one hoisting unit, each hoist shall have its rated capacity marked on it or on its load block. Markings on the bridge, trolley, and load block shall be legible from the ground or floor.

### 7.1.3 MODIFICATION

Cranes may be modified or rerated provided that the modifications or supporting structures are analyzed thoroughly by a qualified engineer or by a manufacturer of cranes. Modifications and reratings must be approved by the cognizant safety organization. A rerated crane, or one whose load-supporting components have been modified, shall be tested in accordance with Section 7.3, "Testing." The new rated capacity shall be displayed in accordance with Section 7.1.2, "Rated-Load Marking."

### 7.1.4 EGRESS

On cab-operated cranes, there shall be at least two means of egress from the crane, remote from each other, and arranged to permit departure under emergency conditions.

### 7.1.5 HOIST BRAKES

- a. Each independent hoisting unit shall be equipped with at least one holding brake applied directly to the motor shaft or some part of the gear train.
- b. Each independent hoisting unit (except worm-gear hoists, the angle of whose

worm prevents the load from accelerating as it is being lowered) shall be equipped with a controlled-braking means in addition to the holding brake to control speed of lowering.

- c. Holding brakes on hoists shall be applied automatically when power is removed.

### 7.1.6 POWER SHUTOFF

- a. The power supply for the runway conductors shall be controlled by a switch or circuit-breaker located on a fixed structure, accessible from the floor, and capable of being locked in the OPEN position.
- b. On cab-operated cranes, an enclosed switch or circuit-breaker (with provisions for locking in the OPEN position) shall be provided in the leads from the runway conductors. A means of opening this device shall be located within reach of the operator when the operator is in the operating position. When the operator opens this switch or circuit-breaker, the holding brakes should set.
- c. On floor, remote, or pulpit-operated cranes, an enclosed disconnect device shall be provided in the leads from the runway conductors. This device shall be mounted on the bridge or footwalk near the runway collectors. There shall be provisions for locking the device in the OPEN position unless the crane is the only load on a lockable switch or circuit breaker that is accessible from the floor. One of the following types of floor, remote, and pulpit-operated disconnects shall be provided.
  1. A nonconductive rope attached to the main disconnect device on a floor-operated crane. If this is selected, the rope shall be suspended adjacent to the operating ropes if manual controllers are used, or near the pendant push-button station if magnetic controls are used.
  2. An under-voltage trip for a main circuit breaker, operated by an emergency stop button in the pendant push-button station or the pulpit.

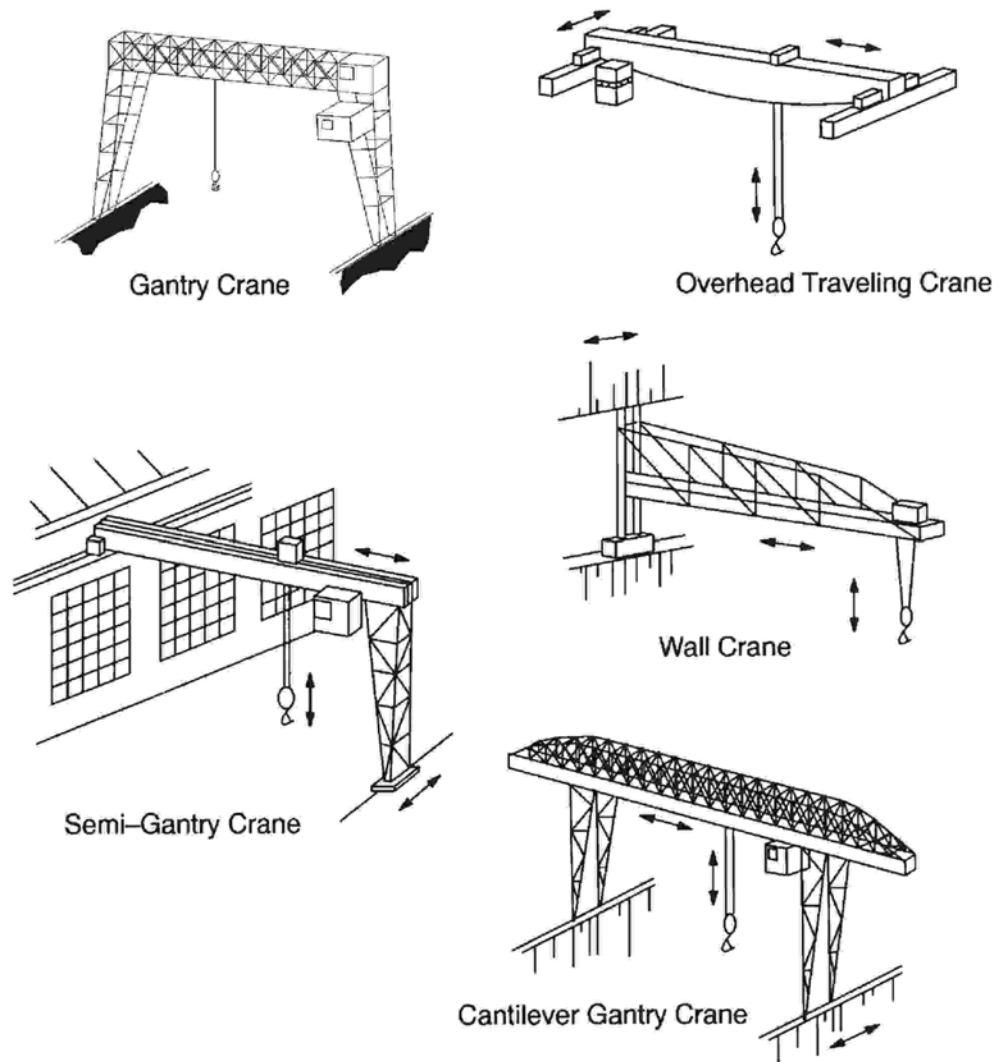

Figure 7-1. Top-running single- or multiple-girder bridge with top-running trolley hoist

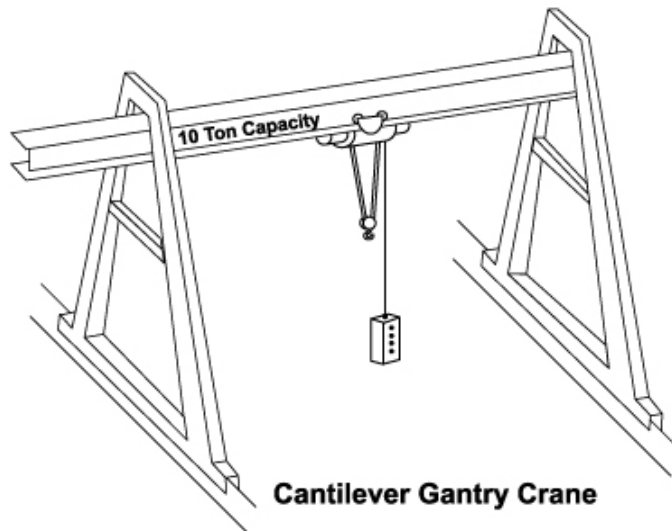
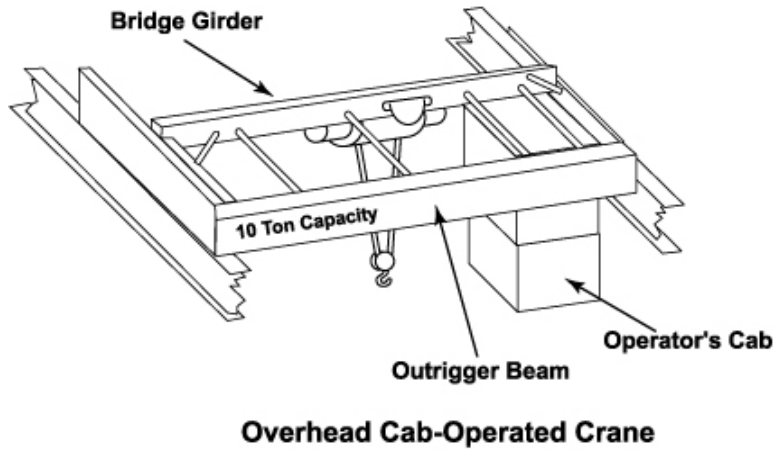

Figure 7-2. Top-running single-girder bridge with underhung trolley hoist.

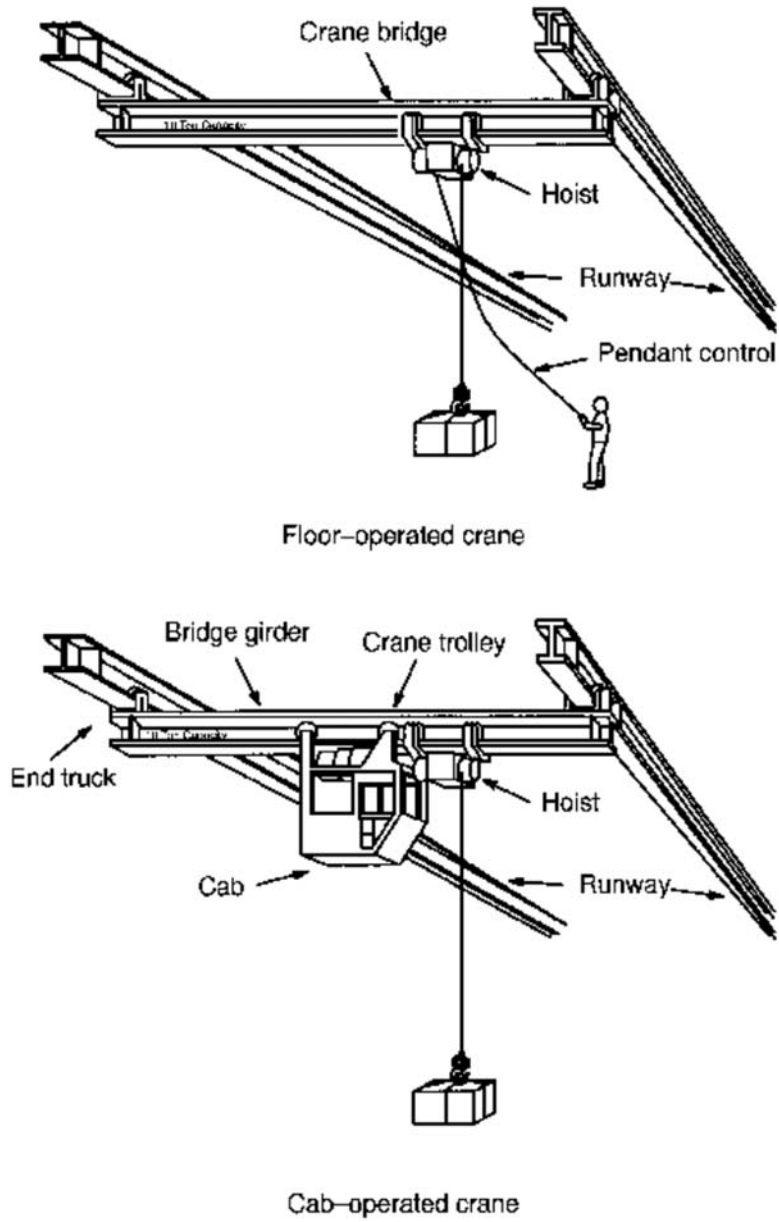

Figure 7-3. Monorails and underhung cranes.

3. A main-line contactor operated by a switch or push button on the pendant push-button station, the remote-control station, or the pulpit.

- b. Lower-travel limit switches/devices should be provided for all hoists where the load block enters pits or hatchways in the floor.

#### **7.1.7 HOIST-LIMIT SWITCH**

- a. The hoisting motion of all cranes shall have an overtravel-limit switch/device in the hoisting direction to stop the hoisting motion.

#### **7.1.8 LOAD LIMITS**

The crane shall not be loaded beyond its rated capacity except for test purposes, as described in Section 7.3.

#### **7.1.9 MAINTENANCE HISTORY**

The maintenance history of the crane shall be retained throughout its service life.

---

## 7.2 INSPECTIONS

---

### 7.2.1 GENERAL

There shall be no apparent damage, excessive wear, or deformation of any load-bearing part of the equipment. Brakes shall work satisfactorily and load brakes shall be designed to hold any load up to at least 125 percent of the rated capacity of the equipment without slipping or overheating. All safety devices, load indicators, controls, and other operating parts of the equipment shall be checked during each inspection and shall be in good working order. Parts found to be defective during any inspection or nondestructive examination shall be replaced or repaired as directed by the responsible line manager or that person's designated representative.

### 7.2.2 CRANE SERVICE

Crane service is defined as follows:

- a. Normal service – operating at less than 85 percent of rated load and not more than 10 lift cycles/hr except for isolated instances.
- b. Heavy service – operating at 85 to 100 percent of rated load or in excess of 10 lift cycles/hr as a regular specified procedure.
- c. Severe service – operating at normal or heavy service under abnormal operating conditions (i.e., extreme temperatures, corrosive atmospheres).

### 7.2.3 INITIAL INSPECTION

Prior to their initial use, all new, reinstalled, modified, or repaired cranes shall be inspected by a qualified inspector to ensure compliance with applicable provisions of this chapter. Inspections of repaired and modified cranes may be limited to the provisions affected by the alteration, repair, or modification as determined by a qualified person. Dated and signed inspection reports shall be kept on file and shall be readily available.

### 7.2.4 DAILY PREOPERATIONAL CHECK

- a. Operators or other designated personnel shall visually inspect the following items each day or prior to first use if the hoist has not been in regular service (records are not required):
  1. All functional operating mechanisms for maladjustment interfering with proper operation.
  2. Deterioration or leakage in lines, tanks, valves, drain pumps, and other parts of air or hydraulic systems.
  3. Hooks for cracks, deformation, latch engagement (if provided), and damage from chemicals (see Chapter 13, "*Load Hooks*," for additional hook requirements).
  4. Hoist rope for significant wear, kinking, crushing, birdcaging, corrosion, or broken strands or wires.
  5. Hoist chains, including end connections, for excessive wear, twist, distorted links interfering with proper function, or stretch beyond manufacturer's recommendations.
  6. Primary hoist upper-limit device for proper operation.
- b. Operators or other designated personnel shall examine deficiencies and determine whether the equipment should be removed from service or if a more detailed inspection is required.

### 7.2.5 MONTHLY ROPE, CHAIN, AND HOOK INSPECTION

- a. On a monthly basis, the operator or other designated person shall thoroughly inspect the following items for damage, wear, or other deficiencies that might reduce capacity or adversely affect the safety of the crane:



1. This shall be accomplished by lowering the hook block to its lowest position and examining for any condition that could result in an appreciable loss of strength.
  2. Hoist rope, including end connections, for significant wear, kinking, crushing, birdcaging, corrosion, broken strands or wires.
  3. Hoist chains, including end connections, for excessive wear, twist, distorted links interfering with proper function, or stretch beyond manufacturer's recommendations.
  4. Hooks for cracks, deformation, damage from chemicals, and evidence of heat damage. The hook attachment and securing means should also be checked. (See Chapter 13, "Load Hooks," for additional hook requirements).
  5. Signed and dated inspections records shall be kept on file and shall be readily available.
- b. Before the crane is returned to service, deficiencies that could reduce its capacity or adversely affect its safety shall be corrected.

**7.2.6 FREQUENT INSPECTION**

- a. Operators or other designated personnel shall visually inspect the crane at the following intervals (records are not required):
  1. Normal service – monthly.
  2. Heavy service – weekly to monthly.
  3. Severe service – daily to weekly.
- b. In addition to the requirements of Section 7.2.4, "Daily Preoperational Check," these inspections shall include the following:
  1. Hoist braking system for proper operation.
  2. Rope or chain reeving for compliance with hoist manufacturer's recommendations.

3. Operating mechanisms for proper operations, proper adjustment, unusual sounds, or excessive wear.
- c. Operators or other designated personnel shall examine deficiencies and determine whether the equipment should be removed from service or if a more detailed inspection is required.

**7.2.7 PERIODIC INSPECTION**

- a. A qualified inspector shall perform a complete inspection at the following intervals:
  1. Normal service – yearly.
  2. Heavy service – Semiannually to annually, dependant upon the nature of the crane's critical components and the degree of their exposure to wear or deterioration.
  3. Severe service –Monthly to quarterly.
- b. The qualified inspector shall examine deficiencies and determine whether they constitute a safety hazard and whether the crane should be removed from service until it is repaired.
- c. Dated and signed inspection records shall be kept on file and shall be readily available.
- d. A sample load test form is included as Exhibit I, which appears at the end of this chapter. This form is intended to be a sample only and is not intended to be mandatory.

**7.2.7.1 Cranes**

In addition to the requirements of Section 7.2.6, "Frequent Inspections," periodic inspections shall include the following:

- a. Components for deformation, cracks, or corrosion.
- b. Bolts, rivets, nuts, and pins for being loose or absent.
- c. Check for suspect/counterfeit parts (see Terminology and Definitions, Chapter 1).

- d. Sheaves and drums for cracks or wear.
- e. Parts such as pins, bearings, shafts, gears, rollers, locking and clamping devices, bumpers, and stops for wear, cracks, or distortion.
- f. Brake-system parts, linings, pawls, and latches for excessive wear.
- g. Load, wind, and other indicators over their full range for any significant inaccuracies.
- h. Gasoline, diesel, electric, or other power plants for improper performance or noncompliance with other applicable standards.
- i. Chain-drive sprockets for excessive wear and chains for excessive stretch.
- j. Electrical apparatus for signs of pitting or any deterioration of controllers, master switches, contacts, limit switches, and push-button stations (not limited to these items).
- k. Hooks for damage from chemicals, deformation, cracks, or having more than 15 percent in excess of normal throat opening, or more than 10 degree twist from the plane of the unbent hook (see Chapter 13 for additional hook requirements).
- l. Hook retaining nuts or collars and pins, welds, or riveting used to secure the retaining members for soundness.
- m. Nondestructive examination of hooks, welds, bearings, or other suspect load-bearing parts when required by the inspector.
- n. Testing of motion limit devices, which interrupt power or cause a warning to be activated, for proper performance (each motion shall be inched or operated at low speed into the limit device with not load on the crane).
- o. All function, instruction, caution, and warning labels or plates for legibility.

include examination of the entire length of the rope, without detaching it from the hoist drum. More frequent intervals shall be determined by a qualified person, and shall be based on such factors as expected rope life as determined by experience on the particular installation or similar installations, severity of environment, percentage of capacity lifts, frequency rates of operation, and exposure to shock loads. The qualified inspector shall carefully note any deterioration such as described below resulting in appreciable loss of original strength and determine whether further use of the rope constitutes an acceptable risk.

1. Reduction of rope size below nominal diameter, whether due to loss of core support, internal or external corrosion, or wear of outside wires (see Table 7-1).
2. The number and distribution or concentration of broken outside wires.
3. Worn outside wires.
4. Sections of rope that are normally hidden during inspection or maintenance procedures, such as parts passing over sheaves (these are points most subject to deterioration).
5. Corroded or broken wires at end connections
6. Corroded, cracked, bent worn, or improperly applied end connections.
7. Kinking, crushing, cutting, or unstranding.

b. All rope on cranes that have been idle for 1 month or more due to shutdown or storage shall be inspected before the crane is returned to service. A dated and signed report of the rope inspection, including results, shall be filed.

c. No precise rules can be given for determining the exact time to replace rope because many variables are involved. Safety in this respect depends largely on the use of good judgment by an appointed person in evaluating remaining strength in a used rope, after allowance for deterioration

**7.2.7.2 Wire Rope**

- a. A qualified inspector shall inspect all ropes at least annually. This inspection shall

disclosed by inspection. Safety of rope operation depends on this remaining strength.

d. Conditions such as the following shall be sufficient reason for questioning rope safety and considering replacement:

1. In running ropes, 12 randomly distributed broken wires in one rope lay, or 4 broken wires in one strand in one rope lay.
2. Wear of one-third of the original diameter of outside individual wires.
3. Kinking, crushing, birdcaging, or any other damage resulting in distortion of the rope structure.
4. Evidence of heat damage from any cause.
5. Reductions from nominal diameter greater than those listed in Table 7-1.

e. Replacement rope and connections shall have a strength at least as great as the original rope and connections furnished by the crane manufacturer. Any deviation from the original size, grade, or construction shall be specified by a rope manufacturer, the crane manufacturer, or a qualified person.

f. Never use discarded rope for slings.

**7.2.7.3 Chain (Welded Link)**

- a. Operate the crane under load in raising and lowering directions, and observe the operation of the chain and sprockets. The chain should feed smoothly into and away from the sprockets.
- b. If the chain binds, jumps, or is noisy, first see that it is clean and properly lubricated. If the trouble persists, inspect the chain and mating parts for wear, distortion, or other damage.
- c. The chain should be cleaned before inspection. Examine visually for gouges, nicks, weld spatter, corrosion, and distorted links. Slacken the chain and move adjacent links to one side to inspect for wear at the contact points. If wear is observed or

stretching is suspected, the chain should be measured according to the hoist manufacturer’s instructions. If instructions are not available, proceed as follows:

1. Select an unworn, unstretched length of the chain (e.g., at the slack end).
2. Suspend the chain vertically under tension and, using a caliper-type gauge, measure the outside length of any convenient number of links approximately 12 in. (305 mm) to 14 in. (356 mm) overall.
3. Measure the same number of links in the used sections and calculate the percentage of increase in length.

**Table 7-1. Maximum allowable rope reductions.**

Rope diameter	Maximum allowable reduction from Nominal diameter
Up to 5/16 in. (8 mm)	1/64 in. (0.4 mm)
Over 5/16 in. to 1/2 in. (13 mm)	1/32 in. (0.8 mm)
Over 1/2 in. to 3/4 in. (19 mm)	3/64 in. (1.2 mm)
Over 3/4 in. to 1 1/8 in. (29 mm)	1/16 in. (1.6 mm)
Over 1 1/8 in. to 1 1/2 in. (38 mm)	3/32 in. (2.4 mm)

- d. Conditions such as the following shall be sufficient reason for questioning safety and for considering replacement:
  1. If the used chain exceeds a crane manufacturer’s recommended length or, in the absence of such a recommendation, the used chain is 1.5 percent longer than the unused chain for powered hoists or is 2.5 percent longer than the unused chain for hand-operated chain, replace the chain.

2. The existence of gouges, nicks, corrosion, weld spatter, or distorted links.
- e. Repairing the load chain by welding or any other means shall not be attempted by anyone other than the chain manufacturer.
- f. Replacement chain shall be the same size, grade, and construction as the original chain furnished by the crane manufacturer unless otherwise recommended by the manufacturer due to working conditions.
- g. Load-chain links that pass over the load sprocket on edge (alternate to those that lie flat in the pockets) should be installed with the welds away from the center of the sprocket. This precaution is not required on idler sprockets, which change the direction but not the tension in the chain.
- h. The chain shall be installed without any twist between the hoist and an anchored end on either the loaded side or the slack side.
- i. When a chain is replaced, is disassemble and inspect the mating parts (sprockets, guides, stripper) for wear, and replace if necessary.
- j. Discarded load chain shall not be used for slings.

#### 7.2.7.4 Chain (Roller)

- a. Test the crane under load in raising and lowering directions, observing the operation of the chain and sprockets. If the chain binds, jumps, or is noisy, clean and properly lubricate it. If the trouble persists, inspect the chain and mating parts for wear distortion, or damage.
- b. If wear is observed or stretching is suspected, the chain shall be measured according to the crane manufacturer's instructions. If instructions are not available, proceed as follows:
  1. Suspend the hoist in normal position and apply a light load of approximately 50 lb (23 kg).
2. Select a 12 in. (305 mm) section of chain that normally travels over the load sprocket.
3. Determine elongation by measuring with a caliper from the edge of one chain pin to the corresponding edge of another pin. If elongation exceeds  $\frac{1}{4}$  in. (6.3 mm) in 12 in. (305 mm) compared to new or unstretched chain values, the chain shall be replaced.
4. Inspect for twist. Replace if the twist in any 5-ft (1.52 m) section exceeds 15 degrees.
5. Check for straightness in a plane perpendicular to the plane of the rollers. Replace if the chain has a bow exceeding  $\frac{1}{4}$  in. (6.3 mm) in any 5-ft (1.52 M) section.
6. Additional inspection shall be made by removing the chain from the crane and cleaning it thoroughly. Deficiencies such as those listed below shall be carefully examined and a determination shall be made as to whether they constitute a safety hazard:
  - i. Pins turned from original position.
  - ii. Rollers that do not run freely with light finger pressure.
  - iii. Joints that cannot be flexed by easy hand pressure.
  - iv. Side plates that are spread open.
  - v. Corrosion, pitting, or discoloration.
  - vi. Gouges, nicks, or weld spatter.
- c. Roller chain shall be replaced if any of the conditions exist as stated in paragraphs 7.2.7.4.b, 1 through 5 above.
- d. Deficiencies as stated in paragraph 7.2.7.4.b.6 above are reason for questioning chain safety and considering its replacement.
- e. Repairing of roller chain by welding or heating shall not be attempted.

- f. Replacement chain shall be the same size, grade, and construction as the original chain furnished by the crane manufacturer unless otherwise recommended by the manufacturer due to working conditions.
- g. Roller chain, discarded or new, shall not be used for slings.
- b. Cranes that have been idle for 6 months or longer shall be inspected before being placed in service according to the requirements listed above in Section 7.2.7, "Periodic Inspection."
- c. The determination supporting these alternate inspection frequencies and procedures shall be made by a qualified person for each affected crane. Documentation supporting this determination shall be kept readily available.

**7.2.8 CRANES NOT IN REGULAR SERVICE**

- a. Cranes that have been idle for 1 month or more but less than 6 months, shall be inspected before being placed in the service according to the requirements listed above in Section 7.2.6, "Frequent Inspection."

---

## 7.3 TESTING

---

### 7.3.1 OPERATIONAL TESTS

- a. Prior to initial use, all new, reinstalled, repaired, or modified cranes shall be tested by a designated person to ensure compliance with this chapter, including the following functions:
1. Lifting and lowering.
  2. Trolley travel.
  3. Bridge travel.
  4. Locking, limiting, and indicating devices, if provided.
  5. Limit switches/devices.
- b. The trip setting of hoist-limit devices shall be determined by tests with an empty hook traveling at increasing speeds up to the maximum speed. The actuating mechanism of the upper-limit device shall be located so that it will trip the device under all conditions and in sufficient time to prevent contact of the hook or load block with any part of the trolley or crane.

the crane and held by the hoist brakes. Personnel shall be kept clear of the test load while it is suspended.

2. Transport the test load by means of the trolley for the full length of the bridge.
3. Transport the test load by means of the bridge for the full length of the runway, in one direction with the trolley as close to the extreme right-hand end of the crane as practical, and in the other direction with the trolley as close to the extreme left-hand end of the crane as practical.
4. Lower the test load, stopping by the brakes.

- e. The replacement of load chain and rope is specifically excluded from this requirement; however, an operational test of the crane shall be made in accordance with paragraph 7.3.1.a.1 prior to putting the crane back in service.

- f. If wire rope clips or wedge socket end connection are installed during wire rope installation:

1. The crane should be cycled several times with a load equal to or greater than the maximum operational load, normally 100 percent of the rated capacity.
2. If wire rope clips are used, then check and retighten nuts to the wire rope clip or wire rope manufacturer's recommended torque value.
3. If a wedge socket is used, then verify that the rope is properly seated.

### 7.3.2 RATED LOAD TEST

- a. Prior to initial use, all new or reinstalled cranes and cranes in which the load sustaining parts have been altered, modified, repaired, or replaced, or whose rated capacities have been affected shall be tested by or under the direction of a qualified inspector.
- b. A written report confirming the rated load testing of the crane shall be furnished by the inspector.
- c. Test loads shall not be less than 100 percent or more than 125 percent of the rated capacity, unless otherwise recommended by the manufacturer or a qualified person.
- d. Testing shall consist of the following operations as minimum requirements:
1. Hoist the test load a sufficient distance to ensure that the load is supported by
- g. Operational testing of altered, repaired, or modified cranes whose load sustaining parts or rated capacities have not been affected may be limited to the functions affected by the alteration, repair or modification as determined by a qualified person.
- h. The transporting of test loads as required by paragraph 7.3.2.a above, shall be done

insofar as interfering equipment/structures permit and in accordance with recommendations from the manufacturer or a responsible engineering organization.

However, test loads should not be carried over critical systems or components.

- i. Test weights shall be accurate to within –5 percent, +0 percent of stipulated values.

---

## 7.4 MAINTENANCE

---

### 7.4.1 OPERATING EQUIPMENT

- a. A preventive maintenance program shall be established and based on the recommendation of the crane manufacturer. If equipment maintenance procedures deviate from published manufacturer's recommendations, the alternate procedures shall be approved in advance by the manufacturer or another qualified person and be kept readily available. Dated maintenance records should be kept where readily available to appointed personnel.
- b. Replacement parts shall be at least equal to the original manufacturer's specifications.
- c. All moving parts of the crane for which lubrication is specified shall be regularly lubricated. Check lubricating systems for delivery of lubricant. Follow manufacturer's recommendations as to points and frequency of lubrication, maintenance of lubricant levels, and types of lubricant to be used.
- d. Maintenance personnel shall take the following precautions before performing maintenance on a crane:
  1. Move the crane to a location where it will cause the least interference with other cranes and operations.
  2. Place any attached loads on the ground or floor.
  3. Place all controllers in the OFF position.
  4. Perform a lockout/tagout procedure.
  5. Use warning signs and barriers on the floor beneath the crane where overhead maintenance work creates a hazard.

6. If the runway remains energized, place stops or signalers full-time at a visual vantage point to observe the approach of active cranes and prohibit contact by the active cranes with the idle crane, with persons performing maintenance, or with the maintenance equipment.
7. Install a guard or barrier between adjacent runways for the length of the established work area to prevent contact between persons performing maintenance and any crane on the adjacent runway.

### 7.4.2 WIRE-ROPE MAINTENANCE

Personnel using wire rope shall ensure proper care by doing the following:

- a. Store rope to prevent damage or deterioration.
- b. Unreel or uncoil rope as recommended by the rope manufacturer and with care to avoid kinking or inducing a twist.
- c. Before cutting rope, use some method to prevent unlaying the strands. Heat affected zones of flame cut wire rope shall not be allowed to bear load.
- d. During installation, avoid dragging the rope in dirt or around objects that will scrape, nick, crush, or induce sharp bends in it.
- e. Maintain rope in a well-lubricated condition to reduce internal friction and prevent corrosion. Ensure that lubricant applied as part of a maintenance program is compatible with the original lubricant and is also a type that does not hinder visual inspection. Those sections of rope located over sheaves or otherwise hidden during inspection and maintenance procedures require special attention when the rope is being lubricated.



---

## 7.5 OPERATION

---

- a. The following shall apply to all personnel involved in overhead and gantry crane operation.
  - b. At the initial stage of the planning process, an appointed person shall classify each lift into one of the DOE-specified lift categories (ordinary, critical, or preengineered production).
- Also, notify the next operator of the defects at shift change.
- i. Contacts with runway stops or other cranes shall be made with extreme caution. If you are ordered to engage with or push other cranes, do this with particular care for the safety of persons on or below the cranes, and only after making certain that any persons on the other cranes are aware of what action is to be taken.

### 7.5.1 CONDUCT OF OPERATOR

- a. Do not engage in any practice that will divert your attention while operating the crane.
  - b. Do not operate cranes without complying with the requirements of Chapter 6. Your immediate supervisor shall participate in this determination.
  - c. Operators shall be held directly responsible for the safe operation of their equipment. Whenever there is any question as to the safety of the activity, an operator has the authority to stop and refuse to handle loads until the matter has been resolved by supervisory personnel.
  - d. Sound a warning signal (if furnished) during travel, particularly when approaching personnel.
  - e. If you find the crane's main or emergency switch open when starting on duty, do not close it until it has been determined that no one is on or close to the crane. If there is a warning sign on the switch, do not remove it unless you placed it there. Do not close the switch until the warning sign has been removed by the person who placed it there.
  - f. Before closing the main switch, ensure that all controllers are in the OFF position.
  - g. If a power failure occurs during operation, immediately switch all controllers to the OFF position.
  - h. Become familiar with your equipment and its proper care. If adjustments or repairs are necessary, or any defects are known, report them promptly to the responsible supervisor.
- j. Secure outdoor cranes before leaving them.
  - k. When the wind-indicating alarm is given, anchor the bridge on outside cranes.
  - l. Lock and tag the main positive electrical control switch in the OPEN position before any crane maintenance is performed.
  - m. Operate all controls before beginning a new shift. If any controls do not operate properly, adjust or repair them before operations begin.
  - n. Do not hoist two or more separately rigged loads in one lift, even though the combined load is within the crane's rated capacity.
  - o. Ensure that a 10BC or larger fire extinguisher is installed in the cab of cab-operated cranes. The extinguisher shall be maintained in a serviceable condition.
  - p. Do not lift, lower, or travel the crane while anyone is on the load or hook.

### 7.5.2 HOIST-LIMIT SWITCH/DEVICE

- a. At the beginning of each work shift, or the first time the crane is used during a shift, test the upper-limit switch/device of each hoist under no load. Exercise extreme care to avoid two-blocking; "inch" the block into the limit switch or run it in at slow speed. If the switch/device does not operate properly, immediately notify the supervisor.
- b. If a lift is in progress during a shift change, this testing requirement is considered to have been satisfied for the completion of

that lift. However, test the limit switch again before the next lift.

- c. Do not use the final hoist-limit switch/device that controls the upper limit of travel of the load block as an operating control.

### 7.5.3 STANDARD HAND SIGNALS

The standard hand signals for DOE use shall be as specified in the latest edition of the ASME B30 standards for the particular type of crane or hoist being used (see Figure 7-4).

### 7.5.4 IDENTIFICATION OF SIGNALERS

- a. All personnel acting as signalers during the crane operations shall be clearly identified to the crane operator by using the following (one or more, as required by the responsible manager): orange hardhat, orange gloves, and orange vest. This requirement may be waived by the responsible manager when the lift is very closely controlled or personnel are required to wear special clothing for protection from a hazardous environment.
- b. In those cases where the crane operator cannot see the signaler, a second person (relay signaler) shall be stationed where he or she can see both the signaler and the crane operator and signals can be relayed to the operator. The relay signaler shall also be clearly identified by the items described in the previous paragraph.
- c. Where voice (direct or two-way radio) communication is used, the signaler shall communicate directly with the operator, not through a third person.
- d. The operator shall obey signals only from the designated signaler. Obey a STOP signal no matter who gives it.

### 7.5.5 SIZE OF LOAD

- a. The weight of the load shall be determined prior to making the lift.
- b. The crane and rigging equipment shall not be loaded beyond its rated capacity, except for authorized testing described in Section 7.3.

### 7.5.6 ATTACHING THE LOAD

- a. Ensure that the hoist rope is free from kinks or twists. Do not wrap the hoist rope around the load.
- b. Ensure the load is attached to the load-block hook by means of slings or other approved devices.
- c. Take care to make certain that the sling clears all obstacles.

### 7.5.7 MOVING THE LOAD

- a. The person appointed to direct the lift shall see that the load is well secured and properly balanced in the sling or lifting device before it is lifted more than a few inches.
- b. Before starting to hoist, note the following conditions:
  1. Hoist rope shall not be kinked.
  2. Multiple-part lines shall not be twisted around each other.
  3. The hook shall be positioned above the center of gravity of the load in such a manner as to minimize swinging when the load is lifted.
  4. If there is a slack-rope condition, it should be determined that the rope is properly seated on the drum and in the sheaves.
  5. All personnel including the qualified rigger shall be clear of the load.
- c. During hoisting, take care to ensure that:
  1. The load is lifted slowly until it clears the ground or other support to minimize swinging.
  2. There is no sudden acceleration or deceleration of the moving load.
  3. The load does not contact any obstructions. A “dry run” shall be conducted in areas where clearance is limited.







 <p><b>HOIST</b> With forearm vertical, forefinger pointing up, move hand in small horizontal circles.</p>	 <p><b>LOWER</b> Extend arm downward, forefinger pointing down, and move hand in small horizontal circles.</p>	 <p><b>BRIDGE</b> Arm extended forward, hand open and slightly raised, make pushing motion in direction of travel.</p>
 <p><b>TROLLEY TRAVEL</b> Palm up, finger closed, thumb pointing in direction of motion, jerk hand horizontally.</p>	 <p><b>STOP</b> Extend arm, palm down, hold position rigidly.</p>	 <p><b>EMERGENCY STOP</b> Extend arm, palm down, moving hand rapidly right and left.</p>
 <p><b>MULTIPLE TROLLEYS</b> Hold up one finger for block marked "1" and two fingers for block marked "2." Regular signals follow.</p>	 <p><b>MOVE SLOWLY</b> Use one hand to give any motion signal and place other hand motionless above hand giving the motion signal. (Hoist slowly shown as example.)</p>	 <p><b>MAGNET IS DISCONNECTED</b> Crane operator spreads both hands apart, palms up.</p>

Figure 7-4. Standard hand signals for controlling overhead crane operation

- d. Cranes shall not be used for side pulls except when specifically authorized by an appointed person who has determined that the stability of the crane is not endangered and that load-bearing parts of the crane will not be overstressed.
  - e. Avoid carrying loads above people.
  - f. Each time a load approaching the rated capacity is handled, test the hoist brakes by raising the load a few inches and applying the brakes. Any slippage or downward motion is unacceptable.
  - g. Do not lower the hook below the point where less than two full wraps of rope remain on the hoisting drum.
  - h. When the load or hook approaches personnel, sound the warning signal.
  - i. Tag lines should be used as required to guide, snub, or otherwise control the load.
  - j. Do not leave a suspended load unattended unless specific precautions have been instituted and are in place.
  - k. Work on suspended loads is prohibited under normal conditions. If the responsible manager decides that it is necessary to work on a suspended load, guidelines for safe operation shall be established through consultation with the appropriate safety organization. Suspended loads that must be worked on shall be secured against unwanted movement.
- operation. If the lift is being made by only one person, that person assumes all responsibilities of the designated leader.
- d. Leadership designation may be by written instructions, specific verbal instructions for the particular job, or clearly defined responsibilities within the crew's organizational structure.
  - e. The designated leader's responsibility shall include the following:
    1. Ensure that personnel involved understand how the lift is to be made.
    2. Ensure that the weight of the load is determined, that proper equipment and accessories are selected, and that rated capacity is not exceeded.
    3. Survey the lift site for hazardous/unsafe conditions.
    4. Ensure that equipment is properly set up and positioned.
    5. Ensure that a signaler is assigned, if required, and is identified to the operator.
    6. Direct the lifting operation to ensure that the job is done safely and efficiently.
    7. Stop the job when any potentially unsafe condition is recognized.
    8. Direct operations if an accident or injury occurs.

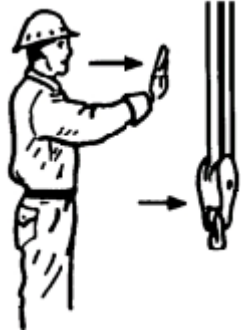
**7.5.8 ORDINARY LIFTS**

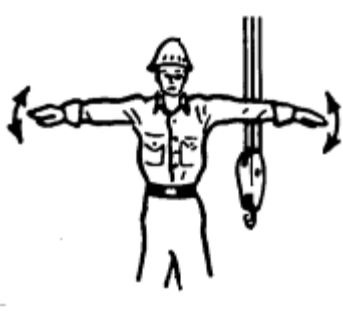
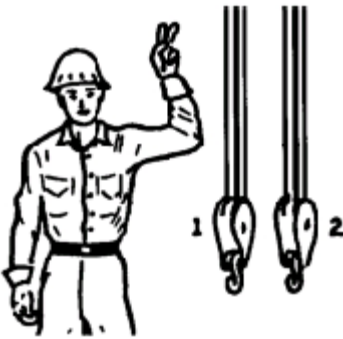
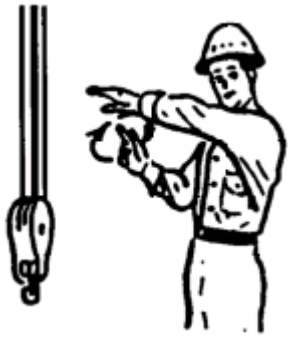
- a. The requirements of all preceding paragraphs in Section 7.5, "Operation," also shall apply to ordinary lifts.
- b. An appointed person shall classify each lift into one of the DOE categories (ordinary, critical, or preengineered production) before the lift is planned.
- c. Hoisting and rigging operations for ordinary lifts require a designated leader who shall be present at the lift site during the entire lifting
- f. The operator, or a designated person, shall ensure that the crane is still within the inspection interval.
- g. The operator, or a designated person, shall visually examine the crane in accordance with Section 7.2.4.

**7.5.9 CRITICAL LIFTS**

See Chapter 2, "Critical Lifts," for critical-lift requirements.

Exhibit I is intended to be a sample form only.  
The equipment manufacturer's inspection/testing  
criteria supercede any other criteria.  
In cases where the equipment manufacturer does not include  
inspection/testing criteria, other forms developed to facilitate  
required inspection/testing are acceptable.

INTENTIONALLY BLANK

**EXHIBIT I  
(SAMPLE FORM)**

BRIDGE, WALL, GANTRY CRANE LOAD TEST FORM

EQUIPMENT NO. \_\_\_\_\_ MAKE \_\_\_\_\_ RATED CAPACITY \_\_\_\_\_ DATE \_\_\_\_\_

**LOAD TEST INSPECTION REPORT**

The following checklist identifies the items to be inspected prior to the load test. Any unusual conditions observed during the inspection should be noted in the Remarks section.

- NOTES:**
1. Craftsmen shall initial and date all tests, work, and inspections completed below.
  2. Qualified inspector shall verify all steps prior to load test.

NO.	CRANE ITEM	DEFECT	OK	NA	NO.	CRANE ITEM	DEFECT	OK	NA
1	Load Hook & Blocks				18	Controllers			
2	Wire Rope and End Connections				19	Relays and Coils			
3	Handrails, Walkways, and Ladders				20	Conductors and Collectors			
4	Bridge and Trucks				21	Panel Wiring			
5	Bridge Wheels and Bearings				22	Resistors			
6	Trolley and Rails				23	Bypass Switches			
7	Trolley Wheels and Bearings				24	Limit Switches			
8	Crane Alignment				25	Contactors (Electrical)			
9	Runway Rail & Clamps				26	Motors			
10	Bumpers/Endstops				27	Gauges			
11	Brake System				28	Lighting System			
12	Drive Shafts, Gears, Couplings & Bearings				29	Heater and Switches			
13	Pawls, Ratchets, Spuds, & Windlocks				30	Operator's Cab			
14	Sheaves				31	Safety			
15	Warning Devices				32	Chain and Sprockets			
16	Capacity Signs				33	Structural			
17	Main Disconnect				34	Wire Rope Drum and Machinery Foundation			

REMARKS (unusual conditions – noises, structural cracks, misalignment, etc.)

**EXHIBIT I (continued)**

BRIDGE CRANE AND FOLLOW UP CHECKS

- NOTES:**
1. Craftsmen shall initial all steps completed below.
  2. Qualified inspector shall verify all steps below.
  3. Load test shall be performed on all new, repaired, or modified cranes prior to initial use.
  4. Load test crane at 125% of rated capacity. In no case shall the load test exceed 125% of rated capacity. Test weights shall be accurate to -5%, +0% of stipulated values.

**INITIAL**

- \_\_\_\_\_ 1. Set crane up for load test and qualified inspector verify inspection is complete prior to load test.
- \_\_\_\_\_ 2. The trip setting of hoist-limit devices shall be determined by tests, with an empty hook traveling at increasing speeds up to the maximum speed. The actuating mechanism of the limit device shall be located so that it will trip the device under all conditions and in sufficient time to prevent contact of the hook or load block with any part of the trolley or crane.
- \_\_\_\_\_ 3. Rig test weight to hoist hook using appropriate slings.
- \_\_\_\_\_ 4. Hoist the test load a sufficient distance to ensure that the load is supported by the crane and held by the hoist brakes.
- \_\_\_\_\_ 5. Transport the test load by means of the trolley for the full length of the bridge. Ensure during operation that the trolley runs true on the bridge. Check trolley motor, brake, and gear case for overheating.
- \_\_\_\_\_ 6. Transport the test load by means of the bridge for the full length of the runway, first in one direction with the trolley as close to the extreme right-hand end of the crane as practical and next in the other direction with the trolley as close to the extreme left-hand end of the crane as practical. Ensure that the bridge runs true on the runway rails and that no undue girder deflection occurs. Check for bridge motor, brake, and gear-case overheating.
- \_\_\_\_\_ 7. Move the test load back into the original position and lower the test load, stopping by the brakes. Hold the load for 10 minutes or the time required to check all primary load-bearing parts while under load for slippage, damage, or permanent deformation.
- \_\_\_\_\_ 8. Slowly lower the test load to the floor.
- \_\_\_\_\_ 9. At the completion of the load test, visually inspect the following load-bearing parts for signs of wear, deformation, and deterioration:



EXHIBIT I (continued)

DEFECTIVE/OK/NA

- \_\_\_\_\_ a. Bridge track
- \_\_\_\_\_ b. Bridge wheels
- \_\_\_\_\_ c. Trolley track
- \_\_\_\_\_ d. Trolley wheels
- \_\_\_\_\_ e. Gears
- \_\_\_\_\_ f. Magnetic brakes
- \_\_\_\_\_ g. Blocks.

Visually inspect rope in accordance with Chapter 11, "Wire Rope and Slings."

- \_\_\_\_\_ a. Rope diameter: (Previous) \_\_\_\_\_ (Present) \_\_\_\_\_
- \_\_\_\_\_ b. Wear
- \_\_\_\_\_ c. Kinks
- \_\_\_\_\_ d. Broken wires
- \_\_\_\_\_ e. Other signs of deterioration.

Visually inspect the rope drum for:

- \_\_\_\_\_ a. Wear
- \_\_\_\_\_ b. Deformation
- \_\_\_\_\_ c. Deterioration.

INITIAL

- \_\_\_\_\_ 10. Qualified inspector shall perform nondestructive tests on hook by visual examination, liquid penetrant examination, or magnetic-particle examination. Acceptance: No cracks, linear indications, laps, or seams.

Hooks with more than 15% normal (new hook) throat opening shall be replaced. Hooks with more than 10 degree twist from the normal (new hook) plane of the hook shall be replaced. Hooks having more than 10% wear in the throat section or 5% elongation of the shank shall be replaced. Lubricate hook bearing and latch pin as applicable.

Establish three marks, A, B, and C, with center punch. For ease in measuring, set distances on an even number of inches.

**BEFORE LOAD TEST**

Length AB \_\_\_\_\_ in.

Length BC \_\_\_\_\_ in.

**AFTER LOAD TEST**

Length AB \_\_\_\_\_ in.

Length BC \_\_\_\_\_ in.

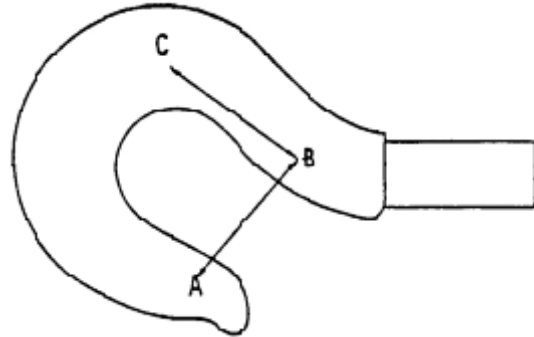

Check for:

1. Wear and deformation
2. Cracks and twisting
3. Signs of opening between Point A and Point B

Load Test Inspection Date \_\_\_\_\_

Qualified Inspector \_\_\_\_\_

Operated By \_\_\_\_\_

Actual Load Test \_\_\_\_\_ lb

**EXHIBIT II  
(SAMPLE FORM)**

OVERHEAD CRANE PRE-OPERATIONAL CHECKLIST  
(Records Are Not Required)

CRANE NO.		CAPACITY	TYPE	LOCATION	SHIFT 1 2 3		
OPERATORS NAME:			INSTRUCTIONS: Check all items. Inspect and indicate as: Satisfactory – S, Unsatisfactory – U, or Not Applicable – NA				
1. WALK AROUND INSPECTION			S/U/ NA	2. MACHINERY INSPECTION		S/U/ NA	
a	Foundations			a	Holding Brake	*	
b	Access			b	Load Control Brake		
c	Secured Items			c	Covers Secured		
d	Walkways/Handrails			d	Upper Sheaves	*	
e	Bridge, Drive Motor			e	Wire Rope	*	
f	Bridge Brake	*		f	Hooks: Cracks, Wear, Deformation Throat Opening, Latch Operation	*	
g	Hydraulics			g	Fluid Leaks		
h	Couplers/Connection Rods			h	Batteries		
i	End Trucks	*		i	Electric Motors		
j	Rail Sweeps			j	Electric Panels		
k	Windlocks/Chock/Stops			k	Runway/Bridge Conductors		
l	Housekeeping			l	Runway/Bridge Collectors		
				m	Electrical Guards		
				n	Festoon System		
				o	Warning Tags/Signs		
				p	Exposed Electrical Hazards		
				q	Trolley Stops	*	

**EXHIBIT II (continued)**

OVERHEAD CRANE PRE-OPERATIONAL CHECKLIST  
(Records Are Not Required)

3. OPERATOR CAB INSPECTION		S/U/ NA	4. OPERATION INSPECTION		S/U/ NA
a	Housekeeping		a	Power Supply Relay *	
b	Warning Tags *		b	Manual Reset	
c	Cab Door(s)		c	Stop Button/Control *	
d	Fire Extinguisher		d	Pendant Buttons *	
e	Controls Identification		e	Upper Limit/Main *	
f	Electrical Enclosures		f	Upper Limit/Auxiliary *	
g	Pendant Strain Relief		g	Lower Limit/Main	
h	Visibility/Windows		h	Lower Limit/Auxiliary	
i	Safety Devices		i	Bridge Controls *	
j	Warning/Indicator Light		j	Bridge Brake *	
k	Alarms		k	Trolley Control *	
			l	Main Hook *	
			m	Auxiliary Hook *	
			n	Work Area	
			o	Runway Stops *	
			p	Travel Limit Relays *	
<p><b>INSTRUCTIONS:</b> Inspect all applicable items each shift of operation. Suspend all operations immediately when observing an unsatisfactory condition for asterisked (*) items. In addition, suspend operation when any unsafe condition is observed and immediately notify supervisor. Other conditions not affecting safety shall be noted under "Remarks" and reported to supervisor.</p>					
<p><b>REMARKS:</b></p>					

**EXHIBIT III  
(SAMPLE FORM)**

PERIODIC CRANE INSPECTION REPORT

MECHANICAL ITEMS						
<b>MAKE:</b>		<b>CAPACITY:</b>		<b>LOCATION:</b>		
<b>STATUS CODE:</b> SR – Should be Replaced NR – Needs Repair R – Repaired SN – See Notes N/A – Not Applicable						
ITEM	OK	CODE		ITEM	OK	CODE
<b>Bridge</b>				- Cam Followers/Guide*		
- Alignment				- Runway End-Stops		
- Girders (camber)				- Railway Sweeps/Safety Lugs		
- Rails				- Energy Absorbing Bumpers		
- Walks, Ladders, Railings				<b>Mono Rail</b>		
- Trucks to Girder Connection				- Girders		
- Trucks				- Girder Supports		
- Wheels, Driver*				- Sway Braces		
- Wheels, Idler*				<b>Misc.</b>		
- Wheels, Bearings*				- Clearances Overhead (3")		
- Axles & Coupling*				- Clearances Lateral (2")		
- Squaring Shaft				Rated Load Markings:		
- Squaring Shaft Bearings				- Each Side of Crane Bridge		
- Squaring Shaft Couplings				- Each Hoist/Load Block		
- Motor Coupling				<b>Trolley Drive</b>		
- Gear Reducer				- Wheels, Driver*		
- Gear Reducer Oil Seals				- Wheels, Idler*		
- Axle Pinion				- Wheels, Bearings*		
- Axle Gear				- Axles & Couplings		
- Runway Alignment				- Motor Couplings*		

**EXHIBIT III (continued)  
(SAMPLE FORM)**

ITEM	OK	CODE		ITEM	OK	CODE
- Gear Reducer				- Drum Grooving		
- Gear Reducer Oil Seals				- Drum Shafts		
- Axle Pinion				- Motor Pinion		
- Axle Gear				- Motor Gear		
- Cam Followers/Guides*				- Intermediate Pinion		
- Energy Absorbing Bumpers				- Intermediate Gear		
- End Stops				- Drum Pinion		
<b>Hoist (M – Main) (A – Auxiliary)</b>				- Drum Gear		
- Hook				- Hoist Case Bearing		
- Hook Bearing				- Mechanical Load Brake*		
- Sheaves*				- Friction Disc*		
- Sheave Bearings*				- Pawl*		
- Equalizer Sheave*				- Pawl Shifter		
- Rope/Chain				- Ratchet or Band		
- Rope Anchors				- Motor Coupling*		
				- Hoist Case Coupling*		
<b>Needs Immediate Action:</b>						
<b>Notes:</b>						
<b>Circle One:                      PASS                                      FAIL</b>						
INSPECTOR: (print) _____ SIGNATURE: _____ DATE: _____						

Items with \* to be inspected prior to use as part of the Pre-Operational check and lubricated as needed. All other items to be inspected and lubricated annually.

**EXHIBIT IV  
(SAMPLE FORM)**

OVERHEAD CRANE PERIODIC INSPECTION REPORT

ELECTRICAL ITEMS						
<b>MAKE:</b>		<b>CAPACITY:</b>		<b>LOCATION:</b>		
<b>STATUS CODE:</b> SR – Should be Replaced NR – Needs Repair R – Repaired SN – See Notes N/A – Not Applicable						
ITEM	OK	CODE		ITEM	OK	CODE
<b>Brakes</b>				- Trolley Motor Rings		
- M.H. Brake Shoes & Disc				- M.H. Motor Bearings		
- M.H. Brake Linings*				- M.H. Motor Brushes*		
- M.H. Brake Linkage				- M.H. Motor Rings		
- M.H. Brake Coil				<b>Misc.</b>		
- A.H. Brake Shoes & Discs						
- A.H. Brake Lining*						
- A.H. Brake Linkage						
- A.H. Brake Coil						
- Trolley Brake Shoes & Disc						
- Trolley Brake Lining*				<b>Controls</b>		
- Trolley Brake Linkage				- <i>For Magnetic Control</i>		
- Trolley Brake Coils				- Master Switches		
- Hydraulic Brake Bleeder*				- Push-button Station		
<b>Motors</b>				- M.H. Contactors		
- Bridge Motor Bearings				- A.H. Contactors		
- Bridge Motor Brushes*				- Trolley Contactors		
- Bridge Motor Rings				- Bridge Contactors		
- Trolley Motor Bearings				- M.H. Overhead Relays		
- Trolley Motor Brushes*				- A.H. Overhead Relays		

**EXHIBIT IV (continued)  
(SAMPLE FORM)**

ITEM	OK	CODE		ITEM	OK	CODE
<b>Controls (continued)</b>				<b>Resistors</b>		
- Trolley Overhead Relays				- M.H. Resistors		
- Bridge Overhead Relays				- A.H. Resistors		
- M.H. Limit Switch Contacts				- Trolley Resistors		
- A.H. Limit Switch Contacts				- Bridge Resistors		
<b>For Manual Drum Control</b>				<b>Mainline</b>		
- M.H. Finger Tips*				- Mainline Switch		
- M.H. Segments*				- Fuses (Sizes.....)		
- A.H. Finger Tips*				- Power Wiring		
- A.H. Segments*				- Control Wiring		
- Trolley Finger Tips*				- Trolley Collectors*		
- Trolley Segments*				- Runway Collectors*		
- Bridge Finger Tips*				- Bridge Conductors		
- Bridge Segments*				- Runway Conductors		
<b>Needs Immediate Action:</b>						
<b>Notes:</b>						
<b>Circle One:                      PASS                                      FAIL</b>						
INSPECTOR: (print) _____ SIGNATURE: _____ DATE: _____						

Items with \* to be inspected prior to use as part of the Pre-Operational check and lubricated as needed. All other items to be inspected and lubricated annually.