

# ***WATER OPERATION AND MAINTENANCE***

**BULLETIN NO. 98**

DECEMBER 1976

**LAST COPY - DO NOT REMOVE**



**LAST COPY - DO NOT REMOVE**

## ***IN THIS ISSUE***

THE RIGHT PUMP FOR YOUR WELL  
HOW TO READ AND USE A PUMP CHART  
ANOTHER SPUR FOR THE SEATBELT  
PHYSICAL STANDARDS FOR MOTOR VEHICLE OPERATORS  
WINDSHIELD WIPER TIP  
CRANE WARNING  
OSHA ANNOUNCES NEW TRAINING PROGRAM ON CONSTRUCTION SHORING  
HEARING LOSS FOUND IN NEW HIRES  
HUGE EXCAVATORS KEEP IRRIGATION CANALS IN SHAPE  
A VACUUM CLEANER FOR TRASHRACKS  
GATE VALVE OPERATOR MODIFICATION

**UNITED STATES DEPARTMENT OF THE INTERIOR**  
**Bureau of Reclamation**

The Water Operation and Maintenance Bulletin is published quarterly for the benefit of those operating water-supply systems. Its principal purpose is to serve as a medium of exchanging operation and maintenance information. It is hoped that the reports herein concerning laborsaving devices and less costly equipment and procedures will result in improved efficiency and reduced costs of the systems for those operators adapting these ideas to their needs.

To assure proper recognition of those individuals whose suggestions are published in the bulletins, the suggestion number as well as the person's name is given. All Bureau offices are reminded to notify their Suggestions Award Committee when a suggestion is adopted.

Any information combined in this bulletin regarding commercial products may not be used for advertisement or promotional purposes and is not to be construed as an endorsement of any product by the Bureau of Reclamation.

Equivalent metric units have been added to all the articles.

\* \* \* \* \*

Division of Water Operation  
and Maintenance  
Engineering and Research Center  
Denver, Colorado 80225



COVER PHOTOGRAPH:

At the end of each irrigation season, the Bureau of Reclamation's Tucumcari Project proceeds with a continuing program of concrete lining project irrigation laterals. Caterpillar is shown pulling slip-form down excavated laterals as transit-mix off-loads concrete. Resultant concrete lateral is practically maintenance free.

WATER OPERATION AND MAINTENANCE  
BULLETIN NO. 98

December 1976

INTRODUCTION

Pump efficiency is getting the most water from your pump with the least amount of fuel as described in the first article on page 1.

An article on page 4 shows how to read and use a pump chart.

A series of six short articles on the various aspects of safety can be found starting on page 7.

To keep irrigation canals open and in good condition, adequate maintenance equipment is most important, as told in the article on page 10.

Starting on page 11, an article from the State of California, Department of Water Resources, describes a most unique method they use for eliminating floating weeds from trashracks.

The article starting on page 17, from the Solano Irrigation District, describes a modified gate valve opener that will save time and effort for the operator.

\* \* \* \* \*

Metric SI Units

km = kilometre  
kg = kilogram  
kPa = kilopascal  
kW = kilowatt  
ℓ = litre  
m<sup>3</sup> = cubic metre  
mm = millimetre  
dam<sup>3</sup> = cubic dekametre

## THE RIGHT PUMP<sup>1</sup> FOR YOUR WELL

Pump the most water with the least fuel. That's what pump efficiency is all about, says Texas Extension irrigation engineer Leon New.

"A pump that's properly matched to a specific well capacity and pumping lift should perform at 70- to 80-percent efficiency when it's in good repair," says Mr. New. "But with the normal wear that occurs after 6 to 8 years of use, it's not unusual for the same pump to decline to 30- or 40-percent efficiency. Low efficiency can also result when the water capacity and lift or head abilities of the pump do not match those of the well.

"Pumps can and should be selected and matched to well capacity and pumping lift by using the pump performance information available from the manufacturer. If you're buying a new pump, you should receive a copy of its specifications. If you don't have the information, you can obtain it from the manufacturer by giving him the pump's model number, bowl number, and size.

"Well capacity and pumping lift can be determined for both new and old wells by test pumping, using a temporary pump," says Mr. New. Do not under-evaluate the benefits of test pumping, especially for new wells. Many drillers can test pump your well for a reasonable cost.

Reliable well capacity and pumping lift readings can also be made on older wells with an existing pump by metering the water and measuring the pumping lift with a long tape or special water drawdown gage. However, these measurements should be made only after the pump has been in operation for 24 hours, or after the water delivery and pumping lift have become stationary. A flow control valve such as a gate valve may be helpful when constant-speed electric power units are used.

Compare well lift and water delivery before relocating a pump. "Pumps, especially in areas where water tables are diminishing, are often selected to lift all of the water that an individual well can continually make available," says Mr. New. "A pump that's properly used to deliver 1893 l (500 gal) of water per minute from a pumping depth of 91.4 m (300 ft) is likely to perform at much lower efficiency if it's relocated to a well that only has a 1136-l (300-gal) per minute capacity and a pumping depth of 137.2 m (450 ft)."

---

<sup>1</sup> Reprinted by special permission of the Editor from the January 1976 issue of IRRIGATION AGE.

Pump efficiency may also suffer when well conditions change. The declining water table characteristics of the West Texas Ogallala underground water supply, for example, gradually create a mismatch between the pump and well. When water tables decline and pumping depths increase, it's characteristic for the well capacity to gradually be reduced. And when these changes in well conditions are combined with normal pump wear, pump efficiency can plummet.

"Irrigation pumping costs have soared to new highs during the past two crop seasons, and there's more likely to come," says Mr. New. "Energy suppliers say that wholesale purchases are more competitive than ever before. Some energy authorities predict critical fuel shortages by 1985. None of this is good news to the irrigating farmer who desperately needs a dependable supply of energy at a cost in line with market prices of crops."

He adds that the only real recourse growers have to skyrocketing irrigation costs is improved equipment efficiency and water management, "or possibly the use of more low-lift playa lake pumps."

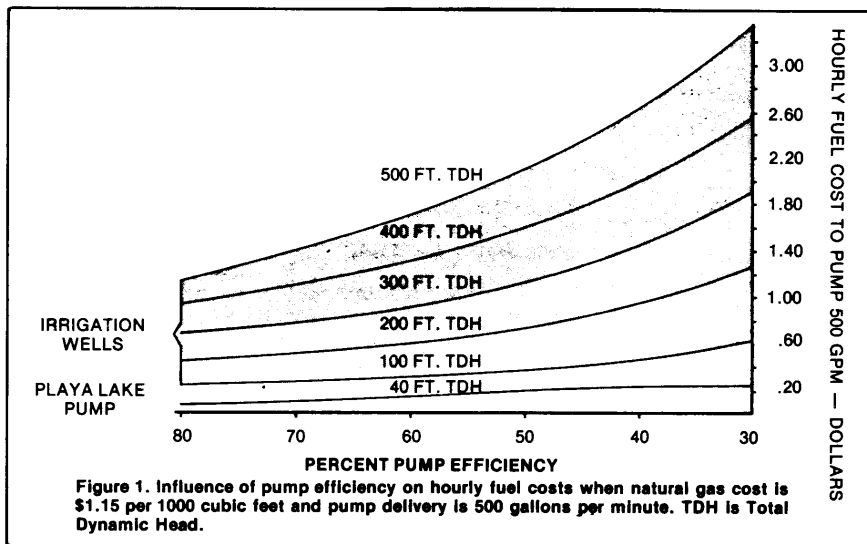

Figure 1 above, illustrates the differences in hourly fuel costs between highly efficient and less efficient pumps when pumping 1893 l (500 gal) per minute with a natural gas power plant. Total Dynamic Head (TDH) is the sum of all head components that oppose water movement and create pressure which the pump and power unit must overcome. Head components include pumping lift, friction loss in suction and discharge pipes, and discharge pressure such as that required for sprinkler irrigation or to pump the water uphill.

The fuel costs as influenced by pump efficiency are shown for irrigation well TDH's of 30.5, 61, 91.4, 121.9, and 152.4 m (100, 200, 300, 400, and 500 ft), and lower fuel cost of low-lift playa lake pumps is also included. These cost comparisons illustrate how much greater the fuel consumption and costs are when the TDH is high and pump efficiency low.

"With a TDH of 91.4 m (300 ft), hourly fuel costs to pump 1893  $\ell$  (500 gal) per minute would be \$0.82, when pump efficiency is 70 percent," says Mr. New. "But the hourly cost rises to \$1.90 after pump efficiency declines to 30 percent. You multiply individual annual hours of pump operation by the difference in hourly pumping cost, in this case \$1.08, to determine the extra fuel cost because of low pump efficiency.

"So, assuming 3,000 hours of annual pumping, the low pump efficiency in this example costs an additional \$3,240.00 per year. That's also the payout rate on the cost of pump repair."

\* \* \* \* \*

#### DAM'S FEATURE--Top Location

If the Gibson Dam is not the longest, or highest, or widest, or any of those other dimensions that virtually every dam claims, at least it can claim a setting in some of the West's prettiest country. Completed in 1929 by the Bureau of Reclamation to provide water storage, it dams the Sun River in Montana as it winds its way from the east slope of the Continental Divide in the Northern U.S. Rockies to Great Falls.

It's located in the heart of the Lewis & Clark National forest 37 km (23 mi) from Augusta, Montana. The 130 000 m<sup>3</sup> (170 000 yd<sup>3</sup>) single-arch structure is 61 m (200 ft) high and 280.4 m (920 ft) long at the crest. Jet-flow gates control river releases and a glory-hole type spillway provides protection to the dam during flood conditions.

Western Construction

## HOW TO READ AND USE<sup>1</sup> A PUMP CHART

Before you buy a pump, it's important to find out if it efficiently satisfies the requirements of your system. That's why manufacturers generally provide charts which include efficiency for each pump model they sell.

University of Nebraska Extension irrigation engineer John Addink offers the following illustration as an example of how to read and use pump performance curves. A typical efficiency pump chart that is easy to read and use is shown in figure 2 below.

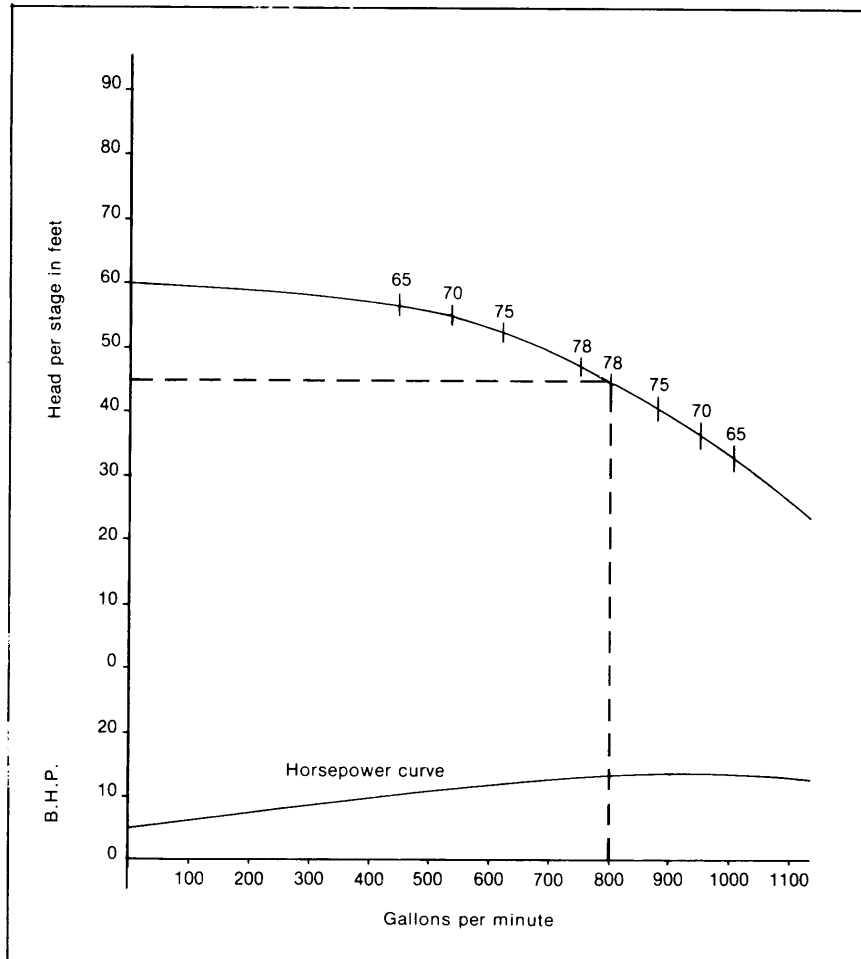

Figure 2

<sup>1</sup> Reprinted by special permission of the Editor from the January 1976 issue of IRRIGATION AGE.

Let's assume you want to obtain 3028  $\ell$  (800 gal) of water per minute from your well, which would be typical of many center pivot systems. You should already know the pumping depth and desired water pressure at the surface. In this example, let's say the pumping depth is 30.5 m (100 ft), and that you need 483 kPa (70 lb/in<sup>2</sup>) of pressure at the surface.

Now, you multiply the desired pressure 483 kPa times 0.98064 to convert head in terms of metres of water (multiply 70 lb/in<sup>2</sup> times 2.31 to convert to head in terms of feet). That comes to 49.3 m (161.7 ft). Then add the pumping depth, or 30.5 m (100 ft), to arrive at the total pumping head of 79.8 m (261.7 ft). There may be miscellaneous head losses which can usually be omitted for a pivot system.

Locate 3028  $\ell$ /min (800 gal/min) at the bottom of the chart and follow it straight up until it intersects the head-discharge curve. On the left side of the chart, you'll find that at 3028  $\ell$ /min the pump produces 13.7 m (45 ft) per stage or bowl. Now divide the total pumping head, or 79.8 by 13.7 m (261.7 by 45 ft), and you'll learn that you need 5.9 stages in the pump assembly. But since you can't use a partial stage, you'll have to go to a 6-bowl assembly.

Generally, the more bowls, or stages, that your pumping assembly has, the more energy required to lift and deliver the water from the well. In this case, a 6-stage assembly would actually create a 82.3-m (270-ft) pumping head, compared to the 79.8-m (261.7-ft) head that you needed. Having extra pumping head usually is good because the bowls may produce less head with increasing wear and the pumping depth may increase. Had you found that you only needed 5.2 stages, however, you still would have had to install a 6-stage pump. In that event, the pumping head would have been substantially greater than you really needed, with a consequent reduction in pumping efficiency. Another pump model might then come closer to what was needed.

Take a look at the efficiency numbers on the chart. Again following the chart upward from the bottom, you'll find that the efficiency of this pump at 3028  $\ell$ /min would be about 78 percent, an average efficiency rate for many irrigation pumps.

Now you're ready to determine the pump's shaft power (kW) (brake horsepower (bhp)), or the amount of power needed to properly operate the pump under typical irrigating conditions. This figure is represented by the bottom curve on the chart. At 3028  $\ell$ /min, this pump requires about 9 kW (12 bhp) per stage. Using a total of 6 stages in the pump assembly, you find that you need approximately 54 kW (72 hp) (number of stages times kW (bhp) stage).

With a power requirement of 54 kW a 56-kW (75-hp) electric motor is fine. Suppose a 58-kW (78-bhp) motor were required. You then have



the option of installing a 56-kW motor, which would be slightly underpowered, or of going to the next larger motor size, which would probably be 75 kW (100 hp). In this case you would probably be ahead to overload the motor by 2.2 or 3 kW (3 or 4 hp) because most electric motors can be overloaded 5 to 10 percent. The amount of motor stress caused by that small amount of overloading is likely to cost you less than the purchase and operating expense of a much larger motor.

What other characteristics should you look for in an irrigation pump? Mr. Addink says you should look for a fairly flat kW (bhp) curve, particularly for an electric motor. For example, if the pump described had required 12 kW (16 bhp) per stage at 4164 l/min (1100 gal/min) for a total of 72 kW (96 bhp), a 56-kW (75-hp) electric motor would be overloaded on pump startup unless a valve was closed and opened each startup.

He also suggests that the adjustments of closed impellers may not be as critical as for semi-open impellers.

Construction, too, plays an important part in your selection. For instance, if pumps in your area have corrosion problems, it might be better if your pump has a thicker-walled pumping column. Otherwise the corrosive effects of the water could ultimately cause holes in the column. Under many situations, thinner-walled columns are sufficient and lower in cost.

Also keep in mind that pump efficiency charts will vary from one manufacturer to the next, so you can't always compare efficiency charts of different manufacturers. It may be necessary to plug the figures from your system into each efficiency formula to find the pump that fits your needs best.

\* \* \* \* \*

The Final Version of the National Interim Drinking Water Standards were recently published by EPA. The Standards, which take effect June 24, 1977, will apply to both public and privately owned public water systems having at least 15 service connections or regularly serving at least 25 individuals. EPA estimates the total investment needed to enable community water systems to achieve compliance will be in the range of 1.05 to 1.765 billion dollars. The Standards were published in the December 24, 1975 Federal Register.

APWA Reporter, February 1976

## ANOTHER SPUR FOR THE SEATBELT<sup>1</sup>

If nothing else can convince motorists to use seatbelts, this may do it. New York State's highest court ruled, in a recent lawsuit, that a driver who didn't have her seatbelt buckled was not entitled to damages for injuries for a smashup allegedly caused by someone else.

The case involved a woman who, driving with seatbelt unbuckled, was hit by a tractor-trailer at an intersection. She was thrown from her car, which rolled over and pinned her legs under a wheel. She sued the trucking firm on grounds that she had the right-of-way and that the truck driver was clearly at fault. The company countered that if her seatbelt had been fastened she would not have been thrown out and injured. The jury agreed. She got nothing.

She ultimately took her case to the highest court in the state, and lost again, because - the verdict read - she had failed to "exercise due care, not only to avoid injury to herself but to mitigate any injury she might sustain."

Here is a precedent that insurance adjusters nationwide can latch on to. So, when you decide it's too much trouble to buckle up, remember: you may have to pay for that wheelchair yourself.

## PHYSICAL STANDARDS FOR MOTOR VEHICLE OPERATORS

The Executive Director of the United States Civil Service Commission has issued the following bulletin to the heads of Federal Departments and Agencies.

1. We recently had occasion to review a National Transportation Safety Board report of a motor vehicle accident in which 13 persons were killed, including the driver. An autopsy revealed that the driver's physical condition was such that he probably should not have been operating a motor vehicle.

2. The driver had been given a preemployment physical examination approximately five months before the accident, and it was noted at that time that his hypertensive condition warranted further medical evaluation. There is no evidence, however, that this further evaluation was made, as the examination report was never completed to show the recommendations of the examining physician and the personnel officer.

---

<sup>1</sup> These safety tips are reprinted here by special permission of the Chief, Division of Safety, from the Reclamation Safety News, First Quarter 1976.

3. Although it was not established that the driver's physical condition was the underlying cause of the accident, that possibility certainly exists.

4. The circumstances surrounding this accident emphasize the importance of obtaining the recommendations of a medical officer in any instance when an operator or incidental operator of a motor vehicle does not meet the physical fitness standards set forth in FPM chapter 930, appendix A.

Please be sure that all of your appointing officers are aware of the provisions in this appendix. Any questions pertaining to the physical standards for motor vehicle operators can be directed to: Chief, Medical Division, Bureau of Retirement, Insurance and Occupational Health, 1900 E Street, NW., Washington, D.C. 20415.

#### WINDSHIELD WIPER TIP

A professional driver makes a particular point of cleaning his windshield wipers before each trip. He had found that during the course of his driving, a film of road oil, dirt, and other contaminants would collect on the wiper blade. If available, he would clean the blade with soap and water, rinsing it carefully afterward. Often, the cleaning process would include the use of a rag and water, and sometimes it would be accomplished with a Kleenex and a little spit. Whichever method he uses, he has avoided that few minutes of "driving blind" after encountering the first rain or heavy fog. It also extends the life of the wiper blade considerably.

\* \* \* \* \*

#### CRANE WARNING

Under the Occupational Safety and Health Standards it is not enough to warn and instruct employees about safety hazards - the employer also has a duty to see that instructions are carried out, and, if possible, to remove job hazards. In one case, employees were instructed not to operate a crane within 3 m (10 ft) of an energized powerline. An employee ignored these instructions and was electrocuted.

An Administrative Judge held the company liable, saying it should have taken steps to remove the hazard by de-energizing the line.

\* \* \* \* \*

OSHA ANNOUNCES NEW TRAINING PROGRAM  
ON CONSTRUCTION SHORING

A one-day training program in safe construction shoring procedures and techniques has been published by the U.S. Department of Labor's Occupational Safety and Health Administration (OSHA).

Produced by OSHA, in cooperation with the Division of Safety and Health, Industrial Commission of Arizona, and the Associated General Contractors of America, the 8-hour course consists of a classroom session and a practical "hands-on" exercise where actual shoring procedures are accomplished by students in a trench specially built for training purposes.

The \$20 training package consists of an instructor's manual and a set of 60 color slides. The package is available from the Order Section, National Audiovisual Center, General Services Administration, Washington, D.C. 20409. Orders should specify Sloping, Shoring, and Shielding.

HEARING LOSS FOUND IN NEW HIRES

A recently published report on the results of one company's hearing survey of new employees adds strong legal and financial persuaders to the case for preemployment medical screening.

A Pennsylvania textile manufacturer in 1972 set up a hearing conservation program which included recording and analyzing audiograms of 800 employees, including 152 new hires who had not yet been exposed to noise in the plant. Results were startling. A third of the new employees had some measurable hearing defect, and 9.2 percent had reached levels which are compensable under the workers' compensation laws of most states.

Recent reports of claim settlements suggest that these employees could have cost the firm at least \$42,000 in compensation if their job-entry hearing disabilities had not been identified and documented. The preplacement audiograms freed the employer from legal or moral responsibility for existing hearing loss.

Knowledge of hearing loss influenced management decisions about job placement, scheduling monitoring audiometry, and the use of hearing protection. A number of the new hires were referred for medical followup.

A report of Allan Heffler, "Hearing Losses of Job Applicants" presents these facts accompanied by further details and charts. Copies may be obtained by writing to: Maico Hearing Instruments, Inc., 7375 Bush Lake Road, Minneapolis, Minnesota 55435.

\* \* \* \* \*

HUGE EXCAVATORS<sup>1</sup>  
KEEP IRRIGATION CANALS  
IN SHAPE

More than ±805 km (500 mi) of open irrigation canals on a large western farm are being maintained by a fleet of three self-propelled rubber-tire excavators, along with the standard use of draglines and sloper graders. The excavators work 50 to 54 hours per week, digging mud and silt, placing riprap erosion protection where needed, dressing slope faces and excavating for canal structures.

The machines are all commercially built in the United States and are equipped with 0.48-m<sup>3</sup> (5/8-yd) buckets, which have been perforated to ease the excavation in wet conditions. A typical canal is over 1.8 m (6 ft) deep, 2.4 m (8 ft) across at the bottom and 7.9 m (26 ft) wide at the top. In the mild California climate where the farm is located, canals quickly become choked with silt accumulations. Cleaning the silt and mud from the canals and carefully dressing the slope faces is a major way farm management can assure an adequate water flow for the crops. Figure 3 below shows two of the machines at work on one of the average unlined canals.



Figure 3

"We use over 185 000 dam<sup>3</sup> (150 000 acre-ft) of water annually to irrigate several thousand acres of barley, wheat, cotton and seed alfalfa," explains the farm's water department equipment foreman. "In order to maintain our flow of water smoothly and without serious interruption, we invest appropriately in canal maintenance equipment."

Dressing the faces of the unlined canal is an exacting job that requires a skilled operator and a machine with responsive hydraulic controls. The excavator bucket is worked diagonally up and down the 1-1/4:1 canal slopes, leaving a smooth surface less subject to erosion.

\* \* \* \* \*

---

<sup>1</sup> Reprinted by special permission of the Editor from the January 1976 issue of IRRIGATION AGE.

## A VACUUM CLEANER FOR TRASHRACKS<sup>1</sup>

The problem of floating weeds piling up at trashracks and customer-turnout racks is one which plagues every water agency. We have had our share and more of this difficulty. There are, more-or-less, standard ways of combatting the problem. The usual method is to cut or scrape the weed loose and then haul it out onto the bank to dry. When dry, the weed is burned or hauled away to be disposed of elsewhere. We have done a lot of this kind of thing in the past and will continue to do it--particularly with large power rakes at the pumping plant trashracks. What compounds the problem at the customer-turnouts along the aqueduct is that none of the stuff can be allowed to get loose, float away, and clog the customer's valves or pumps.

Up until now the most effective method has been to remove the weeds by hand, using long-handled tools. Hand cleaning could only be done effectively down to a depth of about 2.4 m (8 ft). This left a considerable expanse of trashrack uncleaned, since racks extend down nearly 9.75 m (32 ft) below the surface at some locations. Cleaning by hand is a hard, slow, and somewhat risky procedure. It means that men have to stand down on the canal lining, or on a working stage clamped to the rack bars, and fish the weed out with rakes. This is often done in 38°C (100°F) heat, and, of course, with a life vest on. In the San Luis Field Division, during weed season, hand cleaning took so long that by the time the last rack was clean the weed had piled up at the first rack again. The job was never-ending, and so was the danger and expense.



Figure 4

There were several men tied up almost continually in cleaning trashracks and in disposing of the weed afterwards. There have also been one or two strained backs. In spite of all this work, inspection divers reported an almost solid weed covering on the lower trashracks, with long streamers of weed between the bars. Figure 4 at left and figure 5 on the next page, show some typical views of weed conditions at a turnout.

---

<sup>1</sup> Reprinted by special permission of the Editor from a recent issue of Technical Bulletin No. 24, a State of California, Department of Water Resources publication.

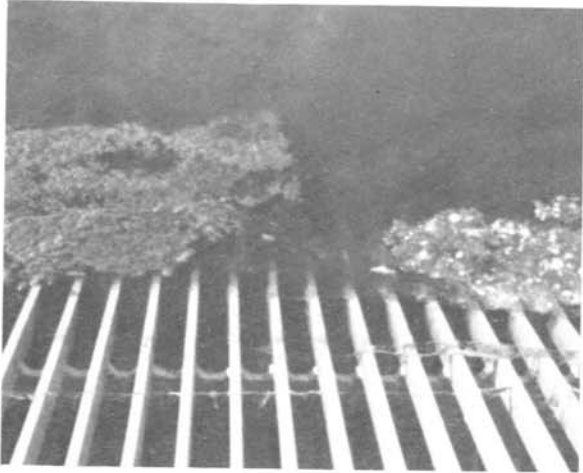

Figure 5

This was a situation which was both irritating and challenging, particularly to John H. Walls, Civil Maintenance Superintendent at San Luis Field Division, Los Banos, California. He was determined to find something that could reach down deep and wipe the trashracks clean without setting the weed adrift to clog up pumps and piping systems downstream. John knew the results he would like to obtain; it was the instrument that he needed. Somewhere there is a solution for every problem. By chance, he read an article telling how

an undesirable waterweed was eliminated in Southern California's Disneyland by a new device produced by The Strange Manufacturing Company. John remembered the Company. They made specialized pumps, particularly sewage lift pumps. A call to the company produced the following information:

Yes, they had used a pump at Disneyland, a new pump with internal blades; no, they did not have a 18.6-kW (25-hp) type presently, but a pump of that size could be specially cast--they quoted a price. Such a specially contracted job would have to be cleared and approved through a higher authority. After presenting his idea and proposal, John was told: go ahead; let us know how it performs. Working closely with the factory representatives, John Walls saw the production of his answer to the trashrack weed problem. A new pump with a 102-mm (4-in) intake and a similar-sized outlet was the instrument. Internally formed and ground into the pump casting were cutting surfaces which matched with cutting blades mounted on the impeller shaft. The pump capacity was great enough to overcome the force of water at a trashrack and draw the long weed up to be shredded. When he had the pump in his shop at the O&M Center, John's next chore was to mount it on something so it could be usable at the site as well as transportable to work locations.

#### Description

As a first order of business, the men made a three-wheeled dolly on which to mount the pump. They used metal-angle for the framework, and salvaged automobile wheels and tires to give it mobility. Because the pump would be doing a suction cleaning job, of sorts, they also welded up a tapering, rectangular nozzle attachment for the intake,

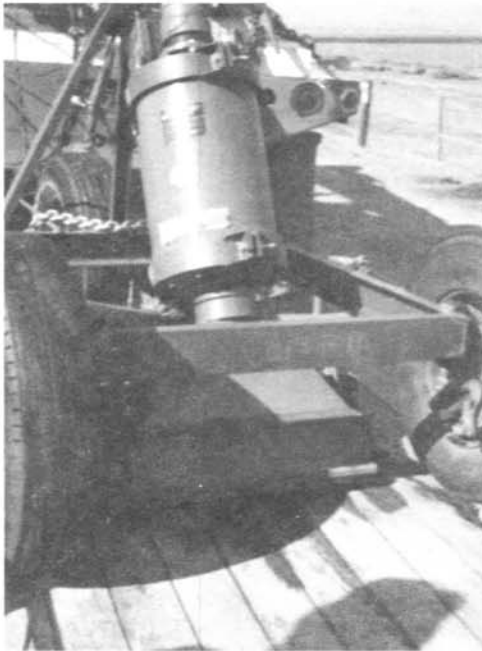

Figure 6

102 mm (4 in) wide by 457 mm (18 in) long. This nozzle resembles a larger version of the nozzle for a home vacuum cleaner--which is most appropriate, as shown in figure 6.

The pump mounting arrangement on the dolly consists of an adjustable slide controlled by a worm gear and hand-wheel. This allows the rectangular nozzle to be lowered to within 19 mm (3/4 in) of the trashrack bars when the pump is in operation, shown in figure 7. The pump sits at an angle on the dolly, which gives it the appearance of a stubby howitzer. This configuration is meant to assure that the pump shaft will be vertical when in operation on the sloping sides of the aqueduct. The men attached a section of stiff-bristled broom to the forward portion of the dolly to help loosen the weed, shown in figure 8.

ure 8. The broom is not really needed, according to Mr. Walls, because the pump alone can do it all.

The pump, a macerating type, has six rotating blades and four stationary blades. The rotary blades are of 44C-type steel and are on the

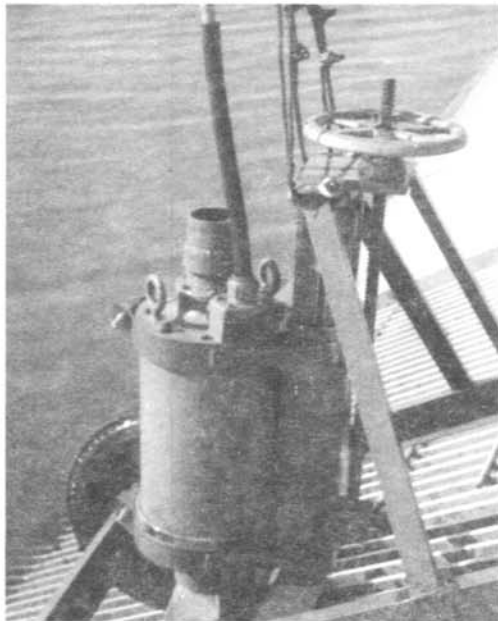

Figure 7

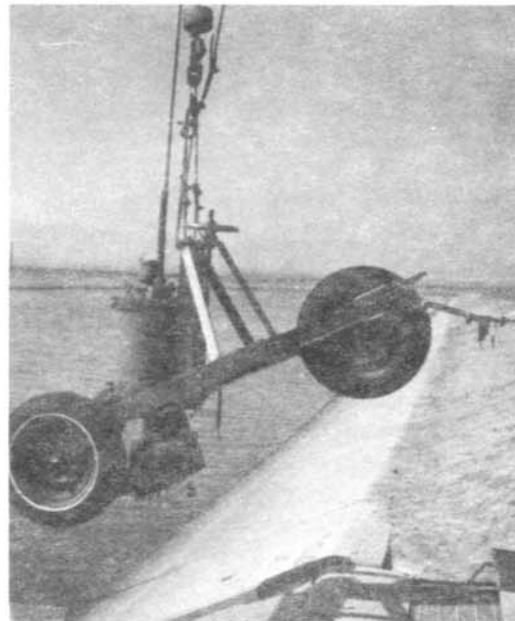

Figure 8





Figure 9

to the Field Division and used for other maintenance jobs is used to haul the trailer, and to lift and control the pump at the worksite. The portable power generator, with wheels removed, is carried on the rear of the truck bed. It makes a compact equipment arrangement, and, with the exception of the generator which was from San Joaquin, all the components were already available in the Division. Figure 9 shows the trailer-truck-pump dolly arrangement for traveling (the generator is visible on the truck). Figure 10 shows how the pump is swung into place on the trashrack by the truck boom.

The movement of the pump up and down the trashrack bars is controlled by the boom-truck operator from a portable winch mounted on the side of the truck bed. At one time it was thought that the tires of the dolly might have to be filled with water to assure close contact with the trashracks. Now, however, it has been demonstrated that the combined weight of the pump and dolly is 363 kg (800 lb), plus the reaction to the pump discharge is sufficient for

impeller shaft; the stationary ones are part of the 4130-steel pump casting. The blades are heat treated and set to a blade clearance of 1.9 mm (75 thousandths of an in); they are capable of 96 000 cuts per minute. The pump motor is a special 18.6-kW (25-hp) model, which performs like a 30-hp. It operates on 440 volts, 60-hertz, 3-phase power supplied from a portable generator. Pump discharge rate is 3785 to 378.5  $\ell/\text{min}$  (1000 to 100 gal/min) at 117-124-kPa (17-18-lb/in<sup>2</sup>) pressure.

To transport the pump to a job, the maintenance men use a trailer already available as transport for their portable street-cleaning machine. A boom truck belonging



Figure 10

for solid contact. A power reel on the end of the truck boom prevents the 213.4 m (700 ft) long power cable for the pump from becoming kinked or tangled as the dolly travels up and down the rack.

### Operation

When the boom-truck and its load arrives at a trashrack to be cleaned, the men rig slings to the pump dolly and lift it from the trailer. The truck is parked so that the hoist drum is on its side, and the special cable support for the slings are opposite the trashrack bars as seen in figure 11.



Figure 11

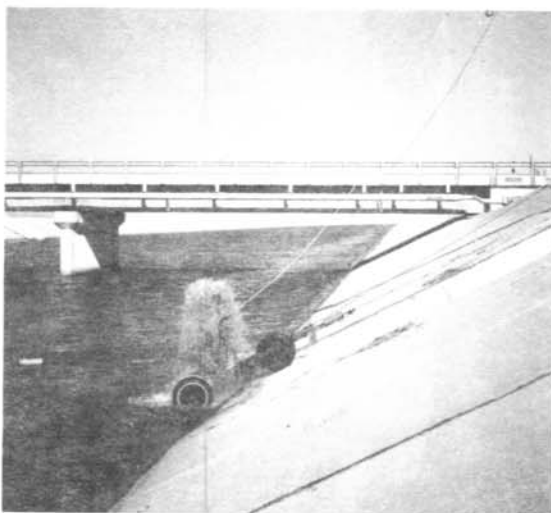

Figure 12

The boom swings the pump dolly over, sets it down at the top of the rack, and holds it secure. Power is turned on as the dolly begins to roll down the trashrack. The operator at the hoisting drum controls regulates the cables and electrical connection so that the pump and dolly can run a true course down the length of the trashrack bars. The powerful suction of the pump draws the weed up into the blades. What comes out of the pump discharge is "green water," as John Walls describes it.

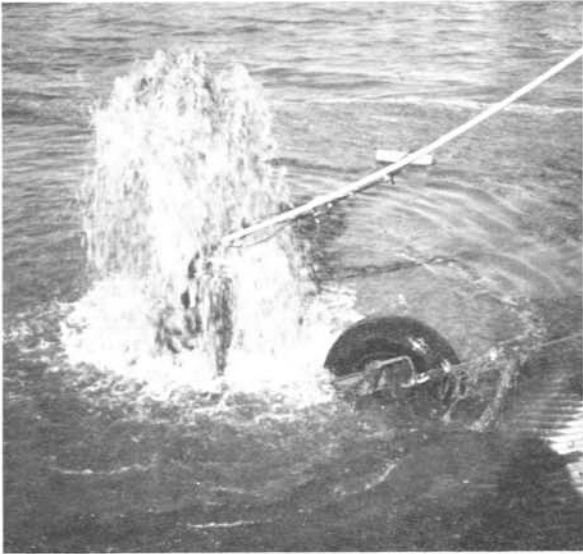

Figure 13



Figure 14

\* \* \* \* \*

Discharge particles so fine that it can be allowed to fall back into the aqueduct without danger of future clogging or loss of water quality. After the pump has vacuumed a trash-rack, underwater inspection divers report that the bars are superclean! Which is what the man at San Luis had in mind in the first place.

The savings in man-hours is better than 50 percent. Now the racks can be cleaned several times a month--or whenever required--without undue problems or danger and at substantial monetary savings.

Figures 12, 13, and 14 show various views of the pump in action: Figure 12 shows the pump just starting down the rack, figure 13 shows a closer view of the pump discharge, and figure 14 shows the darker water coming up from portions of the rack previously uncleaned.

If further information is desired, please write to: The State of California, Department of Water Resources, P.O. Box 388, Sacramento, California 95802.

## GATE VALVE OPERATOR MODIFICATION

The Solano Irrigation District, Vacaville, California, has developed a modification for gate valves located in standard valve boxes that greatly reduces the labor involved in their operation. The information and photographs describing this unique idea were provided especially for this publication by Gordon Johnston of the Solano Irrigation District office.

The location of the gate valve handwheels in standard valve boxes normally are located well below ground level, creating a difficult operating situation for ditchriders. Figure 15 is a view of a standard valve box and gate valve handwheel. Figure 16 presents a more vivid description of the problem with the gate valve handwheel located 813 mm (2 ft 8 in) from the top of the valve box. From these two photographs, it can readily be seen that operation of the handwheel would be almost impossible from the top of the valve box and extremely awkward from inside.

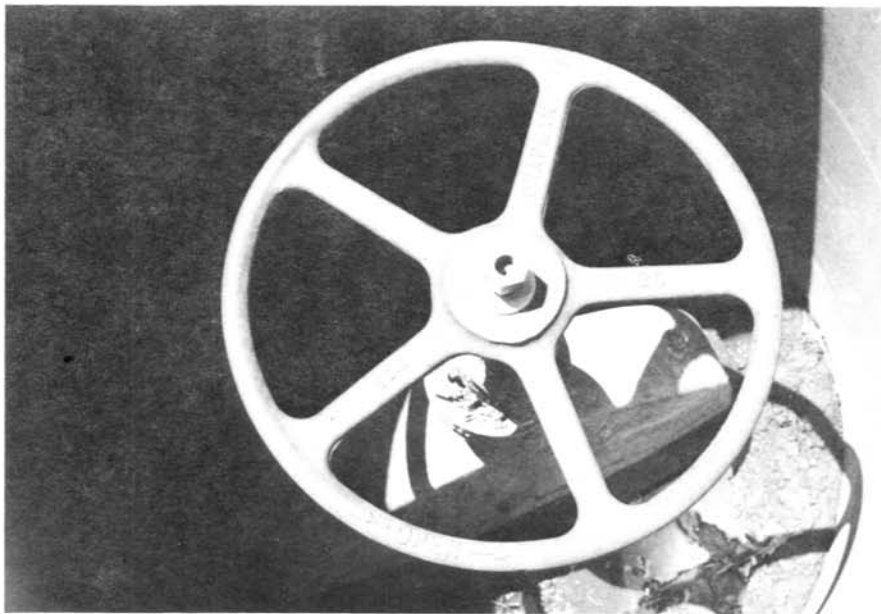

Figure 15

The District recognized the operational problem and set out to relocate the handwheel and at the same time make it easier to operate the gate valve.

An extension for the gate valve stem and reduction gear assembly were designed by District personnel and fabricated in the District Machine Shop. Figure 17 shows the completed assembly in the shop prior to

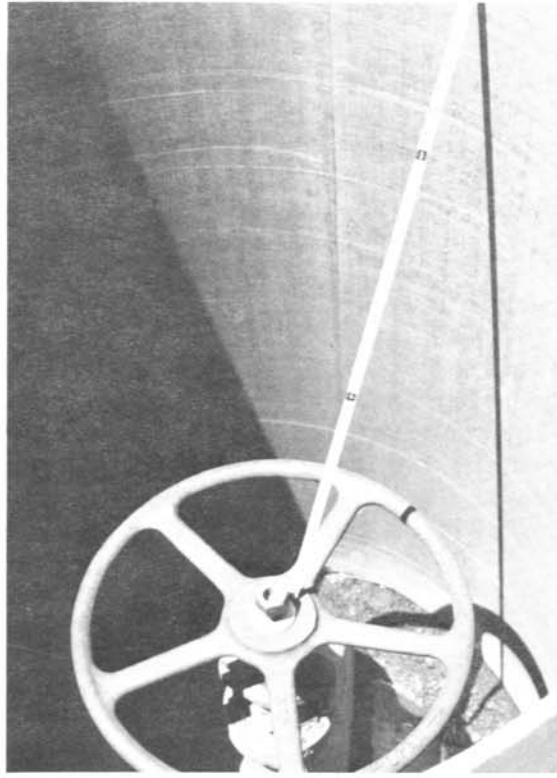

Figure 16

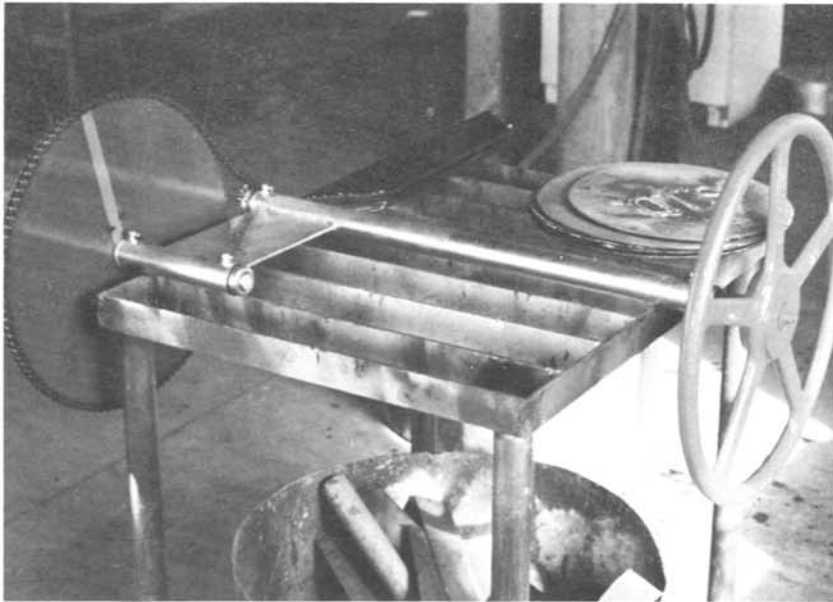

Figure 17

installation in a standard valve box. The mark on the reduction gear serves as an aid to the operator in determining the position of the gate. Figure 18 is another view of the assembly showing the square socket connection to the gate valve stem.

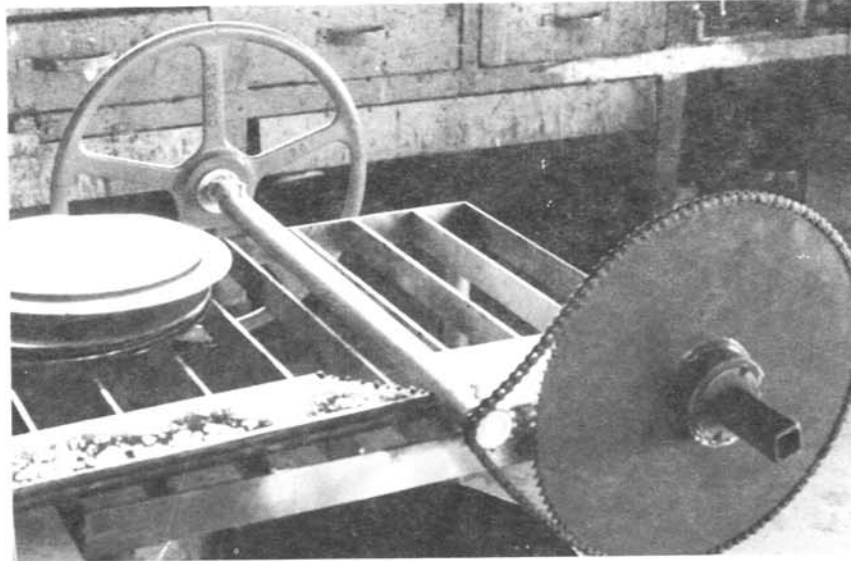

Figure 18



Figure 19

Figure 19 shows the assembly installed in a standard valve box ready for operation. A chain can be seen around the handwheel for locking the valve in one position and preventing unauthorized operation. The valve box cover has been removed to show the assembly more effectively. The use of a reduction gear increases the ease of operation for the ditchrider.

Details of the complete modification are shown in figure 20. The expense for providing one assembly, including one man-day of work and materials amounted to \$215. If further information is desired regarding the valve operator modifications, please write to the District Manager, Solano Irrigation District, 508 Elmira Road, Vacaville, California 95688.

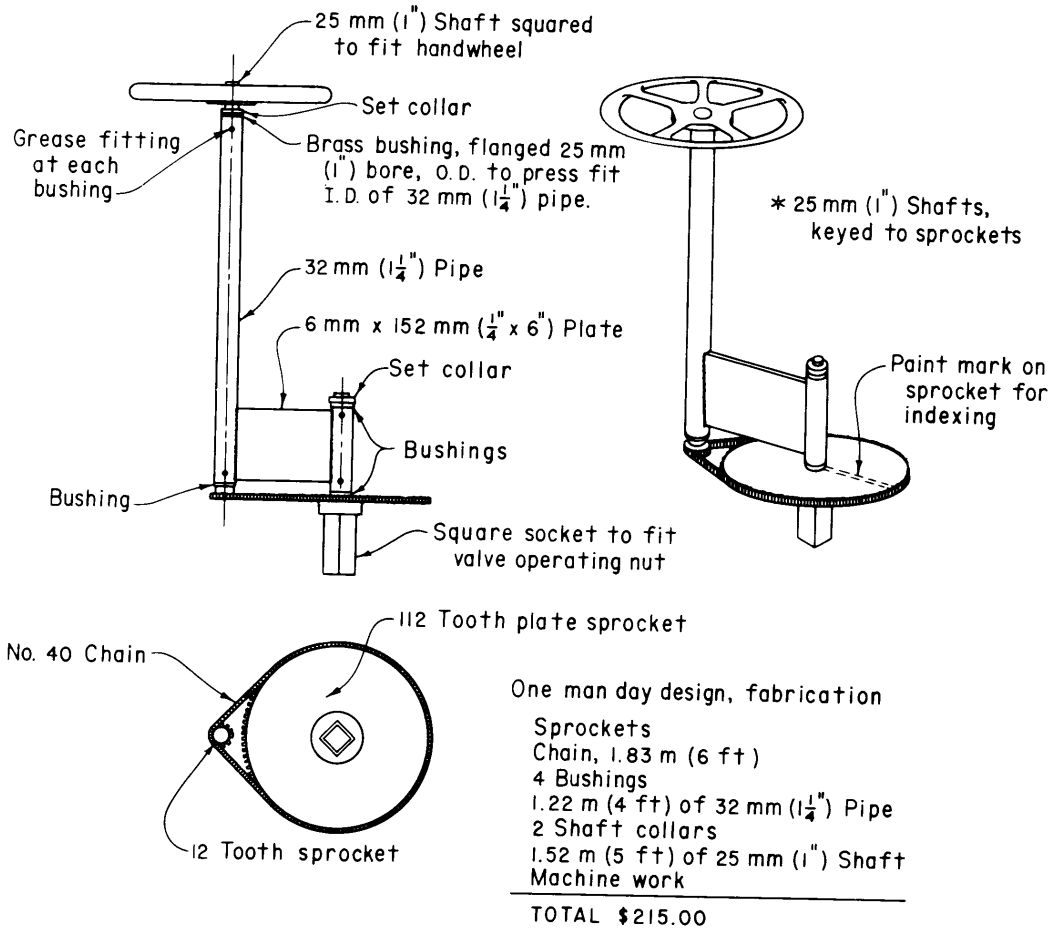

Figure 20

\* \* \* \* \*



The purpose of this Bulletin is to serve as a medium of exchanging operation and maintenance information. Its success depends upon your help in obtaining and submitting new and useful O&M ideas.

Advertise your district's or project's resourcefulness by having an article published in the bulletin! So let us hear from you soon.

Prospective material should be submitted through your Bureau of Reclamation Regional office.