

WATER OPERATION AND MAINTENANCE

BULLETIN NO. 93

SEPTEMBER 1975

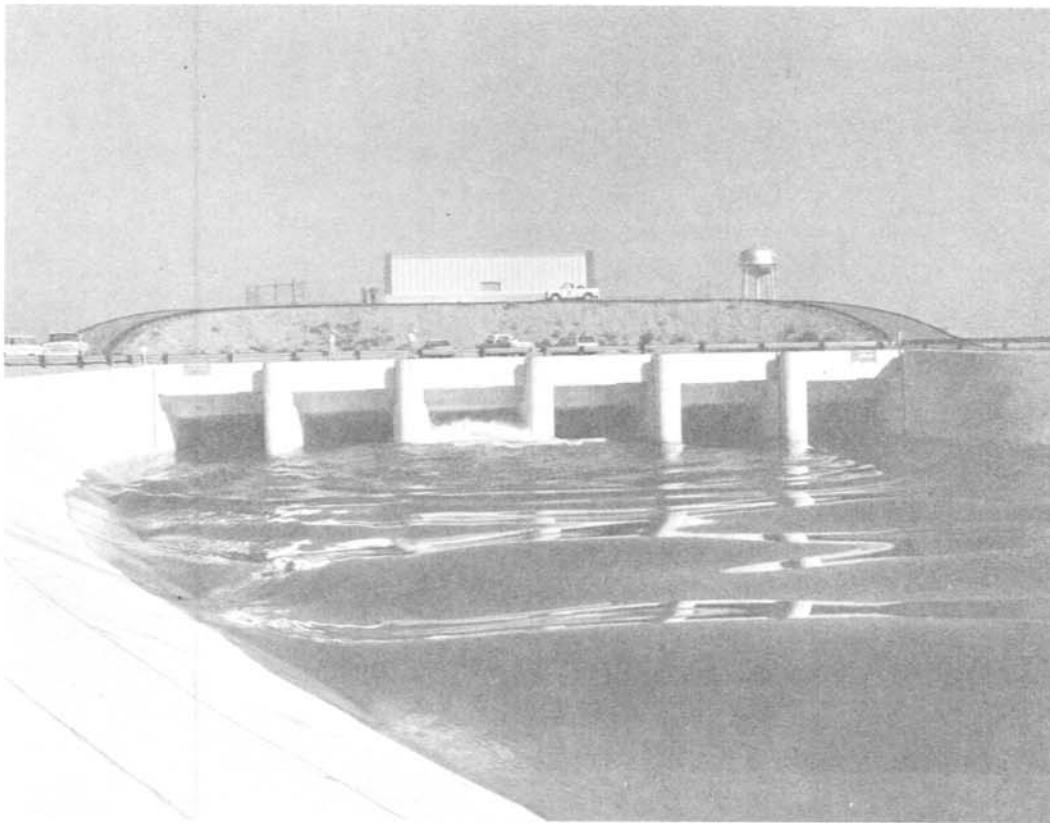

IN THIS ISSUE

QUICKLIME STABILIZES CANAL LINING

BEACH BELT CONVEYOR

A FACE LIFTING FOR THE BOSTON WHALERS

HOW TO MEASURE WELL DRAWDOWN

**UNITED STATES DEPARTMENT OF THE INTERIOR
BUREAU OF RECLAMATION**

The Water Operation and Maintenance Bulletin is published quarterly, for the benefit of those operating water-supply systems. Its principal purpose is to serve as a medium of exchanging operation and maintenance information. It is hoped that the reports herein concerning laborsaving devices and less costly equipment and procedures will result in improved efficiency and reduced costs of the systems for those operators adapting these ideas to their needs.

To assure proper recognition of those individuals whose suggestions are published in the bulletins, the suggestion number as well as the person's name is given. All Bureau offices are reminded to notify their Suggestions Award Committee when a suggestion is adopted.

Any information combined in this bulletin regarding commercial products may not be used for advertisement or promotional purposes and is not to be construed as an endorsement of any product by the Bureau of Reclamation.

* * * * *

Division of Water Operation
and Maintenance
Engineering and Research Center
Denver, Colorado 80225

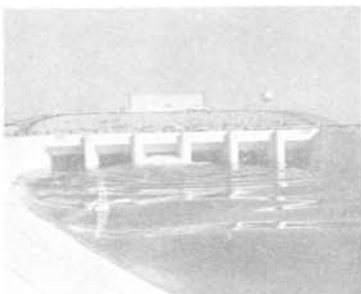

COVER PHOTOGRAPH:

San Luis Canal, West San Joaquin Division, Central Valley Project, California. Photo shows canal structure from Dos Amigos Pumping Plant and discharge line siphon breaker control house in the background. These are joint-use Federal-State facilities.

UNITED STATES DEPARTMENT OF THE INTERIOR
Kent Frizzell
Acting Secretary of the Interior

BUREAU OF RECLAMATION
Gilbert G. Stamm
Commissioner

WATER OPERATION AND MAINTENANCE
BULLETIN No. 93

September 1975

INTRODUCTION

Granular quicklime was used very successfully to stabilize the soil and adjoining service roads on the Friant-Kern Canal in California, as described in the article starting on page 1.

An article on page 10 from the Fresno Field Division, Mid-Pacific Region, shows how they designed and built a unique device for placing beach belt material on canal banks.

Copper sulfate sprinkled over the surface of a lake or reservoir is the most effective method known for the control of aquatic weeds and the article starting on page 14, describes equipment designed for just this purpose. The State of California Department of Water Resources, found Boston Whalers an effective work boat in this application.

"How to Measure Well Drawdown," is the title of the article on page 17. In this article Mr. Roger E. Machmeier of the University of Minnesota describes an economical and accurate way to measure the water level in an irrigation well.

QUICKLIME STABILIZES CANAL LINING¹

Granular quicklime overcame difficult conditions for soil stabilization on the Friant-Kern Canal relining project in central California. The contractor's 250,000 cu yd project there called for lime stabilizing 2 miles of canal lining to a thickness of 4 ft on the banks and 2 ft on the bottom. In addition, the adjoining service roads were stabilized to a depth of 2 ft.

The project consisted of two sections 20 miles apart. One was 8,900 ft of lime-treated earth lining and the other, 1,820 ft of 4 in. unreinforced concrete lining placed over lime-treated backfill. Optimum lime application was 4 percent based on 100 lb per cu ft of dry soil. The soil was a highly plastic, expansive calcium-montmorillonite clay. Over the years this had caused numerous slips and slides and cracked concrete panels.

Because of the thick layers and steep slopes ranging between 1-1/2 to 1 and 2 to 1, construction techniques had to be considerably different from those used in stabilizing highway and airfield subgrades.

Bank lining material could not be processed in place, so it was peeled off and pushed to the canal bottom for mixing with lime. Figure 1 shows how granular quicklime was spread in long windrows in the bottom of the empty canal.



Figure 1

¹ Reprinted by special permission of the Editor, from the January 1975 issue of Roads & Streets.

Then, after mixing, the treated soil was pushed back and compacted in several lifts, the compactor being yo-yoed up and down the bank with a winch. Figure 2 shows the vibrating roller being winched up the steep slopes.



Figure 2

Adequate mixing was especially difficult due to the abundance of rock in the soil which had been placed there over the years by maintenance crews, to repair the numerous cracks and slides. Some of the boulders weighed up to 2 tons. A dragline was used to remove the larger riprap while the smaller pieces were removed by a tractor fitted with a rock rake. Figure 3 shows the dragline working on the canal bank removing the larger riprap.

Compounding the contractor's problem was the need to do the work during December and January, the only time the canal could be taken out of service. This period coincided with California's rainy season, when rainfall

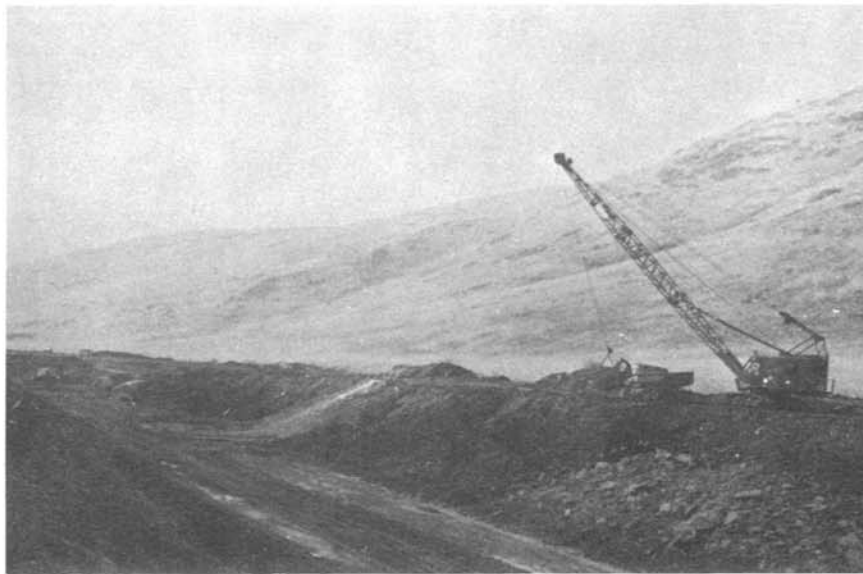

Figure 3

averaged 5.7 in. each month; and temperatures averaged a cool 43 F, while ranging between 22 and 70 F. The problem was especially severe because much of the actual mixing was done on the canal bottom, some 20 ft below grade.

By helping to dry out the clay soil quickly during mixing, and by forming a working table after compaction, lime was an advantage. The contractor actually lost little time due to wet or cold weather.

Anhydrous granular quicklime, used instead of hydrated lime, did an even faster job of drying because of its greater affinity for water. Its appreciable heat of hydration also helped since each pound of quicklime generated 490 Btu of heat during slaking.

Water for slaking came mostly from the soil itself during mixing, although it was often necessary to add sprinkling water to complete the reaction as well as for compaction. The heat of hydration was especially advantageous in helping counteract the winter temperatures, which normally would have impeded the lime-clay cementing reaction. Figure 4 shows how the water was applied to the lime-soil mixture for the next lift of material to be placed.



Figure 4

The large size of the project, coupled with the difficult job conditions, required that work be carried over into a second winter season, with the canal returned to service for agricultural use during the intervening ten months.

This delay, however, turned out to be an advantage since it permitted U.S. Bureau of Reclamation engineers to observe the performance of the first stabilized section underwater during the ten-month period. Results were even better than expected with none of the newly stabilized lining showing any distress. In contrast, some of the unstabilized areas continued to move and deteriorate.

Construction Procedures

Basic steps in the stabilization operation included scarifying and rock removal using a Cat crawler with rock rake; lime spreading, mixing and watering; mellowing for 12 to 24 hours; remixing, spreading and compacting.

Rock removal continued throughout the mixing operation. The general plan consisted of stabilizing the service roads first to provide access to the site, then the canal bottom, and finally the side slopes, working one bank at a time. Completing canal bottom ahead of banks provided a solid working platform for handling the bank material.

The service roads and canal bottom were stabilized to a depth of 2 ft using the same procedure; remove top half of layer, work bottom half by adding lime, mixing, and compacting; bring back top half, add lime, mix, and compact. The service roads were stabilized to 25 ft wide, the canal bottom 60 ft wide in the earth areas and 35 ft wide in the concrete lined sections.

Stabilization of the inclined bank was much more involved because of the 4 ft lining thickness and the steep slope. Initially the contractor used the ramp method but later switched to the bench method to achieve greater control. With either method the first step was to remove the large riprap with a dragline working from the service road.

Two Methods Used

In the ramp method the material was removed from the side slope by bulldozing long sloping ramps from the top of the bank to the canal bottom in 1 ft layers, using half of the lime required (2 percent) to promote primary mixing. The process included cutting the ramp, lime spreading, scarifying using Cat crawlers with rippers and mixing, then blading the treated soil to the bottom, followed by another ramp. Since the long cuts overlapped each other this method lacked control.

The benching technique was similar except that the side slope was worked from the top down in successive 800 ft long benches. Each bench was wide enough to accommodate the lime trucks, and deep enough so that the entire 4 ft lining was excavated. After 2 percent lime spreading and mixing, the material was pushed to the bottom, followed by the construction of a second bench, etc.

Eventually all of the lining material was peeled off and windrowed in the bottom of the canal. Principal advantage of adding only half the lime during benching was to make the soil drier, less plastic and more friable so that it could be handled more readily by the bulldozer. In addition, rock raking was facilitated since clay didn't stick to the rocks so tenaciously.

The second 2 percent lime application was made on the canal bottom, again followed by scarifying, mixing, and watering as needed. Because of the large amount of material processed on the bottom, it was necessary to work the soil in several lifts with each lift bladed to the side to expose the next. Figure 5 shows a tractor dozer with ripper plow and blade used for scarifying and mixing.

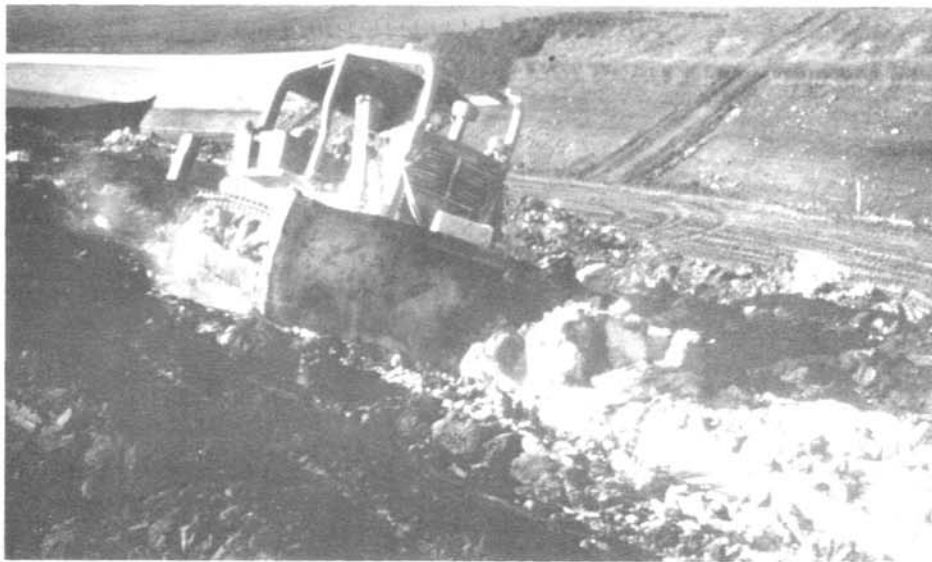

Figure 5

After a brief curing period the treated materials were remixed to assure adequate pulverization and water added as needed for compaction. The soil was then replaced on the canal bank in three equal lifts. Each lift was compacted to 95 percent standard Proctor density with a Dynapac CR 25 vibrating roller, which was winched up and down the slope by a crawler tractor, as shown in figure 2.

Variety of Equipment Tried

Dump trucks were used for lime-spreading with the lime being spread to close tolerance from the tailgates, (See figure 1). This method of spreading ordinarily is not recommended for hydrated lime because of its poor flowability, but was satisfactory for the free-flowing granular quicklime. Its gradation was substantially minus 6 mesh plus 100 mesh in size. The tailgate opening and truck speed were closely controlled to attain the 2 percent application in one pass.

Soil manipulation was handled with rippers, angle and U-dozers, rock rakes, and graders. Initially, a rotary mixer was tried, but tine breakage was excessive due to the large volume of rock. Initial mixing was performed with the rippers having scarifying teeth fitted with spade points.

The soil was first mixed dry but there was usually enough soil moisture present to start the lime slaking process, changing the quicklime to hydrate. Heat of hydration produced considerable amounts of vapor which, at first glance, appeared to be lime dust but was essentially all steam.

After dry mixing with the scarifier, the angle dozers and Cat 16 grader were pressed in to service to attain the proper depth of mixing and to plow the material back and forth. Water was added as needed. Scarifying was repeated until the soil became friable and the lime stopped steaming. Following a brief curing period the soil became mellow, scarcely resembling the original highly plastic clay. In this state it could be readily handled on the moldboard of the grader.

Compaction was initially carried out with a heavy sheepsfoot roller and, in the case of bank compaction, the roller was winched up and down by the dragline. Later the contractor switched to the vibrating pad-type roller previously shown.

Results of Stabilizing

The lime stabilized lining, which had been underwater for ten months, indicated excellent performance with the soil being hard and firm from lime's cementing reaction.

None of the stabilized lining suffered any failure during the period. There was no cracking, sliding or detectable erosion. In fact, sheepsfoot roller impressions made during construction were still evident on the canal bottom. See figure 6 on the next page, showing the sheepsfoot roller indentations which were still evident nearly a year later after the canal had been in full flow. If the layer had not been stabilized the indentations would have been obliterated. In the unstabilized sections, bottom and side slopes were soft and yielding.

Only a small portion of the beach belt at water line and riprap under bridges was placed during the first winter. Because the stabilization was so successful the Bureau eliminated the beach belt and riprap on the balance of the work.

All of the earth backfill for the concrete-lined section had been stabilized the first winter but time ran out after one-third of the 4 in. concrete lining was placed. Thus most of the lime stabilization in this section was exposed to water flow for ten months, without producing any damage.



Figure 6

This was particularly remarkable since the actual slope was steeper than in the earth-lined section, 1-1/2:1 instead of 2:1. Several existing concrete panels adjacent to the stabilized lining failed during the year and had to be replaced. The contrast between the native soil under the failed concrete lining and the adjacent lime stabilized soil was dramatic.

The Friant-Kern Canal, built in 1946, extends from the Friant Dam near Fresno southward for 152 miles to Bakersfield. Up to 150 ft wide, the canal provides irrigation water for nearly a million acres. Its flow is about 4,000 cu ft per sec or about 2.6 billion gal per day at a velocity up to 4.5 ft per sec.

The canal traverses a series of alluvial fan deposits in the foothills of the Sierra Nevada, consisting mainly of reddish brown fat clay known locally as Porterville clay. Liquid limits range between 60 and 90, and the Plasticity Index between 35 and 60. Consisting predominately of camontmorillonite, the clay is highly expansive having shrinkage limits under 10.

Because of this expansive tendency the canal walls suffered periodic cracking and sloughing. In the concrete lined section the swell pressure of the clay backfill has been sufficient to crack many of the panels and, in some places, they have actually popped out into the canal.

Standard maintenance practice over the years for repairing the slide areas involved the use of riprap, but this proved to be only a temporary solution. To find a more permanent solution, the Bureau decided in 1972 to rebuild two sections of the canal and increased the shrinkage limit using lime stabilization because of the highly plastic nature of the soil.

This was a pioneering effort for the Bureau since the treated layer would normally be under running water to a depth of 17 ft. Only limited experience had been available using lime stabilized layers underwater, primarily in stock ponds, small earth dams, and field irrigation channels.

The Bureau's tests showed that 4 percent lime reduced the Plasticity Index of this particular clay from 47 to 12 and increased the shrinkage limit from 7 to 26. Improvement was also noted in reduced swell pressure and increased compressive strength, stability and wet/dry durability. Based on favorable test results, plans were made to lime stabilize trial sections of the canal, but the project never materialized. Alternatively, resloping from 1-1/2:1 to 2:1 along with some riprap stabilization was used. See drawing (figure 7) below.

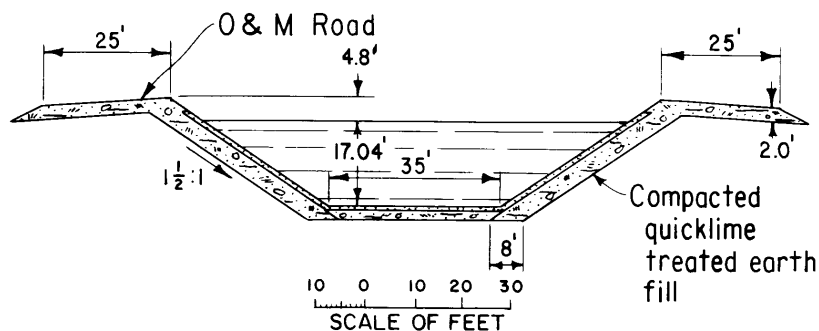

Figure 7

The stabilization concept was then dropped until five years ago when a Bureau maintenance crew tried lime stabilization for the first time on one of the failed areas. Bagged lime was used and was mixed with a dragline bucket and the soil-lime mixture compacted with a sheeps-foot roller winched from the dragline.

Although the method was crude, the results were encouraging; no new slides occurred in the treated area. Untreated areas of the canal banks continued to show distress. This successful trial eventually led to additional testing with lime, and eventually the current 2-mile project was set up for construction during the winter of 1972-1973.

Stabilization Results

It was reported by one of the local farmers, whose farm abutted the canal, that previous to stabilization there had been leakage of water from the canal onto his property. This leakage stopped after the stabilization was completed.

During construction the second winter season, a 2,000 ft long slide occurred in part of the unstabilized bank which destroyed a bridge abutment. The slide was repaired by removing the 7,700 cu yd of material and replacing it with lime treated soil. Thus, in this section the lining thickness was greater than the 4 ft specified on the contract.

On the basis of initial success of this project, the Bureau has set up a second similar rehabilitation project on the Friant-Kern Canal. This type of stabilization may well be applied to new canal construction in the future, as well as to wasteways and drain ditches, levees and earth dams.

Key personnel involved in the unique two-mile canal project representing the Bureau's Mid-Pacific Region, Central Valley Project Construction Office, Fresno, California, were E. J. Brannan, Construction Engineer (recently retired); R. B. Aitken, Project Engineer; S. I. George, Chief, Engineering Branch; G. Drake, Office Engineer; and J. Coutts, Inspector. John Reid was the contractor's manager in charge of construction along with Joe Klein, superintendent.

* * * * *

ERTS: THE EARTH UNDER MICROSCOPE

That's the enthusiastic way scientists describe the benefits of the Earth Resources Technology Satellite program. Fortune magazine reviews the ERTS program; ERTS has helped spot hidden sources of oil and ore. It has revealed underground water supplies in the arid Arizona desert and the most likely breeding grounds for locusts in Saudi Arabia. It has spotted secret earth faults that could cause a mine roof to collapse or a heavy structure to shift dangerously on its foundation. In California's Central Valley researchers identified 13 different crops in 30 minutes from ERTS pictures - a more detailed crop survey than is usually available from USDA's Statistical Reporting Service.

The Washington Report

BEACH BELT CONVEYOR¹

In an effort to prevent canal bank erosion, personnel of the Fresno Field Division, Fresno, California, designed and built a most unique conveyor for spreading gravel on unlined canals. The gravel blanket was uniformly spread about 10 feet wide and 12 inches thick. Figure 8 shows the Friant-Kern Canal and part of the eroded section on the left bank due to wave action.



Figure 8

The conveyor had to be portable and designed to be towed behind a large dump truck. This conveyor also had to be capable of placing loose gravel out over the canal bank shoulder and be able to spread a load of gravel in a matter of minutes.

It soon became evident after checking through equipment catalogs and consulting with equipment companies, that a conveyor with these characteristics would have to be specially built. However, the best estimate to build a conveyor with these requirements was approximately \$20,000.

A Bureau Engineer, Mr. Glen Richardson, of the Fresno Field Division, Operation Branch, undertook the task of designing a conveyor. By exchanging ideas and searching out suitable components he was able to build a very satisfactory machine. The machine was fabricated and assembled by personnel in the Division Maintenance shop, at little cost to the project. Figure 9 on page 11 shows the partially completed conveyor prior to the first trial operation and figure 10 shows the completed assembly prior to being placed in operation.

¹ Submitted for printing exclusively in this publication by Mr. George H. Coulson, Head, Engineering Section, Fresno Field Division, Fresno, California.



Figure 9

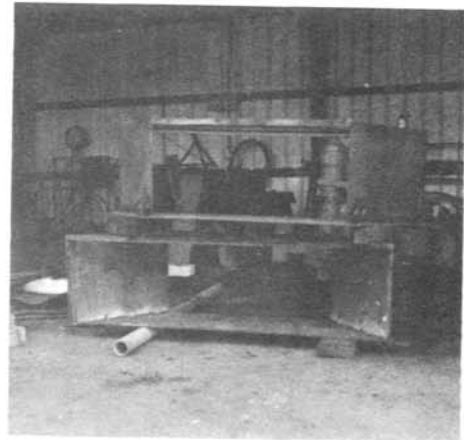

Figure 12



Figure 10



Figure 11

The conveyor was adapted so an 8-yard dump truck could be easily and quickly coupled and uncoupled by the operator. Figure 11 shows the conveyor hookup arrangement on back of the dump truck, and Figure 12 shows tail gate extension that is added on to the truck for discharging material into the conveyor hopper.

A maintenance man regulates the conveyor belt speed and otherwise attends the conveyor unit. He also maintains communication with the dump truck driver who controls the speed along the canal bank operating road.

Figure 13 on page 12 shows a closeup view of the conveyor in operation. Beach belt material is being dumped into the conveyor hopper and it also shows the operator at left of conveyor.

A truckload of sand and or gravel can be spread in less than 5 minutes. The machine is completely portable and is designed so it can be towed lengthwise for clearance when being moved from one job to another.



Figure 13



Figure 16



Figure 14

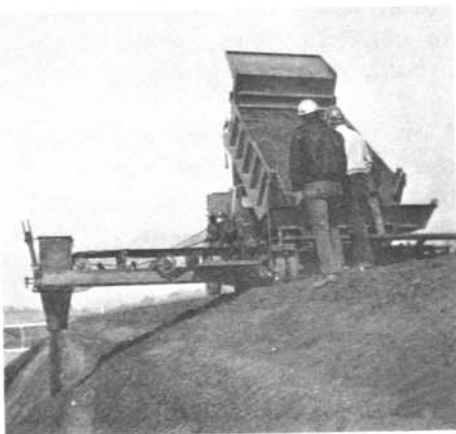

Figure 15

The next series of photographs show how men and machines were utilized to get the job accomplished.

Figure 14 shows the grader cutting a slot for the beach belt material and it also shows how the grader was supported from the canal bank. A rigging was attached from a D-8 caterpillar to the grader working along the slope of the canal.

Figure 15 shows a truck dumping beach belt material onto the conveyor and it also shows how subject conveyor places the material into a precut slot on the canal bank.

Figure 16 shows rock being spread over the previously placed sand, and Figure 17 on the next page was taken on the Friant-Kern Canal looking downstream, and water at the normal elevation. This photograph also shows how the canal bank looked when job was completed.

This has proved to be a most worthwhile undertaking financially. The



Figure 17

canal bank has now been stabilized and very little maintenance work will be needed from now on to keep the canal banks in good repair.

If additional information is desired regarding this conveyor, please write to the Chief, Fresno Field Division, U.S. Bureau of Reclamation, Federal Building, 1130 "O" Street, Room 2215, Fresno, California 97321.

* * * * *

FLASH GORDON SYNDROME

This old world is a funny world
And the people are hard to suit;
The fellow who plays the fiddle
Is a bore to the guy with the flute.

---Which is a rhyming way to say that we are all different and have different interests.

But there is one thing that is close to being universal...the need to "show-off" in some measure or to feel "manly" or uncowardly or not concerned about safety. And that can get you into trouble.

Safety is not sissy-stuff. It's Smartsville. It will keep you at work and on your feet and alive.

You remember Flash Gordon...the comic book hero who dared to do anything and usually got away with it. But you ain't no comic-book hero.

Don't take chances!

...Harry Hatcher, CSP
Corporate Safety Specialist
Abbott Laboratories,
North Chicago, Illinois

(Reprinted from the Industrial Supervisor, dated May 1975, Issued monthly by the National Safety Council.)

A FACE LIFTING FOR THE BOSTON WHALERS¹

There are enough lakes and stretches of water in the Southern Field Division's territory, and enough requirement for water-borne operations, to warrant a fleet of work boats. For instance there is Silverwood Lake with 74,970 acre-feet, Castiac Reservoir with 324,000 acre-feet, and Lake Perris with 127,000 acre-feet, and Pyramid Lake with 179,000 acre-feet. There is also Quail Lake, Tehachapt Afterbay, and (of course) the reaches of the Aqueduct. To supplement their few small craft, the Field Division recently bought three, 21-foot "Boston Whalers"; boats powered by 85 hp out-board engines and capable of carrying out the rigorous schedule of maintenance and water quality surveillance. These boats have proved themselves in recent water sampling operations.

The Boston Whalers are now being fitted for what may be their most consistent role. Copper sulfate granules sprinkled onto the surface of a lake or reservoir is one of the standard methods used by the Department in controlling aquatic weed growth. Applied in a variety of ways, including from aircraft, the copper sulfate successfully retards weed growth without adversely effecting the water. Application techniques by boat have varied in the past, but the equipment being installed aboard the Whalers should be unusually effective.



Figure 18

Description

Figure 18 shows one of the Whalers fitted out in its copper sulfate gear. Designed by Mr. Verne Haller, of support engineering, this equipment consists of the following: a swinging boom, a chemical hopper and tank, and two special pumps. The boom is made of a conduit stiffened with other lengths of pipe welded parallel and at angles, to form a girderlike arm 12 feet long. At the end of this arm is a cap with cross pipes forming a T-shaped nozzle equipped with four jets. The boom moves in pivots of steel pipe clamped on the bottom and side of the boat.

¹ Reprinted by special permission of the Editor, from Technical Bulletin No. 22, June 1974 issue. This is a State of California Publication, issued by the Department of Water Resources, Sacramento, California.

A set of rings at the end of the boom allow for guy ropes to position and secure the boom in action. Close to the boom is a hopper, made of steel angle and sheet metal, into which granulated chemical is placed. The hopper is divided into two sections which taper down to a slot at the bottom. Stainless steel screens prevent large, insoluble, chunks of copper sulfate from jamming the hopper. These two pieces of equipment can be seen in the photograph on page 14 (Figure 18). In Figure 19 it shows a closeup view of the chemical hopper and the screens.

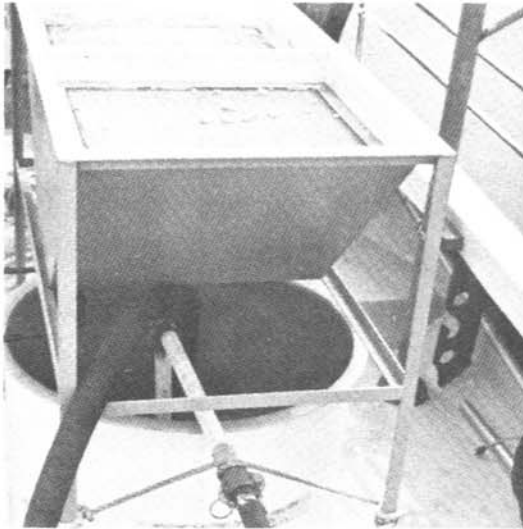

Figure 19

Also visible in Figure 19 is the chemical mixing tank under the hopper. The tank holds approximately 60 gallons and is made of fiberglass. Pipe and hose connections lead from this tank to two pumps, located near the stern of the boat.

All fabrication and assembly, including the mounting of the pumps, was done by Mr. Phil Harvey and the maintenance crew at Castaic Operation and Maintenance Center. They even welded the stainless steel screens.

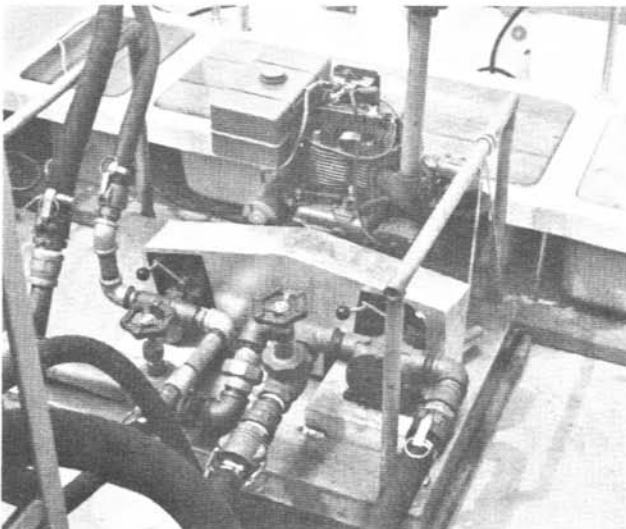

Figure 20

The heart of the Whaler's equipment is, however, the two-pump installation. These are side-by-side bronze pumps powered by a portable gasoline engine. One pump lifts water into the mixing tank; the other one takes the copper sulfate solution from the tank and forces it out through the nozzles at the end of the boom. All of this, including the required valves, fittings, and hose is carefully installed in the boats. Figure 20 shows a closeup of the pumps in place. The drive pulleys for the pumps are under the sheet metal cover in the stern of the boat.

Operation

The Whalers are very stable and capable of carrying a good-sized load, but still not too big to be trailored from lake to lake if necessary. Two of the boats, however, spend most of the time on Silverwood Lake and Castaic Reservoir.

When the boat is underway to a treatment area, the spray boom is folded and carried fore-and-aft. At the selected spot, the boom is swung out and secured with ropes. From sacks amidships, copper sulfate granules are emptied into the hopper. The pump is then started and the mixing tank filled, to make the proper solution.



Figure 21

Figure 21 shows the pump engine about to be started. Even moving slowly, the boat can cover a lot of territory in a few hours.

Figures 22 and 23 give some idea of how the nozzle can be used on floating weeds or along the shoreline.

Operation simply requires keeping the hopper full and guiding the boat. At the end of treatment operations, pure water is pumped through the nozzle to clean out the jets. Two men can handle things very well.



Figure 22



Figure 23

HOW TO MEASURE WELL DRAWDOWN ¹

Concerned about drawdown of your well? There's a simple, inexpensive and accurate way to determine the depth to the water level, says Roger E. Machmeier, University of Minnesota extension agricultural engineer.

If an irrigation well shows a decrease in pumping level during an irrigation season and a decrease in water level when the pump is not being operated, it means the ground water table is dropping. It may or may not be a permanent condition and a comparison of one year's records with the next is the way to find out, says Mr. Machmeier.

Mr. Machmeier recommends the "air line" method, to determine the depth to the water level. All it requires is a known length of small (approximately 1/4-inch) diameter tubing, a pressure gauge and a hand air pump.

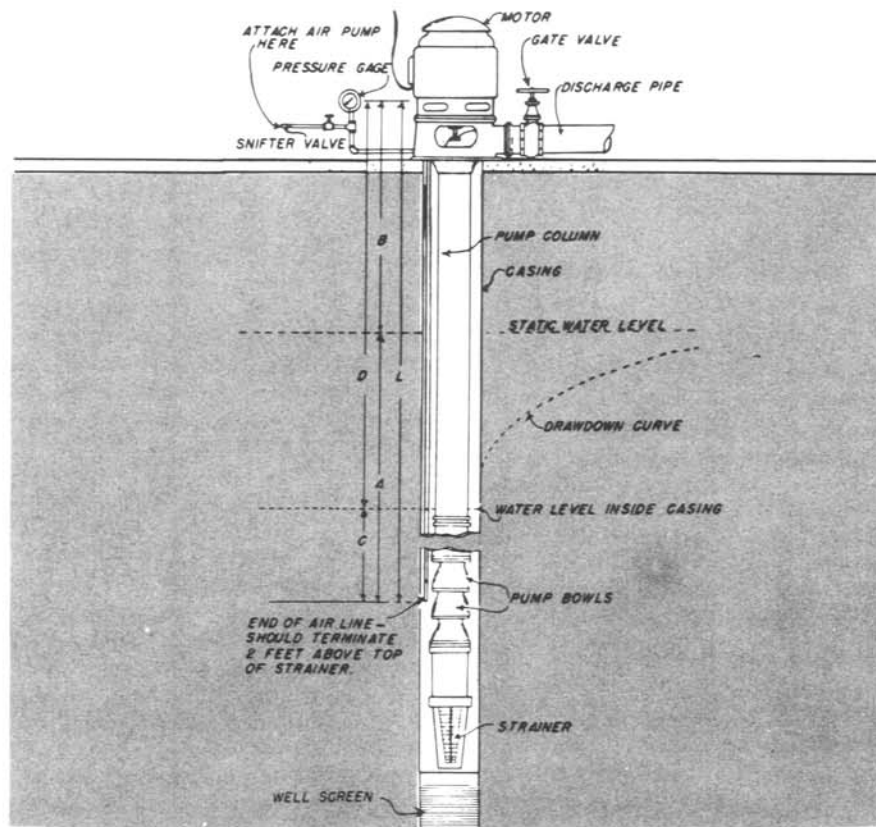

Figure 24

¹ Reprinted by special permission of the editor, Mr. Ron Ross, from the November/December 1974 issue of Irrigation Age.

Figure 24 shows the air line extending to a point about 20 feet below the lowest anticipated pumping level of the water surface. However, the lower end of the air line should terminate at least 2 feet above the upper end of the strainer on the deep well turbine pump. The air line is placed between the pump column and the well casing. The upper part of the air line terminates in a snifter valve, which is a check type valve similar to a tire valve, but specifically made for a water system, and a pressure gauge. There should also be a manual shutoff valve in this line which can be a small globe valve. The air pump can be a tire pump or small hand pump.

The pressure gauge should have a maximum reading greater than the difference between the static water level and the bottom of the air line. If possible, the pressure gauge should read in feet of water. However, most pressure gauges read in pounds per square inch so the following instructions will assume the latter.

How To Proceed

Refer to Figure 24, and take these steps.

1. You must know the air line length, "L". This is the distance from the bottom of the air line to the center of the pressure gauge.
2. Determine the static water level before pumping begins. To do this, pump air into the line until the pressure gauge reaches a maximum reading and remains steady. When this happens air is bubbling out the bottom of the air line and the gauge will read no higher. To determine the depth to the water, the gauge reading in pounds per square inch is multiplied by 2.31 which gives the submergence depth or "A" in Figure 24. The submergence depth, "A", subtracted from the length of air line, "L", will give the depth to the water table, or "B".
3. After the pump has been operating for a time, determine the location of the pumping water table. If the air line system is completely airtight the reading of the pressure gauge multiplied by 2.31 should give the new submergence depth, or "C". However, it probably is a good idea, says Mr. Machmeier, to apply some air pressure to the air line to be sure the gauge is at its maximum reading. The depth to the water is "C", which is subtracted from the length of the air line, "L" to obtain the pumping water level, or "D" in Figure 24.
4. The drawdown which is occurring in the well can be determined simply by subtracting value "B" from value "D".

Example

Using hypothetical figures, here's how to use the instructions. Assume the length of air line, "L" is 120 feet. The air line pressure gauge reading before pumping began is 36 pounds. Therefore the depth of submergence is 36×2.31 , or 83 feet. Depth to the water level before pumping is 120 minus 83 or 37 feet below the level of the pressure gauge.

After the pump operates for 24 hours, the depth to the pumping water level is taken. Air is pumped into the line and the gauge reading is 23 pounds per square inch. The depth of submergence thus is 23×2.31 or 53 feet. Therefore the depth to the water level during pumping is 120 minus 53 or 67 feet. With the static water level at 37 feet and the pumping water level at 67 feet, it means there is a total draw-down of 67 minus 37 or 30 feet.

Tips

- a. Record the length of time the pump has been running as well as the drawdown value. Take readings on the static water level each time before the pump is started, besides taking readings on the drawdown just before the pump is stopped.
- b. In a set type of irrigation system where the period of time between pump starting and stopping is rather short, take readings an average of once a week during the irrigation season so as to develop a good set of records.

Precautions

- a. Keep the airline as tight as possible and not permanently attached to the pump column. Check the airtightness of the air line by checking the gauge reading and how well the gauge retains a constant pressure.
- b. If the lower end of the airline extends at least 20 feet or more below the lowest anticipated water level, you'll get more accurate readings.
- c. If the lower end of the air line terminates at least 2 feet above the top of the suction strainer on the pump, you'll avoid turbulent influence of water entering the suction pipe.
- d. Calibrate the pressure gauge frequently or remove it and keep it under cover when not in use.

* * * * *



The purpose of this Bulletin is to serve as a medium of exchanging operation and maintenance information. Its success depends upon your help in obtaining and submitting new and useful O&M ideas.

Advertise your district's or project's resourcefulness by having an article published in the bulletin! So let us hear from you soon.

Prospective material should be submitted through your Bureau of Reclamation Regional office.