

# 2000-2001

## National Transportation Safety Board Annual Report To Congress



# Foreword



**T**he National Transportation Safety Board (NTSB) is an independent agency charged with determining the probable cause of transportation accidents and promoting transportation safety. The Board investigates accidents, conducts safety studies, evaluates the effectiveness of other government agencies' programs for preventing transportation accidents, and reviews the appeals of enforcement actions involving airman and seaman certificates issued by the Federal Aviation Administration (FAA) and the U.S. Coast Guard (USCG) and civil penalty actions taken by the FAA.

To help prevent accidents, the NTSB develops safety recommendations based on its investigations and studies, which are issued to federal, state and local government agencies and to industry and other organizations in a position to improve transportation safety. These recommendations are the focal point of the NTSB's efforts to improve the safety of the nation's transportation system.

The NTSB's origins can be found in the Air Commerce Act of 1926, in which Congress charged the Department of Commerce with investigating the causes of aircraft accidents. Later, that responsibility was given to the Civil Aeronautics Board's Bureau of Aviation Safety.

In 1967, Congress consolidated all transportation agencies into a new Department of Transportation (DOT) and established the NTSB as an independent agency, placed within the DOT for administrative purposes. In creating the NTSB, Congress envisioned that a single organization with a clearly defined mission could more effectively promote a higher level of safety in the transportation system than the individual modal agencies working separately. Since 1967, the Board has investigated accidents in the aviation, highway, marine, pipeline, and railroad modes as well as hazardous materials transportation-related accidents.

In 1974, Congress reestablished the NTSB as a completely separate entity, outside the DOT, reasoning "...no federal agency can properly perform such (investigatory) functions unless it is totally separate and independent from any other...agency of the United States." Because the DOT is responsible for both the regulation and promotion of transportation within the United States and accidents may suggest deficiencies in the transportation system, the Board's independence was deemed necessary for proper oversight. The NTSB, which has no authority to regulate, fund, or be directly involved in the operation of any mode of transportation, seeks to conduct investigations and to make recommendations from a totally objective

***The NTSB is the  
model for a  
government agency  
that works well and  
costs only pennies for  
each American.***

# Foreword

viewpoint. Under current operating criteria, the Board's response to an accident primarily is determined by the need:

- for independent investigative oversight to ensure public confidence in the transportation system;
- to concentrate on the most significant and life-threatening safety issues; and
- to maintain an aviation database so that trends can be identified and projected.

In 1996, President Clinton and the Congress assigned the Board the additional responsibility of coordinating federal assistance to the families of aviation accident victims.

In 2000, the Safety Board embarked on a major initiative to increase employee technical skills and make its investigative expertise more widely available to the transportation community by establishing the NTSB Academy. The George Washington University Virginia campus was selected as the academy's home. In 2001, the Safety Board established the Office of the Academy; signed a long-term agreement with the university to build a state-of-the art training facility; and set up a Curriculum Development Committee to design and implement new training courses.

Since its inception, the NTSB has investigated more than 114,000 aviation accidents and over 10,000 surface transportation accidents. On call 24 hours a day, 365 days a year, NTSB investigators travel throughout the country and to every corner of the world to investigate significant accidents and develop factual records and safety recommendations with one aim – to ensure that such accidents never happen again.

To date, the NTSB has issued almost 12,000 safety recommendations pertaining to the various transportation modes to more than 1,300 recipients. Because the Board has no authority to regulate the transportation industry, its effectiveness depends on its reputation for conducting thorough and accurate investigations and for producing timely, well-considered recommendations to enhance transportation safety.

The NTSB's role in fostering advances in transportation safety has been significant – more than 82 percent of its recommendations have been adopted by the regulatory and the transportation industry.

## **CONTENTS**

NTSB Board Member Profiles.....	2
The NTSB and Congress .....	8
State and Local Government Outreach .....	10
Most Wanted Safety Recommendations .....	12
Family Affairs .....	14
Aviation Safety .....	17
Highway Safety .....	29
Marine Safety .....	38
Railroad, Pipeline and Hazardous Materials Safety .....	45
Research and Engineering .....	61
Administrative Law Judges .....	73
NTSB Academy .....	75
Public Forums and Symposia .....	76
Public Hearings .....	77

## Marion C. Blakey

Chairman (2001 - )



**M**arion Clifton Blakey was sworn in on September 26, 2001 as the ninth Chairman of the National Transportation Safety Board.

Soon after her arrival, the Chairman visited the sites of the September 11, 2001 terrorist attacks on New York City and the Pentagon. In November 2001, she launched the investigation into the American Airlines flight 587 accident in New York City. The crash killed all 260 on board the plane and five people on the ground. It was the second deadliest airline crash in U.S. history.

Ms. Blakey has served in a number of positions in government, most recently as Administrator of the Department of Transportation's National Highway Traffic Safety Administration (1992-1993). As the nation's leading highway safety official, she was charged with reducing deaths, injuries and economic losses resulting from motor vehicle crashes.

For the last eight years, she has been the principal of Blakey & Associates, a Washington, D.C. public affairs consulting firm particularly focusing on transportation issues and traffic safety.

Before that, she served in five government departments and agencies, including the Department of Commerce, the Department of Education, the National Endowment for the Humanities and the White House, as well as the Department of Transportation. She has held four previous Presidential appointments, two of which required Senate confirmation.

Ms. Blakey received her bachelor's degree with honors in international studies from Mary Washington College of the University of Virginia. She also attended Johns Hopkins University, School of Advanced International Studies for graduate work in Middle East Affairs.

Ms. Blakey's current term as Chairman ends September 23, 2003. Her term as Member of the Safety Board ends December 31, 2005.

## James E. Hall

Chairman (1994 - 2001)

Jim Hall, of Chattanooga, Tennessee, was appointed as a Member of the NTSB in October 1993; he became Chairman in June 1994.

Mr. Hall was the on-scene Board Member at the January 1994 Ringling Brothers Circus train derailment in Florida; the October 1994 American Eagle ATR-72 crash in Roselawn, Indiana; the December 1994 American Eagle Jetstream accident in Raleigh-Durham; the February 1995 and August 1997 cargo plane crashes in Kansas City and Miami; the August 1997 Amtrak accident in Kingman, Arizona; the July 1999 crash of an aircraft near Martha's Vineyard, Massachusetts that claimed the lives of John F. Kennedy, Jr., his wife Carolyn, and her sister Lauren Bessette; and the October 1999 crash of an EgyptAir Boeing 767.



He also served as the Chairman of the Board of Inquiry for public hearings on four major accidents: the September 1994 USAir flight 427 crash; the November 1994 runway collision in St. Louis; the February 1996 commuter train/Amtrak collision in Silver Spring, Maryland; the July 1996 TWA flight 800 crash, and four hearings on heavy truck and bus safety. In addition, Chairman Hall chaired safety forums on commercial air service in Alaska and truck and bus safety and international symposia on the impact of fatigue on transportation safety, preventing pipeline excavation damage, the effects of corporate culture on safety, improving assistance to survivors and families of accident victims, and increasing the use of data recorders in all transportation modes.

In September 1996, President Clinton named Chairman Hall to the White House Commission on Aviation Safety and Security that issued 51 recommendations to improve aviation safety and security around the world.

In January 1996, Chairman Hall was honored by Aviation Week and Space Technology with an Aviation Laurel. In 1997, he was presented the Herbert C. Bonner Award by the National Association of State Boating Law Administrators. That organization also presented him with its Administrator's Award in 1999.

Chairman Hall resigned from the Board on January 18, 2001.

# Carol J. Carmody

## Vice Chairman



Carol J. Carmody of New Orleans was sworn in on June 5, 2000, as the 30th member of the NTSB, and appointed Vice Chairman by President Clinton on January 19, 2001. She served as Acting Chairman from January 22 through September 23, 2001.

Ms. Carmody brings to the job more than 20 years experience with the aviation community. Before coming to the NTSB, she worked as an independent consultant focusing on international and environmental issues. She served as the U.S. Representative to the Council of the International Civil Aviation Organization (ICAO) in Montreal from 1994 to 1999. Early in her term, she was instrumental in persuading ICAO to start a safety oversight program to assess the compliance of countries with ICAO standards. This was a first at ICAO, and the results will improve safety for the traveling public around the world.

Ms. Carmody spent from 1988 to 1994 as a professional aviation staff member of the Senate Commerce Committee. She worked on legislation to mandate inspections for aging aircraft, to improve pilot training, to phase out Stage 2 aircraft, to authorize passenger facility charges, and to reform the FAA — particularly in areas of finance and procurement.

Until 1988, when she joined the Senate Committee, she had worked for 11 years at the FAA in jobs of increasing responsibility, leading to her appointment in 1985 as Deputy Director of Congressional Services in the Office of the Administrator. Her FAA career began in the Budget Office in 1977.

Since her appointment as Board Member, Ms. Carmody has been on-scene member at several accidents, including the aircraft accident that killed Governor Carnahan in October 2000, and the Aspen, Colorado airline crash that killed 18 people.

Her career includes managing a firm that administered Taft-Hartley pension plans; owning and managing an employment agency; serving at the Central Intelligence Agency; and working at Braniff Airlines.

Ms. Carmody has a Master's in Public Administration from American University in Washington, D.C. and a Bachelor of Arts from the University of Oklahoma.

Ms. Carmody's term as Member expires on December 31, 2004.



## John A. Hammerschmidt

### Member

John A. Hammerschmidt has served for over 16 years at the NTSB. He has served as a Member of the Board since June 1991 and, prior to that, served as Special Assistant to the Board Chairman and Member during 1985-91. He has been appointed by the President and confirmed by the U.S. Senate three times.

Mr. Hammerschmidt is a private pilot, and is the senior Safety Board Member. He has participated on-scene in more than five dozen major accident investigations and public hearings involving all modes of transportation: highway; aviation; rail; marine; pipeline; and space launch.

On-scene investigations include the 2001 collision between the U.S. nuclear attack submarine *USS Greenville* and the Japanese fisheries training vessel *Ehime Maru* near Honolulu, Hawaii; the 2000 Alaska Airlines flight 261 accident near Pt Mugu, California; the 1999 gasoline pipeline accident in Bellingham, Washington; the 1997 Comair EMB-120 commuter airline accident near Monroe, Michigan; the 1996 collision of the bulk carrier *Bright Field* with the Port of New Orleans River Walk Shopping Mall; the 1995 Atlantic Southeast Airlines EMB-120 commuter accident at Carrollton, Georgia; the 1994 USAir DC-9 accident at Charlotte, North Carolina; and the 1993 Amtrak accident near Mobile, Alabama, the worst in Amtrak history.



In 2000, Mr. Hammerschmidt chaired the Board's four-day public hearing on the Alaska Airlines flight 261 accident. In 1999, he chaired the Board's public hearing in Miami, Florida on the 1998 fire aboard the cruise ship *MS Ecstasy*. In 1997, he chaired a four-day public hearing in San Juan, Puerto Rico on the worst pipeline accident ever investigated by the Board, an explosion that killed 33 people. In 1996, he chaired the Board's public hearing into the Fox River Grove, Illinois grade crossing accident that killed seven high school students on a school bus. In 1995, he chaired the five-day public hearing in Indianapolis, Indiana on the American Eagle ATR-72 accident near Roselawn, Indiana. In 1994, he chaired the public hearings in Charlotte, North Carolina on the USAir DC-9 accident and in Ypsilanti, Michigan on the American International Airways DC-8 accident at the U. S. Naval Air Station, Guantanamo Bay, Cuba.

Prior to 1985, Mr. Hammerschmidt served in the Office of the Vice President of the United States (1984), and from 1974-83 he was the Chief Executive Officer of the Hammerschmidt Lumber Company, Inc., Harrison, Arkansas. Mr. Hammerschmidt was also president of the Boone County (Arkansas) Industrial Development Corporation.

In 1971, Mr. Hammerschmidt graduated from Dartmouth College "with highest distinction" in his major and was named a Rufus Choate Scholar. He later attended Vanderbilt Law School and Harvard Business School. He also studied at the Catholic University of Ecuador in Quito as part of Georgetown University's foreign study program.

His term on the Safety Board expires on December 31, 2002.

# John J. Goglia

## Member



John Goglia is an internationally recognized expert in aviation maintenance and aircraft operations. Sworn in as a Member of the Safety Board in August 1995, he was reconfirmed in May 2000. He is the first working A&P mechanic to serve on the Safety Board, with over 30 years of aviation experience. Before his Senate confirmation, he was based with USAir and was the recipient of the prestigious Industry Aviation Mechanic of the Year Award in 1994.

Member Goglia is a leading advocate regarding the evaluation of human factors in the aviation workplace. He developed the Maintenance Resource Management Program, combining management, labor, regulatory agencies and academia into what has become the premier human factors program in aviation maintenance. Mr. Goglia served as the Governor's appointee to the Massachusetts Workers Compensation Board and the

Boston Area Second Airport Site Selection Board. He also served as Team Coordinator of the International Association of Machinists and Aerospace Workers' (IAM) Accident Investigation Team and for over 21 years he served as IAM's Flight Safety Representative. He was the IAM's principal specialist on aviation issues, serving as liaison to the FAA, NTSB, DOT, other executive branch agencies, and Congress. He also represented IAM on the Aviation Rulemaking Advisory Committee.

Member Goglia served as Chair and a founding member of the National Coalition for Aviation Education, an aviation industry organization that advances aviation education among America's youth and aviation workforce. He was an original member of the Steering Committee to establish the International Society Aviation Maintenance Professionals, a professional society dedicated to advanced safety and professionalism throughout the aviation maintenance industry. He is an internationally known speaker and author addressing aviation safety issues, lecturing at symposiums and serving as contributing editor to several industry periodicals. In 1960, he learned to fly in a Piper J2-J3, and he was owner/operator of an aircraft service company for over 10 years.

Mr. Goglia was the Member on scene at the Safety Board's investigation of the grade crossing accident in Fox River Grove, Illinois in October 1995 that killed seven high school students on a school bus. In January 1996, he chaired a briefing for government and industry representatives regarding the problem of ingestion of birds in the new generation of air carrier engines.

Member Goglia's term expires on December 31, 2003.

## George W. Black

Member

George W. Black, Jr., P.E., of Georgia became a Member of the NTSB on February 22, 1996, and is the first practicing highway engineer to be a Board Member. He is a 1968 graduate of the Georgia Institute of Technology, with a Bachelor of Civil Engineering degree, and is a registered professional engineer. While at Georgia Tech, Mr. Black worked in one of the original multi-disciplinary traffic crash investigation teams funded by the DOT.

Member Black was an Air Force ROTC graduate and served as an aircraft maintenance officer while stationed in Texas and Southeast Asia. He was assigned to the supervision of flight line maintenance of B-52D and KC-135A aircraft. He returned to traffic safety engineering in 1973 when he became the first traffic engineer for Gwinnett County, Georgia, in the Atlanta metropolitan area. The county has a population of 475,000 and 2,500 miles of roadway. Member Black remained with Gwinnett County for 24 years, retiring as Director of Transportation in 1996. During his last 10 years with the county, he oversaw the implementation of a nearly \$500 million road improvement program.



Mr. Black helped found the County Police Department's fatal accident investigation unit in 1974. He was a member of that unit for the next 22 years and assisted in the investigation of 2,000 fatal or critical injury traffic crashes and rail-highway grade crossing incidents. He also taught accident investigation and reconstruction in the county and state police academies for 23 years. Member Black is a fellow of the Institute of Transportation Engineers, and a member of the American Society of Civil Engineers, the National Society of Professional Engineers, the Society of Automotive Engineers, the Transportation Research Board, the National Committee on Uniform Traffic Control Devices (technical committee) and other professional organizations.

Mr. Black was the recipient of the 1991 Institute of Transportation Engineers' (Georgia Division) Karl Bevins Award and the 1997 Transportation Professional of the Year Award, the Gwinnett County Chamber of Commerce's Public Service Award, and the American Society of Civil Engineers' 1996 National Civil Government Award. In August 1998 he received the International Institute of Transportation Engineers' Edmund R. Ricker Traffic Safety Award. Since his appointment to the Board, Mr. Black has been on-scene Board Member for several accidents including Delta flight 1288 at Pensacola, Florida; United Express flight 5926 at Quincy, Illinois; Korean Air flight 801 on Guam; a general aviation midair collision in Cobb County, Georgia; and American Airlines flight 587 in New York. In other modes of transportation, he was on-scene following a propane gas explosion in San Juan, Puerto Rico; a fatal interstate bus crash in Cheesequake, New Jersey; and school bus accidents in Monticello, Minnesota and Holmdel, New Jersey.

Mr. Black's term as a Board Member expired on December 31, 2001.



## The NTSB and Congress

The NTSB provided testimony to Congressional committees eight times during calendar year 2000, and five times during calendar year 2001. Below is a summary of testimony provided by Safety Board Members and staff. Copies of NTSB testimony are available on the Board's Web site at <http://www.nts.gov/speeches>.

Chairman Jim Hall testified on March 22, 2000, before the Committee on Appropriations, Subcommittee on Transportation and Related Agencies, House of Representatives, regarding aviation safety. The Chairman's testimony discussed runway incursion safety; the dangers of explosive mixtures in fuel tanks of transport category aircraft; the need for next generation recorders, and protection from unwarranted release of recorder information.

On April 4, 2000, the Safety Board submitted testimony for the record to the Committee on Appropriations, Subcommittee on Transportation and Related Agencies, House of Representatives, regarding the NTSB's fiscal year (FY) 2001 budget request. The testimony summarized Board activities for the previous year, the request for \$62.9 million and 458 full-time equivalent (FTE) positions. This FTE level represented an increase of \$5.942 million and 19 FTE positions over the FY 2000 enacted level. The testimony also discussed the need for a supplemental appropriation for the Board's investigations involving EgyptAir flight 990 and Alaska Airlines flight 261.

Chairman Hall testified on April 11, 2000, before the Committee on Transportation and Infrastructure, Subcommittee on Aviation, House of Representatives regarding the crash involving EgyptAir flight 990. The Chairman's testimony summarized the Board's authority under Annex 13 to the Convention on International Civil Aviation, the status of the Board's investigation, the need for video recording the cockpit environment, language communication problems between air traffic controllers and the pilots on the aircraft, and screening pilots for psychopathology.

On April 13, 2000, the Chairman testified before the House Budget Committee's Task on Housing and Infrastructure regarding a DOT Inspector General audit and investigation requested by the NTSB regarding financial discrepancies discovered by the Board's staff.

Member John Hammerschmidt discussed pipeline safety issues on May 11, 2000, before the Committee on Commerce, Science, and Transportation, United States Senate. He discussed the pipeline accident in Bellingham, Washington, and the Board's recommendations regarding pipeline integrity, accident data collection, training of pipeline personnel, valve automation, excavation damage prevention, and state inspection programs.

The Board's Managing Director, Daniel Campbell, discussed criminalization of aircraft accidents before the House Committee on Transportation and Infrastructure, Subcommittee on Aviation, on July 27, 2000. Mr. Campbell's testimony discussed the NTSB's symposium, held in April 2000, on "Transportation Safety and the Law," and the potential for jeopardizing witness cooperation in accident investigations.

With regard to the latter issue, Mr. Campbell discussed the difficulties the Board has encountered as a result of criminal investigations, particularly in regard to the Bellingham, Washington pipeline accident and the Justice Department's investigation. Mr. Campbell stated that the NTSB should be provided the opportunity to conduct its safety investigations before criminal prosecutions are pursued.

Finally, a confirmation hearing was held March 1, 2000, before the Committee on Commerce, Science, and Transportation, United States Senate, regarding the nominations of Carol J. Carmody and John Goglia to be Board Members.

On March 28, 2001, Acting Chairman Carol Carmody testified before the Committee on Appropriations, House of Representatives, regarding aviation safety. She discussed three issues that must be addressed to prevent aviation catastrophes as flight operations increase: runway incursions, an issue on the Board's "Most Wanted" list since its inception in 1990; errors committed by air traffic controllers; and FAA oversight.

The Board's Director of the Office of Railroad, Pipeline, and Hazardous Materials Investigations, Robert Chipkevich, testified before the Committee on Transportation and Infrastructure, House of Representatives, regarding railroad track safety on March 29, 2001. Mr. Chipkevich stated that advanced track inspection technology should be mandated.

Elaine Weinstein, Director of the Board's Office of Safety Recommendations and Accomplishments, testified on April 24, 2001, before the Committee on Commerce, Science, and Transportation regarding child safety booster seats. Ms. Weinstein stated that booster seats should be the next step in child passenger protection after a child outgrows a child safety seat. Without a booster seat, children can slouch and slide forward, causing vehicle seatbelts to ride up onto their abdomens, resulting in serious or fatal injuries.

Acting Chairman Carol Carmody testified, on June 26, 2001, before the Committee on Transportation and Infrastructure, House of Representatives, regarding runway incursions. As air traffic continues to increase, so does the potential for more incidents or accidents on runways. In 2000, there were 431 runway incursions, more than twice the 200 incursions that occurred in 1994 and a significant increase from the 322 incursions in 1999. The Safety Board urged the FAA to continue to explore methods to make certain that the air traffic environment is robust and able to minimize the impact of human mistakes before they result in an accident or incident.

On August 1, 2001, a confirmation hearing was held before the Committee on Commerce, Science, and Transportation, United States Senate, regarding the nomination of John A. Hammerschmidt to be a Member of the NTSB, his term will expire on December 31, 2002.



# State and Local Government Outreach

**D**uring 2000, the Safety Board's state outreach efforts placed more emphasis on building general political support for its safety recommendations, and on promoting programs such as our child safety initiative.

Indeed, one-third of the Safety Board's 35 public appearances were to testify before state legislatures. The remainder, such as a speech to the Southern Legislative Conference, was part of the broader effort to build support for Safety Board recommendations. Former Chairman Hall, as part of his effort to make highway safety a governmental priority, met with individual governors and urged the National Governors' Association to make the Safety Board's child safety initiative one of its priorities. Public appearances were supplemented by the Safety Board's participation in coalitions of government and private sector organizations seeking highway and marine safety improvements. Similarly, the Board worked with organizations of state officials to promote acceptance of its recommendations by the states.

The Board's state outreach program also addressed new issues, such as requiring the use of booster seats for older children, and eliminating the use of school buses that do not conform to federal safety standards. The Safety Board also testified before two legislatures (New Mexico and Maryland) on pipeline accident investigations, the first time testimony has been given the states for this mode of transportation.

The states considered and enacted a large amount of legislation and regulation related to Safety Board recommendations in 2000. The National Conference of State Legislatures reported that more than 1,000 bills regarding highway safety issues were considered by the state legislatures during their 2000 legislative sessions.

More than 200 bills were introduced addressing motor vehicle occupant protection. In addition to measures to strengthen existing laws, two states (Washington and California) became the first to expand their child passenger protection laws to require children up to age six to use booster seats. The Board anticipates that this will be the beginning of a new trend in child passenger protection laws.

Ten jurisdictions enacted either full or partial graduated licensing systems for teen drivers. Most of the 43 states that have implemented elements of a graduated licensing system have done so since 1994.

School bus safety continues to generate interest, as illustrated by the nearly 150 related bills that were considered in the state legislatures. Safety Board staff testified twice in South Carolina on legislation to phase out the use of vans and other vehicles that do not conform to federal school bus standards by private schools and day care centers. The Board's 1999 recommendations on non-conforming buses are credited with providing the impetus for the successful negotiations between private school groups and state regulators that led to the bill's enactment.

Similarly, the states showed ongoing interest in the Board's recreational boating safety recommendations. New safety initiatives included requirements that children use personal flotation devices, restrictions on the operation of personal watercraft, mandatory boater education, and boating-while-intoxicated laws. Alaska became the final state to implement



a statewide boating safety program. The state outreach program continued its high level of activity in 2001. Safety Board representatives made 43 public appearances, including 22 appearances before 14 state legislatures to testify on Safety Board recommendations and investigations.

The focus of the state outreach program changed, with more emphasis on building support for safety recommendations beyond the legislatures themselves. The Board expanded its participation in coalitions of government and private sector organizations seeking highway and marine safety improvements. These coalitions provided opportunities for the Board to relay its message more broadly than is possible when acting alone.

The states considered a large amount of legislation and regulation related to Safety Board recommendations in all modes of transportation. The National Conference of State Legislatures reported that the state legislatures considered more than 1,200 bills regarding highway safety issues during the 2001 legislative sessions.

The Board achieved a significant goal with the enactment of graduated licensing in Texas, where more than 700 persons are killed each year in crashes involving teenage drivers. Arkansas, Nevada and Virginia also enacted graduated licensing systems in 2001, and Georgia significantly strengthened its law. At the end of 2001, only five states had no graduated licensing system, and 14 had partial systems.

More than 200 bills addressing occupant protection were also introduced. Four states (Arkansas, New Jersey, Oregon and Rhode Island) enacted requirements that older children ride in booster seats, and five states (Illinois, New Mexico, South Carolina, Tennessee, and Texas) expanded the coverage of their existing child passenger protection laws. Unfortunately, no state enacted primary safety belt enforcement in 2001.

Most states have considered drunk driving legislation in the past two years in order to avoid TEA-21 sanctions. At least 35 states considered, and 15 states enacted, laws implementing some portion of the Safety Board's model program for addressing hardcore drinking drivers in 2001.

There was continuing interest in mandating education for boat operators and requiring children to wear personal flotation devices. Legislatures in 17 states considered measures addressing Safety Board boating safety recommendations in 2001. The rapidly growing use of these vessels has raised both environmental and safety concerns in the states. Thus, the Safety Board's recommendations that personal watercraft rental operators provide training for renters received substantial attention.

The regulation of cell phone use by drivers became a highway safety issue of particular interest in 2001. New York enacted the first statewide ban on cell phone use by drivers. More than 40 other states considered similar legislation. The National Conference of State Legislatures undertook a major project to identify cell phone use issues and potential solutions for legislators. Although the Safety Board has not made recommendations on this subject, it is closely monitoring developments.

In addition to these direct advocacy activities, the Board routinely informed key state officials of significant Safety Board accident investigation activities, from initial launch to final adoption of reports and recommendations. The Board provided information to the states on 16 separate accident investigations in 2001.

***The Safety Board  
works with state  
and local  
governments to  
promote its  
recommendations  
and programs.***

# Most Wanted Safety Recommendations

The Safety Board uses its Most Wanted transportation safety improvements list to focus attention on Board recommendations that have the most potential to save lives and to highlight recommendations with the greatest impact on transportation safety. In May 2001, the NTSB issued an updated list of 12 safety improvement goals covering all modes of transportation.

Issues highlighted on the Most Wanted list:

***Automatic information recording devices.*** Require adequate recording devices on all types of vehicles, such as flight data recorders on aircraft and voyage event recorders on ships.

***Child occupant protection.*** Educate parents and guardians about transporting kids in back seats, make back seats more child friendly, and require restraints for infants and small children in airplanes.

***Positive train control systems.*** Mandate the installation of automated systems to stop trains when crewmembers make signal or speed mistakes or are incapacitated.

***Human fatigue in transportation operations.*** Translate the latest human fatigue research into meaningful time and duty hour regulations for workers in all modes of transportation.

***Airport runway incursions.*** Move forward with current and new programs aimed at preventing accidents involving aircraft while they are on the ground at airports.

***Excavation damage prevention to underground facilities.*** Urge the federal government to increase its role in excavation damage prevention programs and review of state programs to improve them.

***Recreational boating safety.*** Require states to implement a series of boating safety improvements, educational programs, and regulations.

***Highway vehicle occupant protection.*** Require a series of safety improvements to the design, installation, and usage of vehicle seatbelts, air bags, and child restraints.

***Airframe structural icing.*** Revise icing regulations based on up-to-date research on icing weather conditions. Conduct research with the goal of developing new on-board systems to detect and protect aircraft against freezing drizzle.

***Explosive mixtures in fuel tanks on transport-category aircraft.*** Require design and operational modifications to reduce the potential for explosive fuel-air mixtures in large aircraft fuel tanks.

***The Safety Board's Most Wanted list focuses attention on issues that have the most potential to save lives.***



**Commercial truck and bus safety.** Modify carrier-rating standards, enhance occupant safety, modify hours-of-service regulations, and increase vehicle standards.

**Youth highway safety.** Toughen and enforce minimum drinking and driving laws, and enact laws mandating a provisional license system and nighttime restrictions for young novice drivers.

At its May 15, 2001 Board meeting, the Safety Board kept the 11 issue areas from the 2000 list. Safety recommendations requiring booster seats for children not yet large enough for seat belts and the installation of a crash-protected video recording systems in some of the smaller commercial aircrafts were added to existing issue areas. Child/Youth Safety in Transportation was separated into two issue items: Child Occupant Protection and Youth Highway Safety. Additionally, the Positive Train Separation issue area was given a new name: Positive Train Control Systems.

The Board removed several recommendations that had been successfully accomplished from issue areas on the list: enacting comprehensive legislation to address the problem of alcohol and/or drug use by recreational boat operators and requiring information on the safe operation of personal watercraft in all recreational boating courses. Both recommendations were classified “Closed-Acceptable Action.”

Five of the 12 issue areas on the 2001 list have been on the Most Wanted list since its inception in 1990.

# Family Affairs

In 1996, Congress passed the Aviation Disaster Family Assistance Act that gave the NTSB the responsibility of assisting the families and victims of aviation disasters. The NTSB fulfills this role through its Family Affairs Office. The primary responsibility involves coordination between federal agencies, commercial airlines, state and local authorities, and the families of victims. Additionally, in 1997, Congress enacted the Foreign Air Carrier Support Act to ensure foreign air carriers operating to the United States meet the same standards for victim assistance as their domestic U.S. counterparts.

In the event of an accident in which the Office of Family Affairs is tasked to respond, a team of specialists is launched composed of a family support center specialist; an administrative assistant; and managers for emergency operations, forensic operations, and forensic sciences. Although the office has mandatory responsibilities for major aviation accidents, the expertise and techniques developed by this team have been called upon repeatedly to assist in accidents in all modes.

Primary tasks of the team upon arrival at the accident site include coordinating resources provided by local, state and federal agencies responding to assist victims and their families; establishing a Joint Family Support Operations Center (JFSOC); and ensuring that the airline establishes a Family Assistance Center (FAC). Normally, the JFSOC and the FAC are co-located at a hotel where the families are staying.

## Accident Launches

In 2000, family affairs specialists assisted on the following accidents:

***Alaska Air flight 261 crash in California*** (88 fatalities). Provided direction and support to the victims' families and the Ventura County Medical Examiner's Office; coordinated the efforts of responding local, state and federal agencies; coordinated beach viewing of the crash site by families at Pt. Mugu; supervised memorial service arranged by the American Red Cross for approximately 1,500 family members; and provided forensic support and direction onboard recovery ship.

***Southwest Airlines flight 1455 runway overrun in California*** (no fatalities). Helped Southwest establish its family assistance center for survivors and their families.

***Executive Air crash in Pennsylvania*** (19 fatalities). Assisted local authorities in briefing families and providing information and coordinated movement of the Department of Health and Human Services (HHS) mobile morgue and members of the Disaster Mortuary Operational Response Team (DMORT) and other federal resources to assist the local coroner with victim identification.

***Holland-America cruise ship fire in Alaska*** (no fatalities). Assisted the Office of Marine Safety with interviews of survivors.

***Blue Hawaii tour helicopter crash in Hawaii*** (seven fatalities). Assisted the helicopter company to organize its family assistance program and coordinated federal government resources to assist the local medical examiner with the identification process.

***Piper midair collision in New Jersey*** (11 fatalities). Assisted local authorities in briefing families and providing information and provided forensic support to the investigative team and local officials.

***El Paso natural gas pipeline explosion in New Mexico*** (12 fatalities). Supported the pipeline company to assist victims' families; provided forensic support and expertise to the New Mexico State Police and the Office of the Medical Examiner for the State of New Mexico; and provided technical support to DOT's Office of Pipeline Safety in Washington, D.C. in establishing a victim information website for this explosion.

***Cape Smythe Air Service crash in Alaska*** (five fatalities). Assisted local authorities in briefing families and providing information. Coordinated victim identification with local medical examiner.

***Singapore Airlines flight 006 crash in Taiwan*** (83 fatalities). Assisted NTSB survival factors investigators with forensic expertise and coordinated Singapore Airlines' assistance to U.S. citizens at Los Angeles International Airport.

In 2001, the office participated in these accident investigations:

***Gulfstream crash in Colorado*** (18 fatalities). Assisted victims' families who traveled to Aspen with crisis counseling provided by the American Red Cross. Coordinated with the Federal Bureau of Investigation (FBI) Evidence Response Team's efforts to recover personal effects and the charter company's insurance carrier to ensure personal effects would be returned to the next of kin.

***Papillon Helicopters sightseeing crash at the Grand Canyon*** (six fatalities). Supported investigative team, worked with county medical examiner's office to facilitate victim identification, worked with clergy members to honor specific religious requirements at the crash site. Gave technical direction to helicopter company on victim response issues. Facilitated post accident survivor interview by the investigative team.

***September 11<sup>th</sup> terrorist attacks in New York, Virginia, and in Pennsylvania*** (more than 3,000 fatalities). Responded to the Pentagon for American Airlines flight 77, Pennsylvania for the crash of United Airlines flight 93, New York City for the crashes of American Airlines flight 11 and United Airlines flight 175. Staff supported the FBI; other federal, state and local agencies; American and United Airlines at all crash sites; and the Dover, Delaware Air Force Base Mortuary (victims of the Pentagon attack were taken there for identification).

***Greyhound bus crash in Tennessee*** (six fatalities). Although this was determined to be a criminal act, team supported the Tennessee Bureau of Investigation, the FBI and Greyhound Bus Lines in their investigations.

***American Airlines flight 587 crash in New York*** (265 fatalities). Provided direction and support to the victims' families and the City of New York Medical Examiner's Office; coordinated the efforts of responding local, state and federal agencies; worked closely with American Airlines and the City of New York Mayor's Office and staff.

### Publications

“Morgue Protocols for Aviation Disasters,” a brochure for family members.

“Bulletin for the Medical Examiner,” discusses what medical examiners can expect in a major disaster or transportation accident and how things and resources have changed since the Oklahoma City bombing.

### Partnerships With Other Agencies

Federal Bureau of Investigation — strategic planning on recovering remains and maximizing resources.

State Medical Examiners — worked with representatives from New York, Massachusetts, and California to improve coordination.

U.S. Department of State, Bureau of Consular Affairs — examined possibilities of having a detail at overseas post to help prepare for an overseas disaster involving a U.S. flag carrier.

### Conferences

Co-hosted a three-day conference on airport emergency planning issues with the Association of American Airport Executives in July 2001. Airport representatives attended from across the United States and Guam to attend this conference in Alexandria, Virginia.

# Aviation Safety

The Federal Aviation Act of 1958, as amended, and the Independent Safety Board Act of 1974 placed the responsibility for investigating and determining the probable cause for all civil aviation accidents within the NTSB. Recent legislation also authorized the Board to investigate accidents involving public use (government) aircraft, except those operated by the armed forces and intelligence agencies.

The Board is also authorized to conduct safety studies of transportation problems. A safety study goes beyond the single accident investigation to examine a safety problem from a broader perspective. Because of the international nature of the air transportation industry and of the leading role of the United States in the development of aviation technologies, the Safety Board's investigation of domestic accidents and participation in foreign investigations is essential to the enhancement of aviation safety worldwide. The Board fulfills U.S. obligations with regard to foreign accident investigations, established by treaty under the auspices of ICAO, by sending accredited representatives to participate in investigations in cases where U.S. interests are involved.

These typically concern accidents involving U.S. airlines in foreign territories or U.S.- manufactured aircraft or major components (e.g., engines) operated and/or used by foreign carriers. U.S. manufacturers and operators rely heavily on the Board to facilitate their access to foreign accident investigations. The safety issues that arise in these investigations often have wide-reaching implications for the aviation industry.

Foreign governments often request the assistance of NTSB analysts and laboratory specialists in their investigations. The Board's major aviation accident reports, safety recommendations, and accident statistics are disseminated worldwide and have a direct influence on the safety policies of foreign aviation authorities and airlines. The NTSB's role in international civil aviation safety has a direct impact on ensuring the safe transportation by air of U.S. citizens and other travelers around the world. The Board's role also ensures the high quality of U.S.- manufactured aviation products operated worldwide.

Another aspect of the NTSB's mandate is to investigate more than 2,000 general aviation accidents and incidents annually. These investigations result in safety improvements that have far-reaching impact. In addition, the NTSB investigates accidents and incidents that are less complex and involve only property damage. Typically, NTSB investigations examine all factors surrounding an accident or series of accidents or serious incidents, thereby ensuring that regulatory agencies and the industry are provided a thorough and objective analysis of actual, as well as potential, deficiencies in the transportation system. Only then can solutions be proposed to correct deficiencies that may have caused an accident.

## Office of Aviation Safety

The Office of Aviation Safety has the responsibility for investigating aviation accidents and incidents and for proposing probable cause(s) for the Safety Board's approval. In conjunction with other offices within the Safety Board, the office also works to formulate recommendations to prevent the recurrence of similar accidents and incidents and to improve aviation safety.

The office headquarters is located in Washington, D.C., with 10 regional and field offices



## Aviation Safety

located in Parsippany, New Jersey; Atlanta, Georgia; Miami, Florida; West Chicago, Illinois; Arlington, Texas; Denver, Colorado; Seattle, Washington; Gardena, California; Anchorage, Alaska; and Washington, D.C. Seven divisions comprise the office and reflect the organization of the Safety Board's investigative process: Major Investigations; Regional Operations and General Aviation; Operational Factors; Human Performance; Aviation Engineering; Survival Factors, and Report Writing and Editing.

When the Safety Board is notified of a major aviation accident it launches a go-team, which varies in size depending on the severity of the accident and the complexity of the issues involved. The team normally consists of an investigator-in-charge (IIC) and staff specialists in as many as 14 different specialties. Each staff expert leads a group of other specialists from government agencies, the industry, and first response teams as information is collected and analyzed. Safety Board staff members are designated as group chairmen to coordinate information for their part of the investigation from the on-scene activities through adoption of the final report.

Operational Factors specialists in three disciplines — air traffic control, operations, and weather — support major investigations with intensive work in those areas. Aviation Engineering specialists provide technical skills in the areas of powerplants (engines), structures, systems, and maintenance. Human Performance specialists review the background and performance of those associated with an accident. Survival Factors specialists investigate circumstances that affect the survival of persons involved in accidents, including causes of injuries and fatalities.

The participation of other investigative parties (non-NTSB specialists) augments the Board's resources and allows first-hand access to specialized information. For example, the manufacturer is the best source of information on the design of the specific aircraft being investigated.

Another part of the investigation process is a public hearing. A hearing may be convened, generally within a year of the accident, or depositions may be taken to collect additional information and review the investigation's progress. As an investigation is completed, a detailed narrative report is prepared. This report will analyze the investigative record and identify the probable cause of the accident.

Safety recommendations resulting from major investigations generally are included in the final accident report, although recommendations can be issued at any time during the course of an investigation if an issue is determined by the Board to pose an immediate threat to safety.

The Office of Aviation Safety manages the NTSB's international aviation affairs program as well. It does so by assigning an accredited representative and technical advisors from the manufacturer of the airframe and the engine to assist in the investigation. NTSB accredited representatives support foreign investigations that are conducted by other nations in accordance with the Convention on International Civil Aviation. The office also maintains liaison and coordination with other governments through the U.S. Interagency Group on International Aviation and ICAO.

### ***Completed Major Investigations***

#### **Federal Express Flight 14 Crash**

On July 31, 1997, Federal Express flight 14, a McDonnell Douglas MD-11, crashed while landing on runway 22R at Newark International Airport, New Jersey. The regularly scheduled

***Because of the international nature of the air transportation industry and of the leading role of the United States in the development of aviation technologies, the Safety Board's investigation of domestic accidents and participation in foreign investigations is essential to the enhancement of aviation safety worldwide.***

cargo flight originated in Singapore on July 30 with intermediate stops in Penang, Malaysia; Taipei, Taiwan; and Anchorage, Alaska. All five occupants received minor injuries in the crash and during subsequent egress through a cockpit window. The airplane was destroyed by impact and a post-crash fire.

On July 25, 2000, the NTSB determined that the probable cause of the accident was the captain's overcontrol of the airplane during the landing and his failure to execute a go-around from a destabilized flare. Contributing to the accident was the captain's concern with touching down early to ensure adequate stopping distance.

Issues addressed in the investigation included:

- landing techniques;
- bounced landing recovery;
- training tool and policies to promote proactive decision-making to go around if an approach is unstabilized;
- use of on-board computers to determine the required runway length for landing;
- MD-11 handling characteristics and structural integrity requirements; and
- hard landing inspection requirements.

The tracking of hazardous materials was also discussed in the report. As a result of this accident, 13 safety recommendations were made to the FAA.

### **Trans World Airlines Flight 800 Accident**

On July 17, 1996, Trans World Airlines flight 800, a Boeing 747-131, crashed in the Atlantic Ocean near East Moriches, New York. The flight was operating as a regularly scheduled passenger flight from JFK International Airport, New York to Charles DeGaulle International Airport, Paris, France. All 230 people on board were killed, and the airplane was destroyed. The investigation focused on fuel tank flammability, fuel tank ignition sources, design and certification standards, heat sources beneath the center fuel tank, and the maintenance and aging of aircraft systems.

On August 23, 2000, the NTSB determined the probable cause of this accident was an explosion of the center wing fuel tank resulting from ignition of the flammable fuel/air mixture in the tank. The source of the ignition energy for the explosion could not be determined with certainty, but, of the sources evaluated by the investigation, the most likely source was a short circuit outside of the center fuel tank that allowed excessive voltage to enter it through electrical wiring associated with the fuel quantity indication system.

As a result of this accident, four safety recommendations were made to the FAA in the final report on the investigation. During the course of the investigation, the Safety Board issued 11 other recommendations to the FAA on December 13, 1996; February 19, 1997; and April 7, 1998, regarding techniques and procedures to preclude the development of explosive fuel/air mixtures in fuel tanks and to require the detailed inspection of fuel quantity indicator wiring and components.

### **United Airlines Flight 585 Accident**

The Safety Board issued a revised final report on the March 3, 1991, accident involving a Boeing 737, in Colorado Springs, Colorado. The airplane was on approach for landing when it rolled steadily to the right and pitched nose down until it reached a nearly vertical attitude before hitting the ground in an area known as Widfield Park. The airplane was destroyed, and the two flight crewmembers, three flight attendants, and 20 passengers aboard were killed.



Based on new information developed in the investigation of the 1994 accident involving USAir flight 427, on March 27, 2001, the NTSB determined that the probable cause of the United Airlines flight 585 accident was a loss of control of the airplane resulting from the movement of the rudder surface to its blowdown limit. The rudder surface most likely deflected in a direction opposite to that commanded by the pilots as a result of a jam of the main rudder power control unit servo valve secondary slide to the servo valve housing offset from its neutral position and overtravel of the primary slide.

### **American Airlines Flight 1340 Accident**

The Boeing 727 impacted the ground short of the runway 14R threshold at Chicago O'Hare International Airport on February 9, 1998. The flight was conducting a Category II instrument landing system approach. Twenty-two passengers and one flight attendant received minor injuries, and the airplane was substantially damaged.

On May 14, 2001, the Board determined that the probable cause of this accident was the failure of the flight crew to maintain a proper pitch attitude for a successful landing or go-around. Contributing to the accident were the divergent pitch oscillations of the airplane, which occurred during the final approach and were the result of an improper autopilot desensitization rate. Seven recommendations were issued.

### **American Airlines Flight 1420 Runway Overrun**

On June 1, 1999, an American Airlines MD-82 crashed at Little Rock, Arkansas. There were thunderstorms and heavy rain in the area at the time of the accident. After landing, the airplane departed the end of runway, went down an embankment, and hit approach light structures. There was a crew of six and 139 passengers on board the airplane. Eleven were killed.

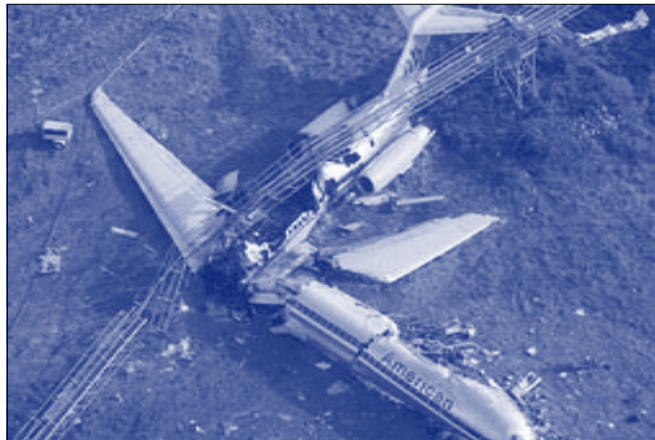

*American Airlines flight 1420 at end of runway in Little Rock.*

On October 23, 2001, the Board determined that the probable causes of this accident were the flight crew's failure to discontinue the approach when severe thunderstorms and their associated hazards to flight operations had moved into the airport area and the crew's failure to ensure that the spoilers had extended after touchdown.

Contributing to the accident were the flight crew's impaired performance resulting from fatigue and the situational stress associated with the intent to land under the circumstances, continuation of the approach to a landing when the company's maximum crosswind component was exceeded, and use of reverse thrust greater than 1.3 engine pressure ratio after landing. Twenty-four recommendations were issued.

## ***Major On-going Aviation Investigations***

### **EgyptAir Flight 990 Crash**

On October 31, 1999, EgyptAir flight 990, a Boeing 767-366-ER aircraft, crashed into the Atlantic Ocean about 60 miles south of Nantucket, Massachusetts. At the request of the



Egyptian government and in accordance with ICAO provisions, the NTSB assumed leadership of the investigation. The Safety Board immediately launched a go-team of 15 members. In order to meet the challenges of an over-water aviation crash, the Safety Board worked closely with the USCG and the U.S. Navy using their search and recovery assets. The Board's investigators remained at the accident site for 36 days.

Additional recovery of wreckage was completed during 10 days in December 1999 when the Navy contracted the *Smit Pioneer*, a large vessel typically used in the petroleum industry and equipped with global positioning systems that allowed the ship to remain in position over the wreckage for long periods of time. For this operation, the *Smit Pioneer* was configured with spider-type and clamshell grabs for retrieval of debris from the ocean floor, heavy material handling equipment, a remotely operated vehicle system, a precision navigation system, and nearly 70 large containers for storage of wreckage.

### **Alaska Airlines Flight 261 Accident**

On January 31, 2000, Alaska Airlines flight 261, an MD-83, crashed into the Pacific Ocean near Pt. Mugu, California. All 88 individuals on the aircraft were killed and the airplane was destroyed. The aircraft had departed Puerto Vallarta, Mexico on a scheduled passenger flight to San Francisco with continuing service to Seattle, Washington. While cruising at 31,000 feet, the flight crew reported to air traffic control and Alaska Airlines maintenance base that they had lost control of the horizontal stabilizer. Witnesses on the ground and water reported seeing the airplane in a rapid descent and in an inverted attitude. In December 2000, the Board conducted a public hearing to gather additional information for the final report.

### **Emery Worldwide Airlines Flight 17 Accident**

On February 16, 2000, Emery Worldwide Airlines flight 17, a DC-8-71, crashed while attempting to land shortly after takeoff from Mather Airport. The airplane was operating as a regularly scheduled cargo flight to Dayton, Ohio. The three persons on the airplane were killed and the airplane destroyed. The flight crew reported an aft center of gravity problem after take off. Examination of the flight recorder data and wreckage prompted the Board to explore the possibility that a stabilizer control tab may have been disconnected prior to impact.

### **Southwest Airlines Flight 1455 Runway Overrun**

On March 5, 2000, Southwest Airlines flight 1455, a Boeing 737-300 overran the departure end of runway 8 after landing at Burbank, California. The airplane touched down at approximately 181 knots and departed the runway 20 seconds later at 32 knots, and then collided with a blast fence and an airport perimeter wall. The airplane came to rest on a city street outside airport property. Of the 142 people on board, 42 persons received minor injuries. The airplane sustained extensive damage.

### **East Coast Airways dba Executive Airlines Accident**

On May 21, 2000, a Jetstream 31, operated by Executive Airlines crashed about nine miles south of the Wilkes-Barre Scranton airport. The airplane was destroyed and the 19 persons on board were killed. The airplane had been chartered by a casino to transport customers between Atlantic City, New Jersey and Wilkes-Barre. The airplane crashed on its second attempted approach. The Board's investigation was hampered because the cockpit voice recorder (CVR) failed to operate properly during the accident flight.

### **AirTran Flight 913 Fire**

On August 8, 2000, the flight crew of AirTran flight 913, a Douglas DC-9, reported smoke

in the cockpit shortly after take off from Greensboro, North Carolina. The airplane landed safely and an emergency evacuation was conducted. Five passengers received minor injuries. The examination of the airplane found evidence of fire in the electrical panel behind the captain's seat and on the cabin side of the bulkhead forming the rear of the cockpit.

### **AirTran Flight 956 Fire**

On November 29, 2000, AirTran flight 956, a Douglas DC-9, returned for an emergency landing at Atlanta, Georgia after the flight crew reported a fire on the airplane. The airplane landed safely and there were no injuries to the 97 people on board. Examination of the airplane revealed substantial sooting on the fuselage exterior, fire damage to the forward cargo bin, and buckling/melting of the passenger floor above the forward cargo bin. Further examination revealed extensive fire damage in the area between the cargo compartment liner and the fuselage skin. This area contains several wiring runs and hydraulic lines that were damaged by fire.

### **American Airlines Flight 1991/TransWorld Airlines Flight 24 Runway Incursion**

The NTSB continues to investigate an incident that occurred on January 22, 2001, when a TWA MD-80 was cleared to land on runway 16R at Seattle while an American Airlines MD-80 was in position on the runway awaiting takeoff clearance. The TWA jet overflew the American Airlines airplane, clearing it by an estimated 60 feet. There were no injuries to the passengers and crew of either airplane.

### **Beech King Air 200 Accident**

On January 28, 2001, the accident airplane descended rapidly before colliding with terrain in Strasburg, Colorado. The flight was transporting members of the Oklahoma State University basketball team. All eight passengers and the two pilots were killed.

### **Comair Flight 5054 Icing Upset**

The NTSB continues to investigate the March 19, 2001, incident when the flight crew of a Comair Embraer 120 reported experiencing an upset event after encountering icing conditions. The aircraft was 46 minutes into a scheduled flight from Nassau, Bahamas, to Orlando, Florida. The airplane diverted to West Palm Beach. Examination of the aircraft found substantial damage to the elevators and the horizontal stabilizer. There were no injuries to the flight crew or 25 passengers.

### **American Airlines Flight 48 Control Problems**

The NTSB continues to investigate an incident that occurred on March 27, 2001, when an American Airlines flight from Dallas, Texas, a 767, experienced pitch control difficulties while on approach to land in Paris. The airplane was descending through 6,000 feet. The flight crew indicated that the airplane did not respond as expected to control column inputs, and that horizontal stabilizer trim was used for pitch control. The flight landed and there were no injuries to the 124 passengers and 13 crew aboard. The French Bureau Enquêtes-Accidents has delegated the investigation of the incident to the NTSB.

### **Gulfstream Accident**

The NTSB continues to investigate the March 29, 2001 crash in Aspen, Colorado of a chartered Gulfstream III. All 15 passengers and three crewmembers were killed when the aircraft crashed on approach to Aspen. The investigation is looking into approach procedures, weather, crew actions, and internal FAA communications.

### September 11<sup>th</sup> Terrorist Attacks

On September 11, 2001, terrorists took command of American Airlines flight 11, United Airlines flight 175, American Airlines flight 77 and United Airlines flight 93. The first two airplanes were crashed into the World Trade Center in New York City and the third was crashed into the Pentagon. The fourth airplane crashed near Shanksville, Pennsylvania, presumably during an intervention by passengers on the flight. It quickly became apparent that the attacks involved criminal intent. Therefore, they were under the jurisdiction of the FBI rather than the NTSB. However, the Safety Board provided extensive support to the FBI, involving more than 80 NTSB personnel in the investigations.

Investigative staff was assigned to each accident site to aid in locating the flight data and cockpit voice recorders and in identifying aircraft components. The flight recorders were also brought to the Safety Board's laboratory for examination and readout. Additionally, Board staff developed detailed flight animations and analysis of air traffic control radio communications and radar data, assisted FBI staff regarding occupational health issues on-scene, and ensured that appropriate information was provided to internal databases and the website.



*NTSB investigators on scene at the World Trade Center following the September 11, 2001 terrorist attack.*

### **American Airlines Flight 587 Crash**

On November 12, 2001, American Airlines flight 587, an Airbus A-300-600, a scheduled flight to the Dominican Republic, crashed shortly after takeoff from John F. Kennedy International Airport, Jamaica, New York. The aircraft crashed into a residential area in Belle Harbor, New York. All 260 on board and five people on the ground were killed in the accident. The airplane and six houses were destroyed, the second deadliest accident in U.S. history.



*Investigators examine the American Airlines flight 587 crash scene.*

## General Aviation

The NTSB's regional and field offices initiated 1,835 general aviation accident investigations in 2000 and 1,996 in 2001. In addition, the NTSB regional offices investigated 57 aviation incidents in 2000 and 46 in 2001. Although these accidents do not have the high visibility of those involving major air carriers, they are an important source of transportation safety information.

A general aviation accident is handled much the same way as a major investigation, but because the investigation is typically much smaller in scope, it often is conducted by a single regional investigator who, working with representatives from other parties, gathers the pertinent information. Analysts at the Board headquarters review the standardized accident forms and narrative reports prepared by regional investigators for the public record. Computer brief reports containing relevant facts, findings, and probable cause are prepared for all regional investigations; and summary narrative reports are prepared for selective cases. Data from all investigations is maintained to identify trends, assess program effectiveness, and provide statistical support for the NTSB safety recommendations and studies.

### ***On-going Regional Investigations***

#### **Piper PA-31 Accident**

On September 18, 2000, a Piper PA-31T3 airplane was destroyed by impact and post-impact fire after colliding with tundra-covered terrain, about 300 yards south of the Nuiqsut Airport, Nuiqsut, Alaska. The airplane was operated as flight 181 by Cape Smythe Air Service Inc., Barrow, Alaska. The airline transport-certificated pilot and four passengers were killed. Five other passengers were seriously injured. The flight originated in Deadhorse, Alaska.

The director of operations for the operator reported that the airplane was equipped with a fuselage-mounted belly cargo pod. The airplane was observed by witnesses at the Nuiqsut Airport touching down on runway 22 with the landing gear retracted. The belly pod lightly scraped the runway for about 40 feet, but the airplane transitioned to a climb. As the airplane began climbing away from the runway, the landing gear was observed extending. The airplane climbed to about 100 to 150 feet above the ground, and then began a descending left turn. The airplane collided with the ground on a 95-degree heading. The wreckage path extended for about 300 feet; the landing gear, left wing, and the left engine separated from the airplane. A post-crash fire destroyed the fuselage, right wing, and right engine.

This accident is under investigation by the NTSB's Northwest Field Office, Anchorage, Alaska.

### **Canadair Challenger 600 Accident**

On October 10, 2000, a Canadair Challenger 600-2B16 airplane, operated by Bombardier Incorporated, was destroyed on impact with terrain and an airport perimeter fence during initial climb from runway 19 at the Wichita Mid-Continent Airport, Wichita, Kansas. The airplane came to rest on a two-lane north-south road located along the western perimeter of the airport. The test flight was not operating on a flight plan. The pilot and flight test engineer were killed; the copilot was seriously injured. The flight originated at Wichita, Kansas.

The accident is under investigation by the NTSB's North Central Regional Office, West Chicago, Illinois.

### **Cessna 335 Accident**

On October 16, 2000, a Cessna 335 airplane, operated by a commercial instrument rated pilot collided with the terrain near Hillsboro, Missouri. The pilot and two passengers were killed. The airplane was destroyed. Instrument meteorological conditions prevailed and the airplane was operating on an instrument flight plan. The business flight had departed the St. Louis Downtown Parks Airport (CPS), Cahokia, Illinois and was en route to New Madrid, Missouri.

On board the airplane were the Governor of Missouri, an aide to the Governor, and the Governor's son who was piloting the airplane. The pilot received a weather briefing and filed an instrument flight rules flight plan with the St. Louis Automated Flight Service Station prior to departing CPS.

While en route to New Madrid, the pilot reported to air traffic control that he was having problems with the primary attitude indicator and he requested to climb to a higher altitude. The pilot was subsequently issued a climb to 4,000 feet. The pilot then reported that the primary attitude indicator was not "reading properly" and he was trying to fly using the copilot's. The pilot then stated that they wanted to divert to Jefferson City where the weather was better. The airplane was in the process of diverting when the accident occurred. The last radar contact with the airplane was at 1931:55 at an altitude of 3,900 feet above mean sea level.

The investigation is being conducted by the NTSB's North Central Regional Office in West Chicago, Illinois.

### **General Dynamics F-16 and Cessna 172 Midair Collision**

On November 16, 2000, a General Dynamics F-16 military jet airplane operated by the United States Air Force and a civilian Cessna 172 were involved in a midair collision in the vicinity of Bradenton, Florida. Visual flight conditions prevailed at the time of the accident. The F-16 was one of two airplanes operating on a low altitude training mission. No flight plan was filed for the Cessna 172. The pilot of the F-16 successfully ejected and the Cessna pilot (who was airline transport pilot qualified) was killed.

Witnesses stated they heard the sound of approaching jets. They looked up and observed the first jet flying towards the south followed by the second jet located to the left and slightly lower than the first jet. They also observed a small civilian airplane flying from west to east perpendicular to the military jets. The second collided with the civilian airplane and initially continued southbound. The airplane was observed making a right turn, and then turning back to the left. A parachute was observed, and the airplane entered into a flat spin to the left and disappeared from view below the trees. An explosion was heard, followed by heavy dark smoke rising above the terrain.

This accident is under investigation by the NTSB's Southeast Regional Office in Miami, Florida.

### **Cessna 501 Accident**

On April 2, 2001, a Cessna 501, was destroyed on impact with a storage facility shortly after takeoff at Ashwaubenon, Wisconsin. The pilot was killed and seven persons on the ground were injured. The aircraft was on a ferry flight that originated at Green Bay, Wisconsin and was en route to Ft. Myers, Florida. Instrument meteorological conditions prevailed and the airplane was operating on an instrument flight plan.

### **Learjet 25D Accident**

On June 12, 2001, a Learjet 25D, operated by Avcon Industries, Newton, Kansas, was destroyed on impact with terrain on airport property during landing at Salina, Kansas. The pilot and co-pilot sustained serious injuries. The aircraft was on a test flight for a supplemental type certificate. Visual meteorological conditions prevailed.

## International Aviation Accidents

The NTSB assists other nations with aircraft accidents that occurred outside the United States. The following are examples of ongoing investigations.

### **Swissair MD-11 Accident**

The NTSB continues to provide assistance to the Transportation Safety Board of Canada in its investigation of the September 2, 1998 crash of a Swissair MD-11 off the coast of Nova Scotia. Flight 111, en route from JFK Airport, NY, to Geneva, Switzerland, crashed in the North Atlantic killing all 229 passengers and crew.

### **Korean Air MD-11 Cargo Accident**

The NTSB assisted Chinese authorities in its investigation and report of an April 1999 Korean Air accident. The MD-11 crashed shortly after takeoff from Shanghai, China. The airplane was destroyed, and the two pilots and mechanic on board were killed. Additionally, five persons on the ground were killed, and 37 others were injured. The flight was a regularly scheduled cargo flight from Shanghai to Seoul, Korea.

### **Air France Concorde Accident**

The NTSB continues to provide assistance to French authorities in its investigation of the July 25, 2000 crash of an Air France Concorde as it took off from Charles DeGaulle Airport, Paris. All 109 on board were killed and five others on the ground were killed.

### **GulfAir A320 Accident**

The NTSB continues to provide assistance to the government of Bahrain in its investigation of the August 23, 2000 crash of a GulfAir A320. The aircraft crashed at sea during a go-around on approach to Manama, Bahrain, killing 143.



### **Singapore Airlines 747 Accident**

The NTSB continues to provide assistance to Singapore authorities in its investigation of the October 31, 2000 crash of a Singapore Airlines 747 as it attempted to take off from Taipei, Taiwan, and struck a barrier. There were 82 fatalities.

### **Learjet Accidents**

The NTSB is providing support to authorities of the governments of Germany and France in separate accidents that occurred in 2000 and 2001. Both accidents exhibited similar scenarios of an engine-related anomaly, a precautionary landing, and a crash during the attempted landing. Both accidents resulted in fatalities and destruction of the airplanes.

### **Thai Airways 737 Explosion**

The NTSB continues to provide technical support to the Government of Thailand's investigation of a March 3, 2001 explosion and fire that destroyed a Thai Airways International 737-400 that was sitting at a gate at Don Muang International Airport, Bangkok. A flight attendant aboard the plane was killed and the airplane destroyed.

### **Express One International, Inc Boeing 727 Accident**

At the request of the Federated States of Micronesia (FSM), the NTSB is investigating a landing accident that occurred on March 11, 2001, at Pohnapei Airport, FSM. The airplane landed short of the island runway, the right main landing gear separated, and the airplane skidded off the right side of the runway. No injuries occurred to the three crewmembers on the cargo flight; the aircraft sustained substantial damage.

### **Cessna Crash**

The NTSB continues to provide assistance to the Bahamian government in its investigation of the August 25, 2001, crash of a Cessna 402B operated by U.S.-based Blackhawk International Airways Inc. The airplane crashed shortly after takeoff at Marsh Harbour Airport, Bahamas. Visual meteorological conditions prevailed at the time. The pilot and eight passengers were killed. The on-demand air taxi flight was destined for Opa-Locka, Florida.

### **CASA 235 Crash**

On August 29, 2001, an Iberia CASA 235 crashed near Malaga, Spain. The airplane was on final approach to the airport when the crew reported an engine failure and then subsequently reported that the other engine had failed. The captain and three passengers were killed and the first officer and 39 passengers were injured. The NTSB provided an accredited representative to participate in the investigation as the engines' country of manufacture.

### **Boeing MD-87 and Cessna Citation Collision**

On October 8, 2001, a Scandinavian Airline System (SAS) MD-87 collided with a Cessna Citation business jet in Milan, Italy. The MD-87 had been cleared for takeoff, and the Citation was taxiing for takeoff on the same runway. All 114 people on the MD-87 and four people on the Citation were killed. Additionally, six people in a baggage handling facility were killed when the MD-87 impacted the building. Heavy fog was present at the time of the collision.

## Public Hearings

### **American Airlines Flight 1420**

The NTSB convened a public hearing in Little Rock, Arkansas, January 26-28, 2000, as part of its ongoing investigation into the fatal runway accident of American Airlines flight 1420. Chairman Jim Hall chaired the hearing.



*Board of Inquiry questions parties during American Airlines flight 1420 public hearing.*

The accident aircraft, a McDonnell Douglas MD-82 on a regularly scheduled passenger flight from Dallas, Texas, on June 1, 1999, overran the end of the runway, went down an embankment, and impacted approach light structures after landing at the Little Rock airport. Thunderstorms and heavy rain were reported in the area at the time of the accident. There were 11 fatalities, including the aircraft captain, and numerous injuries among the 145 passengers and crew aboard the flight.

The hearing focused on:

- flight crew decision-making and its relationship to fatigue;
- availability and dissemination of weather data;
- aircraft performance;
- passenger safety and emergency response;
- runway overrun protection; and
- American Airlines' operational practices and procedures,
- FAA oversight.

### **Alaska Airlines Flight 261**

The NTSB held a public hearing December 13-15, 2000, on the fatal crash of Alaska Airlines flight 261 in the Safety Board's Boardroom and Conference Center in Washington, D.C. Member John Hammerschmidt chaired the hearing. The January 31, 2000 crash of Alaska Airlines flight 261 off the coast of California, near Pt. Mugu, claimed the lives of all 88 aboard.

Some of the issues discussed during the hearing were:

- Alaska Airlines' maintenance organization and procedures;
- its safety program;
- design and service history of the MD-80 series aircraft longitudinal trim system;
- FAA's certification and oversight of the ongoing airworthiness of that system;
- industry lubrication practices of the horizontal stabilizer jackscrew; and
- FAA's surveillance of Alaska Airlines.

## Symposia

### **General Aviation Accident Prevention**

On September 21-22, 2000, the NTSB held a symposium in the NTSB Board Room and Conference Center on issues related to improving transportation safety in general aviation. Discussion included a review of accident investigations by NTSB regional investigators and the analysis of causes, factors, and preventive measures by panels consisting of government/industry experts and safety officials.



# Highway Safety

Highway transportation accidents have a significant impact on American society, though quantifying the total cost is difficult to fully determine. With respect to the cost in lives, more than 41,800 people were killed and more than three million were injured in motor vehicle accidents in 2000. The economic costs are also staggering and easily exceed \$130 billion in medical costs, property damage and lost wages. The Safety Board is charged with mitigating those costs by improving the safety of the public with recommended changes in government and industry transportation policies, practices and systems through independent accident investigations. In that role, the Board attempts to determine first what happened in an accident and then, by establishing a probable cause, why it happened.

Because of the Board's limited highway staff, we have devoted our resources to in-depth investigations of those accidents that have a significant impact on the public's confidence in highway transportation safety, generate high public interest, and highlight national safety issues. Historically, those types of accidents have been primarily single major events after which the Board made recommendations on issues arising from the accident circumstances. However, those catastrophic accidents generally involved large loss of life and property damages, and in some cases may not have been representative of the typical highway accidents occurring daily nationwide. As a result, the Office of Highway Safety has expanded its attention to identifying emerging trends obtained from limited research and accident data and to investigating groups of accidents to identify potential root causes and appropriate countermeasures.

## *Completed Investigations*

### **Burnt Cabins, Pennsylvania Motorcoach Accident**

On June 20, 1998 at about 4:05 a.m., a 1997 Motor Coach Industries 47-passenger motorcoach, operated by Greyhound Lines, Inc., was on a scheduled trip from New York City to Pittsburgh, Pennsylvania, traveling westbound on the Pennsylvania Turnpike near Burnt Cabins, Pennsylvania. As the bus approached milepost 184.9, it traveled off the right side of the roadway into an emergency parking area where it struck the back of a parked tractor-semitrailer, which was pushed forward and struck the left side of another parked tractor-semitrailer.

Of the 23 people on board the bus, the driver and six passengers were killed; the other 16 passengers were injured. The two occupants of the first tractor-semitrailer were injured, and the occupant of the second tractor-semitrailer was uninjured.



*Vehicles involved in the Burnt Cabins, Pennsylvania motorcoach accident.*



Safety issues examined included:

- bus driver's performance;
- carrier oversight;
- design and the appropriateness of the use of pull-off areas;
- lack of motorcoach emergency interior lighting and retro-reflective signage; and
- organization of the disaster preparedness and emergency response management.

On January 5, 2000, the Board determined that the probable cause of the accident was the bus driver's reduced alertness resulting from ingesting a sedating antihistamine and his fatigued condition resulting from Greyhound Lines, Inc., irregular work-rest periods. Contributing to the severity of the accident was the Pennsylvania Turnpike Commission's practice of routinely permitting non-emergency parking in pull-off areas within the highway clear zone.

The Board issued 11 recommendations to the National Highway Traffic Safety Administration (NHTSA), the Pennsylvania Turnpike Commission, Greyhound Lines Inc., the United Motorcoach Association and the American Bus Association to address emergency lighting, pull-off area parking, disaster drills, driver scheduling and the use of electronic vehicle recording devices.

### **Special Investigation Report – Truck Parking Areas**

In April 1999, the NTSB began a truck/bus safety initiative and held four public hearings to obtain information from a variety of sources about the relevant safety issues regarding trucks and buses and on how to address them. Participating in these hearings were representatives from the truck and bus industries, vehicle and equipment manufacturers, labor unions, safety advocacy groups, and various state and federal agencies.

The major issue addressed in the Highway Special Investigation Report – Truck Parking Areas, is the lack of safe available commercial vehicle parking on or near interstates for truck drivers who want or need to use it. The report also discussed the lack of information about parking available to truck drivers and the state-enforced parking time limits.

As a result of its investigation, on May 17, 2000, the Board issued 10 recommendations to the Federal Highway Administration; Federal Motor Carrier Safety Administration (FMCSA); the Governors of Alabama, Delaware, Florida, Georgia, Illinois, Kentucky, Louisiana, Minnesota, Nebraska, New Jersey, Pennsylvania, South Carolina, South Dakota, Tennessee, Virginia, and Washington; the American Trucking Associations, Inc.; the Owner-Operator Independent Drivers Association; the National Private Truck Council; the National Association of Truck Stop Operators; and the National Industrial Transportation League. The recommendations include evaluating the benefits of private development of rest areas on the interstates and the creation of a comprehensive guide to parking areas for trucks.

### **Central Bridge, New York School Bus Accident**

About 10:30 a.m., on October 21, 1999, near Central Bridge, New York, a Kinnicutt Bus Company school bus was transporting 44 students, 5 to 9 years old, and eight adults on a field trip. The bus was traveling north on State Route 30A as it approached the intersection with State Route 7, which is about 1.5 miles east of Central Bridge. Concurrently, an MVF Construction Company dump truck, towing a utility trailer, was traveling west on State Route 7. The driver and a passenger occupied the dump truck. As the 79-year-old school bus driver approached the intersection, he failed to stop as required and the bus was struck by the dump truck. Seven bus passengers sustained serious injuries; 28 bus passengers and the truck driver received minor injuries. Thirteen bus passengers, the bus driver, and the truck passenger were uninjured.

*The NTSB studies emerging trends and investigates accidents to find potential root causes of highway accidents and their counter measures.*

Safety issues examined were:

- potential for passenger injuries as a result of the school bus emergency exit door design;
- potential for passenger injuries as a result of school bus seat cushion bottoms that are removable or hinged; and
- adequacy of commercial vehicle airbrake inspections.

The medical fitness of commercial drivers and the medical examination for the commercial driver's license were also identified as safety issues; however, these issues will be analyzed in a forthcoming Safety Board special investigation report.

On November 14, 2000, the Board determined that the probable cause of this accident was the school bus driver's failure to stop for the stop sign due to his degraded performance or lapse of attention as a result of factors associated with aging or his medical condition or both.

As a result of this accident investigation, the Safety Board made six recommendations to NHTSA, FMCSA, the National Association of State Directors of Pupil

Transportation Services, the Maintenance Council of the American Trucking Associations, and the Commercial Vehicle Safety Alliance to address emergency exit door and seat cushion bottom design, and brake inspections. In addition, two safety recommendations were reiterated to the NHTSA concerning school bus occupant protection systems.



*Vehicle where they came to rest following the Central Bridge, New York school bus accident.*

### **Special Investigation Report – Rear-end Collision Prevention Technologies**

Historically, rear-end collisions have had a significant impact on highway safety. Rear-end collisions account for almost one-third of crashes and 11.8 percent of multi-vehicle fatal crashes, and these figures have been increasing. In a two-year period, the NTSB investigated nine rear-end collisions in which 20 people died and 181 were injured (three accidents involved buses and one accident involved 24 vehicles). Common to all nine accidents was the rear following vehicle driver's degraded perception of traffic conditions ahead from atmospheric conditions (i.e., glare, fog, smoke), failure to notice stopped traffic due to congestion at work zones or other distractions, or fatigue.

A study has shown that if passenger car drivers had a 0.5-second additional warning time, about 60 percent of rear-end collisions can be prevented. An extra second can prevent about 90 percent of rear-end collisions. The NTSB reported in 1995 and further discussed in a public hearing in 1999 that existing technology can prevent these collisions. However, the DOT has been slow to act. In 1999, the DOT commenced operational testing of some equipment and several states also have projects under way. The work being done by private industry and the government is encouraging, but the pace of testing and of standards development for all vehicles and of deployment for commercial vehicles is cause for concern, given the increasing number of rear-end collisions and the number of fatalities when commercial vehicles are involved. Therefore, the NTSB again addressed the subject and has explored the issues involved in deploying technological solutions.

## Highway Safety

One of the accidents investigated for the study took place on March 8, 2000, about 7:58 a.m. on Interstate 10 near Wellborn, Florida. The multi-vehicle collision involved 24 vehicles (including eight tractor semi-trailers); a post-crash fire ensued. Visibility at the time of the collision was significantly reduced as a result of smoke from local forest fires and fog in the area, according to witnesses. The accident resulted in three fatalities, 17 serious injuries, and 12 minor injuries.

The posted speed limit was 70 mph, with a minimum of 40 mph. According to the Florida Highway Patrol and the Florida Department of Forestry, fires had caused hazardous driving conditions in several areas, so the Florida Department of Transportation placed “FOG/ SMOKE” warning signs with a flashing yellow beacon in pairs adjacent to each side of the highway.

Most of the impacts between vehicles occurred on the westbound side of the interstate. Additional collisions occurred on the eastbound side of the highway and within the center median. The initial collision on the westbound side occurred when vehicle 1 began to slow to between 50 and 55 mph as the visibility on the highway increasingly diminished due to the smoke and fog. The truck driver considered pulling off the road and stopping, but before he could do so, he was struck from behind by vehicle 2. Several subsequent drivers said they also began to slow, but were unable to see the wreckage until it was too late to avoid colliding with the other vehicles. Sixteen vehicles were involved in the initial collision.

The first collision on the eastbound side occurred when vehicle 18 stopped on the side of the highway because the smoke and fog conditions prevented the driver from clearly seeing the roadway. The driver of vehicle 18, who had stopped on the shoulder in an area, believed the road was not completely obscured by smoke. The driver of vehicle 17 was traveling about 70 mph, some distance behind vehicle 18. She noticed the FOG/SMOKE signs, but did not think the smoke appeared to be very dense. However, when she entered the smoke, she said her visibility diminished.



*Multi-vehicle collision in Wellborn, Florida.*

As she slowed down, the left front of her vehicle struck the right rear of vehicle 18. The remainder of the collisions on the eastbound side occurred when subsequent vehicles approached this accident and collided with it or debris from it.

In its May 1, 2001 report, the Board issued 11 recommendations to address issues including existing technologies such as adaptive cruise control, collision warning systems, and

infrastructure-based congestion warning systems that can reduce the likelihood of rear-end collisions.

### **New Orleans, Louisiana Motorcoach Accident**

On May 9, 1999, a 55-passenger motorcoach was traveling on Interstate 610 in New Orleans, Louisiana. The bus, carrying 43 passengers, was en route to a casino approximately 80 miles away in Mississippi. The bus departed the right side of the highway, crossed the shoulder, and adjacent grassy slope, struck a guardrail, traveled through a chain-link fence, vaulted over a paved golf cart path, collided with the far side of a dirt embankment, and



then bounced and slid forward upright to its final resting position. Twenty-two passengers were killed, the bus driver and 15 passengers received serious injuries, and six other passengers received minor injuries.

On August 28, 2001, the Board determined that the probable cause of this accident was the driver's incapacitation due to his severe medical conditions and the failure of the medical certification process to detect and remove the driver from service. Other factors that may have had a role in the accident were the driver's fatigue and his use of marijuana and a sedating antihistamine. Thirteen recommendations were issued.

### **Glendale, California Grade Crossing Accident**

The accident in Glendale, California occurred on January 28, 2000, about 5:59 a.m. when a tractor semi-trailer transporting an oil refinery condenser unit made a wrong turn, crossed a highway-railroad grade crossing in Glendale, California, turned around, and was attempting to cross the tracks again when the vehicle became lodged on the railroad tracks. About 90 seconds later a northbound Metro Link commuter train, operated by the Southern California Regional Rail Authority was traveling about 70 miles per hour from Los Angeles to Burbank, California, when the train collided with the semi-trailer. Two crewmembers (conductor and engineer) and four passengers were injured.

The tractor semi-trailer and super load measured 135 feet long, 15 feet wide, and 18 feet, 6 inches tall with a ground clearance of about 6 inches and a gross vehicle weight of 226,000 pounds. The truck, with a load valued at \$1.5 million, was traveling from Houston, Texas to El Segundo, California, and had a specialized moving permit requiring escort vehicles. At the time of the accident, two private pilot vehicles and three California Highway Patrol officers were escorting the tractor semi-trailer.

On November 27, 2001, the Board determined that the probable cause of the collision was inadequate preparation and route planning for the movement, poor coordination between the truck driver, pilot car drivers, police escort, and permit authorities, and a lack of recognition of the potential hazard caused by the accident vehicle at the grade crossing. Contributing to the accident was the fatigue of the pilot car drivers and the truck driver. Eight recommendations were issued.



*Results of the grade crossing accident in Glendale, California.*

### **Conasauga, Tennessee School Bus Accident**

The Conasauga, Tennessee accident occurred at about 6:40 a.m. on March 28, 2000, when a 1999 International school bus with a 72-passenger Blue Bird body was traveling westbound on Liberty Church Road in Conasauga, Polk County, Tennessee. The bus, carrying seven elementary school students, ages five through nine, was on a morning pick-up route for the Murray County School District, headquartered in Chatsworth, Georgia.

After picking up the last student on Liberty Church Road, the driver proceeded on a downgrade towards a single-track railroad crossing that was protected by railroad cross



*School bus after being struck by train in Conasauga, Tennessee.*

bucks. As the driver reached the grade crossing she failed to stop, entered the crossing, and was struck by a south-bound CSX 33-car freight train traveling at approximately 50 mph. The impact separated the school bus body from its frame and both sections came to rest on the west side of the rail. The locomotive came to rest about 1,950 feet south of the crossing.

During the accident sequence, the driver and three children were ejected. The driver and two ejected children sustained serious injuries and the other ejected child was killed. Of the four children who remained inside the school bus, one was killed, one died two days later in the hospital, one sustained serious injuries and one, who was restrained by a lap belt, sustained minor injuries.

On December 11, 2001, the Board determined that the probable cause was the school bus driver's failure to stop before traversing the railroad/highway grade crossing. A contributing factor was the Murray County, Georgia School District's failure to monitor bus driver performance and its lack of school bus route planning to identify hazards on school bus routes and to eliminate the necessity of crossing railroad tracks. Contributing to the injuries of the school bus passengers outside the area of intrusion were incomplete compartmentalization and lack of energy-absorbing material on interior surfaces. Ten recommendations were issued.

### ***On-going Investigations***

#### **Lincoln, Nebraska**

The multi-vehicle accident in Lincoln, Nebraska occurred on October 19, 2000, at about 1:49 p.m. and involved a 1996 Freightliner 3-axle dump truck traveling south on 27th Street. After cresting a slight grade and starting down the other side, the dump truck driver attempted to apply the service brakes and the pedal went all the way to the floor, leaving the driver without service brakes.

The loaded dump truck then went through a red light, struck one car, veered into the drive-through lane of a fast-food restaurant, and struck a second car before ending up in the restaurant. The two car drivers were killed and a restaurant employee was injured. The dump truck driver survived.



*Investigators examine vehicle involved in accident in Lincoln, Nebraska.*

The NTSB's investigation, in cooperation with the local and state police and the Freightliner Corporation, revealed that the truck's brake pedal pushrod had fractured, rendering the service airbrakes inoperable. The investigation found similar accidents elsewhere in the country and established that the same pushrod design was found on other Freightliner trucks, including fire and emergency vehicles.

Based on information compiled by the NTSB, Freightliner reacted quickly and in less than two weeks announced a voluntary recall of approximately 133,000 trucks equipped with such airbrake systems to correct the pushrod problem.

### **Intercession City, Florida Grade Crossing Accident**

The Intercession City, Florida accident occurred on November 17, 2000 at 4:35 p.m. when a very long (230-foot) combination vehicle, consisting of a truck-tractor pulling a modular transport semi-trailer and a four-axle truck-tractor was en route to deliver an 82-ton condenser tube bundle to an electric generating plant under construction. The private access road to the plant facility crosses over a single railroad track of CSX Transportation Inc.

Due to the configuration of the truck and the profile of the roadway, the cargo deck of the modular transport trailer began to bottom out on the surface of the roadway as the vehicle moved across the tracks and began down the descending grade at a speed of between 1-3 mph.

As the vehicle continued slowly across the crossing, the lights and bells at the grade crossing activated. The crossing gates then descended, striking the trailer. Seconds later, Amtrak train 97, the Silver Meteor, traveling at 77 mph and carrying a four-person crew and 83 passengers struck the side of the towed four-axle trailer, located at the end of the 230-foot combination vehicle.

There was no derailment; however the locomotive and dorm lounge car sustained approximately \$125,000 damage and the truck tractor was totally destroyed. Two crewmembers and three passengers were injured.



*Train/truck collision at grade crossing in Intercession City, Florida.*

This accident is nearly identical to one the Safety Board investigated at the same crossing on November 30, 1993. The earlier accident also involved a long, slow moving combination vehicle (operated by a different company) hauling equipment to the same electric plant. An Amtrak train, the Silver Meteor, struck that vehicle. Fifty-nine people were injured in that accident and damage exceeded \$14 million.

The issues being examined include several that were addressed in the 1993 report, but were not adequately implemented, concerning rail and trucking company coordination and procedures to ensure a safe crossing for over-dimension, low clearance, slow moving vehicles.

In addition to the major accidents, Office of Highway Safety has initiated a number of accident investigations to identify emerging trends and/or find potential root causes for accident types highlighted in limited research and accident data. These include accidents involving 15-passenger vans used by college sports teams and school bus rollovers in which emergency hatches fail, allowing passenger ejections.

### **Joliet, Illinois Crash**

The NTSB continues to investigate a van/tractor trailer accident in Joliet, Illinois, in January 2001. A Salvation Army van with 11 occupants crossed an interstate highway median and was struck by a tractor-trailer. All 11 people in the van were killed.

### **Henrietta, Texas and Randleman, North Carolina Van Accidents**

The NTSB continues to investigate two accidents involving 15-passenger vans, one in Henrietta, Texas in May 2001 and the second in Randleman, North Carolina in July 2001. In each case, vans operated by church groups had left rear tire blowouts and subsequent rollovers, killing five and injuring 21 in the two accidents.

### **Mountainburg, Arkansas School Bus Accident**

The NTSB continues to investigate an accident with a school bus and a loaded tractor-trailer near Mountainburg, Arkansas, on May 31, 2001. The tractor-trailer, with inoperative brakes, struck the bus in the side at an intersection and resulted in fatal injuries to three of the nine students onboard.

### **Omaha, Nebraska School Bus Accident**

The NTSB continues to investigate an accident near Omaha, Nebraska, in October 2001, involving a school bus and a motor coach passing each other in a highway bridge construction zone. The school bus struck a guardrail, went over the side of the bridge and fell 50 feet into a stream; four passengers were killed and 25 were injured.

### **Monaca, Pennsylvania Construction Zone Accident**

The NTSB continues to investigate an accident near Monaca, Pennsylvania, in October 2001, involving a truck in a highway construction zone in which five workers were struck and killed by the truck.

## Public Hearings

### ***Commercial Driver's Licenses (CDL)***

In January 2000, the Safety Board conducted a two-day public hearing that examined the adequacy of commercial driver oversight. A wide range of witnesses participated in this



hearing, including truck and bus drivers, members of advocacy groups, federal and state government officials, and industry representatives. Representatives from other countries were also invited to discuss their systems. Discussions centered on the CDL and medical certification programs to determine whether they were effective in ensuring the proficiency, capability, and safety of the commercial vehicle operators traveling on the nation's roadways. Also as part of the hearing, the Board compared the commercial driver licensing and certification processes to that of commercial pilots and to the CDL program in the European Union and Australia.

Topics addressed included:

- industry's role in driver oversight;
- programs carriers have to supplement state and federal requirements;
- actual process of obtaining a CDL and the knowledge and skill testing required;
- success of the CDL program in detecting drivers that are no longer fit or that may have multiple violations;
- process of CDL suspension and revocation; and
- available driver data and the problems associated with incomplete or faulty data.

# Marine Safety



The NTSB is authorized to investigate marine accidents involving foreign vessels in U.S. territorial waters or U.S. vessels anywhere in the world. In past years, the Board has conducted marine accident investigations as far away as the Persian Gulf and the South China Sea.

The marine accident investigation function is performed entirely by NTSB headquarters staff. To carry out its marine safety program, the Board maintains a small staff of professional investigators with maritime knowledge and experience. These investigators include licensed master mariners, marine engineers, naval architects, human performance and survival factors specialists.

About 5,000 accidents involving commercial vessels and more than 8,000 accidents involving recreational boats occur each year in the United States or under U.S. jurisdiction. Given this number of accidents, the Safety Board must decide whether the severity of an accident and the safety issues involved require a NTSB investigation. In practice, the Board tries to target only those accidents that appear to involve the most significant safety issues. Under current marine accident selection criteria, the Board generally will investigate accidents involving:

- the loss of six or more lives;
- the loss of a self-propelled vessel of over 100 gross tons or damage to any vessel and/or property exceeding \$500,000;
- serious hazardous materials threats to life, property, and the environment;
- Coast Guard safety functions (e.g., vessel traffic services, search and rescue operations, vessel inspections, aids to navigation); and
- a public/nonpublic vessel collision with one or more fatalities or \$75,000 or more in property damage.

Investigative areas selected by the Board for special emphasis include:

- large passenger vessels, including ocean cruise ships, ferries, and gaming vessels;
- small passenger vessels carrying more than six passengers for hire and excursion vessels;
- maritime technology and communications;
- tank ships and tank barges carrying hazardous materials;
- fatigue and hours of service on all vessels;
- commercial fishing vessels;
- collisions and groundings involving oceangoing vessels; and
- inland tow vessel rammings and collisions.

The Safety Board has the option of requesting that the Coast Guard investigate an accident without NTSB participation. In such cases, USCG will send the accident file to the Board when the investigation is completed. When the Board decides to investigate a marine accident, it must coordinate with the Coast Guard on whether the investigation will be conducted jointly under USCG rules or independently under NTSB rules.

Marine accident reports of these investigations contain in-depth analysis of the accidents, a finding of probable cause or causes, and safety recommendations to prevent similar accidents from occurring. As in the other transportation modes, the Safety Board undertakes studies involving specific marine safety issues, which typically result in the issuance of recommendations to federal and state agencies and to the maritime industry.

## Completed Major Marine Investigations

### Mississippi River Casino Boat Ramming

About 7:50 p.m., on April 4, 1998, a tow of the *M/V Anne Holly*, comprising 12 loaded and two empty barges, which was traveling northbound on the Mississippi River through the St. Louis Harbor, struck the Missouri-side pier of the center span of the Eads Bridge. Eight barges broke away from the tow and drifted back through the Missouri span. Three of these barges drifted toward the *President Casino on the Admiral (Admiral)*, a permanently moored gaming vessel below the bridge on the Missouri side of the river.



Diagram of Mississippi River Casino boat ramming.

The drifting barges struck the moored *Admiral*, causing eight of its 10 mooring lines to break. The *Admiral*, with about 2,100 people on board including a staff of 250, then rotated clockwise down river, away from the Missouri riverbank. The captain of the *Anne Holly* disengaged his vessel from the six remaining barges in the tow and placed the *Anne Holly*'s bow against the *Admiral*'s bow to hold it against the bank. About the time the *Anne Holly* began pushing against the *Admiral*, the *Admiral*'s next-to-last mooring line parted. The *Anne Holly* and the single mooring wire that remained attached to the *Admiral*'s stern anchor held the *Admiral* near the Missouri bank.

No deaths resulted from the accident; 50 people were examined for minor injuries. Of those examined, 16 were sent to local hospitals for further treatment. Damages were estimated at \$11 million.

The issues involved in this accident included:

- advisability of the *Anne Holly* captain's decision to make an upriver transit during adverse river conditions;

*The NTSB investigates accidents involving foreign vessels in U.S. waters or U.S. vessels anywhere in the world.*

## Marine Safety

- effectiveness of safety management oversight on the part of American Milling, L.P. (owner of the *Anne Holly*);
- effectiveness of safety measures provided for the permanently moored vessel *President Casino on the Admiral*; and
- adequacy of public safety for permanently moored vessels.



*President Casino on the Admiral at its mooring complex below the Eads Bridge.*

On September 8, 2000, the Safety Board found that the probable cause of the ramming of the Eads Bridge in St. Louis Harbor by barges in tow of the *Anne Holly* and the subsequent breakup of the tow was poor decision-making by the captain of the *Anne Holly* in attempting to transit St. Louis Harbor with a large tow, in darkness, under high current and flood conditions, and the failure of the management of American Milling, L.P., to provide adequate policy and direction to ensure the safe operation of its towboats. The Safety Board also determined that the probable cause of the near breakaway of the *President Casino on the Admiral* was the failure of the owner, the local and state authorities, and the USCG to adequately protect the permanently moored vessel from waterborne and current-related risks. Twenty-seven recommendations were issued.

### **Wisconsin Fishing Vessel Sinking**

The NTSB issued a final report to Congress on its review of the disappearance of the fishing vessel *Linda E*, with three crewmembers on December 11, 1998. The 42-foot long steel fishing vessel departed Port Washington, Wisconsin en route to a position in Lake Michigan about nine miles southeast of Port Washington to retrieve and set gill nets. The Coast Guard initiated a search and rescue early on the morning of December 12 and terminated their search on the evening of December 13, 1998.

On December 16, 1999, the Safety Board received a request from the Wisconsin congressional delegation to investigate the disappearance, find the vessel and raise it. After a detailed review of the investigative file provided by the Coast Guard and the resources necessary to find and retrieve the vessel, the Safety Board prepared a summary of the review and, on November 14, 2000, notified the Wisconsin delegation of the necessary, but difficult, decision not to proceed further.

### **Florida Cruise Ship Fire**

On the afternoon of July 20, 1998, the Liberian passenger ship *Ecstasy* had departed the Port of Miami, Florida, en route to Key West, Florida, with 2,565 passengers and 916 crewmembers on board when a fire started in the main laundry. The fire migrated through the ventilation system to the aft mooring deck where mooring lines ignited, creating intense heat and large amounts of smoke.

As the *Ecstasy* was attempting to reach an anchorage north of the Miami sea buoy, the vessel lost propulsion power and steering and began to drift. The master then radioed the USCG for assistance. Six tugboats responded to help fight the fire and to tow the *Ecstasy*. The fire was brought under control by onboard firefighters. Fourteen crewmembers and eight passengers suffered minor injuries. One passenger who required medical treatment as a result of a preexisting condition was categorized as a serious injury victim because of the length of her hospital stay. Carnival Corporation, Inc., the owner of the *Ecstasy*, estimated that losses from the fire and associated damages exceeded \$17 million.



View of M/V *Ecstasy*'s fire damaged aft mooring deck.

The major safety issues examined in this investigation include the adequacy of:

- management safety oversight;
- the fire protection systems;
- passenger and crew safety; and
- engineering system design.

On May 1, 2001, the NTSB determined that the probable cause of the fire aboard the *Ecstasy* was the unauthorized welding by crewmembers in the main laundry that ignited a large accumulation of lint in the ventilation system and the failure of Carnival Cruise Lines to maintain the laundry exhaust ducts in a fire-safe condition. Contributing to the extensive fire damage on the ship was the lack of an automatic fire suppression system on the aft mooring deck and the lack of an automatic means of mitigating the spread of smoke and fire through the ventilation ducts. Twelve recommendations were issued.

### **Automatic Local Sounding Smoke Alarms on Cruise Ships**

After a series of fatal and near-fatal fires on board cruise ships operating from U.S. ports, the Safety Board issued, on July 18, 2000, two safety recommendations to the cruise industry to install automatic local sounding smoke alarms in crew and passenger accommodation areas so that crew and passengers would receive the earliest possible warning of a fire and the maximum possible time to escape. Since issuing these recommendations, the Safety Board has met with many industry representatives and has discussed the need for these alarm systems in great detail. The Board received uniformly positive responses from virtually all of the major cruise lines operating from the United States.

### **Alaska Cruise Ship Fire**

On the morning of May 23, 2000, while the Netherlands-registered passenger ship, *Nieuw Amsterdam*, was en route to Glacier National Park with 1,169 passengers and 542 crewmembers on board, a fire broke out in a crew cabin. A premature effort to extinguish the fire by officers lacking proper gear and backup contributed to the spread of fire and smoke. The fire did not spread beyond the deck of origin; however, the untimely closing of fire screen doors allowed the smoke to migrate up eight decks, creating hazardous conditions in crew and passenger accommodations. Properly outfitted and equipped shipboard



firefighting teams subsequently extinguished the fire. One passenger sustained smoke inhalation injuries requiring evacuation to a shoreside hospital for additional medical treatment. Property damage to the vessel was estimated at more than \$360,000.

### Alaska Passenger Ferry Fire

On June 6, 2000, a fire broke out in the main switchboard in the engine control room of the Alaska Marine Highway System (AMHS) ferry *Columbia*. The ferry, with 434 passengers, a stowaway, and 63 crewmembers on board, was underway in Chatham Strait, about 30 nautical miles southwest of Juneau, Alaska, on a regularly scheduled voyage from Juneau to



*M/V Taku towing the disabled M/V Columbia.*

Sitka, Alaska. As a result of the fire, the vessel lost main propulsion and electrical power and began to drift. The crewmembers on board the *Columbia* responded to the fire first. Soon thereafter, the USCG cutter *Anacapa*, on patrol nearby, sent a firefighting team to the *Columbia*. There were no injuries or deaths.

Three passengers were evacuated by Coast Guard helicopter because of medical pre-existing conditions. The remaining passengers were safely transferred to another AMHS ferry, the *Taku*, which had rendezvoused with the

drifting *Columbia*. The *Columbia* was towed to the Auke Bay Ferry Terminal in Juneau, arriving on June 7. According to the AMHS, the cost of repairs to the ship was about \$2 million.

The issues involved in this accident included adequacy of:

- inspection and maintenance procedures for electrical systems;
- management safety oversight of maintenance procedures; and
- firefighting procedures.

On September 18, 2001, the Safety Board found that the probable cause of the fire was the absence of an effective maintenance and inspection program for the electrical switchboards, resulting in a switchboard fire by arcing, most likely due to a faulty connection or a conductive object. Five recommendations were issued.

### On-going Marine Investigations



*Salvage crew raises the M/V Miss Majestic from the bottom of lake.*

#### DUKW Sinking

Shortly before noon, on May 1, 1999, the *Miss Majestic*, one of four amphibious excursion (DUKW) boats operated by White and Yellow Duck Sightseeing Tours entered Lake Hamilton in Hot Springs, Arkansas, as a regular part of an excursion tour of the area. On board were 20 passengers and the operator. Soon after entering the water, the vessel began to list to port and then



sank rapidly by the stern. The rapidity of the flooding did not allow sufficient time for passengers to escape before the vessel sank in 60 feet of water. Thirteen of the 20 passengers, including three children, lost their lives. The issues in this accident include survivability, vessel maintenance, Coast Guard inspection of the *Miss Majestic* and Coast Guard amphibious passenger vessel inspection guidance.

### **New York/New Jersey Passenger Ferry Fire**

On November 17, 2000, a fire broke out on board the U.S. passenger vessel *Port Imperial Manhattan*, which operated a ferry service in the Hudson River between Manhattan, New York and Weehawken, New Jersey. A fire erupted in the engine room and spread to the main passenger cabin. As a result, the vessel lost power and became adrift in the Hudson River. Other vessels came to its aid and were successful in removing the vessel's crew and passengers before anyone was injured. Damage to the vessel was assessed at about \$2 million. Safety issues involved in this accident include the adequacy of fire detection and suppression requirements and structural fire protection requirements for small passenger vessels.

### **New York/New Jersey Passenger Ferry Grounding**

On January 4, 2001, the U.S. passenger ferry *Finest* ran aground as the master was making a landing at the vessel's Highlands, New Jersey ferry terminal. At the time, the vessel had 258 passengers and six crewmembers on board. Ice surrounded the vessel, which was located about 600 yards offshore, preventing small boats from removing the passengers. The water depth was too shallow to allow larger vessels to come along side.

The vessel remained aground for about 5 hours, but refloated on the next high tide. The *Finest* was safely moored at its terminal dock in Highlands and the passengers were safely disembarked. One passenger, who had suffered an allergic reaction before the grounding, had been air lifted from the vessel by police helicopter. The safety issues involved in this accident include adequacy of crew training and management oversight of navigation safety.

### **U.S. Navy Submarine-Fishing Vessel Collision**

The NTSB continues to investigate the February 2001 collision between the nuclear submarine, *U.S.S. Greenville*, and the Japanese fishing training vessel *Ehime Maru*. The *Greenville* had departed Pearl Harbor with civilian guests on board to demonstrate the ship's maneuvering

capabilities. The crew was putting the submarine through a series of turns, dives, and surfacing operations. As the *Greenville* reached the surface during an emergency ascent maneuver, its conning tower and vertical tail fin struck the *Ehime Maru*, which had left Honolulu earlier that day. Shortly after the collision, the *Ehime Maru* sank.



NTSB investigators prepare to enter the USS Greenville while submarine is in dry dock.

## Marine Safety

Nine of the 35 people on board the Japanese vessel perished. The U.S. Navy subsequently raised and towed the *Ehime Maru* to shallow water and recovered eight of the nine victims. The last victim remains missing and is presumed to have drowned.

### **Fish-Processing Vessel Sinking**

The Safety Board is currently participating in a joint investigation with the USCG into the loss of the *Arctic Rose* and her 15 crewmembers in the Bering Sea. On April 2, 2001, the U. S. fish-processing vessel *Arctic Rose* sank with all hands. Safety issues involved in this accident include the adequacy of commercial fishing vessel stability, emergency egress, and the training and qualification of fishing vessel masters.

### **New York/New Jersey Passenger Ferry Fire**

The NTSB continues to investigate the September 28, 2001, fire that broke out in the starboard engine room of the ferry *Seastreak New York*. At the time it was passing Sandy Hook Pt, New Jersey en route from Highlands, New Jersey to New York City. The fire began on the No. 3 engine in the starboard engine room. It was initially discovered as a small flame by a roving engine room watch. As the watch attempted to get an extinguisher and secure the engine, the fire flared up and drove him from the engine room. The engine room's fixed CO<sub>2</sub> fire-fighting system was actuated and extinguished the fire. The *Seastreak New York* proceeded to a nearby Coast Guard Station on its port engines and discharged its 198 passengers without further incident. No passengers were injured; one crewmember suffered minor injuries. The safety issue involved in this accident is the engine manufacturer's oversight of accessory installations.

# Railroad, Pipeline and Hazardous Materials Safety

## Railroad Safety

**R**ailroads are one of the nation's safest forms of transportation, but the potential for tragedy exists in railroad operations as it does in every other mode of transportation. Millions of passengers are carried each year on Amtrak and rapid rail systems, and over 1.52 million carloads of hazardous materials move by rail each year. Projected growth rates show that there will be 600 million train miles completed in the year 2002, an increase of 108 million miles from 1997.

Since 1967, the primary responsibility for railroad accident investigation has been assigned by Congress to the NTSB. As in the other surface modes, the Safety Board performs in-depth analyses of selected rail accidents, determines the probable causes, and issues recommendations to make changes to prevent similar accidents.

The Safety Board also conducts studies of significant railroad safety issues often based on a set of accident investigations specifically undertaken as the basis for the study. In other cases, the studies may be based on analyses of regulations, railroad safety programs and procedures, audit reviews of management and operations practices, or other research. In addition, the Board investigates selected accidents involving specific life-saving issues.

Because of its small staff and limited resources, the Safety Board does not investigate every rail accident reported to the Federal Railroad Administration (FRA). In order to use the Board's resources most efficiently, accident criteria have been established to help highlight accidents that have significant safety issues for investigation by the Board. Those selection criteria include:

- collisions or derailments involving passenger, rail transit, or commuter trains;
- collisions between trains resulting in a passenger or employee fatality, serious injury to two or more employees, or damage of \$500,000 or more to railroad and/or nonrailroad property;
- accidents involving a passenger or employee fatality;
- accidents resulting in an explosion, fire, or release of hazardous materials resulting in an evacuation; or
- rail/highway grade crossing accidents involving railroad employees or passenger fatalities, failure of crossing protection, or derailment of the train.

The Railroad Division launched 33 accident investigations in FY 2000/2001. Some of the significant investigations were a train collision in Fullerton, California; a railroad grade crossing accident in Glendale, California; two separate light rail vehicle accidents in Baltimore, Maryland; two freight train derailments in Martinsburg and Manson, West Virginia; the derailment of a New York City Transit Authority train in New York City; two separate collisions on the Chicago Transit Authority in Chicago, Illinois; the collision and derailments of freight trains in Cincinnati and Carlisle, Ohio, in Bellemont, Texas, and in Ashby, Nebraska; the derailment of trains and release of hazardous materials in Wilmington, Ohio, and Baltimore, Maryland; and the derailments of Amtrak trains in Palm Springs,



California, in Carbondale, Kansas, in Lake City, South Carolina, in Syracuse, New York, and in Annapolis, Missouri.

### ***Completed Investigations***

#### **Crisfield, Kansas Freight Train Derailment**

At about 6:10 a.m., September 2, 1998, westbound BNSF intermodal freight train SCHILAC derailed the 17th through 20th cars while traveling 68 mph at the west switch at Attica, Kansas, milepost 286.6, on the Panhandle Subdivision of the BNSF Amarillo Division. The derailment resulted in the pile-up of four articulated multi-platform deep-well double-stack, five pack, cars carrying containers. Some of the containers were breached, resulting in the release of hazardous materials and fires. About 200 people were evacuated within a five-mile radius due to the hazardous materials release. No one was injured.

Safety issues examined included:

- Association of American Railroads' and FRA intermodal container loading and securement standards for the preloading inspection of double-stack cars; and
- railroad industry training and practices with respect to emphasizing the importance of removing foreign objects from the wells of double-stack cars before loading.

On July 17, 2000, the Safety Board determined that the probable cause of the derailment was the structural failure of a 125-ton deep-well articulated platform of intermodal car DTTX 72318. The B-end of the car broke at the weld of the floor shear-plate to the bulkhead bottom angle that allowed the car to sag below clearance, catch a part of the switch, and derail. Estimated damage was \$1,268,500 including lading.

#### **Bryan, Ohio Freight Train Collision and Derailment**

On May 9, 2001, the NTSB issued its final report on a January 17, 1999, freight train collision and derailment near Bryan, Ohio. The accident involved three Consolidated Rail Corporation freight trains operating in fog on a double main track. Westbound Mail-9, traveling near maximum authorized speed on track No. 1, struck the rear of a slower moving westbound train, TV-7. The collision caused the derailment of the three locomotive units and the first 13 cars of Mail-9 and the last three cars of TV-7. The derailed equipment fouled the No. 2 track area and struck train MGL-16, which was operating eastbound on the adjacent track. The impact caused 18 cars in the MGL-16 consist to derail. The engineer and conductor of Mail-9 were killed. Total estimated damages were \$5.3 million.

The probable cause was the failure of the crew of train Mail-9 to comply with restrictive signal indications while operating at or near maximum authorized speed in dense fog. Contributing to the accident was the lack of uniformity and consistency in the operating practices of Consolidated Rail Corporation train crews when they encountered conditions of reduced visibility. Also contributing to the accident was the lack of a backup safety system that would have helped alert the crewmembers of train Mail-9 of the restrictive signal indications. Six recommendations were issued.

#### **Arlington, Texas Passenger Train Derailment**

On July 24, 2001, the NTSB issued its final report on a December 20, 1998, passenger train derailment in which Amtrak train No. 21 derailed in the city limits of Arlington, Texas. The train was traveling westbound at a reduced speed of about 36 mph due to reports of rough track. Three locomotives and six cars derailed on a curve. Of the 198 passengers and 18 employees on the train, 12 passengers and 10 employees were injured. Damages were estimated at about \$1.4 million.

***Railroads are one of the nation's safest forms of transportation, but the potential for tragedy exists as rail traffic continues to increase.***

The probable causes were track conditions that were inadequate for the speed of the train, the decision of the dispatcher to delay notifying track department personnel that a train crew had reported encountering rough track, the inadequate effort on the part of the engineer of Amtrak train 22 to contact the dispatcher to report the observed track defect and its location, the failure of the tamper operator to adequately resurface the track four days before the accident, inadequate UP oversight of track maintenance work on this section of track, and inadequate UP requirements for restricting train speed over track with reported rough conditions until track department personnel can assess track condition. Five recommendations were issued.

### **McLean, Illinois Passenger Train/Highway Vehicle Collision**

On September 18, 2001, the NTSB issued its final report on a September 26, 1999, grade crossing accident that took place near McLean, Illinois. Northbound Amtrak train 304-26 collided with an automobile, which was westbound on U.S. Route 136. The collision occurred where the Union Pacific Railroad's (UP's) St. Louis Division main line and U.S. Route 136 cross near McLean. The automobile driver and passenger were killed. Neither the flashing lights nor the gates for the grade crossing activated to warn the automobile driver of the approaching train. A UP signal maintainer had worked on the grade crossing warning devices earlier that day.

The probable cause of the accident was the failure of the signal maintainer to remove a jumper wire from the grade crossing control relay and, as required by the UP's written procedures, to verify the operational status of the grade crossing equipment after he had completed the maintenance work. Four recommendations were issued.

### **Syracuse, New York Passenger and Freight Train Collision**

On November 27, 2001, the NTSB issued its final report on a February 5, 2001, collision between a passenger train and a freight train near Syracuse, New York. Eastbound Amtrak train 286, with 100 passengers and four crewmembers, struck the rear of eastbound CSX Transportation (CSXT) freight train Q620. On impact, the lead Amtrak locomotive unit and four of the train's five cars derailed. The rear truck of the last car of the 92-car CSXT freight train derailed. At the time of impact, the passenger train was traveling 35 mph; the freight train was traveling seven mph. The accident resulted in injuries to all four crewmembers and 58 passengers aboard the Amtrak train. No CSXT crewmembers were injured. A small amount of diesel fuel spilled from the fuel tank on the lead Amtrak locomotive unit, but no fire resulted. Total damages were estimated to be about \$280,600.

The probable cause was the Amtrak engineer's inattention to the operation of his train, which led to his failure to recognize and comply with the speed limit imposed by the governing wayside signal, and the lack of any safety redundancy system capable of preventing a collision in the event of human failure. Four recommendations were issued.

### **Special Investigation Report – Baltimore-Washington International Airport Light Rail Accidents**

On December 11, 2001, the NTSB issued a special investigation report on two light rail accidents that took place on February 13 and August 15, 2000, near Baltimore, Maryland. Both accidents involved the failure of a light rail vehicle train to stop at the designated stopping point at the Baltimore-Washington International (BWI) Airport Light Rail Station.

The first accident occurred on February 13, 2000, when Maryland Transit Administration (MTA) train 24 struck the hydraulic bumping post at the terminus of track No. 1 at the BWI station and derailed. Train 24 carried 26 people; 18 of whom were injured, five seriously.

The MTA estimated the cost of the accident at \$924,000. The second accident occurred on August 15, 2000, when MTA train 22 struck the hydraulic bumping post at the terminus of track No. 2 at the BWI station and derailed. Train 22 carried 22 people; 17 of whom were injured. None had life-threatening injuries. The MTA estimated the cost of that accident at \$935,000.

The probable cause of the February 13, 2000, accident was the train 24 operator's impairment by illicit and/or prescription drugs, which caused the operator to fail to stop the train before it struck the bumping post at the terminus. The probable cause of the August 15, 2000, accident was the train 22 operator's severe fatigue, resulting from undiagnosed obstructive sleep apnea, which caused the operator to fall asleep so that he could not brake the train before it struck the bumping post at the terminus. Four recommendations were issued.

### ***Ongoing Investigations***

#### **Bourbonnais, Illinois Grade Crossing Accident**

On Monday, March 15, 1999, southbound Amtrak train No. 59, the *City of New Orleans*, consisting of two locomotive units and 14 cars, struck an eastbound semi-trailer truck at a railroad/highway grade crossing near Bourbonnais, Illinois. The accident occurred at McKnight Road where it crosses the Illinois Central Railroad track. As a result of the collision, 11 passengers were killed and 122 passengers and crewmembers were injured. The truck driver was not injured. Estimated damages exceeded \$14 million.

Safety issues being examined:

- effectiveness of current state-of-the-art grade crossing traffic control devices;
- highway design and low-cost traffic control devices;
- enforcement of traffic laws pertaining to grade crossings by state and local police;
- sight distance available to truck driver;
- truck driver fatigue and decision-making;
- passenger equipment crashworthiness;
- emergency preparedness of local emergency responders and of train crew members; and
- crashworthiness of and parameters recorded on locomotive event recorders.

#### **Eunice, Louisiana Freight Train Derailment and Release of Hazardous Materials**

About 11:48 a.m., on May 27, 2000, 33 of the 113 cars making up eastbound UP train QFPLI-26, derailed near Eunice, Louisiana. Of the derailed cars, 15 contained hazardous materials and two contained hazardous material residue. As a result of the derailment there was a release of hazardous materials with explosions and fire. Approximately 3,000 people were evacuated from the surrounding area, which included the business area of Eunice. No one was injured during the derailment of the train; however, several people requested treatment after being exposed to smoke or ash from the fire. Total cost of damages as a result of the derailment exceeded \$35 million. Safety issues being examined include UP's track inspection procedures and its supervision of track inspections.

#### **Los Angeles, California Train Collision**

On February 1, 2001, a collision occurred between two cars operated by the Angels Flight Railway Foundation in downtown Los Angeles. There were approximately 20 passengers in the two cars. According to emergency medical personnel, four passengers sustained critical injuries; four passengers sustained moderated injuries; two passengers sustained minor injuries, and about five passengers walked away from the accident site with unknown injuries to seek medical attention on their own. One of the critically injured passengers died later at a local hospital.



### **Carlisle, Ohio Train Collision**

On February 17, 2001, a southbound CSXT train consisting of a two-unit locomotive and 50 auto carrier type freight cars collided with the rear of standing CSXT train. The standing train consisted of 92 hopper cars loaded with ore. One person was killed and two were seriously injured.

### **Nodaway, Iowa Amtrak Derailment**

The NTSB continues to investigate the March 17, 2001 derailment of an Amtrak passenger train in Nodaway, Iowa. The train was traveling from Emeryville, California with 241 passengers and 16 crewmembers aboard. One person was killed and 96 others were injured.

### **Chicago, Illinois Transit Authority Collisions**

Two separate collisions on the Chicago Transit Authority are under investigation. One occurred on June 17, 2001, near the Addison Street Station, and the other on August 3, 2001, near Hill Street in Chicago, Illinois.

On June 17, 2001, a blue line train struck the rear of another train that had stopped south of the Addison Street Station. Each train consisted of four passenger cars. There were 75 passengers on the striking train and 40 passengers on the struck train. Both train operators, an off-duty employee, and 18 passengers sustained minor injuries. The collision did not result in a derailment or fire. Damage was estimated to be \$30,000.

On August 3, 2001, a brown line train collided with the rear of a purple line train stopped on elevated tracks near Hill Street. Each train consisted of six passenger cars; both trains with an estimated 90 passengers per car. The collision did not result in a derailment or a fire. Chicago Fire Department personnel used aerial lifts to remove and transport 12 passengers. The trains were then moved to Chicago Station, where the remaining passengers exited and further medical evaluations were performed. The Chicago Police Department logs indicate that 118 people were transported to area hospitals with minor injuries. Damage to both trains is estimated to be \$136,138.

### **Baltimore, Maryland Freight Train Derailment and Release of Hazardous Materials**

On July 18, 2001, an eastbound CSXT freight train, consisting of 3 locomotive units and 60 cars, derailed 11 cars while traveling through the Howard Street tunnel in downtown Baltimore, Maryland. Three of the derailed cars contained hazardous materials. The derailment resulted in a release of hazardous materials and a fire that lasted several days. The accident caused the city of Baltimore to restrict local traffic and light rail operations and to postpone a Baltimore Orioles baseball game at the Camden Yard Stadium. Commercial communication facilities were also disrupted. A broken water main over the tunnel in the derailment area hampered the firefighting and the investigation. Two firefighters were the only people reported to be injured.



*Rail cars being removed from tunnel.*

### **Clarkston, Michigan Train Collision**

On November 15, 2001, two Canadian National/Illinois Central freight trains collided at the south siding switch near Clarkston, Michigan. The northbound train was composed of a two-unit locomotive, 77 loaded freight cars, and 12 empty ones. Both locomotive units and 11 freight cars derailed in three different locations. The southbound train was composed of a two-unit locomotive, 90 loaded container cars, and four empty ones. Both locomotive units and two container cars derailed. Three of the derailed locomotives were destroyed. One of the derailed container cars held two separate containers of hazardous materials (taluline and chlorine); however, no hazardous materials were released, but approximately 3,000 gallons of diesel fuel were spilled from the locomotives.

The collision and derailment resulted in a fire. As a precaution, an area with a two-mile radius was evacuated. About 100 homes were evacuated, and classes at a nearby technical center and at the Andersonville Elementary School were cancelled for a day. The two train crewmembers on the northbound train were killed, and the two train crewmembers on the southbound train sustained serious injuries.

### **Pacific, Wyoming Train Collision**

On December 13, 2001, an eastbound UP unit coal train with 134 loaded coal cars collided on No. 2 main track with the rear end of a standing UP unit coal train that had 135 loaded coal cars. Upon impact, the rear car of the standing train and a locomotive unit used for pushing the train derailed, fouling the adjacent main track, No. 1 main. A westbound UP train with 104 empty coal cars collided with the derailed equipment, resulting in a fire. Damage was estimated to be about \$10 million. Four train crewmembers were injured.

## ***Other Safety Accomplishments***

### **Bloomington, Maryland Train Derailment**

A CSXT coal train derailed 76 cars in Bloomington, Maryland, on January 30, 2000. The train experienced braking problems and was traveling at more than 55 mph on a descending grade where the maximum authorized speed was 25 mph. The train broke apart and numerous cars destroyed a nearby house, killing a teenager and seriously injuring his mother. Track and equipment damage was estimated at \$3.2 million.

As a result of the investigator's actions and suggestions, the railroad instituted procedures to ensure that dynamic brakes are working before trains depart, and reduced the maximum speed on the mountain grade where the accident occurred to 20 mph. It also reviewed crew training on how to operate in mountainous grade territories, activate emergency brake levers and switches during an emergency, and operate different types of radios.

### **Decatur, Georgia Light Rail Accident**

One signal worker was killed and another critically injured when a Metropolitan Atlanta Rapid Transit Authority (MARTA) light rail train in Decatur, Georgia, struck them on February 25, 2000. The employees were checking a programmed data card in a small electrical box in the center of the track gauge.

As a result of investigators' actions and discussions with MARTA, it clarified its wayside access procedures for inspections. A general order was issued emphasizing that all personnel going wayside are required to have protective personal equipment, including a high visibility reflectorized vest; all train operators must maintain a constant visual check for wayside personnel; and all personnel working wayside must maintain positive communication among other personnel, including maintaining radio contact with MARTA's rail service control center.

# Pipeline Safety

Approximately two million miles of natural gas pipelines in the United States are managed by about 865 transmission and gathering operators; 1,375 distribution operators; 106 liquefied natural gas operators; and 52,000 master meter operators. Over 157,000 miles of hazardous liquid pipelines across the nation are managed by approximately 200 operators. In addition, about 2,200 miles of carbon dioxide pipelines crisscross the United States.

The Safety Board is responsible for investigating all pipeline accidents in which there is a fatality, substantial property damage, or significant environmental impact. The Board may also investigate additional selected accidents that highlight safety issues of national import or that involve a selected accident prevention issue. Under a memorandum of understanding, the Safety Board can delegate to the Office of Pipeline Safety the investigation of any accident that meets these criteria and occurs when the Board is unable to respond due to insufficient resources. The Safety Board may also ask the applicable state agency to perform an accident investigation when necessary.

## Completed Investigations

### St. Cloud, Minnesota Natural Gas Explosion

On December 11, 1998, while attempting to install a utility pole anchor in a sidewalk in St. Cloud, Minnesota, a communications network construction crew struck and ruptured an underground, 1-inch-diameter high-pressure gas service pipeline, generating a natural gas leak.

About 40 minutes later, an explosion occurred. As a result of the explosion; four people were killed; one seriously injured; and 10, including two firefighters and a police officer,

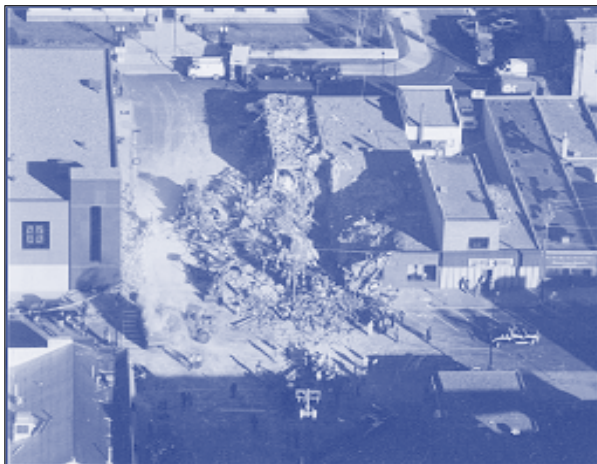

Damage following St. Cloud, Minnesota natural gas explosion.

received minor injuries. Six buildings were destroyed and estimated property losses were approximately \$400,000. Safety issues examined included the contractor's safety and emergency procedures when working in the vicinity of underground facilities; and St. Cloud Fire Department procedures and training for responding to natural gas leaks.

On July 11, 2000, the NTSB determined that the probable cause of this accident was the lack of adequate procedures by the cable contractor to

prevent damage to nearby utilities when its anchor installation crews encountered unusual conditions such as striking an underground obstacle.

Contributing to the severity of the accident was the delay by contractor in notifying the proper authorities. As a result of the accident, the Safety Board made 13 recommendations to RSPA, the Occupational Safety and Health Administration, the Association of General Contractors, the National Utility Contractors Association, the Power and Communications Contractors Association, the National Cable Television Association, the International Association of Fire Chiefs, and Cable Constructors, Inc.



*There are more than two million miles of natural gas, hazardous liquids, and carbon dioxide pipelines in the United States.*

### **Bridgeport, Alabama Natural Gas Explosion**

On January 22, 1999, while digging a trench behind a building in Bridgeport, Alabama, a contractor's backhoe operator damaged a 3/4-inch steel natural gas service line owned by the Utilities Board of the City of Bridgeport. This resulted in two leaks in the natural gas service line, which was operated at 35 psig. One leak occurred where the backhoe bucket had contacted and pulled the natural gas service line. The other was a physical separation of the gas service line at an underground joint near the meter, which was close to the building. Within two hours, gas migrated into a building and ignited. An explosion resulted, which killed three, injured five, and destroyed three buildings. Other buildings within a two-block area of the



*Bridgeport, Alabama natural gas explosion damage.*

explosion sustained significant damage that resulted in property damage and losses of \$1.4 million.

Safety issues examined include the contractor's excavation and emergency procedures; and the Utility Board of the City of Bridgeport emergency procedures for responding to natural gas leaks.

On November 28, 2000, the Safety Board determined that the probable cause of the accident was the failure of

the contractor to establish and follow safe procedures for excavation activities, resulting in damage to a natural gas service line, and the failure of the Utilities Board of the City of Bridgeport to provide appropriate emergency response to the resulting natural gas leak.

As a result of the accident, the Safety Board made seven recommendations to RSPA, the Alabama Public Service Administration, Alabama One Call, the Utilities Board of the City of Bridgeport, and R&B Construction.

### **Knoxville, Tennessee Hazardous Liquid Pipeline Rupture**

A hazardous liquid pipeline rupture occurred in Knoxville, Tennessee, on February 9, 1999. The rupture resulted in a release of about 53,000 gallons of diesel fuel into the Tennessee River.

On March 28, 2001, the Board determined that the probable cause was a pipe rupture initiated by environment-induced cracking in an area of a pipe coating failure. A contributing factor to the failure was the relatively low fracture toughness of the pipe. Contributing to the severity of the accident was Colonial Pipeline Company's failure to determine from the supervisory control and data acquisition system that a leak had occurred.

### **Winchester, Kentucky Hazardous Liquid Pipeline Rupture**

A hazardous liquid pipeline rupture occurred near Winchester, Kentucky on January 27, 2000, resulting in the release of about 489,000 gallons of crude oil. On May 3, 2001, the Board determined that the probable cause was fatigue cracking due to a dent in the pipe that, along with fluctuating pressures in the pipe, produced high local stresses in the pipe wall. Contributing to the accident's severity was the failure of the controller and supervisors to recognize the rupture.

### **South Riding, Virginia Natural Gas Pipeline Explosion and Fire**

A natural gas pipeline explosion and fire occurred in South Riding, Virginia, on July 7, 1998, killing one person and injuring three others. A faulty electric service line led to the failure of a



natural gas service line. On June 12, 2001, the Board determined that the probable cause was arcing at a splice in one of the conductors of a triplex electric service line, which, because of inadequate separation between the electric conductors and the gas service line, led to its failure. Six recommendations were issued.

### **Greenville, Texas Gasoline Pipeline Rupture**

On March 9, 2000, a 28-inch diameter steel pipeline ruptured and released about 13,436 barrels of regular gasoline (564,312 gallons). On July 6, 2001, The Safety Board determined that the probable cause of the pipeline failure was corrosion-fatigue cracking that initiated at the edge of the longitudinal seam weld at a likely pre-existing weld defect. Contributing to the failure was the loss of pipe-coating integrity.

### ***Ongoing Investigations***

#### **Bellingham, Washington Liquid Pipeline Rupture**

On June 10, 1999, a 16-inch diameter steel pipeline ruptured and released approximately ¼ million gallons of gasoline into Whatcom Creek in Bellingham, Washington. The gasoline ignited, killing three people, injuring eight, and causing significant property and environmental damage.



*Investigator inspects pipeline rupture.*

Safety issues being examined:

- excavation damage;
- pipeline integrity assessment;
- overpressure protection;
- leak detection systems; and
- controller response to abnormal conditions.

#### **Chalk Point, Maryland Fuel Oil Pipeline Rupture**

On April 7, 2000, a release of fuel oils occurred from a Potomac Electric Power Company pipeline serving Chalk Point Generating Station (Chalk Point) near Aquasco, Maryland. During a pipe-cleaning operation, an ST Services, Inc. supervisor checked storage tank inventory and determined that 3088.7 barrels (129,725 gallons) were unaccounted for. Fuel oil was spotted on Swanson's Creek near the generating station during a patrol flight arranged for by ST Services. A 2,000-gallon spill was reported to the National Response Center. The product escaped through a crack in the 12-inch diameter pipeline that was located on a buckle at a pipe bend. An internal inspection had been completed in this pipeline in 1997. The cost of the spill exceeded \$60 million.

Safety issues being examined:

- underreporting of the release by the pipeline operator;
- effectiveness of the operator's management of the spill response activities;
- potential environmental impact and remediation from the release of fuel oil from a ruptured liquid pipeline;
- operating procedures;
- pipeline instrumentation; and
- in-line inspection evaluation by the internal inspection tool company.

### **Carlsbad, New Mexico Natural Gas Pipeline Explosion and Fire**

On August 19, 2000, a 30-inch diameter natural gas transmission pipeline, owned by El Paso Natural Gas Pipeline Company, ruptured near Carlsbad, New Mexico. The escaping natural gas ignited and killed 12 members of a family who were camping at a nearby site on the Pecos River. The rupture resulted in a crater about 86 feet long by 46 feet wide and approximately 20 feet deep.

Post-accident inspection of the failed pipe segment revealed significant internal corrosion. At least 50 percent pipe wall loss was found in a 10-foot-long area along the bottom of the pipe. The failed pipeline segment had originally been constructed, in 1950, without pig traps. The pipeline segment that ruptured had not been cleaned by maintenance pigging, nor had an in-line inspection been performed on that pipeline section before the accident. El Paso Natural Gas Pipeline Company monitors the quality of gas entering its pipeline system. Safety Board investigators took samples of pipeline liquids and solids at selected locations for analysis.



*Carlsbad, New Mexico natural gas pipeline explosion crater.*

Safety issues being examined include internal corrosion prevention program and pipeline integrity assessments.

### ***Public Hearings***

#### **Pipeline Integrity Assessment and Leak Detection Systems**

On November 15-16, 2000, the NTSB held a public hearing to examine technologies available to assess the integrity of pipelines, such as the use of internal inspection tools, and the capability of pipeline operating systems to identify leaks for prompt, timely operator responses. The hearing also sought to determine the status of ongoing research in these areas. The hearing was prompted by the Safety Board's investigation into numerous pipeline accidents in which pipes with time-related defects failed as well as accidents in which pipeline integrity issues and delays in recognition that a rupture had occurred are at issue.



# Hazardous Materials Safety

The most current figures published by RSPA indicate that more than 3.1 billion tons of hazardous materials are shipped within the United States each year, and that more than 800,000 shipments of hazardous materials enter this nation's transportation system each day in all modes, nearly a two-fold increase over the RSPA's previous estimate of 500,000 shipments per day.

The growth in the transportation of hazardous materials is also reflected in the number of hazardous materials incidents reported to RSPA over the past 10 years. In 2000, 17,514 hazardous materials incidents were reported, an increase of more than 190 percent from the 9,113 incidents reported in 1991. In 2000, the reported damages were \$72.7 million, an increase of almost 190 percent from the \$38.3 million in reported damages for 1991. Although the number of reported injuries and fatalities have fluctuated over the past 10 years, 225 fatalities and over 4,700 injuries were reported from 1991 through 2000 and attributed to the release of hazardous materials.

## ***Completed Investigations***

During 2000 and 2001, the Office of Railroad, Pipeline and Hazardous Materials Investigations completed the following hazardous materials accident investigations and assisted in the completion of other modal accident investigations involving hazardous materials.

### **Undeclared Hazardous Materials Spill on Passenger Aircraft**

On October 28, 1998, two gallons of a 35 percent hydrogen peroxide solution in water spilled in a cargo compartment of Northwest Airlines flight 957, a passenger-carrying airplane en route from Orlando, Florida, to Memphis, Tennessee. The solution leaked from two undeclared plastic bottles that had been packed in an ice chest belonging to a passenger on the flight. The leaking hydrogen peroxide contaminated three mail sacks and an undetermined number of bags. The leak was not discovered until cargo handlers in Memphis began to unload baggage on the flight. Thinking that the spilled liquid was water, the cargo handlers ignored it and transferred some of the baggage to other Northwest flights, including one that departed for Seattle, Washington. When that flight arrived in Seattle, two bags in a cargo compartment were smoldering, including one that had come from flight 957. As a result of the spill, 13 Northwest employees in Memphis and an employee in Seattle received treatment for exposure to the hydrogen peroxide solution. The total cost of the damage to aircraft, its downtime, and damage to baggage was more than \$40,000.

Safety issues examined include emergency response guidelines, procedures, and training for responding to a hydrogen peroxide spill; and air carrier procedures for responding to a hazardous materials spill.

On May 17, 2000, the Safety Board determined that the probable cause of the release of the undeclared hazardous material was the passenger's failure to properly package and identify the hazardous material and inadequate inquiries from the Northwest Airlines agent about the contents of the passenger's cooler. Safety recommendations were issued to the FAA, U.S. Postal Service (USPS), ATA, Northwest Airlines, and the Hydrogen Peroxide Safety Producers Committee.



*There has been an almost 200 percent increase in the number of hazardous material incidents reported over the past 10 years.*

### **Chemicals Transferred to Wrong Storage Tank**

On November 19, 1998, a cargo tank truck was unloading chemicals at the Ford Motor Company's Kentucky Truck Plant, Louisville, Kentucky. The cargo delivery hose was connected to an incorrect fitting and cargo was transferred to the wrong storage tank. An orange-colored vapor cloud was observed coming from the storage tank. About 2,400 people were evacuated from the plant and surrounding businesses. On June 13, 2000, the Safety Board determined that the probable cause of the accident was inadequate training of Ford Motor Company's employees on the company's procedures for unloading bulk hazardous materials.

On June 4, 1999, a driver delivered a chemical shipment to the Whitehall Leather Company in Whitehall, Michigan. The delivery hose was connected to the wrong storage container. The mixing of the two incompatible chemicals resulted in the liberation of highly toxic hydrogen sulfide gas. A tank truck driver was overcome by the poisonous gas and died.

On June 13, 2000, the Safety Board determined that the probable cause of the accident was the failure of the Whitehall Leather Company to have adequate unloading procedures, practices, and management controls in place to ensure the safe delivery of chemicals to storage tanks.

As a result of the Safety Board investigator's actions and suggestions, the company designated specific employees to assist and supervise the unloading of hazardous materials; and developed specific written procedures and a checklist to follow while unloading bulk hazardous materials. Access to bulk chemical unloading areas are now locked by barrier gates; access doors and transfer couplers are equipped with locks; and emergency remote alarm buttons have been placed at chemical transfer locations.

Safety issues examined:

- employee training programs and offloading procedures at facilities where bulk shipments of hazardous materials are offloaded from cargo tank trucks and other bulk transportation vessels;
- emergency notification procedures at facilities where hazardous materials are transferred between bulk transportation containers and fixed storage tanks; and
- federal accident reporting criteria for hazardous materials releases occurring during loading and unloading of cargo tank trucks and other bulk transportation containers.

Safety recommendations were issued to RSPA, the Occupational Safety and Health Administration, the American Chemistry Council, the Ford Motor Company, and the National Tank Truck Carriers, Inc.

### **Clymers, Indiana Tank Car Rupture**

A February 1999 accident occurred when a railroad tank car, on the west unloading rack at the Essroc Cement Corporation cement plant near Clymers, Indiana, sustained a catastrophic rupture that propelled the tank of the tank car an estimated 750 feet and over multi-story storage tanks. There were no injuries or fatalities. Damages, including property damage and costs from lost production, were estimated at nearly \$8.2 million.

On March 5, 2001, the Board determined that the probable cause was the failure of the management of the cement company and a recycling firm to develop and implement safe

procedures for offloading toluene diisocyanate matter wastes, resulting in the over-pressurization of the tank car from chemical self-reaction and expansion of matter wastes. Safety recommendations were issued to the FRA, RSPA, Association of American Railroads, the Railway Progress Institute, and the four companies involved in the shipment and unloading of the tank car.

During 2000, the Hazardous Materials Division of the Office of Railroad, Pipeline and Hazardous Materials Investigations contributed to the completion of following major accident investigations.

### **Crisfield, Kansas Freight Train Derailment**

On September 2, 1998, a westbound BNSF intermodal freight train derailed at Crisfield, Kansas. The derailment resulted in a pileup involving four articulated multi-platform cars carrying intermodal shipping containers. Some of the containers were breached, resulting in the release of hazardous materials and fires. About 200 people were evacuated within a five-mile radius. There were no injuries. Estimated damage was \$1.3 million. The Safety Board determined that a State program to upgrade the level of preparedness to hazardous materials incidents will correct problems noted in the actions of Harper County emergency response personnel in this accident.

### **Newark, New Jersey FedEx MD-11 Crash**

On July 31, 1997, a McDonnell Douglas MD-11, operated by Federal Express, Inc., (FedEx) as flight 14, crashed while landing on runway 22R at Newark International Airport, Newark, New Jersey. The captain and first officer, one jumpseat passenger, and two cabin passengers received minor injuries in the crash and during their egress from the plane.

Documentation about the quantity and type of hazardous materials on board was carried on the airplane. The only other information was the paper copies of the hazardous materials shipping documents kept at the point of origin. Consequently, FedEx personnel at Newark could not provide the incident commander with this information until 1 ½ hours after the crash. There were similar difficulties in providing information to the incident commander about hazardous materials on board an airplane in an incident involving a FedEx DC-10 at Newburgh, New York, on September 5, 1996. As a result, FedEx is developing an electronic tracking system for hazardous materials shipments that can be accessed from any location in the FedEx system.

### **Winchester, Kentucky Crude Oil Pipeline Rupture**

On January 27, 2000, a 24-inch Marathon Ashland Pipe Line LLC pipeline carrying crude oil ruptured at the Southwind Golf Course near Winchester, Kentucky. During a period of approximately four hours, the pipeline released an estimated 11,644 barrels (489,000 gallons) of crude oil. The released oil traveled approximately 1,200 feet downhill to an unnamed tributary of Two-Mile Creek, and then into a portion of Two-Mile Creek. The spill was contained by a series of earthen dams. There were no declared evacuations of the residents in this rural area and there were no reported injuries. Damages and cleanup costs were estimated at \$7 million.

Safety issue examined was the potential environmental impact and remediation from the release of crude oil from a ruptured liquid pipeline.

### **Greenville, Texas Gasoline Pipeline Rupture**

On March 9, 2000, a 28-inch diameter pipeline carrying unleaded gasoline ruptured in pasture and farmland about 8 miles northwest of Greenville, Texas. The rupture was about

53 inches long (longitudinal) by about one foot wide (at its widest point). The pipeline released an estimated 10,000 to 12,000 barrels (420,000 to 504,000 gallons) of gasoline. The gasoline was initially contained within 2.5 miles of the East Caddo Creek; however, subsequent rains enlarged the spill area to 15 miles of the East Caddo Creek. Three families were evacuated. There were no reported injuries. Environmental clean up and remediation costs may exceed \$16 million.

Safety issue examined was the potential environmental impact and remediation from the release of gasoline from a ruptured liquid pipeline.

### ***Ongoing Investigations***

During 2000 and 2001, the Hazardous Materials Division initiated two hazardous materials accident investigations.

#### **Ramona, Oklahoma Semi-trailer Accident with Hazardous Materials Release**

The NTSB continues to investigate the May 1, 2001 accident between a tractor/“tube” semi-trailer, and a pickup truck near Ramona, Oklahoma. The tube semi-trailer carried 10 cylinders that contained compressed hydrogen, a highly flammable gas. Eight of the 10 individual cylinder valve assemblies were broken and/or sheared off, resulting in the release and ignition of the hydrogen gas. There was a voluntary evacuation in the general vicinity of the accident, and the highway was closed for over 12 hours. Although no injuries or fatalities resulted from the burning hydrogen, the driver of the tractor/semi-trailer suffered fatal traumatic injuries, and the driver of the pickup truck was seriously injured.

#### **Riverview, Michigan Tank Car Accident, Release of Hazardous Materials, and Fire**

The NTSB continues to investigate a July 14, 2001 accident at the ATOFINA chemical plant in Riverview, Michigan. After plant employees had completed preparations to offload a 25,000-gallon tank car containing methyl mercaptan (a flammable and toxic gas), the Riverview Fire Department received a report of a significant leak from the tank car. While the fire department was en route to the plant, a fireball erupted and engulfed the tank car. Three plant employees were killed. One police officer and nine other plant employees were treated and released. Two thousand residents near the plant were also evacuated for 10 hours.

During 2000 and 2001, the Hazardous Materials Division also supported a number of ongoing modal accident investigations.

#### **Rancho Cordova, California Crash of Emery Worldwide Airlines DC-8**

On February 16, 2000, an Emery Worldwide Airlines, Inc. McDonnell Douglas DC-8 departed Mather Airport, Sacramento, California. Moments after takeoff, the flight crew declared an emergency. Two minutes after takeoff, the airplane crashed into an automobile salvage yard east of the airport in Rancho Cordova. The airplane was consumed in the post-crash fire and all three crewmembers on board were killed.

The airplane was transporting a package containing 16 detonating fuses as a declared item of cargo. No other declared shipments of hazardous materials were on board. Safety issue/support area being examined is the potential involvement of declared and/or undeclared shipments of hazardous materials in the crash of the airplane

#### **Carbondale, Kansas Passenger Train Derailment**

On March 15, 2000, an Amtrak train with 139 passengers and 16 crewmembers derailed in Carbondale, Kansas. There were no fatalities, but 32 persons were seen or treated for minor

injuries. Total property damages were \$1.5 million. The train included 14 “road railer” type cars (truck van trailers mounted on rail wheel sets). The road railer positioned as the next to the last car in the train contained a total of six packages, each containing a small quantity of hazardous materials. This road railer was not derailed in the accident. The train conductor did not advise the incident commander about these hazardous materials. The incident commander was not aware that Amtrak transported small quantities of hazardous materials in its freight cars, and did not ask Amtrak personnel about possible hazardous materials on board.

Safety issue being examined is the notification of emergency responders by train crewmembers about the presence of hazardous materials on a train involved in a derailment or accident.

### **Chalk Point, Maryland Fuel Oil Pipeline Rupture**

On April 7, 2000, a 12-inch diameter pipeline carrying #2 fuel oil ruptured in wetlands adjacent to Swanson Creek, about 8 miles east of Aquasco, Maryland. At the time of the release, ST Services was prepping the PEPCO pipeline for routine internal inspection and the pipeline was being flushed with No. 2 fuel oil. As a result of the rupture, an estimated 3,000 barrels (125,000 gallons) of fuel oil were released into Swanson Creek and within 24 hours spread into the Patuxent River to Benedict, Maryland. Damages and cleanup costs exceeded \$60 million.

Safety issues being examined:

- underreporting of the release by the pipeline operator;
- effectiveness of the operator’s management of the spill response activities; and
- potential environmental impact and remediation from the release of fuel oil from a ruptured liquid pipeline.

### **Eunice, Louisiana Freight Train Derailment and Release of Hazardous Materials**

On May 27, 2000, a UP freight train derailed near Eunice, Louisiana. The train consisted of 3 locomotives, 87 loaded freight cars, and 26 empty freight cars. Of the 33 freight cars that derailed, 15 were tank cars loaded with various hazardous materials, including flammable gases, flammable liquids, and poisons. Two other tank cars containing hazardous materials residue also derailed. The derailment resulted in the release of various hazardous materials, fire and explosions. Three fully loaded tank cars that did not derail were exposed to heat and fire. About 3,000 people were evacuated for several days while the fires burned. There were no fatalities and two reported injuries. Damages to the tank cars included punctures, tears, crushing, and ruptures from fire exposure.

Safety issues being examined include tank car performance and potential environmental impact from the release of various chemical cargoes from damaged tank cars.

### **Atlanta, Georgia DC-9 Cargo Compartment Fire**

On November 29, 2000, the crew of AirTran Airways flight 956, a McDonnell-Douglas DC-9, reported an electrical malfunction and returned for an emergency landing at Atlanta Hartsfield International Airport, Atlanta, Georgia. The flight was operated under 14 CFR Part 121 and carried 92 passengers and 5 crewmembers. After landing, an emergency evacuation was conducted. No serious injuries were reported. Visual meteorological conditions prevailed at the time of the accident. Safety issue being examined is the potential involvement of hazardous materials in a cargo compartment fire.

### **Baltimore, Maryland Freight Train Derailment and Release of Hazardous Materials**

On July 18, 2001, an eastbound CSXT freight train, consisting of 3 locomotive units and

## **Hazardous Materials Safety**

60 cars, derailed 11 cars while traveling through the Howard Street tunnel in downtown Baltimore, Maryland. Three of the derailed cars contained hazardous materials. The derailment resulted in a release of hazardous materials and fire that lasted several days.

Safety issues being examined are the performance of the tank cars transporting the hazardous materials, environmental impact, and routing of hazardous materials shipments by the railroad.



# Research and Engineering

As accident investigations become more complex, it is essential that investigators receive support in a wide range of disciplines to precisely determine the source and chronology of an accident or incident. To assist them, technical specialists in the Office of Research and Engineering performed accident reconstructions, vehicle performance analyses, radar analyses, visibility calculations, simulations of vehicle and occupant motion, animations, data recorder readouts and analyses, medical factor analyses, metallurgical examinations, and fire and explosion analyses. In addition, the office supported the NTSB's investigation and administration staff through maintaining the agency's information technology system, aviation accident and other databases, information product distribution, and agency websites.

## Significant Technical Accomplishments

### Alaska Airlines Flight 261

After recovery of the CVR and flight data recorder (FDR) from the ocean in February 2000, they were shipped to the NTSB laboratories in Washington, D.C. Technical specialists in the Office of Research and Engineering immediately began the task of extracting and analyzing the recorder data. Within hours, the CVR and FDR specialists were able to provide on-scene accident investigators with valuable information that alerted them to a possible control problem. In the days following the accident, technical specialists from several divisions in the Office of Research and Engineering used the CVR/FDR data (and radar data supplied by the FAA) to compute the crew's actions and vehicle response during the final minutes of the flight. This work included computer simulations that recreated the aircraft's performance.

All of the technical information produced by NTSB engineers was provided to the IIC and the rest of the investigation team as it was developed. This knowledge led the wreckage recovery team to concentrate efforts on retrieving the horizontal stabilizer assembly from the MD-80 aircraft. Within days, metallurgists in the materials laboratory were examining the jackscrew/gimbal nut assemblies from the aircraft for clues to the cause of the accident. They found that the thread on the accident gimbal nut was completely worn or sheared off, and remnant strips of the thread were wrapped around the jackscrew. No grease was found on the portion of the jackscrew where the gimbal nut would normally be expected to operate.

Determining how a particular part may have failed often requires lengthy research. The condition of the jackscrew from the Alaska Airlines MD-80 led engineers from the Office of Research and

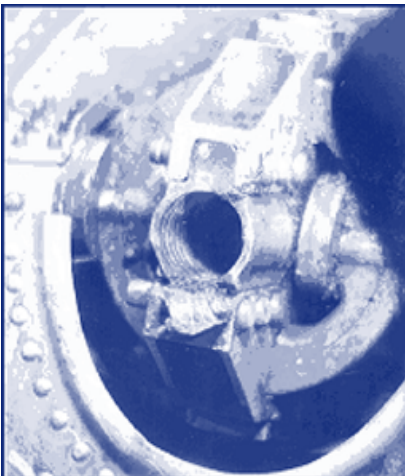

Gimbal nut (left) and jackscrew (right) from Alaska Airlines MD-80.

## Research and Engineering

Engineering to develop an ongoing multidisciplinary research, analysis, and testing program to investigate lubricating greases and the wear characteristics of the steel-aluminum bronze material combination used on aircraft flight control components. Subject areas include physical testing of grease properties, chemical analysis of in-service grease samples, microscopic examination of wear particulate taken from in-service grease samples, wear testing of materials lubricated with various greases, and analysis of chemical effects of greases to metal surfaces.

Some test and research programs are being conducted in cooperation with the U.S. Navy Materials Laboratory, Rensselaer Polytechnic Institute, Falex Corporation, and Science Applications International Corporation. Technical specialists also provided extensive written and visual material for the public hearing into this accident, held in December 2000.

### **TWA Flight 800**

The final report of the TWA flight 800 accident, issued on August 23, 2000, provided the results of 4 years of research and testing by Office of Research and Engineering staff regarding fuel tank flammability issues, including fuel ignition and combustion behavior, chemical analysis of the fuel in its liquid and vapor states, and scale testing and computer modeling of fuel tank explosions.

From the day of the accident on July 17, 1996, investigators often relied on the technical specialists in the NTSB laboratories to examine the recorders and wreckage and point the way for the investigation. FDR and CVR data did not indicate any pre-event problems with the aircraft.



*TWA flight 800 reconstruction.*

*Complex accident investigations require support from a wide range of technical disciplines in the Office of Research and Engineering.*

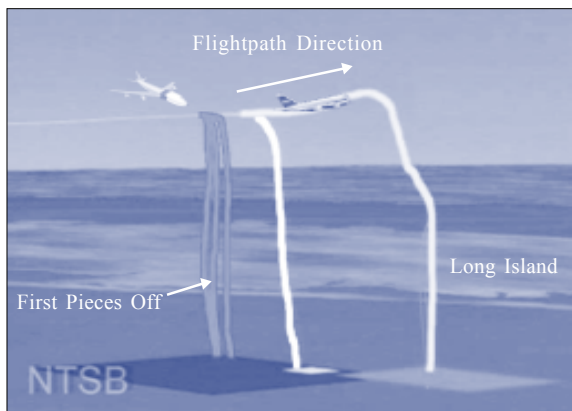

Computer model of trajectory of aircraft components.

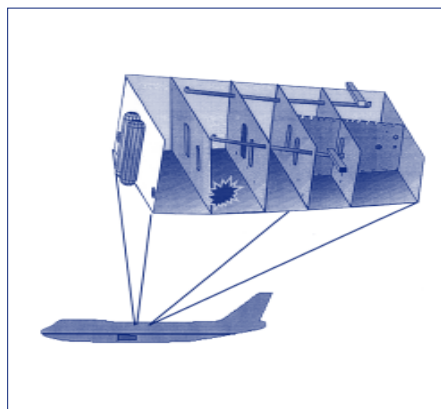

Computer model of explosion in the center fuel tank.

When materials specialists examined the reconstructed pieces of the wreckage, they were able to determine a breakup sequence for the airplane. The sequence began when an overpressure event in the center wing tank caused the forward structural member of the tank to fracture and rotate forward into the front spar. Ignition and rapid burning of the fuel/air vapor within the tank was determined to be the source of the excessive pressure. From this point, the investigation focused on the location and possible causes of ignition of the fuel/air vapor mixture.

Vehicle performance specialists then used computer modeling to calculate the post-event trajectory of the aircraft components and demonstrate that they were consistent with an explosion in the center fuel tank.

Staff fire and explosion specialists then initiated a study to determine the conditions in the center wing fuel tank under which ignition of various ratios of fuel-air mixtures could ignite. These results provided guidance to the investigators who later determined the probable cause of the ignition.

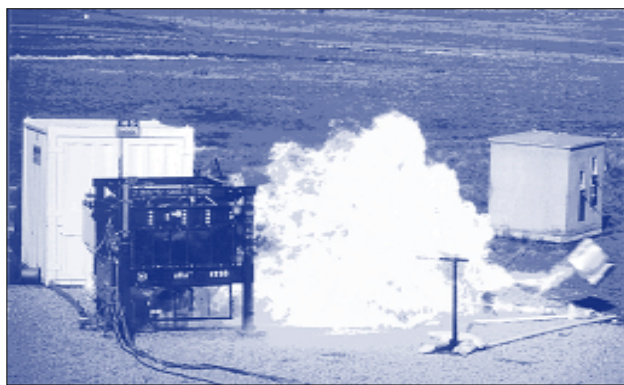

Sub-scale testing of an aircraft fuel tank explosion.

As part of this effort, Office of Research and Engineering staff developed research and testing programs with the California Institute of Technology, Sandia National Laboratories, University of Nevada at Reno, Desert Research Institute, Combustion Dynamics Ltd. of Canada, and Christian Michelsen Research of Norway. This research has provided the aviation community fundamental information toward

forming a comprehensive view of how and why fuel tanks become flammable, methods to reduce flammability, the conditions in which ignition and combustion of the fuel tank vapors can be achieved, and the results and consequences of this combustion.

### School Bus Safety

The investigation of the collision of a dump truck and a school bus on October 21, 1999, in Central Bridge, New York, required staff specialists to create a computer simulation of the crash. Using data gathered at the scene by NTSB highway accident investigators and other sources as input for the simulation, Office of Research and Engineering staff was able to determine the speed of the vehicles and the dynamics of the vehicles during the accident. The simulation also provided information on the potential views of the drivers. The vehicle dynamics were then used in a simulation of occupant kinematics to evaluate occupant injuries with and without the use of seatbelts. An additional animation for this accident showed how seat clips released in the crash and allowed a school bus seat to flip up and down, trapping the legs of students. Investigators used these simulations and animations to formulate safety recommendations presented in the accident report issued on November 14, 2000. The vehicle dynamics were then used in a simulation of occupant kinematics to

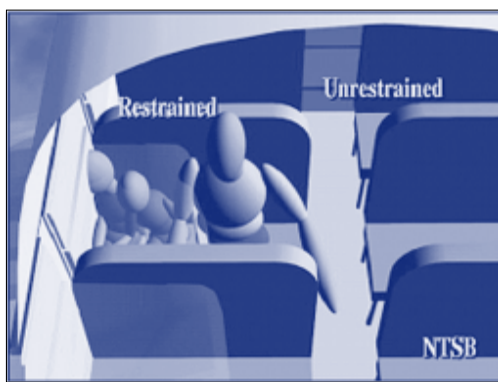

*Computer model used to simulate occupant kinematics.*

evaluate occupant injuries with and without the use of seatbelts. An additional animation for this accident showed how seat clips released in the crash and allowed a school bus seat to flip up and down, trapping the legs of students. Investigators used these simulations and animations to formulate safety recommendations presented in the accident report issued on November 14, 2000.

### Bourbonnais, Illinois Grade Crossing Accident

Determining the circumstances of an accident often takes many months of detailed research. Such is the case with the March 15, 1999, collision of Amtrak train 59 and a tractor-semi-trailer at a grade crossing in Bourbonnais, Illinois. This accident resulted in a derailment that killed 11 train passengers and injured 122 passengers and crewmembers. The truck driver received minor injuries. Total damage in this accident exceeded \$14 million.

Accident investigators called on the technical specialists in the Office of Research and Engineering to provide information about the operation of the crossing signals and the movement of the truck through the crossing. A recorder specialist obtained information about the speed of the train from the train's event recorder. An engineer examined the crossing gate mechanisms, the light bulbs, and the wood to determine how they were operating at the time of the collision and how the damage was related to the crash. Accident investigators provided accident scene diagrams showing the final resting position of the truck and measurements of crash-related pavement and ground markings. Specialists used all of these data to develop simulations and animations that will help investigators determine if the crossing gates were operating properly at the time of the collision and if the truck was driving around a lowered crossing gate and at what speed.

## Other Significant Work Accomplishments

### *Medical Factors*

Concerned about a number of accidents involving prescription or over-the-counter medications, the Office of Research and Engineering produced a series of safety recommendations (I-00-1 through -5; A-00-4 through -6, H-00-12 through -15, M-00-1 through -4; R-00-1 through -8) issued on January 13, 2000, to encourage the DOT and its modal administrations to develop a list of medications that were safe to use while operating a commercial vehicle and to prohibit the use of other medications during such operation. The Food and Drug Administration (FDA) was asked to develop and use a simple standard warning label for medications that could adversely impact vehicle operation. Although the DOT has responded that such a list is impossible and unnecessary, the FDA and the NTSB co-sponsored a public meeting on November 14 and 15, 2001, which discussed various issues that relate to medications and transportation operations, and included interested parties from the government, the transportation and pharmaceutical industries, and academia.

The NTSB has investigated a number of accidents involving commercial drivers with serious medical conditions. As an example, the commercial driver of the bus involved in a crash in New Orleans, Louisiana, on May 9, 1999, in which 22 senior citizens were killed, held a current medical certificate despite his kidney failure, congestive heart failure, and abnormal heart rhythms. Following our investigation of that accident, the NTSB issued recommendations that focused on the medical oversight of commercial drivers.

The staff provides medical consultation to accident investigators in all modes on about 100 accidents a year. The following are some examples from 2000/2001:

- two nonfatal light rail accidents in Baltimore, Maryland, involving prescription medications, illicit drugs, and pre-existing medical conditions;
- a highway accident that killed a Tennessee State trooper and involved a commercial driver previously diagnosed with obstructive sleep apnea;
- a nonfatal general aviation accident in Kansas involving a pilot with a previously undiagnosed brain lesion;
- a nonfatal passenger rail accident in Syracuse, New York, involving an engineer with previously undiagnosed diabetes;
- a fatally injured ramp worker at Reagan Washington Reagan National Airport with significant pre-existing disease; and
- a fatal San Jose, California, police helicopter accident in which evaluation of the injury mechanisms helped shed light on the accident sequence and the performance of restraints.

## Safety Studies

### *Evacuation Study*

In June 2000, the Safety Studies and Statistical Analysis Division, Office of Research and Engineering, completed a study of aircraft emergency evacuations (NTSB/SS-00/01), the only study of its kind to date to take a prospective look at a comprehensive set of emergency evacuations of commercial airplanes. The study analyzed 46 evacuations involving 2,651 passengers of scheduled air carriers that occurred between September 1997 and June 1999.



Eighteen different aircraft types were represented in the study. Those evacuations occurred as a result of both accidents and incidents, and on average, an evacuation occurred every 11 days during the period.

The study examined several safety issues including certification of airplane evacuations; the effectiveness of evacuation equipment; the adequacy of air carrier guidance and airport rescue and firefighting training; and communication during an evacuation. Based on data collected, the NTSB concluded that passengers continue to have problems opening overwing exits. It was also concluded that stowing the hatch created problems that impacted the reliability of emergency slides. In 37 percent of the evacuations where slides were deployed, there were problems with at least one slide. The study also revealed communication problems between cabin and flight crews when initiating evacuations. In several evacuations the cabin crew reported that the flight crew had not adequately communicated the nature of the emergency or the need to evacuate the aircraft.

### ***Aircraft Accident Survivability***

As a follow up to the evacuation study, the Office of Research and Engineering conducted a study of aircraft accident survivability (NTSB/SR-01/01). The study was based on a survey of accidents investigated by the Safety Board from 1983 through 2000 involving large aircraft in scheduled service. The study found that more than 95 percent of passengers — 48,927 of 51,207 — on board these aircraft survived the accident. In the most serious accidents involving fire, serious injury, or substantial aircraft damage, more than 55 percent of the occupants survived. The study also showed that public perception of aircraft accident survivability seems to be substantially lower than the actual survival rate. The study (NTSB/SS-01/01) was adopted on October 23, 2001.

### ***Public Use Aircraft Safety***

Section 702 of Public Law 106–181, the Wendell H. Ford Aviation Investment and Reform Act for the 21st Century, directed the NTSB to “conduct a study to compare the safety of public aircraft and civil aircraft,” and to review safety statistics on aircraft operations since 1993.

“Public aircraft” are aircraft operated for the purpose of fulfilling a government function that meet certain conditions specified under Title 49 United States Code, Section 40102(a)(37). The Safety Board identified 341 public aircraft accidents that occurred during the years 1993-2000. Using activity data from the FAA (for the period 1996-1999), the Board calculated an accident rate of 3.66 accidents per 100,000 flight hours for non-military, non-intelligence public aircraft.

Using activity data from the General Services Administration (GSA) (also for the period 1996-1999), the Safety Board calculated an accident rate of 4.58 per 100,000 flight hours for non-military, non-intelligence federal aircraft. Both rates were lower than the general aviation accident rate (7.2 accidents per 100,000 flight hours), but higher than the accident rate for air taxis (3.47), scheduled Part 135 operations (1.06), or Part 121 operations (0.30).

Comparisons between public and general aviation accidents revealed similar proportions of broad causal factors. However, accidents in these two sectors differed in other ways. A higher proportion of public aircraft crashed during local flights, at off-airport locations, and during maneuvering phases of flight. Also, accident-involved public aircraft pilots were more likely than accident-involved general aviation pilots to hold advanced ratings.



Limitations and flaws associated with the FAA's non-airline activity estimates made it impossible for the Safety Board to make carefully controlled comparisons of the safety of public versus civil aircraft. The data were not sufficiently detailed to support the calculation of public and civil aircraft accident rates for specific purposes of flight (e.g., aerial observation and aerial application). Furthermore, FAA flight hour estimates are potentially biased because they are based on a survey that is administered to a sample of aircraft owners listed in the FAA's Civil Aircraft Registry, which is known to contain many outdated or inaccurate records. As a result of these findings, recommendations were made to the FAA and the GSA.

### ***Other Studies***

A staff specialist also provided data analysis for a safety report on actions to reduce fatalities, injuries, and crashes involving the hard core drinking driver (NTSB/SR-00/01) adopted on June 27, 2000, and another specialist served as a technical panelist at the January 2000 public hearing on commercial driver oversight.

### **Materials**

Staff materials engineers examined parts and wreckage from over 300 accidents from all modes in 2000 and 2001. Among these items were a series of wing spar failures on agriculture application airplanes in 1999 and 2000; sections of pipeline from the Winchester, Kentucky, release of oil on January 27, 2000, the Greenville, Texas, rupture on March 9, 2000, the Chalk Point, Maryland, release of oil on April 7, 2000, and the Carlsbad, New Mexico, explosion on August 19, 2000; sections of track structure from train derailments in Eunice, Louisiana, on May 27, 2000, in Nodaway, Iowa on March 17, 2001, and in a tunnel in Baltimore, Maryland, on July 18, 2001; a bearing from the *M/V Minnow* which sank in Great Lakes, Minnesota, on September 18, 2000; and structure from a bridge that collapsed in Fowler, New York, on February 21, 2001. The results of research on the parts and structure examined by the Materials Laboratory is quite often the primary information used in determining the probable causes of these accidents.

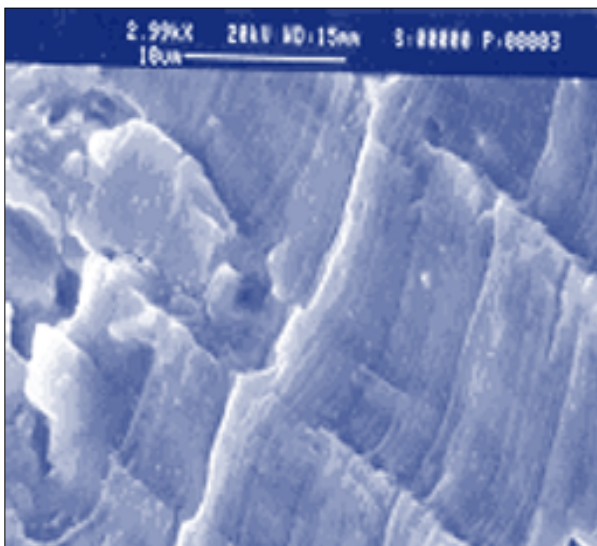

*Fatigue striation pattern, revealed by a scanning electron microscope, from the fracture surface of the wing spar of an airplane that crashed in Tolna, North Dakota, on June 30, 2000.*

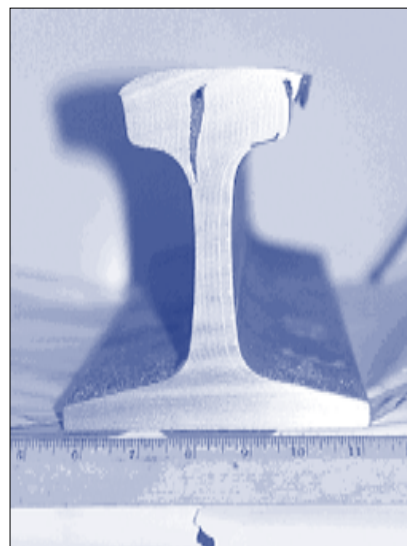

*Laboratory examination of the rail from the Amtrak derailment in Carbondale, Kansas, on March 15, 2000, revealed that the rail fracture was from a vertical split head, a defect related to the quality of the steel used to make the rail.*

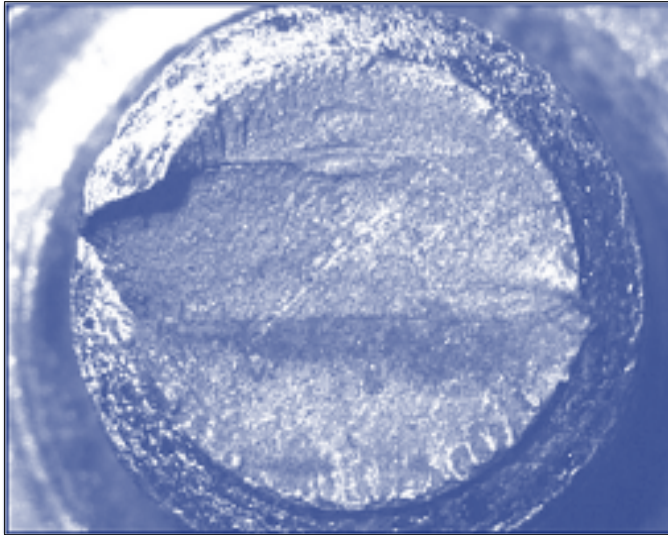

Sheared bolt from the truck accident in Lincoln, Nebraska, on October 19, 2000.

On October 19, 2000, a Freightliner dump truck lost primary braking capability and struck two vehicles, killing two people, in Lincoln, Nebraska. The ongoing investigation has revealed that a brake pin fractured, rendering the brakes inoperable. Staff materials engineers determined that the fracture was caused by fatigue cracking and investigated the material properties of the pin. Freightliner announced a voluntary recall of 133,000 vehicles to correct the problem.

In 2000 and 2001, Materials Laboratory staff provided assistance to foreign accident investigations in Indonesia, Greenland, Brazil, Peru, Tanzania (2), Hong Kong, Saudi Arabia (3), Bali, El Salvador, Guatemala (2), Paraguay, and Mexico.

## Animations/Simulations

Staff specialists produced computer simulations and animations of accident vehicle performance for many investigations, including the American Airlines flight 1420 accident on June 1, 1999 (public hearing held January 26-29, 2000); FedEx flight 14 accident at Newark, New Jersey, on July 31, 1997 (report adopted July 25, 2000); the collision of a truck/semitrailer with three other trucks at a truck rest area in Jackson, Tennessee, on June 3, 1999 (report adopted May 17, 2000); and a marine accident involving a casino boat in St. Louis, Missouri, on April 4, 1998 (report adopted May 31, 2000).

These products, based on data from vehicle recorders and measurements taken at the accident sites, gave investigators insight into the crash dynamics and the causes of the accidents. Animations were also useful in incident research. Board Members viewed the animations of several runway incursions during a public meeting on June 13, 2000, which resulted in the adoption of six safety recommendations aimed at eliminating runway incursions.

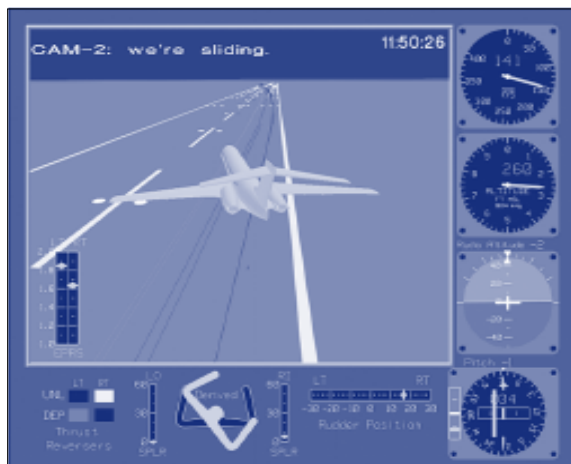

A specialist also developed a video animation of a midair collision for presentation at the General Aviation Accident Safety Symposium held in September 2000. The simulations and animations for many completed investigations are available for public viewing on the NTSB website.

The image at left is from an animation depicting the last minute of flight for American Airlines flight 1420, which crashed while landing at Little Rock, Arkansas, on June 1, 1999. The

reconstruction uses data retrieved from the digital flight data recorder and excerpts from the CVR transcript. The animation shows the airplane touching down to the right of the runway centerline and continuing to track to the right nearly reaching the right edge of the runway before changing direction to the left. The remaining landing roll shows the airplane passing through the runway centerline and eventually departing the left edge of the runway just before reaching the end of the runway.

On June 1, 2000, the Safety Board issued Safety Recommendations A-00-41 through -45 concerning certain autopilot problems on Boeing 727 aircraft. The recommendations asked the FAA to review the certification of all autopilot systems that use time-based desensitization schedules and develop operating limitations, as necessary, for the use of these autopilots on coupled instrument landing system approaches.

The recommendations resulted from the investigation of the crash of American Airlines flight 1340 short of the runway at Chicago O'Hare airport on February 9, 1998, and were developed by specialists in aircraft performance. These specialists used available data to show the position of the aircraft relative to the runway glide slope based on pressure data and integrated accelerations.

**AA1340 Position Relative to ORD 14R Glide Slope based on Pressure Data and Integrated Accelerations**

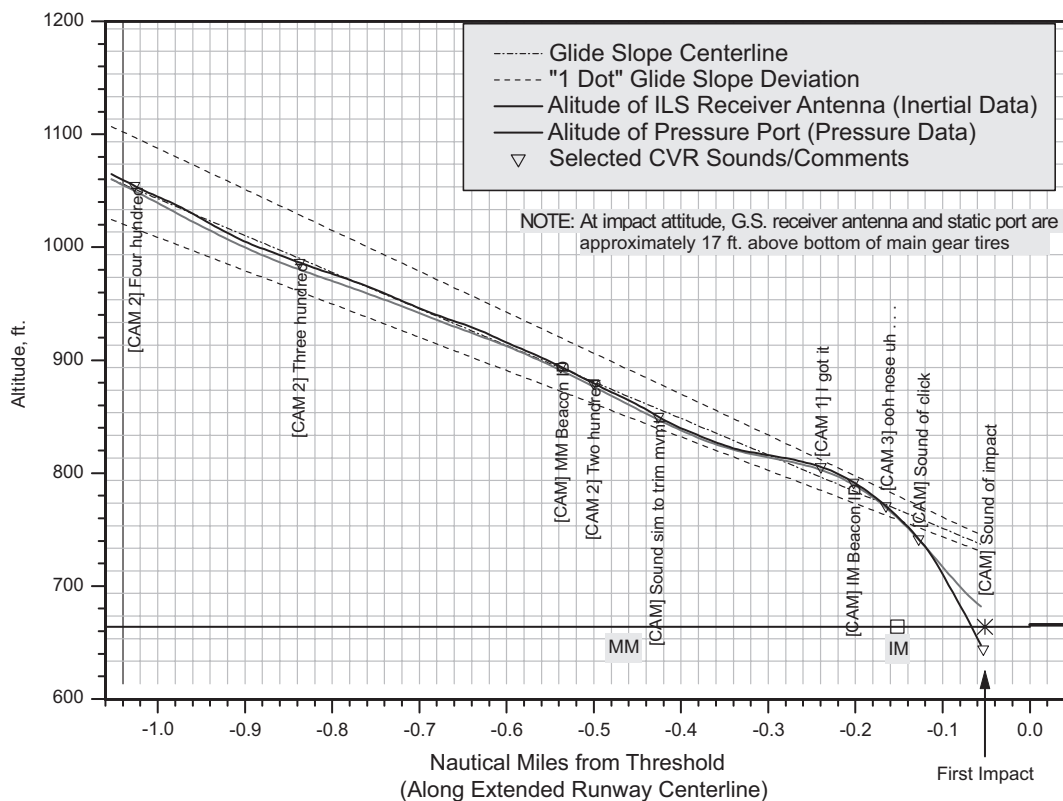

Plot from American Airlines flight 1340 investigation.

NTSB staff also developed a video animation of important passenger vehicle safety features. The video educates the public on the effectiveness of a broad array of car safety features such as seat belts, airbags, anti-lock braking systems, and child restraint systems. This information will increase the level of safety for the traveling public. Chinese language version was extremely well received when presented to transportation officials in Beijing, China, in May 2000.

## Information Technology

In August 2000, Web specialists in the Office of Research and Engineering arranged for the Board Meeting on the TWA flight 800 report to be broadcast to the public via the World Wide Web. The office also arranged for live webcasting of the December 2000 public hearing into the Alaska Airlines flight 261 crash and for delayed webcasting of the January 2000 public hearing on commercial driver oversight, the September 2000 symposium on general aviation accident prevention, and the November 2000 public hearing on pipeline safety. Video archives of the events were posted on the NTSB website.

In 2001, Internet activity showed continued growth, averaging approximately 16,000 hits per day. Over 200,000 publications were downloaded, with the most popular reports continuing to be those involving aviation.

Added to the Web site were 13 accident reports and studies in 2000 and another 30 in 2001. Docket information on the EgyptAir flight 990 accident and selected other accidents was made available on the website. Frequently requested information concerning certain accident investigations is published on the agency's Freedom of Information Act web page.

In November 2001, the Safety Board launched a redesigned intranet site that offered the NTSB's staff better access to administrative and technical information. Work also began on a searchable docket management system that will become an integrated part of the internal website in early spring 2002. Work began in 2001 for a geographic information system-method of mapping aviation accidents in the State of Alaska. A prototype interactive system that provides the ability to retrieve descriptive information for each accident is currently being tested.

In order to increase the efficiency and scope of data analyses, technical specialists in the Office of Research and Engineering developed additional aviation accident investigation software. The Data Analysis Numerical Toolbox and Editor (DANTE) is a Windows-based computer program to simplify, automate, and augment many airplane performance calculations, and to analyze and manage large volumes of electronic data from flight data recorders, radar sites, and simulator and flight tests. Because of interest from the aviation accident investigation community, this program is being shared with government investigation authorities in Canada, Germany, Australia, Taiwan, the U.S. Air Force 84th Radar Evaluation Squadron, and the U.S. Air Force Safety Center. The program and documentation are available to authorized users worldwide by means of a link on the NTSB website that allows a download of the complete program, user manual, and tutorial. Specialists periodically update the program to respond to current investigative needs and as a result of suggestions for improvement made by the large user group.

## Cockpit Voice Recorders/Flight Data Recorders

Because cockpit voice and flight data recorders have had limitations in their usefulness in solving several catastrophic accidents, in April 2000, the NTSB issued two safety recommendations (A-00-30 and -31) asking the FAA to require that passenger and cargo airlines be fitted with crash-protected cockpit image recording systems. The system would record a view of the entire cockpit including each control position and each action taken by people in the cockpit.

Staff engineers analyzing the FDR from a Boeing 737, which was damaged when it encountered clear air turbulence, discovered that the rudder pedal force parameter on the recorder was not working. Inquiries by investigators found that the incident aircraft and 16 other new generation 737s had been mistakenly delivered without rudder pedal force sensors. Once alerted to the omission, Boeing added the sensors to the 17 aircrafts.

As a result of the 1999 International Symposium on Transportation Recorders, which was cosponsored by the NTSB, a Future Flight Data Collection Committee was formed by RTCA, Inc. The committee, cochaired by NTSB and FAA recorder technical specialists, held four plenary sessions and several meetings of its three working groups during 2000. Manufacturers, industry groups, airlines, and U.S. military and other government organizations are working together to improve data collection for accident investigation and other purposes.

Technical specialists provided information regarding CVRs, FDRs, and cockpit video recordings for the NTSB symposium on transportation safety and the law held in April 2000 and continued to provide assistance when requested for foreign accident investigations. The staff examined FDRs from accidents in Indonesia, Brazil, Saudi Arabia, and Peru.

## Accident Data

Data specialists in the Office of Research and Engineering responded to public requests for aviation accident information. Some of these requests concerned the accident frequency of a particular aircraft model or air carrier, others were interested in particular types of accidents. In addition, staff information technology specialists improved the database to access on the NTSB website. Many data users who have commercial or research interests now appreciate and regularly acquire the data directly from the website. The office also issued statistical information on U.S. civil aviation and published the NTSB annual reviews of aircraft accident data for U.S. air carriers and for general aviation.

## Fire and Explosion Factors

Technical specialists in fire and explosion from the Office of Research and Engineering investigated fires on board several marine vessels, including the cruise ship *Ecstasy*, which had 2,565 passengers and 916 crewmembers on board when a fire started in the main laundry on July 20, 1998, shortly after leaving Miami. Specialists examined potential cause and origin scenarios and evaluated fire code regulations. The accident report was adopted on May 1, 2001. Staff specialists also investigated marine fires in the following cases:

- May 23, 2000, incident aboard the cruise ship *Nieuw Amsterdam*, which had 1,767 persons on board when a fire broke out in a crew cabin on D Deck. Two passengers suffered smoke inhalation injuries. Staff conducted laboratory investigation of the electrical appliance suspected of causing the fire.



## Research and Engineering

- June 7, 2000, fire in the control room of the *Columbia*, an Alaska Marine Highway System ferry with 497 persons on board, that resulted in loss of propulsion and electrical power throughout the ship. Staff participated in the supporting laboratory tests of high current electrical arcing at the Applied Physics Laboratory at Johns Hopkins University.
- November 17, 2000, fire aboard the *Port Imperial Manhattan* that resulted in the ferry losing power and going adrift in the Hudson River. Other vessels came to its aid and the ferry's crew and all of its passengers were removed before anyone was injured. The ferry, however, was destroyed by the fire.

Staff fire specialists conducted on-scene investigations of two in-flight fires of commercial aircraft. A DC-9, operated as Air Tran flight 913, in Greensboro, North Carolina, experienced an in-flight fire that involved a relay failure in the forward electrical control panel, and another DC-9, operated as Air Tran flight 956, in Atlanta, Georgia, experienced an electrical fire of unknown origin. In one case, smoke in the cockpit was so dense that it restricted the flight crew's ability to see the cockpit instruments, the visual references outside the airplane, and even each other. Office of Research and Engineering staff also assisted in two additional in-flight fire investigations: Delta Air Lines flight 2030, an MD-88 near Covington, Kentucky; and a Cessna 210 in Atlanta, Georgia.

In support of the investigation of the Amtrak derailment in Bourbonnais, Illinois, on March 15, 1999, fire specialists also monitored testing of passenger rail car cabin interior materials to assess their role in spreading the fire.



# Administrative Law Judges

Since 1967, the Safety Board has served as the “court of appeal” for airmen, mechanics or mariners whenever the FAA or the USCG takes a certificate action.

Under 49 *United States Code* (USC) section 1133 and 49 CFR Part 821, the Board’s administrative law judges hear, consider and issue initial decisions on appeals of FAA certificate actions taken under 49 USC sections 44106, 44709 and 44710. Also covered are petitions from airmen whose applications for certification have been denied under 49 USC section 44703.

Under the FAA Civil Penalty Administrative Assessment Act of 1992 (codified at 49 USC sections 46301, *et. seq.*) the Board’s judges hear all civil penalty appeals to the NTSB of enforcement cases involving pilots, engineers, mechanics and repairmen where the amount in controversy is less than \$50,000.

Under the Equal Access to Justice Act (EAJA), codified at 5 USC Section 504, the NTSB’s judges also review and decide applications for attorneys fees and expenses from airmen who prevail against the FAA in cases brought pursuant to 49 USC sections 44709. Applications filed in connection with actions brought by the FAA under 49 USC section 46301(d) (civil penalty cases) also are decided by the Board’s judges and, on appeal from the judges’ decisions, by the full five-member Safety Board.

The judges’ decisions in these cases may be appealed to the five-member Board by either the certificate holder or the FAA. The Board’s review on appeal of its administrative law judges’ decisions is based on the record of the proceeding, which includes hearing testimony (transcript), exhibits and the judge’s decision, as well as appeal briefs submitted by the parties.

The FAA has the right to appeal decisions of the five-member Board to the U.S. Court of Appeals where that agency determines that the Board’s decision “will have a significant adverse impact” with respect to aviation safety duties and powers designated to be carried out by the FAA. Airmen and mechanics have the right to appeal all adverse Board decisions to the Court of Appeals.

Upon review of the Board’s decision, the Court of Appeals has the power to affirm, modify or set aside that decision in whole or in part — or, if need is found, to order further proceedings by the Board. The decision of the Court of Appeals is subject to review by the U.S. Supreme Court on *writ of certiorari*.

Marine certificate actions are heard first by the Coast Guard’s administrative law judges, and may be appealed to the Commandant of the Coast Guard. The ruling of the Commandant may then be appealed to the NTSB, where the Board follows the same appellate process as it does in considering the initial decisions of its law judges in aviation cases. From 2000-2001, four marine appeals were filed with the NTSB and five cases were closed by the Board.

There were 773 aviation certificate appeals filed with Board’s Office of Administrative Law Judges during 2000-2001; 291 of these cases were from emergency orders. The Board’s judges held 197 hearings and closed 802 cases.

During 2000-2001, 108 of the judges' decisions were appealed to the full five-member Safety Board for review. The Board decided 109 appeals, reversing the judges' decisions in four cases. Eleven of the Board's decisions were appealed to the U.S. Courts of Appeals, which rendered 19 decisions during 2000-2001, affirming the Board in 12 of these and remanding one case back to the Board for additional disposition. The remaining six cases were dismissed or voluntarily withdrawn.

There were 22 EAJA applications filed with the Board's administrative law judges during 2001-2002, and 20 EAJA cases were decided by the judges. In 2000-2001, 13 of the judges' EAJA decisions were appealed to the full Board, which issued rulings in 3 cases.

*The NTSB serves  
as the “Court of  
Appeals” for airmen,  
mechanics  
and mariners.*

# NTSB Academy

The NTSB Academy is a major initiative of the Safety Board aimed at improving the training and skills of its own employees, and making its safety expertise more widely available to the transportation community. An initial step took place in November 2000, when the NTSB selected the George Washington University as the new home for the academy.

The academy's mission is to provide comprehensive education and training for those who improve safety by conducting independent transportation accident investigations; to foster an environment that encourages transportation safety initiatives and technical research; and to promote uniform programs that ensure compassion, understanding, and assistance for those affected by transportation tragedies.



*Artist rendering of planned NTSB Academy.*

The NTSB and the university signed a 20-year lease in July 2001. In November, construction began on the university's campus in Ashburn, Virginia, adjacent to the U.S. Department of Transportation National Crash Analysis Center and near Washington Dulles International Airport.

The state-of-the-art, 72,000-square-foot, two-level facility will contain five classrooms, a large laboratory to house the three-dimensional, 93-foot reconstruction of the forward portion of the TWA flight 800 aircraft's fuselage, ample laboratory space, an outside simulations court, meeting rooms, student and teacher work areas, and offices. The building is set to open in mid-2003.

During 2001, the NTSB selected a core staff of five to plan, develop and execute the Academy's objectives: an academy director, an assistant director of instruction, an operations manager, a communications manager, and an administrative officer.

In September 2001, an Academy Curriculum Development Committee was formed. It is chaired by the Safety Board's managing director and includes all office directors as members. The committee is responsible for determining training needs; identifying and developing curricula in all modes; developing courses and course material; identifying effective instructors; suggesting resources; and reviewing final course proposals.

In addition to refining, updating, and making the Safety Board's current accident investigation course more accessible, the committee will develop courses that discuss innovative investigative tools and critical issues such as human factors, survival factors, vehicle performance, interviewing techniques, accident scene documentation, and investigation management in all modes.

Although the facility is still under construction, four courses were offered in 2001 under the academy's sponsorship. They include a basic two-and-a-half-week accident investigation course for NTSB employees and investigators from other countries, a two-day airline industry training session to familiarize industry representatives with their duties and responsibilities during NTSB accident investigations, a family affairs course designed for law enforcement officers who initially respond to aviation disasters, and a comprehensive family assistance course for those who assist friends and families of major transportation accident victims. At least six courses are planned for 2002.

# Public Forums and Symposia

## **General Aviation Accident Prevention Symposium** *September 21-22, 2000*

The NTSB held a symposium in the NTSB Board Room and Conference Center on issues related to improving transportation safety in general aviation. Discussion included a review of accident investigations by NTSB regional investigators and the analysis of causes, factors, and preventive measures by panels consisting of government/industry experts and safety officials.

## **National Transportation Safety Board/American Association of Airport Executives Airport Family Assistance Workshop** *July 16-18, 2001*

The NTSB Office of Family Affairs co-sponsored a symposium with the American Association of Airport Executives for airport personnel to provide additional information regarding the role of airports in family assistance response following an aviation disaster. In the aftermath of a disaster, airport personnel assist many family members. The role of the airport, however, is one that has not been clearly defined. This conference provided information on the Aviation Disaster Family Assistance Act of 1996, and the Foreign Air Carrier Support Act of 1997. In addition, workshops were held on developing an airport plan, involving the local community, identifying roles and responsibilities of the airport, and an in-depth review of two pertinent case studies.

# Public Hearings

## **Commercial Driver's Licenses**

*January 20-21, 2000*

The Safety Board conducted a two-day public hearing in New Orleans, Louisiana, to examine the adequacy of commercial driver oversight. A wide range of witnesses participated in this hearing, including truck and bus drivers, members of advocacy groups, federal and state government officials, and industry representatives. Representatives from other countries were also invited to discuss their systems.

Discussions centered on the CDL and medical certification programs to determine whether they were effective in ensuring the proficiency, capability, and safety of the commercial vehicle operators traveling on the nation's roadways. Also as part of the hearing, the Board compared the commercial driver licensing and certification processes to that of commercial pilots and to the CDL program in the European Union and Australia.

Topics addressed included:

- industry's role in driver oversight;
- programs carriers have to supplement state and federal requirements;
- actual process of obtaining a CDL and the knowledge and skill testing required;
- process of CDL suspension and revocation;
- success of the CDL program in detecting drivers that are no longer fit or that may have multiple violations; and
- available driver data and the problems associated with incomplete or faulty data.

## **American Airlines Flight 1420**

*January 26-28, 2000*

The NTSB convened a public hearing in Little Rock, Arkansas, as part of its ongoing investigation into the fatal runway accident on June 1, 1999 of American Airlines flight 1420. Chairman Jim Hall chaired the hearing.

The accident aircraft, a McDonnell Douglas MD-82 on a regularly scheduled passenger flight from Dallas, TX, on June 1, 1999, overran the end of the runway, went down an embankment, and impacted approach light structures after landing at Little Rock airport. Thunderstorms and heavy rain were reported in the area at the time of the accident. There were 11 fatalities, including the aircraft captain, and numerous injuries among the 145 passengers and crew aboard the flight.

The hearing focused on:

- flight crew decision-making and its relationship to fatigue;
- availability and dissemination of weather data;
- aircraft performance;
- passenger safety and emergency response;
- runway overrun protection;
- American Airlines' operational practices and procedures, and
- FAA oversight.

### **Pipeline Integrity Assessment and Leak Detection Systems** ***November 15-16, 2000***

The NTSB held an en banc public hearing, with all Board Members in attendance, at its Washington, D.C. Board Room and Conference Center, to examine technologies available to assess the integrity of pipelines, such as the use of internal inspection tools, and the capability of pipeline operating systems to identify leaks for prompt, timely operator responses. The hearing also sought to determine the status of ongoing research in these areas. The hearing was prompted by the Safety Board's investigation into numerous pipeline accidents in which pipes with time-related defects failed as well as accidents in which pipeline integrity issues and delays in recognition that a rupture had occurred are at issue.

### **Alaska Airlines Flight 261** ***December 13 -15, 2000***

The NTSB held a public hearing on the fatal crash of Alaska Airlines flight 261, on January 31, 2000, in the Safety Board's Conference Center in Washington, D.C. Member John Hammerschmidt chaired the hearing. The January 31, 2000 crash of Alaska Airlines flight 261 off the coast of California, near Pt. Mugu, claimed the lives of all 88 aboard.

Some of the issues discussed during the hearing were:

- Alaska Airlines' maintenance organization and procedures;
- its safety program;
- design and service history of the MD-80 series aircraft longitudinal trim system;
- FAA's certification and oversight of the ongoing airworthiness of that system;
- industry lubrication practices of the horizontal stabilizer jackscrew; and
- FAA's surveillance of Alaska Airlines.