

COURTROOM Technology MANUAL

August 1999



**Administrative Office of the U.S. Courts
Leonidas Ralph Mecham, Director**

INTRODUCTION TO COURTROOM TECHNOLOGIES

The Judicial Conference Committee on Automation and Technology has adopted strategic initiatives aimed at reducing the judiciary's reliance on paper and achieving economies in its way of doing business. Among the strategic initiatives included in the 1999 update to the *Long Range Plan for Information Technology in the Federal Judiciary*, approved by the Judicial Conference, are these:

- Using video telecommunications technologies to facilitate judicial proceedings; and
- Employing technologies to improve the quality and efficiency of courtroom proceedings.

The Judicial Conference has endorsed the use of technologies in the courtroom and, subject to the availability of funds and priorities set by the committee, urged that (a) courtroom technologies — including video evidence presentation systems, videoconferencing systems, and electronic methods of taking the record — be considered as necessary and integral parts of courtrooms undergoing construction or major renovation; and (b) the same courtroom technologies be retrofitted into existing courtrooms or those undergoing tenant alterations as appropriate.

In support of this initiative, the *Courtroom Technology Manual* defines roles of GSA, architectural/engineering teams, and technical consultants and provides technical standards for infrastructure, video evidence presentation systems, videoconferencing systems, and sound systems. The manual is designed in discrete sections that can be separated and used by different audiences, resulting in the duplication of certain information in each section.

Please contact Gregg Miller or David Rickerson of the Space and Facilities Division, Administrative Office of the US Courts regarding this document.

ACKNOWLEDGMENTS

ADMINISTRATIVE OFFICE OF THE UNITED STATES COURTS

L. RALPH MECHAM

Director

CLARENCE A. LEE, JR.

Associate Director

Management & Operations

Courtroom Technology Manual Project

Administrative Office Staff

Gregg W. Miller

David K. Rickerson

Space and Facilities Division

Terry A. Cain

Steven D. Eiserman

Office of Information Technology

Philip "Duke" Argetsinger

Office of Court Programs

Production Consultants

George Spano, *Polysonics Corporation*

James Beight, *Phillips Swager Associates*

The following staff of the Administrative Office also participated in the preparation of this manual: C.K. Arora, Thomas L. Jenkins, Gate Y. Lew, Larry Hixson, and Carl A. Tucker.

Table of Contents

SECTION I - GSA Coordination of Courtroom Technology	1-1
A. Needs Assessment	1-4
B. Design Integration	1-12
C. Installation	1-13
D. Quality Control	1-13
SECTION II - Architectural/Engineering Team Coordination of Courtroom Technology	2-1
A. Needs Assessment	2-2
B. Design Integration	2-10
C. Space Planning	2-10
D. Construction Documents	2-11
E. Installation	2-11
F. Quality Control	2-11
SECTION III - Technology Consultant Coordination of Courtroom Technology	3-1
A. Needs Assessment	3-2
B. Methodology	3-2
C. Design Integration	3-12
D. Space Planning	3-12
E. Construction Documents	3-13
F. Installation	3-13
G. Quality Control	3-13
H. Maintenance & Service	3-13
SECTION IV - Infrastructure Standards	4-1
A. Responsibilities	4-1
B. Infrastructure Standards	4-1
SECTION V - General Overview of Audio System Design for U.S. Courthouses	5-1
A. Courtrooms	5-1
B. Prisoner Holding Area, Law Clerk Office, Etc.	5-23
C. Remote Witness Room	5-23
D. Jury Assembly Room	5-24
E. Paging Systems	5-26
F. Specifications	5-28

SECTION VI - Video Evidence System Standards	6-1
A. District Courtrooms	6-1
B. Computer Considerations	6-23
C. Specifications	6-23
SECTION VII - Video Conference Standards	7-1
A. Control Areas for Central Video Conference Processing	7-1
B. District and Bankruptcy Courtrooms	7-5
C. Appeals Courts	7-7
D. Courtroom Video	7-10
E. Specifications	7-10
SECTION VIII - Standards and Glossary	8-1
A. Standards	8-1
B. Glossary	8-4

INDEX TO GRAPHICS

1	Courtroom Technology Project Flow Chart	1-2
2	Cable Management Diagram	1-3
3	Standard U.S. District Courtroom - Movable Witness Box Flat Screen System	1-14
4	Standard U.S. District Courtroom - Clerks on Side Wall Projection Screen	1-15
5	U.S. Magistrate Judge Courtroom	1-16
6	Special Proceedings Courtroom Projection System	1-17
7	U.S. Magistrate Judge Courtroom Portable Monitor	1-18
8	U.S. Magistrate Judge Courtroom Portable Monitor	1-19
9	U.S. Magistrate Judge Courtroom Portable Monitor	1-20
10	U.S. Bankruptcy Courtroom Portable Monitors	1-21
11	U.S. Court of Appeals Panel Courtroom Portable Monitors	1-22
12	U.S. Court of Appeals En Banc Courtroom Portable Monitors	1-23
13	Sample Typical Courthouse Floor Plan	1-24
14	Standard U.S. Courtroom - Ceiling Speaker Layout	1-25
15	Grand Jury Room Portable Monitor	1-26
16	Courtroom A/V Conduit Schematic with Access Floor	4-4
17	Satellite Dish Attachment Details	4-8
18	Microphone Base with Mute	5-1
19	Retrofitted Sound System	5-2
20	ADA Lectern	5-4
21	Interpreter's Control Box / Headset	5-5
22	Typical Floor Box & Poke-Thru	5-6
23	Standard System Audio Block Diagram	5-8
24	Advanced Design Audio Block Diagram	5-9

25	Ceiling Speaker Diagram	5-10
26	Courtroom A/V Racks	5-11
27	Stacked A/V Electronic Cabinets	5-12
28	Standard Audio Electronic Cabinet	5-13
29	Control Panel	5-14
30	Sample Audio Visual Cart	6-5
31	Video Block Diagram	6-7
32	USC Flat Screens	6-10
33	Jury Box with Flat Screen	6-11
34	USC Portable Large Monitor	6-12
35	Portable Large Monitor Details	6-13
36	USC Big Screen	6-14
37	Projector/Screen Details	6-15
38	Projector Pocket Details	6-16
39	Audio Video Touch Panel Menu	6-18
40	Touch Panel Basic Screen	6-19
41	Attorney's Table	6-21
42	Attorneys Table / Built in Monitor	6-22
43	Typical Control Area	7-2
44	Control Room Block Diagram	7-3
45	Camera Pocket	7-6
46	Touch Pad Basic Screen	7-8
47	Video Conference Control Screen	7-9



SECTION I GSA Coordination Issues of Courtroom Technology

Courtroom technology has been installed in many courtrooms with positive operating results and will be implemented into new and existing courtrooms in accordance with the program implementation plan approved by the Judicial Conference Committee on Automation and Technology, subject to available funding. Courtrooms will need to be outfitted with appropriate infrastructure to accommodate the technology. The incorporation of the infrastructure as defined in this manual is critical to the success of the courtroom technology initiative. The success of initial installations as well as the long-term viability and flexibility of the court technology relies on the inclusion of the infrastructure, defined herein within the courthouse. Failure to provide these needs will result in structures which will not be able to accommodate the evolving technology needs of the courts both in the present and in the future.

Coordination of the courtroom technology needs to be a significant focus in the overall design process of the courthouse, especially in the courtroom itself. The technology must be fully integrated and not appear as an afterthought or an add-on to the final designed environment. Proper integration of these components begins by recognizing their requirements early in the design phase. This includes careful attention to the coordination of the acoustics of the space, the lighting concepts as well as the electronic equipment itself. As the courtroom design progresses, more detailed attention is required to properly accommodate the equipment within the overall aesthetic of the court environment. This is especially critical in the millwork associated with the judge's bench, witness, clerk, and jury box. Careful consideration should be given to each component described within this manual as it relates to the overall courtroom aesthetic.

The General Services Administration's (GSA's) role in this effort should be to help facilitate the interaction of the whole design team which includes GSA, GSA's architect/engineering design consultants (A/E consultants), the Administrative Office of the United States Courts (AOUSC), the court, the circuit, and the audio/visual (A/V) consultants. GSA will monitor the design process to make sure the required infrastructure is fully integrated into the design, and that input from the A/V consultant is appropriately incorporated into the project.

This manual will organize and guide the installation process for this technology, including needs assessment, design development, installation, and quality control. The GSA, the A/E consultant and the A/V consultant shall work together to assure all courthouse infrastructure items are successfully implemented. (See Figure #1 on page 1-2)

The incorporation of the infrastructure as defined in this manual is critical to the success of the courtroom technology initiative. The success of initial installations as well as the long term viability and flexibility of the court technology relies on the inclusion of the infrastructure, defined here within the courthouse.

GSA's role in this effort should be to help facilitate the interaction of the whole design team which includes GSA, GSA's architecture/ engineering (A/E) consultant, the Administrative Office of the US Courts (AOUSC), the court, the circuit, and the audio/visual (A/V) consultant. GSA will monitor the design process to make sure the required infrastructure is fully integrated into the design, and that input from the A/V consultant is appropriately incorporated into the project.

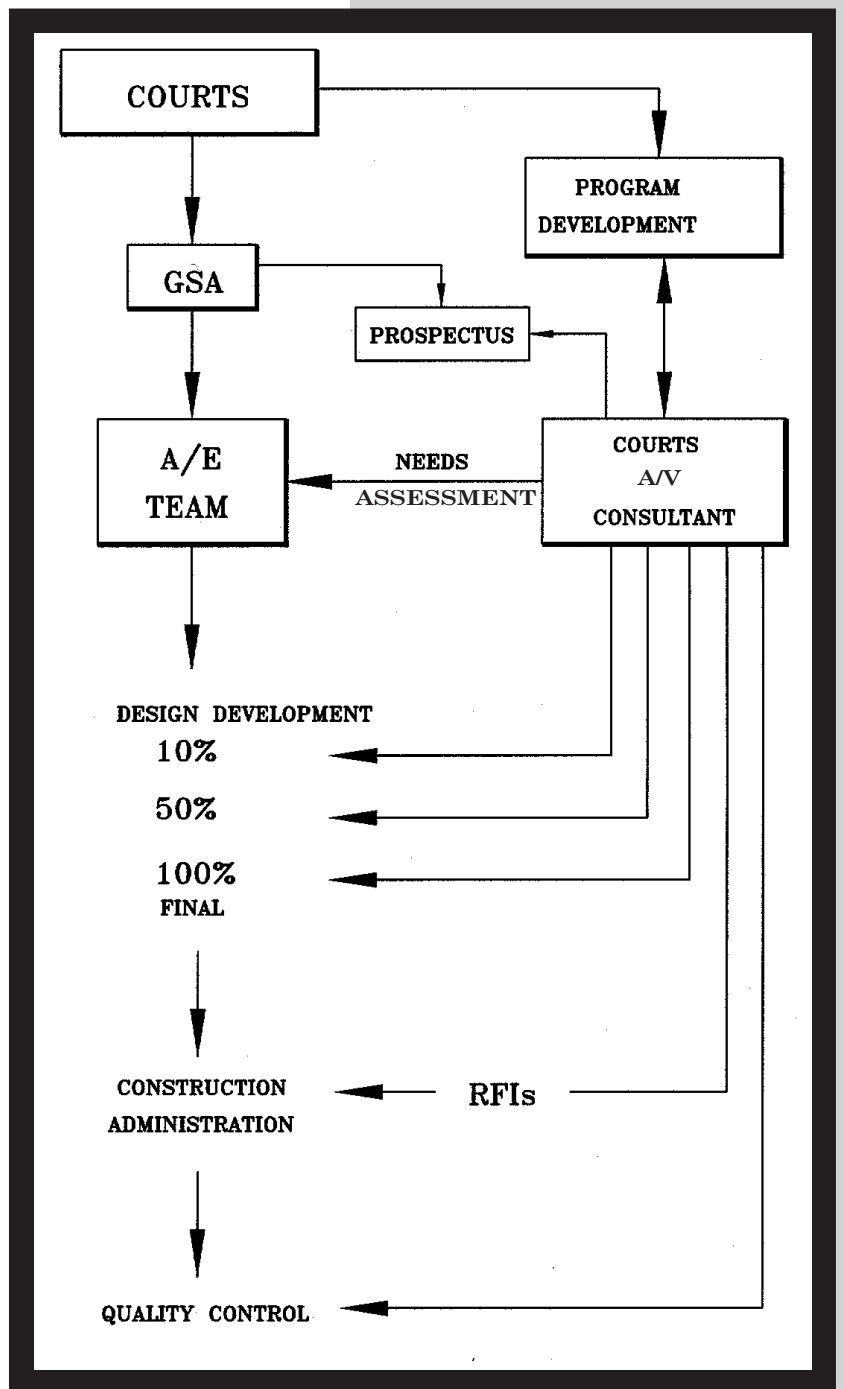



U.S. COURT - COURTROOM TECHNOLOGY PROJECT FLOW CHART

FIGURE 1

FOR ILLUSTRATIVE
PURPOSES ONLY.



KEY

-  CAMERA
-  CEILING SPEAKER
-  COURTROOM EQUIP. RACK

 FLOOR BOX UNDER BENCH/ATTORNEY TABLES/JURYBOX/WITNESS.

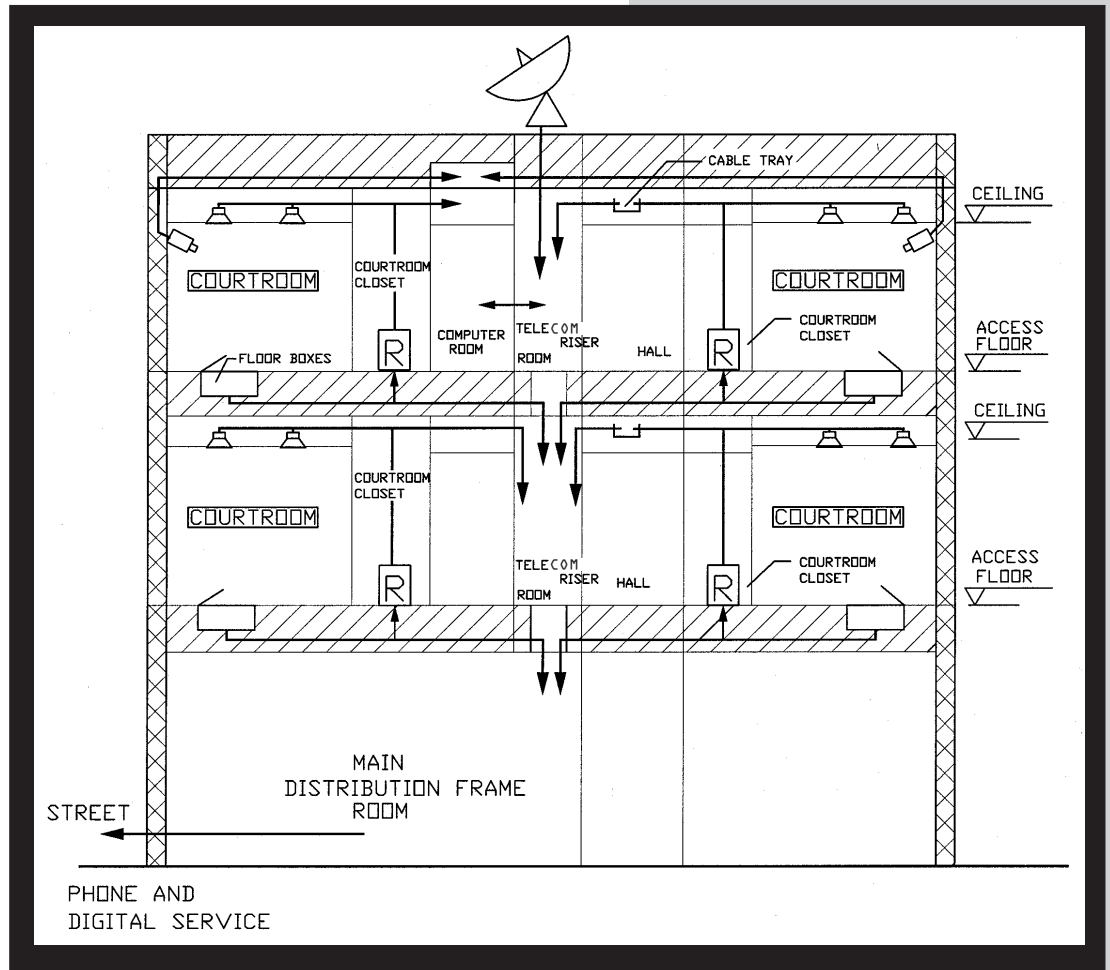

U.S. COURT - CABLE MANAGEMENT DIAGRAM
FIGURE 2

FOR ILLUSTRATIVE
PURPOSES ONLY.



COURTROOM TECHNOLOGY MANUAL

A. Needs Assessment

Infrastructure shall support the following courtroom technology provided by the courts:

- Sound systems
- Video evidence presentation
- Video conferencing
- Computers (access to databases)/phones
- Network's access (data bases)

◆ INFRASTRUCTURE CHECKLIST - COURTROOMS

1. Wire Management - Access Floors

Wire management in the courtroom will require in-floor wiring, using access floors in a 150mm to 200mm depressed slab area. The use of access flooring in the courtroom well is a required infrastructure component. Access flooring provides long term flexibility for the wire management associated with the courtroom technology. No substitutions or value engineering alternatives will be permitted for this component. Concrete topped panels with stringers and screws are appropriate to provide a solid footing and meet the floor load requirements. A depressed slab must be provided for the entire courtroom well (and sometimes including the spectator seating) in all new construction. The accessible floor should cover the entire well, including under the jury box and bench. Typically, twelve (12) high capacity access floor boxes or access floor panels are provided. Floor boxes shall have a modular connection power system; capacity for two (2) RJ-45 connectors using eight (8) pair, cat-5 wiring (the court's standard); and two (2) 25mm conduit to the A/V rack location. (See [Figure #2](#) on page 1-3, [Figures #3](#) through #15 on pages 1-14 through 1-26, and Section IV.)

Retrofit projects may alternately use existing cell floor systems, new floor boxes, and poke-thrus. Shallow access floors (7cm high) may also be considered.

2. Courtroom A/V Rack

The A/V rack is the housing for the sound and video equipment. The A/V rack is normally located in a 1.5m X 2m closet, adjacent to the courtroom with double doors (1.8m wide) to the corridor. Pairs of adjacent courtrooms may share a common rack space. Courtroom technology wiring will converge to this location and will also be routed to a central processing area for all courtrooms. Space for the A/V closet should be identified in the initial space requirements and incorporated in the courtroom floor plans in the initial designs. Provide a dedicated 20-amp 'isolated ground' outlet at the A/V rack.

The use of access flooring in the courtroom well is a required infrastructure component. Access flooring provides long term flexibility for the wire management associated with the courtroom technology. No substitutions or value engineering alternatives will be permitted for this component.

Space for the A/V closet should be identified in the initial space requirements and incorporated in the courtroom floor plans in the initial designs.

Adequate ventilation for ambient air temperatures must be provided to assure reliable operation within the specified operational range.

A/V rack locations in the judge's bench or clerk's space are not encouraged due to limited available space in these locations. In retrofit projects, storage rooms may be appropriate locations.

3. Wall Boxes and Conduit (Suggested Minimum)

The judge, clerk, reporter, and witness will need 100mm wide X 50mm high (5-gang) boxes in the millwork knee space with three (3) 25mm conduits back to the A/V rack. A horizontal plug-mold and low voltage wire management system in the knee space is recommended. The clerk will also need a 5-gang box in the ledge above the work surface. Millwork drawings shall show wire management systems and wall boxes. The gallery and jury box railings will require boxes and conduit, with locations coordinated with the A/V consultant.

4. Millwork Coordination

The Court or AO representative will work with the GSA A/E consultant and the A/V consultant to design and procure the millwork items which are furnished through various arrangements. Coordination of the court technology with the millwork is one of the most critical aspects of the design phase of the courtroom environment. Much of the technology will interface with the millwork and should be fully integrated in its design. Failure to accomplish this will most likely result in unsightly runs of cabling and placement of electronic equipment which will detract from the appearance of the courtroom.

An understanding of the components and their impact on the design should be realized at the earliest phases in the design process. The design team being GSA, the GSA A/E consultant and the A/V consultant are strongly encouraged to incorporate the court technology as a part of the courtroom mock-ups which are usually constructed prior to final approval of the courtroom design. The use of full-scale mock-ups would best facilitate the proper integration of the technology components into the court environment.

a. The GSA will normally furnish:

1) The Judge's Bench with:

- A work surface to accommodate a control panel, monitor, and microphones
- Pullout trays on both sides of the judge for laptops and/or keyboards with convenient receptacles

A/V rack locations in the bench or clerk's space shall not be encouraged due to limited available space in these locations.

Coordination of the court technology with the millwork is one of the most critical aspects of the design phase of the courtroom environment. Much of the technology will interface with the millwork and should be fully integrated in its design.

An understanding of the components and their impact on the design should be realized at the earliest phases in the design process.

- Modem receptacle box
- LAN (DCN) receptacle box
- Realtime transcription receptacle box
- Power receptacles
- Conveniently arranged space for the CPU and paper storage
- Access panel in the floor
- Wire management system

2) The Clerk's Worktable with :

- A work-surface which may accommodate a control panel, monitor, and microphone
- Pullout tray
- Box for two (2) phone receptacles
- LAN (DCN) receptacle box
- Realtime transcription receptacle box
- Power receptacles
- Conveniently arranged space for the CPU and paper storage
- Access panel in the floor
- Wire management system
- Space for video printer

3) The Reporter's Worktable with:

- Space for recording equipment and laptop
- Realtime transcription receptacles box
- Power receptacles
- Access panel in the floor

4) The Witness Box with:

- Work surface to accommodate a monitor
- Ledge for a fixed gooseneck microphone
- Power receptacles
- Access panel in the floor/receptacle box(es)

5) The Jury Box with:

- Microphone receptacle boxes
- Railings which do not obstruct the view of portable monitors in the well
- Railings or posts to accommodate small monitors
- Power receptacles
- Access panels in the floor
- Wire management system

6) The Lectern with:

- Ledge for a gooseneck microphone
- Sufficient provisions to satisfy the requirements of the ADA
- Wire management system

7) Attorney Tables with:

- Pedestals with boxes and flush doors on the table surface for easy wire management
- Integration of monitors and microphones
- CPU space should be considered
- Phone lines for modems

b. The Court Will Normally Furnish:

1) An A/V Cart with:

- Wheels for portability
- Tabletop for the document camera and papers
- Space for A/V equipment
- Wire management system

2) Monitor Stands with:

- Wheels for portability
- The correct height for site lines
- Internal space for equipment
- Wire management system

5. Ceiling Speakers

The GSA shall provide ceiling speaker boxes or alternative speaker systems with conduit back to the A/V rack (coordinated with the A/V consultant). Additional speakers with conduit will be provided in chambers and holding/isolation cells with boxes for wall-mounted volume controls. Reflected ceiling plans shall be properly coordinated with notes showing ceiling speaker box types. The location of the speakers shall provide for proper coverage for sound distribution while integrating with the desired aesthetic of the courtroom environment. Aesthetics should reinforce the proper placement of the speakers within the courtroom. Ceiling speaker boxes shall have grilles and wires for support from the deck above.

6. Infrared Emitters (Assisted Listening/Simultaneous Interpretation)

Assisted listening systems are strongly recommended in order to comply with the Americans with Disabilities Act (ADA). Wall-

mounted infrared emitters shall require a wall box with conduit to the A/V rack and power on the wall near the ceiling. The quantity and location shall be developed by the A/E team and consultants. The infrared emitter power shall be the same phase as the A/V rack. The wall sections shall show the emitters. In some cases, the emitter has been located behind glass for aesthetic reasons. Adequate ventilation for ambient air temperatures must be provided to assure reliable operation within specified operational range.

7. Camera Pockets

Wall-mounted camera pockets shall be recessed into the courtroom wall with 40mm conduit to the A/V rack and/or central processing area. Locations shall be coordinated with the A/V consultant. The wall sections shall show camera pockets. The aesthetic quality of the pockets shall be considered. A ceiling-mounted camera pocket over the witness work-surface may be needed.

8. Recessed Motorized Projection Screens

Ceiling mounted recessed motorized projection screens shall be provided in a size and location coordinated with the A/V consultant. Reflected ceiling plans shall show projection screens. Power and conduit for remote up/down control shall be provided.

9. Video Projection System

Where a video projection system is utilized, a recessed wall pocket may be provided. The size and location of the wall pocket shall be coordinated with the A/V consultant. AC power and a 40mm conduit shall be provided to the A/V rack. The wall sections shall show projector pockets. A section shall be cut through the projector pocket, showing the beam to the screen to assure proper alignment. Adequate ventilation for ambient air temperatures must be provided to assure reliable operation within specified operational range.

10. Centralized Video Conferencing Area

Centralized video conferencing processing shall be provided by the courts, using conduit/cable trays from each courtroom A/V rack and camera wall pocket for wiring to a work station. Its location shall be cable-friendly and integrated with computer rooms where appropriate. Power, heat load, digital service, and arrangement shall be coordinated with the A/V consultant.

11. Acoustics, Lighting, and Window Shading

Acoustics and lighting shall be coordinated with the court's A/V consultant to enhance sound and video systems.

Acoustic performance of the space should be a prime consideration in the spatial development of the courtroom. Shapes and volumes that create spaces with poor acoustic properties should be avoided. The selection of finish materials should be made with an understanding of the need for these finishes to perform acoustically in their particular location.

Acoustic performance of the space should be a prime consideration in the spatial development of the courtroom. Shapes and volumes that create spaces with poor acoustic properties should be avoided. The selection of finish materials should be made with an understanding of the need for these finishes to perform acoustically in their particular location.

The use of indirect lighting with carefully designed zones and dimmers is encouraged both for its aesthetic properties as well as its appropriateness for use in video conferencing. Down lights creating glare on monitors shall be avoided. Windows in courtrooms which may be used as a method to introduce natural light in the space, must be equipped with shading devices to control light emittance into the courtroom. This is required to maintain video image contrast. Windows which allow the entry of direct sunlight into the courtroom may require blackout type shades. Acoustic wall treatment on the back wall of the courtroom is recommended. Acoustic modeling of the courtroom shall be performed to assure Design Guide compliance.

12. Power Requirements

Normally, approximately ten (10) 20-amp circuits will be needed per courtroom with dedicated 20-amp circuits of the same phase at the A/V rack, lectern floor box, and projector (if used). System grounding shall meet National Electrical Code (NEC) standards. Power with isolated grounds shall be available in requested locations. Power for lighting shall be on separate circuits. Dimmers shall not be located in the A/V rack closet.

13. Computers

As an alternative, the clerk's computer can be used as a host for attorney provided evidence stored on discs. This computer may also be connected via a courtroom network to computers at attorney tables and the bench, forming the basis for a 'paperless' courtroom. The infrastructure for this arrangement should be considered. This courtroom network infrastructure must be physically separate from the Local Area Network (LAN) with the Data Communications Network (DCN).

14. Network Security

It is important that the technology not allow opportunities for unauthorized outside access. Use of wireless microphones and the installation of cabling in publicly accessed areas are examples of practices that may result in signals not being confined to the courtroom space. All equipment supporting courtroom technologies with access to the parties in the cases must be kept separate from the LANs provided for the use of judiciary employees. Although the

It is important to ensure the security of the courts' network equipment and cabling. All equipment supporting courtroom technologies with access to the parties in the cases must be kept separate from the LANs provided for the use of judiciary employees.

judges and the courtroom deputy clerks need access to their LAN systems for scheduling and case management purposes, the information on such LANs is considered judiciary-sensitive and is not to be accessible to parties of cases. Therefore, the receptacles for the two systems should be kept separate. Wiring for the courts LAN should always be routed in secure locations. Contracts involving the design and implementation of courtroom technology should have stipulations requiring appropriate background checks for individuals and non-disclosure agreements regarding the design and operational aspects of systems.

15. Additional Requirements

Additional requirements (if any) shall be solicited and provided from the court's A/V consultant.

◆ INFRASTRUCTURE CHECKLIST - GRAND JURY

16. Grand Jury Rooms

Grand jury rooms are provided by the judiciary for use by the US Attorney. It is not used by the judiciary. They are normally provided with a simple sound system with recording and assisted listening only. Grand jury rooms are similar to courtrooms, however they do not have a judge and gallery. Grand jury rooms have two US attorneys in place of a judge and the gallery is replaced by grand jurors. (See [Figure #15 on page 1-26](#))

◆ INFRASTRUCTURE CHECKLIST - BUILDING WIRING

17. Telecom Data Riser Rooms

Riser rooms for integrated technologies (i.e. voice, data, video, A/V, security, etc.) shall be provided with sufficient space, 100mm riser pipes through floors, power, cooling, and connecting cable trays in the ceiling plenums of main corridors. Arrangements shall be coordinated with the A/V consultant. (See EIA/TIA 568/NSID/BICSI, FIPS 175 and 176 standards, and Section IV.)

18. [Satellite Dish](#)

Conduit, support, and space planning shall be provided for the court's satellite dish. The visual impact on the exterior aesthetic of the courthouse and line of sight to the satellites should be considered when placing the satellite dish on the building.

◆ INFRASTRUCTURE CHECKLIST - JURY ASSEMBLY ROOM

19. Wire Management

Normally, a microphone floor receptacle is provided in a floor box at the front of the room with 25mm conduit to the A/V rack. A 100mm X 50mm (double gang) wall box at the front of the room with 25mm conduit to the A/V rack is used to plug in the audio and video output of a VCR.

20. Jury Assembly A/V Rack

The A/V rack may be located in a separate closet, approximately 1.5m X 2m with a dedicated 20-amp power circuit, conduit, wall or floor boxes, and adequate cooling. It may be located in an under-counter location if necessary. A 25mm conduit to the central processing area will be provided. Infrared emitters, TVs, projection screen, projector, and videoconferencing capability can be considered. Provide power and conduit arranged by the A/V consultant. Adequate ventilation for ambient air temperatures must be provided to assure reliable operation within specified operational range.

21. Ceiling Speakers

The GSA shall provide ceiling speaker boxes (coordinated with the A/V consultant) with grilles and conduit back to the A/V rack. Ceiling speakers must be secured to the deck. These items must be shown on the reflected ceiling plan.

22. Monitors/Projectors

Wall-hung monitors or a ceiling/wall-mounted projector will require power and conduit back to the A/V rack. A projector will need a ceiling recessed motorized screen with power and an up/down switch.

23. Acoustics, Lighting, and Window Shading

Large jury assembly rooms will need acoustical considerations to assure clear voice articulation. Lighting and window shading shall be coordinated with the video system.

◆ INFRASTRUCTURE CHECKLIST - CONFERENCE/ TRAINING/JURY DELIBERATION ROOMS

24. Attorney/Client Rooms

Attorney/Client rooms may be provided with a ceiling speaker with conduit to the courtroom sound system A/V rack with local volume

control (as done for chambers). Two (2) RJ-45 phone connections for a modem and for connection to the courtroom may be provided.

25. Judge's Conference Room

The judge's conference room may have video conferencing and may require power and data connections. A 200mm X 100mm (four-gang box) with 25mm conduit to the central processing area should be provided. A floor box under the table locations should be provided with power and two (2) 25mm conduit to the wall box.

26. Training Rooms

Training rooms may have a ceiling-recessed projection screen and ceiling-mounted projector with power and conduit arranged by the A/V consultant. Computer training rooms may have access floors.

27. Jury Deliberation Rooms

At present, no technology is provided in jury deliberation rooms. A conduit for jury call and/or future use may be considered.

B. Design Integration

The technology infrastructure and technology components must be fully integrated within the design of the courthouse. This will require close interaction, coordination and cooperation among GSA, GSA's A/E consultant, and the A/V consultant. The successes, both functionally and aesthetically of the integration of the infrastructure and court technology, rely on an understanding of the required components and addressing those needs early in the design process. Failure to accomplish the above all too often results in new installations having the appearance of a retrofit application.

The GSA A/E consultant will develop floor plans, riser diagrams, electrical plans, and specifications to incorporate the programmed infrastructure, (i.e. access floors, power, cable trays, conduit, boxes, etc.) These plans, diagrams, and specifications shall be submitted to the A/V consultant for review and comment. Integration of the comments shall be coordinated and introduced into the 10-percent, 50-percent, 90-percent progress and final drawings, or according to the GSA stages established for the project. Value engineering concepts shall involve the court's A/V consultant. The construction documents shall include scheduling and procedures for the court's installation of wiring and equipment to assure timely access. Equipment security protocol shall be arranged. Timely construction scheduling and a project timeline shall be developed showing all important milestones (i.e. submissions, meetings, installations, inspections, etc).

The technology infrastructure and technology components must be fully integrated within the design of the courthouse. This will require close interaction, coordination and cooperation among GSA, the GSA A/E consultant, and the A/V consultant.

Value engineering concepts shall involve the A/V consultant.

C. Installation

The GSA representative shall keep the court's A/V consultant aware of infrastructure submittals for review of compliance with the specifications. Installation schedule shall be coordinated with the consultant for site observations. Site observation reports shall be submitted in writing.

The court's wiring installation shall be coordinated to facilitate the various trades and optimize installation scheduling. Equipment installation shall be coordinated to maximize security. A formal Request for Information (RFI) procedure shall be arranged and coordinated.

The representatives of the AO, Circuit, and/or court should be monitoring, along with the Judiciary's A/V consultant, the installation of the courtroom technology equipment.













D. Quality Control

The court's A/V consultant will be a primary resource to integrate pathways for wiring methodology and technology into the building design. Quality control shall be optimized by integrating the consultant into the design and review process. Proper construction observations by the consultant, et. al., will assure the proper installation of these infrastructure items. Requests for Information (RFIs) must be promptly processed and responded to using a coordinated arrangement. Value engineering recommendations shall be developed with and reviewed by the A/V consultant in an effort to reduce cost and assure quality performance. The A/V consultant shall provide acceptance testing and require adequate training of appropriate court personnel at the close of the project to assure proper system operation of the A/V related technology.

The GSA shall keep the court's A/V consultant aware of infrastructure submittals for review of compliance with the specifications. Installation schedule shall be coordinated with the A/V consultant for site observations.

The A/V consultant will be a primary resource to integrate pathways for wiring methodology and technology into the building design. Quality control shall be optimized by integrating the A/V consultant into the design and review process.

LEGEND:

-  Camera
-  Floor Box
-  AV Rack
-  5 Gang Box w/two 25 MM Conduits to AV Rack
-  2 Gang Box w/two 25 MM Conduits to AV Rack
-  Single Gang Box at Judge Entry Signal
-  Depressed Slab w/ Access Floor
-  Depressed Slab
-  Projector
-  Projection Screen
-  Large Monitor on Cart
-  Flat Screen

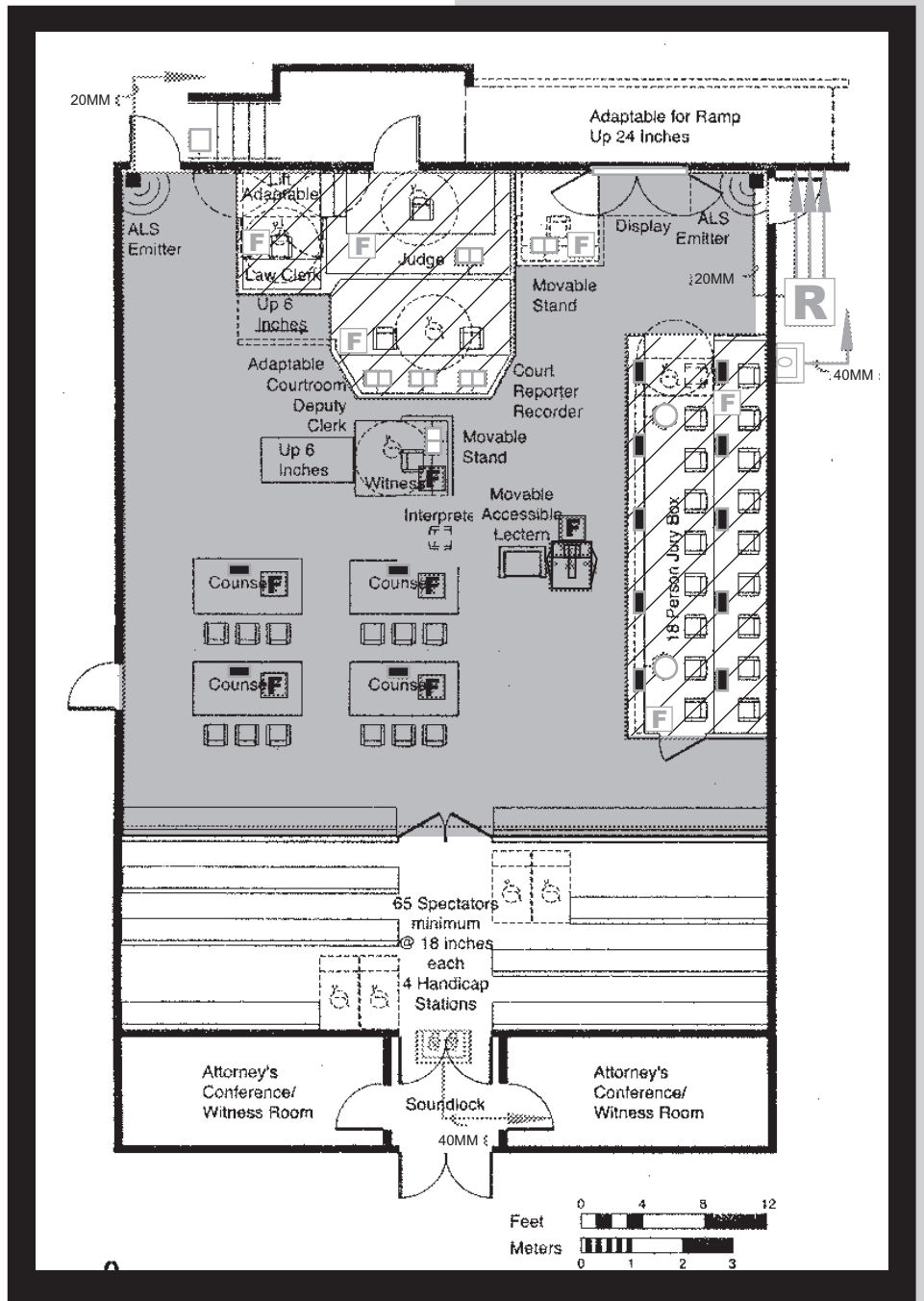

STANDARD U.S. DISTRICT COURTROOM MOVABLE WITNESS BOX FLAT SCREEN SYSTEM













FIGURE 3

FOR ILLUSTRATIVE
PURPOSES ONLY.



COURTROOM TECHNOLOGY MANUAL

LEGEND:

-  Camera
-  Floor Box
-  AV Rack
-  5 Gang Box w/two 25 MM Conduits to AV Rack
-  2 Gang Box w/two 25 MM Conduits to AV Rack
-  Single Gang Box at Judge Entry Signal
-  Depressed Slab w/ Access Floor
-  Depressed Slab
-  Projector
-  Projection Screen
-  Large Monitor on Cart
-  Flat Screen

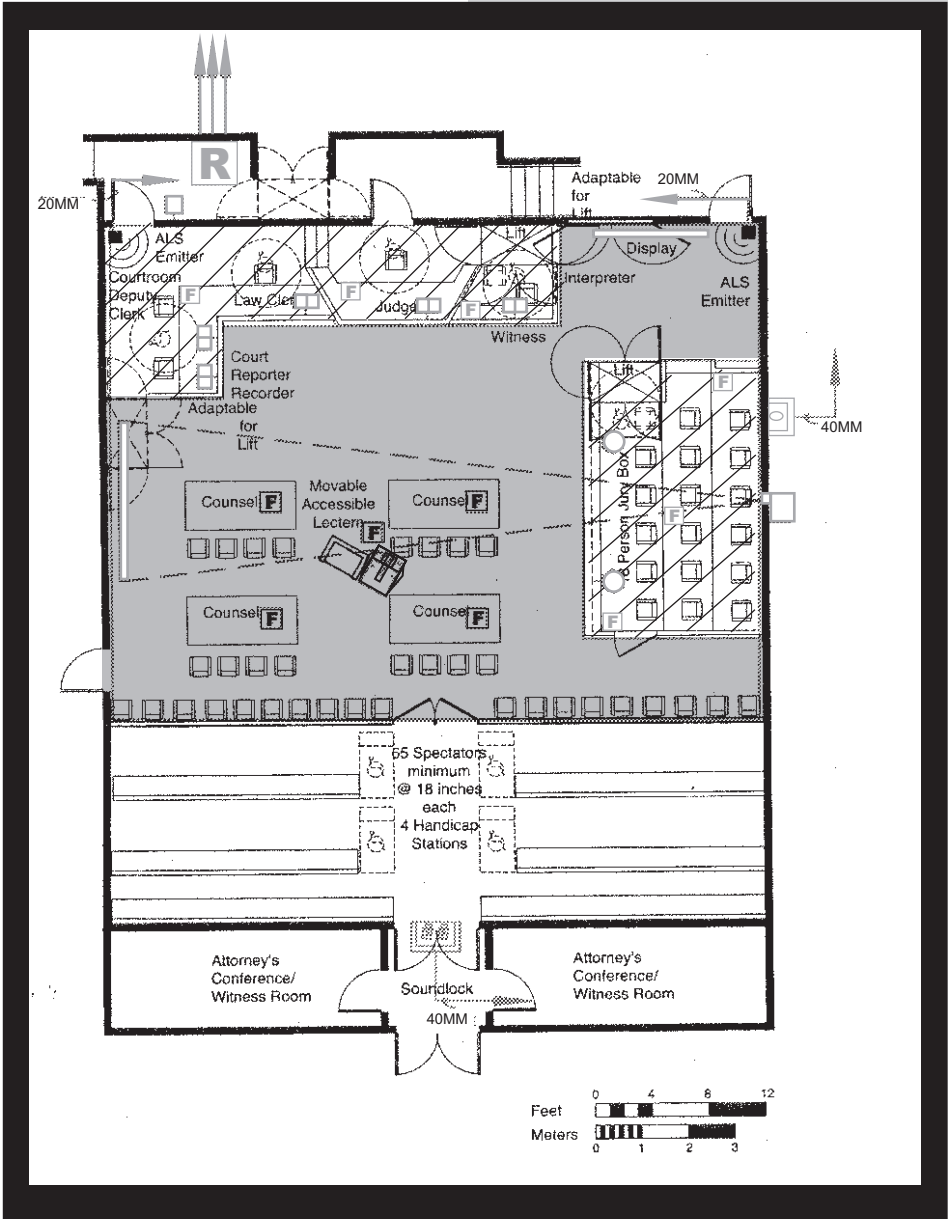

STANDARD U.S. DISTRICT COURTROOM CLERKS ON SIDE WALL PROJECTION SCREEN













FIGURE 4

FOR ILLUSTRATIVE
PURPOSES ONLY.



COURTROOM TECHNOLOGY MANUAL

LEGEND:

-  Camera
-  Floor Box
-  AV Rack
-  5 Gang Box w/two 25 MM Conduits to AV Rack
-  2 Gang Box w/two 25 MM Conduits to AV Rack
-  Single Gang Box at Judge Entry Signal
-  Depressed Slab w/ Access Floor
-  Depressed Slab
-  Projector
-  Projection Screen
-  Large Monitor on Cart
-  Flat Screen

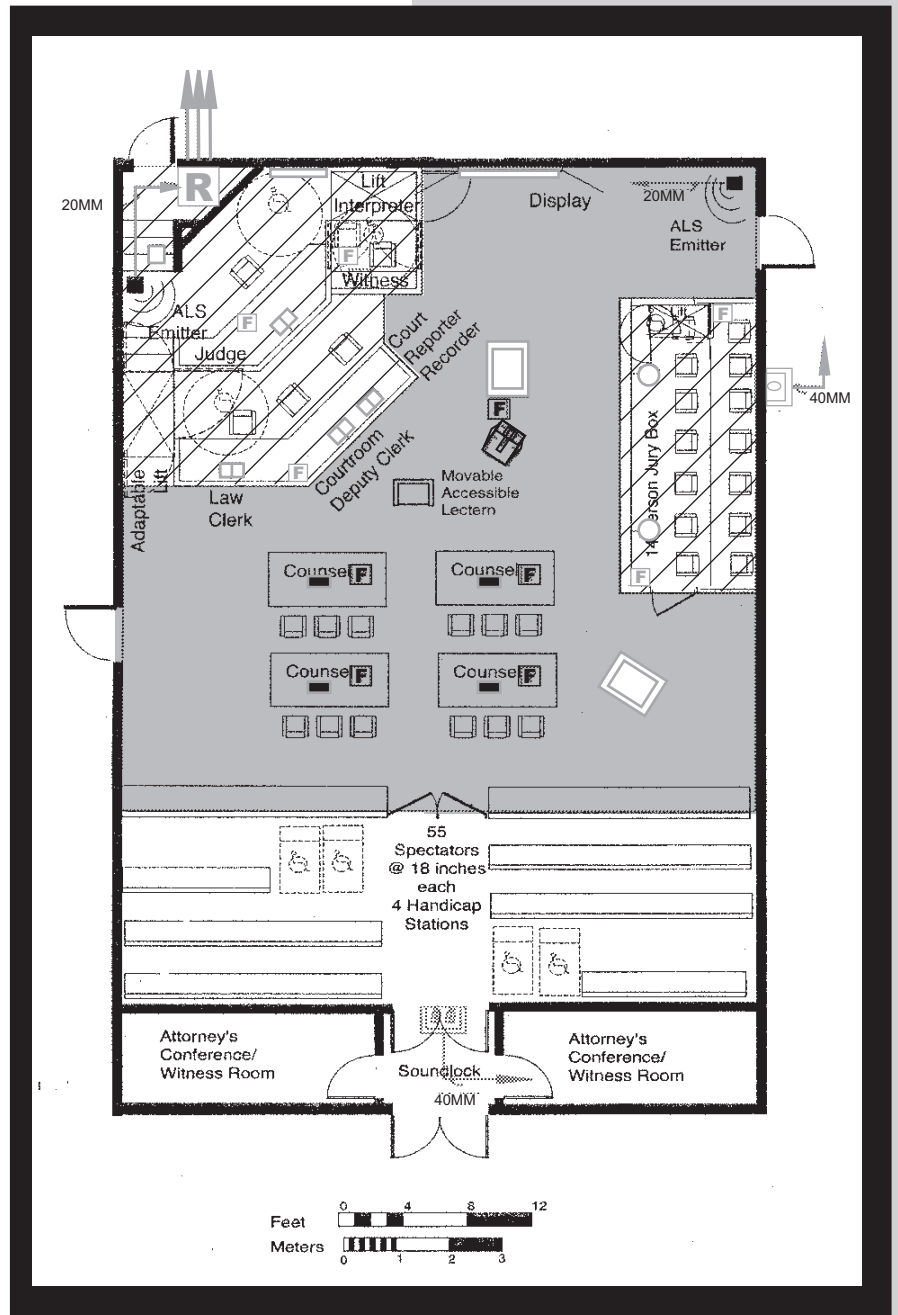

**U.S. MAGISTRATE JUDGE COURTROOM
FIGURE 5**

FOR ILLUSTRATIVE
PURPOSES ONLY.



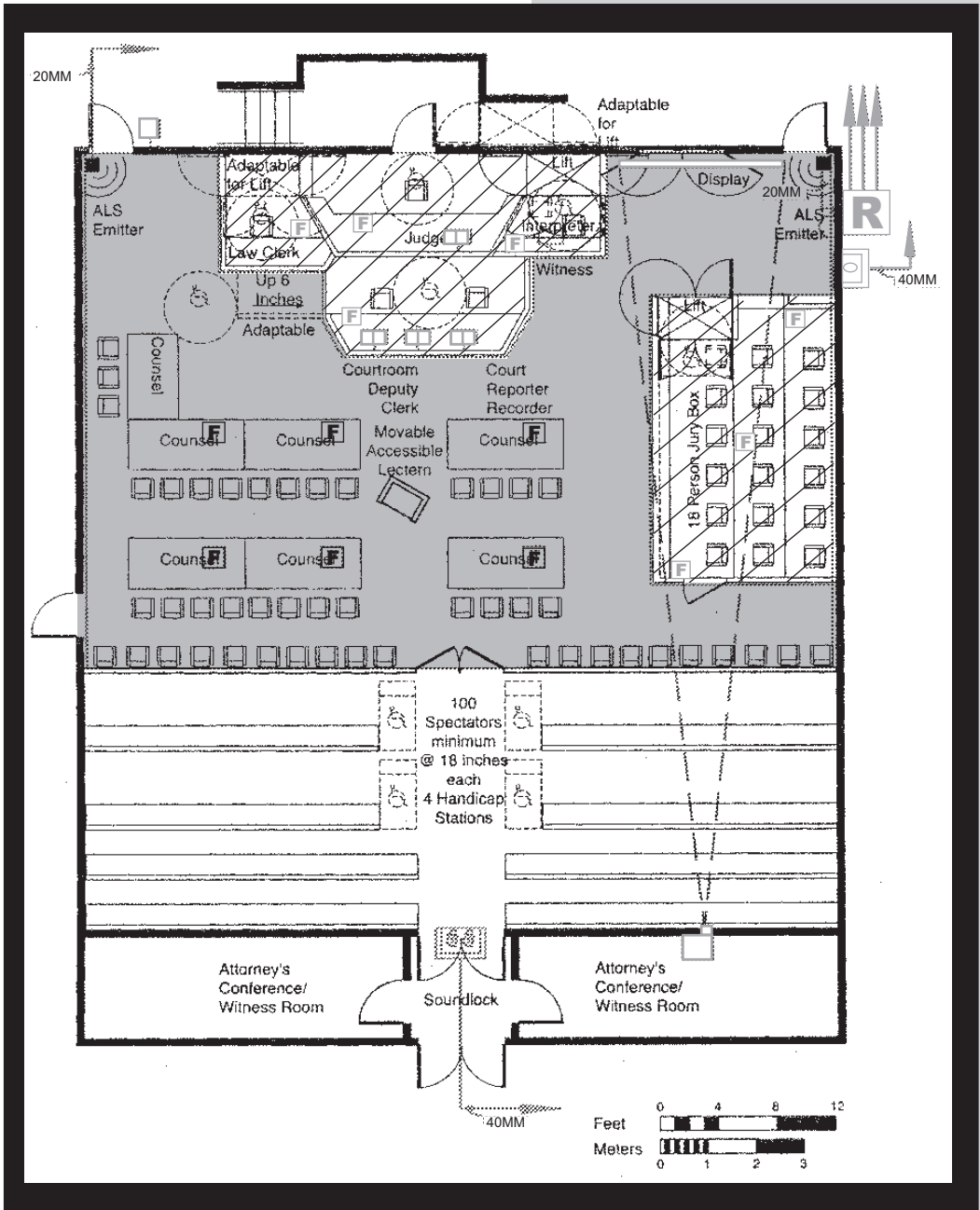
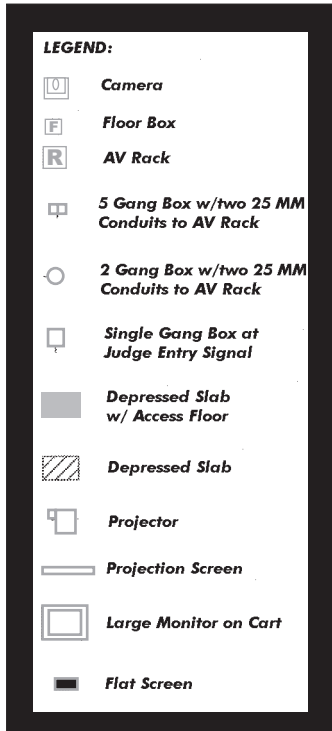













SPECIAL PROCEEDINGS COURTROOM PROJECTION SYSTEM
 FIGURE 6

FOR ILLUSTRATIVE
 PURPOSES ONLY.



LEGEND:

-  Camera
-  Floor Box
-  AV Rack
-  5 Gang Box w/two 25 MM Conduits to AV Rack
-  2 Gang Box w/two 25 MM Conduits to AV Rack
-  Single Gang Box at Judge Entry Signal
-  Depressed Slab w/ Access Floor
-  Depressed Slab
-  Projector
-  Projection Screen
-  Large Monitor on Cart
-  Flat Screen

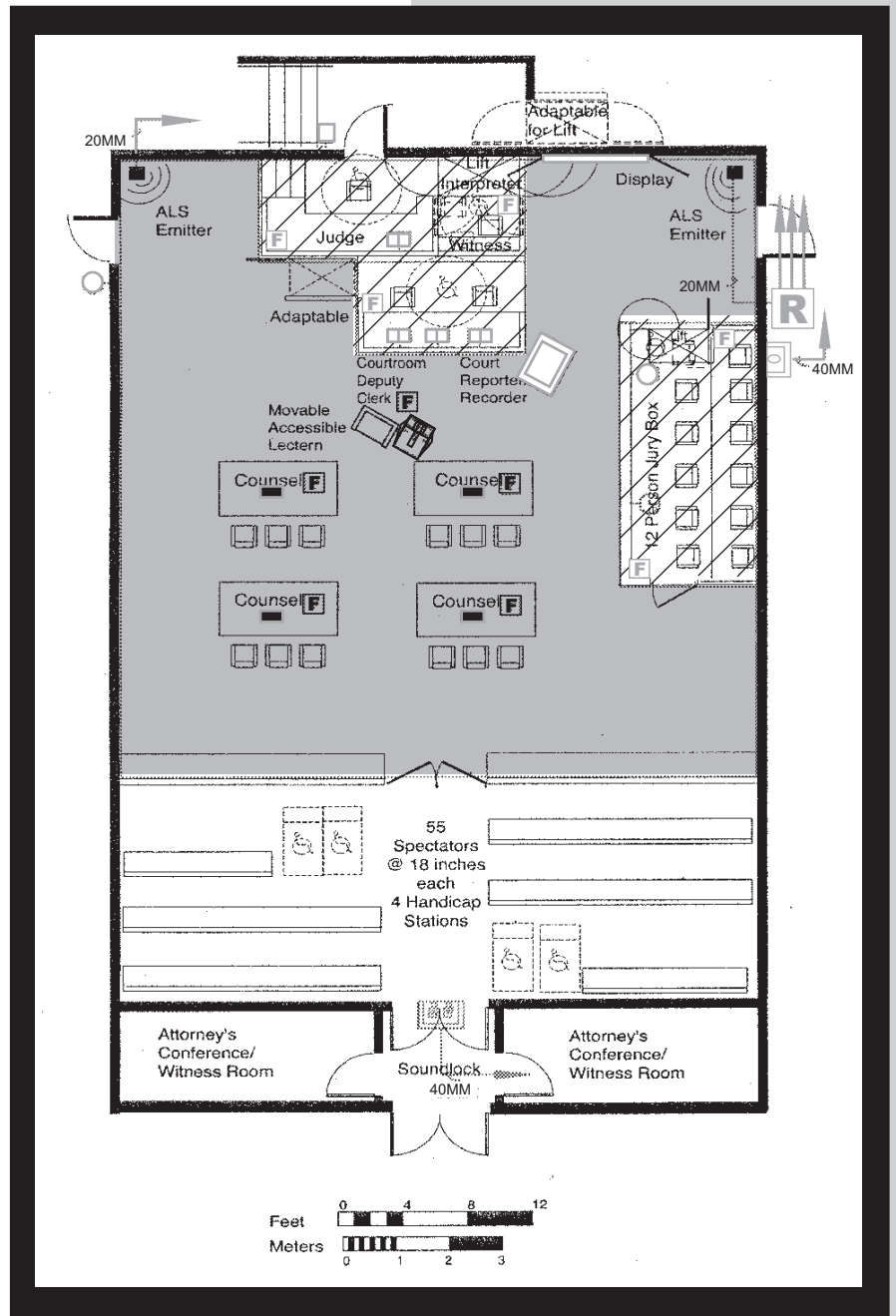













U.S. MAGISTRATE JUDGE COURTROOM PORTABLE MONITOR FIGURE 7

FOR ILLUSTRATIVE
PURPOSES ONLY.



COURTROOM TECHNOLOGY MANUAL

LEGEND:

-  Camera
-  Floor Box
-  AV Rack
-  5 Gang Box w/two 25 MM Conduits to AV Rack
-  2 Gang Box w/two 25 MM Conduits to AV Rack
-  Single Gang Box at Judge Entry Signal
-  Depressed Slab w/ Access Floor
-  Depressed Slab
-  Projector
-  Projection Screen
-  Large Monitor on Cart
-  Flat Screen

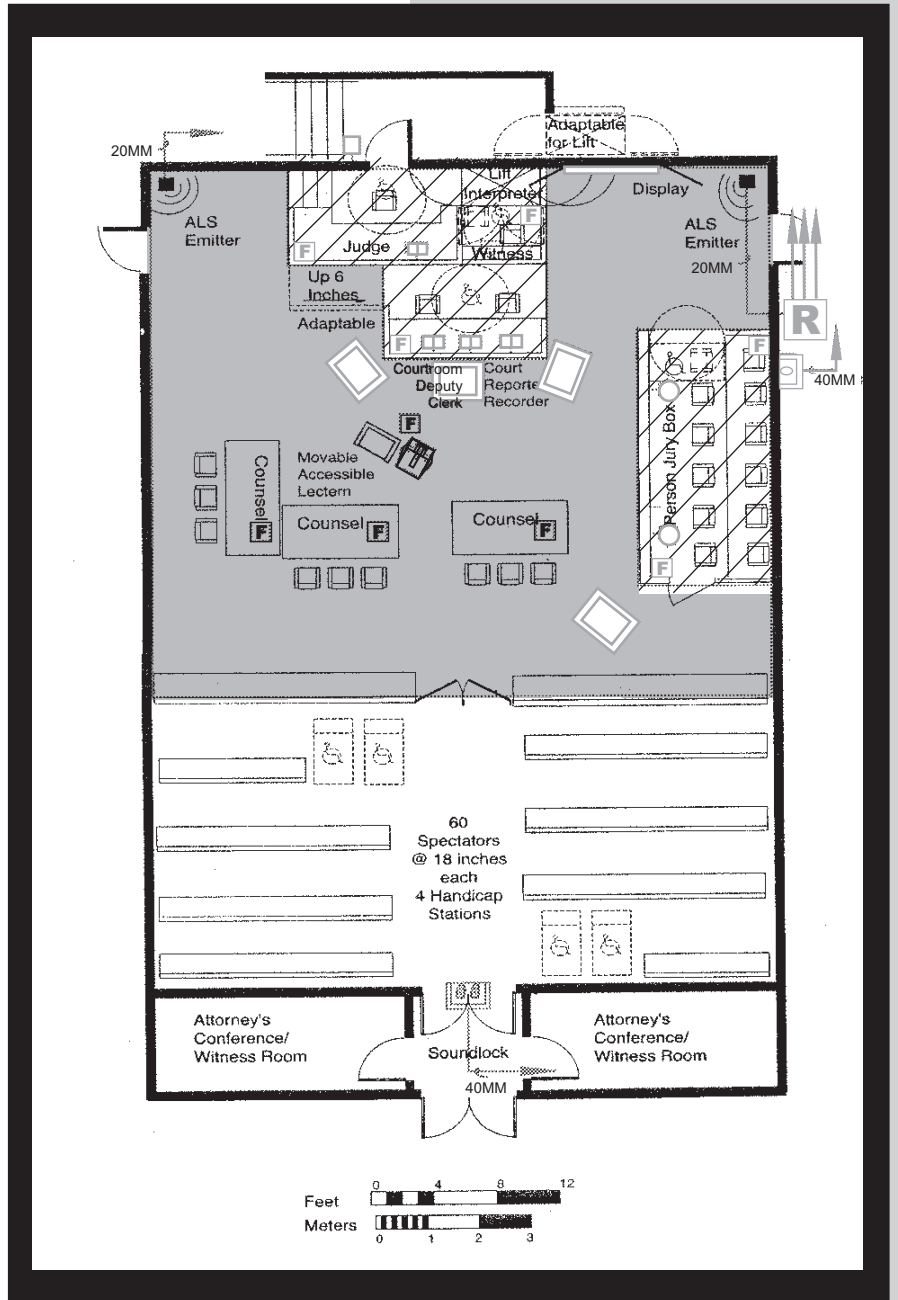













U.S. MAGISTRATE JUDGE COURTROOM PORTABLE MONITOR FIGURE 8

FOR ILLUSTRATIVE
PURPOSES ONLY.



COURTROOM TECHNOLOGY MANUAL

LEGEND:

-  Camera
-  Floor Box
-  AV Rack
-  5 Gang Box w/two 25 MM Conduits to AV Rack
-  2 Gang Box w/two 25 MM Conduits to AV Rack
-  Single Gang Box at Judge Entry Signal
-  Depressed Slab w/ Access Floor
-  Depressed Slab
-  Projector
-  Projection Screen
-  Large Monitor on Cart
-  Flat Screen

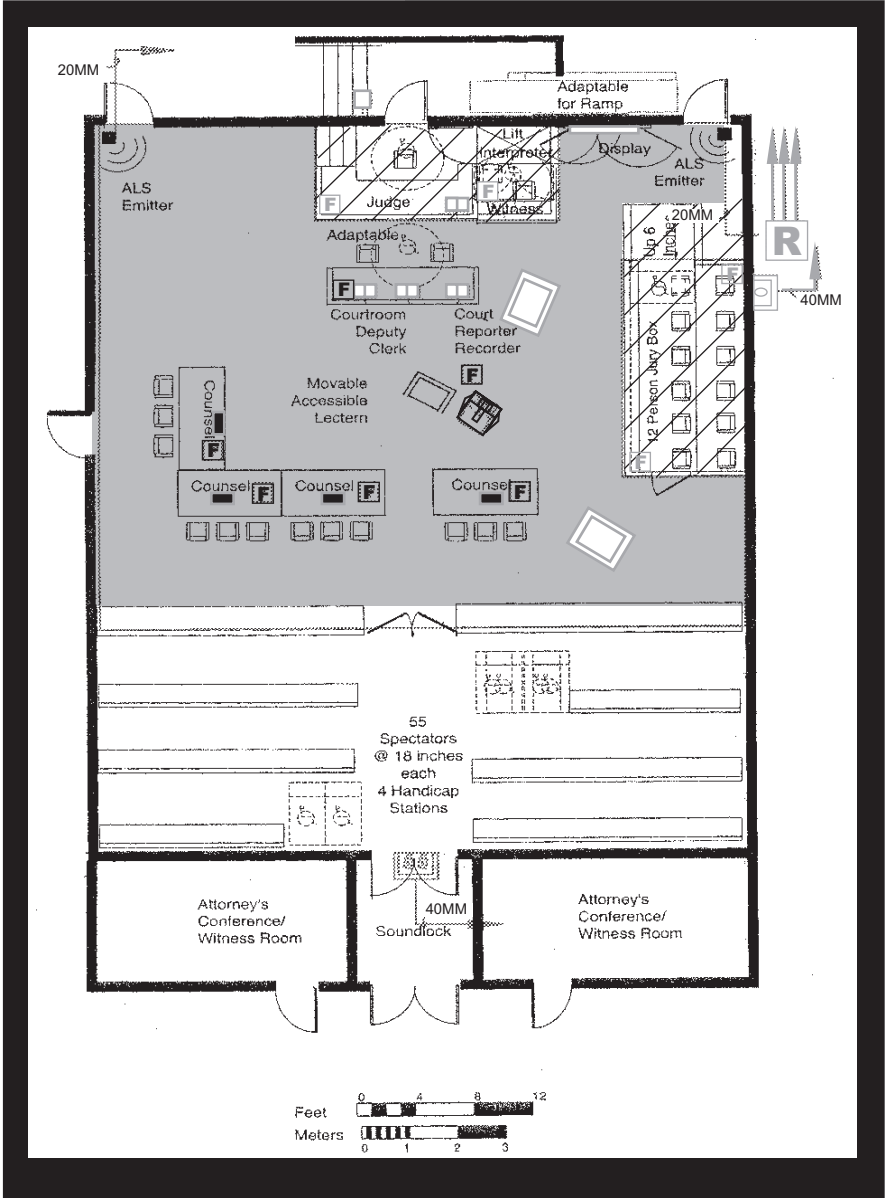













**U.S. MAGISTRATE JUDGE COURTROOM PORTABLE MONITOR
FIGURE 9**

FOR ILLUSTRATIVE
PURPOSES ONLY.



COURTROOM TECHNOLOGY MANUAL

LEGEND:

-  Camera
-  Floor Box
-  AV Rack
-  5 Gang Box w/two 25 MM Conduits to AV Rack
-  2 Gang Box w/two 25 MM Conduits to AV Rack
-  Single Gang Box at Judge Entry Signal
-  Depressed Slab w/ Access Floor
-  Depressed Slab
-  Projector
-  Projection Screen
-  Large Monitor on Cart
-  Flat Screen

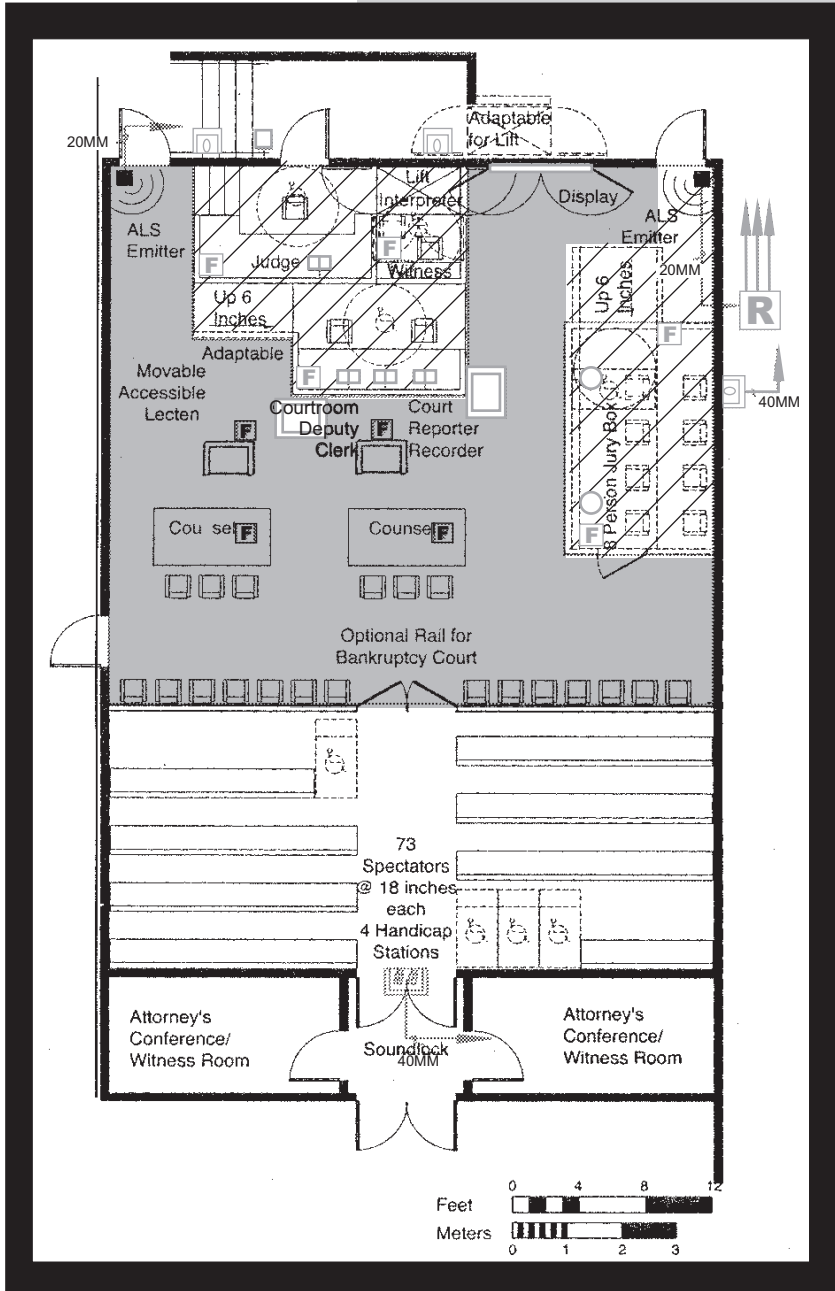













U.S. BANKRUPTCY COURTROOM PORTABLE MONITORS FIGURE 10

FOR ILLUSTRATIVE
PURPOSES ONLY.



COURTROOM TECHNOLOGY MANUAL

LEGEND:

-  Camera
-  Floor Box
-  AV Rack
-  5 Gang Box w/two 25 MM Conduits to AV Rack
-  2 Gang Box w/two 25 MM Conduits to AV Rack
-  Single Gang Box at Judge Entry Signal
-  Depressed Slab w/ Access Floor
-  Depressed Slab
-  Projector
-  Projection Screen
-  Large Monitor on Cart
-  Flat Screen

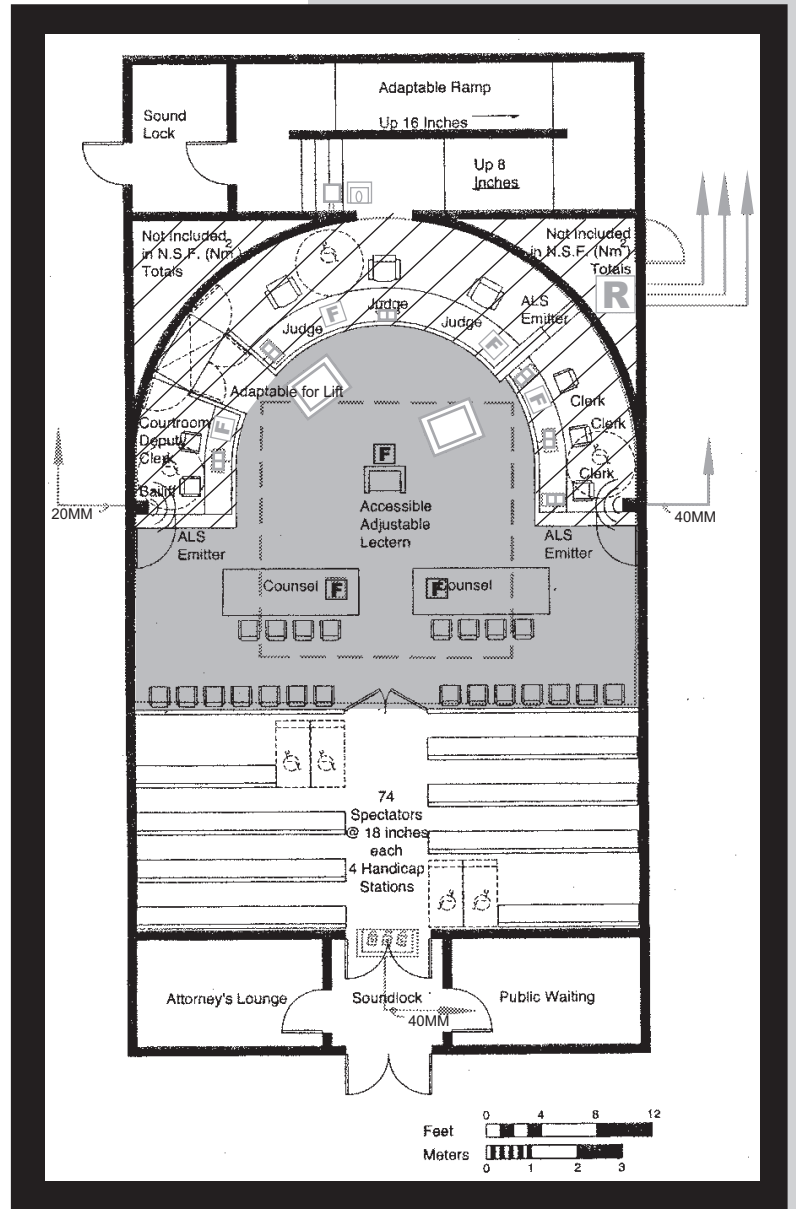













U.S. COURT OF APPEALS PANEL PORTABLE MONITORS FIGURE 11

FOR ILLUSTRATIVE
PURPOSES ONLY.



COURTROOM TECHNOLOGY MANUAL

LEGEND:

-  Camera
-  Floor Box
-  AV Rack
-  5 Gang Box w/two 25 MM Conduits to AV Rack
-  2 Gang Box w/two 25 MM Conduits to AV Rack
-  Single Gang Box at Judge Entry Signal
-  Depressed Slab w/ Access Floor
-  Depressed Slab
-  Projector
-  Projection Screen
-  Large Monitor on Cart
-  Flat Screen

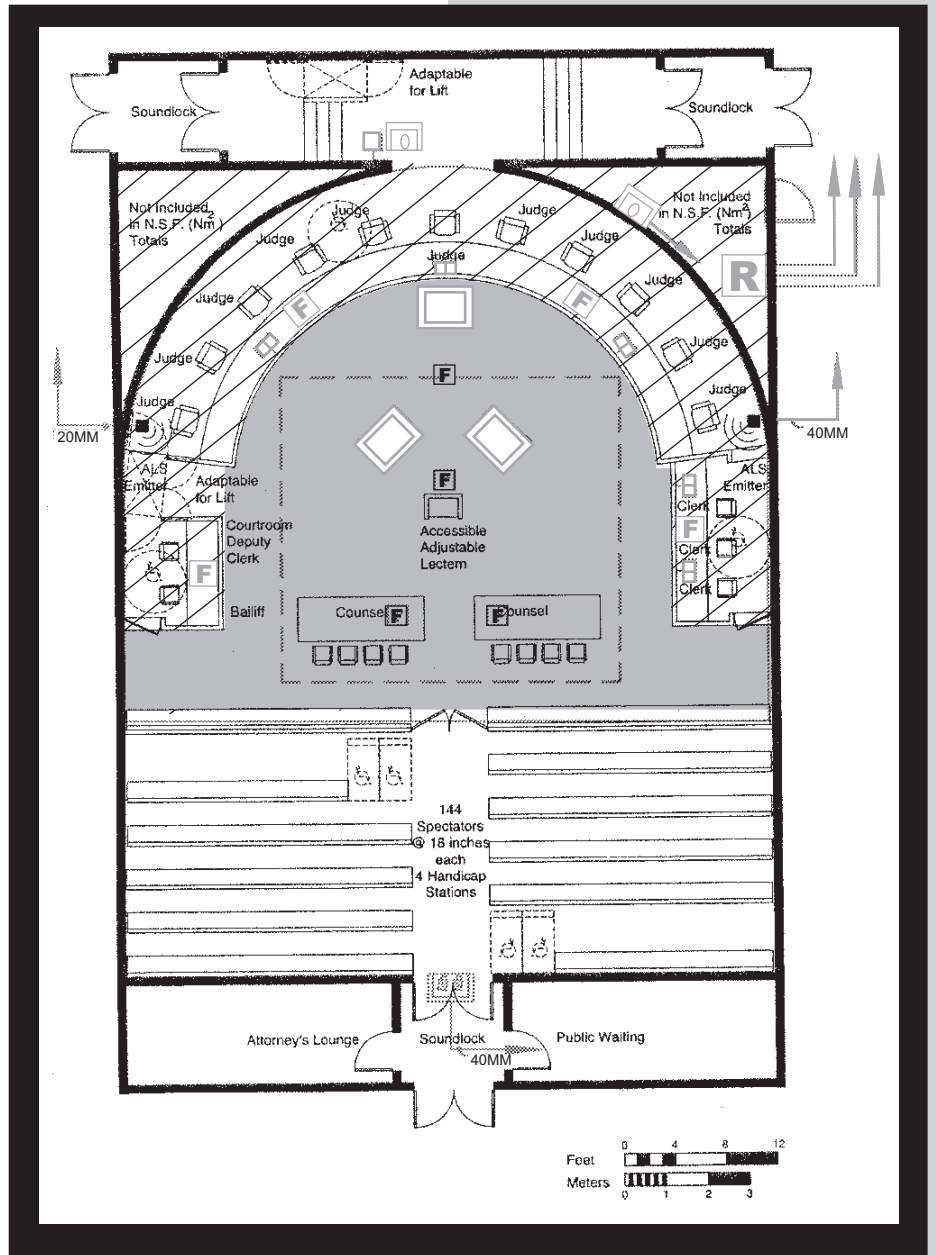

U.S. COURT OF APPEALS EN BANC PORTABLE MONITORS FIGURE 12

FOR ILLUSTRATIVE
PURPOSES ONLY.



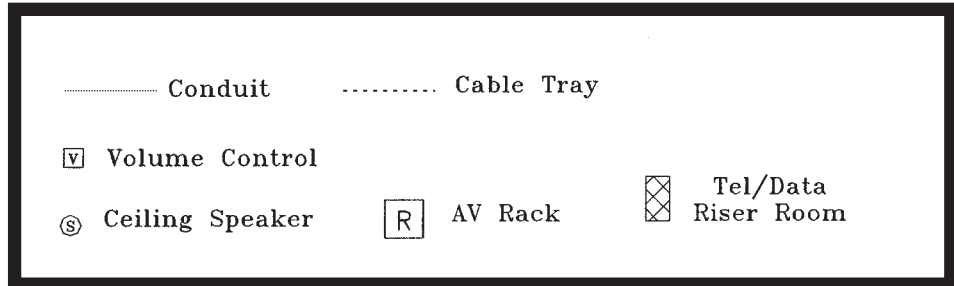
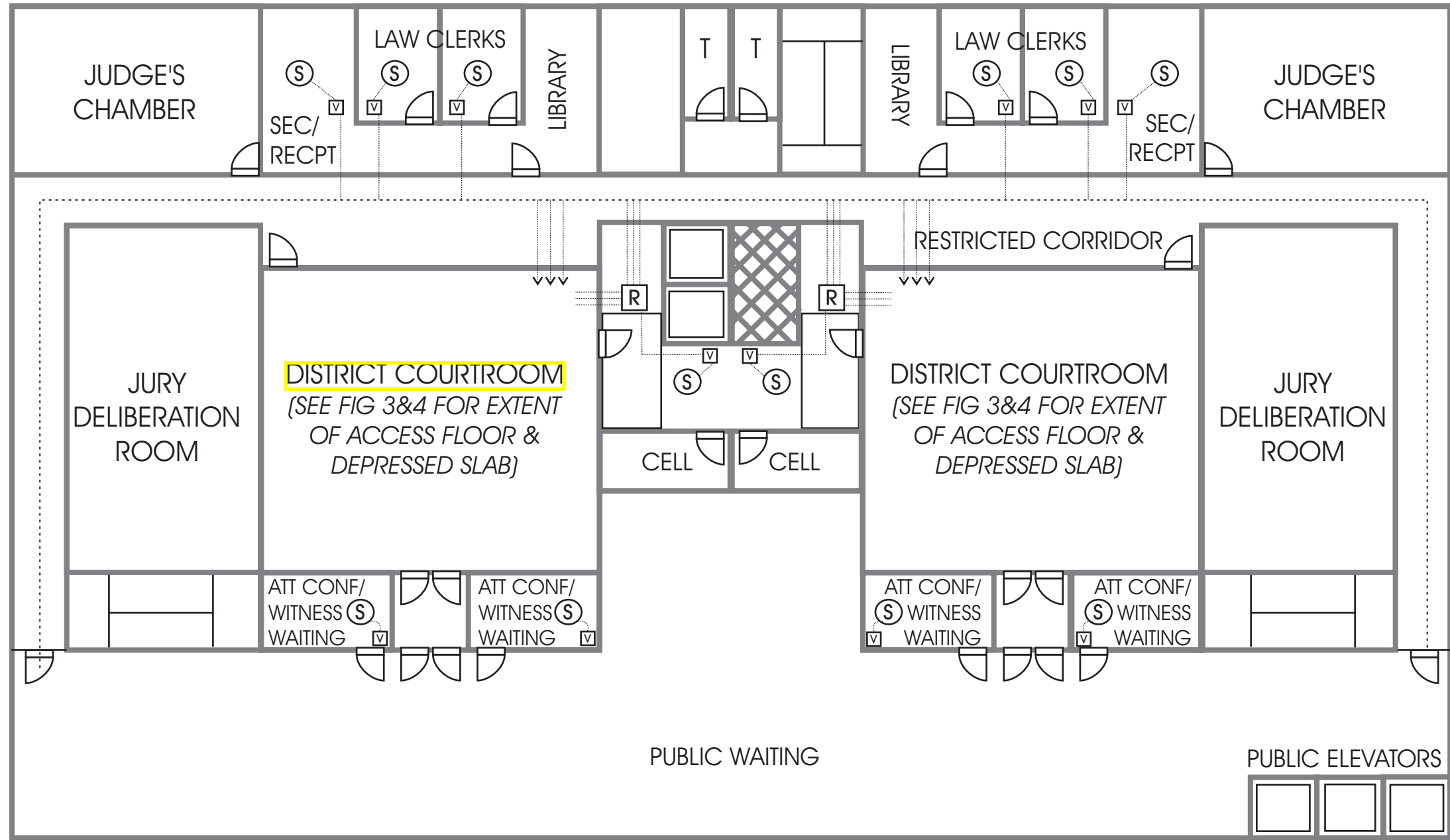

**SAMPLE COURTHOUSE FLOORPLAN
FIGURE 13**

FOR ILLUSTRATIVE
PURPOSES ONLY.



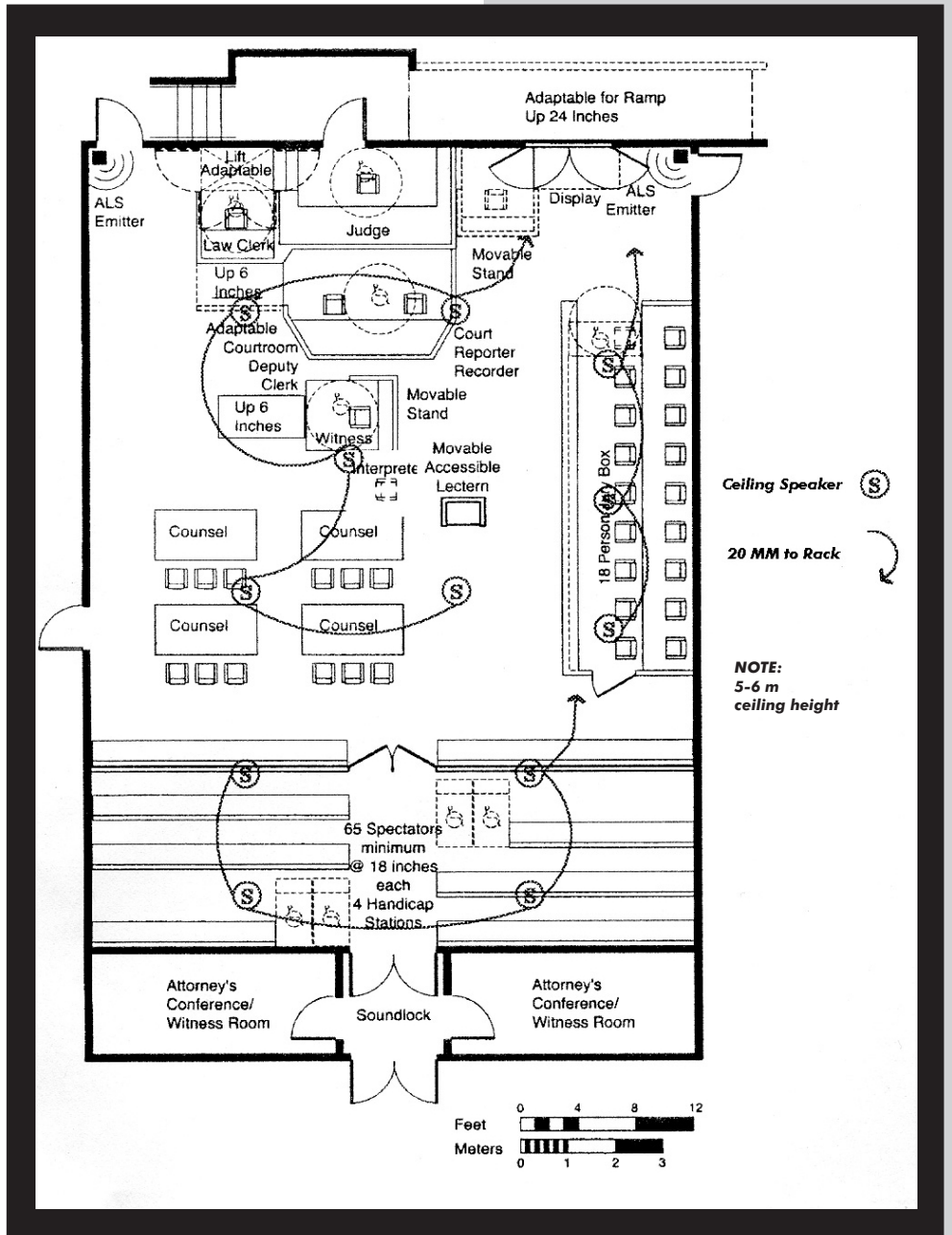

STANDARD U.S. COURTROOM CEILING SPEAKER LAYOUT







FIGURE 14

FOR ILLUSTRATIVE
PURPOSES ONLY.



COURTROOM TECHNOLOGY MANUAL

LEGEND:

-  Camera
-  Floor Box
-  AV Rack
-  5 Gang Box w/two 25 MM Conduits to AV Rack
-  2 Gang Box w/two 25 MM Conduits to AV Rack
-  Single Gang Box at Judge Entry Signal

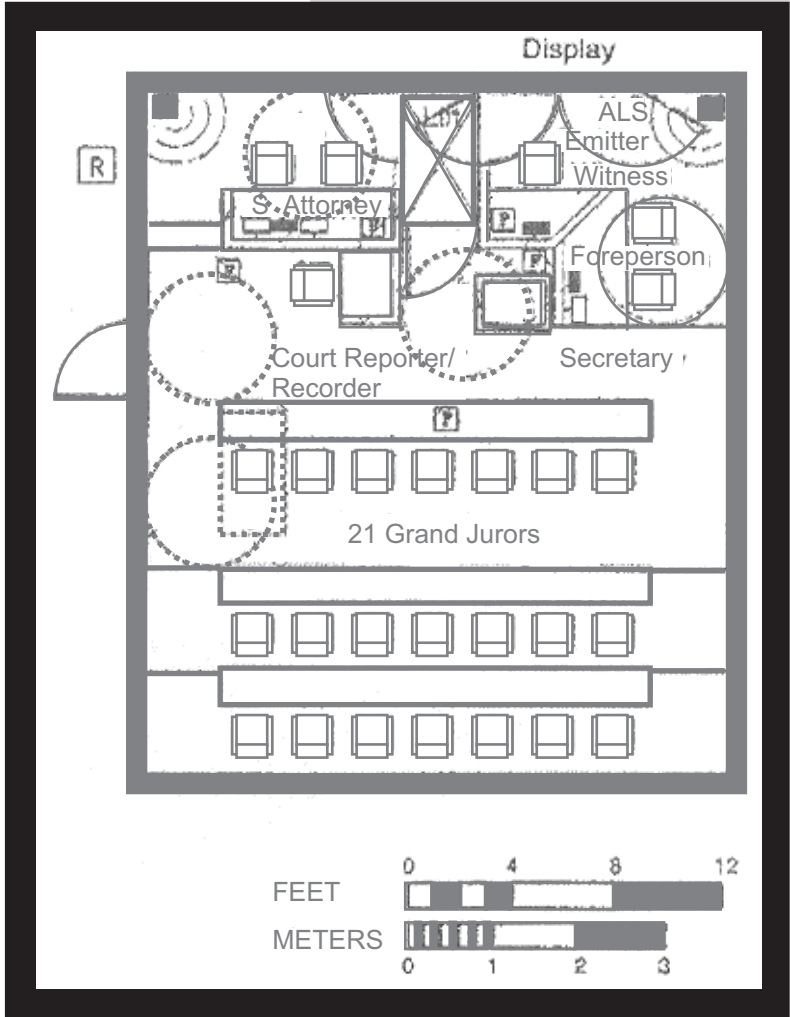

GRAND JURY ROOM PORTABLE MONITOR
 FIGURE 15

FOR ILLUSTRATIVE
 PURPOSES ONLY.





SECTION II

Architectural/Engineering Team Issues

Courtroom technology has been installed in many courtrooms with positive operating results and will be implemented into new and existing courtrooms in accordance with the program implementation plan approved by the Judicial Conference Committee on Automation and Technology, subject to available funding. Courtrooms will need to be outfitted with appropriate infrastructure to accommodate the technology. The incorporation of the infrastructure as defined in this manual is critical to the success of the courtroom technology initiative. The success of initial installations as well as the long-term viability and flexibility of the court technology relies on the inclusion of the infrastructure defined herein within the courthouse. Failure to provide these needs will result in structures which will not be able to accommodate the evolving technology needs of the courts both in the present and in the future.

Coordination of the courtroom technology needs to be a significant focus in the overall design process of the courthouse, especially in the courtroom itself. The technology must be fully integrated and not appear as an afterthought or an add-on to the final designed environment. Proper integration of these components begins by recognizing their requirements early in the design phase. This includes careful attention to the coordination of the acoustics of the space, the lighting concepts, as well as the electronic equipment itself. As the courtroom design progresses, more detailed attention is required to properly accommodate the equipment within the overall aesthetic of the court environment. This is especially critical in the millwork associated with the judge's bench, witness, clerk, and jury box. Careful consideration should be given to each component described within this manual as it relates to the overall courtroom aesthetic.

The architectural/ engineering (A/E) consultant shall take an active role in the proper integration of the technology infrastructure and technology systems in the overall design of the courthouse. As the lead design professionals involved in the project, the successful integration of the technology initiative relies on their ability to properly integrate the systems described in this manual into the overall design. The A/E consultant should work closely with the A/V consultant and make a strong effort to incorporate the A/V consultant's comments into the final design. The design team should avoid design solutions which adversely affect the performance of the court technology.

The incorporation of the infrastructure as defined in this manual is critical to the success of the courtroom technology initiative. The success of initial installations as well as the long term viability and flexibility of the court technology relies on the inclusion of the infrastructure defined here within the courthouse.

The A/E consultant's role in this effort is to take an active role in the proper integration of the technology infrastructure and technology systems in the overall design of the courthouse. As the lead design professionals involved in the project, the successful integration of the technology initiative relies on the A/E consultant's ability to properly integrate the systems described in this manual into the overall design.

This manual will organize and guide the installation process for this technology, including needs assessment, design development, installation, and quality control. The GSA representative, the A/E consultants and the A/V consultant shall work together to assure all courthouse infrastructure items are successfully implemented. Coordination with the consultant shall begin as early as possible to facilitate systems integration. (See Figure #1 on page 1-2)

A. Needs Assessment

Infrastructure shall support the following courtroom technology provided by the courts:

- Sound systems
- Video evidence presentation
- Video conferencing
- Computers/phones
- Network's access (databases)

◆ INFRASTRUCTURE CHECKLIST - COURTROOMS

1. Wire Management - Access Floors

Wire management in the courtroom will require in-floor wiring, using access floors in a 150mm to 200mm depressed slab area. The use of access floors are an essential infrastructure component which address the long-term requirements for wire management flexibility in courtrooms. No substitutions or value engineering alternatives will be permitted for this component. Concrete topped panels with stringers and screws are recommended to provide a solid footing and meet the floor load requirements. The access floor should generally cover the entire well up to the gallery railing, jury box, and bench. Typically, twelve (12) high capacity access floor boxes or access floor panels are provided. Floor boxes shall have a modular connection power system; capacity for two (2) RJ-45 connectors using eight (8) pair, cat-5 wiring (the court's standard); and two (2) 25mm conduit to the A/V rack location. (See Figure #2 on page 1-3, Figures #3 through #15 on pages 1-14 through 1-26, and Section IV.)

Retrofit projects may alternately use existing cell floor systems, new floor boxes, and poke-thrus. Shallow access floors (7cm high) may also be considered.

2. Courtroom A/V Rack

The A/V rack is normally located in a 1.5m X 2m closet, adjacent to the courtroom with double doors (1.8m wide) to the corridor. Pairs of adjacent courtrooms may share a common rack space. Courtroom technology wiring will converge to this location and will also be routed to a central processing area for all courtrooms.

The use of access floors are an essential infrastructure component which address the long term requirements for wire management flexibility in courtrooms. No substitutions or value engineering alternatives will be permitted for this component.

Space for the A/V closet should be identified in the initial space requirements and incorporated in the courtroom floor plans in the initial designs.

Space for the A/V closet should be identified in the initial space requirements and incorporated in the courtroom floor plans in the initial designs. Provide a 20-amp ‘isolated ground’ outlet at the A/V rack. Adequate ventilation for ambient air temperatures must be provided to assure reliable operation within the specified operational range.

A/V rack locations in the judge’s bench or clerk’s space shall not be encouraged due to limited available space in these locations. In retrofit projects, storage rooms may be appropriate locations, otherwise the clerk’s and/or judge’s bench space may be the only cost-effective solutions.

A/V rack locations in the bench or clerk’s space shall not be encouraged due to limited available space in these locations.

3. Wall Boxes in Millwork (Suggested Minimum)

The judge, clerk, reporter, and witness will need 100mm wide X 50mm high (5-gang) boxes in the millwork knee space with conduits to the A/V rack. A horizontal plug-mold and low voltage wire management system in the knee space is recommended. The clerk will also need a 5-gang box in the ledge above the work surface. Millwork drawings shall show wire management systems and wall boxes. The gallery and jury box railings will require boxes and conduit, with locations coordinated with the A/V consultant.

4. Millwork Coordination

The Court or AO representative will work with the A/E consultant and the A/V consultant to design and procure the millwork items for the courtroom. Coordination of the court technology with the millwork is one of the most critical aspects of the design phase of the courtroom environment. Much of the technology will interface with the millwork and should be fully integrated in its design. Failure to accomplish this will most likely result in unsightly runs of cabling, and placement of electronic equipment. An understanding of the components and their impact on the design should be realized at the earliest phases in the design process. The design team being GSA, the A/E consultant and the A/V consultant are encouraged to incorporate technology as a part of the courtroom mock-ups which are usually constructed prior to final approval of the courtroom design. The use of full scale mock-ups would best facilitate the proper integration of the technology components into the court environment.

Coordination of the court technology with the millwork is one of the most critical aspects of the design phase of the courtroom environment. Much of the technology will interface with the millwork and should be fully integrated in its design.

An understanding of the technology components and their impact on the design should be realized at the earliest phases in the design process.

a. The GSA will normally furnish

1) The Judge’s Bench with:

- A work-surface to accommodate a control panel, monitor, and microphones
- Pullout trays on both sides of the judge for laptops and/or keyboards with convenient receptacles

- Modem receptacle box
- LAN (DCN) receptacle box
- Realtime transcription receptacle box
- Power receptacles
- Conveniently arranged space for the CPU and paper storage
- Access panel in the floor
- Wire management system

2) The Clerk's Worktable with:

- A work surface to accommodate a control panel, monitor, and microphone
- Pullout tray
- Box for two (2) phone receptacles
- LAN (DCN) receptacle box
- Realtime transcription box
- Power receptacles
- Conveniently arranged space for the CPU and paper storage
- Access panel in the floor
- Wire management system
- Space for video printer

3) The Reporter's Worktable with:

- Space for recording equipment and laptop
- Realtime transcription receptacles box
- Power receptacles
- Access panel in floor/receptacle box(es)

4) The Witness Box with:

- Work surface to accommodate a monitor
- Ledge for a fixed gooseneck microphone
- Power receptacles
- Access panels in floor

5) The Jury Box with:

- Microphone receptacle boxes
- Railings which do not obstruct the view of portable monitors in the well
- Railings or posts to accommodate small monitors
- Power receptacles
- Access panels in the floor
- Wire management system

6) The Lectern with:

- Ledge for a gooseneck microphone
- Sufficient provisions to satisfy the requirements of the ADA
- Wire management

7) Attorney Tables with:

- Pedestals with boxes and flush doors on the table surface for easy wire management
- Integration of monitors and microphones
- CPU space
- Phone lines for modems

b. The Court Will Normally Furnish:

1) An A/V Cart with:

- Wheels for portability
- Tabletop for a document camera and papers
- Space for A/V equipment
- Wire management

2) Monitor Stands with:

- Wheels for portability
- The correct height for site lines
- Internal space for equipment
- Wire management

5. Ceiling Speakers

The GSA shall provide ceiling speaker boxes or other speaker systems with conduit back to the A/V rack. Additional speakers with conduit will be provided in chambers and holding/isolation cells with boxes for wall-mounted volume controls. Reflected ceiling plans shall be properly coordinated with notes showing ceiling speaker box types. Ceiling speaker boxes shall have grilles and wires for support from the deck above.

6. Infrared Emitters (Assisted Listening/Simultaneous Interpretation)

Assisted listening is required by the Americans with Disabilities Act (ADA). Wall-mounted infrared emitters shall require a wall box with conduit to the A/V rack and power on the wall near the ceiling. The quantity and location shall be developed by the A/E team and consultants. The infrared emitter power shall be the same phase as the A/V rack. The wall sections shall show the emitters. In some cases, emitters have been located behind glass for aesthetic reasons.

In this case, cooling must be provided. Provide details with cooling, access door, conduit, and power.

7. Camera Pockets

Wall-mounted camera pockets shall be recessed into the courtroom wall with 40 mm conduit to the A/V rack and/or centralized processing area. Locations shall be coordinated with the A/V consultant. The wall sections shall show camera pockets. The aesthetic quality of the pockets shall be considered. A ceiling-mounted camera pocket over the witness work surface may be needed. Provide details with cooling, access door, conduit, and power. Use clear optical glass.

8. Recessed Motorized Projection Screens

Ceiling-mounted recessed motorized projection screens shall be provided in a size and location coordinated with the A/V consultant. Reflected ceiling plans shall show projection screens. Power and conduit for remote up/down control shall be provided.

9. Video Projection System

Where a video projection system is utilized, a recessed wall pocket may be provided. The size and location of the wall pocket shall be coordinated with the A/V consultant. AC power and a 40mm conduit shall be provided to the A/V rack. The wall sections shall show projector pockets. A section shall be cut through the projector pocket, showing the beam to the screen to assure proper alignment. Cooling will be provided. Provide details with cooling, access door, conduit, and power. Use clear optical glass.

10. Centralized Video Conferencing Area

Centralized video conferencing processing shall be provided by the courts, using conduit/cable trays from each courtroom A/V rack and camera wall pocket for wiring to a work station. Its location shall be cable-friendly and integrated with computer rooms where appropriate. Power, heat load, digital services, and arrangement shall be coordinated with the A/V consultant.

11. Acoustics, Lighting, and Window Shading

Acoustics and lighting shall be coordinated with the court's A/V consultant to enhance sound and video systems. Acoustic performance of the space should be a prime consideration in the spatial development of the courtroom. Shapes and volumes that create spaces with poor acoustic properties should be avoided. The selection of finish materials should be made with an understanding of

Acoustic performance of the space should be a prime consideration in the spatial development of the courtroom. Shapes and volumes that create spaces with poor acoustic properties should be avoided. The selection of finish materials should be made with an understanding of the need for these finishes to perform acoustically in their particular location.

The use of indirect lighting is encouraged both for its aesthetic properties as well as its appropriateness for usage in video conferencing.

the need for these finishes to perform acoustically in their particular location.

The use of indirect lighting with carefully designed zones and dimmers is encouraged both for its aesthetic properties as well as its appropriateness for use in video conferencing. Down lights creating glare on monitors shall be avoided. Windows in courtrooms which may be used as a method to introduce natural light in the space, must be equipped with shading devices to control light levels entering the courtroom. This is required to maintain video image contrast. Windows which allow the entry of direct sunlight into the courtroom may require blackout type shades. Acoustic wall treatment on the back wall of the courtroom is recommended. Acoustic modeling of the courtroom shall be performed to assure Design Guide compliance.

12. Power Requirements

Normally, approximately ten (10) 20-amp circuits will be needed per courtroom with dedicated 20-amp circuits of the same phase at the A/V rack, lectern floor box, and projector (if used). System grounding shall meet National Electrical Code (NEC) standards. Power with isolated grounds shall be available in requested locations. Power for lighting shall be on separate circuits. Dimmers shall not be located in the A/V rack closet.

13. Computers

As an alternative, the clerk's computer can be used as a host for attorney provided evidence stored on discs. This computer may also be connected via a courtroom network to computers at attorney tables and the bench, forming the basis for a 'paperless' courtroom. The infrastructure for this arrangement should be considered. This courtroom network infrastructure must be physically separate from the Local Area Network (LAN) with the District Court Network (DCN).

14. Network Security

It is important to ensure the security of the courts' network equipment and cabling. All equipment supporting courtroom technologies with access to the parties in the cases must be kept separate from the LANs provided for the use of judiciary employees. Although the judges and the courtroom deputy clerks need access to their LAN systems for scheduling and case management purposes, the information on such LANs is considered judiciary-sensitive and is not to be accessible to parties of cases. Therefore, the receptacles for the two systems should be kept separate. Wiring for the courts LAN should always be routed in secure locations. Persons involved in the design, installation and maintenance of courtroom technologies should have the appropriate clearance.

It is important to ensure the security of the courts' network equipment and cabling. All equipment supporting courtroom technologies with access to the parties in the cases must be kept separate from the LANs provided for the use of judiciary employees.

15. Additional Requirements

Additional requirements (if any) shall be solicited and provided from the court's A/V consultant.

◆ INFRASTRUCTURE CHECKLIST - GRAND JURY

16. Grand Jury Rooms

Grand jury rooms are provided by the judiciary for use by the US Attorney. It is not used by the judiciary. They are normally provided with a simple sound system with recording and assisted listening only. Grand jury rooms are similar to courtrooms, however they do not have a judge and gallery. Grand jury rooms have two state's attorneys in place of a judge and the gallery is replaced by grand jurors. (See Figure #15 on page 1-26)

◆ INFRASTRUCTURE CHECKLIST - BUILDING WIRING

17. Telecom Data Riser Rooms

Riser rooms for integrated technologies (i.e. voice, data, video, A/V, security, etc.) shall be provided with sufficient space, 100mm riser pipes through floors, power, cooling, and connecting cable trays in the ceiling plenums of main corridors. Arrangements shall be coordinated with the A/V consultant. (See EIA/TIA 568-A-2 and 569-A/NSID/BICSI, FIPS 175 and 176 standards, and Section IV.)

18. Satellite Dish

Conduit, support, and space planning shall be provided for the court's satellite dish. The visual impact on the exterior aesthetic of the courthouse and line of sight to the satellite should be considered when placing the satellite dish on the building.

◆ INFRASTRUCTURE CHECKLIST - JURY ASSEMBLY ROOM

19. Wire Management

Normally, a microphone floor receptacle is provided in a floor box at the front of the room with 25mm conduit to the A/V rack. A 100mm X 50mm (double gang) wall box at the front of the room with 25mm conduit to the A/V rack is used to plug in the audio and video output of a VCR.

20. Jury Assembly A/V Rack

The A/V rack may be located in a separate closet, approximately 1.5m X 2m with a dedicated 20-amp power circuit, conduit, wall or floor

boxes, and adequate cooling. It may be located in an under-counter location if necessary. A 25-mm conduit to the central processing area will be provided. Infrared emitters, TVs, projection screen, projector, and videoconferencing capability can be considered. Provide power and conduit arranged by the A/V consultant.

21. Ceiling Speakers

The GSA shall provide ceiling speaker boxes with conduit back to the A/V rack. Ceiling speaker must be secured to the deck. These items must be shown on the reflected ceiling plan.

22. Monitors/Projectors

Wall-hung monitors or a ceiling/wall-mounted projector will require power and conduit back to the A/V rack. A projector will need a ceiling-recessed motorized screen with power and an up/down switch.

23. Acoustics, Lighting, and Window Shading

Large jury assembly rooms will need acoustical considerations to assure clear voice articulation. Lighting and window shading shall be coordinated with the video system.

◆ INFRASTRUCTURE CHECKLIST - CONFERENCE/ TRAINING/JURY DELIBERATION ROOMS

24. Attorney/Client Rooms

Attorney/Client rooms may be provided with a ceiling speaker with conduit to the courtroom sound system A/V rack with local volume control (as done for chambers). Two (2) RJ-45 phone connections for a modem and for connection to the courtroom may be provided.

25. Judge's Conference Room

The judge's conference room may have video conferencing and may require power and data connections. A 200mm X 100mm (four-gang box) with 25mm conduit to the central processing area should be provided. A floor box under the table locations should be provided with power and two (2) 25mm conduit to the wall box.

26. Training Rooms

Training rooms may have a ceiling-recessed projection screen and ceiling-mounted projector with power and conduit arranged by the A/V consultant. Computer training rooms may have access floors.

27. Jury Deliberation Rooms

At present, no technology is provided in jury deliberation rooms. A conduit for jury call and/or future use may be considered.

B. Design Integration

The technology infrastructure and technology components must be fully integrated within the design of the courthouse. This will require close interaction, coordination and cooperation among GSA, the A/E consultant, and the A/V consultant. The successes, both functionally and aesthetically of the integration of the infrastructure and court technology, rely on an understanding of the required components and addressing those needs early in the design process. Failure to accomplish the above all too often results in new installations having the appearance of a retrofit application.

The A/E consultant will develop floor plans, riser diagrams, electrical plans, and specifications to incorporate the programmed infrastructure, (i.e. access floors, power, cable trays, conduit boxes, etc.) These plans, diagrams, and specifications shall be submitted to the A/V consultant for review and comment. Integration of comments shall be coordinated and introduced into the 10-percent, 50-percent, and 90-percent progress and final drawings or according to the GSA established stages for the project. Value engineering recommendations shall be developed and coordinated with the A/V consultant. The construction documents shall include scheduling and procedures for the court's installation of wiring and equipment. Equipment security protocol shall be arranged. Timely construction scheduling and a project time line shall be developed showing all important milestones (i.e. submissions, meetings, installations, inspections, etc).

C. Space Planning

Wiring infrastructure will include space planning for:

- Courtroom A/V equipment racks
- Cable trays
- Floor wire management
- Camera pockets/ceiling camera pockets (if needed)
- Projection screen and projector location
- Telecom riser rooms
- Information services rooms with space for video conference processing
- Main distribution frame room
- Media room
- Satellite dishes

The technology infrastructure and technology components must be fully integrated within the design of the courthouse. This will require close interaction, coordination and cooperation among GSA, the A/E consultant, and the A/V technology consultant.

Value engineering recommendations shall be developed and coordinated with the A/V consultant.

The A/E consultant shall meet with the A/V consultant to develop the needs assessment, review and quality control processes. The A/V consultant shall be used as a source for information for building requirements to support courtroom and infrastructure technologies.

D. Construction Documents

The A/E consultant shall meet with the A/V consultant to develop the needs assessment, review, and quality control processes. The A/V consultant shall be used as a source for information for building requirements which support courtroom and infrastructure technologies. A programming checklist shall be developed from this manual and expanded and modified to include all items tailored and specific to the project. The A/E consultant shall integrate the courtroom technology into the overall design of the courtroom. Consideration shall be given to the aesthetic impact of the technology components on the millwork, and courtroom finishes. The acoustic performance of room finishes shall be considered to determine the appropriateness of their selection for a given location in the courtroom. Lighting shall avoid glare and maximize contrast on video images. Space planning for equipment and telecom riser rooms, etc. shall be provided. During the review process, the A/E consultant and the A/V consultant shall have all necessary communications to assure that all design issues are successfully resolved. A timeline with review process shall be provided and distributed with all milestones indicated for proper coordination. A/V consultant will require CADD files for backgrounds to generate AV layers for coordination.

E. Installation

The GSA shall keep the A/V consultant aware of infrastructure submittals for review of compliance with the specifications. Installation schedule shall be coordinated with the A/V consultant for site observations. Site observation reports shall be submitted in writing by the A/V consultant.

The court's wiring installation shall be coordinated to facilitate the various trades and optimize installation scheduling. Equipment installation shall be coordinated to maximize security. A formal RFI procedure shall be arranged and coordinated.

F. Quality Control

The Court's A/V consultant will be a primary resource to integrate pathways for wiring methodology and technology into the building design. Quality control shall be optimized by integrating the A/V consultant into the design and review process. Proper construction observations by the A/V consultant, et. al., will assure the proper installation of the infrastructure items. Requests for Information (RFIs) must be promptly processed and responded to using a coordinated arrangement. Value engineering recommendations shall be developed with and reviewed by the A/V consultant in an effort to reduce cost and assure quality performance. The A/V consultant shall provide acceptance testing and require adequate training of appropriate court personnel at the close of the project to assure proper system operation of the A/V related technology. (See Figures #3 through #15 on pages 1-14 through 1-26)

The GSA shall keep the A/V consultant aware of infrastructure submittals for review of compliance with the specifications. Installation schedule shall be coordinated with the A/V consultant for site observations.

The A/V consultant will be a primary resource to integrate pathways for wiring methodology and technology into the building design. Quality control shall be optimized by integrating the A/V consultant into the design and review process.



SECTION III Technology Consultant Issues

Courtroom technology has been installed in many courtrooms with positive operating results and will be implemented into new and existing courtrooms in accordance with the program implementation plan approved by the Judicial Conference Committee on Automization and Technology, subject to available funding. Courtrooms will need to be outfitted with appropriate infrastructure to accommodate the equipment. The incorporation of the infrastructure as defined in this manual is critical to the success of the courtroom technology initiative. The success of initial installations as well as the long-term viability and flexibility of the court technology relies on the inclusion of the infrastructure defined herein within the courthouse. Failure to provide these needs will result in structures which will not be able to accommodate the evolving technology needs of the courts both in the present and in the future.

Coordination of the courtroom technology needs to be a significant focus in the overall design process of the courthouse, especially in the courtroom itself. The technology must be fully integrated and not appear as an afterthought or an add-on to the final designed environment. Proper integration of these components begins by recognizing their requirements early in the design phase. This includes careful attention to the coordination of the acoustics of the space, the lighting concepts, as well as the electronic equipment itself. As the courtroom design progresses, more detailed attention is required to properly accommodate the equipment within the overall aesthetic of the court environment. This is especially critical in the millwork associated with the judge's bench, witness, clerk, and jury box. Careful consideration should be given to each component described within this manual as it relates to the overall courtroom aesthetic.

The audio visual (A/V) consultant's role in this effort is to work with the General Services Administration (GSA) and GSA's architectural/engineering (A/E) consultant to keep them apprised of the infrastructure needs and technology requirements for the courthouse and to provide detailed requirements for the technology installation. The A/V consultant shall also review the progress of the design effort at appropriate periodic intervals, as established for each project, and provide critiques of the infrastructure accommodations and technology systems as they are proposed in the design. The A/V consultant needs to monitor the design process to help facilitate the timely integration of all the infrastructure and technology components required by this manual. The A/V consultant should be involved in the design efforts from the very outset of the project and throughout the entire design and construction effort.

The incorporation of the infrastructure as defined in this manual is critical to the success of the courtroom technology initiative. The success of initial installations as well as the long term viability and flexibility of the court technology relies on the inclusion of the infrastructure defined here within the courthouse.

The A/V consultant's role in this effort is to work with GSA and GSA's A/E consultant to keep them apprised of the infrastructure needs and technology requirements for the courthouse and to provide detailed requirements for the technology installation.

The A/V consultant should be involved in the design efforts from the very outset of the project and throughout the entire design and construction effort.

This manual will organize and guide the installation process for this technology, including needs assessment, design development, installation, and quality control. The GSA, the A/E consultant and the A/V consultant shall work together to assure all courthouse infrastructure items are successfully implemented. (See Figure #1 on page 1-2)

A. Needs Assessment

Infrastructure shall support the following courtroom technology provided by the courts:

- Sound systems
- Video evidence presentation
- Video conferencing
- Computers phones
- Network's access (data bases)

B. Methodology

The Administrative Office of the U.S. Courts' (AOUSC) A/V consultant shall develop and integrate infrastructure items for wire management pathways into the design. The A/V consultant will also provide integration of the telecom wire management infrastructure with regard to telecom room risers, computer rooms, cable trays, main distribution frame room with public service carrier hook-up, satellite dish, and generic cable management items, when so tasked. The A/V consultant should consult with the AOUSC's program manager and consider providing:

1. Presentations to the Court/GSA/A/E Consultant

Presentations shall be used to identify courtroom technology systems and define scope. Presentations may include animations, video, perspective drawings, etc. as needed. Development of team/partnering approach is mandatory. All meeting minutes will be prepared with salient issues explained for necessary review and comment.

2. Proactive Programming

Obtaining programming comments from Bankruptcy, Magistrate, District, and Appeals Judges, Clerks, U.S. Marshals, IS department personnel, Assistant Circuit Executive, and the court's Network Systems Integration Division (NSID) is mandatory. Proactive management is necessary to assure comments are obtained and integrated appropriately into the project. Where comments are not received, then notification of such with design intent must include a note "no comments were received from...".

The Administrative Office of the U.S. Courts' (AOUSC) A/V consultant shall develop and integrate infrastructure items for wire management pathways into the design. The consultant will also provide integration of the telecom wire management infrastructure with regard to telecom room risers, computer rooms, cable trays, main switch room with public service carrier hook-up, satellite dish, and generic cable management items.

Presentations shall identify courtroom technology systems and define scope.

Obtaining programming comments from Bankruptcy, Magistrate, District, and Appeals Judges, Clerks, U.S. Marshals, IS department personnel, Assistant Circuit Executive, and the court's Network Systems Integration Division (NSID) is mandatory.

3. Review of Meeting Minutes

All meetings shall have A/V consultant provided meeting minutes with the appropriate distribution. Always follow up on all court comments using a timeline/checklist.

4. Wire Management System (Pathways/Spaces)

Develop an overview and schematic design for the A/E team and review by the Administrative Office's Office of Information Technology (OIT).

5. Courtroom Acoustics and Lighting/Window Shading Review

A review of courtroom acoustics, lighting, and window shades for integration with sound/video systems is mandatory. Provide comments and follow-up. Consult the United States Courts (USC) Design Guide.

6. Coordination of Construction Documents

Provide timing for cable pulling and installation of A/V systems by the courts, assuring access and security at the appropriate times. Reviews with comments of 10-percent, 50-percent, 90-percent drawing submittals, etc. with written comments and follow-up are mandatory.

7. Options for Mock-ups

Integrate proposed A/V equipment into the courtroom mock-up(s). Coordinate and present a mock-up demonstration under controlled circumstances. Consider equipment, lighting, and power requirements.

8. Quality Control

Assure quality in the infrastructure installation. Provide site observations and submittal reviews with written comments and follow-up responses.

9. A/V Specifications and Cost Estimates

Provide A/V construction documents and cost estimates that meet contract requirement and formats. These should be reviewed with sufficient time for comments and revision.

All meetings shall have A/V consultant provided meeting minutes with the appropriate distribution. Always follow-up on all court comments using a time line/check list.

A review of courtroom acoustics, lighting, and window shades for integration with sound/video systems is mandatory. Provide comments and follow-up. Consult the USC Design Guide.

Integrate proposed A/V equipment into the courtroom mock-up. Coordinate and present a mock-up demonstration under controlled circumstances. Consider equipment, lighting, and power requirements.

10. Request for Information (RFI)'s

Written answers to contractor questions are to be coordinated through the appropriate AOUSC branch.

11. Acceptance Testing and Training

Provide assurance of a seamless hand-over from the A/V contractor to the courts. Oversee the systems testing and training process, which is provided by the A/V contractor. Preparation of inventory and check of proper operation is mandatory, resulting in a detailed punch-list for final action.

Provide assurance of a seamless hand-over from the A/V contractor to the courts. Oversee the systems testing and training process, which is provided by the A/V contractor. Preparation of inventory and check of proper operation is mandatory, resulting in a detailed punch-list for final action.

◆ INFRASTRUCTURE CHECKLIST - COURTROOMS

1. Wire Management - Access Floors

Wire management in the courtroom will require in-floor wiring, using access floors in a 150mm to 200mm depressed slab area. The use of access floors are an essential infrastructure component which address the long-term requirements for wire management flexibility in courtrooms. No substitution or value engineering alternatives will be permitted for this component. Concrete topped panels with stringers and screws are appropriate to provide a solid footing and meet the floor load requirements. The depression for the access floor should generally cover the entire well up to, and including under, the gallery railing, jury box, and bench. Typically, twelve (12) high capacity access floor boxes or access floor panels are provided. Floor boxes shall have a modular connection power system; capacity for two (2) RJ-45 connectors using eight (8) pair, cat-5 wiring (the court's standard); and two (2) 25mm conduit to the A/V rack location. (See Figures #2 on page 1-3, Figures #3 through #15 on pages 1-14 through 1-26, and Section IV.)

The use of access floors are an essential infrastructure component to address the long term requirements for wire management flexibility in courtrooms. No substitution or value engineering alternatives will be permitted for this component.

Retrofit projects may alternately use existing cell floor systems, new floor boxes, and poke-thrus. Shallow access floors (7cm high) may also be considered.

2. Courtroom A/V Rack

The A/V rack is the housing for the sound and video equipment. The A/V rack is normally located in a 1.5m X 2m closet, adjacent to the courtroom with double doors (1.8m wide) to the corridor. Pairs of adjacent courtrooms may share a common rack space. Courtroom technology wiring will converge to this location and will also be routed to a central processing area for all courtrooms. Space for the A/V closet should be identified in the initial space requirements and incorporated in the courtroom floor plans in the initial designs. Provide a 20-amp 'isolated ground' outlet at the A/V rack.

Space for the A/V closet should be identified in the initial space requirements and incorporated in the courtroom floor plans in the initial designs.

A/V rack locations in the bench or clerk's space shall not be encouraged due to limited available space in these locations.

Adequate ventilation for ambient air temperatures must be provided to assure reliable operation within the specified operational range.

A/V rack locations in the bench or clerk's space shall not be encouraged due to limited available space in these locations. In retrofit projects, storage rooms may be appropriate locations, otherwise the clerk's and/or judge's bench space may be the only cost-effective solutions.

3. Wall Boxes and Conduit (Suggested Minimum)

The judge, clerk, reporter, and witness will need 100mm wide X 50mm high (5-gang) boxes in the millwork knee space with conduits to the A/V rack. A horizontal plug-mold and low voltage wire management system in the knee space is recommended. The clerk will also need a 5-gang box in the ledge above the work surface. Millwork drawings shall show wire management systems and wall boxes. The gallery and jury box railings will require boxes and conduit, with locations coordinated with the A/V consultant.

4. Millwork Coordination

The Court or AO representative will work with the A/E consultant and the A/V consultant to design and procure the millwork items which are furnished through various arrangements. Coordination of the court technology with the millwork is one of the most critical aspects of the design phase of the courtroom environment. Much of the technology will interface with the millwork and should be fully integrated in its design. Failure to accomplish this will most likely result in unsightly runs of cabling, and placement of electronic equipment which will detract from the desired appearance of the courtroom.

An understanding of the components and their impact on the design should be realized at the earliest phases in the design process. The A/V consultant should provide the technology design criteria to GSA and GSA's A/E consultant in a timely manner and work as a partner with the design team in developing a designed environment which fully integrates this technology in the courtroom. The A/V consultant should encourage the incorporation of the courtroom technology as a part of the courtroom mock-ups. The use of full-scale mock-ups would best facilitate the proper integration of the technology components into the court environment.

a. The GSA will normally furnish

1) The Judge's Bench with:

- A work-surface to accommodate a control panel, monitor, and microphones

Coordination of the court technology with the millwork is one of the most critical aspects of the design phase of the courtroom environment. Much of the technology will interface with the millwork and should be fully integrated in it's design.

An understanding of the components and their impact on the design should be realized at the earliest phases in the design process. The A/V consultant should provide the technology design criteria to GSA and GSA's A/E consultants in a timely manner and work as a partner with the design team in developing a designed environment which fully integrates this technology in the courtroom.

- Pullout trays on both sides of the judge for laptops and/or keyboards with convenient receptacles
- Modem receptacle box
- LAN (DCN) receptacle box
- Realtime transcription receptacle box
- Power receptacles
- Conveniently arranged space for the CPU and paper storage
- Access panel in the floor
- Wire management system

2) The Clerk's Worktable with:

- A work surface to accommodate a control panel, monitor, and microphone
- Pullout tray
- Box for two (2) phone receptacles
- LAN (DCN) receptacle box
- Realtime transcription receptacle box
- Power receptacles
- Conveniently arranged space for the CPU and paper storage
- Access panel in the floor
- Wire management system
- Space for video printer

3) The Reporter's Worktable with:

- Space for recording equipment and laptop
- Realtime transcription receptacles box
- Power receptacles
- Access panel in the floor

4) The Witness Box with:

- Work surface which may accommodate a monitor
- Ledge for a fixed gooseneck microphone
- Power receptacles
- Access panel in the floor/receptacle box(es)

5) The Jury Box with:

- Microphone receptacle boxes
- Railings which do not obstruct the view of portable monitors in the well
- Railings or posts to accommodate small monitors
- Power receptacles
- Access panel in floor
- Wire management system

6) The Lectern with:

- Ledge for a gooseneck microphone
- Sufficient provisions to satisfy requirements of the ADA
- Wire management

7) Attorney Tables with:

- Pedestals with boxes and flush doors on the table surface for easy wire management
- Integration of monitors and microphones
- CPU space
- Phone lines for modems

b. The Court Will Normally Furnish:

1) An A/V Cart with:

- Wheels for portability
- Tabletop for a document camera and papers
- Space for A/V equipment
- Wire management

2) Monitor Stands with:

- Wheels for portability
- The correct height for site lines
- Internal space for equipment
- Wire management

5. Ceiling Speakers

The GSA shall provide ceiling speaker boxes or other speaker systems with conduit back to the A/V rack. Additional speakers with conduit will be provided in chambers and holding/ isolation cells with boxes for wall-mounted volume controls. Reflected ceiling plans shall be properly coordinated with notes showing ceiling speaker box types. The location of the speakers shall provide for proper coverage for sound distribution while integrating with the desired aesthetic of the courtroom environment. Aesthetics should reinforce the proper placement of the speakers within the courtroom. Ceiling speaker boxes shall have grilles and wires for support from the deck above.

6. Infrared Emitters (Assisted Listening/Simultaneous Interpretation)

Assisted listening is required by the Americans with Disabilities Act (ADA). Wall-mounted infrared emitters shall require a wall box with conduit to the A/V rack and power on the wall near the ceiling. The quantity and location shall be developed by the A/E consultants and A/V consultants. The infrared emitter power shall be the same phase

as the A/V rack. The wall sections shall show the emitters. In some cases, emitters have been located behind glass for aesthetic reasons. In this case, cooling must be provided.

7. Camera Pockets

Wall-mounted camera pockets shall be recessed into the courtroom wall with 40mm conduit to the A/V rack and/or control area. Locations shall be coordinated with the A/V consultant. The wall sections shall show camera pockets. The aesthetic quality of the pockets shall be considered. A ceiling-mounted camera pocket over the witness work surface may be needed.

8. Recessed Motorized Projection Screens

Ceiling-mounted recessed motorized projection screens shall be provided in a size and location coordinated with the A/V consultant. Reflected ceiling plans shall show projection screens. Power and conduit for remote up/down control shall be provided.

9. Video Projection System

Where a video projection system is utilized, a recessed wall pocket may be provided. The size and location of the wall pocket shall be coordinated with the A/V consultant. AC power and a 40mm conduit shall be provided to the A/V rack. The wall sections shall show projector pockets. A section shall be cut through the projector pocket, showing the beam to the screen to assure proper alignment. Cooling will be provided. Provide details with cooling, access door, conduit, and power. Use clear optical glass.

10. Centralized Video Conferencing Area

Centralized video conferencing processing shall be provided by the courts, using conduit/cable trays from each courtroom A/V rack and camera wall pocket for wiring to a work station. Its location shall be cable-friendly and integrated with computer rooms where appropriate. Power, heat load, digital service, and arrangement shall be coordinated with the A/V consultant.

11. Acoustics, Lighting, and Window Shading

Acoustics and lighting shall be coordinated with the court's A/V consultant to enhance sound and video systems. Acoustic performance of the space should be a prime consideration in the spatial development of the courtroom. Shapes and volumes that create spaces with poor acoustic properties should be avoided. The selection of finish materials should be made with an understanding of the need for these finishes to perform acoustically in their particular location.

Acoustic performance of the space should be a prime consideration in the spatial development of the courtroom. Shapes and volumes that create spaces with poor acoustic properties should be avoided. The selection of finish materials should be made with an understanding of the need for these finishes to perform acoustically in their particular location.

The use of indirect lighting is encouraged both for its aesthetic properties as well as its appropriateness for usage in video conferencing.

The use of indirect lighting with carefully designed zones and dimmers is encouraged both for its aesthetic properties as well as its appropriateness for use in video conferencing. Windows in courtrooms which may be used as a method to introduce natural light in the space, must be equipped with shading devices to control light levels entering the courtroom. This is required to maintain video image contrast. Down lights creating glare on monitors shall be avoided. Windows which allow the entry of direct sunlight into the courtroom may require blackout type shades. Acoustic wall treatment on the back wall of the courtroom is recommended. Acoustic modeling of the courtroom shall be performed to assure Design Guide compliance.

12. Power Requirements

Normally, approximately ten (10) 20-amp circuits will be needed per courtroom with dedicated 20-amp circuits of the same phase at the A/V rack, lectern floor box, and projector (if used). System grounding shall meet National Electrical Code (NEC) standards. Power with isolated grounds shall be available in requested locations. Power for lighting shall be on separate circuits. Dimmers shall not be located in the A/V rack closet.

13. Computers

As an alternative, the clerk's computer can be used as a host for attorney provided evidence stored on discs. This computer may also be connected via a courtroom network to computers at attorney tables and the bench, forming the basis for a 'paperless' courtroom. The infrastructure for this arrangement should be considered. This courtroom network infrastructure must be physically separate from the Local Area Network (LAN) with the District Court Network (DCN).

14. Network Security

It is important to ensure the security of the courts' network equipment and cabling. All equipment supporting courtroom technologies with access to the parties in the cases must be kept separate from the LANs provided for the use of judiciary employees. Although the judges and the courtroom deputy clerks need access to their LAN systems for scheduling and case management purposes, the information on such LANs is considered judiciary-sensitive and is not to be accessible to parties of cases. Therefore, the receptacles for the two systems should be kept separate. Wiring for the courts LAN should always be routed in secure locations. Persons involved in the design, installation and maintenance of courtroom technologies should have the appropriate clearance.

It is important to ensure the security of the courts' network equipment and cabling. All equipment supporting courtroom technologies with access to the parties in the cases must be kept separate from the LANs provided for the use of judiciary employees.

15. Additional Requirements

Additional requirements (if any) shall be solicited and provided from the court's A/V consultant.

◆ INFRASTRUCTURE CHECKLIST - GRAND JURY

16. Grand Jury Rooms

Grand jury rooms are provided by the judiciary for use by the justice. It is not used by the judiciary. They are normally provided with a simple sound system with recording and assisted listening only. Grand jury rooms are similar to courtrooms, however they do not have a judge and gallery. Grand jury rooms have two state's attorneys in place of a judge and the gallery is replaced by grand jurors. (See Figure #15 on page 1-26)

◆ INFRASTRUCTURE CHECKLIST - BUILDING WIRING

17. Telecom Data Riser Rooms

Riser rooms for integrated technologies (i.e. voice, data, video, A/V, security, etc.) shall be provided with sufficient space, 100mm riser pipes through floors, power, coiling, and connecting cable trays in the ceiling plenums of main corridors. Arrangements shall be coordinated with the A/V consultant. (See EIA/TIA 568/NSID/BICSI, FIPS 175 and 176 standards, and Section IV.)

18. Satellite Dish

Conduit, support, and space planning shall be provided for the court's satellite dish. The visual impact on the exterior aesthetic of the courthouse and line of sight to satellites should be considered when placing the satellite dish on the building.

◆ INFRASTRUCTURE CHECKLIST - JURY ASSEMBLY ROOM

19. Wire Management

Normally, a microphone floor receptacle is provided in a floor box at the front of the room with 25mm conduit to the A/V rack. A 100mm X 50mm (double gang) wall box at the front of the room with 25mm conduit to the A/V rack is used to plug in the audio and video output of a VCR.

20. Jury Assembly A/V Rack

The A/V rack may be located in a separate closet, approximately 1.5m X 2m with a dedicated 20-amp power circuit, conduit, wall or floor boxes and adequate cooling. It may be located in an under-counter location if necessary. A 25-mm conduit to the central processing area will be provided. Infrared emitters, TVs, projection screen, projector, and videoconferencing capability can be considered. Provide power and conduit arranged by the AV consultant.

21. Ceiling Speakers

The GSA shall provide ceiling speaker boxes with conduit back to the A/V rack. The must be shown on the reflected ceiling plan. Ceiling speakers must be secured to the deck.

22. Monitors/Projectors

Wall-hung monitors or a ceiling/wall-mounted projector will require power and conduit back to the A/V rack. A projector will need a ceiling-recessed motorized screen with power and an up/down switch.

23. Acoustics, Lighting and Window Shading

Large jury assembly rooms will need acoustical considerations to assure clear voice articulation. Lighting and window shading shall be coordinated with the video system.

◆ INFRASTRUCTURE CHECKLIST-CONFERENCE/ TRAINING/JURY DELIBERATION ROOMS

24. Attorney/Client Rooms

Attorney/Client rooms may be provided with a ceiling speaker with conduit to the courtroom sound system A/V rack with local volume control (as done for chambers). Two RJ-45 phone connections for a modem and for connection to the courtroom may be provided.

25. Judge's Conference Room

The judge's conference room may have video conferencing and may require power and data connections. A 200mm X 100mm (four-gang box) with 25mm conduit to the central processing area should be provided. A floor box under the table locations should be provided with power and two (2) 25mm conduit to the wall box.

The GSA'S A/E consultant will develop floor plans, riser diagrams, electrical plans, and specifications to incorporate the programmed infrastructure, (i.e. access floors, power, cable trays, conduit boxes, etc.) These plans, diagrams, and specifications shall be submitted to the A/V consultant for review and comment.

The A/V consultant shall ensure that reviews of infrastructure submittals for compliance with the specification are provided in writing. The consultant shall follow-up on the responses and develop a list of items for submittal review. Installation schedule shall be coordinated with the A/V consultant for site observation.

26. Training Rooms

Training rooms may have a ceiling-recessed projection screen and ceiling-mounted projector with power and conduit arranged by the A/V consultant. Computer training rooms may have access floors.

27. Jury Deliberation Rooms

At present, no technology is provided in jury deliberation rooms. A conduit for jury call and/or other future use may be considered.

C. Design Integration

The GSA'S A/E consultant will develop floor plans, riser diagrams, electrical plans, and specifications to incorporate the programmed infrastructure, (i.e. access floors, power, cable trays, conduit boxes, etc.) These plans, diagrams, and specifications shall be submitted to the court's A/V consultant for review and comment. Integration of comments shall be coordinated and introduced into the 10-percent, 50-percent, and 90-percent progress and final drawings, or according to the GSA stages established for the project. Value engineering recommendations shall be developed and coordinated with the A/V consultant. The construction documents shall include scheduling and procedures for the court's installation of wiring and equipment. Equipment security protocol shall be arranged. Timely construction scheduling and a project timeline shall be developed showing all important milestones (i.e. submissions, meetings, inspections, etc).

The A/V consultant shall ensure that reviews of infrastructure submittals for compliance with the specification are provided in writing. The A/V consultant shall follow-up on the responses and develop a list of items for submittal review. Installation schedule shall be coordinated with the A/V consultant for site observations.

D. Space Planning

Wiring infrastructure will include space planning for:

- Courtroom A/V equipment racks
- Cable trays
- Floor wire management
- Camera pockets/ceiling camera pockets (if provided)
- Projection screen and projector location
- Telecom rooms
- Information services rooms with space for video conference processing
- Main distribution frame room
- Media room
- Satellite dishes

Value engineering recommendations shall be developed and coordinated with the A/V consultant.

The A/E consultant shall meet with the A/V consultant to develop the programming, review and quality control processes. The A/V consultant shall be used as a source for building requirements to support courtroom and infrastructure technologies. A programming checklist shall be developed from this manual and expanded and modified to include all items tailored and specific to the project.

The A/E consultant shall endeavor to integrate the courtroom technology, considering the aesthetic appearance including millwork, wall finishes and acoustical considerations.

During the review process, the A/E consultant and A/V consultant shall have all necessary communications to assure that all design issues are successfully resolved. A time line with review process shall be provided and distributed with all milestones indicated for proper coordination.

E. Construction Documents

The A/E consultant shall meet with the A/V consultant to develop the needs assessment, review, and quality control processes. The A/V consultant shall be used as a source for information for building requirements which support courtroom and infrastructure technologies. A programming checklist shall be developed from this manual and expanded and modified to include all items tailored and specific to the project. The A/E consultant shall integrate the courtroom technology into the overall design of the courtroom. Consideration shall be given to the aesthetic impact of the technology components on the millwork, and courtroom finishes. The acoustic performance of room finishes shall be considered to determine the appropriateness of their selection for a given location in the courtroom. Lighting shall avoid glare and maximize contrast on video images. Space planning for equipment and telecom riser rooms, etc. shall be provided. During the review process, the A/E consultant and the A/V consultant shall have all necessary communications to assure that all design issues are successfully resolved. A timeline with review process shall be provided and distributed with all milestones indicated for proper coordination. A/V consultant will require CADD files for backgrounds to generate AV layers for coordination.

F. Installation

The GSA shall keep the A/V consultant aware of infrastructure submittals for review of compliance with the specifications. Installation schedule shall be coordinated with the A/V consultant for site observations. Site observation reports from the A/V consultant shall be submitted in writing.

The court's wiring installation shall be coordinated to facilitate the various trades and optimize installation timing. Equipment installation shall be coordinated to maximize security. A formal RFI procedure shall be arranged and coordinated.

G. Quality Control

Proper construction observations by the A/V consultant, et. al., will assure proper installation of the infrastructure items. Requests for Information (RFIs) must be processed promptly and responded to using a coordinated arrangement. Value engineering recommendations shall be developed with and reviewed by the A/V consultants in an effort to reduce cost and assure quality performance. The A/V consultant shall provide acceptance testing and require adequate training of appropriate court personnel at close of the project to assure proper system operation of the A/V related technology.

H. Maintenance and Service

The AV consultant shall specify and arrange the prompt follow up services to assure reliable operation of technical systems.

The GSA shall keep the A/V consultant aware of infrastructure submittals for review of compliance with the specifications. Installation schedule shall be coordinated with the A/V consultant for site observations. Site observation reports shall be submitted in writing.

The A/V consultant will be a primary resource to integrate pathways for wiring methodology and technology into the building design. Quality control shall be optimized by integrating the A/V consultant into the design and review process.



SECTION IV Infrastructure Standards

A. Responsibilities

Planning for wiring infrastructure must start early in the design process. The proper integration of the infrastructure requirements into the courthouse requires an understanding on the part of the entire design (GSA, A/E consultant, A/V consultant) team of the requirements of these systems at the earliest phases of design. Specific electrical provisions need to be included on the electrical construction documents and incorporated into space planning in the architectural documents. Sizing and arrangement must be investigated for adequate capacity by the A/E consultants. Not all of the following elements will necessarily be configured or specified by the court's A/V consultant. There may be more than one systems design consultant on the team. These infrastructure provisions typically consist of :

- Access flooring
- Empty conduit and boxes
- Ceiling speaker back boxes/ceiling-mounted projection screens
- Telecom room risers
- Cable trays or other delivery systems
- Central video conferencing processing space
- A/V rack rooms or spaces
- Computer rooms
- Main distribution frame room
- Satellite dish area
- Dedicated electrical power circuits
- Media room/satellite truck space

Usually, the access flooring is provided by the general contractor, with the electrical provisions provided by the electrical contractor. The GSA A/E consultant is responsible for including all infrastructure items in the construction documents. The court's A/V consultant is responsible for providing all courtroom technology electrical requirements to the GSA and A/E consultant for incorporation in the contract documents. The A/V consultant shall also coordinate integration of the technology requirements for wire pathways into the contract documents.

B. Infrastructure Standards

Infrastructure items to consider with courtroom technology design include:

The proper integration of the infrastructure requirements into the courthouse requires an understanding on the part of the entire design team of the requirements of these systems at the earliest phases of design.

The GSA A/E consultant is responsible for including all infrastructure items on the construction documents. The A/V consultant is responsible for providing all courtroom technology electrical requirements to the GSA and the A/E consultant for incorporation in the contract documents.

1. Access Flooring

Access floors must have adequate structural capacity for the courtroom floor, generally 567 kg/sm is acceptable. In areas requiring consideration for seismic design loads, these loads must be met by the access floor. The feeling of stability and permanence is also important in establishing the appropriate sense of dignity in the courtroom. The access floor must support this requirement. Concrete topped panels with screws in each corner and stringers between pedestals are standard. The concrete topped panels provide a solid feel for the floor. Carpet shall be integrated for appearance and system operation. Coordination of suitable carpet tiles must be arranged. Carpet seams shall be staggered from access floor seams. The height from the structural floor to the top of the panel should be between 15cm to 20cm. The access floor should cover the courtroom area from the gallery railing to the jury railing and the judge's bench at a minimum. Small areas along the side walls and walls behind the raised millwork may not utilize depressed floors for access flooring to accommodate beams, if necessary. Such areas shall have cast-in-floor boxes as needed. Structural floors will always be depressed to accommodate the access floor. The depressed floor slab area should extend under the bench and jury box with millwork framing down to the deck providing continuation of in-floor cable access. The access floor boxes shall be large-capacity type, 200mm X 250mm, accommodating two (2) duplexes, two (2) RJ-45 connectors, and space for at least five (5) single-gang blank plates. Modular electrical connections are standard.

In cases where access floors cannot be used, a cell floor system may be appropriate. A three-cell type with cell rows on 1.5m spacing with activations every .6m is typical. A trough in the corridor, connecting the courtroom to the A/V rack location, with connection to the telecom riser room, etc. may be appropriate. Activation floor boxes should be as spacious as possible. In renovations, shallow access floor (70mm high) or new floor boxes and conduit are recommended. Poke-thrus are appropriate for power and data, but may not be reliable for plugs which protrude above the floor and may be broken.

2. A/V Equipment Room

A room for the A/V equipment rack shall be provided adjacent to the courtroom(s) with double doors (1.8m wide) to the corridor to provide service access outside the courtroom. A minimum 2m X 1.5m is appropriate for the A/V equipment room considering the rack is approximately .6m X .6m and two racks with walk space will be appropriate. A collector box (100mm high X 500mm wide X wall depth) in the wall for termination of floor conduits, and a second collector box for wall and ceiling conduit termination are appropriate. Racks on access floor may have a floor hole with direct access to the

Structural floors will always be depressed to accommodate the access floor. The depressed floor slab area should extend under the bench and jury box with millwork framing down to the deck providing continuation of in floor cable access.

Poke-thrus are appropriate for power and data, but may not be reliable for plugs which stick-up above the floor and may be broken.

A room for the A/V equipment rack shall be provided adjacent to the courtroom(s) with double doors to the corridor to provide service access that will not disturb the court.

floor plenum. Three (3) 75mm conduits to the corridor cable tray are appropriate for connection to the central processing area. Pairs of adjacent courtrooms may share a common rack space.

Provide one (1) 20-amp isolated ground power circuit with outlet and suitable cooling. Doors may be undercut for supply air with ceiling opening for return air.

3. Central Video Conferencing Processing Area

Courtrooms may send and receive video, audio, and control signals from a central area via conduit, cable trays, and telecommunication riser rooms for processing of video conferencing. A workstation with computer on the LAN, CODEC, video and audio matrix and monitors should be coordinated. Provide three (3) 20-amp dedicated isolated ground power outlets, cable management and suitable acoustics and lighting. An area co-located for centralized digital sound recording should be considered consisting of one (1) workstation per eight (8) courtrooms.

4. Empty Conduit and Boxes

Empty conduit for low voltage wiring shall be sized for 50% maximum fill and not be smaller than 20mm in diameter. Conduit shall be ferrous metal with color-coded and/or tagged pull-strings and connecting grounds. Conduits for A/V, security, etc. shall be tagged for these uses only. The construction manager shall help to enforce designated wiring in their conduits. Plastic conduit is not acceptable. Access floors shall have three (3) 50mm conduits to the nearest cable tray for phone/data wiring and three (3) 75mm conduits to the A/V rack location. Where depressed floors do not continue under millwork, provide three (3) 25mm conduits to the witness box, clerk/reporter, jury box, and bench. (See Figure #16 on page 4-4)

The bench, witness box, clerk, and reporter will all need 5-gang boxes in the knee space with three (3) 25mm conduits to the A/V rack (via appropriate pull boxes in the access floor is typical). Horizontal, surface mounted, or flush two (2) compartment low-voltage raceways may be provided in the knee space. Jury box railing(s) should also have a horizontal wire management system, which may be placed behind a removable kick plate. Provisions for a second row jury rail or posts with conduit should be considered for future use should jury monitors etc. be provided. The wall-mounted infrared emitter will require a 20mm conduit to the A/V rack. The camera wall pockets will require 40mm conduit back to A/V rack control or central control area. Projectors recessed in wall pockets will also require 40mm conduit back to the A/V rack and appropriate cooling.

A wall box at switch level for the judge's courtroom entry door to signal the clerk will need 20mm conduit to the A/V rack.

Empty conduit for low voltage wiring shall be sized for 50-percent maximum fill and not be smaller than 20mm diameter. Conduit shall be ferrous metal with color-coded and/or tagged pull-strings and connecting grounds.

Plastic conduit is not acceptable.

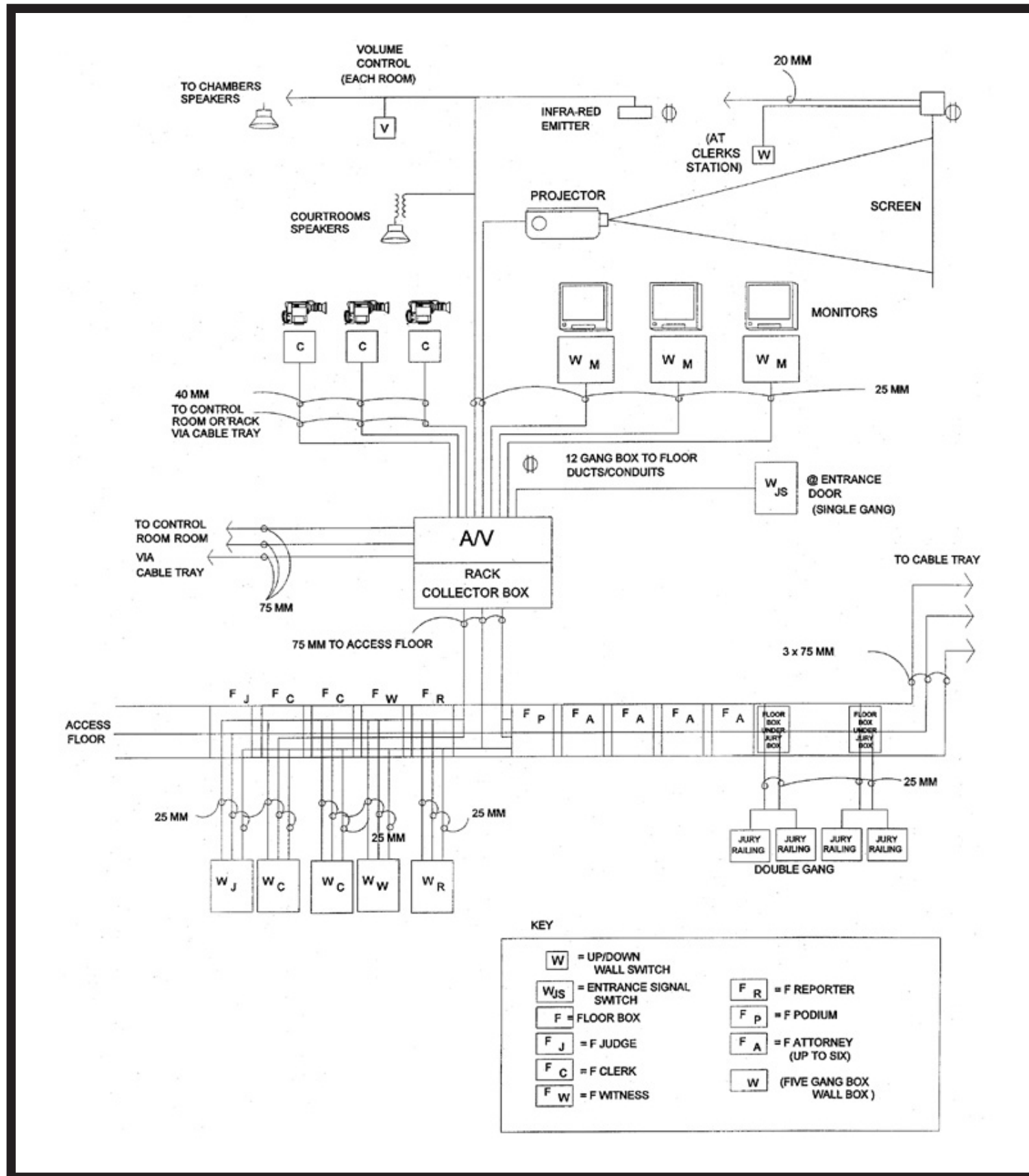

U.S. COURT - COURTROOM
AV CONDUIT SCHEMATIC /
ACCESS FLOOR
FIGURE 16

FOR ILLUSTRATIVE
PURPOSES ONLY.



In some cases, jury room and chambers chimes with associated call boxes are requested. This requires boxes at switch height with chimes in the ceiling and a power supply. Attorney time lights indicating one minute remaining (yellow) and time expired (red) are normally provided in Appeals courts with buttons at the clerk's location and lights on the lectern.

Separate single or double gang boxes shall be provided for phone and data connections with minimum 20mm conduit to the cable trays. These boxes will normally provide at least two (2) RJ-45 receptacles and eight (8) pair Cat-5 wiring, the court standard.

5. Ceiling Speaker Boxes

Ceiling speaker boxes shall be arranged for optimum performance, usually in front of the listener to maintain directionality and minimize feedback. The speakers' placement and design should complement the overall aesthetics of the courtroom ceiling. Proper sound coverage should not be compromised by the design concept of the ceiling in any space.

Gallery speakers may be directly overhead. Speakers shall be selected and arranged to accommodate ceiling height and provide the required sound coverage. Typically three (3) zones are arranged with separate volume controls: 1) Judge/clerk/witness/attorneys; 2) jury; 3) gallery.

Ceiling speakers with wall-mounted volume control should also be provided in chambers for the receptionist and law clerks. A vandal-resistant ceiling speaker with local volume control in a vandal-resistant location should be provided in the holding cell(s) and isolation cell(s) coordinated with the marshals.

Ceiling speakers shall always be supported by the structure above, and not rely on the ceiling for support.

6. Telecom Room Risers

A telecom room riser will be provided in the core with vertical alignment and four (4) 100mm pipes through the floor for cable management. Provide one (1) additional 100mm pipe for every group of five (5) or fewer floors above the fifth floor (i.e. 5 floors-5 pipes, 11 floors-6 pipes, 16 floors-7pipes, etc.) There shall be at least two additional 100mm pipes for security. It must meet CAIT standards, have dedicated power with isolated grounds, and wall surfaces for attachment of wire management systems (fire-rated 20mm plywood). Typically, there should be at least one (1) 3m X 3m telecom riser room per floor. Provide a 3m X 3m riser room for every 1000m² of space served. Provide a second telecom room riser where the area served exceeds 1,000m² or where any horizontal cabling distance exceeds 90m. Multiple closets shall be interconnected with at least

Ceiling speaker boxes shall be arranged for optimum performance, generally in front of the listener to maintain directionality and minimize feedback. The speakers placement and design should complement the overall aesthetics of the courtroom ceiling.

A telecom room riser will be provided in the core with vertical alignment and four (4) 100mm pipes through the floor for cable management

three (3) 50mm conduits. The bottom floor telecom riser should be over or connected with, suitable conduit to the main distribution frame room with public carrier service connection, which may house the telecom switch. The top of the riser should connect via 50mm conduit to the satellite dish location (usually at the south side of the building).

The computer room(s) with control area(s) should be conveniently located next to or near the telecom riser room with convenient cable tray arrangement and access floor. At least four (4) 20-amp dedicated clean power circuits shall be provided with suitable back-up system and adequate cooling.

7. Cable Trays

Cable trays shall be provided in the ceiling plenum of the main circulation corridors, typically in a loop or H arrangement from the core-located telecom riser room. Cable trays shall be located to avoid electrical interference from power lines, lights, etc. (See EIA/TIA 568/NSID/BICSI, FIPS 175 and 176 standards.) Typical frame type trays are .5m wide, spaced 100mm apart, with attachment to the deck approximately every 1.5m with attachments within .3m of tray joints. An appropriate weight rating must be specified, i.e. 50kg/m. The cable tray height shall be assigned and not encroached by pipes, lights, etc.

8. Computer Rooms

Computer rooms or other suitable locations shall accommodate an area for video conferencing processing. The area should be located near the courtrooms and/or the data/phone riser to maintain friendly cable arrangements to each courtroom. (See EIA/TIA 568/NSID/BICSI, FIPS 175 and 176 standards.) Cable trays shall be provided between the computer room and the telecom riser rooms. Adequate cooling must be provided. Suitable power with isolated grounds must be provided with appropriate back-up power system. In extreme cases, additional cooling may be needed.

9. Main Equipment Room/Switch Room

Public network carrier access for voice, data, and video applications will be brought into the building from off site and tied directly into the main equipment room for connection to the main distribution frame (MDF). Provide twenty-four (24) hour cooling and at least three (3) 20-amp dedicated power circuits with suitable back-up power. These rooms shall meet EIA/TIA 569. Provide adequate wire management pathways to telecom riser rooms. Telecommunications consultant(s) will join the project around the time of construction, and will design the phone/computer system. The court's technical

The computer room(s) with control area(s) should be conveniently located next to or near the telecom riser room with convenient cable tray arrangement and access floor.

Cable trays shall be provided in the ceiling plenum of the main circulation corridors, typically in a loop or H arrangement from the core located telecom riser room.

Computer rooms or other suitable locations shall accommodate an area for video conferencing processing. The area should be located near the courtrooms and/or the data/phone riser to maintain friendly cable arrangements to each courtroom.

Public network carrier access for voice, data, and video applications will be brought into the building from off site and tied directly into the main equipment room for connection to the main distribution frame (MDF).

consultant must assure a wire management infrastructure will be incorporated into the construction documents.

10. Satellite Dish Area

The courts will provide one or more down-link satellite dish(es) for receiving educational and training broadcasts. The consultant will assure a location facing south with an unobstructed view with structural and aesthetic considerations. A 50mm conduit to the telecom riser room with turn-down gooseneck for water protection is appropriate. Typically, a ballasted non penetrative roof mount is used for roof top locations. Other mounts such as a pole or ground mount may be used. The type of mount to be used shall be determined by a site survey conducted by the installation contractor. Information about the different types of mounts is available from the AO's office of information technology. (See Figure #17 on page 4-8)

11. Dedicated Electrical Power Circuits

Typically, ten (10) 20-amp circuits on the same breaker panel are needed in a courtroom as follows:

- a. A/V rack/IR emitter (clean power)
- b. A/V cart floor box (same phase as a.)
- c. Defense table floor boxes - same phase
- d. Prosecution table floor boxes - same phase
- e. Judge's bench/witness box
- f. Clerk's work area - clerk's work area
- g. Reporter's work area
- h. Wall receptacles/projection screen motor
- i. Law clerk's/marshal's floor boxes
- j. Jury Box
- k. Projector (if used) - same phase (11th circuit)

These circuits may be augmented with isolated grounds based on the A/E team's design requirements. A study of capacity must be performed by the A/E consultant and/ or GSA to confirm adequate power is provided. Grounding shall meet NEC minimum standards. A transformer for each courtroom may be considered.

12. Media Room/Satellite Truck Access

A media room with phones is sometimes provided on the street level. A connection to the control area with two (2) 50mm conduits for future use is appropriate. Two (2) 25mm conduits from the media room to a designated satellite truck location with weatherproof wall box or remote outdoor box may be considered.

A media room with phones is sometimes provided on the street level. A connection to the control area with two (2) 50mm conduits for future use is appropriate.

Note:
Actual attachment details to
be determined by installation
contractor.

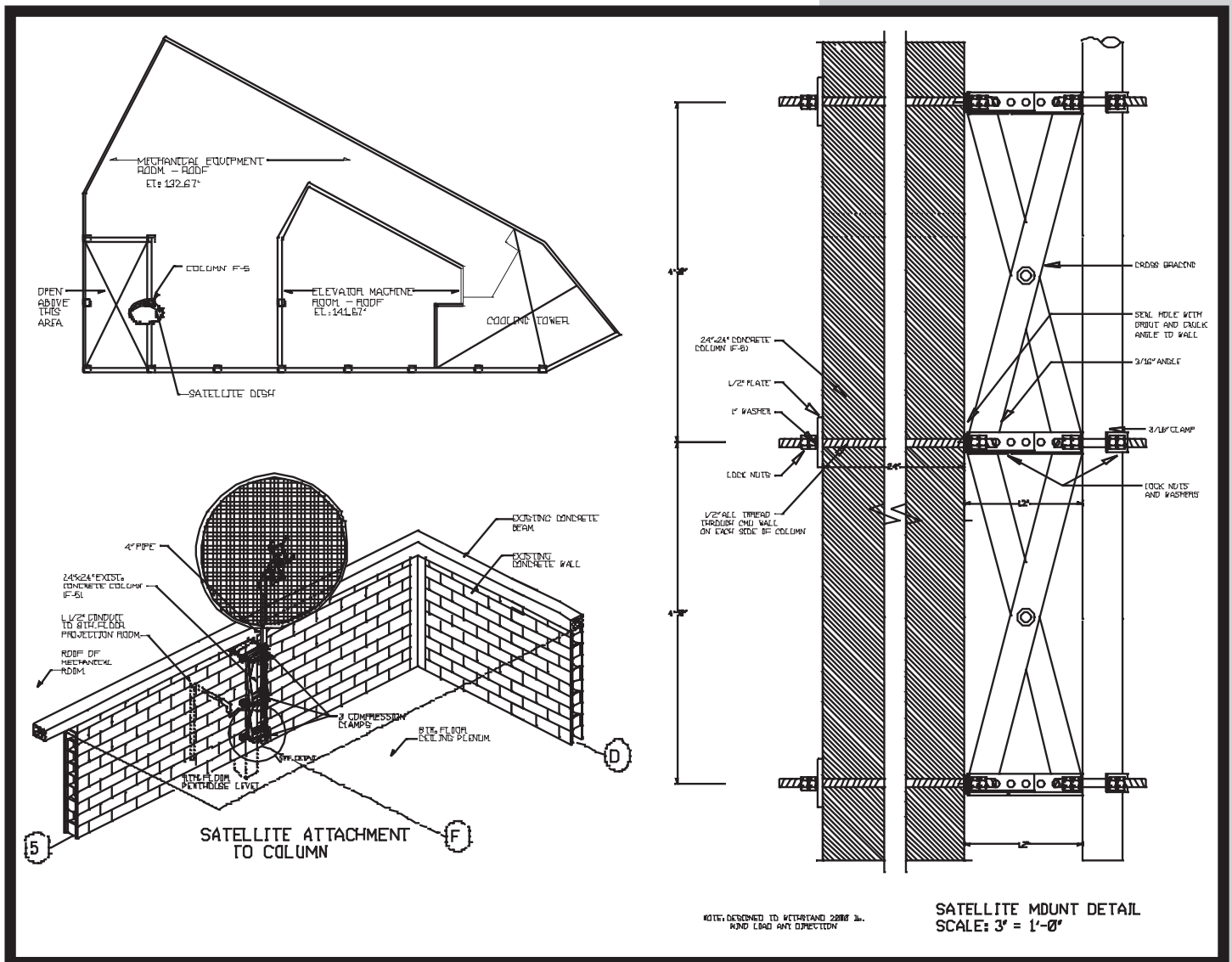

U.S. COURT - SATELLITE DISH ATTACHMENT DETAILS
FIGURE 17

FOR ILLUSTRATIVE
PURPOSES ONLY.





SECTION V General Overview of Audio System Design for U.S. Courthouses

The following information has been prepared as guidance for designing and specifying audio systems for U.S. Court facilities.

A. Courtrooms

Courtrooms over 70sm in area normally require both sound reinforcement and audio recording systems. A sound reinforcement system amplifies voices and allows people within the courtroom to hear the court proceedings. Courtrooms under 70sm in area may still use audio recording systems, but generally do not require sound reinforcement.

Depending on the courtroom, the quantity of audio components will vary. Included are some sample perspectives showing the location of audio components. These systems will vary depending on architecture and user influences. The audio designer shall classify courtrooms as a) a "standard" courtroom where up to eight (8) microphones and two (2) auxiliary inputs are required, or b) an "advanced" courtroom where the requirements will be greater. Audio equipment cabinets should be located in a closet, providing space for future improvements. In retrofits, a cost/benefit analysis must consider reusing the existing clerk's bench location. (See Figure #19 on page 5-2)

The following are major components, which will be included in a typical installation:

1. Microphone

Major components include assemblies, stands, cables, and wall/floor connection plates indicated at designated locations. (See Figure #18 on page 5-1)

a. Judge(s)

Each judge requires a microphone. A shock-isolated desk stand with a cardioid gooseneck microphone with base and mute switch is recommended. However, individual judges may prefer other types such as a lavalier or boundary mic, which should be considered. An "omni-directional" boundary microphone may be provided at the judge's bench for bench conference recordings activated with an illuminated switch in a control box on the bench. Bench conference microphones are for court reporter and recording only.

Courtrooms over 70sm normally require both sound reinforcement and audio recording systems. A sound reinforcement system amplifies voices and allows people within the courtroom to hear the court proceedings.

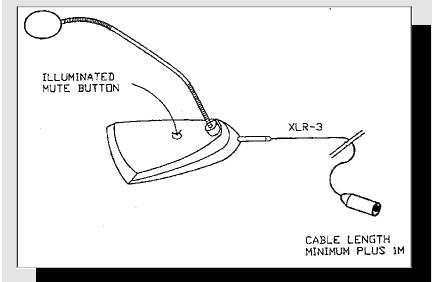
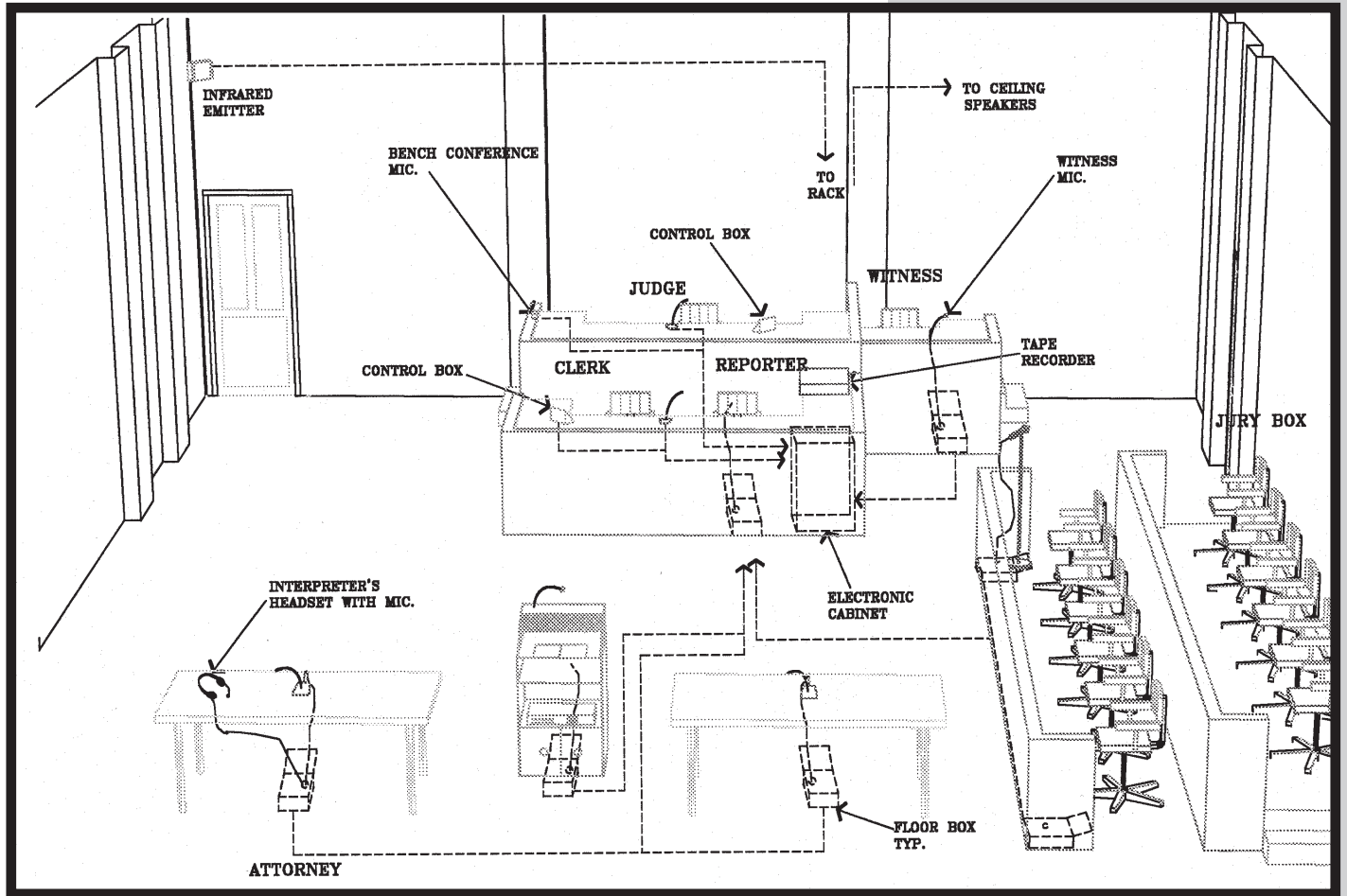

Figure 18
Microphone base with mute.

Each judge requires a microphone. A shock-isolated desk stand with a cardioid gooseneck microphone with base and mute switch is recommended.



U.S. COURT - RETROFITTED SOUND SYSTEM
FIGURE 19

FOR ILLUSTRATIVE
 PURPOSES ONLY.



An input on the mixer should be dedicated for each judge's microphone.

Microphones should not be fixed to the work surface of the judge's bench since judges have individual preferences for microphone locations. The microphone cable should be of sufficient length to enable movement of the microphone.

The base-mounted mute switch can be wired for noiseless switching by shorting Pins 2 and 3 with a suitable capacitor and resistor to minimize switch noise, or a built-in mixer mute may be used. A floor box or wall plate with microphone receptacles may be located within the judge's bench, preferably in a location which will not be subject to accidental contact which could lead to breakage.

Each judge's work surface may have an opening to allow each microphone cable and control box wire to pass through the work surface. Several circular 45mm grommets or a 20mm slot at the back of the work-surface along the face of the bench are appropriate.

b. Witness Box

The witness box should be equipped with a microphone. Consideration should be given to a fixed, cardioid microphone on a semi-flexible metal gooseneck. Gooseneck shall use a shock mount. A 50cm gooseneck is recommended. The witness microphone must be able to be placed close to the mouth of the witness.

The witness box should be equipped with a microphone. Consideration should be given to a fixed, cardioid microphone on a semi-flexible metal gooseneck.

An input on the mixer should be dedicated for the witness microphone.

The microphone base can be the receptacle, or a receptacle can be located in the witness box, preferably in a location which will not be subject to accidental contact which could lead to breakage. Portable witness boxes should be provided with adequate floor receptacle(s).

c. Jury Box

Consideration should be given to providing one (1) or two (2) jury box microphones, although this will vary depending on the court's preference. The microphone may be a cardioid type on a floor stand with sufficient cable to be passed around.

Consideration should be given to providing one (1) or two (2) jury box microphones, although this will vary depending on the court's preference.

An input on the mixer should be dedicated for the jury microphone(s).

Each microphone needs adequate cable length so that it can be removed from the microphone stand and passed around the jury box to any juror. The microphones may also be used by an attorney speaking directly in front of the jury.

A microphone receptacle wall plate needs to be located on either side of the base of the jury box front rail, or floor boxes may be used.

d. Attorneys

The quantity and layout of attorney tables will vary by courtroom. At a minimum, the audio system should be designed to accommodate one (1) microphone at each plaintiff and defendant table. A cardioid microphone on a shock-mounted desk stand with press-to-mute switch is recommended. Cable management shall be integrated into the tables. In most courtrooms, attorneys are requested to speak from a lectern. A cardioid gooseneck microphone, permanently fixed to the lectern, is suitable. Bankruptcy courts will normally have two (2) lecterns. District courts may have a second lectern location facing the jury for opening and closing arguments. (See Figure #20 on page 5-4)

Inputs on the mixer should be dedicated for each attorney's microphone and each lectern microphone.

A flush-mounted floor box for a microphone receptacle can be located under the attorney tables. A floor box can be located under the lectern(s). Provide separate floor boxes for the lectern(s).

e. Clerk

The clerk may have a cardioid microphone on a shock-isolated desk stand if required by the local court preference.

An input on the mixer may be dedicated for the clerk's microphone.

If provided, the clerk microphone should have a mute switch. This switch should be mounted on the microphone stand. The switch must be wired for noiseless switching.

A floor box or wall plate with microphone receptacle may be located within the clerk's desk, preferably in a location which will not be subject to accidental contact which could lead to breakage.

The clerk's work surface may have a grommeted opening to allow the microphone cable and control box wire to pass through the

The quantity and layout of attorney tables will vary by courtroom. At a minimum, the audio system should be designed to accommodate one (1) microphone at each plaintiff and defendant table.

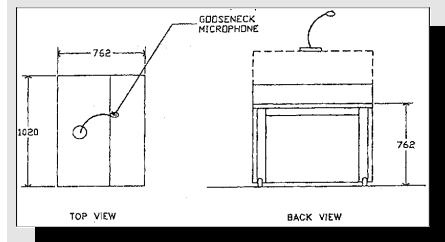

Figure 20
ADA Lectern

The clerk may have a cardioid microphone on a shock isolated desk stand if required by the local court preference.

desk surface. Several circular 45mm grommets or a 20mm slot at the back of the work surface are appropriate.

f. Reporter

Some courts may require a microphone for the court reporter. In such cases, a cardioid microphone on a shock-isolated stand is to be considered.

An input on the mixer may be dedicated for the reporter's microphone.

If provided, the microphone for the reporter should have an on/off switch. This switch should be mounted on the microphone stand. The switch must be wired for noiseless switching.

A microphone receptacle wall plate may be located within the reporter's desk, preferably in a location which will not be subject to accidental contact which could lead to breakage.

The reporter's work surface may have an opening to allow the microphone cable and control box wire to pass through the desk surface. Several circular 45mm grommets or a 20mm slot at the back of the work surface are appropriate.

g. Law Clerk

Law clerks do not require microphones or provisions for microphones.

h. Interpreter Technology Integration

When technology to support language interpretation is utilized it may be integrated into the installed audio system.

When a specific location is defined by the court for an interpreter, provide a microphone wall plate with two (2) microphone connectors. One (1) input feeds a mixer-input channel of the sound reinforcement system; the other feeds the interpretation system modulator. (See Figure #21 on page 5-5)

If an interpreter location is not defined, provide an interpreter microphone input in both counsel's floor boxes and behind the witness. The interpreter may use a headset with courtroom sound with an attached boom microphone. An interpreter's control box shall have a headset volume, mute, and output switch to PA or interpretation system transmitter.

Some courts may require a microphone for the court reporter. In such a case, a cardioid microphone on a shock-isolated stand is to be considered.

Law clerks do not require microphones or provisions for microphones.

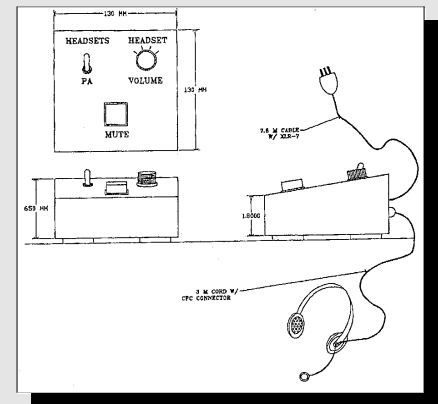

Figure 21
Interpreter's control box

Floor boxes with doors and space for future receptacles and wiring should always be provided for new facilities. Retrofits may consider 10cm poke-thrus modified for microphones, or 7cm access floors.

2. Floor Boxes

Floor boxes with doors and space for future receptacles and wiring should always be provided for new facilities. Retrofits may consider 10cm poke-thrus modified for microphones, or 7cm access floors. (See Figure #22 on page 5-6) Poke-thrus will need recessed microphone receptacles to prevent kicking/cleaning damage. Right angle microphone plugs also may be helpful to avoid damage.

3. Splitters

Splitters may be used to divide the microphone signals to the voice reinforcement system and audio recording system. This will prevent a failure in one (1) system from affecting the other. Splitters must pass phantom power.

4. Sound Equipment

Automatic microphone mixing, signal conditioning, and sound amplification equipment should be located in a designated equipment rack.

a. Mixers

Only mixers with circuitry that attenuates inactive microphones should be used. The mixer logic may be based on sound pressure or threshold levels. Also, the mixers must have circuitry that effectively adjusts the overall gain so that the number of open microphones (NOM) is always equal to one (1). The system chosen must work with a variety of microphones available from different manufacturers, so that a court facility is not dependent on one (1) manufacturer for all of their microphones. Logic output for camera switching is recommended.

All mixer inputs should be transformer isolated and balanced. Phantom power for powering condenser microphones is recommended to be switch selectable on each channel. Direct outputs from each mixer input channel should be available for direct microphone recording and/or mixing to create up to eight (8) recording channels. Normally, the recording is reduced to four (4) channels:

- Judge/clerk
- Witness/interpreter
- Lectern/attorneys
- Remote site

The main output of the mixer should be transformer isolated. The chosen mixer must also accommodate at least two (2) line-level inputs, and be set so that this input does not operate in an

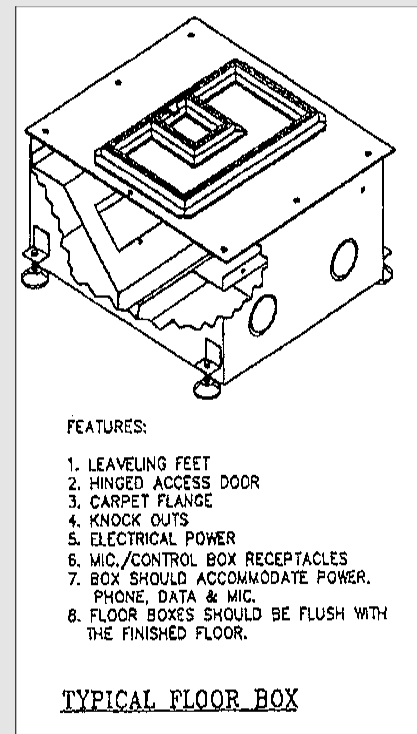
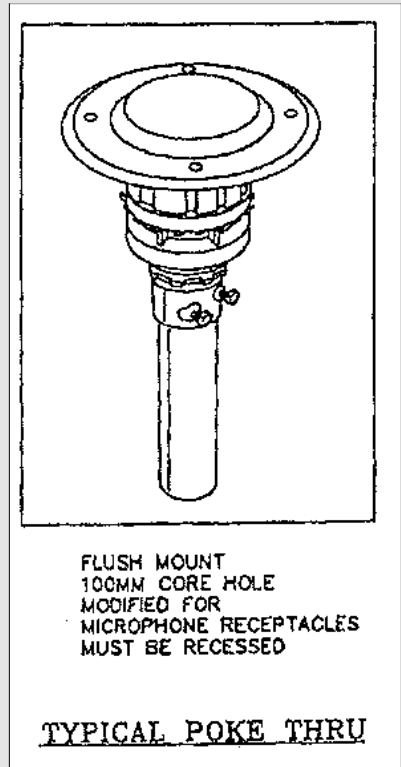

Figure 22
Typical floor box,
and poke-thru.

automatic mixing mode. Where there are adjustable controls on the front of the amplifier, they should be marked to identify the proper setting. Settings can be permanently marked and protected with a plastic or metal mesh security cover.

For "standard" courtrooms, one (1), eight (8) input automatic mixer with two (2) auxiliary inputs should be sufficient. For "advanced" courtrooms, a mixer utilizing a "card" frame input system should be considered. Typically, four (4) inputs are provided per card. Cards are also available which provide equalization, gain control etc., and can be included in the same card frame. (See Figures #23 and #24 on pages 5-8 and 5-9)

b. Equalizers

One-third octave equalizers with boost/cut or cut-only are recommended. The equalizer should have a bypass switch circuit for easy identification of a defective equalizer. Low and high frequency roll-off controls are useful, but not necessary. A plastic or metal mesh security cover should be provided. Equalizer settings may be permanently marked on the face of the equalizer. The equalizer should initially be set for flat response, with a -2 dB per octave slope above 2,000 Hertz. The system can then be adjusted to minimize feedback and improve sound quality. However, adjacent bands should not exceed 6dB difference. Programmable digital equalizers/feedback reducers are recommended.

c. Amplifiers

Audio sound pressure levels within a courtroom should be designed for 70dB SPL at a listener's ear. Therefore, unless large speaker-to-listener distances are encountered, large power amplifiers are not required. Dual channel amplifiers in the 50 to 100 watt/channel size are usually sufficient. The amplifier should have input attenuators. A transformer-isolated input is recommended. The amplifier may have outputs available to drive 4, 8, and 16-ohm loudspeakers, as well as 70 volt distributed loudspeaker systems. A professional, industrial type, rack mounted amplifier is recommended. Where there are adjustable controls on the front of the amplifier, they should be marked to identify the proper setting. Settings can be permanently marked and protected with a plastic or metal mesh security cover.

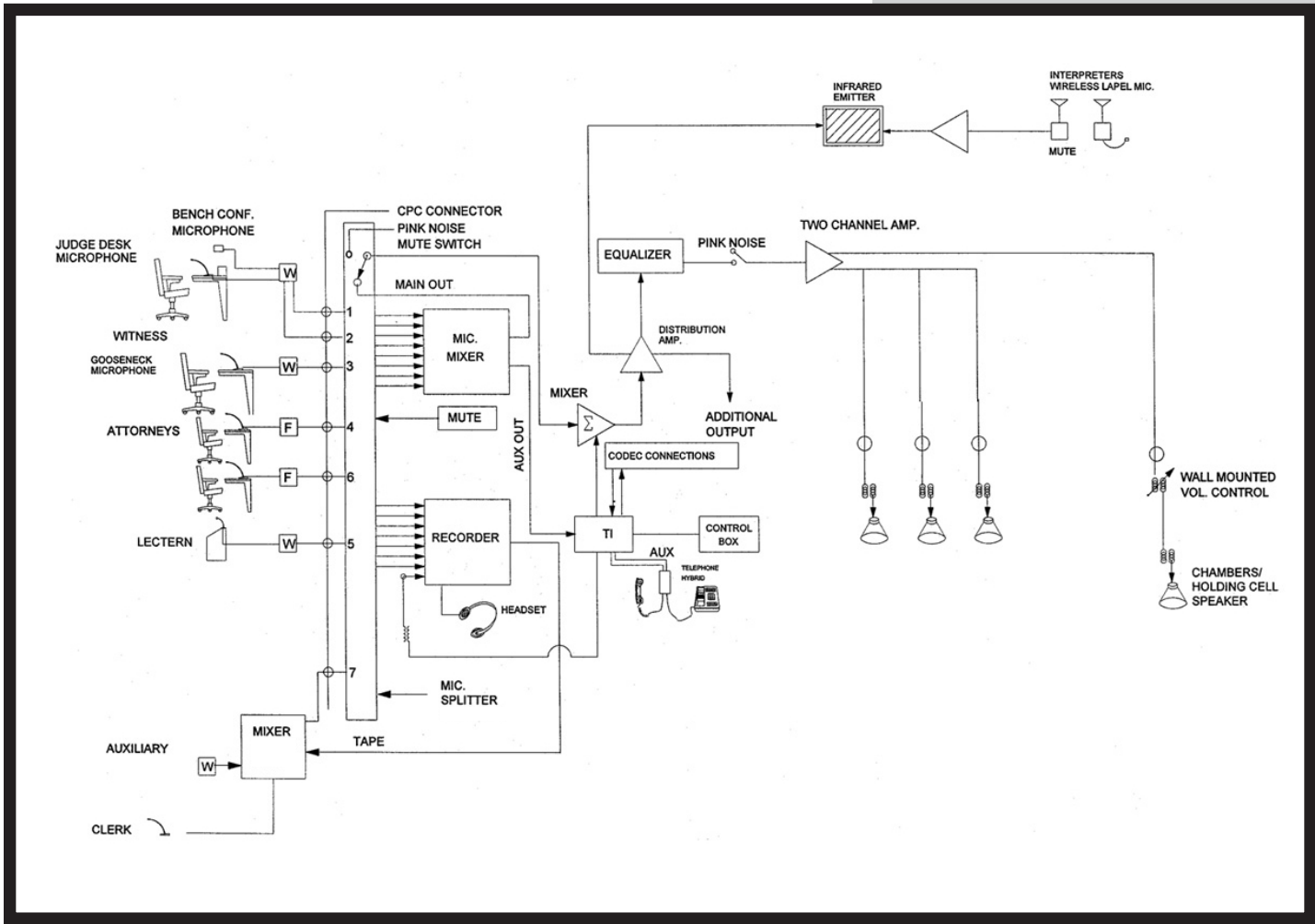

U.S. COURT - STANDARD SYSTEM AUDIO BLOCK DIAGRAM
 FIGURE 23

FOR ILLUSTRATIVE
 PURPOSES ONLY.



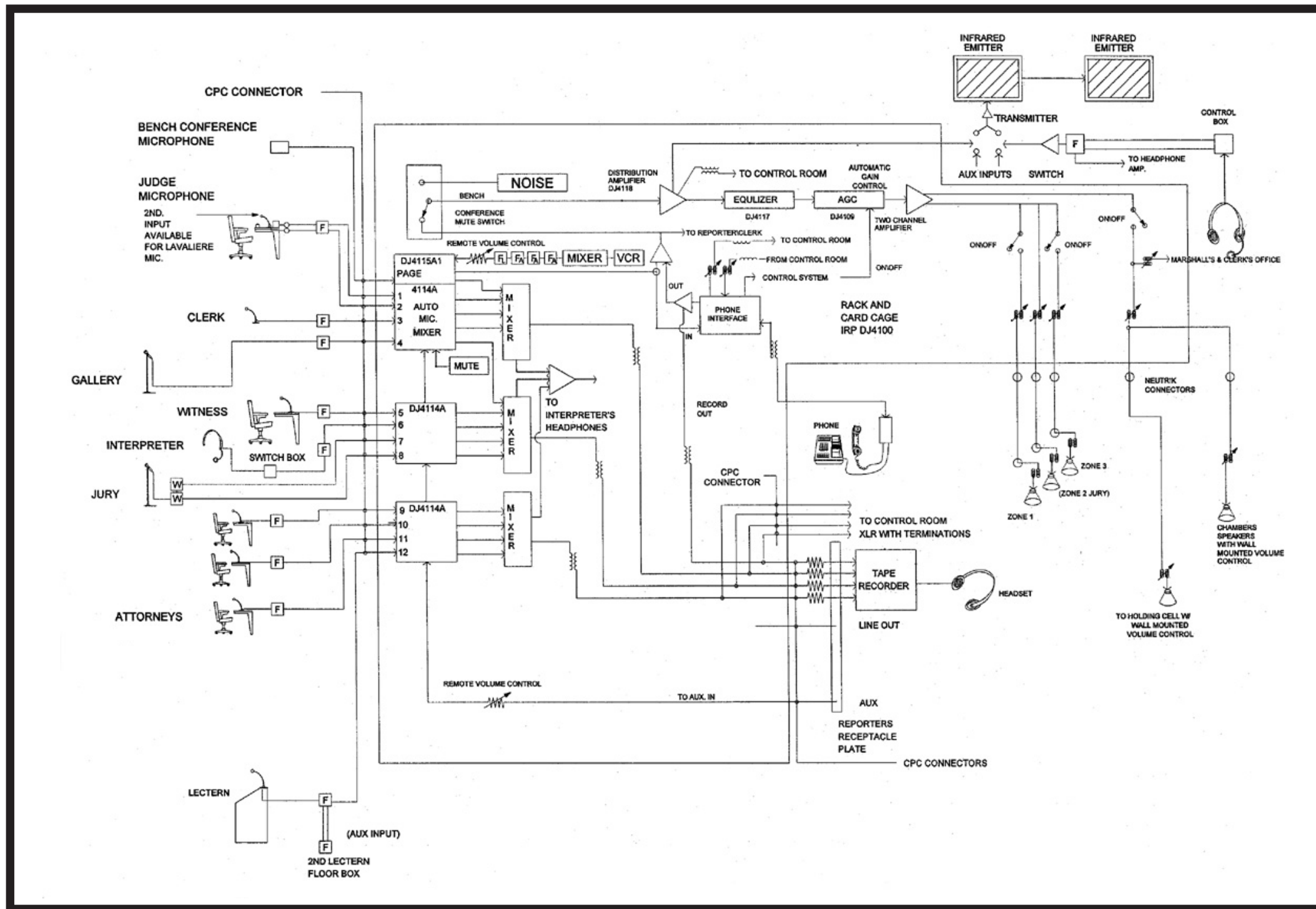

U.S. COURT - ADVANCED DESIGN
 AUDIO BLOCK DIAGRAM
 FIGURE 24

FOR ILLUSTRATIVE
 PURPOSES ONLY.



d. Equipment Cabinet or Rack

The sound system electronics can reside in an enclosed equipment cabinet or rack. This equipment cabinet or rack should have 48.26cm EIA standard rack spacing with drilled and tapped rack rails. The consultant should consider that the courtroom may be fitted with video evidence equipment in the future. (See Figures #26 and #27 on pages 5-11 and 5-12) Larger systems may be installed in a rack that is located in an adjacent room, vestibule, or other secure space. Adjacent courtrooms may share space for co-located racks. In retrofit situations, the equipment cabinet may need to be fitted under the clerk's bench. (See Figure #28 on page 5-13) The equipment enclosure or rack will need side ventilation louvers, blank and vent panels to fill unused rack space, wheels, and a power control panel to control system on/off. The standard equipment enclosure should be portable, with one (1) CPC connector for all microphones, one (1) Neutrix Speak-on speaker connector for all speakers, and CPC control box connectors. The only user interface with the sound system should be for power on/off, mute, and remote speakers on/off. A volume control for auxiliary mixer inputs and telephone interface may be provided, if requested by local practice. A power on/off with receptacle strip should be specified. A dedicated 20-amp circuit with audio quality sound will be needed at this location. Adequate cooling capacity must be provided and built into the rack and building systems.

5. Loudspeakers

Loudspeakers using ceiling, wall, and/or desk mounts should be arrayed for uniform coverage and zoned volume control throughout the listening areas, with consideration given to room architecture and acoustics. Ceiling grilles are available in a variety of shapes and sizes, to fit both 10cm and 20cm speakers, and should be selected to integrate with the specified ceiling system. Ceiling speakers shall be supported from the deck above and not rely on the ceiling for support. (See figure 25 on page 5-10)

Loudspeaker selection and placement is the most difficult part of the sound reinforcement design process. The goal is to provide uniform sound pressure levels to all listener positions while preventing the microphones from regenerating the sound and creating an acoustic feedback condition.

Architectural aesthetics play an important part in the location of loudspeakers, as well as in the planned (or existing) acoustics of the space. The architect is encouraged to integrate ceiling speakers in a visually pleasing manner.

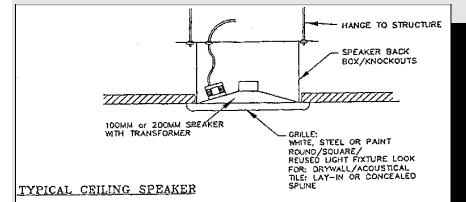
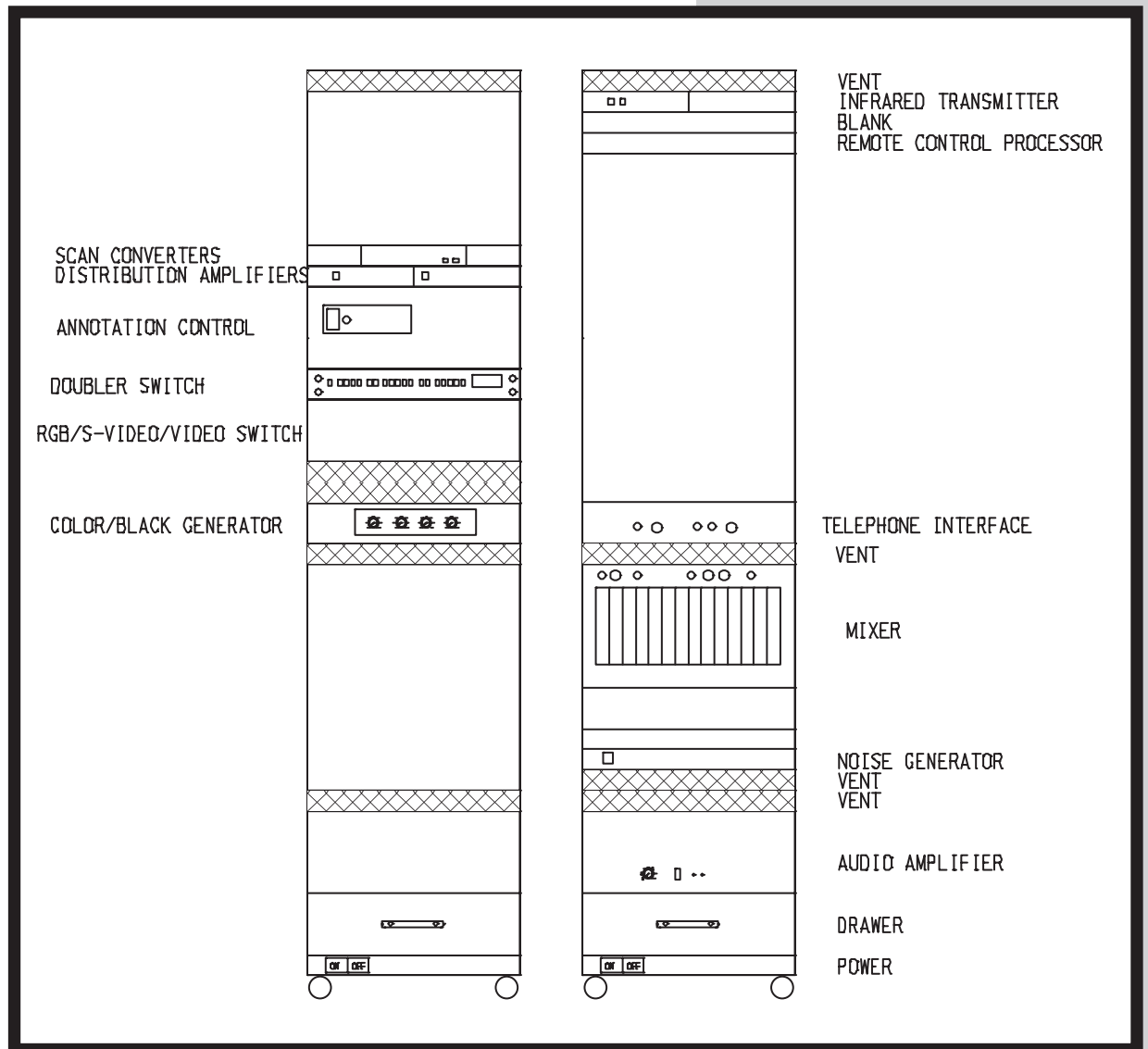

Figure 25
Ceiling Speakers

Loudspeaker selection and placement is the most difficult part of the sound reinforcement design process. The goal is to provide uniform sound pressure levels to all listener positions while preventing the microphones from regenerating the sound and creating an acoustic feedback condition.

Architectural aesthetics plays an important part in the location of loudspeakers, as well as the planned (or existing) acoustics of the space. The architect is encouraged to integrate ceiling speakers in a visually pleasing manner.



U.S. COURT - COURTROOM AUDIO/VIDEO RACKS
FRONT VIEW
FIGURE 26

FOR ILLUSTRATIVE
PURPOSES ONLY.



NOTES:

1. RACK'S DEPTH IS 508 MM

2. BLACK FINISH

3. PROVIDE VENT HOLES

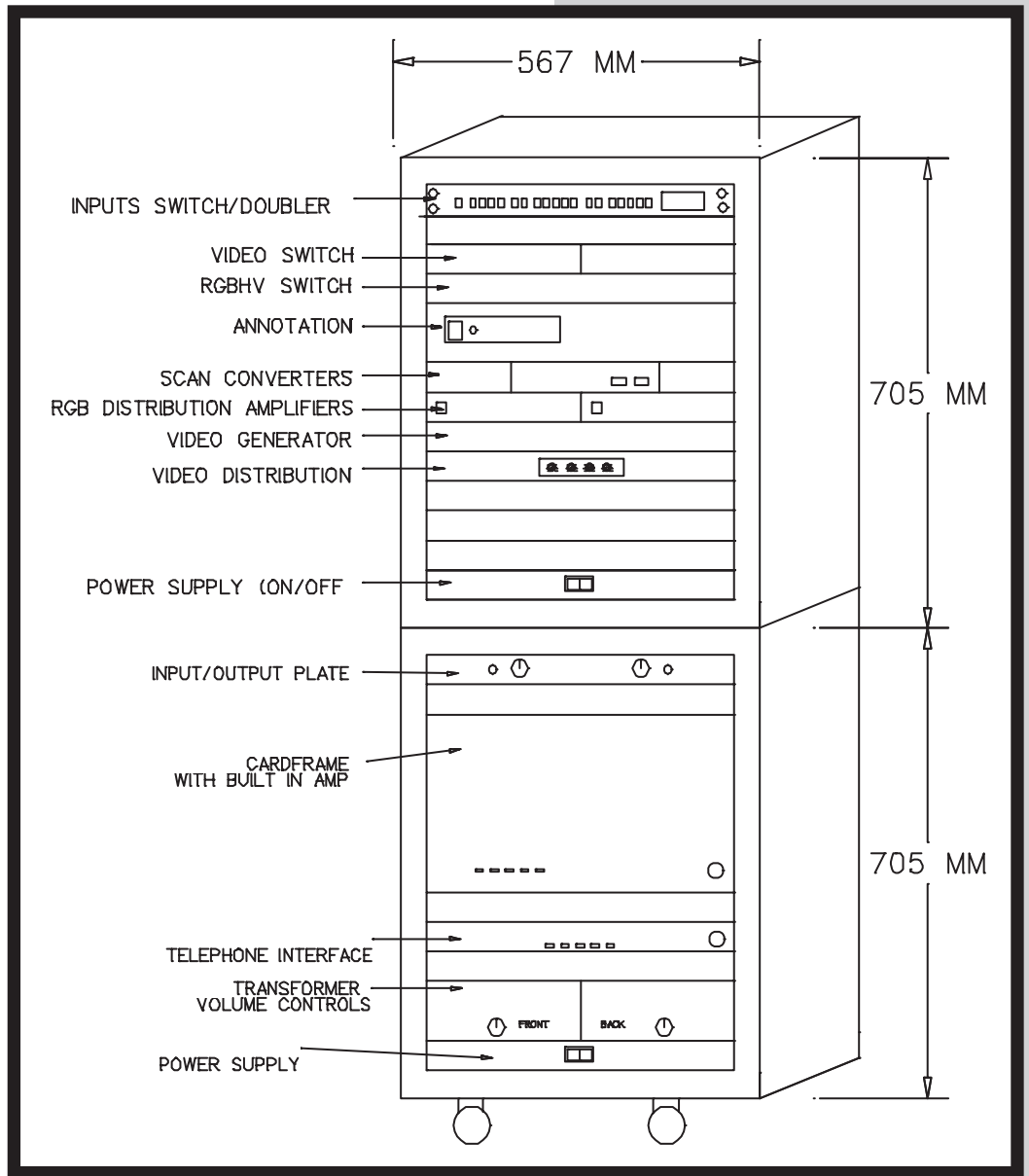

**U.S. COURT - STACKED A/V ELECTRONIC CABINET
BACK VIEW
FIGURE 27**

FOR ILLUSTRATIVE
PURPOSES ONLY.



NOTES:

1. VERTICAL RACK ARRANGEMENT IS ONLY FOR SPACE SAVING WHEN NEEDED

2. RACK'S DEPTH IS 508 MM

3. BLACK FINISH

4. PROVIDE VENT HOLES

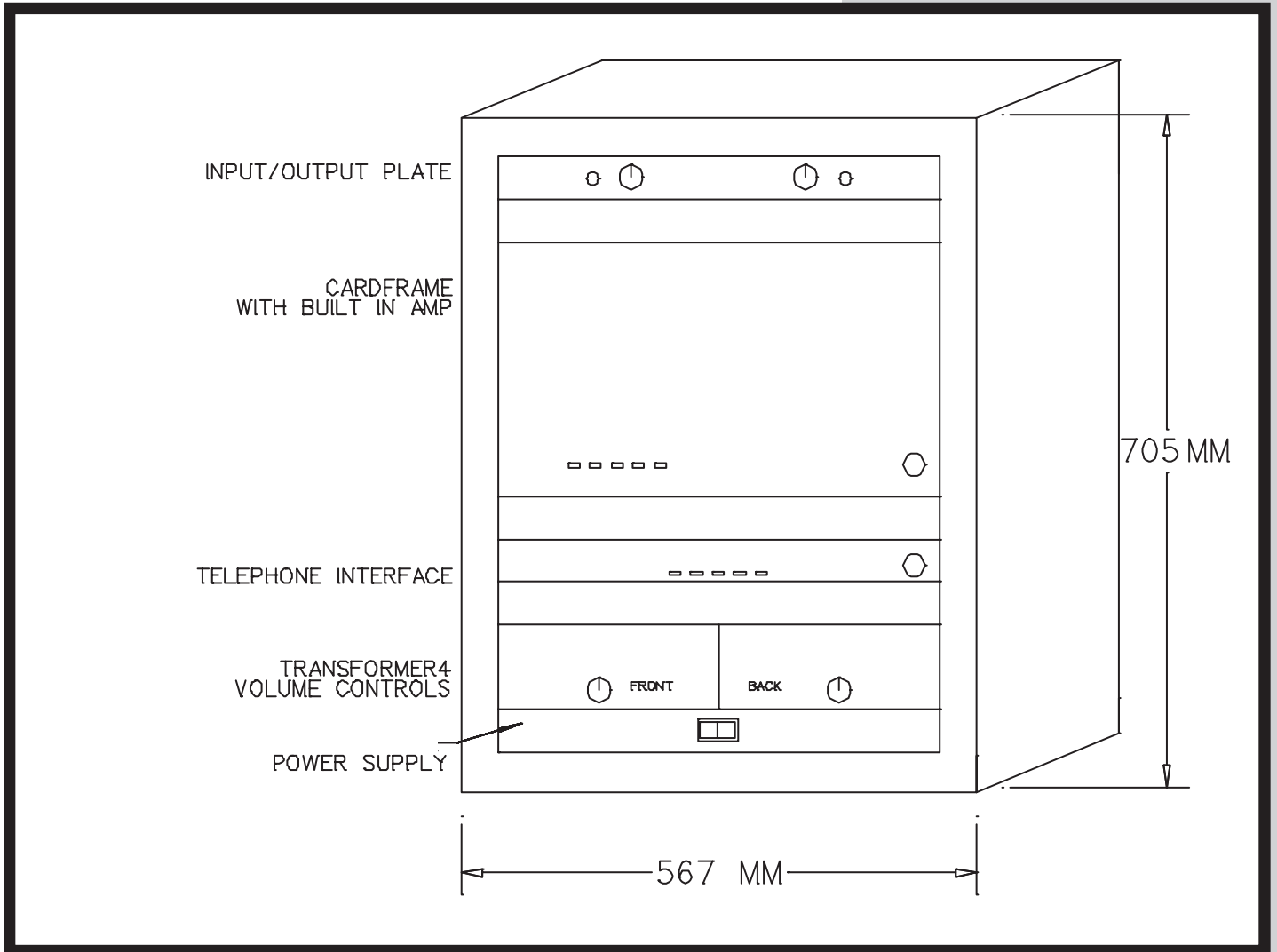

**U.S. COURT - STANDARD AUDIO ELECTRONIC CABINET
FRONT VIEW
FIGURE 28**

FOR ILLUSTRATIVE
PURPOSES ONLY.



For new construction or major renovation projects, an array of 10cm or 20cm ceiling-mounted loudspeakers in back boxes, spaced for proper sound coverage at all listener locations, is appropriate. Ten-centimeter (10cm) speakers take less space and are generally recommended. As a guide for speaker spacing, the following formula may be used:

$$[\text{Ceiling height (in meters)} - 1\text{m}] \times 2 = \text{Distance between speakers (in meters)}$$

Speakers should be placed in front of (but not behind) the judge/clerk witness area, attorney areas, the jury box, and over public seating. Wire speakers directly to the equipment rack for 70-volt operation. Speakers are typically wired in three (3) separate zones using auto-transformers with volume controls for each zone. The three (3) zones should be: front (judge, witness, attorneys), middle (jury), and back (public). Other areas may also have separate acoustic zones, depending on space planning and local preference. The sound pressure levels in these zones can then be controlled by labeled transformers in the equipment rack or cabinet.

For facilities where the ceiling height exceeds 5.4m, or the space is extremely reverberant (RT60 is greater than one (1) second), or where it is impossible to install ceiling-mounted speakers (such as a retrofit application), the use of wall-mounted column loudspeakers and additional "furniture-mounted" loudspeakers is recommended. Column loudspeakers should be located on the side walls in front of the judge's bench, with the bottom of the loudspeaker at 2m above the finished floor. Direct the loudspeakers towards the listening area, based on the published dispersion characteristics of the loudspeaker. Additional column loudspeakers may be mounted on the side walls near the public seating area, if required. Column speakers may be concealed in pockets with a fabric cover to reduce visual impact. Speakers in the jury railing and on the bench may also be considered.

Wire each loudspeaker or groups of speakers directly to the equipment rack, so that individual adjustments can be made after the system is installed and operating.

A ceiling speaker with wall-mounted volume control or desk-mounted speaker with integral volume control may be provided in the law clerk's office, judges' chambers, or other spaces, as required. An on/off control can be provided in the control box for these speakers. Holding/Isolation cell may have ceiling speakers with a vandal-resistant grille with volume control in a vandal-resistant location.

6. Remote Control Systems

Remote control systems may be provided for the judge(s) and clerk to control selected features of the audio system.

Speakers are typically wired in three (3) separate zones using auto-transformers with volume controls for each zone. The three (3) zones should be: front (judge, witness, attorneys), middle (jury), and back (public).

Notes:

- 1.) Mute is momentary.
- 2.) Bench conference mutes all misc. except judge and generates noise in speakers.
- 3.) Bench conference Press on/Press off.
- 4.) Black finish box.
- 5.) LED switches illuminate red.

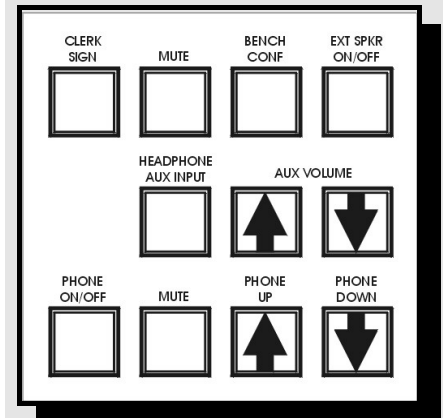

Figure 29
Control Panel

a. Judge's and Clerk's Audio System

For the typical courtroom audio system, the judge(s) and clerk typically require only very limited control of the audio system. For the most part, the audio system shall be self-operating. It should be powered on and off by the clerk at the equipment rack. When remote control of audio system functions is required, the audio designer should specify a system that is easy to configure and easy to maintain. (See Figure #29 on page 5-14)

Functions of the audio system that may be controlled are "Audio System Mute" and "Clerk Signal". "Bench Conference" may also be provided. Remote control of audio volume is not recommended except for auxiliary inputs.

Some individual microphones are controlled by local on/off switches on the microphone base. Remote control of microphone muting, using relays or circuitry within the mixer, may be used if available.

For systems where there are three (3) functions or less, a hardwired, relay-based system is recommended. Individual double-pole, double-throw switches with momentary contacts and illuminated LED pushbuttons should be mounted on the control box and connected to relay drivers. The control box for the judge(s) and clerk should be wired in parallel at the equipment rack. The system should operate using twelve (12) or twenty-four (24) volts DC. Control box may be positioned at each judge, and at the clerk's desk if required.

For systems where there are more than three (3) functions, such as the case when audio-visual equipment and zoned paging must be controlled, a programmable type control system is recommended. This also provides for cost effective upgrades to video systems. Such a system typically uses a 4-wire local area network bus to transfer DC power and control signals between a rack mounted control unit and remote control panels located in the courtroom. The remote control panels come in a variety of types. Typical units have up to 32 pushbutton switches, a 2-line X 16-character LCD display, which provides visual feedback of activated functions, or a touch-sensitive LCD screen. The control panel may be on a desktop base that is hard-wired into the equipment rack.

b. Judge's and Clerk's Control Box

Each judge should have provisions for a remote control box. The box should measure no larger than 15 cm X 15 cm. The clerk should have the same control.

At a minimum, the control should have the following functions:

1) Audio System Mute

This function disables audio from reaching the loudspeakers and any remote areas. Audio is not available for recording and the tape recorder may be paused.

2) Bench Conference

An option for bench conference may be provided. This is typically the same as audio system mute, but all audio is available for recording. Provide noise masking over the jury box when appropriate. Music using CDs has also been provided.

3) Clerk Signal

This is an illuminated signal used to get the attention of the clerk.

A control box receptacle wall plate or floor box should be located within the judge's bench and clerk's desk, preferably in a location which will not be subject to accidental contact which could lead to breakage.

The work surfaces will need an opening to allow the remote control cable to pass through the work surface. This opening can be shared with the microphone cable.

4) Remote Clerk Signal

Provide an LED momentary switch at the judge's entrance door to signal the clerk that the judge is about to enter. The LED may be illuminated by the clerk to acknowledge the judge's entry.

7. Playback/Taped Evidence

Playback/taped evidence can be fed into the sound system.

a. Audio Playback from Portable Tape Machines

Audio playback from portable tape machines via input receptacle(s) at specified locations may be provided. An input receptacle for audio playback, with an engraved front panel, should be located in the clerk's tabletop or ledge. Where necessary, the receptacle can be mounted on the A/V rack. For systems located in a closet, a receptacle and remote volume control with an engraved face plate may be provided. One (1)

input of the auxiliary audio mixer should be dedicated for line level input.

Some courts require the capability to distribute taped audio evidence within the courtroom using headsets. This can be handled by a stereo input with switch to the two channel infrared listening system. Various Justice Department agencies will require the binaural system with the switch controlled by the clerk or judge through the control system and XLR input connector (Pin 1-ground, Pin 2-left, Pin 3-right) at the prosecution floor box. Use of this type of system should be coordinated with the district attorney.

b. Audio Playback through Loudspeakers

The playback audio should be amplified and distributed to the same loudspeakers that are used for speech reinforcement. The nominal playback audio level can be preset at the equipment rack. The overall level of the playback audio can then be adjusted at the auxiliary mixer or via remote control at the judge's bench or clerk's desk.

8. Electronic Sound Recording (ESR)

Electronic Sound Recording (ESR) may use analog or digital tape recorders.

Audio recording of court proceedings is becoming more important in federal courtrooms. In most bankruptcy courtrooms, recording is used extensively. Currently, each court reporter uses a different tape recording machine. The audio system designer should design the recording portion of the audio system using a splitter, so that the audio output levels for recording are adjusted to -40dBm. The recording levels can then be internally preset in the audio distribution unit.

In addition, one channel of composite audio at line level may be provided to an engraved receptacle plate at the court reporter's position.

The audio system should have a suitable splitter or microphone matrixing, mixing, and buffering system capable of driving four (4) or eight (8) separate channels of audio, depending on the number of inputs in the recording system. Audio isolation should be sufficient to prevent audible degradation from any incorrect connections to the audio tape recorder(s). Isolation transformers are necessary to reduce hum.

A multi-pin ESR receptacle can be installed at the court reporter's desk for connection through a custom 4-channel recorder interface

Audio recording of court proceedings is becoming more important in federal courtrooms. In most bankruptcy courtrooms, recording is used extensively.

cable. It is recommended that a tip/ring/sleeve 6mm phone receptacle also be installed at the same location for composite audio recording. Additionally, adapters for mini-plugs should be provided to accommodate a recorder or headphone for monitoring. These outputs shall provide the bench conference microphone signal. Playback of the recorded transcript within the courtroom is not usually required. When it is required, a composite output of all the recorded channels can be played back through the audio system. This can be done from the clerk's position, when the court reporter's position is adjacent to the clerk. Otherwise, a dedicated line connected to the auxiliary input mixer for ESR playback may be provided.

As part of the ESR and mixing unit, an audio distribution amplifier with a minimum of four (4) outputs should be included. This amplifier can be used for distributing audio to various locations within the courtroom and/or court facility, and for assisted listening purposes. Each audio distribution amplifier should have transformer-isolated outputs and be able to drive a 600-ohm load to +4dBm.

Five (5) line level signal cables consisting of (four (4) microphone combinations-judge, witness, lectern, remote site, plus one (1) composite audio) should be run from the equipment rack to the nearest telecom riser room for future connection to a central recording and audio distribution system.

9. Clerk Signaling

Signaling of clerk using switches and lights can be provided.

Provisions should be made for a visual signaling system between each judge and the clerk. The signaling system is for the judge to get the attention of the clerk, since the clerk's back is usually to the judge. It is also to alert the clerk that the judge is about to enter the courtroom. The clerk may signal back to the judge and acknowledge the judge's entrance.

Illuminated indicators should be provided at the judge's bench and clerk's desk, and at the judge's entrance door. These indicators are to be activated by a momentary pushbutton at each location.

The indicators at the judge's bench and clerk's desk are to be provided as part of the audio remote control system, as defined previously. The jury signal and attorney one-minute and time-over lights may also be provided.

10. Assisted Listening

Assisted listening can be provided.

An assisted listening system provides a separate amplification and distribution medium to people who are hearing impaired. The users have wireless receivers that allow them to listen to the court proceedings. Now that the Americans with Disabilities Act (ADA) is federal law, the judiciary has chosen to conform with its requirements, even though the ADA does not apply to federal courts. In retrofit situations, one (1) or two (2) portable systems for the entire courthouse should be sufficient. This system may also be used for playback of recorded evidence (recorded in stereo and played back using both channels of the infrared system with a switch).

An assisted listening system provides a separate amplification and distribution medium to people who are hearing impaired. The users have wireless receivers that allow them to listen to the court proceedings.

Assisted listening systems are typically composed of the following:

a. Composite Audio

One channel of composite audio from the sound system.

The assisted listening system should be designed to broadcast the composite signal from the audio system, but not bench conferencing. The output for assisted listening shall be electronically buffered from the audio system. This is necessary to prevent degradation of the audio system if there is a fault in the assisted listening system.

b. Modulated Infrared Emitter System

A modulated infrared emitter system for wireless broadcast of audio, using light ballast resistant frequencies (above two (2) MHz) is recommended.

The emitter may be hung from the ceiling, mounted on the wall behind the judge, or be placed on a portable tripod located next to the audio line output receptacle at the clerk's desk. For the utmost in privacy, the infrared system should be specified.

c. Portable Receivers

Portable battery-operated receivers with lightweight headsets are for people requiring assisted listening. Hearing aids may be augmented with an induction type neck loop receiver. Receivers may be lightweight under-chin headsets, or an induction loop that can work with a hearing aid that has a short cable. The actual quantity of sets should be 4-percent of the room occupancy, with a minimum of two (2) headsets and one (1) induction unit required per room. The receivers can have either disposable or rechargeable batteries. If rechargeable batteries are specified, a battery-charging unit will be needed.

11. Interpretation

Interpretation can be combined with assisted listening systems for the hearing impaired. It is becoming more common for federal court facilities to provide language translation or interpretation systems. The need for the system should be determined by the use factor for interpretation facilities. If an interpreter is on staff, solely for providing interpretation, then the need for a fixed system is justifiable. In retrofit cases, if interpretation is used rarely, and an outside interpreter is brought in, then one (1) or two (2) portable systems for the entire courthouse could be sufficient. The assisted listening system can double as an interpretation system. A two (2) channel assisted listening system, with the second channel used for interpretation, may be used where interpretation and assisted listening are simultaneously provided. Interpretation systems (and assisted listening systems that double as interpretation systems) should be specified with infrared emitters and receivers. Interpretation system using phones to qualified interpreters has also been developed using the phone interface. In very rare instances, one courtroom may be equipped with multi-channelled systems for the simultaneous translations of several languages in multi-defendant trials.

Interpretation systems typically contain the following components:

a. Interpreter's Microphone

One channel of audio originating and controlled at an interpreter's microphone at a specified location.

For portable interpretation systems in retrofit applications, the interpretation equipment should be independent of the sound reinforcement system. The interpreter can use a hand-held or headset mounted boom microphone connected to the portable system for broadcast of the interpreted audio.

For fixed interpretation systems, the interpretation equipment should be interfaced with the sound reinforcement system. The interpreter will typically have one (1) or two (2) fixed locations within the courtroom, i.e. behind the witness and at the defense table. The interpreter can use either a desk mounted, hand-held, or headset mounted boom microphone to broadcast the interpreted audio. Also, the interpreter should have a switch which directs the audio either to the emitter panel (for translating from English to a foreign language), or to the sound reinforcement system (for translating from a foreign language to English). A mute button and headset with volume control should be provided. Headset may have courtroom audio without interpreter's voice. (See Figure #21 on page 5-5)

The assisted listening system can double as an interpretation system. A two (2) channel assisted listening system, with the second channel used for interpretation, may be used where interpretation and assisted listening are simultaneously provided.

Multiple channel interpretation systems may be accommodated in large courtrooms with six (6) channel transmitters (modulators) with the interpreters and inputs at multiple attorney tables. Two (2) or more emitters may be needed.

b. Infrared Emitter System

A transmitter (modulator) and infrared emitter for wireless broadcast of interpreted audio are recommended.

For fixed interpretation systems, an infrared-based system should be specified. The system proposed should support a minimum of two (2) channels, so that assisted listening and interpretation can share the same equipment. Emitter panels should be located to provide at least 45dB signal to noise ratio at all locations in the courtroom.

c. Portable Receiver

Portable battery-operated receivers with lightweight headsets for people requiring interpretation is recommended. For infrared-based systems, a minimum of two (2) dual-channel receivers with lightweight style or "under-chin" type headsets should be provided for each complete system. The receivers must be equipped with rechargeable batteries. These batteries will require a battery charger.

12. Noise Masking

Noise masking to cover bench conference conversation can be provided.

Noise masking within courtrooms is being used for better acoustical privacy during private bench conferences. A digital noise generator injects pink noise to selected loudspeakers, where masking is desired. The judge's bench conference microphone must be activated so that the bench conferences can be recorded. This switching must be part of the control system.

In some cases, judges have requested music instead of noise. This may be provided with a CD player from the clerk's location into the auxiliary input. While noise masking does increase the privacy of a bench conference, it does not provide acoustical security. If the matter being discussed is extremely sensitive, it is still recommended that the jury be excused, or the discussion be conducted in chambers.

Typical components of a noise masking system are:

Noise masking within courtrooms is being used for better acoustical privacy during private bench conferences. A digital noise generator injects pink noise to selected loudspeakers, where masking is desired.

a. Noise Generator

One channel of noise originating and controlled at the equipment rack.

The noise generator should be rack-mounted in the audio equipment rack. It should have an adjustable audio output so that it can directly feed the audio power amplifier. The noise signal will then be routed to the amplifier by a relay activated from the judge's and/or clerk's remote control console. The relay will disconnect or mute any microphone outputs to prevent them from being routed to the audio power amplifier. Relays can also be provided to disconnect speakers near the bench conference microphone and outside the courtroom. Noise generators may be shared among different courtrooms where courtroom racks are co-located.

The bench conference audio must be recorded and sent to the reporter for headphone use.

b. Switching and Distribution of Noise

The capability of switching and distribution of the noise to selected loudspeakers is required.

Typically, noise will be distributed to the jury speaker zone. The audio level should be no greater than 60dBA-SPL.

13. Audio Conferencing

Phone conferencing and audio for video conferencing can be provided.

A phone interface may be provided in the equipment rack or cabinet, with a two(2)-input mixer to combine courtroom sound and remote site sound to the power amplifier. This will provide audio conferencing through the sound system. A PBX phone may be provided at the clerk's desk with hybrid adapter. Interfaces for connection to digital service via CODEC should be considered. Wires may be routed to the central video conference processing area for CODEC connection or to the CODEC within the courtroom. Receptacles for a CODEC may be provided for easy connection at a future time. Recording is possible by connecting the remote site sound to a channel of the ESR input.

14. Wireless Microphones

Wireless microphones for roving attorneys and voir dire may be provided, but are not recommended.

Wireless microphones may be used if requested. These microphones may be either a lavalier type microphone, or a hand-held type with removable stand and adapter. They are helpful for voir dire, or for roving attorneys. However, they require frequent battery changes, allow detection of audio proceedings both outside the courtroom and outside the courthouse, and can receive fire/rescue/security/TV/FM broadcasts. Additionally, lavalier-type microphones are often left on accidentally, therefore compromising confidentiality.

B. Prisoner Holding Area, Law Clerk Office, Etc.

1. Audio Distribution

Consideration should be given to distributing speaker level audio to the prisoner holding vestibule, and/or isolation cell, and other areas adjacent to the courtroom. A ceiling-mounted back-box with vandal-resistant grille can be provided to accept a loudspeaker assembly, with a wall-mounted control for audio volume in a vandal-resistant location. At a minimum, the back-box and cabling should be provided to accept a future loudspeaker assembly. An on/off switch can be provided on the remote control box at the judge's bench and clerk's desk if remote speakers are installed. This arrangement should be coordinated with the Marshals.

C. Remote Witness Room

1. Audio Distribution

Audio distribution may be provided.

Provisions should be made to distribute speaker level audio to remote witness rooms, if such spaces are provided in the courthouse (or adjacent courtrooms). A wall-mounted volume control and speaker in an appropriate back-box may be provided. At a minimum, the back-box and conduit should be installed to accept a future loudspeaker assembly.

2. Microphone Signal

Microphone signal may be directed via the central processing area.

A wall receptacle may be provided so that a portable, non-directional boundary microphone can be placed on a desk or table. The microphone can connect to a switcher matrix in a central processing area and feed the courtroom telephone interface for echo cancellation or have a speaker mute from the microphone mixer logic. At a minimum, conduit and boxes should be provided to a designated conference room and control room.

D. Jury Assembly Room

Consideration should be given to providing jury assembly rooms larger than 72sm with a sound reinforcement system. The sound reinforcement system can be used for a single zone announcing and paging system, and for amplifying the audio from program soundtracks (videotapes).

1. Administrative Position

A microphone, cable, and wall or floor connection plate at the administrative control position can be provided.

The administrative position is the point of origin for paging and announcements. A cardioid microphone on a rugged microphone base with on/off switch may be provided. If the microphone is not adjacent to the mixer/amplifier location, a microphone receptacle wall plate will be required at this position.

The administrative position's desktop may have a grommeted opening to allow the microphone cable to pass through the desk surface.

2. Audio Equipment

Audio equipment should be provided in a designated equipment location.

a. Mixer/Amplifier

The mixer/amplifier may be a mainframe type with plug-in cards, or may be a unitized mixer/amplifier. It should accommodate both low impedance dynamic microphones and line level audio sources. All mixer inputs should be transformer isolated and balanced. The integral audio power amplifier should be sized to sufficiently drive a 70-volt distributed loudspeaker system in a balanced line configuration. The audio system should be designed for a maximum sound pressure level of 70dB-SPL at a listener's ears within the jury assembly room.

The mixer/amplifier will need bass, treble, and tone controls, and should have a front panel on/off switch.

The unit chosen should be equipment rack-mounted for security and wire management reasons.

b. Equipment Rack

The mixer/amplifier should reside in an equipment rack. This rack will need 48.26cm EIA standard rack spacing with drilled and tapped rack rails, side ventilation louvers, and blank and vent panels to fill unused rack space. It may be located under the

administrative desk/counter, or outside the jury assembly room in an adjacent storeroom, vestibule, or other secure space.

3. Ceiling-Mounted Loudspeakers

Ceiling or wall-mounted loudspeakers arrayed for uniform coverage throughout the jury assembly areas should be provided. Speakers in jury lounges and bathrooms may be provided.

For new construction or major renovation projects where the ceiling height is 5.46m or less, a rectangular array of ceiling-mounted loudspeakers is recommended, spaced for uniform sound coverage at seated ear height. As a guide for speaker spacing, the distance between speakers should be equal to the ceiling height, and any speakers near walls should be located a minimum of one (1) half of this distance away from the walls. Array the speakers into logical acoustic zones. Wire each zone directly to the equipment rack. Speakers should be wired for 70-volt operation, utilizing speaker line matching transformers. Adjust the power taps to provide a maximum uniform sound pressure level required in a given area of 70 dB-SPL minimum at ear height. Other acoustically differing areas may also be zoned to suite the particular situation, i.e. lounge, bathrooms, etc. The sound pressure levels in these acoustic zones can be controlled by speaker line attenuators in the equipment rack.

For facilities where the ceiling height exceeds 5.46m, or the space is extremely reverberant (RT60 is greater than one (1) second), or where it is impossible to install ceiling mounted speakers (as in a retrofit application), column loudspeakers and additional horns may be used. Column/horn loudspeakers should be located on opposite sides of the jury assembly area, with the bottom of the loudspeaker at 2m above the finished floor. Direct the loudspeakers to cover the listening area, based on the published dispersion characteristics of the loudspeaker. Additional column loudspeakers may be mounted on other walls, based on coverage required.

Wire each column/horn loudspeaker directly to the equipment rack so that individual adjustments can be made after the system is installed and operating.

4. Audio Playback

Audio playback from portable tape machines is provided via an input jack at the required location.

Locate an audio input wall plate at the focal point of the jury assembly room, where a television/video cassette player may be connected. Normally, an XLR type input is used with a local input volume control. Provide adapters for phone and RCA plugs.

At the video cassette player location, provide a wall-mounted receptacle. Where there is a video distribution system for multiple televisions, coordinate the wall plates with the video distribution system design.

E. Paging Systems

Library and Other Areas for Paging

For court libraries larger than 225sm, consideration should be given to providing a sound reinforcement system. Jury assembly rooms and other large spaces may also be candidates for paging systems. The sound reinforcement system can be used as a single zone paging system. Multiple zones may be used where paging requirements are necessary in additional rooms.

Typical components are:

1. Administrative Control Position

An interface with the phone switch may be provided. Alternately, a push-to-talk microphone, cable, and wall connection plate at administrative control position can be provided.

The administrative position is the point of origin for paging announcements. Where the phone is the source, locate the audio amplifier in the phone closet and connect to the PBX via a 600 ohm adapter. Alternately, a dynamic, unidirectional microphone on a rugged push-to-talk microphone base should be provided.

If the microphone is not adjacent to the mixer/amplifier location, a microphone receptacle wall plate may be located at this administrative position.

The administrative position's desktop may have a telephone with page button.

2. Audio Equipment

Provide audio mixer/power amplifier equipment in a designated equipment location.

a. Mixer/Amplifiers

The mixer/amplifier may be a mainframe type with plug-in cards or a unitized mixer/amplifier. It should accommodate both low impedance dynamic microphones and line level audio sources. A multiple zone selection control box may be used where necessary.

All mixer inputs should be transformer isolated and balanced.

The integral audio power amplifier section should be sized to sufficiently drive a 70-volt distributed loudspeaker system in a balanced line configuration. The system should be designed to provide a maximum sound pressure level of 70 dB-SPL at a listener's ears within the library room.

The mixer/amplifier will require bass, treble, and tone controls, and a front panel on/off switch.

The unit chosen will need to be equipment rack-mounted for security and wire management reasons.

b. Equipment Rack

The mixer/amplifier may reside in an equipment rack. This rack should have 48.26cm EIA standard rack spacing with drilled and tapped rack rails, side ventilation louvers, and blank and vent panels to fill unused rack space. It may be located under the administrative desk/counter, or outside the library in an adjacent storeroom, or phone closet.

c. Ceiling Mounted Loudspeakers

Provide ceiling or wall-mounted loudspeakers arrayed for uniform coverage throughout the library areas.

For new construction or major renovation projects where the ceiling height is 5.46m or less, ceiling-mounted loudspeakers should be used. The spacing does not need to be designed for uniform sound coverage, since the sound system is only used for paging. As a guide for speaker spacing, distance between speakers should be twice the ceiling height and a minimum of one (1) ceiling height away from any wall. Array each speaker into logical acoustic zones, based on ceiling heights. Wire each zone directly to the equipment rack. Speakers should be wired for 70-volt operation, utilizing speaker line matching transformers. The power taps should be adjusted to provide a maximum uniform sound pressure level in any given area of 70dB-SPL at ear height. Other acoustically differing areas may be zoned to suit the particular situation. The sound pressure levels in these acoustic zones can then be controlled by speaker line attenuators in the equipment rack.

For facilities where the ceiling height exceeds 5.46m, or the space is extremely reverberant (RT60 is greater than one (1) second), or where it is impossible to install ceiling mounted speakers (such as in a retrofit application), column loudspeakers and additional horn loudspeakers may be used. Column loudspeakers should be

located on opposite sides of each area, with the bottom of the loudspeaker at 2.12m above the finished floor. Direct the loudspeakers to cover the listening area, based on the published dispersion characteristics of the loudspeaker. Additional column loudspeakers may be mounted on other walls, based on coverage required.

Wire each column loudspeaker directly to the equipment rack so that individual adjustments can be made after the system is installed and operating.

Assure that speakers are placed between book stacks so that they do not interfere with the speaker coverage.

F. Specifications

Specifications are a necessary part of a complete design, and should be presented in a format suitable for bidding purposes. Additional information on specifications for courtroom technology can be obtained from the AO's office of information technology. The recommended format for specification sections is as follows:

1. General

This section includes instructions to bidders, overall scope, and timing requirements.

2. Products

This section discusses products using GSA schedule equipment and is recommended for cost control.

3. Execution

This section details the minimum installation standards for quality control.

Contractor testing with test report.

AOUSC inspection resulting in written acceptance or rejection.

Warranty, usually one (1) year from acceptance date.

Requirement for on-site training of all personnel by the A/V contractor.

As-built schematics, equipment manuals, instructions, and blank "log book" for each space.

4. Costs

Spreadsheet with equipment list and blank areas for vendors to fill in costs. Provide the AOUSC with the spreadsheet having the estimated costs filled in by the designer.



SECTION VI Video Evidence System Standards

The following information has been prepared as guidance for designing and specifying video systems for U.S. Courthouse courtrooms.

A. Courtrooms

Video evidence system sources typically shall consist of a document camera, VCR, inputs for computers, auxiliary inputs and annotation system. An A/V cart will be provided with a document camera, annotation tablet, and VCR. Video switching and processing equipment will be located in the A/V rack with remote control via touch panel or button control and processor. Jury and gallery monitors shall be black during judicial review at the judge's option. Distribution amplifiers will provide a VGA or higher signal to flat panel screens for the judge, clerk and witness. The witness shall have a touch annotation system. A video printer shall be used to make a copy of the image with annotation for the record. The reporter may also have a flat panel screen.

There are three approaches for video image presentation for the jury and attorneys:

1. Multiple Small Monitors:

This option relies on the placement of numerous small monitors throughout the courtroom. The judge, clerk, court reporter, witness, jurors and attorneys each have a small monitor directly in front of them. One small monitor can be shared by two jurors.

2. Portable large monitors on carts, which may be shared among courtrooms:

The portable large monitor option relies on the placement of large TV monitors placed in the court well. Usually one large screen is supplied for the jurors. A separate screen is turned to the attorney's and if properly located can service the spectator area. The judge, clerk and the witness would have a dedicated small monitor at their station. Consideration in the design phase must be given to the space requirements for accommodating the large monitors in the well of the courtroom

3. Portable or fixed projectors and projection screen:

A single projection screen option locates one large projection screen either across from the jury or behind the witness. These screens are approximately 3 meters wide. Significant attention to the placement

Video evidence system sources shall consist of a document camera, VCR, inputs for computers, auxiliary inputs and annotation system. An A/V cart will be provided with the camera stand, annotation tablet and VCR.

There are three approaches for video image presentation for the jury and attorneys:

1. Multiple Small Monitors

2. Portable large monitors on carts, which may be shared among courtrooms

3. Portable or fixed projectors and projection screen

and sizing of the screen should be given during the conceptual design phase.

Following is a more detailed discussion of each of the three options discussed above.

1. Multiple Small Monitors:

The individual or small monitor approach can provide integrated courtroom technology which minimizes the visual impact of this technology in the courtroom. It provides monitors in close proximity to all the participants in the courtroom while minimizing the effect on the traditional courtroom layout. Also all the participants in the trial are looking at the exact same image. It does not however, provide a central visual focus for the trial.

The witness monitor must be equipped with touch screen annotation.

The jury box will require additional space if this approach is used. It is preferable to provide a solid privacy rail in front of each row of jurors. This provides a mounting surface for the panel screens. This additional panel adds approximately .3m to the depth of the jury box, and may increase the length as well.

Coordination with the millwork provider for fit with electrical power and conduit is necessary to facilitate proper coordination of the screens with the jury box millwork.

2. Portable large monitors on carts, which may be shared among courtrooms:

The large multiple monitor option is a flexible solution for introducing video presentation into the courtroom. It allows monitors to be shared among courtrooms. Large portable monitors are the primary viewing source for the jury, attorneys, and the spectators. These monitors are placed in the well for viewing by these parties. Normally, three large monitor locations will provide flexibility using floor boxes for power and signal.

Care needs to be given to selecting monitor cart heights that do not crowd the courtroom or interfere with the lines of sight. The bottom of the monitor must be visible to each juror. The proper monitor dimension will vary depending on the design of the courtroom, millwork, and placement of the monitors in the space.

The multiple large video monitor approach offers flexibility to the courts in monitor placement, and allows the monitors to be shared between courtrooms. The judge, witness, and the clerk have a dedicated monitor at their station in this option.

The individual or small monitor approach can provide integrated courtroom technology which minimizes the impact of this technology in the courtroom.

The large multiple monitor option is a flexible solution for introducing video presentation into the courtroom. It allows monitors to be shared among courtrooms.

3. Portable or fixed projectors and projection screen:

Large courtrooms are the greatest beneficiaries of the large projection option. This option provides a central focus for the participants in the trial with a built-in permanent appearance. This is also the most expensive option due to the high cost of the projector. The use of the large screen should be carefully coordinated with the design of the overall courtroom.

The screens vary in width and are sized using a height-to-distance ratio. Efforts should be made to keep the screens to a reasonable size (up to a 3.5m width). The projection option is generally not compatible with courtrooms that have a strong source of natural light.

There are two acceptable locations for the projection screen. One is across from the jury box along the side wall of the courtroom. The second is behind the witness box and offset in the corner of the courtroom. The location opposite the juror box requires a larger screen as the image is further from the jury. The judge, witness, and clerk must have a dedicated monitor in this option.

Each system must be tailored to the specifics of that courtroom, considering site lines, space availability, court preference, and cost. The portable large monitors may be the most cost-effective with the A/V cart and portable monitors shared among courtrooms, but may take up too much well space. It is optimal where viewing distances do not exceed 5m.

The projector image may be the most dramatic and persuasive, but it is the most costly and maintenance intensive.

Small monitors may provide the best arrangement for maintaining the courtroom appearance but may focus the juror's attention away from the witness and attorney.

The selected system must be coordinated with the courts operations and meet the space, site line, and budget requirements. Power and signal requirements need to be developed in the design phase.

Video evidence equipment may be provided as follows:

1. Inputs (A/V Cart)

Inputs shall include a document camera on a portable cart. Document cameras have generally provided adequate resolution with a single 12mm CCD, with 800 horizontal X 500 vertical elements and 450 lines using an S-video output. In cases of large screen projection, three (3) 12mm CCD document cameras having 750 horizontal X 580 vertical elements with 750 lines using S-video is necessary. The document test is to see 10-point 80-character text filling the screen (or

Large courtrooms are the greatest beneficiaries of the large projection option. This option provides a central focus for the participants in the trial with a built in permanent appearance.

Each system must be tailored to the specifics of that courtroom, considering site lines, space availability, court preference, and cost.

The projector image may be the most dramatic and persuasive, but it is the most costly and maintenance intensive.

The small monitors may provide the best arrangement maintaining the courtroom appearance but may focus the juror's attention away from the witness and attorney.

Inputs shall include a document camera on a portable cart. Document cameras have generally provided adequate resolution with a single 12mm CCD, with 800 horizontal by 500 vertical elements and 450 lines using an S-video output.

monitor) from left to right, with the top half of the document. A/V carts shall have wheels with sliding trays or folding work surfaces. Shelves shall be provided for a VCR, annotation tablet and audio mixer. Cart heights of 0.95m to 1.1m may be used depending on the location - next to a lectern or table. An output plate on the bottom side of the cart is recommended for ease of use and recognition of cabling. Receptacles shall be provided in floor box(es) for connection. Location(s) for A/V cart shall be considered. A/V cart should consider ADA for ease of use from a wheelchair. Millwork finishes should be considered. (Several vendors have been approached to standardize the design and cost. The Administrative Office's Space and Facilities Division may be contacted for further information.) Computer, auxiliary video, and audio connections should be provided. Where a host computer is provided at the lectern, an additional cart may be used. (See Figure #30 on page 6-5)

2. VCR

A VCR should be provided in the cart with SVHS capability, hi-fi audio, front auxiliary inputs, at least four (4) heads, and video stabilization for stable still-frame images. A portable infrared control is appropriate.

3. Annotation System

An annotation system with control tablet having icon selection, light pen, color selection, and erase shall also be provided in the A/V cart with processor in the A/V rack and input from the witness touch screen. Alternately, the tablet may be used by the clerk with annotation available at the A/V cart and witness monitor. Receptacles for annotation shall be provided, typically using a power supply and a DB-9 connector. When the distance from the A/V cart to the annotation tablet is greater than 5 meters, line drivers may be necessary to provide sufficient signal strength to ensure proper operation. If line drivers are necessary, then their power and space requirements need to be considered during the design phase.

4. Witness Box Document Camera

An alternative or addition to the document camera on the A/V cart is a ceiling-recessed document camera over the witness box work surface. This provides the witness with the document, as opposed to the attorney. The former is more traditional, and the latter is more powerful for the attorney, allowing the attorney to adjust or zoom the image from the A/E cart for emphasis.

The camera may be recessed in the ceiling with 45cm of ceiling height, using camera mount with slide-out assembly. A door with a hole and matching ceiling finish is provided for access. The document camera is typically a three (3) 12mm CCD 750-horizontal

A VCR should be provided in the cart with SVHS capability, hi-fi audio, front auxiliary inputs, at least four (4) heads, and video stabilization for stable still-frame images. A portable infrared control is appropriate.

An annotation system with control tablet having icon selection, light pen, color selection and erase shall also be provided in the A/V cart with processor in the A/V rack and input from the witness touch screen.

X 400-vertical element with 750 lines and 3 lux minimum camera with remote control. An RS232 to RS422 converter may be needed. A 12:1 zoom is appropriate with remote control. Marks may be placed on the witness work surface to allow camera alignment.

Another alternative camera on the A/V cart is a millwork-mounted gooseneck camera. Gooseneck cameras must be evaluated for user-friendly operation.

5. Video, S-video, and Computer Inputs

Inputs consisting of video (NTSC/BNC), S-video and computer (HD15 or BNC RGBHV) shall, at a minimum, be provided at the A/V cart floor box, clerks station, and one (1) defense and one (1) prosecution table floor box. HD-15 receptacles save space and are simple to connect, but require special skill to field assemble and require quality control. The HD-15 receptacle may be provided with a shop-installed pigtail allowing easier field wire connection. Optional additional inputs may be provided at the additional lectern location (jury summation), attorney tables, at the bench for jury instructions and at the reporter for transcript from their computer. Inputs at attorney tables may also be routed up to the plate in the tabletop. Receptacles shall be evaluated for durability to assure long term reliability.

6. Video Rack

Video rack should be a 48.26cm EIA standards for video equipment. A 1.8m tall rack will accommodate audio and video. A master power switch must be provided. A color and black burst generator may be provided in the equipment rack. Racks may be shared with audio equipment. Existing audio racks may be augmented with a separate video rack. (See Figures #26 and #27 on pages 5-11 and 5-12)

7. Switcher/Doubler/Amplifier

Video equipment will consist of RS-232 controlled video/S-video/RGBHV switches and a line doubler. Suitable RGB bandwidth is 300 MHz and 50 MHz video shall meet RS170A. Line doubler, quadrupler, or video scaler should be coordinated with sync to assure compatibility. A suitable number of inputs are at least six (6) of each type. Piggyback 6-in/1-out RGBHV, video/S-video switches on to a combination 4-input switch/doubler should be considered. A black input or no input on a RGB switch shall be provided to generate black on the gallery and jury monitors for judicial review. RGBHV distribution amplifiers shall be provided as needed. Larger matrix type switches are appropriate in very large systems and may be considered if the cost is within the budget. (See Figure #31 on page 6-7)

An alternative or addition to the document camera on the A/V cart is a ceiling-recessed document camera over the witness box work surface. This provides the witness with the document, as opposed to the attorney.

Inputs consisting of video (NTSC/BNC), S-video and computer (HD15 or BNC RGBHV) shall, at a minimum, be provided at the A/V cart floor box, clerks station, and one (1) defense and one (1) prosecution table floor box.

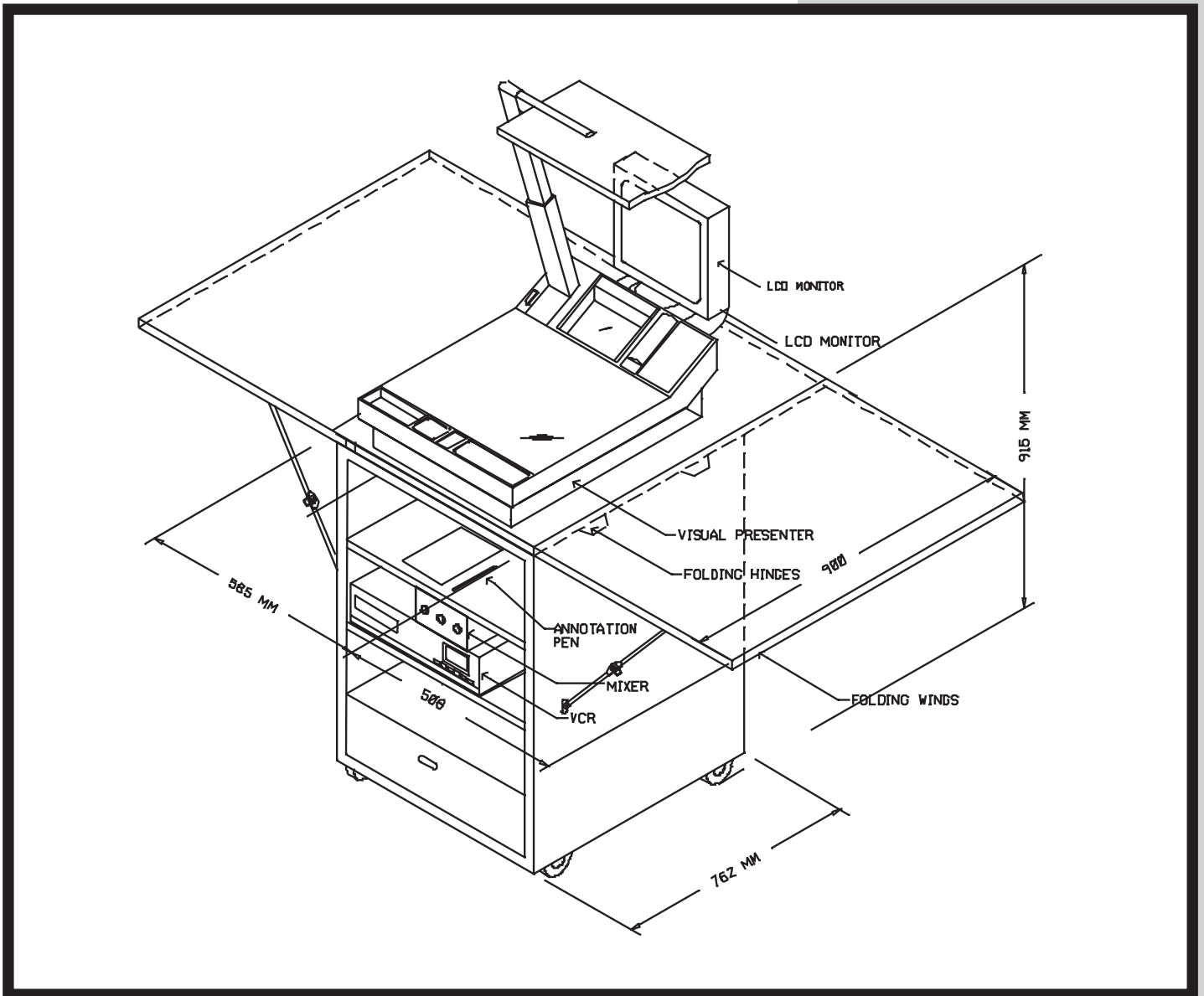

U.S. COURT - AUDIO VISUAL CART / CAMERA STAND
 FIGURE 30

FOR ILLUSTRATIVE
 PURPOSES ONLY.



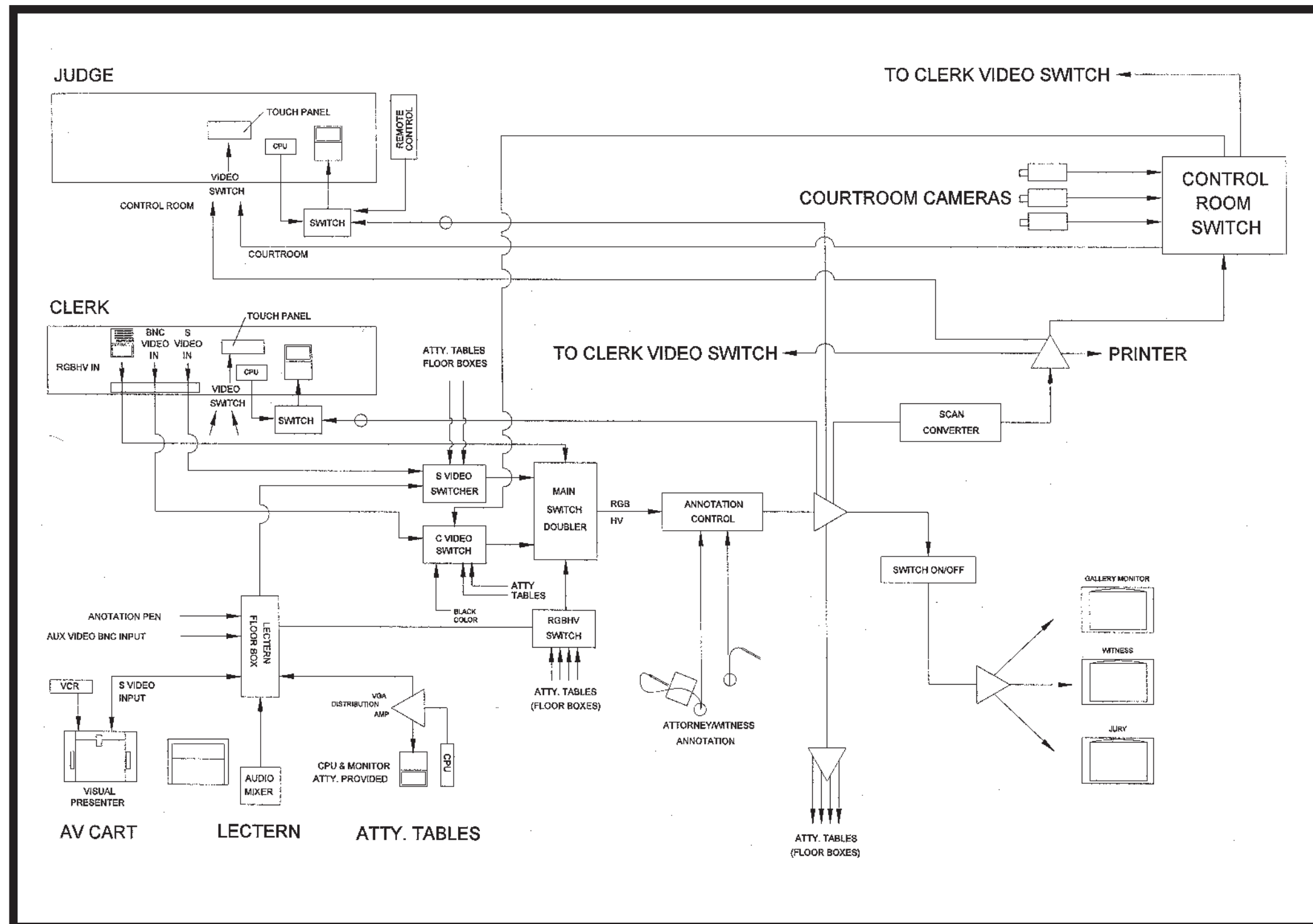

U.S. COURT - VIDEO BLOCK DIAGRAM
 FIGURE 31

FOR ILLUSTRATIVE
 PURPOSES ONLY.



8. Scan Converter

A scan converter on the RGBHV output is needed for the printer and for feeds if video conferencing is used. Distribution of the evidence signal in NTSC format to the central processing area shall be considered. It shall be multi-scanning up to 1024 X 768 (50 kilohertz horizontal) with composite NTSC video output meeting RS170A.

9. Video Printer

A video printer with standard photo size (120mm X 90mm) is acceptable. Printer shall have resolution of over 500 lines with 256 graduations over 16 million colors per pixel.

10. Flat Panel Monitors

a. Judge and Clerk

The judge and clerk may be provided with a minimum 35cm diagonal active matrix LCD flat panel color monitor with maximum 1024 X 768 resolution at 75Hz, 16-million colors, 120:1 contrast ratio, full screen VGA, SVGA, and XGA formats, 45-degree horizontal viewing, and meeting Energy Star VESA and TCO standards. These standards may change with improving technology. The A/V consultant will provide information on monitor specifications during the design phase. Wiring shall be high-resolution type. A switch to allow viewing of the judge's/clerk's CPU or video evidence is recommended. Knee space receptacles with extra wire length shall be provided for a clean cable appearance. Power shall be conveniently provided. (See Figure #31 on page 6-7) Wiring for these arrangements shall use high-resolution wire to meet the system bandwidth. Provide HD-15 or RGBHV BNC receptacles in appropriate locations.

b. Witness

Witness shall have a similar monitor with touch screen annotation and receptacles. Receptacle for video and annotation shall be provided for a clean cable appearance. Power shall be conveniently provided.

11. Attorney Monitors

Attorney tables may also have flat panel monitors. This will be most commonly used with a multiple small monitor evidence presentation system. Some consideration may be given to recessing CRT type monitors in the attorney tables either partially or completely under anti-glare glass. Provide HD-15 or RGBHV BNC receptacles in appropriate locations.

12. Jury Box Monitors

Juror pairs may share 35cm monitors when the multiple small monitor video evidence presentation system is used. The monitors for the first row of jurors are integrated into the jury box rail. The second row of monitors shall be mounted on either an additional jury rail or posts. Monitor mounts will need detailing to consider site lines, visibility, and aesthetic requirements. Receptacles for video shall be provided for a clean cable appearance. Power shall be provided. Wiring for these arrangements shall use high-resolution wire to meet the system bandwidth. Jury box monitors shall have a remote control on/off switch for ease of operation. (See Figures #32 and #33 on pages 6-10 and 6-11)

13. Large Monitors on Carts

Alternately, jurors and attorneys may view large .9m or larger monitors on portable carts; with up to 60KHz horizontal and 75Hz vertical scan rates and auto locking. Provide remote on/off via RS232 control. Typically, one (1) cart faces the jury and one (1) faces the attorneys. Cart heights in the well shall be designed to be low enough to allow good site lines, 1.1m is a good total height. Carts shall have integrated wire management for power and cables. Jury railings should not be higher than 0.9m with a 150mm platform to see the bottom of the screen. Monitors shall be VGA, SVA, and XGA full screen capable with sufficient contrast. HD-15 or RGBHV BNC connectors shall be located at appropriate locations, providing flexibility for future use. The A/E and A/V consultants shall consider the glare from the artificial and/or natural daylighting sources in the courtroom. (See Figures #34 and #35 on pages 6-12 and 6-13) A monitor for the other end of the jury box or the public gallery may also be provided.

14. Projection Screens

A single projection screen can be used to establish a singular focus for the jury, attorneys, and the spectators. The projection screens shall be remote controlled from the clerk's station, motorized and use a recessed ceiling mount. A matte white screen surface generally provides the best wide-angle viewing. Image or screen size is a function of readability with 10-point 80-character line text at the required distance. (Character size shall meet Da-Lite Screen Company Volume IV, No. 8 'Angles of View' standards.) Screens are usually located across from the jury or behind the witness in the corner and are 2.5m to 3.5m wide. (See Figures #36, #37, and #38 on pages 6-14, 6-15, and 6-16, respectively.) Screen height may be adjusted by specifying extra screen length to maximize available image size. Likewise, the screen width could be extended to maximize available space. A 4:3 aspect ratio (width to height) will be replaced by a 16:9 ratio, but this does not address the portrait



U.S. COURT - FLAT SCREENS
FIGURE 32

FOR ILLUSTRATIVE
PURPOSES ONLY.



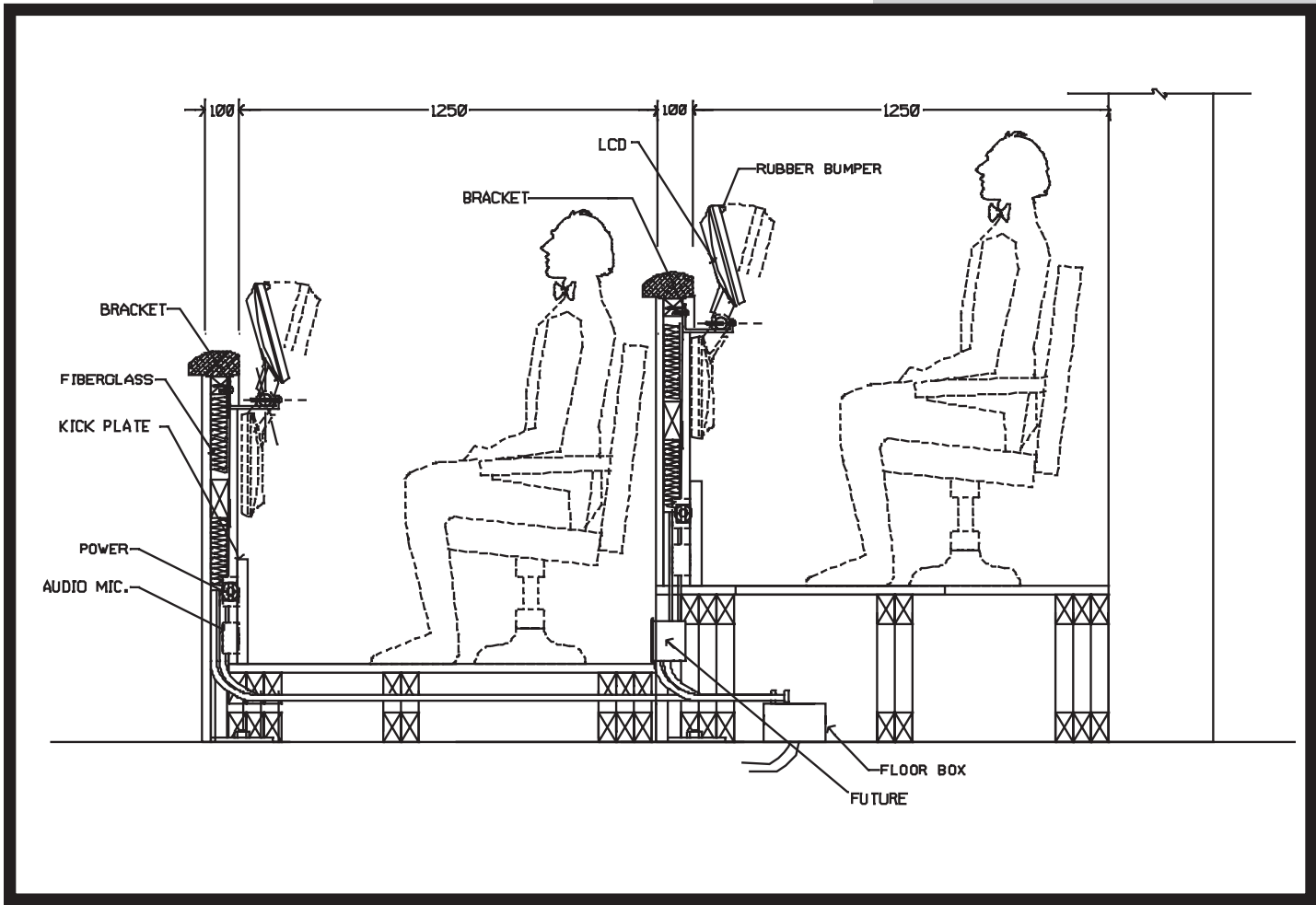

U.S. COURT - JURY BOX / FLAT SCREEN
 FIGURE 33

FOR ILLUSTRATIVE
 PURPOSES ONLY.



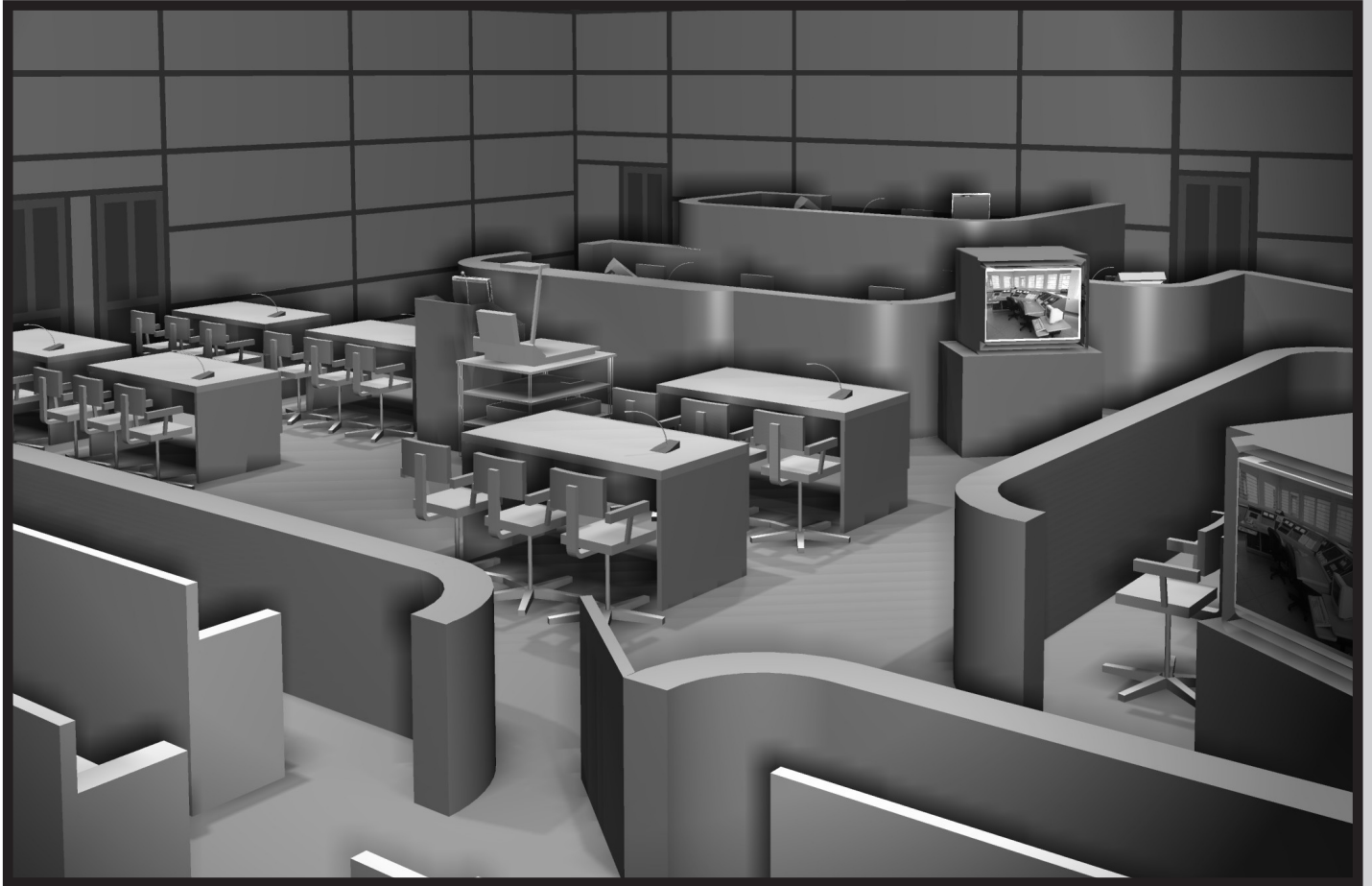

U.S. COURT - PORTABLE LARGE MONITOR
FIGURE 34

FOR ILLUSTRATIVE
PURPOSES ONLY.



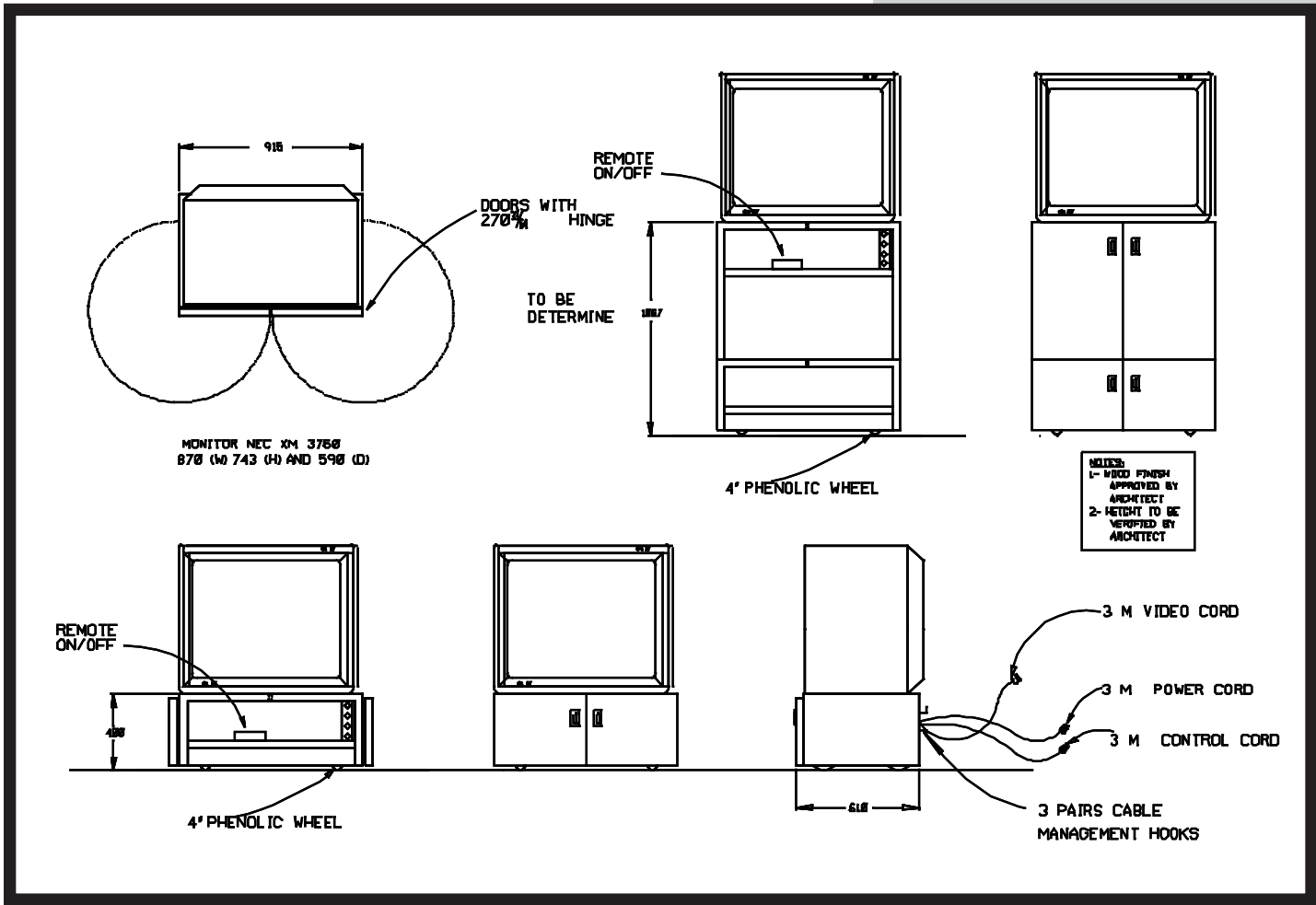

U.S. COURT - PORTABLE LARGE MONITOR DETAILS
FIGURE 35

FOR ILLUSTRATIVE
PURPOSES ONLY.





U.S. COURT - BIG SCREEN
FIGURE 36

FOR ILLUSTRATIVE
PURPOSES ONLY.



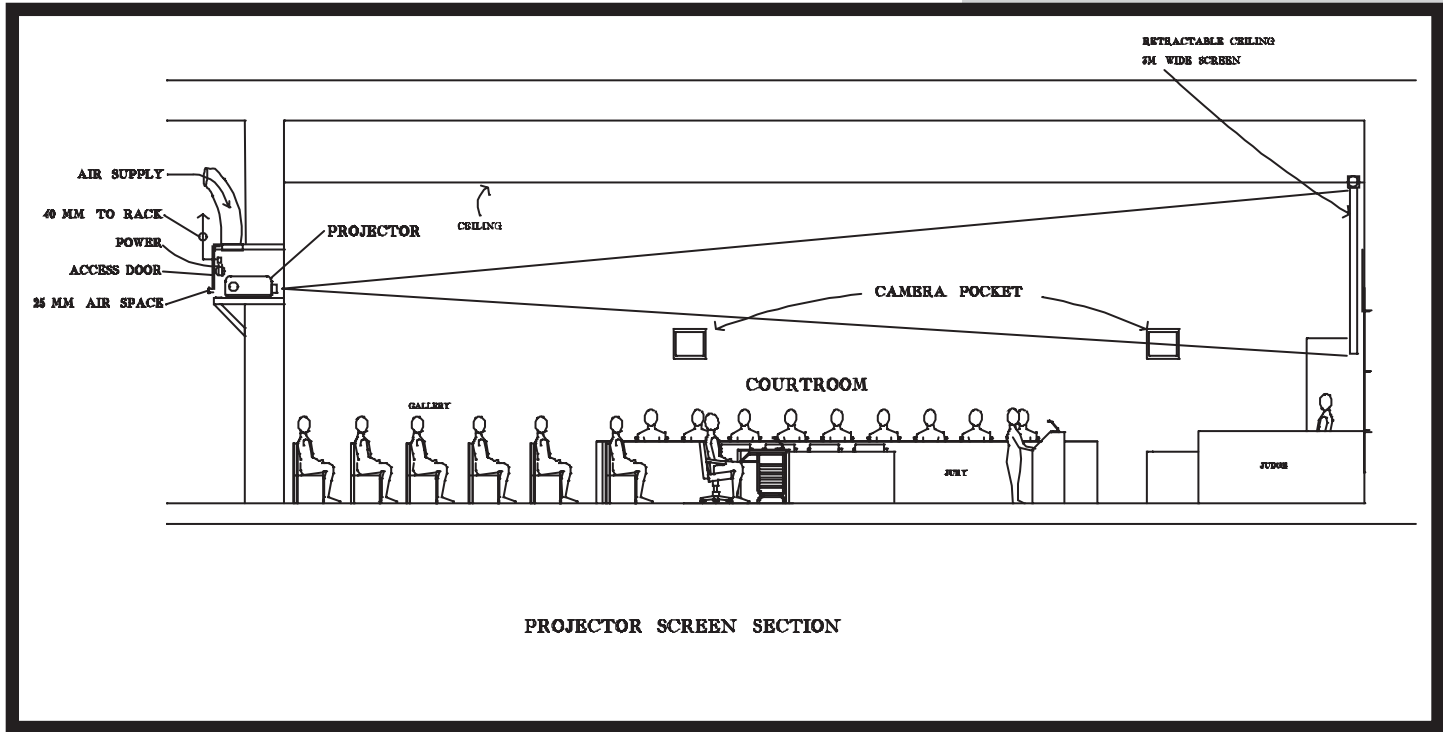

U.S. COURT - PROJECTOR/SCREEN DETAILS
 FIGURE 37

FOR ILLUSTRATIVE
 PURPOSES ONLY.



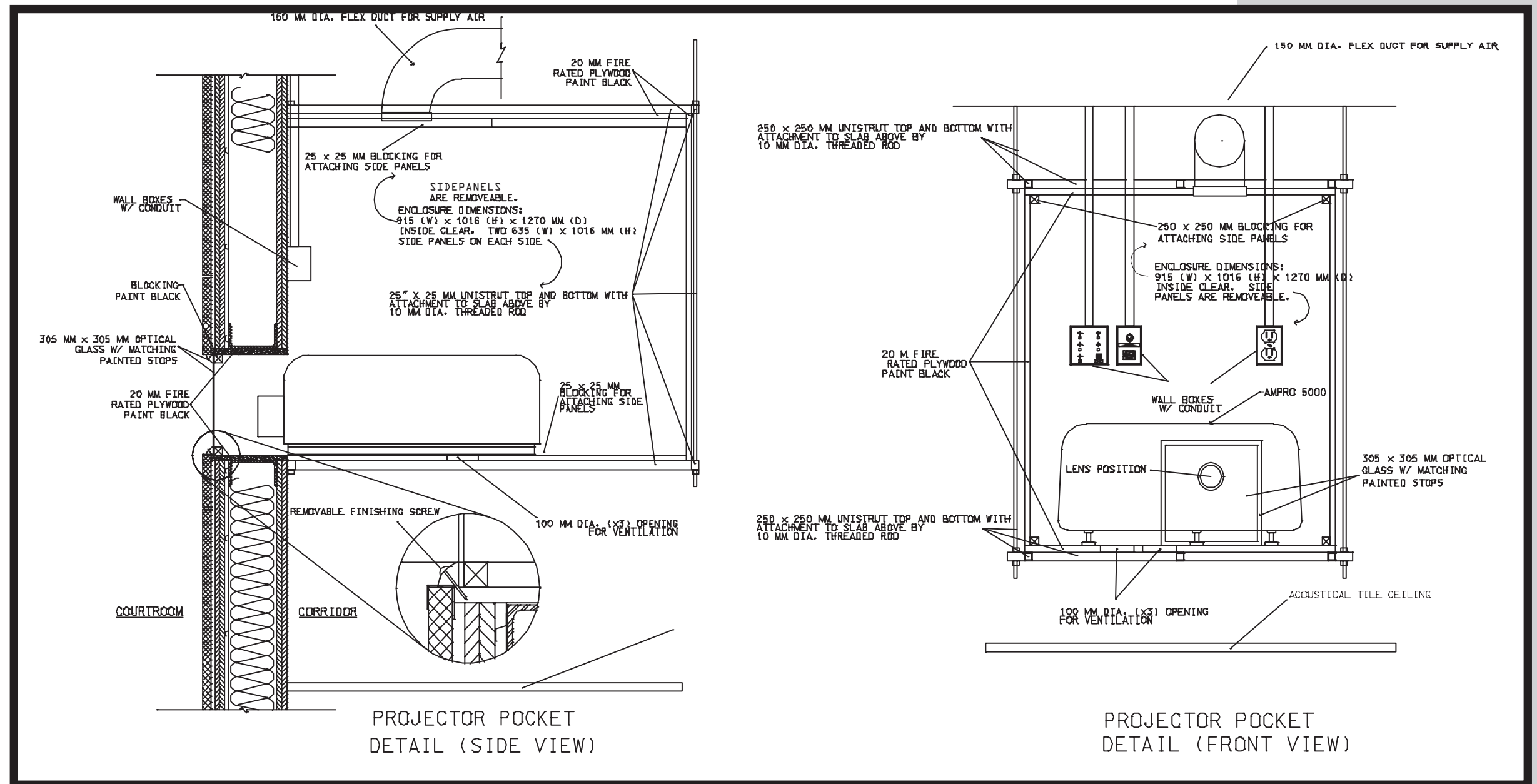

U.S. COURT - PROJECTOR POCKET DETAILS
FIGURE 38

FOR ILLUSTRATIVE PURPOSES ONLY.



document size requested by the court. *This issue must be addressed by the A/V consultant in the design phase.*

15. Video/Data Projectors

Video/data projectors shall have sufficient brightness and resolution to meet the readability test. Generally, 1,000 to 1,500 ANSI lumen at a 120:1 contrast ratio with 1024 X 768 resolution is recommended. A general rule of 250 lumens per sq ft is recommended. In portable installations, 750 lumens have been acceptable where screens are located within 7 meters to the jury box. A portable projector will need a cart. Minimizing the impact of cooling fan noise should be a consideration when locating and selecting the projectors. Projector cart shall have integrated wire management for power and cables. Power and HD-15 or RGBHV BNC connectors shall be provided in the appropriate location.

16. Monitor Connections

Monitor connections shall be provided at the bench, clerk's work surface, reporter's work surface, attorney tables, A/V cart floor box, witness-box, jury box, gallery, and projector locations (if used). Provide high-resolution RGBHV wire with no more than 5dB loss. BNC connectors are appropriate. HD-15 connectors are also appropriate, save space, and are easy to use.

17. Control Systems

Control systems should include control panels for the judge and clerk with a programmable processor. Button controls or touch screen may be considered depending on the number of control functions. Controls should include:

- Input select
- Black for jury and gallery monitors
- On/off for jury/gallery monitors
- Judge's/clerk's CPU or video evidence input to their monitors.
- Auto power shut down for excessive heat.

Selection of pre-set scene lighting, shade open/close and screen up/down may also be provided. (See Figure #39 and #40 on page 6-18 and 6-19)

18. Millwork

Integration of technology into the millwork should be provided as follows.

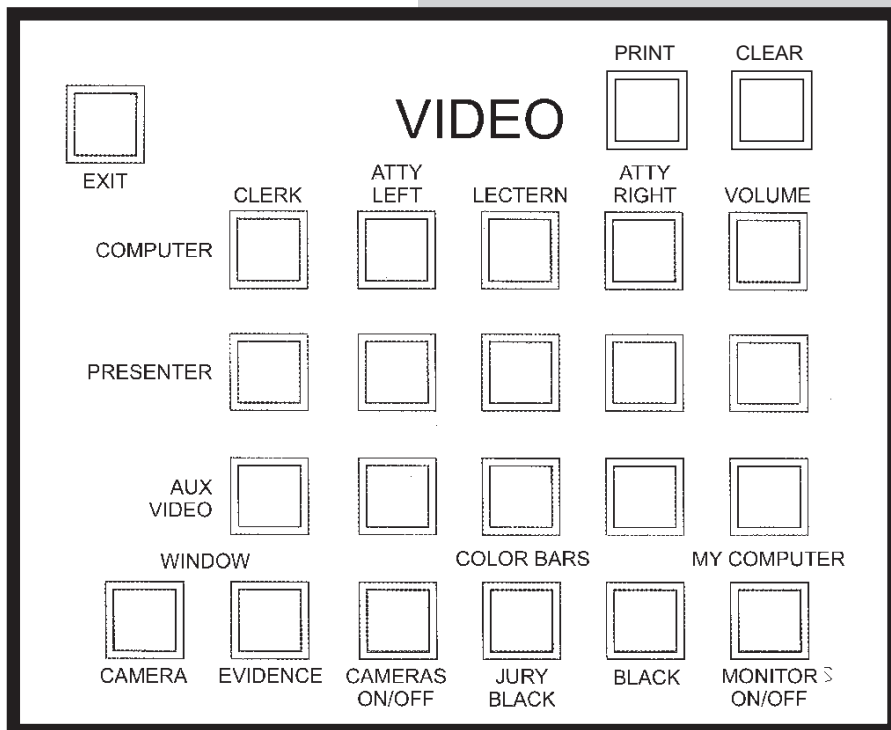
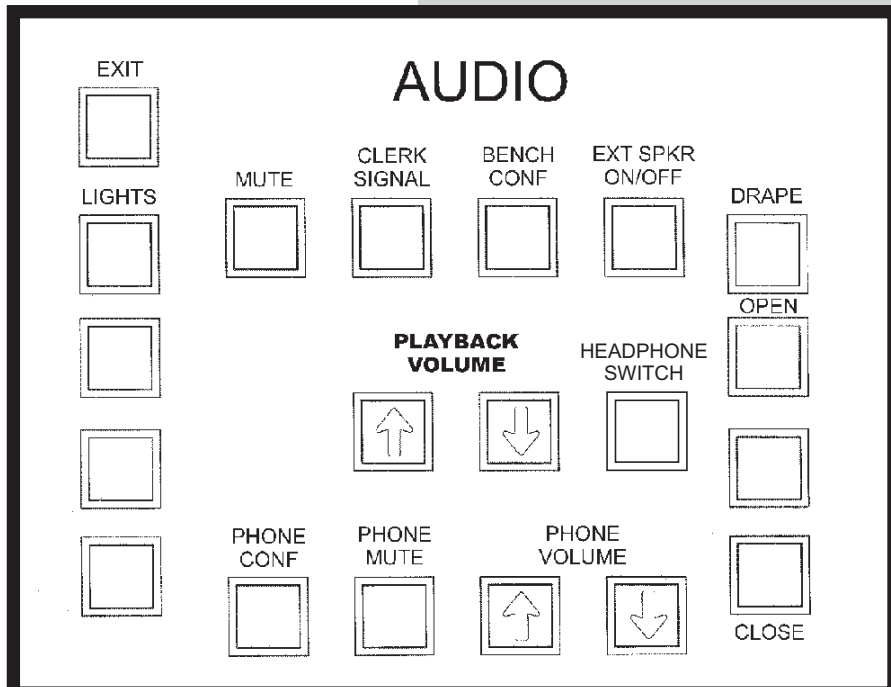

Note:

1. Camera on defaults to Video Conference
2. Camera off sends color bars and mutes audio send
3. Provide camera controls
4. My computer toggles to government provided CPU and back to presentation input

U.S. COURT - AUDIO/VIDEO TOUCHPANEL BASIC SCREEN
FIGURE 39

FOR ILLUSTRATIVE PURPOSES ONLY.



UNITED STATES DISTRICT COURT
MIDDLE DISTRICT OF PENNSYLVANIA



AUDIO

VIDEO

VIDEO CONFERENCE

CAMERA

U.S. COURT - TOUCHPANEL BASIC SCREEN
FIGURE 40

FOR ILLUSTRATIVE
PURPOSES ONLY.



COURTROOM TECHNOLOGY MANUAL

a. Bench

Pullout trays may be provided for laptops to the left and right of the judge's seat with convenient power/modem/LAN connector. Cable management in the knee space with a horizontal plug-mold and two-compartment low voltage raceway are recommended. A slot or grommets near the edge of the judge's work surface provides for cable passage. Monitors are not normally recessed into the work surface since this limits flexibility, however specific situations may require this feature. A removable floor panel should be provided for cable access to the sub-floor.

The judge's technology items include: gooseneck microphone, bench conference microphone, monitor, control panel, computer, and laptop.

b. Clerk's Station

Provisions for technology integration as described above for the judge's bench should be provided for the clerk. In addition typically, a 5-gang input plate in the ledge above the work surface for inputs/outputs shall be provided. Provide a removable access floor panel.

Clerk's technology items typically include: microphone, monitor, control panel, computer, input/output panel, and printer.

c. Reporter's Station

Provide a five-gang box (or other appropriate boxes) for real time transcription and tape recorder input/outputs. Reporter's technology items include: transcription stenography machine, laptop, tape recorder, and optional monitor and microphone. Provide a removable access floor panel.

d. Witness Box

Provide a fixed 50cm gooseneck microphone on the ledge and space for a monitor. Recessing the monitor location should be considered to improve site lines. Monitor location should be in the direction of the jury. Provide a removable access floor panel. Witness technology items include: fixed gooseneck microphone and monitor. Annotation system shall be provided with touch capability or light pen.

e. Jury Box

The jury box railing should have microphone receptacles at each end. Provisions for display systems should be considered. A kick plate may conceal a horizontal cable management system.

A second row rail or posts may be needed if jury monitors are to be used. Provide removable access floor panel on each level.

f. A/V Cart

A/V carts shall have wheels with sliding trays or folding work surfaces. Shelves shall be provided for VCR, annotation tablet and audio mixer. Cart heights of 0.95m to 1.1m have been used depending on the location - next to a lectern or table. An output plate on the bottom side of the cart is recommended for ease of use and recognition of cabling. A/V cart should consider ADA for ease of use from a wheelchair. Millwork finishes should be considered. (Several vendors have been approached to standardize the design and cost. These vendors should be available for consideration.)

g. Lectern

A lectern shall be provided with a microphone, and must be ADA compliant, or an ADA lectern shall be available.

h. Attorney Tables

Attorney tables are being developed for inclusion in the GSA schedule. These tables utilize support pedestals which have a removable inside face for cable management. A door is provided with a plate for receptacles over the pedestals. Receptacles may be arranged in groups for power, phone/data and AV. Brushes are provided on two (2) sides of the door to allow cable passage with the door closed. Pedestals shall align with floor boxes to minimize wire visibility. Monitors may be recessed using anti-reflective glass. CPU space should be considered for future 'paper-less' courtrooms. (See Figures #41 and #42 on pages 6-21 and 6-22, respectively)

The attorney's technology items include: microphone, monitor option, and laptop/computer option.

i. Gallery Railing

A microphone receptacle may be provided on the jury box side or on both sides of the gallery railing. A monitor outlet, power, and remote control receptacle may be provided for portable monitors.

The gallery technology items include: microphone(s) and monitor(s).

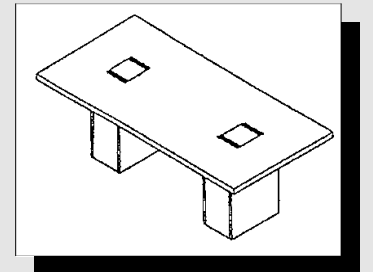
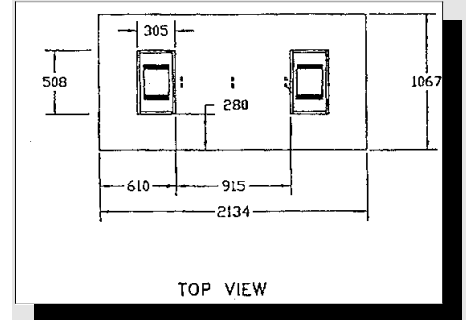
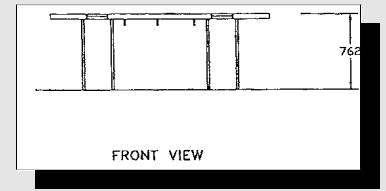
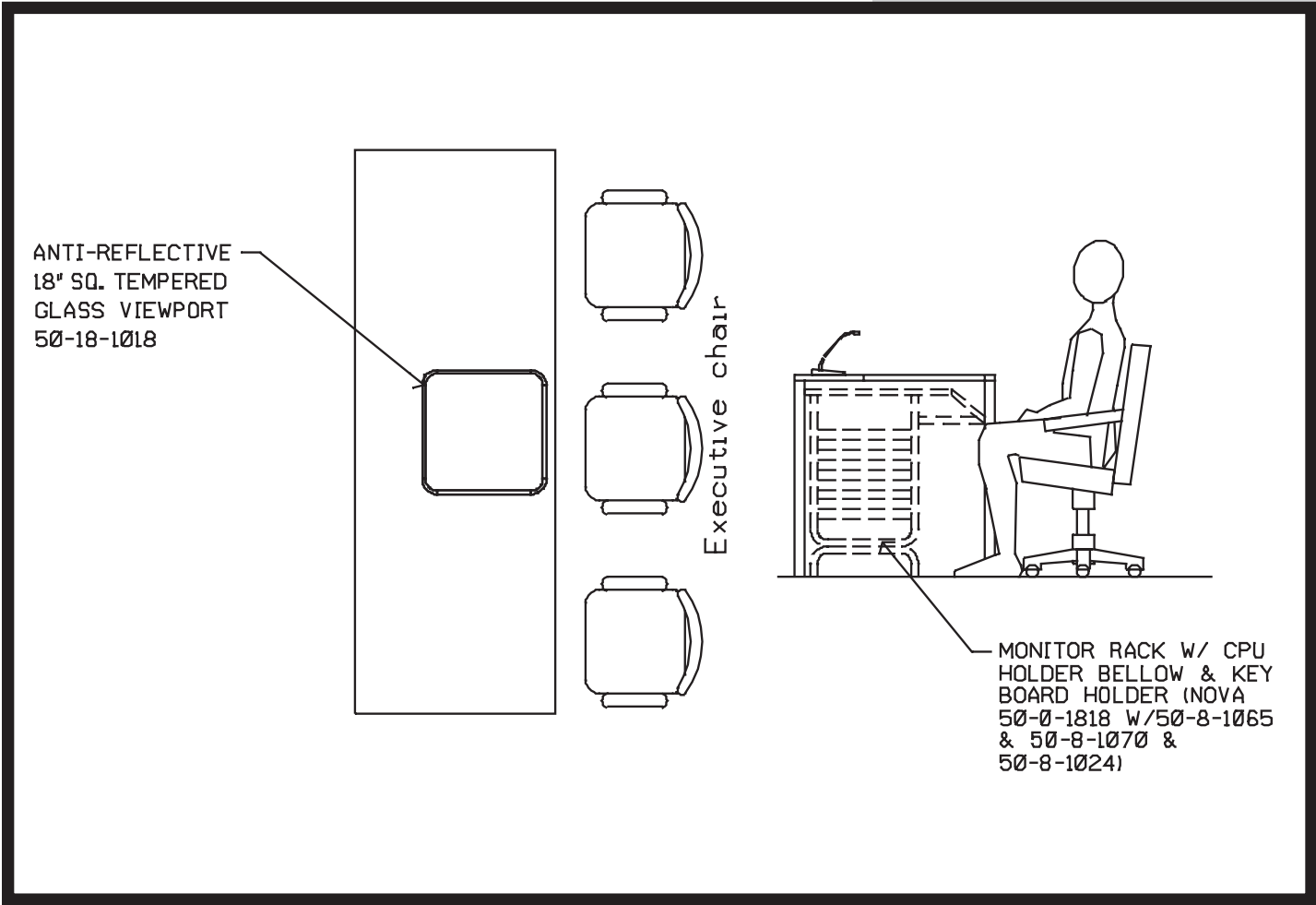

Figure 41
Attorney's table

The attorney tables are being developed for the GSA schedule, using pedestals with the inside face removable for cable management. A door is provided with a plate for receptacles over the pedestals.



U.S. COURT - ATTORNEYS TABLE / BUILT IN MONITOR
 FIGURE 42

FOR ILLUSTRATIVE
 PURPOSES ONLY.



19. Real Time Transcription

Distribution of real time transcription shall be provided from the reporter's station with separate feeds to the judge, clerk, disabled juror location, and attorney floor boxes via dedicated RJ-45 connectors. In some cases, the reporter's output is sent to a reporter's room where editing is accomplished and the signal is returned back to the courtroom reporter. This can be accomplished via the data wiring patched at the data riser room.

B. Computer Considerations

The clerk's computer can be used as a host for attorney-provided discs. A barcode scanner can be used to recall specific images. In this design, the clerk's image output is connected to the video evidence input switch. Alternately, the 'host' computer cable could be located on the A/V cart.

The clerk's computer can be used as a host for attorney provided discs. A barcode scanner can be used to recall specific images.

The clerk's computer and a courtroom network, providing a database with court record, evidence, and transcription would save time and reduce paperwork. A courtroom network would serve the judge and attorneys with a physical disconnect to maintain security. A software organizer/search engine with a menu for scanned documents would organize document retrieval. Future space should be considered for a CPU/monitor at each attorney's station, with network connections. These computers would also be selectable by the judge/clerk for evidence display.

C. Specifications

Specifications are a necessary part of a complete design, and should be presented in a format suitable for bidding purposes. A sample specification is enclosed in the appendix. The recommended format for specification sections is as follows:

1. General

Instruction to bidders, overall scope, and timing requirements.

2. Products

Products using GSA schedule equipment are recommended for cost control.

3. Execution

Minimum installation standards for quality control.

Contractor testing with test report.

AOUSC inspection resulting in written acceptance or rejection.

Warranty, usually one (1) year from acceptance date.

Requirement for on-site training of all personnel by the A/V contractor.

As-built schematics, equipment manuals, instructions, and blank "log book" for each space.

4. Costs

Spreadsheet with equipment list and blank areas for vendors to fill in costs. Provide the AOUSC with the spreadsheet having the estimated costs filled in by the designer.



SECTION VII Video Conference Standards

Generally, in new courthouses the courts have regarded a central processing area with audio, video, and control system connections to each courtroom as appropriate to achieve centralized control, maintenance, and ease of programming. Speed dials and other controls may still be activated from the courtroom via the (RS 422) control connection. Alternately, video conference systems may be built into a courtroom or use a portable system, particularly in retrofit applications. The following information has been prepared as guidance for designing and specifying video conference systems for U.S. Courthouses.

A. Control Areas for Central Video Conference Processing

1. Work Station

A workstation with a monitor bridge and two (2) pedestals with rack mounts and an adjacent rack typically is provided. The workstation provides for a computer operating on the LAN and controls the video conference system. Normally, this computer is supplied by the courts to assure LAN compatibility. The monitor bridge may support four (4) monitors to view the multiple courtroom cameras and remote site video. Two (2) master power switches with three (3) 20-amp clean power circuits are required. (See Figure #43 on page 7-2) The computer may have scheduling software for coordination via the LAN.

2. Hub

A video matrix acts as a hub for connections to the courtroom cameras, video evidence presentation, and CODEC in the control area. An audio matrix acts as a hub to the CODEC ports on the telephone interface in the courtroom A/V rack and to the CODEC. The matrices are computer controlled via the control area system, which is linked via RS-422 to the courtroom system. This provides for programming and maintenance in the control area with speed dial and other functions from the courtroom. The courtroom audio mixer can also provide active microphone information to the courtroom control system, which can then send camera selection commands via the RS-422 link to the central processing area for activating the matrix to the programmed camera. Manual camera selection may also be provided from the courtroom or control area. A color bar generator may be provided to the matrix for transmission of a test signal and a character generator may be provided to generate a message to the remote site and courtroom. (See Figure #44 on page 7-3)

Generally, in new courthouses the courts have regarded a central processing area with audio, video, and control system connections to each courtroom as appropriate to achieve centralized control, maintenance, and ease of programming.

A workstation with a monitor bridge and two (2) pedestals with rack mounts and an adjacent rack typically is provided.

A video matrix acts as a hub for connections to the courtroom cameras, video evidence presentation (if used) and CODEC in the control area. An audio matrix acts as a hub to the CODEC ports on the telephone interface in the courtroom A/V rack and to the CODEC.

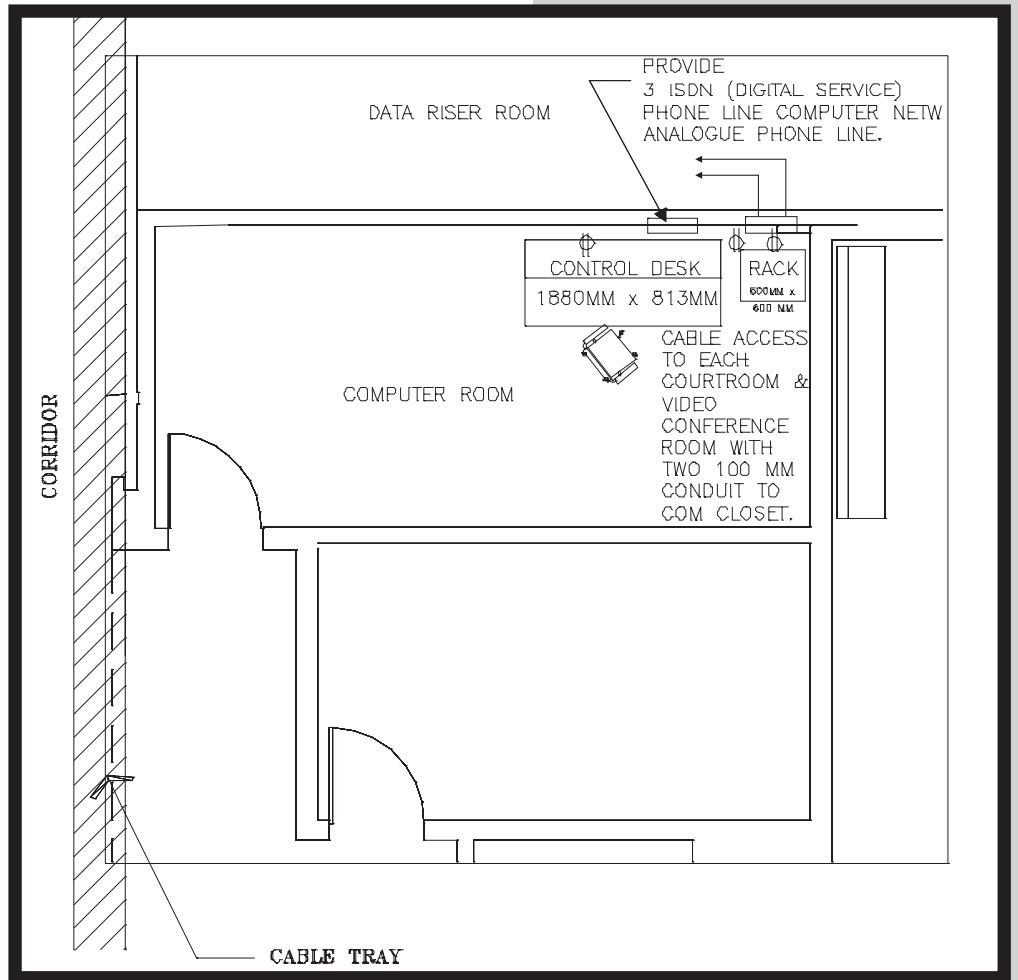

**U.S. COURT - TYPICAL CONTROL AREA
FIGURE 43**

FOR ILLUSTRATIVE
PURPOSES ONLY.



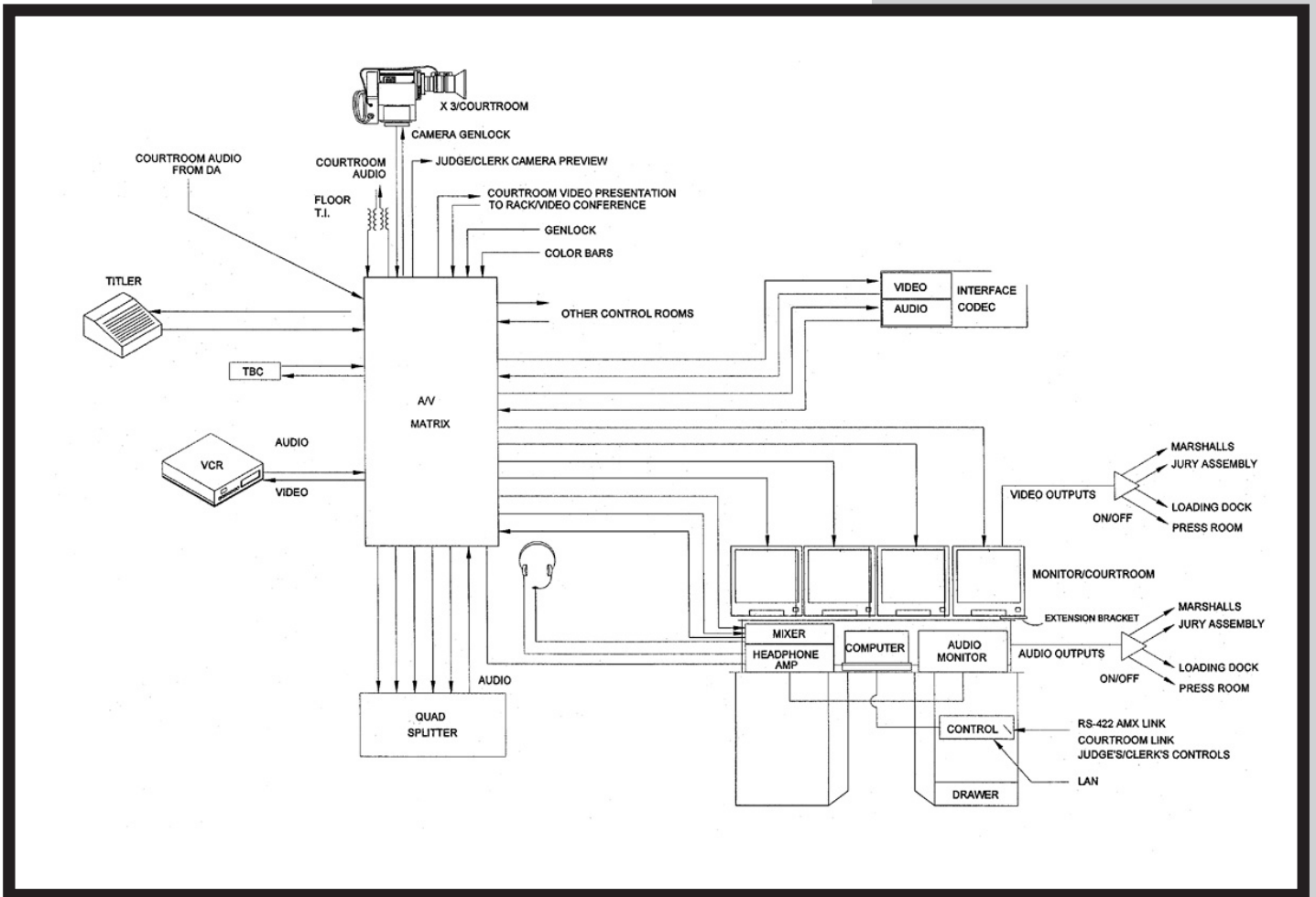

U.S. COURT - CONTROL ROOM BLOCK DIAGRAM
FIGURE 44

FOR ILLUSTRATIVE
PURPOSES ONLY.



3. Courtroom Camera Images

Up to four (4) 33cm monitors may be arranged on the worktable monitor bridge for viewing of the courtroom cameras and remote site signals. A quad-splitter is provided to view all courtroom cameras on one (1) screen if desired. A synchronizing signal (genlock) is provided to the cameras to maintain vertical hold on the TV images. A time base corrector is provided to sync the video evidence feed from the courtroom.

Up to four (4) 33cm monitors may be arranged on the worktable monitor-bridge for viewing of the courtroom cameras and remote site signals.

4. Audio Monitoring

A headphone amplifier, mixer, and headset is provided to allow audio monitoring via the audio matrix output and to speak via the headset microphone with a press-to-talk button, allowing the control room operator to communicate with the courtroom or remote site.

5. Video Conferencing

A CODEC (code/decoder) is provided for video conferencing with at least three (3) ISDN BRI lines (384 kbits/sec), 30 frames per second, picture in picture (receive/send pictures), graphic interface, minimum 10-memory speed dial, and RS-232 control port. Operating speeds up to 768 kbps, down to 64 kbps (in the event of bit errors) and in multiples of 56 kbps are desirable. CODEC shall meet the following standards for compatibility: H.320 (px64), H.261, H.221, G.728, G.722, G.711, ITU.281, H.243, T.120. ISDN lines will need network terminators for each BRI line. The AOUSC Office of Information Technology is investigating multi-point and other terminations for future considerations.

In retrofit applications, where space is not available for central processing, and/or the budget and needs are not appropriate, video conference equipment may be dedicated in a courtroom or a portable unit may be provided. In this case, the CODEC may be in the A/V rack, or in a portable console with hook-up to the telephone interface, additional cameras and a control system.

6. Computer Control Interface

A computer control interface shall be used with a card frame arrangement for RS-422 links to the courtrooms, and RS-232 commands to matrices and CODEC. A PC interface with client server hardware is recommended providing mouse control commands from the PC. Schedule software should also be available on the LAN for arranging video conferencing and scheduling.

B. District and Bankruptcy Courtrooms

1. Video Cameras

Provide up to four (4) video cameras arranged for: judge, witness, lectern plaintiff, and lectern defendant. Provide up to three (3) cameras when only one lectern is used. Cameras should be arranged for optimum shots providing zoom for sufficient detail. A minimum 6x zoom lens is recommended. A single 8mm CCD camera with 420 lines and 7 lux minimum is acceptable. Cameras having three (3) 12mm CCDs with 750 lines and 4 lux minimum are an option. Cameras are best recessed in wall pockets about 36cm wide, deep and high and 2.5m above the finished floor. Camera pockets with four (4)mm optical glass provides an undistorted color image. Pan, tilt, and zoom remote control functions are not standard but may be provided if necessary. Cameras built into the millwork or monitors for views of the lectern(s), etc. may be considered. Normally, cameras will be tested and videotape made to coordinate with the judge to determine the proper pan, tilt, and zoom settings. An RS 422 adapter may be used to provide camera control at distances over fifteen (15) meters and genlock is provided for synchronization. The camera power supply is best located in the A/V rack or central video conference processing area. Video wire shall be selected to provide less than 5dB loss for the length used. (See Figure #45 on page 7-6)

Provide up to four (4) video cameras arranged for: judge; witness; lectern plaintiff; and lectern defendant. Provide up to three (3) cameras when only one lectern is used.

2. Judge, Clerk, and Witness Monitors

Judge, clerk and witness will be provided with minimum 35cm video monitors. The judge's and clerk's monitors shall have an input control to allow viewing of the remote site or active courtroom camera. A picture-in-picture CODEC control is also effective for active camera viewing.

3. 90cm Monitor

A large 90cm video monitor may be provided on a portable cart for the attorneys in a location aligning with the cameras to simulate eye contact. A high-resolution monitor for use with computers is an option.

4. Touch Screen Control

The judge and clerk should have touch screens with similar controls. The touch screen control shall provide:

- Speed dial
- Manual dial
- Quad split image
- Auto camera select
- Evidence camera send

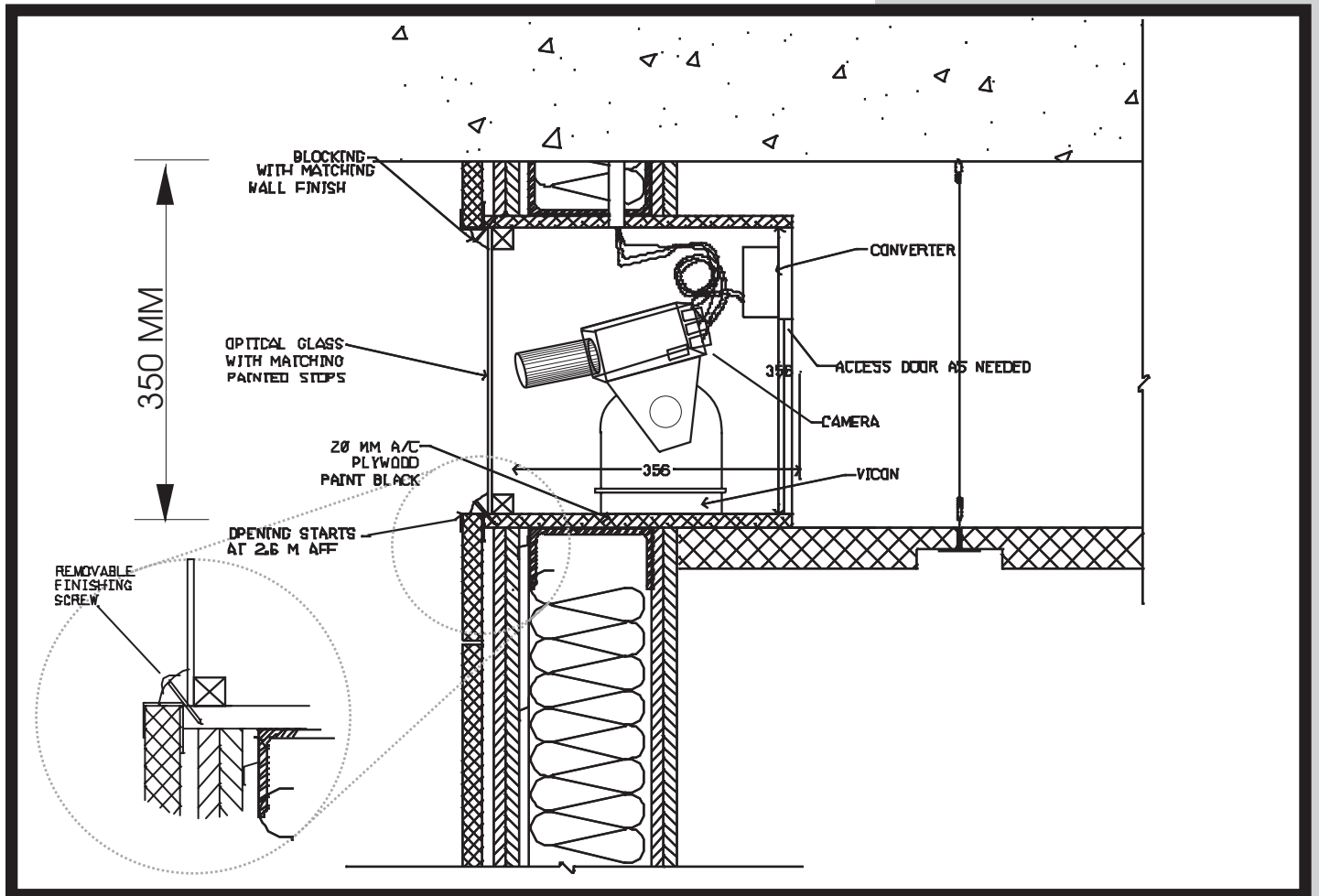

U.S. COURT - CAMERA POCKET
FIGURE 45

FOR ILLUSTRATIVE
PURPOSES ONLY.



- Mute audio/color bars
- Picture-in-picture
- Remote site volume up/down.
- Remote site camera control.

A separate page for camera controls and CODEC dialing should be provided. The processor shall be programmable with suitable RS232/RS422 ports. (See Figures #46 and 47 on pages 7-8 and 7-9)

5. Video Evidence Presentation

Video evidence presentation systems in courtrooms may be used to provide video of the remote site via the control room. Judge's and clerk's monitors shall be provided with a second video feed of the active courtroom camera with a switch. Alternately, picture-in-picture may be used, on the judge's and clerk's monitors only. Video evidence for the evidence camera, etc. may be transmitted via the graphics port on the CODEC.

Video evidence presentation systems in courtrooms may be used to provide video of the remote site from the control room. Judge's and clerk's monitors shall be provided with a second video feed of the active courtroom camera with a switch.

C. Appeals Courts

1. Cameras

Cameras in a panel courtroom (three judges) have a camera for each judge and a camera for the lectern. A quad-splitter may be used to view all participants on one (1) screen. Cameras for the judges are usually located in a recessed wall pocket above the public entrance door.

2. En Banc Court Cameras

An En Banc court (nine or more judges using a horseshoe shaped bench) will need one (1) camera for overview of the judges and one (1) pan, tilt, zoom camera with presets for the speaking judge activated via the microphone mixer logic. A third camera will be used for the lectern. Cameras for the judges are usually in a recessed wall pocket above the public entrance door.

3. 90cm Monitor

One or more 90cm video monitors on portable carts may be provided near the lectern for the judges. Provide one (1) monitor near the bench center for the attorneys. A high resolution monitor may be considered where computers may be used.

4. Clerk's Monitor

The clerk should have a 35cm monitor for viewing.

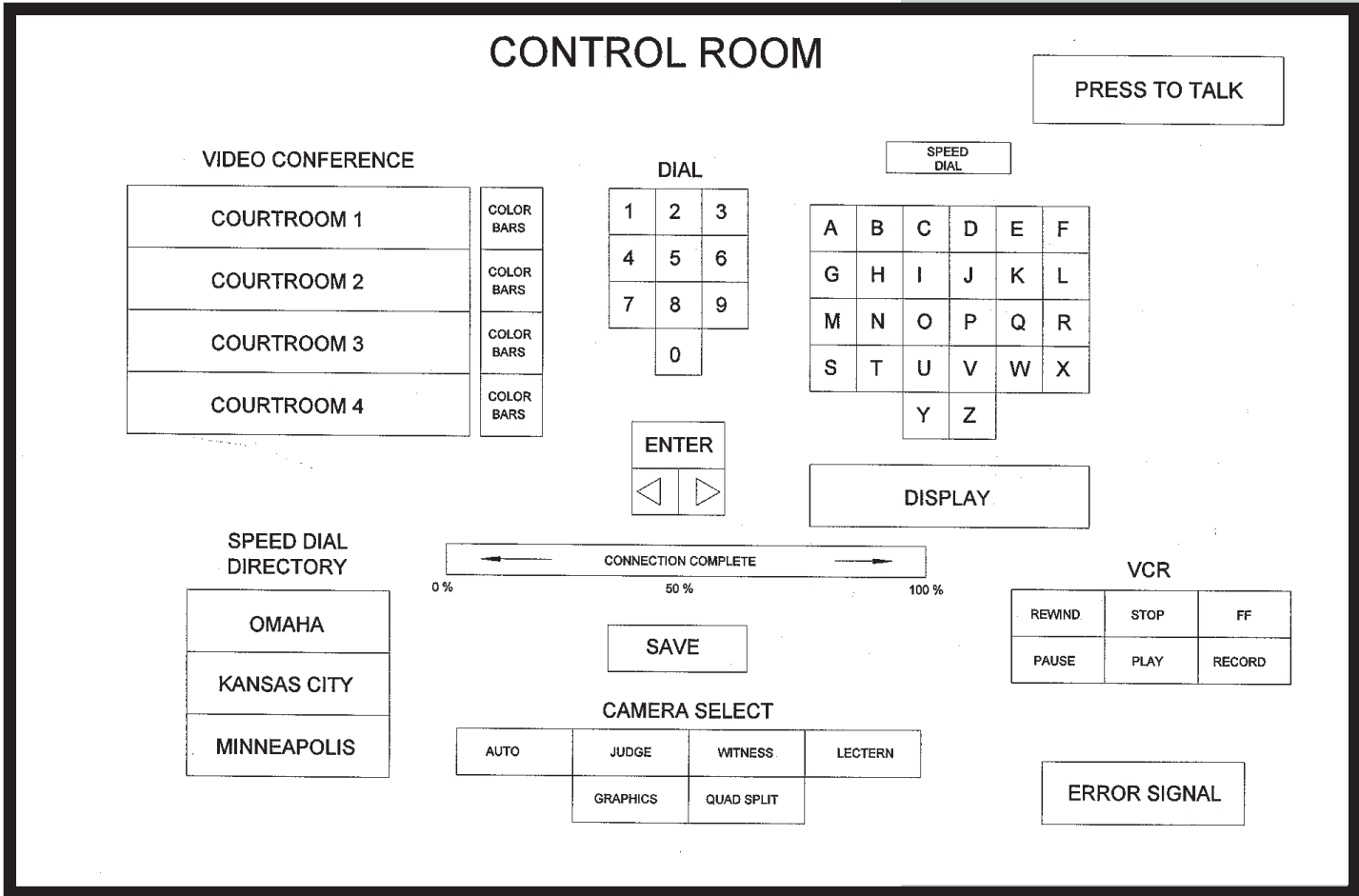

U.S. COURT - TOUCHPAD BASIC SCREEN
FIGURE 46

FOR ILLUSTRATIVE
PURPOSES ONLY.



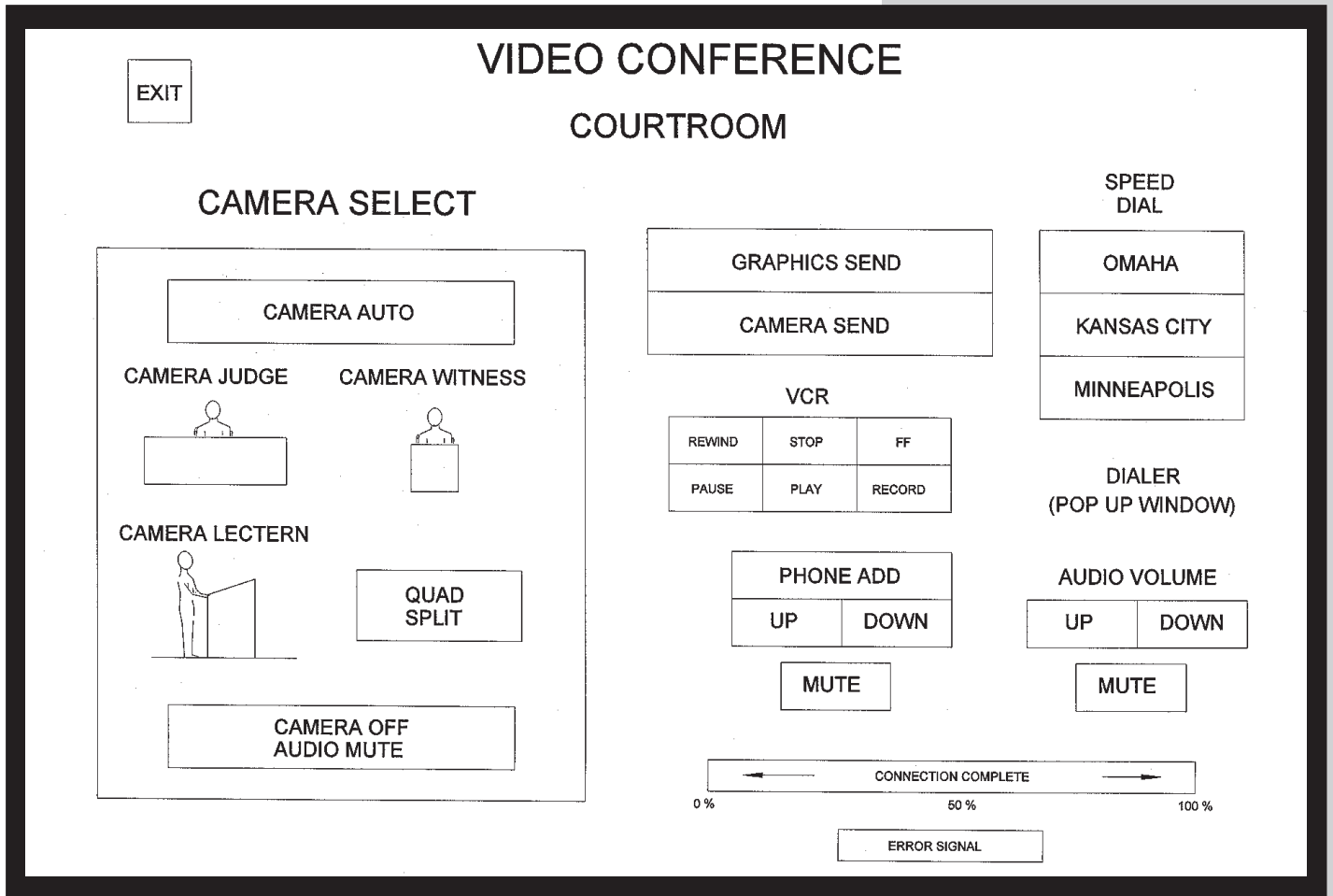

U.S. COURT - VIDEO CONFERENCE CONTROL SCREEN
 FIGURE 47

FOR ILLUSTRATIVE
 PURPOSES ONLY.



5. Clerk's Touch Screen

The clerk should have a touch screen for system control with a programmable processor. Provide:

- Speed dial
- Manual dial
- Camera select, pan/tilt/zoom (if provided)
- Quad split
- Mute/color bars
- Picture in picture
- Remote site volume up/down.
- Remote site camera control.

A screen for camera controls and CODEC dialing should be provided.

D. Courtroom Video

1. Second Courtroom Use

In some cases, the judge and/or local attorneys may want to use a second courtroom or other space for closed circuit connection during a video conference or for questioning of a juvenile. This may be accomplished through the central control area matrices.

2. Unruly Defendant

An unruly defendant in the isolation cell may receive courtroom sound via the sound system and video via a courtroom camera. This is normally provided by the U.S. Marshals' camera. Their cameras are not to be substituted or used for video conferencing, but may be co-located in a camera pocket with a video conference camera.

E. Specifications

Specifications are a necessary part of a complete design, and should be presented in a format suitable for bidding purposes. The recommended format for specification sections is as follows:

1. General

Instruction to bidders, overall scope, and timing requirements.

2. Products

Products using GSA schedule equipment are recommended for cost control.

3. Execution

Minimum installation standards for quality control.

Contractor testing with test report.

AOUSC inspection resulting in written acceptance or rejection.

Warranty, usually one (1) year from acceptance date.

Requirement for on-site training of all personnel by the A/V contractor.

As-built schematics, equipment manuals, instructions, and blank "log book" for each space.

4. Costs

Spreadsheet with equipment list and blank areas for vendors to fill in costs. Provide the AOUSC with the spreadsheet having the estimated costs filled in by the designer.



SECTION VIII Standards and Glossary

A. Standards

1. AMERICAN NATIONAL STANDARDS INSTITUTE (ANSI)

Including ANSI adopted standards of other standards organizations.

- a. ANSI/ASTM B258 Specification for Standard Nominal Diameters and Cross Sectional Areas of AWG Sizes of Solid Round Wires Used as Electrical Conductors.
- b. ANSI C1-1990 (NFPA No. 70-1990) National Electrical Code - 1990
- c. ANSI C16.29 Methods of Measurement of Amplification Gain, Loss, Attenuation, and Amplitude-frequency Response.
- d. ANSI C83.9 (EIA RS-310-C) Racks, Panels, and Associated Equipment
- e. ANSI S1.1 Acoustical Terminology
- f. ANSI S1.2 Method for the Physical Measurement of Sound
- g. ANSI S1.4 Specification for Sound Level Meters
- h. ANSI S1.5 Recommended Practices on Audio and Electroacoustics: Loudspeaker Measurements.
- i. ANSI S1.6 Preferred Frequencies and Band Numbers for Acoustical Measurements.
- j. ANSI S1.10 Method for the Calibration of Microphones

- c. EIA RS-445 General Requirements for Soldering of Electrical Connections and Printed Board Assemblies
 - d. EIA RS-453 Dimensional, Mechanical, and Electrical Characteristics Defining Phone Plugs and Jacks
7. ELECTRICAL TESTING LABORATORIES (ETL)
 8. FEDERAL COMMUNICATIONS COMMISSION (FCC)
 9. THE INSTITUTE OF ELECTRICAL AND ELECTRONIC ENGINEERS (IEEE)
 - a. IEEE STD 200 Reference Designations for Electrical and Electronics Parts and Equipment
 - b. IEEE STD 315 (ANSI Y32.2) (CSA 299) Graphic Symbols for Electrical and Electronics Diagram
 10. INTERNATIONAL ELECTROTECHNICAL COMMISSION (IEC)
 - a. IEC-268, Part 12 Circular Connectors for Broadcast and Similar Use
 11. INTERNATIONAL STANDARDS ORGANIZATION (ISO)
 12. NATIONAL ELECTRIC CODE (NEC)
 13. NATIONAL ELECTRICAL MANUFACTURER'S ASSOCIATION (NEMA)
 14. NATIONAL FIRE PROTECTION ASSOCIATION (NFPA)
 - a. NFPA No. 70-1990 (ANSI C1-1990)National Electrical Code - 1990
 15. SOCIETY OF MOTION PICTURE AND TELEVISION ENGINEERS
 16. SOUND SYSTEMS ENGINEERING, 2nd Ed., Davis and Davis, Howard W. Sams Co., 1987
 17. UNIFORM BUILDING CODE (UBC)
 18. UNDERWRITERS' LABORATORIES (UL)

B. Glossary

ADA (Americans with Disabilities Act): The ADA prohibits discrimination on the basis of disability in employment, programs and services provided by state and local governments, goods and services provided by private companies, and in commercial facilities. The ADA was signed into law on July 26, 1990. It contains requirements for new construction, for alterations or renovations to buildings and facilities, and for improving access to existing facilities of private companies providing goods or services to the public.

AGC (Automatic Gain Control): Electronic circuitry that compensates for either audio or video input level changes by boosting or lowering incoming signals to match a preset level. Using AGC, changing input levels can output at a single constant setting.

Amp (Ampere): A unit of electric current that is equivalent to a flow of one coulomb per second or to the steady current produced by one volt applied across a resistance of one ohm.

Amplifier: An electronic device used to increase signal power or amplitude.

Analog: Information represented by continuous and smoothly varying signal amplitude or frequency over a certain range, such as in human speech or music. Audio and video analog signals stored on tape deteriorate with each copy or generation. In contrast, see digital.

ANSI (American National Standards Institute): The principal standards development body in the U.S. ANSI is a non-profit, non-governmental body supported by trade organizations, professional societies, and industry. It is the U.S.'s member body to the ISO (International Standards Organization).

AOUSC (Administrative Office of the United States Courts): The management agency for the federal courts.

Architect: Design firm under contract to the General Services

Administration (GSA) or AOUSC. Responsible for the design and specification of the building facilities and systems.

Aspect ratio: The width to height ratio of a two-dimensional image such as a television picture. Video's aspect ratio is 4:3.

ATM (Asynchronous Transfer Mode): ATM switching protocol can handle all types of traffic; voice, video, data, and image.

A/V (Audio Visual): Designed to aid in learning or teaching by making use of both hearing and sight.

AWG (American Wire Gauge): A standard specifying wire size; the larger the gauge, the smaller the wire.

Backplane: The rear of a device enclosure, where connectors are located, cable attached, and components inserted.

Bandwidth: The amount of signal that can be processed by a given system (including the cable). Compare bandwidth to a highway; the bigger the highway, the greater the number of cars that travel on it at one time. The greater the bandwidth, the more information that can travel down the transmission channel at one time. Bandwidth for DATA is typically described as: Kbs (kilobits per second), Mbs (megabits per second), Kbs (kilobytes per second), and Mbs (megabytes per second)

Baud: Unit of signaling speed (data transfer rate). The speed in baud is the number of line changes (in frequency, amplitude, etc.) or events per second.

Bidder: Audio system's contractor submitting a proposal response to these specifications.

BICSI (Building Industry Consulting Services International): An international not-for-profit telecommunications association, was founded in 1974 to serve and support telephone company building industry consultants (BICs) responsible for the design and distribution of telecommunications wiring in commercial and multi-family buildings. BICSI provides generic industry best practices documentation manuals, high quality generic education, globally recognized credentials, networking opportunities, and a forum for regulatory advocacy.

Bi-directional Video: Video distribution in two directions which allows video material to be both received and originated from all locations.

Bit (Binary Digit): The smallest unit of information in a binary system; a one or zero condition.

BNC Connector: A type of heavy duty video connector which is sturdier than the F-connectors typically used in home cable TV installations.

BPS (Bits Per Second): A measurement of data speed. Can be preceded by K (kilo/thousands) or M (mega/million).

BRI (Basic Rate Interface): An ISDN service referred to as 2B+D, BRI provides two 64-kbps, bearer digital channels, plus a 16-kbps delta channel. ISDN terminal adapters replace modems as the customer-premise connection to this service for direct connections of data and voice transmissions.

Bridge: A device that connects two LAN segments together, which may be of similar or dissimilar types, such as Ethernet and Token Ring.

Buffer: A temporary-storage device used to compensate for a difference in data rate and data flow between two devices (typically a computer and a printer); also called a spooler.

Byte: A unit of information, usually shorter than a computer 'word'. Eight-bit bytes are most common. Also called a character.

CAD (Computer Aided Design): Acronym for computer-aided design, a term applied to programs (and workstations) used in designing engineering, architectural, and scientific models ranging from simple tools to buildings, aircraft, integrated circuits, and molecules. Various CAD applications create objects in two or three dimensions, presenting the results as wire-frame skeletons, as more substantial models with shaded surfaces, or as solid objects. Some programs can also rotate or resize models, show interior views, generate lists of material required for construction, and perform other allied functions. CAD programs rely on mathematics, often requiring the computing power of a high-performance workstation.

CAT-5 (Category 5) Wiring: Refers to performance levels and cable characteristics for transmitting voice and data at up to 100 MHz or more. Virtually all applications can be accommodated by Category-5 wiring.

CATV (Community Antenna Television): A television cable system which carries programs to home television sets. The cable is broadband in nature to carry numerous TV broadcasts simultaneously.

CCD (Charge-Coupled Device): The computer chip in video cameras that converts light images into an electronic signal.

CCITT (The International Telephone and Telegraph Committee): An international association that sets worldwide communications standards, e.g. H.261. Renamed ITU-T.

CD (Compact Disc): A small plastic optical disc usually containing recorded music or computer data.

CD-ROM (Compact Disc Read-Only Memory): A form of storage characterized by high capacity (approximately 600 megabytes) and the use of laser optics rather than magnetic means for reading data. Used frequently to provide access to encyclopedias, dictionaries, databases, and courseware. Information on disk is read-only and may not be changed or augmented.

CD-ROM Drives: The player for the CD-ROM disc.

Centrex: A type of telephone service offered by local telephone companies distinguished by the fact that the telephone equipment is located on the telephone company premise and thus requires no support operation by the user, and by the fact that there is no usage charge for monthly calls between numbers on the same CENTREX system. Telephone company monthly line charges are dependent on the distance of the end location from the telephone company central office.

CGA (Color Graphics Array): An IBM video-display standard that provides low-resolution text and graphics and was the first graphics standard for the IBM PC that could display a maximum of 16 colors in 2 graphics modes: High Resolution, which has 640 by 200 pixels in black and white, and Low Resolution, which has 320 by 200 pixels in four colors.

Chrominance: That portion of a television signal that contains the color information of the picture.

Coaxial (Coaxial Cable): A shielded cable used for video and low-level audio signals. Transmission medium consisting of one wire conductor (two for twin axial cable) surrounded by a dielectric insulator and encased in either a wire mesh or an extruded metal sheathing. Coaxial cable comes in many varieties, depending on the degree of EMI sheathing afforded and voltages and frequencies accommodated; also call coax.

CODEC: Short for coder/decoder. A device which converts a analog signal into a digital data stream for transmission and converts incoming digital data into the corresponding analog form. The inverse of a modem.

Component Video: Video signal in which the luminance and sync information are recorded separately from the color information. Superior to composite video.

Composite Video: Video signal that combines both luminance and chrominance in a single signal.

Consultant: Design firm under contract to the Architect or AOUSC. Responsible for the design and specification of the audio systems.

Contracting Officer Representative: Project manager authorized to act as a technical representative for the GSA or AOUSC contracting officer.

Contractor: System's contractor who has been awarded the contract to perform the work as proposed.

CPU (Central Processing Unit): The part of a computer which controls all the other parts. The CPU fetches instructions from memory and decodes them. This may cause it to transfer data to or from memory or to activate peripherals to perform input or output.

CRT (Cathode Ray Tube): An electronic device similar to a TV screen that provides a visual display output of stored or transmitted information.

CSU (Channel Service Unit): Digital DCE used to terminate digital circuits (such as DDS or T1 lines) at the customer site. It performs line coding, line conditioning, and equalization functions, and responds to loopback commands sent from the central office.

dB (Decibel): A unit for expressing the relative level of sounds or power using logarithms based on a ratio to a reference level.

DCE (Data Communications Equipment): Devices that provide the functions required to establish, maintain, and terminate a data-transmission connection-for example, a modem.

DCN (District Court Network): The court's network with databases.

Decoder: Any device which modifies transmitted information to a form which can be understood by the receiver.

Digital: Electronic system which functions by converting the analog signal into a series of discrete binary bits (ones and zeros).

Distribution Amplifier: Amplifier that allows one video or audio signal to be sent to several pieces of equipment simultaneously.

DSU (Digital Service Unit): The interface between a user's data terminal device (DTE) and a digital data service, usually via a CSU. Converts and RS-232C or other terminal interface to a DSX-1 interface.

DVD (Digital Versatile Disc): High density optical storage discs.

Dynamic Range: An audio term which refers to the range between the softest and loudest levels a source can produce without distortion.

EGA (Enhanced Graphics Adapter): An IBM video-display standard that provides medium-resolution text and graphics.

EIA (Electronic Industries Association): Develops and promulgates standards specifications and procedures for electronic equipment.

EMI/RFI (Electromagnetic Interference/Radio Frequency Interference): A device's radiation leakage that couples into a transmission medium resulting from the use of high-frequency wave energy signal modulation. EMI is reduced by shielding. Minimum acceptable levels are detailed by the FCC and/or manufacturer specification.

Equipment Rack: A metal rack, usually in a standard 19-inches wide format defined by NEMA standards, used to hold various types of computer and communications equipment.

ESR (Electronic Sound Recording):

F Connector: The type of video connector commonly used on home cable TV installations. It uses the soft copper center conductor of the coaxial cable as the center pin for the connector. The result is fragile and unreliable in constant duty use.

FCC (Federal Communications Commission): A government agency that regulates and monitors the domestic use of the electromagnetic spectrum for communications.

FDMA (Frequency Division Multiple Access): The technique of allocating frequency multiplexed communication channels to satisfy user demands.

FIPS (Federal Information Processing Standards) 175: Specifies minimum requirements for the design and construction of rooms, areas and pathways into which and through which telecommunications equipment and media are to be installed within a building and between buildings in a campus environment.

FIPS (Federal Information Processing Standards) 176: Specifies minimum requirements for telecommunications wiring for connecting one to four exchange access lines to various types of customer premises equipment in small buildings.

Firewall: A network node set up as a boundary to prevent traffic from one segment to cross over to another. Firewalls are used to improve network traffic, as well as for security purposes.

Frame: A set of 525 electron scan lines that completes the entire image of an electronically transmitted or received television picture.

Frequency: A measurement of a signal's vibration, represented as cycles per second or Hertz (Hz).

Frequency-Multiplexed System: A communication system serving several users whereby each user is assigned a different frequency or bandwidth of frequencies within a specified range.

G-711: A standard for audio encoding at 64 kb/s.

G-722: A standard for 7 kHz Audio-coding within 64 kbit/s.

Government: United States Government through the Administrative Office of the United States (AOUSC), Space and Facilities Division.

Ground Loop: An unwanted, continuous ground current flowing back and forth between two devices that are different ground potentials.

GSA (General Services Administration): The GSA is one of the three central management agencies in the Federal Government. The GSA provides expertly managed space, supplies, services, and solutions to enable Federal employees to accomplish their missions. The GSA provides workspace, security, furniture, equipment, supplies, tools, computers, and telephones. The GSA'S Public Buildings Service (PBS) provides work environments for over one million Federal employees nationwide. Since 1949, PBS has served as a builder, developer, lessor, and manager of Federally owned and leased properties.

H-221: A standard for the frame structure for a 64 to 1920 kbit/s channel in audiovisual teleservices.

H-261: A standard for digital video compression for videoconferencing.

H-320: A standard for the framework for videoconferencing over ISDN.

HD-15: A 15 pin connector used for computer monitors.

HDTV (High Definition Television): A new proposed standard for the broadcasting and display of television signals with twice the resolution of current broadcasting and display systems, 1100 lines of resolution in broadcast mode. HDTV is equal to current S-VGA for computers.

Head End: The location in a video distribution system that connects the equipment which originates all outbound signals and redirects all inbound signals to their proper outbound channel.

HVAC (Heating, Ventilation, Air Conditioning): A term used by the building trades.

Install: To erect, mount, and connect complete with related accessories.

IEEE (Institute of Electrical and Electronic Engineers): An international professional society that issues its own standards and is a member of ANSI and ISO.

Infrastructure: The basic facilities, equipment, and installations needed for the functioning of a system or organization.

Interface: A shared boundary defined by common physical interconnection characteristics, signal characteristics, and meanings of interchanged signals.

Internet: 1) Any large network made of several smaller networks. 2) A group of networks that are interconnected so that they appear to be one continuous large network, and can be addressed seamlessly at the OSI model Network Layer through routers. 3) The industry name for the network. Based upon the original Arapanet network, it's used as a reference resource, for e-mail, and an on-line chat room for users around the world.

IP (Internet Protocol): The protocol used in gateways to connect networks at the OSI Network Level (Layer 3) and above. IP routes a message across networks.

ISDN (Integrated Services Digital Network): A network able to receive inputs from a variety of sources (voice, data, text, facsimile, video, etc.) that are digitally encoded and transmitted over a common network and delivered in its original form at the destination. The basic rate interface supports two B channels (each 64 Kbps) and a D channel (16 Kbps) for signaling.

ISO: International Standards Organization. Responsible for many audio, video, and telecommunications standards.

ITU-TSS (International Telegraphic Union Telecommunications Standards Sector): The replacement organization for the CCITT.

LAN (Local Area Network): A data communications network that is geographically limited (typically to a 1 km radius) allowing easy interconnection of terminals, microprocessors, and computers within adjacent buildings. Ethernet and FDDI are examples of standard LANs.

LCD (Liquid Crystal Display): Liquid Crystal Display. A visual display that uses an electric current to charge a thin layer of fluid that is trapped between two glass plates.

Leased Line: A telephone line reserved for the exclusive use of leasing customers without interexchange switching arrangements. Also called a Private Line.

LED (Light Emitting Diode): Light Emitting Diode. A type of light, typically red in color, often used in combinations to indicate numbers or letters.

Line Driver: A DCE device that amplifies a data signal for transmission over cable for distances beyond the RS-232 limit of 50 feet, even up to several miles. Also called 'limited-distance modem' (LDM) or 'short-haul modem' (SHM).

Luminance: Amplitude (strength) of the gray scale or black-and-white portion of the video signal.

Mhz: megahertz

Modem (Modulator-Demodulator): A device used to convert serial digital data from a transmitting terminal to an analog signal for transmission over a telephone channel or to reconvert the transmitted analog signal to serial digital data for acceptance by a receiving terminal.

Monitor: A television that receives and displays baseband information only. i.e. direct feed from a VCR or laser disc.

Multimedia: The merging of different media, e.g., text, graphics, still images, sound, animation, and video on a desktop computer, thus creating a multisensory experience for the participant.

Multiplexor: A device that divides a transmission into two or more subchannels, either by splitting the frequency band into narrower bands (frequency division) or by allotting a common channel to several transmitting devices, one at a time (time division).

Multipoint Line: A single communications line or circuit interconnecting several stations; usually requires some kind of polling mechanism to address each connected terminal with a unique address code.

NEC: National Electrical Code.

Network: A group of computers and associated devices that are connected by communications facilities. A network can involve permanent connections, such as cables, or temporary connections made through telephone or other communication links. Networks are often classified according to their geographical extent: local-area network (LAN), metropolitan-area network (MAN), wide-area network (WAN), and also according to the protocols used.

Network Topology: The physical and logical relationship of nodes in a network; networks typically have a star, ring, tree, or bus topology, or some combination.

NiCad (nickel cadmium): Common rechargeable battery type.

NSID (NameSpace Identifier): A key used for encryption, decryption, and authentication.

NT1 (Network Terminator): A device that terminates an ISDN line at the customer's premises.

NTSC (National Television Standards Committee): The US standard for color television transmission, calling for 525 lines of information, scanned at a rate of 30 frames per second.

OSI (Open System Interconnection): An architectural model developed by the International Standards Organization (ISO) for the design of open systems networks. All communication functions are divided into seven standardized layers: Physical, Data Link, Network, Transport, Session, Presentation, and Application.

Patch Panel: A matrix of sockets that can be interconnected manually by means of patchcords, i.e. short cables with plugs on both ends.

PBX (Private Branch Exchange): A piece of equipment which is controlled via software which connects phones together and controls how they operate. The term Private Branch Exchange describes an exchange which the local user controls. A private automatic branch telephone exchange system used by individual businesses or governmental agencies.

Phase: The time or angle a signal is delayed with respect to some reference position.

Picture Element (Pixel or PEL): The smallest area of a picture whose light characteristics are converted to an equivalent electrical current or voltage.

Picture Tube: An electronic vacuum tube containing the elements necessary to convert transmitted electronic signals into visual images.

POP (Point of Presence): The place where a line from a long-distance carrier (IXC) connects to the line of the local telephone company or to the user if the local company is not involved.

POTS (Plain Old Telephone Service): The basic analog service provided by the public telephone network, without any added facilities.

Protocols: Conventions governing the transmission of data. (Communications Protocol) A set of rules or standards designed to enable computers to connect with one another and to exchange information with as little error as possible. The protocol generally accepted for standardizing overall computer communications is a seven-layer set of hardware and software guidelines known as the OSI (Open Systems Interconnection) model. Protocols represent attempts to ease the complex process of enabling computers of different makes and models to communicate.

Provide: To supply, install, and connect up complete and ready for safe and regular operation of particular work referred to unless specifically noted.

Public Carrier Phone: Telephone source provider.

Public Switched Telephone Network (PSTN): Any switching communications system-such as Telex, TWX, or public telephone networks-that provides circuit switching to many customers.

PVC (Polyvinyl Chloride): The material most commonly used for the insulation and jacketing of cable.

RAM (Random Access Memory): Semiconductor-based memory that can be read and written by the microprocessor or other hardware devices. The storage locations can be accessed in any order. Note that the various types of ROM memory are capable of random access. The term RAM, however, is generally understood to refer to volatile memory, which can be written as well as read. Compare core, EPROM, flash memory, PROM, and ROM.

Receiver: The person or device to which information is sent over a communication link.

RF (Radio Frequency): As opposed to sound or light or infrared or ultraviolet frequency.

RG: Coaxial cable used for bi-directional video. RG-6 is usually used for individual drops to rooms and RG-11 is used for longer cable runs.

RGB (Red, Green, Blue): Abbreviation for the primary colors of light: red, green, and blue.

RGBHV (Red, Green, Blue, Horizontal sync, Vertical sync):

RJ (Registered Jack): The most common jacks used for telephone and data are the RJ-11 (for three-pair connections) and RJ-45 (for four-pair connections).

RJ-45 Connector: An 8-pin data connector.

RS170A: The original black and white television standard used in the United States. NTSC was designed to be compatible with RS-170 black and white television sets.

RS232: An unbalanced serial protocol for data.

RS422: A balanced serial protocol for data.

Satellite Communication Systems: A remote communications technique using a satellite in orbit to receive signals from one location, and retransmit that information to another location.

Scan Line: One pass of an electron beam across the face or target of a television picture tube or camera.

Scan Pattern: The patch of an electron beam which converts an image into electronic signals.

Serial Data: The transfer of data over a single wire in a sequential pattern.

Signal Converter: A communications circuit that converts one form of information signal input into another form of signal output.

Sound Spectrum: The range of frequencies in the electromagnetic spectrum that can be heard by the human ear. Usually from about 20 cycles per second to 10,000 hertz.

SPID (Service Profile Identifier): A number assigned to an ISDN line by the ISDN service provider that identifies certain characteristics of the line.

Supply: To purchase, procure, acquire, and deliver complete with related accessories.

SVGA (Super Video Graphics Array): A set of graphics standards designed to offer greater resolution than VGA. All SVGA standards support a palette of 16 million colors, but the number of colors that can be displayed simultaneously is limited by the amount of video memory installed in a system. The SVGA standards are developed by a consortium of monitor and graphics manufacturers called VESA.

SVHS (Super-VHS): A higher quality version of the VHS videotape format. Separates chrominance and luminance information to produce a sharper picture than regular VHS videotape.

S-video (Y/C video): A S-VHS signal that transmits chrominance and luminance information separately to minimize loss of picture quality.

Switched Line: A communications link for which the physical path may vary with each usage, such as the public telephone network.

Sync (Abbreviation of synchronization): Usually refers to the synchronization pulses necessary to coordinate the operation of several interconnected video components. When the components are properly synchronized, they are said to be 'in sync.'

TAP: A device used to assure proper signal levels when connecting individual video outlets to a backbone cable. The value of the tap must be calculated based on the length of the backbone cable and outlet cable to assure proper signal levels.

TCO (the Swedish Confederation of Professional Employees): A standard which limits monitor emissions, energy consumption, screen flicker, luminance, and keyboard use.

TIA 568: The Standard Commercial Building Telecommunications Wiring Standard, which defines pinouts.

Twisted Pair: This type of wire consists of two insulated copper conductors that are wound around each other to reduce the effects of electrical noise. The two available types are Unshielded Twisted Pair, used by 10Base T, and Shielded Twisted Pair, used

by Token Ring's type 1 cable and which contains wrap-around conductor or a foil used for noise reduction.

UHF (Ultra-High Frequency): The portion of the electromagnetic spectrum from 300 to 3,00 megahertz.

UPS (Uninterruptable Power Supply): A device, connected between a computer (or other electronic equipment) and a power source (usually an outlet receptacle), that ensures that electrical flow to the computer is not interrupted because of a black out and, in most cases, protects the computer against potentially damaging events such as power surges and brownouts. Different models offer different levels of protection. All UPS units are equipped with a battery and a loss-of-power, it immediately switches over to the battery so that the user has time to save his or her work and shut off the computer. The amount of time the battery can sustain power varies with the model of the UPS; generally, higher-end models offer longer battery time. In addition, higher-end models have features such as power filtering, sophisticated surgesprotection, and a serial port so that operating systems capable of communicating with a UPS (such as Windows NT) can work with the UPS to facilitate automatic system shutdown.

VCR (Video Cassette Recorder): A videotape recorder that uses videocassettes.

VESA (Video Electronics Standards Association): a consortium of video adapter and monitor manufacturers whose goal is to standardize video protocols. VESA has developed a family of video standards that offer greater resolution and more colors than VGA. These standards are known collectively as Super VGA (SVGA).

VHS (Video Home System): ½-inch consumer videotape format.

Video Signal: The electrical signal containing the picture content information in a television or facsimile system.

WAN (Wide Area Network): A network, usually constructed with serial lines, extending over distances greater than one kilometer. Compare with local-area network.

XGA (Extended Graphics Array): A high-resolution graphics standard introduced by IBM in 1990. It provides the same resolutions (640 by 480 or 1024 by 768), but supports more simultaneous colors (65 thousand compared to 256 colors). In addition, XGA allows monitors to be non-interlaced.