

FEDERAL ENERGY MANAGEMENT PROGRAM

CHP Potential at Federal Sites



U.S. Department of Energy
Office of Energy Efficiency and
Renewable Energy



May 2002

CHP Potential at Federal Sites

Introduction

Combined heat and power (CHP) systems provide thermal energy for buildings or processes while at the same time generating electricity. There has been a recent upsurge in interest in fuel-efficient distributed energy resources (DER) such as CHP because of their potential to address key power-sector constraints. CHP was highlighted in the Bush Administration’s National Energy Policy Report as a commercially available and feasible option that offers extraordinary efficiency and environmental benefits.

The U.S. Department of Energy’s (DOE’s) Federal Energy Management Program (FEMP) has completed a market assessment of the potential for CHP applications at Federal facilities and the associated costs and benefits including energy and emissions savings.* Results of the assessment indicate that CHP can make significant contributions toward our energy-conservation and emissions-reduction goals and save the government money. The assessment, condensed in this document, is meant to help Federal agencies

Does your facility have CHP potential?

Ideal sites will fit the following profile, but sites meeting only a few of these characteristics may also have a cost-effective CHP opportunity:

- ✓ high electricity prices (>5 cents/kWh);
- ✓ average electric load >1 MW;
- ✓ ratio of average electric load to peak load > 0.7;
- ✓ a central or district heating and/or cooling system in place (or a need for process heat);
- ✓ “spark spread” (difference in price per million site Btu between gas and electricity) >\$12;
- ✓ high annual operating hours (> 6000);
- ✓ thermal demand closely matches electric load; and
- ✓ energy security and reliability upgrades are planned.

understand and capitalize on the opportunities to implement CHP technologies. The assessment offers a broad overview of when and where CHP systems are most likely to serve the Federal sector’s best interest.

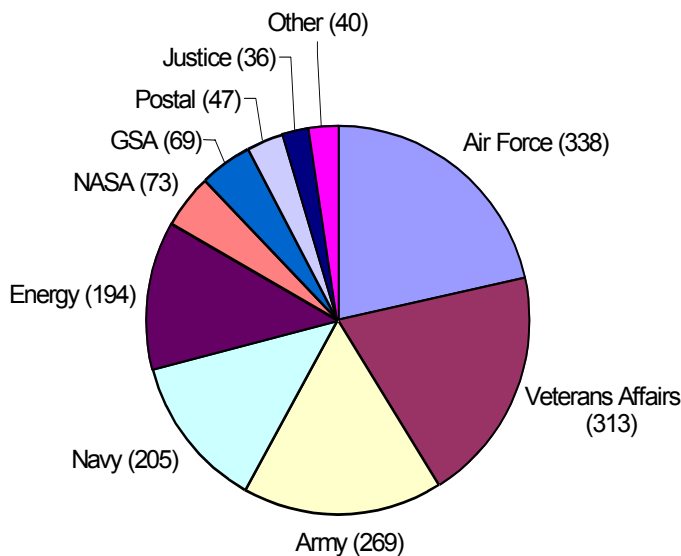

Fig. 1: Potential CHP capacity for major Federal agencies (MW, total = 1590).

Summary of Results

The federal market assessment suggests that CHP could be successfully applied in 9% of large Federal facilities, annually conserve 50 trillion Btu of primary energy, reduce CO₂ emissions by 2.7 million metric tons, and cut utility bills by \$170 million. This level of CHP deployment would require a capital investment of \$1.5–2 billion funded by special appropriations and/or financing from private partners. Despite the challenges in implementing CHP technologies, as of

* This document summarizes results from the *Analysis of CHP Potential at Federal Sites* (ORNL/TM-2001/280, February 2002). For more details on the methodology, assumptions, and results, the full Federal CHP market assessment can be downloaded from the following ORNL web site: http://www.ornl.gov/femp/pdfs/chp_market_assess.pdf.

February 2002, over 50 Federal sites were already benefiting from CHP systems, and another 50 were working on projects to install 100 MW of additional CHP capacity.

The market assessment considered 7 building types for 28 Federal agencies. The Federal building types with greatest CHP potential are hospitals, industrial, and R&D facilities. Figure 1 shows the calculated CHP capacity for the 9 major agencies; the others each show potential capacities of less than 10 MW. Agencies with most potential are the military, Department of Veterans Affairs (VA), and Department of Energy (DOE).

Total potential CHP capacity was estimated to be 1500–1600 MW under base-case assumptions using gas reciprocating engines or gas combustion turbine technologies. This would represent approximately 13% of all electricity use in the Federal sector.

Sensitivity tests resulted in capacity estimates that varied from 390 MW (doubling installation costs) to 2800 MW (using 1999 commercial power and gas rates instead of 2000 industrial rates). Sizing CHP to supply 100% of thermal needs instead of the base percentages of electrical needs gave a capacity of 1760 MW, not too different from the base case.

The assessment reveals significant Federal potential for CHP in the Southwest (California to Texas), Northeastern metropolitan areas (New York to Washington, D.C.), and the Southeast (Florida, Georgia, and Alabama). Figure 2 maps the potential capacity for each state. The 1.5 GW estimated in the base-case scenario has an average simple payback of 7 years and could save the Federal government \$170 million per year in energy costs.

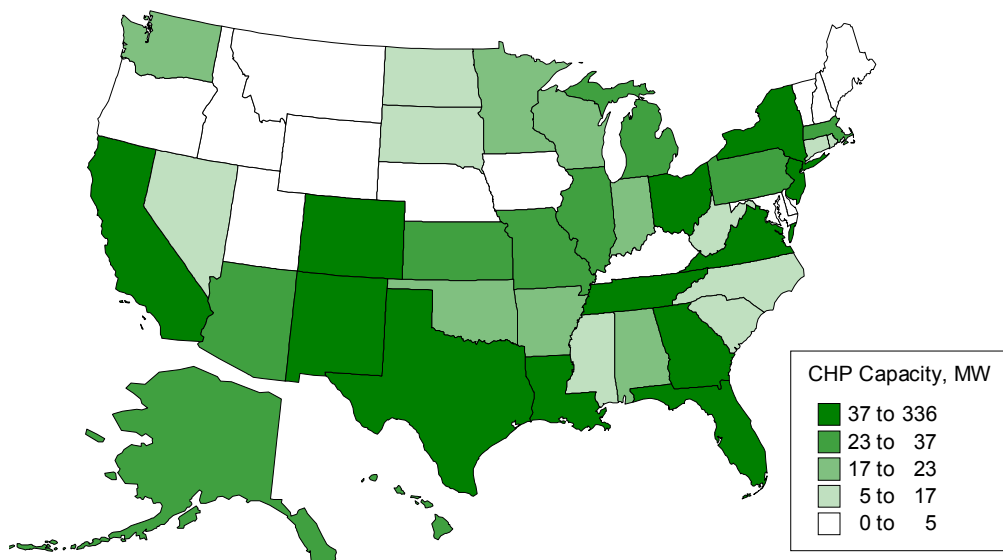

Fig. 2: Distribution of potential CHP capacity in Federal sites under base case, MW.

The National Interest in CHP

It is not surprising that interest in CHP is increasing in Federal facilities across the country. CHP systems play an essential role in our nation's present energy supply and future plans. The National Energy Policy Report highlights the potential for CHP to cost-effectively help agencies meet goals related to energy security, cost reduction, and environmental quality. The United States has over 50 gigawatts (GW) of installed CHP capacity, which produces about 7% of the nation's electricity.

CHP offers an opportunity to meet increased energy needs, reduce transmission congestion, cut emissions, increase power quality and reliability, and increase overall energy security. Networks of interconnected CHP systems can offer increased power security for the grid as well.

What is CHP?

CHP has had many different names—cogeneration, building cooling, heating and power, combined heat and power—all referring to a system that efficiently generates electricity (or shaft power) and uses the heat from that process to produce steam, hot water, and/or hot air for other purposes. The most common building applications use a prime mover (gas turbine or engine) coupled with a generator to produce electricity and capture the waste heat for process steam and space heating, or boiler steam passes through a turbine to generate electricity in addition to serving other thermal applications. One of the simplest strategies is to replace steam pressure relief valves with low-cost backpressure steam turbines and electric generators.

CHP or Cogeneration:
The sequential production of two forms of useful energy from a single fuel source.

A CHP system recovers the heat from electricity generation for productive uses. And because a CHP system generates electricity near the point of use, CHP also avoids transmission losses from distant central stations. For these reasons, properly designed CHP systems can be much more efficient than the average U.S. fossil fuel power plant, as shown in the schematic below. See Appendix A for a discussion of site versus source energy savings.

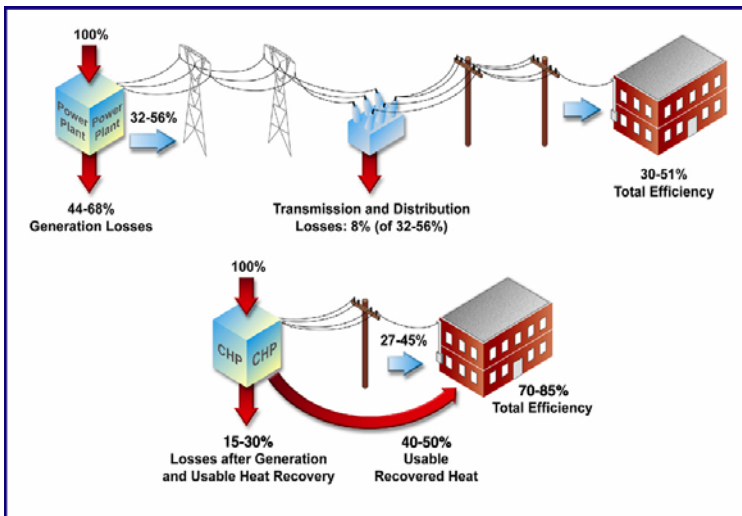

CHP systems recover usable heat and avoid transmission and distribution losses to offer potential total efficiencies of 70–85%.

CHP is based on *system integration*. A well-designed CHP plant integrates proven technologies for power generation (such as turbines or reciprocating engines) and thermal load management (chillers, dehumidifiers, boilers, other HVAC or process heat equipment) to maximize overall efficiency. Usually this involves carefully sizing a system to meet site-specific needs, taking into consideration existing equipment, fuel costs, electric and thermal load duration curves, and other factors. CHP systems can be designed to make a site totally independent from the grid or, more commonly, to maximize savings and provide increased reliability for a strategic portion of the load at a site.

The most common CHP systems tend to be large (over 500 kW) and rely on proven equipment: reciprocating engines, steam turbines, combustion gas turbines and generators. The performance and reliability of these systems has improved steadily based on decades of experience, while operation and

maintenance costs and emissions have fallen. New electronics make power control, fuel switching, and seamless transitions between grid and on-site generation more practical than ever before. Smaller gas turbines and fuel cells are now being demonstrated and could offer expanded opportunities for smaller CHP applications.

CHP is one type of distributed energy resource (DER): it provides power when and where you need it. FEMP's "How-To Guide" on distributed energy describes a broad spectrum of DER technologies and their costs and benefits and offers practical advice for planning DER projects. By using heat that would otherwise be lost, CHP offers an opportunity to improve the efficiency and economics of any DER application that generates heat as well as electricity.

CHP heat recovery systems are based on heat transfers from combustion exhaust, engine jackets, or other elements to either air or fluids. If exhaust heat can be transferred directly to an auxiliary unit (such as an absorption chiller or desiccant dehumidifier), it is called a "direct-fired" application. More common are applications using steam or hot water, and these normally use a heat recovery steam generator (HRSG) as shown in the turbine graphic at right.

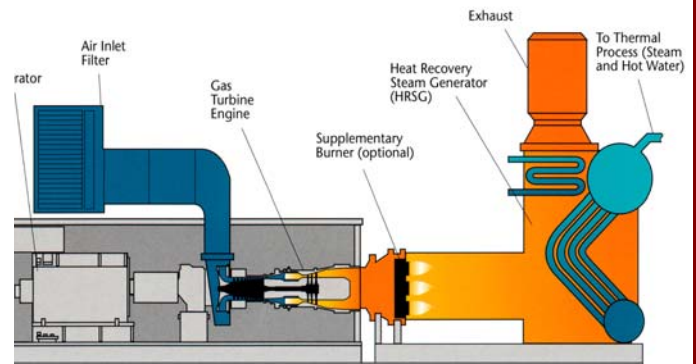

Components of typical gas-fired turbine CHP unit

Graphic (adapted) courtesy of Solar Turbines Corp.

Federal facilities are directed by Executive Order 13123 to lead by example in meeting national energy and environmental goals. This Order specifically directs agencies to "strive to reduce total energy use and other air emissions at the source. To that end, agencies shall undertake life-cycle cost-effective projects in which source energy decreases, even if site energy use increases." The Order also directs agencies to implement district energy systems in new construction or retrofit projects when cost-effective and to consider CHP when upgrading and assessing facility power needs.

Recognizing the federal mandates and benefits of CHP, DOE, the U.S. Environmental Protection Agency (EPA) and the private sector have embarked on a joint effort to double the amount of CHP capacity in the U.S. by 2010. The actions and benefits identified in the National CHP Roadmap (Fig. 3) were developed under the auspices of the U.S. CHP Association. The federal government is one actor among many in this coalition. The majority of new CHP potential in the United States is in private industry. Several DOE and EPA programs are working to address the obstacles to CHP, such as environmental and regulatory issues. FEMP offers unbiased information and technical assistance to any Federal agency interested in developing a CHP project. FEMP also offers services including CHP quick screening, assistance with life-cycle cost analyses, partnership-building between Federal sites and project developers and financiers, baseline data collection, design and technical assistance, component matching and system sizing to thermal and power profiles, and technical/price proposal evaluations. (The back cover of this report lists some useful FEMP resources.)

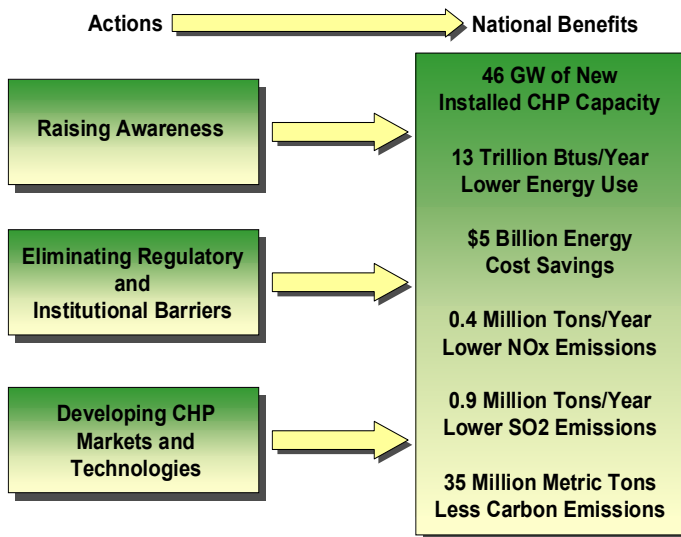

Source: USCHPA 2001

Fig. 3: National CHP roadmap: objectives for 2000–2010.

Federal CHP Market Assessment: Purpose and Approach

Many questions arise regarding CHP in Federal facilities: How much capacity is potentially available nationwide? Is it significant? Where and in which agencies is it concentrated? What are the economics involved? What difference does technology make? What types of buildings are the best candidates for CHP? To help answer these questions, a model was developed that calculates the energy use and costs in different types of Federal buildings across the country. The model allows the user to select various parameters regarding the CHP technology, energy prices, and energy use. It then calculates the financial payback of CHP to determine the amount that could be implemented within prescribed parameters. The base case included only those buildings with simple paybacks of less than 10 years. In a typical Federal installation such as those modeled for this market assessment, CHP is assumed to provide thermal energy for heating and cooling a building while at the same time generating a portion of its electricity needs. While other applications (process steam for industry, laboratories, laundry, hot water, dehumidification) and more complicated systems (thermal storage, multiple units of variable sizes and types, multiple thermal applications) are possible and often result as site-specific conditions are analyzed, it was not practical to make assumptions about these alternatives in the present assessment. Site-specific information is critical to verify CHP potential. Appendix B discusses site-specific variables.

Potential CHP Capacity

The total amount of CHP potential capacity for Federal facilities nationwide is estimated to be between 1500 and 1600 MW (Table 1). Under base case assumptions, the CHP systems would produce 7.7 TWh of electricity representing over 13% of the 57 TWh total electricity purchased by the Federal government in FY 2000. This CHP capacity would provide electricity and thermal energy for about 580 million ft² of building space in 9% of all

Federal sites. The potential will be greatest in large sites with central plants or mechanical rooms and high electricity rates. The assumptions behind these numbers are summarized here:

- use reciprocating gas engines at their current estimated cost and efficiencies;
- energy prices at 2000 industrial rates for each state;
- supply 75% or 50% of estimated electric demand with load factors at 85% or 35%, depending on building type and size;
- consider only the percentage of CHP-compatible Federal facilities;
- assume all recoverable waste heat is utilized by the site; and
- consider only systems with a simple payback less than 10 years.

Changing these parameters can give widely different amounts of CHP potential and energy savings.

Table 1: National CHP potential by building category at Federal facilities using base case assumptions

	Hospital	Industrial	Office	Prison	R&D	School	Service	Total
Total Mft ² , all buildings ^a	141	115	514	41	144	136	463	2757 ^b
Mft ² buildings with CHP payback <10 years	113	80	146	16	100	42	82	579
Total number of sites ^a	331	181	2302	99	421	917	1033	8182 ^b
Number of sites with CHP payback <10 years	235	75	167	38	70	42	74	700
% of sites with CHP potential	71	42	7	38	17	5	7	9
Potential TWh of electricity from CHP	2.9	2.3	0.8	0.2	0.8	0.1	0.7	7.7 ^c
Potential CHP Capacity, MW	440	340	250	40	270	20	210	1570 ^c

^a Includes buildings in General Services Administration database >25,000 ft², even those without CHP potential

^b Total includes other building types not shown.

^c Row total differs due to rounding.

With more than 400 MW, Federal hospitals represent the building category with the highest CHP potential. They also show the most promising target of opportunity, since over two-thirds of large hospitals are expected to have CHP potential. Industrial buildings are next in potential capacity, at 340 MW, and are second in percentage of sites at 42%. R&D facilities, office buildings, and service buildings offered 270, 250, and 210 MW, respectively. It should be noted that the office category is nearly five times larger than most other building categories. Thus, while 250 MW is significant, only 7% of large Federal office facilities showed potential for CHP. Another category with high total floor space was service facilities, but CHP capacity there is limited by a low average energy intensity and a lower percentage of buildings assumed to have CHP-compatible HVAC systems. Schools and prisons ranked relatively low in potential capacity, due both to relatively low floor space and energy intensities. About one-third of Federal prisons show potential, so even though this may be a small niche, it merits exploration. Figure 4 shows the percentage of buildings with CHP potential (payback less than 10 years) in a given category and compares that percentage to corresponding MW of capacity.

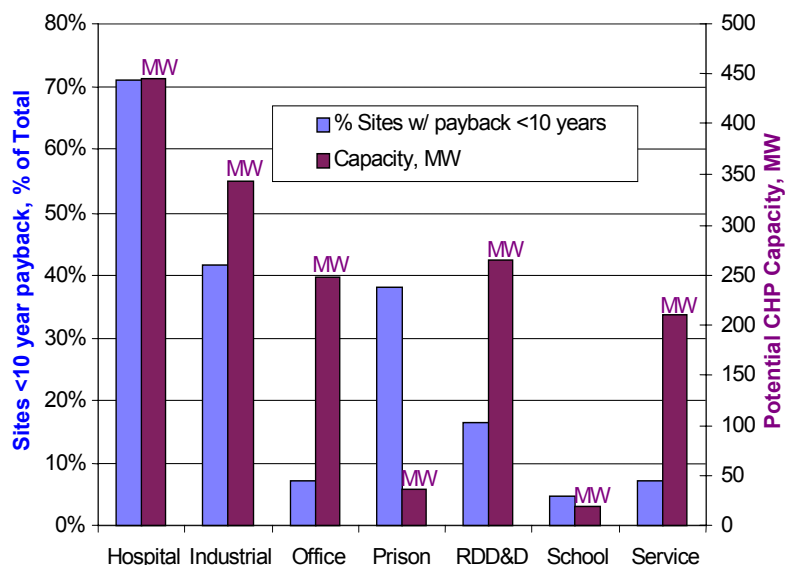

Fig. 4. Percent of Federal sites with CHP potential by building category and corresponding capacity (MW).

CHP and Emissions

EPA considers CHP to be a key pollution prevention tool. EPA estimates that electric power generation plants are responsible for:

- 67% of all emissions of sulfur dioxide (SO₂), the leading component of acid rain and fine particulates;
- 40% of all man-made emissions of carbon dioxide (CO₂), the leading greenhouse gas believed to contribute to global warming;
- 25% of all emission of nitrogen oxides (NO_x), a key component of ozone (smog), acid rain, and fine particulates; and
- 34% of all emissions of mercury (Hg), a toxic heavy metal that is concentrated through the food chain.

The source energy saved through the higher efficiency of CHP lowers the amount of emissions that will occur. With 50 TBtu of source energy saved (assuming all CHP estimated to have paybacks less than 10 years is installed), CO₂ emissions would be reduced by 2.7M metric tons/year, assuming conservatively that all this energy would otherwise have come from central generation equipment using natural gas. This is roughly equivalent to the output of 560,000 cars. In some regions of the country, the avoided fuel would be coal or oil for a portion of the energy. These have higher carbon intensities and additional harmful emissions, so pollution prevention benefits of CHP would be much higher. The actual emission benefits of a project will depend on several site-specific and technology-specific factors. Using state of the art gas turbines and control technologies, CHP can meet stringent emissions requirements as a clean and economically competitive energy alternative.

Federal CHP Potential by Geographic Area

Figure 5 shows the breakdown between building types for each FEMP Regional Office area. Under base case assumptions, the regions with the largest Federal CHP potential are the Western, Central, and Southeast Regions.

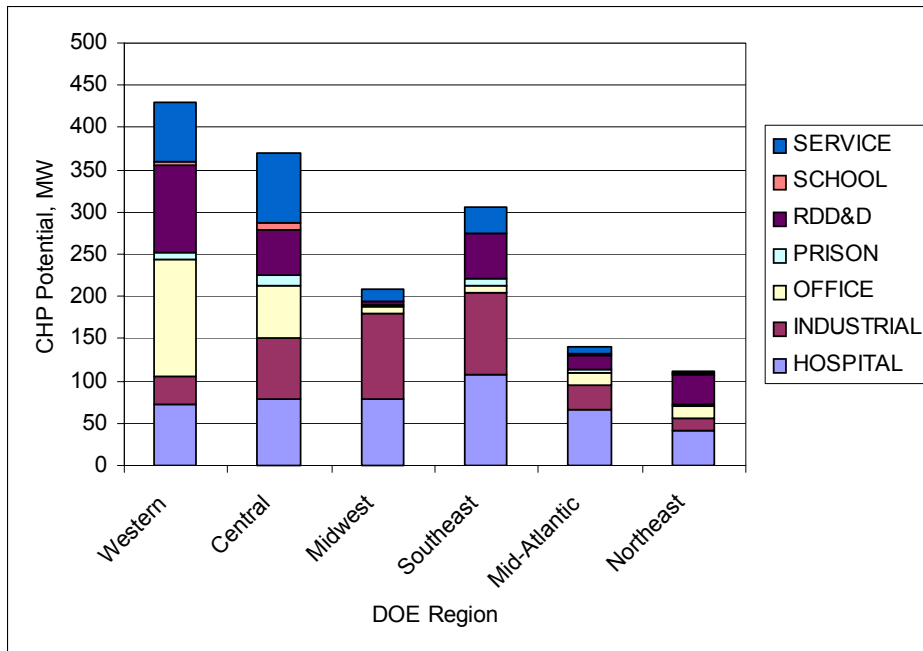

Fig. 5. CHP potential capacity by building type by DOE Regional Office area.

Besides the amount of floor space and energy intensity in any state, a key factor is the relative price of natural gas and electricity. States with low gas prices and high electricity prices are the best candidates for CHP. Contrarily, high gas prices and low electricity prices make CHP less attractive. Figure 6 illustrates the national amount of potential CHP capacity and Fig. 7 shows the states with the highest difference between electricity and gas prices (spark spread). Note that there is a strong correlation between the two figures. Exceptions exist primarily because states with higher numbers of large Federal buildings are more likely to have higher CHP potential.

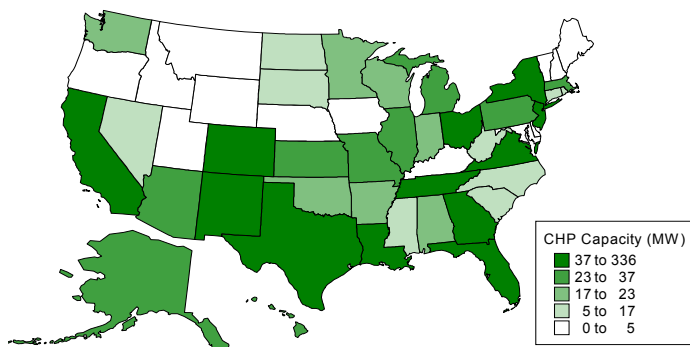

Fig. 6: Federal CHP potential capacity under base case, MW.

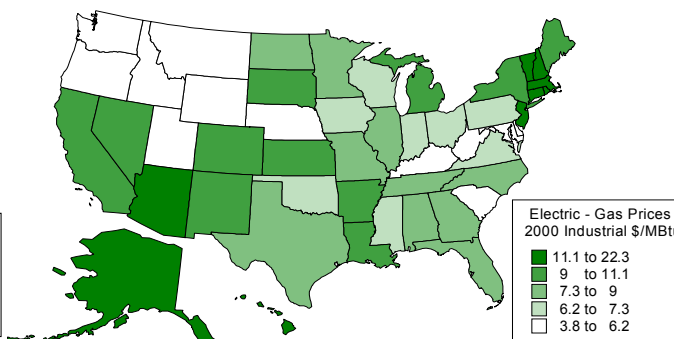

Fig. 7: "Spark spread" difference in electric and gas prices in \$/MBtu.

CHP Potential by Federal Agency

The potential CHP capacity for each agency is estimated in Table 2 by building type. Many agencies showed little potential as calculated using the base case parameters. (The sum does not exactly match the earlier analysis, because agency-by-agency averages by state have slightly different paybacks compared to the building category averages that go above or below the threshold 10 years.)

Nearly all CHP potential is found among nine agencies: the three military services, VA hospitals, DOE, NASA, General Services Administration (GSA), the U.S. Postal Service, and the Department of Justice (Fig. 8). And the first three (military, VA and DOE) represent 83% of the total CHP potential identified in the base case. The military services (over 50% of total) have significant potential CHP capacities in most types of buildings, while the VA has capacity mainly in hospitals.

Energy and NASA capacity is concentrated in R&D and industrial buildings, while GSA and the Postal Service have capacity in the "office" category. It should be mentioned that the categories directly reflect the GSA database, which appears to include Postal Service processing and distribution centers under the office category. The Justice sector capacity is in prisons.

Details of agency capacities by state are presented in Appendix C. Each agency will have the greatest potential capacity in the states with large, campus style facilities and large spark spreads. VA hospitals are fairly evenly scattered across the country. While the database is imperfect, the margin of error occurs in both directions: some facilities may close while others are expanding.

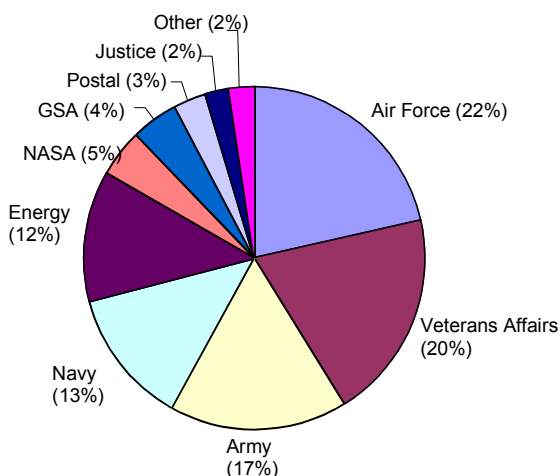

Fig. 8. Potential CHP capacity for major Federal agencies (% of 1590 MW total).

Table 2: Potential CHP capacity by Federal agency and building category, MW

Agency	Hospital	Industry	Office	Prison	R&D	School	Service	Total (MW)
Air Force	43	57	31	0	85	7	116	339
Veterans Affairs (VA)	311	0	1	0	1	0	0	314
Army	55	101	52	2	24	3	33	270
Navy	27	36	39	0	43	2	58	205
Department of Energy	0	113	15	0	64	0	2	195
National Aeronautics and Space Administration (NASA)	0	17	10	0	43	0	3	73
General Services Administration (GSA)	0	1	68	0	0	0	0	69
United States Postal Service	0	0	48	0	0	0	0	48
Justice	0	3	0	34	0	0	0	37
Health and Human Services	6	0	0	0	2	0	0	9
Treasury	0	8	0	0	0	0	0	8
Transportation	0	0	2	0	4	0	0	7
Interior	0	2	2	0	0	3	0	7
Agriculture	0	0	0	0	3	0	0	3
Other	0	0	0	0	2	0	0	7
Grand total (MW)	443	338	269	36	274	16	212	1588

Note: Other = Dept of Commerce, Corps of Engineers, National Science Foundation, U.S. Environmental Protection Agency, and Dept. of Education. Other Federal agencies considered did not show potential under the parameters of this market assessment.

CHP Costs and Savings

Table 3 shows the average costs, payback, and annual savings that would be expected if all the CHP identified in the base case were implemented at Federal sites. Costs include one-time installation, annual operating, and annual gas purchase expenses. Installed costs range from \$600 to \$1300/kW, and operating and maintenance (O&M) from \$5.5 to \$12/MWh, depending on system size and technology. The thermal benefits of CHP are incorporated in the gas cost since the amount of gas needed is the amount to make the electricity minus the amount displaced by CHP waste heat utilization. Dollar savings come from reduced electricity purchases, and the net annual savings (\$171 million/year) are these savings less annual costs. "Simple payback" is the installation cost divided by the annual net savings, to show the number of years until the installation cost is recovered. The payback numbers reflect national averages for each building category for states where that category showed payback under 10 years. Hospitals and industrial and prison facilities show the shortest payback periods.

Table 3: CHP costs, savings, and payback, by building category, under base-case assumptions

	Hospital	Industrial	Office	Prison	R&D	School	Service	Total
Capacity, MW	446	342	248	36	265	18	211	1567
Installation cost, M\$	319	222	174	28	163	14	135	1055
Operating cost, M\$	23	17	6	2	6	0	5	59
Gas cost, M\$	55	42	15	4	16	1	12	145
Electricity savings, M\$	138	100	44	11	44	3	35	375
Net annual savings, M\$	60	41	23	5	22	2	18	171
Average payback, years	5.3	5.5	7.5	5.8	7.4	7.5	7.4	6.2

Results: CHP and FEMP

There is significant potential—1,500 to 1,600 MW of capacity—for CHP to serve Federal facilities. Regions with the greatest CHP potential are the southwest, northeastern metropolitan areas, and the southeast (Fig. 5). Agencies with the most potential are the military, VA, and DOE, especially in hospital, industrial, and R&D facilities. The actual potential could be higher or lower depending on the specific conditions of any given site. Where the Federal government can obtain low-cost electricity, CHP will have difficulty competing. But if on-site energy is required for security, CHP can make the system more efficient and cost-effective. As energy prices increase and CHP system costs decrease, the amount of cost-effective CHP potential will rise.

The 1.5 GW identified under the base-case scenario would be sufficient to power more than a million homes and save the Federal government \$170M per year in energy costs. To install the 1.5 GW of electrical CHP generating capacity (all cases where the simple payback period is under 10 years) would require an estimated \$1.5–\$2 billion in capital investments. The source (primary) energy savings from this level of CHP investment are estimated to be 50 trillion Btus per year, and projected carbon dioxide emissions would be reduced by 2.7 million metric tons per year compared to gas-fired central-electric-power and thermal alternatives.

Although CHP technologies are proven and the potential savings and benefits are significant, project development over the past decade has been modest in the Federal sector. Given the potential for CHP, why haven't more Federal facilities installed this technology? Preliminary discussions with Federal facility managers suggest that the primary reasons include:

- low historical tariffs for electricity;
- high initial cost of CHP systems;
- limited budgets (agencies rarely have sufficient appropriations for even much smaller energy conservation investments);
- complexity of CHP systems due in part to the need for custom engineering and design of different components for each site;
- lack of time and capability for facility managers to evaluate potential applications and benefits to their site;
- obstacles related to local regulations and policies for interconnection, backup/standby fees, siting and emissions (see ORNL/TM- 2001/280); and
- lack of trusted sources of information about the costs, operation, and performance of CHP systems.

Various programs within DOE, along with EPA, are working to address many of the obstacles related to CHP. FEMP in particular provides technical assistance, project financing, and outreach. An initiative called "Accelerated Development and Deployment of Combined Heat and Power," or ADD CHP, is an integral part of FEMP's technical assistance DER program. The strategy is to enable sound investments in CHP systems by providing qualified support to Federal sites with champions motivated to develop a CHP project. FEMP services, include:

- conducting CHP quick technical screening for interested Federal sites;
- performing site survey and feasibility verification;
- fostering partnerships among Federal, state, and private sector project developers that bring financing if needed;
- collecting baseline data;
- fostering partnerships between Federal sites and industry developers of "packaged" CHP;
- providing design and technical assistance to projects selected under FEMP calls for projects;
- providing support in addressing policy and regulatory constraints — siting and permitting, grid interconnection requirements, exit fees, standby/backup charges;
- providing conceptual design, component matching, and sizing verification (thermal/power profiles); and
- evaluating technical/price proposals.

Getting Help Identifying CHP Opportunities

Because many Federal facility managers have no time to investigate whether CHP will work for their site, FEMP can assist through a free screening for CHP potential. The screening provides an initial estimate of site-specific

economics for a CHP project and helps determine if further investigation of CHP opportunities is worth the effort. Basic criteria that influence the economics of a CHP project are listed in the box on page 1. Several other factors affect the economics of CHP projects, for example, if CHP replaces equipment nearing the end of its useful life, or if it is bundled with other energy-efficient measures with shorter payback periods, economics could improve. And as demonstrated earlier, CHP economics are highly sensitive to utility rates. CHP systems could help a facility “flatten” the peaks in electric and gas loads, allowing sites to negotiate reductions in rates and demand charges or to move to a more favorable interruptible rate schedule for part of the load. On the other hand, there could be increased costs related to standby and exit fees. Therefore, once an initial screening indicates there is potential for CHP, interested sites should investigate utility rate issues and opportunities that may arise with the CHP project along with siting and permitting issues.

Strong private partners can support the CHP project development process as well as offer a source of financing. And of course, FEMP can assist Federal sites in their efforts to identify appropriate partners and deploy CHP. FEMP recognizes the significant potential for CHP technologies to reduce the costs of government, increase energy security, and improve air quality and is actively working to make advanced CHP technologies more easily accessible to Federal agencies throughout the nation.

Next Steps

If you think your facility has CHP potential, here are some specific steps you can take to get a better idea about your CHP opportunity:

- Find a private partner to help verify CHP opportunities and sources of project financing.
- Collect and analyze data from the electric utility to determine proper sizing for electrical loads.
- Likewise, detailed data from the gas utility, logs for boiler and/or chiller operation, and thermal demand qualifications at your site (temperature and rate) will allow a better estimate of CHP design parameters for maximum efficiency and use of recovered heat. Site-specific boiler efficiency information will also help adjust the economic analysis to your actual costs.
- Identify any special conditions—energy security, equipment replacement, mission changes—that could impact your CHP project. This will allow a more accurate CHP assessment and a design to meet your needs.
- Emissions and permitting issues will be important. Be sure to identify the state and local requirements for permitting a CHP plant early in the planning process.
- Utility rate schedules are instrumental in defining CHP economics. Identify potential impacts on energy rates under a CHP scenario. Could better gas rates be negotiated? (This is often possible with CHP.) What are the utility’s standby electric rates and terms for on-site generation? Are exit fees applicable? Could your load profile, coupled with CHP, allow you to take advantage of demand-side management or other incentive programs from the electric utility?
- Obtain reliable estimates of the costs and benefits of different CHP technologies. Be clear about your priorities and the operating parameters of your facility. Performance and emissions from different CHP prime movers are well documented and can vary greatly. It is likely that one system will be better suited to your needs than another.
- Look into the full array of alternative financing options for your facility. Does your site have neighbors with similar needs for energy security, heating, and cooling? Since CHP involves a capital asset and a service with potential value to multiple customers, some unique private financing may be possible offering greater advantages to the government in terms of initial costs, interest rates, and risk. Several successful CHP projects involve multiple customers.

As you move forward, take advantage of FEMP’s CHP team to answer your questions and help remove roadblocks. They can provide direct assistance or connect you with people who have worked through similar projects. If you need a partner, FEMP can help identify options to meet your needs. Given the complexities of CHP, a good contractual relationship with a partner can make all the difference. FEMP’s ADD CHP can prepare an analysis based on interval data (by the hour or quarter-hour) for a 1-year period; these data are normally available from your electric utility.

Appendix A: CHP Efficiency—Site Versus Source Energy Savings

A CHP system is generally not more efficient at generating electricity than the central grid, and properly maintained boilers can be more efficient at producing thermal energy alone than a CHP system. However, the combined generation and use of electricity and thermal energy on-site by a well-designed CHP system is more efficient overall than the combined efficiencies of these two standard alternatives. One key to ensuring an efficient CHP system is to maximize the use of thermal energy (waste heat) from the generation process. Emissions or other site-specific factors may override electrical efficiency when determining which CHP system best meets a facility's needs.

Because CHP uses energy to generate electricity on site, and because it is slightly less efficient for thermal purposes than a regular boiler, the energy use at the site will increase with a CHP system, and site-based energy savings will be negative. However, since losses associated with generating and distributing the electricity (from the central grid) will be avoided, CHP results in a net savings of primary, or "source," energy.

Table A-1 estimates the amount of source energy savings for each building type. The additional gas used at the site is higher in Btu value than the electricity generated on site. However, using an average heat rate for central power generation of 10,346 Btu/kWh, the energy losses at the central generating plant avoided by using CHP more than compensate for the extra gas used on site, giving a significant net primary energy savings when comparing site to source. The estimated annual source-based energy savings that would accrue if all 1.6 GW of CHP were implemented under the base case is 50 trillion Btu. This represents about 8% of total primary energy consumption reported for Federal buildings and facilities in 1999.

Table A-1: Site and source energy savings from Federal CHP, TBtu/year

	Hospital	Industrial	Office	Prison	R&D	School	Service	Total
Additional gas use at site	11.0	8.4	2.9	0.9	3.0	0.2	2.4	28.9
Avoided electricity purchases	10.0	7.7	2.6	0.8	2.8	0.2	2.2	26.2
Site energy savings	-1.0	-0.8	-0.3	-0.1	-0.3	0.0	-0.2	-2.7
Avoided source energy use	30.3	23.3	7.9	2.4	8.4	0.6	6.7	79.6
Source energy savings	19.3	14.8	5.0	1.5	5.4	0.4	4.3	50.7

Appendix B: Site-Specific Variables

Given the quality and types of data available and the methodology used in this analysis, it is impossible to make reliable predictions about specific sites and their respective CHP potentials. This analysis used state- or region-wide averages for various building types and energy variables; any actual site can have widely different values. Many site-specific conditions affect the economics of CHP applications and detailed, site-specific data must be

considered in estimating CHP potential for any individual site.

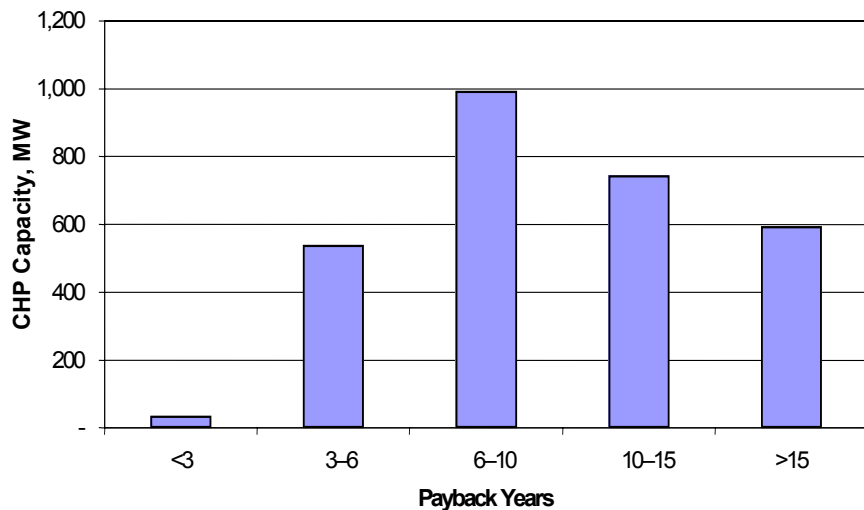

Fig. B-1: CHP capacity in base case at different ranges of payback period.

- Non-economic considerations:** This analysis assumes there is potential CHP capacity only if it is expected to pay from savings within a given period of time. Other factors such as energy security and quality, or emissions, could predominate the decision to install a CHP system.

- Installation costs** of recent CHP projects at Federal sites have varied from less than 50% to 150% of the equipment costs. Some states and utilities may offer

subsidies or reduced tariffs for CHP projects. Also, interconnection and standby fees can vary considerably from one utility district to another. (See ORNL/TM-2001/280, Appendix C, for a discussion of interconnection requirements, standby fees, and exit fees.)

- Fuels and infrastructure:** The availability of gas, condition and type of current HVAC equipment, planned renovations, or other infrastructure factors may facilitate or prevent CHP from being deployed. The assessment assumed that a limited percentage of buildings are CHP-compatible. If a site needs to replace boilers and HVAC equipment, the marginal cost of adding CHP may be small and the returns may be higher than assumed.
- Energy intensities** at Federal sites vary widely and can significantly affect CHP sizing and economics. Many buildings use electricity for mechanical chillers, increasing the electrical intensity but lowering the gas intensity. CHP systems can use the thermal exhaust in absorption chillers for air conditioning, thereby altering the electric and thermal energy intensities of the buildings.
- Fuel Prices:** Prices for electricity and gas vary widely from the state average used in this analysis. Those tariffs may be lower in some cases today, but are likely to rise as contracts expire. Also, this analysis did not attempt to look at the potential for CHP systems to be used in conjunction with peak shaving and load-reduction incentive programs being offered by an increasing number of utilities.

Appendix C: Details on CHP Potential by State

Table C-1 shows potential CHP capacity by state for leading agencies in megawatts. Details of CHP capacity by state and agency represent probabilities as calculated in the model; site-specific information is needed to confirm CHP potential. States not listed showed zero potential with payback <10 years under base-case assumptions.

Table C-1: Potential CHP capacity by state for leading agencies (MW)

State	Air Force	VA	Army	Navy	Energy	NASA	GSA	Postal Service	Justice	Total
AK	13	0	6	1	0	0	3	1	0	24
AL	1	12	4	0	0	1	0	0	0	18
AR	3	8	2	0	0	0	0	0	1	14
AZ	10	4	9	1	0	0	1	1	1	27
CA	75	27	13	99	29	25	32	26	5	331
CO	19	4	14	0	9	0	12	4	2	64
CT	0	2	3	4	0	0	1	1	0	11
DC	0	5	11	0	0	0	0	0	0	16
FL	35	14	0	17	0	27	0	0	4	97
GA	32	10	6	0	0	0	0	0	4	52
HI	4	0	10	13	0	0	1	1	0	29
IA	0	4	0	0	0	0	0	0	0	4
IL	2	15	8	2	1	0	0	0	2	30
IN	0	7	7	4	0	0	0	0	1	19
KS	6	4	16	0	0	0	0	0	1	27
LA	5	6	10	3	0	10	5	2	1	42
MA	8	8	4	2	0	0	4	3	1	30
ME	0	1	0	0	0	0	0	0	0	1
MI	2	9	7	0	0	0	3	4	0	25
MN	2	6	6	5	0	0	0	0	0	19
MO	10	7	9	0	7	0	0	0	0	33
MS	3	5	2	0	0	0	0	0	0	10
NC	0	9	4	3	0	0	0	0	1	17
ND	11	1	0	0	0	0	0	0	0	12
NH	1	1	1	1	0	0	0	0	0	4
NJ	10	4	17	5	1	0	3	5	0	45
NM	17	2	10	0	37	1	3	1	0	71
NV	4	1	1	0	4	0	0	0	0	10
NY	6	27	4	5	10	0	0	0	1	53
OH	3	9	7	0	34	0	0	0	0	53
OK	8	4	4	0	0	0	0	0	1	17
OR	0	5	0	0	0	0	0	0	0	5
PA	0	16	2	1	0	0	0	0	2	21
RI	0	1	0	7	0	0	0	0	0	8
SC	0	0	0	0	13	0	0	0	0	13
SD	8	2	0	0	0	0	0	0	0	10
TN	0	14	7	3	38	0	0	0	0	62
TX	38	22	40	19	4	10	0	0	8	141
UT	0	3	0	0	0	0	0	0	0	3
VA	0	10	13	10	0	0	0	0	0	33
VT	0	1	0	0	0	0	0	0	0	1
WA	0	6	5	0	7	0	0	0	0	18
WI	0	9	8	0	0	0	0	0	0	17
WV	0	8	0	0	0	0	0	0	0	8
Total	339	314	270	205	195	73	69	48	37	1550

*Total does not include 40 MW from other Federal agencies.

Under base case assumptions, the six states with the largest Federal CHP potential are California, Texas, Florida, New Mexico, Colorado, Tennessee, and the New England States. Figure C-1 shows the breakdown between building types for the top 20 states.

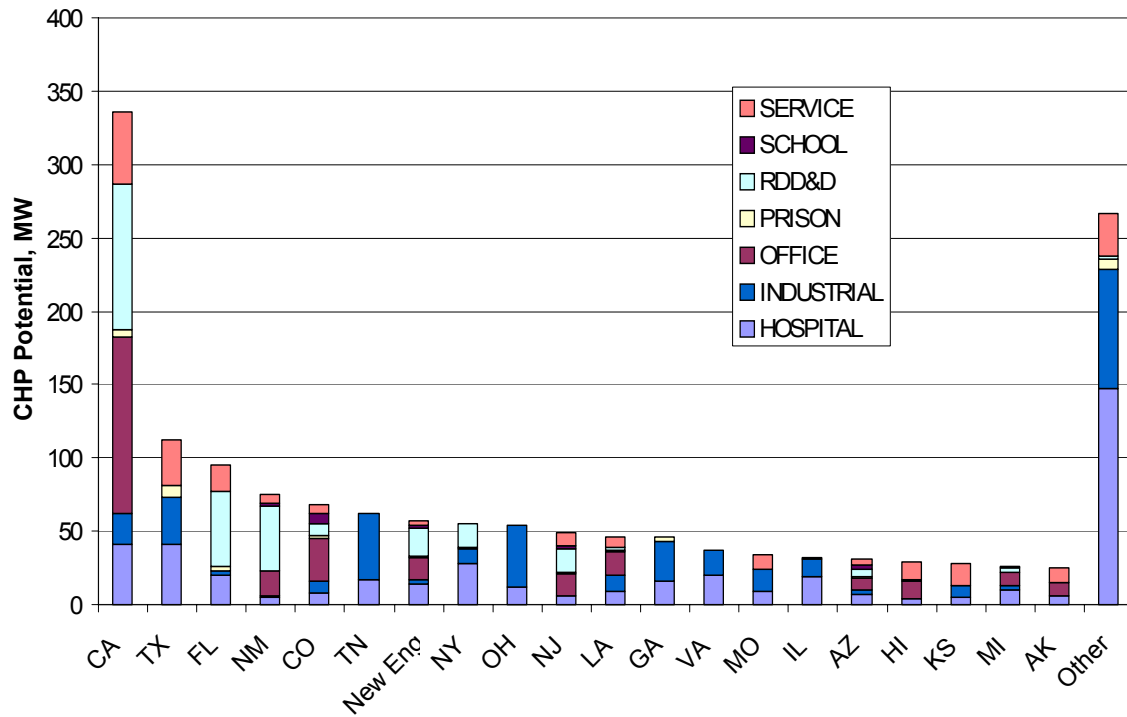

Fig. C-1. CHP potential capacity by building type for top 20 states, MW.

DOE's Regional Offices process requests for technical assistance related to CHP. Learn more about FEMP's team in the regional offices and programs to support financed energy projects by visiting http://www.eren.doe.gov/femp/financing/femp_services_who.html.

Program Contact

CHP/Technical Assistance

Shawn Herrera, DOE FEMP

Phone 202-586-1511, Fax 202-586-3000

shawn.herrera@ee.doe.gov

For More Information

To learn more about CHP, explore the following websites:

FEMP

http://www.eren.doe.gov/femp/techassist/der_resources.html

DOE Office of Power Technologies

<http://www.eren.doe.gov/der/chp/>

Oak Ridge National Laboratory FEMP

<http://www.ornl.gov/femp/index.html>

United States Combined Heat and Power Association

<http://www.nemw.org/uschpa/>

