

DISTRIBUTED ENERGY PROGRAM REPORT

Guide to Developing Air-Cooled LiBr Absorption for Combined Heat and Power Applications

April 2005

By

Robert A. Zogg
Michael Y. Feng
Detlef Westphalen

TIAX LLC



U.S. Department of Energy
Energy Efficiency
and Renewable Energy

Bringing you a prosperous future where energy
is clean, abundant, reliable, and affordable



Table of Contents

1.0 INTRODUCTION/BACKGROUND	1
2.0 LIBR ABSORPTION OVERVIEW	3
3.0 KEY TECHNOLOGY BARRIERS	5
3.1 APPLICATION ISSUES	6
3.2 CLIMATE ISSUES	6
4.0 SUMMARY OF PAST DEVELOPMENT EFFORTS	9
5.0 PATENTS	15
6.0 PAST APPROACHES TO AIR COOLING.....	17
6.1 HEAT/MASS TRANSFER APPROACHES	17
6.1.1. <i>Vertical Falling-Film Absorber.....</i>	17
6.1.2. <i>Separation of Heat and Mass Transfer in Absorber.....</i>	19
6.1.3. <i>Rotating Heat Exchangers</i>	19
6.1.4. <i>Heat Rejection via Secondary Loop and Dry Coil.....</i>	20
6.1.5. <i>Direct-Expansion Evaporator.....</i>	21
6.1.6. <i>Raising Chilled-Water Supply (and/or Supply-Air) Temperature</i>	21
6.2 CHEMISTRY APPROACHES	22
6.2.1. <i>Carrier's Carrol Solution.....</i>	23
6.2.2. <i>Energy Concept's Metal Hydroxide Sorbent.....</i>	23
6.2.3. <i>Yazaki's LiBr/LiCl/LiI Solution.....</i>	23
6.2.4. <i>University of Utah's/GRI's Organic Crystallization Inhibitors</i>	23
6.3 THERMODYNAMIC CYCLE MODIFICATIONS	24
6.3.1. <i>Half-Effect Cycle.....</i>	24
6.4 CASCADED SYSTEM APPROACHES	25
6.4.1. <i>Cascaded System—Vapor-Compression to Absorption</i>	25
6.4.2. <i>Cascaded System—Absorption to Vapor-Compression</i>	26
6.5 CONTROLS	27
7.0 OTHER POTENTIAL APPROACHES TO AIR COOLING	28
7.1 TEMPERING OUTDOOR AIR WITH BUILDING-EXHAUST AIR.....	28
7.2 BOOSTING ABSORBER PRESSURE.....	29
7.3 DROPPING GENERATOR PRESSURE	30
7.4 INTERMITTENT EVAPORATIVE COOLING.....	31
7.5 MICROCHANNEL HEAT EXCHANGERS.....	33
7.6 PRE-COOLING RETURN AIR	33
8.0 SUMMARY/CONCLUSIONS.....	35
REFERENCES.....	37

List of Tables

Table 1: Absorber Temperature and Concentration Limits to Avoid Crystallization ^a	5
Table 2: U.S. and Japan Climate Comparison	7
Table 3: Summary of Published Past Air-Cooled LiBr Development Efforts.....	9
Table 4: Key Reasons for Failures of Past Development Efforts	10
Table 5: Performance Characteristics for Past Air-Cooled LiBr Development Efforts	12
Table 6: LiBr Chiller/Cooler Volume and Weight Comparisons	13
Table 7: Recent U.S. Patents Related to Air-Cooled LiBr Absorption	15
Table 8: Recent Non-U.S. Patents Related to Air-Cooled LiBr Absorption	16
Table 9: Crystallization Inhibitors for Air-Cooled LiBr.....	22
Table 10: Maximum Cooling Provided by Tempering Outdoor Air with Building Exhaust	29

List of Figures

Figure 1: Basic Single-Effect LiBr Absorption Cycle.....	3
Figure 2: Dühring Diagram Comparing Air-Cooled and Water-Cooled Single-Effect Absorption	5
Figure 3: Performance Impacts of High Ambient Temperatures.....	8
Figure 4: Yazaki ACH-8 Air-Cooled LiBr Chiller (8 Ton).....	11
Figure 5: LiBr Chiller/Cooler Size Comparison	13
Figure 6: Conventional Falling-Film Absorber	17
Figure 7: Vertical Falling-Film Absorber	18
Figure 8: Packaging of Vertical Falling-Film Absorber	18
Figure 9: Separation of Heat and Mass Transfer in the Absorber	19
Figure 10: Rotating Absorption Chiller/Heat Pump	20
Figure 11: Heat Rejection Via Secondary Loop and Dry Coil	21
Figure 12: Half-Effect Cycle.....	25
Figure 13: Cascaded System—Vapor-Compression to Absorption	26
Figure 14: Cascaded System—Absorption to Vapor-Compression	26
Figure 15: Tempering Outdoor Air with Building Exhaust.....	28
Figure 16: Boosting Absorber Pressure	30
Figure 17: Mechanical Compression to Boost Absorber Pressure	30
Figure 18: Dropping Generator Pressure (Shown Combined with Boosting Absorber Pressure).....	31
Figure 19: Intermittent Evaporative Cooling	32
Figure 20: Pre-Cooling Return Air	34

Abstract

The objective of our investigation is to summarize the development status of air-cooled lithium bromide (LiBr)-water absorption chillers to guide future efforts to develop chillers for CHP applications in light-commercial buildings (typically 10 to 150 RT). The key technical barrier to air-cooled operation is the increased tendency for LiBr solutions to crystallize in the absorber when heat-rejection temperatures rise. Developers have used several approaches, including chemistry changes to inhibit crystallization, improving heat and mass transfer to lower overall temperature lift, modifying the thermodynamic cycle, combining absorption with vapor-compression to lower the temperature lift for each system, and advanced control systems to sense the onset of crystallization and take corrective action.

Air-cooled LiBr-water absorption chillers/coolers have been analyzed, designed, and prototype-tested since at least the mid-1970s, primarily in Japan, the U.S., and Europe, for solar- and direct-fired applications. Today, only one air-cooled LiBr chiller is on the market (the Yazaki ACH-8), and sales are modest. Key factors in the lack of market success for air-cooled LiBr chillers/coolers are the general down turn in the overall absorption chiller market and the high projected costs for air-cooled designs.

There is relatively little evidence of air-cooled LiBr absorption development efforts specifically targeting CHP applications in light-commercial buildings. In the CHP application, chiller/cooler efficiency is less important relative to direct-fired applications. The efficiencies achieved by single-effect absorption chillers/coolers should be adequate for this application, which simplifies one development challenge for air-cooled products.

There is, however, another formidable design challenge for light-commercial CHP applications in the U.S., namely, operation at high ambient air temperatures. Most air-cooled LiBr absorption development efforts of the past have not adequately addressed operation at high ambient temperatures. Vapor-compression equipment, which can typically deliver over 85 percent of rated capacity in ambient temperatures up to 120°F, sets the benchmark for performance expectations in light-commercial markets.

GRI/Battelle [15] developed and tested an air-cooled, residential LiBr absorption cooler/heater prototype, and achieved performance that approached vapor-compression performance for ambient temperatures up to 110°F.

Chemistry changes to inhibit crystallization have been proven effective in combination with other design measures. Most notably, Carrier's "Carrol" solution (LiBr, ethylene glycol, phenylmethylcarbinol, and water) has been thoroughly tested and proven in solar-fired absorption applications.

Interotex [34] demonstrated a clever rotating absorption system that uses rotational forces to promote heat and mass transfer, as well as to pump solution. The refrigeration system is hermetically sealed, using rotating seals only for cooling water and chilled water. Based on this design approach, operation in ambient temperatures up to 105°F to 115°F should be possible. Development of this technology has been transferred to Fagor Electrodomesticos in Spain, and is now called Rotartica.

We considered several alternative design approaches that are not documented in the open literature for air-cooled LiBr absorption applications. Of these, the most promising is intermittent evaporative cooling. If evaporative cooling is only used at extreme ambient temperatures, it may be possible to avoid many of the disadvantages of full-time evaporative cooling systems such as high water consumption, high maintenance requirements, and risk of harboring Legionella.

The history of air-cooled LiBr chiller/cooler development suggests that developing such a product for light-commercial CHP applications in the U.S. is technically feasible. The key risks lie in whether prominent and capable manufacturers will consider the market potential to be sufficient to justify development costs, and whether product costs can be low enough to appeal to the market.

There are other potentially viable approaches to eliminating the need for cooling towers in light-commercial CHP applications, such as LiBr absorption with ground-coupled heat rejection, ammonia-water absorption, adsorption/chemisorption, and Rankine cycles driving vapor-compression equipment. These approaches were outside the scope of our investigation, but may warrant consideration.

1.0 Introduction/Background

Combined Heat and Power (CHP) systems are widely used in the U.S. in industrial and institutional applications, but are relatively uncommon in commercial-building applications. The DOE Distributed Energy Program is extending CHP to commercial-building applications through the combination of technology development partnerships with industry, and education and information dissemination activities. DOE recognizes the economic and energy-saving benefits of using available heat to provide space cooling through the use of absorption chillers, and is promoting the development and deployment of related technologies. One key market barrier to the use of absorption chillers in light-commercial CHP systems is the need for a cooling tower to reject heat from the condenser and the absorber to the ambient. The use of cooling towers is unpopular in light-commercial applications because cooling towers:

- Can provide breeding grounds for Legionella, the bacteria that cause Legionnaires' disease;
- Increase first costs significantly;
- Require regular maintenance; and
- Require significant physical space.

The development of air-cooled absorption chiller technology could address most of these issues by eliminating the need for a cooling tower.

The objective of our investigation is to summarize the development status of air-cooled lithium bromide (LiBr)-water absorption chillers to guide future efforts to develop chillers for CHP applications in light-commercial buildings (typically 10 to 150 RT). Unfortunately, absorption systems have proven particularly difficult to evaluate analytically with any degree of confidence due to the complex interactions of heat and mass transfer and the number of components involved. While much analytical work suggests that air-cooled LiBr systems are technically and economically feasible, we focused primarily on seeking laboratory and/or field demonstrations of performance and cost-effectiveness.

There are alternatives to LiBr-water absorption that we did not consider, including:

- Ammonia-water absorption (or other refrigerant/sorbent pairs¹);
- Adsorption/chemisorption; and
- Rankine-cycle devices that use waste heat to generate shaft power that, in turn, drives vapor-compression cooling equipment.

These alternatives were simply outside the scope of our investigation. They may very well warrant analysis for CHP applications.

¹ We made one exception by including a metal hydroxide solution developed by Energy Concepts that does not contain LiBr.

There is another approach to eliminating cooling towers for LiBr absorption chillers that we did not consider—ground-coupled heat rejection. This technically sound approach is currently under investigation by other researchers² so we did not duplicate efforts.

Our investigation focused on the air-cooling aspects of the CHP application, rather than the operation of absorption equipment on waste-heat streams. While consideration of the latter is important, approaches to using waste-heat streams appear to be well understood, as at least two major manufacturers (United Technologies and Broad) have commercialized CHP absorption products/systems (using cooling towers).

Foley, et al [21] provides an excellent starting point for this investigation, having reviewed and summarized development work that took place in the 1980's and 1990's. Foley's key observations include:

- The main technical hurdle to air-cooled absorption cooling is the crystallization limit in the absorber;
- Two approaches have been used—mechanical (i.e., improved heat exchangers) and chemical (i.e., additives that shift the crystallization curve);
- Asian manufacturers developed products suitable for moderate climates based primarily on the mechanical approach, but these products are not suitable for U.S. climate conditions; and
- Carrier, in their DOE-funded efforts to develop a solar-fired absorption chiller, developed a solution called Carrol that is suitable for temperature ranges experienced in single-effect absorption machines.

² Researchers at Oak Ridge National Laboratory are investigating ground-coupled heat rejection for LiBr absorption [16].

2.0 LiBr Absorption Overview

Figure 1 illustrates the basic single-effect LiBr-water absorption cycle. The absorber/pump/solution heat exchanger/generator assembly essentially replaces the compressor in a vapor-compression refrigeration system. This assembly is sometimes referred to as a thermal compressor. A dilute (weak) solution of LiBr in water is pumped from the absorber to the generator. A solution heat exchanger preheats the weak solution before entering the generator. Heat is added to the generator to boil the water (the refrigerant) from the solution. The water vapor then flows to the condenser, where it is condensed and heat is rejected to the ambient. The condensed water flows through an expansion device, where the pressure is reduced. The heat flows into the evaporator (providing the desired cooling effect) to evaporate the water. The water vapor then returns to the absorber.

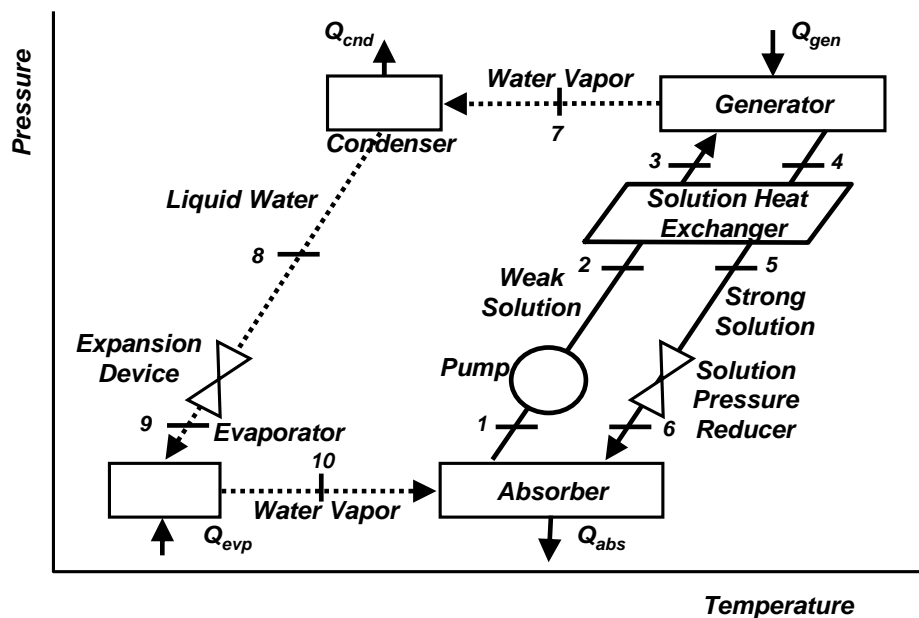

Figure 1: Basic Single-Effect LiBr Absorption Cycle

When the water is boiled out of the weak solution in the generator, the remaining solution becomes strong (high concentration of LiBr). The strong solution is cooled in the solution heat exchanger, flows through a flow restriction to lower its pressure, and returns to the absorber. The strong solution in the absorber absorbs the water vapor returning from the evaporator, diluting the solution. Since the water vapor is now liquid water, this process releases the heat of vaporization, which must be rejected. The entire cycle operates below atmospheric pressure.

In a direct-fired, water-cooled absorption chiller, heat is supplied to the generator from combustion of fossil fuel and cooling water takes the heat rejected by the absorber and condenser to a cooling tower for rejection to the ambient air. In a CHP application, waste heat from the

prime mover is supplied to the generator. There are two options for air cooling of an absorption chiller:

1. Use a conventional, water-cooled condenser and absorber, and substitute a dry coil for the cooling tower to reject heat to the ambient air; or
2. Replace the condenser and absorber with an air-cooled condenser and air-cooled absorber.

3.0 Key Technology Barriers

As characterized by previous investigators such as Foley, et al [21] and Kurosawa, et al [30], the key barrier to air cooling of LiBr chillers in U.S. climates is crystallization of LiBr in the absorber. Table 1 lists typical temperature and LiBr concentration limits for the absorber to avoid crystallization. Figure 2 compares (using Dühring diagrams) the temperature/pressure/concentration characteristics of a typical water-cooled chiller to those for an air-cooled chiller. The figure illustrates that the higher heat-rejection temperatures associated with air cooling bring the cycle closer to the crystallization curve, increasing the possibility of crystallization, especially during transients.

Table 1: Absorber Temperature and Concentration Limits to Avoid Crystallization^a

Chiller Type	Absorber Temperature Limit, °F	Strong Solution Concentration, % by Weight
Single Effect ^b	Approx. 129°F	61 to 64%
Double Effect ^c	Approx. 129°F	64%

- a) For an evaporator condition of 40°F/0.127 psia.
- b) From Liao [31]
- c) From Izquierdo [26]

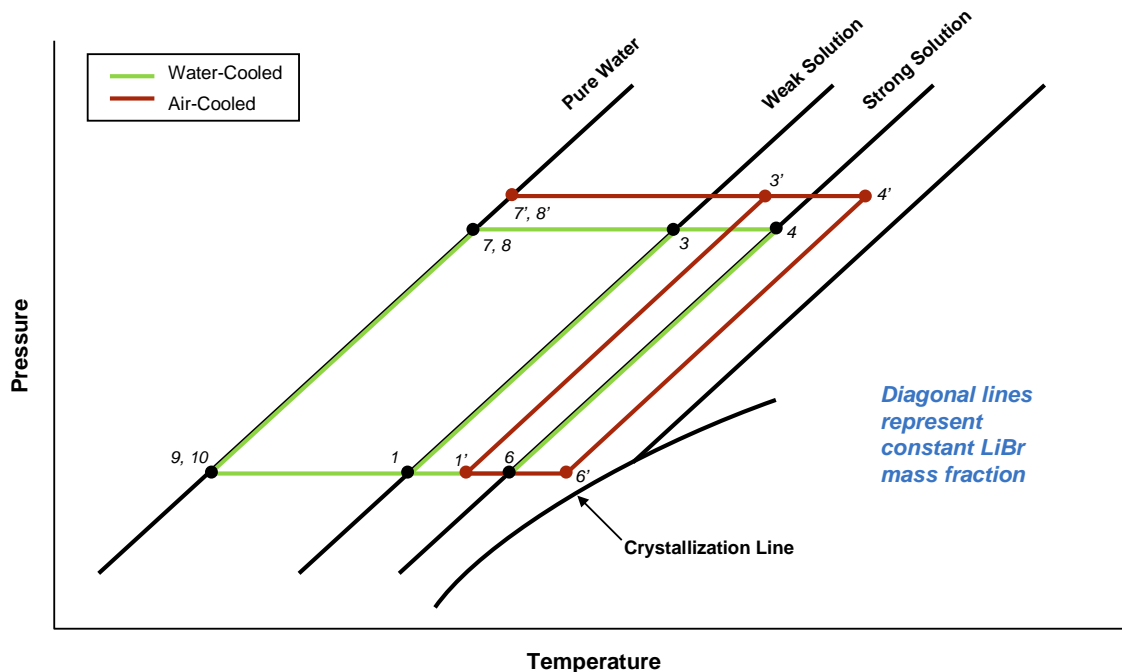

See Figure 1 for definition of state points.
Adapted from Figure 20, ASHRAE Fundamentals Handbook [1].

Figure 2: Dühring Diagram Comparing Air-Cooled and Water-Cooled Single-Effect Absorption

3.1 Application Issues

Past development efforts have been targeted at direct-fired and solar applications. This fact is significant in that the CHP application changes many of the technical and market barriers to air-cooled absorption. From a technical perspective, the higher efficiency of a double-effect chiller is less important in CHP applications than in direct-fired applications because other factors limit the cooling capacity delivered. For example, single-effect chillers can produce 70 to 80 percent as much cooling as double-effect when used with microturbines. While the COP of the double-effect machine can be twice that of single-effect, a single-effect machine can extract useful energy from the microturbine exhaust down to a much lower temperature (typical minimum activation temperature of 170°F versus 340°F). In another example, jacket heat recovered from IC engines (typically 180°F to 250°F—the higher end requiring a pressurized cooling system) is adequate only for single-effect absorption. Using single-effect absorption simplifies the challenge of air cooling because it:

- Lowers the temperature requirements for crystallization and corrosion inhibitors;
- Requires fewer components (i.e., lowers cost); and
- May facilitate the control of crystallization (because the cycle is less complicated).

In solar applications, there are significant cost and performance constraints in the solar collection apparatus that are largely avoided in CHP applications.

Air-cooled absorption does, however, introduce a drawback for CHP applications. Water-cooled absorption chillers can generally operate with heat inputs as low as 340°F (for double-effect) or 170°F (for single-effect). Air-cooled chillers will generally need to operate with higher condensing temperatures compared to water-cooled chillers, which, in turn, will require higher generator temperatures³. Therefore, an air-cooled chiller will be able to utilize less of the waste heat available from exhaust-gas streams, and may require higher temperatures when fired by closed-loop coolant streams (such as coolant from IC engines) unless the generator is redesigned to transfer heat more effectively to compensate. This is an important design consideration when developing air-cooled LiBr absorption for CHP applications.

3.2 Climate Issues

As discussed further below, much of the air-cooled LiBr development work has taken place in Japan. The U.S. market, however, presents a more difficult challenge. Table 2 contrasts the temperature extremes for various U.S. regions to those in Japan. Much of the southern U.S. sees temperatures above 95°F, while temperatures over 95°F are rare in Japan. The values in the table do not include the effects of urban heat islanding (the human impact on temperatures in urban areas), including the elevated temperatures often experienced on rooftops (where light-commercial cooling equipment is normally installed). Therefore, in many applications temperatures may exceed 95°F for a higher percentage of the year than the table indicates. Many

³ Alternatively, one could accept a lower COP at the same generator temperature, but the effect is the same.

past developers have designed air-cooled LiBr absorption chillers for 95°F ambient temperatures, but without demonstrating performance at higher temperatures.

Table 2: U.S. and Japan Climate Comparison

Country	Region/City ^a	Operation Over 95°F ^b	
		Hours/Year	Percent of Year
USA	Northeast/New York	4	0.05%
	Great Lakes/Detroit	0	0%
	California Coast/Los Angeles	12	0.14%
	Gulf Coast/Houston	57	0.65%
	South/Atlanta	8	0.09%
	Central Texas/Dallas	227	2.6%
	Northern Tier/Minneapolis	0	0%
	Pacific Northwest/Seattle	0	0%
	Fresno/El Paso/Fresno	306	3.5%
	Mountains/Denver	10	0.11%
	Desert Southwest/Phoenix	1122	13%
Japan	Osaka	5	0.06%
	Sapporo	0	0%

a) U.S. climate regions from Andersson [2].

b) Estimated based on extreme annual temperature, and 0.4%, 1%, and 2% cooling design-point temperatures from ASHRAE Fundamentals Handbook [1]. Does not account for the effects of urban heat islanding.

Figure 3 shows the impacts on capacity of high ambient temperatures for various chillers and air conditioners. Vapor-compression systems set the performance hurdle very high. Both the Carrier rooftop air conditioner and the air-cooled chiller continue to deliver 86 to 87 percent of their rated capacities for ambient temperatures up to 120°F to 125°F.

The GRI/Battelle prototype air-cooled LiBr air conditioner/heater (discussed further below) performed nearly as well as air-cooled vapor-compression equipment up to 110°F, at which point the unit delivered 87 percent of its rating-point capacity. GRI/Battelle had to increase supply-air temperature (and humidity) to operate at 115°F, which may not provide adequate cooling and dehumidification. Performance of the commercially available Yazaki ACH-8 air-cooled LiBr chiller (discussed further below) falls off much more rapidly as ambient temperature rises (dropping to 48 percent of rated capacity at 109°F, its maximum operating temperature). Interestingly, performance of the Broad’s BCT line of water-cooled LiBr chillers degrades even faster, dropping to 56 percent capacity at 104°F—the highest temperature at which performance is rated.

The light-commercial marketplace will likely insist that performance of air-cooled absorption systems come close to that for vapor-compression equipment (the competing technology) at high ambient temperatures. Even in regions where high ambient temperatures are uncommon, building owners/occupants are not likely to tolerate a building shut down when a conventional

cooling system would have allowed the building to continue operations. Future air-cooled development efforts should specifically address operation at high ambient temperatures.

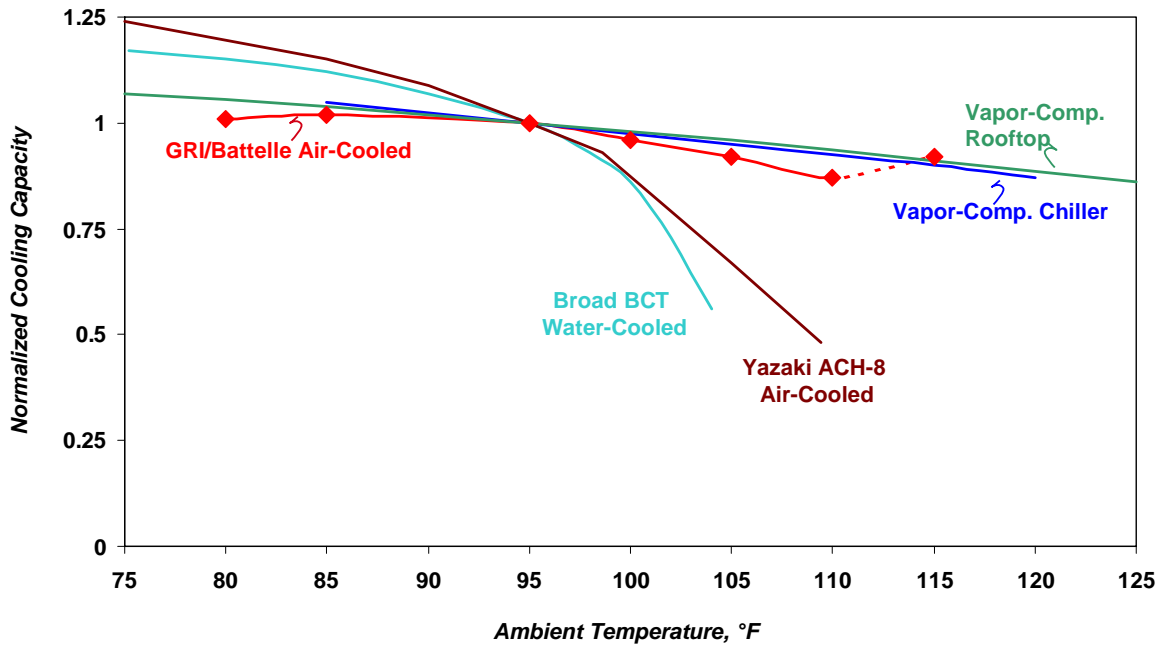

Figure 3: Performance Impacts of High Ambient Temperatures

Notes:

- a) All chiller capacities normalized to 1.0 at 95°F outdoor and 45°F chilled-water delivery temperatures.
- b) All air-conditioner capacities normalized to 1.0 at 95°F outdoor and 80°F DB / 67°F WB supply-air temperatures, unless indicated otherwise.
- c) Vapor-Comp. Rooftop: Carrier 48HJ008 Single-Package Rooftop Unit (7.5 RT) [8]
- d) Vapor-Comp. Chiller: Carrier 30RA-010 Air-Cooled Screw Chiller (10 RT) [9]
- e) GRI/Battelle Air-Cooled: Experimental data from GRI/Battelle Double-Effect Air-Conditioner/Heater (3 RT) [15]. Standard indoor rating conditions maintained to 110°F. Indoor condition increased to 95°F /74°F at 115°F ambient, which may not provide adequate cooling/dehumidification.
- f) Yazaki ACH-8 Air-Cooled: Yazaki ACH-8 LiBr Chiller (8 RT) [24]
- g) Broad BCT Water-Cooled: Broad BCT Line of LiBr Chillers (4.5 - 33 RT) [7]

4.0 Summary of Past Development Efforts

Much of the world's LiBr absorption manufacturing capacity is currently in Asia (Japan and China in particular), as is much of the LiBr-absorption-chiller development work. Published air-cooled LiBr absorption development efforts have taken place in the U.S., Japan, and Europe. Table 3 lists the past air-cooled LiBr hardware development efforts that we uncovered. We are confident that there have been, and currently are, other air-cooled development efforts that have not been made public. As noted previously, most of the past developments targeted direct-fired or solar applications. None of the past development efforts identified specifically targeted CHP applications. With the exceptions of Yazaki and Rotartica, none of these efforts led to a commercialized product, although the TU Delft project is still ongoing. The key reasons cited for this include both technical and market factors (see Table 4).

Table 3: Summary of Published Past Air-Cooled LiBr Development Efforts

Developer	Country	Year	Heat Source	No. of Effects	Intended Application	Key Innovations
Carrier Corporation ^a [5, 6, 32]	USA	1975-1984	Solar	Single	Residential/ Light Commercial	Solution chemistry
Tokyo Gas, Osaka Gas, Toho Gas [30]	Japan	1984-1987	Direct Fired	Double	Light Commercial	Parallel flow for solution; absorber design; heat- exchanger improvements
Hitachi [16, 37]	Japan	Circa 1988 to 1990	Direct Fired	Double	Residential/ Light Commercial	Extended surface in absorber and emulsifier; spray absorber
GRI/Battelle [15, 40]	USA	1987-1991	Direct Fired	Double	Residential	DX evaporator; higher evaporator pressure
Yazaki (Prototype) [47]	Japan	1988-1993	Direct Fired	Double	Light Commercial	Solution chemistry; absorber
GRI ^b [39]	USA	1995				Spray absorber
Universitat Politecnica de Catalunya [11]	Spain	Published 2002	Hot Water ^c	Single	Residential/ Light Commercial	None reported
Interotex/Rotartica ^d [20, 23, 34, 38, 53]	England/ Spain	1989 ^e - Present	Solar and Direct Fired	Single (Solar) and Double (Direct Fired) ^f	Residential/ Light Commercial	Rotating heat exchangers
TU Delft [27, 28]	Netherlands	2003- Present ^g	Solar	Half	Not stated	Cycle
Yazaki (ACH-8) ^h [24]	Japan	1990's- Present ⁱ	Direct Fired	Double	Light Commercial	Solution chemistry

a) With funding from the U.S. Department of Energy

b) Component testing only

c) Intended to simulate solar input.

- d) Development has transferred from Interotex Ltd. in England to Rotartica, a subsidiary of Fagor Electrodomesticos in Spain..
- e) Estimated start date for residential and light-commercial application based on published information.
- f) Earlier direct-fired work was with single effect using a metal-hydroxide sorbent.
- g) As of August 2004, construction of LiBr prototype was not complete. Project is being conducted in parallel with ammonia-water system development and testing.
- h) Commercially available, but no warranty for sales outside of Japan.
- i) We assume that the Yazaki ACH-8 development effort followed closely the prototype development effort cited earlier in the table.

Table 4: Key Reasons for Failures of Past Development Efforts

Technical Factors	Market Factors
Large heat exchangers led to high cost	Fall off of overall absorption market in the U.S.
Efficiencies too low for economic operation in direct-fired applications	Drop in projected market for solar-fired absorption
High cost and limited temperatures associated with solar collection systems	
Crystallization inhibitors sometimes introduced new problems: <ul style="list-style-type: none"> – Corrosion (required expensive materials) – Toxicity/flammability – Impeded heat and mass transfer – Instability at elevated temperatures 	

Figure 4 shows the one of the two commercially available air-cooled LiBr absorption chillers that we identified [24]. Manufactured by Yazaki, this direct-fired, 8-refrigeration-ton unit is available for purchase globally, but they will only warranty the product in Japan. Yazaki ships 2 to 3 units per month within Japan. They have received inquiries from many other countries, especially Europe. They use a “new” LiBr working solution, which may be their patented LiBr/LiCl/LiNO₃ solution [55]. They currently have no plans to adapt this chiller for CHP applications.



From Yazaki Website [56]

Figure 4: Yazaki ACH-8 Air-Cooled LiBr Chiller (8 Ton)

Rotartica [38], a subsidiary of Fagor Electrodomesticos in northern Spain, just commercialized an air-cooled LiBr absorption chiller. The Rotartica Solar 045 is a solar-fired, single-effect product having a nominal cooling capacity of 1.3 RT (4.5 kW). Rotartica plans to announce a direct-fired, double-effect product soon. The Rotartica products use LiBr/water working fluid without crystallization inhibitors [23].

Table 5 lists the performance characteristics reported for the various air-cooled LiBr development efforts. Reported Coefficients of Performance (COPs) range from 0.7 to 1.09 at standard rating conditions (excluding one developer who reported COP at non-standard conditions). The TU Delft unit will certainly achieve a much lower COP when it is tested since it operates on a half-effect cycle (see discussion in Section 6.3.1 below). At least two of the units (the GRI/Battelle prototype and the Yazaki ACH-8) can operate at or near 110°F ambient temperatures while maintaining standard indoor delivery conditions. A third unit, the Interotex/Rotartica, can most likely operate at ambient temperatures exceeding 110°F (see discussion in Section 6.1.3 below).

Table 5: Performance Characteristics for Past Air-Cooled LiBr Development Efforts

Developer	Heat Source	No. of Effects	Nom. Capacity, Tons	Nom. COP ^a	Maximum Ambient Temperature Tested, °F
Carrier Corporation [5, 6, 32]	Solar	Single	2, 3, 10, 20	0.71 to 0.75	Not Available
Tokyo Gas, Osaka Gas, Toho Gas [30]	Direct Fired	Double	10, 20, 30	0.93	95°F
Hitachi [16, 37]	Direct Fired	Double	3	Not Available	Not Available
GRI/Battelle [15, 40]	Direct Fired	Double	3	1.09	110°F/115°F ^b
Yazaki (Prototype) [47]	Direct Fired	Double	3.5	0.8	115°F
Universitat Politecnica de Catalunya [11]	Hot Water ^c	Single	0.85 ^d	0.32 to 0.47 ^e	90°F
Interotex [20, 34, 53]	Direct Fired	Double	2.5	0.76	105°F ^f
Rotartica [38]	Solar	Single	1.3	0.67	95°F
TU Delft [27, 28]	Solar	Half	3	Not Yet Tested	Not Yet Tested
Yazaki (ACH-8) [24]	Direct Fired	Double	8	0.85	109°F

- a) At standard rating conditions. Excludes electric parasitics.
- b) 110°F maximum at standard 80°F/67°F indoor rating conditions. 115°F was at 95°F/74°F indoor conditions, which may not provide adequate cooling and/or dehumidification.
- c) Intended to simulate solar input. Input temperatures ranged from 167°F to 203°F.
- d) Target capacity. Actual capacity was lower.
- e) Reported at non-standard conditions of 68°F chilled-water *return* temperature and 90°F cooling-air temperature. COPs would be lower at standard rating conditions. The range reported reflects the range of input hot-water temperatures (167°F to 203°F) tested.
- f) Estimated. Tested with up to 136°F coolant delivery temperature. May be suitable for even higher ambient temperatures. See discussion in Section 6.1.3 below.

Figure 5 compares the sizes of air-cooled LiBr chillers to that for a comparable water-cooled chiller. Table 6 compares the volumes and weights for the same set of chillers. The Yazaki ACH-8 weighs 24 percent more per ton than the Broad BCT16 water-cooled unit and 53 percent more than the Broad BCT23. As one would intuitively expect, these weight differences suggest that the material-content reduction associated with removal of the cooling tower cannot compensate for the increase in heat-exchanger area required to accomplish air cooling.

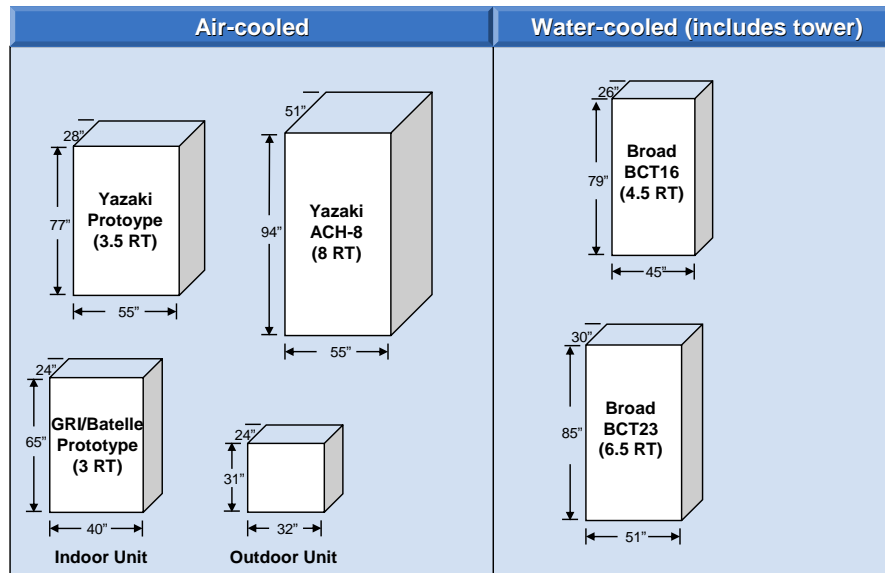

Figure 5: LiBr Chiller/Cooler Size Comparison

Table 6: LiBr Chiller/Cooler Volume and Weight Comparisons

	Manufacturer	Model	Nom. Cooling Capacity (Tons)	Total		Normalized	
				Volume (Cu.Ft.)	Weight (Lb.)	Volume (Cu.Ft./Ton)	Weight (Lb./Ton)
Air-Cooled	GRI/Battelle ^a	DEACH	3.0	49.9 ^b	750 ^c	16.6	250
	Yazaki ^d	1993 Prototype	3.5	68.6	1200	19.6	330
	Yazaki ^e	ACH-8	8.0	151.1	2100	18.9	260
Water-Cooled	Broad ^f	BCT16	4.5	54.2	920 ^g	12.0	210
	Broad ^f	BCT23	6.5	74.9	1100 ^g	11.5	170

- a) From [15]
- b) 36.1 cu.ft. for indoor unit and 13.8 cu.ft. for outdoor unit.
- c) 550 lbs. for indoor unit and 200 lbs. for outdoor unit.
- d) From [47]
- e) From [24]
- f) From [7]. Includes built-in cooling tower.
- g) Shipping weight

In summary, despite several decades of development work targeting direct-fired and solar applications, air-cooled LiBr chillers remain largely uncommercialized. There is little evidence of air-cooled hardware development work specifically targeting CHP applications in the U.S.⁴. However, market success in CHP applications hinges not only on the availability of reliable and

⁴ The University of Maryland [31] reports some semi-empirical work targeting air cooling for CHP applications.



cost-effective air-cooled absorption products, but also on the market demand for on-site electric generation in light-commercial applications.

5.0 Patents

Table 7 lists recent patents identified in the U.S. that relate to air-cooled LiBr absorption. The table indicates how relevant each patent is (high, medium, or low) to air-cooled LiBr absorption for CHP applications, based purely on our judgment. While these patents cover some interesting concepts, we found no evidence of prototype development and testing surrounding these patents.

Table 7: Recent U.S. Patents Related to Air-Cooled LiBr Absorption

Developer	Assignee	State, Territory, or Country	Title	Innovation	Year	Relevance
Angell et al. ^a	Arizona Board of Regents [4]	AZ	Refrigerant Fluid Crystallization Control and Prevention	Modify Chemistry of LiBr-Water Pair	2000	High
Ring et al.	Univ. of Utah [51]	UT	Method of Improving the Efficiency of Absorption Heat Pumps Using a Crystallization-Inhibiting Additive	Crystallization Inhibitor	2002	High
Ring et al.	Univ. of Utah [50]	UT	Absorption Heat Pumps Having Improved Efficiency Using a Crystallization-Inhibiting Additive	Crystallization Inhibitor	2001	High
Martini et al.	Carrier Corp. [10]	NY	Absorption Over-Concentration Control	Device to Monitor Concentration of LiBr Solution	1998	High
Shimomae et al.	Daikin Industries [14]	Japan	Air-Cooled Absorption Type Refrigerating Apparatus	Packaging to improve cooling air flow	2000	Medium
Gonzalez-Cruz et al. ^b	Univ. of Puerto Rico [49]	Puerto Rico	Compact Solar-Powered Air Conditioning Systems	Details of Proposed Heat Exchangers	2003	Low
Antohi	None [3]	MA	Vehicular Absorption Air Conditioning Process and System Utilizing Engine Coolant Waste Heat	Utilizes Engine Coolant Waste Heat and is Air-Cooled	1999	Low

a) The Gas Research Institute (now Gas Technology Institute) funded this work in the mid-1990s.

b) NSF-sponsored research.

Table 8 lists recent patents identified outside the U.S. that relate to air-cooled LiBr absorption. Again, we indicate how relevant each patent is based on our judgment. Most of the relevant patent activity has been in Japan. While we have evidence of continued development work in Japan and Europe, much of it is being conducted privately.

Table 8: Recent Non-U.S. Patents Related to Air-Cooled LiBr Absorption

Pub #	Assignee	Country	Title	Innovation	Year	Relevance
12-08670	Sanyo Electric Co. Ltd [41]	Japan	Air Cooled Type Absorption Refrigerating Machine	Multiple Absorbers	1989	High
06-235559	Tokyo Gas Co. Ltd [46]	Japan	Method and Apparatus for Controlling Operation of Air Conditioning Plant using Absorption Type Refrigerator	Refrigerant Reservoir to Control Flow of Refrigerant as a Function of Ambient Temp.	1994	High
11-257796	Daikin Ind. Ltd [13]	Japan	Air-Cooled Absorber	Heat Exchanger	1999	High
2000-319646	Yazaki Corp. [55]	Japan	Absorbing solution for Absorption Refrigerating Machine and Absorption Refrigerating Machine	Chemistry	2000	High
2004-108731	Rinnai Corp. [36]	Japan	Hybrid Air Conditioner	Vapor Compression Cycle to Remove Heat from Absorber	2004	High
13-10273	Sanyo Electric Co. Ltd [42]	Japan	Air-Cooled Double Effect Absorption Refrigerating Machine	Large Heat Transfer Area on Absorber	1989	Medium
06-265235	Yazaki Corp. [54]	Japan	Absorption Refrigerating Machine	Method to dilute solution concentration to avoid crystallization	1994	Medium
10-122702	Daikin Ind. Ltd [12]	Japan	Air Cooled Absorption-Refrigerator	Multiple Radiating Fins on Absorber	1998	Medium
DE19538383	GEA Luftkuehle Happel GMBH [22]	Germany	System for Controlling Cold Absorption Unit for Air Chilling Units	Limit Fall in Temperature of the Cooling solution to Prevent Crystallization	1997	Low

6.0 Past Approaches to Air Cooling

Historically, five approaches have been employed (separately or in some combination) to avoid crystallization in air-cooled chillers:

1. Enhancing heat and mass transfer;
2. Modifying chemistry (to inhibit crystallization);
3. Modifying the thermodynamic cycle;
4. Using hybrid vapor-compression/absorption systems; and/or
5. Using controls to avoid crystallization.

Each approach is discussed below.

6.1 Heat/Mass Transfer Approaches

Various heat- and mass-transfer approaches are discussed below.

6.1.1. Vertical Falling-Film Absorber

Figure 6 shows a conventional horizontal falling-film absorber (shown with the evaporator). The strong solution is distributed over the outer surfaces of the tubes, and the cooling water flows inside the tubes. The thin film of solution formed on the cooling tubes provides both good heat transfer to the cooling water and ample surface area for absorbing water vapor.

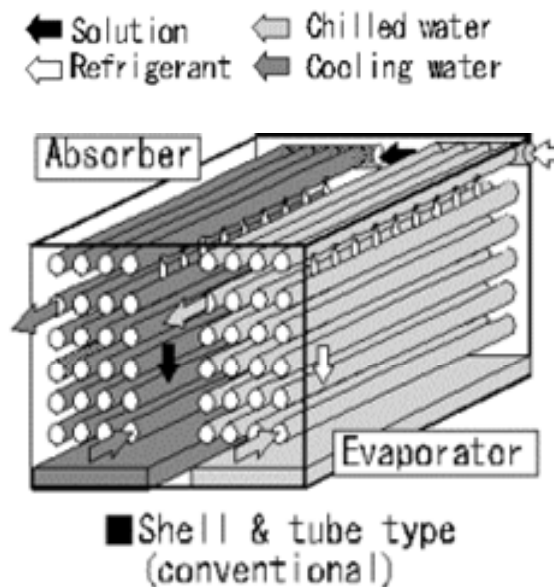

From Tokyo Gas Co. Ltd. [45]

Figure 6: Conventional Falling-Film Absorber

Figure 7 shows a vertical falling-film absorber. In this case, the strong solution is distributed along the inner walls of vertical tubes that carry the water vapor from the evaporator. Figure 8 shows the vertical falling-film absorber packaged in a prototype system. Yazaki [47] found that it was necessary to use internally enhanced tubes to wet the inner tube walls completely and to enhance mass transfer. GRI/Battelle [15] reported good results with vertical falling-film absorbers when tested in sub-scale sections. However, full-scale components yielded reduced performance. GRI/Battelle abandoned this approach in favor of a more conventional horizontal falling film in a coiled tube. Kiyota, et al, at Tokushima University [29], through analysis and experimental work, concluded that air cooling of a vertical falling-film absorber will require about three times the heat-transfer surface compared to water cooling of the same absorber design.

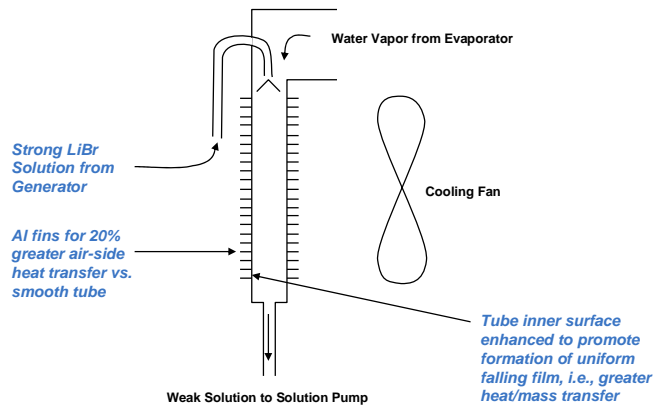

From Tongu, et. al., Yazaki [47]

Figure 7: Vertical Falling-Film Absorber

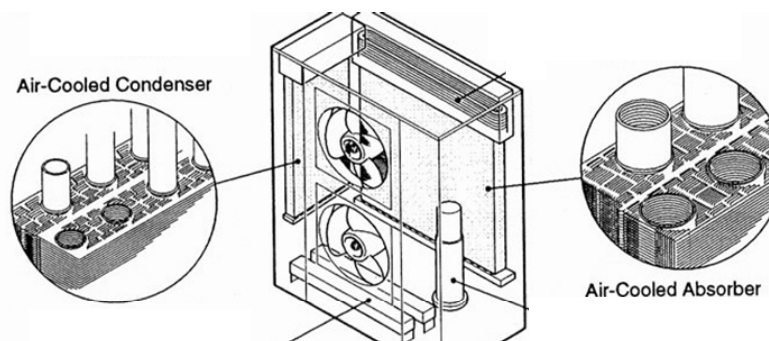

From Tongu, et. al., Yazaki [47]

Figure 8: Packaging of Vertical Falling-Film Absorber

6.1.2. Separation of Heat and Mass Transfer in Absorber

Figure 9 shows an absorber design concept that separates the heat- and mass-transfer processes. GRI [39, 40] analyzed and tested such an absorber, and found it to enhance mass-transfer rates significantly, with the potential to improve overall absorber performance. This work was documented in 1995, and we found no evidence of further work applying this approach to air-cooled LiBr chillers.

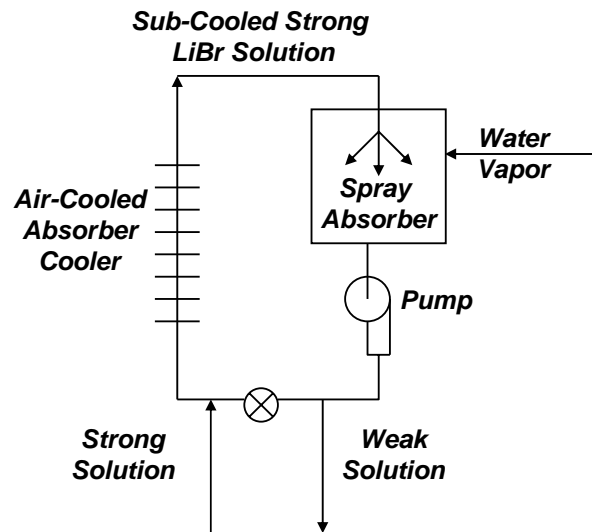

From Ryan, GRI [39]

Figure 9: Separation of Heat and Mass Transfer in the Absorber

6.1.3. Rotating Heat Exchangers

Figure 10 shows the Interotex rotating absorption chiller/heat pump [34]. This cleverly designed device uses rotational forces to form thin films for improved heat transfer in the absorber and the two generators. It uses pitot pumps that convert the kinetic energy of the rotating fluid to pressure energy so that no additional motors are needed for solution circulation. Rotational speed is 550 rpm. The refrigeration system is hermetically sealed. Only the chilled water and cooling water streams rely on rotating seals. The cooling water rejects heat to the ambient air through a dry coil. The system is designed to automatically move to single-effect operation to avoid stalling of the solution pumps at elevated ambient temperatures (above 126°F coolant delivery temperature). This is accomplished via a pressure-relief valve between the high- and medium-pressure zones of the system. Developers report test results up to 136°F coolant temperature. The developers imply that a 126°F coolant delivery temperature corresponds to a 95°F ambient air temperature (allowing for heat rejection to ambient air in a dry coil), which is a generous temperature approach (31°F) in the dry coil. If we assume that 136°F coolant

temperature corresponds to roughly a 105°F ambient temperature⁵, and if a better-performing dry coil is used, the same coolant delivery temperature (136°F) could be achieved at even higher ambient temperatures (perhaps 115°F). Rotartica [38] continued development of this technology. They have just introduced to the market a solar-fired, single-effect product, with a direct-fired, double-effect product soon to come.

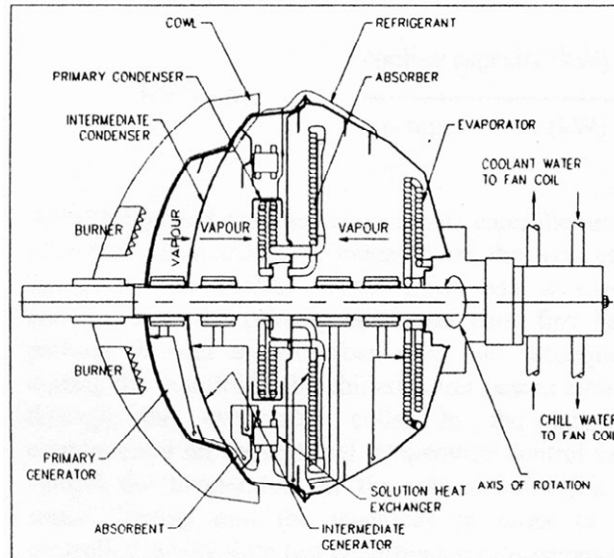

From Lorton, et. al., Interotex [34]

Figure 10: Rotating Absorption Chiller/Heat Pump

6.1.4. Heat Rejection via Secondary Loop and Dry Coil

Heat rejection via a secondary cooling loop and dry coil is a straightforward approach to accomplishing air cooling (see Figure 11). As discussed above, Interotex [34] used this approach. GRI/Battelle [15] also used this approach. The advantage of this approach is that it permits use of conventional water-cooled condensers and absorbers. The disadvantages are that secondary loops generally:

- Increase the overall temperature lift required;
- Introduce additional parasitic losses (both pump and fan required); and
- Require freeze protection of the secondary fluid.

⁵ The developers reported COP at high coolant delivery temperatures, but not cooling capacity. We assumed that the drop off in COP and cooling capacity at high ambient temperatures compensate for each other so that the temperature approach in the dry coil remains roughly the same as ambient temperature rises.

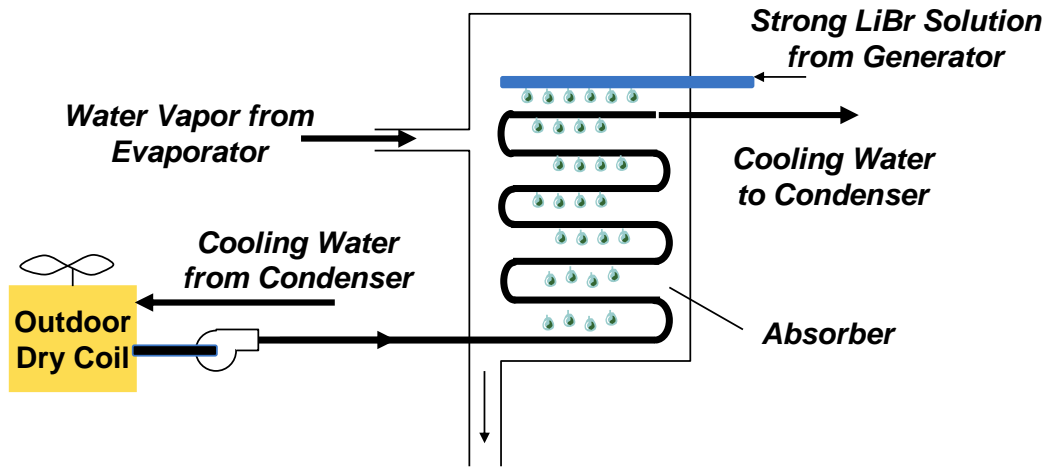

From GRI/Battelle [15]

Figure 11: Heat Rejection Via Secondary Loop and Dry Coil

6.1.5. Direct-Expansion Evaporator

Absorption machines are generally designed as chillers, i.e., they produce chilled water that requires a secondary loop and heat exchanger (in a fan coil or air-handling unit) to condition the building air. However, the overall temperature lift can be reduced by using a direct-expansion (DX) evaporator to cool the building air directly—an approach used by GRI/Battelle [15]. DX evaporators are the standard practice for packaged rooftop vapor-compression systems that are normally used in light-commercial applications, so this approach also fits well with existing HVAC system design practice. The disadvantage is that it requires developing a new evaporator design, probably similar to the vertical, falling-film absorber design discussed above. The type of DX evaporator used in vapor-compression equipment is unlikely to work satisfactorily in LiBr absorption systems given the much lower operating pressure and higher sensitivity to pressure drop.

6.1.6. Raising Chilled-Water Supply (and/or Supply-Air) Temperature

One approach for accommodating air cooling is to allow the evaporator to operate at a higher pressure by raising the chilled-water supply temperature (or increasing the supply-air temperature, if using a DX evaporator). GRI/Battelle [15] used this approach to allow operation at ambient temperatures above 105°F. The University of Maryland [31], in a semi-empirical, semi-analytical investigation, showed that higher evaporator pressures allow operation at higher ambient temperatures while avoiding crystallization. The drawback, of course, is that higher chilled-water (or supply-air) temperatures may not provide adequate cooling and dehumidification. The researchers at the University of Maryland suggests using a chilled-water cooling system in combination with a desiccant dehumidification system (regenerated with waste heat) to permit a higher chilled-water temperature.

6.2 Chemistry Approaches

Modifications to LiBr/water chemistry are nothing new. Water-cooled LiBr absorption chillers have relied on 2-ethyl hexanol for decades to promote heat and mass transfer [21]. Many crystallization inhibitors have been proposed to facilitate the use of air cooling. Unfortunately, many crystallization inhibitors solve one problem just to create another, including:

- Temperature limitations;
- Corrosion;
- Toxicity/flammability;
- Reduced heat and mass transfer (especially in the absorber); and/or
- Incompatibility with the conventional heat- and mass-transfer additive (2-ethyl hexanol).

Table 9 lists some of the chemistry approaches that have been investigated for air cooling.

Table 9: Crystallization Inhibitors for Air-Cooled LiBr

Developers	Description	Crystallization Temperature for p=0.127 psia	Development Hurdle
Baseline	No Additive	129°F (54°C)	n/a
Carrier Corporation [5, 32]	Carrol: LiBr-ethylene glycol/water. Additive: 1-nonaylmine, later replaced with phenylmethylcarbinol ^a	140°F (60°C)	Cannot survive high-generation temperatures in double-effect
Energy Concepts [20, 25, 34]	(NaOH, KOH, CsOH) ^b water	Above 145°F for 45°F chilled-water outlet temperature	Corrosion [20, 37]
Yazaki [47, 55]	LiBr/LiCl/LiI/LiNO ₃	Approximately 147°F (64°C)	Required a new corrosion inhibitor
University of Utah and GRI [17, 35]	Various organo-phosphoric and phosphonic acids, KIO ₃ , and Uramil-N,N-diacetic acid	Decreased experimental crystallization temperatures for fixed solution concentrations (60.54% and 60.82% LiBr by weight) by up to 24°F (13°C) ^c	Not tested in chillers

a) Additive as of last publication [32]

b) Completely replaces LiBr

c) In this investigation, inhibition of crystallization manifests itself as a decrease in crystallization temperature because the researchers used fixed solution concentrations.

6.2.1. Carrier's "Carrol" Solution

As discussed in several references [5, 6, 16, 21, 32], Carrier developed a solution (called "Carrol") during their solar-fired chiller development work that shows much promise for other air-cooled LiBr applications. The Carrier patents on Carrol have expired, so it can be used without license⁶. As published in *Active Solar Systems* [32], Carrol consists of LiBr, water, ethylene glycol, and phenylmethylcarbinol⁷. The ethylene glycol inhibits crystallization, and the phenylmethylcarbinol promotes heat and mass transfer. Temperature limitations prohibit using Carrol in double-effect machines, but it is stable at single-effect temperatures. Carrier has tested Carrol extensively in solar-fired absorption applications both in the laboratory and in the field. It is unlikely that any other air-cooled LiBr chemistry has been tested as thoroughly.

6.2.2. Energy Concept's Metal Hydroxide Sorbent

Energy Concepts has developed a sorbent that is a metal hydroxide blend of NaOH, KOH, and CsOH [20, 25, 34]. This is not an additive as it completely replaces the LiBr sorbent. Interotex licensed this solution from Energy Concepts for use in their rotating absorption chiller. However, Interotex encountered multiple corrosion problems [20]. While they resolved most of these problems, they were stopped by one. Trace amounts of nitrogen (from minor air leakage into the system) were reacting with trace amounts of hydrogen (from the hydroxides) to form ammonia. The ammonia attacked the copper tubing used in their system. The copper, in turn, plugged orifices in the system. Interotex then abandoned work with this sorbent.

6.2.3. Yazaki's LiBr/LiCl/LiI Solution

Yazaki developed and patented a LiBr/LiCl/LiI solution for air-cooled applications that increases allowable absorber and condenser operating temperatures by about 18°F (10°C) and 7°F (4°C), respectively [47, 55]. They needed to use a new corrosion inhibitor, which permitted operation at generator temperatures of about 350°F (175°C).

6.2.4. University of Utah's/GRI's Organic Crystallization Inhibitors

Ring, et al., at the University of Utah, tested various crystallization inhibitors with funding from the Gas Research Institute (now the Gas Technology Institute) [35]. They tested various inhibitors for LiBr-water solutions (typically 500 mole ppm based on LiBr):

- Methylene DiPhosphoric Acid (MDPA);
- Pyrophosphoric Acid (PPA);
- Amino TriMethylene Phosphonic Acid (ATMP);
- DiethyleneTriamine PentaMethylene Phosphonic Acid (DTPMP);
- 1-HydroxyEthylidene-1,1-DiPhosphonic Acid (HEDP);

⁶ Caution—without a license, it may be difficult to determine the exact concentrations of constituents required, and there may be other trade secrets regarding its use that would cut development time and cost significantly.

⁷ Originally, Carrier used 1-nonallylamine, but replaced it with phenylmethylcarbinol. This is the additive used as of last publication.

- Potassium Iodate (KIO_3); and
- 5-Amino-2,4,6-trioxo-1,3-perhydrodizine-N,N-diacetic Acid (Uramil-N,N-diacetic Acid).

They prepared test tubes filled with the above solutions and slowly cooled the test tubes in a temperature-controlled bath to determine the crystallization point, using two LiBr concentrations—60.54 weight percent and 60.82 weight percent. Results showed a 16°F to 24°F (9°C to 13°C) suppression of the crystallization point compared to control tests of LiBr-water solutions without additives. In actual chiller operation, this should translate into allowing the absorber and condenser to operate at higher temperatures without increasing the likelihood of crystallization, but this was not experimentally verified.

6.3 Thermodynamic Cycle Modifications

Most developers of air-cooled LiBr absorption have used either a single-effect or double-effect cycle. While absorption equipment can use the triple-effect cycle (or, in theory, even more effects), these cycles do not lend themselves to CHP applications because of the higher generator temperature requirements and the lower importance of improved efficiency in CHP applications. However, some developers have considered what they call the half-effect cycle for air-cooled applications, which is discussed below.

6.3.1. *Half-Effect Cycle*

Kim and Infante Ferreira at TU Delft are developing an air-cooled LiBr absorption chiller using the half-effect cycle [27, 28]. The half-effect cycle is actually similar in complexity (but not efficiency) to the double-effect cycle. As shown in Figure 12, the half-effect cycle adds a medium-pressure evaporator and a medium-pressure absorber to the single-effect cycle. The half-effect cycle uses the medium-pressure evaporator to cool the low-pressure absorber, thereby allowing the low-pressure absorber to operate at a lower temperature relative to the single-effect cycle, moving it further from the crystallization line. The disadvantages relative to the single-effect cycle are lower efficiency and higher cost/complexity. Analyses conducted by the developers suggest that the COP should be about 0.4. However, as of last publication (August 2004), prototype construction was still underway, so test results are not yet available. Although not discussed by the researchers, it may be possible to design a system that operates as a single-effect chiller when ambient temperatures permit, and then switches to the half-effect when ambient conditions dictate.

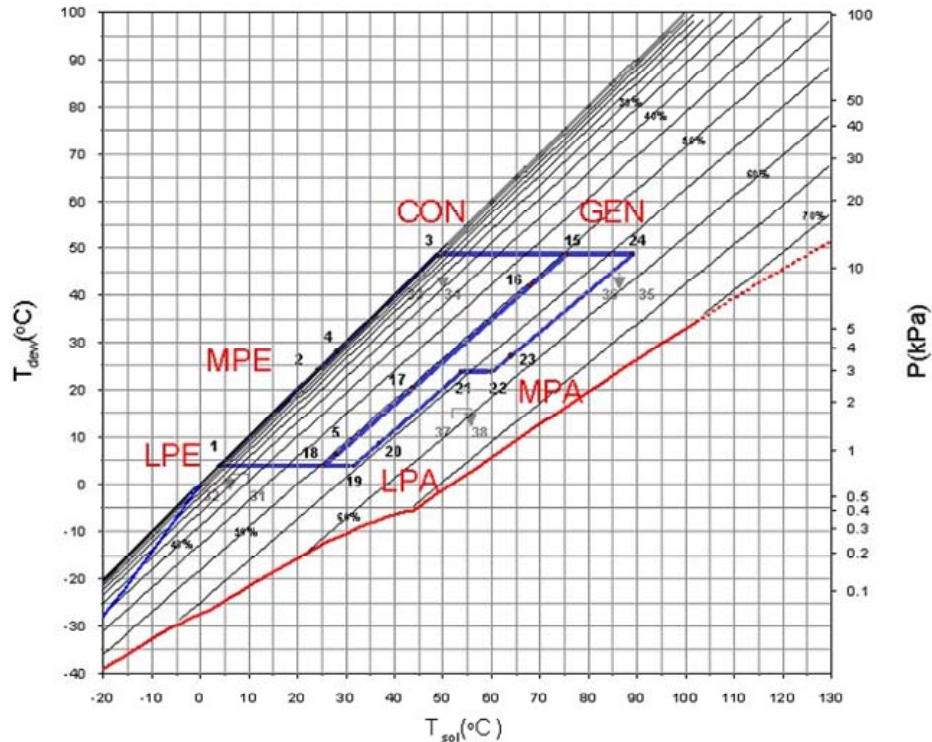

Source: TU Delft [24]

Figure 12: Half-Effect Cycle

6.4 Cascaded System Approaches

Developers have also considered using air-cooled LiBr absorption to augment cooling from vapor-compression equipment, rather than to replace it, thereby reducing the overall temperature lift under which the absorption machine must operate. Two variations on this theme are discussed below. The obvious disadvantage of this approach is that it requires two refrigeration systems (absorption and vapor-compression) to do the job. However, there may be CHP applications in which this is a practical way to use absorption.

6.4.1. Cascaded System—Vapor-Compression to Absorption

Figure 13 shows a cascaded system in which the vapor-compression equipment cools the building space, and the absorption equipment “pumps” the heat rejected from the vapor-compression system up to the temperature needed to reject it to the ambient air. In this case, the vapor-compression condenser and the absorption system evaporator are in thermal communication. The temperature lift for both refrigeration systems is reduced. Saskaki, et al, of Tokyo Gas [43] has proposed such a system.

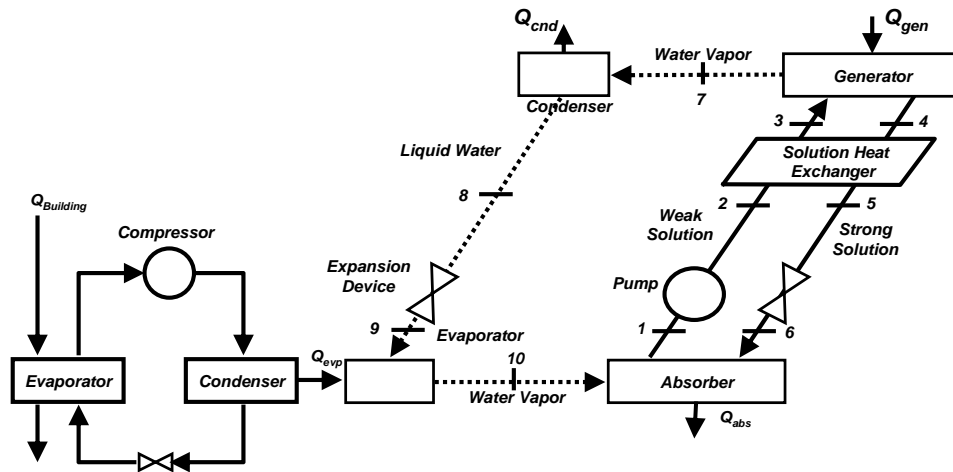

From Sasaki, et. al., Tokyo Gas co. Ltd. [43]

Figure 13: Cascaded System—Vapor-Compression to Absorption

6.4.2. Cascaded System—Absorption to Vapor-Compression

Figure 14 shows a cascaded system in which the absorption equipment cools the building space, and the vapor-compression equipment “pumps” the rejected heat up to the temperature needed to reject it to the ambient air. In this case, the absorber from the absorption system is in thermal communication with the evaporator of the vapor-compression system. Rinnai Corporation has patented such a concept [36].

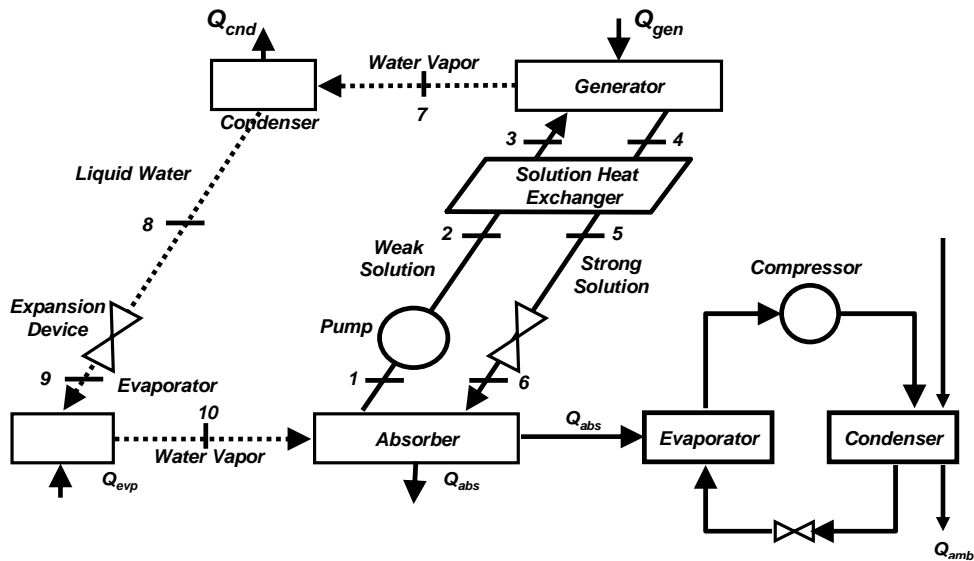

From Rinnai Corp. Patent [36]

Figure 14: Cascaded System—Absorption to Vapor-Compression

6.5 Controls

All modern LiBr absorption chillers have controls to prevent crystallization. Crystallization controls are almost certainly necessary in an air-cooled LiBr absorption chiller⁸, but are not, by themselves, sufficient to permit air cooling. Crystallization control strategies must be used in combination with other approaches. Using crystallization control strategies alone would almost certainly result in unacceptable limits on operation at high ambient temperatures.

Some developers, such as GRI/Battelle [15], have developed and tested techniques to permit self-decrystallization. Their design allows the bypass of burner flue gas to heat the solution heat exchangers, which they judged to be the most likely sites for crystallization. The automatic decrystallization feature would only be activated after an abnormal event.

⁸ Some developers claim that, with the appropriate crystallization additives, controls to prevent crystallization are unnecessary.

7.0 Other Potential Approaches to Air Cooling

We considered other potential approaches to air cooling. While these approaches may have been considered by past developers, we found no documentation in the published literature indicating any had actually been applied to air-cooled LiBr absorption.

7.1 Tempering Outdoor Air with Building-Exhaust Air

ASHRAE Standard 90.1 outlines the requirements for ventilation air in commercial buildings. When ambient temperatures are at their highest, ventilation air exhausted from the building will be substantially cooler than ambient air and, therefore, could be mixed with ambient air to lower the temperature of the air stream to which the absorption machine rejects heat. This approach is illustrated schematically in Figure 15. Table 10 shows a preliminary estimate of the percentage of cooling load that could be provided by this approach for three building types with a 110°F ambient. The results suggest that up to 10 to 20 percent of the building cooling load could be provided by air-cooled, single-effect absorption with this approach. These values increase to about 15 to 30 percent if double-effect absorption is used.

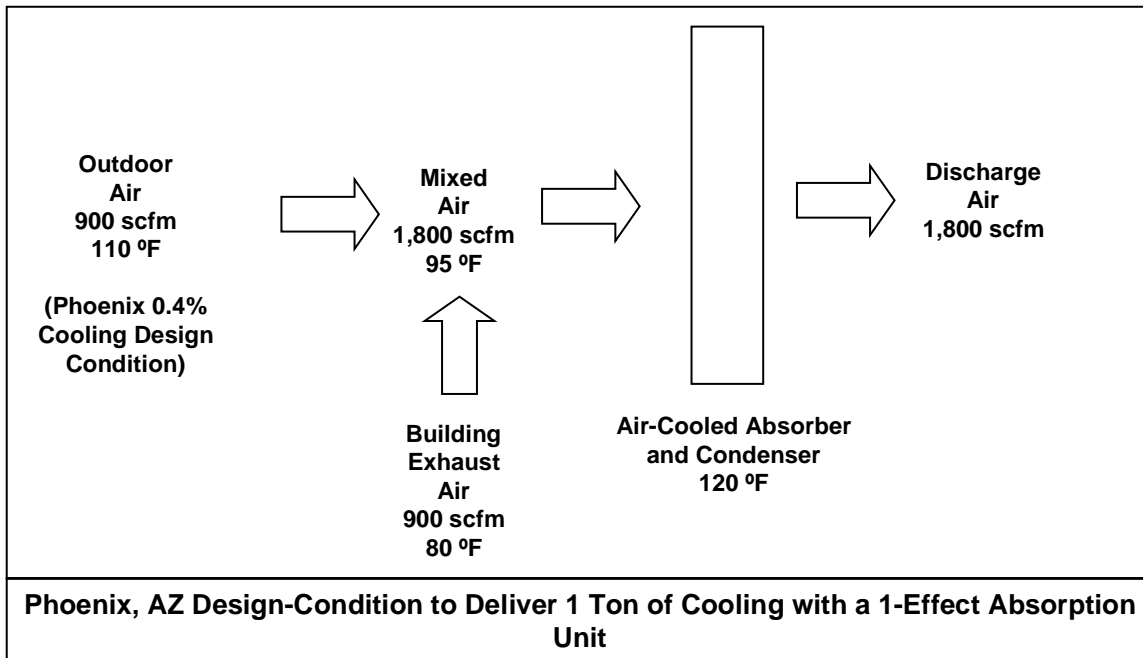

Figure 15: Tempering Outdoor Air with Building Exhaust

Table 10: Maximum Cooling Provided by Tempering Outdoor Air with Building Exhaust

Building Type	Office, Retail	Education	Restaurant
Likely Maximum Exhaust, cfm/sq.ft.	0.2	0.5	1
Possible Cooling, Tons per 1000 sq.ft.	0.22	0.56	1.1
Peak Load Cooling, Tons per 1000 sq.ft.	2.2	2.7	5
Percent of Peak Cooling Load for Single-Effect LiBr	10%	20%	20%
Percent of Peak Cooling Load for Double-Effect LiBr	15%	30%	30%

Our preliminary analysis does not address several issues regarding this approach:

- Most commercial buildings use multiple exhaust fans at various locations. It may be impractical to gather this exhaust air in one place;
- While restaurants require high ventilation rates, which would seem to make them attractive applications, restaurant fume hood exhaust is contaminated with oils and other food residues, and cannot easily be used without fouling heat-transfer surfaces;
- In our preliminary analysis, we assumed that exhaust air flow is roughly equal to outdoor ventilation air requirements. However, exhaust air flow is often lower so that positive building pressure is maintained; and
- If none of the above is a barrier, use of exhaust air for absorption heat rejection would still have to be more attractive than the alternative of using heat-recovery or energy-recovery systems to pre-condition the ventilation air.

7.2 Boosting Absorber Pressure

As shown in Figure 16, if the pressure in the absorber can be raised relative to the evaporator pressure, the absorber will operate further from the crystallization curve. Figure 17 shows conceptually how this would be accomplished with mechanical compression. The desired pressure lift will determine the type of mechanical compression needed. A small amount of lift could be accomplished with an axial-flow fan. We performed a preliminary analysis assuming that a pressure boost equating to a 15°F increase in absorber temperature was desired. This translates to a pressure lift from 6.3 to 10.3 mmHg (pressure ratio of 1.6) and a volume flow of about 500 cfm/ton. If this pressure lift is needed, it will require an axial or centrifugal compressor with a parasitic power consumption of about 0.17kW/ton (assuming 60-percent-efficient compression). Key issues to address include:

- Developing practical and cost-effective designs to separate the evaporator and absorber, and accomplish the mechanical compression; and

- Optimizing the amount of pressure boost, considering cost and parasitic losses versus the benefits achieved for operation in high ambient temperatures.

While no documentation remains, Carrier considered this approach on paper when developing their solar-fired absorption chiller, and abandoned it in favor of modifying chemistry. Carrier, however, did not attempt to design and build any hardware to test the feasibility of the concept [6].

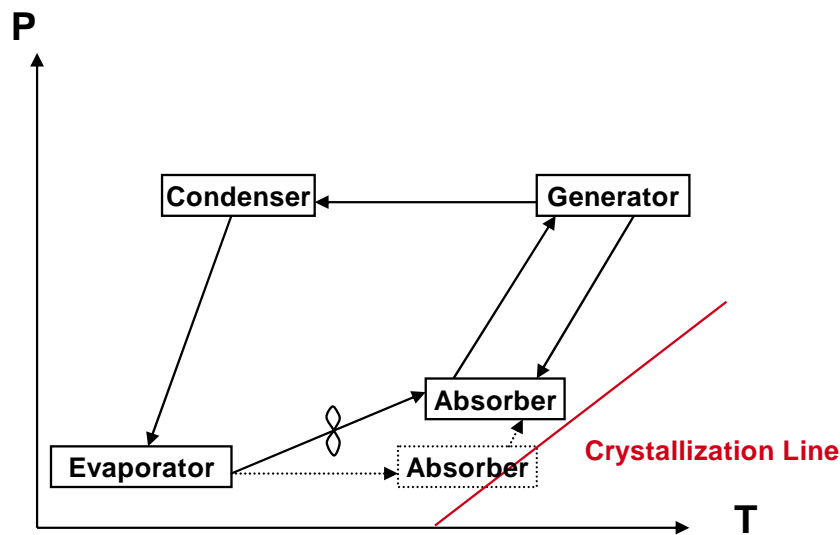

Figure 16: Boosting Absorber Pressure

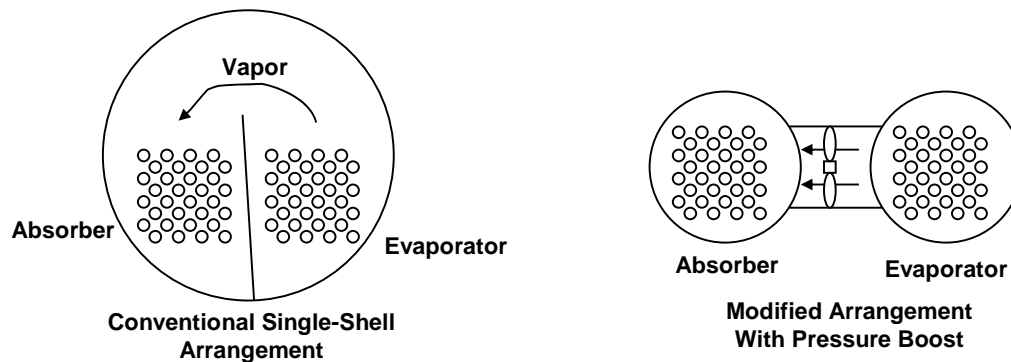

Figure 17: Mechanical Compression to Boost Absorber Pressure

7.3 Dropping Generator Pressure

Using a concept analogous to boosting absorber pressure, it is also possible to drop generator (desorber) pressure to accommodate higher condensing temperatures/pressures without

increasing the risk of crystallization. Figure 18 shows this concept, which can be used by itself or in combination with boosting absorber pressure. We performed a preliminary analysis assuming that a pressure lift equating to a 15°F decrease in condenser temperature was desired. This translates to a pressure lift from 88 to 131 mmHg (pressure ratio of 1.5) and a volume flow of about 41 cfm/ton. If this pressure lift is needed, it will probably require a centrifugal compressor with a parasitic power consumption of about 0.16kW/ton (assuming 60-percent-efficient compression). Similar to the absorber pressure boost concept, key issues to address include:

- Developing practical and cost-effective designs to separate the generator and condenser, and accomplish the mechanical compression; and
- Optimizing the amount of pressure lift, considering cost and parasitic losses versus the benefits achieved for operation in high ambient temperatures.

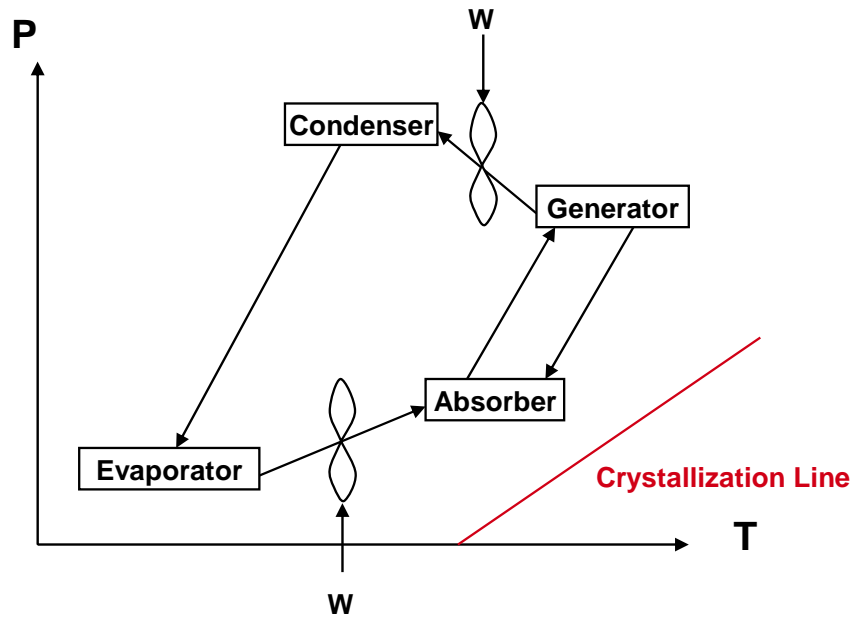

Figure 18: Dropping Generator Pressure (Shown Combined with Boosting Absorber Pressure)

7.4 Intermittent Evaporative Cooling

Full-time evaporative cooling systems impose barriers similar to those for cooling towers, including high water consumption, regular maintenance, and risk of harboring Legionella. However, if the primary concern is avoiding crystallization, evaporative cooling is only needed when ambient temperatures are extremely high (above 95°F). Even in southern states, this may amount to only tens or hundreds of hours per year (except the desert southwest, in which temperatures can exceed 95°F for over a thousand hours per year).

Some water-cooled LiBr absorption developers have taken advantage of this fact by using combined wet/dry cooling towers. These towers operate wet only during high ambient temperatures, thereby conserving water, lowering maintenance requirements, lowering the risk of breeding Legionella, and simplifying system design. ZAE Bayern [42] proposes a combined system that utilizes a wet cooling tower, evaporative cooling, or dry operation depending on ambient conditions. Broad [7] uses a wet/dry cooling tower in their BCT line of chillers. In the Broad BCT units, cooling water first enters an indirectly cooled heat exchanger, which is cooled by the cooling tower exhaust air. If the ambient temperature is high, the cooling water then enters the cooling tower. However, if the ambient temperature is sufficiently low that the cooling water is properly cooled in the indirect heat exchanger, then the cooling tower is bypassed.

Intermittent evaporative cooling (without a cooling tower) has been applied to air-cooled vapor-compression equipment. One supplier, Environmental Process Systems Limited, Cambridgeshire, UK [52], uses a non-metallic wire mesh and a tap-water spray system controlled by ambient temperature or condensing pressure. The rate of spray is controlled to avoid excess water consumption. The manufacturer claims 20 to 35 percent reduction in peak electric draw compared to dry coils, 75 percent reduction in water consumption compared to conventional evaporative coolers, no water treatment, no sump, no regular maintenance, and no risk of Legionella. Most of their installations are in the Middle East and the UK.

Figure 19 illustrates the process flow for intermittent evaporative cooling with LiBr absorption. Using the 0.4-percent cooling design condition for Phoenix, AZ (110°F dry bulb, 70°F mean-coincident wet bulb) and assuming that a 95°F entering air temperature is desired, water consumption will be about 28 lb/hour/ton cooling for a single-effect absorption machine.

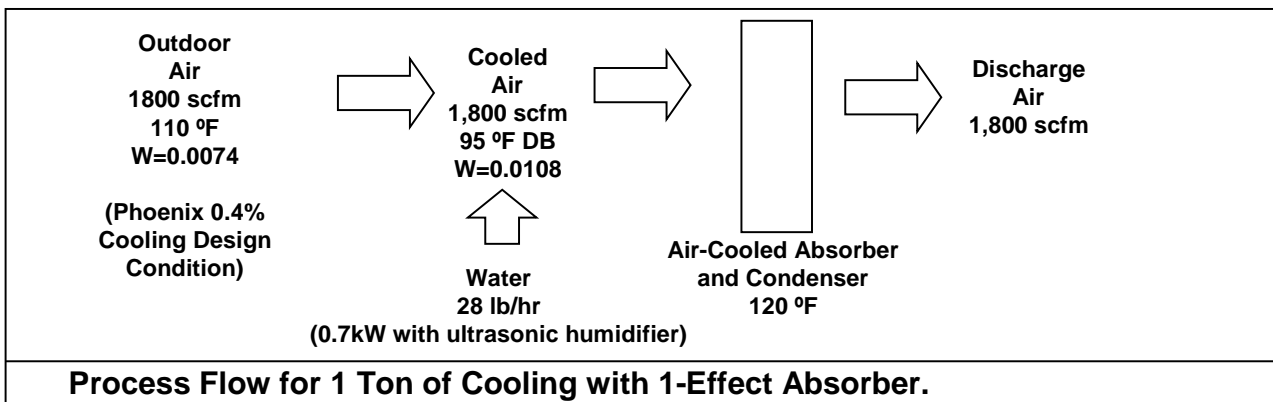

Figure 19: Intermittent Evaporative Cooling

To avoid scaling of heat-transfer surfaces, water droplets must be completely or nearly completely evaporated prior to entering the coils. We considered an ultrasonic process to evaporate the water, but the electric parasitics for such a system appear prohibitive (about 0.7

kW/ton for a single-effect machine). A detailed review is warranted of the experience with this concept as applied to vapor-compression equipment. Such a review should uncover any major issues encountered.

7.5 Microchannel Heat Exchangers

Microchannel heat exchangers are flat tubes having multiple parallel flow passages. Typically, refrigerant or another fluid flows within the passages, and air flows over the outside surface. Heat transfer to the air is often augmented with fins placed between adjacent flat tubes that are either circuited in parallel or in a single serpentine circuit. Microchannel heat exchangers potentially have application in absorption cooling systems and other thermally activated technologies—see, for example, the U.S. Department of Energy, Thermally Activated Technologies, Technology Roadmap [48]. With the exception of a personal-cooling-system development effort at Pacific Northwest National Laboratory (PNNL) [18, 19], which is on the scale of 350 W (0.1 ton) cooling capacity, we found no evidence that microchannel heat exchangers have been applied to LiBr absorption systems. PNNL found that microchannel heat exchangers dramatically improved absorber and evaporator performance, however, these results are not likely to scale up to capacities of interest for light-commercial applications.

Microchannel heat exchangers may be of benefit for air-cooled LiBr absorption as follows:

- Replacing the plate-fin heat exchanger used to reject heat from the cooling water to the ambient air;
- Solution heat exchanger; or
- Microchannel tubes replacing absorber or condenser tubes (with cooling water flowing in the microchannel tubes).

A preliminary analysis of these applications for microchannel heat exchangers would help determine whether detailed analysis and development is warranted.

7.6 Pre-Cooling Return Air or Ventilation Air

Figure 20 illustrates a system that utilizes the absorption equipment to pre-cool the building return air before it enters the vapor-compression rooftop unit. The absorption equipment can operate at a higher evaporator (and absorber) pressure since it does not have to completely cool/dehumidify the air. The vapor-compression rooftop unit now sees a much lighter load than it would without the absorption equipment. Such a system might work well as a Dedicated Outdoor Air System (DOAS), in which case a single packaged system conditions the entire ventilation air stream for the building (or at least for a large portion of the building). However, such an approach should be compared to the alternative of using the CHP system waste heat to regenerate desiccant in a system that pre-conditions incoming ventilation air.

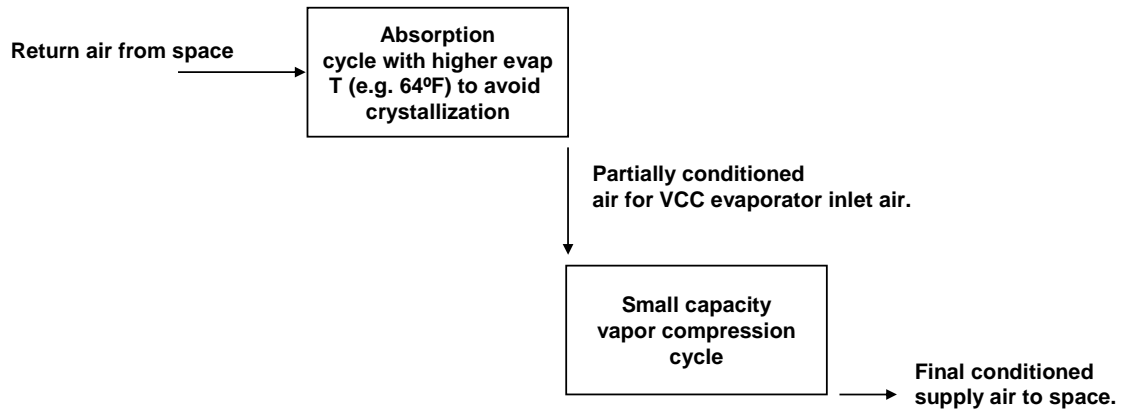

Figure 20: Pre-Cooling Return Air

8.0 Summary/Conclusions

Air-cooled LiBr-water absorption chillers/coolers have been analyzed, designed, and prototype-tested since at least the mid-1970's, primarily in Japan, the U.S., and Europe, for solar-fired and direct-fired applications. Today, only two air-cooled LiBr chillers are on the market:

- Yazaki ACH-8 (sales are modest); and
- Rotartica Solar 045 (just introduced).

Key factors in the lack of market success for air-cooled LiBr chillers/coolers are the general down turn in the overall absorption chiller market and the high cost of air-cooled products.

There is relatively little evidence of air-cooled LiBr absorption development efforts specifically targeting CHP applications in light-commercial buildings. In the CHP application, chiller/cooler efficiency is less important relative to direct-fired applications. The efficiencies achieved by single-effect absorption chillers/coolers should be adequate for this application, which simplifies the development challenge for air-cooled products.

There is a formidable design challenge for CHP applications of air-cooled LiBr systems in light-commercial buildings in the U.S., namely, operation at high ambient air temperatures. The typical vapor-compression cooling equipment currently used in light-commercial buildings can operate in temperatures that exceed the highest temperatures experienced in the U.S. For example, typical vapor-compression rooftop units deliver over 85 percent of their rated capacity in a 120°F ambient. However, the performance of air-cooled LiBr absorption equipment developed to date tends to drop off quickly in ambient temperatures above 95°F. For example, the capacity of the commercialized Yazaki ACH-8 drops to 67 percent of its rated capacity at 105°F, and cannot operate above 109°F (43°C). Many regions of the country experience temperatures in excess of 95°F and, based on the capabilities of the equipment currently in use, building owners/operators will likely expect better high-ambient performance than has been demonstrated to date. At least one air-cooled LiBr absorption developer has demonstrated good performance in high ambient temperatures. GRI/Battelle [15] was able to operate their prototype cooler/heater in up to 110°F ambient temperatures to deliver 87 percent of the rating-point capacity, while maintaining standard rating-point supply-air conditions. The use of a direct-expansion evaporator may have been a key factor in achieving this performance.

While GRI/Battelle apparently achieved good performance at high ambient temperatures without using additives to inhibit crystallization, the use of such additives, in combination with other measures, is a sound approach to air-cooled LiBr absorption development. However, it is important to select crystallization inhibitors that have been thoroughly demonstrated in complete chiller/cooler systems to verify that they:

- Are effective;
- Are stable at peak generator temperatures;

- Do not corrode the materials used in the chiller/cooler; and
- Do not impede heat and mass transfer.

At least one such solution, Carrier's Carrol solution (LiBr, ethylene glycol, phenylmethylcarbinol, and water), has been thoroughly tested in both the laboratory and the field in solar-fired absorption applications.

Interotex [34] demonstrated a clever rotating absorption system that uses rotational forces to promote heat and mass transfer, as well as to pump solution. The refrigeration system is hermetically sealed, using rotating seals only for cooling water and chilled water. Based on this design approach, operation in ambient temperatures up to 105°F to 115°F should be possible. Development of this technology was transferred to Rotartica [38], a subsidiary of Fagor Electrodomesticos in Spain. Rotartica recently introduced a solar product, and expects to introduce a direct-fired product soon. Rotartica does not use crystallization inhibitors.

We considered several alternative design approaches that are not documented in the open literature for air-cooled LiBr absorption applications. Of these, the most promising is intermittent evaporative cooling. If evaporative cooling is only used at extreme ambient temperatures, it may be possible avoid many of the disadvantages of full-time evaporative cooling systems such as high water consumption, high cost, high maintenance requirements, and risk of harboring Legionella. Intermittent evaporative cooling systems have been demonstrated with vapor-compression equipment.

There are alternative approaches to eliminating the need for cooling towers in light-commercial CHP applications that were outside the scope of our investigation, including:

- Ammonia-water absorption (or other refrigerant/sorbent pairs);
- Adsorption/Chemisorption; and
- Waste-heat-fired Rankine cycles to drive vapor-compression cooling.

These alternatives should be considered before proceeding with an air-cooled LiBr system development effort.

The history of air-cooled LiBr chiller/cooler development suggests that developing such a product for light-commercial CHP applications in the U.S. is technically feasible. The key risks lie in whether prominent and capable manufacturers will consider the market potential to be sufficient to justify development costs, and whether product costs can be low enough to appeal to the market.

References

1. American Society of Heating, Refrigeration, and Air Conditioning Engineers; 2001 ASHRAE Handbook; Fundamentals; 2001.
2. Andersson, Brandt, William L. Carroll, and Marlo R. Martin; “Aggregation of U.S. Population Centers Using Climate Parameters Related to Building Energy Use”; Journal of Climate and Applied Meteorology; Vol.25, No. 5; American Meteorological Society; May 1986.
3. Antohi, V.; U.S. Patent 5896747; “Vehicular Absorption Air Conditioning Process and System Utilizing Engine Coolant Waste Heat”; 1999.
4. Arizona Board of Regents, U.S. patent 6155057, “Refrigerant Fluid Crystallization Control and Prevention”, 2000.
5. Biermann, W. and R. Reimann, “Air Cooled Absorption Chillers for Solar Cooling Applications”, Carrier Corporation, EG-77-C-03-1587.
6. Biermann, Wendell J. (retired), formerly of Carrier Corporation; Telephone interview by Robert Zogg of TIAX, Cambridge, MA; January 5, 2005.
7. Broad Air Conditioning Company, Ltd.; Website:
<http://www.broad.com.cn/english/product1.htm>; January 9, 2005.
8. Carrier Corporation, “Product Data, 48TM004-028 48HJ004-017 Single-Package Rooftop Units Gas Heating/Electric Cooling ASHRAE 90.1 Compliant”, Form 48H, T-3PD, 2002.
9. Carrier Corporation; “Product Data, AquaSnap® 30RA010-055 Air-Cooled Chillers 50/60 Hz”; Form 30RA-3PD; Copyright 2002.
10. Carrier Corporation; U.S. Patent 5,724,823; “Absorption Over-Concentration Control”; March 10, 1998.
11. Castro, J., Leal, L, Pozo, P., Perez-Segarra, C.D., and C. Oliet; “Development and Performance of an Air-Cooled Water-LiBr Absorption Cooling Machine”, Universitat Politecnica de Catalunya; International Forum on Renewable Energies; 2002.
12. Daikin Industries, Ltd., Japanese Patent 10-122702, “Air-Cooled Absorption-Refrigerator”, 1998.
13. Daikin Industries, Ltd., Japanese Patent 11-257796, “Air-Cooled Absorber”, 1999.

14. Daikin Industries, Ltd., U.S. Patent 6109060, “Air-Cooled Absorption Type Refrigerating Apparatus”, 2000.
15. De Vuono, A.C., Hanna, W.T., Osborne, R.L., and D.A. Ball, “Development of a Double-effect Air-Conditioner Heater (DEACH). Phase 3 and Final Report, January 1990-December 1991. Phase 3, September 1987-December 1991. Overall Project”, report by Battelle and Gas Research Institute, 1992.
16. DeVault, Robert, Oak Ridge National Laboratory, Oak Ridge, TN; Telephone interview by Robert Zogg of TIAX, Cambridge, MA; October 11, 2004.
17. Dirksen, J.A., and T.A. Ring, “LiBr Crystallization Inhibition”, Gas Research Institute, GRI-97//0049, January 1997.
18. Drost, M. K. and M. Friedrich; “Miniature Heat Pumps for Portable and Distributed Space Conditioning Applications”; AIChE 1998 National Meeting; New Orleans, LA; No. 97464; 1998.
19. Drost, M. K., C. Martin, J. Martin, and R. Cameron; “Recent Developments in Microtechnology-Based Chemical Heat Pumps”; 3rd International Conference on Microreaction Technology; Frankfurt, Germany; April 1999.
20. Erickson, Donald C., President, Energy Concepts Company, Annapolis, MD; Telephone interview by Robert Zogg of TIAX, Cambridge, MA; December 1, 2004.
21. Foley, G., DeVault, R., and R. Sweetser, “The Future of Absorption Technology in America – A Critical Look at the Impact of BCHP and Innovation”, Advanced Building Systems – 2000 conference, June 16, 2000.
22. GEA Luftkuehler Happel GMBH (DE); European Patent DE19538383; “System for Controlling cold Absorption for Air Chilling Units”; April 17, 1997.
23. Gorritxategi, Xabier; Rotartica S.A., Bilbao, Spain; Email communication with Robert Zogg of TIAX LLC, Cambridge, MA; April 20, 2005.
24. Hayashi, Yoshihiko, International Department Manager, Yazaki Corporation, Energy Equipment Division, Japan; Email communication to Trevor R. Judd, Yazaki Energy, Dallas, TX; January 7, 2005; forwarded to Robert Zogg of TIAX, Cambridge, MA on January 7, 2005.
25. Herold, K., Howe, L., and R. Radermacher, “Analysis of a hybrid compression-absorption cycle using lithium bromide and water as the working fluid,” *Int. J. Refrig.*, Vol. 14, September 1991.

26. Izquierdo, M., Venegas, M., Rodriguez, P., and A. Lecuona, “Crystallization as a limit to develop solar air-cooled LiBr-H₂O absorption systems using low-grade heat”, *Solar Energy Materials & Solar Cells*, 81, pp 205-216, 2004.
27. Kim, D.S., and C.A. Infante Ferreira, “Solar Absorption Cooling”, Delft University of Technology, 1st Progress Report to NOVEM, 2003.
28. Kim, D.S., and C.A. Infante Ferreira, “Solar Absorption Cooling”, Delft University of Technology, 2nd Progress Report to NOVEM, 2004.
29. Kiyota, M., Morioka, I., and T. Matsuyama, “Steam Absorption into Aqueous Lithium Bromide Solution Films Falling Inside Vertical Pipes”, *Heat Transfer – Asian Research*, 32 (8), 2003.
30. Kurosawa, S., Yoshida, A., and M. Ogawa, “Development of Next-Generation Gas-Fired Absorption Water Chiller-Heaters”, Advanced Absorption Workshop, October 4, 1988.
31. Liao, X, Garland, P., and R. Radermacher, “The Modeling of Air-Cooled Absorption Chiller Integration in CHP System”, Proceedings of IMECE2004: 2004 ASME International Mechanical Engineering Congress and Exposition, November 13-19, 2004, Anaheim, California.
32. Löf, George, Editor; “Active Solar Systems”; MIT Press; 1993.
33. Longo, G.A., Gasparella, A., and C. Zilio, “Simulation of an Absorption Chiller Driven by the Heat Recovery of an Internal Combustion Engine”, 2002 Purdue Conference.
34. Lorton, R., Gilchrist, K, and R.J. Green, “Development and Operation of a High Performance 10 kW Absorption Chiller”, Proceedings of the International Sorption Heat Pump Conference, March 24-26, 1999, Munich, Germany.
35. Ring, Terry A., James A. Dirksen, Kristin N. Duvall, and Nathalie Jongen; “LiBr Crystallization Inhibition in the presence of Soluble Additives”; 14th International Symposium on Industrial Crystallization; 1999.
36. Rinnai Corp, Japanese Patent 2004-108731, “Hybrid Air Conditioner”, 2004.
37. Rockenfeller, Uwe, President, Rocky Research Institute, Boulder City, NV; Telephone interview by Michael Feng of TIAX, Cambridge, MA; October 20, 2004.
38. Rotartica S.A., Bilbao, Spain; Website: <http://www.rotartica.com/pub/index.html>; April 29, 2005.

39. Ryan, W.A., "Absorption in Sprays: Adiabatic Water Absorption in a Spray of an Aqueous Solution of Lithium Bromide", Gas Research Institute, GRI-96/0404, December 1995.
40. Ryan, William, University of Illinois, Chicago (formerly with the Gas Research Institute); Telephone interview by Michael Feng of TIAX, Cambridge, MA; October 15, 2004.
41. Sanyo Electric Co Ltd, Japanese Patent JP1208670, "Air Cooled Type Absorption Refrigerating Machine", 1989.
42. Sanyo Electric Co Ltd, Japanese Patent JP1310273, "Air Cooled Double Effect Absorption Refrigerating Machine", 1989.
43. Sasaki, H., Ishino, H., Tsuda, H., and K. Enyoji, "Development of a Hybrid Air conditioning system driven by low temperature waste heat", International Gas Research Conference, Vancouver, Canada, Nov. 1-4, 2004.
44. Schweigler, C. Dantele, T., Kren, C., Ziegler, F., Clark, D., Fulachier, M.H., and J. Sahun, "Development of a Direct-Fired partly air-cooled Double-Effect Absorption Chiller", ZAE Bayern, 20th International congress of Refrigeration, IIR/IIF, Sydney, 1999.
45. Shitara, A., M. Oka, and M. Edera; "Study on Compact Absorption Chiller-Heater (Part 2: Study on Compact Absorber)"; Energy & Environmental Technology Laboratory Annual Technical Report Digest; Volume 10/2000; Tokyo Gas Company, Ltd.; <http://www.tokyo-gas.co.jp/techno/eti/ene00/english/16e.html>; 2000.
46. Tokyo Gas Co Ltd, Japanese patent 06-235559, "Method and Apparatus for Controlling Operation of Air Conditioning Plant Using Absorption Type Refrigerator", 1994.
47. Tongu S., Makino, Y, Ohnishi, K, and S. Nakatsugawa, "Practical Operating of Small-Sized Air-Cooled Double-Effect Absorption Chiller-Heater by Using Lithium Bromide and Aqueous", AES-Vol. 31, International Absorption Heat Pump Conference, ASME, 1993.
48. United States Department of Energy; Office of Energy Efficiency and Renewable Energy; "Thermally Activated Technologies, Technology Roadmap"; Available at http://www.eere.energy.gov/de/information/info_docs_thermal.shtml; May 2003.
49. University of Puerto Rico, U.S. Patent 6539738, "Compact Solar-Powered Air Conditioning Systems", 2003.

50. University of Utah, U.S. Patent 6177025, “Absorption Heat Pumps Having Improved Efficiency Using a Crystallization-Inhibiting Additive”, 2001.
51. University of Utah, U.S. Patent 6432319, “Method for Improving the Efficiency of Absorption Heat Pumps Using a Crystallization-Inhibiting Additive”, 2002.
52. Ure, Zafer, Mcibse, and Mashrae; “Adiabatic Air Inlet Cooling for Air Cooled Heat Rejection Equipment”; Environmental Process Systems Limited, Cambridgeshire, UK; ASHRAE 2004, Anaheim Winter Meeting; 2004.
53. Uselton, Dutch, P.E., Principal Engineer, Lennox Industries Inc., Carrollton, TX; Email communication to Michael Feng of TIAX, Cambridge, MA; November 30, 2004.
54. Yazaki Corporation, Japanese Patent 06-265235, “Absorption Refrigerating Machine”, 1994.
55. Yazaki Corporation, Japanese Patent 2000-319646, “Absorbing Solution for Absorption Refrigerating Machine and Absorption Refrigerating Machine”, 2000.
56. Yazaki Corporation; Website: <http://www.yazaki-group.com/products/air/kyusyu03.html>; January 18, 2005.

The Distributed Energy Program would like to acknowledge Oak Ridge National Laboratory for its Technical Project Input of this Report.

OAK RIDGE NATIONAL LABORATORY

MANAGED BY UT-BATTELLE FOR THE DEPARTMENT OF ENERGY



A Strong Energy Portfolio for a Strong America

Energy efficiency and clean, renewable energy will mean a stronger economy, a cleaner environment, and greater energy independence for America. Working with a wide array of state, community, industry, and university partners, the U.S. Department of Energy's Office of Energy Efficiency and Renewable Energy invests in a diverse portfolio of energy technologies.

For more information contact:

EERE Information Center

1-877-EERE-INF (1-877-337-3463)

www.eere.energy.gov