



Opportunities for Micropower and Fuel Cell/Gas Turbine Hybrid Systems in Industrial Applications

Volume I: Main Text

Subcontract No.
85X-TA009V

Notice:

This report was prepared by Arthur D. Little for the account of Lockheed Martin Energy Research Corporation and the DOE's Office of Industrial Technologies. This report represents Arthur D. Little's best judgment in light of information made available to us. This report must be read in its entirety. The reader understands that no assurances can be made that all financial liabilities have been identified. This report does not constitute a legal opinion.

No person has been authorized by Arthur D. Little to provide any information or make any representations not contained in this report. Any use the reader makes of this report, or any reliance upon or decisions to be made based upon this report are the responsibility of the reader. Arthur D. Little does not accept any responsibility for damages, if any, suffered by the reader based upon this report.

Final Report to Lockheed Martin
Energy Research Corporation and
the DOE Office of Industrial
Technologies

January 2000

Arthur D. Little, Inc.
Acorn Park
Cambridge, Massachusetts
02140-2390 U.S.A.

Reference 38410

Table of Contents

1	Executive Summary	1
1.1	Objectives	1
1.2	Background.....	1
1.3	Overview of Micropower Technologies and Markets	2
1.4	Leading Opportunities within the <i>Industries of the Future</i>	4
1.5	Potential Public Benefits	10
1.6	Cross-Cutting R&D Needs	12
1.7	Other Technology Support Needs	15
1.8	Next Steps.....	15
2	Introduction	18
2.1	Background.....	18
2.2	Objectives.....	18
2.3	Approach	19
3	Overview of Micropower Markets, Technologies and Applications	22
3.1	U.S. Electricity Consumption and Onsite Power Generation	22
3.2	Restructuring of U.S. Energy Markets.....	23
3.3	Micropower Technologies and Markets	24
3.4	The Changing Structure of the Electric Power Industry	27
4	Opportunities for Micropower Technologies within the <i>Industries of the Future</i>	30
4.1	Summary.....	30
4.2	Key Applications by Industry	32
4.3	Total Industrial Power Market.....	40
4.4	General Approach to the Industrial Opportunity Analysis	42
4.5	Anticipated Technology Development Schedules	44
4.6	Application-Specific Estimates of the <i>Entire Market</i> in the <i>Industries of the Future</i>	45
4.7	Industry-Specific Conclusions.....	53
5	Public Benefits Analysis	90
5.1	Modest R&D Success	91
5.2	Aggressive R&D Success	93
5.3	Summary.....	98
6	Detailed Technology Assessments	100
6.1	Microturbines	100
6.2	Reciprocating Engines.....	110
6.3	Small Fuel Cell Systems.....	120
6.4	Fuel Cell / Gas Turbine Hybrid Systems (Fuel Cell Hybrids).....	129
7	Summary of Research and Development Needs	134
7.1	Background.....	134
7.2	R&D Needs	135
7.3	Other Technology Support Needs	143
8	Summary and Conclusions	144
8.1	Drivers in Industrial Markets.....	144
8.2	Applications for Micropower and Fuel Cell Hybrid Technology	147
8.3	National Benefits and Potential Supporting OIT Activities.....	160
9	Glossary	164
10	List of Acronyms	168
11	References	170

List of Tables

Table 1: Micropower and Fuel Cell Hybrid Technologies and Markets	3
Table 2: Key Drivers for Onsite Generation.....	3
Table 3: Industrial Power Applications Considered	4
Table 4: Scenarios Considered for the Industrial Opportunities Analysis.....	6
Table 5: Technologies Considered	6
Table 6: Potential Market Penetration for Micropower (25-1,000 kW) and Fuel Cell Hybrids (0.25-20 MW) within the <i>Industries of the Future – Aggressive R&D Success, Deregulated Scenario</i>	11
Table 7: Summary of Potential Public Benefits within the <i>Industries of the Future</i> by Industrial Application – <i>Aggressive R&D Success, Deregulated Scenario</i>	11
Table 8: Summary of Micropower R&D Needs.....	12
Table 9: Micropower and Fuel Cell Hybrid Technologies and Markets	25
Table 10: Key Drivers for Onsite Generation.....	26
Table 11: Definitions of Industries Considered.....	41
Table 12: Assumed Technology Performance Characteristics	44
Table 13: Scenarios Considered for the Industrial Opportunities Analysis.....	54
Table 14: Leading Opportunities for Micropower and Fuel Cell Hybrids in the Food Products Industry ...	56
Table 15: Leading Opportunities for Micropower and Fuel Cell Hybrids in the Textiles Industry.....	58
Table 16: Leading Opportunities for Micropower and Fuel Cell Hybrids in the Primary Aluminum Industry	60
Table 17: Leading Opportunities for Micropower and Fuel Cell Hybrids in the Aluminum Products Industry	62
Table 18: Leading Opportunities for Micropower and Fuel Cell Hybrids in the Large Chemicals Industry	65
Table 19: Leading Opportunities for Micropower and Fuel Cell Hybrids in the Small Chemicals Industry	67
Table 20: Leading Opportunities for Micropower and Fuel Cell Hybrids in the Glass Industry.....	70
Table 21: Leading Opportunities for Micropower and Fuel Cell Hybrids in the Metal Casting Industry	72
Table 22: Leading Opportunities for Micropower and Fuel Cell Hybrids in the Mining Industry.....	74
Table 23: Leading Opportunities for Micropower and Fuel Cell Hybrids in the Oil & Gas E&P Industry .	76
Table 24: Leading Opportunities for Micropower and Fuel Cell Hybrids in the Petroleum Refining Industry	78
Table 25: Leading Opportunities for Micropower and Fuel Cell Hybrids in the Other Petroleum Industry	80
Table 26: Leading Opportunities for Micropower and Fuel Cell Hybrids in the Pulp and Paper Industry ..	82
Table 27: Leading Opportunities for Micropower and Fuel Cell Hybrids in the Wood Products Industry..	84
Table 28: Leading Opportunities for Micropower and Fuel Cell Hybrids in the Steel Industry	86
Table 29: Leading Opportunities for Micropower and Fuel Cell Hybrids in the Steel Products Industry....	88
Table 30: Potential Public Benefits of Micropower (25-1,000 kW) and Fuel Cell Hybrids (0.25-20 MW) in Traditional Cogeneration Applications in the <i>Industries of the Future – Modest R&D Success, Deregulated Scenario</i>	92
Table 31: Potential Public Benefits of Micropower (25-1,000 kW) and Fuel Cell Hybrids (0.25-20 MW) in Generation Using Wastes & Biofuels Applications in the <i>Industries of the Future – Modest R&D Success, Deregulated Scenario</i>	92
Table 32: Potential Public Benefits of Micropower (25-1,000 kW) and Fuel Cell Hybrids (0.25-20 MW) in Simple Generation Applications in the <i>Industries of the Future – Aggressive R&D Success, Deregulated Scenario</i>	93
Table 33: Potential Public Benefits of Micropower (25-1,000 kW) and Fuel Cell Hybrids (0.25-20 MW) in Traditional Cogeneration Applications in the <i>Industries of the Future – Aggressive R&D Success, Deregulated Scenario</i>	94

Table 34: Potential Public Benefits of Micropower (25-1,000 kW) and Fuel Cell Hybrids (0.25-20 MW) in Tightly-Coupled Cogeneration Applications in the <i>Industries of the Future – Aggressive R&D Success, Deregulated Scenario</i>	95
Table 35: Potential Public Benefits of Micropower (25-1,000 kW) and Fuel Cell Hybrids (0.25-20 MW) in Remote Power Applications in the <i>Industries of the Future – Aggressive R&D Success, Deregulated Scenario</i>	96
Table 36: Potential Public Benefits of Micropower (25-1,000 kW) and Fuel Cell Hybrids (0.25-20 MW) in Generation Using Wastes and Biofuels in the <i>Industries of the Future – Aggressive R&D Success, Deregulated Scenario</i>	98
Table 37: Potential Market Penetration for Micropower (25-1,000 kW) and Fuel Cell Hybrids (0.25-20 MW) within the <i>Industries of the Future – Aggressive R&D Success, Deregulated Scenario</i>	99
Table 38: Summary of Potential Public Benefits within the <i>Industries of the Future</i> by Industrial Application – <i>Aggressive R&D Success, Deregulated Scenario</i>	99
Table 39: Technology Performance Characteristics of Microturbines	102
Table 40: Microturbine Design Options	102
Table 41: Current Microturbine Configurations	103
Table 42: Projected Performance Characteristics for Microturbines.....	103
Table 43: Manufacturer Claims for Cost and Performance of Microturbine Technology.....	104
Table 44: Key Markets and Drivers for Microturbines	107
Table 45: Market Barriers to the Acceptance of Microturbine Generation Technology	108
Table 46: Technology Development Needs for Microturbines	108
Table 47: Characteristics of Spark-Ignition and Compression-Ignition Reciprocating Engines	112
Table 48: EPA Emission Standards for New Non-Road Diesel Reciprocating Engines	112
Table 49: Technology Performance Characteristics of Reciprocating Engines.....	113
Table 50: Current and Projected Costs and Efficiencies for Reciprocating Engines.....	114
Table 51: Reciprocating Engine Maintenance Requirements (years 2000 & 2010).....	115
Table 52: Summary of Key Industrial Reciprocating Engine Manufacturers and Products.....	117
Table 53: Technology Development Needs for Reciprocating Engines.....	119
Table 54: Fuel Cell Technology Characteristics	121
Table 55: Fuel Cell Technology Development Paths	122
Table 56: Overall Fuel Cell Characteristics.....	123
Table 57: Fuel Cell Cost and Performance Characteristics	123
Table 58: Leading U.S. Fuel Cell Developers.....	124
Table 59: Key Fuel Cell Applications	126
Table 60: Fuel Cell Allowable Cost Targets	127
Table 61: Fuel Cell Market Barriers.....	127
Table 62: Key Fuel Cell Technology Development Needs	128
Table 63: Technology Performance Characteristics of Fuel Cell/Gas Turbine Hybrid Systems.....	130
Table 64: Technology Characteristics of MCFC and SOFC Hybrid Systems.....	131
Table 65: Projected Performance Characteristics for Fuel Cell Hybrid Systems	131
Table 66: Manufacturer Estimates of the Cost and Performance of Fuel Cell Hybrid Systems.....	132
Table 67: Summary of R&D Needs	136

List of Figures

Figure 1: Questions Addressed in this Study	1
Figure 2: Estimated <i>Entire Market</i> for Industrial Power – All <i>Industries of the Future</i> (MW).....	5
Figure 3: Addressable Micropower (25-1,000 kW) and Fuel Cell Hybrid (0.25-20 MW) Market Opportunities in Simple Generation in the <i>Industries of the Future</i>	7
Figure 4: Addressable Micropower (25-1,000 kW) and Fuel Cell Hybrid (0.25-20 MW) Market Opportunities in Traditional Cogeneration in the <i>Industries of the Future</i>	7
Figure 5: Addressable Micropower (25-1,000 kW) and Fuel Cell Hybrid (0.25-20 MW) Market Opportunities in Tightly-Coupled Cogeneration in the <i>Industries of the Future</i>	8
Figure 6: Addressable Micropower (25-1,000 kW) and Fuel Cell Hybrid (0.25-20 MW) Market Opportunities in Backup Power in the <i>Industries of the Future</i>	8
Figure 7: Addressable Micropower (25-1,000 kW) and Fuel Cell Hybrid (0.25-20 MW) Market Opportunities in Remote Power in the <i>Industries of the Future</i>	9
Figure 8: Addressable Micropower (25-1,000 kW) and Fuel Cell Hybrid (0.25-20 MW) Market Opportunities in Premium Power in the <i>Industries of the Future</i>	9
Figure 9: Addressable Micropower (25-1,000 kW) and Fuel Cell Hybrid (0.25-20 MW) Market Opportunities from Generation Using Waste and Biofuels in the <i>Industries of the Future</i>	10
Figure 10: Questions Answered in this Study.....	19
Figure 11: Overall Approach	20
Figure 12: Industrial Opportunity Characterization Process.....	20
Figure 13: Estimated U.S. Electricity Consumption by Sector - 1997	23
Figure 14: 1997 U.S. Average Electric Rates	24
Figure 15: Key Drivers Affecting Distributed Power Opportunities	26
Figure 16: Impact of Electric Industry Restructuring on Onsite Generation	27
Figure 17: Status of Electric Industry Deregulation as of September 1, 1999.....	28
Figure 18: Relative Importance of Power Applications by Industry.....	33
Figure 19: Characteristics of Simple Generation	34
Figure 20: Characteristics of Traditional Cogeneration.....	35
Figure 21: Characteristics of Tightly-Coupled Cogeneration	36
Figure 22: Characteristics of Backup Power.....	37
Figure 23: Characteristics of Remote Power	38
Figure 24: Characteristics of Premium Power	39
Figure 25: Characteristics of Generation Using Wastes and Biofuels	40
Figure 26: Electricity Consumption Variation by <i>Industry of the Future</i> (1994 data).....	41
Figure 27: Market Size Estimating Methodology	43
Figure 28: Estimated <i>Entire Market</i> for Industrial Power – All <i>Industries of the Future</i> (MW).....	45
Figure 29: <i>Entire Market</i> Potential for Simple Generation in the <i>Industries of the Future</i>	46
Figure 30: <i>Entire Market</i> Potential for Traditional Cogeneration in the <i>Industries of the Future</i>	47
Figure 31: <i>Entire Market</i> Potential for Tightly-Coupled Cogeneration in the <i>Industries of the Future</i>	48
Figure 32: <i>Entire Market</i> Potential for Backup Power in the <i>Industries of the Future</i>	49
Figure 33: <i>Entire Market</i> Potential for Remote Power in the <i>Industries of the Future</i>	50
Figure 34: <i>Entire Market</i> Potential for Premium Power in the <i>Industries of the Future</i>	52
Figure 35: <i>Entire Market</i> Potential for Generation Using Wastes & Biofuels in the <i>Industries of the Future</i>	53
Figure 36: Picture of Microturbine Showing the Major Components.....	101
Figure 37: Status of Microturbine Generation Technology in 1999	105
Figure 38: Illustration of a Four-Stroke Spark-Ignition Engine.....	111

Figure 39: Simplified schematic of a fuel cell	120
Figure 40: Commercial PC25 Fuel Cell Operating Experience	125
Figure 41: Product Development Status of Fuel Cells as of January 1999	125
Figure 42: Basic SOFC and MCFC Gas Turbine Hybrid System Configurations.....	129
Figure 43: Status of Fuel Cell Hybrid Development from Major Manufacturers.....	132
Figure 44: The Technology Development Process	135
Figure 45: Possible Technology Development Activities and Support by OIT.....	136
Figure 46: Cost of Power as a Fraction of Net Value Added in Industry	145
Figure 47: Ozone Non-Attainment Areas in the United States.....	146
Figure 48: Addressable Micropower (25-1,000 kW) and Fuel Cell Hybrid (0.25-20 MW) Market Opportunities in Simple Generation within the <i>Industries of the Future</i>	149
Figure 49: Addressable Micropower (25-1,000 kW) and Fuel Cell Hybrid (0.25-20 MW) Market Opportunities in Traditional Cogeneration within the <i>Industries of the Future</i>	150
Figure 50: Addressable Micropower (25-1,000 kW) and Fuel Cell Hybrid (0.25-20 MW) Market Opportunities in Tightly-Coupled Cogeneration within the <i>Industries of the Future</i>	153
Figure 51: Addressable Micropower (25-1,000 kW) and Fuel Cell Hybrid (0.25-20 MW) Market Opportunities in Backup Power within the <i>Industries of the Future</i>	154
Figure 52: Addressable Micropower (25-1,000 kW) and Fuel Cell Hybrid (0.25-20 MW) Market Opportunities in Remote Power within the <i>Industries of the Future</i>	155
Figure 53: Addressable Micropower (25-1,000 kW) and Fuel Cell Hybrid (0.25-20 MW) Market Opportunities in Premium Power within the <i>Industries of the Future</i>	157
Figure 54: Addressable Micropower (25-1,000 kW) and Fuel Cell Hybrid (0.25-20 MW) Market Opportunities in Generation Using Wastes & Biofuels within the <i>Industries of the Future</i>	159

1 Executive Summary

1.1 Objectives

This report summarizes work conducted by Arthur D. Little on behalf of the Department of Energy's Office of Industrial Technologies (OIT). The OIT retained Arthur D. Little to assess the opportunities for micropower and fuel cell/gas turbine hybrid technologies in the industrial sector. Micropower is defined as microturbines, fuel cells and reciprocating engines under 1 MW. Fuel cell hybrid systems were analyzed for unit sizes of 250kW to 20 MW. The OIT asked Arthur D. Little to address several questions regarding these power generation technologies and their use within the OIT's *Industries of the Future*¹, as summarized in Figure 1.

Figure 1: Questions Addressed in this Study

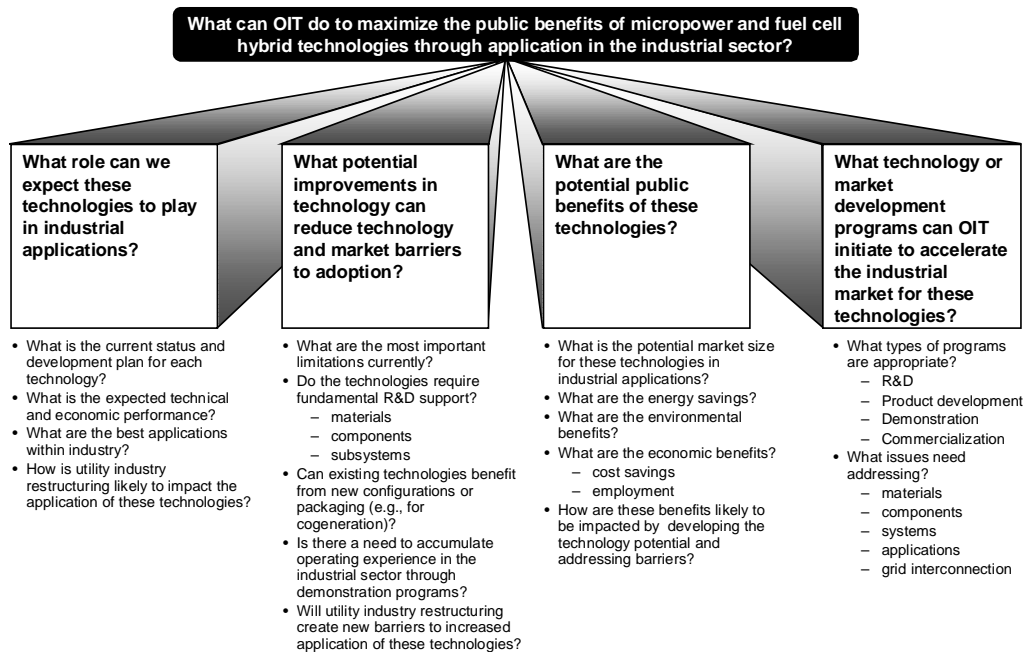

1.2 Background

The OIT supports various programs that aim to significantly improve the resource efficiency and productivity of energy- and waste-intensive industries in the United States. For these *Industries of the Future*, the OIT is helping to develop technology solutions to critical energy and environmental challenges. These partnerships with industry are envisioned to produce important national benefits, including:

¹ These industries are: Agriculture, Aluminum, Chemicals, Forest Products, Glass, Metal Casting, Mining, Petroleum, and Steel.

- A 25 percent improvement in energy efficiency and 30 percent reduction in emissions for selected industries by 2010
- A 35 percent improvement in energy efficiency and 50 percent reduction in emissions for selected industries by 2020.

Several advanced technologies have been identified by the OIT that offer the potential for substantial energy efficiency and emissions improvement that can be applied across a wide range of industries. These *cross-cutting* technologies have the potential to save energy and reduce wastes, not only in the *Industries of the Future*,² but also in other industries, because such technologies address fundamental energy and productivity issues. In industrial electric power generation, these technologies include microturbines, fuel cells, fuel cell/gas turbine hybrid systems (called *fuel cell hybrids* in this study), and reciprocating engines. Gasification has also been identified as an important supporting technology in several industries.

1.3 Overview of Micropower and Fuel Cell Hybrid Technologies and Markets

Micropower technologies are suitable for residential, commercial and industrial onsite power markets. Fuel cell hybrids can address some of these markets. *Distributed power* also includes the concept of installing small power generation equipment throughout the distribution grid (e.g., at substations) as an alternative to central station power plants. Overall, the industrial sector represents about one-third of total U.S. electricity consumption, but most onsite power capacity installed today is found at industrial sites. As such it is important to evaluate the potential for micropower and fuel cell hybrids in the industrial sector, even though at first glance there appears to be a mismatch between unit size and the scale of power needs within the *Industries of the Future*.

Table 1 reviews the target markets for a number of micropower technologies and fuel cell hybrids, including several technologies not covered in this report. Of those listed, several are commercially available, including: reciprocating engines, small gas turbines, photovoltaics, wind power and biomass power. Several microturbine manufacturers will begin to offer commercial products in 1999. A single low-temperature fuel cell product is also commercially available in a 200kW package, but fuel cells in general are considered to be emerging technology.

Within the onsite generation market, a number of factors influence the attractiveness of micropower technologies. These are summarized in Table 2.

² In addition to the *Industries of the Future*, this report also included Textiles and Oil and Gas Exploration and Production.

Table 1: Micropower and Fuel Cell Hybrid Technologies and Markets

		Residential	Commercial	Industrial	Grid-distributed	Portable Power	Transportation	Typical Unit Size Range (installation size can be larger)
		<ul style="list-style-type: none"> ● Primary Target Market ○ Secondary Target Market 						
Covered in Report	Microturbines		●	●	●	○	○	25 - 300 kW
	Reciprocating Engines		●	●	●	●	●	5 kW - 50 MW
	Low-Temperature Fuel Cells	●	●	○	●	○	●	2 - 250 kW
	High-Temperature Fuel Cells		●	●	●	○		100 kW - 3 MW
	Fuel Cell/Gas Turbine Hybrids		○	○	●			250 kW - 20 MW
Not Covered in Report	Small Gas Turbines			●	●			500 kW - 5 MW
	Photovoltaics	●	○	○	●			1 - 500 kW
	Wind Power	○			●			50 kW - 2 MW
	Biomass Power			●	●			250 kW - 50 MW

Table 2: Key Drivers for Onsite Generation

	Favors Onsite Generation	Barriers to Onsite Generation
Residential	<ul style="list-style-type: none"> High electric rates for grid power imply a large potential for savings with onsite generation <i>Green</i> and <i>clean</i> power may become important niches in a deregulated market, and would favor certain micropower technologies, especially fuel cells and photovoltaics 	<ul style="list-style-type: none"> Low load factors for electricity and heat hurt economics. Thermal and electric load profiles do not match well Very small unit sizes required for single family homes (<10 kW) limits choice of technology Non-traditional market for onsite generation requires new approaches to ownership and operation Permitting, interconnect standards and similar issues need to be addressed to facilitate access to this market
Commercial	<ul style="list-style-type: none"> Electric rates for grid power are favorable for onsite generation Loads and load factors well suited to several micropower technologies, especially high-load factor buildings such as hotels and hospitals Moderate cogeneration potential 	<ul style="list-style-type: none"> Non-traditional market for onsite generation requires new approaches to ownership and operation Permitting, interconnect standards and similar issues need to be addressed to facilitate access to this market Many buildings types have low load factors (e.g., retail, office)
Industrial	<ul style="list-style-type: none"> Best cogeneration potential Attractive electric loads and load factors Industrial end-users are most familiar with the concept of onsite generation and cogeneration 	<ul style="list-style-type: none"> Lowest electric rates makes onsite generation more difficult Permitting, interconnect standards and similar issues need to be addressed to facilitate access to this market Micropower technologies are too small for many facilities, even in bundles of several units

1.4 Leading Opportunities within the *Industries of the Future*

Opportunities for industrial power were divided into seven distinct applications (Table 3), covering a range of needs. Total potential industrial power markets within the *Industries of the Future* vary in size but overall, the opportunity is large, as depicted in Figure 2. Note that these estimates do not consider micropower or fuel cell hybrid technology characteristics, nor do they subtract out currently installed industrial power generation capacity. Market sizes are also not additive across applications – for example, capacity installed as traditional cogeneration would reduce the need for simple generation because it would also meet basic power needs. Some applications, such as remote power and premium power have limited application within the *Industries of the Future* because of the nature of the industries. Premium power is likely to be a much more significant opportunity in other industries (e.g., electronics and high-tech manufacturing) as well as growing segments within the commercial sector (e.g., data processing centers and call centers).

Table 3: Industrial Power Applications Considered

Industrial Power Application	Description
Simple Generation	Generation of power only as a substitute for grid power
Traditional Cogeneration	Simultaneous generation of power and heat as steam or hot water
Tightly-Coupled Cogeneration	Simultaneous generation of power and heat as direct process heat
Backup Power	Standby generation capacity used to backup grid power in the event of an outage
Remote Power	Generation of power only at sites that are not connected to the power grid
Premium Power	Generation of power that is of higher quality and/or reliability than grid power
Generation Using Wastes & Biofuels	Generation of power using byproducts of industrial processes that have fuel value

Cogeneration is also called *combined heat and power (CHP)*. These terms can generally be used interchangeably.

Micropower and fuel cell hybrid opportunities were evaluated using a multi-step process that included an assessment and review of each technology, to establish expected cost and performance levels and to identify R&D needs. The bulk of the project was devoted to identifying, characterizing and prioritizing industrial opportunities.

Figure 2: Estimated Entire Market for Industrial Power – All Industries of the Future (MW)

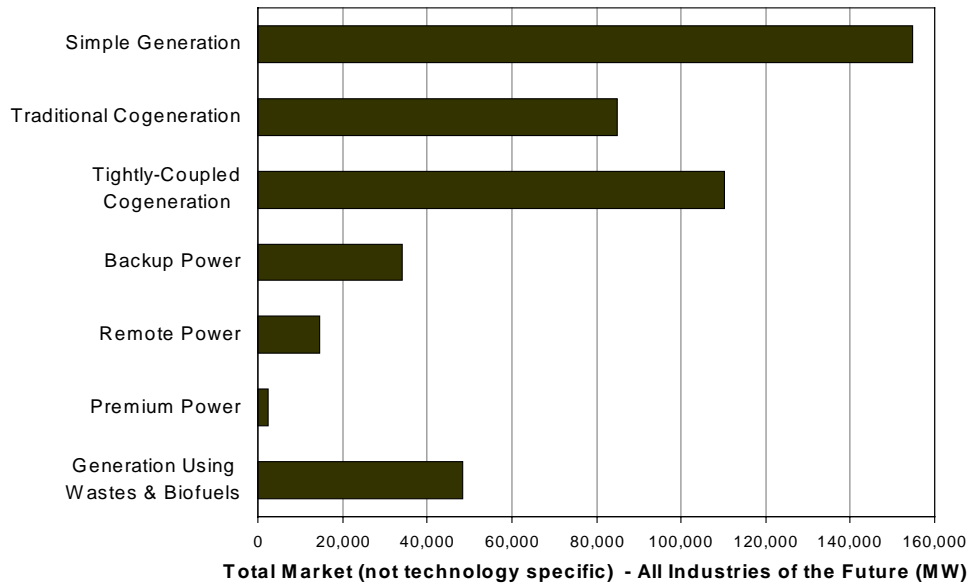

The *Entire Market* represents the total estimated industrial power potential, not annual markets for equipment. It is not technology specific. Actual demand for new power generation equipment on an annual basis will be significantly lower.

Market sizes are not additive across applications, as meeting the power needs of any given application will normally reduce the amount of power needed in other applications (e.g., installing equipment to cogenerate heat and power from wastes and biofuels will reduce the available market for simple generation and traditional cogeneration).

Despite their relatively small unit sizes when compared with many industrial facilities, there appear to be several important micropower and fuel cell hybrid opportunities within the *Industries of the Future*, depending on how technologies develop and improve between now and 2010, the base year for the market opportunity assessment. Within the *Industries of the Future*, the leading opportunities appear to be for microturbines and *large* reciprocating engines (300-1,000 kW in this study). Fuel cell hybrids also appear to have attractive opportunities, in part due to the larger unit size considered (up to 20 MW). Small reciprocating engines (50-300 kW in this study) and low- and high-temperature fuel cells do not appear to fit as well within the *Industries of the Future*, within the limits of the analysis in this study.

Opportunities were characterized in terms of *Modest R&D Success* and *Aggressive R&D Success*. The former represents addressable markets that are attractive even under the most pessimistic assumptions for technology cost and performance. The latter represents the situation where the technologies achieve more aggressive cost and performance levels. The analysis also included a sensitivity on economic payback to look at the impacts of electric industry restructuring on the attractiveness of micropower and fuel cell hybrid technology. The three scenarios evaluated are summarized in Table 4. Comparing the *Modest R&D Success*, *Deregulated* and *Aggressive R&D Success*, *Deregulated* scenarios shows the impact of technology performance, whereas comparing the *regulated* and *deregulated* versions of the *Aggressive R&D Success*

scenario shows the impact of market evolution and ownership options (represented as 3-year payback for industrial ownership and 7-year payback for third-party ownership). The aggregate opportunities for each application are given in Figure 3 through Figure 7. Table 5 below briefly describes the technologies considered. For more detailed descriptions, please see the main text.

Table 4: Scenarios Considered for the Industrial Opportunities Analysis

Scenario	Technology Performance (based on Table 12)	Payback Requirement (years)	Energy Rates
Modest R&D Success, Deregulated	2010 – low	7	Deregulated 2010
Aggressive R&D Success, Regulated	2010 – high	3	Same as of 1998
Aggressive R&D Success, Deregulated	2010 – high	7	Deregulated 2010

Energy Rates are based on the DOE/EIA *Annual Energy Outlook*. "Deregulated 2010" prices are lower than current prices.

Table 5: Technologies Considered

Technology	Description
Recuperated (Recup.) Microturbines	A simple cycle microturbine with a recuperator (for heat recovery to improve efficiency). Unit size of 25 kW – 1,000 kW
Unrecuperated (Unrecup.) Microturbines	A simple cycle microturbine (no recuperator). Unit size of 25 kW – 1,000 kW
Small Reciprocating Engines (Small Recips)	Reciprocating engines with unit sizes of 50 kW – 300 kW
Large Reciprocating Engines (Large Recips)	Reciprocating engines with unit sizes of 300 kW – 1,000 kW
High-Temperature Fuel Cells (High T FCs)	Molten carbonate or solid oxide fuel cells in unit sizes of 250 kW – 1,000 kW
Low-Temperature Fuel Cells (Low T FCs)	Phosphoric acid or proton exchange membrane fuel cells in unit sizes of 50 kW – 250 kW
Fuel Cell Hybrids (FC Hybrids)	Integrated gas turbine/high-temperature fuel cell power systems in unit sizes of 250 kW – 20 MW.

Please note: The estimates described in this analysis do not represent Arthur D. Little's prediction of the actual market size for these technologies, but rather the market **opportunity** that can be cost-effectively addressed if sufficient R&D efforts are undertaken to bring the technologies up certain levels of performance. These performance levels are described in the main text in Table 12.

Figure 3: Addressable Micropower (25-1,000 kW) and Fuel Cell Hybrid (0.25-20 MW) Market Opportunities in Simple Generation in the *Industries of the Future*

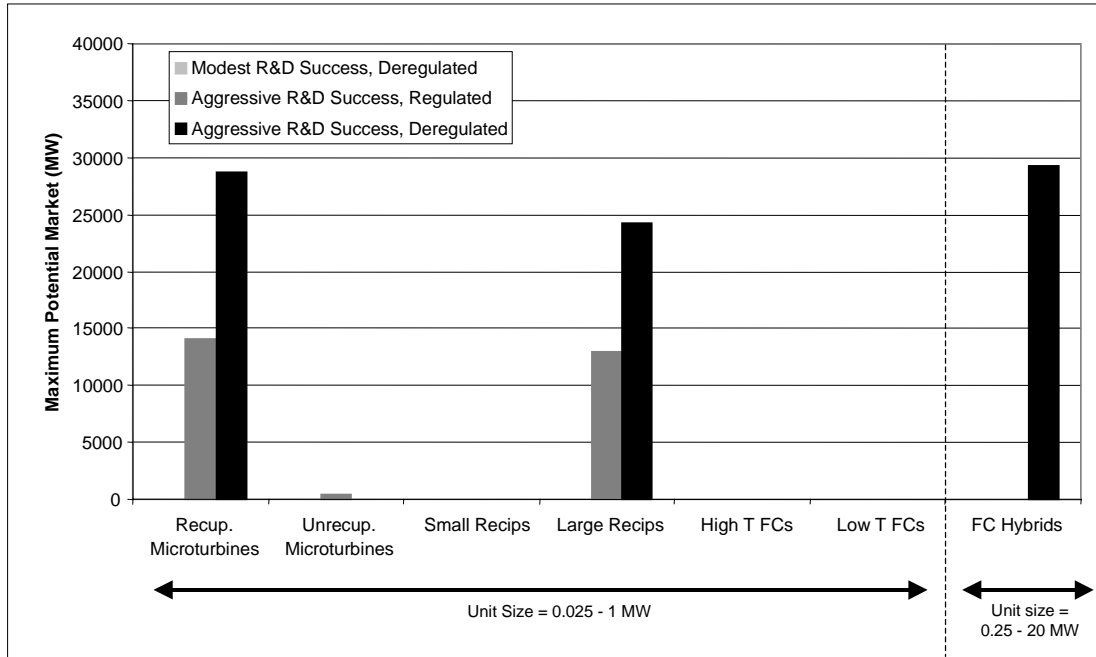

Note: *Small Recips* are from 50 – 300 kW and *Large Recips* are from 300 – 1,000 kW. The *Addressable Market* is the total market opportunity within the *Industries of the Future* through 2010. It is not an annual sales volume.

Figure 4: Addressable Micropower (25-1,000 kW) and Fuel Cell Hybrid (0.25-20 MW) Market Opportunities in Traditional Cogeneration in the *Industries of the Future*

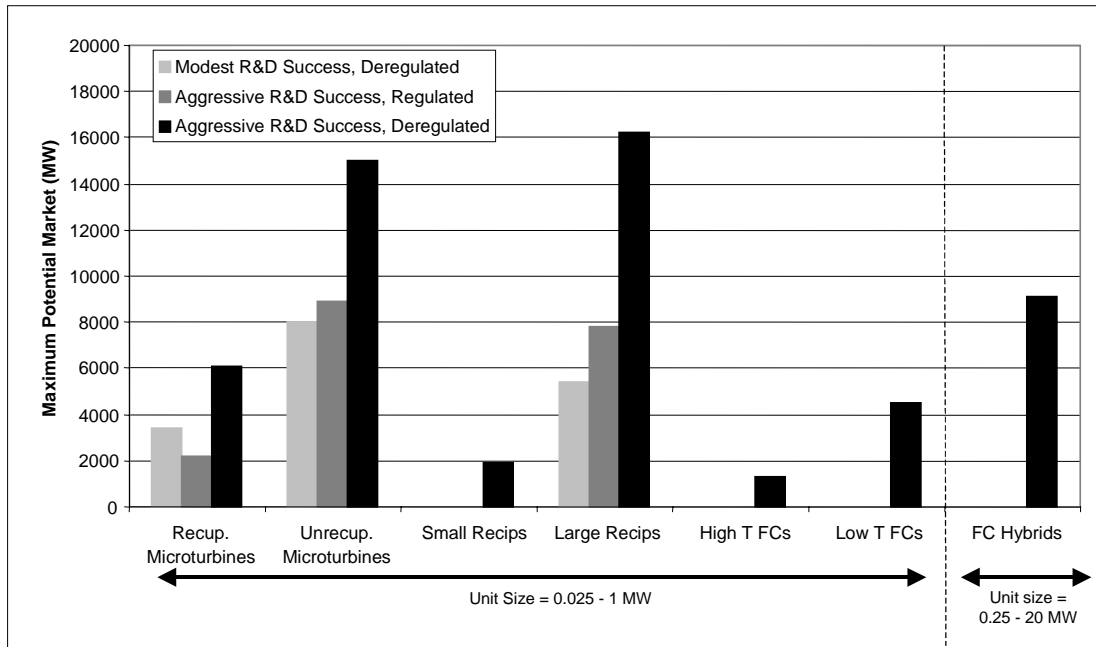

Note: *Small Recips* are from 50 – 300 kW and *Large Recips* are from 300 – 1,000 kW. The *Addressable Market* is the total market opportunity within the *Industries of the Future* through 2010. It is not an annual sales volume.

Figure 5: Addressable Micropower (25-1,000 kW) and Fuel Cell Hybrid (0.25-20 MW) Market Opportunities in Tightly-Coupled Cogeneration in the *Industries of the Future*

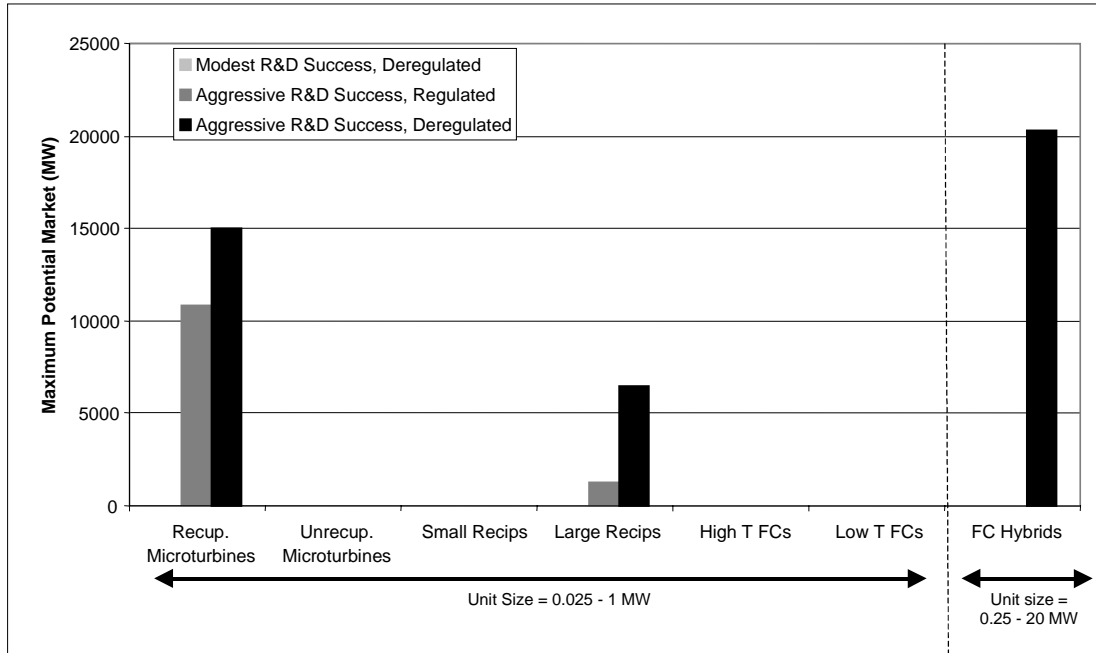

Note: *Small Recips* are from 50 – 300 kW and *Large Recips* are from 300 – 1,000 kW. The *Addressable Market* is the total market opportunity within the *Industries of the Future* through 2010. It is not an annual sales volume.

Figure 6: Addressable Micropower (25-1,000 kW) and Fuel Cell Hybrid (0.25-20 MW) Market Opportunities in Backup Power in the *Industries of the Future*

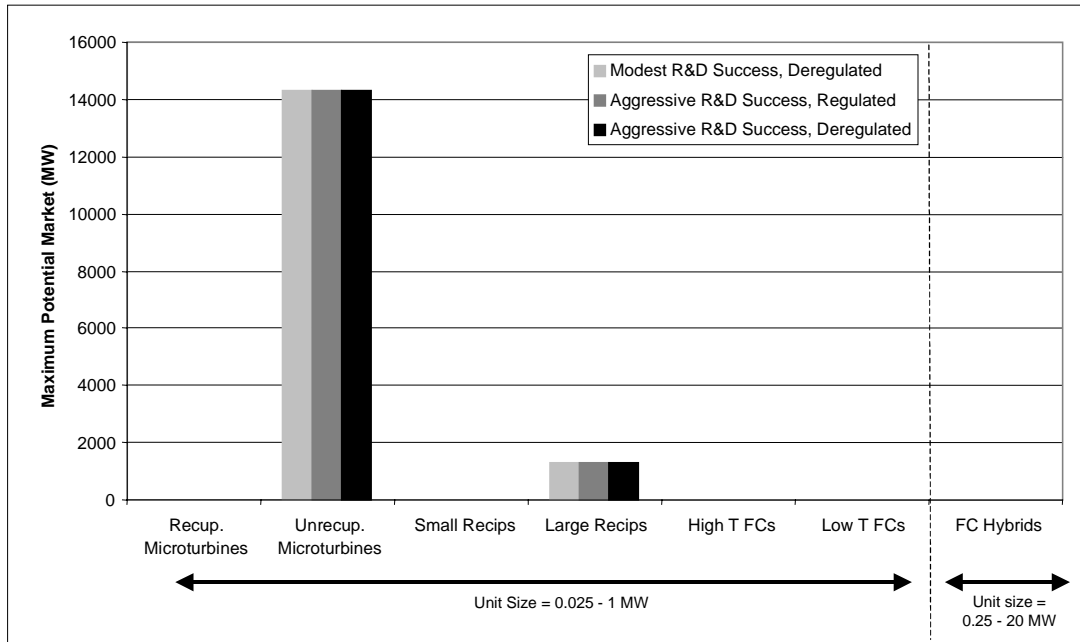

Note: *Small Recips* are from 50 – 300 kW and *Large Recips* are from 300 – 1,000 kW. The *Addressable Market* is the total market opportunity within the *Industries of the Future* through 2010. It is not an annual sales volume.

Figure 7: Addressable Micropower (25-1,000 kW) and Fuel Cell Hybrid (0.25-20 MW) Market Opportunities in Remote Power in the *Industries of the Future*

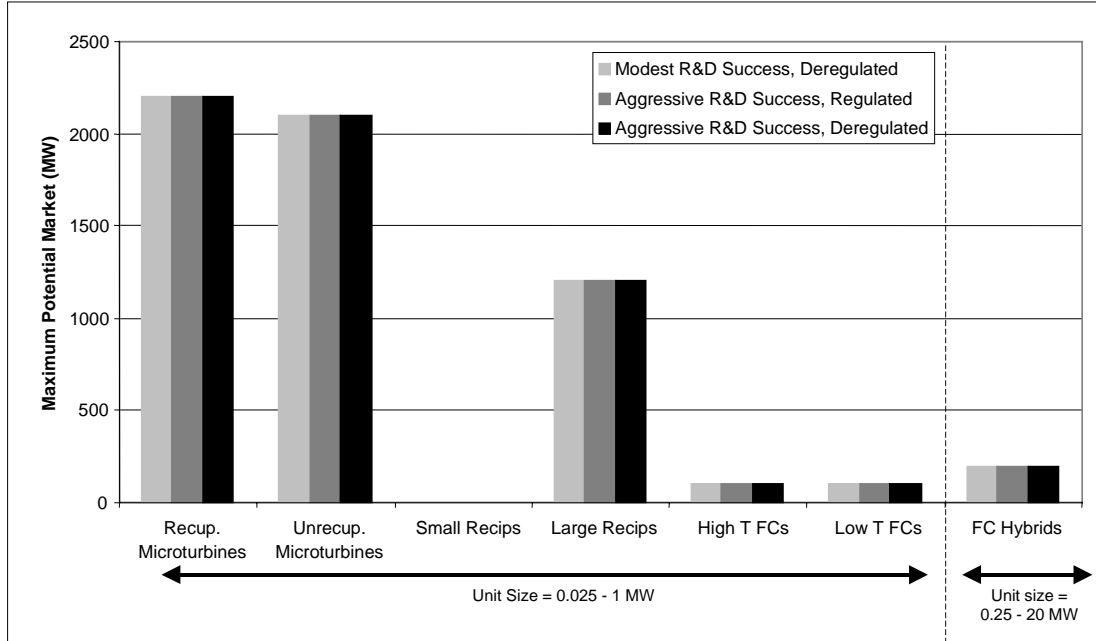

Note: *Small Recips* are from 50 – 300 kW and *Large Recips* are from 300 – 1,000 kW. The *Addressable Market* is the total market opportunity within the *Industries of the Future* through 2010. It is not an annual sales volume.

Figure 8: Addressable Micropower (25-1,000 kW) and Fuel Cell Hybrid (0.25-20 MW) Market Opportunities in Premium Power in the *Industries of the Future*

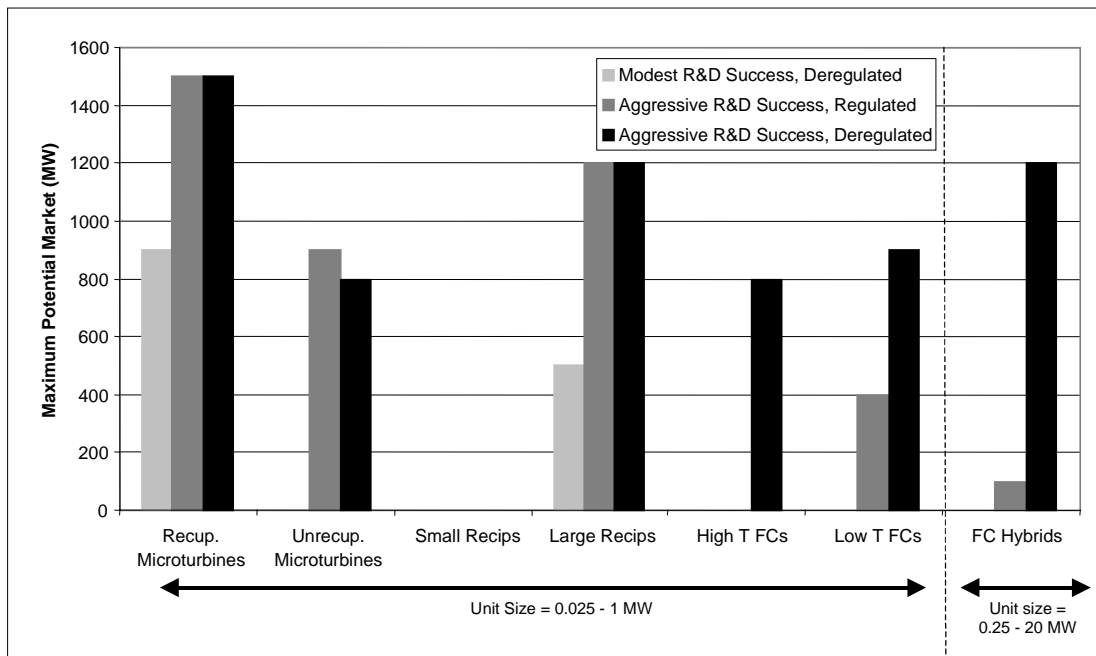

Note: *Small Recips* are from 50 – 300 kW and *Large Recips* are from 300 – 1,000 kW. The *Addressable Market* is the total market opportunity within the *Industries of the Future* through 2010. It is not an annual sales volume.

Figure 9: Addressable Micropower (25-1,000 kW) and Fuel Cell Hybrid (0.25-20 MW) Market Opportunities from Generation Using Waste and Biofuels in the *Industries of the Future*

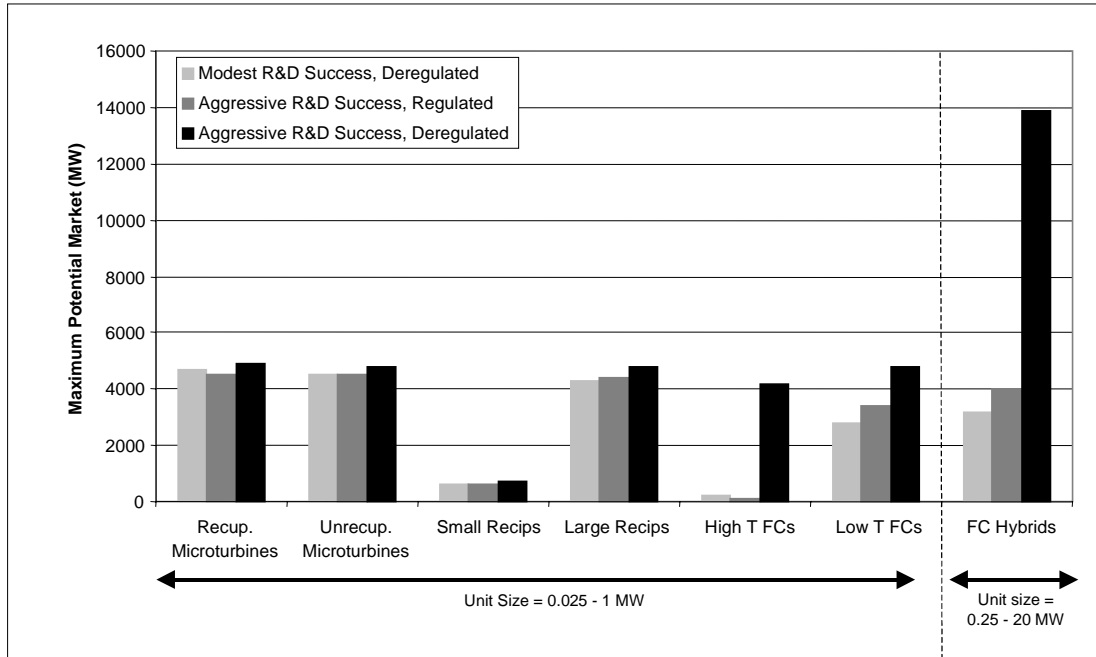

Note: *Small Recips* are from 50 – 300 kW and *Large Recips* are from 300 – 1,000 kW. The *Addressable Market* is the total market opportunity within the *Industries of the Future* through 2010. It is not an annual sales volume.

It is interesting to note that *Generation Using Wastes and Biofuels* appears only moderately attractive, despite a relatively large overall potential (>40,000 MW). This is due mainly to the need to gasify solid feedstocks into synthesis gas for use with the power equipment, which is costly at small scales. The large size of the applications within the pulp & paper industry also limits the micropower market potential in this key industry.

1.5 Potential Public Benefits

Table 6 and Table 7 summarize the potential market penetration and public benefits, respectively, for the *Aggressive R&D Success, Deregulated* scenario only, since benefits are limited otherwise. In the *Modest R&D Success, Deregulated* scenario, only traditional cogeneration and generation using wastes & biofuels appear to offer measurable public benefits, and even then, they are two to three times smaller than the benefits from these applications in the *Aggressive R&D Success, Deregulated* scenario. Benefits were not estimated for the *Aggressive R&D Success, Regulated* scenario, but based on the market opportunity assessment, they would be expected to fall somewhere between the benefits estimated for the other two scenarios.

Potential market size and benefits are not additive across applications, but are additive across technologies within a given application. The highlighted values in Table 6

represent the leading opportunities for each technology. Traditional cogeneration and generation using wastes & biofuels appear to offer opportunities to the broadest range of technologies, whereas other applications appear more likely to be attractive to a subset of technologies. Remote power appears to be a niche opportunity, whereas simple generation offers a significantly larger opportunity, but with fewer benefits per MW installed. Overall, microturbines, large reciprocating engines and fuel cell hybrids have the greatest potential for market penetration. The market for fuel cell hybrids is driven in part by the larger unit size (up to 20 MW) relative to the other technologies here, which were limited to 1 MW. The other technologies do not appear as competitive within the *Industries of the Future*, within the limits of this study.

Table 6: Potential Market Penetration for Micropower (25-1,000 kW) and Fuel Cell Hybrids (0.25-20 MW) within the *Industries of the Future* – Aggressive R&D Success, Deregulated Scenario

	Cumulative MW Installed by 2020				
	Straight Generation	Traditional Cogeneration	Tightly-Coupled Cogeneration	Remote Power	Generation Using Wastes & Biofuels
Recuperated Microturbines	18,600	2,300	14,500	600	1,200
Unrecuperated Microturbines	<100	9,300	<100	600	1,000
Small Reciprocating Engines	<100	100	<100	<100	200
Large Reciprocating Engines	10,800	9,500	1,900	1,600	1,100
High-Temperature Fuel Cells	<100	100	<100	<100	600
Low-Temperature Fuel Cells	<100	700	<100	<100	1,000
<i>Total (micropower)</i>	<i>29,400</i>	<i>22,000</i>	<i>16,400</i>	<i>2,800</i>	<i>5,100</i>
Fuel Cell Hybrids (0.25-20MW)	13,400	1,700	11,300	200	9,100
<i>Total (all)</i>	<i>42,800</i>	<i>23,800</i>	<i>27,700</i>	<i>3,000</i>	<i>14,200</i>

Note: Entries in **bold** represent the best opportunities for each of the technologies. These are market penetration numbers and are different from the estimates of the *Addressable Market*.

Table 7: Summary of Potential Public Benefits within the *Industries of the Future* by Industrial Application – Aggressive R&D Success, Deregulated Scenario

	Annual Public Benefits in 2020				
	Net Primary Energy Displaced (Trillion Btu)	Net Energy Cost Savings (\$Million)	Net CO2 Displaced (kTons)	Net SO2 Displaced (kTons)	Net NOx Displaced (kTons)
Simple Generation	830	\$2,360	146,800	765	595
Traditional Cogeneration	1,170	\$2,130	120,200	450	398
Tightly-Coupled Cogeneration	1,560	\$1,660	150,400	544	456
Remote Power	30	\$180	1,500	10	169
Generation Using Wastes & Biofuels	700	\$1,520	85,700	292	225

Note: Benefits are not additive across applications.

From these results, it can be concluded that significant benefits may be achieved through the introduction of those technologies that can be used for simple generation, tightly-coupled cogeneration and traditional cogeneration, *provided that cost and performance targets as described in the Aggressive R&D Scenarios can be met*. Power generation from wastes and biofuels may also lead to substantial public benefits. In reality, these applications are dependent on one another since the provision of power through one of these applications will necessarily reduce the amount of power that can be supplied by the others. Given the industrial attractiveness of traditional cogeneration, it is likely to achieve the greatest benefits across the widest range of industries and technologies. Finally, recall that these benefits are for the *Industries of the Future* only. Additional benefits would accrue through application of micropower and fuel cell hybrid technologies in other industries.

1.6 Cross-Cutting R&D Needs

Achieving the more aggressive R&D targets is critical realizing significant micropower markets and benefits in the industrial sector. Efforts need to focus on all aspects of performance – capital cost, efficiency, operations and maintenance costs, and emissions – in addition to other issues that will facilitate entry into the industrial sector. These include the availability of cogeneration packages and uniform and appropriate interconnection standards to facilitate the development of small projects. Key R&D needs are summarized in Table 8, followed by a discussion of general R&D needs. For more detailed and technology-specific R&D needs, please see the main text.

Table 8: Summary of Micropower R&D Needs

	Capital Cost	O&M Cost	Efficiency	Emissions	Reliability	Integration
Cross-Cutting Technologies	♦	♦	♦			
Ceramics	♦		♦			
Power electronics						♦
Switchgear						
Compressors	♦		♦			
Remote monitoring		♦			♦	
Controls interface						♦
Cogeneration packages			♦			
Microturbines						
Bearings		♦	♦		♦	
Manufacturing technology	♦					
High-temperature rotors & structures		♦	♦		♦	
System efficiency/design tradeoff analysis	♦	♦	♦			
High-temperature recuperators			♦			
Aerodynamics			♦			
Combustion technology			♦	♦		
Fuel Cells and Hybrids						
Stacks	♦	♦	♦		♦	
Fuel processors	♦	♦	♦		♦	♦
System integration and optimization	♦		♦		♦	♦
Reciprocating Engines						
Engine controls			♦	♦		
Emissions controls				♦		
Natural gas ignition systems		♦	♦	♦	♦	
Low-cost materials (ceramics, other)	♦		♦	♦		

1.6.1 Capital Cost Reduction

Achieving the *aggressive* capital cost targets (as assumed in the opportunity analysis – see Table 12) is critical for all technologies in all applications. Consequently, activities that impact the capital costs of the technologies will have a major impact on market acceptance. Achieving these targets requires mass-production (and thus sales) as well as improvements in technology performance. Several technology improvements that could aid in the overall cost-reduction of these technologies are:

- **Development of low-cost ceramics.** OIT could support the development of advanced ceramic components for a variety of micropower and fuel cell hybrid applications. Examples include fuel cell components, microturbine combustors and rotors, as well as reciprocating engine port liners, coatings and piston crowns.
- **Development of low-cost power electronics** (e.g., thyristors, inverters). These could initially be used for fuel cells and microturbines but eventually with other technologies as well. This technology also has important application with renewable energy technologies so that there are possible synergies with other DOE programs.
- **Development of low-cost, easy-to-use, small capacity switchgear**, which will be needed for each of these technologies. This switchgear needs to be standardized to facilitate the interface with the grid.
- **Development of low-cost gas compressors.** All technologies considered in this analysis require high-pressure natural gas and/or air. Although the gas pressure inside industrial facilities is often somewhat higher than in commercial buildings or residences, the pressure is still limited by the pressure in the gas main (typically no higher than nine inches of water in distribution lines, but somewhat higher elsewhere). Currently available gas compressors for small capacities (up to a few thousand standard cubic feet per hour) will significantly increase the cost of the overall power generation package. Particularly for fuel cell technologies, there is an additional pressing need for low-pressure high-efficiency air compressors to meet the requirements for compressed cathode air. The OIT could consider supporting the development of such compressors, especially for capacities required for micropower and fuel cell hybrid packages.

1.6.2 O&M Cost Reduction

O&M cost has not come forward as a key differentiating issue. Still, O&M costs are a significant part of overall cost. Thus, several technology improvements could aid overall reduction in cost.

- **Development and demonstration of remote monitoring technology** will likely offer significant potential for O&M cost reduction for all technologies, especially in the case of third-party ownership. The role of OIT in this endeavor should probably be one of encouraging support for demonstrations and key technology components, and adaptation to industrial applications. Ultimately, the owners of these technologies

will be concerned with *proven* (as opposed to calculated) O&M costs, and demonstration facilities provide a critically important opportunity to develop the required data.

1.6.3 Efficiency Improvement

Efficiency improvements are a key element of cost reduction and they also obviously support national objectives. Efficiency improvements need to be considered together with capital cost reductions.

- ***Development of cost-effective and robust ceramic components*** (e.g., rotors, combustors, recuperators and other heat exchangers, cylinder and valve lining) could allow higher temperature operation which would aid efficiency in most technologies. See also comments under cost reduction.
- ***Development of efficient compressors***. When compression of the fuel (gas) is required, low-efficiency compressors lead to reduced overall system efficiency, particularly for microturbines, engines, and fuel cell hybrids.
- ***Development of cost effective cogeneration packages***. The importance of cogeneration in the industrial sector implies that this is a critical need amongst micropower and fuel cell hybrid systems. Moreover, this is a key way to improve the overall efficiency of micropower systems. Specifically, small cogeneration systems tend to be expensive and often limited to hot water applications. Therefore, cost reduction, as well as the development of systems that can generate steam or be easily integrated into tightly-coupled cogeneration applications would greatly improve the attractiveness of micropower and fuel cell hybrids in industrial applications.

1.6.4 Emissions Reductions

Emissions reduction does not have the same urgency for all technologies. Although it may not be critical for many technologies today, it may be more important in the future, for two reasons: (i) emissions regulations are constantly changing, and (ii) as the population of distributed generation applications grows, it will represent a larger fraction of total power sector emissions. Therefore, small generating units, which can fall outside of certain emissions regulations today, will begin to receive more attention from regulators. The priority of emissions reductions programs must be seen in this perspective. Reciprocating engines are likely to continue to have the highest levels of emissions relative to other options, and could therefore be more strongly affected by future regulations and needs that will apply to micropower in general.

1.6.5 Reliability

Reliability is a prerequisite for success, but as there are currently no clearly identified problems with reliability with any of the technologies, tests and demonstrations of reliability will first be needed. If problems surface, R&D needs may arise.

1.6.6 Integration of Technology Into Applications

Probably more important in industrial applications than in other applications is the seamless integration of the power generation equipment into the industrial process. Most notably this is the case in cogeneration systems.

- ***Development of convenient and appropriately sized switchgear.*** Availability of so-called *plug-and-play* equipment would much simplify the installation and adoption of micropower and fuel cell hybrid technology. OIT could play a role in ensuring that such switchgear meets specific needs of industrial users with respect to electrical characteristics and safety regulations.
- ***Facilitation of integration of controls into plant or facility control systems.*** In many cases it will be necessary or desirable to integrate the controls of the micropower or fuel cell hybrid systems into the plant control system. This typically allows plants to anticipate demand and balance demand for thermal and electrical load across multiple units. OIT could help in ensuring that manufacturers take into account interface issues for industrial customers when they develop control systems.

1.7 Other Technology Support Needs

In addition to these R&D needs, the micropower technologies and fuel cell hybrid technologies considered here will benefit from other forms of support, including:

- Awareness programs
- Demonstration programs
- Market support
- Facilitation of the recognition/certification of low-emissions technologies

1.8 Next Steps

There appear to be solid opportunities for micropower (25-1,000 kW) and fuel cell hybrid (0.25-20 MW) technologies within the *Industries of the Future* under a range of technology cost and performance assumptions and ownership structures. However, the largest opportunities will only be realized if aggressive cost and performance targets can be met. Moreover, significant public benefits will only accrue if these same aggressive targets can be met. This suggests a clear role for the OIT in order to maximize their impact on energy and emissions savings in the industrial sector.

Several markets may require more careful examination. For example, analysis of the market for *Generation Using Wastes and Biofuels* did not take into account the fact that some fuel may actually be available at a negative “cost” or that other non-economic factors may, in some cases, strongly influence decision making. Other industries that appear to be high priorities may also benefit from more detailed analysis to more

carefully explore the economics and drivers in those industries. Follow-on activities in these industries could include a more detailed evaluation of how energy prices vary by plant size in specific geographic areas.

2 Introduction

2.1 Background

The Department of Energy's Office of Industrial Technologies (OIT) supports various programs that aim to significantly improve the resource efficiency and productivity of energy- and waste-intensive industries in the United States. For these *Industries of the Future*³, the OIT is helping to develop technology solutions to critical energy and environmental challenges. These partnerships with industry are envisioned to produce important national benefits, including:

- A 25 percent improvement in energy efficiency and 30 percent reduction in emissions for selected industries by 2010
- A 35 percent improvement in energy efficiency and 50 percent reduction in emissions for selected industries by 2020.

Several advanced technologies have been identified by the OIT that may offer the potential for substantial energy efficiency and emissions improvement that can be applied across a wide range of industries. These *cross-cutting* technologies have the potential to save energy and reduce wastes, not only in the *Industries of the Future*, but also in other industries, because such technologies address fundamental energy and productivity issues. In industrial electric power generation, these technologies include microturbines, fuel cells, fuel cell/gas turbine hybrid systems (also called *fuel cell hybrids* in this study), and reciprocating engines. Gasification has also been identified by the OIT as an important supporting technology in several industries.

2.2 Objectives

The OIT retained Arthur D. Little to assess the opportunities for micropower and fuel cell/gas turbine hybrid technologies in the industrial sector. Micropower is defined as microturbines, fuel cells and reciprocating engines under 1 MW. Fuel cell hybrid systems were analyzed for unit sizes of 250kW to 20 MW. The OIT asked Arthur D. Little to address several questions regarding these power generation technologies and their use in the industrial sector, as summarized in Figure 10.

³ These industries are: Agriculture, Aluminum, Chemicals, Forest Products, Glass, Metal Casting, Mining, Petroleum, and Steel.

Figure 10: Questions Answered in this Study

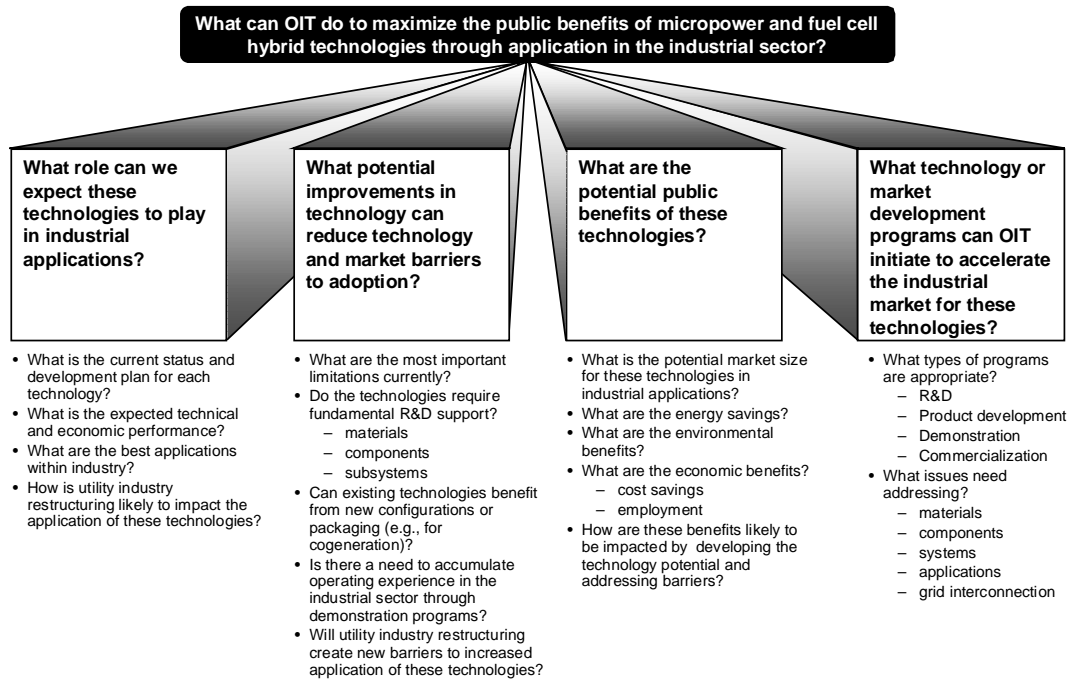

2.3 Approach

Arthur D. Little employed a four task approach to meet the objectives of this project, as shown in Figure 11. Task 1 provided the background information on the various technologies needed to assess the industrial market opportunities. This included an investigation of the following areas for each technology:

- Technology description
- Current and projected technology performance characteristics
- Key players and products
- Product status and development timeline
- Overall markets and applications
- Key drivers and barriers
- Technology development needs

For microturbines, reciprocating engines, and fuel cell/gas turbine hybrid systems, several manufacturers were contacted with a questionnaire to provide input to this task. The fuel cell technology assessment relied primarily on Arthur D. Little's extensive in-house database and experience.

Figure 11: Overall Approach

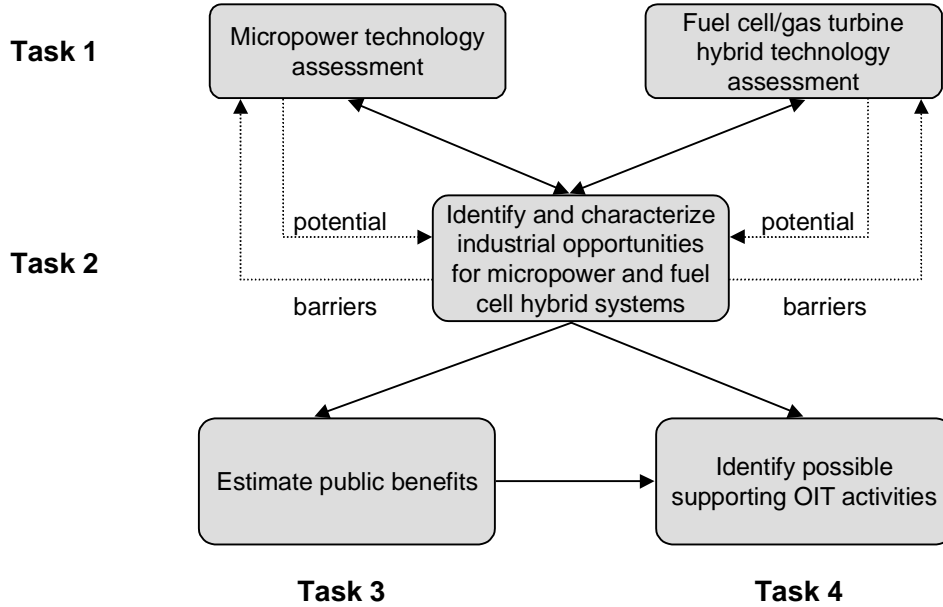

In parallel to Task 1, Arthur D. Little identified and characterized the market opportunities for micropower (<1 MW) and fuel cell hybrid systems (0.25-20 MW) in the OIT’s *Industries of the Future* and selected related industries that were believed to be potentially important markets for micropower and fuel cell hybrid technologies. Clearly, there are numerous opportunities elsewhere within the U.S. industrial sector. The analysis proceeded through a three-step approach, as depicted in Figure 12.

Figure 12: Industrial Opportunity Characterization Process

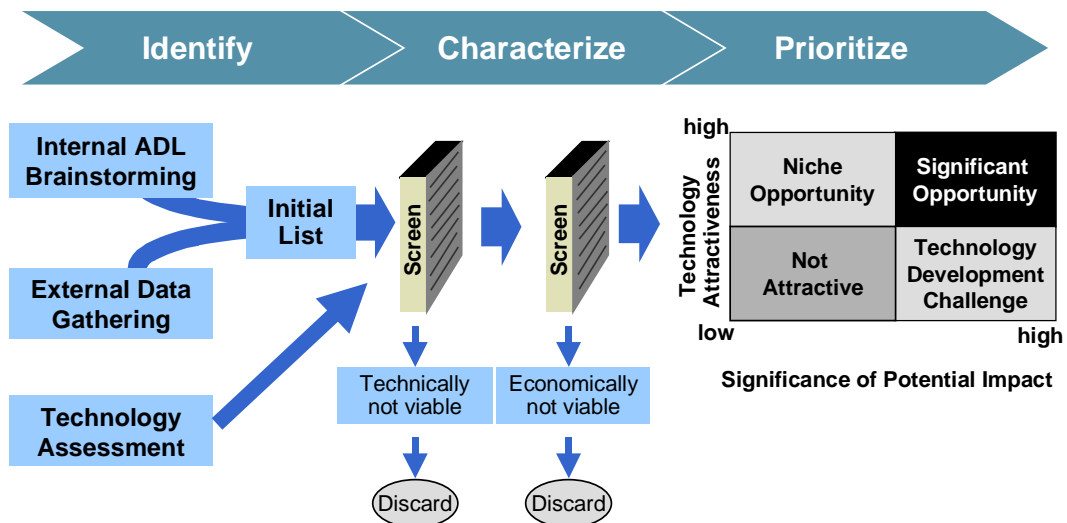

The industrial opportunity assessment included a first-order quantification of *addressable* market potential, based on the technical and economic attractiveness of each technology in each industry/application combination. This market analysis, combined with estimates of market penetration rates and information on technology economic and emissions performance were used to estimate key public benefits of reduced emissions, energy consumption and energy cost savings. The approach used to estimate public benefits was based on previous work by Arthur D. Little for the OIT in support of OIT's Government Performance and Results Act (GPRA) activities.

3 Overview of Micropower Markets, Technologies and Applications

Although the focus of this report is on industrial opportunities within the *Industries of the Future*, micropower and fuel cell hybrid technologies have potential applications across all sectors: residential, commercial, industrial, and distributed power.⁴ This section provides a general overview of these sectors and the broader opportunities and drivers for micropower and fuel cell hybrid technology beyond the industrial sector.

3.1 U.S. Electricity Consumption and Onsite Power Generation

Today, most electricity consumed in the United States is generated in large, central station power plants owned and operated by utilities and independent power producers, as well as in large industrial cogeneration facilities (>50MW). Electricity consumption is split roughly one third each between residential, commercial and industrial users (see Figure 13). Most electricity is purchased from utilities, although about 20% of industrial electricity consumed is generated onsite. Additional electricity is generated at industrial sites and sold into the grid. Currently, onsite generation is often accomplished with cogeneration, the simultaneous generation of electricity and heat (also called combined heat and power, or CHP). In the residential and commercial sectors, very small amounts of electricity are generated onsite, although backup power capability exists at many commercial facilities (e.g., hospitals). Generally, CHP and onsite generation have historically been limited to the industrial sector for a number of reasons, including:

- Existing power technologies, such as steam and gas turbines, have been better suited to the sizes and characteristics typical of industrial applications.
- Thermal-to-electric ratios and load factors⁵ are higher and therefore generally more favorable in industrial settings than in residential and commercial applications.
- In some industries, the conversion of combustible waste products to electricity and heat has been very important for reducing operating costs (e.g., forest products, chemicals and petrochemicals, and integrated steel mills).

⁴ Although residential, commercial and industrial onsite generation are forms of *distributed power*, the term also refers to the concept of siting small generating units throughout the distribution system in place of fewer, large central station power plants. These distributed resources need not be located on customer premises.

⁵ Load factor is the annual electricity consumption divided by the peak power demand * 8760 hours/year. It is a measure of the average demand relative to the peak demand.

Figure 13: Estimated U.S. Electricity Consumption by Sector - 1997

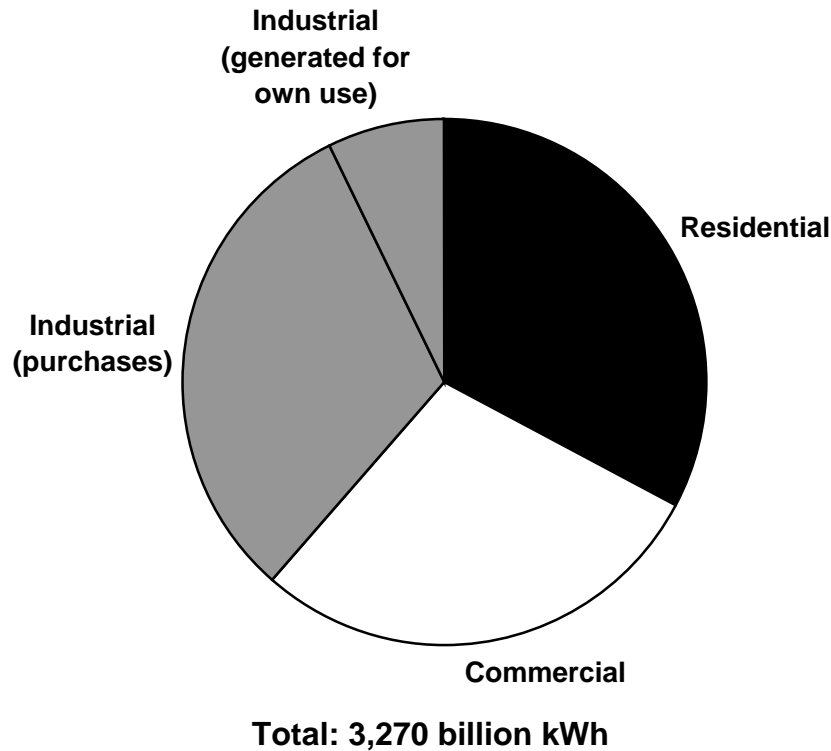

Source: DOE Energy Information Administration, *Electric Power Annual 1997 Volume II* (DOE/EIA-0348(97)/2), October 1998.

3.2 Restructuring of U.S. Energy Markets

As the electric power industry is deregulated, large utility monopolies are increasingly transitioning to or being replaced by competitive energy markets at all stages of the electricity value chain, from generation to retail sales (see Section 0: *The Changing Structure of the Electric Power Industry*, for a more detailed review of the impact of deregulation). Among other potential benefits, this is expected to lead to a much broader array of supplier and service choices for all electricity consumers.

One of the major drivers for electric industry restructuring is the potential for significantly lower electricity rates. Electric rates are expected to drop in all sectors, although it has been argued that industrial users will benefit the most, even though they already enjoy the lowest prices. Since they are the largest customers, they have historically had the most bargaining power in the market, and are expected to continue to be able to exert considerable pressure on electricity prices. As the competitive market matures, the ability of marketers and aggregators to pool the bargaining power of commercial and residential customers may offset this advantage traditionally enjoyed mainly by industrial users.

Even though the industrial sector has historically been the most significant market for onsite power generation, the potential in the residential and commercial sectors is very large. As shown in Figure 14, residential and commercial customers pay significantly more for electricity, on average, than industrial customers. As a result, while the current installed base in these segments is smaller, the potential for energy cost savings is also large, provided that suitable technologies can be deployed in these sectors in a manner that is attractive to customers. The price of natural gas relative to electricity is also important, since it is the most likely fuel to be used for onsite power generation.

Figure 14: 1997 U.S. Average Electric Rates

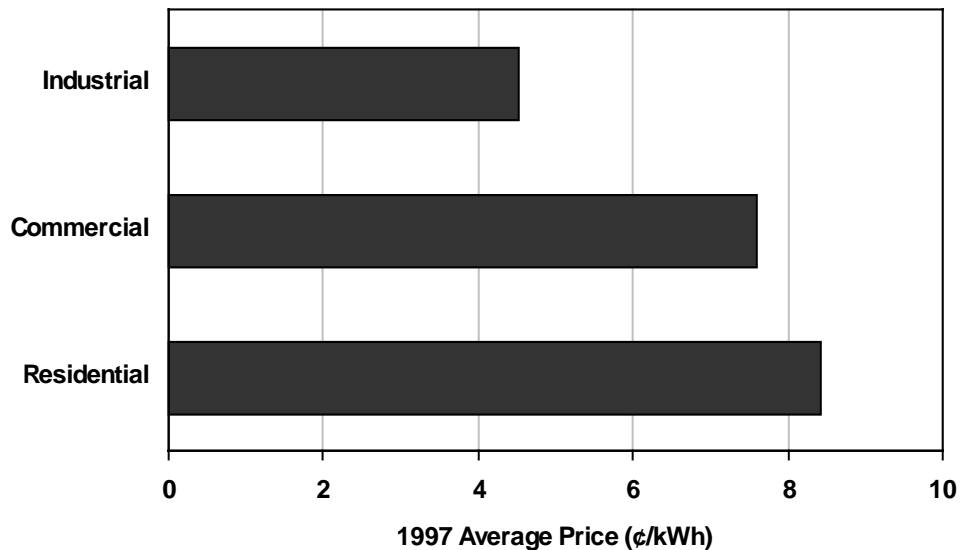

Source: DOE Energy Information Administration, *Electric Power Annual 1997 Volume II* (DOE/EIA-0348(97)/2), October 1998.

3.3 Micropower Technologies and Markets

In this study micropower is defined as ranging from 25 kW to 1 MW, although multiple units could be combined to create installations of several MW. Fuel cell hybrid systems of 250 kW to 20 MW in size were also included.

Micropower technologies are applicable to each of the stationary markets listed earlier: residential, commercial, industrial, and distributed power. Fuel cell hybrids can address some of these markets. Other market segments are also being targeted.

Table 9 reviews the target markets for a number of technologies, including several not covered in this report. Of those listed, several are commercially available, including: reciprocating engines, small gas turbines, photovoltaics, wind power and biomass power. Several microturbine manufacturers are expected to begin to offer commercial

products in 1999. A single low-temperature fuel cell product is also commercially available in a 200 kW package, but fuel cells in general are considered to be an emerging technology.

Table 9: Micropower and Fuel Cell Hybrid Technologies and Markets

		Residential	Commercial	Industrial	Grid-distributed	Portable Power	Transportation	Typical Unit Size Range (installation size can be larger)
		● Primary Target Market ○ Secondary Target Market						
Covered in Report	Microturbines		●	●	●	○	○	25 - 300 kW
	Reciprocating Engines		●	●	●	●	●	5 kW - 50 MW
	Low-Temperature Fuel Cells	●	●	○	●	○	●	2 - 250 kW
	High-Temperature Fuel Cells		●	●	●	○		100 kW - 3 MW
	Fuel Cell/Gas Turbine Hybrids		○	○	●			250 kW - 20 MW
Not Covered in Report	Small Gas Turbines			●	●			500 kW - 5 MW
	Photovoltaics	●	○	○	●			1 - 500 kW
	Wind Power	○			●			50 kW - 2 MW
	Biomass Power			●	●			250 kW - 50 MW

Markets for micropower technologies can be segmented in a number of ways. Broadly speaking, they can be thought of as falling into two categories: onsite generation and grid-sited generation. The former represents the traditional use for small power generation technologies. Two classic examples are backup power and traditional cogeneration (the co-production of steam or hot water with electricity). Grid-sited generation has historically been dominated by large, central-station technologies. However, a number of developments in both emerging and conventional technologies are challenging this paradigm in favor of what is called *distributed generation* or *distributed power*. Some of the key drivers for distributed generation are summarized in Figure 15. Note that onsite generation can be either grid connected or grid independent.

Within the onsite generation market, a number of factors influence the attractiveness of micropower technologies. These are summarized in Table 10.

Figure 15: Key Drivers Affecting Distributed Power Opportunities

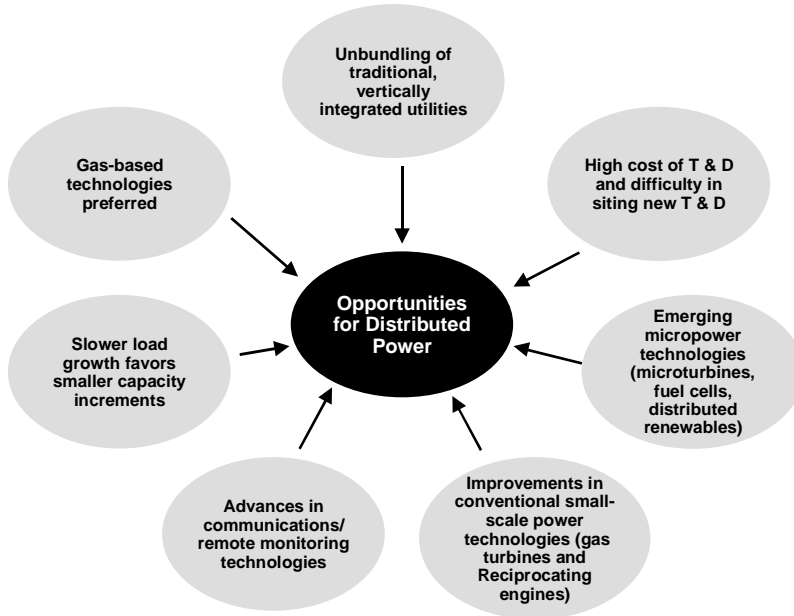

Table 10: Key Drivers for Onsite Generation

	Favors onsite Generation	Barriers to Onsite Generation
Residential	<ul style="list-style-type: none"> • High electric rates for grid power imply a large potential for savings with onsite generation • <i>Green</i> and <i>clean</i> power may become important niches in a deregulated market, and would favor certain micropower technologies, especially fuel cells and photovoltaics 	<ul style="list-style-type: none"> • Low load factors for electricity and heat hurt economics. Thermal and electric load profiles do not match well • Very small unit sizes required for single family homes (<10 kW) limits choice of technology • Non-traditional market for onsite generation requires new approaches to ownership and operation • Permitting, interconnect standards and similar issues need to be addressed to facilitate access to this market
Commercial	<ul style="list-style-type: none"> • Electric rates for grid power are favorable for onsite generation • Loads and load factors well suited to several micropower technologies, especially high-load factor buildings such as hotels and hospitals • Moderate cogeneration potential 	<ul style="list-style-type: none"> • Non-traditional market for onsite generation requires new approaches to ownership and operation • Permitting, interconnect standards and similar issues need to be addressed to facilitate access to this market • Many buildings types have low load factors (e.g., retail, office)
Industrial	<ul style="list-style-type: none"> • Best cogeneration potential • Attractive electric loads and load factors • Industrial end-users are most familiar with the concept of onsite generation and cogeneration 	<ul style="list-style-type: none"> • Lowest electric rates makes onsite generation more difficult • Permitting, interconnect standards and similar issues need to be addressed to facilitate access to this market • Micropower technologies are too small for many facilities, even in bundles of several units

3.4 The Changing Structure of the Electric Power Industry

Today a small, but growing portion of electricity is generated by non-utility generators, which include independent power producers (IPPs) selling wholesale power into the grid, energy service companies (ESCOs), and industrial cogenerators. As states enact utility restructuring legislation, existing utility assets are being sold to non-regulated companies and significant new project development is occurring. Many of these assets, both new and old, will be operated as merchant plants, that is, the owners will not have long-term contracts to sell the all of the output to the local utility. Rather, the output will be sold through a combination of :

- The spot market (or power pool)
- Short-, medium-, and long-term contracts with utilities, aggregators and marketers
- Short-, medium- and long-term direct, bilateral contracts with large end-users

Deregulation will have both positive and negative impacts on onsite generation. Some key issues are summarized in Figure 16. On the positive side, perhaps the most important change will be that the range of products and services offered to end-users will increase dramatically. This will include options from third parties to own and operate onsite generation to meet a variety of needs. These third party owners – which include ESCOs, power marketers, local utilities and local distribution companies (DisCos) – will generally have lower economic hurdles than the end-users themselves. On the negative side, electricity prices should fall, making onsite generation less attractive, all else being equal.

Figure 16: Impact of Electric Industry Restructuring on Onsite Generation

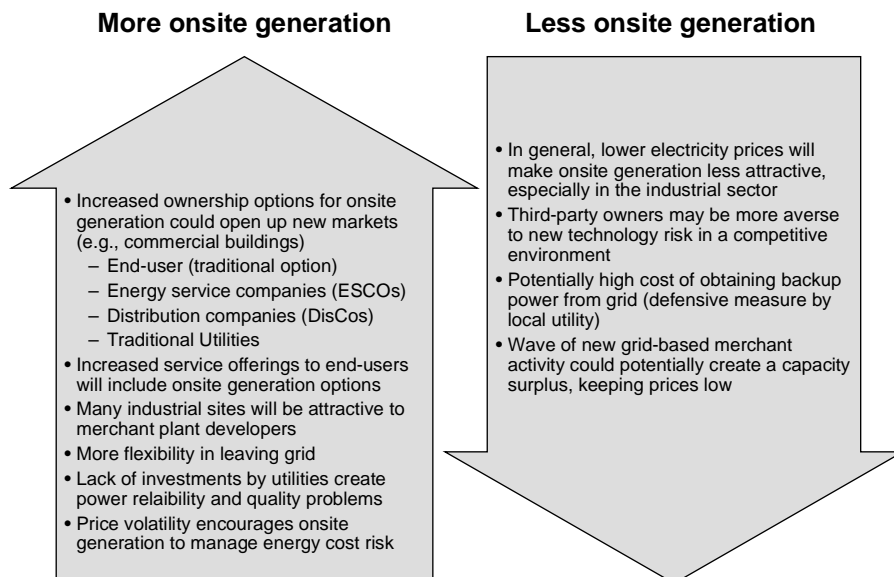

4 Opportunities for Micropower Technologies within the Industries of the Future

4.1 Summary

The following analysis indicates that micropower and fuel cell hybrid technologies could play an important role in meeting the power generation needs of U.S. industry in the coming decades, even though the large per-facility electric power demands in many of the energy-intensive industries lend themselves better to larger technologies. Several industries considered here have power needs that fit well with micropower and fuel cell hybrid technologies, including opportunities where the technologies can be bundled in sets of a few units. Important opportunities exist in four key applications, even under a range of technology performance levels and market conditions:

- **Traditional Cogeneration.** Micropower technologies promise to unlock a significant potential for cogeneration associated with electric power loads too small to be cost-effectively addressed with conventional technology. Cogeneration applications are less sensitive to electric power efficiency and more to capital cost. The largest micropower opportunities exist for unrecuperated microturbines and *large* reciprocating engines (300-1,000 kW in this study), across a range of technology performance and market assumptions. The largest opportunities exist primarily in chemicals and food products (food processing). Recuperated microturbines, low-temperature fuel cells and fuel cell hybrids up to 20 MW in size are also moderately attractive in this application in selected industries, but require both *Aggressive R&D Success* and market conditions that facilitate third-party ownership.
- **Generation Using Wastes & Biofuels** (i.e., utilization of wastes for traditional cogeneration). Driven by the same economics as traditional cogeneration, the utilization of wastes and biofuels also provides a significant opportunity for micropower technologies. Many facilities that have insufficient power demand and/or waste fuel for conventional power generation technologies can self-generate with micropower and fuel cell hybrid technology. However, in the case of solid and some liquid fuels the cost of the gasifier (or other similar technology) is far too costly at small scales. Opportunities are best for microturbines and *large* reciprocating engines, but fuel cells and fuel cell hybrids also look attractive, especially if *Aggressive R&D Success* is achieved and market conditions allow third-party ownership. Opportunities lie primarily in the chemicals, petroleum, and steel industries (i.e., more for “wastes” than for “biofuels”).
- **Backup power.** Backup power applications offer a significant equipment market for micropower technologies. New micropower technologies (notably microturbines) have the potential to offer alternatives to conventional technologies at a lower-cost. In most backup power applications efficiency is not very important and the basis of competition is primarily defined by initial cost and reliability. Operation on storable fuels (such as propane or diesel) is important for this application. Since the dominant economic criterion is first cost, the best opportunities are for unrecuperated microturbines and *large* reciprocating engines, and can be found across all industries. Although there is little opportunity for a significant impact on energy use, this application can help build sales volume which in turn would lead to lower costs.

- **Remote Power** (i.e., off-grid power). Remote power applications provide a niche market that can be addressed by micropower technology. The technologies considered here represent an alternative to conventional reciprocating engines and other options such as small gas turbines. In a variety of remote power applications micropower technologies have the potential to lower the levelized cost of production of power. The ability to operate on storable fuels is critical. The leading opportunities are best for microturbines and reciprocating engines, mostly in the wood products, mining, and oil & gas industries. Fuel cells and fuel cell hybrids do not appear to fit well in this application.

Additional opportunities can be created in simple generation (power-only onsite generation) and tightly-coupled cogeneration (i.e., cogeneration of hot gas) if aggressive R&D targets are met. However, these options are only likely to be chosen if traditional cogeneration is not feasible (it has substantially greater benefits). For the *Industries of the Future*, premium power presents but a small niche opportunity, which may be of most interest for demonstration programs.

The analysis indicated a wide range of applicability of the technologies to various uses:

- **Recuperated microturbines** have the largest market opportunity but will have to compete for power demand with their unrecuperated counterparts. They appear best suited for simple generation and tightly-coupled cogeneration. Achieving the aggressive R&D targets is critical to realizing the large potential.
- **Unrecuperated microturbines** have a similar overall market opportunity and are applicable in traditional cogeneration, generation using wastes & biofuels, backup power, and remote power. These applications are not as sensitive to efficiency as others but require low-cost technology. They also provide the most synergy with the industrial process. Achieving aggressive R&D goals does not appear to significantly enhance their chances of market success.
- **Large reciprocating engines** (300-1,000 kW) provide characteristics from a market perspective very similar to those of microturbines with the difference that they only span part of the capacity range, as defined in this study.
- **Fuel cell hybrids** (0.25-20 MW) could have a significant potential if the aggressive R&D targets are met, especially with respect to cost targets. Their primary areas of application are likely to be in simple generation, tightly-coupled cogeneration and generation using wastes & biofuels. On technical grounds, the technology does not lend itself well to the other applications.

Small reciprocating engines and low- and high-temperature fuel cells are generally not attractive for most significant industrial applications. Small reciprocating engines are hampered by modest efficiencies and relatively high capital costs compared to the other technologies in this study, whereas for fuel cell systems, the main drawback is their higher capital cost. However, there is significant uncertainty in how these technologies will evolve in the future. For low-temperature fuel cells, mass production for automotive

applications could drive costs even lower than the aggressive targets assumed here (which do assume mass production due to automotive applications, but the extent of the cost reduction is still uncertain). For high-temperature fuel cells, the strong technical fit with cogeneration may provide it with some industrial market applications, although the premium paid for high electrical efficiency is less important in cogeneration than in simple generation. Because the analysis presented here used average characteristics for industrial electric and gas rates, and thermal and electric load profiles, there may be specific niche opportunities for fuel cells that were not effectively captured.

4.2 Key Applications by Industry

In the residential and commercial sectors, much of the electricity consumed is used to meet the general needs of the property (e.g., lighting, space conditioning). In industry, electricity is more directly integrated with industrial processes (e.g., motors, process heating, and machinery). The nature of the industrial process dictates which technologies can be used to produce the electricity as well as the nature of the economic decision made when choosing between competing technologies. For example, a facility with high thermal loads may elect to cogenerate some or all of their power, recovering the waste heat to produce process steam. The technology must therefore have reasonably hot offgases, and the choice of a particular technology will take into account both the value of the electricity produced and the fuel savings brought about by the co-production of steam or heat. In contrast, a facility that requires exceptionally reliable electric power may elect to purchase backup power generation equipment, to be activated only when the primary power source fails. This technology must be reliable and start rapidly, but the decision between competing proven technologies will likely be based almost entirely on the installed capital cost of the equipment.

This study has identified seven distinct applications for industrial electric power: simple generation, traditional cogeneration, tightly-coupled cogeneration, backup power, remote power, premium power, and generation using wastes & biofuels. Detailed definitions of each of these applications are provided below. The relative need for each of these applications will vary substantially among industries, as shown in Figure 18.

Figure 18: Relative Importance of Power Applications by Industry

	Simple Generation	Traditional Cogen.	Tightly-coupled Cogen.	Backup power	Remote power	Premium Power	Generation Using Wastes & Biofuels	
Petroleum refining	○	○		●			○	Industry of the Future
Other petroleum	○	○		○			○	
Chemicals	○	○	○	●			○	
Steel	○	○	○	●			○	
Metal Casting	○			●				
Pulp & Paper	○	○	○	●	○	●	●	
Wood Products	○	○	○	○	●		●	
Mining	○		○	●	●		○	
Agriculture (Food Proc)	○	○	○	○			○	
Primary Aluminum	○			●				
Aluminum Products	○	○		●				
Glass	○		○	●				
Printing	○	○	○	○			○	
Textiles	○	○	○	○		●		Manuf.
Misc. manufacturing	○	○	○	○				
Electronics	○			○		●		Other
Oil and Gas E/P	○			●	●			
Agriculture (Prod'n)	○		○	○	○		○	

○ Will employ if economical ● Critical need, integral to normal operation

Note: The quantitative analysis that follows is for the *Industries of the Future*, plus Textiles and Oil and Gas E&P.

Industrial needs have been broken into two distinct classes; those which are critical to the operation of the facility and those which are useful, but will only be pursued if they can be done so economically. For example, the remote nature of some facilities in the mining industry results in remote power generation being a critical application for the industry, whereas cogeneration is typically only applied if it is economic relative to other options. While there is a large technical market for cogeneration, the industrial need is not for cogeneration *per se*, but for process steam and electricity. If it were cost-effective for the industry to replace all of its cogeneration machinery with steam boilers and purchased power, they would be expected to do so.

4.2.1 Simple Generation

Simple generation is described simply as generating power onsite to displace purchased electricity. The maximum possible demand for simple generation is therefore equal to the total power consumption of a given industrial facility (the export of excess electricity to the grid is not included in this study, given the small unit size of most technologies considered). Simple generation applications compete with grid-power, large-scale onsite generation and cogeneration on the basis of their overall cost of produced electric power.

Figure 19: Characteristics of Simple Generation

Non-economic drivers	<ul style="list-style-type: none"> • Improved reliability • Independence from the grid
Critical to which industries?	<ul style="list-style-type: none"> • Industrial importance driven solely by economics
Potential economic benefits	<ul style="list-style-type: none"> • Avoided transmission and distribution charges • Increased process reliability and/or productivity • Decreased electricity costs via peak-shaving • Avoided capacity and energy charges
Technical requirements	<ul style="list-style-type: none"> • Operation on any conventional fuel (natural gas, diesel, propane, etc) • Reliable (e.g. capable of high load factor operation)
Economic criteria	<ul style="list-style-type: none"> • Capital cost • Fuel cost • Operating cost
Conventional technologies	<ul style="list-style-type: none"> • Simple cycle gas turbines • Combined cycle gas turbines • Rankine cycles (steam turbine systems) • Reciprocating engines

4.2.2 Traditional Cogeneration

Traditional cogeneration includes any power production in which the waste heat generated by power production equipment is of a sufficient temperature and volume to be used to raise steam and/or hot water that may in turn be used in an industrial process. The maximum possible demand for traditional cogeneration is a function of total power use, industrial thermal/electric (T/E) ratios, and the fraction of heat used as steam and/or hot water. Traditional cogeneration is often quite attractive relative to simple generation by virtue of the enhanced economic benefits made available by the recovery of waste heat. It also provides significant energy savings and environmental benefits, since it displaces some fuel that would otherwise be burned solely to provide heat.

Figure 20: Characteristics of Traditional Cogeneration

Non-economic drivers	<ul style="list-style-type: none"> • Process requirements for steam or hot water
Critical to which industries?	<ul style="list-style-type: none"> • The decision to meet thermal loads with cogeneration equipment rather than a boiler and a grid connection is driven by economics
Potential economic benefits	<ul style="list-style-type: none"> • Reduction in purchased fuel and electricity costs • Opportunity to sell excess power to grid to offset costs • Regulatory/permitting credits (e.g., investment tax credits and accelerated depreciation to promote improved energy efficiency. May be in response to global climate change policy.)
Technical requirements	<ul style="list-style-type: none"> • Low overall cost • Match between waste heat and process temperatures • Match between waste heat production and process heat needs • Reliability
Economic criteria	<ul style="list-style-type: none"> • Capital cost • Fuel cost • Operating cost
Conventional technologies	<ul style="list-style-type: none"> • Simple cycle gas turbines • Steam injected gas turbines • Combined cycle gas turbines • Extraction and back-pressure steam turbines • Reciprocating engine cogeneration systems

4.2.3 Tightly-Coupled Cogeneration

Tightly-coupled cogeneration includes those applications in which hot process offgases are fed directly into industrial processes. Examples include wood drying in the wood products industry, or preheating in the metal process industries. The total potential demand for tightly-coupled cogeneration is a function of total electricity use, temperature levels, T/E ratios and the fraction of heat used as hot gas or direct heat. Tightly-coupled cogeneration is generally most attractive for low-temperature operations (such as drying), where its low capital cost is accompanied by direct fuel savings. Generally speaking, the benefits associated with tightly-coupled cogeneration are reduced when higher temperatures are required.



Figure 21: Characteristics of Tightly-Coupled Cogeneration

Non-economic drivers	<ul style="list-style-type: none"> • Process need for direct heat
Critical to which industries?	<ul style="list-style-type: none"> • Industrial importance driven solely by economics
Potential economic benefits	<ul style="list-style-type: none"> • Reduction in purchased energy costs • Opportunity to sell excess power to grid to offset costs • Increased process efficiency
Technical requirements	<ul style="list-style-type: none"> • Clean flue-gas from cogen equipment • Flue gas temperature and O₂ concentration matched to process needs • Reliability
Economic criteria	<ul style="list-style-type: none"> • Capital cost • Fuel cost • Operating cost
Conventional technologies	<ul style="list-style-type: none"> • Gas turbines • Industrial burners (heat only) • Electric heaters (heat only)

4.2.4 Backup Power

Backup power generation equipment is typically idle, but always ready to come on-line in the event that the primary power source (grid or otherwise) fails. A classic application for backup power is in hospitals, since a brief loss of power can directly lead to loss of life. In industrial settings, the total potential demand for backup power is a function of facility size, and the cost to the industry of forced shutdowns, both in terms of lost work-in-process, damage to industrial machinery and start-up time. Most industries have some finite level of backup power capacity installed simply to ensure that in the event of an outage, machinery can be shutdown in a controlled sequence.

Figure 22: Characteristics of Backup Power

Non-economic drivers	<ul style="list-style-type: none"> • Legal obligations • Safety • Protect production equipment • Protect high value products (e.g. semiconductor wafers) • Reduce downtime 			
Critical to which industries?	<table style="width: 100%; border: none;"> <tr> <td style="border: none;"> <ul style="list-style-type: none"> • Petroleum • Chemical • Steel • Pulp & Paper • Glass • Aluminum • Electronics </td> <td style="border: none; text-align: center; vertical-align: middle;">  </td> <td style="border: none;"> <ul style="list-style-type: none"> Compressors Circulation Pumps Drive motors Furnaces Misc. material handling equipment </td> </tr> </table>	<ul style="list-style-type: none"> • Petroleum • Chemical • Steel • Pulp & Paper • Glass • Aluminum • Electronics 		<ul style="list-style-type: none"> Compressors Circulation Pumps Drive motors Furnaces Misc. material handling equipment
<ul style="list-style-type: none"> • Petroleum • Chemical • Steel • Pulp & Paper • Glass • Aluminum • Electronics 		<ul style="list-style-type: none"> Compressors Circulation Pumps Drive motors Furnaces Misc. material handling equipment 		
Potential economic benefits	<ul style="list-style-type: none"> • Protection of expensive production equipment during sudden loss of power • Maintenance of production when primary power source is down • Prevention of damage to in-process, high-value materials 			
Technical requirements	<ul style="list-style-type: none"> • Rapid startup • Reliable startup and operation • Operation on available, storable fuel (typically diesel or propane) 			
Economic criteria	<ul style="list-style-type: none"> • Capital cost 			
Conventional technologies	<ul style="list-style-type: none"> • Diesel reciprocating engines • Steam drives • Gas turbines 			

4.2.5 Remote Power

The characteristics of power generation equipment used in remote (i.e., off-grid) locations are not substantially different from those used for simple generation. However, the absence of the grid to serve as backup implies that such equipment must be ultra-reliable. In addition, locations without access to the electricity grid frequently lack access to the natural gas grid as well, so power equipment must be capable of operating on delivered fuels (typically diesel or propane). The market opportunity for remote power is a function of the entire economics of an industrial process, as industries will generally only select off-grid operation if an economic incentive exists to locate facilities in remote locations. In extractive industries, such as mining, oil and gas and forest products, the driver for remote power is the fact that the resource is significantly removed from the power grid. In these industries, the economics of onsite processing of raw materials must be compared to the cost of transportation and processing at a central facility.

Figure 23: Characteristics of Remote Power

Non-economic drivers	<ul style="list-style-type: none"> • Need for electric power in a location not served by the grid
Critical to which industries?	<ul style="list-style-type: none"> • Oil and Gas Exploration/Production (most facilities) • Mining (some facilities) • Pulp and Paper (some facilities)
Potential economic benefits	<ul style="list-style-type: none"> • Provide access to critical resources (lumber, natural gas, minerals, etc) • Elimination of grid-extension costs • Reduce transportation costs via decentralized pre-processing (ore drying, wood chipping)
Technical requirements	<ul style="list-style-type: none"> • Operation on non-grid fuel (typically fuel oil or propane) • Reliability • Low operating/maintenance requirements
Economic criteria	<ul style="list-style-type: none"> • Capital cost • Fuel cost (purchase + delivery) • Operating cost
Conventional technologies	<ul style="list-style-type: none"> • Diesel reciprocating engines • Gas turbines • Small Hydro • Wind/Solar (e.g., telecoms transponder stations, irrigation) • Hybrid systems (e.g. wind/diesel)

4.2.6 Premium Power

A demand for premium power exists at any facility where the owner is willing to pay a premium for alternative power, either for increased power quality and/or reliability over that provided by the grid. Power quality concerns are found in industries with processes involving machinery that requires tightly-controlled, sinusoidal AC wave forms, or machinery that operates on well-defined DC power. Semiconductor manufacturing plants have extraordinarily tight tolerances and rely heavily on the former, while DC drive motors in the paper and textile industries (whose speed is a function of material dryness and elasticity) rely on the latter. Power reliability concerns are found in many of the same industries that require backup power, and are typically met by so-called *uninterruptible power supply* (UPS) systems. The total potential demand for premium power will be highly dependent on the needs of specific industrial processes.

Applications demanding high-quality premium power have been a frequent topic of discussion amongst developers of advanced power technologies, but it should be noted that the extent and value of this “premium” is not well understood, and will likely vary significantly from industry to industry.

Figure 24: Characteristics of Premium Power

Non-economic Drivers	<ul style="list-style-type: none"> • Process requires power with a higher quality than provided by grid <ul style="list-style-type: none"> – AC power with a well defined wave form, frequency and power factor – DC power • Process requires power with a higher reliability than provided by grid
Critical to which industries?	<ul style="list-style-type: none"> • Electronics • Pulp and Paper (DC drives) • Textiles
Potential economic benefits	<ul style="list-style-type: none"> • Elimination of high-cost power conditioning equipment • Allow production of precision products • Increased process flexibility (DC drives, etc) • Reduce process losses
Technical requirements	<ul style="list-style-type: none"> • Capability to meet process power quality requirements • Ultra-high reliability
Economic criteria	<ul style="list-style-type: none"> • Capital cost • Fuel cost • Operating cost • Increased productivity
Conventional technologies	<ul style="list-style-type: none"> • Power conditioning equipment (transformers, etc) • Batteries • Capacitors • UPS systems

4.2.7 Generation Using Wastes and Biofuels

The use of wastes and biofuels for power generation occurs in industries where waste products have fuel value and these wastes can be economically converted into electrical power. These wastes may be solid, as typified by paper sludge and agricultural residues; liquid, as are found in the chemicals industry; or gaseous, as typified by the CO-rich blast furnace offgases produced by the steel industry. The total potential power produced from these applications is a function of the amount of waste produced by a given industry and the amount of heat and power required.

The utilization of waste fuels has been critical to the operational efficiency of U.S. industry for decades. This practice allows for the economic and responsible “disposal” of process wastes, and for the generation of low-cost heat and/or electric power. It serves as an important source of competitive advantage for companies in the steel, chemical and forest products industries.

Figure 25: Characteristics of Generation Using Wastes and Biofuels

Non-economic drivers	<ul style="list-style-type: none"> • Environmental regulations • Need to dispose of process wastes
Critical to which industries?	<ul style="list-style-type: none"> • Pulp & Paper (black liquor, paper sludge, etc) • Steel (blast furnace gas, coke oven gas) • Petroleum (flare gas, tar and coke wastes) • Chemicals
Potential economic benefits	<ul style="list-style-type: none"> • Elimination of disposal and/or cleanup costs • Reduction in electricity and/or fuel purchase costs
Technical requirements	<ul style="list-style-type: none"> • Compatibility with the wastes generated in industrial processes: <ul style="list-style-type: none"> – Dirty fuel (sulfur, metals, etc.) – Solid fuels (hog, bark, paper sludge, etc) – Low BTU fuels (blast furnace gas, miscellaneous VOCs, etc) • Scale suited to rate of waste generation • Tolerant of fluctuations in fuel composition
Economic criteria	<ul style="list-style-type: none"> • Capital cost • Fuel cost • Operating cost • Avoided disposal cost
Conventional technologies	<ul style="list-style-type: none"> • steam turbines with waste fuel boilers • Reciprocating engines (limited application) • Gas turbines (limited application)

4.3 Total Industrial Power Market

Based on these seven applications, this analysis has identified a total market for industrial power among the OIT's nine *Industries of the Future* of almost 1 trillion kWh per year, or approximately 155,000 MW.⁶ Since some of the industries include broad mixes of facilities with widely varying sizes, load profiles and energy consumption, they have been segmented as shown in Table 11. Details of the distinctions within the industries and SIC codes specific to each industry are given in Appendix E.

⁶ All values for energy consumption in the form of electricity, fuel or heat have been taken from the 1994 Manufacturing Consumption of Energy Survey (U.S. Census). This study has assumed that the peak power demand in a given industry is related to the load factor and total consumption as follows: The total installed MW in a given industry = the annual MWh demand x (1/load factor) x (1 year/8760 hours). 1994 is the most recent year for which detailed Census data is available, and these values were used to estimate the total market opportunity afforded by micropower technologies. Subsequent national benefits assessments have assumed that these markets grow at 2% per year.

Table 11: Definitions of Industries Considered

Industry of the Future	Industry Segments Considered
Agriculture	Food Products
	Textiles
Aluminum	Primary Aluminum
	Aluminum Products
Chemicals	Large Chemicals (top 6 energy consuming industries in SIC code 28)
	Small Chemicals (remaining industries in SIC code 28)
Forest Products	Pulp and Paper mills
	Wood products
Glass	Flat and Blown glass products
Metal Casting	All foundries and die-cast products
Mining	Mineral and coal mining (referred to hereafter as Mining)
	Oil and Gas Exploration/Production
Petroleum	Petroleum Refineries
	Other petroleum (primarily Asphalt)
Steel	Steel Mills
	Steel products

Electricity consumption within these industries is concentrated in the chemicals, mining, and forest products industries, as illustrated in Figure 26. However, the size of the market for micropower and fuel cell hybrid technologies within a particular industry depends not only on the total electricity consumption of the industry, but the sizes of the facilities within that industry. There are some industries (such as primary aluminum) in which much of the sites are simply too large for power generation equipment less than 1 MW in size, and even 20 MW in size.

Figure 26: Electricity Consumption Variation by *Industry of the Future* (1994 data)

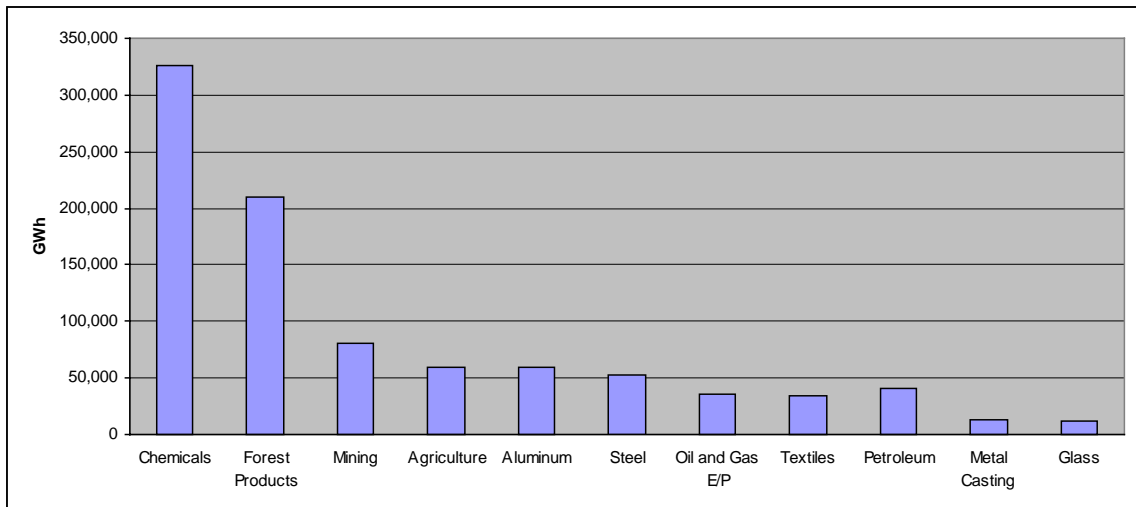

The attractiveness of different micropower technologies (and in fact all power generation technologies) can be further evaluated by considering the *applications* for which power is used. For example, the chemicals industry already cogenerates much of its power, indicating that this is an attractive application in this industry. Therefore, the power generation equipment in this industry must be able to produce both heat and power if it is to displace existing equipment. However, this same cogeneration equipment would be poorly suited to the glass industry, where process temperatures are much too high for traditional cogeneration, but high levels of reliability (in the form of backup power) are required to ensure that glass furnaces do not “freeze” in the event of a power outage. Clearly, the applications in which a given industry expects to use micropower or fuel cell hybrid technology will dictate the required technical performance of that technology.

4.4 General Approach to the Industrial Opportunity Analysis

A detailed description of the methodology used in this report can be found in Appendix A. This section is intended to provide only a brief overview of the analytical framework that underpins this report.

This analysis defined the likely system-level performance and cost for each of the technologies under consideration in a 2000, 2005 and 2010 timeframe, and calculated the attractiveness of these technologies in each of the industries under consideration. Technology performance was defined through a series of manufacturer interviews, along with internal ADL expertise, while the industrial energy needs were based upon available U.S. Census data. The electric power needs of each industry were broken down into the seven applications defined above. The relative needs for each of these applications, within each of the industries under consideration, were quantified as depicted in Figure 27.

The *Entire Market* for onsite power generation represents the MW capacity that would have to be installed within a given industry to meet their annual electricity demand. Note that this value is equivalent to the total demand for simple generation. The *Entire market* for other applications will always be less than or equal to the *Entire Market* for simple generation. Any reduction would be due to the fact that the provision of power for a particular application would represent only some fraction of the total power consumption within the industry.

Figure 27: Market Size Estimating Methodology

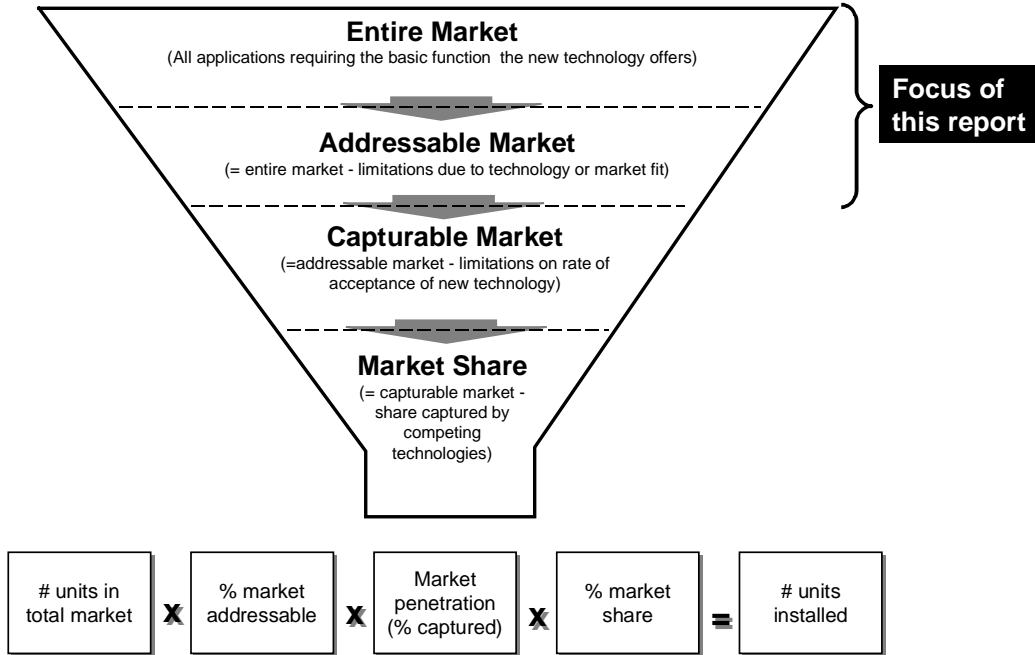

The *Addressable Market* represents the total application-specific power demand that can be cost effectively met by a particular technology. The determination of the *Addressable Market* size considers both economic criteria (capital cost, local energy costs, etc.) and technical criteria (technology unit sizes, efficiency, offgas temperatures, etc.). The *Addressable Market* can be thought of as the total market that could be economically served by a particular technology, within a particular industry for a particular application if there were no other competing technologies.

The majority of the analysis and results in this report are focused on identifying the *Addressable Market*. Additional analysis using established market penetration methodologies was used to evaluate the public benefits of industrial micropower generation. The *Capturable Market* represents the fraction of the *Addressable Market* that can realistically be captured due to the fact that technologies take time to diffuse into the marketplace. The *Market Share* is the portion of the *Capturable Market* that could actually be captured by a particular technology in a competitive environment. Thus, it represents an estimate of the actual sales that would be achieved by a given technology, provided that all of the technologies considered in this analysis realize the technical and economic performance goals described herein. Note that the estimate of the *Market Share* is a first order estimate. It is used in this study only to estimate public benefits, in order to avoid double counting.

4.5 Anticipated Technology Development Schedules

Of the technologies considered in this analysis, only reciprocating engines and low-temperature fuel cells are currently commercially available, and of these two, reciprocating engines are the only technology that can truly be said to be mature. Microturbines are expected to enter the market in 1999, while high-temperature fuel cells and fuel cell hybrids are expected to be commercially available by 2005. Nevertheless, these early, first generation products are expected to improve rapidly as increasing production leads to lower cost, more robust devices.

Based on contacts with manufacturers and in-house data, Arthur D. Little has developed estimates of technology performance characteristics for the years 2000, 2005 and 2010, which are summarized in Table 12. More detailed descriptions are provided in Section 6: *Detailed Technology Assessments*. For each time period, values in this table are given in a range representing both uncertainty in product development and the fact that a range of products are expected to become (or already are) available. The ranges are intended to be independent of one another (i.e., the low end of the capital cost range does not necessarily correlate with the low end of the efficiency range).

Table 12: Assumed Technology Performance Characteristics

		Installed Cost (\$/kW)		Non-fuel O&M (¢/kWh)		Elec Efficiency (LHV)		Unit Size (MW)
		High	Low	High	Low	Low	High	
Recuperated Microturbines	2000	900	750	1.0	0.5	30%	30%	0.025 - 0.3
	2005	700	500	0.5	0.3	33%	36%	0.025 - 0.3
	2010	600	400	0.2	0.1	38%	42%	0.025 - 1
Unrecuperated Microturbines	2000	720	600	1.0	0.5	17%	17%	0.025 - 0.3
	2005	560	400	0.5	0.3	20%	23%	0.025 - 0.3
	2010	480	320	0.2	0.1	23%	30%	0.025 - 1
Small Reciprocating Engines	2000	750	500	2.0	1.5	24%	33%	0.05 - 0.3
	2005	700	450	1.7	1.3	26%	35%	0.05 - 0.3
	2010	650	400	1.3	1.0	26%	37%	0.05 - 0.3
Large Reciprocating Engines	2000	600	400	1.5	0.7	28%	37%	0.3 - 1
	2005	550	375	1.3	0.6	29%	41%	0.3 - 1
	2010	500	350	1.0	0.5	30%	47%	0.3 - 1
High T Fuel Cells	2000	N/A						
	2005	2,000	1,500	2.0	1.0	45%	55%	0.25 - 1
	2010	1,500	1,200	1.5	0.5	50%	60%	0.25 - 1
Low T Fuel Cells	2000	3,000	2,000	2.0	1.5	30%	40%	0.20 - 0.25
	2005	2,000	1,000	1.75	1.0	32%	42%	0.05 - 0.25
	2010	1,000	750	1.5	0.5	35%	45%	0.05 - 0.25
Fuel Cell Hybrids	2000	N/A						
	2005	2,000	1,500	1.9	0.9	65%	70%	3 - 5
	2010	1,500	1,000	1.4	0.4	70%	75%	0.25 - 20

Note: Capital costs refer to non-cogenerating units. Adding cogeneration functionality adds an estimated \$150/kW to the cost of reciprocating engines and 30% to the cost of microturbines. There is assumed to be no additional cost of cogeneration for fuel cell systems, since they are generally being designed as cogeneration units. The provision of steam is also integral to their normal operation.

The high end of the performance goals given in Table 12 represents the long-term potential of the technology, given sufficient time and production volume to mature, as well as aggressive R&D support.

Please note: It must be stressed that estimates described in this analysis do not represent Arthur D. Little’s prediction of the actual market size for these technologies, but rather the market opportunity that can be cost-effectively addressed if sufficient R&D efforts are undertaken to bring the technologies up to these performance goals.

4.6 Application-Specific Estimates of the *Entire Market* in the *Industries of the Future*

The first step to estimating technology specific estimates of the addressable market is to estimate the so-called *entire market*. This represents the total need for power in a particular application without screening for the technical or economic fit of a particular technology in a specific industry. This section provides a useful overview of the overall size of the market by application and industry. Figure 28 summarizes the application-specific power demands in each of the industries considered. **Note that the market size estimates in Figure 28 are not additive across applications.**

Figure 28: Estimated *Entire Market* for Industrial Power – All *Industries of the Future* (MW)

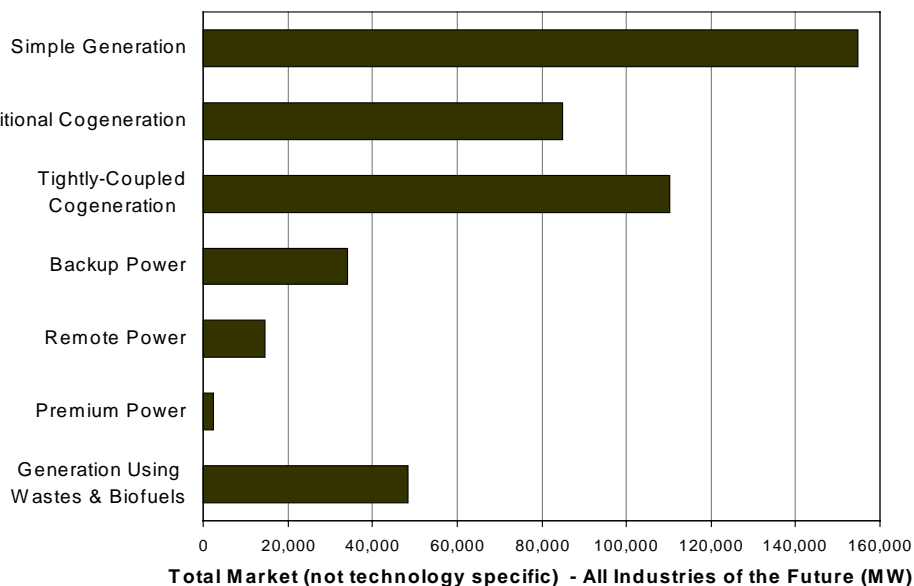

The *Entire Market* represents the total estimated industrial power potential, not annual markets for equipment. It is not technology specific. Actual demand for new power generation equipment on an annual basis will be significantly lower. Market sizes are not additive across applications, as meeting the power needs of any given application will normally reduce the amount of power needed in other applications (e.g., installing equipment to cogenerate heat and power from wastes and biofuels will reduce the available market for simple generation and traditional cogeneration).

4.6.1 Simple Generation

Of the sixteen industries considered, almost two-thirds of the simple generation market opportunity is concentrated in the large chemicals, small chemicals, pulp and paper and mining industries (Figure 29).

Figure 29: *Entire Market Potential for Simple Generation in the Industries of the Future*

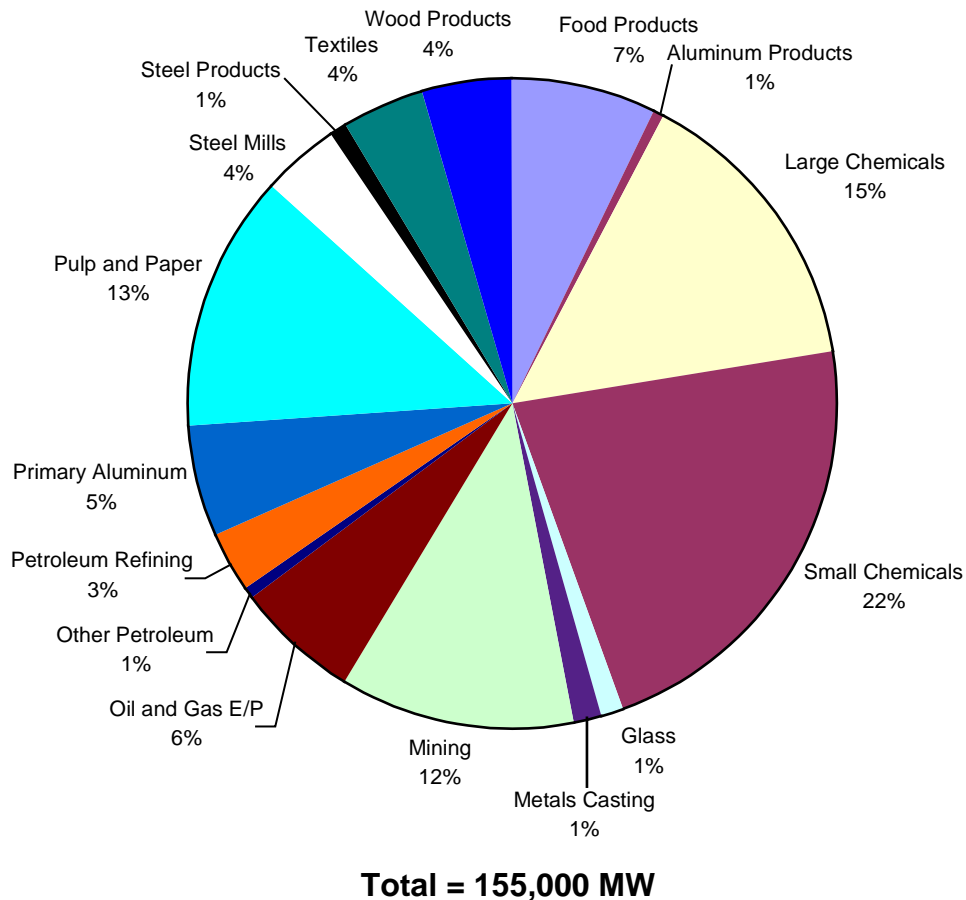

Source: 1994 Manufacturing Consumption of Energy Survey, ADL estimates

4.6.2 Traditional Cogeneration

Traditional cogeneration includes all those markets for power generation equipment in which the waste heat produced is used to produce either hot water or steam for industrial process uses. The total market for industrial cogeneration has been defined in terms of electrical output given the constraints imposed (if any) by the thermal requirements of each industry. It should be noted that this approach leads to larger potential markets for technologies with higher electrical efficiency. The total market for traditional cogeneration within a given industry has been calculated as follows:

$$\begin{aligned}
 & \text{Total industrial power consumption (MW)} \\
 & \times \text{ Industry-specific thermal/electric ratio} \\
 \hline
 & = \text{Total industrial thermal energy use} \\
 & \times \text{Fraction of heat used as hot water or steam} \\
 \hline
 & = \text{Maximum possible traditional cogeneration load (MW}_{\text{elec}})
 \end{aligned}$$

The maximum possible cogeneration load has been assumed to be the number calculated above or the total electricity demand, whichever is smaller. Implicit in this calculation is an assumption that no excess power is sold to the grid. While this may be an oversimplification for cogeneration in general, it is not likely that micropower equipment will be oversized for a given facility.

Over 75% of the 85,000 MW market opportunity for traditional cogeneration is located in the large chemicals, small chemicals and pulp and paper industries (Figure 30).

Figure 30: Entire Market Potential for Traditional Cogeneration in the Industries of the Future

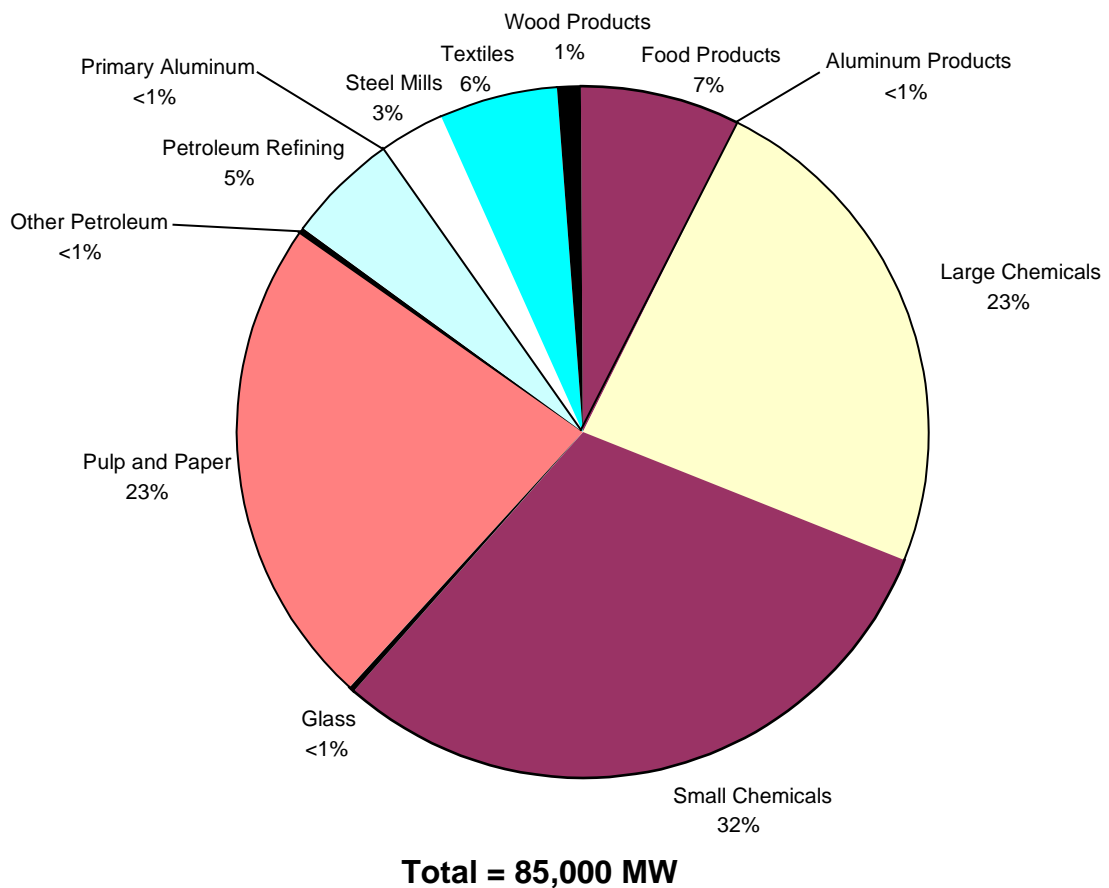

Source: 1994 Manufacturing Consumption of Energy Survey, ADL estimates

4.6.3 Tightly-Coupled Cogeneration

Tightly-coupled cogeneration includes all those markets for power generation equipment in which their offgases can be fed directly into industrial processes. Typical applications for tightly-coupled cogeneration include drying and preheating. The total market for tightly-coupled cogeneration has been defined in terms of electrical output of cogeneration equipment, so more efficient technologies effectively serve larger potential markets. The total market for tightly-coupled cogeneration has been defined as:

$$\begin{aligned}
 & \text{Total industrial power consumption (MW)} \\
 & \times \text{ Industry-specific thermal/electric ratio} \\
 \hline
 & = \text{Total industrial thermal energy use} \\
 & \times \text{Fraction of heat used as hot air or direct heat} \\
 \hline
 & = \text{Maximum possible tightly-coupled cogen load (MW}_{\text{elec}})
 \end{aligned}$$

The maximum potential market has been defined as the smaller of the maximum possible tightly-coupled cogeneration load or the total electric demand. Over 80% of the market opportunity for tightly-coupled cogeneration is concentrated in the large chemicals, small chemicals, pulp and paper and food products industries (Figure 31).

Figure 31: Entire Market Potential for Tightly-Coupled Cogeneration in the Industries of the Future

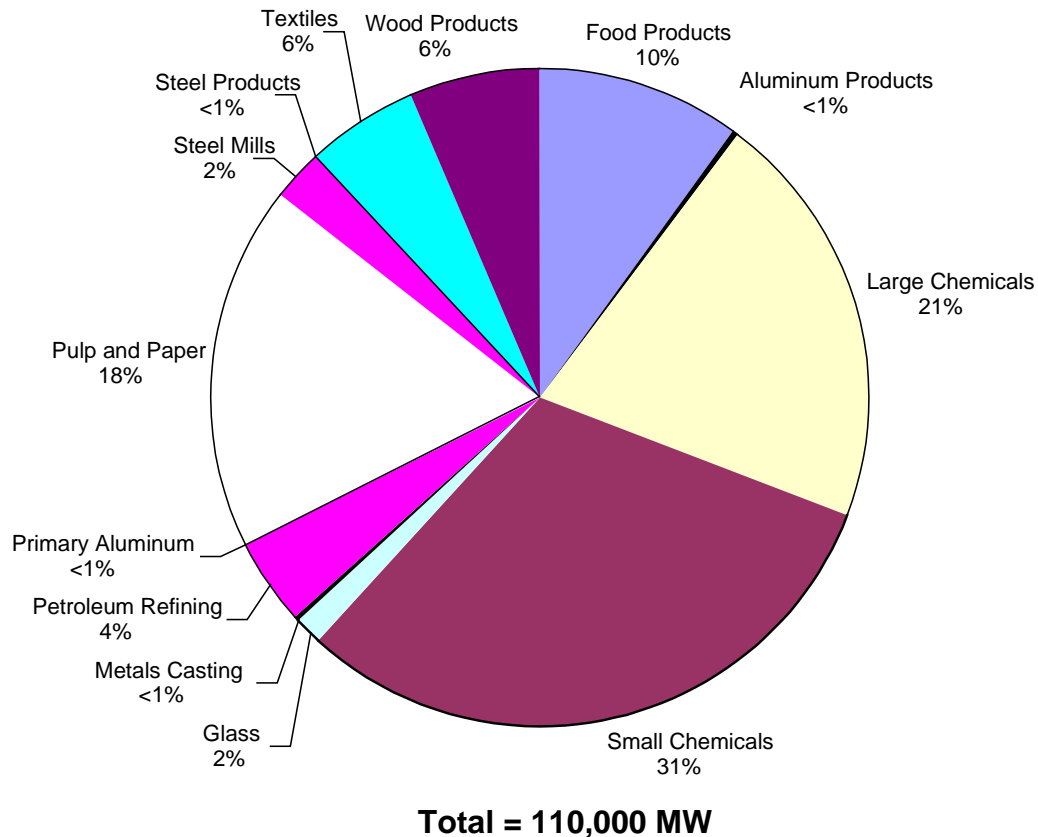

Source: 1994 Manufacturing Consumption of Energy Survey, ADL estimates

4.6.4 Backup Power

Very little data is publicly available with regard to the installed industrial backup power capacity. Internal ADL expertise was relied upon to estimate the relative fractions of the total load that will be installed as backup power in each of the industries as described in more detail in Appendix D.

In general, demand for backup power increases as industrial processes becomes more continuous, or as the cost of shutting down increases, either due to potential damage to machinery or lost work-in-process. The market opportunity for backup power is concentrated in the large chemicals, small chemicals and pulp and paper industries. However, the unusually high backup power demands in the oil and gas E&P and mining industries also make them attractive as markets for backup power generation technology (Figure 32).

Figure 32: Entire Market Potential for Backup Power in the Industries of the Future

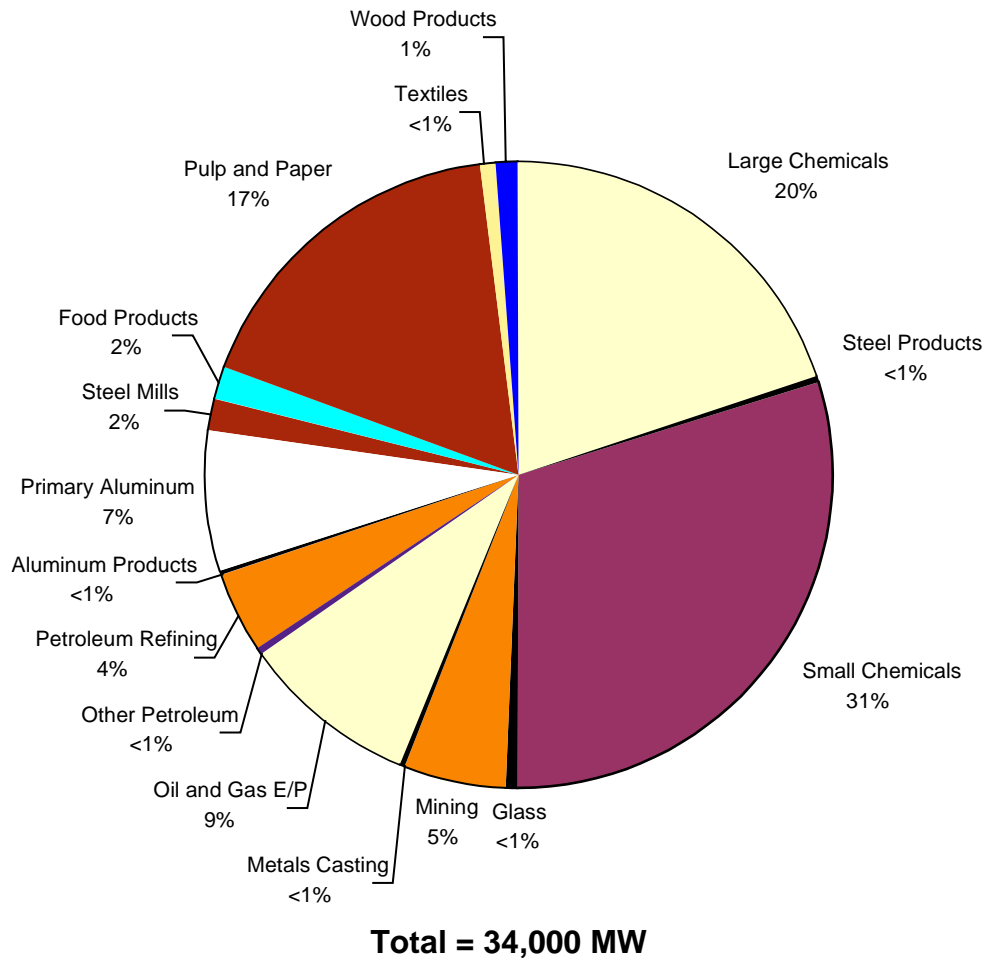

Source: 1994 Manufacturing Consumption of Energy Survey, ADL estimates

4.6.5 Remote Power

Very little data is publicly available with regard to the installed industrial remote power capacity. Internal ADL expertise was relied upon to estimate the relative fractions of the total load that will be installed as remote power in each of the industries as described in more detail in Appendix D.

Over 80% of the nearly 15,000 MW market opportunity for remote power generation is associated with the mining and oil and gas E&P industries (Figure 33).

Figure 33: *Entire Market Potential for Remote Power in the Industries of the Future*

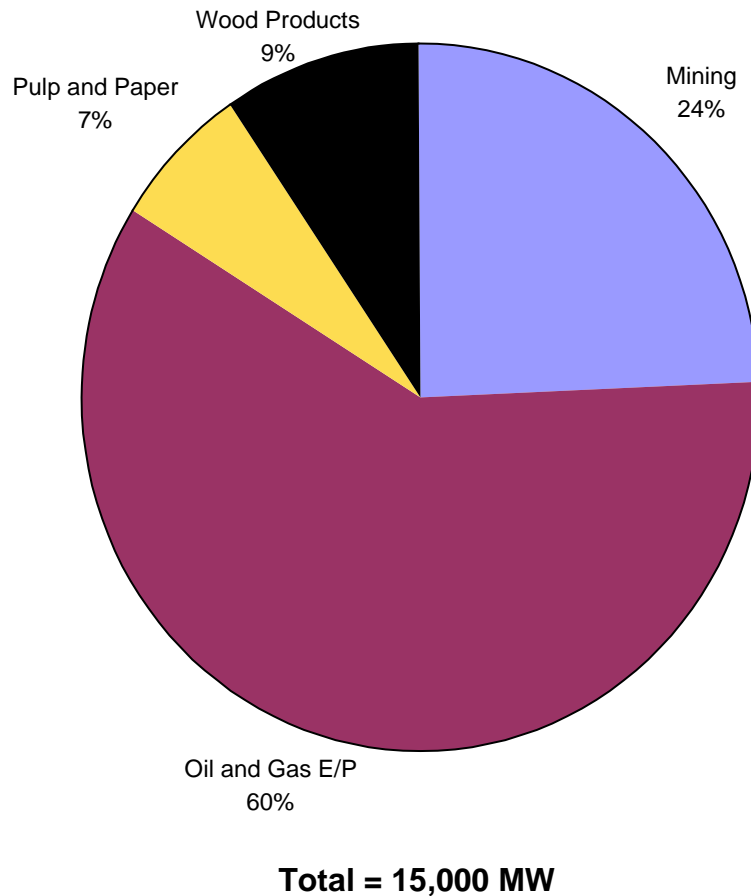

Source: 1994 Manufacturing Consumption of Energy Survey, ADL estimates

4.6.6 Premium Power

Very little data is publicly available with regard to the installed industrial premium power capacity. Internal ADL expertise was relied upon to estimate the relative fractions of the total load that could be met with premium power in each of the industries (see Appendix D for details). It should be noted that the industries typically considered to be the most important markets for premium power (primarily electronics manufacture and

other high-tech) were not covered in this study. Similarly, many commercial operations are considered to be high-priority premium power markets and are not included here.

Much of the estimated 2,400 MW potential demand for premium power is concentrated in the pulp and paper industry, where the small fraction of equipment that requires premium power (primarily DC-drive motors) is spread over an industry with a very large total electric demand. However, it should be noted that any full examination of industrial premium power must also include the electronics industry and other high-tech manufacturing, where the required tolerances effectively require premium power for a substantial portion of the total electric load.

Notwithstanding the significant attention focused on premium power opportunities by developers of advanced power generation technologies, it should be recognized as a niche market within the *Industries of the Future*. However, because of the high-value some will place on this application, and the opportunity to demonstrate some of the unique attributes of the technologies, this market could very well play an important role in early demonstration and market development.

It should be noted that premium power is quite different from the other applications considered in this analysis. The cost structures imposed vary dramatically between industries and are based on a complex calculation of the costs and benefits of premium power. Competing technologies may utilize power generation equipment, such as those considered in this study, but may also involve power handling equipment that stores (e.g., batteries) and/or modifies (e.g., power conditioning equipment) power that is produced elsewhere. Any fair assessment of the size and needs of this market would require a more targeted study. Nevertheless, based on the assumptions used herein, the estimated market potential in each industry is depicted in Figure 34.

Figure 34: *Entire Market Potential for Premium Power in the Industries of the Future*

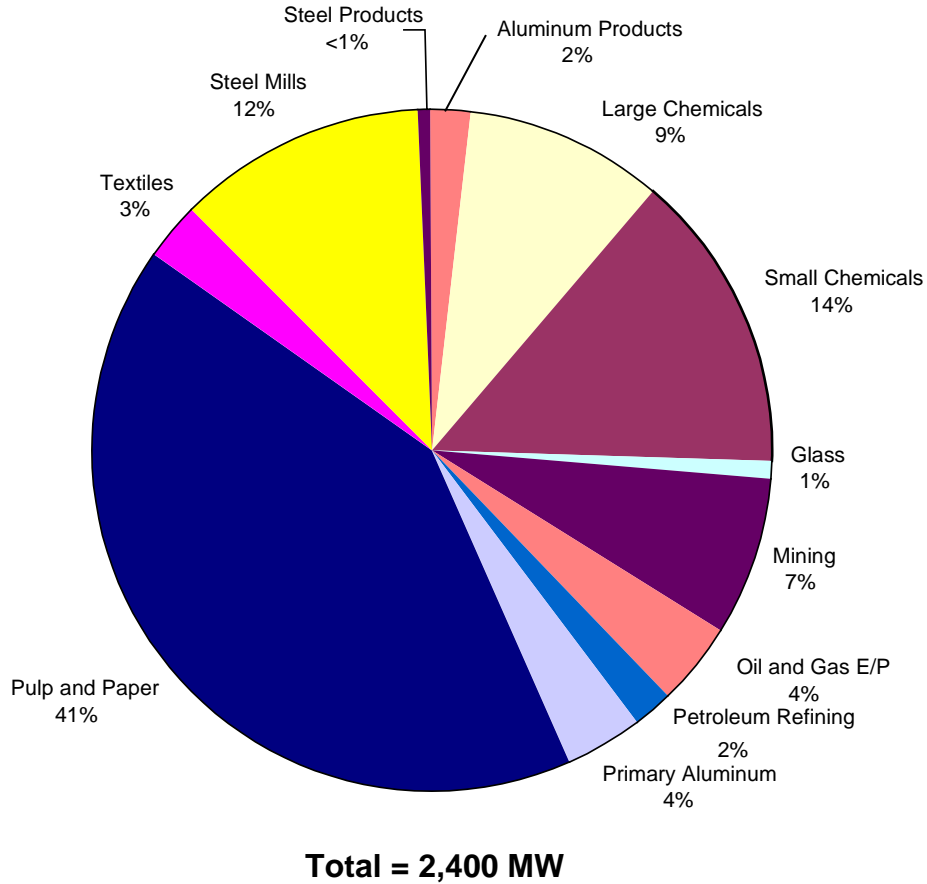

Source: 1994 Manufacturing Consumption of Energy Survey, ADL estimates

4.6.7 *Generation Using Wastes & Biofuels*

Improving the fuel efficiency and economics of power generation from wastes and biofuels could be very attractive to industry, and can lead to substantial increases in the overall energy efficiency of many industries (most notably chemicals, steel and forest products).

The demand for power and heat production from wastes and biofuels is concentrated in the pulp & paper, chemicals, steel, food products and petroleum industries (see Figure 35 and refer also to Appendix D for details). However, because the type of waste product differs significantly from one industry to the other, so will the technologies that may be applied to each.

Figure 35: Entire Market Potential for Generation Using Wastes & Biofuels in the Industries of the Future

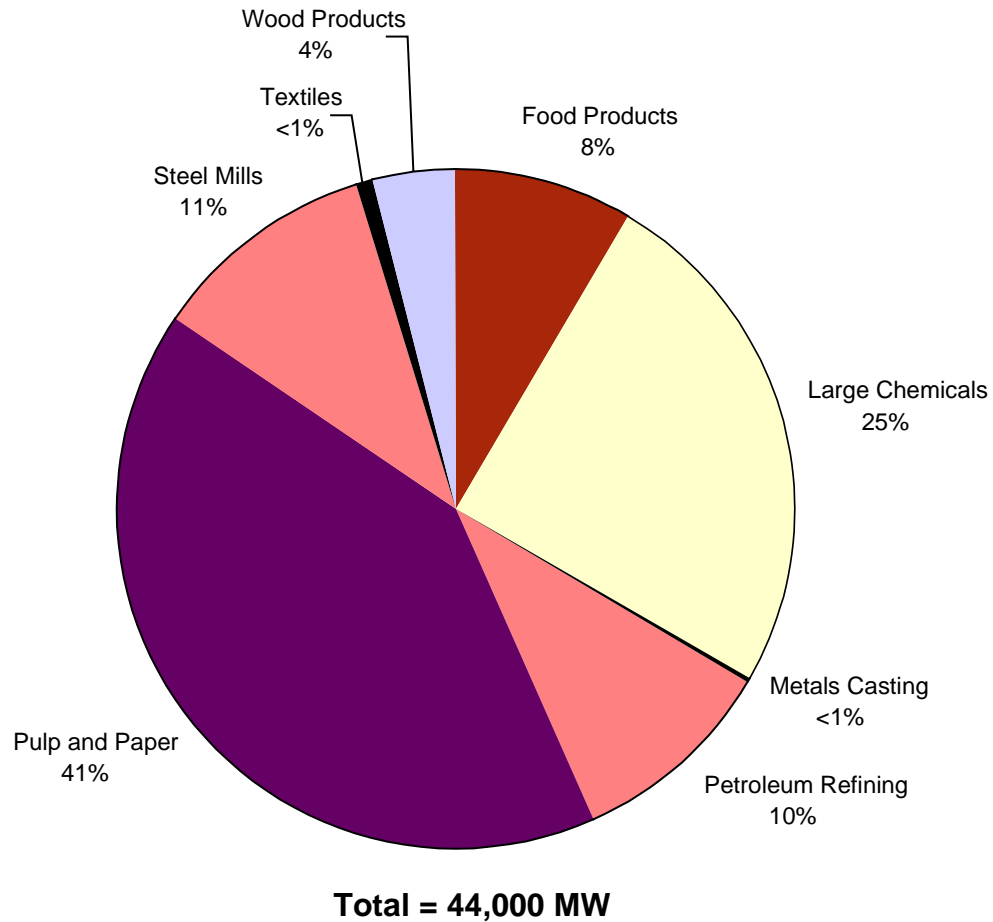

Source: 1994 Manufacturing Consumption of Energy Survey, ADL estimates

4.7 Industry-Specific Market Opportunities

Using the definitions from the previous sections, the size of the *addressable market* for each application within each industry has been estimated. It is important to note that these values represent only the application-specific demand for electric power. The actual market attained by any one technology will depend upon the adoption rates attained in the market and the relative performance of competing technologies.

Arthur D. Little defined three scenarios to describe the potential for micropower within the *Industries of the Future*. The scenarios independently show the impacts of both market and technology assumptions. R&D success was characterized as *Modest* or *Aggressive*, consistent with the “low” and “high” technology performance characteristics, respectively, as found in Table 12. Market conditions were characterized as *Regulated* or *Deregulated*, which were modeled as 3-year and 7-year economic paybacks respectively, consistent with industrial and third-party ownership. Energy rates

were also different in these two market conditions. These scenario assumptions are summarized in Table 13.

Comparing the *Modest R&D Success, Deregulated* and *Aggressive R&D Success, Deregulated* scenarios shows the impact of technology performance, where the OIT can exert influence through its programs. Comparing the *regulated* and *deregulated* versions of the *Aggressive R&D Success* scenario shows the impact of electric industry restructuring. Although the impacts of this industry evolution will be complex, two key changes will be (i) energy prices should fall, and (ii) third parties will enter the industrial sector to provide a variety of energy services. This latter impact could significantly change the economic hurdle for onsite power generation, since third parties who would own these installations are expected to have payback hurdles in the range of seven years, versus three years, which is more typical for industrial ownership.

Table 13: Scenarios Considered for the Industrial Opportunities Analysis

Scenario	Technology Performance (based on Table 12)	Payback Requirement (years)	Energy Rates
Modest R&D Success, Deregulated	2010 – low	7	Deregulated 2010
Aggressive R&D Success, Regulated	2010 – high	3	Same as of 1998
Aggressive R&D Success, Deregulated	2010 – high	7	Deregulated 2010

Energy Rates are based on the DOE/EIA *Annual Energy Outlook*. "Deregulated 2010" prices are lower than current prices.

4.7.1 Agriculture – Food Products

Defining Characteristics

The food products industry as defined in this analysis includes all of SIC code 20, the food processing industry. It does not include harvesting, but does include all industrial processes between harvesting and the consumer. The energy needs of the industry are dominated by electricity consumption and low-temperature heating. Characteristic processes include refrigeration, evaporation, drying, aerating, mixing and pumping. While the total estimated market for onsite power generation equipment in food products is a fairly large 11,000 MW, this is spread across a large number of small facilities, with an estimated average facility size of just 0.5 MW.

Potential Markets for Onsite Power Generation

The high thermal needs of the food products industry create good market opportunities for traditional and tightly-coupled cogeneration as a means of power production. Additionally, biomass wastes generated in the industry create opportunities for technologies that can use wastes and biofuels to produce electric power.

Opportunities for Micropower Technologies (less than 1 MW)

Table 14 shows the size and fit of the opportunities for micropower generation within the food products industry. There are several technologies that appear attractive for both simple generation and cogeneration provided that *Aggressive R&D Success* targets can be met. Although biomass wastes are generated in substantial quantities, there do not appear to be economic opportunities for micropower-based biomass power in this industry. A more detailed study of this industry is probably necessary to understand the true costs and benefits of small-scale gasification-based power generation.

Recuperated Microturbines

Relatively large *addressable* markets exist for recuperated microturbines in simple generation and tightly-coupled cogeneration, but only under the optimistic technology assumptions used in this study. However, the better techno-economic fit in traditional cogeneration provides a pathway for microturbines to gain access to electric power markets in the food products industry.

Large Reciprocating Engines (300-1,000 kW)

Large reciprocating engines have the potential to serve comparable markets in simple generation and also appear attractive in traditional cogeneration.

Low-Temperature Fuel Cells

Low-temperature fuel cells have the potential to serve a cogeneration market of approximately 2,000 MW in the *Aggressive R&D Success, Deregulated* scenario. This industry's facility size range and demand for hot water and low-temperature steam make it relatively well suited to fuel cell technology, and may provide useful demonstration opportunities.

Opportunities for Fuel Cell Hybrids (0.25-20 MW)

Fuel cell hybrids up to 20 MW in size have the potential to serve markets in simple generation (3,100 MW), traditional cogeneration (3,500 MW) and tightly-coupled cogeneration (3,100 MW), but these markets only emerge in the *Aggressive R&D Success, Deregulated* scenario. As with low-temperature fuel cells, the potential to host demonstrations at locations where the provision of low-temperature heat could make the food products industry an important early market for fuel cell hybrids.

Table 14: Leading Opportunities for Micropower and Fuel Cell Hybrids in the Food Products Industry

	Addressable Market Potential based on 2010 Performance (Total MW)						
	Microturbines		Reciprocating Engines		Fuel Cells		
	Recup.	Unrecup.	Small	Large	High Temp.	Low Temp.	Hybrids (0.25-20MW)
Modest R&D Success, Deregulated							
Simple Generation							
Traditional Cogen	1,500	1,000		600			
Tightly-Coupled Cogen							
Backup Power		500					
Remote Power							
Premium Power							
Wastes & Biofuels							
Aggressive R&D Success, Regulated							
Simple Generation	4,000			3,100			
Traditional Cogen	1,800	1,500		2,100			
Tightly-Coupled Cogen	4,000						
Backup Power		500					
Remote Power							
Premium Power							
Wastes & Biofuels							
Aggressive R&D Success, Deregulated							
Simple Generation	5,200			4,800			3,100
Traditional Cogen	2,700	2,200	500	3,400		2,000	3,500
Tightly-Coupled Cogen	5,900						3,100
Backup Power		500					
Remote Power							
Premium Power							
Wastes & Biofuels							

Note: Numbers in this table represent the estimated size of the market in megawatts that is appropriately sized for a given technology (on a facility basis) and is economically attractive. The actual market achieved by any given technology will be smaller as competing technologies capture a portion of the available market.

4.7.2 Agriculture – Textiles

Defining Characteristics

The textiles industry was added to this analysis by virtue of its small facility sizes and relatively high use of low-temperature heat. Both of these factors may make it attractive for onsite micropower generation. The industry as defined includes all of SIC code 22, which includes all those industries involved in the preparation of threads, yarns, fabrics and fabric materials. Characteristic processes include spinning, drying, and material conveyance. The industry has a total estimated power demand of 6,300 MW and an estimated average facility size of approximately 1 MW.

Potential Markets for Onsite Power Generation

The power needs of the textiles industry are dominated by simple generation and cogeneration applications, either as traditional cogeneration (for steam-treating of materials and process heating) or tightly-coupled cogeneration (primarily drying). The temperatures required by these processes tend to be fairly low, thus presenting a clear opportunity for micropower and fuel cell hybrid technologies.

Opportunities for Micropower Technologies (less than 1 MW)

The high thermal demands of the textiles industry, and the relatively low temperature requirements of those demands create several niche opportunities for micropower technologies. Table 15 summarizes the magnitude of these opportunities.

In the *Modest R&D Success, Deregulated* scenario, microturbines and reciprocating engines are expected to be somewhat competitive in traditional cogeneration applications. The larger market for recuperated (as opposed to unrecuperated) microturbines results from the fact that the bulk of the heat required is at fairly low temperatures. In the two *Aggressive R&D Success* scenarios recuperated microturbines and large reciprocating engines also become attractive for simple generation.

Opportunities for Fuel Cell Hybrids (0.25-20 MW)

In the *Aggressive R&D Success, Deregulated* scenario, fuel cell hybrids have the potential to address much of the power needs of the industry, either in simple generation or cogeneration.

Table 15: Leading Opportunities for Micropower and Fuel Cell Hybrids in the Textiles Industry

	Addressable Market Potential based on 2010 Performance (Total MW)						
	Microturbines		Reciprocating Engines		Fuel Cells		
	Recup.	Unrecup.	Small	Large	High Temp.	Low Temp.	Hybrids (0.25-20MW)
Modest R&D Success, Deregulated							
Simple Generation							
Traditional Cogen	1,500	900		500			
Tightly-Coupled Cogen							
Backup Power		300		<100			
Remote Power							
Premium Power							
Wastes & Biofuels							
Aggressive R&D Success, Regulated							
Simple Generation	1,500			1,300			
Traditional Cogen							
Tightly-Coupled Cogen	500						
Backup Power		300					
Remote Power							
Premium Power							
Wastes & Biofuels							
Aggressive R&D Success, Regulated							
Simple Generation	1,700			1,600			1,700
Traditional Cogen	2,600	1,900	100	3,000		2,000	3,100
Tightly-Coupled Cogen	800						1,700
Backup Power		300					
Remote Power							
Premium Power							
Wastes & Biofuels							

Note: Numbers in this table represent the estimated size of the market in megawatts that is appropriately sized for a given technology (on a facility basis) and is economically attractive. The actual market achieved by any given technology will be smaller as competing technologies capture a portion of the available market.

4.7.3 Primary Aluminum

Defining Characteristics

Primary aluminum includes all facilities involved in the processing of raw ores into pure aluminum (SIC code 3334). While most processes are batch, the industry does have substantial backup power requirements for aluminum electrolysis cells. The industry is inherently a very large user of electric power. Since electric power costs are such a substantial portion of the overall cost of production, the facilities are mostly located in areas with very low electric power rates. The industry has a total power demand of approximately 8,500 MW and an estimated average facility demand of 210 MW.

Potential Markets for Onsite Power Generation

Opportunities for onsite power generation from micropower and fuel cell hybrid technologies within the primary aluminum industry are extremely limited due to the large size of most facilities. Additionally, the power needs that exist in the industry are almost entirely for simple generation, with few of the “niche” needs present to provide value-added opportunities for smaller power generation equipment.

Opportunities for Micropower Technologies (less than 1 MW)

The large size of most primary aluminum facilities precludes the use of micropower technology in all but a few of the smallest facilities. Table 16 summarizes the limited opportunities that do exist in this industry.

Opportunities for Fuel Cell Hybrids (0.25-20 MW)

The large size of most primary aluminum facilities also precludes the use of fuel cell hybrids in all but a few of the smallest facilities.

Table 16: Leading Opportunities for Micropower and Fuel Cell Hybrids in the Primary Aluminum Industry

	Addressable Market Potential based on 2010 Performance (Total MW)						
	Microturbines		Reciprocating Engines		Fuel Cells		
	Recup.	Unrecup.	Small	Large	High Temp.	Low Temp.	Hybrids (0.25-20MW)
Modest R&D Success, Deregulated							
Simple Generation							
Traditional Cogen							
Tightly-Coupled Cogen							
Backup Power		<100					
Remote Power							
Premium Power	<100						
Wastes & Biofuels							
Aggressive R&D Success, Regulated							
Simple Generation							
Traditional Cogen							
Tightly-Coupled Cogen							
Backup Power		<100					
Remote Power							
Premium Power	<100	<100					
Wastes & Biofuels							
Aggressive R&D Success, Deregulated							
Simple Generation							
Traditional Cogen							
Tightly-Coupled Cogen							
Backup Power		<100					
Remote Power							
Premium Power	<100						100
Wastes & Biofuels							

Note: Numbers in this table represent the estimated size of the market in megawatts that is appropriately sized for a given technology (on a facility basis) and is economically attractive. The actual market achieved by any given technology will be smaller as competing technologies capture a portion of the available market.

4.7.4 Aluminum Products

Defining Characteristics

The aluminum products industry encompasses those facilities involved in the rolling, drawing and extruding of primary aluminum into secondary aluminum products. Total power demand is approximately 1,000 MW and the average facility size is approximately 3 MW, substantially smaller than in the primary aluminum industry on both counts. Characteristic processes include re-melting of aluminum scrap, along with the casting, extruding, drawing, heat treating and finishing of aluminum products. Key products include wire (e.g., for electrical wiring), sheet (e.g., for automobiles), can stock (primarily for beverage containers), and extrusions (e.g., construction materials). Large-volume facilities mostly use direct firing for melting and heat treating, although, some of the smaller facilities catering to specialty materials use electric (mostly induction and radiant) furnaces.

Potential Markets for Onsite Power Generation

Applications for onsite power generation in the aluminum products industry are dominated by simple generation. Although thermal demands in the industry are mostly for high-temperature heat, there are modest market opportunities for cogeneration technologies that can provide part of the process heat to heat-treating furnaces and finishing ovens.

Opportunities for Micropower Technologies (less than 1 MW)

The relatively small size of the aluminum products industry allows for only a few niche opportunities where micropower technologies may play a role in onsite power generation. Moreover, these opportunities are limited to the *Aggressive R&D Success* scenarios. Large reciprocating engines (300-1,000 kW) and recuperated microturbines each have addressable markets of approximately 200 MW in simple generation. These and other technologies appear to be attractive in other applications, but the sizes of these opportunities are small. Table 17 summarizes the opportunities that do exist in this industry.

Opportunities for Fuel Cell Hybrids (0.25-20 MW)

Fuel cell hybrids up to 20 MW in size have an addressable market of approximately 300 MW in simple generation in the *Aggressive R&D Success, Deregulated* scenario.

Table 17: Leading Opportunities for Micropower and Fuel Cell Hybrids in the Aluminum Products Industry

	Addressable Market Potential based on 2010 Performance (Total MW)						
	Microturbines		Reciprocating Engines		Fuel Cells		
	Recup.	Unrecup.	Small	Large	High Temp.	Low Temp.	Hybrids (0.25-20MW)
Modest R&D Success, Deregulated							
Simple Generation							
Traditional Cogen							
Tightly-Coupled Cogen							
Backup Power		<100					
Remote Power							
Premium Power	<100						
Wastes & Biofuels							
Aggressive R&D Success, Regulated							
Simple Generation	200			200			
Traditional Cogen							
Tightly-Coupled Cogen							
Backup Power		<100					
Remote Power							
Premium Power	<100	<100		<100			
Wastes & Biofuels							
Aggressive R&D Success, Deregulated							
Simple Generation	200			200			300
Traditional Cogen							<100
Tightly-Coupled Cogen							
Backup Power		<100					
Remote Power							
Premium Power	<100	<100		<100	<100	<100	<100
Wastes & Biofuels							

Note: Numbers in this table represent the estimated size of the market in megawatts that is appropriately sized for a given technology (on a facility basis) and is economically attractive. The actual market achieved by any given technology will be smaller as competing technologies capture a portion of the available market.

4.7.5 Chemicals – Large Chemicals (top 6 energy consuming sectors of SIC code 28)

Defining Characteristics

The large chemicals industry, as defined here, includes the six most energy-intensive sectors of the total chemicals industry (SIC code 28). Processes in this industry segment tend to be continuous, and have high demands for low-grade heat, either as steam or hot water, thus providing substantial opportunities for cogeneration. The industry has an estimated total power demand of nearly 23,000 MW and an estimated average facility size of 10 MW. Typical processes include feed pretreatment (grinding, purifying, mixing, compression, pumping), synthesis (chemical reaction, electro-chemical reactions), and product separation (filtration, extraction, distillation, centrifugation, etc.). The electric power intensity of these processes varies widely, from low electric uses in basic petrochemical facilities, to high electricity use in chlor-alkali processes.

Potential Markets for Onsite Power Generation

Thermal demands in the chemicals industry are such that almost all of the process electricity load could be met through traditional or tightly-coupled cogeneration. Indeed, this sector of the chemicals industry is already a leader in the use of cogeneration. Additionally, many facilities have large combustible waste streams, thus providing an opportunity for power generation systems that can operate on these wastes. Most waste fuel use is concentrated in SIC code 2819, *Industrial Inorganic Chemicals, n.e.c.*

Opportunities for Micropower Technologies (less than 1 MW)

The large chemicals industry provides several opportunities for micropower technologies, including backup power and generation using industrial waste fuels. The leading technologies are recuperated microturbines, unrecuperated microturbines and large reciprocating engines (300-1,000 kW). These technologies appear to be competitive under a variety of technology and market development scenarios. The attractiveness of unrecuperated microturbines in several applications suggest that this configuration has merit in the industrial sector, even though recuperated machines are a current focus for the microturbine industry. Table 18 shows the magnitude of these opportunities.

Recuperated Microturbines

The relatively low cost and modest efficiency of recuperated microturbines in the two *Aggressive R&D Success* scenarios combine to create sizeable addressable markets in simple generation and generation using wastes & biofuels. However, simple generation applications are only likely to be accessible under *aggressive* technology assumptions.

Unrecuperated Microturbines

Unrecuperated microturbines appear attractive in traditional cogeneration, backup power and generation using wastes & biofuels, under all three scenarios, suggesting that this industry segment could be an attractive early market for the technology.

Large Reciprocating Engines (300-1,000 kW)

Traditional cogeneration and generation from wastes & biofuels are attractive in all three scenarios. Large reciprocating engines also appear attractive in simple generation and tightly-coupled cogeneration, in both *Aggressive R&D Success* scenarios.

High-Temperature Fuel Cells

High-temperature fuel cells have the potential to address a modest market for traditional cogeneration (900 MW) and a sizeable market for generation using wastes & biofuels, but only in the *Aggressive R&D Success, Deregulated* scenario. It is also worth keeping in mind that while this study has considered only high-temperature fuel cells that are in the sub-MW size range, manufacturers are developing larger configurations that would be able to address the power needs of larger chemicals facilities. Therefore, the large chemicals industry represents one of the more important applications for high-temperature fuel cells within the *Industries of the Future*.

Low-Temperature Fuel Cells

Low-temperature fuel cells have the potential to address a sizeable market based on waste fuel use in all three scenarios. As such, the large chemicals industry represents one of the most important applications for low-temperature fuel cells within the *Industries of the Future*.

Opportunities for Fuel Cell Hybrids (0.25-20 MW)

Fuel cell hybrids up to 20 MW in size have the potential to address large markets in simple generation, tightly-coupled cogeneration, and generation using wastes & biofuels. In the *Aggressive R&D Success, Deregulated* scenario. Reasonable markets for generation using wastes & biofuels also exist in the other two scenarios. The size of the cogeneration opportunity is largely a function of the high electrical efficiency of these devices, as more power can be generated for a given thermal load. Also, the larger package size of fuel cell hybrids relative to the other technologies considered in this analysis result in larger addressable markets, all else equal.

Table 18: Leading Opportunities for Micropower and Fuel Cell Hybrids in the Large Chemicals Industry

	Addressable Market Potential based on 2010 Performance (Total MW)						
	Microturbines		Reciprocating Engines		Fuel Cells		
	Recup.	Unrecup.	Small	Large	High Temp.	Low Temp.	Hybrids (0.25-20MW)
Modest R&D Success, Deregulated							
Simple Generation							
Traditional Cogen	<100	1,000		1,200			
Tightly-Coupled Cogen							
Backup Power		2,900		500			
Remote Power							
Premium Power	100						
Wastes & Biofuels	4,000	4,000	700	3,800		2,500	2,200
Aggressive R&D Success, Regulated							
Simple Generation	1,600			1,600			
Traditional Cogen	100	1,600	100	2,000			
Tightly-Coupled Cogen	700			1,000			
Backup Power		2,900		500			
Remote Power							
Premium Power	200	100		100			<100
Wastes & Biofuels	4,000	4,000	600	3,900		3,100	3,000
Aggressive R&D Success, Deregulated							
Simple Generation	2,100			2,100			6,800
Traditional Cogen	100	2,000	200	2,600	900	100	700
Tightly-Coupled Cogen	900			1,100			6,800
Backup Power		2,900		500			
Remote Power							
Premium Power	200	100		100	100	100	100
Wastes & Biofuels	4,000	4,000	700	3,900	3,700	4,000	7,700

Note: Numbers in this table represent the estimated size of the market in megawatts that is appropriately sized for a given technology (on a facility basis) and is economically attractive. The actual market achieved by any given technology will be smaller as competing technologies capture a portion of the available market.

4.7.6 Chemicals – Small Chemicals (all of SIC code 28 excluding top 6 energy consuming sectors)

Defining Characteristics

The small chemicals industry includes all those industries within SIC code 28 not included in the large chemicals industry. Processes in these facilities tend to be continuous, and have high demands for low-grade heat, either as steam or hot water, thus providing substantial opportunities for cogeneration. The industry has a total estimated power demand of 34,000 MW and an estimated average facility size of 3.5 MW. This is the largest total power demand of all the industries considered. The type of processes common to this industry are the same as those in large chemicals, albeit at a smaller scale (on average) and with less process integration.

Potential Markets for Onsite Power Generation

As in the large chemicals industry, there is a substantial portion of the total power demanded by the small chemicals industry that can potentially be met through traditional or tightly-coupled cogeneration applications. However, there appears to be very little waste fuel available for power generation.

Opportunities for Micropower Technologies (less than 1 MW)

The small chemicals industry is particularly attractive to micropower technologies by virtue of its high energy demands (both thermal and electric), the overall size of the industry, and a favorable facility size distribution. The magnitude of these opportunities is potentially quite significant, given that current onsite power generation technologies cannot effectively serve these small power demands very effectively. Table 19 shows the magnitude of the micropower opportunities.

Recuperated Microturbines

Opportunities for recuperated microturbines in small chemicals are somewhat larger than in the large chemicals industry. These include simple generation and tightly-coupled cogeneration, but are only accessible in the *Aggressive R&D Success* scenarios. However, if these performance goals are achieved, these markets are likely to be attainable under both 3-year and 7-year payback periods, although the latter would be substantially larger.

Unrecuperated Microturbines

One of the more interesting aspects of this industry is the opportunity it affords for *unrecuperated* microturbines in traditional cogeneration and backup power applications in all three scenarios. While they have lower efficiencies than their recuperated counterparts, their higher offgas temperatures significantly expand the available market for cogeneration. Although the development of low-cost recuperated microturbines will, as a matter of course also lead to low-cost unrecuperated microturbines, their potential in the chemicals industry suggests that a more directed effort focused on unrecuperated machines may lead to substantial benefits.

Table 19: Leading Opportunities for Micropower and Fuel Cell Hybrids in the Small Chemicals Industry

	Addressable Market Potential based on 2010 Performance (Total MW)						
	Microturbines		Reciprocating Engines		Fuel Cells		
	Recup.	Unrecup.	Small	Large	High Temp.	Low Temp.	Hybrids (0.25-20MW)
Modest R&D Success, Deregulated							
Simple Generation							
Traditional Cogeneration	200	4,700		2,600			
Tightly-Coupled Cogeneration							
Backup Power		4,600		400			
Remote Power							
Premium Power	100						
Wastes & Biofuels							
Aggressive R&D Success, Regulated							
Simple Generation	2,700			3,100			
Traditional Cogeneration	300	5,800		3,200			
Tightly-Coupled Cogeneration	3,400						
Backup Power		4,600		400			
Remote Power							
Premium Power	200	100		100			
Wastes & Biofuels							
Aggressive R&D Success, Deregulated							
Simple Generation	5,600			4,700			5,700
Traditional Cogeneration	400	8,000	1,100	6,200		300	1,400
Tightly-Coupled Cogeneration	4,400			5,100			5,900
Backup Power		4,600		400			
Remote Power							
Premium Power	200	100		100	100	100	200
Wastes & Biofuels							

Note: Numbers in this table represent the estimated size of the market in megawatts that is appropriately sized for a given technology (on a facility basis) and is economically attractive. The actual market achieved by any given technology will be smaller as competing technologies capture a portion of the available market.

Large Reciprocating Engines (300-1,000 kW)

Large reciprocating engines is the only other technology that appears attractive under a range of technology and market scenarios. As with unrecuperated microturbines, traditional cogeneration is the most attractive applications. Large markets for simple generation and tightly-coupled cogeneration are accessible in the *Aggressive R&D Success* scenarios, especially the *deregulated* scenario.

Small Reciprocating Engines (50-300 kW)

Small reciprocating engines have the potential to access limited markets for traditional cogeneration (2,800 MW). The relatively small market compared to that of large reciprocating engines results from a poorer match with facility size, lower efficiency and higher capital costs.

Low- and High-Temperature Fuel Cells

Opportunities for low- and high-temperature fuel cells appear limited in the small chemicals industry.

Opportunities for Fuel Cell Hybrids (0.25-20 MW)

Large markets for simple generation and tightly-coupled cogeneration are accessible in the *Aggressive R&D Success, Deregulated* scenario, suggesting that accelerated R&D, coupled with longer allowable paybacks (7-year versus 3-year) will be essential for the realization of these markets. Nevertheless, the large size of the addressable market suggests that this could be an important focus for fuel cell hybrids in the industrial sector. It is also important to note that these applications are the same as those in which fuel cell hybrids are expected to be attractive in other industries. As with other applications where fuel cell hybrids are able to address a large market, this is driven in part by the larger unit size considered relative to micropower in this study.

4.7.7 Glass

Defining Characteristics

The glass industry (SIC code 32) includes those facilities involved in the synthesis of flat and blown glass products, and the synthesis of products of purchased glass. Facilities may be dominated either by continuous (float glass facilities) or batch (glass containers) processes, but all have substantial thermal loads to produce and maintain molten material. For most applications, these thermal requirements are at temperatures in excess of 1000°C, substantially higher than could be achieved with the offgases of power generation equipment. The industry has a total power demand of approximately 11,000 MW and an average facility size of just under 1 MW.

Potential Markets for Onsite Power Generation

The needs of the glass industry are dominated by simple generation and tightly-coupled cogeneration. However, it should be noted that the measured need for tightly-coupled cogeneration is based on the power which could be produced for a given heat load *independent of temperature*. While one can envision technologies that produce power with offgases in the >1000°C range required for much of the industry's thermal load, the technologies considered in this analysis all produce markedly cooler exhaust. As such, they will only be able to address a small fraction of the total tightly-coupled cogeneration market in the glass industry.

Opportunities for Micropower Technologies (less than 1 MW)

The relatively small size of the glass industry and the minimal need for low-grade heat affords few opportunities for onsite power generation with micropower technologies. Limited opportunities have been identified in this study for simple generation in cases where micropower technologies achieve aggressive R&D targets. Table 20 summarizes the magnitude of these opportunities.

Opportunities for Fuel Cell Hybrids (0.25-20 MW)

Fuel cell hybrid opportunities are also limited, and are similar in size to those for micropower, suggesting that the limiting factor is economic fit and not technical fit (e.g., product size).

Table 20: Leading Opportunities for Micropower and Fuel Cell Hybrids in the Glass Industry

	Addressable Market Potential based on 2010 Performance (Total MW)						
	Microturbines		Reciprocating Engines		Fuel Cells		
	Recup.	Unrecup.	Small	Large	High Temp.	Low Temp.	Hybrids (0.25-20MW)
Modest R&D Success, Deregulated							
Simple Generation							
Traditional Cogen							
Tightly-Coupled Cogen							
Backup Power		200					
Remote Power							
Premium Power							
Wastes & Biofuels							
Aggressive R&D Success, Regulated							
Simple Generation	700	400		600			
Traditional Cogen				<100			
Tightly-Coupled Cogen	100	<100		100			
Backup Power		200					
Remote Power							
Premium Power							
Wastes & Biofuels							
Aggressive R&D Success, Deregulated							
Simple Generation	1,000			900			1,100
Traditional Cogen		<100		<100	<100		<100
Tightly-Coupled Cogen	100			100			400
Backup Power		200					
Remote Power							
Premium Power							
Wastes & Biofuels							

Note: Numbers in this table represent the estimated size of the market in megawatts that is appropriately sized for a given technology (on a facility basis) and is economically attractive. The actual market achieved by any given technology will be smaller as competing technologies capture a portion of the available market.

4.7.8 Metal Casting

Defining Characteristics

The metals casting industry produces a wide variety of products, primarily from iron, aluminum, and their respective alloys. Key markets include the automotive and aerospace industries. Key energy consuming processes include the melting of metal and heat treating of products. Melting is now mostly accomplished in electric arc furnaces or cupolas for iron, and in reverberatory (mostly gas-fired) furnaces or induction furnaces for aluminum casting. The metal casting industry has a total power demand of approximately 2,000 MW, and an estimated average demand of just under 1 MW per facility.

Potential Markets for Onsite Power Generation

The minimal cogeneration potential in the metal casting industry leads to very low power demands for any application other than simple generation. While there are thermal requirements to melt and/or soften metal products, the energy consumption as reported in census data suggests that much of this heat is provided electrically.

Opportunities for Micropower Technologies (less than 1 MW)

The metal casting industry's relatively small power demands and reliance on simple generation significantly limit the number and size of opportunities for power generation from micropower technologies. The only sizeable opportunities are in simple generation for recuperated microturbines and large reciprocating engines. These opportunities are all dependent on micropower technologies achieving *Aggressive R&D Success*. Table 21 summarizes these opportunities.

Opportunities for Fuel Cell Hybrids (0.25-20 MW)

Fuel cell hybrid opportunities are also limited to simple generation and are also dependent on achieving *Aggressive R&D Success*, but are further limited to longer payback situations.

Table 21: Leading Opportunities for Micropower and Fuel Cell Hybrids in the Metal Casting Industry

	Addressable Market Potential based on 2010 Performance (Total MW)						
	Microturbines		Reciprocating Engines		Fuel Cells		
	Recup.	Unrecup.	Small	Large	High Temp.	Low Temp.	Hybrids (0.25-20MW)
Modest R&D Success, Deregulated							
Simple Generation							
Traditional Cogen							
Tightly-Coupled Cogen							
Backup Power		100					
Remote Power							
Premium Power							
Wastes & Biofuels	<100	<100	<100			<100	
Aggressive R&D Success, Regulated							
Simple Generation	600			700			
Traditional Cogen							
Tightly-Coupled Cogen							
Backup Power		100					
Remote Power							
Premium Power							
Wastes & Biofuels	<100	<100	<100			<100	
Aggressive R&D Success, Deregulated							
Simple Generation	900			700			800
Traditional Cogen							
Tightly-Coupled Cogen							
Backup Power		100					
Remote Power							
Premium Power							
Wastes & Biofuels	<100	<100	<100			<100	

Note: Numbers in this table represent the estimated size of the market in megawatts that is appropriately sized for a given technology (on a facility basis) and is economically attractive. The actual market achieved by any given technology will be smaller as competing technologies capture a portion of the available market.

4.7.9 Mining

Defining Characteristics

The mining industry includes all of SIC codes 10, 12 and 14, which comprise all those facilities involved in the mining of coal, metallic and non-metallic minerals, but does not include those facilities involved in oil and gas exploration and production. The thermal needs of these facilities are fairly low, but many facilities do not have access to grid power or natural gas. Some coal mines however, will have mine-gas available that can be used as a fuel for power generation equipment. Where facilities are off the grid and mine-gases are not available, remote power needs will dominate and power generation equipment must therefore be able to operate on stored fuels such as diesel or propane. Safety and pumping concerns increase the demand for backup power generation equipment in this industry. The industry has a total power demand of approximately 18,000 MW and an estimated average facility size of nearly 2 MW.

Potential Markets for Onsite Power Generation

Power needs in the mining industry are dominated by simple generation, although the remote nature of some sites does lead to a high demand for remote and backup power.

Opportunities for Micropower Technologies (less than 1 MW)

If only *Modest R&D Success* is achieved, modest markets for backup power are addressable by unrecuperated microturbines. Recuperated microturbines and large reciprocating engines could also address sizeable markets for simple generation in the *Aggressive R&D Success, Deregulated* scenario. The failure of more technologies to achieve high economic fits in this industry is driven primarily by the industry's low load factors, which increase the levelized cost of power as equipment capital cost is spread over a smaller number of kilowatt-hours per year. Table 22 summarizes the magnitude of these opportunities.

Opportunities for Fuel Cell Hybrids (0.25-20 MW)

Opportunities for fuel cell hybrids are limited to small markets for remote power, but appear insensitive to assumptions about technology performance or market conditions.

Table 22: Leading Opportunities for Micropower and Fuel Cell Hybrids in the Mining Industry

	Addressable Market Potential based on 2010 Performance (Total MW)						
	Microturbines		Reciprocating Engines		Fuel Cells		
	Recup.	Unrecup.	Small	Large	High Temp.	Low Temp.	Hybrids (0.25-20MW)
Modest R&D Success, Deregulated							
Simple Generation							
Traditional Cogen							
Tightly-Coupled Cogen							
Backup Power		1,500		<100			
Remote Power	100			100	100	100	200
Premium Power	<100						
Wastes & Biofuels							
Aggressive R&D Success, Regulated							
Simple Generation							
Traditional Cogen							
Tightly-Coupled Cogen							
Backup Power		1,500		<100			
Remote Power	100			100	100	100	200
Premium Power	100	<100					
Wastes & Biofuels							
Aggressive R&D Success, Deregulated							
Simple Generation	3,200			2,800			
Traditional Cogen							
Tightly-Coupled Cogen							
Backup Power		1,500		<100			
Remote Power	100			100	100	100	200
Premium Power	100	<100		<100		<100	<100
Wastes & Biofuels							

Note: Numbers in this table represent the estimated size of the market in megawatts that is appropriately sized for a given technology (on a facility basis) and is economically attractive. The actual market achieved by any given technology will be smaller as competing technologies capture a portion of the available market.

4.7.10 Oil and Gas Exploration & Production

Defining Characteristics

The oil and gas exploration and production (oil and gas E&P) industry is described by SIC code 13, and includes all those facilities involved in exploring and drilling for, or producing natural gas or petroleum. Depending on whether a facility is in exploration or production mode, its electricity demand may be dramatically different, as the requirements for drilling are often substantially higher than those required for pumping. Additional equipment installed to meet peak needs may therefore represent 100% redundancy over the base load demands over the life of the field. Much of this excess capacity can effectively be treated as backup power, to be activated only during scheduled maintenance to the primary power source. Facilities may be either on land or at sea, and frequently do not have access to the electricity grid, although they often have access to very low cost natural gas. The industry has an estimated total power demand of 10,000 MW and an estimated average facility demand of 0.5 MW.

Potential Markets for Onsite Power Generation

Oil and gas exploration & production power needs are dominated by remote and backup power. With many facilities being located off-grid, virtually all of the power could be considered as backup power, since common modes of operation are based upon installing multiple identical units, such that each unit may be periodically taken down for scheduled maintenance. However, this backup power will likely be in use much more frequently than more traditional backup equipment, as utilized in other industries. As a result, the decision between competing technologies will be based more on lifecycle (cost of electricity) costs than on capital cost alone. In the terminology used in this study, it has been estimated that 90% of the power demand can be described as “remote”, and only 30% as “backup”.

Opportunities for Micropower Technologies (less than 1 MW)

The most significant opportunities exist for microturbines (both unrecuperated and recuperated) and large reciprocating engines. Unlike the mining industry, the cost of fuel here is quite low, so that high efficiency is not favored as much. However, as in mining, if micropower technologies can be improved to deliver reliable, low-cost electricity at the low load factors common to the industry, there may be additional opportunities for simple generation. This is characterized by the large addressable markets for recuperated microturbines and large reciprocating engines in the *Aggressive R&D Success, Deregulated* scenario. Table 23 summarizes the magnitude of these opportunities.

In the *Modest R&D Success, Deregulated* scenario, opportunities presented for microturbines in this industry may be a particularly useful market for early roll-out of the technology, as many off-shore platforms already rely on small gas turbines to provide their power. Provided that there is the physical space to replace these units with multiple microturbines, this industry may represent an important early market.

Opportunities for Fuel Cell Hybrids (0.25-20 MW)

Like micropower technologies, opportunities for fuel cell hybrids in simple generation exist only in the *Aggressive R&D Success, Deregulated* scenario, but due to larger unit sizes (up to 20 MW), these opportunities are somewhat larger. Fuel cell hybrids do not appear attractive in other applications.

Table 23: Leading Opportunities for Micropower and Fuel Cell Hybrids in the Oil & Gas E&P Industry

	Addressable Market Potential based on 2010 Performance (Total MW)						
	Microturbines		Reciprocating Engines		Fuel Cells		
	Recup.	Unrecup.	Small	Large	High Temp.	Low Temp.	Hybrids (0.25-20MW)
Modest R&D Success, Deregulated							
Simple Generation							
Traditional Cogen							
Tightly-Coupled Cogen							
Backup Power		2,600		<100			
Remote Power	2,100	2,100		1,100			
Premium Power	<100						
Wastes & Biofuels							
Aggressive R&D Success, Regulated							
Simple Generation							
Traditional Cogen							
Tightly-Coupled Cogen							
Backup Power		2,600		<100			
Remote Power	2,100	2,100		1,100			
Premium Power	<100	<100					
Wastes & Biofuels							
Aggressive R&D Success, Deregulated							
Simple Generation	4,500			3,100			5,800
Traditional Cogen							
Tightly-Coupled Cogen							
Backup Power		2,600		<100			
Remote Power	2,100	2,100		1,100			
Premium Power	<100	<100					<100
Wastes & Biofuels							

Note: Numbers in this table represent the estimated size of the market in megawatts that is appropriately sized for a given technology (on a facility basis) and is economically attractive. The actual market achieved by any given technology will be smaller as competing technologies capture a portion of the available market.

4.7.11 Petroleum Refining

Defining Characteristics

The petroleum refining industry includes all those industries involved in the cracking and refining of petroleum products (SIC code 2911). The processes common to the industry are quite similar to those in the chemicals industry, with thermal conversion and separations accounting for most energy use. The industry has a total power demand of approximately 5,000 MW and an estimated average facility size of 21 MW.

Potential Markets for Onsite Power Generation

As in the chemicals industry, industrial power needs are dominated by simple generation and cogeneration applications. However, the temperatures required to meet these cogeneration opportunities tend to be slightly higher than those in the chemicals industry. There are substantial uses of non-traditional fuels, which in all industries have been defined as any material converted into energy that is not explicitly purchased for use as a fuel. Since the primary input to this industry is crude oil, the large observed market for wastes and biofuels is obviously based on fossil-derived fuels.

Opportunities for Micropower Technologies (less than 1 MW)

In the petroleum refining industry, micropower technologies are likely to find application only at those smaller facilities that match their sizes. As the current consolidation in the refining industry leads to the closure of the smallest refineries, opportunities for micropower in this industry are expected to gradually decrease in the foreseeable future. Table 24 summarizes the magnitude of the limited opportunities in this industry.

Opportunities for Fuel Cell Hybrids (0.25-20 MW)

Because of their larger unit sizes, fuel cell hybrids do somewhat better than micropower in this industry, but relative to opportunities in other industries, petroleum refining represents a relatively small market.

Table 24: Leading Opportunities for Micropower and Fuel Cell Hybrids in the Petroleum Refining Industry

	Addressable Market Potential based on 2010 Performance (Total MW)						
	Microturbines		Reciprocating Engines		Fuel Cells		
	Recup.	Unrecup.	Small	Large	High Temp.	Low Temp.	Hybrids (0.25-20MW)
Modest R&D Success, Deregulated							
Simple Generation	<100						
Traditional Cogen		<100		<100			
Tightly-Coupled Cogen							
Backup Power		400		100			
Remote Power							
Premium Power	<100			<100			
Wastes & Biofuels	100	100	<100	100		<100	400
Aggressive R&D Success, Regulated							
Simple Generation	100	<100		100			
Traditional Cogen				100			
Tightly-Coupled Cogen	100	<100		100			
Backup Power		400		100			
Remote Power							
Premium Power	<100	<100		<100			
Wastes & Biofuels	100	100		100		<100	400
Aggressive R&D Success, Deregulated							
Simple Generation	100	<100		100			1,000
Traditional Cogen		<100	<100	100	<100		
Tightly-Coupled Cogen	100	<100		100			1,000
Backup Power		400		100			
Remote Power							
Premium Power							
Wastes & Biofuels	100	100	<100	100	100	100	1,500

Note: Numbers in this table represent the estimated size of the market in megawatts that is appropriately sized for a given technology (on a facility basis) and is economically attractive. The actual market achieved by any given technology will be smaller as competing technologies capture a portion of the available market.

4.7.12 Other Petroleum

Defining Characteristics

The other petroleum industry includes all those facilities included in the petroleum industry (SIC code 29) not included in petroleum refining, defined as above. This industry is dominated by asphalt plants, in which the dominant processes are those involved with the conveyance, mixing, and heating of petroleum products and gravel to form asphalt. The industry has a total estimated power demand of just over 800 MW and an estimated average facility size of only 0.4 MW.

Potential Markets for Onsite Power Generation

The power needs of the other petroleum industry are dominated by simple generation, with some modest cogeneration loads as well.

Opportunities for Micropower Technologies (less than 1 MW)

The small number of asphalt plants that comprises the other petroleum industry have a very small total power demand, and therefore no substantial opportunities for micropower technologies exist. Table 25 summarizes the few opportunities that do exist. Any measurable opportunities would be predicated on achieving aggressive R&D targets in deregulated markets.

Opportunities for Fuel Cell Hybrids (0.25-20 MW)

No opportunities appear to exist for fuel cell hybrids in this industry, within the limits of this study.

Table 25: Leading Opportunities for Micropower and Fuel Cell Hybrids in the Other Petroleum Industry

	Addressable Market Potential based on 2010 Performance (Total MW)						
	Microturbines		Reciprocating Engines		Fuel Cells		
	Recup.	Unrecup.	Small	Large	High Temp.	Low Temp.	Hybrids (0.25-20MW)
Modest R&D Success, Deregulated							
Simple Generation							
Traditional Cogen							
Tightly-Coupled Cogen							
Backup Power		<100					
Remote Power							
Premium Power							
Wastes & Biofuels							
Aggressive R&D Success, Regulated							
Simple Generation							
Traditional Cogen							
Tightly-Coupled Cogen							
Backup Power		<100					
Remote Power							
Premium Power							
Wastes & Biofuels							
Aggressive R&D Success, Deregulated							
Simple Generation	400			300			
Traditional Cogen							
Tightly-Coupled Cogen							
Backup Power		<100					
Remote Power							
Premium Power							
Wastes & Biofuels							

Note: Numbers in this table represent the estimated size of the market in megawatts that is appropriately sized for a given technology (on a facility basis) and is economically attractive. The actual market achieved by any given technology will be smaller as competing technologies capture a portion of the available market.

4.7.13 Pulp and Paper

Defining Characteristics

The pulp and paper industry as defined herein includes all those facilities in SIC codes 2611 (pulp mills), 2621 (paper mills) and 2631 (paperboard mills). These comprise all facilities engaged in the production of pulp and paper products from both raw wood and recycled materials. Characteristic processes within this industry include material conveyance, filtration, pressing and drying. The industry is unique among those considered in this analysis in that it has measurable needs for each of the seven industrial power applications. The industry has a total estimated power demand of 20,000 MW and an estimated average facility size of 37 MW. Of particular note for onsite power generation is the highly-integrated, continuous, and highly-energy-self-sufficient nature of the industry.

Potential Markets for Onsite Power Generation

The fact that all seven industrial power needs are present in the pulp and paper industry deserves further mention. Simple generation is by definition a key application. Traditional cogeneration and tightly-coupled cogeneration are to be expected in an industry with high thermal loads (steam for process heating and hot air for drying). Backup power is required due to the continuous nature of many processes. Waste and biofuel use is due in large part to the high levels of residues remaining after the cellulosic portion of wood has been separated for papermaking. At present, these wastes are typically sent to steam boilers that the industry is eager to replace. This analysis has assumed that a small portion (5%) of the power consumption is as remote power, as a reduction in forest cover has forced the industries to increasingly move facilities into remote, non-grid areas. Also, the premium power demands of the industry exist primarily to provide DC power to paper rolling machinery that are highly controlled and “tuned” to account for decreasing paper elasticity as it dries.

Opportunities for Micropower Technologies (less than 1 MW)

Although power needs span across all applications and in many cases provide opportunities for several micropower technologies, the size of the individual technology/application pairings are limited to less than 1,000 MW each. This is due primarily to the large facility sizes characteristic of the industry. Table 26 summarizes the magnitude of these opportunities.

It should be noted that while the need for energy production from wastes and biofuels is large in this industry, the costs of gasification technologies appear to make this application prohibitively expensive for micropower technologies

Opportunities for Fuel Cell Hybrids (0.25-20 MW)

Despite a better size fit, opportunities for fuel cell hybrids in this industry are not substantially different from those of micropower, implying that economics and other technical fit criteria are the driving factors.

Table 26: Leading Opportunities for Micropower and Fuel Cell Hybrids in the Pulp and Paper Industry

	Addressable Market Potential based on 2010 Performance (Total MW)						
	Microturbines		Reciprocating Engines		Fuel Cells		
	Recup.	Unrecup.	Small	Large	High Temp.	Low Temp.	Hybrids (0.25-20MW)
Modest R&D Success, Deregulated							
Simple Generation							
Traditional Cogen	200	400		400			
Tightly-Coupled Cogen							
Backup Power		700		200			
Remote Power							
Premium Power	500			500			
Wastes & Biofuels	200						
Aggressive R&D Success, Regulated							
Simple Generation	400			400			
Traditional Cogen	100			500			
Tightly-Coupled Cogen	100			100			
Backup Power		700		200			
Remote Power							
Premium Power	800	600		800		300	
Wastes & Biofuels							
Aggressive R&D Success, Deregulated							
Simple Generation	400			400			
Traditional Cogen	300	800		700	400	200	
Tightly-Coupled Cogen	100			100			
Backup Power		700		200			
Remote Power							
Premium Power	800	500		800	500	500	600
Wastes & Biofuels				400	200		

Note: Numbers in this table represent the estimated size of the market in megawatts that is appropriately sized for a given technology (on a facility basis) and is economically attractive. The actual market achieved by any given technology will be smaller as competing technologies capture a portion of the available market.

4.7.14 Wood Products

Defining Characteristics

The wood products industry includes all those facilities typically included in the OIT's definition of forest products, with the exception of pulp and paper facilities. The remaining industries (logging, sawmills, furniture factories, etc.) tend to be fairly small, with a total power demand of approximately 7,000 MW spread over more than 38,000 facilities, for an average demand of just 0.2 MW per facility. Characteristic processes include sawing, milling, and material conveyance. The industry has modest thermal needs but uses substantial amounts of wastes and biofuels (e.g., hog and bark fuel).

Potential Markets for Onsite Power Generation

Power needs in the wood products industry are dominated by simple generation and tightly-coupled cogeneration (primarily for drying).

Opportunities for Micropower Technologies (less than 1 MW)

Table 27 summarizes the micropower opportunities in the wood products industry. In the *Modest R&D Success, Deregulated* scenario, opportunities are limited. However, in the two *Aggressive R&D Success* scenarios, several modest opportunities arise for micropower technologies in simple generation (recuperated microturbines and reciprocating engines) and tightly-coupled cogeneration (recuperated microturbines).

Opportunities for Fuel Cell Hybrids (0.25-20 MW)

In the *Aggressive R&D Success, Deregulated* scenario, opportunities for fuel cell hybrids in this industry are not substantially different from those of large reciprocating engines or recuperated microturbines, implying that economics and other technical fit criteria are the driving factors, and not product size. Given the small average facility size in this industry, the larger unit size of fuel cell hybrids considered here does not increase the size of the addressable market.

Table 27: Leading Opportunities for Micropower and Fuel Cell Hybrids in the Wood Products Industry

	Addressable Market Potential based on 2010 Performance (Total MW)						
	Microturbines		Reciprocating Engines		Fuel Cells		
	Recup.	Unrecup.	Small	Large	High Temp.	Low Temp.	Hybrids (0.25-20MW)
Modest R&D Success, Deregulated							
Simple Generation							
Traditional Cogen		<100					
Tightly-Coupled Cogen							
Backup Power		200					
Remote Power	<100		<100	<100	<100	<100	<100
Premium Power							
Wastes & Biofuels							
Aggressive R&D Success, Regulated							
Simple Generation	1,700			1,300			
Traditional Cogen							
Tightly-Coupled Cogen	1,900						
Backup Power		200					
Remote Power	<100		<100	<100	<100	<100	<100
Premium Power							
Wastes & Biofuels							
Aggressive R&D Success, Deregulated							
Simple Generation	2,600			1,700			1,300
Traditional Cogen	<100	100	<100	100			<100
Tightly-Coupled Cogen	2,700						1,300
Backup Power		200					
Remote Power	<100		<100	<100	<100	<100	<100
Premium Power							
Wastes & Biofuels							

Note: Numbers in this table represent the estimated size of the market in megawatts that is appropriately sized for a given technology (on a facility basis) and is economically attractive. The actual market achieved by any given technology will be smaller as competing technologies capture a portion of the available market.

4.7.15 Steel Mills

Defining Characteristics

The steel mills industry includes all those facilities included in SIC code 3312, blast furnaces and steel mills. This includes both large integrated steel mills, and smaller mini-mills. Characteristic energy-consuming processes can be divided into hot metal production and refining, hot rolling mills and cold rolling mills. Hot metal production in integrated mills occurs at scales substantially beyond the scope of micropower technology. It includes iron production (in a blast furnace) and steel production (in a basic oxygen furnace). In mini-mills hot metal is typically produced by melting scrap in electric arc furnaces. They also have capacities far greater than the micropower technologies under consideration here. Energy consumption in hot-rolling mills is mostly in the form of fuel gas for reheat or tunnel furnaces, and electric power for the mill-stand drives. In cold-rolling mills energy consumption is also primarily burner fuel and power for drives. The industry has a total estimated power demand of 5,700 MW and an average facility size of 27 MW.

Potential Markets for Onsite Power Generation

Power consumption in the steel mills industry is dominated by simple generation and waste fuel use. The latter application is driven primarily by the use of blast-furnace and coke oven offgases as fuel. The CO-rich nature of these gases provides some opportunities for the micropower technologies under consideration. The industry also has substantial thermal requirements, but these tend to be at temperatures that are too high to be met via cogeneration with micropower technologies.

Opportunities for Micropower Technologies (less than 1 MW)

Opportunities for micropower technologies in the steel mills industry are mostly limited to 200 to 400 MW per technology/application pairing due to the fact that most capacity is accounted for in a few large facilities, which tend to favor multi-MW power generation equipment over micropower. Table 28 summarizes the magnitude of the opportunities identified herein.

Opportunities for Fuel Cell Hybrids (0.25-20 MW)

Fuel cell hybrids appear somewhat more attractive, in part due to the larger unit size considered, and opportunities appear to exist in all three scenarios. In the *Aggressive R&D Success, Deregulated* scenario, fuel cell hybrids could achieve modest markets in simple generation, traditional cogeneration or generation using wastes & biofuels (specifically *wastes* in this industry).

Table 28: Leading Opportunities for Micropower and Fuel Cell Hybrids in the Steel Industry

	Addressable Market Potential based on 2010 Performance (Total MW)						
	Microturbines		Reciprocating Engines		Fuel Cells		
	Recup.	Unrecup.	Small	Large	High Temp.	Low Temp.	Hybrids (0.25-20MW)
Modest R&D Success, Deregulated							
Simple Generation							
Traditional Cogen	<100	<100		<100			
Tightly-Coupled Cogen							
Backup Power		200		100			
Remote Power							
Premium Power	200						
Wastes & Biofuels	400	400	<100	400	200	300	600
Aggressive R&D Success, Regulated							
Simple Generation	100			100			
Traditional Cogen				<100			
Tightly-Coupled Cogen							
Backup Power		200		100			
Remote Power							
Premium Power	200	100		200		100	100
Wastes & Biofuels	400	400	<100	400	100	300	600
Aggressive R&D Success, Deregulated							
Simple Generation	100			100			800
Traditional Cogen	<100	<100		100	<100	<100	400
Tightly-Coupled Cogen				<100			
Backup Power		200		100			
Remote Power							
Premium Power							
Wastes & Biofuels	400	400	<100	400	400	400	1,400

Note: Numbers in this table represent the estimated size of the market in megawatts that is appropriately sized for a given technology (on a facility basis) and is economically attractive. The actual market achieved by any given technology will be smaller as competing technologies capture a portion of the available market.

4.7.16 Steel Products

Defining Characteristics

The steel products industry includes all of those facilities included in SIC code 33, but not included in the steel mills industry, as defined previously. Such industries are engaged in the synthesis of steel pipe, wire, tubes and other shapes, along with electro-metallurgical products. Typical processes include heat treating (in direct-fired furnaces), and deforming (requiring electric power for drives), as well as electro-plating processes. The industry has a total power demand of approximately 1,500 MW and an average facility size of 2 MW.

Potential Markets for Onsite Power Generation

Industrial power needs are limited almost exclusively to simple generation.

Opportunities for Micropower Technologies (less than 1 MW)

With power needs dominated by simple generation, there are only a few niche applications for micropower in the steel products industry, which can be found mostly in the two *Aggressive R&D Success* scenarios. Table 29 summarizes the magnitude of these opportunities.

Opportunities for Fuel Cell Hybrids (0.25-20 MW)

Opportunities for fuel cell hybrids in this industry are not substantially different from those of large reciprocating engines or recuperated microturbines, but are limited to the *Aggressive R&D Success, Deregulated* scenario.

Table 29: Leading Opportunities for Micropower and Fuel Cell Hybrids in the Steel Products Industry

	Addressable Market Potential based on 2010 Performance (Total MW)						
	Microturbines		Reciprocating Engines		Fuel Cells		
	Recup.	Unrecup.	Small	Large	High Temp.	Low Temp.	Hybrids (0.25-20MW)
Modest R&D Success							
Simple Generation							
Traditional Cogen							
Tightly-Coupled Cogen							
Backup Power		100					
Remote Power							
Premium Power							
Wastes & Biofuels							
Aggressive R&D Success							
Simple Generation	500			500			
Traditional Cogen							
Tightly-Coupled Cogen							
Backup Power		100					
Remote Power							
Premium Power							
Wastes & Biofuels							
Aggressive R&D Success							
Simple Generation	700			700			800
Traditional Cogen							
Tightly-Coupled Cogen							
Backup Power		100					
Remote Power							
Premium Power							
Wastes & Biofuels							

Note: Numbers in this table represent the estimated size of the market in megawatts that is appropriately sized for a given technology (on a facility basis) and is economically attractive. The actual market achieved by any given technology will be smaller as competing technologies capture a portion of the available market.

5 Public Benefits Analysis

A variety of public benefits arise from the application of micropower technologies in the *Industries of the Future*. Broadly speaking, these benefits can be broken into two classes: environmental benefits and economic benefits. This study has quantified the environmental benefits as reductions in primary energy consumption and CO₂, SO₂, and NO_x emissions. The economic benefits have been quantified as the energy cost savings associated with the application of micropower technologies. For these types of benefits the applications of interest are simple generation, traditional cogeneration, tightly-coupled cogeneration, remote power generation, and generation using wastes & biofuels. The benefits from backup power and premium power are quite different and tend to be highly site specific, and have not been quantified here.

Public benefits were quantified using the following information:

- Estimates of the market potential for each micropower technology and fuel cell hybrids in each industry and application.
- Economics and emissions factors for each micropower technology and fuel cell hybrids.
- Economics and emissions factors associated with the technology that is most likely to be displaced (usually grid power, and in the case of cogeneration, also onsite fuel consumption for thermal energy needs).

Consistent with the market opportunity analysis presented in the preceding section, two scenarios were considered, *Modest R&D Success, Deregulated* and *Aggressive R&D Success, Deregulated*. Therefore, for the benefits analysis, the only difference between *Modest* and *Aggressive R&D Success* is in the assumptions regarding technology cost and performance. In the *Aggressive* scenario, it is assumed that the technology achieves the “high” cost and performance levels as listed in Table 12. In the *Modest* scenario, technology development proceeds more gradually, consistent with the “low” cost and performance levels as listed in Table 12 (page 44).

Using the total market opportunity identified earlier and the relative fits of the technologies in each application, Arthur D. Little estimated the year-by-year market penetration of the various micropower technologies. In previous work for the OIT, Arthur D. Little examined market penetration rates based on classic diffusion or “S” curves for various industrial technologies, and found that the penetration rates ranged significantly depending on the attributes of the technology in question. For the public benefits analysis, an intermediate rate of penetration was chosen as it was felt to best represent micropower and fuel cell hybrid technologies. Annual growth rates of 2% for the total addressable markets have been included to account for industrial growth.⁷

⁷ This is consistent with historical electricity demand growth in the United States in the 1990s.

Please note: The estimated market shares for the different micropower technologies are illustrative and are used to show **potential** public benefits. They are based entirely on relative economics so that in some applications, certain technologies do not achieve a significant fraction of their addressable market potential. To the extent that other factors will enter into the buying decision, such as relative emissions, footprint, noise, etc., market shares will be different than those shown here.

In this analysis, the applications were treated as independent: i.e., the impact of each was evaluated against the status quo. In reality, the applications influence one another. For example, since traditional cogeneration generally offers greater benefits than tightly-coupled cogeneration or simple generation, industrial power demand is more likely to be met using traditional cogeneration technologies, where possible. As these needs are filled, the remaining markets that are available for other applications will be reduced. The reader is strongly encouraged to keep this in mind when considering the magnitudes of the following opportunities and associated benefits.

5.1 Modest R&D Success

In this scenario, there is limited market potential for micropower technologies within the *Industries of the Future*. Of the five applications considered in the public benefits analysis, only traditional cogeneration and generation using wastes & biofuels result in any measurable benefits. These benefits are presented below in Table 30 and Table 31, respectively. Microturbines and large reciprocating engines appear the most attractive in this scenario. There is also limited market penetration of microturbines in remote power, but due to low efficiencies, most benefits are “negative”, with the exception of small reductions in NOx and energy cost savings.

Not surprisingly, cogeneration emerges as the leading opportunity in this scenario, as there are more cost savings to be derived relative to other applications, and the ability to capture these savings is less dependent on electrical generating efficiency than in other applications. Note that generation using wastes and biofuels also assumed cogeneration is taking place. Nevertheless, the potential benefits in this scenario are approximately two to three times smaller than those in the *Aggressive R&D Success* scenario (see below).

It should be noted that these results are somewhat influenced by the approach to the market analysis used here. There are undoubtedly attractive applications within the *Industries of the Future* that are not effectively captured due to the “granularity” of the analysis. Nevertheless, it is clear from the analysis that if micropower and fuel cell hybrid technologies achieve only modest cost and performance levels, there are limited opportunities within the *Industries of the Future*.

Table 30: Potential Public Benefits of Micropower (25-1,000 kW) and Fuel Cell Hybrids (0.25-20 MW) in Traditional Cogeneration Applications in the *Industries of the Future – Modest R&D Success, Deregulated Scenario*

	Net Impacts by 2020 (annual unless otherwise stated)					
	Cumulative Market Penetration (MW)	Primary Energy Displaced (Trillion Btu)	Energy Cost Savings (\$Million)	CO ₂ Displaced (kTons)	SO ₂ Displaced (kTons)	NO _x Displaced (kTons)
Recuperated Microturbines	3,000	150	\$390	15,000	56	50
Unrecuperated Microturbines	7,500	370	\$910	38,000	141	146
Small Reciprocating Engines	0	0	\$0	0	0	0
Large Reciprocating Engines	2,000	100	\$220	10,200	38	34
High-Temperature Fuel Cells	0	0	\$0	0	0	0
Low-Temperature Fuel Cells	0	0	\$0	0	0	0
Total (micropower)	12,500	620	\$1,520	63,200	235	230
Fuel Cell Hybrids (0.25-20MW)	0	0	\$0	0	0	0
Total (all)	12,500	620	\$1,520	63,200	235	230

Table 31: Potential Public Benefits of Micropower (25-1,000 kW) and Fuel Cell Hybrids (0.25-20 MW) in Generation Using Wastes & Biofuels Applications in the *Industries of the Future – Modest R&D Success, Deregulated Scenario*

	Net Impacts by 2020 (annual unless otherwise stated)					
	Cumulative Market Penetration (MW)	Primary Energy Displaced (Trillion Btu)	Energy Cost Savings (\$Million)	CO ₂ Displaced (kTons)	SO ₂ Displaced (kTons)	NO _x Displaced (kTons)
Recuperated Microturbines	2,000	100	\$320	11,700	39	35
Unrecuperated Microturbines	1,800	80	\$350	8,800	33	34
Small Reciprocating Engines	200	10	\$20	1,100	4	-3
Large Reciprocating Engines	1,600	80	\$210	8,200	30	27
High-Temperature Fuel Cells	<100	<10	<\$10	<100	<1	<1
Low-Temperature Fuel Cells	500	20	\$20	4,400	10	9
Total (micropower)	6,100	290	\$920	34,200	117	102
Fuel Cell Hybrids (0.25-20MW)	600	30	\$10	3,200	13	10
Total (all)	6,700	320	\$930	37,400	130	112

5.2 Aggressive R&D Success

5.2.1 Simple Generation

In simple generation, micropower and fuel cell hybrids technologies replace the need for electricity otherwise provided by the grid. By the year 2020, a cumulative potential market penetration of approximately 43,000 could displace over 800 trillion Btu of energy annually if micropower and fuel cell hybrid technology were applied solely in simple generation applications (Table 32). This could potentially result in annual energy cost savings of almost \$2.5 billion and reductions in emissions of 150 million tons of CO₂, 770 thousand tons of SO₂ and 600 thousand tons of NO_x.

In simple generation applications, recuperated microturbines are estimated to have the largest potential market share among the technologies considered in this analysis (18,600 MW), followed by fuel cell hybrids (13,500 MW) and large reciprocating engines (10,800 MW). The large market for fuel cell hybrids is driven in part by the larger unit size (up to 20 MW) relative to the other technologies here, which were limited to 1 MW in size. Based on the assumptions made here, unrecuperated microturbines, small reciprocating engines, and low- and high-temperature fuel cells are expected to have negligible penetration in this available market.

Table 32: Potential Public Benefits of Micropower (25-1,000 kW) and Fuel Cell Hybrids (0.25-20 MW) in Simple Generation Applications in the *Industries of the Future – Aggressive R&D Success, Deregulated Scenario*

	Net Impacts by 2020 (annual unless otherwise stated)					
	Cumulative Market Penetration (MW)	Primary Energy Displaced (Trillion Btu)	Energy Cost Savings (\$Million)	CO ₂ Displaced (kTons)	SO ₂ Displaced (kTons)	NO _x Displaced (kTons)
Recuperated Microturbines	18,600	160	\$1,030	52,800	314	250
Unrecuperated Microturbines	<100	<10	<\$10	<100	<1	<1
Small Reciprocating Engines	0	0	\$0	0	0	0
Large Reciprocating Engines	10,800	170	\$540	34,800	185	150
High-Temperature Fuel Cells	<100	<10	<\$10	<100	<1	<1
Low-Temperature Fuel Cells	<100	<10	<\$10	<100	<1	<1
Total (micropower)	29,400	330	\$1,570	87,600	499	400
Fuel Cell Hybrids (0.25-20MW)	13,400	500	\$790	59,200	266	195
Total (all)	42,800	830	\$2,360	146,800	765	595

In simple generation, fuel cell hybrids up to 20 MW in size have the potential to displace the greatest amount of primary energy (500 trillion Btu) and carbon dioxide (60 million tons), because of their high electrical efficiency. By comparison, recuperated microturbines and reciprocating engines combined produce less energy savings, despite a combined 2020 market penetration of more than double that of fuel cell hybrids. Recuperated microturbines have the largest potential for energy cost savings, and displace the most SO₂ and NO_x emissions in the year 2020 compared to the other technologies considered.

5.2.2 Traditional Cogeneration

At the small size ranges of micropower technologies, there are very few currently available technologies that can economically cogenerate heat and electricity. It has therefore been assumed that the baseline technology that will be displaced by traditional cogeneration is grid-based electricity and an 80% efficient boiler.

By the year 2020, a cumulative potential market penetration of approximately 24,000 MW for all micropower technologies could displace more than 1,100 trillion Btu of energy in traditional cogeneration applications (Table 33). This would result in annual savings in excess of \$2 billion and emissions reductions of approximately 120 million tons of CO₂, 450 thousand tons of SO₂ and 400 thousand tons of NO_x by the year 2020. Note that per MW, these emissions savings are up to 1.5 times greater than for simple generation.

Table 33: Potential Public Benefits of Micropower (25-1,000 kW) and Fuel Cell Hybrids (0.25-20 MW) in Traditional Cogeneration Applications in the *Industries of the Future – Aggressive R&D Success, Deregulated Scenario*

	Net Impacts by 2020 (annual unless otherwise stated)					
	Cumulative Market Penetration (MW)	Primary Energy Displaced (Trillion Btu)	Energy Cost Savings (\$Million)	CO ₂ Displaced (kTons)	SO ₂ Displaced (kTons)	NO _x Displaced (kTons)
Recuperated Microturbines	2,300	110	\$220	11,600	43	37
Unrecuperated Microturbines	9,300	460	\$920	47,200	175	167
Small Reciprocating Engines	100	10	\$10	700	2	-1
Large Reciprocating Engines	9,500	470	\$830	48,000	178	155
High-Temperature Fuel Cells	100	10	\$10	500	2	2
Low-Temperature Fuel Cells	700	30	\$40	3,500	15	12
Total (micropower)	22,000	1,090	\$2,030	111,500	415	372
Fuel Cell Hybrids (0.25-20MW)	1,700	80	\$100	8,700	35	26
Total (all)	23,700	1,170	\$2,130	120,200	450	398

Unrecuperated microturbines and large reciprocating engines are estimated to have the largest (and roughly equal) market shares among the technologies considered in this analysis, followed by recuperated microturbines and fuel cell hybrids. Small reciprocating engines, low-temperature fuel cells and high-temperature fuel cells are all expected to obtain some market share in this application. Note that although the unrecuperated microturbine technology itself is less efficient than the grid, when used in traditional cogeneration, significant overall benefits result, as the economics are less sensitive to electrical efficiency alone and more to capital cost.

5.2.3 Tightly-Coupled Cogeneration

In tightly-coupled cogeneration, micropower and fuel cell hybrid technologies are used to produce electric power and heat for industrial processes, in the form of hot exhaust

gases. At the small size ranges of most of these technologies, there are very few currently existing technologies that can economically cogenerate heat and electricity. It has therefore been assumed that the baseline technology that will be displaced by tightly-coupled cogeneration is grid power and the fuel used to provide direct heat in industrial processes.

By the year 2020, a cumulative potential market penetration of approximately 28,000 MW for micropower and fuel cell hybrid technologies could displace approximately 1,600 trillion Btu of energy from the grid if applied solely in tightly-coupled cogeneration applications (Table 34). In the year 2020, this could potentially result in annual savings of approximately \$1.7 billion, 150 million tons of CO₂, 550 thousand tons of SO₂, and 460 thousand tons of NO_x.

Table 34: Potential Public Benefits of Micropower (25-1,000 kW) and Fuel Cell Hybrids (0.25-20 MW) in Tightly-Coupled Cogeneration Applications in the *Industries of the Future – Aggressive R&D Success, Deregulated Scenario*

	Net Impacts by 2020 (annual unless otherwise stated)					
	Cumulative Market Penetration (MW)	Primary Energy Displaced (Trillion Btu)	Energy Cost Savings (\$Million)	CO ₂ Displaced (kTons)	SO ₂ Displaced (kTons)	NO _x Displaced (kTons)
Recuperated Microturbines	14,500	860	\$770	81,400	278	249
Unrecuperated Microturbines	<100	<10	<\$10	<100	<1	<1
Small Reciprocating Engines	0	0	\$0	0	0	0
Large Reciprocating Engines	1,900	110	\$100	10,200	35	31
High-Temperature Fuel Cells	0	0	\$0	0	0	0
Low-Temperature Fuel Cells	0	0	\$0	0	0	0
Total (micropower)	16,400	970	\$870	91,600	313	280
Fuel Cell Hybrids (0.25-20MW)	11,300	590	\$790	58,800	231	176
Total (all)	27,700	1,560	\$1,660	150,400	544	456

Recuperated microturbines achieve the largest market share among the technologies considered in this analysis (14,500 MW) followed by fuel cell hybrids (11,300 MW) and large reciprocating engines (1,900 MW). Unrecuperated microturbines, small reciprocating engines, and low- and high-temperature fuel cells are not expected to achieve significant market share due to lower overall techno-economic fits. Because higher efficiency technologies are expected to account for a larger portion of the tightly-coupled cogeneration market relative to traditional cogeneration, the energy and emissions savings per MW installed are generally larger.

Although recuperated microturbines are only marginally more efficient than the grid in 2020 in the *Aggressive R&D Success* scenario, when used in tightly-coupled cogeneration applications they could have significant national benefits. Most (>85%) of the energy and CO₂ savings are due to the benefits of cogeneration, whereas the other emissions benefits are more a mix of displacing grid electricity with clean power and of displacing direct fuel use with cogenerated heat.

5.2.4 Remote Power

In remote power, the fuel available for onsite power generation is typically diesel or propane, although well-head natural gas is available at many sites in the oil and gas E&P industry. This was factored into this analysis when considering the technology that is likely to be displaced if micropower or fuel cell hybrid technologies capture market share. In the oil and gas E&P industry where natural gas is present, micropower and fuel cell hybrid technologies were assumed to displace large, conventional gas reciprocating engines, with performance equivalent to the optimistic, year 2000 performance described in this analysis. In all other industries with remote power needs, the micropower and fuel cell hybrid technologies were assumed to displace large diesel reciprocating engines with optimistic performance as described earlier in the report for the year 2000.

By 2020, the cumulative potential market for micropower and fuel cell hybrid technologies could reach approximately 3,000 MW (Table 35). As some of these technologies are more efficient and some are less efficient than the existing technology they are replacing, the net amount of primary energy saved is small. While most of the new technologies are cost competitive, and could potentially result in annual cost savings of approximately \$180 million, the environmental benefits are limited. The greatest potential environmental benefits are in CO₂ and NO_x displacement. SO₂ displacement does not change significantly as this is a function of the type and quantity of fuel used, which does not change significantly in this application.

Table 35: Potential Public Benefits of Micropower (25-1,000 kW) and Fuel Cell Hybrids (0.25-20 MW) in Remote Power Applications in the *Industries of the Future – Aggressive R&D Success, Deregulated Scenario*

	Net Impacts by 2020 (annual unless otherwise stated)					
	Cumulative Market Penetration (MW)	Primary Energy Displaced (Trillion Btu)	Energy Cost Savings (\$Million)	CO ₂ Displaced (kTons)	SO ₂ Displaced (kTons)	NO _x Displaced (kTons)
Recuperated Microturbines	600	<10	\$30	300	<1	33
Unrecuperated Microturbines	600	-10	\$40	-600	Slightly neg.	33
Small Reciprocating Engines	<100	<10	<\$10	Slightly neg.	<1	1
Large Reciprocating Engines	1,600	20	\$70	1,400	2	86
High-Temperature Fuel Cells	<100	<10	<\$10	<100	1	2
Low-Temperature Fuel Cells	0	0	\$0	0	0	0
Total (micropower)	2,800	20	\$140	1,100	3	154
Fuel Cell Hybrids (0.25-20MW)	200	10	\$40	400	7	15
Total (all)	3,000	30	\$180	1,500	10	169

Large reciprocating engines (300-1,000 kW) have the largest potential market share (1,600 MW) among the technologies considered in this analysis. Unrecuperated microturbines, recuperated microturbines, and fuel cell hybrids follow with potential market shares of 600 MW, 600 MW, and 200 MW respectively. Small reciprocating

engines, and low- and high-temperature fuel cells appear to have minimal potential in remote power applications relative to the competition.

Large reciprocating engines could potentially displace over 20 trillion Btu of primary energy in 2020, while unrecuperated microturbines, because of their lower efficiency, would actually increase the demand for primary energy in 2020 by approximately 10 trillion Btu, with an accompanying increase in CO₂ emissions of 600 thousand tons. Nevertheless, they still manage to reduce NO_x emissions.

5.2.5 Generation Using Wastes and Biofuels

In waste and biofuel power generation, industrial process wastes are converted into electricity and process heat, typically as steam or hot water. Waste fuels are commonly used with cogeneration packages both because the industries in which they occur have high thermal needs, and because of the low electrical efficiency of most waste-fuel power systems. However, at the micropower technology scale of under 1 MW, facilities are less likely to have onsite power generation equipment, and are therefore more likely to be simply incinerating the wastes and in some cases recovering the resulting heat. This analysis has therefore assumed that waste-fueled micropower technologies would displace grid-power plus fuel burned onsite to provide process steam or hot water.

In all cases, CO₂ emissions from waste and biofuel use is assumed to be zero, either because the fuel is renewable or, if the waste is derived from fossil-fuels, its use in power generation does not change CO₂ emissions from the plant, since these emissions would have occurred anyway, as long as the waste fuel is already being used. However, any displacement of purchased electricity results in a net reduction of CO₂ emissions.

By the year 2020, a cumulative potential market penetration of approximately 14,000 MW for micropower and fuel cell hybrid technologies could displace nearly 700 trillion Btu of energy if applied solely in waste and biofuel applications (Table 36). This could potentially result in annual savings of approximately \$1.5 billion, and a reduction in emissions of 85 million tons of CO₂, 290 thousand tons of SO₂ and 225 thousand tons of NO_x.

Fuel cell hybrids up to 20 MW in size have the largest potential market share (9,100 MW). Unrecuperated and recuperated microturbines, large reciprocating engines, and low-temperature fuel cells all have market shares of about 1,000 MW. High-temperature fuel cells and small reciprocating engines do not achieve significant market shares relative to the other technologies in this application, based on the study assumptions.

Table 36: Potential Public Benefits of Micropower (25-1,000 kW) and Fuel Cell Hybrids (0.25-20 MW) in Generation Using Wastes and Biofuels in the *Industries of the Future* – Aggressive R&D Success, Deregulated Scenario

	Net Impacts by 2020 (annual unless otherwise stated)					
	Cumulative Market Penetration (MW)	Primary Energy Displaced (Trillion Btu)	Energy Cost Savings (\$Million)	CO ₂ Displaced (kTons)	SO ₂ Displaced (kTons)	NO _x Displaced (kTons)
Recuperated Microturbines	1,200	60	\$160	7,400	25	20
Unrecuperated Microturbines	1,000	50	\$110	5,400	19	18
Small Reciprocating Engines	200	10	\$10	800	3	-2
Large Reciprocating Engines	1,100	60	\$120	6,500	22	19
High-Temperature Fuel Cells	600	30	\$40	3,200	13	10
Low-Temperature Fuel Cells	1,000	50	\$160	9,400	23	19
Total (micropower)	5,100	260	\$600	32,700	105	84
Fuel Cell Hybrids (0.25-20MW)	9,100	440	\$920	53,000	187	141
Total (all)	14,200	700	\$1,520	85,700	292	225

5.3 Summary

Table 37 and Table 38 summarize the potential market penetration and public benefits, respectively, focusing on the *Aggressive R&D Success, Deregulated* scenario only, since benefits are more limited in the *Modest R&D Success, Deregulated* scenario. Recall that potential market size and benefits are not additive across applications, but are additive across technologies within a given application. The highlighted values in Table 37 represent the leading opportunities for each technology.

Traditional cogeneration and generation using wastes & biofuels appear to offer opportunities to the broadest range of technologies, whereas other applications appear more likely to be attractive to a subset of technologies. Remote power appears to be a niche opportunity, whereas simple generation offers a significantly larger opportunity, but with fewer benefits per MW installed. Overall, microturbines, large reciprocating engines and fuel cell hybrids have the greatest potential for market penetration. The market for fuel cell hybrids is driven in part by the larger unit size (up to 20 MW) relative to the other technologies here, which were limited to 1 MW. The other technologies do not appear as competitive within the *Industries of the Future*, within the limits of this study.

Table 37: Potential Market Penetration for Micropower (25-1,000 kW) and Fuel Cell Hybrids (0.25-20 MW) within the *Industries of the Future – Aggressive R&D Success, Deregulated Scenario*

	Cumulative MW Installed by 2020				
	Straight Generation	Traditional Cogeneration	Tightly-Coupled Cogeneration	Remote Power	Generation Using Wastes & Biofuels
Recuperated Microturbines	18,600	2,300	14,500	600	1,200
Unrecuperated Microturbines	<100	9,300	<100	600	1,000
Small Reciprocating Engines	<100	100	<100	<100	200
Large Reciprocating Engines	10,800	9,500	1,900	1,600	1,100
High-Temperature Fuel Cells	<100	100	<100	<100	600
Low-Temperature Fuel Cells	<100	700	<100	<100	1,000
<i>Total (micropower)</i>	<i>29,400</i>	<i>22,000</i>	<i>16,400</i>	<i>2,800</i>	<i>5,100</i>
Fuel Cell Hybrids (0.25-20MW)	13,400	1,700	11,300	200	9,100
<i>Total (all)</i>	<i>42,800</i>	<i>23,800</i>	<i>27,700</i>	<i>3,000</i>	<i>14,200</i>

Note: Entries in **bold** represent the best opportunities for each of the technologies

Table 38: Summary of Potential Public Benefits within the *Industries of the Future* by Industrial Application – *Aggressive R&D Success, Deregulated Scenario*

	Annual Public Benefits in 2020				
	Net Primary Energy Displaced (Trillion Btu)	Net Energy Cost Savings (\$Million)	Net CO2 Displaced (kTons)	Net SO2 Displaced (kTons)	Net NOx Displaced (kTons)
Simple Generation	830	\$2,360	146,800	765	595
Traditional Cogeneration	1,170	\$2,130	120,200	450	398
Tightly-Coupled Cogeneration	1,560	\$1,660	150,400	544	456
Remote Power	30	\$180	1,500	10	169
Generation Using Wastes & Biofuels	700	\$1,520	85,700	292	225

Note: Benefits are not additive across applications.

From these results, it can be concluded that major benefits may be achieved through the introduction of those technologies that can be used for simple generation, tightly-coupled cogeneration and traditional cogeneration, *provided that cost and performance targets as described in the Aggressive R&D Scenarios can be met*. Power generation from wastes and biofuels may lead to smaller, but still substantial, public benefits.

In reality, these applications are dependent on one another since the provision of power through one of these applications will necessarily reduce the amount of power that can be supplied from the others. Given the industrial attractiveness of traditional cogeneration, it is likely to achieve the greatest benefits.

6 Detailed Technology Assessments

This section reviews the technology status of microturbines, reciprocating engines, fuel cells, and fuel cell gas turbine hybrids.⁸

6.1 Microturbines

6.1.1 Technology Description

Microturbines are for the most part, single-stage, single-shaft, low pressure ratio gas turbines. The rotating equipment used in microturbines is relatively small, typically a few inches in diameter. Figure 36 illustrates the major components in a microturbine.

Air is drawn through the generator by the compressor, which increases the pressure of the air from ambient conditions to approximately 70 psig, and forces the air into the recuperator (regenerator), if present. In the recuperator, the exhaust heat is used to preheat the air before it enters the combustion chamber where the heated air is mixed with fuel and burned. The hot gases then expand through the turbine that drives the compressor and the generator. The turbine exhaust is then ducted through the recuperator (in the recuperated configuration) before being discharged. Typically, the generator is mounted on the same shaft as the turbine and rotates at the same speed (70,000-90,000 rpm) to produce high-frequency, alternating-current electric power.

The balance of the system includes:

- Rectifier and inverter, which converts the high-frequency AC power (e.g., 1,800 Hz) to DC power, then back to low-frequency (50-60 Hz), grid-compatible AC power
- Heat recovery equipment, for cogeneration applications
- Boost compressor (for natural gas fuel, if needed)
- Enclosure

As with other gas turbine technology, emissions from microturbines are expected to be quite low; less than 9 ppm NO_x when burning natural gas. Early units will have higher emissions.

Microturbines are usually smaller than 500 kW in size although manufacturers are targeting sizes as high as 1 MW by 2010. Multiple units can be combined for larger installations. Unrecuperated models currently have LHV electrical efficiencies in the mid-teens to low 20's. Recuperated microturbines can currently achieve efficiencies of 25-30% (see Table 39). In cogeneration applications that can effectively use the waste heat, the overall system efficiency can be quite high (80+%). Most manufacturers have assumed that due to the relatively low electrical efficiency, standby and peaking power will be the most attractive non-cogeneration applications in the near term.

⁸ Unless otherwise stated, all efficiencies and heat rates are quoted on a *lower heating value* (LHV) basis.

Figure 36: Picture of Microturbine Showing the Major Components

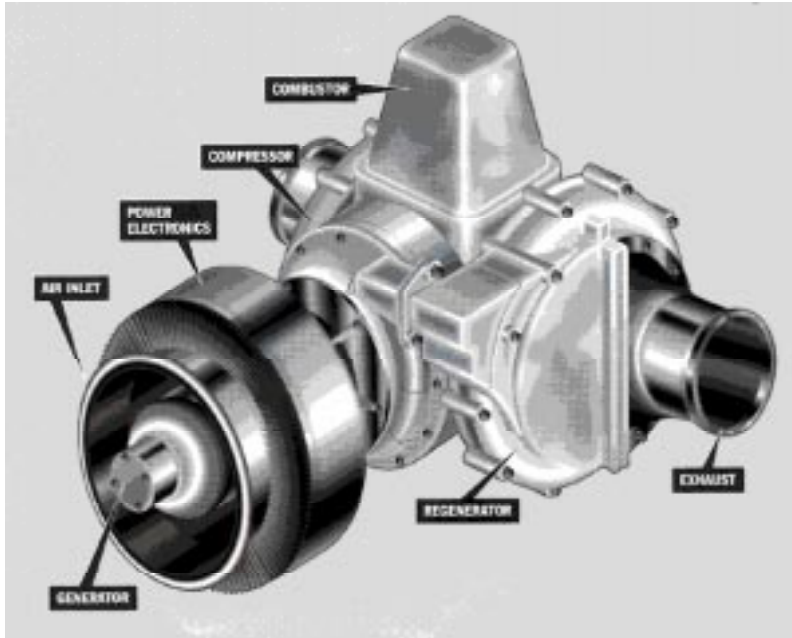

Source: Allison Engine Company marketing literature

Characteristics that differentiate one microturbine from another include:

- The number of shafts in the design
- The type of bearings used
- Whether the system is recuperated
- The type of materials used in the hot section.

Each arrangement has its own advantages and disadvantages (see Table 40). Most manufacturers use a single shaft design with air bearings and recuperators (Table 41).

Table 39: Technology Performance Characteristics of Microturbines

Current System Efficiency (%)	LHV: 17 - 20% unrecuperated, 25 - 30%+ recuperated	
Lifetime (years)	5 - 10 years, depending on duty cycle	
Emissions (natural gas fuel)	Current	Future (2010)
CO ₂	670 - 1,180 g/kWh (17-30% efficiency)	Negligible
SO ₂	Negligible (natural gas)	< 9 ppm
NO _x	9 - 25 ppm	< 9 ppm
CO	25 - 50 ppm	Negligible
PM	Negligible	Negligible
Duty Cycle	<ul style="list-style-type: none"> Fully dispatchable Duty cycle will vary, but currently favors peaking or standby applications due to relatively low efficiency Cogeneration is possible, but usually in the form of hot water rather than steam 	
Typical System Size	<ul style="list-style-type: none"> Current Products: 25-100 kW Future products: up to 1 MW Units can be bundled or "ganged" to produce power in larger increments. 	
Maintenance Requirements	<ul style="list-style-type: none"> 10,000-12,000 hr before major overhaul (rotor replacement) 	

Source: Manufacturer Surveys, ADL estimates

Table 40: Microturbine Design Options

Technology	Advantage	Disadvantage
Single Shaft Design	Fewer moving parts; eliminates the need for gearbox; quieter operation	Compromise between the needs of the turbine engine and a particular load
Two Shaft Design	Flexibility in matching the turbine engine and the load, reduced stresses and prolonged engine life	More moving parts; need for a gearbox; generally higher cost
Air Bearings	Eliminates the need for oil-based cooling system and its associated maintenance	Reliability concerns associated with friction during starts and stops
Oil Bearings	Proven technology with established track record	Oil pump and miscellaneous cooling equipment required
Unrecuperated	Lower cost; higher reliability; more heat available for cogen applications	Significantly lower efficiency with current technology
Recuperated	Higher efficiency; lower thermal : electric ratio	Higher cost, lower reliability and life with current technology
Ceramic Hot Section	Higher operating temperature; improved efficiency	More complicated design; still in R&D phase
Metal Hot Section	More conventional design; commercially available	Lower operating temperature; less efficient

Table 41: Current Microturbine Configurations

Company	Type	Bearings	Recuperator	Comments
AlliedSignal	Single Stage	Air Bearings	Yes	Developing ceramic engine with expected efficiency of 35%
Allison Engine	Single Stage	Air Bearings	Yes	Based on their tank APU
Bowman (UK)	Single Stage	Oil Bearings	Optional	Diesel or natural gas fuel
Capstone	Single Stage	Air Bearings	Yes	Cogen package expected after initial production introduction
Elliott / GE	Single Stage	Oil Bearings	Some models	Multi-fuel flexibility
NREC	Two Stage	Oil Bearings	Yes	Packaged with a NREC-designed chiller
Williams International	Single Stage	Oil Bearings	Yes	APU derivatives for mobile and stationary power applications

Source: Company marketing literature, industry news articles and EPRI

6.1.2 Current and Projected Technology Performance Characteristics

Table 42 below summarizes the projected technology performance characteristics for microturbines. The installed cost values are for straight-generation applications. The installed cost for cogeneration applications would be 30-40% higher. While the year 2000 values are based on first-generation commercial units with relatively low production volumes, the 2010 figures are based on high-volume production and the incorporation of advanced materials, and would be representative of highly-successful commercialization efforts and aggressive R&D.

Table 42: Projected Performance Characteristics for Microturbines

	2000 ¹	2010 ²
Unit size range (kW)	50 - 300	50 - 1,000
Unrecuperated		
Installed cost (\$/kW)	600 - 720	320 - 480
Non-fuel O&M cost (¢/kWh)	0.5 - 1.0	0.1 - 0.2
Electrical efficiency	17 - 20%	23 - 30%
Recuperated		
Installed cost (\$/kW)	750 - 900	400 - 600
Non-fuel O&M cost (¢/kWh)	0.5 - 1.0	0.1 - 0.2
Electrical efficiency (% LHV)	23 - 30%	38 - 42%

Note: The installed cost values are for straight-generation applications. Installed costs would be approximately 30-40% higher for cogeneration applications.

¹ Based on first-generation commercial units and relatively lower production volumes

² Based on high-volume production and application of advanced materials

6.1.3 Key Players and Products

Microturbine manufacturers are hoping to ultimately achieve relatively high efficiency at low cost (see Table 43). These costs, however, are highly dependent on the scale of commercialization, requiring a production rate greater than 10,000 units per year. The electric efficiency figures are based on natural gas fuel and generally do not include power conditioning losses. The efficiency and price numbers shown in Table 43 are taken directly from marketing literature and may not represent actual efficiencies or commercial prices in the near term.

Table 43: Manufacturer Claims for Cost and Performance of Microturbine Technology

Company	Size (kW)	Electric Efficiency	Total Cogen Efficiency	Power Density (W/kg)	Estimated Installed Price (\$/kW)	Comments
AlliedSignal	50, 75, 200	30% +	60-75%	170-180	\$350	Cogen package available in 1999
Allison Engine	50, 250	30%		290	\$225 - 350	
Capstone	30	26-30%+		165	<\$500	37 units in beta testing in early 1998
Elliott	45, 60, 80, 200	30%+	85%	330	\$400-600 (intro prices)	GE Power Systems becomes Elliott's global exclusive distributor
NREC	30 - 250	30%+	80%	66		Commercial production is targeted for 1999
Teledyne Continental Motors	50-55					Teledyne has developed a 50-55kW engine for DOE hybrid vehicle program.
Williams International	40 - 400					GM and Williams announced plans to jointly develop microturbines for power applications

Source: company marketing literature and EPRI. Prices do not include the cost of heat recovery for cogeneration.

6.1.4 Product Status and Development Timeline

The status of microturbine generation technology development in 1999 is depicted in Figure 37 below showing that domestic manufacturers, such as AlliedSignal, Elliott Energy Systems and Capstone are closest to market entry. Arthur D. Little expects European manufacturers, such as Volvo and ABB, to be next, followed closely by the Japanese. Details on selected manufacturers are presented below.

Figure 37: Status of Microturbine Generation Technology in 1999

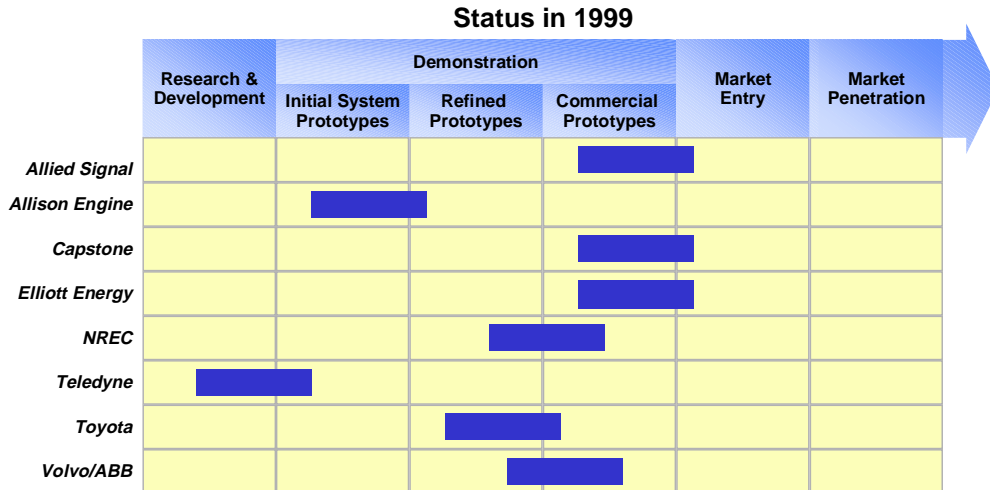

Elliott Energy Systems recently announced that GE Power Systems will become the global distributor for its line of microturbine products to electric and gas utilities and their marketing affiliates, public power utilities, power and gas marketers, independent power producers, energy service companies and regulatory agencies. GE is Elliott’s exclusive distributor in all countries except Japan and Germany. Elliott’s other partner is Magnetek, which provides power electronics and is part of a joint venture for distribution and packaging. Bowman will be assembling and marketing microturbine cogeneration packages in Europe, using the Elliott microturbine.

Nicor, a Naperville, Illinois, based holding company with Nicor Gas as the principal business, has reached an agreement with GE Power Systems to become the exclusive distributor of GE microturbines in Illinois and Wisconsin. Under the agreement, Nicor will also function as the non-exclusive distributor in Nicor’s service areas in Indiana, Ohio, Minnesota, and Michigan.

Northern Research and Engineering (NREC) has developed a 2-stage microturbine with slower rotating speeds, with the turbine shaft connected to a gearbox to drive low-speed equipment for air compression, refrigeration, pumping, as well as power generation. The 70 kW microturbine uses conventional generator and controls and has a net electrical efficiency (LHV) of 33%.

Capstone Turbine is backed by venture capital financiers and has signed a memorandum of understanding with Kohler Power Systems. Under the MOU, Kohler will market, distribute, and service Capstone MicroTurbine generators, in conjunction with related Kohler engineered switchgear and remote communication packages. Capstone plans to market its units in “CapPacs”, which are multi-unit systems with up to 2,000 kW of capacity. Capstone has also reached a preliminary agreement with Lincoln Electric to put Capstone’s microturbine in Lincoln’s arc welding equipment as

a DC power source. Lincoln Electric, based in Cleveland, is a manufacturer of welding equipment, industrial electric motors, plasma and oxyfuel cutting equipment. Under the terms of the agreement, Lincoln will also explore technical integration and marketing opportunities for Capstone's microturbines.

AlliedSignal has developed the Parallon 75, a 75 kW microturbine with a single shaft spinning at 65,000 rpm. Visteon Automotive Systems, an enterprise of Ford Motor Co., will provide the system's power electronic system and related electrical controls. A network of partners has been developed to help accelerate early sales. AlliedSignal's distribution partners include: PSE&G/Energis, Unicom, New Energy Ventures, Mercury Electric, Sonat, and Electricite de France. Each of these companies will have its exclusive territory. Sonat, for example, will purchase an undisclosed number of units from AlliedSignal and has exclusive rights to sell and service the units in 13 southeastern states and the District of Columbia. AlliedSignal has also named Honeywell as the exclusive authorized service provider for the Parallon power system. Honeywell will provide a full range of services, including installation services, scheduled and unscheduled maintenance, and remote monitoring.

General Motors announced in May 1998 that it had formed an alliance with Williams International to jointly develop, market and manufacture microturbines for the energy market. The two companies worked together to create a 40 kW generator for a hybrid electric vehicle in 1998 and will now apply the technology to commercial and industrial markets, which GM estimated to be worth \$5 billion. No further information is available.

6.1.5 Microturbine Markets, Drivers and Barriers

Microturbines are entering the market entry phase of commercialization. In addition to traditional applications such as cogeneration and backup power, manufacturers anticipate that first-generation microturbines will be used in distributed generation applications, including the relief of transmission and distribution constraints, or to reduce costs during hours of peak demand.

Microturbines have the potential to dramatically change the nature of power generation by accelerating the trend towards distributed generation. It should be noted that even if early-generation microturbines are not cost-competitive with competing technologies, their other features may still make them highly attractive in certain early markets.⁹ Their attractiveness is driven mainly by their compact size, potential for low capital cost and minimal maintenance requirements (see Table 44). If successful, the large potential markets could quickly create substantial manufacturing economies of scale that would lead to reduced costs. Modularity, where several microturbines are used in a "ganged" configuration, and improved local electric service reliability have also been cited as

⁹ This phenomenon has been described by Clayton Christensen as the hallmark of a "disruptive" technology, so named because of its ability to disrupt the nature of the industry in which it competes.

potential drivers for the adoption of microturbine generation technology, although these benefits are not exclusive to microturbines.

Table 44: Key Markets and Drivers for Microturbines

Key Applications	Drivers
On-site generation - baseload	<ul style="list-style-type: none"> • Modular design allows for multiple units to be used in “ganged” configuration • Improved local electric service reliability • Minimal maintenance requirements • Compact size, light weight, low noise • Low emissions
On-site generation - peaking	<ul style="list-style-type: none"> • Minimal maintenance requirements • Low capital cost • High reliability • Rapid startup
Cogeneration	<ul style="list-style-type: none"> • High electrical efficiency is less important due to waste heat recovery (efficiency of 80+% when heating load matches heat production) • Standardize package - eliminates site specific design and engineering to control costs

Several barriers exist to the adoption of microturbine generation technology (Table 45). Despite significant commercialization activities, microturbines are as yet unproven in the market and the most successful applications remain to be borne out by the market. Furthermore, microturbines would be subjected to the same barriers as other micropower technologies in a deregulated marketplace, including standby charges or non-bypassable transition charges for stranded assets, which could make distributed generation technologies economically uncompetitive during the transition to fully deregulated markets.

The need for less expensive, standardized switchgear is one of several other issues that needs to be addressed regarding the interface between distributed generation and utility distribution systems. Another issue is the need for broadly accepted interconnection standards that ensure personnel safety and the protection of customer-owned equipment from distribution system operations or anomalies. Although some IEEE standards and guidelines for connecting distributed resources have been developed, compliance is voluntary and often inconsistent.

Table 45: Market Barriers to the Acceptance of Microturbine Generation Technology

Key Applications	Market Barriers
On-site generation - baseload	<ul style="list-style-type: none"> Reliability of microturbines are yet to be proven Non-bypassable transition surcharge for stranded assets in the near term Grid connection – it has yet to be proven that modular technologies can seamlessly supplement the central supply and delivery system
On-site generation - peaking	<ul style="list-style-type: none"> Market uncertainty under electric industry deregulation leading to questionable payback period Competition from proven technologies such as reciprocating engines
Cogeneration	<ul style="list-style-type: none"> Only hot water or low-quality steam available from microturbines Limited applicable size range – other generating technologies may be more cost-effective outside the limited range of microturbines

6.1.6 Technology Development Needs

Some of the significant technology development needs are listed in Table 46. These include improvements to high-temperature materials, recuperators, fuel-gas compressors, and power conditioning equipment.

Table 46: Technology Development Needs for Microturbines

Development Needs	Details
Advanced materials, e.g. ceramics, for high temperature applications	<ul style="list-style-type: none"> Ceramics for turbines, recuperators, and combustors to boost efficiency through higher temperature operation Manufacturing of high-temperature metallic components in quantity
Robust and improved recuperators	<ul style="list-style-type: none"> Improved waste heat recovery Recuperator that maintains its effectiveness over the life of the unit. Near net-shape casting of recuperators with minimal machining
Low-cost onboard natural gas compressor	<ul style="list-style-type: none"> Natural gas will be the preferred fuel due to emission requirements but will often be available at low pressure Design compressors that are sensitive to size limitations and power requirements of microturbines.
Efficient and inexpensive power electronics	<ul style="list-style-type: none"> Improve efficiency by reducing parasitic losses Reduce capital cost

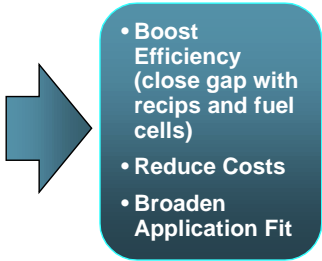

Waste heat recovery through a recuperator has been used in several microturbine systems to improve overall electrical efficiency. While recuperator development today focuses on cost reduction and service life extension, higher operating temperatures will become a focus for the future. Ceramics or high-temperature metals, both for the turbine hot section and the recuperator will allow for higher operating temperatures, and hence higher overall electrical efficiency. Areas of ceramics development include cost reduction, durability testing, and long-term testing to develop a database of properties.

Increasing the pressure ratio can also lead to efficiency improvements. However, there is an optimum pressure ratio for any recuperated machine because of the relative temperatures between the compressor exit and the recuperator inlet. Therefore, higher efficiency levels cannot simply be achieved by increasing pressure ratios. The design tradeoffs between increasing the pressure ratio, increasing the firing temperature, and improving recuperation need to be understood. Manufacturers see a critical need to achieve 40% electrical efficiency in microturbines and to reduce costs to be competitive with reciprocating engines, but a clear path to this target has not yet been defined.

Reliable, efficient and inexpensive power electronic devices are important elements in a microturbine system. Microturbines generate high frequency AC power that must be converted to DC and then back to grid compatible AC. Microturbines will therefore benefit from improved power conditioning equipment such as thyristors and inverters. There are many synergies between such developments for microturbines and other emerging generation technologies including fuel cells, photovoltaics, wind power, and potentially conventional technologies as well. While the technology is commercially available today, costs are relatively high, due in part to limited production volumes.

The reliability of the natural gas pipeline supply pressure in locations with multiple gas powered microturbines has also come into question. Simulation studies suggest that starting and stopping these turbines can cause the local gas main pressure to fluctuate, which may in turn lead to instability of the gas system. Further, fuel-gas boost compressors are needed in locations where the gas pressure is too low for direct introduction into the microturbine. While these compressors are commercially available and have been used successfully in larger power plants, their capital and O&M costs may be too expensive for smaller microturbine systems. Installation of fuel-gas boost compressors which have low reliability and require frequent maintenance also conflicts with the goal of unattended operation in distributed generation systems.

6.2 Reciprocating Engines

6.2.1 Technology Description

Reciprocating engines are in use today in virtually every application requiring mechanical or electrical power. Reciprocating engines, also known as internal combustion engines, fall into one of two categories depending on the ignition source: spark ignition (SI), which is used in conventional gasoline or gaseous-fueled engines; and compression ignition (CI), which is used in Diesel-cycle engines.

An engine can also be categorized according to the number of piston strokes it takes to complete one combustion process. A two-stroke engine completes this process in two piston strokes (one revolution). A four-stroke engine completes its combustion process in four piston strokes (two revolutions). A four-stroke, SI engine (Figure 38) draws fresh fuel and air into the cylinder during the intake stroke when the piston is moving downward. As the piston travels upward, the fuel and air mixture compresses within the combustion chamber. The spark plug then ignites at the appropriate time to combust the compressed fuel-air mixture. In a CI engine, auto-ignition occurs shortly after fuel is injected into the combustion chamber as the piston reaches the top of the compression stroke. In both cases the combustion products expand rapidly, pushing the piston downward and forcing the crank to rotate during the power stroke. The piston then pushes the burned gases out of the cylinder during the exhaust stroke.

A four-stroke engine has a much lower power density than a two-stroke, because it takes twice as many crankshaft revolutions to produce useful work (power). From this perspective, a two-stroke engine is more efficient. However, a four-stroke produces lower emissions than a two-stroke because the intake and exhaust strokes are separate. Two-strokes are prone to fuel short-circuiting, whereby fresh fuel entering the combustion chamber through the intake port exits through the exhaust port (which is also open) rather than remaining in-cylinder. The net result is higher hydrocarbon emissions in the form of unburned fuel.

An engine can also be categorized according to its “breathing” during the intake stroke. A typical, naturally aspirated engine draws its combustion air from its ambient surroundings. A turbocharged engine uses its exhaust heat energy to drive a turbo-compressor to compress the air inducted for combustion. By increasing the charge air’s mass, more fuel can be burned and more power is produced at a given displacement for a given engine speed.

Figure 38: Illustration of a Four-Stroke Spark-Ignition Engine

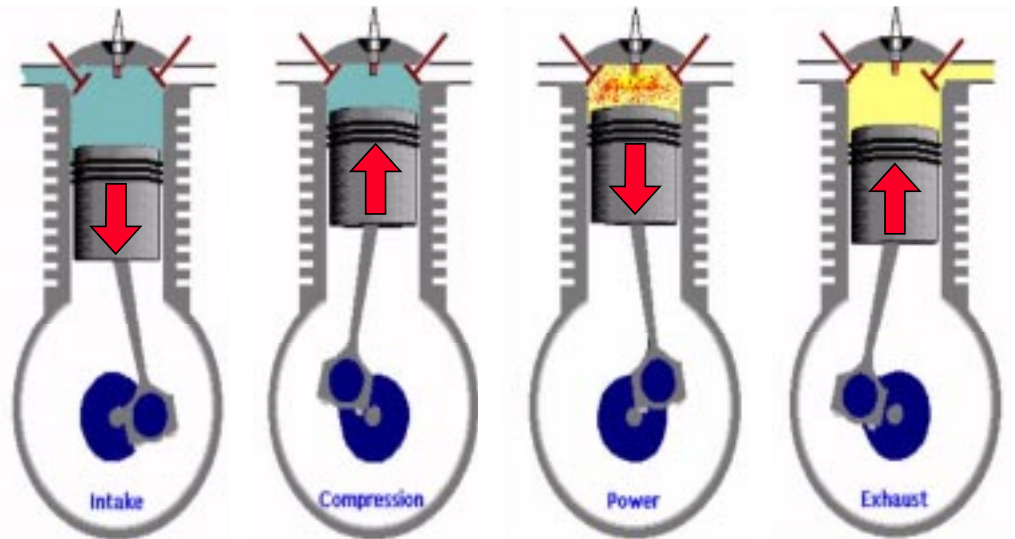

As indicated in Table 47, reciprocating engines exhibit a great deal of fuel flexibility. SI engines can operate on a variety of gaseous and liquid fuels. CI engines typically operate on heavier (i.e., less volatile) liquid fuels, although, natural gas can also be used if a small amount of diesel fuel is injected into the compressed gas-air mixture to act as an ignition pilot. This is known as a *dual fuel* engine. Water-fuel emulsions have also fueled CI engines.

Both SI and CI engines can operate fuel lean, meaning that there is more air in the cylinder charge than is needed for complete combustion. SI engines can also operate at stoichiometry (see Table 47), defined as the chemically correct amounts of fuel and air needed for complete combustion. The advantage of operating engines within these two combustion regimes is reduced emissions. Within these regimes hydrocarbons, nitrogen oxides and carbon monoxide are collectively at their lowest possible levels.

Nevertheless, operating engines at stoichiometric or fuel-lean conditions does not completely solve the emissions problem. Approaches to emission reduction (also listed in Table 47) include electronic engine controls, turbocharging, aftercooling, and high-pressure electronic fuel injection. Both in-cylinder and exhaust aftertreatment approaches to emissions clean-up are under constant development and improvement.

Table 47: Characteristics of Spark-Ignition and Compression-Ignition Reciprocating Engines

Ignition Type	Fuels	Combustion Regime	New Technologies and Trends
Spark Ignition	<ul style="list-style-type: none"> Gasoline Alcohol (methanol, ethanol) Hydrogen (H₂) Natural gas LPG Blast furnace gas (low HV; 100 BTU/cu. ft) Coke oven gas (400-500 BTU/cu. Ft) Refinery fuel gas (H₂, CH₄, C₂'s and C₃'s) Landfill gas (CH₄ with up to 50% CO₂) 	<ul style="list-style-type: none"> Stoichiometric Fuel Lean 	<ul style="list-style-type: none"> Turbocharging Aftercooling / Intercooling Electronic engine management Electronic engine maintenance Four valves per cylinder Variable valve timing Direct injection Exhaust aftertreatment
Compression Ignition	<ul style="list-style-type: none"> Diesel Biodiesel Pyrolysis Oil heavy Fuel Slurries (e.g. coal-water) 	<ul style="list-style-type: none"> Fuel lean 	<ul style="list-style-type: none"> Hydraulic electronic unit injection (HEUI) Mechanical unit injection (MUI) Mechanical pump and line Electronic unit injection (EUI) Shift from IDI to DI Turbocharging Aftercooling / Intercooling Shift focus from 2-strokes to 4-strokes Electronic engine management Electronic engine maintenance Four valves per cylinder Exhaust aftertreatment

LPG = liquefied petroleum gases (primarily propane) HV = heating value

Emissions can vary dramatically depending on the fuel-type. Low-NO_x natural gas engines are the cleanest among reciprocating engines. Diesel engines are also subject to tightening standards according to EPA's new non-road emission standards (Table 48).

Table 48: EPA Emission Standards for New Non-Road Diesel Reciprocating Engines

Engine Size (kW)	1996-1998 Standard (g/kWh)					Proposed Future Standard (g/kWh)				
	Tier	NOx	HC	CO	PM	Tier	Year	NMHC+NOx	CO	PM
37 ≤ kW < 75	1	9.2	--	--	--	3	2008	4.7	5.0	*
75 ≤ kW < 130	1	9.2	--	--	--	3	2007	4.0	5.0	*
130 ≤ kW < 225	1	9.2	1.3	11.4	0.54	3	2006	4.0	3.5	*
225 ≤ kW < 450	1	9.2	1.3	11.4	0.54	3	2006	4.0	3.5	*
450 ≤ kW < 560	1	9.2	1.3	11.4	0.54	3	2006	4.0	3.5	*
kW ⇒ 560	--	--	--	--	--	2	2006	6.4	3.5	0.20

Source: EPA emissions standards retrieved from www.dieselnet.com

Reciprocating engine system efficiency typically runs in the 25-41% range (Table 49) for backup (stand-by) and simple generation (prime power) applications. Large engines operating at full-load achieve the highest efficiencies. Cogeneration applications that effectively use waste heat have higher overall system efficiencies (80+%). Engine lifetime can range from thousands of hours to years, depending on the size, application and maintenance. Typical maintenance requirements include regular oil and oil filters changes in addition to routine inspections. The frequency of particular maintenance routines and issues varies between SI and CI engines.

Table 49: Technology Performance Characteristics of Reciprocating Engines

Technology Performance Characteristics		
System Efficiency (%)	25 - 41% (at rated conditions)	
Lifetime (years)	20 - 30 (for 1000+ kW engines; <1000 kW engines could get as low as 1000's of hours)	
Emissions (grams/kWh) (Natural gas fueled)	Current	Future (2010)
CO ₂ (%)	4 - 6%	
SO ₂	Negligible	Negligible
NO _x	1.3 - 2.7	0.2 - 0.7
CO	1.7 - 3.2	0.8 - 1.6
PM	Negligible	Negligible
HC (Total)	3 - 9	2 - 4
Duty Cycle	<ul style="list-style-type: none"> • Smaller engines (< 250 kW) have intermittent duty cycles; larger engines (> 800 kW) experience more continuous operation • Load following and part-load operation is possible (< 1000 kW) but reduces efficiency 	
System Size	<ul style="list-style-type: none"> • Slow speed (50-600 RPM) engine (2,000-66,000 kW) • Medium speed (800-2000 RPM) engine (400-3,000 kW) • High speed (2100-3800 RPM) engine (10-500 kW) • Multiple units can be combined for larger installations 	
Maintenance Requirements	<ul style="list-style-type: none"> • Oil changes every 500 - 5000 hours (engine size & fuel dependent) • 12,000 - 15,000 hours before major overhaul (CI > 300kW) • 20,000 hours before major overhaul (SI > 300 kW) 	

6.2.2 Current and Projected Technology Performance Characteristics

Because so many models and configuration exist, it is somewhat difficult to define “typical” cost and performance characteristics for reciprocating engines. Broadly speaking smaller units are derived from so-called high-speed engines used in on-road and off-road transportation applications, whereas larger engines use medium-speed technology designed for stationary or large transportation (e.g., marine) applications. On the whole, reciprocating engines present a relatively inexpensive and efficient means of producing mechanical and electrical power. The range of values shown in Table 50 reflects both the impacts of unit size on cost and efficiency, as well as the variability resulting from the availability of so many different products.

When compared to diesel engines in the year 2000, natural gas engines have higher installed costs but lower O&M costs. The capital cost of natural gas engines is higher because they typically start off as diesel engines and are retrofitted for natural gas operation. With respect to maintenance, natural gas engines require less frequent maintenance and inspection (Table 51). Critical components in CI and SI engines are fuel injectors and spark plugs, respectively. Although the injectors have a longer life than the spark plugs, the replacement cost is considerably higher. Diesel engines are more efficient than natural gas engines primarily because of their higher compression ratios. The current use of diesel cylinder heads for natural gas application is believed to have an impact as well.

In addition to these complexities, the capital cost of reciprocating engines varies with the application for which the engine is designed. Backup (stand-by) diesel engines have among the lowest installed cost (typically \$300-450/kW for engines under 300kW and \$225-350/kW for engines between 300 and 1,000kW). Continuous duty cogeneration adds 30-40% to the installed cost due to increased system complexity associated with heat recovery equipment. O&M cost and efficiency remain unchanged.

Table 50: Current and Projected Costs and Efficiencies for Reciprocating Engines

		Year	Installed Cost (\$/kW)	Non-Fuel O&M Cost (¢/kWh)	Electrical Eff. (LHV)
Small Recips (50 - 300 kW)	Natural Gas	2000	500-750	1.5-2.0	24-33%
		2005	450-700	1.3-1.7	25-35%
		2010	400-650	1.0-1.3	26-37%
	Diesel	2000	375-600	2.0-2.5	27-39%
		2005	370-595	1.7-2.0	28-41%
		2010	365-590	1.3-1.6	29-43%
Large Recips (301 - 1000 kW)	Natural Gas	2000	400-600	0.7-1.5	28-37%
		2005	375-550	0.6-1.3	29-41%
		2010	350-500	0.5-1.0	30-45%
	Diesel	2000	300-450	1.5-2.0	34-41%
		2005	295-445	1.3-1.7	35-43%
		2010	290-440	1.0-1.3	36-45%

Source: Engine manufacturers; Engine brochures

By the year 2010, it is estimated that installed costs will decrease and efficiency will increase. While the diesel engine is projected to maintain its first-cost advantage, the natural gas engine is expected to see a more significant decrease in installed cost (on a percentage basis). Natural gas engines are still being developed and *current* capital costs can be three times higher than for comparably-sized diesel engines. As technology

develops and production volumes increase, the costs of natural gas engines are expected to drop. As overall reciprocating engine technology continues to develop through 2010, parts reliability is expected to increase and required maintenance is expected to occur less frequently. As engine manufacturers target lower fuel consumption and improved combustion efficiency, the electrical efficiency is also projected to increase. Manufacturers have goals of reaching up to 50% shaft efficiency by 2010.

Table 51: Reciprocating Engine Maintenance Requirements (years 2000 & 2010)

Maintenance Issue	Engine Fuel Type	Engine Size (kW)	2000 Goal (hours)	2010 Goal (hours)
Oil Filter Change	Natural Gas	0 – 400	2,000	10,000
		401 – 1,000	5,000	20,000
	Diesel	301 – 1,000	1,000	TBD
Oil Change	Natural Gas	0 – 400	2,000	4,000
		401 – 1,000	2,500	5,000
	Diesel	301 – 1,000	1,000	TBD
Spark Plug Change	Natural Gas	0 – 400	4,000	8,000
		401 – 1,000	5,000	10,000
Fuel Injector Change	Diesel	301 – 1,000	5,000	10,000
Major Overhaul	Natural Gas	0 – 400	48,000	75,000
		401 – 1,000	60,000	120,000
	Diesel	301 – 1,000	20,000	30,000

Source: Engine manufacturer data

6.2.3 Key Players and Products

Key U.S. and international industrial engine manufacturers are identified in Table 52 along with the fuel type and size range of their industrial products. Reciprocating engines are a well-established, proven and familiar technology, with a wide range of products currently available on the market. Among the characteristics that differentiate these products are output, power density (2- or 4-stroke), fuel type, ignition type, emissions compliance, price, and efficiency. In addition, off-the-shelf products can be further modified to satisfy particular applications. For example, one manufacturer reported that a natural gas engine was modified in order to run on low-Btu gas derived from wood chip residue for a baseload electric power generation application. The same manufacturer reported that a wellhead gas engine was modified with a corrosion resistant fuel system in order to run on high sulfur fuel for a gas compression application. Whatever the application, there is probably a reciprocating engine that can do the job.

6.2.4 Product Status and Development Timeline

Reciprocating engines have been commercially available and in widespread use for more than 50 years. Despite their well-established status, reciprocating engines are under constant development in order to remain competitive. For example, with future emission regulations only getting tighter, one diesel engine manufacturer is shifting all of its two-stroke product lines over to four-stroke engines, despite the reduced power

density of four-stroke engines. It is these types of necessary product developments that will continue to be addressed.

As previously mentioned, manufacturers are aiming to improve maintenance and reliability. This is reflected in their goals to increase the time between oil changes, oil filter changes, spark plug replacement and major overhauls. Diesel fuel injector life should double over the next 5+ years. Natural gas engine spark plug life and cylinder head life should also double in the same period.

The other major areas where reciprocating engines will continue to develop include the following:

- Emissions reduction – to remain competitive with other technologies and to comply with emission regulations (National Ambient Air Quality Standards, EPA Non-Road Diesel Emissions Standards, New Source Performance Standards)
- Mechanical efficiency increase – targeted reductions in fuel consumption
- Operating cost reduction

Table 52: Summary of Key Industrial Reciprocating Engine Manufacturers and Products

Company	Fuel Type						Industrial Engine Size Range (MW)								
	D	HF	DF	NG	LPG	O	0	0.25	0.50	0.75	1.0	5.0	10.0	20.0	30.0
Caterpillar	X			X			[Red bar from 0 to 10]								
Coltec Industries	X	X	X	X			[Red bar from 0.5 to 20]								
Cooper Cameron	X		X	X		X	[Red bar from 0.5 to 1.0]								
Cummins	X			X		X	[Red bar from 0 to 1.0]								
Daewoo	X						[Red bar from 0 to 0.25]								
Daihatsu	X						[Red bar from 0 to 1.0]								
Deere & Co.	X			X			[Red bar from 0 to 0.25]								
Detroit Diesel	X			X			[Red bar from 0 to 1.0]								
Deutz AG	X			X		X	[Red bar from 0 to 5.0]								
EMD GM	X						[Red bar from 0.5 to 1.0]								
Ford Power	X			X	X	X	[Red bar from 0 to 0.25]								
GEC Alsthom	X	X	X	X			[Red bar from 0.5 to 10.0]								
GM Powertrain	X			X	X	X	[Red bar from 0 to 0.25]								
Isuzu	X						[Red bar from 0 to 0.25]								
Jenbacher				X	X	X	[Red bar from 0.5 to 1.0]								
Komatsu	X						[Red bar from 0.25 to 1.0]								
MAN ¹	X		X	X	X		[Red bar from 0 to 30.0]								
Mercedes-Benz	X						[Red bar from 0 to 0.5]								
Mitsubishi ²	X			X			[Red bar from 0 to 30.0]								
MTU	X						[Red bar from 0 to 1.0]								
Niigata	X		X	X			[Red bar from 0 to 20.0]								
Perkins	X			X		X	[Red bar from 0 to 1.0]								
SEMT Pielstick	X	X					[Red bar from 0.5 to 10.0]								
Volvo Penta	X			X			[Red bar from 0 to 0.5]								
Waukesha				X			[Red bar from 0 to 1.0]								
Wartsila ³	X			X			[Red bar from 0.5 to 30.0]								
Yanmar	X						[Red bar from 0 to 1.0]								

D = Diesel; HF - Heavy Fuel; DF= Dual Fuel; NG - Natural Gas; LPG - Liquefied Petroleum Gases;
O = Other (Gasoline/Landfill/Sewage/Coking Gas/Propane/Pyrolysis/Wood or Lean Gas)

¹ MAN's largest engines are rated at 68 MW

² Mitsubishi's largest engines are rated at 47 MW

³ Wartsila's largest engines are rated at 40 MW

Source: 1998 Diesel & Gas Turbine Worldwide Catalog

6.2.5 Key Drivers and Barriers

Overall, the use of reciprocating engines is driven by cost, durability, fuel flexibility, and performance. On the less technical side are drivers like familiarity, availability, selection, and experience.

Equally important are the barriers that prevent a technology from being chosen in the future or from ever penetrating a market. These barriers can be technical, regulatory or market. A number of the technical barriers that confront reciprocating engines include:

- **Emissions.** Advanced emission control is available via exhaust aftertreatment (e.g., catalysts, selective catalytic reduction) or in-cylinder approaches, but effective aftertreatment can be expensive. In-cylinder approaches such as higher diesel fuel injection pressure raise questions about component and subsystem reliability.
- **Reliability.** Increased reliability is a continuous focus as transportation engines (under 300 kW) are modified and applied toward industrial applications. Primary issues include bearing life, inlet and exhaust valve wear, spark plug life and fuel injector life.
- **Noise.** Especially in distributed power applications, reciprocating engine noise (and vibration) can be a barrier, as it is in Europe where reciprocating engine noise is being regulated.
- **Cost.** Advanced designs aimed at achieving performance targets tend to increase engine cost. For example, manufacturers aim to improve fuel efficiency, because over a ten-year life, 70% of an engine's lifecycle cost is related to fuel consumption. The ability to implement some of these improvements is limited by materials costs (e.g., ceramics, titanium castings).

A number of the regulatory and market barriers that confront reciprocating engines (and for that matter, other micropower technologies) include:

- Lack of customer knowledge on the potential benefits of cogeneration
- Lack of uniform interconnections and safety standards that address the unique issues faced by small power generation equipment
- Lack of standardized emission regulations between mobile and stationary applications
- Lack of standardized and streamlined permitting processes among local and state agencies
- Laws and regulations that favor central station power plants
- Lack of air quality regulations that address market power held by holders of emission reduction credits
- Lack of tariffs or other mechanisms that credit distributed generation for avoided transmission and distribution lines and/or upgrades to central station power plants.

6.2.6 Technology Development Needs

Some of the significant technology development needs are listed in Table 53. These needs are predominantly aimed at improving reciprocating engine efficiency and emissions.

Table 53: Technology Development Needs for Reciprocating Engines

Development Need	Rationale
New turbocharger methods	<ul style="list-style-type: none"> To improve transient and wide load performance
Heat recovery equipment specifically for reciprocating engines	<ul style="list-style-type: none"> More efficient exhaust energy recovery for cogeneration
Alternate ignition systems	<ul style="list-style-type: none"> More robust spark plug ignition suitable for heavy-duty NG industrial applications Future high output NG engines demand high energy ignition for combustion efficiency
Emission control technologies	<ul style="list-style-type: none"> Required to satisfy upcoming emission regulations Required to stay competitive with cleaner technologies
Improved generator technology	<ul style="list-style-type: none"> Increased generator efficiency (> 97%) converts more engine output to electricity
Frequency inverters	<ul style="list-style-type: none"> Produce a desired frequency output without having to precision-control the engine at a standard speed (e.g. 60 Hz, 1800 RPM)
Controls/Sensors	<ul style="list-style-type: none"> Intelligent controls to enhance engine diagnostics and remote monitoring Electronic fuel management & engine speed control to improve efficiency and emissions
Higher compression ratio (direct injection) for natural gas engines	<ul style="list-style-type: none"> Improves fuel conversion efficiency Increases power per displacement
Natural gas cylinder heads	<ul style="list-style-type: none"> To enhance fuel-air mixing; diesel heads are now being used

6.3 Small Fuel Cell Systems

6.3.1 Technology Description

Similar to a battery, fuel cells have an anode and a cathode separated by an electrolyte (Figure 39). Fuel (primarily hydrogen) enters the anode and air (or pure O₂) enters the cathode. The hydrogen and oxygen are separated into ions and electrons. Ions are conducted through the electrolyte while electrons travel between the anode and cathode through an external electrical circuit. In the process, energy, in the form of a voltage drop, is extracted from the electrons to perform useful work. The electrons and ions then combine to form water vapor. Heat is also produced because the process is not 100% efficient.

Figure 39: Simplified schematic of a fuel cell

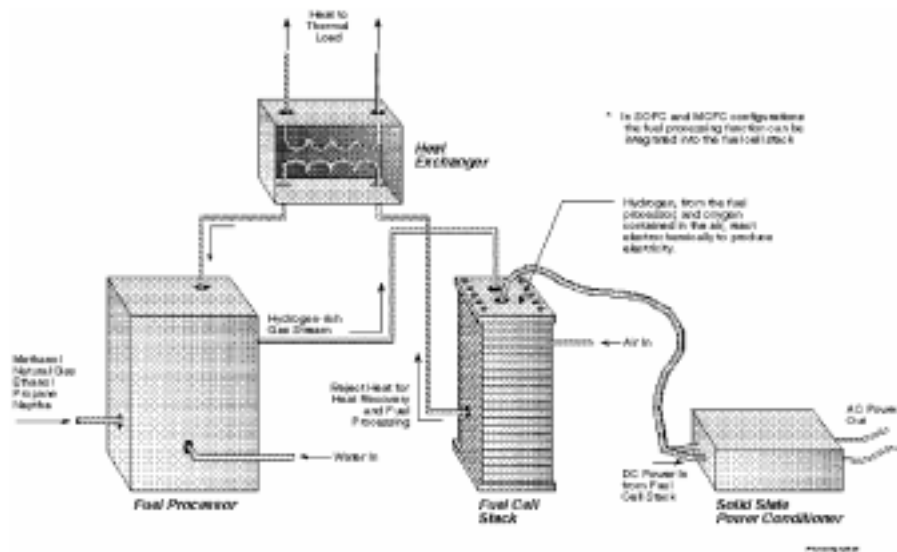

In addition to the fuel cell stack, system components include:

- The fuel processor, to convert primary fuel (natural gas, methanol, gasoline, etc.) into hydrogen. Depending on the fuel cell type, the fuel processor itself could consist of several components, including a fuel reformer, shift reactors, heat exchangers, a steam generator and a CO control device.
- air handling equipment (blowers and/or compressors)
- water purification/management system
- power conditioning equipment (to convert DC electricity to AC)
- heat recovery equipment (for cogeneration applications)
- controls
- enclosure

Emissions tend to be very low because fuels are not combusted, and high efficiency is possible, even at very small scales relative to conventional technologies, especially if pure hydrogen is the fuel.

The main technology characteristic that distinguishes one fuel cell type from another is the electrolyte. The five principal types are: alkaline, proton exchange membrane (also called the solid polymer electrolyte), phosphoric acid, molten carbonate, and solid oxide (see Table 54). The type of electrolyte determines the operating temperature, which ranges from less than 100°C to 1000°C. Alkaline fuel cells are included in Table 54 for completeness but are not considered further because they are not well suited to terrestrial applications. It should be noted however, that AFCs are the fuel cell type used in the space program, including the Apollo missions and the Space Shuttle.

Table 54: Fuel Cell Technology Characteristics

Fuel Cell Type	Electrolyte	Operating Temperature (°C)	Electrical Efficiency ¹ (% LHV)	Commercial Availability	Typical Unit Size Range ³
Alkaline (AFC)	KOH	60-90	??	??	??
Proton Exchange Membrane ² (PEMFC)	Fluorinated-sulfonic acid polymer membrane	70–90	35–45%	2000-2001	5-250 kW
Phosphoric Acid (PAFC)	Phosphoric acid	200	35–45%	since 1993	200 kW
Molten Carbonate (MCFC)	Lithium, potassium carbonate salt	600–650	45–55% (FC only) 65-75% (hybrid)	Post 2000	2-3 MW
Solid Oxide (SOFC)	Yttria & zirconium oxides	800–1,000	45–55% (FC only) 65–75% (hybrid)	Post 2000	Tubular: 100 kW - 5 MW Planar: 50-100 kW

Source: Arthur D. Little data and *Fuel Cells: A Handbook (Revision 3)*, DOE/METC-94/1006, January 1994.
 1. Net efficiency based on natural gas fuel. "Hybrids" are discussed in the section on fuel cell gas turbine hybrids.
 2. Also sometimes called a solid polymer electrolyte fuel cell (SPEFC).
 3. Includes current commercial demonstrations and future products.

Two fundamental technology paths are being pursued for fuel cells, high-temperature and low-temperature operation. PEM and PAFC (and AFC) fall into the low-temperature category whereas MCFC and SOFC make up the high-temperature options. Although fuel cells all operate on the same principle, operating temperature has important implications for balance of system design and application fit. Specifically, low-temperature fuel cells require more complex fuel processing since PEM and PAFC can only convert hydrogen to electricity. These fuel cell types are also more sensitive to CO poisoning. High-temperature fuel cells are able to directly convert hydrogen and CO to electricity and can internally reform simple hydrocarbon molecules into these compounds. Low-temperature fuel cells have great potential for cost reduction if PEM technology is widely adopted in the transportation industry. High-temperature fuel cells are mainly being targeted at the stationary power market. These issues and others are summarized in Table 55.

Table 55: Fuel Cell Technology Development Paths

	Low Temperature Fuel Cells	High Temperature Fuel Cells
Applicable Technologies	<ul style="list-style-type: none"> • AFC • PAFC • PEMFC 	<ul style="list-style-type: none"> • MCFC • SOFC
Typical Size	<ul style="list-style-type: none"> • Commercial products available or under development are focused on 250 kW and smaller 	<ul style="list-style-type: none"> • Most current development activity is focused on packaged units 2MW and higher but units <1MW are also planned
Key Drivers	<ul style="list-style-type: none"> • Transportation market (PEMFC) and associated energy and emissions issues 	<ul style="list-style-type: none"> • Potential for very high efficiency, including integrated coal and biomass gasification fuel cell systems (IGFC) • Low emissions
Advantages	<ul style="list-style-type: none"> • High Efficiency • Low emissions • Rapid startup time (esp. PEMFC) • Potential for significant cost reduction through mass production resulting from transportation markets, if successful 	<ul style="list-style-type: none"> • Very high efficiency • Low emissions • Simpler fuel processing • No need for precious metal catalysts • Stack not sensitive to CO poisoning • High grade waste heat improves cogeneration potential • Larger module sizes (1-5 MW)
Disadvantages	<ul style="list-style-type: none"> • Limited cogeneration potential • Smaller module sizes (200-250kW) • Relatively complex fuel processing • Stack is more sensitive to CO poisoning (PEMFC requires <10 ppm CO) • Requires precious metal catalysts • Current high cost structures (PAFC) 	<ul style="list-style-type: none"> • Market limited primarily to power generation, reducing overall market potential (and hence potential for cost reductions through mass production) • Complexity of hybrid cycles

6.3.2 Current and Projected Technology Performance Characteristics

Table 56 summarizes the overall performance characteristics of fuel cells, whereas Table 57 summarizes the specific fuel cell cost and performance characteristics used in this study for 2000, 2005 and 2010. The range of costs and efficiencies reflects both uncertainty in the estimates as well as the impacts of size. The aggressive reductions in low-temperature fuel cell costs are predicated on the technology being widely adopted in the transportation sector, in which cost parity with conventional engine technologies will require that fuel cell systems for automotive applications reach costs of approximately \$50/kW. It must be noted that even if fuel cells do reach these cost targets, stationary systems will be substantially more expensive because:

- Required operating life of stationary systems is near 40,000 hours, as opposed to the 4,000-5,000 hour life of automotive engines; this implies higher catalyst loadings in the fuel processor and fuel cell and overall more robust design.
- Efficiency/Cost tradeoffs tend to favor low-cost devices in automotive applications, but will favor efficiency (up to a point) in stationary applications.
- Duty cycles of the two applications (nearly base-loaded for stationary applications, but frequent transients for automotive applications), coupled with a fuel cell’s characteristic *increase* in efficiency at partial load implies that stationary fuel cell units will achieve high efficiency by increasing the stack area (and thus the cost).
- Production volumes for stationary units will likely be substantially smaller than automotive engines, and therefore may not be subject to the same economies of scale, depending on the degree of commonality.

Table 56: Overall Fuel Cell Characteristics

System Efficiency (%)	35-55% (65-75% for gas turbine/fuel cell hybrids)
Lifetime (years)	20-30
Emissions (grams/kWh) CO ₂ (natural gas fuel) SO ₂ NO _x	360-570 @ 35-55% efficiency, 270-310 @ 65-75% negligible negligible
Duty Cycle	<ul style="list-style-type: none"> • Fully dispatchable • Typically, high capacity factors (>65%) are favored because of the high capital costs • Cogeneration is possible to varying degrees with all fuel cell types, which further favors baseload operation
Typical System Size	<ul style="list-style-type: none"> • Single- and multi-family residential (1-50kW) • Commercial/Industrial Buildings (200kW-2MW) • Grid Connected Distributed for T&D Support (200kW-10MW) • Grid Connected Central (>10MW)
Maintenance	<ul style="list-style-type: none"> • Quarterly/annual: routine preventative maintenance/inspection • 5-10 years: stack replacement • Remote monitoring/autonomous operation possible

Table 57: Fuel Cell Cost and Performance Characteristics

		Unit Size (kW)	Installed Cost (\$/kW)	Non-Fuel O&M cost (¢/kWh)	Electrcal Efficiency (LHV)
Low Temperature Fuel Cells	2000	200 - 250	2,000 - 3,000	1.5 - 2	30 - 40%
	2005*	50 - 250	1,500 - 2,000	1 - 2	35 - 40%
	2010*	50 - 250	750 - 1,000	0.5 - 1.5	35 - 45%
High Temperature Fuel Cells	2005	250 - 3,000	1,500 - 2,000	1 - 2	45 - 55%
	2010	250 - 20,000	1,000 - 1,500	0.5 - 1.5	50 - 60%

Note: Only low temperature fuel cells are expected to be available in the year 2000.

The range in O&M costs reflects uncertainty in the frequency and cost of stack replacement.

Efficiencies are for natural gas fuel.

Year 2000 size range reflects commercially available products.

Cogeneration: These costs include the cost of cogeneration. Steam requirements for fuel reforming mandate the presence of a steam generator within all units so that the marginal cost of producing more steam is assumed to be near zero. For low temperature fuel cells some additional equipment would be required to produce hot water using waste heat from the stack itself. High temperature fuel cell stacks are air cooled using excess air supplied to the cathode.

* Assumes significant investment and success in transportation applications

6.3.3 Key Players and Products and Development Timeline

Fuel cells have become the focus of extremely active product development in the late 1990s, driven in part by the prospect of widespread adoption of PEM technology for transportation applications, as well as electric industry restructuring. A significant number of companies, large and small, domestic and international, are currently involved in fuel cell development. Table 58 highlights the products under development or available from leading U.S. fuel cell developers.

Table 58: Leading U.S. Fuel Cell Developers

Participant	Fuel Cell Technology			
	PAFC	PEMFC	MCFC	SOFC
International Fuel Cells (including ONSI)	●	●	●	
Fuel Cell Corporation of America	●			
Siemens - Westinghouse				●
Energy Research Corporation			●	
M-C Power			●	
Energy Partners		●		
AlliedSignal (AiResearch)		●		●
SOFCo (Ceramtec/Babcock & Wilcox)				●
Ztek (Waltham, MA)				●
Analytic Power (Boston, MA)		●		
Ballard Power Systems ¹ (Canada)		●		
H-Power		●		
Plug Power (MTI and DTE)		●		
ElectroChem (Woburn, MA)		●		

1. Partners for stationary fuel cells include GPU International, GEC Alsthom and Ebara

There have been a number of fuel cell demonstrations covering all four types, in both the United States and abroad. However, at the time of writing, the only truly commercially available fuel cell product is the PC25, a 200kW PAFC unit manufactured by International Fuel Cells (sold by ONSI). This product has set a very high standard for reliability and performance. A summary of PC25 performance is given in Figure 40. Figure 41 shows the commercialization status of the different fuel cell types.

Figure 40: Commercial PC25 Fuel Cell Operating Experience

1992–1998 Total Shipments of PC25 Fuel Cell Systems	
Power Plants Delivered	150 30
Power Plants Operational	130 24
Longest Running Unit	>40,000 hours
Longest Continuous Run	9,500 hours
Total Fleet Operating Hours	>2 million
Mean Time between Forced Outages	2,200 hours
Fleet Adjusted Availability	95%



ONSI PC25C

Source: ONSI Website, 6/9/98 and personal communication with Greg Sandelli, ONSI Corp, June 1998.

Figure 41: Product Development Status of Fuel Cells as of January 1999

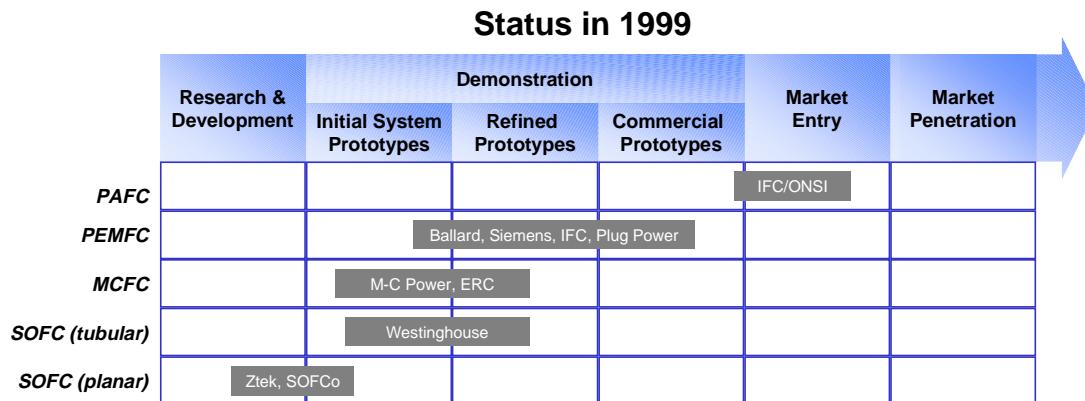

Note: Companies shown are selected key players today, but many small and large companies not shown are also involved in fuel cell development.

6.3.4 Fuel Cell Markets, Drivers and Barriers

The different characteristics of the various fuel cell technologies naturally lead to different strengths and weaknesses. As a result, fuel cells will compete with each other in some areas, but in others the focus will be on competition with other technologies. Table 59 summarizes the key applications for the various fuel cell types. Much attention has been focused on the commercial building market as a high-value application for small-scale fuel cell cogeneration. Relative to other micropower technologies, fuel cells have many attributes that would favor them in commercial building applications, including: high electrical efficiency, low noise and vibration, and almost near zero emissions of criteria pollutants. Coupled with relatively attractive electric rates, well-

matched thermal needs, and relatively high load factors (especially for certain building types such as hospitals and hotels), the commercial sector offers some of the most attractive economics for fuel cells, as shown in Table 60.

More recently, the residential sector has been receiving increased attention. In the United States, several small-scale PEM fuel cell cogeneration products are under development by companies such as Plug Power, Analytic Power and Energy Partners, in the 2-7 kW size range. The key challenges in this market segment will be reducing the first cost of the units to a level acceptable to individual consumers, and providing attractive economic paybacks in an application with a very low load factor.

Table 59: Key Fuel Cell Applications

		PEMFC	PAFC	MCFC	SOFC	
					Tubular	Planar ¹
Grid Sited	Central	○	○	●	●	◐
	Distributed	●	●	●	●	◐
	Repowering	○	○	●	●	◐
Customer Sited Cogeneration	Residential	●	○	○	○	◐
	Commercial	●	●	◐	○	◐
	Light Industrial	◐	●	●	●	◐
	Heavy Industrial	○	○	●	●	◐
Transportation	Light Duty	●	○	○	○	○
	Heavy Duty	●	●	◐	◐	○
Premium Power		●	●	●	●	◐
Portable Power		●	●	○	○	◐

● Likely ◐ Under Consideration ○ Unlikely

1.Characteristics not yet sufficiently well-defined to identify priority markets.

A third application that may have broad application throughout the commercial and industrial sectors is so-called *premium power*. Examples of premium power applications would be high-tech manufacturing, data processing centers and call centers, where either interruptions in power or poor power quality result in substantial economics losses. In the continuous process industries, loss of power to all or part of a plant could also result in significant economic losses, due to costs of restarting the facility after an outage and due to loss of product. The main competition for fuel cells in this application is conventional UPS technology. Whereas UPS systems “kick-in” in the event of an outage, acting as a backup for the grid, fuel cell premium power systems would provide continuous power (and heat), using the grid as a backup. The two systems are not mutually exclusive, as any fuel cell premium power system would include components

of conventional UPS systems, in order to ensure the highest quality power. An example of a company entering this market with a fuel cell product is Sure Power Corporation. Although each application is site specific, customers seeking very high quality premium power should be willing to pay prices in excess of those listed in Table 60.

Table 60: Fuel Cell Allowable Cost Targets

Market Segment	Typical Capacity	Allowable Cost Targets ¹ (\$/kW)	
		Entry ²	Sustained ²
Commercial Cogeneration	200 kW–2 MW	\$1,500–2,000	\$800–1,300
Industrial Cogeneration	5–200 MW	\$1,000–1,200	\$800–1,000
Distributed Power	5–20 MW	\$1,300–1,500	\$800–1,300
Repowering	50–500 MW	\$1,100–1,500	\$800–1,100
Central Station	100 –500 MW	\$900–1,100	\$700–900

Source: Various Arthur D. Little analyses

Note: Allowable costs will rise as electricity prices fall.

1. Total installed system costs, including all owners costs—targets apply widely to industrialized country markets (except Japan)

2. "Entry" refer to early high value markets, "sustained" refers to ability to achieve significant market penetration

These cost targets can be viewed as the economic hurdles for fuel cells. Fuel cells must also overcome a number of other barriers, as summarized in Table 61.

Table 61: Fuel Cell Market Barriers

Key Fuel Cell Applications	Market Barriers
Grid-connected Central Station	<ul style="list-style-type: none"> • Project scale is large relative to fuel cell module sizes • High first cost of technology relative to competing technologies such as gas turbine combined cycle • Large gas turbine combined cycles (GTCCs) are also achieving efficiencies approaching 60% (LHV) and NOx emissions below 10 ppm
Grid-connected Distributed (substations etc.)	<ul style="list-style-type: none"> • High first cost of technology relative to competing technologies such as simple cycle gas turbines and IC-engines • Distributed power has yet to emerge as a significant market
Customer Sited, Grid-connected (residential, commercial, industrial)	<ul style="list-style-type: none"> • High cost of electricity in many locations/applications relative to grid power • Education/awareness • Service infrastructure • Rapid payback requirements of building owners • Non-traditional power market, requiring new approaches to ownership and operation.
Off-Grid	<ul style="list-style-type: none"> • Technology development required
Transportation	<ul style="list-style-type: none"> • Technology development required • Low cost of petroleum-based fuels in the United States

6.3.5 Technology Development Needs

As stated earlier, fuel cells are the focus of intense R&D today. In terms of components, there are three main areas for R&D: the fuel cell stack, the fuel processing system, and power conditioning (see Table 62). For the stack, the focus for high-temperature fuel cells is on increasing stack power density, which will permit the use of smaller stacks and operation at more favorable efficiency levels. MCFC fuel cells also need improvements in stack life, whereas SOFCs have demonstrated good life characteristics, but operation at somewhat lower temperatures than the current 1,000°C is seen as an advantage for non-hybrid applications.

For low-temperature stacks, especially PEM, the focus is on reducing costs and stack optimization for operation on reformed fuels as well as on development of high-temperature membranes, which will permit operation at more favorable conditions in terms of both efficiency and tolerance to CO. For PAFC, which is already fairly mature technology, reducing costs is the main goal, such as through the use of alternative materials (e.g., separator plates) and through increasing the volume of production.

Fuel processing is critical for fuel cells, particularly low-temperature fuel cells, as it represents a significant component of total cost and heavily impacts system-level efficiency. Most experience is on natural gas and methanol, but in order to access transportation and other markets (e.g., remote power), other fuels will need to be used, such as gasoline or diesel fuel. The need is to develop low-cost, reliable systems, and could include better integration as well as the application of improved catalysts and control systems.

Advances in power electronics would benefit fuel cells through lower conversion losses, reduced costs, and more seamless integration with the grid.

Table 62: Key Fuel Cell Technology Development Needs

	Tubular SOFC	Planar SOFC	MCFC	PAFC	PEMFC
Increased stack power density	✓	✓	✓✓		
Improved stack structure (e.g., low electric losses, improved electrolyte)	✓	✓✓	✓	✓	✓
Improved/lower cost materials (e.g., seals, separator plates, compatibility)		✓✓	✓✓		✓
Reliable, low-cost fuel processing				✓	✓✓
Fuel processing of non-CH ₄ fuels	✓	✓	✓	✓	✓

6.4 Fuel Cell / Gas Turbine Hybrid Systems (Fuel Cell Hybrids)

6.4.1 Technology Description

Gas turbines can produce low cost electricity with low-emissions from natural gas, but their efficiency is thermodynamically limited by the combustion process. Fuel cells offer the potential for lower emissions and high efficiency at relatively small scales, but are likely to be too expensive for many applications in the near term. By coupling a high-temperature ($>600^{\circ}\text{C}$) fuel cell to a gas turbine, it becomes possible to produce electric power at a higher efficiency than could be produced by either technology alone, at a capital cost that has the potential to fall between the two.

In the simplest representation of a fuel cell/gas turbine hybrid (FC/GT) system, the gas turbine combustor is replaced with a high-temperature fuel cell. This allows for overall system *electrical* efficiencies of 70% or higher (LHV basis). Alternatively, the fuel cell can be placed downstream of the gas turbine to more efficiently utilize the residual energy in the power cycle. In both configurations, heat-recovery steam cycles may also be placed downstream to produce process heat and/or additional electricity.

The type of configuration chosen is a function of the fuel cell technology employed. Solid oxide fuel cells (SOFCs) have operating temperatures of about 1000°C and can therefore function effectively in a “topping” mode, while molten carbonate fuel cells (MCFCs) have operating temperatures in the range of 650°C and are more appropriately used in a “bottoming” mode of operation. These configurations are shown in Figure 42. More complex integration schemes are also possible.

Figure 42: Basic SOFC and MCFC Gas Turbine Hybrid System Configurations

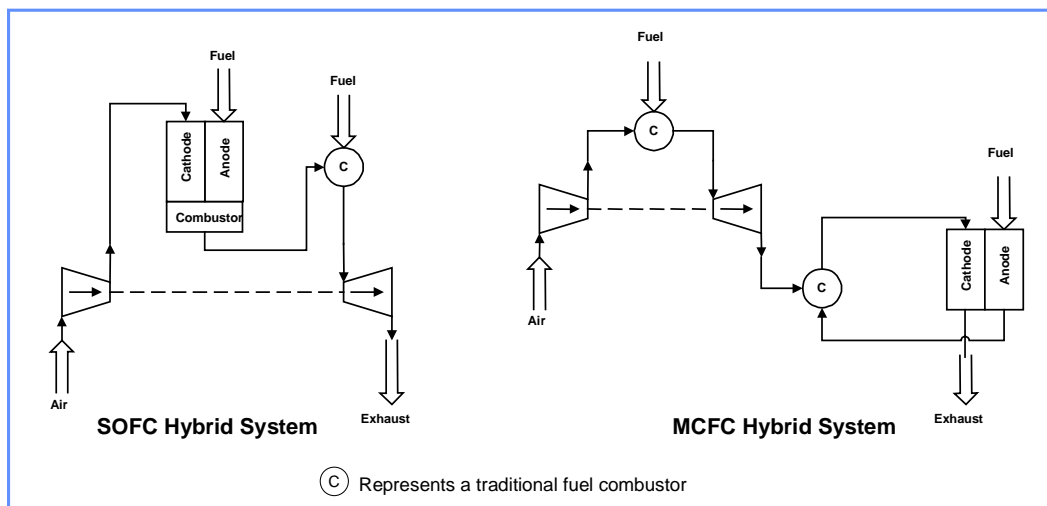

Both fuel cells can directly reform hydrocarbons and CO into hydrogen, thus providing the capability to run on available fuels (natural gas, landfill gas, syngas, etc.) without additional fuel-reforming system components. Operation on waste fuel, however, may require some fuel treatment or cleanup. The balance of plant includes water handling, air handling, heat recovery equipment, DC/AC power conditioning equipment, controls and enclosure.

Relative to most fossil fuel fired power generation options, fuel cell hybrid systems have minimal emissions and substantially higher efficiencies. The technology performance characteristics of fuel cell hybrid systems are summarized in Table 63.

Fuel cell hybrid systems are fully dispatchable but high capacity factors are favored because of high capital costs and startup/shutdown issues. Cogeneration is possible, which further favors baseload applications, but due to their high efficiencies and low offgas temperatures, the quantity and quality of waste heat is limited.

Table 63: Technology Performance Characteristics of Fuel Cell/Gas Turbine Hybrid Systems

Electrical Efficiency (%)	65-75%	
Lifetime (years)	20-30 (estimated)	
Emissions (grams/kWh) CO₂ (natural gas fuel) SO₂ NO_x CO HC	Current 270-310 @ 65-75% negligible <0.009 <0.027 <0.015	Future (2010) 270-310 @ 65-75% negligible <0.009 <0.027 <0.015
Duty Cycle	<ul style="list-style-type: none"> Fully dispatchable Typically, high capacity factors (>65%) are favored because of the high capital costs and startup/shutdown issues High temperature fuel cells are amenable to cogeneration, which further favors baseload operation Cogeneration potential will be limited by low T/E ratios 	
System Size	<ul style="list-style-type: none"> Microturbine hybrids: 200 - 500 kW Others: up to 25 MW 	
Maintenance Requirements	<ul style="list-style-type: none"> Quarterly/annual: routine preventative maintenance/inspection 5-10 years: stack replacement 30 year life for balance of plant 	

The type of fuel cell used in a fuel cell hybrid cycle will impact the overall system architecture as well as the need for fuel cleanup. SOFCs operate at a higher temperature and are optimal for the topping cycle. They can also tolerate a higher sulfur content in the fuel than MCFC systems. Table 64 below compares the characteristics of MCFC and SOFC hybrids.

Table 64: Technology Characteristics of MCFC and SOFC Hybrid Systems

	MCFC Hybrid	SOFC Hybrid
Fuel Cell Operating Temperature (°C)	600-650	800-1,000
Electrical Efficiency (%LHV)	65-75%	65-75%
Power cycle vis a vis fuel cell¹	Bottoming	Topping
Sulfur tolerance	<1 ppm (implies cleanup even of natural gas to remove S-species added for odor)	<50 ppm (pipeline natural gas is acceptable, but other fuels will need to be cleaned)
Commercial Availability	Current product development is focused on FC-only systems	2005 ²
Other issues	<ul style="list-style-type: none"> • Lower pressure of bottoming cycle implies lower FC power density • Lower temperature implies more complex thermal management systems 	<ul style="list-style-type: none"> • Topping cycles require more complex control systems

1. Bottoming cycles are those in which the fuel cell is placed at the lowest temperature point in the cycle (e.g. downstream of the gas turbine), while topping cycles are those in which the fuel cell is placed at the highest temperature point in the cycle (e.g. in addition to, or in lieu of the GT combustion chamber)

2. Projected availability date of Westinghouse's SureCELL SOFC/GT hybrid system.

6.4.2 Current and Projected Technology Performance Characteristics

Table 65 below summarizes the projected technology performance characteristics for fuel cell hybrid systems. The values for 2010 are aspirations based in part on the needs identified by manufacturers and assuming sufficient volume production.

Table 65: Projected Performance Characteristics for Fuel Cell Hybrid Systems

	2005	2010
Unit Size Range (MW)	3 - 5	0.25 - 20
Installed Cost (\$/kW)	1,500 - 2,000	1,000 - 1,500
Electrical Efficiency (LHV)	65 - 70%	70 - 75%
Non-Fuel O&M Cost (¢/kWh)¹	0.9 - 1.9	0.4 - 1.4

¹ Includes a range of values for stack replacements costs, levelized over the life of the equipment.

6.4.3 Key Players and Products

The only fuel cell hybrid systems that are currently under development are SOFC-based systems from Siemens-Westinghouse and Ztek. However, Energy Research Corporation has completed several conceptual studies of MCFC-based hybrids. While MC-Power has not made any public pronouncements with respect to fuel cell hybrid systems, they

are an important player in the field of MCFC technology. Table 66 summarizes the cost and performance characteristics according to leading fuel cell hybrid developers.

Table 66: Manufacturer Estimates of the Cost and Performance of Fuel Cell Hybrid Systems

Company	Type	Size (MW)	Electric Efficiency (LHV)	Estimated Installed Price (\$/kW)	Comments
Siemens-Westinghouse	SOFC	0.2 - 50	60 - 75%	\$900 - 1,200 ¹	SureCELL projected market availability 2000-2005
Ztek	SOFC	<1 - 10	64 - 71%	<\$1,000 ²	Demonstrated cell performance of >15,000 hours
Solar Turbines	SOFC	1 - 10	58 - 80%	\$1,000 - 1,400 ³	Very preliminary analyses to date.
Energy Research Corporation	MCFC	4 - 20	70 - 80%	\$1000	Estimate 200 MW plant can sell electricity for \$0.046/kWh

¹ Siemens-Westinghouse's cost projections for a 3-10 MW sized unit.

² Cost target

³ Solar's estimate for a year 2004 1-2 MW power-only unit. Range is based upon an unspecified range in production volume.

6.4.4 Product Status and Development Timeline

Siemens-Westinghouse, who is using tubular SOFC technology, is expected to be the first to market with a fuel cell hybrid product. Ztek, on the other hand, is developing a fuel cell hybrid based on planar SOFC. No other major fuel cell manufacturer is actively developing a hybrid system, although Edison Technology Solutions is managing a project to develop a hybrid power plant using a 200kW Siemens-Westinghouse SOFC and a 50 kW microturbine. The project is being funded by the DOE and the California Energy Commission. The current status of major product development efforts is illustrated in Figure 43.

Figure 43: Status of Fuel Cell Hybrid Development from Major Manufacturers

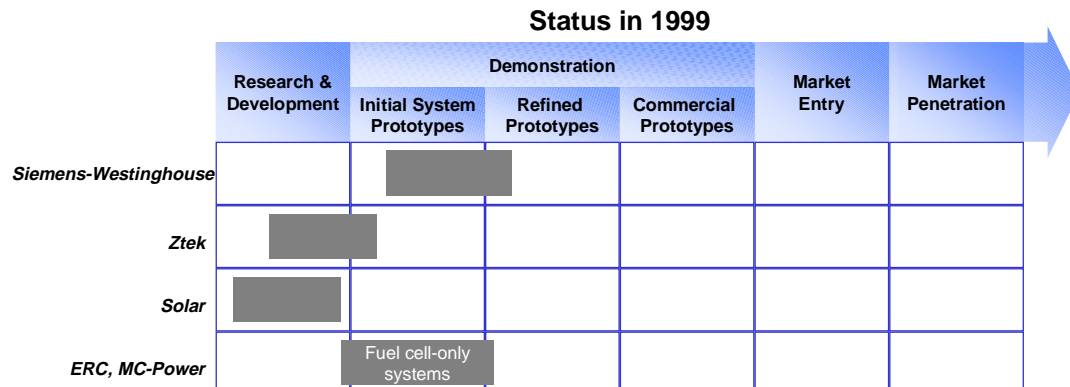

6.4.5 Fuel Cell Hybrid Applications, Drivers and Barriers

For the most part, the same issues that apply to fuel cells systems also apply to fuel cell hybrids. Fuel cell hybrids are best suited to baseload power generation applications, given their relatively high capital cost and high efficiency. The high temperatures required for operation of these systems favors continuous operation with minimal starts/stops and thermal cycling. In contrast, PEM fuel cells can be cycled much more easily. Cogeneration is possible, but their very high efficiency limits the amount and temperature of the waste heat. To the extent that industries are gradually reducing their T/E ratios, fuel cell hybrids should become more attractive over time.

Like fuel cells, it is as yet unclear exactly how fuel cell hybrid systems will be sold and distributed since current efforts are in the proof-of-concept stage. In short, the infrastructure for fuel cell hybrid systems is still emerging.

A major barrier to fuel cell hybrids is in determining exactly what are the leading applications, particularly in the United States, where energy prices are low, and gas turbines already achieve high efficiencies in combined cycle mode, albeit not at scales as small as is possible with fuel cell hybrids. Should energy prices rise or global warming become the focus of specific greenhouse gas reduction goals, fuel cell hybrids represent an attractive means of meeting these challenges.

6.4.6 Technology Development Needs

Obviously, any specific technology development needs for high-temperature fuel cells and gas turbines carry over to fuel cell hybrid systems. Where there are new needs, they deal mainly with the tight integration of the two technologies, and can be considered more as engineering challenges than fundamental technology development needs. Depending on the configuration however, there may be a need for improved high-temperature heat exchangers (recuperators), but to the extent this technology is being developed for microturbines and small industrial gas turbines (e.g., through the ATS program), it should be readily transferable to fuel cell hybrids.

One fuel cell development that is particularly relevant to fuel cell hybrids is pressurized operation. In general, fuel cells operate at or near atmospheric pressure, even though pressurization improves stack performance. Generally, the complexity and added parasitic loads make pressurization somewhat difficult, especially at small scales. However, for certain fuel cell hybrid configurations, fuel cells will need to operate at pressures as high as 20 atmospheres, to match gas turbine compressor discharge pressures.

7 Summary of Research and Development Needs

7.1 Background

A key objective of this study was to identify possible actions that the OIT could take to maximize the national benefits derived from micropower and fuel cell hybrid technology when applied in the *Industries of the Future*. This section addresses this topic in two parts:

- A re-examination of the technology/industry/application combinations categorized as *Aggressive R&D Success*, in light of the national benefits they create. Specifically, those technology improvements that OIT could effectively support are discussed.
- An assessment of other activities OIT could undertake to accelerate market acceptance of attractive technologies.

The national benefits of the technology improvements have also been evaluated, including those which are neutral to the industry drivers that formed the basis of the techno-economic fits that were used to identify potential markets.

Not all R&D needs can suitably be fulfilled by OIT. Some areas are better handled by other parts of DOE and the government, or manufacturers and other commercial parties. In general, the OIT's efforts are best directed towards those applications in which one or more of the following are true:

- The need arises uniquely (or mainly) from industrial application of the technology
- OIT is already involved in R&D in other areas (for example with the vision industries) that present unique opportunities for OIT to help fulfill the need
- R&D is of high risk and high payoff, and is therefore unlikely to be pursued by industry alone.

Prior to describing these needs, it is useful to review some of the basics of technology development and to examine what government policy activities may be available to influence the development and commercialization of new technologies. With the exception of reciprocating engines, the technologies studied here are all emerging technologies at this point in time. Early involvement in such emerging technologies can substantially impact their development path. However, making rational decisions about such involvement requires an understanding of the technology development path. Figure 44 shows a schematic representation of this process, indicating the status of each technology.

Figure 45: Possible Technology Development Activities and Support by OIT

Technology R&D	Manufacturing Support
<ul style="list-style-type: none"> • Sponsored R&D <ul style="list-style-type: none"> –on components –on systems –on manufacturing –on markets/applications/economics –case studies • Demonstration programs (technology) • Sponsored competitions; “fly-off” 	<ul style="list-style-type: none"> • Sponsored manufacturing R&D <ul style="list-style-type: none"> • Manufacturer investment tax credit • Accelerated depreciation • Production tax incentive • Sales/property tax exemption • Investment subsidy • Manufacturing buy down • Loans <ul style="list-style-type: none"> –guaranteed –insured –low interest –buy down
Marketing Support	End-User Incentives
<ul style="list-style-type: none"> • Sponsored R&D <ul style="list-style-type: none"> –on markets, applications, economics –case studies • Demonstration programs (commercial) • Information clearinghouse • Education • Communications/marketing program • Technology seminars, publications • Technical assistance • Standard setting <ul style="list-style-type: none"> • Mandated buy programs • Mandated floor pricing 	<ul style="list-style-type: none"> • Grants <ul style="list-style-type: none"> • Application grants • Rebates/refunds <ul style="list-style-type: none"> –to end-users –to others –utility rebates • Investment tax credits <ul style="list-style-type: none"> –to end-users –to third parties • Accelerated depreciation • Sales/property tax exemption • Loans <ul style="list-style-type: none"> –low interest

Table 67: Summary of R&D Needs

	Capital Cost	O&M Cost	Efficiency	Emissions	Reliability	Integration
Cross-Cutting Technologies	♦	♦	♦			
Ceramics	♦		♦			
Power electronics						♦
Switchgear						
Compressors	♦		♦			
Remote monitoring		♦			♦	
Controls interface						♦
Cogeneration packages			♦			
Microturbines						
Bearings		♦	♦		♦	
Manufacturing technology	♦					
High-temperature rotors & structures		♦	♦		♦	
System efficiency/design tradeoff analysis	♦	♦	♦			
High-temperature recuperators			♦			
Aerodynamics			♦			
Combustion technology			♦	♦		
Fuel Cells and Hybrids						
Stacks	♦	♦	♦		♦	
Fuel processors	♦	♦	♦		♦	♦
System integration and optimization	♦		♦		♦	♦
Reciprocating Engines						
Engine controls			♦	♦		
Emissions controls				♦		
Natural gas ignition systems		♦	♦	♦	♦	
Low-cost materials (ceramics, other)	♦		♦	♦		
Component life and wear		♦	♦	♦	♦	

7.2.1 Capital Cost Reduction

Activities that impact the capital costs of the technologies will have a major impact on market acceptance. Consequently, achieving the *aggressive* targeted capital cost reductions (assumed in the opportunity analysis) is critical for all technologies in all applications. Achieving the targets needed for significant market acceptance requires mass-production (and thus sales) as well as improvements in technology performance. Several technology improvements could aid in the overall cost-reduction of these technologies.

General

- *Low-cost ceramics.* OIT could support the development of advanced ceramic components for a variety of micropower and fuel cell hybrid applications. Examples include fuel cell components, microturbine combustors and rotors, as well as reciprocating engine port liners, coatings and piston crowns.
- *Low-cost power electronics* (e.g., thyristors, inverters). These could initially be used for fuel cells and microturbines but eventually in other industrial applications as well. This technology also has important application with renewable energy technologies so that there are possible synergies with other DOE programs.
- *Low-cost, small capacity switchgear.* This switchgear needs to be standardized to facilitate the interface with the grid.
- *Low-cost gas compressors.* All technologies considered in this analysis require high-pressure natural gas and/or air. Although the gas pressure inside industrial facilities is often somewhat higher than in commercial buildings or residences, the pressure is still limited by the pressure in the gas main (typically no higher than nine inches of water in distribution lines, but somewhat higher elsewhere). Currently available gas compressors for small capacities (up to a few thousand standard cubic feet per hour) will significantly increase the cost of the overall power generation package. Particularly for fuel cell technologies, there is an additional pressing need for low-cost, low pressure, high-efficiency air compressors to meet the requirements for compressed cathode air. The OIT could consider supporting the development of both types of compressors, especially for capacities required for industrial-scale micropower and fuel cell hybrid packages.

Microturbines

- *Development of low cost bearings, technologies for improved efficiency, and high-temperature materials.* These advanced technologies are central to all of the microturbine applications and thus the role of OIT must be carefully considered. Some results from the ATS and CFCC programs and OIT's former and current automotive and heavy vehicle engine programs should be applicable. OIT could investigate if it could leverage the expertise in some of its materials engineering and production programs in the aluminum, steel, and metal casting vision programs.

- *Development of high-volume production methods.* As high-volume production is a central premise for the successful commercialization of microturbines, production technology will likely be a core technology for their manufacturers. Certain ceramics and metal casting manufacturing technologies that OIT has supported could be adapted to the manufacture of microturbine components.
- *Development of low-cost recuperators.* There is a need for low-cost metallic recuperators. In the longer term, the use of ceramics may also help reduce the cost of high-temperature recuperators needed for higher efficiency.

Fuel Cells

- *Development of low cost stacks* (plate materials, power density improvement, and reduction of losses). This need is general to all applications of fuel cells. Consequently, significant investments are being made to develop low cost stack materials. Therefore, Arthur D. Little has not identified specific ways in which OIT could significantly accelerate these efforts.
- *Low cost fuel processing equipment.* This is also an area of very active government and corporate R&D (Shell and Daimler-Chrysler as examples). There may be, however, an opportunity to develop fuel processors that are adapted for specific waste fuels generated within the industrial sector. In particular in the chemicals industry, a variety of hydrogen-containing waste streams are present that may be reformed or upgraded to feed fuel cells.

Fuel Cell Hybrids

Generally speaking, the technology challenges associated with fuel cell hybrids are common to those of high-temperature fuel cells and microturbines, since both of these components must be developed before they can be successfully integrated into these combined systems. Challenges that are unique to fuel cell hybrids include:

- *Systems engineering considerations.* Those issues that involve assembling known components into production-ready packages are most appropriately handled by manufacturers, but OIT may play a role early in the development of this technology in the development of alternative system considerations.
- *Air and gas pressurization equipment.* While this equipment has been identified as a general need of all the technologies covered in this report, the pressurization of fuel cells is particularly relevant to their application in hybrid systems, some of which will operate at much higher pressures than micropower technologies.

7.2.2 O&M Cost Reduction

O&M cost has not come forward as a key differentiating issue. Still, O&M costs are a significant part of overall cost. Thus, several technology improvements could aid overall reduction in cost.

General

- *Development and demonstration of remote monitoring technology* will likely offer significant potential for O&M cost reduction for all technologies, especially in the case of third-party ownership. The role of OIT in this endeavor should probably be one of encouraging support for demonstrations and key technology components, and adaptation to industrial applications. Ultimately, the owners of these technologies will be concerned with *proven* (as opposed to calculated) O&M costs, and demonstration facilities provide a critically important source for this data.

Technology Specific

- *Develop and demonstrate long-life rotors (and bearings)* for microturbines
- *Reduce stack-replacement cost, and/or increase stack lifetime* for fuel cells
- *Develop longer life ignition systems (natural gas) and fuel injectors (diesel)* for reciprocating engines.

7.2.3 Efficiency Improvement

Efficiency improvements are a key element of cost reduction and they also obviously support national objectives. Efficiency improvements need to be considered together with capital cost reductions.

General

- *Development of cost-effective and robust ceramic components* (e.g., rotors, combustors, recuperators and other heat exchangers, cylinder and valve lining) could allow higher temperature operation which would aid efficiency in most technologies. See also comments under cost reduction.
- *Development of efficient compressors.* When compression of the fuel (gas) is required, low-efficiency compressors lead to reduced overall system efficiency, particularly for microturbines, engines, and fuel cell hybrids.
- *Development of cost effective cogeneration packages.* The importance of cogeneration in the industrial sector implies that this is a critical need amongst micropower and fuel cell hybrid systems. Moreover, this is a key way to improve the overall efficiency of micropower systems. Specifically, small cogeneration systems tend to be expensive and often limited to hot water applications. Therefore, cost

reduction, as well as the development of systems that can generate steam or be easily integrated into tightly-coupled cogeneration applications would greatly improve the attractiveness of micropower and fuel cell hybrids in industrial applications.

Microturbines

- *Develop a better understanding of the trade-offs between pressure ratio, temperature, and degree of recuperation on efficiency and cost.* There is some uncertainty over the influence of these critical design and operating parameters. A solid understanding of their interrelation would aid in the optimization of microturbines in general, and assist in defining R&D objectives. OIT has significant experience through its participation in the ATS program, which could be brought to bear on microturbines.
- *Development of improved aerodynamics.*
- *Development of high-speed, high efficiency and low-cost electric generators.*
- *Development of high-temperature recuperators.* Higher temperature metallic recuperators would help increase the efficiency of microturbines. In the long-term, ceramics could also play a role in increasing the operating temperatures of recuperators. The exact temperature requirements would need to be determined as part of the trade-off assessment described above.

Fuel Cells and Fuel Cell Hybrids

- These technologies are already expected to be highly efficient. However, PEM systems could benefit from stack and reformer technology developments that enable consistent 40%+ efficiency at reasonable capital costs.

Reciprocating Engines

- *Continue to transfer the transportation industry's knowledge of electronic fuel management to the industrial market.* Control systems that can compensate for transients, environmental conditions and fuel quality will positively impact engine efficiency and emissions.
- *Develop cylinder heads specifically for natural gas engines.*
- *Develop heat recovery equipment specifically for reciprocating engine cogeneration applications.*

7.2.4 Emissions Reductions

Emissions reduction does not have the same urgency for all technologies. Although it may not be critical for many technologies today, it may be more important in the future, for two reasons: (i) emissions regulations are constantly changing, and (ii) as the population of distributed generation applications grows, it will represent a larger fraction of total power sector emissions. Therefore, small generating units, which can

fall outside of certain emissions regulations today, will begin to receive more attention from regulators. The priority of emissions reductions programs must be seen in this perspective.

Microturbines

- *Develop low-emission combustion.* Catalytic combustion and other approaches (e.g., lean pre-mix) may be needed to lower microturbine emissions to meet standards in the future.

Fuel Cells and Fuel Cell Hybrids

- Fuel cell emissions are already very low. This is not an area where OIT involvement is required.

Reciprocating Engines

While reciprocating engines have a substantial advantage over other micropower technologies by virtue of their well-established current position, microturbines and fuel cells are expected to produce markedly lower emissions. As such, emission reduction technologies (especially of NO_x) are likely to be critical for reciprocating engines to retain their strong position in industrial markets.

- *Diesel engine conversions.* Natural gas fueled engines have lower emissions (NO_x, PM and SO₂) than diesel engines. Converting diesel engines over to natural gas or dual fuel (natural gas-air mixture ignited by a diesel pilot) operation will reduce emissions.
- *Develop electronic fuel management systems and engine speed control in concert with improved fuel delivery systems (CI engines).*
- *Develop low-cost catalysts for long life and lean-burn operation.*

7.2.5 Reliability

Reliability is a prerequisite for success, but as there currently are no clearly identified problems with reliability with any of the technologies, tests and demonstrations of reliability will first be needed. If problems surface, R&D needs may arise.

7.2.6 Integration of Technology Into Applications

Probably more important in industrial applications than in other applications is the seamless integration of the power generation equipment into the industrial process. Most notably this is the case in cogeneration systems.

General

- *Development of convenient and appropriately sized switchgear.* Availability of so-called *plug-and-play* equipment would much simplify the installation and adoption of micropower and fuel cell hybrid technology. OIT could play a role in ensuring that such switchgear meets specific needs of industrial users with respect to electrical characteristics and safety regulations.
- *Facilitation of integration of controls into plant or facility control systems.* In many cases it will be necessary or desirable to integrate the controls of the micropower or fuel cell hybrid systems into the plant control system. This typically allows plants to anticipate demand and balance demand for thermal and electrical energy across multiple units. OIT could help in ensuring that in the development of control systems, manufacturers take into account interface issues for industrial customers.

Microturbines

- *Development of cogeneration packages for microturbines.* Currently, most manufacturers have not developed cogeneration packages for their microturbines. Development of both hot water and steam generator heat recovery packages that are appropriately sized for microturbines is needed. Preferably this would take advantage of the economies of manufacturing scale (such as is the case with commercial boilers). OIT could support the development of such technology.
- *Development of packages for tightly-coupled cogeneration,* allowing the integration of the microturbine exhaust into the burner or furnace system. This will require developing particularly the control systems and backup firing systems. OIT could support the development of such technology.

Fuel Cells

- *Cogeneration packages for high-temperature fuel cells.* The high cost of high-temperature fuel cells provides a strong driver to identify mechanisms to reduce their effective cost to the end user. The fact that they generate high-temperature off-gases suggests that cogeneration packages may provide such a mechanism. However, the recovery of the heat from these off-gases will probably require the development of integrated cogeneration units. Since the characteristics and performance of high-temperature fuel cells is still changing as the technologies mature, the development of such units is probably not appropriate at this time.

Reciprocating Engines

- Already in fairly widespread use, but *improved cogeneration packages* was also identified as a need for this technology.

7.3 Other Technology Support Needs

In addition to these R&D needs, the micropower and fuel cell hybrid technologies considered here will benefit from other forms of support.

7.3.1 Awareness Programs

OIT could include micropower technology in its awareness programs. Currently, those responsible for utility technology in industry are not generally aware of micropower technology, much less so of emerging micropower technology such as microturbines. Moreover, microturbine manufacturers have generally not considered the industrial market as an opportunity. OIT's activities could be focused (such as the motor challenge program) or part of a more general program (such as IAC program).

7.3.2 Demonstration Programs

As reliability, proven performance, and reputation are so important to break into industrial markets, demonstrating technology performance in industry is critical. For many industries a demonstration within the same industry is required for broad market penetration. OIT could support demonstration programs. This could take the form of dedicated demonstration programs, or it could be done in the context of existing programs such as NICE³.

7.3.3 Market Support

Micropower and fuel cell hybrid technologies all require the benefit of economy of manufacturing scale (i.e., mass production) to offset the inherent disadvantage in economy of scale of each machine compared with conventional power technology. If large-volume markets cannot be accessed by these technologies, no amount of technology improvement will lead to the cost reductions required for anything but marginal market acceptance. These large-volume markets are not likely to be supported by the industrial sector. Consequently OIT is likely to have few opportunities to influence the establishment of such large-volume markets. However, there are a few industrial markets that could offer early opportunities for micropower technologies as they do not require high performance standards to be successful. These applications include remote power and backup power. OIT might consider supporting demonstrations in these areas.

7.3.4 Emissions

Although individual technologies may have favorable emissions characteristics, industrial owners may not be able to take advantage of them unless the regulatory agencies recognize them as such. Traditionally, for larger equipment, owners had equipment certified by compliance tests. However, for small units these compliance tests are likely to be unacceptably costly, outweighing any expected economic benefits. Therefore, OIT could support activities that facilitate this recognition, such as:

- Factory certification
- Demonstration and evaluation of new technologies with respect to emissions
- Testing to establish BACT status

8 Summary and Conclusions

Arthur D. Little was asked by the Department of Energy's Office of Industrial Technologies (OIT) to identify opportunities for micropower and fuel cell hybrid technologies within the OIT's *Industries of the Future*, and to consider how the OIT might help increase their likelihood of having a significant impact on national objectives of reduced emissions and improved energy efficiency. This required examining the following dimensions:

- What motivates industry in their choice of technology? What are its *drivers*?
- How would industry use the new technology? What are its *applications*?
- How strong and how large is the need for these applications in each industry? What is the *size of the market*?
- How well will each technology perform in each of these applications? What is its *fit*?
- *How could OIT further improve* the chances of success of these technologies and what would be the national benefits (especially energy savings, emissions reductions, and strengthening of the competitiveness of U.S. industry) of an OIT-directed program?

This chapter highlights the most important lessons from this report for each of these elements.

8.1 Drivers in Industrial Markets

Economic considerations will dominate technology choices in industry. In each of the industries considered, electric power costs are a significant part of the production cost (Figure 46).

Figure 46: Cost of Power as a Fraction of Net Value Added in Industry

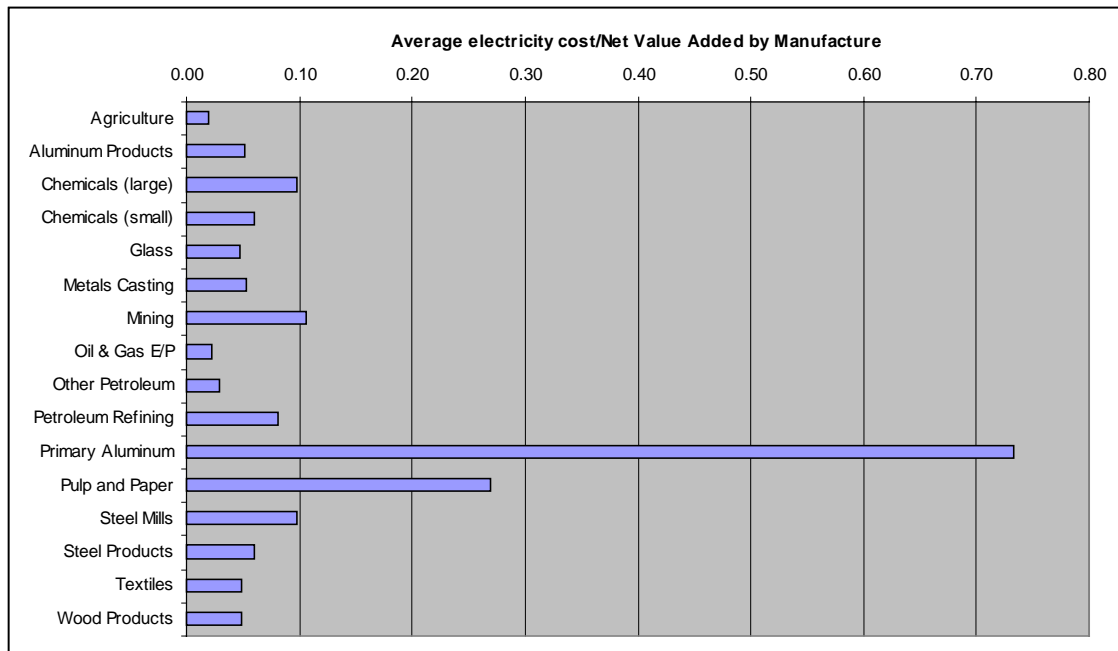

Source: *Manufacturing Consumption of Energy 1994*. DOE Office of Integrated Analysis and Forecasting, Energy Information Administration. December 1997.

The most important driver for companies to consider generating electric power onsite is a reduction of their energy costs.¹⁰ In general cost considerations include capital (or first cost) as well as variable cost (fuel cost, operation and maintenance). However, in certain applications, such as backup power, the load factor is so low that capital cost dominates the economic decision. For virtually all the other applications, all aspects of the cost of electric power production need to be considered. These are primarily influenced by:

- Capital cost
- Fuel efficiency
- Operating and maintenance cost
- Equipment life

Emissions of criteria pollutants can play an important secondary role in the technology choice in selected locations. Emissions regulations of criteria pollutants (CO, NO_x, ground-level ozone, mercury, particulate matter and SO₂) from industrial and power

¹⁰ This is also true in the case of third-party ownership, but in that case the benefit and costs are shared between the third-party energy provider and the industrial energy user.

generation technologies are driven by the National Ambient Air Quality Standards (NAAQS). Regulations are determined on a state-by-state basis to ensure that the national ambient air quality standards are met in each county (the so-called State Implementation Plans). As a result of widespread non-attainment with respect to the ozone standard many states have devised regulations for NO_x emissions from industrial and power generation sources (Figure 47). Most regulations provide industrial sites with some flexibility in technology choice in the implementation of the regulations (e.g., in trading and off-set programs). Nevertheless, in certain non-attainment areas, new installations have to use best available control technology (BACT) or lowest achievable emission rates (LAER). EPA determines what technologies constitute BACT or LAER. Therefore, technologies that are recognized as BACT or LAER have a strong advantage in non-attainment markets.

Figure 47: Ozone Non-Attainment Areas in the United States

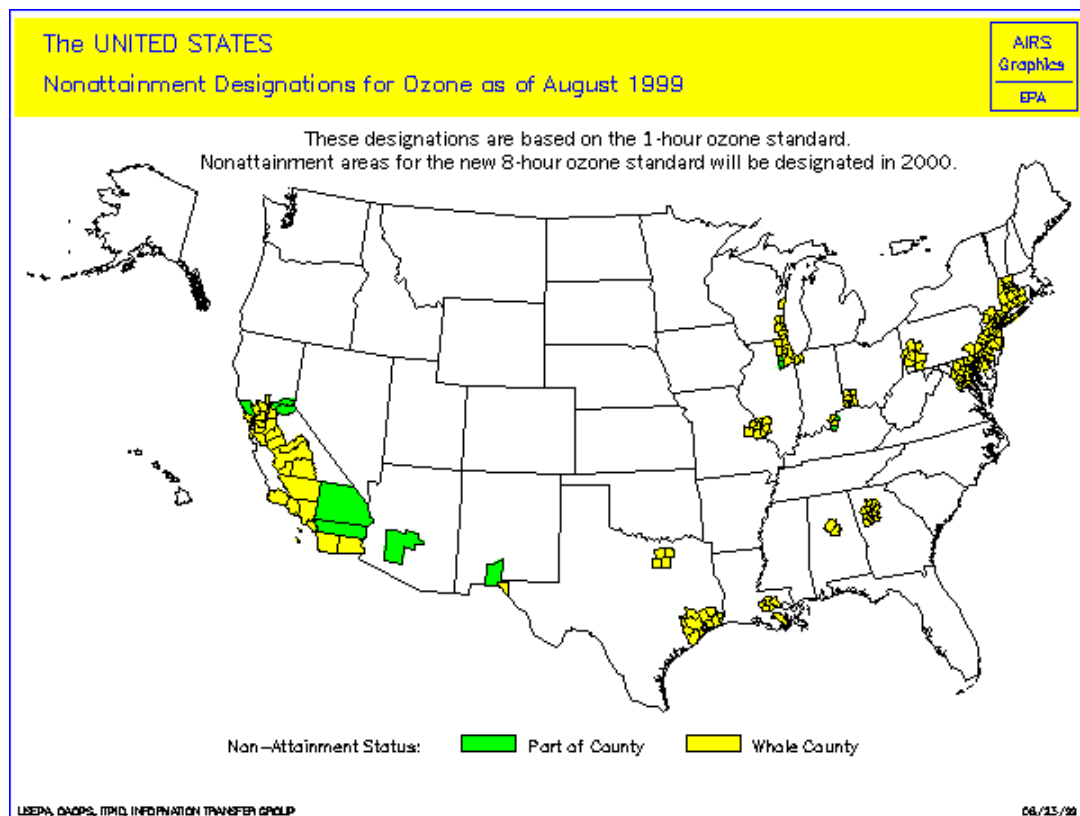

Currently prevailing NAAQS are based on the 1990 amendments to the Clean Air Act. It is generally viewed as unlikely that these standards will be changed in the next few years (with the exception of particulate standards). This has kept state-regulations relatively constant over the past several years. However, this could change if a new wave of ambient air quality standards is passed. If this occurs, it is most likely to happen after 2005.

Similarly, it appears unlikely that regulations on greenhouse gas (GHG) emissions will be passed in the next few years in the U.S. However, in the ten to twenty year timeframe many consider GHG emissions regulations a strong possibility. Many industrial companies are therefore starting to consider if they need to take GHG emissions into account in medium- to long-term investment and technology choice decisions. In addition, the possible advent of regulations on greenhouse gas emissions may provide a further impetus for efficiency improvements and efficient use of combustible wastes and biofuels. Many European countries are moving at a faster pace with respect to GHG emissions, and in those countries GHG emissions are already an important consideration in technology strategy and selection. It is likely that U.S. technology exporters will be driven to offer high efficiency technologies in order to be able to compete in these countries.

Reliability, safety, and reputation of the manufacturer will be considered prerequisites for any technology's success in the industrial market. Power and steam generation do not usually impact product quality or production directly; they are not considered core business functions by most industries covered in this report. But if the utility technology fails (or causes a safety-related shut-down), resulting in loss of production or reduced product quality, these clearly affect the core business. Consequently, industrial customers attach great value to (and even demands for) proven reliability and a good safety record for a technology before adopting it. This cautiousness is often amplified by the conservative nature of the physical plant management, which is in turn driven by the risk/rewards structure of the company, which does not favor taking chances on utility or other supporting technology.

Deregulation is expected to increase the importance of onsite generation, cogeneration, and premium power to industry. Also, to the extent that deregulation increases the opportunities for third-parties to own and operate onsite generation equipment, this will have a decisive impact on improving the economics of onsite power. Third-party ownership also fits well with the continuing trend in industry to outsource non-core business functions. These two trends make a significant increase in third-party ownership of onsite energy systems in industry in the coming decade likely. At the same time, third-party ownership will likely make very tight integration of the onsite power generation system with the industrial production process slightly more difficult because of potential for liability issues arising from greater interdependence. Finally, in the transition period to deregulated markets, considerable uncertainty may exist over the future of regulations and the power market. This will tend to favor new technologies with low first cost and a high degree of flexibility.

8.2 Applications for Micropower and Fuel Cell Hybrid Technology

To facilitate the analysis of opportunities for micropower and fuel cell hybrid technologies Arthur D. Little identified seven potential applications (modes of use) for

these technologies within the *Industries of the Future*. For this analysis ADL considered each of these applications in each industry separately. This summary represents a synthesis of all of these separate analyses. As the need for each application varies by industry, each application was examined on an industry-specific basis.

Please note: Figure 48 through Figure 54 below account for the overall technical and economic fits of each technology in each application. In applications where technologies scored low relative to the others, they were assumed to have little or no potential market in that application. More detailed analysis could reveal specific opportunities that were not captured in this report.

The applications can be divided into two categories: large and niche. Simple generation and cogeneration (both traditional and tightly-coupled) represent large power demands in industry. Even though micropower and fuel cell hybrid technologies are expected to capture only a small fraction of these markets, their sheer size makes them important potential markets to consider. Backup power, remote power, premium power, and waste and biofuel applications must be considered as niche opportunities – the demand for them in industry varies considerably by industry and is generally smaller than for the other applications. Nevertheless, micropower and fuel cell hybrid technologies are expected to be able to address a considerable fraction of some of these markets, especially in selected industries.

8.2.1 Simple Generation

Simple generation is the onsite generation of electric power simply to off-set power purchases from the grid. This may be done in a peak-shaving or base-load mode.

Market

Simple generation represents a large demand across industry (Figure 48). In theory all industrial power demand could be met by onsite generation. Even though deregulation is expected to remove some regulatory barriers to onsite generation, application of these technologies in simple generation in industry is expected to remain a challenging proposition. Energy prices (both gas and electric power) have traditionally been low for industry (compared with those for commercial and residential customers), and deregulation is expected to reduce prices even further.

Most importantly, many industrial sites have high thermal loads, and therefore see no compelling benefit to simple generation as compared to cogeneration. This is likely to limit the number of sites where simple generation is the most attractive option.

Technology

Simple generation requires technologies that can compete with the economics of the grid and therefore implicitly with larger capacity generating equipment. In general, low capital cost, low O&M cost, high fuel efficiency, low fuel cost, and high availability are critical technology requirements for simple generation applications. To compete with base-load

power plants, fuel efficiency and availability are more important, while to compete with peaking power plants a technology should have low capital and O&M cost.

Most micropower technologies are not competitive in this application, as indicated in Figure 48, where technologies are only expected to compete under the most aggressive R&D goals. Advanced gas turbine-based systems offer fierce competition with very high efficiency (approaching 60% for the largest units) and low cost (especially for the larger systems). In addition, the performance and cost characteristics of such systems are continuing to improve, partly with the help of the DOE through its Advanced Turbine Systems program.

Recuperated microturbines, advanced large reciprocating engines (300-1,000 kW), and fuel cell hybrids may be able to serve this application competitively. It is noteworthy that these three technologies are also the ones being most actively targeted to electric power companies as power generation technologies. Even so they will likely face stiff competition from more conventional technologies such as gas turbine combined cycles. Finally, third-party ownership is critical to create the economic conditions required for broader success of any of these three technologies within the *Industries of the Future*.

Figure 48: Addressable Micropower (25-1,000 kW) and Fuel Cell Hybrid (0.25-20 MW) Market Opportunities in Simple Generation within the *Industries of the Future*

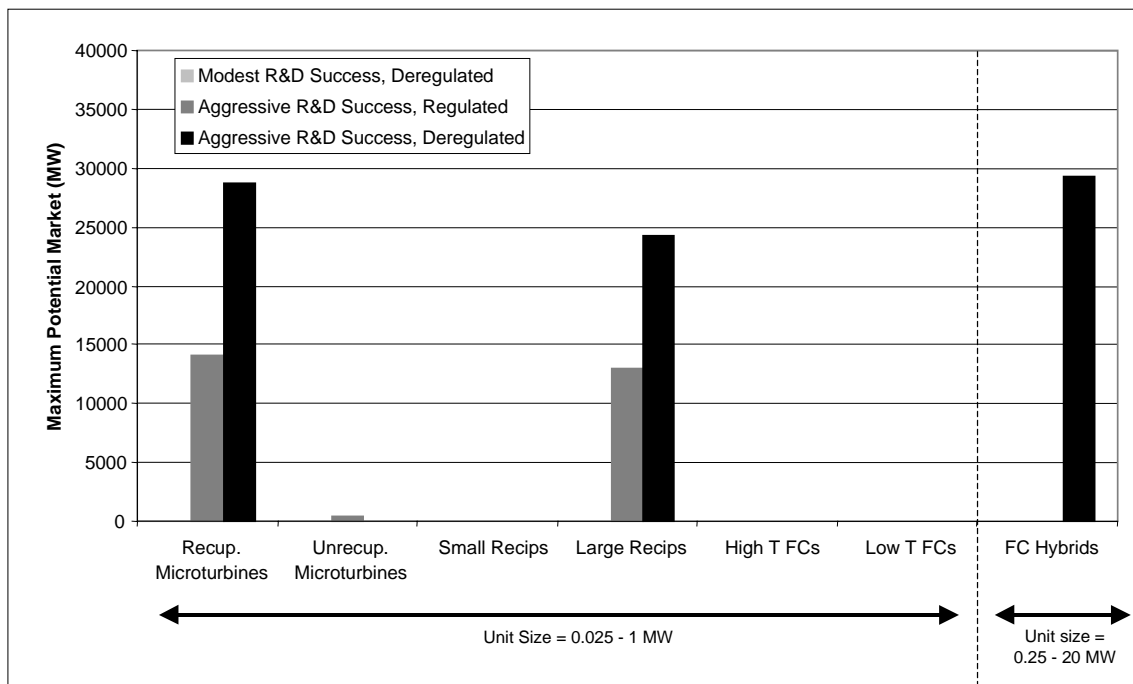

Note: *Small Recips* are from 50 – 300 kW and *Large Recips* are from 300 – 1,000 kW. The *Addressable Market* is the total market opportunity within the *Industries of the Future* through 2010. It is not an annual sales volume.

8.2.2 Traditional Cogeneration

Traditional cogeneration is defined as the combined generation of electric power and heat as either steam or hot water.

Market

In all industries with significant steam and hot water demands, traditional cogeneration represents a large potential market (Figure 49). Given the small size of most of these technologies, the largest opportunities for cogeneration are in the small facilities found in the food products, chemicals and textiles industries. The large cogeneration demands in the pulp and paper industry tend to be too large to be served by these technologies. Energy savings measures (improved insulation, heat recovery, etc.) and switching to direct heating is expected to continue to reduce specific steam and hot water demand in industry over the next twenty years. Nevertheless as industry overall grows, a significant steam and hot water demand will remain, representing a significant untapped potential for cogeneration. Cogeneration can provide significant cost savings to the industrial company or to the energy service company providing utilities for the industrial customer, which is the primary driver for installing cogeneration over simple generation.

Figure 49: Addressable Micropower (25-1,000 kW) and Fuel Cell Hybrid (0.25-20 MW) Market Opportunities in Traditional Cogeneration within the *Industries of the Future*

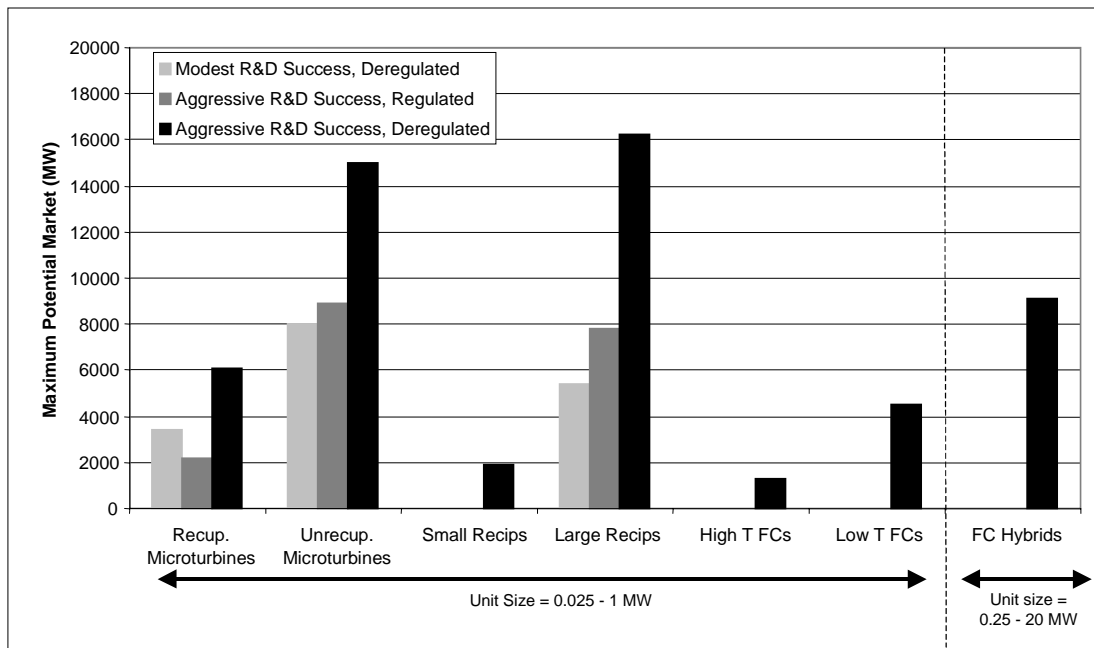

Note: *Small Recips* are from 50 – 300 kW and *Large Recips* are from 300 – 1,000 kW. The *Addressable Market* is the total market opportunity within the *Industries of the Future* through 2010. It is not an annual sales volume.

Technology

The temperature level of the waste heat available for cogeneration applications can limit the choice of technology. For example, low-temperature fuel cells and recuperated microturbines may not have waste heat at temperatures high enough for steam

generation¹¹, limiting their use to hot water applications. Reciprocating engines and low-temperature fuel cells produce hot cooling water that must be cooled and therefore requires little extra cost for cogeneration of hot water. In fact, low-temperature fuel cell products are generally being packaged for cogeneration as the primary application. In microturbines most of the waste energy is contained in the exhaust gas stream, so that a boiler or steam generator is required for cogeneration. This adds cost. If attractive micropower cogeneration packages were readily available, it could significantly expand the application of cogeneration in smaller industries such as small chemicals, and possibly other industries outside of the *Industries of the Future*.

Overall, a good technical and economic fit exists for large advanced reciprocating engines and unrecuperated microturbines. The large potential market for unrecuperated microturbines is predicated upon achieving the cost targets, but not necessarily on achieving the efficiency targets. Thus this application may offer excellent early opportunities for micropower technologies. In general, because electric efficiency is less critical in cogeneration, opportunities exist for some micropower technologies even in scenarios where R&D success is only modest, or if rapid payback criteria are used. Large engines are currently used in a variety of applications but for continued broad application, achieving emissions targets will be critical, especially in light of the superior emissions characteristics of competing technologies.

Unrecuperated microturbine technology has the potential to significantly expand the application of cogeneration in industry, provided cogeneration packages are developed and demonstrated in industry. For example, low-cost and effective heat recovery steam generators for microturbines may need to be developed for industrial applications. Preferably such systems would also leverage the economy of manufacturing scale of other equipment such as commercial boilers.

From a technical perspective, high-temperature fuel cells are attractive devices for cogeneration by virtue of their high electrical efficiency and high-temperature offgases. However, their expected higher cost limits their application. As their costs are further reduced, they could present an attractive option for industrial cogeneration.

The attractiveness of fuel cell hybrids is primarily in the food products and textiles industries, where low-temperature thermal loads can be met by this technology. However, they are expected to be economically attractive only if the most aggressive R&D targets are met. It should be noted that the size of the market for these technologies is in part due to their high efficiency, since a given heat load will be accompanied by a much larger amount of electricity production.

The use of low-temperature fuel cells is limited primarily to the food products and textile industries, which have a high demand for low-temperature heat (in particular hot

¹¹ Low-temperature fuel cells with emerging high-temperature membrane technology may be more suitable to steam generation.

water). Low-temperature fuel cells do not appear to fit well with cogeneration applications in other industries.

8.2.3 Tightly-Coupled Cogeneration

Tightly-coupled cogeneration is defined as the use of exhaust gas from power generation systems for direct process heating, either by direct use or by using the exhaust gas as preheated vitiated air for industrial burners.

Market

Direct process heating (rather than via steam or hot water) represents a major fraction of industrial energy consumption in many industries, notably iron and steel, chemicals, and petroleum refining. In addition, industries that have traditionally used steam for heating (such as the pulp and paper industry) are switching increasingly to direct heating. Therefore the opportunities for tightly-coupled cogeneration are increasing. The total market opportunity for each technology is shown in Figure 50.

Provided that compact and easily controllable power generation systems are available, they are potentially attractive options because the additional investment cost required can be minimal (the exhaust gas is simply ducted into the furnace or heater). Nevertheless, because direct-fired heating applications often have higher process temperatures, the amount of usable energy may be limited, thus leading to a somewhat limited economic benefit.

Technology

Because most direct-fired process-heating processes require higher temperatures than steam generation and hot-water heating, benefits can only be obtained in a combination of low-temperature processes (such as drying) and a technology with high exhaust temperatures. This makes these applications unsuitable for small engines and low-temperature fuel cells.

The market opportunity profile for this application, shown in Figure 50, is similar to that of simple generation. However, the slight economic benefit obtained for recuperated microturbines by this application relative to simple generation suggests that this might be a valuable early market for microturbine technology.

As in traditional cogeneration applications, the size of the market for fuel cell hybrids is made particularly large by the high efficiency of these devices, which effectively require that more electricity is produced for a given amount of heat demand. Also, the larger unit size considered here relative to micropower results in a larger opportunity, all else equal.

In some niche markets where thermal loads and electric loads are closely coupled, tightly-coupled cogeneration may be particularly attractive. For example, in paint drying applications, combined electric infrared-convection ovens can provide an excellent drying solution. However, some of the toll-coaters that would be operators of such ovens have limitations on the electrical capacity of the infrastructure, and have very

high cost electric rates. A self-powered system may be very attractive for such a company, as well as for the local electric utility.

Complexity of the system controls and matching load profiles of the heat load will need to be resolved and may prove difficult to achieve reliably in some highly-integrated processes. Special control systems may be required to achieve this.

Figure 50: Addressable Micropower (25-1,000 kW) and Fuel Cell Hybrid (0.25-20 MW) Market Opportunities in Tightly-Coupled Cogeneration within the *Industries of the Future*

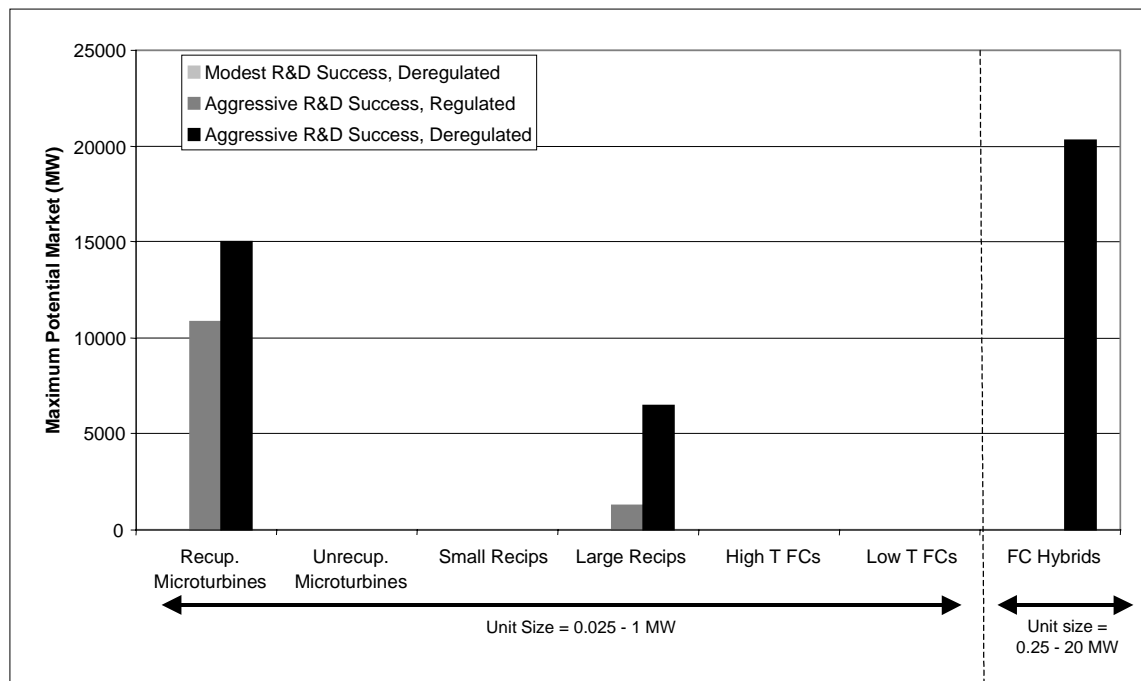

Note: *Small Recips* are from 50 – 300 kW and *Large Recips* are from 300 – 1,000 kW. The *Addressable Market* is the total market opportunity within the *Industries of the Future* through 2010. It is not an annual sales volume.

8.2.4 Backup Power

Most industrial sites have a backup power system to ensure that critical systems will continue to operate during a primary power source failure.

Market

The need for backup power is ubiquitous in industry. Most industrial sites require some minimal backup power for safety-related systems such as lighting and control systems. In addition, certain production systems and products can be substantially damaged in the case of power outages (refineries, steel mills, glass melters, and computer systems). Thus the market for equipment in backup power is substantial. Currently, reciprocating engines and gas turbines dominate most backup power demands. For very small loads, battery backup may be used.

This market may be somewhat affected by deregulation. Power reliability may become a commodity with a price, so that some customers may have to weigh the cost of backup

power equipment against a premium cost for high-reliability purchased electric power. Many customers however will continue to have a need for onsite backup power that is driven by safety or insurance considerations.

Figure 51: Addressable Micropower (25-1,000 kW) and Fuel Cell Hybrid (0.25-20 MW) Market Opportunities in Backup Power within the *Industries of the Future*

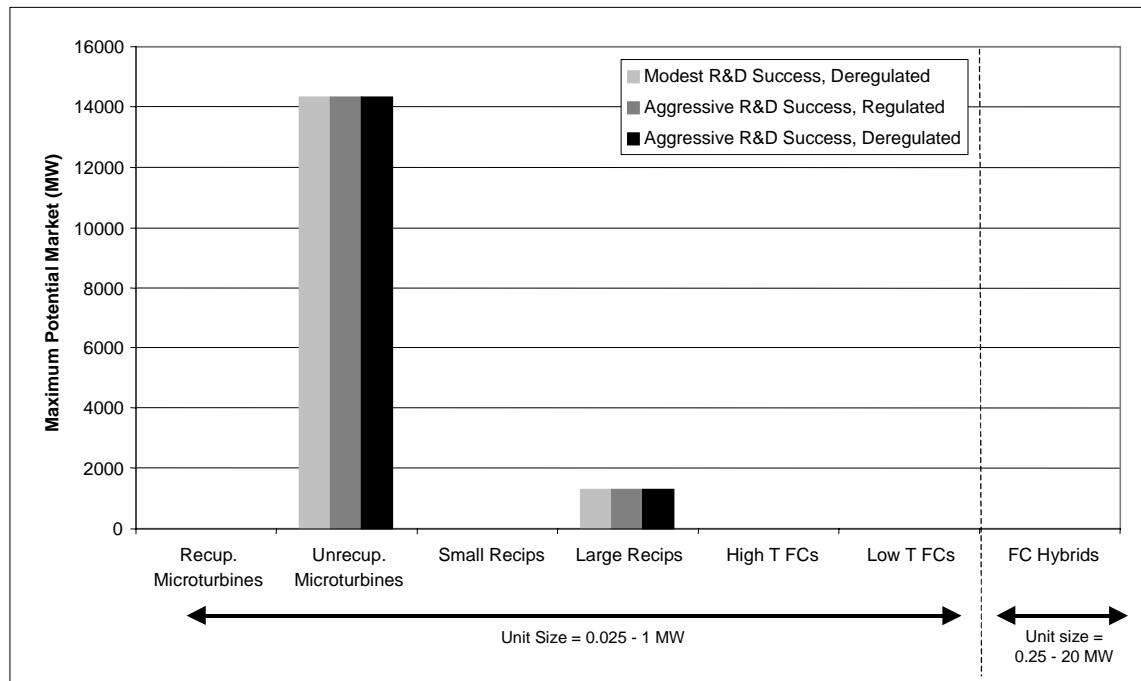

Note: *Small Recips* are from 50 – 300 kW and *Large Recips* are from 300 – 1,000 kW. The *Addressable Market* is the total market opportunity within the *Industries of the Future* through 2010. It is not an annual sales volume.

Technology

Technologies for backup power must, of course, provide rapid and reliable start upon demand, and not rely on external power supplies for start-up or operation. In addition to considering these technical requirements, the purchase decision is based largely on capital cost, whereas efficiency and operating costs are of limited importance due to the intermittent operation of the equipment.

The importance of low capital cost in this application precludes the use of most fuel cell-based technologies (Figure 51). Fuel cells are further handicapped by a relatively slow start-up time due to the need to heat up the stacks (high-temperature fuel cells) and the reformers (low-temperature fuel cells). Nevertheless, continued automotive investment in PEMFC technology could eventually lead to very low cost direct-hydrogen fuel cell systems that could be used in some locations for backup power, provided hydrogen fuel was available.

In contrast, backup power applications may provide early markets for unrecuperated microturbines (provided a low first cost can be achieved). Additional improvement in performance is much less important than reduction of cost of new technologies.

Although reciprocating engines are expected to continue to be a significant technology in the backup power market, at the scales considered here, they may face stiff competition from microturbines, depending on the sensitivity of users to small differences in capital costs.

8.2.5 Remote Power

Remote power is defined as off-grid generation of electric power.

Market

The remote power market is a niche market, albeit a considerable one for micropower technologies, as only a small minority of industrial sites are not connected to the power grid (Figure 52). Remote power opportunities are concentrated in a few industries (mining, oil & gas exploration and production, forest products). The current market for remote power is dominated by reciprocating engines.

Figure 52: Addressable Micropower (25-1,000 kW) and Fuel Cell Hybrid (0.25-20 MW) Market Opportunities in Remote Power within the *Industries of the Future*

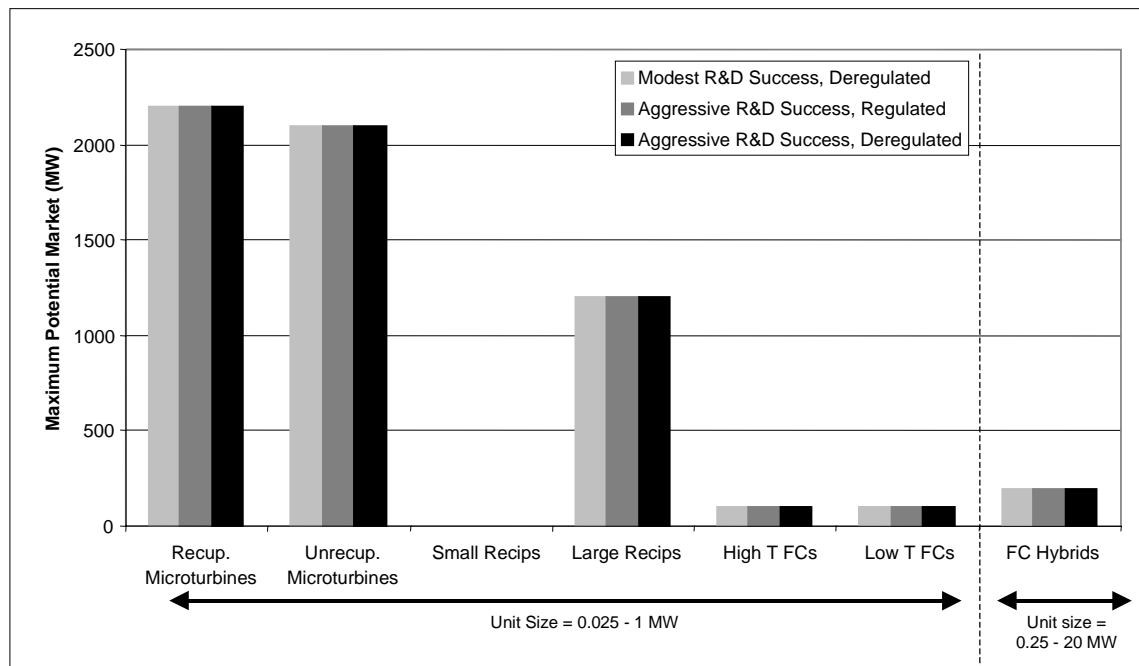

Note: *Small Recips* are from 50 – 300 kW and *Large Recips* are from 300 – 1,000 kW. The *Addressable Market* is the total market opportunity within the *Industries of the Future* through 2010. It is not an annual sales volume.

Technology

Remote power applications require technology that can operate on non-grid fuels: i.e., propane or diesel. Reciprocating engines are generally capable of using such fuels, as are microturbines. Although it may be relatively straightforward to modify fuel cells (with reformers) for operation on propane, significant modifications to their reformers would be necessary for operation on diesel. However, the large industrial markets for remote power in the oil and gas exploration/production industry (where natural gas is often readily available) may afford some opportunities for fuel cell technologies.

As the provision of remote power demands much higher reliability than other locations with grid-backup, proven performance in other environments must be achieved before micropower technologies can succeed in these markets.

8.2.6 Premium Power

For some industrial applications, a secure and or high-quality supply of power is so valuable that customers are willing to pay a premium for ensuring it. Such applications are referred to as premium power.

Market

Although the premium power market is just now emerging, it is bound to be a relatively small niche market in the industries evaluated in this report (Figure 53). There remains significant uncertainty about its possible size and the amount of premium that may be obtained. Electric industry deregulation is expected to significantly influence the development of this market. Two types of premium power exist: power with high quality spectral characteristics (waveform) and power that is reliable. Manufacturers of micropower technologies have pointed out the benefit of their technologies for the provision of high quality power. However, it must be noted that the high quality of this power is due in large part to the redundancy in the power generation package and the use of power conditioning equipment. Both redundancy and power conditioning could in principle also be incorporated into other types of technologies. Thus the premium that can be obtained is likely to be limited and is likely to shrink in time as the cost of the power electronics packages is reduced. In fact, it is likely that the very success of micropower technologies will reduce the cost of power conditioning equipment (through mass production) and thus reduce the cost of premium power.

Technology

The attractiveness of microturbines and large reciprocating engines in premium power applications is a direct result of their lower levelized cost of electricity and their ability to produce high quality power. Potential markets exist for all technologies, but microturbines and large reciprocating engines are the only technologies that are expected to be competitive with *Modest R&D Success*. As the premium achievable for this market is to some extent determined by the cost of power electronics that provide part of the premium quality, differentiation between technologies will be challenging, although technologies with demonstrated superior reliability characteristics will be favored.

If *Aggressive R&D Success* is achieved, fuel cell hybrids and most micropower technologies look attractive in premium power.

Figure 53: Addressable Micropower (25-1,000 kW) and Fuel Cell Hybrid (0.25-20 MW) Market Opportunities in Premium Power within the *Industries of the Future*

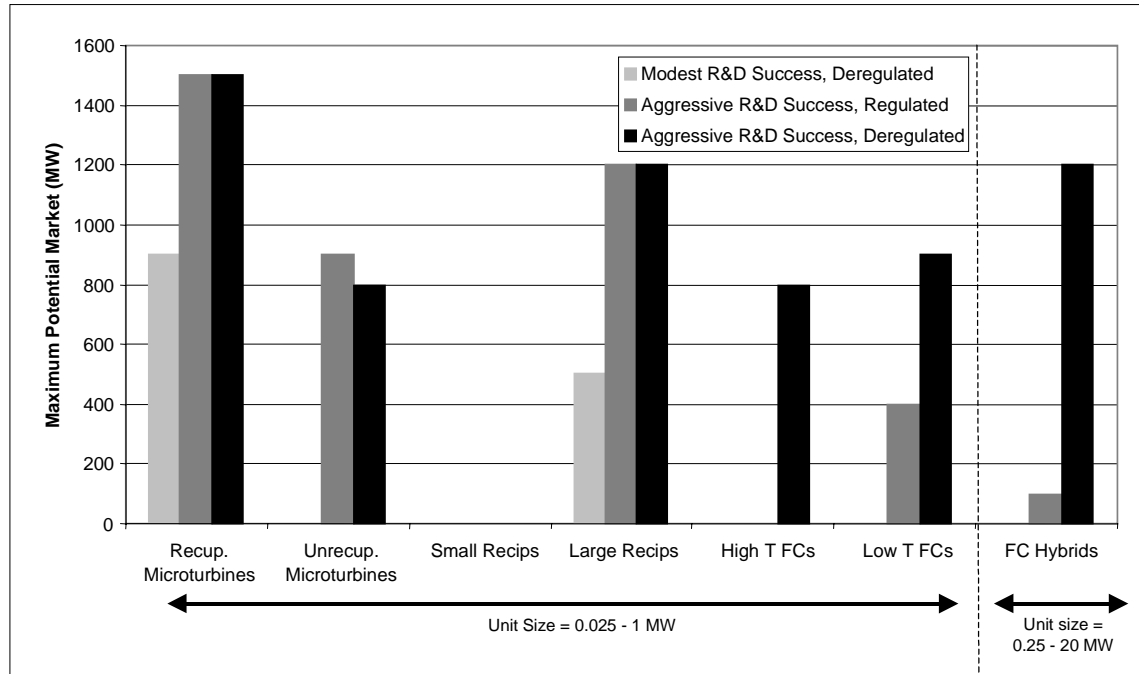

Note: *Small Recips* are from 50 – 300 kW and *Large Recips* are from 300 – 1,000 kW. The *Addressable Market* is the total market opportunity within the *Industries of the Future* through 2010. It is not an annual sales volume.

8.2.7 Generation Using Wastes and Biofuels

Combustible wastes and biofuels can be used for power generation applications or for cogeneration (Figure 54).

Market

Many industries generate residues in their processes that have a useable heating value. In some industries these are predominantly gaseous in nature (chemicals, refining, and iron and steel), while other industries have solid waste fuels (especially forest products). It should be immediately apparent from this list that power generation from wastes and biofuels is particularly concentrated in those industries with large average facility sizes. Amongst the solid waste fuels, biologically-derived plant wastes are common to many industries (food products, forest products, and some textiles). The use of these wastes as fuel affords the potential for zero net CO₂ emissions, since CO₂ released during combustion is taken back up through photosynthesis.

Much of these waste fuels are currently being used, either as process fuel, as boiler fuel, or in cogeneration applications. The motivation to switch to new technologies and to

cogeneration lies in the desire to increase power self-sufficiency, reduce emissions, and reduce overall waste disposal and purchased power costs.

Although efforts to improve process yields in most industries are continually reducing the amount of waste fuels produced, significant amounts of waste fuels will likely continue to be available in the future. Moreover, as the heat demand in many industries will decline in favor of electric power demand, some industries will find themselves with an excess of waste-fuel while they are still importing electric power.

Technology

As the motivation to use waste fuels in a cogeneration mode is similar to that of traditional cogeneration, the technology requirements are also similar. But the low cost of the fuel (often considered free) changes the impact of economics somewhat.

Many of the gaseous waste fuels may be used in micropower and fuel cell hybrid technologies with minor modifications. Liquid and especially solid fuels will require significant pretreatment for most technologies. Most will require gasification. Gasification, and the associated gas-cleaning technology, is not readily available at small scales. Its development presents significant technical and economic challenges, given the current state-of-the-art. The cost of gasification technology can *double* the capital cost over conventionally-fueled equipment. This additional cost is significant, so that it effectively favors the use of high efficiency equipment where higher electricity production can potentially offset these higher costs. Note that this is comparable to the increased attractiveness of high-efficiency technologies in remote power applications where fuel costs are particularly high, even though in this case, the fuel is often free.

Figure 54: Addressable Micropower (25-1,000 kW) and Fuel Cell Hybrid (0.25-20 MW) Market Opportunities in Generation Using Wastes & Biofuels within the *Industries of the Future*

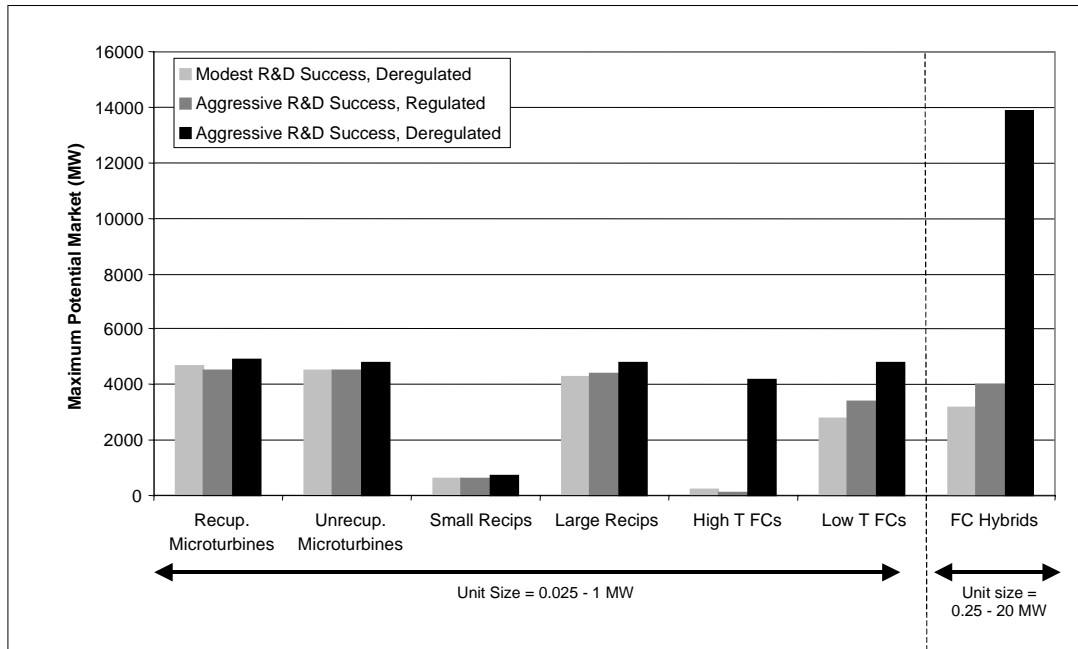

Note: *Small Recips* are from 50 – 300 kW and *Large Recips* are from 300 – 1,000 kW. The *Addressable Market* is the total market opportunity within the *Industries of the Future* through 2010. It is not an annual sales volume.

8.2.8 Summary

The competitiveness of micropower and fuel cell hybrid technologies industrial power applications within the *Industries of the Future* can be summarized as follows:

- In general, microturbines and reciprocating engines appear to be most competitive for these markets, based on a combination of low capital cost and reasonable efficiency.
- The high capital cost of simple-cycle fuel cell technologies appears not to be offset by their higher efficiency for small-scale industrial applications.
- Fuel cell hybrids appear to provide attractive economics in applications with high capacity factors, but these opportunities are mainly limited to the *Aggressive R&D Success, Deregulated* scenario.
- The continued competitive strength of reciprocating engines is predicated on continued improvement in technical performance, especially efficiency, emissions and reduced O&M costs.
- The competitive strength of microturbines is predicated on achieving low capital cost and reasonable efficiency. Low capital cost is critical for its competitiveness in all applications, high efficiency is not so important in backup power, waste and biofuels use, and cogeneration.

- A significant reduction in cost is required to make fuel cells more attractive in industrial markets. In regions with strong NO_x emissions regulations, fuel cell competitiveness could be significantly enhanced but this level of analysis was beyond the scope of the study.
- Although compound packaging of the technologies (e.g., a package of multiple microturbines) will probably be able to support demands up to 10 MW economically, most of these technologies will have to target smaller plants.

8.3 National Benefits and Potential Supporting OIT Activities

The commercial introduction of these technologies can lead to a broad range of national benefits, including:

- *Cost-savings to industry.* This report has identified those opportunities in which the application of micropower and fuel cell hybrid technologies for on-site industrial power generation can be economically attractive relative to current technology (typically grid-power at the size range represented by these technologies). This economic benefit implies a direct cost savings to those industries that implement these advanced technologies, which in turn leads to enhanced competitiveness, all else equal.
- *Decreased energy consumption.* Virtually all of the technologies considered herein have, or can achieve, electrical generation efficiencies that are greater than the local electric grid, which is approximately 33% efficient on a national average today. Technologies with lower efficiencies (such as unrecuperated microturbines) may still be attractive in cogeneration applications, where the fuel savings brought about by the recovery of waste heat can more than offset their lower electrical efficiency.
- *Decreased emissions of criteria pollutants.* Microturbines, fuel cells and fuel cell hybrids are expected to produce markedly reduced emissions of NO_x, and SO₂ relative to conventional technologies and the grid average.
- *Decreased CO₂ emissions.* Micropower technologies have the potential to reduce CO₂ emissions via their increased electrical efficiency, tendency to favor low-carbon, natural gas fuels and by providing opportunities for industries to convert their process wastes into useful energy at scales that have not previously been economic. In the case where micropower technologies are less efficient than the grid, they can still reduce CO₂ emissions when applied in cogeneration.

The realization of these benefits will require continued technology-specific developments, along with general activities that enhance the viability of small-scale, distributed power. In the terminology of this report, micropower and fuel cell hybrid technologies will need to achieve *Aggressive R&D Success* to have a significant impact. *Modest R&D Success* will lead to substantially smaller benefits. Deregulation of energy

markets is also critical for widespread acceptance of small onsite generation in most industrial applications.

Broadly speaking, the activities that could be undertaken by OIT to accelerate the development and introduction of micropower and fuel cell hybrid technologies are as follows:

8.3.1 Microturbines

For all microturbine technologies, success will be greatly enhanced with the realization of low cost and high efficiency consistent with the *Aggressive R&D Success* scenarios. Recommended OIT activities include a broad array of actions that will enable or accelerate the realization of these design goals.

Realizing the potential national benefits of unrecuperated microturbines will require cost reductions as well, but their low electrical efficiency and high potential for cogeneration applications implies that OIT activities favoring the development of small-scale industrial cogeneration packages will be crucial to the adoption of this technology by industry.

8.3.2 Fuel Cells and Fuel Cell Hybrids

All fuel cell-based technologies display inherently low emissions and several are expected to operate at electrical efficiencies well in excess of the national electric grid average. Additionally, laboratory and field data suggests that the operating cost of fuel cell systems is likely to be quite low. However, they must meet increasingly stringent capital cost targets if they are to achieve significant market penetration. Analyses described herein suggest that fuel cell technologies may be competitive with conventional technologies in many industrial applications, but competition amongst other micropower technologies may dramatically reduced their actual market share in the absence of continued cost reductions. It is recommend that OIT efforts focus on activities that will reduce the capital cost of these technologies.

8.3.3 Reciprocating Engines

As the most mature technology considered in this study, OIT's role in technology development is less crucial to the overall success of the technology than for the other technologies considered. The low cost and demonstrated reliability of these devices pose formidable challenges to competing micropower technologies. However, in order to make new inroads into the industrial market and to remain competitive in the long term, it will be necessary to take reciprocating engines to "the next level" in terms of efficiency, emissions and operating costs. In the near term, the primary challenge to reciprocating engines is expected to be in those regions where air-quality concerns favor low-emission technologies. Therefore, primary near-term focus of OIT development efforts for reciprocating engines should be those activities that reduce their emissions.

8.3.4 General

In addition to these technology-specific goals, there are a number of general activities that will be required for the successful introduction of distributed generation technologies. Among these are:

- The development of universal interconnection standards to facilitate distributed power production.
- The development of convenient and appropriately sized switchgear.
- The development of controls to integrate micropower and fuel cell hybrid technologies into industrial control systems.

9 Glossary

Addressable Market – In this report, this term is taken to mean the estimated size of the market for a given technology, after accounting for its technical and economic fits. Thus, it represents that portion of the *Entire Market* in which the technology meets both technical and economic criteria. It can be given in either in annual or cumulative sales. Others sometimes refer to this as the “economic market potential”.

Application – Generically, this describes an industrial use for onsite power generation equipment. This report has identified seven distinct applications: *simple generation*, *traditional cogeneration*, *tightly-coupled cogeneration*, *remote power*, *backup power*, *premium power*, and *generation using wastes & biofuels*.

Backup Power – A specific industrial application for onsite power generation technology. This applies to any equipment that exists solely to provide a redundant power source in the case of a failure of the primary power source. Backup power devices are characterized by low load factors, rapid startup and high reliability (also called standby power or standby generation).

Economic Fit – The percentage of facilities within a specific industry for which a specific technology/application pair is economically attractive. Note that this value is independent of the *Technical Fit* of a technology to a particular application.

Fuel Cell/Gas Turbine Hybrid – See *Fuel Cell Hybrid*

FC Hybrid – An abbreviation for *Fuel Cell Hybrid* or *Fuel Cell/Gas Turbine Hybrid*.

Fuel Cell Hybrid – A technology in which a gas turbine and high-temperature fuel cell are combined into a single system.

Generation Using Wastes & Biofuels – A specific industrial application for onsite power generation technology. This applies to any equipment that converts industrial wastes into power and/or heat (in the form of steam or hot water). This analysis has considered Generation Using Wastes & Biofuels to be viable only if all of the power and heat thus produced can be used onsite.

High-Temperature Fuel Cell - Molten carbonate fuel cells (MCFC) and solid oxide fuel cells (SOFC), which have stack operating temperatures of 650°C and 1000°C, respectively.

High T FC – An abbreviation for *High-Temperature Fuel Cell*.

Higher Heating Value (HHV) – The standard measure of the energy released during combustion of a fuel, assuming the product water is in the liquid state. For natural gas fuel, the HHV is approximately 10% higher than the *lower heating value (LHV)*.

Large Recip – An abbreviation for *Large Reciprocating Engine*.

Large Reciprocating Engine – A power generation technology based upon a piston-driven, reciprocating engine with an output power rating from 300 kW – 1 MW.

Load Factor – A ratio of the amount of electricity produced by a particular piece of power generation equipment in a given year, divided by the amount that it could have produced if it were operated continuously at full power. For those readers familiar with the terminology common to power generation equipment, this is equivalent to an average (or annual) load factor, and is not to be confused with the instantaneous actual load/rated load ratio.

Low-Temperature Fuel Cell – Generally, fuel cell technology with electrolyte operating temperatures below 200°C. For the purposes of this report, this refers to proton-exchange membrane fuel cells (PEMFC) and phosphoric acid fuel cells (PAFC).

Low T FC – An abbreviation for *Low-Temperature Fuel Cell*

Lower Heating Value (LHV) – The standard measure of the energy released during combustion of a fuel, assuming the product water is in the gaseous state. For natural gas fuel, the LHV is approximately 10% lower than the *higher heating value (HHV)*.

Micropower – This is used generically in this report to describe all power generation equipment considered herein with unit sizes under 1 MW. It includes all microturbines, reciprocating engines and fuel cells.

Microturbine – Any gas turbine rated for 1 MW or less of output power. Usually based on high-speed (>65,000 rpm) technology.

Premium Power - A specific industrial application for onsite power generation technology. This applies to any equipment that exists solely to provide power with a higher quality than that which is available from a conventional power source. This power may have a well-defined waveform, it may be direct current, or it may be more reliable than the conventional source.

Recuperated Microturbine – A microturbine that includes a recuperator to recover some of the residual energy from the hot offgases exiting the expander, thereby increasing electrical efficiency.

Remote Power - A specific industrial application for onsite power generation technology. This applies to any power generation equipment that operates in locations that lack access to grid-power.

Simple Generation - A specific industrial application for onsite power generation technology. This applies to any equipment that exists solely to produce electric power. Such equipment can be thought to be base loaded (or nearly so), with load factors that match those of the industrial facilities they serve. This analysis has considered simple generation to be viable only if all of the power thus produced can be used onsite.

Small Recip – An abbreviation for *Small Reciprocating Engine*.

Small Reciprocating Engine – A power generation technology based upon a piston-driven, reciprocating engine with an output power rating from 50 kW – 300 kW.

Technical Fit – A measure of the technical suitability of a technology to a particular application. It is independent of the economics of a technology in a particular application.

Techno-economic Fit – The product (Technical Fit) * (Economic Fit), normalized to a value between 1 and 4. This has been used to represent the overall suitability of a technology to a specific application within a given industry.

T/E Ratio – An abbreviation for *Thermal/Electric Ratio*

Thermal/Electric Ratio – A ratio describing the energy use of a particular industry (or facility), in which the total energy used as heat is divided by the total energy used as electric power. This refers to energy used within the plant rather than energy purchased at the plant gate. This value is usually used in conjunction with assessments of cogeneration options.

Tightly-Coupled Cogeneration – A specific industrial application for onsite power generation technology. This applies to any power generation equipment that provides hot offgases (exhaust) directly to an industrial process. Typical uses of this offgas include drying and preheating. This analysis has considered tightly-coupled cogeneration to be viable only if all of the power and heat thus produced can be used onsite.

Traditional Cogeneration – A specific industrial application for onsite power generation technology. This applies to any system that produces power, and then uses the waste heat to produce either steam or hot water, which is subsequently used in an industrial process. This analysis has considered traditional cogeneration to be viable only if all of the power and heat thus produced can be used onsite.

Unrecuperated Microturbine – A microturbine that lacks a recuperator to recover the residual energy from the hot offgases exiting the expander.

10 List of Acronyms

<i>AC</i>	Alternating Current
<i>ADL</i>	Arthur D. Little
<i>AFC</i>	Alkaline Fuel Cell
<i>ATS</i>	Advanced Turbine Systems
<i>BACT</i>	Best Available Control Technology
<i>CFCC</i>	Continuous Fiber Ceramic Composites
<i>CHP</i>	Combined Heat and Power
<i>CI</i>	Compression-Ignition
<i>CO</i>	Carbon monoxide
<i>CO₂</i>	Carbon dioxide
<i>DC</i>	Direct Current
<i>DisCo</i>	Distribution Company
<i>DOE</i>	Department of Energy
<i>EIA</i>	Energy Information Administration
<i>E&P</i>	Exploration and Production
<i>EPA</i>	Environmental Protection Association
<i>ESCo</i>	Energy Services Company
<i>FC/GT</i>	Fuel Cell / Gas Turbine hybrid
<i>GHG</i>	Greenhouse Gas
<i>GPRA</i>	Government Performance and Results Act
<i>GWh</i>	Gigawatt-hour
<i>HHV</i>	Higher Heating Value
<i>IEEE</i>	Institute of Electrical and Electronic Engineers
<i>IPP</i>	Independent Power Producer
<i>LAER</i>	Lowest Achievable Emissions Reduction
<i>LHV</i>	Lower Heating Value
<i>kTon</i>	kiloton
<i>kW</i>	Kilowatt
<i>kWh</i>	Kilowatt-hour
<i>MCES</i>	Manufacturing Consumption of Energy Survey
<i>MCFC</i>	Molten Carbonate Fuel Cell
<i>MW</i>	Megawatt
<i>NAAQS</i>	National Ambient Air Quality Standards
<i>NICE³</i>	National Industrial Competitiveness through Energy, Environment and Economics
<i>NO_x</i>	Nitrogen Oxides
<i>NREC</i>	Northern Research and Engineering Corporation
<i>OIT</i>	Office of Industrial Technologies
<i>O&M</i>	Operating and Maintenance
<i>PAFC</i>	Phosphoric Acid Fuel Cell
<i>PEM</i>	Proton Exchange Membrane
<i>PEMFC</i>	Proton Exchange Membrane Fuel Cell
<i>ppm</i>	parts per million
<i>psig</i>	pounds per square inch (gauge)
<i>R&D</i>	Research and Development
<i>rpm</i>	revolutions per minute
<i>SI</i>	Spark-Ignition
<i>SIC</i>	Standard Industrial Classification
<i>SO₂</i>	Sulfur dioxide
<i>SOFC</i>	Solid Oxide Fuel Cell
<i>T/E</i>	Thermal/Electric ratio
<i>UPS</i>	Uninterruptible Power Supply
<i>VOCs</i>	Volatile Organic Compounds

11 References

1992 Census of Manufactures. U.S. Department of Commerce, Bureau of the Census. Issued September 1996.

1992 Census of Mineral Industries. U.S. Department of Commerce, Bureau of the Census. Issued September 1996.

1996 Annual Survey of Manufactures. U.S. Department of Commerce, Bureau of the Census. Issued February 1998.

Administration Give U.S. Fuel Cell Industry Major Boost by Assisting Early Commercial Buyers, DOE Office of Fossil Energy (www.fe.doe.gov/techline/tl_fcbuy.html), issued 20 August 1996.

Ali, Sy, Director, Advanced Industrial Programs, Rolls-Royce Allison Engine Company, Personal Communication, September 1998.

Annual Energy Outlook 1998 With Projections to 2020. DOE, Office of Integrated Analysis and Forecasting, Energy Information Administration. December 1997.

Assessment of Micro-Generation Technologies for Distributed Generation Applications, EPRI, TR-107634, Final Report, September 1997.

Baldwin, Peter, President, Northern Research and Engineering, Personal Communication, December 1998.

Bevc, F. "Advances in solid oxide fuel cells and integrated power plants", *Proceedings of the Institution of Mechanical Engineers*. 211:A5, 1997.

Bowman, Michael, Mechanical Engineer, GE Corporate Research & Development, Personal Communication, December 1998.

Brogan, Michael, Vice President, Generator Set Power, Detroit Diesel Corporation, Personal Communication, October 1998.

Brown, R.A. "SOFC Combined Cycle Systems for Distributed Generation". presented at the *American Power Conference*, Chicago Illinois. April 1, 1997.

Callahan, Timothy, Principal Engineer, Gas and Industrial Engine Group, Southwest Research Institute, Personal Communication, December 1998.

Carroll, Phil, Manager, New Business Development, Solar Turbines. Personal Communication. December 1998.

Climate Change Fuel Cell Program. Project Factsheet. DOE Office of Fossil Energy, Federal Energy Technology Center.

Christensen, C.M. *The Innovators Dilemma*. Harvard Business School Press, 1997.

DeBiasi, V. "Low Cost and High Efficiency Make 30 to 80 kW Microturbines Attractive". *Gas Turbine World*, January-February 1998.

DeLuchi, M.A. *Emissions of Greenhouse Gases from the Use of Transportation Fuels and Electricity*. Center for Transportation Research, Argonne National Laboratory. U.S. Department of Energy, November 1993.

Department of Defense Fuel Cell Demonstration Program. Fact sheet. (www.cecer.army.mil/facts/sheets/UL12.html), January 1998.

Developing the Second-Generation Fuel Cell – The Energy Research Project. Project Factsheet. DOE Office of Fossil Energy, Federal Energy Technology Center.

Developing the Second-Generation Fuel Cell – The M-C Power Project. Project Factsheet. DOE Office of Fossil Energy, Federal Energy Technology Center.

Diesel and Gas Turbine World Catalog, Brookfield Wisconsin, Volume 63, 1998.

Duggal, Vinod, Cummins, Personal Communication, November 1998.

Duggan, Kevin, Capstone Turbine Corporation, Personal Communication, 1998.

Exley, Ted, Manager, Advanced Programs, Turbine Engines/Turbogenerators, Teledyne Continental Motors, Personal Communication. October 1998.

Fuel Cell Commercialization Group, Technology Transition Corporation (www.ttcorp.com/fccg/fccg_abt.htm)

Fuel Cell Manufacturing Corporation, Energy Research Corporation (www.ercc.com/fcmc.html)

Fuel Cells for Building Applications: Definitions of Performance/Cost Requirements. Prepared for the DOE Office of Building Technologies by Arthur D. Little, February 1994.

Gerber, Gordan, Manager, New Product Introduction, Caterpillar, Personal Communication, October 1998.

Gilshannon, S.T. and D.R. Brown. *Review of Methods for Forecasting the Market Penetration of New Technologies*. U.S. Department of Energy, December 1996.

Hines, Tony, Senior Vice President, Marketing, Capstone Turbine Corporation, November 1998.

Hirschenhofer, J.H., Stauffer, D.B. and Engleman, R.R. *Fuel Cells: A Handbook (Revision 3)*. DOE/METC-94/1006. Morgantown, WV: U.S. Department of Energy, Office of Fossil Energy, January 1994.

Hsu, Michael, Daniel Nathanson and Rocky Goldstein. "Ztek's Ultra-high Efficiency Fuel Cell/Gas Turbine System for Distributed Generation", *Proceedings of the American Power Conference*. Volume 59-I, 1998.

Largest Solid Oxide Fuel Cell to Date Passes Factory Test at Westinghouse, DOE Office of Fossil Energy (www.fe.doe.gov/techline/tl_solidox_test.html)

Kush, Ashok, Director, Product Development, Energy Research Corporation. Personal Communication, October 1998.

Mankeane, Gregory, Director, Power Generation, Cummins, Personal Communication, November 1998.

Manufacturing Consumption of Energy 1994. DOE Office of Integrated Analysis and Forecasting, Energy Information Administration. December 1997.

Miramar Project Profile, M-C Power (www.mcpower.com/projects.html)

Monthly Electric Utility Sales and Revenue Report with State Distributions, Form EIA-826. DOE Office of Integrated Analysis and Forecasting, Energy Information Administration. December 1998.

Natural Gas Monthly. DOE Office of Integrated Analysis and Forecasting, Energy Information Administration. July 1998.

PC25 Scoreboard. ONSI Website, June 9, 1998.

Petroleum Marketing Monthly. DOE Office of Integrated Analysis and Forecasting, Energy Information Administration. November 1998.

Phosphoric Acid Fuel Cell Commercialization. Project Factsheet. DOE Office of Fossil Energy, Federal Energy Technology Center.

Renewable Energy Technology Characterizations (EPRI Topical Report No. TR-109496). Prepared by the Electric Power Research Institute and the U.S. DOE Office of Utility Technologies, December 1997.

Sandelli, Greg. Marketing Manger, ONSI Corporation. Personal Communication, June 1998.

Scoping Study of Renewable Electric Resources for Rhode Island and Massachusetts, Burlington, VT: C.T. Donovan Associates, November 1997.

SERI Report TR-790. Prepared by the Institute for Energy Analysis. 1974.

Skowronski, Mark, AlliedSignal Power Systems Inc., Personal Communication, September 1998.

Solid Oxide Fuel Cell, Westinghouse Corporation
(www.stc.westinghouse.com/dept/SOFC/index.html).

Solid Oxide Fuel Cell Project. Project Factsheet. DOE Office of Fossil Energy, Federal Energy Technology Center.

Stationary Applications, Ballard Power Systems website (www.ballard.com)

Steinfeld, George, Hans C. Maru and Robert A. Sanderson. "High Efficiency Carbonate Fuel Cell/Turbine Hybrid Power Cycle". presented at *IECEC '96*, Washington, DC. August 11-16, 1996.

Survey of Plant Capacity. U.S. Department of Commerce, Bureau of the Census. Issued September 1996.

The Power of an Idea, M-C Power (www.mcpower.com/about.html)

Williams, Mark C. and Charles M. Zeh (editors). *Proceedings of the Workshop on Very High Efficiency Fuel Cell/Gas Turbine Power Cycles*. U.S. Department of Energy, Office of Fossil Energy. Morgantown, West Virginia. October 1995.