

DISTRIBUTED ENERGY PROGRAM REPORT

Cooling, Heating, and Power (CHP) for Commercial Buildings Benefits Analysis

April 2002

By

Arthur D. Little, Inc.



U.S. Department of Energy
Energy Efficiency
and Renewable Energy

Bringing you a prosperous future where energy
is clean, abundant, reliable, and affordable



This report was prepared as an account of work sponsored by an agency of the United States Government. None of the following entities makes any warranty, expressed or implied, or assumes any legal liability or responsibility for the accuracy, completeness, or usefulness of any information, apparatus, product, or process disclosed, or represents that its use would not infringe privately owned rights: a) the United States Government, b) any agency, contractor, or subcontractor thereof, and c) any of their respective employees. Any use the reader makes of this report, or any reliance upon or decisions to be made based upon this report, are the responsibility of the reader. The reader understands that no assurances can be made that all relevant factors have been identified. Reference herein to any specific commercial product, process, or service by trade name, trademark, manufacturer, or otherwise, does not necessarily constitute or imply its endorsement, recommendation, or favoring by the United States government or any agency, contractor or subcontractor thereof. The views and opinions of the authors expressed herein do not necessarily state or reflect those of the United States Government or any agency thereof.

Abstract

Investigators analyzed the energy consumption and end-user economics of Cooling, Heating, and Power (CHP) systems in large office buildings, large hotels, and hospitals in five U.S. cities. The analysis model makes an hourly generate-versus-purchase decision to minimize operating costs, accounting for the impacts of electric demand charges and the savings associated with heat recovery. Key findings include:

- High electric generation efficiency is more important to CHP energy savings and economics than use of recovered heat.
- Heat recovery increases primary energy savings. For example, heat recovery in a large office building in New York City using an advanced IC-engine generator increases primary energy savings from 21 to 31 percent.
- Heat recovery has little impact on simple payback period, although more sophisticated economic analysis techniques would likely show an economic benefit for heat recovery.
- CHP simple payback periods were generally 1 to 2 years in Los Angeles, 2 to 3 years in New York City, 5 to 7 years in Chicago, and over 15 years in Miami.

Company and Contact Information

The Technology & Innovation business of Arthur D. Little, Inc. prepared this report. TIAX LLC acquired this business on May 10, 2002. TIAX is an independent and privately held collaborative R&D company with headquarters in Cambridge, MA and a west-coast presence in Cupertino, CA.

Contact information for the lead author is:

Robert A. Zogg, Associate Principal
TIAX LLC
15 Acorn Park
Cambridge, MA 02140-2390

617-498-6081
zogg.r@tiaxllc.com

Acknowledgements

The authors of this report (Robert A. Zogg, Sephir D. Hamilton, and Richard C. Williams – all of Arthur D. Little, Inc.) performed this analysis with funding from the DOE Office of Power Technologies (DOE/OPT), through Oak Ridge National Laboratory (ORNL) Subcontract 4000008858. The guidance and direction provided by the following individuals was critical to the success of this assignment: Ronald Fiskum, DOE/OPT; Robert DeVault, ORNL; and Richard Sweetser, *EXERGY* Partners.

In addition, numerous manufacturers of distributed generation equipment and thermally activated cooling equipment provided valuable input and review to help us establish equipment performance and cost characteristics.

Table of Contents

Acknowledgements	iv
List of Acronyms and Abbreviations	ix
Executive Summary	ES-1
1. Introduction	1-1
2. Objectives	2-1
3. Approach	3-1
4. System Configurations for Analysis	4-1
4.1 Generation Technologies.....	4-1
4.2 Building Types.....	4-2
4.3 Baseline Building Characteristics	4-5
4.4 Thermally Activated Cooling Equipment	4-7
4.5 Heat-Recovery Heating Equipment	4-8
4.6 Fuel Types	4-8
4.7 Cities and Utility Rates	4-9
5. Simplified Analysis	5-1
5.1 Economics of Distributed Generation (Power Only).....	5-1
5.2 Economics of Heating with a “Free” Heat Source	5-1
5.3 Economics of Cooling with a “Free” Heat Source	5-2
5.4 Primary Energy Impacts of CHP in a New York Office Building	5-2
5.5 Cost/Performance Tradeoff of the Microturbine Recuperator in CHP Systems	5-3
6. Detailed Analysis	6-1
6.1 Key Assumptions	6-1
6.2 Computer Model Structure.....	6-1
6.3 Equipment Cost and Performance Projections	6-2
6.4 Operating Strategies and Associated Control Algorithms	6-2
6.4.1 “Dumb” Operating Strategy.....	6-3
6.4.2 “Smart” Operating Strategy	6-4
6.5 Utility Rates.....	6-5
6.6 CHP System Sizing.....	6-6
6.7 Analysis Matrix	6-7
6.8 Results of Detailed Analysis.....	6-7
6.8.1 Explanation of Energy Plots.....	6-7
6.8.2 Microturbine Recuperator Performance.....	6-9
6.8.3 Primary Energy Consumption and End-User Economics	6-10
7. Summary and Conclusions	7-1
8. Next Steps	8-1
Appendix A: System Schematics	A-1
Appendix B: Microturbine Recuperator Cost-Efficiency Optimization	B-1
Appendix C: Structure of Detailed Analytical Model	C-1
Appendix D: Cost and Performance Estimates for CHP Components/Systems	D-1
Appendix E: Flow Charts for Control Algorithms	E-1
Appendix F: Utility Rate Structures	F-1
Appendix G: Detailed Analysis Matrix, Summary of Results, and Results	G-1
Appendix H: Recommended Scope and Approach for Phase 2	H-1

Figure 1-1:	National Primary Energy Consumption in Commercial Buildings	1-2
Figure 3-1:	Approach to CHP Benefits Analysis.....	3-2
Figure 4-1:	CHP Benefits Analysis System Selection.....	4-10
Figure 4-2:	Generation-Technology Cost Versus Efficiency.....	4-11
Figure 4-3:	Overall Thermal Loads in Prototypical Buildings.....	4-12
Figure 4-4:	Average Commercial Natural Gas and Electricity Prices for Selected States	4-13
Figure 4-5:	Characteristics of Utility Rate Structures for the Cities Selected for Analysis	4-14
Figure 5-1:	Economics of Generation Technologies for Power-Only Applications (No Heat Recovery) Calculated Using Average Utility Rates	5-5
Figure 5-2:	Economics of Operating a Heat-Recovery Heat Exchanger with "Free" Heat	5-6
Figure 5-3:	Economics of Operating an Absorption Chiller with "Free" Heat	5-7
Figure 5-4:	Primary Energy Consumption Intensities for New York Office – 25 Percent Generation Efficiency	5-8
Figure 5-5:	Primary Energy Consumption Intensities for New York Office – 40 Percent Generation Efficiency.....	5-9
Figure 5-6:	Net Value of a CHP System – Heat Recovery for Heating Loads Only – Favorable Utility Rates.....	5-10
Figure 5-7:	Net Value of a CHP System – Heat Recovery for Cooling Loads Only – Favorable Utility Rates.....	5-11
Figure 5-8:	Net Value of a CHP System – Heat Recovery for Heating Loads Only – Typical Utility Rates	5-12
Figure 5-9:	Net Value of a CHP System – Heat Recovery for Cooling Loads Only – Typical Utility Rates	5-13
Figure 6-1:	Overview of Detailed Computer Model for CHP – System Simulation	6-14
Figure 6-2:	Average Utility Prices for the Prototypical Buildings Modeled.....	6-15
Figure 6-3:	Summary of Method to Select CHP System Size.....	6-16
Figure 6-4:	Summary of Detailed Analysis Matrix	6-17
Figure 6-5:	Primary Energy Consumption Intensity for a Standard Microturbine CHP System in a New York Large Office Building.....	6-18
Figure 6-6:	Primary Energy Consumption Intensity for a Standard Engine CHP System in a New York Large Office Building.....	6-19
Figure 6-7:	Primary Energy Consumption Intensities for Three Microturbine Recuperator Configurations – New York Large Office Application....	6-20
Figure 6-8:	Simple Payback Periods for Three Microturbine Recuperator Configurations – New York Large Office Application	6-21
Figure 6-9:	Equipment Cost Breakdown of CHP Systems Installed in a Large New York Office Building	6-22

List of Figures (Continued)

Figure 6-10: Primary Energy Consumption Intensities for Standard Microturbine and Advanced Engine in New York Large Office Building – Power Only Versus CHP.....	6-23
Figure 6-11: Simple Payback Periods for Standard Microturbine and Advanced Engine in New York Large Office Building – Power Only Versus CHP.....	6-24
Figure 6-12: Primary Energy Consumption Intensities for Standard Microturbine and Advanced Engine in New York Large Office Building – "Smart" Versus "Dumb" Operating Strategies	6-25
Figure 6-13: Simple Payback Periods for Standard Microturbine and Advanced Engine in New York Large Office Building – "Smart" Versus "Dumb" Operating Strategies	6-26
Figure 6-14: Primary Energy Consumption Intensities for Various Generation Technologies in Los Angeles Large Office Building	6-27
Figure 6-15: Simple Payback Periods for Various Generation Technologies in Los Angeles Large Office Building.....	6-28
Figure 6-16: Primary Energy Consumption Intensities for Various Generation Technologies in New York Large Office Building	6-29
Figure 6-17: Simple Payback Periods for Various Generation Technologies in New York Large Office Building	6-30
Figure 6-17: Primary Energy Consumption Intensities for Various Generation Technologies in Los Angeles Hospital	6-31
Figure 6-18: Primary Energy Consumption Intensities for Various Generation Technologies in Los Angeles Hospital	6-31
Figure 6-19: Simple Payback Periods for Various Generation Technologies in Los Angeles Hospital.....	6-32
Figure 6-20: Primary Energy Consumption Intensities for Various Generation Technologies in New York Hospital.....	6-33
Figure 6-21: Simple Payback Periods for Various Generation Technologies in New York Hospital	6-34
Figure 6-22: Primary Energy Consumption Intensities for Various Generation Technologies Los Angeles Large Hotel.....	6-35
Figure 6-23: Simple Payback Periods for Various Generation Technologies in Los Angeles Large Hotel	6-36
Figure 6-24: Primary Energy Consumption Intensities for Various Generation Technologies in New York Large Hotel	6-37
Figure 6-25: Simple Payback Periods for Various Generation Technologies in New York Large Hotel.....	6-38
Figure 6-26: Primary Energy Consumption Intensities for Advanced Engine in Large Office Building for Various Cities.....	6-39
Figure 6-27: Simple Payback Periods for Advanced Engine in Large Office Building for Various Cities.....	6-40

Figure 6-28: Primary Energy Consumption Intensities for Standard Microturbine and
Advanced Engine in New York Large Office Building – Natural Gas
Versus Fuel Oil..... 6-41

Figure 6-29: Simple Payback Periods for Standard Microturbine and Advanced Engine
in New York Large Office Building – Natural Gas Versus Fuel Oil..... 6-42

List of Tables

Table 4-1: Generation Technologies Summary	4-2
Table 4-2: Prototypical Hospital Characteristics	4-3
Table 4-3: Prototypical Large Hotel Characteristics	4-3
Table 4-4: Prototypical Large Office Characteristics.....	4-4
Table 4-5: Baseline Electric Chiller Efficiency Calculation.....	4-6
Table 4-6: Cooling Technologies Summary	4-7
Table 4-7: Summary of Heat-Recovery Heating Equipment.....	4-8
Table 4-8: U.S. Cities Selected for Analysis	4-9
Table 6-1: Key Assumptions used in Detailed Analysis	6-1
Table 6-2: CHP Operating Strategies Analyzed	6-3

List of Acronyms and Abbreviations

Btu:	British Thermal Unit
CHP:	Cooling, Heating and Power
COP:	Coefficient of Performance
DER:	Distributed Energy Resources
DG:	Distributed Generation
dP:	Pressure Gradient
DR:	Distributed Resources
HHV:	Higher Heating Value
HTPEM:	High-Temperature Proton-Exchange Membrane
HVAC:	Heating, Ventilating, and Air Conditioning
IPLV:	Integrated Part-Load Value
kW:	Kilowatt
kWh:	Kilowatt-Hour
LHV:	Lower Heating Value
O&M:	Operating and Maintenance
P:	Absolute Pressure
PEM:	Proton-Exchange Membrane
TMY:	Typical Meteorological Year
UPS:	Uninterruptible Power Supply

High electric-generation efficiency is of primary importance for CHP systems in typical commercial-building applications.

Key Findings

- ◆ The increased production of waste heat associated with lower generation efficiencies cannot compensate for the lower electricity output
- ◆ For example, microturbines should use highly effective recuperators to maximize generation efficiency, even if waste heat is utilized
- ◆ CHP systems using less-efficient generation technologies (such as microturbines) have only modest impacts on primary energy consumption (ranging from 3 percent savings to 7 percent increase)

Based on the New York Large Office Building example, CHP offers greater primary energy savings and often better economics relative to DG (power only).

Generation Technology	Primary Energy Impact ¹		Simple Payback (Years)	
	DG	CHP	DG	CHP
Standard Microturbine	5% Increase	4% Savings	5.0 ²	4.7 ²
Advanced Engine	21% Savings	31% Savings	2.8 ²	3.0 ²

1) Relative to a conventional building

2) DG and CHP offer similar payback periods in these examples. However, the CHP systems provide higher annual savings and, therefore, CHP will often be considered more economically attractive.

The economics of CHP are highly dependent on utility rates and rate structures.

Large Office Building with Advanced-Engine CHP System	
City/Rate Structure	Payback Period (Years)
Los Angeles	1 - 2
New York	2 - 3
Chicago	5 - 7
Miami	>15
Phoenix	>15

We investigated a selection of large commercial building and equipment combinations.

Generation Technologies	Chillers
<ul style="list-style-type: none">◆ Standard microturbine◆ Advanced microturbine◆ Standard engine◆ Advanced engine◆ High-temperature PEM fuel cell	<ul style="list-style-type: none">◆ Single-effect (water/steam fired, COP = 0.7, parasitics = 0.25 kW/ton)◆ Double-effect (exhaust fired, COP=1.1 parasitics = 0.20 kW/ton)◆ Baseline electric (0.66 kW/ton + 0.13 kW/ton parasitics)
Building Types	Cities
<ul style="list-style-type: none">◆ Hospital◆ Large hotel◆ Large office	<ul style="list-style-type: none">• New York City• Los Angeles• Chicago• Miami• Phoenix

See Appendix D for a complete list of cost and performance estimates, rate structure details, and sources.

We projected generator costs based on achieving significant economics of scale and generator performance based on achieving R&D goals.

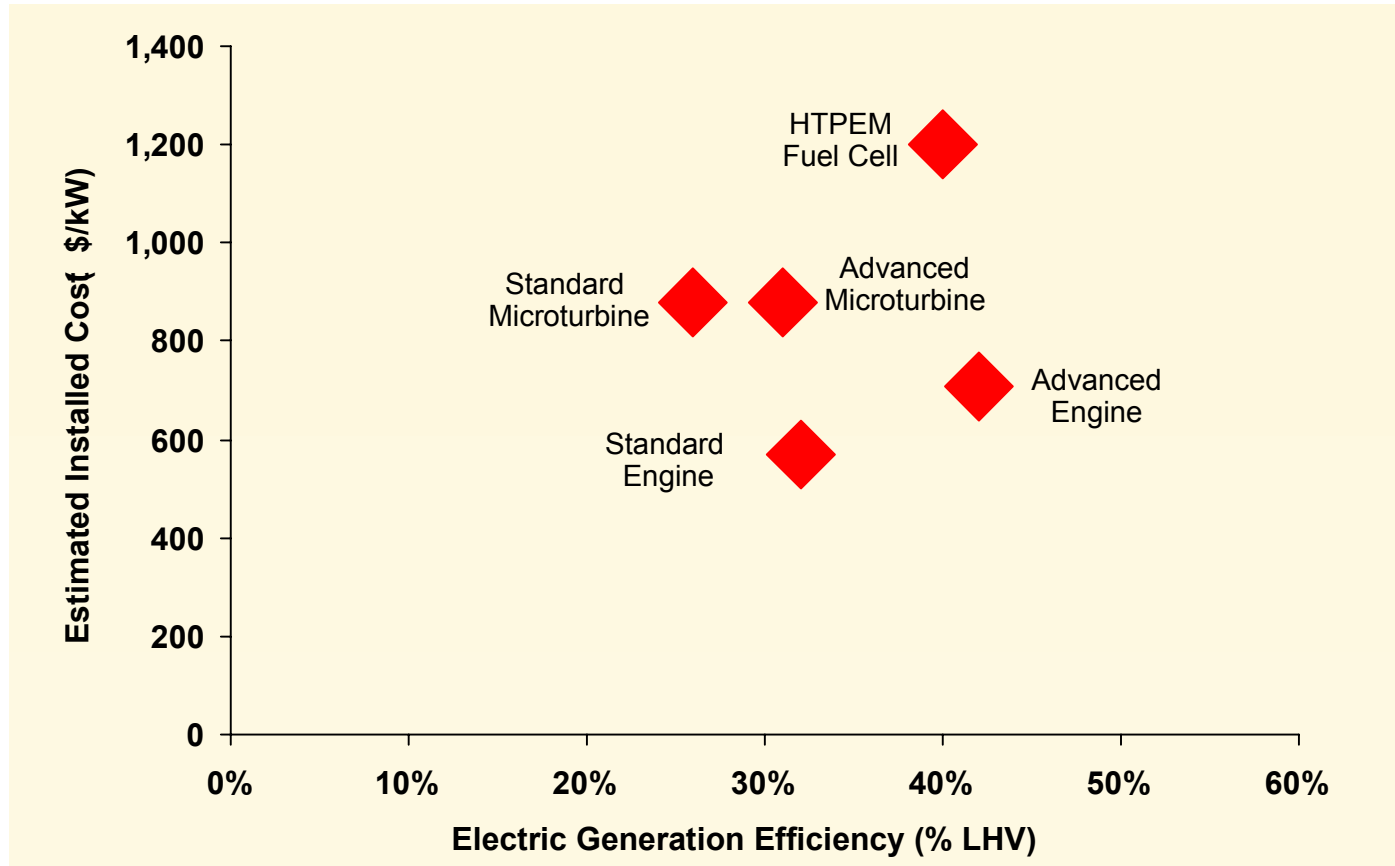

Microturbine and fuel cell costs are based on 10,000 units/yr. production with 40% mark-up over manufacturer's cost, and 50% installation costs.

Advanced engine costs are based on Y2010 industry goals for natural gas compression-ignition engines. Standard engine costs are based on current retail cost projections for beyond Y2005.

A simplified analysis suggests that CHP, combined with an efficient generation technology, can reduce primary energy consumption by about 20 percent.

New York Large Office – 40 Percent Generation Efficiency

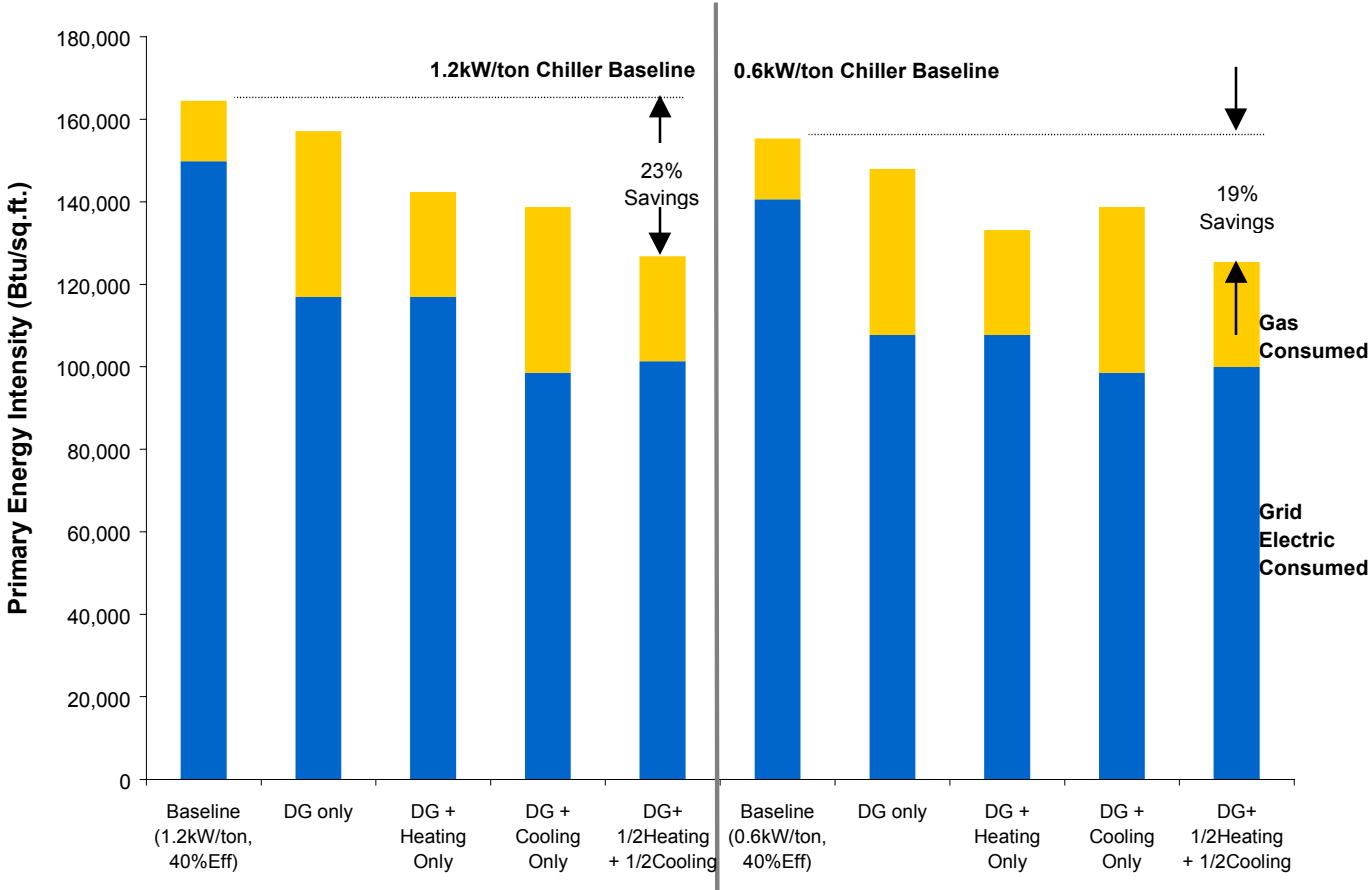

See Section 4 for equipment costs and performance. 25% of baseline electric loads are met by generation. 70% of heat is recoverable. 70% of recoverable heat is recovered.

A simplified analysis based on average utility rates suggests that CHP provides a net benefit of about \$0.03 to \$0.05 per Kilowatt-hour generated, if waste heat is used for heating loads only.

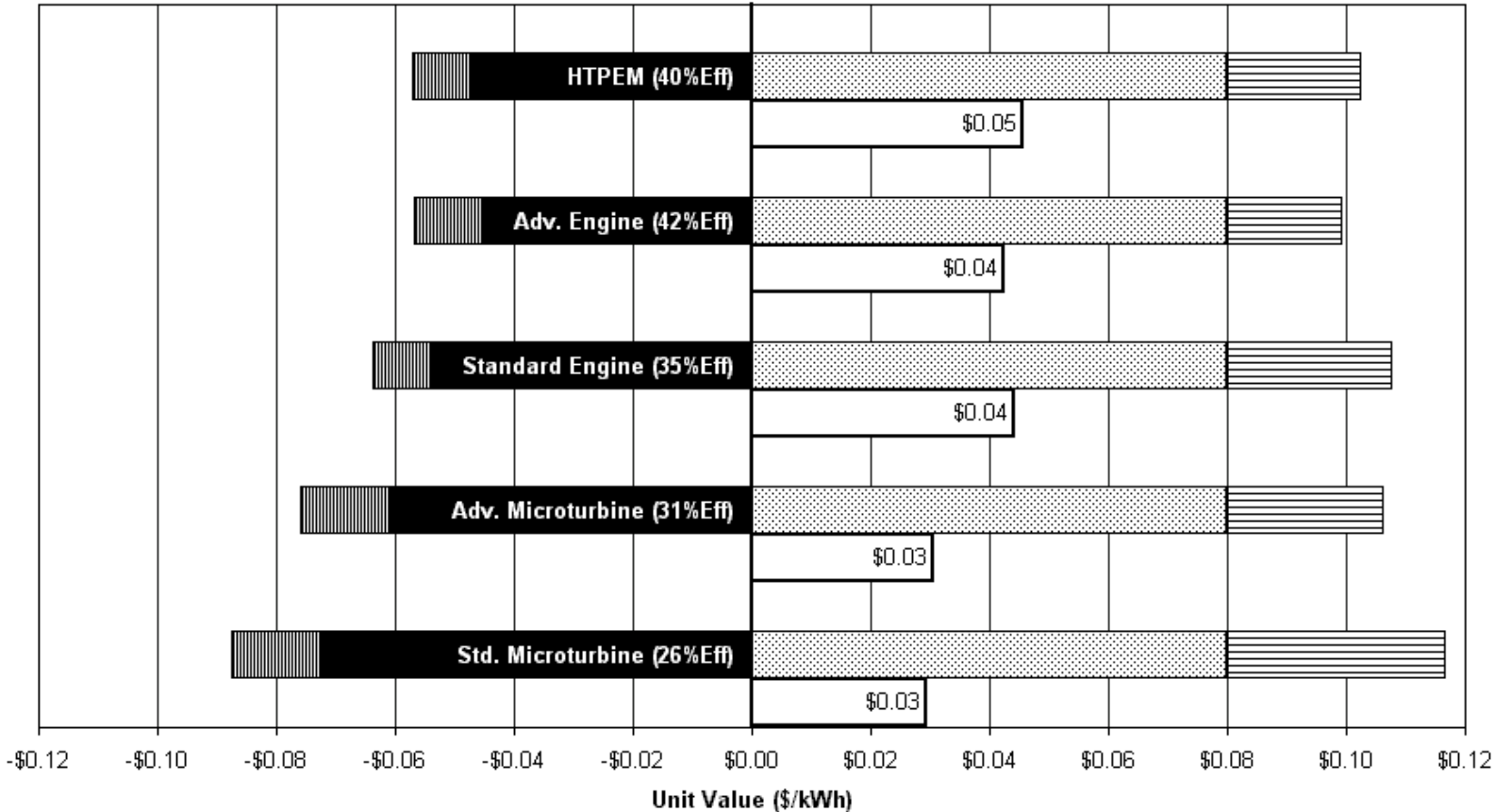

Generation O&M Cost
 Generation Fuel Cost
 Value of Grid Electricity Saved
 Value of Heating
 Net Value of CHP System

See Section 4 for equipment cost and performance. Gas rate is \$5/MMBtu, electric rate is \$0.08/kWh. Assumes *all* recoverable heat is utilized. Capital cost not considered.

A simplified analysis based on average utility rates suggests that CHP provides a net benefit of \$0.01 to \$0.04 per Kilowatt-hour generated, if waste heat is used for cooling loads only.

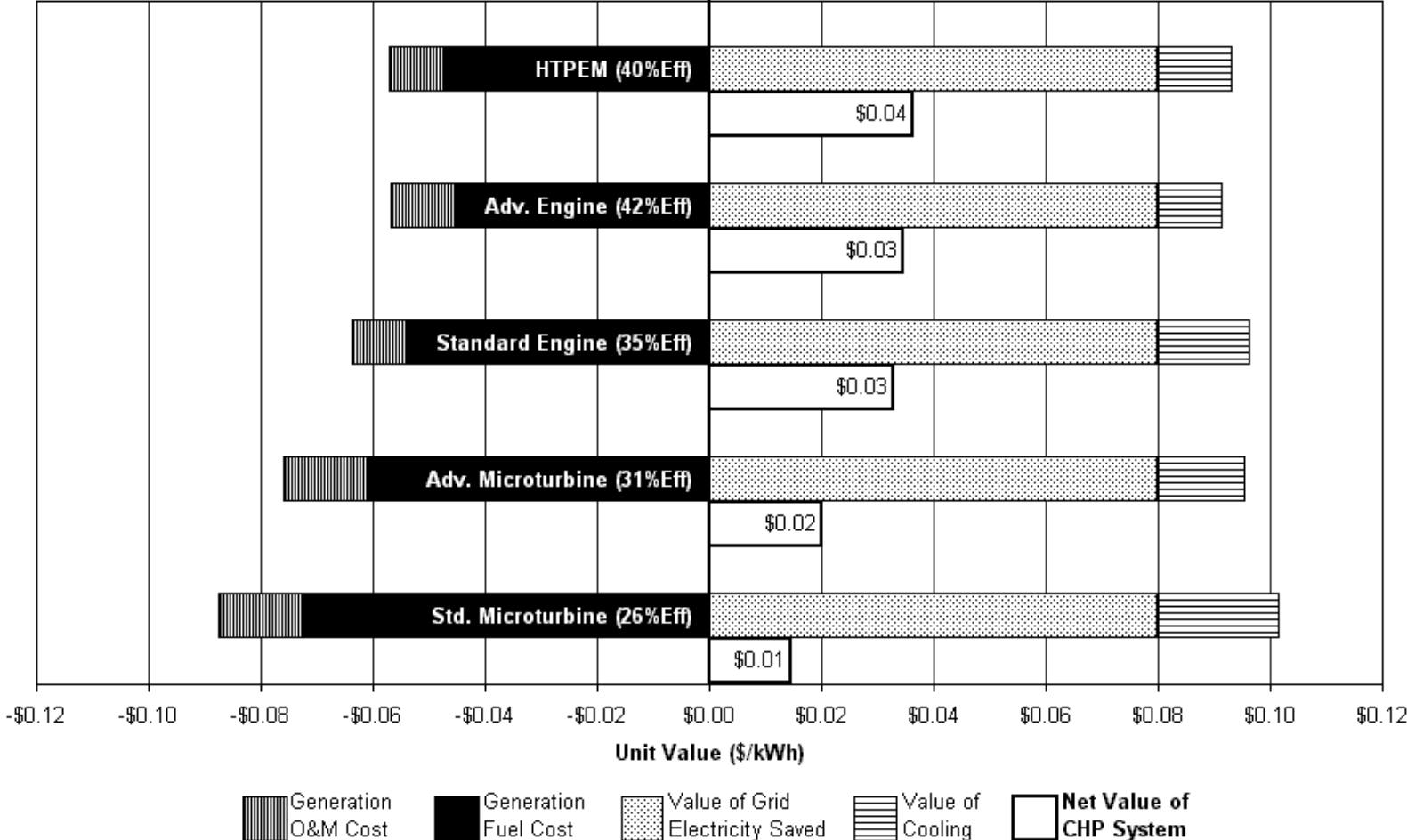

See Section 4 for equipment cost and performance. Gas rate is \$5/MMBtu, electric rate is \$0.08/kWh. Assumes *all* recoverable heat is utilized. Capital cost not considered.

Our computer model performs an hour-by-hour analysis, accounting for variations in ambient temperature, building loads, and utility rates.

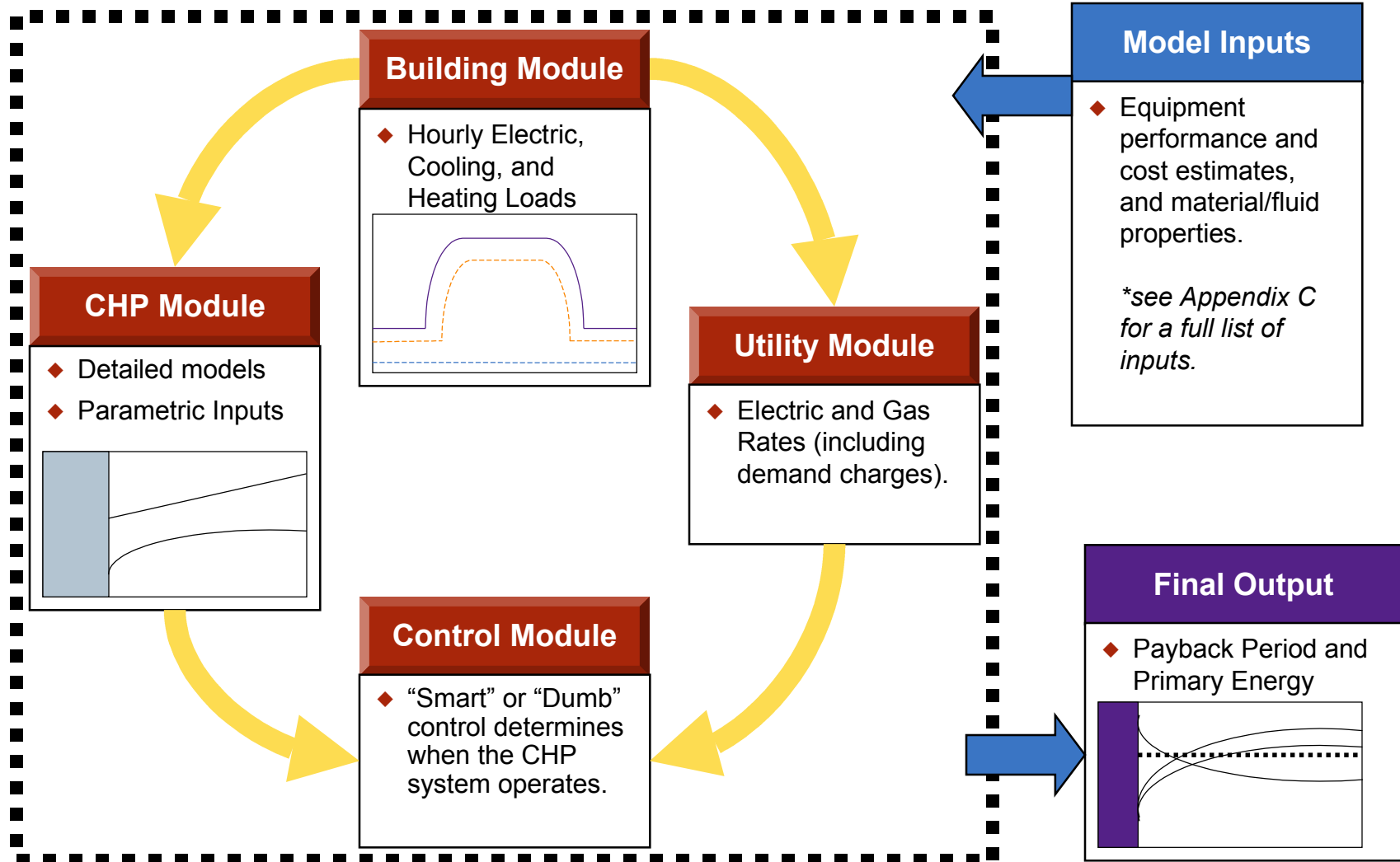

Where simplifying assumptions were needed, most tended to favor CHP.

Tending to Favor CHP

- ◆ Microturbine and fuel cell installed costs and maintenance costs based on achieving economies of scale.
- ◆ No part-load efficiency degradation for generators or chillers.
- ◆ No significant time required for ramp up or ramp down for generation capacity.
- ◆ Did not consider utility stand-by charges.
- ◆ Did not consider impacts of unscheduled outages.
- ◆ Set 5-year allowable payback period

Tending to Favor Conventional Grid Power

- ◆ Did not consider value of premium power
- ◆ No net metering
- ◆ No thermal or electric storage systems
- ◆ No shifting of discretionary loads

We defined two operating strategies, and employed the “Smart” strategy for most analyses.

**Maximize Generator Operation
(aka, “Dumb”)**

- ◆ Generator runs whenever there is an electric load.
- ◆ Economics are not considered.

**Minimize Operating Costs
(aka, “Smart”)**

- ◆ Runs CHP system when electric energy cost savings alone justify it (without considering demand charge savings).
- ◆ Runs additional hours, as appropriate, to achieve demand charge savings. Uses iterative procedure to determine optimum level of peak shaving.

We selected the economically optimum generation capacity based on a 5-year allowable payback.

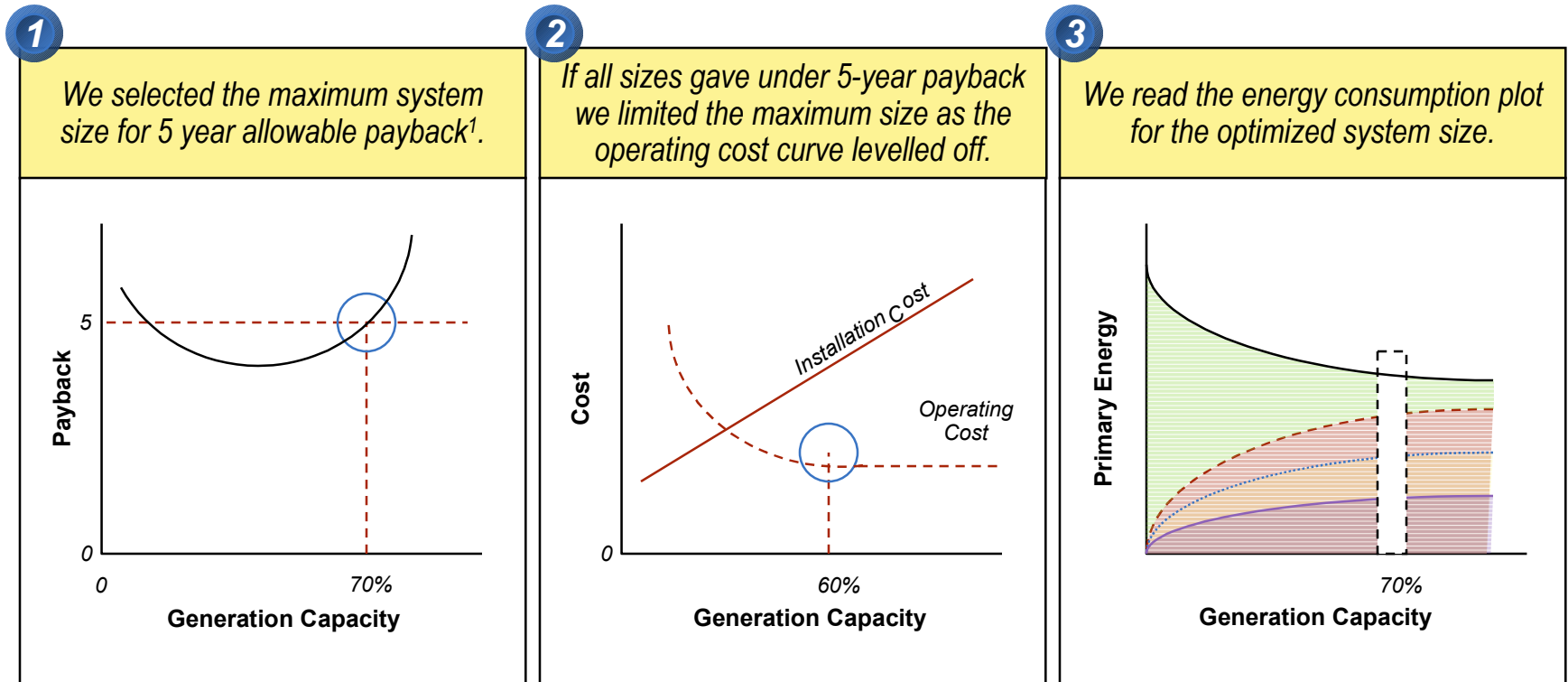

¹ If payback exceeded 5 years across the range, we assumed that the CHP system would not be installed.

See Appendix G for detailed energy, cost, and payback plots of each run.

Of the cities analyzed, Los Angeles has rates most favorable to CHP, while Phoenix and Miami have rates least favorable.

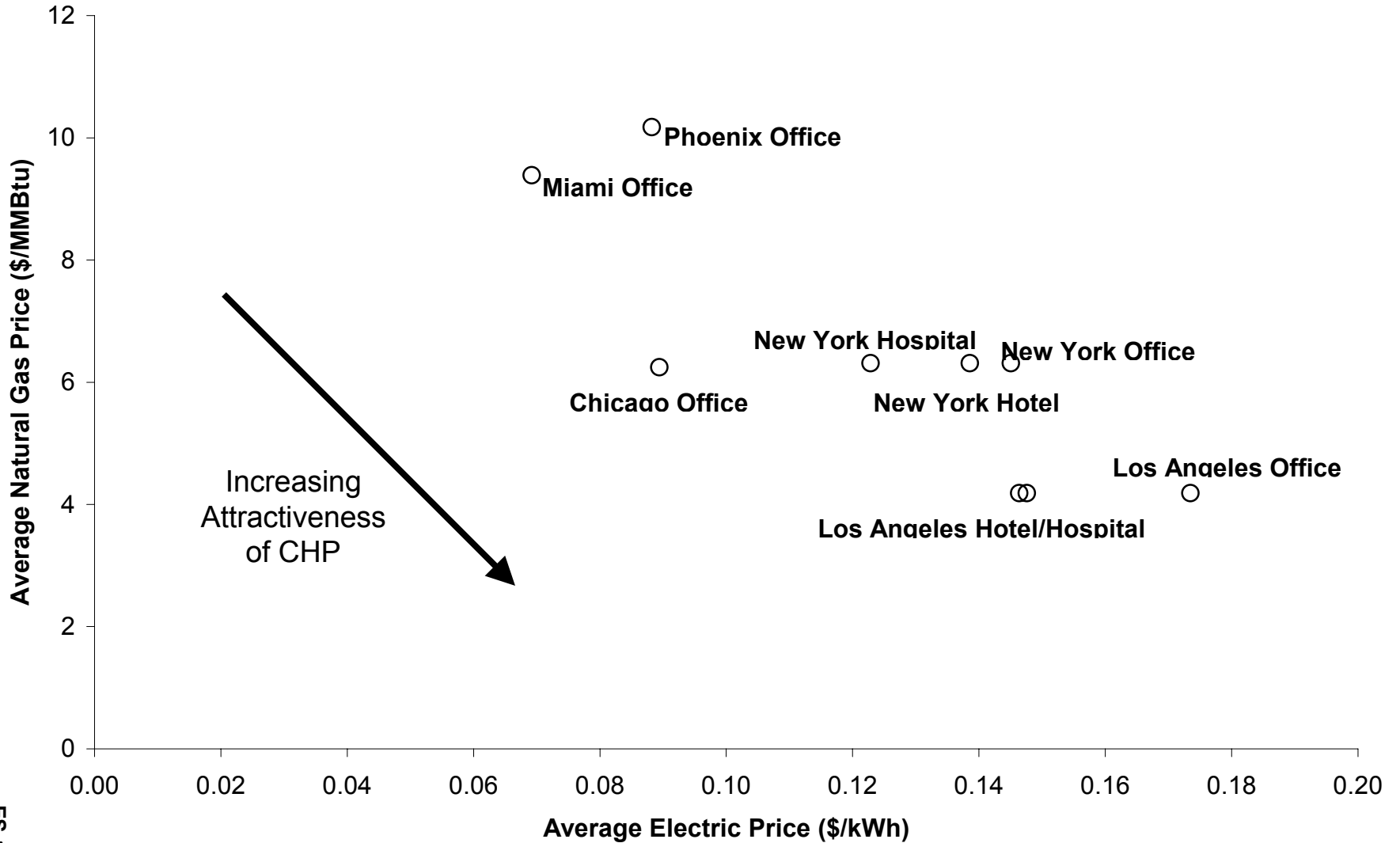

60 to 70 percent of CHP-system capital costs are associated with the generator.

Standard Microturbine in New York Large Office Building

Total Installed Cost = \$1.20 Million

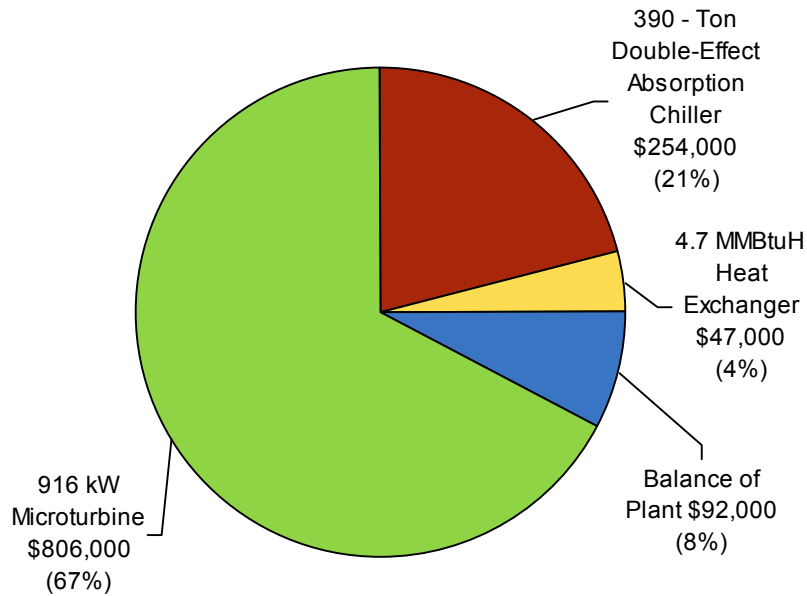

**Based on run #12 in Appendix G, at economic optimum 50% generation capacity (916 kW)*

Standard Engine in New York Large Office Building

Total Installed Cost = \$1.21 Million

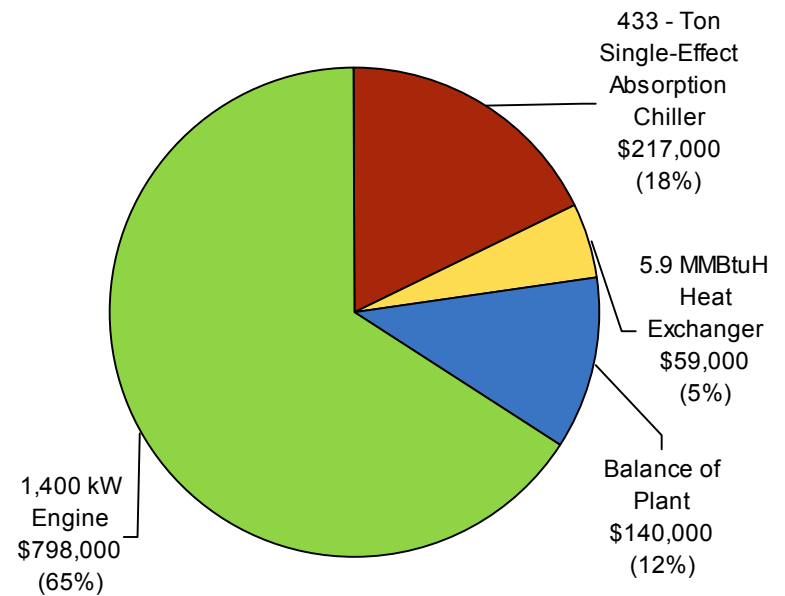

**Based on run #42 in Appendix G, at economic optimum 80% generation capacity (1,400 kW)*

In the New York Large Office Building, CHP can effect primary energy savings of 4 to 30 percent, depending on the generation technology.

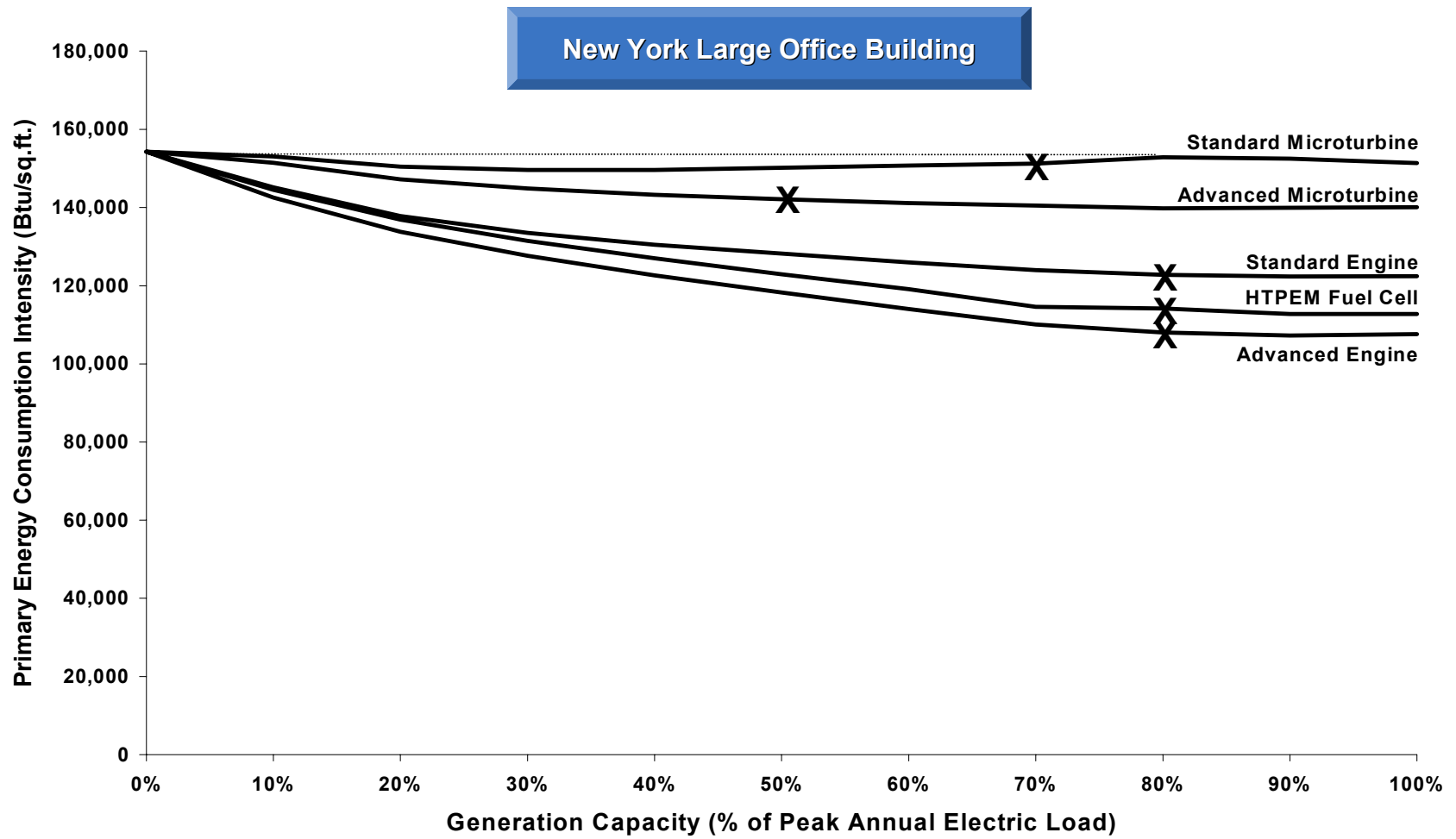

"X" denotes the economic optimum, as detailed in Section 6.6 and Figure 6-3

In the New York Large Office Building, payback periods generally range from 2 to 5 years, depending on the generation technology.

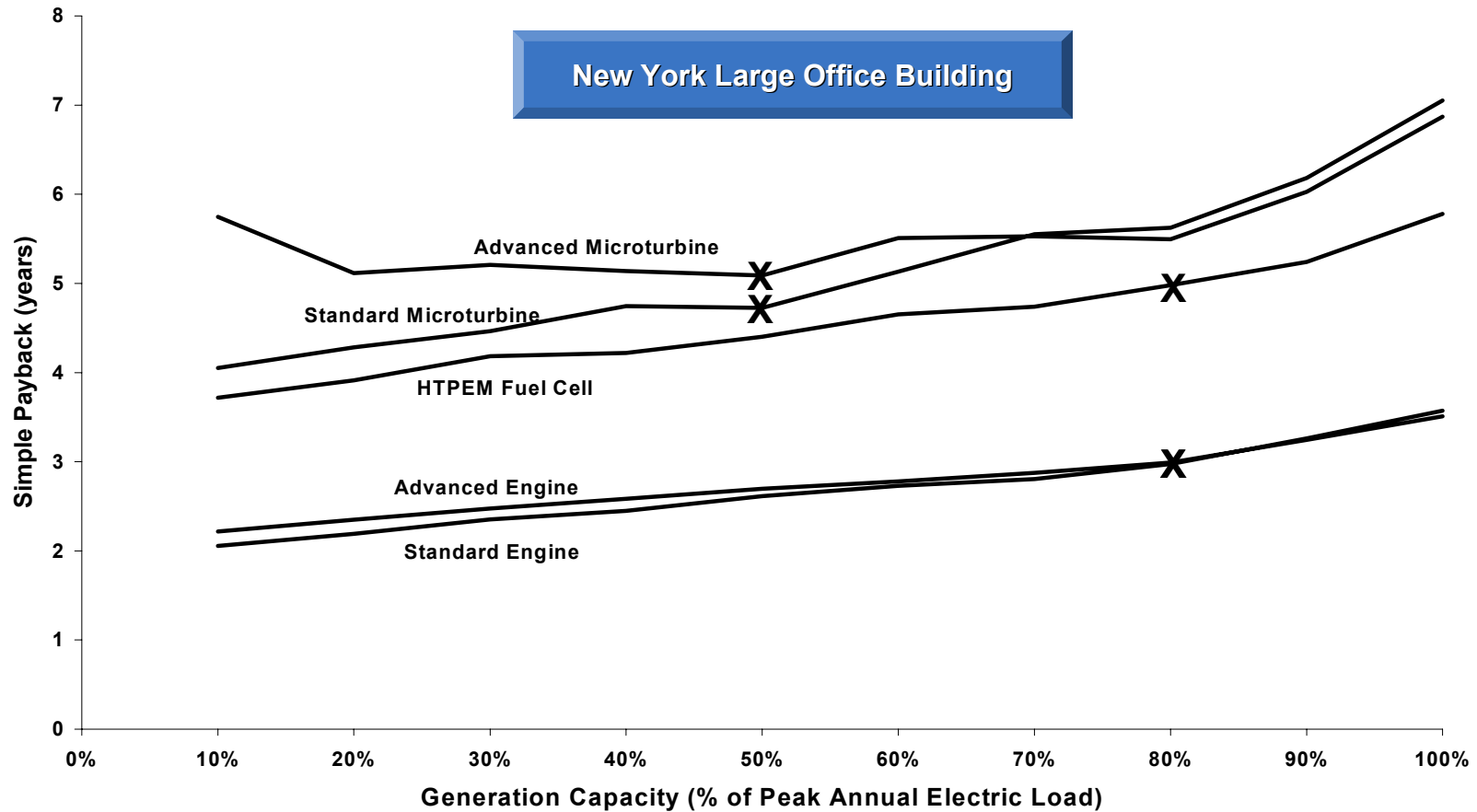

"X" denotes the economic optimum, as detailed in Section 6.6 and Figure 6-3

In the Large Office Building, CHP can effect primary energy savings up to about 30 percent.

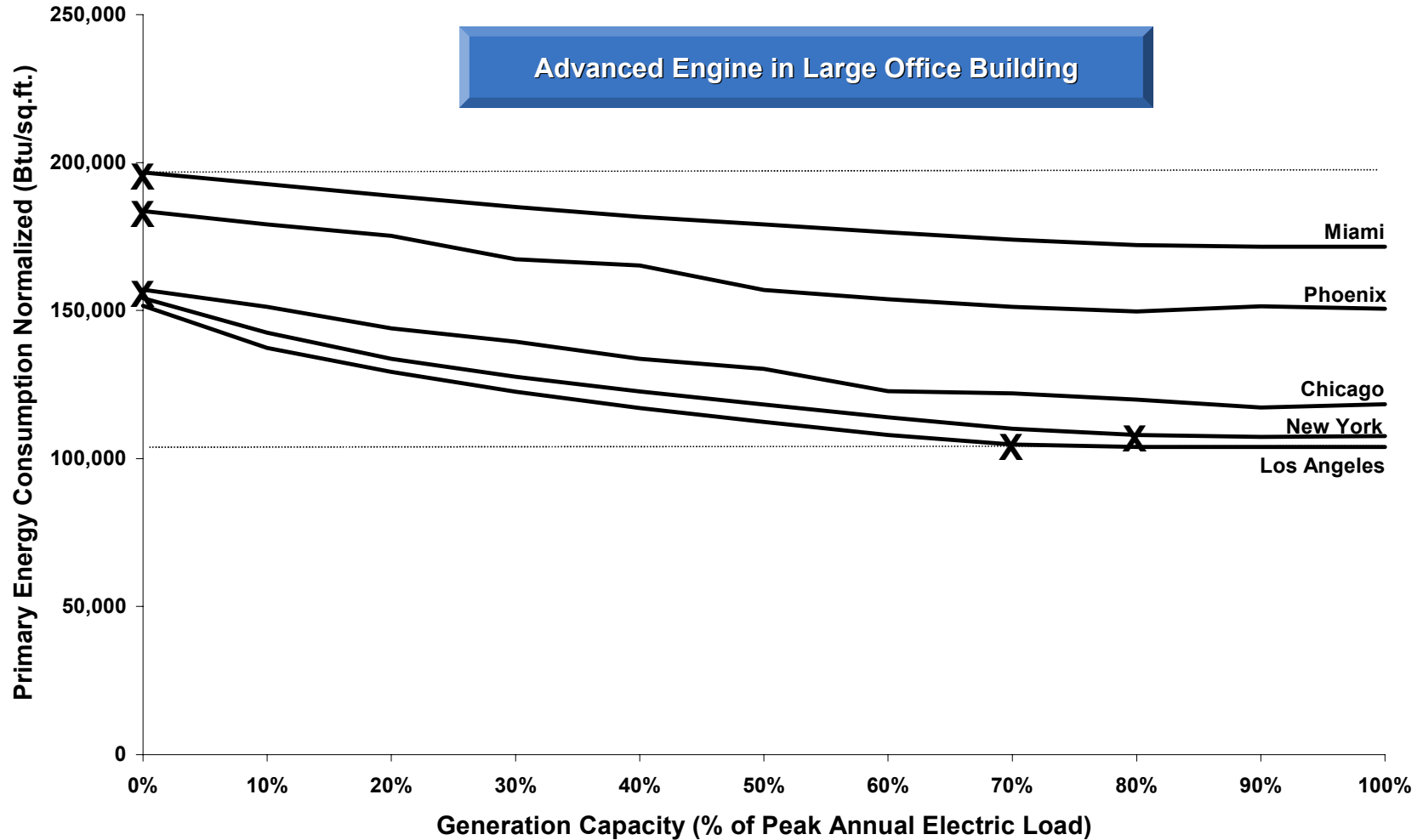

"X" denotes the economic optimum, as detailed in Section 6.6 and Figure 6-3

Utility rates and rate structures are key to achieving attractive CHP-system economics.

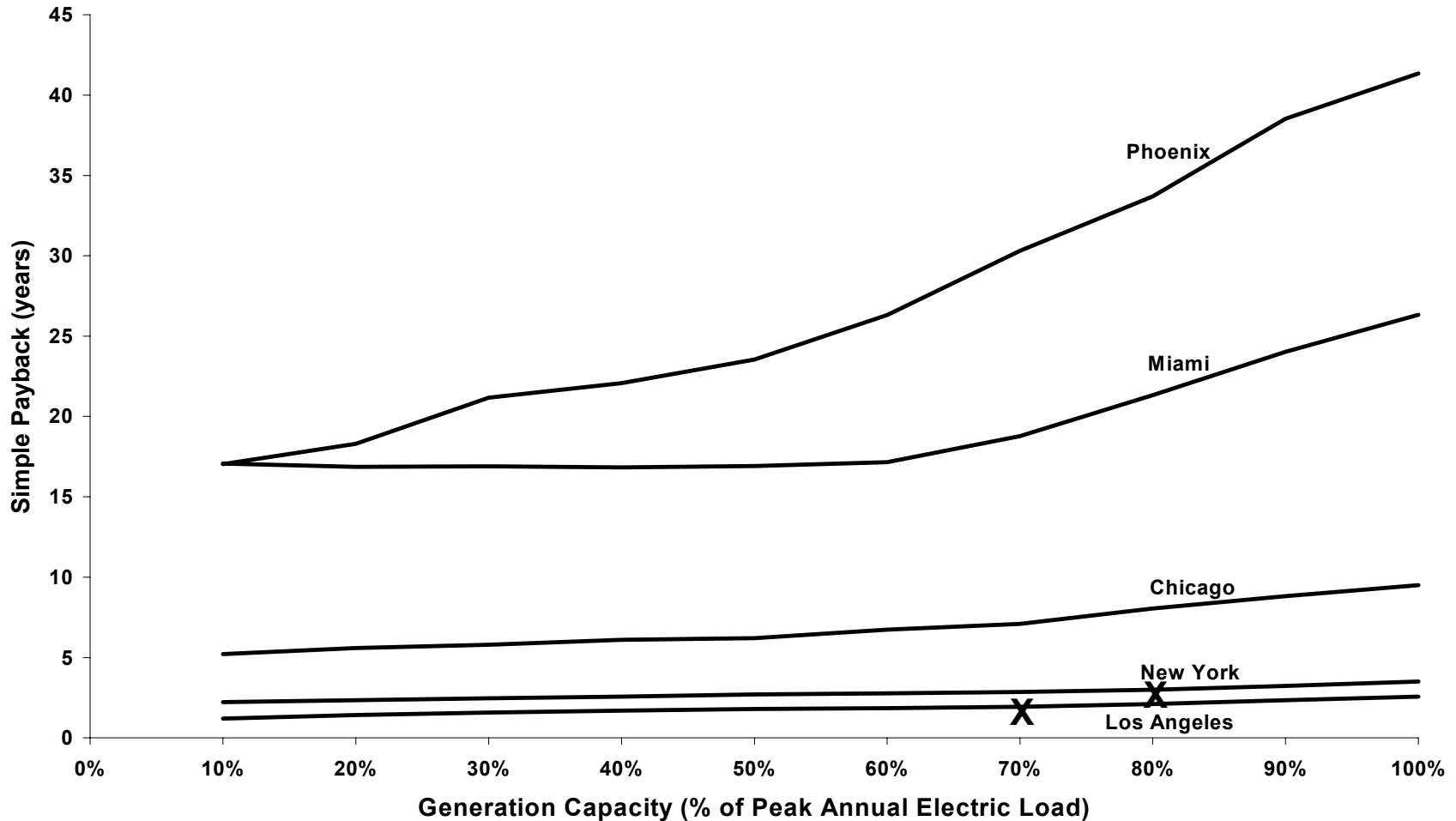

"X" denotes the economic optimum, as detailed in Section 6.6 and Figure 6-3

1. Introduction

Distributed Energy Resources (DER)¹ provide significant opportunities for energy and energy cost savings, as well as improved power quality and reliability. In industrial applications, energy and energy cost savings are generally increased significantly by recovering and utilizing the heat produced as a by-product of electricity generation. This, however, is not necessarily the case for many commercial buildings. As shown in Figure 1-1, office buildings and retail stores represent the bulk of the commercial building floorspace. In these building types, heating loads (primarily space heating and service water heating) are generally modest because:

- The need for service water heating is primarily limited to hand washing; and
- Space-heating loads, even in northern climates, are significantly offset by two factors:
 1. Internal heat loads, associated with occupants, computers, printers, servers, fax machines, copiers, and other office equipment; and
 2. Much of the floorspace, especially in large buildings, is not adjacent to external building surfaces, and, hence, is not rapidly cooled by the ambient.

To more fully utilize the recoverable heat produced, thermally activated cooling equipment (such as absorption equipment and desiccant systems) can be used to serve space-cooling loads. Such systems are called Cooling, Heating and Power (CHP) systems². We performed an analysis of CHP systems for a limited selection of commercial building applications to provide a better understanding of the energy consumption impacts and economics of CHP systems.

¹ DER is sometimes referred to as Distributed Resources (DR). Distributed Generation (DG) is also used, but DG generally refers to power-only applications (without heat recovery).

² The acronym CHP is also used for Combined Heating and Power, which can be considered a subset of Cooling, Heating and Power. In this report, CHP always refers to Cooling, Heating and Power.

Figure 1-1: National Primary Energy Consumption in Commercial Buildings

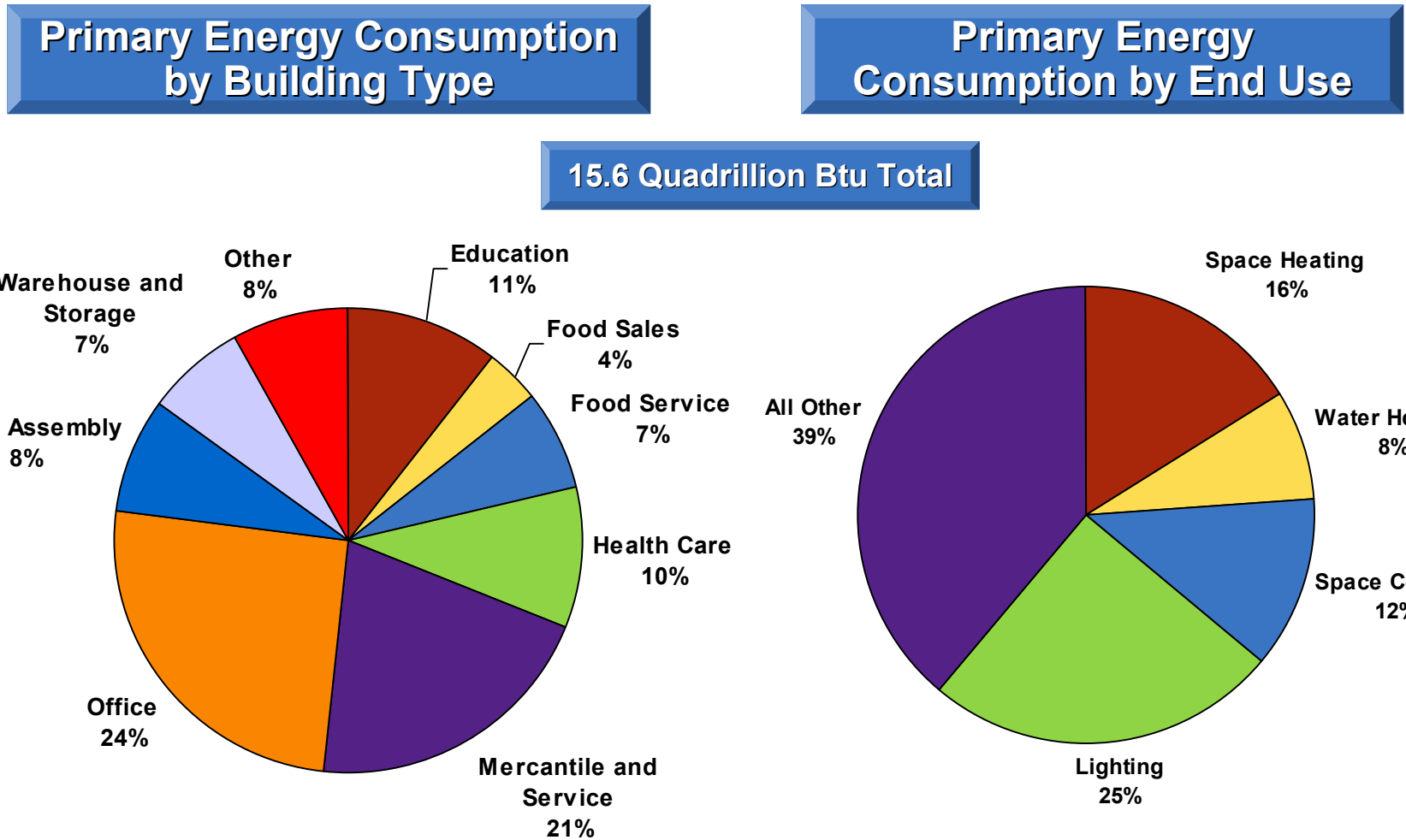

Sources: EIA. "1998 Commercial Building Energy Consumption Survey (CBECS)." U.S. Energy Information Administration. Table 1.
DOE/BTS. "2001 BTS Core Databook." U. S. Department of Energy, Office of Building Technology, State and Community Programs. Summary Sheet 1, Table 7.

2. Objectives

The key objectives of this analysis are:

1. To evaluate the primary energy impacts and economics of applying CHP systems in selected commercial building applications; and
2. To determine the optimum cost/performance tradeoff for microturbine recuperators when used in CHP systems.

Regarding the first objective, there are few detailed studies available that evaluate the energy impacts and economics of CHP systems in commercial buildings. A study is needed that accounts for a) the variability in building electric and thermal loads, and b) key features of utility rates, such as demand and time-of-day charges.

Regarding the second objective, microturbine recuperators add significantly to the physical size, first cost, and maintenance costs of microturbines. Furthermore, eliminating the recuperator, or reducing its effectiveness, would increase the temperature of the exhaust, potentially allowing for greater utilization of the heat in a CHP system. Therefore, we analyzed the relative attractiveness of various microturbine recuperator configurations applied to CHP systems.

3. Approach

Figure 3-1 outlines the approach taken to analyze the benefits of CHP systems in commercial building applications. We employed a combination of simplified analyses (generally requiring relatively simple spreadsheet calculations only) and detailed analyses (requiring a detailed computer model that accounts for hourly variations in building loads and utility rates). The simplified analyses provided useful insights, and helped guide the detailed analyses. The detailed analyses helped account for the all-important impacts of utility rate structures (demand and energy charges) and for the degree of coincidence between electric and thermal loads (which determines the extent to which waste heat can be utilized).

We generally report technical performance in terms of percent primary energy savings achieved relative to a conventional building (without DG or CHP). The percentage is calculated by comparing the total primary energy used with the CHP system to that used by the conventional building.

Some analysts report a combined efficiency, or energy utilization efficiency, for CHP systems. The combined efficiency is the combined electric energy and thermal load served by the CHP system, divided by the fuel input³. However, we believe that combined efficiency can be very misleading, so we avoid its use. As we discuss in Section 4.3, the electric grid provides electricity at an average efficiency of about 35 percent (LHV)⁴. On the other hand, conventional fuel-fired heating equipment provides heat at a typical efficiency of 90 percent (LHV)⁵. Therefore, it can be difficult to judge whether a combined efficiency for a CHP system is higher than that for conventional equipment without calculating a weighted-average efficiency for conventional equipment providing the same electric and heating loads.

³ The convention for power systems is to base efficiency on the lower heating value (LHV) of the fuel. In contrast, the efficiency of cooling and heating equipment is generally based on the higher heating value (HHV).

⁴ See Table 4-1.

⁵ Corresponds to about 81 percent (HHV) efficiency

Figure 3-1: Approach to CHP Benefits Analysis

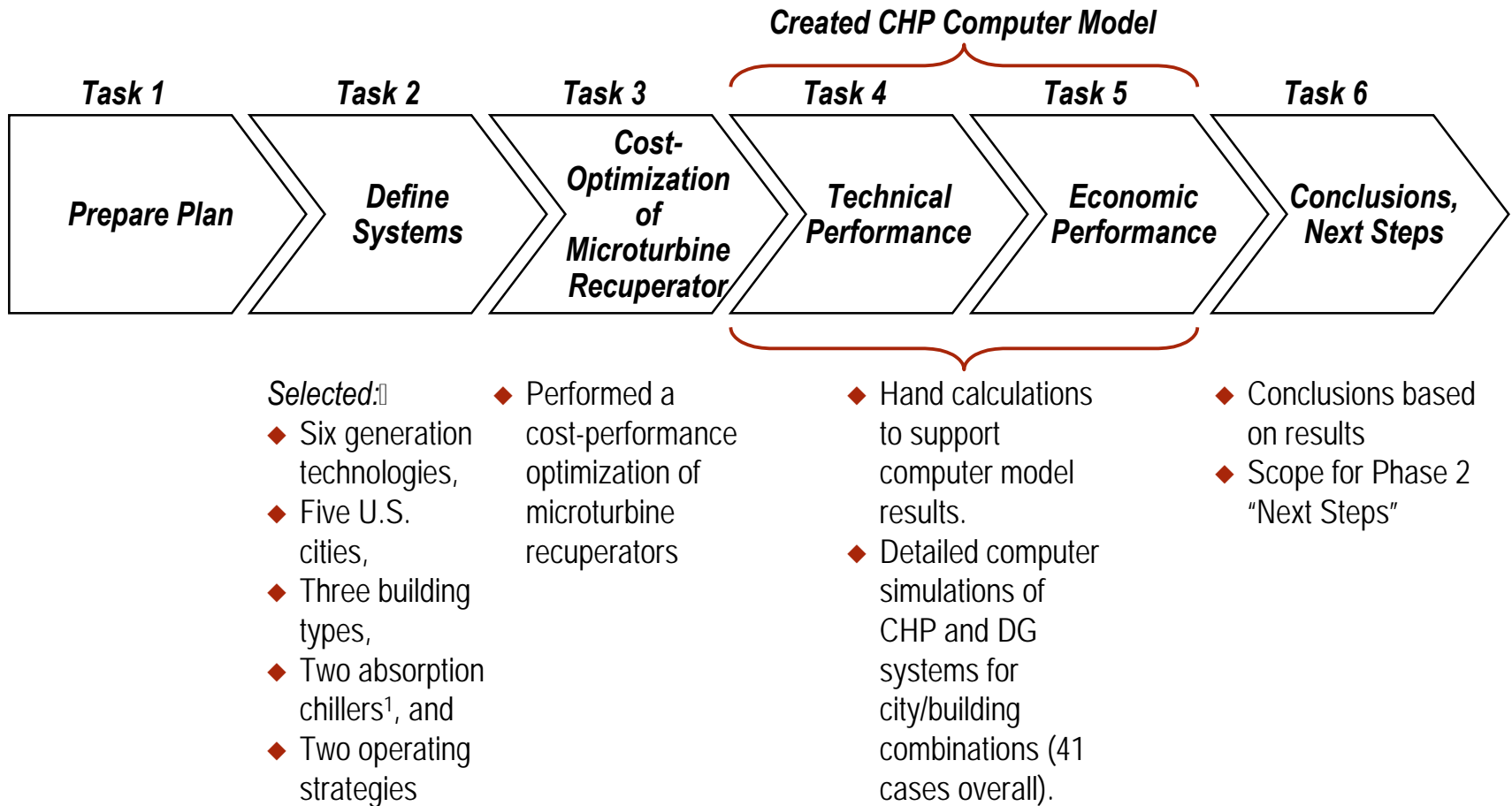

¹ We recommend examining desiccants under Phase 2.

4. System Configurations for Analysis

Figure 4-1 outlines the matrix of generation technologies, thermally activated cooling equipment, building types, and cities considered. These variables are discussed below, along with the “baseline” (i.e., conventional) equipment characteristics assumed. ***We did not analyze CHP systems having either electric or thermal storage systems.*** Storage systems add cost and complexity, but may provide significant energy and operating-cost benefits. ***Furthermore, we did not consider strategies that shift discretionary loads to maximize the energy utilization of CHP systems.***

4.1 Generation Technologies

We evaluated five generation technologies (see Table 4-1). We projected cost and performance characteristics for each technology for the year 2005 (or after), and for production volumes of 10,000 units/year. This production volume is much higher than current production volumes for microturbines and, therefore, our installed-cost projections for microturbines are below current costs.

We use the term “standard” technology (for example, standard microturbine) to refer to a technology having performance characteristics typical of the products on the market today. We use the term “advanced” technology to refer to a technology that is further developed relative to the “standard” technology. Although we do not specifically designate it as advanced, the high-temperature proton-exchange-membrane (HTPEM) fuel cell is most definitely an advanced technology. In fact, no such technology is in the market place today (to which we could refer as “standard”)⁶. ***Our cost and performance projections for advanced technologies assume that ongoing research and development efforts will achieve their cost and performance goals.*** In particular, the HTPEM cost and performance projections are the most speculative among the generation technologies. Realistically, the time horizon for achieving the cost and performance projections for HTPEM will probably be beyond 2005.

Appendix A includes CHP system schematics for the various generation technologies considered in this analysis.

⁶ HTPEM is not to be confused with conventional PEM, which is further along in development, but still just beginning to be commercialized. Waste-heat temperatures for conventional PEM typically range from 140 to 180°F, whereas waste-heat temperatures for HTPEM typically range from 220 to 320°F.

Table 4-1: Generation Technologies Summary^a

Generation Technology	Installed Cost (\$/kW)	Non-Fuel O&M Cost (\$/kWh)	Nominal Electric Generation Efficiency (% LHV) ^b
Standard Microturbine	\$880	\$0.015	26%
Advanced Microturbine	\$880	\$0.015	31%
Standard Engine	\$570	\$0.010	35%
Advanced Engine	\$710	\$0.012	42%
High-Temperature Proton-Exchange-Membrane (HTPEM) Fuel Cell ^c	\$1200	\$0.015	40%
<i>Grid Electric Baseline</i>	\$0	\$0	35% ^d

- a) Cost and performance characteristics projected for 2005 and for production volumes of 10,000 units/year, unless noted otherwise. See Appendix D, Tables 1 to 4, for further details of projections.
- b) Includes power-conditioning equipment and/or electric-generator efficiencies, as appropriate.
- c) We analyzed high-temperature PEM because the temperature of the heat available from low-temperature (conventional) PEM is too low for practical use in most commercial building heating applications.
- d) For year 2000. Source: *2001 BTS Core Databook*; US Department of Energy, Office of Building Technology, State and Community Programs: July 13, 2001; Table 6.2.4. HHV value of 31.7 percent converted to LHV assuming that the weighted average of HHV-to-LHV ratios for the mix of fuels used in generating grid-supplied electricity is the same as the ratio for natural gas.

Figure 4-2 shows generator technology cost as a function of generation efficiency. As evident from the figure, the engines have much lower cost-to-efficiency ratios relative to microturbines or fuel cells. This does not mean, however, that engines will always be the preferred choice for CHP systems. Engines may have disadvantages relative to the other technologies, such as more noise and vibration, higher weight, higher emissions, and more frequent maintenance requirements. Our analysis attempts to account for only some of these factors (such as weight and vibration, to the extent that they impact installation costs, and more frequent maintenance, to the extent that it impacts non-fuel O&M costs).

4.2 Building Types

We selected hospitals, large hotels, and large office buildings for analysis. We focussed on larger commercial buildings because we judged them to be more likely candidates for CHP systems. For our detailed analysis (see Section 6), we required hourly load data for prototypical buildings. Tables 4-2, 4-3, and 4-4 summarize the characteristics of the prototypical buildings selected. The characteristics of each building type vary depending on the city, reflecting the regional variations in typical construction characteristics. In some cases, the variations are substantial. For example, a prototypical large office in New York is 419,000 square feet, while a prototypical large

office in Phoenix is only 142,000 square feet. To better focus on energy impacts associated with climate and utility rates, we report energy impacts per square foot of floor area (commonly referred to as energy intensities). However, the building types will also vary from city to city in a) type and number of windows, b) wall, floor, and roof insulation, and c) other construction characteristics – all of which will impact building loads independent of climate.

Table 4-2: Prototypical Hospital Characteristics

Hospital ^a	City	Floor Area (ft ²)	Coil ^b Heating: Peak (MMBtu/hr)/ Annual (MMBtu/yr)	Coil ^b Cooling: Peak (MMBtu/hr)/ Annual (MMBtu/yr)	Non-Coil ^c Electric: Peak (MW)/ Annual (MWh/yr)
	New York	386,000	10.5 / 16,000	8.4 / 22,000	1.4 / 9,000
	Chicago	364,000	13.0 / 7,000	8.5 / 20,000	1.3 / 8,500
	Miami	315,000	4.2 / 1,200	6.5 / 55,000	1.1 / 7,300
	L.A.	250,000	2.3 / 1,100	6.8 / 15,000	0.9 / 5,700
	Phoenix	254,000	4.2 / 1,300	8.3 / 30,000	0.9 / 6,000

- a) The hospital is current vintage, meaning that its envelope (wall and ceiling R-values for example) complies with ASHRAE Standard 90.1. The heating set-point is fixed at 74°F and the cooling set-point is fixed at 76°F at all hours. A complete description of the hospital prototype is found on pages 4.4 – 4.13 of the report by Lawrence Berkley National Labs titled “481 Prototypical Commercial Buildings for Twenty Urban Market Areas” published for the Gas Research Institute in June of 1990.
- b) Coil loads are given as the thermal loads at the chiller or boiler and do not include hot water loads.
- c) Non-coil electric loads include all electric loads including lighting, equipment, and HVAC parasitic loads (fans, etc.) but do not include loads from electric cooling or heating equipment.

Table 4-3: Prototypical Large Hotel Characteristics

Hotel ^a	City	Floor Area (ft ²)	Coil ^b Heating: Peak (MMBtu/hr)/ Annual (MMBtu/yr)	Coil ^b Cooling: Peak (MMBtu/hr)/ Annual (MMBtu/yr)	Non-Coil ^c Electric: Peak (MW)/ Annual (MWh/yr)
	New York	494,000	15.5 / 6,300	9.6 / 18,000	1.4 / 6,300
	Chicago	218,000	9.2 / 6,400	4.9 / 8,800	0.6 / 2,800
	Miami	194,000	2.9 / 97	3.6 / 27,000	0.5 / 2,500
	L.A.	203,000	1.7 / 610	4.6 / 4,600	0.5 / 2,600
	Phoenix	178,000	3.3 / 580	5.3 / 16,000	0.5 / 2,300

- a) The large hotel is current vintage, meaning that its envelope (wall and ceiling R-values for example) complies with ASHRAE Standard 90.1. The heating set-point is fixed at 74°F and the cooling set-point is fixed at 76°F at all hours. A complete description of the hospital prototype is found on pages 4.4 – 4.13 of the report by Lawrence Berkley National Labs titled “481 Prototypical Commercial Buildings for Twenty Urban Market Areas” published for the Gas Research Institute in June of 1990.
- b) Coil loads are given as the thermal loads at the chiller or boiler and do not include hot water loads.
- c) Non-coil electric loads include all electric loads including lighting, equipment, and HVAC parasitic loads (fans, etc.) but do not include loads from electric cooling or heating equipment.

Table 4-4: Prototypical Large Office Characteristics

Office ^a	City	Floor Area (ft ²)	Coil ^b Heating: Peak (MMBtu/hr)/ Annual (MMBtu/yr)	Coil ^b Cooling: Peak (MMBtu/hr)/ Annual (MMBtu/yr)	Non-Coil ^c Electric: Peak (MW)/ Annual (MWh/yr)
	New York	419,000	5.9 / 4,600	5.8 / 7,400	1.3 / 4,900
Chicago	352,000	5.4 / 3,500	5.7 / 7,000	1.1 / 4,200	
Miami	159,000	1.7 / 150	2.3 / 11,000	0.6 / 2,100	
L.A.	197,000	1.7 / 910	3.9 / 5,200	0.7 / 2,300	
Phoenix	142,000	1.8 / 760	3.5 / 7,600	0.5 / 1,800	

- a) The large office (12-hour occupancy) is current vintage, meaning that its envelope (wall and ceiling R-values for example) complies with ASHRAE Standard 90.1. The heating set-point is fixed at 74oF and the cooling set-point is fixed at 76oF at all hours. A complete description of the hospital prototype is found on pages 4.4 – 4.13 of the report by Lawrence Berkley National Labs titled “481 Prototypical Commercial Buildings for Twenty Urban Market Areas” published for the Gas Research Institute in June of 1990.
- b) Coil loads are given as the thermal loads at the chiller or boiler and do not include hot water loads.
- c) Non-coil electric loads include all electric loads including lighting, equipment, and HVAC parasitic loads (fans, etc.) but do not include loads from electric cooling or heating equipment.

As noted in the tables, we derived the prototypical building characteristics from two sources:

- Space-Heating, Space-Cooling, and Non-Coil Electric Loads: Lawrence Berkeley National Laboratory (LBNL) databases developed through DOE-2 computer modeling of prototypical buildings using TMY-2 weather data; and
- Service-Water-Heating Loads: We used hot-water-draw data for each building type as assembled by the DOE Analysis Platform software program. All prototypical hospitals have hourly water draws of about 3,400 gallons/hour on weekdays and about 1,200 gallons/hour on weekends. All prototypical large hotels have hourly water draws of about 73 gallons/hour on weekdays and about 54 gallons/hour on weekends. All prototypical large office buildings have very small hot-water loads, and we assumed that it would be impractical to use waste heat to serve those loads. The water draws are converted into thermal loads by the CHP simulation model (described in Section 6.2 of this report) assuming a constant water-temperature rise of 70°F. The hot-water loads are then combined with space-heating loads to approximate total building thermal loads.

Figure 4-3 shows a breakdown of the annual thermal loads for each prototypical building type in New York and Los Angeles. The service-water-heating loads represent between about zero and four percent of the total thermal loads for each prototypical building. Water-heating loads in office buildings are small and probably not practical to service with heat-recovery equipment. Therefore, we neglected office water-heating

loads. The water-heating *loads* for hospitals and hotels appear low compared to the relative magnitudes of water-heating energy *consumption*⁷ shown in Figure 1-1 (and compared to one's intuition about water use in hotels and hospitals). We did not attempt to resolve this anomaly and, therefore, the magnitude of the total building heating loads used in our analysis may be somewhat underestimated.

4.3 Baseline Building Characteristics

An analysis of a building using CHP only has relevance if compared to a baseline building against which energy consumption and cost comparisons can be made. Since the vast majority of commercial buildings purchase all electricity consumed from the electric grid, grid-purchased electricity is the logical source of electricity for the baseline building. The national average generation, transmission, and distribution efficiency is roughly 35 percent on a LHV basis (see Table 4-1). We did not account for variations in the efficiency of grid-supplied electricity associated with various utility service areas, building location within the grid, temperature and weather conditions, overall demand on the grid, or other factors.

Since the waste heat recovered and utilized will displace thermal loads normally supplied by other means, it is also important to define the baseline equipment used to supply thermal loads, including service-water heating, space heating, and space cooling. There are two general categories of space-conditioning equipment used in commercial buildings:

- Light Commercial: Packaged unitary equipment (rooftop equipment); and
- Large Commercial: Engineered systems (chillers and boilers).

Since the building types considered in this analysis typically use engineered systems, we used chillers and boilers for the baseline space-cooling and heating equipment. Since electric chillers dominate the chiller market⁸, we used electric chillers as a baseline. We further assumed that the electric chillers are water-cooled because:

- The building types we analyzed often use water-cooled chillers; and
- The absorption chiller(s) used to supply space-cooling loads will require cooling towers. If an end user did not consider water-cooled electric chillers, then they likely would not consider a CHP system incorporating absorption chillers.

The most common types of water-cooled electric chillers are reciprocating and centrifugal. Rather than double the size of the analysis matrix by considering both

⁷ One must exercise caution when comparing ratios of loads to ratios of energy consumption, given the range of fuel types and efficiencies associated with the equipment serving those loads. However, the national energy consumption data would suggest that, in the typical commercial building, more than zero to four percent of the thermal load is associated with water heating.

⁸ An estimated 97 percent of the chiller market is electric chillers. Most of the remainder is absorption chillers, followed by a few engine-driven chillers. Source: Presentation by Broad USA on December 5, 2001.

reciprocating and centrifugal chiller baselines, we simply averaged the efficiencies of the two chiller types, using efficiencies of best-available chillers, to form a hybrid baseline, (see Table 4-5).

Table 4-5: Baseline Electric Chiller Efficiency Calculation

Equipment Type	Seasonal Performance, IPLV (kW/ton)
Water-Cooled, Reciprocating Chiller – Best Available	0.84 ^a
Water-Cooled, Centrifugal Chiller – Best Available	0.47 ^a
Average Water-Cooled Chiller	0.66
Cooling Tower ^b	0.13 ^a
Average Used for Analysis (Chiller and Tower)	0.79

a) Source: DeVault, Robert; Oak Ridge National Laboratory; Cooling, Heating & Power Comparison. Excel spreadsheet. Updated March 29, 2001. Provided to Arthur D. Little on August 23, 2001.

b) Cooling-tower parasitics are included because they differ for electric and absorption chillers. Parasitics associated with the building distribution system are not included, since they will be the same for either chiller type.

We assumed that the baseline building uses a fuel-fired⁹ boiler having an 81 percent (HHV) efficiency for space heating. We assumed that the service-water-heating equipment in the baseline building uses the same fuel, and has the same efficiency, as the space-heating equipment.

We assumed that end users who install CHP systems will insist on having sufficient capacity in the baseline cooling system to meet the building’s design cooling load because:

- In retrofit applications, the baseline chiller plant already exists, so it is too late to avoid the full capital investment; and
- In new construction or retrofit applications in which the baseline equipment requires replacement anyway, the end user may not wish to be obliged to operate the CHP system to meet peak cooling loads when operation for electric generation is not justified. Also, the end user may not feel that the reliability of the CHP system is sufficiently high to depend on it to meet peak cooling loads.

Therefore, our economic analysis includes no credit for reduced capital costs for the baseline cooling plant.

The selection of baseline equipment can have a significant impact on the calculated economics and energy savings of CHP systems. For example, seasonal efficiencies of light-commercial equipment (often used in buildings of three stories or less) are typically 1.2 to 1.6 kW/ton for space cooling. For the purposes of this analysis, this equipment would consume over 50 percent more energy per unit of cooling delivered

⁹ The fuel is the same fuel as used by the CHP system. In most cases in this analysis, the fuel is natural gas.

relative to the baseline equipment we used¹⁰. If space heating in the baseline building is supplied by electric-resistance heating, the baseline equipment would consume about 2.5 times as much primary energy¹¹ per unit of space heating delivered relative to the baseline we used. In fact, if the heat recovered is displacing electric-resistance heating, the utilized heat has as much value as the electricity generated by the CHP system¹².

Section 5.4 discusses the impacts of baseline equipment efficiency on overall CHP system energy consumption.

4.4 Thermally Activated Cooling Equipment

Table 4-6 lists the waste-heat-fired, thermally activated cooling equipment evaluated in this analysis. For each generation technology, we selected an appropriate type of absorption chiller to operate off the waste heat. We did not evaluate desiccant dehumidification systems. Evaluation of CHP systems using desiccants should be the subject of future analyses.

Table 4-6: Cooling Technologies Summary^a

Generation Technology	Cooling Technology	Installed Cost (\$/Rated Ton)	Annual Non-Fuel O&M cost (\$/Rated Ton)	Minimum Activation Temperature	Chiller COP ^b	Cooling Tower Parasitics (kW/ton)	Combined Chiller and Tower COP
Standard and Advanced Engines; HTPEM	Water/ Steam-Fired Single-Effect Absorption Chiller	\$500	\$15	170°F	0.7	0.25	0.6 ^c
Standard and Advanced Microturbines	Exhaust-Fired Double-Effect Absorption Chiller ^d	\$650	\$20	340°F	1.1	0.20	0.9 ^c
--	<i>Displaced Electric Chiller</i>	\$300 ^e	\$25 ^e	--	1.7 ^f	0.13	1.4 ^g

- a) See Appendix D, Table 5, for further details of cost and performance estimates.
- b) Coefficient of Performance (Btu of cooling Output / Btu of Heat Input). Calculated based on higher-heating value (HHV) of fuel, consistent with conventional practice for cooling equipment.

¹⁰ Light-commercial cooling equipment does not necessarily consume more energy relative to large-commercial equipment. Large-commercial equipment has significant energy requirements associated with the distribution system, which we do not consider here.

¹¹ For electricity, primary energy accounts for the losses associated with generation, transmission, and distribution. For natural gas, primary energy account for the losses associated with transmission and distribution. However, these losses are small for natural gas, and are often neglected.

¹² Of course, one might question if a building that uses electric-resistance heating would be likely to consider a CHP system. An end user sophisticated enough to consider a CHP system, and having fossil fuel available (as would be needed by the CHP system), would likely already utilize that fuel for heating – or at least evaluate it as an alternative to CHP.

- c) Primary energy COP. Tower parasitics converted to primary energy based on 31.7 percent (HHV) efficiency of the electric generation, transmission, and distribution system (from Table 4-1).
- d) Exhaust-fired, single-effect chillers can be used with microturbines, as is being demonstrated currently at the University of Maryland. Depending on the application, the single-effect chiller may be more cost effective. However, the cooling load provided by either chiller would be similar, as the ability of the single-effect chiller to extract more heat from the exhaust gas is roughly balanced by the higher COP of the double-effect chiller.
- e) For reference only. We assumed that there will be no savings in capital cost or non-fuel O&M cost for the electric chiller plant when a CHP system is used.
- f) Primary energy COP corresponding to 0.66 kW/ton IPLV (from Table 4-5) and 31.7 percent (HHV) efficiency of the electric generation, transmission, and distribution system (from Table 4-1).
- g) Primary energy COP corresponding to 0.79 kW/ton IPLV, including tower parasitics (from Table 4-5) and 31.7 percent (HHV) efficiency of the electric generation, transmission, and distribution system (from Table 4-1).

4.5 Heat-Recovery Heating Equipment

Table 4-7 lists the cost and performance characteristics of the equipment used to recover heat for heating loads. Basically, the equipment is simply a heat exchanger, as shown in the schematics in Appendix A.

Table 4-7: Summary of Heat-Recovery Heating Equipment^a

Heat Source	Heat-Recovery Equipment	Installed Cost (\$/MMBtuh)	O&M Costs (\$/MMBtuh)	Effectiveness	Pressure Drop (dP/P) ^b
Microturbine Exhaust; HTPEM Tail Gas	Gas-to-Water Heat Exchanger	\$10,000	~\$0	85% ^c	2%
Engine Coolant Loop ^d	Coolant-to-Water Heat Exchanger	\$10,000	~\$0	85% ^c	-- ^e
<i>Displaced Boiler</i>	--	--	--	81% (HHV) ^f	--

- a) See Appendix D, Table 6, for further details.
- b) Pressure drop divided by absolute pressure at heat-exchanger inlet.
- c) Heat loss to ambient is assumed negligible, so the heat-exchanger *efficiency* is 100 percent.
- d) Coolant recovers heat from both engine jacket and exhaust.
- e) Additional coolant-pump parasitics associated with the heat exchanger are neglected.
- f) This is actually an *efficiency*, not an *effectiveness*.

4.6 Fuel Types

For the bulk of our evaluations, we assumed natural gas is the fuel available for on-site generation. However, we considered fuel oil for two cases, as fuel oil is used in some commercial buildings in the northeast and northwest, and can be used in some microturbines and engines. We neglected the impacts of fuel type on performance, equipment cost, and non-fuel O&M cost.

4.7 Cities and Utility Rates

Table 4-8 lists some of the climate characteristics of the five cities selected for analysis. The five cities provide a range of climate conditions. More importantly, they provide a range of utility rates and rate structures. Figure 4-4 shows average commercial-building gas and electric utility rates for 16 states across the US, including the states in which the five selected cities reside. As discussed further in Section 6.5, statewide average rates can vary substantially from the average rates for the cities and building types selected for analysis.

Table 4-8: U.S. Cities Selected for Analysis

City	Latitude	1% Heating Design Dry-Bulb Temperature	1% Cooling Design Dry-Bulb Temperature	Coincident Humidity	DOE Climate Zone
Los Angeles	33.93N	45°F	81°F	39%	5
New York	40.65N	15°F	88°F	46%	3
Chicago	41.98N	-1°F	88°F	50%	2
Phoenix	33.43N	37°F	108°F	14%	4
Miami	25.82N	50°F	90°F	56%	5

Figure 4-5 lists key characteristics of the gas and electric rate *structures* for the cities selected for analysis. These are current rate structures appropriate for the building types considered in our analysis. *However, we did not account for the fact that incorporating CHP may change the rate structure applicable to the building, nor did we account for stand-by or other charges that may be imposed on CHP system users.*

Fuel oil rates were estimated at a constant \$4 per MMBtu for all cities and building types. This represents the U.S. average price of No. 2 fuel oil to commercial customers in 1999 (\$0.558 per gallon), while the average fuel oil price in 2000 was substantially higher (\$0.927 per gallon), the 1999 price is representative of the 10-year average of \$0.614 per gallon (1989-1998).¹³

¹³ Source: Energy Information Administration. *Petroleum Marketing Monthly* DOE/EIA. September 1001. Table 2.

Figure 4-1: CHP Benefits Analysis System Selection

Generation Technologies	Chillers
<ul style="list-style-type: none">◆ Standard microturbine◆ Advanced microturbine◆ Standard engine◆ Advanced engine◆ High-temperature PEM fuel cell	<ul style="list-style-type: none">◆ Single-effect (water/steam fired, COP = 0.7, parasitics = 0.25 kW/ton)◆ Double-effect (exhaust fired, COP=1.1 parasitics = 0.20 kW/ton)◆ Baseline electric (0.66 kW/ton + 0.13 kW/ton parasitics)
Building Types	Cities
<ul style="list-style-type: none">◆ Hospital◆ Large hotel◆ Large office	<ul style="list-style-type: none">• New York City• Los Angeles• Chicago• Miami• Phoenix

See Appendix D for a complete list of cost and performance estimates, rate structure details, and sources.

Figure 4-2: Generation-Technology Cost Versus Efficiency

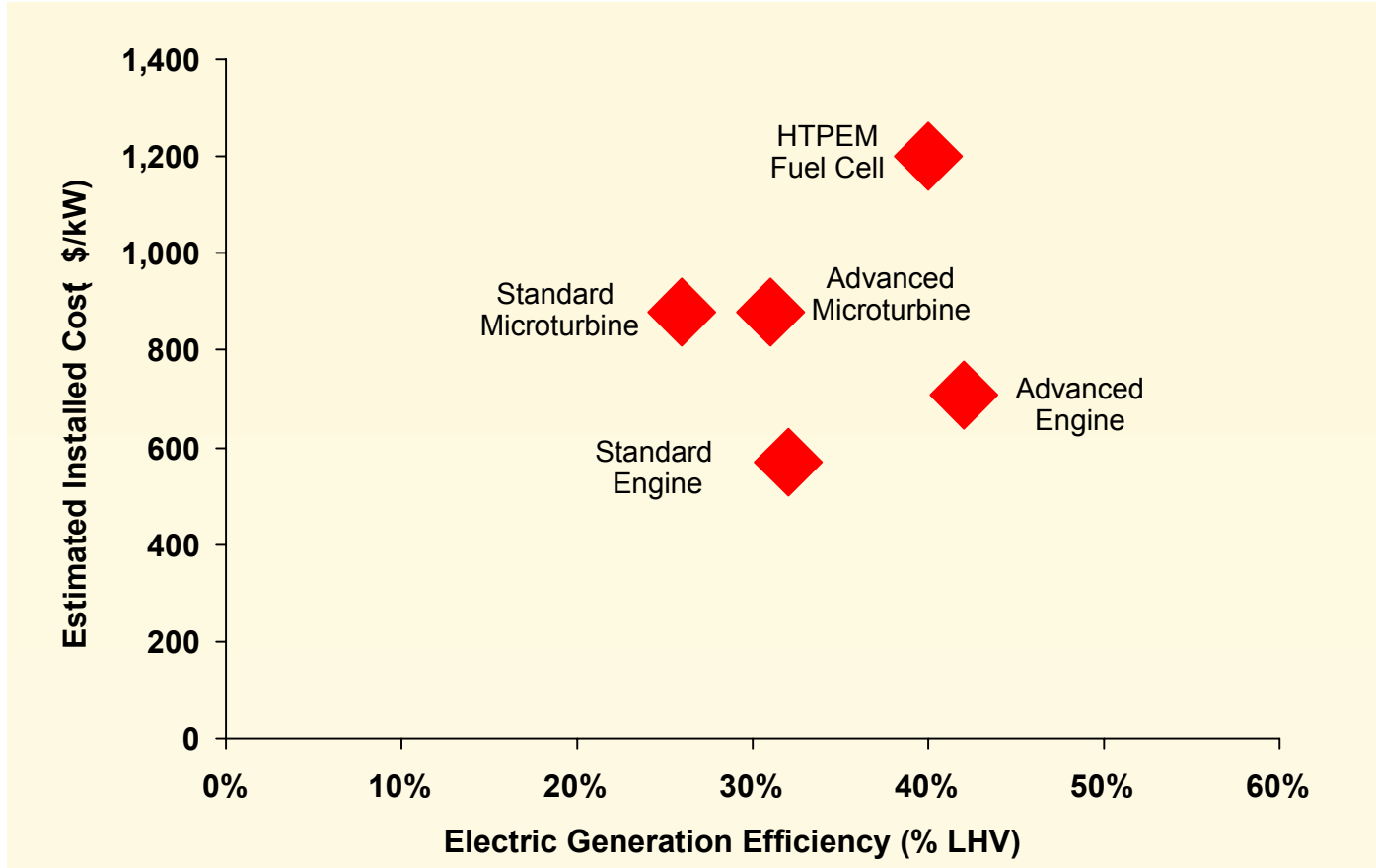

Microturbine and fuel cell costs are based on 10,000 units/yr. production with 40% mark-up over manufacturer's cost, and 50% installation costs.

Advanced engine costs are based on Y2010 industry goals for natural gas compression-ignition engines. Standard engine costs are based on current retail cost projections for beyond Y2005.

Figure 4-3: Overall Thermal Loads in Prototypical Buildings

NY Office

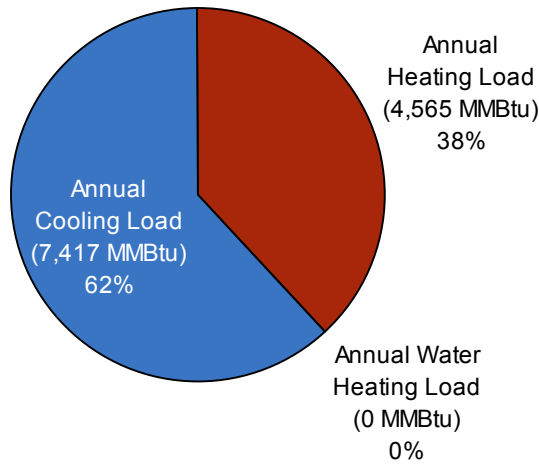

NY Hospital

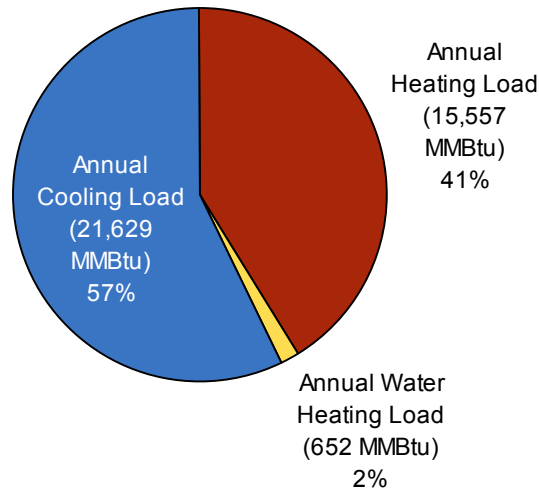

NY Hotel

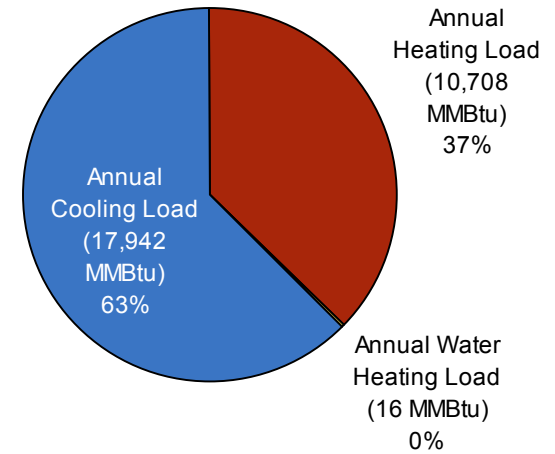

LA Office

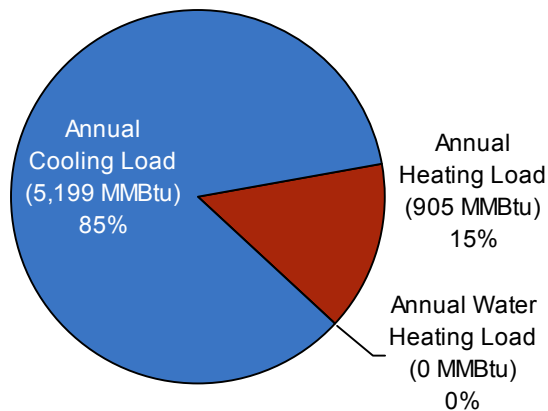

LA Hospital

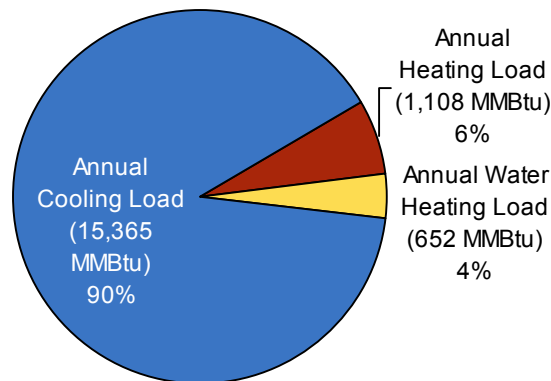

LA Hotel

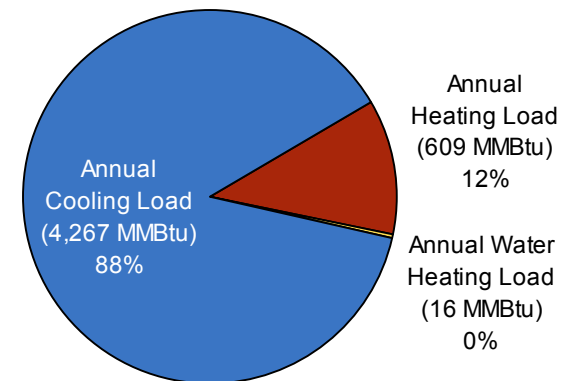

Figure 4-4: Average Commercial Natural Gas and Electricity Prices for Selected States

Commercial Energy Prices

State Averages Between Y2000 and Y2001 (through October) as reported by the EIA

Area of bubble represents variation in rates between 2000 and 2001

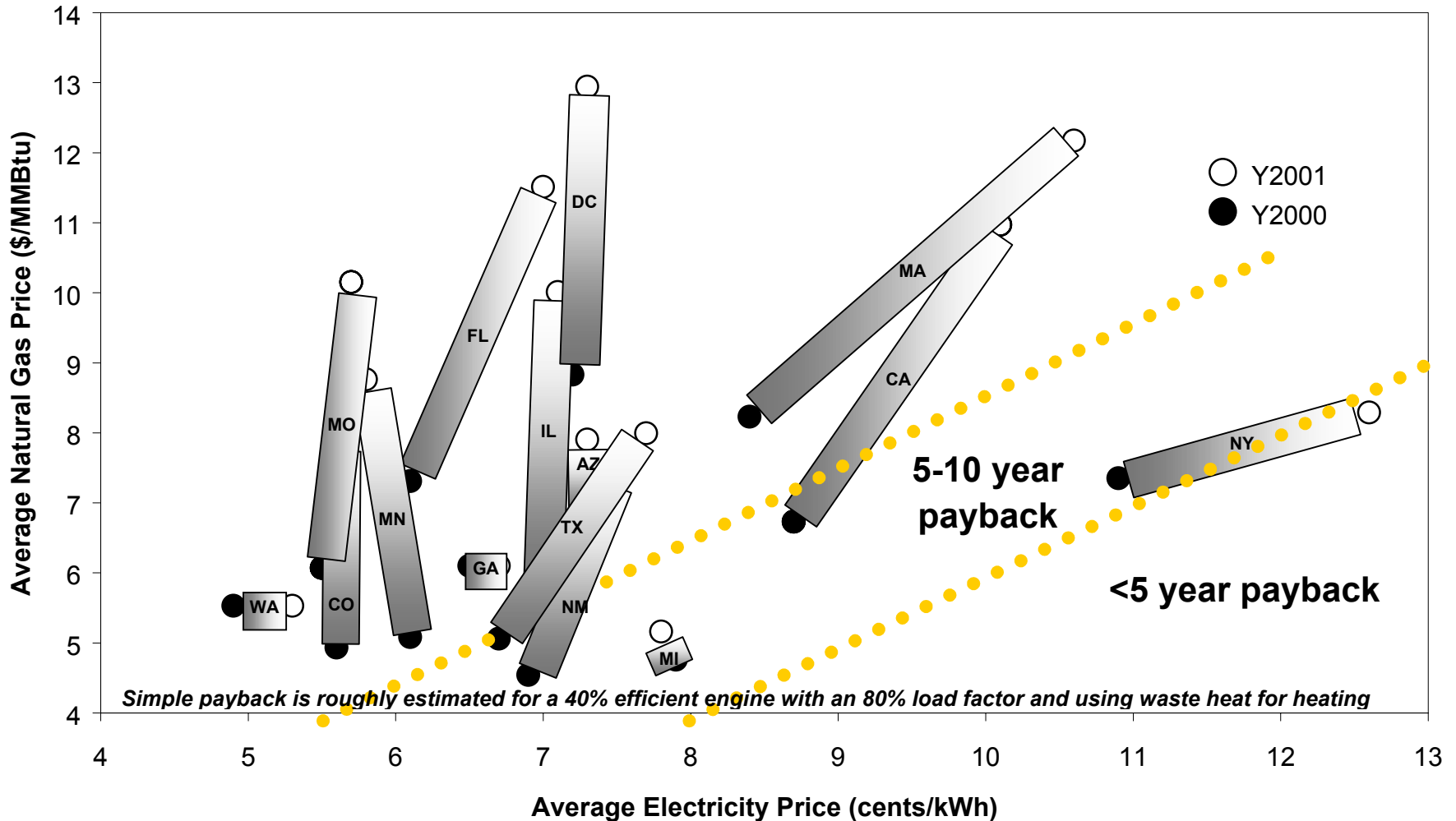

Figure 4-5: Characteristics of Utility Rate Structures for the Cities Selected for Analysis

Favorable to CHP?	City	Electric			Gas
		Peak Demand Charge (\$/kWh)	Off-Peak Demand Charge (\$/kWh)	Average Energy Charge (\$/kWh)	Energy Charge (\$/MMBTU)
Most Favorable	Los Angeles	SoCalEdison			\$5.026
		Up to \$24	\$6.40	\$0.113	
Highly Favorable	New York	ConEdison			\$5.716
		Up to \$21	Down to \$16	\$0.078	
Favorable	Chicago	CommEdison			Peoples Gas \$5.656
		\$16.41	\$12.85	\$0.037	
Less Favorable	Phoenix	Arizona Public Services			South West Gas \$9.2146
		\$6.35	\$5.67	\$0.063	
Least Favorable	Miami	Florida Power and Light			City Gas Company of Miami \$7.65 - \$11.69
		\$3.77	\$0.94	\$0.055	

See Appendix F for a detailed description of each rate structure

5. Simplified Analysis

As discussed in Section 3, we employed simplified calculations to provide useful insights and to guide the detailed analysis. Unless noted otherwise, the simplified calculations employ:

- Average annual electric and gas rates (fixed \$/kWh and fixed \$/MMBtu);
- Assumed (rather than calculated) utilization of recoverable waste heat;
- Assumed generator capacity factors¹⁴ (based on previous modeling experience); and
- Fixed electric generation efficiencies.

While these simplified calculations provide useful insights, the results documented in this section should be considered preliminary unless confirmed by the more detailed analysis documented in Section 6.

5.1 Economics of Distributed Generation (Power Only)

Figure 5-1 shows the economics of the various generation technologies (for \$0.08/kWh electricity and \$5/MMBtu gas) when used for power generation only (no heat recovery). The penalty of low generation efficiency is evident. The standard and advanced engines have a clear economic advantage relative to the other generation technologies (as shown previously in Figure 4-2). However, the caveats associated with engine use, discussed in Section 4, mean that engines may not always be the “best” choice of generation technology. The figure suggests that engines can achieve paybacks of 5 years or less only for capacity factors over 70 to 80 percent. No other generation technology achieves payback of 5 years or less at any capacity factor. *The actual economics can be much better, as shown in Section 6.8.3, where detailed utility rate structures are considered and when rates are more favorable.*

5.2 Economics of Heating with a “Free” Heat Source

We also investigated the economics of utilizing “free” heat to supplement heating loads (see Figure 5-2). In this example, the capacity factor of the heat-recovery heat exchanger can be relatively low (4 to 7 percent) to achieve payback in 3 to 5 years. Capacity factors of 10 percent or more should significantly improve CHP system economics for most installations.

¹⁴ Generator Capacity Factor is the actual annual generator electric output divided by the theoretical maximum annual generator output.

5.3 Economics of Cooling with a “Free” Heat Source

We investigated the economics of operating an absorption chiller with “free” heat (see Figure 5-3). While the waste heat from a generation system can be considered free, making use of the heat for cooling is not free. The end user invests capital to install the absorption chiller, incurs increased operating costs associated with a) absorption-chiller O&M, and b) an incremental increase in cooling-tower load (due to the higher heat rejection requirements relative to the baseline electric chiller). For this example, the capacity factor of a single-effect absorption chiller must be at least in the range of 30 to 45 percent to achieve payback within 3 to 5 years. If absorption-chiller capacity factor can be 60 percent or more, CHP system economics should be enhanced significantly for most installations. These estimates do not account for the added hardware and controls costs associated with integrating the absorption chiller with the waste-heat stream.

5.4 Primary Energy Impacts of CHP in a New York Office Building

Figures 5-4 and 5-5 show the variation in primary energy consumption intensities of a New York office building using CHP as a function of the generation efficiency, type of heat recovery, and baseline equipment. The simplified analysis suggests that CHP can reduce building primary energy consumption by 10 to 23 percent, depending on equipment mixes. It also suggests that generation efficiency and heat recovery are both important contributors to the energy savings achieved. In fact, in the case of a 25-percent generation efficiency, heat recovery is essential to achieving energy savings.

Using waste heat to supply cooling loads is more valuable than supplying heating loads when the baseline cooling system is 1.2 kW/ton, but heating is more valuable than cooling when the baseline cooling system is 0.6 kW/ton. However, the overall impacts of the efficiency of the baseline cooling system are modest. *Doubling the efficiency of the baseline cooling system effects less than a five-percentage-point reduction in energy savings*¹⁵.

Figures 5-6 to 5-9 show the value of a CHP system versus operating cost for the various generation technologies, two uses of waste heat, and two average utility-rate scenarios. For the range of average utility rates and generation technologies considered:

- The net value of the CHP system ranges from about \$0.01/kWh to about \$0.09/kWh;
- Using waste heat effectively has a value impact similar to that of having high generation efficiency, but the electricity generated provides most of the value – not the recovered heat. Still, the value of the recovered heat can be significant and, in

¹⁵ Had we compared electric resistance heating to the gas-fired baseline heating equipment assumed in this example, the impact of baseline equipment would be much higher. However, for reasons discussed in Section 4, we do not consider electric-resistance heating to be the appropriate baseline-equipment alternative for the typical CHP application.

some cases, can make the difference between the CHP system lowering operating costs or increasing them; and

- Because we assumed that a fixed percentage of the waste heat can be utilized, and because less-efficient generation technologies produce more waste heat, the heat recovered from less-efficient technologies appears to provide more value relative to the heat recovered from more-efficient technologies. This will only be true, however, if the building can utilize the additional waste heat.

5.5 Cost/Performance Tradeoff of the Microturbine Recuperator in CHP Systems

One key objective of this project is to determine the optimum cost/performance tradeoff for microturbine recuperators when used in CHP systems. The recuperator uses the turbine exhaust to preheat the compressed air entering the combustor. (The microturbine CHP system schematics in Appendix A show the recuperator.) Without a recuperator, turbine exhaust temperatures would be on the order of 1000°F to 1100°F. A typical microturbine recuperator will cool the turbine exhaust to on the order of 500°F to 550°F. The recuperator typically boosts generation efficiency by about 10 points (from around 15 percent to around 25 percent). However, the recuperator poses significant disadvantages:

- A recuperator is large relative to compressor/turbine and dramatically increases the size of the microturbine package;
- Recuperators are expensive; and
- Recuperators may pose maintenance/life issues.

Each of these disadvantages can be reduced or eliminated if the effectiveness of the recuperator can be decreased, or if the recuperator can be eliminated altogether. When used for power only (no heat recovery), a highly effective recuperator is important to maximize electric output. However, if waste heat is effectively utilized, perhaps the optimum recuperator effectiveness would be lower.

We considered three recuperator configurations:

- 85 percent effective recuperator (typical of current microturbine designs);
- 50 percent effective recuperator; and
- No recuperator.

Appendix B contains a simplified analysis of the three recuperator configurations in a microturbine-based CHP system for a New York hospital. The analysis concludes that, except for low generation capacities (below 20 percent of building peak electric load), the 85-percent-effective recuperator is the most economical. The analysis also shows that:

- The 85-percent-effective recuperator provides primary energy savings (relative to the baseline building) over the full range of generation capacities;
- The 50-percent-effective recuperator provides primary energy savings only at generation capacities below 20 percent of building peak electric load; and
- The no-recuperator case provides little or no primary energy savings across the full range of generation capacities.

This analysis suggests that utilizing waste heat will not lower the optimum microturbine generation efficiency. Using a highly effective recuperator will still be important.

As documented in Section 6.8.2, we confirmed this preliminary conclusion using a more detailed analysis for a New York Large Office building.

Figure 5-1: Economics of Generation Technologies for Power-Only Applications (No Heat Recovery) Calculated Using Average Utility Rates

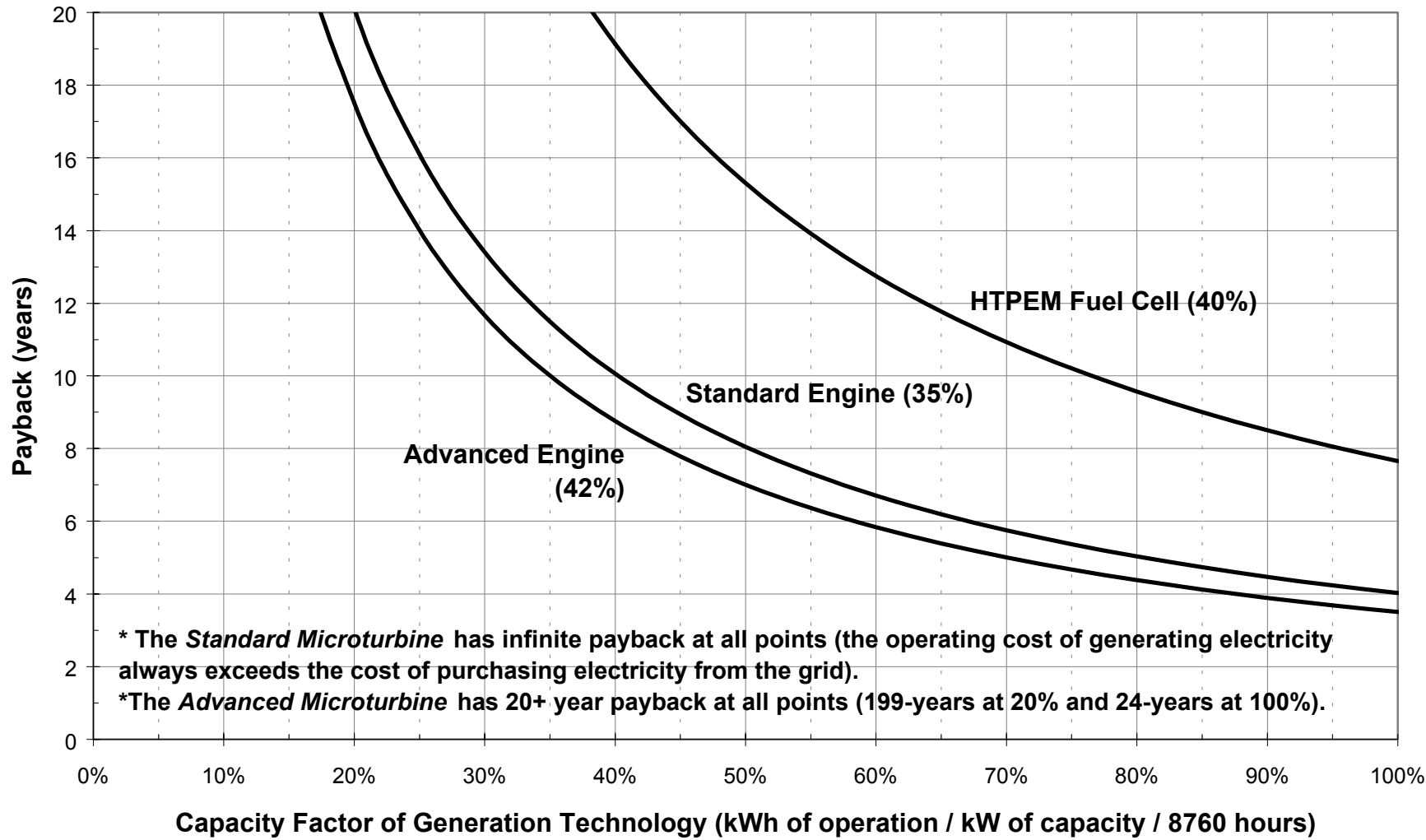

See Table 4-1 for Efficiency and cost data of equipment. Based on an electric rate of \$0.08/kWh which is slightly higher than the Y2000 U.S. National Average of \$0.0669/kWh. Based on \$5/MMBTU gas rate, which is approximately equal to the Y2000 U.S. national average of \$5.196/MMBTU.

Figure 5-2: Economics of Operating a Heat-Recovery Heat Exchanger with “Free” Heat

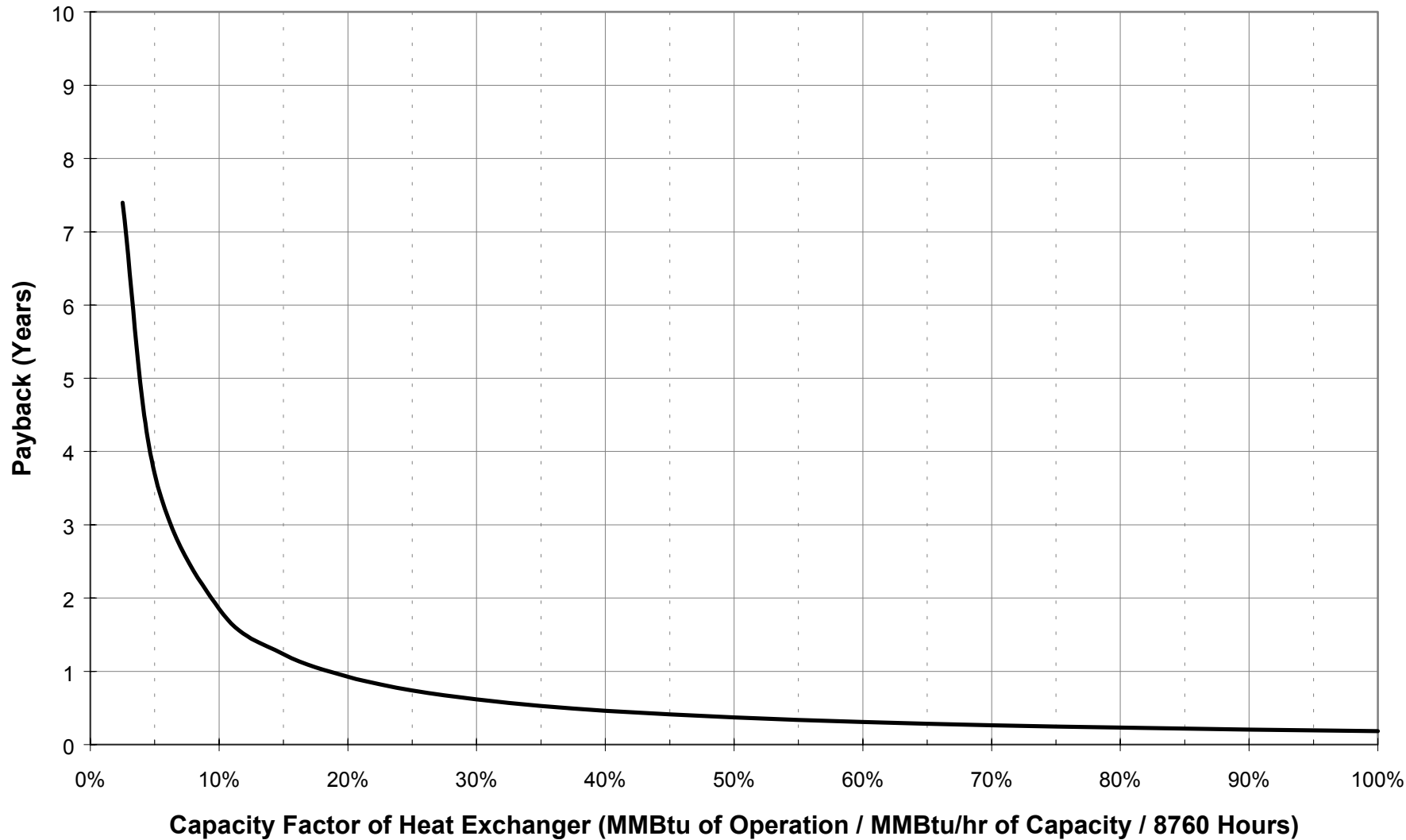

See Table 4-7 for performance and cost data (81%-HHV Displaced Fuel Heating). Gas rate is a constant \$5/MMBtu (close to Y2000 national average).

Figure 5-3: Economics of Operating an Absorption Chiller with “Free” Heat

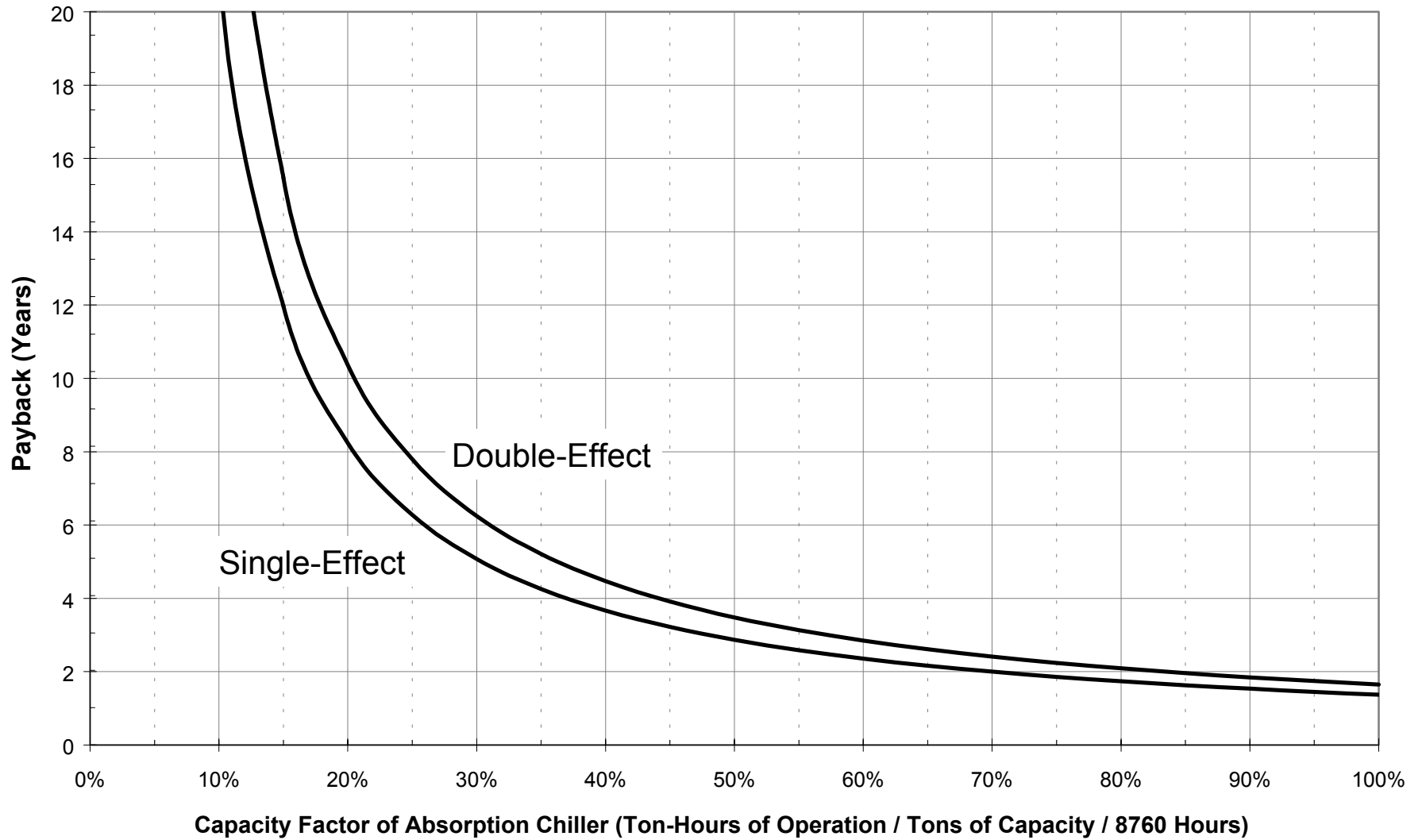

See Tables 4-5 and 4-6 for performance and cost data. Electric rate is a constant \$0.080/kWh (above Y2000 National average of \$0.0669/kWh).

**Figure 5-4: Primary Energy Consumption Intensities for New York Office
– 25 Percent Generation Efficiency**

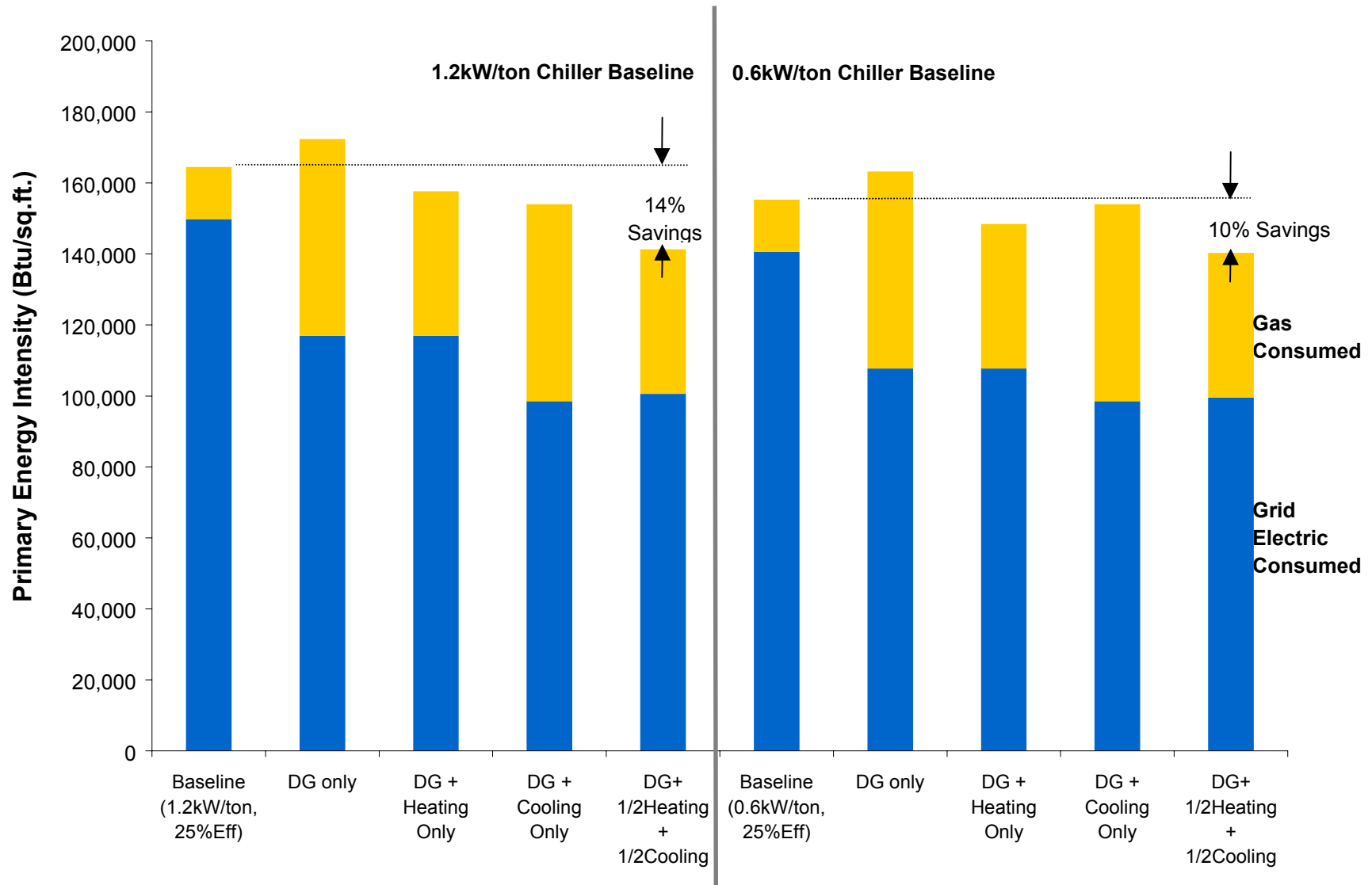

See Section 4 for equipment costs and performance. 25% of baseline electric loads are met by generation. 70% of heat is recoverable. 70% of recoverable heat is recovered.

**Figure 5-5: Primary Energy Consumption Intensities for New York Office
– 40 Percent Generation Efficiency**

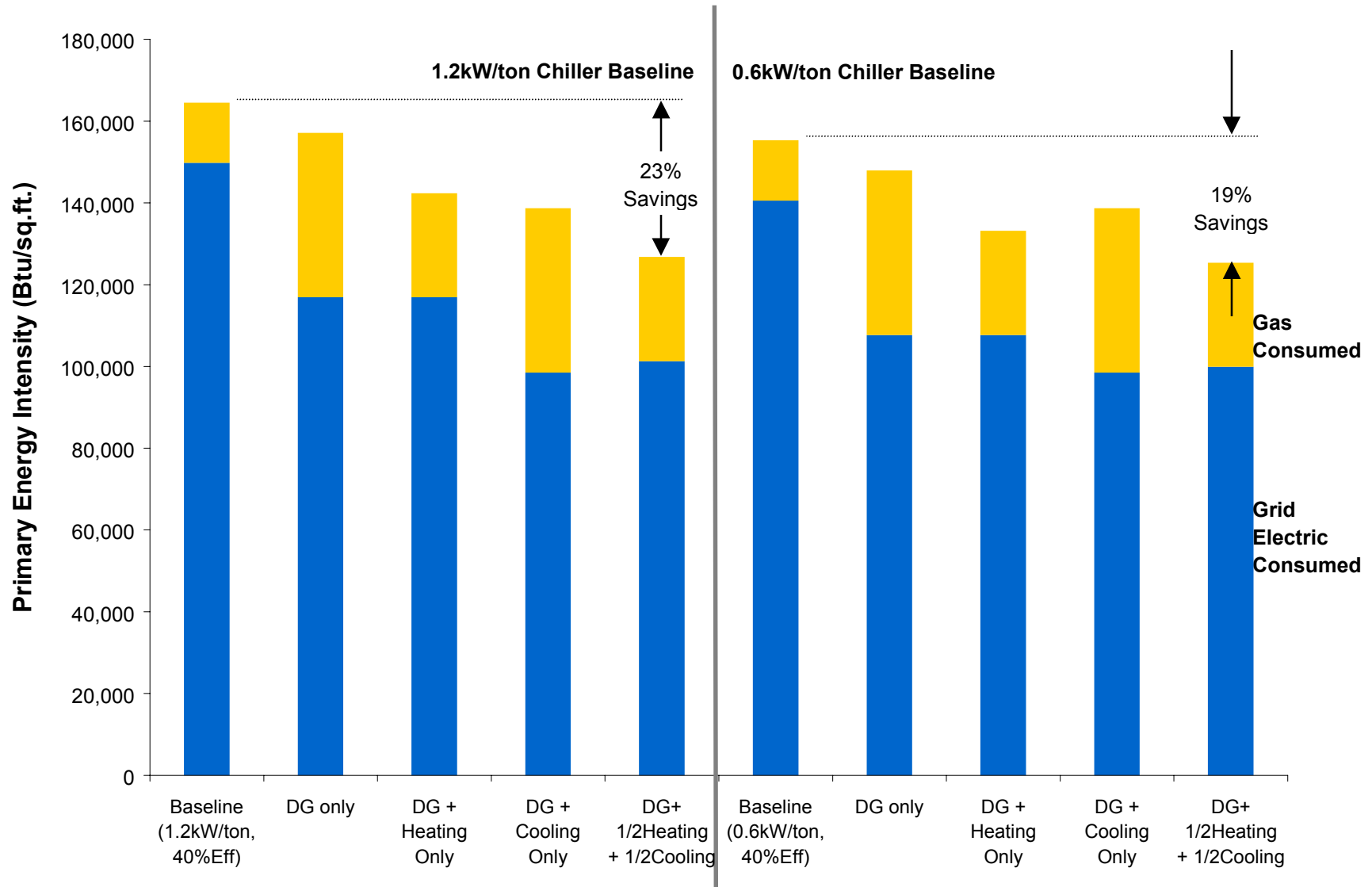

See Section 4 for equipment costs and performance. 25% of baseline electric loads are met by generation. 70% of heat is recoverable. 70% of recoverable heat is recovered.

Figure 5-6: Net Value of a CHP System – Heat Recovery for Heating Loads Only – Favorable Utility Rates (\$5/MMBtu Gas and \$0.12/kWh Electric)

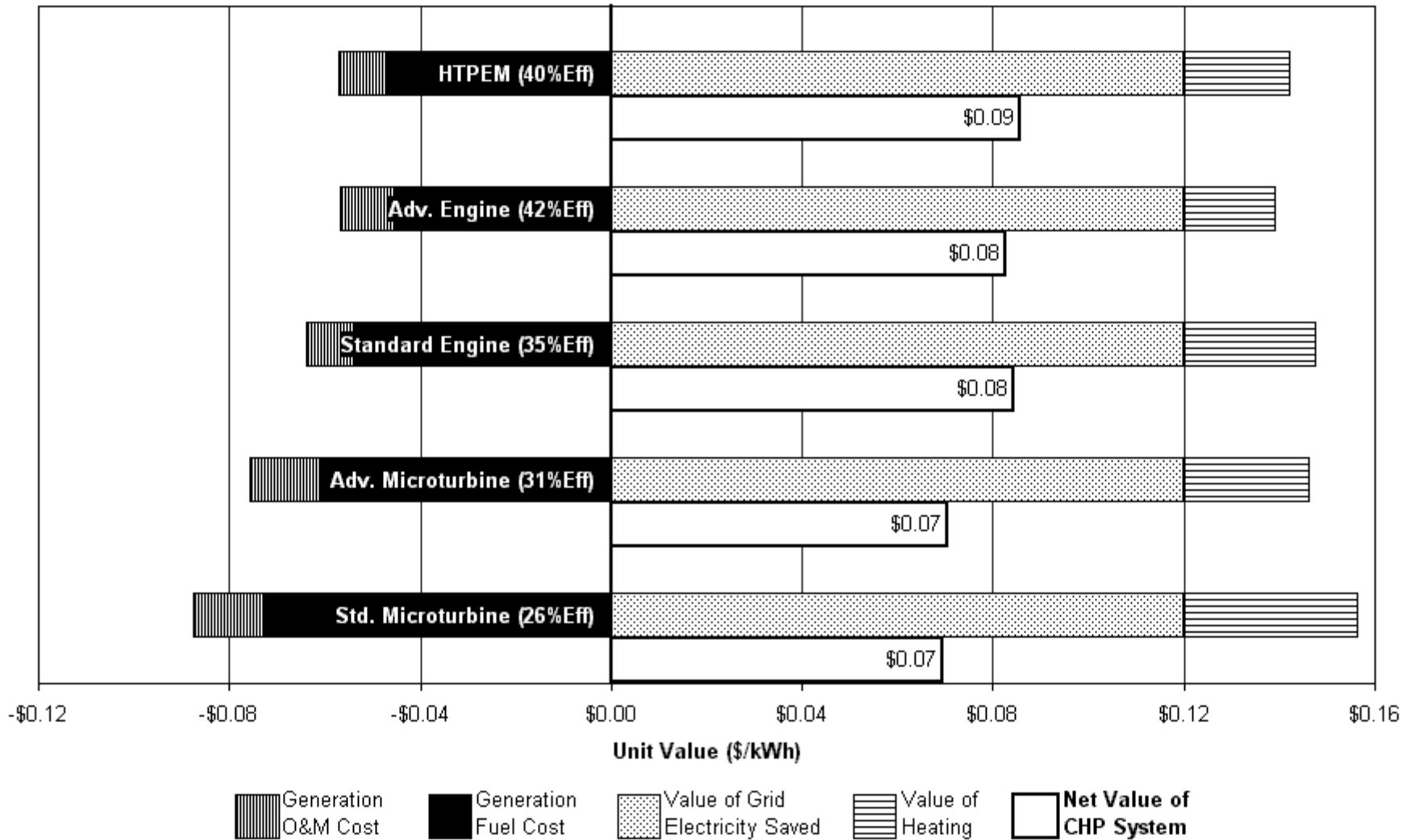

See Section 4 for equipment cost and performance. Assumes *all* recoverable heat is utilized. Capital cost not considered.

Figure 5-7: Net Value of a CHP System – Heat Recovery for Cooling Loads Only – Favorable Utility Rates (\$5/MMBtu Gas and \$0.12/kWh Electric)

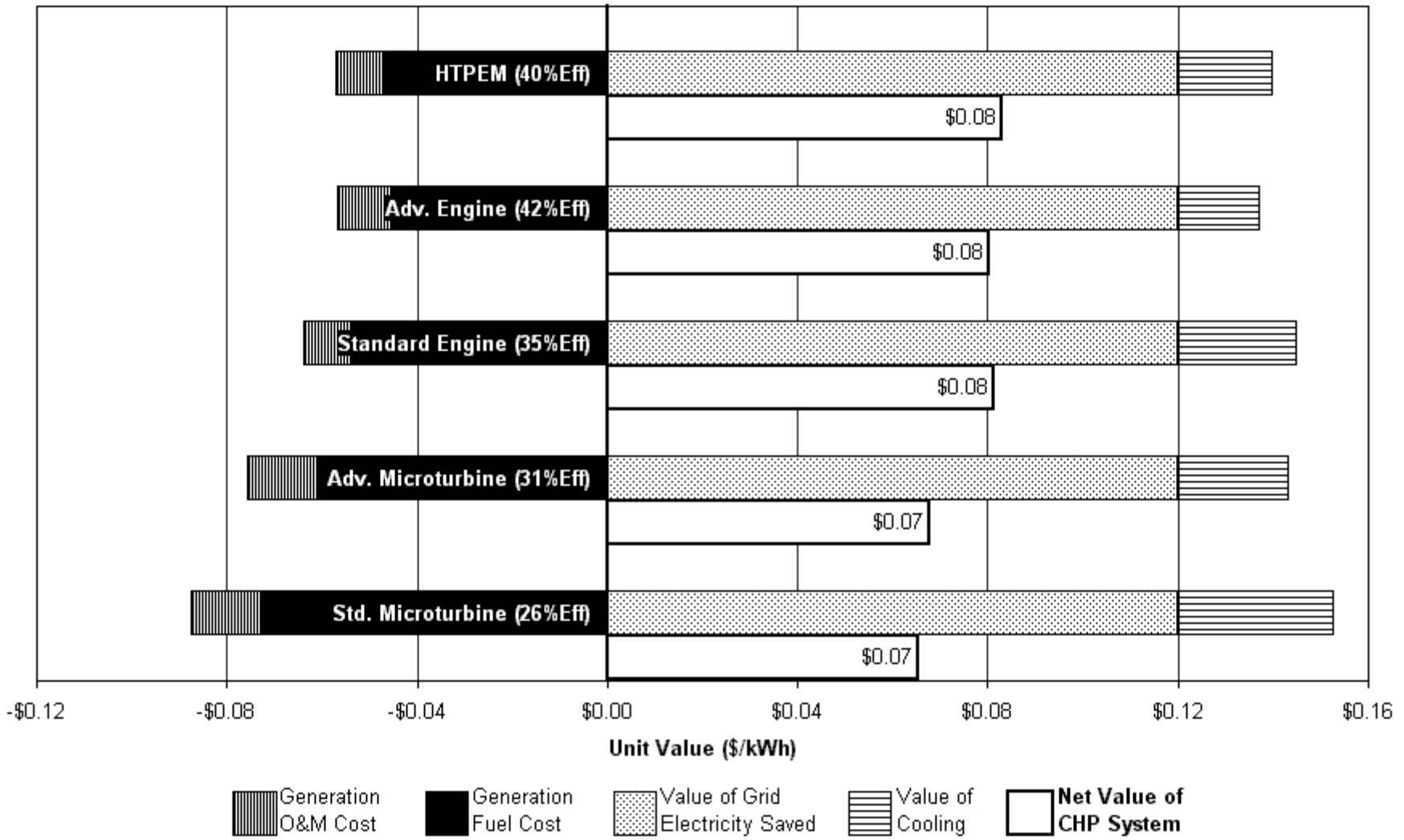

See Section 4 for equipment cost and performance. Assumes *all* recoverable heat is utilized. Capital cost not considered.

Figure 5-8: Net Value of a CHP System – Heat Recovery for Heating Loads Only – Typical Utility Rates (\$5/MMBtu Gas and \$0.08/kWh Electric)

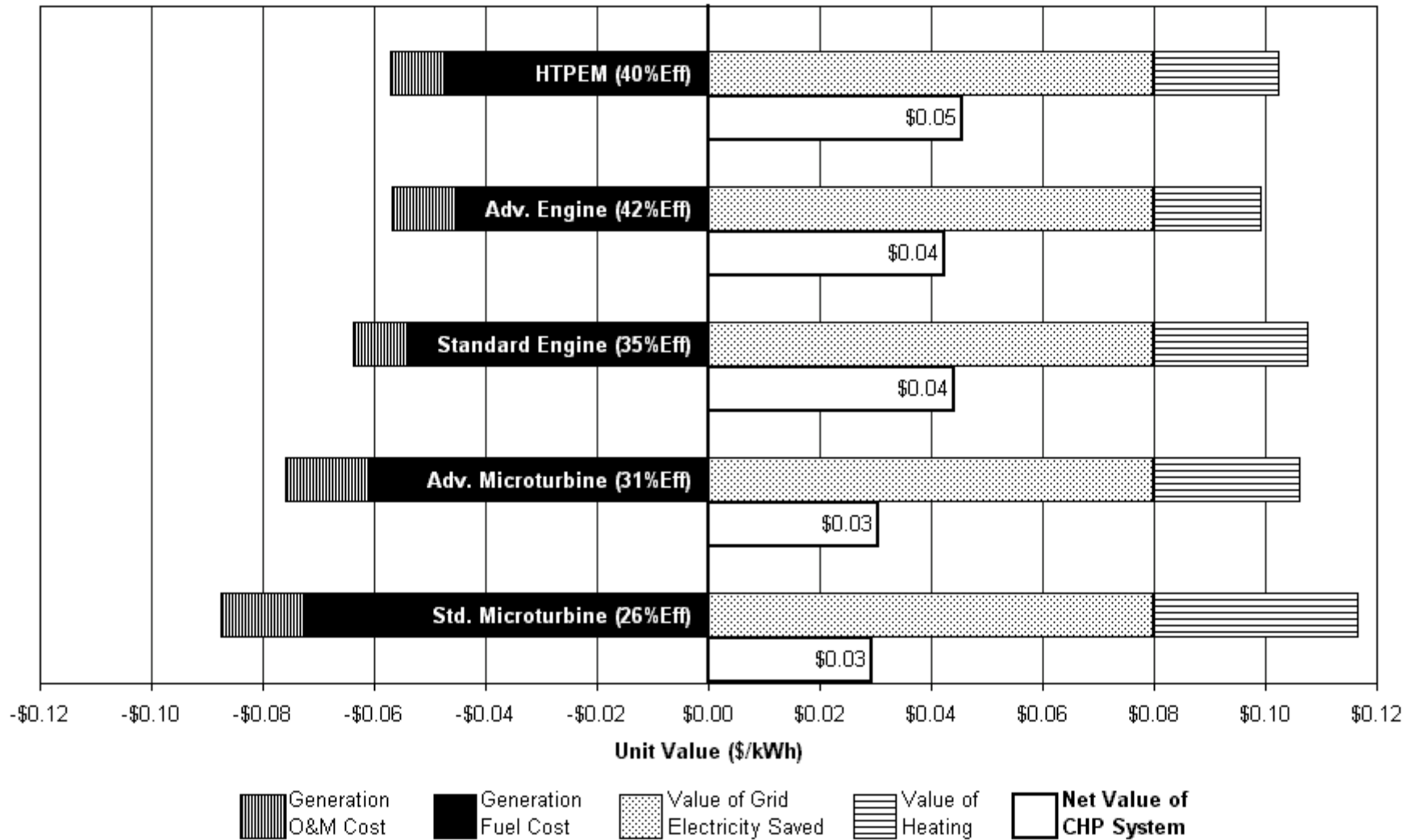

See Section 4 for equipment cost and performance. Assumes *all* recoverable heat is utilized. Capital cost not considered.

Figure 5-9: Net Value of a CHP System – Heat Recovery for Cooling Loads Only – Typical Utility Rates (\$5/MMBtu Gas and \$0.08/kWh Electric)

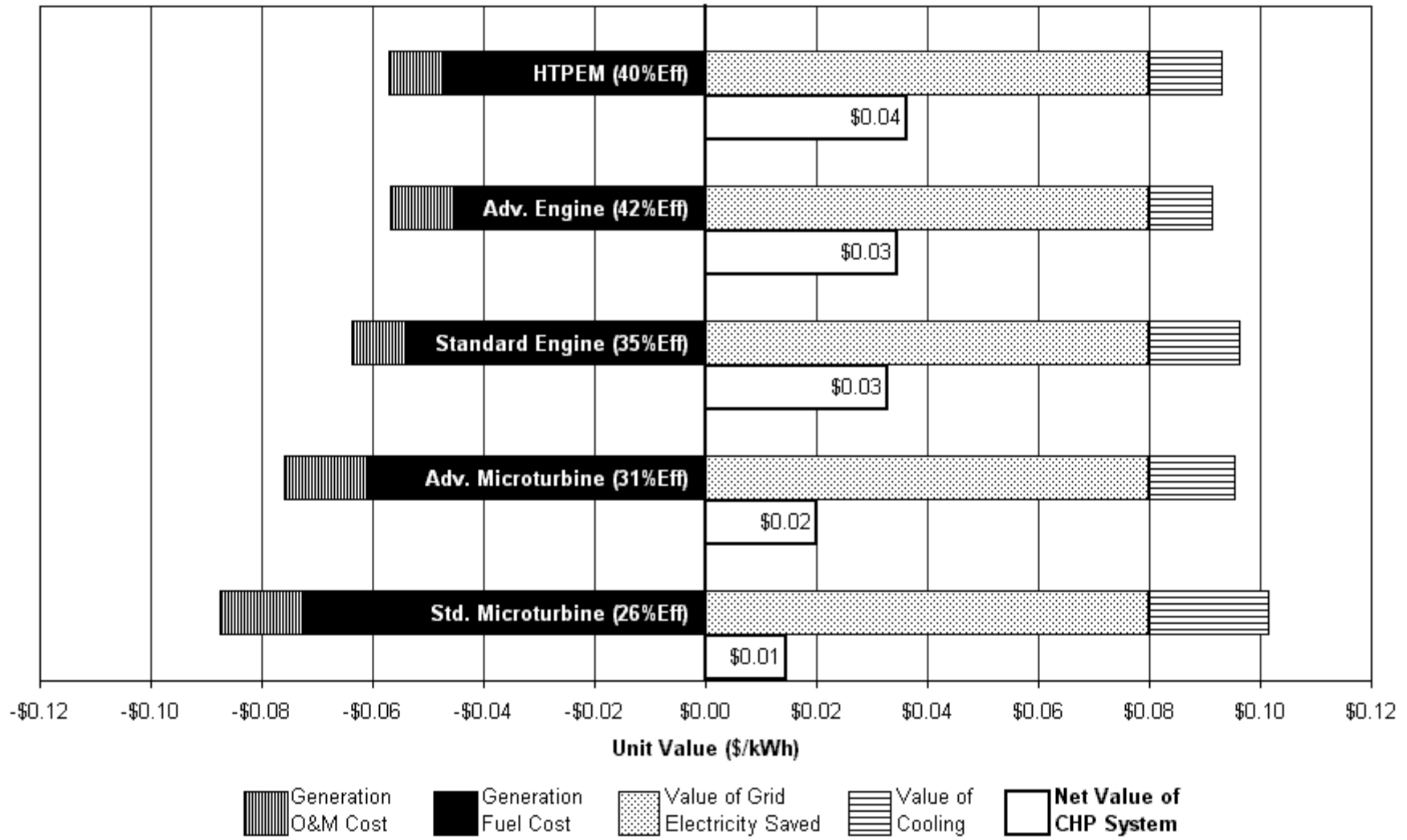

See Section 4 for equipment cost and performance. Assumes *all* recoverable heat is utilized. Capital cost not considered.

6. Detailed Analysis

We developed a detailed computer model to evaluate the energy savings and economics of CHP systems in selected commercial building applications. We discuss our approach to the detailed analysis and our results below.

6.1 Key Assumptions

- Table 6-1 lists the key assumptions used in our detailed computer model. The table divides the key assumptions into those tending to favor CHP systems and those tending to favor conventional grid power. In our judgement, the net impact of these assumptions generally favors CHP systems, but there certainly may be cases where this is not true.

Table 6-1: Key Assumptions used in Detailed Analysis

Tending to Favor CHP	Tending to Favor Conventional Grid Power
<ul style="list-style-type: none"> • Did not consider utility stand-by charges. • Did not consider impacts of unscheduled outages. • No part-load efficiency degradation for generators or chillers. • No significant time required for ramp up or ramp down for generation capacity. • “Smart” control algorithm assumes perfect knowledge of future building loads and ambient temperatures. • Microturbine and fuel cell installed costs and maintenance costs based on achieving economies of scale. • Performance estimates for fuel cells, advanced engines, and advanced microturbines based on achieving R&D goals. • Manufacturing economies of scale are achieved. • Set 5-year allowable payback period. • Weekday rate structures are assumed to apply on weekends as well. • There are no penalties or restrictions for increased site emissions associated with CHP. 	<ul style="list-style-type: none"> • Thermal and electric storage systems not considered. • Shifting of discretionary loads not considered. • Did not consider value of premium power (baseline would be conventional building with back-up generator or UPS in that case). • No rebates or incentives are available for use of CHP. • Did not use interruptible utility rates. • No net metering. • Cooling equipment installed for CHP system is in addition to conventional cooling plant. • Did not consider co-fired absorption equipment . • Waste heat supplies cooling loads first, then heating loads, regardless of which provide greater economic value. • Model uses hourly averages, which tends to under estimate peak electric demand and hence, tends to underestimate demand charge savings. • Absorption chiller plant and heat-recovery heat exchanger are sized to utilize to all heat available from the generator operating at full load. The economically optimized plant and heat exchanger would likely be smaller. • Desiccant systems not considered in this analysis but may improve economics in some applications.

Perhaps the most important assumptions tending to favor CHP systems are:

- *Manufacturing economies of scale are achieved;*
- *There is no degradation in generation efficiency when operating at part load;*
- *Generation capacity can ramp up or ramp down as quickly as necessary to match building loads;*

- *There are no stand-by charges or other utility-imposed charges for CHP;*
- *The impacts of unscheduled outages are not considered; and*
- *A five-year simple payback is acceptable.*

Perhaps the most important assumptions tending to favor conventional grid power are:

- *No value is assigned to premium power;*
- *No net metering is allowed (i.e., no sale of excess electricity to the grid);*
- *Thermal and electric storage systems are not considered; and*
- *Strategies to shift discretionary loads are not considered.*

6.2 Computer Model Structure

To perform a more refined analysis of CHP systems, we developed a detailed computer model using Microsoft[®] Visual Basic (version 6.0) and an object-oriented programming strategy. The model uses an hour-by-hour simulation for one year of CHP-system operation, as outlined in Figure 6-1. Appendix C provides the details of the computer-model structure.

6.3 Equipment Cost and Performance Projections

Appendix D provides a detailed listing, including sources, of the equipment cost and performance estimates used in the computer model. Section 4 summarized most of the projections used.

We projected equipment cost and performance characteristics for 2005 (or after), based on annual production volumes of 10,000 units. In general, we based cost and performance projections on some combination of:

- Bottom-up analyses using detailed cost and/or performance models;
- Top-down analyses based on current cost and performance characteristics, extrapolated to the appropriate production volumes and (for advanced generation technologies) targeted design enhancements; and
- Discussions with equipment manufacturers and distributors.

6.4 Operating Strategies and Associated Control Algorithms

We considered two operating strategies as shown in Table 6-2. We used the “dumb” strategy for only a few runs to determine the impact of operating strategy on energy

consumption and economics. We used the “smart” operating strategy for most runs. Our smart strategy takes full advantage of the model’s perfect knowledge of future building loads. In real life, one does not have perfect knowledge of future building loads, so any real-life operating strategy may not do quite as well as our model would suggest. It does, however, reasonably represent the best one can do.

Table 6-2: CHP Operating Strategies Analyzed

Maximize Generator Operation (AKA, “Dumb”)	Minimize Operating Costs (AKA, “Smart”)
<ul style="list-style-type: none"> • Generator runs whenever there is an electric load • Economics are not considered 	<ul style="list-style-type: none"> • Runs CHP system when electric energy cost savings alone justify it (without considering demand charge savings) • Runs additional hours, as appropriate, to achieve demand charge savings. Uses iterative procedure to determine optimum level of peak shaving

We developed a control algorithm for each operating strategy. The control algorithm ensures that building loads (power, heating, and cooling) are always met. Loads are met through some combination of on-site-generated power, grid-purchased power, utilization of recoverable heat for cooling and/or heating, and use of conventional cooling and heating equipment for cooling and heating. The key decision made by the control algorithm is, for each hour of the simulated year, whether to operate the on-site generator and at what capacity to operate it (between 0 and 100 percent capacity).

For each operating strategy, recoverable heat from the generator is first utilized to satisfy cooling loads, and then (to the extent additional heat is available) to supply heating loads. No comparison is made of the “value” of supplying cooling loads versus heating loads.

Each operating strategy is based on having a completely specified CHP system configuration, including rated generation capacity. (Section 6.6 describes our approach to optimal sizing of the CHP system.)

Appendix E includes flow charts of the control algorithms based on each operating strategy. Each operating strategy and associated control algorithm is described below.

6.4.1 “Dumb” Operating Strategy

The control algorithm we developed for the “dumb” operating strategy completely ignores operating costs and economics. The algorithm simply calls for operation of the generator whenever the building has an electric load. The generator output is matched to the building load unless the capacity of the generator is exceeded, in which case the generator operates at full capacity and additional electricity required is purchased from the grid. Heat is recovered to supply first cooling loads, then heating loads, to the extent that the waste heat can be utilized. Since using recovered heat for cooling impacts the building’s electric load (by reducing the electricity needed for the building’s baseline

electric chiller plant), the algorithm includes an iterative process to determine the building's net electric load.

While the “dumb” operating strategy would probably never be used in an actual installation, by analyzing it and comparing it to the “smart” operating strategy we can gauge the impact operating strategy has on system energy consumption and economics.

6.4.2 “Smart” Operating Strategy

An economically sound operating strategy will need to consider utility rate structures (primarily the electric rate structure) to deliver the most cost-effective service to the end user. In fact, utility rate structures can have a significant impact on the logic of the control algorithm for such an operating strategy.

Once a CHP system has been selected and installed, most end users will want to operate the system in such a way that overall operating costs are minimized. Therefore, the control algorithm determines the hourly operation of the CHP system that minimizes operating costs, accounting for electric and gas/fuel-oil prices, and non-fuel O&M costs. As for the “dumb” operating strategy, the algorithm for the “smart” strategy accounts for the offset in electricity and gas/fuel-oil consumption associated with utilizing recoverable heat. The algorithm does not, however, directly consider primary energy savings or emissions reductions in determining whether to run the generator or purchase from the grid.

The control algorithm takes advantage of knowing exactly what the simulated future building loads will be. While control algorithms for real buildings will not know future loads exactly, we wanted to evaluate CHP systems with the full advantage afforded by a sophisticated and “smart” control algorithm. Our control algorithm takes advantage of knowledge of future loads (which is important in predicting when demand charges will be incurred). However, the algorithm does not ensure that the absolute minimum possible annual operating cost was achieved based on full and exact knowledge of future building loads and utility rates, so it does approximate some of the non-idealities of the “real world”.

Accounting for the impacts of demand charges introduces a significant level of complexity since demand charges are not incurred on an hourly basis, but rather assessed at the end of the month, when all grid-electric-power draws are known.

Essentially, the algorithm used in our model minimizes operating costs as follows:

1. Analyze each hour of Month 1 using the baseline (conventional) equipment to determine baseline fuel and electricity costs, including electric demand charge;
2. For each hour of the month, compare the baseline operating costs to the operating costs of the building with the CHP system, *excluding demand-charge savings*. For the hours for which the CHP provides operating savings even without consideration

- of demand-charge savings, run the CHP system at 100 percent capacity (or to match the building electric load, if the load is less than the generator capacity);
3. For the remaining hours, operate the CHP system in a “peak-shaving” mode for five levels of peak shaving, spanning the range from zero to the full capacity of the CHP system¹⁶;
 4. Select the level of peak shaving that minimizes operating costs. Operate the system at this level of peak shaving for all hours *not* identified in Step 2 above; and
 5. Repeat steps 1 to 4 for all months of the year.

Step 2 above is necessary because a straight “peak-shaving” strategy can miss savings opportunities when CHP system operation can be justified based on the electric *energy* cost (kWh cost) alone.

6.5 Utility Rates

Our model utilizes actual current electric rate structures for each city analyzed. For each city, we selected the rate structure that, in our judgement, best applied to large offices, large hotels, and hospitals (the building types analyzed). We selected only one rate structure per city.

While our model of electric utility rates includes some simplifications, it captures the key features of most rate structures, including demand charges, energy charges, and time-of-day charges, all of which can be varied by month. For each month, the user can input up to 24 (one for each hour) electric demand charges, 24 electric energy charges, 24 gas energy charges, and 24 fuel oil energy charges. The model does not include weekday/weekend pricing, time-of-day demand charges, or ratchet rates. Demand charges are calculated based on hour-long average power draws (because our model analyzes hour-long increments), even though in real-life demand charges are generally assessed based on 15-minute intervals. This assumption will tend to underestimate demand charges. The model does not include real-time pricing rate structures, although this would be an interesting addition for future analysis.

The model does not consider net metering (selling generated electricity to the grid) or stand-by charges (or other charges that utilities may impose on CHP system users). Net metering and/or stand-by charges can have significant impacts on the energy savings and economics of CHP.

Figure 6-2 shows the average electric and gas rates for the buildings that we modeled. The average utility rates for specific buildings with specific load profiles can vary significantly relative to the statewide averages shown in Figure 4-4. For New York,

¹⁶ “Peak shaving” is often interpreted to mean shaving only the highest peaks during the day or the month. In contrast, we considered peak shaving over the full range achievable by the CHP System.

Chicago, and especially for Los Angeles, the “true” average utility rates are more favorable than state-wide averages would suggest.

Appendix F details the utility rate structures used for each city.

6.6 CHP System Sizing

The operating strategies discussed in Section 6.4 minimize operating costs once a CHP system has been selected and installed. However, we also need an approach to determining the most appropriate CHP system plant size for a particular application. We simulated CHP systems ranging in generation capacity from 0 percent (no CHP system) to 100 percent of the baseline building peak electric load¹⁷ (using 10-percent increments). We did not independently vary the sizes of the absorption chiller plant and the heat-recovery heat exchanger. Rather, we simply sized the absorption chiller plant to be able to utilize the all of the waste heat available from the generator operating at full capacity. We sized the heat-recovery heat exchanger similarly. These simplifying sizing assumptions undoubtedly result in absorption chiller plants and heat-recovery heat exchangers that are larger (and more expensive) than is economically optimum. However, since the capital cost of the CHP system is dominated by the cost of the generator (see Section 6.8.3), the impacts of these sizing assumptions probably have only a modest negative impact on system economics.

We made several important assumptions about end-user economics:

- All end users are willing to accept up to a five-year simple payback period for a CHP system installation;
- No rebates or other incentives (from government, manufacturers, utilities, or other parties) are considered¹⁸;
- ***No economic value is placed on the benefits of improved power quality and reliability associated with the CHP system.*** In reality, these benefits would be of significant value to many end users¹⁹;
- ***No stand-by charges or other penalties are imposed by the electric utility;***
- ***Net metering is not permitted;***
- End users place no value on reducing energy consumption (except to achieve cost savings); and
- There will be no penalties or restrictions for increased site emissions (such as NO_x) associated with CHP-system operation.

¹⁷ The peak electric load of the baseline building varies from that for the building using CHP because the heat recovered and utilized reduces the electric load on the building.

¹⁸ While rebates and other incentives may be important elements in a program to promote CHP systems, we wanted to evaluate the *fundamental* economics of CHP.

¹⁹ A logical way to include power-quality benefits in the economic analysis would be to subtract from the CHP system capital investment the capital investment avoided by not having to install back-up generators, uninterruptible power supplies (UPS), and other equipment that would be needed to provide similar power quality.

We based our economic analysis on simple payback period because this metric is understood by a wide audience. However, we also recognize the limitations of simple payback²⁰, and sought to capture some of the realities associated with more sophisticated economic analysis techniques (such as net-present value or life-cycle cost analyses). However, we did not actually use these more sophisticated techniques.

We simulated the performance of CHP systems for a given building type and city over the full range of plausible generation capacities (from 0 to 100 percent of the baseline building peak electric load). We then plotted primary energy consumption intensity (consumption per square foot), installed cost, operating cost, and payback period as a function of system capacity. Finally, we used the method outlined in Figure 6-3 to select the economic optimum CHP-system size.

6.7 Analysis Matrix

Figure 6-4 summarizes the characteristics of the computer runs executed for the detailed analysis, and the first page of Appendix G lists the full matrix of runs executed. Each “run” is actually a set of 11 simulations in which CHP system generation capacity is varied from 0 percent (i.e., baseline building) to 100 percent of the baseline building peak electric demand. The matrix consists of 41 runs, with the focus on the large office building and on the cities of New York and Los Angeles, which have utility rates favorable to DG and CHP.

6.8 Results of Detailed Analysis

Appendix G lists the complete set of results for the detailed analysis, including primary energy consumption intensity (consumption per square foot), installed cost, annual operating cost, and simple payback, plotted as a function of CHP system generation capacity. Selected results of the detailed analysis are summarized below.

6.8.1 Explanation of Energy Plots

The energy-intensity plots in Appendix G breakdown energy consumption by:

1. Grid-Purchased Electricity (converted to primary energy);
2. Fuel Consumed for Heating – Fuel consumed by the conventional space- and water-heating equipment (to provide heating loads that are not met by heat recovery);

²⁰ One of the limitations of simple payback is that it does not provide a fair basis of comparison among mutually exclusive investments having significant differences in first costs. This is exactly the situation we have when comparing CHP systems of various capacities for a single end use.

3. Electric Energy Generated – Btu equivalent of the electricity generated on site (*not* the energy consumed to generate electricity);
4. Heat Utilized for Heating – Heat input to the heat-recovery heat exchanger, extracted from the waste-heat stream;
5. Heat Utilized for Cooling – Heat input to the absorption chiller plant, extracted from the waste-heat stream;
6. Unutilized Heat – Waste heat that was unutilized because the coincident building thermal loads were not sufficient to use the heat; and
7. Unrecoverable Heat – Sensible portion of the waste heat that cannot be utilized regardless of building thermal loads, either because it is too cool to serve the building loads, or (if the waste heat is a gas) because further heat extraction would risk condensation. Unrecoverable heat is referenced to ambient temperature, but it includes only *sensible* portion of heat in exhaust gases (latent heat *not* included). When liquid cooling loops are used, we assumed the coolant temperature is high enough that *none* of the coolant-loop heat is *unrecoverable*.

For example, Figures 6-5 and 6-6 compare the primary energy consumption intensities as a function of generation capacity for a standard microturbine and standard engine, respectively, in a New York Large Office building. Both examples use the “smart” operating strategy. Figure 6-5 indicates:

- For this application, a CHP system using a standard microturbine of any capacity will effect a modest reduction in primary energy consumption relative to the baseline building operating on grid electricity ; and
- For a CHP system sized at 50 percent of the baseline building’s peak electric load²¹:
 - About 65 percent of the waste heat is *recoverable* (excluding latent heat);
 - About 50 percent of the recoverable heat is utilized, corresponding to a utilization of about 33 percent of the total waste heat (excluding latent heat); and
 - About 37 percent of the *utilized* heat is used for cooling, and about 63 percent is used for heating.

Figure 6-6 indicates that, for the likely range of CHP plant sizes (50 to 80 percent of baseline building’s peak electric load)²²:

- For this application, a CHP system using a standard engine will effect about a 25 to 30 percent savings in primary energy consumption;
- About 65 percent of the waste heat is *recoverable* (excluding latent heat) across the range of capacities;

²¹ The payback curve for this application suggests that the economic optimum capacity is about 50 percent of the baseline building’s peak electric load (see Appendix G, Run #12).

²² The payback curve for this application suggests the probable size range of interest is between 50 and 80 percent of the baseline building peak electric load (see Appendix G, Run #42).

- About 65 to 70 percent of the *recoverable* heat is utilized across the range of capacities, corresponding to utilization of about 40 to 45 percent of the total waste heat (excluding latent heat);
- 65 to 70 percent of the *utilized* heat is used for cooling, and 30 to 35 percent is used for heating.

As illustrated by these examples, it is difficult to utilize more than about 30 to 40 percent of CHP system waste heat (excluding latent heat) without employing energy or thermal storage systems, or discretionary-load-shifting strategies – none of which were considered in our analysis.

As discussed in Section 4.2, the thermal loads for the prototypical building used seem to under-represent typical buildings. The energy intensity plots in Appendix G show that thermal loads in the baseline buildings (at zero generation capacity) range from about 10 to 15 percent of the building total primary energy consumption. In contrast, Figure 1-1 shows that, in the national average commercial building, 24 percent of total primary energy consumption is for thermal loads (16 percent for space heating and 8 percent for water heating).

6.8.2 Microturbine Recuperator Performance

Section 5.5 discussed a simplified analysis performed to assess the cost/performance tradeoffs of reducing the effectiveness of the recuperator in a microturbine (New York Hospital example). We revisited this question in the detailed analysis for the New York Large Office example (see Runs 12, 53, and 54 in Appendix G). Figure 6-7 compares the energy consumption intensities for a New York Large Office building using three microturbine recuperator configurations:

1. 85 percent effective microturbine (typical of current practice);
2. 50 percent effective microturbine; and
3. No recuperator.

The figure clearly shows the impact of recuperator performance on primary energy consumption. Utilization of waste heat cannot compensate fully for the increase in primary energy consumption associated with lowering the performance of, or eliminating, the recuperator. The waste heat produced increases by about 33 percent as recuperator effectiveness is lowered from 85 percent to 0 (no recuperator). For each of the three recuperator configurations, about 25 percent of the microturbine waste heat is utilized. This indicates that the building is able to take advantage of some of the additional waste heat available, in approximate proportion to the additional waste heat produced.

Figure 6-8 compares the payback of the three recuperator microturbine configurations for the New York Large Office building application. The 85-percent-effective

recuperator yields the fastest payback across the entire system capacity range. *We conclude that using a high-performance recuperator is important, even if microturbine waste heat is utilized to offset building thermal loads.*

We reached the same conclusion through simplified analysis of a hospital, as discussed in Section 5.5. This conclusion can be understood by considering the second law of thermodynamics. The value of electricity, being a high-quality energy source, is much higher than the value of thermal energy. Therefore, it is difficult to offset the loss in value associated with lower electric generation efficiency with a gain in thermal energy.

6.8.3 Primary Energy Consumption and End-User Economics

Figure 6-9 shows the breakdown of the equipment capital costs required to install a CHP system for a New York Large Office building and two generation technologies – standard microturbine and standard engine. Capital costs associated with the generation technology alone account for 60 to 70 percent of the CHP-system installed cost.

Figures 6-10 through 6-29 compare primary energy consumption intensities and simple payback periods, respectively, for logical groupings of the simulations completed. Energy consumption and payback are plotted as a function of generation capacity, up to 100 percent of the annual peak electric load for the baseline building. The economic optimum capacity (determined as outlined in Section 6.6) is indicated on each curve. Observations drawn from each figure follow.

DG (Power Only) Vs. CHP – Standard Microturbine and Advanced Engine; New York Large Office Building (Figures 6-10 and 6-11):

- The trends shown are reasonably consistent of those found in the simplified analysis (see Section 5.4);
- Heat recovery improves the primary energy impact associated with a standard microturbine CHP system from a modest increase (relative to the baseline building) to a modest savings;
- Heat recovery increases the primary energy savings associated with an advanced-engine generator CHP system from 21 percent to 31 percent at the economic optimum generation capacities;
- Heat recovery has little impact on payback for either the standard microturbine or the advance engine. Therefore, the use of heat recovery should be economically attractive if the use of on-site generation is attractive; and
- Paybacks are significantly better for the advanced engine (2 to 3 years) relative to the standard microturbine (4 to 5 years).

“Smart” Vs. “Dumb” Operating Strategies – Standard Microturbine and Advanced Engine; New York Large Office Building (Figures 6-12 and 6-13):

- Operating strategy appears to have little impact on energy savings for New York rate structures. Most likely, this occurs because savings relative to electric energy charges alone justify generator operation most of the time;
- For standard microturbines sized in the range of economic interest (low-to-medium generation capacities), operating strategy has a significant impact on payback; and
- For advanced engines, operating strategy has almost no impact on payback over the full range of capacities; and
- It is not clear why the economics differ for the microturbine, but not for the engine.

Various Generation Technologies in Los Angeles Large Office Building (Figures 6-14 and 6-15):

- The standard microturbine effects very little change in primary energy consumption across the range of generation capacities;
- The advanced microturbine effects an 8 percent primary-energy savings at the economic optimum capacity;
- The HTPEM fuel cell effects a 26 percent primary-energy savings at the economic optimum capacity;
- The advanced engine effects a 31 percent primary-energy savings at the economic optimum capacity; and
- Payback periods are between 1 and 3 years for a wide range of generation capacities for all technologies analyzed.

Various Generation Technologies in New York Large Office Building (Figures 6-16 and 6-17):

- Primary energy savings at the economic-optimum capacities are:
 - 4 percent for the standard microturbine;
 - 8 percent for the advanced microturbine;
 - 20 percent for the standard engine;
 - 26 percent for the HTPEM fuel cell; and
 - 30 percent for the advanced engine; and
- Payback periods range from:
 - 4 to 5-plus years for HTPEM fuel cells, standard microturbines, and advanced microturbines; and
 - 2 to 3 years for both the standard and advanced engines.

Various Generation Technologies in Los Angeles Hospital (Figures 6-18 and 6-19):

- Primary energy savings at the economic-optimum capacities are:
 - -3 percent (3 percent increase) for the standard microturbine;
 - 7 percent for the advanced microturbine;
 - 21 percent for the standard engine;
 - 28 percent for the HTPEM fuel cell; and
 - 32 percent for the advanced engine; and
- Payback periods are:
 - 1.6 to 2.3 years for HTPEM fuel cells, standard microturbines, and advanced microturbines; and
 - Just over 1 year for both the standard and advanced engines.

Various Generation Technologies in New York Hospital (Figures 6-20 and 6-21):

- Primary energy savings at the economic-optimum capacities are:
 - 5 to 12 percent for the standard and advanced microturbines, respectively; and
 - 25, 29, and 34 percent for the standard engine, HTPEM fuel cell, and advanced engine, respectively; and
- Payback periods are:
 - About 3 years for the standard and advanced microturbines;
 - 2.4 years for the HTPEM fuel cell; and
 - 1.3 to 1.4 years for the standard and advanced engines.

Various Generation Technologies in Los Angeles Large Hotel (Figures 6-22 and 6-23):

- Primary energy savings at the economic-optimum capacities are:
 - -8 percent (8 percent increase) for the standard microturbine;
 - 5 percent for the advanced microturbine;
 - 18 percent for the standard engine;
 - 27 percent for the HTPEM fuel cell; and
 - 30 percent for the advanced engine; and
- Payback periods are:
 - 2.4, 2.6, and 2.7 years for the advanced microturbine, HTPEM fuel cell, and standard microturbine, respectively; and
 - 1.4 and 1.5 years for the standard and advanced engines, respectively.

Various Generation Technologies in New York Large Hotel (Figures 6-24 and 6-25):

- Primary energy savings at the economic-optimum capacities are:
 - 5 and 10 percent for the standard and advanced microturbines, respectively; and
 - 22, 25, and 30 percent for the standard engine, HTPEM fuel cell, and advanced engine, respectively; and
- Payback periods are:
 - 4.1, 4.5, and 4.8 years for the HTPEM fuel cell, advanced microturbine, and standard microturbine, respectively; and
 - 2.4 and 2.7 years for the standard and advanced engines, respectively.

Advanced Engine in Large Office Building – Various Cities (Figures 6-26 and 6-27):

Primary energy savings are 30 and 31 percent, and payback periods are 1.9 and 3.0 years, for Los Angeles and New York, respectively. Paybacks in the remaining cities exceed the payback threshold we imposed (5 years) for installation of CHP systems.

Fuel Oil Versus Natural Gas in New York Large Office Building (Figures 6-28 and 6-29):

- Primary energy savings at the economic-optimum capacities are:
 - 4 and 9 percent for the standard microturbine with natural gas and fuel oil, respectively; and
 - 31 and 35 percent for the advanced engine with natural gas and fuel oil, respectively; and
- Simple payback periods are:
 - 3.9 and 4.7 years for the standard microturbine with natural gas and fuel oil, respectively, and;
 - 2.3 and 3.0 years for the advanced engine with natural gas and fuel oil, respectively.

Figure 6-1: Overview of Detailed Computer Model for CHP-System Simulation

Our computer model performs an hour-by-hour analysis, accounting for variations in ambient temperature, building loads, and utility rates.

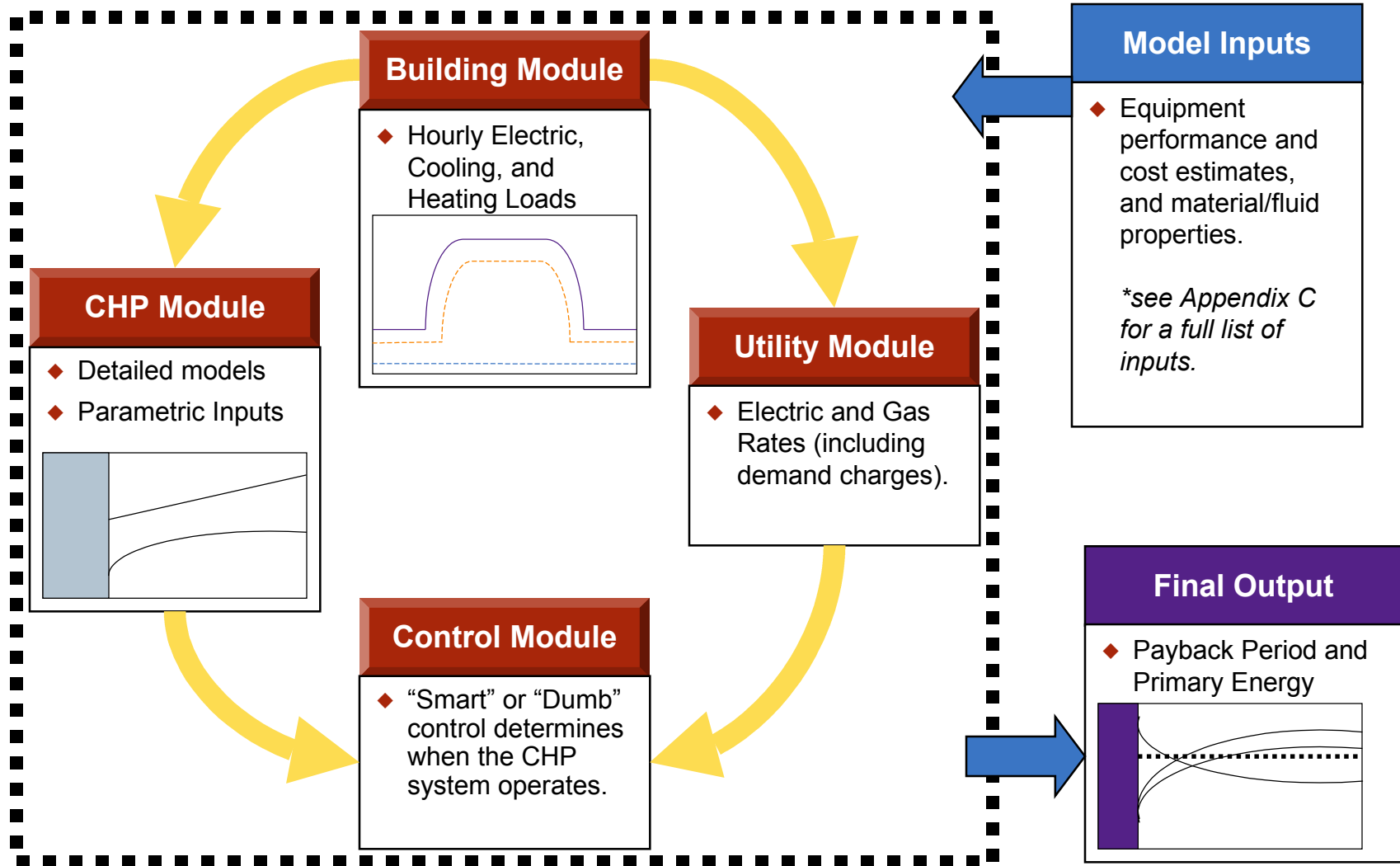

Figure 6-2: Average Utility Prices for the Prototypical Buildings Modeled

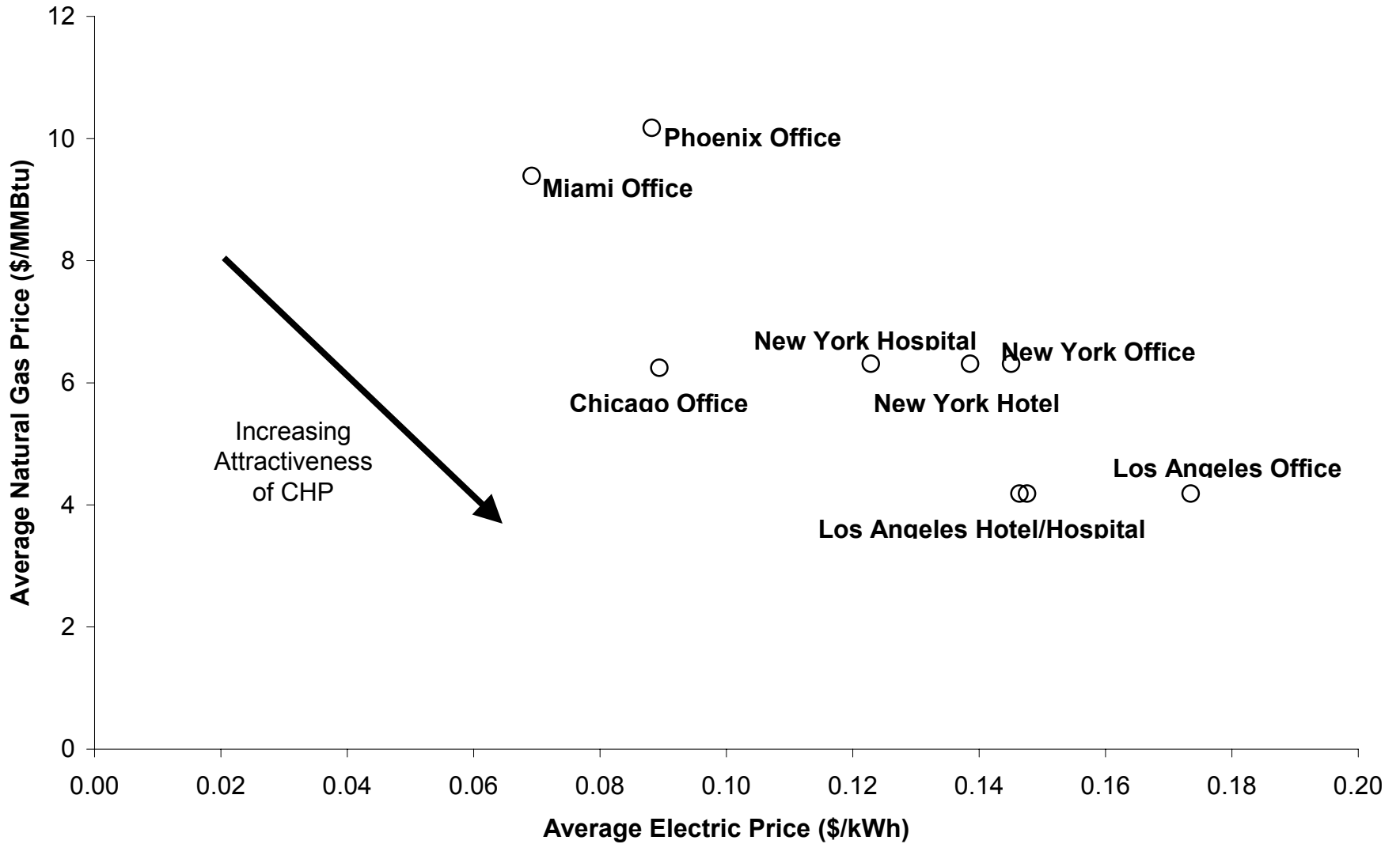
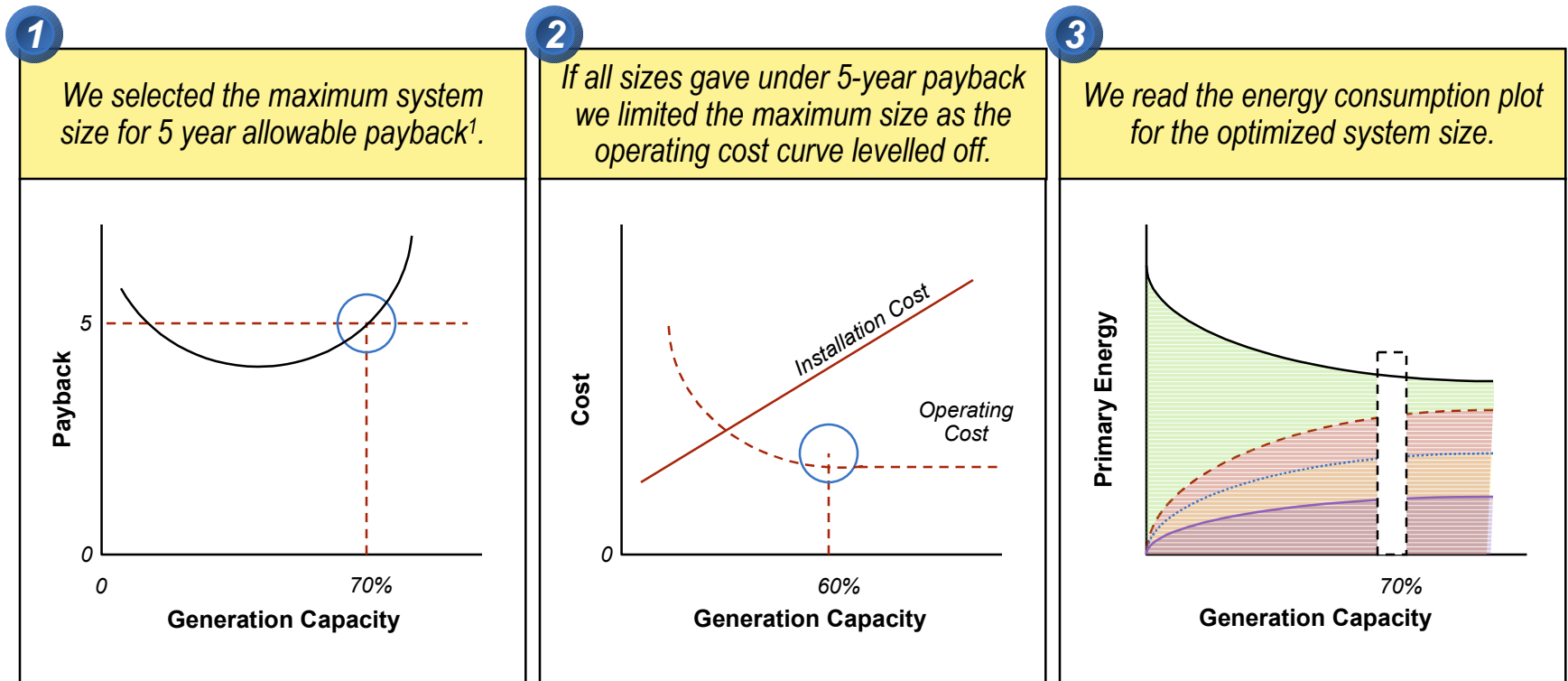

Figure 6-3: Summary of Method to Select CHP System Size

For each completed run, we selected the optimum generation capacity for from the plots based on a 5-year allowable payback.



¹ If payback exceeded 5 years across the range, we assumed that the CHP system would not be installed.

See Appendix G for detailed energy, cost, and payback plots of each run.

Figure 6-4: Summary of Detailed Analysis Matrix

Number of Run for Each Generation Technology				
Standard Microturbine	Advanced Microturbine	Standard Engine	Advanced Engine	HPEM
11	6	5	13	6

For Each City				
NYC	LA	CHI	MIA	PHX
24	14	1	1	1

For Each Building Type		
Office	Hotel	Hospital
21	10	10

See Appendix G for a complete list of the runs performed and the resulting plots.

Figure 6-5: Primary Energy Consumption Intensity for a Standard Microturbine CHP System in a New York Large Office Building

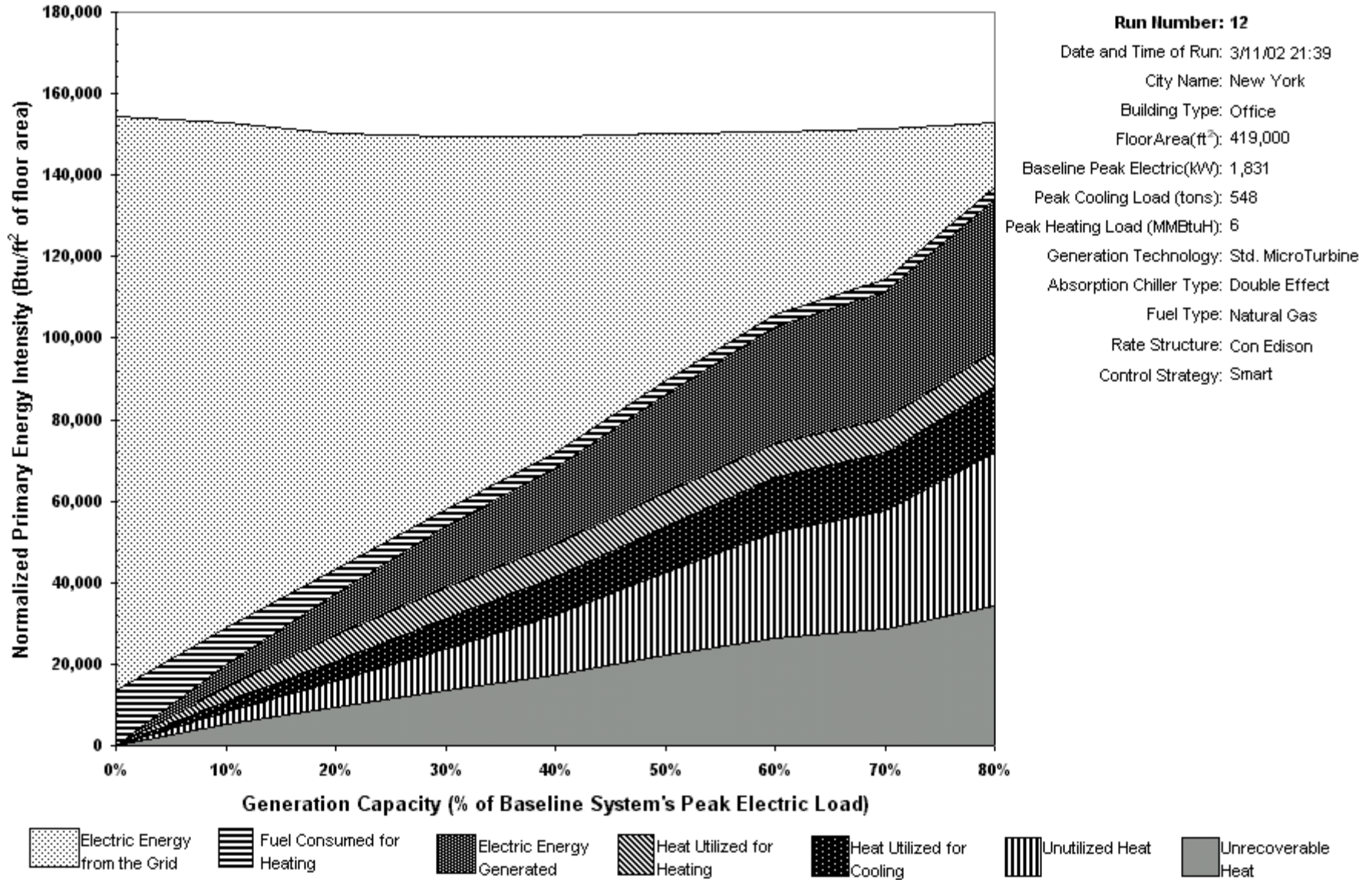

Figure 6-6: Primary Energy Consumption Intensity for a Standard Engine CHP System in a New York Large Office Building

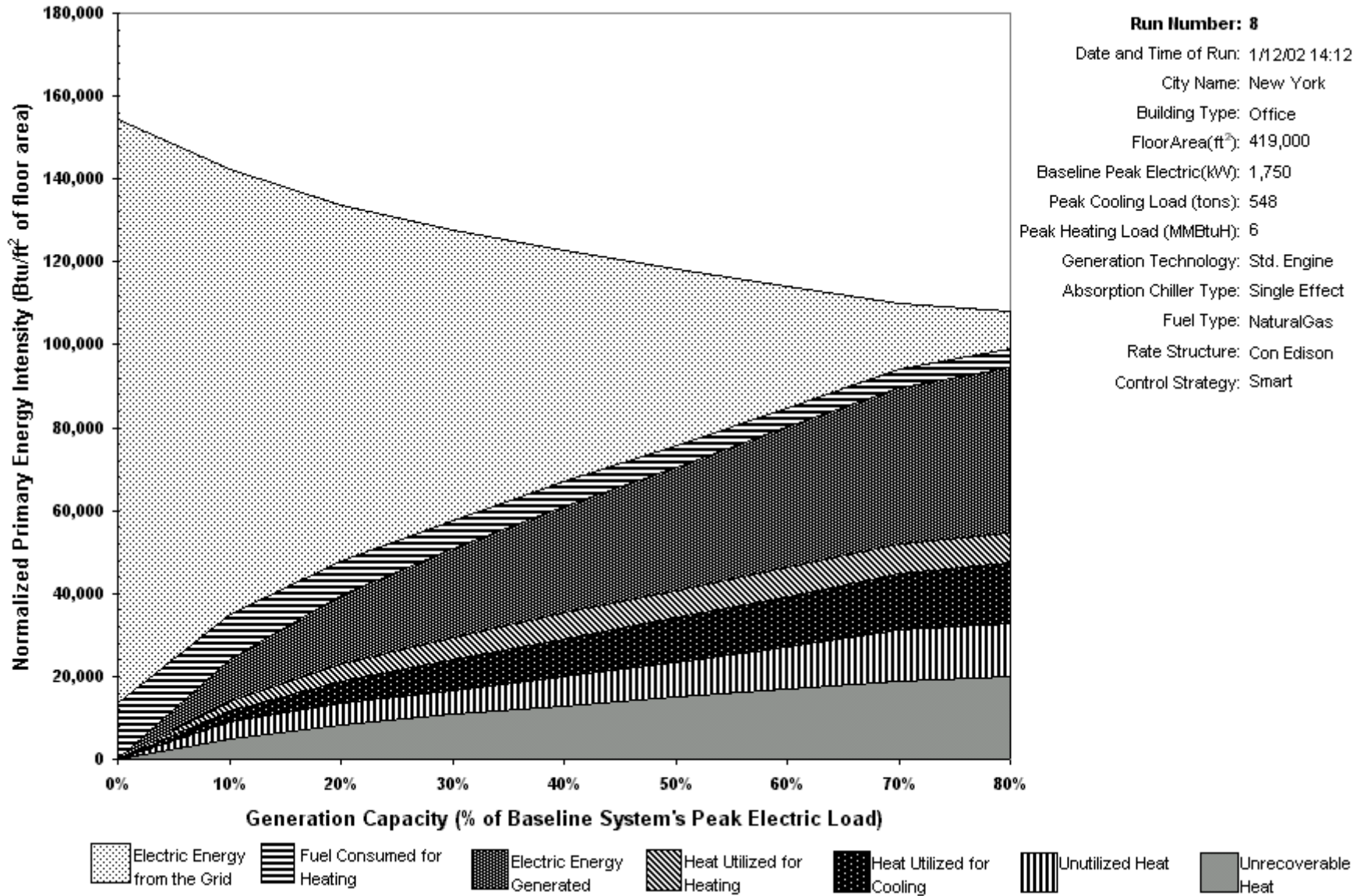
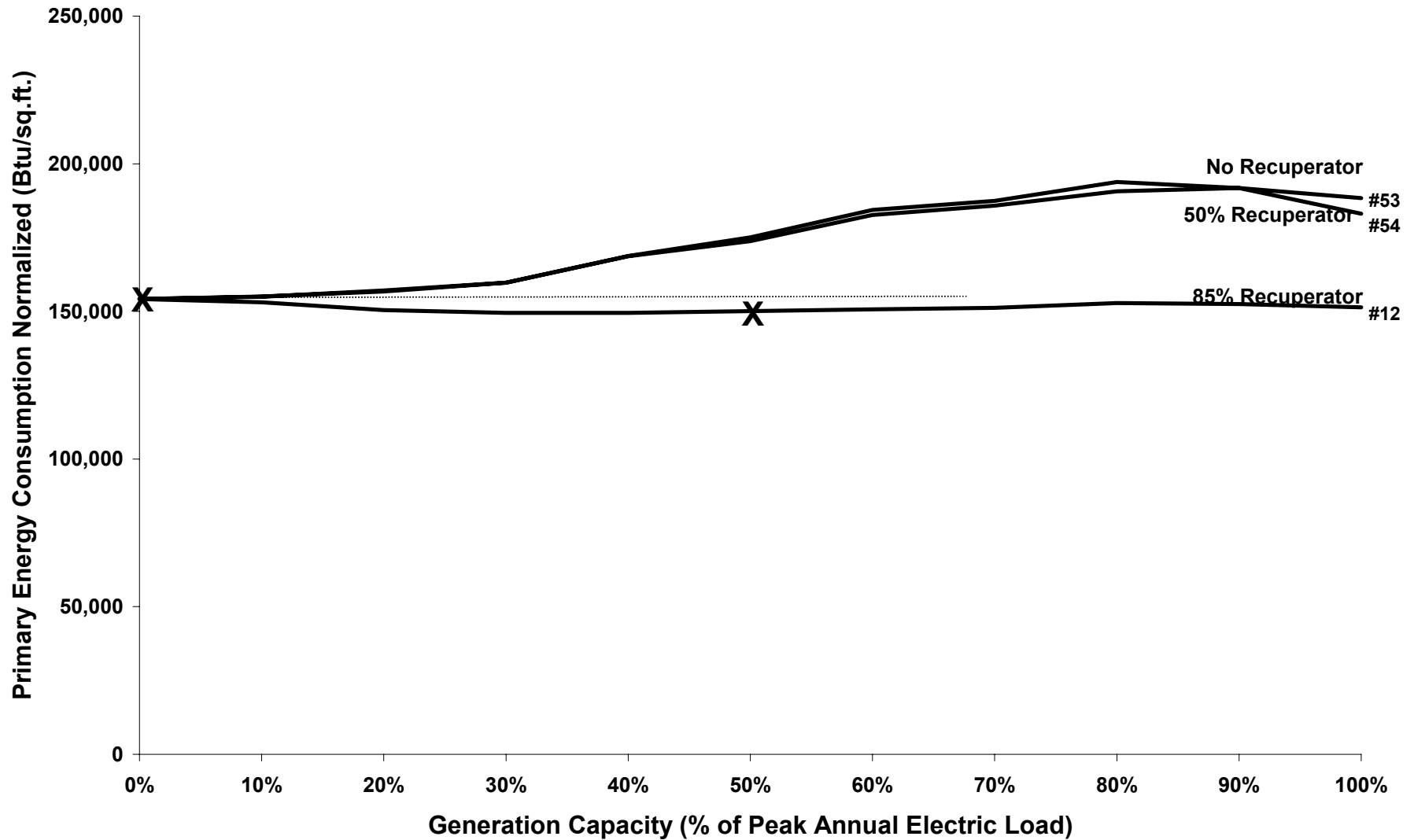
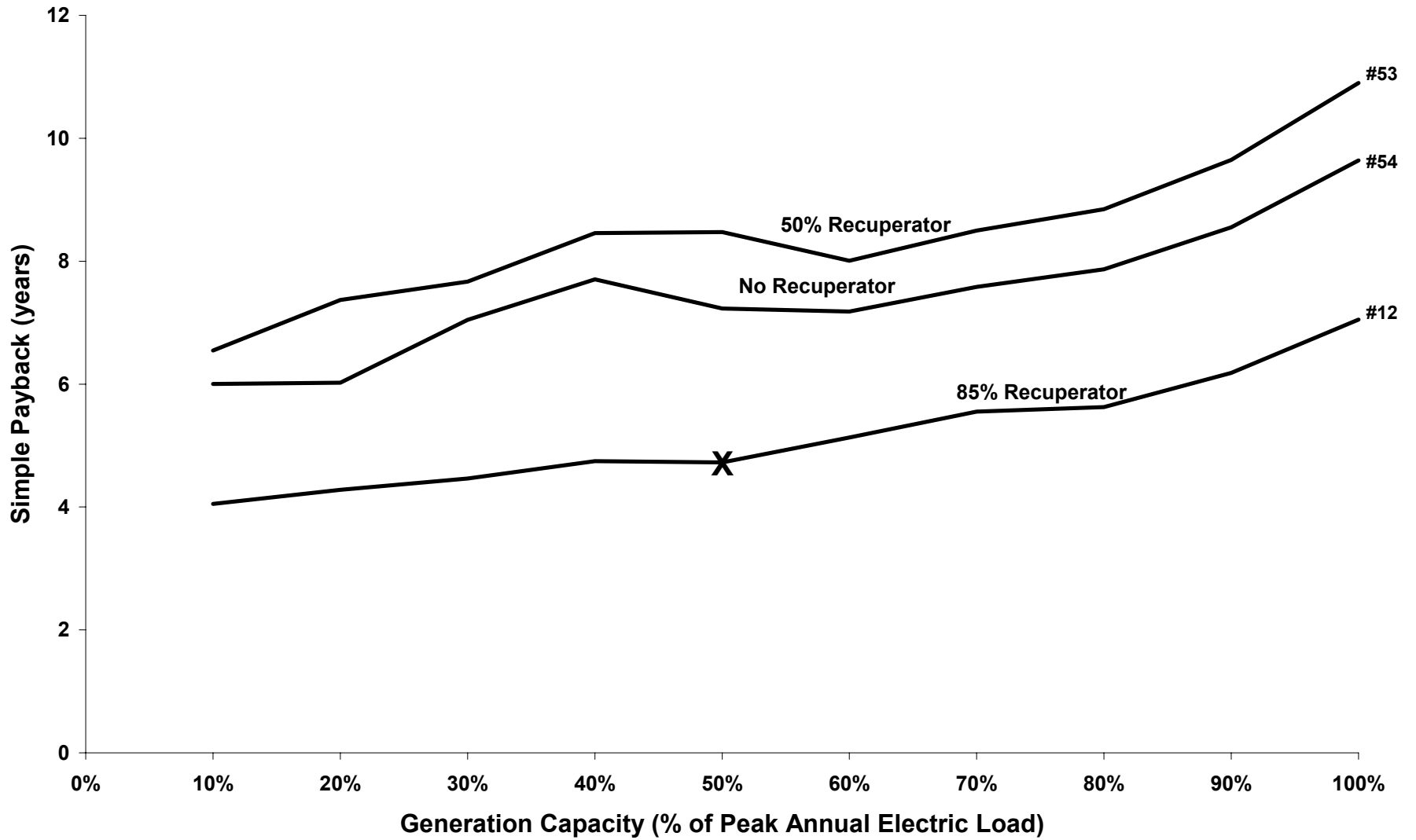

Figure 6-7: Primary Energy Consumption Intensities for Three Microturbine Recuperator Configurations – New York Large Office Application



“X” denotes the economic optimum, as detailed in Section 6.6 and Figure 6-3. Numbers indicate computer run numbers (see Appendix G).

Figure 6-8: Simple Payback Periods for Three Microturbine Recuperator Configurations – New York Large Office Application



"X" denotes the economic optimum, as detailed in Section 6.6 and Figure 6-3. Numbers indicate computer run numbers (see Appendix G).

Figure 6-9: Equipment Cost Breakdown of CHP Systems Installed in a New York Large Office Building

Standard Microturbine

Total Installed Cost = \$1.20 Million

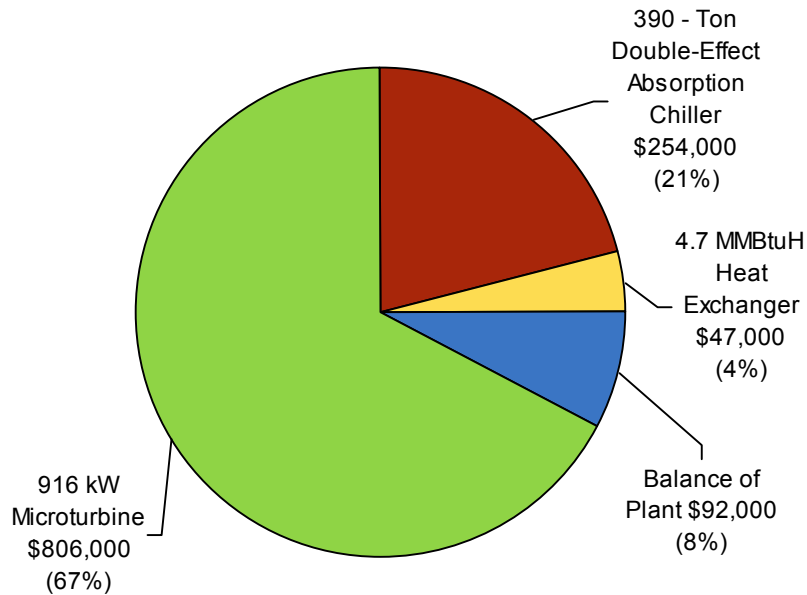

**Based on run #12 in Appendix G, at economic optimum 50% generation capacity (916 kW)*

Standard Engine

Total Installed Cost = \$1.21 Million

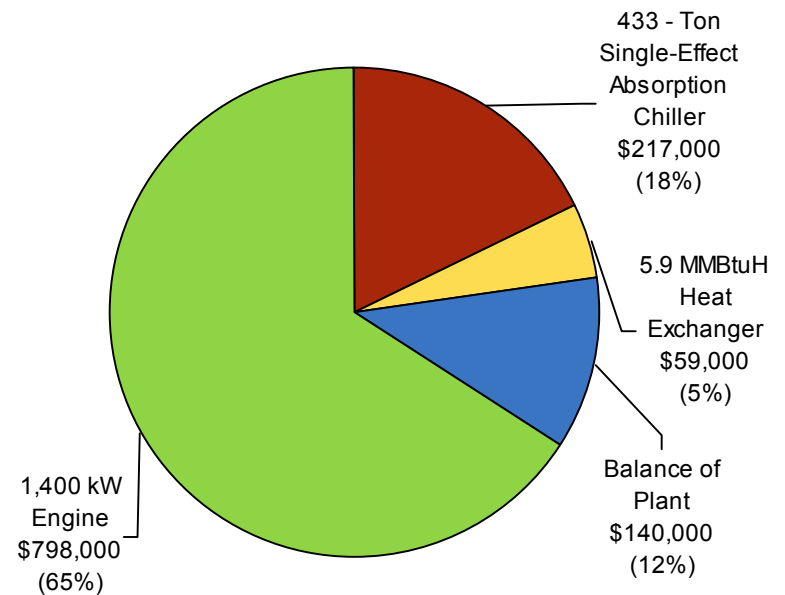

**Based on run #42 in Appendix G, at economic optimum 80% generation capacity (1,400 kW)*

Figure 6-10: Primary Energy Consumption Intensities for Standard Microturbine and Advanced Engine in New York Large Office Building – Power Only Versus CHP

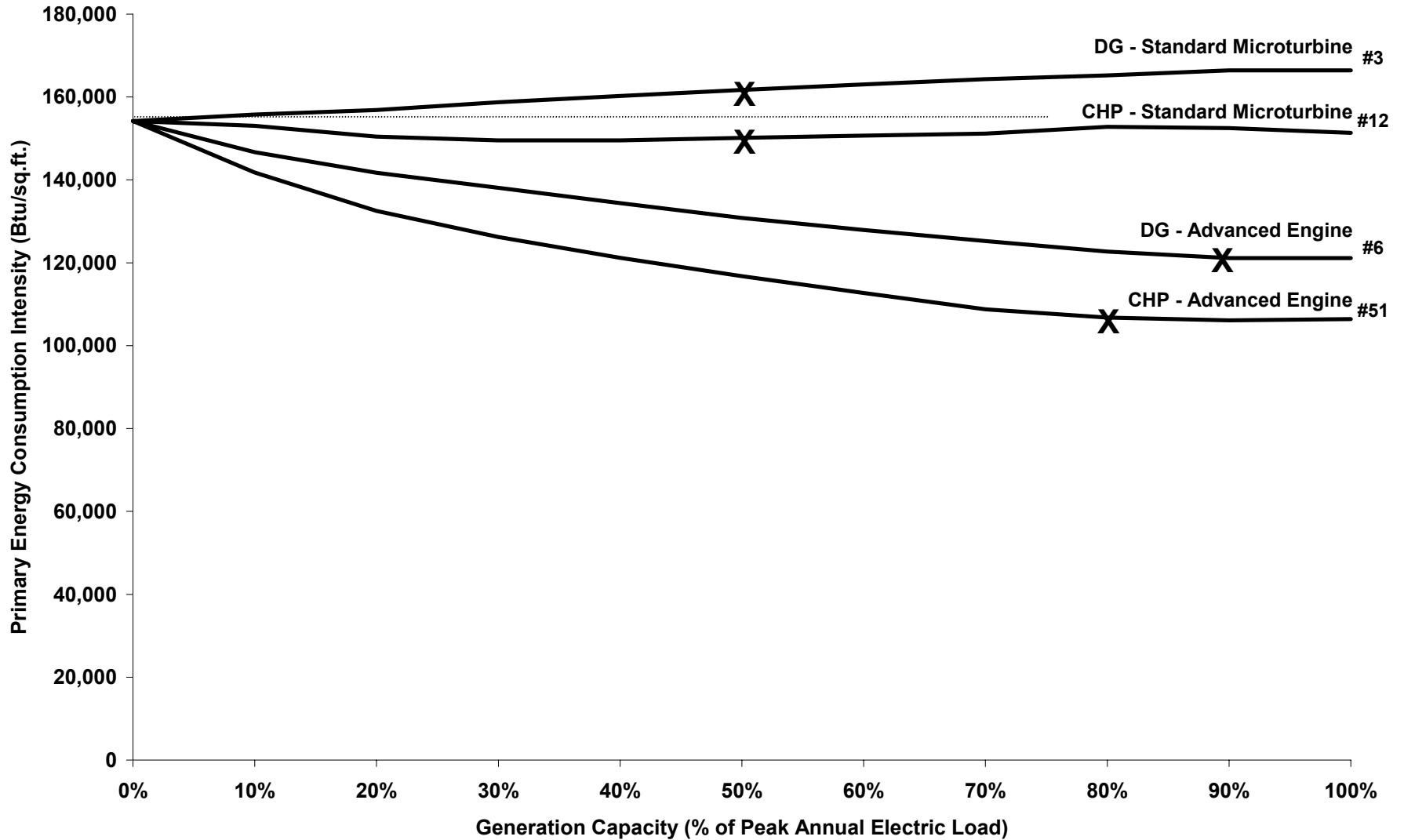

“X” denotes the economic optimum, as detailed in Section 6.6 and Figure 6-3. Numbers indicate computer run numbers (see Appendix G).

Figure 6-11: Simple Payback Periods for Standard Microturbine and Advanced Engine in New York Large Office Building – Power Only Versus CHP

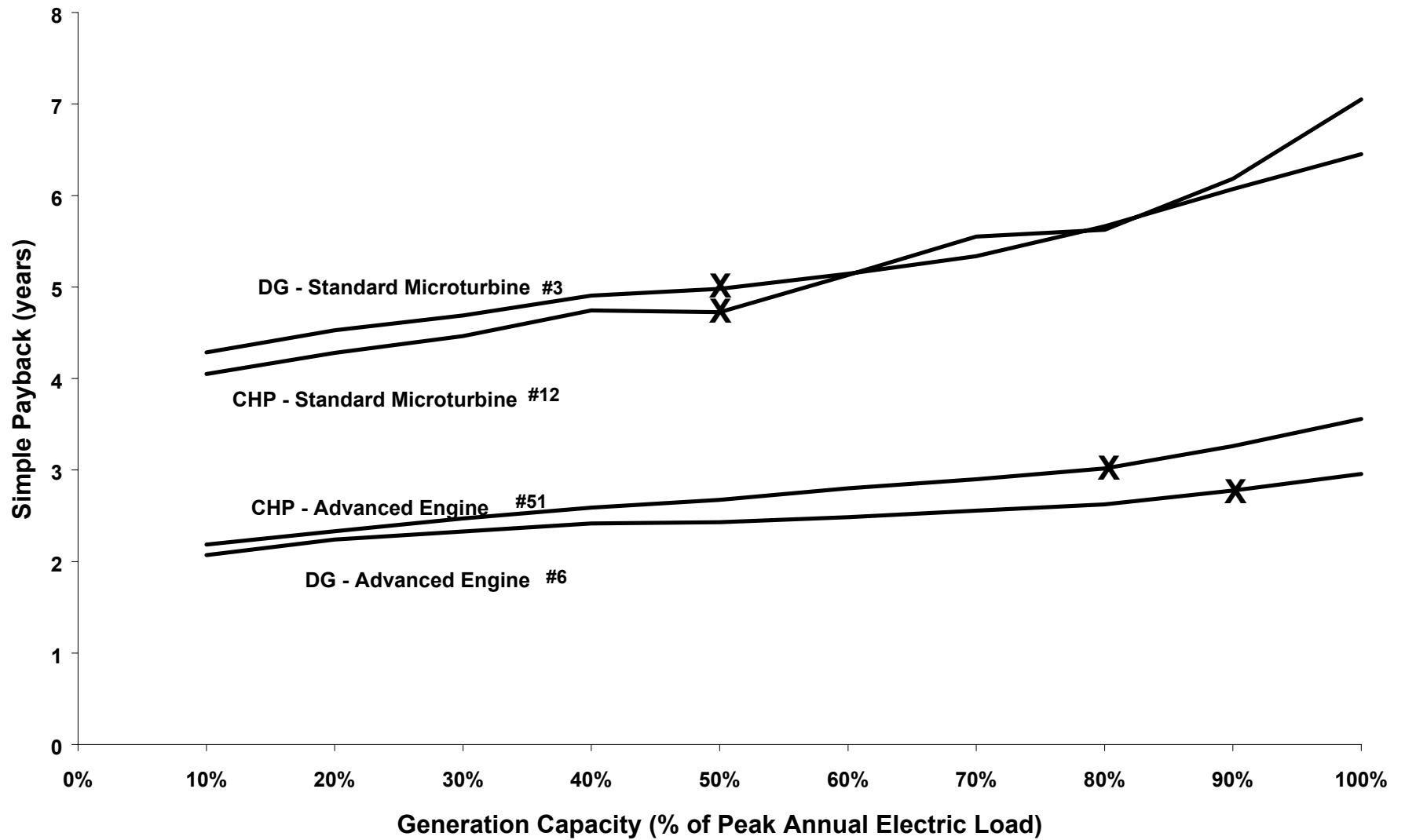

“X” denotes the economic optimum, as detailed in Section 6.6 and Figure 6-3. Numbers indicate computer run numbers (see Appendix G).

Figure 6-12: Primary Energy Consumption Intensities for Standard Microturbine and Advanced Engine in New York Large Office Building – “Smart” Versus “Dumb” Operating Strategies

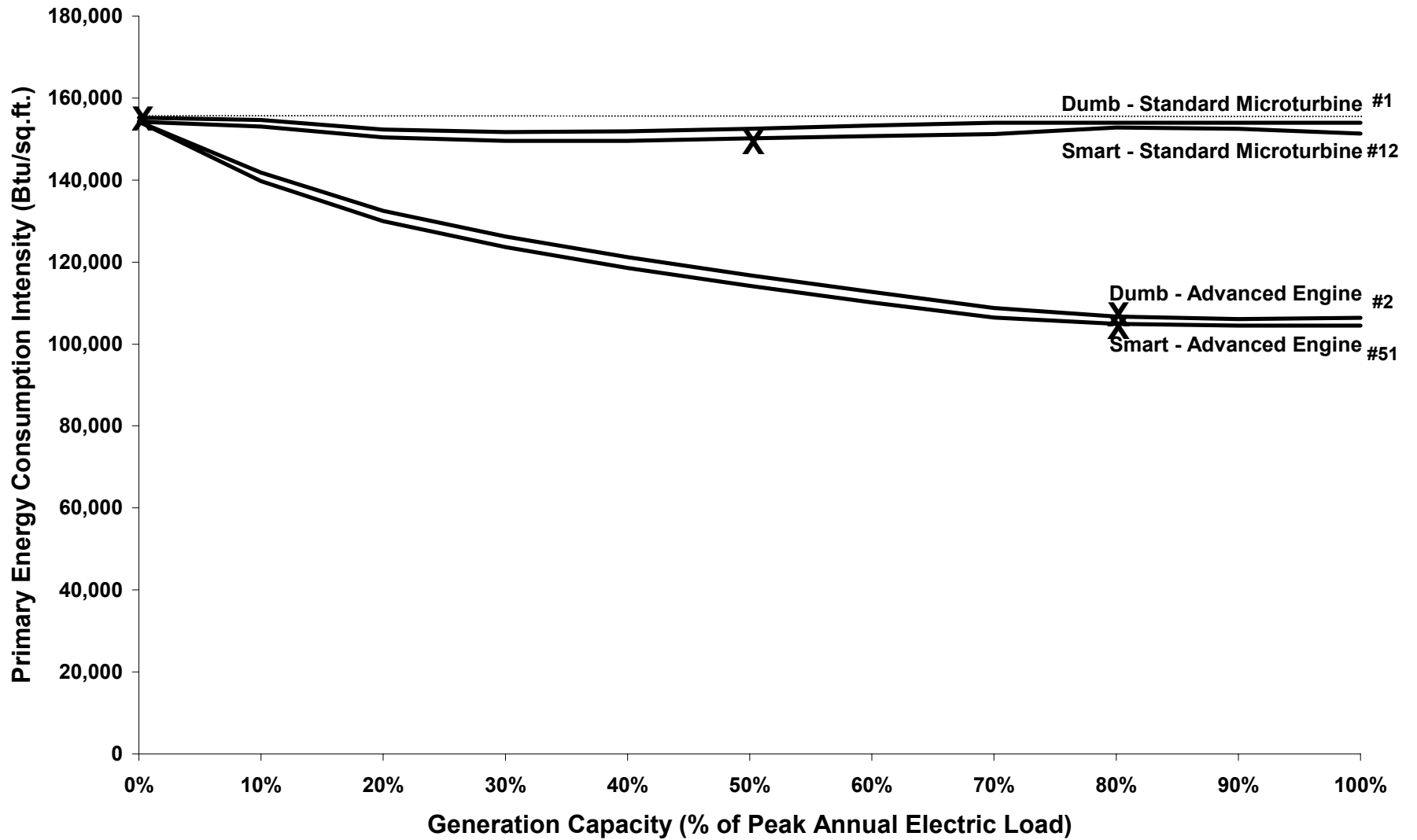

“X” denotes the economic optimum, as detailed in Section 6.6 and Figure 6-3. Numbers indicate computer run numbers (see Appendix G).

Figure 6-13: Simple Payback Periods for Standard Microturbine and Advanced Engine in New York Large Office Building – “Smart” Versus “Dumb” Operating Strategies

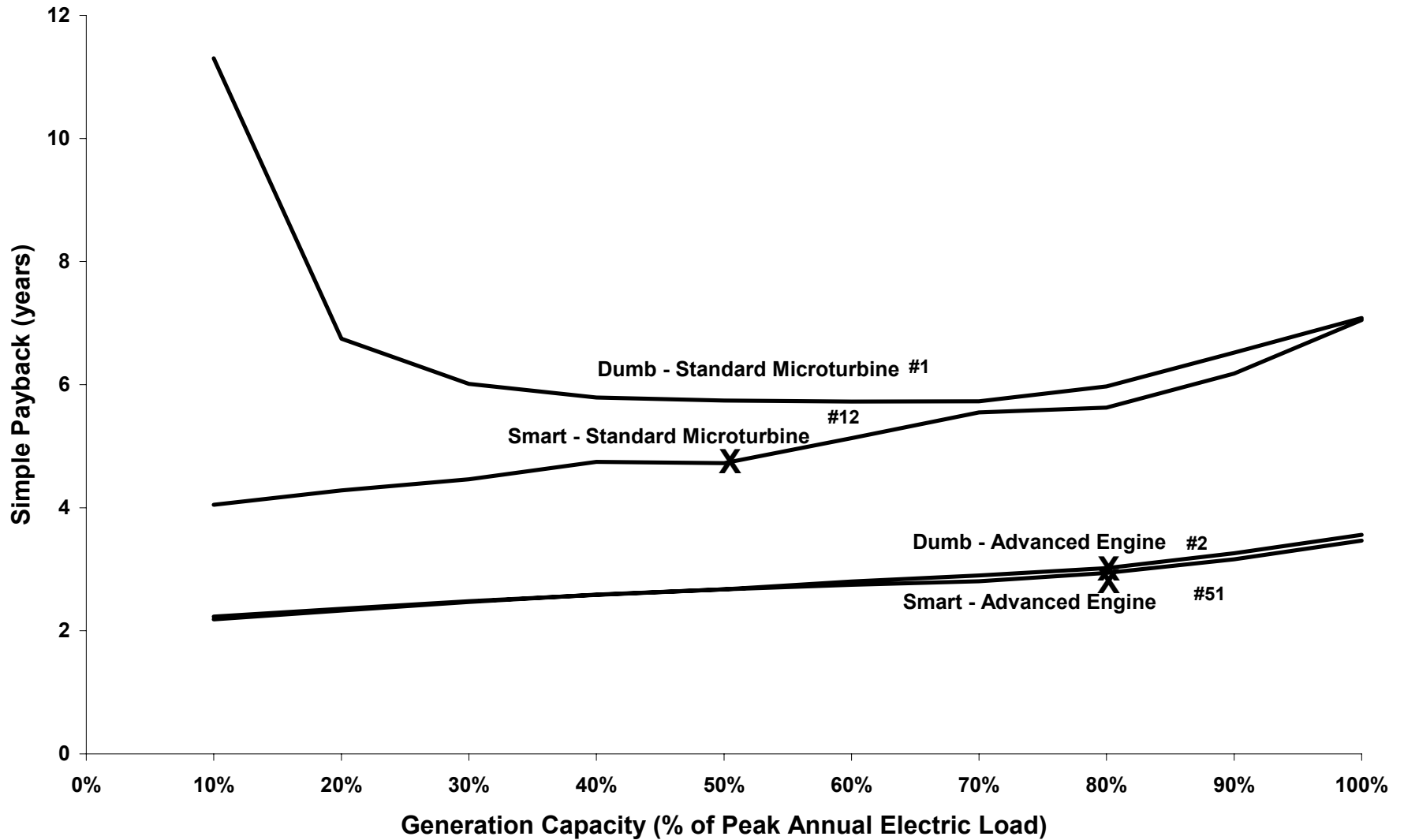

“X” denotes the economic optimum, as detailed in Section 6.6 and Figure 6-3. Numbers indicate computer run numbers (see Appendix G).

Figure 6-14: Primary Energy Consumption Intensities for Various Generation Technologies in Los Angeles Large Office Building

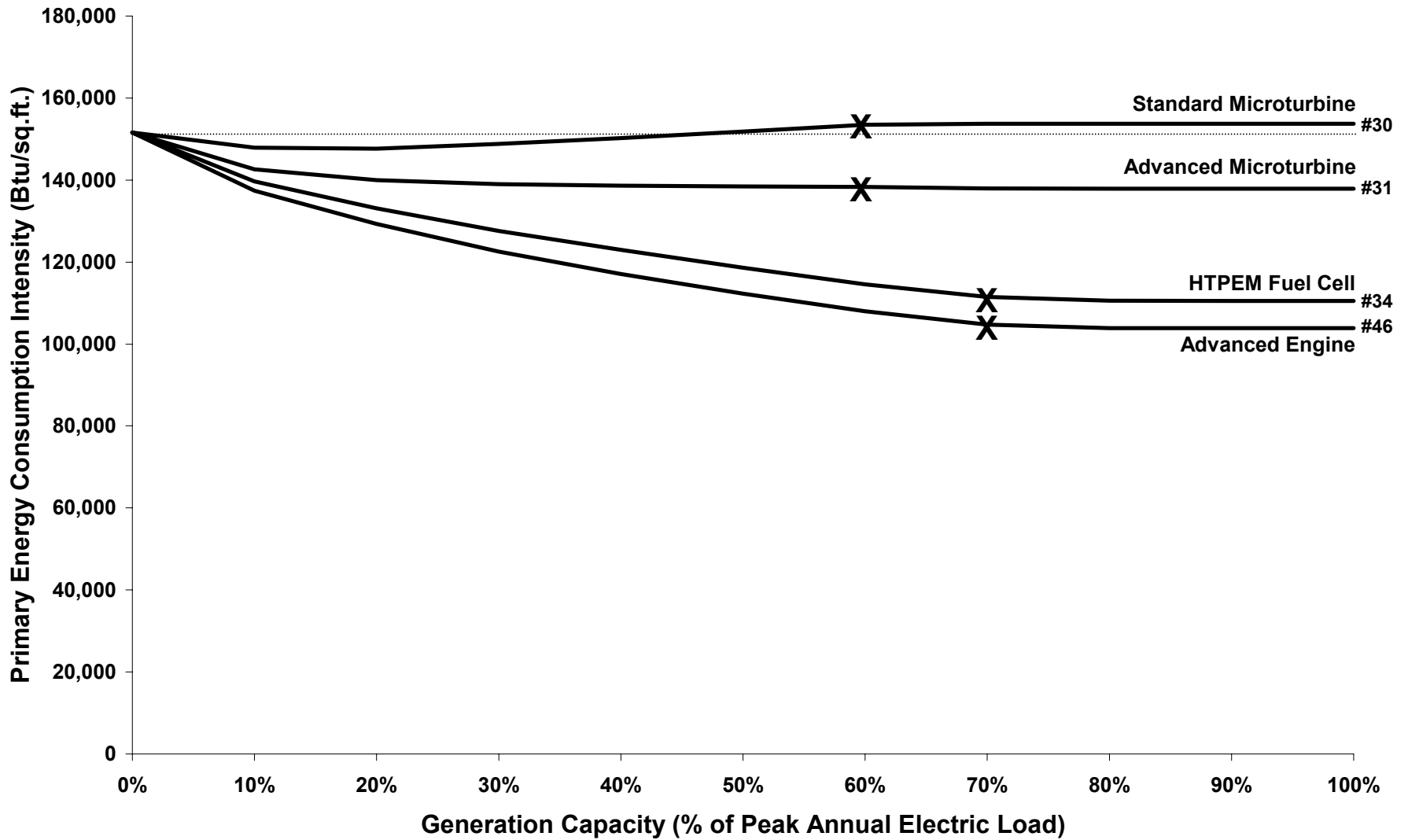

“X” denotes the economic optimum, as detailed in Section 6.6 and Figure 6-3. Numbers indicate computer run numbers (see Appendix G).

Figure 6-15: Simple Payback Periods for Various Generation Technologies in Los Angeles Large Office Building

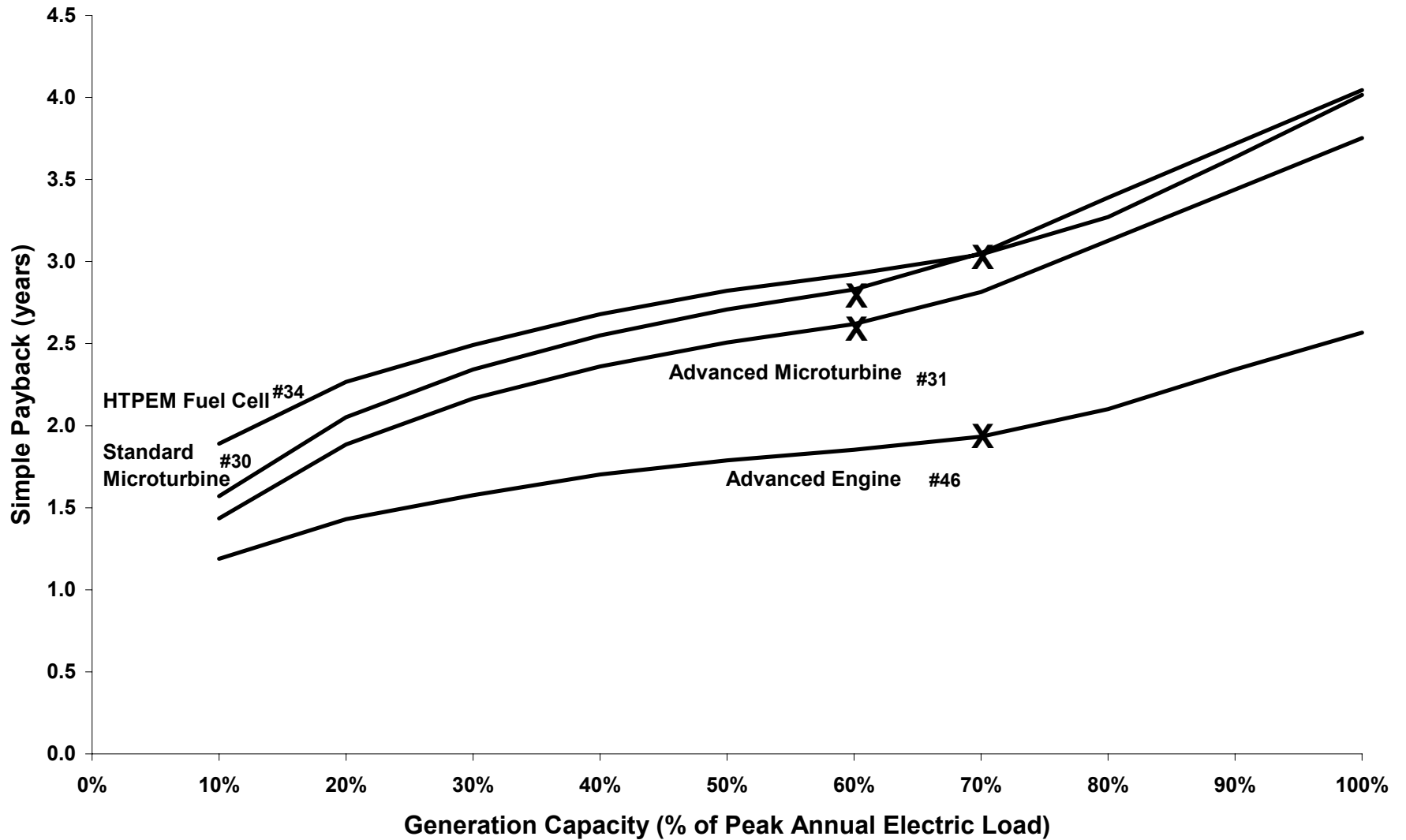

“X” denotes the economic optimum, as detailed in Section 6.6 and Figure 6-3. Numbers indicate computer run numbers (see Appendix G).

Figure 6-16: Primary Energy Consumption Intensities for Various Generation Technologies in New York Large Office Building

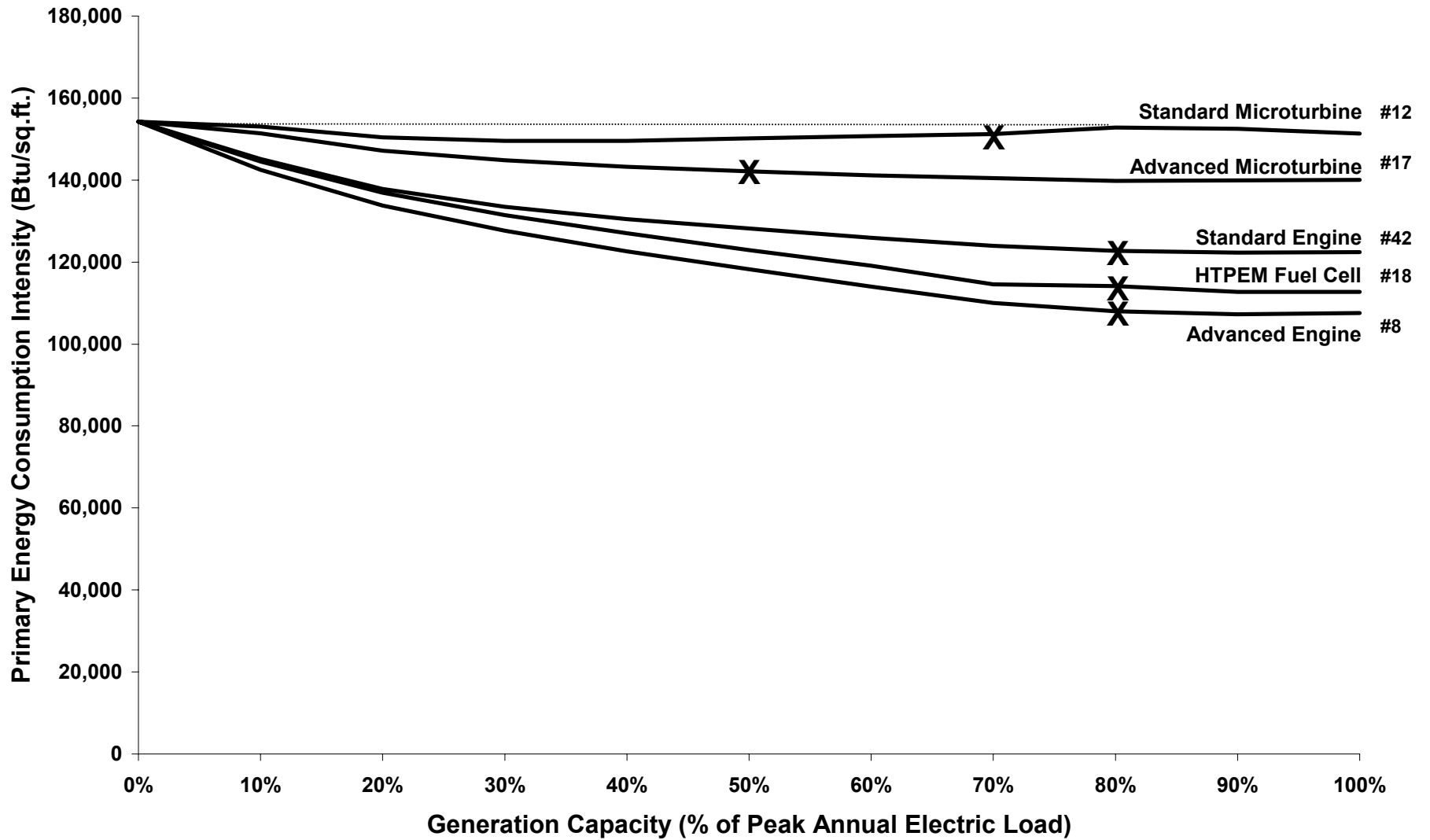

“X” denotes the economic optimum, as detailed in Section 6.6 and Figure 6-3. Numbers indicate computer run numbers (see Appendix G).

Figure 6-17: Simple Payback Periods for Various Generation Technologies in New York Large Office Building

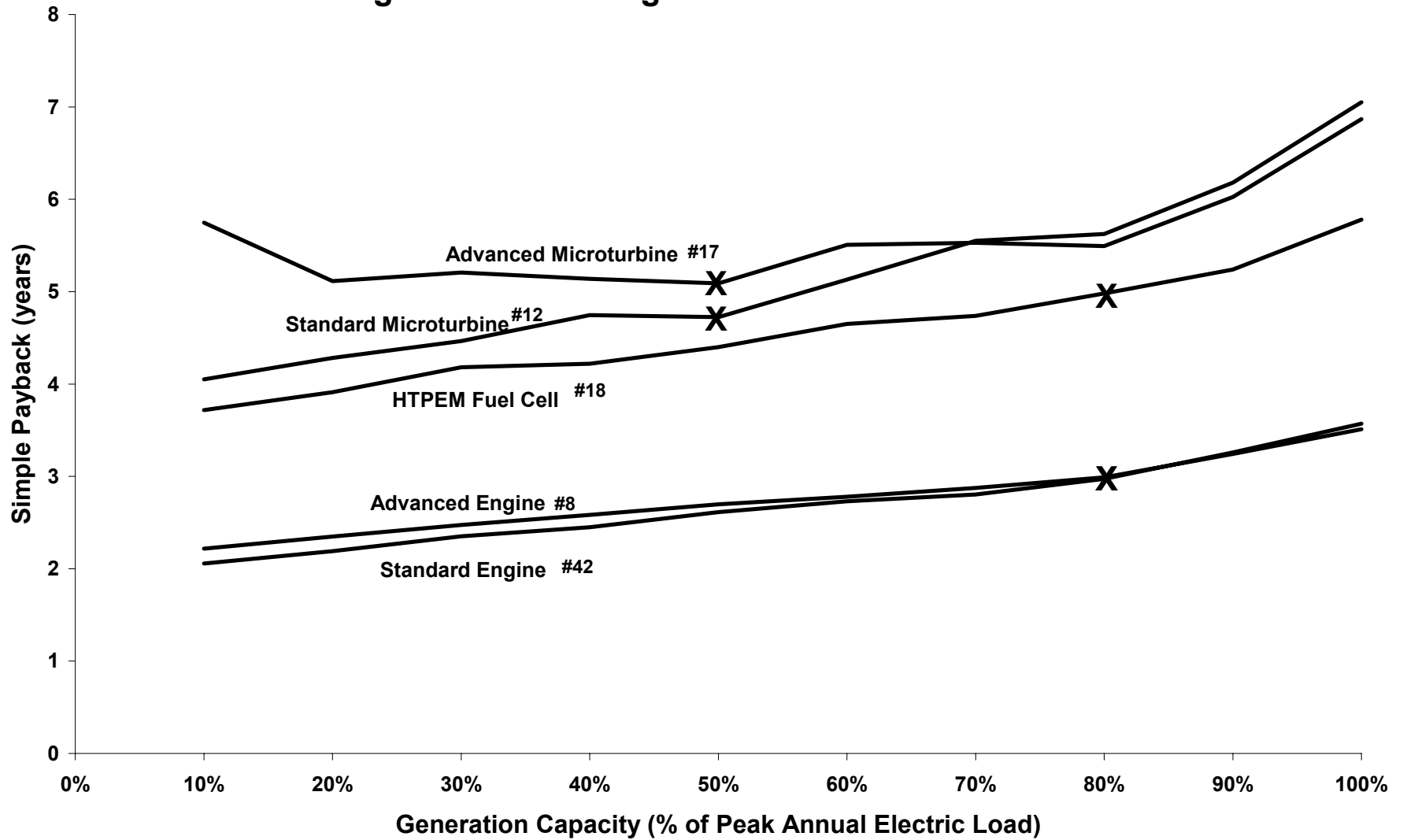

“X” denotes the economic optimum, as detailed in Section 6.6 and Figure 6-3. Numbers indicate computer run numbers (see Appendix G).

Figure 6-18: Primary Energy Consumption Intensities for Various Generation Technologies in Los Angeles Hospital

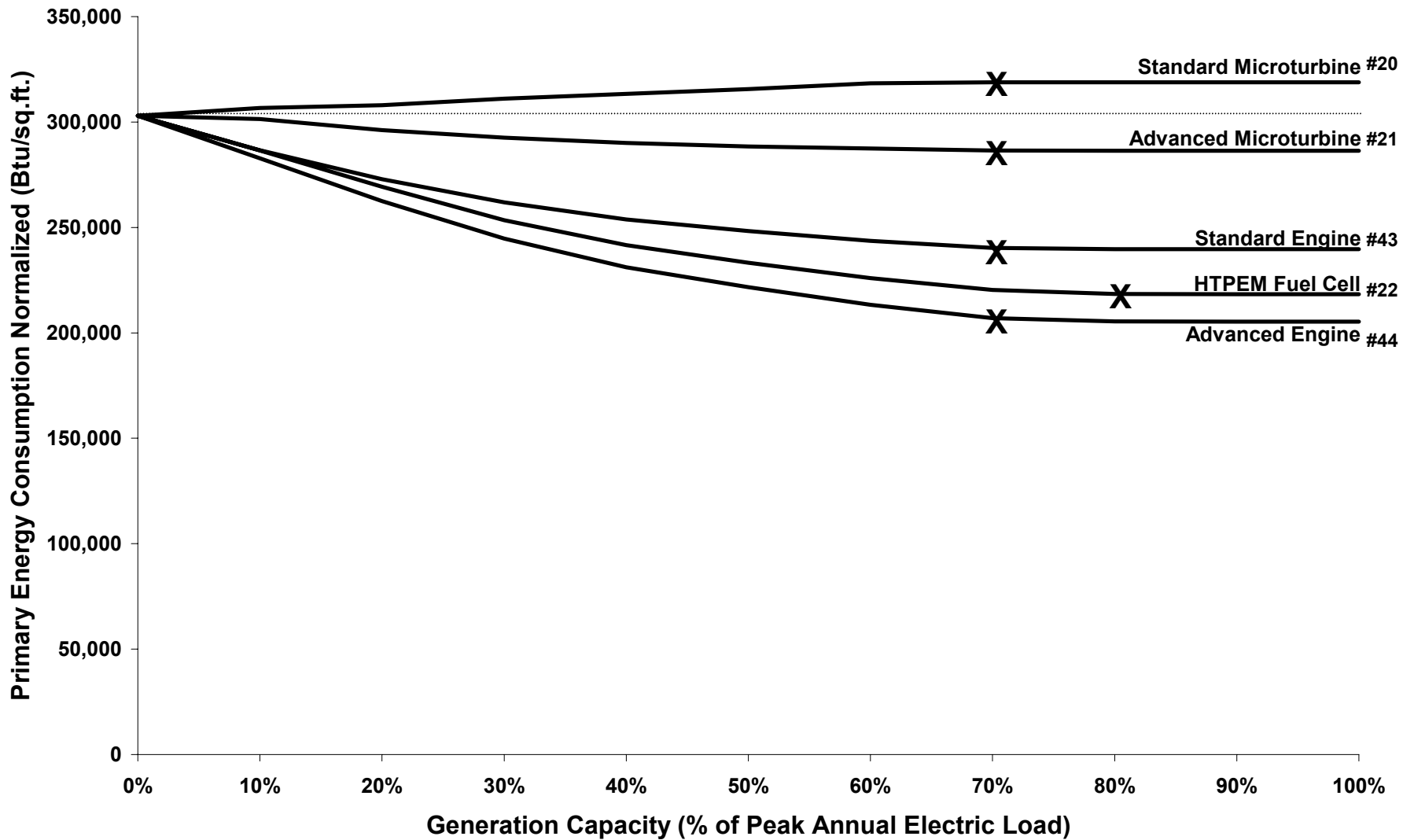

“X” denotes the economic optimum, as detailed in Section 6.6 and Figure 6-3. Numbers indicate computer run numbers (see Appendix G).

Figure 6-19: Simple Payback Periods for Various Generation Technologies in Los Angeles Hospital

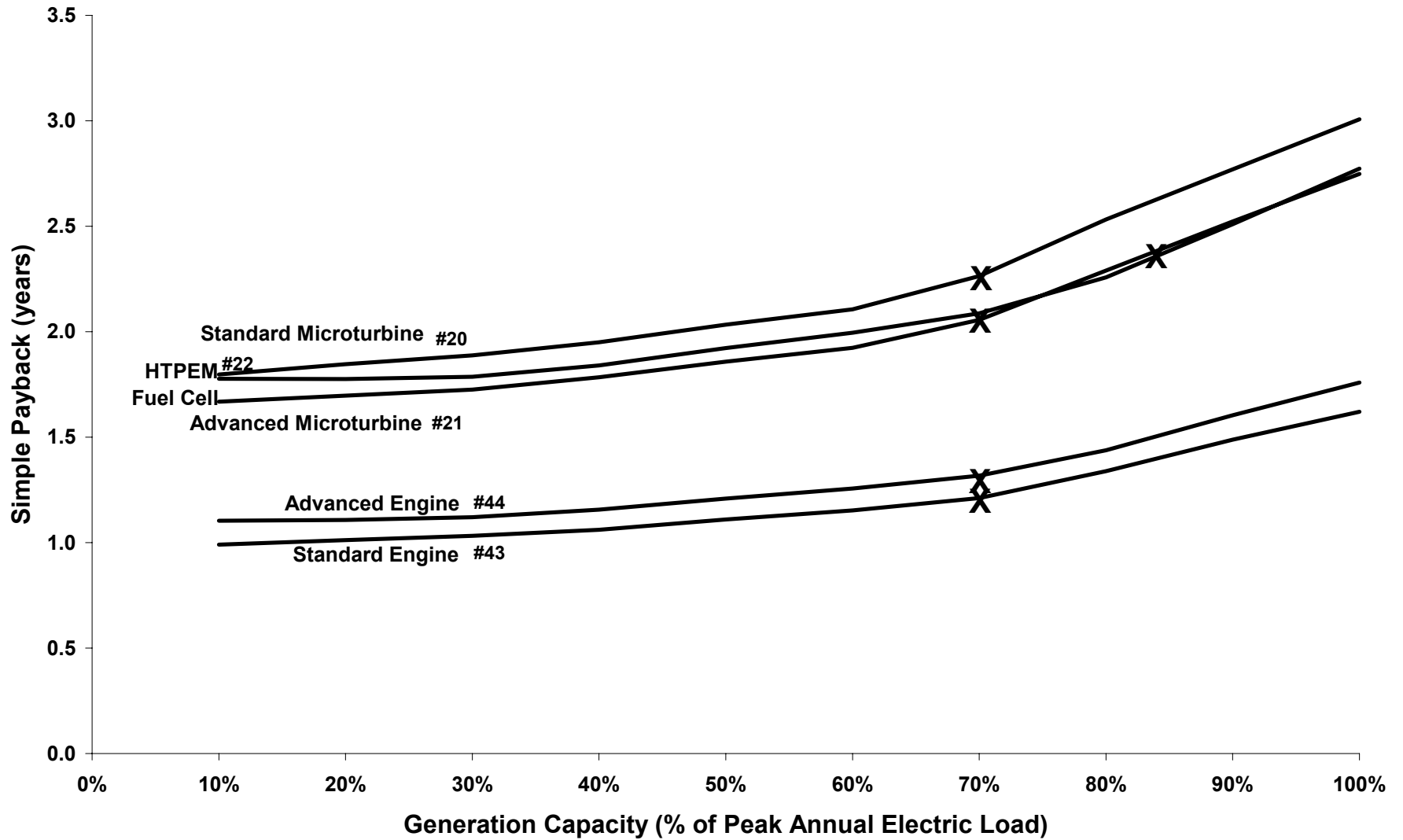

"X" denotes the economic optimum, as detailed in Section 6.6 and Figure 6-3. Numbers indicate computer run numbers (see Appendix G).

Figure 6-20: Primary Energy Consumption Intensities for Various Generation Technologies in New York Hospital

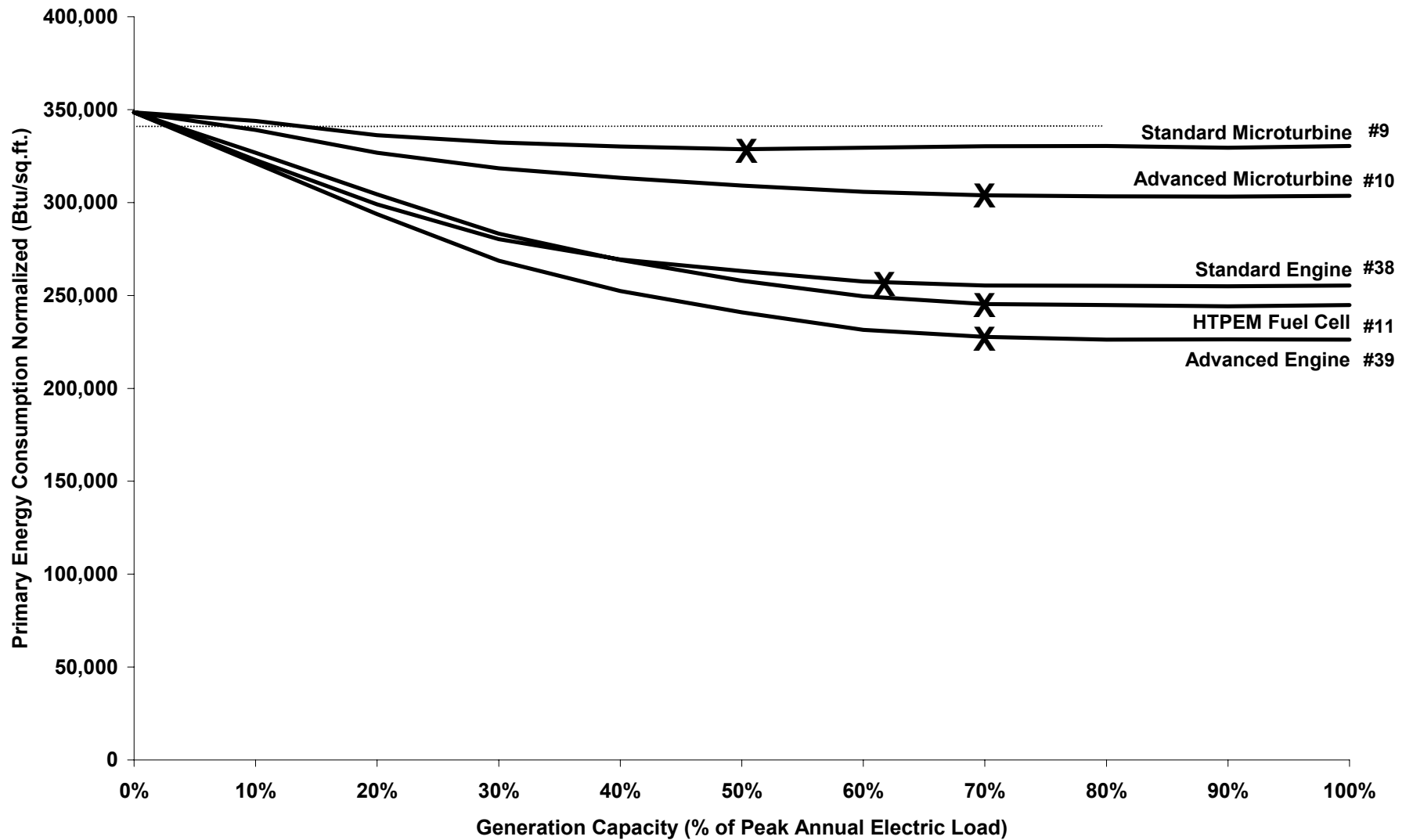

“X” denotes the economic optimum, as detailed in Section 6.6 and Figure 6-3. Numbers indicate computer run numbers (see Appendix G).

Figure 6-21: Simple Payback Periods for Various Generation Technologies in New York Hospital

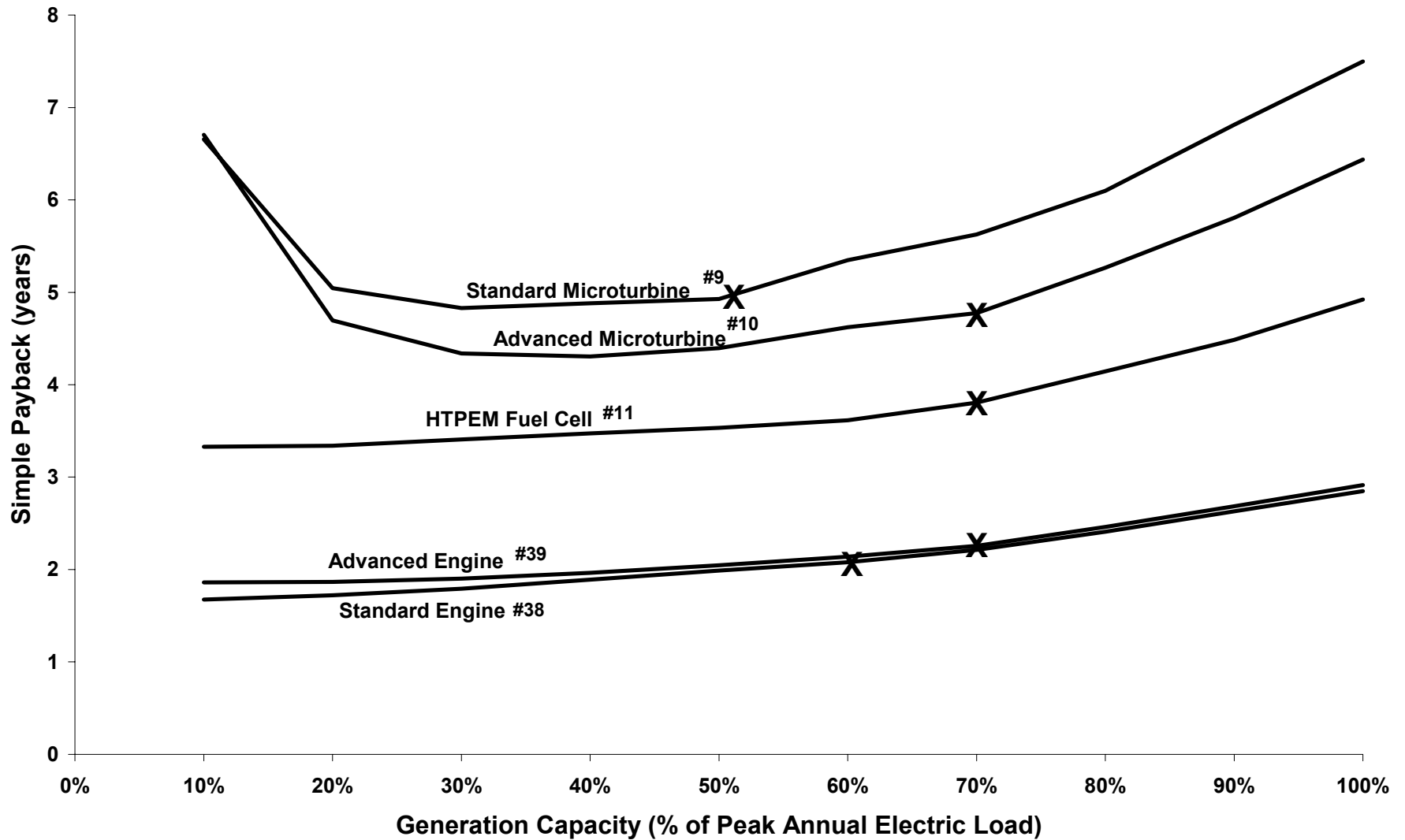

“X” denotes the economic optimum, as detailed in Section 6.6 and Figure 6-3. Numbers indicate computer run numbers (see Appendix G).

Figure 6-22: Primary Energy Consumption Intensities for Various Generation Technologies Los Angeles Large Hotel

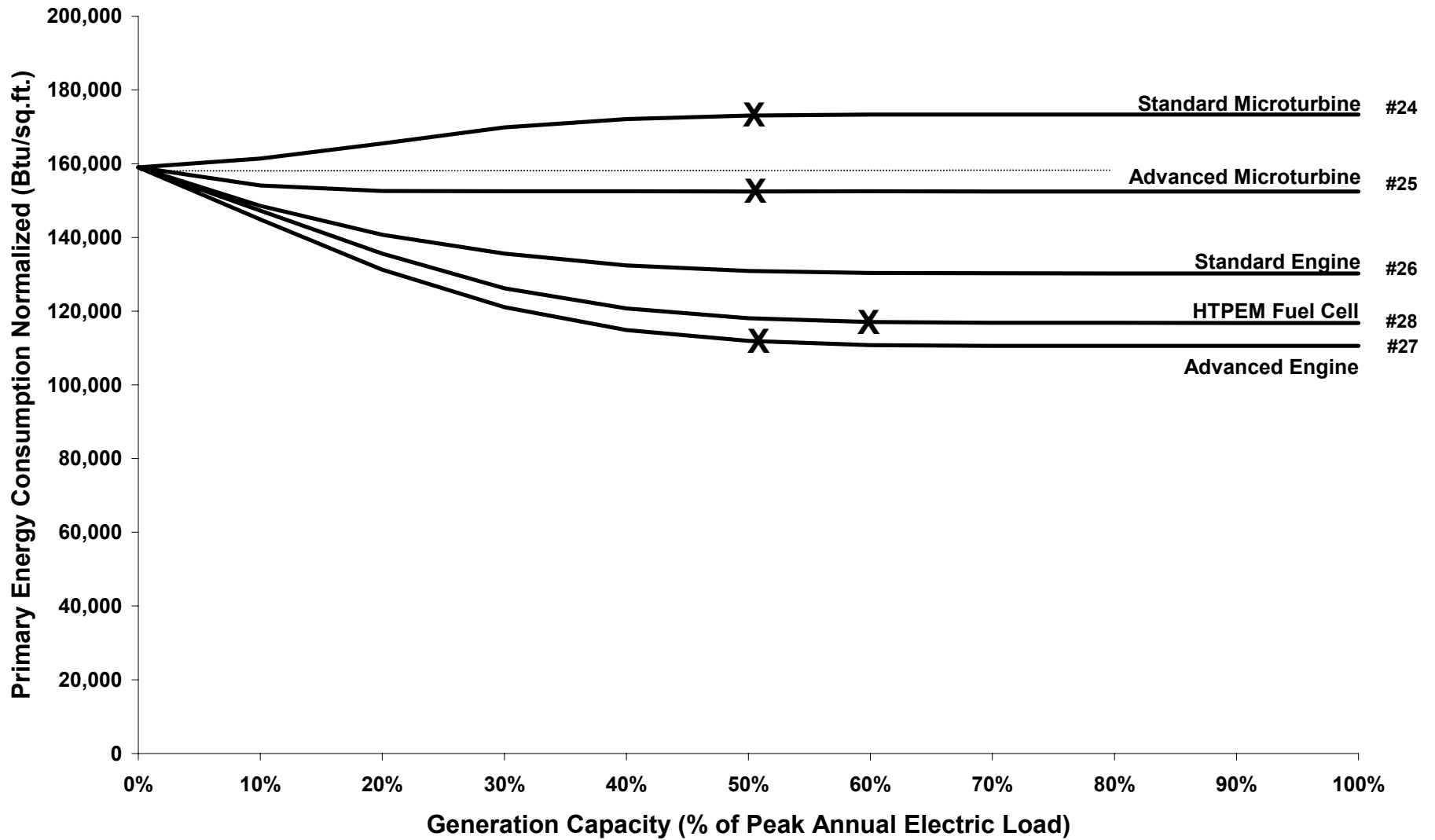

“X” denotes the economic optimum, as detailed in Section 6.6 and Figure 6-3. Numbers indicate computer run numbers (see Appendix G).

Figure 6-23: Simple Payback Periods for Various Generation Technologies in Los Angeles Large Hotel

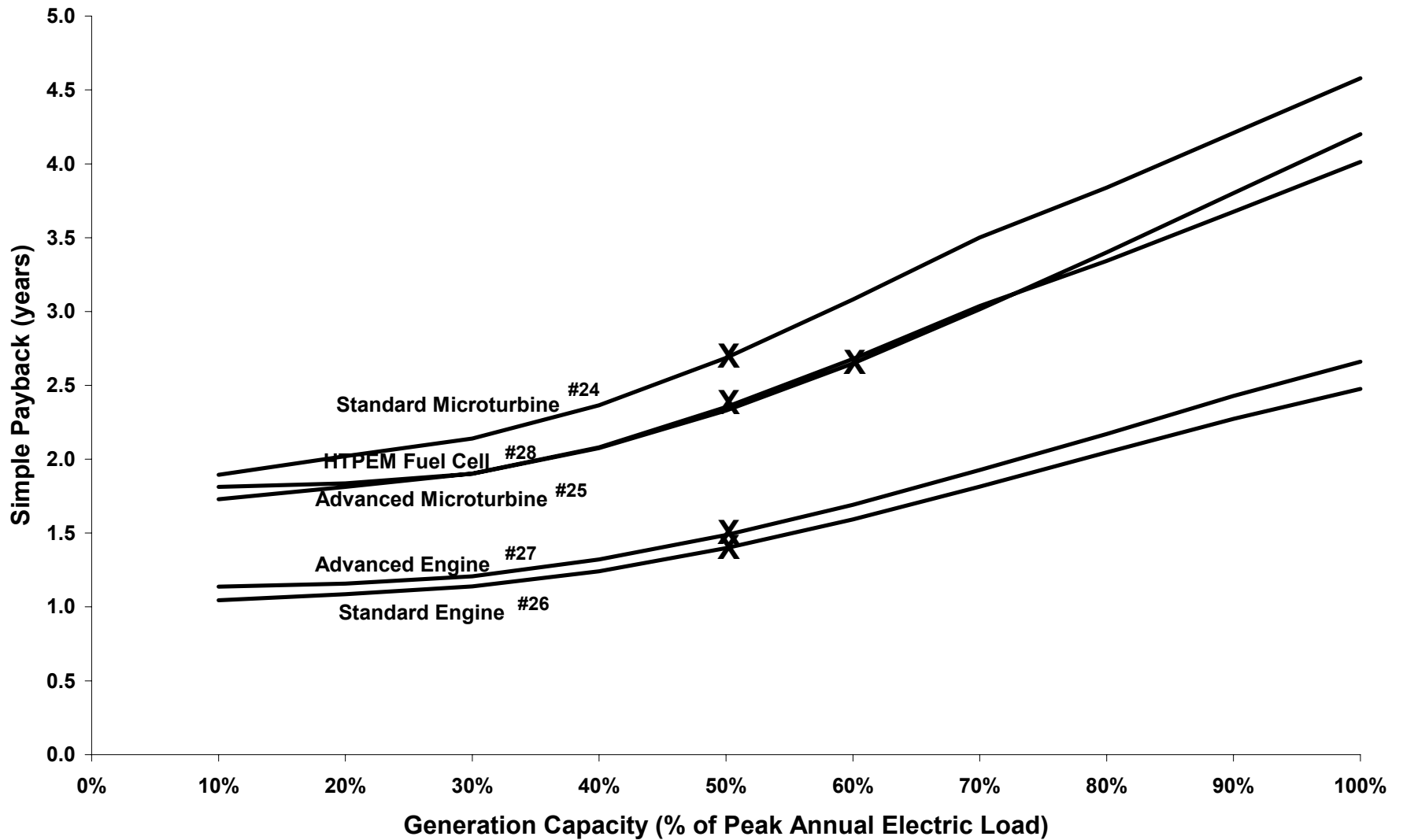

“X” denotes the economic optimum, as detailed in Section 6.6 and Figure 6-3. Numbers indicate computer run numbers (see Appendix G).

Figure 6-24: Primary Energy Consumption Intensities for Various Generation Technologies in New York Large Hotel

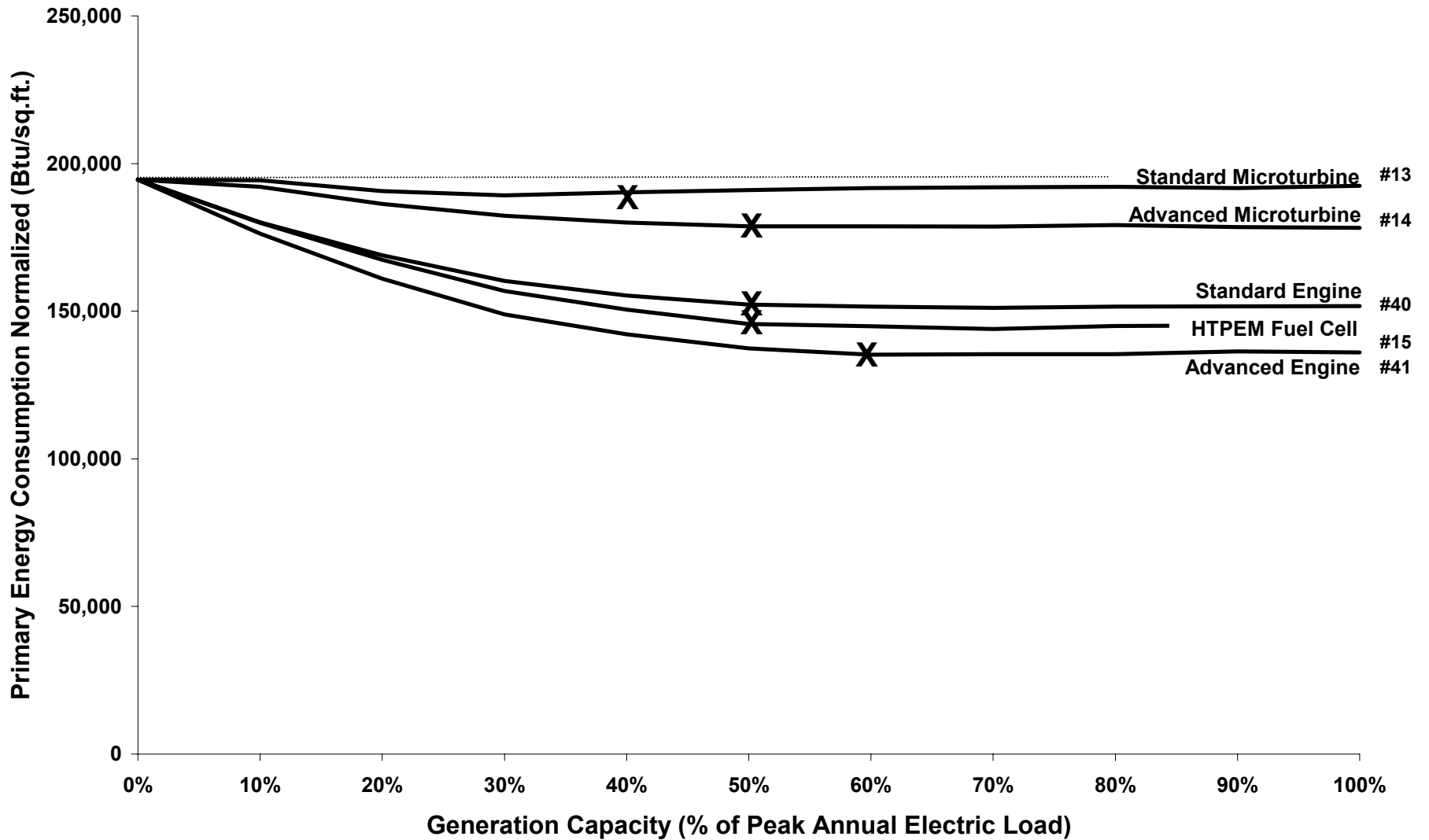

“X” denotes the economic optimum, as detailed in Section 6.6 and Figure 6-3. Numbers indicate computer run numbers (see Appendix G).

Figure 6-25: Simple Payback Periods for Various Generation Technologies in New York Large Hotel

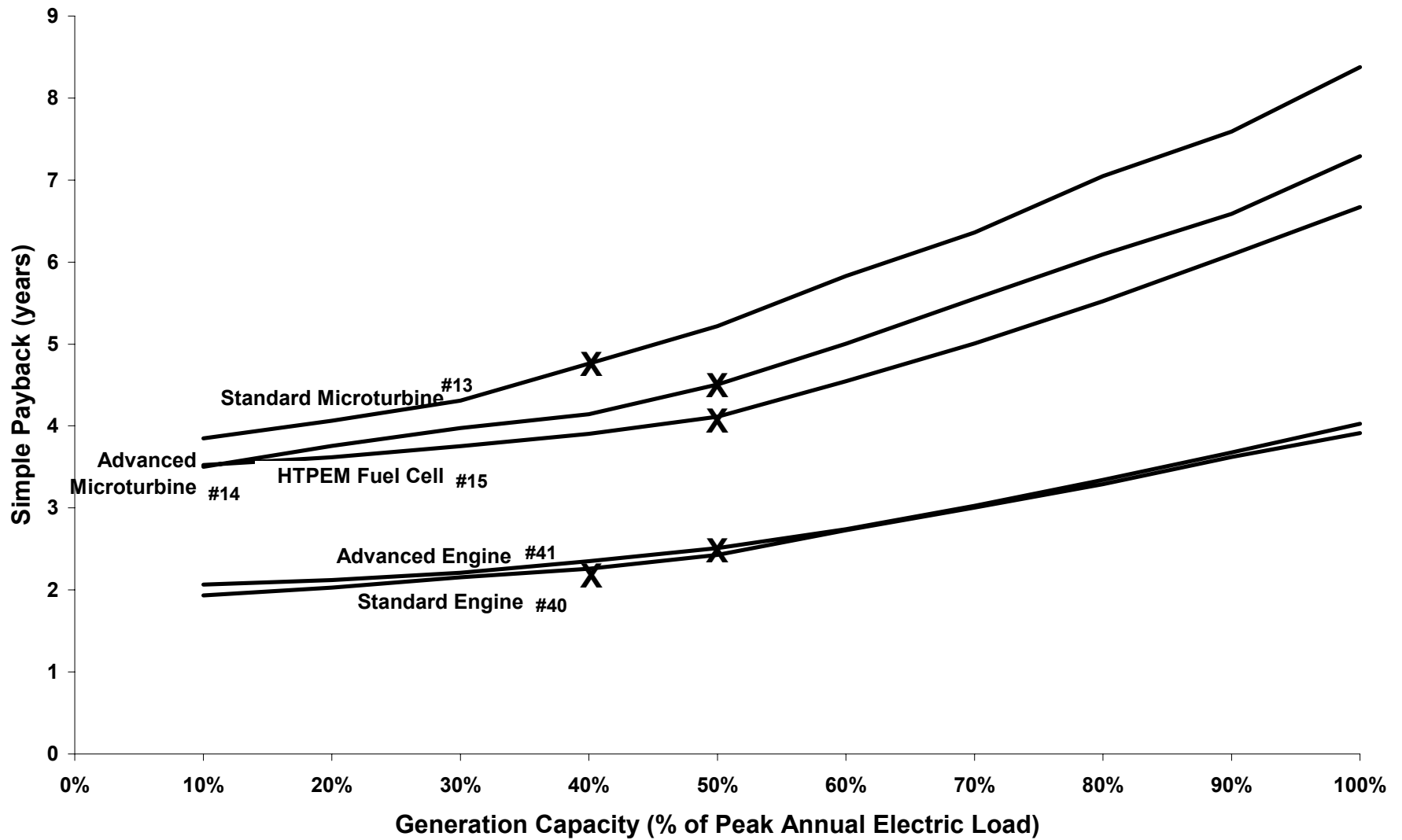

“X” denotes the economic optimum, as detailed in Section 6.6 and Figure 6-3. Numbers indicate computer run numbers (see Appendix G).

Figure 6-26: Primary Energy Consumption Intensities for Advanced Engine in Large Office Building for Various Cities

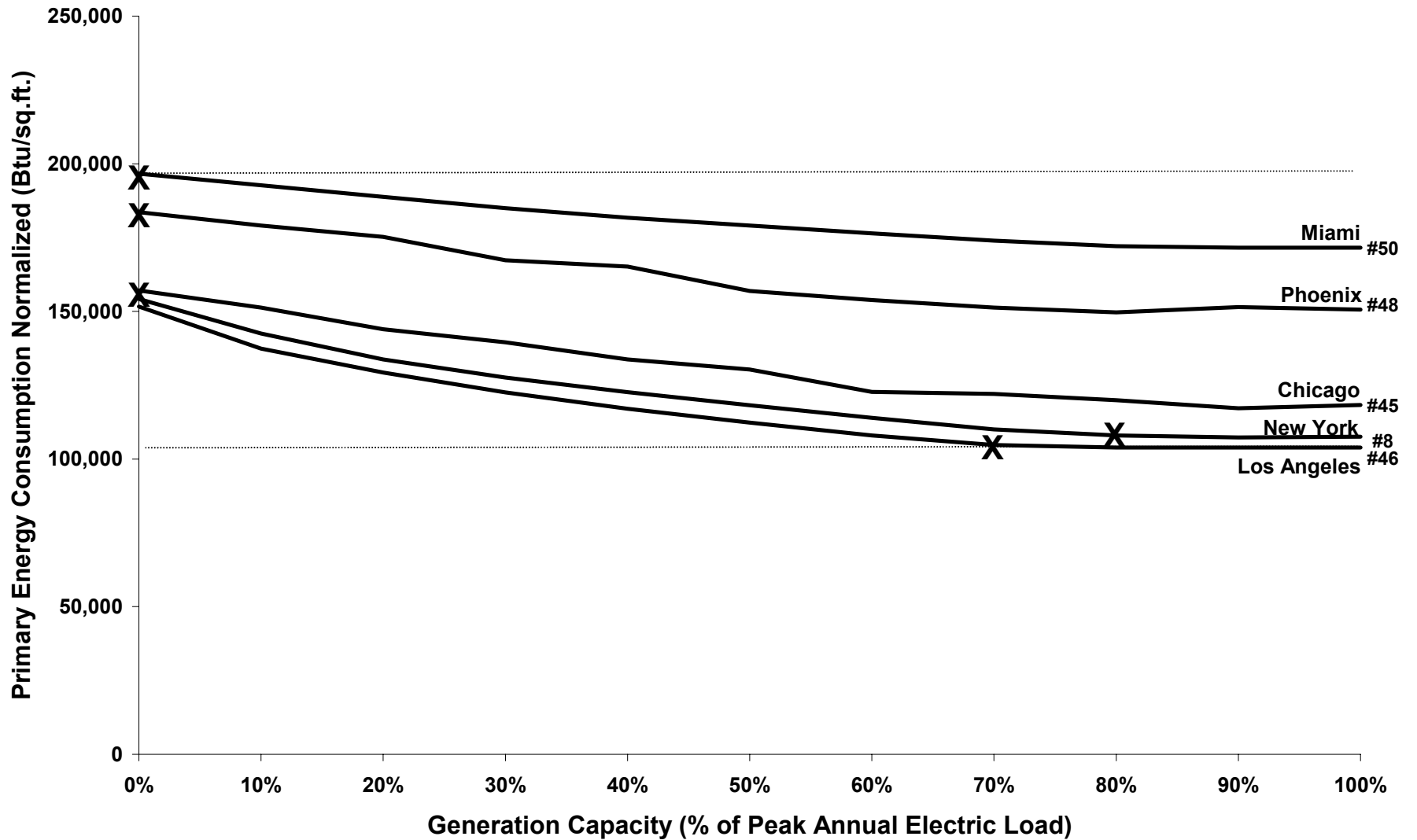

"X" denotes the economic optimum, as detailed in Section 6.6 and Figure 6-3. Numbers indicate computer run numbers (see Appendix G).

Figure 6-27: Simple Payback Periods for Advanced Engine in Large Office Building for Various Cities

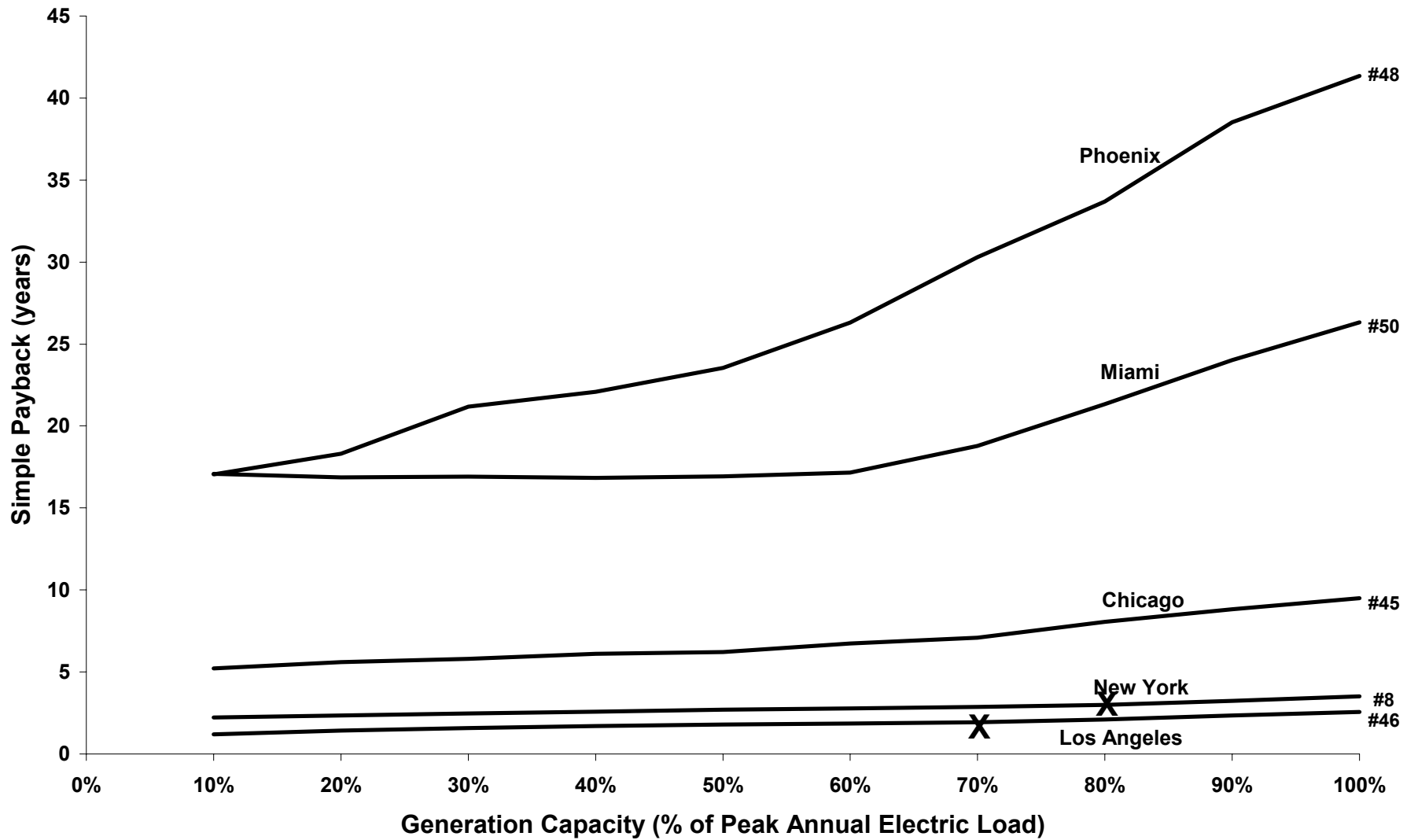

“X” denotes the economic optimum, as detailed in Section 6.6 and Figure 6-3. Numbers indicate computer run numbers (see Appendix G).

Figure 6-28: Primary Energy Consumption Intensities for Standard Microturbine and Advanced Engine in New York Large Office Building – Natural Gas Versus Fuel Oil

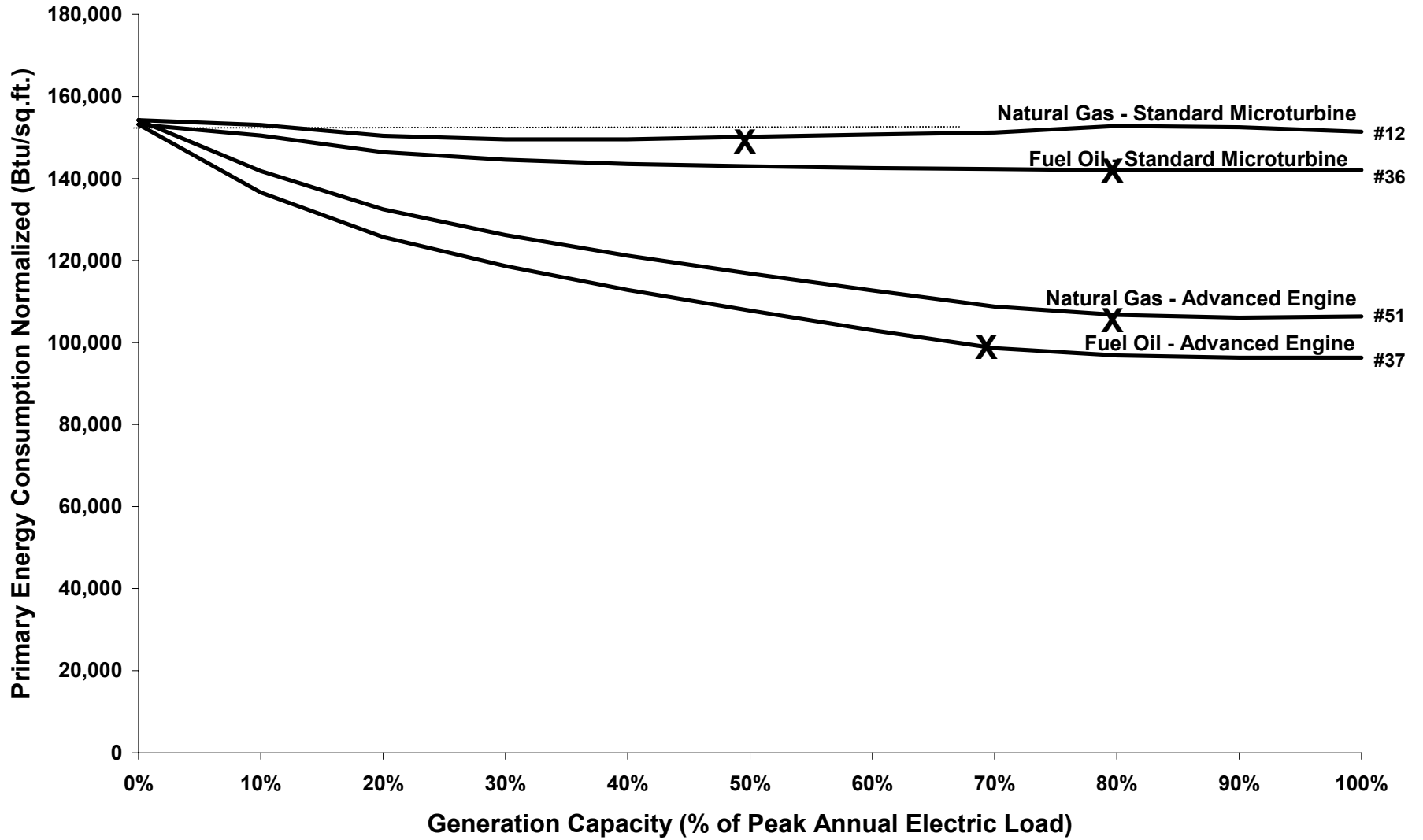

"X" denotes the economic optimum, as detailed in Section 6.6 and Figure 6-3. Numbers indicate computer run numbers (see Appendix G).

Figure 6-29: Simple Payback Periods for Standard Microturbine and Advanced Engine in New York Large Office Building – Natural Gas Versus Fuel Oil

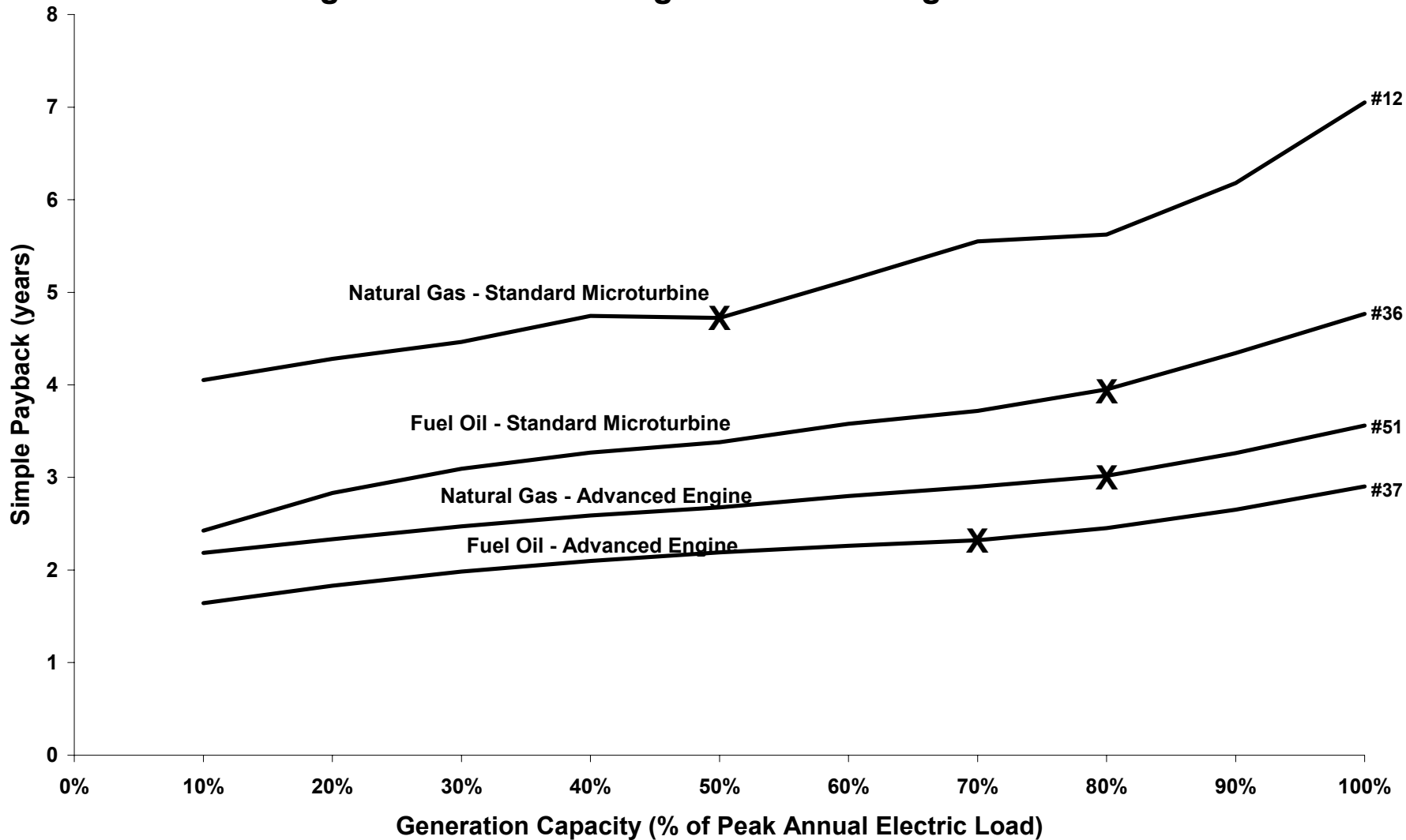

“X” denotes the economic optimum, as detailed in Section 6.6 and Figure 6-3. Numbers indicate computer run numbers (see Appendix G).

7. Summary and Conclusions

The key observations and conclusions from this analysis include:

- Electric generation efficiency is of primary importance for CHP installations. While lower generation efficiency means more waste heat to serve heating and cooling loads, the increase in heat available is less valuable than the lost electric output;
- Consistent with the above, the first-cost savings, maintenance-cost savings, and increased production of waste heat associated with eliminating the recuperator (or reducing its performance) in a microturbine will not offset the benefits lost by the resulting reduction in generation efficiency;
- An efficient CHP system can effect primary energy savings up to 30 percent or more;
- CHP systems using less-efficient generation technologies (such as microturbines) have modest impacts on primary energy consumption, ranging from a 3 percent savings to a 7 percent increase;
- Recovering heat from a microturbine can mean the difference between reducing primary energy consumption and increasing it;
- Typically, installation of the distributed generator accounts for 60 to 70 percent of the capital costs of installing a CHP system. The remaining 30 to 40 percent is for the absorption cooling equipment, heat-recovery heat exchanger, and ducting/piping, controls, and other balance-of-plant components;
- Based on analysis of a New York Large Office Building, CHP provides higher energy savings and similar payback periods relative to a power-only DG system. Since CHP provides higher annual returns and a similar payback period, CHP will be more economically attractive than DG;
- For a Large Office Building with an advanced engine CHP system, current utility rate structures, the analysis assumptions documented herein, and assuming five years is an acceptable payback period, the economics of CHP are poor in Phoenix and Miami (over 15 year paybacks), questionable in Chicago (5 to 7 year paybacks), and very good in New York and Los Angeles (1 to 3 year paybacks);
- CHP system operating costs per kWh generated are often close to the electric *energy* charge (excluding demand charges) avoided. Therefore, small changes in operating costs or energy charges can have significant impacts on the frequency with which the CHP system is operated, which, in turn, can have significant impacts on energy savings;
- For a New York Large Office Building, only about 65 percent of the CHP-system waste heat (excluding latent heat) is suitable for recovery due to temperature requirements for heating and cooling and/or to avoid condensation in exhaust gases (for microturbines);
- For a New York Large Office Building, without using thermal or electric storage, or load-shifting strategies, CHP systems can utilize between 30 and 45 percent of the total waste heat (or between 50 and 70 percent of the recoverable heat), excluding latent heat;

- The value of using waste heat to supply cooling loads varies with the efficiency of the electric cooling equipment that is displaced. However, using waste heat for cooling is similar in value to using waste heat for heating (assuming that the displaced heating equipment is fuel fired);
- The water-heating loads of the prototypical buildings studied may under represent typical water-heating loads for these building types. A parametric study of the impact of water-heating loads is warranted;
- Demand charges complicate the operating strategy for CHP systems, since they necessitate making detailed projections of the building load profile for the entire month;
- Demand charges also can mean large negative impacts of unscheduled outages of distributed generators;
- Economically optimized CHP systems can be quite large – often having generation capacities in the range of 50 to 80 percent of the annual peak electric load for the baseline building; and
- Based on our analysis, economically optimized CHP systems will generally have capacity factors ranging from 40 to 70 percent for the generator and 10 to 50 percent for the absorption cooling plant. Since we sized the absorption plant to handle the waste heat available at full output of the generator, the absorption plant may, in some cases, be larger than the true economic optimum.

8. Next Steps

Appendix H includes a letter report documenting the scope and approach recommended for Phase 2. Also included are recommended additional refinements to the Phase 1 analysis that are not included in the recommended Phase 2 scope.

Appendix A: System Schematics

The waste heat from the microturbine provides heat for an absorption chiller and a hot-water HTX.

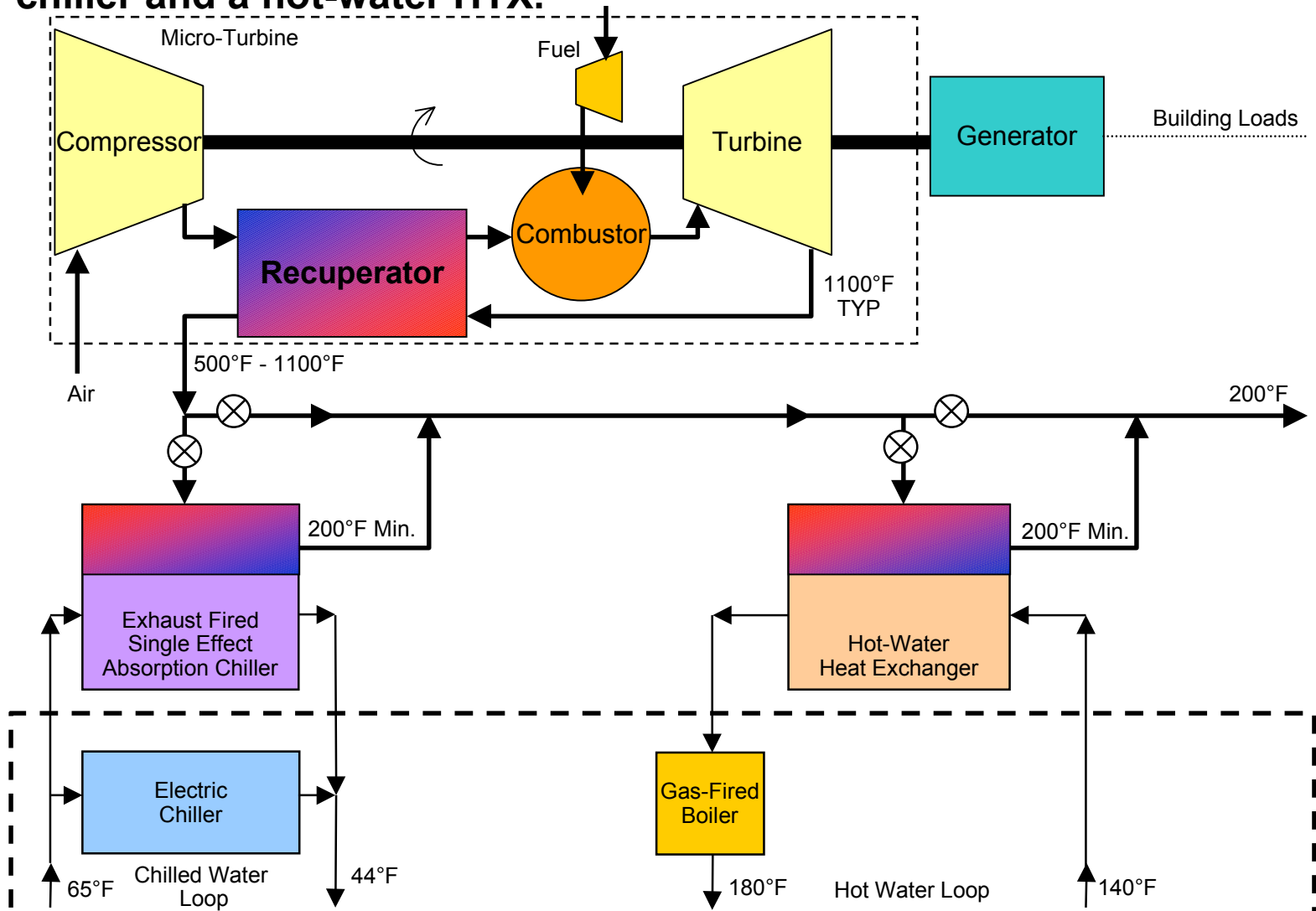

The waste heat from the engine is recovered and drives a single-effect absorption chillers and provides heat to a hot-water heat-exchanger.

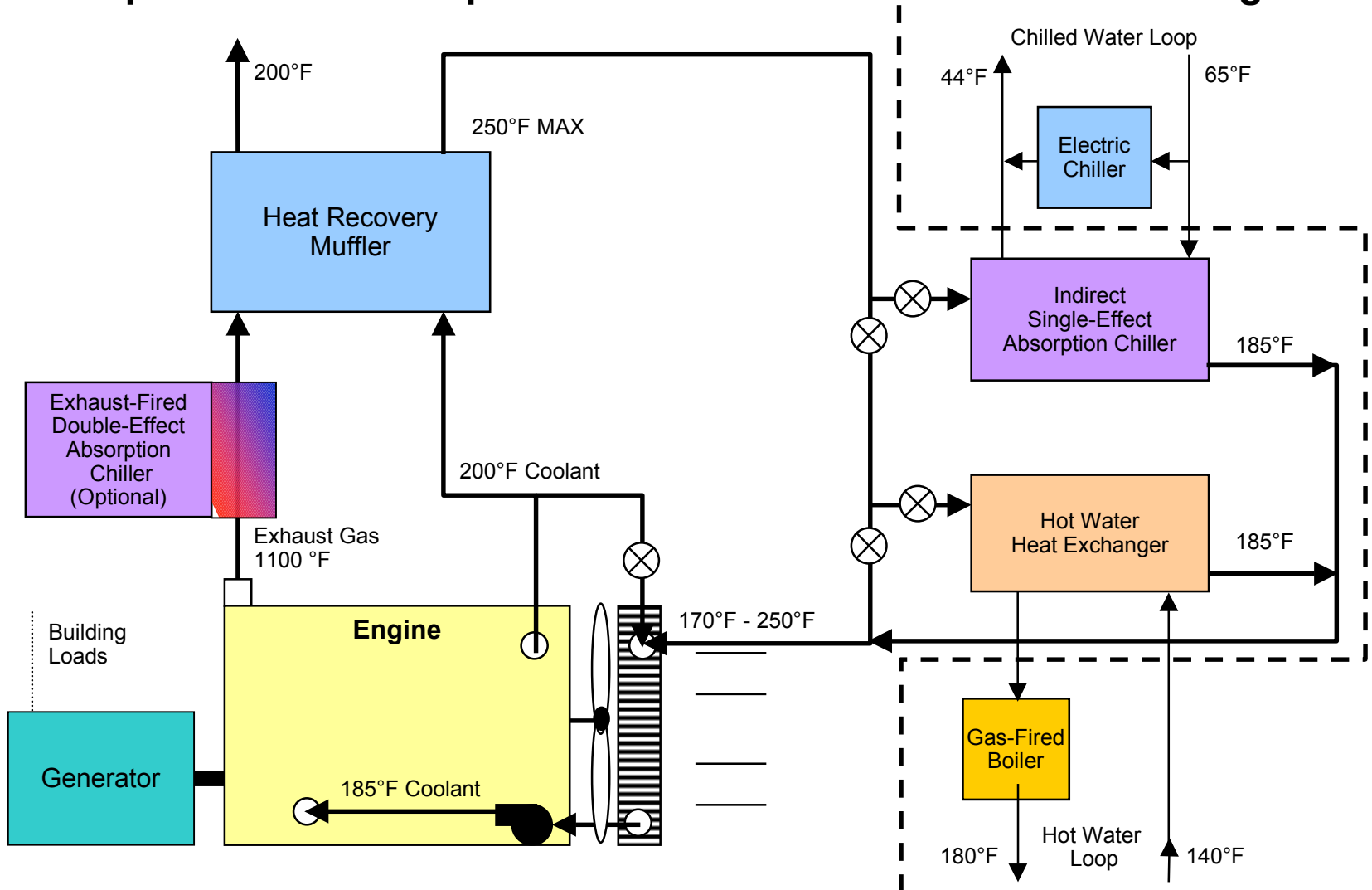

The cooling loop of a high-temperature PEM fuel cell could drive a single-effect absorption chiller and provide heat for hot water.

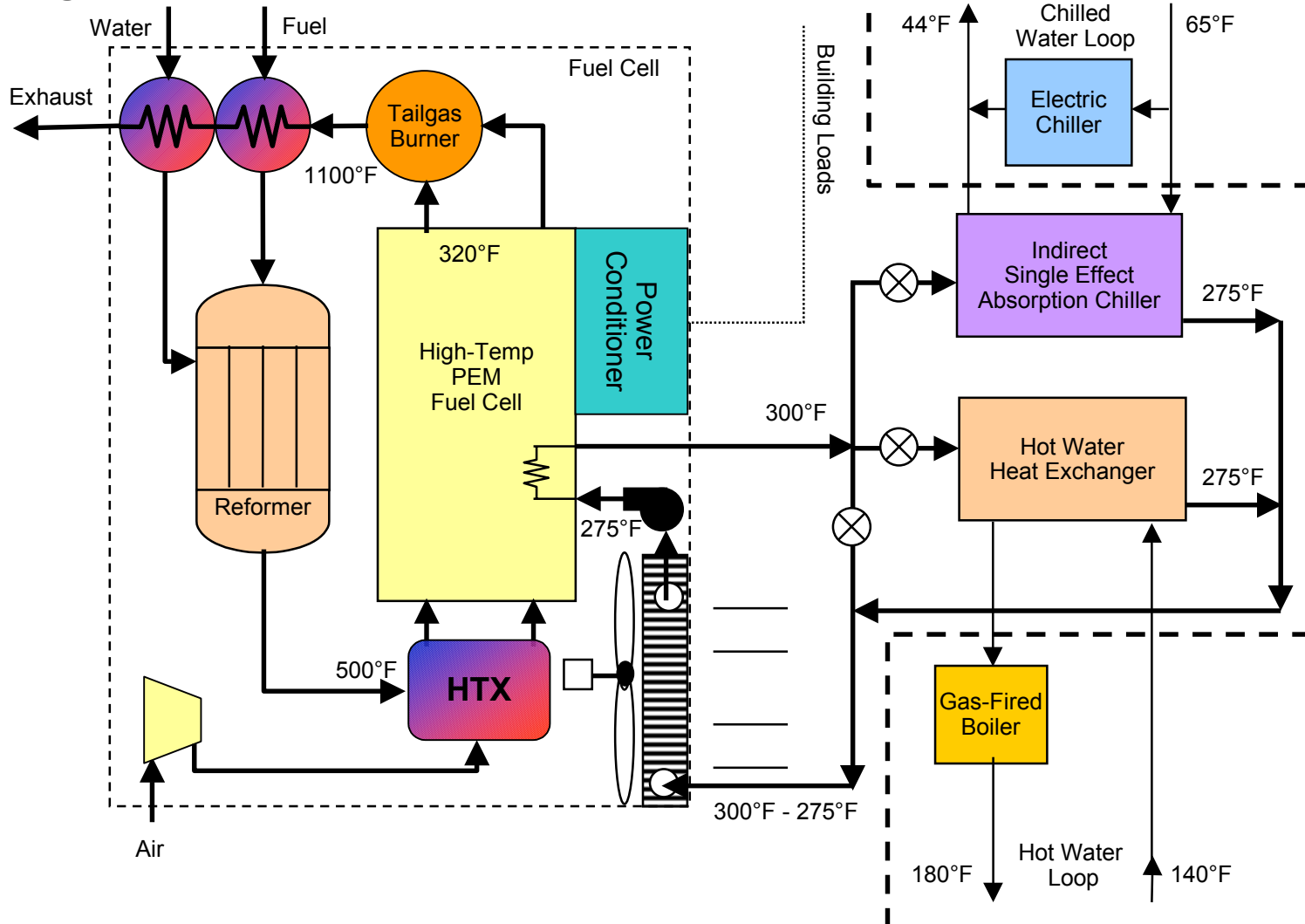

Appendix B: Microturbine Recuperator Cost-Efficiency Optimization

The Statement of Work for Task 3 in the Subcontract calls on Arthur D. Little to define three microturbine recuperator design strategies that “offer performance and cost tradeoffs.” Essentially, it suggests that a less-effective microturbine recuperator may result in a more economical *CHP for Buildings* system than would a highly effective recuperator. **The results presented here suggest that a less-effective recuperator will not be more cost-effective than a highly effective recuperator.** Therefore, we suggest that only a highly effective recuperator (85% effectiveness for example) should be considered in any further analysis. We reach this conclusion after presenting background information on microturbine recuperators, establishing three recuperator design strategies with performance and cost information, and simulating the economics of a *CHP for Buildings* system in a prototypical New York City hospital. In this evaluation, we used estimates and assumptions that tend to favor the no-recuperator and less-effective-recuperator design strategies. Therefore, it is unlikely that further refinements of the evaluation will change the conclusion.

Background on Microturbine Recuperators

Recuperators recover heat in the exhaust of a microturbine by transferring it to the microturbine’s combustion air (after the air compressor and before the combustion chamber). Microturbines designed for generation only (without heat recovery) require highly effective recuperators to maximize generation efficiency and minimize the heat rejected to the ambient air via the exhaust gas.

The costs (initial and O&M) of a highly effective recuperator are significant because it is designed to operate in the high-temperature, high-pressure, and highly corrosive environment of the exhaust gas. One might therefore propose that a microturbine in a *CHP for Buildings* system with a less-effective recuperator, or without a recuperator, is more economical than one with a highly effective recuperator (since exhaust heat can be utilized effectively for space cooling and heating, instead of preheating the combustion air). We begin to check the above claim by first establishing performance and cost information for three possible recuperator design strategies.

Three Recuperator Design Strategies

With input from Oak Ridge National Laboratory, Arthur D. Little selected the three recuperator design strategies suggested in the Subcontract’s Statement of Work:

- 85% effective recuperator (typical of existing microturbine technology)
- 50% effective recuperator (hypothetical, lower cost design)
- No recuperator

Using a “bottom-up” cost model developed by Arthur D. Little, we calculated the cost of manufacturing a conventional plate-fin-type recuperator for a 50kW microturbine. The model considers material costs (347 stainless steel, brazing alloy, etc.), processing costs, and labor. While microturbine manufacturers may use a primary-surface-type recuperator (instead of a plate-fin type), the costs will be on the same order of

magnitude²³. Figure 1 shows the cost/effectiveness tradeoff of a conventional microturbine recuperator.

Figure 1: Recuperator Cost/Effectiveness Tradeoff

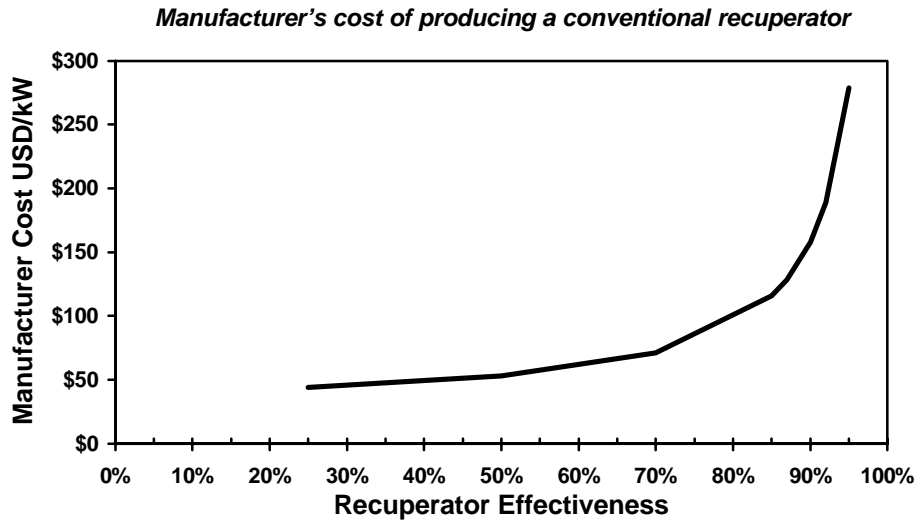

Based on Arthur D. Little cost model for 50kW microturbine with 10,000-unit annual production.

The cost of the 85% effective recuperator, for the purposes of this report, is taken directly from Figure 1 (\$116/kW). Figure 1 also indicates that a 50% effective recuperator has a manufactured cost of \$53/kW. However, consistent with our approach of using estimates that favor the no-recuperator and less-effective-recuperator design strategies, we assumed that a lower-cost design could be developed to reduce this cost to \$40/kW (a 25-percent reduction). *We are unaware, however, of any design approach that could achieve this cost reduction.*

Table 1, below, shows the combined microturbine cost for each recuperator design. We have assumed that installation costs increase in proportion to manufactured cost. While actual installation costs may increase only slightly as manufactured costs increase, this assumption is consistent with our approach of using estimates that favor the no-recuperator and less-effective-recuperator design strategies. Table 2 shows the estimated O&M cost for each recuperator design.

²³ "A 'Primary Surface Heat Exchanger' is conceptually similar to a plate-fin design, but is fabricated by stamping an intricate surface topology into a single piece of sheet metal." Based on previous study by Arthur D. Little

Table 1: Microturbine Installed-Cost Estimates

	(US Dollars per kW)		
	85% Recuperator	50% Recuperator	No Recuperator
Recuperator	\$116/kW	\$40/kW	\$0
Power Conditioning	\$129/kW	\$129/kW	\$129/kW
Balance of Microturbine	\$175/kW	\$175/kW	\$175/kW
Profit Margin (40%)	\$168/kW	\$138/kW	\$122/kW
Installation	\$293/kW	\$293/kW	\$293/kW
Total Installed Cost	\$880/kW	\$775/kW	\$718/kW

Based on Arthur D. Little's cost model for a typical 50kW microturbine, 40% gross profit margin, fixed installation cost (including delivery and permitting), and 10,000-unit annual production. "Balance of Microturbine" includes compressor/expander, PM alternator, combustor, microturbine housing, chassis/enclosure, fuel compressor, and balance of plant.

Table 2: Microturbine Non-Fuel O&M Cost Estimates

	(US Cents per kWh)		
	85% Recuperator	50% Recuperator	No Recuperator
Recuperator	0.86¢/kWh	0.30¢/kWh	0¢
Balance of Microturbine	0.25¢/kWh	0.25¢/kWh	0.25¢/kWh
Down-time and labor	0.40¢/kWh	0.40¢/kWh	0.40¢/kWh
Total O&M Cost	1.51¢/kWh	0.95¢/kWh	0.65¢/kWh

Based on Arthur D. Little's cost model for 50kW microturbine, 20,000-hour component lifetime, 80% load factor, and 10,000-unit annual production. The 50% recuperator O&M cost is estimated by scaling the O&M cost of the 85% recuperator according to the ratio of their initial costs. "Balance of Microturbine" includes the other hot-side components (compressor/expander and combustor), only.

Economics of a CHP for Buildings system in a prototypical New York Hospital

To demonstrate the economics of a *CHP for Buildings* system for each of the three microturbine/recuperator designs, we present performance and cost results for a prototypical hospital in New York City. Consistent with our approach to this evaluation, the New York hospital is expected to give the "advantage" to the no-recuperator and less-effective-recuperator design strategies because the large thermal loads associated with a hospital in a northern climate will help the *CHP for Buildings* system utilize the extra waste heat these design strategies produce.

Table 3 summarizes the properties of the prototypical New York hospital. Table 4 shows the performance of a single-effect steam-fired absorption chiller and a conventional reciprocating electric chiller. While most hospitals likely use higher-performance centrifugal chillers, the relative performance of the three recuperator designs will be the same with a reciprocating chiller and a centrifugal chiller.

Table 3: Prototypical Hospital in New York City

	New York Hospital
Floor Area	386,000 square feet
Number of Floors	7
Peak Electric Load	1,903 kW
Annual Electric Consumption	9,900 MWh
Peak Cooling Load	1,166 tons
Annual Cooling Consumption	22,000MMBtu
Peak Heating Load	11 MMBtu per hour
Annual Heating Consumption	16,000 MMBtu

Sources: Huang, et. al. 481 Prototypical Commercial Buildings for Twenty Urban Market Areas. 1990. Lawrence Berkley National Laboratory.

Table 4: Chiller Performance

	Absorption Chiller	Electric Chiller
Chiller Efficiency	0.7 (COP)	0.66 kW/ton
Cooling Tower Efficiency	0.25 kW/ton	0.13 kW/ton
Steam Activation Temperature	200°F	not applicable

Source: Cooling, Heating & Power Comparison Excel worksheet (updated March 29th, 2001) sent to ADL by ORNL on 8/23/01. Absorption chiller is single-effect steam-fired type. Electric chiller is water-cooled (average performance of best-available reciprocating [0.84-kW/ton] and best-available centrifugal [0.47-kW/ton]).

The performance of the *CHP for Buildings* system in the prototypical New York hospital is determined by ADL's preliminary performance model. The model performs an hourly simulation using building load and weather data to output annual primary energy consumption. The model uses a simplified control strategy that first runs the microturbine to meet any electric demand up to its rated capacity and purchases electricity from the grid to meet any remaining demand. Then it uses the exhaust heat to meet any cooling load (excess cooling load is met by purchasing electricity from the grid to run the electric chiller). Finally, it uses any remaining exhaust heat (down to a minimum exhaust temperature of 200°F) to meet space heating load and service water heating load (excess heating load is met by purchasing gas from the grid to run an 81%-LHV efficient boiler). The performance estimates of each microturbine design are shown in Table 5.

Table 5: Microturbine Performance

	85% Effective Recuperator	50% Effective Recuperator	No Recuperator
Generation efficiency	24%	20%	16%
Exhaust temperature	528°F	735°F	1,045°F

Sources: Arthur D. Little's preliminary *CHP for Buildings* performance model.

Figure 2 shows the performance results of the *CHP for Buildings* system for the three recuperator design strategies. The plot displays the primary energy savings of the *CHP for Buildings* system (versus the conventional system) as a function of generation capacity. It is clear that the 85% effective recuperator design performs significantly better than the other two recuperator designs.

Figure 2: Performance of a *CHP for Buildings* system

Installation in New York hospital

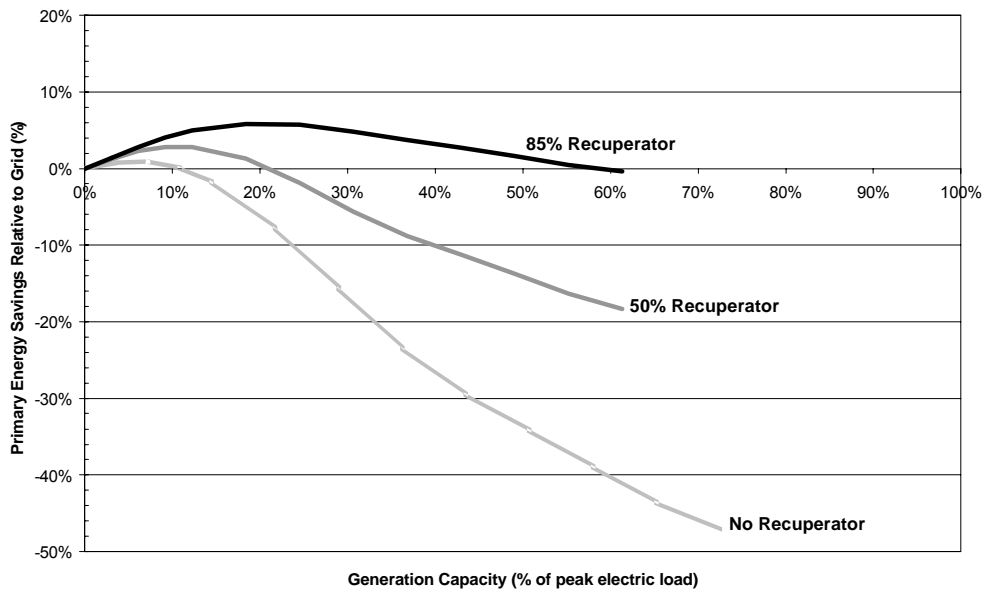

Source: Arthur D. Little's preliminary *CHP for Buildings* performance model.

The preliminary performance analyses presented here are intended for comparison of the recuperator options only.

The costs of the *CHP for Buildings* system include installed cost and operating costs (gas, electricity, and O&M). The installed cost estimate used the microturbine cost data from Table 1, and Table 6 shows the costs of the chillers. Without more detailed information on *CHP for Buildings* system plant costs, we roughly estimate a “balance of

plant” cost at 100/kW (of generation capacity). The resulting installed cost of the *CHP for Buildings* system in the New York hospital is illustrated in Figure 3.

Table 6: Chiller Installed Cost Estimates

	Absorption Chiller	Electric Chiller
Chiller Cost	\$300/ton	\$200/ton
Installation Cost	\$150/ton	\$100/ton
Cooling Tower Premium	\$50/ton	--
Total Cost	\$500/ton	\$300/ton

Arthur D. Little estimates. Regardless of how much absorption chilling is available, the conventional chillers are sized to meet full cooling capacity. Installation cost is estimated as 50% of the chiller cost. The cooling tower premium is the cost of additional cooling tower capacity needed for the absorption chiller compared with the electric chiller.

Figure 3: Installed Cost of *CHP for Buildings* system

Installation in New York hospital

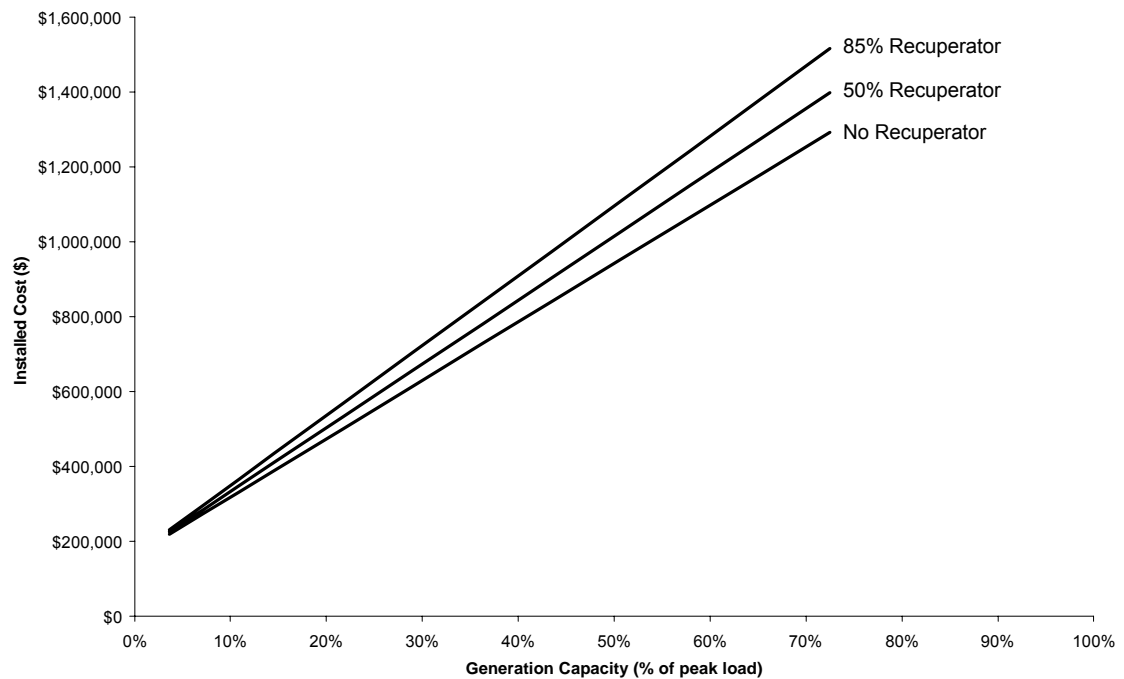

Source: Arthur D. Little's preliminary CHP for Buildings performance model.

The annual operating cost consists of O&M costs, natural gas costs, and electric costs. Table 2 gives the O&M cost for the microturbine while Table 7 gives the O&M costs for the chillers. We estimated electric and natural gas costs using constant energy rates

of \$0.08/kWh and \$5/MMBtu respectively. The resulting annual operating cost of the CHP for Buildings system in a New York hospital is illustrated in Figure 4.

Table 7: Chiller Non-Fuel O&M Cost Estimates

	Absorption Chiller	Reciprocating Chiller
Total Annual O&M Cost	\$15/ton	\$20/ton

Source: Based on Arthur D. Little's discussion with chiller manufacturers (service contract rates).

Figure 4: Annual Operating Cost of CHP for Buildings system

Installation in New York hospital

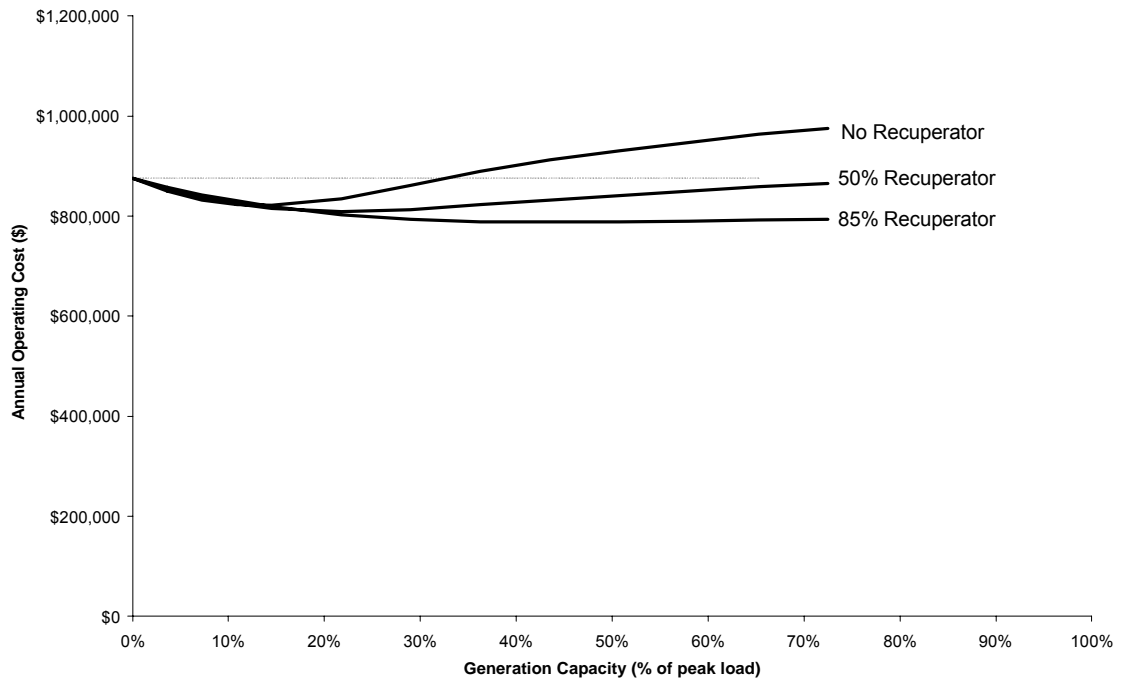

Source: Arthur D. Little's preliminary CHP for Buildings performance model.

Comparing Payback Periods

With installed costs and annual operating costs defined for the three recuperator design strategies, we used a simple payback analysis to illustrate the relative economics of the three design strategies.

The simple payback period is calculated using the following equation:

$$Payback(\text{years}) = \frac{InitialCost_{CHP \text{ for Buildings}} - InitialCost_{Conventional}}{AnnualOperatingCost_{Conventional} - AnnualOperatingCost_{CHP \text{ for Buildings}}}$$

Figure 5 illustrates the resulting payback periods for each of the three recuperator designs. We see that an 85% effective recuperator is the most economical choice, except for very low generation capacities where the 50% effective recuperator design offers marginal economic benefit. Noting that our assumptions throughout this evaluation were deliberately biased in favor of the “no recuperator” and 50% effective recuperator designs, the marginal economic benefit of the 50% effective recuperator at small generation capacities will likely disappear in a more rigorous analysis. ***The economic analyses presented in this report are intended for comparison of the recuperator options only.***

Figure 5: Payback Period of a CHP for Buildings system

Installation in New York hospital

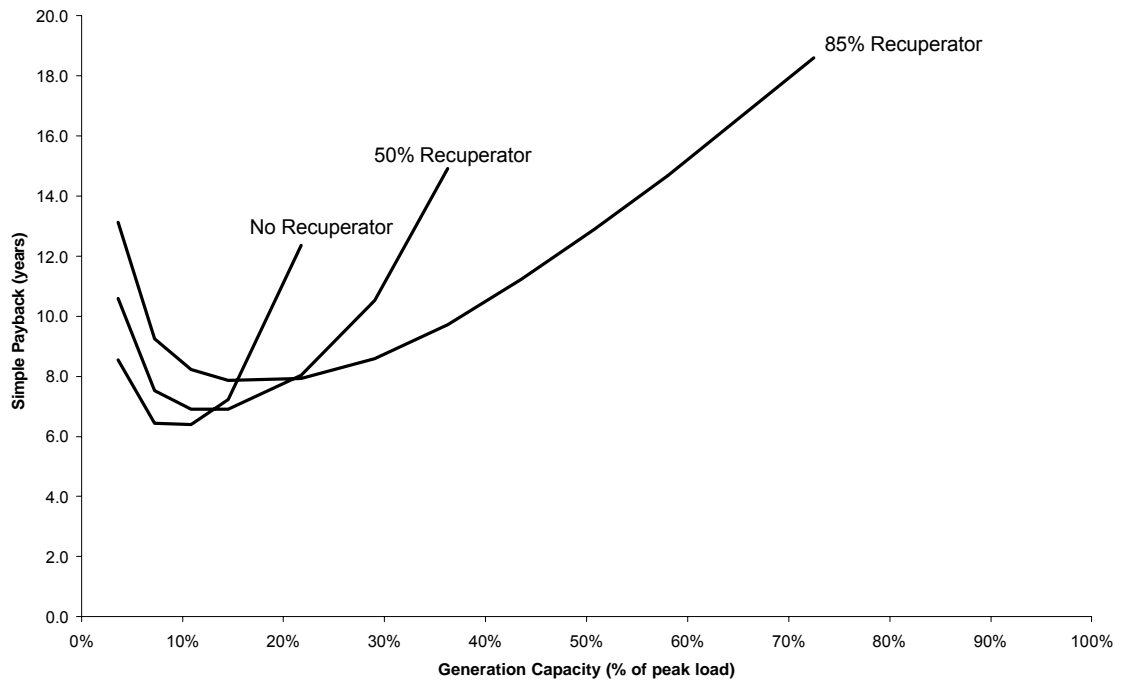

Source: Arthur D. Little's preliminary CHP for Buildings performance model.

The preliminary economic analyses presented here are intended for comparison of the recuperator options only.

Appendix C: Structure of Detailed Analytical Model

The model consists of three major objects: a building object, a utility object, and the BCHP System object. The BCHP serves the building loads while the utility provides the fuel and energy required by the BCHP system. Statepoint objects are common to the model's objects and transfer load and energy information between objects. The statepoints contain the thermophysical information required to represent the loads (fluid type, mass, temperature, etc.). The exception is power, which is referenced through the objects' public variable.

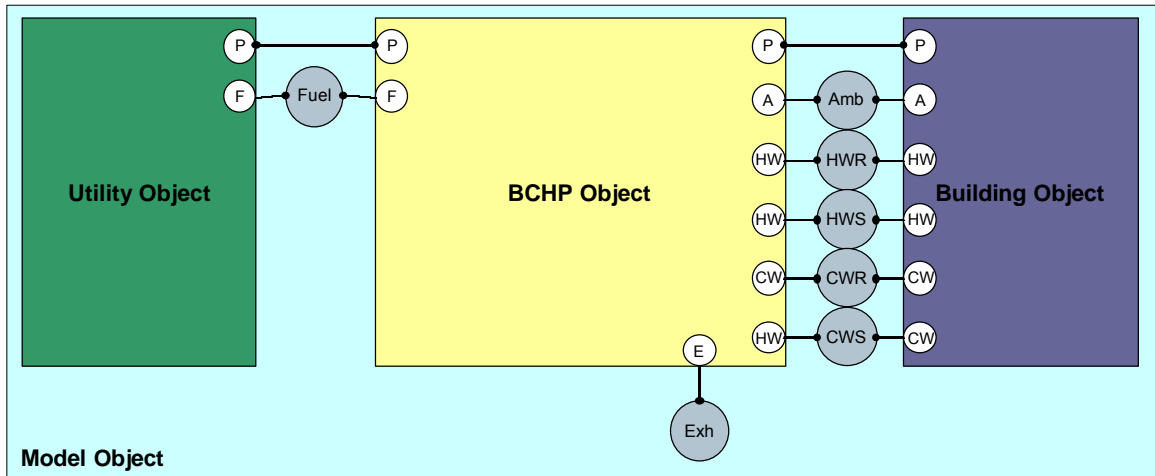

Figure 1 Model Object

When the model object is created, the utility rate structure, building location, building type, generation technology, cooling technology, heating technology, and control type are all specified. The model creates the statepoint objects (used to connect the objects), utility object, BCHP object, and building object as shown in Figure 2. The model object then connects each object to the appropriate statepoints. Once the objects are created and initialized, the model then begins the yearlong, hour-by-hour simulation of the BCHP system.

system and the utility object). In addition, the cost of the energy supplied to the BCHP system is calculated.

Once the model has determined the solution for each hour of the month, the utility object will calculate the energy cost, demand cost, and fuel cost for each hour of the month. Similar to the simulation, the cost of energy ($E\$$) is calculated as:

$$E\$ = \sum_n \dot{E}_n \cdot P_n$$

where,

n = hour of the month,

\dot{E} = energy rate, and

P = power delivered to BCHP.

The demand cost ($D\$$) is calculated by determining the maximum power delivered during any single hour of the month and multiplying that amount by the demand rate:

$$D\$ = \dot{D} \cdot \max(P_n)$$

where,

n = hour of the month,

\dot{D} = demand rate, and

P = power delivered to BCHP.

As with the energy cost, the cost of fuel ($F\$$) is calculated as:

$$F\$ = \sum_n \dot{F}_n \cdot mf_n$$

where,

n = hour of the month,

\dot{F} = fuel rate, and

mf = mass flow of fuel to BCHP.

The monthly cost of energy, the demand cost, and cost of fuel is stored by the utility object for later retrieval.

The building object provides the loads the BCHP system needs to satisfy. For every hour of the year, the heating, cooling, and power loads are calculated by the building object. The loads are transferred to the BCHP system through the statepoints that are common to the building and BCHP system.

The building loads are generated from the building load database maintained by the building object. When the building object is created, the database is loaded and the records corresponding to the specified location and building type are selected. The building object uses the selected records to calculate the loads for each hour of the simulation. During the initialization of the building object the return and supply temperatures of the chilled and hot water lines are specified. The temperatures are held constant throughout the simulation, with the mass flow of the water varying with load.

For every hour of the year, the database contains values for the:

- Ambient dry-bulb temperature (°F),
- Ambient wet-bulb temperature (°F),
- Non HVAC Electric Load (kW)
- Heating coil load (Btu/hr),
- Service Water Load (gallons/hr),
- Sensible Cooling Load (Btu/hr), and
- Latent Cooling Coil Load (Btu/hr).

During the simulation, the model calls the building object with the current month, date, and hour. The mass flow (m) of the supply and return chiller water statepoints is calculated by:

$$m = \frac{Q_{sensible} + Q_{latent}}{Cp \cdot (T_{return} - T_{supply})}$$

where,

$Q_{sensible}$ = sensible cooling load from database,

Q_{latent} = latent cooling load from database,

Cp = specific heat of water (constant),

T_{return} = return (to the BCHP) temperature of the chilled water, and

T_{supply} = supply (to the building) temperature of the chilled water.

Similarly, the mass flow of the supply and return hot water statepoints is calculated as:

$$m = \frac{Q_h + Q_{sw}}{Cp \cdot (T_{supply} - T_{return})}$$

where,

Q_h = heating coil load from database,

Q_{sw} = service water load from database (converted to Btu/hr)

Cp = specific heat of water (constant),

T_{supply} = supply (to the building) temperature of the hot water, and

T_{return} = return (to the BCHP) temperature of the hot water.

The electric load for the given hour comes directly from the non-HVAC electric load available in the database.

BCHP System Object

The BCHP object is comprised of three objects:

- A generation technology object,
- A cooling technology object, and
- A heating technology object.

The structure (and therefore solution logic) of the BCHP is dependent upon the type of generation technology. For those technologies that utilize the flue gas, as with the microturbine, the waste stream is utilized in series as shown in the figure on the left.

For technologies utilizing the thermal energy from a coolant loop (engines and the PEM fuel cell), the coolant loop is distributed in parallel between the cooling technology and heating technologies as shown in the figure on the right. In both cases, the cooling technology acts as the primary consumer of the thermal energy and the heating technology as the secondary consumer using the remaining thermal energy.

When the BCHP object is created, the specified generation technology, cooling technology, heating technology, and control object are created. During the creation process, the internal statepoints are also created. The statepoints are then connected as needed to provide the structure dictated by the generation technology.

The process the BCHP object uses to solve the BCHP system depends on whether the system utilizes the flue gas (serial solution), or utilizes the thermal energy through the coolant loop (parallel solution).

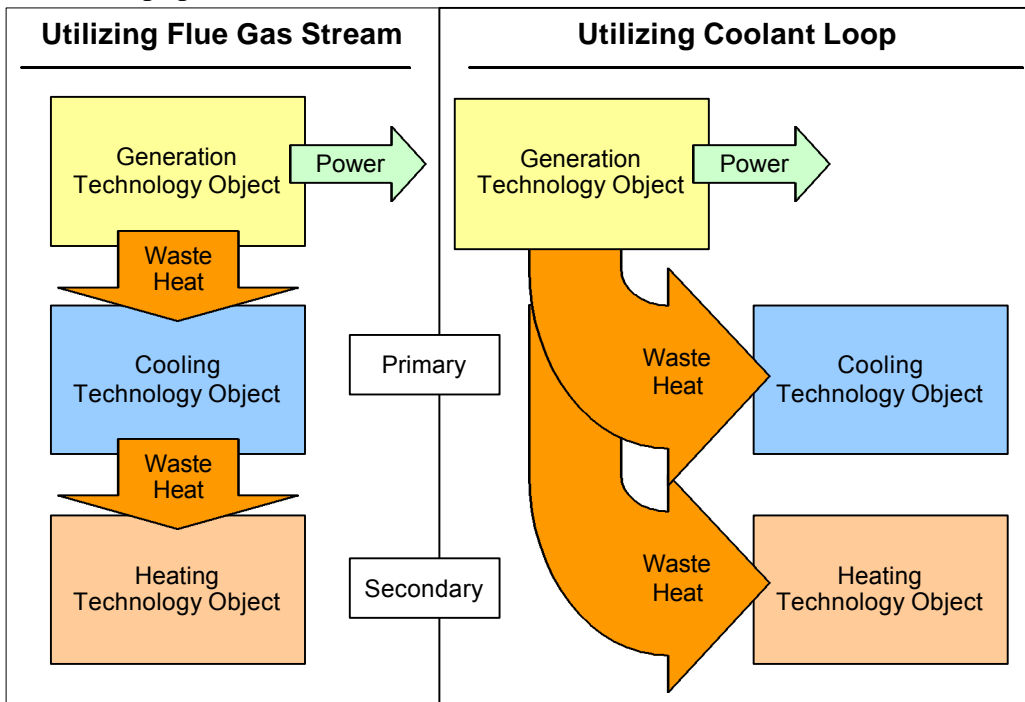

Figure 4 BCHP Utilization of Thermal Energy

BCHP Structure Utilizing Flue Gas

The structure of the BCHP that utilizes the flue gas from the generation technology is presented in Figure 5. The solution process of the BCHP object in this case is presented in Figure 6.

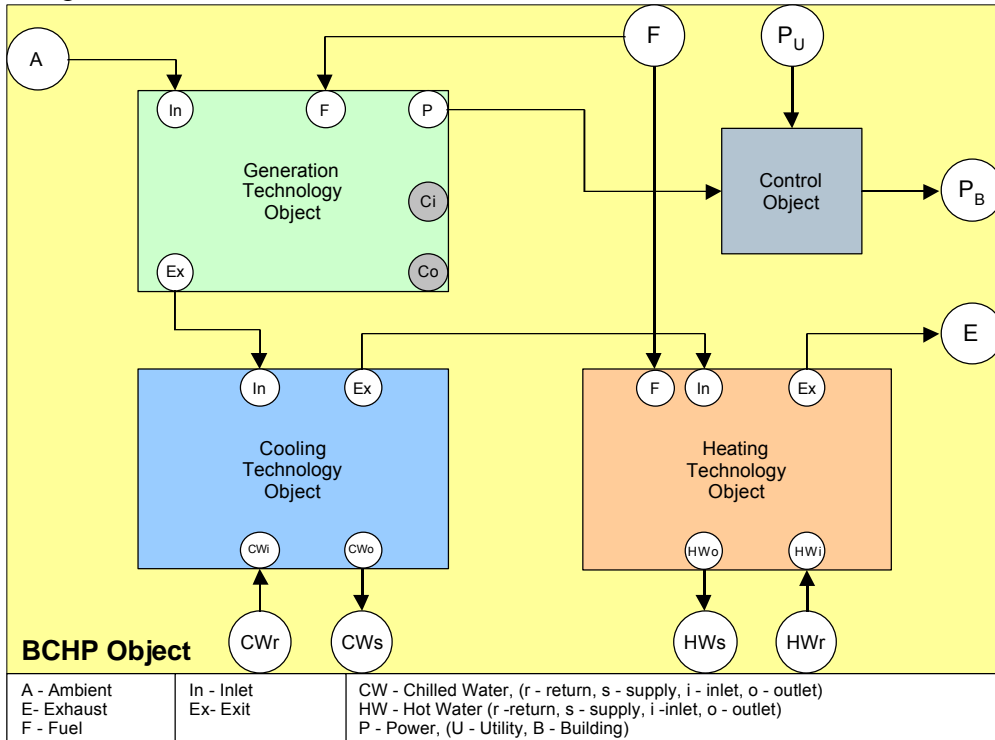

Figure 5 BCHP Structure Utilizing Flue Gas

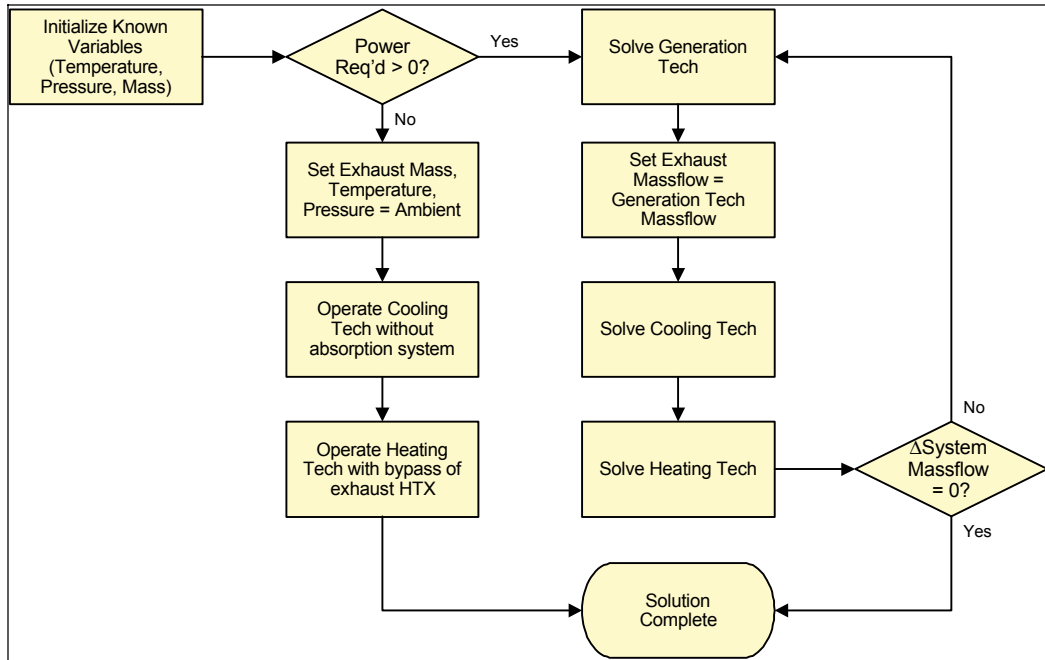

Figure 6 BCHP Solution Utilizing Flue Gas

BCHP Structure Utilizing Coolant Loop

The structure of the BCHP that utilizes the flue gas from the generation technology is presented in Figure 7. The solution process of the BCHP object in this case is presented in Figure 8.

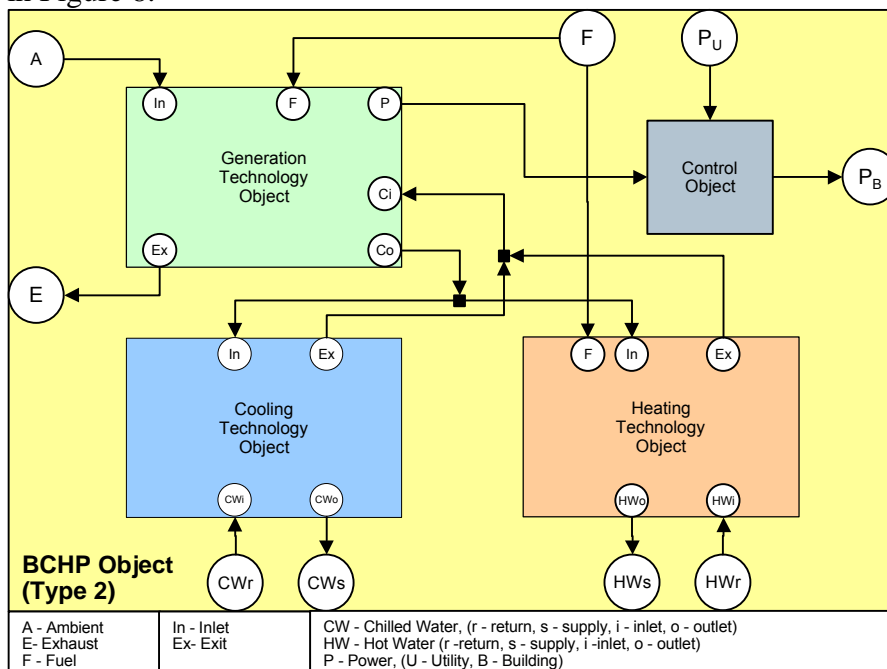

Figure 7 BCHP Structure Utilizing Coolant Loop

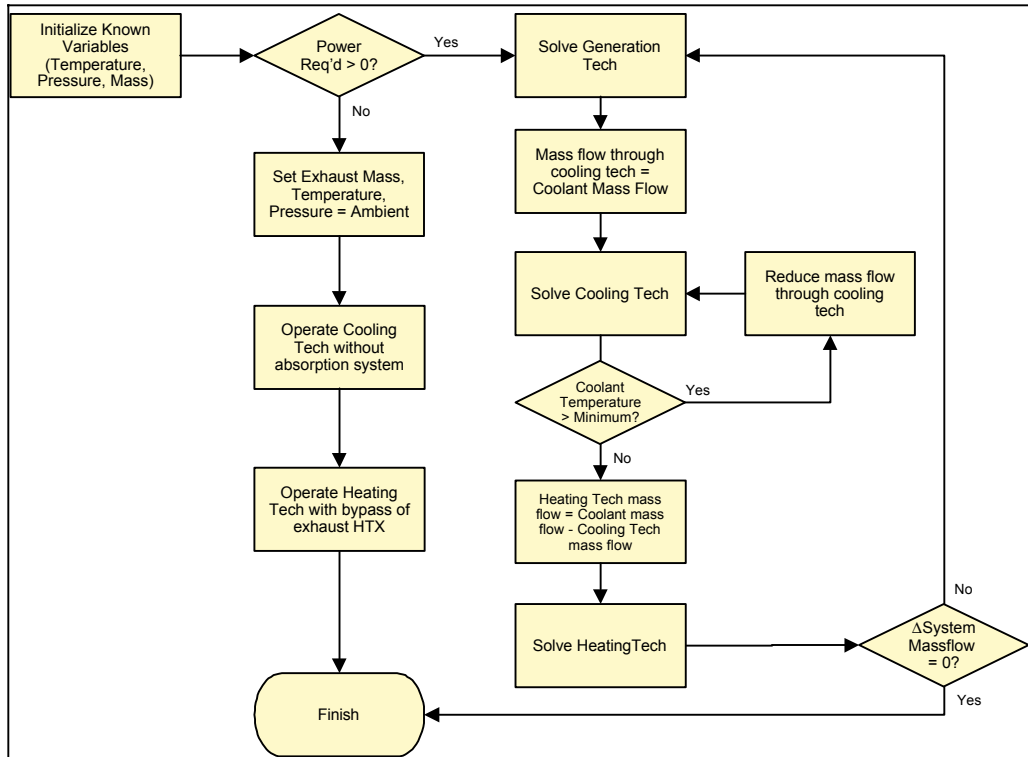

Figure 8 BCHP Solution Utilizing Coolant Loop

Generation Technology

There are four generic generation technologies: a microturbine, an engine, and a PEM fuel cell. A general description of each object and the solution process is discussed below.

Microturbine Object

The microturbine object's components include the compressor object (air and fuel), a heat exchanger object (recuperator), the combustor object, a turbine object, and a generator object as shown in Figure 9.

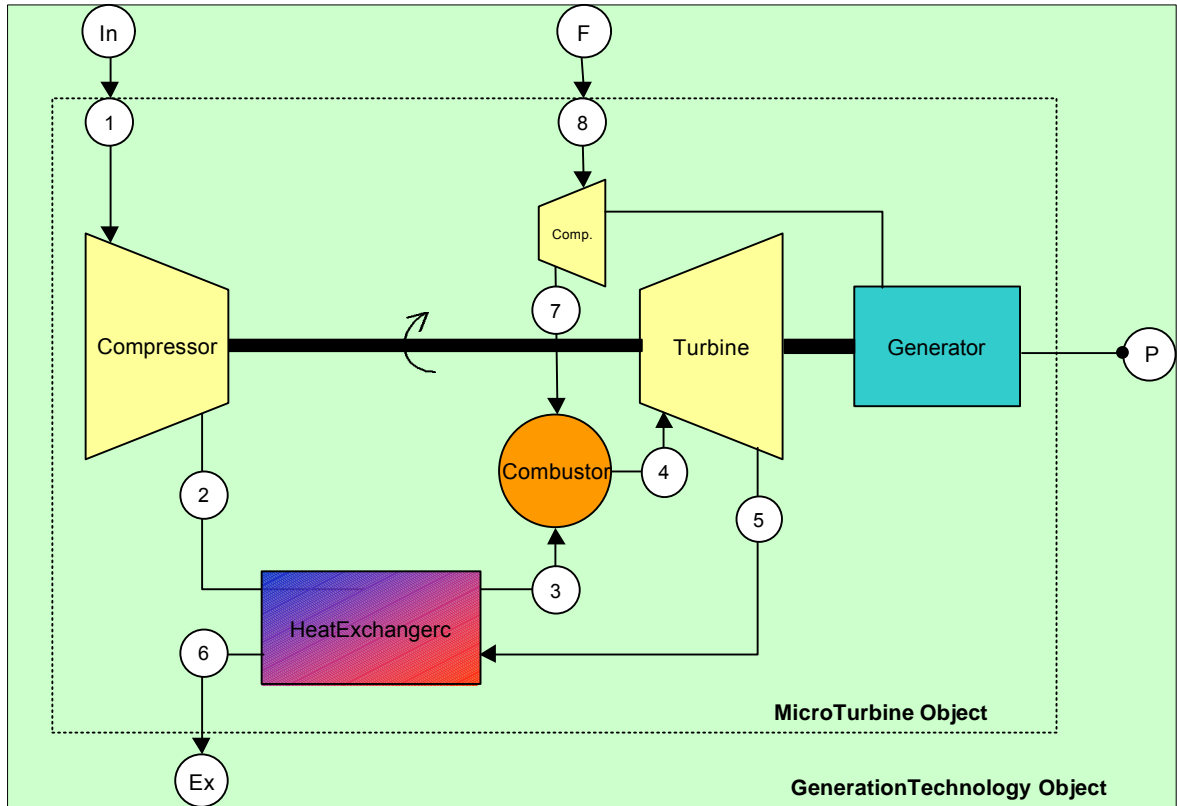

Figure 9 Schematic of Microturbine Object

The solution of the microturbine is dependent upon the power required by the BCHP System object, the ambient conditions, and the exhaust pressure (backpressure) of the turbine due to the pressure drops through the downstream pieces of equipment.

The solution proceeds as follows:

1. Calculate the pressure at each of the internal statepoints using the specified microturbine pressure ratio and the microturbine's exhaust pressure.
2. Determine the air-compressor shaft work and turbine work on per-lb-air basis using the compressor and turbine objects respectively. The turbine and compressor objects assume a constant isentropic efficiency.
3. Determine the outlet temperatures of the recuperator using the heat exchanger object. The exhaust temperature of the microturbine is determined at this step.
4. Determine the fuel mass flow on a per-lb-air basis using the combustor object and the fixed inlet temperature of the turbine.
5. Determine the fuel-compressor shaft work on a per-lb-air basis using the compressor object.
6. Determine the mass flow of exhaust air (m_{air}) through the microturbine using the following relationship:

$$m_{air} = \frac{W}{(w_t - w_c - w_{fc}) \cdot h_g}$$

where,

W = net work delivered by the microturbine to the BCHP system,

w_t = gross work of the turbine,

w_c = work required to operate the air compressor,

w_{fc} = work required to operate the fuel compressor, and

h_g = mechanical to electrical efficiency of generator equipment.

Engine Object

The engine object's components include the engine object (air and fuel), a generator object, and two heat exchanger objects (muffler and radiator).

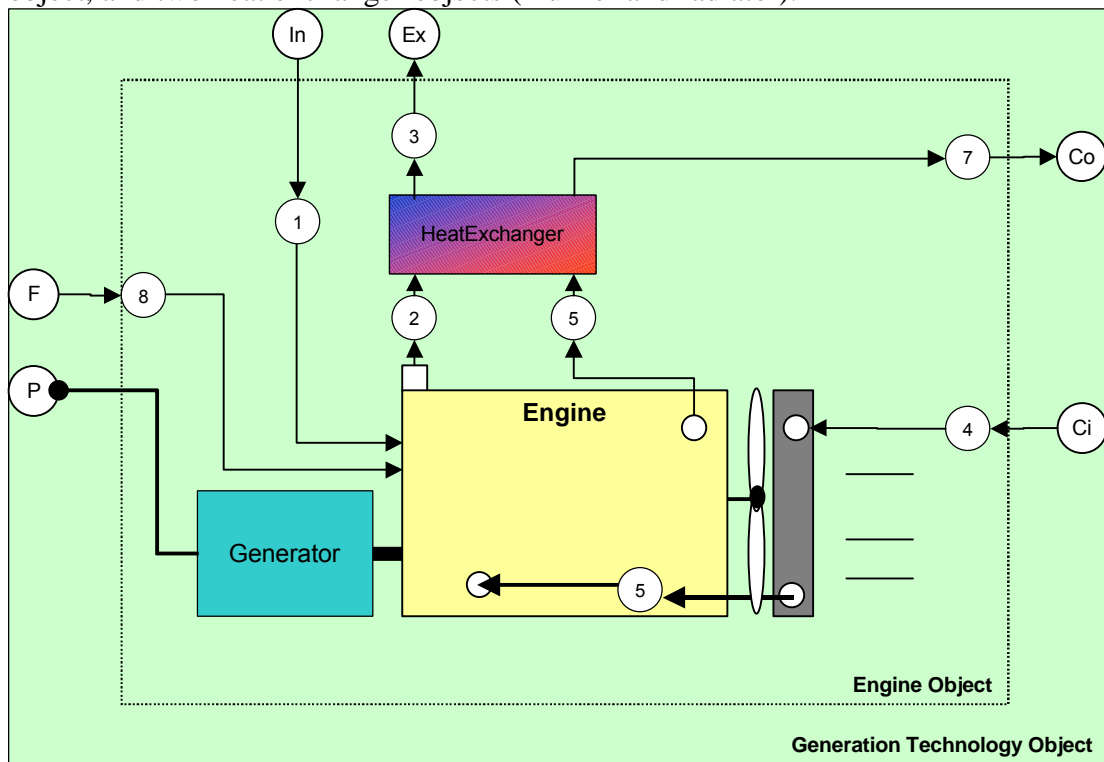

Figure 10 Schematic of Engine Object

The solution of the engine is simplified by assuming a constant thermal efficiency and a constant fuel-air ratio throughout the simulation. In addition, the amount of thermal energy transferred to the coolant loop and exhaust flow is held constant. As seen in the schematic of the engine object, some of the heat from the exhaust flow is also transferred to the coolant loop through the heat exchanger.

The solution proceeds as follows:

1. Initialize the incoming engine coolant temperature. This assumes we have a completely effective radiator that is capable of always bringing the temperature down to the minimum inlet temperature of the engine.
2. Determine the mass flow of the fuel (m_{fuel}) with the relationship:

$$m_{fuel} = \frac{W_{net}}{h_g \cdot LHV_{fuel}}$$

where,

W_{net} = net work output by engine/generator set

h_g = efficiency of generator set, and

LHV_{fuel} = lower heating value of the fuel.

3. Determine the mass flow of the air given the constant fuel-air ratio.
4. Determine the fraction of heat transferred to the coolant and the fraction transferred to the exhaust.
5. Determine the exhaust temperature of the engine given the inlet temperature.
6. Calculate the outlet temperature of the coolant from the engine. If the difference between the outlet temperature and inlet temperature exceeds the maximum allowable temperature difference then adjust the mass flow to satisfy the limit.
7. Determine the amount of heat transferred from the exhaust flow to the coolant flow through the exhaust muffler.

PEM Fuel Cell Object

The PEM fuel cell is not constructed using any other objects. Although the actual PEM fuel cell is comprised of many different components, the simplifying assumptions we used in the analysis did not warrant the creation of additional objects to represent the PEM fuel cell. The schematic and statepoint interfaces of the object are presented in Figure 11.

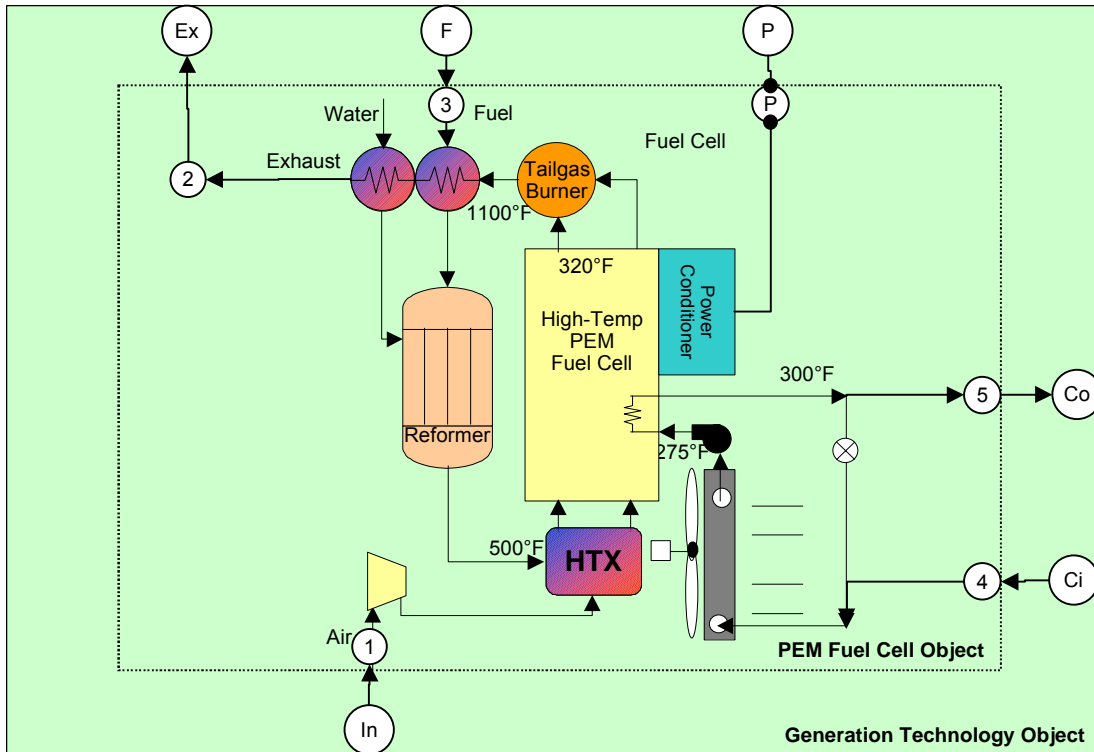

Figure 11 PEM Fuel Cell Object

The solution proceeds as follows:

1. Initialize the incoming coolant temperature. This assumes we have a completely effective radiator that is always capable of bringing the temperature down to the minimum inlet temperature of the fuel cell.
2. Determine the mass flow of the fuel (m_{fuel}) using the relationship:

$$m_{fuel} = \frac{W_{net}}{h_g \cdot LHV_{fuel}}$$

where,

W_{net} = net work output by fuel cell and power conditioning equipment,

h_g = efficiency of power conditioning equipment, and

LHV_{fuel} = lower heating value of the fuel.

3. Determine the mass flow of the air given the constant fuel-air ratio.
4. Determine the fraction of heat transferred to the coolant and the fraction transferred to the exhaust.
5. Determine the exhaust temperature of the fuel cell given the inlet temperature.
6. Calculate the outlet temperature of the coolant from the fuel cell. If the difference between the outlet temperature and inlet temperature exceeds the maximum allowable temperature difference then adjust the mass flow to satisfy the limit.

Cooling Technology

There are two objects within the cooling technology object, an absorption equipment object and an electric chiller object as shown in Figure 12. The cooling technology object will always satisfy the building's cooling load by using whatever waste energy is available and then using the electric chiller to supplement.

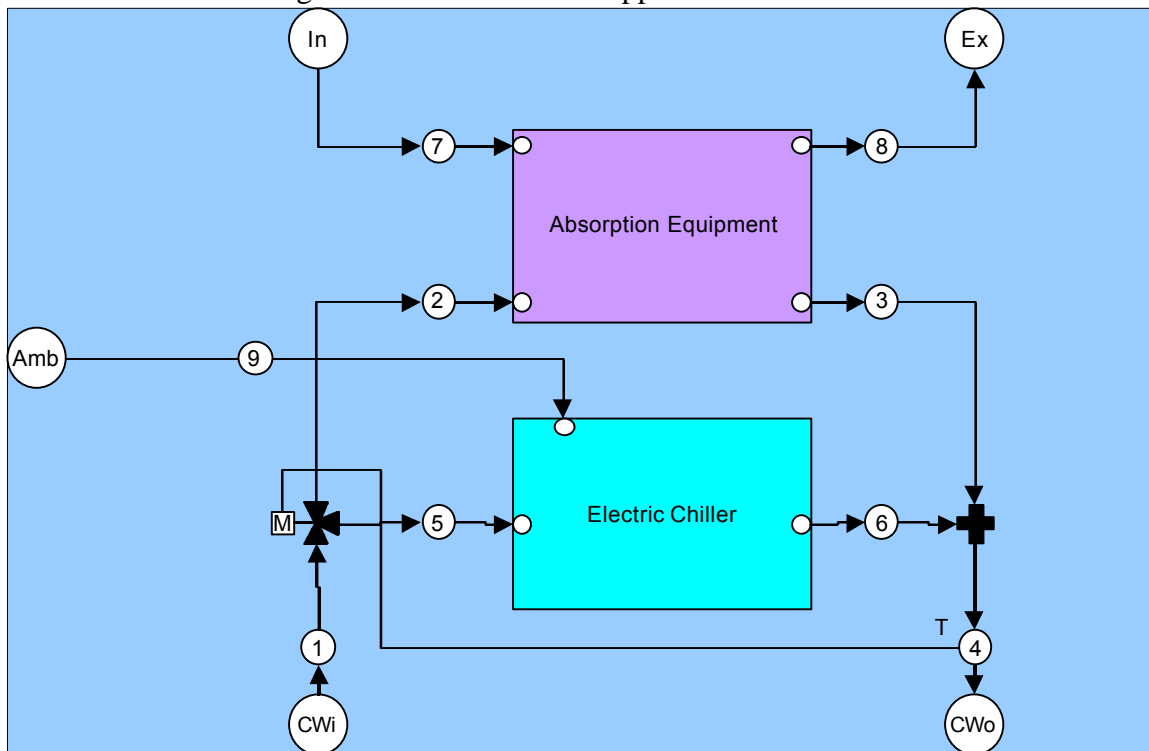

Figure 12 Cooling Technology Object

The solution proceeds as follows:

1. If there is no cooling load (because there is not any massflow at the chilled water inlet and outlet) then the exhaust statepoint (state 8 in the above figure) is the same as the inlet statepoint (state 7).
2. If there is a cooling load, but no mass flow at the inlet (state 7) and exhaust (state 8) statepoints then there is no thermal energy available to satisfy the load. The electric chiller satisfies the entire cooling load.
3. If there is a cooling load and there is thermal energy available then the absorption equipment object will produce chilled water. There are two possibilities:
 - a. The absorption equipment object is not able to entirely satisfy the cooling load:
 - i) In this case, the exhaust stream is reduced to the minimum allowable temperature (either the minimum temperature that will drive the absorption process or the minimum allowable exhaust temperature of the BCHP system).

- ii) The massflow of the coolant passing through the absorption system is reduced until the chilled water temperature leaving the absorption system is at the desired setpoint temperature.
- iii) The electric chiller object is used to chill the remainder of the coolant massflow to the desired setpoint temperature.
- b. The absorption equipment object satisfies the entire cooling load. The exhaust stream temperature is reduced just meet the cooling requirements of the cooling technology.

Heating Technology

There are two objects within the heating technology object, a heat exchanger object and a boiler object as shown in Figure 13. Like the cooling technology, the heating technology always satisfies the building's heating load by using whatever waste energy is available and then using the boiler to satisfy the temperature requirement.

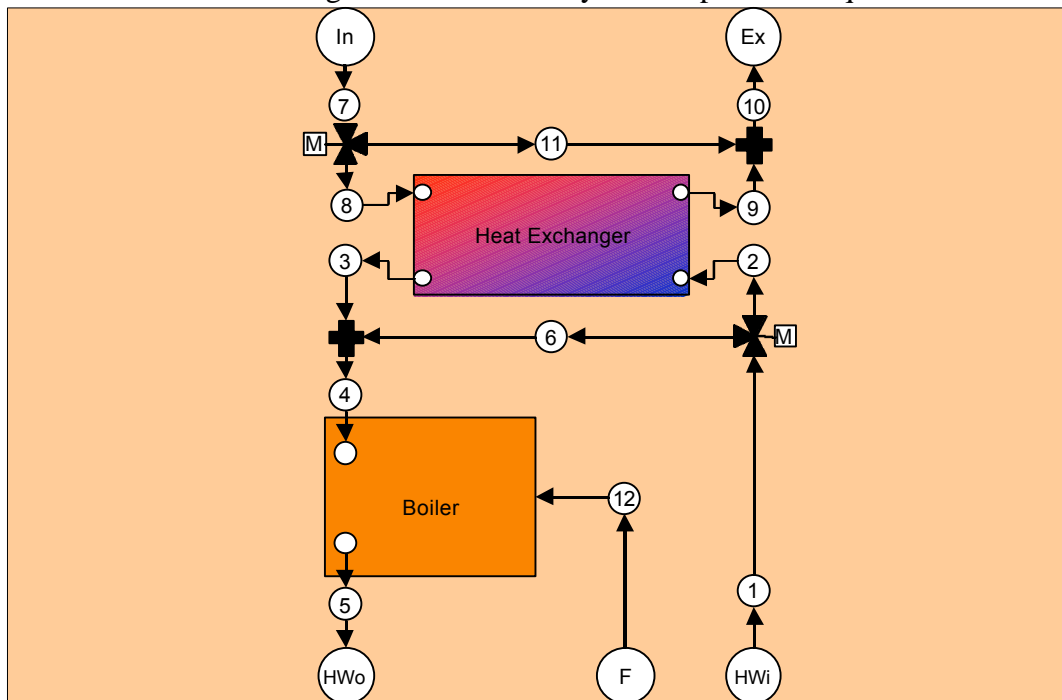

Figure 13 Heating Technology Object

The solution proceeds as follows:

4. If there is no heating load (because there is not any massflow at the hot water inlet and outlet) then the exhaust statepoint (state 10 in the above figure) is the same as the inlet statepoint (state 7).
5. If there is a heating load, but no mass flow at the inlet (state 7) and exhaust (state 10) statepoints then there is no thermal energy is available to satisfy the load. The boiler satisfies the entire heating load.
6. If there is a heating load and thermal energy available then the heat exchanger will heat as much water as possible. There are two possibilities:

- a. The heat exchanger object is not able to entirely satisfy the heating load:
 - i) In this case, the exhaust stream temperature is reduced to the minimum allowable exhaust temperature.
 - ii) The water temperature is raised as much as possible (but below the setpoint temperature).
 - iii) The boiler object heats the water to the desired setpoint temperature.
- b. There is more than enough thermal energy in the waste stream to heat all of the water.
 - i) In this case, the water is heated to the setpoint temperature.
 - ii) The exhaust temperature is reduced to satisfy the heating load.

Appendix D: Cost and Performance Estimates for CHP Components/Systems

The following table contains all the variable and constant inputs for the model segmented into six tables:

1. Common/Miscellaneous
2. Microturbines
3. Engines
4. Fuel Cells
5. Cooling Plant
6. Heating Plant

Table 1: Common / Miscellaneous		
Name	Value(s)	Description and Source
Stoichiometric Fuel-Air Ratio (F/A) _s	0.069 - Natural Gas 0.0292 - Hydrogen 0.069 - Fuel Oil	Used with the engines and fuel cells together with their equivalence ratios to determine the overall fuel-air ratio during combustion. <i>Source:</i> Heywood. 1988. <u>Internal Combustion Engine Fundamentals</u> . New York, McGraw-Hill. Table D.4, pp.915.
Specific Heat	0.240 Btu/lb-R - Air and Exhaust 1.0 Btu/lb-R - Water 0.53 Btu/lb-R - Natural Gas	Specific heats of fluids as simulated in the model, assumed constant at all temperatures and pressures. <i>Source:</i> Moran and Shapiro. 1996. <u>Fundamentals of Engineering Thermodynamics</u> . 3e. New York, Wiley. Tables A-19E and A-20E, pp. 813-814.
Fuel LHV	19,795 Btu/lb - Natural Gas 18,250 Btu/lb - Fuel Oil	Lower heating value is a measure of the potential combustion heat energy contained within a fuel, <u>excluding</u> the latent heat of the water vapor in the combustion gas. <i>Source:</i> Marks' Standard Handbook for Mechanical Engineers. Table 4.1.6, pp.4-26.
Fuel HHV	21,856 Btu/lb - Natural Gas 19,420 Btu/lb - Fuel Oil	Higher heating value is a measure of the potential combustion heat energy contained within a fuel, <u>including</u> the latent heat of the water vapor in the combustion gas. <i>Source:</i> Marks' Standard Handbook for Mechanical Engineers. Table 4.1.6, pp.4-26.
Isentropic Expansion Coefficient	1.40 - Air 1.32 - Natural Gas	
Balance of Plant Cost	\$100/kW	Balance of plant for the CHP system includes controls, piping, valving, pumping, etc., not included under generation technology, cooling plant, or heating plant costs. <i>Source:</i> ADL estimate.

Table 2: Microturbines		
<i>Standard Microturbine is based on existing microturbines (50-150kW)</i>		
<i>Advanced Microturbine is based on projections of future microturbines (200-400kW)</i>		
Name	Value(s)	Description and Source
Compressor Isentropic Efficiency	80% - Standard Microturbine 82% - Advanced Microturbine	Isentropic efficiency of the air compressor. <i>Source:</i> ADL estimates of existing microturbine performance and projections of future microturbine performance.
Compressor Inlet $\Delta P/P$	1% - Standard Microturbine 1% - Advanced Microturbine	The pressure drop given as a percent of the total pressure. <i>Source:</i> ADL estimates of existing microturbine performance and projections of future microturbine performance.
Compressor Outlet $\Delta P/P$	5% - Standard Microturbine 5% - Advanced Microturbine	The pressure drop given as a percent of the total pressure. <i>Source:</i> ADL estimates of existing microturbine performance and projections of future microturbine performance.
Overall Pressure Ratio	4:1 - Standard Microturbine 4:1 - Advanced Microturbine	Pressure ratio between the air compressor outlet and ambient air pressure. <i>Source:</i> ADL estimates of existing microturbine performance and projections of future microturbine performance.
Turbine Isentropic Efficiency	85% - Standard Microturbine 88% - Advanced Microturbine	Isentropic efficiency of the turbine. <i>Source:</i> ADL estimates of existing microturbine performance and projections of future microturbine performance.
Turbine Inlet $\Delta P/P$	1% - Standard Microturbine 1% - Advanced Microturbine	The pressure drop given as a percent of the total pressure. <i>Source:</i> ADL estimates of existing microturbine performance and projections of future microturbine performance.
Turbine Outlet $\Delta P/P$	1% - Standard Microturbine 1% - Advanced Microturbine	The pressure drop given as a percent of the total pressure. <i>Source:</i> ADL estimates of existing microturbine performance and projections of future microturbine performance.
Turbine Inlet Temperature	1700°F - Standard Microturbine 1700°F - Advanced Microturbine	Based on maximum temperature threshold of 2400°F and 0.25 pattern factor. <i>Source:</i> ADL estimates of existing microturbine performance and projections of future microturbine performance.

Fuel Compressor Isentropic Efficiency	60% - Standard Microturbine 65% - Advanced Microturbine	Isentropic efficiency of the natural gas fuel compressor. <i>Source:</i> ADL estimates of existing microturbine performance and projections of future microturbine performance.
Fuel Compressor Inlet $\Delta P/P$	1% - Standard Microturbine 1% - Advanced Microturbine	The pressure drop given as a percent of the total pressure. <i>Source:</i> ADL estimates of existing microturbine performance and projections of future microturbine performance.
Fuel Compressor Outlet $\Delta P/P$	5% - Standard Microturbine 5% - Advanced Microturbine	The pressure drop given as a percent of the total pressure. <i>Source:</i> ADL estimates of existing microturbine performance and projections of future microturbine performance.
Combustion Efficiency	100% - Standard Microturbine 100% - Advanced Microturbine	The percent of a fuel's potential heating value that is converted to heat energy during combustion. <i>Source:</i> ADL estimates of existing microturbine performance and projections of future microturbine performance.
Combustor $\Delta P/P$	4% - Standard Microturbine 3% - Advanced Microturbine	The pressure drop given as a percent of the total pressure. <i>Source:</i> ADL estimates of existing microturbine performance and projections of future microturbine performance.
Recuperator Effectiveness	85% - Standard Microturbine 85% - Advanced Microturbine	<i>Source:</i> ADL estimates of existing microturbine performance and projections of future microturbine performance.
Recuperator $\Delta P/P$	5% - Standard Microturbine 5% - Advanced Microturbine	The pressure drop given as a percent of the total pressure. Each side of the recuperator has a 5% dP/P <i>Source:</i> ADL estimates of existing microturbine performance and projections of future microturbine performance.
Generator Efficiency	95% - Both Microturbines	Conversion efficiency from shaft power input to electric power output (heat from generator is not recoverable).

Power-Conditioning Efficiency	95% - Both Microturbines		Efficiency of conditioning the electric power coming out of the generator (heat from power conditioning equipment is not recoverable). Engines and fuel cells use the same power conditioning efficiency.
Minimum Exhaust Temperature	200°F - Both Microturbines		Condensation temperature of the microturbine combustion gas is 120°F (calculated by ADL at 14.7 psia exhaust pressure, water-fuel ratio of 1.25, and equivalence ratio of 0.12). Since the minimum hot water coil temperature (140°F) is above the condensing temperature, the stack is the spot where condensation will first occur. ADL selects 200°F as a minimum average exhaust temperature to avoid stack wall condensation.
Installed Cost (both microturbines)	Manufacturer's Cost	\$420/kW	Manufacturer costs are based on 10,000-units/year production of a 50kW microturbine. <i>Source:</i> ADL cost model, using bottom-up labor and material cost estimates for each component.
	Manufacturer's Profit	\$168/kW	40% gross margin
	Installation Cost	\$292/kW	50% installation charge (includes grid tie-in costs and permitting fees).
	Total Installed Cost	\$880/kW	Cost to the end user of installing a microturbine for power generation.
Non-Fuel O&M Cost (both microturbines)	Replacement Cost	~\$0.01/kWh	Based on recuperator, combustor, and turbine replacement after 20,000 hours and 80% load factor. Other O&M costs are estimated as negligible. <i>Source:</i> ADL cost model, using bottom-up labor and material cost estimates for each component.
	Labor and Downtime	\$0.005/kWh	50% charge above replacement material cost. <i>Source:</i> ADL Estimate.
	Total O&M Cost	\$0.015/kWh	Cost to the end user for maintaining a microturbine used for power generation.

Table 3: Engines

The Standard Engine is based on existing spark-ignition natural gas engines for power generation. The Advanced Engine is based on existing compression-ignition natural gas engines for power generation. Both engines are for capacities between 250kW and 1MW.

Name	Value(s)	Description and Source
Shaft Efficiency	37% - Standard Engine 44% - Advanced Engine	Efficiency of the shaft output (kW of mechanical shaft energy output divided by kW of lower heating value in the fuel input). Assumed constant over all operating conditions (no part-load efficiencies). The Standard Engine efficiency is based on a spark-ignition gasoline automotive engine (33% efficient) modified by ADL to reflect the higher compression ratios typical used with natural gas (and the resulting higher efficiency). The Advanced Engine numbers are based on a standard heavy diesel engine (numbers were not modified for natural gas operation, since higher compression ratios are not feasible). Based on rating-point full-load operation with inlet air at 77°F, 30% relative air humidity, and 1bar absolute pressure. Both engines are fired by natural gas and sized for electric generation in large commercial buildings (~100kW-2MW). Generator and power conditioning efficiencies are considered separately and contributes to the unrecoverable losses of generating electricity. <i>Source: Plint and Martyr. <u>Engine Testing</u>. 1999. Table 11.4. pg. 210.</i>
Generator Efficiency	95% - Standard and Advanced Engines	Conversion efficiency of generator (heat from generator is not recoverable).
Power-Conditioning Efficiency	No power conditioning losses (100%)	Engines operate at fixed frequencies and require minimal, if any, power conditioning.
Heat in Exhaust	28% - Standard Engine 29% - Advanced Engine	Percent of the fuel LHV input that ends up in the exhaust gas as heat. <i>Source: Plint and Martyr. <u>Engine Testing</u>. 1999. Table 11.4. pg. 210.</i>
Heat in Coolant	28% - Standard Engine 20% - Advanced Engine	Percent of the fuel LHV input that ends up in the coolant fluid as heat. <i>Source: Plint and Martyr. <u>Engine Testing</u>. 1999. Table 11.4. pg. 210.</i>
Convection/Radiation Loss	7% - Standard Engine 7% - Advanced Engine	Percent of the fuel LHV input that ends up being lost to the environment via heat radiation and convection (including loss to oil loop in advanced engine). <i>Source: Plint and Martyr. <u>Engine Testing</u>. 1999. Table 11.4. pg. 210.</i>
Equivalence Ratio	1.4 – Standard Engine 0.5 – Advanced Engine	Indicates how “lean” a fuel-air mixture is (smaller is leaner). Equals the actual fuel-air mass ratio over the stoichiometric fuel-air mass ratio. <i>Source: ADL estimate of typical engine operation.</i>

Minimum Exhaust Temperature	200°F – Standard Engine 200°F – Advanced Engine	<p>Condensation temperature of the standard and advanced engines' combustion gasses are 125°F and 100°F, respectively (calculated at 14.7 psia exhaust pressure, water-fuel ratio of 1.25 for advanced engine and 0.97 for standard engine from Avallone and Baumeister 1996). Since water/coolant coils are above these condensing temperatures (~180°F or higher), the exhaust stack is the spot where condensation will first occur. To account for cold stack wall temperatures the minimum exhaust temperature is set at 200°F.</p> <p><i>Sources:</i> Avallone and Baumesiter. 1996. Mark's Standard Handbook for Mechanical Engineers. New York, McGraw Hill. Table 9.6.2. pp.9-94.</p>
Maximum Coolant Temperature	250°F - Both Engines	Temperature selected by ADL to maintain pressurized water below 30psia in the coolant loop.
Maximum Coolant Temperature Increase Through Engine	15°F - Both Engines	Maximum change in temperature of the coolant from when it enters the engine block to when it leaves the engine block. Selected by ADL (JR Linna) to minimize thermal stresses in the engine – typical in practice.
Minimum Coolant Inlet Temperature	180°F - Both Engines	Minimum temperature of the coolant at the inlet to the engine block. Selected by ADL to minimize thermal stresses associated with hot combustion gas – typical in practice.
Installed Cost	\$570/kW - Standard Engine \$710/kW - Advanced Engine	<p>Cost to the end user of installing an engine for power generation (including all capital grid tie-in costs). Costs are estimates for Y2005 and beyond. Based on engines smaller than 1MW.</p> <p><i>Source:</i> 1999 ADL study of existing engine costs (for distributed generation) and projection that installed costs will not change substantially in the near future.</p>
Non-Fuel O&M Cost	\$0.010/kWh - Standard Engine \$0.012/kWh - Advanced Engine	<p>Cost to the end user for maintaining an engine used for power generation. Based on capacity factor of 80%, and engines smaller than 1MW.</p> <p><i>Source:</i> 1999 ADL study of existing engine O&M costs (for distributed generation) and projection that O&M costs will decrease by ~20% by Y2005.</p>

Table 4: Fuel Cells

Both fuel cells are projections of what may be available in Y2008 and beyond for stationary power generation (50-250kW).

Name	Value(s)	Description and Source
Electrical Efficiency	42% - HTPEMFC 53% - SOFC	<p>Efficiency of the unconditioned electric output (kW of electric energy output divided by kW of lower heating value in the fuel input). Assumed constant over all operating conditions (no part-load efficiencies).</p> <p>The high-temperature PEM fuel cell (HTPEMFC) is based on 0.75V cell voltage, 80% anode fuel utilization, 320°F fuel cell temperature, SMR fuel reformer, 1.5-atm maximum system pressure, and 70% compressor/blower efficiency. The solid-oxide fuel cell (SOFC) is based on 0.75V cell voltage, 85% anode fuel utilization, 1472°F fuel cell temperature, SMR fuel reformer, 1.2-atm maximum system pressure, and 70% compressor/blower efficiency. Both fuel cells are fired by natural gas using a steam methane reformer (SMR) and sized for electric generation between 50kW and 250kW. Power conditioning efficiency is considered separately and contributes to the unrecoverable losses of generating usable electricity.</p> <p><i>Sources:</i> Arthur D. Little, Inc. <u>Conceptual Design of POX/SOFC 5kW net System</u>. 2001 Final Report. Prepared for DOE NETL. Arthur D. Little, Inc. <u>Cost Analysis of Fuel Cell System for Transportation – Pathways to Low Cost</u>. 2001 Final Report. Prepared for DOE. Arthur D. Little, Inc. <u>50kW PEMFC System Design/Fabrication and Test</u>. 2000 Progress Report. Prepared for EPRI Solutions Inc and DOE. ADL computer models developed for DOE Subcontract 736222-00600-01. Not yet published.</p>
Power-Conditioning Efficiency	95% - Both Fuel Cells	<p>Efficiency of conditioning the electric power coming out of the fuel cell (heat from power conditioning equipment is not recoverable).</p>
Heat in Exhaust	21% - HTPEMFC 41% - SOFC	<p>Percent of the fuel LHV input that ends up in the tail-gas as heat (after the tail-gas burner).</p> <p><i>Sources:</i> ADL computer models developed for DOE Subcontract 736222-00600-01. Not yet published.</p>
Heat in Coolant	32% - HTPEMFC 0% - SOFC	<p>Percent of the fuel LHV input that ends up in the coolant fluid as heat (solid-oxide fuel cells do not have a coolant loop for recovering heat).</p> <p><i>Sources:</i> ADL computer models developed for DOE Subcontract 736222-00600-01. Not yet published.</p>

Convection/ Radiation Loss	5% - HTPEMFC 6% - SOFC		Percent of the fuel LHV input that is lost to the environment via heat radiation and convection. <i>Source:</i> ADL computer models developed for DOE Subcontract 736222-00600-01. Not yet published.
Equivalence Ratio	0.50 - HTPEMFC 0.14 - SOFC		Indicates how "lean" a fuel-air mixture is (smaller is leaner). Equals the actual fuel-air mass ratio over the stoichiometric fuel-air mass ratio. <i>Sources:</i> Arthur D. Little, Inc. <u>Conceptual Design of POX/SOFC 5kW net System</u> . 2001 Final Report. Prepared for DOE NETL. Arthur D. Little, Inc. <u>50kW PEMFC System Design/Fabrication and Test</u> . 2000 Progress Report. Prepared for EPRI Solutions Inc and DOE. ADL computer models developed for DOE Subcontract 736222-00600-01. Not yet published.
Minimum Tail Gas Temperature	200°F - HTPEMFC 200°F - SOFC		Condensation temperatures of the fuel cells' tail gasses are 90°F and 160°F for the SOFC and HTPEMFC respectively. To account for cold stack wall temperatures the minimum tail gas temperature is set at 200°F. <i>Sources:</i> ADL computer models developed for DOE Subcontract 736222-00600-01. Not yet published.
Maximum Coolant Temperature	300°F - HTPEMFC		Temperature selected by ADL to maintain pressurized water below 70psia in the coolant loop. (not applicable to the SOFC)
Maximum Coolant Temperature Increase Through Fuel Cell	25°F - HTPEMFC		Maximum change in temperature of the coolant from when it enters the fuel cell stack to when it leaves the stack. Selected by ADL to minimize thermal stresses in the fuel cells. (not applicable to the SOFC)
Minimum Coolant Inlet Temperature	275°F - HTPEMFC		Minimum temperature of the coolant at the inlet to the fuel cell stack. Selected by ADL to maintain 320°F fuel cell temperature. (not applicable to the SOFC)
Installed Cost (both fuel cells)	Manufacturer's Cost	\$600/kW	Costs are estimates for 10,000-units/year production for a 50kW (HTPEMFC) stationary fuel cell system, and 10,000-units/year production for a 250kW (SOFC) stationary fuel cell system. Based on power densities of 400mW/cm ² and 600mW/cm ² for the HTPEMFC and SOFC, respectively. Includes power-conditioning equipment costs of (\$100/kW). <i>Source:</i> ADL bottom-up cost models developed for DOE subcontract 736222-00600-01. Not yet published.
	Manufacturer's Profit	~\$200/kW	40% gross margin
	Installation Cost	~\$400/kW	50% installation charge (including grid tie-in charges and permitting fees).

Total Cost	\$1,200/kW	Cost to the end user of installing a fuel cell for power generation.
Non-Fuel O&M Cost	\$0.015/kWh - HTPeMFC \$0.015/kWh - SOFC	Cost to the end user for maintaining a fuel cell used for power generation. Estimate is based on stack replacement after 10,000 hours of operation at 80% load factor (HTPeMFC and SOFC). Non-stack O&M costs are estimated to be negligible. <i>Source:</i> ADL cost models developed in 1999 for EPRI, and extended SOFC systems tests by Siemens-Westinghouse without replacement of major subsystems.

Table 5: Cooling Plant

Name	Value(s)	Description and Source
Absorption Chiller Efficiency (COP)	0.7 - Water/Steam Single-Effect Absorption Chiller 1.1 - Exhaust Double-Effect Absorption Chiller	For the absorption machines, COP is the thermal cooling output divided by the thermal heat input (does not include cooling tower or distribution system parasitics). The absorption chiller COP are typical of equipment operating at design conditions. <i>Source:</i> <u>Cooling, Heating & Power Comparison</u> Excel worksheet (updated March 29th, 2001) sent to ADL by ORNL on 8/23/01.
Baseline Electric Chiller Efficiency	0.66 kW/ton (5.3 COP equivalent)	The electric chiller efficiency (0.66 kW/ton) was derived by averaging the efficiencies of best-available water-cooled reciprocating (0.84 kW/ton) and centrifugal (0.47 kW/ton) chillers. Efficiencies are stated as <i>IPLV seasonal efficiency</i> . <i>Source:</i> <u>Cooling, Heating & Power Comparison</u> Excel worksheet (updated March 29th, 2001) sent to ADL by ORNL on 8/23/01.
Distribution System Parasitics	–	Distribution system parasitics are assumed equal to the baseline electric chiller plant (so the difference in energy consumed is zero).
Cooling Tower Parasitics	0.25kW/ton - Water/Steam Single-Effect Absorption Chiller 0.20kW/ton - Exhaust Double-Effect Absorption Chiller 0.13kW/ton - Electric Chiller	<i>Source:</i> <u>Cooling, Heating & Power Comparison</u> Excel worksheet (updated March 29th, 2001) sent to ADL by ORNL on 8/23/01.

Minimum Activation Temperature	170°F - Water/Steam Single-Effect Absorption Chiller 340°F - Exhaust Double-Effect Absorption Chiller	The minimum activation temperature is the lowest coolant or exhaust temperature that can power the absorption chillers. While it may be possible to use slightly lower temperatures in certain equipment it will result in decreased capacities and efficiencies, so we do not consider using temperatures lower than the minimum activation temperature. Source: ADL's discussions with the manufacturers Broad USA and Thermax
Chilled Water Temperatures	All Chillers: 44°F - Outlet 65°F - Inlet	The chilled water loop temperatures are fixed for all chillers.
Installed Cost	Retail Price	\$200/ton – centrifugal electric chiller \$300/ton – single-effect absorption \$400/ton - double-effect absorption Price to the consumer (delivered to the site) including any manufacturer's profit: averaged for centrifugal electric chillers (0.5-0.65 kW/ton) and gas-fired absorption chillers, over the range 200 - 1200 tons. 10% was deducted from the absorption chiller costs to account for the burner (which is not present in water/steam fired nor exhaust fired units). <i>Source:</i> Costs are estimates based on ADL's discussions with manufacturers, discussions with AGCC and GRI, product literature, and previous studies by ADL.
	Installation Cost	\$100/ton – centrifugal/reciprocating electric \$150/ton – single-effect absorption \$200/ton – double-effect absorption Includes installation of chiller, engineering guidance, and electrical connection (costs of gas piping and flue stack installation were removed from the original source estimates). A 30% premium was added to the double-effect absorption chiller (exhaust-fired) to account for the added complexity of installing the exhaust ductwork.
	Cooling Tower Premium	\$50/ton same for single and double-effect Cost premium above cooling tower cost required for electric chillers. <i>Source:</i> 1996 ADL estimate based on discussions with AGCC, GRI, and AGA.
	Total Cost	\$300/ton – electric chiller \$500/ton – single-effect absorption \$650/ton – double-effect absorption Cost to the end user of installing an absorption chiller in addition to the cost of installing electric chillers as backup.
Non-Fuel O&M Cost	\$15/ton-year - Single Effect \$20/ton-year - Double Effect	Cost to the end user for maintaining an absorption chiller is ~5% of the retail price, annually. (based on typical service plan costs provided to the end-user by a third party.) Assumed not to vary with absorption chiller utilization (hours used). <i>Source:</i> Costs are estimates based on ADL's discussions with manufacturers Broad USA and Thermax, and previous ADL study.

Table 6: Heating Plant

Name	Value(s)	Description and Source
Boiler Efficiency	81% (HHV)	Typical value of existing gas-fired boilers and water heaters (based on lower heating value). <i>Source: ADL. HVAC. Vol.I for DOE.</i>
Hot Water Loop Temperatures	180°F - Outlet 140°F - Inlet	Building-side heat recovery loop for heating loads. The hot water loop inlet and outlet temperatures are fixed.
Heat Exchanger Effectiveness	85%	Heat exchanger effectiveness (Heat loss from heat exchangers to the environment is neglected).
Heat Exchanger dP/P	2%	
Installed Cost (Heat Exchangers)	\$10,000/MMBtuH	Cost of heat exchangers (for recovering exhaust and coolant heat for building heating loads) is based on MMBtuH of maximum annual heat load extracted from the waste stream by the heat exchangers. Includes pump and piping costs not included elsewhere. <i>Source: ADL estimate.</i>
Non-Fuel O&M Cost	\$0	Cost to maintain heat exchangers is assumed negligible. (no additional cost over baseline)

Engine Model Parameters

In the *CHP for Buildings* benefits analysis, we model the cost and performance of a typical spark-ignition engine and a typical compression-ignition engine. We are modeling stationary engines, fired by natural gas and sized for electric generation in large commercial buildings (~100kW-2MW).

Performance Model

In the performance model we assume that each engine has constant shaft efficiency and steady heat distribution (neglects part-load effects). The performance estimates for the spark-ignition engine are based on a high-compression natural-gas spark-ignition engine (37% efficient). The performance estimates for the compression-ignition engine are based on a standard industrial engine (44% efficient). The table below shows the complete energy balance for both engines. Generator efficiency of 95% will be incorporated to determine the overall generation efficiency (no power-conditioning equipment).

Energy Balance for Engine Models

	% of Fuel Lower Heating Value	
	Typical Spark-Ignition Engine	Typical Compression-Ignition Engine
Shaft Power Output	37%	44%
Cooling Fluid Heat	28%	20%
Exhaust Gas Heat	28%	29%
Convection/Radiation Heat Loss	7%	7%
Total	100%	100%

Source: Plint and Martyr. *Engine Testing*. 1999. Table 11.4. pg. 210.

The spark-ignition engine numbers are based on a gasoline automotive engine (33% efficient) modified to reflect the higher compression ratios typical used with natural gas (and the resulting higher efficiency). The compression-ignition engine numbers are based on a standard heavy diesel engine (numbers were not modified for natural gas operation, since higher compression ratios are not feasible). Based on rating-point full-load operation with inlet air at 77°F, 30% relative humidity, and 1bar absolute pressure. Both engines are fired by natural gas and sized for electric generation in large commercial buildings (~100kW-2MW). Generator efficiency is considered separately and contributes to the unrecoverable losses of generating electricity.

We model both engines according to the above energy balances, and the criteria below. (see the attached schematic diagram to see how the engine is built into the CHP system.)

- The inlet air temperature is maintained at a minimum of 50°F by using exhaust gas recycling if necessary (EGR not to exceed 30%).

- The exhaust gas temperature is calculated after solving for the fuel input required for a given shaft power output, and fixing the equivalence ratio²⁴ at 2.0 for the compression-ignition engine and 0.7 for the spark-ignition engine.
- The heat in the coolant is fully recoverable and operates at a maximum engine exit temperature of 250°F (though the coolant temperature may be higher downstream after recovering heat from the exhaust).
- The heat in the exhaust is recovered down to a minimum of 200°F (to avoid condensation) using a heat exchanger with the coolant.

Cost Model

In the simple cost model we estimate the typical installed costs and O&M costs (present 1999 costs) of the engines based on data from previous ADL work shown in the tables below.

Installed Engine Costs

	\$US/kW of installed capacity		
	Equipment Cost	Installation Cost	Installed Cost
Typical Spark-Ignition Engine	\$380/kW	\$190/kW	\$570/kW
Typical Compression-Ignition Engine	\$473/kW	\$237/kW	\$710/kW

ADL estimates based on previous work. Costs are present estimates (1999), but installed cost is not expected to decrease in the near future (beyond 2005). Based on 50% installation charge, annual capacity factor of 80%, and engines smaller than 1MW.

Engine Non-Fuel Operating and Maintenance (O&M) Costs

	\$US/kWh of operation
	O&M Cost
Typical Spark-Ignition Engine	\$0.010/kWh
Typical Compression-Ignition Engine	\$0.012/kWh

ADL estimates based on previous work. Costs are future estimates (beyond 2005). Based on 50% installation charge, annual capacity factor of 80%, and engines smaller than 1MW.

²⁴ Equivalence ratio equals the actual fuel-air mass ratio over the stoichiometric fuel-air mass ratio (F/A_s is 0.069 for natural gas).

Microturbine Model Parameters

The B CHP simulation model we are currently developing requires input of performance and cost data for two microturbines that will be simulated by the model.

In the *CHP for Buildings* benefits analysis, we model the cost and performance of a “standard” microturbine (50-150kW) and a “large” microturbine (200-400kW). Arthur D. Little previously investigated standard microturbines and established performance and cost baselines. Large microturbines are still in development, and ADL projects their performance and cost parameters based on those of the standard microturbine. Both microturbines are fired by natural gas and sized for electric generation in large commercial buildings (~100kW-2MW). (*While inlet air-cooling is an option, we have not considered it.*)

Performance Model Parameters

Table 1 summarizes estimated performance values for the microturbine for the CHP simulation model.

	Standard Microturbine (50-150kW)	Advanced Microturbine (200-400kW)
Compressor Efficiency	80%	82%
Compressor Inlet dP/P	1%	1%
Compressor Outlet dP/P	5%	5%
Overall Pressure Ratio	4:1	4:1
Turbine Efficiency	85%	88%
Turbine Inlet dP/P	1%	1%
Turbine Outlet dP/P	1%	1%
Turbine Inlet Temperature	1700°F	1700°F
Fuel Compressor Efficiency	60%	65%
Fuel Compressor Inlet dP/P	1%	1%
Fuel Compressor Outlet dP/P	5%	5%
Combustion Efficiency	~100%	~100%
Combustor dP/P	4%	3%
Recuperator Effectiveness	85%	85%
Recuperator dP/P	5%	5%
Generator Efficiency	95%	95%
Power Conditioning Efficiency	95%	95%
Rating Point Efficiency (with fuel compressor)	25.9%	31.2%
Rating Point Efficiency (without fuel compressor)	26.7%	32.0%

Arthur D. Little estimates based on previous work. Performance estimates for the advanced microturbine were based on the standard microturbine, but with higher compressor/expander efficiencies. Rating point efficiency according to ISO testing standard.

Cost Model Parameters

Table 2 summarizes the estimated cost values for the microturbines in the CHP simulation model.

Table 2: Costs of the microturbines

	Small Microturbine	Large Microturbine
Installed Cost	\$880/kW	\$880/kW
Non-fuel O&M Cost	\$0.015/kWh	\$0.015/kWh

Based on Arthur D. Little's projected cost model for a 50kW microturbine, 20,000-hour component lifetime, 80% load factor, and 10,000-unit annual production. We estimate that the large microturbine will have the same costs (per unit capacity) as the standard microturbine.

Fuel Cell Model Parameters

The BCHP simulation model we are currently developing requires input of performance and cost data for two fuel cells that will be simulated by the model.

In the *CHP for Buildings* benefits analysis, we model the cost and performance of a high temperature (~160 C) polymer electrolyte membrane fuel cell (PEMFC) and an anode supported solid oxide fuel cell (SOFC). Arthur D. Little has performed previous analyses on both low and high temperature PEMFCs and anode supported SOFCs^{25,26,27}. We are currently in the process of establishing performance and cost baselines for low temperature PEMFCs and anode supported SOFCs for stationary power under DOE contracts DE-FC02-EE27565 and P3EA990700362 (subcontract 736222-00600-01), respectively.

Fuel cell systems cost and performance are consistent with what we estimate may be available in the 2008 and beyond timeframe. Both low temperature PEMFCs and anode supported SOFCs are in the demonstration phase of development. High temperature PEMFCs are in the earliest stage of development, with no developers publicly demonstrating acceptable performance to date. However, if acceptable performance is achieved, high temperature PEMFCs have potential to reduce overall cost and improve cogen heating potential over low temperature PEMFCs. Sealing continues to be a problem for planar (anode supported) SOFCs especially with thermal cycling. However, if leaks can be effectively prevented, planar SOFCs promise to have improved power density and can operate at lower temperatures than current (tubular) SOFC designs. For this project, we have assumed both fuel cell systems will operate on reformat generated in a steam methane reformer (SMR) fired by natural gas and sized for electric generation in large commercial buildings (50-250kW).

Performance Model Parameters

In the performance model, we assume that the fuel cell systems have constant electrical efficiency and steady heat distribution (neglects part-load efficiencies). Table 1 summarizes estimated performance values for the fuel cell systems for the CHP simulation model.

²⁵ Arthur D. Little, Inc. [Conceptual Design of POX/SOFC 5kW net System](#). 2001 Final Report. Prepared for DOE NETL.

²⁶ Arthur D. Little, Inc. [Cost Analysis of Fuel Cell System for Transportation – Pathways to Low Cost](#). 2001 Final Report. Prepared for DOE.

²⁷ Arthur D. Little, Inc. [50kW PEMFC System Design/Fabrication and Test](#). 2000 Progress Report. Prepared for EPRI Solutions Inc and DOE.

Table 1: Performance of the Fuel Cell Systems

	High Temperature PEMFC	Anode Supported SOFC
Single Cell Voltage	0.75 V	0.75 V
Anode Fuel Utilization	80%	85%
Excess Air Ratio	2	7 ¹
Fuel Cell Temperature	160 C	800 C
Reformer Type	SMR	SMR
Maximum System Pressure	1.5 atm	1.2 atm ²
Compressor/Blower Efficiency	70%	70%
Power Conditioning Efficiency	95%	95%
Electrical Efficiency	40%	50%
<i>Heat Energy in Exhaust (% of fuel input, LHV)</i>	21%	41%
<i>Heat Energy in Coolant (% of fuel input, LHV)</i>	32%	N/A

¹ Based on cathode inlet temperature of 650 C. Lower excess air ratios could result if inlet temperatures could be reduced.

² Maximum system pressure based on estimated heat exchanger and fuel cell pressure drops.

Cost Model Parameters

Bottom-up activity based cost models were used to determine the factory cost of each fuel cell system. Costs are based on assumed power densities of 400 mW/cm² and 600 mW/cm² for the high temperature PEMFC and anode supported SOFC, respectively. (Note: high temperatures allow the PEMFC to achieve higher power density at a given cell voltage and catalyst loading.) The PEM cost model is based on a 50 kW stationary system at production volumes of 25,000 units/year (1,250 MW/year). The SOFC cost model is based on a 250 kW stationary system at production volumes of 10,000 units/year (2,500 MW/year). Given the early stages of development, these volumes will not be achieved until after 2008. Many components and manufacturing processes assumed in the cost analyses are not currently available. Materials costs are based on current prices (i.e. catalysts, membrane materials). Table 2 summarizes the estimated cost values for the fuel cell Systems in the CHP simulation model.

Table 2: Costs of the Fuel Cell Systems

	High Temperature PEMFC	Anode Supported SOFC
Fuel Cell System Factory Cost	\$500/kW	\$500/kW
Power Electronics Factory Cost	\$100/kW	\$100/kW
Installed Cost	\$1200/kW	\$1200/kW
Non-fuel O&M Cost	\$0.015/kWh	\$0.015/kWh

Based on Arthur D. Little's projected cost models for 50-250kW fuel cell systems, 40,000-hour component lifetime, 80% load factor, and 10,000-25,000 unit annual production. Installed cost assumes 40% markup from factory cost and 50% installation charge (after markup). O&M cost estimates are based on ADL cost models created for the 1999 EPRI report.

Appendix E: Flow Charts for Control Algorithms

Flow charts of the control algorithms for both the “dumb” and “smart” operating strategies are attached.

The control algorithm for the “smart” operating strategy performs six major tasks (denoted on the flow chart with the corresponding letter):

- A. Determine the baseline loads and energy costs using a conventional system (setting the CHP operating capacity = 0);
- B. Determine the energy and cost savings by operating the system at up to 100% of the rated capacity (but never more than the required electric load);
- C. Decide whether the target demand step size should be based on the rated capacity or the baseline peak load;
- D. Save those hours of the month that provide cost savings;
- E. Determine the operating capacity necessary to just meet the target demand; and
- F. Determine at what level of target demand the CHP provides the most cost savings.

Control Algorithm for “Dumb” Operating Strategy

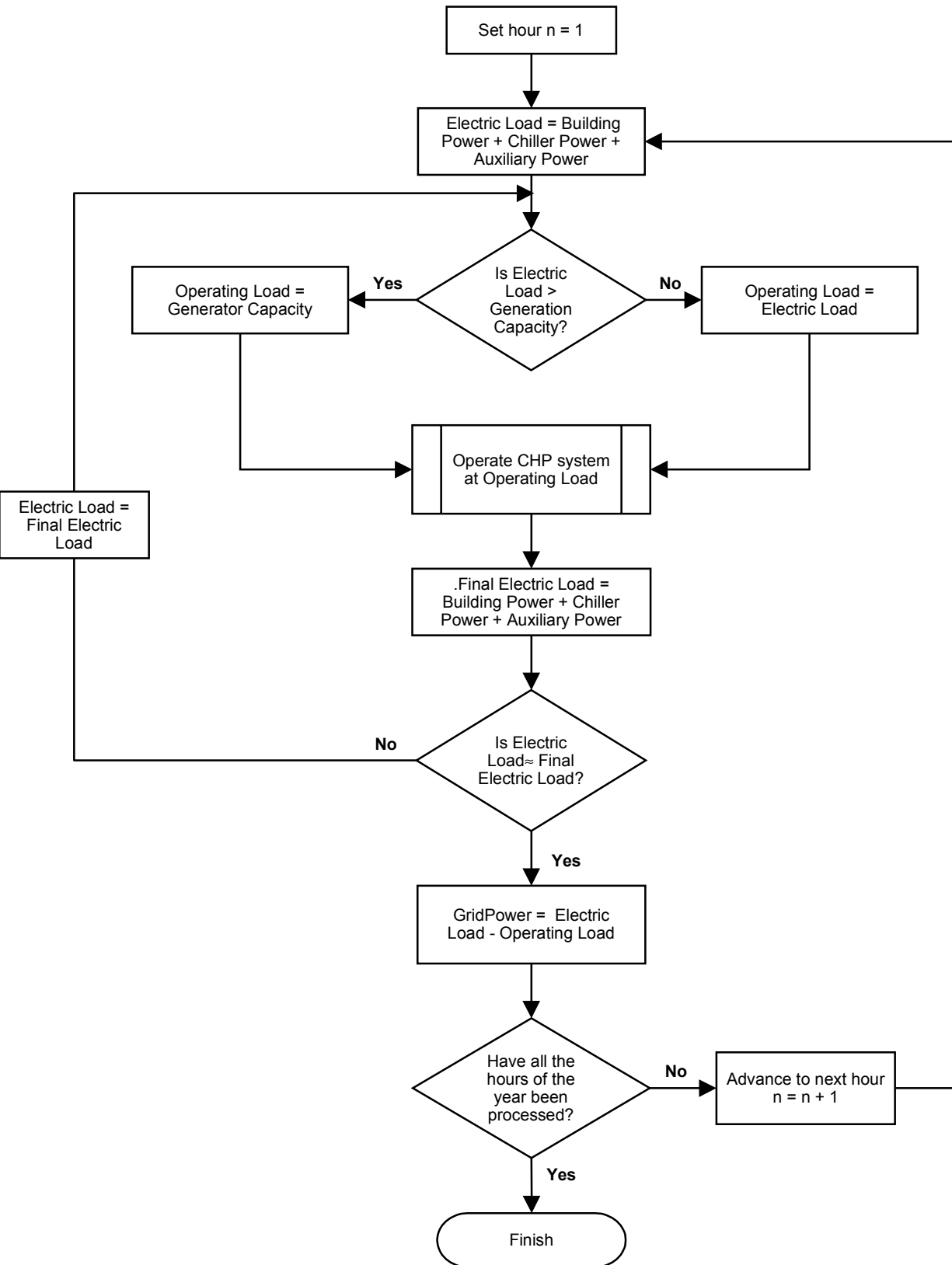

Control Algorithm for "Smart" Operating Strategy

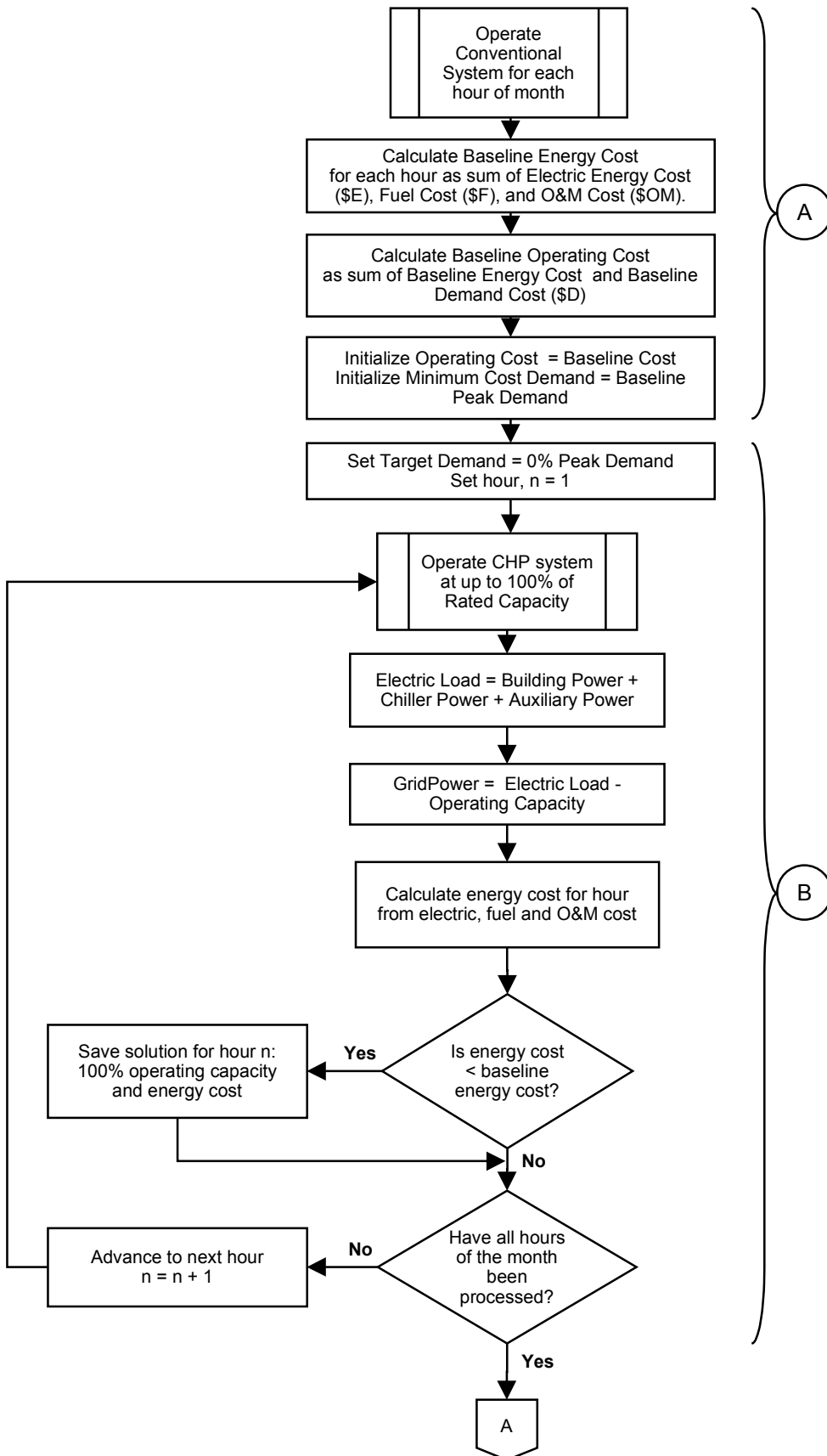

Control Algorithm for "Smart" Operating Strategy (Page 2)

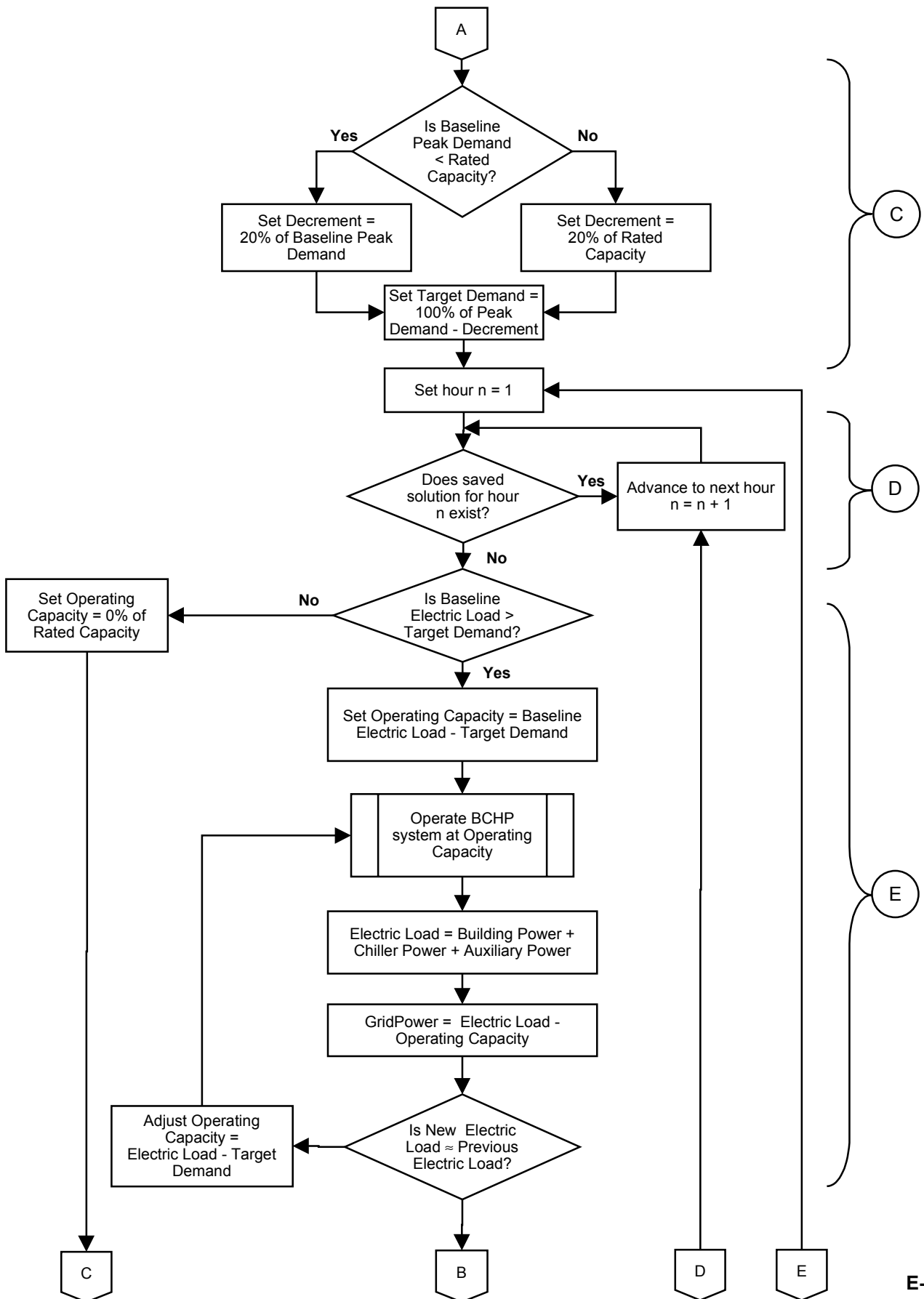

Control Algorithm for "Smart" Operating Strategy (Page 3)

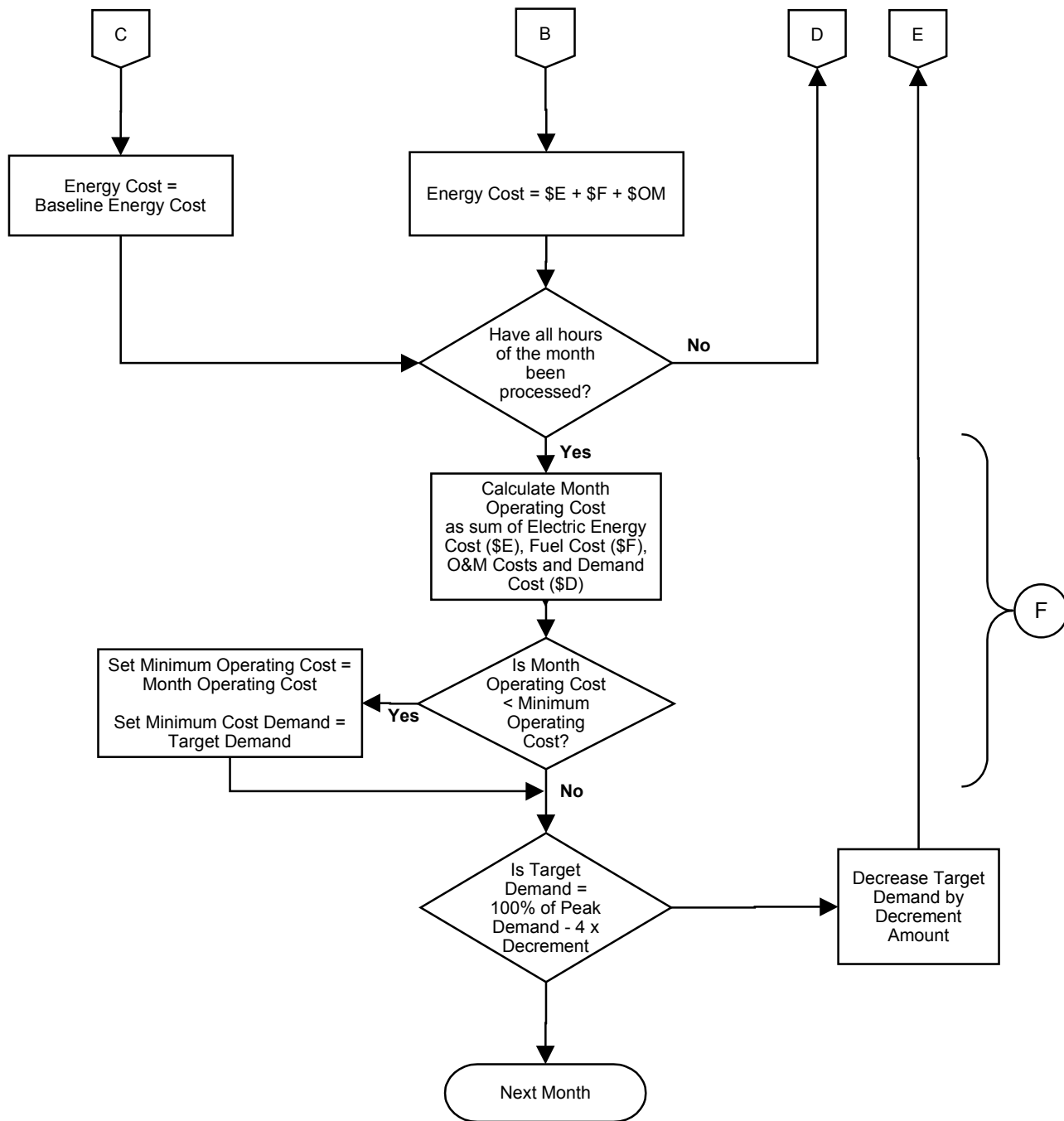

Appendix F: Utility Rate Structures

For each of five cities investigated in this CHP study (Chicago, Los Angeles, Miami, New York, and Phoenix) we selected a currently available gas and electric rate structure that best suited all three building types based on peak and annual usage.

With the rate structure selected, we simplified the rate structures to “fit” into a database that our analysis model could read. The database contains 288 rows (24 hours times 12 months) and four columns (electric demand charge, electric energy charge, natural gas energy charge, and fuel oil energy charge). Electric and natural gas rates are based on real rate structures, but fuel oil rates are set at \$4/MMBtu for every city based on the national average. Since real rate structures often have more detail than we could input into the database, we made the following simplifications when necessary:

- Weekends were not considered off-peak in the database (peak versus off-peak hours for electric were based on time-of-day and month),
- Monthly customer charges were either neglected or absorbed into the energy charge,
- Tiered energy charges (natural gas) were combined into one rate based on a weighted average (while the weighting will vary by building type and month, we averaged it all into one weighting).

Gas Rate Structures

Table 1 presents the natural gas rate structures *as simplified* for the database. Detailed descriptions of the rate structures (including any details that were omitted in the database) for each city follow the table.

Table 1. Summary of Natural Gas Rate Structures as Used in the Database

City	Gas Company	Rate Schedule	Energy Charge ^a (average \$/MMBtu)
Chicago	Peoples Gas	Service Classification 4 – Large Volume Demand	\$5.6565 <i>every hour, every month</i>
Los Angeles	Southern California Gas	Core Service (GN-10)	\$3.7863 <i>every hour, every month</i>
Miami	City Gas Company of Florida	General Commercial Service	\$8.500 <i>every hour, every month</i>
New York	Consolidated Edison	Service Classification 2 – General Firm Sales <i>Rate II – General – Heating</i>	\$5.716 <i>every hour, every month</i>
Phoenix	Southwest Gas	General Gas Service (G-25)	\$9.2146 <i>every hour, every month</i>

a) Includes all charges except fixed charges. See detailed discussions below

Chicago – Peoples Gas, Light and Coke Company

We selected the gas rate structure “Service Classification No. 4 – Large Volume Demand Service” for Chicago.

It features a tiered energy charge of \$5.6565/MMBtu for the first 7,500 therms (750 MMBtu)²⁸ each month and \$4.1660/MMBtu for all other usage after 7,500 therms. We selected the lower tier rate of \$5.6565/MMBtu for the database because most buildings in Chicago use less than 750 MMBtu of gas in any given month (when not generating electricity). While the second tier is more applicable for buildings that are generating electricity, we did not use it.

We neglected the following rate structure features while simplifying for the database:

- A monthly customer charge of \$1000,
- A standby charge of \$2.100 per MMBtu of standby demand, and
- A distribution charge of \$0.0852/MMBtu.

Los Angeles - Southern California Gas

The applicable natural gas rate structure for commercial customers in Los Angeles is Southern California Gas’s Commercial and Industrial Gas Rates, GN-10 Core Service to Small Commercial and Industrial Customers. This rate structure applies to customers using up to 21,000 therms per month. Above this level, customers generally negotiate individual contracts.

It uses a tiered energy charge of \$6.7343/MMBtu for the first 10 MMBtu (first 25 MMBtu in winter), \$5.0262/MMBtu up to 416.7 MMBtu, and \$3.7863/MMBtu for all gas used above 416.7 MMBtu. Although the peak monthly demand of any of the three buildings in L.A. never exceeds 400 MMBtu when not generating electricity, every building uses at least 1500 MMBtu of gas when generating electricity (even at 10% generator sizes). Therefore, we selected the highest tier for the database (\$3.7863/MMBtu) because it will have a weight of (75% to 95%) in any given month versus the other two tiers.

We neglected the monthly customer charge of \$14.7945 while simplifying for the database.

Miami - City Gas Company

The natural gas rate structure for Miami was obtained by contacting a manager of City Gas Company of Florida. Table 2 details the monthly customer charge and energy charge for the *General Commercial Service* gas rate structure. Commercial customers may also opt for "Transportation Gas" rather than general service. For transportation gas, there is not a customer charge and the energy charge is generally 15-25 percent less than the general service energy charge. Furthermore, they are not subject to taxes. Transportation Gas is bought through a broker and delivered through the same distribution network as general service gas.

²⁸ One MMBtu = 10 therms = 1,000,000 Btu

For the database we used an un-weighted annual average energy charge of \$10.117/MMBtu and discounted it by 15% to account for customers using transportation gas giving a final rate of \$8.50/MMBtu (constant for every hour of every month).

Table 2. City Gas Company Commercial Rates

Charge Type	Month											
	Jan	Feb	Mar	Apr	May	Jun	Jul	Aug	Sep	Oct	Nov	Dec
Monthly Customer Charge (\$)	20	20	20	20	20	20	20	20	20	20	20	20
Energy Charge (\$/MMBtu)	10.30	11.41	12.49	12.49	11.69	10.69	10.69	8.93	8.93	7.651	7.651	8.486

The City Gas Company of Florida services approximately half of Miami-Dade County Florida, with Peoples Gas System TICO serving the other half. Prices are comparable between the two companies.

New York - Consolidated Edison Company

The natural gas rate structure used for New York City is Consolidated Edison, Service Classification 2, General Firm Sales Service, Rate II - General – Heating. New York has two other rate schedules, in addition to Rate II-heating, that could apply to the commercial buildings we are investigating: (Rate I) for months when gas is not used for heating and (Rate I & II Air Conditioning - June 14-Oct 14) for any gas that is used for air-conditioning equipment (direct-fired absorption chillers for example) from June 14-October 14. Only the Rate I schedule is used because it is assumed that heating is used in all months, in which case, Rate I is the appropriate rate schedule.

It uses a tiered energy charge of \$118.20/MMBtu for the first 0.3 MMBtu, \$7.84/MMBtu for the next 8.7 MMBtu, \$6.855/MMBtu for the next 291 MMBtu, and \$5.716/MMBtu for all gas used above 300 MMBtu. Even when not generating electricity, all the buildings in this study use over 1200 MMBtu in most months. Therefore, we selected the highest tier for the database (\$3.7863/MMBtu) because it will have a weight of (78% to 93%) in any given month versus the other three tiers.

Phoenix – Southwest Gas Corporation

The natural gas rate structure used for Phoenix is Southwest Gas Corporations, General Gas Service (G-25), for “medium” size customers using between 60 and 1,500 MMBtu per month maximum in a year.

The energy charge is \$9.2146/MMBtu. We neglected the monthly customer charge of \$90 while simplifying for the database.

Electricity Rate Structures

Table 3 presents the electricity rate structures *as simplified* for the database (though the only simplifications for the electric rates were neglecting monthly customer charges and viewing weekends as on-peak). Further descriptions of the rate structures for each city follow the table. Two clarifications are important. First, to calculate total demand charge, the maximum demand (kW) for the respective time period is multiplied by the demand charge rate (\$/kW) for that time period. Second, one simplifying assumption to the model is that it does not distinguish between weekdays and weekend-days. Therefore, the model assumes that there are on-peak hours for all days.

Table 3. Commercial Electricity Rate Structures

City	Energy Charge (¢/kWh)				Demand Charge (\$/kW of maximum demand)	
	Summer		Winter		Summer	Winter
	On-Peak	Off-Peak	On-Peak	Off-Peak		
Chicago ^a	5.0	2.1	5.0	2.1	16.41	12.85
Los Angeles ^b	20.2 11.0 (mid-peak)	8.9	12.4 (mid-peak)	9.0	23.95 (peak) 9.20 (mid) 6.4 (off-peak)	6.4
Miami ^c	8.4	3.8	8.4	3.8	3.77	3.77
New York ^d	10.5	6.9	6.7	5.5	18.06	16.34
Phoenix ^e	8.1	5.8	7.3	5.2	6.35	5.67

^aOn-peak hours for Chicago are Monday-Friday, 9am to 10pm. Summer months are June-September.

^bOn-Peak hours for Los Angeles are Monday-Friday, noon to 6pm in the summer only. Los Angeles also has “mid-peak” hours Monday-Friday: 8am to noon and 6pm to 9pm (in the summer); 8am to 9pm (in the winter). Summer months are June-September.

^cOn-Peak hours for Miami are Monday-Friday, 6am to 10am and 6pm to 10pm (in the winter); noon to 9pm (in the summer: April-October).

^dOn-peak hours for New York are Monday-Friday, 8am to 10pm. Summer months are April-October.

^eOn-peak hours for Phoenix are Monday-Friday, 9am to 10pm. Summer months are June-September.

Chicago – Commonwealth Edison Company

We selected *Rate 6L – Large General Service* for electric service in Chicago. It applies to customers with a 30-minute maximum demand of 1MW or more over the previous twelve months.

We neglected a monthly customer charge of \$246.39 when simplifying for the database.

Los Angeles – Southern California Edison

The applicable electricity rate schedule for Los Angeles is Southern California Edison's Schedule TOU-8 (Time-of-Use, General Service, Large). This schedule applies to all customers whose monthly maximum demand (kW) is expected to exceed 500 kW. The appropriate classification of service for this project is "service metered and delivered at voltages below 2 kV." The rates apply to service metered and delivered at secondary, primary, and sub-transmission voltages.

The Southern California Edison electricity rate schedule contains three charges: customer charge (\$), demand charge (\$/kW), and energy charge (\$/kWh).

We neglected a monthly customer charge of \$298.65 when simplifying for the database.

Miami – Florida Power Company

The applicable electricity rate schedule for Miami is Florida Power Company's, Commercial/Industrial Rate Schedules (effective April 1, 2001). The "Demand Option Time-of-Use" Service rates, which include a customer charge, demand charge and energy charge, are the appropriate rates.

We neglected a monthly customer charge of \$155.50 when simplifying for the database.

New York – Consolidated Edison Company

The applicable electricity rate schedule for New York City is the Consolidated Edison Company of New York, P.S.C No. 9 – Electricity (Rate II, Commercial and Industrial, Redistribution, Time-of Day). This schedule (Rate II) applies to all customers whose monthly maximum demand (kW) is expected to exceed 900 kW. High tension service, versus low tension service, is the appropriate classification. All rates vary by month. This rate structure does not have a monthly customer charge.

Phoenix – Arizona Public Service Company

The applicable electricity rate schedule for Phoenix is Arizona Public Service Company's Tariff E-23, Time-of-Use schedule (rev. 11).

We neglected a monthly customer charge of \$50 when simplifying for the database.

Appendix G: Detailed Analysis Matrix, Summary of Results, and Results

Run #	location					building type			generation technology				fuel type		system type		cntrl	Optimum Gen. Cap. (%)	Primary Energy Savings vs. Baseline (%)	Payback (years)	Operating Cost Savings vs. Baseline (%)	Recoverable Waste Heat Unutilized (%)	Total Waste Heat Unutilized (%)	Generator Capacity Factor (%)	Absorption Chiller Capacity Factor (%)					
	Chicago, Illinois	Los Angeles, California	Miami, Florida	New York City, New York	Phoenix, Arizona	Hospital	Hotel (Large)	Office Building (Large, 12-hour)	Standard Microturbine (50-150kW)	Advanced Microturbine (200-400kW)	Standard Engine	Advanced Engine	High-Temperature PEM Fuel Cell	Solid Oxide Fuel Cell	Natural Gas	Fuel Oil										DG Only	DG + Heating	CHP (DG + Heating + Cooling)	"Smart"	"Dumb"
1				x				x	x						x							0%	-	>5	-	-	-	-	-	-
2				x				x			x				x							80%	32%	2.9	56%	18%	31%	41%	16%	
3				x				x							x		x					50%	-5%	5.0	21%	21%	32%	32%	NA	
not used																														
6				x				x			x			x		x						90%	21%	2.8	50%	29%	46%	36%	NA	
not used																														
8				x				x			x			x					x	x		80%	30%	3.0	53%	12%	30%	39%	16%	
9				x		x		x						x					x	x		50%	3%	4.9	23%	13%	31%	65%	23%	
10				x		x			x					x					x	x		70%	13%	4.8	32%	16%	37%	60%	24%	
11				x		x								x					x	x		70%	30%	3.8	42%	3%	28%	71%	38%	
12				x				x	x					x					x	x		50%	4%	4.7	30%	14%	28%	36%	13%	
13				x				x						x					x	x		40%	5%	4.8	27%	14%	29%	45%	15%	
14				x					x					x					x	x		50%	10%	4.5	33%	17%	35%	45%	13%	
15				x										x					x	x		50%	25%	4.1	39%	8%	30%	60%	28%	
not used																														
17				x				x		x				x					x	x		50%	8%	5.0	29%	12%	26%	37%	11%	
18				x				x						x					x	x		80%	26%	5.0	49%	9%	33%	38%	16%	
not used																														
20		x						x						x					x	x		70%	-3%	2.3	57%	28%	53%	70%	31%	
21		x							x					x					x	x		70%	7%	2.1	59%	25%	50%	71%	35%	
22		x												x					x	x		80%	28%	2.3	67%	5%	32%	67%	53%	
not used																														
24		x						x	x					x					x	x		50%	-7%	2.7	52%	35%	60%	68%	18%	
25		x							x					x					x	x		50%	4%	2.4	54%	32%	56%	72%	19%	
26		x								x				x					x	x		50%	18%	1.4	62%	31%	42%	72%	25%	
27		x									x			x					x	x		50%	30%	1.5	64%	21%	35%	72%	30%	
28		x												x					x	x		60%	26%	2.6	63%	14%	41%	62%	31%	
not used																														
30		x						x	x					x					x	x		60%	-3%	2.8	58%	34%	58%	44%	11%	
31		x						x		x				x					x	x		60%	8%	2.6	60%	31%	54%	44%	11%	
not used																														
not used																														
34		x						x						x					x	x		70%	26%	3.0	67%	8%	34%	42%	28%	
not used																														
36				x				x	x						x				x	x		80%	9%	3.9	57%	30%	56%	38%	12%	
37				x				x							x				x	x		70%	36%	2.3	63%	19%	33%	46%	16%	
38				x						x				x					x	x		60%	26%	2.1	41%	14%	24%	79%	35%	
39				x							x			x					x	x		70%	35%	2.3	47%	7%	20%	70%	35%	
40				x						x				x					x	x		50%	22%	2.4	41%	18%	27%	58%	23%	
41				x							x			x					x	x		60%	30%	2.7	47%	13%	25%	52%	22%	
42				x						x				x					x	x		80%	20%	3.0	50%	21%	30%	37%	14%	
43		x								x				x					x	x		70%	21%	1.2	66%	19%	29%	74%	45%	
44		x									x			x					x	x		70%	32%	1.3	67%	10%	23%	74%	52%	
45	x							x						x					x	x		0%	-	>5	-	-	-	-	-	
46		x						x						x					x	x		70%	31%	1.9	70%	14%	27%	42%	25%	
not used																														
48				x				x						x					x	x		0%	-	>5	-	-	-	-	-	
not used																														
50				x				x						x					x	x		0%	-	>5	-	-	-	-	-	
51				x				x						x					x	x		80%	31%	3.0	54%	16%	28%	39%	16%	
not used																														
53				x				x	x					x					x	x		0%	-	>5	(No Recuperator)			-	-	
54				x				x	x					x					x	x		0%	-	>5	(50% Effective Recuperator)			-	-	

Annual Primary Energy Consumption Breakdown

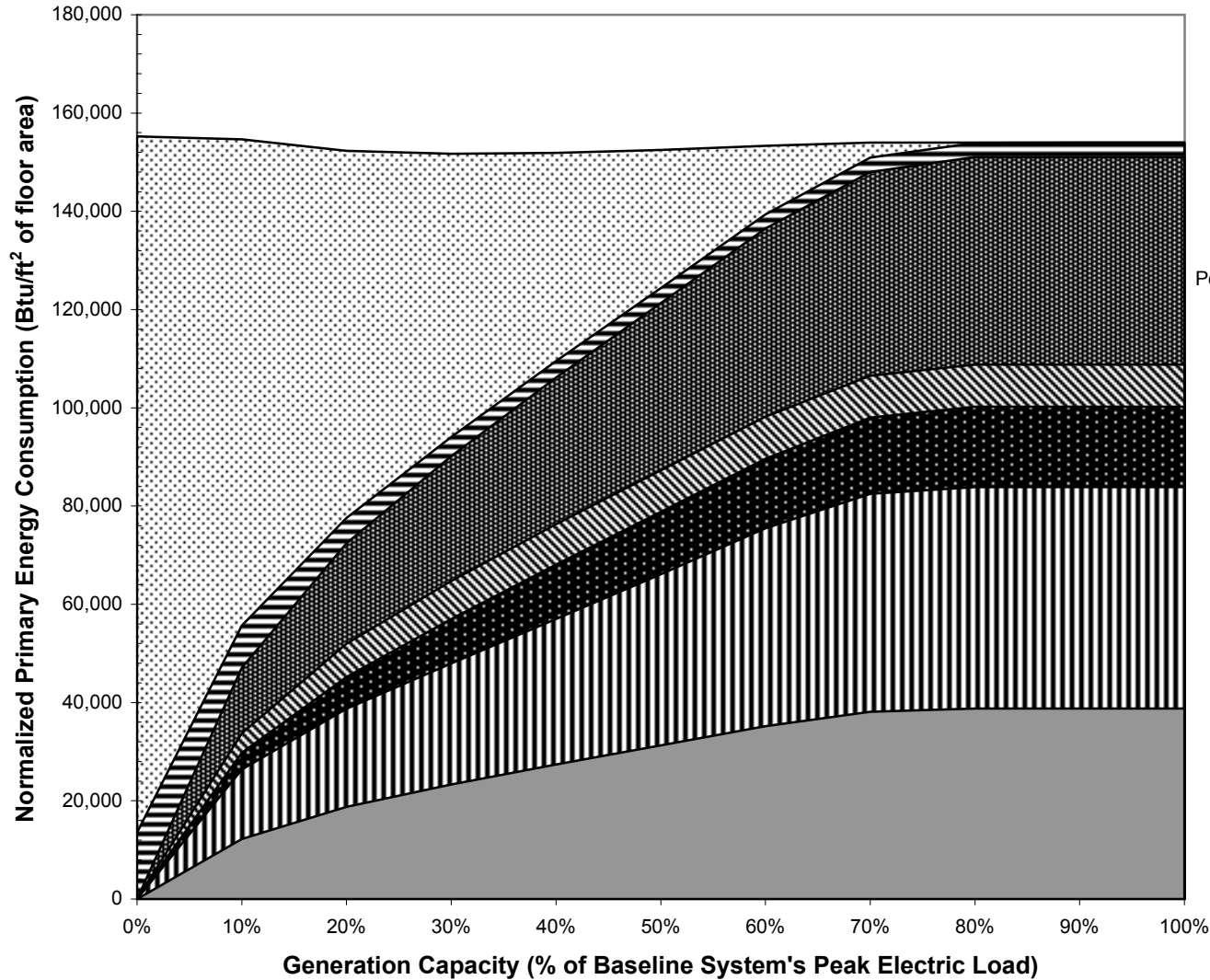

Run Number: 1
 Date and Time of Run: 1/16/02 16:41
 City Name: New York
 Building Type: Office
 FloorArea(ft²): 419,000
 Baseline Peak Electric(kW): 1,831
 Peak Cooling Load (tons): 548
 Peak Heating Load (MMBtuH): 6
 Generation Technology: Std. MicroTurbine
 Absorption Chiller Type: Double Effect
 Fuel Type: Natural Gas
 Rate Structure: Con Edison
 Control Strategy: Dumb



Installed Cost and Annual Operating Cost

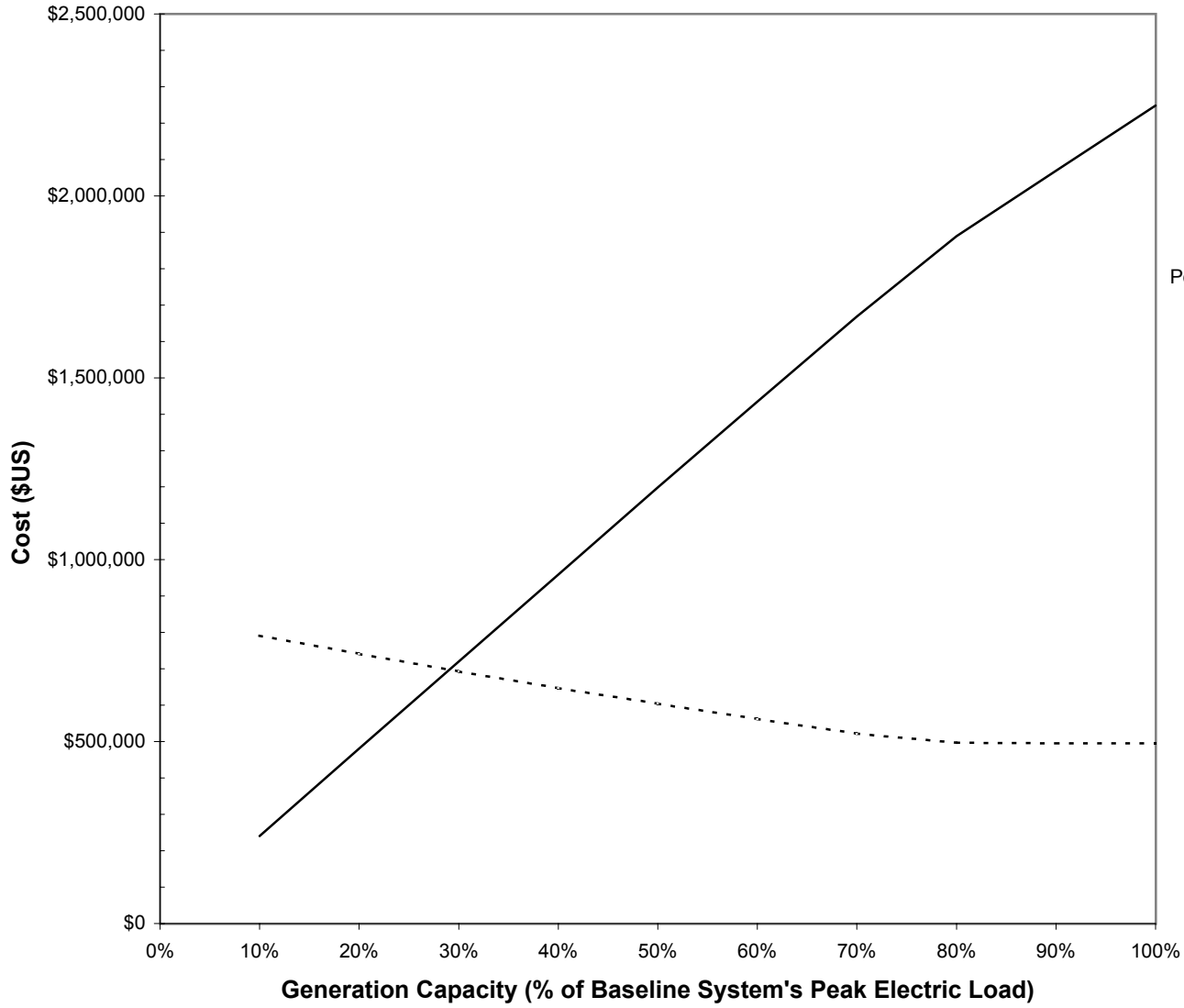

— Installed Cost - - - - Annual Operating Cost

Run Number: 1
Date and Time of Run: 1/16/02 16:41
City Name: New York
Building Type: Office
FloorArea(ft²): 419,000
Baseline Peak Electric(kW): 1,831
Peak Cooling Load (tons): 548
Peak Heating Load (MMBtuH): 6
Generation Technology: Std. MicroTurbine
Absorption Chiller Type: Double Effect
Fuel Type: Natural Gas
Rate Structure: Con Edison
Control Strategy: Dumb

Payback Period

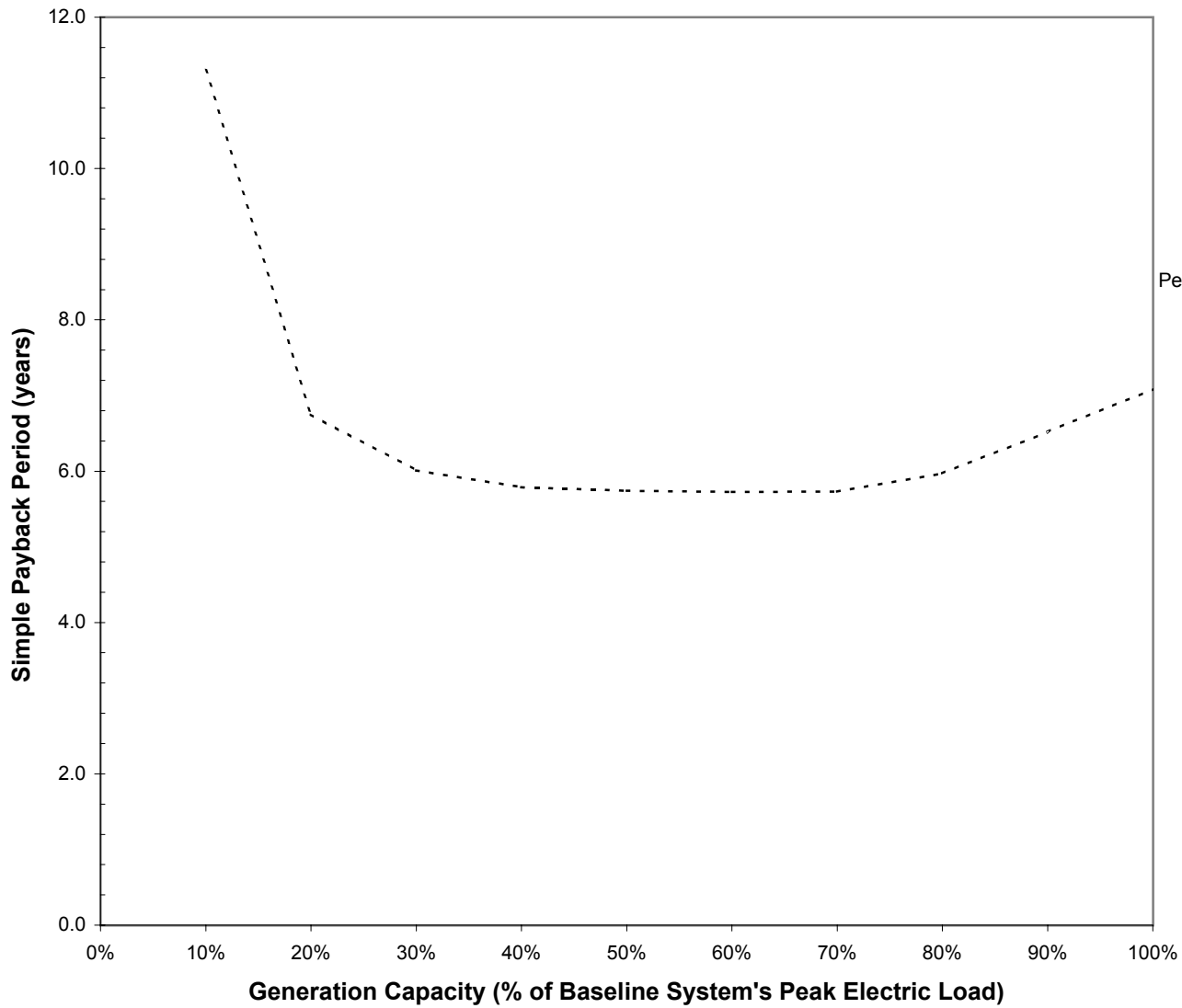

Run Number: 1

Date and Time of Run: 1/16/02 16:41

City Name: New York

Building Type: Office

FloorArea(ft²): 419,000

Baseline Peak Electric(kW): 1,831

Peak Cooling Load (tons): 548

Peak Heating Load (MMBtuH): 6

Generation Technology: Std. MicroTurbine

Absorption Chiller Type: Double Effect

Fuel Type: Natural Gas

Rate Structure: Con Edison

Control Strategy: Dumb

Annual Primary Energy Consumption Breakdown

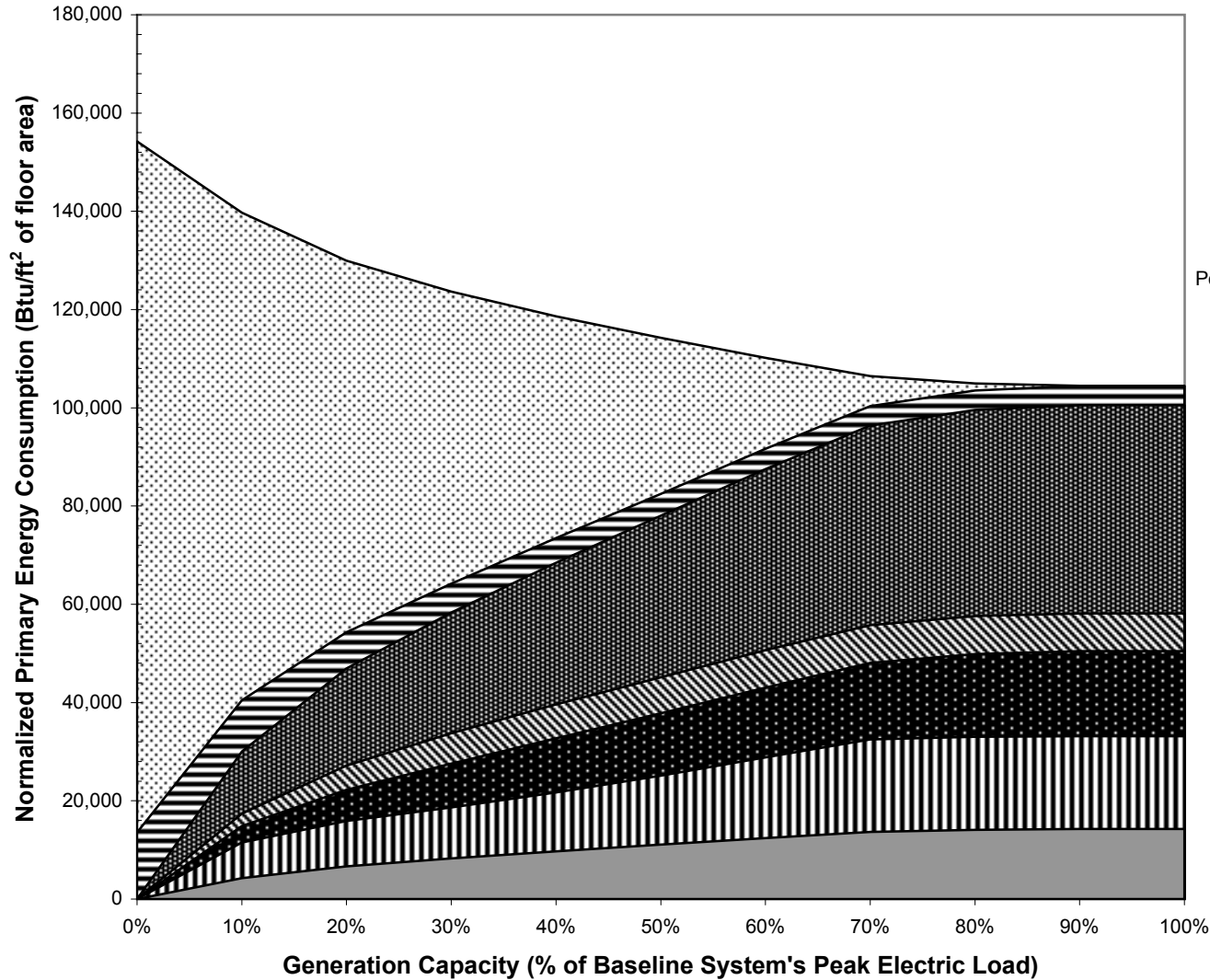

Run Number: 2
 Date and Time of Run: 1/16/02 17:22
 City Name: New York
 Building Type: Office
 FloorArea(ft²): 419,000
 Baseline Peak Electric(kW): 1,750
 Peak Cooling Load (tons): 548
 Peak Heating Load (MMBtuH): 6
 Generation Technology: Adv. Engine
 Absorption Chiller Type: Single Effect
 Fuel Type: Natural Gas
 Rate Structure: Con Edison
 Control Strategy: Dumb



Installed Cost and Annual Operating Cost

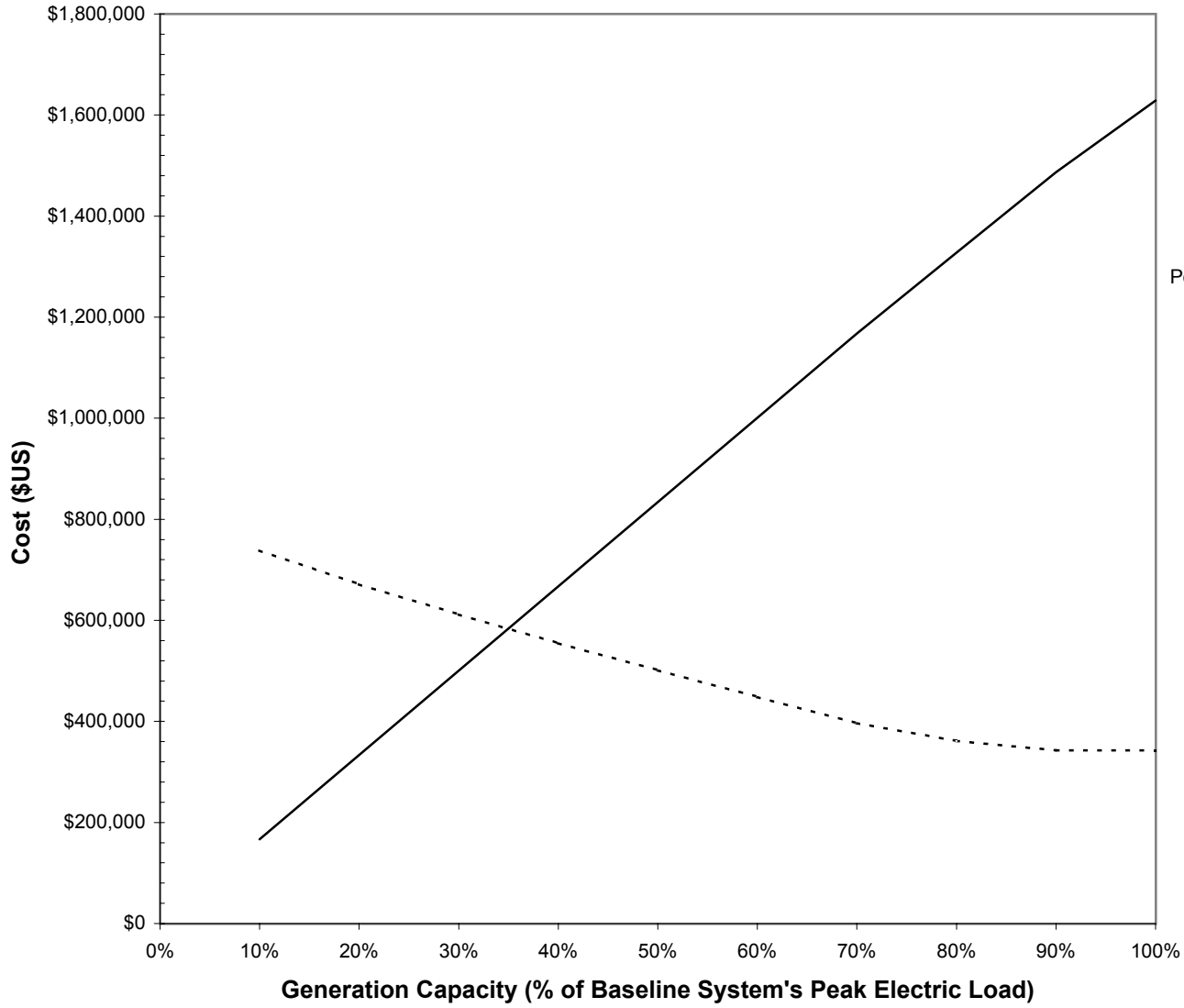

— Installed Cost - - - - Annual Operating Cost

Run Number: 2
Date and Time of Run: 1/16/02 17:22
City Name: New York
Building Type: Office
FloorArea(ft²): 419,000
Baseline Peak Electric(kW): 1,750
Peak Cooling Load (tons): 548
Peak Heating Load (MMBtuH): 6
Generation Technology: Adv. Engine
Absorption Chiller Type: Single Effect
Fuel Type: Natural Gas
Rate Structure: Con Edison
Control Strategy: Dumb

Payback Period

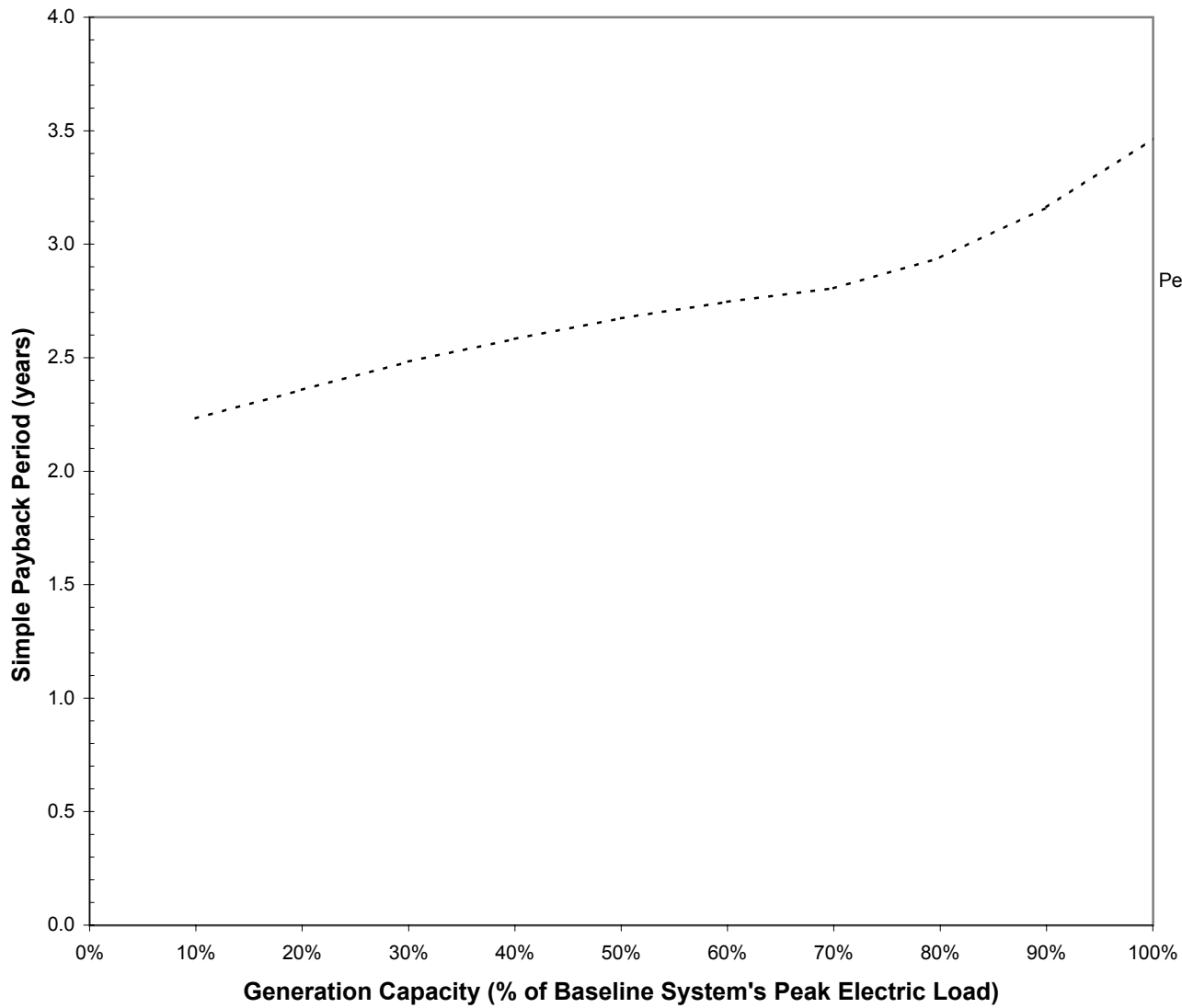

Run Number: 2

Date and Time of Run: 1/16/02 17:22

City Name: New York

Building Type: Office

FloorArea(ft²): 419,000

Baseline Peak Electric(kW): 1,750

Peak Cooling Load (tons): 548

Peak Heating Load (MMBtuH): 6

Generation Technology: Adv. Engine

Absorption Chiller Type: Single Effect

Fuel Type: Natural Gas

Rate Structure: Con Edison

Control Strategy: Dumb

Annual Primary Energy Consumption Breakdown

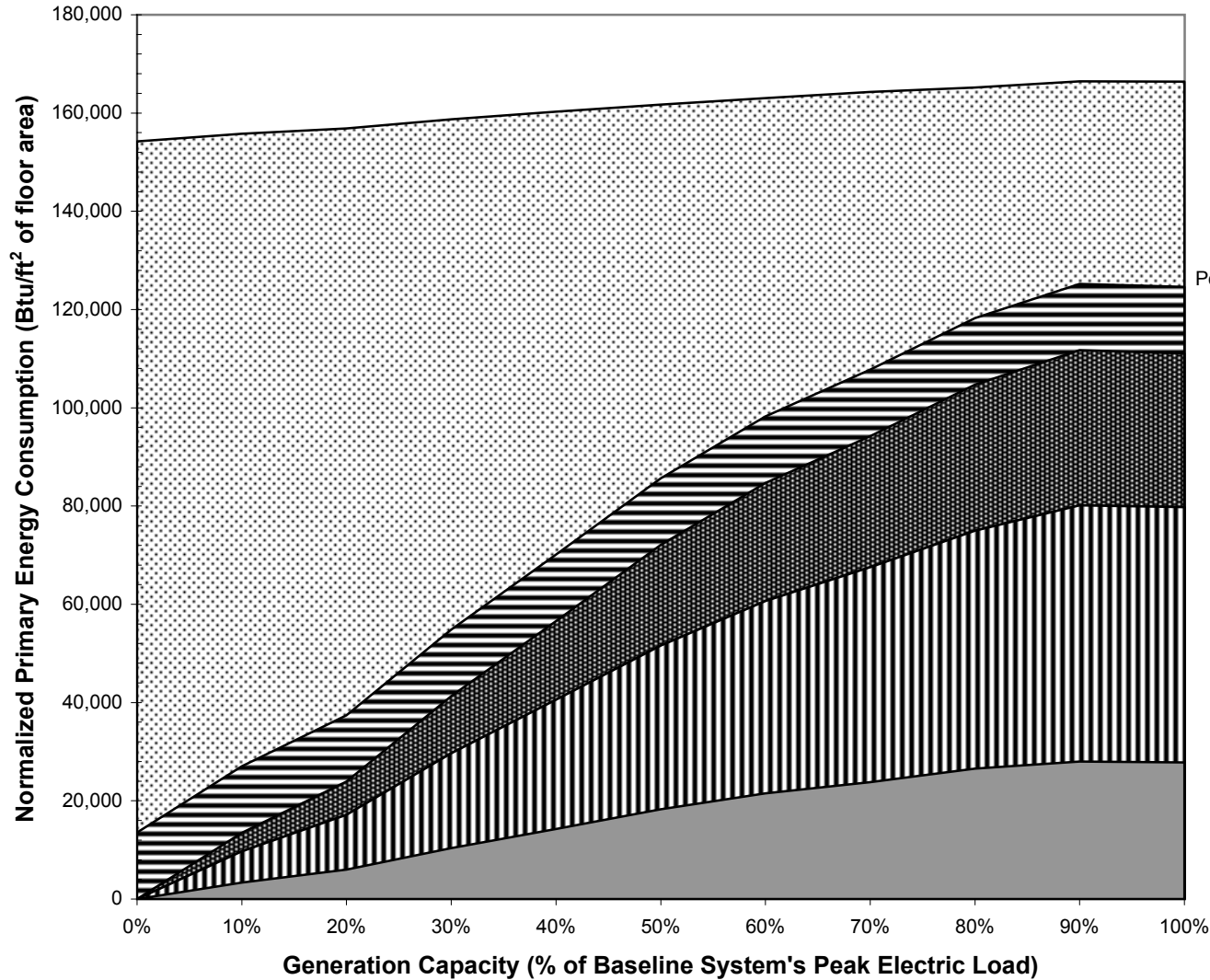

Run Number: 3
 Date and Time of Run: 1/17/02 0:47
 City Name: New York
 Building Type: Office
 FloorArea(ft²): 419,000
 Baseline Peak Electric(kW): 1,750
 Peak Cooling Load (tons): 548
 Peak Heating Load (MMBtuH): 6
 Generation Technology: Std. Microturbine
 Absorption Chiller Type: electric (DG only)
 Fuel Type: Natural Gas
 Rate Structure: Con Edison
 Control Strategy: Smart



Installed Cost and Annual Operating Cost

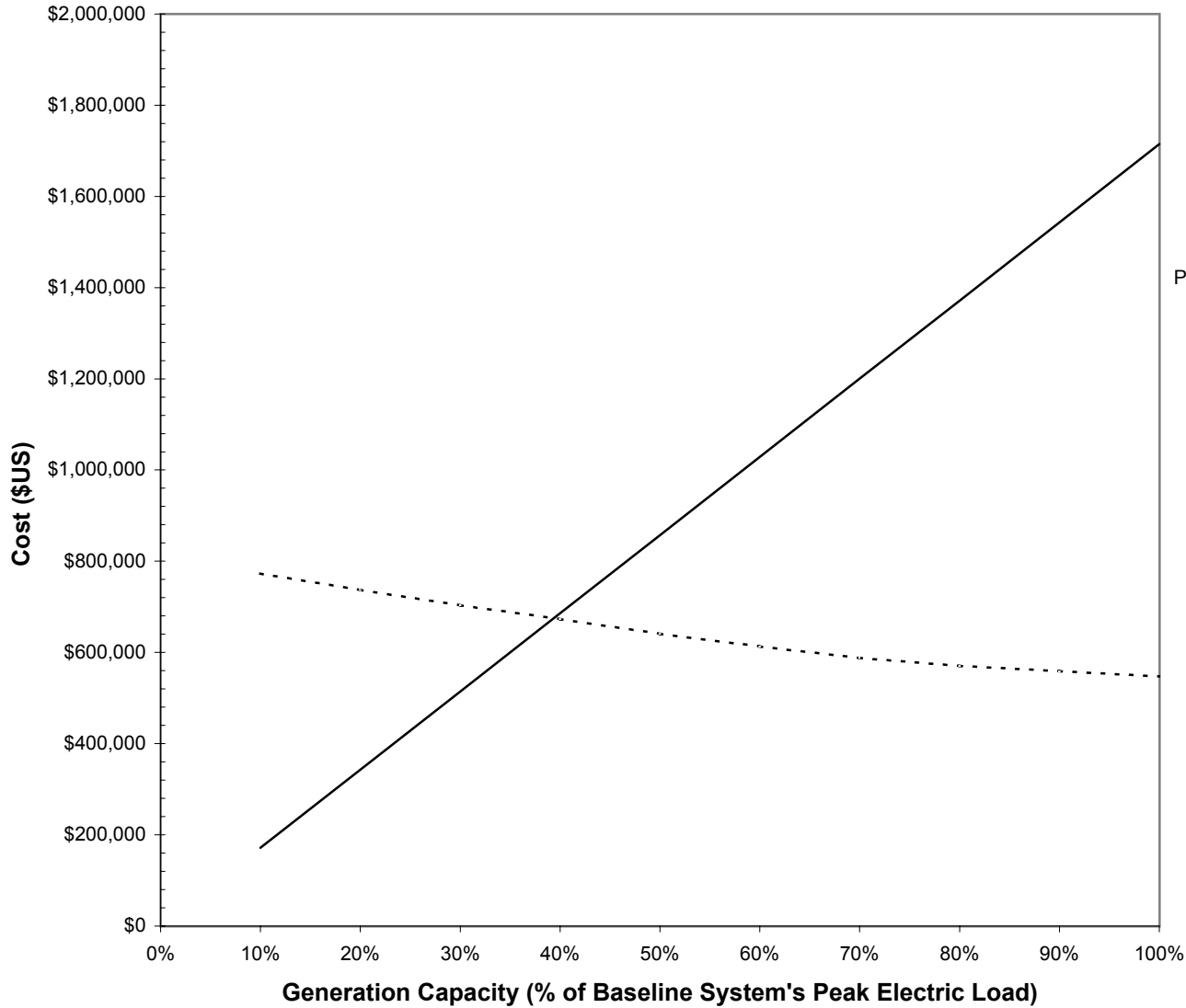

— Installed Cost - - - - Annual Operating Cost

Run Number: 3
Date and Time of Run: 1/17/02 0:47
City Name: New York
Building Type: Office
FloorArea(ft²): 419,000
Baseline Peak Electric(kW): 1,750
Peak Cooling Load (tons): 548
Peak Heating Load (MMBtuH): 6
Generation Technology: Std. Microturbine
Absorption Chiller Type: electric (DG only)
Fuel Type: Natural Gas
Rate Structure: Con Edison
Control Strategy: Smart

Payback Period

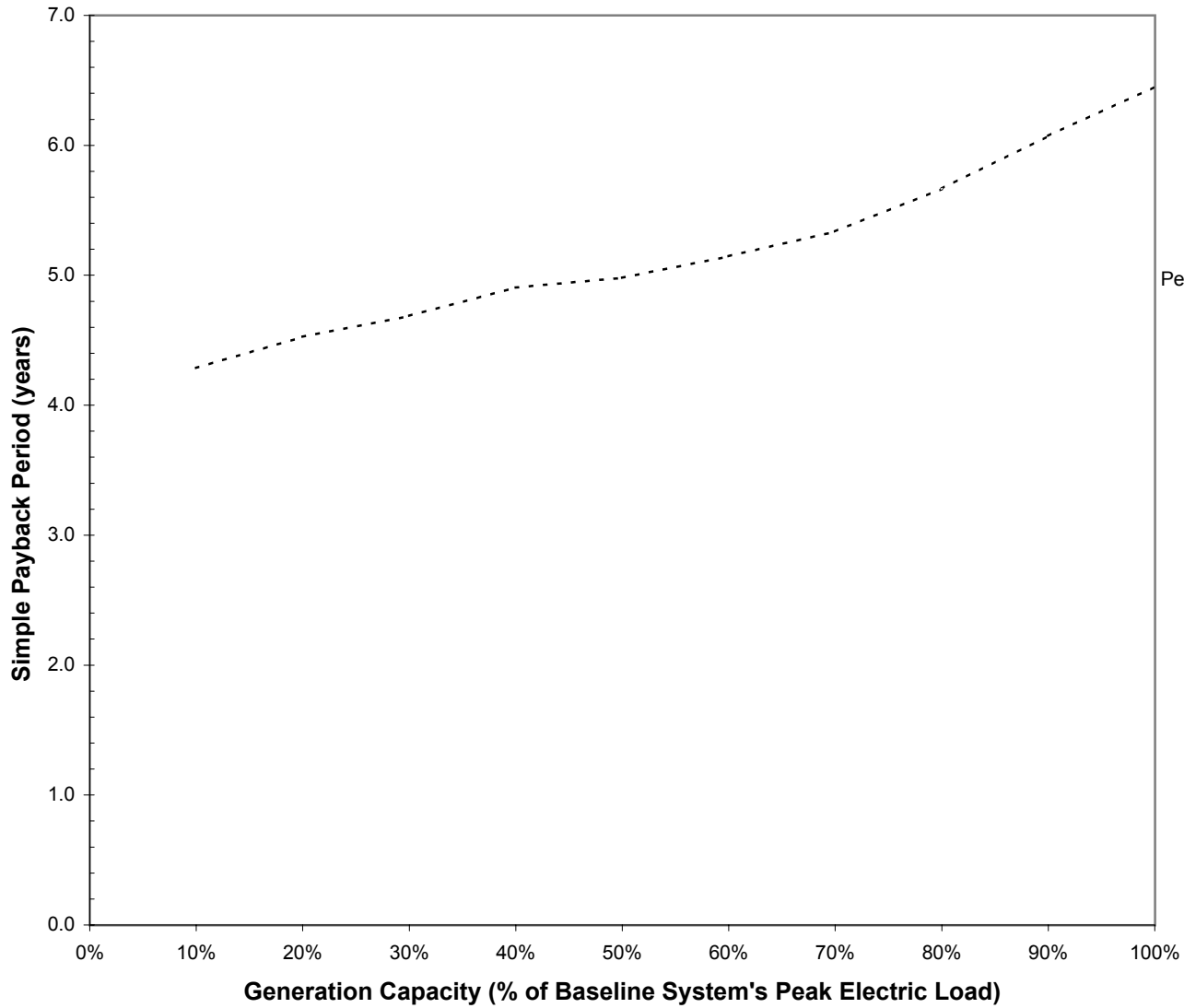

Run Number: 3

Date and Time of Run: 1/17/02 0:47

City Name: New York

Building Type: Office

FloorArea(ft²): 419,000

Baseline Peak Electric(kW): 1,750

Peak Cooling Load (tons): 548

Peak Heating Load (MMBtuH): 6

Generation Technology: Std. Microturbine

Absorption Chiller Type: electric (DG only)

Fuel Type: Natural Gas

Rate Structure: Con Edison

Control Strategy: Smart

Annual Primary Energy Consumption Breakdown

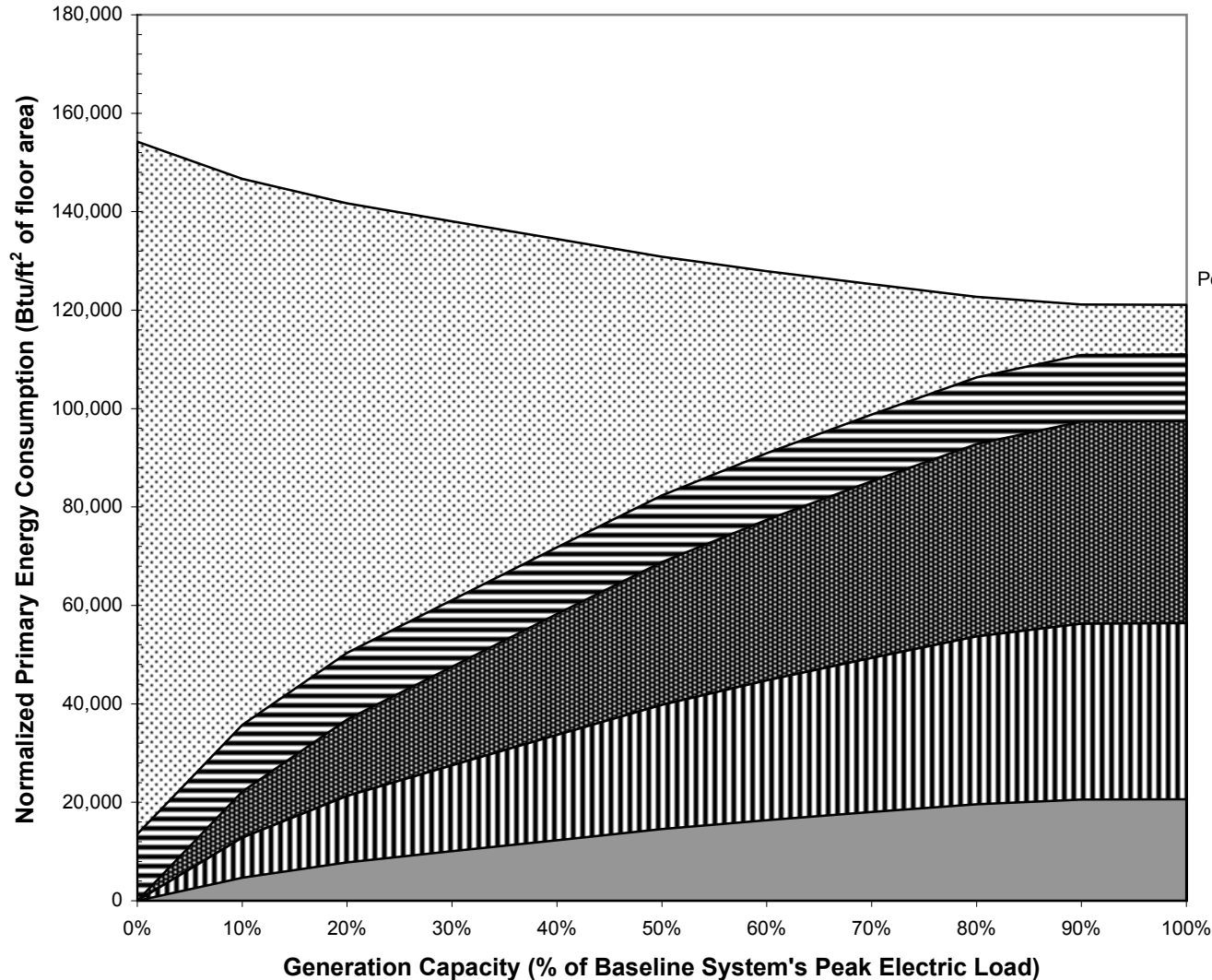

Run Number: 6
 Date and Time of Run: 1/12/02 10:20
 City Name: New York
 Building Type: Office
 FloorArea(ft²): 419,000
 Baseline Peak Electric(kW): 1,750
 Peak Cooling Load (tons): 548
 Peak Heating Load (MMBtuH): 6
 Generation Technology: Adv. Engine
 Absorption Chiller Type: Chiller Only
 Fuel Type: NaturalGas
 Rate Structure: Con Edison
 Control Strategy: Smart

**DG ONLY, no
 heat recovery**



Installed Cost and Annual Operating Cost

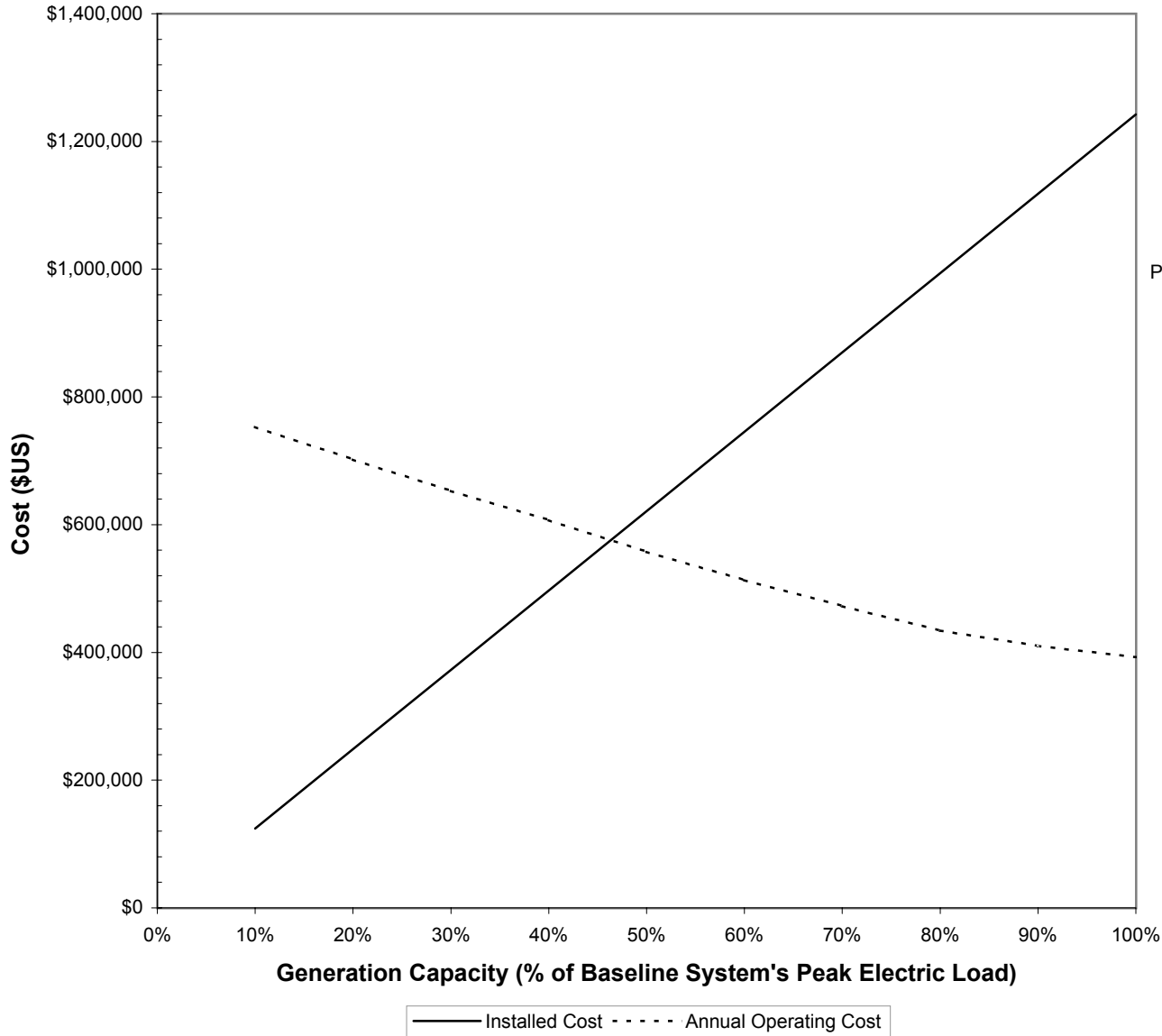

Run Number: 6
Date and Time of Run: 1/12/02 10:20
City Name: New York
Building Type: Office
FloorArea(ft²): 419,000
Baseline Peak Electric(kW): 1,750
Peak Cooling Load (tons): 548
Peak Heating Load (MMBtuH): 6
Generation Technology: Adv. Engine
Absorption Chiller Type: Chiller Only
Fuel Type: NaturalGas
Rate Structure: Con Edison
Control Strategy: Smart

**DG ONLY, no
heat recovery**

Payback Period

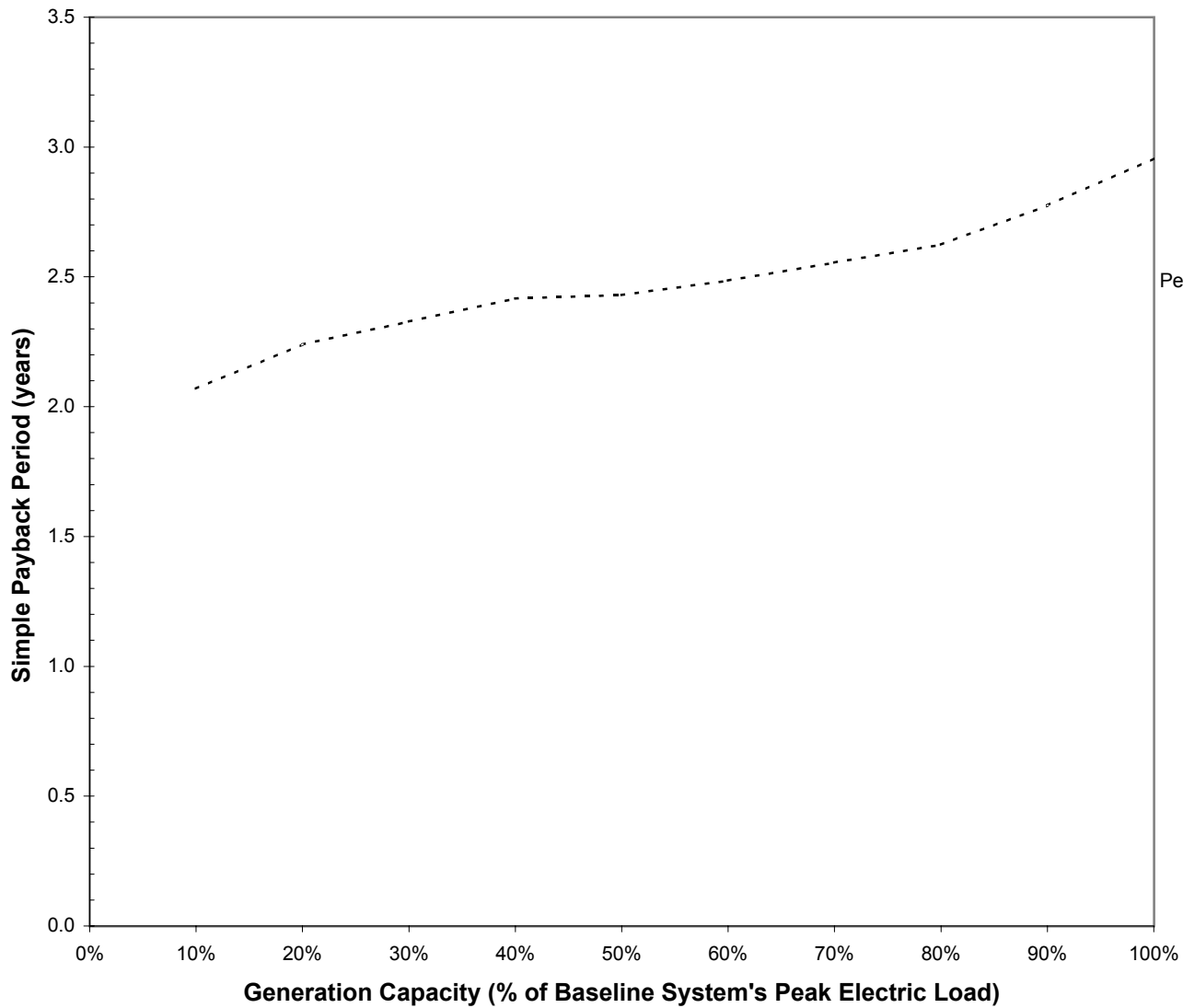

Run Number: 6

Date and Time of Run: 1/12/02 10:20

City Name: New York

Building Type: Office

FloorArea(ft²): 419,000

Baseline Peak Electric(kW): 1,750

Peak Cooling Load (tons): 548

Peak Heating Load (MMBtuH): 6

Generation Technology: Adv. Engine

Absorption Chiller Type: Chiller Only

Fuel Type: NaturalGas

Rate Structure: Con Edison

Control Strategy: Smart

**DG ONLY, no heat
recovery**

Annual Primary Energy Consumption Breakdown

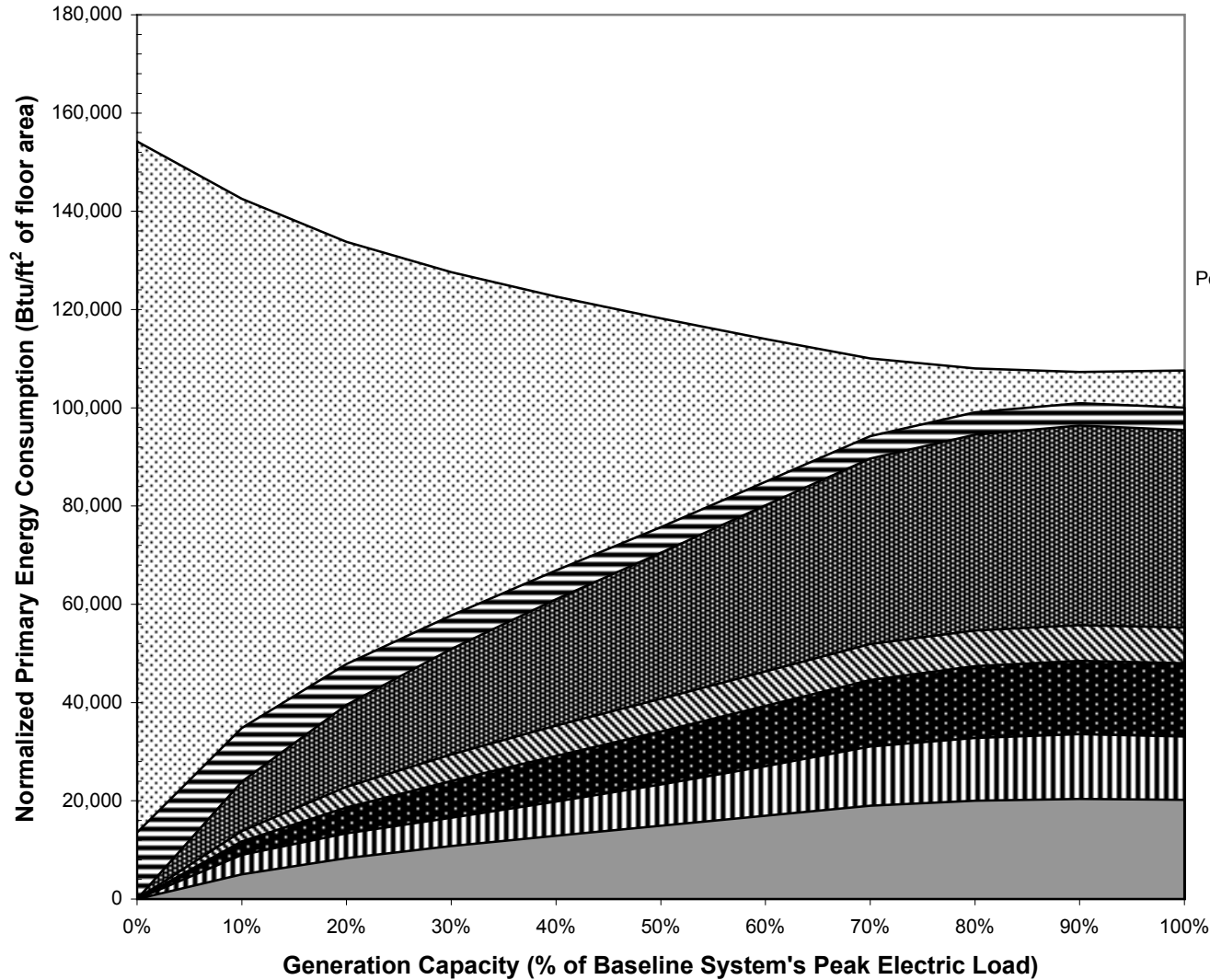

Run Number: 8
 Date and Time of Run: 1/12/02 14:12
 City Name: New York
 Building Type: Office
 FloorArea(ft²): 419,000
 Baseline Peak Electric(kW): 1,750
 Peak Cooling Load (tons): 548
 Peak Heating Load (MMBtuH): 6
 Generation Technology: Std. Engine
 Absorption Chiller Type: Single Effect
 Fuel Type: NaturalGas
 Rate Structure: Con Edison
 Control Strategy: Smart



Installed Cost and Annual Operating Cost

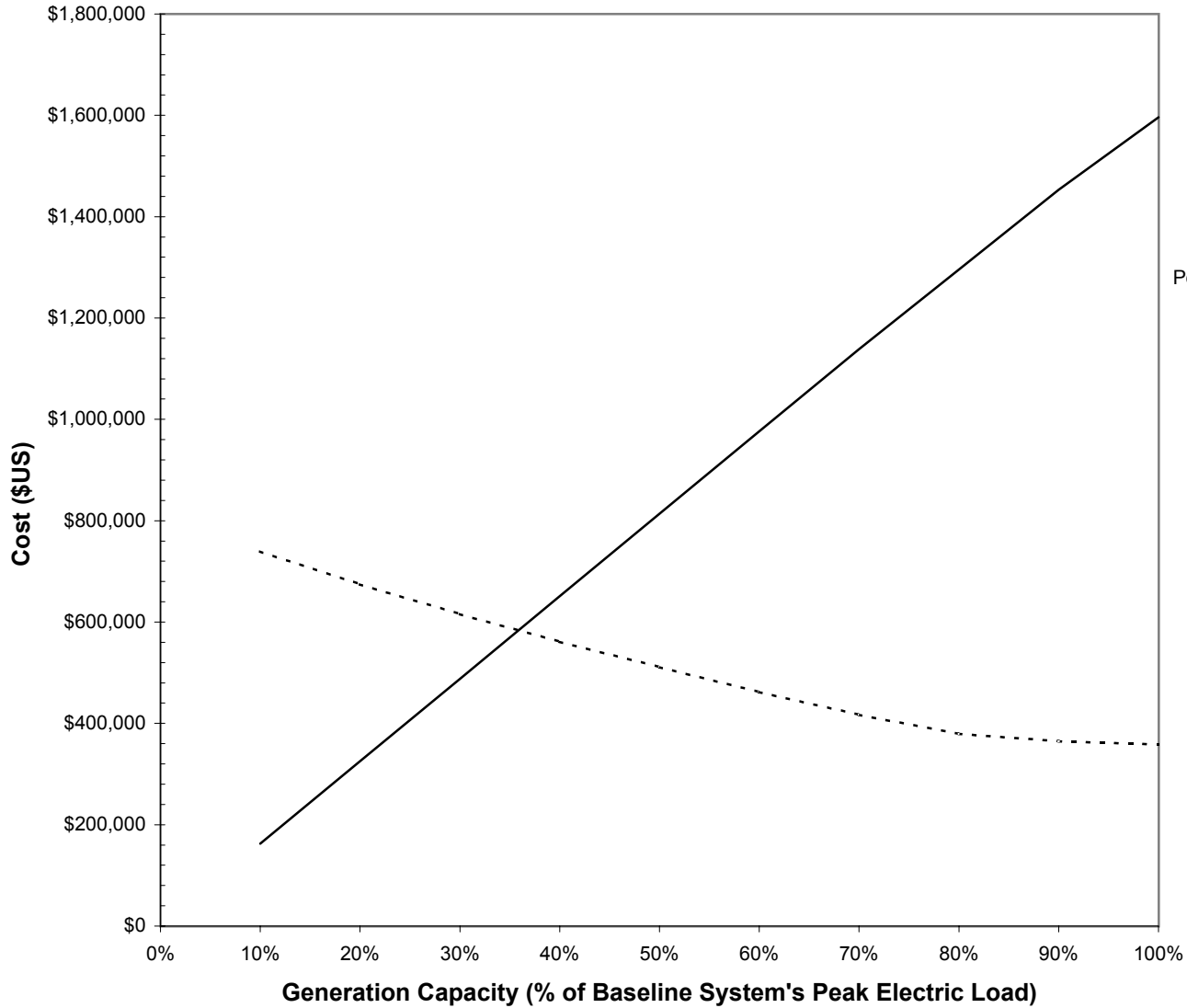

— Installed Cost - - - - Annual Operating Cost

Run Number: 8
Date and Time of Run: 1/12/02 14:12
City Name: New York
Building Type: Office
FloorArea(ft²): 419,000
Baseline Peak Electric(kW): 1,750
Peak Cooling Load (tons): 548
Peak Heating Load (MMBtuH): 6
Generation Technology: Std. Engine
Absorption Chiller Type: Single Effect
Fuel Type: NaturalGas
Rate Structure: Con Edison
Control Strategy: Smart

Payback Period

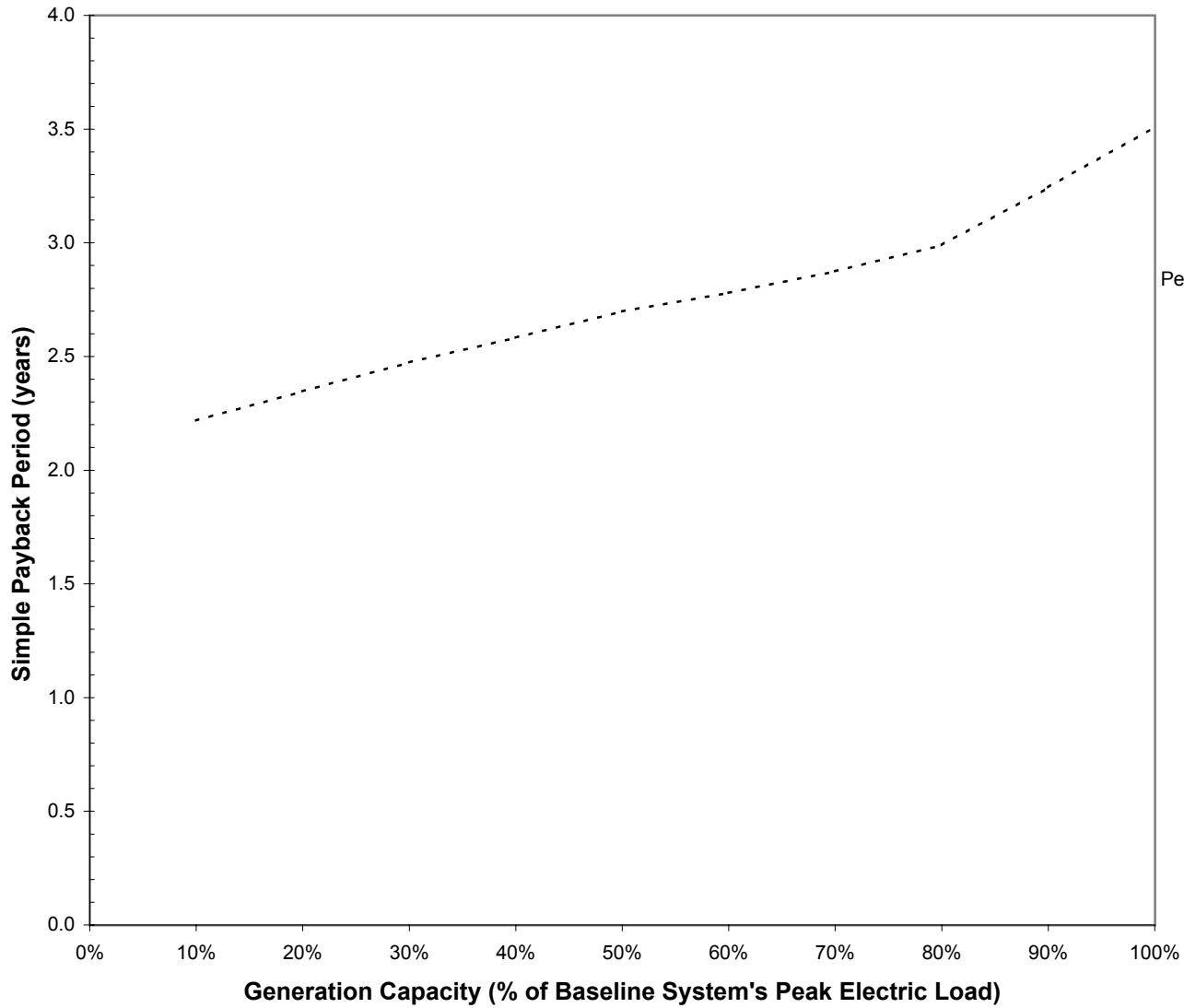

Run Number: 8

Date and Time of Run: 1/12/02 14:12

City Name: New York

Building Type: Office

FloorArea(ft²): 419,000

Baseline Peak Electric(kW): 1,750

Peak Cooling Load (tons): 548

Peak Heating Load (MMBtuH): 6

Generation Technology: Std. Engine

Absorption Chiller Type: Single Effect

Fuel Type: NaturalGas

Rate Structure: Con Edison

Control Strategy: Smart

Annual Primary Energy Consumption Breakdown

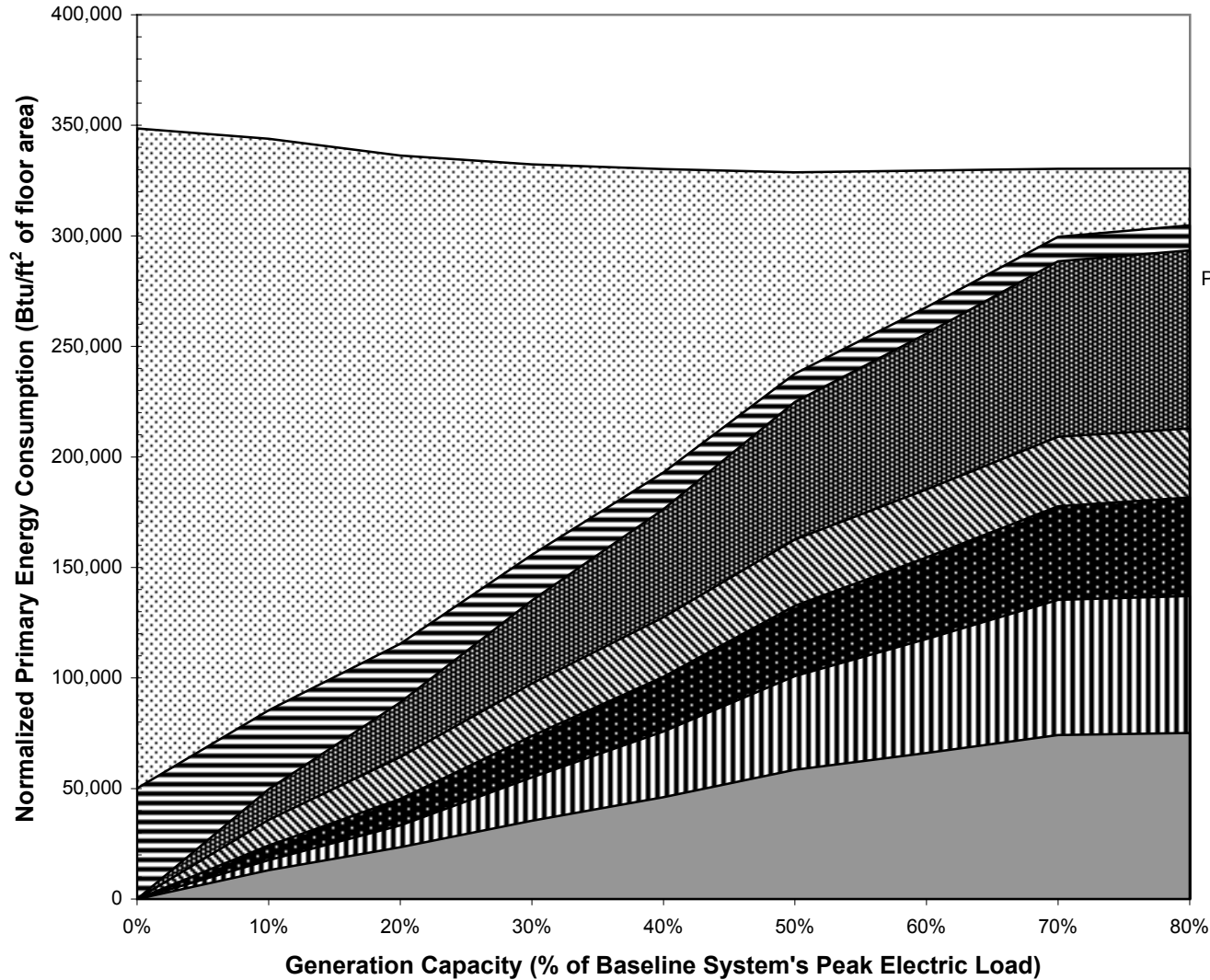

Run Number: 9
 Date and Time of Run: 1/15/02 20:19
 City Name: New York
 Building Type: Hospital
 FloorArea(ft²): 386,000
 Baseline Peak Electric(kW): 2,418
 Peak Cooling Load (tons): 1,138
 Peak Heating Load (MMBtuH): 10
 Generation Technology: Std. MicroTurbine
 Absorption Chiller Type: Double Effect
 Fuel Type: Natural Gas
 Rate Structure: Con Edison
 Control Strategy: Smart

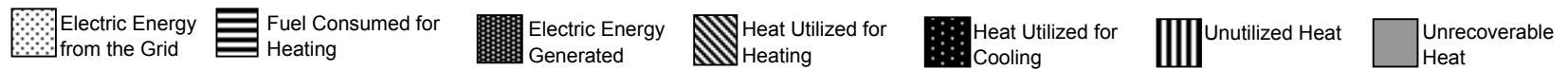

Installed Cost and Annual Operating Cost

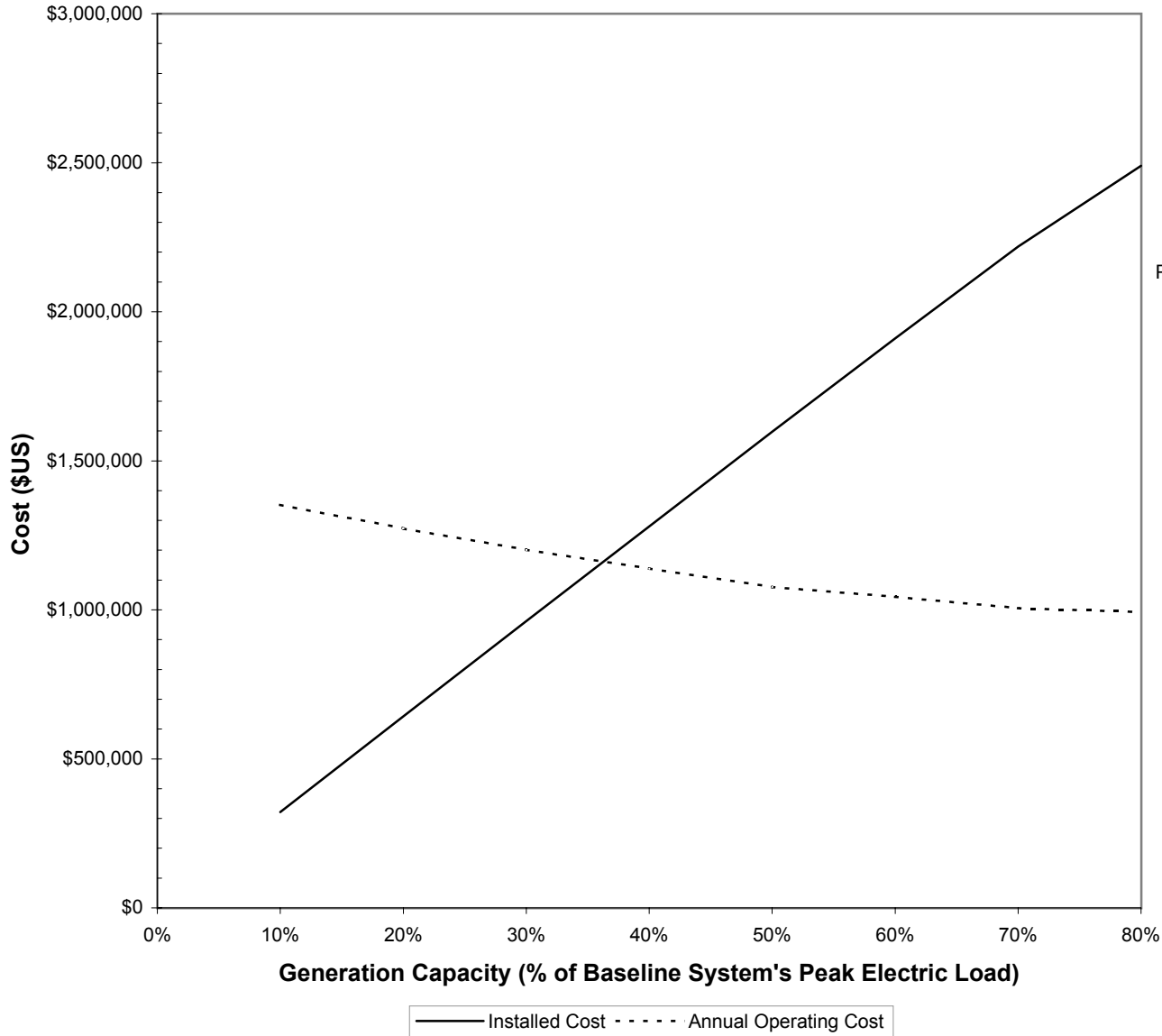

Run Number: 9
Date and Time of Run: 1/15/02 20:19
City Name: New York
Building Type: Hospital
FloorArea(ft²): 386,000
Baseline Peak Electric(kW): 2,418
Peak Cooling Load (tons): 1,138
Peak Heating Load (MMBtuH): 10
Generation Technology: Std. MicroTurbine
Absorption Chiller Type: Double Effect
Fuel Type: Natural Gas
Rate Structure: Con Edison
Control Strategy: Smart

Payback Period

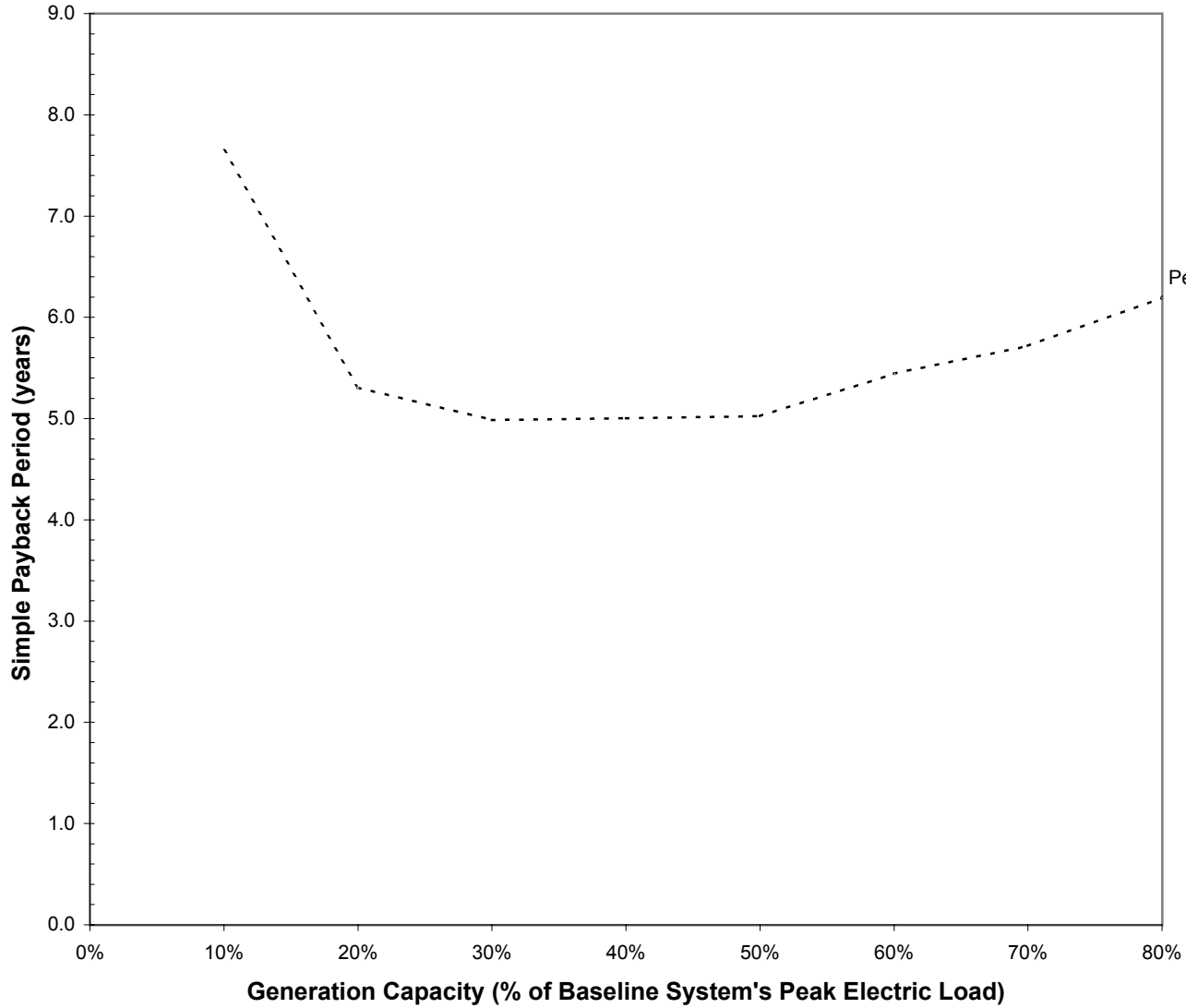

Run Number: 9

Date and Time of Run: 1/15/02 20:19

City Name: New York

Building Type: Hospital

FloorArea(ft²): 386,000

Baseline Peak Electric(kW): 2,418

Peak Cooling Load (tons): 1,138

Peak Heating Load (MMBtuH): 10

Generation Technology: Std. MicroTurbine

Absorption Chiller Type: Double Effect

Fuel Type: Natural Gas

Rate Structure: Con Edison

Control Strategy: Smart

Annual Primary Energy Consumption Breakdown

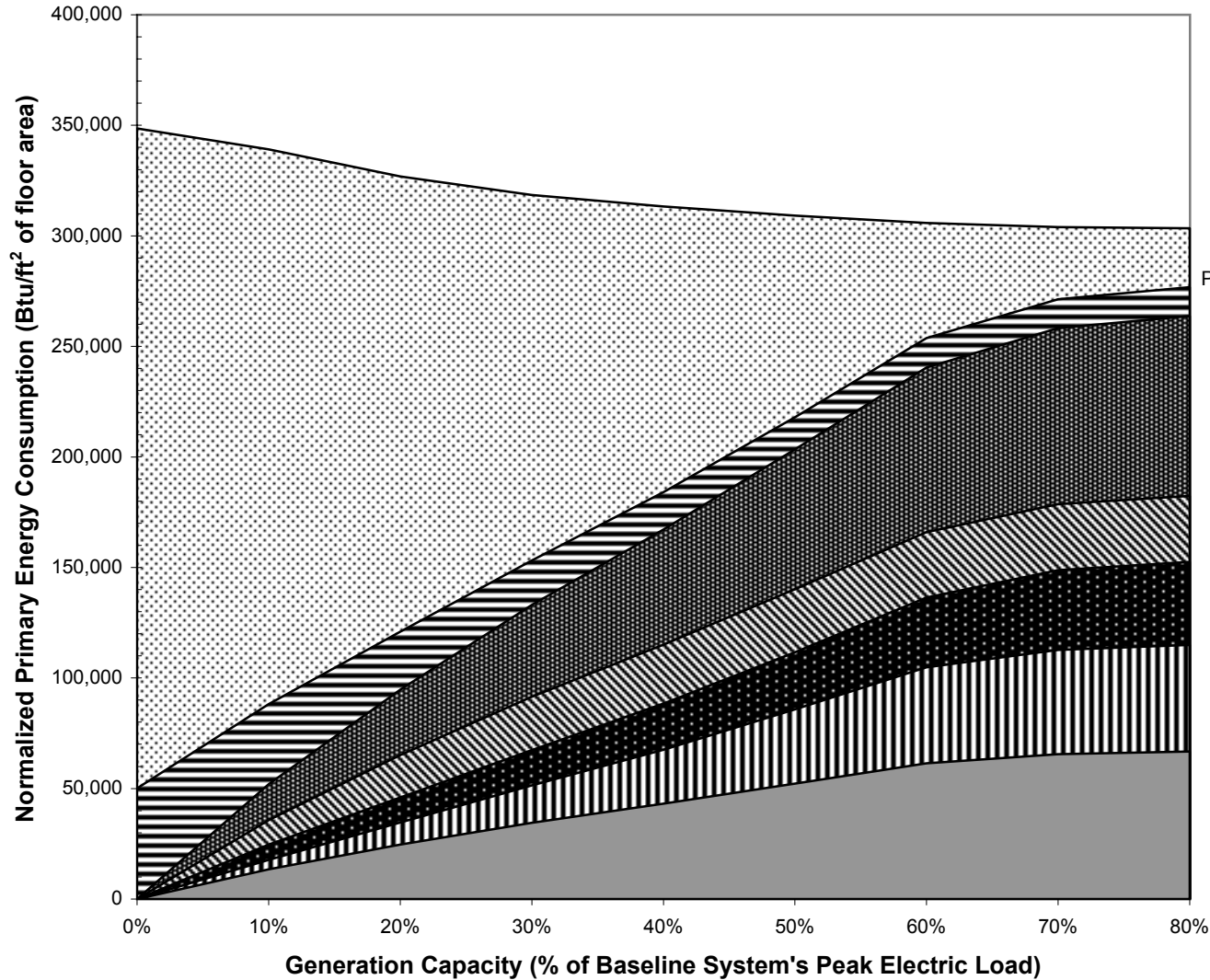

Run Number: 10
 Date and Time of Run: 1/15/02 23:31
 City Name: New York
 Building Type: Hospital
 FloorArea(ft²): 386,000
 Baseline Peak Electric(kW): 2,418
 Peak Cooling Load (tons): 1,138
 Peak Heating Load (MMBtuH): 10
 Generation Technology: Adv. Microturbine
 Absorption Chiller Type: Double Effect
 Fuel Type: Natural Gas
 Rate Structure: Con Edison
 Control Strategy: Smart

Electric Energy from the Grid

 Fuel Consumed for Heating

 Electric Energy Generated

 Heat Utilized for Heating

 Heat Utilized for Cooling

 Unutilized Heat

 Unrecoverable Heat

Installed Cost and Annual Operating Cost

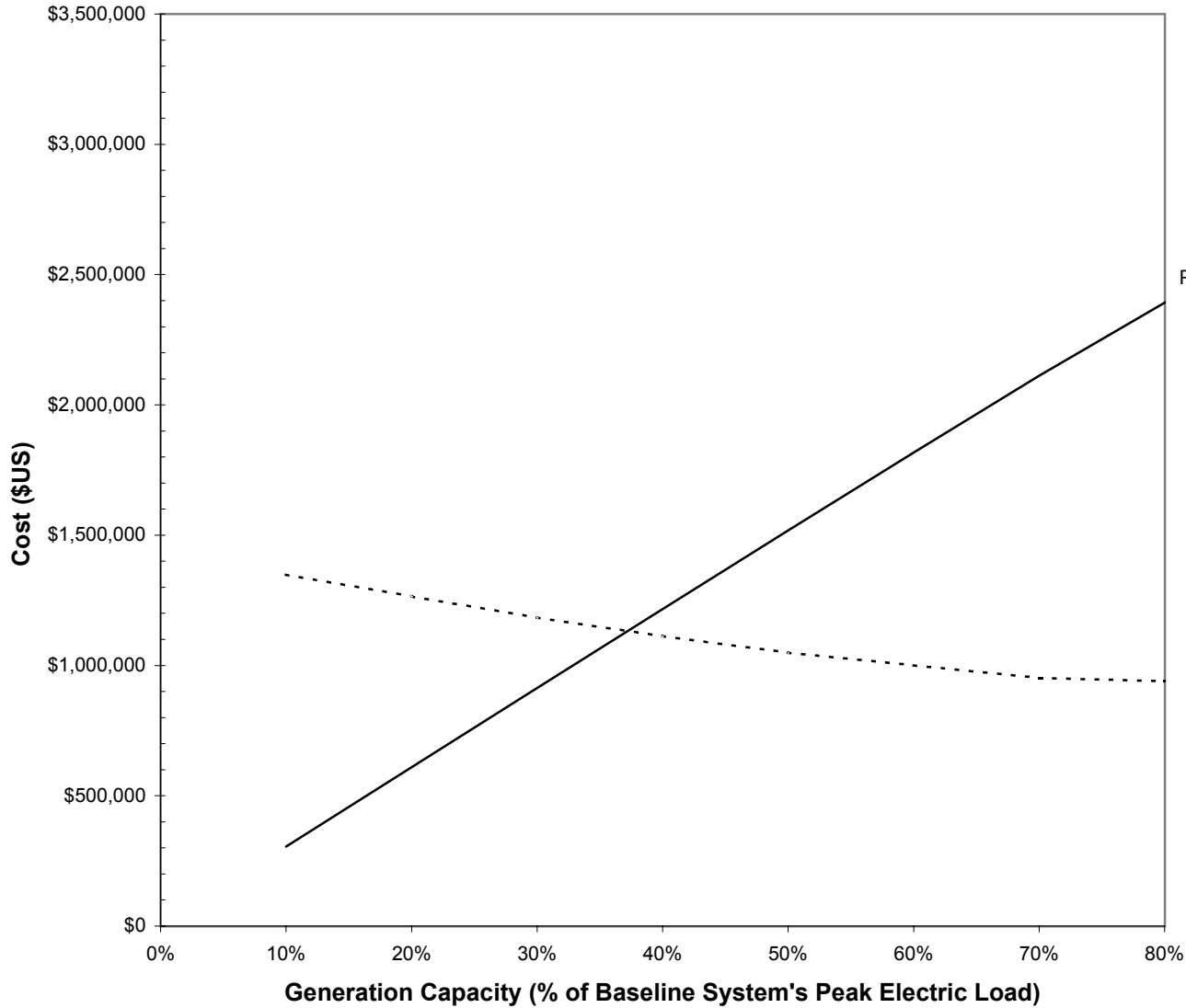

Run Number: 10
Date and Time of Run: 1/15/02 23:31
City Name: New York
Building Type: Hospital
FloorArea(ft²): 386,000
Baseline Peak Electric(kW): 2,418
Peak Cooling Load (tons): 1,138
Peak Heating Load (MMBtuH): 10
Generation Technology: Adv. Microturbine
Absorption Chiller Type: Double Effect
Fuel Type: Natural Gas
Rate Structure: Con Edison
Control Strategy: Smart

— Installed Cost - - - - Annual Operating Cost

Payback Period

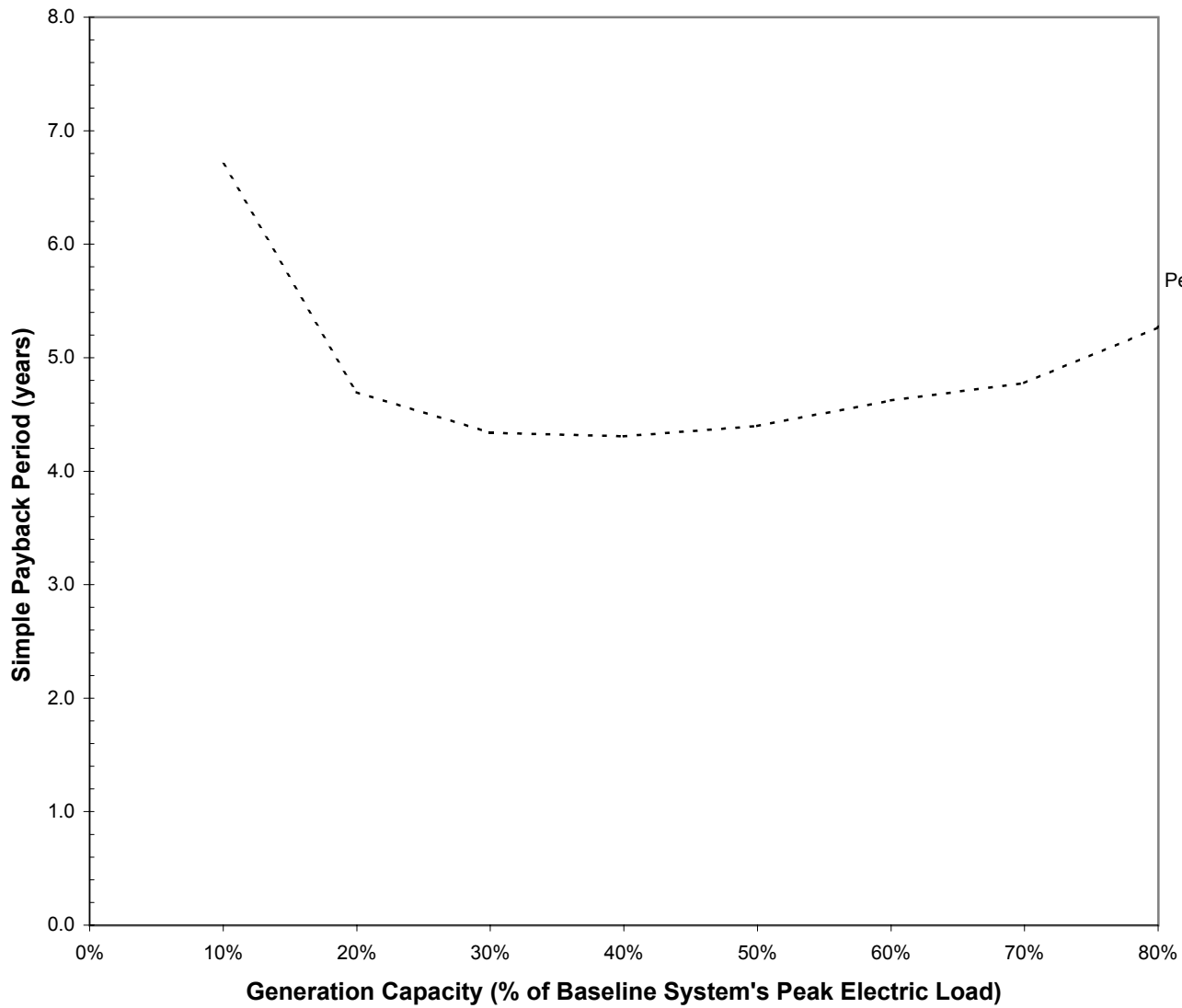

Run Number: 10

Date and Time of Run: 1/15/02 23:31

City Name: New York

Building Type: Hospital

FloorArea(ft²): 386,000

Baseline Peak Electric(kW): 2,418

Peak Cooling Load (tons): 1,138

Peak Heating Load (MMBtuH): 10

Generation Technology: Adv. Microturbine

Absorption Chiller Type: Double Effect

Fuel Type: Natural Gas

Rate Structure: Con Edison

Control Strategy: Smart

Annual Primary Energy Consumption Breakdown

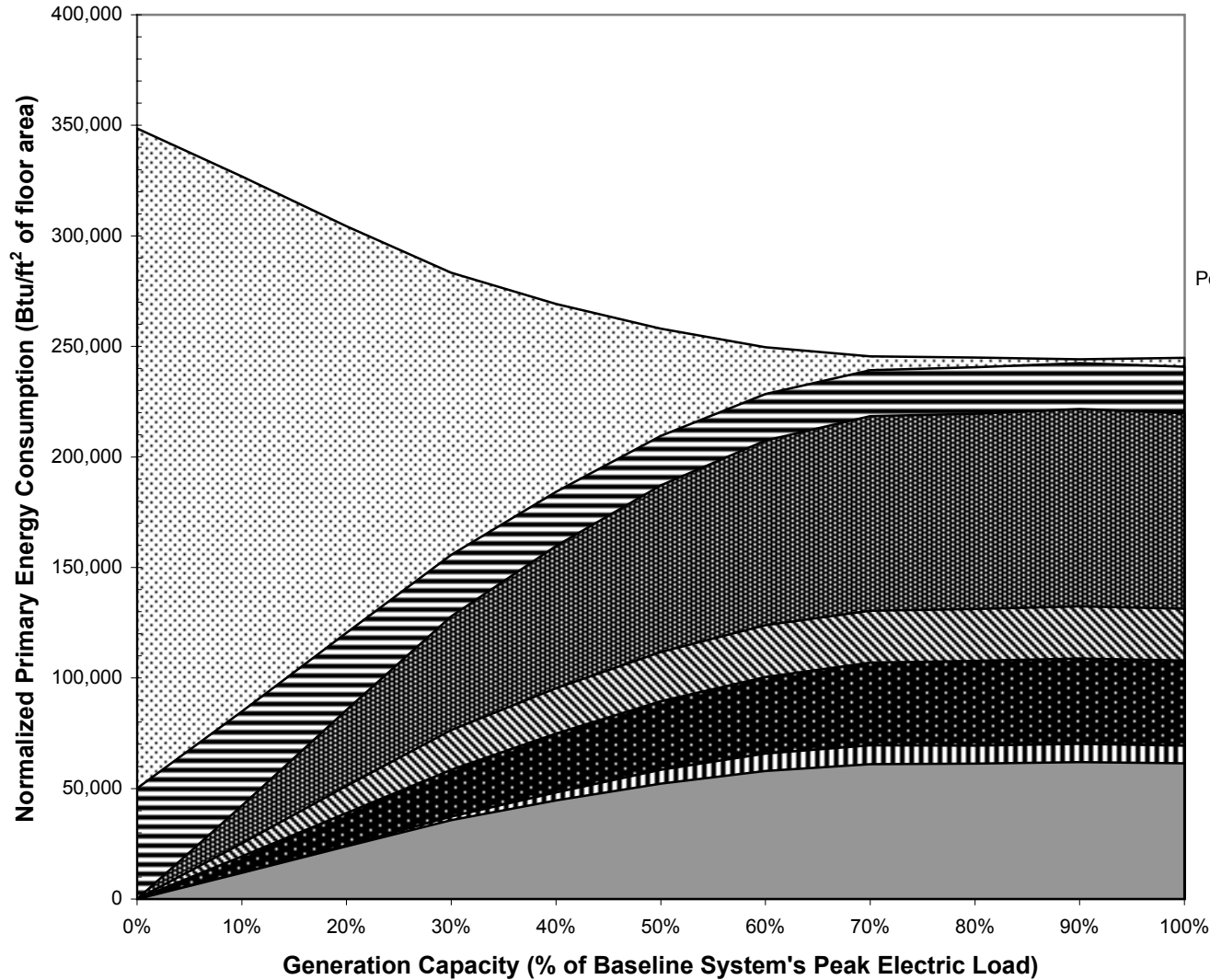

Run Number: 11
 Date and Time of Run: 1/12/02 23:05
 City Name: New York
 Building Type: Hospital
 FloorArea(ft²): 386,000
 Baseline Peak Electric(kW): 2,249
 Peak Cooling Load (tons): 1,138
 Peak Heating Load (MMBtuH): 10
 Generation Technology: HTPeM Fuel Cell
 Absorption Chiller Type: Single Effect
 Fuel Type: NaturalGas
 Rate Structure: Con Edison
 Control Strategy: Smart



Installed Cost and Annual Operating Cost

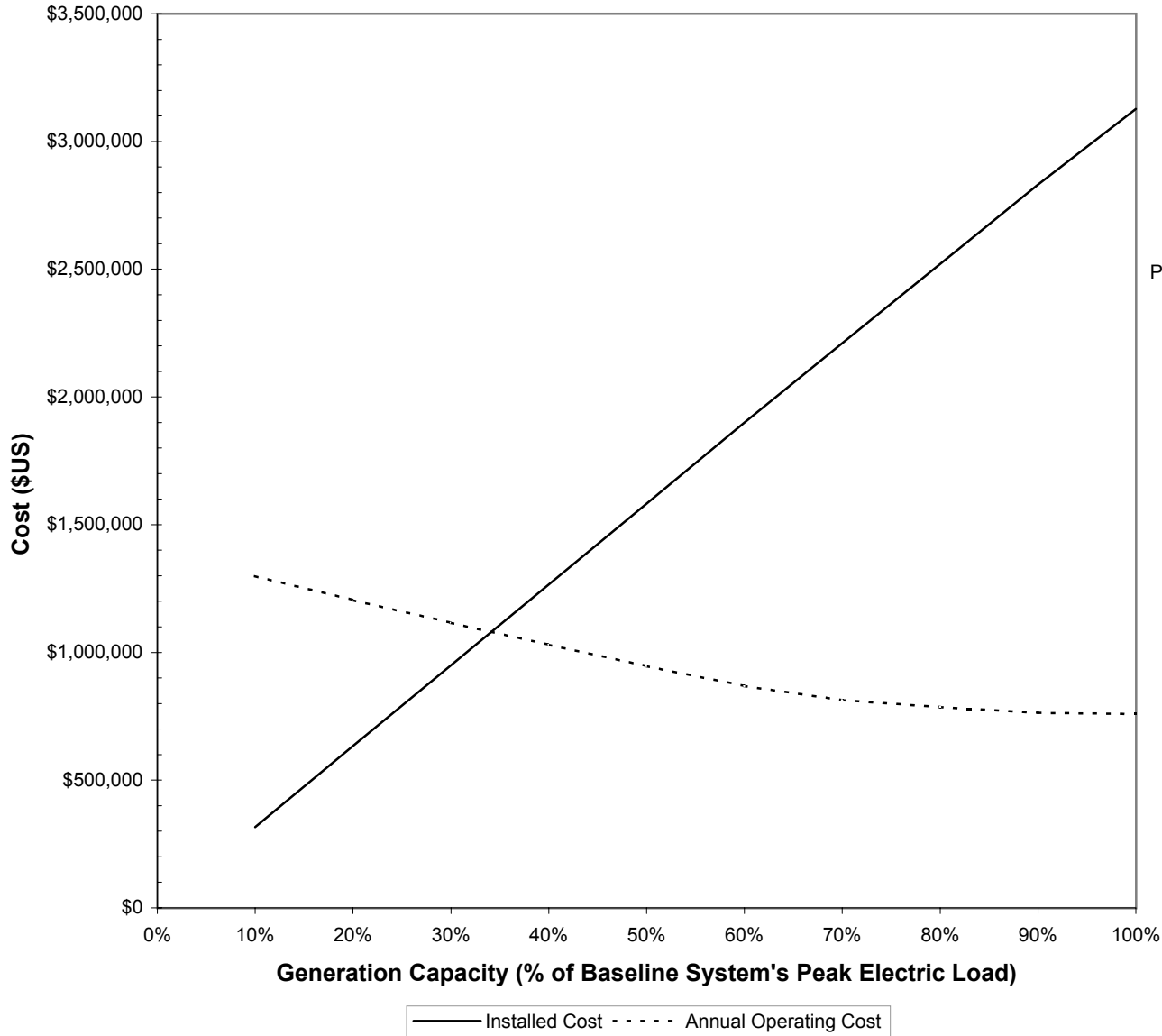

Run Number: 11
Date and Time of Run: 1/12/02 23:05
City Name: New York
Building Type: Hospital
FloorArea(ft²): 386,000
Baseline Peak Electric(kW): 2,249
Peak Cooling Load (tons): 1,138
Peak Heating Load (MMBtuH): 10
Generation Technology: HTPeM Fuel Cell
Absorption Chiller Type: Single Effect
Fuel Type: NaturalGas
Rate Structure: Con Edison
Control Strategy: Smart

Payback Period

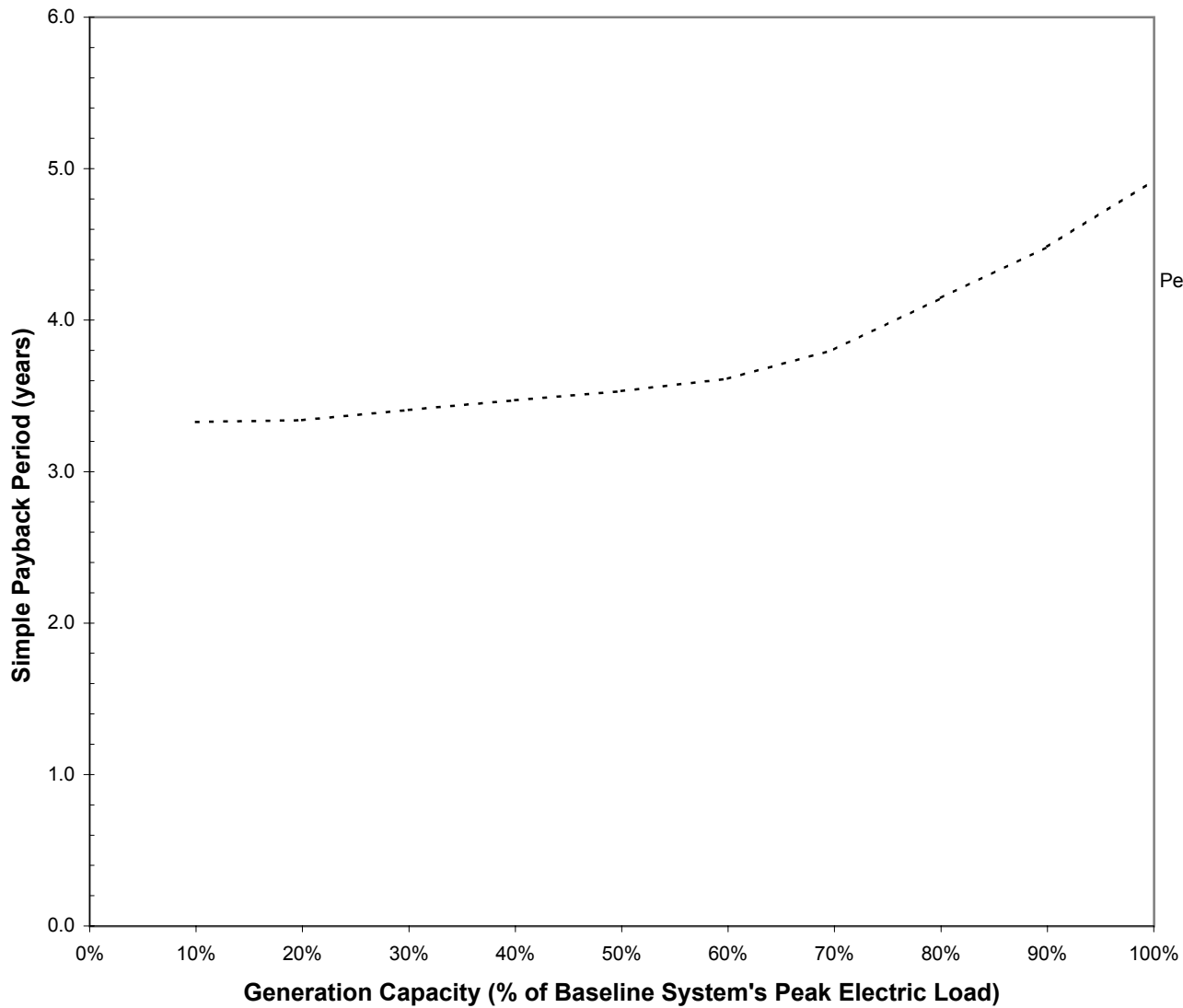

Run Number: 11

Date and Time of Run: 1/12/02 23:05

City Name: New York

Building Type: Hospital

FloorArea(ft²): 386,000

Baseline Peak Electric(kW): 2,249

Peak Cooling Load (tons): 1,138

Peak Heating Load (MMBtuH): 10

Generation Technology: HTPeM Fuel Cell

Absorption Chiller Type: Single Effect

Fuel Type: NaturalGas

Rate Structure: Con Edison

Control Strategy: Smart

Annual Primary Energy Consumption Breakdown

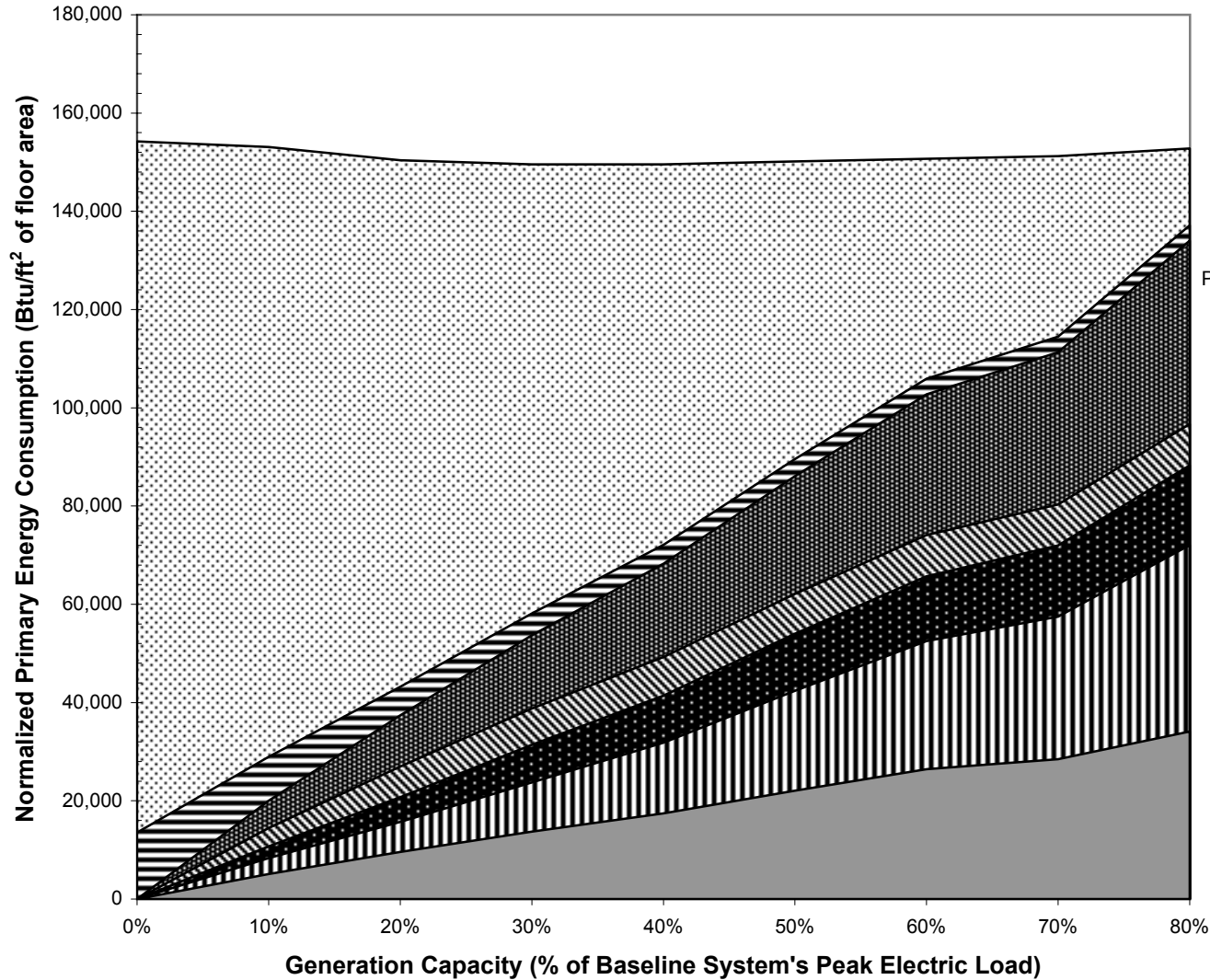

Run Number: 12
 Date and Time of Run: 3/11/02 21:39
 City Name: New York
 Building Type: Office
 FloorArea(ft²): 419,000
 Baseline Peak Electric(kW): 1,831
 Peak Cooling Load (tons): 548
 Peak Heating Load (MMBtuH): 6
 Generation Technology: Std. MicroTurbine
 Absorption Chiller Type: Double Effect
 Fuel Type: Natural Gas
 Rate Structure: Con Edison
 Control Strategy: Smart



Installed Cost and Annual Operating Cost

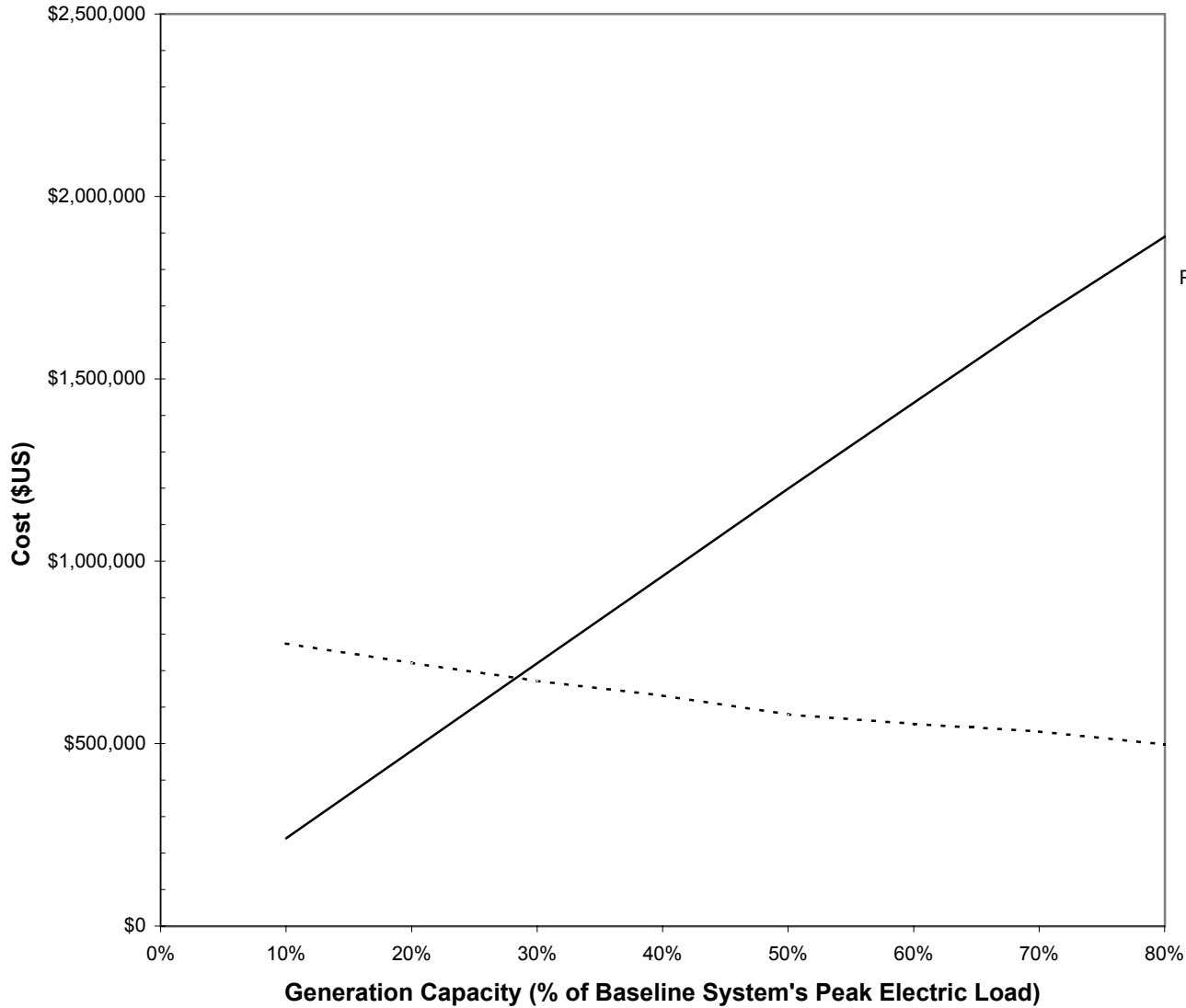

— Installed Cost - - - - Annual Operating Cost

Run Number: 12
Date and Time of Run: 3/11/02 21:39
City Name: New York
Building Type: Office
FloorArea(ft²): 419,000
Baseline Peak Electric(kW): 1,831
Peak Cooling Load (tons): 548
Peak Heating Load (MMBtuH): 6
Generation Technology: Std. MicroTurbine
Absorption Chiller Type: Double Effect
Fuel Type: Natural Gas
Rate Structure: Con Edison
Control Strategy: Smart

Payback Period

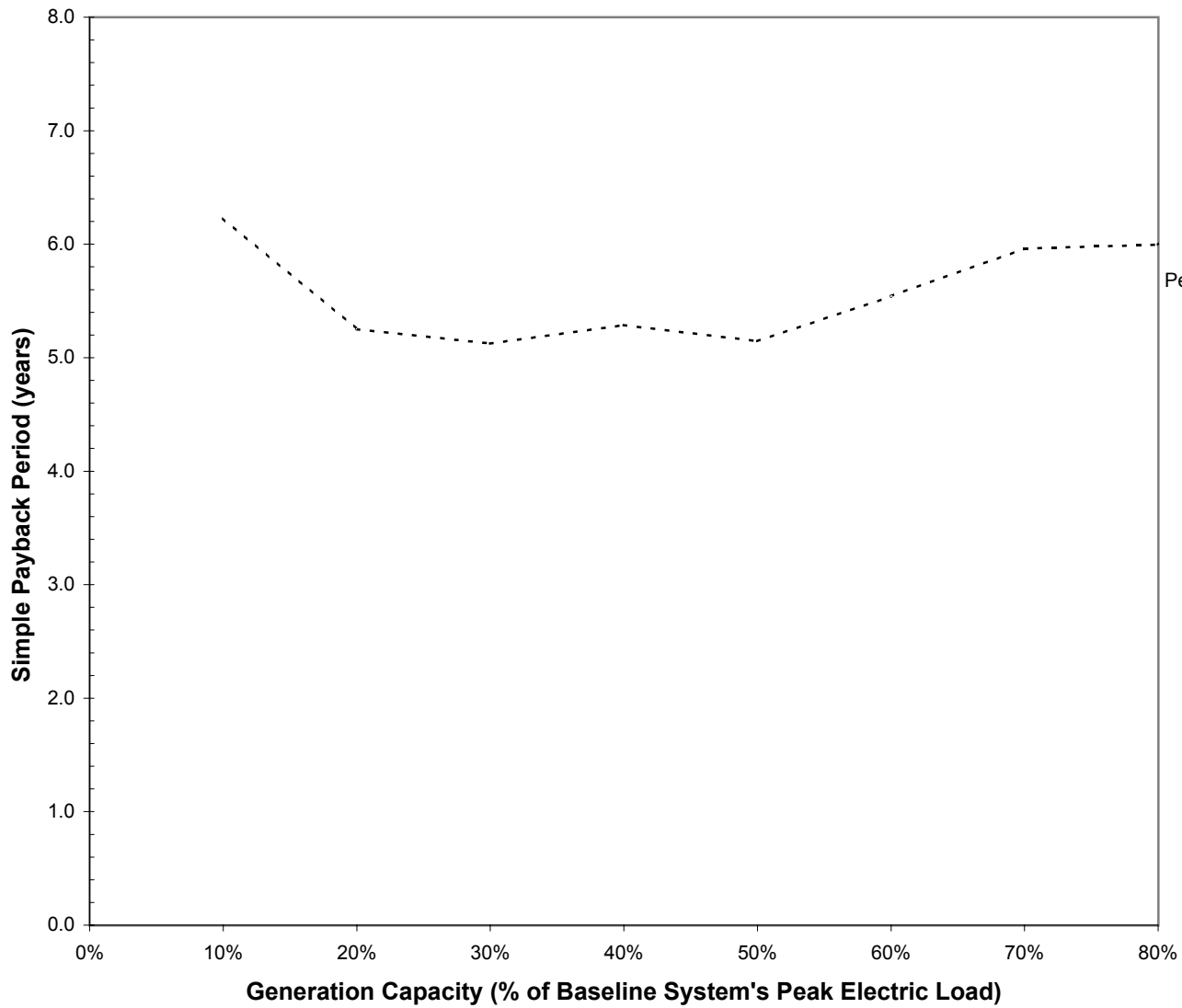

Run Number: 12

Date and Time of Run: 3/11/02 21:39

City Name: New York

Building Type: Office

FloorArea(ft²): 419,000

Baseline Peak Electric(kW): 1,831

Peak Cooling Load (tons): 548

Peak Heating Load (MMBtuH): 6

Generation Technology: Std. MicroTurbine

Absorption Chiller Type: Double Effect

Fuel Type: Natural Gas

Rate Structure: Con Edison

Control Strategy: Smart

Annual Primary Energy Consumption Breakdown

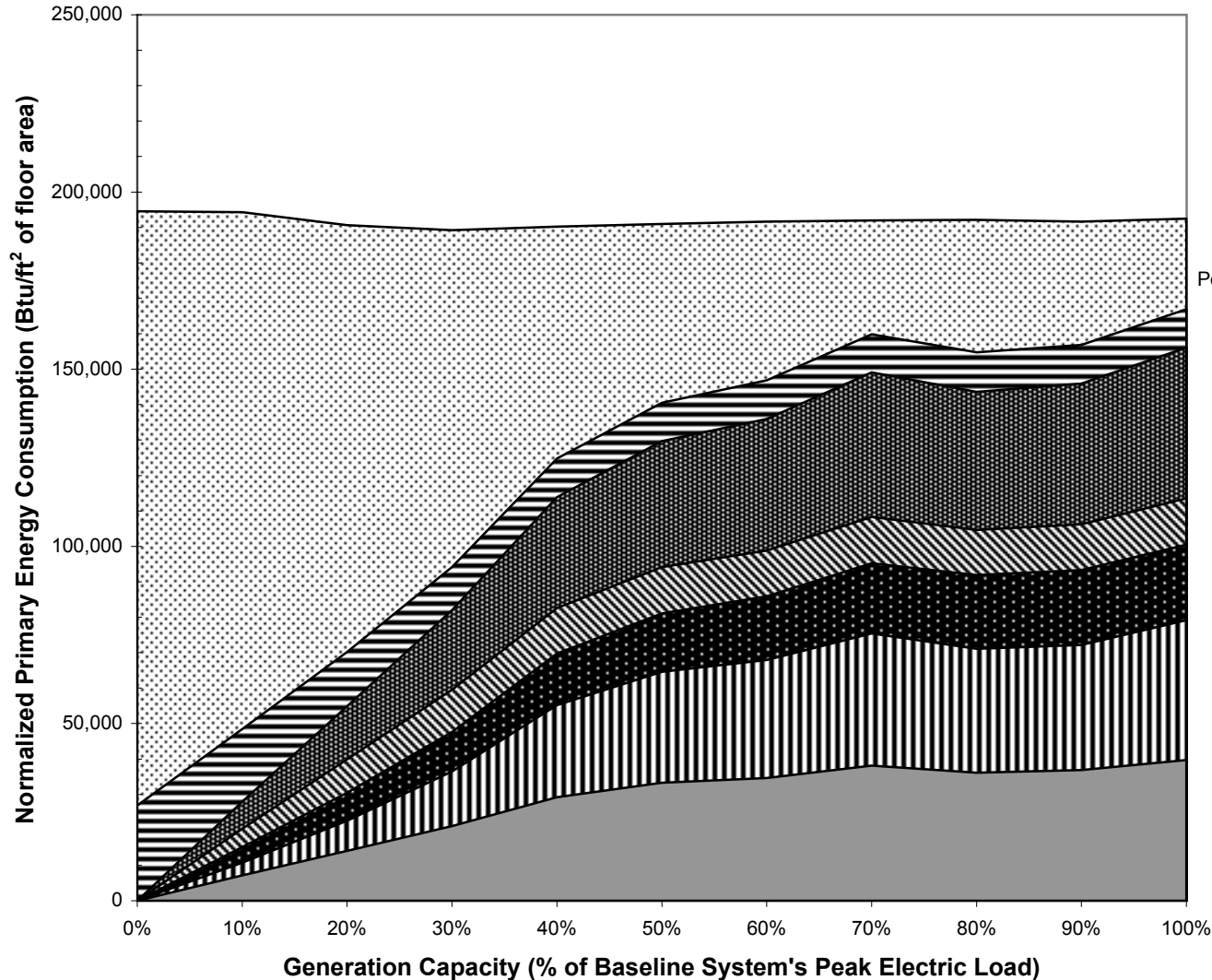

Run Number: 13
 Date and Time of Run: 1/16/02 9:09
 City Name: New York
 Building Type: Hotel
 FloorArea(ft²): 494,000
 Baseline Peak Electric(kW): 2,778
 Peak Cooling Load (tons): 1,672
 Peak Heating Load (MMBtuH): 15
 Generation Technology: Std. Microturbine
 Absorption Chiller Type: Double Effect
 Fuel Type: Natural Gas
 Rate Structure: Con Edison
 Control Strategy: Smart



Installed Cost and Annual Operating Cost

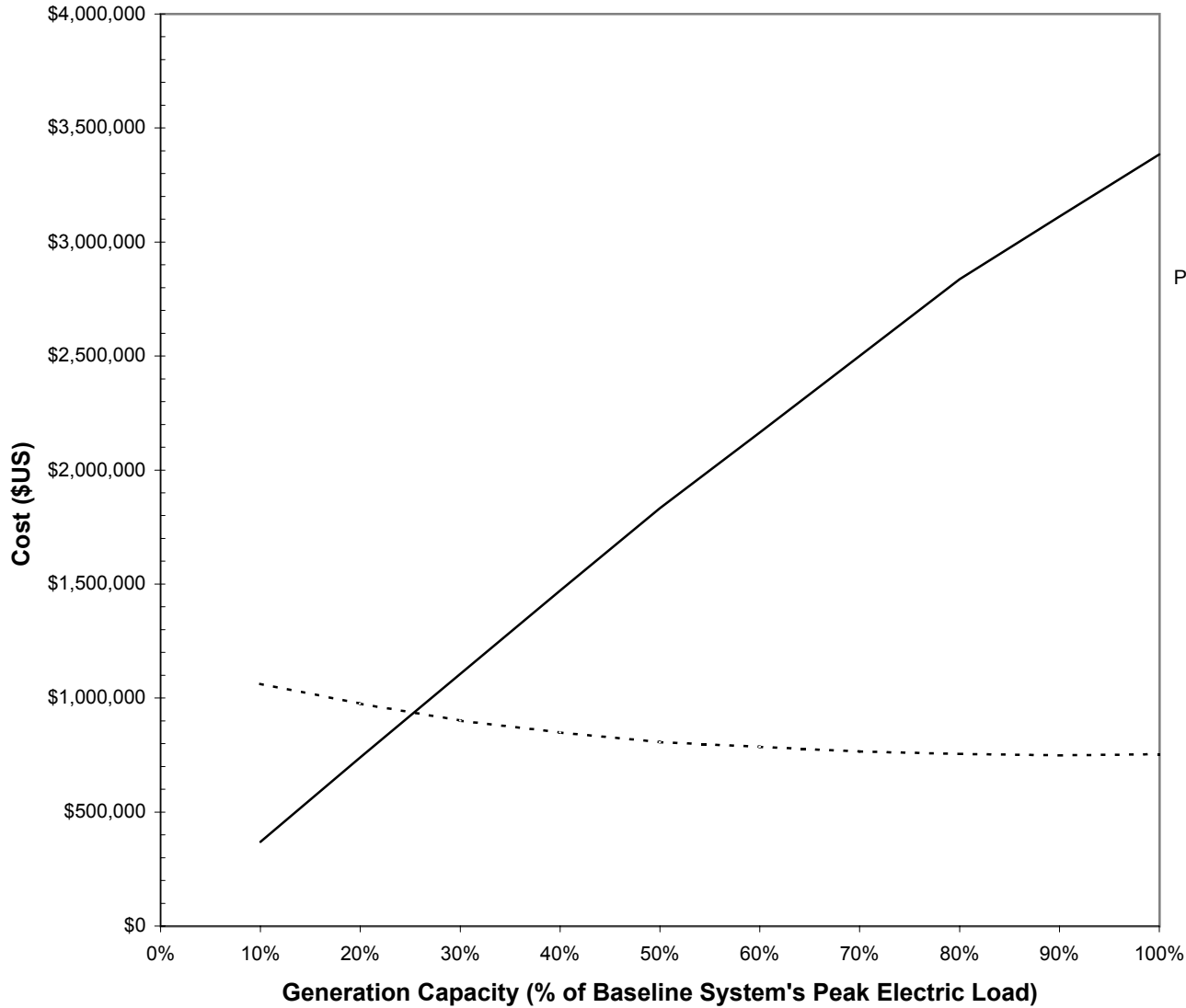

— Installed Cost - - - - Annual Operating Cost

Run Number: 13
Date and Time of Run: 1/16/02 9:09
City Name: New York
Building Type: Hotel
FloorArea(ft²): 494,000
Baseline Peak Electric(kW): 2,778
Peak Cooling Load (tons): 1,672
Peak Heating Load (MMBtuH): 15
Generation Technology: Std. Microturbine
Absorption Chiller Type: Double Effect
Fuel Type: Natural Gas
Rate Structure: Con Edison
Control Strategy: Smart

Payback Period

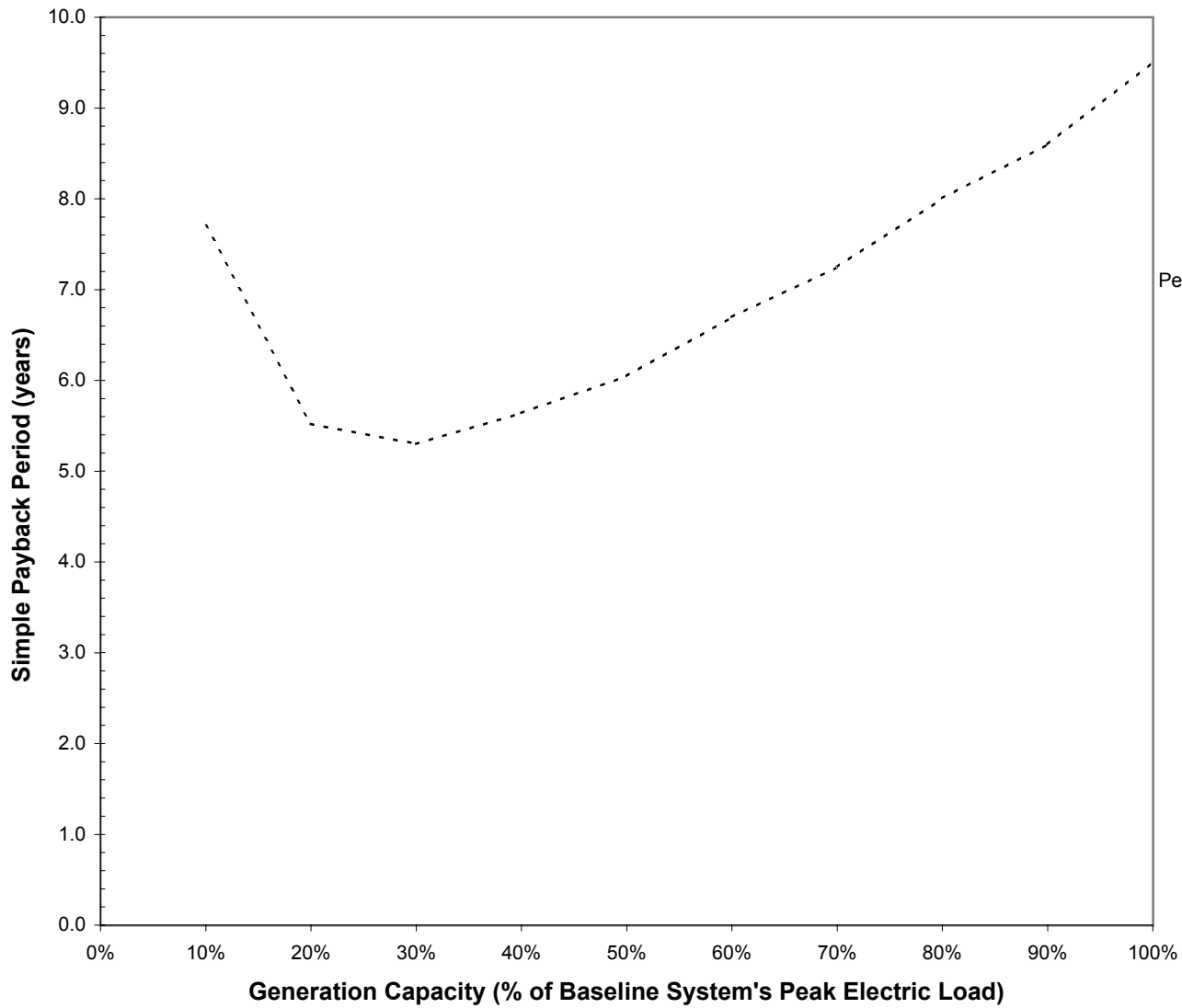

Run Number: 13

Date and Time of Run: 1/16/02 9:09

City Name: New York

Building Type: Hotel

FloorArea(ft²): 494,000

Baseline Peak Electric(kW): 2,778

Peak Cooling Load (tons): 1,672

Peak Heating Load (MMBtuH): 15

Generation Technology: Std. Microturbine

Absorption Chiller Type: Double Effect

Fuel Type: Natural Gas

Rate Structure: Con Edison

Control Strategy: Smart

Annual Primary Energy Consumption Breakdown

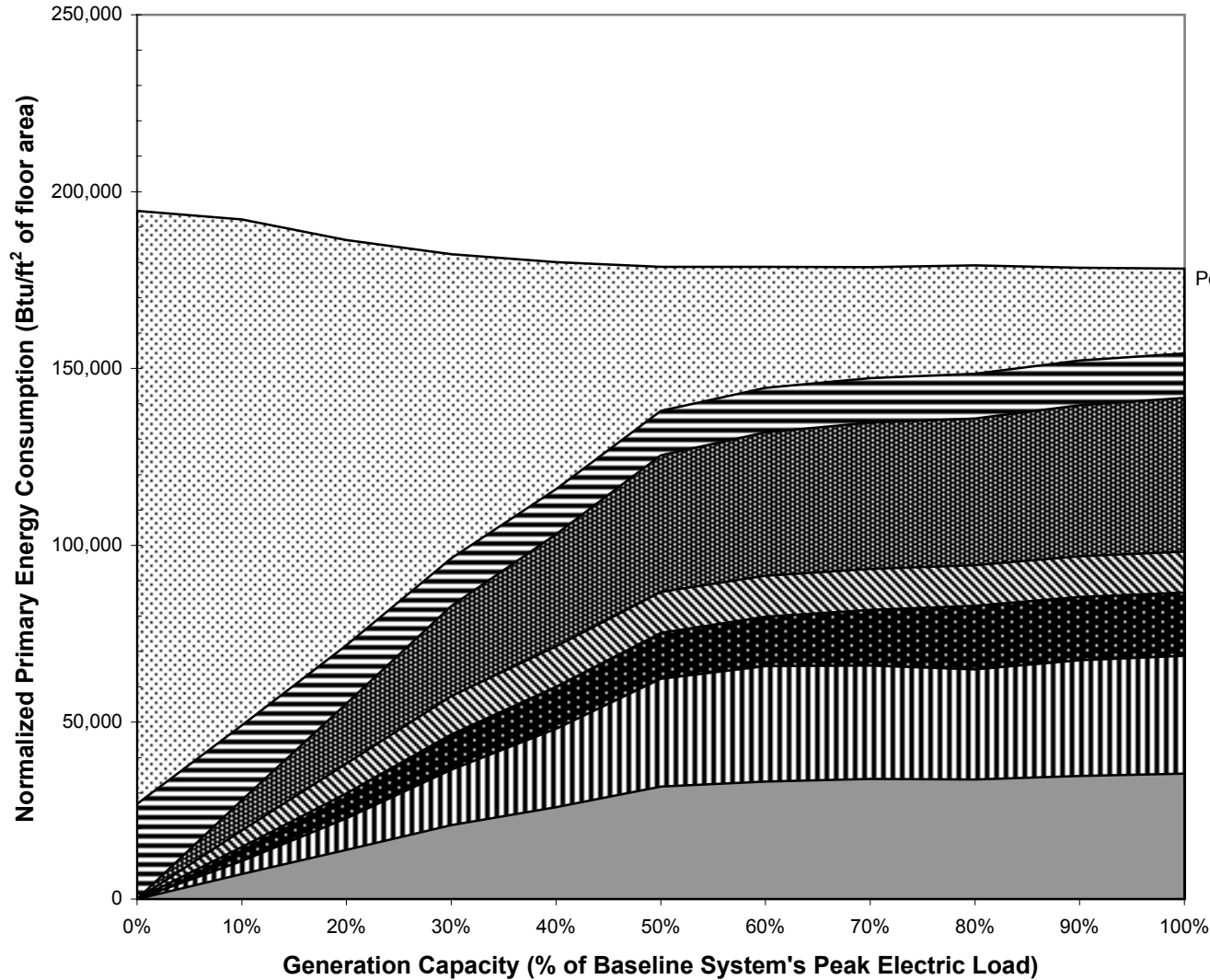

Run Number: 14

Date and Time of Run: 1/14/02 4:49

City Name: New York

Building Type: Hotel

FloorArea(ft²): 494,000

Baseline Peak Electric(kW): 2,778

Peak Cooling Load (tons): 1,672

Peak Heating Load (MMBtuH): 15

Generation Technology: Adv. Microturbine

Absorption Chiller Type: Double Effect

Fuel Type: Natural Gas

Rate Structure: Con Edison

Control Strategy: Smart



Installed Cost and Annual Operating Cost

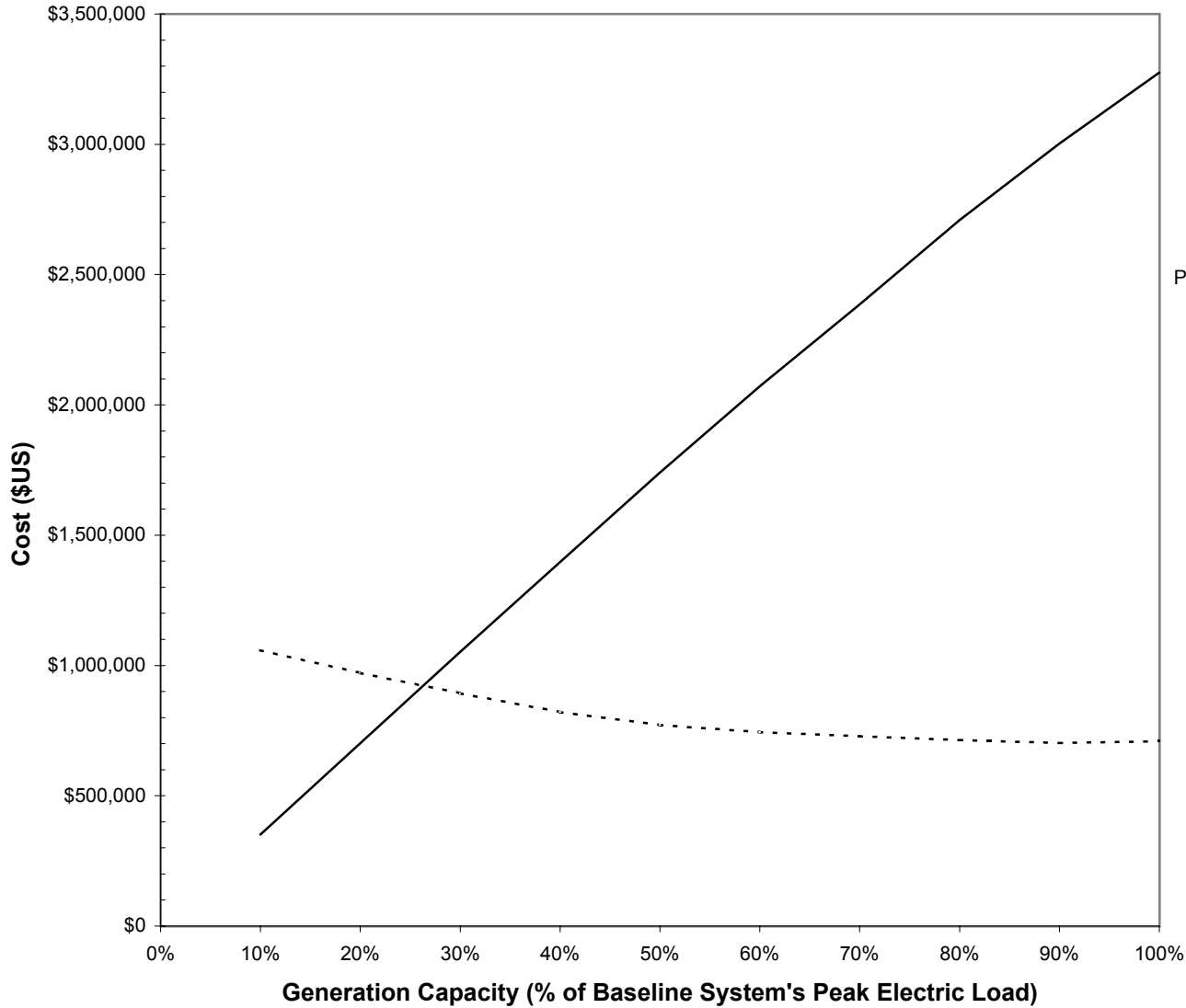

— Installed Cost - - - - Annual Operating Cost

Run Number: 14
Date and Time of Run: 1/14/02 4:49
City Name: New York
Building Type: Hotel
FloorArea(ft²): 494,000
Baseline Peak Electric(kW): 2,778
Peak Cooling Load (tons): 1,672
Peak Heating Load (MMBtuH): 15
Generation Technology: Adv. Microturbine
Absorption Chiller Type: Double Effect
Fuel Type: Natural Gas
Rate Structure: Con Edison
Control Strategy: Smart

Payback Period

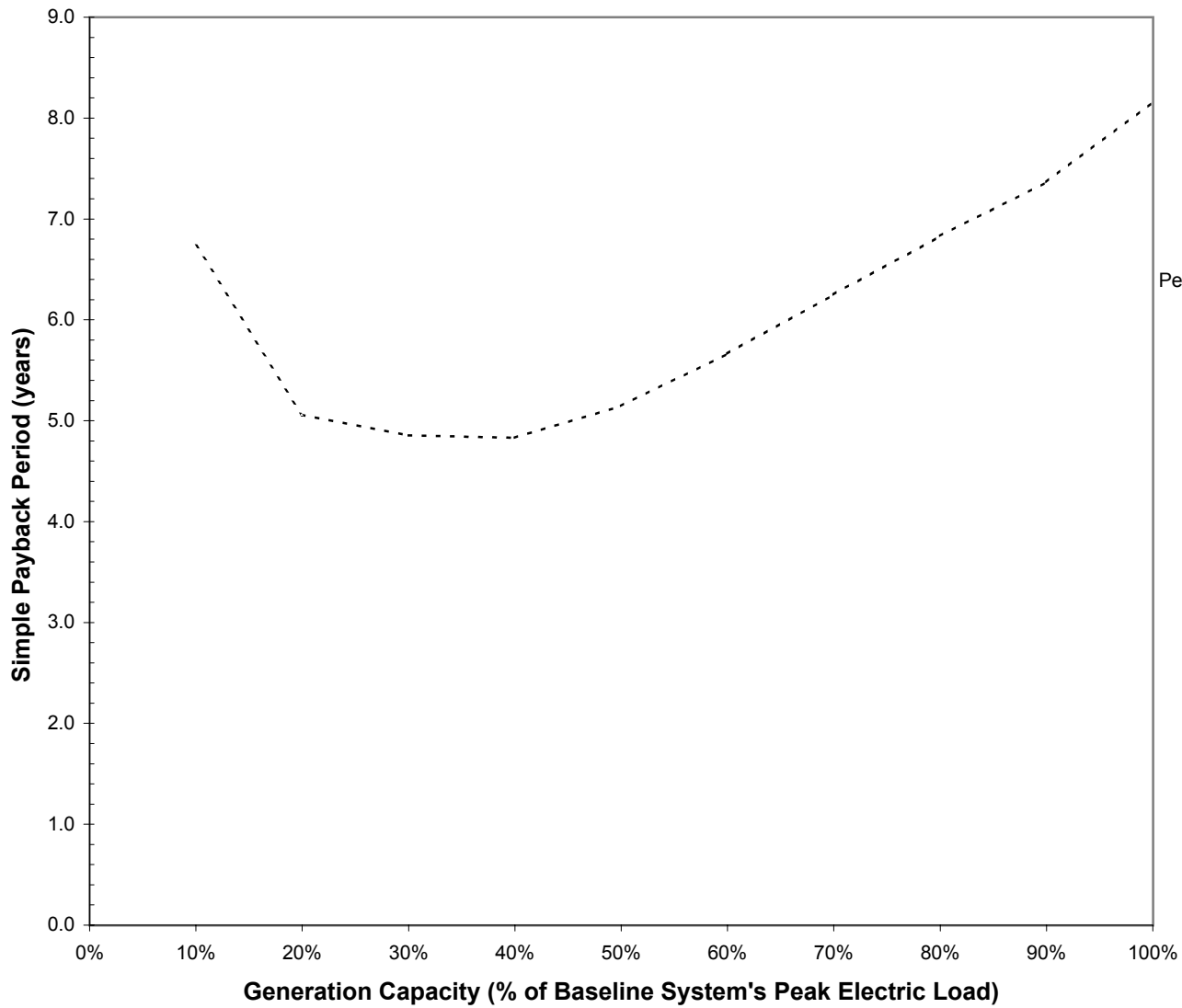

Run Number: 14

Date and Time of Run: 1/14/02 4:49

City Name: New York

Building Type: Hotel

FloorArea(ft²): 494,000

Baseline Peak Electric(kW): 2,778

Peak Cooling Load (tons): 1,672

Peak Heating Load (MMBtuH): 15

Generation Technology: Adv. Microturbine

Absorption Chiller Type: Double Effect

Fuel Type: Natural Gas

Rate Structure: Con Edison

Control Strategy: Smart

Annual Primary Energy Consumption Breakdown

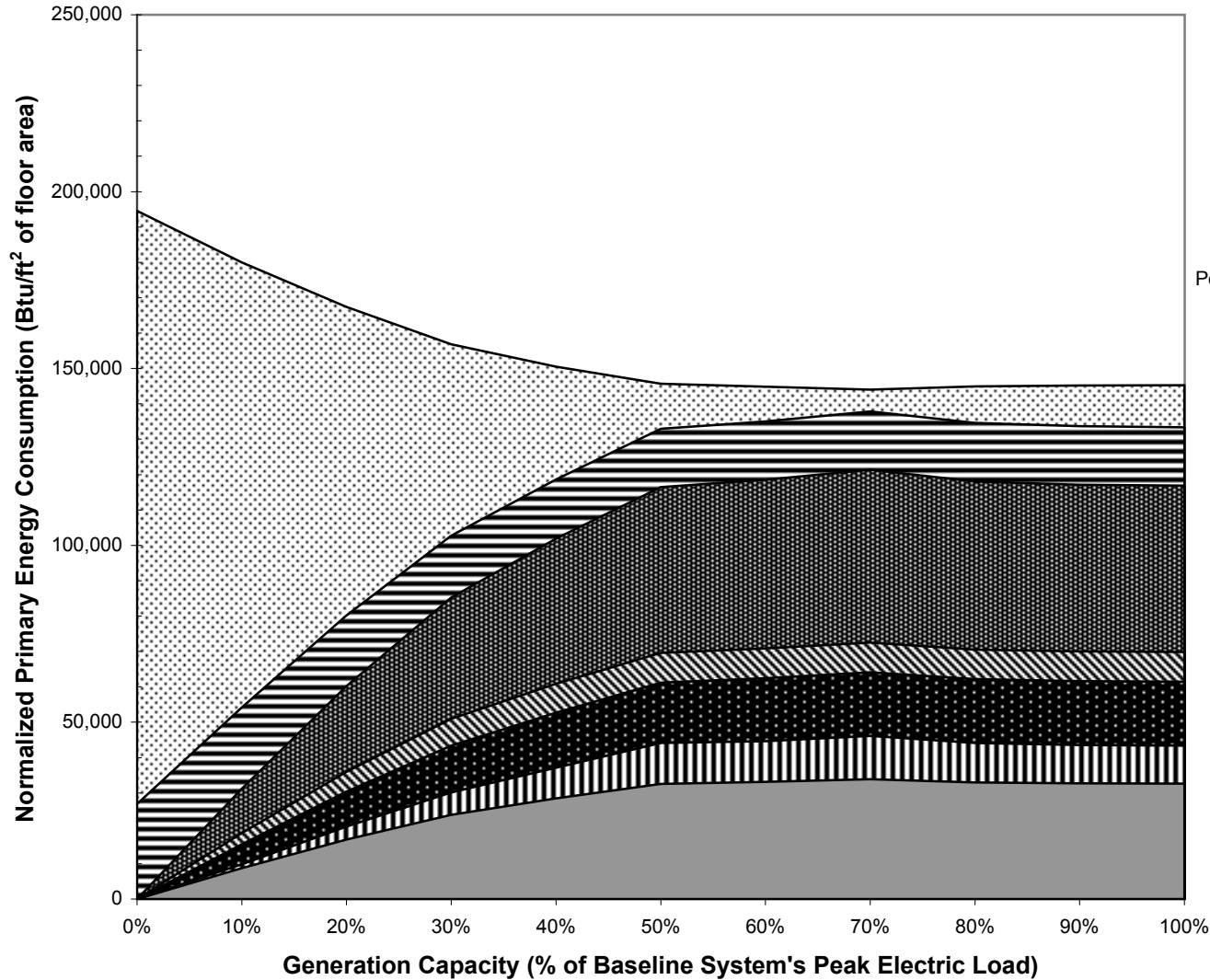

Run Number: 15
 Date and Time of Run: 1/16/02 16:44
 City Name: New York
 Building Type: Hotel
 FloorArea(ft²): 494,000
 Baseline Peak Electric(kW): 2,526
 Peak Cooling Load (tons): 1,672
 Peak Heating Load (MMBtuH): 15
 Generation Technology: HTPEM Fuel Cell
 Absorption Chiller Type: Single Effect
 Fuel Type: Natural Gas
 Rate Structure: Con Edison
 Control Strategy: Smart



Installed Cost and Annual Operating Cost

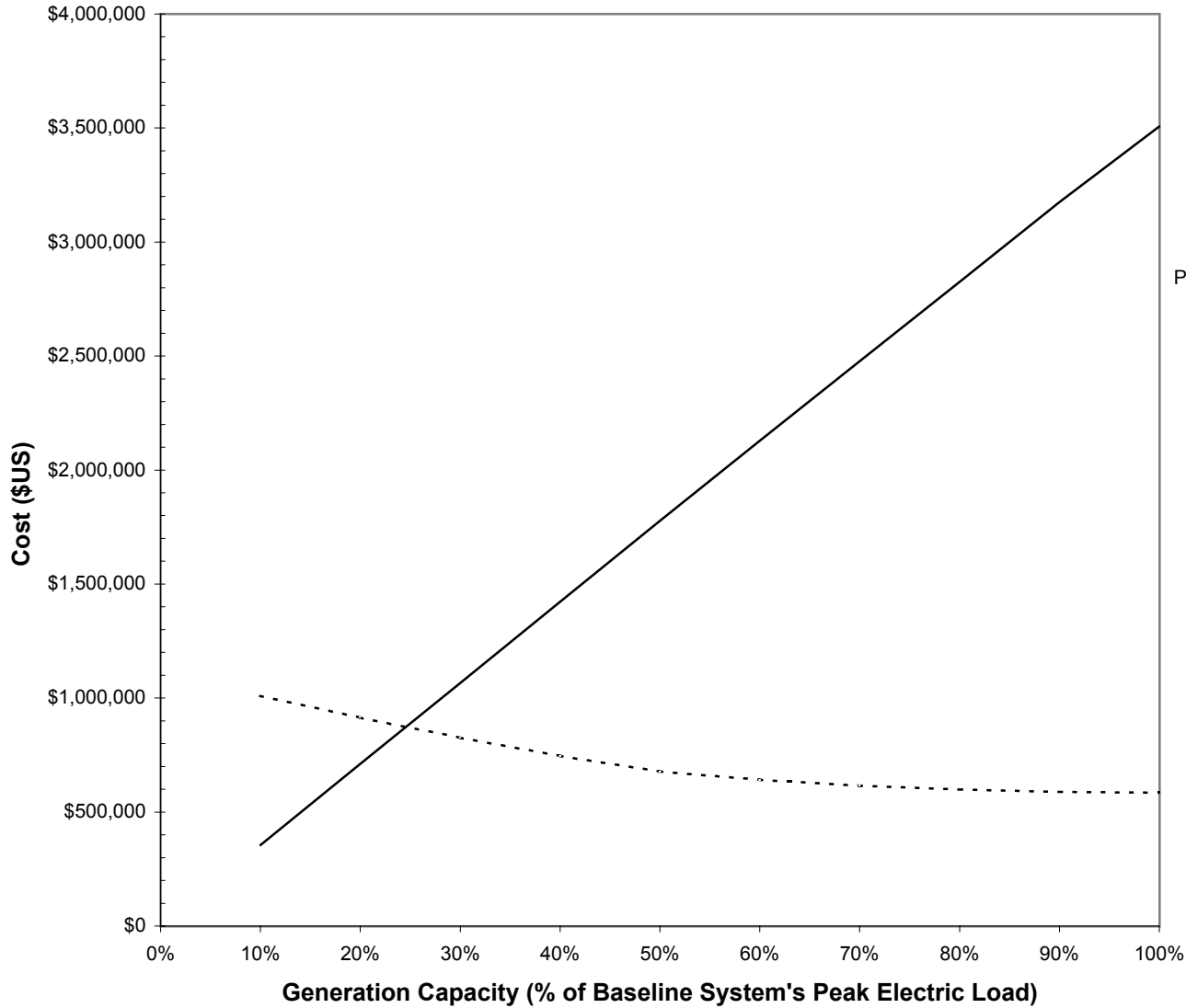

— Installed Cost - - - - Annual Operating Cost

Run Number: 15
Date and Time of Run: 1/16/02 16:44
City Name: New York
Building Type: Hotel
FloorArea(ft²): 494,000
Baseline Peak Electric(kW): 2,526
Peak Cooling Load (tons): 1,672
Peak Heating Load (MMBtuH): 15
Generation Technology: HTPeM Fuel Cell
Absorption Chiller Type: Single Effect
Fuel Type: Natural Gas
Rate Structure: Con Edison
Control Strategy: Smart

Payback Period

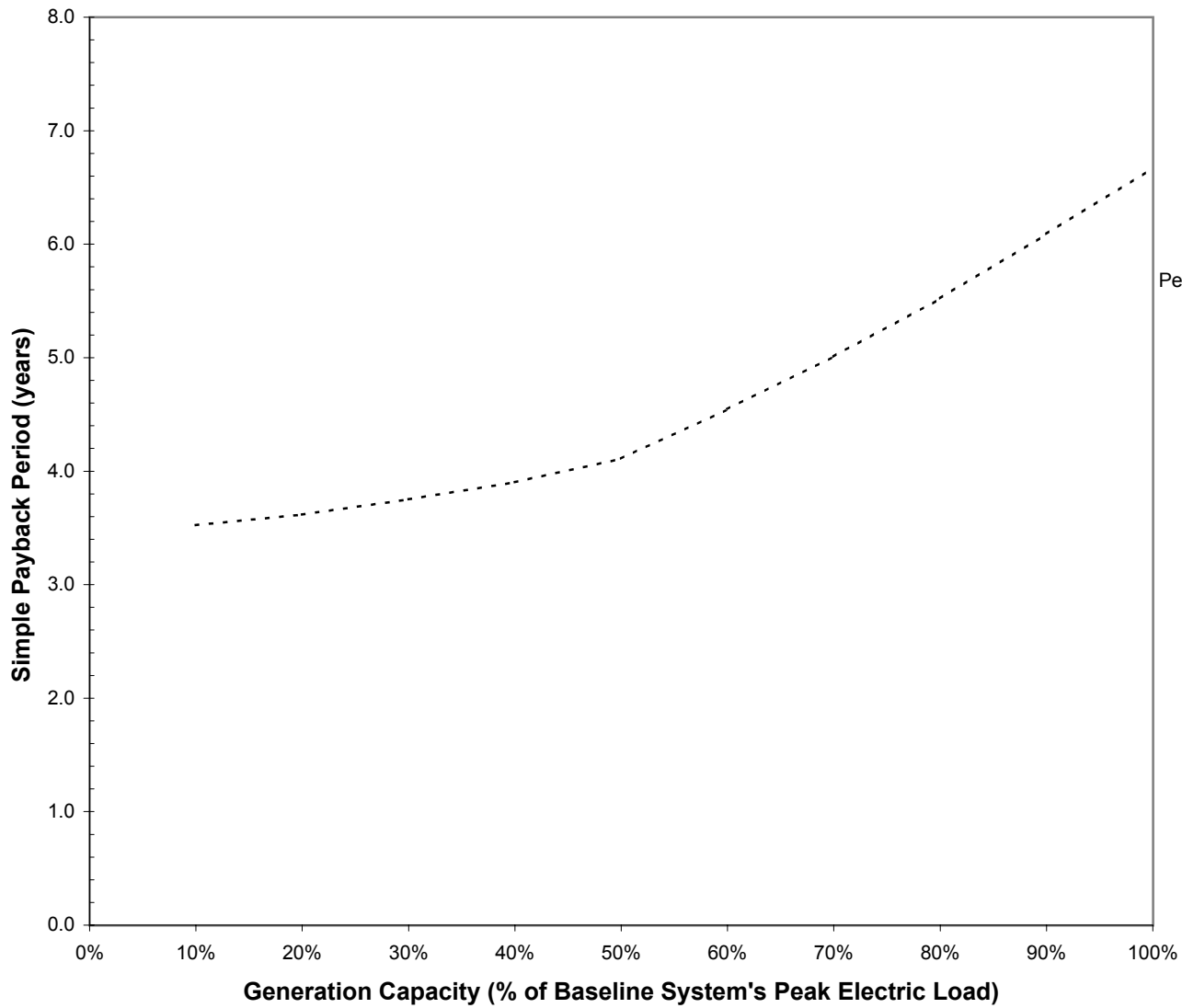

Run Number: 15

Date and Time of Run: 1/16/02 16:44

City Name: New York

Building Type: Hotel

FloorArea(ft²): 494,000

Baseline Peak Electric(kW): 2,526

Peak Cooling Load (tons): 1,672

Peak Heating Load (MMBtuH): 15

Generation Technology: HTPeM Fuel Cell

Absorption Chiller Type: Single Effect

Fuel Type: Natural Gas

Rate Structure: Con Edison

Control Strategy: Smart

Annual Primary Energy Consumption Breakdown

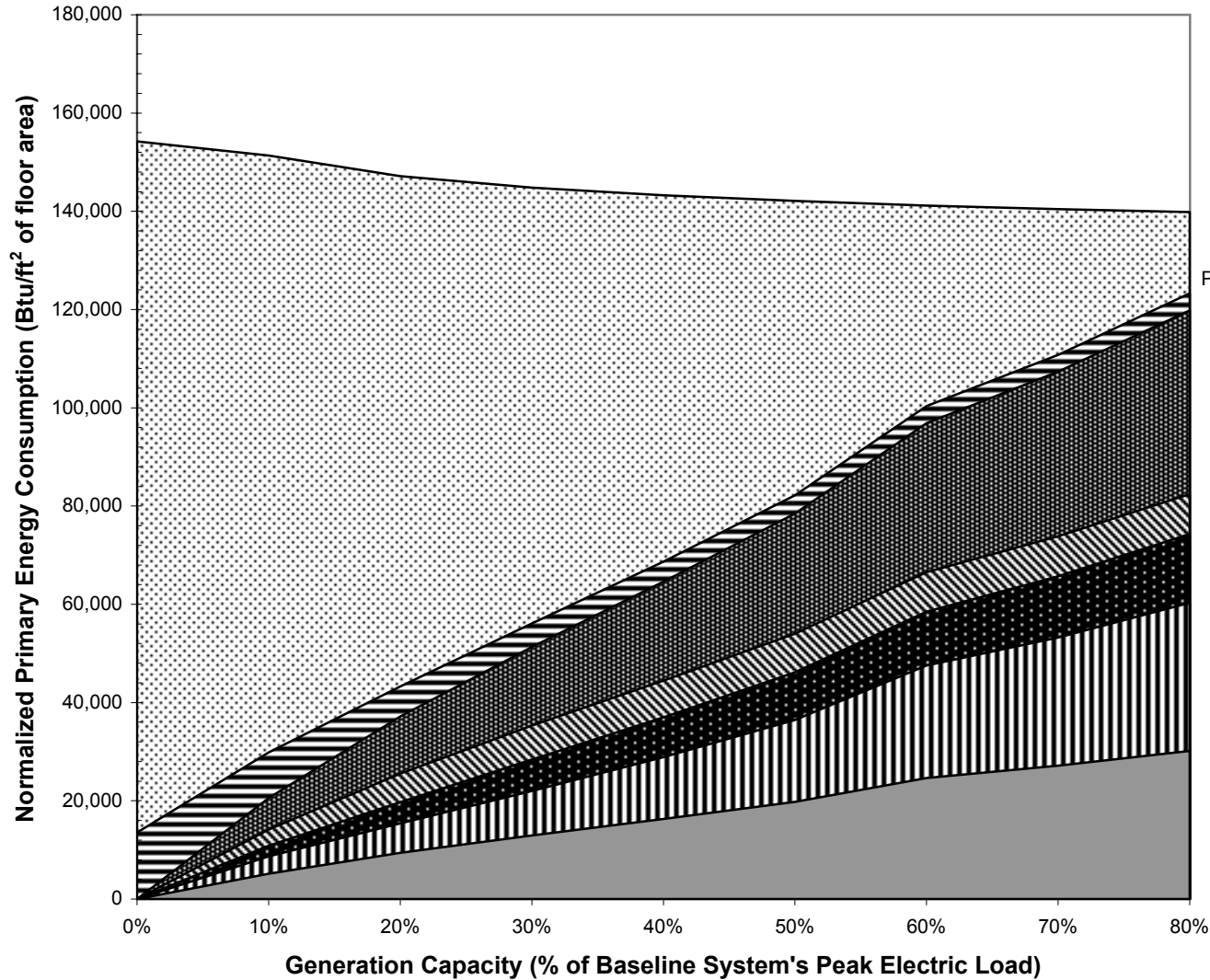

Run Number: 17
 Date and Time of Run: 1/16/02 21:07
 City Name: New York
 Building Type: Office
 FloorArea(ft²): 419,000
 Baseline Peak Electric(kW): 1,831
 Peak Cooling Load (tons): 548
 Peak Heating Load (MMBtuH): 6
 Generation Technology: Adv. Microturbine
 Absorption Chiller Type: Double Effect
 Fuel Type: Natural Gas
 Rate Structure: Con Edison
 Control Strategy: Smart



Installed Cost and Annual Operating Cost

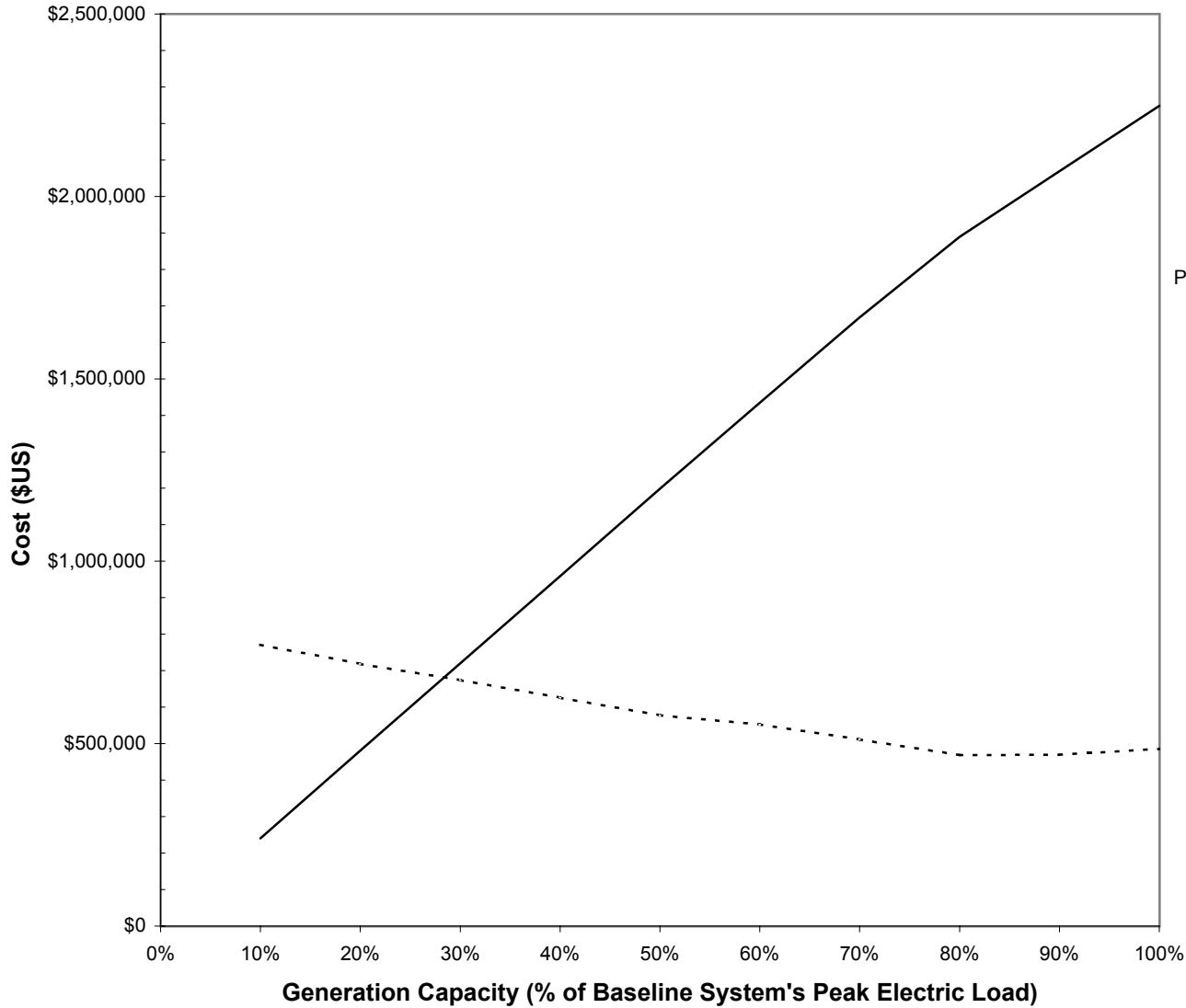

— Installed Cost - - - - Annual Operating Cost

Run Number: 17
Date and Time of Run: 1/16/02 21:07
City Name: New York
Building Type: Office
FloorArea(ft²): 419,000
Baseline Peak Electric(kW): 1,831
Peak Cooling Load (tons): 548
Peak Heating Load (MMBtuH): 6
Generation Technology: Adv. Microturbine
Absorption Chiller Type: Double Effect
Fuel Type: Natural Gas
Rate Structure: Con Edison
Control Strategy: Smart

Payback Period

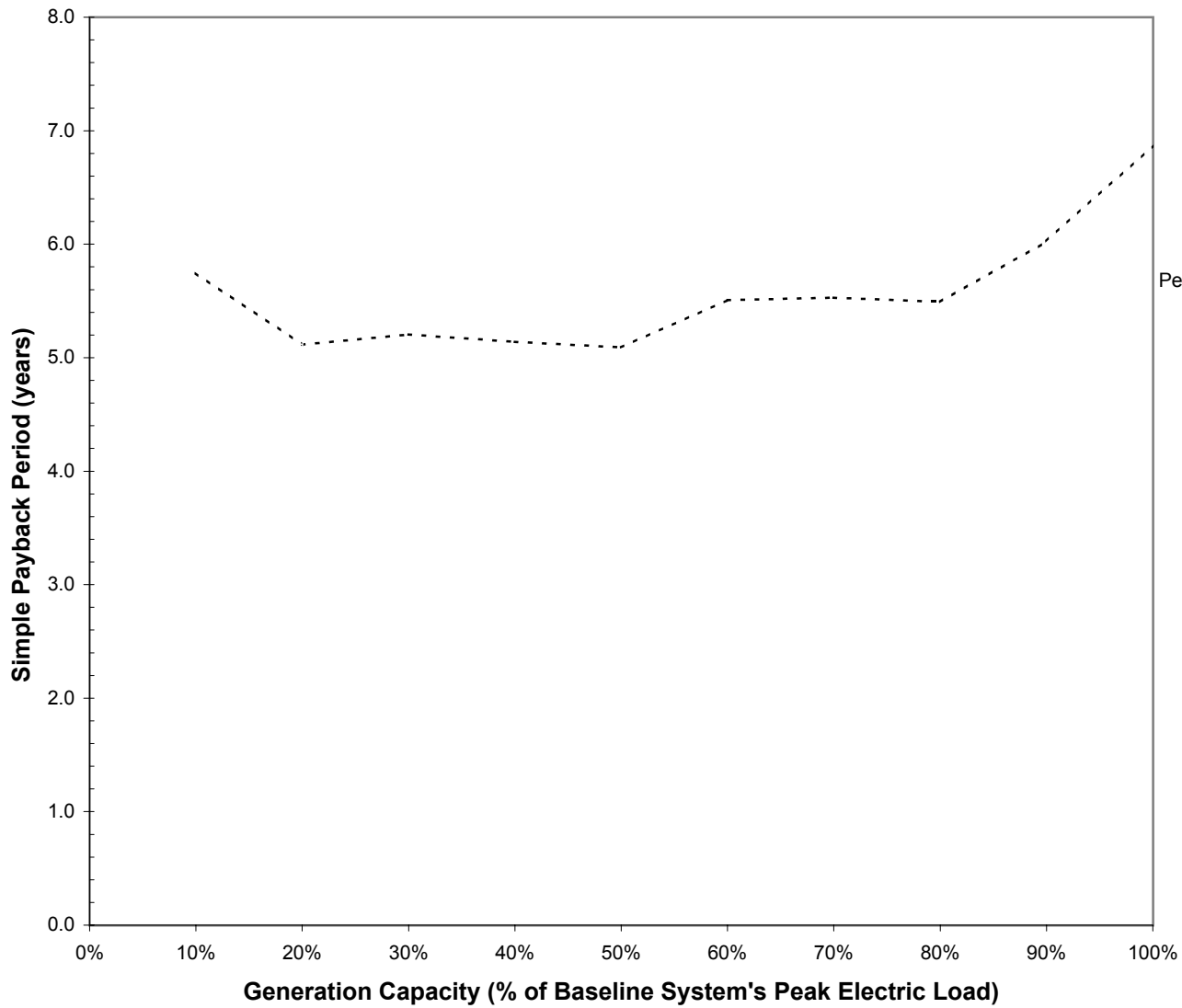

Run Number: 17

Date and Time of Run: 1/16/02 21:07

City Name: New York

Building Type: Office

FloorArea(ft²): 419,000

Baseline Peak Electric(kW): 1,831

Peak Cooling Load (tons): 548

Peak Heating Load (MMBtuH): 6

Generation Technology: Adv. Microturbine

Absorption Chiller Type: Double Effect

Fuel Type: Natural Gas

Rate Structure: Con Edison

Control Strategy: Smart

Annual Primary Energy Consumption Breakdown

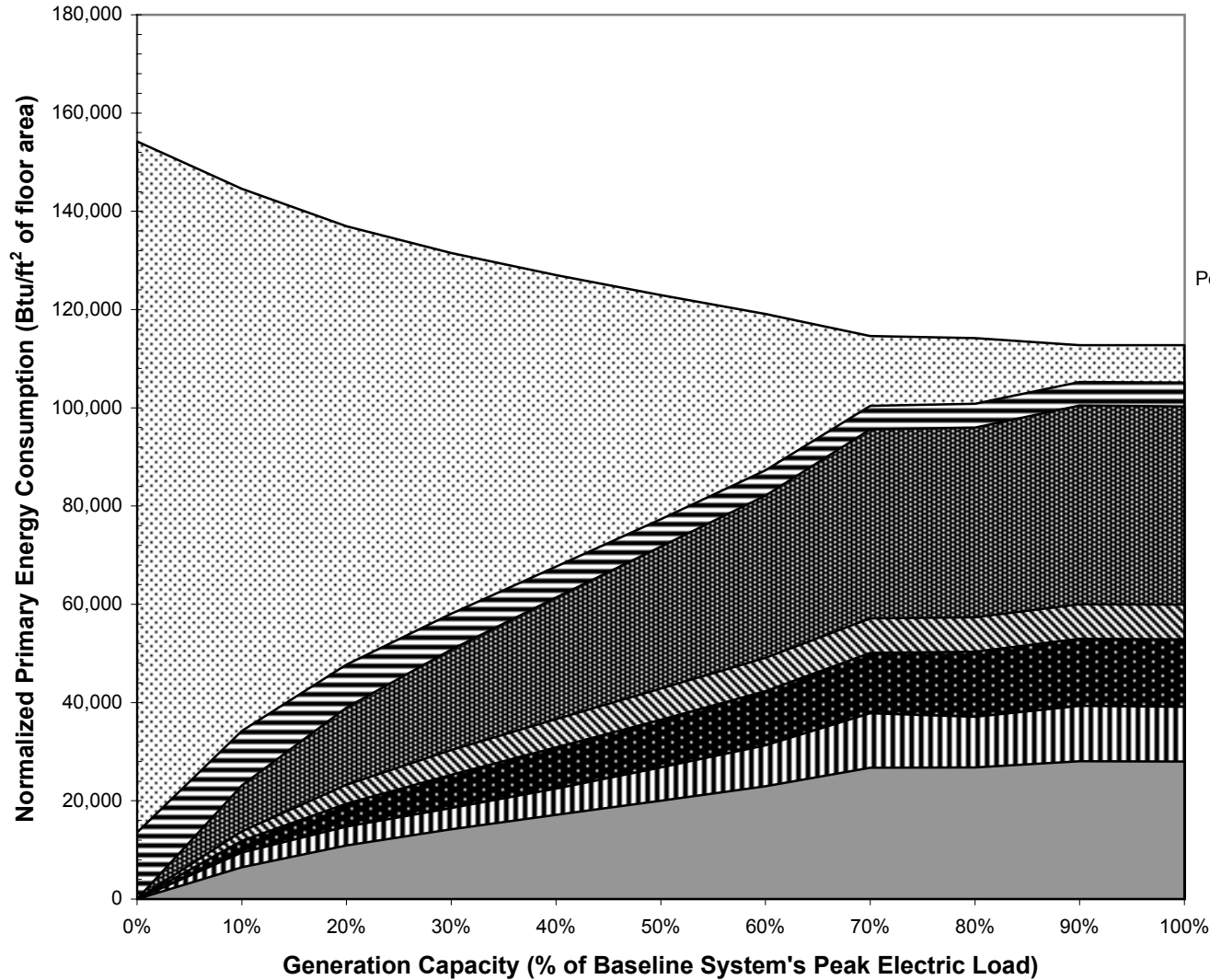

Run Number: 18
 Date and Time of Run: 1/13/02 15:18
 City Name: New York
 Building Type: Office
 FloorArea(ft²): 419,000
 Baseline Peak Electric(kW): 1,750
 Peak Cooling Load (tons): 548
 Peak Heating Load (MMBtuH): 6
 Generation Technology: HTPeM Fuel Cell
 Absorption Chiller Type: Small Single
 Fuel Type: NaturalGas
 Rate Structure: Con Edison
 Control Strategy: Smart



Installed Cost and Annual Operating Cost

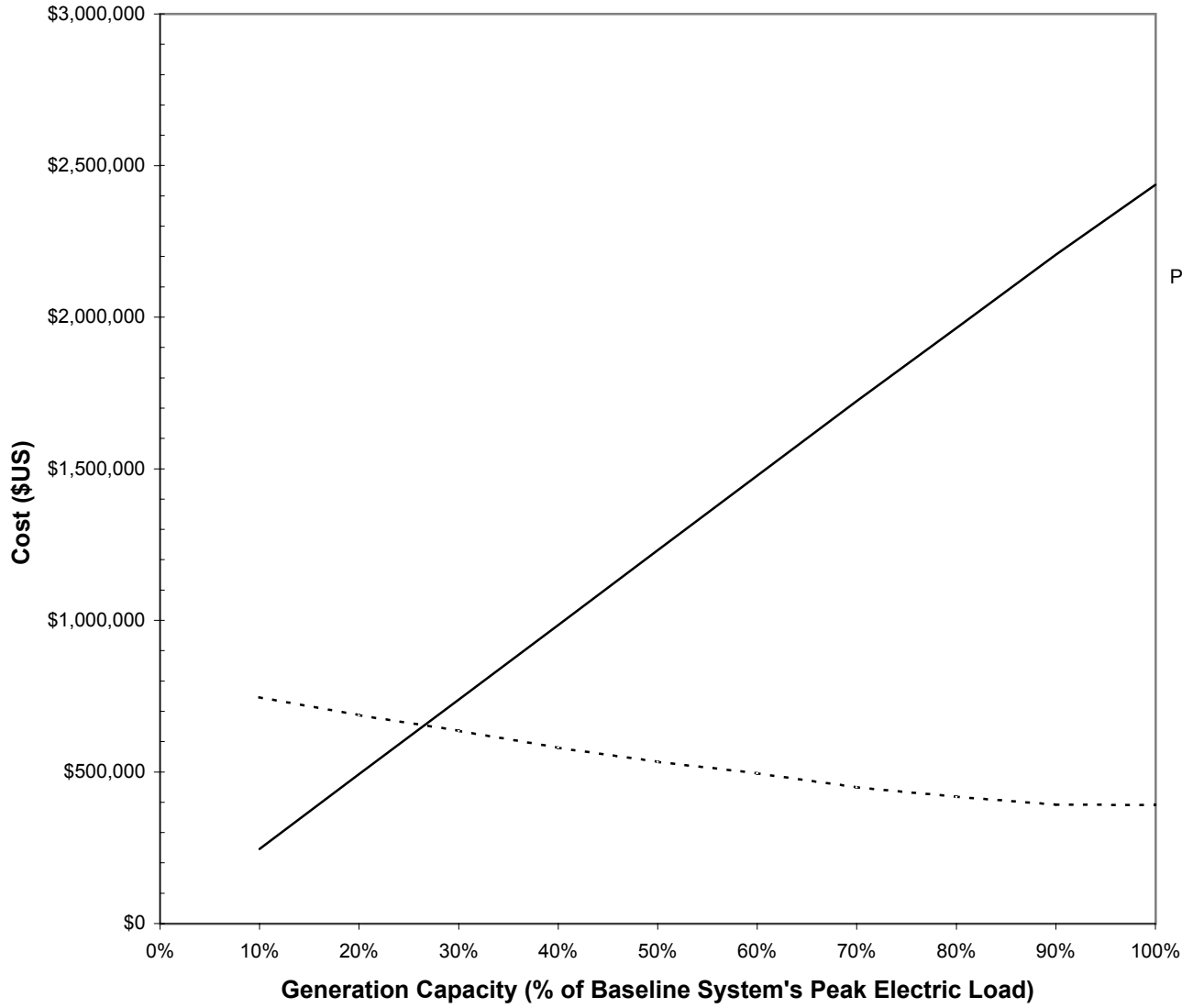

— Installed Cost - - - - Annual Operating Cost

Run Number: 18
Date and Time of Run: 1/13/02 15:18
City Name: New York
Building Type: Office
FloorArea(ft²): 419,000
Baseline Peak Electric(kW): 1,750
Peak Cooling Load (tons): 548
Peak Heating Load (MMBtuH): 6
Generation Technology: HTPeM Fuel Cell
Absorption Chiller Type: Small Single
Fuel Type: NaturalGas
Rate Structure: Con Edison
Control Strategy: Smart

Payback Period

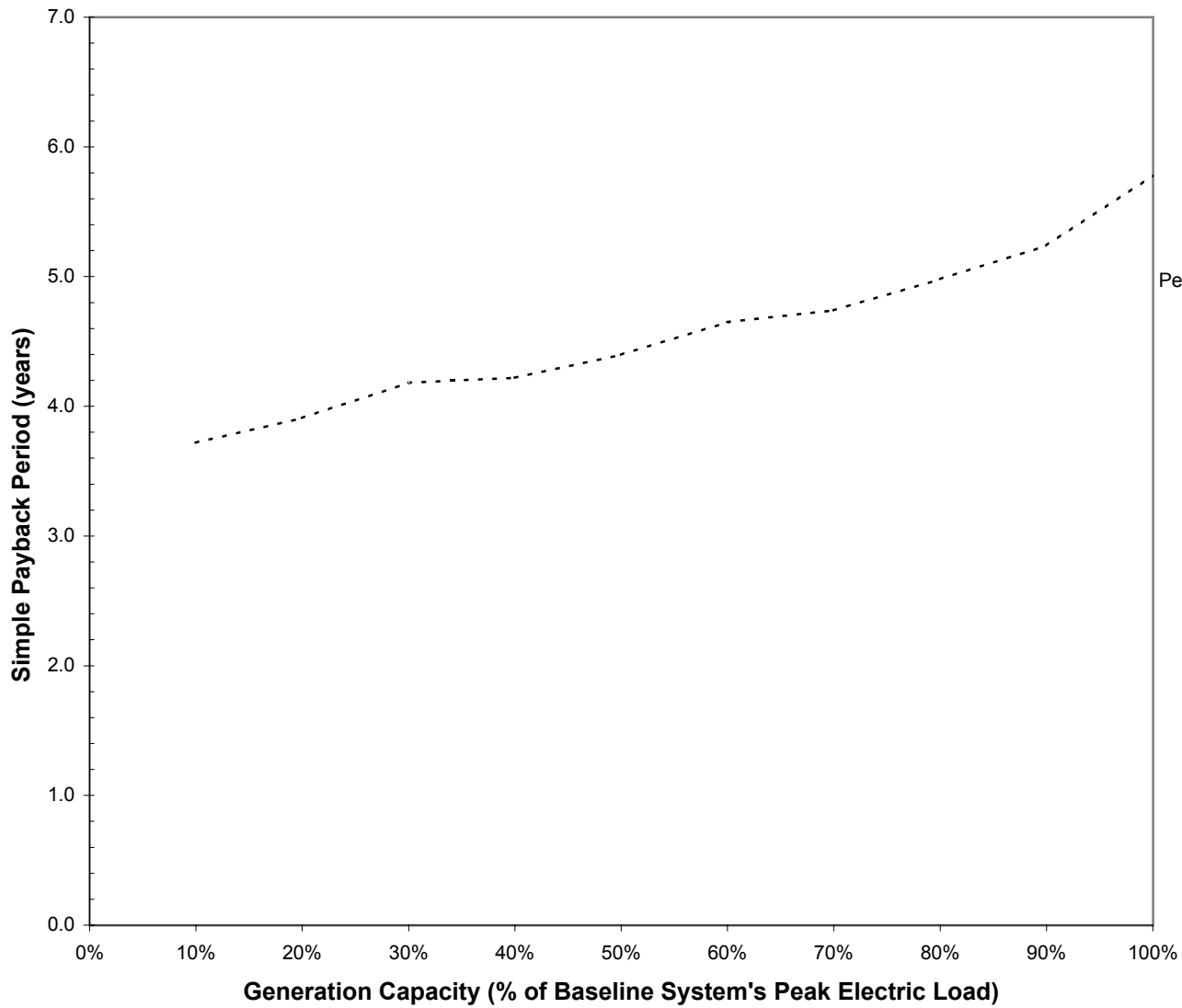

Run Number: 18

Date and Time of Run: 1/13/02 15:18

City Name: New York

Building Type: Office

FloorArea(ft²): 419,000

Baseline Peak Electric(kW): 1,750

Peak Cooling Load (tons): 548

Peak Heating Load (MMBtuH): 6

Generation Technology: HTPeM Fuel Cell

Absorption Chiller Type: Small Single

Fuel Type: NaturalGas

Rate Structure: Con Edison

Control Strategy: Smart

Annual Primary Energy Consumption Breakdown

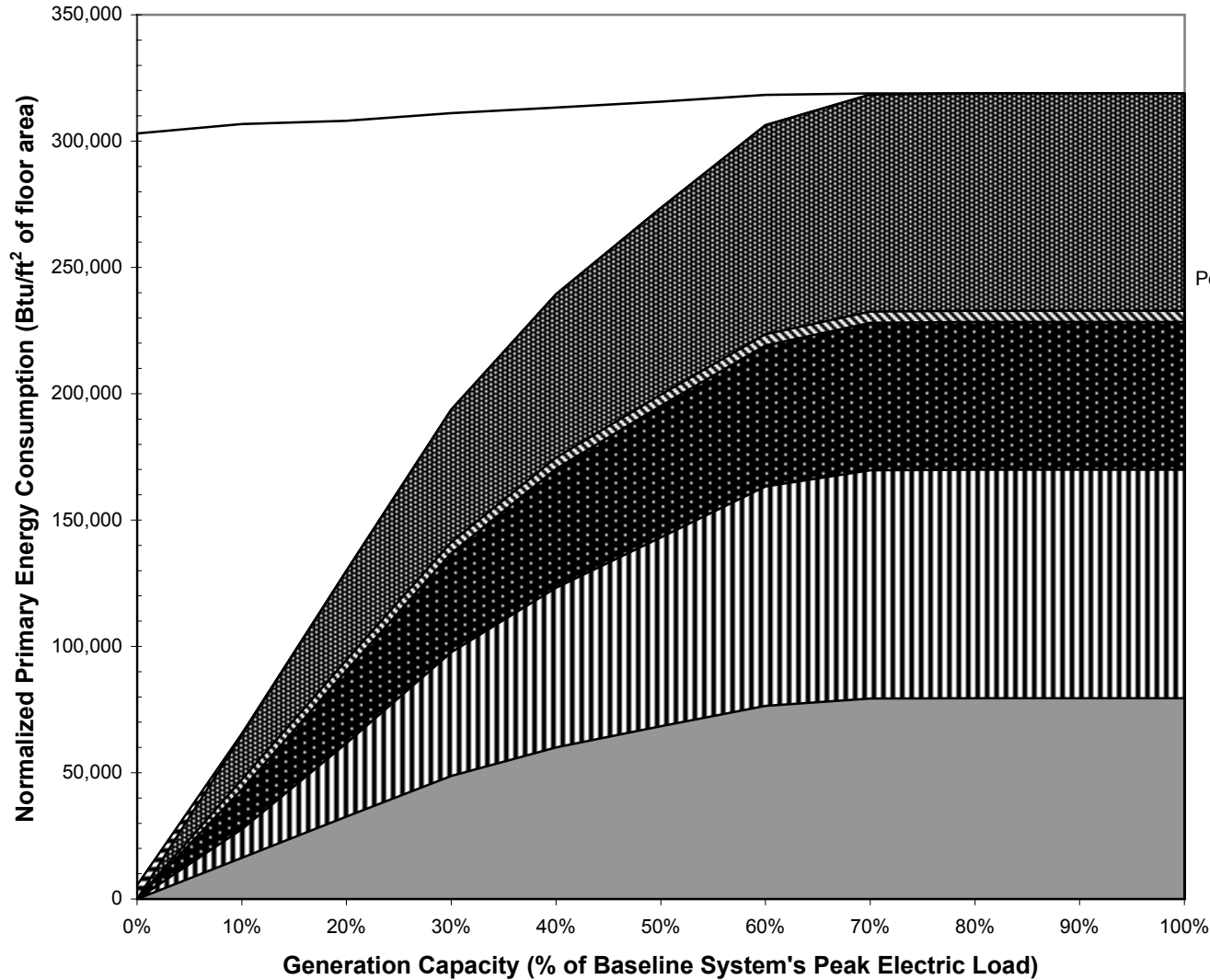

Run Number: 20
 Date and Time of Run: 1/16/02 11:07
 City Name: Los Angeles
 Building Type: Hospital
 FloorArea(ft²): 250,000
 Baseline Peak Electric(kW): 1,437
 Peak Cooling Load (tons): 603
 Peak Heating Load (MMBtuH): 2
 Generation Technology: Std. Microturbine
 Absorption Chiller Type: Double Effect
 Fuel Type: Natural Gas
 Rate Structure: So. Cal. Edison
 Control Strategy: Smart



Installed Cost and Annual Operating Cost

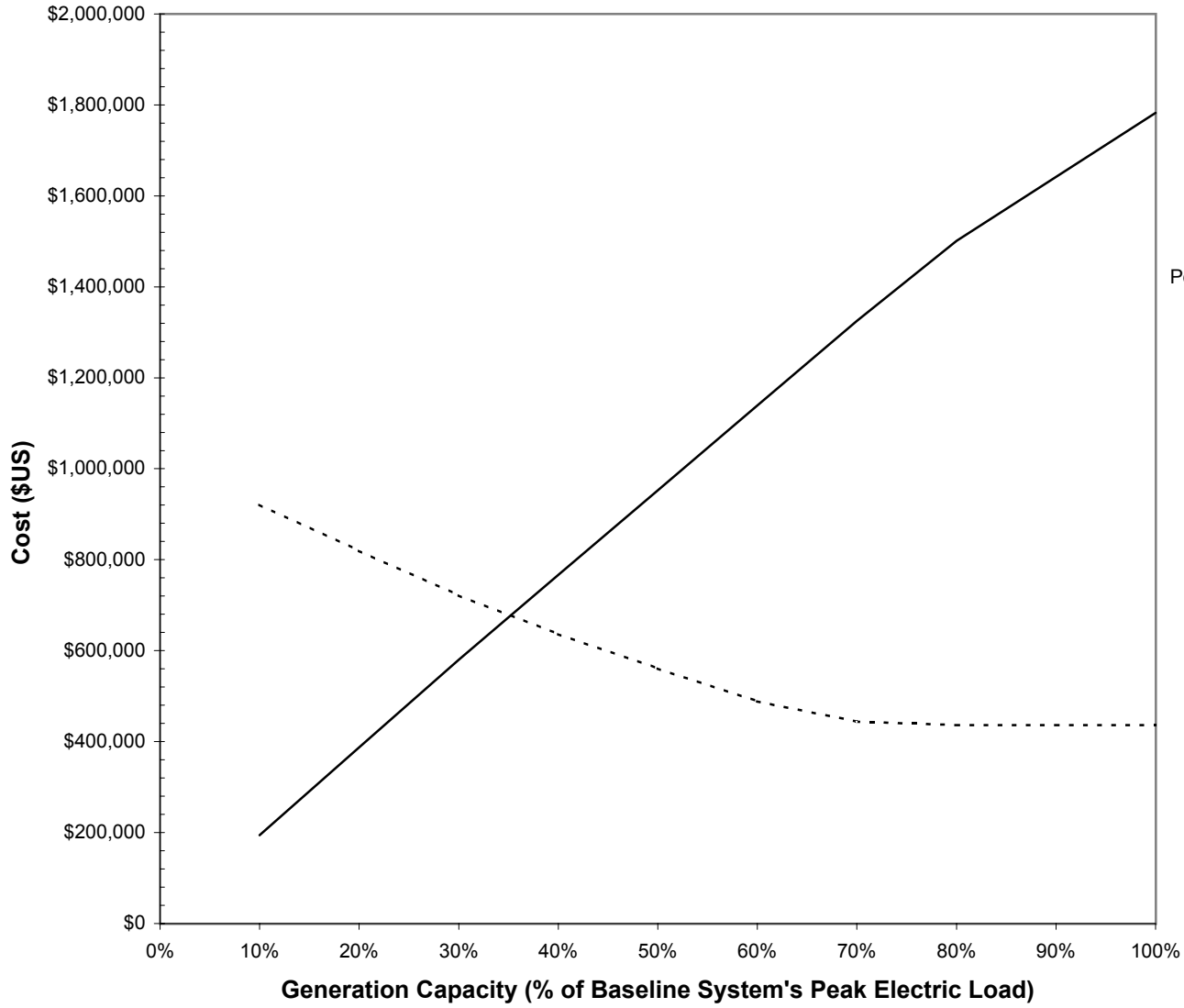

— Installed Cost - - - - Annual Operating Cost

Run Number: 20
Date and Time of Run: 1/16/02 11:07
City Name: Los Angeles
Building Type: Hospital
FloorArea(ft²): 250,000
Baseline Peak Electric(kW): 1,437
Peak Cooling Load (tons): 603
Peak Heating Load (MMBtuH): 2
Generation Technology: Std. Microturbine
Absorption Chiller Type: Double Effect
Fuel Type: Natural Gas
Rate Structure: So. Cal. Edison
Control Strategy: Smart

Payback Period

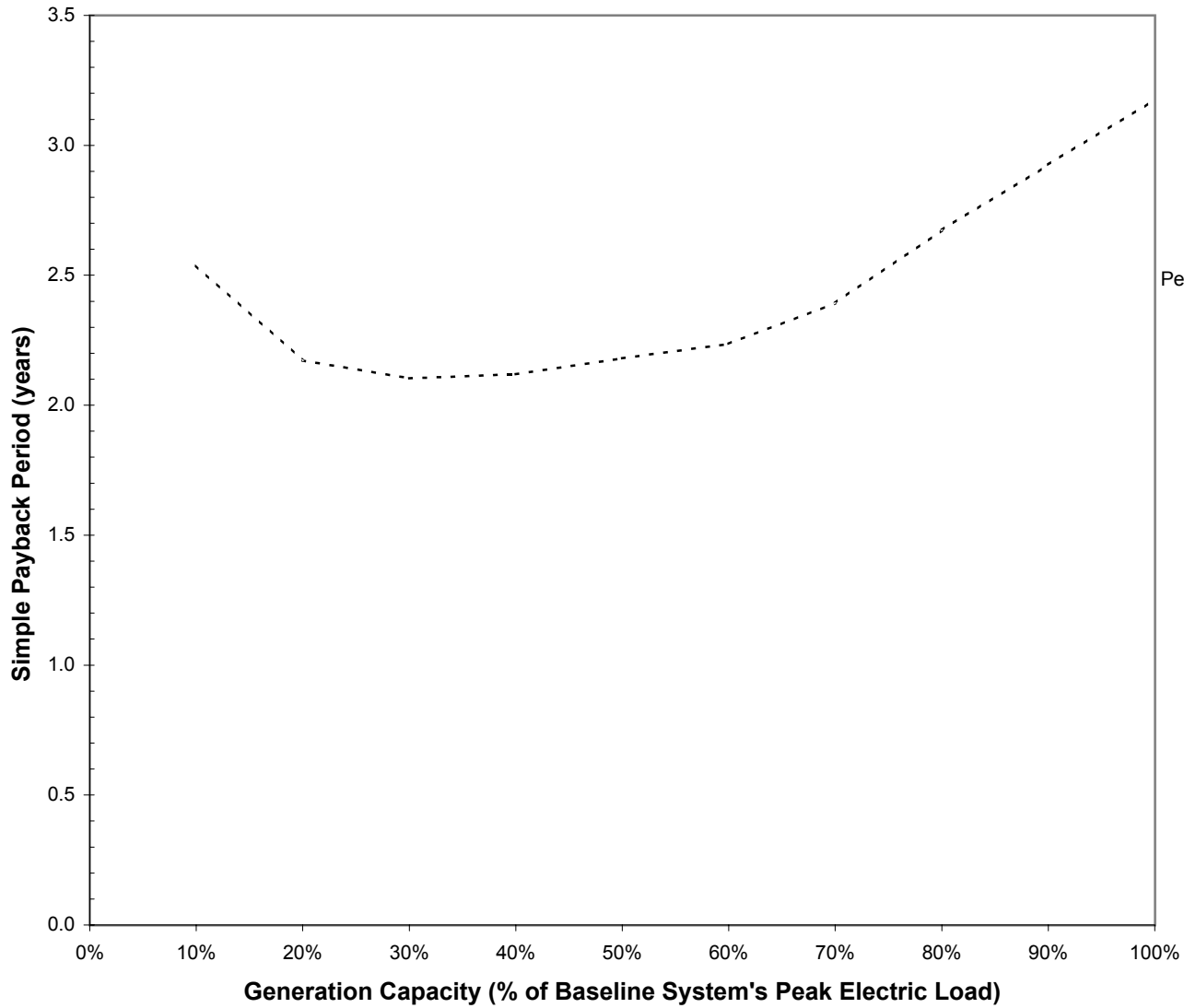

Run Number: 20

Date and Time of Run: 1/16/02 11:07

City Name: Los Angeles

Building Type: Hospital

FloorArea(ft²): 250,000

Baseline Peak Electric(kW): 1,437

Peak Cooling Load (tons): 603

Peak Heating Load (MMBtuH): 2

Generation Technology: Std. Microturbine

Absorption Chiller Type: Double Effect

Fuel Type: Natural Gas

Rate Structure: So. Cal. Edison

Control Strategy: Smart

Annual Primary Energy Consumption Breakdown

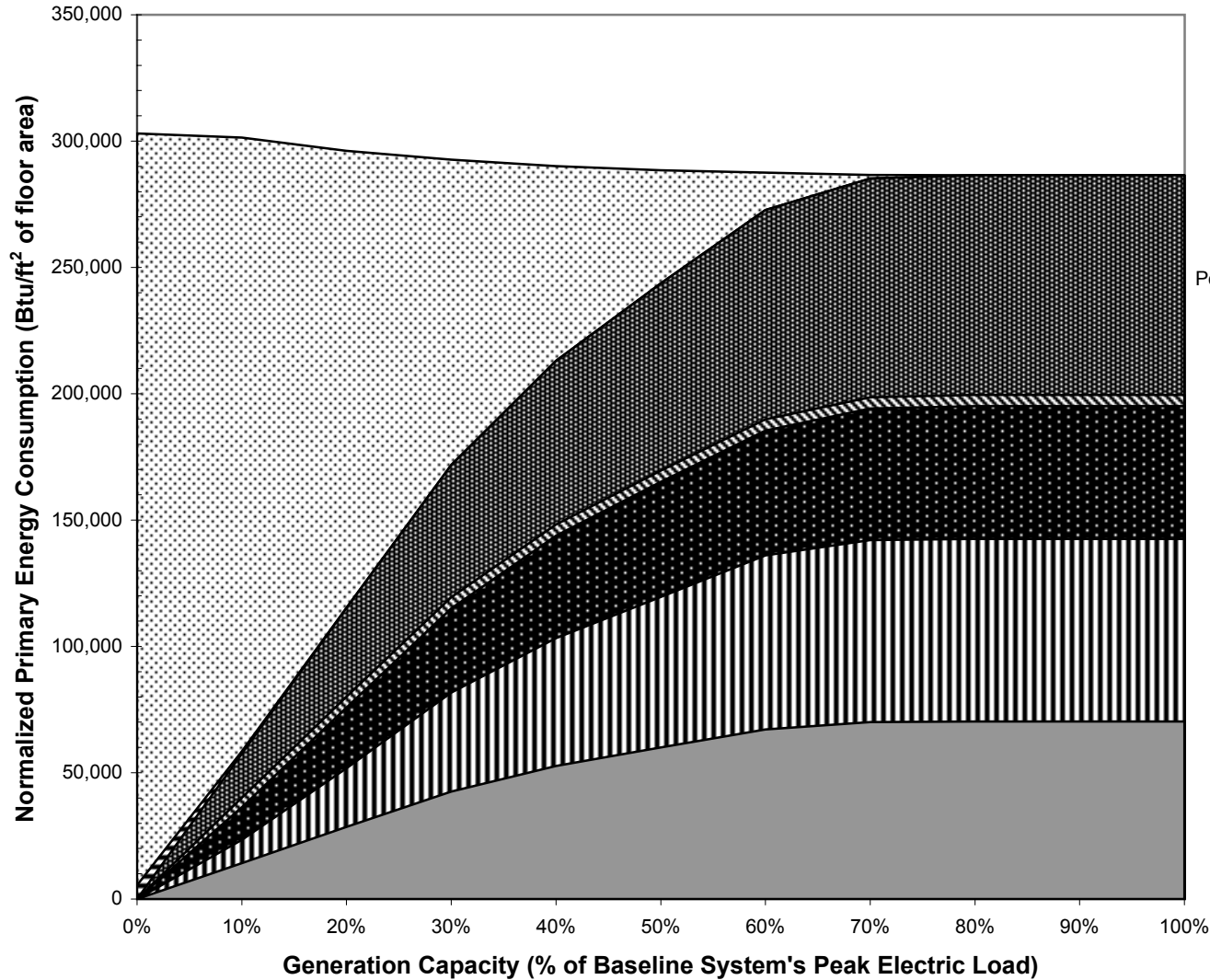

Run Number: 21
 Date and Time of Run: 1/16/02 12:40
 City Name: Los Angeles
 Building Type: Hospital
 FloorArea(ft²): 250,000
 Baseline Peak Electric(kW): 1,437
 Peak Cooling Load (tons): 603
 Peak Heating Load (MMBtuH): 2
 Generation Technology: Adv. Microturbine
 Absorption Chiller Type: Double Effect
 Fuel Type: Natural Gas
 Rate Structure: So. Cal. Edison
 Control Strategy: Smart



Installed Cost and Annual Operating Cost

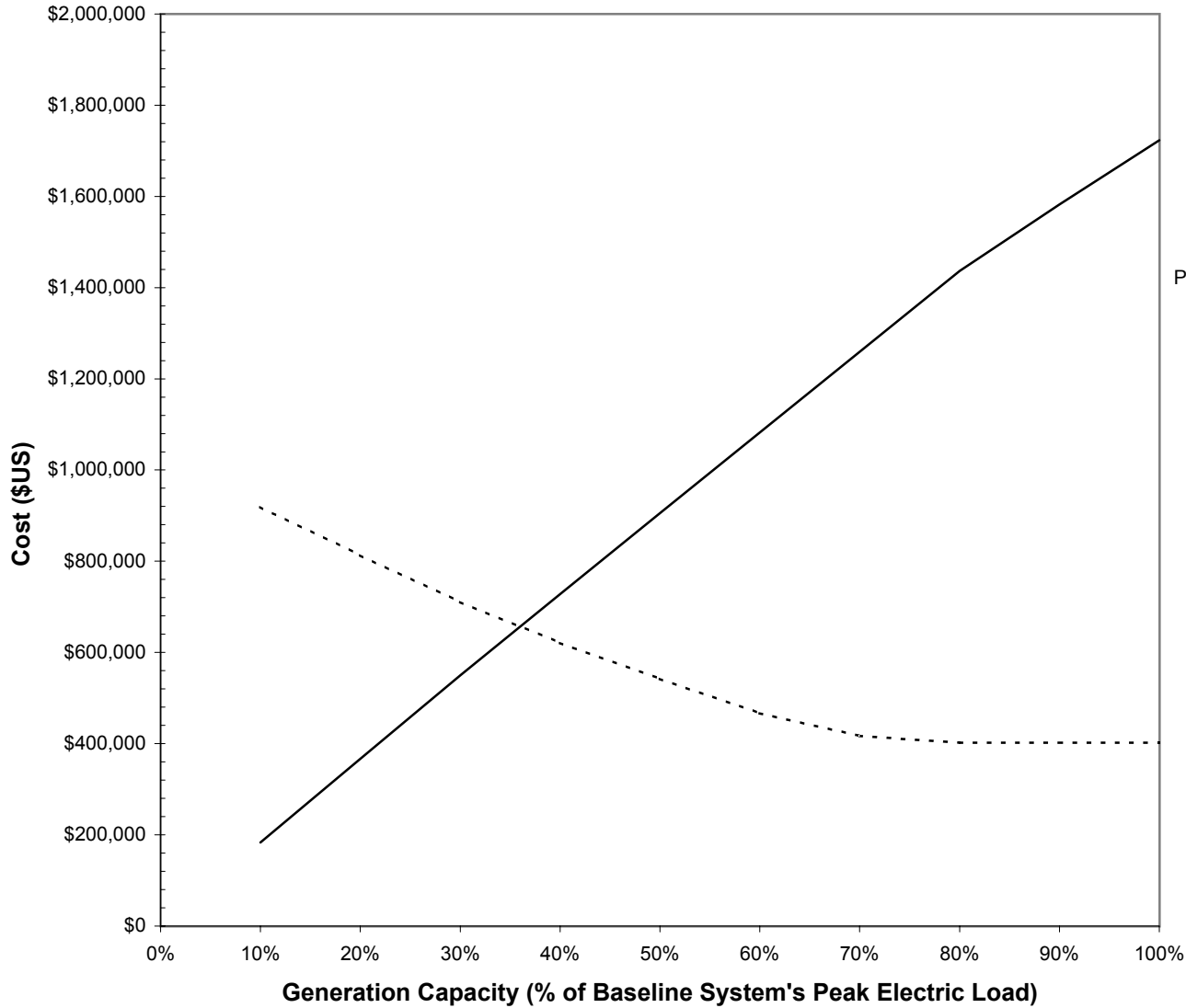

— Installed Cost - - - - Annual Operating Cost

Run Number: 21
Date and Time of Run: 1/16/02 12:40
City Name: Los Angeles
Building Type: Hospital
FloorArea(ft²): 250,000
Baseline Peak Electric(kW): 1,437
Peak Cooling Load (tons): 603
Peak Heating Load (MMBtuH): 2
Generation Technology: Adv. Microturbine
Absorption Chiller Type: Double Effect
Fuel Type: Natural Gas
Rate Structure: So. Cal. Edison
Control Strategy: Smart

Payback Period

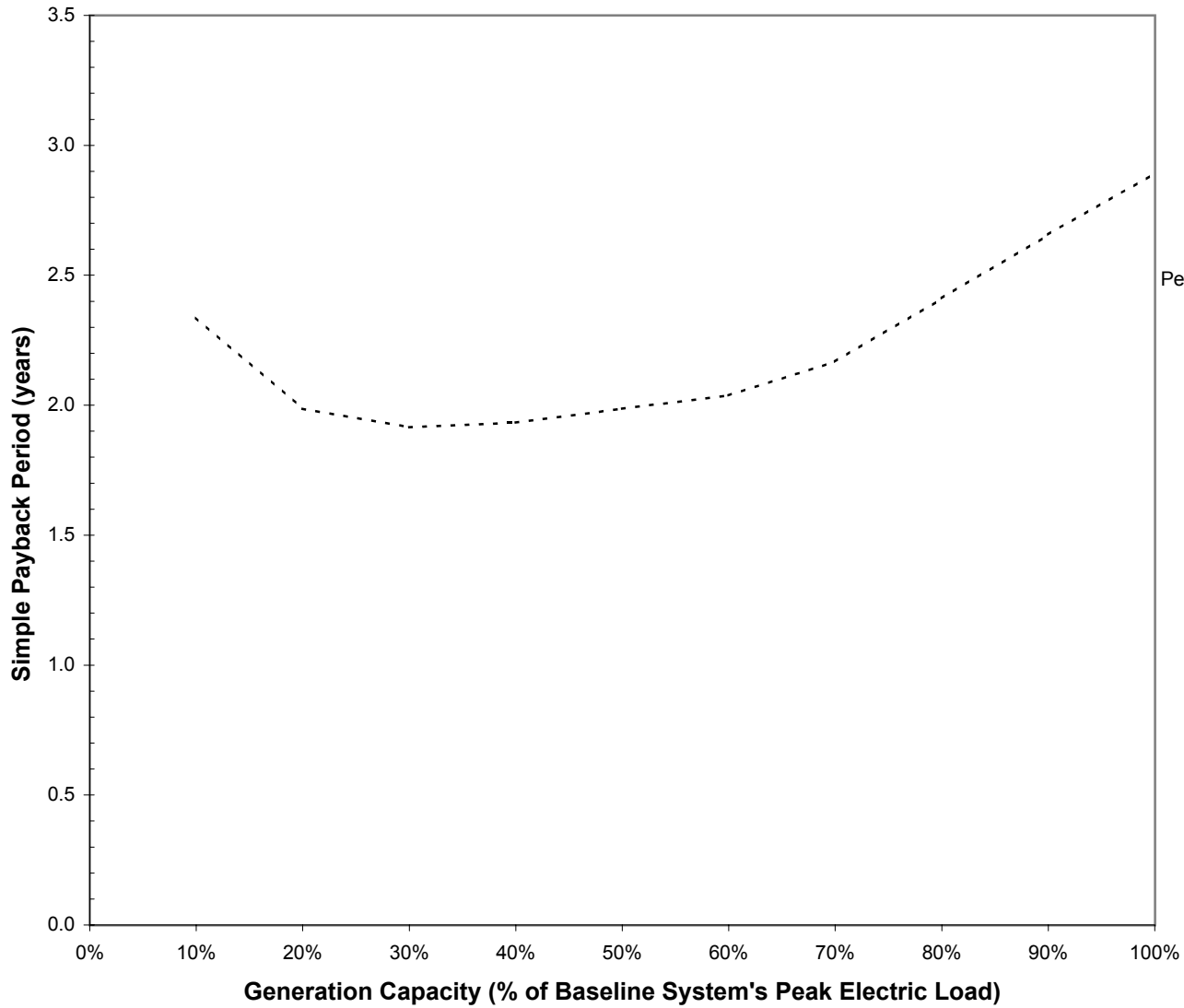

Run Number: 21

Date and Time of Run: 1/16/02 12:40

City Name: Los Angeles

Building Type: Hospital

FloorArea(ft²): 250,000

Baseline Peak Electric(kW): 1,437

Peak Cooling Load (tons): 603

Peak Heating Load (MMBtuH): 2

Generation Technology: Adv. Microturbine

Absorption Chiller Type: Double Effect

Fuel Type: Natural Gas

Rate Structure: So. Cal. Edison

Control Strategy: Smart

Annual Primary Energy Consumption Breakdown

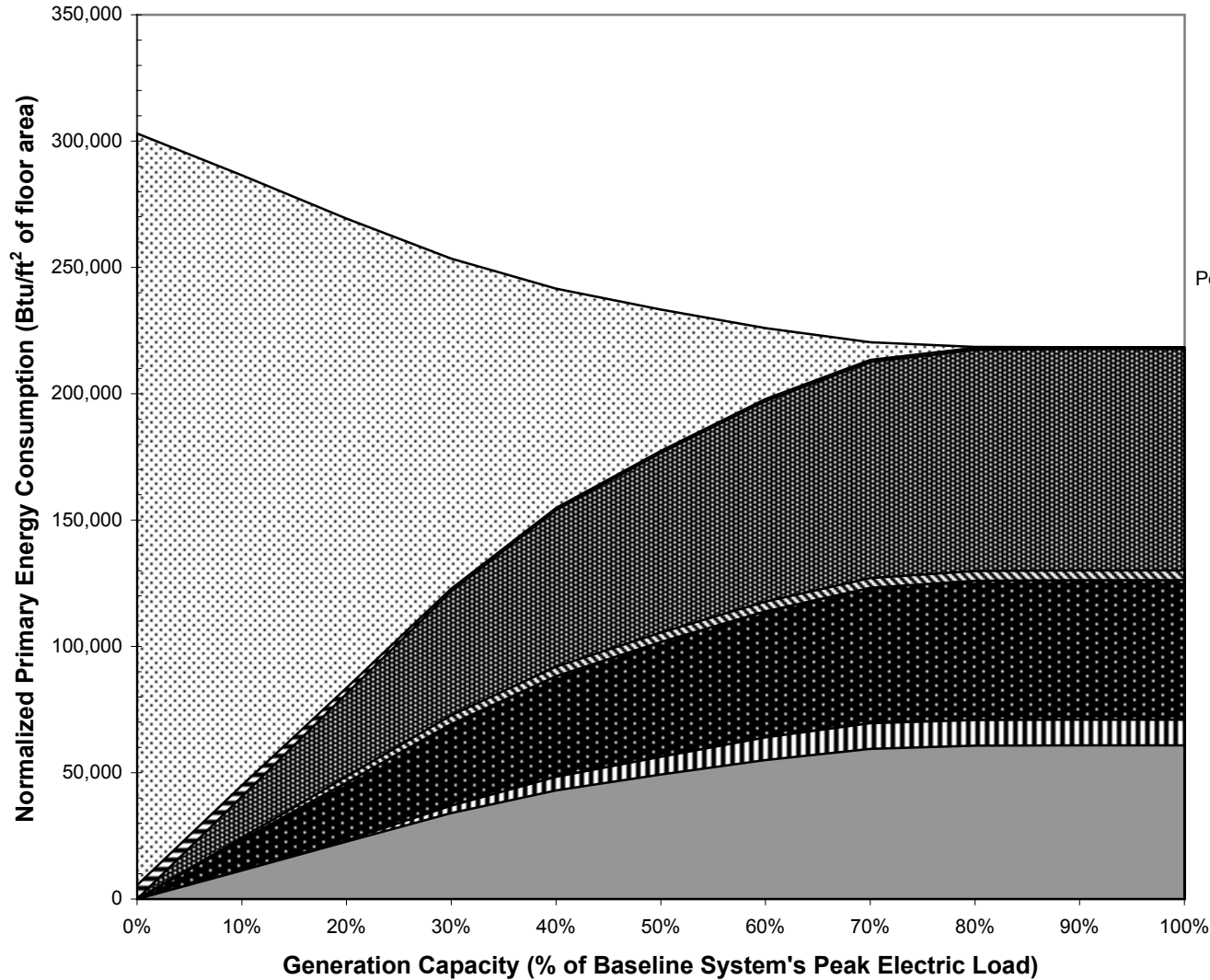

Run Number: 22
 Date and Time of Run: 1/12/02 21:39
 City Name: Los Angeles
 Building Type: Hospital
 FloorArea(ft²): 250,000
 Baseline Peak Electric(kW): 1,346
 Peak Cooling Load (tons): 603
 Peak Heating Load (MMBtuH): 2
 Generation Technology: HTPeM Fuel Cell
 Absorption Chiller Type: Small Single
 Fuel Type: NaturalGas
 Rate Structure: So. Cal. Edison
 Control Strategy: Smart



Installed Cost and Annual Operating Cost

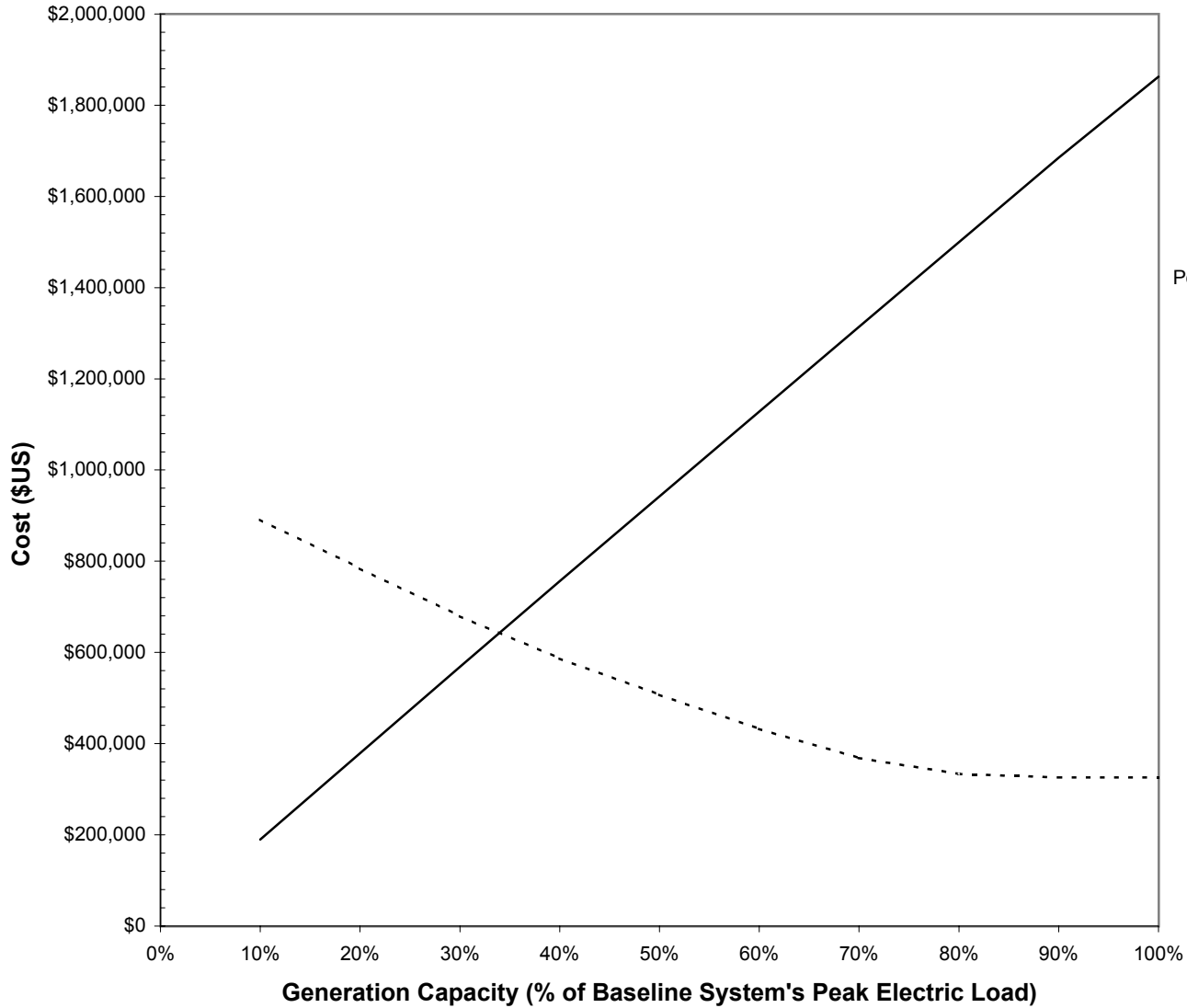

— Installed Cost - - - - Annual Operating Cost

Run Number: 22
Date and Time of Run: 1/12/02 21:39
City Name: Los Angeles
Building Type: Hospital
FloorArea(ft²): 250,000
Baseline Peak Electric(kW): 1,346
Peak Cooling Load (tons): 603
Peak Heating Load (MMBtuH): 2
Generation Technology: HTPeM Fuel Cell
Absorption Chiller Type: Small Single
Fuel Type: NaturalGas
Rate Structure: So. Cal. Edison
Control Strategy: Smart

Payback Period

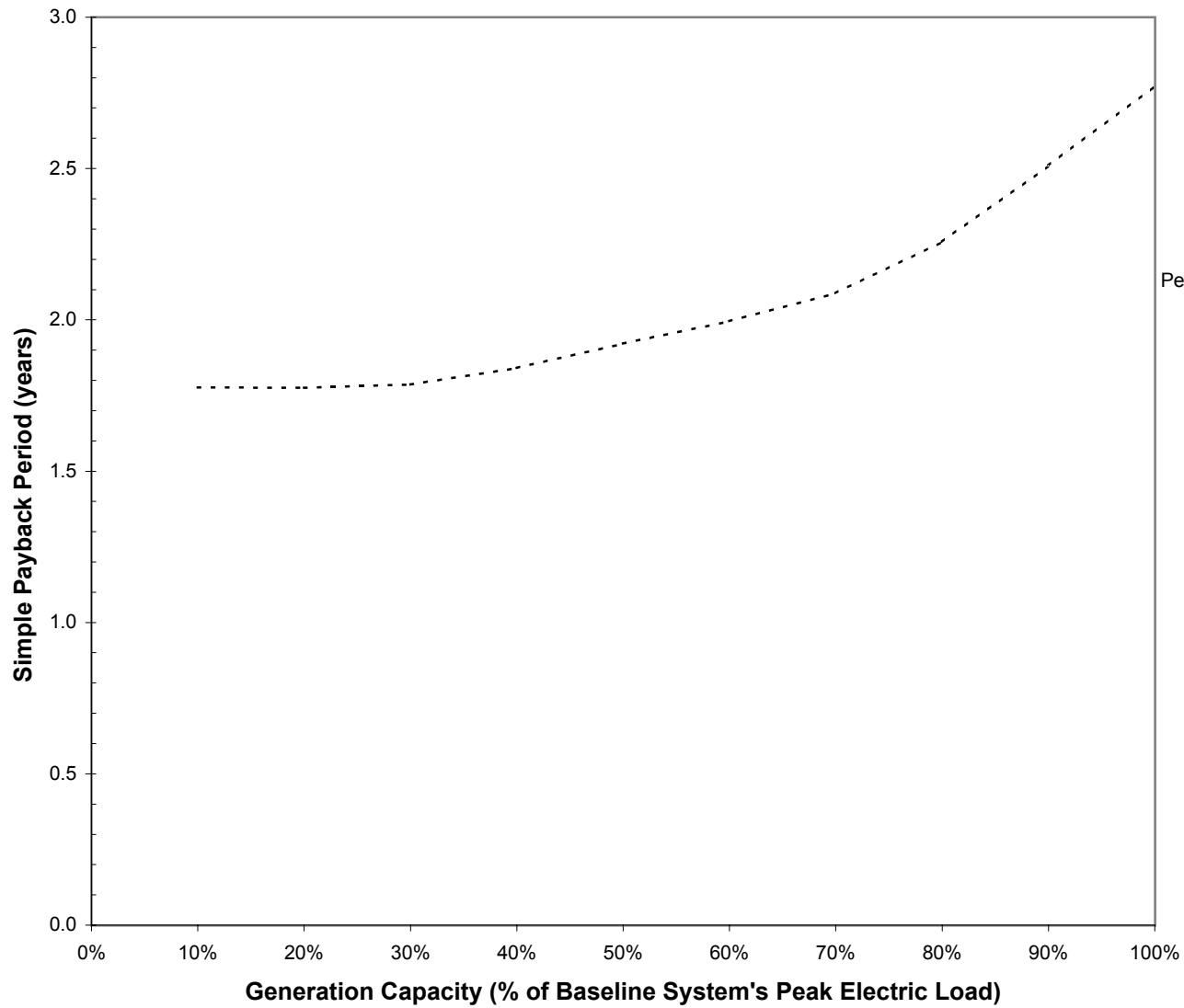

Run Number: 22

Date and Time of Run: 1/12/02 21:39

City Name: Los Angeles

Building Type: Hospital

FloorArea(ft²): 250,000

Baseline Peak Electric(kW): 1,346

Peak Cooling Load (tons): 603

Peak Heating Load (MMBtuH): 2

Generation Technology: HTPeM Fuel Cell

Absorption Chiller Type: Small Single

Fuel Type: NaturalGas

Rate Structure: So. Cal. Edison

Control Strategy: Smart

Annual Primary Energy Consumption Breakdown

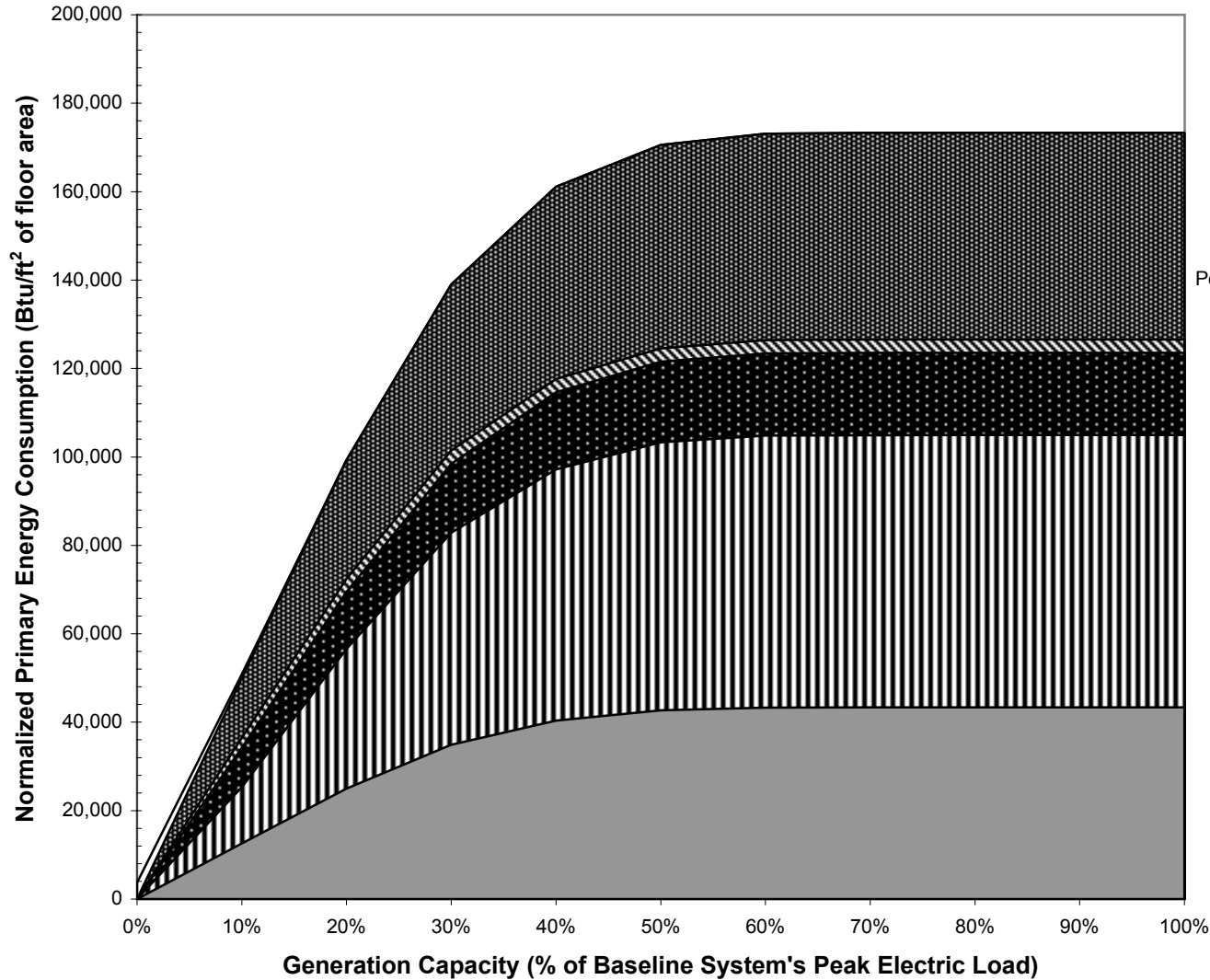

Run Number: 24
 Date and Time of Run: 1/17/02 4:57
 City Name: Los Angeles
 Building Type: Hotel
 FloorArea(ft²): 203,000
 Baseline Peak Electric(kW): 897
 Peak Cooling Load (tons): 548
 Peak Heating Load (MMBtuH): 2
 Generation Technology: Std. Microturbine
 Absorption Chiller Type: Double Effect
 Fuel Type: Natural Gas
 Rate Structure: So. Cal. Edison
 Control Strategy: Smart



Installed Cost and Annual Operating Cost

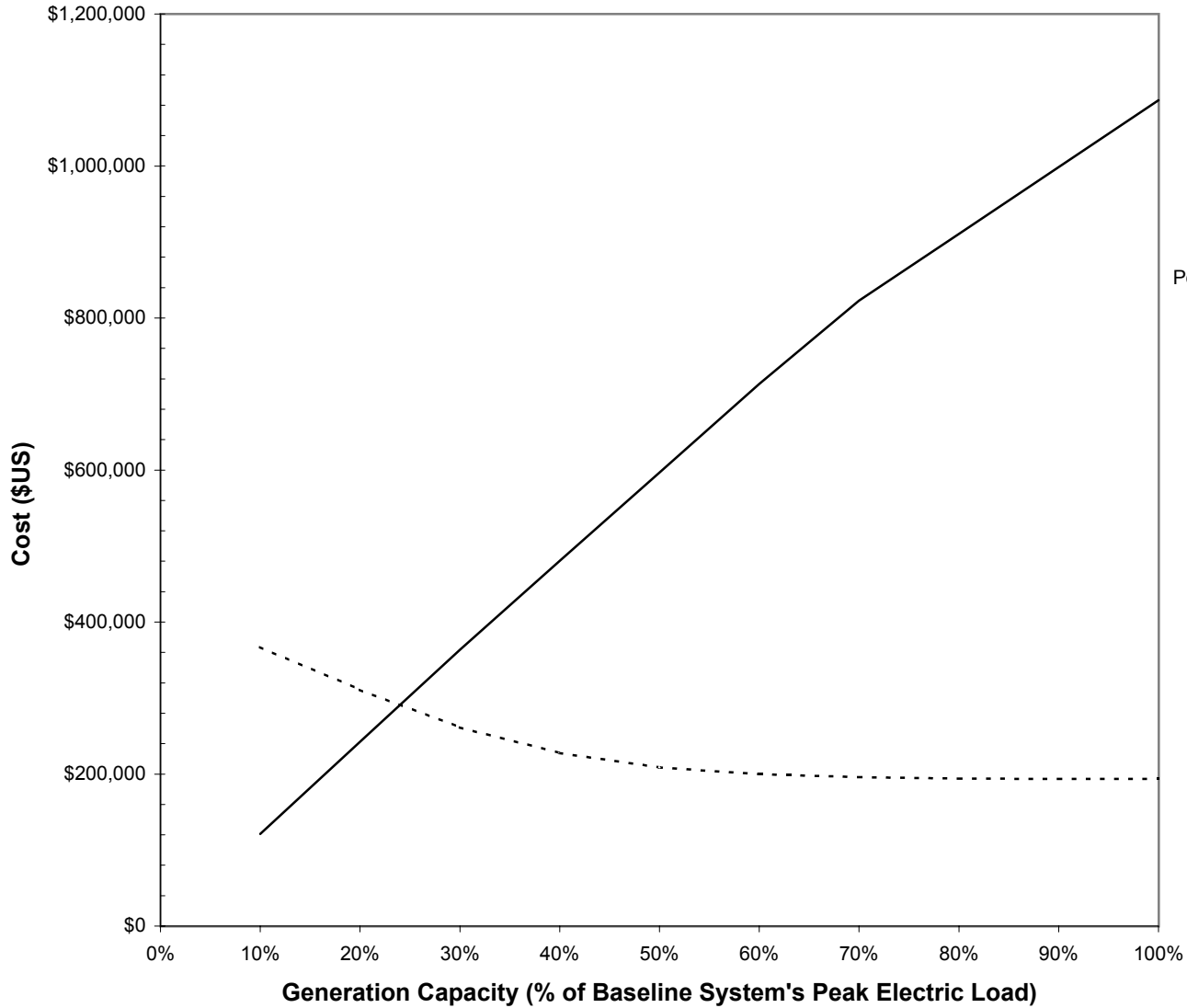

— Installed Cost - - - - Annual Operating Cost

Run Number: 24
Date and Time of Run: 1/17/02 4:57
City Name: Los Angeles
Building Type: Hotel
FloorArea(ft²): 203,000
Baseline Peak Electric(kW): 897
Peak Cooling Load (tons): 548
Peak Heating Load (MMBtuH): 2
Generation Technology: Std. Microturbine
Absorption Chiller Type: Double Effect
Fuel Type: Natural Gas
Rate Structure: So. Cal. Edison
Control Strategy: Smart

Payback Period

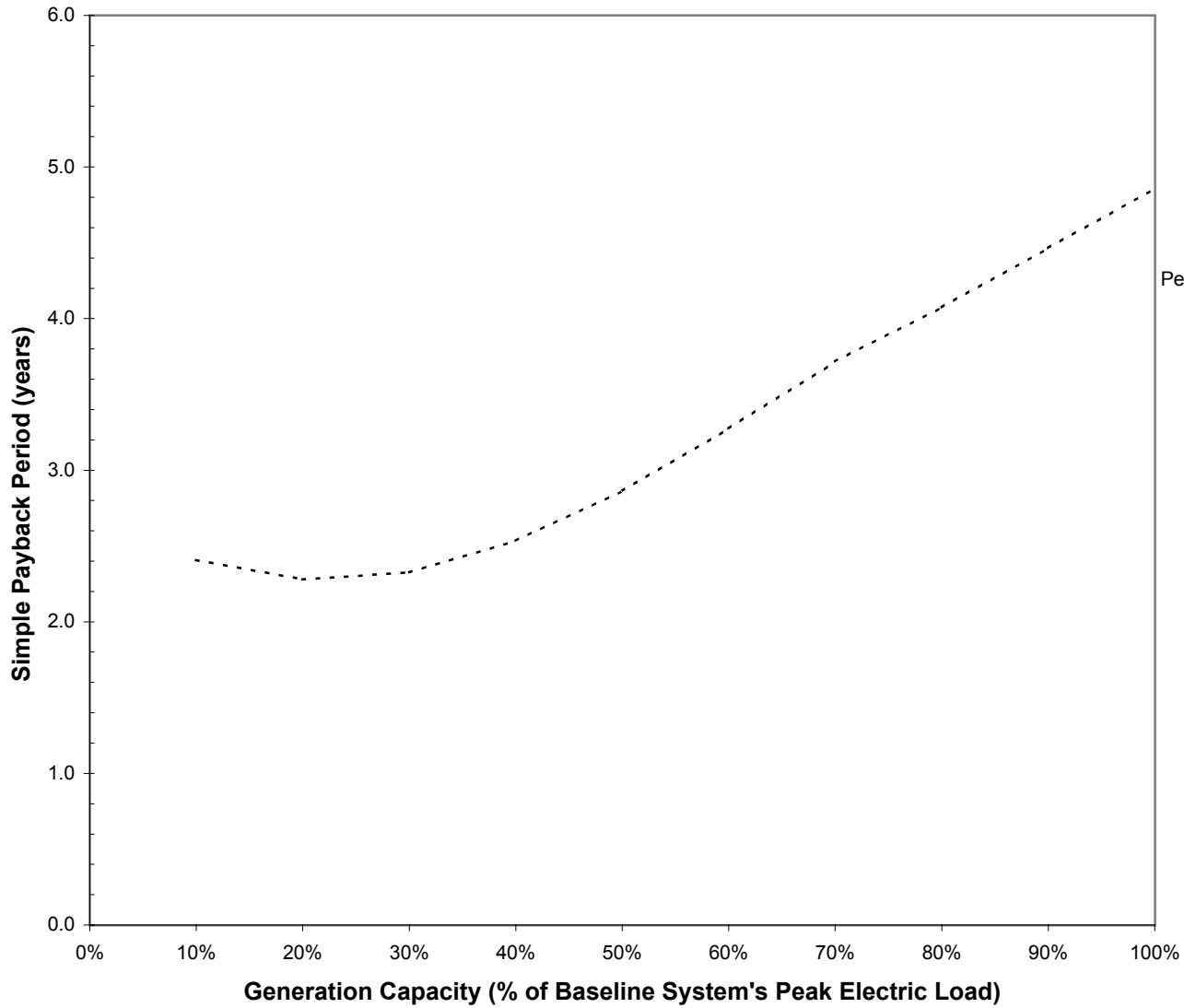

Run Number: 24

Date and Time of Run: 1/17/02 4:57

City Name: Los Angeles

Building Type: Hotel

FloorArea(ft²): 203,000

Baseline Peak Electric(kW): 897

Peak Cooling Load (tons): 548

Peak Heating Load (MMBtuH): 2

Generation Technology: Std. Microturbine

Absorption Chiller Type: Double Effect

Fuel Type: Natural Gas

Rate Structure: So. Cal. Edison

Control Strategy: Smart

Annual Primary Energy Consumption Breakdown

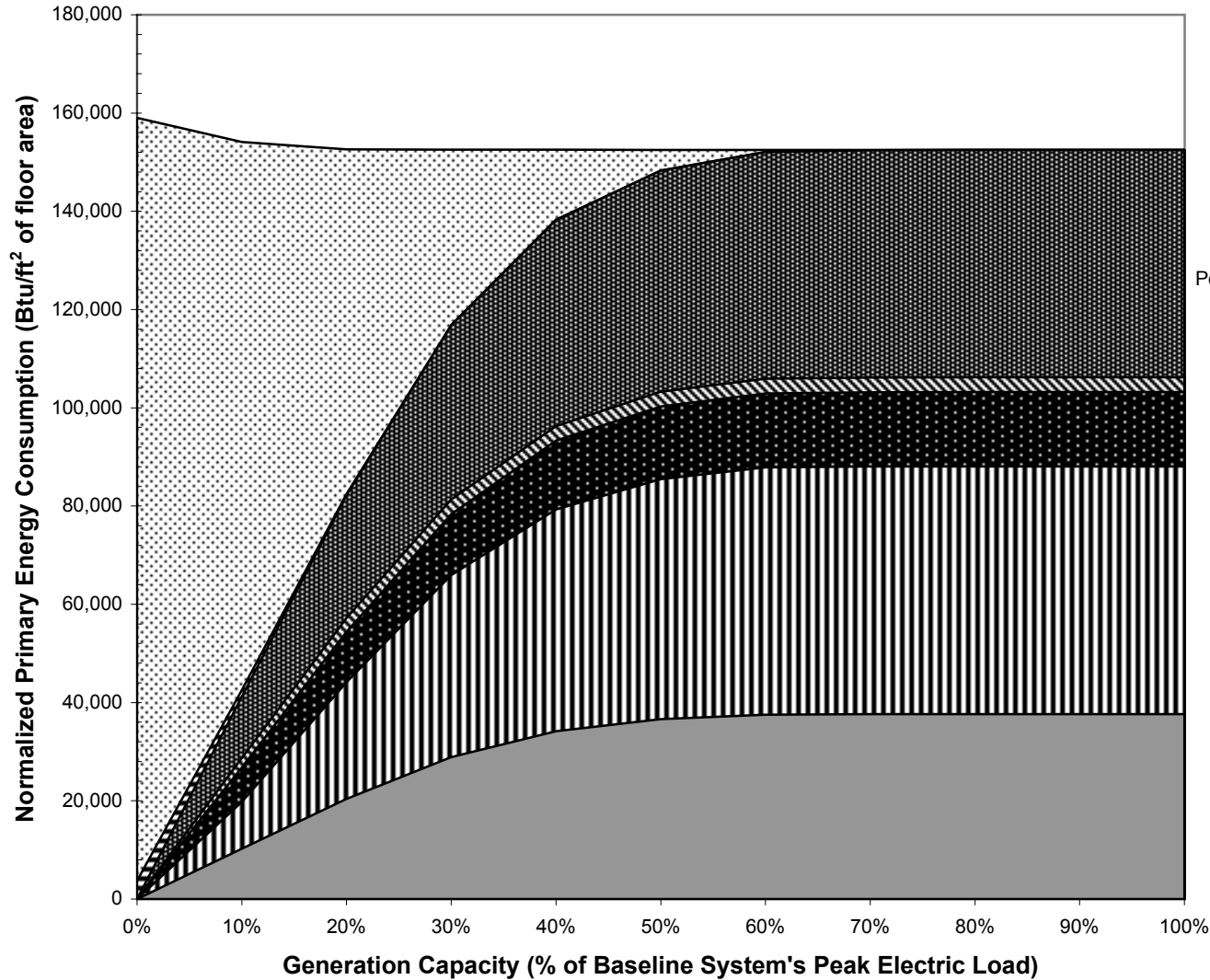

Run Number: 25
 Date and Time of Run: 1/13/02 8:59
 City Name: Los Angeles
 Building Type: Hotel
 FloorArea(ft²): 203,000
 Baseline Peak Electric(kW): 834
 Peak Cooling Load (tons): 548
 Peak Heating Load (MMBtuH): 2
 Generation Technology: Adv. Microturbine
 Absorption Chiller Type: Large Double
 Fuel Type: NaturalGas
 Rate Structure: So. Cal. Edison
 Control Strategy: Smart



Installed Cost and Annual Operating Cost

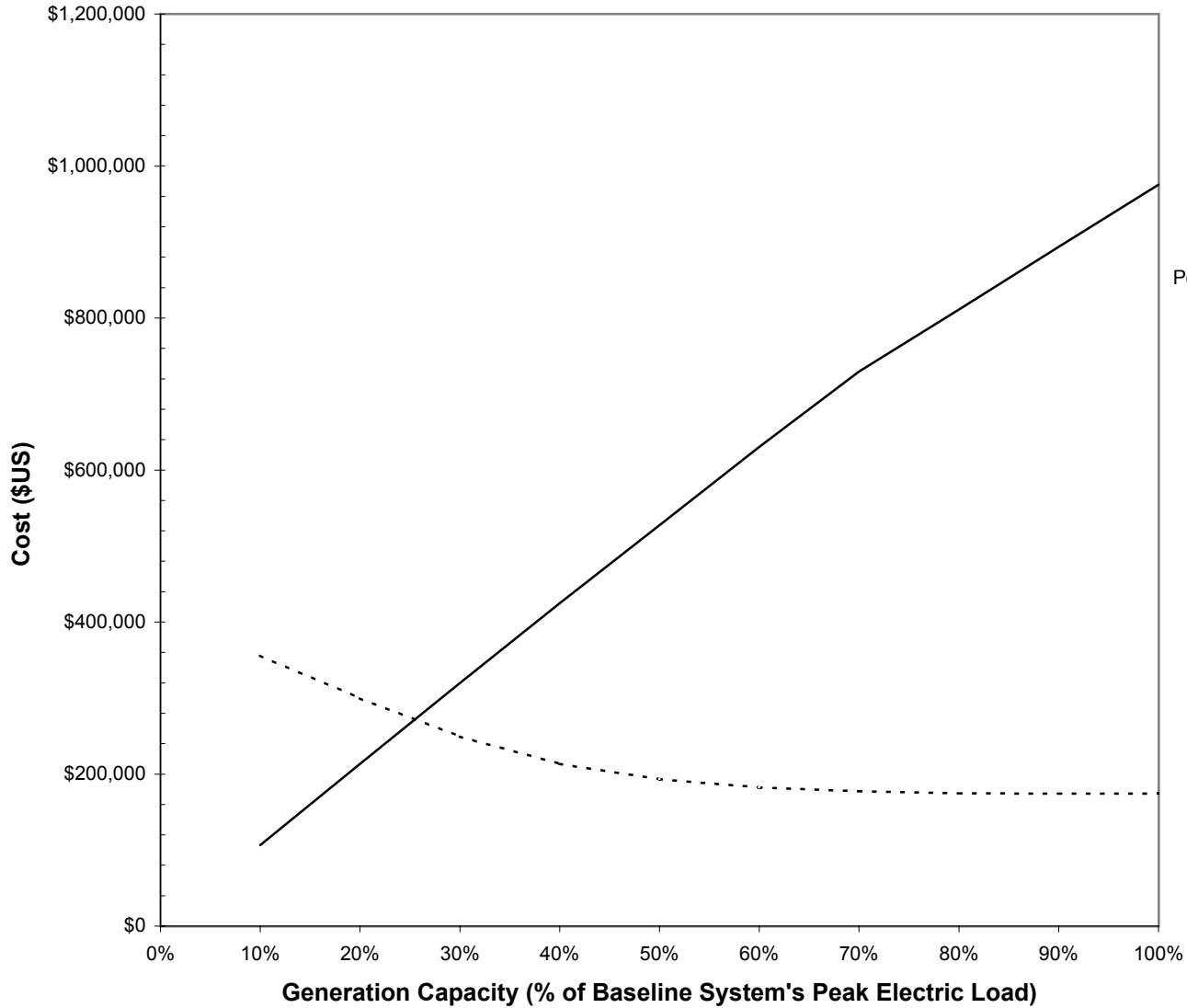

— Installed Cost - - - - Annual Operating Cost

Run Number: 25
Date and Time of Run: 1/13/02 8:59
City Name: Los Angeles
Building Type: Hotel
FloorArea(ft²): 203,000
Baseline Peak Electric(kW): 834
Peak Cooling Load (tons): 548
Peak Heating Load (MMBtuH): 2
Generation Technology: Adv. Microturbine
Absorption Chiller Type: Large Double
Fuel Type: NaturalGas
Rate Structure: So. Cal. Edison
Control Strategy: Smart

Payback Period

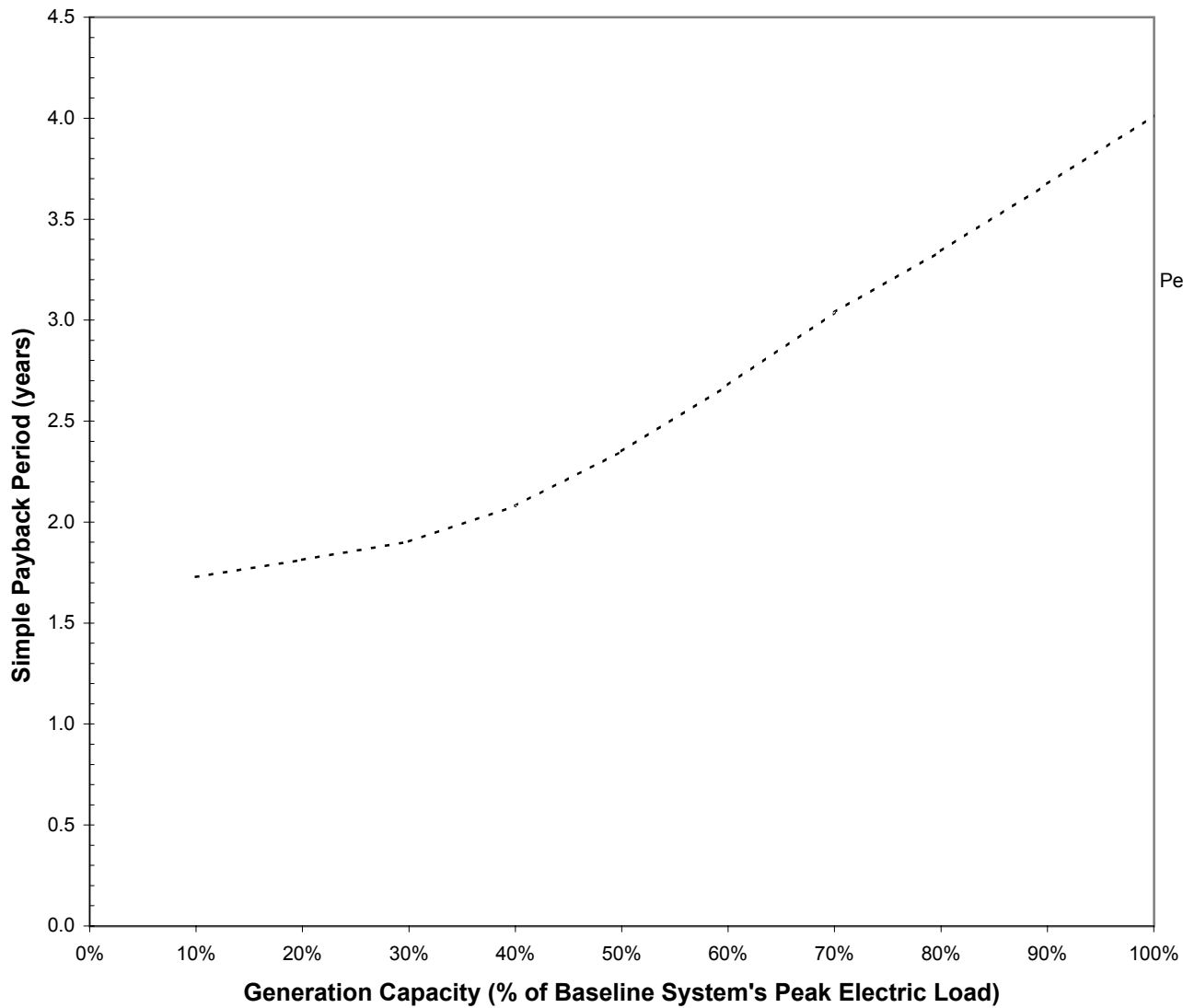

Run Number: 25

Date and Time of Run: 1/13/02 8:59

City Name: Los Angeles

Building Type: Hotel

FloorArea(ft²): 203,000

Baseline Peak Electric(kW): 834

Peak Cooling Load (tons): 548

Peak Heating Load (MMBtuH): 2

Generation Technology: Adv. Microturbine

Absorption Chiller Type: Large Double

Fuel Type: NaturalGas

Rate Structure: So. Cal. Edison

Control Strategy: Smart

Annual Primary Energy Consumption Breakdown

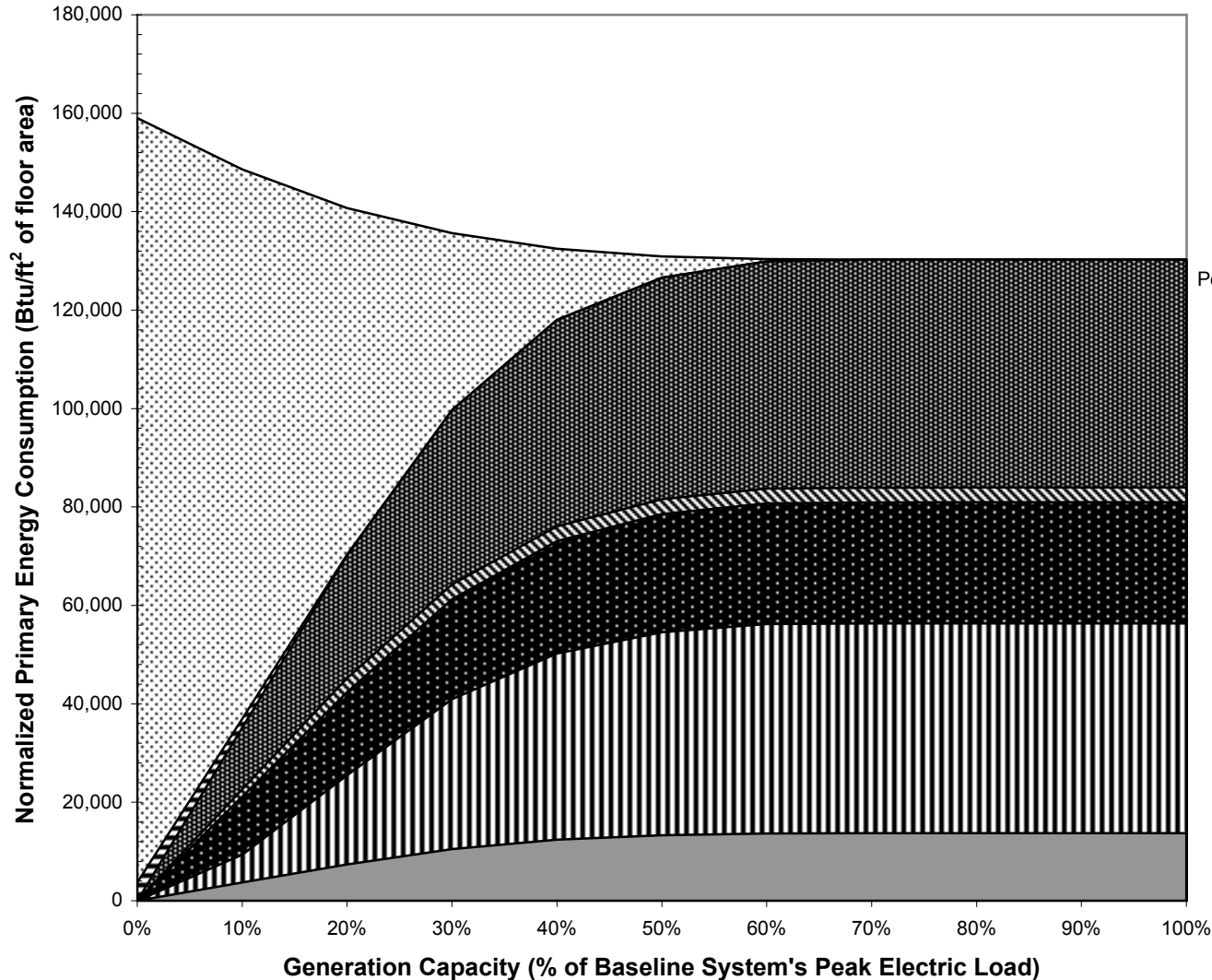

Run Number: 26
 Date and Time of Run: 1/17/02 6:20
 City Name: Los Angeles
 Building Type: Hotel
 FloorArea(ft²): 203,000
 Baseline Peak Electric(kW): 834
 Peak Cooling Load (tons): 548
 Peak Heating Load (MMBtuH): 2
 Generation Technology: Std. Engine
 Absorption Chiller Type: Single Effect
 Fuel Type: Natural Gas
 Rate Structure: So. Cal. Edison
 Control Strategy: Smart



Installed Cost and Annual Operating Cost

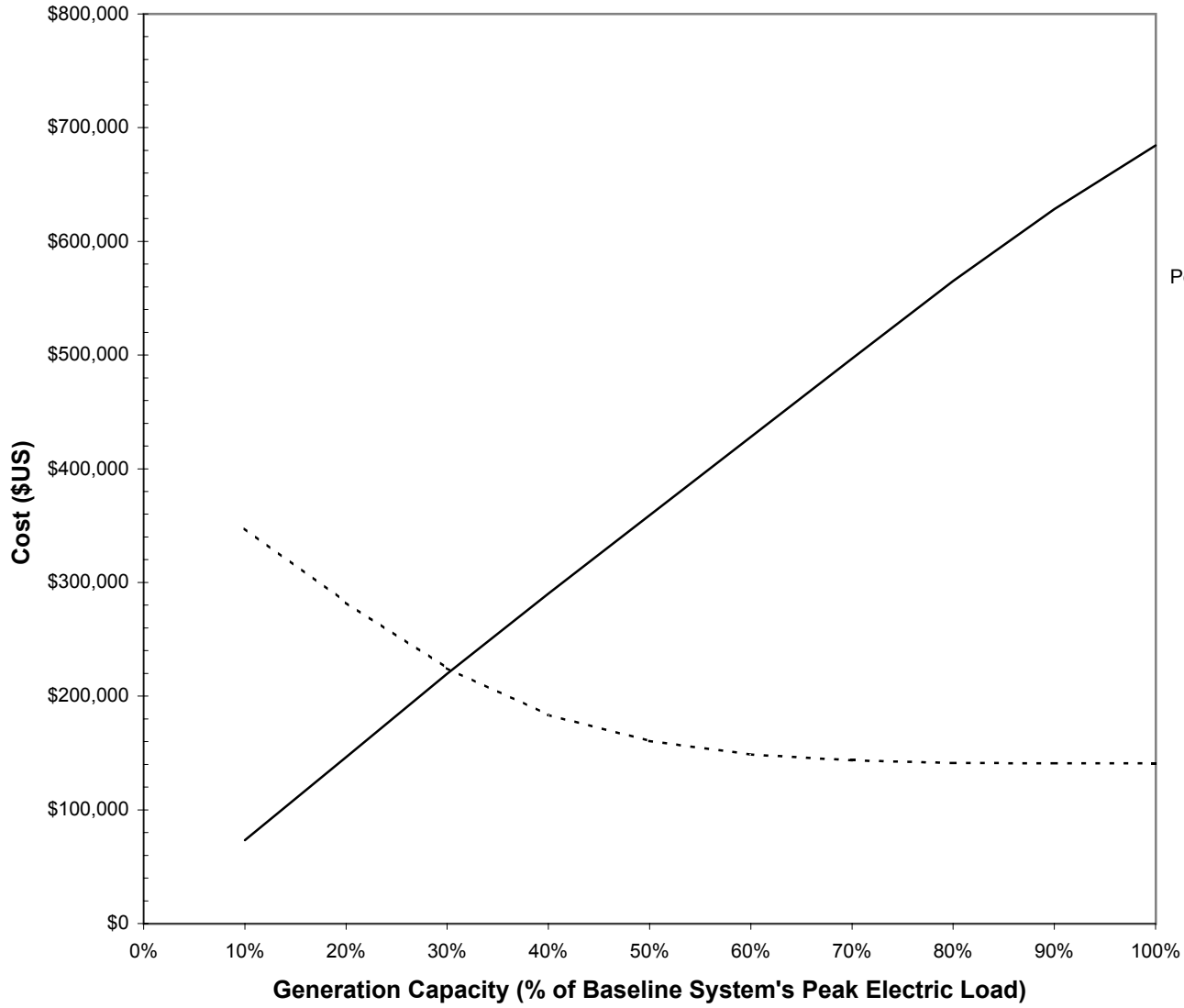

Run Number: 26
Date and Time of Run: 1/17/02 6:20
City Name: Los Angeles
Building Type: Hotel
FloorArea(ft²): 203,000
Baseline Peak Electric(kW): 834
Peak Cooling Load (tons): 548
Peak Heating Load (MMBtuH): 2
Generation Technology: Std. Engine
Absorption Chiller Type: Single Effect
Fuel Type: Natural Gas
Rate Structure: So. Cal. Edison
Control Strategy: Smart

— Installed Cost - - - - Annual Operating Cost

Payback Period

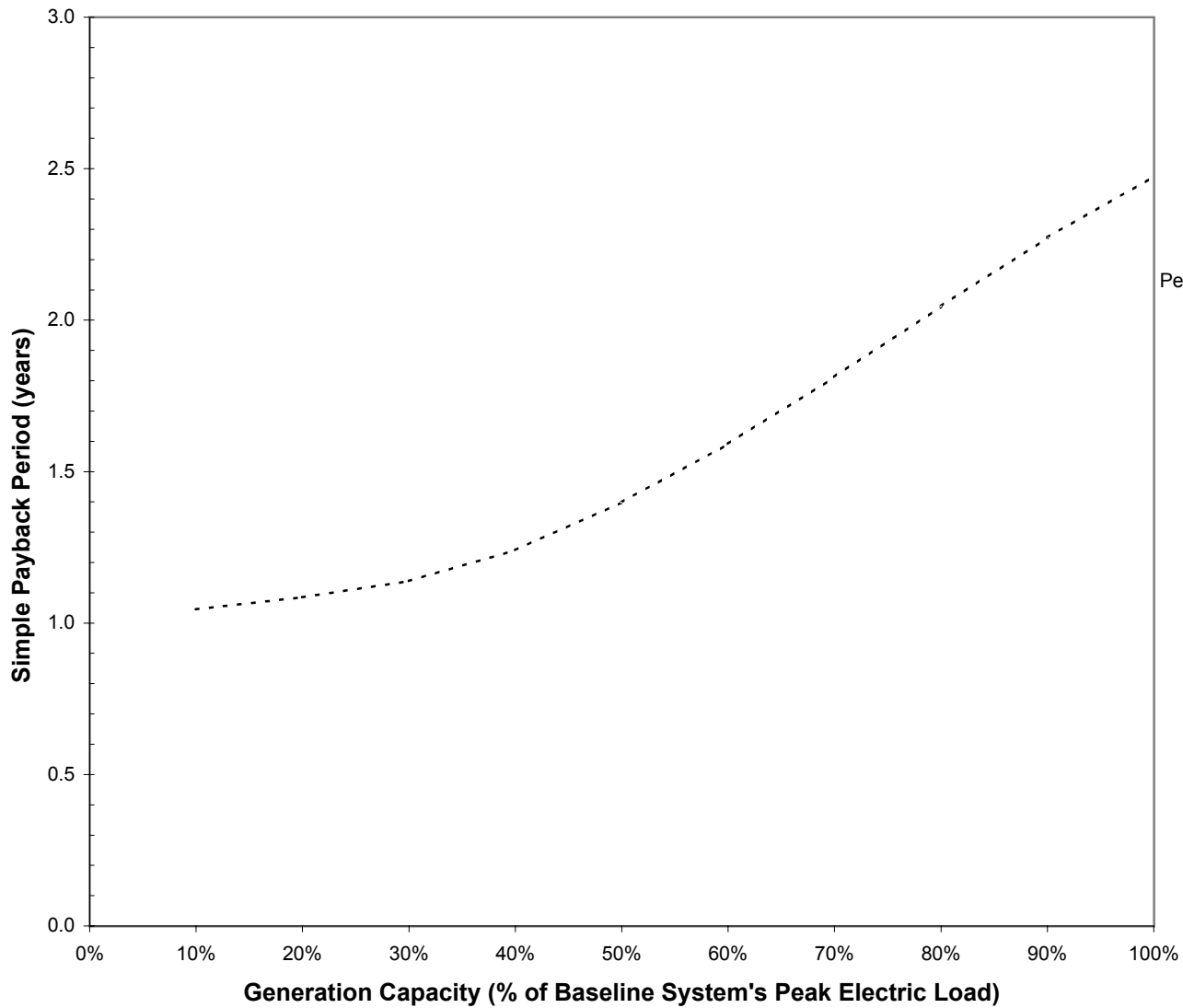

Run Number: 26

Date and Time of Run: 1/17/02 6:20

City Name: Los Angeles

Building Type: Hotel

FloorArea(ft²): 203,000

Baseline Peak Electric(kW): 834

Peak Cooling Load (tons): 548

Peak Heating Load (MMBtuH): 2

Generation Technology: Std. Engine

Absorption Chiller Type: Single Effect

Fuel Type: Natural Gas

Rate Structure: So. Cal. Edison

Control Strategy: Smart

Annual Primary Energy Consumption Breakdown

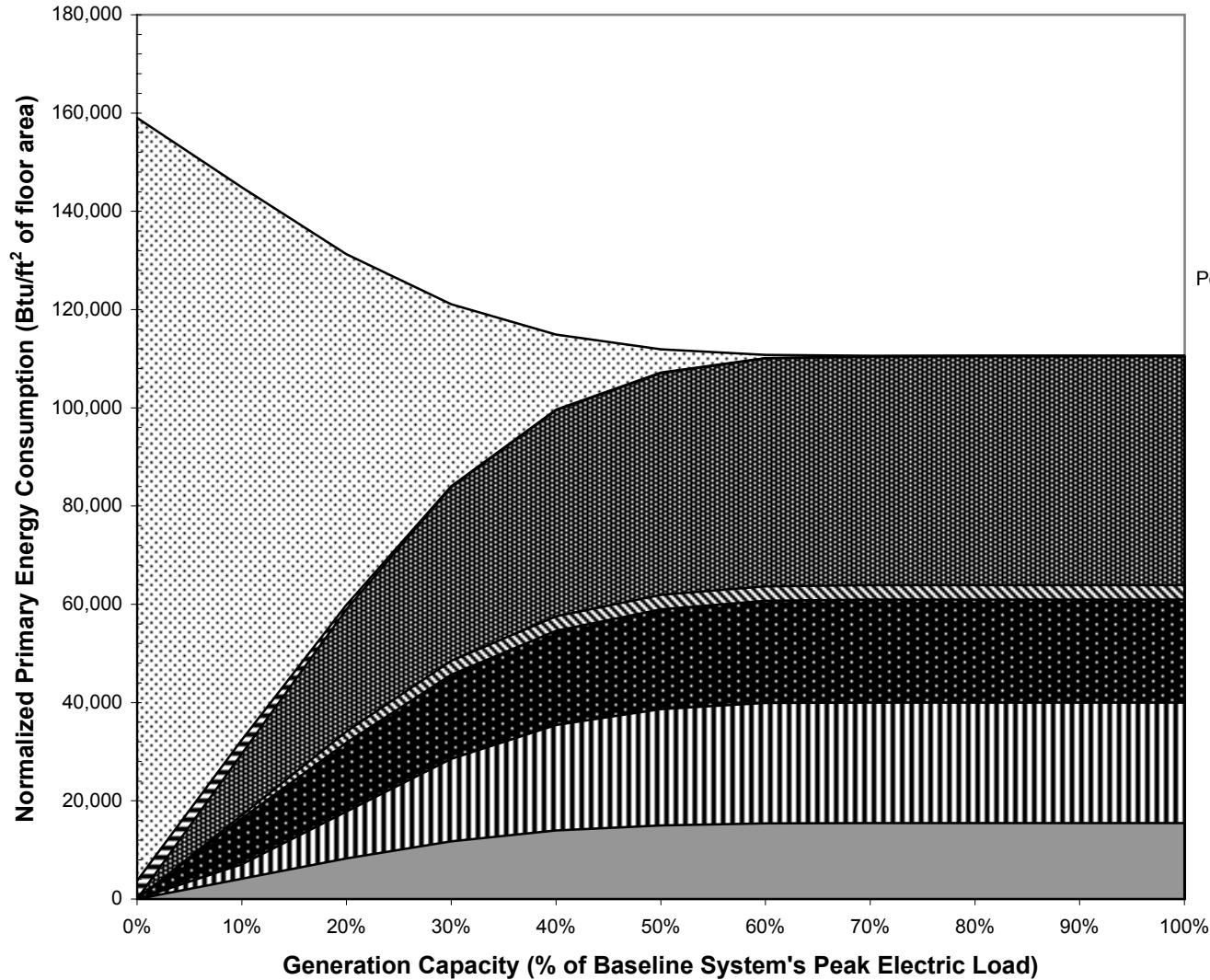

Run Number: 27
 Date and Time of Run: 1/17/02 8:06
 City Name: Los Angeles
 Building Type: Hotel
 FloorArea(ft²): 203,000
 Baseline Peak Electric(kW): 834
 Peak Cooling Load (tons): 548
 Peak Heating Load (MMBtuH): 2
 Generation Technology: Adv. Engine
 Absorption Chiller Type: Single Effect
 Fuel Type: Natural Gas
 Rate Structure: So. Cal. Edison
 Control Strategy: Smart

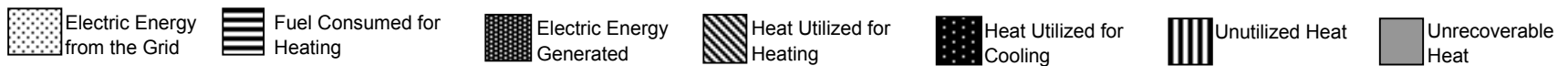

Installed Cost and Annual Operating Cost

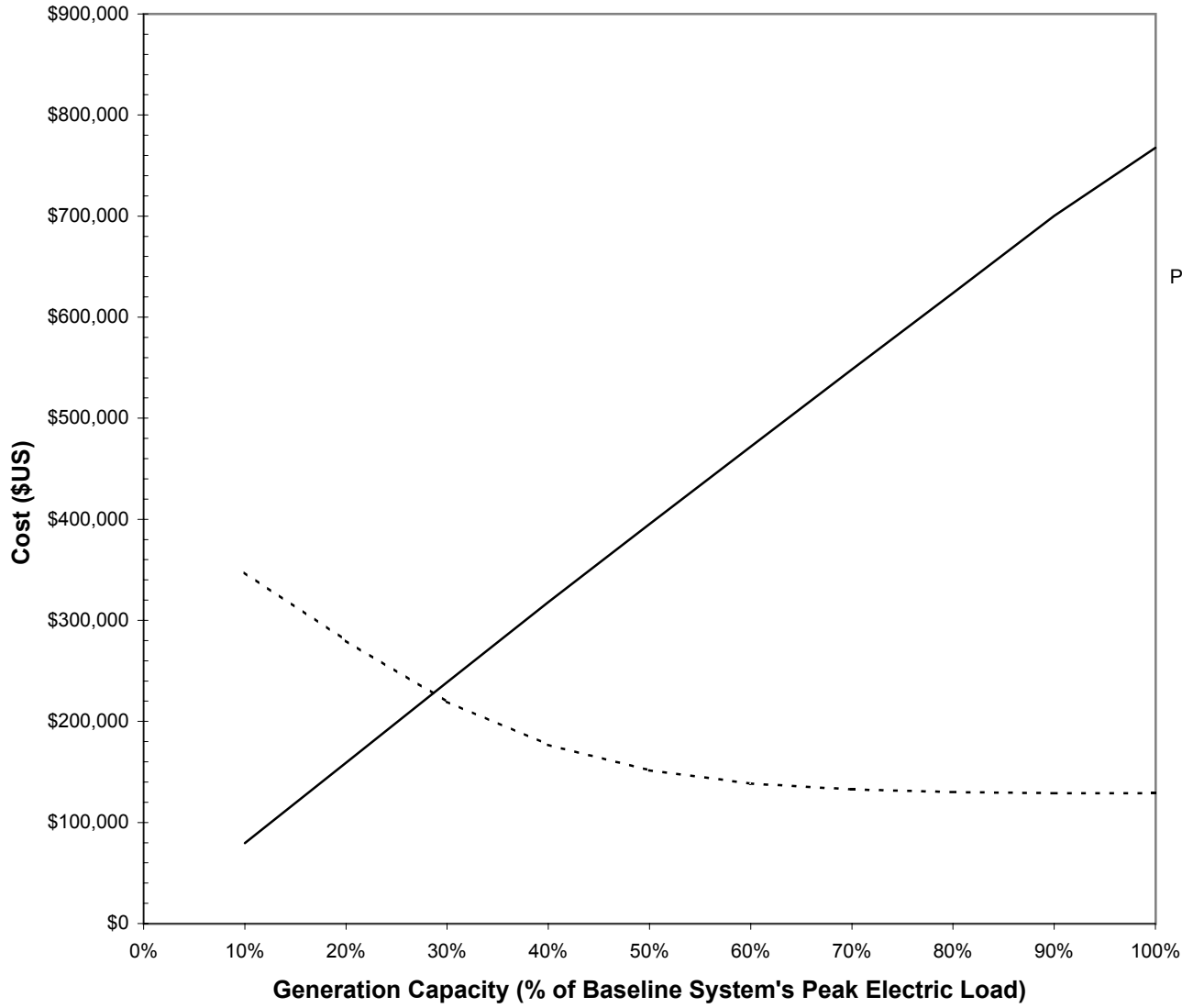

Run Number: 27
Date and Time of Run: 1/17/02 8:06
City Name: Los Angeles
Building Type: Hotel
FloorArea(ft²): 203,000
Baseline Peak Electric(kW): 834
Peak Cooling Load (tons): 548
Peak Heating Load (MMBtuH): 2
Generation Technology: Adv. Engine
Absorption Chiller Type: Single Effect
Fuel Type: Natural Gas
Rate Structure: So. Cal. Edison
Control Strategy: Smart

— Installed Cost - - - - Annual Operating Cost

Payback Period

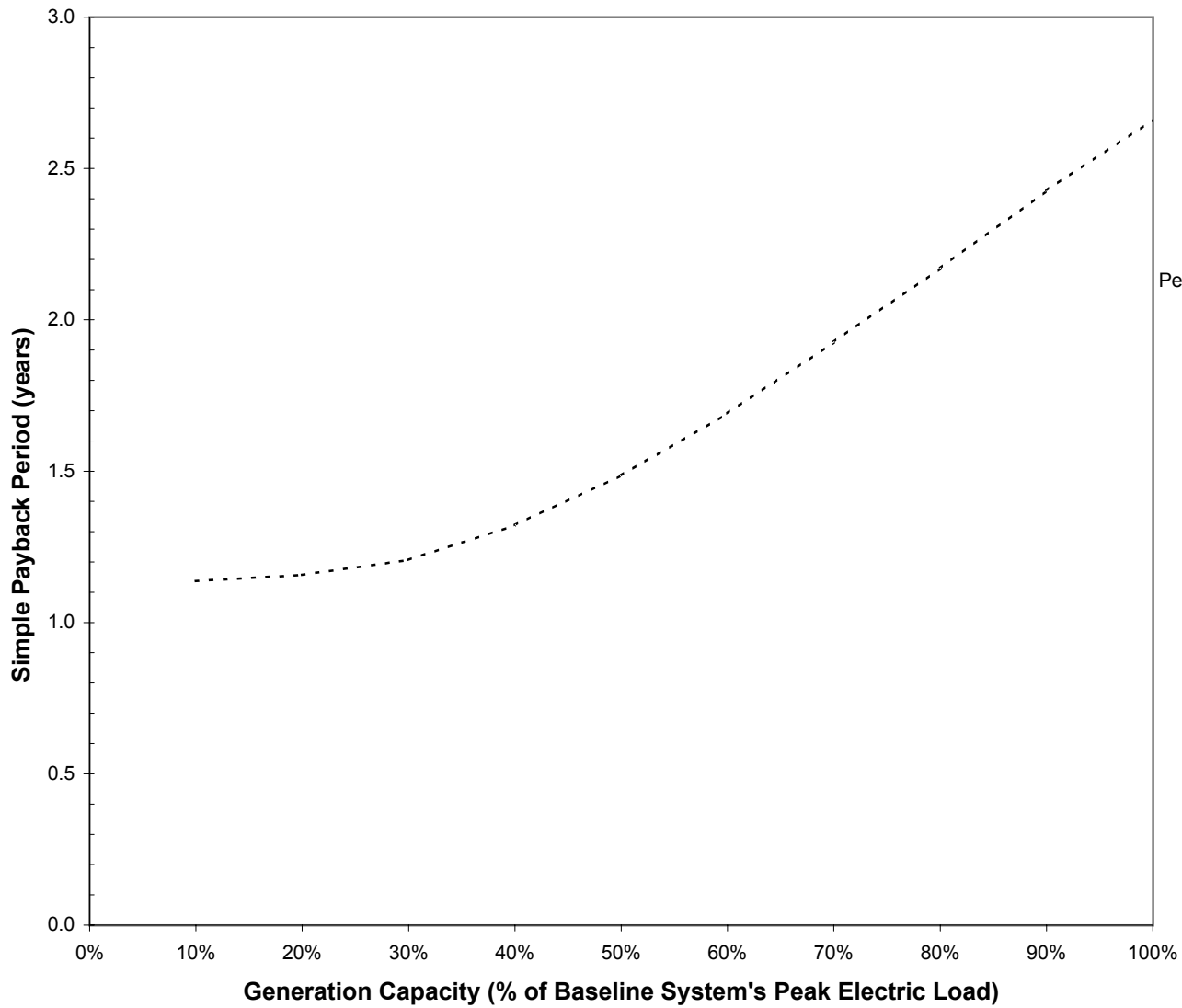

Run Number: 27

Date and Time of Run: 1/17/02 8:06

City Name: Los Angeles

Building Type: Hotel

FloorArea(ft²): 203,000

Baseline Peak Electric(kW): 834

Peak Cooling Load (tons): 548

Peak Heating Load (MMBtuH): 2

Generation Technology: Adv. Engine

Absorption Chiller Type: Single Effect

Fuel Type: Natural Gas

Rate Structure: So. Cal. Edison

Control Strategy: Smart

Annual Primary Energy Consumption Breakdown

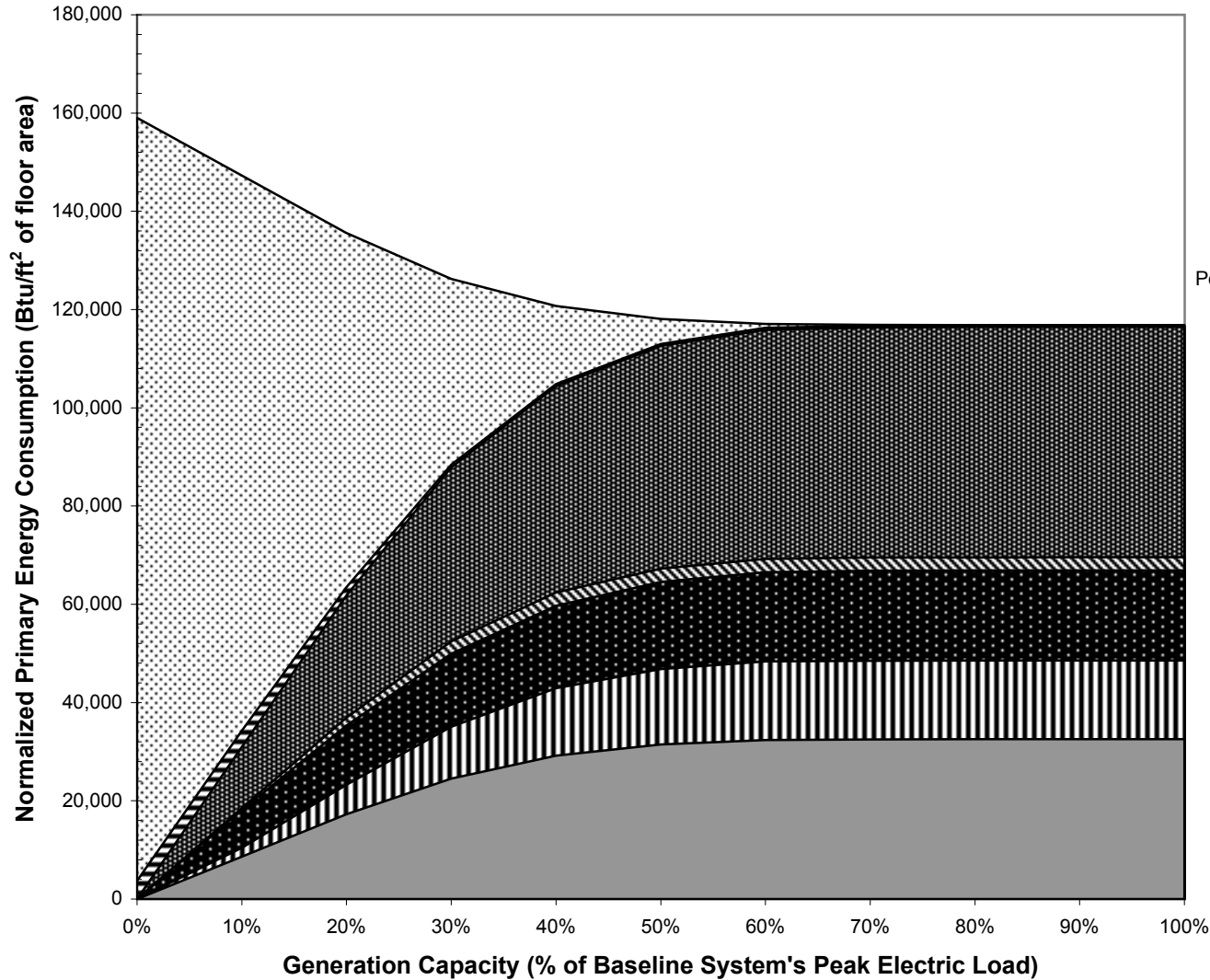

Run Number: 28
 Date and Time of Run: 1/13/02 11:47
 City Name: Los Angeles
 Building Type: Hotel
 FloorArea(ft²): 203,000
 Baseline Peak Electric(kW): 834
 Peak Cooling Load (tons): 548
 Peak Heating Load (MMBtuH): 2
 Generation Technology: HTPEM Fuel Cell
 Absorption Chiller Type: Small Single
 Fuel Type: NaturalGas
 Rate Structure: So. Cal. Edison
 Control Strategy: Smart



Installed Cost and Annual Operating Cost

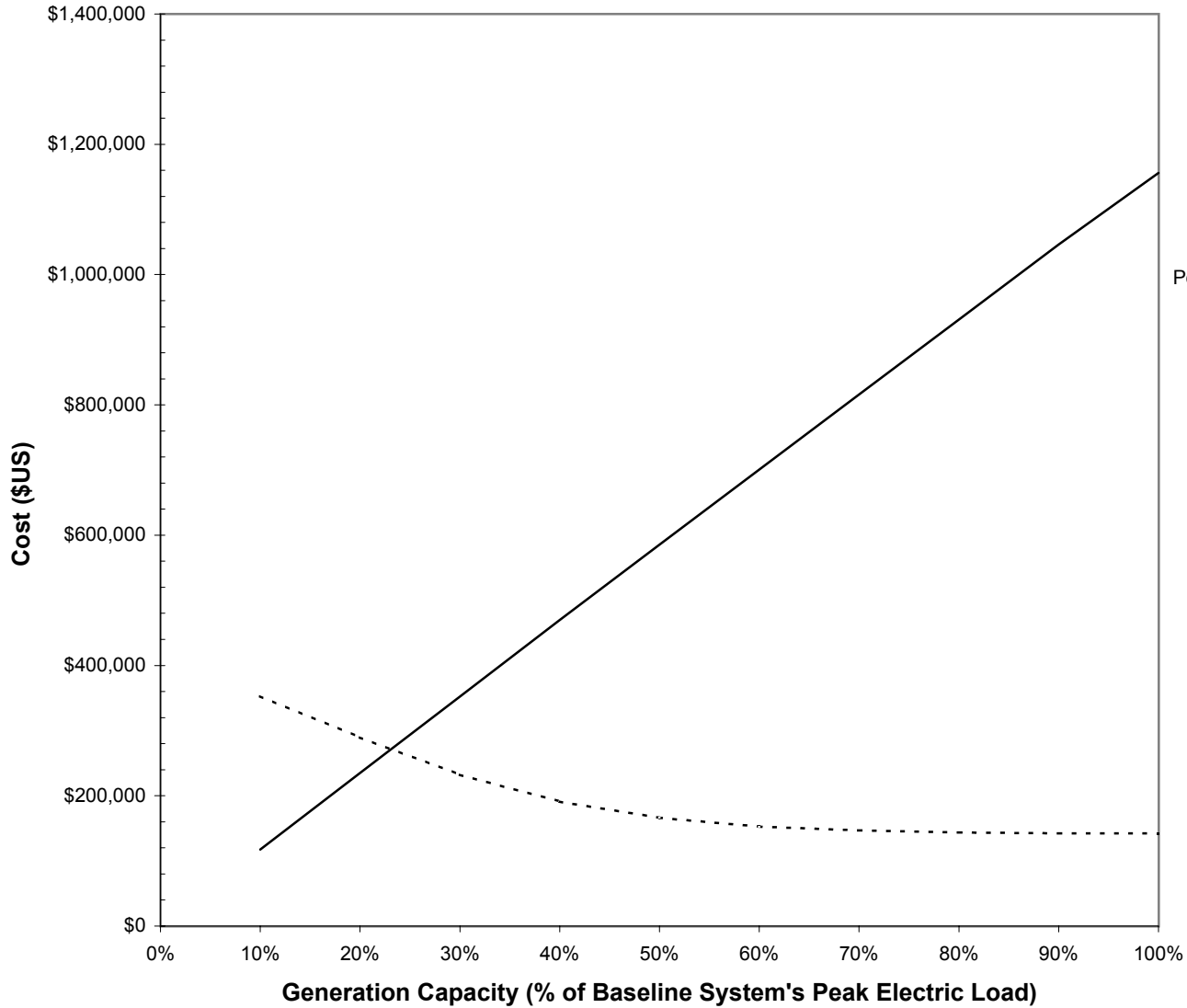

— Installed Cost - - - - Annual Operating Cost

Run Number: 28
Date and Time of Run: 1/13/02 11:47
City Name: Los Angeles
Building Type: Hotel
FloorArea(ft²): 203,000
Baseline Peak Electric(kW): 834
Peak Cooling Load (tons): 548
Peak Heating Load (MMBtuH): 2
Generation Technology: HTPeM Fuel Cell
Absorption Chiller Type: Small Single
Fuel Type: NaturalGas
Rate Structure: So. Cal. Edison
Control Strategy: Smart

Payback Period

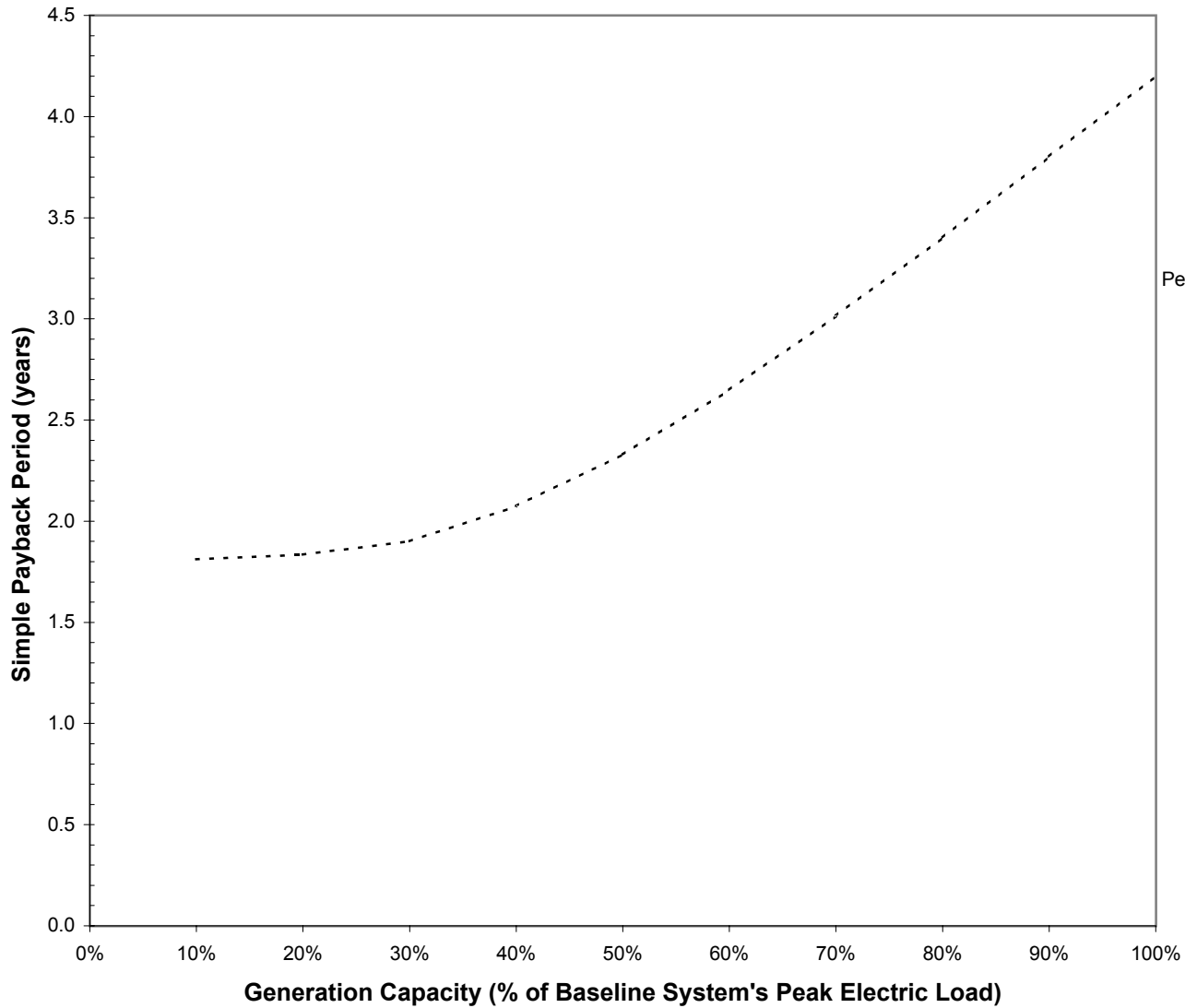

Run Number: 28

Date and Time of Run: 1/13/02 11:47

City Name: Los Angeles

Building Type: Hotel

FloorArea(ft²): 203,000

Baseline Peak Electric(kW): 834

Peak Cooling Load (tons): 548

Peak Heating Load (MMBtuH): 2

Generation Technology: HTPeM Fuel Cell

Absorption Chiller Type: Small Single

Fuel Type: NaturalGas

Rate Structure: So. Cal. Edison

Control Strategy: Smart

Annual Primary Energy Consumption Breakdown

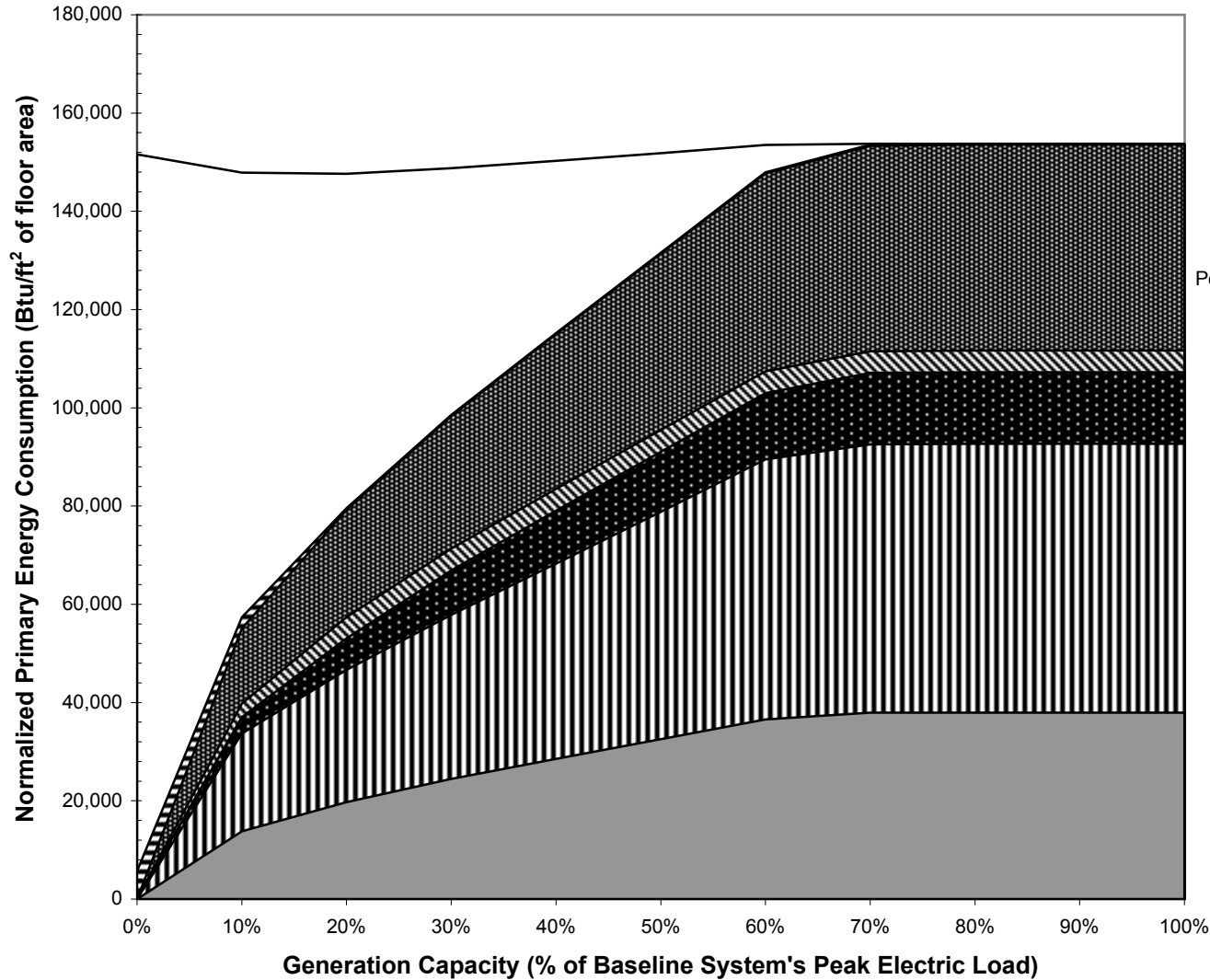

Run Number: 30
 Date and Time of Run: 1/14/02 1:58
 City Name: Los Angeles
 Building Type: Office
 FloorArea(ft²): 197,000
 Baseline Peak Electric(kW): 989
 Peak Cooling Load (tons): 330
 Peak Heating Load (MMBtuH): 2
 Generation Technology: Std. Microturbine
 Absorption Chiller Type: Double Effect
 Fuel Type: Natural Gas
 Rate Structure: So. Cal. Edison
 Control Strategy: Smart



Installed Cost and Annual Operating Cost

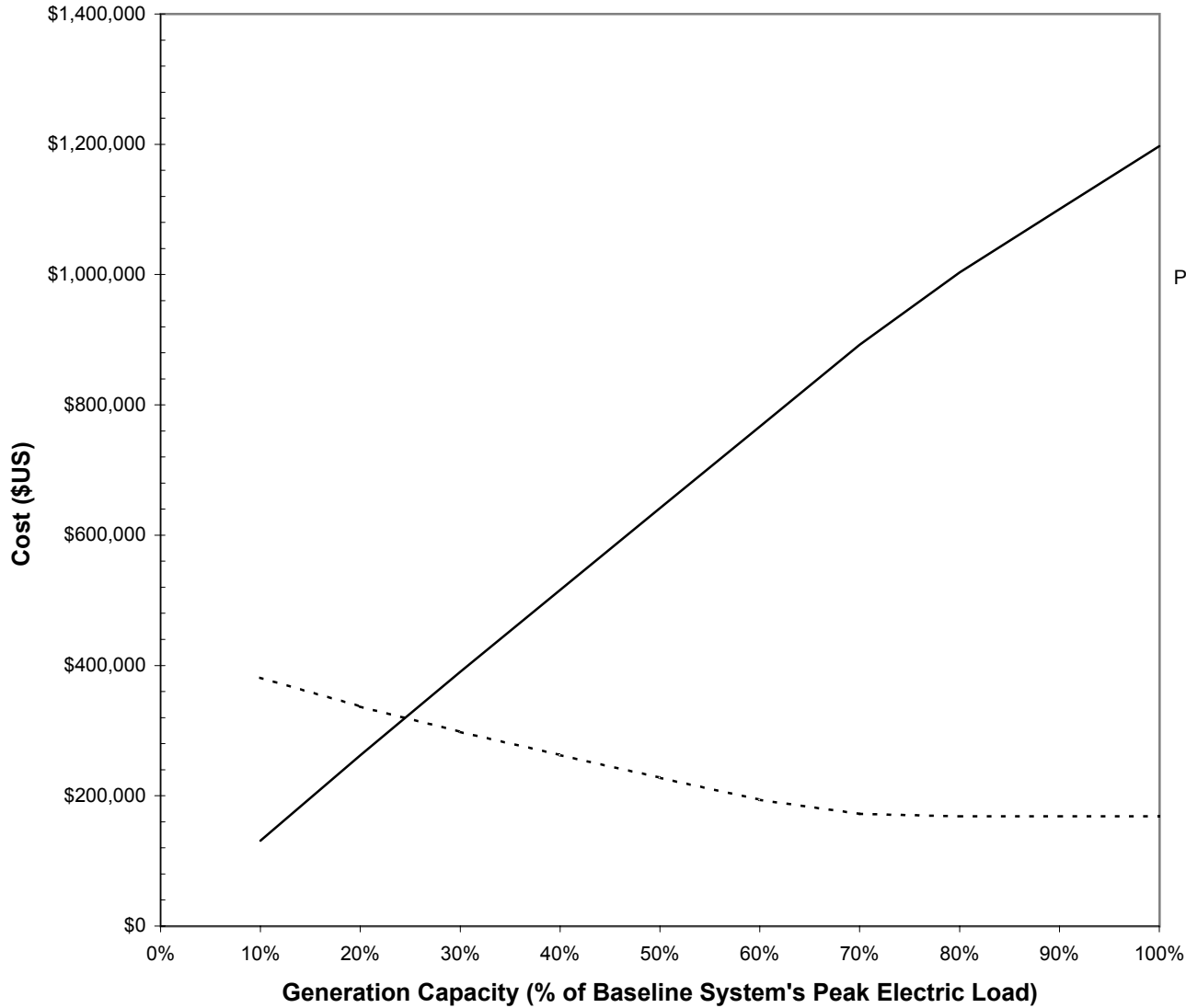

— Installed Cost - - - - Annual Operating Cost

Run Number: 30
Date and Time of Run: 1/14/02 1:58
City Name: Los Angeles
Building Type: Office
FloorArea(ft²): 197,000
Baseline Peak Electric(kW): 989
Peak Cooling Load (tons): 330
Peak Heating Load (MMBtuH): 2
Generation Technology: Std. Microturbine
Absorption Chiller Type: Double Effect
Fuel Type: Natural Gas
Rate Structure: So. Cal. Edison
Control Strategy: Smart

Payback Period

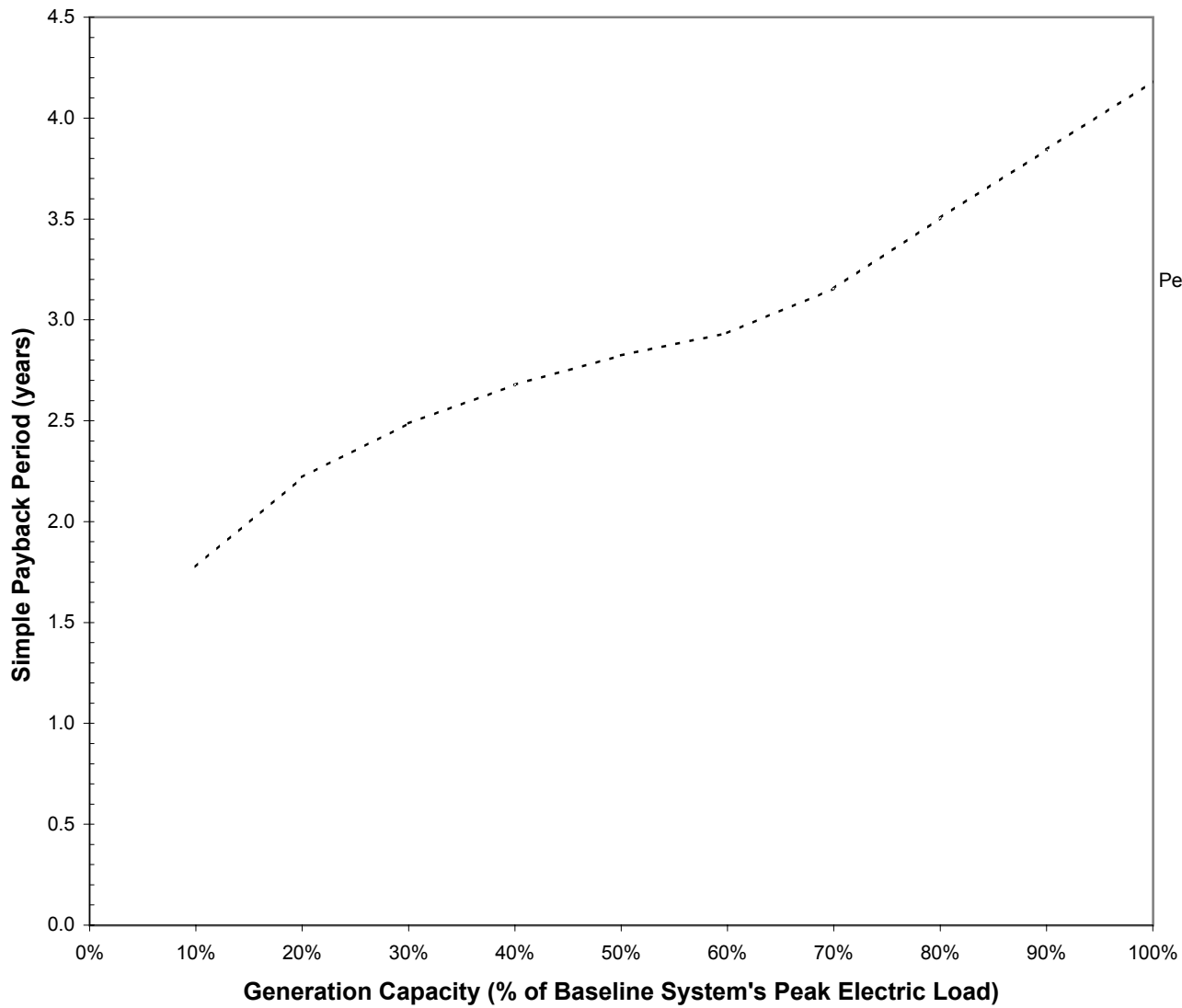

Run Number: 30

Date and Time of Run: 1/14/02 1:58

City Name: Los Angeles

Building Type: Office

FloorArea(ft²): 197,000

Baseline Peak Electric(kW): 989

Peak Cooling Load (tons): 330

Peak Heating Load (MMBtuH): 2

Generation Technology: Std. Microturbine

Absorption Chiller Type: Double Effect

Fuel Type: Natural Gas

Rate Structure: So. Cal. Edison

Control Strategy: Smart

Annual Primary Energy Consumption Breakdown

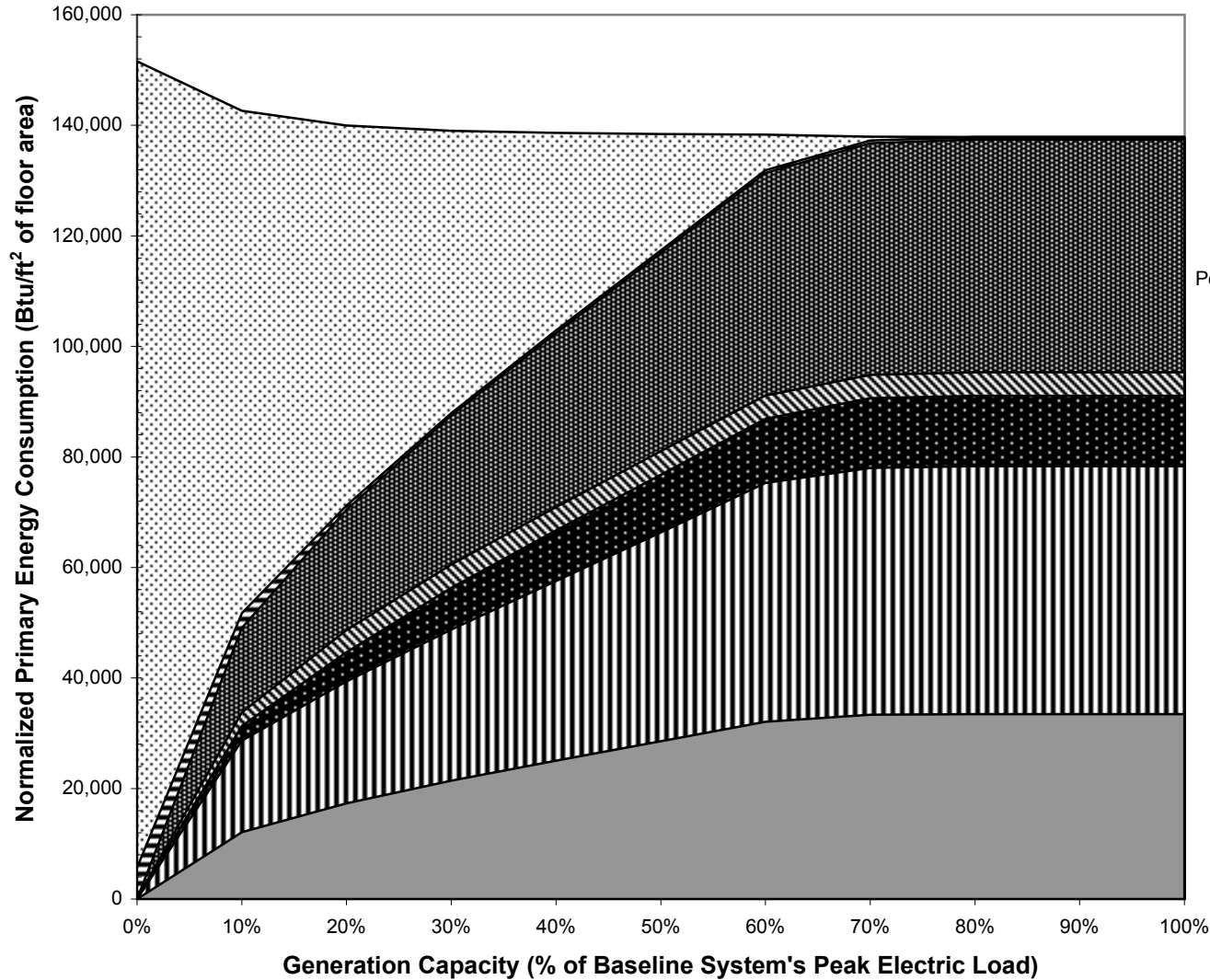

Run Number: 31
 Date and Time of Run: 1/14/02 3:07
 City Name: Los Angeles
 Building Type: Office
 FloorArea(ft²): 197,000
 Baseline Peak Electric(kW): 989
 Peak Cooling Load (tons): 330
 Peak Heating Load (MMBtuH): 2
 Generation Technology: Adv. Microturbine
 Absorption Chiller Type: Double Effect
 Fuel Type: Natural Gas
 Rate Structure: So. Cal. Edison
 Control Strategy: Smart



Installed Cost and Annual Operating Cost

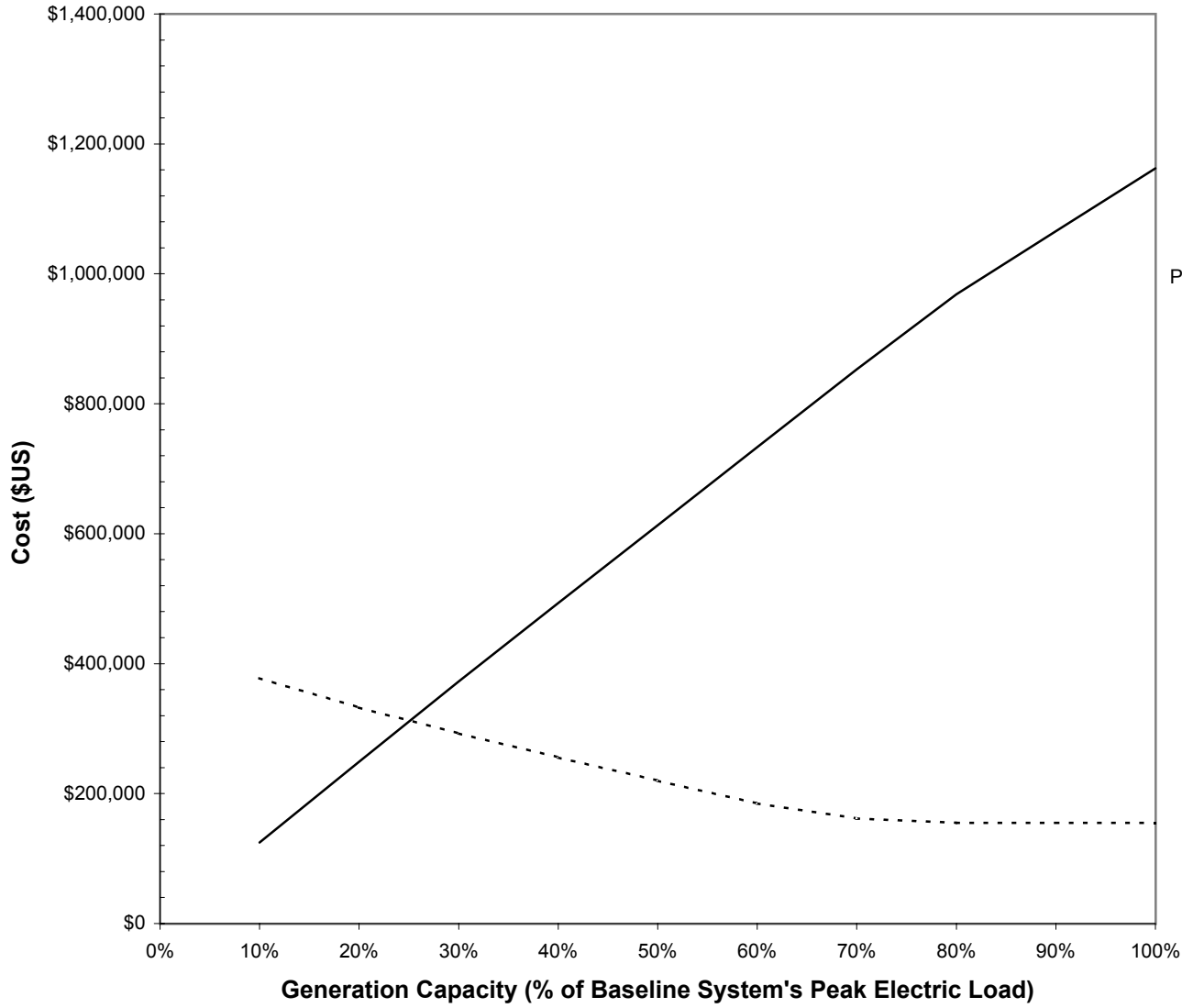

— Installed Cost - - - - Annual Operating Cost

Run Number: 31
Date and Time of Run: 1/14/02 3:07
City Name: Los Angeles
Building Type: Office
FloorArea(ft²): 197,000
Baseline Peak Electric(kW): 989
Peak Cooling Load (tons): 330
Peak Heating Load (MMBtuH): 2
Generation Technology: Adv. Microturbine
Absorption Chiller Type: Double Effect
Fuel Type: Natural Gas
Rate Structure: So. Cal. Edison
Control Strategy: Smart

Payback Period

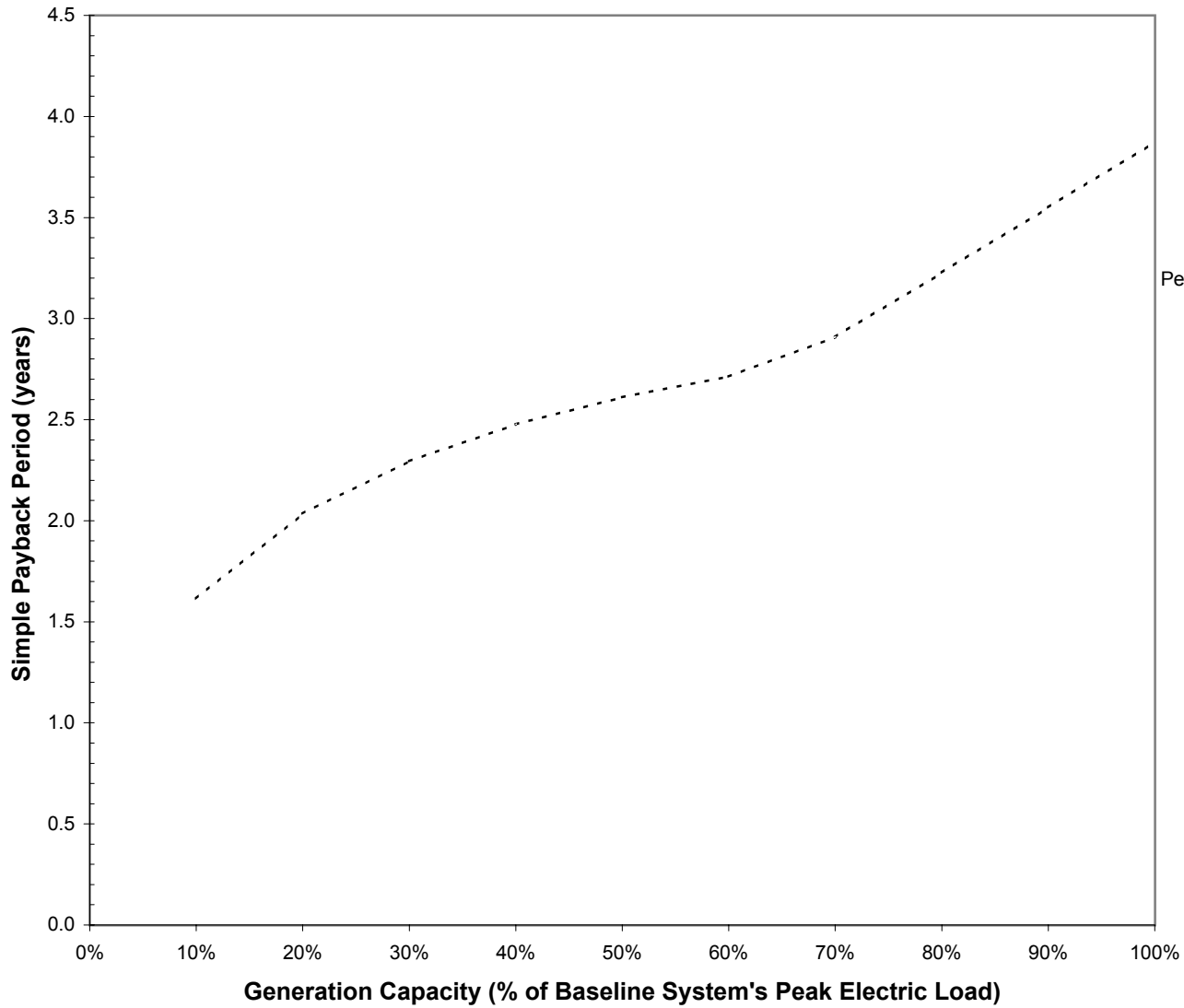

Run Number: 31

Date and Time of Run: 1/14/02 3:07

City Name: Los Angeles

Building Type: Office

FloorArea(ft²): 197,000

Baseline Peak Electric(kW): 989

Peak Cooling Load (tons): 330

Peak Heating Load (MMBtuH): 2

Generation Technology: Adv. Microturbine

Absorption Chiller Type: Double Effect

Fuel Type: Natural Gas

Rate Structure: So. Cal. Edison

Control Strategy: Smart

Annual Primary Energy Consumption Breakdown

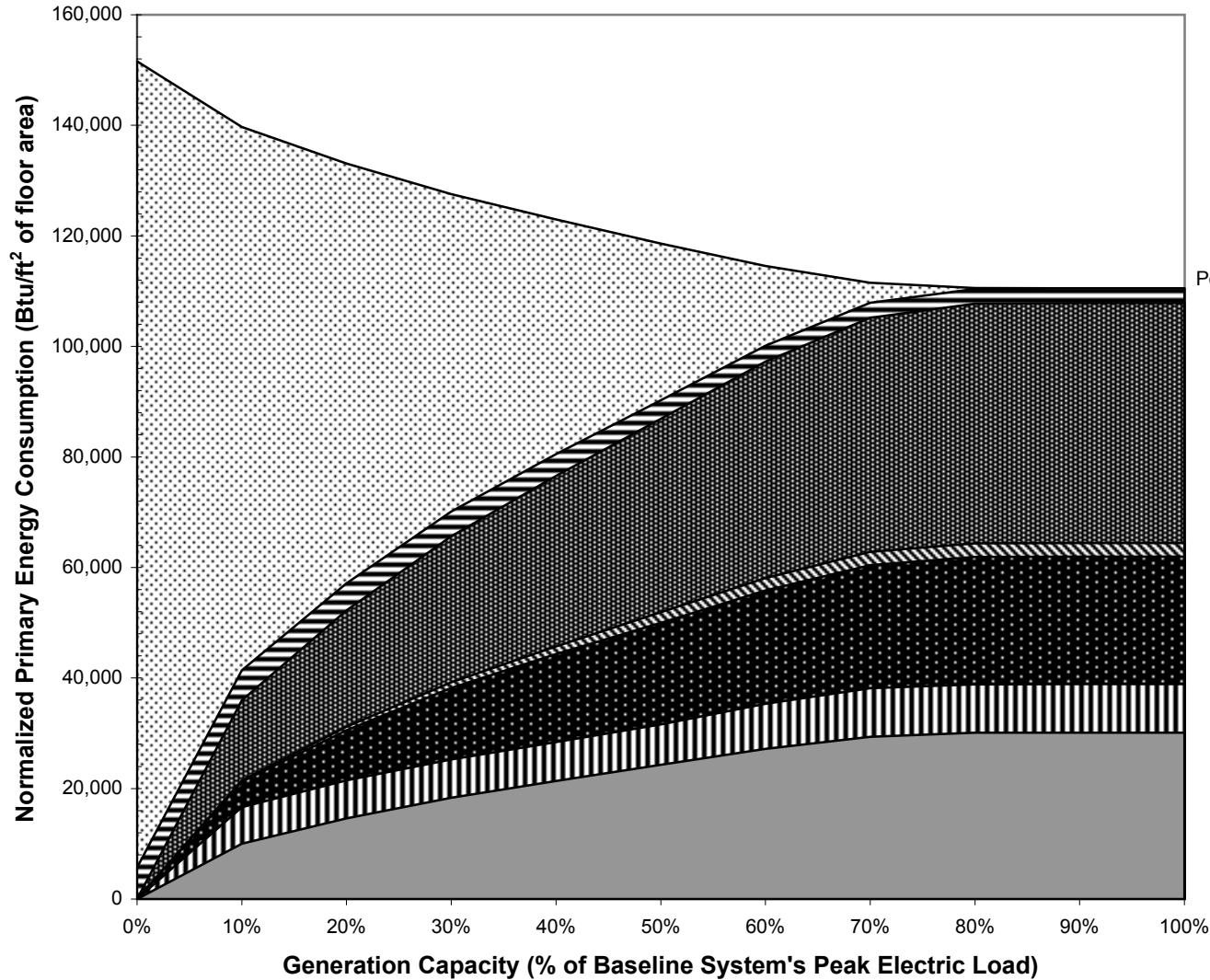

Run Number: 34
 Date and Time of Run: 1/16/02 10:06
 City Name: Los Angeles
 Building Type: Office
 FloorArea(ft²): 197,000
 Baseline Peak Electric(kW): 940
 Peak Cooling Load (tons): 330
 Peak Heating Load (MMBtuH): 2
 Generation Technology: HTPEM Fuel Cell
 Absorption Chiller Type: Single Effect
 Fuel Type: Natural Gas
 Rate Structure: So. Cal. Edison
 Control Strategy: Smart

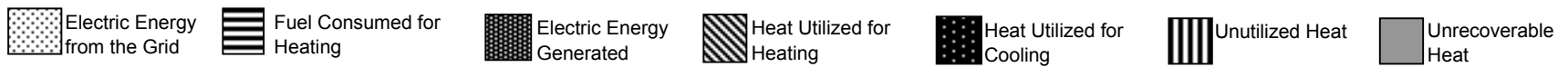

Installed Cost and Annual Operating Cost

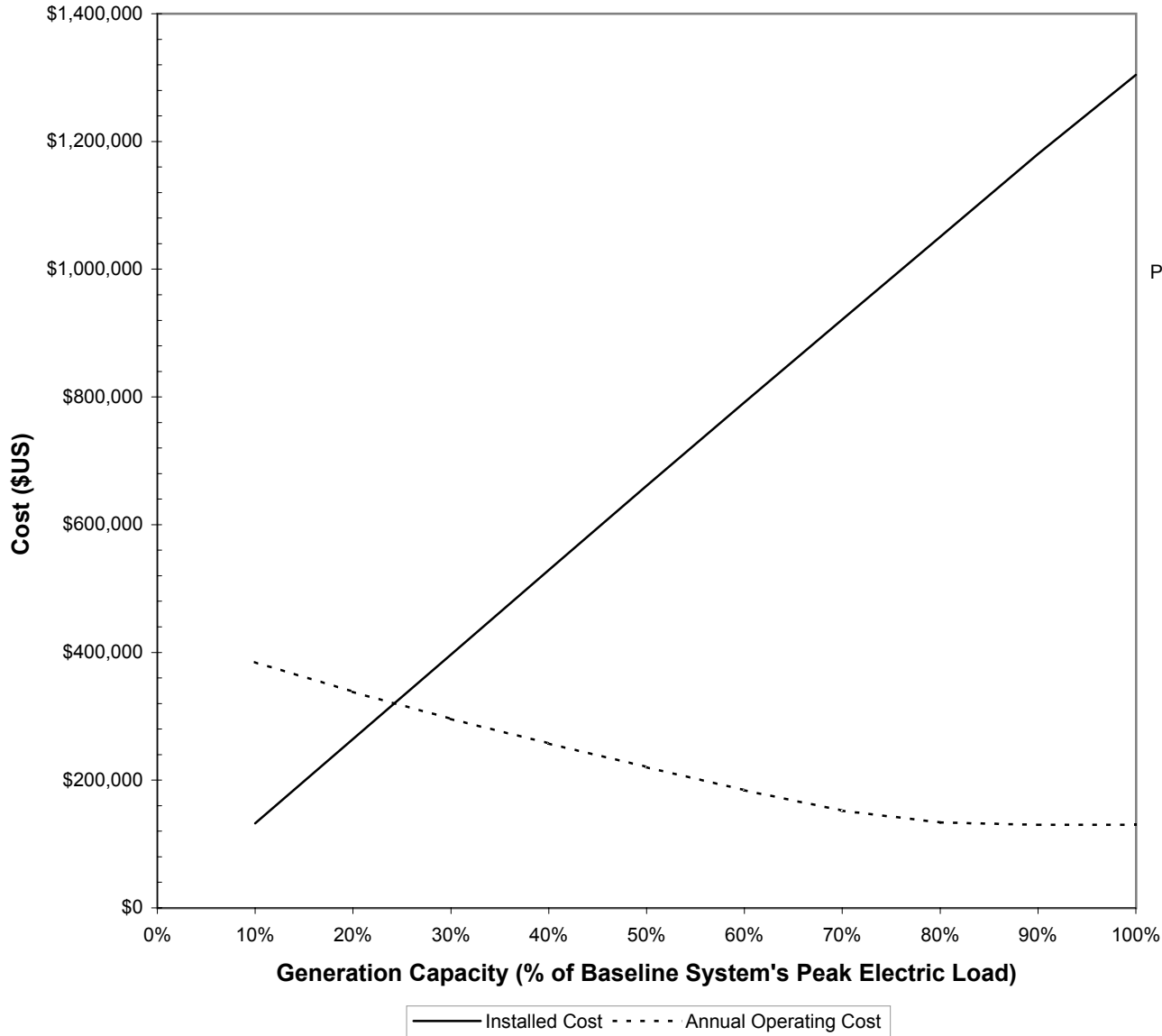

Run Number: 34
Date and Time of Run: 1/16/02 10:06
City Name: Los Angeles
Building Type: Office
FloorArea(ft²): 197,000
Baseline Peak Electric(kW): 940
Peak Cooling Load (tons): 330
Peak Heating Load (MMBtuH): 2
Generation Technology: HTPeM Fuel Cell
Absorption Chiller Type: Single Effect
Fuel Type: Natural Gas
Rate Structure: So. Cal. Edison
Control Strategy: Smart

Payback Period

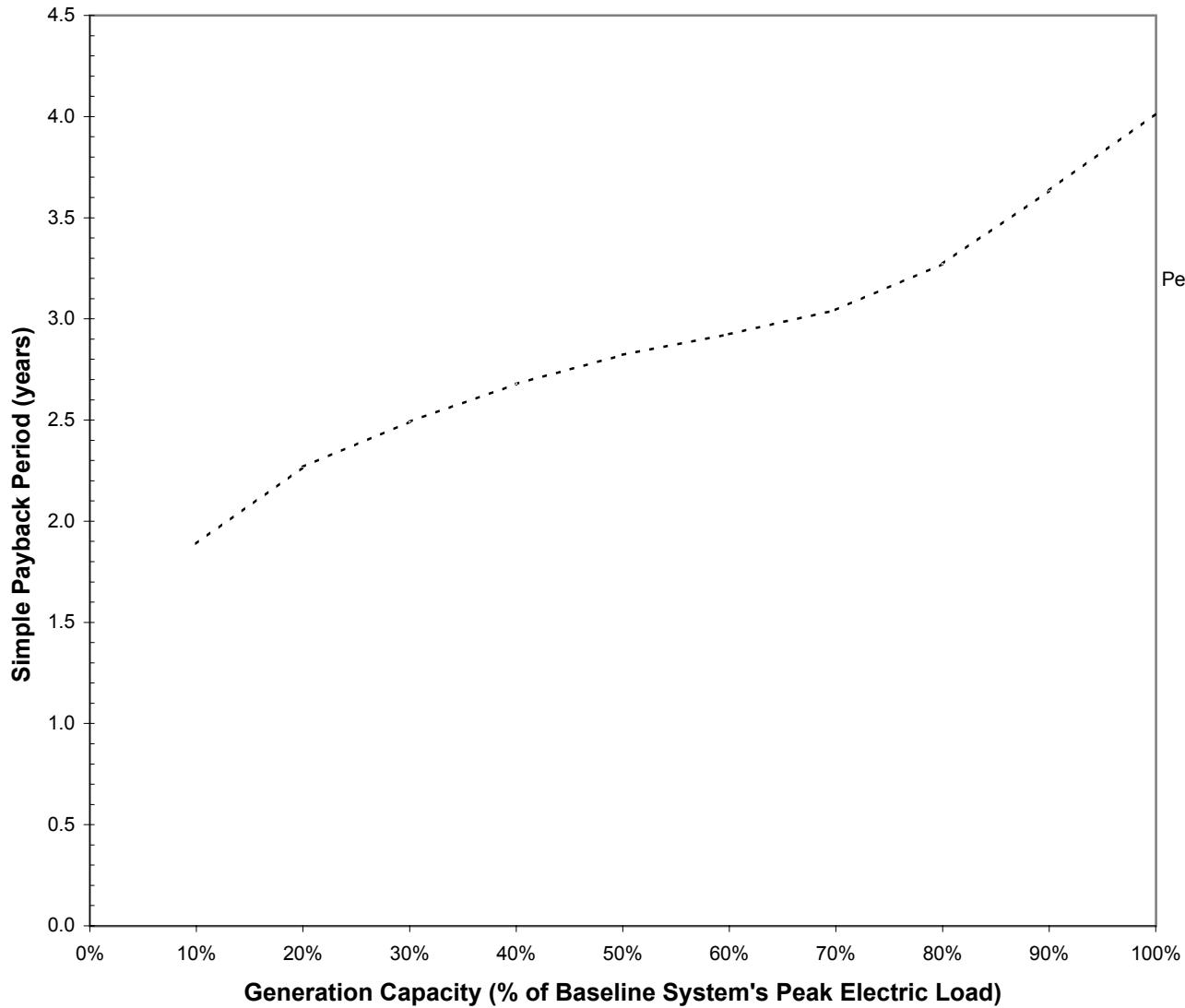

Run Number: 34

Date and Time of Run: 1/16/02 10:06

City Name: Los Angeles

Building Type: Office

FloorArea(ft²): 197,000

Baseline Peak Electric(kW): 940

Peak Cooling Load (tons): 330

Peak Heating Load (MMBtuH): 2

Generation Technology: HTPeM Fuel Cell

Absorption Chiller Type: Single Effect

Fuel Type: Natural Gas

Rate Structure: So. Cal. Edison

Control Strategy: Smart

Annual Primary Energy Consumption Breakdown

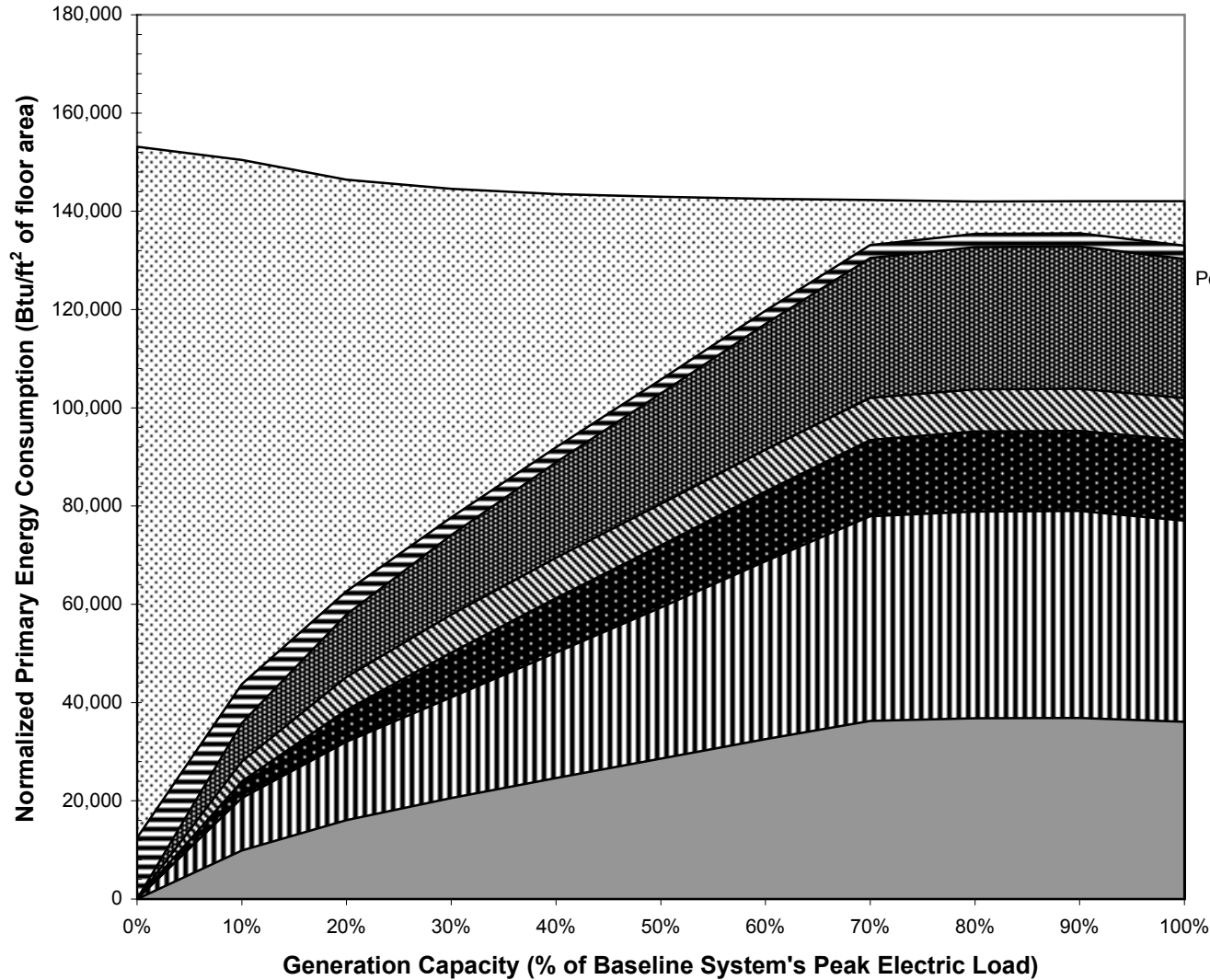

Run Number: 36
 Date and Time of Run: 1/16/02 13:00
 City Name: New York
 Building Type: Office
 FloorArea(ft²): 419,000
 Baseline Peak Electric(kW): 1,831
 Peak Cooling Load (tons): 548
 Peak Heating Load (MMBtuH): 6
 Generation Technology: Std. Microturbine
 Absorption Chiller Type: Double Effect
 Fuel Type: Fuel Oil
 Rate Structure: Con Edison
 Control Strategy: Smart



Installed Cost and Annual Operating Cost

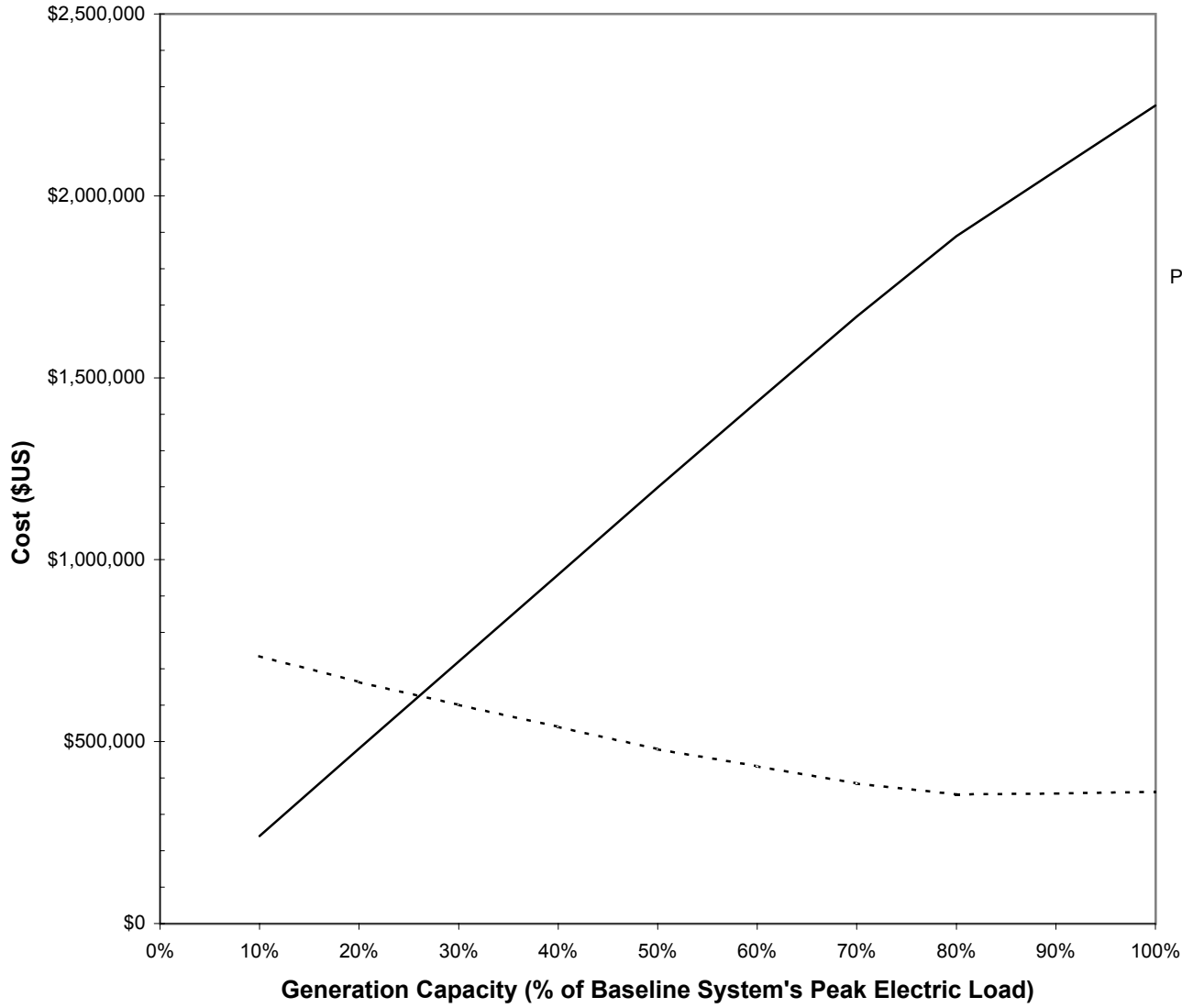

— Installed Cost - - - - Annual Operating Cost

Run Number: 36
Date and Time of Run: 1/16/02 13:00
City Name: New York
Building Type: Office
FloorArea(ft²): 419,000
Baseline Peak Electric(kW): 1,831
Peak Cooling Load (tons): 548
Peak Heating Load (MMBtuH): 6
Generation Technology: Std. Microturbine
Absorption Chiller Type: Double Effect
Fuel Type: Fuel Oil
Rate Structure: Con Edison
Control Strategy: Smart

Payback Period

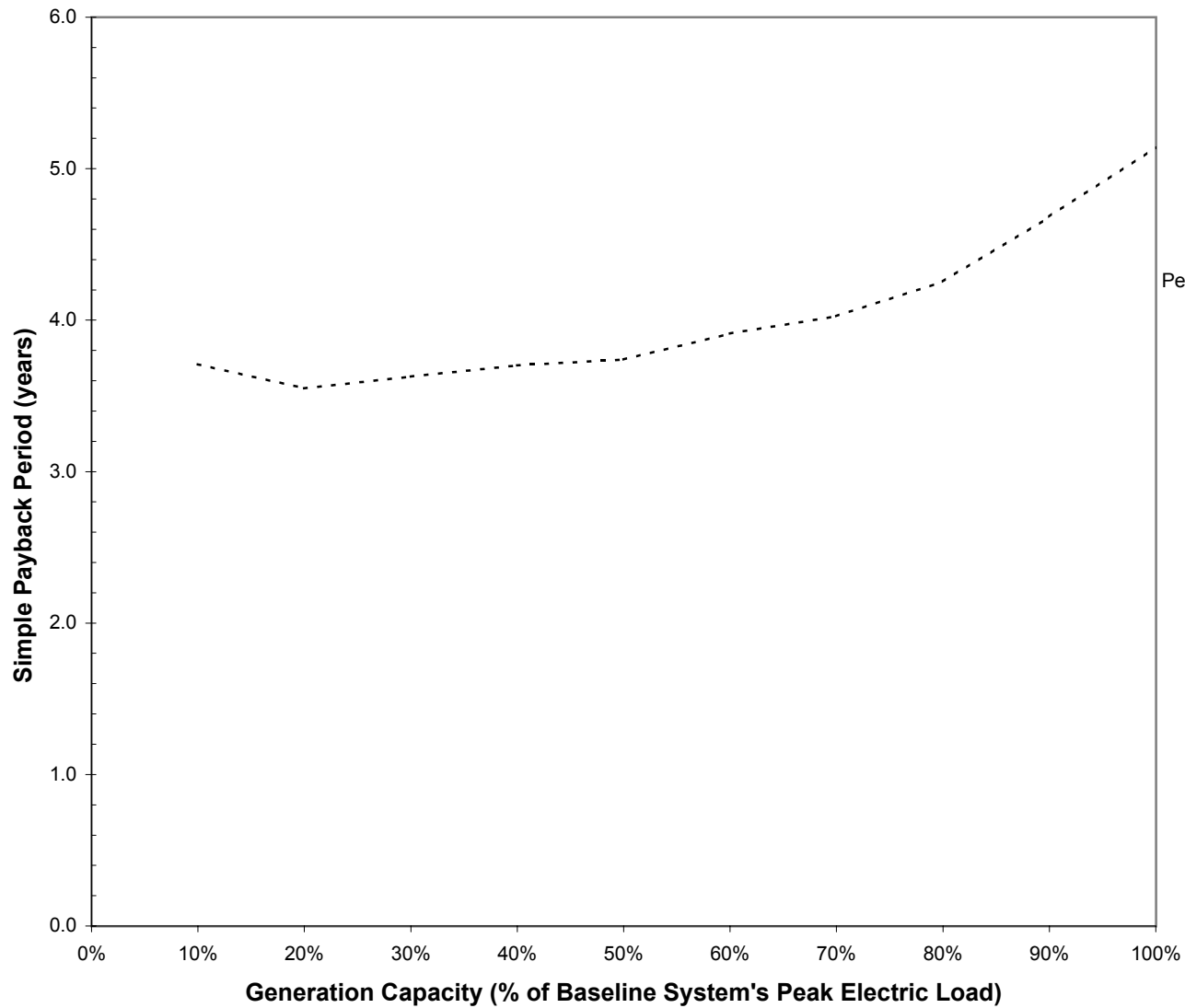

Run Number: 36

Date and Time of Run: 1/16/02 13:00

City Name: New York

Building Type: Office

FloorArea(ft²): 419,000

Baseline Peak Electric(kW): 1,831

Peak Cooling Load (tons): 548

Peak Heating Load (MMBtuH): 6

Generation Technology: Std. Microturbine

Absorption Chiller Type: Double Effect

Fuel Type: Fuel Oil

Rate Structure: Con Edison

Control Strategy: Smart

Annual Primary Energy Consumption Breakdown

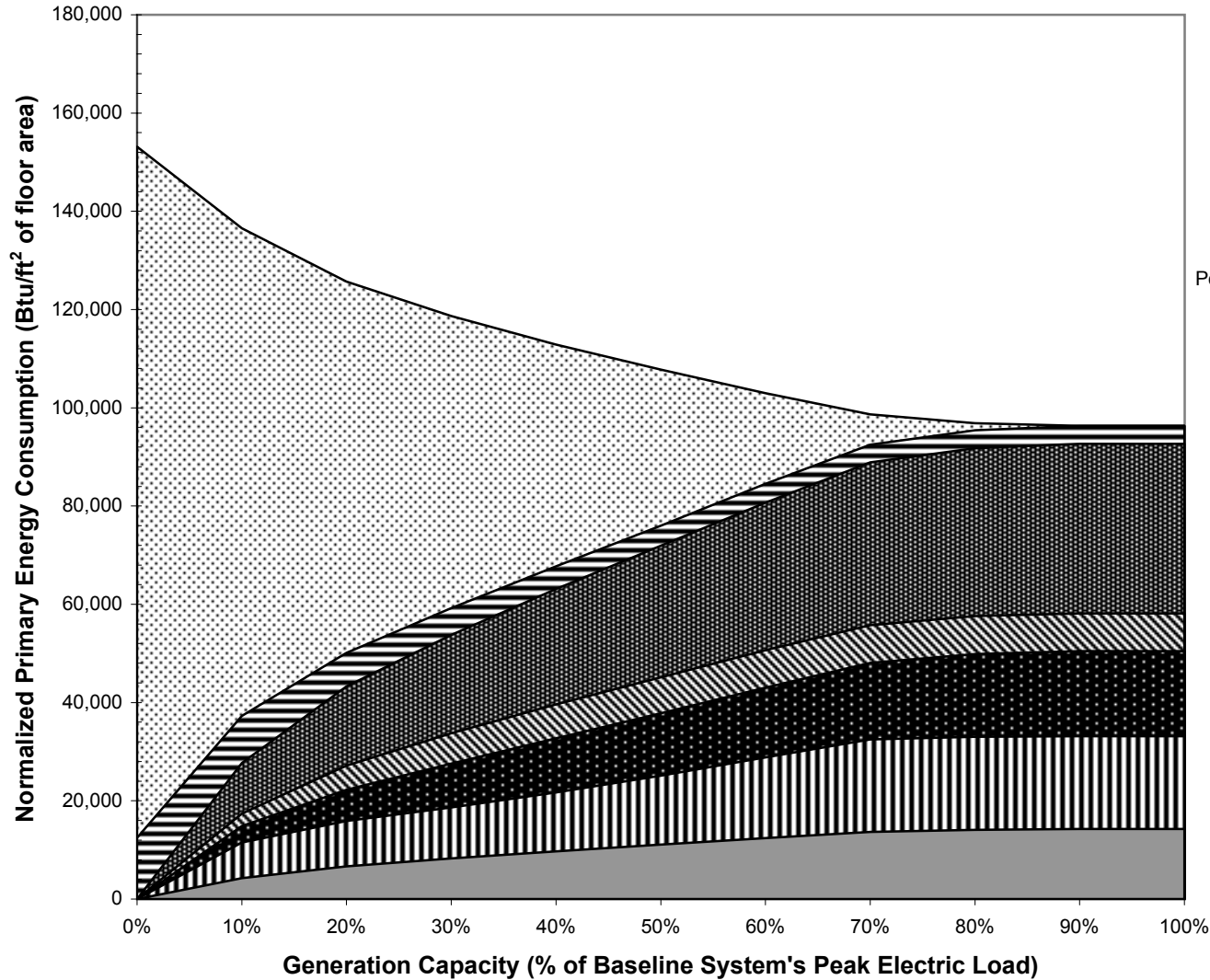

Run Number: 37
 Date and Time of Run: 1/16/02 14:38
 City Name: New York
 Building Type: Office
 FloorArea(ft²): 419,000
 Baseline Peak Electric(kW): 1,750
 Peak Cooling Load (tons): 548
 Peak Heating Load (MMBtuH): 6
 Generation Technology: Adv. Engine
 Absorption Chiller Type: Single Effect
 Fuel Type: Fuel Oil
 Rate Structure: Con Edison
 Control Strategy: Smart



Installed Cost and Annual Operating Cost

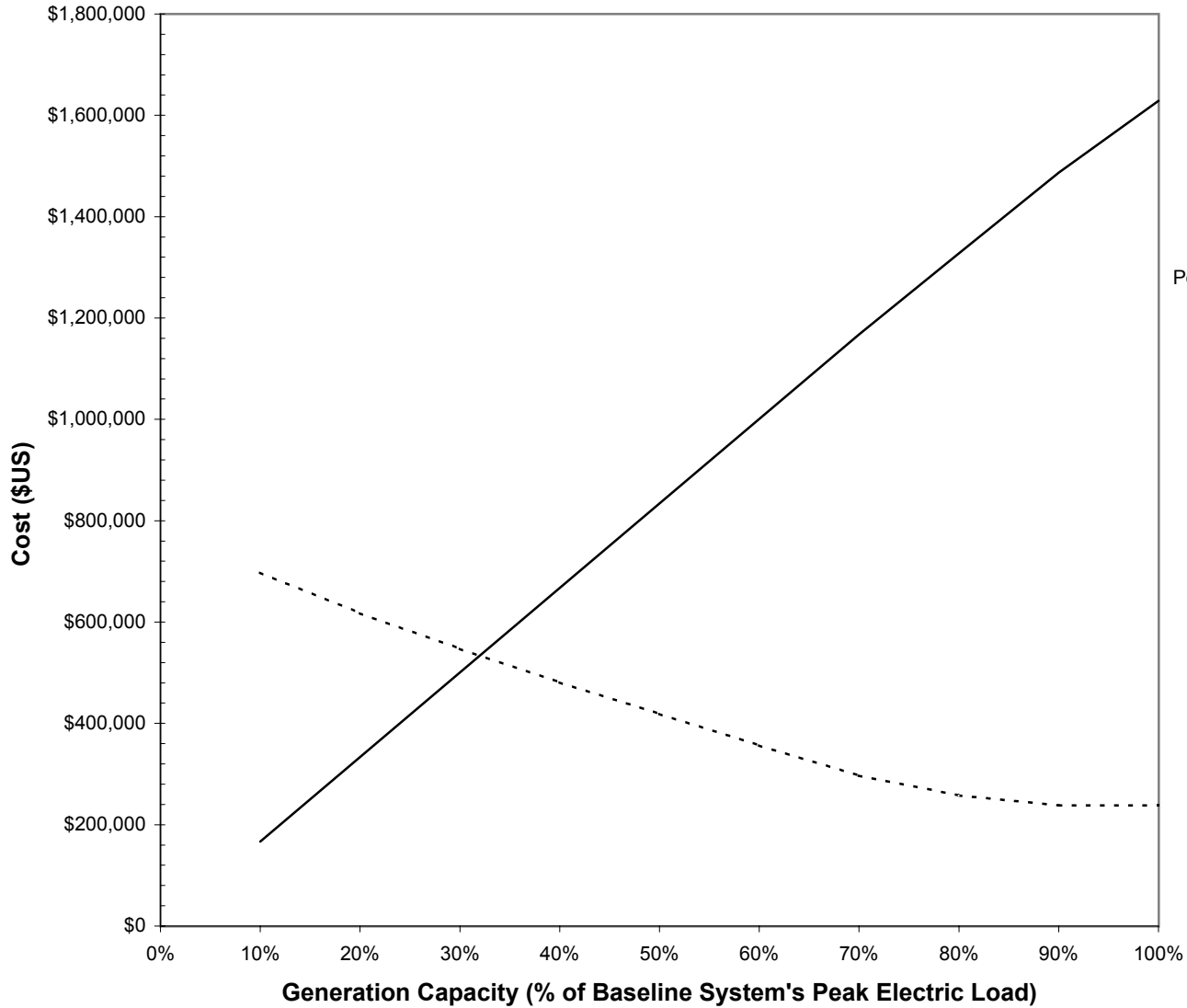

— Installed Cost - - - - Annual Operating Cost

Run Number: 37
Date and Time of Run: 1/16/02 14:38
City Name: New York
Building Type: Office
FloorArea(ft²): 419,000
Baseline Peak Electric(kW): 1,750
Peak Cooling Load (tons): 548
Peak Heating Load (MMBtuH): 6
Generation Technology: Adv. Engine
Absorption Chiller Type: Single Effect
Fuel Type: Fuel Oil
Rate Structure: Con Edison
Control Strategy: Smart

Payback Period

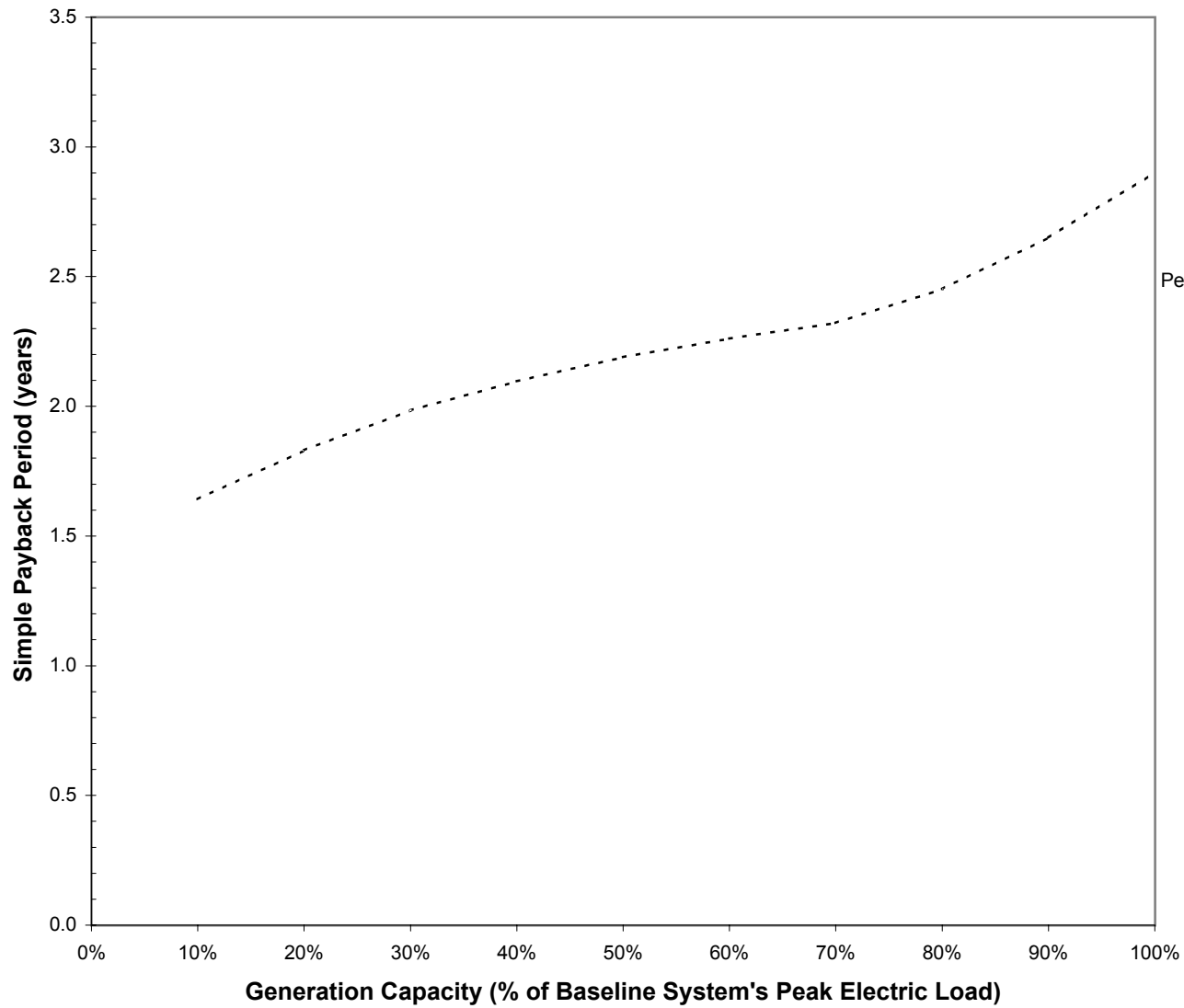

Run Number: 37

Date and Time of Run: 1/16/02 14:38

City Name: New York

Building Type: Office

FloorArea(ft²): 419,000

Baseline Peak Electric(kW): 1,750

Peak Cooling Load (tons): 548

Peak Heating Load (MMBtuH): 6

Generation Technology: Adv. Engine

Absorption Chiller Type: Single Effect

Fuel Type: Fuel Oil

Rate Structure: Con Edison

Control Strategy: Smart

Annual Primary Energy Consumption Breakdown

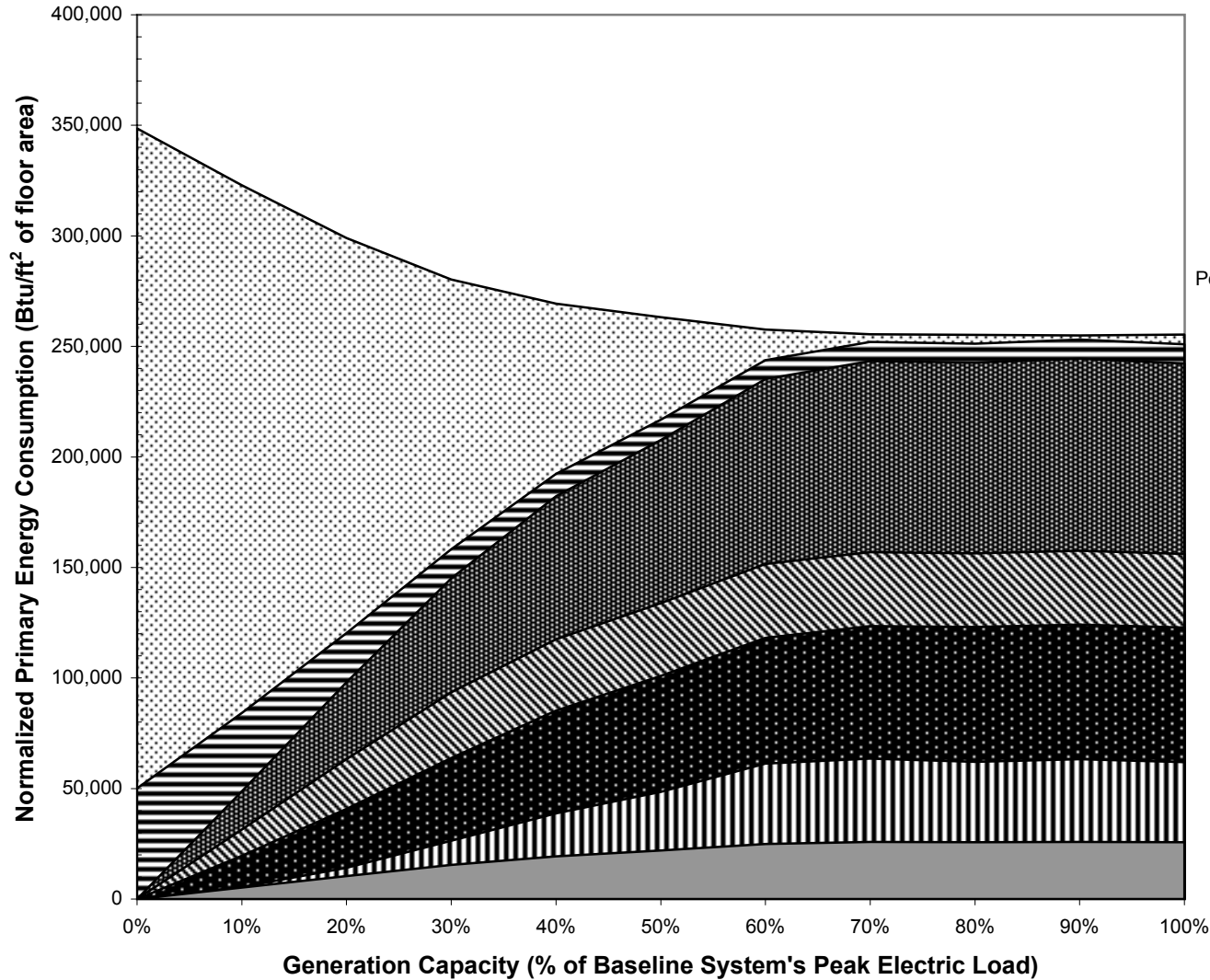

Run Number: 38
 Date and Time of Run: 1/15/02 22:27
 City Name: New York
 Building Type: Hospital
 FloorArea(ft²): 386,000
 Baseline Peak Electric(kW): 2,249
 Peak Cooling Load (tons): 1,138
 Peak Heating Load (MMBtuH): 10
 Generation Technology: Std. Engine
 Absorption Chiller Type: Single Effect
 Fuel Type: Natural Gas
 Rate Structure: Con Edison
 Control Strategy: Smart



Installed Cost and Annual Operating Cost

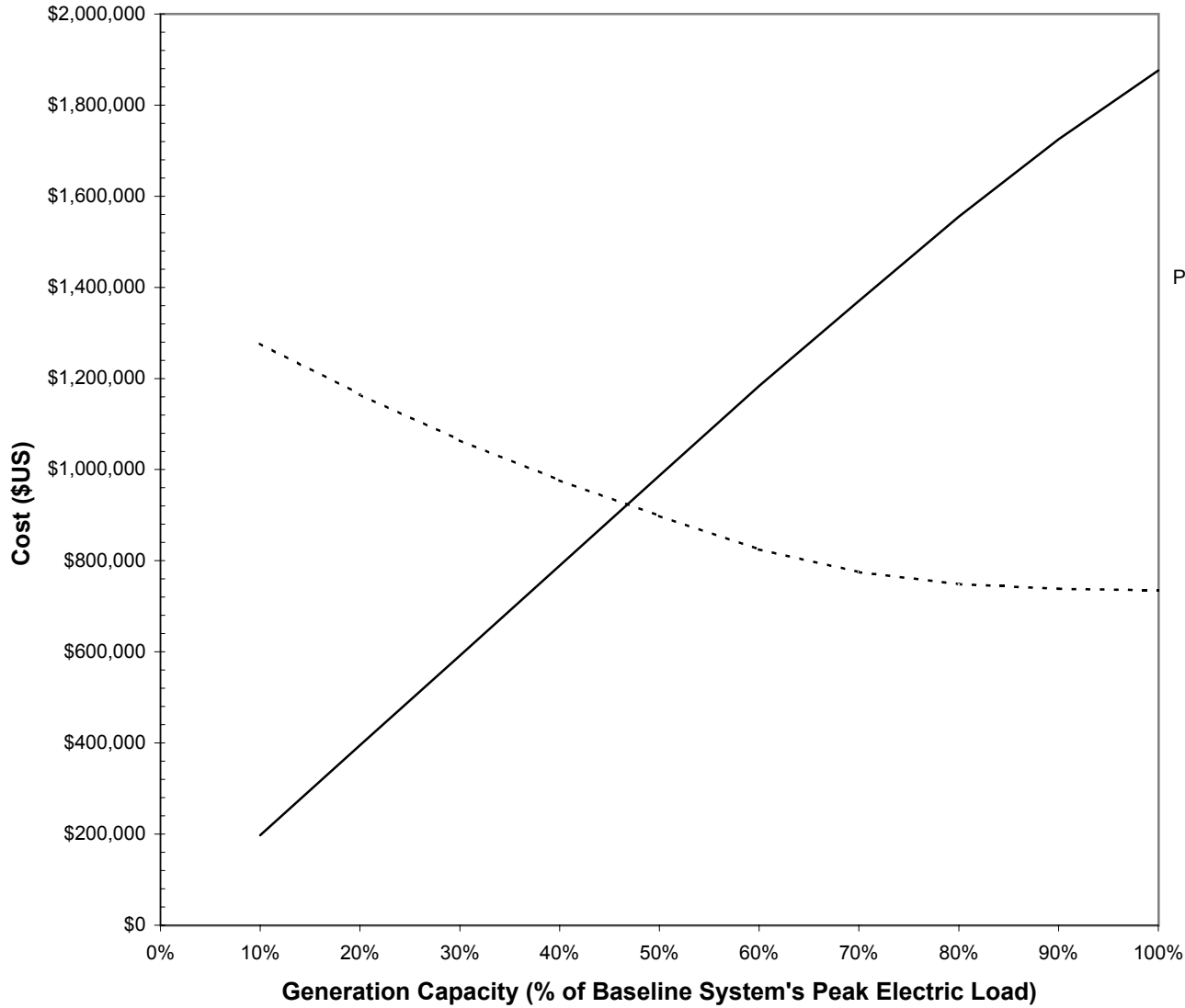

— Installed Cost - - - - Annual Operating Cost

Run Number: 38
Date and Time of Run: 1/15/02 22:27
City Name: New York
Building Type: Hospital
FloorArea(ft²): 386,000
Baseline Peak Electric(kW): 2,249
Peak Cooling Load (tons): 1,138
Peak Heating Load (MMBtuH): 10
Generation Technology: Std. Engine
Absorption Chiller Type: Single Effect
Fuel Type: Natural Gas
Rate Structure: Con Edison
Control Strategy: Smart

Payback Period

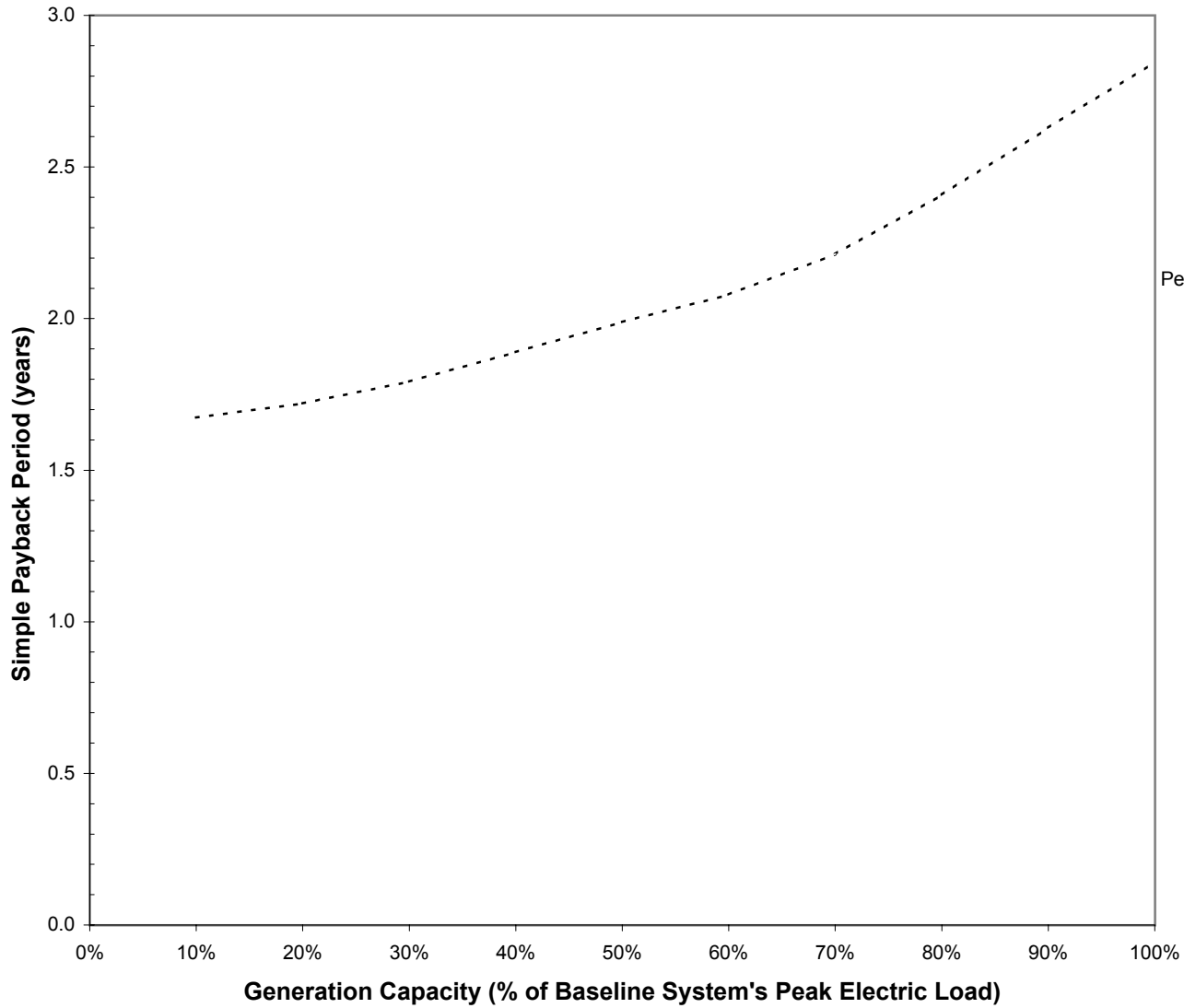

Run Number: 38

Date and Time of Run: 1/15/02 22:27

City Name: New York

Building Type: Hospital

FloorArea(ft²): 386,000

Baseline Peak Electric(kW): 2,249

Peak Cooling Load (tons): 1,138

Peak Heating Load (MMBtuH): 10

Generation Technology: Std. Engine

Absorption Chiller Type: Single Effect

Fuel Type: Natural Gas

Rate Structure: Con Edison

Control Strategy: Smart

Annual Primary Energy Consumption Breakdown

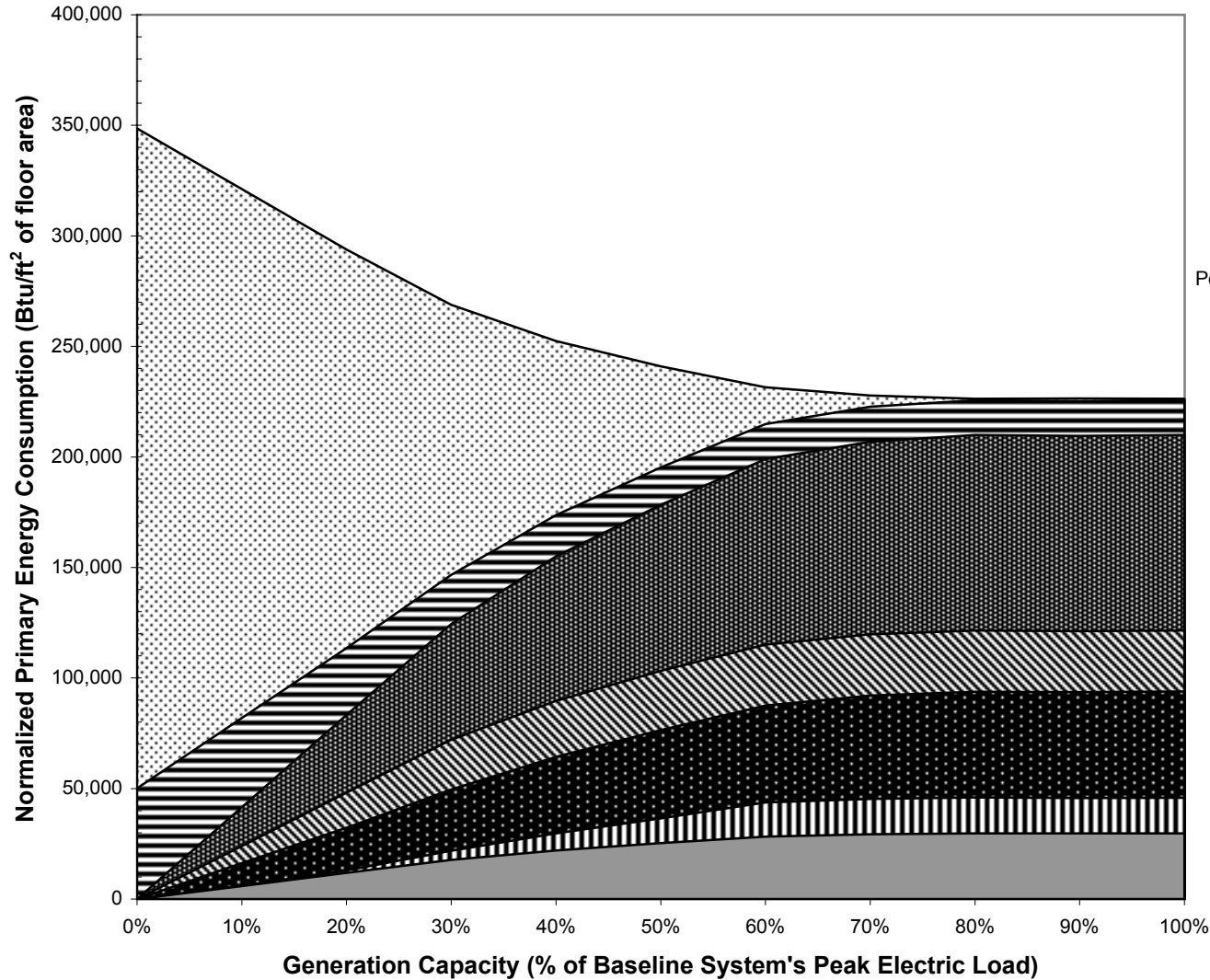

Run Number: 39
 Date and Time of Run: 1/16/02 0:27
 City Name: New York
 Building Type: Hospital
 FloorArea(ft²): 386,000
 Baseline Peak Electric(kW): 2,249
 Peak Cooling Load (tons): 1,138
 Peak Heating Load (MMBtuH): 10
 Generation Technology: Adv. Engine
 Absorption Chiller Type: Single Effect
 Fuel Type: Natural Gas
 Rate Structure: Con Edison
 Control Strategy: Smart



Installed Cost and Annual Operating Cost

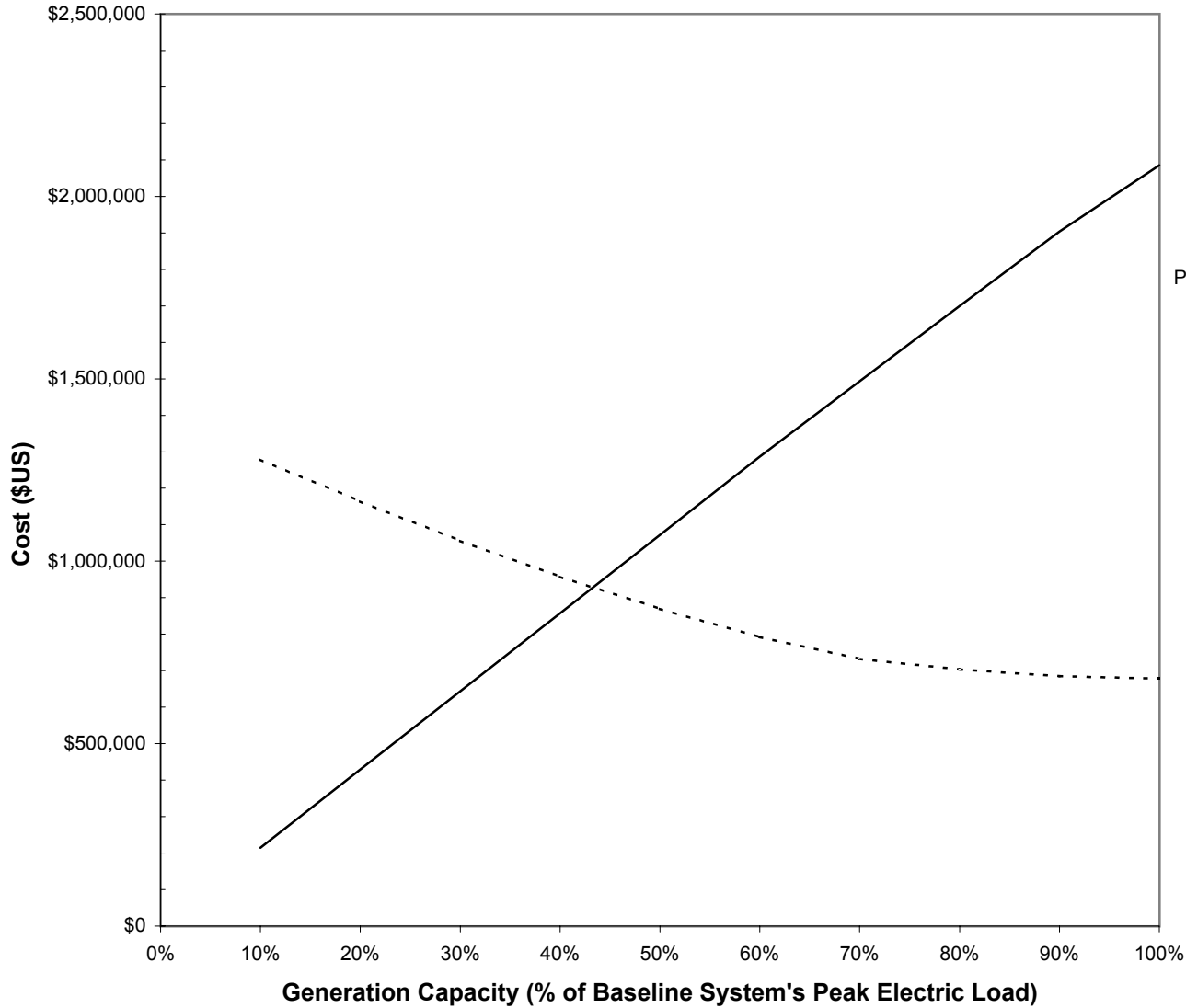

— Installed Cost - - - - Annual Operating Cost

Run Number: 39
Date and Time of Run: 1/16/02 0:27
City Name: New York
Building Type: Hospital
FloorArea(ft²): 386,000
Baseline Peak Electric(kW): 2,249
Peak Cooling Load (tons): 1,138
Peak Heating Load (MMBtuH): 10
Generation Technology: Adv. Engine
Absorption Chiller Type: Single Effect
Fuel Type: Natural Gas
Rate Structure: Con Edison
Control Strategy: Smart

Payback Period

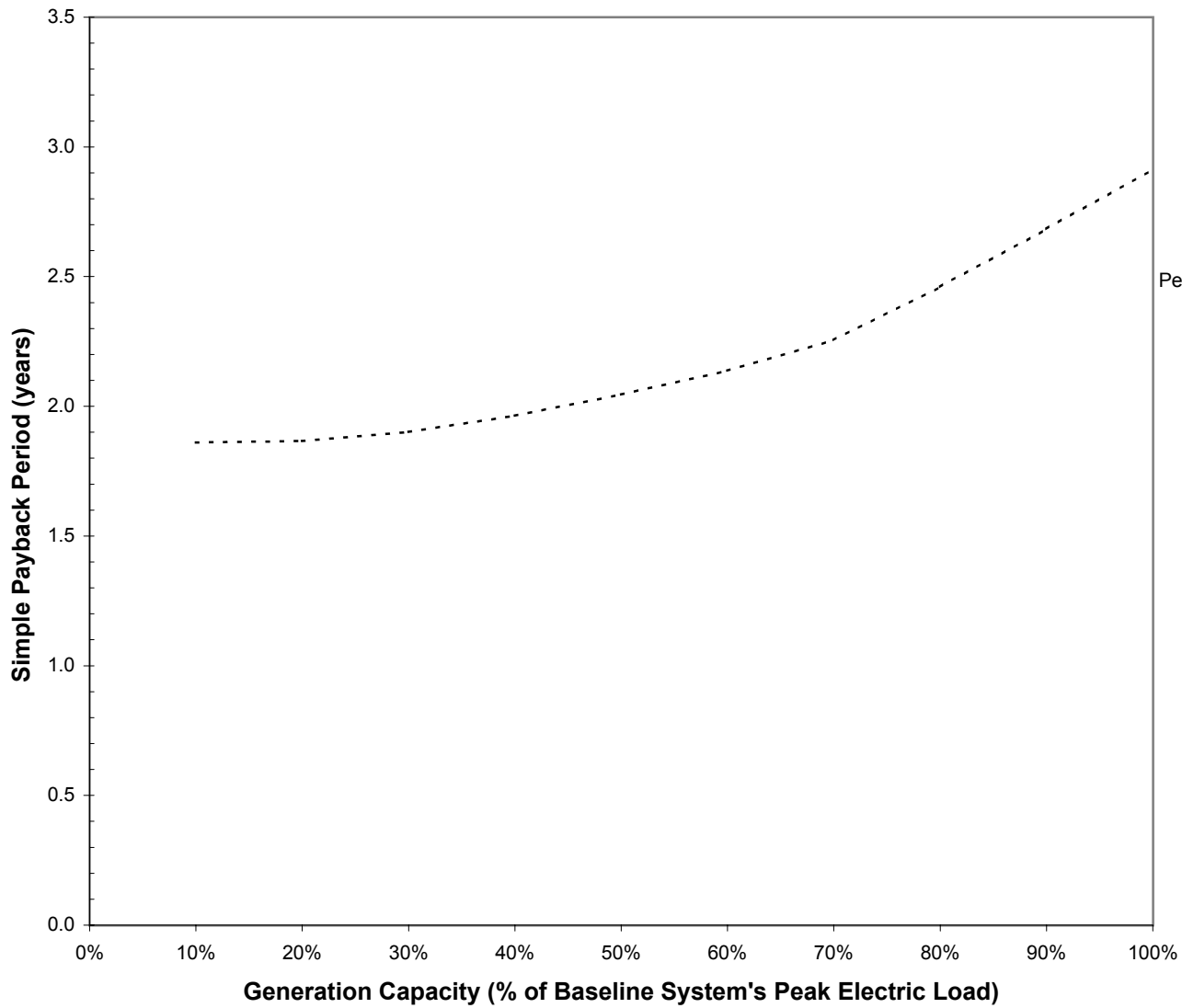

Run Number: 39

Date and Time of Run: 1/16/02 0:27

City Name: New York

Building Type: Hospital

FloorArea(ft²): 386,000

Baseline Peak Electric(kW): 2,249

Peak Cooling Load (tons): 1,138

Peak Heating Load (MMBtuH): 10

Generation Technology: Adv. Engine

Absorption Chiller Type: Single Effect

Fuel Type: Natural Gas

Rate Structure: Con Edison

Control Strategy: Smart

Annual Primary Energy Consumption Breakdown

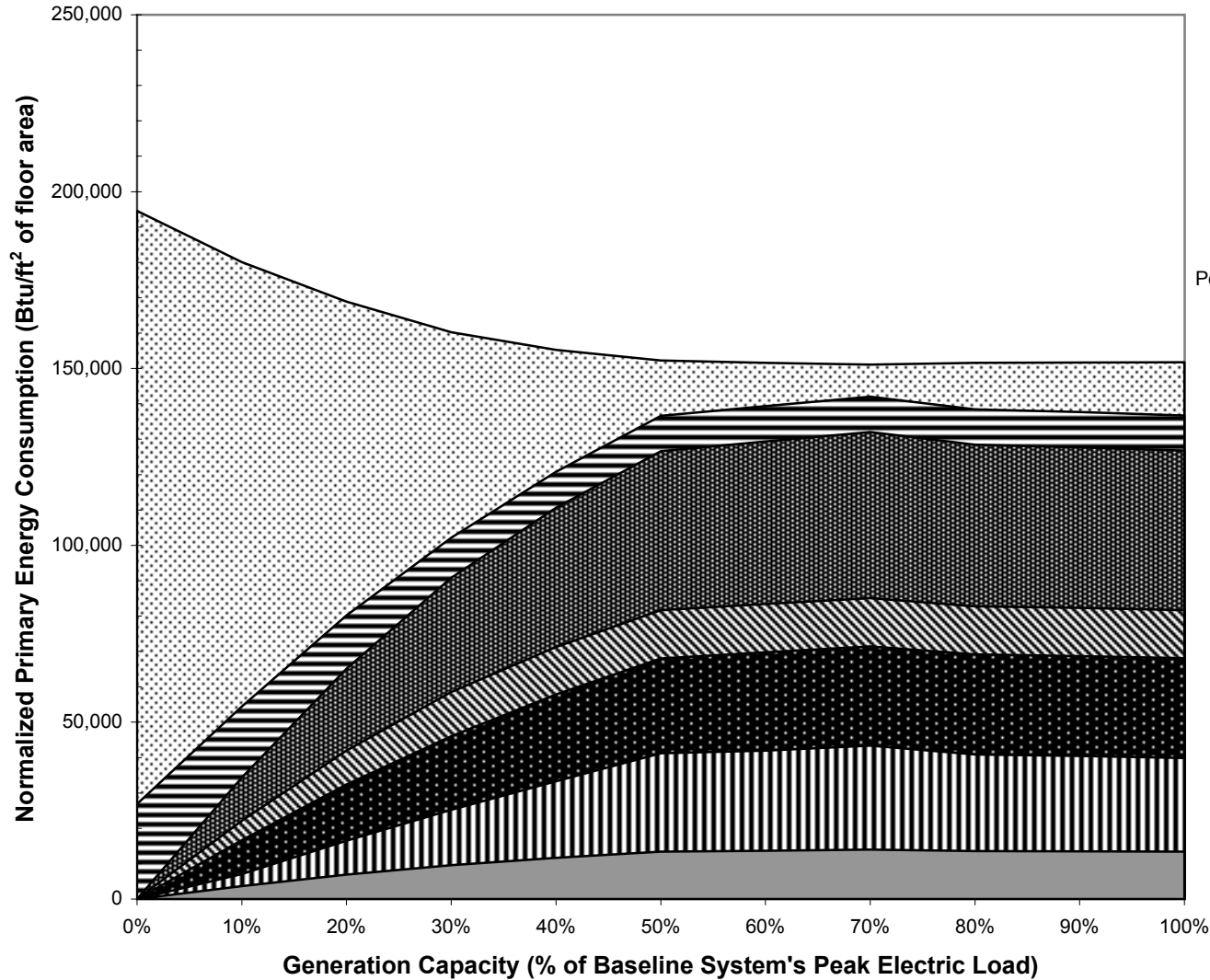

Run Number: 40
 Date and Time of Run: 1/16/02 7:26
 City Name: New York
 Building Type: Hotel
 FloorArea(ft²): 494,000
 Baseline Peak Electric(kW): 2,526
 Peak Cooling Load (tons): 1,672
 Peak Heating Load (MMBtuH): 15
 Generation Technology: Std. Engine
 Absorption Chiller Type: Single Effect
 Fuel Type: Natural Gas
 Rate Structure: Con Edison
 Control Strategy: Smart



Installed Cost and Annual Operating Cost

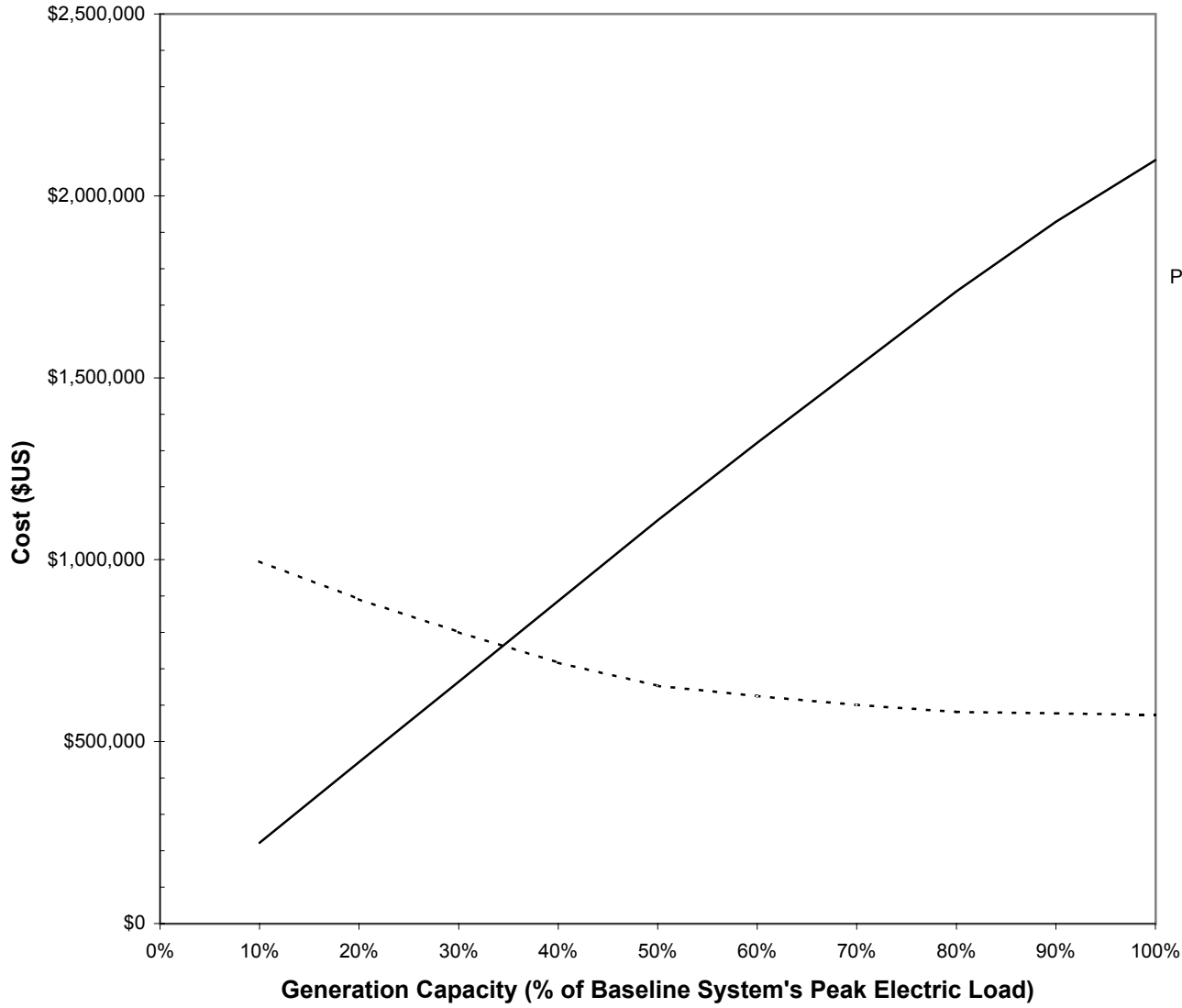

— Installed Cost - - - - Annual Operating Cost

Run Number: 40
Date and Time of Run: 1/16/02 7:26
City Name: New York
Building Type: Hotel
FloorArea(ft²): 494,000
Baseline Peak Electric(kW): 2,526
Peak Cooling Load (tons): 1,672
Peak Heating Load (MMBtuH): 15
Generation Technology: Std. Engine
Absorption Chiller Type: Single Effect
Fuel Type: Natural Gas
Rate Structure: Con Edison
Control Strategy: Smart

Payback Period

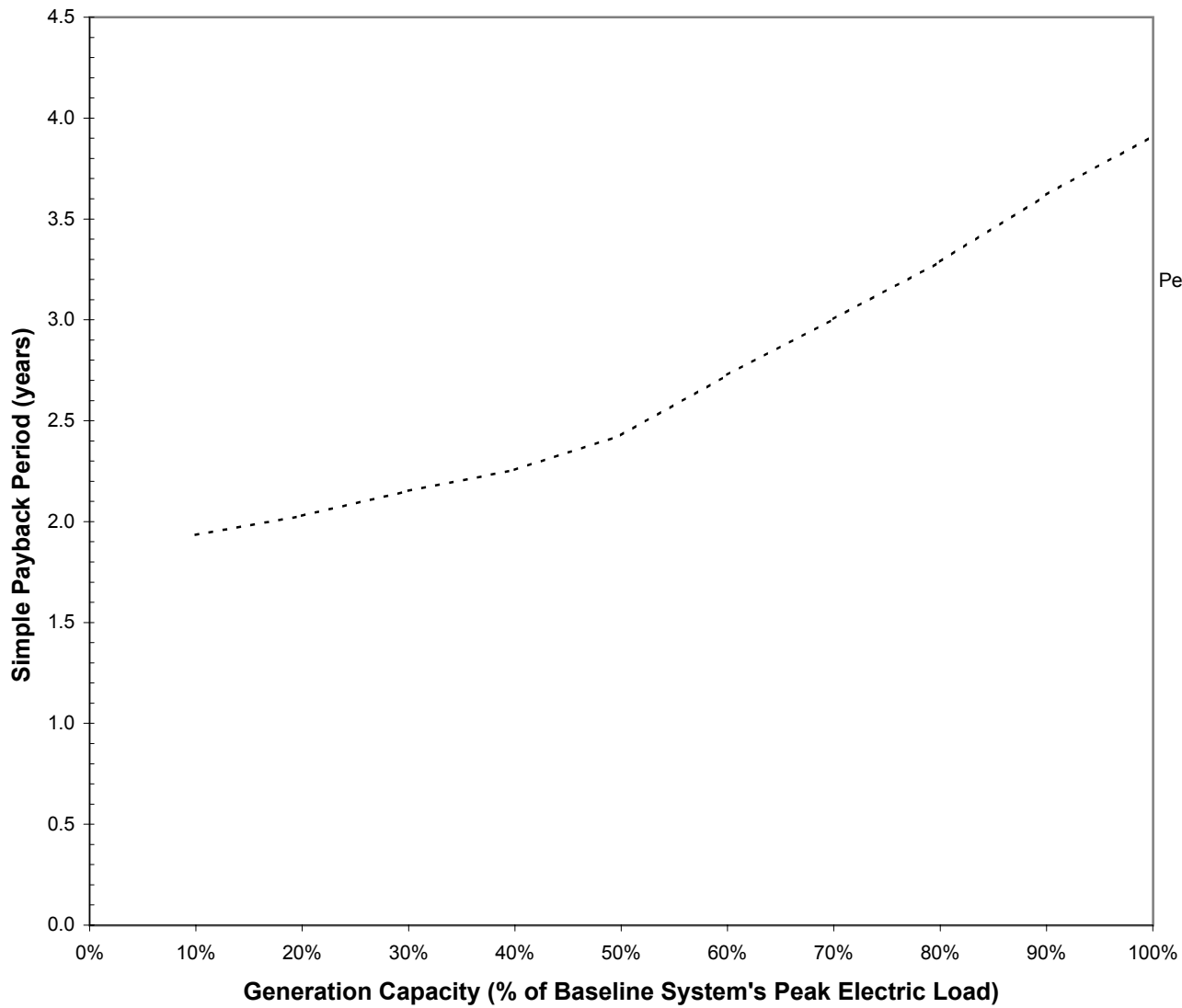

Run Number: 40

Date and Time of Run: 1/16/02 7:26

City Name: New York

Building Type: Hotel

FloorArea(ft²): 494,000

Baseline Peak Electric(kW): 2,526

Peak Cooling Load (tons): 1,672

Peak Heating Load (MMBtuH): 15

Generation Technology: Std. Engine

Absorption Chiller Type: Single Effect

Fuel Type: Natural Gas

Rate Structure: Con Edison

Control Strategy: Smart

Annual Primary Energy Consumption Breakdown

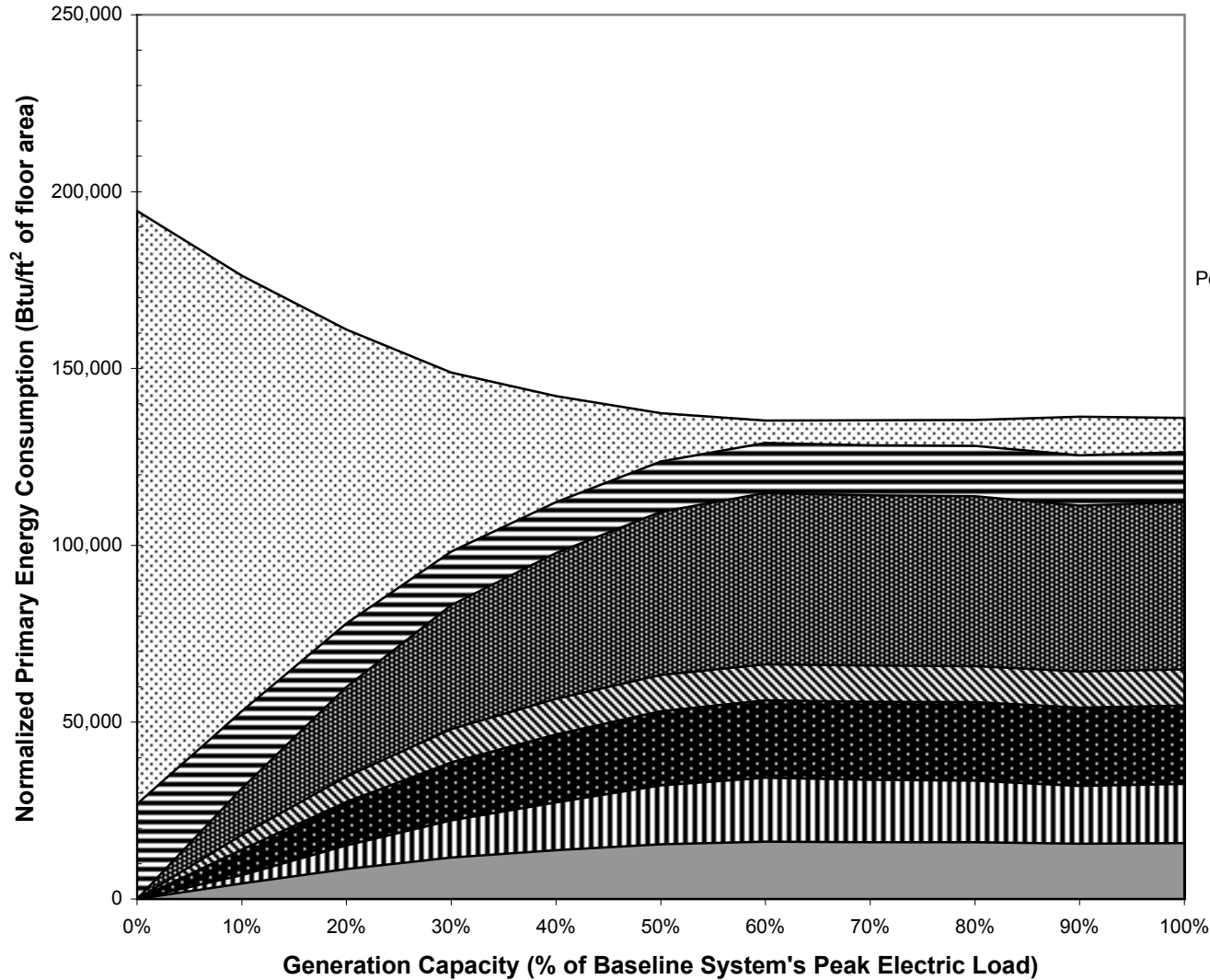

Run Number: 41
 Date and Time of Run: 1/16/02 16:24
 City Name: New York
 Building Type: Hotel
 FloorArea(ft²): 494,000
 Baseline Peak Electric(kW): 2,526
 Peak Cooling Load (tons): 1,672
 Peak Heating Load (MMBtuH): 15
 Generation Technology: Adv. Engine
 Absorption Chiller Type: Single Effect
 Fuel Type: Natural Gas
 Rate Structure: Con Edison
 Control Strategy: Smart



Installed Cost and Annual Operating Cost

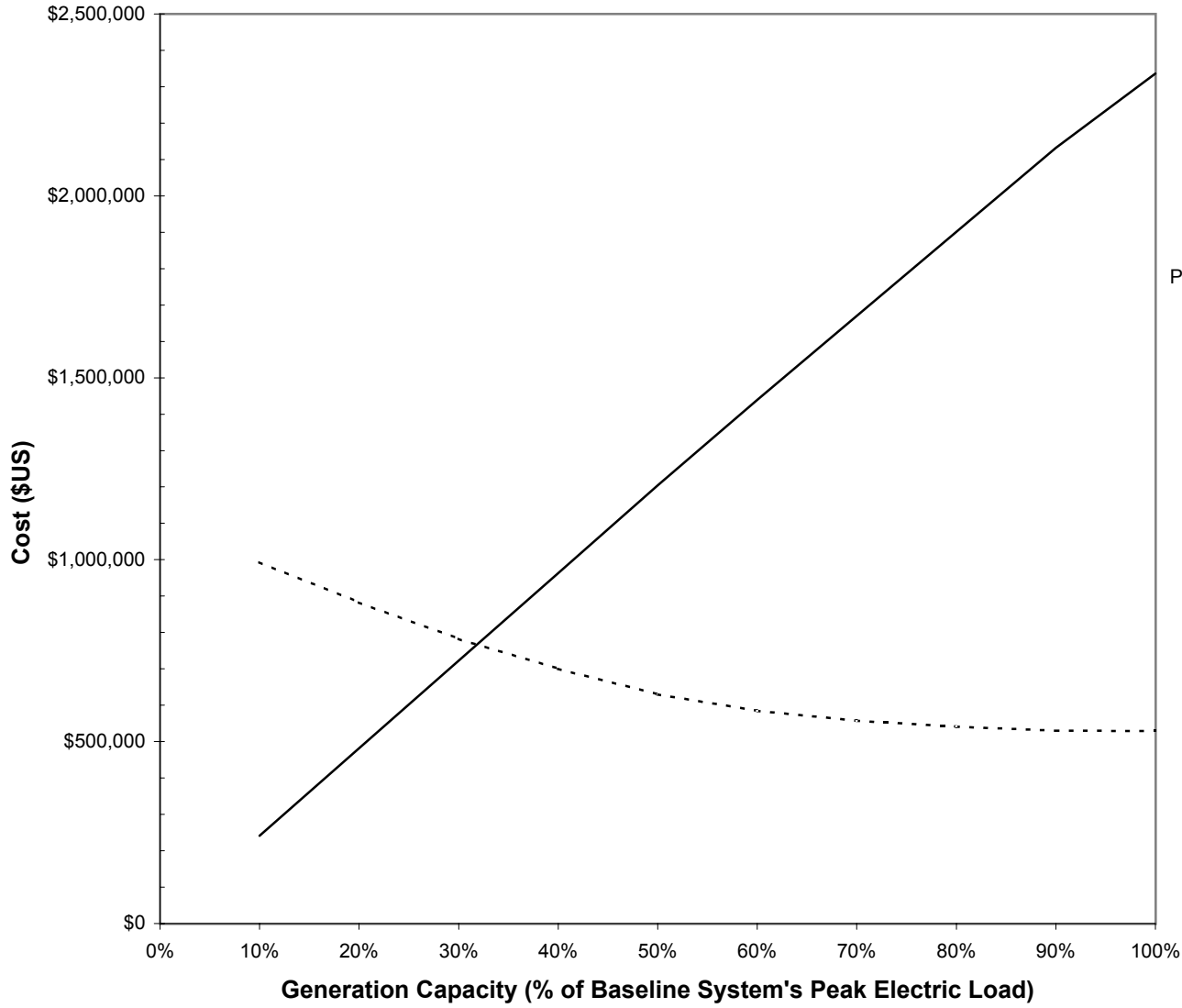

— Installed Cost - - - - Annual Operating Cost

Run Number: 41
Date and Time of Run: 1/16/02 16:24
City Name: New York
Building Type: Hotel
FloorArea(ft²): 494,000
Baseline Peak Electric(kW): 2,526
Peak Cooling Load (tons): 1,672
Peak Heating Load (MMBtuH): 15
Generation Technology: Adv. Engine
Absorption Chiller Type: Single Effect
Fuel Type: Natural Gas
Rate Structure: Con Edison
Control Strategy: Smart

Payback Period

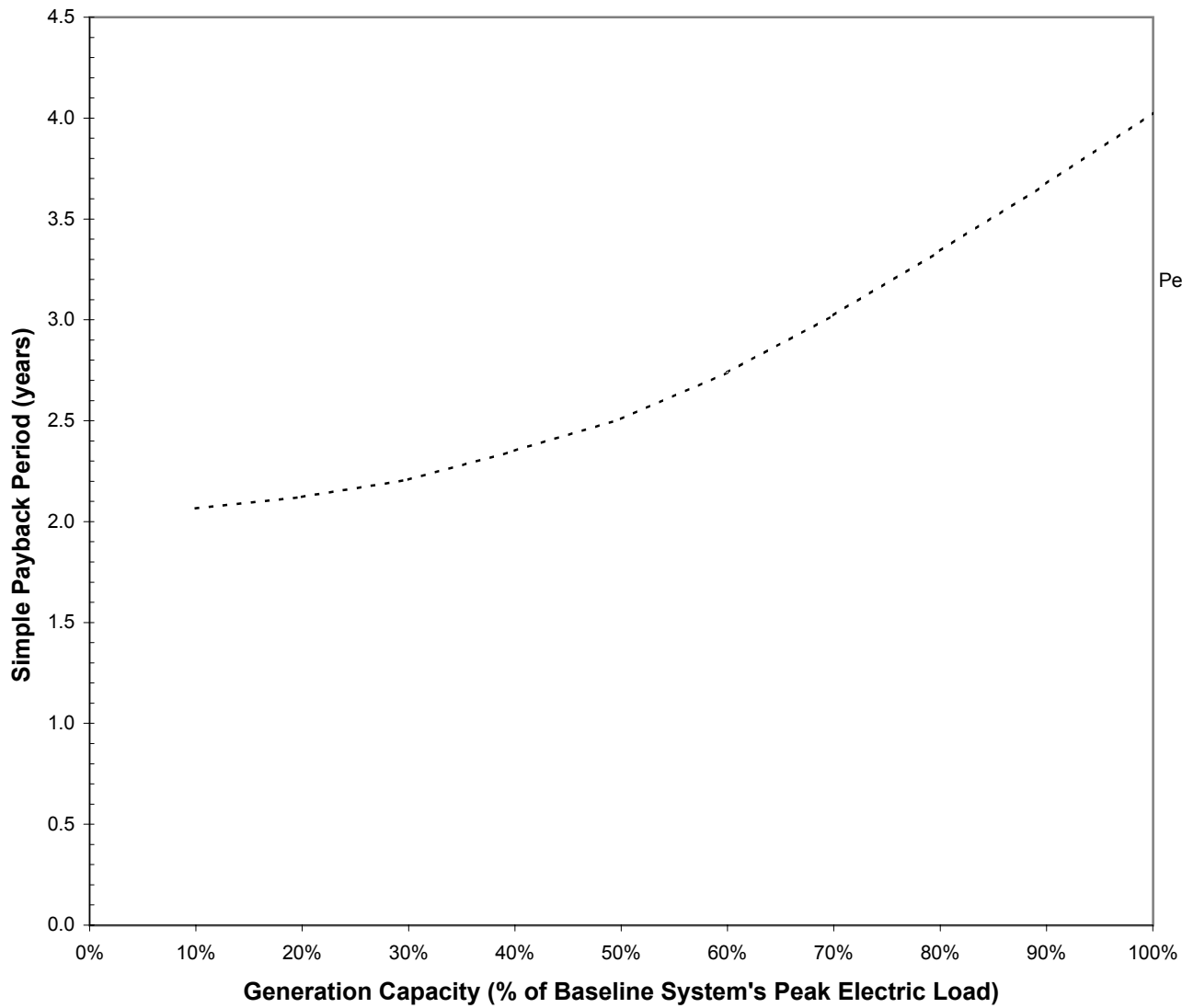

Run Number: 41

Date and Time of Run: 1/16/02 16:24

City Name: New York

Building Type: Hotel

FloorArea(ft²): 494,000

Baseline Peak Electric(kW): 2,526

Peak Cooling Load (tons): 1,672

Peak Heating Load (MMBtuH): 15

Generation Technology: Adv. Engine

Absorption Chiller Type: Single Effect

Fuel Type: Natural Gas

Rate Structure: Con Edison

Control Strategy: Smart

Annual Primary Energy Consumption Breakdown

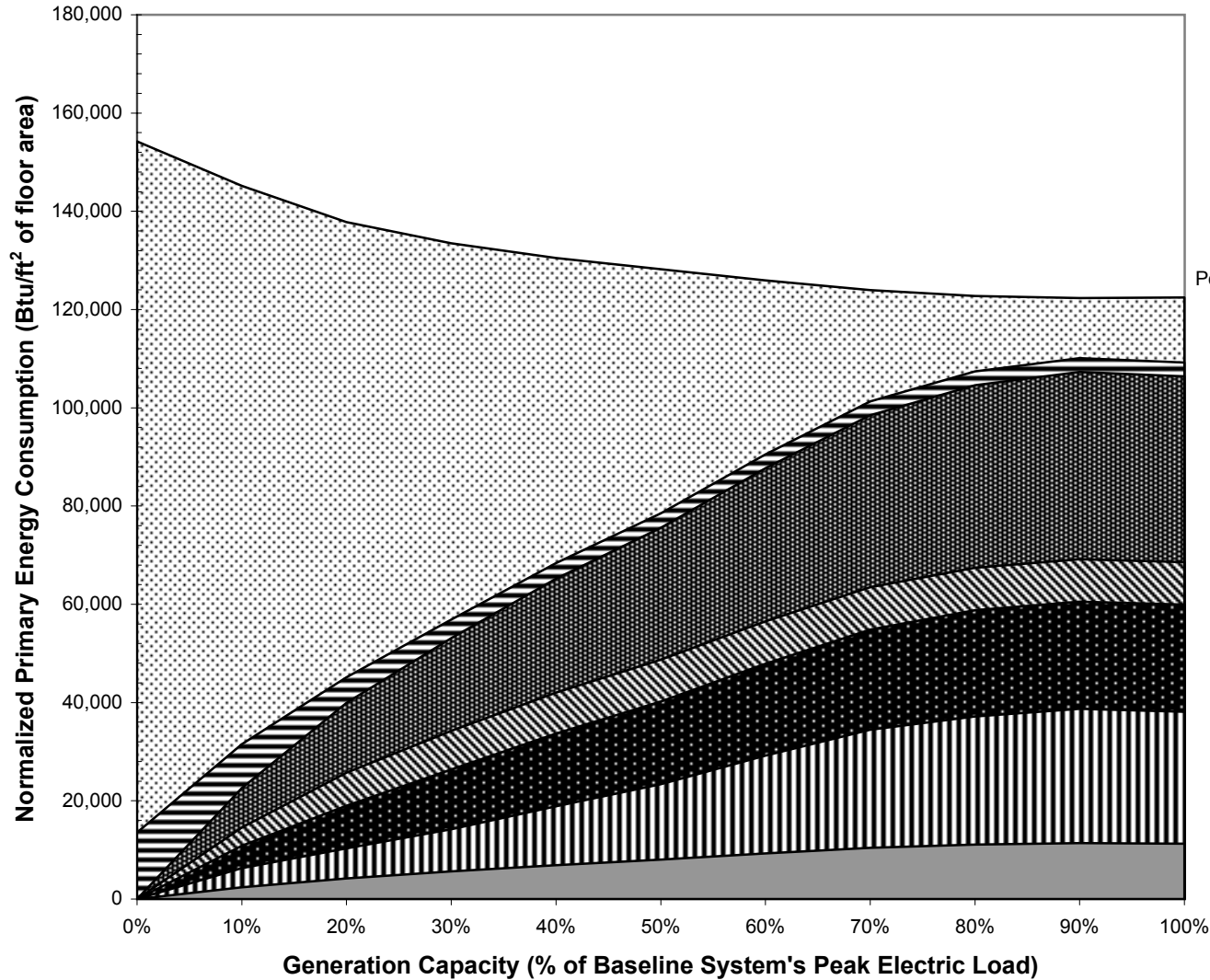

Run Number: 42
 Date and Time of Run: 1/16/02 18:32
 City Name: New York
 Building Type: Office
 FloorArea(ft²): 419,000
 Baseline Peak Electric(kW): 1,750
 Peak Cooling Load (tons): 548
 Peak Heating Load (MMBtuH): 6
 Generation Technology: Std. Engine
 Absorption Chiller Type: Single Effect
 Fuel Type: Natural Gas
 Rate Structure: Con Edison
 Control Strategy: Smart



Installed Cost and Annual Operating Cost

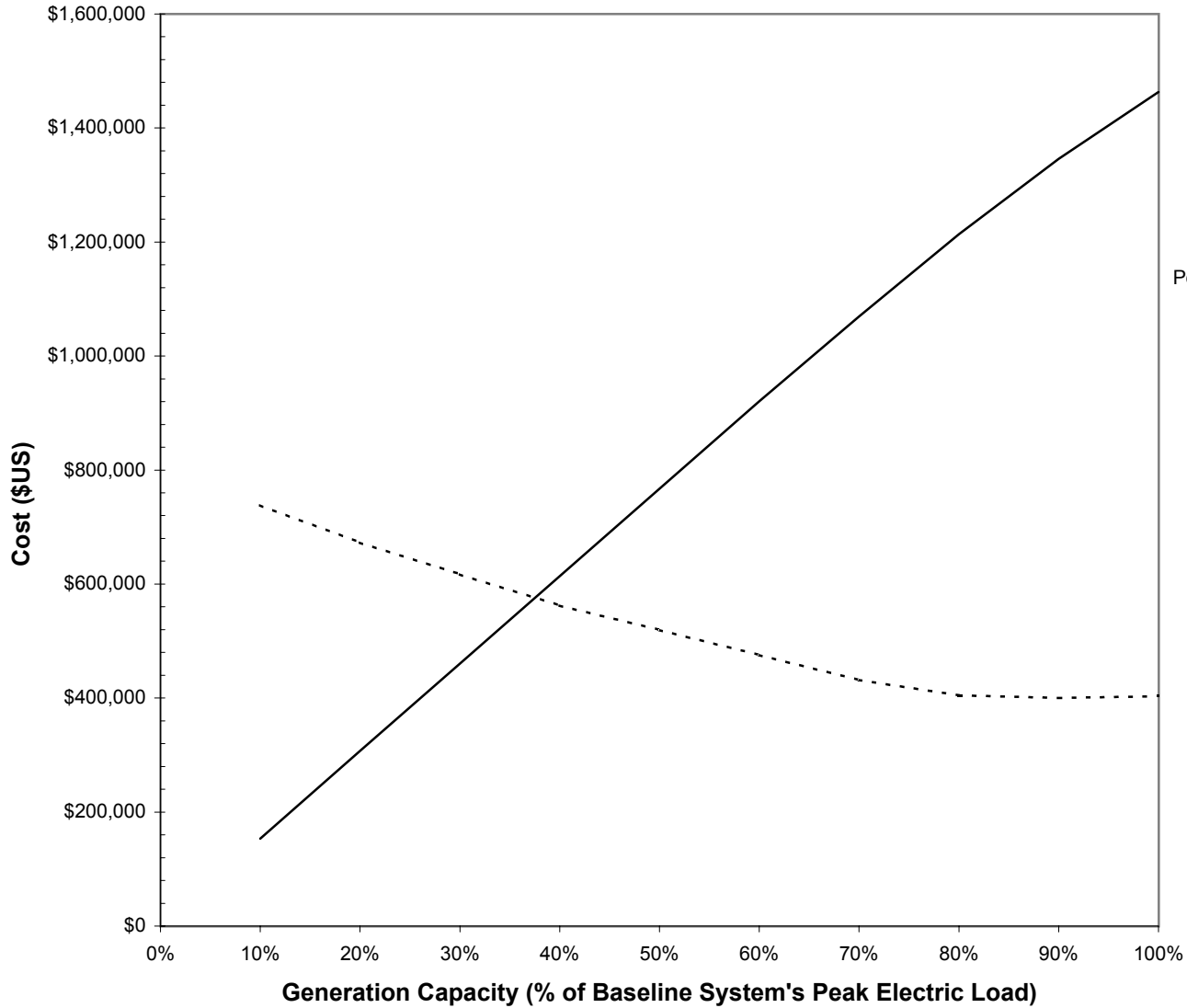

— Installed Cost - - - - Annual Operating Cost

Run Number: 42
Date and Time of Run: 1/16/02 18:32
City Name: New York
Building Type: Office
FloorArea(ft²): 419,000
Baseline Peak Electric(kW): 1,750
Peak Cooling Load (tons): 548
Peak Heating Load (MMBtuH): 6
Generation Technology: Std. Engine
Absorption Chiller Type: Single Effect
Fuel Type: Natural Gas
Rate Structure: Con Edison
Control Strategy: Smart

Payback Period

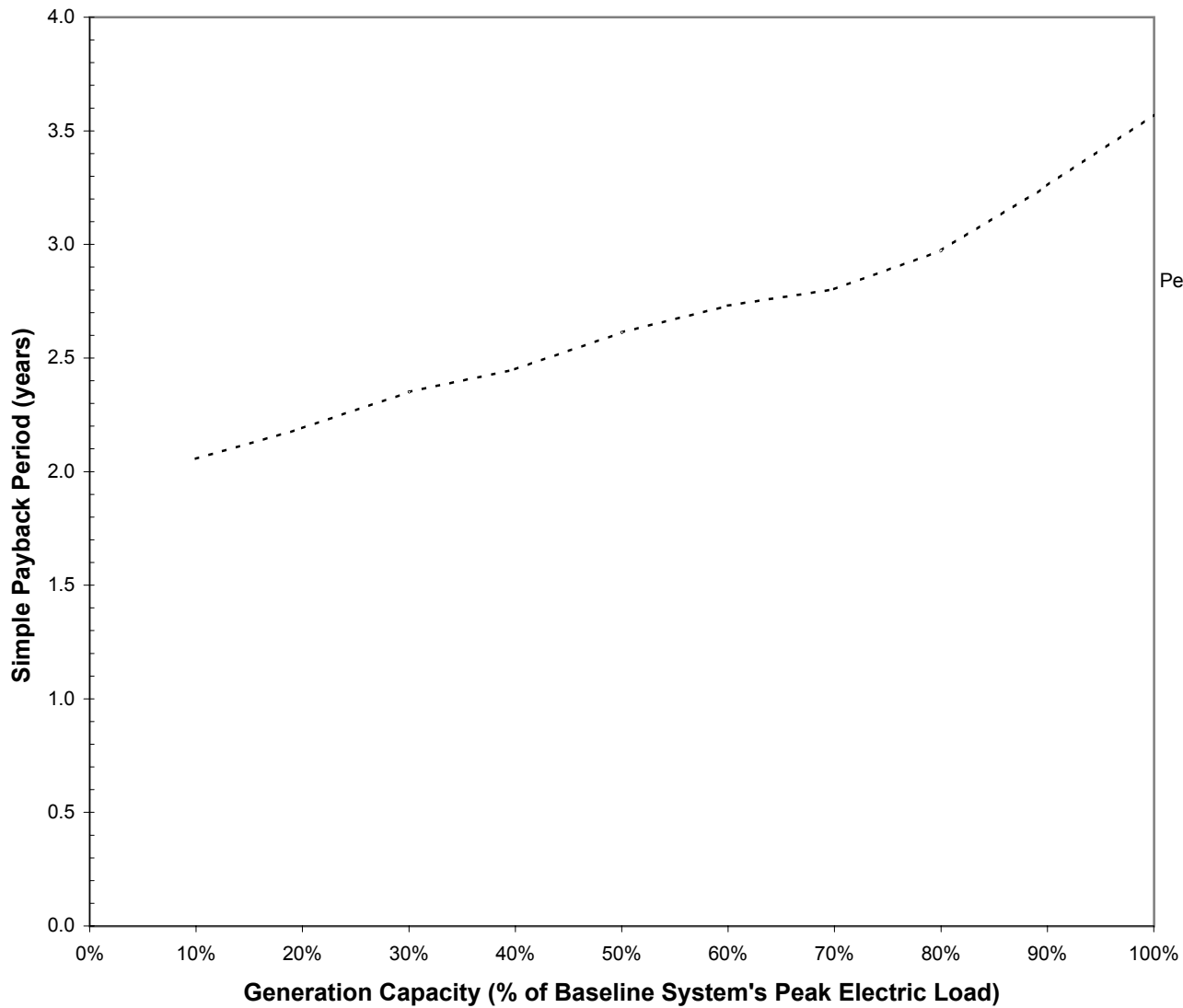

Run Number: 42

Date and Time of Run: 1/16/02 18:32

City Name: New York

Building Type: Office

FloorArea(ft²): 419,000

Baseline Peak Electric(kW): 1,750

Peak Cooling Load (tons): 548

Peak Heating Load (MMBtuH): 6

Generation Technology: Std. Engine

Absorption Chiller Type: Single Effect

Fuel Type: Natural Gas

Rate Structure: Con Edison

Control Strategy: Smart

Annual Primary Energy Consumption Breakdown

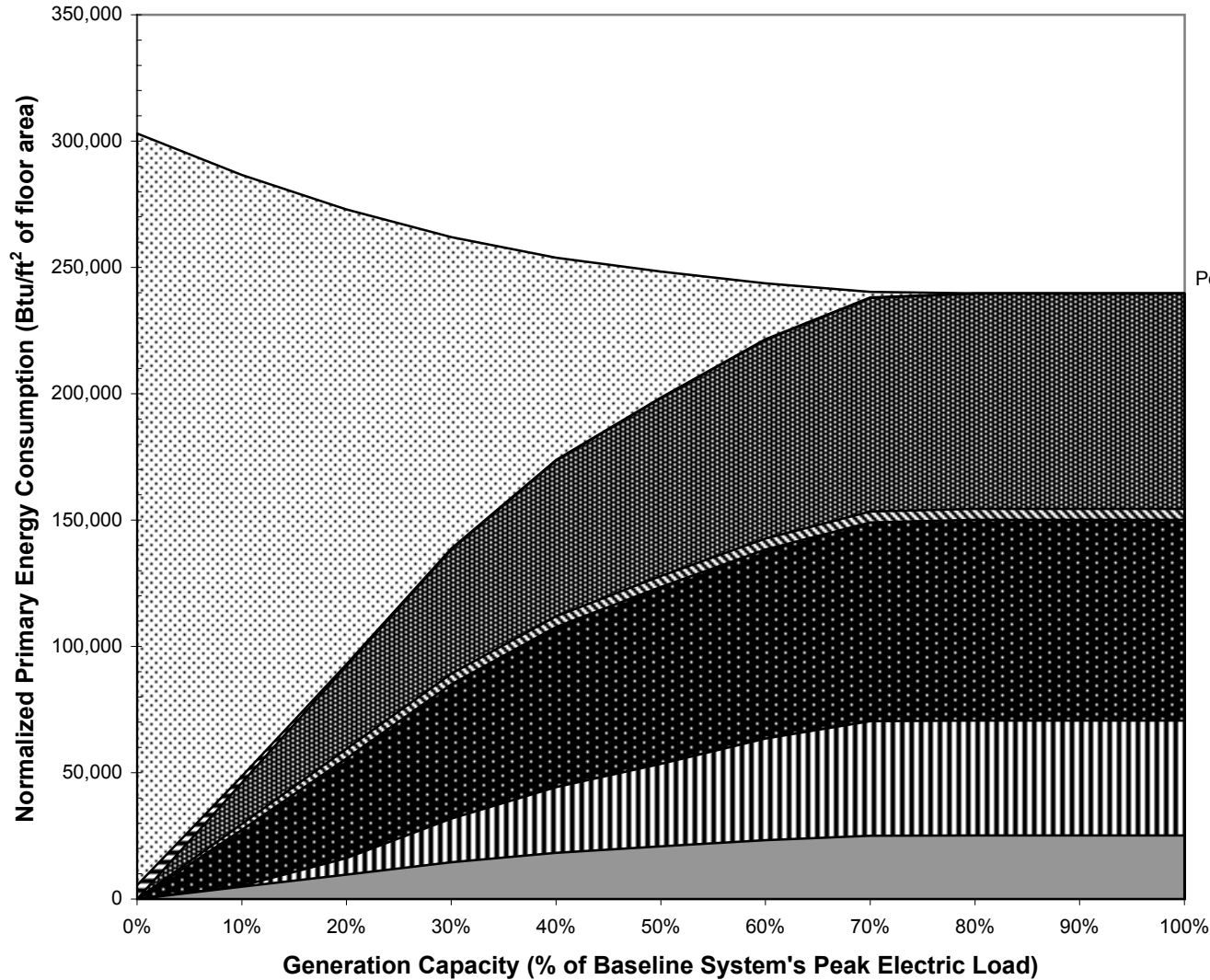

Run Number: 43
 Date and Time of Run: 1/16/02 20:33
 City Name: Los Angeles
 Building Type: Hospital
 FloorArea(ft²): 250,000
 Baseline Peak Electric(kW): 1,346
 Peak Cooling Load (tons): 603
 Peak Heating Load (MMBtuH): 2
 Generation Technology: Std. Engine
 Absorption Chiller Type: Single Effect
 Fuel Type: Natural Gas
 Rate Structure: So. Cal. Edison
 Control Strategy: Smart



Installed Cost and Annual Operating Cost

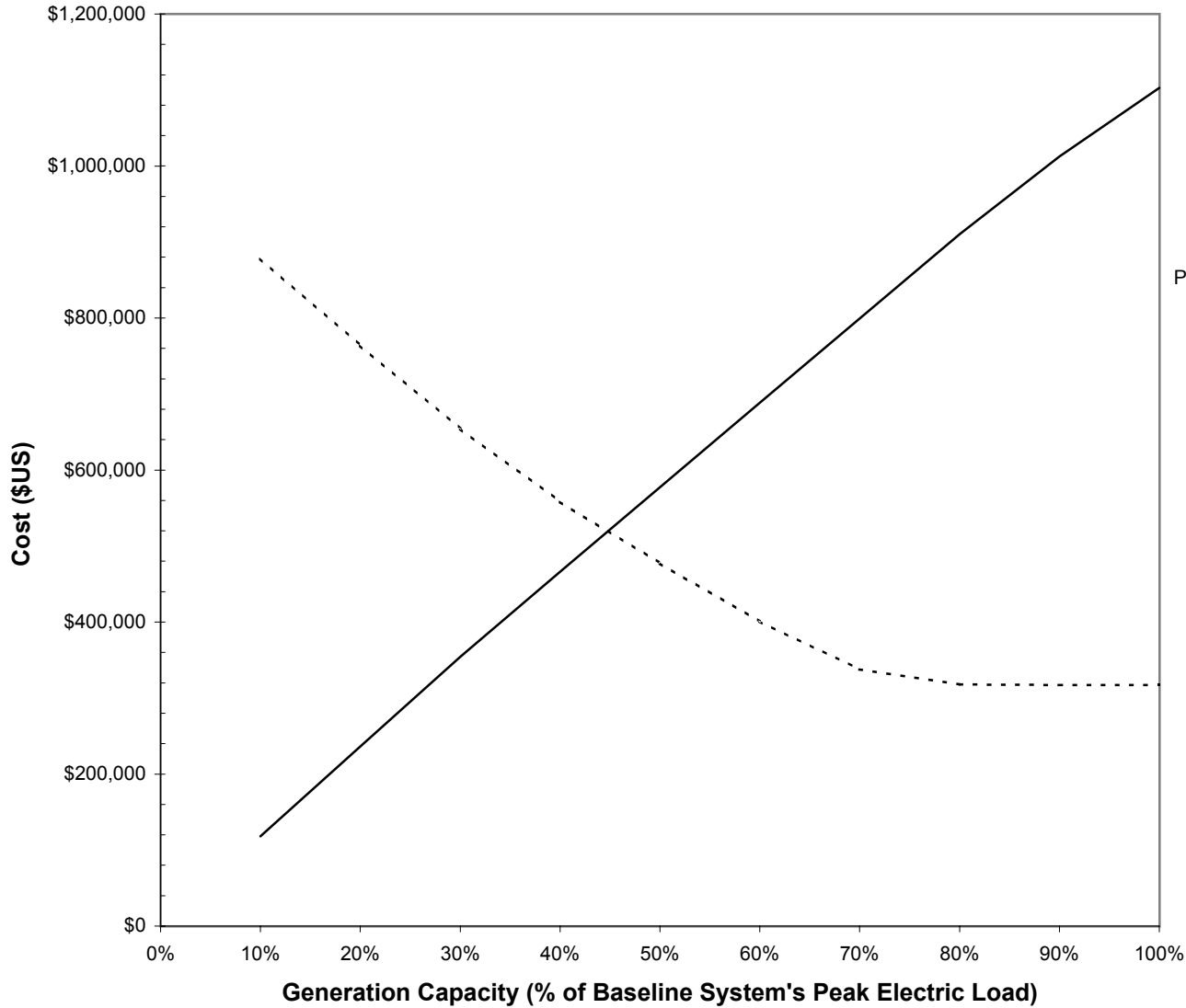

— Installed Cost - - - - Annual Operating Cost

Run Number: 43
Date and Time of Run: 1/16/02 20:33
City Name: Los Angeles
Building Type: Hospital
FloorArea(ft²): 250,000
Baseline Peak Electric(kW): 1,346
Peak Cooling Load (tons): 603
Peak Heating Load (MMBtuH): 2
Generation Technology: Std. Engine
Absorption Chiller Type: Single Effect
Fuel Type: Natural Gas
Rate Structure: So. Cal. Edison
Control Strategy: Smart

Payback Period

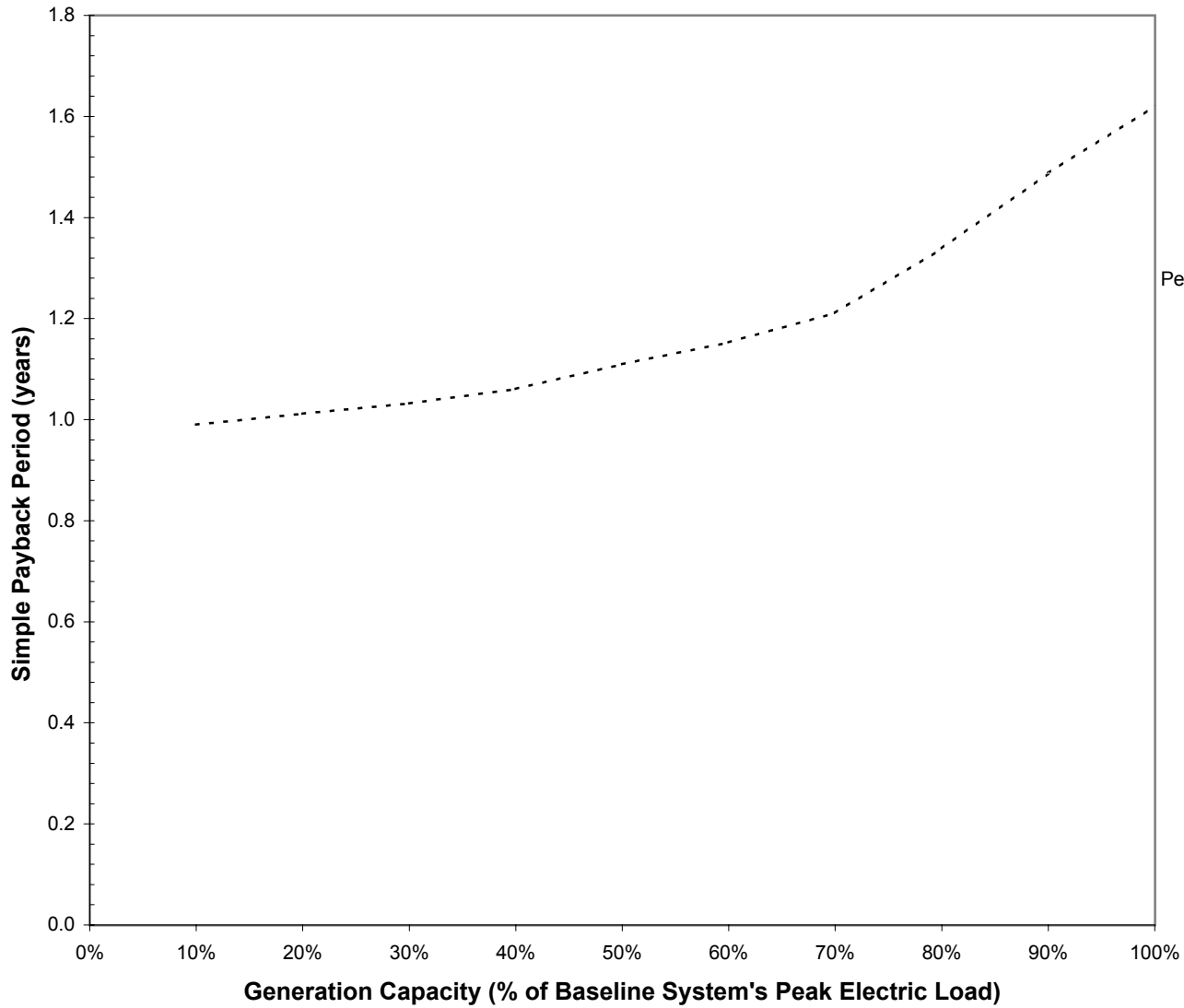

Run Number: 43

Date and Time of Run: 1/16/02 20:33

City Name: Los Angeles

Building Type: Hospital

FloorArea(ft²): 250,000

Baseline Peak Electric(kW): 1,346

Peak Cooling Load (tons): 603

Peak Heating Load (MMBtuH): 2

Generation Technology: Std. Engine

Absorption Chiller Type: Single Effect

Fuel Type: Natural Gas

Rate Structure: So. Cal. Edison

Control Strategy: Smart

Annual Primary Energy Consumption Breakdown

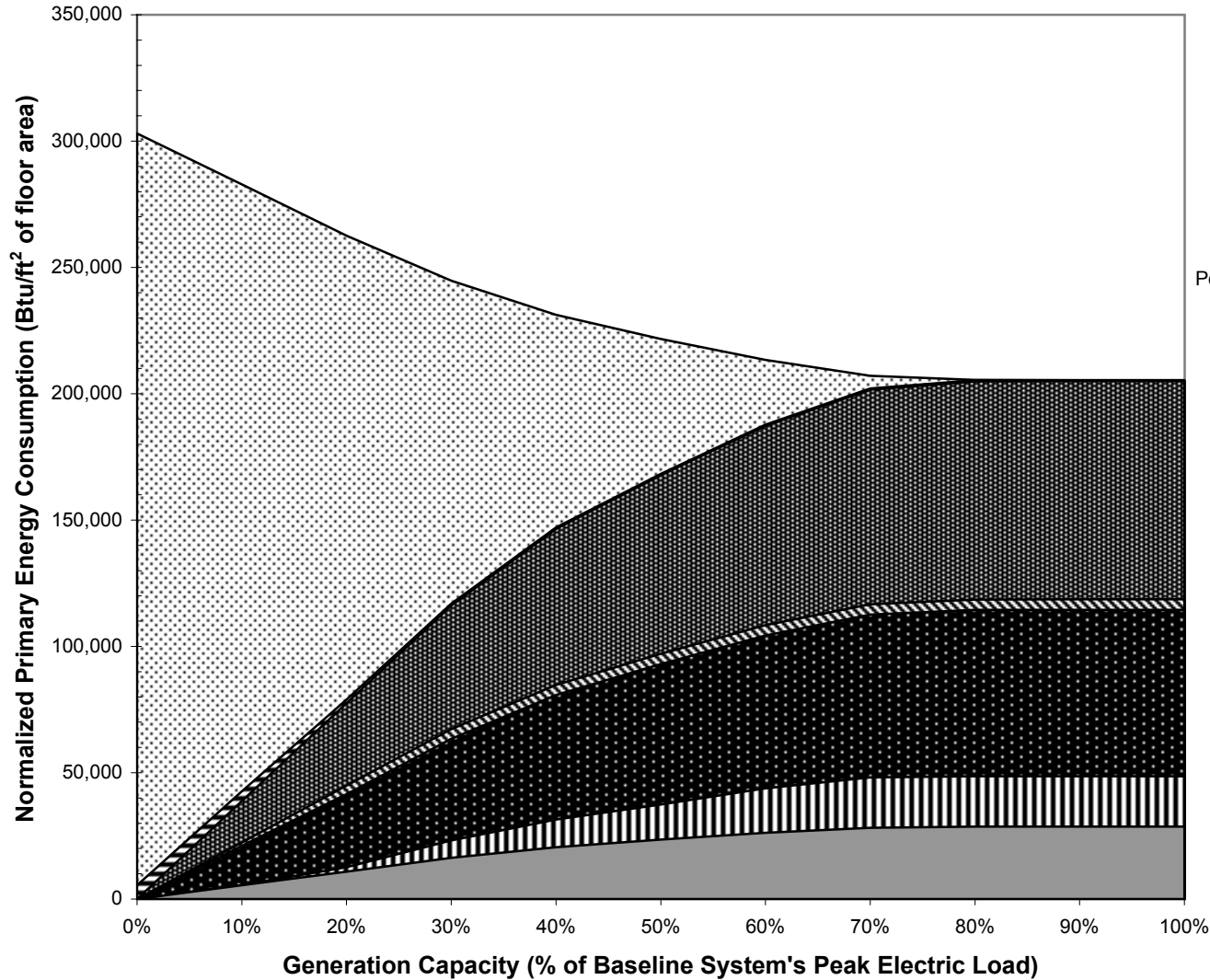

Run Number: 44
 Date and Time of Run: 1/16/02 22:20
 City Name: Los Angeles
 Building Type: Hospital
 FloorArea(ft²): 250,000
 Baseline Peak Electric(kW): 1,346
 Peak Cooling Load (tons): 603
 Peak Heating Load (MMBtuH): 2
 Generation Technology: Adv. Engine
 Absorption Chiller Type: Single Effect
 Fuel Type: Natural Gas
 Rate Structure: So. Cal. Edison
 Control Strategy: Smart



Installed Cost and Annual Operating Cost

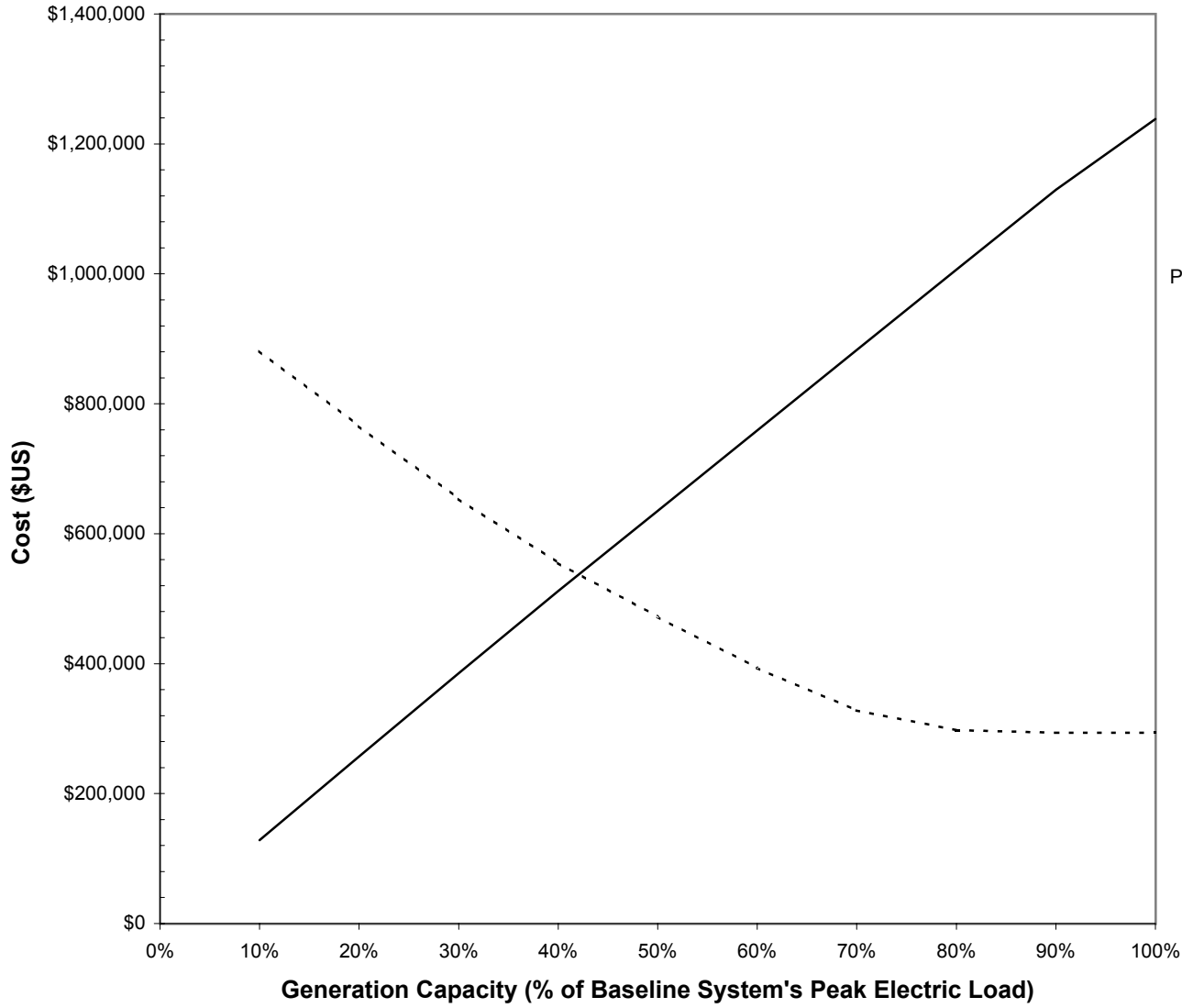

— Installed Cost - - - - Annual Operating Cost

Run Number: 44
Date and Time of Run: 1/16/02 22:20
City Name: Los Angeles
Building Type: Hospital
FloorArea(ft²): 250,000
Baseline Peak Electric(kW): 1,346
Peak Cooling Load (tons): 603
Peak Heating Load (MMBtuH): 2
Generation Technology: Adv. Engine
Absorption Chiller Type: Single Effect
Fuel Type: Natural Gas
Rate Structure: So. Cal. Edison
Control Strategy: Smart

Payback Period

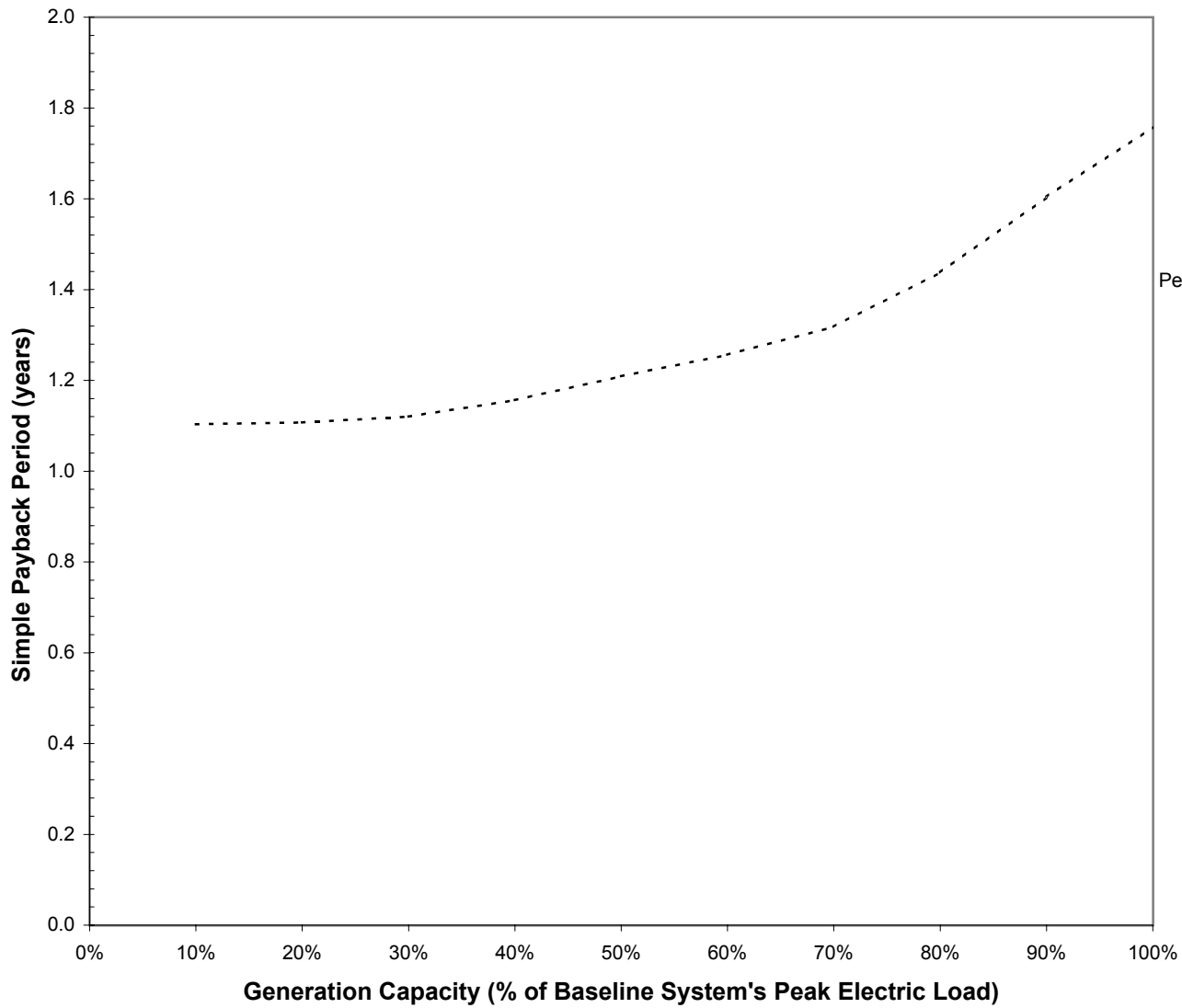

Run Number: 44

Date and Time of Run: 1/16/02 22:20

City Name: Los Angeles

Building Type: Hospital

FloorArea(ft²): 250,000

Baseline Peak Electric(kW): 1,346

Peak Cooling Load (tons): 603

Peak Heating Load (MMBtuH): 2

Generation Technology: Adv. Engine

Absorption Chiller Type: Single Effect

Fuel Type: Natural Gas

Rate Structure: So. Cal. Edison

Control Strategy: Smart

Annual Primary Energy Consumption Breakdown

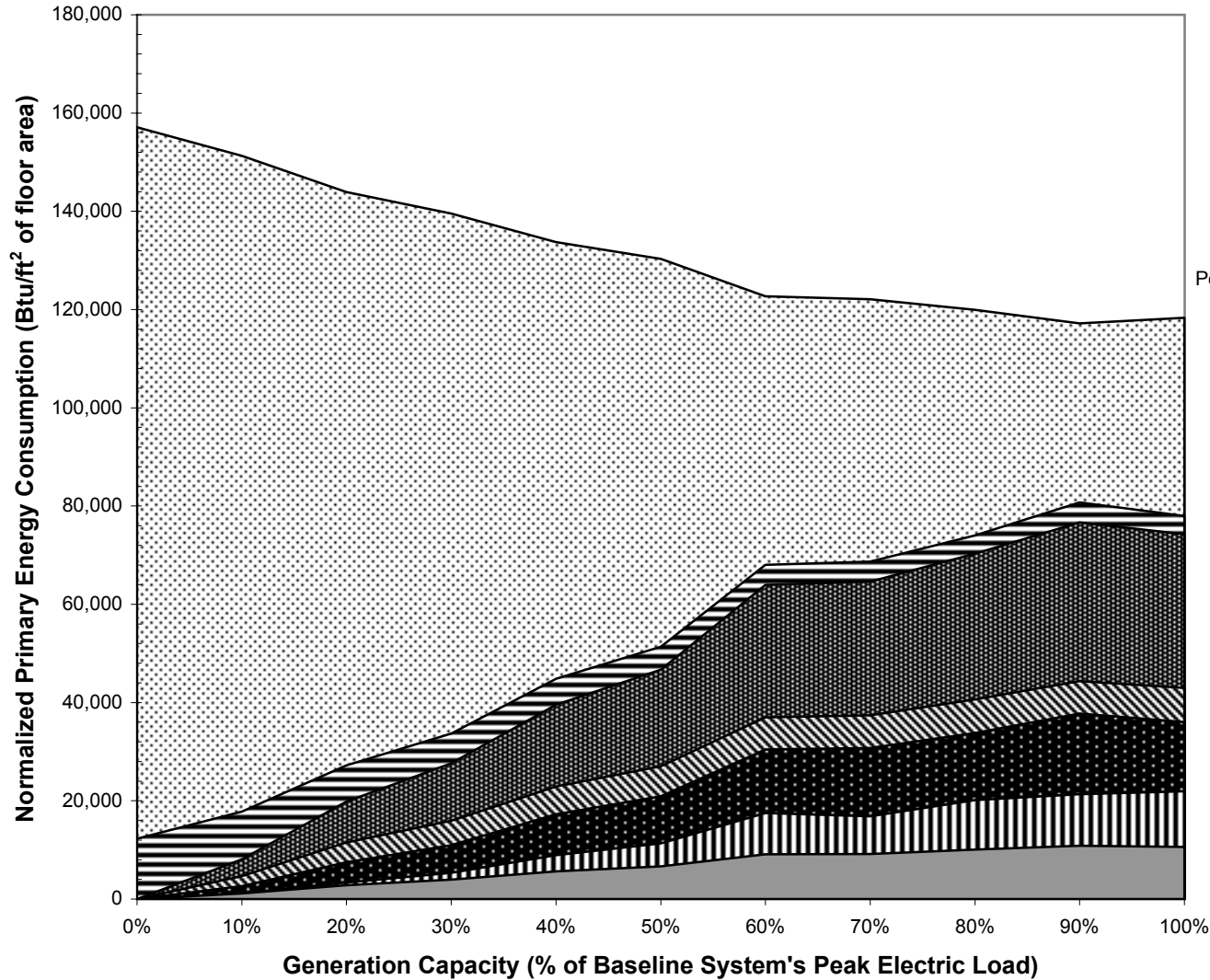

Run Number: 45
 Date and Time of Run: 1/17/02 0:08
 City Name: Chicago
 Building Type: Office
 FloorArea(ft²): 352,000
 Baseline Peak Electric(kW): 1,552
 Peak Cooling Load (tons): 531
 Peak Heating Load (MMBtuH): 5
 Generation Technology: Adv. Engine
 Absorption Chiller Type: Single Effect
 Fuel Type: Natural Gas
 Rate Structure: CommEdison
 Control Strategy: Smart



Installed Cost and Annual Operating Cost

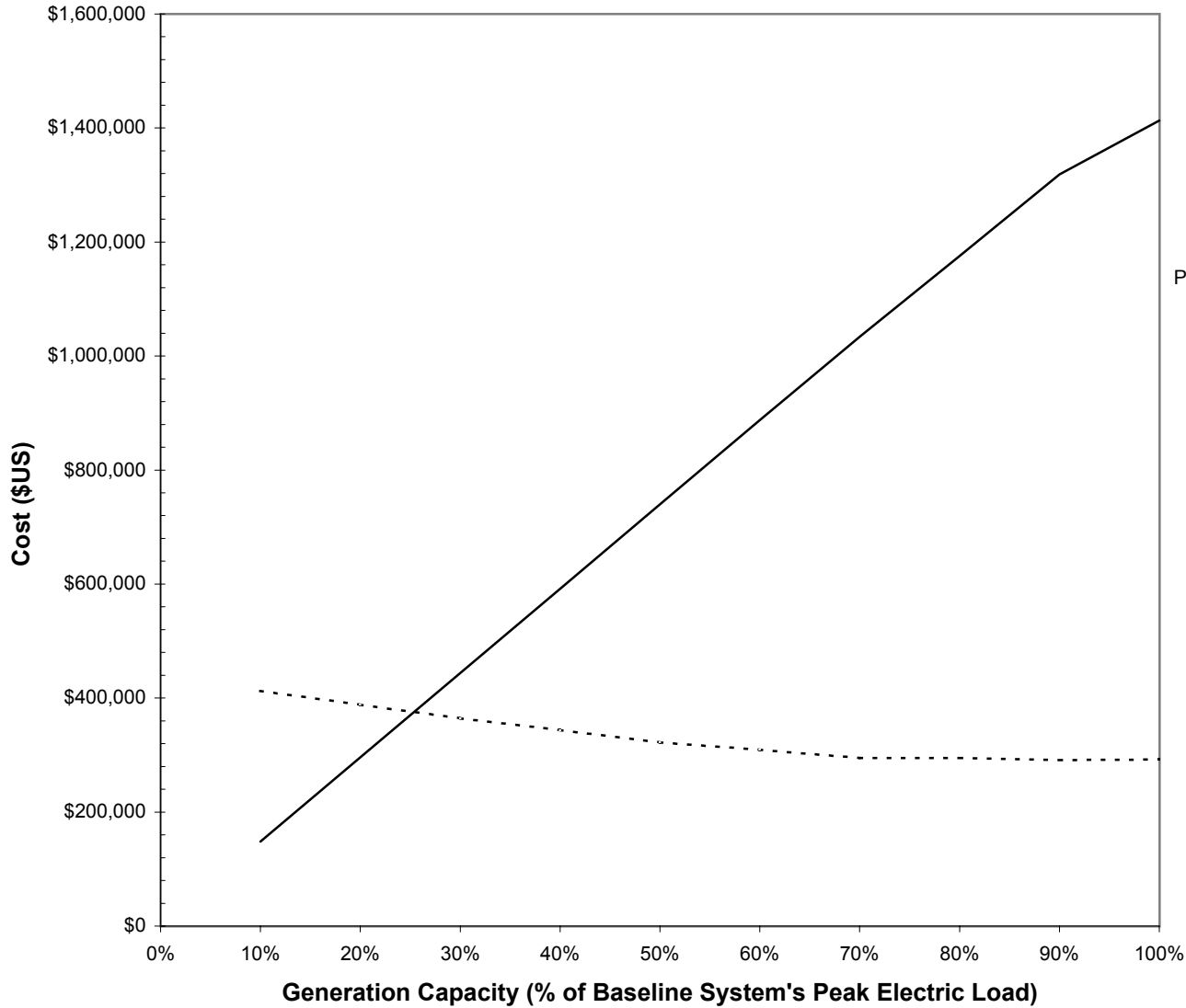

— Installed Cost - - - - Annual Operating Cost

Run Number: 45
Date and Time of Run: 1/17/02 0:08
City Name: Chicago
Building Type: Office
FloorArea(ft²): 352,000
Baseline Peak Electric(kW): 1,552
Peak Cooling Load (tons): 531
Peak Heating Load (MMBtuH): 5
Generation Technology: Adv. Engine
Absorption Chiller Type: Single Effect
Fuel Type: Natural Gas
Rate Structure: CommEdison
Control Strategy: Smart

Payback Period

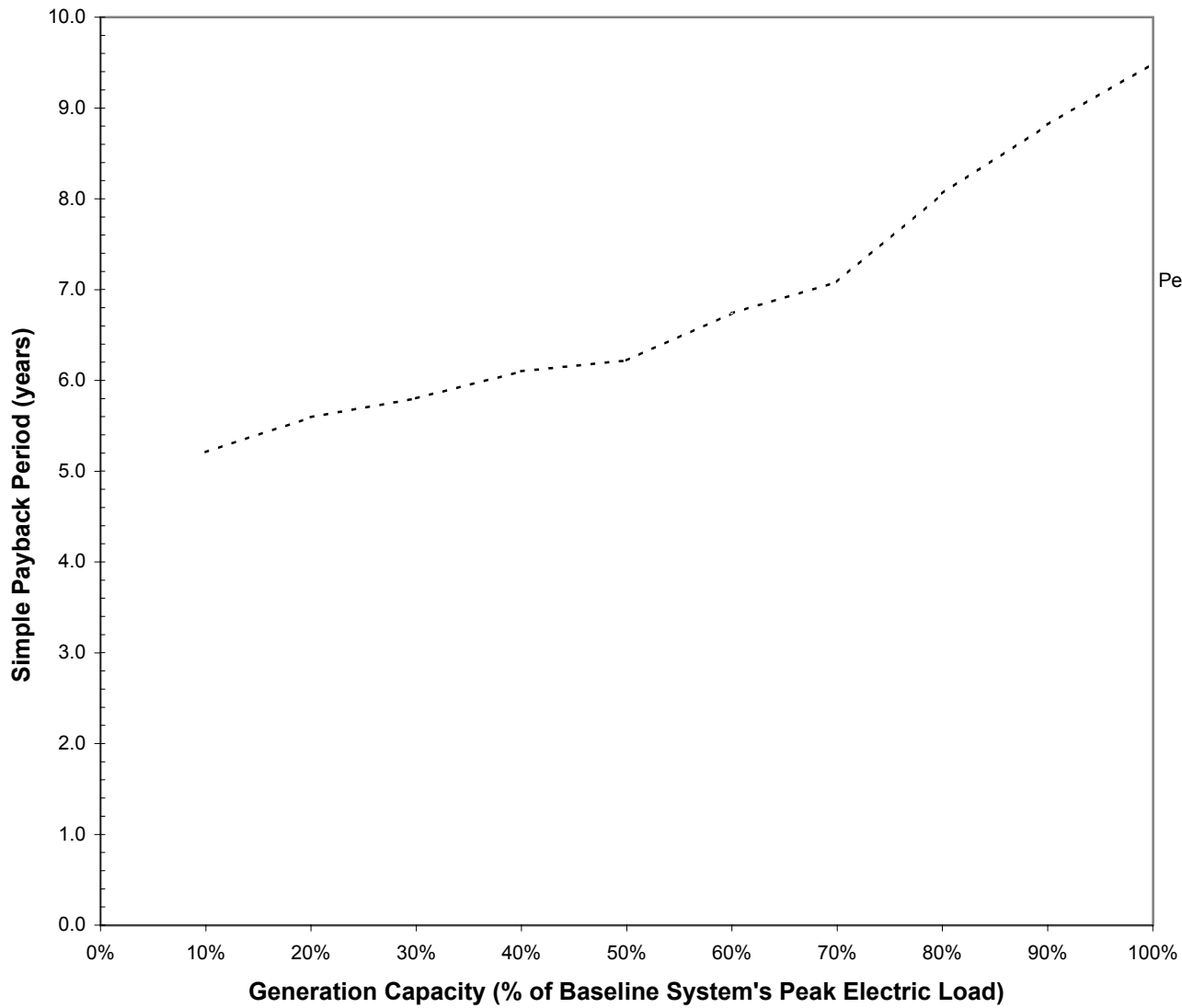

Run Number: 45

Date and Time of Run: 1/17/02 0:08

City Name: Chicago

Building Type: Office

FloorArea(ft²): 352,000

Baseline Peak Electric(kW): 1,552

Peak Cooling Load (tons): 531

Peak Heating Load (MMBtuH): 5

Generation Technology: Adv. Engine

Absorption Chiller Type: Single Effect

Fuel Type: Natural Gas

Rate Structure: CommEdison

Control Strategy: Smart

Annual Primary Energy Consumption Breakdown

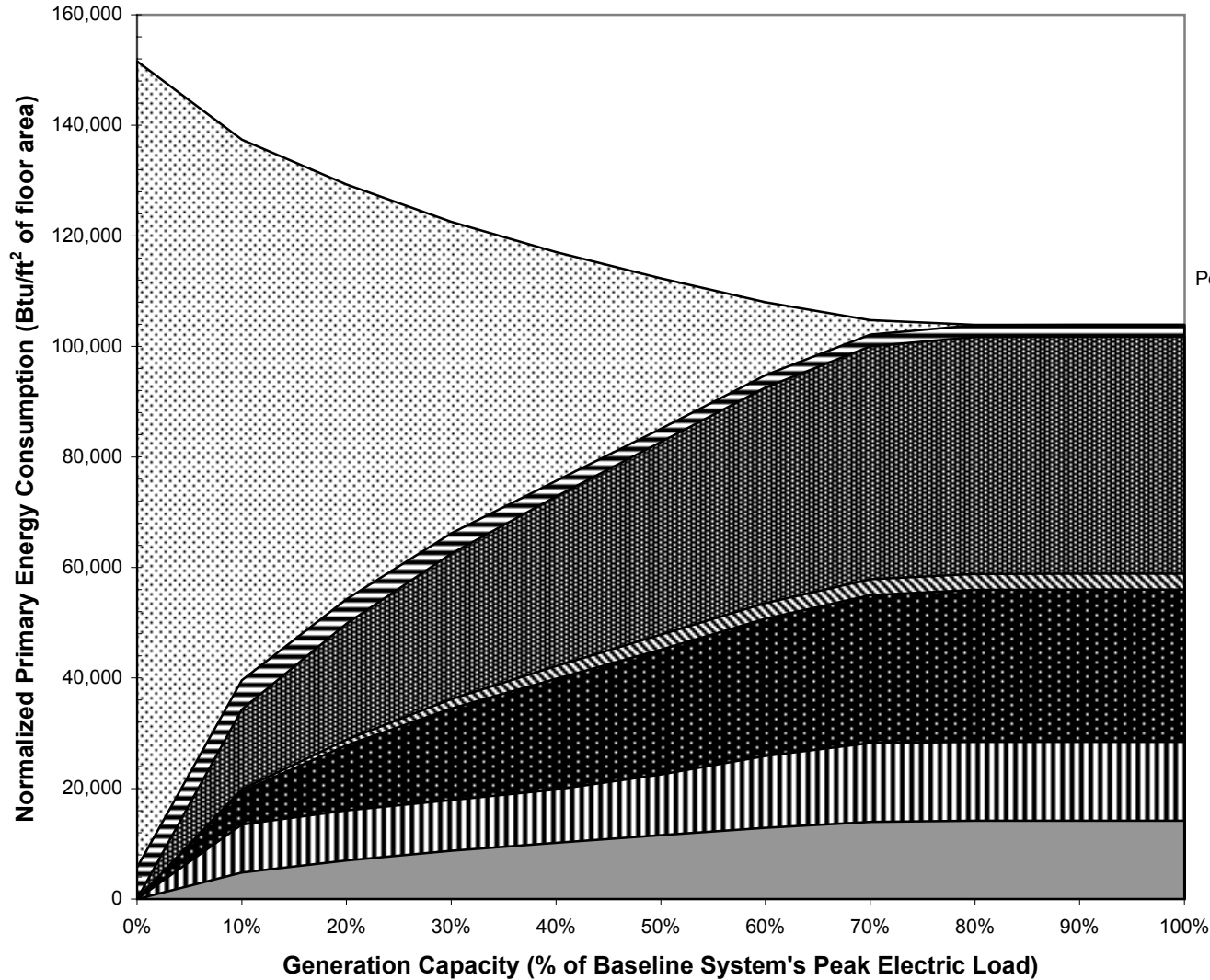

Run Number: 46
 Date and Time of Run: 1/17/02 3:12
 City Name: Los Angeles
 Building Type: Office
 FloorArea(ft²): 197,000
 Baseline Peak Electric(kW): 940
 Peak Cooling Load (tons): 330
 Peak Heating Load (MMBtuH): 2
 Generation Technology: Adv. Engine
 Absorption Chiller Type: Single Effect
 Fuel Type: Natural Gas
 Rate Structure: So. Cal. Edison
 Control Strategy: Smart



Installed Cost and Annual Operating Cost

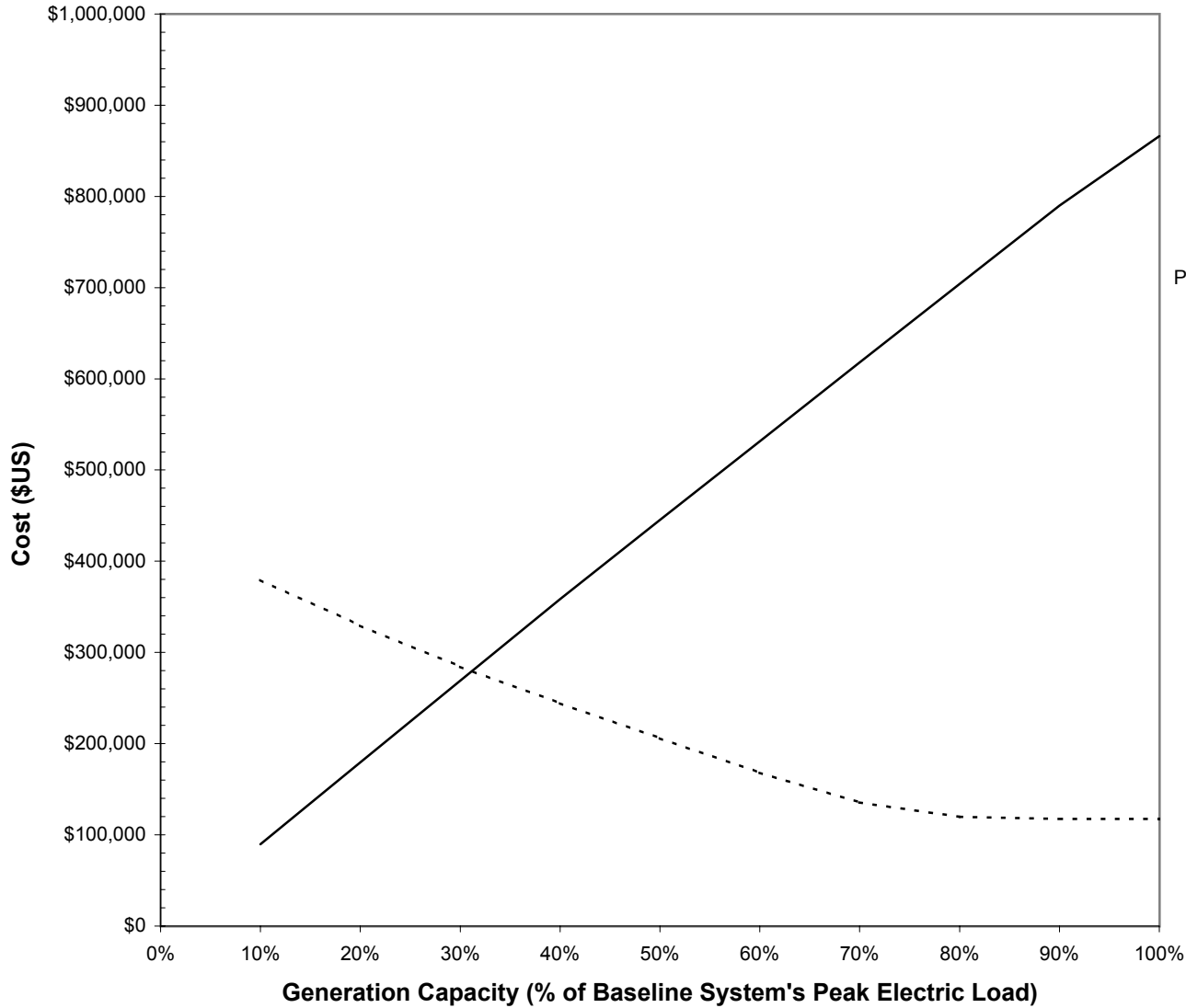

— Installed Cost - - - - Annual Operating Cost

Run Number: 46
Date and Time of Run: 1/17/02 3:12
City Name: Los Angeles
Building Type: Office
FloorArea(ft²): 197,000
Baseline Peak Electric(kW): 940
Peak Cooling Load (tons): 330
Peak Heating Load (MMBtuH): 2
Generation Technology: Adv. Engine
Absorption Chiller Type: Single Effect
Fuel Type: Natural Gas
Rate Structure: So. Cal. Edison
Control Strategy: Smart

Payback Period

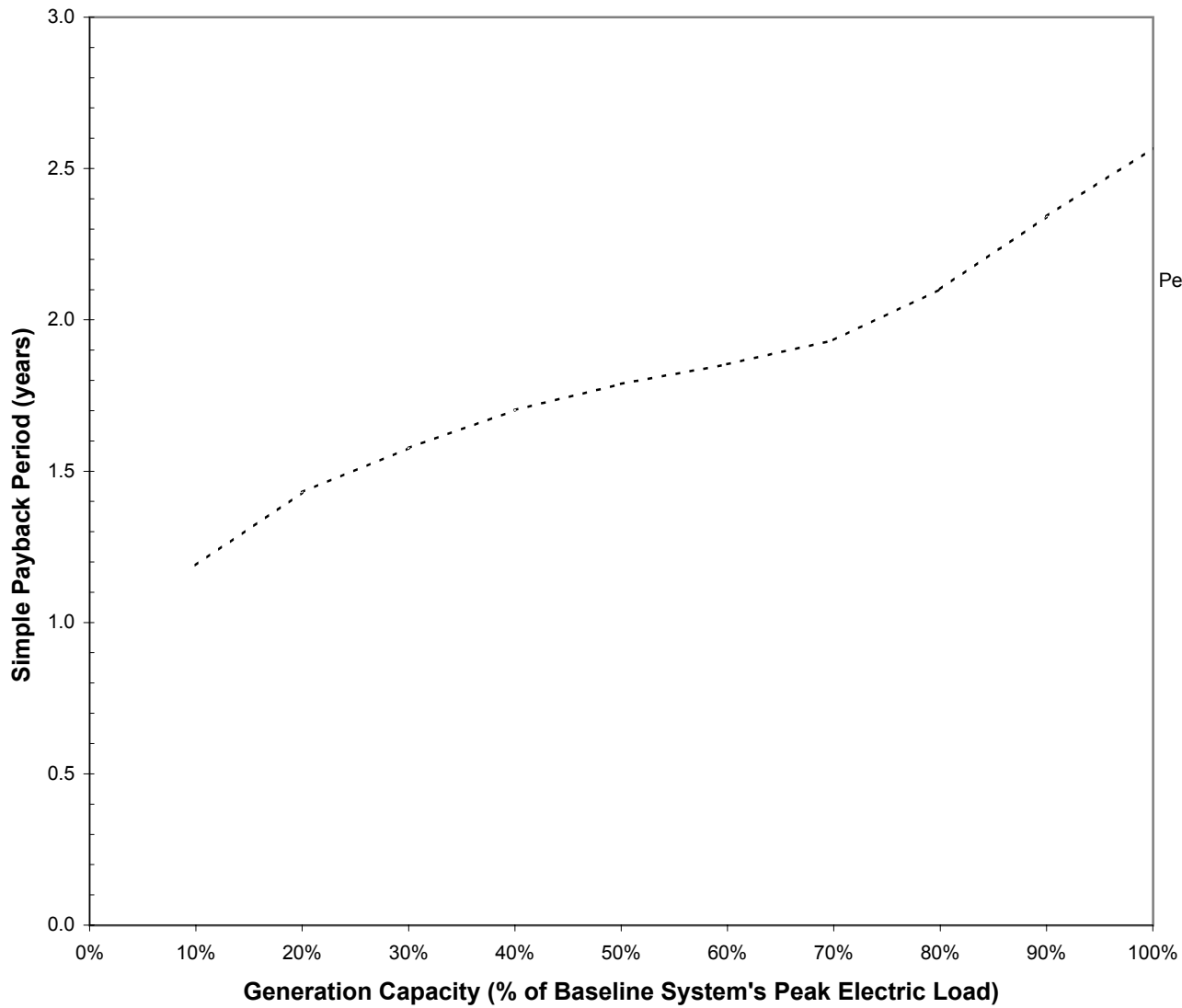

Run Number: 46

Date and Time of Run: 1/17/02 3:12

City Name: Los Angeles

Building Type: Office

FloorArea(ft²): 197,000

Baseline Peak Electric(kW): 940

Peak Cooling Load (tons): 330

Peak Heating Load (MMBtuH): 2

Generation Technology: Adv. Engine

Absorption Chiller Type: Single Effect

Fuel Type: Natural Gas

Rate Structure: So. Cal. Edison

Control Strategy: Smart

Annual Primary Energy Consumption Breakdown

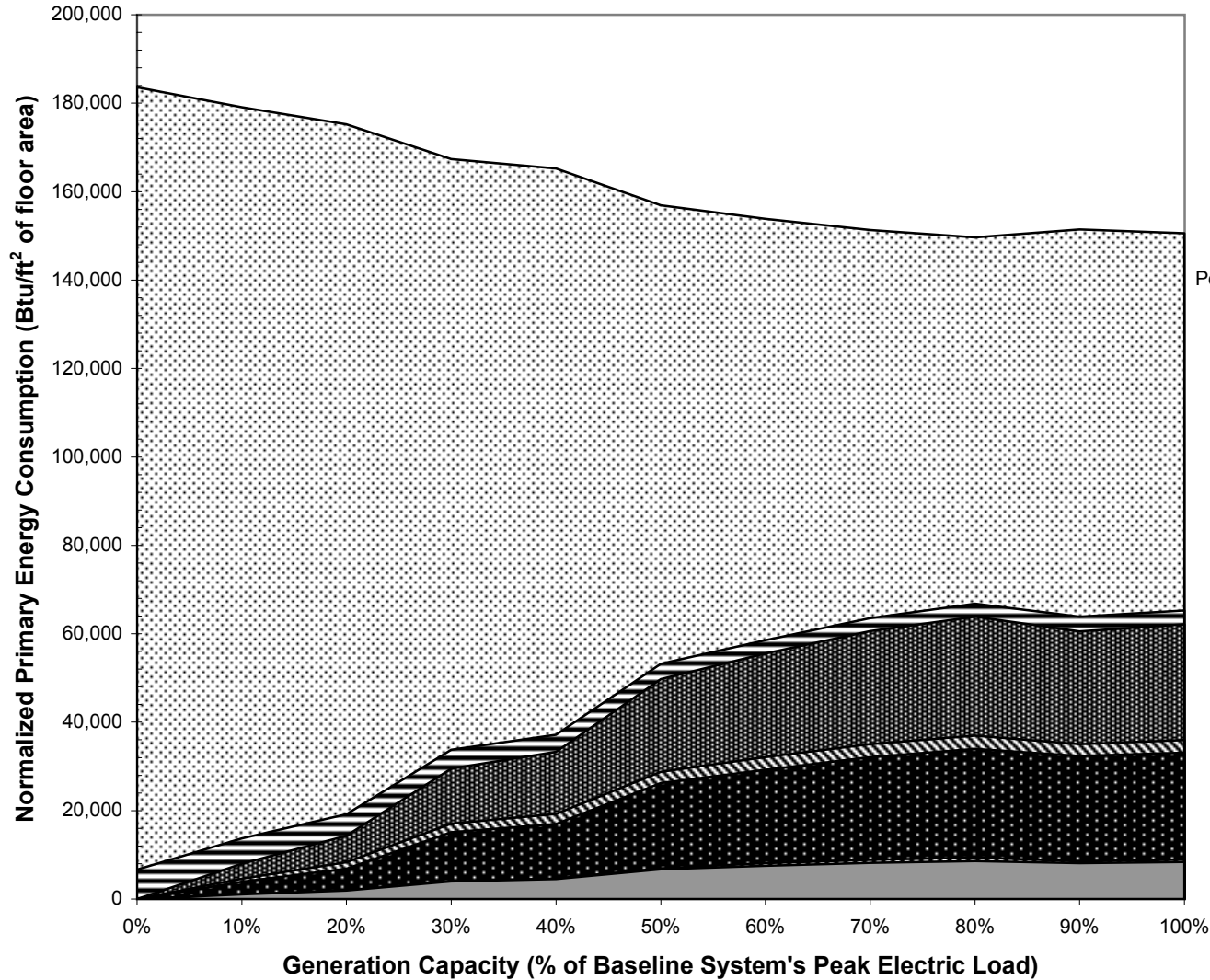

Run Number: 48
 Date and Time of Run: 2/16/02 18:42
 City Name: Phoenix
 Building Type: Office
 FloorArea(ft²): 142,000
 Baseline Peak Electric(kW): 756
 Peak Cooling Load (tons): 302
 Peak Heating Load (MMBtuH): 2
 Generation Technology: Adv. Engine
 Absorption Chiller Type: Single Effect
 Fuel Type: Natural Gas
 Rate Structure: 0.00
 Control Strategy: Smart



Installed Cost and Annual Operating Cost

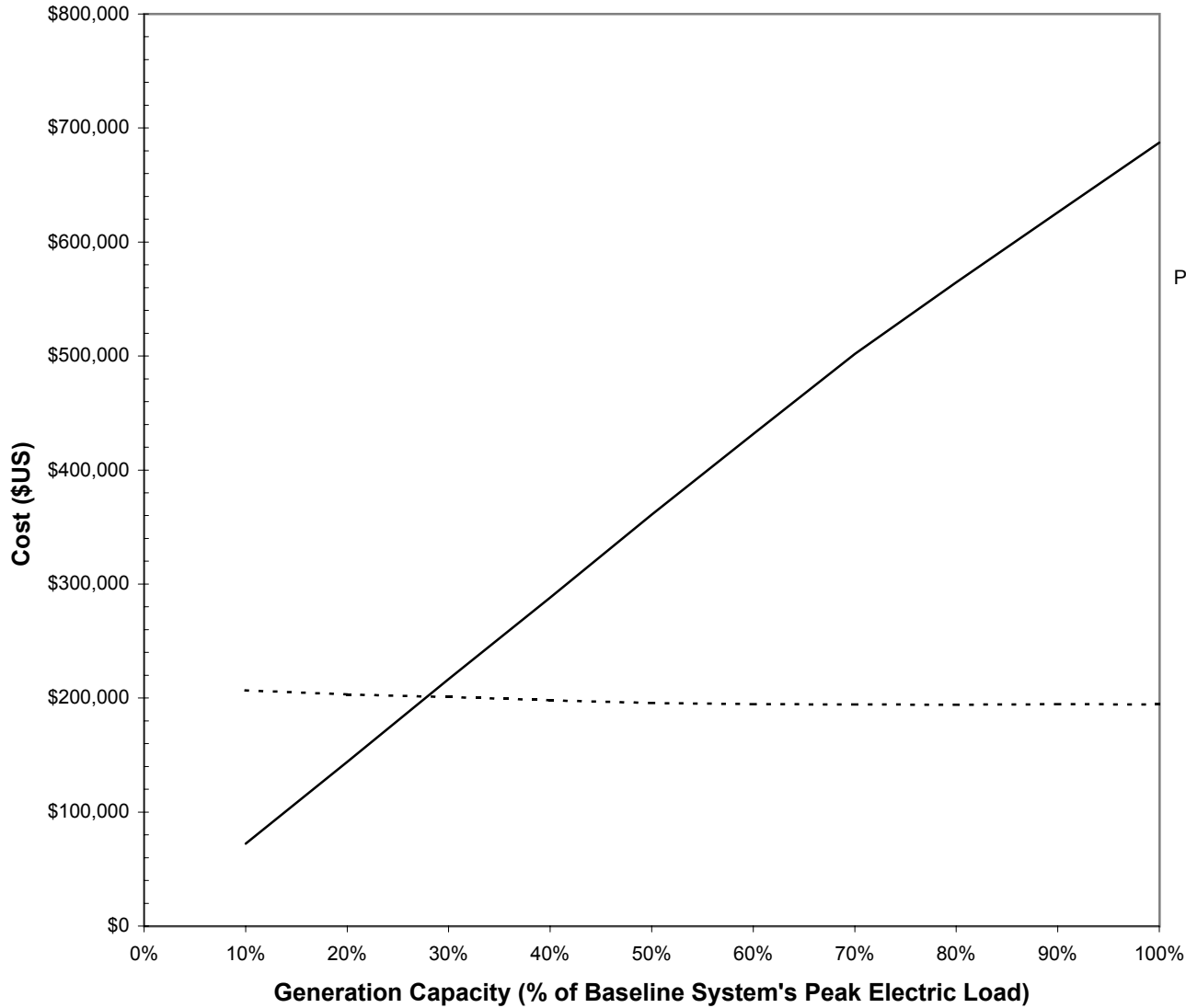

Run Number: 48
Date and Time of Run: 2/16/02 18:42
City Name: Phoenix
Building Type: Office
FloorArea(ft²): 142,000
Baseline Peak Electric(kW): 756
Peak Cooling Load (tons): 302
Peak Heating Load (MMBtuH): 2
Generation Technology: Adv. Engine
Absorption Chiller Type: Single Effect
Fuel Type: Natural Gas
Rate Structure: 0.00
Control Strategy: Smart

— Installed Cost - - - - Annual Operating Cost

Payback Period

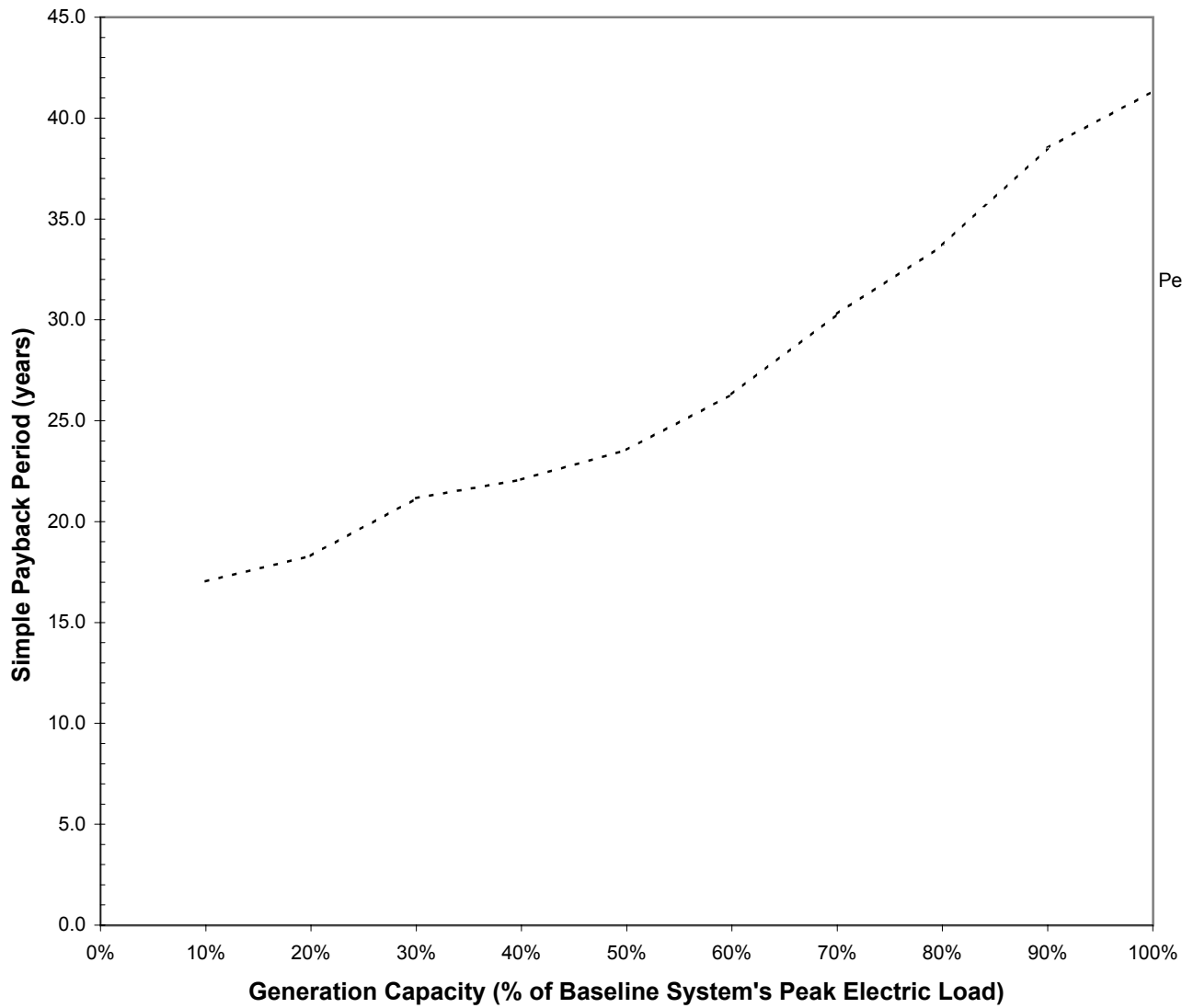

Run Number: 48

Date and Time of Run: 2/16/02 18:42

City Name: Phoenix

Building Type: Office

FloorArea(ft²): 142,000

Baseline Peak Electric(kW): 756

Peak Cooling Load (tons): 302

Peak Heating Load (MMBtuH): 2

Generation Technology: Adv. Engine

Absorption Chiller Type: Single Effect

Fuel Type: Natural Gas

Rate Structure: 0.00

Control Strategy: Smart

Annual Primary Energy Consumption Breakdown

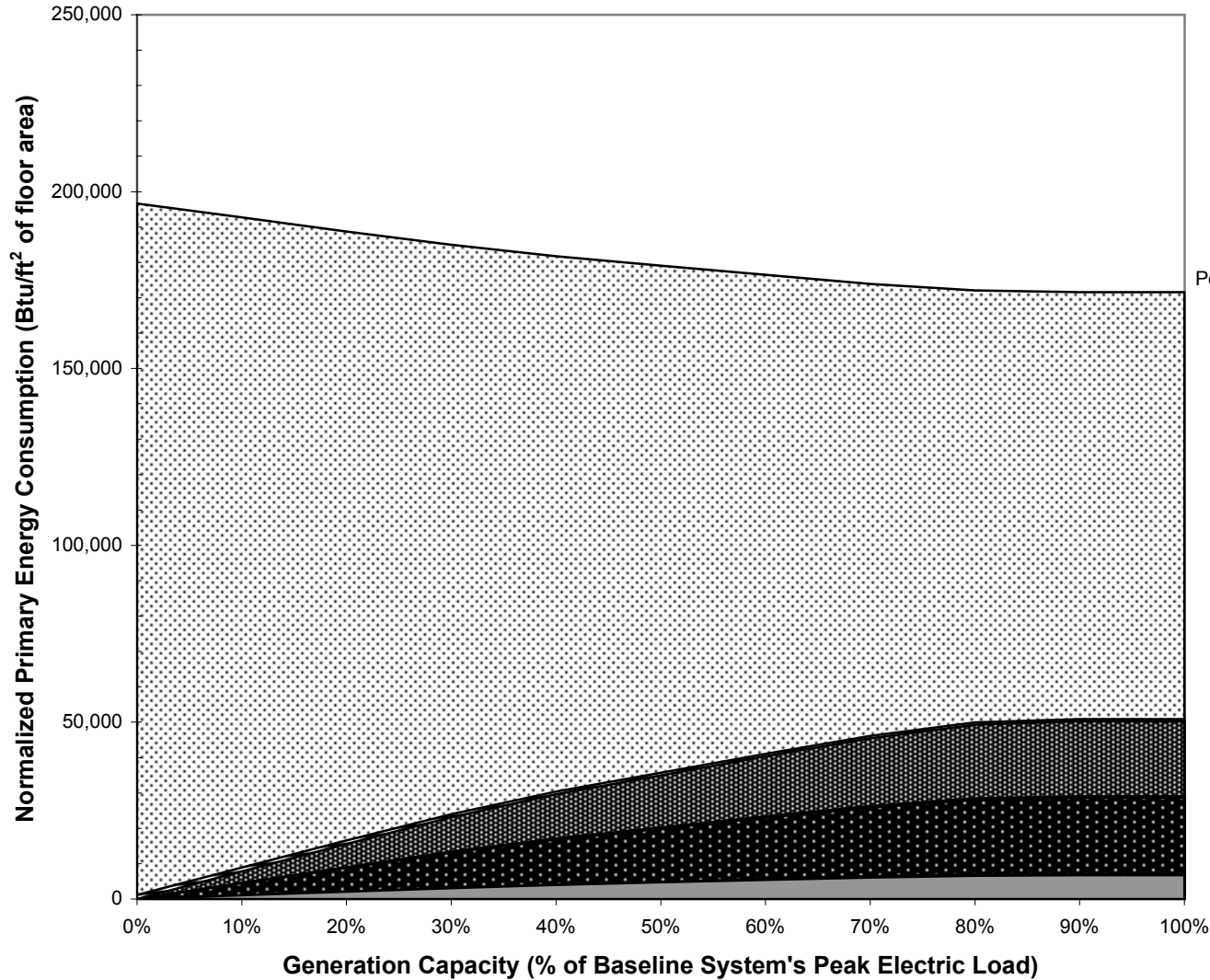

Run Number: 50
 Date and Time of Run: 1/16/02 23:42
 City Name: Miami
 Building Type: Office
 FloorArea(ft²): 159,000
 Baseline Peak Electric(kW): 794
 Peak Cooling Load (tons): 305
 Peak Heating Load (MMBtuH): 2
 Generation Technology: Adv. Engine
 Absorption Chiller Type: Single Effect
 Fuel Type: Natural Gas
 Rate Structure: FloridaPower
 Control Strategy: Smart



Installed Cost and Annual Operating Cost

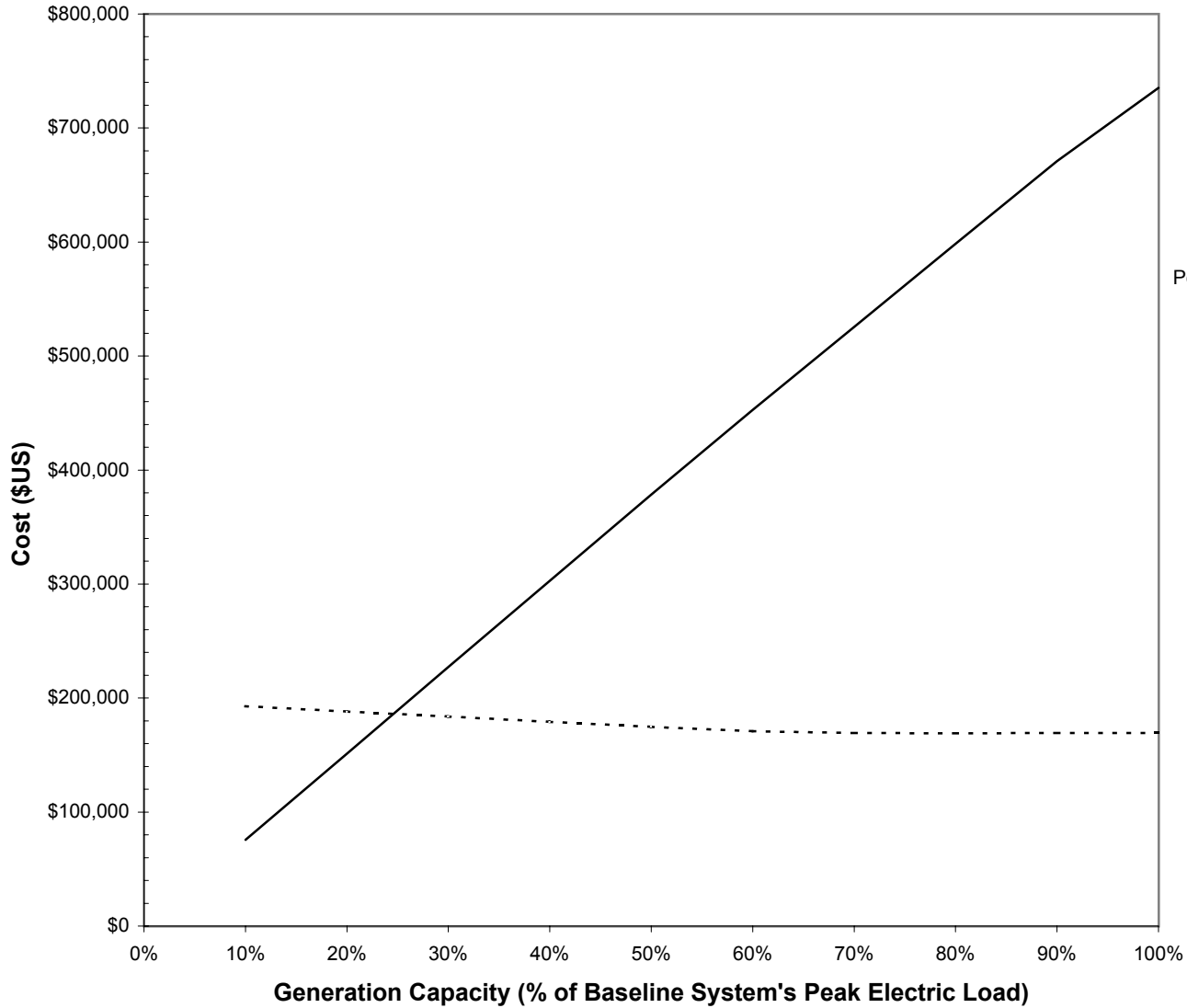

Run Number: 50
Date and Time of Run: 1/16/02 23:42
City Name: Miami
Building Type: Office
FloorArea(ft²): 159,000
Baseline Peak Electric(kW): 794
Peak Cooling Load (tons): 305
Peak Heating Load (MMBtuH): 2
Generation Technology: Adv. Engine
Absorption Chiller Type: Single Effect
Fuel Type: Natural Gas
Rate Structure: FloridaPower
Control Strategy: Smart

— Installed Cost - - - - Annual Operating Cost

Payback Period

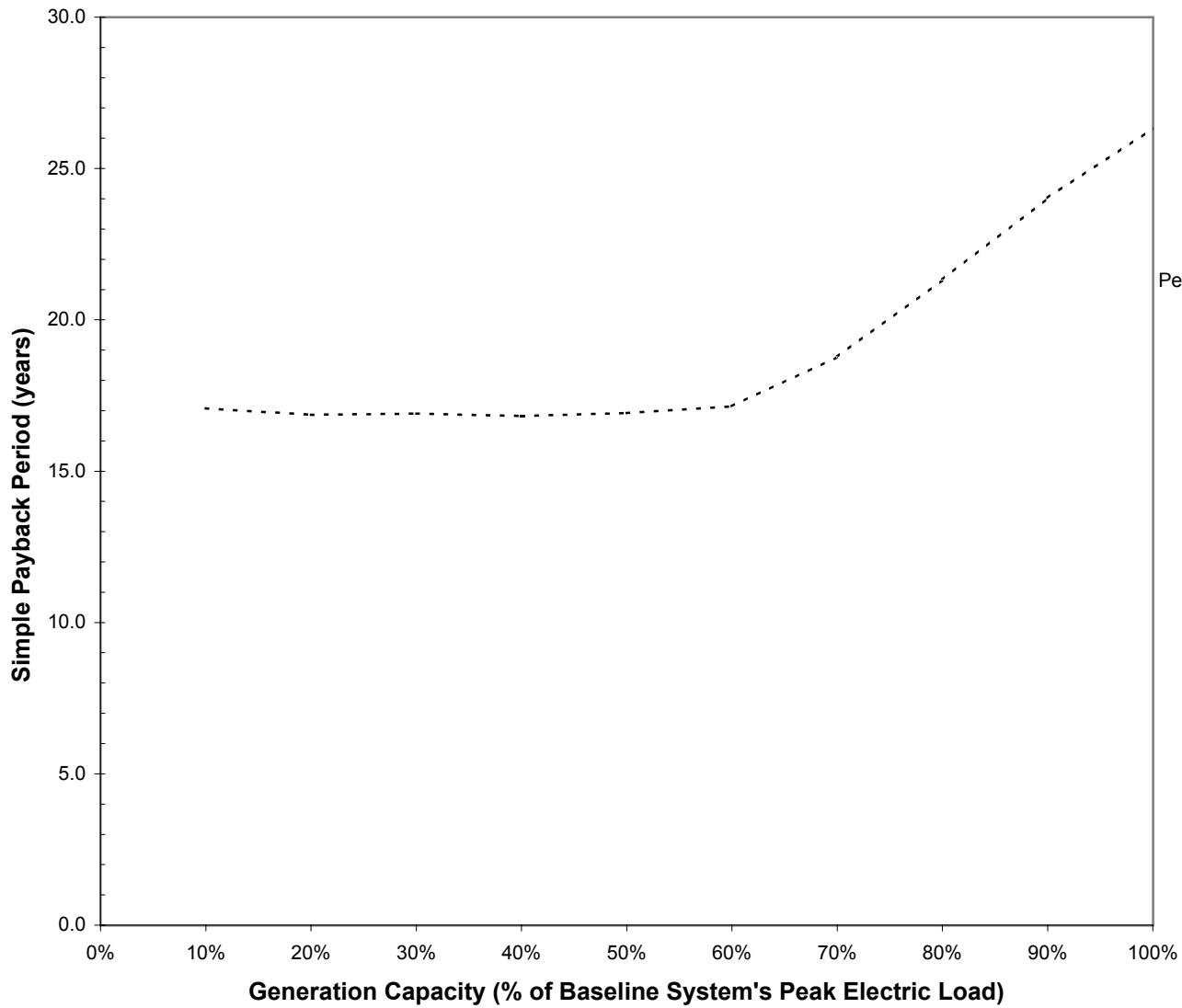

Run Number: 50

Date and Time of Run: 1/16/02 23:42

City Name: Miami

Building Type: Office

FloorArea(ft²): 159,000

Baseline Peak Electric(kW): 794

Peak Cooling Load (tons): 305

Peak Heating Load (MMBtuH): 2

Generation Technology: Adv. Engine

Absorption Chiller Type: Single Effect

Fuel Type: Natural Gas

Rate Structure: FloridaPower

Control Strategy: Smart

Annual Primary Energy Consumption Breakdown

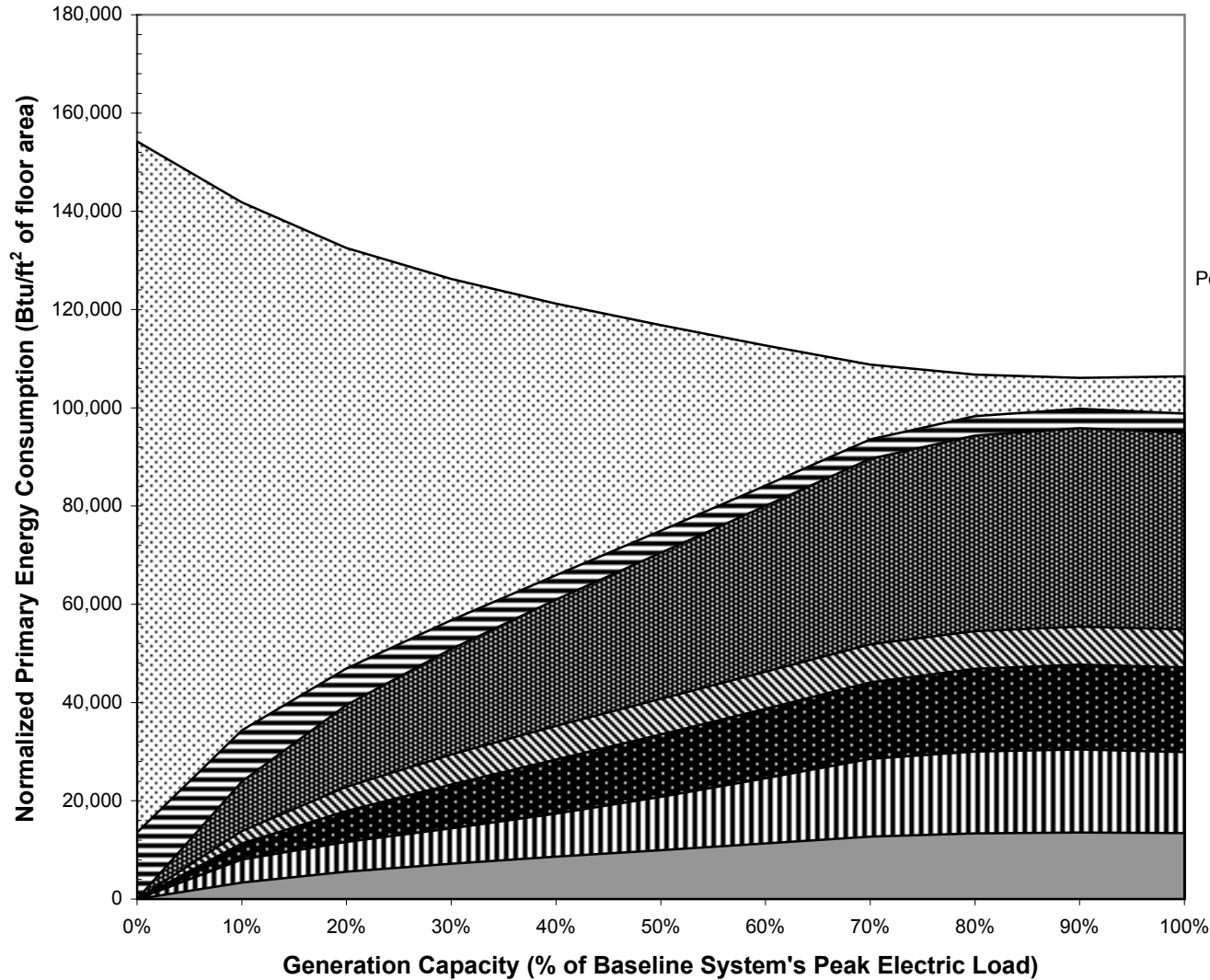

Run Number: 51
 Date and Time of Run: 1/17/02 1:22
 City Name: New York
 Building Type: Office
 FloorArea(ft²): 419,000
 Baseline Peak Electric(kW): 1,750
 Peak Cooling Load (tons): 548
 Peak Heating Load (MMBtuH): 6
 Generation Technology: Adv. Engine
 Absorption Chiller Type: Single Effect
 Fuel Type: Natural Gas
 Rate Structure: Con Edison
 Control Strategy: Smart



Installed Cost and Annual Operating Cost

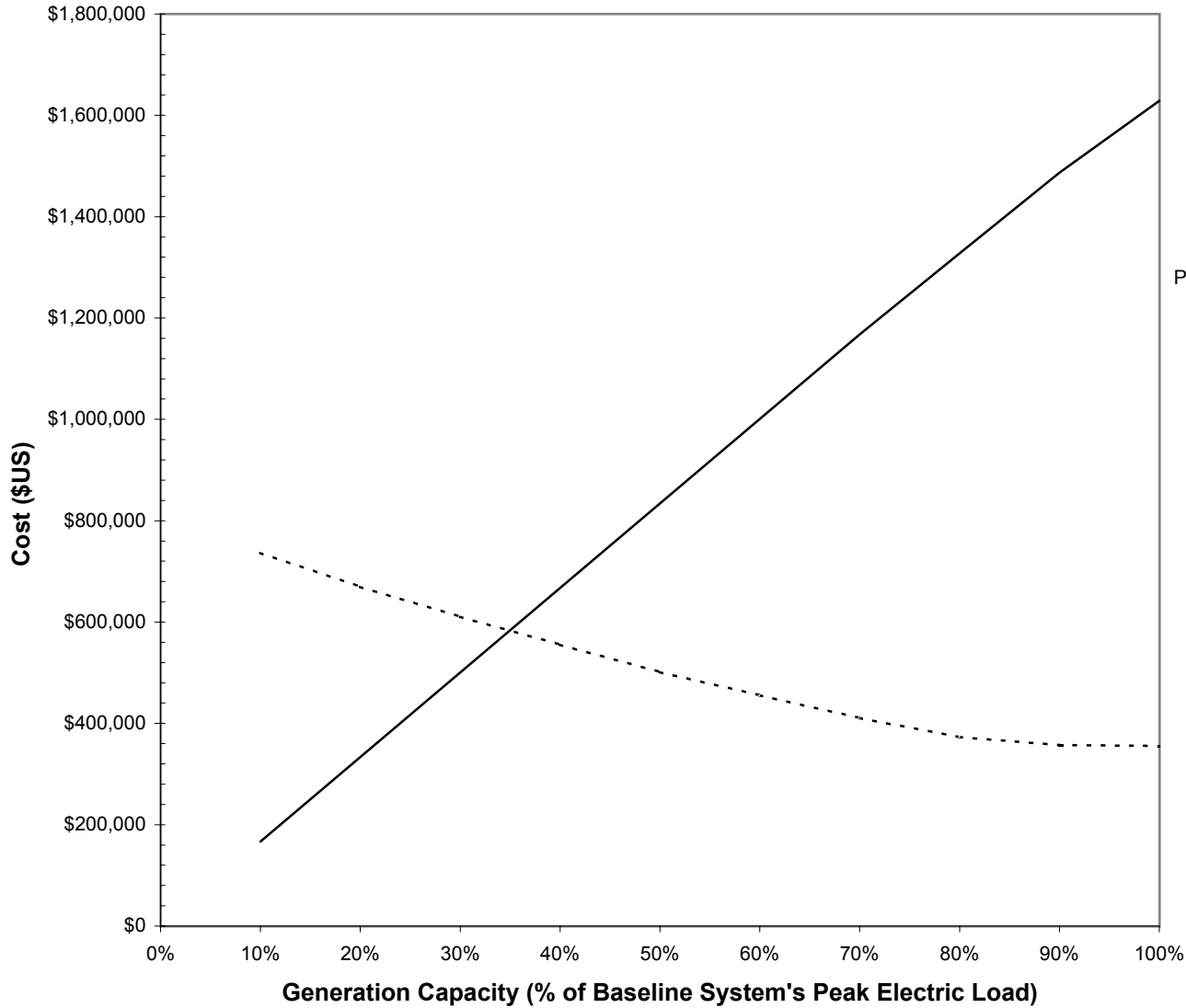

— Installed Cost - - - - Annual Operating Cost

Run Number: 51
Date and Time of Run: 1/17/02 1:22
City Name: New York
Building Type: Office
FloorArea(ft²): 419,000
Baseline Peak Electric(kW): 1,750
Peak Cooling Load (tons): 548
Peak Heating Load (MMBtuH): 6
Generation Technology: Adv. Engine
Absorption Chiller Type: Single Effect
Fuel Type: Natural Gas
Rate Structure: Con Edison
Control Strategy: Smart

Payback Period

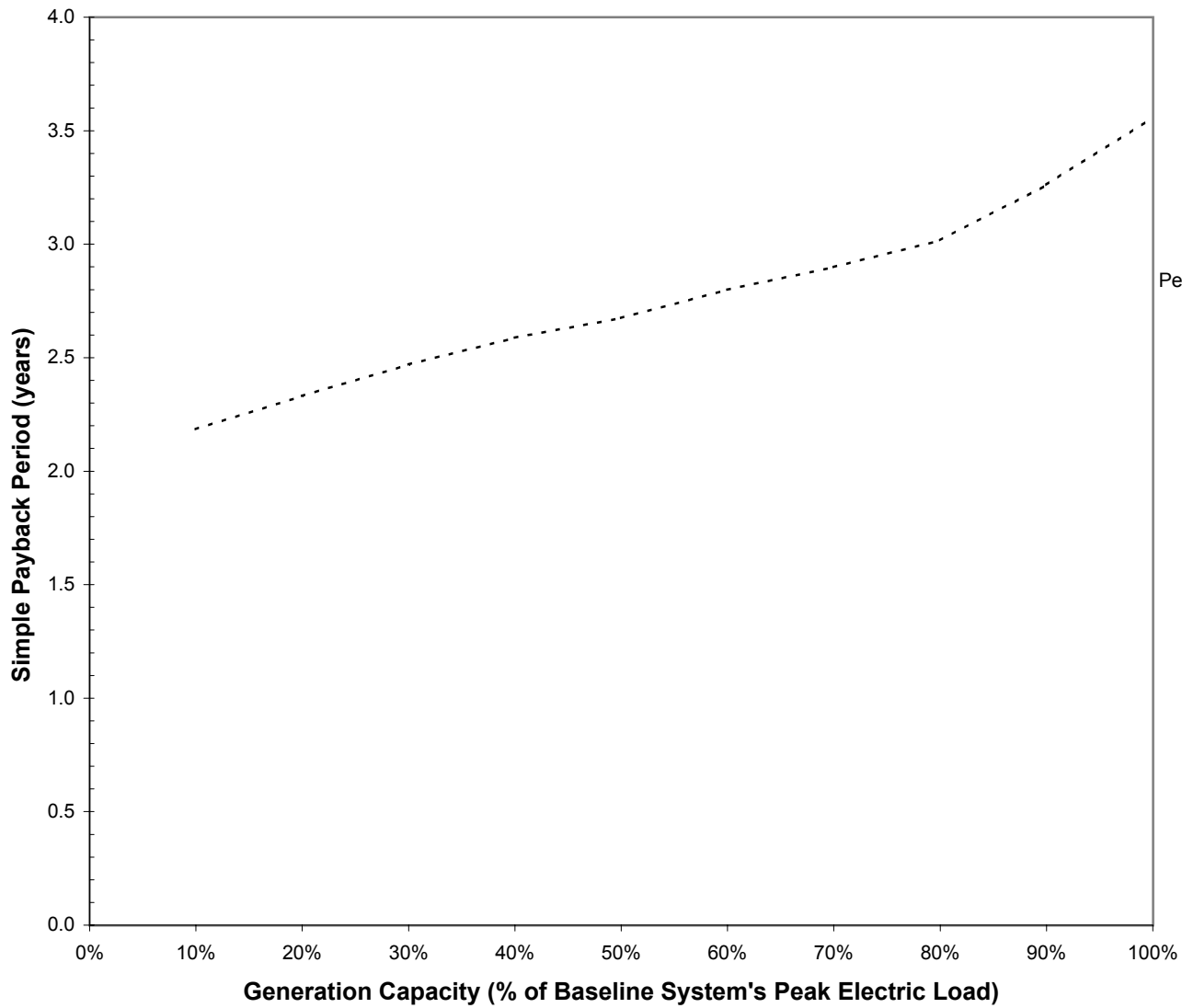

Run Number: 51

Date and Time of Run: 1/17/02 1:22

City Name: New York

Building Type: Office

FloorArea(ft²): 419,000

Baseline Peak Electric(kW): 1,750

Peak Cooling Load (tons): 548

Peak Heating Load (MMBtuH): 6

Generation Technology: Adv. Engine

Absorption Chiller Type: Single Effect

Fuel Type: Natural Gas

Rate Structure: Con Edison

Control Strategy: Smart

Annual Primary Energy Consumption Breakdown

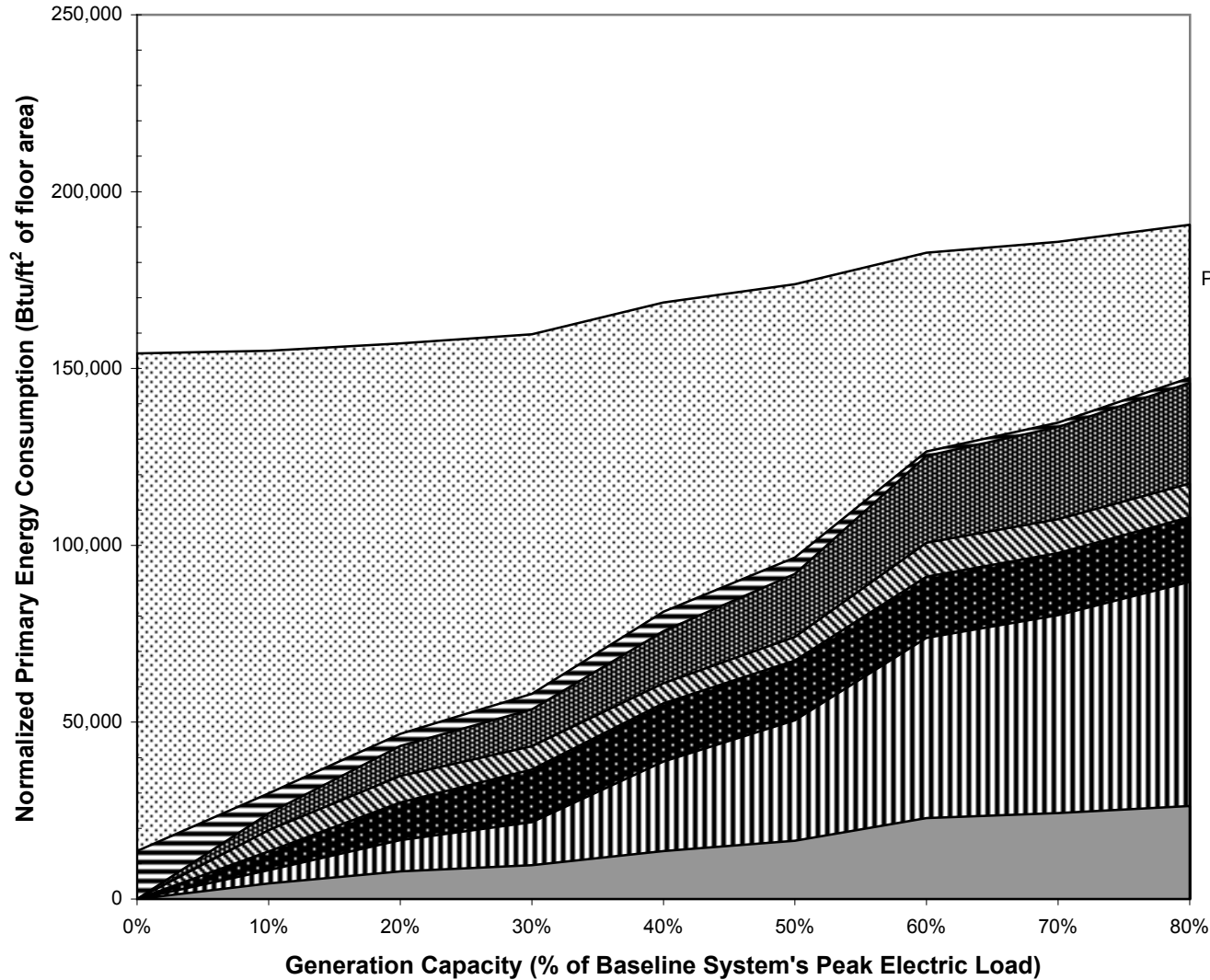

Run Number: 53
 Date and Time of Run: 1/17/02 12:32
 City Name: New York
 Building Type: Office
 FloorArea(ft²): 419,000
 Baseline Peak Electric(kW): 1,831
 Peak Cooling Load (tons): 548
 Peak Heating Load (MMBtuH): 6
 Generation Technology: 50% Recuperator
 Absorption Chiller Type: Double Effect
 Fuel Type: Natural Gas
 Rate Structure: Con Edison
 Control Strategy: Smart

	Electric Energy from the Grid		Fuel Consumed for Heating		Electric Energy Generated		Heat Utilized for Heating		Heat Utilized for Cooling		Unutilized Heat		Unrecoverable Heat
--	-------------------------------	--	---------------------------	--	---------------------------	--	---------------------------	--	---------------------------	--	-----------------	--	--------------------

Installed Cost and Annual Operating Cost

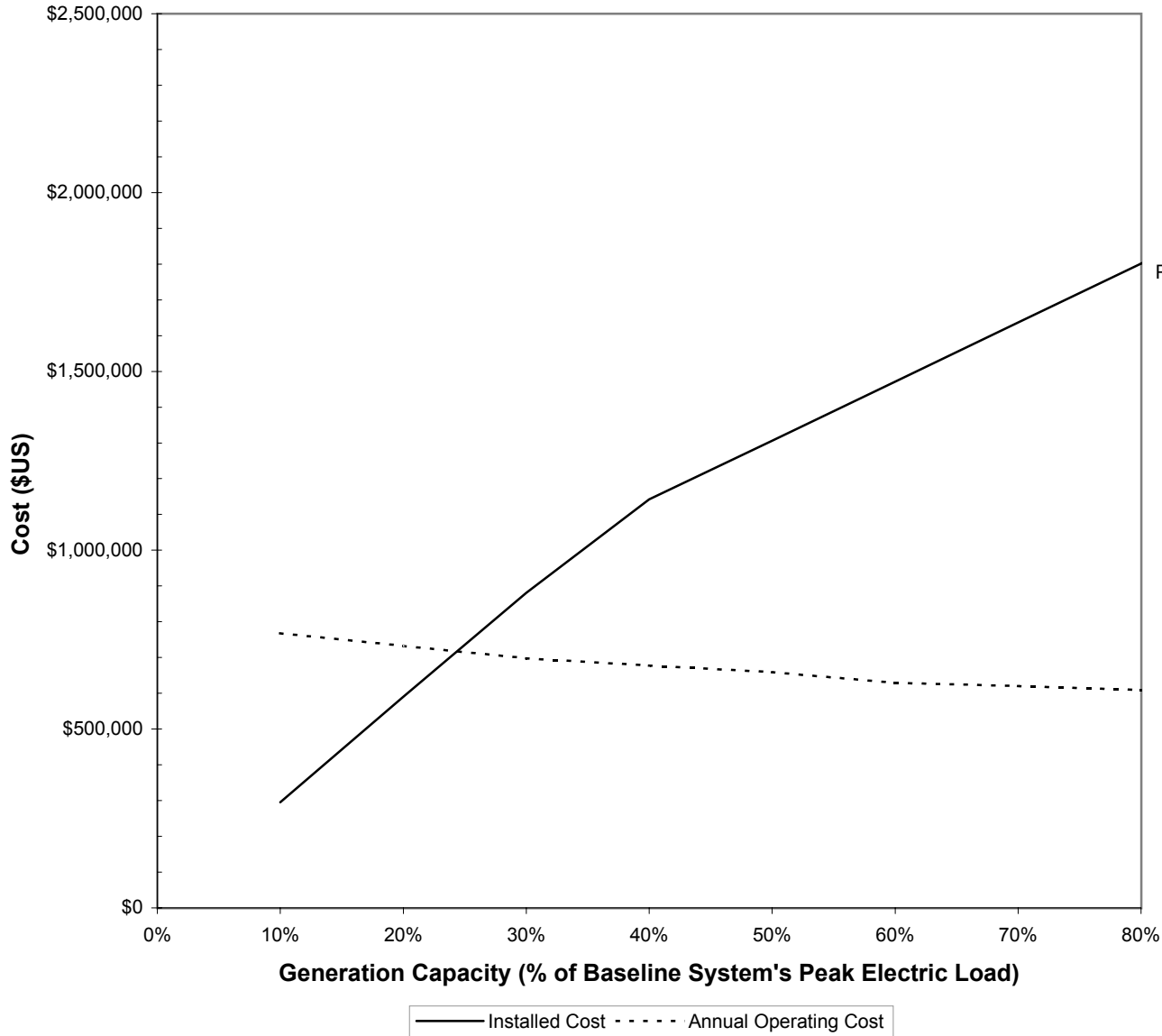

Run Number: 53
Date and Time of Run: 1/17/02 12:32
City Name: New York
Building Type: Office
FloorArea(ft²): 419,000
Baseline Peak Electric(kW): 1,831
Peak Cooling Load (tons): 548
Peak Heating Load (MMBtuH): 6
Generation Technology: 50% Recuperator
Absorption Chiller Type: Double Effect
Fuel Type: Natural Gas
Rate Structure: Con Edison
Control Strategy: Smart

Payback Period

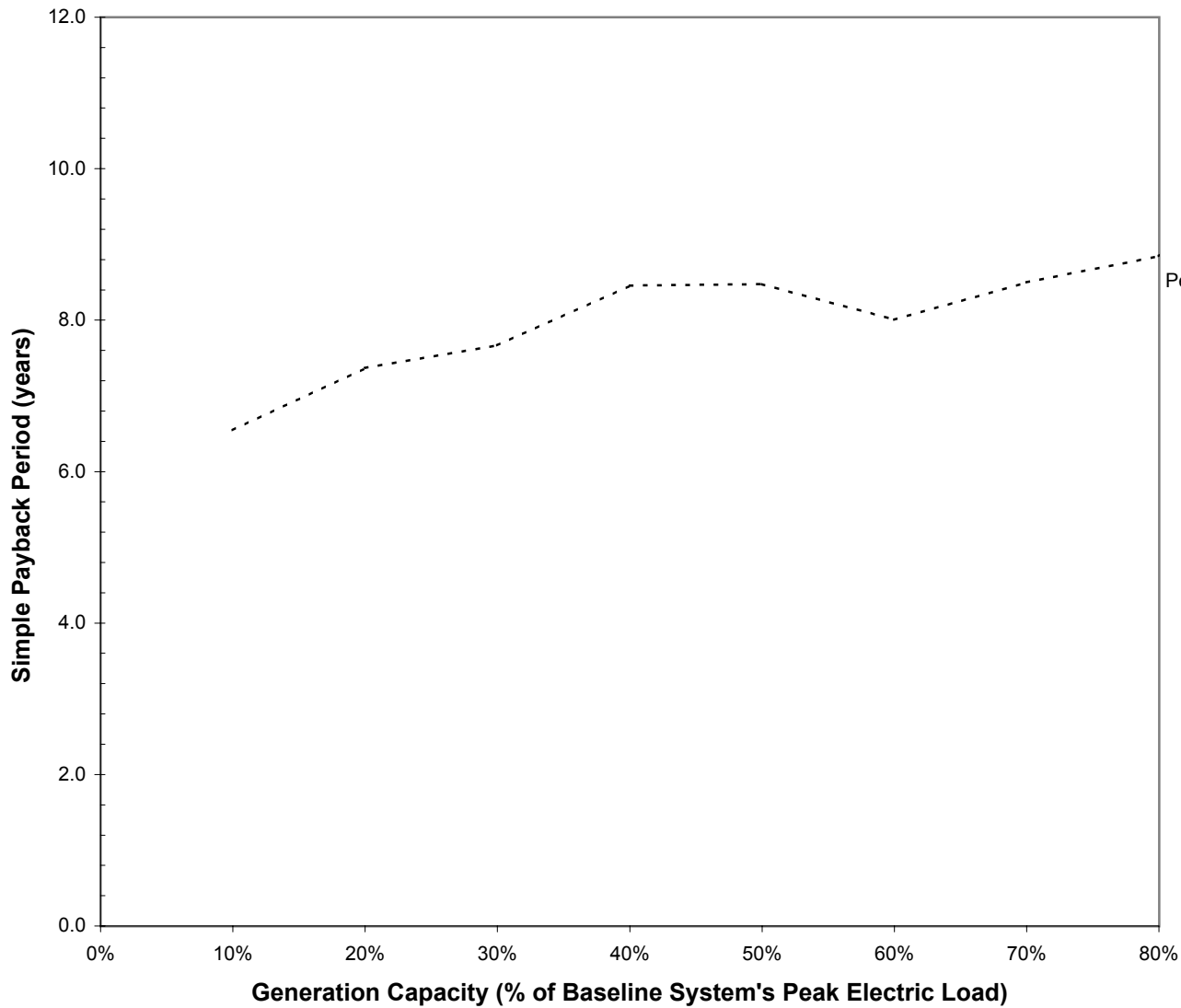

Run Number: 53

Date and Time of Run: 1/17/02 12:32

City Name: New York

Building Type: Office

FloorArea(ft²): 419,000

Baseline Peak Electric(kW): 1,831

Peak Cooling Load (tons): 548

Peak Heating Load (MMBtuH): 6

Generation Technology: 50% Recuperator

Absorption Chiller Type: Double Effect

Fuel Type: Natural Gas

Rate Structure: Con Edison

Control Strategy: Smart

Annual Primary Energy Consumption Breakdown

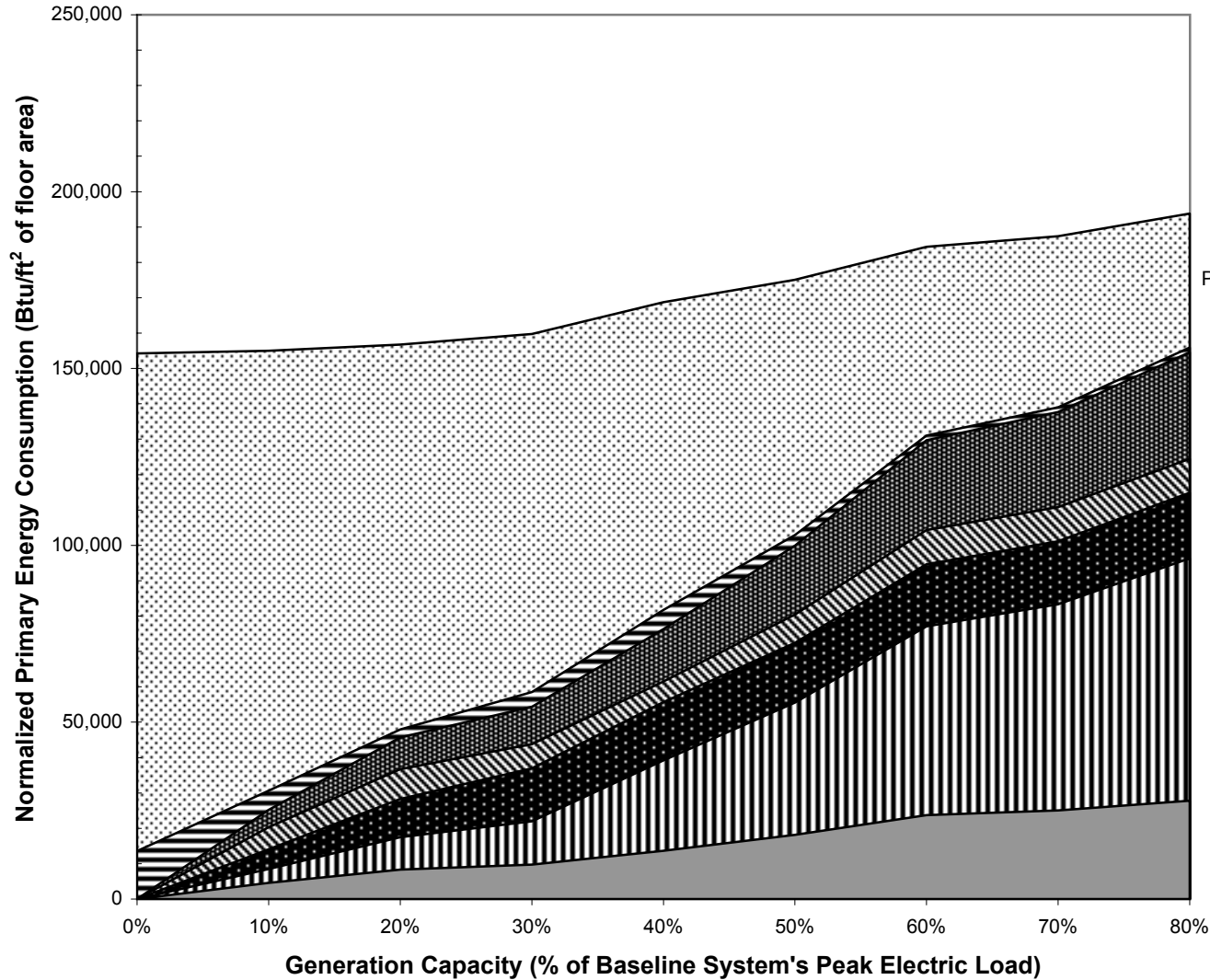

Run Number: 54
 Date and Time of Run: 1/17/02 13:06
 City Name: New York
 Building Type: Office
 FloorArea(ft²): 419,000
 Baseline Peak Electric(kW): 1,831
 Peak Cooling Load (tons): 548
 Peak Heating Load (MMBtuH): 6
 Generation Technology: No Recuperator
 Absorption Chiller Type: Double Effect
 Fuel Type: Natural Gas
 Rate Structure: Con Edison
 Control Strategy: Smart



Installed Cost and Annual Operating Cost

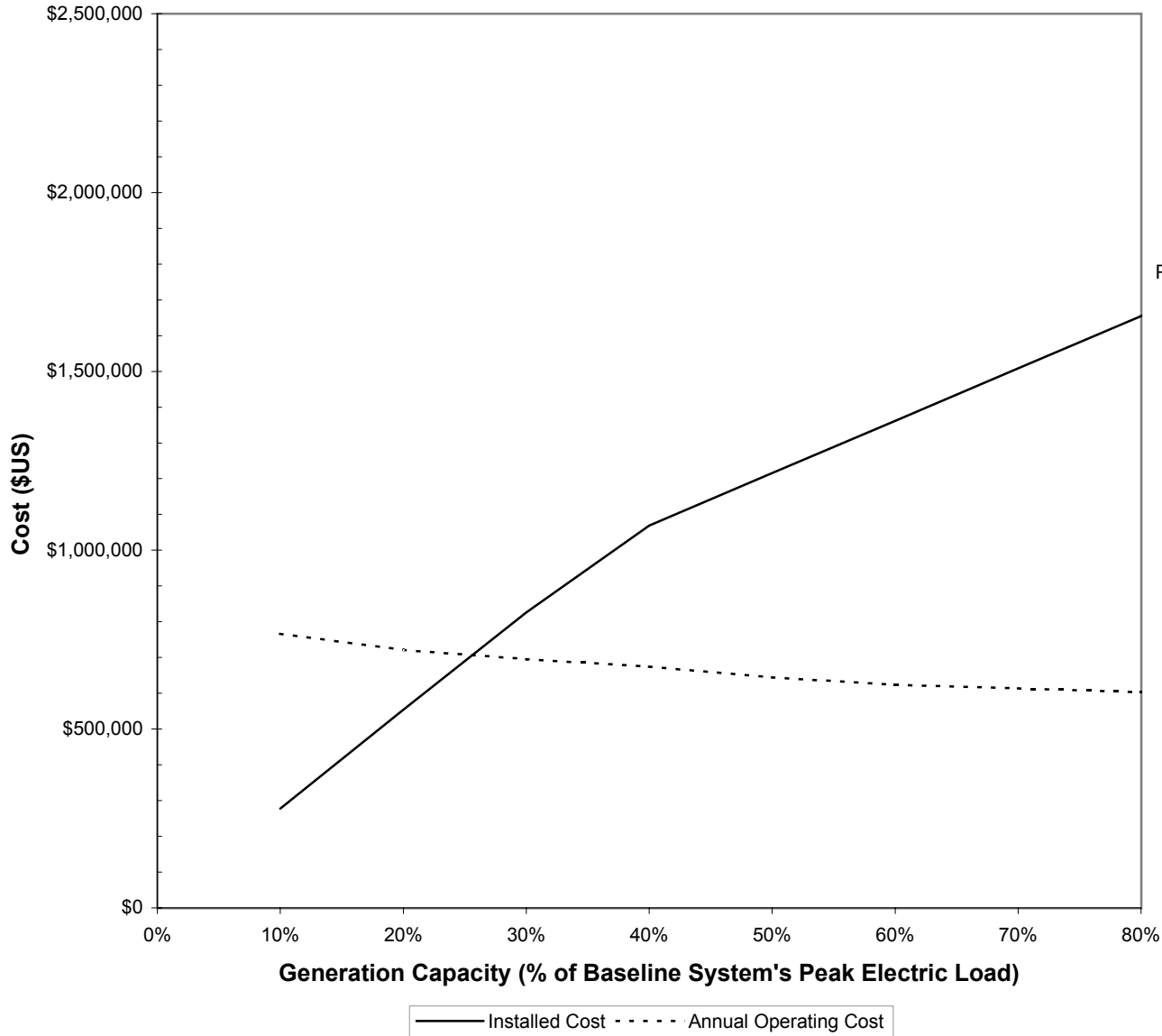

Run Number: 54
Date and Time of Run: 1/17/02 13:06
City Name: New York
Building Type: Office
FloorArea(ft²): 419,000
Baseline Peak Electric(kW): 1,831
Peak Cooling Load (tons): 548
Peak Heating Load (MMBtuH): 6
Generation Technology: No Recuperator
Absorption Chiller Type: Double Effect
Fuel Type: Natural Gas
Rate Structure: Con Edison
Control Strategy: Smart

Payback Period

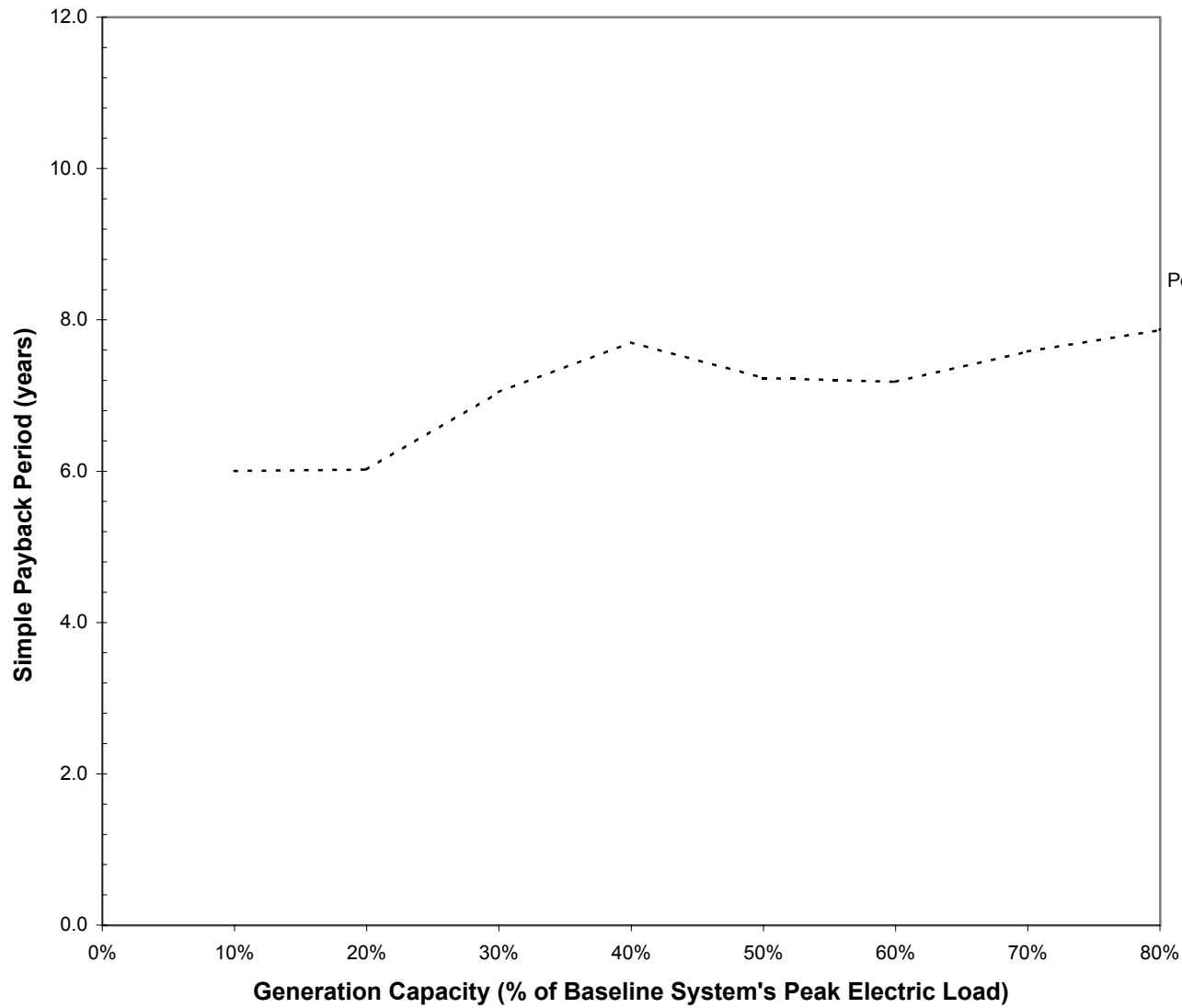

Run Number: 54

Date and Time of Run: 1/17/02 13:06

City Name: New York

Building Type: Office

FloorArea(ft²): 419,000

Baseline Peak Electric(kW): 1,831

Peak Cooling Load (tons): 548

Peak Heating Load (MMBtuH): 6

Generation Technology: No Recuperator

Absorption Chiller Type: Double Effect

Fuel Type: Natural Gas

Rate Structure: Con Edison

Control Strategy: Smart

Appendix H: Recommended Scope and Approach for Phase 2

April 10, 2002

Robert DeVault
Oak Ridge National Laboratory
Building 3147, MS-6070
Oak Ridge, TN 37831-6070

Re: CHP for Buildings Benefits Analysis – Task 6 Final Report – Recommended
Scope for Phase 2
UT-Battelle Subcontract No. 4000008858
ADL Reference 74299

Dear Bob:

The deliverables for Task 6 under the above-referenced subcontract include both a draft report and a final task report. We submitted the draft task report on February 8, 2002. This report constitutes the final task report submittal for Task 6. Relative to the draft report, we now recommend:

- An explicit task targeting industry review and outreach;
- A reduction in the analysis matrix for desiccants; and
- Additional refinements to the Phase 1 analysis, availability of resources permitting, separate from the Phase 2 effort. These additional refinements include an analysis of solid-oxide fuel cells, quantifying premium-power benefits, and other important refinements to the Phase 1 analysis.

The objective of Task 6 is to develop a recommended scope and approach to refining the analysis performed under the current (first) phase of this project. The scope and approach are to be developed in collaboration with DOE, ORNL, and *EXERGY* Partners.

During Project Review Meeting #2 on January 18, 2002, ADL presented some potential activities to be performed under a Phase 2 effort (see Table 1).

Based on feedback received at the meeting, the priorities for Phase 2 (in descending order of importance) are shown in Table 2. Item 1 resulted from discussions about the impact the baseline equipment efficiency has on CHP energy savings and economics. In the Phase 1 analysis, we assumed that the baseline equipment types were water-cooled electric chillers (for cooling) and fuel-fired boilers (for heating). However, if the baseline equipment is packaged rooftop equipment, the baseline equipment efficiencies could be much lower, and CHP would look somewhat more attractive. Item 2 is

Robert DeVault
Oak Ridge National Laboratory

important, as desiccant systems are potentially a very attractive use of waste heat. Item 3 reflects the performance improvements possible with state-of-the-art absorption chillers (not accounting for any performance degradation when used with waste-heat streams). ADL suggested Item 4 (steam turbines). If end users are willing to consider operating a high-pressure boiler on site (which requires a trained and certified operator), steam turbines can generate electricity at very high efficiencies (80 percent or more), assuming that the low-pressure steam is needed for other loads.

Table 1: Potential Phase 2 Activities (Presented at Project Review Meeting #2)

1. Analyze desiccant examples
2. Calculate economics relative to back-up generation baseline (to capture value of power quality and reliability)
3. Enhance fuel cell and engine models (component-based modeling)
4. Account for part-load efficiency degradation and ramp-up/ramp-down characteristics
5. Look into steam turbines
6. Model co-fired absorption chillers (including comparison to a baseline system that includes one or more absorption chillers)
7. Impacts of unscheduled outages – design and operating strategy implications
8. Model additional building types and cities
9. Perform a parametric rate-structure study (various rates in each city)

Table 2: Priorities for Phase 2 (Based on Feedback at Project Review #2)

1. Analyze commercial building applications having rooftop air conditioners for the baseline cooling system. Analyze two types of baseline heating equipment – natural gas heating (gas packs) and electric-resistance heating.
2. Analyze CHP systems using waste heat to regenerate desiccant in desiccant dehumidification systems.
3. Analyze the impact of using double-effect absorption chillers having COPs of 1.3 (rather than 1.1 as used in Phase 1)
4. Analyze CHP systems utilizing steam turbines to generate power.

As discussed below, we recommend reconsideration of some of the Phase 2 priorities established at the Project Review Meeting #2.

April 10, 2002 Page 3

Robert DeVault
Oak Ridge National Laboratory

The proposed change in efficiency of double-effect absorption chiller (Table 2, Item 3) is modest, and will have little impact on the results. Therefore, we do not recommend analyzing Item 3 under the Phase 2 effort.

The steam turbine (Table 2, Item 4), while interesting, may face significant barriers (such as the need for an on-site operator) to broad-based adoption. Therefore, we do not recommend analyzing Item 4 under the Phase 2 effort.

Based on the above, we defined a recommended scope and approach for Phase 2 (see Attachment A).

If additional resources can be made available, there are a number of additional refinements that should be considered. Table 3 lists the highest priority additional refinements (not included in the proposed Phase 2 scope). Table 3 includes Items 2 and 9 from Table 1. Attachment B outlines the scope and approach for the work listed in Table 3.

Table 4 lists further refinements (also not included in the proposed Phase 2 scope) that are of second priority. Table 4 includes the remaining items from Tables 1 and 2, plus other items.

Robert DeVault
Oak Ridge National Laboratory

Table 3: Additional Recommended Refinements, Not Included in Phase 2 – First Priority

Activity	Justification
1. Refine the SOFC model and conduct detailed analyses. (The current model over-predicts the amount of waste heat available.)	SOFC is a very promising generation technology that may provide higher electric generation efficiencies than any other DG/CHP technology currently being considered.
2. Conduct parametric analysis of Phase 1 applications, varying building heating loads and utility rates.	First, the prototypical building loads used in Phase 1 may underestimate water-heating loads. Second, electric energy charges can be very close to the operating costs of a CHP system. Whether energy charges are slightly lower or slightly higher than operating costs can have significant impact on energy savings and economics.
3. Account for the savings associated with avoiding the installation of an emergency back-up power system.	Improved power quality and reliability are significant benefits of DG and CHP systems, yet we do not currently take credit for these benefits for new construction and other applications requiring new provisions for premium power.
4. Base system-sizing approach on net-present value or life-cycle cost (rather than simple payback).	Simple payback calculations do not provide fair comparisons among mutually exclusive investments that have significant differences in first costs.
5. Refine our SOFC model and conduct detailed analyses. (The current model over-predicts the amount of waste heat available.)	SOFC is a very promising generation technology that may provide higher electric generation efficiencies than any other DG/CHP technology currently being considered.
6. Conduct simplified analyses at conditions more closely matching those of the detailed analyses (i.e., use exact matches of average utility rates and equipment efficiencies).	Having a better comparison between the simplified analyses and the detailed analyses will help us understand when simplified analyses can be used, and when they cannot.
7. Incorporate the above into the Phase 1 report, along with expanded discussion of the conclusions and recommendations.	The refinements above will make the final report a more useful tool to guide OPT investment decisions and to educate stakeholders of CHP performance and cost characteristics.

Robert DeVault
Oak Ridge National Laboratory

Table 4: Further Recommended Refinements, Not Included in Phase 2 – Second Priority

1. Enhance fuel cell and engine models (component-based modeling) – From Table 1.
2. Account for part-load efficiency degradation and ramp-up/ramp-down characteristics – From Table 1.
3. Model co-fired absorption chillers (including comparison to a baseline system that includes one or more absorption chillers) – From Table 1.
4. Impacts of unscheduled outages – design and operating strategy implications – From Table 1.
5. Analyze the impact of using double-effect absorption chillers having COPs of 1.3 (rather than 1.1 as used in Phase 1) – From Table 2.
6. Analyze CHP systems utilizing steam turbines to generate power. – From Table 2.
7. Compare building loads (and load profiles) used in Phase 1 to other sources of data for similar building types.
8. Option to recover heat for heating first, then cooling. (Current model uses waste heat for cooling first, then heating.)
9. Modify model to calculate minimum allowable exhaust gas temperature to avoid condensation (rather than assuming a fixed temperature).
10. Analyze use of waste heat to cool microturbine inlet air (via absorption cooling)
11. Determine the reliability and availability of DER relative to conventional emergency generator backup.
12. Refine O&M cost estimates (break into fixed-cost and variable-cost components).
13. Add to the model all additional building types and cities (climate and rates).
14. Analyze net metering scenarios (i.e., allow selling electricity to grid).
15. Evaluate benefits of CHP on T&D infrastructure and Capacity Margin.
16. Verify model against University of MD test results.
17. Analyze applications using waste heat for refrigeration (e.g., supermarkets).
18. Analyze under what utility rate scenarios the “dumb” versus “smart” operating strategy makes a significant difference. The example we chose in Phase 1 (NY rates) doesn’t show much difference.
19. Perform parametric, simplified analysis showing impacts of percent of waste heat utilized.
20. Study impact of real-time pricing, including developing the appropriate operating strategy.
21. Include the impacts of stand-by charges in the economics (report economics both ways).

April 10, 2002 Page 6

Robert DeVault
Oak Ridge National Laboratory

Please do not hesitate to contact me if you have any questions regarding this report.

Very truly yours,

Robert A. Zogg
Senior Manager

Cc: R. Fiskum, DOE/OPT
W. Goetzler, ADL

R. Sweetser, *EXERGY*
R. C. Williams, ADL

W. P. Teagan, ADL
S. Hamilton, ADL

Attachment A to Task 6 Report

Recommended Scope and Approach for CHP Benefits Analysis Phase 2

Purpose

The purpose of this assignment is to extend the analysis performed under Phase 1, *Cooling, Heating, and Power for Buildings (CHP) Benefits Analysis*, as outlined below.

Scope and Approach

The Contractor shall perform the tasks outlined below to complete this assignment. The Contractor shall coordinate closely with key technical experts at ORNL and *EXERGY* Partners, as appropriate, in the execution of this assignment

Task 1: Prepare Project Plan

The Contractor shall prepare a project plan for this assignment, and submit the plan for review and approval. The plan shall indicate, in detail, the allocation of financial and personnel resources, timing of principal events that are to occur during the execution of the assignment, decision points and milestones, technical approach and other items of direct relevance to the timely and successful accomplishment of the project objectives. As part of the project plan, the Contractor shall prepare and submit to the ORNL-TM a quality assurance plan responsive to ORNL QAP-X-90-E-003.

The Contractor shall submit a final project plan reflecting approved resolution of comments from the ORNL-TM review of the draft project plan.

No changes shall be made to the approved project plan without the approval of the ORNL-TM.

Task 2: Analyze Selected CHP Applications that Conventionally Use Rooftop HVAC Equipment

Identify and analyze selected applications for CHP systems that would conventionally use rooftop HVAC equipment. Tentative applications are listed in Table A1.

To perform this analysis, modify the analytical tools developed under Phase 1 to include load profiles for the new building types and to permit the new baseline options. If available, use previously generated building-load databases from sources such as LBNL.

An important consideration for this analysis will be whether a single CHP system interfaces with one, or multiple, rooftop units.

Utilizing waste heat for service water heating may be omitted if water-heating loads are low and/or plumbing logistics are judged to be costly or impractical.

Table A1: Tentative Analysis Matrix for Task 2¹

Run	Building Type ²	City ³	Generator Type
1-2	Large Retail Store (70,000 to 100,000 sq. ft.)	Los Angeles	Standard Microturbine
3-4		Los Angeles	Standard Engine
5-6		New York	Standard Microturbine
7-8		New York	Standard Engine
9-10	Medium Office (approx. 50,000 sq. ft)	Los Angeles	Standard Microturbine
11-12		Los Angeles	Standard Engine
13-14		New York	Standard Microturbine
15-16		New York	Standard Engine

- 1) Repeat matrix for both natural-gas-fired heating and electric heating baselines (16 total combinations). The electric baseline may be either electric resistance or electric heat pump (but not both).
- 2) May substitute alternate building types (such as sit-down restaurant, supermarket, or nursing home), depending on availability of building loads data.
- 3) May substitute alternate cities, depending on availability of building loads data.

Task 3: Analyze Selected CHP Applications using Desiccant Dehumidification

Identify and analyze selected applications for CHP systems that include waste-heat-regenerated desiccant systems. Tentative applications are listed in Table A2.

To perform this analysis, modify the analytical tools developed under Phase 1 to model desiccant dehumidification equipment that can be regenerated using waste heat, including projections for equipment and installation costs, maintenance costs, and relevant performance characteristics.

Table A2: Tentative Analysis Matrix for Task 3¹

Run	Building Type	City	Generator Type
1	Large Hotel	Los Angeles	Standard Microturbine
2		Los Angeles	Standard Engine
3		New York	Standard Microturbine
4		New York	Standard Engine
5	Hospital	Los Angeles	Standard Microturbine
6		Los Angeles	Standard Engine
7		New York	Standard Microturbine
8		New York	Standard Engine

- 1) Baseline systems consist of water-cooled electric chillers and natural-gas-fired boilers (as used in Phase 1).

Task 4: Industry Review and Outreach

After completing Tasks 1 to 3, review the results with selected industry stakeholders, targeting three-to-five stakeholder organizations. Stakeholder organizations may include end users, engineering firms, commercial builders and developers, ESCOs, utilities, other energy service providers, and/or manufacturers. Focus on stakeholders having the greatest influence on CHP installation decisions. Consult with ORNL and *EXERGY* Partners to help identify target stakeholders. If at all feasible, stakeholder reviews should take place in person, at the stakeholders' places of business or at other mutually convenient meeting locations. Based on the review comments received, identify appropriate adjustments to the analysis and documentation, indicating which adjustments can be completed under Phase 2 and which must be deferred to future assignments. Then proceed with the adjustments that can be completed under Phase 2.

Recommend a conference, workshop, or other appropriate forum at which to present the results of this analysis. Upon approval from the ORNL Technical Project Officer and subject to acceptance by the organization sponsoring the conference or workshop, present the results of the analysis. Reflect any additional feedback received during the presentation, as appropriate, in the project final report.

Management and Reporting

The Contractor will submit a detailed management plan that includes (1) a schedule with key milestones identified, (2) a spending plan, and (3) a quality assurance (QA) plan responsive to ORNL QAP-X-90-E-003.

Reporting

A schedule for completing work under each task shall be provided to the Technical Monitor (ORNL-TM) within 5 working days of receipt of approval to start a task.

Monthly reports shall be provided summarizing the work conducted, progress made, problems encountered, and plans for the next reporting period. One written copy of the report and one electronic copy in Microsoft Word 2000 (or other approved compatible format) shall be submitted by the 10th working day of the following month.

Task Reports and Final Report

The following reports shall be submitted:

- Task 1: Draft project plan and final project plan;
- Task 2: Update of Phase 1 report including the analyses performed under Task 2;
- Task 3: Update of Task 2 report including the analyses performed under Task 3; and
- Task 4: Update of Task 3 report including the analyses performed under Task 4. This report will constitute the final report for the project.

Reports for Tasks 1 to 3 need only include those appendices that have been modified. The Task 4 report (final report) shall be complete and comprehensive for both Phases 1 and 2.

Project Review Meeting

The Contractor shall attend at least one project review meeting during the course of this assignment. It is anticipated that the meeting will be held in Washington, DC.

Attachment B to Task 6 Report

Recommended Scope and Approach for Additional Refinements to Phase 1 Analysis

We recommend additional refinement of the Phase 1 analysis, not included in proposed scope and approach for Phase 2, as outlined below.

Refine the Phase 1 analysis to include the tasks listed in Table B1, using the approach described in Table B2.

Table B1: Recommended Additional Refinements to Phase 1 Analysis

Activity	Purpose
1. Solid-Oxide Fuel Cells: Include analysis of SOFC as a generation technology.	Provide analysis of an important generation technology being developed by some major manufacturers. (Because the SOFC model developed under the Phase 1 effort calculated an unrealistically high quantity of waste heat available for heat recovery, SOFC was not included in the Phase 1 documentation.)
2. Parametric Analysis: Conduct parametric analysis of Phase 1 applications, varying building heating loads and utility rates.	Determine the sensitivity of the results to the magnitude of the building heating loads, and to the electric energy charges and natural gas rates
3. Premium Power: Account for the savings associated with avoiding the installation of an emergency back-up power system.	Capture the value of power quality/reliability provided by the CHP system for new-construction applications and other applications requiring new provisions for premium power.
4. System Sizing: Base system-sizing approach on net-present value or life-cycle cost (rather than simple payback).	Approximate more closely the economic criteria applied by most end users.
5. Simplified Analyses: Conduct simplified analyses at conditions more closely matching those of the detailed analyses (i.e., use exact matches of average utility rates and equipment efficiencies).	Provide greater insights into when simplified analyses can be used and when detailed analyses are needed.
6. Documentation: Incorporate the above into the Phase 1 report, along with expanded discussion of the conclusions and recommendations.	Incorporate the above tasks into a document that will guide DOE/OPT decisions and aid in educating stakeholders.

Table B2: Recommended Approach to Additional Refinements to Phase 1 Analysis

Activity	Approach
1. SOFC	Analyze SOFC for 3 building types (Large Office, Large Hotel, and Hospital) and 2 cities (New York and Los Angeles), using the same baseline building systems as used in Phase 1.
2. Parametric Analysis	For heating loads: Analyze 2 new heating load profiles (100% and 200% greater than current model) for the New York Hospital and Large Hotel. 4 new runs. For utility rates: Analyze 3 energy charges (current, higher, and lower) and 3 gas rates (current, higher, and lower) for the New York Large Office Building. 9 runs total – 8 new runs.
3. Premium Power	Estimate the installed cost/kW for an emergency generator with the appropriate UPS system. Estimate the typical portion of building electric load that would be considered “critical” for each of three building types. Calculate the economics of CHP in which the CHP system negates the need for a new emergency back-up system. Check that the CHP system capacity meets or exceeds that needed for critical loads. Do this for: <ul style="list-style-type: none"> • New York and Los Angeles, for three building types and two generation technologies (standard microturbine and standard engine); and • Chicago, for Large Office Building and two generation technologies (standard microturbine and standard engine). Run detailed simulations for these two applications, since they weren’t analyzed in Phase 1.
4. System Sizing	Select the most appropriate economic metric, in consultation with DOE/OPT and ORNL. Repeat the system sizing exercise performed for Phase 1 with the selected economic metric. Generate additional plots to help explain the “optimum” CHP system size, including: a) for each baseline building, hours of operation as a function of electric load; and b) CHP-system capacity factors as a function of generation capacity.
5. Simplified Analyses	Perform simplified analyses to generate primary-energy-intensity curves and economics curves (as a function of generation capacity) for the applications listed under Activity 2 above.
6. Documentation	Update the Phase 1 final report to include the above. Expand upon the conclusions and recommendations in the report, as appropriate, to capture new insights resulting from the above.

The Distributed Energy Program would like to acknowledge Oak Ridge National Laboratory for its Technical Project Input of this Report.

OAK RIDGE NATIONAL LABORATORY

MANAGED BY UT-BATTELLE FOR THE DEPARTMENT OF ENERGY



A Strong Energy Portfolio for a Strong America

Energy efficiency and clean, renewable energy will mean a stronger economy, a cleaner environment, and greater energy independence for America. Working with a wide array of state, community, industry, and university partners, the U.S. Department of Energy's Office of Energy Efficiency and Renewable Energy invests in a diverse portfolio of energy technologies.

For more information contact:

EERE Information Center

1-877-EERE-INF (1-877-337-3463)

www.eere.energy.gov