

ZERO DISCHARGE WASTE BRINE MANAGEMENT FOR DESALINATION PLANTS

FINAL REPORT

University of Texas at El Paso
El Paso, Texas

Agreement Number: 99-FC-81-0181
Desalination Research and Development Program Report No. 89

December 2002

U.S. DEPARTMENT OF THE INTERIOR
Bureau of Reclamation
Technical Service Center
Water Treatment Engineering and Research Group
Denver, CO

REPORT DOCUMENTATION PAGE			Form Approved OMB No. 0704-0188	
Public reporting burden for this collection of information is estimated to average 1 hour per response, including the time for reviewing instructions, searching existing data sources, gathering and maintaining the data needed, and completing and reviewing the collection of information. Send comments regarding this burden estimate or any other aspect of this collection of information, including suggestions for reducing this burden to Washington Headquarters Services, Directorate for Information Operations and Reports, 1215 Jefferson Davis Highway, Suit 1204, Arlington VA 22202-4302, and to the Office of Management and Budget, Paperwork Reduction Report (0704-0188), Washington DC 20503.				
1. AGENCY USE ONLY (Leave Blank)	2. REPORT DATE December 2002	3. REPORT TYPE AND DATES COVERED Final		
4. TITLE AND SUBTITLE Zero Discharge Waste Brine Management for Desalination Plants			5. FUNDING NUMBERS	
6. AUTHOR (S) Andrew H.P. Swift, Huanmin Lu, and Humberto Becerra				
7. PERFORMING ORGANIZATION NAME(S) AND ADDRESS(ES) University of Texas at El Paso El Paso, TX			8. PERFORMING ORGANIZATION REPORT NUMBER DRDP Report No. 89	
9. SPONSORING/MONITORING AGENCY NAME(S) AND ADDRESS(ES) Bureau of Reclamation Denver Federal Center PO Box 25007 Denver CO 80225-0007			10. SPONSORING/MONITORING AGENCY REPORT NUMBER	
11. SUPPLEMENTARY NOTES				
12a. DISTRIBUTION/AVAILABILITY STATEMENT Available from the National Technical Information Service, Operations Division, 5285 Port Royal Road, Springfield, VA 22161			12b. DISTRIBUTION CODE	
13. ABSTRACT (Maximum 200 words) Desalination of brackish water at inland locations must consider environmentally appropriate and cost effective brine concentrate management and/or disposal. The Zero Discharge Waste Brine Management for Desalination Plants project examines a systems approach for desalination/brine management via a Salinity Gradient Solar Pond (SGSP) coupled with a Brine Concentrator and Recovery System (BCRS). The BCRS was tested over a broad range of operational conditions with the thermal energy derived from a SGSP. The relationship between system performance and operating conditions was analyzed to determine the economic and technical viability of the BCRS technology. Mathematical and computer models have been developed to describe the physical behavior of the BCRS and to predict its performance.				
14. SUBJECT TERMS— brackish water, desalination, concentrate management and disposal, brine management, thermal energy, Brine Concentrator and Recovery System, zero discharge waste brine, solar pond			15. NUMBER OF PAGES 41	
			16. PRICE CODE	
17. SECURITY CLASSIFICATION of REPORT UL	18. SECURITY CLASSIFICATION OF THIS PAGE UL	19. SECURITY CLASSIFICATION OF ABSTRACT UL	20. LIMITATION OF ABSTRACT UL	

ZERO DISCHARGE WASTE BRINE MANAGEMENT FOR DESALINATION PLANTS

FINAL REPORT

Andrew H.P. Swift, Huanmin Lu, and Humberto Becerra
University of Texas at El Paso
El Paso, Texas

Agreement Number: 99-FC-81-0181
Desalination Research and Development Program Report No. 89

December 2002

U.S. DEPARTMENT OF THE INTERIOR
Bureau of Reclamation
Technical Service Center
Water Treatment Engineering and Research Group
Denver, CO

**U.S. Department of the Interior
Mission Statement**

The mission of the Department of the Interior is to protect and provide access to our Nation's natural and cultural heritage and honor our trust responsibilities to tribes.

**Bureau of Reclamation
Mission Statement**

The mission of the Bureau of Reclamation is to manage, develop, and protect water and related resources in an environmentally and economically sound manner in the interest of the American public.

Disclaimer

Information contained in this report regarding commercial products or firms was supplied by those firms. It may not be used for advertising or promotional purposes and is not to be construed as an endorsement of any product or firm by the Bureau of Reclamation.

The information contained in this report was developed for the Bureau of Reclamation; no warranty as to the accuracy, usefulness, or completeness is expressed or implied.

ABSTRACT

Desalination of brackish water at inland locations must consider environmentally appropriate and cost-effective brine concentrate management and/or disposal. The Zero Discharge Waste Brine Management for Desalination Plants project examines a systems approach for desalination/brine management via a Salinity Gradient Solar Pond (SGSO) coupled with a Brine Concentrator and Recovery System (BCRS). The BCRS was tested over a broad range of operational conditions with the thermal energy derived from a SGSP. The relationship between system performance and operating conditions was analyzed to determine the economic and technical viability of the BCRS technology. Mathematical and computer models have been developed to describe the physical behavior of the BCRS and to predict its performance.

TABLE OF CONTENTS

	<i>Page</i>
1. Executive Summary	1
2. Background and Introduction to the Project	1
3. Conclusions and Recommendations	3
3.1 Conclusions.....	3
3.2 Recommendations	3
4. Description of Test Facilities.....	4
4.1 Salinity Gradient Solar Pond.....	4
4.2 BCRS Unit.....	7
4.2.1 Equipment Description	7
4.2.2 Process Description	12
5. Work Performed	13
5.1 Modification of the BCRS Unit	13
5.2 Performance Testing	14
5.3 Data Collection	14
6. Results and Analysis.....	17
6.1 Evaporation Rate	17
6.2 Freshwater Production Rate	20
6.3 Energy Consumption Rate	20
7. Mathematical Models.....	22
7.1 Evaporation Chambers.....	22
7.2 Condensation Tower	25
7.3 Comparison with Test Data	27
8. Economic Analysis	29
8.1 Method and Procedure of Cost Analysis.....	30
8.2 Results of Cost Analysis.....	31
8.2.1 Concentration Cost for Hot Evaporation.....	31
8.2.2 Concentration Cost for Cold Evaporation	32
8.2.3 Concentration Cost and Freshwater Production Cost for Hot and Cold Evaporation	32
8.2.4 Costs of a Zero Discharge System with BCRS	33
8.3 Comparison With Alternative Disposal Methods	36
9. References	39
10. List of Symbols	40

Appendix—Summary of Test Data

Tables

	<i>Page</i>
1 Operating conditions of the BCRS unit	14
2 List of process variables for measurement at the BCRS	15
3 Evaporation rates	18
4 Evaporation rates in hot evaporation chamber.....	18
5 Evaporation rates in cold evaporation chamber	18
6 Condensation rate	21
7 Energy consumption rate	21
8 Differential equations for evaporation	24
9 Calculated coefficient of performance for evaporation.....	25
10 Differential equations for condensation.....	26
11 Calculated coefficients of performance for condensation	27
12 Assumed operating conditions for hot evaporation	31
13 Estimated concentration costs for hot evaporation	31
14. Assumed operating conditions for cold evaporation	32
15. Estimated concentration costs for cold evaporation.....	32
16. Assumed operating conditions for condensation.....	33
17. Estimated costs for hot and cold evaporation as a stand-alone unit.....	33
18. Costs of produced water with zero discharge system.....	34
19. Costs of produced water with deep well injection.....	37
20. Costs of produced water with evaporation ponds	37
21. Costs of produced water with crystallizer	38
22. Comparison of produced water costs	38

Figures

	<i>Page</i>
1. Schematic of zero discharge desalination system.....	5
2. El Paso Solar Pond	5
3 Specific gravity profile of El Paso Solar Pond	5
4 Temperature profile of El Paso Solar Pond	6
5 Temperature development of El Paso Solar Pond.....	6
6 BCRS unit.....	7
7 Schematic of the BCRS unit and piping system	8
8 Basin of the cold evaporation chamber	9
9 End section of the hot evaporation chamber	9
10 The spray net at the hot evaporation chamber	10
11 Spray nozzles at the top of the packed condensation duct	10
12 Mist eliminators in the cooling jackets	1
13 Intermediate heat exchanger.....	12
14 Heat exchange for cooling water conveyed to condensation tower.....	13
15 Process flow diagram of the BCRS testing system.....	16
16 Daily averaged evaporation rate	17
17 Evaporation rate versus salinity.....	19
18 Evaporation rate versus humidity	19
19 Evaporation rate versus brine temperature	20

Figures (continued)

	<i>Page</i>
20 Daily averaged condensation rate.....	21
21 Sketch of flowchart of the evaporation chamber	23
22 Mass interactions in the evaporation chambers	23
23 Energy and mass interactions in the condensation tower.....	25
24 Comparison between calculated data and experimental data for evaporation	28
25 Comparison between calculated data and experimental data for condensation.....	29
26 Flowchart of zero discharge system.....	34
27 Marginal concentration costs	35
28 Comparison of produced water costs	38

1. EXECUTIVE SUMMARY

Limited fresh water supplies represent a serious constraint to the development and continued viability of inland communities in states of the arid Southwestern United States. In many of these communities, there are abundant supplies of brackish groundwater that can be utilized if appropriate methods of desalination and brine concentrate management or disposal can be developed. This project addresses these issues by examining a systems approach for desalination/brine management, using a Salinity Gradient Solar Pond (SGSP), coupled with a Brine Concentrator and Recovery System (BCRS). This project involved comprehensive testing and analysis of a BCRS that was reconstructed and modified from a brine concentrator. The BCRS was tested over a broad range of operational conditions, with the thermal energy derived from a SGSP. The relationship between system performance and operating conditions was analyzed to determine the economic and technical viability of the BCRS technology. Mathematical and computer models have been developed to describe the physical behavior of the BCRS and to predict its performance.

This research provides useful data and information for developing zero discharge waste brine management for desalting plants. These data and information are also useful for improving the design of a BCRS, which is driven by low- or medium-temperature heat sources.

2. BACKGROUND AND INTRODUCTION TO THE PROJECT

Desalination of brackish water at inland locations must consider not only the equipment and energy required to drive the process, but also environmentally appropriate and cost-effective brine concentrate management and/or disposal. This project addresses both of these major issues for inland locations by examining a SGSP coupled with a BCRS.

Combining the BCRS with the SGSP technology and other desalination technologies can lead to a "zero discharge" desalination process [1]. From a system viewpoint, the BCRS is the final stage in a multi-process desalination and concentrate management system. Initially, more efficient desalination technologies (such as membrane treatment) or multi-stage flash systems (such as multi-effect, multi-stage [MEMS] desalination units) would be applied to desalinate brackish waters as shown in the systems diagram (figure 1). The SGSP-BCRS would represent the final stage in the process, with the reject concentrate from the primary desalination process providing makeup water to the SGSP, which, in turn, provides feed brine for the BCRS. The BCRS is driven by thermal energy from the SGSP, producing additional fresh water and a near-slurry salt discharge. The salt discharge is then used to recharge the solar pond, adding to SGSP capacity, or is processed as chemicals for use or sale. This systems approach addresses two critical environmental issues for inland desalting plants: (1) reusing the brine concentrate, thereby negating the need for disposal (zero discharge); and (2) providing additional pollution-free renewable energy for the desalting process.

The major objective of this project is to examine the systems approach for desalination/brine management, using a SGSP coupled with a BCRS, and to determine its technical and economic feasibility. The scope of work of this project is as follows:

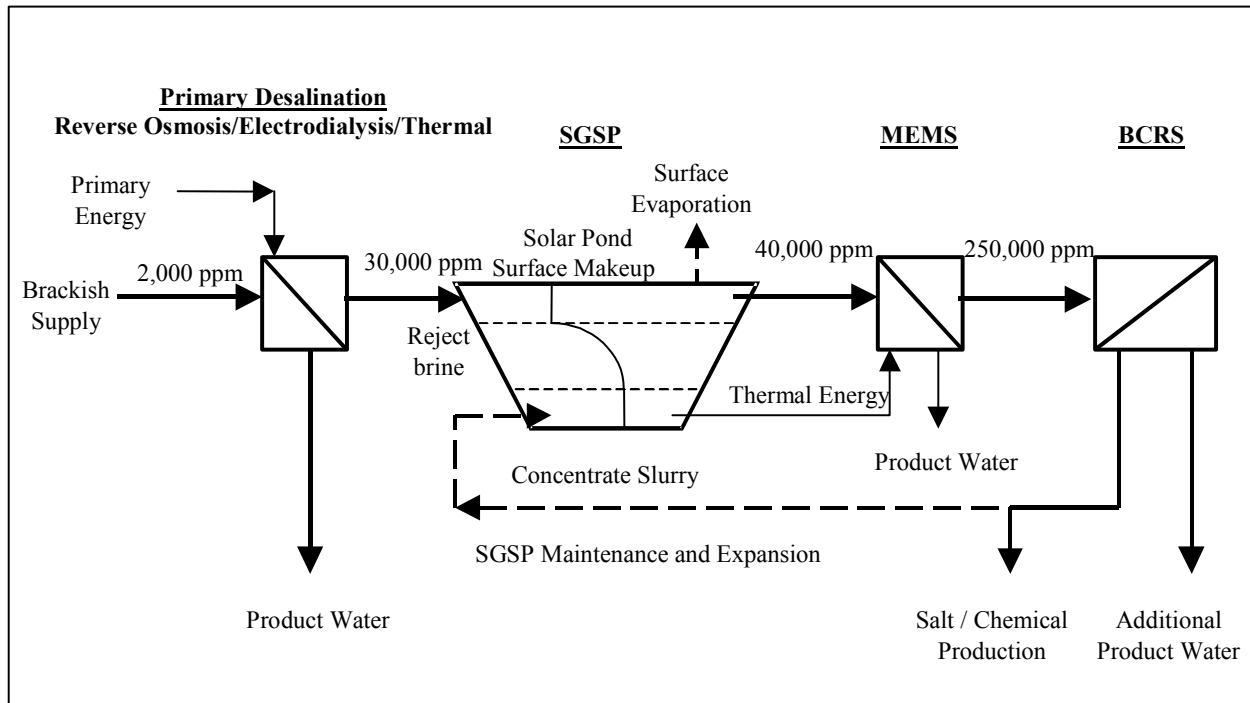

Figure 1.—Schematic of zero discharge desalination system.

- Testing the BCRS over a broad range of operating conditions, including heat input variation from the SGSP, brine temperature variation (typically 40-70 °C), and various ambient air conditions.
- Analyzing test data and establishing experimental correlations between system performance and operating conditions.
- Establishing the physical theory related to the thermodynamics and heat and mass transfer of the processes involved, using appropriate mathematical expressions.
- Developing a numerical model and a computational program to characterize and predict the equipment performance.

This project has a positive impact on the environment for both the short term and long term. Brine concentrates are managed and reused for energy and/or chemical production from excess recovered salts, rather than being classified as waste and disposed of. The information derived from the testing will also be useful for improving the design of the brine concentration and recovery systems.

3. CONCLUSIONS AND RECOMMENDATIONS

3.1 CONCLUSIONS

- BCRS unit was modified and tested over a broad range of operating and ambient conditions with heat supply from a salinity gradient solar pond.
- The BCRS produces concentrated salt slurry, which can be used to recharge the solar pond. The BCRS is essential for accomplishing the concept of zero discharge desalination.
- The evaporation rates of the BCRS unit ranged from 330 to 605 liters per hour (LPH) (90 to 160 gallons per hour, GPH). These evaporation rates are equivalent to the ones of evaporation ponds of 1,600 to 2,900 m² (0.4 to 0.7 acre) at the climate conditions of El Paso, Texas.
- The hot evaporation chamber contributes 60 to 88 percent of the total evaporation of the unit.
- The evaporation rate of the BCRS unit is affected by ambient conditions and brine concentration. It increases with lower relative humidity, higher dry-bulb ambient temperature, and lower brine concentration. The evaporation rate in the hot chamber also increases with higher brine temperature.
- A portion of the feed water to the BCRS can be recovered. The freshwater production rate of the BCRS unit ranged from 25 to more than 115 liters per hour (LPH) (30 gallons per hour [GPH]). The freshwater recovery ratio (defined as the ratio of volumetric flow rate of fresh water produced to the volumetric flow rate of feed brine into the system) ranged from 10 to 26 percent.
- Computer-based models have been developed to describe the concentration process in both hot and cold evaporation chambers and the condensation process in the condensation tower. With these models and experimental data, relationships between operating conditions and performance of the BCRS unit have been developed. These relationships can be used to predict the performance and to modify the design of the BCRS.
- No scaling and fouling problems were found during the test period.

3.2 RECOMMENDATION

- Further study is needed to improve the nozzle system, so as to optimize the evaporation rate, while reducing required flow rate of brine, and, hence, to reduce the electricity consumption rate.
- The heat transfer efficiency of the condensing tower must be improved to increase the freshwater recovery ratio.

- The structure of the BCRS must be redesigned for easier salt removal.
- As thermal energy cost represents about 60 percent of the operation cost for hot evaporation, further review of the design and operation of the heat exchangers is recommended. Also, because the BCRS is an intensive consumer of electrical energy but an effective brine concentrator, it is advisable to explore the use of alternative hybrid systems to supply the power as noted by Farid [3].

4. DESCRIPTION OF TEST FACILITIES

4.1 SALINITY GRADIENT SOLAR POND

A salinity gradient solar pond is a body of water that collects and stores solar energy. Generally, it has three regions (from top to bottom): (1) the upper convective zone (UCZ) (also called surface zone); (2) the main gradient zone (MGZ); and (3) the lower convective zone (LCZ). The UCZ is a homogeneous layer of low-salinity brine or fresh water, and the LCZ is a homogeneous, concentrated salt solution that can be either convecting or temperature stratified. In between is the nonconvective MGZ, which constitutes a thermally insulating layer in which the salinity increases with depth [4]. Insulation is then absorbed and stored in the lower levels of the pond with operating temperatures in the range of 60 to 90 °C. SGSPs have the potential to produce low-cost thermal energy from a renewable source at large scale for industrial applications, including desalination.

The El Paso Solar Pond (shown in figure 2) is a research, development, and demonstration project operated by the University of Texas at El Paso and funded by the Bureau of Reclamation and the State of Texas. The project, which is located on the property of Bruce Foods, Inc., a food canning company, was initiated in 1983. The El Paso Solar Pond has been operated since 1985. It was the first solar pond in the world to deliver industrial process heat to a commercial manufacturer in 1985, the first solar pond electric power generating facility in the United States in 1986, and the Nation's first experimental solar pond powered water desalting facility in 1987. The pond has a surface area of 3,000 square miles (m^2) (0.75 acre) and a depth of about 3.25 meters (m) (10.7 feet [ft]). The thicknesses of its UCZ, MGZ, and LCZ are approximately 0.7 m (2.3 ft), 1.2 m (3.9 ft), and 1.35 m (4.4 ft), respectively. Figures 3 and 4 show the typical density and temperature profiles of the pond, respectively. An annual temperature plot for both LCZ and UCZ is shown in figure 5, based on the years 1991 to 1993. For comparison, the average ambient temperature is also shown in figure 5. The operation temperature of the pond ranged from 70 °C in winter to 90 °C in early fall. The highest temperature observed at the El Paso Solar Pond during these years was 93 °C, and the maximum temperature difference between the LCZ and UCZ was well above 70 °C. The observed temperatures in the storage zone at the bottom of the pond were influenced by ambient conditions and heat removal to operate testing equipment and generate electricity.



Figure 2.—El Paso Solar Pond.

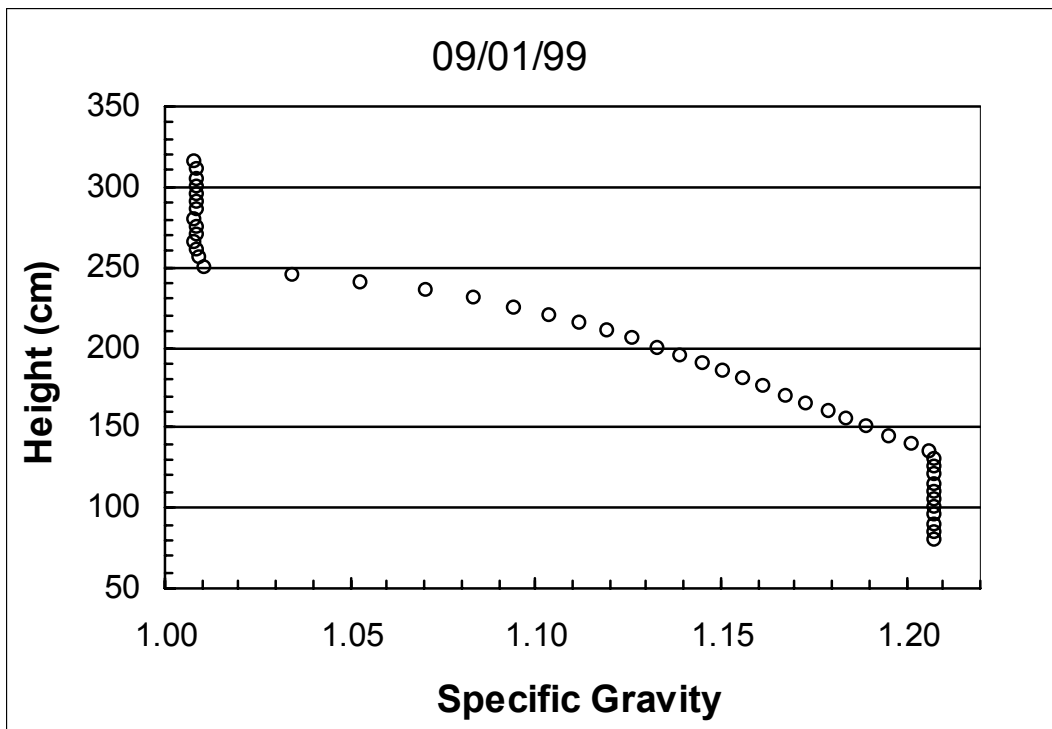

Figure 3.—Specific gravity profile of El Paso Solar Pond.

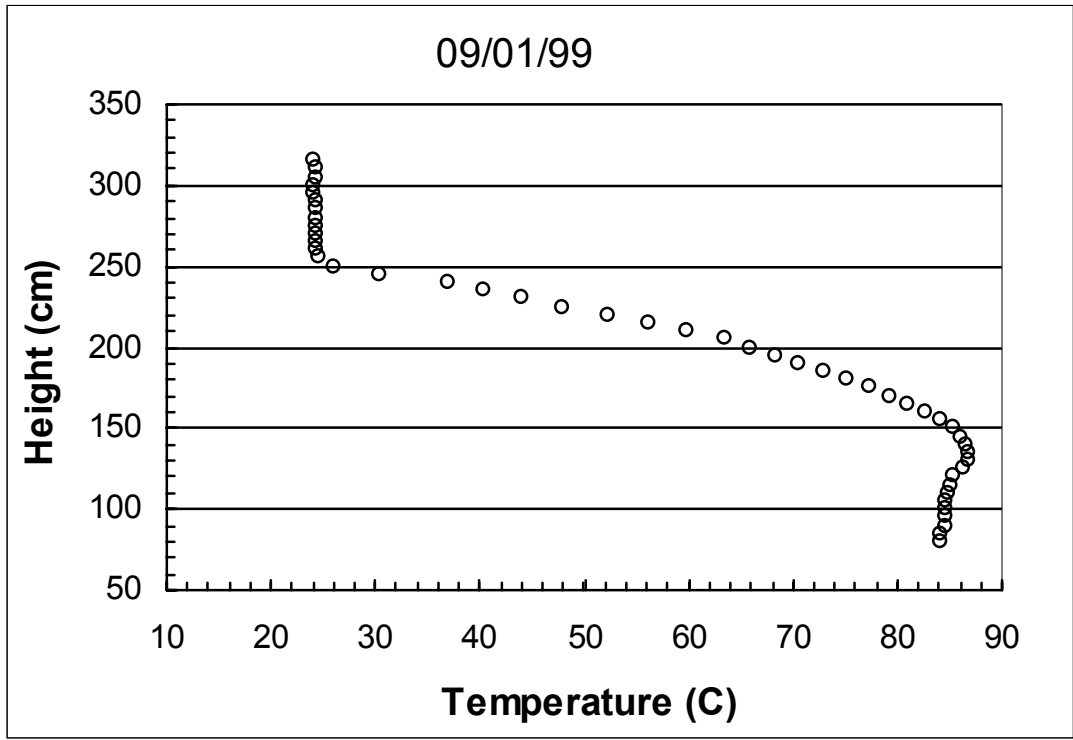

Figure 4.—Temperature profile of El Paso Solar Pond.

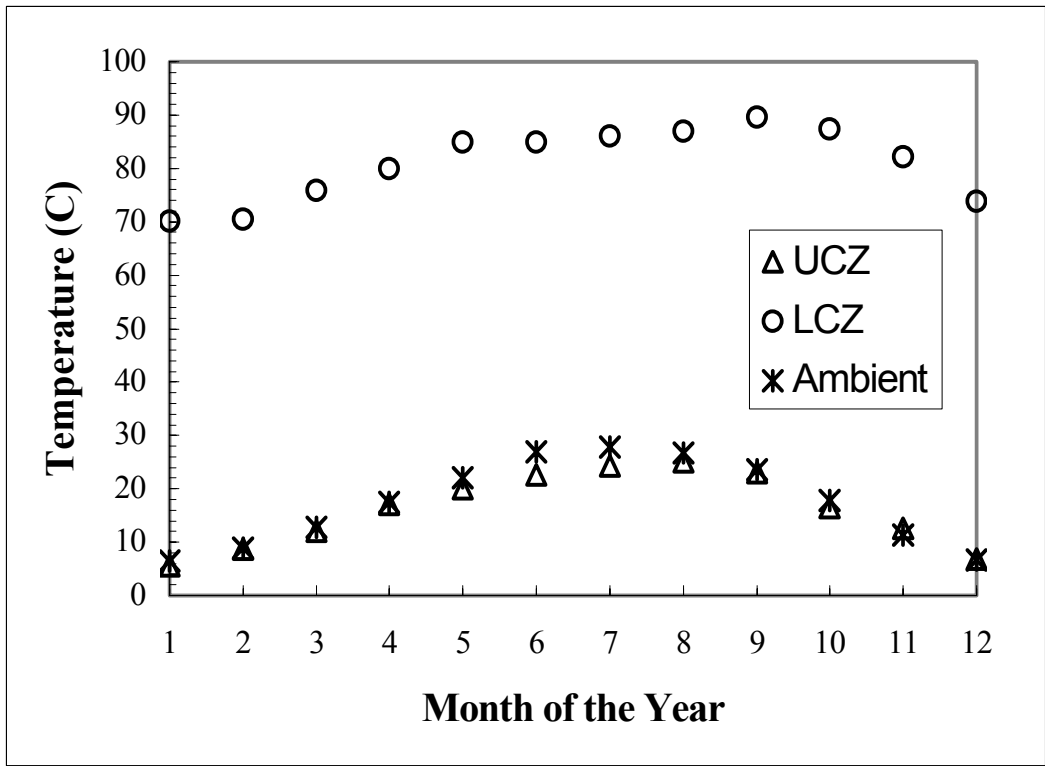

Figure 5.—Temperature development of El Paso Solar Pond.

4.2 BCRS UNIT

4.2.1 Equipment Description

The BCRS tested in this project (shown in figure 6) is a unit that was reconstructed from a brine concentrator designed by Frontier AquaDynamic and Environmental Ingenuity Group [5]. The brine concentrator was originally designed to use moderate temperature thermal energy to drive evaporative concentration of saline waste streams. In addition, the BCRS incorporates a condensation tower to recover some fresh water. Figure 7 shows a schematic of the BCRS. The BCRS consists of an approximately 40-foot-long evaporation chamber box supporting a 30-foot-high condenser tower for condensate water recovery. The major components of the BCRS are described as follows.

Evaporation Chamber Box.—The evaporation chamber box consists of a hot evaporation chamber and a cold evaporation chamber. Both hot and cold evaporation chambers are constructed in a similar way and formed by a basin, walls, ceiling, and spray nozzles. As shown in figure 7, the outer ends of both



Figure 6.—BCRS unit.

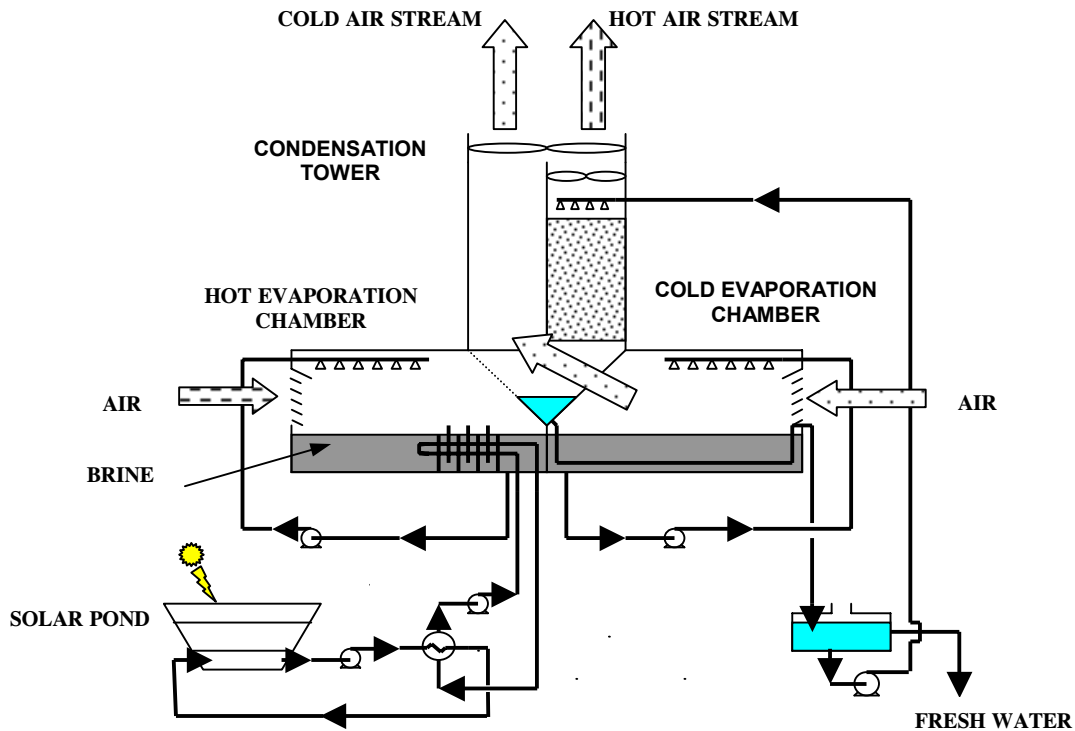

Figure 7.—Schematic of the BCRS unit and piping system.

hot and cold evaporation chambers (i.e., the two ends of the evaporation chamber box) are open inlets for air streams. The air outlets for both hot and cold evaporation chambers are at the inner ends of the two chambers. The hot air outlet duct is at the center of the evaporation chamber, and the cold air exits from two sides of the hot air outlet, so that the two air streams are separated from each other without mixing. The major difference between the two evaporation chambers is that there is an inside heat exchanger in the hot evaporation chamber, but not in the cold evaporation chamber. The inside heat exchanger is installed at the inner end of the hot evaporation chamber basin and is used to heat the brine in the hot chamber. The inside heat exchanger is constructed of 26 copper tubes arranged in 8 passes. Hot water flows inside the copper tubes of the heat exchanger and heats the brine in the hot evaporation chamber basin, which flows across the outside of the copper tubes. The brine in the cold evaporation chamber is not heated, and the cold chamber acts like an evaporative cooler. A polyvinyl chloride (PVC) pipe connects the basins of both evaporation chambers, allowing brine to flow from the hot evaporation chamber into the cold evaporation chamber by gravity. Figure 8 shows the basin of the cold evaporation chamber. Figure 9 shows a view of the inner end of the hot evaporation chamber, including the inside heat exchanger and the air exit to the condensation tower. A picture of the spray nozzles is shown in figure 10.

Condensation Tower.—The condensation tower consists of a packed condensation duct for direct-contact heat and mass transfer between cold water (product water) and the entering hot air stream. The packing material filled in the condensation duct is film-type and made of formed cellulose sheets. A set of nozzles, as shown in figure 11, was installed above the packing material. Through the nozzles,



Figure 8.—Basin of the cold evaporation chamber.



Figure 9.—End section of the hot evaporation chamber.

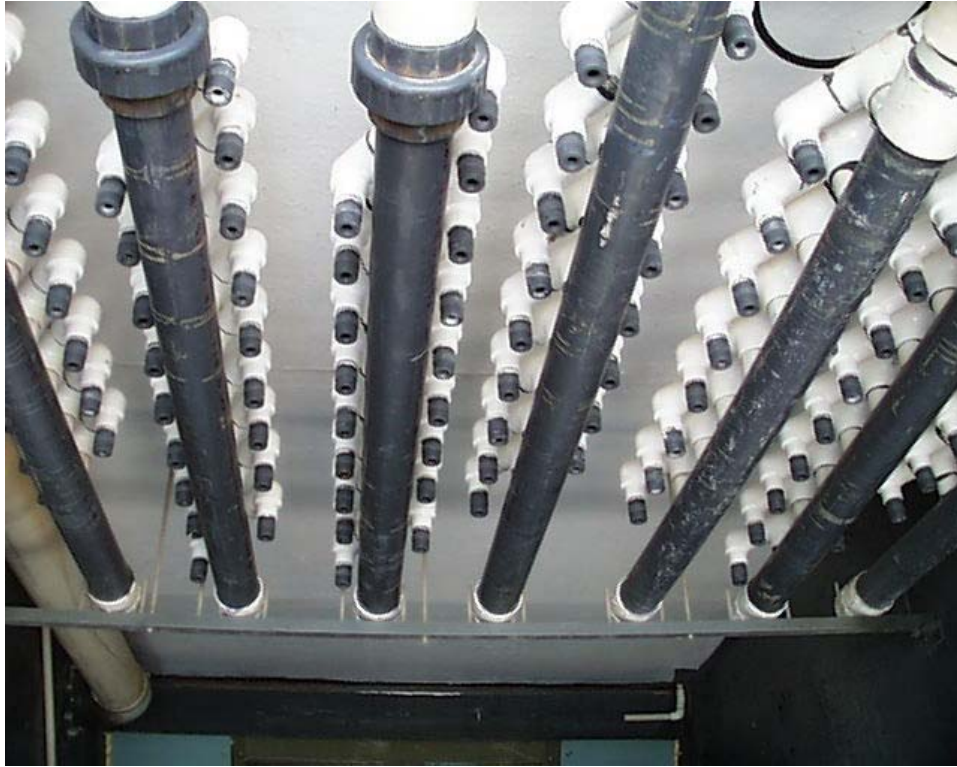

Figure 10.—The spray net at the hot evaporation chamber.



Figure 11.—Spray nozzles at the top of the packed condensation duct.

cooled product water is sprayed downward and circulates through the packed section by gravity towards the freshwater basin. The condensation duct is jacketed to allow an auxiliary cooling process using the cold air stream. This jacket covers three walls of the condensation duct. An inside view of the cooling jacket at the condensation tower is presented in figure 12, where mist eliminators are installed to prevent salt contamination from brine droplets in the cold air stream.



Figure 12.—Mist eliminators in the cooling jackets.

Fan System.—The fan system is installed at the top of the condensation tower. It consists of a big fan and a small fan. The big fan is used for both hot and cold air streams, and the small fan is used for the hot air stream only. A filtering mesh is installed at the inlet of the hot air stream, and mist eliminators are installed for each stream. In addition, drift eliminators are installed at the exit of the condensation tower.

Pumping Systems.—There are three major pumping systems: (1) the brine pumping system; (2) the condensate pumping system; and (3) the heat supply pumping system. The brine pumping system consists of two identical brine circulation pumps: one for each evaporation chamber. The brine pumping system is used to circulate the brine in the evaporation chamber basins and spray the brine into the air streams through the nozzles installed on the ceiling of the evaporation chambers. The condensate pumping system is used to circulate the condensate passing through a cooling heat exchanger, and to spray the cooled condensate into the hot air stream through the nozzles installed at the top of the condensation tower, in order to recover more condensate. This pumping system consists of two pumps, which are connected in parallel, a flowmeter, and associated piping systems. The heat supply pumping system is used to supply heat from the solar pond to the feed brine in the hot evaporation chamber. This pumping system is a closed loop, which consists of two pumps, the inside heat exchanger in the hot evaporation chamber, a shell-and-tube heat exchanger (also called an intermediate heat exchanger), an expansion tank, and associated piping systems. Working fluid (water)

is circulated in the closed system, is heated in the shell-and-tube heat exchanger by the hot brine from the solar pond, and then transfers heat to the brine in the basin of the hot evaporation chamber. A picture of the intermediate heat exchanger is shown in figure 13.



Figure 13.—Intermediate heat exchanger.

To reduce the corrosion problems in the BCRS, fiberglass is used for main assembly parts, although some steel is also used to provide structural rigidity. Fiberglass and plastic materials are used for auxiliary components such as fan blades, louvers, drift eliminators, curtains, and basins. Plumbing is done with PVC piping and fittings.

4.2.2 Process Description

Air enters from two sides of the unit: the warm side (hot evaporation chamber) and the cold side (cold evaporation chamber). The warm side receives the initial brine to be evaporated. Heat derived from the SGSP is then added into the brine in the hot evaporation chamber through the inside heat exchanger. The heated brine is pumped by the brine circulation pump and sprayed from the nozzles. The brine is sprayed in a cross-flow pattern through circulated atmospheric air. A lower airflow rate, lower salinity, and higher temperature all act to increase the vapor pressure of water on the warm side as compared to the cold side. The warmed, moist air exits up a plenum in the center of the condensation tower. The cold evaporation chamber receives brine by gravity feed from the hot evaporation chamber and sprays the brine droplets into an air stream, somewhat like an evaporative cooler. During normal operation, the brine in the cold side is saturated and slurry salt can be obtained. No heat exchangers are present in the cold side, which helps to prevent fouling and scaling problems. The cold side air exits on the outside of the central stack warm air plenum. Condensation occurs in the warmed air stream as heat is transferred through the plenum walls to the cold air and through direct contact with

recycled cold product water when it passes through the packed condensation duct. Condensate is collected in the freshwater basin and cooled to the air temperature of the cold side through a heat exchanger.

Because the BCRS operates at low temperature levels, it can utilize low grade heat, such as solar, geothermal, and waste heat, thereby eliminating high energy costs. Scaling and fouling are common problems for conventional brine concentrators. However, the BCRS is designed to avoid these problems by operating at low temperature levels and causing evaporation to occur in mid-air. The advantage of the system is that it can process very high concentration brines using no chemicals, other than pH control.

5. WORK PERFORMED

5.1 MODIFICATION OF THE BCRS UNIT

The BCRS unit was constructed in 1998, and preliminary testing began in 1999. Based on the results and experience of the preliminary test, the unit has been modified prior to or during conducting the performance test of this project in order to improve its performance. Also, its instrumentation system has been improved. Major modifications and improvements are as follows:

- Improved the mist elimination device in the warm side to protect product water from saline contamination.
- Installed mist elimination curtains in the cold side
- Designed, constructed, and installed a heat exchanger in the cold side of the BCRS unit for cooling the condensate (see figure 14) and to improve thermal efficiency and water recovery.



Figure 14.—Heat exchange for cooling water conveyed to condensation tower.

- Improved the baffle plate system to prevent brine from spraying out of the unit
- Installed a product water tank
- Installed temperature and relative humidity sensors in the unit
- Installed several flowmeters for monitoring the flow rates of hot brine from the solar pond, feed saline water into the BCRS, and produce fresh water.
- Installed a data acquisition system for automated data recording

5.2 PERFORMANCE TESTING

Performance tests were conducted from May through November 2000. The BCRS unit was tested under a broad range of operating conditions with feed brine at different salt concentrations. Table 1 summarizes the ranges of operating conditions. The controlled operating parameters include: (1) heat supply to the hot evaporation chamber (and, hence, brine temperature in the hot evaporation chamber); (2) flow rate of fresh water into the condensation tower; and (3) salt concentration of feed water. The feed waters were local brackish water and saline waters from the solar pond surface zone and the evaporation pond adjacent to the BCRS unit. The salinity of the feed brine ranged from 3 percent to near saturation (3,000 to 300,000 milligrams per liter [mg/L] in total dissolved solids [TDS]). In order to get a relatively steady-state condition for each individual test, these parameters were maintained relatively stable during each test. Spray flow rates of brine and airflow rates in both evaporation chambers were not adjustable, and they were determined by the exiting piping systems and the capacities of brine pumps or fan system.

Parameter	Range
Ambient condition	
Dry bulb temperature (°C)	11 ~ 35
Relative humidity (%)	7 ~ 52
Brine temperature in the hot side (°C)	30 ~ 44
Brine temperature in the cold side (°C)	12 ~ 24
TDS of feedstock (mg/L)	3,000 ~ 300,000

5.3 DATA COLLECTION

Table 2 lists the major parameters for this testing. The reference numbers under the “STATE” correspond to the numbers indicated in the process-flow diagram (figure 15). Data was collected using the data acquisition system LABTECH®. A sample of the raw-data sheets is included in appendix A. It should be mentioned that not all of the parameters listed in table 2 were directly measured in the testing, because of the limitation of BCRS reconstruction and availability of instruments. Instead of being directly measured, some of the parameters were derived from other measured parameters. These derived parameters include flow rate and brine temperature at the spray nozzles, and the airflow rate through the evaporation chambers and condensation tower. The airflow rate was derived from the average air velocity at the entrance of each evaporation chamber and cross sectional areas of the entrances. A hot wire anemometer was used to measure the air velocity at different entry points.

Table 2.—List of process variables for measurement at the BCRS

Fluid		Process variables for measurement			
Name	State	Name	Required	Measured	Derived
Ambient air	0	Dry bulb temperature	■	■	
	0	Wet bulb temperature	■	■	
	0	Relative humidity	■	■	
Hot air	1	Dry bulb temperature	■	■	
	1	Mass flow rate, moist	■		■
	2	Dry bulb temperature	■	■	
	2	Relative humidity	■	■	
	3	Dry bulb temperature	■	■	
	3	Relative humidity	■		
Cold air	6	Dry bulb temperature	■	■	
	6	Mass flow rate, moist	■		
	7	Dry bulb temperature	■	■	
	7	Relative humidity	■	■	
	8	Dry bulb temperature	■		
	8	Relative humidity	■		
Fresh water	13	Temperature	■	■	
	13	Volume flow rate	■	■	
	13	Mass flow rate	■		■
	14	Temperature	■	■	
	10	Temperature	■	■	
	16	Specific gravity	■	■	
	16	Volume flow rate	■	■	
	16	Volume accumulated	■		■
Hot chamber spraying brine	16	Mass flow rate	■		■
	18	Temperature	■	■	
	18	Specific gravity	■	■	
	20	Temperature	■		
	20	Volume flow rate	■		
Cold chamber spraying brine	20	Mass flow rate	■		
	22	Temperature	■	■	
	22	Specific gravity	■	■	
	24	Temperature	■		
Feed brine	24	Volume flow rate	■		
	24	Mass flow rate	■		
	17	Specific gravity	■	■	
	17A-H	Volume accumulated	■	■	
	17B-C	Volume accumulated	■	■	
Heat source brine	17	Volume accumulated	■		■
	17	Mass flow rate (average)	■		■
	26	Temperature	■	■	
	26	Volume flow rate	■	■	
	26	Mass flow rate	■		■
Heating water	27	Temperature	■	■	
	28	Temperature	■	■	
	28	Volume flow rate	■	■	
	28	Mass flow rate	■		■
	29	Temperature	■	■	

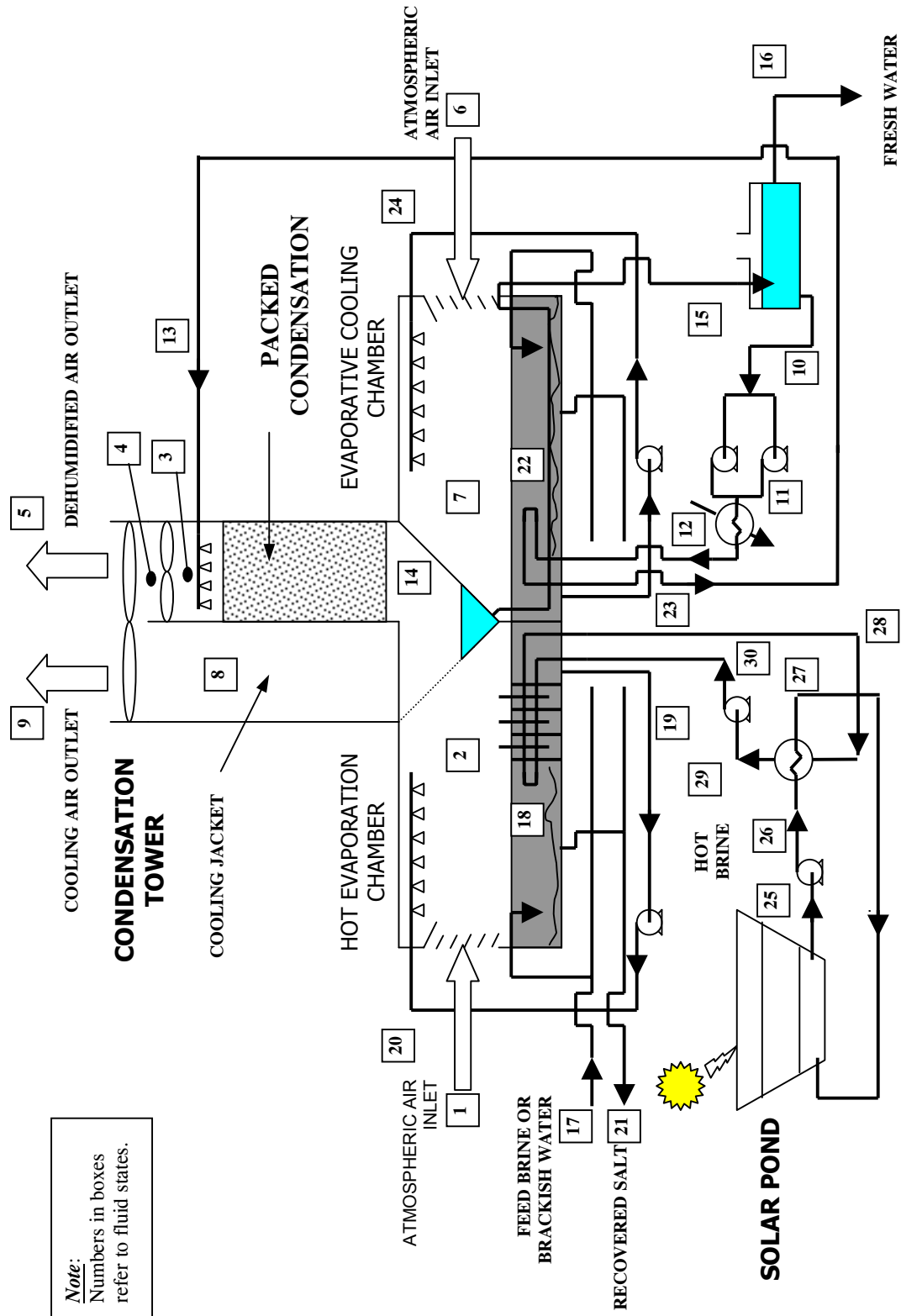

Figure 15.—Process flow diagram of the BCERS testing system.

6. RESULTS AND ANALYSIS

Based on the data collected, the following parameters were analyzed:

- Evaporation rate of the BCRS unit
- Freshwater production (condensation) rate and recovery ratio
- Heat input from the solar pond
- Energy consumption rate

6.1 EVAPORATION RATE

Figure 16 shows evaporation rates of both evaporation chambers for the tests performed from September through November 2000. Table 3 shows the minimum, maximum, and average evaporation rates observed for the same time period. The evaporation rates of the BCRS unit ranged from 330 to 605 liters per hour (LPH) (90 to 160 gallons per hour [GPH]). These evaporation rates are equivalent to the rates of evaporation ponds of 1,600 to 2,900 square miles (m²) (0.4 to 0.7 acre) at the climate conditions of El Paso, Texas. The contribution of the hot evaporation chamber to the total evaporation ranges from 60 percent to 88 percent, depending on the ambient and process conditions.

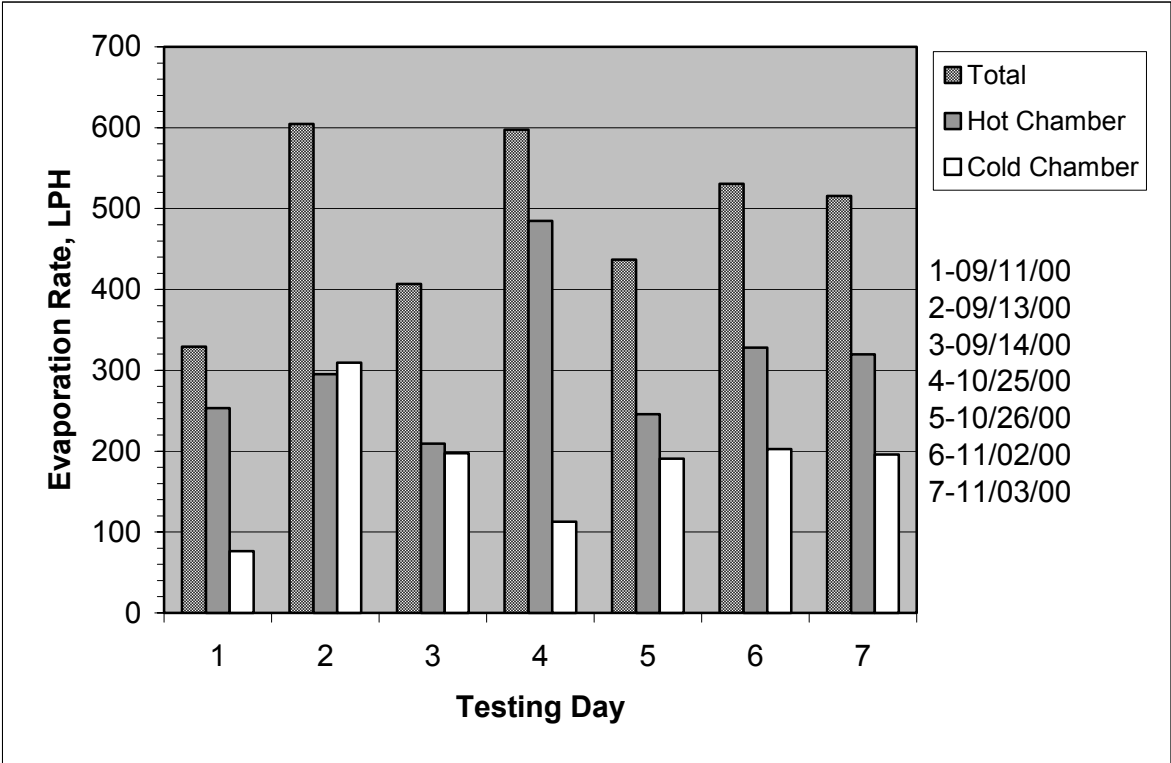

Figure 16.—Daily averaged evaporation rate.

Table 3.—Evaporation rates

	Minimum		Maximum		Average	
	LPH	GPH	LPH	GPH	LPH	GPH
Hot chamber	209	55	485	128	291	77
Cold chamber	76	20	310	82	177	47
Total	329	87	605	160	489	129

Tables 4 and 5 show evaporation rates and corresponding operating conditions for the hot evaporation chamber and cold evaporation chamber, respectively (where T_{ad} and T_{aw} are dry bulb and wet bulb ambient temperatures, respectively). Note that the evaporation rates of both evaporation chambers of the BCRS unit are affected by ambient conditions and brine concentration. As shown in figures 17 and 18, respectively, the evaporation rates decrease with higher salinity and higher relative humidity. In the hot evaporation chamber, the evaporation rates increase with higher brine temperature (see figure 19).

Table 4.—Evaporation rates in hot evaporation chamber

Date	T_{ad}	T_{aw}	RH	Brine T	Salinity	Evap. rate
	(C)	(C)	(%)	(C)	(%)	LPH
9/11/00	31.8	16.8	23.0	40.0	15.60	274
9/13/00	33.0	16.0	17.0	42.0	26.00	310
9/14/00	31.6	16.8	23.5	40.0	24.00	255
10/25/00	21.0	12.4	40.0	37.0	3.50	445
10/26/00	21.3	13.1	42.0	34.0	4.00	297
11/2/00	17.5	10.5	45.0	32.0	4.60	330
11/3/00	16.0	10.8	48.0	34.0	5.00	346

Table 5.—Evaporation rates in cold evaporation chamber

Date	T_{ad}	T_{aw}	RH	Brine T	Salinity	Evap. rate
	(C)	(C)	(%)	(C)	(%)	LPH
9/11/00	31.8	16.8	23.0	20.0	26.5	102
9/13/00	33.0	16.0	17.0	23.0	26.5	301
9/14/00	31.6	16.8	23.5	22.0	26.4	226
10/25/00	21.0	12.4	40.0	18.0	26.4	106
10/26/00	21.3	13.1	42.0	18.0	26.4	143
11/2/00	17.5	10.5	45.0	14.5	26.4	156
11/3/00	16.0	10.8	48.0	15.0	26.4	122

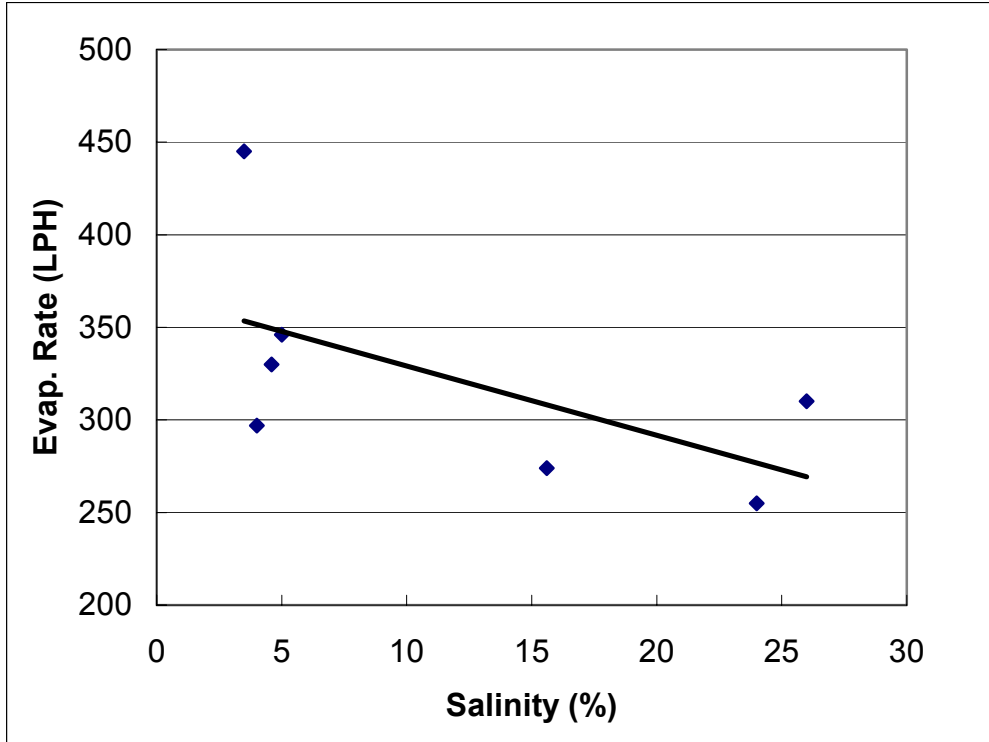

Figure 17.—Evaporation rate versus salinity.

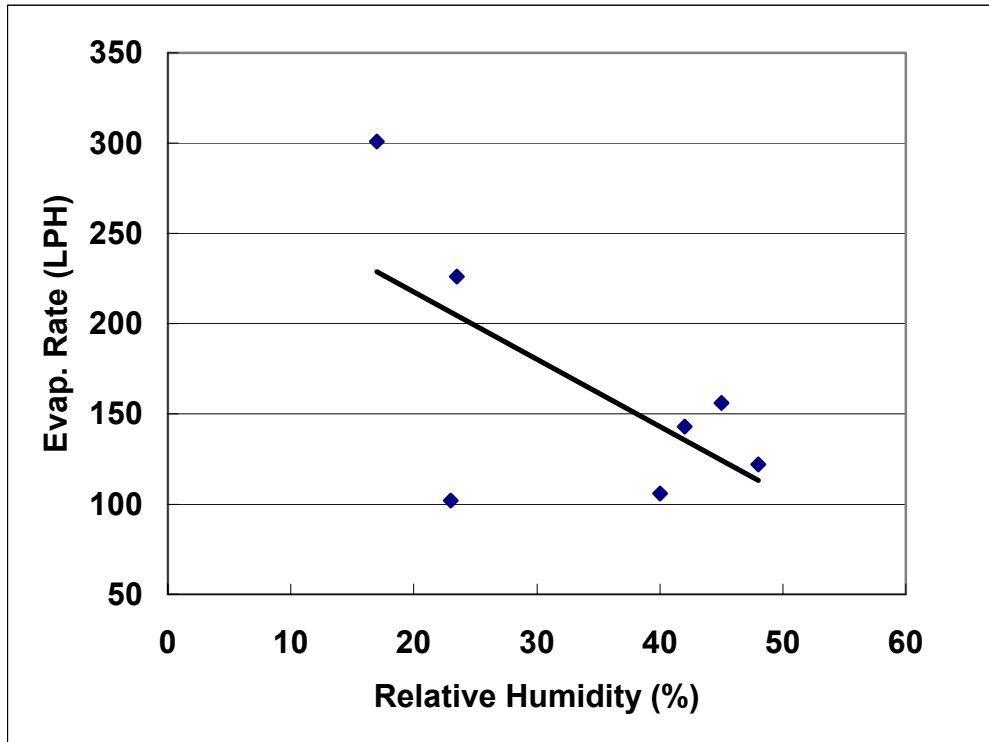

Figure 18.—Evaporation rate versus relative humidity.

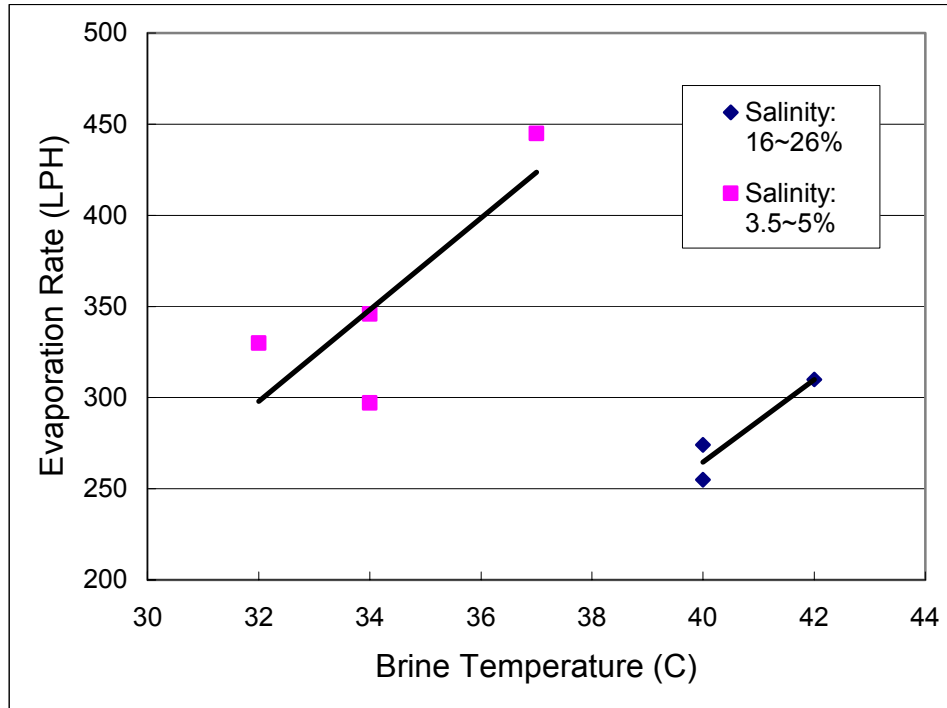

Figure 19.—Evaporation rate versus brine temperature.

6.2 FRESHWATER PRODUCTION RATE

Figure 20 shows the freshwater production rates (condensation rate) of the BCRS unit for the test period of May through November 2000. In September 2000, a copper tubing heat exchanger was installed in the cold evaporation chamber. This heat exchanger used the brine of the cold chamber to cool the product water before it was sprayed at the top of the condensate tower. It can be seen that the addition of the heat exchanger improved the condensation rate. With the heat exchanger, the condensation rate ranged from 52 to 115 LPH (14 to 30 GPH). The freshwater recovery ratio (defined as the ratio of volumetric flow rate of fresh water produced to the volumetric flow rate of feed brine into the system) ranged from 10 to 26 percent. Table 6 shows the minimum, maximum, and average condensation rates for the test period of September through November 2000. It was found that the condensation rate is significantly affected by ambient and process conditions.

6.3 ENERGY CONSUMPTION RATE

The BCRS requires both thermal energy and electricity. Thermal energy is required to heat the brine in the hot evaporation chamber, and electrical energy is needed to operate pumps, fans, and auxiliary equipment. Energy consumption rates (both thermal and electrical) of the BCRS were analyzed, based on average evaporation or condensation rates, and typical operating conditions. In this analysis, thermal energy consumption was calculated with measured data, but the electrical energy consumption was estimated by nominal powers of each piece of electric equipment. The estimated energy consumption rates are shown in table 7. The energy consumption rates are given in kilowatthours per unit mass of water evaporated (for evaporation) or produced (for condensation).

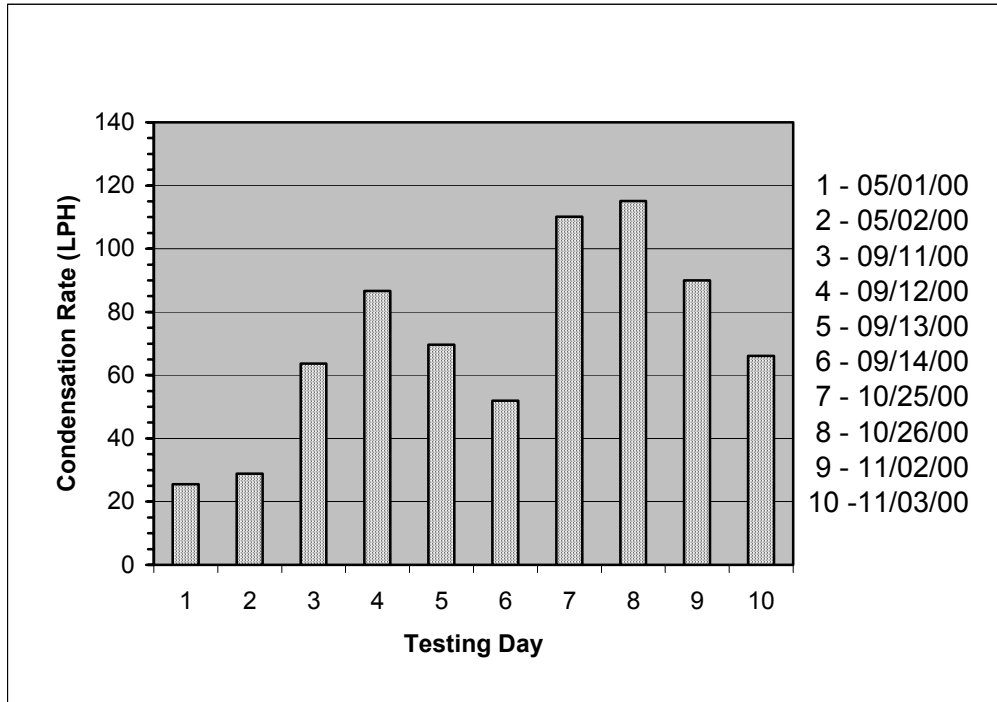

Figure 20.—Daily averaged condensation rate.

Table 6.—Condensation rate

Minimum		Maximum		Average	
LPH	GPH	LPH	GPH	LPH	GPH
25	7	115	30	71	19

Table 7.—Energy consumption rate

	Power kW	Specific kWh/kg
Hot chamber		
Average evaporation: 291 LPH (0.0808 kg/s)		
Thermal consumption: at 757 LPM (200 GPM), $\rho = 1,159 \text{ kg/m}^3$, $c_B = 4,167 \text{ J/kg-}^\circ\text{C}$, and $\Delta T = 10 \text{ }^\circ\text{C}$	609	2.093
Electrical consumption	35	0.122
Thermal plus electrical energy consumption for hot evaporation chamber:	644	2.215
Cold chamber		
Average evaporation: 177 LPH (0.0492 kg/s)		
Electrical consumption:	21	0.072
Total energy consumption for both evaporation chambers:	665	2.287
Condensation tower		
Average condensation: 71 LPH (0.0197 kg/s)		
Electrical consumption	13	0.183
Total energy consumption for condensation (including evaporation chambers):	678	9.560

Note: kW = kilowatt, kWh/kg = kilowatthours per kilogram; kg/s = kilograms per second; kg/m^3 = kilograms per cubic meter.

7. MATHEMATICAL MODELS

Computer based mathematical models have been developed to describe the evaporation process in both evaporation chambers and the condensation process in the condensation tower. These models are based on the thermodynamic analysis of heat and mass transfer for evaporation or condensation processes. The evaporation process analysis utilized the generally accepted concepts for cooling towers, and the condensation analysis utilized the concepts for direct-contact condensers. Variables involved in the models include the properties and flow rates of different fluids such as air, brine, and fresh water, and the geometries of evaporation chambers and condensation tower. The computer models were built in the form of a spreadsheet (MS Excel), and can be easily used to simulate the evaporation process and condensation process of the BCRS. With these models and experimental data, relationships between operating conditions and performance of the BCRS unit have been developed. These relationships can be used to predict the performance and to modify the design of the BCRS. This report provides only a brief description of these models. For more details about the models, see Becerra [6].

7.1 EVAPORATION CHAMBERS

A two-dimensional model was used for the thermodynamic analysis of the evaporation chambers. Figure 21 shows a sketch of the flow diagram in the evaporation chamber, and figure 22 shows the mass transfer diagram in the evaporation chamber. Where \dot{m} denotes corresponding mass flow rate, subscripts a , v , B , and S denote dry air, vapor, brine, and salt, respectively, and subscripts i and e denote inlet or outlet, respectively. At the top of the evaporation chamber, brine is sprayed into a low-humidity air space, creating many near-spherical brine droplets, and a relatively stagnant air film forms on the brine droplet surface. For simplification, it is assumed that the size of a brine droplet is small enough so that its temperature can be considered to be uniform. The temperature of the air film is approximated to the temperature of the droplet. It is also assumed that the air film is saturated at a vapor concentration corresponding to the temperature and salinity of the brine droplet.

Steady state operation conditions are also assumed in the modeling. Thus the mass flow rates of air, sprayed brine, feed brine, and salt, as well as the composition of the brine remain constant during the process. The dry air and water vapor are considered as ideal gases. The brine is treated as a pure aqueous solution of sodium chloride. The changes in kinetic and potential energy of the fluids are assumed to be negligible.

Direct-contact heat and mass transfer process was used to analyze the evaporation process, and four differential equations, as shown in table 8, were derived; where K is the mass transfer coefficient, and a is the heat transfer surface area per unit volume of brine droplets. These equations were used to determine the two-dimensional distribution of the specific humidity, hot air temperature, cold air temperature, and salinity in the evaporation chambers. For details of the derivation of these equations, see Becerra [6].

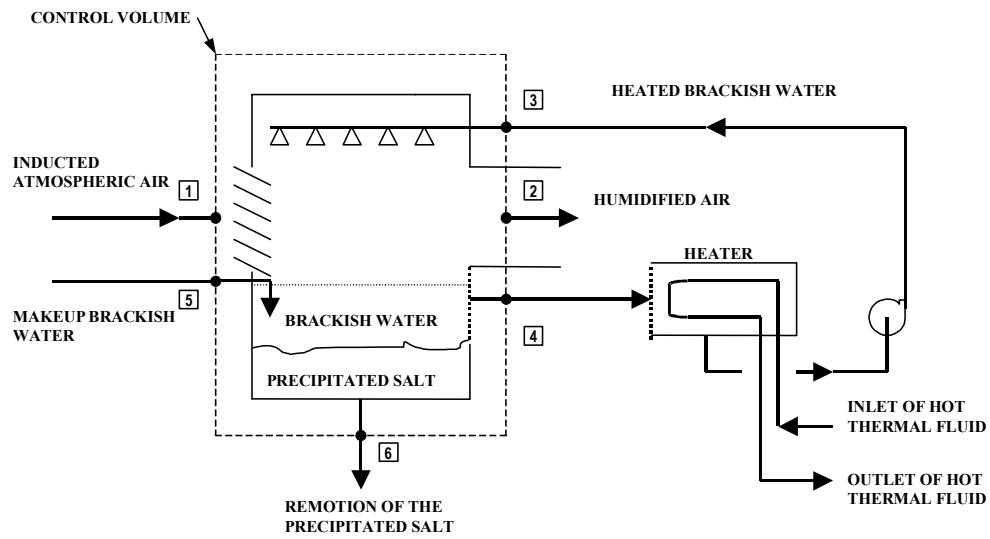

Figure 21.—Sketch of flowchart of the evaporation chamber.

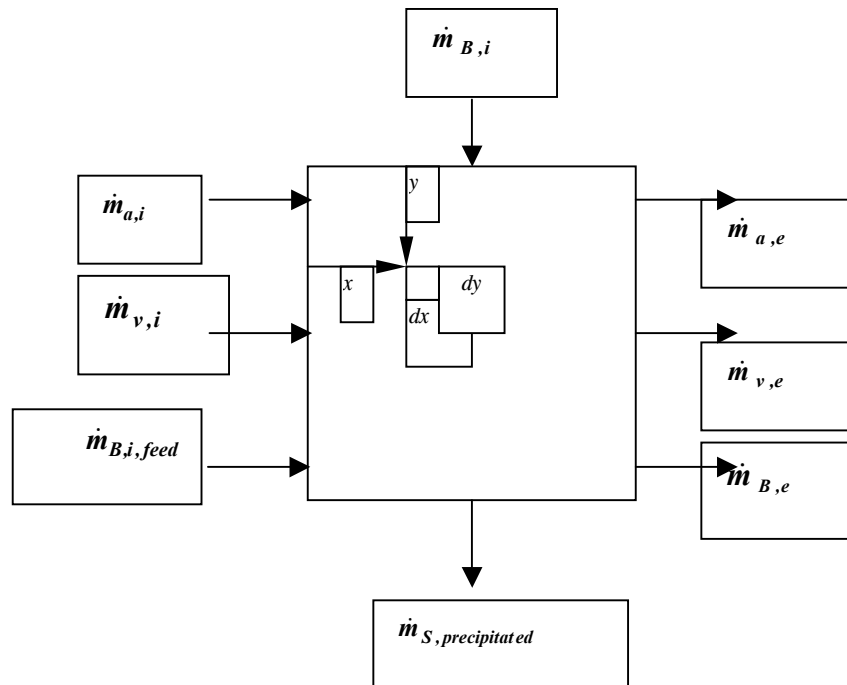

Figure 22.—Mass interactions in the evaporation chambers.

Table 8.—Differential equations for evaporation

Specific humidity	$\int_0^X \frac{\partial \omega_a}{\partial x} dx + \int_0^Y \frac{\partial \omega_a}{\partial y} dy = \frac{1}{\dot{m}_a} \int_0^V K a (\omega_{af} - \omega_a) dV$
Brine temperature	$\int_0^X \frac{\partial T_B}{\partial x} dx + \int_0^Y \frac{\partial T_B}{\partial y} dy = \int_0^V \frac{[h_H a (T_B - T_a) + K a (\omega_{af} - \omega_a) h_{fg}]}{\dot{m}_B c_B} dV$
Air temperature	$\int_0^X \frac{\partial T_a}{\partial x} dx + \int_0^Y \frac{\partial T_a}{\partial y} dy = \int_0^V \frac{[h_H a (T_B - T_a) + K a (\omega_{af} - \omega_a) h_{fg}]}{\dot{m}_a (c_{p,a} + \omega_a c_{p,v})} dV$
Salinity	$\int_0^X \frac{\partial}{\partial x} \left(\frac{1}{S} \right) dx + \int_0^Y \frac{\partial}{\partial y} \left(\frac{1}{S} \right) dy = \frac{1}{\dot{m}_S} \int_0^V K a (\omega_{af} - \omega_a) dV$

Based on these equations, a dimensionless coefficient, KaV / \dot{m}_B , called the coefficient of performance, was derived as shown in the following equation:

$$\frac{KaV}{\dot{m}_B} = \int \frac{(1+S)c_B}{[(h_{af,m} - h_a) + c_{p,a}(T_B - T_a)(Le-1)h_{fg}]} \left(\frac{\partial T_B}{\partial x} dx + \frac{\partial T_B}{\partial y} dy \right)$$

where \dot{m}_B = the mass flow rate of brine through the spray nozzles

$Le = \frac{h_H}{K c_{p,a,m}}$ = the Lewis number, a dimensionless parameter measuring the heat and mass transfer

With the coefficient of performance, the evaporation rate can be expressed as follows.

$$\dot{m}_{Evap} = \left(\frac{KaV}{\dot{m}_B} \right) \dot{m}_B [\omega_{af} - \omega_a]$$

where \dot{m}_B = the flow rate of sprayed brine in the evaporation chamber,

ω_a = the humidity ratio of air in the evaporation chamber,

ω_{af} = the corresponding saturated humidity ratio of the air

The coefficient of performance was computed numerically with actual operating conditions as boundary conditions. The calculated results are shown in table 9.

Table 9.—Calculated coefficient of performance for evaporation

Test	$T_{a,db,i}$	$T_{a,wb,i}$	$T_{a,db,o}$	$\dot{m}_{a,m}$	$T_{B,i}^*$	\dot{m}_B	Salinity	$\frac{K a V}{\dot{m}_B}$
	(°C)	(°C)	(°C)	(kg/s)	(°C)	(kg/s)	(%, mass)	(kg _a /kg _w)
1	31.8	16.8	36.8	10.7	40.0	37.17	15.6	0.15
2	33.0	16.0	38.5	10.7	42.0	37.17	26.0	0.20
3	31.6	16.8	36.8	10.7	40.0	37.20	24.3	0.18
4	21.0	12.4	33.9	11.1	37.0	38.00	3.5	0.25
5	21.3	13.1	32.0	11.1	34.0	38.60	4.0	0.20
6	19.0	10.5	30.3	11.2	32.0	38.95	4.6	0.25
7	17.0	10.8	30.8	11.3	34.0	39.18	5.0	0.23

7.2 CONDENSATION TOWER

Similar to the evaporation analysis, a two-dimensional model was used for the thermodynamic analysis of the condensation tower. Figure 23 shows the heat and mass transfer diagram in the condensation tower. The packed condensation duct of the condensation tower (shown in figure 15) is enclosed by four walls. Three walls are surrounded by the cooling jacket, through which the cold air stream from the cold evaporation chamber flows. The fourth wall is in contact with ambient air. The thermal performance of the condensation tower is affected by two simultaneous heat exchange processes: (1) direct-contact heat transfer inside the packed condensation duct between the warm humid air stream from the hot evaporation chamber and the cold fresh water sprayed from the top of the condensation tower; and (2) indirect contact heat exchange through the walls between the warm air stream inside the condensation duct and the cold air stream in the cooling jacket. In the condensation duct, the humid air stream flowing upward is cooled through both the heat exchange processes. As a result, condensation occurs, and liquid films form on the surface of the packing material and inner surface of the duct wall and flow downward by gravity.

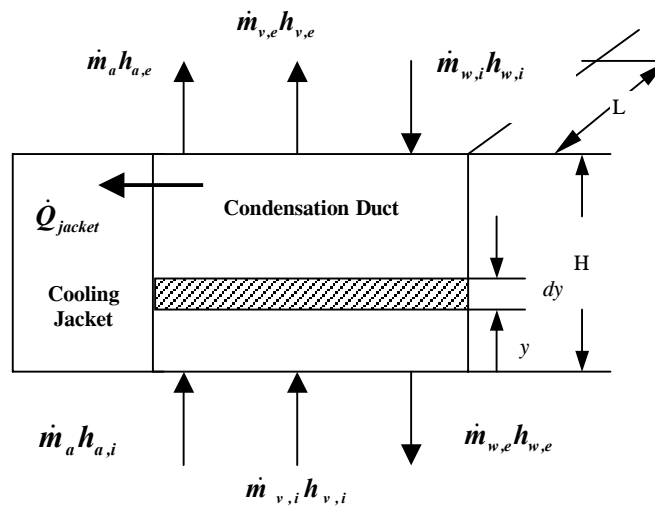

Figure 23.—Energy and mass interactions in the condensation tower.

As in the evaporation analysis, steady-state operation conditions are also assumed in the condensation modeling, and the dry air and water vapor are considered ideal gases. The changes in kinetic and potential energy of the fluids are assumed to be negligible. It is also assumed that the air film adjacent to the liquid film is relatively stagnant and saturated. Compared with the heat transfer to the cooling jacket, the heat transfer to ambient through the condensation duct wall is small. Therefore, this modeling considered only the heat transfer between the condensation tower and the cooling jacket, and the condensation duct wall which is in contact with the atmospheric surroundings was considered adiabatic.

Five differential equations (shown in table 10) were derived for condensation. These differential equations express the changes of the specific humidity and temperature of the hot air in the condensation duct, the temperature of water in the duct, the temperature of cold air in the cooling jacket, and the temperature of the jacket wall as functions of the condensation tower height, respectively. For details of the derivation of these equations, see Becerra [6].

Table 10.—Differential equations for condensation

Specific humidity	$\frac{d\omega_{ha}}{dy} = -\frac{I}{\rho_{ha,m}u_{ha}} K a [(1-f_a)(\omega_{ha} - \omega_{af,bulk}) + f_a(\omega_{ha} - \omega_{af,wall})]$
Water temperature	$\frac{dT_w}{dy} = -\frac{[h_{H,ha}(T_{ha} - T_w) - K(\omega_{ha} - \omega_{af,bulk})h_{fg,bulk}](1-f_a)a}{\rho_w u_w c_w}$
Hot air temperature	$\frac{dT_{ha}}{dy} = -\frac{[(1-f_a)F_1 + f_a F_2]a}{\rho_{ha,m}u_{ha}(c_{p,a} + \omega c_{p,v})_{ha}}$
Cold air temperature	$\frac{dT_{ca}}{dy} = \frac{h_{H,ca}(T_{ca} - T_{wall})L}{\dot{m}_{ca,m}(c_{p,a} + \omega c_{p,v})_{ca}}$
Wall temperature	$\frac{dT_{wall}}{dy} = \frac{h_{H,ha}\frac{dT_{ha}}{dy} + h_{H,ca}\frac{dT_{ca}}{dy}}{h_{H,ha} + h_{H,ca}}$

From these differential equations, a dimensionless coefficient of performance for condensation, KaV / \dot{m}_w , was derived, as shown as the following equation:

$$\frac{KaV}{\dot{m}_w} = \int_{y=0}^{y=H} \frac{c_w dT_w + \frac{\dot{m}_{ca,m}}{\dot{m}_w} dh_{ca,m}}{(1-f_a)Z_1 + f_a Z_2}$$

where \dot{m}_w = the mass flow rate of fresh water sprayed from the top of the condensation tower,

$$Z_1 = (h_{ha,m} - h_{af,m,sat,bulk}) + c_{p,ha,m}(T_{ha} - T_w)(Le - 1),$$

$$Z_2 = (h_{ha,m} - h_{af,m,sat,wall}) + c_{p,ha,m}(T_{ha} - T_{wall})(Le - 1),$$

$$T_{wall} = T_{wall}(Nu_{ca}, U_{ca}/ha),$$

and $Le = \frac{h_H}{K c_{p,a,m}} = \text{the Lewis number.}$

With the coefficient of performance, the condensation rate can be expressed as follows:

$$\dot{m}_{Cond} = \left(\frac{K a V}{\dot{m}_W} \right) \dot{m}_W [\omega_{ha} - \omega_{af}]$$

where

- \dot{m}_W = the flow rate of sprayed water at the top of the condensation tower
- ω_{ha} = is the humidity ratio of the hot air in the condensation duct
- ω_{af} = is the saturated humidity ratio of the air at cooled temperature

The coefficient of performance for condensation was computed numerically with actual operating conditions as boundary conditions. The calculated results are shown in table 11.

Table 11.—Calculated coefficient of performance for condensation

Test	T _{ha,i}	T _{hao}	T _{ca,i}	T _{ca,o}	T _{w,i}	T _{w,o}	\dot{m}_w / \dot{m}_{ha}	\dot{m}_{ca}	f_a	$\frac{K a V}{\dot{m}_w}$
	(°C)	(°C)	(°C)	(°C)	(°C)	(°C)	(kg/s)	(kg/s)	(%)	(kg _a /kg _w)
1	36.2	34.8	19.9	20.0	29.6	33.1	0.61	5.61	3.0	0.80
2	36.5	34.8	18.6	18.7	28.4	33.0	0.59	5.49	0.4	0.90
3	38.7	37.3	21.5	21.6	30.0	34.0	0.59	5.48	3.0	0.40
4	39.0	38.0	24.7	24.7	32.1	35.3	0.57	5.31	0.4	0.50
5	35.3	33.7	18.1	18.2	30.4	32.7	1.03	9.59	0.6	0.70
6	31.9	30.4	15.8	15.9	25.0	29.7	0.77	7.11	0.6	0.60
7	31.1	28.6	14.5	14.6	23.8	28.3	0.67	6.25	3.0	1.30
8	30.9	29.3	15.4	15.5	22.9	30.2	0.26	2.45	0.4	3.00

7.3 COMPARISON WITH TEST DATA

From experimental data, the following correlations for both evaporation chambers and condensation tower were developed by regression analysis. The coefficient of performance for evaporation can be expressed as:

$$\frac{K a V}{\dot{m}_B} = 0.0114 \left(\frac{T_{B,i} - T_{a,wb,i}}{T_{B,i}} \right)^{-1.1419} S^{-0.0021}$$

The coefficient of performance for condensation can be expressed as:

$$\frac{K a V}{\dot{m}_w} = 0.0011 \left(\frac{\dot{m}_w}{\dot{m}_{ha}} \right)^{-1.5544} \left(\frac{T_{ha,i} - T_{w,i}}{T_{ha,i}} \right)^{-1.5402}$$

The evaporation rate can be expressed as:

$$\frac{\dot{m}_{evap}}{\dot{m}_B} = 0.0061 \left(\frac{T_B - T_{a,wb}}{T_B} \right)^{0.4457} S^{-0.0866}$$

The condensation rate can be expressed as:

$$\frac{\dot{m}_{cond}}{\dot{m}_w} = 0.0075 \left(\frac{\dot{m}_w}{\dot{m}_{ha}} \right)^{-0.7183} \left(\frac{T_{ha} - T_w}{T_{ha}} \right)^{0.1646}$$

Figures 24 and 25 show the comparisons between the calculated data with the models and the experimental data for evaporation rate and condensation rate, respectively.

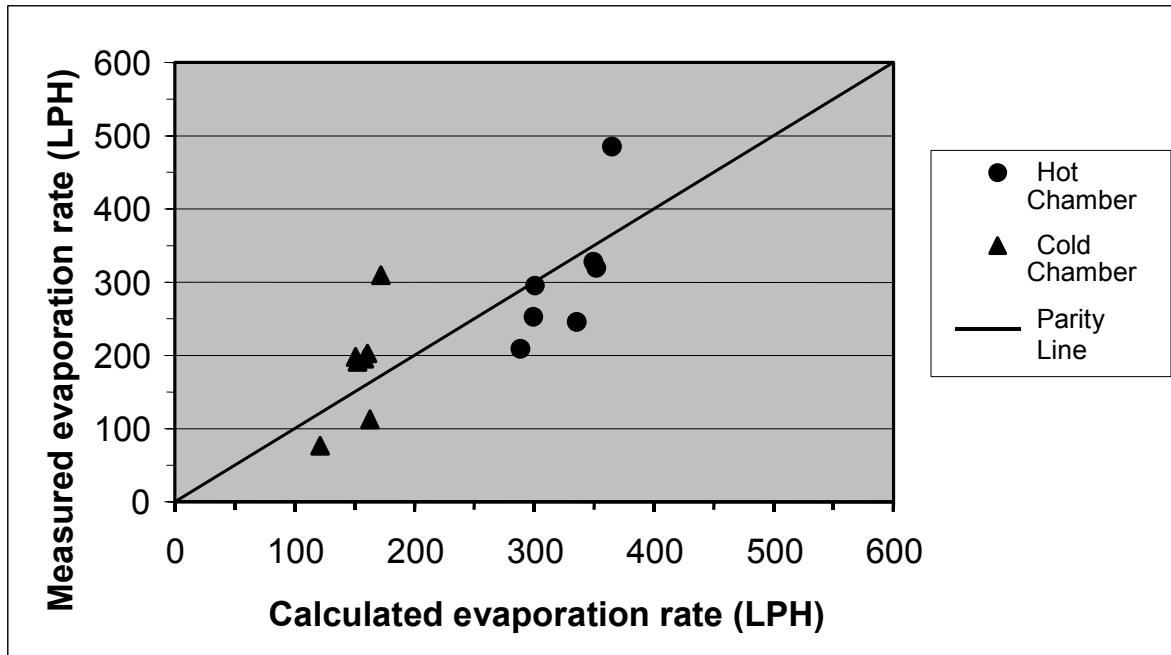

Figure 24.—Comparison between calculated data and experimental data for evaporation.

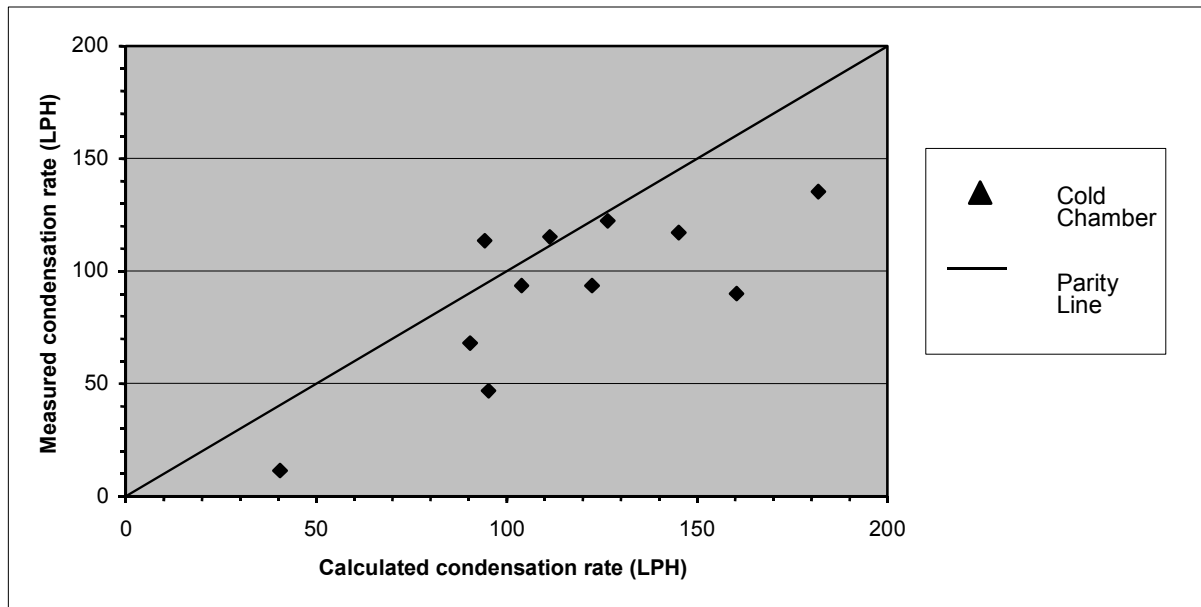

Figure 25.—Comparison between calculated data and experimental data for condensation.

8. ECONOMIC ANALYSIS

Based on the experimental data, economic analysis was performed to estimate the costs of brine concentration and freshwater production of the BCRS. As seen from the previous discussion, brine temperature is one of the major factors affecting the evaporation/concentration rate of a brine concentrator. With elevated brine temperature, a higher concentration rate can be achieved. However, thermal energy is needed to heat the brine, and additional equipment (such as a heat exchanger) is required. On the other hand, a concentrator with only cold evaporation does not need a heat supply, but its concentration rate is lower. Compared to a hot evaporation unit, a cold evaporation unit needs a larger size and, thus, higher capital cost to achieve the same water process capacity. In order to compare the economics of different operations of a brine concentrator, three different options are considered in this analysis. These three options are summarized as follows:

- **Brine concentrator with hot evaporation only.** The process of this option is the same as the hot evaporation chamber of the BCRS unit tested in this project. In this option, thermal energy is needed to elevate the temperature of feed brine and, hence, to increase the evaporation/concentration rate. There is freshwater recovery in this option.
- **Brine concentrator with cold evaporation only.** The process of this option is the same as the cold evaporation chamber of the BCRS unit tested in this project. In this option, the feed brine is at its naturally occurring temperature; therefore, no heat is provided to the concentrator. This option provides no freshwater recovery.
- **Brine concentrator combining hot evaporation and cold evaporation, with fresh water produced as a byproduct.** The process of this option is the same as the whole BCRS unit tested in this project.

The economic analysis is summarized in the following sections. For details, see Becerra [6]. The cost of concentration with brine concentrator is also compared with the costs of other concentrate disposal options, especially deep well injection and evaporation pond disposal.

8.1 METHOD AND PROCEDURE OF COST ANALYSIS

The factored estimate method [7] was used to evaluate the costs of concentration and freshwater production of the BCRS. The costs, denoted by p and expressed in dollars per 1,000 gallons of processed water, were estimated by using the following equation:

$$p = \frac{C + \frac{(e + i_m - dt)I_F}{1-t}}{G}$$

where:

- G = the water process rate
- I_F = the total capital cost of the BCRS
- C = operation and maintenance (O&M) cost
- t = tax rate
- d = depreciation rate
- e = capital recovery factor
- i_m = minimum acceptable rate of return

The O&M cost includes energy cost and maintenance and repair cost. In this analysis, the maintenance and repair cost is assumed as 2 percent of the capital cost I_F , and other factors are assumed as follows:

Tax rate	t = 0.06	\$/
Depreciation rate	d = 0.10	\$/\$/-year
Capital recovery factor	e = 0.10	\$/\$/-year
Minimum acceptable rate of return	i_m = 0.20	\$/\$/-year

The cost analysis was performed in two steps. The first step was to estimate the costs of using a BCRS unit of the same size as the one tested in this project. The second step was to estimate the costs of using larger units by scaling up. The small unit tested in this project has concentration rates ranging from 2,000 to 4,000 GPD, and its costs tend to be very high. The costs of this unit were used as base values for calculating the costs of larger units. For most practical applications, the necessary amount of concentrate to be treated is in the order of millions of GPD; therefore, much larger BCRS units will be required. Costs would decrease significantly as the plant capacities increase from several thousand GPD to several million GPD. In the scaling-up calculation, it was assumed that all unit costs, except the unit energy cost, decrease at the same proportion and are estimated by the following equation [6]:

$$p = p_0 \left(\frac{G}{G_0} \right)^{-\frac{1}{7}}$$

where

- p = is the scaled up cost
- p_0 = is the base cost
- G = the desired production rate (concentration rate or freshwater production rate)
- G_0 = the base production rate, which equals the rate of the BCRS unit tested in this project

8.2 RESULTS OF COST ANALYSIS

8.2.1 Concentration Cost for Hot Evaporation

In this cost analysis, the assumed operating conditions are shown in table 12. The thermal energy consumption rate was estimated as 895 kilowatthours per cubic meter (kWh/m³) or 3,400 kilowatthours per 1,000 gallons (kWh/1,000 gal) of brine evaporated. Here it was assumed that there was a heat loss of 20 percent through the unit and piping system. The electricity consumption rate was about 80 kWh/m³ or 300 kWh/1,000 gal of brine evaporated. The cost of thermal energy is assumed as \$0.01/kWh (thermal), based on estimated cost of heat from a moderate-sized solar pond [8], and the cost of electricity was assumed as \$0.10/kWh. The estimated costs are shown in table 13. As an example, for a 1-million-gallon-per-day (MGD) unit of hot evaporation, the total capital cost is about \$10 million, and the concentration cost is about \$24/m³ or \$91/1,000 gal. For this unit, the energy cost represents about 80 percent of the total concentration cost for the BCRS with hot evaporation. Thermal energy constitutes about 55 percent, and electricity counts about 25 percent, of the total concentration cost.

Table 12.—Assumed operating conditions for hot evaporation

Inlet air conditions:	
Wet bulb temperature	15 °C (288 K)
Mass flow rate	11 kg/s
Sprayed brine conditions:	
Salinity	25%
Temperature	46 °C (319 K)
Density	1,170 kg/m ³
Enthalpy	192,629 J/kg
Mass flow rate	37 kg/s (500 GPM)
Brine conditions at basin:	
Salinity	25%
Temperature	43 °C (311 K)
Density	1,175 kg/m ³
Enthalpy	180,098 J/kg

Table 13.—Estimated concentration costs for hot evaporation

Processed brine		Cost as a stand-alone unit	
(m ³ /day)	(MGD)	(\$/m ³)	(\$/1,000 gal)
400	0.1	27	104
4,000	1.0	24	91
20,000	5.0	22	84
100,000	25.0	21	79

8.2.2 Concentration Cost for Cold Evaporation

The assumed operating conditions for cold evaporation are shown in table 14. The electricity consumption rate was about 174 kWh/m³ or 660 kWh/1,000 gal of brine evaporated. The cost of electricity was assumed as \$0.10/kWh. The estimated concentration costs are shown in table 15. As an example, for a 1-MGD unit, the total capital cost is about \$13.5 million, and the concentration cost is about \$15/m³ or \$56/1,000 gal. It was found that for this 1-MGD unit, electricity constitutes about 80 percent of the total concentration cost.

Table 14.—Assumed operating conditions for cold evaporation

<i>Inlet air conditions:</i>	
Wet bulb temperature	17 °C (290 K)
Mass flow rate	11 kg/s
<i>Sprayed brine conditions:</i>	
Salinity	25%
Temperature	22 °C (295 K)
Density	1,185 kg/m ³
Enthalpy	79,764 J/kg
Mass flow rate	37 kg/s (500 GPM)
<i>Brine conditions at basin:</i>	
Salinity	25%
Temperature	20 °C (293 K)
Density	1,185 kg/m ³
Enthalpy	83,951 J/kg

Table 15.—Estimated concentration costs for cold evaporation

Processed brine		Cost as a stand-alone unit	
(m ³ /day)	(MGD)	(\$/m ³)	(\$/1,000 gal)
400	0.1	17	64
4,000	1.0	15	56
20,000	5.0	14	53
100,000	25.0	13	49

8.2.3 Concentration Cost and Freshwater Production Cost for Hot and Cold Evaporation

In this case, the BCRS unit contains a hot evaporation chamber, a cold evaporation chamber, and a condensation tower. In addition to concentrating the brine through evaporation, this unit also recovers some fresh water as a byproduct. The assumed operating conditions for condensation are shown in table 16. The estimated costs are shown in table 17. As an example, for a 1-MGD unit, the capital cost of evaporation chambers is about \$11 million, and the capital cost of condensation tower is about \$15,000. The concentration cost is about \$20/m³ or \$77/1,000 gal, and the cost for freshwater production is about \$13/m³ or \$50/1,000 gal.

Table 16.—Assumed operating conditions for condensation

<i>Hot air conditions at the inlet of the tower:</i>	
Dry bulb temperature	38 °C (311 K)
Relative humidity	100%
Mass flow rate	11 kg/s
<i>Sprayed water conditions:</i>	
Temperature	30 °C (303 K)
Mass flow rate	10 kg/s (160 GPM)
<i>Water conditions at basin:</i>	
Temperature	33 °C (306 K)

Table 17.—Estimated costs for hot and cold evaporation as a stand-alone unit

Processed brine		Concentration cost		Freshwater cost	
(m ³ /day)	(MGD)	(\$/m ³)	(\$/1,000 gal)	(\$/m ³)	(\$/1,000 gal)
400	0.1	28	107	15	59
4,000	1.0	20	77	13	50
20,000	5.0	16	61	12	46
100,000	25.0	13	49	11	42

8.2.4 Costs of a Zero Discharge System with BCRS

In addition to considering the BCRS as a stand-alone unit, this analysis also considered the case in which the BCRS is integrated into a "zero discharge" desalination system [1]. In the zero discharge system (shown in figure 26), the first desalination process is assumed to be membrane filtration. The second stage is a thermal desalination process that will treat the concentrate reject from membrane filtration. The concentrate from thermal desalination is then fed into the third stage, brine concentrators. It was estimated that the volume of brine fed into the BCRS is about 3 percent of the volume of total processed water, which equals the total volume fed into the first stage of the zero discharge system. Therefore, the additional cost introduced by using BCRS will be about 3 percent of the cost of the BCRS as a stand-alone unit [6]. This additional cost is called "marginal cost" in this report. As examples, estimated costs of produced water with the zero discharge system are shown in table 18 and figure 27. The overall cost of produced water was calculated by the following equation and is in the unit \$/1,000 gal:

$$\text{Overall water cost} = \frac{P_m \times \dot{m}_m + P_{th} \times \dot{m}_{th}}{\dot{m}} + P_{BCRS} \times \left(\frac{\dot{m}_{BCRS}}{\dot{m}} \right)$$

where

- P_m = unit water price of membrane filtration, in dollars per thousand gallons (\$/kgal)
- P_{th} = unit water price of thermal desalination, in \$/kgal
- \dot{m}_m = production rate of membrane filtration, in MGD
- \dot{m}_{th} = production rate of thermal desalination, in MGD
- P_{BCRS} = concentration cost of BCRS as a stand along unit, in \$/kgal
- \dot{m}_{BCRS} = flow rate into the BCRS, in MGD

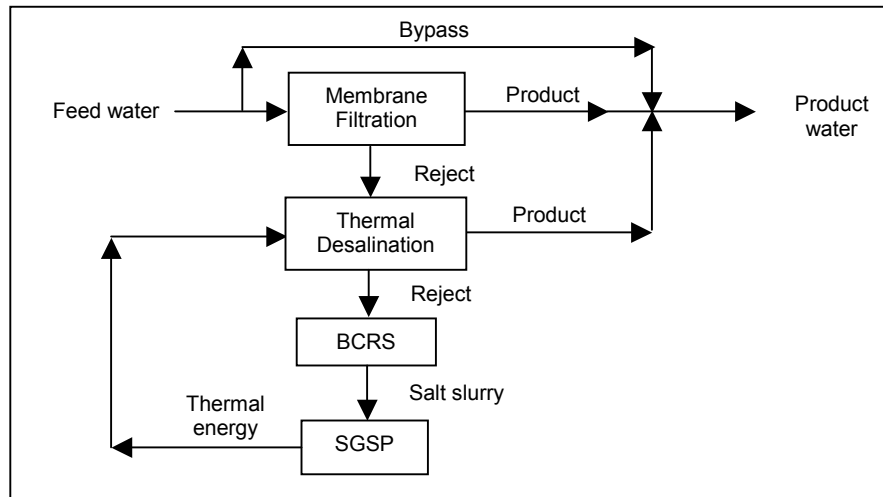

Figure 26.—Flowchart of zero discharge system.

Table 18.—Costs of produced water with zero discharge system

Plant capacity (MGD)	1	5	10	15	20	25
Membrane feed (MGD)	0.87	4.36	8.73	13.09	17.45	21.81
Bypass rate (MGD)	0.15	0.77	1.54	2.31	3.07	3.84
Membrane filtration						
Production rate (MGD)	0.6	3.1	6.1	9.2	12.2	15.3
Reject TDS (mg/L)	9,860	9,860	9,860	9,860	9,860	9,860
Reject rate (MGD)	0.26	1.31	2.62	3.93	5.24	6.54
Thermal distillation						
Production rate (MGD)	0.23	1.18	2.36	3.53	4.71	5.89
Reject TDS (mg/L)	98,510	98,510	98,510	98,510	98,510	98,510
Reject rate (MGD)	0.026	0.131	0.262	0.393	0.524	0.654
Economy ratio	4.0	4.0	4.0	4.0	4.0	4.0
Thermal (MBtu/d)	490	2,456	4,915	7,374	9,830	12,286
Electricity (kWh/d)	4,309	21,595	43,214	64,834	86,429	108,024
Solar radiation						
(kWh/m ² /d)	5.7	5.7	5.7	5.7	5.7	5.7
(MBtu/ac/d)	77.8	77.8	77.8	77.8	77.8	77.8
Solar pond costs						
Pond size (acre)	45	226	451	677	903	1,128
Total capital cost	\$1,773,932	\$8,890,049	\$17,790,294	\$26,690,538	\$35,580,587	\$44,470,636
Instrumentation	\$62,499	\$152,755	\$265,639	\$378,523	\$491,278	\$604,033
Thermal equipment						
Total capital cost	\$2,320,369	\$11,754,179	\$23,481,792	\$35,209,405	\$46,923,584	\$58,637,763
Interest rate	6%	6%	6%	6%	6%	6%
Depreciation (yr)	25	25	25	25	25	25
Annualized cost	\$181,515	\$919,491	\$1,836,904	\$2,754,316	\$3,670,678	\$4,587,040
O&M cost						

Table 18.—Costs of produced water with zero discharge system

Maintenance (\$/yr)	\$18,151	\$82,754.18	\$146,952.28	\$192,802.13	\$220,240.68	\$229,351.99
Electricity (\$/yr)	\$157,281	\$788,211	\$1,577,326	\$2,366,441	\$3,154,652	\$3,942,863
Annual O&M cost (\$/yr)	\$175,432	\$870,965	\$1,724,278	\$2,559,243	\$3,374,893	\$4,172,215
Total annual cost	\$356,947	\$1,790,456	\$3,561,182	\$5,313,559	\$7,045,571	\$8,759,255
Water cost						
Membrane (\$/kgal)	\$2.00	\$2.00	\$2.00	\$2.00	\$2.00	\$2.00
Thermal (\$/kgal)	\$4.16	\$4.17	\$4.14	\$4.12	\$4.10	\$4.08
BCRS (\$/kgal)	\$1.40	\$1.12	\$1.01	\$0.95	\$0.91	\$0.89
Overall cost (\$/kgal)	\$4.01	\$3.72	\$3.61	\$3.54	\$3.50	\$3.46

Note: MBtu/d = million British thermal units per day, Mbtu/ac/d = million British thermal units per acre per day, kWh/d = kilowatt-hours per day, kWh/m²/d = kilowatt-hours per square meter per day

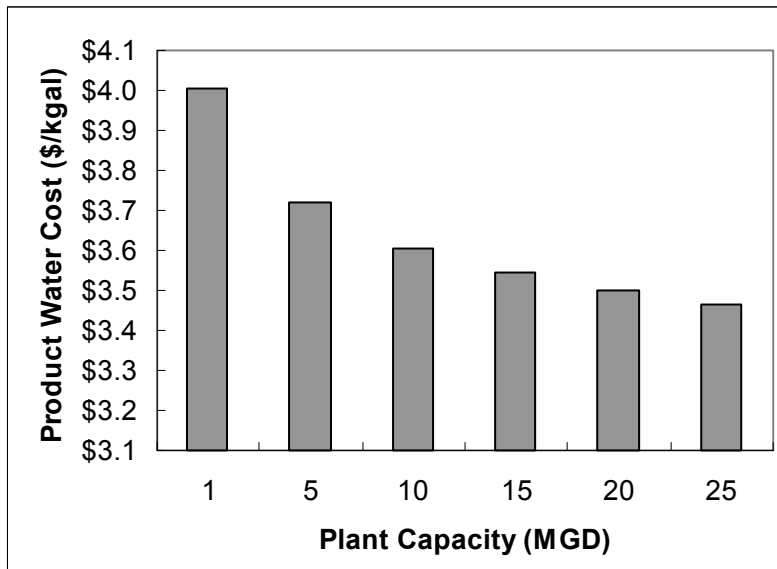

Figure 27.—Marginal concentration costs.

Some assumptions used in this cost estimation are as follows:

- The zero discharge desalination system consists of membrane filtration, multistage thermal desalination, a BCRS, and a SGSP.
- The recovery ratio of membrane filtration process is 0.7.
- The recovery ratio of thermal desalination is 0.9.
- The TDS of feed water is 3,000 mg/L.
- The TDS of membrane product is 60 mg/L.

- The TDS of thermal desalination product is 10 mg/L.
- The required product water TDS is 500 mg/L.
- Some feed water bypasses the processing system and mixed with the two product streams from membrane and thermal desalination to meet product TDS requirements.
- Membrane product cost is \$2.0/1,000 gal.
- The BCRS uses cold evaporation process and concentrates the brine to salt slurry. The salt slurry is charged into the SGSP.
- Electricity was purchased at \$0.10/kWh.
- SGSP provides thermal energy to the thermal desalination process.
- The thermal efficiency of SGSP is 14 percent.

8.3 COMPARISON WITH ALTERNATIVE DISPOSAL METHODS

Three alternative brine disposal methods were compared with the BCRS: (1) deep-well injection; (2) evaporation ponds; and (3) conventional crystallizer. The costs for brine disposal using these methods were estimated based on the study by Mickley [9]. Tables 19, 20, and 21 show the produced water costs with deep well injection, evaporation ponds, and crystallizer, respectively. For estimating the cost of using the crystallizer, Mickley's model is valid for flows ranging from a 0.4-MGD to 2.0 MGD. Therefore, the costs for flows over 2.0 MGD were estimated by assuming their capital costs are directly proportional to the capital cost of 2.0 MGD plant. Costs for solid salt disposal were added into the costs of both evaporation ponds and crystallizer methods. It was assumed that the solid salt disposal cost is \$30/ton. Table 22 and figure 28 show the comparison of produced water costs with different disposal methods. Among these four disposal methods, deep well injection is the cheapest method, and crystallizer is the most expensive method. The cost of brine concentration using a BCRS-SGSP combination is similar to the cost using evaporation ponds but uses much less land than evaporation ponds. It should be noted that the BCRS tested in this project is not optimized, and its electricity consumption rate (about 520 kWh/1,000 gal of feed water flow) is very high. If the electricity consumption rate can be reduced to about 100 kWh/1,000 gal, which is approximately the electricity consumption rate of commercial brine concentrators [9], the cost of the zero discharge system would be reduced.

Table 19.—Costs of produced water with deep well injection

Plant capacity (MGD)	1	5	10	15	20	25
Membrane feed (MGD)	1.14	5.71	11.42	17.12	22.83	28.54
Membrane recovery ratio	0.70	0.70	0.70	0.70	0.70	0.70
Disposal rate (MGD)	0.34	1.71	3.43	5.14	6.85	8.56
Tube diameter (inch)	4	10	12	16	16	20
Well depth (ft)	5,000	5,000	5,000	5,000	5,000	5,000
Total capital cost	\$4,065,600	\$4,941,000	\$5,232,800	\$5,816,400	\$5,816,400	\$6,400,000
Interest rate	6%	6%	6%	6%	6%	6%
Depreciation (yr)	25	25	25	25	25	25
Annualized cost	\$318,039	\$386,518	\$409,345	\$454,998	\$454,998	\$500,651
O&M						
Flow rate (gpm)	238	1,190	2,379	3,567	4,756	5,946
Pumping cost (\$/yr)	\$158,333	\$793,056	\$1,586,111	\$2,377,778	\$3,170,833	\$3,963,889
Maintenance (\$/yr)	\$15,902	\$19,326	\$20,467	\$22,750	\$22,750	\$25,033
Annual O&M cost (\$/yr)	\$174,235	\$812,381	\$1,606,578	\$2,400,528	\$3,193,583	\$3,988,921
Total annual cost	\$492,274	\$1,198,900	\$2,015,923	\$2,855,526	\$3,648,581	\$4,489,572
Water cost						
Membrane cost (\$/kgal)	\$2.00	\$2.00	\$2.00	\$2.00	\$2.00	\$2.00
Disposal cost (\$/kgal)	\$1.35	\$0.66	\$0.55	\$0.52	\$0.50	\$0.49
Overall cost (\$/kgal)	\$3.35	\$2.66	\$2.55	\$2.52	\$2.50	\$2.49

Table 20.—Costs of produced water with evaporation ponds

Plant capacity (MGD)	1	5	10	15	20	25
Membrane feed (MGD)	1.14	5.71	11.42	17.12	22.83	28.54
Disposal rate (MGD)	0.34	1.71	3.43	5.14	6.85	8.56
Reject TDS (mg/l)	9,860	9,860	9,860	9,860	9,860	9,860
Dike height (ft)	8	8	8	8	8	8
Total area (acre)	125	588	1,157	1,722	2,286	2,849
Liner thickness (mil)	60	60	60	60	60	60
Land cost (\$/acre)	2,000	2,000	2,000	2,000	2,000	2,000
Land clearing (\$/acre)	1,000	1,000	1,000	1,000	1,000	1,000
Unit capital cost (\$/acre)	38,117	38,117	38,117	38,117	38,117	38,117
Total capital cost	\$4,774,641	\$22,403,964	\$44,092,924	\$65,626,532	\$87,137,047	\$108,608,621
Interest rate	6%	6%	6%	6%	6%	6%
Depreciation (yr)	25	25	25	25	25	25
Annualized cost	\$373,504	\$1,752,589	\$3,449,245	\$5,133,748	\$6,816,445	\$8,496,096
O&M						
Maintenance (\$/yr)	\$1,868	\$8,763	\$17,246	\$25,669	\$34,082	\$42,480
Total salt (ton/yr)	\$5,125	\$25,668	\$51,335	\$76,958	\$102,626	\$128,293
Salt disposal (\$/yr)	\$153,736	\$770,029	\$1,540,058	\$2,308,738	\$3,078,767	\$3,848,795
Annual O&M cost (\$/yr)	\$155,604	\$778,792	\$1,557,304	\$2,334,407	\$3,112,849	\$3,891,276
Total annual cost	\$529,108	\$2,531,380	\$5,006,549	\$7,468,155	\$9,929,294	\$12,387,372
Water cost						
Membrane (\$/kgal)	\$2.00	\$2.00	\$2.00	\$2.00	\$2.00	\$2.00
Disposal cost (\$/kgal)	\$1.45	\$1.39	\$1.37	\$1.36	\$1.36	\$1.36
Overall cost (\$/kgal)	\$3.45	\$3.39	\$3.37	\$3.36	\$3.36	\$3.36

Table 21.—Costs of produced water with crystallizer

Plant capacity (MGD)	1	5	10	15	20	25
Membrane feed (MGD)	1.14	5.71	11.42	17.12	22.83	28.54
Disposal rate (MGD)	0.34	1.71	3.43	5.14	6.85	8.56
Reject TDS (mg/l)	9,860	9,860	9,860	9,860	9,860	9,860
Reject percentage (%)	5.00	5.00	5.00	5.00	5.00	5.00
Electricity price (\$/kWh)	0.10	0.10	0.10	0.10	0.10	0.10
Annualized cost	\$1,939,000	\$7,225,924	\$14,382,831	\$21,561,652	\$28,753,068	\$35,944,483
Salt disposal						
Total salt (ton/yr)	5,125	25,668	51,335	76,958	102,626	128,293
Salt disposal (\$/yr)	\$153,736	\$770,029	\$1,540,058	\$2,308,738	\$3,078,767	\$3,848,795
Total annual cost	\$2,092,736	\$7,995,953	\$15,922,889	\$23,870,390	\$31,831,834	\$39,793,279
Water cost						
Membrane (\$/kgal)	\$2.00	\$2.00	\$2.00	\$2.00	\$2.00	\$2.00
Disposal cost (\$/kgal)	\$5.73	\$4.38	\$4.36	\$4.36	\$4.36	\$4.36
Overall cost (\$/kgal)	\$7.73	\$6.38	\$6.36	\$6.36	\$6.36	\$6.36

Table 22.—Comparison of produced water costs (\$/kgal)

Plant capacity (MGD)	1	5	10	15	20	25
Zero discharge with BCRS	\$4.01	\$3.72	\$3.61	\$3.54	\$3.50	\$3.46
Deep well	\$3.35	\$2.66	\$2.55	\$2.52	\$2.50	\$2.49
Evaporation ponds	\$3.45	\$3.39	\$3.37	\$3.36	\$3.36	\$3.36
Crystallizer	\$7.73	\$6.38	\$6.36	\$6.36	\$6.36	\$6.36

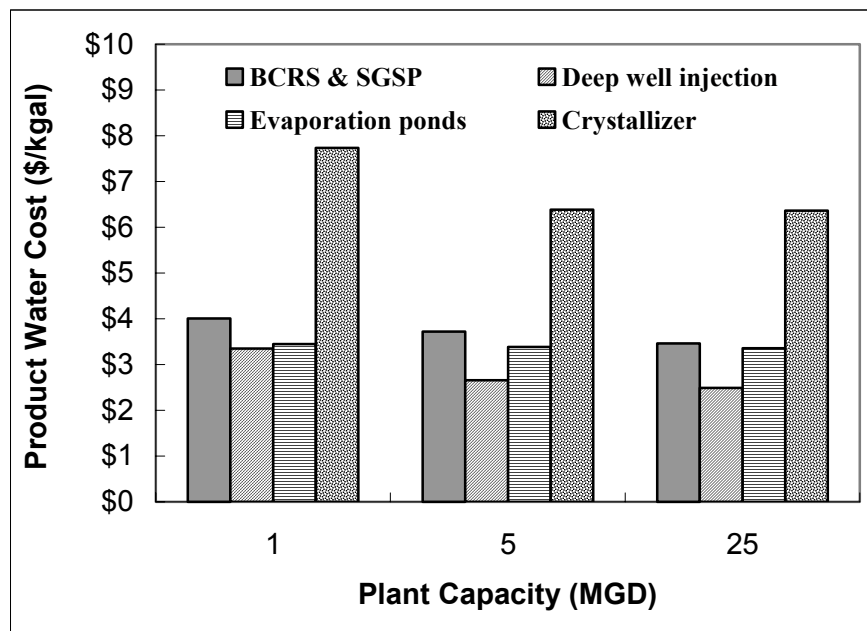

Figure 28.—Comparison of produced water costs

9. REFERENCES

1. Lu, H, J. C. Walton and A. H. P. Swift, "Zero discharge desalination," *Desalination & Water Reuse*, November/December 2000, Vol. 10/No. 3.
2. "Squeezing water from the sea," *Economist*, April 4th, 1998, p. 85-86.
3. Farid, M. and A. W. Al-Hajaj, "Solar desalination with a humidification-dehumidification cycle," *Desalination* 106 (1996) 427-429.
4. Hull, J. R., C. E. Nielsen and P. Golding, *Salinity-Gradient Solar Ponds*, CRC Press, Inc., Boca Raton, Florida, 1989.
5. Frontier AquaDynamic, Technical Bulletin - Advanced Evaporation Technology for Wastewater Reduction and Aquifer Remediation.
6. Becerra Lopez, H. R., *Performance Analysis of a Brine Concentrator and Water Recovery System*, Master's Thesis, University of Texas at El Paso, 2001.
7. Rudd, Dale F., and Watson, C.C., *Strategy of Process Engineering*, John Wiley & Sons, 1968, p. 114-141.
8. Esquivel, Patricia M., *Economic Feasibility of Utilizing Solar Pond Technology to Produce Industrial Process Heat, Base Load Electricity, and Desalted Brackish Water*, Master Thesis, University of Texas at El Paso, 1992.
9. Mickley, Michael C., *Membrane Concentrate Disposal: Practices and Regulation – Final Report*, Desalination and Water Purification Research and Development Program, US Department of Interior, Bureau of Reclamation, 2001.

10. LIST OF SYMBOLS

h_H	Convective heat transfer coefficient [W/m ² -°C]
K	Mass transfer coefficient [(kg/s-m ²)/(kg/kg)]
k	Thermal conductivity [W/m-K]
Le	Lewis number
m	Mass [kg]
\dot{m}	Mass flow rate [kg/s]
M	Molecular mass [kg/mol]
Nu	Nusselt number
P	Pressure [Pa]
Pr	Prandtl number
q	Heat flux [W/m ²], or heat transfer per unit mass [J/kg]
Q	Total heat transfer [J]
\dot{Q}	Rate of heat flow [W]
r	Ratio heat/work, dimensionless
R_u	Universal gas constant [J/mol-K]
Re	Reynolds number
S	Salinity, percentage by mass or concentration [kg _{NaCl} /kg _w]
S	Total entropy [J/K]
T	Temperature [K, or °C]
U	Internal energy [J/kg]
v, V	Velocity [m/s]
\bar{v}	Specific volume in molar base [m ³ /mol]
V	Volume [m ³]
w	Work per unit mass [J/kg]
W	Total work [J]
\dot{W}	Power [W]

Greek Symbols

α	Thermal diffusivity [m ² /s]	μ	Viscosity [kg/m-s]
Δ	Finite change in quantity	ρ	Density [kg/ m ³]
ε	Thermal effectiveness	ω	Specific humidity [kg/kg _a]
ε_c	Thermal effectiveness for condensation		
ε_e	Thermal effectiveness for evaporation		
ε_n	Thermal effectiveness for heat exchange		
η	Efficiency		

Subscripts

a	Air or dry air	i	Inlet
ATM	Atmospheric	L	Latent
B	Brine	m	Mixture
c, cond	Condensate	mt	Mass transfer
ca	Cold air	max	Maximum
db	Dry bulb	min	Minimum
dp	Dew point	o	Outlet
e, ev	Evaporation	s	Salt
e	Exit	v	Vapor
f	Saturated liquid	w	Water
fw	Freshwater	wb	Wet bulb
g	Saturated gas	1	Initial or inlet state
ha	Hot air	1, 2,...	State
HUM	Humid	2	Final or exit state

Superscripts

a	Dry air	v	Vapor
s	Salt	w	Water

—	(bar)	Average
—	(bar)	Quantity per unit mole
°	(circle)	Degree or standard reference state
.	(dot)	Quantity per unit time

APPENDIX

SUMMARY OF TEST DATA

05/01/00

STARTING TIME 9:00 Hrs.

FLUID	STATE	VARIABLE		05/01/00	05/01/00	05/01/00	05/01/00	05/01/00	05/01/00		
		NAME	UNITS	9:15	9:50	10:35	12:00	13:30	AVG		
AMBIENT AIR	0	Dry bulb temperature	°C	16.00	18.00	17.00	20.00	21.00	18.400		
	0	Wet bulb temperature	°C	8.00	9.00	10.00	10.00	11.00	9.600		
HOT AIR	1	Dry bulb temperature	°C	16.50	18.90	22.20	26.50	30.60	22.940		
	1	Mass flow rate, moist	kg/s	9.26	9.26	9.26	9.26	9.26	9.260		
	2	Dry bulb temperature	°C	35.20	35.90	36.60	39.10	38.30	37.020		
	2	Relative humidity	%								
	3	Dry bulb temperature	°C						0.000		
	3	Relative humidity	%						0.000		
COLD AIR	6	Dry bulb temperature	°C	14.40	17.60	18.00	19.80	21.10	18.180		
	6	Mass flow rate, moist	kg/s	9.35	9.35	9.35	9.35	9.35	9.350		
	7	Dry bulb temperature	°C	15.40	16.70	16.80	17.60	15.60	16.420		
	7	Relative humidity	%								
	8	Dry bulb temperature	°C						0.000		
	8	Relative humidity	%						0.000		
FRESH WATER	13	Temperature	°C	19.80	23.70	24.00	25.20	21.80	22.900		
	13	Volume flow rate	GPM	100.00	100.00	100.00	100.00	100.00	100.000		
	13	Mass flow rate	kg/s	6.31	6.31	6.31	6.31	6.31	6.308		
	14	Temperature	°C						0.000		
	10	Temperature	°C	29.70	31.40	31.70	33.50	31.80	31.620		
	16	Specific gravity		0.997	0.995	0.915	1.003	1.003	0.983		
	16	Volume flow rate	Gal	0.00	13.00	9.00	15.00	0.00	7.400		
	16	Volume	Gal	37						37.000	
	16	Mass flow rate	kg/s	0.000	0.023	0.013	0.011	0.000	0.008		

HOT CHAMBER SPRAYING BRINE	18	Temperature	°C	33.60	37.00	37.20	38.90	38.70	37.080
	18	Specific gravity		1.168	1.170	1.195	1.188	1.188	1.182
	20	Temperature	°C						0.000
	20	Volume flow rate	GPM	90.00	90.00	90.00	90.00	90.00	90.000
	20	Mass flow rate	kg/s	6.63	6.64	6.78	6.74	6.74	6.710
COLD CHAMBER SPRAYING BRINE	22	Temperature	°C	14.80	17.40	17.40	18.30	15.80	16.740
	22	Specific gravity		1.181	1.180	1.181	1.185	1.191	1.184
	24	Temperature	°C						0.000
	24	Volume flow rate	GPM	90.00	90.00	90.00	90.00	90.00	90.000
	24	Mass flow rate	kg/s	6.71	6.70	6.71	6.73	6.76	6.720
FEED BRINE	17	Specific gravity							0.000
	17A-H	Volume	Gal						0.000
	17B-C	Volume	Gal						0.000
	17	Volume	Gal	0					0.000
	17	Mass flow rate (avg.)	kg/s	0.00					0.000
HEAT SOURCE BRINE	26	Temperature	°C	78.00	78.00	77.00	77.00	78.00	77.600
	26	Volume flow rate	GPM	200.00	200.00	200.00	200.00	200.00	200.000
	26	Mass flow rate	kg/s	15.14	15.14	15.14	15.14	15.14	15.140
	27	Temperature	°C	68.00	68.00	69.00	69.00	69.00	68.600
HEATING WATER	28	Temperature	°C	59.00	59.00	58.00	58.00	59.00	58.600
	28	Volume flow rate	GPM	138.00	148.00	140.00	140.00	140.00	141.200
	28	Mass flow rate	kg/s	8.71	9.34	8.83	8.83	8.83	8.907
	29	Temperature	°C	46.00	47.00	48.00	48.00	49.00	47.600

CONDENSATION RATIO	%
--------------------	---

* Shaded cells mean calculated data.

05/02/00

STARTING TIME 9:00 Hrs.

FLUID	VARIABLE		05/02/00	05/02/00	05/02/00	05/02/00	05/02/00	05/02/00	05/02/00	05/02/00	05/02/00
	STATE	NAME	UNITS	9:19	10:00	11:30	12:30	13:00	14:00	15:20	AVG
AMBIENT AIR	0	Dry bulb temperature	°C	21.00	22.00	24.00	25.00	25.00	28.00	29.00	24.857
	0	Wet bulb temperature	°C	10.00	11.00	12.00	12.00	12.00	14.00	13.00	12.000
HOT AIR	1	Dry bulb temperature	°C	20.00	24.70	30.10	30.80	30.60	33.30	36.80	29.471
	1	Mass flow rate, moist	kg/s	9.26	9.26	9.26	9.26	9.26	9.26	9.26	9.260
	2	Dry bulb temperature	°C	33.10	33.40	42.60	38.40	32.40	39.20	40.30	37.057
	2	Relative humidity	%								
	3	Dry bulb temperature	°C								0.000
	3	Relative humidity	%								0.000
COLD AIR	6	Dry bulb temperature	°C	19.40	16.70	24.70	26.90	26.90	26.90	27.80	24.186
	6	Mass flow rate, moist	kg/s	9.35	9.35	9.35	9.35	9.35	9.35	9.35	9.350
	7	Dry bulb temperature	°C	15.30	21.80	16.20	19.00	19.50	19.40	20.20	18.771
	7	Relative humidity	%								
	8	Dry bulb temperature	°C								0.000
	8	Relative humidity	%								0.000
FRESH WATER	13	Temperature	°C	19.90	24.70	28.20	28.90	28.90	32.20	35.80	28.371
	13	Volume flow rate	GPM	100.00	100.00	100.00	100.00	100.00	100.00	100.00	100.000
	13	Mass flow rate	kg/s	6.31	6.31	6.31	6.31	6.31	6.31	6.31	6.308
	14	Temperature	°C								0.000
	10	Temperature	°C	29.70	31.40	31.70	33.50	31.80	31.80	31.80	31.671
	16	Specific gravity		0.997	0.996	0.996	0.996	0.996	0.996	0.996	0.996
	16	Volume flow rate	Gal	0.00	14.00	3.00	11.00	3.00	13.00	4.00	6.857
	16	Volume	Gal	48							
16	Mass flow rate	kg/s	0.000	0.022	0.002	0.012	0.006	0.014	0.003	0.010	

HOT CHAMBER SPRAYING BRINE	18	Temperature	°C	32.70	37.70	42.50	40.50	41.10	40.30	39.10	39.129
	18	Specific gravity		1.197	1.198	1.199	1.199	1.197	1.197	1.197	1.198
	20	Temperature	°C								0.000
	20	Volume flow rate	GPM	90.00	90.00	90.00	90.00	90.00	90.00	90.00	90.000
	20	Mass flow rate	kg/s	6.80	6.80	6.81	6.81	6.80	6.80	6.80	6.800
COLD CHAMBER SPRAYING BRINE	22	Temperature	°C	15.50	17.60	17.00	19.60	20.30	19.90	20.60	18.643
	22	Specific gravity		1.201	1.201	1.201	1.204	1.205	1.204	1.205	1.203
	24	Temperature	°C								0.000
	24	Volume flow rate	GPM	90.00	90.00	90.00	90.00	90.00	90.00	90.00	90.000
	24	Mass flow rate	kg/s	6.82	6.82	6.82	6.84	6.84	6.84	6.84	6.830
FEED BRINE	17	Specific gravity		1.136	1.136	1.136	1.136	1.136	1.136	1.136	1.136
	17A-H	Volume	Gal	445							445.000
	17B-C	Volume	Gal								0.000
	17	Volume	Gal	445							445.000
	17	Mass flow rate (avg.)	kg/s	0.08							0.084
HEAT SOURCE BRINE	26	Temperature	°C	77.00	77.00	77.00	77.00	78.00	78.00	78.00	77.429
	26	Volume flow rate	GPM	200.00	200.00	200.00	200.00	200.00	200.00	200.00	200.000
	26	Mass flow rate	kg/s	15.14	15.14	15.14	15.14	15.14	15.14	15.14	15.140
	27	Temperature	°C	68.00	69.00	69.00	70.00	69.00	69.00	69.00	69.000
HEATING WATER	28	Temperature	°C	56.00	59.00	61.00	60.00	61.00	60.00	60.00	59.571
	28	Volume flow rate	GPM	136.00	135.00	136.00	135.00	135.00	135.00	135.00	135.286
	28	Mass flow rate	kg/s	8.58	8.52	8.58	8.52	8.52	8.52	8.52	8.534
	29	Temperature	°C	44.00	48.00	53.00	51.00	52.00	49.00	49.00	49.429

CONDENSATION RATIO	11.59%
--------------------	--------

* Shaded cells mean calculated data.

09/11/00

STARTING TIME 9:00 Hrs.

FLUID	VARIABLE		09/11/00	09/11/00	09/11/00	09/11/00	09/11/00	09/11/00	09/11/00	
	STATE	NAME	UNITS	10:14	11:02	12:21	13:21	14:15	15:00	AVG
AMBIENT AIR	0	Dry bulb temperature	°C	28.00	29.00	31.00	35.00	35.00	33.00	31.833
	0	Wet bulb temperature	°C	19.00	16.00	16.00	17.00	17.00	16.00	16.833
HOT AIR	1	Dry bulb temperature	°C	39.70	39.70	46.33	44.60	44.40	39.40	42.355
	1	Mass flow rate, moist	kg/s	9.26	9.26	9.26	9.26	9.26	9.26	9.260
	2	Dry bulb temperature	°C	36.20	36.30	36.40	37.50	37.90	36.40	36.783
	2	Relative humidity	%							
	3	Dry bulb temperature	°C							0.000
	3	Relative humidity	%							0.000
	COLD AIR	6	Dry bulb temperature	°C	26.40	26.80	29.00	30.10	21.10	31.00
6		Mass flow rate, moist	kg/s	9.35	9.35	9.35	9.35	9.35	9.35	9.350
7		Dry bulb temperature	°C	19.90	19.70	20.10	21.00	20.90	21.00	20.433
7		Relative humidity	%							
8		Dry bulb temperature	°C							0.000
8		Relative humidity	%							0.000
FRESH WATER	13	Temperature	°C	29.60	30.10	29.10	30.60	30.10	30.10	29.933
	13	Volume flow rate	kg/s	89.00	89.00	89.00	89.00	89.00	89.00	89.000
	13	Mass flow rate	kg/s	5.61	5.61	5.61	5.61	5.61	5.61	5.614
	14	Temperature	°C	33.10	32.80	32.10	32.40	34.10	33.10	32.933
	10	Temperature	°C	32.10	33.50	32.10	32.40	33.10	33.60	32.800
	16	Specific gravity		1.003	1.003	1.003	1.003	1.003	1.003	1.003
	16	Volume flow rate	Gal	30.00	8.00	22.00	12.00	11.00	18.00	16.833
	16	Volume	Gal	101						101.000
	16	Mass flow rate	kg/s	0.026	0.011	0.018	0.013	0.013	0.025	0.017

HOT CHAMBER SPRAYING BRINE	18	Temperature	°C	36.80	37.20	37.70	39.70	38.90	38.70	38.167
	18	Specific gravity		1.129	1.129	1.139	1.140	1.140	1.140	1.136
	20	Temperature	°C							0.000
	20	Volume flow rate	GPM	90.00	90.00	90.00	90.00	90.00	90.00	90.000
	20	Mass flow rate	kg/s	6.41	6.41	6.47	6.47	6.47	6.47	6.451
COLD CHAMBER SPRAYING BRINE	22	Temperature	°C	20.10	21.70	21.50	22.10	23.10	23.20	21.950
	22	Specific gravity		1.209	1.209	1.209	1.208	1.209	1.209	1.209
	24	Temperature	°C							0.000
	24	Volume flow rate	GPM	90.00	90.00	90.00	90.00	90.00	90.00	90.000
	24	Mass flow rate	kg/s	6.86	6.86	6.86	6.86	6.86	6.86	6.863
FEED BRINE	17	Specific gravity		1.103	1.103	1.103	1.103	1.103	1.103	1.103
	17A-H	Volume	Gal	401						401.000
	17B-C	Volume	Gal	121						121.000
	17	Volume	Gal	522						522.000
	17	Mass flow rate (avg.)	kg/s	0.10						0.101
HEAT SOURCE BRINE	26	Temperature	°C	83.00	83.00	83.00	83.00	83.00	83.00	83.000
	26	Volume flow rate	GPM	200.00	200.00	200.00	200.00	200.00	200.00	200.000
	26	Mass flow rate	kg/s	15.14	15.14	15.14	15.14	15.14	15.14	15.140
	27	Temperature	°C	75.00	75.00	75.00	75.00	75.00	75.00	75.000
HEATING WATER	28	Temperature	°C	60.20	60.20	60.20	61.80	61.40	61.70	60.917
	28	Volume flow rate	GPM	140.00	140.00	140.00	140.00	140.00	140.00	140.000
	28	Mass flow rate	kg/s	8.83	8.83	8.83	8.83	8.83	8.83	8.832
	29	Temperature	°C	44.30	44.40	44.40	46.40	45.80	45.30	45.100

CONDENSATION RATIO	17.24%
--------------------	--------

* Shaded cells mean calculated data.

09/12/00

STARTING TIME 8:00 Hrs.

FLUID	VARIABLE		09/12/00	09/12/00	09/12/00	09/12/00	09/12/00	09/12/00	09/12/00	09/12/00	09/12/00	09/12/00
	STATE	NAME	UNITS	8:20	9:42	10:35	11:20	12:25	13:37	14:35	15:25	AVG
AMBIENT AIR	0	Dry bulb temperature	°C	24.00	27.00	30.00	34.00	34.00	34.00	36.00	36.00	31.875
	0	Wet bulb temperature	°C	13.00	14.00	15.00	17.00	17.00	16.00	16.00	16.00	15.500
HOT AIR	1	Dry bulb temperature	°C	25.30	37.50	39.00	41.60	45.70	48.10	47.60	47.10	41.488
	1	Mass flow rate, moist	kg/s	9.26	9.26	9.26	9.26	9.26	9.26	9.26	9.26	9.260
	2	Dry bulb temperature	°C	31.90	36.50	37.70	37.70	38.60	38.70	38.40	37.80	37.163
	2	Relative humidity	%									
	3	Dry bulb temperature	°C									0.000
	3	Relative humidity	%									0.000
COLD AIR	6	Dry bulb temperature	°C	21.70	24.40	27.80	28.00	31.00	32.00	32.60	33.10	28.825
	6	Mass flow rate, moist	kg/s	9.35	9.35	9.35	9.35	9.35	9.35	9.35	9.35	9.350
	7	Dry bulb temperature	°C	16.00	18.60	19.20	21.00	20.20	21.50	20.50	21.00	19.750
	7	Relative humidity	%									
	8	Dry bulb temperature	°C									0.000
	8	Relative humidity	%									0.000
FRESH WATER	13	Temperature	°C	23.40	28.40	29.80	29.90	29.80	30.00	29.90	30.50	28.963
	13	Volume flow rate	GPM	85.60	87.10	86.60	86.70	87.20	87.10	86.90	86.70	86.738
	13	Mass flow rate	kg/s	5.40	5.49	5.46	5.47	5.50	5.49	5.48	5.47	5.472
	14	Temperature	°C	27.50	33.00	33.70	33.10	34.60	34.00	34.00	33.50	32.925
	10	Temperature	°C	26.60	32.40	33.20	34.00	34.00	34.00	33.60	33.50	32.663
	16	Specific gravity		1.004	1.003	1.003	1.003	1.004	1.004	1.004	1.004	1.004
	16	Volume flow rate	Gal	0.00	33.00	19.00	18.00	23.00	22.00	19.00	13.00	18.375
	16	Volume	Gal	147								
16	Mass flow rate	kg/s	0.000	0.025	0.023	0.025	0.022	0.019	0.021	0.016	0.019	

HOT CHAMBER SPRAYING BRINE	18	Temperature	°C	32.70	37.70	42.50	40.50	41.10	40.30	39.10	39.10	44.714	
	18	Specific gravity		1.197	1.198	1.199	1.199	1.197	1.197	1.197	1.197	1.369	
	20	Temperature	°C									0.000	
	20	Volume flow rate	GPM	90.00	90.00	90.00	90.00	90.00	90.00	90.00	90.00	90.00	102.857
	20	Mass flow rate	kg/s	6.80	6.80	6.81	6.81	6.80	6.80	6.80	6.80	6.80	7.771
COLD CHAMBER SPRAYING BRINE													
	22	Temperature	°C	15.50	17.60	17.00	19.60	20.30	19.90	20.60	20.60	21.586	
	22	Specific gravity		1.201	1.201	1.201	1.204	1.205	1.204	1.205	1.205	1.375	
	24	Temperature	°C									0.000	
	24	Volume flow rate	GPM	90.00	90.00	90.00	90.00	90.00	90.00	90.00	90.00	90.00	102.857
	24	Mass flow rate	kg/s	6.82	6.82	6.82	6.84	6.84	6.84	6.84	6.84	7.807	
FEED BRINE	17	Specific gravity		1.136	1.136	1.136	1.136	1.136	1.136	1.136	1.136	1.298	
	17A-H	Volume	Gal	445								445.000	
	17B-C	Volume	Gal									0.000	
	17	Volume	Gal	445								445.000	
	17	Mass flow rate (avg.)	kg/s	0.07								0.072	
HEAT SOURCE BRINE	26	Temperature	°C	77.00	77.00	77.00	77.00	78.00	78.00	78.00	78.00	88.571	
	26	Volume flow rate	GPM	200.00	200.00	200.00	200.00	200.00	200.00	200.00	200.00	228.571	
	26	Mass flow rate	kg/s	15.14	15.14	15.14	15.14	15.14	15.14	15.14	15.14	17.303	
	27	Temperature	°C	68.00	69.00	69.00	70.00	69.00	69.00	69.00	69.00	69.00	78.857
HEATING WATER	28	Temperature	°C	56.00	59.00	61.00	60.00	61.00	60.00	60.00	60.00	68.143	
	28	Volume flow rate	GPM	136.00	135.00	136.00	135.00	135.00	135.00	135.00	135.00	154.571	
	28	Mass flow rate	kg/s	8.58	8.52	8.58	8.52	8.52	8.52	8.52	8.52	9.751	
	29	Temperature	°C	44.00	48.00	53.00	51.00	52.00	49.00	49.00	49.00	56.429	

CONDENSATION RATIO	26.50%
--------------------	--------

* Shaded cells mean calculated data.

09/13/00

STARTING TIME 8:43 Hrs.

FLUID	VARIABLE			09/13/00	09/13/00	09/13/00	09/13/00
	STATE	NAME	UNITS	10:43	12:43	15:00	AVG
AMBIENT AIR	0	Dry bulb temperature	°C	22.00	30.00	34.00	28.667
	0	Wet bulb temperature	°C	15.00	17.00	16.00	16.000
HOT AIR	1	Dry bulb temperature	°C	32.30	32.30	32.30	32.300
	1	Mass flow rate, moist	kg/s	9.26	9.26	9.26	9.260
	2	Dry bulb temperature	°C	38.40	38.80	38.40	38.533
	2	Relative humidity	%				
	3	Dry bulb temperature	°C				0.000
	3	Relative humidity	%				0.000
	COLD AIR	6	Dry bulb temperature	°C	27.80	29.40	29.50
6		Mass flow rate, moist	kg/s	9.35	9.35	9.35	9.350
7		Dry bulb temperature	°C	21.90	21.40	21.40	21.567
7		Relative humidity	%				
8		Dry bulb temperature	°C				0.000
8		Relative humidity	%				0.000
FRESH WATER	13	Temperature	°C	30.90	31.10	31.20	31.067
	13	Volume flow rate	GPM	82.80	82.00	83.40	82.733
	13	Mass flow rate	kg/s	5.22	5.17	5.26	5.219
	14	Temperature	°C	34.10	34.20	34.30	34.200
	10	Temperature	°C	34.40	34.30	34.30	34.333
	16	Specific gravity		1.004	1.004	1.004	1.004
	16	Volume flow rate	Gal	50.00	25.00	40.00	38.333
	16	Volume	Gal	115			115.000
	16	Mass flow rate	kg/s	0.026	0.013	0.018	0.019

HOT CHAMBER SPRAYING BRINE	18	Temperature	°C	39.30	39.50	39.50	39.433
	18	Specific gravity		1.164	1.198	1.199	1.187
	20	Temperature	°C	1.17	1.18	1.18	1.175
	20	Volume flow rate	GPM	90.00	90.00	90.00	90.000
	20	Mass flow rate	kg/s	6.61	6.80	6.81	6.739
COLD CHAMBER SPRAYING BRINE	22	Temperature	°C	23.60	24.40	24.50	24.167
	22	Specific gravity		1.208	1.209	1.209	1.209
	24	Temperature	°C				0.000
	24	Volume flow rate	GPM	90.00	90.00	90.00	90.000
	24	Mass flow rate	kg/s	6.86	6.86	6.86	6.862
FEED BRINE	17	Specific gravity		1.105	1.105	1.105	1.105
	17A-H	Volume	Gal	468			468.000
	17B-C	Volume	Gal	493			493.000
	17	Volume	Gal	961			961.000
	17	Mass flow rate (avg.)	kg/s	0.178			0.178
HEAT SOURCE BRINE	26	Temperature	°C	81.00	81.00	81.00	81.000
	26	Volume flow rate	GPM	150.00	150.00	150.00	150.000
	26	Mass flow rate	kg/s	11.36	11.36	11.36	11.355
	27	Temperature	°C	70.00	69.00	69.00	69.333
HEATING WATER	28	Temperature	°C	57.10	57.20	57.30	57.200
	28	Volume flow rate	GPM	140.00	140.00	140.00	140.000
	28	Mass flow rate	kg/s	8.83	8.83	8.83	8.832
	29	Temperature	°C	46.40	47.10	47.20	46.900

CONDENSATION RATIO	10.85%
--------------------	--------

* Shaded cells mean calculated data.

09/14/00

STARTING TIME 8:46 Hrs.

FLUID	VARIABLE			09/14/00	09/14/00	09/14/00	09/14/00	09/14/00	09/14/00	
	STATE	NAME	UNITS	9:46	11:46	13:46	14:46	15:10	AVG	
AMBIENT AIR	0	Dry bulb temperature	°C	26.00	32.00	34.00	33.00	33.00	31.600	
	0	Wet bulb temperature	°C	16.00	18.00	16.00	15.00	19.00	16.800	
HOT AIR	1	Dry bulb temperature	°C	26.30	31.30	37.30	34.20	34.20	32.660	
	1	Mass flow rate, moist	kg/s	9.26	9.26	9.26	9.26	9.26	9.260	
	2	Dry bulb temperature	°C	36.00	36.80	39.00	36.40	35.70	36.780	
	2	Relative humidity	%							
	3	Dry bulb temperature	°C						0.000	
	3	Relative humidity	%						0.000	
COLD AIR	6	Dry bulb temperature	°C	24.10	27.40	32.80	32.00	31.40	29.540	
	6	Mass flow rate, moist	kg/s	9.35	9.35	9.35	9.35	9.35	9.350	
	7	Dry bulb temperature	°C	19.80	20.70	24.70	21.40	20.50	21.420	
	7	Relative humidity	%	100.00	100.00	100.00	100.00	100.00	100.000	
	8	Dry bulb temperature	°C						0.000	
	8	Relative humidity	%						0.000	
FRESH WATER	13	Temperature	°C	27.60	28.80	32.10	28.50	28.60	29.120	
	13	Volume flow rate	GPM	83.30	83.20	84.10	82.90	82.30	83.160	
	13	Mass flow rate	kg/s	5.25	5.25	5.31	5.23	5.19	5.246	
	14	Temperature	°C	31.90	33.30	35.30	31.40	31.20	32.620	
	10	Temperature	°C	31.70	33.30	34.50	31.90	31.30	32.540	
	16	Specific gravity		1.003	1.004	1.004	1.004	1.003	1.004	
	16	Volume flow rate	Gal	0.00	50.00	24.00	10.00	4.00	17.600	
	16	Volume	Gal	88						88.000
	16	Mass flow rate	kg/s	0.000	0.026	0.013	0.011	0.011	0.012	

HOT CHAMBER SPRAYING BRINE	18	Temperature	°C	36.80	38.30	40.40	37.00	37.40	37.980
	18	Specific gravity		1.164	1.164	1.177	1.176	1.175	1.171
	20	Temperature	°C						0.000
	20	Volume flow rate	GPM	90.00	90.00	90.00	90.00	90.00	90.000
	20	Mass flow rate	kg/s	6.61	6.61	6.68	6.68	6.67	6.649
COLD CHAMBER SPRAYING BRINE	22	Temperature	°C	20.00	22.80	23.30	22.30	21.60	22.000
	22	Specific gravity		1.208	1.208	1.208	1.208	1.208	1.208
	24	Temperature	°C						0.000
	24	Volume flow rate	GPM	90.00	90.00	90.00	90.00	90.00	90.000
	24	Mass flow rate	kg/s	6.86	6.86	6.86	6.86	6.86	6.858
FEED BRINE	17	Specific gravity		1.105	1.105	1.105	1.105	1.105	1.105
	17A-H	Volume	Gal	335					335.000
	17B-C	Volume	Gal	313					313.000
	17	Volume	Gal	648					648.000
	17	Mass flow rate (avg.)	kg/s	0.118					0.118
HEAT SOURCE BRINE	26	Temperature	°C	80.00	80.00	79.00	79.00	79.00	79.400
	26	Volume flow rate	GPM	100.00	100.00	100.00	100.00	100.00	100.000
	26	Mass flow rate	kg/s	7.57	7.57	7.57	7.57	7.57	7.570
	27	Temperature	°C	64.00	64.00	64.00	64.00	64.00	64.000
HEATING WATER	28	Temperature	°C	54.00	53.70	56.50	53.60	52.80	54.120
	28	Volume flow rate	GPM	140.00	140.00	140.00	138.00	140.00	139.600
	28	Mass flow rate	kg/s	8.83	8.83	8.83	8.71	8.83	8.806
	29	Temperature	°C	44.00	44.70	47.30	43.60	43.40	44.600

CONDENSATION RATIO	10.19%
--------------------	--------

* Shaded cells mean calculated data.

10/25/00

STARTING TIME 9:30 Hrs.

FLUID	VARIABLE			10/25/00	10/25/00	10/25/00	10/25/00	10/25/00	10/25/00
	STATE	NAME	UNITS	11:16	12:00	13:00	14:00	15:00	AVG
AMBIENT AIR	0	Dry bulb temperature	°C	20.00	21.00	22.00	21.00	21.00	21.000
	0	Wet bulb temperature	°C	10.00	13.00	13.00	13.00	13.00	12.400
HOT AIR	1	Dry bulb temperature	°C	19.00	18.50	11.40	20.10	25.10	18.820
	1	Mass flow rate, moist	kg/s	9.26	9.26	9.26	9.26	9.26	9.260
	2	Dry bulb temperature	°C	34.20	35.30	32.80	33.50	33.80	33.920
	2	Relative humidity	%						
	3	Dry bulb temperature	°C						0.000
	3	Relative humidity	%						0.000
COLD AIR	6	Dry bulb temperature	°C	16.20	18.50	18.30	16.50	19.00	17.700
	6	Mass flow rate, moist	kg/s	9.35	9.35	9.35	9.35	9.35	9.350
	7	Dry bulb temperature	°C	16.10	18.10	10.30	17.00	17.00	15.700
	7	Relative humidity	%	100.00	100.00	100.00	100.00	100.00	100.000
	8	Dry bulb temperature	°C						0.000
	8	Relative humidity	%						0.000
FRESH WATER	13	Temperature	°C	28.90	30.40	28.30	27.90	27.70	28.640
	13	Volume flow rate	GPM	152.00	152.00	154.60	152.30	150.70	152.320
	13	Mass flow rate	kg/s	9.59	9.59	9.75	9.61	9.51	9.609
	14	Temperature	°C	31.90	32.70	31.00	30.10	31.70	31.480
	10	Temperature	°C	31.50	33.20	31.00	33.10	32.00	32.160
	16	Specific gravity		1.003	1.003	1.003	1.002	1.002	1.003
	16	Volume flow rate	Gal	57.00	24.00	26.00	26.00	27.00	32.000
	16	Volume	Gal	160					160.000
16	Mass flow rate	kg/s	0.034	0.034	0.027	0.027	0.028	0.030	

HOT CHAMBER SPRAYING BRINE	18	Temperature	°C	31.50	34.20	34.00	34.20	34.00	33.580
	18	Specific gravity		1.045	1.054	1.055	1.056	1.056	1.053
	20	Temperature	°C						0.000
	20	Volume flow rate	GPM	90.00	90.00	90.00	90.00	90.00	90.000
	20	Mass flow rate	kg/s	5.93	5.98	5.99	6.00	6.00	5.980
COLD CHAMBER SPRAYING BRINE	22	Temperature	°C	17.50	17.00	19.80	18.20	19.80	18.460
	22	Specific gravity		1.207	1.206	1.207	1.205	1.205	1.206
	24	Temperature	°C						0.000
	24	Volume flow rate	GPM	90.00	90.00	90.00	90.00	90.00	90.000
	24	Mass flow rate	kg/s	6.85	6.85	6.85	6.84	6.84	6.847
FEED BRINE	17	Specific gravity		1.034	1.034	1.034	1.034	1.034	1.034
	17A-H	Volume	Gal	641					641.000
	17B-C	Volume	Gal	149					149.000
	17	Volume	Gal	790					790.000
	17	Mass flow rate (avg.)	kg/s	0.156					0.156
HEAT SOURCE BRINE	26	Temperature	°C	73.00	73.00	73.00	73.00	73.00	73.000
	26	Volume flow rate	GPM	200.00	200.00	200.00	200.00	200.00	200.000
	26	Mass flow rate	kg/s	15.14	15.14	15.14	15.14	15.14	15.140
	27	Temperature	°C	63.00	63.00	64.00	64.00	64.00	63.600
HEATING WATER	28	Temperature	°C	46.50	50.30	49.90	49.10	49.40	49.040
	28	Volume flow rate	GPM	190.00	190.00	190.00	190.00	190.00	190.000
	28	Mass flow rate	kg/s	11.99	11.99	11.99	11.99	11.99	11.986
	29	Temperature	°C	43.20	42.50	41.80	43.20	42.50	42.640

CONDENSATION RATIO	19.39%
---------------------------	--------

* Shaded cells mean calculated data.

10/26/00

STARTING TIME 10:34 Hrs.

FLUID	STATE	VARIABLE		10/26/00	10/26/00	10/26/00	10/26/00	10/26/00	10/26/00
		NAME	UNITS	11:34	12:34	13:34	14:31	15:25	AVG
AMBIENT AIR	0	Dry bulb temperature	°C	19.00	20.40	21.00	23.40	22.50	21.260
	0	Relative humidity	%	49.00	46.00	32.00	37.90	28.90	38.760
HOT AIR	1	Dry bulb temperature	°C	19.10	22.50	17.30	24.50	24.60	21.600
	1	Mass flow rate, moist	kg/s	9.26	9.26	9.26	9.26	9.26	9.260
	2	Dry bulb temperature	°C	32.00	31.90	31.60	32.40	32.20	32.020
	2	Relative humidity	%						
	3	Dry bulb temperature	°C						0.000
	3	Relative humidity	%						0.000
COLD AIR	6	Dry bulb temperature	°C	14.60	20.20	21.30	19.00	21.80	19.380
	6	Mass flow rate, moist	kg/s	9.35	9.35	9.35	9.35	9.35	9.350
	7	Dry bulb temperature	°C	15.60	15.80	16.10	17.00	17.20	16.340
	7	Relative humidity	%						
	8	Dry bulb temperature	°C						0.000
	8	Relative humidity	%						0.000
FRESH WATER	13	Temperature	°C	24.90	25.00	24.80	25.70	27.30	25.540
	13	Volume flow rate	GPM	115.80	112.70	113.70	113.40	113.00	113.720
	13	Mass flow rate	kg/s	7.31	7.11	7.17	7.15	7.13	7.174
	14	Temperature	°C	29.00	27.40	29.70	30.20	23.80	28.020
	10	Temperature	°C	29.70	29.20	29.70	29.80	25.10	28.700
	16	Specific gravity		1.003	1.002	1.002	1.002	1.002	1.002
	16	Volume flow rate	Gal	30.40	30.40	30.40	30.40	30.40	30.400
	16	Volume	Gal	152					152.000
	16	Mass flow rate	kg/s	0.032	0.032	0.032	0.034	0.036	0.033

HOT CHAMBER SPRAYING BRINE	18	Temperature	°C	32.90	32.40	32.30	33.50	33.30	32.880
	18	Specific gravity		1.060	1.061	1.065	1.061	1.070	1.063
	20	Temperature	°C						0.000
	20	Volume flow rate	GPM	90.00	90.00	90.00	90.00	90.00	90.000
	20	Mass flow rate	kg/s	6.02	6.02	6.05	6.02	6.07	6.037
COLD CHAMBER SPRAYING BRINE	22	Temperature	°C	16.00	16.50	17.10	33.50	18.90	20.400
	22	Specific gravity		1.205	1.202	1.207	1.208	1.201	1.205
	24	Temperature	°C						0.000
	24	Volume flow rate	GPM	90.00	90.00	90.00	90.00	90.00	90.000
	24	Mass flow rate	kg/s	6.84	6.82	6.85	6.86	6.82	6.839
FEED BRINE	17	Specific gravity		1.031	1.031	1.031	1.031	1.031	1.031
	17A-H	Volume	Gal	325					325.000
	17B-C	Volume	Gal	253					253.000
	17	Volume	Gal	578					578.000
	17	Mass flow rate (avg.)	kg/s	0.129					0.129
HEAT SOURCE BRINE	26	Temperature	°C	72.00	72.00	72.00	72.00	72.00	72.000
	26	Volume flow rate	GPM	152.00	152.00	152.00	152.00	152.00	152.000
	26	Mass flow rate	kg/s	11.51	11.51	11.51	11.51	11.51	11.506
	27	Temperature	°C	61.00	61.00	62.00	61.00	61.00	61.200
HEATING WATER	28	Temperature	°C	47.70	47.50	47.70	47.90	47.80	47.720
	28	Volume flow rate	GPM	154.00	154.00	154.00	154.00	154.00	154.000
	28	Mass flow rate	kg/s	9.71	9.71	9.71	9.71	9.71	9.715
	29	Temperature	°C	39.50	40.70	39.40	40.30	39.70	39.920

CONDENSATION RATIO	25.55%
--------------------	--------

* Shaded cells mean calculated data.

11/02/00

STARTING TIME 9:45 Hrs.

FLUID	STATE	VARIABLE		11/02/00	11/02/00	11/02/00	11/02/00	11/02/00	11/02/00
		NAME	UNITS	10:16	11:16	12:20	13:15	14:15	AVG
AMBIENT AIR	0	Dry bulb temperature	°C	15.40	16.30	17.80	18.60	19.60	17.540
	0	Relative humidity	%	40.30	31.50	26.60	28.40	30.80	31.520
HOT AIR	1	Dry bulb temperature	°C	15.80	16.90	16.60	17.50	18.90	17.140
	1	Mass flow rate, moist	kg/s	9.26	9.26	9.26	9.26	9.26	9.260
	2	Dry bulb temperature	°C	27.80	30.20	31.10	31.20	31.10	30.280
	2	Relative humidity	%						
	3	Dry bulb temperature	°C						0.000
	3	Relative humidity	%						0.000
COLD AIR	6	Dry bulb temperature	°C	11.70	14.30	14.50	15.50	16.60	14.520
	6	Mass flow rate, moist	kg/s	9.35	9.35	9.35	9.35	9.35	9.350
	7	Dry bulb temperature	°C	7.80	11.90	13.10	13.10	14.50	12.080
	7	Relative humidity	%						
	8	Dry bulb temperature	°C						0.000
	8	Relative humidity	%						0.000
FRESH WATER	13	Temperature	°C	13.70	16.80	23.80	23.50	15.80	18.720
	13	Volume flow rate	GPM	97.40	100.90	99.00	98.80	100.20	99.260
	13	Mass flow rate	kg/s	6.14	6.37	6.25	6.23	6.32	6.262
	14	Temperature	°C	21.00	28.50	28.30	29.90	30.20	27.580
	10	Temperature	°C	17.20	28.00	26.00	29.20	29.20	25.920
	16	Specific gravity		1.001	1.001	1.001	1.002	1.002	1.001
	16	Volume flow rate	Gal	0.00	28.00	33.00	23.00	23.00	21.400
	16	Volume	Gal	107					107.000
	16	Mass flow rate	kg/s	0.000	0.029	0.033	0.026	0.024	0.023

HOT CHAMBER SPRAYING BRINE	18	Temperature	°C	28.60	31.20	32.50	31.40	28.70	30.480
	18	Specific gravity		1.068	1.068	1.070	1.071	1.071	1.070
	20	Temperature	°C						0.000
	20	Volume flow rate	GPM	90.00	90.00	90.00	90.00	90.00	90.000
	20	Mass flow rate	kg/s	6.06	6.06	6.07	6.08	6.08	6.073
COLD CHAMBER SPRAYING BRINE	22	Temperature	°C	6.80	11.50	12.20	13.60	15.60	11.940
	22	Specific gravity		1.201	1.201	1.201	1.207	1.205	1.203
	24	Temperature	°C						0.000
	24	Volume flow rate	GPM	90.00	90.00	90.00	90.00	90.00	90.000
	24	Mass flow rate	kg/s	6.82	6.82	6.82	6.85	6.84	6.830
FEED BRINE	17	Specific gravity		1.038	1.038	1.038	1.038	1.038	1.038
	17A-H	Volume	Gal	346					346.000
	17B-C	Volume	Gal	214					214.000
	17	Volume	Gal	560					560.000
	17	Mass flow rate (avg.)	kg/s	0.136					0.136
HEAT SOURCE BRINE	26	Temperature	°C	71.00	71.00	71.00	71.00	71.00	71.000
	26	Volume flow rate	GPM	200.00	200.00	200.00	200.00	200.00	200.000
	26	Mass flow rate	kg/s	15.14	15.14	15.14	15.14	15.14	15.140
	27	Temperature	°C	61.00	61.00	61.00	61.00	61.00	61.000
HEATING WATER	28	Temperature	°C	45.30	47.00	47.20	46.70	45.90	46.420
	28	Volume flow rate	GPM	190.00	190.00	190.00	190.00	190.00	190.000
	28	Mass flow rate	kg/s	11.99	11.99	11.99	11.99	11.99	11.986
	29	Temperature	°C	37.80	40.00	39.80	40.20	39.30	39.420

CONDENSATION RATIO	16.57%
--------------------	--------

* Shaded cells mean calculated data.

11/03/00

STARTING TIME 7:30 Hrs.

FLUID	STATE	VARIABLE		11/03/00	11/03/00	11/03/00	11/03/00	11/03/00	11/03/00
		NAME	UNITS	7:44	8:44	9:44	10:44	13:01	AVG
AMBIENT AIR	0	Dry bulb temperature	°C	11.28	13.70	15.70	18.54	20.70	15.984
	0	Relative humidity	%	63.90	55.80	48.40	47.70	45.80	52.320
HOT AIR	1	Dry bulb temperature	°C	8.10	13.70	16.80	16.10	22.40	15.420
	1	Mass flow rate, moist	kg/s	9.26	9.26	9.26	9.26	9.26	9.260
	2	Dry bulb temperature	°C	8.00	30.80	29.60	30.90	32.00	26.260
	2	Relative humidity	%						
	3	Dry bulb temperature	°C						0.000
	3	Relative humidity	%						0.000
COLD AIR	6	Dry bulb temperature	°C	7.20	10.40	12.60	15.40	18.90	12.900
	6	Mass flow rate, moist	kg/s	9.35	9.35	9.35	9.35	9.35	9.350
	7	Dry bulb temperature	°C	8.90	13.00	12.50	14.10	15.40	12.780
	7	Relative humidity	%						
	8	Dry bulb temperature	°C						0.000
8	Relative humidity	%						0.000	
FRESH WATER	13	Temperature	°C	8.20	20.80	21.50	22.90	22.70	19.220
	13	Volume flow rate	GPM	39.20	38.70	38.80	38.90	38.70	38.860
	13	Mass flow rate	kg/s	2.47	2.44	2.45	2.45	2.44	2.451
	14	Temperature	°C	7.30	28.90	29.30	30.20	30.40	25.220
	10	Temperature	°C	7.00	28.50	28.70	29.60	29.40	24.640
	16	Specific gravity		1.002	1.002	1.002	1.002	1.002	1.002
	16	Volume flow rate	Gal	0.00	0.00	19.00	30.00	47.00	19.200
	16	Volume	Gal	96					
16	Mass flow rate	kg/s	0.000	0.000	0.020	0.032	0.022	0.015	

HOT CHAMBER SPRAYING BRINE	18	Temperature	°C	34.10	31.20	31.60	32.10	32.10	32.220
	18	Specific gravity		1.071	1.074	1.074	1.073	1.072	1.073
	20	Temperature	°C						0.000
	20	Volume flow rate	GPM	90.00	90.00	90.00	90.00	90.00	90.000
	20	Mass flow rate	kg/s	6.08	6.10	6.10	6.09	6.09	6.091
COLD CHAMBER SPRAYING BRINE	22	Temperature	°C	12.30	12.10	13.20	15.10	16.40	13.820
	22	Specific gravity		1.207	1.204	1.204	1.203	1.201	1.204
	24	Temperature	°C						0.000
	24	Volume flow rate	GPM	90.00	90.00	90.00	90.00	90.00	90.000
	24	Mass flow rate	kg/s	6.85	6.84	6.84	6.83	6.82	6.835
FEED BRINE	17	Specific gravity		1.038	1.034	1.025	1.025	1.025	1.029
	17A-H	Volume	Gal	470					470.000
	17B-C	Volume	Gal	288					288.000
	17	Volume	Gal	758					758.000
	17	Mass flow rate (avg.)	kg/s	0.150					0.150
HEAT SOURCE BRINE	26	Temperature	°C	70.00	70.00	70.00	70.00	70.00	70.000
	26	Volume flow rate	GPM	200.00	200.00	200.00	200.00	200.00	200.000
	26	Mass flow rate	kg/s	15.14	15.14	15.14	15.14	15.14	15.140
	27	Temperature	°C	61.00	60.00	60.00	60.00	60.00	60.200
HEATING WATER	28	Temperature	°C	52.20	45.80	46.60	46.70	46.10	47.480
	28	Volume flow rate	GPM	190.00	190.00	190.00	190.00	190.00	190.000
	28	Mass flow rate	kg/s	11.99	11.99	11.99	11.99	11.99	11.986
	29	Temperature	°C	50.60	40.30	39.70	44.90	44.10	43.920

CONDENSATION RATIO	9.76%
--------------------	-------

* Shaded cells mean calculated data.