

**APPLICATION OF ELECTRET TECHNOLOGY  
TO LOW COST DESALINATION**

**University of Denver  
Department of Physics  
Environmental Materials Laboratory  
Denver, Colorado**

**Cooperative Assistance Agreement No. 98-FC-81-0050**

**Desalination Research and Development Program Report No. 73**

**June 2002**

**U.S. DEPARTMENT OF THE INTERIOR  
Bureau of Reclamation  
Technical Service Center  
Water Treatment Engineering and Research Group**

# REPORT DOCUMENTATION PAGE

*Form Approved*  
OMB No. 0704-0188

Public reporting burden for this collection of information is estimated to average 1 hour per response, including the time for reviewing instructions, searching existing data sources, gathering and maintaining the data needed, and completing and reviewing the collection of information. Send comments regarding this burden estimate or any other aspect of this collection of information, including suggestions for reducing this burden to Washington Headquarters Services, Directorate for Information Operations and Reports, 1215 Jefferson Davis Highway, Suit 1204, Arlington VA 22202-4302, and to the Office of Management and Budget, Paperwork Reduction Report (0704-0188), Washington DC 20503.

<b>1. AGENCY USE ONLY (Leave Blank)</b>	<b>2. REPORT DATE</b> June 2002	<b>3. REPORT TYPE AND DATES COVERED</b>	
<b>4. TITLE AND SUBTITLE</b>  Application of Electret Technology to Low Cost Desalination			<b>5. FUNDING NUMBERS</b>  Agreement No. 98-FC-81-0050 Requisition No. 98-DS-8230-125
<b>6. AUTHOR(S)</b>  Dr. Robert C. Amme, Principal Investigator and Haifeng Ni			
<b>7. PERFORMING ORGANIZATION NAME(S) AND ADDRESS(ES)</b> Bureau of Reclamation                      University of Denver Denver Federal Center                      Department of Physics P.O. Box 25007                                  Environmental Materials Laboratory Denver, CO 80225-0007                      Denver, Colorado			<b>8. PERFORMING ORGANIZATION REPORT NUMBER</b>
<b>9. SPONSORING/MONITORING AGENCY NAME(S) AND ADDRESS(ES)</b> Bureau of Reclamation Denver Federal Center PO Box 25007 Denver CO 80225-0007			<b>10. SPONSORING/MONITORING AGENCY REPORT NUMBER</b> Desalination Research and Development Program Report No. 73
<b>11. SUPPLEMENTARY NOTES</b>			
<b>12a. DISTRIBUTION/AVAILABILITY STATEMENT</b> Available from the National Technical Information Service, Operations Division, 5285 Port Royal Road, Springfield, Virginia 22161			<b>12b. DISTRIBUTION CODE</b>
<b>13. ABSTRACT (Maximum 200 words)</b>  Desalination using permanent electric fields generated by electrets is investigated and described. Electrets are fabricated from non-conducting polymers such as polypropylene sheets. Electrets do not give up their charges but force positive and negative charge migration out of the flowing stream of salt water. Since electrets do not supply an electric current, the process is viewed as low cost as the stream flow or thermal energy can be used for the energy needed for ion separation. This work tests Douglas MacGregor's patents (4,958,514 and 5,061,376). The work provides a critique of these patents and of MacGregor's reported results.  The work tests electric field strengths up to 18 kV/cm . To allow better temperature control, the tests are with column lengths of 4 and 8 feet rather than the 18 foot length in MacGregor's design. The study also investigated a shorter, wider configuration. The modest results to date have not supported the large removal efficiencies at the concentrations reported by MacGregor.			
<b>14. SUBJECT TERMS -</b> Desalination, electric fields, electrets, water treatment, insulator surfaces			<b>15. NUMBER OF PAGES</b> 56
			<b>16. PRICE CODE</b>
<b>17. SECURITY CLASSIFICATION OF REPORT</b>  UL	<b>18. SECURITY CLASSIFICATION OF THIS PAGE</b>  UL	<b>19. SECURITY CLASSIFICATION OF ABSTRACT</b>  UL	<b>20. LIMITATION OF ABSTRACT</b>  UL

**APPLICATION OF ELECTRET TECHNOLOGY  
TO LOW COST DESALINATION**

**University of Denver  
Department of Physics  
Environmental Materials Laboratory  
Denver, Colorado**

**By  
Dr. Robert C. Amme, Principal Investigator and Haifeng Ni**

**Cooperative Assistance Agreement No. 98-FC-81-0050**

**Desalination Research and Development Program Report No. 73**

**June 2002**

**U.S. DEPARTMENT OF THE INTERIOR  
Bureau of Reclamation  
Technical Service Center  
Water Treatment Engineering and Research Group**

## Mission Statements

### *U.S. Department of the Interior*

The mission of the Department of the Interior is to protect and provide access to our Nation's natural and cultural heritage and honor our trust responsibilities to tribes.

### *Bureau of Reclamation*

The mission of the Bureau of Reclamation is to manage, develop, and protect water and related resources in an environmentally and economically sound manner in the interest of the American public.

### *Federal Disclaimer*

The information contained in this report regarding commercial products of firms may not be used for advertising or promotional purposes and is not to be construed as an endorsement of any product or firm by the Bureau of Reclamation.

The information contained in this report was developed for the Bureau of Reclamation: no warranty as to the accuracy, usefulness, or completeness is expressed or implied.

## Table of Contents

	<u>Page Number</u>
ABSTRACT	1
I. INTRODUCTION	2
A. Objectives Restated	2
B. General Approach and Rationale	4
1. Accumulation of ions on insulator surfaces	4
2. Developing known field strengths that are adequate to produce the MacGregor Effect	5
3. Control of other variables, such as pressure and temperature	5
C. The Main Question	5
II. BACKGROUND	6
A. "MacGregor" Effect: Patent Claims	6
B. Electrets - Background	6
C. Use of Electric Fields for Water Treatments	7
D. Laws Related to E-Field Effects	7
III. APPARATUS EMPLOYED FOR INVESTIGATING THE MACGREGOR EFFECT	8
A. Insulated Parallel Plates	8
B. Rectangular Flow Channels	9
C. Layered Electrets	10
D. Aqueous Ion Chromatograph	11
E. Three-Chambered Desalinators	11
F. Membranes	12
G. Ancillary Apparatus	12
1. Peristaltic Pump	12
2. pH/Conductivity Meter	13
3. Computer Interface	13
4. E-Field Meter	13
5. Capacitance Meter	13
6. Thermal Bath	13
IV. RESEARCH PERFORMED	14
A. Overview	14
B. Properties of Polypropylene Electrets	14
1. Field Relaxation in Open Air	14
2. Stacking of Electrets	16
3. Subtractivity	22
4. Uniformity of Charge	22
5. Effect of Teflon Channel Plate	23
6. Effects of Water	26

## Table of Contents – Continued

	<u>Page Number</u>
C. Experiments with Coated Aluminum Parallel Plates	28
D. Electrets and Ion Chromatography	31
E. Electret Fields for Desalination	34
1. Three-Chamber Desalinators	34
F. Other Experiments	41
1. Adsorption by Membranes	41
2. Capacitance Bridge for Dielectric Constants	42
3. Concentration Measurements from Electrical Conductivity	42
4. Viscoelectric Effect	43
G. Analysis Performed	44
1. Energy Considerations	44
2. Electrical Boundary Layers	44
V. DISCUSSION OF RESULTS	46
A. Insulated-Plate Fields	46
B. Electret Studies	46
C. Chromatography and Elution Curves	47
D. Desalination Results and Parameters Varied	47
VI. CRITIQUE OF MacGREGOR PATENTS AND REPORTED RESULTS	48
A. Time Dependence	48
B. Cylindrical Configuration vs. Parallel Plates	48
C. Expectations Regarding Length Dependence	49
D. Flow Rate Inconsistencies	50
1. MacGregor's Quoted Flow Rates vs. Calculated Rates	50
2. Mass Balance	51
E. Reynolds' Numbers	52
F. Electrets and Field Strength (in water)	52
VII. CONCLUSIONS FROM THIS WORK	53
A. The MacGregor Effect	53
B. Alternatives	53
C. Economic Considerations	54
VIII. PROSPECTS AND FURTHER STUDIES	54
IX. ACKNOWLEDGEMENTS	55
X. REFERENCES	56

## ABSTRACT

This report describes our extensive efforts to investigate the process of desalination using permanent electric fields generated by electrets. In such a process, the electrets do not give up their charges (they are fabricated from non-conducting polymers such as polypropylene sheets), but serve only to force positive and negative charge migration out of the flowing stream of salt water. Such a device was described by Douglas MacGregor<sup>1,2</sup> in two patents (4,958,514 and 5,061,376) in 1990-91 (see Sec. X for references), but never fully demonstrated owing to his subsequent illness and death. Since no electrical current is supplied by the electrets (insulators), the process has been viewed as one of low cost, the energy for ion separation presumably being supplied by the mechanical energy arising from the stream flow or by thermal effects. This work has been directed at testing MacGregor's patents by studying the effects of transverse electric fields on charge migration in water, wherein the field strengths are on the order of several kV/cm and at the probable adverse effects of water, especially saline, on the stability or durability of candidate electret materials. In addition, the energetics of desalination by this device have been investigated, along with alternative methods for electrostatic field generation by (insulated) parallel plates as a charged capacitor, again with no current flow or ion neutralization on the surfaces. The field configurations investigated are uniform (rather than radial, as employed by MacGregor).

The imposed electric field strengths employed in our investigation were up to 18 kV/cm, the same as that claimed by MacGregor. Flow rates were comparable, although the 18-ft length reported in his patents was compromised here in favor of a more compact configuration allowing good temperature control. The two column lengths investigated were 4 ft and 8 ft, sufficient we believe to test the concept over a wide range of salinity. In addition we investigated a shorter, wider configuration.

Our modest results to date have not supported the large removal efficiencies at the concentrations reported by MacGregor. There is evidence that some of the salt removal in MacGregor's apparatus was due to adsorption by the membranes. A critique of his patents and of his reported results is provided. We do hope to test the concept of double membranes further in a number of ways as described in Sections VII and VIII of this report. Other funding is being sought for this effort.

## I. INTRODUCTION

### A. Objectives Restated.

The goal of this work has been to investigate a low-cost method for desalination as claimed by Douglas MacGregor in his 1990 and 1991 patents describing the use of a permanent electrostatic field for deflecting ions from a stream of flowing saline water. The patents, entitled "Method and Apparatus for Separating Ions from Liquids", describe a specific configuration for which it was asserted that a stream of 3% (wt) saline water was reduced to two streams, viz., one providing 80% of the volume flow at 5.2 ppm salinity, and the second yielding 11.8% salt-enriched water, as depicted in Figure 1 from MacGregor. This investigation was intended to confirm his results, if possible, and to seek optimization.

Specific goals have been:

- a. Select a suitable source of electrets, i.e., those possessing adequate material properties to permit retention of charge (both positive and negative) or of polarization, to resist degradation with time, and to avoid degradation in the presence of highly saline water. Size and physical strength were other selection criteria. Had we failed to locate such electrets commercially, it would have been necessary to undertake a major development project, since MacGregor's patents were his only records discovered and there was no clue provided (other than Mr. Ed Ott's recollections) as to how his electrets were prepared (see Sec. III. C).
- b. Construct a desalinator of suitable design to permit the control of essential variables (temperature, plate or electret separation, input saline concentrations, membrane installation, concentrations versus time for effluent streams, column length, and flow properties, i.e. pumping or flow speed and Reynold's numbers).
- c. Develop a means for establishing the actual field strength inside the channel or channels (this task is made difficult for several reasons, as described in Sec. IV).



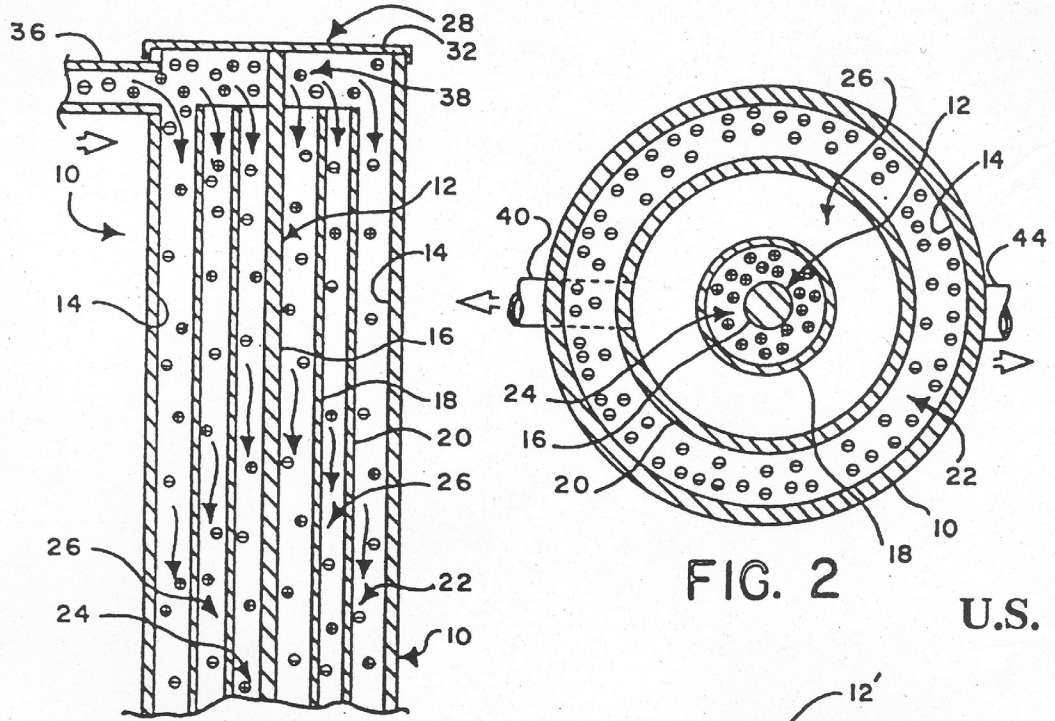

FIG. 2

U.S. Patent

5,061,376

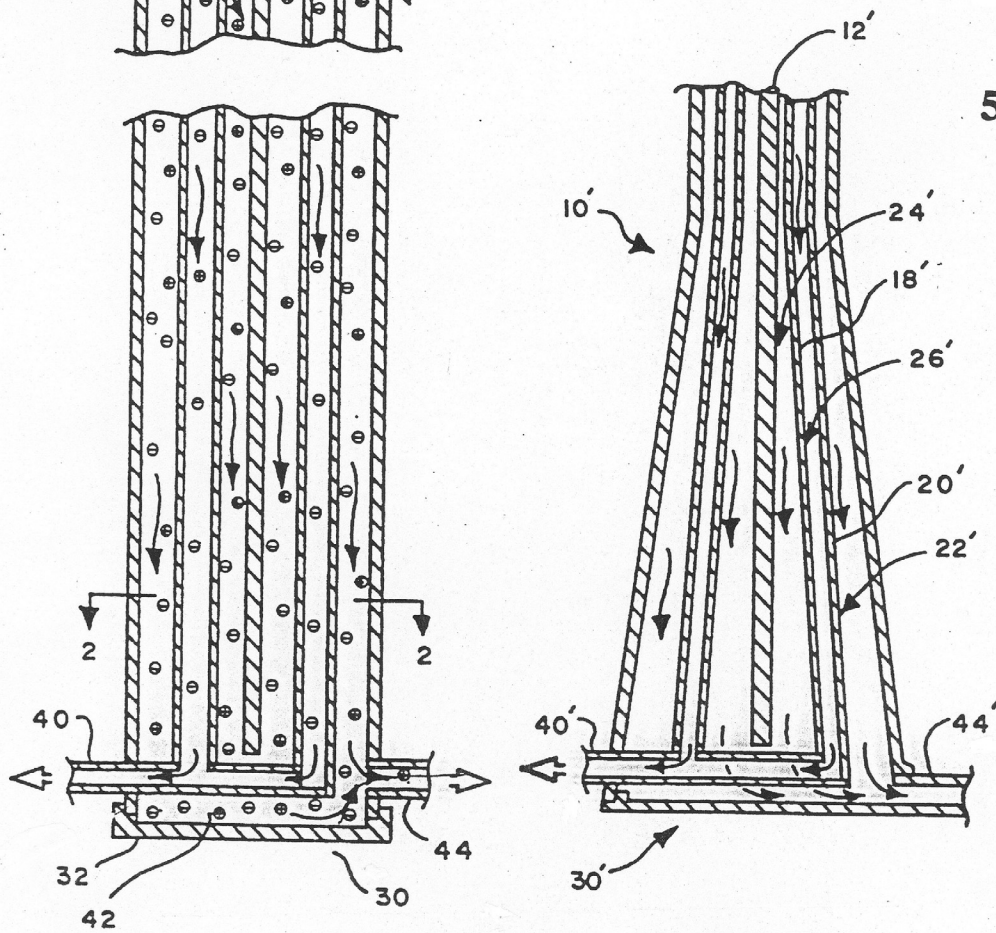

Fig. 1. Schematic diagram from MacGregor's 1991 patent

## B. General Approach and Rationale.

There are several concerns that needed to be addressed in order to meet the stated objectives. These concerns are presented here, with more details appearing below.

### 1. Accumulation of ions on insulator surfaces.

For the MacGregor concept to work in steady state, two important conditions must be met:

- (a) the field must have sufficient strength to force ions, even when very enriched (i.e., ca. 1% molar) to migrate away from the central stream, through a pair of membranes, and into either of two outer channels paralleling the center channel, all under normal viscous flow;
- (b) the ions accumulating in the outer channels must be swept along with the overall fluid flow and forced out of the desalinator in steady state, without charge buildup anywhere interior to the system. This implies that any charge built up initially on the membranes defining the three chambers must not be sufficient to repel charges of like sign migrating across the membrane. Thus, ion retention by surface adsorption on the membrane is an important parameter to investigate. The approach we have taken in this respect entails: 1) mass balance measurements by injection of known slugs of saline water into a steady flow and measurement of conductivity of the effluent versus time; and 2) soaking the exposed membranes in a measured volume of pure water and measuring the resultant salinity.

If, in the desalinator, the electrets are removed and replaced by an uncharged film of Teflon, any loss of salinity must be attributed to adsorption by the Teflon, the membranes if present, or both. This provides an experimental means of determining what fraction of the observed desalination is due to factors other than the electric field ("E-field") itself.

2. Developing known field strengths that are adequate to produce the "MacGregor Effect".

MacGregor evidently fabricated his own electrets out of polymers, but gave no clues about his process. Our approach was to seek a commercial product and to measure the field strengths from these products using accepted instrumentation out of the electrostatics industry. This has the additional advantage of allowing investigations into the effects of water, with variable salinity, on the electrets. MacGregor never indicated how his fields were determined or what the environmental conditions were. As an additional approach, we also experimented with E-fields generated by metallic (aluminum alloy) plates, suitably insulated by Teflon coatings to prevent current flow, as a substitute for charged polymers. Such fields have two advantages in principle, viz., reversible field direction and accurately known voltages. Using high voltage, low-current power supplies, one should be able to reach equivalent or greater field strengths, up to the threshold for electrical breakdown.

3. Control of other variables, such as pressure and temperature.

The long, cylindrical geometry described by MacGregor was operated without the benefit of temperature control other than simply room temperature, and no details regarding the pumping system (which might introduce pressure pulsing and impurities) were provided. Our approach has been that of employing a serpentine channel of shorter dimension to permit the use of a thermostatically controlled environment. A peristaltic pumping arrangement permits better control over impurities (no exposure of the pump's components) and over pumping pressures. MacGregor's (18 feet long) plastic tubing was at least unwieldy (and in fact was broken during an operation). The E-field could not be uniform in a cylindrical configuration, either, and the field strength at the negative electret surface was evidently several times that at the positive surface (assuming that the surfaces were charged to the same potential). Our approach, employing parallel plates or parallel electrets, avoids these complexities.

C. The Main Question.

It is clear that the objectives translate to the need to answer the question: "Were MacGregor's quoted values of ion separation correct?" and if so, is the process leading to these values a steady-state result or were they merely a transient effect that can be accounted for by some process other than an E-field

separation? MacGregor assumed that steady state prevailed, i.e., no regeneration would be required. This was never fully demonstrated. Thus, an auxiliary question must be asked: "Might regeneration be necessary with this process?" From a more fundamental perspective, one can calculate the electret's (or insulated metal plate's) charge density and compare this surface charge with that which will accumulate in the Stern layer on the surface and in the diffuse layer, then compare this with the ion concentration in the main flow. This comparison (which clearly indicates a rapid diminution of E-field strength as one penetrates into the solution) shows that the system could work only if the flow velocity is capable of moving the boundary-region ions downstream to permit additional ions to move into the diffuse layer. Thus, the main fundamental question is: "Can flow and field conditions be established in the device such that the field migration of saline ions through the membranes permits these ions to be concentrated near the diffuse layers and thence be swept downstream?" We return to this question in Sections V and VI.

## II. BACKGROUND

### A. "MacGregor" Effect: Patent Claims.

In his two patents, MacGregor claims that virtually 100% of ionic dissolved solids can be removed from saline water by the application of an electric field, viz., one produced by a pair of electrets with opposite polarities to the solution. The polymeric electrets (PTFE Teflon in his case) are electric insulators and therefore no external voltage need be applied. Likewise, no external current is drawn; the ions are postulated to be drawn by the field into flowing side chambers and are later recombined as an enriched solution at the end of the column. An early version of the desalinators was of a rectangular configuration; water of remarkable purity (8 ppm range) was claimed to be produced. A later version, a long tubular, coaxial arrangement, is the one described in his patents (Fig. 1). MacGregor made his own electrets, but no claims or description are provided in the patents. The field strength was simply quoted as 18 kV/cm.

### B. Electrets - Background.

Mr. Ed Ott, a witness to some of MacGregor's efforts, has provided us with some additional background regarding MacGregor's efforts in making electrets of various sizes, but a search of MacGregor's laboratory records unfortunately turned up no new information on the subject.

Historically, electrets were fabricated first by placing a polar substance (beeswax was perhaps the first substance to be investigated) into a high intensity electric field (such as between capacitor plates), then heated to a forming temperature (just below melting) that allows the naturally polar molecules to become partially aligned in the field, then cooling the material with the field on. The polarization was thus "frozen in," and would retain its polarized character for some period of time. A considerable volume of literature now exists<sup>3,4,5</sup> on electrets, formed in a variety of ways and with a variety of materials. For polymers having little inherent polar nature, charge injection may be used to produce permanent (or at least long-lived) electric fields (both dipolar and homopolar). Some of these materials have been employed commercially in a range of products, from acoustic transducers to alpha-particle detectors. Nearly all of these products, however, are small in size (on the order of a few square centimeters or less) with one noteworthy exception, viz., products from Permcharge Corporation, Rio Rancho, NM. It is their polarized polypropylene sheets that we have used in this study.

#### C. Use of Electret Fields for Water Treatments.

To our knowledge, Dr. MacGregor's efforts are the only ones to attempt the use of electrets to reduce the saline content of water. Two issues of obvious concern in this application are 1) the possibly adverse effects of humidity (or liquid water itself) on charge storage, particularly when the water is grounded and highly ionic (conducting), and 2) charge storage and durability, even when dry, when employed for long periods (weeks or months). Several measurements have been reported<sup>6</sup> on the water uptake by polymers; Teflon is probably the most resistant. But if any polymers are to be employed in this type environment, such studies are essential.

#### D. Laws Related to E-field Effects.

Here, we address the need to infer the surface charge density for an electret, given a measured value for the electric field strength in air above the surface. The applicable laws relate to E-field direction and to Gauss's Law, one of the four Maxwell equations of electrodynamics. For the first one, it is sufficient here to state that the electric field intensity above a flat, charged surface is a constant near the surface, as long as the dimensions of the charged sheet are large compared with the field point distance considered. For MacGregor's device, the electrets are cylindrical. The inner electret (a solid 0.5-inch diameter rod) is

not flat, so the field strength would be constant only for a very short distance from the rod. Moving out from the rod, the fields diminish as  $1/r$ . Similarly, the outer electret surface is the inner wall of the 2-inch diameter tube (Fig. 1), so its field is not constant owing to surface curvature. Any point interior to these two surfaces will have a field that is a superposition of the two fields, originating from surface charges of opposite polarity.

These observations are valid in the absence of a conducting medium which in this case is an electrolyte. The presence of the ions in saline water (or for that matter even in pure water which is weakly dissociated) will have a profound influence on the interior field strength, as discussed in more detail below (see esp. Sec. IV.G.2).

Gauss's law<sup>5</sup> tells us that, for a single plane sheet of charge, the electric field near the sheet is normal to the sheet and is related to the surface charge density  $\sigma$  by:  $E=\sigma/2\epsilon\epsilon_0$ ,  $\epsilon$  being the dielectric constant for the medium surrounding the sheet and  $\epsilon_0$  the permittivity of free space ( $\epsilon\approx 1$  for air). For two sheets with equal but opposite charges and facing each other, the fields are additive, so that

$$E=\sigma/\epsilon\epsilon_0.$$

These equations permit us to determine the surface or near-surface charge densities on the electret, which in turn gives us the upper limit to the surface ion concentration when saline water is in contact with an electret (see also Sec. IV.G.2 and VI.F).

### III. APPARATUS EMPLOYED FOR INVESTIGATING THE MacGREGOR EFFECT

#### A. Insulated Parallel Plates.

At the outset of this project, our search for large, commercially available electrets had been fruitless. In addition, we saw an advantage to an apparatus in which the field direction could be reversed at will. With this objective, we contacted NordicWare, Inc. in Minneapolis through a local company and arranged to have two alloy plates (1/4 in. x 10.5 in. x 15 in.) coated with 0.002 in. of Teflon. These dimensions were chosen so as to fit into a thermostated bath unit for closer temperature control as needed. The plates form a capacitor as well as the structure for holding the water channels or columns of the desalinator. A

single, sandwiched sheet of Teflon with a channel cut in it could also serve as a liquid ion chromatograph, through which pure water could flow and a saline solution of known concentration could be injected (see Figures 2 and 3). The Teflon is necessarily kept thin in order to maximize the E-field strength within the channel bounded by the coated plates (See IV.C).

### B. Rectangular Flow Channels.

The rectangular channels formed between parallel plates were elected for use in this study since the field strengths will be uniform within the channel (at least when no water is present), unlike MacGregor's cylindrical configuration. Moreover, the ease of assembly and access, interchangeability, and simplicity of membrane installation and support adds to the desirability, along with the increased ease for temperature control. Sheets of commercial grade Teflon were used for the channel material; it is available in a variety of thicknesses and can be readily cut for various channel thicknesses.

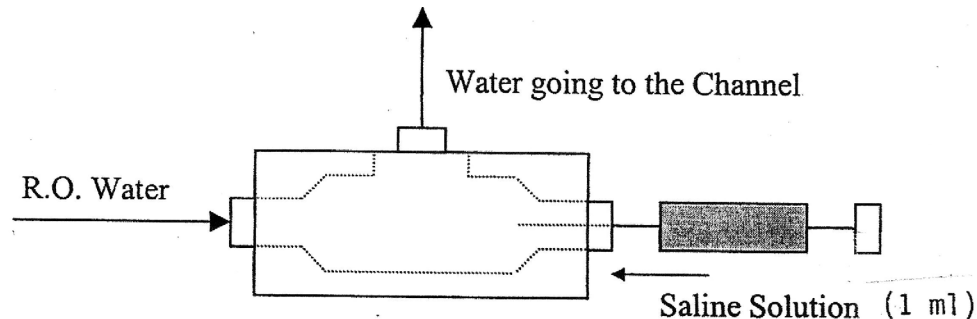

Fig. 2. Ion chromatograph injector port

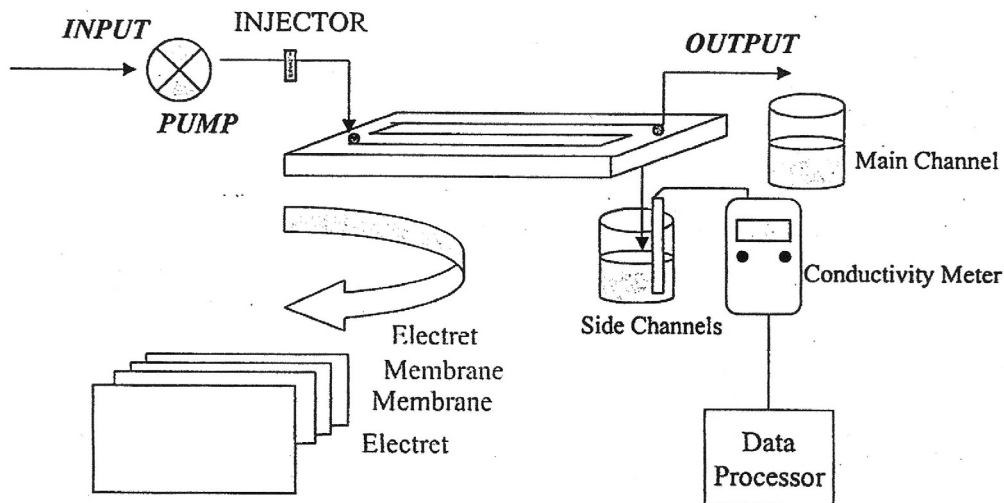

Fig. 3. Instrumentation

### C. Layered Electrets.

The commercial electrets we have been able to find are fabricated from 0.005 in. sheets of polypropylene. The method for charging involves the transport from one roll (ca. 26 in width) to a second (take-up) roll, moving through the charging device at a specified rate. The company name is Permcharge Corporation, of Rio Rancho, New Mexico (near Albuquerque). The principal product is called "Wall-Write," or "Clingz," owing to its use as a write-on bulletin board, or as a wall poster bearing printed images. Their supplier of polypropylene sheets provides either clear sheets or white, the latter being treated in some manner with  $TiO_2$ . To date we have used only the latter. We had hoped to compare the two for charge strength and durability, however, we were unsuccessful in obtaining delivery of the clear material.

When supplied fresh from the manufacturer, the surface field strength of the white sheets is found to be around 3.8 kilovolts per centimeter (kV/cm). On one side, the field is positive, while on the other, it is negative and of closely the same magnitude. This equality usually persists as the electrets degrade with time (air exposure, etc.) (See Sec. IV. B).



#### D. Aqueous Ion Chromatograph.

Two versions of a single-channel ion chromatograph were constructed as future components of the multi-chambered desalinators; one version employs coated (insulated) metal alloy plates, while the other employs two plastic (Lucite) plates and a pair of Permcharge electrets. Both employ a Teflon separator plate into which is cut a serpentine, 1-cm wide channel provided with fittings at each end (Figure 3). Highly purified water is then pumped through the channel, and the conductivity of the effluent stream is measured continuously and recorded. A saline-rich slug of water is injected into the input stream with a calibrated syringe, so that a known quantity of NaCl is sent through the system. The saline water is dispersed by the velocity gradients (Poiseuille flow), and by possible adherence to the Teflon (and membrane, if included) walls. A plot of conductivity versus time for the effluent permits study of the salt dispersion and mass balance, both in the presence and absence of an electric field. The purpose is clearly to investigate transient "desalination" that might appear as a consequence of surface adsorption of the components of the apparatus, as opposed to ion transferral as asserted by MacGregor. The effect, if any, of an applied E-field on the absorption or release of ions can also be observed. Results of these studies are described in Section IV.F.

#### E. Three-Chambered Desalinator.

The configurations described in Sec. III.D above can be modified to provide two additional channels, one on either side of the main or central channel, for the collection of positive or negative ions drifting toward their respective electrets. This configuration provides equal volumes for the negative and positive ion collection regions, whereas in MacGregor's cylindrical configuration, the ratio  $V+/V-$  is 0.43; MacGregor's radial separations between the central electrode and the first membrane was 0.25 inch, as was the separation between the outer (positive) tube and the second (outer) membrane. The same separation existed between the two membranes, since the center (negative) rod was 0.5 inch in diameter and the overall ID was 2.0 inches.

Each configuration we have employed provides equal spacing between each electret and its corresponding membrane; typically this spacing was  $\frac{1}{2}$  of that for the central channel, providing equal volumes for the sum of the enriched

component flow and the depleted flow channel. Examples are 1/16," 1/8," 1/16," and 1/8," 1/4," 1/8." Flow from the two outer channels were combined at the outlet end, as was the case in MacGregor's system (Figure 1).

#### F. Membranes.

Two general types of membranes are in common use: The simple semipermeable membrane, available from various suppliers and with a range of pore sizes, and the **ionic** membrane, which is ion-selective. The anionic membrane permits passage of anions (negative ions) only, whereas the cationic membrane permits the passage of cations only. MacGregor employed only one type - the semipermeable, with 5-micron pore size, obtained from Millipore Corporation (no longer available). In our work, we have employed similar membranes, provided by Osmonics of Vista, California, and Millipore's newer versions. Osmonics pore sizes closest to that used by MacGregor are three and four microns. Recently Osmonics has phased these out; currently available membranes in sheet form have smaller pores (1-3um) and are twice as thick (ca. .007 inch). Ion-selective membranes have not been tested, although in future work we intend to do so. The supplier will probably be Ionics Corp. (see Sec. VII).

Referring to Figure 1, MacGregor employed two cylindrical membranes "of identical material," the inner membrane (1 in. diameter) he claimed had surface area of 1.18 ft<sup>2</sup> (see ref. 2). MacGregor described the purpose of the membranes as providing "mechanical barriers" that discourage the ions from remixing into the neutral region. Since MacGregor claimed that the flow was slow enough to maintain Poiseuille or laminar behavior, the fluid flow velocity is expected to be close to zero on the membrane surfaces as well as on the electret surfaces. Mass movement through the membranes would then be zero except for ion (or hydrated ion cluster) drift due to the applied electrostatic field. It does not appear that MacGregor experimented with ionic membranes, or anticipated their possible use.

#### G. Ancillary Apparatus.

1. Peristaltic Pump. With a large reservoir as a source of fluid for either the ion chromatograph or the desalination apparatus, a fairly constant head can be maintained on the channels for runs of several minutes, simply by adjusting the height of the reservoir. Alternatively, the pressure can be applied by a peristaltic pump (Cole-Parmer Master Flex model 77200-12) having a double

action to minimize pulsing. This model has an adjustable speed and a throughput that depends on the selected pump head.

2. pH/Conductivity Meter. A Cole-Parmer Instruments' model ES-14 meter is employed to measure the salinity, pH, or electrical conductivity of solutions versus time. The meter (manufactured by Horiba of Japan) utilizes a probe possessing a cell constant of  $1 \text{ cm}^{-1}$ .

3. Computer Interface. The model ES-14 conductivity meter provides a 0-1 volt analog output that permits continuous monitoring and recording. The output is sent to a Computer Boards Corporation data acquisition card (C10-DA508-AOL), installed in a Pentium-based computer for processing, recording, and plotting.

4. E-Field Meter. A Monroe Instruments' model 257C electrostatic field meter is employed to investigate the field strength of the electrets used in this study. Although the meter is factory-calibrated, a pair of 15-inch diameter metal parallel plates can be used to check this calibration as desired. This is accomplished by inserting the meter probe into a centered rectangular hole (10 mm by 36 mm) flush with the surface of one plate, and applying a known voltage  $V$  across the plates with known separation,  $d$ ; the field strength is given by  $E=V/d$  volts/cm.

5. Capacitance Meter. To ascertain the electric field strength within a channel that is sandwiched between plastic (e.g., Teflon) sheets inside conducting parallel plates, it is important to determine the dielectric constant for the plastic material. This measurement is performed by means of an ESI Corp. Model 252 impedance meter, with 0-200 picofarads the most sensitive range. The importance of these measurements is illustrated in Sec. IV. B and IV.F.2.

6. Thermal Bath. In order to improve our control over fluid temperatures, a 28-liter Cole-Parmer Model PT 2800 C/P, double-walled bath was acquired. The internal dimensions of this tank limit the size of the columns we constructed; if longer columns were needed, a vertically stacked configuration could be readily accommodated in the bath.

## IV. RESEARCH PERFORMED

### A. Overview.

The central objective of the laboratory effort has been to determine whether MacGregor's results could be replicated, even if desalination by electrets is but a transient effect. An analysis of MacGregor's claimed results with his given operating conditions is presented in Sec. VI. One consequence of this analysis was our decision to employ a geometry that would provide a uniform electric field using flat sheets of well-characterized electret material. All the electret material we employed was polypropylene, obtained from Permacharge Corporation. Their material was received in 50-ft long rolls. Since no details of their process were disclosed, a major effort was undertaken to investigate the properties of sheets cut from these rolls.

Measurements performed during this project can actually be divided into four major components:

- Electrets and their properties (in this case, the polypropylene),
- Selected measured properties of water and saline water,
- Interactions of saline water with electret surfaces, and
- Desalination efforts and related studies.

We now present a number of these measurements in detail.

### B. Properties of Polypropylene Electrets

#### 1. Field Relaxation in Open Air

During this study, we received two shipments of "Wall-Write" white polypropylene sheet electret from Permacharge Corporation. Both shipments were received in rolls (21-in. and 29-in. widths), from which individual pieces were cut for experimentation. (Rolls were kept tightly sealed in their shipping boxes otherwise). The nominal sheet thickness is 0.1 mm.

While no information could be obtained from Permacharge regarding the charging process (a "trade secret"), it appears to us that the material was passed through a proprietary charging device that deposits positively charged ions on one side and negative electrons on the other. The first roll showed good time

stability over several months, in spite of the fact that it contained many layers. The nominal field strength we typically observed was about 2.8 to 3.5 kV/cm when measured on a fresh sample from the roll. The measurements are taken by the Monroe electrostatic field meter, always at 1 cm from the surface. If the sample is left exposed to laboratory air (unfiltered), the field slowly diminishes owing to the attraction to the surface of charged dust particles. The reduction is approximately one volt/hr average, as seen from Figure 4. The field above a stack of three electret sheets in air was found to lose strength at about 4 times that rate when the sheets are in intimate contact. It is tempting to suspect that some of the depletion could result from charge migration between the surfaces of contact, which are of opposite polarity, but this would not explain why the rolls can store well for many weeks. This would indicate that the larger E-fields so generated are capable of inducing charge migration. After the sheets are again separated in lab air, the field strength of each is found to be permanently reduced.

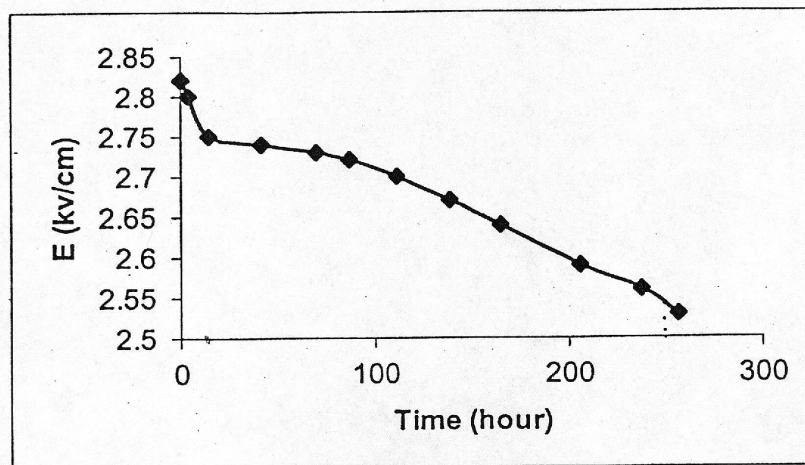

Fig. 4. Typical decay of the measured field strengths of a polypropylene electret suspended in Laboratory air.

## 2. Stacking of electrets

Stacking of the polypropylene sheets can produce a range of results; when firmly pressed together, the total field strength is not additive. (This is probably why the shelf life of the stored roll is several months.) If separated by a thin air gap, the resulting field is more closely so. This is true of both the positive side and the negative side of the stack.

To further investigate additivity, additional stacks were prepared with separators made of 0.005 in. Teflon sheets and also of common (Xerox) plain paper (ea. 0.004 in) sheets.

Table 1 lists the field measurements at 3 different positions on each of 6 fresh sheets of electrets A through F.

Table 1. – Field measurements in kv/cm

Electret	Position 1	Position 2	Position 3
A	3.03	2.39	3.30
B	3.66	3.69	3.13
C	2.68	3.03	1.64
D	3.49	3.75	3.10
E	2.77	2.37	2.73
F	2.55	2.30	3.11

Using "T" to represent a Teflon sheet, the stacking arrangement is presented progressively in Table 2. It is seen from the measurements at three similar positions that, within the uncertainty, the resulting fields were roughly additive.

Table 2. – Stacking Arrangements

Arrangement	Position 1	Position 2	Position 3
A,T	2.86	2.05	3.01
A,T,B	7.30	6.42	5.82
A,T,B,T,C	10.06	9.45	7.60
A,T,B,T,C,T,D	13.22	13.38	11.48
A,T,B,T,C,T,D,T,E	16.98	17.02	14.55
A,T,B,T,C,T,D,T,E,T,	18.27	17.18	18.15

When the full stack was pressed very firmly and the fields remeasured, we obtained somewhat lower values: 15.2, 14.5, and 14.2 kV/cm, respectively. The values were unchanged after waiting 20 minutes. The same behavior was found on the negative side of the stack, with approximately the same magnitudes, viz., -14.5, -13.6, and -14.01 kV/cm at three locations.

With the paper separators, the observed field strengths for the stacks turned out to be considerably less (ca. 9.5 kV/cm) and changed rapidly with time (roughly halved in 30 minutes). The paper separators acquire a net charge.

The conclusion from this work is that fields on the order of 18 kV/cm (for a stack of six polypropylene Wall-Write electrets) can be readily prepared with adequate durability, if protected from dust collection and if separated by thin Teflon sheets. In our desalinator work, we need two stacks separated by the thickness of the three Teflon channel plates, plus two membranes. We note that since the size of the electrets covering these Teflon plates is about 27 cm by 38 cm, the field close to the (flat) surfaces can be both reasonably uniform and additive. Three sheets can be used to generate a field of ca. + 9 kV/cm on one side of the flow channels and three more of -9 kV/cm on the other, giving an 18 kV/cm field across the assembly, since the pair of stacks will be separated by distances of only 1.3 cm or less. Sample measurements follow:

# 1. Electret sheet & paper

(1)

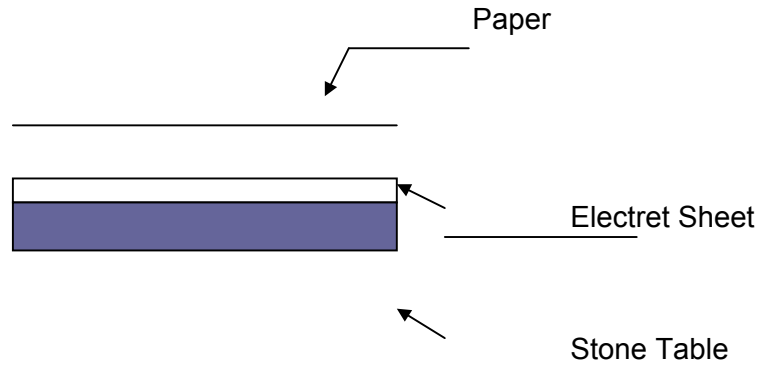

- Original E field of the electret sheet: 3.49 Kv/cm
- With a piece of paper contacting Electret sheet, the electric field initially changed to 3.01 Kv/cm, then decreased more gradually (ca. 10 min) to 0.77 Kv/cm.
- After removing the paper, the electric field became 2.34 Kv/cm; and inverse side: -2.37 Kv/cm.

(Original electric fields are measured 1 cm above the Electret sheet which lies on a stone table top.)

(2)

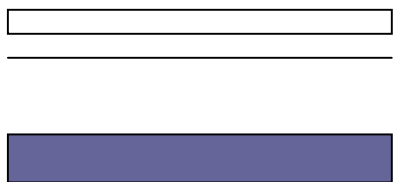

- Original electric field of the electret sheet: 3.67 Kv/cm
- With a piece of paper under the electret sheet, the electric field did not change; it remained at 3.69 Kv/cm.



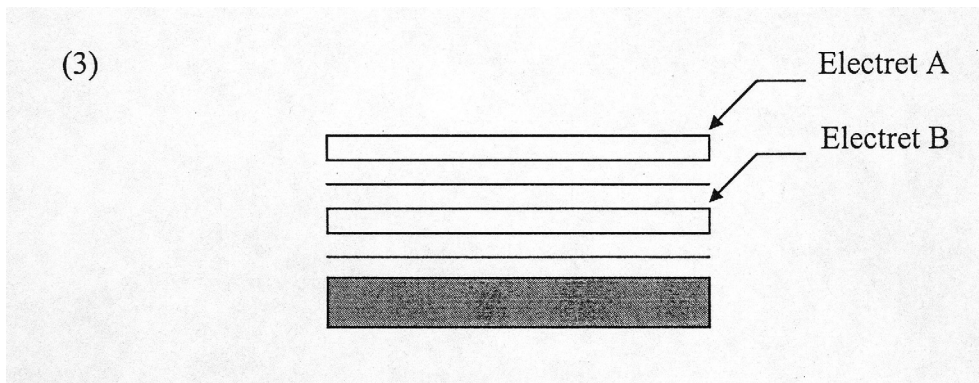

- Original electric fields:

Electret A: 3.68 Kv/cm; Electret B: 3.70 Kv/cm

- After stacking, the electric changed to 6.80 Kv/cm. In 30 minutes later, it became 4.41 Kv/cm.

Removing Electret A, the electric field of A, measured 3.42 Kv/cm; the electric field of the rest stack(2-paper+Electret B) measured 0.62 Kv/cm. The electric field of Electret B is 1.36 Kv/cm, and the reverse side measured -1.49 Kv/cm.

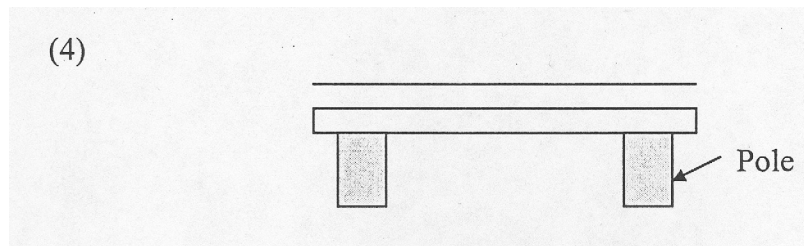

- Original electric field of the Electret sheet: 4.04 Kv/cm
- The paper did not affect the electric field of the electret sheet when the sheet was suspended in the air.
- After the treatment, the electric field became 4.17 Kv/cm.

## 2. Electret sheet & Teflon sheet

(1)

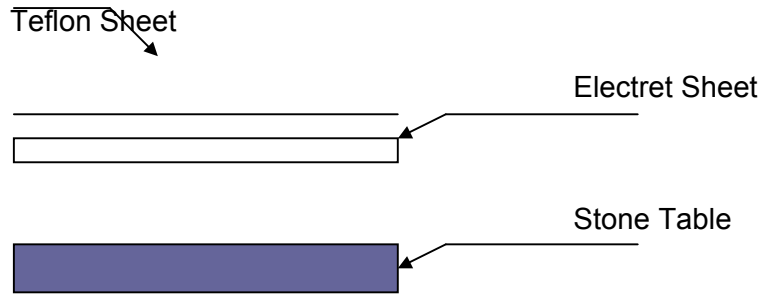

- Original electric field of the electret sheet: 3.97 kv/cm
- Covered with a piece of Teflon sheet, the electret sheet's field became 3.98 Kv/cm. Removing the Teflon sheet, the electric field changed to 3.93 Kv/cm. Small charge transfer occurs.

(2)

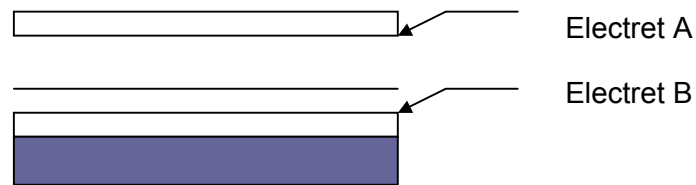

- Original electric fields:  
Electret A: 4.57 Kv/cm; Electret b: 3.80 Kv/cm
- After stacking, the electric field was 8.47 Kv/cm.

If we suspend the Electret sheets, the field doesn't change much with a Teflon sheet on top.

### 3. Electret sheet & Teflon and paper sheets

(1)

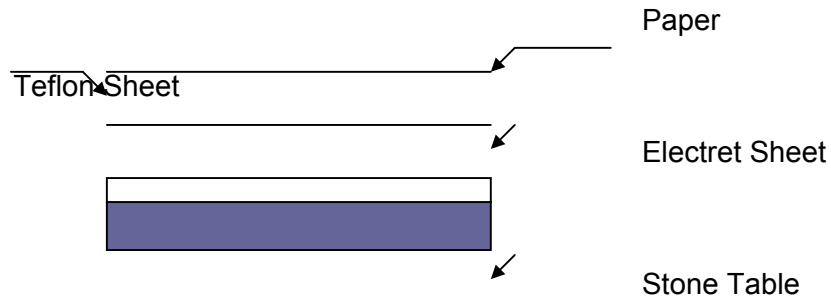

- Original electric field: 3.28 Kv/cm
- The electret sheet covered with 1-paper and 1-Teflon sheet, the electric field changed to 0.68 Kv/cm after 10 minutes. Removing the stacking, the electric field of the electret became 2.26 Kv/cm, and  $-2.19$  Kv/cm on the reverse side.

(2)

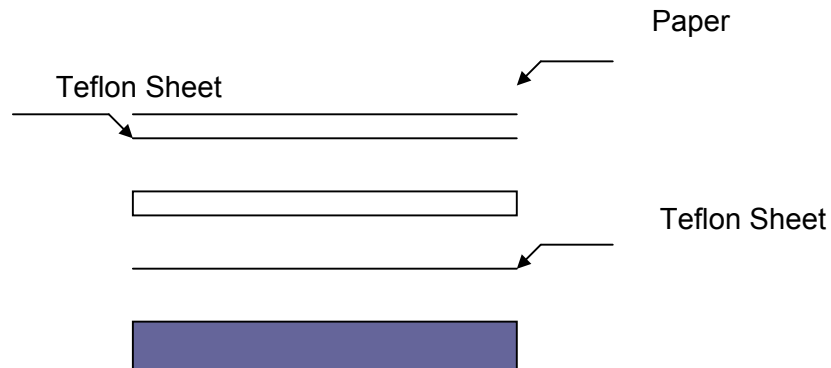

- Original electric field: 3.79 Kv/cm
- After 15 minutes, the electric field changed to 1.66 Kv/cm.
- Removing the paper and Teflon sheets, the electric field of the electret became 3.41 Kv/cm, and  $-3.83$  Kv/cm on the reverse side.

Additional experiments using successive contact between an electret sheet and a series of the .005" thick Teflon spacers showed an additional effect: with pressing and then removal of the first Teflon sheet, the electret's E-field declined by ca. 4%. The next contact made with a second Teflon sheet caused, after removal, a reduction by another 0.9%. The third contact had virtually no effect. Evidently, the electret sheet (positive side) possessed a fraction (ca. 5%) of surface electrostatic charge that could be removed by charge transfer, while the remaining charge (perhaps more deeply embedded) appears more immobile. It may be this former component that accounts for the rapid field reduction seen in the first few hours of exposure to laboratory air (Fig. 4); on the other hand, the field strength after charge removal by the Teflon did partially recover after several minutes.

### 3. Subtractivity.

It is also of interest to determine how electric fields of two or more polypropylene sheet electrets behave when arranged in an opposing configuration. In these experiments, two electrets are arranged with the same polarity facing each other, rather than facing the same direction, and the separation varied while the E-field on either side of the pair is observed. Two fresh electret samples were separated by a sheet of 5-mil Teflon, first with fields aligned and then with fields opposed. The field (at 1 cm distance) was then measured at three different locations. With the fields aligned, the total field of the pair had an average strength of 4.4 kV/cm, compared to 4.6 kV/cm for the sum of the individual positive-side fields. When the upper sheet was reversed, the measured field averaged -0.4 kV/cm, which compares with the difference of 0.1 kV/cm. As the separation was increased, the measured comparison was essentially unchanged. If the charge densities were perfectly uniform and equal in magnitude on all faces, we would expect the opposing fields to almost exactly cancel.

### 4. Uniformity of Charge.

For our purposes, uniformity of charge is a significant need. Before their use in a desalinator application, sections were cut from the polypropylene roll and tested for uniformity before stacking and assembly. The routine was to measure a sheet at positions every 3 cm from edge to edge. These points describe an array of values typically 9x9 per side, or 162 measurements per sheet. For the first roll of material we received, uniformity was quite good, usually

+/-10% over each surface except near the edges. The second (wider) roll we received, however, was inferior in this regard, necessitating numerous samples to be tested. With this material, we occasionally saw an actual change of sign on a single surface, from which we inferred that the company's charging process had changed in some manner (this was confirmed by a Permacharge engineer). Such material is not useful for our purposes, and had to be rejected.

#### 5. Effect of Teflon Channel Plate.

While we have no means for making direct measurement of field strength inside the closed desalinator (nor, we believe, did MacGregor), it is straightforward to cover an electret with a Teflon channel plate and scan each of the seven arms of the channel for field variations. Such variations, while not predictable in detail, are expected to arise because of previous effects observed when Teflon (an excellent electrostatic insulator) is placed in contact with an electret. Figure 5 is a schematic of a folded-channel desalinator, indicating the layered arrangement, in which a single electret is depicted for each of the two side chambers. Each dark line in the channel plate represents a 1-cm wide arm (see also Fig. 11 in IV.D below). For the present tests, scans were performed 0.92 cm above the 1/32-inch Teflon channel, or 1 cm above the electret. The field here roughly corresponds to that which is imposed on the main channel from one of the pair of electrets when fully assembled. Many such scans were performed, some for which the Teflon had been wetted. A scan of the field along an inner arm ("Channel #3") is presented in Fig. 6 as an example. The variability of the electret itself along this path is represented by the top curve ("No Teflon"), while the trace with the Teflon channel plate in place is seen to produce somewhat lowered values, averaging about 10-15% less. The wetted Teflon shows considerably lower fields (ca. 1.4-1.5 kV/cm), but this is strictly a measure of just the vertical component of E; the horizontal component resulting from charges residing along the vertical edge of the channel could be significant (one of the reasons why we also tested a much wider channel; see below). However, when a second electret is placed over this structure, as for either the desalinator or ion chromatography configuration, the non-vertical component of the total field in the cavity should be roughly halved, so that the E-field available for desalination is closer to the sum of the fields from each. (A greater concern for the field strength is the large dielectric constant for water, just as in MacGregor's system - see Sec. IV.G.3). The reduction observed in the open channel (Fig. 6) when the Teflon is wet is probably due to the charge mobility in the water along the

Teflon's edge, permitting some of the electret's field lines to terminate there. When the entire channel becomes filled with water, this lateral (horizontal) field-line deflection is expected to diminish, but this points up the fact that the electric field will be attenuated within the water stream at a rate that should depend on the ion concentration when the channel is filled with saline water, as discussed in the next section.

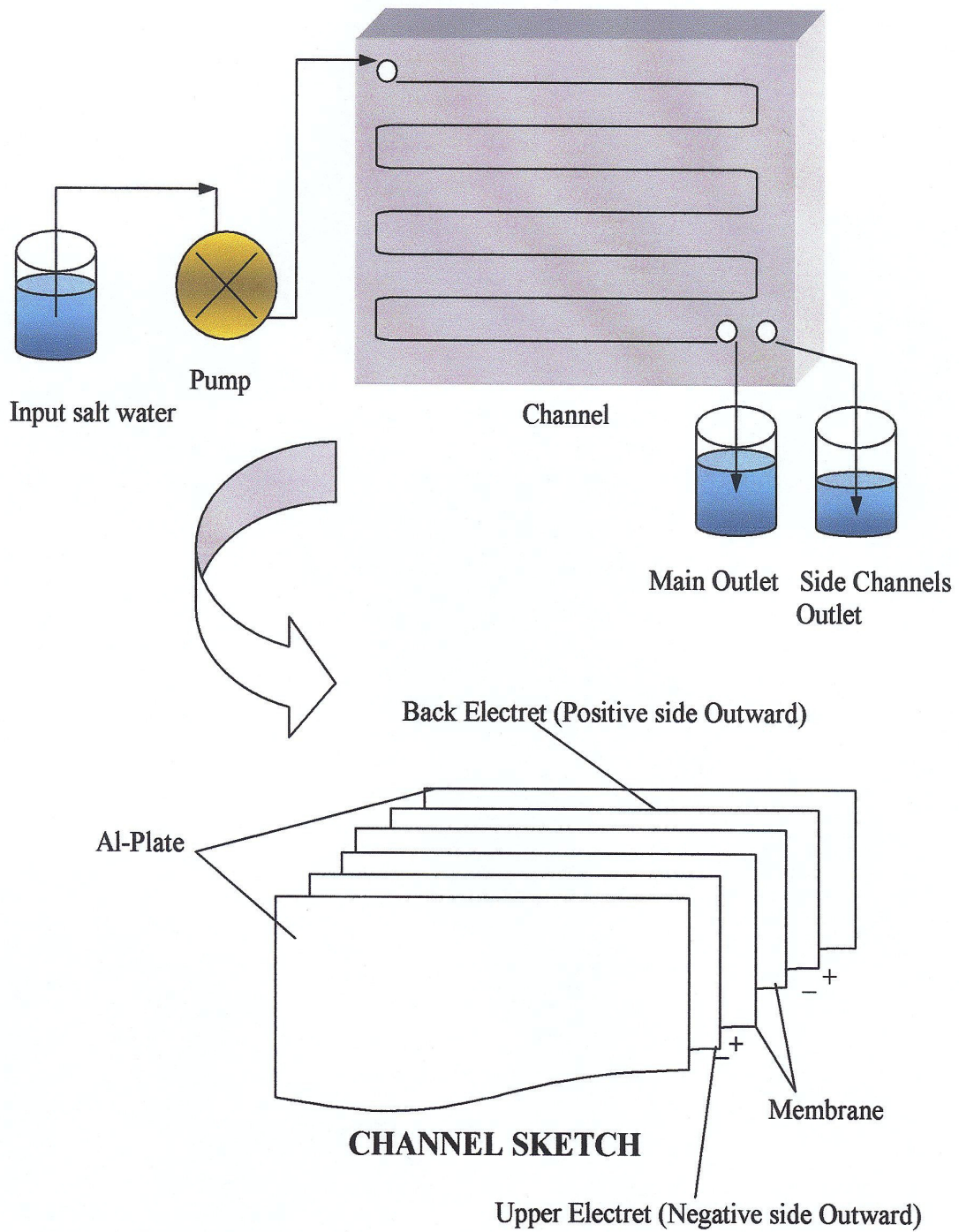

**Three Teflon plates omitted**

Fig. 5. Desalinator Arrangement: Channel (sketched here as a single dark line) is 1 cm in width.

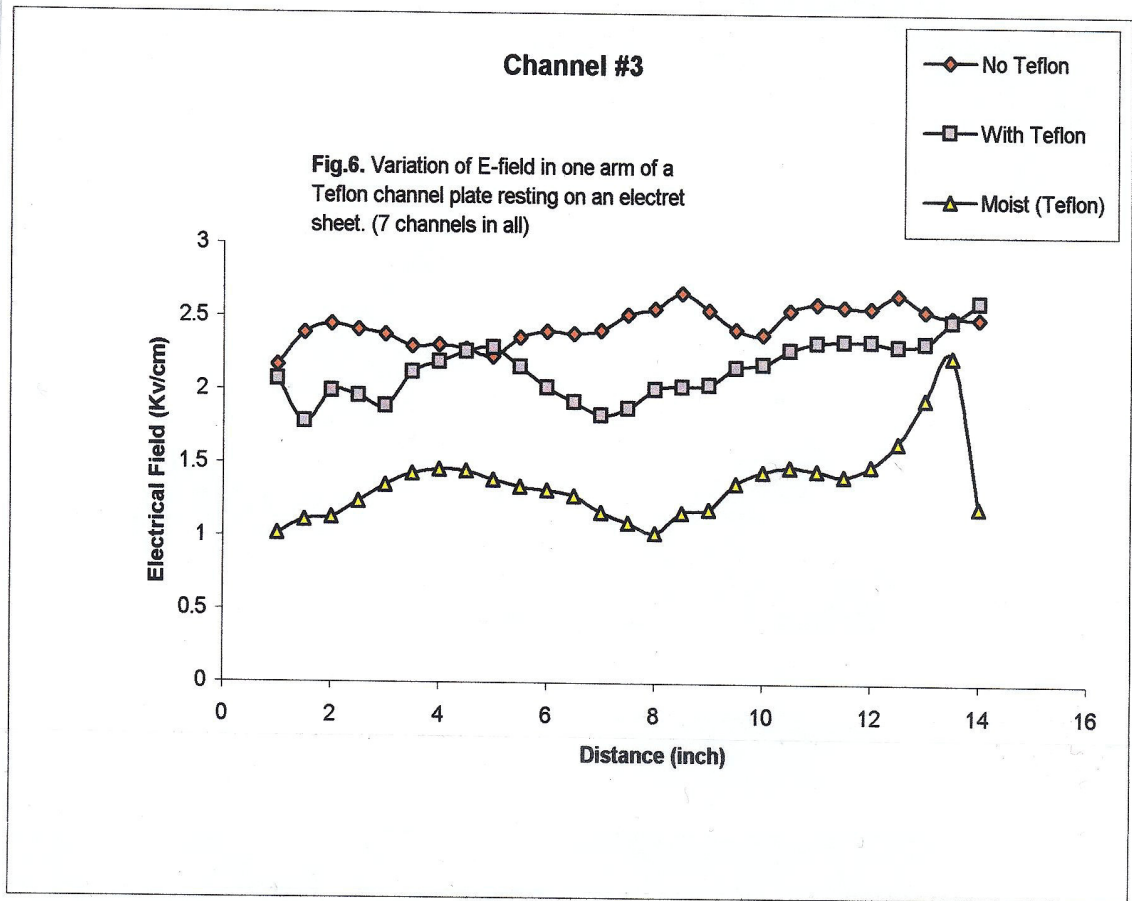

## 6. Effects of Water.

The aqueous environment to be experienced by electrets in a desalinator system is of considerable importance and concern. Thus, several experiments were undertaken to investigate the compatibility of polypropylene electrets with both pure and saline water. The most significant outcome of these studies is that one can place several millimeters of water on the electret surface for an extended period without diminution of the field strength. The surface water polarizes, and by touching the water briefly with a grounded conductor, this charge can be bled off, or if ungrounded it can be partially transferred.

The surface water allows the formation of an electrical double layer on the surface (see Sec. IV.G.2).



Using a sensitive electrometer (Keithley 462) to measure the charge removed from the water by making a grounded metallic contact, we generated the following curves showing the slow reduction of accumulated charge with time (Fig. 7):

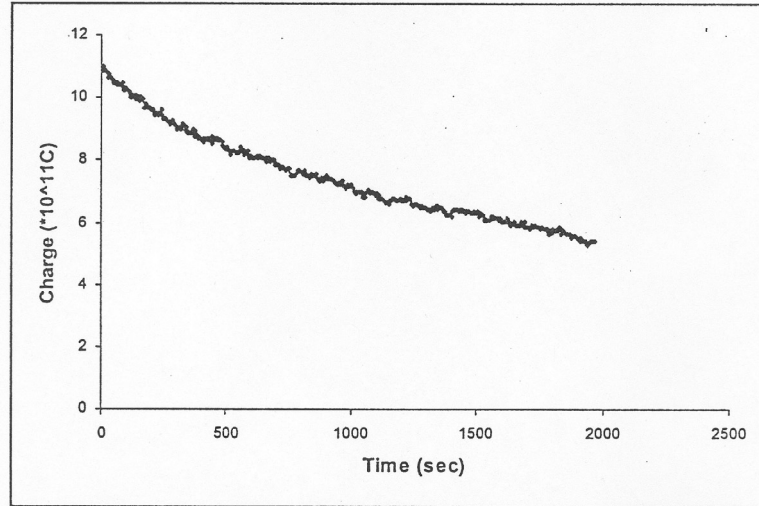

Fig. 7. Charge removal as a function of time.

Touching the water's surface with a grounded conductor for 10 seconds and repeating every 10 minutes produces a diminution in the E-field strength as seen in Fig. 8. There is little difference whether the water is saline or pure. The electret's field strength does not recover, even when the water evaporates overnight.

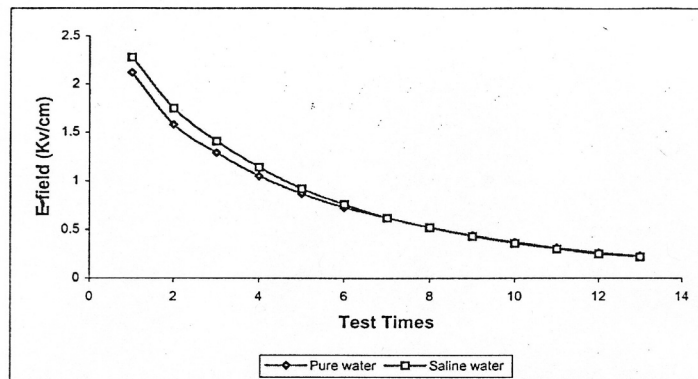

Fig. 8. Diminution of E-Field by bleed-off of charges in surface water.

If the water is not contacted by any conductor, the E-field will remain constant for long periods; the actual decay rate in this case has not been thoroughly studied, but appears to be comparable to the air-exposed electret surface.

Water absorption rates are known for a number of polymers, although we have not found published data for polypropylene. PTFE Teflon, for example, shows no significant water uptake in a 24-hr. period, while FEP Teflon shows about 0.01% (wt) in that time (see Table 1, p. 5, First Quarterly Report (25 Jan. 1999)).

### C. Experiments with Coated Aluminum Parallel Plates.

Experiments using coated parallel plates as a substitute for electrets were initiated in the first few months of effort, owing to two factors: 1) no commercial electrets of suitable size had yet been found, and 2) the advantages of having an easily-varied field with known intensities were apparent. As this work developed, we noted that, since no neutralization of ions could occur on a Teflon-coated surface, no serious problems arising from electrolysis or gas bubble formation were anticipated. Further, the electrical breakdown strength of Teflon (ca. 600 volts/mil) appeared adequate. The two plates were coated with a 0.002 in. (0.05 mm) layer of FEP Teflon and separated by Teflon channel plates of 0.08 cm to 0.64 cm thickness.

When a specified voltage  $V$  is applied to the parallel plates, we must consider the field intensity both in the Teflon and in the channel. When water fills the channel, the dielectric constant  $\epsilon$  of water which is 78.5 at 25°C must also be considered, because this significantly affects the E-field in both the water and the Teflon. The dielectric **strength** of water is also of interest, although the ionic conductivity of water forces a behavior that resembles a conductor or semiconductor, with both positive and negative charge carriers (of different mobilities). Under high fields, the behavior will eventually depart dramatically from Ohm's law when the limiting field strength is attained. A massive arc or corona is not expected, however, since the plates are insulated (unless the dielectric strength of the Teflon is exceeded in the process)

When one considers a capacitor filled with materials of differing dielectric constants  $\epsilon_1$  and  $\epsilon_2$  (see, for example, Jefimenko,<sup>5</sup> pp. 228-231) the potential drop across each slab of material can be determined by the relations:

$$V_b = V / [1 + \epsilon_b t / \epsilon_i b] \quad (1)$$

in which the two slabs are of thickness  $t$  and  $b$ , with dielectric constants  $\epsilon_t$  and  $\epsilon_b$ , respectively, and

$$V_t = V / [1 + \epsilon_t B / \epsilon_b t] \quad (2)$$

$V$  is the applied voltage across the capacitor plates. In our configuration,  $t$  is the combined thickness of the insulating Teflon on the two plates and  $b$  is filled with water,  $\epsilon_b=78.5$ , while  $\epsilon_t$ , we found to be 2.1 based on our measurements (Sec. IV. F.2.). When air is in the channel,  $\epsilon_b=1$ . As an example, with  $t=0.004$  in. and a channel of 1/8 in. (0.3175 cm) thickness, an applied voltage of  $V=3$  kV produces field intensities  $\dot{E}$  of about 4.3 kV/cm in the water and 160 kV/cm in the Teflon film (the latter is well below the 240 kV/cm required to break down the Teflon). The breakdown strength for water is quite difficult to measure and varies with impurities, but an approximate value is 100,000 V/cm.

Early in our experiments with this system, a breakdown in the 0.002 in. coating was experienced. Since the theoretical breakdown voltage had not been attained, it was concluded that either the applied film was imperfect or that a bubble of air had passed into the column, permitting a discharge. To avoid this problem, an extra layer of Teflon sheet was applied to each plate, 0.004 in. in thickness. All successive studies with the plates were performed with this configuration (V. Skorykh (1986)<sup>8</sup> determined that 1.5 mm bubbles in his apparatus decreased the breakdown voltage from 30 kV to 16 kV).

This insulated parallel-plate approach has a disadvantage, as inferred from Eqns. 1 and 2 since the applied voltage  $V$  is not that applied to the saline water. When electrets are used,  $E=V/b$  (ignoring field attenuation - see Sec. IV.G.2,3), where again  $b$  is the channel thickness separating the electrets and  $E$  is the (combined) electret field. We have tabulated the field strength  $E_b=V_b/b$  for a range of channel thicknesses and different insulator thicknesses  $t$ . One finds that the more insulation is placed on the plates, the lower the field imposed on the water channel becomes, if the applied voltage is held constant. As an example, if the plastic plate insulation thickness  $t$  is 0.95 mm and the applied voltage is 8 kV, the E-field on a channel plate of 1/16 inch (1.59 mm) gives a field of 0.92 kV/cm imposed on the water column, and 1.0 kV/cm for a 1/32 inch channel. As a first effort to investigate the effect of E-field strengths on saline water flow, the 1/16-inch channel plate was operated as a liquid ion chromatograph with R.O. water, and a 1-ml slug of saline water having a conductivity of 246  $\mu$ S/cm (0.015% salt) was injected into the column, with applied voltages of 1160, 3600, and 7000 volts

(E-fields in the water, with  $\epsilon=78.5$ , were only 184, 570, and 1100 V/cm). From the three measurements, it appeared that the conductivity of the effluent (after 150 ml had passed) decreased by over 10% with this increase in field. This result indicates that the electric field was causing increasing quantities of salt to adhere to the insulator plates.

Numerous additional experiments were performed with the insulated aluminum plates using the platinum conductivity cell and associated data collection apparatus. The latter is comprised of a dc bridge, a data acquisition board with A/D conversion and fast response time, a Pentium-based computer, and a printer. Field strengths, flow rates, and salinity were the variables. The conductivity curves that were produced typically resembled those seen in the figures in Sec. IV.D employing electrets, with relatively sharp leading edges (depending on flow rate) and trailing edges of longer duration. The time-of-decay to time-of-rise ratios are typically 7 to 10. If the E-fields in these studies were causing salt to be deposited on the Teflon insulating surfaces, the quantity would have to be quite small, and not readily measurable.

It should be noted that in all our work, channels of rectangular cross section were employed. From the Chemical Engineers Handbook (1988), laminar flow in such channels is described in accordance with the equation for volume flow rate  $Q$  (in l/s) and flow velocity  $V_x$  (in m/s):

$$Q = \frac{2}{3} \frac{B^3 W}{\eta l} \Delta P, \quad (3)$$

$$v_x = \frac{B^2}{2\eta L} [1 - x^2 / B^2] \Delta P, \quad (4)$$

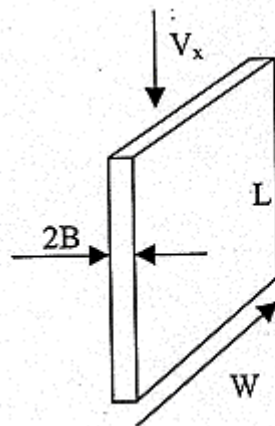

for a channel of length  $L$ , thickness  $2B$ , and width  $W$ . Here  $\Delta P$  is the pressure drop over the length of the channel and  $\eta$  is the viscosity. Note that the flow velocity becomes zero at  $x = \pm B$ , i.e., at the walls, in a manner similar to a circular pipe with viscous flow (Poiseuille's equation - see Sec. VI regarding MacGregor's apparatus). In our experiments, the flow rates were in the laminar flow regime (low Reynolds numbers), as was the work of Macgregor.

#### D. Electrets and Ion Chromatography.

In this section, we describe several of the runs performed using the Permcharge polypropylene electrets, characterized as described in Sec. IV.B, rather than the insulated metal plates (Sec. IV.C). Since the E-field imposed on the channel can be varied by simply adding more electrets, and the fields are higher than those we can readily achieve with a power supply, more attention was given to configurations with electrets. Another factor weighing in favor of electret use was the determination that aqueous solutions have little adverse effect on their behavior, at least in the short term (several days). In addition, we determined that water in contact with either or both surfaces is acceptable **provided** that water is not permitted to contact any edge when both surfaces are wet. Such contact has the effect of greatly diminishing the field strength on both sides, and can completely destroy the field. It will not recover with heating and drying. This surprising finding is not fully understood, and time did not permit further investigation, except: if an electret is immersed part way in a container of water, we found that the portion in the water loses its field (apparently by edge conduction) while that portion not immersed appears unaffected. The field remains high there, whether the water is pure or saline. The immersion time required to destroy the field is several minutes; a short immersion (one second or so) can cause a 12-16% reduction. These effects can probably be related to the neutralization of the double-layers formed in the water-polypropylene contact.

In using these electrets for this application, it is necessary to ensure that the edges are sealed and are kept dry. Otherwise, the charge on the wetted surface may be lost and the field destroyed.

The chromatographic configuration employed here is the same as that described in IV.C, using a single 1/16-in. thick Teflon channel plate with external aluminum plates for structural rigidity. RO water (0.89 uS/cm) was used for the flowing medium, and again syringe injection was employed for 1.0 ml slugs of 2% saline solution.

Results are presented here for two different flow rates: 0.12 ml/s and 0.29 ml/s. These rates are low for this example because the channel is thin and the volume correspondingly low (ca. 40 ml). Therefore, at the lower rate, the emergence of the salt requires about 1.5 min. and the peak occurs after another 1.5 min., with the decay occurring in about 10 to 11 minutes. These results apply for an electret field of approximately 2 kV/cm or zero. (The zero field was generated by electret replacement with a Teflon sheet or with a "dead" electret (i.e., polypropylene). The traces are presented in Figs. 9 and 10.

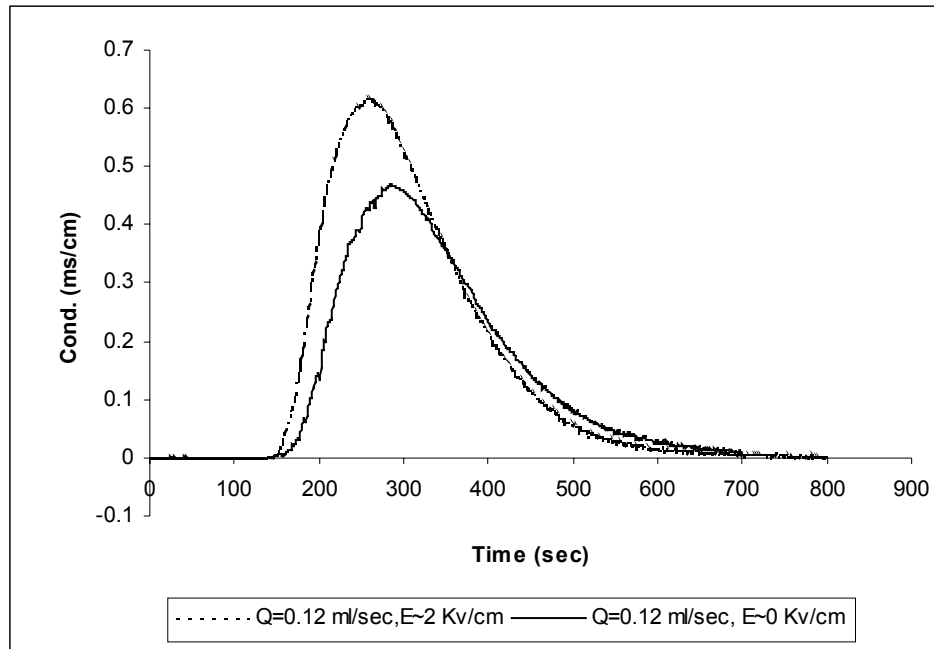

**Fig.9 Elution curves for a flow rate of 0.12 ml/sec (see text)**

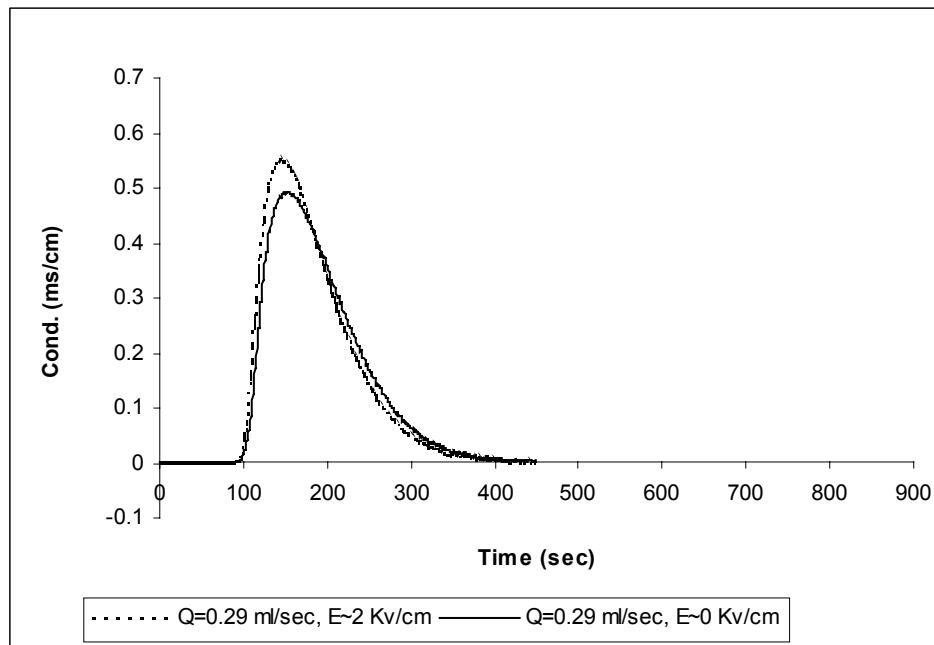

**Fig. 10. Elution curves for a flow rate of 0.29 ml/sec (see text)**

From these figures, it appears that the elution curve for the 2 kV/cm field rises somewhat more steeply and goes higher than the corresponding zero field case. Additional runs indicate that this difference is not likely attributable to slight variations in the injection rate. Note that for these results, the injected slugs are fairly high in salt concentration (2%).

E. Electret Fields for Desalination.

1. Three-Chamber Desalinators.

In the main configuration to search for desalination by stacked electret pairs, we assembled three Teflon channel plates (Fig. 11) separated by membranes containing 3 $\mu$ m to 5 $\mu$ m pore sizes, with the electrets on the outside covered by Plexiglass plates. The electrets were first cut from the Permacolor material (Fig. 12), tested and fitted with inlet and outlet fittings (Fig. 13), and assembled, taking care to avoid water contact or cross-leaks between channels. (A later version than that shown in Fig. 14 contains cross-bar reinforcing on the outside to further tighten the assembly.) The entire apparatus is sketched in Fig. 15, showing the pump, conductivity meter, and two collection vessels, one for the side channels and one for the main channel. Channel length is 250 cm and the width is 1 cm, with a thickness that varies depending on the channel plates installed (e.g., 3 ea of 1/8-inch thick, etc.).

Several tests were performed using the combined columns as an ion chromatograph, both with and without membranes. The objective was to investigate the salt retention by the membranes, and by post-treatment of the membranes, the amount of salt not released. An example is provided here:

Carrier fluid:	RO ("pure") water (0.89 uS/cm)
Injected fluid:	1 ml 3.44% (wt) salt solution
Applied E-field:	19.7 kV/cm (sum of pos. and neg. electrets)
Membrane:	Osmonics (4 $\mu$ m)
Flow rate:	13.2cc/min
Channels:	3 ea, 1/32 inch
Two runs:	With and without membranes
Total volume:	171 ml



The two elution curves are presented in Fig.16. It is observed that the peak conductivities are very close; the roughly 65-sec difference in peak elution times indicates that there is more retention with the membranes than without. The areas under the two curves are nearly equal, although the slightly smaller area with the membrane suggests that some salt adherence is occurring.

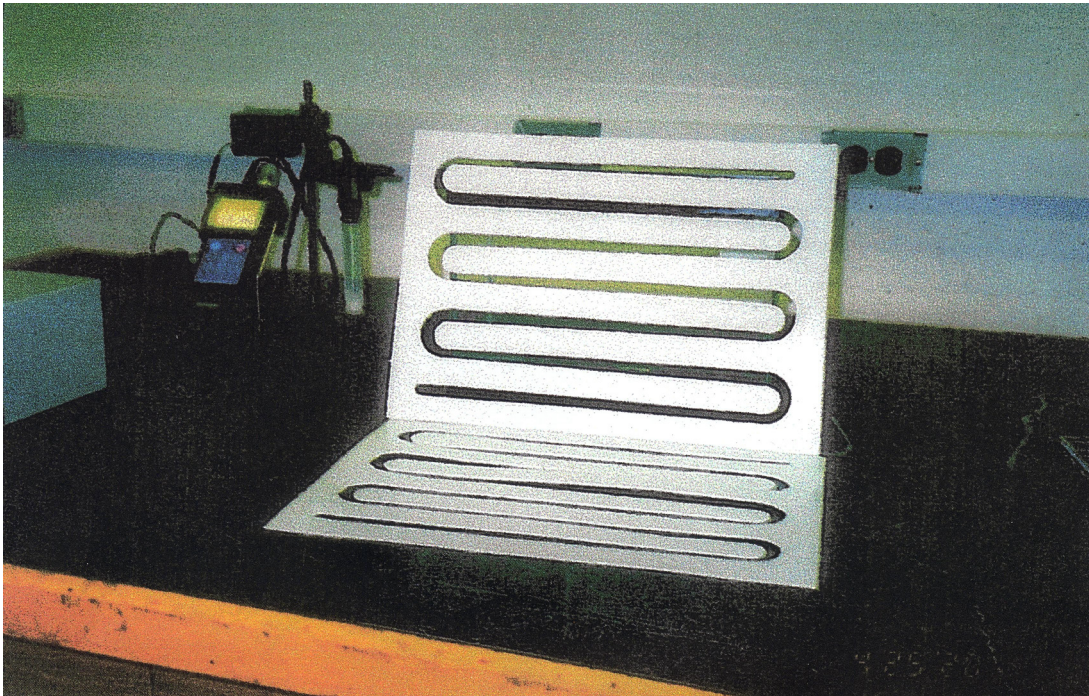

Fig. 11. Center and lower channel plates. Channel width is 1cm; center channel thickness is 1/16 inch (1.6mm), lower and upper channels are 1/32-in. thick.

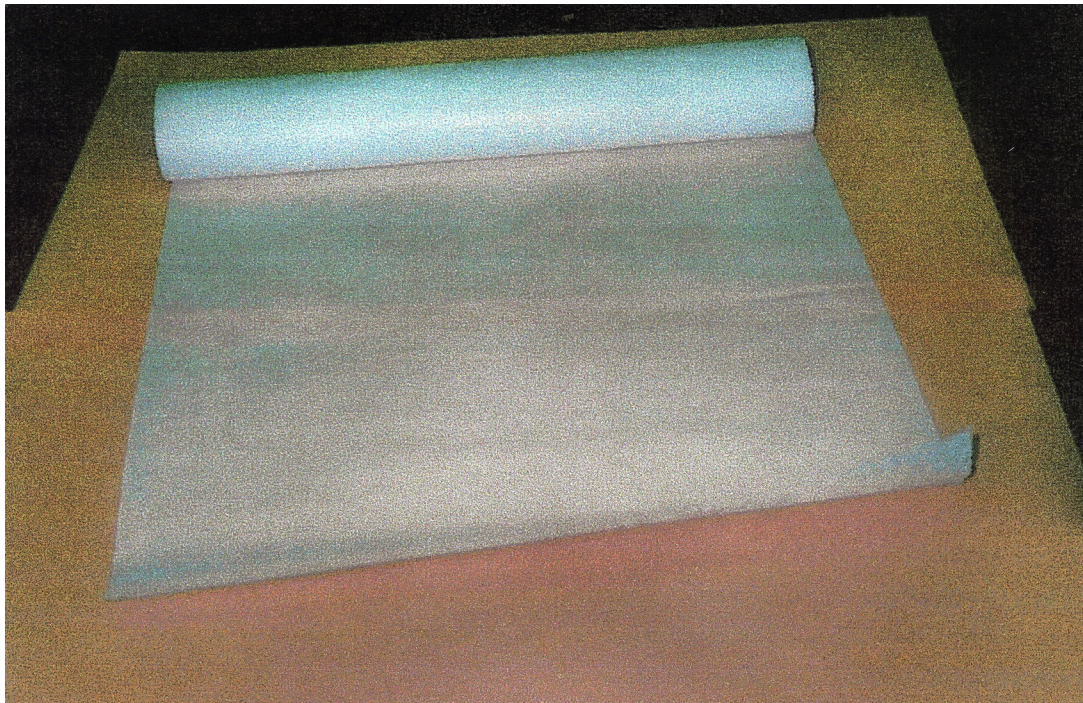

Fig. 12. Electret sheet material identified by Permcharge Corp. as polypropylene. Width is 30 cm, thickness is 0.06mm.

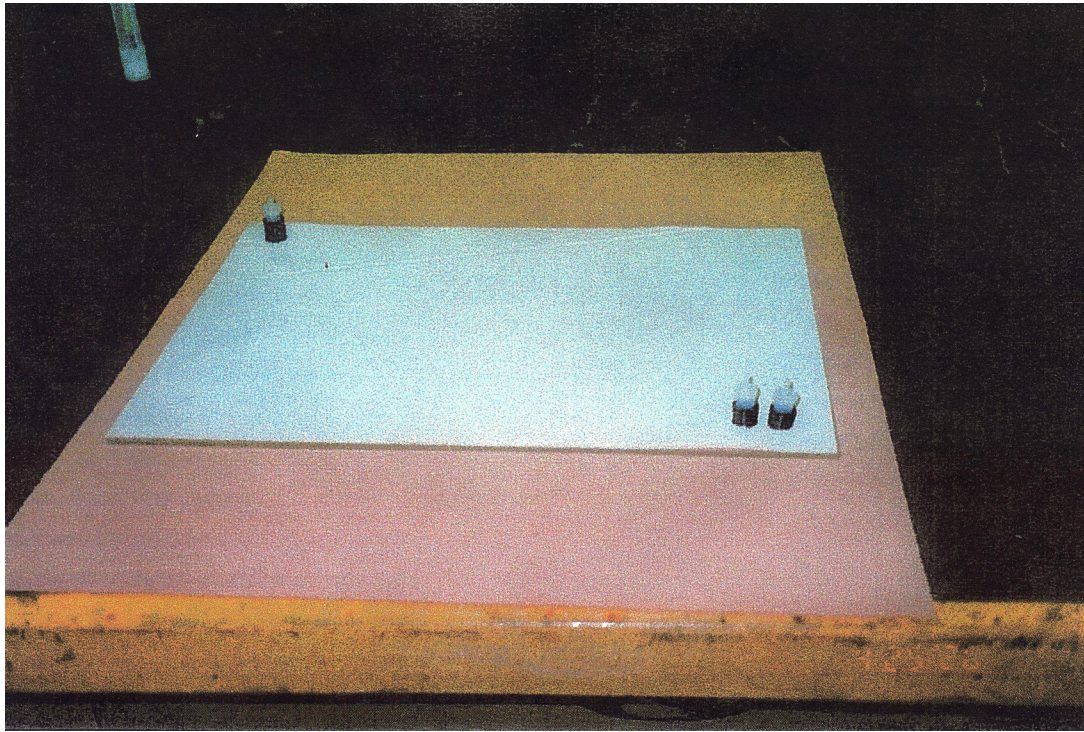

Fig. 13. A double thickness of electret with fittings cemented in place. Upper left is feedstock inlet, lower right fittings are for center and upper-channel effluents.

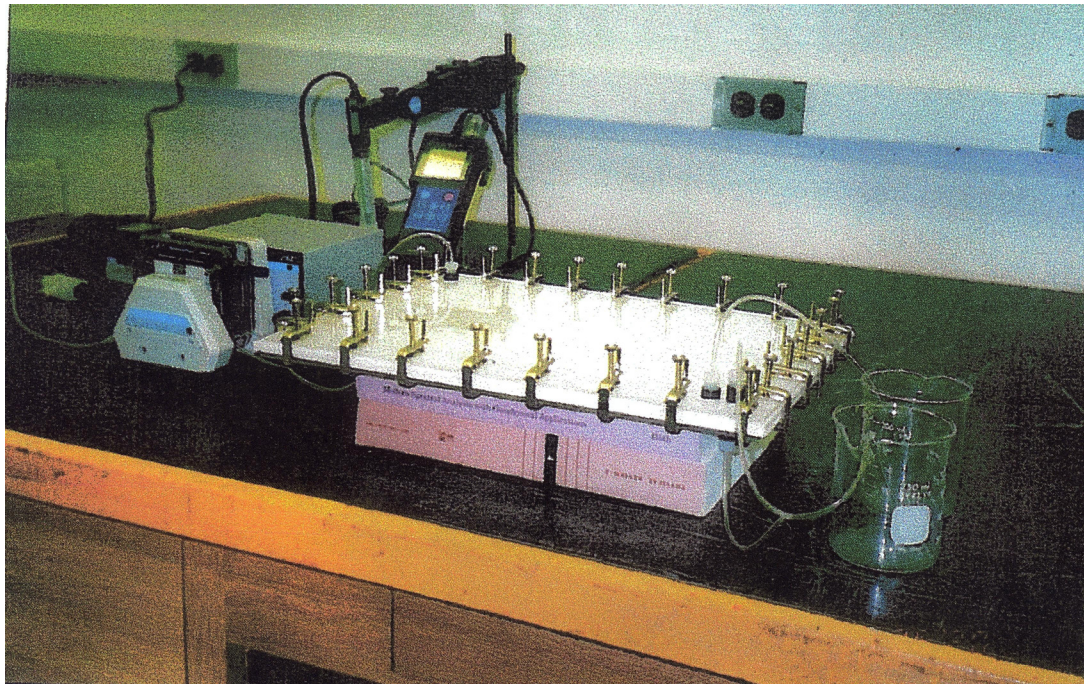

Fig. 14. Assembled system, with upper and lower channel effluents recombined externally. Saline feedstock is to left of photo.

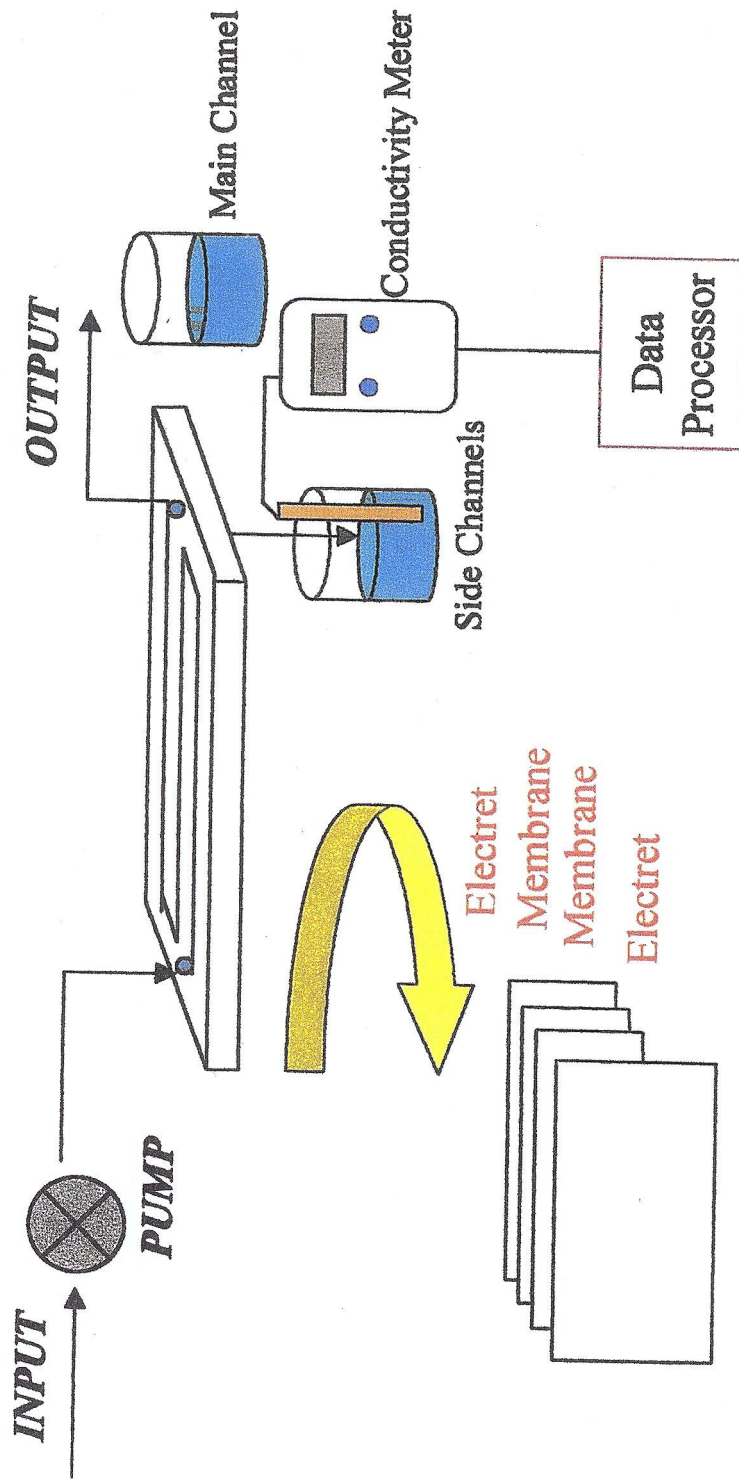

Figure 15. Schematic of assembled desalinator employing three channel plates, membranes, and electrets.

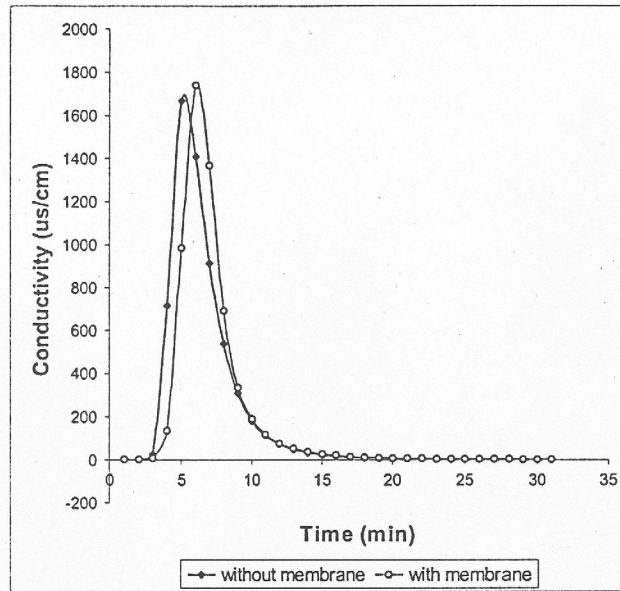

Fig. 16. Elution curves for 1 ml injection of 3.4% salt solution

A series of runs were undertaken with these membranes in which the channel depth  $d$ , the flow rate  $Q$ , and the E-field were all varied. Results are summarized in Tables 3, 4 and 5. The channel depth was varied four-fold, from 1/32 inch to 1/8 inch; flow rate ranged from 0.47 ml/s to 0.91 ml/s, and the field was varied (by adding electrets to each stack) from 5.3 to 15.3 kV/cm. Continuous flow of saline water of 2.98% salinity was employed. For this set of variables, little or no significant reduction in salinity was observed in the main channel effluent.

Table 3. Effect of dimension (flow rate: 0.69 ml/sec; E-field: 15kV/cm)

d of the channel (inch)	Input concentration (%)	Diluted concentration (%)	Thickness concentration (%)
1/8	2.98	2.98	2.98
1/16	2.98	2.96	2.99
1/32	2.98	2.94	3.03

Table 4. Effect of flow rate (E-field; 15kV/cm; d=1/16 in.)

Flow rate	Input concentration	Diluted concentration	Enriched concentration
(ml/sec)	(%)	(%)	(%)
0.47	2.98	2.98	2.98
0.69	2.98	2.97	2.98
0.91	2.98	2.96	2.99

Table 5. Effect of field (flow rate: 0.69 ml/sec; d=1/16 in.)

E-field	Input concentration	Diluted concentration	Enriched concentration
(kV/cm)	(%)	(%)	(%)
5.3	2.98	2.97	2.98
10.2	2.98	2.97	2.98
15.3	2.98	2.97	2.99

Lingering concerns about the fixed 1-cm channel width led to a shorter but much wider channel arrangement, viz., 3.5 inches across. The 1/32-inch Teflon material was used for the channel plates and of course the inlet and outlet fittings were relocated. Both 3  $\mu$ m and 5  $\mu$ m pore-size membranes were tried, and two methods of injection employed. Injection was (1) through the main inlet only, so that solution entered the outer channels through the membranes and (2) into all channels at once. The continuous-flow input solution was 2.98%. After 500 ml had passed through the system with the 5  $\mu$ m membranes in place, the salinity of the main channel effluent was found to be 2.88% and that of the side channels was 2.87%.

The membranes were changed out and additional tests were performed with an Osmonics 3  $\mu$ m pore-size membrane, and an input solution of conductivity 12.33 mS/cm. The flow rate was adjusted to a value similar to MacGregor's, 1.85 gal/hr, with the side channels flowing at 0.08 gal/hr. (This latter flow rate is automatically determined by the geometry and the overall permeability of the membrane; MacGregor had used a model of Millipore 5  $\mu$ m membrane that is now obsolete.)

The minimum conductivity in the main chamber was 11.99 mS/cm, a reduction of just 3.6%. Oddly, the conductivity of the (recombined) side channels also declined slightly, to 12.2mS/cm, clearly indicating that no ion enrichment was occurring. A subsequent analysis of the membrane showed that 0.19 gm of salt had adhered to it. (Even so, this would not account for the missing salt inferred from MacGregor's data, Sec. VI.)

#### F. Other Experiments.

A set of experiments performed in support of the desalination studies is worthy of mention. Those of particular significance are now described.

##### 1. Adsorption by Membranes.

These studies were undertaken in part to shed light on the "missing salt" computed by a mass balance calculation performed on MacGregor's data (Sec. VI.D,G). These measurements were made by immersion of a known area and mass of the membranes (100 mg, 28 cm<sup>2</sup>) into a 3% saline solution at room temperature for one hour. The membranes were then removed and submerged (successively) in measured volumes of RO ("pure") water (0.89 uS/cm) and the salinities observed. These results, coupled with additional weight measurements of the dried membrane, permit the determination of adsorbed salt (essentially all of it is removed by this process). Results of two such measurements, viz., for the 5um Millipore membrane and the 3 µm Osmonics membrane are presented in Table 6.

Table 6. Adsorption on Membrane  
(with membrane inserted in 3% saline solution for 1 hour)

- Millipore membranes (pore size 5um)

Adsorption: 14 mg

- Osmonics membrane (pore size 3µm)

Adsorption: 7.6 mg

These measurements provide insight into any salt uptake to be expected within our columns and the consequent reduction of salt observed in the effluent stream resulting from adsorption rather than from the "MacGregor effect."

## 2. Capacitance Bridge for Dielectric Constants.

An apparatus was needed for measurement of the dielectric constant  $\epsilon$  for the (industrial grade) Teflon used for the channel plates, as well as that used to insulate the parallel-plate electrodes employed in the aqueous ion chromatograph (Sec. IV.C). To obtain these values, we employed a pair of aluminum plates that formed a capacitor having an air gap, and the ESI Model 252 impedance meter. The capacitance is given by<sup>5</sup>

$$C = \epsilon_0 \epsilon A / d, \quad (5)$$

wherein  $\epsilon_0$  is the permittivity of free space,  $8.85 \times 10^{-12}$ ,  $\epsilon$  is the dielectric constant (essentially unity for air),  $A$  is the area of the plates, and  $d$  their separation. With air, the C-measurement is a validity test for the meter. The values obtained by this procedure are  $\epsilon = 2.15$  for the Teflon components and 1.96 for the electret material, with about  $\pm 5\%$  uncertainty, quite adequate for our needs.

## 3. Concentration Measurements from Electrical Conductivity.

The Horiba model conductivity meter we employed (Sec. III.G.2) has several conductivity ranges, the most sensitive being 0 to 1.999  $\mu\text{S}/\text{cm}$ . However, the concentration ranges only from 0 to 19.99 % by weight and a much finer range is needed on the low conductivity scale. Thus, it was desirable to further calibrate the meter since in our work the concentration scale would give a zero percent readout, or nearly so at low conductivities. Experimental data were developed ranging from 0.3114% concentration down to .0057%, with meter readings ranging from 5.53  $\text{mS}/\text{cm}$  down to 2.71  $\mu\text{S}/\text{cm}$ . These data were then fitted with four different polynomials to select the best fit. A sample is shown in Fig. 17, for the concentration range 0 to  $1.0 \times 10^{-2}\%$  for which the conductivity varies from 0 to roughly 200  $\mu\text{S}/\text{cm}$ . the lowest conductivity reading for this calibration was 2.71  $\mu\text{S}/\text{cm}$ , for which the concentration was  $5.7 \times 10^{-5}\%$ .



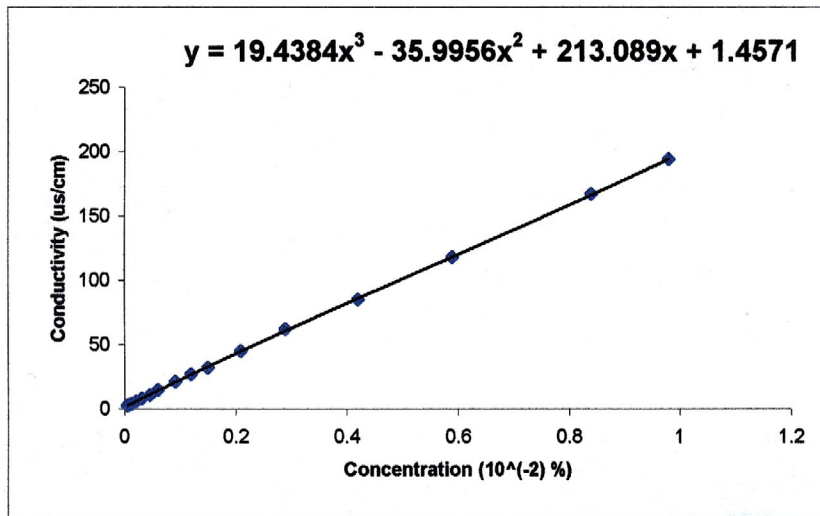

Fig. 17. One of several calibration curves for the Horiba conductivity meter at low concentrations, here 0 to 1 x 10<sup>-2</sup>%. The fit in this range is to a cubic equation.

#### 4. Viscoelectric Effect.

Water is a polar molecule, so in an electric field it is expected to interact with that field in a manner which would influence its effective collision cross-section, thus changing its fluid transport coefficients by a small amount. In addition, in a viscous flow region, a saline aqueous solution might also exhibit a change in viscosity if ions are drawn across the (one-dimensional) fluid flow direction by a transverse E-field. If, for example, the laminar flow is along the x-axis and an additional velocity is introduced to the ions owing to a y-directed electric field, both positive and negative ions acquire a velocity component perpendicular to their flow velocities. This additional transverse velocity component imparts momentum and energy to the surrounding water molecules, which would suggest an observable change in viscosity over and above that relating to the viscoelectric effect, which is a basic property of the neutral polar molecules. This latter effect has been described by Hunter and Leyendekkers<sup>10</sup> and others.<sup>11</sup> The value for  $\Delta\eta/\eta$  is small and depends quadratically on E. The effect owing to ion motion under an E-field we had hoped to observe, which would be an indication that ion migration is indeed occurring. An associated increase in viscosity would then mean that more work is done on the fluid when the flow rate is held constant; this work would then be a measure of the energy required to perform the ion removal. That we saw no increase in pressure required to maintain constant flow when the field was turned on was consistent

with the observation that no decrease in the conductivity of fluid flowing from the main channel was observed either.

## G. Analyses Performed.

### 1. Energy Considerations.

An early concern about the MacGregor Effect was that of the source of the required energy. Since no desalination current is made to flow (the electrets do not conduct electricity but merely deflect the ions), the energy required to concentrate the +/-ions in the channels adjacent to the main stream must come from elsewhere. If the process were adiabatic, one would expect to see a drop in temperature along the column (First law:  $du=dW$ ). If it were isothermal, then additional work must be performed to provide the energy. In the above paragraph, we interpreted this process as an apparent change in viscosity, so that under constant laminar flow,  $\Delta P/\eta$  is a constant (by Eqn. 3) . The power required to force laminar flow is essentially<sup>14</sup>

$$P_{wr} = Q\Delta P \text{ watts} \quad (6)$$

where Q is the volume flow rate (say,  $\text{m}^3/\text{s}$ ), and  $\Delta P$  is the pressure in pascals. For MacGregor's system the pressure drop across the 18-ft. column appears to be quite small (see Sec. VI.D), so the power consumption (and associated heating of the fluid) is also small. The energy required to desalinate a 3% (wt) solution is quoted<sup>16</sup> as  $0.8 \text{ MJ}/\text{m}^3$ , or  $0.8 \text{ J}/\text{cm}^3$ ; at a flow rate of  $1.9 \text{ cm}^3/\text{s}$  (MacGregor's), the desalination power would be  $0.8 \times 1.9 = 1.5$  watts. This (average) power is greater than that required to produce the fluid flow alone, so if the energy is to be derived from the fluid flow it would appear to be impossible. Thus, the source of energy would have to be thermal, and temperature drops should be present if heat flow into the apparatus is low. In our own apparatus, temperature changes were not detected.

### 2. Electrical Boundary Layers.

For an electrolyte in contact with a charged surface, an electric double layer is formed;<sup>12</sup> description of this double layer is a subject of electrochemistry. The simplest model is based on the notion that for every charge in the surface (here, the electret), there is an equal but opposite charge adhering to the surface (the "Helmholtz" model). A more realistic approach is that of Gouy and Chapman,

in which a partial charged layer of ions appears on the surface (Stern model), and the remainder of the (unbalanced) charge extends further from the surface as a diffuse layer, as illustrated in Fig. 18 for a positively charged electret:

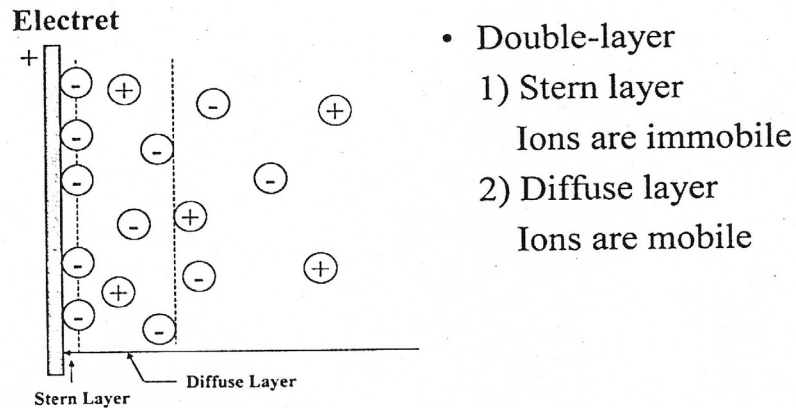

Figure 18. Electret in contact with ionic solution.

The thickness of the Stern layer normally corresponds to an ionic monolayer, while the diffuse layer of mobile ions creates a potential falling off exponentially:

$$\Phi(r) \sim \exp[-(a-r)/\lambda_D] \quad (7)$$

where  $a$  is the thickness of the immobile Stern layer, and  $\lambda_D$  is the Debye screening length, a measure of the thickness of the "ion atmosphere." Its value depends on the ion concentration in the electrolyte. Eqn. 7 is derived on the assumption of dilute solutions for which the governing Poisson-Boltzmann equation can be linearized and solved analytically. Regrettably, in our case (sea water) this assumption is quite poor: concentrations are such that the ion-ion interactions in the double layer and the diffuse layer cannot be ignored. Moreover, the surface charge densities on the electret are quite high corresponding to the high field strength and high potential near the electret surface. We can only say at this point that the Gouy-Chapman theory cannot be quantitatively correct here, and that the Debye screening length  $\lambda_D$  is likely to be less than 1nm for the concentrations we are considering. We surmise that the Stern layer of immobile ions is correspondingly thickened.

## V. DISCUSSION OF RESULTS

### A. Insulated Plate Fields.

As described above, the early efforts on this project were directed at finding a suitable substitute for commercially available electrets. The use of a voltage supply requiring essentially zero current for this application appeared as a realistic alternative, especially if electrets proved to be vulnerable to degradation in aqueous saline solutions. The high field strengths sought for this work, however, put severe demands on the insulating layers deposited on the plates, and bubbles appearing in the stream presented a serious breakdown problem at the higher voltages. Furthermore, the E-field strengths in all the sandwiched layers between the plates should be determined, and the field imposed on the water columns is diminished owing to the dielectric constants of the other materials. Nevertheless, we were able to make use of the parallel-plate fields in experiments involving the injection of saline slugs into streams of pure water (liquid ion chromatography). A main finding was that, for the field strengths employed, ion elution curves were not significantly affected by the imposed fields except for low concentrations (see below).

### B. Electret Studies.

The high electrostatic field of 18 kV/cm claimed by MacGregor for his cylindrical desalinators remains in doubt (see Sec. VI.B) for several reasons, just one being the difficulty in achieving such high potentials/fields with PTFE Teflon. Our studies of polypropylene electrets, however, demonstrated clearly that multilayers of this sheet material, separated by similarly thin Teflon insulating sheets, can easily meet or exceed this value with saline water in contact. Had these studies produced meaningful ion removal levels, a further step would have been to explore the long-term durability of this material, over periods of several weeks or months. Lacking that level of durability, one would need to further evaluate the insulated parallel-plate alternative or develop better electrets.

### C. Chromatography and Elution Curves.

From these studies employing the injection of 1-ml slugs of saline water into a flowing column, we had hoped to see evidence, either through the shapes of the elution curves or peak heights of an observable effect owing to the application of an E-field of varying strength. Such an observation would be evidence of the "MacGregor Effect" and might set boundaries on E-field strength requirements and concentrations. It developed that the experiments were also useful in investigating salt adsorption by membranes, electrets, and Teflon surfaces; missing salt that appears evident in MacGregor's numbers was thought to be collecting internally on surfaces, accounting (in part) for his observed desalination effect.

In both Figs. 9 and 10, we see that an E-field of only 2 kV/cm appears to affect the elution curves at these low flow rates (0.12 ml/s and 0.29 ml/s) with the difference relative to zero field more pronounced at the lower flow rate. In these tests, the single column width was only 1/16 inch (1.6 mm), and the 1 ml of 2% (wt) salinity becomes diluted with ca. 30 ml of pure driver water, so that the salinity becomes only about 0.06% as it traverses the column.

There are several known electrokinetic phenomena<sup>13</sup> that arise from the movement of electrolytic solutions past a charged surface, several of which may be understood in terms of the diffuse double layer theory. In the application of this theory to our own experiments, the governing parameter appears to be the characteristic screening distance  $\lambda_D$ , referred to in Debye-Hückel theory as the Debye screening length.

### D. Desalination Results and Parameters Varied.

Judging from the ion chromatograph results discussed above and other similar runs, electric fields do appear to influence the elution curves at low salt concentrations. Our desalination efforts, as represented by Tables 3, 4 and 5, (Sec. IV.E), demonstrate that for high saline concentrations (3%), fields as high as 15 kV/cm have no significant effect at flow rates down to 0.47 ml/s and channel thicknesses of only 1/32 inch (0.8 mm). The column length employed for these studies was 8 ft. (244 cm) and the width was 1 cm. A much wider (but shorter) desalination apparatus (Sec. IV.E.1) employing a 2.9% saline solution also showed no significant ion separation when a pair of 20 kV/cm stacked electrets was used.

It is our view that a weak MacGregor Effect may be demonstrable, after accounting for salt adsorption on all internal surfaces **only** if the concentration is quite low, i.e., probably below 0.1% salinity. While we have failed to pin down the concentration dependence exactly, additional work will be undertaken in the near future to do so (see Sec. VII). We will also examine the question of turbulence.

## VI. CRITIQUE OF MacGREGOR PATENTS AND REPORTED RESULTS

### A. Time Dependence.

The MacGregor patents make no assertions regarding any time dependence of the desalination efficiency. However, Mr. Ott (who often assisted MacGregor) does recall that there were difficulties in obtaining good steady-state results. In retrospect, we could explain this as loss of the electret field strength owing to high concentrations of ions collecting on their surfaces and being immobilized there, or possibly damage to the electret from saline water in contact. The former would appear the most plausible explanation since, in his configuration, there are no edges except at the ends where end caps are in place (see also Sec. B).

Another possible explanation for Mr. Ott's observations is that the salt initially can become adsorbed on the membrane and Teflon surfaces, and the apparent desalination due primarily to this adsorption, which could eventually saturate (see Sec. IV. F. 1 re: our adsorption studies).

### B. Cylindrical Configuration vs. Parallel Plates.

A consultant, Dr. H. David Stensel PhD., P.E. (a civil engineer from the University of Utah), independently measured in 1989 the saline concentration in water samples taken from compartments in a MacGregor parallel-plate desalinators. The values Stensel reported were: influent, 18%, effluent, 7 ppm ("Dissolved Solids"). Evidently, MacGregor moved on to his cylindrical configuration, hoping to obtain better consistency; however, assuming that Stensel's reported values are valid, it would appear that the rectangular configuration was remarkably effective. Our choice of this configuration was based on the ability to establish known, fairly uniform E-fields employing industrial quality electret sheets with known or measurable properties. The claimed value of 18 kV/cm for MacGregor's cylindrical version was presumably obtained by imparting either polarization to the PTFE Teflon or a charge. But the central electrode is a solid rod and is claimed to be negative over its entire

surface, which precludes polarization. Moreover, it is difficult to obtain a high degree of polarization in PTFE, so it seems probable that MacGregor imparted a net charge to both rod (negative) and the 2-inch diameter tube, on the positive inner surface. That, however, leaves a big question as to what he meant by "18 kV/cm", since it would be most difficult to measure the field strength using conventional electrostatic probes within these curved surfaces. Such a uniform field in a cylindrical configuration appears unlikely. Nevertheless, his quoted value is what we sought to achieve for the parallel-plate configuration.

Given MacGregor's stated geometrical values, the cylindrical membranes had radii of 0.25 inch and 0.75 inch. The length of the membranes (not stated) is somewhat less than the column length of 18 feet (216 inches). Using 208 inches for the length, the areas for the membranes we calculate to be 4.54 ft<sup>2</sup> and 6.81 ft<sup>2</sup>, the ratio being  $r_2/r_1 = 1.50$ . These values are in great contrast to those given in the 1990 patent, viz., 1.18 ft<sup>2</sup> and 2.35 ft<sup>2</sup> (with a ratio of 2). For these to be valid the assumed lengths would have to be very much shorter than the 18 ft. column length, which seems implausible. We note that the areas we calculate would provide a total surface area (both sides) of nearly 23 ft<sup>2</sup>. MacGregor's column has a volume of

$$V = \pi(R_2^2 - R_1^2)L \approx 0.368 \text{ ft}^3 \quad (8)$$

$$\approx 10.4L,$$

where  $R_2$  and  $R_1$  are radii of the outer cylinder wall (ID) and the central rod, respectively. According to our measurements on adsorption of salt by a similar membrane material, 23 ft<sup>2</sup> could retain 11 grams from MacGregor's column (see Table 6 in Sec. IV. F. 1). At 3.5% (wt), a full column would contain about 360 grams of salt in solution.

### C. Expectations regarding Length Dependence.

It is unknown why MacGregor selected a length of 18 ft, and there is nothing in the patent to indicate whether experiments were performed with shorter lengths. However, with the quoted result of only 5.2 ppm effluent, it would appear that a column of 8 ft length would produce significant reduction. If the reduction is simply linear with his column length and ALL of the 18 feet are required to get from 3% down to low ppm concentrations, then the 8 ft column should have yielded a 1.7% salinity, i.e., a reduction of salt concentration by 44%. (A 4 foot column under this loose assumption should have yielded a reduction from 3% to

2.3% salinity i.e., assuming that the removal efficiency (per unit length) is no better than MacGregor's). Because, in several of our tests, the electret separation is much less than MacGregor's, the efficiency of our system is expected to be greater. Further, if the efficiency scales as the electret separation (with roughly equally strong electrets), then our efficiency ratio should be 0.75 in./0.125 in.  $\approx$  6 times that of MacGregor's. Combining these two efficiencies suggests that our 8-ft column has greater efficiency than MacGregor's (by about 2.6-fold) as would the 4-ft column (by 1.3-fold).

D. Flow Rate Inconsistencies.

1. MacGregor's Quoted Flow Rate vs. Calculated Rates.

The 18-ft long cylindrical column described in MacGregor's patents was evidently pumped by a "small" pump as described by Mr. Ed Ott and also as shown in a videotape provided by him. According to both patents, the stated flow rate into the device was 1.8 gal/hr. or 1.9 cm<sup>3</sup>/sec. The fluid temperature is not provided, but one can safely approximate the viscosity as ca. 1 centipoise. For laminar flow in a cylindrical annulus, the volume flow rate is given by a modified Poiseuille equation:<sup>14</sup>

$$Q = \frac{\pi R_2^4 \Delta p}{8\eta L} \alpha, \quad (9)$$

where the geometrical factor  $\alpha$  is a function of the ratio  $k = R_1/R_2$ , the radius of the inner rod and the outer tube  $R_2$ :

$$\alpha = \left[ (1 - k^4) + \frac{(1 - k^2)^2}{\ln k} \right] \quad (10)$$

For MacGregor's arrangement,  $L=549$  cm,  $k=(1/4)/1=0.25$ , and  $\alpha=0.362$ . Using his  $Q=1.9$  cm<sup>3</sup>/sec one can solve for the required pressure drop  $\Delta p$ , in dynes/cm<sup>2</sup> (cgs). This turns out to be 1.75, which is only 1.3 $\mu$ m of Hg or  $1.7 \times 10^{-6}$  psi. This minuscule pressure is quite different from a nominal pump pressure expected to be on the order of a psi: for 1 psi one expects, for example, a flow rate of over 1100 cm<sup>3</sup>/sec through an unrestricted annulus.



This would be the situation if one neglects the influence of the set of membranes separating the flow into three components. If we now assume that the flow is laminar in each of the three annular sections and that the flow velocity is zero at each wall, we then must apply Eqn. 2 to each section, A, B, and C and assume negligibly thin membranes. We then have three values of k: 0.75 for the outer annulus A, 0.67 for the central annulus, and 0.5 for the inner annulus C. The three flow rates for viscous behavior are then:

$$Q_A (l/s) = 5.44 \times 10^{-4} \Delta P, \quad (11a)$$

$$Q_B (l/s) = 3.89 \times 10^{-4} \Delta P, \quad (11b)$$

$$Q_C (l/s) = 2.34 \times 10^{-4} \Delta P, \quad (11c)$$

with  $\Delta P$  in pascals. Hence, for MacGregor's total flow rate of 1.9 cm<sup>3</sup>/sec,

$$\begin{aligned} \Sigma Q_i &= 1.167 \Delta P = 1.9, \text{ or} \\ \Delta P &= 1.63 Pa. \end{aligned} \quad (12)$$

This is a mere  $2.3 \times 10^{-4}$  psi which would appear nonsensical, since if the column were held in a vertical position the pressure drop from top to bottom would be 18 ft/34 ft or 0.53 atm (7.8 psi) due to gravity alone. Furthermore, the central annulus appears to carry 3.89/11.67 of the fluid flow (33%), while MacGregor claims that it carried 1.5/1.8 or 83%. Unless there existed major obstructions in the outer annulus, it should produce nearly half of the total flow. A support structure for the two membranes would indeed be necessary, but nothing is stated by MacGregor about the location or shape of these supports. If they were attached to the inner and outer surfaces, the central annulus B would be unimpaired for flow, and Eqn. 11b would remain valid. Even for such impaired flow in A and C, the pressure drop inferred from his stated flow rate of 1.5 gal/hr through annulus B is still inconsistent (far too low). We concluded that the column must have been valved down in order to obtain his low flow rate.

## 2. Mass Balance.

MacGregor states in both his patents that a 3% NaCl solution flowing into his apparatus at 1.8 gal/hr produced a purified effluent of 5.2 ppm NaCl. One can calculate the mass of NaCl flowing into the column each second to be 0.057 gram, and the total NaCl mass leaving (nearly all in the enriched effluent) to be

0.037 gram, or about  $\frac{2}{3}$  of that entering. Thus the inference from his data is that about 20 mg/sec of salt was accumulating in the column. If this is attributed to NaCl absorbing on the 10,500 cm<sup>2</sup> of membrane material only (i.e. none on the PTFE Teflon) and on both sides of each membrane, then a capacity 11 grams could be reached in about 10 minutes. We do know that MacGregor had difficulty with attaining any steady performance.

#### E. Reynolds Numbers.

As stated in MacGregor's patents, his device was run at quite low rates of flow, and the Reynolds numbers ( $N_R = \rho v D / \eta$  for a pipe of circular cross section) are correspondingly low, well below the onset of turbulence. While the applicable equations for  $N_R$  in each flowing annulus are somewhat more complex, involving the radii of the two walls, the flow must still be laminar, ensuring that MacGregor's concerns for remixing the separating ions owing to turbulent flow are satisfied. On the other hand, neither MacGregor nor we have demonstrated that the concern is real, and in fact, if ions tend to concentrate within the diffuse surface layer, one might argue that at least minimal turbulence near the electret surfaces might be beneficial in moving ions in the mobile diffuse layer along the wall. We are unaware of any analogous studies, for example, of how the electrokinetic effect known as the "streaming potential" (or streaming current) of electrolytes is affected by the onset of turbulence.<sup>15</sup> While of possible relevance, we did not explore the question further during this study.

#### F. Electrets and Field Strength E (in water).

MacGregor referred to the field strength E in his system as 18 kV/cm; as we discussed in VI.B, the cylindrical geometry he used means in all probability that the field strength between the two electrets diminishes as 1/r in the **absence** of ions. In the presence of a strong electrolyte the electric field is rapidly attenuated. Since the ion concentrations within a narrow, thickened Stern layer will greatly lower the field strength very near the electret surface, this remaining E-field will approach zero beyond, say, 10  $\lambda_D$  or 10 nm. The drift of ions toward either electret should, we conclude, be minuscule beyond 0.1 mm, while the distance required to clear the central chamber of ions is, for our thinnest configuration, roughly 0.16 mm. For MacGregor's spacings, the distance is 13 mm.

## VII. CONCLUSIONS FROM THIS WORK

### A. The MacGregor Effect.

We have used electrostatic fields generated both by an insulated metal-plate capacitor and by stacked polypropylene electrets to search for the reduction in salinity of various concentrations up to ca. 3.5% (wt) NaCl in the general manner prescribed by MacGregor in his 1990 and 1991 patents. Various field strengths, geometries, and concentrations were employed, but no significant effect was observed for concentrations of 1 % and above. An extensive study was made of electret behavior in the presence of aqueous saline solutions in order to ensure that electric field strengths were both known and predictable. Flow conditions, as prescribed by MacGregor, were always in the laminar regime, with the rationale that turbulence would cause a remixing of the enriched and depleted sections. No statistically significant separation was observed (i.e. typically less than a few percent change, which could be attributable to adsorption on the membranes).

If the laminar flow equation (Eqn. 4) is used to compute  $V_x$  at a distance  $L$  from the electret surface roughly equal to the diffuse layer thickness, the resulting value is quite small, indicating that the ions near or within the diffuse layer are moving extremely slowly, perhaps too much so to permit them to be swept downstream in accordance with MacGregor's presumed mechanism (Sec. 1.C).

### B. Alternatives.

During the course of this work, the Principal Investigator has developed working relationships with two individuals who are also researching the question of low-cost desalination. One of these, Azar Yazdanbod (of Tehran) has been doing studies of the MacGregor patent, but has also found a null result to date. His proposal is next to investigate a configuration in which there is significant field and charge imbalance between the two (insulated) electrodes (no electrets are available to him, so he uses insulated plates as we have described above (Sec. IIIA, IV.C)). We are considering a cooperative investigation. The second individual, Dr. Rashid Haydarov of Tashkent University, Uzbekistan, has visited our laboratory and together we have submitted a proposal to investigate a low-cost desalination configuration employing pairs of dissimilar membranes (sans electrets). Still a third approach we are considering for investigation is based on a reverse-osmosis concept. Any further work on the "MacGregor Effect" would probably employ ionic membranes.

### C. Economic Considerations.

It has always been the goal to develop a low-cost desalination system, and MacGregor's invention appeared to be a possible approach. All three of the alternative prospects referred to below are similarly motivated. In many "third world" (or economically emergent) nations, safe drinking water remains a serious problem, particularly for rural areas too sparse in population to make large, commercial desalination plants affordable. It is especially this population that is in need of help, as well as individuals residing in similar regions in the U.S. We shall continue to seek a solution.

### VIII. PROSPECTS AND FURTHER STUDIES

We have become pessimistic about the prospects for MacGregor's invention as it has been presented. Our analyses, even though not thoroughly pursued owing to time constraints, indicate that in the viscous flow regime there is little likelihood that dissolved ions will experience a field sufficient to cause migration to the electret surfaces. In our configuration, the required lateral migration distance (electret separation) was as low as  $3/32$  inch (2.4 mm), vs.  $3/4$  inch (19 mm) for MacGregor's column, and although our longest column length is but 44% of his, no success was achieved. Unless the Debye screening length is on the order of migration distance (very thin channels and low concentrations), it appears doubtful that significant separation will occur. One possible exception might be that of higher Reynolds numbers that would increase the rate of lateral ion diffusion; however, the down side would be the increased remixing of ions that may occur. The membranes, of course, play a role in this; behavior might be different if ionic membranes were employed, and they might allow higher Reynolds numbers.

The amount of energy required to collect most of the negative ions in the anodic side channel and the positive ions in the cathodic side channel has been estimated for sea water and is quite large compared with the energy expended by the pressure drop through the column in moving one volume of contents in MacGregor's apparatus. This energy issue must be addressed in any future investigations, including those we hope to perform with our thin rectangular channels.

Further studies we expect to undertake as time and funds permit are:

- 1) Effects of Reynolds numbers on the elution curves from a water-driven ion-chromatographic column, with varying field strength and salinities. Depending on outcome, devise a new desalinator configuration, acquire both ionic and conventional membranes of the highest available permeability, and investigate turbulence effects on ion removal, especially at very low concentrations.
- 2) (with Yazdanbod - see Sec. VII.B). Investigate a strong field gradient configuration that forces an imbalance in the ion distribution.
- 3) Small desalinator employing RO-type membranes and moderate pressures.

## IX. ACKNOWLEDGMENTS

The principal investigator wishes to express his gratitude to the U.S. Bureau of Reclamation and its staff for the support provided for this study, and also for their extended patience as we continued to search for success. We hope that the experience gained in this effort will help lead to success in future endeavors. He also wishes to thank Mr. Haifeng Ni, Graduate Research Assistant in Materials Science, for his extraordinary diligence and contributions to this effort, as well as Drs. Clayton Smith and Paul Predecki of DU for their willingness to provide advice whenever sought. We thank Permacharge Corp. for samples of their electret materials, and also Osmonics and Millipore Corp. for providing samples of their membrane products. Finally, thanks are due Mr. Ed Ott, who gave willingly many hours of his time to further this study.

## X. REFERENCES

1. D. MacGregor, U.S. Patent No. 4,948,514 (1990) "Method of separating ions from liquids".
2. D. MacGregor, U.S. Patent No. 5,061,376 (1991).
3. "Electrets", 3<sup>rd</sup> Edition, Vol. 1, G.M. Sessler, Ed., Laplacian Press, Morgan Hill, CA (1998).
4. "Electrets - Charge Storage and Transport", M.M. Perlman, Ed., The Electrochemical Society, Princeton, NJ (1972).
5. O.D. Jefimenko, "Electricity and Magnetism", Appleton-Century-Crofts (Meridith Publishing) (1966).
6. See Table 1, p. 5, R.C. Amme, First Quarterly Report (ref. 7).
7. R.C. Amme, Quarterly Reports to the U.S. Bureau of Reclamation, 25 Jan. (1999), 28 April (1999), 8 Oct. (1999), 31 Jan. (2000), 28 April (2000).
8. V.V. Skorykh, "Influences of gas bubbles on electrical breakdown in water", *Soviet Physics-Techn. Phys.* **31**, 930-932 (1986) (API Publication).
9. M. Law, T. Wen and G.S. Solt, "Thickness and concentration profiles of the boundary layer in electro dialysis", *Desalination* **109**, 95-103 (1997).
10. P.J. Hunter and J.V. Leyendekkers, "The Viscoelectric Coefficient in Water", *J. Chem. Soc (Faraday Trans.)* **74**, 450 (1978).
11. E.N. da C. Andrade and C. Dodd, *Proc. Roy. Soc.* **A187** 296 (1947), R. Eisenschitz and G.H.A. Cole, *Proc. Phys. Soc.* **A62**, 394 (1954).
12. P.H. Rieger, "Electrochemistry", 2<sup>nd</sup> Ed., pp. 73075, Chapman & Hall, NY (1994).
13. D.J. Shaw, "Introduction to Colloid and Surface Chemistry", 4<sup>th</sup> Ed., Butterworth/Heineman, Woburn, MA (1992).
14. V.L. Shreeter, "Fluid Mechanics", p. 147, McGraw Hill, NY (1958).
15. W.J. Beek and K.M. Mutzall, "Transport Phenomena", J. Wiley and Sons, NY (1975), pp. 61-63.
16. R. Haydarov, private communication to project manager (2000).