



NATIONAL AERONAUTICS AND SPACE ADMINISTRATION

FINAL

APOLLO 11 LUNAR SURFACE OPERATIONS PLAN

PREPARED BY

LUNAR SURFACE OPERATIONS OFFICE
MISSION OPERATIONS BRANCH
FLIGHT CREW SUPPORT DIVISION

JUNE 27, 1969

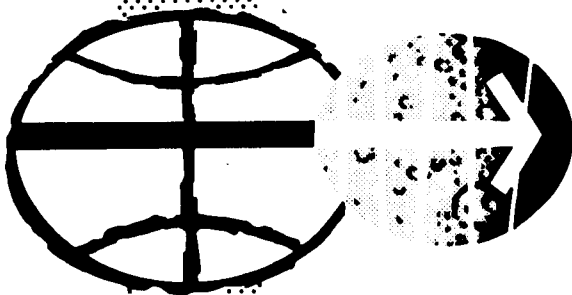

MANNED SPACECRAFT CENTER
HOUSTON, TEXAS



FINAL EDITION

APOLLO 11

LUNAR SURFACE OPERATIONS PLAN

JUNE 13, 1969

Prepared by: William H. Wood, Jr.
W. H. Wood, Jr.
Lunar Surface Operations Office

Approved by: R. G. Zedekar
R. G. Zedekar
Lunar Surface Operations Office

Helmuth Kuehnel
H. A. Kuehnel
Chief, Mission Operations Branch

C. H. Woodling
C. H. Woodling
Assistant Chief for Crew Training

W. J. North
W. J. North
Chief, Flight Crew Support Division

Donald K. Slayton
Donald K. Slayton
Director of Flight Crew Operations

APOLLO 11
LUNAR SURFACE OPERATIONS PLAN
(FINAL EDITION)

PREFACE

This document has been prepared by the Flight Crew Support Division, Flight Crew Operations Directorate, Manned Spacecraft Center, Houston, Texas. The information contained within this document represents the Lunar Surface Operations Plan for Apollo 11, the first planned lunar landing mission.

This is the final edition of the Apollo 11 Lunar Surface Operations Plan. The plan is under the configuration control of the Crew Procedures Control Board (CPCB) and all proposed changes to this document should be submitted to the CPCB via a Crew Procedures Change Request. Changes and comments to the plan should be directed to W. H. Wood, Jr., Lunar Surface Operations Office, FCSD.

CONTENTS

	Page
Preface	iii
List of Figures and Tables	vii
1.0 INTRODUCTION	1
2.0 MISSION PLAN	
2.1 Mission Purpose	3
2.2 Mission Description	3
2.3 Summary of Mission Requirements	6
2.3.1 Introduction	6
2.3.2 Mission Objectives and Experiments	8
3.0 NOMINAL LUNAR EVA	
3.1 Timeline Description and Rationale	10
3.1.1 Lunar Surface Stay	10
3.1.2 Extravehicular Activity	10
3.2 Task and Data Descriptions	13
3.2.1 Environmental Familiarization	13
3.2.2 Preliminary Checks	14
3.2.3 Television Coverage	14
3.2.4 S-band Erectable Antenna Deployment	19
3.2.5 Photography	19
3.2.6 EVA and Environment Evaluation	20
3.2.7 Sample Collections	21
3.2.8 LM Inspection	22
3.2.9 Experiment Deployments	23
3.2.10 Use of Lunar Equipment Conveyor	26
3.2.11 EVA Termination	27
3.3 Summary Timeline	30
3.4 Timeline	31
3.5 Detailed Procedures	39
3.5.1 Nominal Activities Sequence	39
3.5.2 Procedures	40

4.0	ALTERNATE AND CONTINGENT PLANS	PAGE
4.1	Alternate EVA (With S-band Erectable Antenna Deployment)	72
	4.1.1 Description and Rationale	72
	4.1.2 Summary Timeline	73
	4.1.3 Timeline	74
	4.1.4 Detailed Procedures	81
4.2	Contingent EVA 1-Minimum Time, One Man	86
	4.2.1 Description and Rationale	86
	4.2.2 Summary Timeline	87
	4.2.3 Timeline	88
4.3	Contingent EVA 2-One Man, Two Hours	90
	4.3.1 Description and Rationale	90
	4.3.2 Summary Timeline	92
	4.3.3 Timeline	93
5.0	APPENDIX	
5.1	Abbreviations	98
5.2	Detailed Objectives and Experiments	99
	5.2.1 Introduction	99
	5.2.2 Definitions	99
	5.2.3 Objectives	100
	5.2.4 Experiments	161
5.3	Lunar Surface Operational Constraints	169
	5.3.1 Introduction	169
	5.3.2 Constraints Classification	169
	5.3.2.1 Constraint Categories	169
	5.3.2.2 Violation Classification	170
	5.3.3 Mission Operations Constraints	170
	5.3.4 Lunar Surface Operations Constraints	171
	5.3.5 Equipment Operation Constraints	173
	5.3.6. Equipment Design Constraints	174
	5.3.7 General Constraints	175
5.4	Nominal Lunar Surface EVA Metabolic Profiles	177
	5.4.1 Introduction	177
	5.4.2 CDR Metabolic Profile	178
	5.4.3 LMP Metabolic Profile	181
5.5	References	184

FIGURES

Figure Number	Title	Page
3-1	Lunar surface activity timeline for 22-hour stay	12
3-2	Radar coverage during lunar stay for launch date of July 16	17
3-3	TV field of view from MESA	18
3-4	TV field of view from tripod (with Lunar Day lens)	18a
3-5	Quad I inspection points	24
3-6	Quad II inspection points	24
3-7	Quad III inspection points	25
3-8	Quad IV inspection points	25
3-9	Probable areas for lunar surface activity	38

TABLES

Table No.		
3-1	Performance margins for LM communications	16
3-2	Loose equipment left on lunar surface	29

SECTION 1.0

INTRODUCTION

INTRODUCTION

This final edition of the Lunar Surface Operations Plan defines equipment requirements, crew/equipment interfaces, and final flight planning and crew activities for lunar surface EVA operations during the first manned lunar landing mission.

This plan delineates how the lunar surface operational and scientific objectives for the first manned lunar landing mission will be accomplished through pre-mission timing and procedures definition. Although the primary concern of this plan is the lunar surface EVA operational aspects of the mission, interface relationships are presented to provide clarity and continuity to the overall mission plan.

The nominal plan is for a single two-man lunar excursion. The planned duration will be two hours and forty minutes or upon reaching a pre-determined red line on one of the PLSS consumables. The red line is defined as having either a 30 minute supply of oxygen or a 30 minute supply of feedwater remaining after repressurization. The battery is not considered to be a constraint on the lunar surface time for this mission. Based on an estimation of each crewman's BTU expenditure to accomplish his respective EVA tasks, a PLSS expendable red line should not be reached during the EVA. The Commander is expected to expend approximately 3625 BTU's which will leave a 1175 BTU PLSS reserve or approximately 50 minutes Lunar surface time. (Metabolic profiles are presented in the Appendix, Section 5.4)

In addition to the nominal timeline, the plan presents three other timelines for the lunar EVA. One timeline is referred to as an alternate timeline and two are referred to as contingent timelines. These timelines differ from the nominal primarily by additions or deletions of tasks. The major difference in the alternate timeline, from the nominal, is the addition of the S-band erectable antenna deployment which reduces the time available for the documented sample collection. The first contingent timeline, Contingent EVA 1, is a presentation of activities for a minimum-time, one-man EVA. The second contingent timeline, Contingent EVA 2, is for a one-man, two-hour EVA.

The plan also presents two forms of timelines. The EVA timelines and a timeline for the complete lunar surface stay, from touchdown to liftoff, are in summary form. Each of the EVA timelines is also presented in an expanded timeline and abbreviated procedures form.

Detailed procedures are included for the nominal lunar EVA. Since the alternate timeline, in general, only adds the deployment of the erectable antenna and reduces the time for collection of a documented sample, detailed procedures for the entire alternate EVA would be redundant. Thus, only detailed procedures for the S-band erectable antenna deployment are included. For the contingent EVA's, the timelines present the procedures in sufficient detail that, with an understanding or reference to the nominal procedures, separate procedures are unnecessary.

SECTION 2.0

MISSION PLAN

2.0 MISSION PLAN

2.1 Mission Purpose

The primary purpose of the Apollo 11 mission is to perform a manned lunar landing and return. Subordinate objectives are to perform limited selenological inspection, photography, survey, evaluation, and sampling during the lunar stay. Data will be obtained to assess the capability and limitations of the astronaut and his equipment in the lunar environment. The accomplishment of the detailed lunar surface mission objectives and experiments will contribute an essential part to the success of the mission.

2.2 Mission Description

This section provides a brief summary of the major events for a July 16, 1969 launch date.

Launch to Earth Orbit:

The July 16 mission will allow a range of launch azimuths from 72 to 108 degrees with a window opening at 13:32:00 (hr:min:sec) gmt for a duration of 4:24:00. The spacecraft will be inserted into an approximately 100 nautical mile circular earth parking orbit for spacecraft checkout.

Translunar Injection (TLI):

The July window permits a Pacific translunar injection. The S-IVB will be re-ignited during the second earth parking orbit to provide the nominal injection.

Translunar Coast:

Two hours after TLI, the CSM will separate from the S-IV, transpose, dock and initiate ejection of the LM/CSM. Prior to lunar orbit insertion (LOI), two astronauts will enter the LM, accomplish a limited status check, and return to the command module.

Lunar Orbit Insertion:

The service module propulsion system will insert the spacecraft into an orbit of approximately 60 by 170 nautical miles. After two revolutions in this orbit for spacecraft system and orbit parameter checks, the orbit will be reduced to 66 by 54 nautical miles.

Lunar Module Descent:

During the thirteenth orbit after the Lunar Orbit Insertion, LM/CSM undocking is accomplished in preparation for lunar landing. The powered descent maneuver is initialized at pericyynthion of the descent transfer orbit. For the July 16 launch, the lunar landing will be at Site 2 (previously designated II-P-6 and located at 0° 43' N, 23° 42' E). The range of sun elevation angles, for landing, will be from 10.5 to 13.5 degrees.

Lunar Surface Operations:

The planned lunar surface staytime is 22 hours. The nominal plan provides for a single, two-man EVA, with a duration of two hours and forty minutes.

Immediately after landing, the LM will be checked to assess its launch capability. After the post-landing checks, there will be a four hour rest period, with eat periods before and after, prior to preparation for EVA. Following the EVA and post-EVA activities, there will be another rest period, of four hours and forty minutes duration, prior to preparation for liftoff.

In addition to the tasks required to successfully complete the landing and ascent and the pre-EVA and post-EVA operations, the lunar surface activities will include the following major items in order of priority:

- 1) Photographs of the landing area through the LM cabin window.
- 2) Contingency sample collection.

- 3) EVA evaluation.
- 4) LM inspection.
- 5) Bulk sample collection.
- 6) Deployment of experiments: Early Apollo Scientific Experiments Package (S-031, Lunar Passive Seismology and S-078, Laser Ranging Retro-Reflector) and S-080, Solar Wind Composition.
- 7) Documented sample collection.

Real time TV coverage will be provided early in the EVA using the steerable antenna or, if required, the erectable antenna. Both the Goldstone and Parkes 210-foot antennas will be utilized as available.

Photography will be employed throughout the EVA to document the activities and observations.

LM Ascent:

During the LM lunar surface stay, the CSM will make the required plane change to permit a nominally coplanar rendezvous. After LM ascent and docking to the CSM, the two crewmen will transfer to the CSM with exposed film and samples of the lunar surface. The CSM will then jettison the LM using the SM RCS.

Transearth Injection:

The service module propulsion system will be used to boost the CSM out of lunar orbit. The return flight duration shall not exceed 110 hours and the return inclination shall not exceed 40 degrees.

Entry and Recovery:

Prior to atmospheric entry, the command module will be separated from the service module using the SM RCS. The nominal range from 400,000 feet altitude to touchdown shall be 1285 nautical miles. Touchdown will be in the Pacific near Hawaii approximately 11 days after launch from earth.

Post Landing Operations:

Following splashdown, the crew will egress the CM after the flotation collar has been attached, don biological isolation garments, transfer to the recovery ship by helicopter and immediately enter the Mobile Quarantine Facility (MQF). They will be transported in the MQF to the LRL at MSC. The CM, sample return containers, film, tapes and astronaut logs will also be transported to the LRL.

In order to minimize the risk of contamination of the earth's biosphere by lunar material, quarantine measures will be enforced. The crew will be quarantined for approximately 21 days after liftoff from the lunar surface.

2.3 Summary of Mission Requirements

2.3.1 Introduction

The following information is from the "Mission Requirements SA-506/CSM-107/LM-5 G Type Mission, Lunar Landing", Dated April 17, 1969. (Revised May 1, 1969)

The following single primary mission objective is assigned to this mission by the Office of Manned Space Flight (OMSF):

- 1) Perform manned lunar landing and return.

In addition, the following subordinate objectives are delineated by OMSF:

- 1) Perform selenological inspection and sampling.
- 2) Obtain data to assess the capability and limitations of the astronaut and his equipment in the lunar surface environment.

Finally, the following experiments have been assigned to this mission:

- 1) S-031 Lunar Passive Seismology
- 2) S-078 Laser Ranging Retro-Reflector

- 3) S-080 Solar Wind Composition
- 4) S-151 Cosmic Ray Detection
- 5) T-029 Pilot Describing Function

The Mission Requirements document incorporates these various objectives and experiments, details them where necessary, and places them in the proper order of priority, thereby providing the level of detail necessary for mission planning. The document notes, however, that:

- 1) There are no Detailed Objectives, as such, which have been derived from the primary objective of "perform manned lunar landing and return". Detailed Objectives have, however, been derived from the two OMSF subordinate objectives. The mission will be flown as an operational mission in the sense that it will be performed in the most expeditious manner possible with no interference from special tests or operations which are not necessary for the performance of this basic objective. The manner in which the detailed performance of this objective is met will be contained in the Mission Report.
- 2) Experiments are detailed and prioritized in the requirements document only when they are such as to require some action by the crew or otherwise impact the timeline. Thus, the Cosmic Ray Detection experiment, S-151, a passive experiment limited to post mission analysis of the flight helmets, is only mentioned and does not appear in the priority list or as a detailed objective. Similarly, the Pilot Describing Function experiment, T-029, only requires certain portions of voice and telemetry data recordings and does not appear in the list of objectives and experiments.

The Detailed Objectives for the first lunar landing mission will be objectives which concern equipment and crew operations only during the lunar surface phase of the mission. The capability to successfully complete other mission phases will have been demonstrated on prior missions.

2.3.2 Mission Objectives and Experiments

The following summary of lunar EVA objectives and experiments is in order of priority, with the objective or experiment of highest priority listed first. The order of priority is based upon the relative importance to the Apollo spacecraft development program or to the advancement of lunar science. The Detailed Objectives and Experiments are included in the Appendix, Section 5.2.

The objectives "Television Coverage" and "Photographic Coverage" will be performed in conjunction with several of the other objectives or experiments. The associated operations will take place at various points in the timeline. Hence, these two objectives cannot be assigned any specific priority in the list below and are therefore included at the end.

<u>Priority</u>		<u>Objectives and Experiments</u>
1	A	Contingency Sample Collection
2	B	Lunar Surface EVA Operations
3	C	EMU Lunar Surface Operations
4	D	Landing Effects on LM
5	E	Lunar Surface Characteristics
6	F	Bulk Sample Collection
7	G	Landed LM Location
8	H	Lunar Environment Visibility
9	I	Assessment of Contamination by Lunar Material
10	S-031	Lunar Passive Seismology
11	S-078	Laser Ranging Retro-Reflector
12	S-080	Solar Wind Composition

13	J	Documented Sample Collection
14	K	(Included in Photographic Coverage, Change A, May 1, 1969)
-	L	Television Coverage
-	M	Photographic Coverage

SECTION 3.0

NOMINAL LUNAR EVA

- 3.0 NOMINAL LUNAR EVA
- 3.1 Timeline Description and Rationale
- 3.1.1 Lunar Surface Stay

The nominal plan is for two crewmen, the Commander and the Lunar Module Pilot, to remain on the lunar surface for approximately 22 hours. During this period, the crew will accomplish postlanding and pre-ascent procedures and extravehicular activity. There will be two rest and several eat periods. A timeline for the lunar surface stay is presented in Figure 3-1.

There are several considerations which are the basis for the sequence of activity for the lunar surface stay. An early rest period is planned which will provide rest before the strenuous pre-EVA, EVA, and post-EVA activities and insure the work day is not prohibitively long if liftoff is required before the other planned rest period. A second rest period of four hours and forty minutes is provided after the EVA before the crucial liftoff and rendezvous sequence.

- 3.1.2 Extravehicular Activity

The first lunar EVA is designed to maximize the return of scientific and operational data. However, the timeline permits rest periods and a gradual increase in task complexity with simple tasks initially for crew acclimation and PLSS-EMU data analysis.

There will be two major areas of evaluation during the lunar surface EVA. The first concern is with comprehensive crew familiarization and evaluation of EVA capability and the lunar environment. The investigation will be a methodical approach which will enhance the accomplishment of this EVA as well as demonstrate astronaut and equipment capability for future lunar surface exploration. The second area is the collection of operational and scientific data. The analysis of this data will assist in the update of equipment designs as well as increase our general understanding of the lunar surface.

The first few minutes of the EVA, the Lunar Module Pilot (LMP) will remain inside the LM ascent stage to monitor the Commander's (CDR) surface activity and the LM systems in the

depressurized state. The CDR will descend to the lunar surface to conduct several preliminary tasks. He will determine his ability to operate in the lunar environment, collect a contingency lunar sample and take still color photographs (with an electric 70mm camera) as he checks the LM and the lunar surface condition which affect the accomplishment of the EVA tasks. In addition to the TV coverage and still photographs, the LMP can visually observe and obtain sequence camera (data acquisition) coverage to supplement the documentation of the CDR activity.

With only one crewman on the surface during the first few minutes of the EVA, a more effective PLSS telemetry data analysis can be conducted. The real time use rate for the PLSS consumables will be compared with the predicted rate to determine the PLSS capability for EVA continuation.

After the CDR accomplishes the preliminary EVA tasks, the LMP will descend to the surface and spend a few minutes in the familiarization and evaluation of his capability or limitations to conduct further operations in the lunar environment. After this short period of time he will deploy the Solar Wind Composition (SWC) experiment. The CDR, after photographing the LMP's egress and descent to the surface, will remove the TV camera and tripod from the descent for stage modularized equipment stowage assembly (MESA) and move them to a position for optimum coverage of the subsequent surface EVA operations. Then, while the CDR collects a bulk sample of lunar surface material, the LMP will continue to become more familiar with his ability to operate in the lunar environment as he conducts the EVA and Environment Evaluation. The LMP begins the LM inspection and is joined by the CDR after the bulk sample has been collected. When the crewmen reach the scientific equipment (SEQ) bay in Quad II, the LMP removes the Early Apollo Scientific Experiments Package (EASEP) as the CDR completes the LM inspection and photographically documents the LMP's activity. After they deploy the EASEP, the crew will select, describe, photograph, and collect samples until they terminate the EVA.

In summary, there is a general increase in task complexity for both crewmen. The conservative timeline permits the crew to follow a slow, methodical approach in accomplishing each task. Additionally, the frequent rest periods within

the timeline add to this conservatism and insure that each crewman and his PLSS remain in a nominal operating condition. However, should the EVA be terminated at any point in the timeline, the maximum data return for the time spent on the surface will be assured.

3.2 Task and Data Descriptions

Although the detailed procedures describe the steps to accomplish each task, further explanation of the desired data and data collection processes is desirable.

3.2.1 Environmental Familiarization

As mentioned previously, the timeline considerations for the lunar surface extravehicular activity will permit a slow buildup of task complexity to insure thorough crew familiarization with the lunar environment yet optimize the data return. The approach with which the crewmen will proceed will permit them to adapt to the environment while determining the ease or difficulty which they can expect through out the EVA. The first crewman to egress, after determining his initial EVA capability, can advise the second crewman on what to expect and possibly suggest methods to accomplish the additional tasks. Both crewmen's experiences will be invaluable for predicting crew capability on future lunar surface explorations.

Once on the surface, the CDR will move slowly from the footpad to check his balance and determine his ability to continue with the EVA--the ability to move and to see or, specifically, to perform the surface operations within the constraints of the EMU and the lunar environment. Although a more thorough evaluation and documentation of a crewman's capabilities will occur later in the timeline, this initial familiarization will assure the CDR that he and the LMP are capable of accomplishing the assigned EVA tasks. Also, should it be necessary to unexpectedly terminate the EVA prior to further environment evaluation, this early familiarization will insure some data return on EVA capability and the lunar surface properties.

3.2.2 Preliminary Checks

For the Preliminary Checks the CDR will transfer the 70mm EL Data camera to the surface, conduct a brief LM check and a preliminary evaluation of the lunar environment. The Hasselblad camera will enable the CDR to take still color photographs to supplement the sequence (data acquisition) camera photography which the LMP will attain through the LM ascent stage window to document the surface activity.

A brief check of the LM status is a simple task which can be used to extend the CDR's environment familiarization and, at the same time, provide an important contribution to the postflight assessment of the LM landing should a full or nominal LM inspection not be accomplished later.

The preliminary evaluation of the conditions which will influence the crewmen's surface operations, such as the terrain surface features and lighting or visibility, will also enhance the CDR's environmental familiarization as well as his assessment of an astronaut's capability to accomplish EVA tasks.

From a position near the ladder the CDR will make a general inspection of the LM and surface about the LM. For the LM and surface visible to him, he will briefly examine the gear struts, footpads, and major parts of the spacecraft to assure that the LM is stable and will provide a safe operations base for the lunar stay. An inspection of the surface will provide preliminary data on the LM effect on the surface during the landing.

3.2.3 TV Coverage

The primary purpose of the TV is to provide a supplemental real time data source to assure or enhance the scientific and operational data return. It may be an aid in determining the exact LM location on the lunar surface, in evaluating the EMU and man's capabilities in the lunar environment and in documenting the sample collections. The TV will be useful in providing continuous observation for time correlation of crew activity with telemetered data, voice comments, and photographic coverage.

TV reception, without a degradation of both voice and telemetered information, may be dependent on having the LM steerable S-band antenna radiate to a 210-foot antenna, either the Goldstone (California) or the Parkes (Australia) antenna, or deploy the S-band erectable antenna on the lunar surface. (A comparison of the performance expected with the 210-foot/steerable antennas or 85-foot/erectable antennas is presented in Table 3-1 on the following page.) The erectable antenna makes it possible to receive TV transmissions with the 85-foot antenna dishes at either Goldstone, Madrid, or Canberra, which are equivalent to the 210-foot/steerable combination.

If a 210-foot antenna is not in view or the erectable antenna has not been deployed, TV coverage may be obtained by accepting the loss or degradation of voice and telemetry. The final decision for such coverage will be made in real time and based on the quality of the communications up to that point.

For the nominal mission, with a July 16 launch date, the Goldstone and/or the Parkes antennas will be in view during the EVA. The coverage provided by the 210-foot and 85-foot antennas during the lunar stay is shown in Figure 3-2.

The TV camera will have two primary positions or fields of view for coverage of the surface activity. The camera will be mounted in the descent stage Modularized Equipment Stowage Assembly (MESA) to view the crewmen's descent to the surface and the CDR's activity in the immediate ladder area. (See Figure 3-3). After the LMP's descent to the surface, the CDR removes the camera and tripod from the MESA and places the tripod with camera on the surface in an optimum position for coverage of subsequent surface activity. (See Figure 3-4).

TABLE 3-1

PERFORMANCE MARGINS FOR LM COMMUNICATIONS*

(FM Mode - High Power)

	85' MSFN STATION		210' MARS STATION	
	<u>NOMINAL</u>	<u>WORST CASE</u>	<u>NOMINAL</u>	<u>WORST CASE</u>
<u>Erectable Antenna</u>				
51.2 kbps Telemetry**	+ 8.8 dB	+ 6.8 dB	+16.8 dB	+14.8 dB
EVA Voice (dual)	+ 9.2	+ 7.2	+17.2	+15.2
EVA EKG & PLSS Data (dual)	+ 3.8	+ 1.8	+11.8	+ 9.8
Television (B&W)	+ 9.7	+ 7.7	+17.7	+15.7
1.6 kbps Telemetry**	+17.4	+15.4	+25.4	+23.4
EVA Voice (dual)	+ 9.2	+ 7.2	+17.2	+15.2
EVA EKG & PLSS Data (dual)	+ 3.8	+ 1.8	+11.8	+ 9.8
Television (B&W)	+ 9.7	+ 7.7	+17.7	+15.7
<u>Steerable Antenna</u>				
51.2 kbps Telemetry**	+ 0.7	- 1.5	+ 8.7	+ 6.5
EVA Voice (dual)	+ 1.1	- 1.1	+ 9.1	+ 6.9
EVA EKG & PLSS Data (dual)	- 4.3	- 6.5	+ 3.7	+ 1.5
Television (B&W)	+ 1.6	- 0.6	+ 9.6	+ 7.4
1.6 kbps Telemetry**	+ 9.3	+ 7.1	+17.3	+15.1
EVA Voice (dual)	+ 1.1	- 1.1	+ 9.1	+ 6.9
EVA EKG & PLSS Data (dual)	- 4.3	- 6.5	+ 3.7	+ 1.5
Television (B&W)	+ 1.6	- 0.6	+ 9.6	+ 7.4

* Based on measured LM-5 data and MSC test data on new (1969) Motorola FM demodulator. The MSC tests were conducted in the ISD Electronic Systems Test Facility (on one unit).

** For a BER of 10^{-4} .

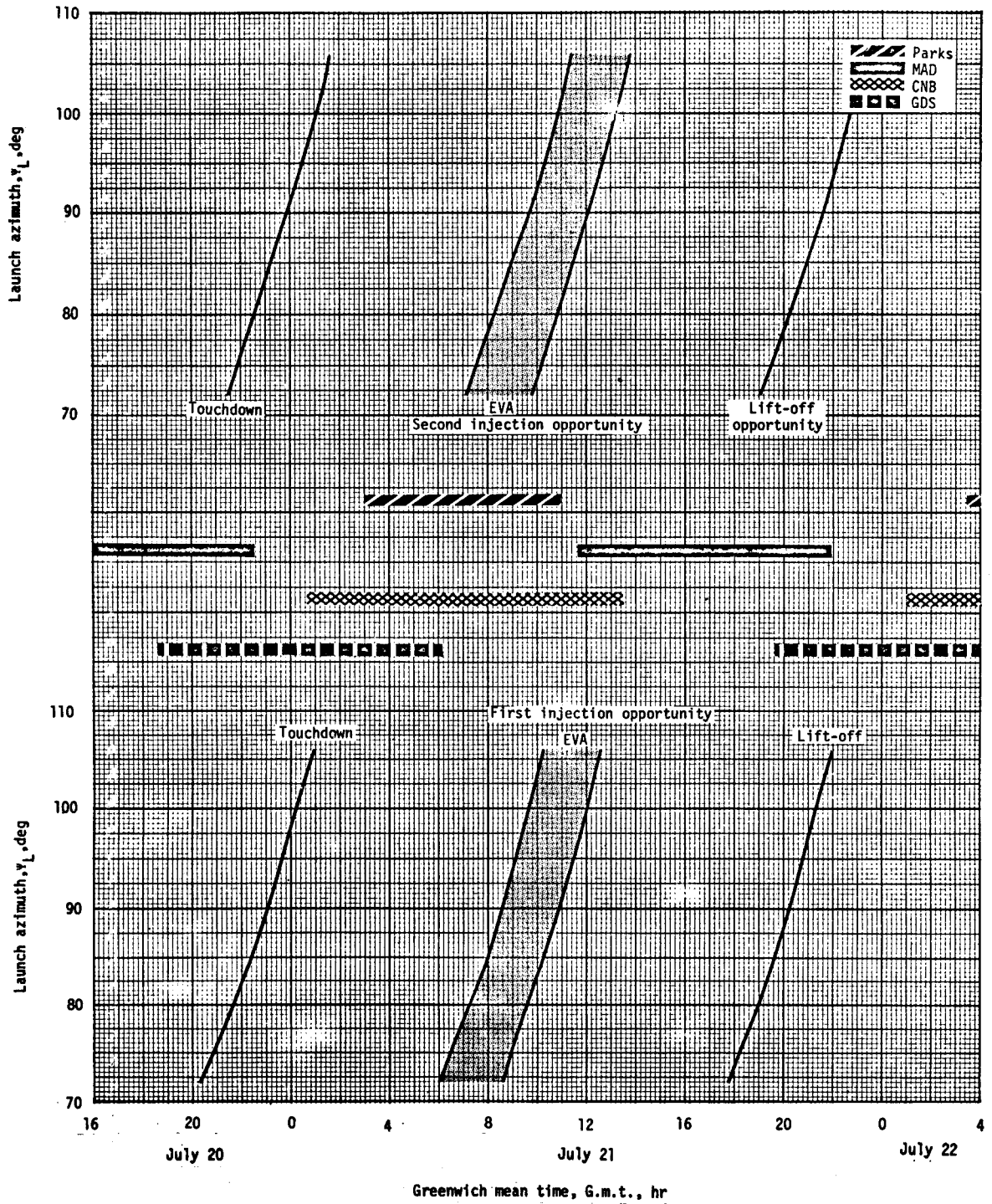

Figure 3-2. - Radar coverage during lunar stay for launch date of July 16.

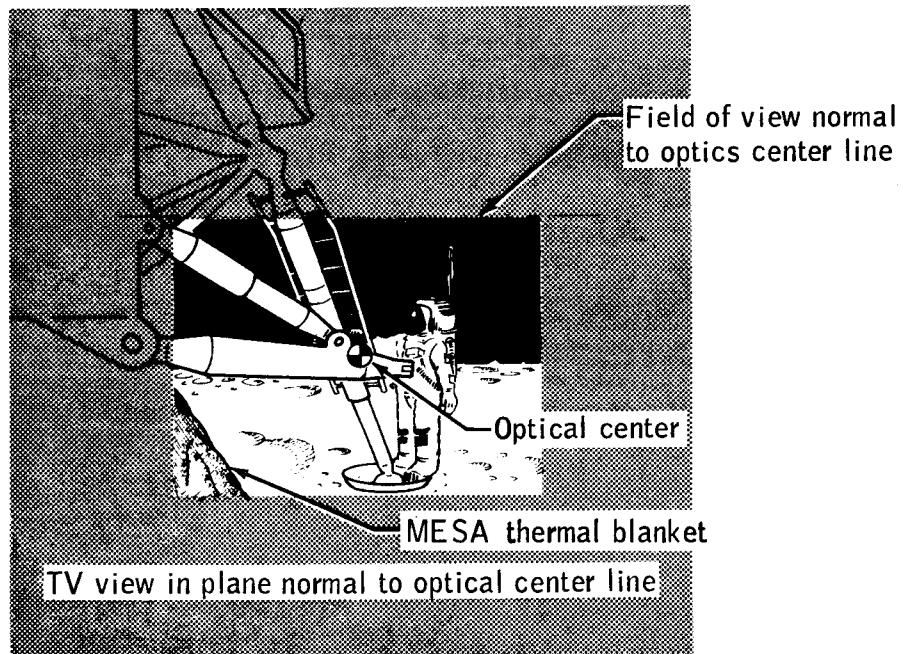
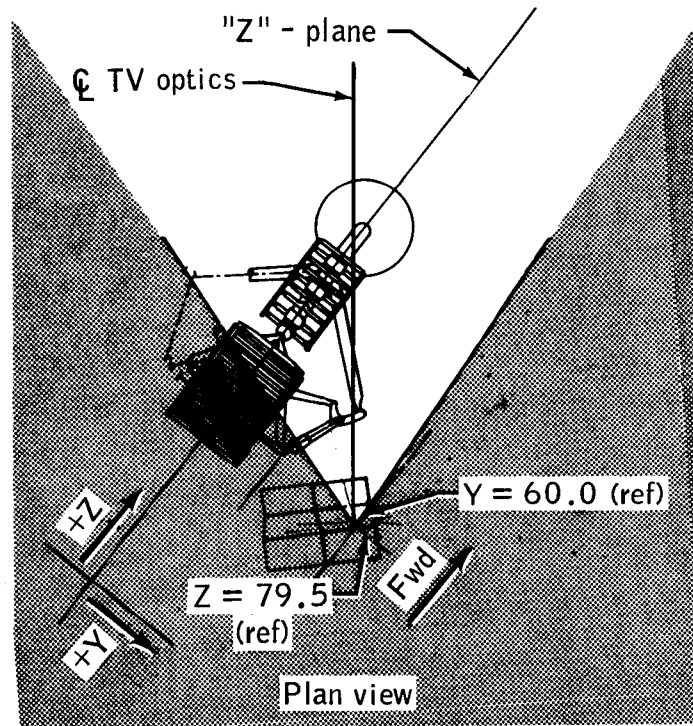

Figure 3-3. - TV field of view from MESA.

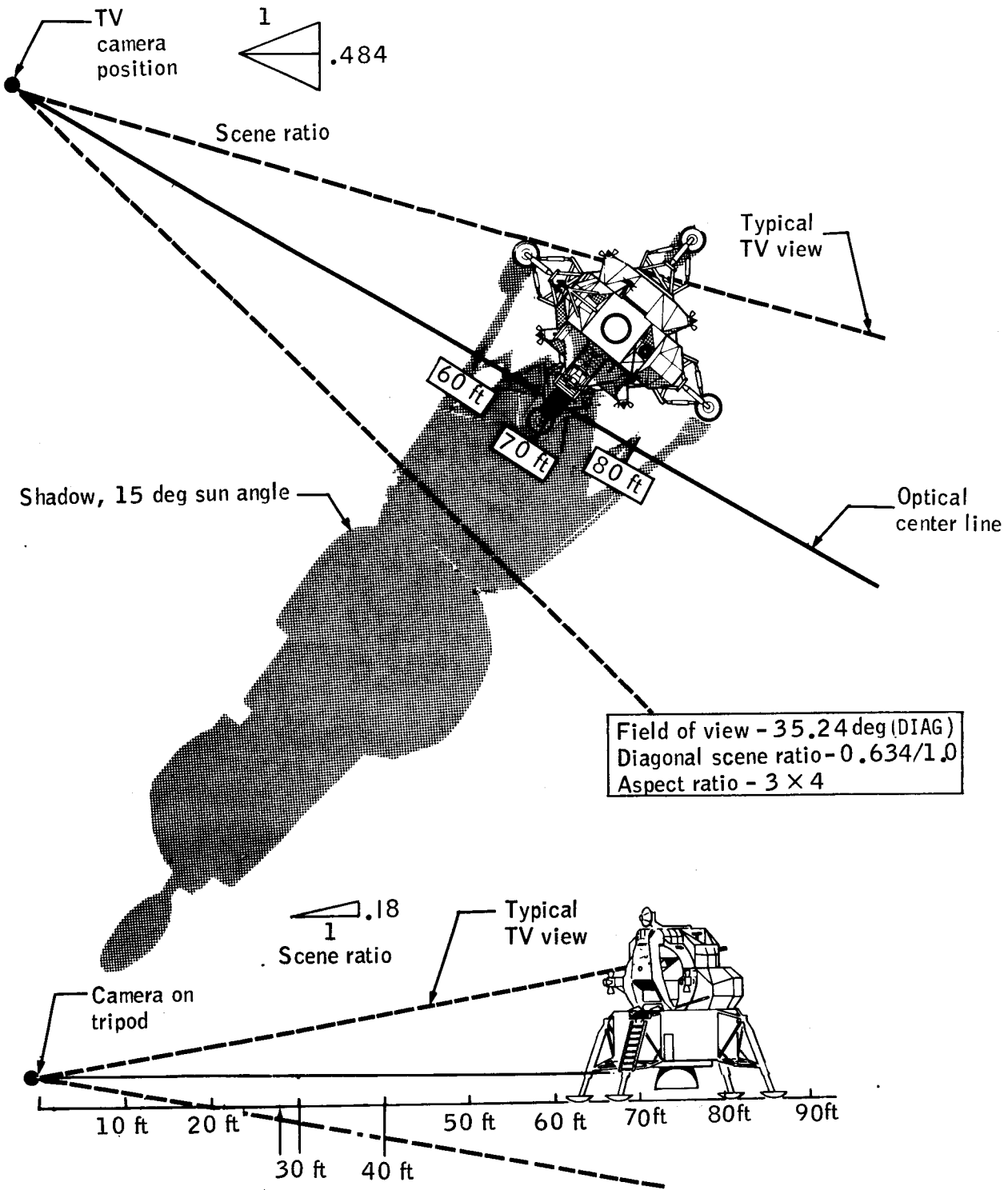

Figure 3-4.- TV field of view from tripod (with Lunar day lens)

3.2.4 S-Band Erectable Antenna Deployment (Alternate Timeline)

The S-band erectable antenna will be deployed to increase the communications capability. It's major impact to the EVA is in obtaining an equivalent communications capability that will be possible otherwise only if a 210-foot antenna is in view. This communications capability may be required for simultaneous TV, voice, and telemetered data return. (See the discussion on this subject in the previous section on TV coverage, Section 3.2.3).

The deployment of the erectable antenna is a time-consuming task--deployment time is expected to be 19 minutes. However, the TV coverage, without a degradation of voice and telemetry, gained through the use of the antenna may require it to be deployed. In this situation, although it is desirable to attain this advantage provided by the antenna and to permit the crewman inside the LM to switch to the erectable antenna earlier in the timeline, the crewman's familiarization with lunar operations before this point is considered to be insufficient to safely and effectively accomplish the deployment task.

3.2.5 Photography

Photography, still color photographs with the 70mm EL data camera, close-up stereo photographs with the Apollo Lunar Surface Close-up Camera (ALSCC), and motion pictures with the 16mm (data acquisition) camera, will be a vital part of the data collection process for the EVA. A 70mm camera, with black and white film, will be used for surface photography from the LM and will be transferred to the surface if a malfunction of the other camera occurs.

The crewmen will use the EL data camera extensively on the surface to document each major task which they accomplish. Additional photography, such as panoramas and scientific documentation, will supplement other data in the postflight analysis of the lunar environment and the astronaut's capabilities or limitations on conducting lunar surface operations.

With the ALSCC the crewmen may photograph areas of the lunar surface not disturbed during the landing or surface activity, their footprints, areas affected by the LM footpads and the scientific equipment, and other phenomena of operational and scientific interest.

The sequence camera, from the LM ascent stage window, will provide almost continuous coverage of the surface activity. The Lunar Module Pilot, who remains inside the ascent stage for the first few minutes of the EVA, will use the sequence camera to document the Commander's initial surface activities. Then, before he egresses, the LMP will position the camera for optimum surface coverage while both crewmen are on the surface. And, after the LMP ingresses, he can use the sequence camera to provide coverage of the remaining surface activity.

A complete description of the camera equipment and their operational procedures, as well as the details of the documentation provided by the three cameras, are contained in Reference 6.

3.2.6 EVA and Environment Evaluation

The primary purpose of the Environmental Familiarization period, early in the timeline, is to allow the crew sufficient time to adapt to the new environment and operating conditions. The EVA and Environment Evaluation, however, involves a detailed investigation and documentation of a crewman's capability within the constraints of the EMU, the PLSS/EMU performance under varying conditions of sunlight, shadow, crewman activity or inactivity, and the characteristics of the lunar environment which influence operations on the surface.

The preliminary familiarization will be of the most benefit in real time--to prepare the crewmen to operate during this EVA. On the other hand, the EVA and Environment Evaluation period should be of significant value for future lunar surface exploration. From the assessment of data gathered during this period, sufficient knowledge should be gained to accurately predict the capabilities and limitations of the astronaut and his equipment for future lunar surface extravehicular activity.

During the EVA and Environment Evaluation the LMP will determine, in detail, the combined effects of the EMU constraints and lunar gravity on his physical capabilities. He will compare his capabilities in this lunar environment with similar experiences during earth gravity and simulated lunar gravity exercises. He will observe how the lunar surface is affected by the actions he performs and carefully examine the terrain to determine the surface characteristics. Also, he will determine his visual perception of the surface features and his visual acuity within the constraints of the extravehicular visor assembly (EVVA).

3.2.7 Sample Collections

The nominal plan is to conduct three sample collections of lunar surface material. They are, in order of priority, the contingency, the bulk, and the documented sample collection.

The contingency sample collection is a simple task which can be accomplished within a few minutes early in the EVA timeline. This will assure the return of a small sample in a contingency situation where a crewman may remain on the surface for only a short period of time. One to two kilograms of loose material will be collected near the LM ladder and the sample bag restowed in the suit pocket to be carried into the ascent stage when the crewman ingresses.

In the bulk sample collection at least 10 kilograms of unsorted surface debris and selected rock chunks will be placed in a special container, an Apollo Lunar Sample Return Container (SRC), to provide a near vacuum environment for its return to the Lunar Receiving Laboratory (LRL). Apollo Lunar Handtools (ALHT), stowed in the MESA with the SRC, will be used to collect this large sample (30 to 60 pounds) of loose lunar material from the surface near the MESA in Quad IV of the LM. As each rock sample or scoop of loose material is collected it will be placed into a large sample bag. Placing the sealed bag, rather than the loose material directly into the SRC, also prevents contamination and possible damage to the container seals.

The documented sample collection, like that of the bulk sample collection, will involve a large mass of lunar material placed into an SRC for return to earth. However, the documented sample will differ significantly in content and in its collection process. As the name implies the documented sample collection will involve the documentation of the individual samples and the area from which they are taken. It can be classified as a very limited lunar field geology investigation.

Within the documented sample collection a core tube sample is first collected to provide an aseptic and stratified sample near the LM. At a site representative of the landing area, the crew will examine, describe, photograph, and collect rock fragments and loose surface material samples and place them individually in pre-numbered bags. The samples, in the small bags numbered one through fourteen, are placed in a large bag for transfer to and stowage in the documented sample SRC. If time permits after collecting the small bags of samples, the crew will collect two environment samples, representative of the bulk sample, and a second core tube sample. Additionally, the large sample bag will be filled, as the bulk sample bag, to return the maximum amount of surface material.

The various samples within the documented sample collection will be taken from areas near the LM out to possibly 300 feet away. Although the limiting distance from the LM for this first surface mission is 300 feet, there are several reasons for the crew to remain within 100 feet. First, since the documented sample collection will be late in the EVA, the capability of the crew and their equipment will be limited at this time. Additionally, on this first landing mission a relatively conservative approach is necessary. Also, it is unlikely that the terrain at 300 feet will be significantly different from the terrain within 100 feet of the LM.

3.2.8 Lunar Module Inspection

The purpose of the LM inspection is to visually check and photographically document the external condition of the LM after the flight to the lunar surface and the effects of the LM landing on the lunar surface. The inspection data will be used to verify the LM as a safe and effective vehicle for lunar excursions. The data will also be used to gain more knowledge of the lunar surface characteristics. In general the benefit of the inspection will serve to advance the equipment design and our understanding of the environment in which it operates.

The crewmen will methodically inspect and report the status of all external parts and surfaces of the LM which are visible to them. They will examine the lunar surface about the LM to determine the interactions of the LM footpads with the lunar soil for study of the lunar surface properties. The still color

photographs with the Hasselblad and closeup cameras, will supplement their visual documentation for postflight engineering analysis and design verification. They will observe and photograph the Reaction Control System (RCS) effects on the LM, the landing gear performance, the interactions of the surface and footpads, and the Descent Propulsion System (DPS) effects on the surface as well as the general condition of all quadrants and landing struts. (Refer to Figures 3-5, 3-6, 3-7, and 3-8 for the major LM inspection points.)

3.2.9 Experiment Deployments

There are three scientific experiments which will be deployed. The Solar Wind Composition (SWC) experiment deployment, although of lowest priority, is accomplished first as it is a simple task and the results depend on the exposure time. At least an hour of exposure time is desired before it is placed in an SRC for return to earth. The other two experiments, the Passive Seismic (PSE) and Laser Ranging Retro-reflector (LR3), are deployed later but will continue to return data after the mission.

The SWC consists of a panel of very thin aluminum foil rolled and assembled into a combination handling and deployment container. It is stowed in the MESA. Once the thermal blanket is removed from around the MESA equipment it is a simple task to remove the SWC, deploy the staff and the foil "window shade", and place it in direct sunlight where the foil will be exposed to the sun's rays. The SWC is designed to entrap noble gas constituents of the solar wind, such as Helium, Neon, Argon, Krypton and Xenon. The foil is later rolled up, removed from the staff, and placed in an SRC. If it is known at the time the bulk sample SRC is packed that a documented sample will not be collected, the SWC will be placed in the bulk sample SRC. If the bulk sample SRC has been sealed before deciding not to collect the documented sample the SWC may be put into the LMP's suit pocket for transfer to the ascent stage.

At the same time the foil is recovered, the astronaut will push the staff into the lunar surface to determine, for postflight soil mechanics analysis, the depth of penetration.

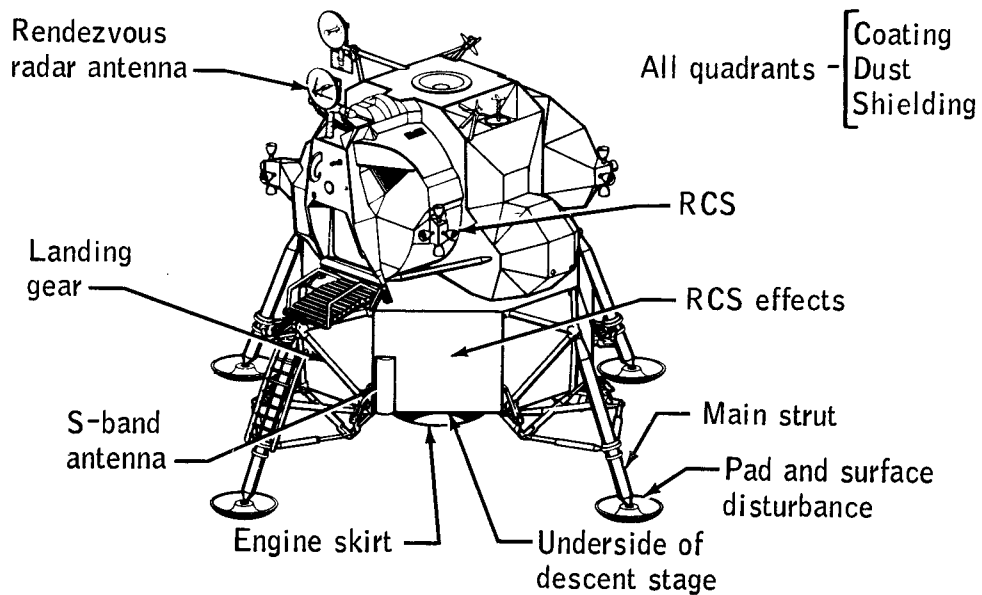

Figure 3-5. - Quad I inspection points.

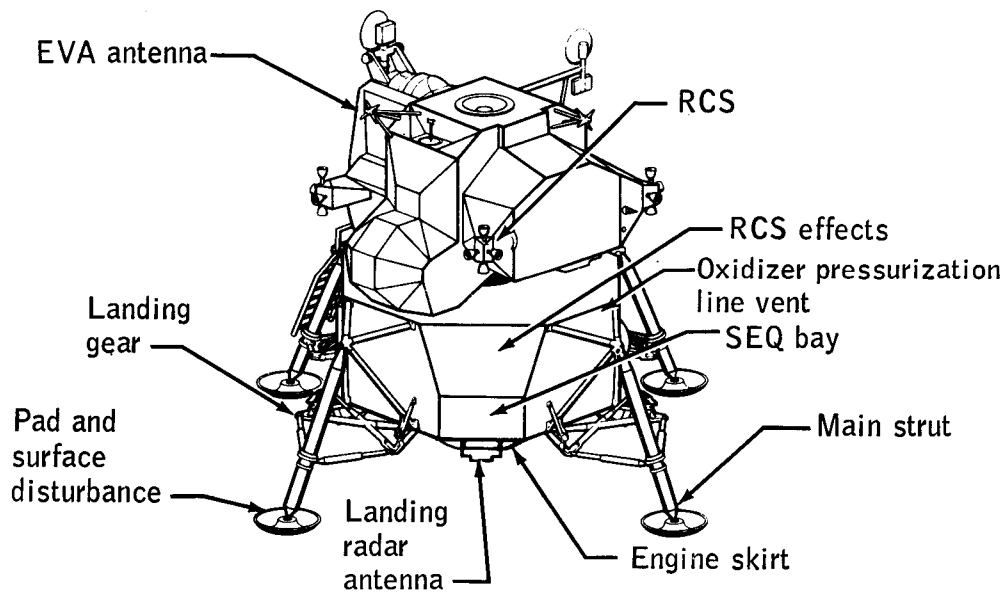

Figure 3-6. - Quad II inspection points.

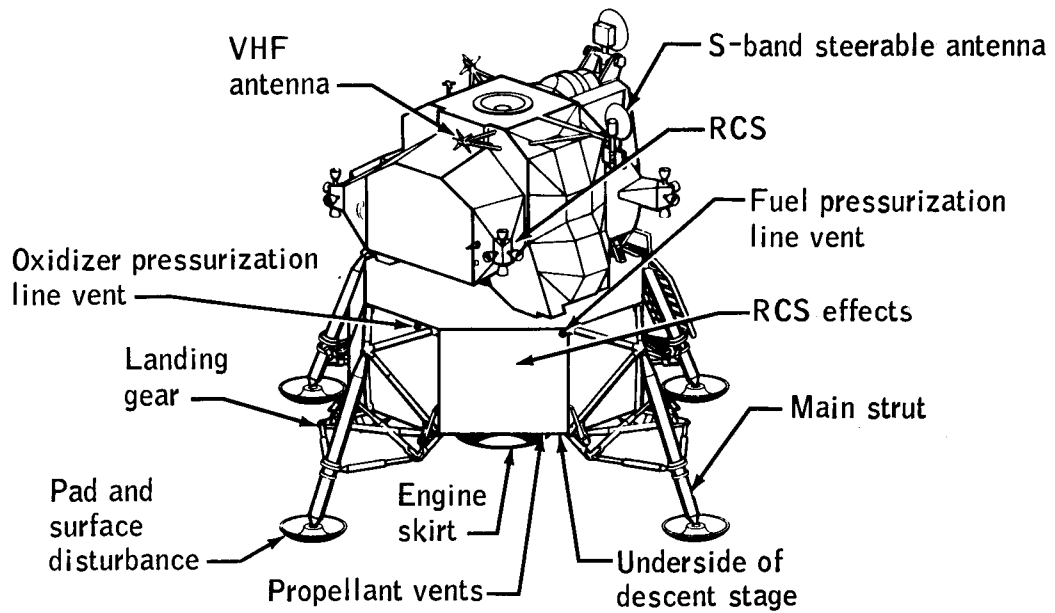

Figure 3-7. - Quad III inspection points.

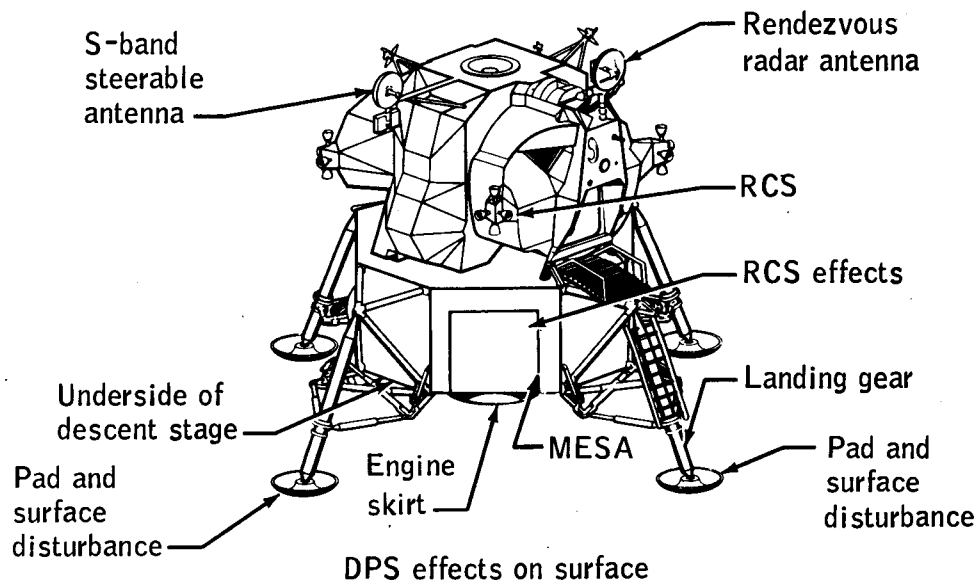

Figure 3-8. - Quad IV inspection points.

The PSE, or the PSE package (PSEP), is one of two packages of the Early Apollo Scientific Experiments Package (EASEP). It will be placed on the lunar surface to monitor lunar seismic activity and detect meteoroid impacts, free oscillations of the moon, and lunar internal activity. It may also detect surface deformations and variations of external gravitational fields acting on the moon. Data from this self-contained, solar-powered experiment package should reveal the properties of the seismic events, the physical properties of the subsurface materials, and the general structure of the lunar interior.

The LR3 is also one of the two EASEP packages. The package provides a corner reflector (actually an array of 100 reflectors) for laser ranging from earth. From this experiment the nature of the earth's irregular rotation may be determined. Also, the data will help refine the lunar motions and the relative motion of the earth and moon.

The PSEP and LR3 are on separate pallets which are stowed in the Scientific Experiment (SEQ) bay of the descent stage Quad II. In the nominal deployment the LMP removes both packages and carries them to the deployment site simultaneously. The crewmen will select a level site, nominally within ± 15 degrees of the LM -Y axis and 70 to 110 feet from the LM. The selection of the site is based on a compromise between a site which minimizes the effects of the LM ascent engine during liftoff heat and contamination by dust and insulation debris (kapton) from the LM descent stage, and a convenient site near the SEQ bay.

3.2.10 Use of the Lunar Equipment Conveyor

The Lunar Equipment Conveyor (LEC) is a device which the astronauts will use during the EVA to transfer equipment to or from the ascent stage. It may also be used by the crewmen as a safety tether when moving down the ladder or as an aid in ascending to the ascent stage.

The LEC is a thin 60 foot continuous loop of one inch wide strap, which loops through a support point in the ascent stage and back to the crewman on the surface. The end of the loop is closed by two hooks, attached together, which

provide a means of securing equipment to the LEC for transfer. The crewman on the surface can effect a transfer to the ascent stage by pulling the top strap which causes equipment hooked to the lower strap to move into the ascent stage.

Although the transfer of equipment with the LEC is simple in principle, the actual transfer operation can require a significant amount of time and effort - more if caution is not observed in keeping the straps untangled or if the proper operational procedures are not used. Because of the time involved (up to five minutes plus a rest period), the number of equipment transfers is kept to a minimum. In the nominal timeline three transfers are planned, one to transfer the Hasselblad camera to the surface and one transfer for each of the two SRC's.

3.2.11 EVA Termination

For EVA termination there are several advantages gained by one crewman ingressing before an SRC is transferred. Although it is possible to transfer an SRC into the ascent stage before the first crewman ingresses, the crewman inside will provide some assistance during the transfer. Additionally, he will remove the SRC and place it where it does not interfere with ingress. The first crewman to ingress will also make a LM system check, change the sequence camera film magazine, and reposition the camera to cover the SRC transfer and other crewman's ladder ascent.

As each man begins his EVA termination he will clean the EMU. Although the crew will have a very limited capability to remove lunar material from their EMU's, they will attempt to brush off any dust or particles from the portions of the suit which they can reach and from the boots on the footpad and ladder.

In the EVA termination there are two tasks which will require some increased effort. The first is the ascent from the footpad to the lowest ladder rung. In the unstroked position the vertical distance from the top of the footpad to the lowest ladder rung is 31 inches. In a nominal level landing this distance will be decreased only about four inches. Thus, unless the strut is stroked significantly the crewmen are required to spring up using their legs and arms to best advantage to reach the bottom rung of the ladder from the footpad.

The second task will be the ingress or the crewmen's movement through the hatch opening to a standing position inside the LM. The hatch opening and the space inside the LM are small. Therefore, the crewmen must move slowly to prevent possible damage to their EMU's or to the exposed LM equipment.

Before the crew closes the hatch and begins the cabin re-pressurization, they will jettison the equipment they no longer need. The items to jettison are the used ECS cannister and bracket, OPS brackets (adapters), and 3 armrests. Numerous pieces of loose equipment will be left on the lunar surface after they have been deployed or used during the EVA. A complete list of this equipment except for a few pip-pins, brackets, and other small pieces of the larger pieces of equipment listed, is presented as Table 3-2 on the following page.

TABLE 3-2

Loose Equipment Left on Lunar Surface

During EVA

- . TV Equipment
 - . camera
 - . tripod
 - . handle/cable assembly
 - . MESA bracket
- . Solar Wind Composition staff
- . Apollo Lunar Handtools -
 - . scoop
 - . tongs
 - . extension handle
 - . hammer
 - . gnomon
- . Equipment stowed in sample return containers (outbound) -
 - . extra York mesh packing material
 - . SWC bag (extra)
 - . spring scale
 - . unused small sample bags
 - . two core tube bits
 - . two SRC seal protectors
 - . environmental sample containers O rings and small rods in lids
- .
- . Apollo Lunar Surface Close-up Camera (film cassette returned)
- . EL Data Camera (magazine returned)

EVA termination

- . Lunar Equipment Conveyor
- . ECS cannister and bracket
- . OPS brackets
- . Three armrests
- . Bag of used urine bags

Post-EVA equipment jettison

- . Two Portable Life Support Systems
- . Left Hand Side Stowage Compartment (with equipment inside)
- . One armrest

3.4 NOMINAL TIMELINE LUNAR SURFACE EVA

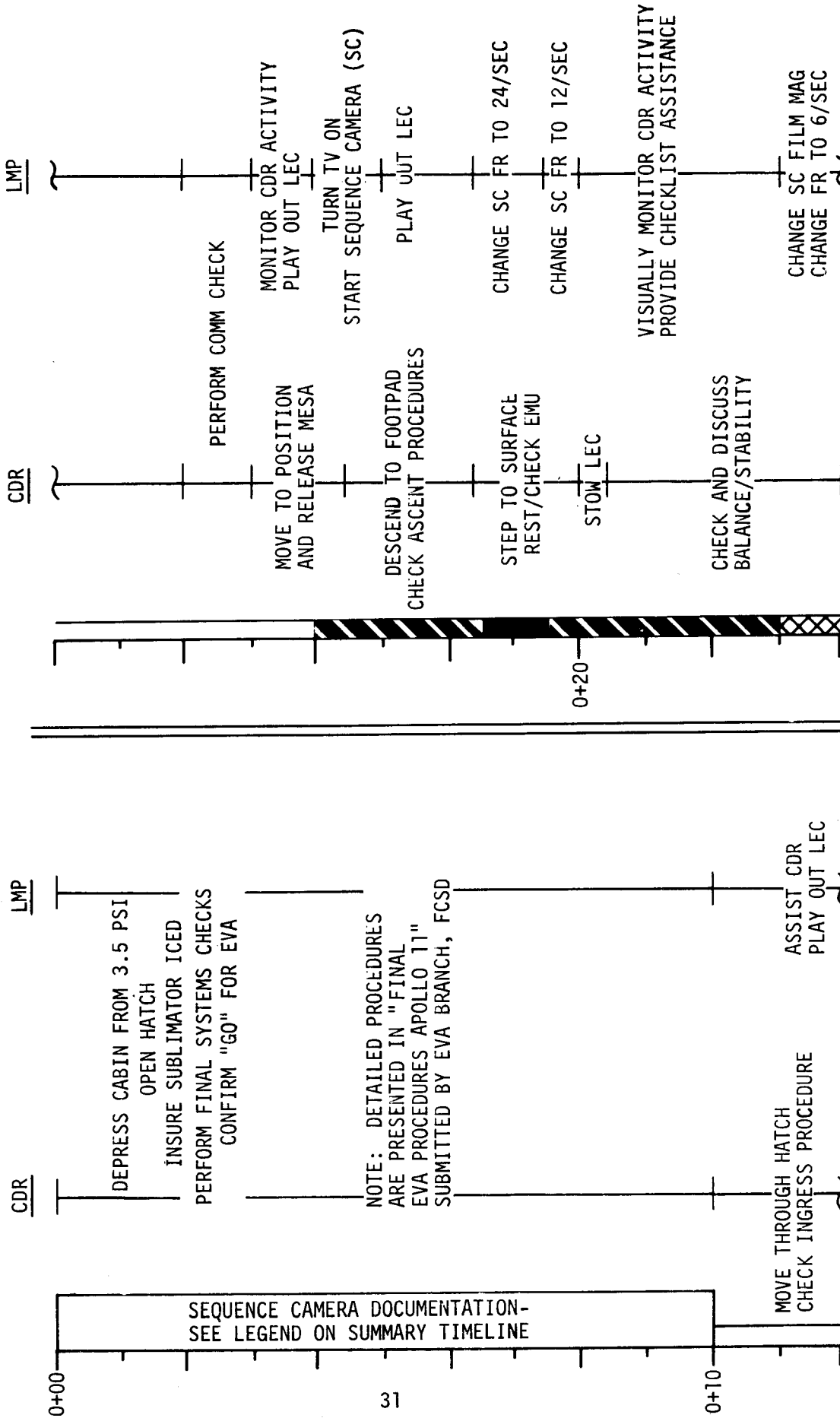

MISSION	EDITION	DATE	MISSION TIME	DAY/REV	PAGE
APOLLO 11	FINAL	JUNE 27, 1969	112+30 - 112+54	5/19	1 of 7

NOMINAL TIMELINE

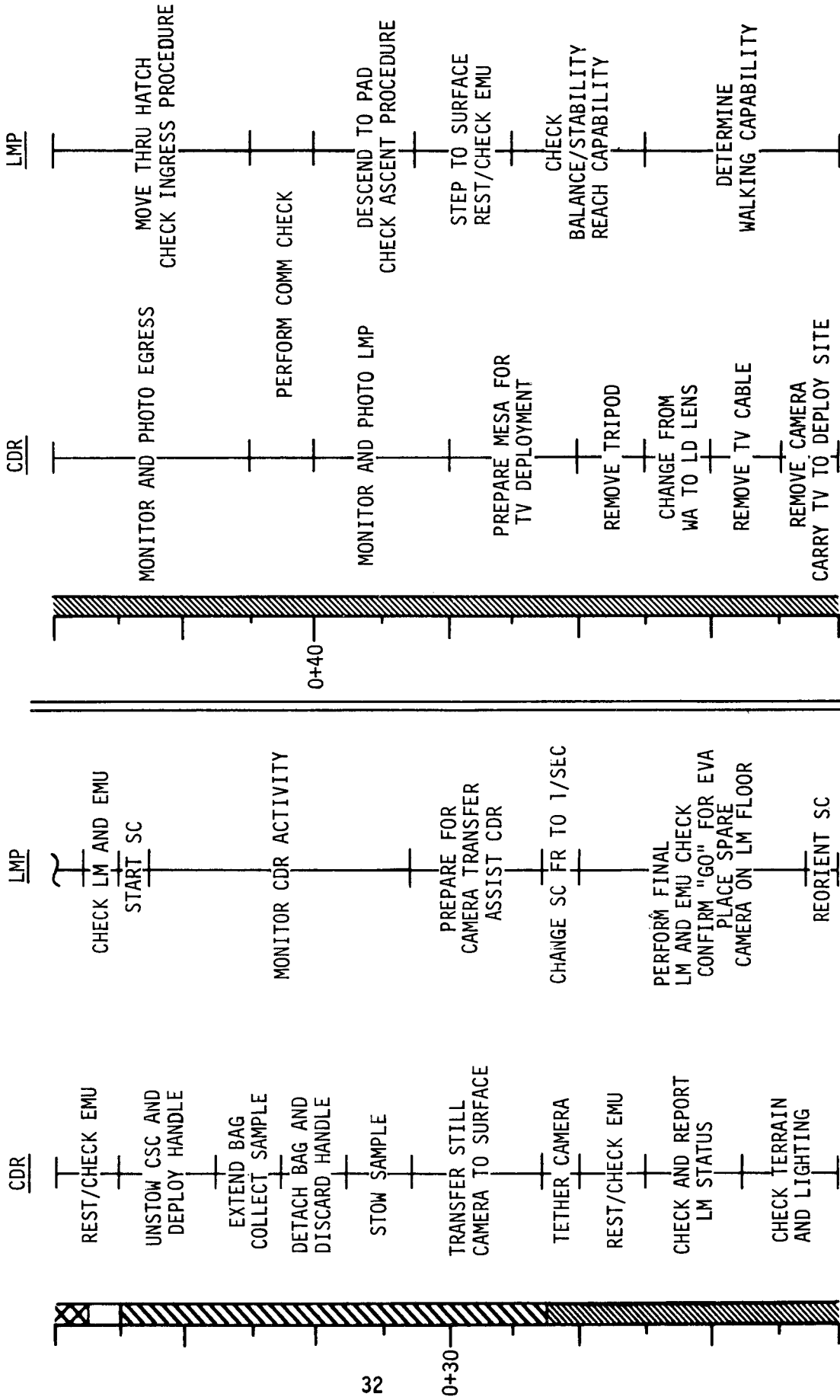

MISSION	EDITION	DATE	MISSION TIME	DAY/REV	PAGE
APOLLO 11	FINAL	JUNE 27, 1969	112+54 - 113+18	5/20	2 of 7

NOMINAL TIMELINE

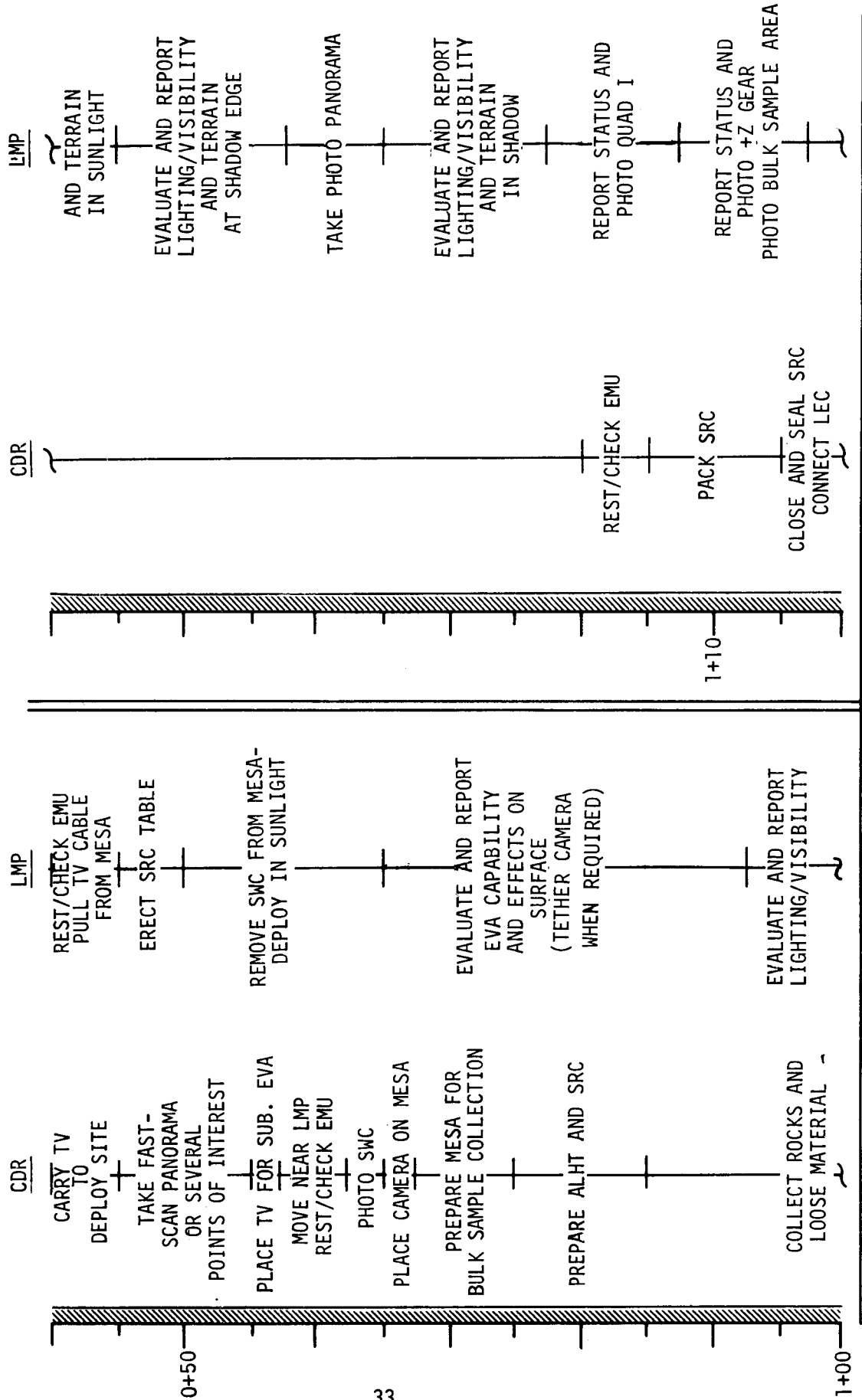

MISSION	EDITION	DATE	MISSION TIME	DAY/REV	PAGE
APOLLO 11	FINAL	JUNE 27, 1969	113+18 - 113+42	5/20	3 of 7

NOMINAL TIMELINE

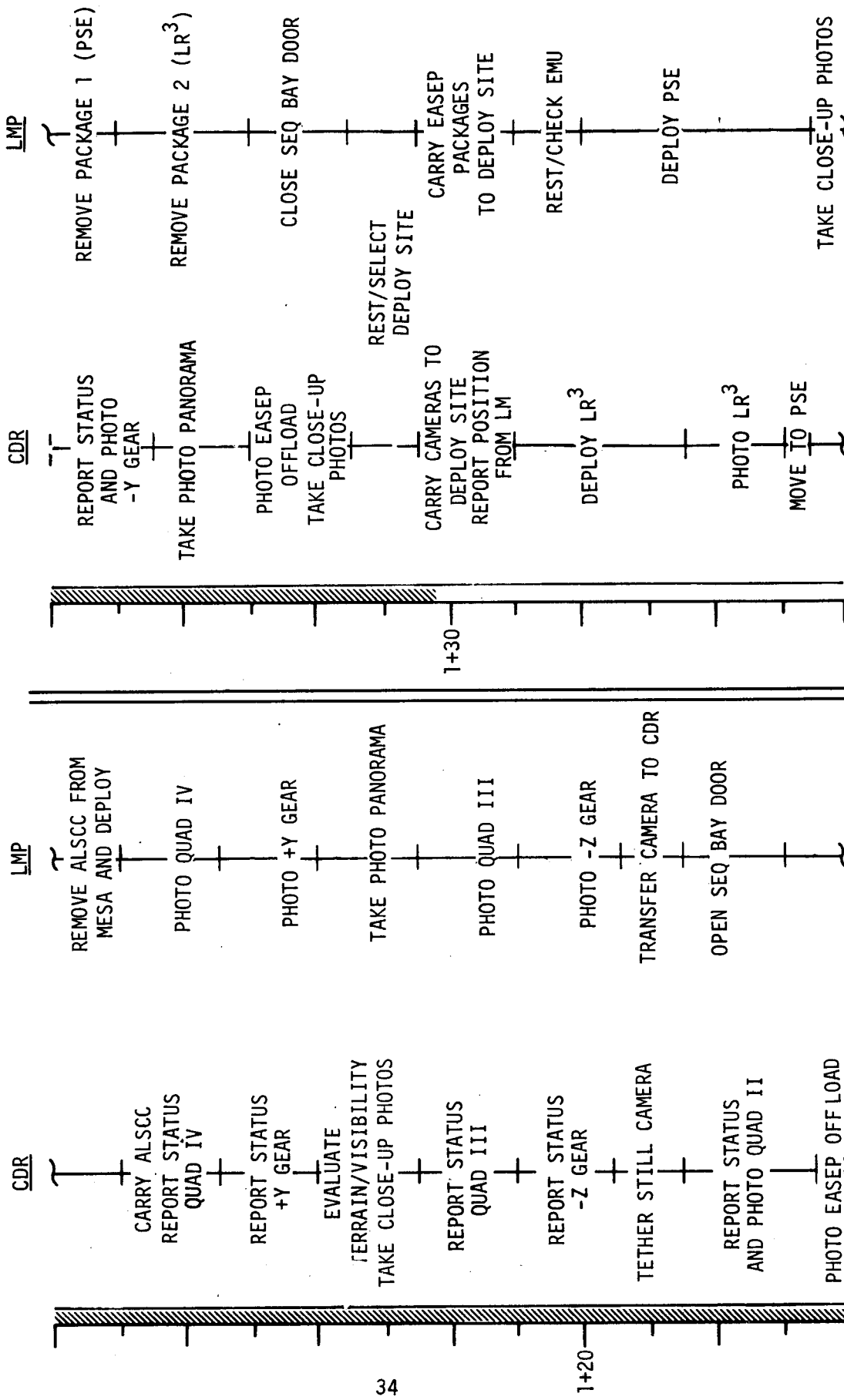

MISSION	EDITION	DATE	MISSION TIME	DAY/REV	PAGE
APOLLO 11	FINAL	JUNE 13, 1969	113+42 - 114+06	5/20	4 of 7

NOMINAL TIMELINE

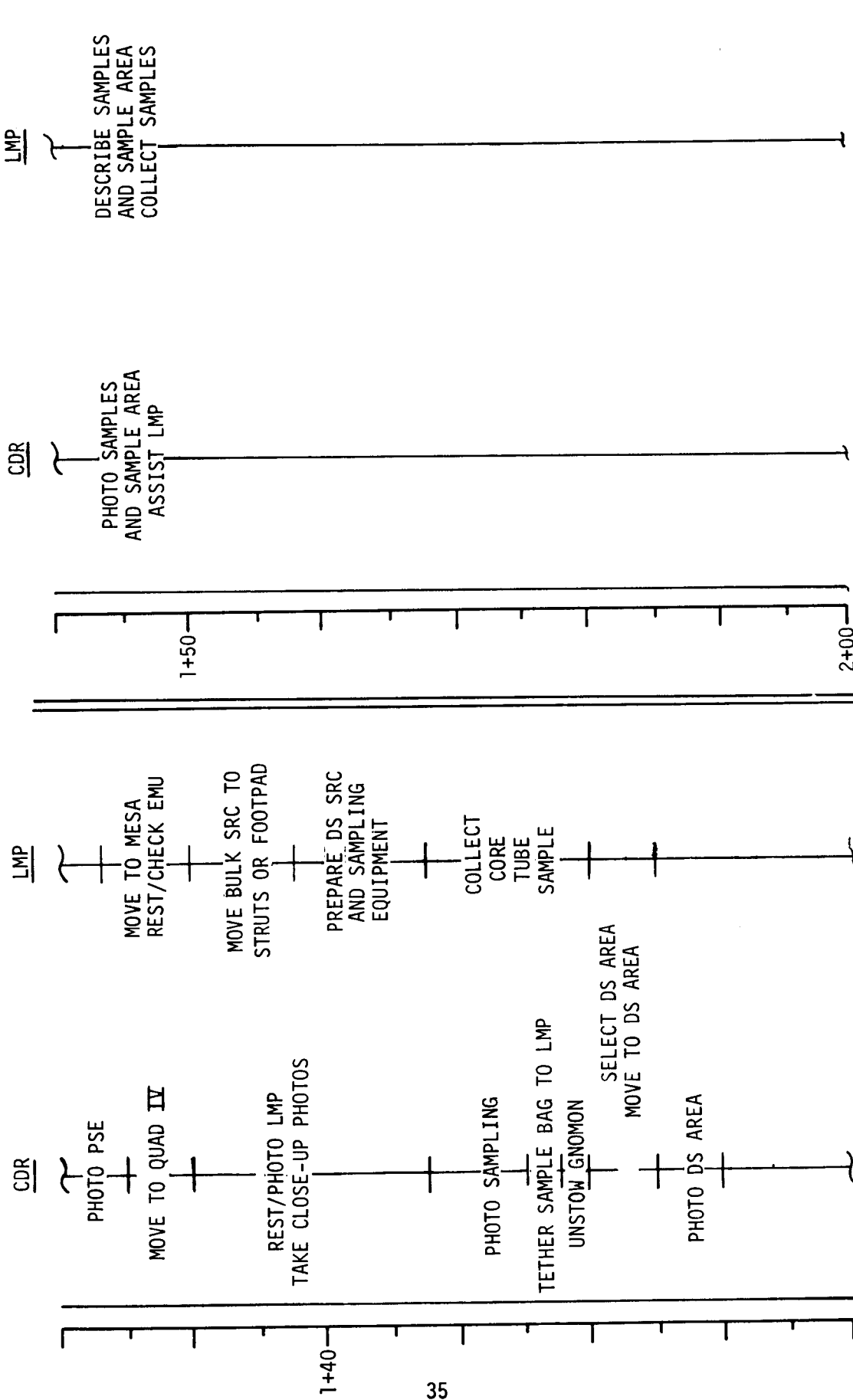

1+40

MISSION	EDITION	DATE	MISSION TIME	DAY/REV	PAGE
APOLLO 11	FINAL	JUNE 27, 1969	114+06 - 114+30	5/20	4 of 7

NOMINAL TIMELINE

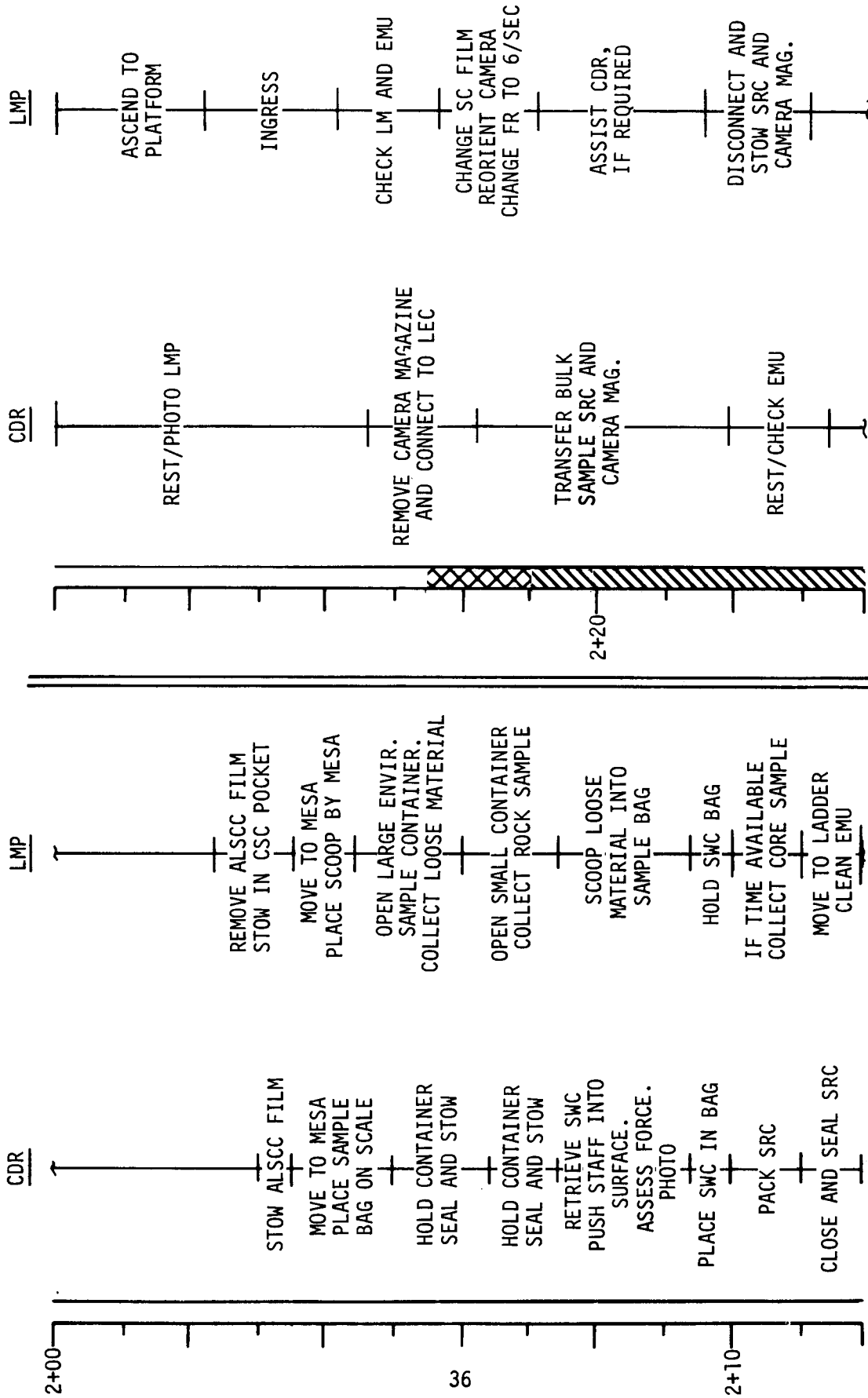

MISSION	EDITION	DATE	MISSION TIME	DAY/REV	PAGE
APOLLO 11	FINAL	JUNE 27, 1969	114+30 - 114+54	5/20-21	6 of 7

NOMINAL TIMELINE

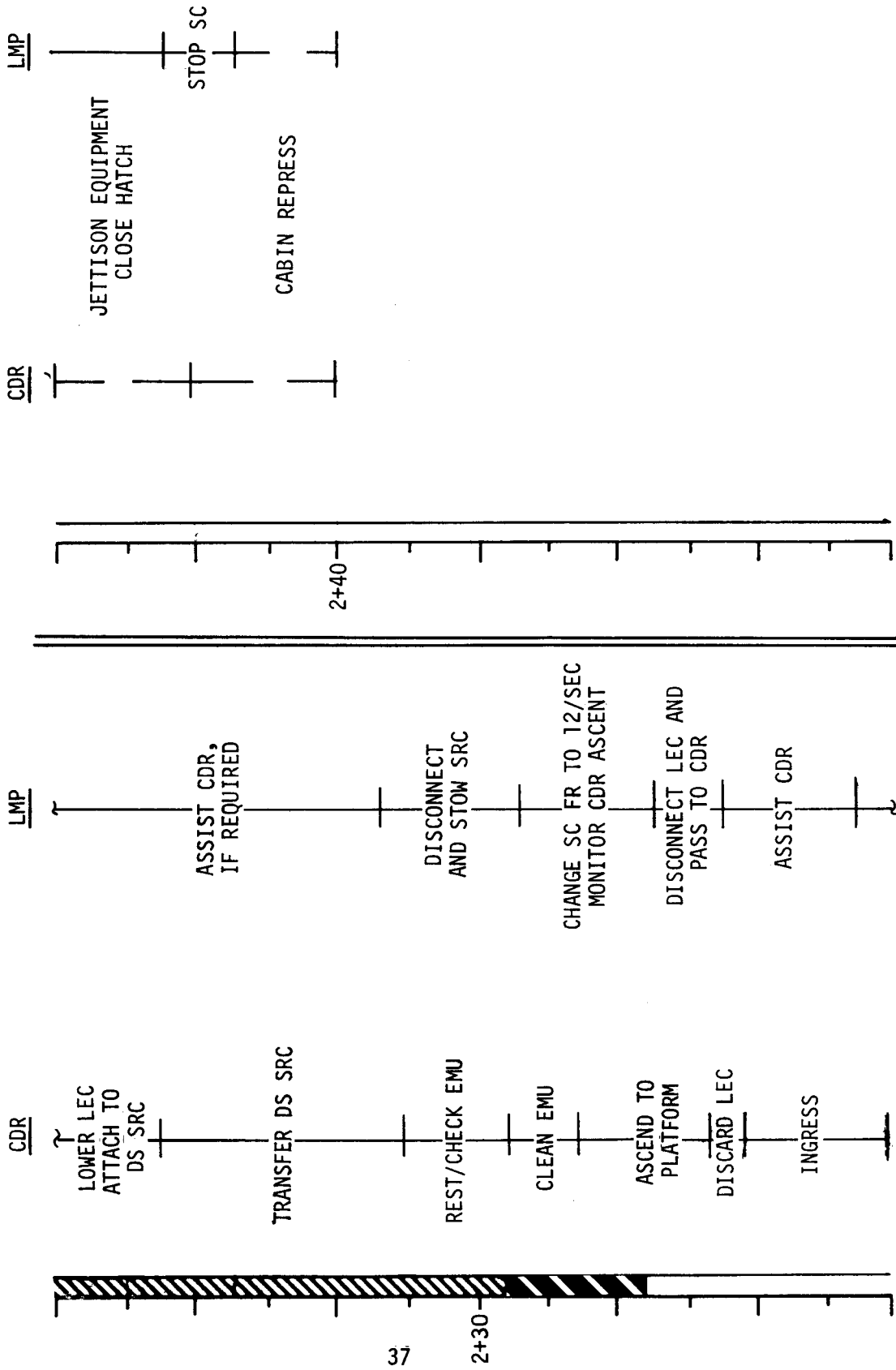

MISSION	EDITION	DATE	MISSION TIME	DAY/REV	PAGE
APOLLO 11	FINAL	JUNE 27, 1969	114+54 - 115+18	5/21	7 of 7

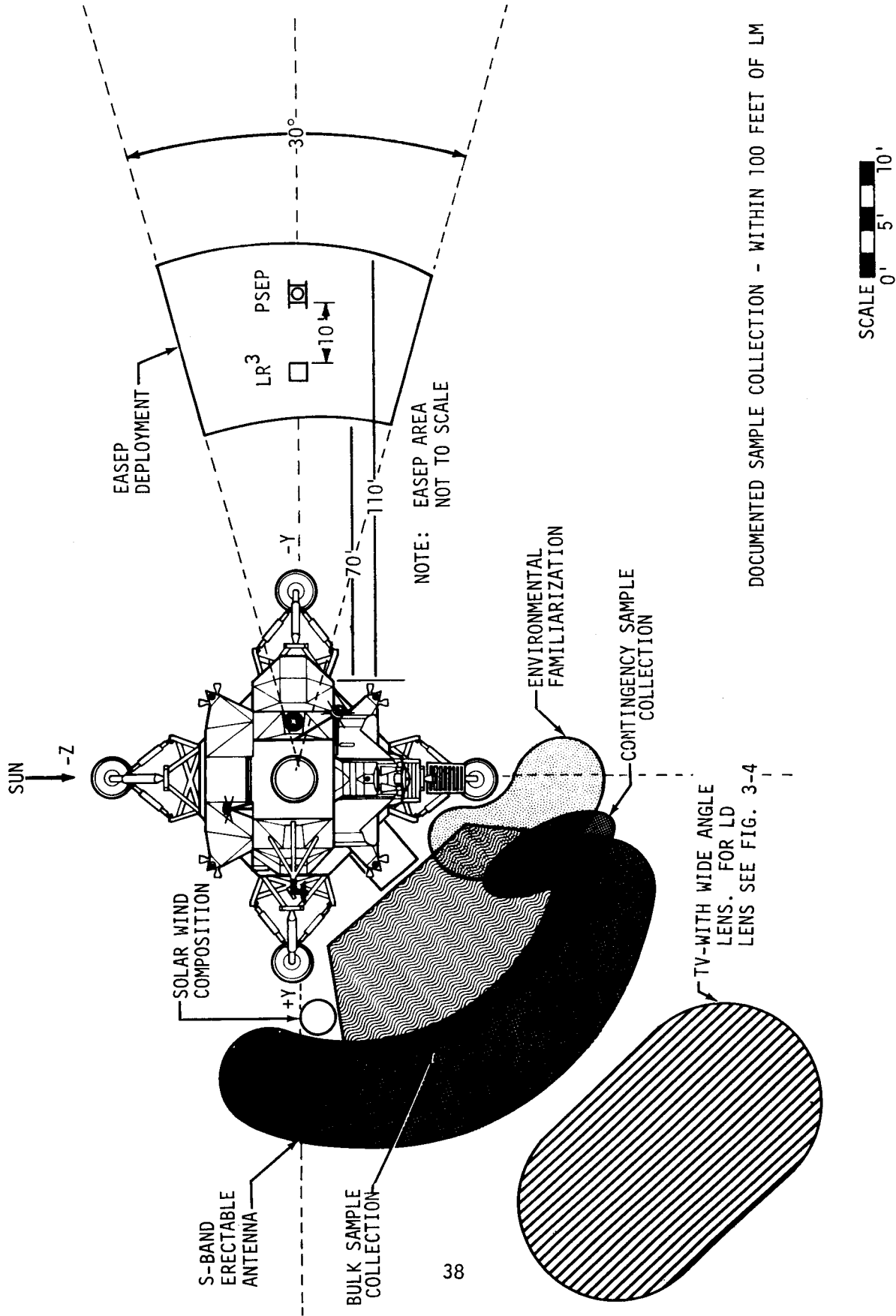

FIGURE 3-9. - PROBABLE AREAS FOR LUNAR SURFACE ACTIVITY

3.5 Detailed Procedures

3.5.1 Nominal Activities Sequence

<u>Section</u>	<u>Event</u>	<u>Page</u>
I.	Final Pre-EVA Operations	40
II.	CDR Initial EVA	40
III.	CDR Environmental Familiarization	41
IV.	Contingency Sample Collection	42
V.	Preliminary Checks	43
VI.	LMP Initial EVA	44
VII.	TV Deployment	45
VIII.	LMP Environmental Familiarization	47
IX.	SWC Deployment	48
X.	EVA and Environment Evaluation	49
XI.	Bulk Sample Collection	51
XII.	LM Inspection*	54
XIII.	EASEP Deployment	58
XIV.	Documented Sample Collection	62
XV.	LMP EVA Termination	69
XVI.	SRC Transfer	69
XVII.	CDR EVA Termination	71

* Nominally, the Apollo Lunar Surface Close-up Camera (ALSCC) will be deployed during the LM inspection.

3.5.2 Procedures

CDR

LMP

I. FINAL PRE-EVA OPERATIONS

NOTE: For the detailed procedures of this section, refer to the "Final EVA Procedures Apollo 11", which is submitted by the EVA Branch, FCSD

Depressurize cabin from 3.5 psi

Open hatch

Insure sublimator iced

Perform final systems checks

Confirm "go" for EVA

II. CDR INITIAL EVA

Move through hatch (with LEC tethered) Assist CDR
Check ingress procedure

Perform communications
check with MSFN - Compare level,
clarity and relay capability
with that experienced inside the
LM.

NOTE: Further mention of
communications checks will
be made only when communication
conditions change, however,
they will be conducted as
required for system or crew-
men monitoring.

Move to position on ladder to release
MESA

Play out LEC and use as
safety tether

CDR

Release MESA (If MESA does not deploy, pull manual deployment lanyard located on left side of MESA)

NOTE: If the MESA will not deploy after pulling the manual deployment lanyard, the following EVA tasks cannot be accomplished:

- 1) TV Deployment (no TV coverage)
- 2) SWC Deployment
- 3) Bulk Sample Collection
- 4) Documented Sample Collection
- 5) SRC Transfer
- 6) Close-up Photography

Descend ladder to footpad. Check pad-to-ladder ascent procedures

Step to surface

Rest beside ladder/check EMU. Check RCU. Report O2 and suit pressure

Assess egress/ingress capability

LMP

Turn TV on and verify TV reception

Start sequence camera. Check orientation and frame rate at 12 frames/sec

Play out LEC

Change sequence camera (SC) frame rate (FR) to 24/sec

Change SC FR to 12/sec. Check LM and EMU. Check RCU and report O2 and suit pressure

III. CDR ENVIRONMENTAL FAMILIARIZATION

Detach and temporarily stow LEC on gear strut or ladder

Visually monitor CDR activity. Provide checklist assistance

In the vicinity of the ladder, check individual stability and perform preliminary mobility evaluation

Check and report balance/stability:

- a. Effect of CG shift - lean forward, backward, and to each side
- b. Downward reach
- c. Arm motion effects

CDR

Evaluate and report walking capability:

- a. Balance
- b. Best pace
- c. Boot penetration
- d. Traction
- e. Soil scattering (cohesion)
- f. Soil adhesion
- g. General comments

Rest/check EMU. Check RCU. Report O2 and suit pressure. Report physical comfort. Assess EVA capability.

LMP

Change SC film magazine when necessary. Change FR to 6/sec

Check LM and EMU. Check RCU Report O2 and suit pressure

IV. CONTINGENCY SAMPLE COLLECTION

Remain within a few feet of ladder

Remove the CSC from suit pocket

Deploy the CSC handle and pull strap at base of bag to open

Collect sample (in undisturbed area)

Pull locking pin on handle release lever

Press release lever and separate handle from lip/bag assembly

Discard handle under or away from LM

Detach bag from lip assembly

Discard lip assembly under or away from LM

Seal sample bag

Restow and secure bag in suit pocket

Start SC. Check FR at 6/sec Visually monitor CDR activity Reorient SC if necessary

CDR

LMP

V. PRELIMINARY CHECKS

Transfer Hasselblad EL Data camera (with color film and 60mm lens) to surface:

- | | |
|--|---|
| a. Remove LEC from temporary stowage location | Prepare to transfer the Electric Hasselblad camera to surface |
| b. Walk out +Z with LEC | Play out LEC. Remove LEC stowage bag and stow in LHSSC |
| c. Transfer camera to surface by pulling on lower strap of LEC | Assist CDR, if necessary |
| d. Detach camera from LEC and tether to suit. Mount camera on RCU bracket when desired | Change sequence camera FR to 1/sec |

NOTE: Only the one Hasselblad camera is transferred to the surface. If a failure occurs, manual film advance and a fuse change are the only actions possible to correct the malfunction. If malfunction is not corrected, the 70mm Hasselblad, with black and white film and 80mm lens, can be transferred.

- e. Place LEC back at stowage location

Check and report LM status. From immediate vicinity of the ladder, check and report:

Reorient camera to view CDR activity.

- a. Stability of LM (all pads contacting surface, terrain slope, boulders, craters)

(The LMP prepares to egress)

CDR

LMP

- b. Gear status (take two photos, one each of +Y and -Y, and one of +Z pad/surface)
 - (1) Contact
 - (2) Penetration, slip, burial
 - (3) Stroke
 - (4) Soil adhesion
- c. DPS skirt status (1 photo)
- d. DPS effect on surface:
 - (1) Crater
 - (2) Radial erosion

Perform final LM and EMU check. Confirm "GO" for two-man EVA Place spare Hasselblad camera on floor at left side of +Z hatch. Check EVA tether attached

(Refer to the next section for LMP egress procedures)

Check terrain status for crew operations:

- a. Check slope, obstructions and roughness in
 - (1) MESA area
 - (2) TV deployment area
 - (3) S-band antenna deployment area
 - (4) Quad I area
- b. Check lighting/visibility status:
 - (1) Bright and dark areas
 - (2) TV deployment
 - (3) MESA
 - (4) S-band antenna area
 - (5) General sampling areas (take two (stereo) photos of bulk sample and one photo, close up, of contingency sample area)
 - (6) Up sun
 - (7) Cross sun (two photos, one each direction)
 - (8) Down sun

VI. LMP INITIAL EVA

Rest/Monitor and photograph LMP egress and descent to surface

Reorient SC

Photo (3) LMP

Move through hatch. Check ingress procedure (Pull +Z hatch closed)

CDR

LMP

Perform communications check
(Include relay check with
CSM, if possible)

Photo (3) LMP

Descend ladder to footpad

Check pad-to-ladder ascent
procedures

Photo (3) LMP

Step to surface

(Deploy TV, see procedures below)

Rest beside ladder/check
EMU. Assess egress/ingress
capabilities

VII. TV DEPLOYMENT

Walk to MESA

(After completion of a
rest period the LMP
conducts environmental
familiarization, see
Section VIII)

Adjust MESA height, if necessary,
by pulling upward on adjustment
strap

Pull strap (velcroed) to remove
MESA thermal blanket from around
TV lens

Complete removal of thermal
blanket

Remove tripod from MESA:

- a. Pull two straps to unsnap
tripod
- b. Lift tripod from MESA
- c. Extend telescoping section
- d. Deploy legs
- e. Place on surface near right
side of MESA

Walk to right side of MESA

Remove wide angle lens from TV camera
and stow on MESA holder

Remove LD lens from holder and attach
to camera

Pull several feet of TV cable from
MESA

Remove camera from MESA:

- a. Pull the two pins at the forward edge of mounting frame
- b. Grasp TV handle and rotate TV toward rear of MESA to free from frame
- c. Lift camera from frame
- d. Check camera temperature and report (cold, normal, hot)

Place camera on tripod. Check camera secure

Carry camera with tripod to site to view subsequent EVA operations (See figure 3-4)

As required, pull more TV cable from MESA

Take a step-wise, fast-scan (10 frames/sec) panorama or, if time not available, select several points of interest. Do not point camera within 20° to sun. Start panorama at approximately 22° from an upsun view, move through down sun, continue to other view 22° from up sun. Place camera on surface for a few seconds at approximately 22 1/2° increments. (15 increments are required for the panorama)

Recheck camera temp. and report. Place TV on surface for optimum coverage of surface activity (See Figure 3-4)

Move near LMP.
Rest/check EMU. Check RCU.
Report O2 and suit pressure.

Photo SWC (stereo pair) after LMP deploys it. Return to MESA

VIII. LMP ENVIRONMENTAL FAMILIARIZATION

(At this point the CDR is deploying the TV, see Section VII)

In the vicinity of ladder and in view of TV (and sequence camera, if practical), check and report balance/stability:

- a. Effect of CG shift-lean forward, backward, and to each side
- b. Downward reach
- c. Arm motion effects

Evaluate and report reach capability (with and without support):

- a. Right up
- b. Right down
- c. Both up and down

NOTE: Perform following evaluations within a few yards of S/C and in view of sequence camera, if practical

Evaluate and report walking capability:

- a. Pace
- b. Stability
- c. Traction
- d. General evaluation

Rest/check EMU. Check RCU. Report oxygen and suit pressure. Report physical comfort. Assess EVA capability

IX. SWC DEPLOYMENT

(At this time the CDR is de-
ploying the TV, see Section VII)

Erect SRC table:

- a. Pull Velcro tabs to free table
- b. Pull table forward from stowed position and rotate into horizontal position
- c. Attach Velcro tape to hold table in correct position (level, fore and aft)

Pull the two straps holding SWC and remove SWC from MESA

Walk to sunlit area

Deploy SWC:

- a. Extend each section of staff until it locks. (red band should be visible)
Apply a compressing force to each section to check sections locked
- b. Extend shade cylinder and rotate toward red side of pivot point, i.e., red to red
- c. Extend foil shade and hook to lower portion of staff
- d. Press staff into surface with foil normal to sun (side marked SUN to Sun)

X. EVA AND ENVIRONMENT EVALUATION

Remove camera from MESA
and tether when required
in the following evaluation

NOTE: The following list
of tasks is presented as
a guide. The activities
within this period are not
limited to the items listed
or the order in which they
appear.

If necessary further
evaluate:

- a. Effect of CG shift
(leaning, reach, etc.)
- b. Walking capability

In undisturbed area and
in view of TV and SC, if
practical, observe and
report:

- a. Best pace
- b. Technique for starting
and stopping
- c. Balance at increased
pace and length of step
- d. Traction
- e. Dust
- f. Boot penetration (take
stereo pair)
- g. Scuffing
- h. Cohesion
- i. Adhesion (photo boots)
- j. General evaluation of EVA
capability

CDR

LMP

In each direction, up sun,
down sun and cross sun,
observe and report surface:

- a. Brightness/reflections
- b. Color perception
- c. Contrast variation
- d. Texture determination
- e. Reflection in shadow
- f. Rock and crater
distribution
- g. General terrain
evaluation
- h. Visual and terrain
phenomena different
from that expected

Check EMU status with MSFN
after stay in sunlight.
Report comfort/problems

Move to shadow edge and
repeat lighting/visibility
and terrain evaluation as
above. Additionally,
observe shadow edge sharpness
(look down sun)

Check EMU status with MSFN
after stay.

Take 12 photo panorama
(from position 20 feet in
front of +Z pad). As pano-
rama is taken, estimate dis-
tance to several prominent
terrain features.

Repeat evaluation, as
above, in shadow

Check EMU after stay in
shadow

XI. BULK SAMPLE COLLECTION

Remove camera and place on
MESA

(The LMP is conducting
the EVA and Environment
Evaluation, Section X)

Prepare MESA:

- a. Proceed to MESA
- b. Insure area about MESA
is suitable for operations
- c. Adjust height of MESA, if
required
- d. Insure all equipment is
accessible

Deploy ETB:

- a. Unfold and position bag on
right side of MESA (Check bag
top folded inside bag)

Prepare SRC and ALHT:

- a. Unstow scoop and hammer. Place in ETB.
- b. Check security of SRC table
- c. Release bulk sample SRC carry
handle from detent position
- d. Rotate handle 90° clockwise to
release SRC from MESA
- e. Pull perpendicular to MESA top
with carry handle to remove
from stowage position
- f. Place SRC on table with
T-handle up and SRC aligned
with the table
- g. Rotate and place the SRC on
table with SRC handle point-
ing away from the spacecraft
- h. Release the two strap latches
by pressing the latch locking
mechanism, with the hand on the
release handle, in a sideways
motion toward the center of the
SRC and rotating the handle
forward and upward

- i. Continuing to grasp second strap latch release handle, after release, rotate the SRC top to an open stable position. NOTE: If necessary restrain SRC with other hand on carry handle in order to break seal
- j. Check the seal spacer is still in place over the seal
- k. Unpack SRC. Place packing material, and small sample bags in SRC lid, in transfer bag or on MESA
- l. Remove spring scale
- m. Hook scale to left front of MESA
- n. Attach large sample bag to scale
- o. Place SWC stowage bag in SRC lid or on MESA

NOTE: If practical collect samples in view of TV and sequence camera

(NOTE: If practical use the scoop to collect rocks and loose material simultaneously. Attempt to collect same volume of rocks as loose material)

Collect rock fragments:

- a. Pull strap to free vibration attenuator from tongs
- b. Remove the tongs from the MESA, pull the two lanyards to release snaps
- c. Move within several yards of the MESA to collect rock fragments placing each fragment into the sample bag at the time of collection
- d. At the completion of fragment sampling, place the tongs in temporary stowage in the MESA or ETB

Rest/check EMU systems

Collect loose material:

- a. Remove extension handle from stowed position on MESA. Pull two snap lanyards on extension handle to release. Remove vibration attenuator from small handle.
- b. Remove scoop from ETB and connect to extension handle
- c. Use scoop to fill sample bag with loose material. Comment on collection process, soil adhesion and cohesion, difficulty of scooping, volume of material, general evaluation
- d. Disconnect extension handle from scoop. Place scoop and extension handle in temporary stowage on MESA or in ETB

Rest/check EMU systems

Pack and seal SRC:

- a. Remove sample bag from spring scale
- b. Place sample bag in SRC
- c. Close bag and place bag in center of SRC so that bag ends are toward SRC ends.
- d. Place packing material in SRC to minimize void space Use caution to keep SRC seal clean.
- e. Remove seal protector. If an O-ring seal is loose, remove from SRC and discard

CDR

LMP

- f. Rotate the top closed with a strap latch handle
- g. Seal the SRC by rotating the two strap latches downward to the locked position

Prepare for SRC transfer:

- a. Retrieve LEC from stowed position
- b. Walk to SRC
- c. Attach LEC lower hook (marked with "L") to SRC top-left front bracket
- d. Attach LEC upper hook (marked with "R") to the SRC top-right rear bracket and lock hook

Rest/check EMU

XII. LM INSPECTION

(At this point the CDR is completing the Bulk Sample Collection, Section XI)

During inspection evaluate visual perception

Report status of Quad I:

- a. Both LM stages
 - (1) Coating
 - (2) Dust
 - (3) Shielding
- b. Ascent stage (one photo)
 - (1) RCS
 - (2) Rendezvous radar
- c. Descent stage (one photo)
 - (1) Engine skirt

Report status of +Z gear:

- a. Main strut (take one photo)
- b. Secondary struts (two photos, one on each side)
- c. Take stereo pair of pad/surface

CDR

LMP

Photo area where bulk
sample was collected

Deploy ALSCC: (Deployment
of the ALSCC will be de-
layed until the documented
sample collection if behind
in the timeline)

- a. Remove isolator latch pin
and pivot cover
- b. Pull camera from MESA
- c. Place camera on secondary
gear strut and exert
pressure on camera cover.
Pull the two skirt lanyards
- d. Rotate handle retaining
latch
- e. Swing handle clockwise
150° and pull until fully
extended
- f. Place camera on surface

ALSCC OPERATION

Close-up photographs will be
taken by either crewman
when time is available between
or during other tasks. Several
times within the EVA are sug-
gested when it may be convenient
for the crew to take photos.
This is not a requirement to
take photos nor does it prohibit
them from obtaining photographs
at other times which may be
feasible.

In general the camera operation
is:

- a. Estimate position of object
plane relative to camera
bearing surface
- b. Position camera over object
(Describe object and location)

CDR

LMP

- c. If object is below ALSCC bearing surface depress skirt until object is within focus plane
- d. If object is above bearing surface tilt camera back until object is within focus plane
- e. Activate trigger located on handle grip
- f. Read and report frame counter
- g. Observe cycle completion by light on handle

Carry the ALSCC around the LM during the inspection and take photos as practical

Report status of Quad IV:

a. Both LM stages

- (1) Coating
- (2) Dust
- (3) Shielding

b. Ascent stage

- (1) RCS
- (2) Steerable antenna
- (3) Rendezvous radar

c. Descent stage

- (1) Descent engine skirt
- (2) MESA

Take one photo of A/S

Take one photo of skirt
Take one photo of MESA
(Include all Quad IV, if practical)

Report status of +Y gear assembly:

a. Main strut

b. Secondary struts

c. Pad/surface

Take one photo of main strut
Take two photos, one on each side of secondary struts
Take stereo pair of pad/surface

CDR

Rest/evaluate and report lighting/visibility in all directions, particularly S/C reflections. Observe and report terrain characteristics. Estimate distance to several prominent terrain features. Take close-up photos if possible

Report status of Quad III:

- a. Both LM stages (same as Quad IV)
- b. Ascent stage
 - (1) RCS
 - (2) Steerable antenna
 - (3) VHF antenna
- c. Descent stage
 - (1) Propellant vents
 - (2) Fuel vent
 - (3) Tanks (Oxygen, Helium (2))
 - (4) Descent engine skirt
 - (5) Note if surface discolored

Report status of -Z gear assembly (same items as +Y and:

- a. Landing track
- b. Oxidizer vent
- c. EVA antenna)

Receive camera and tether to suit

Report status of Quad II:

- a. Both LM stages (same as Quad IV)
- b. Descent stage (one photo)
 - (1) Landing radar
 - (2) SEQ bay

Take 12 photo panorama (from 20 ft out from -Y pad and 30° CCW from -Y axis or 120° from last panorama position)

LMP

Take panorama (12 photos) from position approx 20 ft out from +Y pad and 30 deg CW from +Y axis or 120 deg from last panorama

Take one photo of A/S

Take one photo of skirt (Photo if surface discolored)

Take same photos as +Y

Hand Hasselblad camera to CDR

(The LMP begins the EASEP deployment. See the following section)

CDR

LMP

Report status of -Y gear assembly:

- a. Main strut (take one photo)
- b. Secondary struts (one photo from each side)
- c. Pad/surface (take stereo pair)

XIII. EASEP DEPLOYMENT

(At this point the CDR is completing the LM inspection. See the preceding section)

NOTE: If LMP cannot raise door, stand clear of door and manually assist

Open SEQ bay door:

- a. Remove thermal cover from door lanyard
- b. Retrieve lanyard from right side of SEQ bay (remove lower velcro strap)
- c. Move to position clear of door
- d. Pull white portion of lanyard to raise door
- e. Temporarily stow lanyard on strut
- f. If Quad II is in a low attitude connect folded doors with velcro strap

PACKAGES REMOVED BY BOOMS

Remove Package 1 (PSE):

- a. Retrieve boom lanyard from package (handle)
- b. Move to position clear of package (approximately 10 feet)
- c. Pull white portion of lanyard to unlock and move package from SEQ bay to fully extended boom position

Photograph package removal

CDR

LMP

- d. Pull black and white striped portion of lanyard to lower package to surface
- e. Release white portion of lanyard from base of package
- f. Pull small lanyard (velcroed to handle) on package to release boom cable and lanyards. Reattach lanyard to velcro
- g. Move package clear
- h. Pull black and white striped lanyard to retract boom (or push boom back with hand)

Remove Package 2 (LR³):

- a. Repeat Package 1 procedure (set package clear of SEQ bay)

MANUAL PACKAGE REMOVAL

Remove Package 1:

- a. Pull small lanyard, at top or bottom of package, to release hockey stick from boom
- b. Remove deployment lanyard from package and pull white portion to unlock package from bay
- c. Release white portion of lanyard from base of package
- d. Move deployment lanyard to side clear of package
- e. Manually pull package clear of SEQ bay
- f. Set package on surface clear of bay area

CDR

LMP

Remove Package 2:

- a. Repeat Package 1 procedure

NOTE: Simultaneous accomplishment, although indicated of the following tasks, is not required.

Photo LMP and take close-up photos as practical

Close SEQ bay door:

- a. Retrieve door lanyard
- b. Move to position clear of door
- c. Pull black and white stripe portion of lanyard until door is closed
- d. Discard lanyard

Select site for PSE and LR³ deployments, nominally 70 ft south of the S/C

Move to deployment site with cameras. Estimate distance and position with respect to the LM

Carry PSE and LR³ to deployment site (Nominally 70 feet out the LM-Y axis. Report site location if it is not nominal)

Place LR³ with base toward Earth. (Astronaut faces east for Sites 1 and 2 and west for Sites 3,4, and 5). Rest/prepare area (clear rocks, smooth surface as required)

Place LR³ package on surface (on end) in a clear, level location, if practical. Move PSE approximately 10 feet further from LM and place on surface with base toward north (Arrow on handle points to south)

Deploy LR³:

- a. Simultaneously grasp deployment boom ("hockey stick") and pull pin inside carry handle. Remove and discard "hockey stick"

Rest/check EMU

① *

- b. Simultaneously grasp deployment handle and release ring (Left side of package) to release deployment handle pull pin ②
- c. Pull deployment handle to extend handle six inches, to the first detent position, and to partially release array. Discard handle release ring
- d. Grasp pull ring on array tilting handle, pull to remove protective cover. Discard cover ③
- e. Grasp deployment handle to steady package. ④A Grasp array tilting handle, push down rotate handle 45°. Pull outward to extend to detent position (9.5 inches) and complete array release ④B
- f. Use deployment handle to steady package. Use array tilting handle to tilt array (to detent for landing site)

Deploy PSE:

- a. Prepare area (move rocks, etc.) if required
- b. From base of package pull lanyard to release gnomon ①
- c. Grasp carry handle with one hand and use the other to remove and discard the right solar panel-restraining pull pin ② and panel support bracket pull pin ③
- d. Grasp first solar panel support bracket, rotate bracket forward lift bracket upward to release and remove first rear support bracket pull pin. ④ Discard bracket/lanyard/pull pin

* The circled numbers and symbols correspond to decals on the packages.

- g. Release tilting handle (should spring back into stowed position)
- h. Depress trigger on deployment handle, pull handle to extend to full ⑤ extent (an additional 27 inches) and rotate package to lunar surface
- i. Check and report experiment aligned and level to within +5°. ⑥ **ALIGN** Use gnomon shadow cast on partial compass rose for alignment. Use bubble for level indication. Use deployment handle to align and level as required

- e. Repeat procedures c. and d. for the left solar panel bracket ⑤ ⑥ ⑦
- f. From side of PSE pull deployment handle ("working height") pip pin ⑧ and remove "hockey stick" ⑨
- g. Grasp deployment handle, rotate and pull to extend to 30 inch working height and lock in place ⑩
- h. Use deployment handle to rotate package to surface
- i. With deployment handle, embed package mounting tabs in lunar surface (smooth surface and align package) ⑪ **ALIGN**

CDR

LMP

Photograph scientific packages:

CAUTION:

Do not walk up-sun of the PSE.
Shadows on the solar panels
affect internal electronics

- a. Take closeup photo of LR3
- b. Take stereo pair of LR3
- c. Take one photo from about same distance as stereo pair but at entirely different angle
- d. Move to PSE
- e. Repeat photos as in a, b, and c

- j. Check and report experiment aligned and level to within $+5^\circ$ as indicated by gnomon shadow cast on partial compass rose and bubble level, respectively. Use deployment handle to align and level as required.
- k. Pull antenna release lanyard from deployment handle (velcroed to handle) (12)
- l. Pull lanyard to deploy solar panels and antenna

NOTE: If panels do not deploy, stand clear of deployment area and check rear support brackets clear of solar panels and release levers (underneath forward edge of panels) pulled

- m. Rotate antenna to designated landing offset (site dependent) (13)
- n. Recheck package level and aligned. Report shadow on compass rose

Move to the Quad IV area

Move to MESA with ALSCC. Take photos as practical. Photo footprint made while carrying EASEP

Rest/check EMU

Rest/check EMU

XIV. DOCUMENTED SAMPLE COLLECTION

Rest/photo LMP. Take close-up photos

Transfer bulk sample SRC to footpad or gear struts:

- a. Extend loop end of LEC until section of strap going to A/S is taut
- b. Lift SRC from table by left (lower) hook

CDR

LMP

- c. Carry SRC and place on footpad or secondary struts
- d. Temporarily stow LEC on gear strut
- e. Return to MESA

Prepare documented sample SRC for sample collection:

- a. Check security of table
- b. Pull the lanyard on left side of TV mounting bracket to release the two pull pins.
- c. Remove and discard bracket under LM
- d. Release DS SRC carry handle from detent position
- e. Rotate handle 90° clockwise to release SRC from MESA
- f. Pull perpendicular to MESA top with carry handle to remove from stowage position
- g. Place SRC on table with T-handle up and SRC aligned with the table
- h. Rotate and place the SRC on table with SRC handle pointing away from the spacecraft
- i. Release the two strap latches by pressing the latch locking mechanism with the hand on the release handle in a sideways motion toward the center of the SRC and rotating the handle forward and upward

CDR

LMP

Walk to LMP

- j. Continuing to grasp second strap latch release handle, after release, rotate the SRC top to an open stable position.
NOTE: If necessary restrain SRC with other hand on carry handle in order to break seal
- k. Check the seal spacer is still in place over the bottom seal
- l. Remove and stow packing material on SRC lid, or in MESA or ETB
- m. Remove one core tube from SRC and place in SRC lid or ETB
- n. Remove tube caps and place in SRC lid (two caps wrapped in packing material)
- o. Remove small sample bag containing York mesh. Seal bag and place in SRC lid

Collect core tube sample:

- a. Remove core tube from SRC (check bit attached) and connect to the extension handle
- b. Remove hammer from ETB
- c. Move to an undisturbed point near the MESA (in view of TV, if practical)
- d. Place the core tube at the sampling location. Push tube into surface the length of the tube. Drive with the hammer if necessary
- e. Retrieve tube by pulling along its vertical axis, rotating necessary

Take stereo pair after tube is pushed into surface

CDR

Remove large sample collection bag
(small bags attached) from SRC

Hook large sample bag
to LMP

Remove guard from small
sample bags

Remove gnomon from MESA:

- a. Pull lanyards to release
gnomon
- b. Remove gnomon
- c. Unfold gnomon legs

Select area for sample
collection (Report location
from LM)

Move to selected area
with Hasselblad and close-up
cameras and gnomon

Place ALSCC on surface near
sample area

Place gnomon in field of
view and photograph full
area for documented samp-
ling if practical

LMP

- f. Rotate the core tube, bit up,
to prevent loss of sample
- g. Return to MESA

Stow core sample:

- a. Stow hammer in MESA or ETB
- b. Remove the core tube bit and
discard under or away from
LM
- c. Obtain a core tube cap from
SRC and attach to tube
- d. Release the extension
handle from core tube
- e. Place the capped tube in
SRC lid

Rest/check EMU

Remove scoop from MESA or ETB
and connect to extension handle

Remove tongs from MESA or ETB and
connect to tether

Move to sample area with tongs
and scoop

Describe sample(s) and sample
area

CDR

LMP

If procedure above is not practical or if time permits, place gnomon near prospective fragment and/or soil sample (near several samples if possible) and take two photos of sample site. From approximately five feet away, take two photos (stereo pair) from near 90° to sun line

NOTE: The types of samples and the order in which they are collected will be dependent on the terrain features investigated and crew judgement on the best investigative approach within operational limitations.

Remove a small bag(s) from large bag. Report number on bag. (Bags are numbered 1 through 14)

Open small bag and hold for LMP

Seal small bag and place in in large collection bag

Photograph area(s) where sample(s) was taken

Collect sample(s) with scoop or tongs. Place in bag (collect several samples if possible)

NOTE: The scoop can be used to simultaneously collect a small fragment and a small quantity of loose material

Select another sample and describe or select a new sample area

Pick up gnomon (if gnomon cannot be conveniently included in photographs of next sample)

CDR

LMP

Move to a new sampling area

Repeat sampling procedure at new site(s)-until the collection bag is filled or the allotted time has elapsed. Rest/Check EMU as appropriate.

Take surface close-up photographs if feasible

Move to MESA with still and close-up cameras

Move to MESA with tongs, scoop, and samples

Remove ALSCC film cassette and stow:

- a. Pull the two cover lanyards and remove cover
- b. Rotate cassette film cutter lever
- c. Lift cassette retaining arm
- d. Remove cassette and place in CSC pocket on CDR's suit.

Close CSC pocket

Remove large sample bag from LMP and attach to spring scale on MESA

Place scoop by or on MESA

Remove the environmental sample container, the larger of the two small containers in the SRC, and open. Remove o-ring from seal

Hold container for LMP

Hand container to CDR

	Use scoop to collect loose material from an undisturbed area where bulk sample was taken. Place sample in container. Place scoop by MESA
Seal container and place in SRC	
	Remove the gas analysis container from SRC and open. Remove o-ring seal
Hold container for LMP	Hand container to CDR
	Use tongs to collect a small rock fragment from bulk sample area and place in container.
Seal container and place in SRC	Detach tongs and place in ETB
Recover SWC:	Use scoop to collect rocks and loose material. Fill large sample bag to designated weight or volume
a. Move to SWC	
b. Withdraw staff from surface	
c. Roll up foil	
d. Rotate foil roller to detach position and remove from staff	
e. Let staff rest on surface, vertically and with only its weight acting on surface, report depth of penetration	
f. Push staff into surface as deep as possible Assess amount of force applied and staff depth	Place bag in SRC. Seal bag
g. If time permits photograph staff and repeat e and f several times. Check staff rigidity in surface	
h. Carry SWC foil to MESA	Remove SWC bag from temporary stowage on MESA and open
Insert foil into bag	Hold bag for CDR
	Seal SWC bag and place in SRC
Place York mesh sample (in SRC lid) in SRC. Place packing material in SRC to minimize void space	Collect second core tube sample if time available (See procedures on page 55) If time not available assist C

CDR

LMP

Close and seal SRC:

- a. Remove spacer (seal protector) from lower part of SRC. (Use caution to keep seal clean. Do not touch seal. If an O-ring is loose, pull from SRC and discard)
- b. Rotate the top closed with a strap latch handle
- c. Seal the SRC by rotating the two strap latch handles downward to the locked position

(At this point the LMP proceeds with EVA termination, see the following section)

XV. LMP EVA TERMINATION

Photograph LMP

Photograph LMP

Clean EMU by dusting with hands and wiping or kicking boots against footpad

Ascend to platform

Swing hatch open

Position LEC for ingress

Ingress

Move to right side of cabin

Check LM and EMU

Change SC film magazine.
Reorient camera if necessary.
Change FR to 6/sec

XVI. SRC TRANSFER

Remove Hasselblad camera from suit tether

Detach camera magazine. Discard camera

Attach magazine to lower (left) LEC hook (on SRC)

CDR

LMP

Transfer bulk sample SRC and magazine: (If there is time for the transfer of only one SRC, the bulk sample SRC will be transferred)

- a. Extend loop end of LEC until section of strap going to A/S is taut
- b. Grasp loop grip on the LEC top line
- c. Lift SRC from strut
- d. Walk to the front of the ladder with SRC suspended on LEC
- e. Walk away from ladder (in +Z direction) while holding LEC top strap (loop) to transfer magazine and SRC to A/S

Assist CDR, if required

Rest/check EMU

Disconnect and temporarily stow SRC and camera magazine

Prepare for transfer of documented sample SRC:

- a. Pull LEC lower line to transfer LEC hooks to surface
- b. With LEC hooks in hand, walk to SRC on MESA
- c. Attach LEC lower hook to SRC top-left front bracket and lock hook
- d. Attach upper (right) hook to SRC top-right rear bracket and lock hook

Transfer SRC:

- a. Extend loop end of LEC until section of strap going to A/S is taut
- b. Grasp LEC top line by loop grip

CDR

LMP

- c. Lift SRC from table
- d. Walk to the front of the ladder with SRC suspended on LEC
- e. Walk away from ladder (in +Z direction) while holding LEC top strap loop to transfer SRC to A/S

Assist CDR, if required

Rest/check EMU

Disconnect and temporarily stow SRC

XVII. CDR EVA TERMINATION

Clean EMU by dusting with hands and wiping or kicking boots against footpad

Ascend to platform

Change SC FR to 12/sec

Disconnect LEC from ascent stage

Receive and discard end of LEC away from LM

Hand end of LEC through hatch to CDR

Ingress

Assist CDR, if required

Jettison ECS canister and bracket, OPS brackets (adapters), 3 armrests, bag of used urine bags

Close hatch

Repressurize cabin

SECTION 4.0

ALTERNATE AND CONTINGENT PLANS

4.0 ALTERNATE AND CONTINGENT PLANS

4.1 Alternate EVA (With S-band Erectable Antenna Deployment)

4.1.1 Description and Rationale

An alternate timeline is presented for the situation in which deployment of the S-band erectable antenna is required. Such a situation will occur if the Goldstone or Parkes (Australia) 210-foot antennas are not in view and the communications capability with the LM steerable/85-foot antenna combination is not sufficient to simultaneously obtain acceptable TV coverage and voice-biomedical and telemetry data. Thus, due to the present uncertainty of the communications capability - possible unsatisfactory equipment performance and/or contingencies which may cause mission event times to vary so that a 210-foot antenna is not in view, the erectable antenna will be carried on the mission and a real time decision made to deploy or not deploy it, i.e., follow the alternate or the nominal timeline.

With the addition of the erectable antenna deployment, the major impact to the timeline is the reduction of time available for the documented sample collection. Also, for the alternate timeline, the LMP must delay his egress to switch to the erectable antenna after the CDR has deployed it.

4.1.3 ALTERNATE TIMELINE LUNAR SURFACE EVA

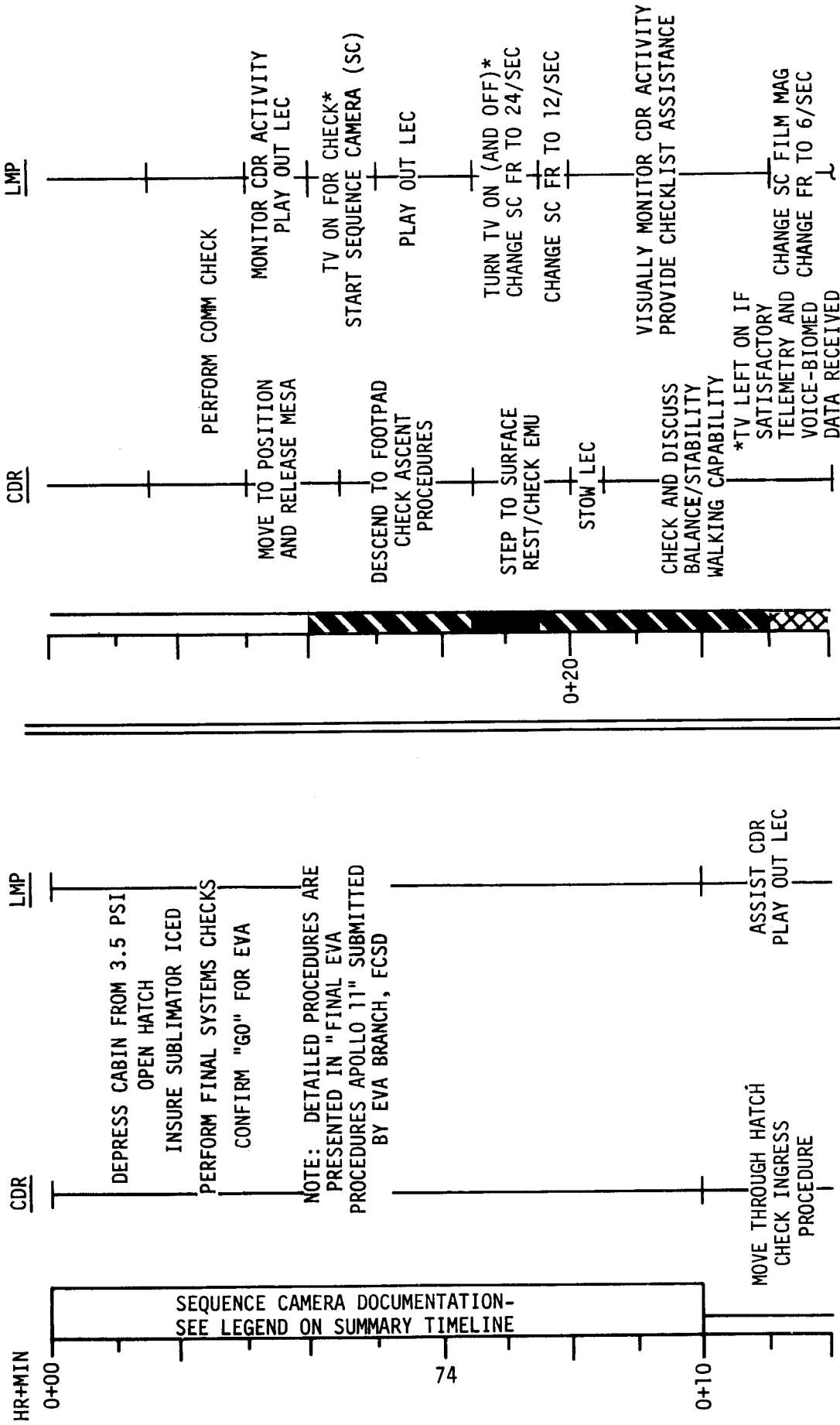

MISSION	EDITION	DATE	MISSION TIME	DAY/REV	PAGE
APOLLO 11	FINAL	JUNE 27, 1969	112+30 - 112+54	5/19	1 of 7

ALTERNATE TIMELINE

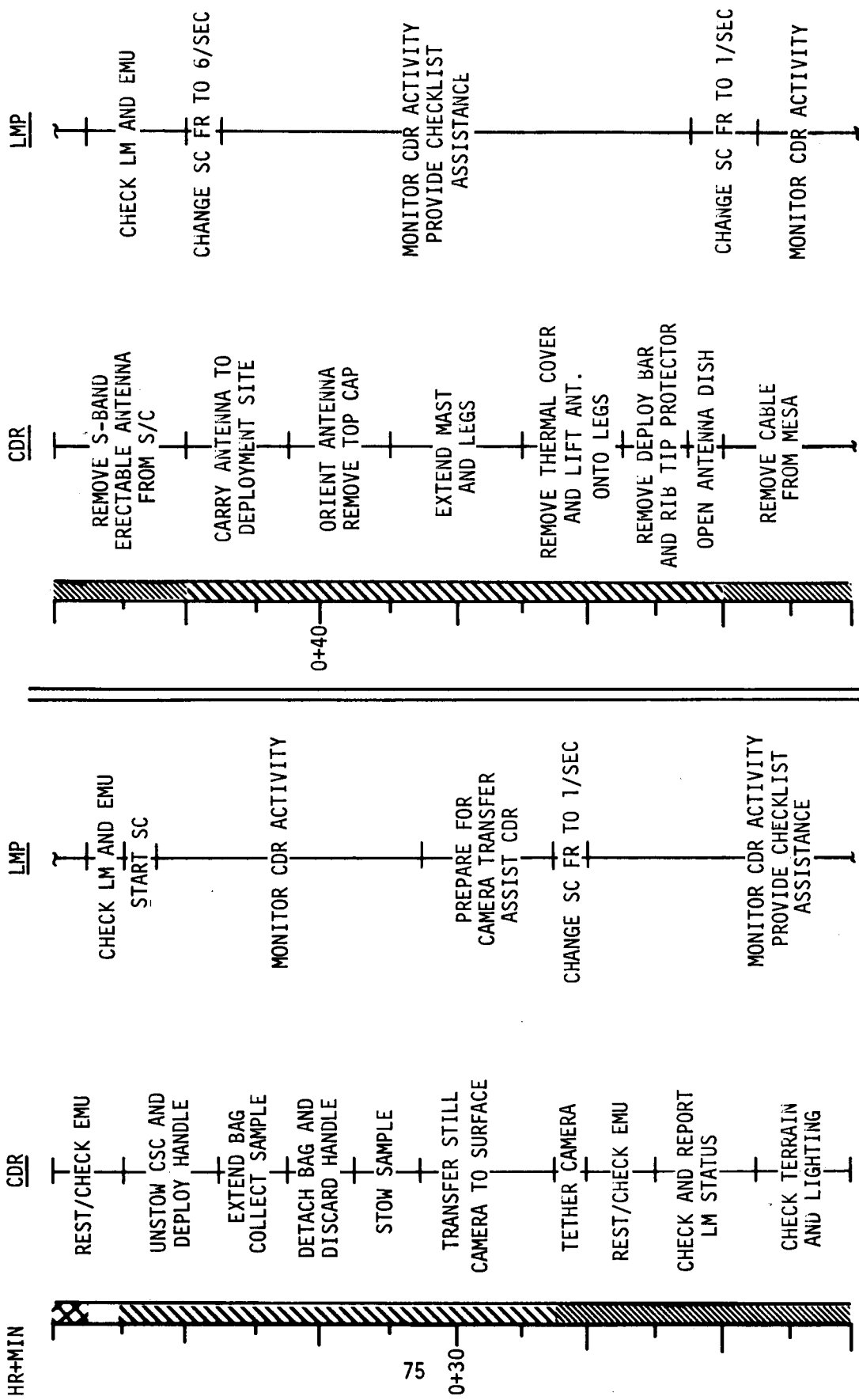

MISSION	EDITION	DATE	MISSION TIME	DAY/REV	PAGE
APOLLO 11	FINAL	JUNE 27, 1969	112:54 - 113:18	5/20	2 of 7

ALTERNATE TIMELINE

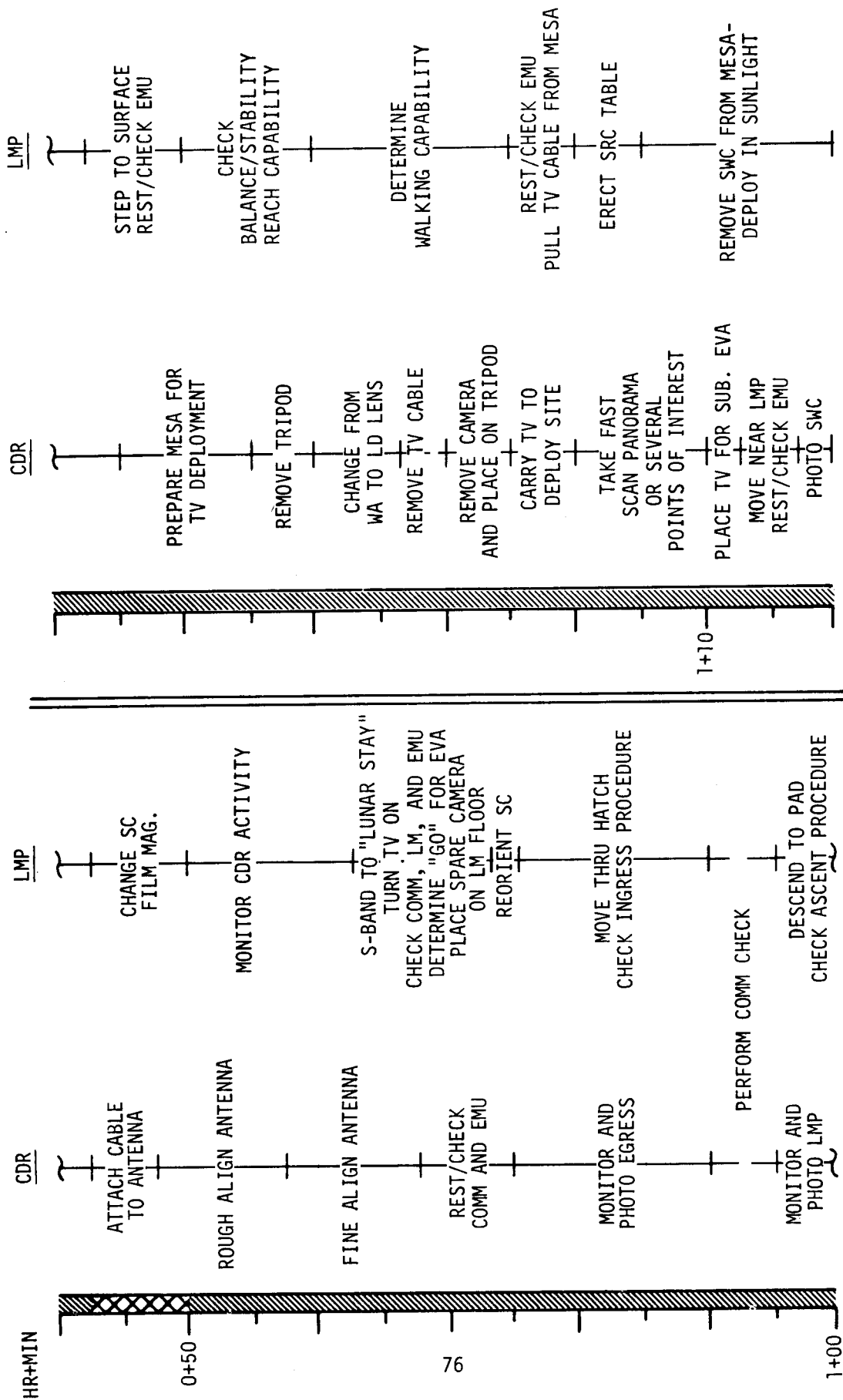

MISSION	EDITION	DATE	MISSION TIME	DAY/REV	PAGE
APOLLO 11	FINAL	JUNE 27, 1969	113+18 - 113+42	5/20	3 of 7

ALTERNATE TIMELINE

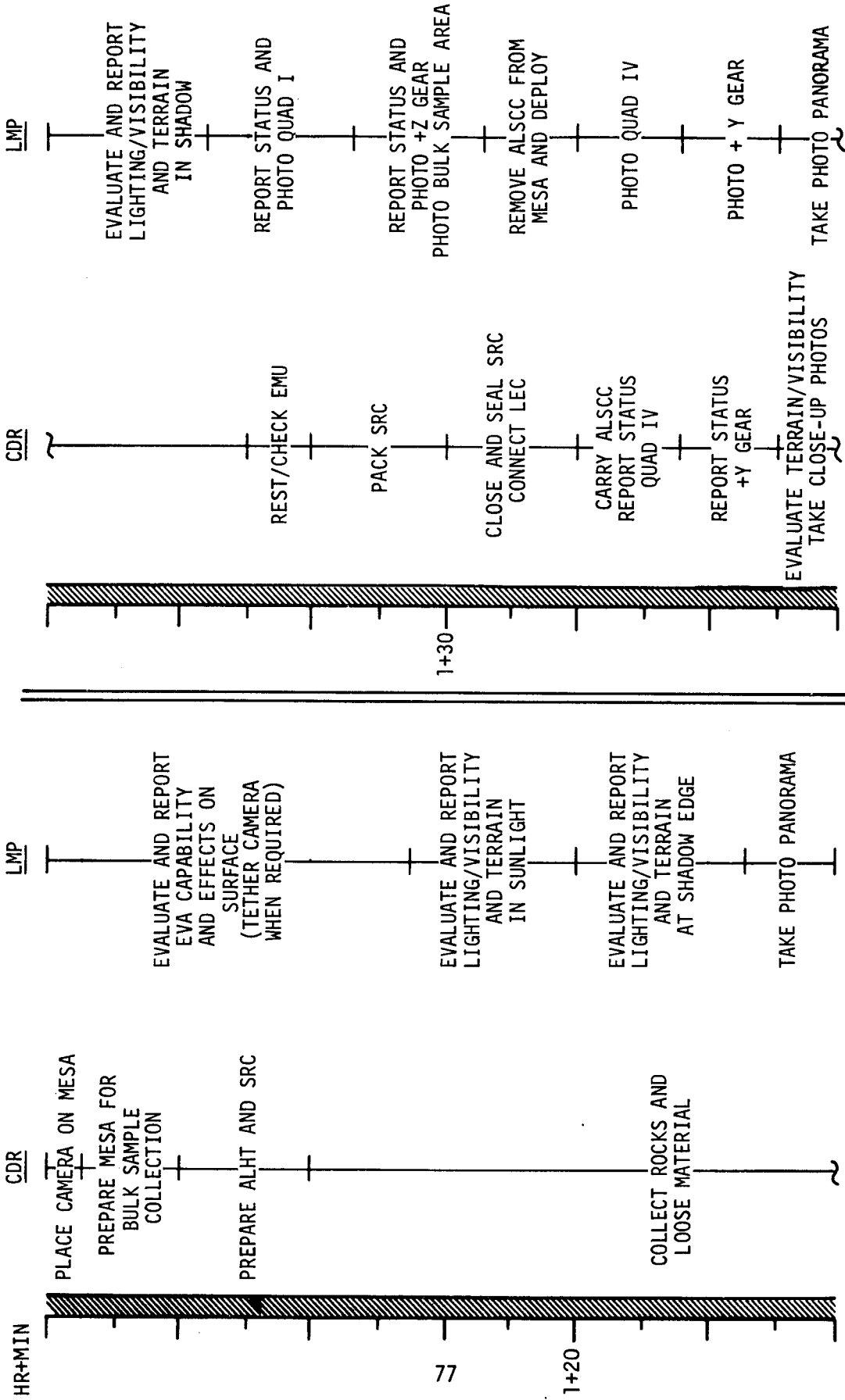

MISSION	EDITION	DATE	MISSION TIME	DAY/REV	PAGE
APOLLO 11	FINAL	JUNE 27, 1969	113+42 - 114+06	5/20	4 of 7

ALTERNATE TIMELINE

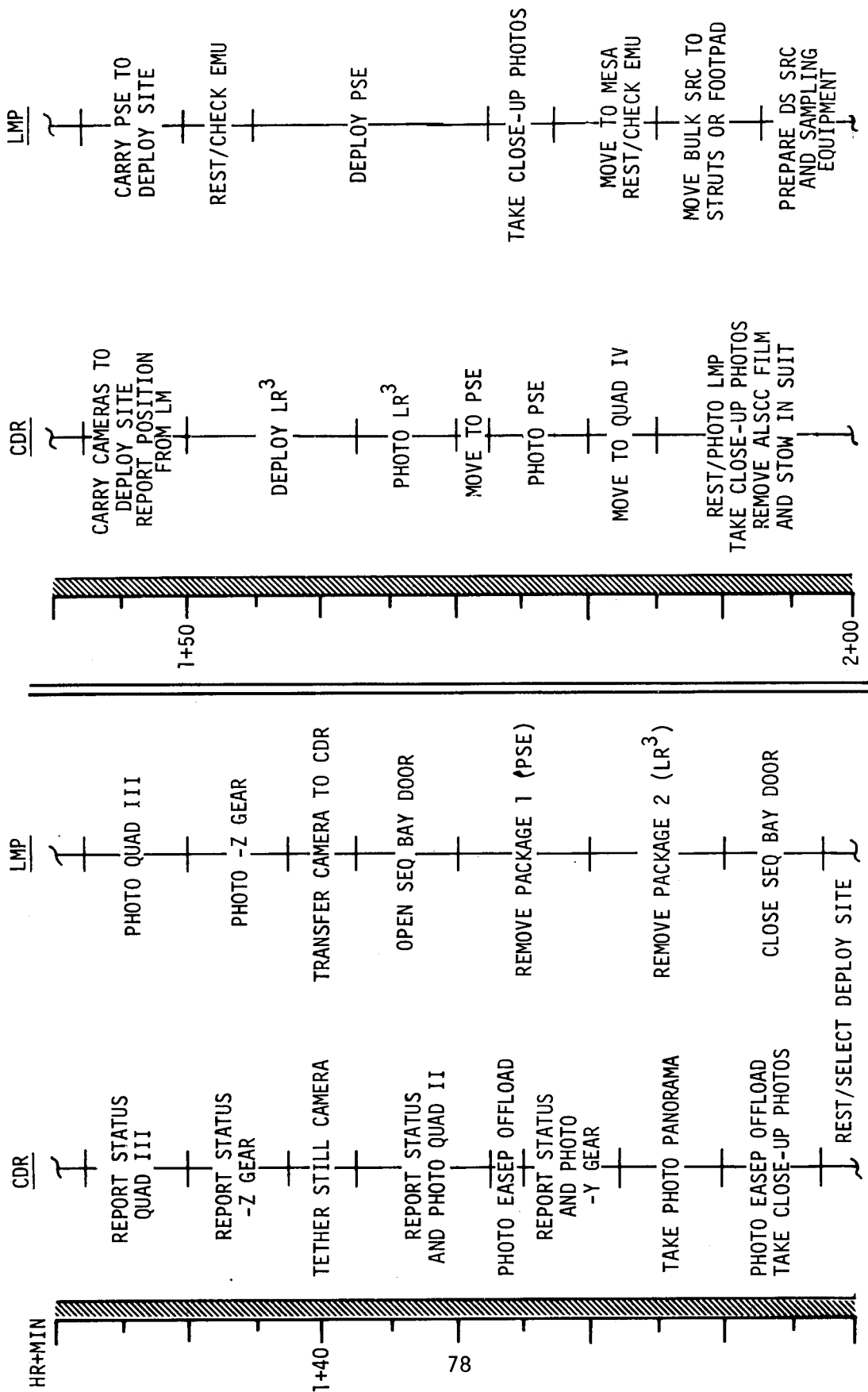

MISSION	EDITION	DATE	MISSION TIME	DAY/REV	PAGE
APOLLO 11	FINAL	JUNE 27, 1969	114+06 - 114+30	5/20	5 of 7

ALTERNATE TIMELINE

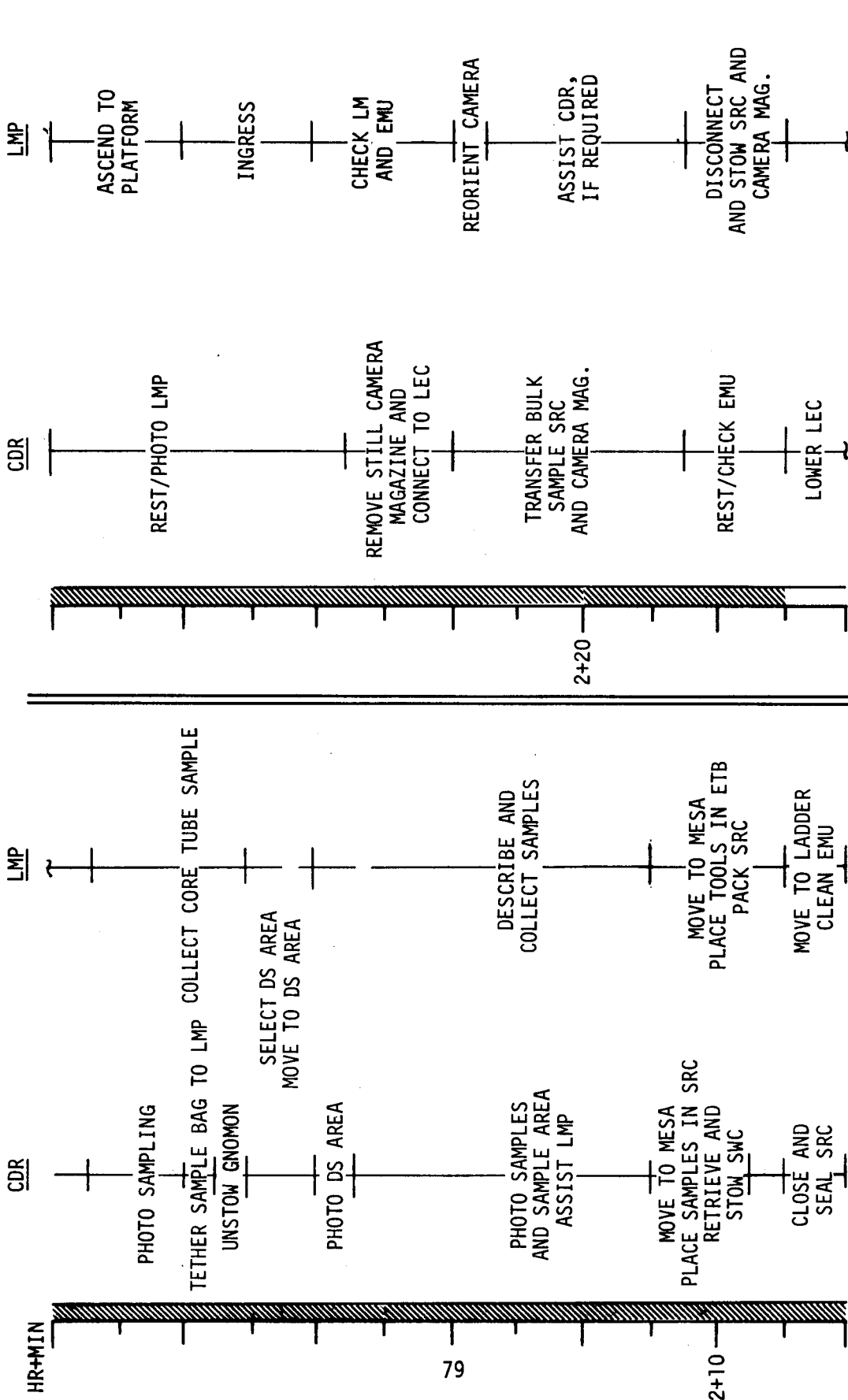

MISSION	EDITION	DATE	MISSION	DAY/REV	PAGE
APOLLO 11	FINAL	JUNE 27, 1969	114+30 - 114+54	5/20-21	6 of 7

ALTERNATE TIMELINE

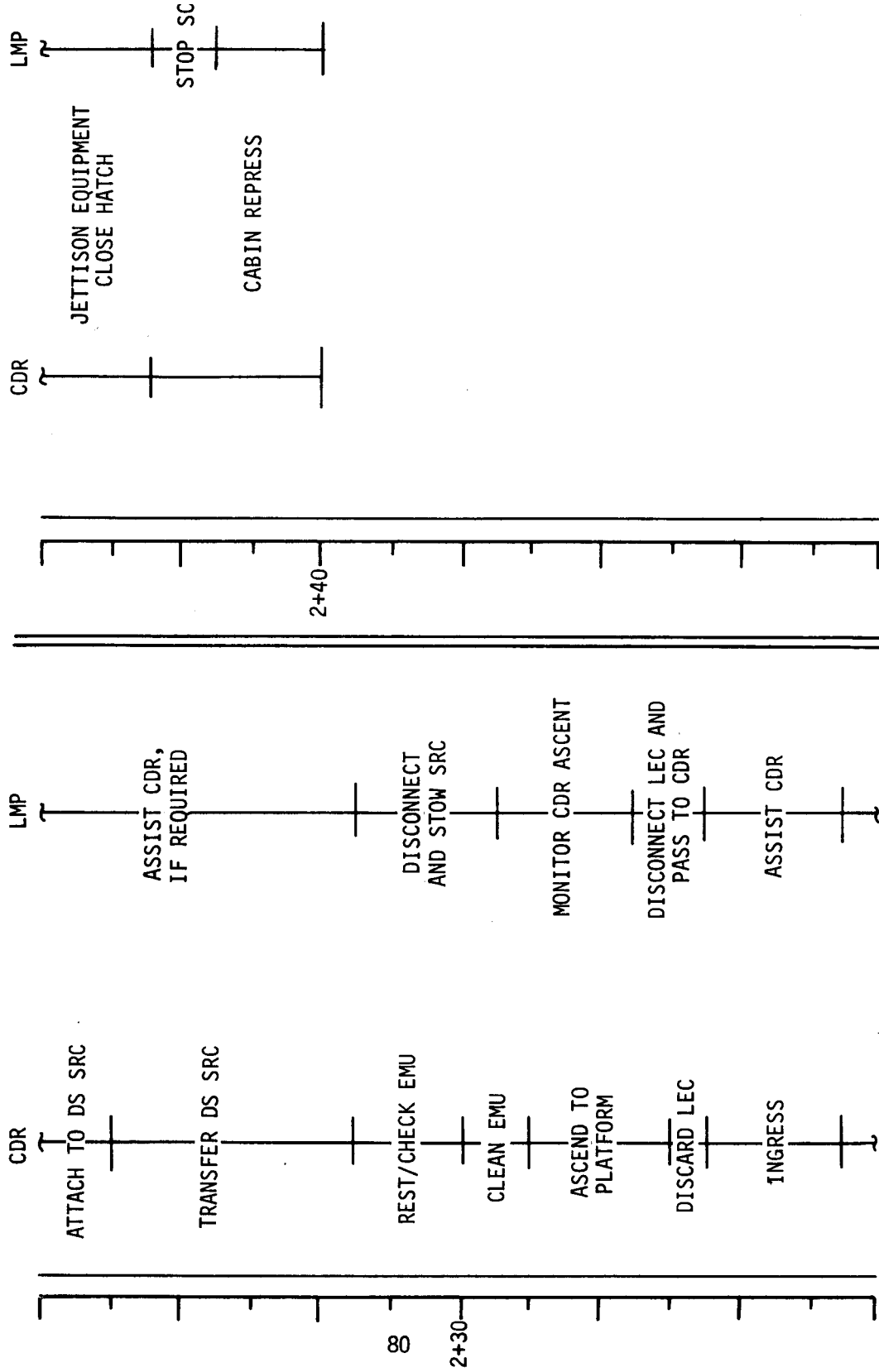

MISSION	EDITION	DATE	MISSION TIME	DAY/REV	PAGE
APOLLO 11	FINAL	JUNE 27, 1969	114+54 - 115+18	5/21	7 of 7

4.1.4 Detailed Procedures

Refer to the Nominal Lunar EVA Detailed Procedures Section 3.5, for the procedures which precede the S-band Erectable Antenna Deployment.

CDR

LMP

S-BAND ERECTABLE ANTENNA DEPLOYMENT

Transfer antenna to deployment site:

- a. Walk to antenna stowage position (Quad I)
- b. Remove thermal shield
- c. Remove Velcro straps and pull to release pins at base of antenna
- d. Grasp antenna by deployment "shimmy" bar and folded lift handle
- e. Pull antenna out and down by lift handle to clear LM structure
- f. Hold antenna by deployment bar and deploy folded lift handle by pulling handle out of stowage detent and down to locked position
- g. Rotate antenna to horizontal position and carry the antenna to the deployment site by the shimmy bar

When CDR moves into SC field of view, change SC frame rate to 6/sec

- (NOTE: The site to be used should provide a clear view of Earth and be approximately 20 feet from the MESA).
- h. Place the antenna down with the bottom antenna handle resting on the surface and the orientation arrow on top cap pointing to Earth.

Remove top cap:

- a. Release each of the three leg clamps by rotating them out and down
- b. Depress the three leg tips and push them radially outward to free the antenna top cap
- c. Discard metal top cap and foam piece in area away from the LM

Raise antenna mast:

- a. While holding the antenna vertical, grasp antenna horn top plate and raise the first section of the antenna feed support. (Insure the first section only is deploying by applying a 2-finger pressure on outer mast section. The outer section has orange stripes.)
CAUTION: Do not touch helix element when extending feed assembly
- b. Check first section fully deployed and locked in detent
- c. Extend the second antenna feed support section in the same manner as the first. Check the second section fully extended and locked in detent.

Deploy tripod:

- a. Extend antenna legs by placing 2 fingers about the leg section and applying force against loops on either side of leg. Continue to extend each leg section to the proper length, i.e., the proper paint ring and lock with clamps. Check adequacy of each leg lock
- b. Check antenna point toward earth by arrow on rib programmer

- c. Move around to the right into the antenna lifting position by the shimmy bar
- d. Pull each of three Velcro leg retention straps and let the legs fall outward to a horizontal position on the surface
- e. Remove thermal covering from antenna and discard away from LM
- f. Lift the antenna from the surface using both hands on the shimmy bar until the antenna is high enough to permit the crewmember to grasp the lift handle
- g. While holding the antenna aloft with one hand, grasp lift handle with other hand
- h. Lift the antenna to the high detent position
- i. Check each leg locked securely in detent by holding the antenna aloft with one hand and pushing outboard on the legs individually
- j. Set antenna on surface
- k. Release pull pin fastener at base of shimmy bar. Pull deployment bar down and away from antenna
- l. Discard bar in the area away from the LM
- m. Firmly implant each leg into surface

Open antenna reflector:

- a. Remove rib tip protector and allow it to slide down antenna leg to surface
- b. Uncoil antenna reflector release cable from around antenna. Hold cable taut and in straight line to plunger
- c. Remove release trigger guard pin and discard in area away from LM
- d. Grabs an antenna leg with free hand and position self at arms length from leg
- e. With head down, squeeze release trigger to deploy antenna dish.

Attach antenna cable:

- a. Walk to front of MESA, adjust MESA if necessary
- b. Pull Velcro straps to free left side of thermal blanket
- c. Unfold left side of blanket to permit easy access to cable
- d. Release antenna cable connector by pulling Velcro tab and snap free
- e. Grasp cable connector and pass the connector under the MESA support strap
- f. With cable connector in hand, walk to the left of the antenna
- g. Walk past the antenna and deploy the cable completely (until black and white striped section visible)
- h. Walk to antenna
- i. Connect antenna cable by mating the two connector parts - turning the outer part clockwise as viewed from cable end

Change SC FR to 1/sec

Rough align antenna:

- a. Move around antenna leg to rough antenna alignment position
- b. Unstow alignment crank by pushing down and away on crank handle
- c. Uncoil crank cable by passing crank around and behind the antenna base
- d. Rough align antenna in pitch (CCW rotation of the handle pitches the antenna down)
- e. Rough align antenna in azimuth. Pull antenna crank out from housing then rotate handcrank to change antenna azimuth

Change SC film magazine when necessary

Fine align antenna:

- a. Press each leg into surface
- b. Check antenna alignment by sighting along antenna mast and using optical alignment sight
- c. Fine align antenna, as required, by using remote control crank-handle "in" for pitch and "out" for azimuth

Rest-check communications and EMU systems. Take one photo of antenna

Switch to erectable antenna-S-band selector to "Lunar Stay" (FM, Mode 10)

Perform communications check. Check signal strength indication > 1.0. Verify voice and telemetry with MSFN. Check LM and EMU systems. Determine "GO" for EVA

Refer to the Nominal
EVA procedures, Section 3.5,
for the LMP Initial EVA procedures.

4.2 Contingent EVA 1 - Minimum Time, One Man

4.2.1 Description and Rationale

For various reasons, on the first lunar landing mission only a very limited time may be available to accomplish the EVA.* For such a situation the choice of objectives are, first, those with the highest priority and, secondly, those which can be accomplished in a short period of time and do not require the accomplishment of a previous task. The timeline presented here, referred to as the Contingent EVA 1 or Minimum-Time, One-Man EVA, is to optimize the accomplishment of the choice of objectives by providing the maximum data return for the minimum amount of time expended. (An EVA timeline of approximately 49 minutes).

There are several other considerations which enter into the selection of the tasks and the procedural detail of the activities for a minimum time EVA. As this will be an unplanned or contingent EVA, it is desirable to have the procedures and sequence of events closely related to the nominal. Either crewman should be equally capable of conducting the desired tasks and contributing to the data returned. And in general, to achieve the maximum diversified data collection, the crewman on the surface will not go into the procedural detail, particularly with verbal descriptions, as he is expected to in the nominal timeline.

In this contingent EVA, for the environmental familiarization, the crewman will spend only enough time to assure himself that he can safely proceed with the EVA. After the contingency sample collection he will continue to become more adapted to the new environment as he conducts a limited EVA evaluation. Primarily, this EVA evaluation will involve a brief investigation to determine an astronaut's general capabilities or limitations for conducting EVA tasks within the lunar environment. Photographs taken during this evaluation will be a postflight aid to the crewman's recall and the documentation of this activity. A limited LM inspection, with very brief comments and several documentary photographs, can be conducted for the forward half of the spacecraft within a few minutes. To conclude the surface activity the crewman will take a photographic panorama and possibly a few additional photographs of documentary value.

In conclusion it should be mentioned that the crewman's surface activity will be confined to an area where he can be constantly monitored by and in communications with the crewman inside the LM. Practically all of the activity can be documented with the sequence camera, and, if the communications capability exists, with the TV. Also, there should be sufficient time and activity for a thorough PLSS analysis.

* The final Flight Mission Rules for Apollo 11 will govern the selection of the crewman to egress and the EVA he will accomplish.

4.2.2 SUMMARY TIMELINE CONTINGENT EVA 1

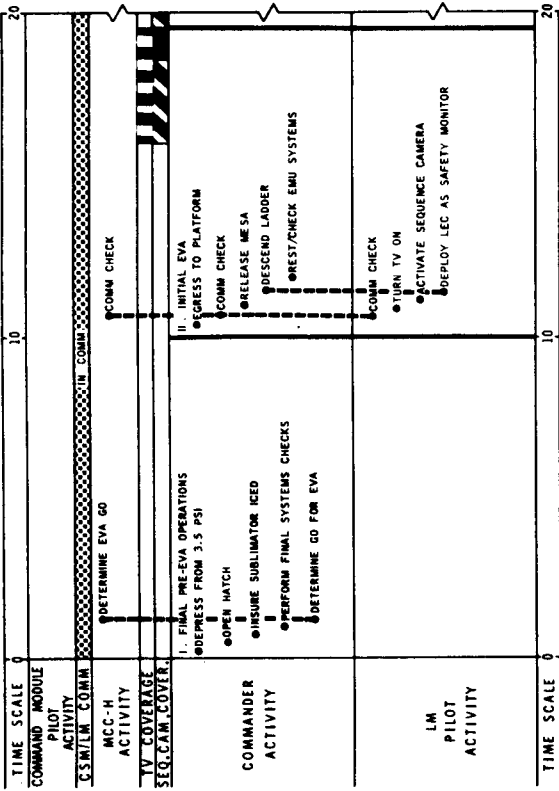

MINIMUM TIME, ONE MAN

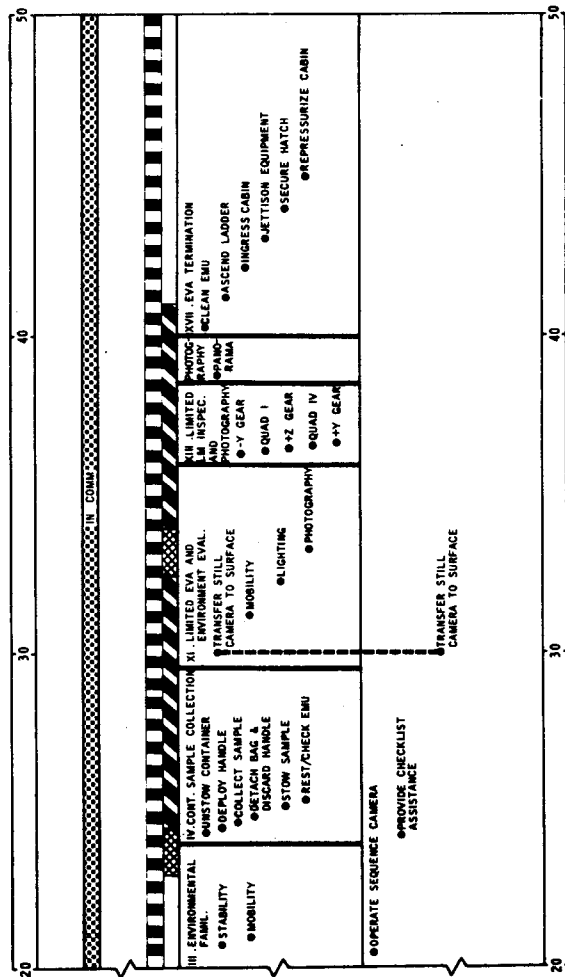
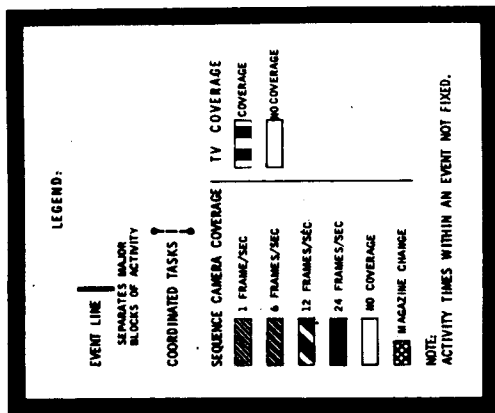

NAME	INITIAL	ORIGIN	
W.N. WOOD	EW/JD	L500	
DR. HENRICHES	Cv		

NATIONAL AERONAUTICS & SPACE ADMINISTRATION
MANNED SPACECRAFT CENTER HOUSTON, TEXAS

REV. APRIL '69
REV. MARCH '69
REV. FEB. '69

4.2.2 SUMMARY TIMELINE
CONTINGENT EVA 1

BASC JAN. 1969

4.2.3 CONTINGENT TIMELINE MINIMUM TIME, ONE MAN

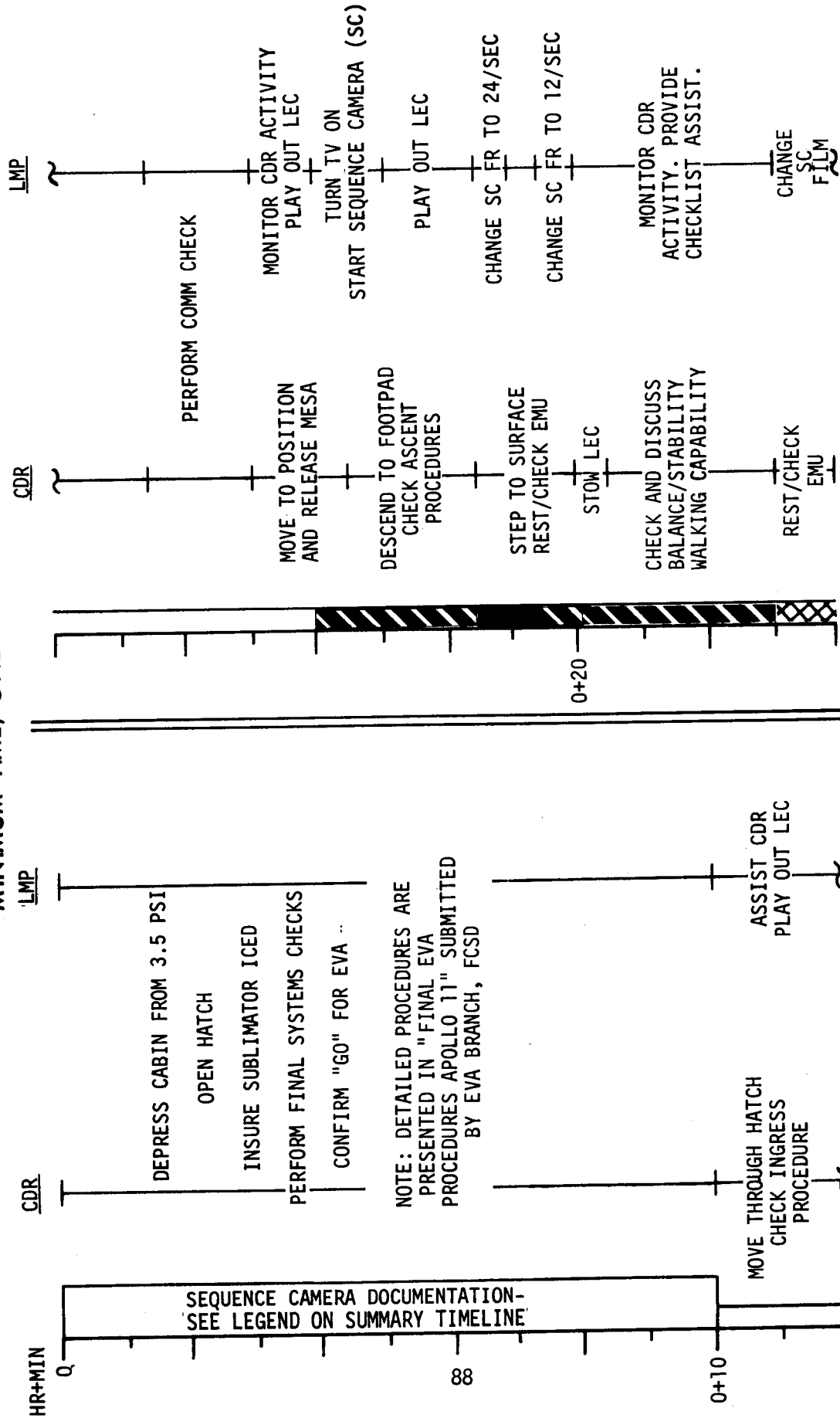

MISSION	EDITION	DATE	MISSION TIME	DAY/REV	PAGE
APOLLO 11	FINAL	JUNE 27, 1969	112+30 - 112+54	5/19	1 of 2

CONTINGENT TIMELINE

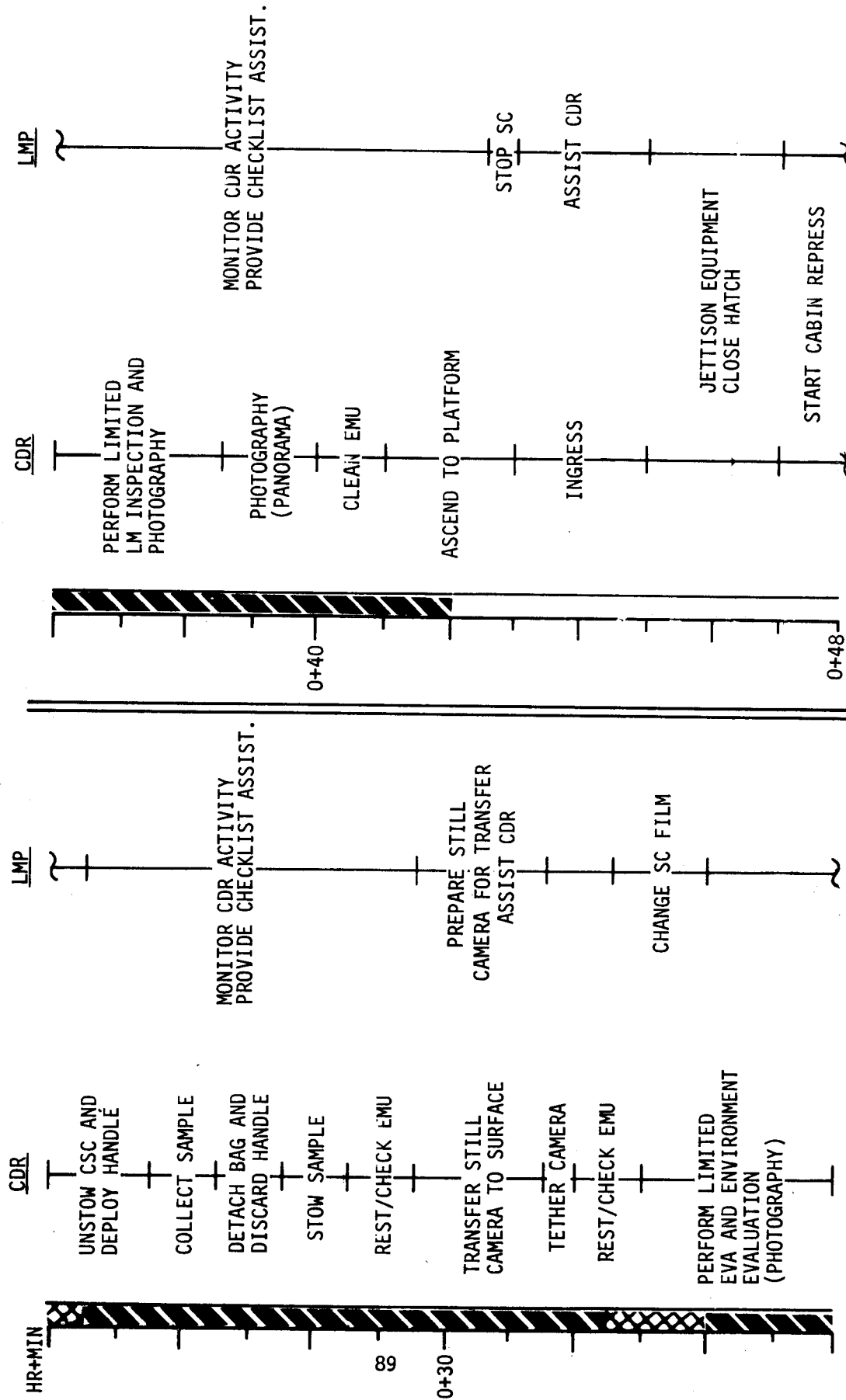

MISSION	EDITION	DATE	MISSION TIME	DAY/REV	PAGE
APOLLO 11	FINAL	JUNE 27, 1969	112+54 - 113+18	5/20	2 of 2

4.3 Contingent EVA 2 - One Man, Two Hours

4.3.1 Description and Rationale

A second contingent EVA timeline is presented for a situation where only one crewman will egress.* The use of this EVA timeline, as for the other contingent timeline, will require a real time decision. All of the reasons, or even if one would be considered in real time, have not yet been determined. One reason might be the failure of one PLSS to check out. Another might be a LM subsystem malfunction which required continuous monitoring. Other suppositions could require a decision to conduct a one man EVA.

As for Contingent EVA 1, it is assumed that the CDR can egress. However, if this is not possible, each crewman should be capable of accomplishing the other crewman's tasks.

For this contingent situation the crewman on the surface should be able to accomplish most of the nominal activities within two hours. He may, however, require verbal assistance from the other crewman as well as more time to perform the tasks which he nominally does not perform.

* The Final Flight Mission Rules for Apollo 11 will govern the selection of the crewman to egress and the EVA he will accomplish.

4.3.3. CONTINGENCY TIMELINE ONE MAN, TWO HOURS

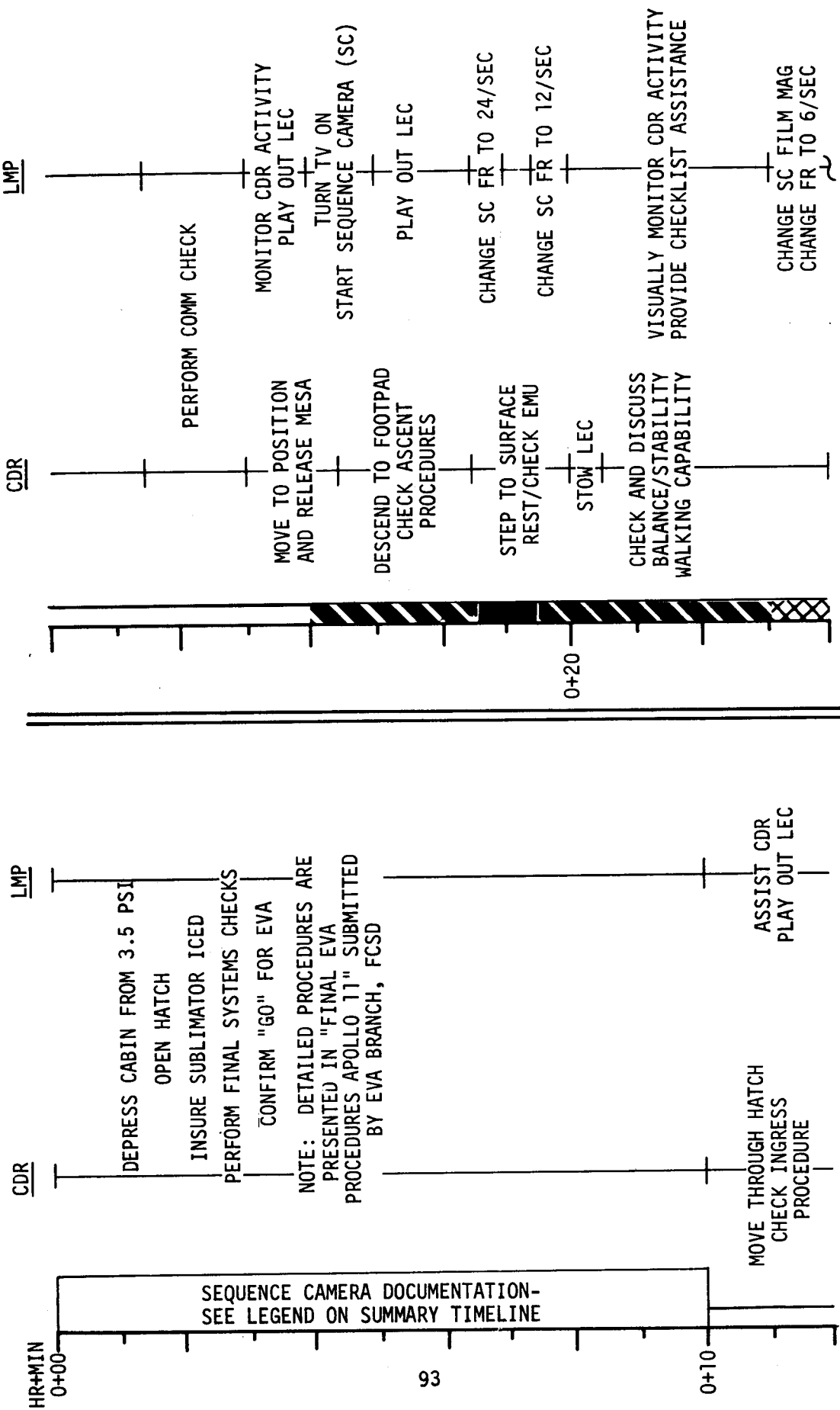

HR+MIN
0+00

0+10

SEQUENCE CAMERA DOCUMENTATION-
SEE LEGEND ON SUMMARY TIMELINE

MISSION	EDITION	DATE	MISSION TIME	DAY/REV	PAGE
APOLLO 11	FINAL	JUNE 27, 1969	112+30 - 112+54	5/19	1 of 5

CONTINGENT TIMELINE

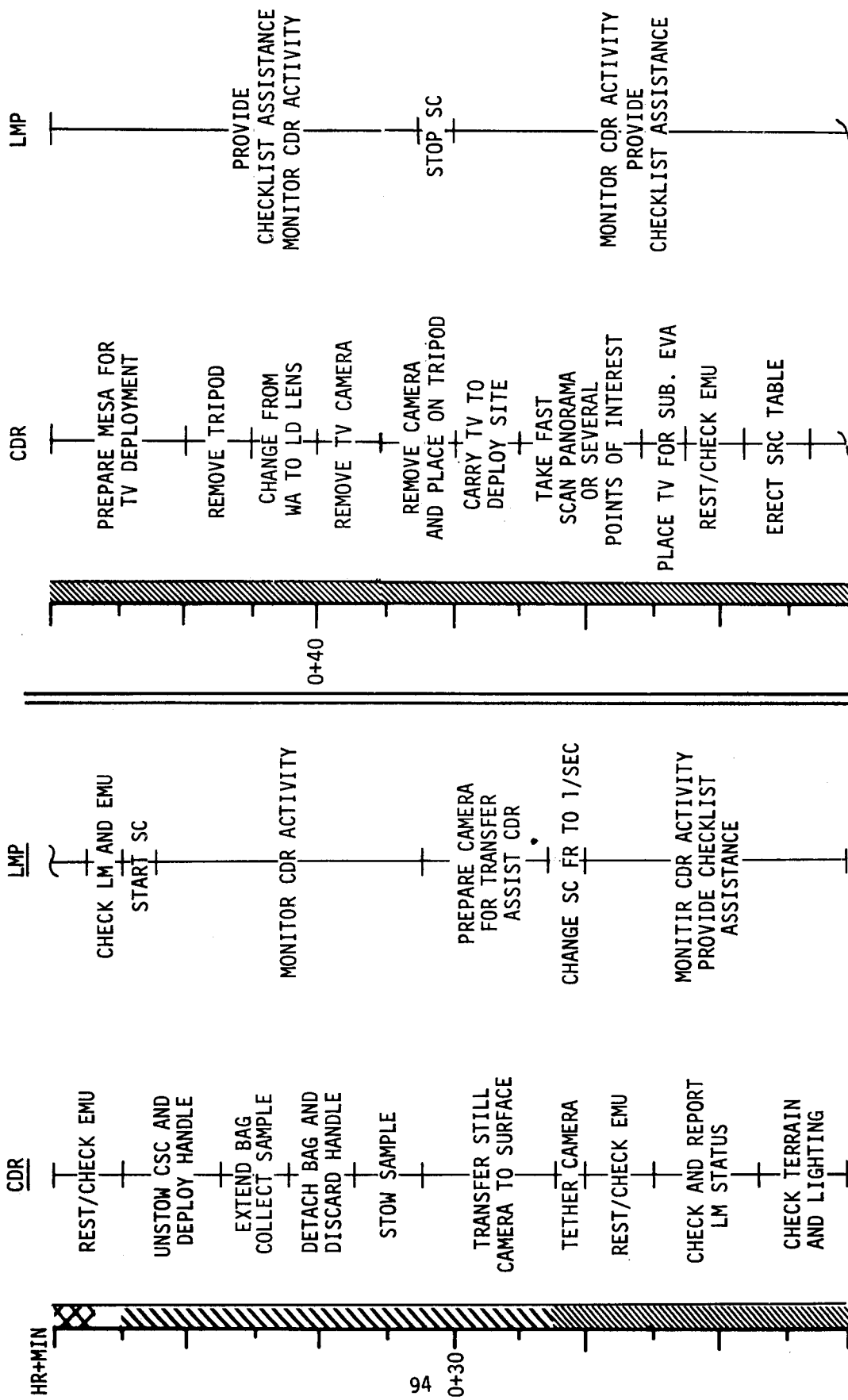

MISSION	EDITION	DATE	MISSION TIME	DAY/REV	PAGE
APOLLO 11	FINAL	JUNE 27, 1969	112+54 - 113+18	5/20	2 of 5

CONTINGENT TIMELINE

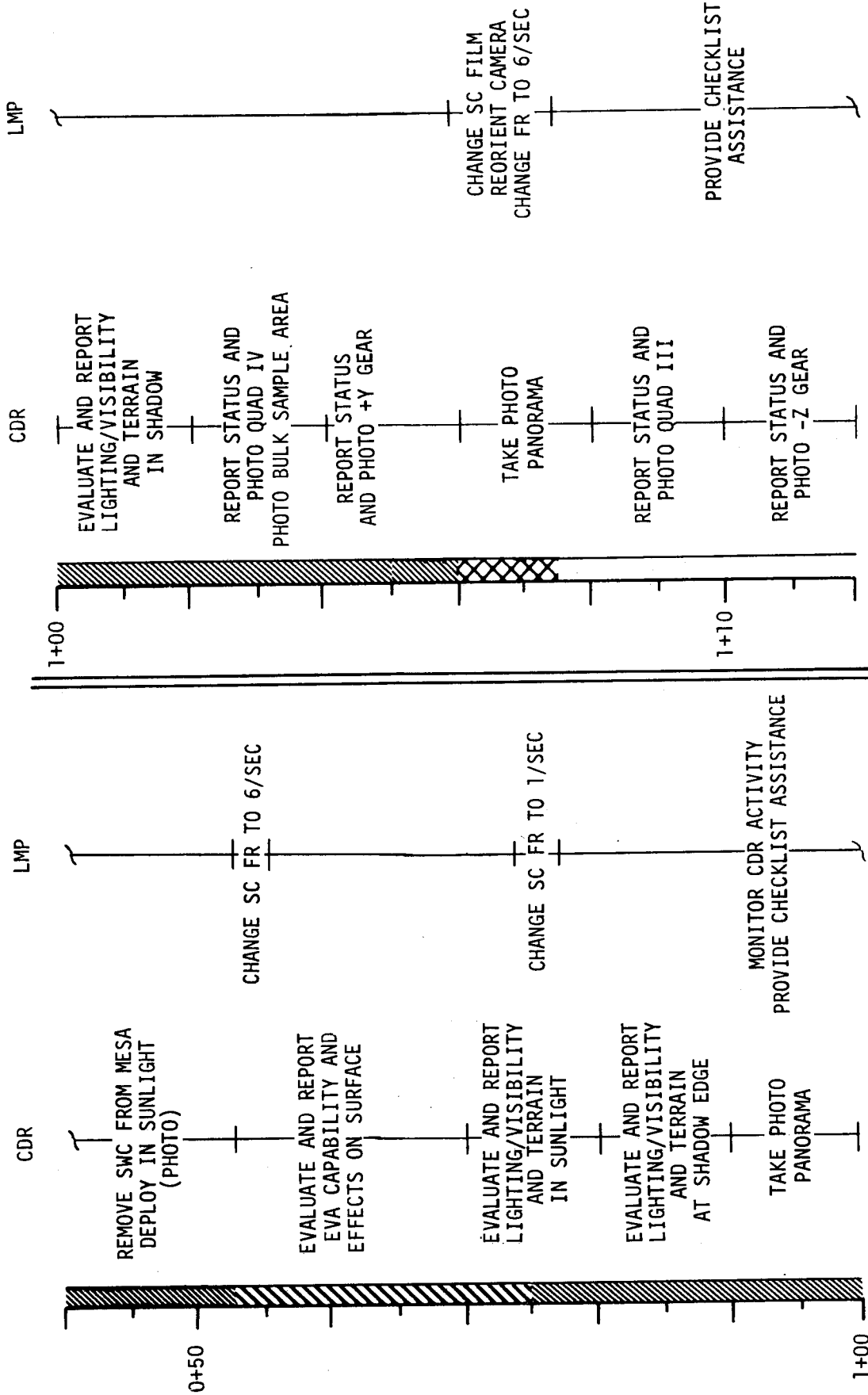

MISSION	EDITION	DATE	MISSION TIME	DAY/REV	PAGE
APOLLO 11	FINAL	JUNE 27, 1969	113+18 - 113+42	5/20	3 of 5

CONTINGENT TIMELINE

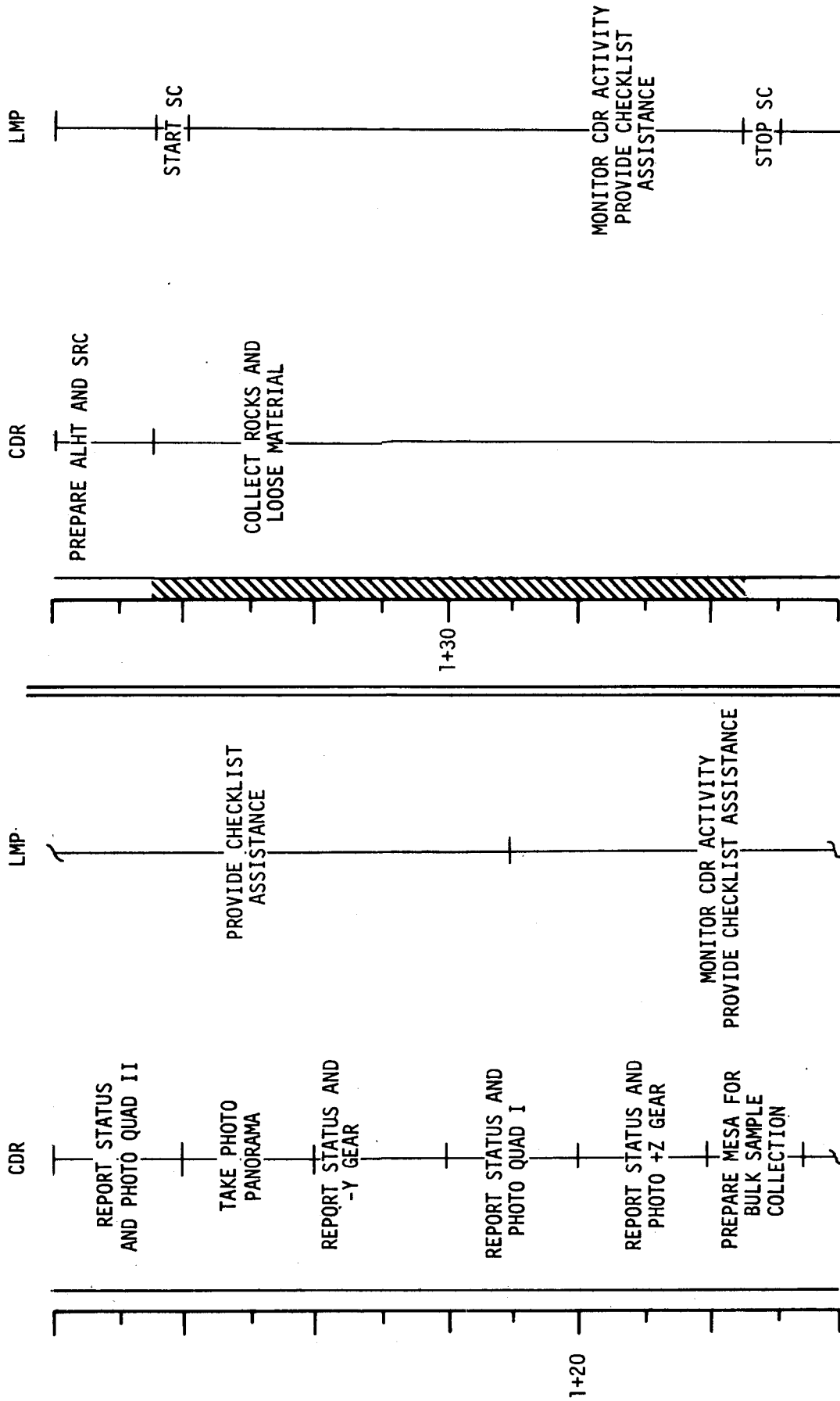

MISSION	EDITION	DATE	MISSION TIME	DAY/REV	PAGE
APOLLO 11	FINAL	JUNE 27, 1969	113+42 - 114+06	5/20	4 of 5

CONTINGENT TIMELINE

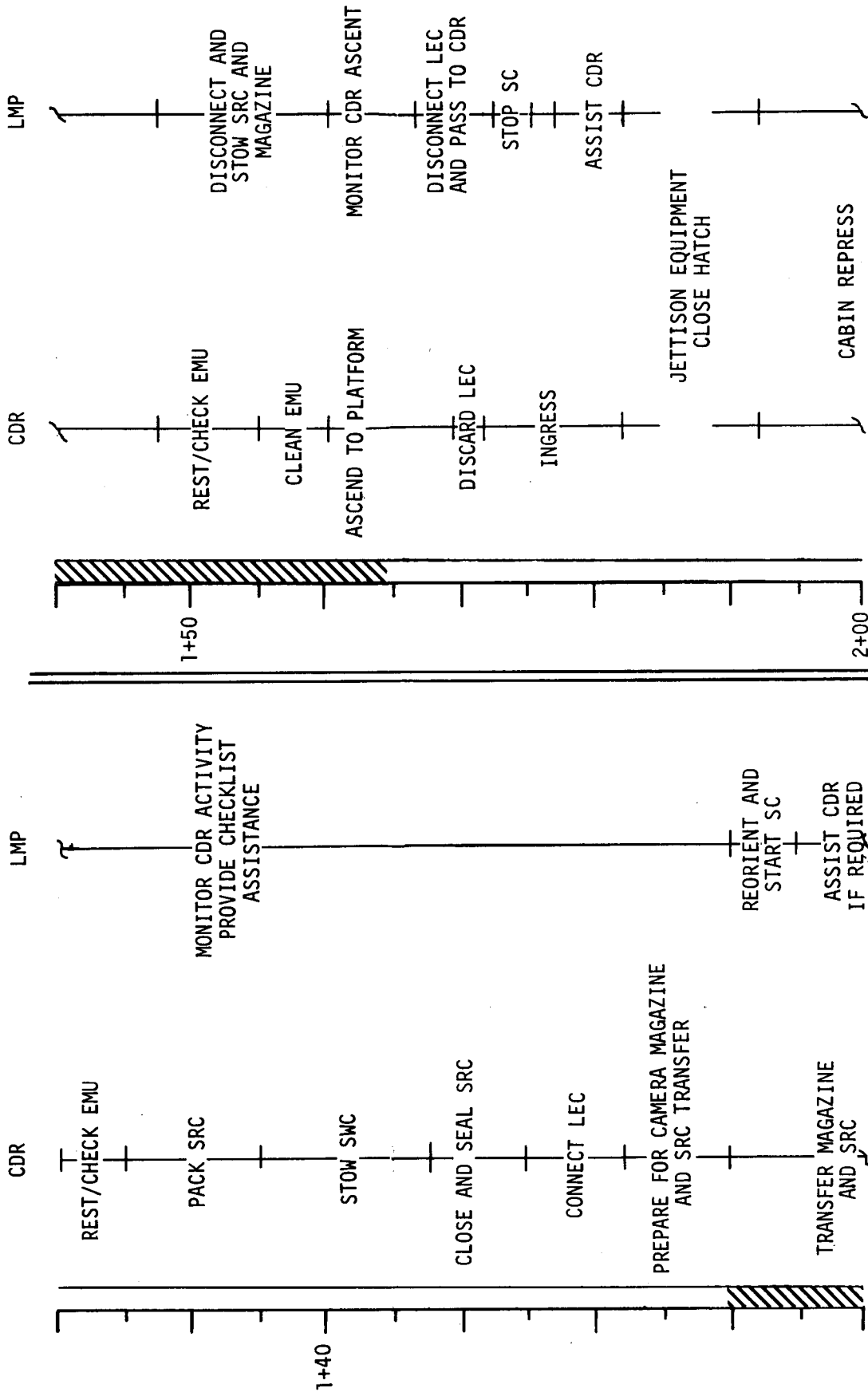

MISSION	EDITION	DATE	MISSION TIME	DAY/REV	PAGE
APOLLO 11	FINAL	JUNE 27, 1969	114+06 - 114+30	5/20	5 of 5

SECTION 5.0

APPENDIX

5.1 ABBREVIATIONS

ALHT	Apollo Lunar Handtool(s)
ALSCC	Apollo Lunar Surface Close-Up Camera
A/S	Ascent Stage
BS	Bulk Sample
CCW	Counterclockwise
CDR	Commander
CM	Command Module
CS	Contingency Sample
CSC	Contingency Sample Container
CSM	Command and Service Modules
CW	Clockwise
DPS	Descent Propulsion System
DS	Documented Sample
D/S	Descent Stage
EASEP	Early Apollo Scientific Experiment Package
ECS	Environmental Control System
EMU	Extravehicular Mobility Unit
ETB	Equipment Transfer Bag
EVA	Extravehicular Activity
FR	Frame Rate (Sequence Camera)
ITMG	Integrated Thermal-Meteoroid Garment
LD	Lunar Day (TV Lens)
LEC	Lunar Equipment Conveyor
LHSSC	Left Hand Side Stowage Compartment
LM	Lunar Module
LMP	Lunar Module Pilot
LR ³ or LR3	Laser Ranging Retro-Reflector (Experiment)
LRL	Lunar Receiving Laboratory
MCC-H	Mission Control Center - Houston
MESA	Modularized Equipment Stowage Assembly (Descent Stage)
MSFN	Manned Spaceflight Network
OPS	Oxygen Purge System
PLSS	Portable Life Support System
PSE	Passive Seismic Experiment
PSEP	Passive Seismic Experiment Package
RCS	Reaction Control System
SC	Sequence Camera
S/C	Spacecraft
SEQ	Scientific Equipment (Bay) (Descent Stage)
SRC	Sample Return Container
SWC	Solar Wind Composition (Experiment)
TV	Television
WA	Side Angle (TV Lens)

5.2 Detailed Objectives and Experiments

5.2.1 Introduction

The Detailed Objectives and Experiments presented herein are contained in the Mission Requirements SA-506/CSM-107/LM-5 G Type Mission, Lunar Landing, dated April 17, 1969, revised by change A, May 1, 1969.

Each detailed objective and experiment provides the necessary details for its implementation into the flight plan, the criteria for data retrieval and data evaluation, and the criteria for determining that the objective or experiment was successfully accomplished.

5.2.2 Definitions

- 1) The Test Conditions stated in the Detailed Objectives or Experiments are those required conditions that must exist for the objective or experiment to be satisfied.
- 2) The priorities as assigned to each item in Data Requirements of the Detailed Objectives and Experiments are based on the following definitions:
 - a) Mandatory - A mandatory item is essential for evaluation of the objective or experiment.
 - b) Highly Desirable - A highly desirable item furnishes information which aids evaluation of the objective or experiment. These items supply information which is available from alternate sources or which is not required for evaluation of the essential parts of the objective or experiment.
- 3) The numbers appearing in the "Mode" column of the telemetry listings in the Detailed Objectives and Experiments indicate the following:
 - a) "1" - Telemetry available in high bit rate format only.
 - b) "2" - Telemetry available in high bit rate and low bit rate formats.
- 4) Data storage equipment (DSE) recordings are acceptable in lieu of telemetry.

5.2.3 Objectives

A. CONTINGENCY SAMPLE COLLECTION

Collect a contingency sample.

Purpose

The purpose is to collect a small sample of loose material (approximately two pounds) in the immediate vicinity of the LM during the early part of the EVA period. This will increase the probability of returning a lunar sample to earth.

The functional test objective is as follows:

- FTO 1) Provide a contingency sample for postflight scientific investigations.

Test Conditions

- FTO 1) The crewman will descend from the LM with the contingency sample container and quickly scoop up a loose sample. Sequence photographs will be made showing the astronaut collecting the sample. The sample container will be sealed and stowed in the LM ascent stage.

Success Criteria

- FTO 1) The contingency sample will be delivered to the Lunar Receiving Laboratory (LRL).

Evaluation

- FTO 1) Astronaut records, the sample and the photographs will be studied in the LRL and by the sample Principal Investigators. (Astronaut records, photographs and sample)

Data Requirements

- 1) Astronaut Logs or Voice Records: (HD)
 - (a) Location of area in relation to LM where sample was obtained.
 - (b) Lunar surface observations.

2) Photographs: (HD)

Sequence photographs of an astronaut collecting a sample.

3) Single sample of lunar surface material. (M)

A. CONTINGENCY SAMPLE COLLECTION

Background and Justification

The contingency sample will be collected as early as possible during the EVA period before the Bulk Sample Collection and the Documented Sample Collection are conducted. This will increase the probability of return of a minimal lunar sample should a contingency situation arise early in the lunar surface mission.

Previous Flight Objectives

<u>Objective Number</u>	<u>Title</u>	<u>Mission</u>
None		

B. LUNAR SURFACE EVA OPERATIONS

Egress from the LM to the lunar surface, perform lunar surface EVA operations and ingress into the LM from the lunar surface.

Purpose

The purpose is to evaluate the ability of the crew to accomplish lunar surface EVA operations.

The functional test objectives are as follows:

- FTO 1) Demonstrate the capability to egress to and ingress from the lunar surface.
- FTO 2) Evaluate the capability of the crew to perform EVA tasks on the lunar surface.

Test Conditions

- FTO 1) The crew will exit from the LM, descend to the surface and return to the LM in accordance with the EVA Procedures document and the Lunar Surface Operations Plan.
- FTO 2) The crew will perform lunar surface EVA operations in accordance with the Lunar Surface Operations Plan, including but not limited to the following:
 - (a) Evaluation of general EVA capability including balance while standing, mobility, stability and traverse capability.
 - (b) Evaluation of astronaut's reach and grasp capability for EVA operations on the lunar surface.
 - (c) Lifting and maneuvering equipment for transfer between the LM cabin and lunar surface.
 - (d) Unstowing, deploying and using equipment on the lunar surface.
 - (e) Viewing the exterior of the LM and the lunar terrain features from the lunar surface.

Success Criteria

- FTO 1) The egress and ingress of at least one astronaut between the LM and the lunar surface will be accomplished.
- FTO 2) Sufficient data shall be obtained to evaluate the astronaut's capability to unload storage compartments, deploy equipment and experiments, operate the TV and still cameras and gather surface samples while in the lunar surface EVA environment.

Evaluation

- FTO 1) The adequacy of the hardware and procedures to accomplish
FTO 2) lunar surface EVA operations will be determined. (Astronaut records, photographs, and GT 9991 U)

Data Requirements

1) Telemetry Measurements:

<u>Measurement Number</u>	<u>Description</u>	<u>TM</u>	<u>Mode</u>	<u>Priority</u>
GT 8100	EVCS No. 1 Sync	FM/FM*	N/A	M
GT 8101 V	Volt, EVCS No. 1 Calib 0 Pct	FM/FM*	N/A	M
GT 8102 V	Volt, EVCS No. 1 Calib 100 Pct	FM/FM*	N/A	M
GT 8110 P	Press, PLSS Feed No. 1 H ₂ O	FM/FM*	N/A	M
GT 8124 J	Electrocardiogram No. 1	FM/FM*	N/A	M
GT 8140 C	PLSS Batt Current No. 1	FM/FM*	N/A	M
GT 8141 V	Volt, PLSS No. 1 Battery	FM/FM*	N/A	M
GT 8154 T	Temp, LCG H ₂ O Inlet No. 1	FM/FM*	N/A	M
GT 8168 P	Press, PGA O ₂ No. 1	FM/FM*	N/A	M
GT 8170 T	Temp, PLSS No. 1 Subl O ₂ Outlet	FM/FM*	N/A	M
GT 8175 P	PLSS, CO ₂ PP No. 1	FM/FM*	N/A	M
GT 8182 P	Press, PLSS O ₂ Supply No. 1	FM/FM*	N/A	M
GT 8196 T	Delta Temp, LCG H ₂ O In/Out No. 1	FM/FM*	N/A	M
GT 8200	EVCS No. 2 Sync	FM/FM*	N/A	M
GT 8201 V	Volt, EVCS No. 2 Calib 0 Pct	FM/FM*	N/A	M
GT 8202 V	Volt, EVCS No. 2 Calib 100 Pct	FM/FM*	N/A	M
GT 8210 P	Press, PLSS No. 2 Feed H ₂ O	FM/FM*	N/A	M
GT 8224 J	Volt, PLSS No. 2 EKG	FM/FM*	N/A	M
GT 8240 C	Curr, PLSS No. 2 Battery	FM/FM*	N/A	M
GT 8241 V	Volt, PLSS No. 2 Battery	FM/FM*	N/A	M
GT 8254 T	Temp, LCG No. 2 H ₂ O Inlet	FM/FM*	N/A	M
GT 8268 T	Press, PGA No. 2	FM/FM*	N/A	M
GT 8270 T	Temp, PLSS No. 2 Subl O ₂ Outlet	FM/FM*	N/A	M
GT 8275 P	PLSS CO ₂ PP No. 2	FM/FM*	N/A	M
GT 8282 P	Press, PLSS No. 2 O ₂	FM/FM*	N/A	M
GT 8296 T	Delta Temp, LCG No. 2 H ₂ O In/Out	FM/FM*	N/A	M
GT 9991 U	EMU TM Outputs	FM/FM*	N/A	M

*Measurements GT 8100 through GT 8296 T are all parts of measurement GT 9991 U.

2) Astronaut Logs or Voice Records: (M)

The crew will provide data on the adequacy of hardware and procedures, and the time required to perform the egress from the LM, the lunar surface EVA operations and the ingress to the LM. Records may be obtained from postflight debriefings, from voice records recorded by MSFN, DSEA or DSE, or from written logs.

3) Photographs: (HD)

a) Sequence camera coverage through the LM window of:

- (1) A crew member descending to the lunar surface.
- (2) A crew member walking on the lunar surface.
- (3) A crew member performing lunar surface EVA operations.
- (4) A crew member ascending the LM ladder.

b) Still camera coverage of an astronaut performing lunar surface EVA operations.

4) Television: (HD)

Ground recorded television signals of:

- a) A crew member descending to the lunar surface.
- b) A crew member walking on the lunar surface.
- c) A crew member performing lunar surface EVA operations.
- d) A crew member ascending the LM ladder and ingressing into the LM.

B. LUNAR SURFACE EVA OPERATIONS

Background and Justification

The capability to egress from the LM, descend the ladder and return to the LM cabin has been demonstrated by astronauts in pressurized extravehicular mobility units (EMU) while working under the one-g condition of the earth. The capability to egress from the LM and return was demonstrated during Apollo 9 by an astronaut in a pressurized EMU while in the zero-g environment of space. To perform all the tasks associated with exploring and gathering data on the lunar surface, the astronauts are required to leave the LM, descend to the lunar surface, walk about, use their hands and fingers, and return to the LM cabin. This objective will provide the data necessary to determine how long various tasks take and what tasks the astronauts can reasonably be expected to perform while working in the lunar surface EVA environment.

Previous Flight Objectives

<u>Objective Number</u>	<u>Title</u>	<u>Mission</u>
20.35	Extravehicular Activity	9

C. EMU LUNAR SURFACE OPERATIONS

Perform lunar surface operations with the EMU.

Purpose

The purposes are to demonstrate extravehicular mobility unit (EMU) performance on the lunar surface and to demonstrate satisfactory operation of the EVA-LM-MSFN communications relay links.

The functional test objectives are as follows:

- FTO 1) Demonstrate the capability of the EMU to provide a habitable environment.
- FTO 2) Demonstrate the capability of the EMU to provide sufficient mobility, dexterity and comfort to allow the crew to egress/ingress the LM and perform useful work on the lunar surface.
- FTO 3) Demonstrate satisfactory operation of the EVA-LM-MSFN two-way voice relay, EVA-LM-MSFN one-way relay of EMU and biomedical data from two EVA crewmen simultaneously and two-way voice communications between the two EVA crewmen.

Test Conditions

- FTO 1) Crewmen donning, doffing and checking out the applicable portions of the EMU (i.e., PLSS, EV visor, gloves and boots) will be accomplished in accordance with the EVA Procedures document.

EMU checkout will be performed prior to all extravehicular activities on the lunar surface and will be conducted in accordance with the EVA Procedures document.

PLSS shutdown will be accomplished in accordance with the EVA Procedures document. The water will be drained into a calibrated container from the PLSS sustaining the longest duration EVA.
- FTO 2) Crewmen egress to the lunar surface and ingress to the spacecraft will be accomplished in accordance with the EVA Procedures document. Activities on the lunar surface will be accomplished in accordance with the Lunar Surface Operations Plan.
- FTO 3) The EVA crewmen will communicate with MSFN via the EVA-LM-MSFN two-way voice relay.

EMU and biomedical data from the two EVA crewmen will be simultaneously transmitted to MSFN via the EVA-LM-MSFN one-way relay.

Two-way voice communications will be performed between the two EVA crewmen.

Success Criteria

- FTO 1) The EMU shall provide a habitable environment for the extra-vehicular crewmen on the lunar surface.

Sufficient data shall be obtained to evaluate the performance of the PLSS and to determine the consumables required to perform the EVA.

- FTO 2) The lunar surface excursion will be accomplished and completed within the PLSS consumables budget and time allowed. The EMU shall provide sufficient mobility, dexterity and comfort to allow the crew to egress/ingress the LM.

- FTO 3) Sufficient data shall be obtained to determine that the EVA-LM-MSFN two-way voice relay link was satisfactory.

Sufficient data shall be obtained to determine that the EVA-LM-MSFN one-way relay link contained acceptable EMU and biomedical data.

Sufficient data shall be obtained to determine that the two-way voice communications between the two EVA crewmen were satisfactory.

Evaluation

- FTO 1) The adequacy of the EMU to provide a habitable environment will be assessed. (Astronaut records, Flight Director's Post-Mission Report and GT 9991 U) The quantity of water used during EVA will be determined. (Astronaut records)

- FTO 2) Mobility, dexterity and comfort of the crew will be assessed. (Astronaut records)

- FTO 3) The adequacy of the EMU communications (including relay links) will be assessed. (Astronaut records, MSFN voice recording and GT 9991 U)

Data Requirements

1) Telemetry Measurements:

<u>Measurement Number</u>	<u>Description</u>	<u>TM</u>	<u>Mode</u>	<u>Priority</u>
GT 8100	EVCS No. 1 Sync	FM/FM*	N/A	M
GT 8101 V	Volt, EVCS No. 1 Calib 0 Pct	FM/FM*	N/A	M
GT 8102 V	Volt, EVCS No. 1 Calib 100 Pct	FM/FM*	N/A	M
GT 8110 P	Press, PLSS Feed No. 1 H ₂ O	FM/FM*	N/A	M
GT 8124 J	Electrocardiogram No. 1	FM/FM*	N/A	M
GT 8140 C	PLSS Batt Current No. 1	FM/FM*	N/A	M
GT 8141 V	Volt, PLSS No. 1 Battery	FM/FM*	N/A	M
GT 8154 T	Temp, LCG H ₂ O Inlet No. 1	FM/FM*	N/A	M
GT 8168 P	Press, PGA O ₂ No. 1	FM/FM*	N/A	M
GT 8170 T	Temp, PLSS No. 1 Subl O ₂ Outlet	FM/FM*	N/A	M
GT 8175 P	PLSS CO ₂ PP No. 1	FM/FM*	N/A	M
GT 8182 P	Press, PLSS O ₂ Supply No. 1	FM/FM*	N/A	M
GT 8196 T	Delta Temp, LCG H ₂ O In/Out No. 1	FM/FM*	N/A	M
GT 8200	EVCS No. 2 Sync	FM/FM*	N/A	M
GT 8201 V	Volt, EVCS No. 2 Calib 0 Pct	FM/FM*	N/A	M
GT 8202 V	Volt, EVCS No. 2 Calib 100 Pct	FM/FM*	N/A	M
GT 8210 P	Press, PLSS No. 2 Feed H ₂ O	FM/FM*	N/A	M
GT 8224 J	Volt, PLSS No. 2 EKG	FM/FM*	N/A	M
GT 8240 C	Curr, PLSS No. 2 Battery	FM/FM*	N/A	M
GT 8241 V	Volt, PLSS No. 2 Battery	FM/FM*	N/A	M
GT 8254 T	Temp, LCG No. 2 H ₂ O Inlet	FM/FM*	N/A	M
GT 8268 P	Press, PGA No. 2	FM/FM*	N/A	M
GT 8270 T	Temp, PLSS No. 2 Subl O ₂ Outlet	FM/FM*	N/A	M
GT 8275 P	PLSS CO ₂ PP No. 2	FM/FM*	N/A	M
GT 8282 P	Press, PLSS No. 2 O ₂	FM/FM*	N/A	M
GT 8296 T	Delta Temp, LCG No. 2 H ₂ O In/Out	FM/FM*	N/A	M
GT 9991 U	EMU TM Outputs	FM/FM*	N/A	M

*Measurements GT 8100 through GT 8296 are all parts of measurement GT 9991 U.

2) Astronaut Logs or Voice Records:

- a) The crew will notify MSFN of the initial and final positions of the PLSS water diverter valve, primary oxygen shutoff valve, and water shutoff/relief valve each time they are changed. (M)
- b) The crew will notify MSFN whenever the following PLSS remote control unit status indicators and audible warning tone come on. (M)

1) High O₂ flowrate

2) Low vent flow

- 3) Low feed water pressure
- 4) PGA pressure low
- c) The crew will record EMU radiation dosimeter readings just prior to and after completion of the extravehicular activities. (M)
- d) The crew will notify MSFN whenever the following occur. (HD)
 - 1) Noxious odors, if any
 - 2) Condensation, if any, on the visor assembly
- e) The crew will comment on the adequacy of procedures and difficulties encountered during donning and doffing EMU equipment; i.e., PLSS, EV visor, gloves and boots. (HD)
- f) The crew will comment on time required and adequacy of the EMU checkout procedures. (HD)
- g) The crew will comment at least one time on the adequacy of EMU thermal environment when walking from a sunlit area to shadow and vice versa. (M)
- h) The crew will comment on their estimated energy expenditure and comfort as compared to their simulation experience. (HD)
- i) The LM crew will comment on voice quality for EVA-EVA and EVA-LM-MSFN communications. (M)
- j) The LM crew will record the quantity of water drained from the PLSS at the end of the EVA period.
- 3) Flight Director's Post-Mission Report to include the GET corresponding to the crew supplied data as listed in Data Requirements items 2) a), 2) b) and 2) d). (M)
- 4) MSFN recording of EVA-LM-MSFN conference voice. (M)

C. EMU LUNAR SURFACE OPERATIONS

Background and Justification

This objective is essential on the mission since the success of the lunar surface operations is dependent on the capability of the extra-vehicular mobility unit to provide the astronauts a habitable environment.

Previous space suits have been designed to act primarily as a backup to the spacecraft cabin pressurization system. Should the cabin become decompressed, the space suit protects the astronaut during reentry. A space suit which will permit lunar exploration must provide the crewman with a pressurized, ventilated environment and a self-contained, portable system, providing life support capabilities to accommodate the characteristics of the lunar environment. It must also provide sufficient mobility, dexterity and comfort to allow the crew to egress/ingress from the spacecraft and perform useful work on the lunar surface.

The major concern of the EMU is the heat loads that will be handled by the portable life support system (PLSS) which involve the removal of metabolic and equipment heat generated within the space suit system plus removal of thermal inputs from the lunar environment. Tests show that a man in a pressurized suit generates 500 to 1000 BTU/hr of heat at low work levels and 1500 to 2000 BTU/hr when walking and working in a moderate manner. A fully charged PLSS can assimilate an average output of 1600 BTU/hr for three hours with peak rates of 2000 BTU/hr for fifteen minutes. In addition to the heat load generated within the space suit, there are thermal inputs from the lunar environment. Although there are a number of thermal sources, the following are considered in most analyses to

present the most severe situations: direct solar, lunar emitted, lunar reflected, crater emitted and crater reflected. Of thermal energy emitted or reflected from these sources a certain amount is conducted through the garment to the man. An analysis indicates that, during the lunar day, the suit surface temperature will reach TBD°F with a corresponding thermal input into the suit of TBD BTU/hr. On the lunar night side, or in shadows, the skin temperature of the suit will stabilize at plus TBD°F with an outboard heat leak from the suit of TBD BTU/hr. The suit designated for this mission (i.e., A7L) has been designed to withstand suit surface temperatures that would be encountered on the lunar surface. The portable life support system has also been designed to handle an additional 250 BTU/hr heat leak inward and 350 BTU/hr heat leak out of the suit over and above the anticipated crewman's metabolic rate.

Reliability and performance testing of assemblies, materials and components of the EMU under extreme environment and operational conditions has been conducted; i.e., hard vacuum, extreme temperature, cycling, fatigue, etc., in order to validate suit reliability and performance.

Apollo 9 included a test objective to evaluate the EMU performance in extravehicular, zero-g earth orbit environment. Although that mission provided the only flight experience gained using the EMU as an independent life support source prior to its commitment on the lunar landing mission, it did not provide the combination of influencing elements (i.e., one sixth-g and thermal vacuum) that will be encountered on the lunar surface.

Data obtained by this objective will resolve physiological and thermal unknowns while performing lunar surface activities in sunlight and shadows. In addition, data will verify procedures, timelines and consumables predicted from analyses, ground simulations and flight tests.

Previous Flight Objectives

<u>Objective Number</u>	<u>Title</u>	<u>Mission</u>
20.35	Extravehicular Activity	Apollo 9

D. LANDING EFFECTS ON LM

Obtain data on the landing effects on the LM.

Purpose

The purpose is to assess the performance of the LM under the imposed landing conditions.

The functional test objectives are as follows:

- FTO 1) Determine the LM landing gear performance under the imposed landing conditions.
- FTO 2) Determine the effects on the LM structure and components under the imposed landing conditions.
- FTO 3) Determine the extent and probable cause of any descent engine skirt damage and skirt ground clearance after lunar landing.
- FTO 4) Determine the effects on the LM structure and components caused by RCS plume impingement during lunar landing.

Test Conditions

- FTO 1) The LM will land on the lunar surface. Lunar surface operations
- FTO 2) will include obtaining data by crew observations and photographs.
- FTO 3)
- FTO 4)

Success Criteria

- FTO 1) Sufficient data shall be obtained to determine the LM landing gear performance under the imposed landing conditions.
- FTO 2) Sufficient data shall be obtained to determine the effects on the LM structure and components caused by landing loads and by interaction of the DPS plume with the lunar surface.
- FTO 3) Sufficient data shall be obtained to determine the descent engine skirt ground clearance after lunar landing and the extent and probable cause of any skirt damage.
- FTO 4) Sufficient data shall be obtained to determine the effects on the LM structure and components caused by RCS plume impingement during lunar landing.

Evaluation

- FTO 1) Landing gear stroking will be determined. (Astronaut records and photographs)

Landing gear stroking will be correlated with any LM structural damage, lunar surface slope, crew reaction and LM touchdown conditions. Foot pad-soil interaction will be determined from photographs. The touchdown conditions will be determined from lunar approach trajectory data, descent engine and RCS thrust and vehicle inertia properties. Surface slope will be determined by observations and LM attitude referenced to landing gear stroking and foot pad penetration. (Astronaut records; photographs; LM mass, center of gravity and mass moment of inertia; GG 0001 X, GG 2112 V, GG 2113V, GG 2142 V, GG 2143 V, GG 2172 V, GG 2173 V, GH 1313 V, GH 1314 V, GH 1418 V through GH 1433 V, GH 1461 V through GH 1463 V, GQ 6510 P and GQ 6806 H)

- FTO 2) The existence of any LM structure and component damage caused by landing loads and the interaction of the DPS plume with the lunar surface will be determined through observations and photographs. (Astronaut records and photographs)

The telemetry data will be used to correlate LM attitude, trajectory data and DPS engine operation with the effects of plume impingement. (GG 0001 X, GG 2122 V, GG 2113 V, GG 2142 V, GG 2143 V, GG 2172 V, GG 2173 V, GH 1313 V, GH 1314 V, GH 1461 V, GH 1462 V, GH 1463 V, GQ 6510 P and GQ 6806 H)

- FTO 3) Final descent engine skirt ground clearance will be determined. (Astronaut records and photographs) The extent and probable cause during landing will be determined. (Astronaut records, photographs, GQ 6510 P and GQ 6806 H)

- FTO 4) The effects of RCS plume impingement will be determined. (Astronaut records and photographs)

RCS plume effects will be correlated with RCS use during landing.

Data Requirements

1) Telemetry Measurements:

<u>Measurement Number</u>	<u>Description</u>	<u>TM</u>	<u>Mode</u>	<u>Priority</u>
GG 0001 X	PGNS Downlink Data (To TM)	PCM	1	M
GG 2112 V	Volt, IG 1X Res Output, Sin	PCM	2*	M
GG 2113 V	Volt, IG 1X Res Output, Cos	PCM	2*	M
GG 2142 V	Volt, MG 1X Res Output, Sin	PCM	2*	M
GG 2143 V	Volt, MG 1X Res Output, Cos	PCM	2*	M
GG 2172 V	Volt, OG 1X Res Output, Sin	PCM	2*	M
GG 2173 V	Volt, OG 1X Res Output, Cos	PCM	2*	M
GH 1313 V	Volt, Pitch GDA Position (Ret/Ext)	PCM	2	M
GH 1314 V	Volt, Roll GDA Position (Ext/Ret)	PCM	2	M
GH 1418 V	Volt, Jet No. 4U Driver Output, 28V	PCM	1	HD
GH 1419 V	Volt, Jet No. 4D Driver Output, 28V	PCM	1	HD
GH 1420 V	Volt, Jet No. 4F Driver Output, 28V	PCM	1	HD
GH 1421 V	Volt, Jet No. 4S Driver Output, 28V	PCM	1	HD
GH 1422 V	Volt, Jet No. 3U Driver Output, 28V	PCM	1	HD
GH 1423 V	Volt, Jet No. 3D Driver Output, 28V	PCM	1	HD
GH 1424 V	Volt, Jet No. 3F Driver Output, 28V	PCM	1	HD
GH 1425 V	Volt, Jet No. 3S Driver Output, 28V	PCM	1	HD
GH 1426 V	Volt, Jet No. 2U Driver Output, 28V	PCM	1	HD
GH 1427 V	Volt, Jet No. 2D Driver Output, 28V	PCM	1	HD
GH 1428 V	Volt, Jet No. 2F Driver Output, 28V	PCM	1	HD
GH 1429 V	Volt, Jet No. 2S Driver Output, 28V	PCM	1	HD
GH 1430 V	Volt, Jet No. 1U Driver Output, 28V	PCM	1	HD
GH 1431 V	Volt, Jet No. 1D Driver Output, 28V	PCM	1	HD
GH 1432 V	Volt, Jet No. 1F Driver Output, 28V	PCM	1	HD
GH 1433 V	Volt, Jet No. 1S Driver Output, 28V	PCM	1	HD
GH 1461 V	Volt, Yaw RG Signal (18 KC)	PCM	2	M
GH 1462 V	Volt, Pitch RG Signal (.8 KC)	PCM	2	M
GH 1463 V	Volt, Roll RG Signal (18 KC)	PCM	2	M
GQ 6510 P	Press, Thrust Chamber	PCM	2	M**
GQ 6806 H	Position, Variable Inj Actuator	PCM	2	M**

*Required in high bit rate format.

**One measurement is mandatory, the other is highly desirable.

Telemetry measurements GH 1418 V through GH 1433 V are desired during the entire landing operation. The remaining measurements are required only for the period immediately prior to touchdown until the LM comes to rest.

- 2) Astronaut Logs or Voice Records: (M)
 - a) Comments on any lunar dust observed during the final approach, the severity of the landing and vehicle stability after touchdown.
 - b) Comments on any LM surface or component damage to include any visible discoloration or lunar soil accumulation.
 - c) Comments on observations of slope and roughness of the landing terrain.
 - d) Comments describing any descent engine skirt damage and an estimate of any skirt ground clearance.
 - e) If for any reason the landing gear strut assembly photographs cannot be obtained, an estimate of the amount of stroking of each primary and secondary strut assembly will be made.
 - f) Comments on LM foot pad-lunar soil interactions to include estimates of the amount of penetration, soil displacement and foot pad skidding, if any.

- 3) Photographs:
 - a) Photographs of the landing gear to show the stroking of the primary and secondary strut assemblies. One photograph is required for each of the eight secondary strut assemblies and the adjoining primary strut assembly. (The line of sight from the camera should be approximately perpendicular to the plane containing the strut assembly.) Each field of view should be as small as possible but should include all of the secondary strut assembly and all of the primary strut assembly at and below the attachment of the secondary assembly. In addition, these members must be photographed prior to the mission. (M)
 - b) Photographs of the LM exterior showing any structural damage. (M)
 - c) Photographs of each landing gear assembly along the Z axis and the Y axis. (HD)
 - d) Photographs of the descent engine skirt. (HD)
 - e) Photographs of the LM base heat shield before earth launch and after lunar landing. (HD)

- f) Photographs of the LM exterior before earth launch and after lunar landing (i.e., structure, antenna, RCS jets, windows and foot pads). (HD)
 - g) Photographs of the soil accumulation, if any, on the LM. (HD)
 - h) Photographs of each LM foot pad and surrounding lunar soil exhibiting evidence of LM foot pad-lunar soil interaction. (HD)
- 4) LM mass, center of gravity and mass moment of inertias at touchdown as determined from preflight measurement and consumable usage. (M)

D. LANDING EFFECTS ON LM

Background and Justification

The data gathered in support of this objective, together with LM landing dynamic analyses and ground tests results, will allow assessment of the LM lunar landing performance.

Landing dynamic analyses have been conducted and are reported in GAEC report LED-520-17, "Landing Dynamics of Lunar Module (Performance Characteristics)", 15 June 1967. A ground drop test program of one-sixth scale LM model has been conducted and is discussed in GAEC report LED-520-12, "Landing Dynamics of the Lunar Excursion Module (1/6 Scale Model 3 Test Analysis Correlation)", 16 May 1966. Full-scale landing gear assembly tests are reported in GAEC report LTR-904-14009, "Results of the LM 167 Inch Semi-Tread (10-7-4) Landing Gear Assembly Drop Test Program", 12 October 1967. DPS nozzle skirt crushing tests are being accomplished at GAEC in accordance with LM test plan document LTP 901-12001, "Plan for Fire until Touchdown of LM Descent Engine", 5 December 1968.

Pressures and temperatures imposed by the engine plume may adversely affect the base heat shield structure and may cause adverse lunar surface erosion. Surface fragments could cause damage to the LM shielding and cabin pressure shell and dust may obscure astronaut visibility during landing.

Apollo 9 included an objective covering the LM landing gear deployment and thermal effects of the DPS operation on the deployed landing gear. The data are currently being evaluated.

Previous Flight Objectives

<u>Objective Number</u>	<u>Title</u>	<u>Mission</u>
17.9	Landing Gear Deployment/Thermal	9

E. LUNAR SURFACE CHARACTERISTICS

Obtain data on the characteristics and mechanical behavior of the lunar surface.

Purpose

The purpose is to determine the mechanical properties of the lunar surface material and the effects of the LM landing on the lunar surface.

The functional test objectives are as follows:

- FTO 1) Obtain data on the mechanical behavior and terrain characteristics of the lunar surface.
- FTO 2) Determine the lunar soil erosion caused by DPS plume impingement.
- FTO 3) Obtain data on the effect, if any, of DPS venting on the lunar surface.

Test Conditions

- FTO 1) The LM will land on the lunar surface. Lunar surface operations
- FTO 2) will include obtaining returned lunar samples, a record of
- FTO 3) crew observations and photographs.

Success Criteria

- FTO 1) Data shall be obtained on the mechanical behavior and terrain characteristics of the lunar surface including LM foot pad-lunar soil interactions, lunar surface texture, consistency, compressibility, cohesiveness, adhesiveness, density and color.
- FTO 2) Sufficient data shall be obtained to determine lunar soil erosion caused by DPS plume impingement.
- FTO 3) Data shall be obtained to determine what effect, if any, DPS venting had on the lunar surface.

Evaluation

- FTO 1) The mechanical behavior and terrain characteristics of the lunar surface will be assessed through analyses of the LM foot pad-lunar soil interactions, soil mechanics data obtained during

Eva and from studies of the returned lunar surface samples. The Investigator Team will observe the behavior of the soil samples returned to earth in the LRL. The team will debrief the astronauts using questions based on the results of examination of the returned data. (Astronaut records, photographs, video tapes and soil mechanics data)

FTO 2) Lunar soil erosion will be determined. (Astronaut records, photographs and soil mechanics data)

The effects of plume impingement will be correlated with LM attitude and DPS engine operation for the landing phase. (Astronaut records, photographs, GG 0001 X, GG 2112 V, GG 2113 V, GG 2142 V, GG 2143 V, GG 2172 V, GG 2173 V, GH 1313 V, GH 1314 V, GH 1461 V through GH 1463 V, GQ 6510 P and GQ 6806 H)

FTO 3) The effects, if any, of DPS venting will be assessed and correlated with the helium tank pressure, and the pressure, temperature and volume of the ullage gases in the propellant tanks. (Astronaut records, photographs, GQ 3435 P, GQ 3603 Q, GQ 3604 Q, GQ 3611 P, GQ 3718 T, GQ 3719 T GQ 4103 Q, GQ 4104 Q, GQ 4111 P, GQ 4218 T and GQ 4219 T)

Data Requirements

1) Telemetry Measurements:

<u>Measurement Number</u>	<u>Description</u>	<u>TM</u>	<u>Mode</u>	<u>Priority</u>
GG 0001 X	PGNS Down Link Data (To TM)	PCM	1	HD
GG 2112 V	Volt, IG 1X Res Output, Sin	PCM	2	HD
GG 2113 V	Volt, IG 1X Res Output, Cos	PCM	2	HD
GG 2142 V	Volt, MG 1X Res Output, Sin	PCM	2	HD
GG 2143 V	Volt, MG 1X Res Output, Cos	PCM	2	HD
GG 2172 V	Volt, OG 1X Res Output, Sin	PCM	2	HD
GG 2173 V	Volt, OG 1X Res Output, Cos	PCM	2	HD
GH 1313 V	Volt, Pitch GDA Position (Ret/Ext)	PCM	2	HD
GH 1314 V	Volt, Roll GDA Position (Ext/Ret)	PCM	2	HD
GH 1461 V	Volt, Yaw RG Signal (.8 KC)	PCM	2	HD
GH 1462 V	Volt, Pitch RG Signal (.8 KC)	PCM	2	HD
GH 1463 V	Volt, Roll RG Signal (.8 KC)	PCM	2	HD
GQ 3435 P	Press, Super/Crit He Supply Tank	PCM	2	HD
GQ 3603 Q	Quantity, Fuel Tank No. 1	PCM	2	HD
GQ 3604 Q	Quantity, Fuel Tank No. 2	PCM	2	HD
GQ 3611 P	Press, Engine Interface Fuel	PCM	2	HD
GQ 3718 T	Temp, Fuel Tank No. 1 Fuel Bulk	PCM	1	HD
GQ 3719 T	Temp, Fuel Tank No. 2 Fuel Bulk	PCM	1	HD
GQ 4103 Q	Quantity, Ox Tank No. 1	PCM	2	HD
GQ 4104 Q	Quantity, Ox Tank No. 2	PCM	2	HD

<u>Measurement Number</u>	<u>Description</u>	<u>TM</u>	<u>Mode</u>	<u>Priority</u>
GQ 4111 P	Press, Engine Interface Ox	PCM	2	HD
GQ 4218 T	Temp, Ox Tank No. 1 Ox Bulk	PCM	2	HD
GQ 4219 T	Temp, Ox Tank No. 2 Ox Bulk	PCM	2	HD
GQ 6510 P	Press, Thrust Chanber	PCM	2	HD
GQ 6806 H	Position, Variable Inj Actuator	PCM	2	HD

Telemetry data are desired immediately prior to touchdown through the zeroing of the attitude measurements. Data are also desired during the period of DPS venting.

2) Astronaut Logs or Voice Records:

- a) Comments on LM foot pad-lunar soil interactions to include estimates of the amount of penetration, soil displacement and foot pad skidding, if any. (M)
- b) Comments describing the interaction between astronaut boots and lunar surface while walking. (M)
- c) Comments on slope and roughness characteristics of the landing terrain to include descriptions of craters, depressions, embankments or other obstacles. The comments are to be made relative to the differences between the actual terrain characteristics and those characteristics expected as a result of crew training. The comments are also to include estimates of the ease of foot traverses on the lunar surface and traverses by use of various types of vehicles. (M)
- d) Comments on the color and texture of both undisturbed and mechanically disturbed areas of the lunar surface. (M)
- e) Comments on lunar soil conditions adjacent to DPS vents to include any discoloration. (M)
- f) Comments describing the lunar surface penetration by the Solar Wind Composition staff and core sample tool under their own weight and the estimated force necessary to push them into the soil. (Mandatory for either the staff or the sample tool; highly desirable for the remaining item)
- g) Comments on lunar soil erosion as caused by the DPS plume impingement during landing. (M)
- h) Record that the vent valves were opened as indicated by the following: (M)
 - GQ 3500 X Fuel Vent, Sol Valve Open; from Flag No 5 on Panel No 8.
 - GQ 4000 X Oxid Vent, Sol Valve Open; from Flag No 6 on Panel No 8.

- i) Comments on soil behavior (i.e., texture, consistency and adhesiveness) during collection of samples defined in Bulk Sample Collection objective. (M)
 - j) Comments on soil behavior (i.e., texture, consistency and adhesiveness) during collection of samples defined in Documented Sample Collection objective. (HD)
 - k) Estimate of volume of fine grained fragmental material placed in at least one of the pre-numbered bags defined in the Documented Sample Collection objective. (HD)
- 3) Photographs:
- a) Photographs of the lunar surface showing DPS plume impingement erosive effects. (M)
 - b) Photographs of each LM foot pad and surrounding lunar soil exhibiting evidence of LM foot pad-lunar soil interaction. (M)
 - c) Photographs of the lunar surface adjacent to DPS vents if soil discoloration is observed. (M)
 - d) Photographs of an astronaut foot print showing interaction between astronaut boots and lunar surface. (M)
 - e) Photographs of the Solar Wind Composition Experiment staff and core sampling tool after being inserted to their maximum depth as penetrometers. (HD)
 - f) Photographs of natural slopes, crater walls and embankments in the vicinity of the landing site. (M)
 - g) Photographs from the CSM of the lunar surface surrounding the LM showing possible interaction of the DPS and lunar surface. (HD)
 - h) Photograph of a representative depression caused by use of the scoop in collecting fine grained fragmental material for the Bulk Sample Collection or Documented Sample Collection objectives. (M)
- 4) Soil mechanics data as derived from the returned contingency, bulk and documented samples. (HD)

E. LUNAR SURFACE CHARACTERISTICS

Background and Justification

Data on the LM interaction and the astronaut interaction with the lunar soil will aid greatly in defining the behavior of the lunar surface at the landing site. The results of each facet of this objective have been predicted in advance, based on the information from the Lunar Orbiter and Surveyor series. Thus this investigation is a necessary test of the present prediction techniques.

The lunar surface soil mechanics investigation will provide data needed for planning future lunar surface missions. It will also aid in gaining a better scientific understanding of the nature and mode of deposition of the materials and the mechanisms and processes active in producing the present morphology and consistency of the lunar surface.

Anticipated lunar soil erosion resulting from LM DPS impingement on the lunar surface is presented in TRW Report 05952-H210-00, "An Investigation of Soil Erosion During the LM Lunar Landing", May 1968 and TRW Report 05952-H415-R0-00, "LM Soil Erosion Studies Final Report", 31 January 1968. These reports are based on various Surveyor spacecraft data and vacuum tests. They indicate that soil erosion will not begin until the LM is about 10 feet above the lunar surface and that it will not be extensive.

DPS venting is a source of lunar surface contamination and must be evaluated. The escaping gases could cause discoloration of the lunar soil in a manner which may be distinguished from the disturbance pattern caused by landing.

The data from this objective will aid greatly in defining the lunar surface consistency at the landing site. These data will not only aid in planning future lunar landings but will be vital in the development of lunar exploration techniques and equipment.

Previous Flight Objectives

<u>Objective Number</u>	<u>Title</u>	<u>Mission</u>
None		

F. BULK SAMPLE COLLECTION

Collect samples of lunar material.

Purpose

The purpose is to collect approximately 30 pounds of representative lunar material during the lunar surface EVA.

The functional test objectives are as follows:

- FTO 1) Collect individual rock samples and fine grained fragmental material.
- FTO 2) Photograph the immediate area from which the samples are collected.

Test Conditions

- FTO 1) Several samples of rock fragments with varied texture or mineralogy will be collected and the remainder of the sample collection will be completed with loose materials representative of the landing area. Approximately one-third of the 30 pounds will be fragmentary with the remaining two-thirds loose material. The container will be weighed to assure that sufficient material was gathered. Upon completion of the sample gathering, samples will be sealed in the sample return container and prepared for transfer to the LM.
- FTO 2) Photographs of the immediate sample gathering area will be obtained. The distance from the LM to the sample collection area will be as defined in the Lunar Surface Operations Plan.

Success Criteria

- FTO 1) Several samples of rock fragments and loose materials will be collected and delivered to the LRL.
- FTO 2) Photographs of the sample area will be obtained and delivered to the LRL and to the appropriate Principal Investigators.

Evaluation

- FTO 1) Postflight data evaluation will include evaluation of photographs and analysis of the samples in the LRL and by the individual Principal Investigators in their laboratories. (Astronaut records, photographs and samples)
- FTO 2)

Data Requirements

- 1) Astronaut Logs or Voice Records: (M)
 - a) Location of area in relation to the LM where samples were obtained.
 - b) Lunar surface observations.
- 2) Photographs: (M)

Photographs of lunar surface sample areas.
- 3) Lunar Surface Samples: (M)
 - a) Samples of rock fragments with varied texture or mineralogy.
 - b) Samples of loose material representative of the landing site.

F. BULK SAMPLE COLLECTION

Background and Justification

Samples collected during the lunar surface traverses of the Documented Sample Collection will be documented with photographs and verbal descriptions. Sample collecting and cataloging for the Documented Sample Collection will require considerable time and may not be completed. The lunar material samples, therefore, should be collected early in the EVA period to assure the return of a considerable sample of material in any contingency situation.

Previous Flight Objectives

<u>Objective Number</u>	<u>Title</u>	<u>Mission</u>
None		

G. LANDED LM LOCATION

Determine the position of the LM on the lunar surface.

Purpose

The purpose is to establish the location of the LM on the lunar surface (in both real time and post mission) in order to evaluate the various methods of determining its location, and to enhance the value of the scientific experiments and returned samples. The data collected in support of this objective will be used postflight in conjunction with on board guidance system computation of position and computation of LM position using MSFN tracking data.

The functional test objectives are as follows:

- F¹TO 1) Using data obtained by the LM crewmen during descent and lunar surface stay, determine the location of the landed LM for post mission analysis.
- F¹TO 2) Using data obtained by the CSM crewman, determine the location of the landed LM for post mission analysis.
- F¹TO 3) Using data from both the LM and CSM crew and from MSFN, determine the capability of locating the landed LM in real time.

Test Conditions

- F¹TO 1) During descent the crew will observe the lunar surface and verbally annotate location and identity of features. After landing the LM crew will visually observe lunar surface features surrounding the landing site, correlate these features with photomaps and mark the location of the landed LM with respect to them.

Photographs will be taken through the LM window during descent and after touchdown for the purpose of correlating the landing site location with prominent terrain features. In addition, photographs will be taken for the same purpose during EVA. All photographs will be accomplished as defined by the Photographic and Television Operations Plan.

At least two sets of LM IMU alignments will be conducted in accordance with procedure "PGNCS Lunar Surface Align Program (P57)" of LM Apollo Operations Handbook LMA790-3-IM5.

The CSM will be tracked during at least one pass by the RR in accordance with procedure "Lunar Surface Navigation Program (P22)" of LM Apollo Operations Handbook LMA790-3-IM5.

It is highly desirable that TV coverage of prominent terrain features be provided from the lunar surface.

- F'TO 2) An attempt will be made to track the landed LM from the CSM during at least two orbital passes in accordance with procedure "Orbital Navigation (P22)" of CSM Apollo Operations Handbook SM2A-03-SC107-(2). In addition, it is highly desirable that one mark be obtained on a landmark near the landed LM during each of the above tracking periods.

If the landed LM cannot be discerned from the CSM, then some known landmark in the vicinity of the assumed landing site will be tracked using the same procedure described above.

An attempt will be made to obtain photographs of the landed LM (or its shadow) and surrounding lunar features. The data should include a sequence of 70mm photographs that will provide the best possible resolution as defined by the Photographic Operations Plan. This sequence should consist of approximately five photographs taken with the camera optical axis aligned with the spacecraft X axis, and with the camera bracket mounted, and cycling from the intervalometer. The CM pilot should sight on the assumed landing area through the COAS and rotate the spacecraft so that the X axis remains pointed at the same surface area. This sequence should be initiated one minute prior to closest approach to the landing area and stopped 30 seconds after passing over the site. This can be carried out during the lunar stay period or after rendezvous with the LM.

- F'TO 3) An attempt will be made to determine the landed LM location in real time by obtaining LM crew comments on terrain features during descent, crew descriptions of surface features after landing, TV from the lunar surface, MSFN tracking data, rendezvous radar data, CM crewman observations of the landed LM, inertial system state vector data and LM IMU alignment data using gravity vector and AOT star observations.

Success Criteria

- FTO 1) Sufficient data shall be obtained to permit a postflight
FTO 2) determination of the location of the landed LM from each of the independent data sources; i.e., visual observations, IMU alignment data, RR data, CSM optical tracking data, MSFN tracking data and inertial system state vector data.
- FTO 3) The capability of locating the LM in real time shall be determined.

Evaluation

- FTO 1) The relative location of the landed LM (with respect to lunar surface features) as indicated on the crew's photomaps will be compared to that indicated by photographs and TV. It will also be compared to the location computed from data obtained during optical tracking of the LM by the CSM; i.e., the offset mark. (Astronaut records, photographs, TV and CG 0001 V)

The location of the landed LM (latitude and longitude) will be computed from data obtained during conduct of sequential LM IMU alignments and compared to that computed from MSFN tracking data, RR tracking data, CSM optical tracking data and inertial system state vector data. (MSFN tracking data, BET, CG 0001 V and GG 0001 X)

The location of the landed LM (latitude, longitude and altitude) will be computed from data obtained during tracking of the CSM by the RR and compared to that computed from MSFN tracking data, IMU alignment data, CSM optical tracking data and inertial system state vector data. (MSFN tracking data, IMU alignment data, BET, CG 0001 V and GG 0001 X)

The location of the landed LM (latitude, longitude and altitude) as measured by the onboard inertial system will be compared to that computed from MSFN tracking data, IMU alignment data, CSM optical tracking data and RR tracking data. (MSFN tracking data, IMU alignment data, BET, CG 0001 V and GG 0001 X)

- FTO 2) The location of the landed LM (latitude, longitude and altitude) will be computed from data obtained during tracking of the LM by the CSM optics and compared to that computed from MSFN tracking data, IMU alignment data and inertial system state vector data. (MSFN tracking data, IMU alignment data, BET, CG 0001 V and GG 0001 X)

- FTO 3) The location of the LM determined in real time will be compared with the locations from other independent sources postflight. This technique of locating the LM in real time will be evaluated as to the accuracy of position and the usefulness of determining the position in real time. The accuracy of the real time determination of the LM location will be evaluated as to its usefulness for increasing future mission scientific and technological data return. (Astronaut records, MSFN tracking data, TV from the lunar surface and GG 0001 X)

Data Requirements

1) Telemetry Measurements:

<u>Measurement Number</u>	<u>Description</u>	<u>TM</u>	<u>Mode</u>	<u>Priority</u>
CG 0001 V	Computer Digital Data 40 Bits	PCMD+	2	M
GG 0001 X	PGNS Down Link Data (To TM)	PCM	1	M

2) Astronaut Logs or Voice Records:

- a) Lunar photomaps containing crew's estimate of the location of the landed LM. (M)
- b) Comments by LM crew regarding any difficulties encountered in estimating the location of the LM with respect to lunar surface features (visibility problems, range perception problems, etc.). (HD)
- c) Comments by CM crewman on location of landed LM with respect to prominent terrain features. (M)
- d) Voice track regarding observations of surface features during the descent phase. (M)

3) Trajectory Data: (M)

- a) Best estimate of trajectory (BET) of the CSM during the lunar surface phase.
- b) Best estimate of trajectory (BET) of the LM from DOI through touchdown.
- c) MSFN tracking data of the LM from acquisition of signal through touchdown.

4) IMU Data: (HD)

Accumulated calibration data of the LM IMU.

5) Photographs:

- a) Photographs of the landing site and surrounding lunar surface features taken through a LM window during descent. (M)
- b) Photographs of the landing area obtained during previous lunar missions. (HD)
- c) High resolution photographs of the landing area taken from the CSM. (M)
- d) Photographs of the landing site and surrounding lunar surface features taken through a LM window after landing. (M)
- e) Photographs of the landing site and surrounding lunar surface features taken during EVA. (M)

6) Television: (M)

TV of lunar surface as viewed from the LM

G. LANDED LM LOCATION

Background and Justification

During the conduct of lunar explorations, scientific experiments will be emplaced on, and soil samples will be collected from the lunar surface. The value of these samples will, in many cases, be dependent on how well their position with respect to specific terrain features is known. The location of the landed LM should be made with respect to local lunar surface features and determined in both selenographic and selenocentric coordinate systems.

It should be noted that a determination of the location of the landed LM will be made during the simulated countdown following touchdown on the lunar surface. Various sources of data will be used including onboard guidance, MSFN tracking and crew observations. This determination will be an essential part of the nominal mission because it will provide information necessary for supporting rendezvous.

The information on LM location required to support the determination for rendezvous is of a different nature compared to the information necessary to provide a detailed knowledge for post mission geological sample assessment, or for that required to allow real time scientific support in future missions. In addition, it is desired that supplementary data be obtained (over and above the minimum required to support rendezvous) in order to provide a more thorough post mission evaluation of the various methods used in determining the LM location. It is for these reasons, then, that this Detailed Objective is written and why it appears in its present position on the priority list.

Previous Flight Objectives

<u>Objective Number</u>	<u>Title</u>	<u>Mission</u>
None		

H. LUNAR ENVIRONMENT VISIBILITY

Obtain data on the effects of illumination and contrast conditions on crew visual perception.

Purpose

The purposes are to determine the adequacy of flight crew visibility provisions for this mission, to assess visibility limitations for subsequent lunar missions and to investigate specific visibility phenomena (e.g., color and contrast perception) in the lunar environment.

The functional test objectives are as follows:

- FTO 1) Obtain data on the effectiveness of visual landing aids and on the visibility of the lunar surface during the final approach and landing phases of the LM descent.
- FTO 2) Obtain data on the LM crew's ability to perform visual tasks while on the lunar surface.

Test Conditions

- FTO 1) During the final approach and landing phases, the LM crew will comment on the landing site visibility, including extent of washout and visibility of landing site landmarks. Photographs will be taken through the LM pilot's window by the data acquisition camera (fixed to the LM) throughout the above phases, using film with a densitometer strip. Comments will be made on the effectiveness of the Landing Point Designator and on the crew's ability to correlate terrain features seen during descent to the maps and photographs used during training.

The crew will comment on any visual phenomena during LM landing which are significantly different from expectations as a result of their training. Photographs of the phenomena will be taken whenever possible.

- FTO 2) While on the lunar surface, a LM crewman will view and take still photographs of the terrain at various azimuths with respect to the sun to include 0 degrees, 90 degrees and 180 degrees, and comment on his ability to see terrain features

in these areas. An estimate will be made of the distance to prominent terrain features within the field of view of the above photographs. The crew will comment on the visibility related aspects of performing the postlanding LM exterior inspection, deploying the scientific experiments, collecting samples and traversing the lunar surface. The crew will comment on the ability to detect contrast in shadows. The crew will also comment on any differences noted in color perception under lunar lighting conditions during EVA as compared to color perception on the earth.

The crew will comment on any visual phenomena during lunar stay which are significantly different from their expectations as a result of their training. Photographs of the phenomena will be taken whenever possible.

Success Criteria

- FTO 1) The LM crew's comments and the data acquisition camera photographs during lunar landing will be obtained.
- FTO 2) The crew's comments on the visibility of the lunar terrain as a function of the sun/viewing angle and on their ability to perform visual tasks will be obtained. Still photographs will be obtained of the terrain at various azimuths with respect to the sun to include 0 degrees, 90 degrees and 180 degrees.

Evaluation

- FTO 1) The LM crew comments, data acquisition camera photographs, and LM attitude and position history during the final approach and landing phases will be time-correlated. These data, with the camera angle and the sun elevation angle, will be used to determine the landing site appearance versus time for known viewing and illumination angles. In this manner the visibility limitations for subsequent lunar landing missions will be assessed. It will also be determined that the related crew visibility requirements were met. Crew comments on any significant unexpected visual phenomena will be used to refine simulations and other crew training. (Astronaut records, photographs, BET of LM and GG 0001 X)
- FTO 2) Photographs of the lunar terrain and crew comments on terrain visibility and on their ability to perform visual tasks while on the lunar surface will be assessed. Crew estimates of distance to identifiable terrain features will be compared to

photomaps to assess the crew's ability to estimate distance under the imposed conditions. Crew comments on any significant unexpected visual phenomena will be used to refine simulations and other crew training. (Astronaut records, photographs and landed LM position data)

Data Requirements

1) Telemetry Measurements:

<u>Measurement Number</u>	<u>Description</u>	<u>TM</u>	<u>Mode</u>	<u>Priority</u>
GG 0001 X	PGNS Downlink Data (To TM)	PCM	1	M

2) Astronaut Logs or Voice Records:

- a) LM crew comments on landing site visibility during final approach and landing phases and on effectiveness of the Landing Point Designator and landing site recognition aids. (M)
- b) GET at start of data acquisition camera photographs during LM final approach. (M)
- c) LM crew comments on the visibility of the lunar terrain as a function of the sun/viewing angle and on their ability to perform visual tasks while on the lunar surface. (M)
- d) LM crew comments on their color and contrast perception. (M)
- e) LM crew comments on any significant unexpected visual phenomena. (M)
- f) LM crew estimate of distance to at least one prominent terrain feature within the field of view of the photographs in Data Requirements item 3) b). (HD)

3) Photographs:

- a) Data acquisition camera photographs of the landing site from high gate to touchdown. (M)
- b) Still photographs of the lunar terrain at various sun azimuths to include 0 degrees, 90 degrees and 180 degrees. (M)
- c) Photographs of any unexpected visual phenomena. (HD)

4) Trajectory Data: (M)

Best estimate of trajectory (BET) of LM during the final approach and landing phases.

5) LM position on lunar surface as determined by objective Landed LM Location. (HD)

H. LUNAR ENVIRONMENT VISIBILITY

Background and Justification

Data were obtained during Apollo 8 on the visibility of the lunar surface from the CSM while in lunar orbit. Photographs and television coverage were provided during the translunar, lunar orbit and transearth phases for operational and scientific purposes. In addition, the ability to perform lunar landmark tracking in lunar orbit was accomplished.

Apollo Mission F will provide additional data on visibility of the lunar surface from the CSM and LM in lunar orbit. Vehicle-to-vehicle visibility data will also be obtained as the LM descends to and ascends from an altitude of approximately 50,000 feet.

Apollo Mission G will demonstrate the adequacy of the procedures and hardware developed to fulfill the visibility requirements for altitudes below 50,000 feet, including LM landing and lunar stay. These visibility requirements have influenced the choice of sun elevation and LM azimuth during the final approach phase. They are reflected in the design of the Landing Point Designator and in the choice of landing site recognition aids.

Visual observations on the surface can answer many questions concerning the effect of sun angle and viewing direction on visibility. The ability to observe contrast in the lunar shadow is a significant factor for future missions in performing surface traverses, for operating equipment on the surface, for collecting geological samples and for operating in shadowed areas. Visibility at the zero phase point is

significant for many aspects of mission planning, including LM descent and use of advanced mission mobility aids such as Lunar Flyer and Rover. Color perception on the lunar surface can also affect geological identification and exploration and may affect equipment design and/or operating procedures for subsequent missions.

The ability to accomplish extended exploration on subsequent missions will be affected by the accuracy of the estimated distance to lunar surface features of interest. It is expected that crew estimates of distance on the lunar surface will be difficult because of illumination conditions and unfamiliarity with the environment. Studies to date show a decided tendency to underestimate distance under these conditions. It is important to know if these errors will exist and to obtain an estimate of the magnitude of these errors.

Previous Flight Objectives

<u>Objective Number</u>	<u>Title</u>	<u>Mission</u>
20.111	Lunar Landmark Tracking	8
20.115	Lunar Mission Photography From the CSM	8
20.86	Lunar Orbit Visibility	F
20.91	Lunar Landing Site Determination	F
20.121	Lunar Orbit Determination	F

I. ASSESSMENT OF CONTAMINATION BY LUNAR MATERIAL

Demonstrate procedures and hardware used to prevent contamination of the earth's biosphere.

Purpose

The purposes are to determine the adequacy of the measures taken to prevent back contamination of the earth's biosphere and to minimize contamination of the crew and spacecraft.

The functional test objectives are as follows:

- FTO 1) Prevent contamination of the earth's biosphere by lunar or lunar exposed material.
- FTO 2) Minimize crew and CM contamination by lunar or lunar exposed material.
- FTO 3) Collect a sample of lunar surface material for quarantine testing and exobiological investigations.

Test Conditions

- FTO 1) The procedures used will be in accordance with the Lunar
- FTO 2) Surface Operations Plan, the EVA Procedures document, pro-
- FTO 3) cedures TBD of the CSM and LM Apollo Operations Handbooks, and quarantine procedures established by the Manned Spacecraft Center's Director of Medical Research and Operations. The above procedures will include all contamination related operations from the initial astronaut egress to the lunar surface until the postflight crew and CM quarantine is completed.
- FTO 3) A sample of lunar material will be collected during the extra-vehicular activities and returned to earth for use in performing quarantine and exobiological investigations. The aseptic sample or core sample collected in support of the Documented Sample Collection objective will be the most acceptable for these investigations. If neither of these samples is available, alternate choices are the geologic samples or the contingency sample (collected in support of the Documented Sample Collection, the Bulk Sample Collection or the Contingency Sample Collection objectives).

Success Criteria

- FTO 1) All mandatory data listed under Data Requirements shall be
- FTO 2) obtained. There shall be no indication of lunar material
- FTO 3) found outside the Lunar Receiving Laboratory.

Evaluation

- FTO 1) The adequacy of procedures and hardware used to quarantine and transfer the astronauts, medical personnel and CM to the Lunar Receiving Laboratory will be determined. (Ground support personnel comments)

The CM will be examined by procedures TBD to determine the existence, if any, of lunar material other than the lunar material in the sample return containers.

The astronauts will be examined by procedures TBD to determine the existence, if any, of lunar material on their clothing or body.

- FTO 2) The adequacy of the procedures and hardware used to minimize back contamination from the initial astronaut egress to the lunar surface and during all subsequent operations through crew and CM quarantine will be determined. (Astronaut records and Lunar Receiving Laboratory report)
- FTO 3) The presence of any living organisms or other substance of extraterrestrial origin which is harmful to life on earth will be determined by an exobiological investigation. (Samples obtained during EVA)

Data Requirements

- 1) Astronaut Logs or Voice Records: (M)

Crew comments on the adequacy of equipment (e.g., Biological Isolation Garment, sample return containers, Mobile Quarantine Facility and related equipment) and procedures used to prevent back contamination.
- 2) Photographs: (HD)

Still camera photographs of astronauts' boots, clothing and equipment showing adhesion of particles, if any.
- 3) The samples obtained during EVA will be delivered to the Lunar Receiving Laboratory. (M)

- 4) The CM will be delivered to the Lunar Receiving Laboratory. (M)
- 5) The Mobile Quarantine Facility containing the astronauts and medical personnel will be delivered to the Lunar Receiving Laboratory. (M)
- 6) Comments by ground support personnel on the adequacy of procedures and hardware used for retrieval, biological isolation and CM transfer to the Lunar Receiving Laboratory. (M)
- 7) Lunar Receiving Laboratory report on the existence, if any, of contamination of the crew or CM by lunar or lunar exposed material. (M)

I. ASSESSMENT OF CONTAMINATION BY LUNAR MATERIAL

Background and Justification

"Federal laws require that all precautionary steps be taken to prevent the introduction of pathogens that are harmful or destructive to human, animal or plant life. The regulatory responsibility for the execution of these laws has been placed with the Public Health Service of the Department of Health, Education and Welfare; the Department of Agriculture; and the Department of Interior. Because of the possibility of the introduction of such pathogens into the biosphere as a result of the manned lunar landing missions, MSC has the responsibility of taking all necessary precautions as required by these agencies to prevent such back-contamination."¹

In complying with the above cited reference, stringent requirements and procedures must be implemented for handling the payload of lunar material returned to the earth's biosphere by the Apollo spacecraft. These requirements are necessary both to insure integrity of the lunar material sample for valid exobiological investigations, and to provide against the possible danger of back contamination of the earth by the introduction of extraterrestrial organisms.

¹MSC Management Instruction, Assignment of Responsibility for the Prevention of Contamination of the Biosphere by Extraterrestrial Life, MSC: 8030.1, dated 9 January 1967.

Exobiological investigations of lunar surface samples will include a search for living organism and will involve the investigation of all stages in the evolutionary development of life on the lunar surface, with special interest in those phases before creation of life (Prebiotic phase).

Delivery of an optimum sample for exobiological investigation would require that procedures be implemented to aseptically retrieve a sample which was not contaminated by the descent engine exhaust plume and provide protection from contamination during the return trip. Since the astronaut cannot determine if a sample is contaminated or not, the sample collection should be planned so as to minimize the probability. This requires that the proper tools be provided and that the sample be collected at the greatest possible distance from the LM.

The results of this exploration of the lunar surface may prove the previous existence of life on the lunar surface in that it may carry the residue of previously living forms or possibly material that is in the nature of precursors to life. Also, it may clarify the questions concerning the existence and nature of extraterrestrial life. If the lunar surface bears any form of life, it will probably contain microbes. Therefore, not only the integrity of the soil sample must be preserved, but also stringent quarantine requirements must be considered to avoid any hazardous effects that may result from the release and growth of any microbes during return to earth or subsequent to earth landing.

Previous Flight Objectives

<u>Objective Number</u>	<u>Title</u>	<u>Mission</u>
None		

J. DOCUMENTED SAMPLE COLLECTION

Collect documented samples of lunar material.

Purpose

The purpose is to provide a more detailed and selective variety of lunar material than will be obtained from the contingency and bulk samples. These samples will provide a better understanding of the nature and origin of the maria, and the processes which have modified the mare surfaces.

The functional test objectives are as follows:

- FTO 1) Deleted
- FTO 2) Obtain a core sample of lunar material.
- FTO 3) Examine, describe, photograph and collect lunar geologic samples for return to earth.
- FTO 4) Collect a lunar environment sample from the same area as used for the Bulk Sample Collection objective.
- FTO 5) Study and describe field relationships (such as shape, size, range, patterns of alignment or distribution) of all accessible types of lunar topographic features.

Test Conditions

- FTO 1) Deleted
- FTO 2) A core sample will be collected with a drive tube provided in the sample return container.
- FTO 3) Samples will be collected using tools stowed in the MESA and will be documented by photographs. Samples will be placed individually in pre-numbered bags and the bags placed in the sample return container.

FTO 4) A lunar environment sample representative of the lunar surface area as used for the Bulk Sample Collection objective will be sealed in a special gas analysis container and placed in the sample return container. A single rock sample is preferred.

FTO 5) Features and relationships will be described and photographed.

The position of the LM will be determined as defined by objective

FTO 2) Landed LM Location.

FTO 3)

FTO 4)

FTO 5)

Success Criteria

FTO 1) Deleted

FTO 2) A core sample will be collected and delivered to the LRL.

FTO 3) The collection of verbally and photographically documented samples, the placing of samples in the sample return container, and return of the container and film data to the LRL will be accomplished.

FTO 4) The lunar environment sample will be collected and delivered to the LRL in a gas analysis container.

FTO 5) Lunar surface features will be observed, described and photographed and the film data will be returned to the LRL.

Evaluation

FTO 2) The Principal Investigator and Investigator Team will evaluate and study the samples and data returned to earth. The investigations will be conducted in the LRL and in individual investigation laboratories. The Investigator Team will debrief the astronauts using questions based on the results of examination of the data returned. (Astronaut records, Flight Director's Post-Mission Report, lunar surface samples, photographs, video tapes, MSFN tapes and photomaps)

Data Requirements

- 1) Astronaut Logs or Voice Records: (M)
 - a) Comments and identification of samples and photographs.

- b) Records of where samples were obtained (location, depth and reason for selection).
 - c) Geologic observations of lunar surface.
- 2) Photographs: (M)
- Photographs of lunar surface sample areas and of the samples as defined in the Photographic and Television Operations Plan for this mission. (M)
- 3) Lunar surface samples: (M)
- a) Aseptic sample.
 - b) Lunar geologic samples.
 - c) Core sample.
 - d) Lunar environment sample.
- 4) Lunar surface TV; real time and video tapes. (HD)
- 5) LM position on lunar surface as determined in support of objective Landed LM Location. (M)
- 6) Astronaut debriefing data during quarantine period. (M)
- 7) MSFN recordings of all MSFN/EVA voice conferences. (M)

J. DOCUMENTED SAMPLE COLLECTION

Background and Justification

The fundamental objective of the documented soil sample collection is to provide data for use in the interpretation of the geologic history of the moon in the vicinity of the landing site. The Apollo lunar landing mission offers the first opportunity to correlate carefully collected samples with a variety of observational data on at least the upper portions of the mare basin filling, one of the two major geologic subdivisions of the moon. The nature and origin of the maria will bear directly on the history of lunar differentiation and differentiation processes. From the lunar bedrock, structure, land forms and special materials, information will be gained about the internal processes of the moon. The nature and origin of the debris layer, or regolith, and land superimposed on the maria are a record of lunar history subsequent to the formation of the maria. This later history predominantly reflects the history of the extra-lunar environment. Within and on the regolith, there will also be materials that will aid in the understanding of geologic units elsewhere on the moon and the broader aspects of lunar history.

Previous Flight Objectives

<u>Objective Number</u>	<u>Title</u>	<u>Mission</u>
None		

LUNAR SURFACE STRUCTURE PHOTOGRAPHY

Obtain close-up stereo photographs of lunar surface material.

This objective was deleted by change A, May 1, 1969.

L. TELEVISION COVERAGE

Obtain television coverage during the lunar stay period.

Purpose

The purpose is to obtain television coverage and to evaluate the utility and limitations of television during the lunar stay.

The functional test objectives are as follows:

- FTO 1) Provide TV camera coverage of an astronaut descending to the lunar surface.
- FTO 2) Provide TV camera coverage of an external view of the landed LM.
- FTO 3) Provide TV camera coverage of the lunar surface in the general vicinity of the LM.
- FTO 4) Provide TV camera panoramic coverage of distant terrain features.
- FTO 5) Provide TV camera coverage of an astronaut during lunar surface activities.

Test Conditions

- FTO 1) The MESA pallet with a pre-mounted TV camera will be released and the camera power turned on prior to the astronaut's descent to the lunar surface.
- FTO 2) The astronaut, after descending to the lunar surface, will re-
- FTO 3) move the TV camera from its mounting on the MESA and select and
- FTO 4) install the appropriate lens on the camera. Lens selection is made on the basis of the scene to be viewed and the available illumination. Two TV camera lenses are provided:
 - a) Wide angle lens for viewing close up scenes and large areas.
 - b) Lunar day lens for viewing lunar surface features and activities in the near field of view with sunlight illumination.

The TV camera will be operated by the astronaut to provide an external view of the LM, scenes showing the lunar surface in the vicinity of the LM and panoramic scenes of distant terrain features.

FTO 5) The TV camera will be deployed and hard mounted on the TV tripod in a position to view lunar surface activities. Camera power will be turned on and the TV camera left unattended while providing coverage of an astronaut on the lunar surface during the EVA period.

Success Criteria

- FTO 1) Data shall be obtained from which the utility and limitations
- FTO 2) of television coverage of lunar surface operations can be
- FTO 3) evaluated.
- FTO 4)
- FTO 5)

Evaluation

- FTO 1) Television coverage provided during the lunar surface operations
- FTO 2) will be evaluated with regard to picture quality, information
- FTO 3) content and utility of information. Influences of contributing
- FTO 4) factors such as the lens in use, illumination, frame rate,
- FTO 5) relative motion of camera, relative motion of subject, camera supply voltage, operating temperature, photometric properties of subject material, signal strength and transmission mode will also be evaluated. (Astronaut records, MSFN records, illumination estimates, GC 0302 V and GT 0993 E)

Data Requirements

1) Telemetry Measurements:

<u>Measurement Number</u>	<u>Description</u>	<u>TM</u>	<u>Mode</u>	<u>Priority</u>
GC 0302 V	Volt, System Eng's Bus	PCM	2	HD*
GT 0993 E	Power, Selected S-Band Xmtr RF Pwr	PCM	2	HD*

*During video transmission only.

2) Astronaut Logs or Voice Records:

- a) Condition of the two temperature indicator viewing ports on the TV camera after removal from the MESA and at the end of the TV operations. (M)
- b) Position of the TV camera scan rate switch at start of each TV operation. (HD)

- 3) MSFN records:
 - a) Post-scan conversion video tape of all TV coverage. (M)
 - b) Record of S-band signal strength during video transmission. (HD)
 - c) GET at beginning and end of each TV transmission. (M)
 - d) Time period, if any, when LBR TM (in lieu of HBR TM) was transmitted simultaneously with TV data. (M)
 - e) Identity of ground station(s) used to record video transmission from LM. (M)
 - f) Time period, if any, when erectable antenna was used on lunar surface to transmit TV data. (M)
- 4) Estimate of incident illumination, based on: (M)
 - a) Solar illumination as established by mission geometry.
 - b) Reflectivity and geometry of surfaces contributing to indirect illumination.
 - c) Photographs of TV scenes (postflight).

Background and Justification

Television scenes transmitted to earth from the spacecraft during the Apollo 7, 8 and 9 missions demonstrated the feasibility of using television to provide real time coverage of crew activities and views of the earth and moon during space missions.

Television coverage of lunar surface operations will provide operational documentation of astronauts' mobility on the lunar surface, deploying scientific experiments and collecting samples of lunar material. Real time support resulting from television observations of the astronauts during the EVA period will also be provided. An external view of the landed LM will provide data in real time on the status of the LM structure and the lunar surface in the LM landing area. Televised views of the visible horizon will aid in establishing the landing site in relation to significant terrain features and will be useful in locating the areas from which the lunar material samples are collected.

The television coverage of the lunar surface operations on this first lunar landing mission will provide an opportunity to evaluate the utility and limitations of existing TV equipment for use on future lunar landing missions.

Previous Flight Objectives

<u>Objective Number</u>	<u>Title</u>	<u>Mission</u>
20.10	CSM/MSFN S-Band Communications Performance	7
6.11	CSM/MSFN Communications Lunar Distance	8
20.21	LM/MSFN S-Band Communication Performance	9

M. PHOTOGRAPHIC COVERAGE

Obtain photographs during lunar landing and the lunar stay period.

Purpose

The purpose is to obtain photographs of lunar landing and of EVA operations.

The functional test objectives are as follows:

- FTO 1) Obtain photographs of the lunar surface during LM descent.
- FTO 2) Obtain photographs of the lunar surface after touchdown and prior to cabin depressurization.
- FTO 3) Obtain photographs of the landed LM, of various EVA evaluation tasks and of operations related to geologic inspection and sampling.

Test Conditions

- FTO 1) Photographs of the landing site and surrounding lunar surface features will be obtained through a LM window during lunar descent as defined in the Photographic and Television Operations Plan. These photographs may be the same photographs taken in support of objectives "Landed LM Location" and "Lunar Environment Visibility".
- FTO 2) Photographs of the lunar surface will be obtained through a LM window after lunar landing and prior to cabin depressurization as defined in the Photographic and Television Operations Plan. These photographs may be the same photographs taken in support of objective "Landed LM Location".
- FTO 3) Photographs will be obtained during EVA of the LM, of various EVA evaluation tasks and of operations related to geologic inspection and sampling as defined by the Photographic and Television Operations Plan. These photographs may be the same photographs taken in support of objectives "Lunar Surface EVA Operations", "Landing Effects on LM", "Lunar Surface Characteristics", "Bulk Sample Collection", "Landed LM Location", "Lunar Environment Visibility" and "Documented Sample Collection".

Success Criteria

- FTO 1) The photographs as defined by the Photographic and Television
- FTO 2) Operations Plan will be returned to earth and processed.
- FTO 3)

Evaluation

- FTO 1) The photographs will be studied for general scientific interest
- FTO 2) and in support of specific objectives and experiments
- FTO 3) where applicable. In addition, the photographs will be evaluated to determine the feasibility of accomplishing various lunar surface operations on subsequent missions. (Photographs)

Data Requirements

- 1) Photographs:
 - a) Photographs defined as (M) in support of objectives "Landing Effects on LM", "Lunar Surface Characteristics", "Bulk Sample Collection", "Landed LM Location", "Lunar Environment Visibility" and "Documented Sample Collection", and still or sequence camera coverage defined as (HD) in support of objective "Lunar Surface EVA Operations". (M)
 - b) All remaining photographs defined as (HD) in support of detailed objectives and experiments. (HD)
 - c) Photographs obtained by use of the close-up stereo camera of the following classes of targets: (HD)
 - (1) Undisturbed surface of fine-grained lunar soil at various distances away from the LM and at various points around the LM.
 - (2) Clumps of undisturbed, fine-grained lunar soil exhibiting some cohesion.
 - (3) Same target as item (2), but after the clump has been mechanically disturbed.
 - (4) Trench excavated by scoop with view showing trench wall.

- (5) Astronaut footprint with view showing base and sidewall of impression.
- (6) LM footpad showing contact with surface.
- (7) Material adhering to objects such as astronaut boots, hand tools or LM surfaces.
- (8) Typical undisturbed lunar rocks of as many different appearances as possible (e.g., pitted or fractured).
- (9) Small craters, possible caused by micrometeoroid impact.
- (10) Any other targets which the crew considers to be of scientific or engineering interest.

M. PHOTOGRAPHIC COVERAGE

Background and Justification

The photographs identified in the Test Conditions of this objective will provide data useful in the following manner:

Data specifically in support of other objectives and experiments on this mission.

Data of general interest to the scientific community.

Data of general interest to the public.

Data to aid in the planning of future lunar landing missions.

This objective does not require any photographs other than those taken in support of other objectives. The objective is not intended to include the entire photographic activities during the mission. It is restricted only to the mandatory photographic requirements imposed on the LM crew during descent and lunar stay. Additional photography is defined in the Photographic and Television Operations Plan.

Previous Flight Objectives

<u>Objective Number</u>	<u>Title</u>	<u>Mission</u>
None		

5.2.4 Experiments

Experiment S-031 LUNAR PASSIVE SEISMOLOGY

Deploy the Passive Seismic Experiment.

Purpose

The purpose is to deploy the Passive Seismic Experiment Package on the lunar surface to obtain geophysical data.

The functional test objective is as follows:

FTO 1) Deploy the Passive Seismic Experiment Package (PSEP) (S-031).

Test Conditions

FTO 1) The crewman will remove the experiment from the descent stage of the LM and carry it to the deployment site.

The PSEP package will be emplaced, leveled and oriented. The solar panels will then be deployed, and the antenna will be aimed at the earth.

Telemetry data from the Passive Seismic Experiment will be transmitted on an S-band carrier and received and recorded at an appropriate MSFN ground station. Telemetry data will be routed to the MCC for display and control, and the command data generated at the MCC will be transmitted to the PSEP.

The deployment area and the deployed experiment will be photographed showing the relative position and the emplacement on the lunar surface.

Success Criteria

FTO 1) Telemetry data shall be received from the Passive Seismic Experiment after activation of the experiment on the lunar surface and upon commanding the experiment ON by MSFN.

Evaluation

FTO 1) Postflight evaluation will consist of telemetry data analysis on the PSEP experiment and a determination of proper experiment operation. Tapes will be formatted in Houston for processing by the Principal Investigator. Data processing of the PSEP tapes will be accomplished by the Principal Investigator utilizing his computer systems and programs. (Astronaut records, photographs and telemetry measurements)

Data Requirements

1) Telemetry Measurements: (M)

Data requirements for the PSEP are specified in Bendix document EASEP-SE-03, "Measurements Requirements Document".

2) Astronaut Logs or Voice Records: (M)

Comments on deployment.

3) Photographs: (HD)

Photographs of deployment area with the deployed experiment.

Background and Justification

The Passive Seismic Experiment is contained in one of the two packages comprising the Early Apollo Scientific Experiments Package (EASEP).

The Passive Seismic Experiment is designed to monitor seismic activity and affords the opportunity to detect meteoroid impacts, free oscillations of the moon, and internal activity. It may also detect surface tidal deformations resulting in part from periodic variations in the strength and direction of external gravitational fields acting upon the moon.

Analysis of the velocity, frequency, amplitude and attenuation characteristics of the seismic waves should provide data on the number and character of lunar seismic events, the approximate azimuth and distance to their epicenters, the physical properties of subsurface materials and the general structure of the lunar interior.

Deploy the Laser Ranging Retro-Reflector Experiment.

Purpose

The purpose is to deploy the Laser Ranging Retro-Reflector Experiment Package on the lunar surface to provide a corner reflector for laser ranging from earth.

The functional test objective is as follows:

- FTO 1) Deploy the Laser Ranging Retro-Reflector (LRRR) Experiment (S-078).

Test Conditions

- FTO 1) The crewman will remove the experiment from the descent stage of the LM and carry it to the deployment site.

The LRRR Experiment will be emplaced, leveled, oriented and adjusted to the calibration marks corresponding to the landing site.

Success Criteria

- FTO 1) Successful ranging data shall be obtained at the earth by use of the passive corner reflector system of the LRRR on the moon.

Evaluation

- FTO 1) Ranging data obtained by use of the LRRR Experiment will be studied by the Principal Investigator and by other scientists who obtain ranging data from the LRRR. (Astronaut records, photographs and LRRR ranging data)

Data Requirements

- 1) Astronaut Logs or Voice Records: (HD)
Comments on orientation and elevation setting used for deployment.
- 2) Photographs: (HD)
Photographs of the deployment area with the deployed experiment.
- 3) LRRR ranging data received at appropriate stations. (M)

Background and Justification

The Laser Ranging Retro-Reflector Experiment is contained in one of the two packages comprising the Early Apollo Scientific Experiments Package (EASEP).

Various factors will affect laser ranging such as lunar motion, lunar librations and earth rotation.

The nature of the irregular variations in the earth's rotation, and hence its cause, may be determined from the laser ranging data. Factors affecting earth rotation such as material imperfections, ocean loading and energy interchanges between atmosphere and crust or core and mantle are not well understood and the corresponding data will be analyzed. Additionally, this study should refine the definition of lunar motion and libration.

Conduct the Solar Wind Composition Experiment.

Purpose

The purpose is to determine the elemental and isotopic composition of the noble gases and other selected elements in the solar wind by measurement of particle entrapment on an exposed aluminum foil sheet.

The functional test objective is as follows:

FTO 1) Conduct the Solar Wind Composition Experiment (S-080).

Test Conditions

FTO 1) The crewman will remove the Solar Wind Composition Experiment from the LM MESA and deploy it on the lunar surface.

The experiment will remain deployed for approximately one hour and will then be disassembled. The reel and foil will be placed in a teflon bag and stored in a sample return container for return.

Success Criteria

FTO 1) The foil sheet shall be exposed to the solar wind and delivered to the LRL.

Evaluation

FTO 1) Postflight data evaluation will include tests to analyze the particle content in the foil by means of mass spectrometers and low level counting devices. These tests will be performed at the Principal Investigator's laboratory facility. (Astronaut records, photographs of reel and foil from the experiment)

Data Requirements

1) Astronaut Logs or Voice Records: (M)

Comments on location of deployed experiment with respect to the LM, attitude of deployed foil with respect to the sun and total time foil was deployed.

2) Photographs: (HD)

Photographs of the deployed experiment.

3) Reel and foil from the Solar Wind Composition Experiment. (M)

Background and Justification

Both the particle density and energy distribution of the solar wind have been investigated in considerable detail. Little is known, however, about its elemental and isotopic composition. Results of the investigation of the solar wind composition are expected to contribute in deciding between competitive theories in the field of elemental synthesis, origin of the solar system, history of planetary atmospheres and solar wind dynamics. The reel and foil will remain at the LRL until its release to the Principal Investigator's laboratory facility is authorized.

5.3 Lunar Surface Operational Constraints

5.3.1 Introduction

The lunar surface operational constraints presented in this section are taken from the "Flight Crew Operational Constraints for Lunar Surface Operations" (Reference 8).^{*} This section and the reference document identify, and are restricted to, the flight crew operational constraints which are concerned with lunar surface extravehicular activity. The constraints presented here are further restricted to the lunar surface EVA constraints for the first landing mission. Excluded are spacecraft constraints except where those constraints have a direct bearing on the crew members during the EVA operations.

By definition, a lunar surface constraint is any limitation imposed on lunar equipment design, operational procedure or sequence, etc. due to an equipment, human or environmental characteristic.

5.3.2 Constraint Classification

The constraints are divided into five different categories. The activity or equipment being constrained determines the category of the constraint. The constraints which fall into two or more categories are classified as GENERAL.

Each constraint is also identified according to the impact on the mission that a violation of the constraint would produce. Only the direct results of the constraint violation are considered in determining the violation classification. Multiple malfunctions and the different possible contingencies are not considered. The constraints violation classification is enclosed in parentheses following the constraint.

5.3.2.1 Constraint Categories

Mission Operations:

Constraints on mission operations that are necessary due to considerations of a lunar surface activity.

Lunar Surface Operations:

Constraints on lunar surface operations that are necessary due to equipment design and/or the lunar environment.

^{*}Other references presented are for constraints which are not contained in Reference 8 but have been added to this document.

Equipment Operation:

Constraints on equipment operation that are necessary due to the equipment design.

Equipment Design:

Constraints that must be considered in the design of equipment due to the lunar environment.

General:

Constraints that apply to two or more phases of the Apollo lunar landing mission.

5.3.2.2 Violation Classification

Critical:

A constraint that is necessary to prevent a compromise of mission safety. A violation of a critical constraint would jeopardize the safety of the crew or equipment essential to the completion of the mission.

Major:

A constraint that is necessary to prevent the compromise of the mission requirement.

Minor:

A constraint that cannot be classified as CRITICAL or MAJOR but is necessary to optimize lunar surface activities.

5.3.3 Mission Operations Constraints

Landing Site:

The lunar landing site must be selected such that the postlanding angle of the LM X-axis with the local gravity vector does not exceed 30°. This must include all combined effects of surface inclination and contour, and the asymmetric compression of the landing gear struts. (CRITICAL)

Lighting:

The lighting constraint at LM landing is as follows: The optimum sun elevation angle is 6° to 7° (sun in the east). The sun elevation

angle range of 5° to 12° is highly desirable. The landing will not be considered if the sun angle is outside the bounds of 5° and 20°. (CRITICAL)

Landing Site Slope:

The constraints on LM touchdown point imposed by touchdown dynamics considerations are: maximum topographical slope -12°, maximum protuberance height - 24 inches; and soil bearing strength - Surveyor I equivalent. (CRITICAL)

5.3.4 Lunar Surface Operations Constraints

Spacecraft Attitude:

Lunar surface EVA operations will not be conducted when the angle of the LM X-axis with the local gravity vector exceeds 15°. This attitude may arise from the combination of all factors such as asymmetric compression of the landing gear struts and terrain conditions. (CRITICAL) (Provisional, documentation to substantiate is unavailable)

Landing Site Slope:

The maximum topographical slope on which lunar surface EVA operations will be conducted will be that which the astronaut can safely negotiate unassisted. This is presently established as 15°. (CRITICAL) (Reference: Unpublished report of test "Crewman Capability Investigation", by Dr. D. L. Lind, Astronaut, Partial Gravity Simulator, Building 5, MSC, November 8, 1968.)

LM Forward (+Z) Hatch Operations:

The forward hatch may be left fully open during the EVA (up to 3 hours) provided: (CRITICAL) (GAEC LM Engineering Memorandum LMO-510-1201, April 24, 1969)

- 1) The cabin temperature, GF 1641T, must be between 60°F and 90°F at the beginning of the EVA, and
- 2) The sun vector is outside a 65° cone about the +Z axis.

Otherwise, the limit is:

- 1) 15 minutes for hatch fully open or
- 2) For the duration of the EVA provided the door is no more than 3 inches from the closed position, using the door snubber device for control.

SEQ Bay Door Open Limit:

After the EASEP is removed the SEQ bay door must be closed within TBD in order to maintain thermal control (CRITICAL)

Forward Contamination Control:

Fecal bags and other human wastes will be processed with a disinfectant and double-bagged prior to jettisoning. It is preferred that these be returned to earth by transfer to the CSM. As alternatives the wastes will be stowed in the descent stage if possible. Otherwise, it will be left on the lunar surface. (MINOR)

EMU Helmet and Visor Exposure:

The cumulative ultraviolet exposure limit on the helmet shield is 111 minutes. Extravehicular visor assembly visor-up configuration is not permitted in daylight operations so as to preclude damage to the eyes. (CRITICAL) (Reference: NASA, CSM/LM Spacecraft Operational Data Book, SNA 8-D-027, February 26, 1969.)

Extravehicular Communications System:

The first crewman to the lunar surface will operate in the relay mode For two-man EVA operations the dual mode is nominal. (MAJOR) (Reference: NASA, Land, C.K., "Performance Analysis of The Extravehicular Communication System", MSC Internal Note EB-R-68-14, May 16, 1969.)

The PLSS antenna will be operated in the unstowed position after egress to preclude damage to the receiver. (MAJOR) (Reference: NASA, Minutes of the Configuration Control Board Meeting, Agenda Item 7, May 9, 1969.)

The fully unstowed PLSS antenna physically interferes with the S-band erectable antenna reflector during alignment operations. (MAJOR) (Reference: Slight, J. B., "S-band Erectable Antenna/EMU Physical Interference Test," Memorandum EC 64-111, July 20, 1967.)

OPS Metabolic Capability:

The maximum heat removal of the Oxygen Purge System (OPS) is about 950 BTU/HR average over the period in which the man is storing 300 BTU. The heat removal capacity of the OPS is 475 BTU's. (CRITICAL).

5.3.5 Equipment Operation Constraints

Still Camera (Hasselblad):

- 1) Magazine Changing - The magazines should be changed in the pressurized LM cabin. (MINOR)
- 2) Film Environment - The film magazine should not be exposed to vacuum conditions for periods in excess of 3 hours. The film temperature must be maintained in the range of 50-100°F. (MAJOR)
- 3) Camera Tether - The still camera must be tethered to the crewmember while in use. (MINOR)

Sequence (Data Acquisition) Camera:

Magazine Temperature - The film magazine limits 110°F as indicated by temperature gage on side of magazine (MAJOR) (Ref: NASA R. Gerlach in Minutes Third Meeting Lunar Surface Operations Planning Meeting, 1/19/69.)

Television Camera:

- 1) The Operating Environment Temperature Range is 0 to 100°F (MAJOR) (Reference: NASA, P. Coan in Minutes First Meeting Lunar Surface Operations Planning Meeting, November 17, 1967, also applies to items 2, 3 below).
- 2) In all operations the radiating surface of the TV camera body must face in direction of deep space. (MAJOR)
- 3) The TV camera lens must not be pointed into the sun to avoid damage to vidicon tube screen. (MAJOR)

S-Band Erectable Antenna:

- 1) Line of Sight: The antenna requires unobstructed line of sight of the earth, free of any blockage of spacecraft elements or terrain. (CRITICAL) (Reference -NASA, S. Kelley, Minutes Second Lunar Surface Operations Planning Meeting, January 1, 1968; also applies to items 2 and 3 below)
- 2) Antenna Stability: The maximum equivalent pitch down reflector angle for tripod stability is 60°. This includes the actual pitch of the reflector to account for site location, correction for earth-moon undulations and terrain slope. The tripod design limit to terrain slope which can be manually compensated by tripod adjustment is 5°. (CRITICAL)

- 3) Cable Length: The antenna cable length outside the MESA is 30 feet. However, the usable length is determined after allowance is made to permit some lay of cable on surface to avoid pull on the antenna. The effective radius to deploy the antenna is then approximately 20 feet. (MINOR)

Early Apollo Scientific Experiments Package (EASEP):

Based on a compromise between thermal effects of the LM ascent engine plume and contamination by insulation debris blown from the LM descent stage, the deployment site for the Passive Seismometer Experiment (PSE) should be along the LM -Y axis approximately 70 feet from the LM. The Laser Ranging Retro-reflector (LR³) should be deployed at the PSE site. In a contingent situation the LR³ may be deployed beside the -Y footpad. In the latter case the LR³ is assumed to be capable of withstanding the high temperature near the LM. (MAJOR) (Reference: Grenada, R. N., "Selection of an Optimum Deployment Site for Early Apollo Scientific Experiments Package (EASEP)", General Electric Company, Memo T/R 712-38-9032(s), March 17, 1969.)

5.3.6 Equipment Design Constraints

Anthropometric Requirements:

Astronaut operations must be capable of being conducted within the contractural anthropometric envelopes supplied, unless modified by more definitive test data. (CRITICAL)

Reach Limits:

- 1) The minimum reach heights to grasp an object while suited are: One handed-22 inches; two handed-27.5 inches. (MAJOR)
- 2) The low reach limit to manually extract EASEP or ALSEP packages from the SEQ bay is governed by the interference of the opened bay door. A minimum height for the opened door is 50 inches above the standing surface. (MAJOR) (Reference: NASA, Unpublished report "Lunar Surface Equipment Tests", Test Crewmen Dr. D. L. Lind and H. H. Schmitt, May 31, 1967; also 3 and 4 below.)
- 3) The high reach limit to "push button" while wearing A5L suit is 76 inches. (MAJOR)
- 4) The high reach limit to "reach handle" while wearing A5L suit is 74 inches. (MAJOR)

Astronaut Pull Force:

- 1) The maximum two-hand pull force that can be applied by a free standing astronaut in an A6L suit is 27 pounds. (MAJOR) (Reference: NASA Unpublished Report "Crew Capabilities of Suited Astronaut Operating in Partial Gravity Simulator", Test Crewman Dr. D. L. Lind, Test Conductor C. Klabosh, November 8, 1968; also 2 below.)
- 2) The maximum one-hand pull force that can be applied by a free standing astronaut in an A6L suit is 17 pounds. (MAJOR)

One Man Design:

Since surface excursions or any given part of an excursion may be limited to one man, all equipment must be designed for this mode of operation. (MAJOR)

5.3.7 General Constraints

Skin Heat:

The maximum tolerable heat flow to a crewman's skin through suit contact is 18 BTU/FT minute. The pain threshold for heat applied to any part of the body is 113°F. (CRITICAL)

Radiation

The maximum Operational Dose (MOD) Depth Dose (set for Apollo 7), is 50 rads. (CRITICAL) (Reference: NASA; Dr. J. Zieglschmid in Minutes, Second Lunar Surface Operations Planning Meeting (12/15/67)).

Awake/Sleep Cycle:

The maximum planned continuous awake time for normal mission operations shall not exceed 16 hours. For planned contingency operations this continuous awake time can be extended an additional four hours provided this 20-hour awake period is followed by an eight-hour sleep period and return to the normal sleep awake cycle. The minimum sleep time for a crewman during any 24-hour period is 4 hours. The nominal sleep time is 8 hours. (CRITICAL) (Reference: CSM/LM Spacecraft Operational Data Book, Vol II, LM Data Book Part I, Revision 1, March 15, 1969.)

Body Heat Storage:

The amount of heat that can be planned for a crewmember to store in his body during Oxygen Purge System (OPS) operations is 300 BTU. (CRITICAL)

Window Heaters:

The window heaters require up to 90 minutes of operation to clear the window so that there is no interference with the view through the windows. (CRITICAL)

Time In A Hard Suit:

A crewman can remain in a hard suit (EMU) and function properly for up to 3 hours. (CRITICAL) (Reference: CSM/LM Spacecraft Operational Data Book, Vol II, LM Data Book Part I, Revision 1, March 15, 1969.)

5.4 Nominal Lunar Surface EVA Metabolic Profiles

5.4.1 Introduction

The following metabolic profiles were derived under the direction of G. F. Humbert, M.D., Chief of Environmental Medicine, and give the current estimates of the work loads to be experienced by the Commander and Lunar Module Pilot during a nominal Apollo 11 Lunar Surface EVA. The estimates are based on Gemini XI and XII reports, underwater simulations, Mission D EVA, and crew training exercises.

The profiles represent estimates of the work load and are subject to revision as further data becomes available. The CDR's BTU output, for the two hour and forty minute timeline, is estimated to be 3625 BTU with a mean rate of 1360 BTU/Hour. For the LMP the estimate is 3370 BTU with a mean of 1265 BTU/Hour.

ESTIMATED METABOLIC EXPENDITURE	
TASK	(BTU/HR)
Final Pre-EVA Operations - - - - -	900
Initial EVA - - - - -	2000
Environmental Familiarization - - - - -	1000
Contingency Sample Collection - - - - -	900
Preliminary Checks - - - - -	1100
Rest-Photo LMP - - - - -	500
TV Deployment - - - - -	1300
Bulk Sample Collection - - - - -	1400
LM Inspection - - - - -	1100
EASEP Deployment - - - - -	1400
Documented Sample Collection - - - - -	1400
Sample Return Container Pack and Transfer - - - - -	1600
Terminate EVA - - - - -	2000
LMP Monitor (Inside LM) - - - - -	900
S-Band Deployment - - - - -	1500

5.4.2 CDR
 NOMINAL LUNAR SURFACE
 METABOLIC PROFILE

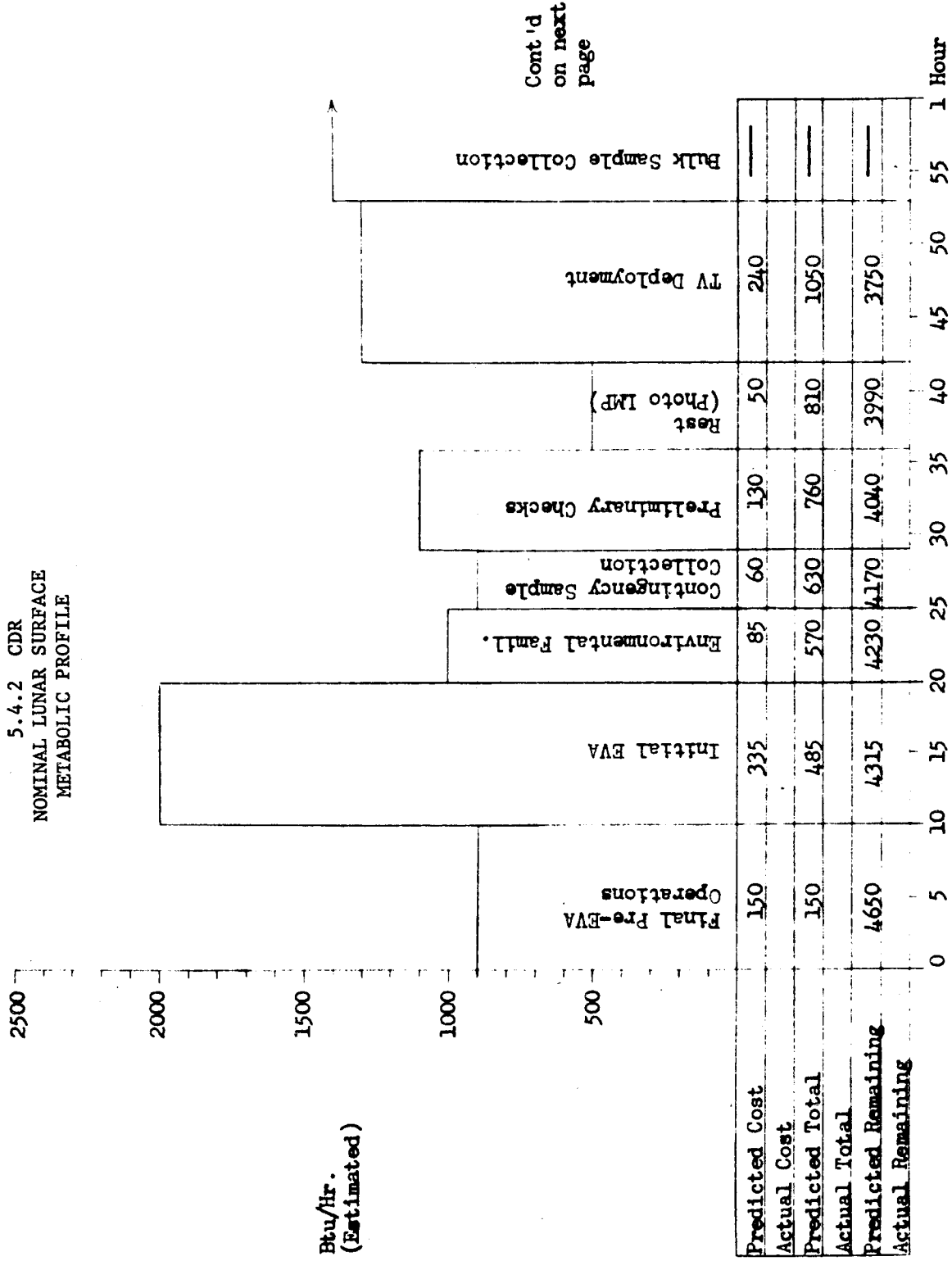

Cont'd
 on next
 page

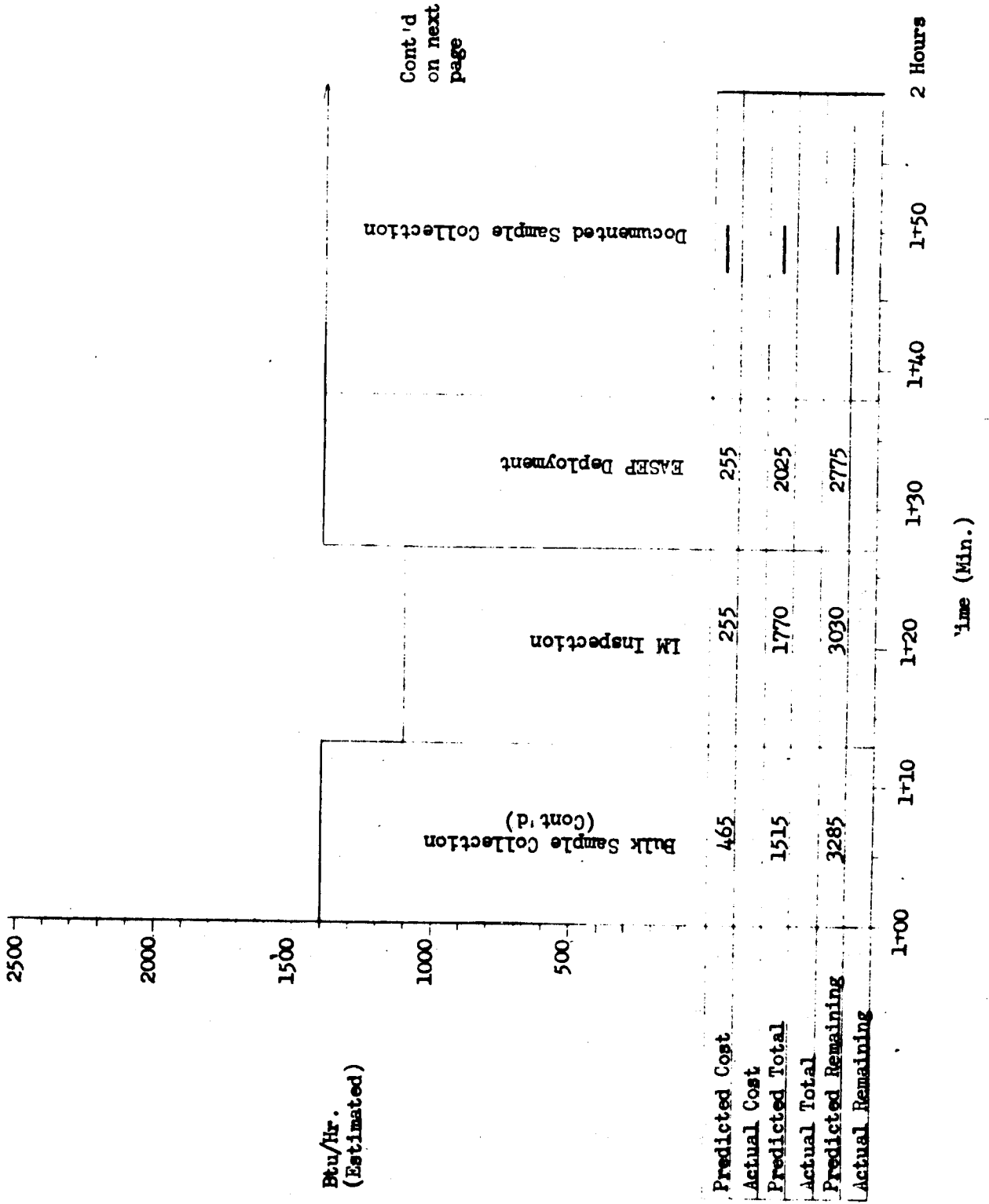

Cont'd
on next
page

Source for Activities:
Preliminary Apollo 11
Lunar Surface Plan of
5/7/69 Figure 3.3

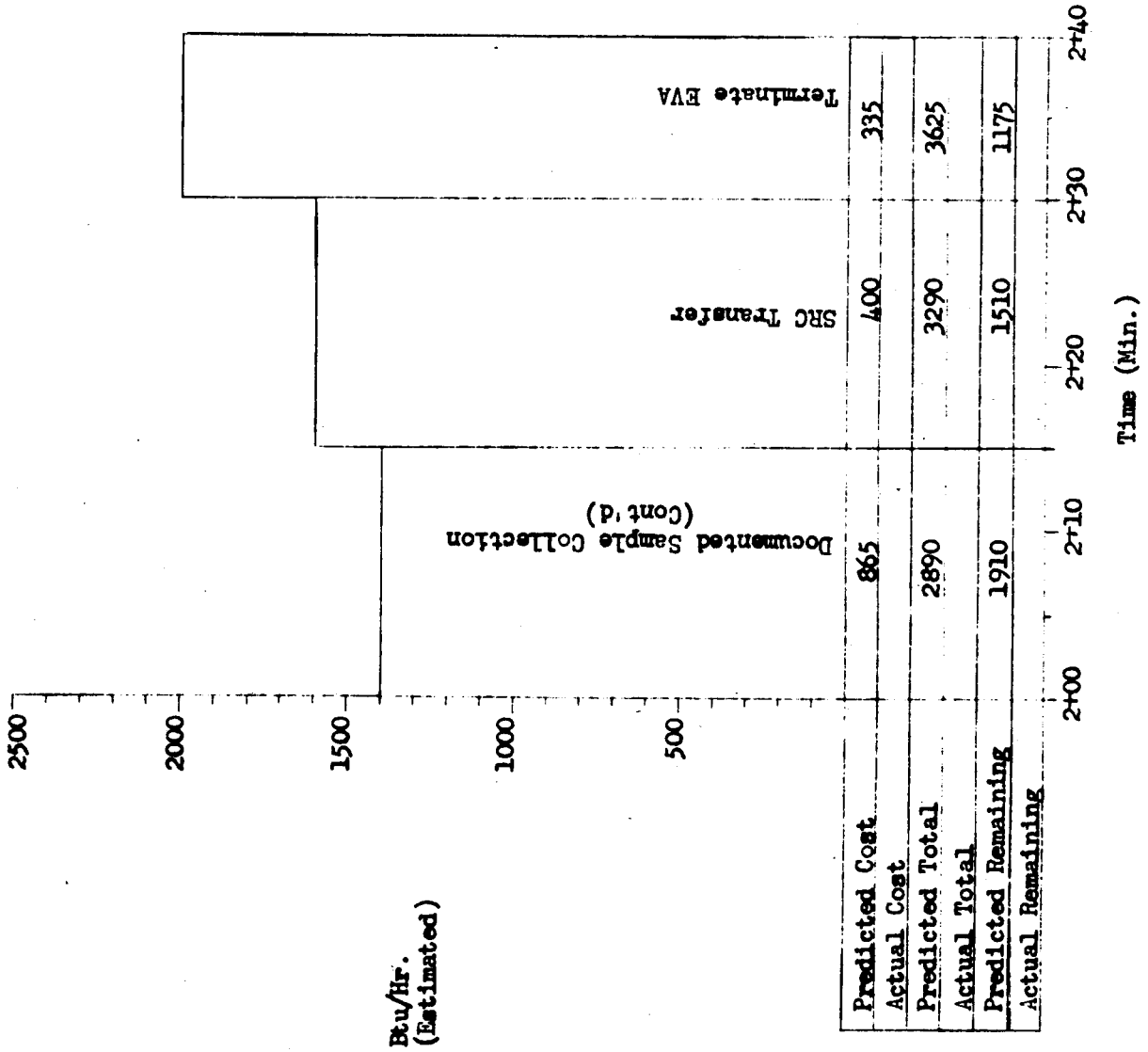

5.4.3 LMP
 NOMINAL LUNAR SURFACE EVA
 METABOLIC PROFILE

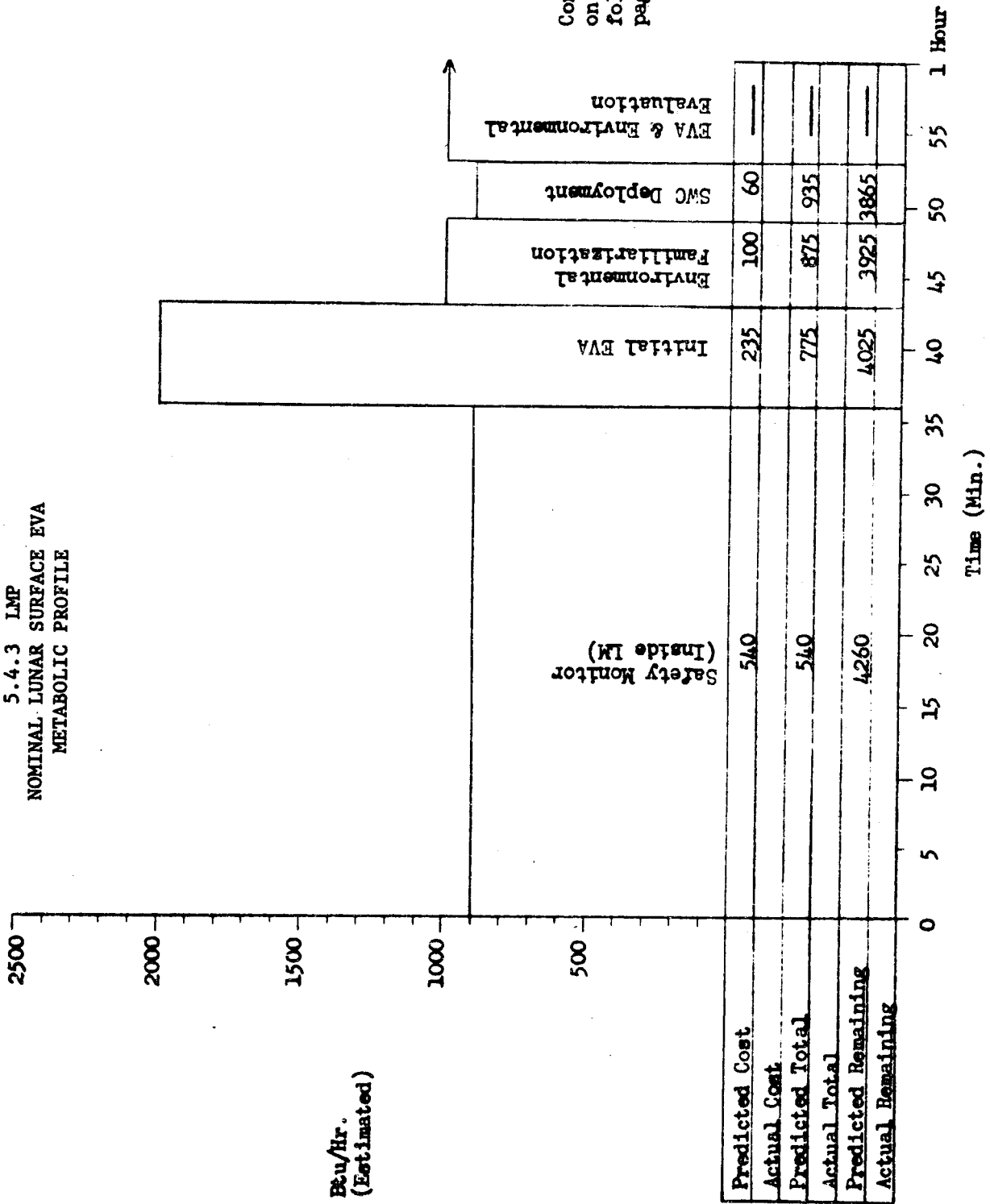

Cont'd
 on
 following
 page

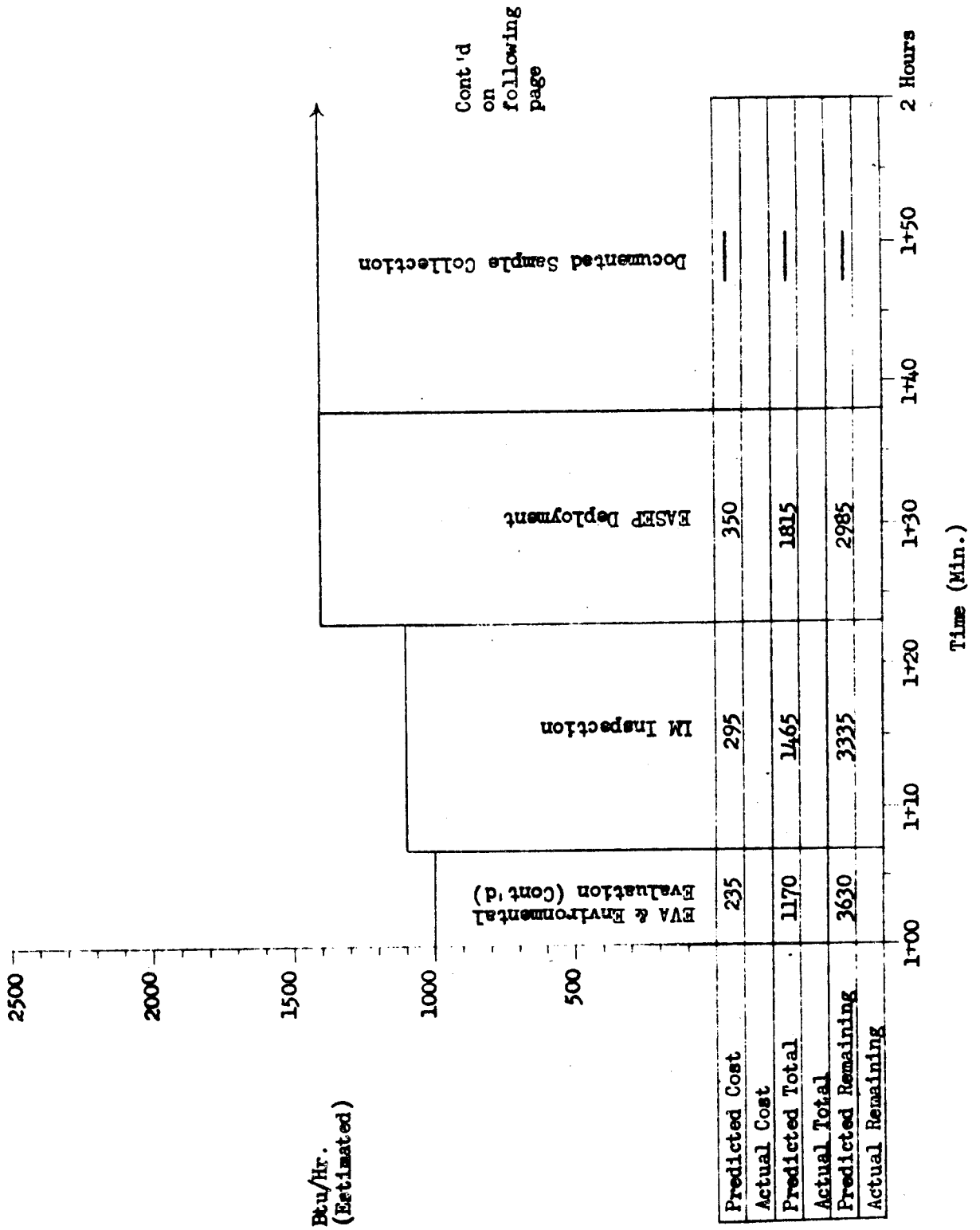

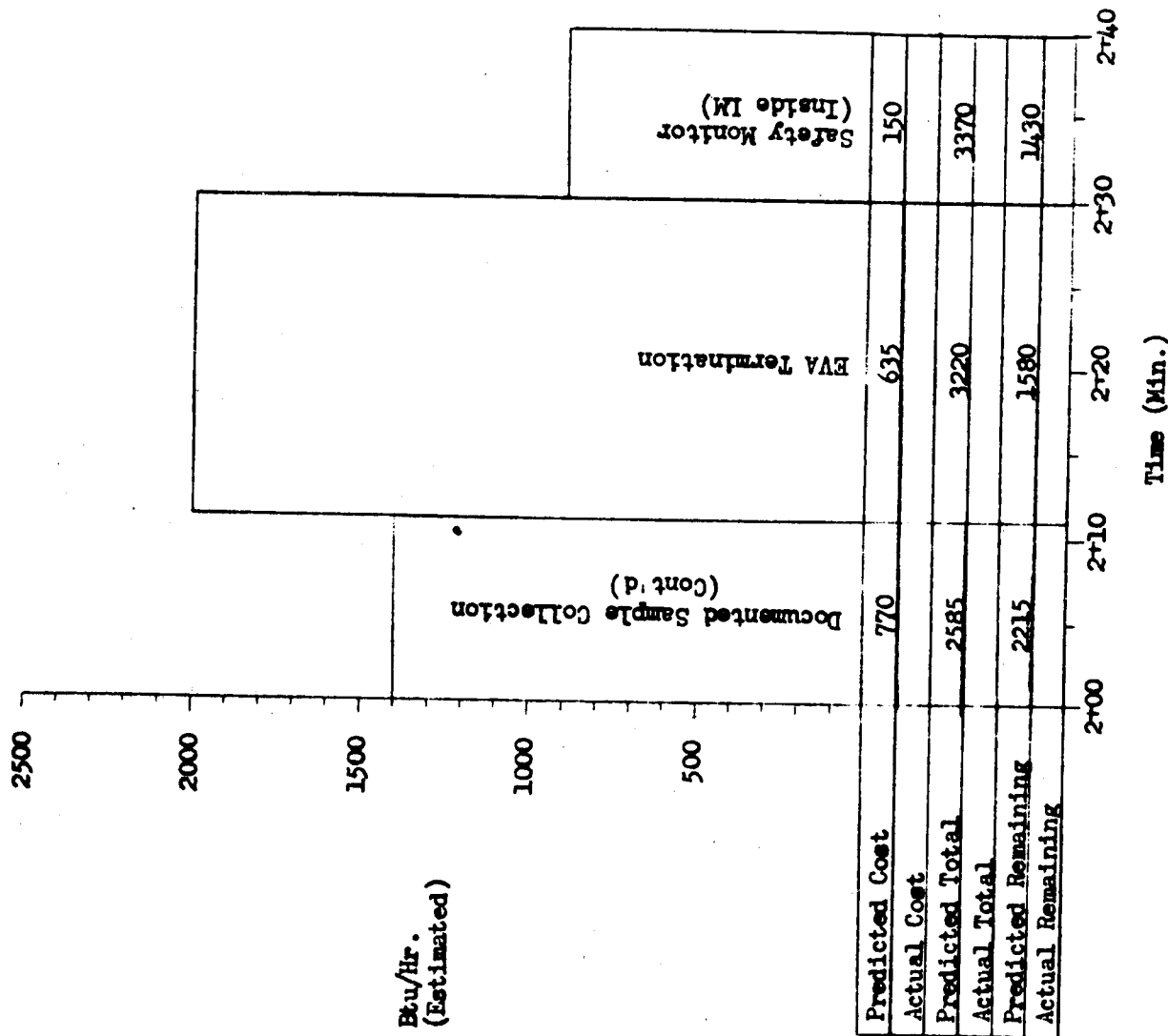

Source for Activities:
Preliminary Apollo 11
Lunar Surface Plan of
5/7/69 Figure 3.3

5.5 REFERENCES

1. BellComm memorandum; "Use of Goldstone Mars Station for Reception of LM Television from Lunar Surface", June 11, 1968.
2. Mission Planning and Analysis Division; Spacecraft Operational Trajectory for Mission G, Volume I, MSC Internal Note 69-FM-98, May 16, 1969.
3. EVA Branch, FCSD; Final EVA Procedures Apollo 11, May 26, 1969.
4. Systems Engineering Division; Mission Requirements SA-506/CSM-107/LM-5 G Type Mission Lunar Landing, SPD9-R-038, April 17, 1969. (Revised May 1, 1969)
5. Flight Planning Branch, FCSD, Preliminary Apollo 11 Flight Plan, April 15, 1969.
6. Mission Operations Branch, FCSD; Final Photographic and TV Operations Plan, June 18, 1969.
7. Lunar Mission Analysis Branch, MPAD; Revised MSFN coverage of Mission "G" EVA periods for third quarter of 1969, Memo 69-FM51-129, May 12, 1969.
8. Lunar Surface Operations Office, FCSD; Flight Crew Operational Constraints for Lunar Surface Operations, November 1, 1968.
9. Environmental Medicine Branch, MROD; Updated Mission G Metabolic Profile, Memo DD5-69-M-156, May 21, 1969
10. Boeing Life Sciences and Technology Division; Updated Mission G Extravehicular Activity (EVA) Estimated Metabolic Profile, Ltr 6.1.4-1-2972-116, June 2, 1969.

