



# Microbial Remediation



Web site: [www.laborerslearn.org](http://www.laborerslearn.org)



*Laborers-AGC Education and Training Fund presents:*



# Microbial Remediation

**Module 1 - Indoor Air Pollution and Sick Building Syndrome**

**Module 2 - Health Effects**

**Module 3 - Work Area Sampling**

**Module 4 - Hazard Communication**

**Module 5 - Personal Protective Equipment**

**Module 6 - Work Area Preparation and Remediation Techniques**

**Module 7 - Decontamination**

**LIUNA**  
**INNOVATION**  
**AT WORK**

© Laborers-AGC Education and Training Fund June 2003

All rights reserved.

Printed in the United States of America

Some images © 2003 [www.clipart.com](http://www.clipart.com).

All rights reserved. The reproduction or use of this document in any form or by any electronic, mechanical, or other means, now known or hereafter invented, including photocopying and recording, and including republication as or in connection with instructional or training seminars, and in any information storage and retrieval system, is forbidden without the written permission of Laborers-AGC Education and Training Fund. The information in this manual does not necessarily reflect the views or policies of the Laborers-AGC Education and Training Fund, nor does the mention of trade names, commercial products, or organizations imply endorsement by the U.S. Government.

## Tips for Using this Manual

Listed below are some of the components to this manual with a brief statement of the purposes they serve.

**Modules or Sections** - cover specific, major topics of the manual.

**Objectives** - list the important concepts that you should learn from each module or section.

**Assignment Sheet Questions** - assess your knowledge of important information within the text.

 - signals the location of important information; this symbol appears within the side margins.

**CFR** - identifies information related to regulations.

 - signals the location of important safety and health information; this symbol appears within the side margins.

 - provides bibliographic information and/or references to other publications discussed within the text.

**Appendix** - provides additional, helpful information; is found at the end of the manual, following the last module or section.

**Regulations** - provide the actual text of regulations that are referred to in the manual.

**Glossary** - provides definitions for italicized words in the manual; is found at the end of the manual.



# Table of Contents

## 1

### Indoor Air Pollution and Sick Building Syndrome

<b>Participant Objectives</b> .....	1-1
<b>Introduction</b> .....	1-3
What Causes Indoor Air Pollution? .....	1-3
<b>Illnesses Caused by Indoor Air Pollution</b> .....	1-4
<b>Mold, Mildew, and Moisture</b> .....	1-6
Mold .....	1-6
<b>Water Leakage</b> .....	1-8
<b>Air Tightness and Ventilation</b> .....	1-8
<b>Summary</b> .....	1-8
<b>Assignment Sheet</b> .....	1-11

## 2

### Health Effects

<b>Participant Objectives</b> .....	2-1
<b>Introduction</b> .....	2-3
<b>Categories of Indoor Air Pollution</b> .....	2-3
<b>Chemical Pollutants</b> .....	2-3
<b>Biological Airborne Pathogens</b> .....	2-4
Viruses .....	2-4
Bacteria .....	2-4
Fungi .....	2-5
Mycotoxins .....	2-6
Stachybotrys Chartarum (Arta) .....	2-7
Aspergillus .....	2-7
Penicillium .....	2-8
<b>Fungi Routes of Entry</b> .....	2-8
<b>Worker Precautions</b> .....	2-9
<b>Medical Testing and Surveillance</b> .....	2-9
<b>Summary</b> .....	2-10
<b>Appendix - Sample Medical Clearance Form</b> .....	2-11
<b>Assignment Sheet</b> .....	2-13

## Table of Contents (continued)

### 3

#### Work Area Sampling

<b>Participant Objectives</b> .....	3-1
<b>Introduction</b> .....	3-3
<b>Visual Inspection</b> .....	3-4
<b>Bulk Sampling of Visible Material</b> .....	3-4
<b>Air Sampling</b> .....	3-5
Sampling of Bioaerosols .....	3-5
<b>Sterile Swab Wiping</b> .....	3-6
<b>Cultures</b> .....	3-6
<b>Summary</b> .....	3-6
<b>Assignment Sheet</b> .....	3-7

### 4

#### Hazard Communication

<b>Participant Objectives</b> .....	4-1
<b>Introduction</b> .....	4-3
Scope .....	4-3
Multiple Employer Sites .....	4-4
Information and Training .....	4-5
<b>Exposure Guides</b> .....	4-6
Permissible Exposure Limits .....	4-7
Threshold Limit Values .....	4-11
<b>Exposure Control Measures</b> .....	4-11
<b>Inventory Lists</b> .....	4-12
<b>Material Safety Data Sheet</b> .....	4-13
<b>Hazardous Chemical Labels and Lists</b> .....	4-17
Special Labels .....	4-19
National Fire Protection Association Labels .....	4-21
Department of Transportation Labels .....	4-21
<b>Assignment Sheet</b> .....	4-25

### 5

#### Personal Protective Equipment

<b>Participant Objectives</b> .....	5-1
<b>Introduction</b> .....	5-3
<b>Respiratory Protection</b> .....	5-3
Protection Factors .....	5-4
Maximum Use Concentration .....	5-5



## Table of Contents (continued)

<b>Air Purifying Respirators</b> . . . . .	5-6
Negative Pressure Respirators . . . . .	5-6
Limitations of APRs . . . . .	5-9
<b>Filtering Devices</b> . . . . .	5-12
Particulate Filters . . . . .	5-12
Vapor and Gas Removing Cartridges and Canisters . . . . .	5-17
<b>Respirator Program Requirements</b> . . . . .	5-20
Respirator Program Administration . . . . .	5-21
<b>Respirator Selection</b> . . . . .	5-21
Gather Information . . . . .	5-21
General Use Conditions and Determination of Contaminants . . . . .	5-22
Properties of the Contaminants . . . . .	5-23
Odor Threshold Data . . . . .	5-23
Exposure Limits . . . . .	5-23
IDLH Concentrations . . . . .	5-23
Eye Irritation . . . . .	5-24
Service Life Information . . . . .	5-24
<b>Medical Evaluation</b> . . . . .	5-24
<b>Fit Testing</b> . . . . .	5-24
Fit Testing Protocols . . . . .	5-25
Qualitative Fit Test . . . . .	5-25
Quantitative Fit Test . . . . .	5-27
<b>Respirator Use</b> . . . . .	5-28
Facepiece Seal Conditions . . . . .	5-28
User Seal Checks . . . . .	5-29
Continued Respirator Effectiveness . . . . .	5-30
IDLH Conditions . . . . .	5-31
<b>Maintenance and Care</b> . . . . .	5-31
Cleaning and Disinfecting . . . . .	5-31
Storage . . . . .	5-32
Inspection . . . . .	5-32
Repair . . . . .	5-33
<b>Training</b> . . . . .	5-33
<b>Program Evaluation</b> . . . . .	5-34
<b>Recordkeeping</b> . . . . .	5-34
Fit Testing Records . . . . .	5-34
Training Records . . . . .	5-35
<b>Donning and Doffing</b> . . . . .	5-35
<b>In-Use Monitoring</b> . . . . .	5-35
<b>Inspections</b> . . . . .	5-35
<b>Protective Clothing</b> . . . . .	5-36
Full-Body Protective Suits . . . . .	5-36

## Table of Contents (continued)

Protective Gloves .....	5-37
<b>Eye Protection .....</b>	<b>5-38</b>
<b>Assignment Sheet .....</b>	<b>5-39</b>
<b>Standard Operating Procedure 1 – Half-Face APR .....</b>	<b>5-41</b>
<b>Standard Operating Procedure 2 – Full-Face APR - Inspect, Don, and Seal Check .....</b>	<b>5-43</b>
<b>Standard Operating Procedure 3 – Qualitative Fit Test .....</b>	<b>5-45</b>
<b>Standard Operating Procedure 4 – Full-Face APR - Clean, Sanitize, and Maintain .....</b>	<b>5-49</b>
<b>Appendix – Respirator Information .....</b>	<b>5-51</b>

## 6

### Work Area Preparation and Remediation Techniques

<b>Participant Objectives .....</b>	<b>6-1</b>
<b>Introduction .....</b>	<b>6-3</b>
Scope of the Work .....	6-3
<b>Work Practices, Remediation Techniques, and Disposal Procedures ..</b>	<b>6-4</b>
<b>General Remediation Concerns .....</b>	<b>6-4</b>
Work Area Preparation .....	6-4
Worker Protection .....	6-6
Containment and Isolation .....	6-7
Movable Objects .....	6-8
Negative Pressure Enclosures .....	6-12
Portable HEPA-Filtered Negative Pressure Unit .....	6-12
Eliminations of Contaminants on Hard Surfaces .....	6-23
Eliminations of Contaminants on Porous Surfaces .....	6-24
Remediation Process .....	6-24
Post-Remediation Inspection .....	6-26
Final Clean Up .....	6-27
Waste Load-Out Area .....	6-29
Transportation to the Disposal Site .....	6-30
Methods to Reduce or Eliminate Recurrence of Infestations .....	6-30
<b>Assignment Sheet .....</b>	<b>6-31</b>

## 7

### Decontamination

<b>Participant Objectives .....</b>	<b>7-1</b>
<b>Introduction .....</b>	<b>7-3</b>
<b>The Importance of Decontamination .....</b>	<b>7-3</b>
<b>Personal Hygiene .....</b>	<b>7-4</b>
<b>Decontamination Units .....</b>	<b>7-4</b>

## Table of Contents (continued)

Three-Chamber Decontamination Unit . . . . .	7-4
Two-Chamber Decontamination Unit. . . . .	7-5
Change Area Only. . . . .	7-6
<b>Setting Up a Decontamination Unit . . . . .</b>	<b>7-6</b>
Unit Construction. . . . .	7-6
<b>Decontamination Unit Layout and Process. . . . .</b>	<b>7-6</b>
Equipment Room . . . . .	7-8
Shower Room . . . . .	7-8
Clean Room. . . . .	7-8
<b>Materials and Equipment List . . . . .</b>	<b>7-9</b>
<b>Assignment Sheet . . . . .</b>	<b>7-11</b>

<b>A</b> Appendix - Resources . . . . .	A-1
---	-----

<b>R</b> Regulations - 29 CFR 1910.134 . . . . .	R-1
--	-----

<b>G</b> Glossary . . . . .	G-1
-----------------------------	-----



---

# Module 1

## Microbial Remediation Indoor Air Pollution and Sick Building Syndrome

---

1

### **PARTICIPANT OBJECTIVES**

After completing Module 1, you will be able to:

1. Define the following terms:
  - Sick Building Syndrome
  - Spores
  - Microbial Contamination
2. List six causes of indoor air pollution.
3. Identify and describe the ideal environment for mold growth.



## INTRODUCTION

According to recent articles, 40 percent of buildings in the U.S. suffer from “sick building syndrome.” Of that 40 percent, 40 percent have microbial problems.

**microbial:**  
pronounced,  
*my-crow-be-ul*

Studies suggest that ten to twenty-five million office workers—one in five—suffer health problems caused by indoor air pollution and inadequate ventilation. Health care costs from poor indoor air quality are estimated to run into the tens of billions of dollars each year.

The *Environmental Protection Agency* (EPA) ranks indoor air pollution as one of the top five air quality problems affecting the general population. Air quality poses greater problems to Americans than toxic waste dumps, emissions from industrial plants, and pesticides used for farming.

Even though the EPA has worked on problems associated with indoor air pollution, action by Congress has been slow in coming. Although legislation is being considered, actual EPA and *Occupational Safety and Health Administration* (OSHA) rules and recommendations will take time before far-reaching changes are seen in the work place.

Not all the news is negative, however. EPA funding for indoor air programs has risen steadily. In 1987, only \$350,000 was spent on indoor air programs but increased to \$7 million by 1993.

### What Causes Indoor Air Pollution?

Some of the causes of indoor air pollution are:

- Poor ventilation: Heating and cooling systems harbor dust, viruses, bacteria, mold, mildew, and mold spores. ⓘ
- Mold and mildew: Air conditioning and water leaks in roofs, behind walls, or in carpets create ideal breeding grounds for microorganisms (fungi and bacteria). ⓘ

- ① • **Building construction, renovation, and demolition:** Construction activities inside and outside an occupied building can cause indoor air pollution. Examples include removing or installing walls, carpet or roofing materials, and painting or repainting.
- ① • **Sewer backups and flooding:** Residues left on carpeting, drywall, and wood framing can also become breeding grounds if not attended to properly.
- **Dust, dust mites, and pollen:** Poor housekeeping, poorly designed ventilation systems, or dirty filters can create dust and pollen problems.
- **Building materials and furnishings:** Building materials and furnishings (e.g., cabinets, paneling, plywood, carpets, drapes) can sometimes be a source of pollution.
- **Gases:** Formaldehyde, trichloroethylene, ammonia, volatile organic compounds (VOCs), and other potentially dangerous gases are released by other sources and can become indoor pollution.
- **Office equipment:** Many printers and copiers emit VOCs, ammonia, and other gases as pollutants.
- **Other sources:** Pesticides, cleaning supplies, solvents, strippers, and wood preservatives as well as other such materials emit VOCs and organic gases.

### **ILLNESSES CAUSED BY INDOOR AIR POLLUTION**

- ① *Sick building syndrome* is a general category for a number of ailments, allergies, and complaints for which there is no obvious cause and where medical tests reveal no unusual trends. The existence of low levels of pollutants, synthetic irritants, fungi, microorganisms, or simply a lack of adequate fresh air are sufficient to cause reactions in a percentage of building occupants. Sometimes extremely low levels of several different pollutants or irritants are sufficient to affect sensitive individuals.



Typically, no single cause for sick building syndrome is identified, and complaints are resolved only after individuals leave the building. Because sick building syndrome is often related to the ventilation system of a building, resolving these problems or moving an individual's work station can also provide relief.

The use of various terms related to indoor air pollution can get confusing. Sick building syndrome usually refers to a variety of mild complaints such as headaches or respiratory irritation experienced by building occupants. *Building related illness* usually refers to a physician-diagnosed illness such as asthma with a known cause related to poor indoor air quality. Some individuals may be severely affected, but this may not indicate an overall severe building problem. In practice, the two terms are often used interchangeably.

The diversity of both causes and effects of sick building syndrome have led some to claim it does not exist, but problems continue to occur. The symptoms can vary considerably from one person to another. This is because of the genetic diversity of humans, the wide range of contaminants that could be encountered, and the dose each person may receive.

Often the only common denominator of sick building syndrome is insufficient ventilation air to remove contaminants. Sometimes the source of the problem is microbial growth inside ductwork or other air-handling equipment. If microbial growth is suspected but not observed, cell culturing should be performed on the supply air of the ventilation system to determine the existence of microorganisms.

In some new buildings, indoor air pollution problems can be traced to the use of synthetic materials, such as insulation or carpeting, which release hydrocarbons or other vapors into the air at a very low rate.

In addition to synthetic materials, bioaerosols contribute to indoor air problems. *Bioaerosols* are airborne particles that are living, or that originate from living organisms, including fungi and bacteria.

**bioaerosol:**  
pronounced,  
*bi-o-air-ah-sol*

**mold** = a type of fungi that can grow where there is moisture, oxygen, and a good food source.

**fungi** = parasitic plants living on living organisms or on materials made from living organisms, such as paper, lumber, and fabrics.



**spores** = single-celled reproductive structure of fungus and bacterium

## MOLD, MILDEW, AND MOISTURE

*Mold*, mildew, and moisture are discussed together because they are almost always found together. If there are problems with mold or mildew in a building, a moisture problem has contributed to it. The moisture can come from a leak in the roof or from excess humidity in the air such as in a basement or crawl space.

There is no such thing as a totally mold-free environment. However, people are affected generally only when mold levels are very high.

### Mold

Molds belong to a category of organisms called fungi. Molds, mildews, yeasts, rusts, and mushrooms are all fungi. Fungi are similar to plants although they are not the same as the plants we are used to. Fungi are parasites.

Fungi steal their energy and food from other living organisms. They can also obtain their food from decaying matter or from a variety of building materials such as wood, paint, dirt, and wallpaper paste. In fact there are so many food sources available for fungi it would be impossible to remove them all. Even though over 60,000 of different types of fungi have been identified, only a few dozen are commonly found in the buildings in which we work or in our homes. There are over 70 different types of fungi that have been found in indoor air pollution. They often result in allergies because of the inhalation of fungal spores. Spores are the single-celled reproductive structure of fungus and bacterium. They are dormant structures capable of surviving harsh conditions for long periods. Most spores are extremely small, sometimes as small as one micron (a human hair is between 40 and 120 microns). The larger spores can be removed with an ordinary air filter, but smaller spores simply pass through most standard filters. As stated in asbestos, lead, and hazardous waste training, *high efficiency particulate air* (HEPA) filters will remove particles as small as 0.3 microns. However, even though they are becoming more common, HEPA filters are not the standard filters used in indoor ventilation. They are useful, though, on microbial remediation projects.

### **Where Does Mold Grow?**

Mold can grow practically anywhere there is moisture, oxygen, and a food source. Molds can tolerate a temperature range of 40° to 100° F. They are found in the soil and as high as 10,000 feet in altitude. Different varieties are found in deserts, near the ocean, and in cold and hot climates. Because air consists of about 21 percent oxygen, and there are so many potential sources of food, curbing moisture and humidity is the primary method of control. In general, as the temperature and humidity fall in winter months, outdoor mold problems decrease. This is why many people with mold allergies are less troubled in the winter months.

Molds grow on rotting logs, in damp shady areas, on compost piles, and so forth. On farms, grains are subject to mold growth, so grain bins and silos are often problem areas for an individual with a mold allergy. Workplaces such as bakeries, breweries, dairies, greenhouses, paper mills, upholstery shops, and woodworking industries have the potential to irritate a mold-allergic person.

There are generally different species of molds inhabiting the indoor environment than those found outdoors. Indoor and outdoor climates are different, so they support different types of organisms. If the windows in a building are typically kept open, the types of mold spores indoors and outdoors are similar. Air conditioning often helps someone with a mold allergy for two reasons:

1. Removing humidity from the air helps to create a drier environment that is less favorable to mold growth.
2. Outdoor molds will remain outdoors if the windows are closed.

### **Relative Humidity and Mold**

A certain amount of humidity in the air is desirable for human health and comfort, but too much can result in mold growth. *Relative humidity* is a big factor in controlling mold and fungi growth. Mold growth does not always require the presence of standing water. It can occur when high relative humidity is present. Generally, relative humidity below 60 percent will not support excessive mold growth.



## WATER LEAKAGE

Water leakage is also a major concern in controlling mold growth. Leakage from pipes, evaporative air conditioning units, condensation in bathrooms, sewer backups, and in areas on and around windows can create fertile growing areas for molds. Mold from these areas can release large amounts of spores into indoor air and potentially create significant health problems for building occupants.

The work that Laborers are responsible for in *microbial remediation* often involves creating barriers around these water leakage areas, removing the developed mold and any affected building materials, replacing those materials, and reconditioning the area to prevent the recurrence of mold growth.

## AIR TIGHTNESS AND VENTILATION

An airtight structure creates an ideal growing area for certain microorganisms. If moisture is also present, growth of these organisms can occur even faster.

Therefore, one remedy to indoor air pollution is to pull in outdoor air, filter it, and circulate it throughout the building thereby exhausting any contaminated air, stabilizing humidity levels, and creating positive pressure inside the building

## SUMMARY

Mold and mildew have existed for thousands of years but have become a problem in buildings only in the last 30 years. Because of changes in building construction relating to the energy crisis in the early 1970s, buildings were constructed virtually airtight. The air-tightness restricts air movement to the *heating, ventilation, and air conditioning (HVAC)* system. Improper maintenance or a lack of humidity control makes it easier for mold and mildew to grow in HVAC systems.

For a case study of a sick building, please refer to Appendix B, Resources, for a document from the EPA headquarters in Washington, DC.



The problems associated with indoor air pollution are serious and increasing. As an example, mold-related claims increased from \$9.1 million in the 1st quarter of 2000 to \$79.5 million in the 1st quarter of 2001 (Texas Department of Insurance). Additionally, some sources project that mold remediation work could cost billions of dollars a year.

At this time, there are no regulations that govern indoor air pollution or worker health and safety during microbial remediation. The work is available now. Laborers must be aware of the problems and *hazards* associated with microbial contamination (fungi and bacteria) in buildings, indoor air pollution, the remediation process, and how to protect themselves.



**MODULE 1 - ASSIGNMENT SHEET**

**1. Define the following terms:**

Sick Building Syndrome \_\_\_\_\_

Spores \_\_\_\_\_

Microbial Contamination \_\_\_\_\_

**2. List six causes of indoor air pollution.**

1. \_\_\_\_\_  
\_\_\_\_\_

2. \_\_\_\_\_  
\_\_\_\_\_

3. \_\_\_\_\_  
\_\_\_\_\_

4. \_\_\_\_\_  
\_\_\_\_\_

5. \_\_\_\_\_  
\_\_\_\_\_

6. \_\_\_\_\_

**3. Identify and describe the ideal environment for mold growth.**

\_\_\_\_\_  
\_\_\_\_\_





---

# Module 2

## Microbial Remediation Health Effects

---

### **PARTICIPANT OBJECTIVES**

After completing Module 2, you will be able to:

1. Define the following terms:
  - Aspergillus
  - Bacteria
  - Fungi
  - HP
  - Mycotoxins
  - ODTS
  - Penicillium
  - Stachybotrys Chartarum (Atra)
  - Trichothecene Mycotoxin
  - Viruses
2. Identify the routes of entry for fungi to enter the body.
3. Identify at least two common symptoms associated with mold exposure.



## INTRODUCTION

Health implications of fungal and bacterial contamination of indoor air have become an issue of increasing concern in recent years. Essential dose-response information is needed to correlate microbial exposures to health effects in humans.

Tolerance to molds appears to vary among individuals and appears to at least partially be related to allergic sensitization. It is recognized that microbial exposure in humans can have allergic, infectious, or toxic effects. These effects vary based on personal susceptibility (e.g., age, personal health) and dose (i.e., amount and time of exposure).

There are no federal or state regulations at this time that address sick building syndrome issues. Complaints arise from those who work in sick buildings. They experience diverse symptoms as a result of exposure to biological and chemical agents. The majority of health complaints are related to mucous membrane discomfort (e.g., eye, nose, and throat irritation).

## CATEGORIES OF INDOOR AIR POLLUTION

Indoor air pollutants can be divided into two broad categories:

- Chemicals
- Biological airborne particles

## CHEMICAL POLLUTANTS

As discussed in Section 1, building materials and furnishings, office equipment, cleaning supplies, and coatings can emit chemicals into indoor air.

The obvious pathway for chemical pollutants into the human body is through *inhalation*. Inhaled chemicals can produce chemical sensitivities that can cause allergic reactions as well as severe health problems in affected individuals.

## BIOLOGICAL AIRBORNE PATHOGENS

A *pathogen* is a specific cause of a disease. Biological airborne pathogens have at least three categories that can cause human disease:

- Viruses
- Bacteria
- Fungi

### Viruses



*Viruses* are any of a large group of submicroscopic infectious agents. Viruses can grow and multiply only in living cells and cause diseases in humans, animals, and plants. They are typically not considered to be living organisms.

There are approximately 20 viruses that can be carried by air currents in buildings. Some of the diseases caused by viruses are:

- Chickenpox
- Colds
- Fifth's disease
- Flu
- Measles
- Mumps
- Pneumonia (certain types)
- Roseola
- Rubella (German measles)
- Smallpox

Strong disinfectants are normally used to kill viral agents outside the body. Normally, once a human contracts a virus, a licensed physician must provide treatment.

### Bacteria



*Bacteria* is the plural for "bacterium." There are seemingly countless types of bacteria in the world; most are harmless to people. A few one-celled microorganisms cause infectious diseases in plants, animals, and people. Bacterial diseases that can be transmitted by a building's air currents are:

- Certain types of pneumonia — an inflammation of the lungs caused by an infection.

- Tuberculosis — an infection caused by a species of mycobacterium
- Anthrax — Recently there has been a concern about infections caused by the spores of the anthrax bacterium. This bacterial threat has its own unique features and is covered in a separate course developed by Laborers-AGC.

*Disinfectants* such as alcohol, bleach, and ammonia can be used to kill bacteria outside the body. Historically, antibiotics have proven useful in combating diseases caused by bacteria. However, a problem that is developing with antibiotics is that many bacteria have developed immunity to them. For example, streptomycin was used to combat tuberculosis (TB). TB was once thought to have been eliminated altogether, but a resurgence of the disease has been seen because it has developed a resistance to the antibiotic.

## Fungi

*Fungi* comprise 25 percent of the living matter of the earth. Therefore, human exposure to fungi is common but most do not cause health problems. Although there are thousands of fungal species, reports of human and animal diseases related to fungal exposure have involved fewer than 100 species. We use fungi, in the form of yeast, to raise bread and ferment beer and wine. It is also found in cheese and gives different types of cheese their distinct tastes.

Molds, mildews, rusts, smuts, mushrooms, toadstools, puffballs, yeasts, and slime molds are all types of fungi.

Unlike plants, fungi do not have seeds. Instead, fungi reproduce themselves by spores. Spores can become airborne and can be carried by building air currents.

In addition, spores can be transported in dust from contaminated soil. *Histoplasmosis* is a fungal infection that varies in symptoms and seriousness. Histoplasmosis is caused by a fungus, *Histoplasma capsulatum*. This fungus primarily grows in soil that has been enriched by bird and bat droppings. Infection occurs when the soil containing the fungus becomes dry and disturbed. There are times when Laborers are required to clean up areas that contain large amounts of bat and bird droppings. For additional information regarding bird



and bat dropping cleanup, refer to *Histoplasmosis; Protecting Workers at Risk*. (This document, Publication 97-146, is available by calling 1-800-35-*NIOSH*. See Appendix B, Resources) Information may also be obtained from the Laborers' Health and Safety Fund of North America at 202-628-5465.

### **Fungal Diseases**

Although more research needs to be done to fully understand the relationship between microbial exposure and resulting illnesses, there is no question that consistent exposure to mold spores makes some people sick. Once inhaled, these spores may lead to allergic reactions, cause toxic effects, or cause infections. The most common symptoms are very similar to the common cold: runny nose, eye irritation, cough, congestion, headache, and fatigue.



Workers performing renovation, demolition, and cleaning of fungal contamination can develop Organic Dust Toxic Syndrome (ODTS) or Hypersensitivity Pneumonitis (HP), which can also occur in building occupants.

ODTS can occur after a single heavy exposure to dust contaminated with fungi and produces flu-like symptoms. HP may occur after repeated exposures to an allergen (fungi or bacteria) and can cause permanent lung damage.

### **Mycotoxins**



Some molds can produce *mycotoxins*. Mycotoxins are toxic compounds that are fungal metabolites released into the air by fungi. Building occupants unknowingly inhale these compounds and can become sick. Many, if not all, molds can produce mycotoxins with the potential to cause toxic reactions. There are more than 300 known mycotoxins. Mycotoxin production is affected by a variety of conditions such as fungal strain, genetic insusceptibility of the host plant, moisture content, temperature, aeration, microbial population, and stress factors. Virtually all the information related to diseases caused by mycotoxins concern ingestion of contaminated foods.

Although there are more than 300 of types of mycotoxins, one class called trichothecenes has received considerable attention.

### **Trichothecene Mycotoxins**

Trichothecene mycotoxins are some of the most potent toxic chemicals known. The United States government considered using trichothecene mycotoxins for bio-warfare agents, but determined that they were too dangerous to produce and handle.



### **Stachybotrys Chartarum (Arta)**

Fungi of the genus *Stachybotrys* are found worldwide and have been isolated from soil and a wide variety of substances rich in cellulose such as hay, wood pulp, cotton, grains, various plant components, paper, and glue in book bindings. Buildings where *Stachybotrys* growth problems are reported have typically experienced chronic water damage and were kept at a temperature conducive to its growth (72-82 °F.). It is usually found as a slimy black mold. *Stachybotrys* can affect:



- Immune system
- Brain and nervous system
- Digestive system
- Blood system
- Respiratory system
- Skin (dermatitis and rash)

Not all people exposed to *Stachybotrys* are severely affected. There is some controversy about the severity of its effects.

### **Aspergillus**

*Aspergillus* is a common mold. There are over 600 different types of species in the *Aspergillus* family. Most *Aspergillus* species are found in soil, although many species can be found on a wide variety of substrates, including forage and food produce, cotton, and other organic debris. *Aspergillus fumigatus*, one of the most common species, accounts for most diseases attributable to *Aspergillus*, both allergic and infectious. Groups at high risk of exposure to this fungus include farmers, bird hobbyists, workers in sawmills, greenhouses, cane mills, and breweries. People who work around mushrooms, tobacco, grain, compost piles, or decomposing haystacks have also been known to develop illnesses due to *Aspergillus* exposure. Additionally, people with weakened immune systems, such as AIDS patients or those



undergoing chemotherapy, are at risk. Exposure to the *Aspergillus* species has been reported to cause a variety of long-term (chronic) health problems.

Short-term (acute) symptoms may occur 6 to 12 hours after exposure. These include muscle ache, fatigue, chest tightness, and shortness of breath.

### **Penicillium**

*Penicillium* is a common contaminant in indoor environments. Contaminated humidifier water or moldy *heating, ventilation, and air conditioning* (HVAC) systems can cause exposure to these blue-green molds. Inhalation of airborne spores is the major route of entry. These molds are common contaminants of grain products and some of the mycotoxins produced by these species are also produced by fungi common in house dust. *Penicillium* infections of clinical importance are rare, although this mold has been associated with asthma and hypersensitivity pneumonitis. Some *Penicillium* species are fairly common indoor fungi, even in clean environments. This particular species of fungi can breed quickly in indoor environments. *Penicillium* species can be found at the sub-basement levels of offices and homes, in libraries, auditoriums, storage rooms of paper materials, and ventilation systems.

### **FUNGI ROUTES OF ENTRY**

The fungi we have been discussing can be carried by air currents and inhaled. Fungi may also be absorbed by skin contact, including entry through wounds or cuts. Fungi may also pass into body systems by eating or drinking. Therefore the four routes of entry that need to be considered when dealing with fungi are:

1. *Inhalation*
2. *Ingestion*
3. *Absorption*
4. *Penetration*





## WORKER PRECAUTIONS

Sewage and wastewater contain bacteria, fungi, and viruses that can cause infections. Training, personal protective equipment, and good worker hygiene are essential for sewage and wastewater treatment plant workers.

You should heed the following precautions on microbial remediation projects while you are in the work area, just as on asbestos, lead, and hazardous waste projects. You should **NOT**:

- Drink
- Smoke
- Chew gum or tobacco products
- Apply cosmetics
- Eat

These precautions are meant to reduce the chance of exposure from ingestion and skin absorption within a work area.

## MEDICAL TESTING AND SURVEILLANCE

As previously stated, federal or state regulations have not been promulgated that specifically relate to you when you are working on a microbial remediation project. Therefore, there are no government requirements relating to medical testing and surveillance. However, there are medical diagnostic tests for some building-related illnesses (such as allergic fungal sinusitis, hypersensitivity pneumonitis, organic dust toxic syndrome, and rhinitis). It is advisable that employers implement a program that identifies any potential health problems in microbial remediation workers.

When respirator usage is required, a physical examination in accordance with the *Occupational Safety and Health Respiratory Protection Standard*, 29 CFR 1910.134, is mandatory. As per 1910.134(e): “Using a respirator may place a physiological burden on employees that varies with the type of respirator worn, the job and the workplace condition in which the respirator is used, and the medical status of the employee. Accordingly, this paragraph [1910,134(e)] specifies the minimum requirements to determine the employee’s ability to use a respirator. At a minimum, a mandatory OSHA

Respirator Medical Evaluation Questionnaire located in Appendix C of 29 CFR 1910.134 must be completed and evaluated by a physician or a licensed health care professional.”

Thus, before being fit tested for respirator usage, the steps outlined in paragraph (e) of the standard must be followed. Refer to Appendix A of this manual for a copy of 29 CFR 1910.134. Included as an appendix to this module is a sample copy of a microbial remediation respirator clearance form.

For additional information regarding all of the elements of a respiratory program, refer to Module 5 of this manual.

## **SUMMARY**

There are dangers involved in the remediation of buildings with indoor air contaminants. Some types of molds can have very adverse health effects in humans, some of whom are more susceptible than others. Although there are no actual government regulations enacted at this time, it is important that workers know the hazards associated with microbial remediation and how to avoid exposure to these hazards.

In most remediation situations, workers will encounter multiple types of molds and fungi. Building occupants would also have experienced many different symptoms including headaches and respiratory irritations.

Although the health effects of microbial contamination continue to be studied and debated, the American Industrial Hygiene Association (AIHA) task force (May 2001) found that “All currently available consensus guidance documents agree that the growth of mold on building surfaces requires remediation.”

**MODULE 2 — APPENDIX**

**SAMPLE Medical Clearance Form  
for  
Mold and Fungi Remediation Workers**

A worker doing mold and fungi remediation should be medically fit and healthy. This work almost always involves respirator use. The medical clearance and other requirements of the OSHA respirator standard must be met.

Exposure to mold and fungi as part of this work may cause health problems for some people with specific medical conditions. People with asthma, hay fever, and other allergic conditions may have these conditions aggravated by this exposure. People with diabetes, cancer, organ transplants, or other conditions or who are taking medications that may suppress their immune systems may also be at greater risk for developing illnesses from exposure to mold and fungi. These conditions should be considered on an individual basis in clearing a person for this type of work.

I, \_\_\_\_\_, have performed a medical examination of \_\_\_\_\_ (Patient Name) which followed the mandatory guidelines in OSHA Standards 29 CFR 1910.134, 1910.1001, and 1926.1101, Appendix D. Based on the results of this examination, I declare this person:

\_\_\_\_\_ Has no restrictions in working on mold and fungi remediation while wearing a negative pressure respirator

\_\_\_\_\_ Cannot work on mold and fungi remediation while wearing a respirator

Additional comments regarding clearance: \_\_\_\_\_  
\_\_\_\_\_  
\_\_\_\_\_

Name of Medical Provider: \_\_\_\_\_

Signature: \_\_\_\_\_

Date: \_\_\_\_\_

Address: \_\_\_\_\_

Phone Number \_\_\_\_\_



## MODULE 2 - ASSIGNMENT SHEET

### 1. Define the following terms:

Aspergillus \_\_\_\_\_  
\_\_\_\_\_  
\_\_\_\_\_

Bacteria \_\_\_\_\_  
\_\_\_\_\_  
\_\_\_\_\_

Fungi \_\_\_\_\_  
\_\_\_\_\_  
\_\_\_\_\_

HP \_\_\_\_\_  
\_\_\_\_\_  
\_\_\_\_\_

Mycotoxins \_\_\_\_\_  
\_\_\_\_\_  
\_\_\_\_\_

ODTS \_\_\_\_\_  
\_\_\_\_\_  
\_\_\_\_\_  
\_\_\_\_\_

Penicillium \_\_\_\_\_

\_\_\_\_\_

Stachybotrys Chartarum (Atra) \_\_\_\_\_

\_\_\_\_\_

Trichothecene Mycotoxin \_\_\_\_\_

\_\_\_\_\_

Viruses \_\_\_\_\_

\_\_\_\_\_

**2. Identify the routes of entry for fungi to enter the body.**

\_\_\_\_\_

\_\_\_\_\_

**3. Identify at least two common symptoms associated with mold exposure.**

1. \_\_\_\_\_

\_\_\_\_\_

2. \_\_\_\_\_

\_\_\_\_\_

---

# Module 3

## Microbial Remediation Work Area Sampling

---

### **PARTICIPANT OBJECTIVES**

After completing Module 3, you will be able to:

1. List at least three reasons for performing work area monitoring and sampling.
2. List at least three methods of sampling used to detect and identify the presence of microbial contamination.





## INTRODUCTION

Work area monitoring and sampling are done on microbial remediation projects to determine:

- The presence of mold, fungi, or similar microbes
- The types of microbes present
- If workers are being exposed
- The effectiveness of remediation

There are no fully reliable commercial *direct reading instruments* (DRIs) to monitor mold spores and similar microbial organisms. They must be collected and analyzed at a laboratory that specializes in biological analysis.

Because no exposure limits exist for exposure to mold or mold spores, monitoring and sampling are of limited use in determining if remediation workers or building occupants are being overexposed. The best methods for ensuring workers and building occupants are protected are to maintain a negative pressure enclosure and use good work practices to keep airborne concentrations low.

In the Environmental Protection Agency (EPA) publication, *Mold Remediation in Schools and Commercial Buildings Report*, there are guidelines for when sampling should be done:

*If visible mold is present, sampling is unnecessary. In specific instances, such as cases where litigation is involved, the source(s) of the mold contamination is unclear, or health concerns are a problem, you may consider sampling as part of your site evaluation.*

Samples collected by professionals with specific experience in designing mold sampling protocols, sampling methods, and interpretation of results should be used to detect the presence of harmful microbial contamination on surfaces as well as airborne or stationary bioaerosols in buildings. As noted in the NYC Guidelines (Appendix B, Resources), a laboratory specializing in mycology should be consulted for specific sample and delivery instructions.

The monitoring and sampling methods that are discussed in this section are:

- Visual inspection
- Bulk sampling of visible material
- Air sampling
- Sterile swab wiping

## VISUAL INSPECTION



An initial visual inspection is the most important step in identifying a possible contamination problem. Ventilation systems and building materials such as gypsum wallboard and ceiling tiles should be thoroughly inspected. The extent of any water damage and mold growth should be evaluated. This will be important in determining remediation techniques. The larger the area affected, the more precautions that must be taken. If visible mold exists, it is an indication that bigger problems could exist.

## BULK SAMPLING OF VISIBLE MATERIAL



Bulk sampling can be done if there is visible contamination. Dust samples that have settled on surfaces can provide information on airborne concentrations that have been deposited over time.

Bulk sampling involves collecting a small sample of the material and placing it in a Ziplock® bag. Collecting is done either by scraping the material into the bag or by stripping the surface with vinyl acetate tape. Tape pulls the sample off the surface and preserves it for analysis, although this method is not always successful.

You should always use proper PPE, including respiratory protection and protective clothing, when doing bulk sampling because it involves disturbing contaminated material, which means there is a chance of exposure during the process.

Bulk samples are sent to a laboratory for analysis.

## AIR SAMPLING

Air sampling is now being used less often on microbial remediation projects because it can often lead to “false negatives.” Such “false negative” results can lead to the conclusion that risks are lower than they actually are—and this could mean trouble for both building occupants and cleanup workers. When used, air sampling must be performed in conjunction with an initial visual inspection and surface sampling. Also, if the building is ventilated with outdoor air, at least one outdoor air sample should be taken. This will allow for a comparison with indoor air samples after remediation has been completed.



### Sampling for Bioaerosols

Reasons for collecting area air samples are to:

- Detect and quantify the presence of bioaerosols
- Identify bioaerosol releases
- Assess human exposures to biological agents
- Monitor the effectiveness of control measures

Many of the same techniques that are used for non-biological aerosols can be used for bioaerosols such as mold and fungi. Airborne particles are captured in some type of sampling media where they can be analyzed in a laboratory using techniques such as high magnification. In order to do this, collection must be done in a way that ensures the survival of organisms during and after collection. The mold and fungi must remain biologically active during the laboratory analysis.

Traditionally, liquid-filled impingers have been preferred as devices for collecting bioaerosols. Impingers use air that is drawn in at a high velocity into a liquid-filled (usually water) flask through a glass nozzle or jet. The particles collide with a flat plate at the bottom of the flask, lose their velocity, and are trapped in the liquid. Liquid-filled impingers offer the advantage of easy microbial analysis because portions of the collection liquid can be placed directly onto agar (a jelly-like substance derived from algae), which is heated or incubated so that the samples will grow. The resulting colonies are counted and identified.



## STERILE SWAB WIPING

Surface samples can be taken with sterile swabs (such as moistened cotton wool swabs individually packed in tubes) from hard surfaces. The swabs are then sent to a laboratory where they are analyzed.

Sterile swab wiping is the most widely used sampling method on microbial remediation projects. Sampling protocols that use a grid or matrix help to identify where each sample was taken.

## CULTURES

Laboratory testing methods use cultures, a special growing medium, to indicate the presence of viruses, bacteria, or fungi. The growing medium can be tissue material, agar, or even a cellulose material suspended in a special jelly.

The growing medium is placed in petri dishes and left in the open air to collect organisms. Airborne organisms land on the jelly-like material and begin to reproduce, forming what are called colonies. (The molds found on bread are usually colonies of *Penicillium*, for example.) Samples of the colonies on the petri dishes can be removed and analyzed under a microscope to identify them. Quantities of fungi have been traditionally assessed by the measure colony-forming units (CFU).

## SUMMARY

The field of microbial remediation sampling continues to evolve. Sample analysis at this time should follow American Industrial Hygiene Association (AIHA), American Conference of Governmental Industrial Hygienist (ACGIH), or other professional guidelines. Work area sampling and monitoring is also overseen by a qualified person. The sampling is important to the proper performance of the job to both ensure a safer working environment for Laborers and a safe place for building occupants.

### MODULE 3 - ASSIGNMENT SHEET

**1. List at least three reasons for performing work area monitoring and sampling.**

- 1. \_\_\_\_\_
- 2. \_\_\_\_\_
- 3. \_\_\_\_\_

**2. List at least three methods of sampling used to detect and identify the presence of microbial contamination.**

- 1. \_\_\_\_\_
- 2. \_\_\_\_\_
- 3. \_\_\_\_\_



---

# Module 4

## Microbial Remediation Hazard Communication

---

### **PARTICIPANT OBJECTIVES**

After completing Module 4, you will be able to:

1. List the five requirements of the Hazard Communication Standard's written program.
2. Calculate TWA and determine exposure levels.
3. Given a list of questions, demonstrate how to use a MSDS by answering the questions.
4. List the three basic types of labeling systems.
5. Given a list of questions, demonstrate how to read a label by answering the questions.





## INTRODUCTION

An effective Hazard Communication Program needs the cooperation of employers and workers. The employer must provide workers with specific information and training about hazardous substances in the work area. Workers must use the information and training to recognize chemical hazards in the work area and take steps to prevent exposure.

The Occupational Safety and Health Administration (OSHA) has implemented the Hazard Communication Standard for both the construction industry (29 CFR 1926.59) and general industry (29 CFR 1910.1200). The standard states:

“The purpose of this section is to insure that the hazards of all chemicals produced or imported are evaluated and that information concerning their hazards is transmitted to employers and employees.”

These standards require that hazardous chemical manufacturers inform employers about the hazards of a product. The employer must inform all workers who will use or come into contact with the chemical about its hazards.

### Scope

The Hazard Communication Standard applies to any chemical known to be present in the workplace to which workers may be exposed during normal use. It also applies when exposure to chemicals may occur during a foreseeable emergency. In microbial remediation, the standard only applies to the hazardous materials or substances used for the *cleanup* process. The standard does **not** apply to:

- Microbial material, such as mold or mildew
- Hazardous waste
- Tobacco or tobacco products
- Wood or wood products
- Articles (chairs, tables, etc.)
- Food, drugs, and cosmetics
- Alcoholic beverages
- Consumer products

Workers cleaning up mold, mildew, and similar microbial wastes must be trained in the standard specifically because of the hazardous materials they use for cleanup work, such as bleach, ammonia, ozone, chlorine dioxide, and other hazardous chemicals.

### **Hazard Determination**

The Hazard Communication Standard requires chemical manufacturers, importers, and employers to determine if the chemicals or substances they produce, import, or use in the workplace are hazardous. In most cases, hazard determinations are done by chemical manufacturers before the chemicals are sold to customers.

### **Written Hazard Communication Program**

Under the standard, employers and/or contractors must develop, implement, and maintain a written Hazard Communication Program. This written program must be available at the workplace and provide the following information:

- List the hazardous chemicals on the job site.
- Explain how the employer will inform workers of the hazards associated with nonroutine tasks involving hazardous chemicals.
- Explain labels and other forms of warning used by the employer.
- Explain how workers will be provided with material safety data sheets (MSDSs).
- Describe the training the employer will use to teach workers about hazardous chemicals.

### **Multiple Employer Sites**

Some work sites have more than one employer working on the site at the same time. The standard requires that all employers on a multiple employer site provide information to each other on the hazardous chemicals they are using. This sharing of information will help prevent worker exposure to chemical hazards from another employer. The written Hazard Communication Program of a multiple employer site must:

- Explain how MSDSs will be provided to the other employer(s), or identify the location of the MSDSs for each hazardous chemical the other employer's workers may be exposed to while working.
- List the methods an employer will use to inform other employer(s) of measures that need to be taken to protect workers during normal operating conditions and in foreseeable emergencies.
- Explain how the employer will inform the other employer(s) of the hazardous chemical labeling system being used.

The written Hazard Communication Program must be made available upon request to workers, their representatives, and OSHA.

### **Information and Training**

The Hazard Communication Standard requires employers to provide specific information and training on hazardous chemicals so workers will:

- Be aware of the hazardous chemicals used on the job
- Know how to recognize these hazardous chemicals
- Know the safety issues and health effects of the hazardous chemicals
- Be able to protect themselves

As a minimum, training must cover the following hazard communication information:

- Requirements of the Hazard Communication Standard.
- Operations in the work area where hazardous chemicals are present.
- Location and availability of the:
  - Written Hazard Communication Program
  - List of hazardous chemicals stored on site
  - MSDSs for all hazardous chemicals used on site

Employers must provide or ensure that workers have been provided with the following information:

- The ways to detect the presence or release of hazardous chemicals in the work area. The characteristics of a chemical are important pieces of information for workers. These characteristics include color, chemical state (solid, liquid, gas), and odor.
- The physical and health hazards caused by exposure to the hazardous chemicals on the job.
- How to protect themselves through work practices, personal protective equipment (PPE), and emergency procedures.
- Details of the Hazard Communication Program used by the employer, including labels, lists, MSDSs, and methods by which workers can get and use hazard information.

**Note:** This section covers the general information that must be included in the Hazard Communication Program. The section does not fulfill an employer's obligation to supply workers with hazard communication training on site-specific hazards.

## EXPOSURE GUIDES

When working around hazardous chemicals, exposure is an important consideration. Hazardous chemicals can have devastating health effects on the human body. Therefore, *exposure guides* are used to inform workers about warnings and exposure limits and to make decisions about worker exposure to chemicals.

Some exposure guides are general. They give instructions or information about a chemical using a short phrase, word, numbers, or symbols. For example, "avoid skin contact" and "avoid breathing vapors" are general exposure guides. These general guides are usually found on labels or placards on chemical containers. However, the identity of the chemical needs to be known in order for general guidelines to be useful.

When the employer knows both the identity of a chemical and its air concentration at the work site, more specific exposure guides can be applied. Permissible exposure limits (*PELs*) and threshold limit values (*TLVs*) are two commonly used exposure guides that deal with concentration levels.

**Exposure limits** = concentrations of a toxic substance in the air over an 8-hour work shift

Exposure limits set the basis for safe working exposures. In most cases, exposure limits refer to concentrations of a toxic substance in the air over a normal 8-hour work shift. Safe exposure limits represent conditions under which nearly all workers can be exposed repeatedly day after day without adverse acute or chronic health effects.

The MSDS for a product must list chemical exposure limits. The limits may also appear on the container label of the product. Exposure limits usually are given as parts per million (*ppm*) or milligrams per cubic meter (*mg/m<sup>3</sup>*). One ppm is like one inch in 16 miles. Many chemicals can affect your body at 1 ppm or even smaller amounts.

Several organizations have published, required, or recommended safe working guidelines for exposures to hazardous chemicals. These organizations are OSHA, the National Institute of Occupational Safety and Health (*NIOSH*), and the American Conference of Governmental Industrial Hygienists (*ACGIH*).

### **Permissible Exposure Limits**

Permissible Exposure Limits (PELs) are exposure guides for airborne concentrations of regulated substances. They set limits on a worker's inhalation exposure or the amount of a substance a worker can legally breathe in a set amount of time.

There are three ways to represent PELs:

1. Time weighted average
2. Short-term exposure limit
3. Ceiling limit

PELs are the **only** legally enforceable limits because they are set by OSHA. This means that by law, employers must keep a worker's exposure below the PEL. PELs are meant to offer the minimum levels of protection. However, more protective limits are always allowed.

Because PELs refer to inhalation exposures, they cannot be used to determine exposure that occurs through the skin. A worker may have an exposure below the PEL but still become overexposed to a chemical through skin absorption.

The skin notation that is sometimes listed in the PELs means a chemical can be absorbed through the skin. It is **not** an exposure guide. There are no concentration guidelines for skin exposure. Therefore avoid skin contact with chemicals whenever possible, especially when the skin notation is used.

**Note:** PELs are important for protecting workers from overexposure to hazardous chemicals. However, workers should be aware of the drawbacks of PELs. Many PELs are not set to protect workers from chronic health effects such as cancer. In addition, PELs that apply to the construction industry were established in 1970. Although OSHA has updated PELs for some substances since that date, such as lead and asbestos, there are many PELs that are outdated.

### **Time Weighted Average**

*Time weighted average (TWA)* is the average concentration of a substance in an area over an 8-hour work shift of a 40-hour workweek. To determine a TWA, exposure levels are collected over a work shift. The exposure levels are averaged out for 8 hours and the results compared with OSHA's PEL lists. For example, a worker's exposure to chlorine dioxide is 90 ppm for 2 hours, 120 ppm for 1 hour, and 20 ppm for 5 hours. The worker's actual exposure to chlorine dioxide, averaged for the day is 50 ppm. The calculations are shown in Figure 4-1. The allowable TWA exposure for chlorine dioxide is 100 ppm. Therefore, on this particular day, this worker was not overexposed according to OSHA limits.

### **Overtime Calculations**

If a worker works longer than eight hours, overtime calculations must be done to determine the total exposure (Figure 4-2). Overtime does **not** allow an employer to expose a worker to higher concentrations. In fact, the worker must be exposed to lower concentrations because he or she will be working for a longer time period.

$$\text{TWA} = \frac{(90 \text{ ppm} \times 2 \text{ hrs}) + (120 \text{ ppm} \times 1 \text{ hr}) + (20 \text{ ppm} \times 5 \text{ hrs})}{8 \text{ hrs}}$$

$$\text{TWA} = \frac{180 \text{ ppm hrs} + 120 \text{ ppm hrs} + 100 \text{ ppm hrs}}{8 \text{ hrs}}$$

$$\text{TWA} = \frac{400 \text{ ppm hours}}{8 \text{ hrs}}$$

$$\text{TWA} = 50 \text{ ppm}$$

Figure 4-1. Calculating the TWA for chlorine dioxide

*Overtime Calculations:*

Equation:  $\frac{\text{PEL} \times 8 \text{ hrs}}{\text{hrs worked}}$

PEL = 100 ppm  
Hours Worked = 10

*Calculation:*  $\frac{100 \text{ ppm} \times 8 \text{ hrs}}{10 \text{ hrs}} = 80 \text{ ppm}$

Worker can only be exposed to 80 ppm for the duration of the time worked.

Figure 4-2. Overtime calculations

### Mixture Calculations

When a worker is exposed to more than one substance or to a mixture of substances that have similar chemical properties, mixture calculations must be done to determine the actual exposure. Chemicals with similar properties have a tendency to attack the same target organs, which increases the chance of overexposure. Figure 4-3 gives an example of a mixture calculation.

1. Calculate exposure for each chemical:		$\text{Exposure} = \frac{\text{TWA}}{\text{PEL}}$
Ammonia	TWA exposure is 25 ppm PEL = 50 ppm	
	$\frac{25 \text{ ppm}}{50 \text{ ppm}} = 50\% \text{ of PEL}$	
Chlorine dioxide	TWA exposure is .08 ppm PEL = .1 ppm	
	$\frac{.08 \text{ ppm}}{.1 \text{ ppm}} = 80\% \text{ of PEL}$	
2. Add exposures for each chemical to find total chemical exposure:		
TOTAL	50% + 80% = 130%	
Exposure is 30% above the PEL so the <b>worker is overexposed.</b>		
<b>NOTE:</b> Above chemicals are incompatible; do not mix them.		

Figure 4-3. Mixture calculation for a worker's exposure to ammonia and chlorine dioxide

### Short-Term Exposure Limits

*Short-term exposure limits (STELs)* are the maximum concentration that workers can be exposed to for a short period of time (usually 10 to 15 minutes) without suffering from adverse health effects.

STELs should **not** occur more than four times per shift, and there should be at least 60 minutes between exposures. The daily TWA PEL must not be exceeded.

Not all chemicals have assigned STELs. For substances without STELs, it is usually recommended that exposure should not exceed three times the PEL for a short term (10 to 15 minutes). For example, OSHA's PEL for perchloroethylene or perc is 25 ppm. Perc has no STEL listed, so a STEL is estimated by calculating:

$$3 \times 25 \text{ ppm} = 75 \text{ ppm}$$



### **Ceiling Limits**

*Ceiling limit (C)* is an exposure level that should **never** be exceeded. However, not all chemicals have assigned ceiling values. If a ceiling limit is not assigned to a substance or chemical, it is generally recommended that exposures never exceed five times the PEL.

### **Threshold Limit Values**

*Threshold limit values (TLVs)* are set by the ACGIH. They are based on the best available information from industrial experience, experimental human studies, and animal studies. The basis on which the values are established may differ from chemical to chemical. TLVs are only advisory and are not legally enforceable. A revised list of TLVs is published each year which makes them more current than PELs. However, chronic effects are not always given enough consideration in setting TLVs.

As with PELs, TLVs refer only to inhalation exposures.

Some chemicals cause adverse health effects if short-term exposures exceed a certain level. Special exposure limits are set for these chemicals. *Immediately dangerous to life or health (IDLH)* values identify an exposure level in an environment that is likely to cause death or serious health effects with very brief exposures.

## **EXPOSURE CONTROL MEASURES**

Exposure control measures were developed to protect workers from chemical exposure and include:

- Substitution
- Engineering controls
- Administrative controls
- PPE

*Substitution* generally is the most desirable control measure because it eliminates the original hazard. The hazardous chemical is replaced with a nonhazardous or less hazardous chemical that works as well. However, this is often not easy to do. If chemicals are part of the cleanup approach for a microbial problem, the chemicals have to be strong enough to

destroy the mold, fungus, or spores. Chemicals that are less hazardous to the cleanup workers may not be powerful enough to do the job that is needed.

*Engineering controls* reduce or eliminate exposures by using mechanical means such as ventilation systems, acoustical material, or clean air control booths. It does not eliminate the hazard.

*Administrative controls* reduce exposures to an acceptable limit in two ways:

1. Removing the worker from exposure after a specific length of time. This method is used extensively by the nuclear industry to reduce radiation exposures.
2. Establishing work rules, such as no eating, drinking, or smoking.

*PPE* is the least desirable exposure control measure because the hazard is still present so exposure is possible. However, it is also the most commonly used method in construction. PPE includes respirators, gloves, protective suits, boots, and other gear that are worn to protect workers from exposures. PPE is not an engineering control.

## INVENTORY LISTS

Every employer who uses or stores hazardous chemicals on a job site is required to develop and make available a chemical inventory list. This list identifies the potentially dangerous chemicals that workers are exposed to on a work site. The chemical or product name located on the employer's chemical inventory list must be the same as the name on the container label and its corresponding MSDS. In this way, a worker can easily locate any additional information needed for protection. The inventory list must be on the job site and available for a worker's review. It is updated whenever any new chemical or substance is brought to the site or if a chemical is no longer used. A sample chemical inventory list is shown in Figure 4-4.

<p style="text-align: center;"><b>THIS COMPANY, INC.</b>  <b>111 MAIN STREET</b>  <b>ANYWHERE, U.S.A 12345</b></p> <p style="text-align: center;"><b>CHEMICAL INVENTORY LIST</b></p> <p>Acrylic Water Base Paint (Lambert)  Ater Blasting Shop Primer Red 53-R-101  Cosmiscoat Pavement Sealer  Deck Paint Blue Gray 58-F-23 (Mobile Chemical Co.)  Deck Paint Brown 58-D-95 (Mobile Chemical Co.)  Deck Paint Ocean Gray 58-F-14 (Mobile Chemical Co.)  Duracrylic Extra High Gloss Thinner (PPG Industries)  E Enton 37-127 Epoxy Resin (Reichold Chemical)  E Enton 37-620 Epoxy Resin Hardener (Reichold Chemical)  Paint Thinner 21-263 (PPG Industries)  2 - Propanol Solvent (Fisher)  Styrofoam Plastic Forms (Dow Chemical)  Varsol 1 Petroleum Solvent (Exxon)  Varsol 18 Petroleum Solvent (Exxon)</p>
---

Figure 4-4. Sample chemical inventory list

## MATERIAL SAFETY DATA SHEET

*A material safety data sheet (MSDS)* is the primary source of information about hazardous chemicals used on the job site. Employers are required to have an MSDS for every hazardous

chemical used or stored on each job site. They must make the MSDSs available to workers or the workers' representative for review.

MSDSs come in many different formats, but they all must contain the same basic information. Table 4-1 lists the minimum information that must be contained in every MSDS. Figure 4-5 shows the manufacturer's MSDS for bleach.

**Note:** The MSDS for chlorine bleach, shown in Figure 4-5, is provided courtesy of MEDTROL, INC.

Table 4-1. Minimum information needed on an MSDS

<b>MSDS Section Title</b>	<b>Information Included</b>
Product Identity and Manufacturer's Information	<ul style="list-style-type: none"> <li>• Identity of the chemical (as on label)</li> <li>• The name and address of the manufacturer</li> <li>• Emergency phone numbers</li> <li>• Date when MSDS was prepared</li> </ul>
Hazardous Ingredients	<ul style="list-style-type: none"> <li>• Hazardous ingredients</li> <li>• Properties of the chemical</li> <li>• Common name and trade name</li> <li>• OSHA PELs</li> <li>• ACGIH TLVs</li> <li>• Other recommended limits</li> </ul>
Physical/Chemical Characteristics	<ul style="list-style-type: none"> <li>• Boiling point</li> <li>• Vapor pressure and density</li> <li>• Solubility in water</li> <li>• Appearance and odor</li> <li>• Evaporation rate</li> <li>• Melting point</li> </ul>
Fire and Explosion Hazard Data	<ul style="list-style-type: none"> <li>• Fire and explosion hazard data</li> <li>• Flash point</li> <li>• Flammable limits</li> <li>• Extinguishing media</li> <li>• Special firefighting procedures</li> <li>• Physical hazards</li> </ul>
Reactivity Data	<ul style="list-style-type: none"> <li>• Stability of the substance</li> <li>• Conditions to avoid</li> <li>• Incompatibility with other materials</li> <li>• Hazardous decomposition properties</li> <li>• Associated by-products</li> </ul>
Health Hazard Data	<ul style="list-style-type: none"> <li>• Acute (short-term) health hazards</li> <li>• Chronic (long-term) health hazards</li> <li>• Routes of entry</li> <li>• Target organs</li> <li>• Carcinogenicity (cancer-causing)</li> <li>• Signs and symptoms of exposure</li> <li>• Medical conditions aggravated</li> <li>• Emergency first aid procedures</li> </ul>
Precautions for Safe Handling and Use	<ul style="list-style-type: none"> <li>• Precautions for safe handling</li> <li>• Precautions for safe use</li> <li>• Spill containment procedures</li> <li>• Waste disposal methods</li> <li>• Precautions for storage</li> </ul>
Control Measures	<ul style="list-style-type: none"> <li>• Exposure control measures</li> <li>• Engineering controls</li> <li>• Administrative controls</li> <li>• Work practices</li> <li>• Personal protective equipment</li> </ul>

MEDTROL -- SUPER CHLOR CHLORINE BLEACH  
 MATERIAL SAFETY DATA SHEET  
 NSN: 685000F055026  
 Manufacturer's CAGE: 08VB4  
 Part No. Indicator: A  
 Part Number/Trade Name: SUPER CHLOR CHLORINE BLEACH

=====  
 General Information  
 =====

Company's Name: MEDTROL INC  
 Company's Street: 7157 N AUSTIN AVENUE  
 Company's City: NILES  
 Company's State: IL  
 Company's Country: US  
 Company's Zip Code: 60714-5000  
 Company's Emerg Ph #: 847-647-6555  
 Company's Info Ph #: 847-647-6555  
 Record No. For Safety Entry: 001  
 Tot Safety Entries This Stk#: 001  
 Status: SE  
 Date MSDS Prepared: 19AUG97  
 Safety Data Review Date: 16JAN98  
 Preparer's Company: MEDTROL INC  
 Preparer's St Or P. O. Box: 7157 N AUSTIN AVENUE  
 Preparer's City: NILES  
 Preparer's State: IL  
 Preparer's Zip Code: 60714-5000  
 MSDS Serial Number: CGHZK

=====  
 Ingredients/Identity Information  
 =====

Proprietary: NO  
 Ingredient: SODIUM HYPOCHLORITE, HYPOCHLOROUS ACID SODIUM SALT  
 Ingredient Sequence Number: 01  
 NIOSH (RTECS) Number: NH3486300  
 CAS Number: 7681-52-9  
 Proprietary: NO  
 Ingredient: CHLORINE  
 Ingredient Sequence Number: 02  
 Percent: 95%  
 NIOSH (RTECS) Number: FO2100000  
 CAS Number: 1782-50-5  
 OSHA PEL: 3 MG/CUM  
 ACGIH TLV: 3 MG/CUM

=====  
 Physical/Chemical Characteristics  
 =====

Appearance And Odor: CLEAR, PALE YELLOW W/CHLORINE ODOR  
 Vapor Pressure (MM Hg/70 F): 17.5  
 Vapor Density (Air=1): 74.4  
 Solubility In Water: COMPLETE  
 Percent Volatiles By Volume: 89

=====  
 Fire and Explosion Hazard Data  
 =====

Flash Point: NON-FLAMMABLE  
 Extinguishing Media: WATER SPRAY

Figure 4-5. MSDS for bleach courtesy of MEDTROL, INC.

Special Fire Fighting Proc: USE WATER SPRAY TO COOL FIRE TO DILUTE & CONTROL VAPORS IF PACKET IS EXTERNALLY IGNITED. WEAR PROTECTIVE CLOTHING & RESPIRATOR.

Reactivity Data

Stability: NO

Materials To Avoid: CHEMICALS, QUATERNARY AMMONIUM CHLORIDE

Hazardous Poly Occur: NO

Health Hazard Data

Route Of Entry - Inhalation: YES

Route Of Entry - Skin: YES

Route Of Entry - Ingestion: YES

ESOPHAGEAL, STOMACH & LARYNCEAL EDEMA. EXTREME EXPOSURE MAY CAUSE CIRCULATORY COLLAPSE, PULMONARY EDEMA.

Carcinogenicity - NTP: NO

Carcinogenicity - IARC: NO

Carcinogenicity - OSHA: NO

Explanation Carcinogenicity: NONE

Signs/Symptoms Of Overexp: NAUSEA, VOMITING

RINSE MOUTH W/WATER. GIVE LARGE QUANTITIES OF MILK. OBTAIN MEDICAL ATTENTION IN ALL CASES.

Precautions for Safe Handling and Use

Steps If Matl Released/Spill: CAN BE FLUSHED TO A SUITABLE HOLDING AREA & THEN FLUSHED W/WATER TO HIGH DILUTION SEWER.

Neutralizing Agent: WHEN NECESSARY HYPOCHLORITE CAN BE NEUTRALIZED W/ BUFFER COMPOUND/REDUCING AGENTS

Waste Disposal Method: DISPOSE OF IN ACCORDANCE W/LOCAL, STATE & FEDERAL REGULATIONS.

Precautions-Handling/Storing: STORE AT ROOM TEMPERATURE AWAY FROM INCOMPATIBLE MATERIALS. KEEP SEPARATE FROM ACIDS & ORGANICS.

Other Precautions: DON'T MIX W/ACIDIC CLEANING AGENTS WHICH CAN RELEASE CHLORINE GAS. AVOID VAPORS, FUMES.

Control Measures

Respiratory Protection: IN CASE OF MASS EXPOSURE OF 12%/GREATER, A GAS FILTERED RESPIRATOR MAY BE USED.

Protective Gloves: RECOMMENDED

Eye Protection: REQUIRED

Transportation Data

Disposal Data

Label Data

Figure 4-5. MSDS for bleach courtesy of MEDTROL, INC.

## HAZARDOUS CHEMICAL LABELS AND LISTS

Under OSHA regulations, manufacturers, importers, and distributors of hazardous chemicals must label all products with information that identifies the specific hazards of the products. Employers may not remove these labels. If an employer transfers hazardous material into another container to be used by another employee for longer than one shift, the new container must also be labeled. Figure 4-6 shows two examples of product labels. Labels must include:

- Product name.
- Name, address, and phone number of the manufacturer, importer, or supplier.
- Hazards of the product including information such as:
  - Precautionary warning words, such as caution or warning.
  - Reactivity hazards of the product. For example, can the product be safely mixed with water?
  - Health hazards of the product, such as cancer-causing or respiratory irritant.
  - Target organs that might be affected by exposure, such as the lungs or kidneys.
  - Measures to protect the user, such as adequate ventilation or protective clothing.
  - Emergency first-aid information. For example, wash exposed areas with water for 15 minutes.

# F

For laboratory and manufacturing use only, not for drug, food, or household use.

Class 1B  
4L

S77798

Isopropanol UN1219

## 2 - Propanol

WARNINGS!

FLAMMABLE FLASH POINT...59°F. HARMFUL IF INHALED. 20,000 ppm, IMMEDIATELY DANGEROUS TO LIFE AND HEALTH. CAUSES IRRITATION TO EYES, SKIN, AND MUCOUS MEMBRANES. IRRITANT AND ANESTHETIC. HARMFUL IF SWALLOWED. OVEREXPOSURE MAY CAUSE NARCOSIS, DEPRESSED RESPIRATION, ANEMIA, UREMIA, COMA, AND DEATH FROM RESPIRATORY PARALYSIS.

TARGET ORGANS AFFECTED: Eyes, mucous membranes, skin, respiratory and central nervous systems. Do not breathe vapors. Keep container closed. Use only with adequate ventilation by providing local exhaust or process enclosure to meet permissible exposure limits or use NIOSH recommended respirators listed in the Material Safety Data Sheet. Keep away from heat, sparks, and open flame. Wash thoroughly after handling. Do not take internally. **FIRST AID - INHALATION** - Remove from exposure area to fresh air immediately.

Fisher Chem AL Guide

---

SAFETY CODE

Goggles

Gloves

Apron

---

NFPA CODE

711 Forbes Avenue  
Pittsburg, PA 15219-4785  
(412) 562-8300

ACETONITRILE

CAS NO. 75-05-08 NA-1648 RQ

WARNING!

FLAMMABLE

MAY BE HARMFUL OR FATAL IF SWALLOWED, INHALED, OR ABSORBED THROUGH THE SKIN.

MAY BE IRRITATING TO THE SKIN, EYES, AND RESPIRATORY TRACT.

TOXIC EFFECTS MAY BE DELAYED.

Before using this product, read the MSDS which contains more detailed precautionary measures, handling instructions, and emergency procedures.

Keep away from heat, sparks, and flame. Avoid breathing vapor. Use with adequate ventilation. Avoid contact with eyes, skin, and clothing. If contact is unavoidable, wear protective clothing, face protection, and gloves. Wash thoroughly after handling and before eating, drinking, or smoking. Keep container closed.

FIRST AID:

**If swallowed/**

Give 1-3 glasses of water or milk and INDUCE VOMITING. Do not induce vomiting with a

**victim is**

semi-conscious or unconscious person. GET IMMEDIATE MEDICAL ATTENTION.

**conscious:**

**If in eyes:**

Flush immediately with plenty of water for at least 15 minutes. Eyelid should be held away from the eye to ensure thorough rinsing. Get medical attention if irritation persists.

**If on skin:**

Wash exposed area thoroughly with soap and water. Remove contaminated clothing and shoes. Wash clothing and thoroughly clean shoes before reuse. GET MEDICAL ATTENTION.

**If inhaled:**

Remove affected person from the source of exposure. If not breathing, administer CPR. If breathing is difficult, ensure a clear airway and oxygen may be given. GET IMMEDIATE MEDICAL ATTENTION.

Standard Oil Chemical Company  
(216) 586-4141  
Cleveland, Ohio, 44114-2375, U.S.A.

Figure 4-6. Examples of two product labels



Information might be presented on the container in the form of a sign, symbol, or written word. Important warning words frequently used on labels include:

- *Caution* – Use with care. Workers are at some risk.
- *Warning* – The product presents more risk than one with a caution label.
- *Danger* – The most severe rating. The product presents a serious potential threat.

### Special Labels

Although special labels are not required by the standard, employers may use them when hazardous chemicals are transferred from larger to smaller containers on the job site. These labels must not be removed or defaced because they provide important information. Figure 4-7 shows a typical label used for identifying hazardous materials with the Hazardous Materials Identification System (*HMIS*). The name of the product is listed and the appropriate boxes are marked under the headings:

- Target organs and effects
- Health hazards
- Physical hazards
- Route of entry

The label in Figure 4-7 has circles in front of health, flammability, reactivity, and protective equipment. These circles are filled in with a letter or number from the lists in the figure. Information from MSDSs, product labels, and Department of Transportation (*DOT*) or National Fire Protection Association (*NFPA*) labels are also used to fill out these special labels.



































There may be other labels on a hazardous chemical container providing hazard information. The two most common labels are from the *NFPA* and the *DOT*.

<b>NAME OF PRODUCT</b> <u>2 - Propanol</u>	
<p><b>CHECK APPROPRIATE BOXES</b></p> <p><b>TARGET ORGANS &amp; EFFECTS</b></p> <input type="checkbox"/> Lungs <input type="checkbox"/> Liver <input type="checkbox"/> Kidney <input type="checkbox"/> Blood <input checked="" type="checkbox"/> Skin, Eyes <input type="checkbox"/> Heart <input type="checkbox"/> Cardiovascular System <input checked="" type="checkbox"/> Central Nervous System <input checked="" type="checkbox"/> Respiratory System <p><b>HEALTH HAZARDS</b></p> <input type="checkbox"/> Toxic <input type="checkbox"/> Corrosive <input type="checkbox"/> Highly Toxic <input type="checkbox"/> Sensitizer <input checked="" type="checkbox"/> Irritant <input type="checkbox"/> Carcinogen <input type="checkbox"/> Reproductive Toxin <input type="checkbox"/> None <p><b>PHYSICALS HAZARDS</b></p> <input type="checkbox"/> Compressed Gas <input type="checkbox"/> Explosive <input type="checkbox"/> Combustible Liquid <input type="checkbox"/> Organic Peroxide <input type="checkbox"/> Oxidizer <input type="checkbox"/> Reactive <input checked="" type="checkbox"/> Flammable Liquid/Solid <input type="checkbox"/> Flammable Gas <p><b>ROUTE OF ENTRY</b></p> <input checked="" type="checkbox"/> Inhalation <input type="checkbox"/> Ingestion <input checked="" type="checkbox"/> Absorption (skin or eye contact)	<p><b>1 HEALTH</b></p> <p><b>4 FLAMMABILITY</b></p> <p><b>1 REACTIVITY</b></p> <p><b>(H) PROTECTIVE EQUIPMENT</b></p>

**Hazard Level**

- 4 Severe Hazard
- 3 Serious Hazard
- 2 Moderate Hazard
- 1 Slight Hazard
- 0 Minimal Hazard

**Personal Protection Index**

- A** 
- B**  + 
- C**  +  + 
- D**  +  + 
- E**  +  + 
- F**  +  +  + 
- G**  +  + 
- H**  +  +  + 
- I**  +  + 
- J**  +  +  + 
- K**  +  +  + 
- X** ASK YOUR SUPERVISOR FOR SPECIALIZED HANDLING DIRECTIONS

**Key**











-  Safety Glasses
-  Splash Goggles
-  Face Shield
-  Supplied Air Respirator
-  Chemical Resistant Gloves
-  Chemical Resistant Apron
-  Dust Air Purifying Respirator
-  Vapor Air Purifying Respirator
-  Combination Dust Vapor Air Purifying Respirator
-  Full Chemical Resistant Suit
-  Chemical Resistant Boots

Figure 4-7. A typical label used for identifying hazardous materials

## National Fire Protection Association Labels

The NFPA label is a hazard identification label developed to warn firefighters about potential chemical hazards in a fire. It is commonly used today and provides important information to the worker.

The NFPA label is a diamond containing four squares in different colors. The squares are red, blue, yellow, and white. The red, blue, and yellow squares contain a hazard rating, ranging from 0 to 4, that indicates the severity of the hazard. The white square is reserved for symbols representing special hazards.

Figure 4-8 shows an example of an NFPA label and identifies the following:

- Color code designations
- Hazard rating information
- Special hazard symbols

Table 4-2 is a more detailed explanation of the NFPA color codes and hazard rating information.

**Note:** An NFPA label does not cover chronic health effects. In addition, the names of the chemical, the product, and the manufacturer are not given.

## Department of Transportation Labels

The DOT label is used on containers and cartons of hazardous materials or products that are shipped across state lines. These labels are in addition to those required by OSHA regulations. A DOT label contains three types of information: color, hazard word, and hazard symbol. Figure 4-9 shows the DOT label for a corrosive chemical. The combination of color, hazard word and hazard symbol gives a great deal of information about the hazardous material. However, the DOT label does not identify the product's name, manufacturer, or chemical contents.

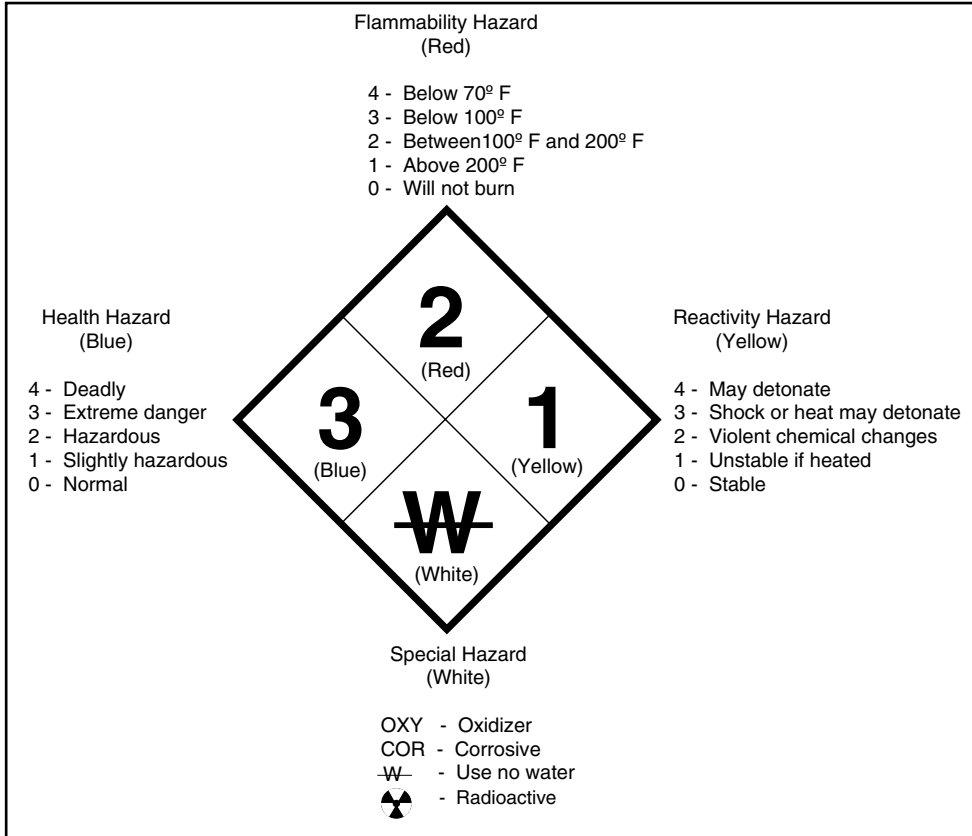

Figure 4-8. NFPA label

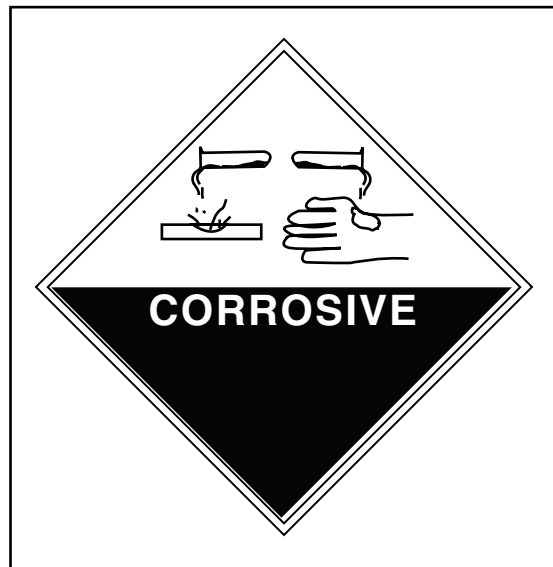

Figure 4-9. A DOT label for a corrosive chemical

<b>Health Hazard</b> Color Code: <b>BLUE</b> Health hazards are noted in the blue square and are rated from 0 to 4, with 4 the most dangerous level.		<b>Flammability Hazard</b> Color Code: <b>RED</b> Fire hazards are noted in the red square and are rated from 0 to 4, with 4 the most dangerous level.		<b>Reactivity Hazard</b> Color Code: <b>YELLOW</b> Explosion hazards are noted in the yellow square and are rated from 0 to 4, with 4 the most dangerous level.	
Type of possible injury:		Susceptibility of Materials to Burn		Susceptibility to Release of Energy	
<b>4</b>	Extremely Hazardous (deadly) - very short exposure can cause death or major long-term injury	<b>4</b>	Extremely Flammable (below 73°F) - turns into a gas rapidly under normal conditions and burns easily.	<b>4</b>	Extremely Unstable (may detonate) - under normal conditions, this chemical may explode or react violently.
<b>3</b>	Highly Hazardous (extreme danger) - short exposure can cause serious temporary or possible long-term injury	<b>3</b>	Highly Flammable (below 100°F) - liquid or solid can be ignited at almost any ordinary temperature.	<b>3</b>	Unstable (shock or heat may detonate or explode) - may react with water, or may need heating or another strong initiating source.
<b>2</b>	Moderately Hazardous (hazardous) - intense or continued exposure can cause temporary or possible long-term injury.	<b>2</b>	Moderately Combustible (between 100°F and 200°F) - must be heated somewhat or be in a very hot place before ignition can occur.	<b>2</b>	Unstable (violent chemical changes) - may react violently with water, or undergo violent chemical changes without exploding.
<b>1</b>	Slightly Hazardous (slightly hazardous) - exposure can cause irritation but only minor injury.	<b>1</b>	Slightly Combustible (above 200°F) - must be heated before ignition can occur.	<b>1</b>	Unstable if Heated - normally stable, but can become unstable when hot or under pressure. Reactions with water are not violent.
<b>0</b>	No Health Hazard (normal) - exposure under fire conditions would offer no hazard beyond that of ordinary combustibles	<b>0</b>	Nonflammable or Noncombustible - will not burn.	<b>0</b>	Stable - normally stable, even in fire. Does not react with water.

Table 4-2. NFPA color codes and hazard rating information

Table 4-3 lists the color-coded backgrounds and hazard words used on DOT labels. Figure 4-10 shows the different hazard symbols used on the label.

When shipping hazardous materials, the severity of a hazard may be indicated on the shipping container. Hazards are divided into three packing groups:

- Packing Group I - Great Danger
- Packing Group II - Medium Danger
- Packing Group III - Minor

Table 4-3. Color-coded backgrounds and hazard words found on DOT labels.

Color Codes	Hazard Words
Orange	Explosive Blasting agent
Red	Flammable Combustible
Green	Nonflammable
Yellow	Oxidizer Oxygen Organic peroxide
White with red stripes	Flammable solids
Yellow and white	Radioactive
White and black	Corrosive
White	Poison Chlorine
Blue	Dangerous when wet
Special	Biological agent









	Explosive		Compressed gas Nonflammable gas
	Flammable		Radioactive
	No water		Corrosive
	Poisonous		Biological agent
	Oxidizer		

Figure 4-10. Examples of hazard symbols used on a DOT label

**MODULE 4 - ASSIGNMENT SHEET**

- 1. List the five requirements of the Hazard Communication Standard's written program.**

1. \_\_\_\_\_

2. \_\_\_\_\_

3. \_\_\_\_\_

4. \_\_\_\_\_

5. \_\_\_\_\_

- 2. Answer the following question using the chart on page 4-26. The chart describes a worker's exposure during a single working shift on a hazardous waste job site.**

What is this worker's TWA for this particular day?

\_\_\_\_\_

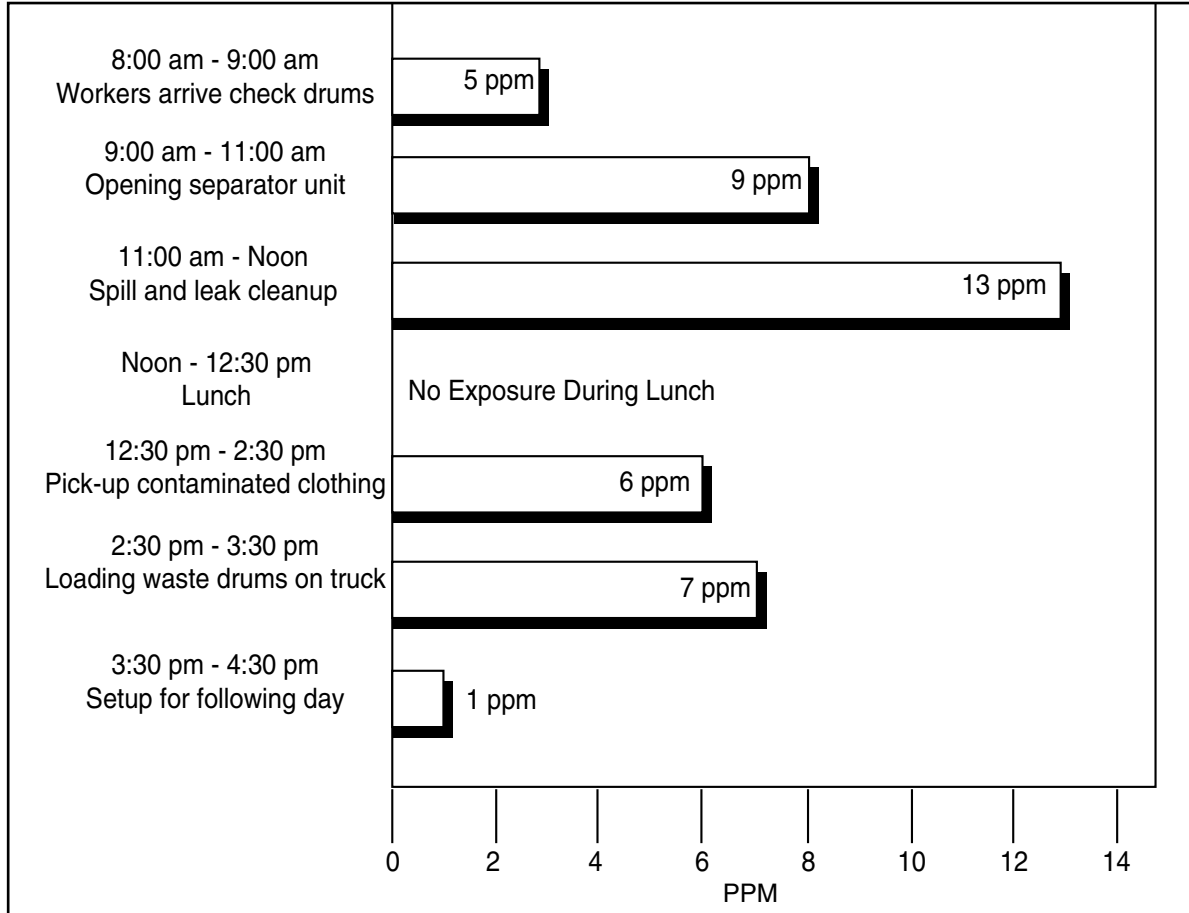

**3. Demonstrate how to use a MSDS by answering the following questions. (Use the sample MSDS on pages 4-15 and 4-16.)**

a. What is the name of the product? \_\_\_\_\_

b. List the hazardous components of this product.

\_\_\_\_\_

\_\_\_\_\_

c. Is this product lighter than air?

\_\_\_\_\_ Yes      \_\_\_\_\_ No

d. What is the appearance and odor of this product? \_\_\_\_\_

e. What is the flash point of this product? \_\_\_\_\_

f. Is this product flammable or combustible? \_\_\_\_\_

g. What is the extinguishing media for this product? \_\_\_\_\_



h. Does this product contain cancer-causing components?

\_\_\_\_\_ Yes      \_\_\_\_\_ No

i. Is respiratory protection required while using this product?

\_\_\_\_\_ Yes      \_\_\_\_\_ No

j. What other PPE is to be used with this product? \_\_\_\_\_

\_\_\_\_\_  
\_\_\_\_\_

k. What special precautions should be taken when using this product?

\_\_\_\_\_  
\_\_\_\_\_

l. When was this MSDS revised? \_\_\_\_\_

m. What is the emergency phone number for this product?

\_\_\_\_\_

n. Is emergency and first-aid information given?

\_\_\_\_\_ Yes      \_\_\_\_\_ No

**4. List the three basic types of labeling systems.**

1. \_\_\_\_\_

2. \_\_\_\_\_

3. \_\_\_\_\_

**5. Demonstrate how to read a label by answering the following questions. (Use either label in Figure 4-6 on page 4-18.)**

a. What is the name of the product?

\_\_\_\_\_

b. Who makes it?

\_\_\_\_\_

c. What is the physical hazard from this product?

\_\_\_\_\_

\_\_\_\_\_

d. What are the health hazards?

---

---

e. What are the target organs?

---

---

f. What are the safe handling recommendations?

---

---

g. What measures are to be used to limit worker exposure?

---

---

h. What is the first aid information given?

---

---

---

# Module 5

## Microbial Remediation Personal Protective Equipment

---

### **PARTICIPANT OBJECTIVES**

After completing Module 5, you will be able to:

1. Define the following terms:
  - Maximum use concentration
  - Protection factor
  - Qualitative fit test
  - Quantitative fit test
2. List three types of respirators and their protection factors.
3. List the limitations of air purifying respirators (APRs).
4. Perform the following Standard Operating Procedures:
  1. Inspect a full-face APR.  
Don a full-face APR.  
Perform a negative pressure check with a full-face APR.  
Perform a positive pressure check with a full-face APR.
  2. Complete an irritant smoke or banana oil qualitative fit test.
  3. Clean, sanitize, and maintain a full-face APR.
5. List and describe the two most common materials used in the protective clothing of microbial remediation workers.
6. List the three most common materials used for protective gloves by microbial remediation workers.



## INTRODUCTION

*Personal protective equipment (PPE)* is any protective clothing or device worn to prevent contact with, and exposure to, hazards in the work place. Examples of PPE include respirators, gloves, protective suits, boots, hardhats, and safety glasses.

Appropriate PPE is critical to the safe performance of microbial remediation. Therefore, workers need an appreciation of the types of PPE, their limitations, and what goes into the selection process. This section discusses the following areas of PPE:

- Respirators
- Protective clothing
- Eye protection

## RESPIRATORY PROTECTION

A *respirator* is a piece of equipment that reduces airborne exposures by preventing contaminants from being inhaled. There are many different types of respirators, all useful in specific situations. Respirators are composed of a facepiece that seals out contaminants, and a device that provides clean air. Two types of respirators are used for obtaining clean air:

1. Air purifying – Filters are used to purify the air
2. Atmosphere supplying – A supply of clean air is provided from a tank or compressor

Because atmosphere supplying respirators are typically not used during microbial remediation, they will not be discussed during this course.

Respirators differ in how much protection they afford. A paper mask is less protective than a firefighter's respirator with an air tank. But how much difference is there? Industrial hygienists have developed a scoring system to rank different types of respirators. Each respirator is given a score based on the amount of protection it can provide. This score is known as a *protection factor (PF)*.



### Protection Factors

The key to understanding respiratory protection is to realize that all respirators leak to a certain degree. The amount of leakage depends on how well the facepiece seals to the face. A leak in the facepiece means that contaminated air can enter the facepiece. The act of inhaling creates negative pressure inside the facepiece that results in a slight suction effect. The suction can draw in contaminated air. These leaks compromise the protection given by the respirator. Breathing contaminated air can lead to adverse health effects depending on the type and amount of exposure.

Respirators are tested for leakage by measuring the contaminant levels both outside and inside the respirator. Using the ratio of these two measurements, a PF is assigned. A PF is based on the assumption that the respirator is working properly, is worn correctly, and fits the wearer. Respirator PFs range from 5 to 10,000. However, the most protective air purifying respirator only has a PF of 100.

**The lower the PF, the lower the protection. The higher the PF, the higher the protection.** Figure 5-1 shows the calculation for determining the PF.

**NOTE:**

The lower the PF, the lower the protection.  
The higher the PF, the higher the protection.

*The PF is calculated by dividing:*

$$\begin{aligned}
 \text{PF} &= \frac{\text{Concentration of airborne contaminant outside respirator}}{\text{Concentration inside the respirator}} \\
 &= \frac{500 \text{ ppm (concentration outside the respirator)}}{50 \text{ ppm (concentration inside the respirator)}} \\
 &= 10
 \end{aligned}$$

Figure 5-1. Calculating the protection factor

The goal of a respirator is to reduce the amount of a hazardous substance inside the mask to below the Occupational Safety and Health Administration (OSHA) permissible exposure limit (PEL). Respirators must be chosen to ensure that you are never overexposed while wearing the respirator. The practical definition of PF can be summed up as: How much of the outside contaminant level is reduced by the respirator?

Examples follow:

- A respirator with a PF of 10 reduces a worker's exposure by 10 times, or to 1/10 of the outside level. Therefore, if the contaminant level outside the respirator is 500 ppm, the level inside the respirator is 50 ppm. Should the PEL for the contaminant be below 50 ppm, the worker is overexposed. A PF of 10 means that the respirator can only be used in exposures up to 10 times over the PEL.
- A respirator with a PF of 10,000 reduces the worker's exposure by 10,000 times. Concentration inside the respirator may be 1/10,000 of the outside level.

**Remember:** The lower the PF, the lower the protection. The higher the PF, the higher the protection.

**Note:** OSHA has not assigned protection factors but will eventually add them to the final standard. Meanwhile, according to CPL 2-0.120 *Instruction Procedures for the Respiratory Protection Standard*, OSHA will refer to the NIOSH-assigned protection factors. The exceptions to this rule will be in cases in which the assigned protection factors have been published in substance-specific standards or where they are addressed by OSHA in separate letters of interpretation.

### Maximum Use Concentration

Maximum use concentration (MUC) is that level of contaminants which, if exceeded, will cause a worker to be exposed above the PEL because of leakage into the respirator. The MUC is the highest concentration of contaminants in which a respirator can be used safely. At no time should a respirator be used in an environment that exceeds the MUC.

The MUC is calculated by multiplying PF times PEL. Figure 5-2 gives an example of calculating the MUC for nitric acid.



$$\text{MUC} = \text{PF} \times \text{PEL}$$

*Calculate the MUC of nitric acid:*

$$\begin{aligned} \text{MUC} &= \text{PF} \times \text{PEL} \\ \text{PEL for nitric acid} &= 2 \text{ ppm} \\ \text{PF of half-face respirator} &= 10 \end{aligned}$$

$$\begin{aligned} \text{MUC} &= 2 \text{ ppm} \times 10 \\ &= 20 \text{ ppm} \end{aligned}$$

A half-face respirator cannot be used in atmospheres with a nitric acid concentration greater than 20 ppm. (TWA)

Figure 5-2. Calculating the MUC for nitric acid

## AIR PURIFYING RESPIRATORS

Air purifying respirators (APRs) clean the air you breathe by removing or filtering a contaminant from the air before it enters your lungs. APRs have two components—the facepiece and the filter or cartridge. When you inhale, contaminated air is pulled into the respirator through a filter or cartridge attached to the facepiece. The filter or cartridge removes the contaminant from the air before it enters the inside of the respirator through the inhalation valve. When you exhale, air from the lungs reverses the airflow through the facepiece and out a separate valve called the exhalation valve.

### Negative Pressure Respirators

APRs are commonly called negative pressure respirators. They depend on lung power to pull the air through the filters. The suction created when you inhale draws air into the respirator. This suction creates a momentary negative pressure. During inhalation, the negative pressure brings contaminants into the facepiece through leaks and improper seals. During exhalation air is blown out and a positive pressure is created in the facepiece. It is important to remember that negative pressure respirators must only be used if the oxygen level in the work place is above 19.5 percent oxygen.



### **Disposable Paper Masks and Quarter Masks**

You may be familiar with the disposable paper masks. They are the throwaway type and do not seal to the face well enough to provide a good fit. Laboratory tests done with mannequins show PFs of 5 to 10. However, studies done under actual work conditions show even lower PFs. The leakage for this type of mask is severe. Furthermore, the paper of a disposable mask is only effective for large-particle dusts. Gases, vapors, fumes, and fine particles, such as mold may pass right through the paper. However, in some cases, NIOSH-approved filtering facepieces with the N95 designation are recommended. The N95 designation will be discussed later in this section.

The quarter mask is usually a rubber mask, which fits from the top of the nose to the top of the chin. It uses cloth or cartridge filters. The PF is rated at 5. This type of mask is not recommended for use during microbial remediation.

### **Half-Face APRs**

The half-face APR is made of rubber or plastic. It fits from the top of the nose to under the chin. Figure 5-3 shows a typical half-face APR.

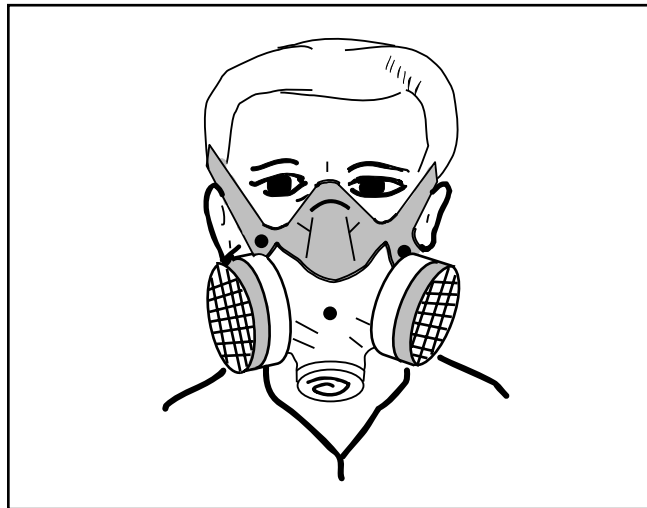

Figure 5-3. The half-face APR fits from the top of the nose to under the chin

A half-face APR uses one or two filter cartridges attached to the facepiece to filter the air. The fit given by the respirator rates a fairly low PF of 10 by the National Institute of



Occupational Safety and Health (*NIOSH*). These respirators are the minimum type recommended during microbial remediation.

### **Full-Face APRs**

A full-face APR is made of rubber or plastic. It covers the whole face, starting at the forehead, down over the temples and the eyes, and under the chin (Figure 5-4). The full-face APR has a NIOSH-assigned PF of 50 because it is easier to get a good seal across the forehead than across the nose. Also, the respirator is held more securely in place because it has a harness instead of straps. The full-face APR uses the same types of filters as the half-face APR, so it also carries the same limitations. It does protect the eyes, although it has a tendency to fog up.

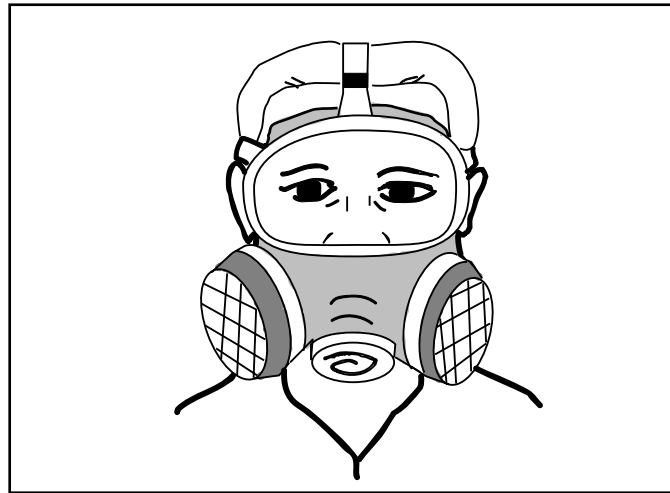

Figure 5-4. The full-face APR covers the whole face

Some full-face APRs can use larger chin, chest, or back-mounted canister-type filters. These filters are larger, and have fewer limitations. There are several filters available in larger sizes for full-face APRs that are not available for half-face APRs. Because canisters are larger than cartridges, they have higher capacities. Even though full-face APRs protect more than half-face APRs, they still do not offer enough protection to be used in immediately dangerous to life and health (IDLH) conditions.

### **Powered Air Purifying Respirators**

The powered air purifying respirator (*PAPR*) is an APR that uses a small, lightweight battery-operated blower to draw air through the filters and into the facepiece. It uses the same type of facepiece and filters as the full-face APR.

The blower keeps a slight positive pressure inside the facepiece. This positive pressure reduces the likelihood of contaminants leaking into the respirator during inhalation. Any leaks from an imperfect seal tend to be outward.

Additionally, the blower offers the advantage of increased comfort for the user. Because the blower draws air into the facepiece, less work is required for inhalation. In addition, air is blown across your face and provides some degree of cooling. NIOSH assigns a PF of 50.

#### **PAPR Limitations**

The PAPR has two limitations:

1. Weak batteries cause the fan motor to slow down, thus delivering less air to the facepiece. The batteries are designed to last a full shift, and then require a full charge. PAPR units come with a small flow meter that enables you to test the air flow and, thus, the battery charge.
2. Under heavy work conditions, you can use more air than the PAPR provides, creating a negative pressure in the facepiece. This condition is called *overbreathing* a PAPR. When overbreathing occurs, the PAPR functions just like a negative pressure full-face respirator.

#### **Hoods and Helmets**

Some PAPRs have loose-fitting hoods and helmets instead of facepieces. While these hoods are comfortable, they provide less protection. NIOSH assigns a PF of only 25 for loose-fitting PAPRs.

#### **Limitations of APRs**

As long as exposure levels are known and are low enough, APRs can be used, but they do have limitations. The following list also covers problems that can be encountered when working around hazardous chemicals.



All APRs, including PAPRs, have limitations in the following areas:

- Cartridge life
- Cartridge efficiency
- Oxygen limitations
- Unknown chemicals or chemical concentrations
- IDLH concentrations
- Humidity
- Usage
- Eye protection
- No eye protection



### **Cartridge Life**

The filter of an APR has a limited ability to remove chemical contaminants. When the saturation point is reached, chemicals begin to pass through the filter. This condition is called breakthrough. Some chemicals have poor warning properties so you would not notice any chemical smell when breakthrough occurs. As a result, the half-face APR cannot be used for chemicals with poor warning properties. Some filters have end of service life indicators (ESLI), that change color when a filter is used up.

### **Cartridge Efficiency**

There are many types of organic vapors, but only one type of organic vapor filter. Studies show that while this filter is very efficient for some organic vapors, it allows others to pass through quickly. For example, the organic vapor filter lasts 143 minutes in an atmosphere with a concentration of 1,000 ppm of 1-nitropropane. But at 1,000 ppm of ethyl chloride, the filter only lasts 5.6 minutes. Therefore, APRs are not used for organic vapors that have rapid breakthrough. However, not all vapors have been tested.

### **Oxygen Limitations**

The half-face APR can only be used when sufficient oxygen is present in the work atmosphere. (Per OSHA, this is between 19.5 and 23.5 percent by volume.) Normal breathing air contains about 21 percent oxygen.

**Unknown Chemicals or Levels**

The protection offered by an APR is limited; therefore, it cannot be used for unknown situations. The levels might exceed 10 times the PEL or different chemicals might go right through the filter to cause adverse health effects. Specific cartridges are manufactured to protect against specific chemicals and may not be used in some mixed chemical atmospheres.

**IDLH Concentrations**

Under no circumstances should an APR be used in an IDLH atmosphere. For most chemicals this is not an issue, because the MUC is lower than the IDLH level. But there are exceptions. For some chemicals, the IDLH is lower than the MUC, and the respirator cannot be used if the level approaches the IDLH level.

**Humidity**

Some studies have shown that breakthrough occurs more quickly under conditions of high humidity. This can be a problem during microbial remediation cleanup when using wet methods. High humidity is also contained within enclosures erected to reduce the spread of contaminants.

**Usage**

The useful life of a filter is limited once the filter is opened. Usually filters are discarded after each use, not to exceed one shift. If breakthrough occurs and is noticed, then filters are changed at that time even if it is less than one shift.

**No Eye Protection**

In addition to the filter-related limitations, the half-face APR has the additional limitation of having no eye protection. Tight fitting goggles must be used during microbial remediation if using a half-face APR.

## FILTERING DEVICES

Air purifying respirators are manufactured with two basic types of filtering devices:

1. Particulate filters
2. Vapor and gas removing canisters and cartridges

### Particulate Filters

Particulate filter respirators use a filter made of a fibrous material to capture contaminant particles before the air reaches the wearer's lungs. The particles are pulled through the filter as you inhale and become trapped by the fibers of the filter. Particulate filter respirators are used for protection against particles of dusts, fumes, and/or mists. Typical examples on construction sites include welding fumes, oil mists, silica, and asphalt fumes. Mold spores are also particulates.

### **42 CFR 84 for Particulate Filters**

Respirator certification regulations 30 CFR 11 were created in 1972 and were commonly referred to as Part 11. Since that date new research, tests, and technologies have required that certification regulations be revised. In July 1995, the Part 11 standard was revised and retitled 42 CFR 84 or Part 84.

NIOSH plans to revise the certification requirements for all respirator classes, although the process is expected to take many years. The revisions will take place in modules. The first module completed was the certification requirements for nonpowered, air-purifying, particulate-filtering respirators. These respirators now fall under Part 84. All other respirators (PAPRs, SCBAs, etc.) are still under the Part 11 standard.

### Filter Labels

Part 84 filter labels have two changes from Part 11 filter labels, which will help to tell them apart. These changes are as follows:

1. Sequence of approval numbers:
  - Part 84 – TC-84A-XXXX
  - Part 11 – TC-21C-XXX
2. Approving agencies:

- Part 84 – NIOSH and the Department of Health and Human Services (DHHS)
- Part 11 – NIOSH and Mine Safety and Health Administration (MSHA)

Labels are normally found on the box in which the respirator or cartridge is shipped. Figure 5-5 shows the Part 84 label for nonpowered, air-purifying particulate filters. Figure 5-6 shows the Part 11 label for all other respirators.

### **Particulate Filter Efficiency**

Particulate filters are not designed to be 100 percent efficient in removing particulates from the air. It would be too hard for you to pull air through the filters when inhaling. Filters are manufactured to create maximum filter efficiency while keeping the resistance to breathing low. As contaminated air is drawn through the filter, the particles are captured by the filter, plugging up the holes between the fibers of the filter. This increases breathing resistance for the wearer.

<b>PERMISSIBLE</b>		
<small>Department of Health and Human Services</small> <b>DHHS</b>	<b>Respirator for Dusts, Fumes, Mists, Asbestos, and Radionuclides</b>	<small>U.S. Department of Health and Human Services Centers for Disease Control</small> <b>NIOSH</b> <small>National Institute for Occupational Safety and Health</small>
<small>DEPARTMENT OF HEALTH AND HUMAN SERVICES NATIONAL INSTITUTE FOR OCCUPATIONAL SAFETY AND HEALTH</small>		
<b>APPROVAL NO. TC-84A-1234</b>		
<small>ISSUED TO WILSON SAFETY PRODUCTS READING, PENNSYLVANIA, U.S.A.</small>		
<b>LIMITATIONS</b>		
<small>Approved for respiratory protection against dust, fumes, and mists having a Time Weighted Average (TWA) less than 0.05 milligrams per cubic meter, asbestos containing dusts and mists, and radionuclides. Not for use in atmospheres immediately dangerous to life or health. This respirator shall be selected, fitted, used, and maintained in accordance with Mine Safety and Health Administration, Occupational Safety and Health Administration, and other applicable regulations.</small>		
<b>CAUTION</b>		
<small>In making renewals or repairs, parts identical with those furnished by the manufacturer under the pertinent approval shall be maintained. Follow the manufacturers instructions for changing filters.</small>		

Figure 5-5. Part 84 label showing NIOSH and DHHS as the approving agency

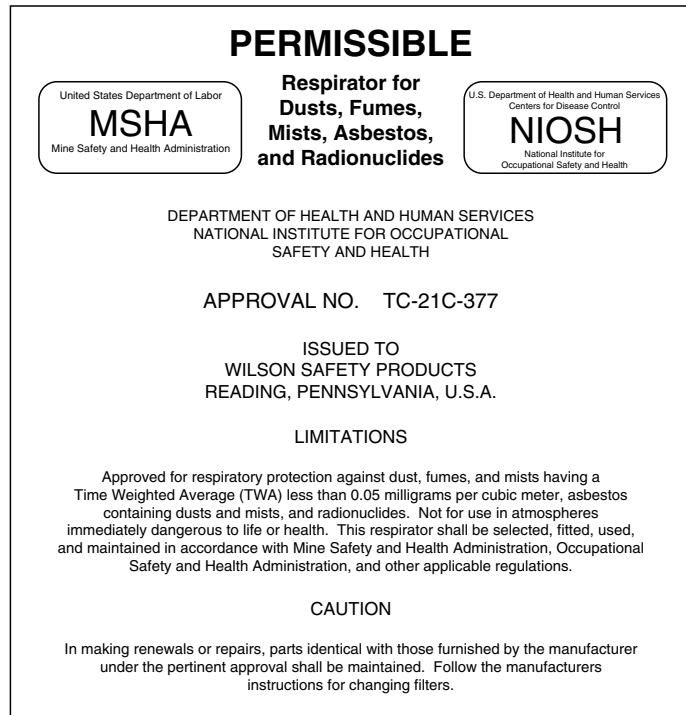

Figure 5-6. Part II label showing NIOSH and MSHA as the approving agencies

Particulate filter efficiencies are classified into two groups, high efficiency and lower efficiency. High efficiency filters are capable of capturing 99.97 percent of the particles pulled through the filter. Filters of this type are commonly called high efficiency particulate air (HEPA) filters. HEPA filters are used for dusts, fumes, and mists having an exposure limit less than 0.05 milligrams per cubic meter of air (0.05 mg/m<sup>3</sup>).

Particulates with exposure limits this low are the most hazardous to workers' health, which explains why high efficiency filters are to be used. For example, HEPA filters must be used for exposures to asbestos or lead and are recommended by the NYC Guidelines (Appendix B, Resources) during large scale microbial remediation projects.

Lower efficiency filters are capable of capturing approximately 95 to 99 percent of dust, fume, and mist particulates. Lower efficiency filters are used for particulates that have exposure limits greater than 0.05 mg/m<sup>3</sup>. These substances are not as hazardous to the health of exposed workers in low concentrations.



**Particulate Filter Classification**

NIOSH regulation Part 84 created nine classes of particulate filters, made up of:

- Three filter series for resistance to filter efficiency degradation.
- Three filter efficiency levels.

**Filter Series**

The three filter series define different degrees of resistance to filter efficiency degradation. They are labeled as N, R, and P.

**N series filters** have the following characteristics:

- Used for solid or water-based particulates.
- **Not** resistant to oil. Cannot be used in atmospheres containing oil or for oil-based particulates.
- Can be used for more than one work shift if there are no problems with hygiene, damage, or breathing.

**R series filters** have the following characteristics:

- Used for solid or liquid particles.
- Resistant to oil but not oil proof.
- Can be used for an extended time in an oil-free atmosphere.
- Has limited use time in an environment containing oil (one 8-hour shift or a combined total of 8 hours.)

**P series filters** have the following characteristics:

- Used for solid or liquid particles, both oil-based and non-oil based.
- Considered oil proof. Can be used as long as a worker has no breathing problems.

An easy way to remember the filter series is:

- N is Not resistant to oil
- R is Resistant to oil
- P is oil Proof

**NIOSH update to selection guide:** Originally, it was assumed P-series filters would not degrade from oil exposure and would only need to be changed when breathing resistance, hygiene concerns, or filter damage occurred. However, a recent NIOSH study indicates the P-series particulate filter may lose efficiency with long-term exposure to oil. Therefore, NIOSH recommends replacing any P-filter that has been exposed to oil after the work shift. No changes were made to the selection logic for the N and R series filters.

#### Filter Efficiency Levels

Each of the three filter series has three filter efficiency levels. The minimum efficiency levels are 95, 99, and 99.97 percent. They have the following designations:

- Filters with N95, R95, and P95 designations are certified as having a minimum efficiency of 95 percent. The series of 95 percent efficiency filters replaces the dust/fume and dust/fume/mist filters.
- Filters with N99, R99, and P99 designations are certified as having a minimum efficiency of 99 percent.
- Filters with N100, R100, and P100 designations are certified as having a minimum efficiency of 99.97 percent. These filters replace the HEPA filters under the old certification standard. Unlike the old HEPAs, the N100 and R100 have the following limitations:
  - N100 - no oil exposure
  - R100 - oil exposure for one shift only

The P100 filter is the only filter that will keep the familiar magenta color.

Table 5-1 lists the nine classes of particulate filters.

Filter Series	Filter Efficiency Levels	Filter Classes	Service Time
N-Series	99.97%	N100	Non-specific
	99%	N99	Non-specific
	95%	N95	Non-specific
R-Series	99.97%	R100	One Shift
	99%	R99	One Shift
	95%	R95	One Shift
P-Series	99.97%	P100	Non-specific
	99%	P99	Non-specific
	95%	P95	Non-specific

Table 5-1. The nine classes of particulate filters are shown in the table

### Vapor and Gas Removing Cartridges and Canisters

Vapor and gas removing cartridges and canisters are used with APRs to protect workers from exposures to air that is contaminated with toxic vapors and gases.

While particulate filters are effective for nearly all types of particles, gas and vapor removing cartridges and canisters are designed to protect against specific individual contaminants. Examples include carbon monoxide, ammonia gas, or combinations of gases and vapors, such as acid gases or organic vapors. There are some types of microbes which are known to release organic vapors, or *microbial volatile organic compounds (MVOCs)*.

Contaminants are removed as inhaled air enters the cartridge or canister and passes through a granular material called a *sorbent*. The sorbent absorbs contaminants from the air, and provides protection to the wearer from the toxic effects of the gas or vapor.

Materials used as sorbents include activated charcoal, silica gel, and various mixtures of specific chemicals that will capture the contaminant. Initially a gas and vapor sorbent is 100 percent efficient in capturing a contaminant. As the sorbent is

used up, the efficiency decreases. When the sorbent is exhausted, the contaminant passes completely through the sorbent and into the facepiece where it is inhaled by the wearer. This loss of capturing efficiency is opposite to particulate filters which become more efficient as particles collect on the filter.

Sorbents for gases and vapors are packaged into either cartridges or canisters. The only difference between a cartridge and a canister is the amount of sorbent they contain. Cartridges are designed to be used singly or in pairs on half- and full-facepieces. The amount of sorbent contained in a cartridge is small, making their useful lifetime short in duration. This limitation restricts the use of cartridges to low concentrations of gases and vapors.

Canisters contain larger amounts of sorbent material than cartridges. Therefore, they can be used in situations where the workplace air concentration of gases or vapors is higher.

Canisters are designed as chin, front, or back-mounted devices. When a canister is used with a facepiece, the respirator is called a gas mask.

Cartridges or canisters are designed for either one specific type of gas or vapor, or a combination of gases and vapors together. In addition, some cartridges and canisters are manufactured to protect against both gases and vapors, as well as particulates by combining particulate filters with sorbent materials. When filters are combined with gas and vapor sorbents, the filter is located in the inlet side of the cartridge. It is either built into the cartridge itself or held to the outside of the cartridge by a snap-on cover.

A color coding scheme has been established to identify the contaminants that a gas and vapor canister or cartridge protects against. The color coding is assigned to either individual contaminants or combinations of contaminants as shown in table 5-2.

Table 5-2. Contaminant color coding is shown in the table

<b>Atmospheric Contaminant</b>	<b>Assigned Color</b>
Acid Gases	White
Organic Vapors	Black
Ammonia Gas	Green
Carbon Monoxide Gas	Blue
Acid Gases and Organic Vapors	Yellow
Acid Gases, Ammonia, and Organic Vapors	Brown
Acid Gases, Ammonia, Carbon Monoxide, and Organic Vapor	Red
Other Vapors and Gases not listed above	Olive
Radioactive Materials (except Tritium and Noble Gases)	Purple (magenta)

When the sorbent becomes exhausted or used up, breakthrough will occur. Warning signs include odor, taste, or throat irritation. If the wearer notices any warning signs, follow these steps:

1. Leave the work area immediately
2. Go to a location with fresh air
3. Notify the safety and health officer
4. Replace the cartridge or canister

Gas and vapor cartridges have short useful service times. Therefore, employers must establish a cartridge change-out schedule for workers to follow if the cartridge is not equipped with an end-of-service-life indicator (*ESLIs*), even if no odor, taste, or irritation is detected. Some canisters are designed for use against substances with poor warning properties (no odor or taste). These canisters have *ESLIs* that show the canister is exhausted and needs to be replaced. For example, cartridges used for mercury have *ESLIs* because mercury has poor warning properties that are not readily noticed by a worker being exposed.

## RESPIRATOR PROGRAM REQUIREMENTS

Using a respirator safely and effectively involves much more than simply knowing how to put it on. OSHA Standard 1910.134 governs general requirements for respirator usage (Appendix A). The respiratory protection program must cover certain required work site-specific procedures for respirator use. Also it must be updated when there are changes in workplace conditions that affect respirator use. The respiratory protection program includes the following requirements:

1. Procedures for selecting respirators for use in the workplace.
2. Medical evaluations of employees who are required to use respirators.
3. Fit testing procedures for tight-fitting respirators.
4. Procedures for proper use of respirators in routine situations and reasonably foreseeable emergencies.
5. Procedures and schedules for cleaning, storing, inspecting, repairing, discarding, and otherwise maintaining respirators.
6. Procedures to ensure adequate air quality, quantity, and flow of breathing air for atmosphere supplying respirators.
7. Employee training in the respiratory hazards to which they are potentially exposed during routine and emergency situations.
8. Employee training in the proper use of respirators, including:
  - *Donning* and *doffing*
  - Limitations
  - Maintenance
9. Procedures for regularly evaluating the effectiveness of the program.

## Respirator Program Administration

The employer must designate a respirator program administrator (RPA) to oversee the respiratory protection program and to conduct the required evaluations of program effectiveness. To fulfill these duties, the RPA must have the training or experience that matches the complexity of the program.

As part of the administration of the program, the RPA is responsible for ensuring the following:

- Appropriate care is taken to properly select, use, and maintain the respirators.
- The nature of the air contaminant and its exposure concentration is considered in properly selecting a respirator.
- Workers are trained in the proper use and care of the respirators that are provided.
- Workers are medically fit to wear the respirator.

## RESPIRATOR SELECTION

Employers are responsible for selecting the appropriate respirators for their employees. To do this the employer must:

1. Gather information
2. Apply information to respirator selection process
3. Choose the respirator based on the selection process

### Gather Information

It is impossible to choose a respirator without knowing the hazards on the work site and the workers' potential exposure levels. The employer can use two methods for identifying the hazards and their airborne levels:

1. Personal air monitoring devices
2. Past exposure levels encountered on similar jobs

It is very important that some actual or educated estimate of exposure levels is known before selecting a respirator. In the absence of such information, OSHA requires that the exposure level of the job be considered IDLH.

In addition to airborne hazards and their exposure levels, the employer must gather other types of information:

- General use conditions and determination of contaminants
- Properties of the contaminants
- Odor threshold data
- Exposure limits
- IDLH concentrations
- Eye irritation potential
- Service life information

Once the criteria information is gathered and evaluated, the employer applies it to a respirator selection process. The selection process uses a sequence of questions to identify the recommended class of respirators for the airborne contaminants.

### **General Use Conditions and Determination of Contaminants**

General use conditions include the following:

- Descriptions of the job tasks to be performed
- Duration and frequency of the tasks to be performed
- Work location
- Physical demands of the work to be performed
- Respirator comfort

Determination of contaminants includes the following:

- Identity of the substances present in the air.
- Actual measured exposure level of the contaminant on the job.
- If possible, an estimate of the highest level of exposure that workers are likely to encounter.



## Properties of the Contaminants

Information is needed on the physical, chemical, and toxic properties of the contaminant. This information includes:

- Form in which the substance is found on the job site, such as dust, mist, fume, gas or vapor.
- Chemical properties, such as organic vapor, pesticide, metal, or acid gas.
- Toxicological properties of the substance as they pertain to adverse health effects (e.g., *carcinogen*) and warning properties.

## Odor Threshold Data

Information on odor threshold is essential to determine whether a contaminant has warning properties at or below the exposure limit that would allow an APR to be selected. If the odor threshold exceeds the exposure limits, the contaminant is considered to have *poor warning properties*. Therefore, an APR would not be recommended for use unless it had an *end-of-service-life indicator (ESLI)*. Odor threshold data would be obtained from industrial hygienists or other experts such as NIOSH or OSHA.

## Exposure Limits

Several organizations require, recommend, or publish exposure limits. They are:

- OSHA - Permissible exposure limit (PEL)
- NIOSH - Recommended exposure limit (REL)
- ACGIH - Threshold limit value (TLV)

Exposure limit information is necessary to calculate MUCs for the types or classes of respirators using their assigned PFs. The *NIOSH Pocket Guide to Chemical Hazards* is an excellent source of information for many chemicals and their exposure limits.

## IDLH Concentrations

Contaminant concentrations that are IDLH are life threatening and call for the most protective respirators for the wearer. The *NIOSH Pocket Guide to Chemical Hazards* provides IDLH



concentrations for many chemicals found in the workplace. The IDLH concentration for a substance must be compared to the actual concentration measurement of the substance on the job.

### **Eye Irritation**

Some contaminants have the potential to cause eye irritation. In these situations, a full facepiece, hood, or helmet should be selected instead of a half mask to provide eye protection.

### **Service Life Information**

Service life refers to the length of time a filter cartridge or canister will provide protection to the wearer. This information is necessary to determine a filter change schedule for the chosen respirator.

## **MEDICAL EVALUATION**

Wearing a respirator may place a physiological burden on the wearer. Therefore, OSHA requires that an employer provide a medical evaluation to determine if a worker can wear a respirator. The evaluation must be done before a worker is fit tested or required to use a respirator.

## **FIT TESTING**

*A qualitative fit test (QLFT) or quantitative fit test (QNFT)* must be performed on all negative or positive pressure tight-fitting respirator before a worker is required to wear it. The worker must be fit tested on the same make, model, size, and style of respirator that will be used in the workplace.

A *fit test* must be conducted at least annually and whenever changes in the worker's physical condition could affect the respirator fit. Such conditions include, but are not limited to:

- Cosmetic surgery
- Dental changes
- Facial scarring
- Obvious changes in body weight

Fit testing atmosphere supplying respirators and PAPRs must be done by performing the fit tests in negative pressure mode.



## Fit Testing Protocols

OSHA has provided specific procedures for performing QLFTs and QNFTs. By following these procedures for each fit test, the test results will be consistent from one test to another. For a QLFT, the worker is tested using a testing agent to ensure that the respirator is fitting properly. For a QNFT, a machine is used to make sure that the respirator fits correctly.

## Qualitative Fit Test

A QLFT is a pass/fail fit test used to check respirator fit that relies on the user's response to a test agent. It involves introducing a harmless odorous or irritating test agent into the breathing zone of the user. If the user does not detect the test agent, the respirator fits properly.



Four test agents are approved by OSHA for conducting a QLFT:

1. Banana oil (isoamyl acetate or isopentyl acetate)
2. Irritant smoke (stannic oxychloride or titanium tetrachloride)
3. Saccharin (sodium saccharin) solution
4. Bitrex™ (denatonium benzoate) solution

Before a test agent is used, OSHA requires an odor and taste threshold screening be conducted. The screening determines if the user can smell or taste the test agent at low concentrations. If the user can smell or taste the testing agent, he or she can be fit tested with it.

Qualitative fit testing addresses the following issues:

- Choosing the respirator needed.
- Determining comfort level. Comfort is important when respirators are used for long periods of time.
- Establishing a facepiece-to-face seal with a particular respirator.
- Identifying facial complications that affect the fit, such as dentures, facial surgery, or dental/oral surgery.

A QLFT is simple and inexpensive, which makes it the most common type of fit testing done for respirators. However, a QLFT relies upon a user's subjective response to the testing

agent. In other words, the user must inform the tester if he/she can smell or taste the substance. Because of the subjectivity of the QLFT, a respirator cannot be assigned a PF higher than 10 when using this type of test.

**Note:** Before performing any test, make sure the correct respirator cartridge for the testing agent has been installed.

### ***Isoamyl Acetate Protocols***

Isoamyl acetate (*IAA*) is also known as banana oil. This test requires the respirator be fitted with organic vapor cartridges or offer protection against organic vapors. The user stands inside a fit test chamber while taking this test (Figure 5-7).

In some individuals, exposure to *IAA* can cause the following health effects:

- Olfactory fatigue - the sense of smell is dulled
- Feelings of lightheadedness and drunkenness

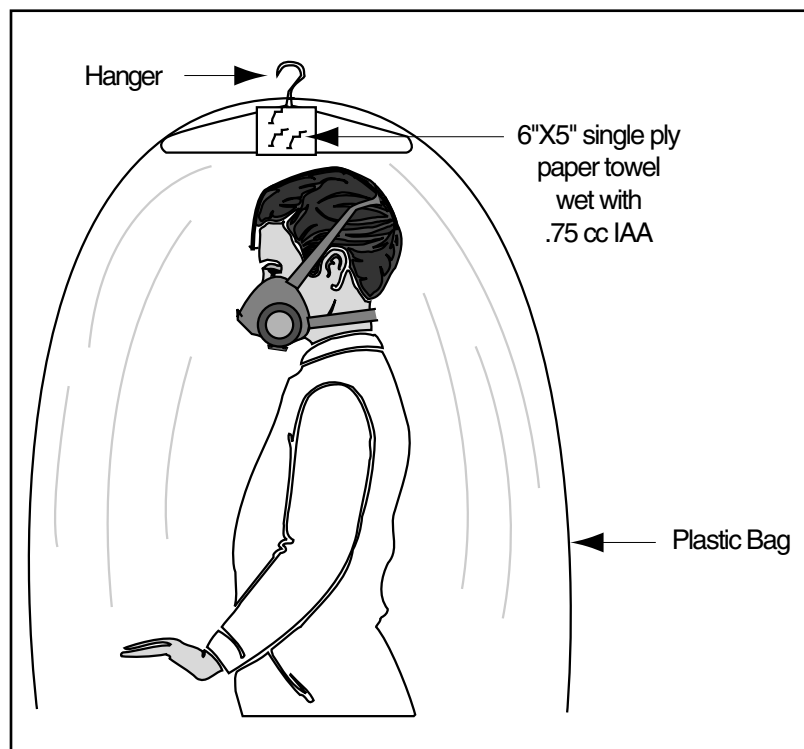

Figure 5-7. The fit test chamber is set up for use with isoamyl acetate (*IAA*), also called banana oil

**Irritant Smoke Test**

Irritant smoke is very irritating to the eyes, nose, and throat and usually causes coughing. The worker being tested must keep his or her eyes closed during the fit test when wearing a half facepiece. This test requires the respirator be fitted with a HEPA filter or P100 particulate filter.

**Saccharin Test**

The saccharin test uses a saccharin aerosol. If saccharin leaks into the facepiece, the worker will have a sweet taste on the lips and tongue. Workers must take a taste test before using this testing agent because some people cannot taste saccharin. A small nebulizer is used to create a saccharin aerosol inside the test chamber. This test uses a particulate filter.

**Bitrex™ Test**

The Bitrex™ test uses a Bitrex aerosol that has a citrus or orange flavor. The fit testing protocol for Bitrex is identical to the saccharin protocol.

**Quantitative Fit Test**

A quantitative fit test (QNFT) is a more sophisticated fit test. It measures the actual amount of leakage into the respirator. A variety of methods are available for performing a QNFT, and each one uses a different technology. The quantitative fit test protocols are:

- Generated aerosol – An aerosol is generated and dispersed in a room. Air monitoring instruments are used to measure both the concentration in the room and the concentration inside the actual facepiece.
- Ambient aerosol condensation nuclei counter – The amount of natural dusts in the air is measured and compared to the amount of dust inside the facepiece.
- Controlled negative pressure – Air pressure inside the facepiece is kept constant. As air leaks into the facepiece, air is exhausted to maintain the constant inside air pressure. Therefore, the exhausted air is equivalent to the amount of leakage and can be measured to determine leakage.



## RESPIRATOR USE

The employer is required to establish and implement procedures for the proper use of respirators. These procedures are listed below:

- Prohibiting conditions that may result in facepiece seal leakage.
- Preventing workers from removing respirators in hazardous environments.
- Taking actions to ensure continued effective respirator operation throughout the work shift.
- Establishing procedures for the use of respirators in IDLH atmospheres.

### Facepiece Seal Conditions

OSHA does not permit respirators to be worn when conditions prevent a good seal. These conditions include the following:

- Facial hair that crosses the sealing surface (stubble or beard growth, beard, mustache, or sideburns)
- Skull cap that projects under the facepiece
- Temple pieces on glasses
- Absence of one or both dentures
- Facial scars or deformities that hinder a good seal

The need for a good seal is the reason facial hair is prohibited for workers who must wear respirators. Facial hair prevents the facepiece from sealing against the face and results in a high rate of leakage.

Eyeglasses pose another facepiece seal problem. The temple bars on eyeglasses prevent a respirator from sealing against the side of the head. However to go without eyeglasses creates vision-related problems, such as tripping hazards. Respirator manufacturers make fittings that hold lenses in place in the facepiece without temple bars. OSHA requires that this type of fitting be made available at the employer's expense to workers who wear glasses.

## User Seal Checks

A respirator must be adjusted each time it is put on to ensure the best possible seal. To do this, conduct a user seal check. Use either of the two methods listed:

1. Positive pressure seal check and negative pressure check
2. Manufacturer's recommended user seal check

User seal checks are **not** substitutes for qualitative or quantitative fit tests.

### **Positive Pressure User Seal Check**

To perform a positive pressure user seal check, follow these steps:

1. Cover the exhalation valve of the respirator.
2. Exhale gently for about 10 seconds. Do not exhale too hard or push the mask into the face because the check will be inaccurate.

If the respirator fits, a slight pressure should build up inside the facepiece. If air leaks out, the respirator does not fit properly. Figure 5-9 illustrates a positive pressure seal check.

This test is done on an atmosphere supplying respirator by covering the inlet and exhalation valve with your hands and exhaling.



Figure 5-9. Cover the exhalation valve when performing a positive pressure user seal check

### **Negative Pressure User Seal Check**

To perform a negative pressure user seal check, follow these steps:

1. Cover the filter openings with the palms of your hands.
2. Inhale gently and hold your breath for about 10 seconds. Do not push the respirator into the face too hard, or the check will be inaccurate.

If the respirator fits correctly, the facepiece should collapse slightly inward. If the respirator does not fit correctly the facepiece will not collapse, and you will feel an air leak (Figure 5-10).

This test is done on an atmosphere supplying respirator by covering the inlet with the hand and inhaling.

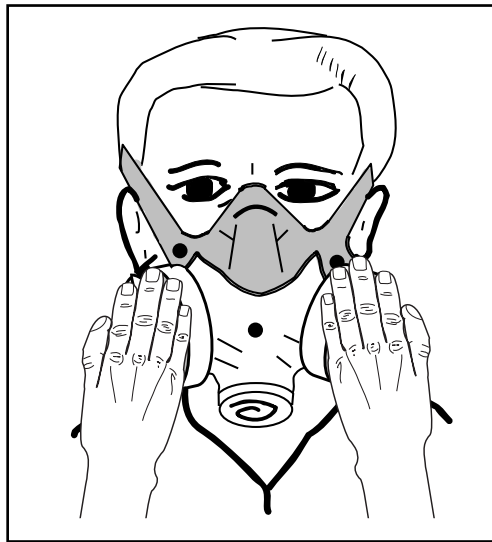

Figure 5-10. Cover the filter openings when performing a negative pressure user seal check

### **Continued Respirator Effectiveness**

OSHA requires the employer to monitor the workplace for changes that may affect the effectiveness of respirators. Examples include changes in work area conditions or in worker exposure or stress. When such changes occur, the employer shall reevaluate the continued effectiveness of the respirator.



If any trouble is experienced with the respirator, leave the area and fix the problem. Specifically, leave the work area for any of the following conditions:

- To wash your face and respirator to prevent eye or skin irritation
- If you detect vapor or gas breakthrough
- If you experience increased breathing resistance
- If you detect a leak in the facepiece seal
- To replace the respirator or the filter, cartridge, or canister

### **IDLH Conditions**

OSHA requires that additional standby worker(s) be located outside an IDLH atmosphere when a worker(s) has entered that area. The purpose of the standby worker is to assist co-workers in case of an emergency. The standby person must:

- Be trained and equipped to provide effective emergency response.
- Maintain visual, voice, or signal line of communication with worker(s) in the IDLH atmosphere.

**Note:** Workers can never enter or work in IDLH atmospheres when using APRs because they do not provide adequate protection.

## **MAINTENANCE AND CARE**

The employer must provide for the following regarding the respirators used by workers:

- Cleaning and disinfecting
- Storage
- Inspection
- Repair

### **Cleaning and Disinfecting**

It is the employer's responsibility to provide a clean and disinfected respirator to the user. A respirator issued for the exclusive use of one worker must be cleaned and disinfected by that worker to maintain the respirator in a sanitary condition. However, if a respirator is issued to more than one worker, for

emergency use, or for fit testing, it must be cleaned and disinfected after each use. NIOSH has issued guidelines for cleaning and sanitizing respirators.

### **Storage**

For a respirator to remain in good condition and proper working order, it must be stored correctly to protect it from the following:

- Chemicals
- Contamination
- Damage
- Dust
- Excessive moisture
- Extreme temperatures
- Sunlight

In addition, a respirator shall be packed and stored to prevent the facepiece and exhalation valve from being deformed.

### **Inspection**

All respirators must be inspected before each use and during cleaning. Atmosphere supplying respirators and respirators used for emergency purposes must be inspected monthly or according to manufacturer specifications. All written inspection records for emergency use respirators must be kept.

Air cylinders must be maintained in a fully charged state. They must be recharged when the pressure falls below 90 percent of manufacturer's recommended pressure.

Check the following items when conducting a respirator inspection:

- Function
- Connections, including tightness
- Condition of parts, especially rubber parts, for flexibility and deterioration
- Parts, including facepiece, headstraps, valves, connecting tubes
- Cartridges, canisters, filters

## Repair

The following list outlines OSHA's requirements regarding respirator repairs:

- Repairs must be performed by a trained individual.
- Only the manufacturer's NIOSH-approved parts designed for the specific respirator shall be used.
- Repairs performed on the regulator, alarms, or admission valves of an atmosphere supplying respirator shall be performed by the manufacturer or a technician trained by the manufacturer.

## TRAINING

The respiratory protection standard requires that the employer provide effective training to workers who are required to use respirators. Training must be:

- Given to workers before they begin using respirators
- Understandable to the worker
- Comprehensive enough that it covers all required items
- Provided annually or more often if necessary

Workers who voluntarily wear a respirator shall be given the information located in 29 CFR 1910.134, Appendix D. This information can be given written or verbally.

An employer must ensure that workers can demonstrate knowledge in the following topics:

- Why a respirator is necessary and how improper fit, usage, or maintenance can compromise the protection of a respirator.
- Limitations and capabilities of the respirator.
- How to use the respirator in an emergency situation.
- How to inspect, don, doff, use, and seal check the respirator.
- Procedures for maintaining and storing the respirator.
- How to recognize medical signs and symptoms that may limit or prevent the effective use of the respirator.

Retraining shall be done every year, or sooner, for the following reasons:

- Changes in the workplace or type of respirator render the old training ineffective.
- A worker does not retain information from the initial course.
- Any other situation occurs in which retraining appears necessary to ensure safe respirator use.

## **PROGRAM EVALUATION**

The employer is required to evaluate the written respiratory protection program as necessary to ensure it is being properly implemented and is effective. The evaluation shall include consulting workers who use respirators for their views on program effectiveness as well as problems.

## **RECORDKEEPING**

The employer must establish and retain written information regarding the following:

- Exposure assessments
- Medical evaluations
- Respirator inspections
- Written respirator program

### **Fit Testing Records**

Qualitative and quantitative fit testing records also must be kept. They must be retained until the worker's next fit test. These records shall contain the following:

- Name of the worker tested
- Type of fit test performed
- Make, model style, and size of the respirator tested
- Test date
- Test results
  - Pass/fail results of qualitative fit tests
  - Fit factor and strip chart recording
  - Other recordings of test results for QNFTs

## Training Records

Written documentation of worker respirator training and respirator program evaluation results shall also be maintained.

## DONNING AND DOFFING

*Donning* is the act of putting on PPE. It is not difficult to put on the equipment. However, a specific routine must be followed for the best results. Assistance is usually provided by another worker, especially if a SCBA is involved.

*Doffing* is the act of removing PPE. Again, it is important to follow the specific steps when removing PPE. Doffing is made more complicated by the fact that the PPE may be contaminated. (Procedures for doffing PPE are discussed in the Decontamination module of this manual.)

## IN-USE MONITORING

When wearing PPE, workers should be alert to conditions that signal chemical exposure has occurred. These conditions include the following:

- Any signs that the protective ensemble has degraded
- Chemical odors
- Skin irritation
- Unusual fatigue
- Breathing difficulties
- Vision problems
- Restrictions in the ability to move
- Physical discomfort, rapid pulse, nausea, or chest pain

## INSPECTIONS

Inspections are an important part of a good PPE program. Checklists and written records are needed to verify and maintain the effectiveness and safety of the PPE. There are different types of inspections.

1. Inspection and testing of new equipment
2. Inspection of equipment at the time it is issued to workers
3. Inspection after use
4. Periodic inspection of stored equipment
5. Inspection when problems are reported

The responsibility to inspect PPE must be assigned to a specific qualified person. However, it is a good practice for workers to know how to do a basic equipment inspection.

## PROTECTIVE CLOTHING

The purpose of wearing protective clothing is to keep contaminated materials off of worker's skin and clothing. Typical skin protection for microbial remediation consists of full-body protective suits and protective gloves. In some cases, protective boots may also be worn. The specific type of protective clothing must be based on the type of exposure that workers may get. Skin hazards can present themselves to microbial remediation workers in the form of particulates or liquids. The form of the hazard will be related to the method of remediation. For example, if workers are demolishing contaminated drywall and lumber, they may only be exposed to particulate matter. However, if workers are required to pressure-wash mold or other microbial growth from the work area or are exposed to material damaged by sewage, they could be exposed to contaminated liquids.

Another reason for wearing protective clothing is so that workers keep contaminated material off of clothing that they may wear home. Any clothing that is not disposable and that has been worn during remediation activities should be removed during the decontamination process, double bagged, and washed separately from other clothing in a 5 percent bleach solution.

### Full-Body Protective Suits

Full-body protective suits may also be worn by workers during microbial remediation work. The two most common types of material used to manufacture these suits are described below.

#### **Tyvek®**

Tyvek® is a plastic fiber. It is breathable, so the risk of heat stress that is commonly caused by wearing non-permeable protective clothing is reduced. It provides skin protection from particles as small as 0.5 microns. Tyvek® has reasonable puncture and abrasion resistance; however, it provides little

protection from chemicals or liquids. Resistance to chemicals can be increased when coated with other materials. Tyvek® is inexpensive and garments made from it are disposable.

### **Saranex®**

Saranex® is also a plastic fiber. It is made from material similar to Tyvek and then coated with Saran®, the same plastic in Saran Wrap®. It provides excellent resistance to a wide variety of chemicals. Like Tyvek®, Saranex® is an inexpensive, disposable solution to protective clothing.

### **Protective Gloves**

Protective gloves are worn because hands are the most likely to come in contact with contaminated material. Some job tasks, such as demolition, also require extra protection to prevent hand injuries. Gloves protect workers from skin irritation from exposure to microbial contaminated substances, but also protect them from contacting contaminated material and then later accidentally ingesting that material. Additionally, cleaning solutions such as bleach can be irritating to the skin. EPA recommendations call for gloves that come to the middle of the arm. However, glove selection must be based on the type of work being done, expected contaminants, and any chemicals that are used.

### **Latex**

Latex is made from rubber. Latex gloves are the most common type worn by microbial remediation workers. They are used as a barrier from exposure to microbes. They are the same as those used in the medical industry. Latex is inexpensive and disposable.

One problem with latex is that many people develop sensitivities to this material. Latex allergies are being diagnosed at an increased rate. Latex allergies in the workplace can result in potentially serious health problems for workers who are often unaware of the risk. Although health care workers face the greatest risk, frequency rates of up to 11 percent are reported for non-health care workers exposed to latex at work. Other materials can be used to make disposable gloves. If a worker has developed a rash after wearing latex

gloves, he or she should request latex-free vinyl or nitrile gloves instead. For a detailed report of “Latex Allergies: Potential Risk to Abatement Workers,” refer to Appendix B, Resources.

### ***Vinyl***

Vinyl is Poly Vinyl Chloride, or PVC. Because there are no latex proteins in vinyl, it is a good alternative for workers who have latex allergies. It is also resistant to acids and caustic materials and costs about the same as latex. In some cases, heavier vinyl gloves are also used as outer gloves with lighter, vinyl or latex gloves worn underneath.

### ***Nitrile***

Nitrile is a synthetic rubber. It is also referred to as BUNA-N, NBR, and milled nitrile. Nitrile is not made with latex proteins, so it also is a good alternative for workers who have latex allergies. It is resistant to punctures and abrasion, has resistance to a much wider range of chemicals, and has better barrier properties than latex. However, nitrile is a more expensive material.

## **EYE PROTECTION**

Because of the possibility of microbial-contaminated dust particles coming in contact with the eyes, workers should always wear tight-fitting eye protection. If full-face APRs are being used, the eye protection is part of the respirator.

However, if full face APRs are not being used, then goggles designed to prevent the entry of dust and small particles should be used. Safety glasses or goggles with open vent holes are not acceptable.



## MODULE 5 - ASSIGNMENT SHEET

### 1. Define the following terms:

Maximum use concentration

---

---

---

---

Protection factor

---

---

---

---

Qualitative fit test

---

---

---

---

Quantitative fit test

---

---

---

---

### 2. List three types of respirators and their protection factors.

1. \_\_\_\_\_
2. \_\_\_\_\_
3. \_\_\_\_\_

**3. List at the limitations of air purifying respirators (APRs).**

1. \_\_\_\_\_
2. \_\_\_\_\_
3. \_\_\_\_\_
4. \_\_\_\_\_
5. \_\_\_\_\_
6. \_\_\_\_\_
7. \_\_\_\_\_
8. \_\_\_\_\_
9. \_\_\_\_\_

**4. Perform Standard Operating Procedures:**

1. Inspect a full-face APR.  
Don a full-face APR.  
Perform a negative pressure check with a full-face APR.  
Perform a positive pressure check with a full-face APR.
2. Complete an irritant smoke or banana oil qualitative fit test.
3. Clean, sanitize, and maintain a full-face APR.

**5. List and describe the two most common materials used in the protective clothing of microbial remediation workers.**

1. \_\_\_\_\_
2. \_\_\_\_\_

**6. List the three most common materials used for protective gloves by microbial remediation workers.**

1. \_\_\_\_\_
2. \_\_\_\_\_
3. \_\_\_\_\_

## MODULE 5 - STANDARD OPERATING PROCEDURE 1

### Half-Face APR

- A. Inspect the half-face APR. Check all parts for signs of dirt, wear, tears, and integrity. Ensure all parts can and will work properly by using the following steps.
1. General appearance (no deformities).
  2. Harness and strap assemblies.
  3. Facepiece seal area.
  4. Nose cup.
  5. Inhalation valves.
  6. Exhalation valve, valve seats and cover.
  7. Filter or cartridge holder and gaskets.
  8. Filter(s) or cartridge(s).
  9. Install proper filter(s) or cartridge(s).
- B. Don a half-face APR using the following steps.
1. Inspect the respirator.
  2. Loosen the harness assembly completely.
  3. Hang the facepiece around the neck using the neck strap (if available).
  4. Raise the facepiece upward and open exposing the chin and nose cup.
  5. Place chin in the chin cup and pull the harness over the top of the head. Make sure there is no hair or other obstructions between the face and facepiece.
  6. Tighten the bottom two harness straps (not too tight).
  7. Tighten the top strap slightly.
  8. Adjust facepiece if needed. (It should be centered on the face.)
- C. Perform a negative pressure check with the half-face APR.
1. Inspect the respirator.
  2. Don the respirator.
  3. Cover the filter or cartridge inlet openings. The palms of the hands, duct tape, plastic wrap, or surgeon's gloves may be used.
  4. Inhale so the facepiece collapses inward and hold for ten seconds.
  5. If the facepiece stays collapsed, continue with step 7.
  6. If there is leakage, readjust the facepiece and try again. If there is still leakage, re-inspect the respirator and try again. If it's still not possible to get a seal, try a different size or make of respirator.
  7. Remove the coverings from the filter or cartridge inlets.

- D. Perform a positive pressure check with the half-face APR.
1. Inspect the respirator.
  2. Don the respirator.
  3. Cover the exhalation outlet. The palm of the hand, duct tape, plastic wrap, or surgeon's gloves may be used.
  4. Exhale so that the facepiece is enlarged slightly and hold for ten seconds.
  5. If the facepiece stays enlarged, continue with step 7.
  6. If there is leakage, readjust the facepiece and try again. If there is still leakage, re-inspect the respirator and try again. If it is still not possible to get a seal, try a different size or make of respirator.
  7. Remove the coverings from the exhalation outlet.
- E. Clean, sanitize, and maintain a half-face APR using the following steps.
1. Remove and properly discard filters and/or cartridges.
  2. Immerse the respirator in a warm (about 110°F/43.3°C) solution of germicidal or disinfecting detergent.
  3. Scrub the respirator body and parts gently with a cloth or soft brush.
  4. Rinse in clean, warm (about 110° F/43.3°C) water.
  5. Shake gently to remove excess water. It may be necessary to tip the respirator several directions.
  6. Wipe the respirator with a soft, clean cloth (if available) or allow to air dry away from direct heat or sunlight.
  7. Inspect the respirator.
  8. Replace all damaged or missing parts according to the manufacturer's instructions.
  9. Loosen harness straps.
  10. Place respirator in a clean bag, box, or appropriate storage area. The storage area should be in a cool, dry place. Do not place any weight on the respirator.

## MODULE 5 - STANDARD OPERATING PROCEDURE 2

### Full-Face APR - Inspect, Don, and Seal Check

- A. Inspect a full-face APR using the following 10 steps. Check for signs of dirt and wear and tear. Check to ensure that all parts work properly.
1. Overall general appearance (no deformities).
  2. Harness assembly and connections.
  3. Lens and lens gasket.
  4. Facepiece seal area.
  5. Inner nose cup.
  6. Inhalation valves and their seating surfaces.
  7. Exhalation valves and its seating surface.
  8. Filter or cartridge holder and gaskets.
  9. Filter(s) or cartridge(s).
  10. Install proper filter(s) or cartridge(s).
- B. Don a full-face APR using the following steps.
1. Inspect the respirator.
  2. Loosen the harness assembly completely.
  3. Hang the facepiece around the neck using neck strap (if available).
  4. Raise the facepiece upward and open to expose the chin and nose cup.
  5. Place chin in the chin cup and pull the harness over the top of the head. Make sure no hair or other obstructions are between the face and facepiece.
  6. Tighten the bottom harness straps (not too tight).
  7. Tighten the middle two harness straps.
  8. Tighten the top strap slightly.
  9. Adjust the facepiece if needed. (It should be centered on the face.)
- C. Perform a negative pressure user seal check with a full-face APR.
1. Inspect the respirator.
  2. Don the respirator.
  3. Cover the filter or cartridge inlet openings. The palms of the hands, duct tape, plastic wrap, or surgeon's gloves may be used.
  4. Inhale so the facepiece collapses inward and hold for ten seconds.
  5. If the facepiece stays collapsed, go to step 7.
  6. If there is leakage, re-adjust the facepiece and try again. If there is still leakage, re-inspect the respirator and try again. If it is still not possible to get a seal, try a different size or make of respirator.
  7. Remove the coverings from the filter or cartridge inlets.

- D. Perform a positive pressure user seal check with a full-face APR.
1. Inspect the respirator.
  2. Don the respirator.
  3. Cover the exhalation outlet. The palm of the hand, duct tape, plastic wrap, or surgeon's gloves may be used.
  4. Exhale so that the facepiece comes off the face slightly and hold for ten seconds.
  5. If the facepiece stays enlarged, go to step 7.
  6. If there is leakage, readjust the facepiece and try again. If there is still leakage, reinspect the respirator and try again. If it is still not possible to get a seal, try a different size or make of respirator.
  7. Remove the coverings from the exhalation outlet.

## MODULE 5 - STANDARD OPERATING PROCEDURE 3

### Qualitative Fit Test

- A. Complete an irritant smoke or banana oil qualitative fit test using the following steps:

#### *Irritant Smoke*

1. Smell a weak concentration of the test agent.
2. Inspect the respirator.
3. Don the respirator.
4. Perform a negative pressure check.
5. Perform a positive pressure check.
6. Wear the respirator for at least 5 minutes.
7. Close eyes.
8. Breathe normally.
9. Breathe deeply. Breaths must be deep and regular.
10. Turn head from side to side.
11. Nod head up and down.
12. Read the Rainbow passage.
13. Jog in place.
14. Breathe normally.
15. If the test agent is detected, re-adjust the mask. Repeat steps 4 through 14.
16. If the test agent is still detected, select another size or type respirator and repeat steps 2 through 14.
17. Clean, sanitize, and maintain the respirator.

#### *Banana Oil*

1. Read the following instructions which will be typed on a card and placed on the table in front of the two test jars (1 and 2).

“The purpose of this test is to determine if you can smell banana oil at a low concentration. The two jars in front of you contain water. One of these jars also contains a small amount of banana oil. Be sure the covers are on tight, then shake each jar for two seconds. Unscrew the lid of each jar, one at a time, and sniff at the mouth of the jar. Indicate to the test conductor which jar contains banana oil.”

2. Make sure each of the covers are on tight and shake each jar for two seconds.
3. Unscrew the lid of each jar one at a time, and sniff at the mouth of the jar.

4. Indicate to the person conducting the test which jar contains the banana oil.
5. If you are unable to correctly identify the jar containing the odor test solution, the IAA QLFT may not be used.
6. If you correctly identify the jar containing the odor test solution, you may proceed to step 7.
7. Select the most comfortable respirator from the various sizes and manufacturers by holding each facepiece up to your face and eliminate those which are obviously not giving a comfortable fit. Normally, selection will begin with a half-mask and if a fit cannot be found here, go to the full facepiece respirators. (A small percentage of users will not be able to wear any half-mask.) Each respirator represents a different size and shape and if fit properly, will provide adequate protection. The selection process shall be conducted in a room separate from the fit-test chamber to prevent odor fatigue. A mirror shall be available to assist you in evaluation of the fit and positioning of the respirator.
8. Inspect the chosen respirator, making sure that it is equipped with organic vapor cartridges. Don and wear the most comfortable mask for at least five minutes to assess comfort. Assess comfort by discussing and reviewing the following points with your instructor(s).
  - Chin properly placed
  - Positioning of mask on nose
  - Strap tension
  - Fit across nose bridge
  - Room for safety glasses
  - Distance from nose to chin
  - Room to talk
  - Tendency to slip
  - Cheeks filled out
  - Self-observation in mirror
  - Adequate time for assessment
9. If you are not familiar with using a particular respirator, your instructor(s) will help you inspect and then don the mask several times and adjust the straps each time, so that you set the proper tension on the straps.
10. After selecting, donning, and properly adjusting a respirator, “seat” the mask by rapidly moving the head side to side and up and down, taking a few deep breaths.
11. Conduct the conventional negative and positive pressure fit checks (e.g., see ANSI Z88.2-2980).
12. Wear the respirator for at least 10 minutes before starting the fit test.
13. Enter the fit test room, get a 6 x 5 inch (15.2 x 12.7 cm) piece of paper towel or other porous absorbent single-ply material, folded in half and wetted with 0.75 cc of pure IAA from the instructor. Hang the wet towel on the hook at the top of the chamber.



14. Allow two minutes for the IAA test concentration to be reached before starting the fit-testing exercises. Read the test exercises that are taped to the inside of the test chamber. Use this time to ask the instructor(s) any questions you may have or to have the exercises demonstrated.
15. Perform the following test exercises for at least one minute each.

*Test Exercises*

- a. Normal breathing.
- b. Deep breathing. Be certain breaths are deep and regular.
- c. Turn head from side to side. Be certain movement is complete. Do not bump the respirator on your shoulders. Inhale when the head is at either side.
- d. Nod head up and down. Be certain motions are complete and made about every second. Do not bump the respirator on your chest. Inhale when your head is in the full up position.
- e. Talking. Talk aloud and slowly for several minutes. Read the following Rainbow Passage. Reading it will result in a wide range of facial movements, and thus be useful to satisfy this requirement.

“When the sunlight strikes raindrops in the air, they act like a prism and form a rainbow. The rainbow is a division of white light into many beautiful colors. These take the shape of a long round arch, with its path high above, and its two ends apparently beyond the horizon. There is, according to legend, a boiling pot of gold at one end. People look, but no one ever finds it. When a man looks for something beyond reach, his friends say he is looking for the pot of gold at the end of the rainbow.”

16. If at any time during the test, you detect the banana-like odor of IAA, quickly exit the test chamber and leave the test area to avoid olfactory fatigue.
17. If you have detected the odor, return to the selection room and remove the respirator. Repeat the odor sensitivity test and select another respirator. If you cannot be fitted with the selection of half-mask respirators, include full facepiece models in your selection process. Return to the test by starting at step 8 above.
18. If you complete the test without detecting the banana-like odor, break the face seal and take a breath before exiting the chamber. This demonstrates the efficiency of the respirator.
19. Remove the saturated towel from the hook, leave the test chamber, and return the towel to the instructor(s).

20. If you successfully passed this fit test, you may be assigned the use of the tested respirator in atmospheres with up to 10 times the PEL. In other words, this IAA protocol may be used to assign a protection factor no higher than 10.
21. After passing the fit test, assess the comfort of the respirator by using the steps outlined above. If it has become uncomfortable, another model of respirator shall be tried and tested.

## MODULE 5 - STANDARD OPERATING PROCEDURE 4

### Full-Face APR - Clean, Sanitize, and Maintain

- A. Clean, sanitize, and maintain a full-face APR using the following steps.
1. Remove and properly discard filters and/or cartridges.
  2. Immerse the respirator in a warm (about 110°F/43.3°C) solution of germicidal or disinfecting detergent.
  3. Scrub respirator body and parts gently with a cloth or soft brush.
  4. Rinse in clean, warm (about 110°F/43.3°C) water.
  5. Shake gently to remove excess water. It may be necessary to tip the respirator several directions.
  6. Wipe the lens and respirator with a soft, clean cloth (if available) or allow to air dry away from direct heat or sunlight.
  7. Inspect the respirator.
  8. Replace all damaged or missing parts according to the manufacturer's instructions.
  9. Loosen harness straps.
  10. Place respirator in a clean bag, box, or appropriate storage area. The storage area should be in a cool, dry place. Do not place any weight on the respirator.



## MODULE 5 APPENDIX

### RESPIRATOR INFORMATION

#### Protection Factors

Protection factor (PF) is a value assigned to a respirator based on its efficiency. If a respirator allows contaminants to leak around the face seal into the mask, it is less efficient.

The technical definition of PF is the concentration outside the respirator divided by the concentration that can get inside the respirator.

$$\text{PF} = \frac{\text{Concentration of contaminant outside the respirator}}{\text{Concentration inside the respirator}}$$

The practical definition of PF is how much of the outside contaminant level is reduced by the respirator.

- A respirator with a PF of 10 reduces exposure 10 times. The wearer is exposed to a concentration 1/10 of the outside concentration level.
- A respirator with a PF of 10,000 reduces exposure 10,000 times. The wearer is exposed to a concentration 1/10,000 of the outside concentration level.

A rule of thumb for protection factors is: Low PFs give the **LOWEST PROTECTION** and high PFs give the **HIGHEST PROTECTION**

#### Maximum Use Concentrations

Using the PF and the OSHA Permissible Exposure Limit (PEL), you can determine the highest level at which a respirator can be safely used. This level is called the maximum use concentration (MUC). The MUC is the PF multiplied by the PEL.

$$\text{MUC} = \text{PF} \times \text{PEL}$$

Example for chlorine dioxide and full-face air purifying respirator (APR):

OSHA PEL for chlorine dioxide	=	.1	ppm
PF of FF APR	=	50	
MUC	=	50 x .1	
	=	5	ppm

A full-face mask cannot be used when chlorine dioxide levels exceed 5 ppm. At no time should a respirator be used in an environment that exceeds the MUC.

## Respirator Selection

The industrial hygienist selects the correct respirator with the protection factor in mind. If airborne chemical levels are high, there is a chance that the respirator does not reduce exposure enough. If this happens, the worker may be overexposed even wearing a respirator.

### Example

Workers are using full-face masks in an area where chlorine dioxide levels are 50 ppm. Is this acceptable? No. The MUC for chlorine dioxide and a full-face APR is 5 ppm.

**PARTICIPANT OBJECTIVES**

After completing Module 6, you will be able to:

1. Identify and describe at least three elements of work area preparation that should be completed before any microbial remediation can begin.
2. List at least two of the most common chemicals used to destroy microbial organisms.
3. List the proper mixture for a bleach and water solution used during microbial remediation.
4. Given a space, calculate its volume and determine the appropriate number of negative air units to achieve four air exchanges per hour.
5. Given a space, tools, and equipment, contain the space and set up a negative pressure enclosure according to the procedures recommended in this section.
6. Given one container of bleach and one container of water, combine each by the recommended mixing ratio without error.
7. Given the tools and materials, and while suited, apply the seven steps of the remediation process.





## INTRODUCTION

The goal of remediation is to remove and/or clean contaminated materials in a way that prevents fungi, bacteria, mold spores, and dust contaminated with these substances from leaving the work area, while protecting the health of workers performing the remediation.

Microbial remediation is an evolving industry. New techniques are currently being developed. The innovative methods that will be used in the future to upgrade indoor air quality in buildings containing unhealthy air pollutants are unknown at this time. However, the basic principles and practices described in this section should be appropriate no matter what new methods may become available in the future.

In this section, microbial contamination of building components (e.g., walls, ventilation systems, support beams) that are chronically moist or water damaged are discussed. This work generally draws on the expertise developed in other remediation disciplines such as asbestos, lead, and hazardous waste. Laborers with a foundation of training and experience in these fields readily adapt to methods used in microbial remediation. The *Guidelines on Assessment and Remediation of Fungi in Indoor Environments*, published by the New York City Department of Health, Bureau of Environmental & Occupational Disease Epidemiology (see Appendix B, Resources) are recommended as minimum safe work practices.

### Scope of the Work

The scope of the work varies from site to site depending on the site condition. In addition to removal and cleaning of contaminated material, the work may also include demolition, mechanical, and electrical work to correct conditions that develop due to the water damage and mold growth.

## **WORK PRACTICES, REMEDIATION TECHNIQUES, AND DISPOSAL PROCEDURES**

The NYC Guidelines characterize microbial remediation projects by the extent of contamination. The Guidelines recommend special precautions including worker training and containment of the area to be remediated.

The information in this section is recommended for the cleanup of extensive contamination in areas greater than 10 square feet in heating, ventilating, air conditioning (HVAC) systems and contaminated surfaces greater than 20 square feet.

### **GENERAL REMEDIATION CONCERNS**

The following items are the major issues of concern on most microbial remediation projects:

- Work area preparation
- Worker protection
- Containment and isolation
- Movable objects
- Negative pressure enclosures
- Elimination of contaminants
- Remediation process
- Waste disposal
- Post-remediation inspection
- Methods to reduce or eliminate recurrence of infestations

### **Work Area Preparation**



Work area preparation includes all work that should be performed before work begins. This includes conveying the scope of the work to the workers, training for worker protection, and the construction of the containment.

Contamination should not be disturbed until proper controls have been implemented that avoid exposures to workers, building occupants, and all areas adjacent to the contamination. Work area preparation also includes:

- Limiting access to only authorized personnel trained in the hazards of the contamination present and hazards regarding remediation. To avoid unauthorized entry, signs should be posted at entrances to the work area.
- Correcting any conditions that caused contamination and that will prevent it from reoccurring in the future (water leaks, problems in ventilation/air filtration systems, humidity, and condensation).
- Reviewing the design of the building to ensure that all areas affected by water damage or microbial growth will be dealt with. This includes any hidden areas such as wall cavities. Also, water leaks occurring on one floor of a building could affect all of the floors below it.
- Controlling electrical hazards in damp/wet areas by shutting down and locking out power.
- Salvaging materials such as books or documents for preservation.
- Removing any objects that can be moved, such as furniture and light fixtures.
- Containment of fixed objects in the work place.
- Containment to control exposure to adjacent areas.
- Training those who prepare the work area or otherwise work in the area of contamination in the proper use of PPE and other safe work practices.

### **Limiting Access**

Remediation procedures should be designed to prevent unauthorized entry into the work area. Signs should be posted at all entrances to the work area warning against the hazards present (Figure 6-1). Written notification to building occupants will also help prevent exposure risk and the spread of contamination. Signs explaining the present dangers should be color coded, legible, and in English. Additional languages may be required on signs for non-English speaking individuals. You—as well as contractors, supervisors, and remediation workers—are responsible for enforcing this limited access.

### Worker Protection

Before entering the work area, it is recommended that you (and any visitors) be instructed in the use of respirators, dress, decontamination, and entry and exit procedures.

Appropriate personal protective equipment (PPE) must be used to protect you from exposure to contaminating organisms and chemicals used during the remediation process.

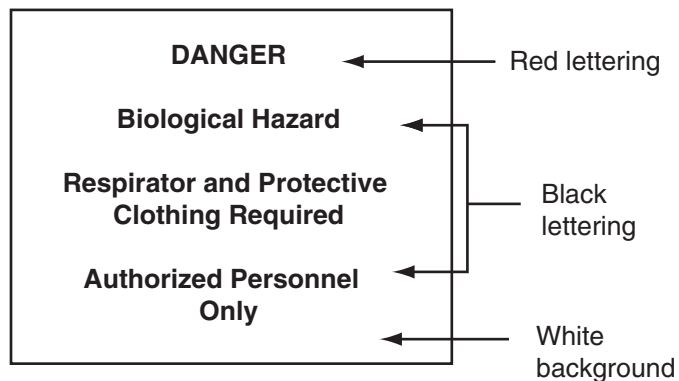

Figure 6-1. Signs should be posted to limit access to the work area

The use of respirators, rubber boots, rubber gloves, eye protection, and protective clothing is highly recommended. Extensive contamination should be assessed by an experienced health and safety professional and remediated by personnel with additional training and experience handling environmentally contaminated materials (i.e., hazardous waste workers).

Open sores and cuts should not be left exposed. Also, injuries resulting in breaks of the skin should be treated and reported immediately.

Respirators with high efficiency particulate air (HEPA) filters are necessary during the remediation of biological agents. The use of chemical agents to destroy organisms requires appropriate chemical cartridges. When eliminating biological agents with chemicals, the use of combination HEPA/chemical cartridges is essential.

Showers and equipment rooms are also recommended for large remediation projects for your safety as well as to control the spread of contamination. (See Section 6, Decontamination.)

### **Containment and Isolation**

Containment prevents the spread of contaminants outside the work area. Containment procedures include:

- Isolating the entire work area from occupied spaces and sealing all openings, fixtures, and HVAC components with polyethylene sheeting (poly) and tape (just as with asbestos or lead).
- Establishing negative pressure in the work area. Guidelines for creating negative pressure enclosures, use of negative air units, and recommended air exchanges are discussed later in this section.
- Establishing airlocks and decontamination chambers for exiting the work area.
- Isolating and remedying the problem that is contributing to the growth of contaminants, such as:
  - Shut off water sources
  - Repair or replace damaged pipes
  - Remove accumulations of stagnant water
  - Repair or improve ventilation or air filtration systems
  - Reduce the relative humidity to below 60 percent
  - Eliminate sources of condensation

After a walk-through inspection has been performed to identify areas of contamination and any existing damage, work area preparation should be implemented. HVAC systems should be shut down and isolated to prevent contaminated dust from being blown throughout the building. The HVAC control panel should be tagged and locked out to prevent activation during remediation. If electricity is shut down it, too, must be locked out. Any temporary lighting and electrical systems must be ground faulted.

### Movable Objects

For practical purposes, any movable objects such as furniture and light fixtures should be removed. This will reduce the chances of contamination remaining or reoccurring when the job is finished. Before removing such items they should be HEPA-vacuumed, wet wiped with a detergent and water solution, and dried. Non-movable objects should be covered with plastic after completing the same process. Before covering, the object must be free of all moisture. Contaminated items made of fabric, such as drapes and rugs should be discarded or cleaned by a professional cleaner that handles such contamination; otherwise reinfestation may occur if conditions are right for growth. Next, the work area and surrounding areas should be HEPA-vacuumed. Care should be taken not to disturb areas of visible contamination.

Microbes can be carried to other parts of a building through HVAC systems. So any vents and air ducts inside the work area should be covered and sealed with two layers of poly and duct tape. During final cleanup of the work area, all poly except for the first layer installed should remain in place until the area has passed inspection. HVAC filters, which could be contaminated, should be removed and disposed of as remediated waste. Adjacent areas to the work area should be contained to reduce the spread of contaminants. See Figure 6-2.

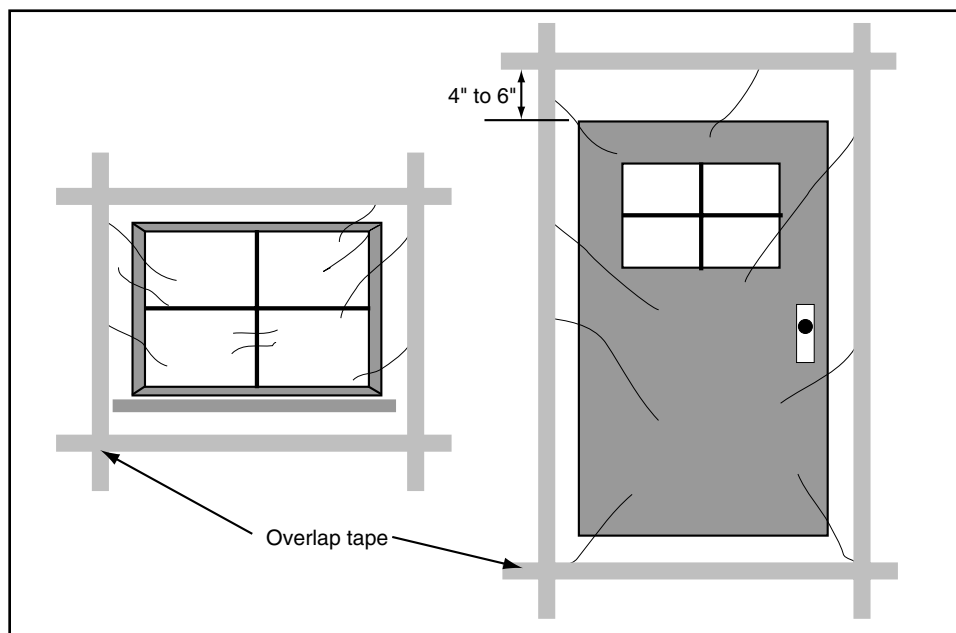

Figure 6-2. Sealing windows and doors

There should only be one entrance into the work area. By limiting access, the risk of spreading contaminants in and out of the work area is further reduced. Any other doors should be locked inside the work area to prevent unauthorized entries. It is recommended that windows and doors be sealed with 3-inch wide duct tape and completely covered with two layers of 6-mil poly. Stairways and elevators should also be sealed off and have signs posted to limit access.

Walls and floors within the work area that are not contaminated should be covered with poly to protect them from becoming cross contaminated. Several sheets of poly may be needed to cover floors. Because floors will receive a lot of wear and tear during the course of the project, layers of poly should be seamed together using spray adhesives and duct tape to prevent separation. However, be aware when applying spray adhesives that most are flammable and contain toxic vapors. Consult the MSDSs.

Floor coverings should be cut so that the poly can extend 24 inches up each wall. The poly should be flush with the walls at each corner and secured with duct tape to prevent damage from foot traffic. See Figure 6-3. After the first layer of poly is in place, a layer should be applied to the walls. Then, a second layer of poly can be applied to the floor. It should be installed with the seams of the first layer (if they exist) offset from the seams of the second layer. The second layer of poly on the floor should extend a few inches above the first and is secured with duct tape (Figure 6-4).

The walls of the work area also should be covered with two layers of poly. Wall coverings should extend as close to the ceiling/wall joint as permitted and cover the wall down to the wall/floor joists. The use of nails, furring strips, adhesive, and duct tape is the most effective way to support the poly so that it remains in place for the duration of the job. The second layer of poly on walls will be applied after the second layer of floor sheeting has been placed.

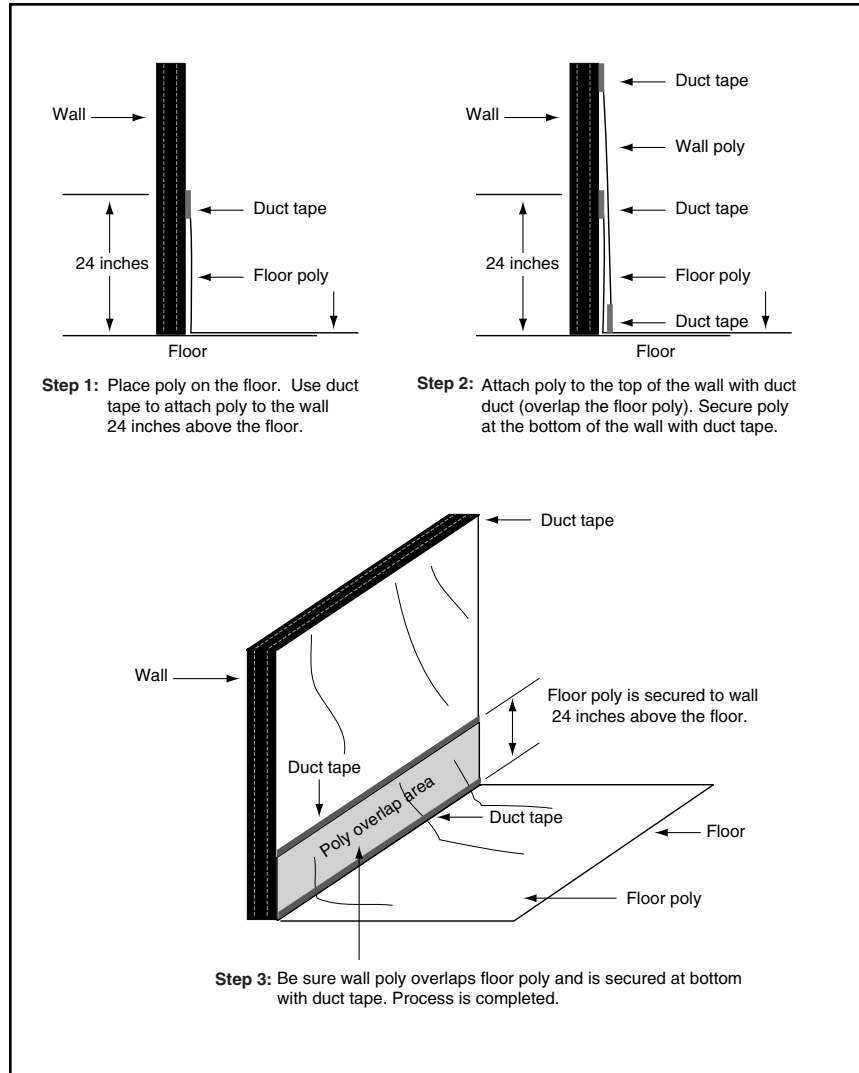

Figure 6-3. Covering the floors and walls with poly

Stairs or ramps that have been covered with poly can be slippery and should be constructed with traction for foot traffic. Tape or furring strips can be placed on top of the poly in these areas to reduce the risk of slips and falls.

Where full containment is not required, the recommended minimum distance for poly sheeting is to extend the poly 8 feet from the contaminated surface.



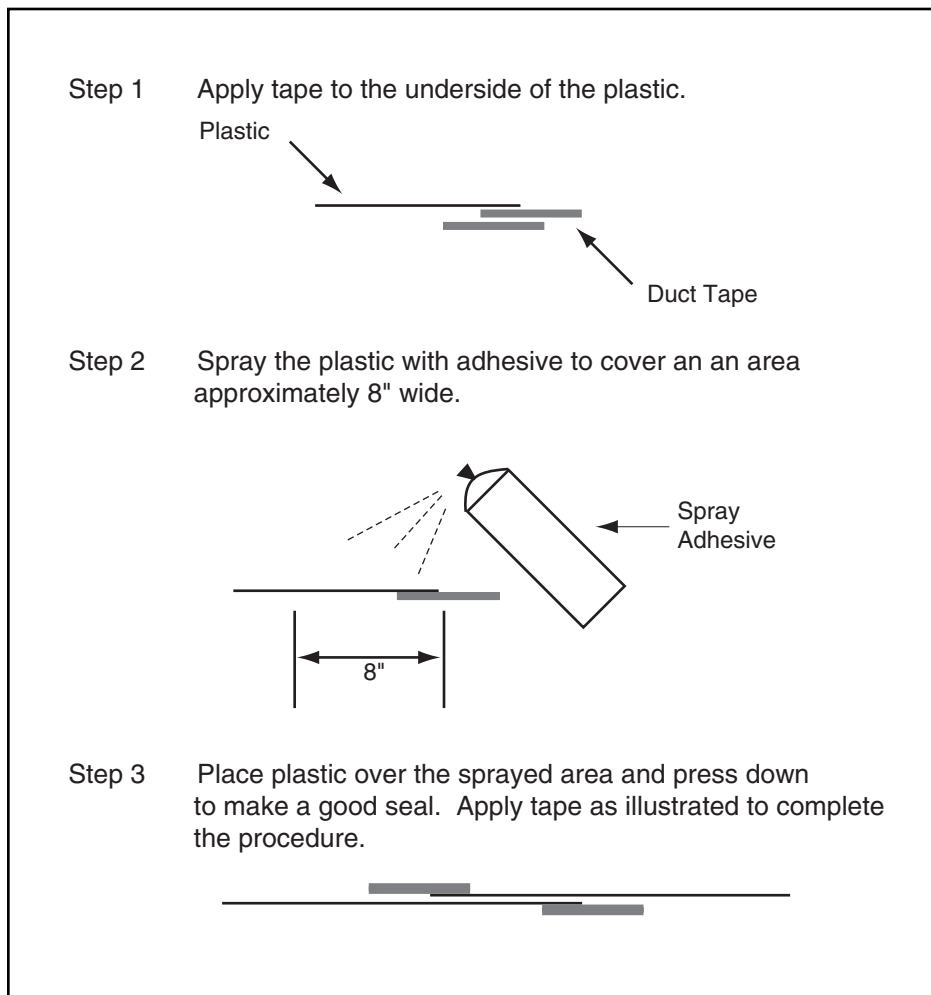

Figure 6-4. Follow these steps to secure poly

### **Doorways and Airlocks**

All doorways through the decontamination chamber and to the work area should be sealed with three sheets of 6-mil poly attached to the framing of the doorway. One sheet is attached to the top, bottom, and sides of the doorway opening. A slit is cut into the plastic to allow entrance. The second sheet is attached to the top of the opening and to one side of the doorway. The third sheet of poly is attached to the top and opposite side of the doorway to create an s-shaped entryway (Figure 6-5).

It should be noted that some building codes require the use of flame retardant poly when containments are built inside of buildings. This should be outlined in the project specifications.

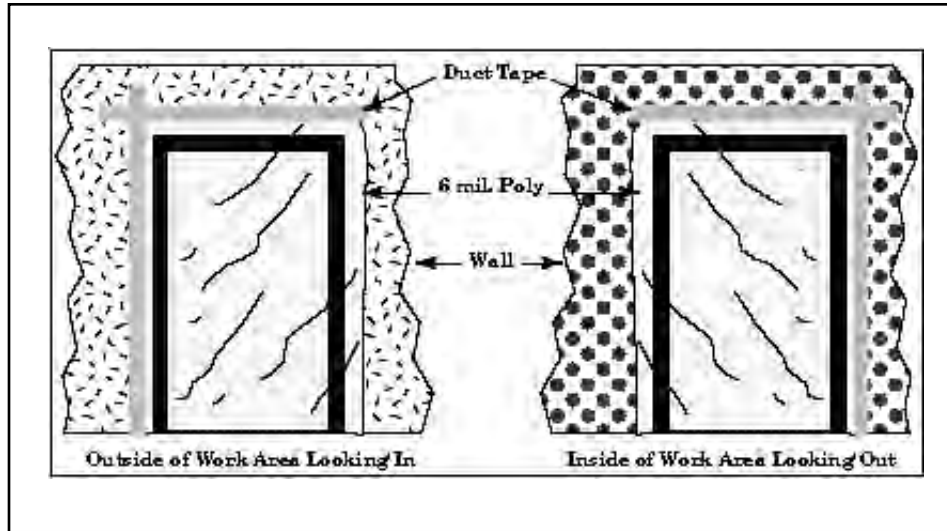

Figure 6-5. Simple containment

### Negative Pressure Enclosures

*Negative pressure* is created by a ventilation system within the containment that acts as a vacuum, drawing air to the area. The ventilation system should be equipped with HEPA filters to make sure that contaminated air is filtered before being released to the outside air or to any other area within the building. This system should operate 24 hours a day for the entire project. A pressure of 0.02" of water should be maintained. A gauge for measuring the air pressure should be installed and checked regularly. OSHA regulations for asbestos abatement require that before beginning work within the enclosure, and at the beginning of each shift, the negative pressure enclosure must be inspected for breaches and smoke-tested for leaks. If any leaks are found, they must be sealed. These guidelines also should be followed for microbial remediation.

### Portable HEPA-Filtered Negative Pressure Unit

A portable HEPA-filtered negative pressure unit consists of a cabinet with an opening at each end, one for air intake and one for exhaust, as shown in Figure 6-6. A fan and a series of filters are arranged inside the cabinet between the openings. See the cross-section view of the HEPA-filtered unit in Figure 6-7.

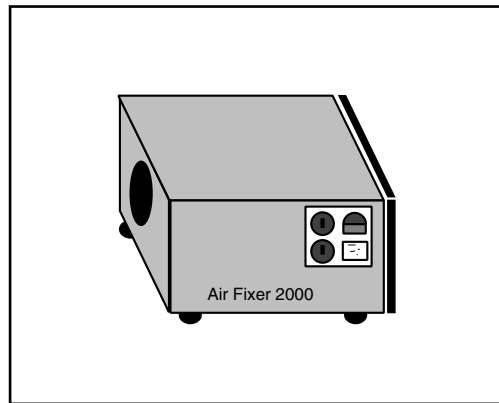

Figure 6-6. HEPA-filtered negative pressure unit

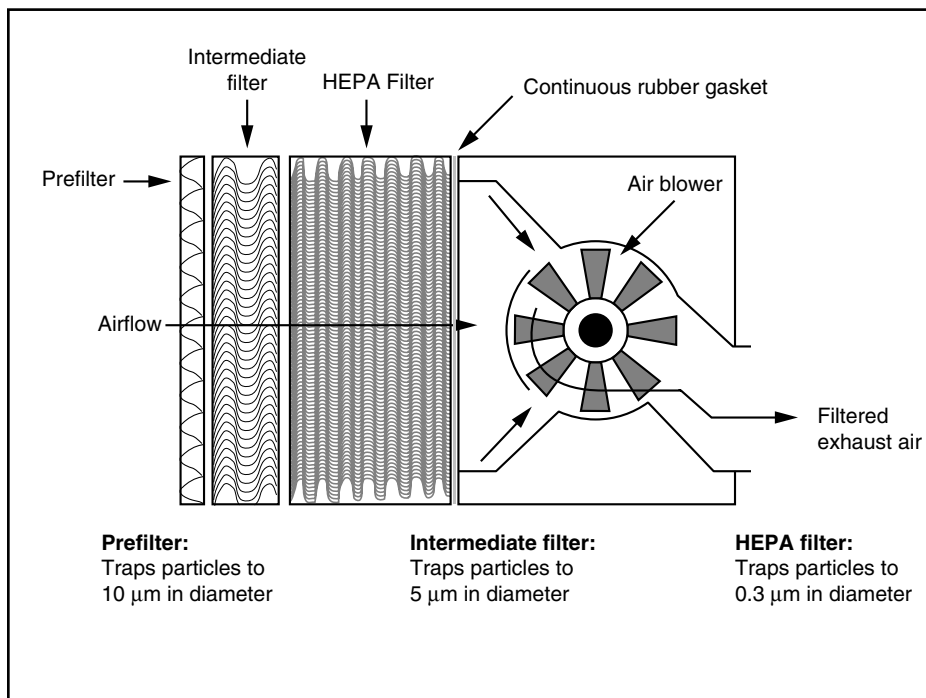

Figure 6-7. Cross-section view of a HEPA-filtered exhaust fan

The fan draws contaminated air through the intake and filters and discharges clean air through the exhaust. The final filter should be the HEPA type. The HEPA filter is made of a paper-like material that is folded into tight pleats. Typical HEPA filters for negative air systems are about 24 inches high by 24 inches wide and 11 1/2 inches deep.

The filter has a continuous rubber gasket, as shown in Figure 6-7, that allows it to form a tight seal to the filter housing. The gasket should be checked for cracks and gaps when installing the filter because contaminated air can leak through any breaks.

Each filter should be individually tested and certified by the manufacturer to have an efficiency of not less than 99.97 percent for 0.3 $\mu$  m (micron) particles at the rated airflow. Each HEPA filtration unit can be tested on-site to ensure that it is working properly. This is called an in-place test and should be done by an independent consultant. In-place filter testing is especially recommended if the HEPA units must be vented indoors.

#### Filter Markings

Each filter should be marked with the following:

- Name of the manufacturer
- Serial number
- Airflow rating
- Efficiency and resistance
- Direction of air flow

#### **Negative Pressure Unit Components**

Each negative pressure unit should have pre-filters, which lengthen the life of the more expensive HEPA filter by taking out the larger particles in the air first. Pre-filters keep the HEPA filter from getting overloaded too quickly. One (minimum) or two (preferred) stages of pre-filters may be used. The first-stage pre-filter should be a low-efficiency type (i.e., for particles 10  $\mu$ m and larger). The second-stage (or intermediate) filter should have a medium efficiency (i.e., effective for particles down to 5  $\mu$ m). Intermediate filters should be installed in the intake grid of the unit and held in place with special housings or clamps.

Each unit should be equipped with a Magnehelic gauge or manometer to measure the pressure drop across the filters and to indicate when filters are loaded and need to be changed. The gauges will show an increase in pressure (increased resistance across the filters) as the filters become loaded with dust. This will affect the ability of the unit to move the volume of air it should.

The motor, fan, fan housing, and cabinet should be grounded. The unit should have an electrical (or mechanical) lockout to prevent the fan from operating without a HEPA filter

### Optional Unit Components

Other recommended, but optional, features of the negative pressure unit are:

- An automatic shutdown system to stop the fan if there is a major break in the HEPA filter or if the exhaust gets blocked.
- Warning lights to indicate if the pressure gets too high or too low.
- An elapsed-time meter to show the total number of hours the unit was in operation.

### **Setting Up a Negative Pressure System**

The following procedures are recommended for setting up a negative pressure system.

#### Determining the Amount of Air to Exhaust From a Work Area

For a negative pressure enclosure to be effective, a continuous supply of fresh air is pulled into the work area. Essentially, the air inside the containment is being exchanged with air from somewhere outside the space. The term that commonly refers to this process is an air change. When the amount of fresh air brought into a space equals the size of the space, it is equivalent to one air change.

There are no requirements or recommendations for a specific amount of air changes in microbial remediation. However, OSHA requires a minimum of four air changes per hour in its Asbestos Standard (1910.1101). Areas such as large or oddly shaped rooms, or rooms that are difficult to seal, may require

**Note:**

An air change is when air inside a containment area is replaced by air outside the area.

air exchange rates that are even greater (up to ten times an hour). For the purpose of this training, we will use four air changes per hour.

In order to determine the amount of air that must be moved in order to obtain four changes an hour, the volume (amount) of air in the room must be determined. Volume is calculated by multiplying length by width by height. For this calculation, volume is written in cubic feet (ft<sup>3</sup>).

$$\text{Volume} = \text{length} \times \text{width} \times \text{height}$$

Because four air changes an hour are desired, the volume is multiplied by four to get the total amount of air to be moved. Below is an example of how to calculate the volume of a room, the amount of air that has to be moved to obtain four air changes in an hour, and the number of negative air machines that are required to achieve this goal.

Example: If we have a room with the dimensions:

$$80' \times 40' \times 20'$$

- a. How many cubic feet (ft<sup>3</sup>) are in this room?
  - b. If we want four changes in an hour, what is the total amount of air that must be exhausted in 15 minutes?
  - c. How much air will an 800 cfm HEPA unit exhaust?
  - d. How many HEPA units will we need to obtain four air changes an hour in a room of this size?
1. Calculate the volume (cubic feet) of the room as follows:

$$80' \times 40' \times 20' = 64,000 \text{ ft}^3$$

The room has a total volume of 64,000 cubic feet (64,000 ft<sup>3</sup>)

2. Calculate the total amount of air that has to be moved to change the air in the room four times. To do this, divide 64,000 ft<sup>3</sup> air by 15 minutes.

$$64,000 \text{ ft}^3 \div 15 = 4,266.67 \text{ cfm}$$

The next step depends on the capacity of the negative air machine that is used to move the air. Negative air machines come in many different sizes or capacities. The capacity of the machine is a rating by the manufacturer to describe the amount of air the machine is able to move in a minute. This is referred to as “rated capacity” and is written as “*cfm*” (cubic feet per minute). A machine that has a rated capacity of 800 cfm is capable of moving 800 cubic feet of air in one minute.

It is common for manufacturers to overrate the effectiveness of their negative air machines. Most machines are tested under controlled laboratory conditions. Therefore, it is recommended that no more than 80 percent or less of the manufacturer’s rated capacity should be used to calculate the actual on-the-job performance of the machine.

The negative air machine used in this example has a rated capacity of 800 cfm. Because 80 percent of the rated capacity is used, multiply 800 by 80 percent (.80).

$$800 \text{ cfm} \times .80 = 640 \text{ cfm}$$

3. Now that the 800 cfm negative air machine has been calculated to actually move 640 cfm, divide the 4,266.67 cfm calculated earlier by 640 cfm.

$$4,266.67 \div 640 \text{ cfm} = 6.67$$

4. For this space, 6.67 negative air machines will be needed. Round the figure up to 7.

Negative air machines should operate 24 hours a day for the duration of the job. Backup units should also be on the job in case of a breakdown. The general rule is to have one backup unit for up to four machines.

#### Location of Negative Pressure Unit(s)

The negative pressure unit(s) should be located so that makeup air (air from outside the chamber) enters the work area mostly through the decontamination facility and sweeps across the work area as much as possible (the location of the decontamination facility will be discussed in Module 7). This

may be accomplished by putting the negative pressure unit(s) as far as possible from the work area entrance/exit or the makeup air sources.

Whenever practical, negative pressure units can be located on the floor and in or near unused doorways or windows. The end of the unit (or its exhaust duct) should be placed through an opening in the plastic barrier or wall covering. The plastic around the unit or duct should then be sealed with tape. Each unit must have electrical power (115 AC). If necessary, three-wire extension cords can supply power to a unit. The cords must be in continuous lengths (without splices), in good condition, and should be no more than 100 feet long. They must not be fastened with staples, hung from nails, or suspended by wire. Extension cords should be suspended off the floor and out of the way to protect them from traffic, sharp objects, pinching, and water. Units should use separate fused outlets so that only one unit shuts down if a fuse is burned out.

Whenever possible, exhaust units should be vented to the outside of the building. This may involve the use of additional lengths of flexible or rigid duct connected to the air outlet and routed to the nearest outside opening. The additional resistance of this ductwork will reduce the airflow through the unit so this should be taken into consideration when calculating the number of units needed.

Additional makeup air may be necessary to avoid creating too big a difference in pressure between the inside and the outside of the chamber or the plastic coverings and temporary barriers may “pull in.” Makeup air inlets should be as far as possible from the negative pressure unit(s) (e.g., on an opposite wall), off the floor (preferably near the ceiling), and away from barriers that separate the work area from occupied clean areas. This will allow air to circulate through the entire work area more effectively.

Figure 6-8 illustrates three typical examples of negative pressure system setups.



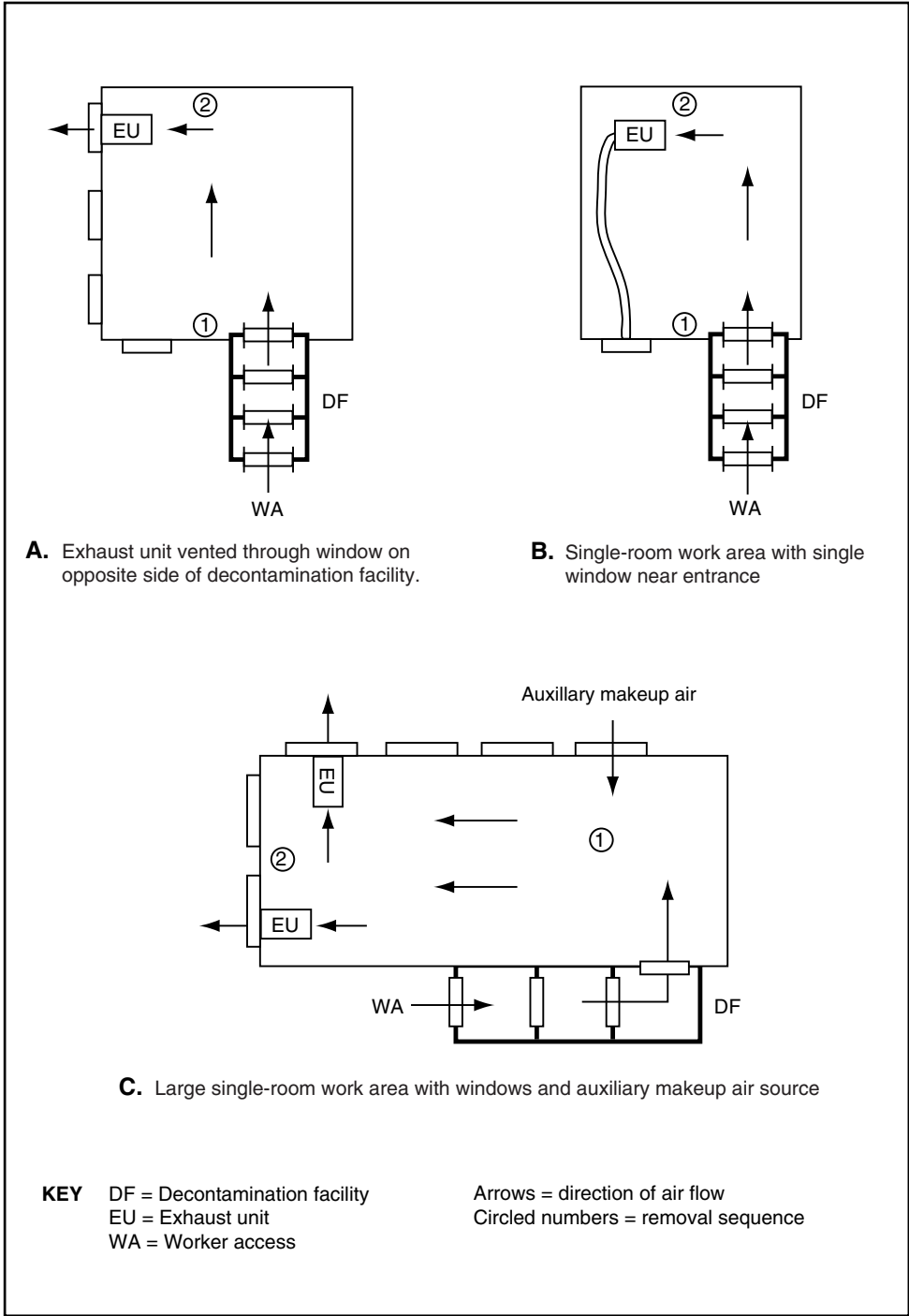

Figure 6-8. Examples of negative pressure system setups

### Testing the System

The negative pressure system should be tested before any contaminated material is disturbed. After the work area has been prepared, the decontamination facility set up, and the negative pressure units installed, they should be started one at a time. Look at the barriers and plastic sheeting. The plastic curtains of the decontamination facility may move slightly in toward the work area. The use of smoke tubes is the preferred way to check system performance visually, as well as the direction of airflow through openings in the barrier. For example, smoke emitted on the inside of the work area should move toward the exhaust units. Smoke emitted in the shower room of the decontamination unit should move inward to the work area. Smoke tubes can also be used to check if air flow is moving inward at high and low levels to the work area.

### ***Use of Negative Pressure Systems During Removal Operations***

The negative pressure units should be started just before beginning removal (i.e., before any microbial contaminated material is disturbed). After removal has begun, the units should run continuously to maintain a constant negative pressure until the work area is decontaminated. The units should not be turned off at the end of the work shift or when removal operations stop temporarily. Air movement should be directed away from other workers in the enclosure and toward the negative air machine.

Workers should start removing the microbial-contaminated material farthest from the negative air machine and work toward them. If a power failure occurs, work should stop and should not start again until the power is restored and negative pressure units are operating again.

### Changing the Air Filters

Because the negative air machine filters are changed from within the containment—that is, from the contaminated side of the barrier—the workers responsible for changing filters should wear approved respirators and other protective equipment. The length of time a HEPA filter will last depends on the concentration of contaminants in the air. During use, filters become loaded with dust. This will eventually cause the negative air machine to handle less air.

When the pressure drop across the filters (as shown by the Magnehelic gauge or manometer on the unit) exceeds 1.0" of H<sub>2</sub>O above the pressure of the system with new filters, the prefilter should be replaced first. Because suction holds the prefilter in place, carefully remove the prefilter by curling or folding the sides in. Any dust dislodged from the prefilter during removal will be collected on the intermediate filter. The used prefilter should be disposed of with other remediated waste. A new prefilter is then placed on the intake grill. Prefilters may be purchased as individual pre-cut panels or in a roll of specified width that must be cut to size. If the pressure drop still exceeds 1.0" of H<sub>2</sub>O above the pressure of the system with new filters (after the prefilter is replaced), the intermediate filter should be replaced. With the unit operating, the prefilter should be removed, the intake grill or filter access opened, and the intermediate filter removed. Any dust dislodged from the intermediate filter during removal will be collected on the HEPA filter. The used intermediate filter also should be disposed of with remediated waste. A new replacement filter is then installed and the grill or access closed.

The HEPA filter should be replaced if prefilter and intermediate filter replacement does not restore the pressure drop across the filters to an acceptable resistance reading or if the HEPA filter becomes damaged. HEPA filters will fail if they absorb too much moisture. The exhaust unit must be shut off and disconnected from the power source to replace the HEPA filter. The used HEPA filter should be disposed of with remediated waste.

When several negative pressure units are used, negative pressure can be maintained while the HEPA filter is replaced. This way, the negative pressure in the work area will be maintained and the risk of contaminated materials being released to the outside environment is controlled.

### Shutting Down the System

As gross removal nears completion, filters should be checked for loading and replaced if necessary. When the negative air system is shut down at the end of the project, the filters should be left in the unit and the openings should be sealed with poly

and duct tape. Filters should be replaced after final cleanup is complete in order to avoid any risk of recontaminating the area.

#### Tips for Using Negative Air Machines

The following are tips for using negative pressure units most efficiently and successfully:

- Check for breaks in the gasket between the HEPA filter and housing each time the filter is changed or moved to a new location.
- Change the 1/2-inch prefilter frequently (every 20 to 30 minutes) during heavy removal. This prolongs the life of the more expensive HEPA filters and keeps the airflow high. As a general rule, the filter life during a typical removal is:
  - 2 hours for 1/2-inch prefilters
  - 24 hours for 2-inch prefilters
  - 700 hours for 12-inch HEPA filters
- Before removal begins, check the availability of a 20-amp circuit. Most negative pressure units require 18 amps for startup and 15 amps during normal operation.
- Negative pressure units usually pull a lower volume than the rating assigned by the manufacturer. For instance, a unit rated at 2,000 cfm may pull 1,000 to 1,500 cfm on an actual work site. Also, as filters load, the cfm is reduced.
- Start the negative pressure system before beginning work. Check to see that it is functioning properly. Make sure there is enough makeup air; otherwise, the poly may pull away from the walls even if installed properly.
- Smoke tubes are useful for checking airflow inside the chamber.
- Use heavy-duty extension cords to energize the negative pressure units. If a series of cords are connected, take necessary precautions to avoid shock hazards. Make sure the temporary electrical system is properly grounded.
- All electrical devices must be on a ground fault circuit interrupter (*GFCI*).

- The negative air system is most effective in reducing the contamination of previously cleaned areas when removal is started at the farthest point from the negative air units and worked toward them.

### Elimination of Contaminants on Hard Surfaces

Fungi, viruses, and bacterial organisms on **hard** non-porous surfaces such as ceramic tile, metal, or concrete can be removed by a variety of different chemical treatments.

By far the most common chemical used to kill biological sources is a combination of household bleach and water. The recommended mixing ratio is one cup of bleach (sodium hydroxide) to one gallon of water. Care should be taken not to mix the bleach with any other chemical. Bleach and ammonia, for instance, can create a dangerous gas when combined. Also, concentrations of more than one cup of bleach to a gallon of water can burn exposed skin. It is also important to ventilate the work area when using bleach to prevent the possibility of inhaling the vapors released into the air. A bleach solution that is applied to contaminated surfaces should be allowed to remain on the surfaces for at least 15 minutes to be effective. After the 15-minute period, the surface can be wiped and HEPA-vacuumed.

Other biocides may be used to destroy organisms. Some examples are:

- Alcohol
- Hydrogen peroxide
- Iodine
- Quaternary ammonium compounds (such as dimethylbenzyl ammonium chloride)
- Ammonia

The hazards of these products are identified in their MSDSs (see Appendix B, Resources). Proper PPE must be used and safe handling practices must be followed when using these products.

Some biocides are also manufactured as aerosol bombs, which can also be used to kill organisms on hard surfaces. Typically, the area is isolated and contained. After the area is vacated, a worker enters wearing a fully encapsulated suit and activates



the aerosol bomb. The bomb fills the air with a biocide. The aerosol must contact the area for a specified time. Workers then wipe down all surfaces with a solution of isopropyl alcohol and water to remove any dead organisms.

After using biocides, it is recommended that surfaces be HEPA-vacuumed to remove any residue of dead fungal organisms that may still be present.

### **Elimination of Contaminants on Porous Surfaces**

If organisms are growing on **porous** surfaces (such as wallboard, carpets, padded furniture, wallpaper, wood products, and textured ceiling tiles), time should not be wasted in disinfecting. Disposal of these materials is required.

Organisms such as mold and fungi physically grow and penetrate deep into these materials and it is impossible to destroy all of the organisms. Also, full protective measures should be used during demolition because mold spores will be released into the air during the process.

In flooding situations, porous materials such as drywall, cardboard boxes, ceiling tiles, carpets, and so forth must be discarded unless they are completely dried within 48 hours of the flooding.

### **Remediation Process**

Following are the seven steps to follow during the remediation process.

**Step 1:** Before removal of either porous or hard materials, all contaminated surfaces should be misted with a bleach solution to stop the growth of contamination and to reduce the formation of dust aerosols.

**Note:** Organisms such as mold and mildew can be toxic even after a biocide has been used. Precautions such as PPE and containment must still remain in effect until all traces of these organisms have been removed. Biocides and bleach solutions will have limited effectiveness if the conditions that promote contamination growth (flooding, dampness, etc.) are not corrected to prevent reoccurrence.

Bleach solutions should be applied with an airless sprayer and left on contaminated surfaces for 15 minutes before wiping. Improper disinfecting can occur if the bleach solution is left on for less than 15 minutes.

**Step 2:** After bleaching, surfaces containing high levels of contamination should be disposed of when feasible.

**Step 3:** Double plastic bags or two layers of poly sheeting should be used for the disposal of these surface items (6-mil poly is recommended).

**Step 4:** Contaminated surfaces that remain after the bleaching process should be scraped to remove contamination and then wet scrubbed with the bleach solution to remove any residue.

**Step 5:** A final sanitation wash using a non-reactive detergent solution is then used. The surface should then be rinsed with water, dried, and HEPA-vacuumed for final cleaning.

**Step 6:** All contaminated debris should be bagged and disposed of as recommended.

**Step 7:** Carpets should be HEPA-vacuumed and steam-cleaned. HEPA vacuuming should be performed at a rate no faster than 90 seconds per square yard. Complete drying of the carpet should follow steam cleaning.

### ***Wet Abrasive Blasting***

If structural elements (e.g., wood beams and joists, wood floor, and subfloor) are affected, they can be cleaned using controlled wet abrasive blasting. This procedure should be conducted with enough force and aggregate content to remove visible

contamination. The area should then be sealed with mold-resistant antimicrobial paint. For this process to be effective, contamination of the surface and subsurface must be removed. The water used in the blasting procedure should contain a five percent solution (or manufacturer's recommended strength) of biocide that will penetrate and protect the substrate from re-growth. Gross debris from blasting should be collected and disposed of in drums. The area should be HEPA-vacuumed and final cleanup procedures followed.

However, there are problems associated with this process, including:

- Adding water to already water-damaged areas
- Possibly affecting the integrity of structural members
- Probably impacting lower floors when done on upper floors of a building, unless water is contained

### ***Demolition and Removal***

In cases where other methods are not effective or practical, demolition and removal of building materials is done. Any porous building material exposed to water, such as lumber or wallboard, must be removed completely if it is wet and cannot be dried. If any of these materials are not demolished, regrowth and reinfestation of mold, mildew, or fungi could occur.

### ***Waste Disposal***

Contaminated materials must be removed as soon as possible and placed in double plastic bags sealed with duct tape. This will prevent any further microbial growth from occurring. Items that cannot be sealed in double bags should be wrapped in two layers of plastic and sealed with duct tape.

**Note:** At present there are no federal regulations governing the disposal of microbial waste. Individuals should contact their state department of health for any information on prescribed guidelines that may exist at the state or local level.

### ***Post-Remediation Inspection***

A visual inspection should be made after completion of the project to ensure the elimination of any organisms. Basements, lower rooms, crawl spaces, and rooms with water or flooding damage should be given special attention. Window frames, ceiling tiles, as well as any cellulose-based materials, should also be closely examined.

Carefully examine all accessible heating, ventilation, and air conditioning components. Any indoor space with exposed soil, such as unfinished basement or crawl spaces, must also be examined.



Air monitoring should be conducted after extensive or large scale remediation to determine its effectiveness and to determine whether an area is fit for symptomatic persons to reoccupy. If post-remediation air samples indicate the presence of any organisms present before cleanup started, even in minor amounts, further investigation of possible sources is required.

### **Final Clean Up**

Wipe samples or a post-remediation inspection are typically performed to check for any remaining organisms. If the area passes inspection, then the isolation barriers around the containment area can be removed. After all gross contamination has been removed from the work area, a visual inspection should be performed. The poly should be HEPA-vacuumed and wet wiped with a bleach and water solution before being removed. The poly can be disposed of using the same methods used in gross removal. The last layer of poly should remain in place until a final inspection has been completed. After removing poly from walls, floor, and covered objects, the entire work area should be HEPA-vacuumed, wet wiped with an alcohol and water solution, and dried. Wipe sampling and/or air monitoring should be performed to ensure that contamination no longer exists. The shutting down of negative air machines is done after a clean environment has been documented. In some cases, owner specifications have required that negative air machines and dehumidifiers be shut down for 48 to 72 hours. Remediated areas should then be checked for any regrowth of microbial organisms before installation of new building products.

After shutting down the negative air machines, they should be bagged and removed from the work area to prevent recontamination. The last layers of poly can then be removed. The underneath surfaces of the poly should also be wet wiped with alcohol and water and the surface area allowed to dry.

The decontamination chamber outside the work area should be disassembled following the same cleanup procedures used in removal of the containment structure. Signs should be removed from the entrance to the work area and any other areas, and the electrical and HVAC systems should be turned on. Outside furnishings should be returned to the area. Then the area can be authorized for occupation.

**Final Disposal Procedures**

The final step of the remediation process is to remove contaminated debris from the work area. Care must be taken to avoid spreading any contaminated debris back into the areas determined to be clean. Follow these guidelines for safe handling and disposal of microbial remediation debris:

1. Debris that has been removed from surfaces should be placed in 6-mil bags or equivalent containers. Because the material may be wet (to prevent the generation of airborne particulates during cleanup from water leakage or from water-based disinfecting solutions) consideration should be given to the quantity of debris placed in each container, given the additional water weight. These bags can be stored temporarily in a waste load out area before being removed from the work area.
2. Materials that may puncture the bag (such as wallboard, wood, metal, sharp objects) should be carefully sealed in two layers of 6-mil poly.
3. Wet wipe or HEPA-vacuum any debris from the outside of the bags.
4. Place the bags in fiberboard drums with locking rims. Generally four to five bags can be put in each drum.

**Note:** Before each drum is brought into the work area for loading, the outside of the drum should be covered with a large plastic bag. This outside bag should be kept on the drum while it is being filled.

5. Drums should be labeled with appropriate information to identify their contents.
6. Once the drum is filled, lock the lid or rim into place. The drum will then be ready for transportation out of the work area.
7. Before leaving the work area (at the doorway to the waste load-out area), remove the plastic bag on the outside of the drum and put it on the next drum to be filled with waste.

8. Before the drum enters the load-out area, it should be wet wiped to make sure there is no contamination on the outside of the drum.
9. Move the sealed drum into the waste load-out area and into the enclosed truck.

Note: Drums may not be used for mold and fungi removal in some states, because many landfills will not accept them.

### Waste Load-Out Area

As shown in Figure 6-9, the waste load-out area is separate from the decontamination unit, and is used for the following:

- Short-term storage for bagged waste
- Port for transferring waste to a truck or dumpster

An enclosure can be constructed to form an airlock between the exit of the load-out area and an enclosed truck.

Gross contamination should be wiped or scraped off containers before they are placed in the load-out area.

Any remaining contamination should be removed by wet-wiping. The bagged material can also be placed in a second bag.

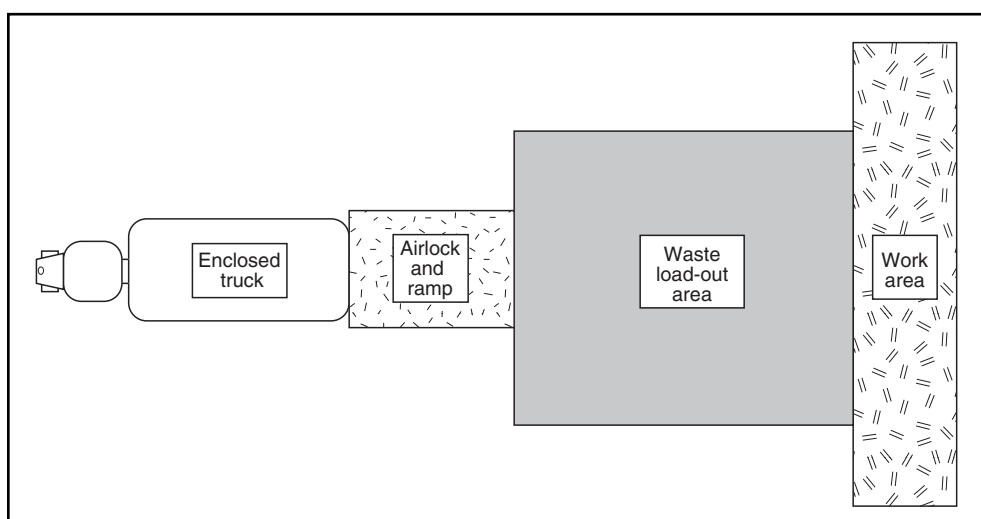

Figure 6-9. Waste Load-out area

**Transportation to the Disposal Site**

As work progresses—and to prevent exceeding available on-site storage capacity—sealed and labeled containers of microbial waste should be removed and transported to the prearranged disposal location. Safe transportation procedures should be followed in any operation involving microbial waste disposal.

**Methods to Reduce or Eliminate Recurrence of Infestations**

After organisms have been destroyed and removed, paints for hard surfaces or a coat of light oil that will not stain fabrics or surfaces (such as propylene glycol, containing a small quantity of a biocide) can be applied to remediated surfaces. Workers should refer to the manufacturer's instructions when applying biocides in this manner. Such a biocide mixture will prevent re-infestation, sometimes for years afterward. It is recommended that yearly inspections of the remediated surfaces be made to ensure the integrity of the treatment.

**MODULE 6 - ASSIGNMENT SHEET**

- 1. Identify and describe at least three elements of work area preparation that should be completed before any microbial remediation can begin.**

1. \_\_\_\_\_
2. \_\_\_\_\_
3. \_\_\_\_\_

- 2. List at least two of the most common chemicals used to destroy microbial organisms.**

1. \_\_\_\_\_
2. \_\_\_\_\_

- 3. List the proper mixture for the bleach and water solution used during microbial remediation.**

\_\_\_\_\_

- 4. Given a space, calculate its volume and determine the appropriate number of negative air units to achieve four air exchanges per hour.**
- 5. Given a space, tools, and equipment, contain the space and set up a negative pressure enclosure according to the procedures recommended in this section.**
- 6. Given one container of bleach and one container of water, combine each by the recommended mixing ratio without error.**
- 7. Given the tools and materials, and while suited, apply the seven steps of the remediation process.**



---

# Module 7

## Microbial Remediation Decontamination

---

### **PARTICIPANT OBJECTIVES**

After completing Module 7, you will be able to:

1. List the elements of a three-chamber decontamination unit and explain the function of each.
2. Working in small groups, construct a three-chamber decontamination unit according to the guidelines in this section.
3. Given a full-face APR, a protective suit, boots, and gloves, simulate the decontamination process according to the guidelines in this section.

7





## INTRODUCTION

On a microbial remediation project, workers wear personal protective equipment (PPE) to protect against hazards. However, the nature of the work is such that the PPE itself will be exposed to contaminants. For example, puddles resulting from the water or biocides applied during the removal process can contaminate boots. Handling contaminated tools can contaminate gloves. Therefore, it is important for workers to know how to remove their PPE without being exposed. A formal decontamination sequence must be followed. *Decontamination* is the process of removing or neutralizing contaminants that have accumulated on PPE, tools, or equipment used on the job.

## THE IMPORTANCE OF DECONTAMINATION

It is important to understand what could occur if decontamination were not done. The following are examples of how workers could be exposed:

- Direct exposure of worker. Without regular decontamination, chemicals used in remediation could permeate the material of the suit or gloves and expose your skin.
- Microbial materials such as mold spores may remain on PPE as it is removed. You could become exposed because you are no longer protected.
- Exposure from contaminants on protective clothing. If there is any contaminated material on the outside of the protective clothing, it could be a source of exposure when workers remove it.
- Exposure from tools. Accidental exposure could also occur from handling contaminated tools. A worker might not notice these exposures, because some materials, including spores and some chemicals can pass through the skin or cuts in the skin without any noticeable sensation.
- Family members can also be exposed. If workers do not perform the decontamination process correctly, they may bring contaminants home from the job.

All workers should constantly be aware of their responsibility to protect themselves, their co-workers, and their families. Not performing the process just one time could result in an unnecessary exposure.

## **PERSONAL HYGIENE**

Even if the decontamination process is not a requirement, you must take a personal responsibility to thoroughly clean yourself upon leaving the work area. You must always wash your hands and face before consuming food or any other hand-to-mouth contact. Additionally, clothing that could have been exposed should be bagged at the job and washed separately from other clothing. Good personal hygiene is a good habit to form when working in the field of microbial remediation, just as it is in other types of environmental cleanup.

## **DECONTAMINATION UNITS**

Several types of decontamination units can be used when performing microbial remediation. The construction of a decontamination unit at the entrance to the work area prevents contamination from spreading to outside areas by you or your co-workers. Units can have one, two, or three chambers, as illustrated in Figure 7-1. All doorways leading to the work area should contain airlocks to prevent contamination and contaminated dust from spreading to outside areas. (The construction of air locks is detailed in Module 6.)

### **Three-Chamber Decontamination Unit**

A three-chamber decontamination unit is the best way to prevent spreading contamination. It has a “dirty” or equipment room, a shower room, and a “clean” or change room. In this case, you remove contaminated clothing in the equipment room, step into the shower room to remove any remaining contaminants, and then proceed to the change room to put on street clothes.

## Two-Chamber Decontamination Unit

The two-chamber decontamination unit consists of a clean change room and a shower, as shown in Figure 7-1. You remove dirty clothes before leaving the work area, then enter the shower room. Next you enter the change area to put on clean street clothing.

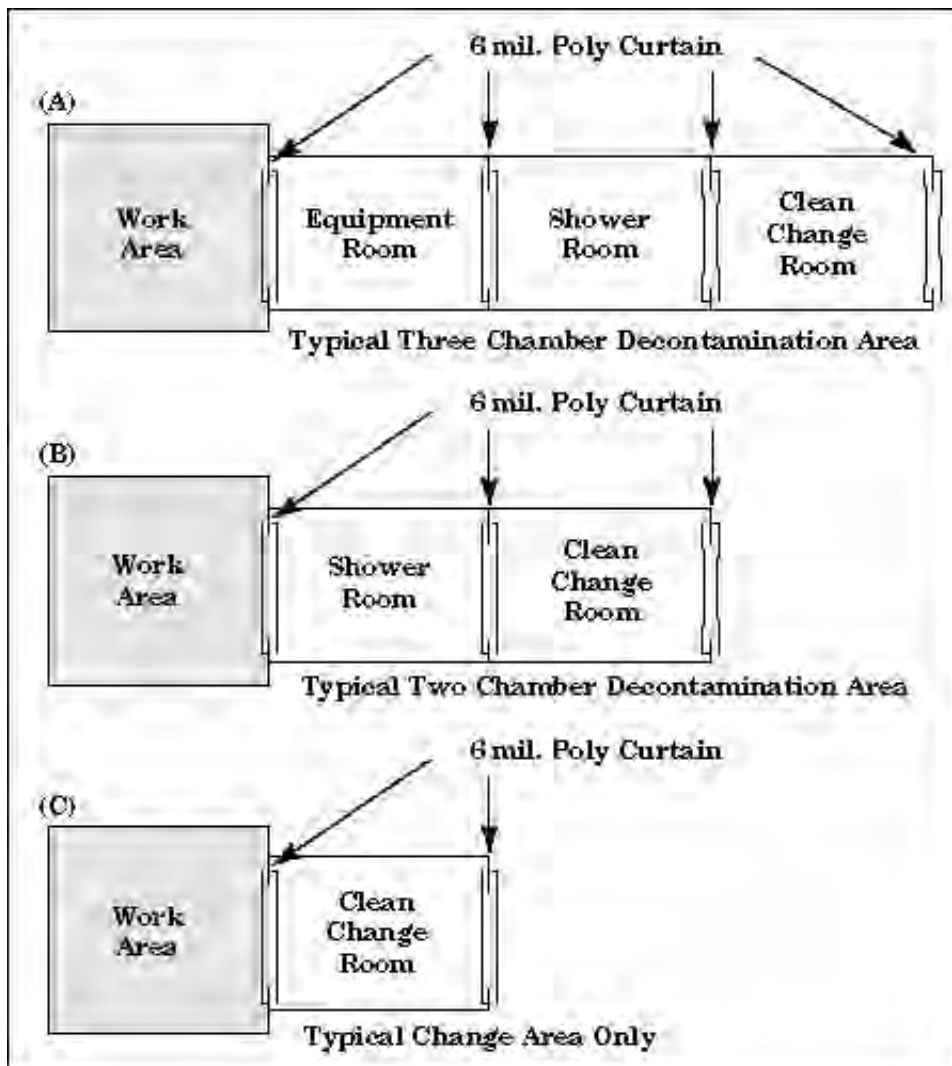

Figure 7-1. Typical decontamination unit configurations

**Change Area Only**

A one-room decontamination area does not provide shower facilities but does provide a clean change area. You remove your dirty clothing in the work area and pick up clean clothing in the clean change area. This type of decontamination provides minimum protection against spreading contamination and personal exposure.

**SETTING UP A DECONTAMINATION UNIT**

The decontamination unit is designed to allow passage to and from the work area during removal operations with minimal leakage of contaminants outside the work area enclosure.

**Unit Construction**

Materials used to construct a typical unit include:

- 2 x 4 lumber for the frame
- 1/4 to 1/2 inch plywood OR 6-mil polyethylene sheeting (poly) for the walls
- Duct tape, staples, and nails

The floor should be covered with three layers of poly. The decontamination unit can be built in sections to allow for disassembly and re-use in other areas of the building. The design of the decontamination unit will vary with each project, depending on the size of the crew and the physical layout of the facility. Customized trailers, which can readily be moved from one location to another, are also used as decontamination units.

A unit typically costs between \$20,000 to \$50,000 depending on the size and features.

**DECONTAMINATION UNIT LAYOUT AND PROCESS**

A three-chamber decontamination unit includes an equipment room, a shower room, and a clean room. Refer to Figure 7-2 for detailed procedures for using the three-chamber unit.

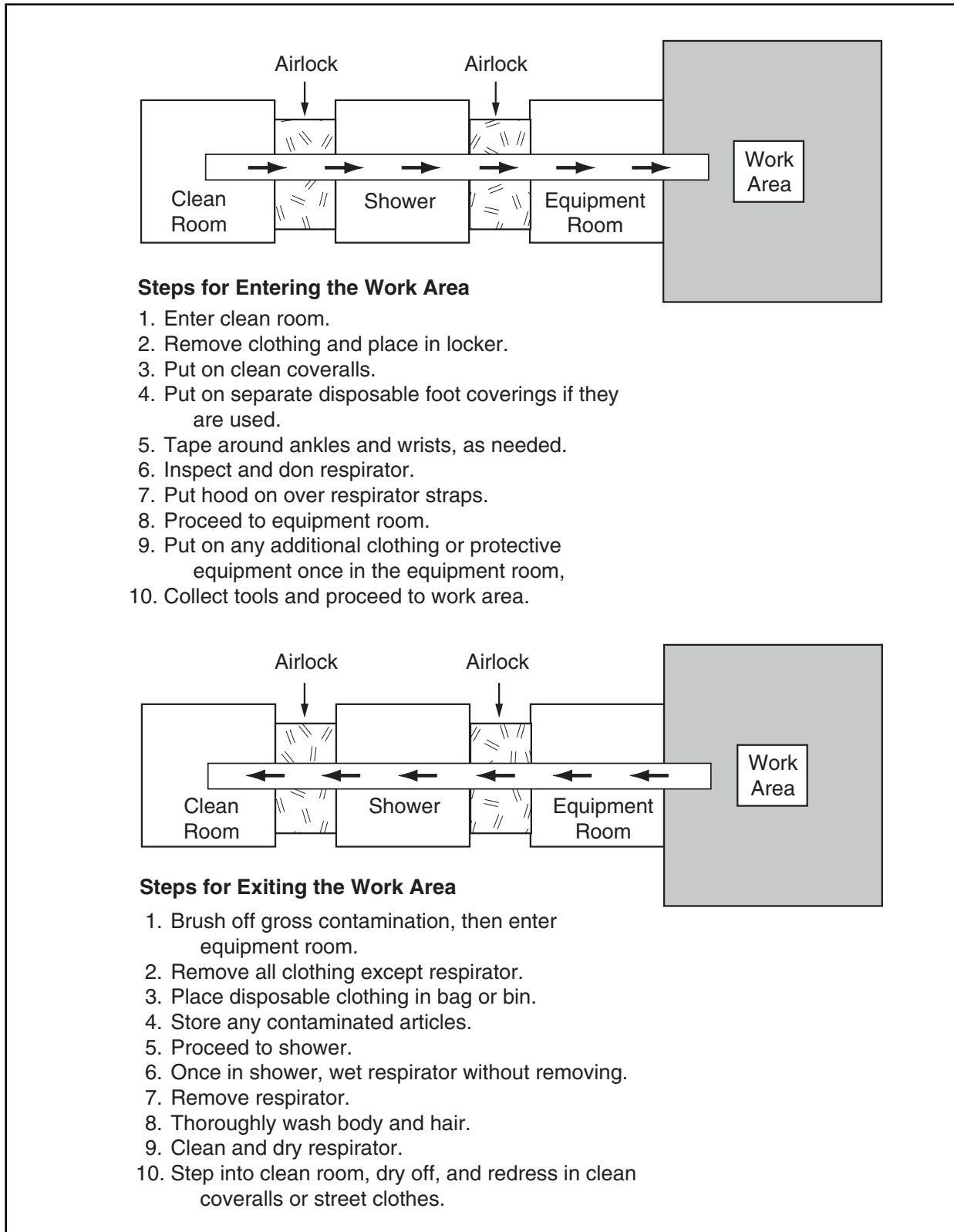

Figure 7-2. Entering and exiting work area procedures

**Equipment Room**

The equipment room is a contaminated area for storage of the following:

- Boots or shoes
- Equipment
- Goggles
- Hardhats
- Any contaminated work clothes

Place disposable clothing in bins before leaving for the shower room.

Respirators are worn until you enter the showers and thoroughly soak them with water. Cartridge filters should be discarded.

The equipment room may require cleanup several times each day to prevent contaminated material from being tracked into the shower and clean rooms. The room should be HEPA-vacuumed and wiped with a damp cloth and/or a mop and detergent solution before the removal of isolation barriers. The same procedure should be followed as in the final cleanup.

**Shower Room**

After you have removed your protective clothing, step into the shower room. Wash thoroughly using soap and hot water. This reduces the possibility of carrying any contaminants into the clean room or bringing them home where family members could be exposed. You also pass through the shower on your way into the work area.

**Clean Room**

No microbial-contaminated items should enter the clean room. This area is used to:

- Don protective clothing and respiratory protection before entering the work area
- Store street clothes
- Redress before leaving the job

Ideally this room should be furnished with benches, lockers for clothes and valuables, and storage areas for respirators and protective clothing.

## MATERIALS AND EQUIPMENT LIST

Table 7-1 is a materials and equipment list for preparing the work area and setting up the decontamination unit for performing microbial remediation work.

Table 7-1. Materials and equipment list for preparing a work area and setting up a decontamination unit.	
Material and Equipment	Description and Uses
Polyethylene sheeting material	Seal off work areas and items in work areas; protect surfaces in the work area (other than those being altered). Construct decontamination and enclosure systems. Some localities require fire-retardant poly.  Types: 4-mil thickness 12' x 100' rolls 20 Lbs 6-mil thickness 20' x 100' rolls 60 Lbs
Duct tape	Seam poly sheets together. Form airtight seal between poly and wall. Provide some support for vertical sheets.
Adhesive spray	Seal seams. Provide additional support to vertical sheet.
Furring strips (cut into blocks)	Support vertical sheets of poly.
Nails	Attach furring strips to top edge of poly and wall. Construct frame of decontamination unit.
Staples and staple gun	Attach poly to wood frame.
Retractable razor knives	Slice poly and tape.
Warning signs	Post at entrances to building and decontamination unit.
Vacuum cleaner with HEPA filter	Clean nonstationary items before removing them from the work area.
Ladders, scaffolding	
Carpentry tools	Hammers and saws
Prefab showers or materials for shower construction	





**MODULE 7 - ASSIGNMENT SHEET**

- 1. List the elements of a three-chamber decontamination unit and explain the function of each.**

---

---

---

---

---

---

---

---

- 2. Working in small groups, construct a three-chamber decontamination unit according to the guidelines in this section.**
- 3. Given a full-face APR, a protective suit, boots, and gloves, simulate the decontamination process according to the guidelines in this section.**



---

# Appendix

## Microbial Remediation Resources

---

An EPA publication, *Mold Remediation in Schools and Commercial Buildings* (EPA 402-K-01-001, March 2001), is available via this web site as a series of HTML files and as an Adobe Acrobat PDF file (5MB file size).

<http://www.epa.gov/iaq/molds/index.html>

New York City Department of Health  
Bureau of Environmental & Occupational Disease Epidemiology  
*Guidelines on Assessment and Remediation of Fungi in Indoor Environments*  
<http://www.ci.nyc.ny.us/html/doh/html/epi/moldrpt1.html>

EPA Publication from Indoor Environments Division (6609J)  
Office of Air and Radiation (OAR)  
EPA-402-K-97-002, October 1997  
*Should You Have the Air Ducts in Your Home Cleaned?*  
<http://www.epa.gov/iaq/pubs/airduct.html>

National Institute for Occupational Safety and Health  
Publications Dissemination  
4676 Columbia Parkway  
Mail Stop C-13  
Cincinnati, OH 45226-1998  
1-800-356-4674  
*Publication No. 97-146*  
*Histoplasmosis: Protecting Workers at Risk*



# Regulations

## Microbial Remediation 29 CFR 1910.134 Respiratory Protection Standard

<b>§1910.134</b>	<b>RESPIRATORY PROTECTION</b> .....	R-3
(a)	<b>Permissible practice.</b> .....	R-3
(b)	<b>Definitions</b> .....	R-3
(c)	<b>Respiratory protection program</b> .....	R-4
(d)	<b>Selection of respirators</b> .....	R-5
(e)	<b>Medical evaluation</b> .....	R-6
(f)	<b>Fit testing</b> .....	R-8
(g)	<b>Use of respirators</b> .....	R-9
(h)	<b>Maintenance and care of respirators.</b> .....	R-10
(i)	<b>Breathing air quality and use</b> .....	R-11
(j)	<b>Identification of filters, cartridges, and canisters.</b> .....	R-12
(k)	<b>Training and information</b> .....	R-12
(l)	<b>Program evaluation</b> .....	R-12
(m)	<b>Recordkeeping</b> .....	R-13
(n)	<b>Dates</b> .....	R-13
(o)	<b>Appendices</b> .....	R-13
	<b>Appendix A to §1910.134: Fit Testing Procedures (Mandatory)</b> .....	R-14
	Part I. OSHA-Accepted Fit Test Protocols .....	R-14
	Part II. New Fit Test Protocols .....	R-25
	<b>Appendix B-1 to §1910.134: User Seal Check Procedures (Mandatory)</b> ..	R-25
	I. Facepiece Positive and/or Negative Pressure Checks .....	R-25
	II. Manufacturer's Recommended User Seal Check Procedures .....	R-25
	<b>Appendix B-2 to §1910.134: Respirator Cleaning Procedures (Mandatory)</b> .....	R-26
	I. Procedures for Cleaning Respirators .....	R-26
	<b>Appendix C to Sec. 1910.134: OSHA Respirator Medical Evaluation Questionnaire (Mandatory)</b> .....	R-26
	Part A. Section 1. (Mandatory) .....	R-26
	Part A. Section 2. (Mandatory) .....	R-27
	Part B. ....	R-28
	<b>Appendix D to Sec. 1910.134 (Mandatory) Information for Employees Using Respirators When Not Required Under the Standard</b> .....	R-30

REGULATIONS



### §1910.134 Respiratory Protection.

This section applies to General Industry (part 1910), Shipyards (part 1915), Marine Terminals (part 1917), Longshoring (part 1918), and Construction (part 1926).

#### (a) Permissible practice.

(1) In the control of those occupational diseases caused by breathing air contaminated with harmful dusts, fogs, fumes, mists, gases, smokes, sprays, or vapors, the primary objective shall be to prevent atmospheric contamination. This shall be accomplished as far as feasible by accepted engineering control measures (for example, enclosure or confinement of the operation, general and local ventilation, and substitution of less toxic materials). When effective engineering controls are not feasible, or while they are being instituted, appropriate respirators shall be used pursuant to this section.

(2) Respirators shall be provided by the employer when such equipment is necessary to protect the health of the employee. The employer shall provide the respirators which are applicable and suitable for the purpose intended. The employer shall be responsible for the establishment and maintenance of a respiratory protection program which shall include the requirements outlined in paragraph (c) of this section.

#### (b) Definitions.

The following definitions are important terms used in the respiratory protection standard in this section.

**Air-purifying respirator** means a respirator with an air-purifying filter, cartridge, or canister that removes specific air contaminants by passing ambient air through the air-purifying element.

**Assigned protection factor (APF)**  
[Reserved]

**Atmosphere-supplying respirator** means a respirator that supplies the respirator user with breathing air from a source independent of the ambient atmosphere, and includes supplied-air respirators (SARs) and self-contained breathing apparatus (SCBA) units.

**Canister or cartridge** means a container with a filter, sorbent, or catalyst, or combination of these items, which removes specific contaminants from the air passed through the container.

**Demand respirator** means an atmosphere-supplying respirator that admits breathing air to the facepiece only when a negative pressure is created inside the facepiece by inhalation.

**Emergency situation** means any occurrence such as, but not limited to, equipment failure, rupture of containers, or failure of control equipment that may or does result in an uncontrolled significant release of an airborne contaminant.

**Employee exposure** means exposure to a concentration of an airborne contaminant that would occur if the employee were not using respiratory protection.

**End-of-service-life indicator (ESLI)** means a system that warns the respirator user of the approach of the end of adequate respiratory protection, for example, that the sorbent is approaching saturation or is no longer effective.

**Escape-only respirator** means a respirator intended to be used only for emergency exit.

**Filter or air purifying element** means a component used in respirators to remove solid or liquid aerosols from the inspired air.

**Filtering facepiece (dust mask)** means a negative pressure particulate respirator with a filter as an integral part of the facepiece or with the entire facepiece composed of the filtering medium.

**Fit factor** means a quantitative estimate of the fit of a particular respirator to a specific individual, and typically estimates the ratio of the concentration of a substance in ambient air to its concentration inside the respirator when worn.

**Fit test** means the use of a protocol to qualitatively or quantitatively evaluate the fit of a respirator on an individual. (See also Qualitative fit test QLFT and Quantitative fit test QNFT.)

**Helmet** means a rigid respiratory inlet covering that also provides head protection against impact and penetration.

**High efficiency particulate air (HEPA) filter** means a filter that is at least 99.97% efficient in removing monodisperse particles of 0.3 micrometers in diameter. The equivalent NIOSH 42 CFR 84 particulate filters are the N100, R100, and P100 filters.

**Hood** means a respiratory inlet covering that completely covers the head and neck and may also cover portions of the shoulders and torso.

**Immediately dangerous to life or health (IDLH)** means an atmosphere that poses an immediate threat to life, would cause irreversible adverse health effects, or would impair an individual's ability to escape from a dangerous atmosphere.

**Interior structural firefighting** means the physical activity of fire suppression, rescue or both, inside of buildings or enclosed structures which are involved in a fire situation beyond the incipient stage. (See 29 CFR 1910.155)

**Loose-fitting facepiece** means a respiratory inlet covering that is designed to form a partial seal with the face.

**Maximum use concentration (MUC)**

[Reserved].

**Negative pressure respirator (tight fitting)** means a respirator in which the air pressure inside the facepiece is negative during inhalation with respect to the ambient air pressure outside the respirator.

**Oxygen deficient atmosphere** means an atmosphere with an oxygen content below 19.5% by volume.

**Physician or other licensed health care professional (PLHCP)** means an individual whose legally permitted scope of practice (i.e., license, registration, or certification) allows him or her to independently provide, or be delegated the responsibility to provide, some or all of the health care services required by paragraph (e) of this section.

**Positive pressure respirator** means a respirator in which the pressure inside the respiratory inlet covering exceeds the ambient air pressure outside the respirator.

**Powered air-purifying respirator (PAPR)** means an air-purifying respirator that uses a blower to force the ambient air through air-purifying elements to the inlet covering.

**Pressure demand respirator** means a positive pressure atmosphere-supplying respirator that admits breathing air to the facepiece when the positive pressure is reduced inside the facepiece by inhalation.

**Qualitative fit test (QLFT)** means a pass/fail fit test to assess the adequacy of respirator fit that relies on the individual's response to the test agent.

**Quantitative fit test (QNFT)** means an assessment of the adequacy of respirator fit by numerically measuring the amount of leakage into the respirator.

**Respiratory inlet covering** means that portion of a respirator that forms the protective barrier between the user's respiratory tract and an air-purifying device or breathing air source, or both. It may be a facepiece, helmet, hood, suit, or a mouthpiece respirator with nose clamp.

**Self-contained breathing apparatus (SCBA)** means an atmosphere-supplying respirator for which the breathing air source is designed to be carried by the user.

**Service life** means the period of time that a respirator, filter or sorbent, or other respiratory equipment provides adequate protection to the wearer.

**Supplied-air respirator (SAR) or airline respirator** means an atmosphere-supplying respirator for which the source of breathing air is not designed to be carried by the user.

**This section** means this respiratory protection standard.

**Tight-fitting facepiece** means a respiratory inlet covering that forms a complete seal with the face.

**User seal check** means an action conducted by the respirator user to determine if the respirator is properly seated to the face.

### (c) Respiratory protection program.

This paragraph requires the employer to develop and implement a written respiratory protection program with required worksite-specific procedures and elements for required respirator use.

The program must be administered by a suitably trained program administrator. In addition, certain program elements may be required for voluntary use to prevent potential hazards associated with the use of the respirator. The Small Entity Compliance Guide contains criteria for the selection of a program administrator and a sample program that meets the requirements of this paragraph. Copies of the Small Entity Compliance Guide will be available on or about April 8, 1998 from the Occupational Safety and Health Administration's Office of Publications, Room N 3101, 200 Constitution Avenue, NW, Washington, DC, 20210 (202-219-4667).



(1) In any workplace where respirators are necessary to protect the health of the employee or whenever respirators are required by the employer, the employer shall establish and implement a written respiratory protection program with worksite-specific procedures. The program shall be updated as necessary to reflect those changes in workplace conditions that affect respirator use. The employer shall include in the program the following provisions of this section, as applicable:

- (i) Procedures for selecting respirators for use in the workplace;
- (ii) Medical evaluations of employees required to use respirators;
- (iii) Fit testing procedures for tight-fitting respirators;
- (iv) Procedures for proper use of respirators in routine and reasonably foreseeable emergency situations;
- (v) Procedures and schedules for cleaning, disinfecting, storing, inspecting, repairing, discarding, and otherwise maintaining respirators;
- (vi) Procedures to ensure adequate air quality, quantity, and flow of breathing air for atmosphere-supplying respirators;
- (vii) Training of employees in the respiratory hazards to which they are potentially exposed during routine and emergency situations;
- (viii) Training of employees in the proper use of respirators, including putting on and removing them, any limitations on their use, and their maintenance; and
- (ix) Procedures for regularly evaluating the effectiveness of the program.

(2) Where respirator use is not required:

- (i) An employer may provide respirators at the request of employees or permit employees to use their own respirators, if the employer determines that such respirator use will not in itself create a hazard. If the employer determines that any voluntary respirator use is permissible, the employer shall provide the respirator users with the information contained in Appendix D to this section (“Information for Employees Using Respirators When Not Required Under the Standard”); and
- (ii) In addition, the employer must establish and implement those elements of a written respiratory protection program necessary to ensure that any employee using a respirator voluntarily is medically able to use that

respirator, and that the respirator is cleaned, stored, and maintained so that its use does not present a health hazard to the user.

Exception: Employers are not required to include in a written respiratory protection program those employees whose only use of respirators involves the voluntary use of filtering facepieces (dust masks).

(3) The employer shall designate a program administrator who is qualified by appropriate training or experience that is commensurate with the complexity of the program to administer or oversee the respiratory protection program and conduct the required evaluations of program effectiveness.

(4) The employer shall provide respirators, training, and medical evaluations at no cost to the employee.

#### **(d) Selection of respirators.**

This paragraph requires the employer to evaluate respiratory hazard(s) in the workplace, identify relevant workplace and user factors, and base respirator selection on these factors. The paragraph also specifies appropriately protective respirators for use in IDLH atmospheres, and limits the selection and use of air-purifying respirators.

##### **(1) General requirements.**

(i) The employer shall select and provide an appropriate respirator based on the respiratory hazard(s) to which the worker is exposed and workplace and user factors that affect respirator performance and reliability.

(ii) The employer shall select a NIOSH-certified respirator. The respirator shall be used in compliance with the conditions of its certification.

(iii) The employer shall identify and evaluate the respiratory hazard(s) in the workplace; this evaluation shall include a reasonable estimate of employee exposures to respiratory hazard(s) and an identification of the contaminant’s chemical state and physical form. Where the employer cannot identify or reasonably estimate the employee exposure, the employer shall consider the atmosphere to be IDLH.

(iv) The employer shall select respirators from a sufficient number of respirator models and sizes so that the respirator is acceptable to, and correctly fits, the user.

**(2) Respirators for IDLH atmospheres.**

(i) The employer shall provide the following respirators for employee use in IDLH atmospheres:

(A) A full facepiece pressure demand SCBA certified by NIOSH for a minimum service life of thirty minutes, or

(B) A combination full facepiece pressure demand supplied-air respirator (SAR) with auxiliary self-contained air supply.

(ii) Respirators provided only for escape from IDLH atmospheres shall be NIOSH-certified for escape from the atmosphere in which they will be used.

(iii) All oxygen-deficient atmospheres shall be considered IDLH. Exception: If the employer demonstrates that, under all foreseeable conditions, the oxygen concentration can be maintained within the ranges specified in Table II of this section (i.e., for the altitudes set out in the table), then any atmosphere-supplying respirator may be used.

**(3) Respirators for atmospheres that are not IDLH.**

(i) The employer shall provide a respirator that is adequate to protect the health of the employee and ensure compliance with all other OSHA statutory and regulatory requirements, under routine and reasonably foreseeable emergency situations.

(A) Assigned Protection Factors (APFs)  
[Reserved]

(B) Maximum Use Concentration (MUC)  
[Reserved]

(ii) The respirator selected shall be appropriate for the chemical state and physical form of the contaminant.

(iii) For protection against gases and vapors, the employer shall provide:

(A) An atmosphere-supplying respirator, or

(B) An air-purifying respirator, provided that:

(1) The respirator is equipped with an end-of-service-life indicator (ESLI) certified by NIOSH for the contaminant; or

(2) If there is no ESLI appropriate for conditions in the employer's workplace, the employer implements a change schedule for canisters and cartridges that is based on objective information or data that will ensure that canisters and cartridges are changed before the end of their service life. The employer shall describe in the respirator program the information and data relied upon and the basis

for the canister and cartridge change schedule and the basis for reliance on the data.

(iv) For protection against particulates, the employer shall provide:

(A) An atmosphere-supplying respirator; or

(B) An air-purifying respirator equipped with a filter certified by NIOSH under 30 CFR part 11 as a high efficiency particulate air (HEPA) filter, or an air-purifying respirator equipped with a filter certified for particulates by NIOSH under 42 CFR part 84; or

(C) For contaminants consisting primarily of particles with mass median aerodynamic diameters (MMAD) of at least 2 micrometers, an air-purifying respirator equipped with any filter certified for particulates by NIOSH.

TABLE I. -- Assigned Protection Factors [Reserved]

TABLE II

Altitude (ft.)	Oxygen deficient atmospheres (%O <sub>2</sub> ) for which the employer may rely on atmosphere-supplying respirators
Less than 3,001.....	16.0-19.5
3,001-4,000.....	16.4-19.5
4,001-5,000.....	17.1-19.5
5,001-6,000.....	17.8-19.5
6,001-7,000.....	18.5-19.5
7,001-8,000 <sup>1</sup> .....	19.3-19.5

<sup>1</sup>Above 8,000 feet the exception does not apply. Oxygen-enriched breathing air must be supplied above 14,000 feet.

**e) Medical evaluation.**

Using a respirator may place a physiological burden on employees that varies with the type of respirator worn, the job and workplace conditions in which the respirator is used, and the medical status of the employee. Accordingly, this paragraph specifies the minimum requirements for medical evaluation that employers must implement to determine the employee's ability to use a respirator.

**(1) General.**

The employer shall provide a medical evaluation to determine the employee's ability to use a respirator, before the employee is fit tested or required to use the respirator in the workplace. The employer may discontinue an employee's medical evaluations when the employee is no longer required to use a respirator.

**(2) Medical evaluation procedures.**

The employer shall identify a physician or other licensed health care professional (PLHCP) to perform medical evaluations using a medical questionnaire or an initial medical examination that obtains the same information as the medical questionnaire.

(ii) The medical evaluation shall obtain the information requested by the questionnaire in Sections 1 and 2, Part A of Appendix C of this section.

**(3) Follow-up medical examination.**

(i) The employer shall ensure that a follow-up medical examination is provided for an employee who gives a positive response to any question among questions 1 through 8 in Section 2, Part A of Appendix C or whose initial medical examination demonstrates the need for a follow-up medical examination.

(ii) The follow-up medical examination shall include any medical tests, consultations, or diagnostic procedures that the PLHCP deems necessary to make a final determination.

**(4) Administration of the medical questionnaire and examinations.**

(i) The medical questionnaire and examinations shall be administered confidentially during the employee's normal working hours or at a time and place convenient to the employee. The medical questionnaire shall be administered in a manner that ensures that the employee understands its content.

(ii) The employer shall provide the employee with an opportunity to discuss the questionnaire and examination results with the PLHCP.

**(5) Supplemental information for the PLHCP.**

(i) The following information must be provided to the PLHCP before the PLHCP makes a recommendation concerning an employee's ability to use a respirator:

(A) The type and weight of the respirator to be used by the employee;

(B) The duration and frequency of respirator use (including use for rescue and escape);

(C) The expected physical work effort;

(D) Additional protective clothing and equipment to be worn; and

(E) Temperature and humidity extremes that may be encountered.

(ii) Any supplemental information provided previously to the PLHCP regarding an employee need not be provided for a subsequent medical evaluation if the information and the PLHCP remain the same.

(iii) The employer shall provide the PLHCP with a copy of the written respiratory protection program and a copy of this section.

**Note to Paragraph (e)(5)(iii):** When the employer replaces a PLHCP, the employer must ensure that the new PLHCP obtains this information, either by providing the documents directly to the PLHCP or having the documents transferred from the former PLHCP to the new PLHCP. However, OSHA does not expect employers to have employees medically reevaluated solely because a new PLHCP has been selected.

**(6) Medical determination.**

In determining the employee's ability to use a respirator, the employer shall:

(i) Obtain a written recommendation regarding the employee's ability to use the respirator from the PLHCP. The recommendation shall provide only the following information:

(A) Any limitations on respirator use related to the medical condition of the employee, or relating to the workplace conditions in which the respirator will be used, including whether or not the employee is medically able to use the respirator;

(B) The need, if any, for follow-up medical evaluations; and

(C) A statement that the PLHCP has provided the employee with a copy of the PLHCP's written recommendation.

(ii) If the respirator is a negative pressure respirator and the PLHCP finds a medical condition that may place the employee's health at increased risk if the respirator is used, the employer shall provide a PAPR if the PLHCP's medical evaluation finds that the employee can use such a respirator; if a subsequent medical evaluation finds that the employee is medically able to use a negative pressure respirator, then the employer is no longer required to provide a PAPR.

**(7) Additional medical evaluations.**

At a minimum, the employer shall provide additional medical evaluations that comply with the requirements of this section if:

- (i) An employee reports medical signs or symptoms that are related to ability to use a respirator;
- (ii) A PLHCP, supervisor, or the respirator program administrator informs the employer that an employee needs to be reevaluated;
- (iii) Information from the respiratory protection program, including observations made during fit testing and program evaluation, indicates a need for employee reevaluation; or
- (iv) A change occurs in workplace conditions (e.g., physical work effort, protective clothing, temperature) that may result in a substantial increase in the physiological burden placed on an employee.

**(f) Fit testing.**

This paragraph requires that, before an employee may be required to use any respirator with a negative or positive pressure tight-fitting facepiece, the employee must be fit tested with the same make, model, style, and size of respirator that will be used. This paragraph specifies the kinds of fit tests allowed, the procedures for conducting them, and how the results of the fit tests must be used.

(1) The employer shall ensure that employees using a tight-fitting facepiece respirator pass an appropriate qualitative fit test (QLFT) or quantitative fit test (QNFT) as stated in this paragraph.

(2) The employer shall ensure that an employee using a tight-fitting facepiece respirator is fit tested prior to initial use of the respirator, whenever a different respirator facepiece (size, style, model or make) is used, and at least annually thereafter.

(3) The employer shall conduct an additional fit test whenever the employee reports, or the employer, PLHCP, supervisor, or program administrator makes visual observations of, changes in the employee's physical condition that could affect respirator fit. Such conditions include, but are not limited to, facial scarring, dental changes, cosmetic surgery, or an obvious change in body weight.

(4) If after passing a QLFT or QNFT, the employee subsequently notifies the employer, program administrator, supervisor, or PLHCP that the fit of the respirator is unacceptable, the employee shall be given a reasonable opportunity to select a different respirator facepiece and to be retested.

(5) The fit test shall be administered using an OSHA-accepted QLFT or QNFT protocol. The OSHA-accepted QLFT and QNFT protocols and procedures are contained in Appendix A of this section.

(6) QLFT may only be used to fit test negative pressure air-purifying respirators that must achieve a fit factor of 100 or less.

(7) If the fit factor, as determined through an OSHA-accepted QNFT protocol, is equal to or greater than 100 for tight-fitting half facepieces, or equal to or greater than 500 for tight-fitting full facepieces, the QNFT has been passed with that respirator.

(8) Fit testing of tight-fitting atmosphere-supplying respirators and tight-fitting powered air-purifying respirators shall be accomplished by performing quantitative or qualitative fit testing in the negative pressure mode, regardless of the mode of operation (negative or positive pressure) that is used for respiratory protection.

(i) Qualitative fit testing of these respirators shall be accomplished by temporarily converting the respirator user's actual facepiece into a negative pressure respirator with appropriate filters, or by using an identical negative pressure air-purifying respirator facepiece with the same sealing surfaces as a surrogate for the atmosphere-supplying or powered air-purifying respirator facepiece.

(ii) Quantitative fit testing of these respirators shall be accomplished by modifying the facepiece to allow sampling inside the facepiece in the breathing zone of the user, midway between the nose and mouth. This requirement shall be accomplished by installing a permanent sampling probe onto a surrogate facepiece, or by using a sampling adapter designed to temporarily provide a means of sampling air from inside the facepiece.

(iii) Any modifications to the respirator facepiece for fit testing shall be completely removed, and the facepiece restored to NIOSH-approved configuration, before that facepiece can be used in the workplace.

**(g) Use of respirators.**

This paragraph requires employers to establish and implement procedures for the proper use of respirators. These requirements include prohibiting conditions that may result in facepiece seal leakage, preventing employees from removing respirators in hazardous environments, taking actions to ensure continued effective respirator operation throughout the work shift, and establishing procedures for the use of respirators in IDLH atmospheres or in interior structural firefighting situations.

**(1) Facepiece seal protection.**

(i) The employer shall not permit respirators with tight-fitting facepieces to be worn by employees who have:

(A) Facial hair that comes between the sealing surface of the facepiece and the face or that interferes with valve function; or

(B) Any condition that interferes with the face-to-facepiece seal or valve function.

(ii) If an employee wears corrective glasses or goggles or other personal protective equipment, the employer shall ensure that such equipment is worn in a manner that does not interfere with the seal of the facepiece to the face of the user.

(iii) For all tight-fitting respirators, the employer shall ensure that employees perform a user seal check each time they put on the respirator using the procedures in Appendix B-1 or procedures recommended by the respirator manufacturer that the employer demonstrates are as effective as those in Appendix B-1 of this section.

**(2) Continuing respirator effectiveness.**

(i) Appropriate surveillance shall be maintained of work area conditions and degree of employee exposure or stress. When there is a change in work area conditions or degree of employee exposure or stress that may affect respirator effectiveness, the employer shall reevaluate the continued effectiveness of the respirator.

(ii) The employer shall ensure that employees leave the respirator use area:

(A) To wash their faces and respirator facepieces as necessary to prevent eye or skin irritation associated with respirator use; or

(B) If they detect vapor or gas breakthrough, changes in breathing resistance, or leakage of the facepiece; or

(C) To replace the respirator or the filter, cartridge, or canister elements.

(iii) If the employee detects vapor or gas breakthrough, changes in breathing resistance, or leakage of the facepiece, the employer must replace or repair the respirator before allowing the employee to return to the work area.

**(3) Procedures for IDLH atmospheres.**

For all IDLH atmospheres, the employer shall ensure that:

(i) One employee or, when needed, more than one employee is located outside the IDLH atmosphere;

(ii) Visual, voice, or signal line communication is maintained between the employee(s) in the IDLH atmosphere and the employee(s) located outside the IDLH atmosphere;

(iii) The employee(s) located outside the IDLH atmosphere are trained and equipped to provide effective emergency rescue;

(iv) The employer or designee is notified before the employee(s) located outside the IDLH atmosphere enter the IDLH atmosphere to provide emergency rescue;

(v) The employer or designee authorized to do so by the employer, once notified, provides necessary assistance appropriate to the situation;

(vi) Employee(s) located outside the IDLH atmospheres are equipped with:

(A) Pressure demand or other positive pressure SCBAs, or a pressure demand or other positive pressure supplied-air respirator with auxiliary SCBA; and either

(B) Appropriate retrieval equipment for removing the employee(s) who enter(s) these hazardous atmospheres where retrieval equipment would contribute to the rescue of the employee(s) and would not increase the overall risk resulting from entry; or

(C) Equivalent means for rescue where retrieval equipment is not required under paragraph (g)(3)(vi)(B).

**(4) Procedures for interior structural firefighting.**

In addition to the requirements set forth under paragraph (g)(3), in interior structural fires, the employer shall ensure that:

(i) At least two employees enter the IDLH atmosphere and remain in visual or voice contact with one another at all times;

(ii) At least two employees are located outside the IDLH atmosphere; and

(iii) All employees engaged in interior structural firefighting use SCBAs.

**Note 1 to paragraph (g):** One of the two individuals located outside the IDLH atmosphere may be assigned to an additional role, such as incident commander in charge of the emergency or safety officer, so long as this individual is able to perform assistance or rescue activities without jeopardizing the safety or health of any firefighter working at the incident.

**Note 2 to paragraph (g):** Nothing in this section is meant to preclude firefighters from performing emergency rescue activities before an entire team has assembled.

**(h) Maintenance and care of respirators.**

This paragraph requires the employer to provide for the cleaning and disinfecting, storage, inspection, and repair of respirators used by employees.

**(1) Cleaning and disinfecting.**

The employer shall provide each respirator user with a respirator that is clean, sanitary, and in good working order. The employer shall ensure that respirators are cleaned and disinfected using the procedures in Appendix B-2 of this section, or procedures recommended by the respirator manufacturer, provided that such procedures are of equivalent effectiveness. The respirators shall be cleaned and disinfected at the following intervals:

**(i)** Respirators issued for the exclusive use of an employee shall be cleaned and disinfected as often as necessary to be maintained in a sanitary condition;

**(ii)** Respirators issued to more than one employee shall be cleaned and disinfected before being worn by different individuals;

**(iii)** Respirators maintained for emergency use shall be cleaned and disinfected after each use; and

**(iv)** Respirators used in fit testing and training shall be cleaned and disinfected after each use.

**(2) Storage.**

The employer shall ensure that respirators are stored as follows:

**(i)** All respirators shall be stored to protect them from damage, contamination, dust, sunlight, extreme temperatures, excessive moisture, and damaging chemicals, and they shall be packed or stored to prevent deformation of the facepiece and exhalation valve.

**(ii)** In addition to the requirements of paragraph (h)(2)(i) of this section, emergency respirators shall be:

**(A)** Kept accessible to the work area;

**(B)** Stored in compartments or in covers that are clearly marked as containing emergency respirators; and

**(C)** Stored in accordance with any applicable manufacturer instructions.

**(3) Inspection.**

**(i)** The employer shall ensure that respirators are inspected as follows:

**(A)** All respirators used in routine situations shall be inspected before each use and during cleaning;

**(B)** All respirators maintained for use in emergency situations shall be inspected at least monthly and in accordance with the manufacturer's recommendations, and shall be checked for proper function before and after each use; and

**(C)** Emergency escape-only respirators shall be inspected before being carried into the workplace for use.

**(ii)** The employer shall ensure that respirator inspections include the following:

**(A)** A check of respirator function, tightness of connections, and the condition of the various parts including, but not limited to, the facepiece, head straps, valves, connecting tube, and cartridges, canisters or filters; and

**(B)** A check of elastomeric parts for pliability and signs of deterioration.

**(iii)** In addition to the requirements of paragraphs (h)(3)(i) and (ii) of this section, self-contained breathing apparatus shall be inspected monthly. Air and oxygen cylinders shall be maintained in a fully charged state and shall be recharged when the pressure falls to 90% of the manufacturer's recommended pressure level. The employer shall determine that the regulator and warning devices function properly.

**(iv)** For respirators maintained for emergency use, the employer shall:

**(A)** Certify the respirator by documenting the date the inspection was performed, the name (or signature) of the person who made the inspection, the findings, required remedial action, and a serial number or other means of identifying the inspected respirator; and

**(B)** Provide this information on a tag or label that is attached to the storage compartment for the respirator, is kept with the respirator, or is included in inspection reports stored as paper or

electronic files. This information shall be maintained until replaced following a subsequent certification.

**(4) Repairs.**

The employer shall ensure that respirators that fail an inspection or are otherwise found to be defective are removed from service, and are discarded or repaired or adjusted in accordance with the following procedures:

(i) Repairs or adjustments to respirators are to be made only by persons appropriately trained to perform such operations and shall use only the respirator manufacturer's NIOSH-approved parts designed for the respirator;

(ii) Repairs shall be made according to the manufacturer's recommendations and specifications for the type and extent of repairs to be performed; and

(iii) Reducing and admission valves, regulators, and alarms shall be adjusted or repaired only by the manufacturer or a technician trained by the manufacturer.

**(i) Breathing air quality and use.**

This paragraph requires the employer to provide employees using atmosphere-supplying respirators (supplied-air and SCBA) with breathing gases of high purity.

(1) The employer shall ensure that compressed air, compressed oxygen, liquid air, and liquid oxygen used for respiration accords with the following specifications:

(i) Compressed and liquid oxygen shall meet the United States Pharmacopoeia requirements for medical or breathing oxygen; and

(ii) Compressed breathing air shall meet at least the requirements for Grade D breathing air described in ANSI/Compressed Gas Association Commodity Specification for Air, G-7.1-1989, to include:

(A) Oxygen content (v/v) of 19.5-23.5%;

(B) Hydrocarbon (condensed) content of 5 milligrams per cubic meter of air or less;

(C) Carbon monoxide (CO) content of 10 ppm or less;

(D) Carbon dioxide content of 1,000 ppm or less; and

(E) Lack of noticeable odor.

(2) The employer shall ensure that compressed oxygen is not used in atmosphere-supplying respirators that have previously used compressed air.

(3) The employer shall ensure that oxygen concentrations greater than 23.5% are used only in equipment designed for oxygen service or distribution.

(4) The employer shall ensure that cylinders used to supply breathing air to respirators meet the following requirements:

(i) Cylinders are tested and maintained as prescribed in the Shipping Container Specification Regulations of the Department of Transportation (49 CFR part 173 and part 178);

(ii) Cylinders of purchased breathing air have a certificate of analysis from the supplier that the breathing air meets the requirements for Grade D breathing air; and

(iii) The moisture content in the cylinder does not exceed a dew point of -50 deg.F (-45.6 deg.C) at 1 atmosphere pressure.

(5) The employer shall ensure that compressors used to supply breathing air to respirators are constructed and situated so as to:

(i) Prevent entry of contaminated air into the air-supply system;

(ii) Minimize moisture content so that the dew point at 1 atmosphere pressure is 10 degrees F (5.56 deg.C) below the ambient temperature;

(iii) Have suitable in-line air-purifying sorbent beds and filters to further ensure breathing air quality. Sorbent beds and filters shall be maintained and replaced or refurbished periodically following the manufacturer's instructions.

(iv) Have a tag containing the most recent change date and the signature of the person authorized by the employer to perform the change. The tag shall be maintained at the compressor.

(6) For compressors that are not oil-lubricated, the employer shall ensure that carbon monoxide levels in the breathing air do not exceed 10 ppm.

(7) For oil-lubricated compressors, the employer shall use a high-temperature or carbon monoxide alarm, or both, to monitor carbon monoxide levels. If only high-temperature alarms are used, the air supply shall be monitored at intervals sufficient to prevent carbon monoxide in the breathing air from exceeding 10 ppm.

(8) The employer shall ensure that breathing air couplings are incompatible with outlets for nonrespirable worksite air or other gas systems. No asphyxiating substance shall be introduced into breathing air lines.

(9) The employer shall use breathing gas containers marked in accordance with the NIOSH respirator certification standard, 42 CFR part 84.

**(j) Identification of filters, cartridges, and canisters.**

The employer shall ensure that all filters, cartridges and canisters used in the workplace are labeled and color coded with the NIOSH approval label and that the label is not removed and remains legible.

**(k) Training and information.**

This paragraph requires the employer to provide effective training to employees who are required to use respirators. The training must be comprehensive, understandable, and recur annually, and more often if necessary. This paragraph also requires the employer to provide the basic information on respirators in Appendix D of this section to employees who wear respirators when not required by this section or by the employer to do so.

(1) The employer shall ensure that each employee can demonstrate knowledge of at least the following:

(i) Why the respirator is necessary and how improper fit, usage, or maintenance can compromise the protective effect of the respirator;

(ii) What the limitations and capabilities of the respirator are;

(iii) How to use the respirator effectively in emergency situations, including situations in which the respirator malfunctions;

(iv) How to inspect, put on and remove, use, and check the seals of the respirator;

(v) What the procedures are for maintenance and storage of the respirator;

(vi) How to recognize medical signs and symptoms that may limit or prevent the effective use of respirators; and

(vii) The general requirements of this section.

(2) The training shall be conducted in a manner that is understandable to the employee.

(3) The employer shall provide the training prior to requiring the employee to use a respirator in the workplace.

(4) An employer who is able to demonstrate that a new employee has received training within the last 12 months that addresses the elements

specified in paragraph (k)(1)(i) through (vii) is not required to repeat such training provided that, as required by paragraph (k)(1), the employee can demonstrate knowledge of those element(s). Previous training not repeated initially by the employer must be provided no later than 12 months from the date of the previous training.

(5) Retraining shall be administered annually, and when the following situations occur:

(i) Changes in the workplace or the type of respirator render previous training obsolete;

(ii) Inadequacies in the employee's knowledge or use of the respirator indicate that the employee has not retained the requisite understanding or skill; or

(iii) Any other situation arises in which retraining appears necessary to ensure safe respirator use.

(6) The basic advisory information on respirators, as presented in Appendix D of this section, shall be provided by the employer in any written or oral format, to employees who wear respirators when such use is not required by this section or by the employer.

**(l) Program evaluation.**

This section requires the employer to conduct evaluations of the workplace to ensure that the written respiratory protection program is being properly implemented, and to consult employees to ensure that they are using the respirators properly.

(1) The employer shall conduct evaluations of the workplace as necessary to ensure that the provisions of the current written program are being effectively implemented and that it continues to be effective.

(2) The employer shall regularly consult employees required to use respirators to assess the employees' views on program effectiveness and to identify any problems. Any problems that are identified during this assessment shall be corrected. Factors to be assessed include, but are not limited to:

(i) Respirator fit (including the ability to use the respirator without interfering with effective workplace performance);

(ii) Appropriate respirator selection for the hazards to which the employee is exposed;



(iii) Proper respirator use under the workplace conditions the employee encounters; and

(iv) Proper respirator maintenance.

**(m) Recordkeeping.**

This section requires the employer to establish and retain written information regarding medical evaluations, fit testing, and the respirator program. This information will facilitate employee involvement in the respirator program, assist the employer in auditing the adequacy of the program, and provide a record for compliance determinations by OSHA.

**(1) Medical evaluation.**

Records of medical evaluations required by this section must be retained and made available in accordance with 29 CFR 1910.1020.

**(2) Fit testing.**

(i) The employer shall establish a record of the qualitative and quantitative fit tests administered to an employee including:

- (A) The name or identification of the employee tested;
- (B) Type of fit test performed;
- (C) Specific make, model, style, and size of respirator tested;
- (D) Date of test; and
- (E) The pass/fail results for QLFTs or the fit factor and strip chart recording or other recording of the test results for QNFTs.

(ii) Fit test records shall be retained for respirator users until the next fit test is administered.

(3) A written copy of the current respirator program shall be retained by the employer.

(4) Written materials required to be retained under this paragraph shall be made available upon request to affected employees and to the Assistant Secretary or designee for examination and copying.

**(n) Dates.**

**(1) Effective date.**

This section is effective April 8, 1998. The obligations imposed by this section commence on the effective date unless otherwise noted in this paragraph. Compliance with obligations that do not commence on the effective date shall occur no later than the applicable start-up date.

**(2) Compliance dates.**

All obligations of this section commence on the effective date except as follows:

(i) The determination that respirator use is required (paragraph (a)) shall be completed no later than September 8, 1998.

(ii) Compliance with provisions of this section for all other provisions shall be completed no later than October 5, 1998.

(3) The provisions of 29 CFR 1910.134 and 29 CFR 1926.103, contained in the 29 CFR parts 1900 to 1910.99 and the 29 CFR part 1926 editions, revised as of July 1, 1997, are in effect and enforceable until October 5, 1998, or during any administrative or judicial stay of the provisions of this section.

**(4) Existing Respiratory Protection Programs.**

If, in the 12 month period preceding April 8, 1998, the employer has conducted annual respirator training, fit testing, respirator program evaluation, or medical evaluations, the employer may use the results of those activities to comply with the corresponding provisions of this section, providing that these activities were conducted in a manner that meets the requirements of this section.

**(o) Appendices.**

(1) Compliance with Appendix A, Appendix B-1, Appendix B-2, and Appendix C of this section is mandatory.

(2) Appendix D of this section is non-mandatory and is not intended to create any additional obligations not otherwise imposed or to detract from any existing obligations.

[63 FR 1152, Jan. 8, 1998; 63 FR 20098, April 23, 1998]

## Appendix A to § 1910.134: Fit Testing Procedures (Mandatory)

### Part I. OSHA-Accepted Fit Test Protocols

#### A. Fit Testing Procedures—General Requirements

The employer shall conduct fit testing using the following procedures. The requirements in this appendix apply to all OSHA-accepted fit test methods, both QLFT and QNFT.

1. The test subject shall be allowed to pick the most acceptable respirator from a sufficient number of respirator models and sizes so that the respirator is acceptable to, and correctly fits, the user.

2. Prior to the selection process, the test subject shall be shown how to put on a respirator, how it should be positioned on the face, how to set strap tension and how to determine an acceptable fit. A mirror shall be available to assist the subject in evaluating the fit and positioning of the respirator. This instruction may not constitute the subject's formal training on respirator use, because it is only a review.

3. The test subject shall be informed that he/she is being asked to select the respirator that provides the most acceptable fit.

Each respirator represents a different size and shape, and if fitted and used properly, will provide adequate protection.

4. The test subject shall be instructed to hold each chosen facepiece up to the face and eliminate those that obviously do not give an acceptable fit.

5. The more acceptable facepieces are noted in case the one selected proves unacceptable; the most comfortable mask is donned and worn at least five minutes to assess comfort. Assistance in assessing comfort can be given by discussing the points in the following item A.6. If the test subject is not familiar with using a particular respirator, the test subject shall be directed to don the mask several times and to adjust the straps each time to become adept at setting proper tension on the straps.

6. Assessment of comfort shall include a review of the following points with the test subject and allowing the test subject adequate time to determine the comfort of the respirator:

- (a) Position of the mask on the nose
- (b) Room for eye protection

- (c) Room to talk

- (d) Position of mask on face and cheeks

7. The following criteria shall be used to help determine the adequacy of the respirator fit:

- (a) Chin properly placed;

- (b) Adequate strap tension, not overly tightened;

- (c) Fit across nose bridge;

- (d) Respirator of proper size to span distance from nose to chin;

- (e) Tendency of respirator to slip;

- (f) Self-observation in mirror to evaluate fit and respirator position.

8. The test subject shall conduct a user seal check, either the negative and positive pressure seal checks described in Appendix B-1 of this section or those recommended by the respirator manufacturer which provide equivalent protection to the procedures in Appendix B-1. Before conducting the negative and positive pressure checks, the subject shall be told to seat the mask on the face by moving the head from side-to-side and up and down slowly while taking in a few slow deep breaths. Another facepiece shall be selected and retested if the test subject fails the user seal check tests.

9. The test shall not be conducted if there is any hair growth between the skin and the facepiece sealing surface, such as stubble beard growth, beard, mustache or sideburns which cross the respirator sealing surface. Any type of apparel which interferes with a satisfactory fit shall be altered or removed.

10. If a test subject exhibits difficulty in breathing during the tests, she or he shall be referred to a physician or other licensed health care professional, as appropriate, to determine whether the test subject can wear a respirator while performing her or his duties.

11. If the employee finds the fit of the respirator unacceptable, the test subject shall be given the opportunity to select a different respirator and to be retested.

12. Exercise regimen. Prior to the commencement of the fit test, the test subject shall be given a description of the fit test and the test subject's responsibilities during the test procedure. The description of the process shall include a description of the test exercises that the subject will be performing. The respirator to be tested shall be worn for at least 5 minutes before the start of the fit test.

13. The fit test shall be performed while the test subject is wearing any applicable safety

equipment that may be worn during actual respirator use which could interfere with respirator fit.

14. Test Exercises. (a) The following test exercises are to be performed for all fit testing methods prescribed in this appendix, except for the CNP method. A separate fit testing exercise regimen is contained in the CNP protocol. The test subject shall perform exercises, in the test environment, in the following manner:

(1) Normal breathing. In a normal standing position, without talking, the subject shall breathe normally.

(2) Deep breathing. In a normal standing position, the subject shall breathe slowly and deeply, taking caution so as not to hyperventilate.

(3) Turning head side to side. Standing in place, the subject shall slowly turn his/her head from side to side between the extreme positions on each side. The head shall be held at each extreme momentarily so the subject can inhale at each side.

(4) Moving head up and down. Standing in place, the subject shall slowly move his/her head up and down. The subject shall be instructed to inhale in the up position (i.e., when looking toward the ceiling).

(5) Talking. The subject shall talk out loud slowly and loud enough so as to be heard clearly by the test conductor. The subject can read from a prepared text such as the Rainbow Passage, count backward from 100, or recite a memorized poem or song.

#### **Rainbow Passage**

When the sunlight strikes raindrops in the air, they act like a prism and form a rainbow. The rainbow is a division of white light into many beautiful colors. These take the shape of a long round arch, with its path high above, and its two ends apparently beyond the horizon. There is, according to legend, a boiling pot of gold at one end. People look, but no one ever finds it. When a man looks for something beyond reach, his friends say he is looking for the pot of gold at the end of the rainbow.

(6) Grimace. The test subject shall grimace by smiling or frowning. (This applies only to QNFT testing; it is not performed for QLFT)

(7) Bending over. The test subject shall bend at the waist as if he/she were to touch his/her toes. Jogging in place shall be substituted for this exercise in those test environments such as

shroud type QNFT or QLFT units that do not permit bending over at the waist.

(8) Normal breathing. Same as exercise (1).

(b) Each test exercise shall be performed for one minute except for the grimace exercise which shall be performed for 15 seconds. The test subject shall be questioned by the test conductor regarding the comfort of the respirator upon completion of the protocol. If it has become unacceptable, another model of respirator shall be tried. The respirator shall not be adjusted once the fit test exercises begin. Any adjustment voids the test, and the fit test must be repeated.

### **B. Qualitative Fit Test (QLFT) Protocols**

#### **1. General**

(a) The employer shall ensure that persons administering QLFT are able to prepare test solutions, calibrate equipment and perform tests properly, recognize invalid tests, and ensure that test equipment is in proper working order.

(b) The employer shall ensure that QLFT equipment is kept clean and well maintained so as to operate within the parameters for which it was designed.

#### **2. Isoamyl Acetate Protocol**

Note: This protocol is not appropriate to use for the fit testing of particulate respirators. If used to fit test particulate respirators, the respirator must be equipped with an organic vapor filter.

##### **(a) Odor Threshold Screening**

Odor threshold screening, performed without wearing a respirator, is intended to determine if the individual tested can detect the odor of isoamyl acetate at low levels.

(1) Three 1 liter glass jars with metal lids are required.

(2) Odor-free water (e.g., distilled or spring water) at approximately 25 deg. C (77 deg. F) shall be used for the solutions.

(3) The isoamyl acetate (IAA) (also known as isopentyl acetate) stock solution is prepared by adding 1 ml of pure IAA to 800 ml of odor-free water in a 1 liter jar, closing the lid and shaking for 30 seconds. A new solution shall be prepared at least weekly.

(4) The screening test shall be conducted in a room separate from the room used for actual fit testing. The two rooms shall be well-ventilated to

prevent the odor of IAA from becoming evident in the general room air where testing takes place.

(5) The odor test solution is prepared in a second jar by placing 0.4 ml of the stock solution into 500 ml of odor-free water using a clean dropper or pipette. The solution shall be shaken for 30 seconds and allowed to stand for two to three minutes so that the IAA concentration above the liquid may reach equilibrium. This solution shall be used for only one day.

(6) A test blank shall be prepared in a third jar by adding 500 cc of odor-free water.

(7) The odor test and test blank jar lids shall be labeled (e.g., 1 and 2) for jar identification. Labels shall be placed on the lids so that they can be peeled off periodically and switched to maintain the integrity of the test.

(8) The following instruction shall be typed on a card and placed on the table in front of the two test jars (i.e., 1 and 2): "The purpose of this test is to determine if you can smell banana oil at a low concentration. The two bottles in front of you contain water. One of these bottles also contains a small amount of banana oil. Be sure the covers are on tight, then shake each bottle for two seconds. Unscrew the lid of each bottle, one at a time, and sniff at the mouth of the bottle. Indicate to the test conductor which bottle contains banana oil."

(9) The mixtures used in the IAA odor detection test shall be prepared in an area separate from where the test is performed, in order to prevent olfactory fatigue in the subject.

(10) If the test subject is unable to correctly identify the jar containing the odor test solution, the IAA qualitative fit test shall not be performed.

(11) If the test subject correctly identifies the jar containing the odor test solution, the test subject may proceed to respirator selection and fit testing.

**(b) Isoamyl Acetate Fit Test**

(1) The fit test chamber shall be a clear 55-gallon drum liner suspended inverted over a 2-foot diameter frame so that the top of the chamber is about 6 inches above the test subject's head. If no drum liner is available, a similar chamber shall be constructed using plastic sheeting. The inside top center of the chamber shall have a small hook attached.

(2) Each respirator used for the fitting and fit testing shall be equipped with organic vapor cartridges or offer protection against organic vapors.

(3) After selecting, donning, and properly adjusting a respirator, the test subject shall wear it to the fit testing room. This room shall be separate from the room used for odor threshold screening and respirator selection, and shall be well-ventilated, as by an exhaust fan or lab hood, to prevent general room contamination.

(4) A copy of the test exercises and any prepared text from which the subject is to read shall be taped to the inside of the test chamber.

(5) Upon entering the test chamber, the test subject shall be given a 6-inch by 5-inch piece of paper towel, or other porous, absorbent, single-ply material, folded in half and wetted with 0.75 ml of pure IAA. The test subject shall hang the wet towel on the hook at the top of the chamber. An IAA test swab or ampule may be substituted for the IAA wetted paper towel provided it has been demonstrated that the alternative IAA source will generate an IAA test atmosphere with a concentration equivalent to that generated by the paper towel method.

(6) Allow two minutes for the IAA test concentration to stabilize before starting the fit test exercises. This would be an appropriate time to talk with the test subject; to explain the fit test, the importance of his/her cooperation, and the purpose for the test exercises; or to demonstrate some of the exercises.

(7) If at any time during the test, the subject detects the banana-like odor of IAA, the test is failed. The subject shall quickly exit from the test chamber and leave the test area to avoid olfactory fatigue.

(8) If the test is failed, the subject shall return to the selection room and remove the respirator. The test subject shall repeat the odor sensitivity test, select and put on another respirator, return to the test area and again begin the fit test procedure described in (b) (1) through (7) above. The process continues until a respirator that fits well has been found. Should the odor sensitivity test be failed, the subject shall wait at least 5 minutes before retesting. Odor sensitivity will usually have returned by this time.

(9) If the subject passes the test, the efficiency of the test procedure shall be demonstrated by having the subject break the respirator face seal and take a breath before exiting the chamber.

(10) When the test subject leaves the chamber, the subject shall remove the saturated towel and return it to the person conducting the

test, so that there is no significant IAA concentration buildup in the chamber during subsequent tests. The used towels shall be kept in a self-sealing plastic bag to keep the test area from being contaminated.

### 3. Saccharin Solution Aerosol Protocol

The entire screening and testing procedure shall be explained to the test subject prior to the conduct of the screening test.

#### (a) Taste threshold screening.

The saccharin taste threshold screening, performed without wearing a respirator, is intended to determine whether the individual being tested can detect the taste of saccharin.

(1) During threshold screening as well as during fit testing, subjects shall wear an enclosure about the head and shoulders that is approximately 12 inches in diameter by 14 inches tall with at least the front portion clear and that allows free movements of the head when a respirator is worn. An enclosure substantially similar to the 3M hood assembly, parts # FT 14 and # FT 15 combined, is adequate.

(2) The test enclosure shall have a 3/4-inch (1.9 cm) hole in front of the test subject's nose and mouth area to accommodate the nebulizer nozzle.

(3) The test subject shall don the test enclosure. Throughout the threshold screening test, the test subject shall breathe through his/her slightly open mouth with tongue extended. The subject is instructed to report when he/she detects a sweet taste.

4) Using a DeVilbiss Model 40 Inhalation Medication Nebulizer or equivalent, the test conductor shall spray the threshold check solution into the enclosure. The nozzle is directed away from the nose and mouth of the person. This nebulizer shall be clearly marked to distinguish it from the fit test solution nebulizer.

(5) The threshold check solution is prepared by dissolving 0.83 gram of sodium saccharin USP in 100 ml of warm water. It can be prepared by putting 1 ml of the fit test solution (see (b)(5) below) in 100 ml of distilled water.

(6) To produce the aerosol, the nebulizer bulb is firmly squeezed so that it collapses completely, then released and allowed to fully expand.

(7) Ten squeezes are repeated rapidly and then the test subject is asked whether the saccharin can be tasted. If the test subject reports tasting the sweet taste during the ten

squeezes, the screening test is completed. The taste threshold is noted as ten regardless of the number of squeezes actually completed.

(8) If the first response is negative, ten more squeezes are repeated rapidly and the test subject is again asked whether the saccharin is tasted. If the test subject reports tasting the sweet taste during the second ten squeezes, the screening test is completed. The taste threshold is noted as twenty regardless of the number of squeezes actually completed.

(9) If the second response is negative, ten more squeezes are repeated rapidly and the test subject is again asked whether the saccharin is tasted. If the test subject reports tasting the sweet taste during the third set of ten squeezes, the screening test is completed. The taste threshold is noted as thirty regardless of the number of squeezes actually completed.

(10) The test conductor will take note of the number of squeezes required to solicit a taste response.

(11) If the saccharin is not tasted after 30 squeezes (step 10), the test subject is unable to taste saccharin and may not perform the saccharin fit test.

**Note to paragraph 3. (a):** If the test subject eats or drinks something sweet before the screening test, he/she may be unable to taste the weak saccharin solution.

(12) If a taste response is elicited, the test subject shall be asked to take note of the taste for reference in the fit test.

(13) Correct use of the nebulizer means that approximately 1 ml of liquid is used at a time in the nebulizer body.

(14) The nebulizer shall be thoroughly rinsed in water, shaken dry, and refilled at least each morning and afternoon or at least every four hours.

#### (b) Saccharin solution aerosol fit test procedure.

(1) The test subject may not eat, drink (except plain water), smoke, or chew gum for 15 minutes before the test.

(2) The fit test uses the same enclosure described in 3. (a) above.

(3) The test subject shall don the enclosure while wearing the respirator selected in section I. A. of this appendix. The respirator shall be properly adjusted and equipped with a particulate filter(s).

(4) A second DeVilbiss Model 40 Inhalation Medication Nebulizer or equivalent is used to

spray the fit test solution into the enclosure. This nebulizer shall be clearly marked to distinguish it from the screening test solution nebulizer.

(5) The fit test solution is prepared by adding 83 grams of sodium saccharin to 100 ml of warm water.

(6) As before, the test subject shall breathe through the slightly open mouth with tongue extended, and report if he/she tastes the sweet taste of saccharin.

(7) The nebulizer is inserted into the hole in the front of the enclosure and an initial concentration of saccharin fit test solution is sprayed into the enclosure using the same number of squeezes (either 10, 20 or 30 squeezes) based on the number of squeezes required to elicit a taste response as noted during the screening test. A minimum of 10 squeezes is required.

(8) After generating the aerosol, the test subject shall be instructed to perform the exercises in section I. A.14. of this appendix.

(9) Every 30 seconds the aerosol concentration shall be replenished using one half the original number of squeezes used initially (e.g., 5, 10 or 15).

(10) The test subject shall indicate to the test conductor if at any time during the fit test the taste of saccharin is detected. If the test subject does not report tasting the saccharin, the test is passed.

(11) If the taste of saccharin is detected, the fit is deemed unsatisfactory and the test is failed. A different respirator shall be tried and the entire test procedure is repeated (taste threshold screening and fit testing).

(12) Since the nebulizer has a tendency to clog during use, the test operator must make periodic checks of the nebulizer to ensure that it is not clogged. If clogging is found at the end of the test session, the test is invalid.

#### **4. Bitrex™ (denatonium benzoate) Solution Aerosol Qualitative Fit Test Protocol**

The Bitrex™ (denatonium benzoate) solution aerosol QLFT protocol uses the published saccharin test protocol because that protocol is widely accepted. Bitrex is routinely used as a taste aversion agent in household liquids which children should not be drinking and is endorsed by the American Medical

Association, the National Safety Council, and the American Association of Poison Control Centers. The entire screening and testing procedure shall be explained to the test subject prior to the conduct of the screening test.

##### **(a) Taste Threshold Screening.**

The Bitrex taste threshold screening, performed without wearing a respirator, is intended to determine whether the individual being tested can detect the taste of Bitrex.

(1) During threshold screening as well as during fit testing, subjects shall wear an enclosure about the head and shoulders that is approximately 12 inches (30.5 cm) in diameter by 14 inches (35.6 cm) tall. The front portion of the enclosure shall be clear from the respirator and allow free movement of the head when a respirator is worn. An enclosure substantially similar to the 3M hood assembly, parts # FT 14 and # FT 15 combined, is adequate.

(2) The test enclosure shall have a 3/4 inch (1.9 cm) hole in front of the test subject's nose and mouth area to accommodate the nebulizer nozzle.

(3) The test subject shall don the test enclosure. Throughout the threshold screening test, the test subject shall breathe through his or her slightly open mouth with tongue extended. The subject is instructed to report when he/she detects a bitter taste.

(4) Using a DeVilbiss Model 40 Inhalation Medication Nebulizer or equivalent, the test conductor shall spray the Threshold Check Solution into the enclosure. This Nebulizer shall be clearly marked to distinguish it from the fit test solution nebulizer.

(5) The Threshold Check Solution is prepared by adding 13.5 milligrams of Bitrex to 100 ml of 5% salt (NaCl) solution in distilled water.

(6) To produce the aerosol, the nebulizer bulb is firmly squeezed so that the bulb collapses completely, and is then released and allowed to fully expand.

(7) An initial ten squeezes are repeated rapidly and then the test subject is asked whether the Bitrex can be tasted. If the test subject reports tasting the bitter taste during the ten squeezes, the screening test is completed. The taste threshold is noted as ten regardless of the number of squeezes actually completed.

(8) If the first response is negative, ten more squeezes are repeated rapidly and the test subject is again asked whether the Bitrex is tasted. If the test subject reports tasting the

bitter taste during the second ten squeezes, the screening test is completed. The taste threshold is noted as twenty regardless of the number of squeezes actually completed.

(9) If the second response is negative, ten more squeezes are repeated rapidly and the test subject is again asked whether the Bitrex is tasted. If the test subject reports tasting the bitter taste during the third set of ten squeezes, the screening test is completed. The taste threshold is noted as thirty regardless of the number of squeezes actually completed.

(10) The test conductor will take note of the number of squeezes required to solicit a taste response.

(11) If the Bitrex is not tasted after 30 squeezes (step 10), the test subject is unable to taste Bitrex and may not perform the Bitrex fit test.

(12) If a taste response is elicited, the test subject shall be asked to take note of the taste for reference in the fit test.

(13) Correct use of the nebulizer means that approximately 1 ml of liquid is used at a time in the nebulizer body.

(14) The nebulizer shall be thoroughly rinsed in water, shaken to dry, and refilled at least each morning and afternoon or at least every four hours.

**(b) Bitrex Solution Aerosol Fit Test Procedure.**

(1) The test subject may not eat, drink (except plain water), smoke, or chew gum for 15 minutes before the test.

(2) The fit test uses the same enclosure as that described in 4. (a) above.

(3) The test subject shall don the enclosure while wearing the respirator selected according to section I. A. of this appendix. The respirator shall be properly adjusted and equipped with any type particulate filter(s).

(4) A second DeVilbiss Model 40 Inhalation Medication Nebulizer or equivalent is used to spray the fit test solution into the enclosure. This nebulizer shall be clearly marked to distinguish it from the screening test solution nebulizer.

(5) The fit test solution is prepared by adding 337.5 mg of Bitrex to 200 ml of a 5% salt (NaCl) solution in warm water.

(6) As before, the test subject shall breathe through his or her slightly open mouth with tongue extended, and be instructed to report if he/she tastes the bitter taste of Bitrex.

(7) The nebulizer is inserted into the hole in the front of the enclosure and an initial concentration of the fit test solution is sprayed into the enclosure using the same number of squeezes (either 10, 20 or 30 squeezes) based on the number of squeezes required to elicit a taste response as noted during the screening test.

(8) After generating the aerosol, the test subject shall be instructed to perform the exercises in section I. A. 14. of this appendix.

(9) Every 30 seconds the aerosol concentration shall be replenished using one half the number of squeezes used initially (e.g., 5, 10 or 15).

(10) The test subject shall indicate to the test conductor if at any time during the fit test the taste of Bitrex is detected. If the test subject does not report tasting the Bitrex, the test is passed.

(11) If the taste of Bitrex is detected, the fit is deemed unsatisfactory and the test is failed. A different respirator shall be tried and the entire test procedure is repeated (taste threshold screening and fit testing).

**5. Irritant Smoke (Stannic Chloride) Protocol**

This qualitative fit test uses a person's response to the irritating chemicals released in the "smoke" produced by a stannic chloride ventilation smoke tube to detect leakage into the respirator.

**(a) General Requirements and Precautions**

(1) The respirator to be tested shall be equipped with high efficiency particulate air (HEPA) or P100 series filter(s).

(2) Only stannic chloride smoke tubes shall be used for this protocol.

(3) No form of test enclosure or hood for the test subject shall be used.

(4) The smoke can be irritating to the eyes, lungs, and nasal passages. The test conductor shall take precautions to minimize the test subject's exposure to irritant smoke. Sensitivity varies, and certain individuals may respond to a greater degree to irritant smoke. Care shall be taken when performing the sensitivity screening checks that determine whether the test subject can detect irritant smoke to use only the minimum amount of smoke necessary to elicit a response from the test subject.

(5) The fit test shall be performed in an area with adequate ventilation to prevent exposure of

the person conducting the fit test or the build-up of irritant smoke in the general atmosphere.

**(b) Sensitivity Screening Check**

The person to be tested must demonstrate his or her ability to detect a weak concentration of the irritant smoke.

(1) The test operator shall break both ends of a ventilation smoke tube containing stannic chloride, and attach one end of the smoke tube to a low flow air pump set to deliver 200 milliliters per minute, or an aspirator squeeze bulb. The test operator shall cover the other end of the smoke tube with a short piece of tubing to prevent potential injury from the jagged end of the smoke tube.

(2) The test operator shall advise the test subject that the smoke can be irritating to the eyes, lungs, and nasal passages and instruct the subject to keep his/her eyes closed while the test is performed.

(3) The test subject shall be allowed to smell a weak concentration of the irritant smoke before the respirator is donned to become familiar with its irritating properties and to determine if he/she can detect the irritating properties of the smoke. The test operator shall carefully direct a small amount of the irritant smoke in the test subject's direction to determine that he/she can detect it.

**(c) Irritant Smoke Fit Test Procedure**

(1) The person being fit tested shall don the respirator without assistance, and perform the required user seal check(s).

(2) The test subject shall be instructed to keep his/her eyes closed.

(3) The test operator shall direct the stream of irritant smoke from the smoke tube toward the face seal area of the test subject, using the low flow pump or the squeeze bulb. The test operator shall begin at least 12 inches from the facepiece and move the smoke stream around the whole perimeter of the mask. The operator shall gradually make two more passes around the perimeter of the mask, moving to within six inches of the respirator.

(4) If the person being tested has not had an involuntary response and/or detected the irritant smoke, proceed with the test exercises.

(5) The exercises identified in section I.A. 14. of this appendix shall be performed by the test subject while the respirator seal is being continually challenged by the smoke, directed around the perimeter of the respirator at a distance of six inches.

(6) If the person being fit tested reports detecting the irritant smoke at any time, the test is failed. The person being retested must repeat the entire sensitivity check and fit test procedure.

(7) Each test subject passing the irritant smoke test without evidence of a response (involuntary cough, irritation) shall be given a second sensitivity screening check, with the smoke from the same smoke tube used during the fit test, once the respirator has been removed, to determine whether he/she still reacts to the smoke. Failure to evoke a response shall void the fit test.

(8) If a response is produced during this second sensitivity check, then the fit test is passed.

**C. Quantitative Fit Test (QNFT) Protocols**

The following quantitative fit testing procedures have been demonstrated to be acceptable: Quantitative fit testing using a non-hazardous test aerosol (such as corn oil, polyethylene glycol 400 [PEG 400], di-2-ethyl hexyl sebacate [DEHS], or sodium chloride) generated in a test chamber, and employing instrumentation to quantify the fit of the respirator; Quantitative fit testing using ambient aerosol as the test agent and appropriate instrumentation (condensation nuclei counter) to quantify the respirator fit; Quantitative fit testing using controlled negative pressure and appropriate instrumentation to measure the volumetric leak rate of a facepiece to quantify the respirator fit.

**1. General**

(a) The employer shall ensure that persons administering QNFT are able to calibrate equipment and perform tests properly, recognize invalid tests, calculate fit factors properly and ensure that test equipment is in proper working order.

(b) The employer shall ensure that QNFT equipment is kept clean, and is maintained and calibrated according to the manufacturer's instructions so as to operate at the parameters for which it was designed.



## 2. Generated Aerosol Quantitative Fit Testing Protocol

### (a) Apparatus.

(1) Instrumentation. Aerosol generation, dilution, and measurement systems using particulates (corn oil, polyethylene glycol 400 [PEG 400], di-2-ethyl hexyl sebacate [DEHS] or sodium chloride) as test aerosols shall be used for quantitative fit testing.

(2) Test chamber. The test chamber shall be large enough to permit all test subjects to perform freely all required exercises without disturbing the test agent concentration or the measurement apparatus. The test chamber shall be equipped and constructed so that the test agent is effectively isolated from the ambient air, yet uniform in concentration throughout the chamber.

(3) When testing air-purifying respirators, the normal filter or cartridge element shall be replaced with a high efficiency particulate air (HEPA) or P100 series filter supplied by the same manufacturer.

(4) The sampling instrument shall be selected so that a computer record or strip chart record may be made of the test showing the rise and fall of the test agent concentration with each inspiration and expiration at fit factors of at least 2,000. Integrators or computers that integrate the amount of test agent penetration leakage into the respirator for each exercise may be used provided a record of the readings is made.

(5) The combination of substitute air-purifying elements, test agent and test agent concentration shall be such that the test subject is not exposed in excess of an established exposure limit for the test agent at any time during the testing process, based upon the length of the exposure and the exposure limit duration.

(6) The sampling port on the test specimen respirator shall be placed and constructed so that no leakage occurs around the port (e.g., where the respirator is probed), a free air flow is allowed into the sampling line at all times, and there is no interference with the fit or performance of the respirator. The in-mask sampling device (probe) shall be designed and used so that the air sample is drawn from the breathing zone of the test subject, midway between the nose and mouth and with the probe extending into the facepiece cavity at least 1/4 inch.

(7) The test setup shall permit the person administering the test to observe the test subject inside the chamber during the test.

(8) The equipment generating the test atmosphere shall maintain the concentration of test agent constant to within a 10 percent variation for the duration of the test.

(9) The time lag (interval between an event and the recording of the event on the strip chart or computer or integrator) shall be kept to a minimum. There shall be a clear association between the occurrence of an event and its being recorded.

(10) The sampling line tubing for the test chamber atmosphere and for the respirator sampling port shall be of equal diameter and of the same material. The length of the two lines shall be equal.

(11) The exhaust flow from the test chamber shall pass through an appropriate filter (i.e., high efficiency particulate filter) before release.

(12) When sodium chloride aerosol is used, the relative humidity inside the test chamber shall not exceed 50 percent.

(13) The limitations of instrument detection shall be taken into account when determining the fit factor.

(14) Test respirators shall be maintained in proper working order and be inspected regularly for deficiencies such as cracks or missing valves and gaskets.

### (b) Procedural Requirements.

(1) When performing the initial user seal check using a positive or negative pressure check, the sampling line shall be crimped closed in order to avoid air pressure leakage during either of these pressure checks.

(2) The use of an abbreviated screening QLFT test is optional. Such a test may be utilized in order to quickly identify poor fitting respirators that passed the positive and/or negative pressure test and reduce the amount of QNFT time. The use of the CNC QNFT instrument in the count mode is another optional method to obtain a quick estimate of fit and eliminate poor fitting respirators before going on to perform a full QNFT.

(3) A reasonably stable test agent concentration shall be measured in the test chamber prior to testing. For canopy or shower curtain types of test units, the determination of the test agent's stability may be established after the test subject has entered the test environment.

(4) Immediately after the subject enters the test chamber, the test agent concentration inside the respirator shall be measured to ensure that the peak penetration does not exceed 5 percent for a half mask or 1 percent for a full facepiece respirator.

(5) A stable test agent concentration shall be obtained prior to the actual start of testing.

(6) Respirator restraining straps shall not be over-tightened for testing. The straps shall be adjusted by the wearer without assistance from other persons to give a reasonably comfortable fit typical of normal use. The respirator shall not be adjusted once the fit test exercises begin.

(7) The test shall be terminated whenever any single peak penetration exceeds 5 percent for half masks and 1 percent for full facepiece respirators. The test subject shall be refitted and retested.

(8) Calculation of fit factors.

(i) The fit factor shall be determined for the quantitative fit test by taking the ratio of the average chamber concentration to the concentration measured inside the respirator for each test exercise except the grimace exercise.

(ii) The average test chamber concentration shall be calculated as the arithmetic average of the concentration measured before and after each test (i.e., 7 exercises) or the arithmetic average of the concentration measured before and after each exercise or the true average measured continuously during the respirator sample.

(iii) The concentration of the challenge agent inside the respirator shall be determined by one of the following methods:

(A) Average peak penetration method means the method of determining test agent penetration into the respirator utilizing a strip chart recorder, integrator, or computer. The agent penetration is determined by an average of the peak heights on the graph or by computer integration, for each exercise except the grimace exercise. Integrators or computers that calculate the actual test agent penetration into the respirator for each exercise will also be considered to meet the requirements of the average peak penetration method.

(B) Maximum peak penetration method means the method of determining test agent penetration in the respirator as determined by strip chart recordings of the test. The highest peak penetration for a given exercise is taken to be representative of average penetration into the respirator for that exercise.

(C) Integration by calculation of the area under the individual peak for each exercise except the grimace exercise. This includes computerized integration.

(D) The calculation of the overall fit factor using individual exercise fit factors involves first converting the exercise fit factors to penetration values, determining the average, and then converting that result back to a fit factor. This procedure is described in the following equation:

$$\text{Overall Fit Factor} = \frac{\text{Number of exercises}}{1/ff_1 + 1/ff_2 + 1/ff_3 + 1/ff_4 + 1/ff_5 + 1/ff_7 + 1/ff_8}$$

Where ff1, ff2, ff3, etc. are the fit factors for exercises 1, 2, 3, etc.

(9) The test subject shall not be permitted to wear a half mask or quarter facepiece respirator unless a minimum fit factor of 100 is obtained, or a full facepiece respirator unless a minimum fit factor of 500 is obtained.

(10) Filters used for quantitative fit testing shall be replaced whenever increased breathing resistance is encountered, or when the test agent has altered the integrity of the filter media.

### 3. Ambient aerosol condensation nuclei counter (CNC) quantitative fit testing protocol.

The ambient aerosol condensation nuclei counter (CNC) quantitative fit testing (Portacount TM ) protocol quantitatively fit tests respirators with the use of a probe. The probed respirator is only used for quantitative fit tests. A probed respirator has a special sampling device, installed on the respirator, that allows the probe to sample the air from inside the mask. A probed respirator is required for each make, style, model, and size that the employer uses and can be obtained from the respirator manufacturer or distributor. The CNC instrument manufacturer, TSI Inc., also provides probe attachments (TSI sampling adapters) that permit fit testing in an employee's own respirator. A minimum fit factor pass level of at least 100 is necessary for a half-mask respirator and a minimum fit factor pass level of at least 500 is required for a full facepiece negative pressure respirator. The entire screening and testing procedure shall be explained to the test subject prior to the conduct of the screening test.

**(a) Portacount Fit Test Requirements.**

(1) Check the respirator to make sure the sampling probe and line are properly attached to the facepiece and that the respirator is fitted with a particulate filter capable of preventing significant penetration by the ambient particles used for the fit test (e.g., NIOSH 42 CFR 84 series 100, series 99, or series 95 particulate filter) per manufacturer's instruction.

(2) Instruct the person to be tested to don the respirator for five minutes before the fit test starts. This purges the ambient particles trapped inside the respirator and permits the wearer to make certain the respirator is comfortable. This individual shall already have been trained on how to wear the respirator properly.

(3) Check the following conditions for the adequacy of the respirator fit: Chin properly placed; Adequate strap tension, not overly tightened; Fit across nose bridge; Respirator of proper size to span distance from nose to chin; Tendency of the respirator to slip; Self-observation in a mirror to evaluate fit and respirator position.

(4) Have the person wearing the respirator do a user seal check. If leakage is detected, determine the cause. If leakage is from a poorly fitting facepiece, try another size of the same model respirator, or another model of respirator.

(5) Follow the manufacturer's instructions for operating the Portacount and proceed with the test.

(6) The test subject shall be instructed to perform the exercises in section I. A. 14. of this appendix.

(7) After the test exercises, the test subject shall be questioned by the test conductor regarding the comfort of the respirator upon completion of the protocol. If it has become unacceptable, another model of respirator shall be tried.

**(b) Portacount Test Instrument.**

(1) The Portacount will automatically stop and calculate the overall fit factor for the entire set of exercises. The overall fit factor is what counts. The Pass or Fail message will indicate whether or not the test was successful. If the test was a Pass, the fit test is over.

(2) Since the pass or fail criterion of the Portacount is user programmable, the test operator shall ensure that the pass or fail criterion meet the requirements for minimum respirator performance in this Appendix.

(3) A record of the test needs to be kept on file, assuming the fit test was successful. The record must contain the test subject's name; overall fit factor; make, model, style, and size of respirator used; and date tested.

**4. Controlled negative pressure (CNP) quantitative fit testing protocol.**

The CNP protocol provides an alternative to aerosol fit test methods. The CNP fit test method technology is based on exhausting air from a temporarily sealed respirator facepiece to generate and then maintain a constant negative pressure inside the facepiece. The rate of air exhaust is controlled so that a constant negative pressure is maintained in the respirator during the fit test. The level of pressure is selected to replicate the mean inspiratory pressure that causes leakage into the respirator under normal use conditions. With pressure held constant, air flow out of the respirator is equal to air flow into the respirator. Therefore, measurement of the exhaust stream that is required to hold the pressure in the temporarily sealed respirator constant yields a direct measure of leakage air flow into the respirator. The CNP fit test method measures leak rates through the facepiece as a method for determining the facepiece fit for negative pressure respirators. The CNP instrument manufacturer Dynatech Nevada also provides attachments (sampling manifolds) that replace the filter cartridges to permit fit testing in an employee's own respirator. To perform the test, the test subject closes his or her mouth and holds his/her breath, after which an air pump removes air from the respirator facepiece at a pre-selected constant pressure. The facepiece fit is expressed as the leak rate through the facepiece, expressed as milliliters per minute. The quality and validity of the CNP fit tests are determined by the degree to which the in-mask pressure tracks the test pressure during the system measurement time of approximately five seconds. Instantaneous feedback in the form of a real-time pressure trace of the in-mask pressure is provided and used to determine test validity and quality. A minimum fit factor pass level of 100 is necessary for a half-mask respirator and a minimum fit factor of at least 500 is required for a full facepiece respirator. The entire screening and testing procedure shall be explained to the test subject prior to the conduct of the screening test.

**(a) CNP Fit Test Requirements.**

(1) The instrument shall have a non-adjustable test pressure of 15.0 mm water pressure.

(2) The CNP system defaults selected for test pressure shall be set at -- 15 mm of water (-0.58 inches of water) and the modeled inspiratory flow rate shall be 53.8 liters per minute for performing fit tests.

**(Note:** CNP systems have built-in capability to conduct fit testing that is specific to unique work rate, mask, and gender situations that might apply in a specific workplace. Use of system default values, which were selected to represent respirator wear with medium cartridge resistance at a low-moderate work rate, will allow inter-test comparison of the respirator fit.)

(3) The individual who conducts the CNP fit testing shall be thoroughly trained to perform the test.

(4) The respirator filter or cartridge needs to be replaced with the CNP test manifold. The inhalation valve downstream from the manifold either needs to be temporarily removed or propped open.

(5) The test subject shall be trained to hold his or her breath for at least 20 seconds.

(6) The test subject shall don the test respirator without any assistance from the individual who conducts the CNP fit test.

(7) The QNFT protocol shall be followed according to section I.C. 1. of this appendix with an exception for the CNP test exercises.

**(b) CNP Test Exercises.**

(1) Normal breathing. In a normal standing position, without talking, the subject shall breathe normally for 1 minute. After the normal breathing exercise, the subject needs to hold head straight ahead and hold his or her breath for 10 seconds during the test measurement.

(2) Deep breathing. In a normal standing position, the subject shall breathe slowly and deeply for 1 minute, being careful not to hyperventilate. After the deep breathing exercise, the subject shall hold his or her head straight ahead and hold his or her breath for 10 seconds during test measurement.

(3) Turning head side to side. Standing in place, the subject shall slowly turn his or her head from side to side between the extreme positions on each side for 1 minute. The head shall be held at each extreme momentarily so the subject can inhale at each side. After the turning head side to side exercise, the subject needs to

hold head full left and hold his or her breath for 10 seconds during test measurement. Next, the subject needs to hold head full right and hold his or her breath for 10 seconds during test measurement.

(4) Moving head up and down. Standing in place, the subject shall slowly move his or her head up and down for 1 minute. The subject shall be instructed to inhale in the up position (i.e., when looking toward the ceiling). After the moving head up and down exercise, the subject shall hold his or her head full up and hold his or her breath for 10 seconds during test measurement. Next, the subject shall hold his or her head full down and hold his or her breath for 10 seconds during test measurement.

(5) Talking. The subject shall talk out loud slowly and loud enough so as to be heard clearly by the test conductor. The subject can read from a prepared text such as the Rainbow Passage, count backward from 100, or recite a memorized poem or song for 1 minute. After the talking exercise, the subject shall hold his or her head straight ahead and hold his or her breath for 10 seconds during the test measurement.

(6) Grimace. The test subject shall grimace by smiling or frowning for 15 seconds.

(7) Bending Over. The test subject shall bend at the waist as if he or she were to touch his or her toes for 1 minute. Jogging in place shall be substituted for this exercise in those test environments such as shroud-type QNFT units that prohibit bending at the waist. After the bending over exercise, the subject shall hold his or her head straight ahead and hold his or her breath for 10 seconds during the test measurement.

(8) Normal Breathing. The test subject shall remove and re-don the respirator within a one-minute period. Then, in a normal standing position, without talking, the subject shall breathe normally for 1 minute. After the normal breathing exercise, the subject shall hold his or her head straight ahead and hold his or her breath for 10 seconds during the test measurement. After the test exercises, the test subject shall be questioned by the test conductor regarding the comfort of the respirator upon completion of the protocol. If it has become unacceptable, another model of a respirator shall be tried.

**(c) CNP Test Instrument.**

(1) The test instrument shall have an effective audio warning device when the test subject fails to hold his or her breath during the test. The test shall be terminated whenever the test subject failed to hold his or her breath. The test subject may be refitted and retested.

(2) A record of the test shall be kept on file, assuming the fit test was successful. The record must contain the test subject's name; overall fit factor; make, model, style and size of respirator used; and date tested.

**Part II. New Fit Test Protocols**

A. Any person may submit to OSHA an application for approval of a new fit test protocol. If the application meets the following criteria, OSHA will initiate a rulemaking proceeding under section 6(b)(7) of the OSH Act to determine whether to list the new protocol as an approved protocol in this Appendix A.

B. The application must include a detailed description of the proposed new fit test protocol. This application must be supported by either:

1. A test report prepared by an independent government research laboratory (e.g., Lawrence Livermore National Laboratory, Los Alamos National Laboratory, the National Institute for Standards and Technology) stating that the laboratory has tested the protocol and had found it to be accurate and reliable; or

2. An article that has been published in a peer-reviewed industrial hygiene journal describing the protocol and explaining how test data support the protocol's accuracy and reliability.

C. If OSHA determines that additional information is required before the Agency commences a rulemaking proceeding under this section, OSHA will so notify the applicant and afford the applicant the opportunity to submit the supplemental information. Initiation of a rulemaking proceeding will be deferred until OSHA has received and evaluated the supplemental information.

[63 FR 20098, April 23, 1998]

**Appendix B-1 to § 1910.134: User Seal Check Procedures (Mandatory)**

The individual who uses a tight-fitting respirator is to perform a user seal check to ensure that an adequate seal is achieved each time the respirator is put on. Either the positive and negative pressure checks listed in this appendix, or the respirator manufacturer's recommended user seal check method shall be used. User seal checks are not substitutes for qualitative or quantitative fit tests.

**I. Facepiece Positive and/or Negative Pressure Checks****A. Positive pressure check.**

Close off the exhalation valve and exhale gently into the facepiece. The face fit is considered satisfactory if a slight positive pressure can be built up inside the facepiece without any evidence of outward leakage of air at the seal. For most respirators this method of leak testing requires the wearer to first remove the exhalation valve cover before closing off the exhalation valve and then carefully replacing it after the test.

**B. Negative pressure check.**

Close off the inlet opening of the canister or cartridge(s) by covering with the palm of the hand(s) or by replacing the filter seal(s), inhale gently so that the facepiece collapses slightly, and hold the breath for ten seconds. The design of the inlet opening of some cartridges cannot be effectively covered with the palm of the hand. The test can be performed by covering the inlet opening of the cartridge with a thin latex or nitrile glove. If the facepiece remains in its slightly collapsed condition and no inward leakage of air is detected, the tightness of the respirator is considered satisfactory.

**II. Manufacturer's Recommended User Seal Check Procedures**

The respirator manufacturer's recommended procedures for performing a user seal check may be used instead of the positive and/or negative pressure check procedures provided that the employer demonstrates that the manufacturer's procedures are equally effective.

[63 FR 1152, Jan. 8, 1998]

### Appendix B-2 to § 1910.134: Respirator Cleaning Procedures (Mandatory)

These procedures are provided for employer use when cleaning respirators. They are general in nature, and the employer as an alternative may use the cleaning recommendations provided by the manufacturer of the respirators used by their employees, provided such procedures are as effective as those listed here in Appendix B-2. Equivalent effectiveness simply means that the procedures used must accomplish the objectives set forth in Appendix B-2, i.e., must ensure that the respirator is properly cleaned and disinfected in a manner that prevents damage to the respirator and does not cause harm to the user.

#### I. Procedures for Cleaning Respirators

A. Remove filters, cartridges, or canisters. Disassemble facepieces by removing speaking diaphragms, demand and pressure- demand valve assemblies, hoses, or any components recommended by the manufacturer. Discard or repair any defective parts.

B. Wash components in warm (43 deg. C [110 deg. F] maximum) water with a mild detergent or with a cleaner recommended by the manufacturer. A stiff bristle (not wire) brush may be used to facilitate the removal of dirt.

C. Rinse components thoroughly in clean, warm (43 deg. C [110 deg. F] maximum), preferably running water. Drain.

D. When the cleaner used does not contain a disinfecting agent, respirator components should be immersed for two minutes in one of the following:

1. Hypochlorite solution (50 ppm of chlorine) made by adding approximately one milliliter of laundry bleach to one liter of water at 43 deg. C (110 deg. F); or,

2. Aqueous solution of iodine (50 ppm iodine) made by adding approximately 0.8 milliliters of tincture of iodine (6-8 grams ammonium and/or potassium iodide/100 cc of 45% alcohol) to one liter of water at 43 deg. C (110 deg. F); or,

3. Other commercially available cleansers of equivalent disinfectant quality when used as directed, if their use is recommended or approved by the respirator manufacturer.

E. Rinse components thoroughly in clean, warm (43 deg. C [110 deg. F] maximum), preferably running water. Drain. The importance of thorough rinsing cannot be overemphasized.

Detergents or disinfectants that dry on facepieces may result in dermatitis. In addition, some disinfectants may cause deterioration of rubber or corrosion of metal parts if not completely removed.

F. Components should be hand-dried with a clean lint-free cloth or air-dried.

G. Reassemble facepiece, replacing filters, cartridges, and canisters where necessary.

H. Test the respirator to ensure that all components work properly.

[63 FR 1152, Jan. 8, 1998]

### Appendix C to Sec. 1910.134: OSHA Respirator Medical Evaluation Questionnaire (Mandatory)

To the employer: Answers to questions in Section 1, and to question 9 in Section 2 of Part A, do not require a medical examination.

To the employee:

Can you read (circle one): Yes/No

Your employer must allow you to answer this questionnaire during normal working hours, or at a time and place that is convenient to you. To maintain your confidentiality, your employer or supervisor must not look at or review your answers, and your employer must tell you how to deliver or send this questionnaire to the health care professional who will review it.

#### Part A. Section 1. (Mandatory)

The following information must be provided by every employee who has been selected to use any type of respirator (please print).

1. Today's date: \_\_\_\_\_
2. Your name: \_\_\_\_\_
3. Your age (to nearest year): \_\_\_\_\_
4. Sex (circle one): Male/Female
5. Your height: \_\_\_\_\_ ft. \_\_\_\_\_ in.
6. Your weight: \_\_\_\_\_ lbs.
7. Your job title: \_\_\_\_\_

8. A phone number where you can be reached by the health care professional who reviews this questionnaire (include the Area Code):  
\_\_\_\_\_
9. The best time to phone you at this number:  
\_\_\_\_\_
10. Has your employer told you how to contact the health care professional who will review this questionnaire (circle one): Yes/No
11. Check the type of respirator you will use (you can check more than one category):  
a. \_\_\_\_\_ N, R, or P disposable respirator (filter-mask, non- cartridge type only).  
b. \_\_\_\_\_ Other type (for example, half- or full-facepiece type, powered-air purifying, supplied-air, self-contained breathing apparatus).
12. Have you worn a respirator (circle one):  
Yes/No  
  
If "yes," what type(s): \_\_\_\_\_  
\_\_\_\_\_  
\_\_\_\_\_
- Part A. Section 2. (Mandatory)**
- Questions 1 through 9 below must be answered by every employee who has been selected to use any type of respirator (please circle "yes" or "no").
1. Do you currently smoke tobacco, or have you smoked tobacco in the last month: Yes/No
2. Have you ever had any of the following conditions?  
a. Seizures (fits): Yes/No  
b. Diabetes (sugar disease): Yes/No  
c. Allergic reactions that interfere with your breathing: Yes/No  
d. Claustrophobia (fear of closed-in places): Yes/No  
e. Trouble smelling odors: Yes/No
3. Have you ever had any of the following pulmonary or lung problems?  
a. Asbestosis: Yes/No  
b. Asthma: Yes/No  
c. Chronic bronchitis: Yes/No  
d. Emphysema: Yes/No  
e. Pneumonia: Yes/No  
f. Tuberculosis: Yes/No  
g. Silicosis: Yes/No  
h. Pneumothorax (collapsed lung): Yes/No  
i. Lung cancer: Yes/No  
j. Broken ribs: Yes/No  
k. Any chest injuries or surgeries: Yes/No  
l. Any other lung problem that you've been told about: Yes/No
4. Do you currently have any of the following symptoms of pulmonary or lung illness?  
a. Shortness of breath: Yes/No  
b. Shortness of breath when walking fast on level ground or walking up a slight hill or incline: Yes/No  
c. Shortness of breath when walking with other people at an ordinary pace on level ground: Yes/No  
d. Have to stop for breath when walking at your own pace on level ground: Yes/No  
e. Shortness of breath when washing or dressing yourself: Yes/No  
f. Shortness of breath that interferes with your job: Yes/No  
g. Coughing that produces phlegm (thick sputum): Yes/No  
h. Coughing that wakes you early in the morning: Yes/No  
i. Coughing that occurs mostly when you are lying down: Yes/No  
j. Coughing up blood in the last month: Yes/No  
k. Wheezing: Yes/No  
l. Wheezing that interferes with your job: Yes/No  
m. Chest pain when you breathe deeply: Yes/No  
n. Any other symptoms that you think may be related to lung problems: Yes/No
5. Have you ever had any of the following cardiovascular or heart problems?  
a. Heart attack: Yes/No  
b. Stroke: Yes/No  
c. Angina: Yes/No  
d. Heart failure: Yes/No  
e. Swelling in your legs or feet (not caused by walking): Yes/No  
f. Heart arrhythmia (heart beating irregularly): Yes/No  
g. High blood pressure: Yes/No  
h. Any other heart problem that you've been told about: Yes/No

6. Have you ever had any of the following cardiovascular or heart symptoms?
- Frequent pain or tightness in your chest: Yes/No
  - Pain or tightness in your chest during physical activity: Yes/No
  - Pain or tightness in your chest that interferes with your job: Yes/No
  - In the past two years, have you noticed your heart skipping or missing a beat: Yes/No
  - Heartburn or indigestion that is not related to eating: Yes/ No
  - Any other symptoms that you think may be related to heart or circulation problems: Yes/No
7. Do you currently take medication for any of the following problems?
- Breathing or lung problems: Yes/No
  - Heart trouble: Yes/No
  - Blood pressure: Yes/No
  - Seizures (fits): Yes/No
8. If you've used a respirator, have you ever had any of the following problems? (If you've never used a respirator, check the following space and go to question 9):
- Eye irritation: Yes/No
  - Skin allergies or rashes: Yes/No
  - Anxiety: Yes/No
  - General weakness or fatigue: Yes/No
  - Any other problem that interferes with your use of a respirator: Yes/No
9. Would you like to talk to the health care professional who will review this questionnaire about your answers to this questionnaire: Yes/No

Questions 10 to 15 below must be answered by every employee who has been selected to use either a full-facepiece respirator or a self-contained breathing apparatus (SCBA). For employees who have been selected to use other types of respirators, answering these questions is voluntary.

10. Have you ever lost vision in either eye (temporarily or permanently): Yes/No

11. Do you currently have any of the following vision problems?
- Wear contact lenses: Yes/No
  - Wear glasses: Yes/No
  - Color blind: Yes/No
  - Any other eye or vision problem: Yes/No
12. Have you ever had an injury to your ears, including a broken ear drum: Yes/No
13. Do you currently have any of the following hearing problems?
- Difficulty hearing: Yes/No
  - Wear a hearing aid: Yes/No
  - Any other hearing or ear problem: Yes/No
14. Have you ever had a back injury: Yes/No
15. Do you currently have any of the following musculoskeletal problems?
- Weakness in any of your arms, hands, legs, or feet: Yes/No
  - Back pain: Yes/No
  - Difficulty fully moving your arms and legs: Yes/No
  - Pain or stiffness when you lean forward or backward at the waist: Yes/No
  - Difficulty fully moving your head up or down: Yes/No
  - Difficulty fully moving your head side to side: Yes/No
  - Difficulty bending at your knees: Yes/No
  - Difficulty squatting to the ground: Yes/No
  - Climbing a flight of stairs or a ladder carrying more than 25 lbs: Yes/No
  - Any other muscle or skeletal problem that interferes with using a respirator: Yes/No

### Part B

Any of the following questions, and other questions not listed, may be added to the questionnaire at the discretion of the health care professional who will review the questionnaire.

1. In your present job, are you working at high altitudes (over 5,000 feet) or in a place that has lower than normal amounts of oxygen: Yes/No
- If "yes," do you have feelings of dizziness, shortness of breath, pounding in your chest, or other symptoms when you're working under these conditions: Yes/No



2. At work or at home, have you ever been exposed to hazardous solvents, hazardous airborne chemicals (e.g., gases, fumes, or dust), or have you come into skin contact with hazardous chemicals: Yes/No  
 If "yes," name the chemicals if you know them: \_\_\_\_\_  
 \_\_\_\_\_  
 \_\_\_\_\_

3. Have you ever worked with any of the materials, or under any of the conditions, listed below:  
 a. Asbestos: Yes/No  
 b. Silica (e.g., in sandblasting): Yes/No  
 c. Tungsten/cobalt (e.g., grinding or welding this material): Yes/No  
 d. Beryllium: Yes/No  
 e. Aluminum: Yes/No  
 f. Coal (for example, mining): Yes/No  
 g. Iron: Yes/No  
 h. Tin: Yes/No  
 i. Dusty environments: Yes/No  
 j. Any other hazardous exposures: Yes/No  
 If "yes," describe these exposures: \_\_\_\_\_  
 \_\_\_\_\_  
 \_\_\_\_\_

4. List any second jobs or side businesses you have: \_\_\_\_\_  
 \_\_\_\_\_

5. List your previous occupations: \_\_\_\_\_  
 \_\_\_\_\_  
 \_\_\_\_\_

6. List your current and previous hobbies: \_\_\_\_\_  
 \_\_\_\_\_  
 \_\_\_\_\_

7. Have you been in the military services? Yes/No  
 If "yes," were you exposed to biological or chemical agents (either in training or combat): Yes/No

8. Have you ever worked on a HAZMAT team? Yes/No

9. Other than medications for breathing and lung problems, heart trouble, blood pressure, and seizures mentioned earlier in this questionnaire, are you taking any other

medications for any reason (including over-the-counter medications): Yes/No  
 If "yes," name the medications if you know them: \_\_\_\_\_

10. Will you be using any of the following items with your respirator(s)?  
 a. HEPA Filters: Yes/No  
 b. Canisters (for example, gas masks): Yes/No  
 c. Cartridges: Yes/No

11. How often are you expected to use the respirator(s) (circle "yes" or "no" for all answers that apply to you)?  
 a. Escape only (no rescue): Yes/No  
 b. Emergency rescue only: Yes/No  
 c. Less than 5 hours per week: Yes/No  
 d. Less than 2 hours per day: Yes/No  
 e. 2 to 4 hours per day: Yes/No  
 f. Over 4 hours per day: Yes/No

12. During the period you are using the respirator(s), is your work effort:  
 a. Light (less than 200 kcal per hour): Yes/No  
 If "yes," how long does this period last during the average shift: \_\_\_\_\_ hrs. \_\_\_\_\_ mins.  
 Examples of a light work effort are sitting while writing, typing, drafting, or performing light assembly work; or standing while operating a drill press (1-3 lbs.) or controlling machines.

b. Moderate (200 to 350 kcal per hour): Yes/No  
 If "yes," how long does this period last during the average shift: \_\_\_\_\_ hrs. \_\_\_\_\_ mins.  
 Examples of moderate work effort are sitting while nailing or filing; driving a truck or bus in urban traffic; standing while drilling, nailing, performing assembly work, or transferring a moderate load (about 35 lbs.) at trunk level; walking on a level surface about 2 mph or down a 5-degree grade about 3 mph; or pushing a wheelbarrow with a heavy load (about 100 lbs.) on a level surface.

c. Heavy (above 350 kcal per hour): Yes/No  
 If "yes," how long does this period last during the average shift: \_\_\_\_\_ hrs. \_\_\_\_\_ mins.  
 Examples of heavy work are lifting a heavy load (about 50 lbs.) from the floor to your waist or shoulder; working on a loading dock; shoveling; standing while bricklaying or chipping castings; walking up an 8-degree

grade about 2 mph; climbing stairs with a heavy load (about 50 lbs.).

13. Will you be wearing protective clothing and/or equipment (other than the respirator) when you're using your respirator: Yes/No  
If "yes," describe this protective clothing and/or equipment:

\_\_\_\_\_  
\_\_\_\_\_

14. Will you be working under hot conditions (temperature exceeding 77 deg. F): Yes/No

15. Will you be working under humid conditions: Yes/No

16. Describe the work you'll be doing while you're using your respirator(s):

\_\_\_\_\_  
\_\_\_\_\_  
\_\_\_\_\_

17. Describe any special or hazardous conditions you might encounter when you're using your respirator(s) (for example, confined spaces, life-threatening gases):

\_\_\_\_\_  
\_\_\_\_\_  
\_\_\_\_\_

18. Provide the following information, if you know it, for each toxic substance that you'll be exposed to when you're using your respirator(s): Name of the first toxic substance: \_\_\_\_\_

Estimated maximum exposure level per shift \_\_\_\_\_

Duration of exposure per shift \_\_\_\_\_

Name of the second toxic substance: \_\_\_\_\_

Estimated maximum exposure level per shift: \_\_\_\_\_

Duration of exposure per shift: \_\_\_\_\_

Name of the third toxic substance: \_\_\_\_\_

\_\_\_\_\_

Estimated maximum exposure level per shift:

Duration of exposure per shift: \_\_\_\_\_

The name of any other toxic substances that you'll be exposed to while using your respirator: \_\_\_\_\_

\_\_\_\_\_  
\_\_\_\_\_

19. Describe any special responsibilities you'll have while using your respirator(s) that may affect the safety and well-being of others (for example, rescue, security): \_\_\_\_\_

\_\_\_\_\_  
\_\_\_\_\_

[63 FR 1152, Jan. 8, 1998; 63 FR 20098, April 23, 1998]

**Appendix D to Sec. 1910.134 (Mandatory) Information for Employees Using Respirators When Not Required Under the Standard**

Respirators are an effective method of protection against designated hazards when properly selected and worn. Respirator use is encouraged, even when exposures are below the exposure limit, to provide an additional level of comfort and protection for workers. However, if a respirator is used improperly or not kept clean, the respirator itself can become a hazard to the worker.

Sometimes, workers may wear respirators to avoid exposures to hazards, even if the amount of hazardous substance does not exceed the limits set by OSHA standards. If your employer provides respirators for your voluntary use, or if you provide your own respirator, you need to take certain precautions to be sure that the respirator itself does not present a hazard.

You should do the following:

- 1. Read and heed all instructions provided by the manufacturer on use, maintenance, cleaning, and care, and warnings regarding the respirator's limitations.

2. Choose respirators certified for use to protect against the contaminant of concern. NIOSH, the National Institute for Occupational Safety and Health of the U.S. Department of Health and Human Services, certifies respirators. A label or statement of certification should appear on the respirator or respirator packaging. It will tell you what the respirator is designed for and how much it will protect you.

3. Do not wear your respirator into atmospheres containing contaminants for which your respirator is not designed to protect against. For example, a respirator designed to filter dust particles will not protect you against gases, vapors, or very small solid particles of fumes or smoke.

4. Keep track of your respirator so that you do not mistakenly use someone else's respirator.

[63 FR 1152, Jan. 8, 1998; 63 FR 20098, April 23, 1998]



## A

**Absorption** - The process by which a chemical or particle is captured and trapped while passing through pores or interstices in a filter or similar device.

**Acute** - Health problems of a short-term nature, which may occur 6 to 12 hours after exposure.

**ACGIH** - American Conference of Governmental Industrial Hygienists

**Administrative controls** - Exposure control measures that reduce exposure to an acceptable limit by scheduling reduced work times in contaminated areas and establishing work rules.

**AIHA** - American Industrial Hygiene Association

**Air purifying respirator** - A respirator that cleans inhaled air by means of filters before it enters the user's lungs.

**ANSI** - American National Standards Institute

**Antibiotic** - A substance produced by certain fungi, bacteria, or other organisms that is used to inhibit the growth or destroy other microorganisms that cause diseases. Antibiotics include penicillin and streptomycin.

**Anthrax bacterium** - The spore-forming bacterium that cause a very serious infectious disease.

**APR** - Air purifying respirator

**Aspergillus** - Group of molds that can cause allergic and infectious diseases.

**Asthma** - A disorder characterized by the narrowing of bronchial airways due to inflammation of the bronchi. Asthma has many causes, among them Aspergillus molds.

## B

**Bacteria** - One-celled microorganisms. Most are harmless, but some can cause infectious diseases in humans, animals, and plants. Tuberculosis and anthrax are two examples of diseases caused by bacteria.

**Bioaerosols** - Airborne particles that are living, or that originate from living organisms, including fungi and bacteria.

**Breakthrough** - The point at which chemicals begin to pass through a respirator filter because the saturation point of the filter has been reached.

**Building related illness** - A physician-diagnosed illness such as asthma brought on or exacerbated by poor indoor air quality.

## C

**C** - Ceiling limit

**C°** - Celsius or centigrade

**Carcinogen** - A substance that causes cancer.

**Caution** - A warning word used on a label to indicate that the worker must use the material with care.

**CDC** - Center for Disease Control

**Ceiling limit** - Exposure level for a substance that must never be exceeded.

**CFR** - Code of Federal Regulations

**cfm** - Cubic feet per minute; the rated capacity of a negative air machine; that is, the amount of air the machine can move in a minute.

**CFU** - Colony-forming units

**Chronic** - Long-term health problems, which include asthma, HP, allergic bronchopulmonary aspergillosis, allergic sinusitis, and infection.

**CIH** - Certified industrial hygienist

**Cleanup or clean-up operation** - Actions taken to deal with a hazardous substance that could affect people or the environment. The term “cleanup” is sometimes used interchangeably with the terms remedial action, removal action, response action, remedy, remediation, or corrective action.

## D

**Danger** - The most severe warning word used on a label and indicates that the worker must use the material with extreme care.

**Decontamination** - Process of removing or neutralizing contaminants that have accumulated on PPE, tools, or equipment used on the job.

**DHHS** - Department of Health and Human Services

**Disinfectant** - A substance used to clean surfaces of pathogenic microorganisms.

**Doffing** - The act of removing PPE.

**Donning** - The act of putting on PPE.

**DOT** - Department of Transportation

**DRI** - Direct reading instruments

## E

**Engineering controls** - Exposure control measure that reduces or eliminates exposures by using mechanical means, such as ventilation systems, acoustical material, and clean air control booths. This measure does not eliminate the hazard.

**EPA** - Environmental Protection Agency

**ESLI** - End of service life indicator

**Exposure guides** - Phrase, word, number, or symbol used to inform workers about potentially hazardous chemicals.

## F

**Fungi** - Parasitic plants living on living organisms or on materials made from living organisms, such as paper, lumber, fabrics, etc.; can cause indoor air pollution.

## G

**GFCI** - Ground fault circuit interrupter

## H

**Hazard** - Any condition, situation, or agent that has the potential to produce an undesirable effect.

**Hazardous substances** - Any substances, materials, or chemicals that can damage the health and well-being of workers or the environment.

**HEPA filter** - High efficiency particulate air filter

**High efficiency particulate air filter** - A filter capable of capturing 99.97% of the particles pulled through it.

**Histoplasmosis** - Fungal infection caused by exposure to soil contaminated by bird and/or bat droppings.

**HMIS** - Hazardous materials identification system

**HP** - Hypersensitivity Pneumonitis

**HVAC** - Heating, ventilation, and air conditioning system

## I

**IAA** - Isoamyl acetate (banana oil), which is used in the process of respirator qualitative fit testing.

**IDLH** - Immediately dangerous to life or health

**Immediately dangerous to life or health** - An exposure level in an environment likely to cause death or serious health effects with very short exposures.

**Ingestion** - 1. The act of taking food and other substances into the body by the mouth. 2. A route of entry into the body along with food or water, or through inhalation and then swallowing.

**Inhalation** - 1. The act of breathing in a substance in the form of a gas, vapor, fume, mist, or dust. 2. A route of entry into the body for microorganisms, chemicals, or physical agents during breathing.

## L

**LIUNA** - Laborers' International Union of North America

## M

**Material safety data sheet** - The primary source of information for hazardous chemicals used on a microbial remediation work site.

**Maximum use concentration** - The highest concentration of a specific contaminant for which a cartridge or canister provides approved protection.

**mg/m<sup>3</sup>** - milligrams per cubic meter

**Microbial** - Refers to microorganisms; a minute life-form; a microscopic organism, especially one that can cause disease

**Mold** - A type of fungi that can grow where there is moisture, oxygen, and a good food source; can cause indoor air pollution

**MSDS** - Material safety data sheet

**MSHA** - Mine Safety and Health Administration

**MUC** - Maximum use concentration

**MVOC** - Microbial volatile organic compounds

**Mycotoxins** - Toxic compounds that are released into the air by fungi.

## N

**Negative Pressure** - Created in an enclosure by the ventilation system, which acts as a vacuum, drawing air into the area.

**NFPA** - National Fire Protection Association

**NIOSH** - National Institute of Occupational Safety and Health

## O

**ODTS** - Organic Dust Toxic Syndrome

**OSHA** - Occupational Safety and Health Administration

**Overbreathing** - When, under heavy work conditions, a worker uses more air than a PAPR can provide, creating negative pressure in the mask.

**P**

**PAPR** - Powered air purifying respirator

**Pathogen** - The specific cause of a disease.

**PEL** - Permissible exposure limit

**Penetration** - The process of a chemical passing through a garment by way of openings in the material, such as zippers and seams.

**Penicillium** - Common blue-green mold associated with asthma and hypersensitivity pneumonitis

**Personal protective equipment** - Any protective clothing or device used to prevent contact with and exposure to chemical and nonchemical hazards in the work place.

**PF** - Protection factor

**PPE** - Personal protective equipment

**ppm** - parts per million

**Poor warning properties** - Absence of odor, taste, or other traits that warns of the presence of a chemical.

**Protection factor** - The rating assigned to a respirator or class of respirators that represents the level of protection it provides.

**PVC** - Polyvinyl chloride

**Q**

**QLFT** - Qualitative fit testing

**QNFT** - Quantitative fit testing

**Qualitative fit test** - A test that determines respirator fit and involves introducing a harmless, odorous, or irritating substance into the breathing zone of the wearer.

**Quantitative fit test** - A sophisticated type of fit test that measures the actual amount of leakage into the respirator.

**R**

**REL** - Recommended exposure level (NIOSH).

**Relative humidity** - The amount of water vapor in the air compared with the amount of vapor needed to make the air saturated at the current temperature of the air.

**Remediation** - The actual work of cleaning up a microbial work site, which involves identification and removal of contaminated materials, then reconditioning the area to a prevent recurrence.

**Respirator** - A piece of equipment used to reduce airborne exposures by preventing contaminants from being inhaled by the user.

**S**

**Short-term exposure limit** - Maximum concentration level of a substance to which workers can be exposed for a short period of time (usually 10 to 15 minutes) without suffering from adverse health effects.

**Sick building syndrome** - A general category for a number of ailments, allergies, and complaints due to the physical aspects of a building.

**SOP** - Standard operating procedure

**Sorbent** - Granular material in a respirator cartridge or canister that absorbs specific contaminants from the air as the air is inhaled.

**Spores** - Single-celled reproductive structure of fungus and bacterium.

**Stachybotrys Chartarum** - Fungi found in substances rich in cellulose and that have typically experienced water damage.

**Standard operating procedure** - Required procedures for performing the variety of work associated with activities at a hazardous waste site.



**Substitution** - Exposure control measure that eliminates a hazardous chemical by replacing it with a nonhazardous or less hazardous chemical that works as well. This control measure is the most desirable.

## T

**Threshold Limit Values** - Inhalation exposure limits set yearly by the ACGIH.

**Time weighted average** - Average concentration of a substance in an area over an 8-hour work shift of a 40-hour work week.

**TLV** - Threshold limit values

## U

**No entries**

## V

**Viruses** - Any of a large group of non-living submicroscopic organisms. Viruses grow and multiply only in living cells. Some cause serious diseases in humans, animals, and plants. Polio and smallpox are caused by specific viruses, for example.

**VOC** - Volatile organic compound

## W

**Warning** - A warning word used on a label to indicate that the worker must use the material with care and that it presents more risk than a caution label.

## X, Y, Z

**No entries**







**Laborers-AGC Education and Training Fund**

37 Deerfield Road, P.O. Box 37

Pomfret Center, CT 06259

(860) 974-0800