

# NATIONAL AERONAUTICS AND SPACE ADMINISTRATION

## ORGANIZATION CHART

JULY 18, 1958

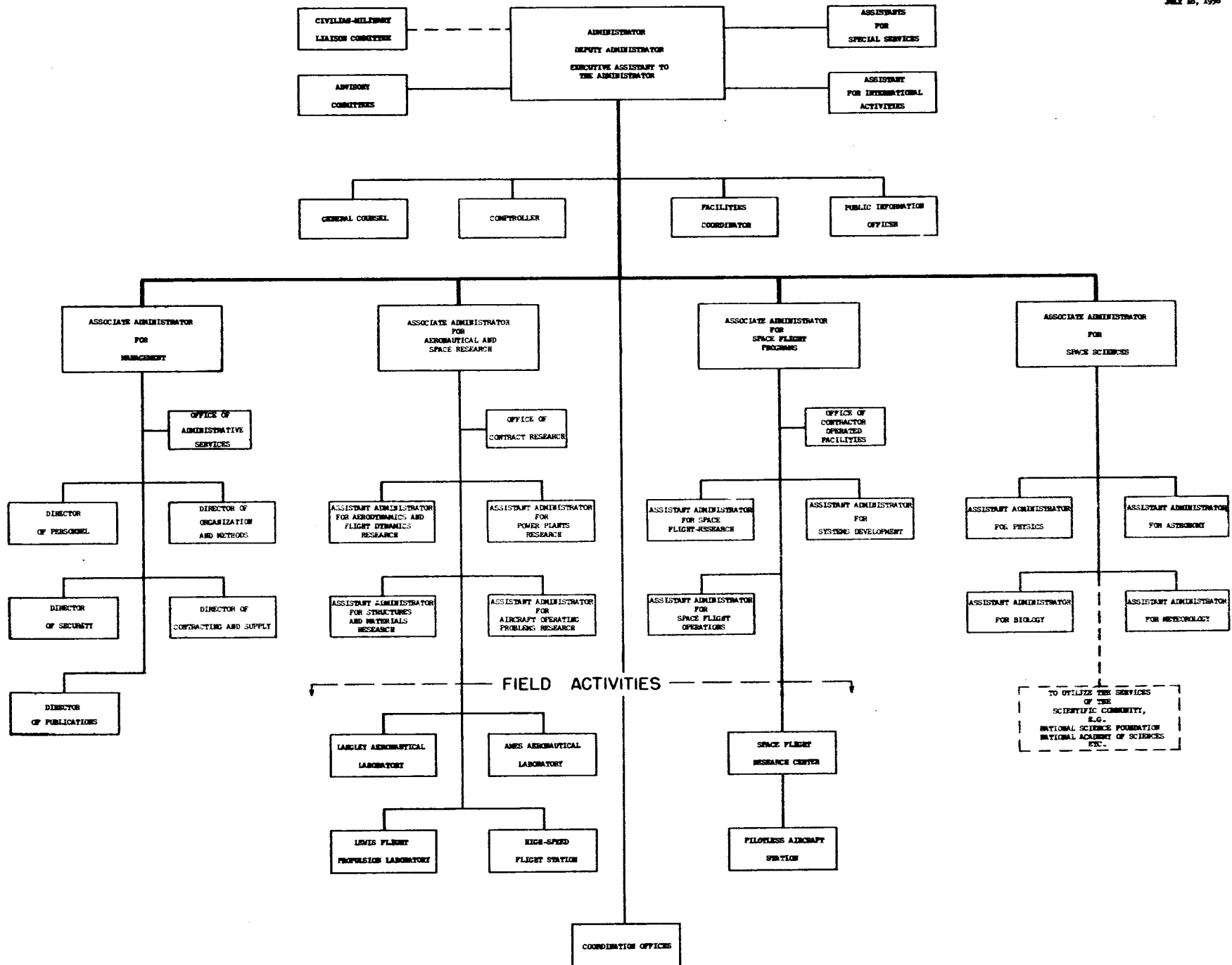

# NATIONAL AERONAUTICS AND SPACE ADMINISTRATION

## ORGANIZATION CHART

AUGUST 11, 1958

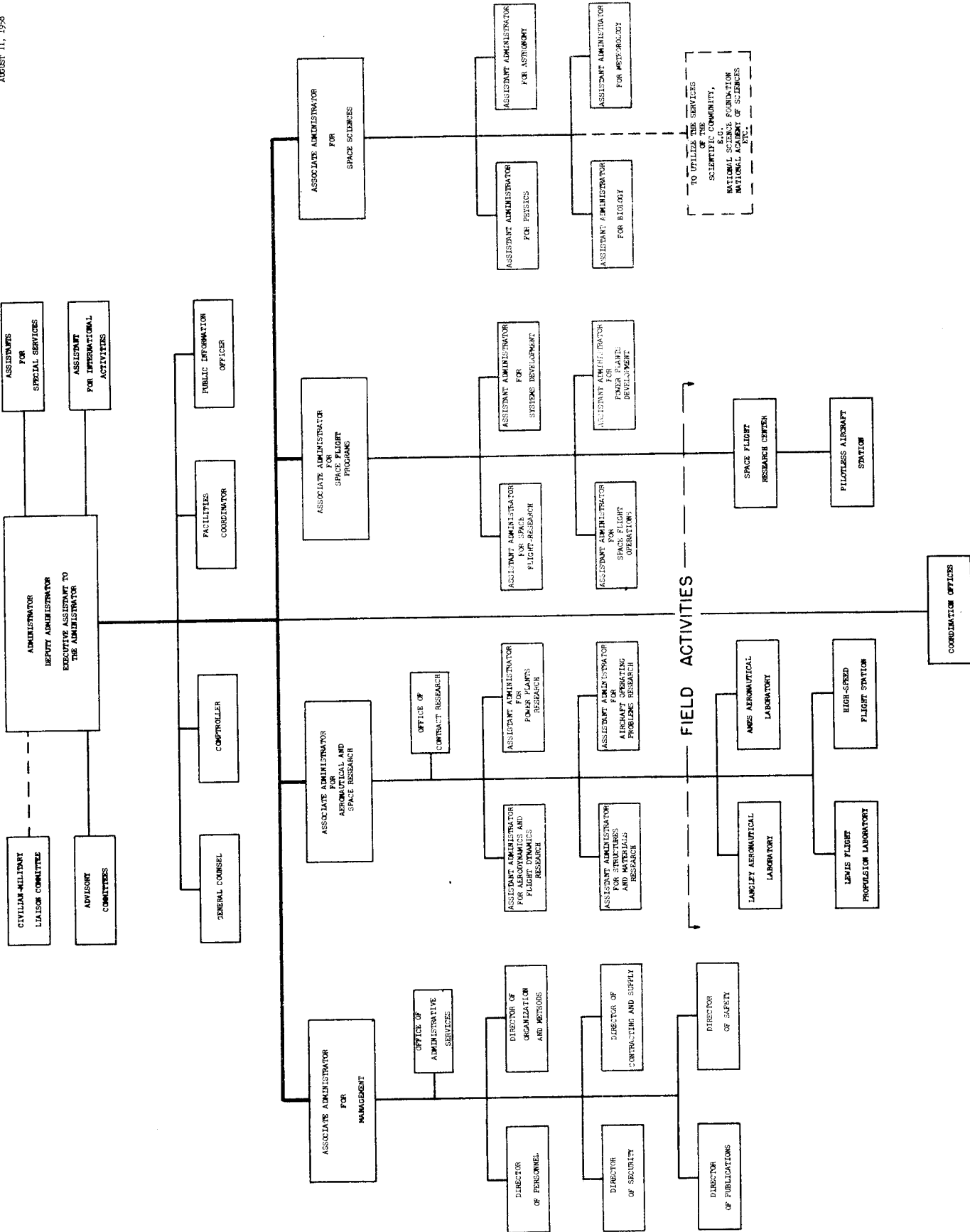

(COPY)

NATIONAL AERONAUTICS AND SPACE ADMINISTRATION, ORGANIZATION CHART (8-21-58)

Administrator  
Deputy Administrator

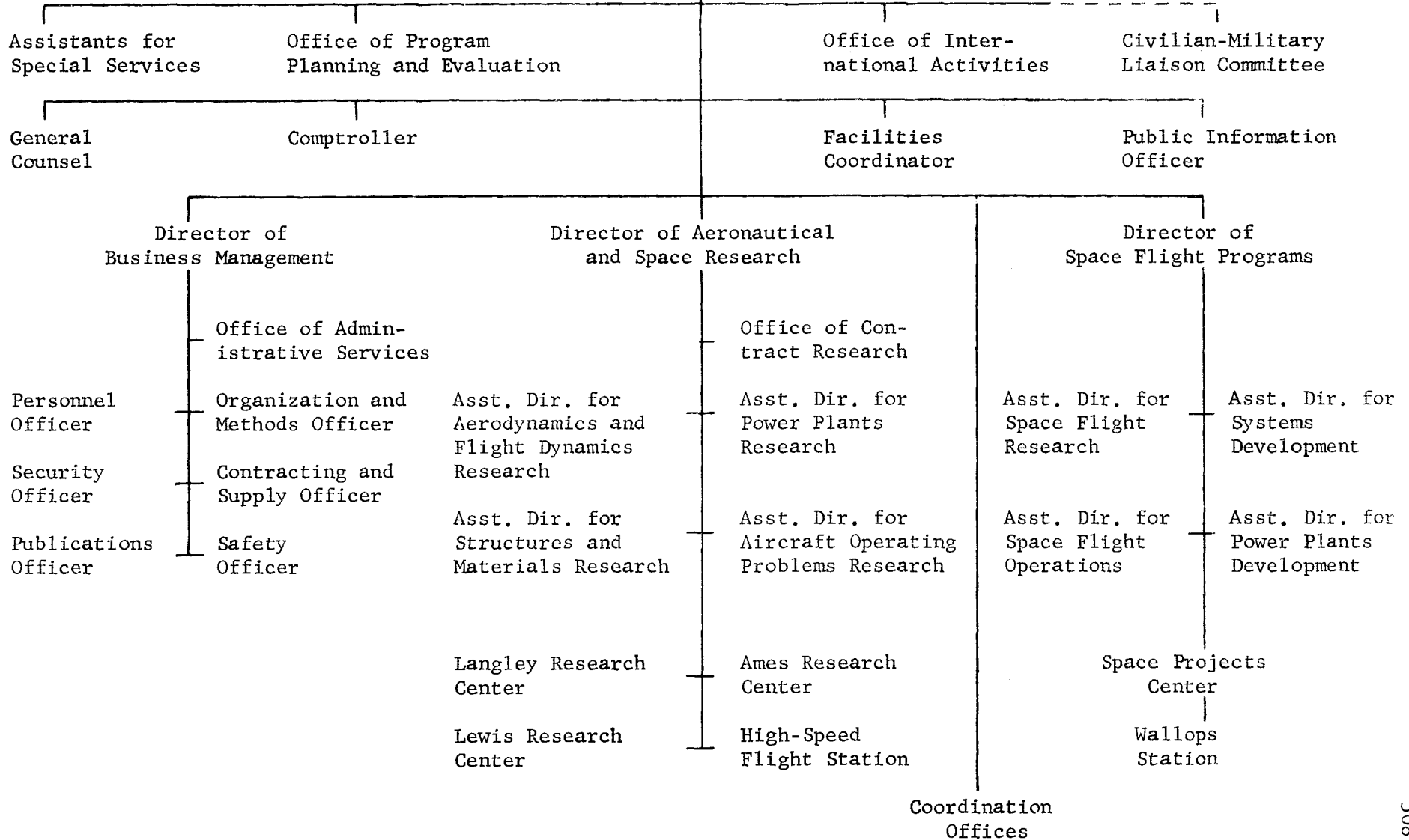

NATIONAL AERONAUTICS AND SPACE ADMINISTRATION

ORGANIZATION CHART

Transmittal - October 24, 1958

(FOR INTERNAL USE ONLY)

Office of the Administrator

Office of the ADMINISTRATOR  
- T. Keith Glennan  
DEPUTY ADMINISTRATOR  
- Hugh L. Dryden

Staff Assistants in the  
Assistants to the Administrator  
- John F. Victory  
- Wesley L. Horvath  
- Franklin W. Phillips  
Assistants for International Scientific  
Affairs  
- Ver.  
Director of Planning and  
Execution  
- Homer J. Stewart  
Office of the  
General Counsel  
- John A. Johnson

Assistants to the Deputy  
Administrator  
- Christine Wheeler  
- Charlotte Wood  
- Administrator

Civilian-Military Liaison  
Committee

Office of the  
Director of Public Information  
- Walter T. Bennett

Office of the  
DIRECTOR OF SPACE FLIGHT  
DEVELOPMENT  
- Abe Silverstein

Asst. to the Director  
- D. D. Wright

Office of the  
DIRECTOR OF AERONAUTICS AND  
SPACE RESEARCH  
John W. Crowley, Jr.

Assistants  
- Thomas T. McMill  
- Robert E. Linnell

Office of the  
DIRECTOR OF BUSINESS ADMINISTRATION  
- Albert F. Stegert

Executive Officer  
- E. H. Chamberlin  
Security Officer  
- George D. McCalley

Budget Division  
- Ralph E. Ulmer  
Budget Officer

Fiscal Division  
- W. M. Thompson  
Fiscal Officer

Personnel Division  
- Robert J. Lachen  
Director of Personnel

Procurement and Supply  
Division  
- Ralph E. Cushman  
Procurement and Supply Officer

Research Information  
Division  
Chief, - Bertram Bludsky

Security Division  
Director of Security  
- Robert L. Bell

Administrative Services  
Division  
Chief, - John C. Maber

Office of the  
Asst. Director for Aerodynamics  
and Flight Mechanics Research  
- Ira H. Abbott

Research Division  
Chief  
- Milton B. Ames, Jr.  
Asst. Chief - E. O. Pearson, Jr.

Office of the  
Asst. Director for Power Plants  
Research  
- Addison M. Rothrock  
Chief  
- Wm. H. Woodward  
Power Plants Research  
Division

Office of the  
Asst. Director for Aircraft  
and Materials Research  
- Richard V. Moore  
Chief  
- Lloyd A. Wood  
Asst. Ch. - T. K. L. Smith

Structures and Materials Research  
Division  
Chief  
- Harvey Brown  
Asst. Chief - Harry Brown

Operating Problems Research  
Division  
Chief - Boyd C. Myers, III

Office of the  
Asst. Director of Space  
Sciences  
- Homer E. Newell, Jr.  
Chief of Programs  
- John F. Clark  
- Space Sciences  
- Meteorology  
- John W. Townsend, Jr.

Office of the  
Asst. Director for Advanced  
Technology  
- Howell D. Madors  
Chief of Programs  
- Adv. Technology  
- Development  
- Edgar Cortright  
- Lunar Probe  
- E. E. Callaghan

LANGLEY RESEARCH  
CENTER  
Director  
- Henry J. E. Reid  
Assoc. Director  
- Floyd L. Thompson  
AMES RESEARCH  
CENTER  
Director  
- Smith J. DeFrance  
Assoc. Director  
- John F. Parsons  
LEWIS RESEARCH  
CENTER  
Director  
- Edward R. Sharp  
Assoc. Director  
- E. E. Manganiello  
HIGH-SPEED  
FLIGHT STATION  
Division  
Chief - Walter C. Williams

LIAISON OFFICES

SPACE PROJECTS  
CENTER  
Wallops Station

Office of the  
Asst. Director for Advanced  
Technology  
- Howell D. Madors  
Chief of Programs  
- Adv. Technology  
- Development  
- Edgar Cortright  
- Lunar Probe  
- E. E. Callaghan

Office of the  
Asst. Director of Space  
Sciences  
- Homer E. Newell, Jr.  
Chief of Programs  
- John F. Clark  
- Space Sciences  
- Meteorology  
- John W. Townsend, Jr.

Office of the  
Asst. Director for Population  
- Abraham Hyatt  
Chief of Programs  
- Propulsion Development  
- Milton W. Rosen  
- Large Engine Rockets  
- A. O. Tschler  
- Nuclear Engines  
- Harold B. Ranger

Office of the  
Asst. Director for Aircraft  
and Materials Research  
- Richard V. Moore  
Chief  
- Lloyd A. Wood  
Asst. Ch. - T. K. L. Smith

Operating Problems Research  
Division  
Chief - Boyd C. Myers, III

Structures and Materials Research  
Division  
Chief  
- Harvey Brown  
Asst. Chief - Harry Brown

Office of the  
Asst. Director for Power Plants  
Research  
- Addison M. Rothrock  
Chief  
- Wm. H. Woodward  
Power Plants Research  
Division

Office of the  
Asst. Director for Aerodynamics  
and Flight Mechanics Research  
- Ira H. Abbott

Research Division  
Chief  
- Milton B. Ames, Jr.  
Asst. Chief - E. O. Pearson, Jr.

Office of the  
Asst. Director for Aircraft  
and Materials Research  
- Richard V. Moore  
Chief  
- Lloyd A. Wood  
Asst. Ch. - T. K. L. Smith

Operating Problems Research  
Division  
Chief - Boyd C. Myers, III

Structures and Materials Research  
Division  
Chief  
- Harvey Brown  
Asst. Chief - Harry Brown

Office of the  
Asst. Director for Space  
Sciences  
- Homer E. Newell, Jr.  
Chief of Programs  
- John F. Clark  
- Space Sciences  
- Meteorology  
- John W. Townsend, Jr.

Office of the  
Asst. Director for Advanced  
Technology  
- Howell D. Madors  
Chief of Programs  
- Adv. Technology  
- Development  
- Edgar Cortright  
- Lunar Probe  
- E. E. Callaghan

NATIONAL AERONAUTICS AND SPACE ADMINISTRATION  
ORGANIZATION CHART

TENTATIVE  
(November 14, 1958)

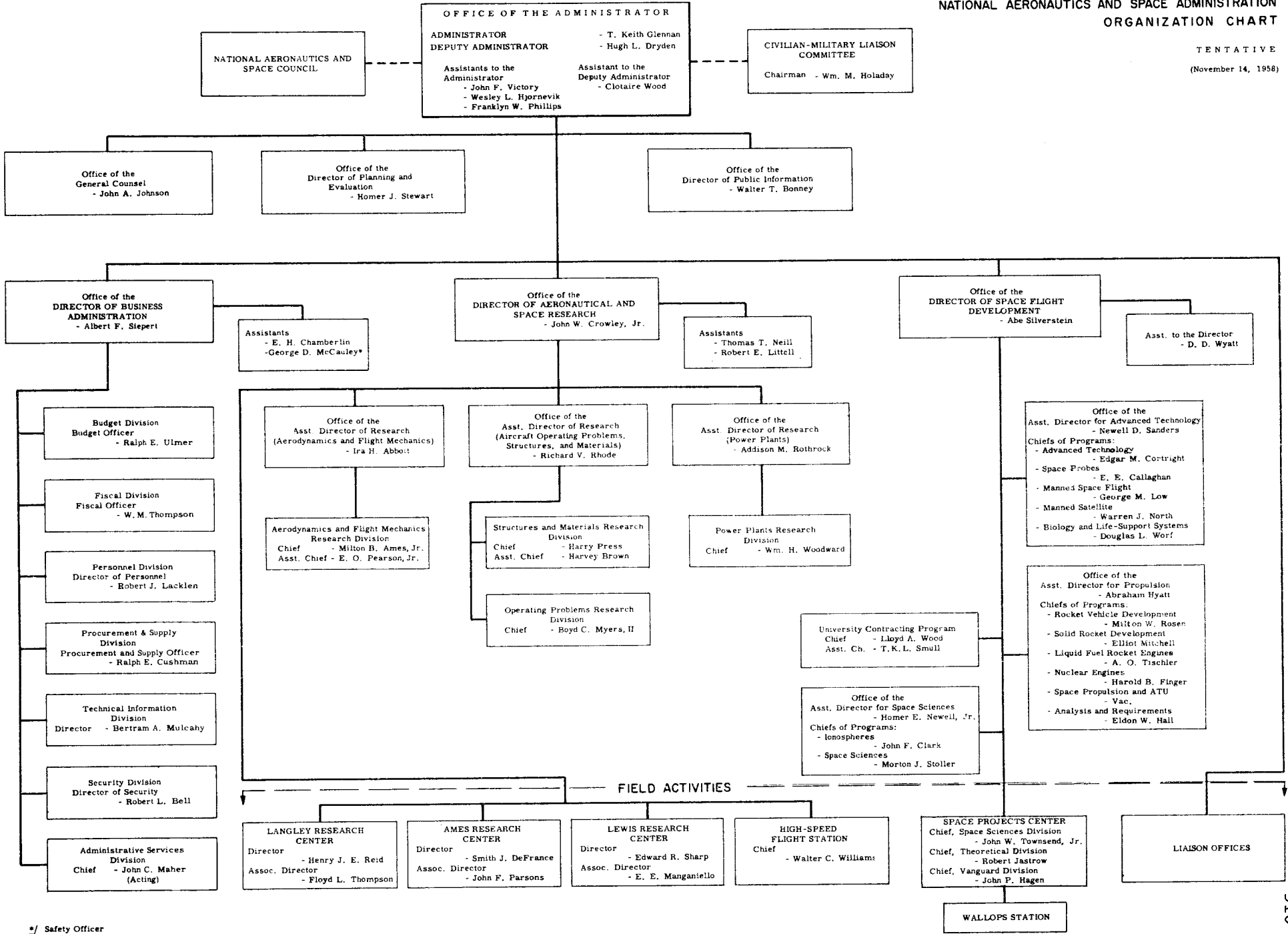

#/ Safety Officer

PROPOSED ORGANIZATION OF THE NATIONAL AERONAUTICS AND SPACE ADMINISTRATION

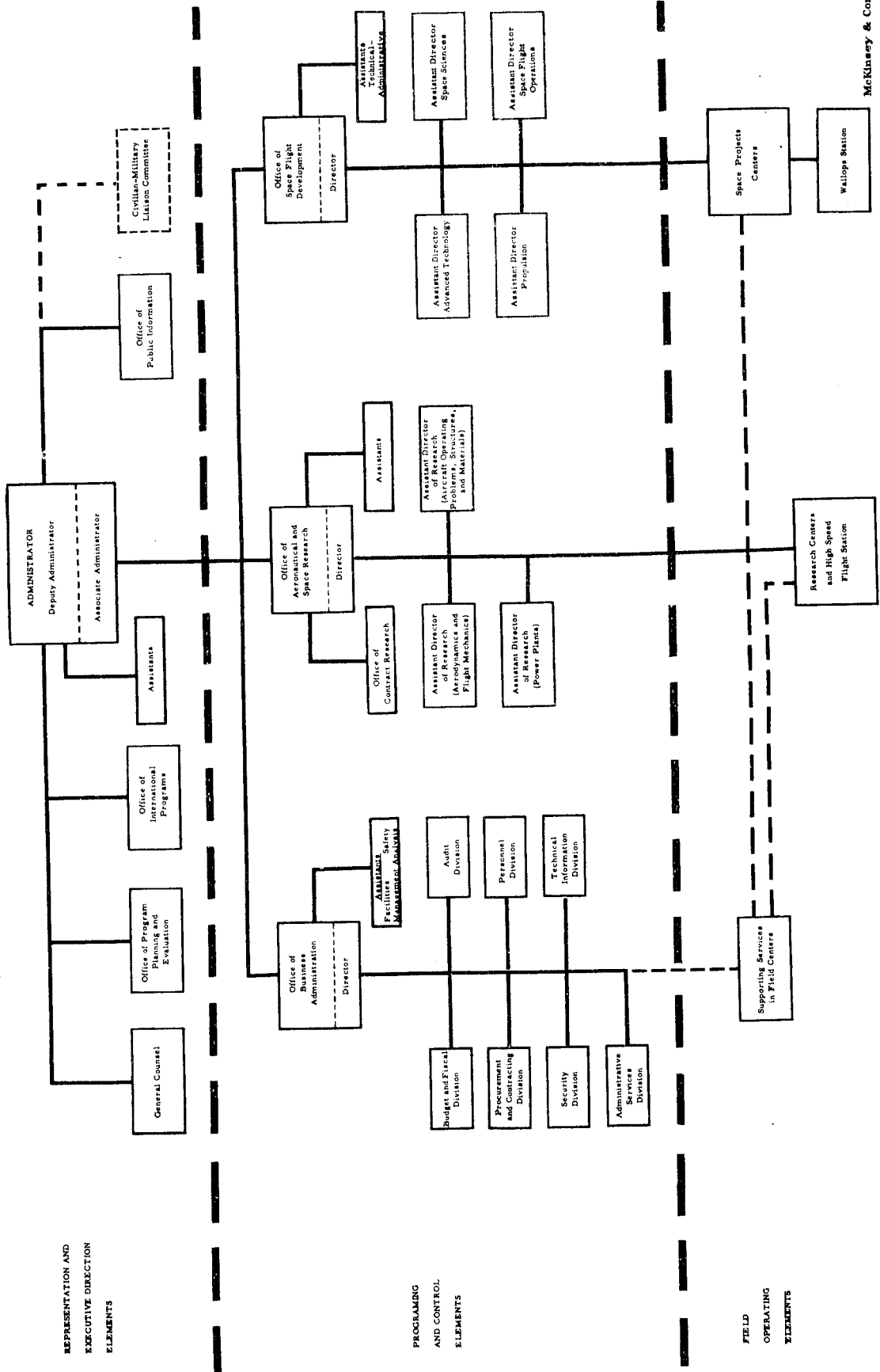

REPRESENTATION AND EXECUTIVE DIRECTION ELEMENTS

PROGRAMMING AND CONTROL ELEMENTS

FIELD OPERATING ELEMENTS

# NATIONAL AERONAUTICS AND SPACE ADMINISTRATION

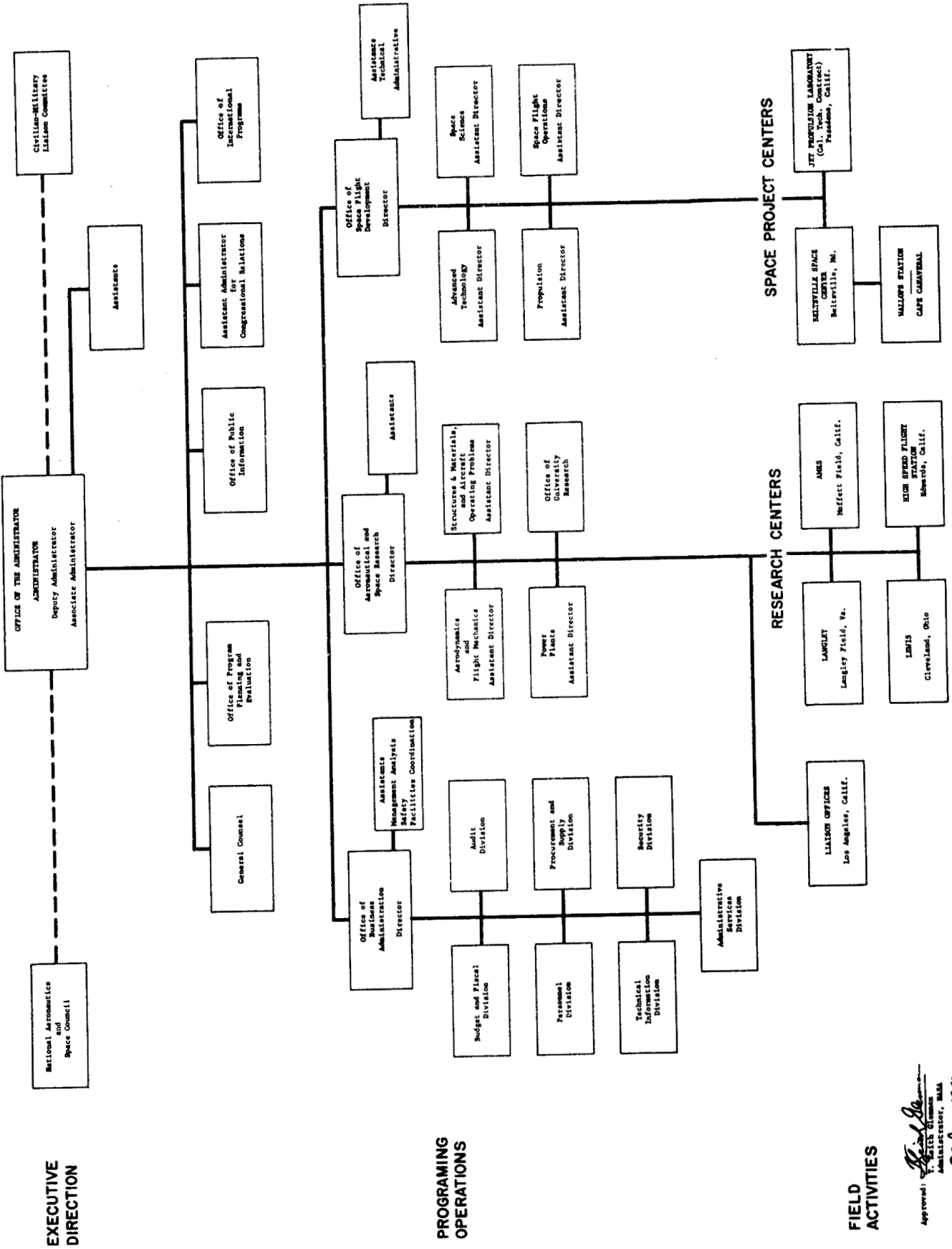

**EXECUTIVE DIRECTION**

**PROGRAMING OPERATIONS**

**FIELD ACTIVITIES**

Approved: *[Signature]*  
 Director, NASA  
 Date: 29 June 1959





# NATIONAL AERONAUTICS AND SPACE ADMINISTRATION

**EXECUTIVE  
DIRECTION**

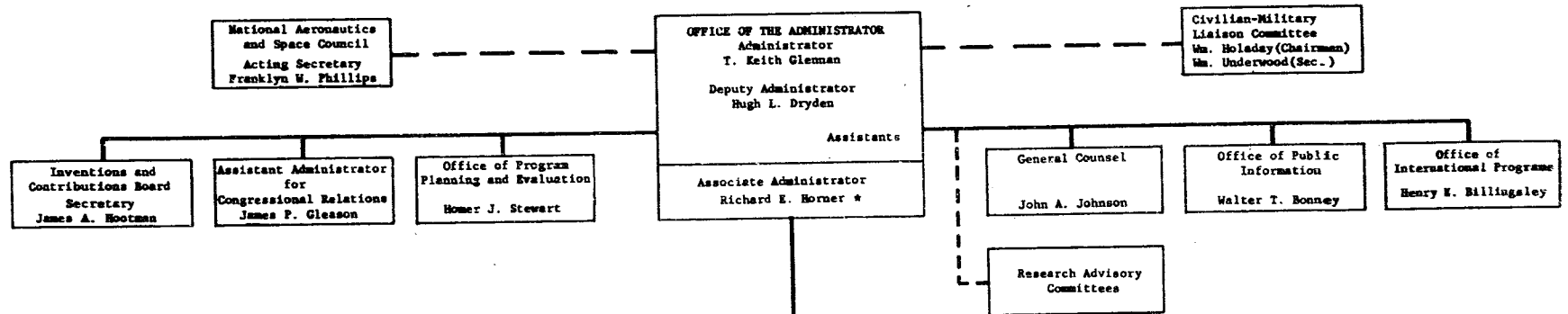

**PROGRAMING  
OPERATIONS**

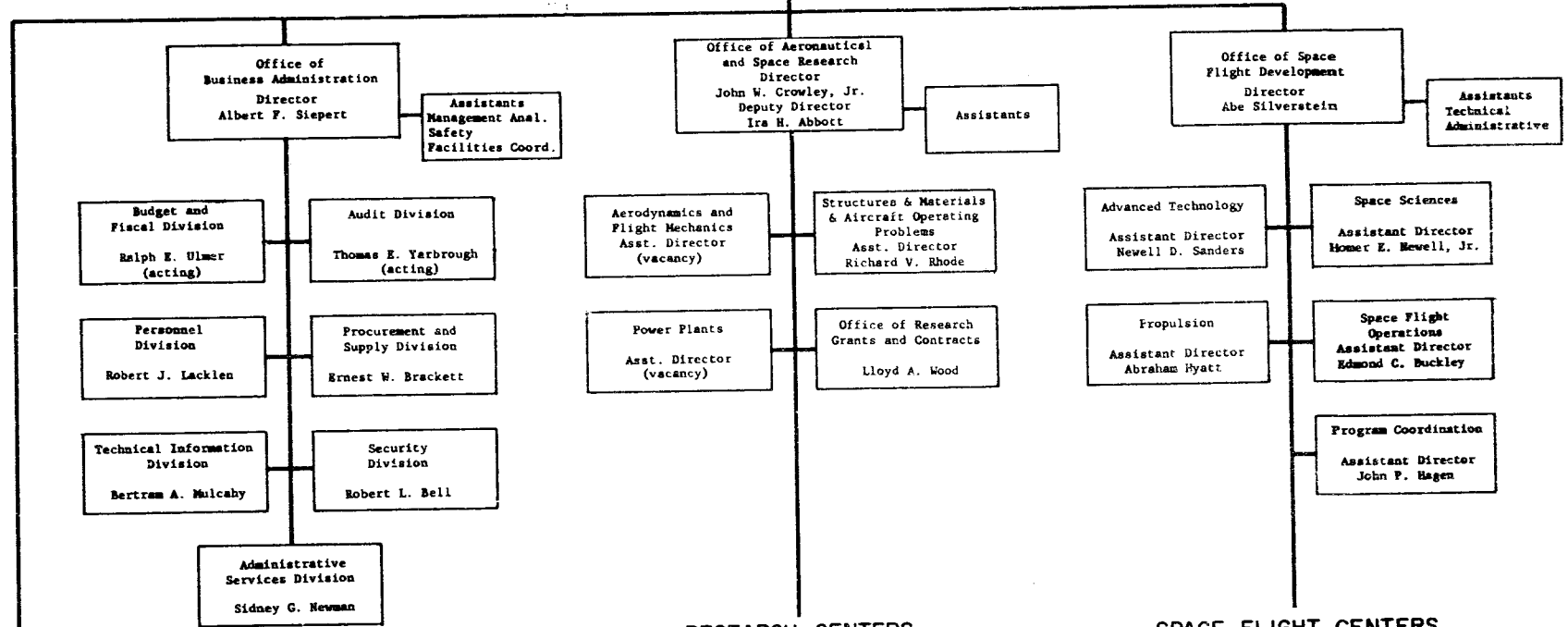

**FIELD  
ACTIVITIES**

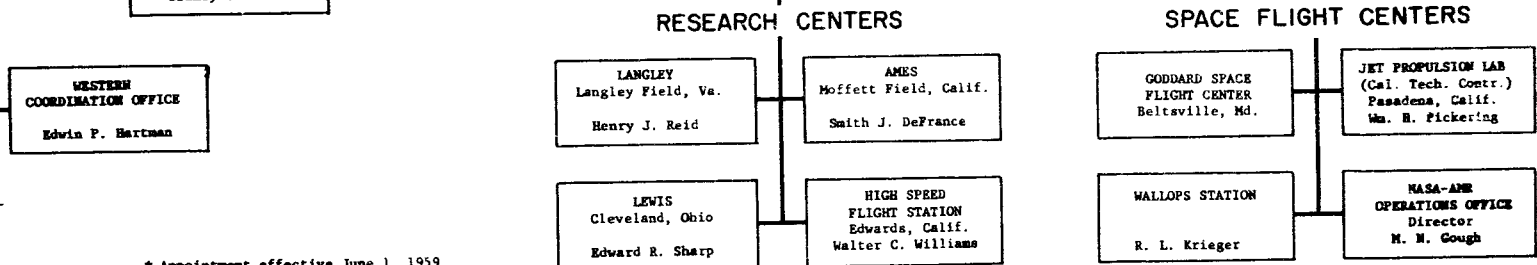

Approved: *T. Keith Glennan*  
T. Keith Glennan  
Administrator, NASA

Date: May 1, 1959

\* Appointment effective June 1, 1959

# NATIONAL AERONAUTICS AND SPACE ADMINISTRATION

EXECUTIVE  
DIRECTION

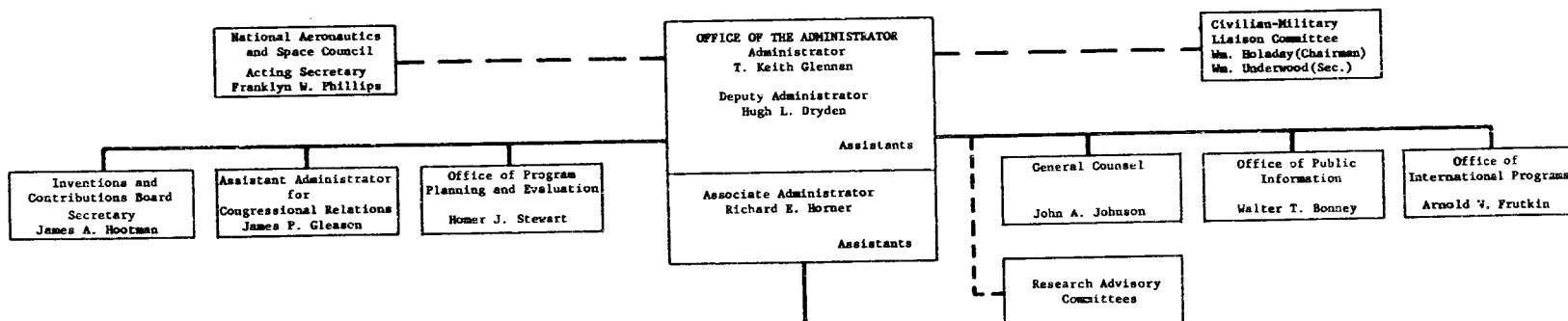

PROGRAMING  
OPERATIONS

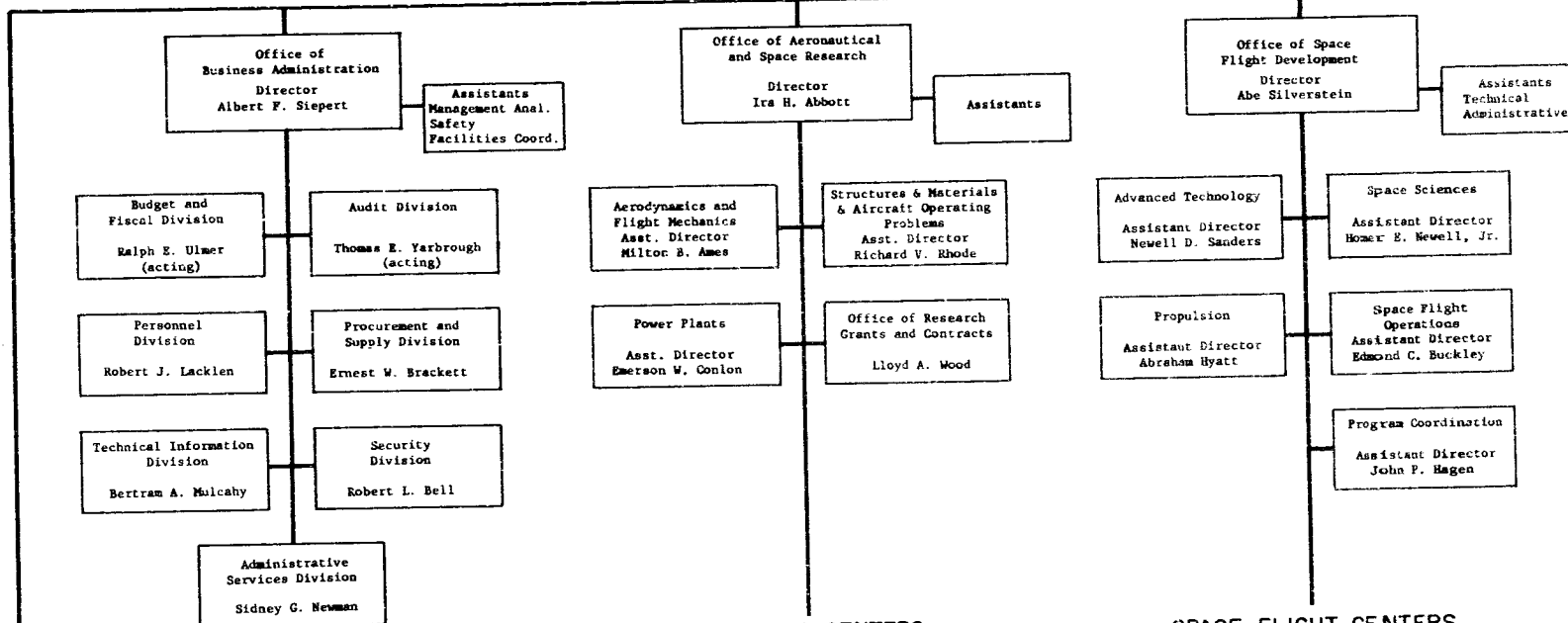

FIELD  
ACTIVITIES

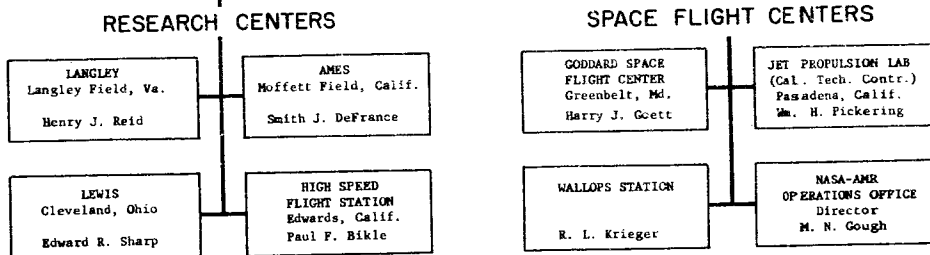

Approved:

*T. Keith Glennan*  
T. Keith Glennan  
Administrator, NASA

Date:

September 15, 1959

Supersedes chart dated May 1, 1959



# NATIONAL AERONAUTICS AND SPACE ADMINISTRATION

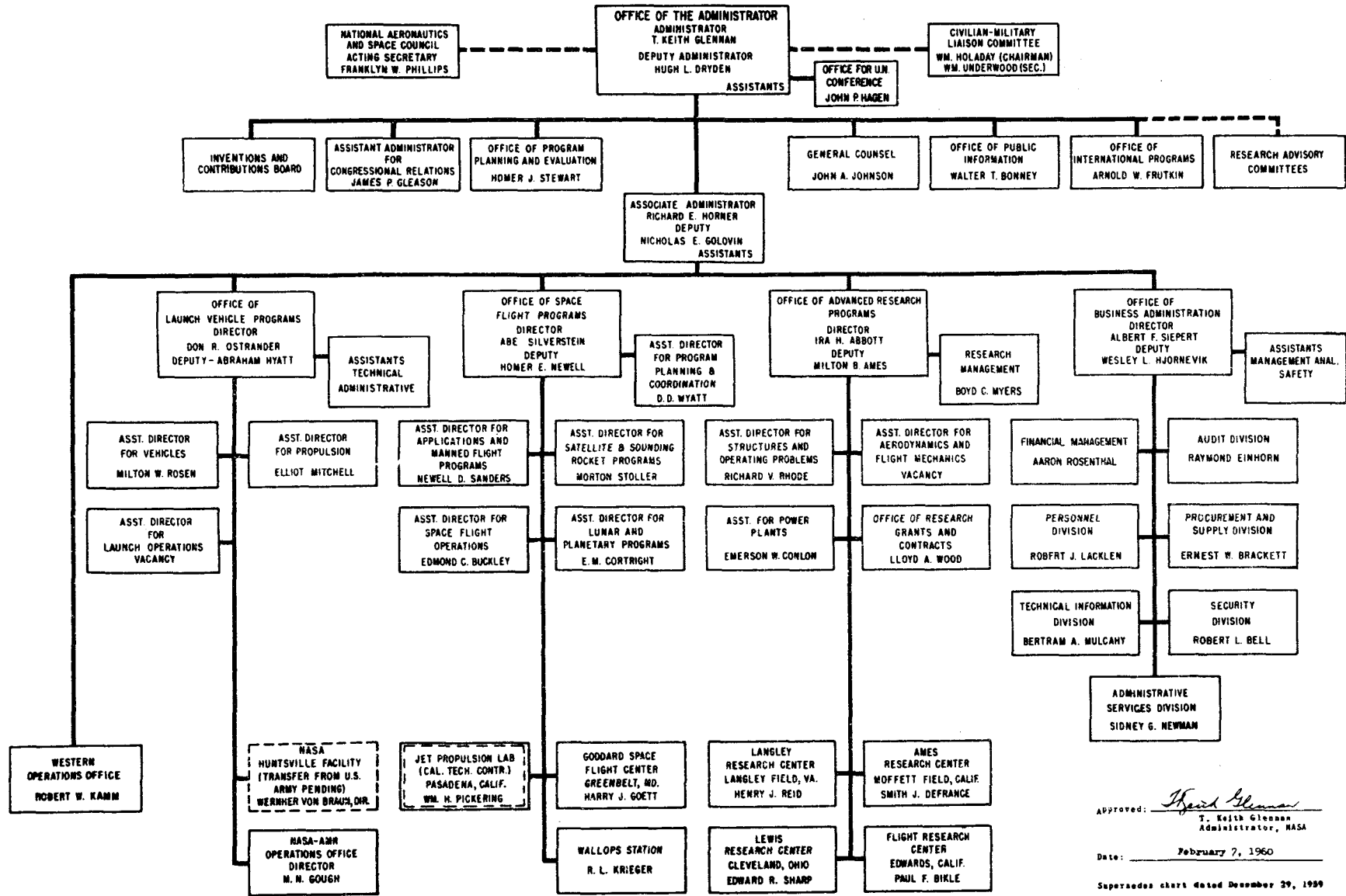

Approved: *T. Keith Glennan*  
T. Keith Glennan  
Administrator, NASA

Date: February 7, 1960

Supersedes chart dated December 29, 1959



# NATIONAL AERONAUTICS AND SPACE ADMINISTRATION

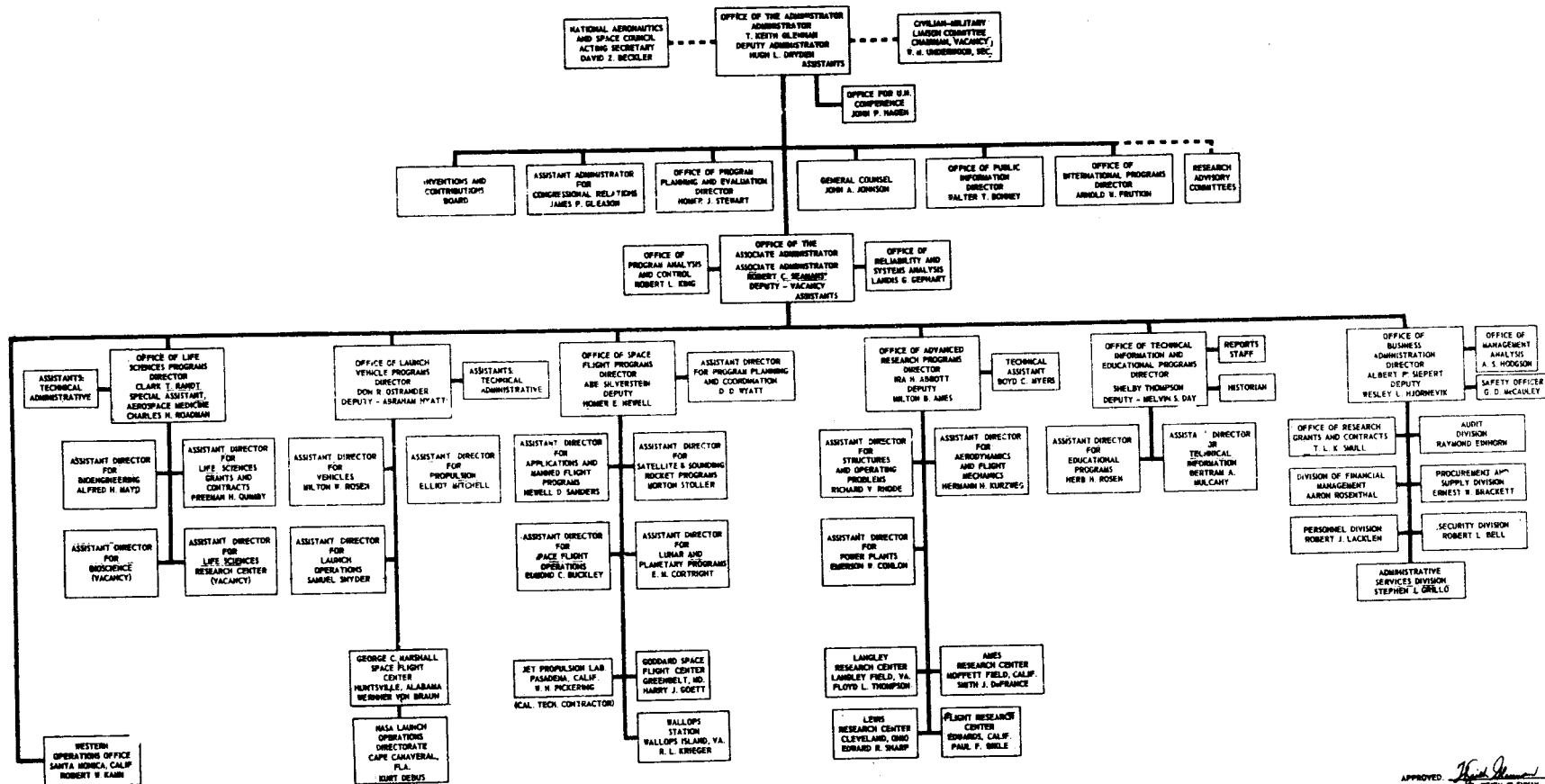

\*APPOINTMENT EFFECTIVE SEPTEMBER 1, 1960

APPROVED: *Keith Glennan*  
T. KEITH GLENNAN  
ADMINISTRATOR, NASA

DATE: *15 August 1960*  
SUPERSEDES CHART DATED APRIL 4, 1960