



BMPs for

Erosion Control for

Logging Practices

in Ohio



Bulletin 916



For-sale publication

Copyright © 2004, Ohio State University Extension

All educational programs conducted by Ohio State University Extension are available to clientele on a nondiscriminatory basis without regard to race, color, creed, religion, sexual orientation, national origin, gender, age, disability or Vietnam-era veteran status.

Keith L. Smith, Associate Vice President for Agricultural Administration and Director, Ohio State University Extension

TDD No. 800-589-8292 (Ohio only) or 614-292-1868

5/04—6M—XXXXXX

ACKNOWLEDGMENTS

The Silvicultural Nonpoint Source Pollution Plan is part of the Ohio Nonpoint Source Management Program, authorized by Section 319 of the 1987 Federal Water Quality Act. The Plan prescribes mechanisms to handle sources of pollution from forestry activities. One such mechanism is the creation of a Silvicultural Nonpoint Source (NPS) Pollution Technical Advisory Committee, which shall provide NPS pollution control recommendations to the Chief of the Ohio Department of Natural Resources Division of Forestry, the agency providing leadership on this segment of the statewide plan. This book represents the guidelines for control of NPS as approved by the Chief of the ODNR-Division of Forestry.

This handbook was reviewed by the following individuals: Dave Chamberlin, MeadWestvaco; Dennis Cavalier, American Electric Power; Pete Woyar, Consulting Forester; Nathan Paskey, Ashtabula Soil and Water Conservation District; Ronnie Shepard Jr., Shepard Timber; Bill Lawhon, Tree Farm; Dan Houston, Sylvancare Forestry Consultants; Kathy Smith, Ohio State University Extension; Martin Joyce, Ohio Department of Natural Resources, Division of Soil & Water; Andy Sabula, Ohio Department of Natural Resources, Division of Forestry; and Don Karas, ODNR Division of Forestry. Edited by Kathy Smith, Ohio State University Extension and Andy Sabula, ODNR, Division of Forestry.

Topographical maps on pages 5 and 6, courtesy of Ohio GAP Analysis Project, The Ohio State University Center for Mapping. All other photos in this publication were provided by Pete Woyar, consulting forester, MeadWestvaco, American Electric Power, and Ashtabula SWCD.

The authors would like to thank Nathan Watermeier, Ohio State University Extension, for his invaluable assistance in preparing the topographical maps.



MeadWestvaco



AEP
AEP: America's Energy Partner®

PREFACE

Silvicultural Nonpoint Source Pollution (NPS) can result if sediment enters the natural drainage system as a result of logging, tree planting, site preparation, or other cultural activities required to grow or harvest forest products.

Scientific research indicates that NPS pollution can be controlled by the use of Best Management Practices (BMPs). These practices must be applied during the actual period of operation, and as a final “close-out” of the site when the operation is completed.

Application of Silvicultural BMPs is specified by Section 319 of the Federal Water Quality Act (1987) and by the Ohio Agricultural and Silvicultural Pollution Abatement Law (1991). Adherence to guidelines and application of techniques specified in this handbook allows logging and other silvicultural operations to conform to prescribed standards and be in compliance with the federal and state statutes.

Failure to plan for and correctly implement silvicultural BMPs during forest operations will result in unacceptable NPS pollution and can result in regulatory action(s) initiated against the landowner and operator in order to achieve pollution abatement.

Ohio Agricultural Pollution Abatement Rules Standards provide the option for filing an Operation and Management (O&M) plan with the County Soil and Water Conservation District (SWCD) prior to starting operations.

On occasion there may be circumstances encountered in the field where installation of the traditional BMPs listed in this guide may not be possible. In those situations, alternative BMP/mitigation measures shall be used to minimize the loss of sediment from the logging activity. The person(s) responsible for the logging operation should consult with their local SWCD, ODNR-Division of Forestry, Service Forester, or Private Consulting Forester to develop alternative measures. Alternative measures that are to be used should be thoroughly described and included as part of the O&M plan developed for the site. It is recommended that the O&M plan be submitted to the local SWCD for review and approval prior to start of any logging activity.

TABLE OF CONTENTS

	Section	Page
List of Figures		v
List of Tables		vi
Planning the Operation	I	1
Landings	II	7
Haul Roads	III	8
Skid Trails	IV	29
Maintenance	V	36
Stream Crossings	VI	37
Filter and Shade Strips	VII	46
Sale Closing	VIII	49
Glossary		58
Sources		60

LIST OF FIGURES

Figure	Page
1A	Photo shows locations of decks, haul roads, and skid trails along with stream crossings 5
1B	Topographic map with details of road system and landings marked..... 6
2	Well-designed and maintained haul road..... 9
3	Haul road graveled at entrance to logging site... 10
4A	Proper installation of a sediment barrier 11
4B	Temporary sediment barriers: hay or straw bales ... 13
5	Properly installed straw bales 14
6	Temporary sediment barriers: silt fence 15
7	Effective application of silt fence 16
8	Water diversion: water turnouts..... 17
9	Rolling dip..... 18
10A	Broad-based dip examples..... 19
10B	Construction guidelines for broad-based dip 20
11	Correct installation of a pipe culvert for water diversion..... 21
12	Water diversion: open-top box culvert 22
13	Water diversion: open-top pole culvert 23
14	Water diversion: energy dissipaters for culvert outlets..... 24
15	Straight up excavated side cut 26
16	Protective wooden mud mats..... 27
17A	Using grade breaks to divert water..... 30
17B	Good application of grade breaks..... 31
18	Water bar for water diversion..... 32

19A	Constructing water bars with mechanized equipment.....	33
19B	Re-vegetated water bar on closed logging road..	34
20	Alternative water bars: hand construction	35
21	Culvert stream crossings: culvert slope.....	40
22A	Portable logging bridge installed with skidder....	42
22B	Alternative bridge design.....	43
23A	Pole crossing.....	44
23B	Pole crossing.....	44
24	Filter strips	48
25	Re-vegetated logging road	51
26	Properly re-vegetated and closed logging road	52
27	Properly installed mulch on new seeding	54

LIST OF TABLES

Table	Page	
1	Culvert spacing chart	25
2	Culvert sizing chart.....	40
3	Determining filter strip width.....	47
4	Determining water bar spacing.....	50
5	Suggested seeding, fertilizer, and lime rates	55
6	Suggested grass seed mixtures for disturbed sites...	55
7	Calculating seed and fertilizer needs	56

PLANNING THE OPERATION

Pre-harvest planning is critical to the success of the operation. An Operation and Management (O&M) plan is a useful tool in planning. A well-planned harvesting operation will allow efficient removal of forest products, and at the same time protect water quality and help save money.

Before cutting, meet with the landowner or forest manager and decide on the location of landings, haul roads, skid trails, and which best management practices need to be implemented and included in the O&M plan. It is recommended that once completed, the O&M plan be submitted to the local SWCD for review and approval. This should take place prior to the start of the harvest.

The pre-harvest plan should include a map(s) identifying (see Figures 1A and 1B):

1. Property boundaries
2. Streams and drainages
3. Critical areas
4. Road and trail locations
5. Stream and drainage crossings
6. Log landings and mill seats
7. Buffer zones
8. Soil(s) information
9. Other environmental concerns

Also, consider and perhaps make notes on the following items:

1. Road and trail specifications
2. Harvesting equipment to be used
3. Time of harvest
4. Logging contract specifications
5. Special planning for wet areas
6. Obstructions, such as rock outcroppings
7. Management of slash

Plan stream crossings. Stream crossings are critical areas that require intensive planning. Most of the soil loss that occurs on logging jobs is a result of poorly planned stream crossings. (See information on stream crossings in Section VI.)

Consider distribution and volume of timber to be removed. The more timber that is hauled from an area, the better the road that is needed. Loads at landings are computed from the estimate of timber that will be skidded to each landing. Where timber is uniformly distributed, this can be determined from the area served by each landing.

Expressing the proposed use of a logging road in terms of number of loads that will be hauled over it can serve as a guide to the design and standards to which the various sections and spurs need to be constructed.

For more information concerning pre-harvest planning, contact:

The Ohio Department of Natural Resources:

Division of Forestry

District 1 Office
1855 Fountain Square Ct., H-1
Columbus, OH 43224
614-265-6694 or
1-877-247-8733

District 3 Office
2205 Reiser Ave SE,
New Philadelphia, OH 44663
330-339-2205

District 2 Office
952 Lima Ave., Box B
Findlay, OH 45840
419-424-5004

District 4 Office
360 E State St.
Athens, OH 45701
740-589-9901

Web site: www.ohiodnr.com/forestry/

Soil and Water Conservation Districts/Natural Resources Conservation Service (NRCS)

There is usually an office in each county. To find contact information for the SWCD in your area go to the following web site: [www.dnr.state.oh.us/odnr/soil & water/](http://www.dnr.state.oh.us/odnr/soil%20&%20water/) or call 614-265-6610.

Consulting and Industry Foresters

Private consulting foresters and industry foresters can also be contacted. Contact with individuals from either group can be made through the Ohio Forestry Association, Inc., 4080 S. High St., Columbus, Ohio 43207, 614-497-9580, Fax: 614-497-9581. Web site: www.ohioforest.org. A list of consulting foresters can also be obtained by going to

the Ohio Division of Forestry web site, www.ohiodnr.com/forestry/ and looking under landowner assistance.

Maps and Aerial Photos

U.S. Geological Survey topographic maps can be obtained from the Ohio Department of Natural Resources, Geological Survey, Fountain Square, Columbus, Ohio 43224 and various other sources around the state. Call 614-265-6576 for more information. Many SWCDs also carry topographical maps.

Copies of aerial photos can be obtained from the USDA Farm Service Agency office located in most counties. Copies of O&M plans and soil maps can be obtained from your local SWCD.

Figure 1A. Photo shows locations of decks, haul roads, and skid trails along with stream crossings. Compare this with the topographic map in Figure 1B.

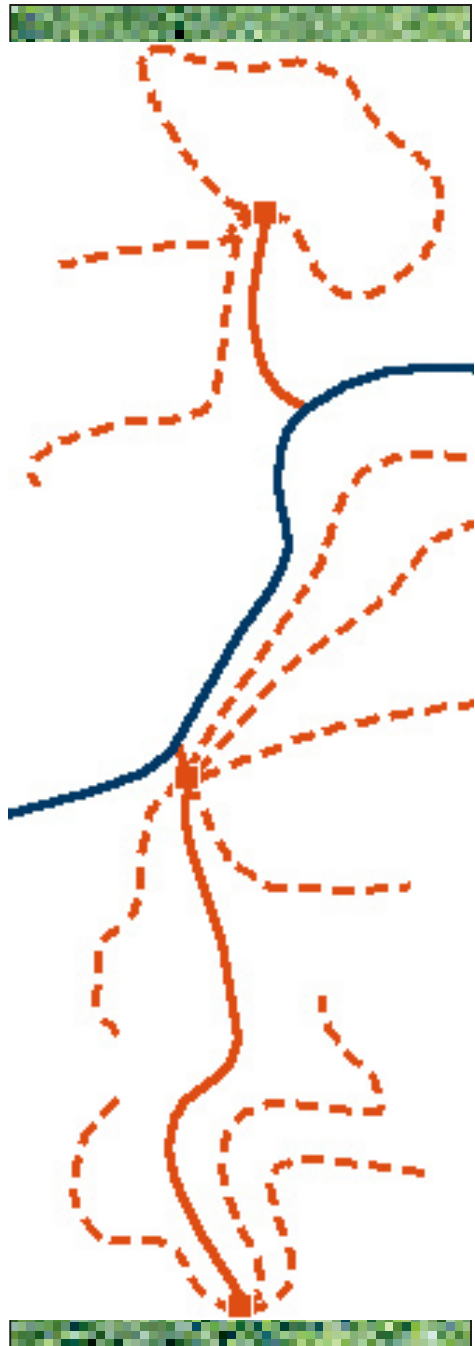

Legend





	Skid Trails
	Existing Road
	Main Haul Road
	Log Landings

Image courtesy of Ohio GAP Analysis Project, The Ohio State University Center for Mapping.

Figure 1B.
Topographic map with details of road system and landings marked.



Legend

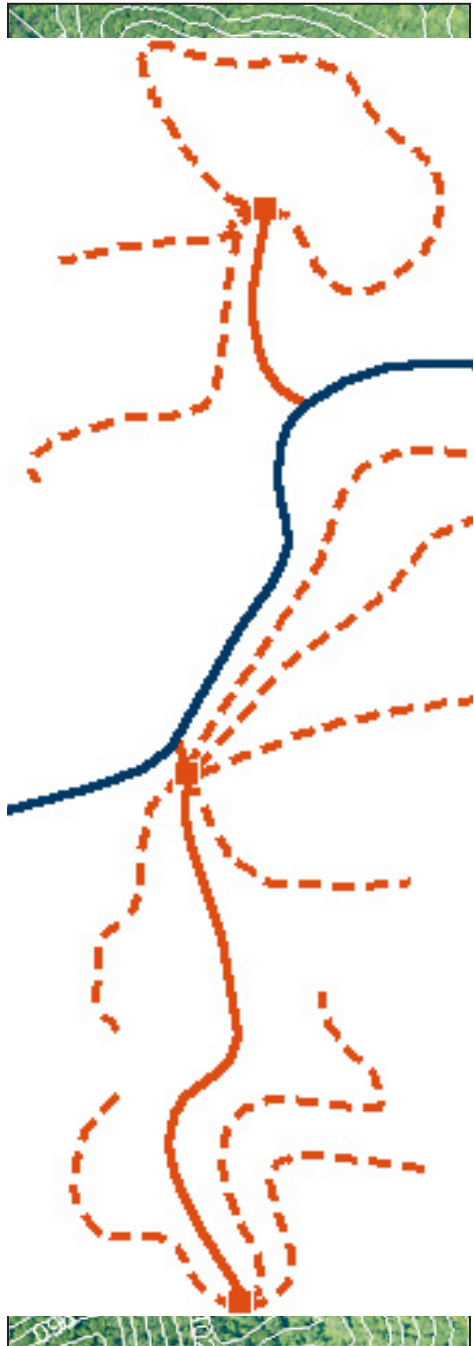



	Skid Trails
	Existing Road
	Main Haul Road
	Log Landings

Image courtesy of Ohio GAP Analysis Project, The Ohio State University Center for Mapping.

LANDINGS

Landings should be planned before harvesting starts (see Section I, Planning the Operation), taking into consideration the location and amount of timber to be harvested and the ground conditions. The following things should also be taken into consideration:

- Haul road location
- Skid road location
- Drainage
- Safe access to the highway
- Size of the operation
- Stream location

Landings should be located outside filter and shade strips.

Landings and yards should be located on a dry site and have a slight slope to allow for drainage. Provide for adequate drainage on approach roads (truck/skid) so that road drainage does not enter landing area, and landing drainage does not impact skid or truck roads.

Remove all trash, such as, used oil filters, equipment, parts, and other items from the harvest site.

Re-vegetate landings and yards as soon as possible after completion of the operation. For a complete discussion of re-vegetation, see Section VIII, Sale Closing.

HAUL ROADS

The purpose of the haul road is to provide for efficient transportation from the landing to public access. The ideal haul road (Figures 2 and 3) would:

- Be straight
- Have a slight grade
- Be well drained
- Enter public road at right angle (90°)
- Enter public road on long straight stretch of road
- Have a firm base to keep mud off road
- Have culvert at entrance to public road

A. Existing Roads: Repair or Relocate?

Many forested tracts in Ohio already have existing roads. Many of these existing roads are eroding and have washed-out areas due to lack of maintenance or bad location and design. Old roads often do not meet present BMP guidelines for design or location. Consider the effects of construction, continued use, and maintenance when making decisions regarding existing roads.

Figure 2. Well-designed and maintained haul road.



Figure 3. Haul road graveled at entrance to logging site.



B. Controlling Sediment During Construction

Erosion is a problem during the construction of haul roads and landings. Before permanent erosion control practices are installed and functional and/or new vegetation has been established, temporary measures may be necessary. Temporary measures consist of sediment barriers across a slope or at the base of a slope. There are two types of barriers used for temporary measures: hay or straw bales and silt fences. These barriers trap sediment from a disturbed area by slowing and filtering storm water runoff.

With either straw bales (Figures 4A, 4B, and 5) or silt fences (Figures 6 and 7), the ground level at the end points must be higher than the top of the lowest point of the barrier.

Figure 4A. Proper installation of a sediment barrier.

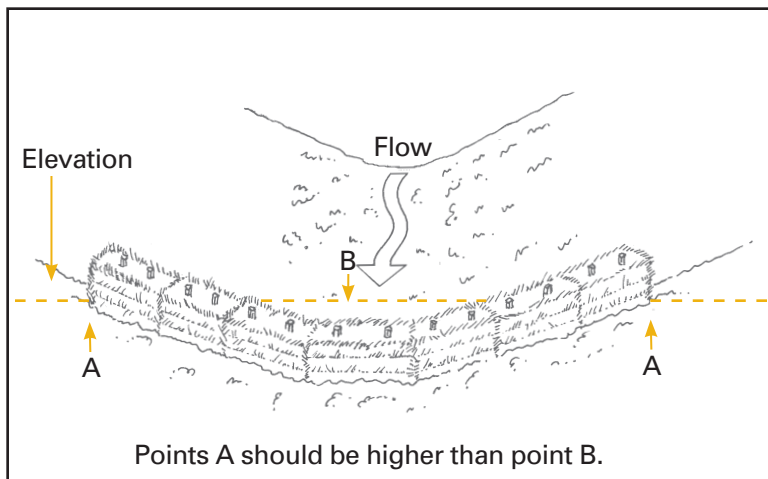

Construction Guidelines for Sediment Barriers

1. Place hay or straw bales in a row along the contour with adjacent bales securely tied with either wire or nylon string. Anchor each bale with two metal or wood stakes. Wooden stakes should be at least 2 inches X 2 inches and driven in the ground a minimum of 1½ feet. Bales should be placed in the ground at least 4 inches.
2. Place silt fences on the contour. Space fence posts not more than 10 feet apart. If woven wire fence is used, fasten it securely on the upstream side of the fence posts.

Spacing is governed by slope. Use the following guidelines.

Slope (percent)	Distance between barriers (feet)
2–8	110–92
8–12	92–75
12–18	80–60
18–24	60–52

Notes:

Figure 4B. Temporary sediment barriers: hay or straw bales.

Straw Bale Dike

- 1 Dig trench 4" deep x width of straw bale.

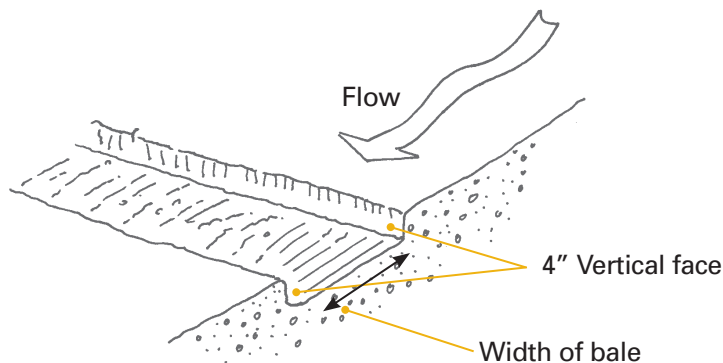

- 2 Fit straw bales into trench and secure with 2 re-bars, steel pickets, or 2" x 2" stakes 1½' to 2' in ground.

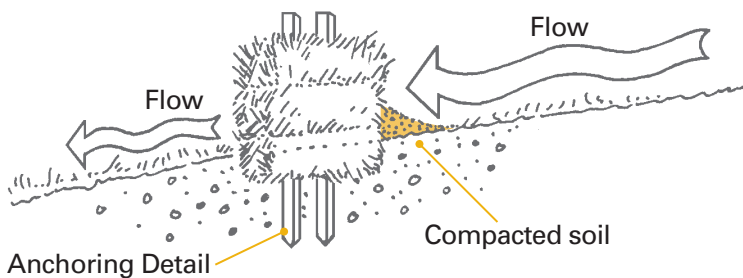

- 3 Wire or nylon bound bales placed on the contour.

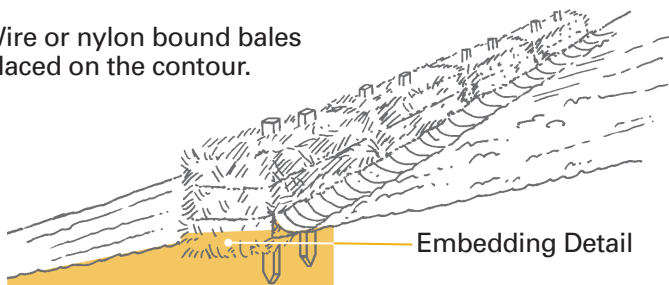
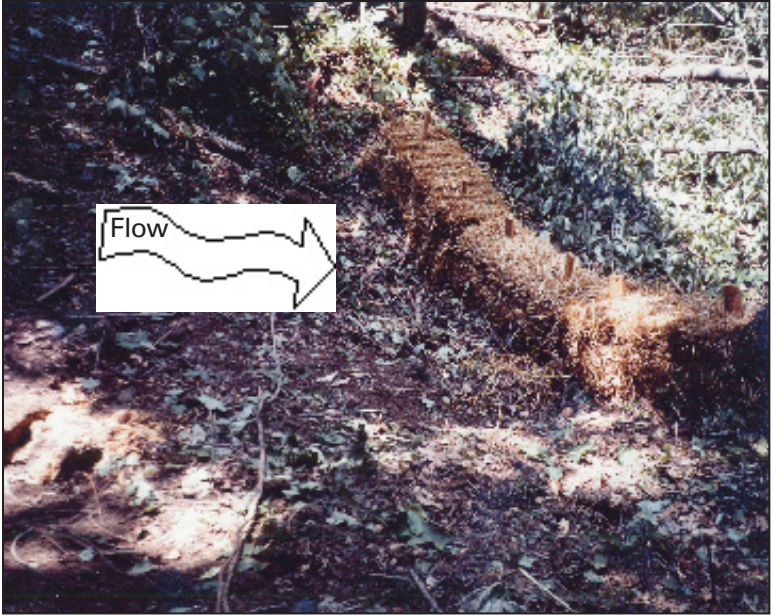

Figure 5. Properly installed straw bales.



Notes:

Figure 6. Temporary sediment barriers: silt fence.

- ❶ Set posts and excavate trench.
- ❷ If utilizing wire fencing, staple wire fencing to posts. Otherwise, skip to step 3.

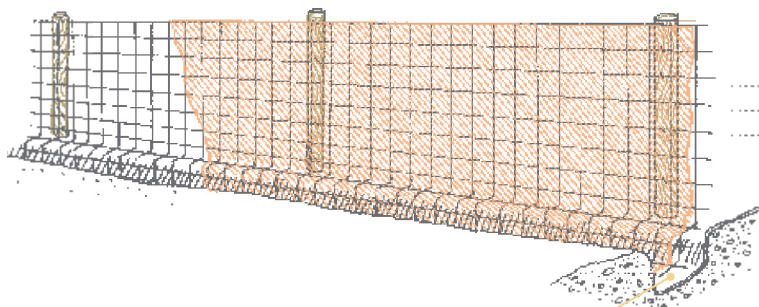

- ❸ Attach filter fabric to posts (or wire fencing) allowing extension into trench as shown.
- ❹ Backfill and compact excavated soil.

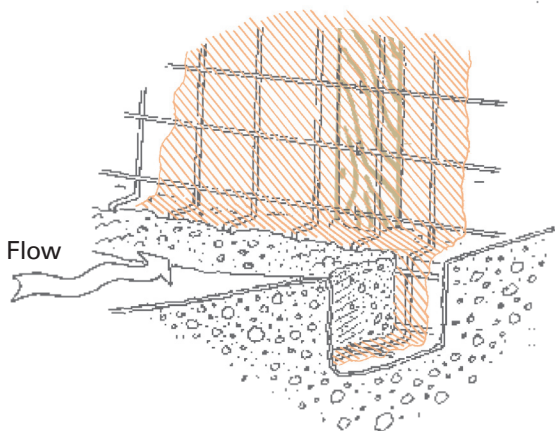

C. Slope

Keep all roads between 2 and 10 percent slope. If necessary, 15 percent grades can be used for distances up to 200 feet. Avoid long, straight grades by following contours along hillsides. Breaking or changing grade frequently will reduce erosion problems. Use topographic maps to help locate roads.

Figure 7. Effective application of silt fence.



Notes:

D. Drainage

Locate roads on side slopes where side drainage is possible, and insure good cross drainage for dispersing surface water (Figures 8, 9, 10A, and 10B). On level surfaces provide proper drainage by crowning and/or ditching.

Figure 8. Water diversion: water turnouts.

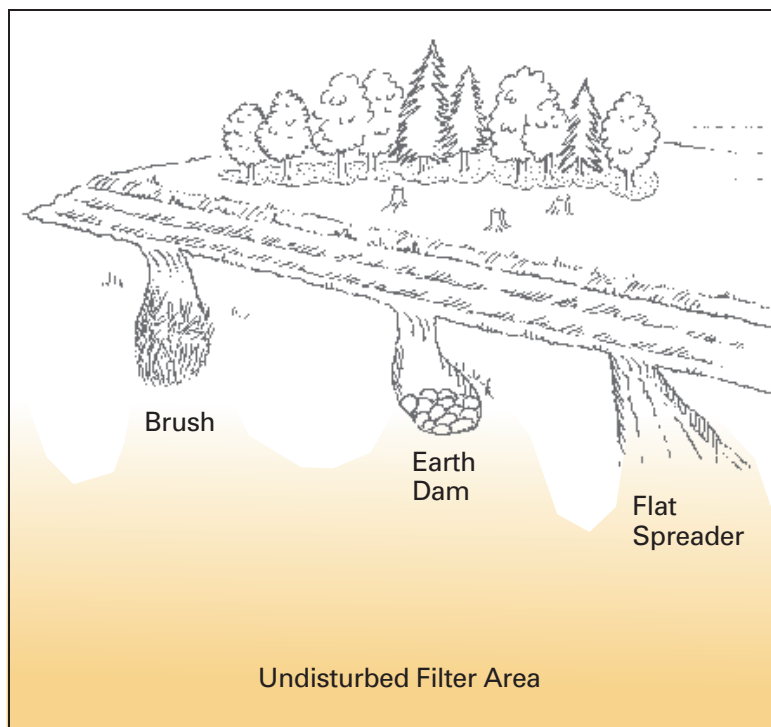
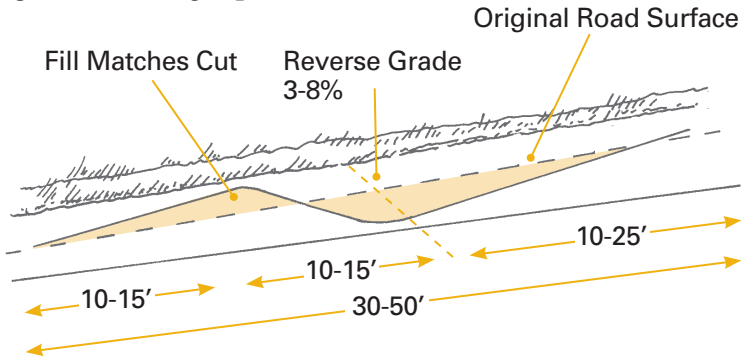

Figure 9. Rolling dip.

A rolling dip is a low outsloped diversion in the road designed to catch water and drain it from the road surface. A rolling dip is shorter in length and deeper than a broad-based dip. Rolling dips should be used on slopes of up to 15 percent. They should be used during the road construction period and at the road closing; not when the road is being actively used for hauling.

Notes:

Figure 10A. Broad-based dip examples.



Figure 10B. Construction guidelines for broad-based dip.

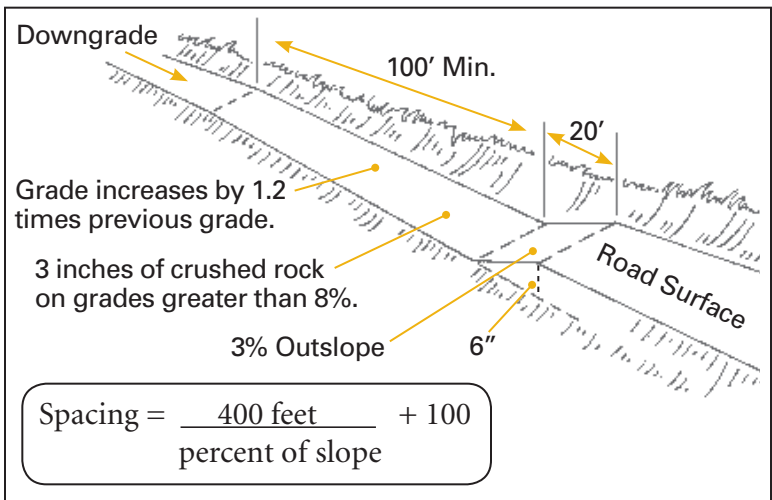
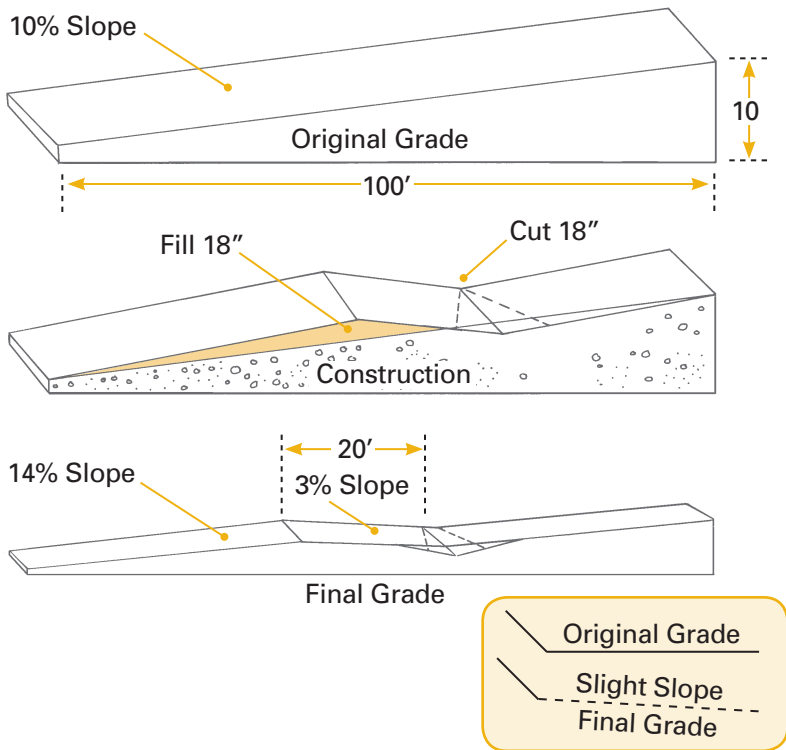
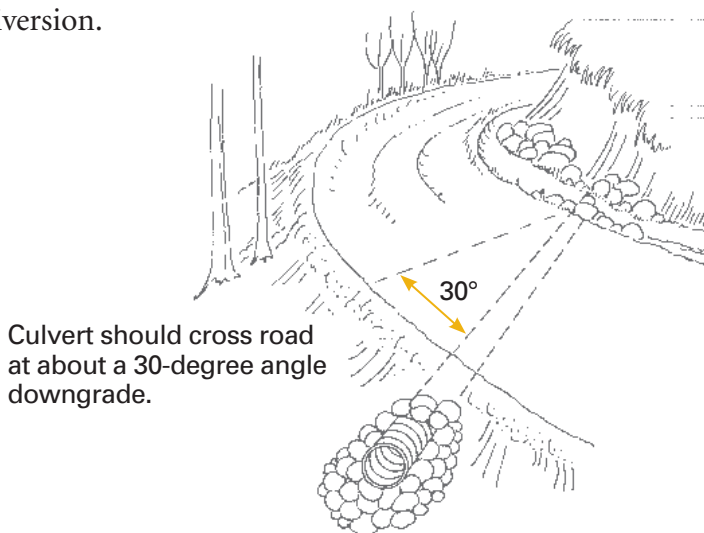

Figure 11. Correct installation of a pipe culvert for water diversion.



CULVERT INSTALLATION

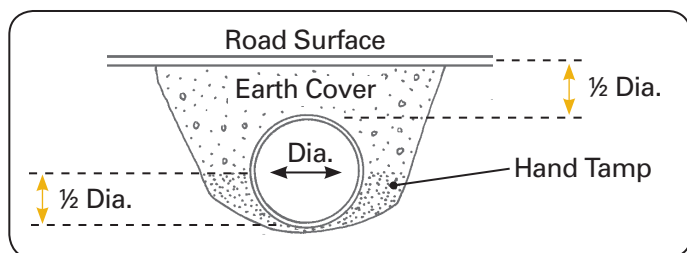

Figure 12. Water diversion: open-top box culvert.

OPEN-TOP CULVERT LAYOUT

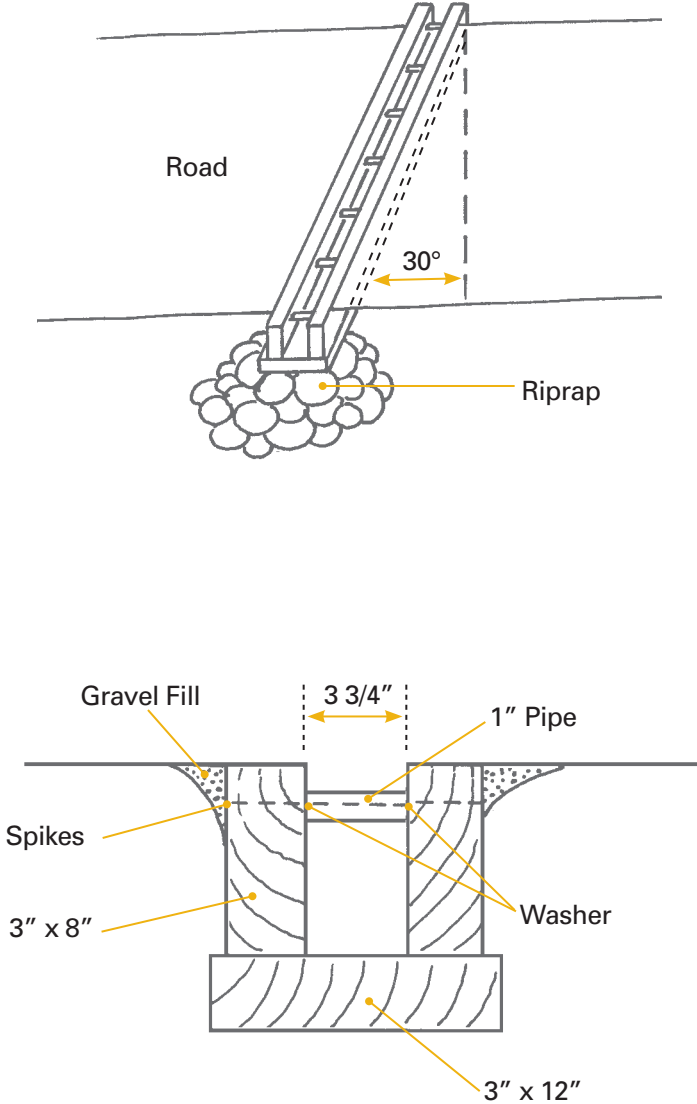
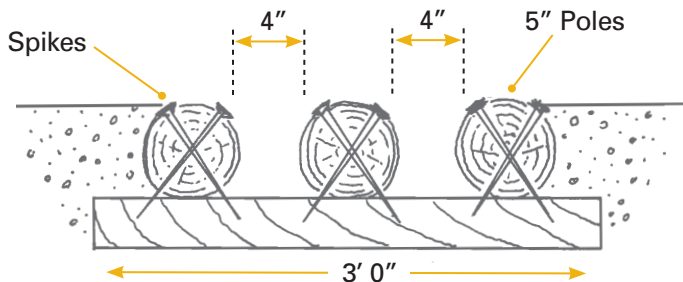

Figure 13. Water diversion: open-top pole culvert.

POLE CULVERT



NOTE: All culverts should fall not less than $\frac{1}{2}$ " to the foot.

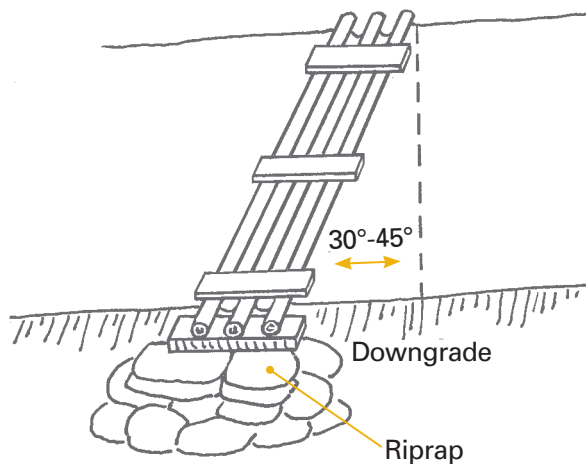
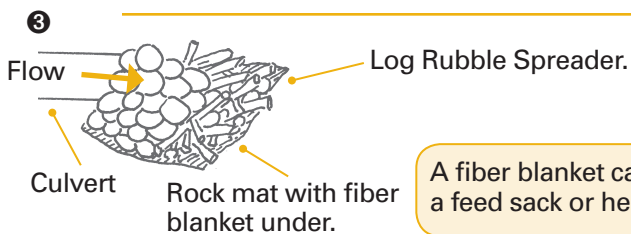
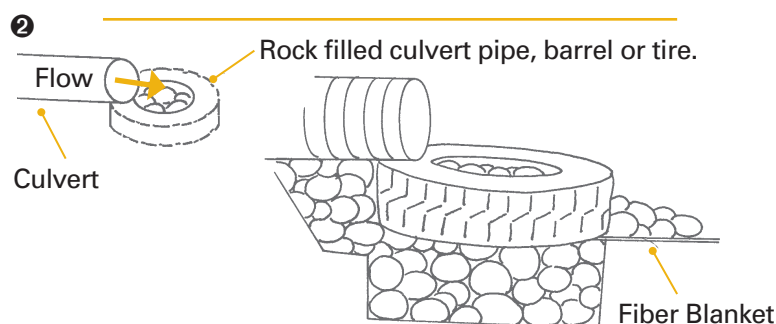
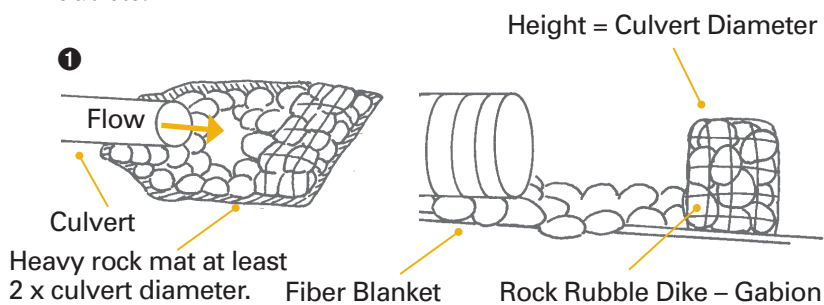

Figure 14. Water diversion: energy dissipaters for culvert outlets.



A fiber blanket can consist of a feed sack or heavy plastic.



Table 1. Culvert spacing chart.

Slope (percent)	Distance (feet)
0–2	500–300
3–5	250–180
6–10	165–140
11–15	135–130
16–20	125–120
21–25	100–65
> 26	50

E. Design Standards

Design the road so that it is able to accommodate vehicles and their loads safely and without damage to the road.

Design Guidelines

1. Minimum roadbed width should be 14 feet for a single lane and 20 feet for a double lane.
2. Side slopes for excavated cuts should be straight up and stepped or sloped. Up to a 5-foot vertical cut is acceptable; greater than 5 feet should not exceed 1½:1.
3. Earthen fill slopes should be no steeper than 2:1.
4. Install side ditches on road sections where surface runoff endangers fill areas.

Notes:

Example

For the 1½:1 Ratio

Road bank height X 1½ + Horizontal Distance

Example: If road bank is 6.6 feet high, then 6.6 feet X 1½ = 9.9 feet or 10 feet of horizontal distance.

Figure 15. Straight up excavated side cut.



F. Daylighting

If possible, trees may be removed along the sides of the road to allow sunlight to enter and dry the road's surface.

G. Filter Areas

See Section VII, Filter and Shade Strips.

H. Stream Crossings

1. Cross streams at right angles (90°) (see Section VI, Stream Crossings).

2. Armor stream bottom and protect banks.
3. Break grade at both approaches.
4. Use culverts and bridges where appropriate (see Section VI, Stream Crossings).

I. Wet and Critical Areas

Where possible, avoid wet and critical areas. Build roads using fill or borrow material, such as gravel or crushed rock. Geo-Textile, poles, slabs, or logs or tree tops placed side by side can provide a base for borrow material. Wooden mats (see Figure 16), planking, or other appropriate material can be used to prevent rutting.

Figure 16. Protective wooden mud mats.



J. Access Roads

Gravel the haul road entrance up to 200 feet from the public highway when necessary to reduce mud on the highway.

K. Maintenance

During the construction period and the harvest operation period, roads and their drainage systems should be maintained so as to remain functional. Operations that will cause adverse erosion and sediment problems should not be conducted in times of extreme weather conditions. See Section V, Maintenance, for a detailed discussion.

L. Closing or Putting to Bed

If the road is to be closed, retire the road as in Section VIII, Sale Closing.

Notes:

SKID TRAILS

Skid trails are unsurfaced single-lane trails or narrow roads, usually steeper and narrower than a truck haul road, and are used for skidding harvested products, such as logs, tree lengths, or other roundwood products, from the stump to a common landing or concentration area.

Locate landings first and lay out approaches with low grades. Major skid trails should have planned locations to minimize damage to the residual stand, reduce erosion and sedimentation, and provide the most economical method for skidding products.

Existing Roads: Repair or Relocate?

Many forested tracts in Ohio already have existing roads. Many of these existing roads are eroding and have washed-out areas due to lack of maintenance or bad location and design. Old roads often do not meet present BMP guidelines for design or location. Consider the effects of construction, continued use, and maintenance when making decisions regarding existing roads.

A. Slope

Keep grades less than 20 percent when possible. Steeper grades are acceptable when other practices, such as water diversions or large water bars, are used to prevent channelized water flow down the skid trail. Whenever possible, do not cross contours at a right angle with skid roads. Do not go straight up the hill, but proceed slanting up the slope (Figures 17A and 17B).

B. Location

Avoid stream channels, rocky places, spring seeps, adverse grades, and wet areas.

C. Drainage

Avoid long, steep grades and creating entrenched roads by taking advantage of natural cross drainage by locating skid trails on hillsides and changing (breaking) road grade as the slope changes. Where no natural grade breaks exist, grade breaks can be obtained by turning the skid trails up the hill a few feet then turning downhill again. By reversing grade in this way, water will run off the downhill side of the skid trails. Rolling dips and temporary water bars can also be employed to control drainage. Maintenance of skid roads during use is necessary to direct surface water.

Figure 17A. Using grade breaks to divert water.

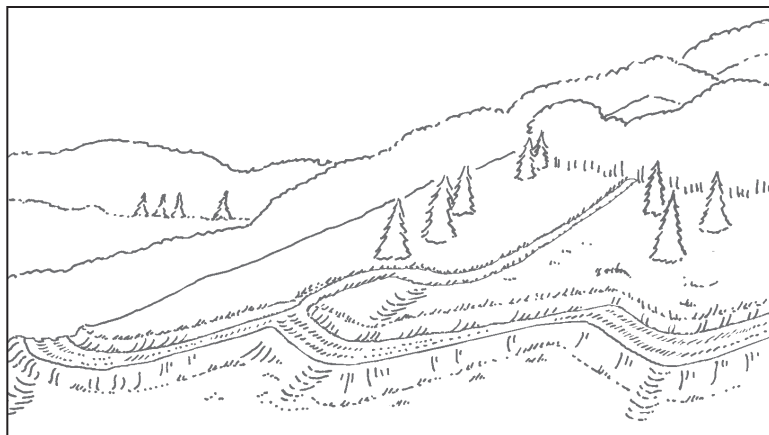

Notes:

Figure 17B. Good application of grade breaks.



D. Stream Crossings

1. Cross stream at right angles (90°).
2. Armor streambanks and bottoms.
3. Break grade at both approaches.
4. Use culverts and bridges where appropriate.

Also see Section VI, Stream Crossings.

E. Filter and Shade Strips

Keep skid trails out of stream side filter and shade strips.
(Also see Section VII, Filter and Shade Strips.)

F. Closing Skid Trails (Temporary or Permanent)

Restored stream crossings and channels should be clear of slash and restored to their natural shape and grade.

At the time of temporary, seasonal, or job completion, skid trails should receive proper erosion control treatments. These could include water bars, rolling dips, application of logging debris, and seed and straw application. (Also see Section VIII, Sale Closing.)

Logging debris can be used as an erosion control treatment in conjunction with water bars on skid trails. Brush and logs need to be limbed sufficiently so there is enough ground contact to break the flow of water on the ground. Large limbs and small logs should lay with the contour of the hill.

Figure 18. Water bar for water diversion.

Use material excavated from dip to construct hump.

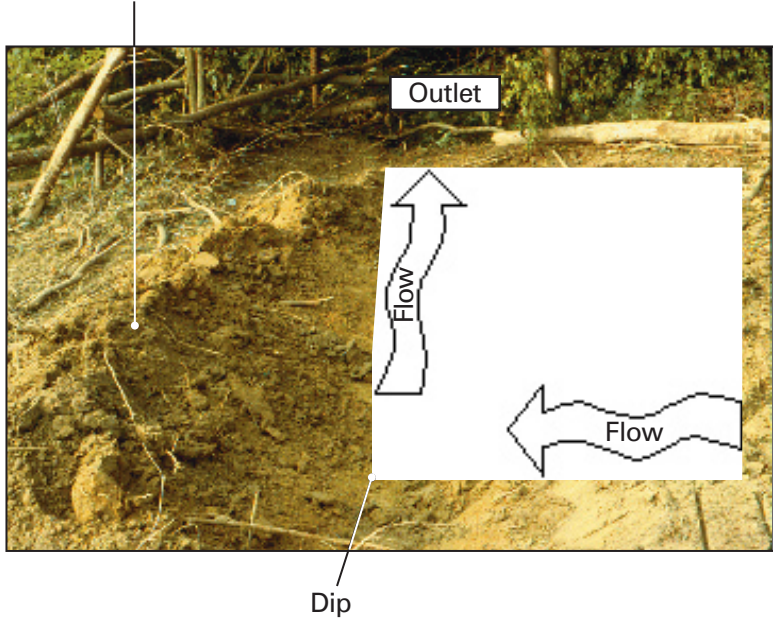
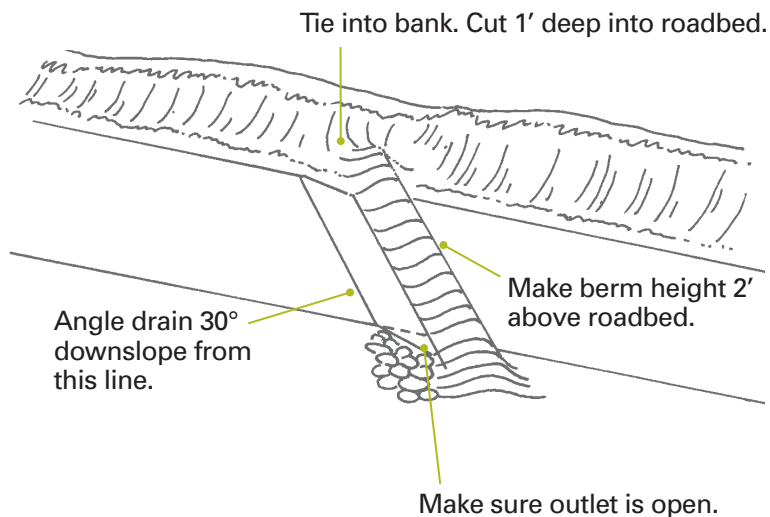

Figure 19A. Constructing water bars with mechanized equipment.

WATER BARS – TOP VIEW



WATER BARS – CROSS SECTION

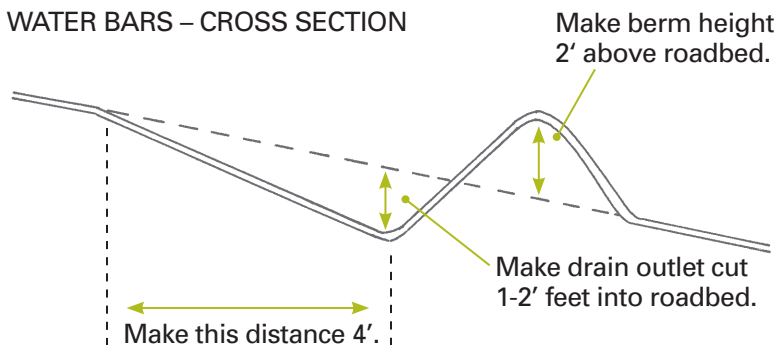

Figure 19B. Re-vegetated water bar on closed logging road.



Notes:

Figure 20. Alternative water bars: hand construction.

- 1 Dig trench with mattock at slight angle to trail deeper than bottom of skid trail.

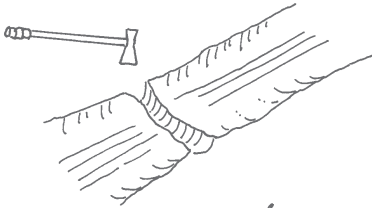

- 2 Cut log for water bar from 6' to 8' tree that is crooked, top broken or damaged. Used fender poles make good water bars.

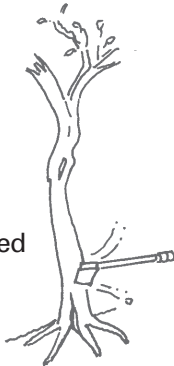

- 3 Place log in trench deep enough to keep water from running under log. Extend log well beyond trail on both sides.

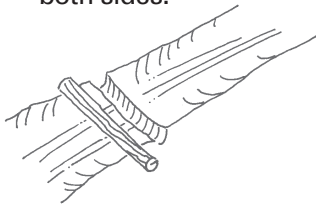

- 4 Place stakes, rocks on down hill side to hold log in trench. Provide outlet to carry water away from trail.

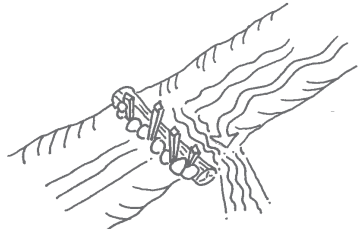

- 5 Throw brush on skid trail between water bars. Roll cull logs and rocks on top of brush.

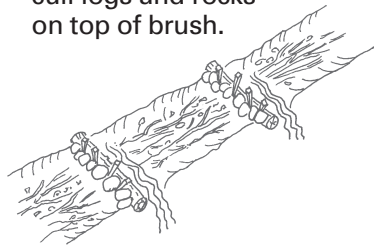

SPACING OF WATER BARS

Place water bars:

20' on steep slopes

50' on medium slopes

100' on slight slopes

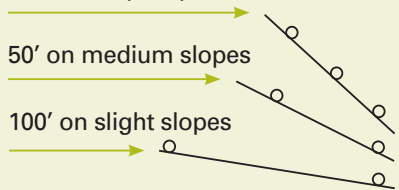

Skid Trail Erosion Control Devices.

The erosion control practice shown above requires a considerable amount of hand labor. The more common practice is to install these devices with bulldozers using the blade.

MAINTENANCE

Best management practices are effective only if they are maintained during the entire logging operation. Below are some simple maintenance techniques that can be employed during a logging operation.

A. During Road Construction

Care needs to be given during periods of new road and landing construction to keep soil movement *out* of the waterways. Refer to Figures 4A, 4B, and 6 for temporary measures for reducing soil erosion.

B. During Logging

Periodically check all ditches, culverts, energy dissipators, rolling and broad-based dips, water turnouts, and silt fences for obstructions no matter how minor. *Much maintenance can be accomplished by one individual and a #2 long handle shovel.* Recrowning haul roads and skid roads is a must for water management. Be on the watch for wet areas or seeps during rainy periods and as a prevention measure during normal logging operations.

Also see Section III (A).

Notes:

STREAM CROSSINGS

General Guidelines

1. Avoid stream crossing when possible.
2. There is one best place to cross a stream.
3. Cross streams as far up the watershed as possible.
4. A well-defined channel is a desirable place to cross.
5. Minimize the amount of road that would impact the Streamside Management Zone (SMZ).
6. Use portable bridges when practical.
7. Stream crossings are critical areas that should be restored.

Stream Crossing Design Goals

1. Cross streams at a right angle (90°).
2. Break grade as soon as possible on both approaches*.
3. Armor the stream bottom, and protect the banks from collapsing.

Haul Road Crossings

1. Use a portable bridge when practical (Figure 22A and 22B).
2. Use a culvert if necessary (See Table 2).
3. Gravel should be used to cover temporary culvert placement when necessary; gravel and/or soil is acceptable for permanent installation (Figure 11).
4. When fording a stream, armor both banks and approaches through break in grade or water diversion device*. Armor the stream bottom with

gravel unless a solid rock bottom exists. Geo-Textile fabrics and Geo-Cell should be considered for permanent crossings.

Skid Road Crossings

1. Use a portable bridge when practical.
2. Use a culvert or pipe if necessary (see Table 2).
3. Pole wood crossings should utilize long poles with a 6-inch diameter small end to fill channel level with banks; culverts may need to be installed under the wood to facilitate water flow. Not recommended for perennial streams.
4. Utilize standing bumper-trees on both banks when possible to keep wood and logs behind the skidder.
5. Approaches should be stabilized up through the break in grade or water diversion device* to minimize rutting and collapsing of the banks.

When crossing low wet areas where no channeled water flow exists, use tree tops, brush, mudmats, etc., to armor the area. Break grade on both sides and daylight if possible.

Stream Crossing Restoration

1. All stream crossings should be restored.
2. Remove bridge, culvert, soil, and all wood from temporary crossings.
3. Carefully restore stream bottom and banks to original contour where necessary.
4. Water bar or maintain break in grade or water diversion device.*

5. Grade roads to minimize rutting.
6. Seed, fertilize, lime, and mulch all disturbed soil up through break in grade or water diversion device.

* Breaks in grade or water diversion devices should be installed with sufficient filter strip below them to keep sediment from being transported to the stream.

Notes:

Figure 21. Culvert stream crossings: culvert slope.

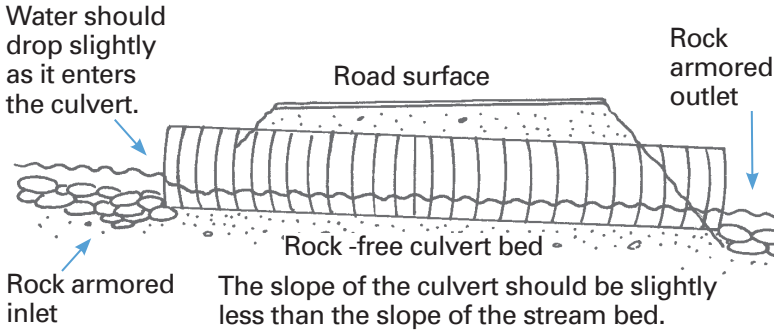

- Inlet set too deep increases the risk of plugging.
- Inlet not deep enough lets water undercut culvert.
- Outlet set too high undercuts road fill and stream bed.

Table 2. Culvert sizing chart.

**RECOMMENDED DIAMETERS OF CULVERTS
BASED ON DRAINAGE AREA**

Pipe Diameter (inches)	Area Above Pipe (acres)
12	2
15	4
18	7
21	12
24	16
30	27
36	47
42	64
48	90
54	120
60	160
66	205
72	250
78	350

BRIDGES

General Guidelines

- Bridges are effective ways to keep equipment out of flowing streams.
- Utilize a bridge design that will provide safe access and minimize disturbance to the streambank, channel, and the streamside management zone.
- Use temporary or portable bridges instead of culverts to access areas where permanent structures are not needed.
- Place them so as not to unduly constrict stream channels or impede flood waters.
- Anchor temporary bridges on one end with a cable or other device so they do not float away during high water.
- Install so they can be removed easily and promptly when they are no longer necessary.

Notes:

Figure 22A. Portable logging bridge installed with skidder.



Figure 22B. Alternative bridge design.



Notes:

Figure 23A. Pole crossing.



Notes:

Figure 23B. Pole crossing.



FILTER AND SHADE STRIPS

A *filter strip* is a protective strip of undisturbed forest soil. The filter strip separates areas that have been disturbed down to mineral soil from a watercourse. It provides a relatively undisturbed zone to trap and filter suspended solids before the particles reach the stream. The steeper the slope, the wider the filter strip should be (Table 3 and Figure 24).

A *shade strip* is a no cut or light cut 25-foot-wide strip on each side of the streambank that preserves adequate shading of permanently flowing streams and maintains satisfactory stream water temperature. Filter and shade strips may also be referred to as Streamside Management Zones or SMZs.

Equipment operation in filter strips should be minimized. If mineral soil is exposed, it should be seeded and mulched as soon as possible.

Skid trails and haul roads should not be located in filter and shade strips except when crossing streams. No skidding should be done in filter or shade strips. No landings or yards should be constructed in these areas.

Energy dissipators should be installed at culvert outlets where the culverts are not in the natural streambed at natural grade (Figure 14).

Cut and fill in filter and shade strips should be minimal to be consistent with safety and other design criteria.

The filter strips along perennial streams may be selectively harvested only. All trees casting shade on the stream should be left.

Logging slash greater than 6 inches in diameter shall be removed from the channel of perennial streams as identified on U.S.G.S. 7.5 minute quadrangles. Management of logging slash in filter strips should be a part of the O&M plan. Judgment should be used on treatment of slash as to its likelihood to cause streambank erosion for all streams. Pull slash away from channel and bank.

Table 3. Determining filter strip width.

Slope of Land Between Road and Stream (percent)	Width of Filter Strip for Common Logging Areas (feet)	Width of Filter Strip in Municipal Watersheds and Critical Areas (feet)
0	25	50
10	45	90
20	65	130
30	85	170
40	105	210
50	125	250
60	145	290
70	165	330
80	185	370
90	205	410
100	225	450

Figure 24. Filter strips.

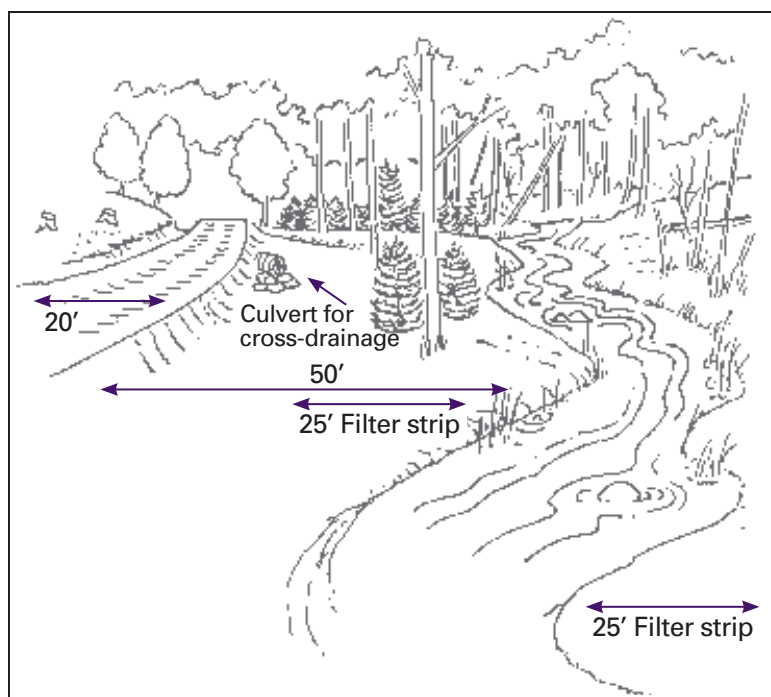

SALE CLOSING

The timber sale closure will determine the site's future soil erosion and sedimentation potential. The main purpose of the timber sale closure is to stabilize the soil to prevent soil erosion. However, improved wildlife habitat and aesthetics may be benefited by the sale closeout. Sale closure procedures should be completed as soon as a section of the timber harvest area is completed.

A. Water Bars

Water bars should be built on skid trails and haul roads that will not have vehicular traffic (Figures 18A, 18B, 19A, and 20).

Water bars should have an angle to the road of 30 degrees and an outslope of 2 to 3 degrees. The water bars should be spaced according to Table 4. Soil conditions may warrant closer spacing.

Table 4. Determining water bar spacing.

Slope (percent)	Spacing (feet)
2	250
5	135
10	80
15	60
20	45
25	40
30	35

The uphill end of the water bar should tie into the bank.

The downhill outlet of the water bar should only extend to the undisturbed forest floor.

Improperly constructed water bars will fail and cause soil erosion and sedimentation. Water bars should be a minimum of 2 feet above roadbed.

Pipe culverts, box culverts, rolling dips, or broad-based dips should be installed and maintained on roads that will continue to have vehicular traffic (see Section III, Haul Roads, and Section IV, Skid Trails).

B. Re-vegetation of Landings and Roads

Vegetation should be reestablished on all critical areas that have exposed mineral soil. *The goal should be to have 50 percent vegetative cover within one year of sale closing.* Lime, fertilizer, seed, and mulch may need to be applied in order to achieve this goal.

Seeding—Seeding to re-vegetate sites keeps the disturbed soil stabilized. Using various seed mixtures can benefit wildlife also (Table 6).

Lime and Fertilizer—Lime and fertilizer application may be necessary to insure seeding success. The lime applications should be incorporated to a depth of 3 to 6 inches. Seed and fertilizer should be surface-applied (Tables 5 and 7).

Figure 25. Re-vegetated logging road.



Figure 26. Properly re-vegetated and closed logging road.



Mulching

Mulch is extremely important on new seedings, especially those on steep slopes, regardless of soil conditions.

Immediately after seeding, mulch all seeded areas steeper than 20 percent with fresh straw (preferably wheat) spread uniformly at the rate of 1½ to 2 tons per acre, or 100 pounds (2–3 bales) per 1,000 square feet and cover lightly 75–90 percent of the surface area. Twenty-five bales is typical per ¼ acre landing.

When practical, anchor mulch with one of the following methods:

1. Mulch anchoring tool. This tool has a series of flat, notched disks that punch and anchor the mulch material into the soil.
2. Mulch netting of lightweight, fibrous materials.
3. Excelsior Blanket may be used in lieu of other mulch in gutters, channels, or other areas of concentrated runoff.

Notes:

General Note

All mulches will provide some degree of:

1. erosion control
2. moisture conservation
3. weed control
4. reduction of soil crusting

For dormant seedings mulching rates will be increased 50 percent.

Figure 27. Properly installed mulch on new seeding.



Table 5. Suggested seeding, fertilizer, and lime rates.

50#	Grass Seed per Acre
200#	14-14-14 Fertilizer per Acre
400#	Pelletized Lime per Acre

Table 6. Suggested grass seed mixtures for disturbed sites.

SKID TRAILS AND ROAD CUTS

February 1 to May 1	August 16 to November 15
25 lbs/acre Spring Oats	50 lbs/acre Winter Wheat or Rye
10 lbs/acre Orchard Grass	10 lbs/acre Orchard Grass
15 lbs/acre Perennial Rye Grass	15 lbs/acre Perennial Rye Grass
10 lbs/acre Red Clover	10 lbs/acre Red Clover

May 1 to August 15	November 16 to January 31
20 lbs/acre Annual Rye Grass	30 lbs/acre Annual Rye or Winter Wheat
5 lbs/acre Orchard Grass	10 lbs/acre Orchard Grass
10 lbs/acre Red Clover	15 lbs/acre Perennial Rye
15 lbs Perennial Rye	10 lbs/acre Red Clover

The above seed mixtures are acceptable for sun and shade conditions and may also be regarded as a wildlife mixture.

Table 7. Calculating seed and fertilizer needs.

How to Calculate Seed and Fertilizer Needs for Roads and Disturbed Areas

A. Road Area (acres)

Road Length (feet)	Road Width (feet)					
	8'	10'	12'	14'	18'	20'
50	0.01	0.01	0.01	0.02	0.02	0.02
100	0.022	0.02	0.03	0.03	0.04	0.05
250	0.05	0.06	0.07	0.08	0.10	0.11
500	0.09	0.12	0.14	0.16	0.21	0.23
750	0.144	0.17	0.21	0.24	0.31	0.34
1000	0.18	0.24	0.28	0.32	0.41	0.46
1500	0.28	0.34	0.41	0.48	0.62	0.69
2000	0.36	0.48	0.56	0.64	0.83	0.92
5000	0.92	1.15	1.38	1.61	2.07	2.30
5280	0.97	1.21	1.45	1.70	2.18	2.43

Multiply the appropriate table figure times the pounds per acre that is recommended for seed mixtures.

B. Other Areas

- To determine acreage and pounds of seed needed for other areas, such as loading decks, turnouts, tank batteries, etc., use the following formula:

$$\begin{aligned} \text{Average length} \times \text{average width} &= \text{square feet} \\ \text{Square feet} \times 0.000023 & \end{aligned}$$

Multiply the answer times the pounds per acre as recommended in seed mixture tables to determine amount of seed.

2. To determine fertilizer and mulch needs, use the above procedures.

Example:

An access road is 12 feet wide and 500 feet long.

The well site is 200 feet wide and 250 feet long.

What is the total area?

Area of Road (from Chart) 0.14 acres

Area of Landing Site 1.15 acres

1.29 acres total

Use 1.29 x recommended seeding rates per acre to determine quantities needed.

Notes:

GLOSSARY

Buffer zone—An undisturbed area of vegetation used for screening roads or other sensitive areas.

Contour lines—Lines on a topographic map that determine slopes.

Critical areas—Areas subject to erosion due to soil type or slope including stream crossings.

Erosion—The movement of soil through the action of wind or water.

Geo-Textile fabric—Woven, non-woven, or knitted fabric that is water permeable and usually non-biodegradable that is used to separate, filter, and reinforce aggregate.

Landings—Logging decks; areas where logs are skidded for concentration.

Mitigation—The use of management practices to compensate for or reduce the negative impact of harvests on a forest.

Operation and Management Plan (O&M)—A written course of action to ensure that BMPs are incorporated into any silvicultural practice to maintain water quality.

Rip-rap—Heavy stone used on banks and soil to avoid erosion.

Sediment—Soil that settles to the bottom of bodies of water.

Silt—Soil particles suspended in water.

Slash—Logs, branches, tree tops, or brush created as a result of logging.

Stream—A body of water running or flowing on the earth's surface, or channel in which such flow occurs. Flow may be seasonally intermittent.

Stream crossings—For purposes of discussion in this book, stream crossings are defined as the area of disturbed soil from break in grade on opposing banks.

Streamside Management Zone (SMZ)—Land adjacent to perennial, intermittent, and ephemeral streams, ponds, or lakes requiring special attention during forestry operations. They are to be treated in a way that meets water quality standards for nonpoint source pollution.

Perennial stream—Identified by well-defined banks and natural channels, and have continuously flowing water most years. They are usually shown on a topographic map as a solid blue line.

Intermittent stream—Has well-defined banks and natural channels, but typically has flowing water from a headwater source for only a portion of the year. They are usually shown on a topographic map as broken blue lines.

Ephemeral stream—A flow as a result of wet weather conditions when the ground is saturated. The channel is characterized by being free of leaf litter showing bare rock soil that has been exposed by flowing water. Not shown on topographic maps.

Water bars—Water diversion structure.

SOURCES

“Logger’s Handbook: A Guide to Recommended Logging Practices, 1986,” Timber Industry Council, Ohio Forestry Association.

“Permanent Logging Roads for Better Woodlot Management,” USDA Forest Service Publication NA-FR-18.

“Woodlands of the Northeast: Erosion and Sediment Control Guides,” USDA Soil Conservation Service.

“Building Water Pollution Control into Small Private Forest and Ranch Roads,” USDA Soil Conservation Service.

“Montana Forestry BMP’s,” Forest Service Guidelines for Water Quality.

Best Management Practices for Road Construction and Harvesting Operations in Oklahoma.”

