

***GLOBAL POSITIONING SYSTEM
STANDARD POSITIONING SERVICE
SIGNAL SPECIFICATION***



2nd Edition

June 2, 1995

TABLE OF CONTENTS

SECTION 1.0 The GPS Standard Positioning Service.....	1
1.1 Purpose	1
1.2 Scope.....	1
1.3 Policy Definition of the Standard Positioning Service.....	2
1.4 Key Terms and Definitions.....	3
1.4.1 General Terms and Definitions	3
1.4.2 Performance Parameter Definitions	4
1.5 Global Positioning System Overview.....	5
1.5.1 The GPS Space Segment.....	5
1.5.2 The GPS Control Segment	6
SECTION 2.0 Specification of SPS Ranging Signal Characteristics.....	9
2.1 An Overview of SPS Ranging Signal Characteristics.....	9
2.1.1 An Overview of SPS Ranging Signal RF Characteristics.....	9
2.1.2 An Overview of the GPS Navigation Message.....	9
2.2 Minimum Usage Conditions.....	10
2.2.1 Satellite Tracking and Selection.....	10
2.2.2 SPS Receiver Design and Usage Contributions to Position Solution Error.....	11
2.2.3 Position Fix Dimensions.....	12
2.2.4 Position Fix Rate	12
2.2.5 Position Solution Ambiguity.....	12
2.3 SPS Ranging Signal RF Characteristics.....	12
2.3.1 Ranging Signal Carrier Characteristics.....	12
2.3.1.1 Frequency Plan	12
2.3.1.2 Correlation Loss	13
2.3.1.3 Carrier Phase Noise.....	13
2.3.1.4 Spurious Transmissions.....	13
2.3.1.5 Equipment Group Delay.....	13
2.3.1.6 Signal Polarization.....	13
2.3.2 C/A Code Generation and Timing.....	13
2.3.2.1 C/A Code Structure	14
2.3.2.2 C/A-Code Generation.....	14
2.3.2.3 Non-Standard Code	14
2.3.3 Code Modulation and Signal Transmission.....	14
2.3.3.1 Navigation Data.....	14
2.3.3.2 L-Band Signal Structure	14
2.3.4 Signal Coverage and Power Distribution.....	18
2.3.5 GPS Time and the Satellite Z-Count.....	18
2.4 Navigation Message Data Structure.....	19
2.4.1 Message Structure	19
2.4.1.1 Data Page Format.....	20
2.4.1.2 Data Parity.....	20
2.4.1.3 Default Navigation Data Transmission.....	20
2.4.2 Telemetry and Handover Words	20
2.4.2.1 Telemetry Word.....	23
2.4.2.2 Handover Word	23
2.4.3 Subframe 1 - Satellite Clock and Health Data.....	24
2.4.3.1 Week Number	24

TABLE OF CONTENTS (continued)

2.4.3.2	User Range Accuracy	24
2.4.3.3	Satellite Health	25
2.4.3.4	Issue of Data, Clock	25
2.4.3.5	Estimated Group Delay Differential	25
2.4.3.6	Satellite Clock Correction Parameters	25
2.4.3.7	Reserved Data Fields	25
2.4.4	Subframes 2 and 3 - Satellite Ephemeris Data	26
2.4.4.1	Ephemeris Parameters	26
2.4.4.2	Issue of Data, Ephemeris	26
2.4.4.3	Spare and Reserved Data Fields	27
2.4.5	Subframes 4 and 5 - Support Data	27
2.4.5.1	Data and Satellite IDs	28
2.4.5.2	Almanac	28
2.4.5.3	Health Summary	30
2.4.5.4	Satellite Configuration Summary	31
2.4.5.5	Universal Coordinated Time (UTC) Parameters	32
2.4.5.6	Ionospheric Parameters	32
2.4.5.7	Special Message	33
2.4.5.8	Spare Data Fields	33
2.5	User Algorithms	34
2.5.1	Mathematical Constants	34
2.5.2	Parity Algorithm	35
2.5.3	User Range Accuracy	35
2.5.4	User Algorithm for Ephemeris Determination	35
2.5.4.1	Coordinate System	35
2.5.4.2	Geometric Range Correction	37
2.5.5	Application of Correction Parameters	37
2.5.5.1	Group Delay Application	39
2.5.5.2	Satellite Clock Correction	39
2.5.5.3	Ionospheric Model	40
2.5.6	Universal Coordinated Time (UTC)	42
2.5.7	Almanac Data	43
	Acronyms	45

Annex A: Standard Positioning Service Performance Specification

Annex B: Standard Positioning Service Performance Characteristics

Annex C: Means of Measuring GPS Performance

NOTE: Table of Contents for the Annexes are contained within each respective Annex.

FIGURES

Figure 1-1. SPS Ranging Signal Generation and Transmission.....	6
Figure 1-2. The GPS Control Segment.....	7
Figure 2-1. Navigation Message Content and Format Overview.....	10
Figure 2-2. G1 Shift Register Generator Configuration.....	16
Figure 2-3. G2 Shift Register Generator Configuration.....	16
Figure 2-4. C/A-Code Generation.....	17
Figure 2-5. C/A Code Timing Relationships.....	17
Figure 2-6. User Received Minimum Signal Levels.....	18
Figure 2-7. Time Line Relationship of HOW Word.....	19
Figure 2-8. Data Format (Sheet 1 of 2).....	21
Figure 2-8. Data Format (Sheet 2 of 2).....	22
Figure 2-9. TLM and HOW Formats.....	23
Figure 2-10. Example Flow Chart for User Implementation of Parity Algorithm.....	37
Figure 2-11. Application of Correction Parameters.....	39

TABLES

Table 2-1. Code Phase Assignments.....	15
Table 2-2. Subframe 1 Parameters.....	24
Table 2-3. Subframe 1 Reserved Data Fields.....	26
Table 2-4. Ephemeris Data Definitions.....	26
Table 2-5. Ephemeris Parameters.....	27
Table 2-6. Subframe 2 and 3 Spare and Reserved Data Fields.....	27
Table 2-7. Data IDs and Satellite IDs in Subframes 4 and 5.....	29
Table 2-8. Almanac Parameters.....	30
Table 2-9. Navigation Data Health Indications.....	31
Table 2-10. Codes for Health of Satellite Signal Components.....	31
Table 2-11. UTC Parameters.....	32
Table 2-12. Ionospheric Parameters.....	33
Table 2-13. Spare Bits in Subframes 4 and 5.....	34
Table 2-14. Parity Encoding Equations.....	36
Table 2-15. Elements of Coordinate Systems.....	38

SECTION 1.0 The GPS Standard Positioning Service

The Global Positioning System (GPS) is a space-based radionavigation system which is managed for the Government of the United States by the U.S. Air Force (USAF), the system operator. GPS was originally developed as a military force enhancement system and will continue to play this role. However, GPS has also demonstrated a significant potential to benefit the civil community in an increasingly large variety of applications. In an effort to make this beneficial service available to the greatest number of users while ensuring that the national security interests of the United States are observed, two GPS services are provided. The Precise Positioning Service (PPS) is available primarily to the military of the United States and its allies for users properly equipped with PPS receivers. The Standard Positioning Service (SPS) is designed to provide a less accurate positioning capability than PPS for civil and all other users throughout the world.

1.1 Purpose

The GPS SPS Signal Specification defines the service to be provided by GPS to the civil community. This document is written to satisfy the following four objectives:

- 1) Specify GPS SPS ranging signal characteristics.
- 2) Specify SPS performance, given a receiver designed in accordance with this Signal Specification.
- 3) Standardize SPS performance parameter definitions and measurement methodologies.
- 4) Define SPS performance characteristics.

The Signal Specification consists of this document and three Annexes. This document specifies GPS SPS signal characteristics and the minimum requirements for receiving and using the SPS ranging signal. The Annexes provide technical data that quantifies SPS performance. Provided below is a definition of each Annex's purpose:

- **Annex A: SPS Performance Specification.** This Annex specifies GPS SPS performance in terms of minimum performance standards, and conditions and constraints associated with the provision of the service.
- **Annex B: SPS Performance Characteristics.** This Annex defines GPS SPS performance parameters and their characteristics as a function of time, user location, system design and changing operational conditions.
- **Annex C: Means of Measuring GPS Performance.** This Annex defines the specific measurement processes which a user must apply to evaluate GPS performance, in order to obtain results which are consistent with the parameter definitions and performance standards established in this Signal Specification.

1.2 Scope

This Signal Specification defines SPS ranging signal characteristics and minimum usage conditions. The Annexes establish the SPS performance which a minimally equipped SPS user can expect to experience anywhere on or near the surface of the Earth, and the means to evaluate that performance. SPS signal and performance specifications are independent of how the user applies the basic positioning and timing services provided. Performance specifications do not take into consideration the measurement noise or reliability attributes of the SPS receiver or possible signal interference.

This Signal Specification and the Annexes establish new definitions and relationships between traditional performance parameters such as coverage, service availability, service reliability and accuracy. GPS performance specifications have previously been made to conform to definitions which apply to fixed terrestrial positioning systems. The new definitions are tailored to better represent the performance attributes of a space-based positioning system. Refer to Annex B for a more comprehensive discussion of GPS performance parameter definitions and relationships.

Due to the nature of the system design and its operation, individual GPS satellite ranging measurements will not necessarily exhibit unchanging SPS ranging error statistics. Furthermore, the Department of Defense (DOD) does not guarantee that GPS ranging or positioning error statistics will remain stationary, or that individual satellite ranging error statistics will be consistent throughout the constellation.

The DOD will base its on-going measurement and assessment of all specified aspects of SPS performance on data gathered from Control Segment (CS) monitor stations. If the minimum performance standards are met at each of the monitor stations, the DOD will assume that standards are being met on a global basis. Geographic variations in performance will be taken into consideration in the assessment process.

1.3 Policy Definition of the Standard Positioning Service

The United States Government defines the GPS Standard Positioning Service as follows:

SPS is a positioning and timing service, and is provided on the GPS L1 frequency. The GPS L1 frequency, transmitted by all GPS satellites, contains a coarse acquisition (C/A) code and a navigation data message. The GPS L1 frequency also contains a precision (P) code that is reserved for military use and is not a part of the SPS. The P code can be altered without notice and will not normally be available to users that do not have valid cryptographic keys. GPS satellites also transmit a second ranging signal known as L2. This signal is not a part of the SPS, although many civil receivers have incorporated technologies into their design that enables them to use L2 to support two-frequency corrections without recourse to code tracking logic. SPS performance standards are not predicated upon use of L2.

Any planned disruption of the SPS in peacetime will be subject to a minimum of 48-hour advance notice provided by the DOD to the Coast Guard Navigation Information Center and the FAA Notice to Airmen (NOTAM) system. A disruption is defined as periods in which the GPS is not capable of providing SPS as it is defined in this Specification. Unplanned service disruptions resulting from system malfunctions or unscheduled maintenance will be announced by the Coast Guard and the FAA as they become known.

1.4 Key Terms and Definitions

Terms and definitions which are key to understanding the scope of the GPS Standard Positioning Service are provided below.

1.4.1 General Terms and Definitions

The terms and definitions discussed below are used throughout the Signal Specification. An understanding of these terms and definitions is a necessary prerequisite to full understanding of the Signal Specification.

Standard Positioning Service (SPS). Three-dimensional position and time determination capability provided to a user equipped with a minimum capability GPS SPS receiver in accordance with GPS national policy and the performance specifications established in this Signal Specification.

Minimum SPS Receiver Capabilities. The minimum signal reception and processing capabilities which must be designed into an SPS receiver in order to experience performance consistent with the SPS performance standards. Minimum SPS receiver capabilities are identified in Section 2.2.

Selective Availability. Protection technique employed by the DOD to deny full system accuracy to unauthorized users.

Block I and Block II Satellites. The Block I is a GPS concept validation satellite; it does not have all of the design features and capabilities of the production model GPS satellite, the Block II. The FOC 24 satellite constellation is defined to consist entirely of Block II/IIA satellites. For the purposes of this Signal Specification, the Block II satellite and a slightly modified version of the Block II known as the Block IIA provide an identical service.

Operational Satellite. A GPS satellite which is capable of, but may or may not be, transmitting a usable ranging signal. For the purposes of this Signal Specification, any satellite contained within the transmitted navigation message almanac is considered to be an operational satellite.

SPS Signal, or SPS Ranging Signal. An electromagnetic signal originating from an operational satellite. The SPS ranging signal consists of a Pseudo Random Noise (PRN) Coarse/Acquisition (C/A) code, a timing reference and sufficient data to support the position solution generation process. A full definition of the GPS SPS signal is provided in Section 2.

Usable SPS Ranging Signal. An SPS ranging signal which can be received, processed and used in a position solution by a receiver with minimum SPS receiver capabilities.

SPS Ranging Signal Measurement. The difference between the ranging signal time of reception (as defined by the receiver's clock) and the time of transmission contained within the satellite's navigation data (as defined by the satellite's clock) multiplied by the speed of light. Also known as the *pseudo range*.

Geometric Range. The difference between the estimated locations of a GPS satellite and an SPS receiver.

Navigation Message. Message structure designed to carry navigation data. This structure is defined in Section 2.4.

Navigation Data. Data provided to the SPS receiver via each satellite's ranging signal, containing the ranging signal time of transmission, the transmitting satellite's orbital elements, an almanac containing abbreviated orbital element information to support satellite selection, ranging measurement correction information, and status flags.

Position Solution. The use of ranging signal measurements and navigation data from at least four satellites to solve for three position coordinates and a time offset.

Dilution of Precision (DOP). The magnifying effect on GPS position error induced by mapping GPS ranging errors into position through the position solution. The DOP may be represented in any user local coordinate desired. Examples are HDOP for local horizontal, VDOP for local vertical, PDOP for all three coordinates, and TDOP for time.

SPS Performance Standard. A quantifiable minimum level for a specified aspect of GPS SPS performance. SPS performance standards are defined in Annex A to this Signal Specification.

SPS Performance Envelope. The range of variation in specified aspects of SPS performance. Expected SPS performance characteristics are defined in Annex B to this Signal Specification.

Service Disruption. A condition over a time interval during which one or more SPS performance standards are not supported, but the civil community was warned in advance.

Major Service Failure. A condition over a time interval during which one or more SPS performance standards are not met and the civil community was not warned in advance.

1.4.2 Performance Parameter Definitions

The definitions provided below establish the basis for correct interpretation of the GPS SPS performance standards. As was stated in Section 1.2, the GPS performance parameters contained in this Signal Specification are defined differently than other radionavigation systems in the Federal Radionavigation Plan. For a more comprehensive treatment of these definitions and their implications on system use, refer to Annex B.

Coverage. The percentage of time over a specified time interval that a sufficient number of satellites are above a specified mask angle and provide an acceptable position solution geometry at any point on or near the Earth. For the purposes of this Signal Specification, the term "near the Earth" means on or within approximately 200 kilometers of the Earth's surface.

Service Availability. Given coverage, the percentage of time over a specified time interval that a sufficient number of satellites are transmitting a usable ranging signal within view of any point on or near the Earth.

Service Reliability. Given service availability, the percentage of time over a specified time interval that the instantaneous predictable horizontal error is maintained within a specified

reliability threshold at any point on or near the Earth. Note that service reliability does not take into consideration the reliability characteristics of the SPS receiver or possible signal interference. Service reliability may be used to measure the total number of major failure hours experienced by the satellite constellation over a specified time interval.

Positioning Accuracy. Given reliable service, the percentage of time over a specified time interval that the difference between the measured and expected user position or time is within a specified tolerance at any point on or near the Earth. This general accuracy definition is further refined through the more specific definitions of four different aspects of positioning accuracy:

- **Predictable Accuracy.** Given reliable service, the percentage of time over a specified time interval that the difference between a position measurement and a surveyed benchmark is within a specified tolerance at any point on or near the Earth.
- **Repeatable Accuracy.** Given reliable service, the percentage of time over a specified time interval that the difference between a position measurement taken at one time and a position measurement taken at another time at the same location is within a specified tolerance at any point on or near the Earth.
- **Relative Accuracy.** Given reliable service, the percentage of time over a specified time interval that the difference between two receivers' position estimates taken at the same time is within a specified tolerance at any point on or near the Earth.
- **Time Transfer Accuracy.** Given reliable service, the percentage of time over a specified time interval that the difference between a Universal Coordinated Time (commonly referred to as UTC) time estimate from the position solution and UTC as it is managed by the United States Naval Observatory (USNO) is within a specified tolerance.

Range Domain Accuracy. Range domain accuracy deals with the performance of each satellite's SPS ranging signal. Range domain accuracy is defined in terms of three different aspects:

- **Range Error.** Given reliable service, the percentage of time over a specified time interval that the difference between an SPS ranging signal measurement and the "true" range between the satellite and an SPS user is within a specified tolerance at any point on or near the Earth.
- **Range Rate Error.** Given reliable service, the percentage of time over a specified time interval that the instantaneous rate-of-change of range error is within a specified tolerance at any point on or near the Earth.
- **Range Acceleration Error.** Given reliable service, the percentage of time over a specified time interval that the instantaneous rate-of-change of range rate error is within a specified tolerance at any point on or near the Earth.

1.5 Global Positioning System Overview

Sufficient information is provided below to promote a common understanding of the minimum GPS baseline configuration. The GPS baseline system is comprised of two segments, whose purpose is to provide a reliable and continuous positioning and timing service to the GPS user community. These two segments are known as the Space Segment and the Control Segment.

1.5.1 The GPS Space Segment

The GPS Block II/IIA satellite constellation normally consists of 24 operational satellites*. The Block II satellite and a slightly modified version, the Block IIA satellite, will be the mainstays of the constellation over the next decade. From a civil user's perspective, the Block II and Block IIA satellites provide an identical service.

Each satellite generates a navigation message based upon data periodically uploaded from the Control Segment and adds the message to a 1.023 MHz Pseudo Random Noise (PRN) Coarse/Acquisition (C/A) code sequence. The satellite modulates the resulting code sequence onto a 1575.42 MHz L-band carrier to create a spread spectrum ranging signal, which it then broadcasts to the user community. This broadcast is referred to in this Signal Specification as the SPS ranging signal. Each C/A code is unique, and provides the mechanism to identify each satellite in the constellation. A block diagram illustrating the satellite's SPS ranging signal generation process is provided in Figure 1-1. The GPS satellite also transmits a second ranging signal known as L2, that supports PPS user two-frequency corrections. L2, like L1, is a spread spectrum signal and is transmitted at 1227.6 Mhz.

The Block II satellite is designed to provide reliable service over a 7.5 year design life through a combination of space qualified components, multiple redundancies for critical subsystems, and internal diagnostic logic. The Block II satellite design requires minimal interaction with the ground and allows all but a few maintenance activities to be conducted without interruption to the ranging signal broadcast. Periodic uploads of data to support navigation message generation are designed to cause no disruption to the SPS ranging signal.

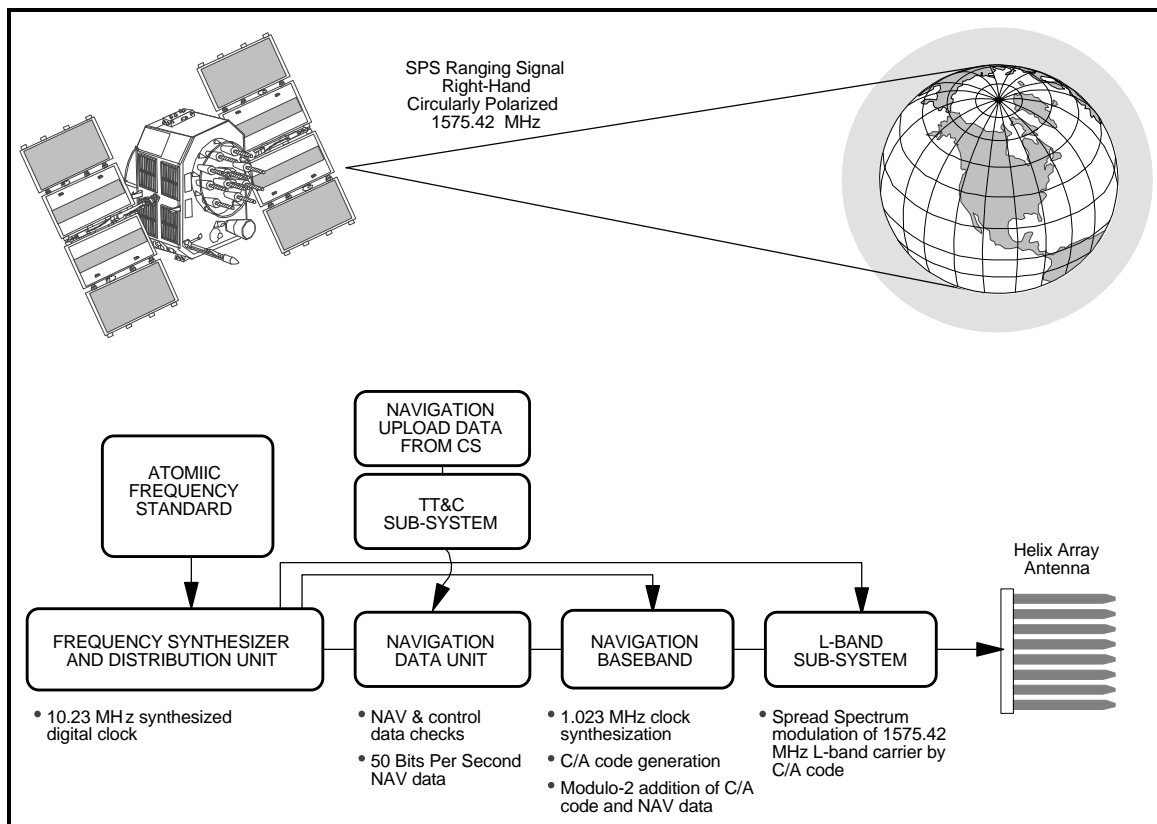

Figure 1-1. SPS Ranging Signal Generation and Transmission

* There may be some Block I satellites in the constellation, as long as they remain operable.

1.5.2 The GPS Control Segment

The GPS Control Segment (CS) is comprised of three major components: a Master Control Station (MCS), ground antennas, and monitor stations. An overview of the CS is provided in Figure 1-2.

The MCS is located at Falcon Air Force Base, Colorado, and is the central control node for the GPS satellite constellation. Operations are maintained 24 hours a day, seven days a week throughout each year. The MCS is responsible for all aspects of constellation command and control, to include:

- Routine satellite bus and payload status monitoring.
- Satellite maintenance and anomaly resolution.
- Monitoring and management of SPS performance in support of all performance standards.
- Navigation data upload operations as required to sustain performance in accordance with accuracy performance standards.
- Prompt detection and response to service failures.

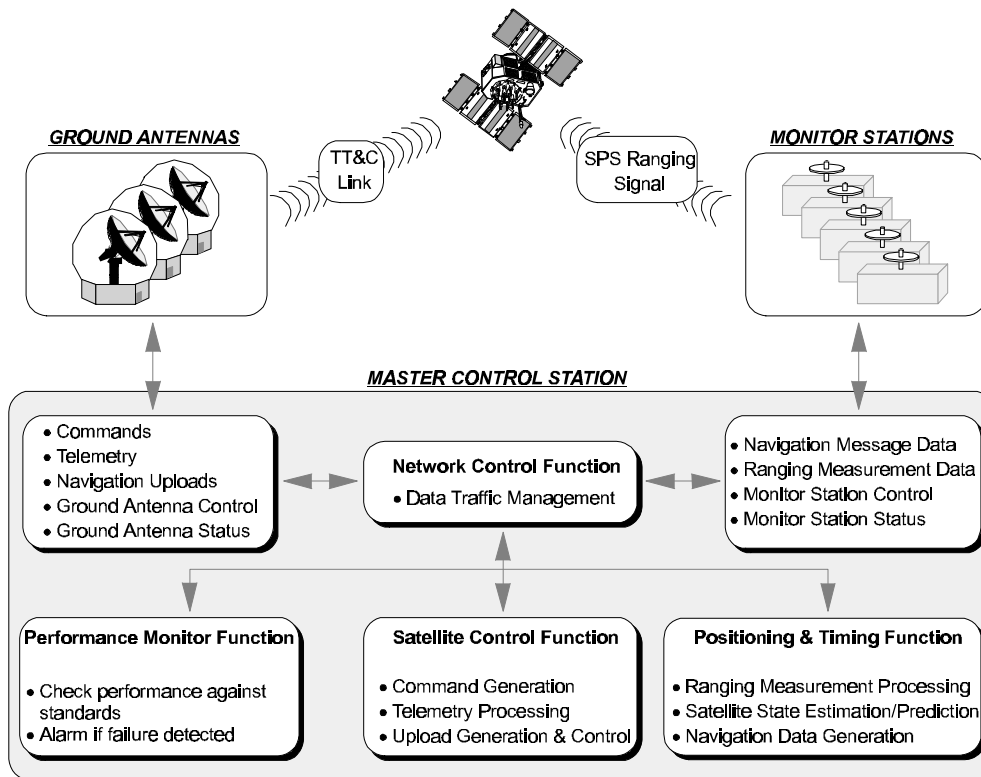

Figure 1-2. The GPS Control Segment

The CS's three ground antennas provide a near real-time Telemetry, Tracking and Commanding (TT&C) interface between the GPS satellites and the MCS. The five monitor stations provide near

real-time satellite ranging measurement data to the MCS and support near-continuous monitoring of constellation performance.*

* Approximately 92% global coverage, with all monitor stations operational, with a 5° elevation mask angle.

SECTION 2.0 Specification of SPS Ranging Signal Characteristics

This section defines the SPS ranging signal and specifies its functional characteristics. The SPS receiver must be capable of receiving and processing the GPS ranging signal in accordance with the requirements provided in this Signal Specification as a prerequisite to the receiver supporting minimum SPS performance standards.

The section begins with an overview of the SPS ranging signal. The SPS signal is then specified in terms of minimum usage conditions, Radio Frequency (RF) characteristics, the navigation message data structure, and user algorithms necessary to correctly interpret and apply the navigation data.

2.1 An Overview of SPS Ranging Signal Characteristics

This section provides an overview of SPS ranging signal characteristics. SPS ranging signal characteristics are allocated to two categories: carrier and modulation RF characteristics, and the structure, protocols and contents of the navigation message.

2.1.1 An Overview of SPS Ranging Signal RF Characteristics

The GPS satellite transmits a Right Hand Circularly Polarized (RHCP) L-band signal known as L1 at 1575.42 MHz. This signal is transmitted with enough power to ensure a minimum signal power level of -160 dBw at the Earth's surface. The SPS signal generation and transmission process is represented in Figure 1-1, in Section 1.5. The GPS satellite also transmits a second ranging signal known as L2 at 1227.6 Mhz. This signal is transmitted with enough power to ensure a minimum signal power level of -166 dBw at the Earth's surface. This signal is not considered by the DOD to be a part of the SPS. However, we note that many civil receivers have incorporated carrier tracking and cross-correlation technology into their design that enables them to use L2 to support two-frequency corrections. Neither these signal characteristics nor the SPS performance standards (Annex A) and characteristics (Annex B) are predicated upon use of L2.

L1 is Bipolar-Phase Shift Key (BPSK) modulated with a Pseudo Random Noise (PRN) 1.023 MHz code known as the Coarse/Acquisition (C/A) code. This C/A code sequence repeats each millisecond. The transmitted PRN code sequence is actually the Modulo-2 addition of a 50 Hz navigation message and the C/A code. The SPS receiver demodulates the received code from the L1 carrier, and detects the differences between the transmitted and the receiver-generated code. The SPS receiver uses an exclusive-or truth table to reconstruct the navigation data, based upon the detected differences in the two codes.

2.1.2 An Overview of the GPS Navigation Message

Each GPS satellite provides data required to support the position determination process. Figure 2-1 provides an overview of the data contents and structure within the navigation message. The data includes information required to determine the following:

- Satellite time of transmission
- Satellite position
- Satellite health
- Satellite clock correction
- Propagation delay effects
- Time transfer to UTC
- Constellation status

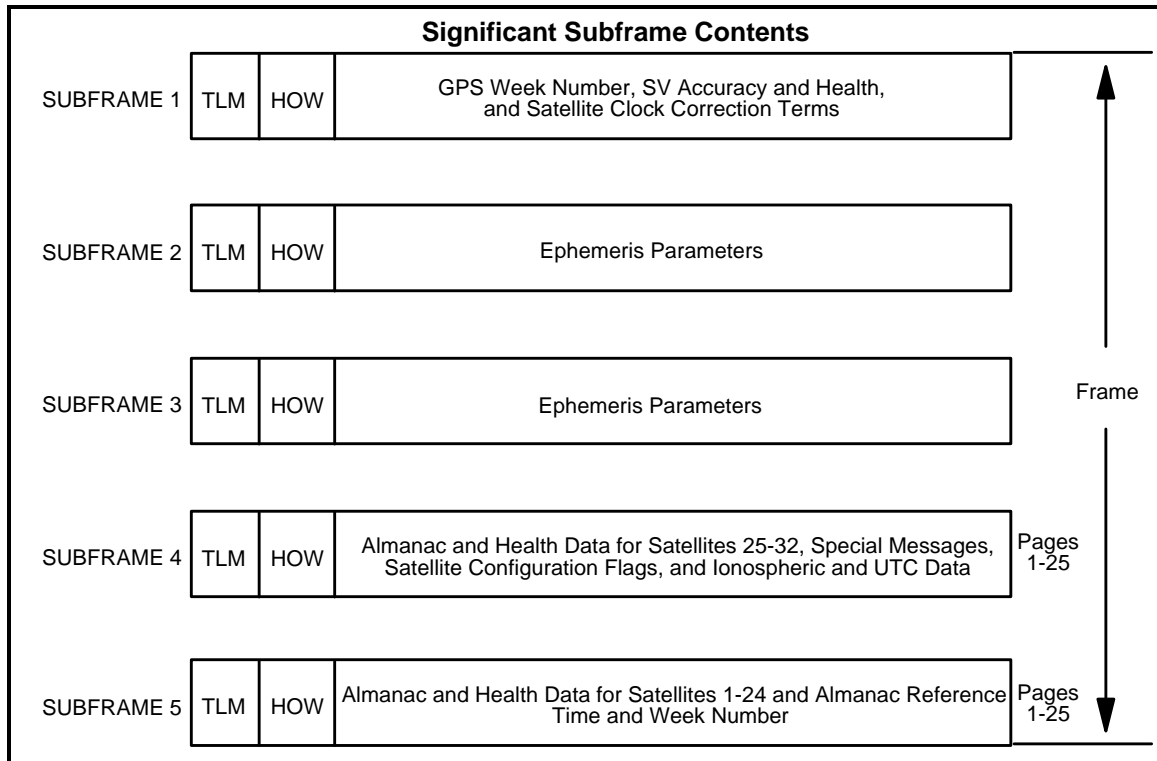

Figure 2-1. Navigation Message Content and Format Overview

2.2 Minimum Usage Conditions

Although the DOD specifies and controls the characteristics and performance of the GPS ranging signals, SPS performance must be specified in the positioning domain. However, since the definition of SPS receiver design requirements is not within the scope of this document, certain minimum assumptions concerning receiver design and usage must be made in order to map ranging signal performance characteristics into the positioning domain. These assumptions establish the minimum position and time determination capabilities which an SPS receiver must possess to meet the minimum performance standards, as they are specified in Annex A. Users whose receiver designs do not meet these assumptions may not experience performance in accordance with the performance standards.

2.2.1 Satellite Tracking and Selection

The SPS receiver must provide the capability to track and generate a position solution based upon measurements and data taken from at least four satellites. No other assumptions are made regarding the SPS receiver's channel architecture or ranging signal measurement strategy.

The SPS receiver must be capable of tracking and using satellites down to a 5 mask angle with respect to the local horizon. The local horizon is defined for the purposes of this Signal

Specification to be equivalent to the local tangent plane, with respect to the ellipsoid model used in the position solution. Performance standards do not take into consideration the presence of obscuring terrain above the 5° mask angle.

The SPS receiver must be able to compensate for dynamic Doppler shift effects on nominal SPS ranging signal carrier phase and C/A code measurements. The SPS receiver manufacturer is responsible for ensuring that the receiver compensates for Doppler shift behavior unique to the receiver's anticipated application. Doppler shift behavior is a function of expected satellite-to-user relative velocities, where the primary uncertainty is the dynamics of the user platform.

Satellite selection must be based upon the minimum Position Dilution of Precision (PDOP). The performance standard definitions are based upon an assumption that the SPS receiver will recompute the optimum PDOP every five minutes, or whenever a satellite used in the position solution sets below the 5° mask angle.

The SPS receiver must have the capability to read the health field and status bits in the navigation message, and exclude unhealthy satellites from the position solution. Note that the Subframe 1 health field takes precedence over the almanac health field.

Each time the SPS receiver is powered on, it must ensure that it is using up-to-date ephemeris and clock data for the satellites it is using in its position solution. The SPS receiver designer is encouraged to monitor the Issue of Data, Clock (IODC)/Issue of Data, Ephemeris (IODE) values, and to update ephemeris and clock data based upon a detected change in one or both of these values. At a minimum, the SPS receiver must update its ephemeris and clock data for a given satellite no more than two hours after it last updated its data for that satellite. The SPS receiver must ensure that the datasets it uses in the position solution process are internally consistent for a given satellite, and are not mixes of old and new data.

2.2.2 SPS Receiver Design and Usage Contributions to Position Solution Error

The SPS receiver's error contribution to the SPS ranging error is not taken into consideration in the definition of SPS performance standards. SPS accuracy standards reflect only the error characteristics of the signal-in-space.

Atmospheric propagation path effects on single-frequency range measurement accuracy are taken into consideration in the positioning accuracy performance standard development. The positioning accuracy performance standard development assumes that the SPS receiver design implements the satellite position estimate, measured range computation, ionospheric correction, and satellite time correction algorithms in accordance with this Signal Specification. The performance standards do not consider the possible effects of multipath on position solution accuracy, other than the specification of a 5° mask angle.

Platform dynamics are not explicitly taken into consideration in performance standard development. However, receivers that are designed to operate under medium dynamic conditions should not experience degradations in service availability or accuracy. The term *medium dynamic conditions* is defined here to mean SPS user motion which does not: 1) impart acceleration or jerk effects on frequency, phase or code measurements in excess of those experienced by a stationary user, or 2) change the receiver antenna's nominal orientation with respect to local horizontal.

The SPS receiver must implement the Universal Coordinated Time (UTC) corrections supplied in the navigation message, in order to experience position solution time transfer accuracies as specified in the accuracy performance standard.

2.2.3 Position Fix Dimensions

The GPS architecture provides the inherent capability to solve for a four-dimensional solution. The specific coordinate system used to define the position solution's output dimensions will be unique to a given SPS receiver's design and user's needs. However, GPS operates in a well-defined set of coordinate systems, and all performance standard definitions assume their usage. The satellite position and geometric range computations must be accomplished in the World Geodetic Survey 1984 (WGS-84) Earth-Centered, Earth-Fixed (ECEF) coordinate system. In order for the user to experience performance consistent with the performance standards, the position solution must be accomplished in WGS-84 local coordinates, or in a local coordinate system which meets the following conditions:

- The coordinate system must have an accepted mathematical relationship with the WGS-84 ECEF coordinate system.
- Latitude must be defined with respect to the equator of a documented ellipsoid model.
- Longitude must be defined with respect to the Greenwich meridian, or another reference that has a documented relationship with the Greenwich meridian.
- Local horizontal must be defined as a plane perpendicular to a documented ellipsoid model's local radius of curvature, or tangent to the ellipsoid surface at the user's location.
- Local vertical must be defined to be parallel with a documented ellipsoid model's local radius of curvature, or perpendicular to the local horizontal plane.

2.2.4 Position Fix Rate

SPS accuracy measurement algorithms (defined in Annex C) are based upon a position fix rate of once per second, to support high confidence interval evaluations. However, the use of different fix rates is not precluded in the performance standard definition, since the instantaneous position solution predictable error is independent of the fix rate.

2.2.5 Position Solution Ambiguity

SPS performance standards (as specified in Annex A) assume no ambiguities in the position solution process. The formal derivation of the GPS position solution does however admit the possibility of position determination ambiguities due to bifurcate solutions, although the probability is nil for users on or near the surface of the Earth. The potential for ambiguity arises from the occurrence of very specific and rare conditions in the position solution geometry. The probability of an ambiguity occurring is completely dependent on how the receiver manufacturer's position solution implementation deals with bifurcate solution conditions.

2.3 SPS Ranging Signal RF Characteristics

This section specifies the functional characteristics of the SPS L-band carrier and the C/A code.

2.3.1 Ranging Signal Carrier Characteristics

The L-band carrier is modulated by a bit train which is a composite generated by the Modulo-2 addition of a Pseudo Random Noise (PRN) ranging code and downlink system data (referred to as navigation data or the navigation message).

2.3.1.1 Frequency Plan

The L-band SPS ranging signal is contained within a 2.046 MHz band centered about L1. The carrier frequency for the L1 signal is coherently derived from a frequency source within the satellite. The nominal frequency of this source -- as it appears to an observer on the ground -- is 1.023 MHz. To compensate for relativistic effects, the output frequency of the satellite's frequency standard -- as it would appear to an observer located at the satellite -- is 10.23 MHz offset by a $\Delta f/f = -4.4647 \times 10^{-18}$ or a $\Delta f = -4.567 \times 10^{-3}$ Hz. This frequency offset results in an output of 10.22999999543 MHz, which is frequency divided to obtain the appropriate carrier modulation signal (1.022999999543 MHz). The same output frequency source is also used to generate the nominal L1 carrier frequency (f_0) of 1575.42 MHz.

2.3.1.2 Correlation Loss

Correlation loss is defined as the difference between the satellite power received in a 2.046 MHz bandwidth and the signal power recovered in an nominal correlation receiver of the same bandwidth. On the L1 channel, the correlation loss apportionment is as follows:

- Satellite modulation imperfections 0.6 dB
- Ideal user receiver waveform distortion 0.4 dB

2.3.1.3 Carrier Phase Noise

The phase noise spectral density of the unmodulated carrier is such that a phase locked loop of 10 Hz one-sided noise bandwidth is able to track the carrier to an accuracy of 0.1 radians RMS.

2.3.1.4 Spurious Transmissions

In-band spurious transmissions are at least 40 dB below the unmodulated L1 carrier over the allocated channel bandwidth.

2.3.1.5 Equipment Group Delay

Equipment group delay is defined as the delay between the L-band radiated output of a specific satellite (measured at the antenna phase center) and the output of that satellite's on-board frequency source; the delay consists of a bias term and an uncertainty. The bias term is of minimal concern to the SPS user since the majority of its value is included in clock correction parameters relayed in the navigation data, and is therefore accounted for by the user computations of system time (reference paragraph 2.5.5.2). The SPS receiver manufacturer and user should note that a C/A code epoch may vary up to 10 nanoseconds (2σ) with respect to the clock correction parameters provided in the navigation message.

2.3.1.6 Signal Polarization

The transmitted signal is right-hand circularly polarized. The ellipticity for L1 will not exceed 1.2 dB for the angular range of ± 14.3 degrees from boresight.

2.3.2 C/A Code Generation and Timing

The SPS PRN ranging code is known as the Coarse/Acquisition (C/A) code. Appropriate code-division-multiplexing techniques allow differentiating between the satellites even though they all transmit on the same L-band frequency.

The characteristics of the C/A code are defined below in terms of its structure and the basic method used for generating it. The C/A code consists of 1.023 Mbps $G_i(t)$ patterns with Modulo 2 addition of the navigation data bit train, $D(t)$, which is clocked at 50 bps. The resultant composite bit train is then used to BPSK modulate the L-band carrier. The user receiver is then required to independently generate and synchronize with the satellite transmitted C/A code and perform Modulo 2 addition in order to decode and interpret the navigation message.

2.3.2.1 C/A Code Structure

The linear $G_i(t)$ pattern (C/A-code) is the Modulo-2 sum of two 1023-bit linear patterns, G_1 and G_2 . The latter sequence is selectively delayed by an integer number of chips to produce 36 unique $G(t)$ patterns (defined in Table 2-1). This allows the generation of 36 unique C/A(t) code phases using the same basic code generator. The G_1 and G_2 shift register generator configurations are represented in Figures 2-2 and 2-3, respectively.

2.3.2.2 C/A-Code Generation

Each $G_i(t)$ sequence is a 1023-bit Gold-code which is itself the Modulo-2 sum of two 1023-bit linear patterns, G_1 and G_2 . The G_2 sequence is formed by effectively delaying the G_2 sequence by an integer number of chips ranging from 5 to 950. The G_1 and G_2 sequences are generated by 10-stage shift registers having the following polynomials as referred to in the shift register input (see Figures 2-4 and 2-5).

$G_1: X^{10} + X^3 + 1$, and

$G_2: X^{10} + X^9 + X^8 + X^6 + X^3 + X^2 + 1$.

The initialization vector for the G_1 and G_2 sequences is (1111111111). The G_1 and G_2 registers are clocked at a 1.023 MHz rate. The effective delay of the G_2 sequence to form the G_2 sequence is accomplished by combining the output of two stages of the G_2 shift register by Modulo-2 addition (see Figure 2-4). Thirty-six of the possible combinations are selected. Table 2-1 contains a tabulation of the G_2 shift register taps selected and their corresponding PRN signal numbers together with the first several chips of each resultant PRN code. Timing relationships related to the C/A code are shown in Figure 2-5.

2.3.2.3 Non-Standard Code

An operational GPS satellite will transmit an intentionally "incorrect" version of the C/A code where needed to protect the users from receiving and utilizing an anomalous navigation signal. This "incorrect" code is termed the non-standard C/A (NSC) code. A satellite will transition to NSC as a result of an autonomously detected malfunction in the satellite's navigation payload. Since the NSC is designed to protect the user, it is not for utilization by the user and, therefore, is not defined in this document. Note that Block I satellites do not have NSC capability.

2.3.3 Code Modulation and Signal Transmission

2.3.3.1 Navigation Data

The navigation data, $D(t)$, includes satellite ephemerides, system time, correction data, satellite clock behavior data, status messages, etc. The 50 bps data is Modulo-2 added to the C/A code.

2.3.3.2 L-Band Signal Structure

The SPS L1 carrier is Bipolar-Phase Shift Key (BPSK) modulated by the composite C/A code/navigation data bit train. For a particular satellite, all transmitted signal elements (carrier, code, and data) are coherently derived from the same on-board frequency source.

Table 2-1. Code Phase Assignments

Satellite ID Number	GPS PRN Signal Number	Code Phase Selection	Code Delay Chips	First 10 Chips Octal*
		C/A (G ₂)	C/A	C/A
1	1	2 ⊕ 6	5	1440
2	2	3 ⊕ 7	6	1620
3	3	4 ⊕ 8	7	1710
4	4	5 ⊕ 9	8	1744
5	5	1 ⊕ 9	17	1133
6	6	2 ⊕ 10	18	1455
7	7	1 ⊕ 8	139	1131
8	8	2 ⊕ 9	140	1454
9	9	3 ⊕ 10	141	1626
10	10	2 ⊕ 3	251	1504
11	11	3 ⊕ 4	252	1642
12	12	5 ⊕ 6	254	1750
13	13	6 ⊕ 7	255	1764
14	14	7 ⊕ 8	256	1772
15	15	8 ⊕ 9	257	1775
16	16	9 ⊕ 10	258	1776
17	17	1 ⊕ 4	469	1156
18	18	2 ⊕ 5	470	1467
19	19	3 ⊕ 6	471	1633
20	20	4 ⊕ 7	472	1715
21	21	5 ⊕ 8	473	1746
22	22	6 ⊕ 9	474	1763
23	23	1 ⊕ 3	509	1063
24	24	4 ⊕ 6	512	1706
25	25	5 ⊕ 7	513	1743
26	26	6 ⊕ 8	514	1761
27	27	7 ⊕ 9	515	1770
28	28	8 ⊕ 10	516	1774
29	29	1 ⊕ 6	859	1127
30	30	2 ⊕ 7	860	1453
31	31	3 ⊕ 8	861	1625
32	32	4 ⊕ 9	862	1712
***	33	5 ⊕ 10	863	1745
***	34**	4 ⊕ 10	950	1713
***	35	1 ⊕ 7	947	1134
***	36	2 ⊕ 8	948	1456
***	37**	4 ⊕ 10	950	1713

* In the octal notation for the first 10 chips of the C/A code as shown in this column, the first digit (1) represents a "1" for the first chip and the last three digits are the conventional octal representation of the remaining 9 chips. (For example, the first 10 chips of the C/A code for PRN Signal Assembly No. 1 are: 1100100000).

** C/A codes 34 and 37 are common.

*** PRN sequences 33 through 37 are reserved for other uses (e.g. ground transmitters). GPS satellites shall not transmit using PRN sequences 33 through 37.

⊕ = "exclusive or"

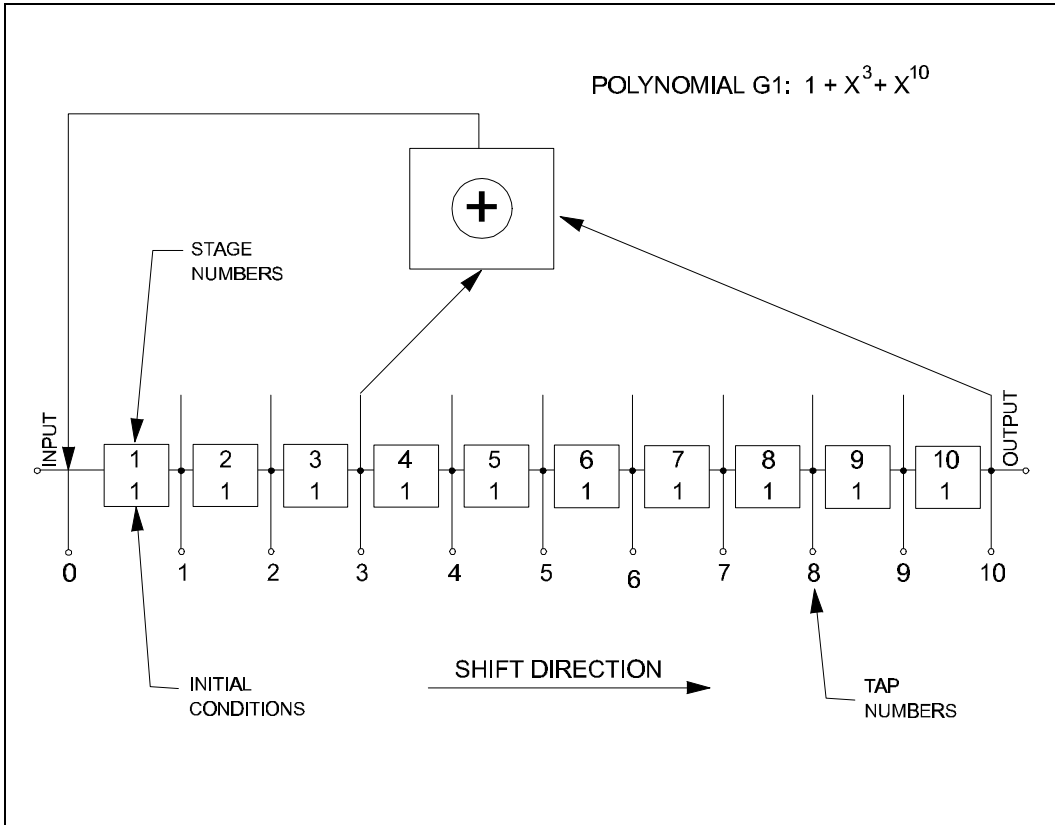

Figure 2-2. G1 Shift Register Generator Configuration

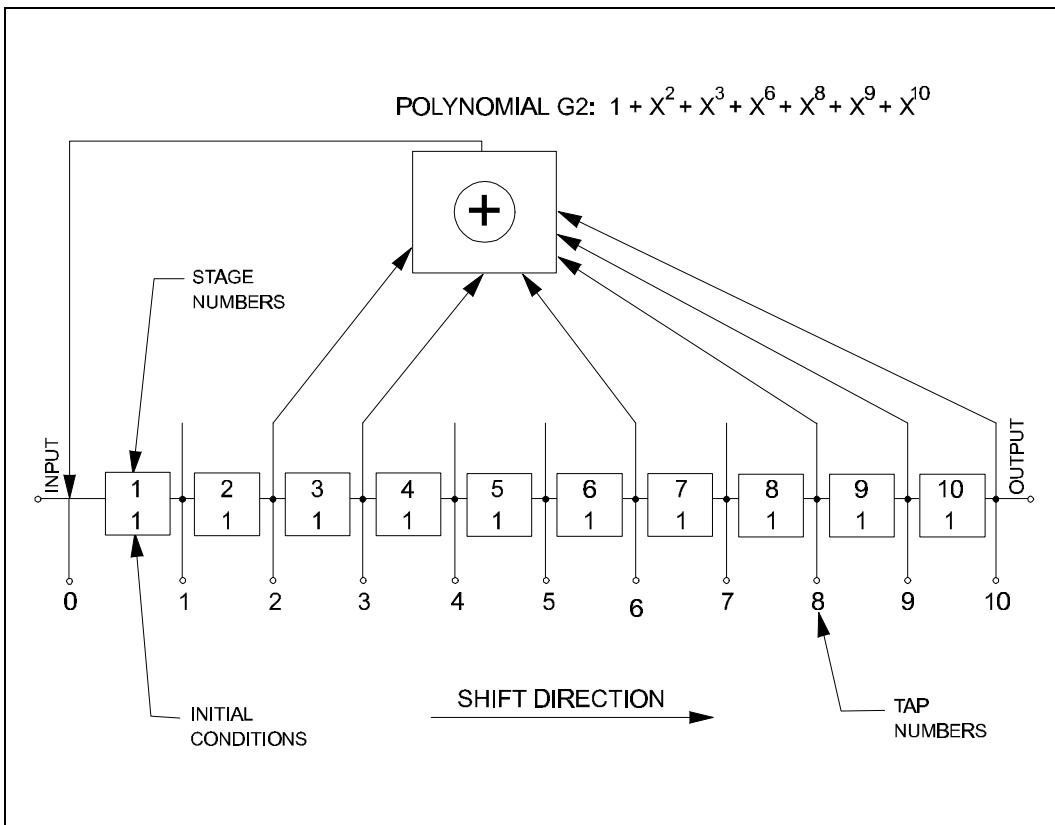

Figure 2-3. G2 Shift Register Generator Configuration

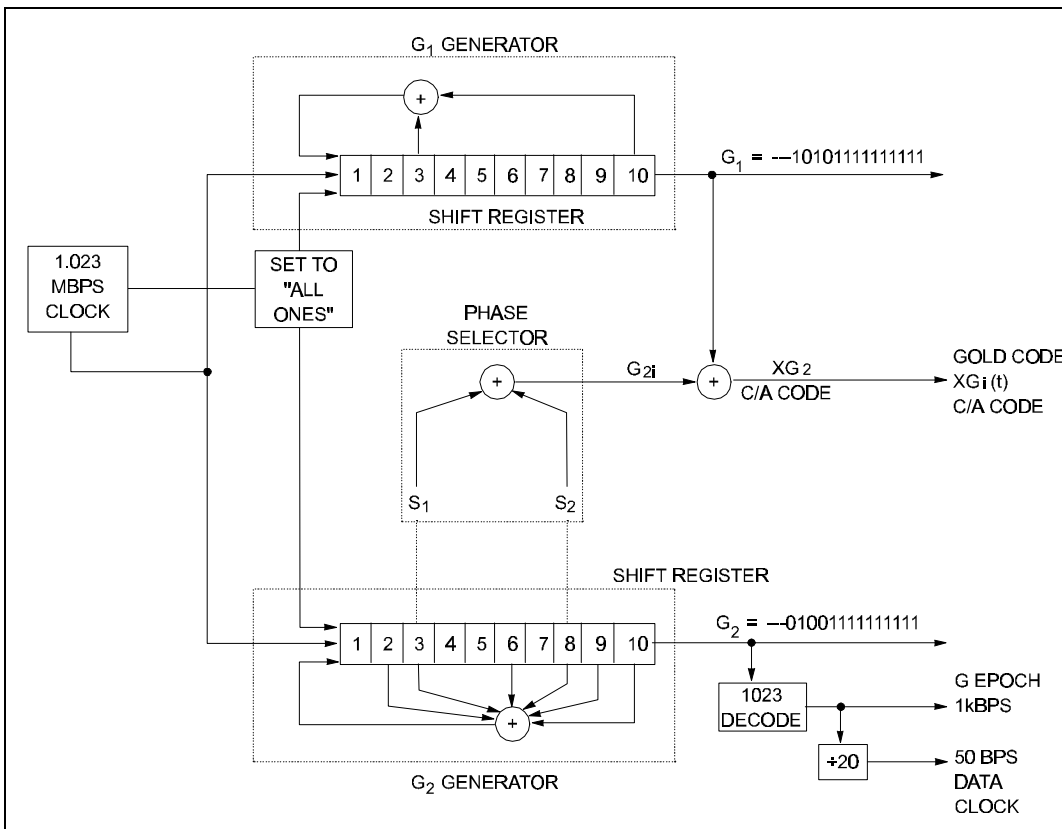

Figure 2-4. C/A-Code Generation

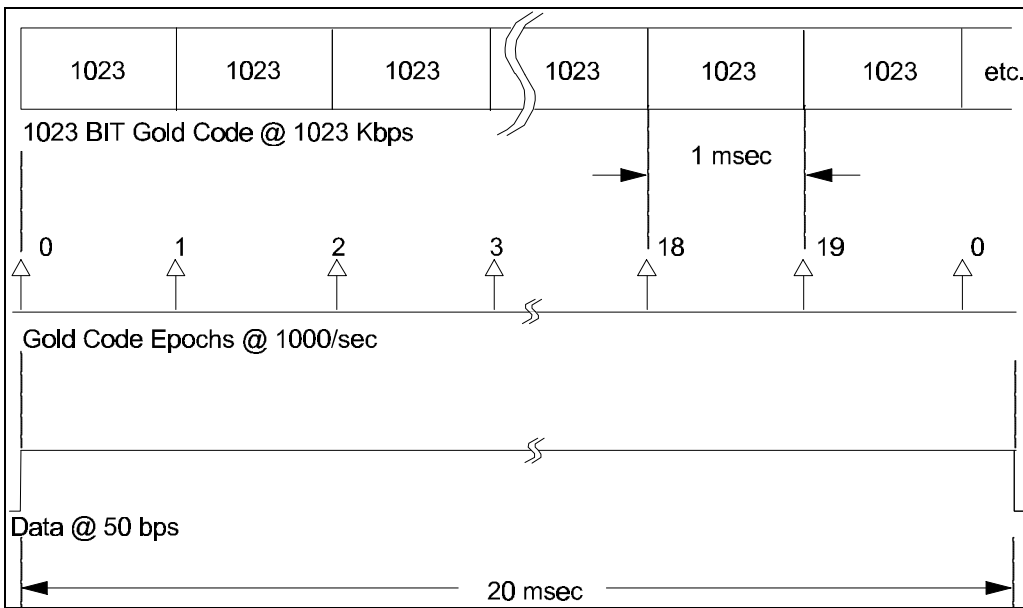

Figure 2-5. C/A Code Timing Relationships

2.3.4 Signal Coverage and Power Distribution

Figure 2-6 illustrates the minimum power of the near-ground user-received L1 signal as a function of satellite elevation angle using the following assumptions: (a) the signal is measured at the output of a 3 dBi linear polarized receiving antenna, (b) the satellite is at or above a 5 degree elevation angle, (c) the received signal levels are observed within the in-band allocation defined in paragraph 2.1.1, (d) the atmospheric path loss is 2.0 dB, and (e) the satellite attitude error is 0.5 degrees (towards reducing signal level).

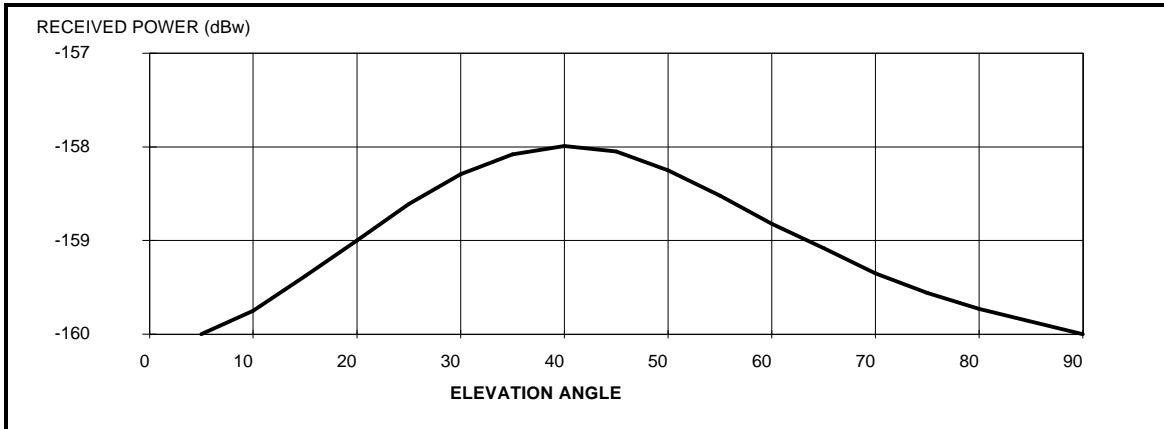

Figure 2-6. User Received Minimum Signal Levels

Higher received signal levels can be caused by such factors as satellite attitude errors, mechanical antenna alignment errors, transmitter power output variations due to temperature variations, voltage variations and power amplifier variations, and due to a variability in link atmospheric path loss. The maximum received L1 C/A signal levels as a result of these factors is not expected to exceed -153.0 dBw. This estimate assumes that the receiving antenna characteristics are as described above, the atmospheric loss is 0.6 dB and the satellite attitude error is 0.5 degrees (towards increased signal level).

2.3.5 GPS Time and the Satellite Z-Count

GPS time is established by the Control Segment and is used as the primary time reference for all GPS operations. GPS time is referenced to a UTC (as maintained by the U.S. Naval Observatory) zero time-point defined as midnight on the night of January 5, 1980/morning of January 6, 1980. The largest unit used in stating GPS time is one week, defined as 604,800 seconds. GPS time may differ from UTC because GPS time is a continuous time scale, while UTC is corrected periodically with an integer number of leap seconds. There also is an inherent but bounded drift rate between the UTC and GPS time scales. The GPS time scale is maintained to be within one microsecond of UTC (Modulo one second). The navigation data contains the requisite data for relating GPS time to UTC.

In each satellite, an internally derived 1.5 second epoch provides a convenient unit for precisely counting and communicating time. Time stated in this manner is referred to as a Z-count. The Z-count is provided to the user as a 29-bit binary number consisting of two parts as follows:

- a. The binary number represented by the 19 least significant bits of the Z-count is referred to as the time of week (TOW) count and is defined as being equal to the number of 1.5 second epochs that have occurred since the transition from the previous week. The count is short-cycled such that the range of the TOW-count is from 0 to 403,199 1.5 second epochs (equaling one week) and is reset to zero at the end of each week. The TOW-count's zero state is defined as that 1.5 second epoch which is coincident with the start of the present week. This epoch occurs at (approximately) midnight Saturday night-Sunday morning, where midnight is defined as 0000

- a. hours on the Universal Coordinated Time (UTC) scale which is nominally referenced to the Greenwich Meridian. Over the years, the occurrence of the "zero state epoch" may differ by a few seconds from 0000 hours on the UTC scale, since UTC is periodically corrected with leap seconds while the TOW-count is continuous without such correction. A truncated version of the TOW-count, consisting of its 17 most significant bits, is contained in the hand-over word (HOW) of the L-Band downlink data stream; the relationship between the actual TOW-count and its truncated HOW version is illustrated by Figure 2-7.
- b. The ten most significant bits of the Z-count are a binary representation of the sequential number assigned to the present GPS week (Modulo 1024). The range of this count is from 0 to 1023, with its zero state being defined as that week which starts with the 1.5 second epoch occurring at (approximately) midnight on the night of January 5, 1980/morning of January 6, 1980. At the expiration of GPS week number 1023, the GPS week number will rollover to zero (0). Users must account for the previous 1024 weeks in conversions from GPS time to a calendar date.

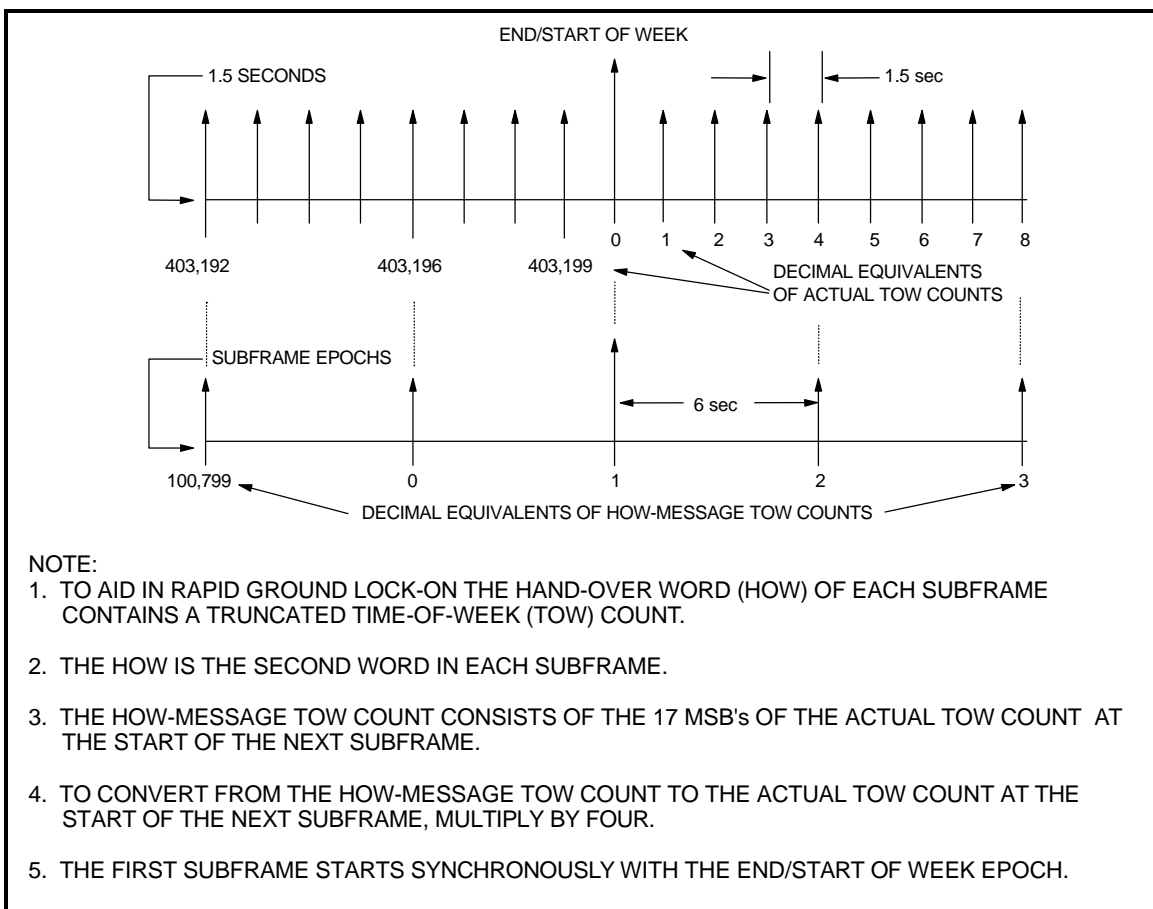

Figure 2-7. Time Line Relationship of HOW Word

2.4 Navigation Message Data Structure

2.4.1 Message Structure

The navigation message is transmitted by the satellite on the L1 data link at a rate of 50 bps. The following sections define the navigation data format and contents. Implementation algorithms for this data are provided in Section 2.5.

2.4.1.1 Data Page Format

As shown in Figure 2-8, the message structure utilizes a basic format of a 1500 bit long frame made up of five subframes, each subframe being 300 bits long. Subframes 4 and 5 are subcommutated 25 times each, so that a complete data message will require the transmission of 25 full frames. The 25 versions of subframes 4 and 5 are referred to as pages 1 through 25 of each subframe. Each subframe will consist of ten words, each 30 bits long; the MSB of all words is transmitted first.

Each subframe and/or page of a subframe starts with a Telemetry (TLM) word and a Handover word (HOW) pair. The TLM word is transmitted first, immediately followed by the HOW. The latter is followed by eight data words. Each word in each frame contains parity.

At end/start of week (a) the cyclic paging to subframes 1 through 5 will restart with subframe 1 regardless of which subframe was last transmitted prior to end/start of week, and (b) the cycling of the 25 pages of subframes 4 and 5 will restart with page 1 of each of the subframes, regardless of which page was the last to be transmitted prior to the end/start of week. All upload and page cutovers will occur on frame boundaries (i.e., Modulo 30 seconds relative to end/start of week); accordingly, new data in subframes 4 and 5 may start to be transmitted with any of the 25 pages of these subframes.

2.4.1.2 Data Parity

Words one through ten of subframes 1-5 each contain six parity bits as their LSBs. In addition, two non-information bearing bits are provided as bits 23 and 24 of words two and ten for parity computation purposes. The algorithm provided to the user to properly compute parity is listed in Section 2.5.2.

2.4.1.3 Default Navigation Data Transmission

Under certain conditions, GPS satellites can transmit default navigation data in place of valid data in the navigation message. Default navigation data is defined as follows:

- A pattern of alternating ones and zeros in words 3 through 10,
- The two trailing bits of word 10 will be zeros, to allow the parity of subsequent subframes to be valid, and
- The parity of affected words will be invalid.

If the condition is a lack of a data element, only those subframes supported by that data element will transition to this condition. Other conditions can cause all the subframes to transition to default navigation data, and cause the subframe ID in the HOW to equal one (see Section 2.4.2.2). Users are cautioned not to use a satellite when it transmits default navigation data, even though they may still have valid navigation data previously collected for that satellite.

2.4.2 Telemetry and Handover Words

The format and contents of the Telemetry (TLM) word and the Handover Word (HOW) are described in the following subparagraphs. Figure 2-9 provides a definition of TLM word and HOW formats.

2.4.2.1 Telemetry Word

Each TLM word is 30 bits long, occurs every six seconds in the data frame, and is the first word in each subframe/page. The format is as shown in Figure 2-9. Bit 1 is transmitted first. Each TLM word begins with a preamble, followed by 16 reserved bits and six parity bits.

2.4.2.2 Handover Word

The HOW is 30 bits long and is the second word in each subframe/page, immediately following the TLM word. A HOW occurs every 6 seconds in the data frame. The format and content of the HOW is as shown in Figure 2-9. The MSB is transmitted first. The HOW begins with the 17 MSBs of the time-of-week (TOW) count. (The full TOW count consists of the 19 LSBs of the 29-bit Z-count). These 17 bits correspond to the TOW-count at the 1.5 second epoch which occurs at the start (leading edge) of the next following subframe (reference paragraph 2.3.5).

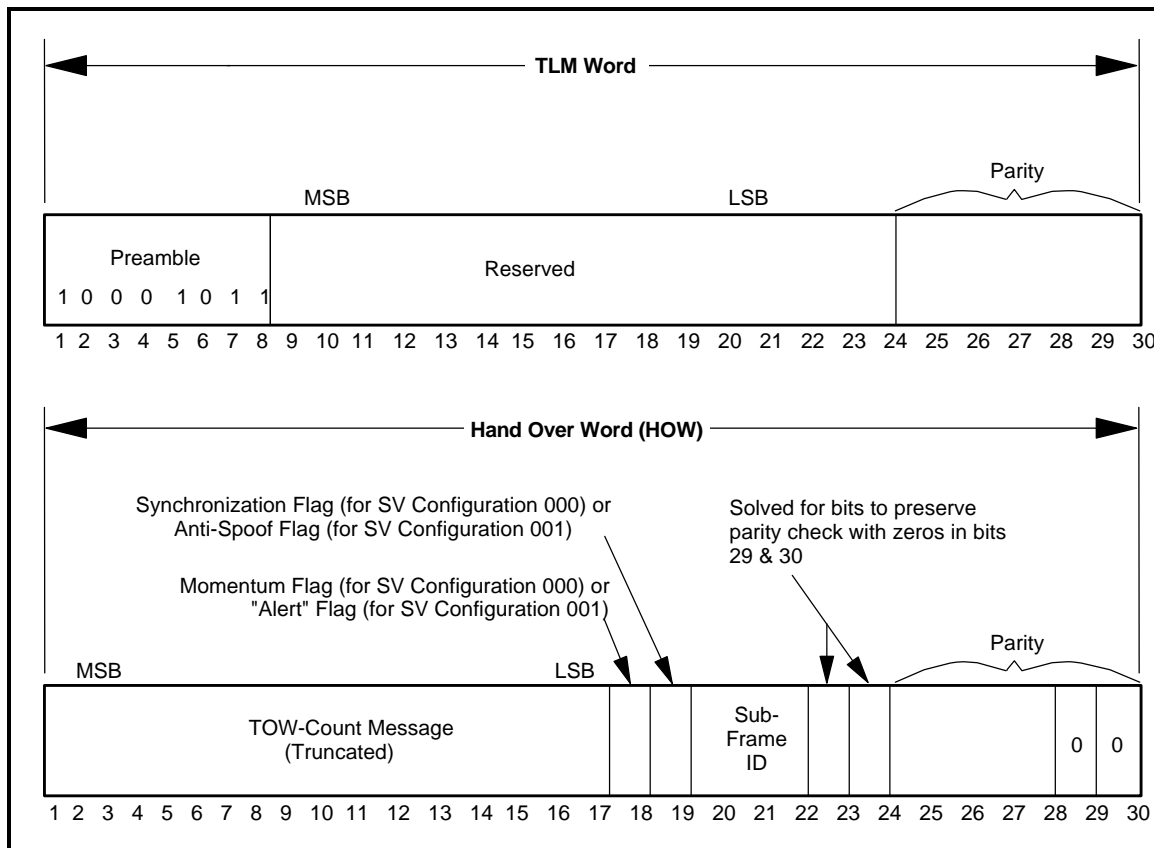

Figure 2-9. TLM and HOW Formats

Bit 18 is used in two ways: (a) on satellites that are designated by configuration code 000, bit 18 is the roll momentum dump flag with a "1" in this bit-position indicating that a non-conservative (thruster type) momentum dump has occurred since the last upload (this flag is reset at a new end-of message transmission at the conclusion of the next upload); and (b) on satellites designated by configuration code 001, bit 18 is an "alert" flag. For the definition of configuration codes and their usage, see Section 2.4.5.4. When this flag is raised (bit 18 = "1"), it will indicate to the SPS user that the satellite URA may be worse than indicated in subframe 1 and that the user will use that satellite at the user's own risk.

Bit 19 also has a dual role: (a) on satellites that are designated by configuration code 000 in page 25 of subframe 4, bit 19 is used as a synchronization flag; and (b) on satellites designated by configuration code 001, bit 19 is an anti-spoof (A-S) flag.

When used as a synchronization flag, a "0" in bit position 19 indicates that the satellite is in synchronism, which is defined as the condition in which the leading edge of the TLM word is coincident with the 1.5 second epoch. If bit 19 is a "1", this condition may not exist; i.e., the satellite is not in synchronism, and further data from this satellite should not be used since it may be erroneous. When used as an A-S flag, a "1" in bit position 19 indicates that the A-S mode is ON in that satellite.

Bits 20, 21, and 22 of the HOW provide the ID of the subframe in which that particular HOW is the second word; the ID code is as follows:

Subframe	ID Code
1	001
2	010
3	011
4	100
5	101

2.4.3 Subframe 1 - Satellite Clock and Health Data

The content of words three through ten of subframe 1 contain the clock parameters and other data described in the following discussion. The number of bits, the scale factor of the LSB (which is the last bit received), the range, and the units are as specified in Table 2-2.

Table 2-2. Subframe 1 Parameters

Parameter	No. of Bits	Scale Factor (LSB)	Effective Range***	Units
Week No.	10	1		Week
satellite accuracy	4			(see text)
satellite health	6	1		discretes
T_{GD}	8*	2^{-31}		seconds
IODC	10			(see text)
t_{oc}	16	2^4	604,784	seconds
a_{f2}	8*	2^{-55}		sec/sec^2
a_{f1}	16*	2^{-43}		sec/sec
a_{f0}	22*	2^{-31}		seconds
* Parameters so indicated are two's complement, with the sign bit (+ or -) occupying the MSB;				
** See Figure 2-8 for complete bit allocation in subframe;				
*** Unless otherwise indicated in this column, effective range is the maximum range attainable with indicated bit allocation and scale factor.				

The clock parameters describe the satellite time scale during the period of validity. The parameters in a data set are valid during the interval of time in which they are transmitted and will remain valid for an additional period of time after transmission of the next data set has started.

2.4.3.1 Week Number

The ten MSBs of word three contain the ten MSBs of the 29-bit Z-count as qualified herein. These ten bits represent the number of the current GPS week at the start of the data set transmission interval with "all zeros" indicating week "0". The GPS week number increments at each end/start of week epoch.

2.4.3.2 User Range Accuracy

Bits 13 through 16 of word three give the predicted User Range Accuracy (URA) of the satellite. URA is a statistical indicator of the ranging accuracies obtainable with a specific satellite. The URA reported in the navigation message shall correspond to the maximum value anticipated during the validity period of the transmitted data, with uniform SA levels invoked. Note that the URA does not include error estimates due to inaccuracies of the single-frequency ionospheric delay model. Please refer to Section 2.5.3 for a quantitative definition of URA.

2.4.3.3 Satellite Health

The six-bit health indication given by bits 17 through 22 of word three refers to the transmitting satellite. The MSB indicates a summary of the health of the navigation data, where

- 0 = all navigation data is OK
- 1 = some or all navigation data is bad.

The five LSBs indicate the health of the signal components in accordance with the codes given in paragraph 2.4.5.3. The health indication is given relative to the "as designed" capabilities of each satellite (as designated by the configuration code -- see paragraph 2.4.5.4). Accordingly, any satellite which does not have a certain capability will be indicated as "healthy" if the lack of this capability is inherent in its design or it has been configured into a mode which is normal from a user standpoint and does not require that capability.

Additional satellite health data is given in subframes 4 and 5. The data given in subframe 1 may differ from that shown in subframes 4 and/or 5 of other satellite's since the latter may be updated at a different time.

2.4.3.4 Issue of Data, Clock

Bits 23 and 24 of word three in subframe 1 are the two MSBs of the ten-bit Issue of Data, Clock (IODC) term; bits one through eight of word eight in subframe 1 will contain the eight LSBs of the IODC. The IODC indicates the issue number of the data set and thereby provides the user with a convenient means of detecting any change in the correction parameters. The transmitted IODC will be different from any value transmitted by the satellite during the preceding seven days. The relationship between the IODC and the IODE (Issue Of Data, Ephemeris) terms are defined in Section 2.4.4.2.

2.4.3.5 Estimated Group Delay Differential

Bits 17 through 24 of word seven contain the correction term, T_{GD} , to account for the effect of satellite group delay differential. Application of the T_{GD} correction term is identified in Section 2.5.5.1.

2.4.3.6 Satellite Clock Correction Parameters

Bits nine through 24 of word eight, bits one through 24 of word nine, and bits one through 22 of word ten contain the parameters needed by the users for apparent satellite clock correction (t_c , a_{f2} , a_{f1} , a_{f0}). Application of the clock correction parameters is identified in Section 2.5.5.2.

2.4.3.7 Reserved Data Fields

Table 2-3 provides the locations of reserved data fields within subframe 1. All reserved data fields support valid parity within their respective words.

Table 2-3. Subframe 1 Reserved Data Fields

Word	Bits
3	11-12
4	1-24
5	1-24
6	1-24
7	1-16

2.4.4 Subframes 2 and 3 - Satellite Ephemeris Data

Subframes 2 and 3 contain the ephemeris representation parameters of the transmitting satellite.

2.4.4.1 Ephemeris Parameters

Table 2-4 gives the definition of the orbital parameters using terminology typical of Keplerian or bital parameters; it is noted, however, that the transmitted parameter values are expressed in a coordinate system which allows the best trajectory fit in Earth fixed coordinates for each specific fit interval. The user will not interpret intermediate coordinate values as pertaining to any conventional or stable coordinate system.

For each parameter contained in subframe 2 and 3, the number of bits, the scale factor of the LSB (which is the last bit received), the range, and the units are as specified in Table 2-5.

Table 2-4. Ephemeris Data Definitions

M_0	Mean Anomaly at Reference Time
Δn	Mean Motion Difference from Computed Value
e	Eccentricity
$(A)^{1/2}$	Square Root of the Semi-Major Axis
$(\text{OMEGA})_0$	Longitude of Ascending Node of Orbit Plane at Weekly Epoch
i_0	Inclination Angle at Reference Time
ω	Argument of Perigee
OMEGADOT	Rate of Right Ascension
IDOT	Rate of Inclination Angle
C_{uc}	Amplitude of the Cosine Harmonic Correction Term to the Argument of Latitude
C_{us}	Amplitude of the Sine Harmonic Correction Term to the Argument of Latitude
C_{rc}	Amplitude of the Cosine Harmonic Correction Term to the Orbit Radius
C_{rs}	Amplitude of the Sine Harmonic Correction Term to the Orbit Radius
C_{ic}	Amplitude of the Cosine Harmonic Correction Term to the Angle of Inclination
C_{is}	Amplitude of the Sine Harmonic Correction Term to the Angle of Inclination
t_{oe}	Reference Time Ephemeris
IODE	Issue of Data (Ephemeris)

2.4.4.2 Issue of Data, Ephemeris

The Issue of Data, Ephemeris (IODE) is an 8 bit number equal to the 8 LSBs of the 10 bit IODC of the same data set. The issue of ephemeris data (IODE) term will provide the user with a convenient means for detecting any change in the ephemeris representation parameters. The IODE is provided in both subframes 2 and 3 for the purpose of comparison with the 8 LSBs of the IODC term in subframe 1. Whenever these three terms do not match, a data set cutover has occurred and new data must be collected. The transmitted IODE will be different from any value transmitted by the satellite during the preceding six hours.

Table 2-5. Ephemeris Parameters

Parameter	No. of Bits	Scale Factor (LSB)	Effective Range***	Units
IODE	8			(see text)
C_{rs}	16*	2 ⁻⁵		meters
Δn	16*	2 ⁻⁴³		semi-circles/sec
M_0	32*	2 ⁻³¹		semi-circles
C_{uc}	16*	2 ⁻²⁹		radians
e	32	2 ⁻³³	0.03	dimensionless
C_{us}	16*	2 ⁻²⁹		radians
$(A)^{1/2}$	32	2 ⁻¹⁹		meters ^{1/2}
t_{oe}	16	2 ⁴	604,784	seconds
C_{ic}	16*	2 ⁻²⁹		radians
$(\text{OMEGA})_0$	32*	2 ⁻³¹		semi-circles
C_{is}	16*	2 ⁻²⁹		radians
i_0	32*	2 ⁻³¹		semi-circles
C_{rc}	16*	2 ⁻⁵		meters
ω	32*	2 ⁻³¹		semi-circles
OMEGADOT	24*	2 ⁻⁴³		semi-circles/sec
IDOT	14*	2 ⁻⁴³		semi-circles/sec

* Parameters so indicated are two's complement, with the sign bit (+ or -) occupying the MSB;
 ** See Figure 2-8 for complete bit allocation in subframe;
 *** Unless otherwise indicated in this column, effective range is the maximum range attainable with indicated bit allocation and scale factor.

Any change in the subframe 2 and 3 data will be accomplished in concert with a change in both IODE words. Cutovers to new data sets will occur only on hour boundaries except for the first data set of a new upload. The first data set may be cut-in (reference paragraph 2.4.1.1) at any time during the hour and therefore may be transmitted by the satellite for less than one hour. Additionally, the t_{oe} value, for at least the first data set transmitted by an satellite after an upload, will be different from that transmitted prior to the cutover.

2.4.4.3 Spare and Reserved Data Fields

Table 2-6 provides the locations of spare and reserved data fields within subframe 2. All spare and reserved data fields support valid parity within their respective words. Contents of spare data fields are alternating ones and zeros until they are allocated for a new function. Users are cautioned that the contents of spare data fields can change without warning.

Table 2-6. Subframe 2 Spare and Reserved Data Fields

Word	Bits	Status
10	17	Reserved
10	18-22	Spare

2.4.5 Subframes 4 and 5 - Support Data

Both subframes 4 and 5 are subcommutated 25 times each; the 25 versions of these subframes are referred to as pages 1 through 25 of each subframe. With the possible exception of "spare" pages and explicit repeats, each page contains different data in words three through ten. As shown in Figure 2-8, the pages of subframe 4 use six different formats, while those of subframe 5 use two.

A brief summary of the various data contained in each page of subframes 4 and 5 is as follows:

a. Subframe 4:

- Pages 2, 3, 4, 5, 7, 8, 9, and 10: almanac data for satellite 25 through 32 respectively; These pages may be designated for other functions; the format and content for each page is defined by the satellite ID of that page. In this case, the six-bit health word of page 25 is set to "6 ones" (Refer to 2.4.5.3) and the satellite ID of the page will not have a value in the range of 25 through 32;
- Pages 17: special messages;
- Pages 18: ionospheric and UTC data;
- Page 25: satellite configurations for 32 satellites
- Pages 1, 6, 11, 12, 16, 19, 20, 21, 22, 23, and 24: (reserved):
- Pages 13, 14, and 15: spares;

b. Subframe 5:

- Pages 1 through 24: almanac data for satellite 1 through 24;
- Page 25: satellite health data for satellite 1 through 24, the almanac reference time and the almanac reference week number.

2.4.5.1 Data and Satellite IDs

The two MSBs of word three in each page contain the data ID which defines the applicable GPS navigation data structure. Data ID one (denoted by binary code 00) was utilized during Phase I of the GPS program and is no longer in use: data ID two (denoted by binary code 01) is described in this Signal Specification. Future data IDs will be defined as necessary.

As shown in Table 2-7, the data ID is utilized to provide one of two indications: (a) for those pages which are assigned to contain the almanac data of one specific satellite, the data ID defines the data structure utilized by that satellite whose almanac data are contained in that page; and (b) for all other pages, the data ID denotes the data structure of the transmitting satellite.

The satellite ID is given by bits three through eight of word three in each page, as shown in Table 2-7. Specific IDs are reserved for each page of subframe 4 and 5; however, the satellite ID of pages 2, 3, 4, 5, 7, 8, 9 and 10 of subframe 4 may change for each page to reflect the alternate contents for that page. The satellite IDs are utilized in two different ways: (a) for those pages which contain the almanac data of a given satellite, the satellite ID is the same number that is assigned to the PRN code phase of that satellite (reference Table 2-1), and (b) for all other pages the satellite ID assigned in accordance with Table 2-7 serves as the "page ID". IDs 1 through 32 are assigned to those pages which contain the almanac data of specific satellites (pages 1-24 of subframe 5 and pages 2-5 plus 7-10 of subframe 4). The "0" ID (binary all zeros) is assigned to indicate a dummy satellite, while IDs 51 through 63 are utilized for pages containing other than almanac data of a specific satellite. The remaining IDs (33 through 50) are unassigned.

Pages which contain identical data (for more frequent repetition) carry the same satellite ID (e.g., in subframe 4, pages 1, 6, 11, and 21 carry an ID of 57, while pages 12 and 24 are designated by an ID of 62).

2.4.5.2 Almanac

Pages 1 through 24 of subframe 5, as well as pages 2 through 5 and 7 through 10 of subframe 4 contain the almanac data and a satellite health word for up to 32 satellites (the health word is discussed in paragraph 2.4.5.3). The almanac data are a reduced-precision subset of the clock and ephemeris parameters. The data occupy all bits of words three through ten of each page except the eight MSBs of word three (data ID and satellite ID), bits 17 through 24 of word five (satellite health), and the 50 bits devoted to parity. The number of bits, the scale factor (LSB), the

range, and the units of the almanac parameters are given in Table 2-8. The almanac message for any dummy satellite will contain alternating ones and zeros with valid parity.

2.4.5.2.1 Almanac Reference Time

The almanac reference time, t_{ba} , is nominally the multiple of 2^{12} seconds truncated from 3.5 days after the first valid transmission time for this almanac data set. The almanac is updated often enough to ensure that GPS time, t , will differ from t_{ba} by less than 3.5 days during the transmission period. The almanac parameters are updated at least once every 6 days during normal operations.

2.4.5.2.2 Almanac Time Parameters

The almanac time parameters consist of an 11-bit constant term (a_0) and an 11-bit first order term (a_{f1}).

Table 2-7. Data IDs and Satellite IDs in Subframes 4 and 5

Page	Subframe 4		Subframe 5	
	Data ID	satellite ID*	Data ID	satellite ID*
1	Note (2)	57	Note (1)	1
2 Note (3)	Note (1)	25	Note (1)	2
3 Note (3)	Note (1)	26	Note (1)	3
4 Note (3)	Note (1)	27	Note (1)	4
5 Note (3)	Note (1)	28	Note (1)	5
6	Note (2)	57	Note (1)	6
7 Note (3)	Note (1)	29	Note (1)	7
8 Note (3)	Note (1)	30	Note (1)	8
9 Note (3)	Note (1)	31	Note (1)	9
10 Note (3)	Note (1)	32	Note (1)	10
11	Note (2)	57	Note (1)	11
12	Note (2)	62	Note (1)	12
13	Note (2)	52	Note (1)	13
14	Note (2)	53	Note (1)	14
15	Note (2)	54	Note (1)	15
16	Note (2)	57	Note (1)	16
17	Note (2)	55	Note (1)	17
18	Note (2)	56	Note (1)	18
19	Note (2)	58 Note (4)	Note (1)	19
20	Note (2)	59 Note (4)	Note (1)	20
21	Note (2)	57	Note (1)	21
22	Note (2)	60 Note (4)	Note (1)	22
23	Note (2)	61 Note (4)	Note (1)	23
24	Note (2)	62	Note (1)	24
25	Note (2)	63	Note (2)	51

* Use "0" to indicate "dummy" satellite. When using "0" to indicate dummy satellite, use the data ID of the transmitting satellite.

Note 1: Data ID of that satellite whose satellite ID appears in that page.

Note 2: Data ID of transmitting satellite.

Note 3: Pages 2, 3, 4, 5, 7, 8, 9, and 10 of subframe 4 may contain almanac data for satellites 25 through 32, respectively, or data for other functions as identified by a different satellite ID from the value shown.

Note 4: Satellite ID may vary.

Table 2-8. Almanac Parameters

Parameter	No. of Bits	Scale Factor (LSB)	Effective Range***	Units
e	16	2 ⁻²¹		dimensionless
t _{oa}	8	2 ¹²	602,112	seconds
δi****	16*	2 ⁻¹⁹		semi-circles
OMEGADOT	16*	2 ⁻³⁸		semi-circles/sec
(A) ^{1/2}	16*	2 ⁻¹¹		meters ^{1/2}
(OMEGA) ₀	24*	2 ⁻²³		semi-circles
ω	24*	2 ⁻²³		semi-circles
M ₀	24*	2 ⁻²³		semi-circles
a _{f0}	11*	2 ⁻²⁰		seconds
a _{f1}	11*	2 ⁻³⁸		sec/sec
* Parameters so indicated are two's complement, with the sign bit (+ or -) occupying the MSB;				
** See Figure 2-8 for complete bit allocation in subframe;				
*** Unless otherwise indicated in this column, effective range is the maximum range attainable with indicated bit allocation and scale factor				
**** Relative to i ₀ = 0.30 semi-circles.				

2.4.5.2.3 Almanac Reference Week

Bits 17 through 24 of word three in page 25 of subframe 5 will indicate the number of the week (WN_a) to which the almanac reference time (t_{ba}) is referenced. The WN_a term consists of the eight LSBs of the full week number. Bits 9 through 16 of word three in page 25 of subframe 5 will contain the value of t_{oa} which is referenced to this WN_a.

2.4.5.3 Health Summary

Subframes 4 and 5 contain two types of satellite health data: (a) each of the 32 pages which contain the clock/ephemeris related almanac data provide an eight-bit satellite health status word regarding the satellite whose almanac data they carry, and (b) the 25th pages of subframe 4 and of subframe 5 jointly contain six-bit health status data for up to 32 satellites.

The eight-bit health status words occupy bits 17 through 24 of word five in those 32 pages which contain almanac data for individual satellites. The six-bit health status words occupy the 24 MSBs of words four through nine in page 25 of subframe 5 plus bits 19 through 24 of word 8, the 24 MSBs of word 9, and the 18 MSBs of word 10 in page 25 of subframe 4.

The three MSBs of the eight-bit health words indicate health of the navigation data in accordance with the code given in Table 2-9. The six-bit words provide a one-bit summary of the navigation data's health status in the MSB position in accordance with paragraph 2.4.3.3. The five LSBs of both the eight-bit and the six-bit health words provide the health status of the satellite's signal components in accordance with the code given in Table 2-10. A special meaning is assigned, however, to the "6 ones" combination of the six-bit health words in the 25th pages of subframes 4 and 5: it indicates that "the satellite which has that ID is not available and there may be no data regarding that satellite in that page of subframes 4 or 5 that is assigned to normally contain the almanac data of that satellite" (NOTE: (a) this special meaning applies to the 25th pages of subframes 4 and 5 only; and (b) there may be data regarding another satellite in the almanac-page referred to above as defined in paragraph 2.4.5.1). The health indication shall be given relative to the "as designed" capabilities of each satellite (as designated by the configuration code - see paragraph 2.4.5.4). Accordingly, any satellite which does not have a certain capability will be indicated as "healthy" if the lack of this capability is inherent in its design or it has been configured into a mode which is normal from a user standpoint and does not require that capability.

Table 2-9. Navigation Data Health Indications

BIT POSITION IN PAGE			INDICATION
137	138	139	
0	0	0	ALL DATA OK
0	0	1	PARITY FAILURE -- some or all parity bad
0	1	0	TLM/HOW FORMAT PROBLEM -- any departure from standard format (e.g., preamble misplaced and/or incorrect, etc.), except for incorrect Z-count, as reported in HOW
0	1	1	Z-COUNT IN HOW BAD -- any problem with Z-count value not reflecting actual code phase
1	0	0	SUBFRAMES 1, 2, 3 -- one or more elements in words three through ten of one or more subframes are bad.
1	0	1	SUBFRAMES 4, 5 -- one or more elements in words three through ten of one or more subframes are bad.
1	1	0	ALL UPLOADED DATA BAD -- one or more elements in words three through ten of any one (or more) subframes are bad.
1	1	1	ALL DATA BAD -- TLM word and/or HOW and one or more elements in any one (or more) subframes are bad.

Table 2-10. Codes for Health of Satellite Signal Components

MSB					LSB					
0	0	0	0	0	0	0	0	0	0	⇒ ALL SIGNALS OK
1	1	1	0	0	0	0	0	0	0	⇒ SATELLITE <u>IS</u> TEMPORARILY OUT~do not use this satellite during current pass**
1	1	1	0	1	0	0	0	0	0	⇒ SATELLITE <u>WILL BE</u> TEMPORARILY OUT~ use with caution**
1	1	1	1	0	0	0	0	0	0	⇒ SPARE
1	1	1	1	1	0	0	0	0	0	⇒ MORE THAN ONE COMBINATION WOULD BE REQUIRED TO DESCRIBE ANOMALIES, EXCEPT THOSE MARKED BY **
All Other Combinations										⇒ SATELLITE EXPERIENCING CODE MODULATION AND/OR SIGNAL POWER LEVEL TRANSMISSION PROBLEMS. Modulated navigation data valid, however user may experience intermittent tracking problems if satellite is acquired.

The predicted health data will be updated at the time of upload. The transmitted health data may not correspond to the actual health of the transmitting satellite or other satellites in the constellation. The data given in subframes 1, 4, and 5 of the other satellites may differ from that shown in subframes 4 and/or 5 since the latter may be updated at a different time.

2.4.5.4 Satellite Configuration Summary

Page 25 of subframe 4 contains a four-bit-long term for each of up to 32 satellites to indicate the configuration code of each satellite. The first MSB of each field is reserved. The three LSBs indicate the configuration of each satellite using the following code:

<u>Code</u>	<u>Satellite Configuration</u>
000	"Block I" satellite.
001	"Block II" satellite.

These four-bit terms occupy bits 9 through 24 of word three, the 24 MSBs of words four through seven, and the 16 MSBs of word eight, all in page 25 of subframe 4.

2.4.5.5 Universal Coordinated Time (UTC) Parameters

Page 18 of subframe 4 includes: (1) the parameters needed to relate GPS time to UTC, and (2) notice to the user regarding the scheduled future or recent past (relative to navigation message upload) value of the delta time due to leap seconds (Δt_{LSF}), together with the week number (WN_{LSF}) and the day number (DN) at the end of which the leap second becomes effective. "Day one" is the first day relative to the end/start of week and the WN_{LSF} value consists of the eight LSBs of the full week number. The user must account for the truncated nature of this parameter as well as truncation of WN , WN_t , and W_{LSF} due to rollover of the full week number (see paragraph 2.3.5(b)). The absolute value of the difference between the untruncated WN and WN_{LSF} values will not exceed 127.

The 24 MSBs of words six through nine plus the eight MSBs of word ten in page 18 of subframe 4 contain the parameters related to correlating UTC time with GPS time. The bit length, scale factors, ranges, and units of these parameters are given in Table 2-11. The related algorithms are described in paragraph 2.5.6.

Table 2-11. UTC Parameters

Parameter	No. of Bits	Scale Factor (LSB)	Effective Range***	Units
A_0	32*	2^{-30}		seconds
A_1	24*	2^{-50}		sec/sec
Δt_{LS}	8	1		seconds
t_{ot}	8	2^{12}	602,112	seconds
WN_t	8	1		weeks
WN_{LSF}	8	1		weeks
DN	8****	1	7	days
Δt_{LSF}	8*	1		seconds
* Parameters so indicated are two's complement, with the sign bit (+ or -) occupying the MSB;				
** See Figure 2-8 for complete bit allocation in subframe;				
*** Unless otherwise indicated in this column, effective range is the maximum range attainable with indicated bit allocation and scale factor.				
**** Right justified.				

2.4.5.6 Ionospheric Parameters

The ionospheric parameters which allow the SPS user to utilize the ionospheric model (reference paragraph 2.5.5.3) for computation of the ionospheric delay are contained in page 18 of subframe 4. They occupy bits 9 through 24 of word three plus the 24 MSBs of words four and five. The bit lengths, scale factors, ranges, and units of these parameters are given in Table 2-12.

Table 2-12. Ionospheric Parameters

Parameter	No. of Bits	Scale Factor (LSB)	Effective Range***	Units
α_0	8 *	2^{-30}		seconds
α_1	8 *	2^{-27}		sec. per semi-circle
α_2	8 *	2^{-24}		sec. per semi-circles ²
α_3	8 *	2^{-24}		sec. per semi-circles ³
β_0	8 *	2^{11}		seconds
β_1	8 *	2^{14}		sec. per semi-circles
β_2	8 *	2^{16}		sec. per semi-circles ²
β_3	8 *	2^{16}		sec. per semi-circles ³
* Parameters so indicated are two's complement, with the sign bit (+ or -) occupying the MSB; ** See Figure 2-8 for complete bit allocation in subframe; *** Unless otherwise indicated in this column, effective range is the maximum range attainable with indicated bit allocation and scale factor.				

2.4.5.7 Special Message

Page 17 of subframe 4 is reserved for special messages with the specific contents at the discretion of the system operator. It will accommodate the transmission of 22 eight-bit ASCII characters. The requisite 176 bits will occupy bits 9 through 24 of word three, the 24 MSBs of words four through nine, plus the 16 MSBs of word ten. The eight MSBs of word three contain the data ID and satellite ID, while bits 17 through 22 of word ten are spares containing alternating ones and zeros. The remaining 50 bits of words three through ten are used for parity (six bits/word) and parity computation (two bits in word ten). The eight-bit ASCII characters is limited to the following set:

Alphanumeric Character	ASCII Character	Code (Octal)
A - Z	A - Z	101 - 132
0 - 9	0 - 9	060 - 071
+	+	053
-	-	055
. (Decimal point)	.	056
' (Minute mark)	'	047
° (Degree sign)	°	370
/	/	057
Blank	Space	040
:	:	072
" (Second mark)	"	042

2.4.5.8 Spare Data Fields

All bits of words three through ten, except the 58 bits used for data ID, satellite (page) ID, parity (six LSBs of each word) and parity computation (bits 23 and 24 of word ten) of pages 13, 14 and 15 of subframe 4, and those almanac pages assigned satellite ID of zero are designated as spares. In addition, as shown in Table 2-13, several smaller groups of spare bits exist in subframes 4 and 5. These spare bit positions of each word will contain a pattern of alternating ones and zeroes with valid word parity. Users are cautioned that the contents of spare data fields can change without warning. In all cases, valid parity will be maintained.

Table 2-13. Spare Bits in Subframes 4 and 5

Subframe	Pages	Words	Spare Bit Position in Word
4	12, 19, 20, 22, 23, 24	9	9 - 24
4	1, 6, 11, 12, 16, 19, 20, 21, 22, 23, 24	10	1 - 22
4	17	10	17 - 22
4	18	10	9 - 22
4	25	8	17 - 18
4	25	10	19 - 22
5	25	10	4 - 22

NOTE: In addition, all bits of words three through ten in pages 13, 14, and 15 of subframe 4 (except the 58 bits used for data ID, satellite (page) ID, parity and parity computation) are also designated as spares.

2.5 User Algorithms

This section provides guidance in the implementation of measurement processing algorithms. The discussions in this section include:

- Mathematical constants used in GPS position determination computations.
- The GPS parity algorithm implementation to permit the user to detect demodulation errors within the decoded navigation message.
- Interpretation of the satellite transmitted URA parameter.
- Satellite position determination using broadcast ephemeris parameters.
- Correction of the code phase time received from the satellite with respect to both satellite code phase offset and relativistic effects.
- Compensation for the effects of satellite group delay differential.
- Correction for ionospheric propagation delay.
- Performing time transfer to UTC.
- Use of almanac data and time parameters.

2.5.1 Mathematical Constants

The speed of light used for generating the data described in the above paragraphs is:

$$c = 2.99792458 \times 10^8 \text{ meters per second}$$

which is the official WGS-84 speed of light. The user should use the same value for the speed of light in computations. Other WGS-84 constants the user is required to use for satellite ephemeris calculations are:

$$\mu = 3.986005 \times 10^{14} \text{ meters}^3 / \text{sec}^2$$

WGS-84 value of the Earth's universal gravitational parameter

$$\dot{\Omega}_e = 7.2921151467 \times 10^{-5} \text{ rad / sec}$$

WGS-84 value of the Earth's rotation rate

The sensitivity of the satellite's antenna phase center position to small perturbations in most ephemeris parameters is extreme. The sensitivity of position to the parameters $(A)^{1/2}$, C_{rc} and C_{rs} is about one meter/meter. The sensitivity of position to the angular rate parameters is on the order of 10^8 meters/semicircle, and to the angular rate parameters is on the order of 10^2 meter/semicircle/second. Because of this extreme sensitivity to angular perturbations, the value of π used in the curve fit is given here. π is a mathematical constant, the ratio of a circle's circumference to its diameter. Here π is taken as

$$\pi = 3.1415926535898$$

2.5.2 Parity Algorithm

The user must perform error detection of the decoded navigation data using the parity algorithm equations provided in Table 2-14. Figure 2-10 presents an example flow chart that defines one way of recovering data (d_n) and checking parity. The parity bit D_{30}^* is used for recovering raw data. The parity bits D_{29}^* and D_{30}^* , along with the recovered raw data (d_n) are modulo-2 added in accordance with the equations appearing in Table 2-14 for $D_{25} \dots D_{30}$, which provide computed parity to compare with transmitted parity $D_{25} \dots D_{30}$.

2.5.3 User Range Accuracy

The URA reported in the navigation message will correspond to the maximum value anticipated during each subframe fit interval with uniform SA levels invoked. Referring to the decimal equivalent of the transmitted four-bit binary number as N -- with N a positive integer in the range of 0 through 15 -- the accuracy value is defined to mean "no better than X meters", in accordance with the following relationships:

- If the value of N is 6 or less, $X = 2^{(1 + N/2)}$,
- If the value of N is 6 or more, but less than 15, $X = 2^{(N-2)}$,
- N = 15 will indicate the absence of an accuracy prediction and will advise the SPS user to use that satellite at the user's own risk.

For N = 1, 3, and 5, X is rounded to 2.8, 5.7, and 11.3 meters respectively; the above relationships yield integer values of X for all other values of N. Using these values of X the user may utilize a look-up table approach for interpreting the URA message.

2.5.4 User Algorithm for Ephemeris Determination

The user will compute the ECEF coordinates of position for the phase center of each satellite's L-Band antenna utilizing a variation of the equations shown in Table 2-15. Subframes 2 and 3 parameters are Keplerian in appearance; the values of these parameters, however, are obtained via a least squares curve fit of the predicted ephemeris for the phase center of the satellite's antenna (time-position quadruples; t, x, y, z).

2.5.4.1 Coordinate System

The equations given in Table 2-15 provide the satellite's antenna phase center position in the WGS-84 Earth-Centered Earth-Fixed reference frame defined as follows:

ORIGIN = Earth's center of mass*

Z-AXIS = Parallel to the direction of the CONVENTIONAL INTERNATIONAL ORIGIN (CIO) for polar motion, as defined by the BUREAU INTERNATIONAL DE L'HEURE (BIH) on the basis of the latitudes adopted for the BIH stations**

X-AXIS = Intersection of the WGS-84 reference meridian plane and the plane of the mean astronomic equator, the reference meridian being parallel to the zero meridian defined by the BUREAU INTERNATIONAL DE L'HEURE (BIH) on the basis of the longitudes adopted for the BIH stations***

Y-AXIS = Completes a right-handed Earth-Centered, Earth-Fixed orthogonal coordinate system, measured in the plan of the mean astronomic equator 90 degrees east of the X-axis***

* Geometric center of WGS-84 ellipsoid

** Rotation axis of WGS-84 ellipsoid

*** X, Y axis of WGS-84 ellipsoid

Table 2-14. Parity Encoding Equations

$D_1 = d_1 \oplus D_{30}^*$
$D_2 = d_2 \oplus D_{30}^*$
$D_3 = d_3 \oplus D_{30}^*$
• •
• •
• •
• •
$D_{24} = d_{24} \oplus D_{30}^*$
$D_{25} = D_{29}^* \oplus d_1 \oplus d_2 \oplus d_3 \oplus d_5 \oplus d_6 \oplus d_{10} \oplus d_{11} \oplus d_{12} \oplus d_{13} \oplus d_{14} \oplus d_{17} \oplus d_{18} \oplus d_{20} \oplus d_{23}$
$D_{26} = D_{30}^* \oplus d_2 \oplus d_3 \oplus d_4 \oplus d_6 \oplus d_7 \oplus d_{11} \oplus d_{12} \oplus d_{13} \oplus d_{14} \oplus d_{15} \oplus d_{18} \oplus d_{19} \oplus d_{21} \oplus d_{24}$
$D_{27} = D_{29}^* \oplus d_1 \oplus d_3 \oplus d_4 \oplus d_5 \oplus d_7 \oplus d_8 \oplus d_{12} \oplus d_{13} \oplus d_{14} \oplus d_{15} \oplus d_{16} \oplus d_{19} \oplus d_{20} \oplus d_{22}$
$D_{28} = D_{30}^* \oplus d_2 \oplus d_4 \oplus d_5 \oplus d_6 \oplus d_8 \oplus d_9 \oplus d_{13} \oplus d_{14} \oplus d_{15} \oplus d_{16} \oplus d_{17} \oplus d_{20} \oplus d_{21} \oplus d_{23}$
$D_{29} = D_{30}^* \oplus d_1 \oplus d_3 \oplus d_5 \oplus d_6 \oplus d_7 \oplus d_9 \oplus d_{10} \oplus d_{14} \oplus d_{15} \oplus d_{16} \oplus d_{17} \oplus d_{18} \oplus d_{21} \oplus d_{22} \oplus d_{24}$
$D_{30} = D_{29}^* \oplus d_3 \oplus d_5 \oplus d_6 \oplus d_8 \oplus d_9 \oplus d_{10} \oplus d_{11} \oplus d_{13} \oplus d_{15} \oplus d_{19} \oplus d_{22} \oplus d_{23} \oplus d_{24}$
where:
d_1, d_2, \dots, d_{24} are the source data bits
the symbol (*) is used to identify the last 2 bits of the previous word of the subframe,
D_{25}, \dots, D_{30} are the computed parity bits
$D_1, D_2, D_3, \dots, D_{29}, D_{30}$ are the bits transmitted by the satellite, and
\oplus is the "Modulo-2" or "Exclusive-Or" operation.

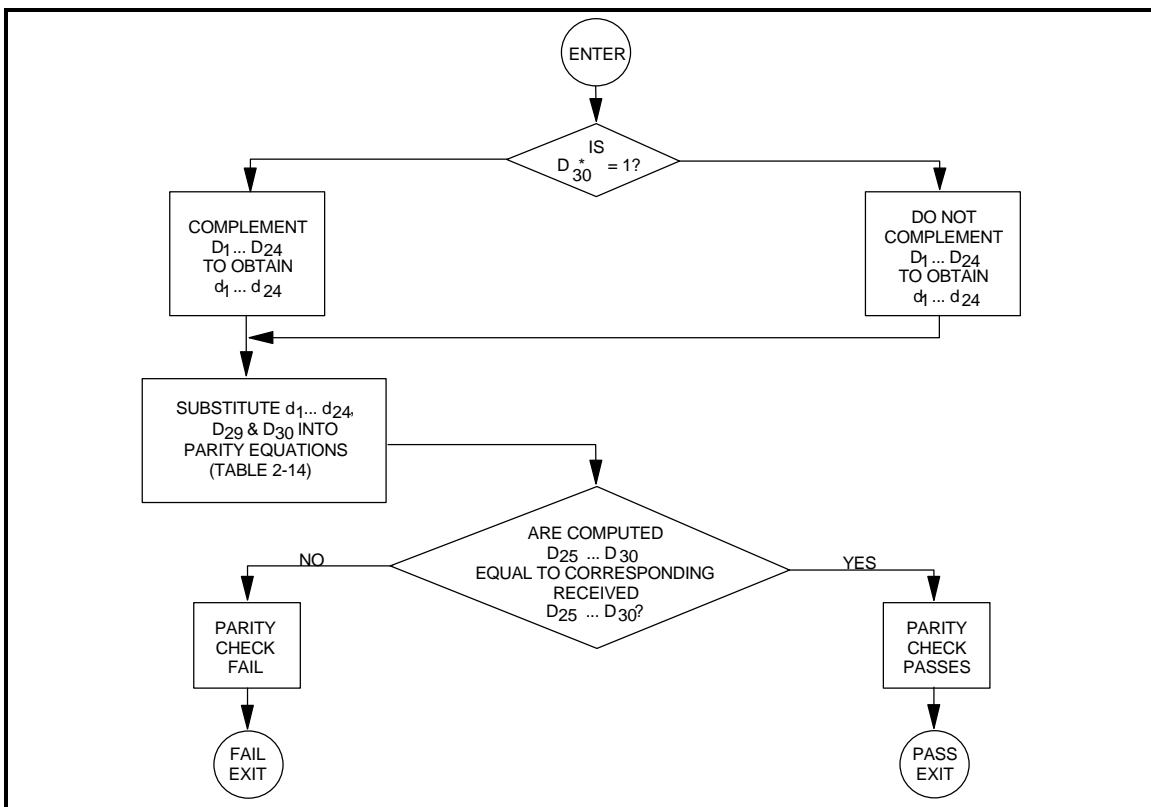

Figure 2-10. Example Flow Chart for User Implementation of Parity Algorithm

2.5.4.2 Geometric Range Correction

When computing the geometric range, the user will account for the effects due to earth rotation rate (reference Table 2-15) during the time of signal propagation so as to evaluate the path delay in an inertially stable coordinate system. Specifically, if the user works in Earth-fixed coordinates the user should add $(-\dot{\Omega}_e y \Delta t, \dot{\Omega}_e x \Delta t, 0)$ to the position estimate (x, y, z) .

2.5.5 Application of Correction Parameters

In order to properly account for satellite clock bias and propagation delays, the user receiver must perform corrections to observed pseudo range measurements. The pseudo range is defined as:

$$PR_{\text{measured}} = c(t_{\text{received}} - t_{\text{transmitted}})$$

where

- PR_{measured} = measured pseudo range
- t_{received} = time that ranging measurement was received at the user location
- $t_{\text{transmitted}}$ = time that ranging signal was transmitted from the satellite

Table 2-15. Elements of Coordinate Systems

$A = (\sqrt{A})^2$	Semi-major axis
$n_0 = \sqrt{\frac{\mu}{A^3}}$	Computed mean motion - rad/sec
$t_k = t - t_{oe}^*$	Time from ephemeris reference epoch
$n = n_0 + \Delta n$	Corrected mean motion
$M_k = M_0 + nt_k$	Mean anomaly
$M_k = E_k - e \sin E_k$	Kepler's equation for eccentric anomaly (may be solved by iteration) - radians
$v_k = \tan^{-1} \left\{ \frac{\sin v_k}{\cos v_k} \right\} = \tan^{-1} \left\{ \frac{\sqrt{1 - e^2} \sin E_k / (1 - e \cos E_k)}{(\cos E_k - e) / (1 - e \cos E_k)} \right\}$	True anomaly
$E_k = \cos^{-1} \left\{ \frac{e + \cos v_k}{1 + e \cos v_k} \right\}$	Eccentric anomaly
$\Phi_k = v_k + \omega$	Argument of latitude
	<u>Second Harmonic Perturbations</u>
$\delta u_k = C_{us} \sin 2\Phi_k + C_{uc} \cos 2\Phi_k$	Argument of latitude correction
$\delta r_k = C_{rc} \cos 2\Phi_k + C_{rs} \sin 2\Phi_k$	Radius correction
$\delta i_k = C_{ic} \cos 2\Phi_k + C_{is} \sin 2\Phi_k$	Correction to inclination
$u_k = \Phi_k + \delta u_k$	Corrected argument of latitude
$r_k = A(1 - e \cos E_k) + \delta r_k$	Corrected radius
$i_k = i_0 + \delta i_k + (\text{IDOT}) t_k$	Corrected inclination
$\left. \begin{aligned} x_k' &= r_k \cos u_k \\ y_k' &= r_k \sin u_k \end{aligned} \right\}$	Positions in orbital plane
$\Omega_k = \Omega_0 + (\dot{\Omega} - \dot{\Omega}_e) t_k - \dot{\Omega}_e t_{oe}$	Corrected longitude of ascending node
$\left. \begin{aligned} x_k &= x_k' \cos \Omega_k - y_k' \sin \Omega_k \\ y_k &= x_k' \sin \Omega_k + y_k' \cos \Omega_k \\ z_k &= y_k' \sin i_k \end{aligned} \right\}$	Earth-Centered, Earth-Fixed coordinates
<p>* t is GPS system time at time of transmission, i.e., GPS time corrected for transit time (range/speed of light). Furthermore, t_k shall be the actual total time difference between the time t and the epoch time t_{oe}, and must account for beginning or end of week crossovers. That is, if t_k is greater than 302,400 seconds, subtract 604,800 seconds from t_k. If t_k is less than -302,400 seconds, add 604,800 seconds to t_k.</p>	

The system application of the correction parameters for user receiver pseudorange measurements is shown in Figure 2-11. The ionospheric model referred to in Figure 2-11 is discussed in paragraph 2.5.5.3 using the related data contained in page 18 of subframe 4.

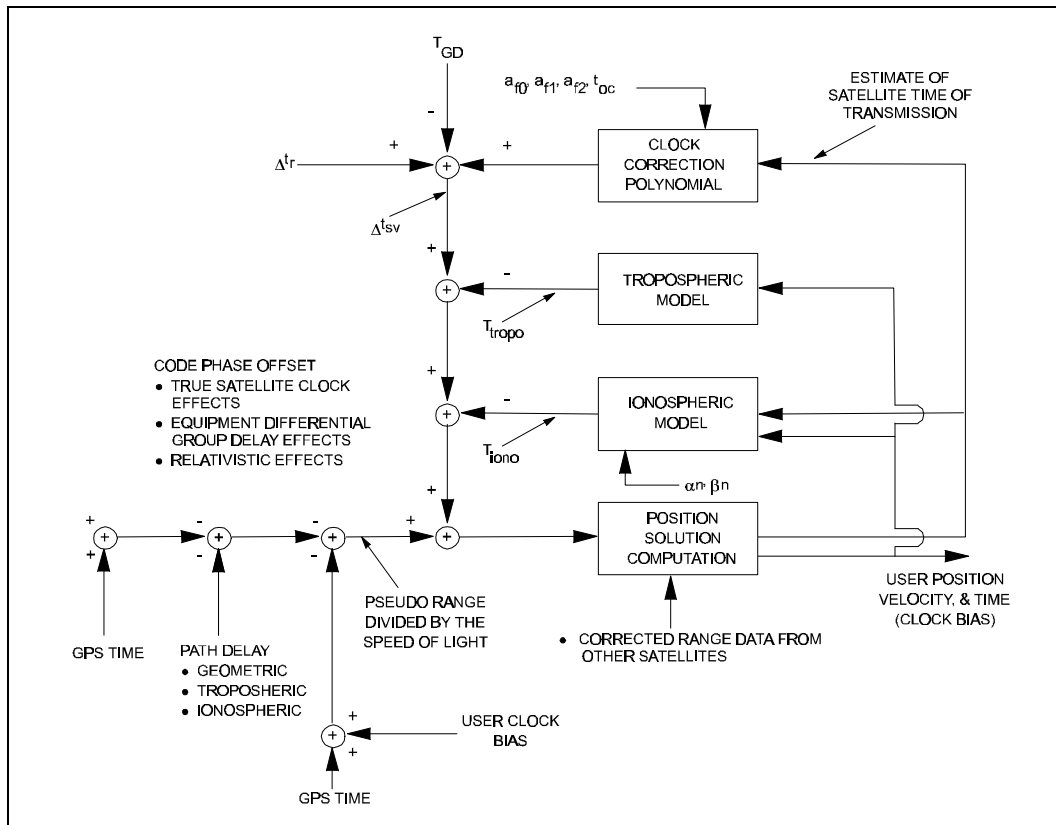

Figure 2-11. Application of Correction Parameters

2.5.5.1 Group Delay Application

The SPS user who utilizes the L1 frequency will modify the code phase offset with the equation:

$$(\Delta t_{SV})_{L1} = \Delta t_{SV} - T_{GD}$$

where T_{GD} is provided to the user as subframe 1 data.

2.5.5.2 Satellite Clock Correction

The polynomial defined in the following allows the user to determine the effective satellite PRN code phase offset referenced to the phase center of the satellite antennas (Δt_{SV}) with respect to GPS system time (t) at the time of data transmission.

The coefficients transmitted in subframe 1 describe the offset apparent to the control segment two-frequency receivers for the interval of time in which the parameters are transmitted. This estimated correction accounts for the deterministic satellite clock error characteristics of bias, drift and aging, as well as for the satellite implementation characteristics of group delay bias and mean differential group delay. Since these coefficients do not include corrections for relativistic effects, the user's equipment must determine the requisite relativistic correction. Accordingly, the offset given below includes a term to perform this function.

The user will correct the time received from the satellite with the equation (in seconds)

$$t = t_{sv} - (\Delta t_{sv})_{L1} \quad (1)$$

where

$$\begin{aligned} t &= \text{GPS system time (seconds),} \\ t_{sv} &= \text{effective SV PRN code phase time at message transmission time (seconds),} \\ (\Delta t_{sv})_{L1} &= \text{SV PRN code phase time offset (seconds).} \end{aligned}$$

The satellite PRN code phase offset is given by

$$(\Delta t_{sv})_{L1} = a_{f0} + a_{f1}(t - t_{oc}) + a_{f2}(t - t_{oc})^2 + \Delta t_r - T_{GD} \quad (2)$$

where a_{f0} , a_{f1} , and a_{f2} are the polynomial coefficients given in subframe 1, t_{oc} is the clock data reference time in seconds, and Δt_r is the relativistic correction term (seconds) which is given by

$$\Delta t_r = F e (A)^{1/2} \sin E_k.$$

The orbit parameters (e , A , E_k) used here are described in discussions of data contained in subframes 2 and 3, while F is a constant whose value is

$$F = \frac{-2(\mu)^{1/2}}{c^2} = -4.442807633 (10)^{-10} \text{ sec / (meter)}^{1/2}.$$

Note that equations (1) and (2), as written, are coupled. While the coefficients a_{f0} , a_{f1} , and a_{f2} are generated by using GPS time as indicated in equation (2), sensitivity of t_{sv} to t is negligible. This negligible sensitivity will allow the user to approximate t by t_{sv} in equation (2). The value of t must account for beginning or end of week crossovers. That is, if the quantity $t - t_{oc}$ is greater than 302,400 seconds, subtract 604,800 seconds from t . If the quantity $t - t_{oc}$ is less than -302,400 seconds, add 604,800 seconds to t .

2.5.5.3 Ionospheric Model

The SPS user should correct the time received from the satellite for ionospheric effect by utilizing parameters contained in page 18 of subframe 4 in the model given below. It is estimated that the use of this model will provide at least a 50 percent reduction in the SPS user's RMS error due to ionospheric propagation effects.

The ionospheric correction model is given by

$$T_{iono} = \begin{cases} F * \left[5.0 * 10^{-9} + (AMP) \left(1 - \frac{x^2}{2} + \frac{x^4}{24} \right) \right], & |x| < 1.57 \\ F * (5.0 * 10^{-9}) & , |x| \geq 1.57 \end{cases} \text{(sec)}$$

where

$$AMP = \begin{cases} \sum_{n=0}^3 \alpha_n \phi_m^n, & AMP \geq 0 \\ \text{if } AMP < 0, & AMP = 0 \end{cases} \text{(sec)}$$

$$x = \frac{2\pi(t - 50400)}{\text{PER}}, \text{ (radians)}$$

$$\text{PER} = \left\{ \begin{array}{l} \sum_{n=0}^3 \beta_n \phi_m^n, \text{ PER} \geq 72,000 \\ \text{if PER} < 72,000, \text{ PER} = 72,000 \end{array} \right\} \text{ (sec)}$$

$$F = 1.0 + 16.0[0.53 - E]^3, \text{ and}$$

α_n and β_n are the satellite transmitted data words with $n = 0, 1, 2,$ and $3.$

Other equations that must be solved are

$$\phi_m = \phi_i + 0.064 \cos(\lambda_i - 1.617) \text{ (semi-circles),}$$

$$\lambda_i = \lambda_u + \frac{\psi \sin A}{\cos \phi_i} \text{ (semi-circles),}$$

$$\phi_i = \left\{ \begin{array}{l} \phi_u + \psi \cos A \text{ (semi-circles), } |\phi_i| \leq 0.416 \\ \text{if } \phi_i > 0.416, \text{ then } \phi_i = +0.416 \\ \text{if } \phi_i < -0.416, \text{ then } \phi_i = -0.416 \end{array} \right\} \text{ (semi-circles),}$$

$$\psi = \frac{0.00137}{E + 0.11} - 0.022 \text{ (semi-circles),}$$

$$t = 4.32 * 10^4 \lambda_i + \text{GPS time (sec)}$$

where

$0 \leq t < 86400$, therefore: if $t \geq 86400$ seconds, subtract 86400 seconds;



if $t < 0$ seconds, add 86400 seconds.

The terms used in computation of ionospheric delay are as follows:

- **Satellite Transmitted Terms**
 - α_n the coefficients of a cubic equation representing the amplitude of the vertical delay (4 coefficients = 8 bits each)
 - β_n the coefficients of a cubic equation representing the period of the model (4 coefficients = 8 bits each)
- **Receiver Generated Terms**
 - E elevation angle between the user and satellite (semi-circles)
 - A azimuth angle between the user and satellite, measured clockwise positive from the true North (semi-circles)
 - ϕ_u user geodetic latitude (semi-circles) WGS-84
 - λ_u user geodetic longitude (semi-circles) WGS-84
 - GPS time receiver computed system time
- **Computed Terms**
 - x phase (radians)
 - F obliquity factor (dimensionless)
 - t local time (sec)
 - ϕ_m geomagnetic latitude of the earth projection of the ionospheric intersection point (mean ionospheric height assumed 350 km) (semicircles)
 - λ_i geomagnetic latitude of the earth projection of the ionospheric intersection point (semi-circles)

- Computed Terms (continued)
 - ϕ_i geomagnetic latitude of the earth projection of the ionospheric intersection point (semi-circles)
 - ψ earth's central angle between user position and earth projection of ionospheric intersection point (semi-circles)

2.5.6 Universal Coordinated Time (UTC)

Depending upon the relationship of the effectivity date to the user's current GPS time, the following three different UTC/GPS-time relationships exist:

- a. Whenever the effectivity time indicated by the WN_{LSF} and the DN values is not in the past (relative to the user's present time), and the user's present time does not fall in the timespan which starts at DN + 3/4 and ends at DN + 5/4, the UTC/GPS-time relationship is given by

$$t_{UTC} = (t_E - \Delta t_{UTC}) \text{ \{Modulo 86400 seconds\}}$$

where t_{UTC} is in seconds and

$$\Delta t_{UTC} = \Delta t_{LS} + A_0 + A_1 (t_E - t_{ot} + 604800 (WN - WN_t)), \text{ (seconds);}$$

$$t_E = \text{GPS time as estimated by the user on the basis of correcting } t_{sv} \text{ for factors described in paragraph 2.5.5.2 as well as for ionospheric and SA (dither) effects;}$$

$$\Delta t_{LS} = \text{delta time due to leap seconds;}$$

A_0 and A_1 = constant and first order terms of polynomial;

$$t_{ot} = \text{reference time for UTC data;}$$

$$WN = \text{current week number (derived from subframe 1);}$$

$$WN_t = \text{UTC reference week number.}$$

The estimated GPS time (t_E) is in seconds relative to end/start of week. The reference time for UTC data (t_{ot}) is referenced to the start of that week whose number (WN) is given in word eight of page 18 in subframe 4. The WN_t value consists of the eight LSBs of the full week number. The user must account for the truncated nature of this parameter as well as truncation of WN , WN_t , and W_{LSF} due to rollover of the full week number (see paragraph 2.3.5(b)). The absolute value of the difference between the untruncated WN and WN_t values will not exceed 127.

- b. Whenever the user's current time falls within the timespan of DN + 3/4 to DN + 5/4, proper accommodation of the leap second event with a possible week number transition is provided by the following expression for UTC:

$$t_{UTC} = W \text{ [Modulo } (86400 + \Delta t_{LSF} - \Delta t_{LS}) \text{]}, \text{ (seconds);}$$

where

$$W = (t_E - \Delta t_{UTC} - 43200) \text{ [Modulo 86400] } + 43200, \text{ (seconds);}$$

and the definition of Δt_{UTC} (as given in "a" above) applies throughout the transition period. Note that when a leap second is added, unconventional time values of the form 23: 59: 60.xxx are encountered. Some user equipment may be designed to approximate UTC by decrementing the running count of time within several seconds after the event, thereby promptly returning to a

proper time indication. Whenever a leap second event is encountered, the user equipment must consistently implement carries or borrows into any year/week/day counts.

c. Whenever the effectivity time of the leap second event, as indicated by the WN_{LSF} and DN values, is in the "past" (relative to the user's current time), the relationship previously given for t_{UTC} in "a" above is valid except that the value of Δt_{LSF} is substituted for Δt_{LS} . The CS will coordinate the update of UTC parameters at a future upload so as to maintain a proper continuity of the t_{UTC} time scale.

2.5.7 Almanac Data

The almanac is a subset of the clock and ephemeris data, with reduced precision. The user algorithm is essentially the same as the user algorithm used for computing the precise ephemeris from the subframe 1, 2, and 3 parameters (see Table 2-15). The almanac content for one satellite is given in Table 2-8. A close inspection of Table 2-8 will reveal that a nominal inclination angle of 0.30 semicircles is implicit and that the parameter δi (correction to inclination) is transmitted, as opposed to the value being computed by the user. All other parameters appearing in the equations of Table 2-15, but not included in the content of the almanac, are set to zero for satellite position determination. In these respects, the application of the Table 2-15 equations differs between the almanac and the ephemeris computations.

Almanac time is computed using a first-order polynomial. The applicable first order polynomial, which will provide time to within 2 microseconds of GPS time (t) during the interval of applicability, is given by

$$t = t_{sv} - \Delta t_{sv}$$

where

- t = GPS system time (seconds)
- t_{sv} = effective satellite PRN code phase time at message transmission time (seconds),
- Δt_{sv} = satellite PRN code phase time offset (seconds).

The satellite PRN code phase offset is given by

$$\Delta t_{sv} = a_{f0} + a_{f1} t_k$$

The time from epoch t_k is computed as described in Table 2-15, except that t_{be} is replaced with t_{oa} and the polynomial coefficients a_0 and a_1 are given in the almanac. Since the periodic relativistic effect is less than 25 meters, it need not be included in the time scale used for almanac evaluation. Over the span of applicability, it is expected that the almanac time parameters will provide a statistical URE component of less than 135 meters, 1σ . This is partially due to the fact that the error caused by the truncation of a_0 and a_1 , may be as large as 150 meters plus 50 meters/day relative to the t_{oa} reference time.

Acronyms

BIH	BUREAU INTERNATIONAL DE L'HEURE
bps	bits per second
BPSK	Bipolar-Phase Shift Key
C/A	Coarse/Acquisition
CS	Control Segment
dBi	Decibels, isotropic
dBw	Decibels, watt
DN	Day Number
DOD	Department of Defense
DOP	Dilution of Precision
ECEF	Earth-Centered, Earth-Fixed
FOC	Full Operational Capability
GPS	Global Positioning System
HOW	Hand-Over Word
ID	Identification
IODC	Issue of Data, Clock
IODE	Issue of Data, Ephemeris
LSB	Least Significant Bit
LSF	Leap Seconds Future
Mbps	Million bits per second
MCS	Master Control Station
MSB	Most Significant Bit
NSC	Non-Standard C/A-Code
NTE	Not-To-Exceed
OCS	Operational Control System
PRN	Pseudo Random Noise
RF	Radio Frequency
RHCP	Right Hand Circularly Polarized
RMS	Root Mean Square
SA	Selective Availability
SS	Space Segment
TLM	Telemetry
TOW	Time of Week
TT&C	Telemetry, Tracking and Commanding

Acronyms (continued)

UE	User Equipment
URA	User Range Accuracy
URE	User Range Error
U.S.	United States
USNO	U.S. Naval Observatory
UTC	Universal Coordinated Time
WGS-84	World Geodetic System 1984
WN	Week Number