

**NWCG FIRELINE HANDBOOK
APPENDIX B
FIRE BEHAVIOR**

**APRIL, 2006
PMS 410-2
NFES 2165**



Additional copies of this publication may be ordered from:

**National Interagency Fire Center
ATTN: Supply
3833 S. Development Avenue
Boise, Idaho 83705**

Order NFES 2165

CONTENTS

PURPOSE	4
FIRE BEHAVIOR WORKSHEETS	5
INPUT 0–Projection Point	10
INPUT 1–Selecting a Fuel Model	10
Fire Behavior Fuel Model Key	12
Fire Behavior Fuel Model Descriptions	16
Grass Group	16
Shrub Group	17
Timber Litter Group	18
Logging Slash Group	19
Table 1–Description of Fuel Models	21
INPUT 2–Fine Dead Fuel Moisture (1-H FDFM)	22
Table 2–Reference Fuel Moisture, Day (0800-1959)	25
Table 3–Dead Fuel Moisture Content Corrections, Day (0800-1959) May, June, July	26
Table 4–Dead Fuel Moisture Content Corrections, Day (0800-1759) February, March, April, August, September, October	27
Table 5–Fine Dead Fuel Moisture Content Corrections, Day (0800-1759) November, December, January	28
INPUT 3–Live Fuel Moisture (LFM) Fuel Models 2, 4, 5, 7 and 10	29
Table 6–Live Fuel (Foliage) Moisture Content %	29
INPUT 4–Midflame Windspeed (MFWS)	30
Diagram 1: 20-Foot Windspeed Adjusted to Midflame Windspeed Based on Overstory	32
Table 7–Wind Adjustment Table	33
Table 8–Modified Beaufort Scale for Estimating 20-Foot Windspeed	34
INPUT 5–Slope (SLP)	35
Slope Determination Process	35
Table 9–Map Scale Conversion Factors	36

CONTENTS (continued)

INPUT 6–Effective Windspeed (EWS)	37	
FIRE BEHAVIOR OUTPUTS		
OUTPUT 1–Rate of Spread	38	
OUTPUT 2–Heat Per Unit Area	38	
OUTPUT 3–Fireline Intensity	38	
OUTPUT 4–Flame Length	38	
OUTPUT 5–Spread Distance	38	
OUTPUT 6/7–Projected Fire Perimeter and Area	40	
Table 10–Perimeter Estimations for Point Source Fires	41	
Table 11–Area Estimations for Point Source Fires	44	
Diagram 2: Approximate Fire Shapes for Various Effective Windspeeds	47	
OUTPUT 8–Maximum Spotting Distance	48	
Nomogram 1–Flame Height	50	
Nomogram 2–Flame Duration	51	
Nomogram 3–Ratio of Lofted Firebrand Height to Flame Height	52	
Nomogram 4–Maximum Spotting Distance	53	
OUTPUT 9–Probability of Ignition	54	
Table 12–Probability of Ignition Table	55	
INTERPRETATION OF FIRE BEHAVIOR INFORMATION		
Table 13–Fire Severity Related to Fuel Moisture Chart	56	
Diagram 3: Fire Behavior Characteristics Chart (Light Fuel)	57	
Diagram 4: Fire Behavior Characteristics Chart (Heavy Fuel)	58	
Table 14–Fire Suppression Interpretations	59	
SAFETY AND FIRE BEHAVIOR		60
Look Up/Look Down/Look Around	61	
Tables 15 through 78 – Rate of Spread and Flame Length Tables by Fuel Type and Percent Slope	63	

PURPOSE

The purpose of this appendix is to provide some basic fire behavior information that will enable a person with a moderate level of fire behavior training (Introduction to Wildland Fire Behavior Calculations, S-390) to predict and calculate some basic elements of fire behavior and fire size.

Information in this appendix will provide the qualified user with the means to:

- Predict rate of spread (ROS) and flame length (FL) for each Fire Behavior Fuel Model based on the 1-hour timelag dead fuel moisture, live fuel moisture for Fuel Models 2, 4, 5, 7 and 10, midflame windspeed and percent slope.
- Estimate the area and perimeter of a fire, given inputs of spread distance (rate of spread x time) and midflame windspeed.
- Predict maximum spotting distance and probability of ignition.
- Provide worksheets for fire behavior prediction.

The Fire Behavior Worksheet is on page B-5. Other worksheets that help track fire behavior input and output data (Fine Dead Fuel Moisture/Probability of Ignition, Wind Adjustment, Slope, Map-Spread, Size, Spotting, and Map-Spot) are provided on pages B-6 through B-9. Pages B-10 through B-37 go over the six required input items on the Fire Behavior Worksheet and B-38 through B-55 cover the output items.

It is imperative that the user of information contained in this appendix know the assumptions, limitations, and appropriate uses of fire behavior prediction models and is able to recognize how environmental factors and processes affect fire behavior predictions and safety.

FIRE BEHAVIOR WORKSHEET

NAME OF FIRE _____ FIRE PRED SPEC _____
 DATE _____ TIME _____

PROJ PERIOD DATE _____ PROJ TIME FROM _____ TO _____

INPUT

0	PP	PROJECTION POINT	___	___	___
1	MODEL#	FUEL MODEL NUMB (1-13)	___	___	___
2	1H-FDFM	FINE DEAD FUEL MOIST, %	___	___	___
3	LFM	LIVE FUEL MOISTURE, %	___	___	___
4	MFWS	MIDFLAME WINDSPD, mi/h	___	___	___
5	SLP	SLOPE, %	___	___	___
6	EWS	EFFECTIVE WNDSPD, mi/h	___	___	___

OUTPUT

1	ROS	RATE OF SPREAD, ch/h	___	___	___
2	HA	HEAT PER UNIT AREA, Btu/sq ft	___	___	___
3	FLI	FIRELINE INTENSITY, Btu/ft/s	___	___	___
4	FL	FLAME LENGTH, ft	___	___	___
5	SD	SPREAD DISTANCE, ch MAP SPREAD DIST, in	___	___	___
6	PER	PERIMETER, ch	___	___	___
7	AC	AREA, ac	___	___	___
8	SPOT	MAX SPOTTING DIST, mi MAP DIST SPOT, in	___	___	___
9	PIG	PROB OF IGNITION, %	___	___	___

FINE DEAD FUEL MOISTURE/PROBABILITY OF IGNITION WORKSHEET

INPUT

0	PP	PROJECTION POINT	_____	_____	_____
1	D	DAY TIME CALCULATION	<u> D </u>	<u> D </u>	<u> D </u>
2	DB	DRY BULB TEMP. °F	_____	_____	_____
3	WB	WET BULB TEMP. °F	_____	_____	_____
4	DP	DEW POINT, °F	_____	_____	_____
5	RH	RELATIVE HUMIDITY, %	_____	_____	_____
6	RFM	REFERENCE FUEL MOIST, % (TABLE 2)	_____	_____	_____
7	MO	MONTH	_____	_____	_____
8	SH	UNSHADED (U) SHADED (S)	<u> U/S </u>	<u> U/S </u>	<u> U/S </u>
9	T	TIME	_____	_____	_____
10	CH	ELEVATION CHANGE	<u> B/L/A </u>	<u> B/L/A </u>	<u> B/L/A </u>
		B = 1000' to 2000' below site			
		L = ±1000' of site location			
		A = 1000' to 2000' above site			
11	ASP	ASPECT, (N, E, S, W)	_____	_____	_____
12	SLP	SLOPE %	_____	_____	_____
13	FMC	FUEL MOIST CORRECT, % (TABLE 3, 4, OR 5)	_____	_____	_____

OUTPUT

1	1H- FDFM	FINE DEAD FUEL MOIST, % (line 6 + line 13)	_____	_____	_____
2	PIG	PROB OF IGNITION, % (TABLE 12)	_____	_____	_____

WIND ADJUSTMENT WORKSHEET

INPUT

0	PP	PROJECTION POINT	_____	_____	_____
1	20' W	20-FT WINDSPEED, mi/h	_____	_____	_____
2	MODEL #	FUEL MODEL # (1-13)	_____	_____	_____
3	SHLTR	WIND SHELTERING	_____	_____	_____
		1=Unsheltered			
		2=Partially Sheltered			
		3=Fully Sheltered, Open			
		4=Fully Sheltered, Closed			
4	WAF	WIND ADJUST FACTOR (TABLE 7)	_____	_____	_____

OUTPUT

1	MFWS	MIDFLAME WNDSPD, mi/h (line 1 x line 4)	_____	_____	_____
---	------	--	-------	-------	-------

SLOPE WORKSHEET

INPUT

0	PP	PROJECTION POINT	_____	_____	_____
1	CON INT	CONTOUR INTERVAL	_____	_____	_____
2	SLC	MAP SCALE	_____	_____	_____
3	CF	CONVERSION FACTOR, ft/in	_____	_____	_____
4	# INTVLS	# CONTOUR INTERVALS	_____	_____	_____
5	RISE	RISE IN ELEVATION	_____	_____	_____
6	MD	MAP DISTANCE, in (Between Points)	_____	_____	_____
7	HZGD	HORIZ GROUND DIST, ft	_____	_____	_____

OUTPUT

1	SLP %	SLOPE, %	_____	_____	_____
---	-------	----------	-------	-------	-------

MAP-SPREAD WORKSHEET

INPUT

0	PP	PROJECTION POINT	_____	_____	_____
1	ROS	RATE OF SPREAD, ch/h	_____	_____	_____
2	PT	PROJECTION TIME, hr	_____	_____	_____
3	SDCH	SPREAD DISTANCE, ch (line 1 x line 2)	_____	_____	_____
4	SDFT	SPREAD DISTANCE, ft (line 3 x 66 ft/ch)	_____	_____	_____
5	SCL	MAP SCALE	_____	_____	_____
6	CF	CONVERSION FACTOR, ft/in (See Map Scale Conversion)	_____	_____	_____

OUTPUT

1	MD	MAP SPREAD DIST, in (line 4 divided by line 6)	_____	_____	_____
---	----	---	-------	-------	-------

SIZE WORKSHEET

INPUT

0	PP	PROJECTION POINT	_____	_____	_____
1	ROS	RATE OF SPREAD, ch/h	_____	_____	_____
2	EWS	EFFECTIVE WINDSPD, mi/h	_____	_____	_____
3	PT	PROJECTION TIME, hr	_____	_____	_____
4	SD	SPREAD DISTANCE, ch (line 1 x line 3 = line 4)	_____	_____	_____

OUTPUT

1	PER	PERIMETER, ch	_____	_____	_____
2	AC	AREA, ac	_____	_____	_____

SPOTTING WORKSHEET

INPUT

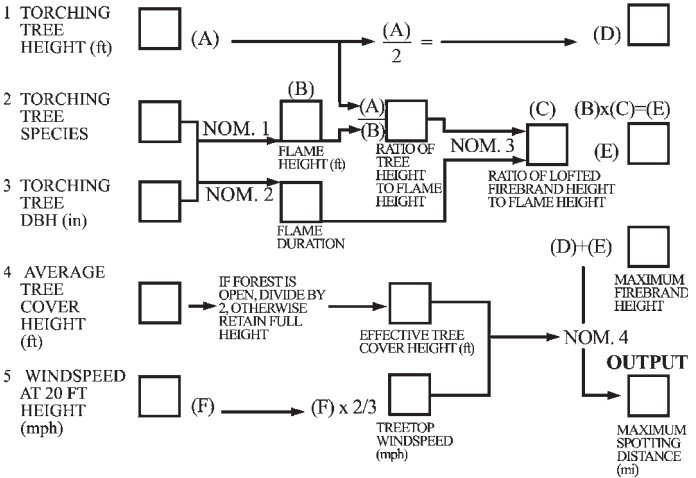

MAP-SPOT WORKSHEET

INPUT

0	PP	PROJECTION POINT	___	___	___
1	SPOTMI	SPOTTING DISTANCE, mi	___	___	___
2	SPOTFT	SPOTTING DISTANCE, ft (line 1 x 5,280 ft)	___	___	___
3	SCL	MAP SCALE	___	___	___
4	CF	CONVERSION FACTOR, ft/in	___	___	___

OUTPUT

1	SPOT	MAP DISTANCE SPOT, in (line 2 divided by line 4)	___	___	___
---	------	---	-----	-----	-----

COMPLETING THE FIRE BEHAVIOR WORKSHEET

INPUT 0: Projection Point (PP)

Assign a number or letter to designate the projection point location and enter as Input 0 on the Fire Behavior Worksheet on page B-5.

INPUT 1: Fuel Model (Model #)

- Using the guidelines below, proceed through the fuel model key and descriptions which follow and select a fuel model and enter as Input 1 on the Fire Behavior Worksheet on page B-5.
- Determine the primary carrier of fire.
- Determine which stratum of the surface fuels is most likely to carry the spreading fire (grass, needle litter, leaves, logging slash, etc.).
- Determine the appropriate fuel group/general vegetation type; i.e., Grass (Models 1-3), Shrub (Models 4-7), Timber Litter (Models 8-10), or Logging Slash (Models 11-13).
- Using the fuel model key, determine the appropriate fuel model.
- Go to the fuel model description and determine if it fits.
- If yes, use it and enter into Input 1 on the Fire Behavior Worksheet.
- If no, find another that more closely fits your situation.
- The fuel models used here are those used by Albini (1976)¹ to develop the nomograms published in his paper Estimating Wildfire Behavior and Effects. There are 13 models which are called the Fire Behavior Fuel Models.

¹Albini Frank A.; Estimating Wildfire Behavior and Effects. Gen. Tech. Report INT-30; 1976.

They are tuned to the fine fuels that carry the fire and thus describe the conditions at the head of the fire or the flaming front. These models are designed to give predictions for fire spread at a steady rate. It is important to recognize that rate of spread (ROS) and flame length (FL) predictions are estimates and the actual ROS and FL may vary considerably from the predicted.

- Assessment of fire behavior is simpler if a single fuel model is used to describe the fuels in the area. In fact, as experience is gained by observation of fires and estimating their behavior, it is possible to pick the fuel model not only by its description of physical vegetation, but also by its known fire behavior characteristics.

Examples: The fire may be in timbered area, but the timber is relatively open and dead grass, not needle litter, is the stratum carrying the fire. In this case, Fuel Model 2, which is not listed as a timber model, should be considered, or

In the same area if the grass is sparse and there is no wind or slope, the needle litter would be the stratum carrying the fire and Fuel Model 9 would be the better choice.

- Determine the general depth and compactness of the fuel. This information will be needed when using the fuel model key. There are very important considerations when matching fuels, particularly in the grass and timber types.
- Determine which fuel models are present and what their influence on fire behavior is expected to be.

Example: Green fuel may be present, but will it play a significant role in fire behavior? Large fuels may be present, but are they sound, or decaying and breaking up? Do they have limbs and twigs attached or are they bare cylinders? Look for the fine fuels and choose a model that represents their depth, compactness, and to some extent, the amount of live fuel and its contribution to fire. Do not be restricted by the model name or the original intended application.

FIRE BEHAVIOR FUEL MODEL KEY¹

- I. PRIMARY CARRIER OF THE FIRE IS GRASS.** Expected rate of spread is moderate to high, with low to moderate fireline intensity (flame length).
- A. Grass is fine structured, generally below knee level, and cured or primarily dead. Grass is essentially continuous. SEE THE DESCRIPTION OF MODEL 1.
 - B. Grass is coarse structured, above knee level (averaging about 3 ft.) and is difficult to walk through. SEE THE DESCRIPTION OF MODEL 3.
 - C. Grass is usually under an open timber or brush overstory. Litter from the overstory is involved, but grass carries the fire. Expected spread rate is slower than Fuel Model 1 and intensity is less than Fuel Model 3. SEE THE DESCRIPTION OF MODEL 2.

¹ Richard C. Rothermel; How to Predict the Spread and Intensity of Forest and Range Fires. Gen. Tech Report INT-143; June 1983 (NFES 1574).

II. PRIMARY CARRIER OF THE FIRE IS SHRUB or LITTER BENEATH SHRUB. Expected rates of spread and fireline intensities (flame length) are moderate to high.

- A. Vegetative type is southern rough or low pocosin. Shrub is generally 2 to 4 ft. high. SEE THE DESCRIPTION OF MODEL 7.
- B. Live fuels are absent or sparse. Brush averages 2 to 4 ft. in height. Brush requires moderate winds to carry fire. SEE THE DESCRIPTION OF MODEL 6.
- C. Live fuel moisture can have a significant effect on fire behavior.
 - 1. Shrub is about 2 ft. high, with light loading of brush litter underneath. Litter may carry the fire, especially at low windspeeds. SEE THE DESCRIPTION OF MODEL 5.
 - 2. Shrub is head-high (6 ft.), with heavy loadings of dead (woody) fuel. Very intense fire with high spread rates expected. SEE THE DESCRIPTION OF MODEL 4.
 - 3. Vegetative type is high pocosin. SEE THE DESCRIPTION OF MODEL 4.

III. PRIMARY CARRIER OF THE FIRE IS LITTER BENEATH A TIMBER STAND. Spread rates are low to moderate, fireline intensity (flame length) may be low to high.

- A. Surface fuels are mostly foliage litter. Large fuels are scattered and lie on the foliage litter, that is, large fuels are not supported above the litter by their branches. Green fuels are scattered enough to be insignificant to fire behavior.
 - 1. Dead foliage is tightly compacted, short needle (2 inches or less) conifer litter or hardwood litter. SEE THE DESCRIPTION OF MODEL 8.
 - 2. Dead foliage litter is loosely compacted long needle pine or hardwoods. SEE THE DESCRIPTION OF MODEL 9.
- B. There is a significant amount of larger fuels with attached branches and twigs, or it has rotted enough that it is splintered and broken. The larger fuels are fairly well distributed over the area. Some green fuel may be present. Overall depth of the fuel is primarily below the knees, but some fuel may be higher. SEE THE DESCRIPTION OF MODEL 10.

IV. PRIMARY CARRIER OF THE FIRE IS LOGGING SLASH. Spread rates are low to high, fireline intensities (flame lengths) are low to very high.

- A. Slash is aged and overgrown.
 - 1. Slash is from hardwood trees. Leaves have fallen and cured. Considerable vegetation (tall weeds) has grown in amid the slash and has cured or dried out. SEE THE DESCRIPTION OF MODEL 6.
 - 2. Slash is from conifers. Needles have fallen and considerable vegetation (tall weeds and some shrubs) has overgrown the slash. SEE THE DESCRIPTION OF MODEL 10.

- B. Slash is fresh (0-3 years) and not overly compacted.
1. Slash is not continuous. Needle litter or small amounts of grass or shrubs must be present to help carry the fire, but primary carrier is still slash. Live fuels are absent or do not play a significant role in fire behavior. The slash depth is about 1 ft. SEE THE DESCRIPTION OF MODEL 11.
 2. Slash generally covers the ground (heavier loadings than Model 11), though there may be some bare spots or areas of light coverage. Average slash depth is about 2 ft. Slash is not excessively compacted. Approximately one-half of the needles may still be on the branches but are not red. Live fuels are absent, or are not expected to affect fire behavior. SEE THE DESCRIPTION OF MODEL 12.
 3. Slash is continuous or nearly so (heavier loadings than Model 12). Slash is not compacted and has an average depth of 3 ft. Approximately one-half of the needles are still on the branches and are red, OR all the needles are on the branches but they are green. Live fuels are not expected to influence fire behavior. SEE THE DESCRIPTION OF MODEL 13.
 4. Same as 3, EXCEPT all the needles are attached and are red. SEE THE DESCRIPTION OF MODEL 4.

FIRE BEHAVIOR FUEL MODEL DESCRIPTIONS²

- Grass Group

Fuel Model 1 (1 foot deep) Fire spread is governed by the fine herbaceous fuels that have cured or are nearly cured. Fires are surface fires that move rapidly through cured grass and associated material. Very little shrub or timber is present, generally less than one-third of the area.

Grasslands and savanna are represented along with stubble, grass-tundra, and grass-shrub combinations that meet the above area constraint. Annual and perennial grasses are included in this fuel model.

Fuel Model 2 (1 foot deep) Fire spread is primarily through the fine herbaceous fuels, either curing or dead. These are surface fires where the herbaceous material, besides litter and dead-down stemwood from the open shrub or timber overstory, contribute to the fire intensity. Open shrub lands and pine stands or scrub oak stands that cover 1/3 to 2/3 of the area may generally fit this model but may include clumps of fuels that generate higher intensities and may produce firebrands. Some pinyon-juniper may be in this model.

Fuel Model 3 (2.5 feet deep) Fires in this fuel are the most intense of the grass group and display high rates of spread under the influence of wind. The fire may be driven into the upper heights of the grass stand by the wind and cross over standing water. Stands are tall, averaging about 3 feet, but considerable variation may occur. Approximately one-third or more of the stand is considered dead or cured and maintains the fire.

² Anderson, Hal E.; Aids to Determining Fuel Models for Estimating Fire Behavior. Gen. Tech Report INT-122, 1982.

- Shrub Group

Fuel Model 4 (6 feet deep) Fire intensity and fast spreading fires involve the foliage and live and dead fine woody materials in the crowns of a nearly continuous secondary overstory. Examples are stands of mature shrub, 6 or more feet tall, such as California mixed chaparral, the high pocosins along the east coast, the pine barrens of New Jersey or the closed jack pine stands of the north-central states. Besides flammable foliage, there is dead woody material in the stand that significantly contributes to the fire intensity. Height of stands qualifying for this model vary with local conditions. There may be also a deep litter layer that confounds suppression efforts.

Fuel Model 5 (2 feet deep) Fire is generally carried in the surface fuels made up of litter cast by the shrubs and the grasses or forbs in the understory. Fires are generally not very intense as surface fuel loads are light, the shrubs are young with little dead material, and the foliage contains little volatile material. Shrubs are generally not tall, but nearly cover the entire area. Young, green stands with little or no deadwood such as laurel, vine maple, alder, or even chaparral, manzanita, or chamise are examples. As the shrub fuel moisture drops, consider using a Fuel Model 6.

Fuel Model 6 (2.5 feet deep) Fires carry through the shrub layer where the foliage is more flammable than Fuel Model 5, but require moderate winds (>8 mi/h) at midflame height. Fire will drop to the ground at low windspeeds or openings in the stand. Shrubs are older, but not as tall as shrub types of Model 4, nor do they contain as much fuel as Model 4. A broad range of shrub conditions is covered by this model. Typical examples include intermediate stands of chamise, chaparral, oak brush, low pocosins, Alaskan spruce taiga, and shrub tundra. Cured hardwood slash can be considered. Pinyon-juniper shrublands may fit, but may overpredict rate of spread except at high winds (20 mi/h at the 20-foot level).

Fuel Model 7 (2.5 feet deep) Fire burns through the surface and shrub strata equally. Fire can occur at higher dead fuel moisture contents due to the flammable nature of live foliage. Shrubs are generally 2 to 6 feet high. Examples are Palmetto-gallberry understory-pine overstory sites, low pocosins, and Alaska Black Spruce-shrub combinations.

- Timber Litter Group

Fuel Model 8 (0.2 foot deep) Slow burning ground fires with low flame heights are generally the case, although an occasional “jackpot” or heavy fuel concentration may cause a flare up. Only under severe weather conditions do these fuels pose fire problems. Closed-canopy stands of short needle conifers or hardwoods that have leafed out support fire in the compact litter layer. This layer is mainly needles, leaves, and some twigs since little undergrowth is present in the stand. Representative conifer types are white pine, lodgepole pine, spruce, true firs, and larches.

Fuel Model 9 (0.2 foot deep) Fires run through the surface litter faster than model 8 and have higher flame height. Both long-needle conifer and hardwood stands, especially the oak-hickory types, are typical. Fall fires in hardwoods are representative, but high winds will actually cause higher rates of spread than predicted because of spotting caused by rolling blowing leaves. Closed stands of long-needled pine like ponderosa, Jeffrey, and red pines or southern pine plantations are grouped in this model. Concentrations of dead-down woody material will contribute to possible torching out of trees, spotting, and crowning activity.

Fuel Model 10 (1 foot deep) The fires burn in the surface and ground fuels with greater fire intensity than other timber litter models. Dead-down fuels include greater quantities of 3-inch or larger limb wood resulting from over-maturity or natural events that create a large load of dead material on the forest floor. Crowning out, spotting, and torching of individual trees are more frequent in this fuel situation leading to potential fire control difficulties. Any forest type may be considered when heavy down materials are present; examples are insect or diseased stands, wind-thrown stands, over-mature situations with deadfall, and cured light thinning or partial-cut slash.

- Logging Slash Group

Fuel Model 11¹ (1 foot deep) Fires are fairly active in the slash and herbaceous material intermixed with the slash. The spacing of the rather light fuel load, shading from overstory, or the aging of the fine fuels can contribute to limiting the fire potential. Light partial cuts or thinning operations in mixed conifer stands, hardwood stands, and southern pine harvests are considered. Clear-cut operations generally produce more slash than represented here. The <3 inch material load is less than 12 tons per acre. The >3 inch material is represented by not more than 10 pieces, 4 inches in diameter along a 50-foot transect.

Fuel Model 12¹ (2.3 feet deep) Rapidly spreading fires with high intensities capable of generating firebrands can occur. When fire starts, it is generally sustained until a fuel break or change in fuels is encountered. The visual impression is dominated by slash and much of it is <3 inches in diameter. These fuels total less than 35 tons per acre and seem well distributed. Heavily thinned conifer stands, clear-cuts and medium or heavy partial cuts are represented. The >3 inch material is represented by encountering 11 pieces, 6 inches in diameter, along a 50-foot transect.

¹ When working in Fuel Model 11 or 12 with significant “red” needles attached to limbs, consider using the next heavier model. For example: Fuel Model 11 with “red” needles, use Fuel Model 12.

Fuel Model 13² (3 feet deep) Fire is generally carried by a continuous layer of slash. Large quantities of >3 inch material are present. Fires spread quickly through the fine fuels and intensity builds up as the large fuels start burning. Active flaming is sustained for long periods and a wide variety of firebrands can be generated. These contribute to spotting problems as the weather conditions become more severe. Clear-cut and heavy partial-cuts in mature and over-mature stands are depicted where the slash load is dominated by the >3 inch material. The total load may exceed 300 tons per acre, but the <3 inch fuel is generally only 10 percent of the total load. Situations where the slash still has “red” needles attached, but the total load is lighter like a Model 12, can be represented because of the earlier high intensity and faster rate of spread.

² If “red” needles are attached consider using a Fuel Model 4.

TABLE 1: Description of Fuel Models

Fuel Model	Typical Fuel Complex	1-H	10-H	100-H	T/A	Live	Fuel Bed Depth (ft)	Moist. of Extinction Dead Fuels (%)	ROS* ch/h	FL* (ft)
1	Short Grass	0.74	0.00	0.00	0.00	0.00	1.0	12	78	4
2	Timber	2.00	1.00	.50	.50	.50	1.0	15	35	6
3	Tall Grass	3.01	.00	.00	.00	.00	2.5	25	104	12
4	Chaparral	5.01	4.01	2.00	2.00	5.01	6.0	20	75	19
5	Brush	1.00	.50	.00	.00	2.00	2.0	20	18	4
6	Dormant brush	1.50	2.50	2.00	2.00	.00	2.5	25	32	6
7	Southern rough	1.13	1.87	1.50	1.50	.37	2.5	40	20	5
8	Closed timber litter	1.50	1.00	2.50	2.50	0.00	0.2	30	2	1
9	Hardwood litter	2.92	.41	.15	.00	.00	0.2	25	8	3
10	Timber	3.01	2.00	5.01	5.01	2.00	1.0	25	8	5
11	Light logging slash	1.50	4.51	5.51	5.51	0.00	1.0	15	6	4
12	Medium logging slash	4.01	14.03	16.53	16.53	.00	2.3	20	13	8
13	Heavy logging slash	7.01	23.04	28.05	28.05	.00	3.0	25	14	11

*ROS and FL are represented under a fine dead fuel moisture of 8%, a midflame windspeed of 5 mi/h, and live fuel moisture, if present, of 100% (Anderson, 1982).

INPUT 2: Fine Dead Fuel Moisture (1-H FDFM), %

Fine Dead Fuel Moisture Content is an important input to fire behavior predictions. Fuel moisture measurements are difficult to make in the field; however, estimates can be made from measured or predicted values of dry bulb temperature and relative humidity.

Due to solar radiation differences that exist between aspect, time of year, shading, and the adiabatic difference between position on the slope, it is necessary to calculate an estimate of fuel moisture. This is necessary as the National Fire Danger Rating System (NFDRS) tables used here were developed for “worst case” conditions (summer, 1400, SW aspect, open conditions). These predictions are for fine, dead forest fuels. Heavier fuels can be estimated by other means as needed.

Temperature and humidity are predicted for a specific site (projection point) in relation to a site (site location) where dry bulb temperatures and relative humidity are measured. Since temperature and relative humidity change with elevation, it is necessary to estimate these changes between the projection point and the site location. There are tables to correct for elevation changes of 0 to 2000 feet above or below the site location, but a new site location is needed if the elevation difference between the site location and the projection point exceeds 2000 feet.

Time corrections **cannot** be made. Temperature and relative humidity must be obtained for the time in question.

The tables may be used to adjust the moisture of fuels in valley bottoms from conditions measured on the slopes above, but do not use weather data taken beneath a valley inversion and attempt to interpolate fuel moistures at drier sites upslope. The corrections are too large and uncertain, and you may get meaningless results.

To use the Fine Dead Fuel Moisture/Probability of Ignition Worksheet on page B-6, complete the following input/output items. **Enter the fine dead fuel moisture as Output 1 on the Fine Dead Fuel Moisture/Probability of Ignition Worksheet and as Input 2 on the Fire Behavior Worksheet on page B-5.**

INPUT

- 0 (Projection Point)—Record the number of the projection point for which a fire behavior prediction is to be made.
- 1 (Day Time Calculation)—Only day time calculations will be considered.
- 2 (Dry Bulb Temperature)—Dry bulb temperature is determined for the time period in question, either by measurement or forecast. The site location may or may not be at the projection point. Record temperature in degrees Fahrenheit.
- 3 (Wet Bulb Temperature)—Wet bulb temperature is determined for the time period in question, either by measurement or forecast. The site location may or may not be at the projection point. Record temperature in degrees Fahrenheit.
- 4 (Dew Point)—Record dew point for the time period in question.
- 5 (Relative Humidity)—Record relative humidity for the time period in question.
- 6 (Reference Fuel Moisture)—Go to Table 2 and determine the reference fuel moisture percent from the intersection of temperature and relative humidity (Inputs 2 and 5). Record as a percent.
- 7 (Month)—Record the appropriate month.
- 8 (Unshaded or Shaded)—Circle “U” if fine dead fuels ahead of the projection point are unshaded (<50% shading) from solar radiation due to cloud cover and/or canopy cover. Circle “S” if fine dead fuels ahead of the projection point are shaded (>50% shading) from solar radiation due to cloud and/or canopy cover.

- 9 (Time)—Record the expected time when the projection point will be used to estimate fire behavior. The temperature/RH forecast or measurement must be the same time period as the projection time period.
- 10 (Elevation Change)—Record the elevation difference between the location of the projection point and the temperature/RH site location and circle:
 - “B” if the projection point is 1000 to 2000 feet below the site location.
 - “L” if the projection point is 0 to 1000 feet above or below the site location.
 - “A” if the projection point is 1000 to 2000 feet above the site location.

If the projection point is more than 2000 feet above or below the site location, get a new forecast or reading.
- 11 (Aspect)—Record the aspect of the projection point location (north, south, east, or west).
- 12 (Slope)—Record the slope in percent (%) at the project point. (See pages B-35 and B-36 for determining percent slope.)
- 13 (Fuel Moisture Correction)—From Input Values 7 through 12 and the appropriate Daytime Correction Tables (Tables 3, 4, or 5) determine fuel moisture correction. Record in percent.

OUTPUT

- 1 (Fine Dead Fuel Moisture)—Determine the fine dead fuel moisture by adding Input Item 6 and Input Item 13. Record as a percent.

TABLE 2: Reference Fuel Moisture, Day (0800-1959)

Dry Bulb Temp (°F)	Relative Humidity (Percent)																				
	0	5	10	15	20	25	30	35	40	45	50	55	60	65	70	75	80	85	90	95	100
10-29	1	2	2	3	4	5	5	6	7	8	8	8	9	9	10	11	12	12	13	13	14
30-49	1	2	2	3	4	5	5	6	7	7	7	8	9	9	10	10	11	12	13	13	13
50-69	1	2	2	3	4	5	5	6	6	7	7	8	8	9	9	10	11	12	12	12	13
70-89	1	1	2	2	3	4	5	5	6	7	7	8	8	8	9	10	10	11	12	12	13
90-109	1	1	2	2	3	4	4	5	6	7	7	8	8	8	9	10	10	11	12	12	13
109+	1	1	2	2	3	4	4	5	6	7	7	8	8	8	9	10	10	11	12	12	12

GO TO TABLE 3, 4, OR 5 FOR FUEL MOISTURE CONTENT CORRECTIONS.

NOTE: When using Tables 3, 4, and 5:

B = 1000-2000 feet below the site location.

L = 0-1000 feet above or below the site location.

A = 1000-2000 feet above the site location.

TABLE 3: Dead Fuel Moisture Content Corrections, Day
(0800-1959)
May, June, July

Aspect		UNSHADED - LESS THAN 50% SHADING OF SURFACE FUELS																							
		0800>		1000>		1200>		1400>		1600>		1800>													
%Slope		B	L	A	B	L	A	B	L	A	B	L	A	B	L	A	B	L	A	B	L	A	B	L	A
N	0-30	2	3	4	1	1	0	0	1	0	0	1	1	1	1	1	1	1	1	1	1	1	1	1	1
	31+	3	4	4	1	2	2	1	1	2	1	1	2	1	2	1	2	1	2	2	3	4	4	4	4
E	0-30	2	2	3	1	1	0	0	1	0	0	1	0	1	1	1	1	1	1	1	1	1	1	1	1
	31+	1	2	2	0	0	1	0	0	1	1	1	1	1	1	2	2	3	4	4	5	6	6	6	
S	0-30	2	3	3	1	1	0	0	1	0	0	1	0	0	1	1	1	1	1	1	1	1	1	1	
	31+	2	3	3	1	1	2	0	1	1	0	1	1	1	1	1	1	1	1	1	1	1	1	1	
W	0-30	2	3	4	1	1	2	0	0	1	0	0	1	0	1	1	1	1	1	1	1	1	1	1	
	31+	4	5	6	2	3	4	1	1	2	0	0	1	0	1	1	1	1	1	1	1	1	1	1	
SHADED - 50% OR MORE SHADING OF SURFACE FUELS																									
N	all	4	5	5	3	4	5	3	3	4	3	3	4	3	3	4	3	4	3	4	5	4	5	5	
E	all	4	4	5	3	4	5	3	3	4	3	4	4	3	4	4	3	4	3	4	5	4	5	6	
S	all	4	4	5	3	4	5	3	3	4	3	3	4	3	3	4	3	4	3	4	5	4	5	5	
W	all	4	5	6	3	4	5	3	3	4	3	3	4	3	3	4	3	4	3	4	5	4	4	5	

TABLE 4: Dead Fuel Moisture Content Corrections, Day
(0800-1759)
February, March, April, August, September, October

Aspect		UNSHADED - LESS THAN 50% SHADING OF SURFACE FUELS																							
		0800>		1000>		1200>		1400>		1600>		1800>													
% Slope		B	L	A	B	L	A	B	L	A	B	L	A	B	L	A	B	L	A	B	L	A	B	L	A
N	0-30	3	4	5	1	2	3	1	1	2	1	1	2	1	1	2	1	2	1	2	3	3	4	5	
	31+	3	4	5	3	3	4	2	3	4	2	3	4	3	3	4	3	4	3	4	3	4	5		
E	0-30	3	4	5	1	2	3	1	1	1	1	1	2	1	1	2	1	2	1	2	4	3	4	5	
	31+	3	3	4	1	1	1	1	1	1	1	1	2	3	3	4	5	4	5	6					
S	0-30	3	4	5	1	2	2	1	1	1	1	1	1	1	1	1	1	2	3	4	5				
	31+	3	4	5	1	2	2	0	1	1	0	1	1	1	1	2	2	3	4	5					
W	0-30	3	4	5	1	2	3	1	1	1	1	1	1	1	1	2	3	3	4	5					
	31+	4	5	6	3	4	5	1	2	3	1	1	1	1	1	1	1	1	1	3	3	4	5	6	
		SHADED - 50% OR MORE SHADING OF SURFACE FUELS																							
N	all	4	5	6	4	5	5	3	4	5	3	4	5	4	5	5	4	5	5	6					
E	all	4	5	6	3	4	5	3	4	5	3	4	5	4	5	5	6	4	5	6					
S	all	4	5	6	3	4	5	3	4	5	3	4	5	3	4	5	4	5	6						
W	all	4	5	6	4	5	6	3	4	5	3	4	5	3	4	5	3	4	5	6					

TABLE 5: Fine Dead Fuel Moisture Content Corrections, Day
(0800-1759)
November, December, January

Aspect		UNSHADED - LESS THAN 50% SHADING OF SURFACE FUELS																		
		0800>		1000>		1200>		1400>		1600>		1800>								
%Slope		B	L	A	B	L	A	B	L	A	B	L	A	B	L	A	B	L	A	
		0-30	N	4	5	6	3	4	5	2	3	4	2	3	4	3	4	5	4	5
31+	N	4	5	6	4	5	6	4	5	6	4	5	6	4	5	6	4	5	6	
0-30	E	4	5	6	3	4	4	2	3	3	2	3	3	3	3	4	5	4	5	6
31+	E	4	5	6	2	3	4	2	2	3	3	4	4	4	4	5	6	4	5	6
0-30	S	4	5	6	3	4	5	2	3	3	2	2	3	3	3	4	4	4	5	6
31+	S	4	5	6	2	3	3	1	1	2	1	1	2	2	2	3	3	4	5	6
0-30	W	4	5	6	3	4	5	2	3	3	2	3	3	3	3	4	4	4	5	6
31+	W	4	5	6	4	5	6	3	4	4	2	2	3	2	3	4	4	4	5	6
SHADED - 50% OR MORE SHADING OF SURFACE FUELS																				
all	N	4	5	6	4	5	6	4	5	6	4	5	6	4	5	6	4	5	6	
all	E	4	5	6	4	5	6	4	5	6	4	5	6	4	5	6	4	5	6	
all	S	4	5	6	4	5	6	4	5	6	4	5	6	4	5	6	4	5	6	
all	W	4	5	6	4	5	6	4	5	6	4	5	6	4	5	6	4	5	6	

INPUT 3: Live Fuel Moisture (LFM), %

Live fuel moisture (foliage moisture) is required for Fire Behavior Models 2, 4, 5, 7 and 10. If data are unavailable for estimating live fuel moisture, the following rough estimates (Table 6) can be used.

Enter the live fuel moisture for Fire Models 2, 4, 5, 7 and 10 as Input 3 on the Fire behavior Worksheet on page B-5.

TABLE 6: Live Fuel (Foliage) Moisture Content (Percent)

Moisture Content (%)	Stage of Vegetative Development
300	Fresh foliage, annuals developing early in the growing cycle.
200	Maturing foliage, still developing, with full turgor.
100	Mature foliage, new growth complete and comparable to older perennial foliage.
50	Entering dormancy, coloration starting, some leaves may have dropped from stem.
30	Completely cured, treat as dead fuel.

INPUT 4: Midflame Windspeed (MFWS), mi/h

Midflame wind is the wind which acts directly on the flaming fire front at the level of one half the flame height. Fire generated convective winds must be ignored.

You may take wind readings directly with a handheld anemometer or other measuring device; however, the readings must be taken far enough upwind of the fire to ensure that the wind is not influenced by convective indrafts.

If you choose to use a weather forecast to estimate windspeeds, you must determine whether the forecast is for 20-foot windspeeds or midflame windspeeds.

When midflame winds are forecast, enter them directly in Input 4 of the Fire Behavior Worksheet.

If the 20-foot winds are forecast (which they usually are), the midflame windspeed must be calculated. Use the Wind Adjustment Worksheet on page B-7 and complete the following Input and Output Values.

Enter midflame windspeed as Output 1 on the Wind Adjustment Worksheet and as Input 4 on the Fire Behavior Worksheet on page B-5.

INPUT

- 0 (Projection Point)—Record the number of the projection point for which a fire behavior prediction is to be made.
- 1 (20-foot Windspeed)—Enter the 20-foot windspeed provided in the Special Weather Forecast.
- 2 (Fuel Model Number)—Enter one of the 13 FBPS fuel models.
- 3 (Wind Sheltering)—Using Diagram 1 on page B-32, determine whether fuels are: 1) unsheltered, 2) partially sheltered, 3) fully sheltered (open) or 4) fully sheltered (closed).
- 4 (Wind Adjustment Factor)—Using Table 7 on page B-33, select the appropriate adjustment factor for the specific fuel and sheltering condition.

OUTPUT

- 1 (Midflame Windspeed)—Multiply Input 1 x Input 4 on the Wind Adjustment Worksheet for the midflame windspeed.

Remember, for basic point source predictions the wind should be blowing within ± 30 degrees of upslope.

DIAGRAM 1: 20-Foot Windspeed Adjusted to Midflame Windspeed Based on Overstory

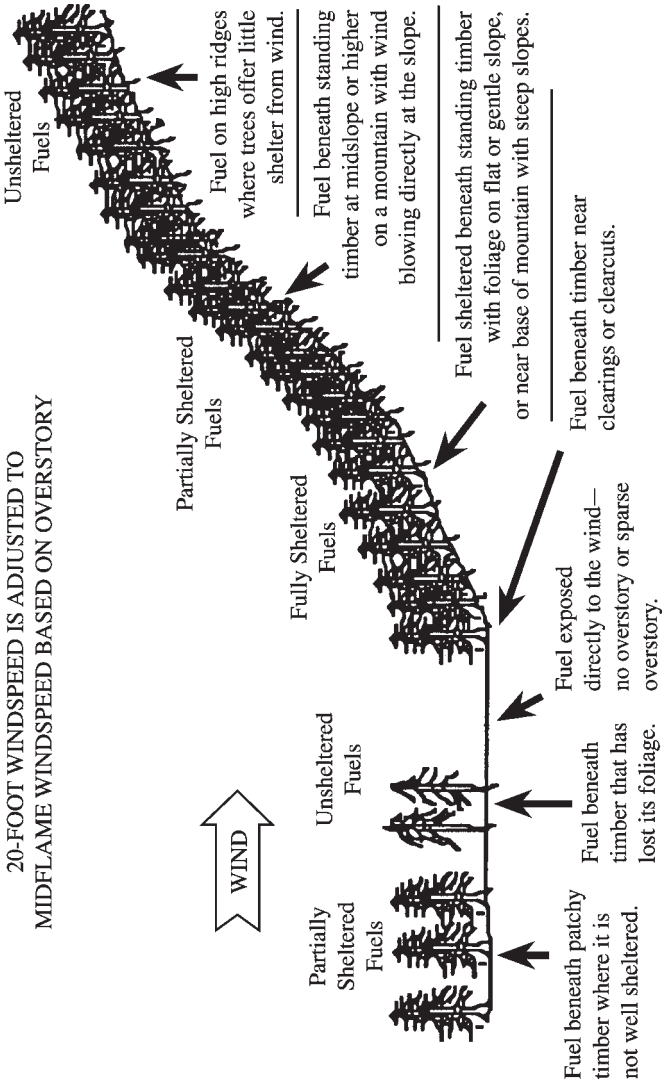

TABLE 7: Wind Adjustment Table

Fuel Exposure	Fuel Model	Adjustment Factor
UNSHeltered Fuels: Fuel exposed directly to the wind. No or sparse overstory. Fuel beneath timber that has lost its foliage; fuel beneath timber near clearings or clearcuts; fuel on high ridges where trees offer little shelter from the wind.	4	0.5
	13	0.5
	1, 3, 5, 6,	0.4
	11, 12	0.4
	(2, 7) ¹	0.4
	(8, 9, 10) ²	0.4
PARTIALLY SHELTERED Fuels: Fuel beneath patchy timber where it is not well sheltered; fuel beneath standing timber at midslope or higher on a mountain with wind blowing directly at the slope.	All Fuel Models	0.3
FULLY SHELTERED Fuels: Fuel sheltered beneath standing timber on flat or gentle slope or near base of mountain with steep slopes.	All Fuel Models	Open Stands 0.2 Dense Stands 0.1
¹ Fuels usually partially sheltered.		
² Fuels usually fully sheltered.		

TABLE 8: Modified Beaufort Scale for Est. 20-Foot Windspeed

Range of Speeds mi/h	Nomenclature
≤3	Very Light—Smoke rises nearly vertically. Leaves of quaking aspen in constant motion; small branches of bushes sway; slender branchlets and twigs of trees move gently; tall grasses and weeds sway and bend with wind; wind vane barely moves.
4-7	Light—Trees of pole size in the open sway gently; wind felt distinctly on face; loose scraps of paper move; wind flutters small flag.
8-12	Gentle Breeze—Trees of pole size in the open sway very noticeably; large branches of pole-size trees in the open toss; tops of trees in dense stands sway; wind extends small flag; a few crested waves form on lakes.
13-18	Moderate Breeze—Trees of pole size in the open sway violently; whole trees in dense stands sway noticeable; dust is raised in the road.
19-24	Fresh—Branchlets are broken from trees; inconvenience is felt in walking against wind.
25-31	Strong—Tree damage increases with occasional breaking of exposed tops and branches; progress impeded when walking against wind; light structural damage to buildings.
32-38	Moderate Gale—Severe damage to tree tops; very difficult to walk into wind; significant structural damage occurs.
≥39	Fresh Gale—Surfaced strong Santa Ana; intense stress on all exposed objects, vegetation, buildings; canopy offers virtually no protection; wind flow is systematic in disturbing everything in its path.

INPUT 5: Slope (SL), %

Slope Determination Process

To use the Slope Worksheet on page B-7 complete the following Input and Output Items. **Enter slope as Output 1 on the Slope Worksheet and as Input 5 on the Fire Behavior Worksheet on page B-5.**

INPUT

- 0 (Projection Point)—Record the number of the projection point for which a fire behavior prediction is to be made.
- 1 (Contour Interval)—Determine the contour interval from the map; i.e., 40 ft. This is the elevation change between contour lines.
- 2 (Map Scale)—Determine the map scale; i.e., 1:24,000. This is the number of units on the map to ground distance in the same units; i.e., one inch on the map equals 24,000 inches on the ground.
- 3 (Conversion Factor)—Determine how many feet are in one inch of map distance; i.e., 1 inch = 2,000 ft. To determine this, measure the distance between section lines (east to west) in inches and tenths of an inch. Divide the number of feet in a mile (5,280) by the measured map distance for the mile in inches.

Choose an area with uniform contour line separation. From the lowest point on the slope, Point A, draw a line up the slope with the contour lines intersecting at right angles, to Point B.

- 4 (# of Contour Intervals)—Count the number of contour interspaces crossed between Points A and B.
- 5 (Rise in Elevation)—Determine vertical change in elevation by counting the contour interspaces between Points A and B. Multiply by the contour interval (Input 1); i.e., 40 ft x 11 contours = 440 ft.

- 6 (Map Distance)—Measure horizontal distance with a ruler in inches to the tenth of an inch.
- 7 (Horizontal Ground Distance)—Multiply the Map Distance (Input 6) by the conversion factor (Input 3); i.e., 0.5 in x 2,000 ft/in = 1,000 ft.

OUTPUT

- 1 (Slope)—Calculate slope by dividing rise (Input 5) by run (Input 7) on the Slope Worksheet and multiplying by 100; i.e., rise (Input 5) divided by run (Input 7) x 100 or 440 ft divided by 1,000 ft x 100 = 44%.

$$\frac{\text{RISE}}{\text{RUN}} = \frac{\text{Vertical Distance}}{\text{Horizontal Distance}} \times 100 = \% \text{ Slope}$$

TABLE 9: Map Scale Conversion Factors

Scale	Representative Fraction	Map in/mi	Map in/ch	Ft/Map in
1:253,440	253.44	.25	0.0031	21,120
1:126,720	126.72	.50	0.0063	10,560
1:63,360	63.36	1	0.0125	5,280
1:62,500	62.50	1.01	0.0127	5,208
1:31,680	31.68	2	0.025	2,640
1:24,000	24.00	2.64	0.033	2,000
1:21,120	21.12	3	0.038	1,760
1:15,840	15.84	4	0.05	1,320
1:7,920	7.92	8	0.1	660

This table allows the selection of conversion factors for different map scales.

INPUT 6: Effective Windspeed (EWS), mi/h

Effective windspeed is determined using the lower left quadrant of the nomogram of the fuel model being used. Enter slope (Input 5) on the horizontal axis, and the midflame windspeed (Input 4) from the Fire Behavior Worksheet on the right axis.

Interpolation between the midflame windspeed line may be necessary. Read the effective windspeed on the left side of the graph. **Enter effective windspeed as Input 6 on the Fire Behavior Worksheet on page B-5.**

FIRE BEHAVIOR OUTPUTS

Determine the Fire Behavior Output Items (1-9) listed below and enter them on the Fire Behavior Worksheet on page B-5.

OUTPUT 1: Rate of Spread (ROS), ch/h

Using the upper right quadrant (left vertical axis) of the nomogram and input items recorded on the Fire Behavior Worksheet, determine rate of spread. Tables 15 through 78 can also be used to approximate rate of spread.

OUTPUT 2: Heat per Unit Area (HA), Btu/sq ft

Using the upper right quadrant of the nomogram, determine heat per unit area from the lower axis.

OUTPUT 3: Fireline Intensity (FLI), Btu/ft/s

Using the upper right quadrant of the nomogram, determine fireline intensity along the curved lines.

OUTPUT 4: Flame Length (FL), ft

Using the upper right quadrant of the nomogram, determine the flame length along the curved lines. Flame length can also be approximated using Tables 15 through 78.

OUTPUT 5: Spread Distance (SD), ch

Rate of spread (Output 1) on the Fire Behavior Worksheet, multiplied by the hours in which a fire spreads at that rate, equals spread distance. Convert to map distance using the Map-Spread Worksheet as outlined on page 39.

Map-Spread Worksheet

Use the Map-Spread Worksheet on page B-8 and complete the following Input and Output Items to determine map-spread distance. **Enter the map-spread distance as Output 1 on the Map-Spread Worksheet and as Output 5 on the Fire Behavior Worksheet on page B-5.**

INPUT

- 0 (Projection Point)—Record the number of the projection point for which a fire behavior prediction is to be made.
- 1 (Rate of Spread)—Fire Behavior Worksheet, Output 1.
- 2 (Projection Time)—Hours or part of an hour in which a fire has spread.
- 3 (Spread Distance, ch)—Input 1 multiplied by Input 2.
- 4 (Spread Distance, ft)—Input 3 multiplied by 66 ft/ch.
- 5 (Map Scale)—Table 9 on page B-36.
- 6 (Conversion Factor)—Table 9.

OUTPUT

- 1 (Map Spread Distance)—Input 4 divided by Input 6.

OUTPUT 6 and 7: Projected Fire Perimeter (PER), ch and Fire Area (AC), ac

Use the Size Worksheet on page B-8 and complete the following Input and Output Items to determine fire perimeter and area. **Enter perimeter as Output 1 on the Size Worksheet and as Output 6 on the Fire Behavior Worksheet on page B-5. Enter area as Output 2 on the Size Worksheet and as Output 7 on the Fire Behavior Worksheet on page B-5.**

INPUT

- 0 (Projection Point)—Record the number of the projection point for which a fire behavior prediction has been made.
- 1 (Rate of Spread)—Output 1 from the Fire Behavior Worksheet.
- 2 (Effective Windspeed)—Input 6 from the Fire Behavior Worksheet.
- 3 (Projection Time)—The time in which a fire has spread.
- 4 (Spread Distance)—Input 1 multiplied by Input 3.

OUTPUT

- 1 (Perimeter)—From Table 10 using the spread distance (Input 4) and effective windspeed (Input 2) determine perimeter.
- 2 (Area)—From Table 11 using the spread distance (Input 4) and effective windspeed (Input 2) determine area (acres).

TABLE 10: Perimeter Estimations for Point Source Fires

Spread Distance Chains	Effective Windspeed mi/h									
	1	3	5	7	9	11	13	15	17	19
1	4	3	2	2	2	2	2	2	2	2
2	7	6	5	5	5	4	4	4	4	4
3	11	8	7	7	7	7	6	6	6	6
4	14	11	10	9	9	9	9	9	8	8
5	18	14	12	12	11	11	11	11	11	10
6	21	17	15	14	14	13	13	13	13	13
7	25	19	17	16	16	15	15	15	15	15
8	28	22	20	19	18	18	17	17	17	17
9	32	25	22	21	20	20	19	19	19	19
10	35	28	25	23	23	22	22	21	21	21
11	39	30	27	26	25	24	24	23	23	23
12	43	33	30	28	27	26	26	26	25	25
13	46	36	32	30	29	29	28	28	27	27
14	50	39	35	33	32	31	30	30	30	29
15	53	41	37	35	34	33	32	32	32	31
16	57	44	40	37	36	35	35	34	34	34
17	60	47	42	40	38	37	37	36	36	36
18	64	50	45	42	41	40	39	38	38	38
19	67	52	47	44	43	42	41	41	40	40
20	71	55	50	47	45	44	43	43	42	42
21	74	58	52	49	47	46	45	45	44	44
22	78	61	55	51	50	48	48	47	46	46
23	82	64	57	54	52	51	50	49	49	48
24	85	66	60	56	54	53	52	51	51	50
25	89	69	62	59	56	55	54	53	53	52
26	92	72	65	61	59	57	56	55	55	54
28	99	77	70	66	63	62	61	60	59	59
30	106	83	74	70	68	66	65	64	63	63
32	113	88	79	75	72	70	69	68	68	67
34	121	94	84	80	77	75	73	73	72	71
36	128	99	89	84	81	79	78	77	76	75
38	135	105	94	89	86	84	82	81	80	80
40	142	110	99	94	90	88	86	85	84	84

TABLE 10: Perimeter Estimations for Point Source Fires
(continued)

Spread Distance Chains	Effective Windspeed mi/h									
	1	3	5	7	9	11	13	15	17	19
42	149	116	104	98	95	92	91	90	89	88
44	156	122	109	103	99	97	95	94	93	92
46	163	127	114	108	104	101	99	98	97	96
48	170	133	119	112	108	106	104	102	101	101
50	177	138	124	117	113	110	108	107	106	195
52	184	144	129	122	117	114	112	111	110	109
54	191	149	134	126	122	119	117	115	114	113
56	199	155	139	131	126	123	121	119	118	117
58	206	160	144	136	131	128	125	124	122	122
60	213	166	149	140	135	132	130	128	127	126
62	220	171	154	145	140	136	134	132	131	130
64	227	177	159	150	144	141	138	137	135	134
66	234	182	164	154	149	145	143	141	139	138
68	241	188	169	159	153	150	147	145	144	142
70	248	193	174	164	158	154	151	149	148	147
72	255	199	179	169	162	158	156	154	152	151
74	262	204	184	173	167	163	160	158	156	155
76	269	210	189	178	171	167	164	162	160	159
78	277	215	194	183	176	172	169	166	165	163
80	284	221	199	187	180	176	173	171	169	168
82	291	227	204	192	185	180	177	175	173	172
84	298	232	209	197	189	185	182	179	177	176
86	305	238	214	201	194	189	186	183	182	180
88	312	243	219	204	198	194	190	188	186	184
90	319	249	223	211	203	198	194	192	190	189
92	326	254	228	215	207	202	199	196	194	193
94	333	260	233	220	212	207	203	200	199	197
96	340	263	238	225	217	211	207	205	203	201
98	347	271	243	229	221	216	212	209	207	205
100	355	276	248	234	226	220	216	213	211	210
105	372	290	261	246	237	231	227	224	222	220
110	390	304	273	257	248	242	238	235	232	230
115	408	318	286	269	259	253	249	245	243	241
120	425	331	298	281	271	264	259	256	253	251

TABLE 10: Perimeter Estimations for Point Source Fires
(continued)

Spread Distance Chains	Effective Windspeed mi/h									
	1	3	5	7	9	11	13	15	17	19
	Chains									
125	443	345	310	293	282	275	270	267	264	262
130	461	359	323	304	293	286	281	277	275	272
135	479	373	335	316	304	297	292	288	285	283
145	498	387	348	328	316	308	303	299	296	293
145	514	401	360	339	327	319	313	309	306	304
150	532	414	372	351	338	330	324	320	317	314
155	550	428	385	363	350	341	335	331	327	325
160	567	442	397	374	361	352	346	341	338	335
165	585	456	410	386	372	363	357	352	348	346
170	603	470	422	398	383	374	367	363	359	356
175	620	485	435	410	395	385	378	373	370	367
180	638	497	447	421	406	396	389	384	380	377
185	656	511	459	433	417	407	400	395	391	388
190	674	525	472	445	429	418	411	405	401	398
195	691	539	486	456	440	429	421	416	412	409
200	709	552	497	468	451	440	432	427	422	419
210	744	580	571	491	474	462	454	448	443	440
220	780	608	546	515	496	484	475	469	465	461
230	815	635	571	538	519	506	497	491	486	482
240	851	663	596	562	541	528	519	512	507	503
250	886	691	621	585	564	550	540	533	528	524
260	922	718	646	608	586	572	562	555	549	545
270	957	746	670	632	609	594	583	576	570	566
280	993	773	695	655	631	616	605	597	591	587
290	1028	801	720	679	654	638	627	619	612	608
300	1064	829	745	702	677	660	648	640	634	629

This table can be used to estimate the perimeter of a fire in chains from estimates of total spread distance (rate of spread x time) and effective windspeed. When the effective windspeed is an even number or when spread distance is not broken out, estimations can be made or interpolation may be necessary.

TABLE 11: Area Estimations for Point Source Fires

Spread Distance Chains	Effective Windspeed mi/h									
	1	3	5	7	9	11	13	15	17	19
	Acres									
1	.1	.1	<.1	<.1	<.1	<.1	<.1	<.1	<.1	<.1
2	.4	.2	.2	.1	.1	.1	.1	.1	.1	.1
3	.9	.5	.3	.3	.2	.2	.2	.2	.1	.1
4	1.6	.9	.6	.5	.4	.3	.3	.3	.2	.2
5	2.5	1.4	1.0	.8	.6	.5	.5	.4	.4	.3
6	3.5	1.9	1.4	1.1	.9	.8	.7	.6	.5	.5
7	4.8	2.7	1.9	1.5	1.2	1.1	.9	.8	.7	.7
8	6.3	3.5	2.5	2.0	1.6	1.4	1.2	1.1	1.0	.9
9	8.0	4.4	3.1	2.5	2.1	1.8	1.5	1.4	1.2	1.1
10	9.8	5.4	3.9	3.1	2.5	2.2	1.9	1.7	1.5	1.4
11	11.9	6.6	4.7	3.7	3.1	2.6	2.3	2.0	1.8	1.7
12	14.1	7.8	5.6	4.4	3.7	3.1	2.7	2.4	2.2	2.0
13	16.6	9.2	6.6	5.2	4.3	3.7	3.2	2.9	2.6	2.3
14	19.2	10.6	7.6	6.0	5.0	4.3	3.7	3.3	3.0	2.7
15	22.1	12.2	8.7	6.9	5.7	4.9	4.3	3.8	3.4	3.1
16	25.1	13.9	9.9	7.8	6.5	5.6	4.9	4.3	3.9	3.6
17	28.4	15.7	11.2	8.8	7.3	6.3	5.5	4.9	4.4	4.0
18	31.8	17.5	12.6	9.9	8.2	7.0	6.2	5.5	4.9	4.5
19	35.4	19.6	14.0	11.1	9.2	7.8	6.9	6.1	5.5	5.0
20	39.3	21.7	15.5	12.2	10.2	8.7	7.6	6.8	6.1	5.5
21	43.3	23.9	17.1	13.5	11.2	9.6	8.4	7.5	6.7	6.1
22	47.5	26.2	18.8	14.8	12.3	10.5	9.2	8.2	7.4	6.7
23	52	29	21	16	13	11	10	8.9	8.1	7.3
24	57	31	22	18	15	13	11	9.7	8.8	8.0
25	61	34	24	19	16	14	12	10.6	9.5	8.7
26	66	37	26	21	17	15	13	11.4	10.3	9.4
28	77	42	30	24	20	17	15	13	12	11
30	88	49	35	28	23	20	17	15	12	12
32	101	55	40	31	26	22	19	17	16	14
34	113	63	45	35	29	25	22	20	18	16
36	127	70	50	40	33	28	25	22	20	18
38	142	78	56	44	37	31	27	24	22	20
40	157	87	62	49	41	35	30	27	24	22

TABLE 11: Area Estimations for Point Source Fires
(continued)

Spread Distance Chains	Effective Windspeed mi/h									
	1	3	5	7	9	11	13	15	17	19
	Acres									
42	173	96	69	54	45	38	34	30	27	24
44	190	105	75	59	49	42	37	33	30	27
46	208	115	82	65	54	46	40	36	32	29
48	226	125	90	71	58	50	44	39	35	32
50	245	135	97	77	63	54	48	42	38	35
52	265	146	105	83	69	59	51	46	41	38
54	286	158	113	89	74	63	55	49	44	40
56	308	170	122	96	80	68	60	53	48	43
58	330	182	131	103	85	73	64	57	51	47
60	353	195	140	110	91	78	68	61	55	50
62	377	208	149	118	98	84	73	65	59	53
64	402	222	159	125	104	89	78	69	62	57
66	428	236	169	133	111	95	83	74	66	60
68	454	250	180	142	117	100	88	78	70	64
70	481	265	190	150	124	106	93	83	75	68
72	509	281	201	159	132	113	99	88	79	72
74	538	297	213	168	139	119	104	93	83	76
76	567	313	224	177	147	125	110	98	88	80
78	597	329	236	186	154	132	116	103	93	84
80	628	347	249	196	162	139	122	108	98	89
82	660	364	261	206	171	146	128	114	102	93
84	693	382	274	216	179	153	134	119	108	98
86	726	401	287	226	188	161	141	125	113	103
88	760	419	301	237	197	168	147	131	118	107
90	795	439	315	248	206	176	154	137	123	112
92	831	458	329	259	215	184	161	143	129	117
94	867	479	343	271	224	192	168	149	135	123
96	905	499	358	282	234	200	175	156	140	128
98	943	520	373	294	244	209	183	162	146	133
100	982	542	388	306	254	217	190	169	152	139
105	1082	597	428	338	280	240	210	186	168	153
110	1188	655	470	371	307	263	230	205	184	168
115	1298	716	514	405	336	287	251	224	202	183
120	1414	780	559	441	366	313	274	244	219	200

TABLE 11: Area Estimations for Point Source Fires
(continued)

Spread Distance Chains	Effective Windspeed mi/h									
	1	3	5	7	9	11	13	15	17	19
	Acres									
125	1534	846	607	478	397	339	297	264	238	217
130	1659	915	657	517	429	367	321	286	258	234
135	1789	987	708	558	463	396	346	308	278	253
140	1924	1061	761	600	497	426	373	331	299	272
145	2064	1139	817	644	534	457	400	356	320	292
150	2209	1219	874	689	571	489	428	381	343	312
155	2359	1301	933	736	610	522	457	406	366	333
160	2513	1386	995	784	650	554	487	433	390	355
165	2673	1474	1058	834	691	591	518	460	415	378
170	2837	1565	1123	885	734	628	549	489	440	401
175	3007	1659	1190	938	777	665	582	518	467	425
180	3181	1755	1259	992	822	704	616	548	494	449
185	3360	1854	1330	1048	869	743	651	579	522	475
190	3544	1955	1402	1105	916	784	686	611	550	501
195	3733	2059	1477	1164	965	826	723	643	579	527
200	3927	2166	1554	1225	1015	869	760	676	610	555
210	4330	2388	1713	1350	1119	958	838	746	672	612
220	4752	2621	1880	1482	1229	1051	920	819	738	671
230	5193	2865	2055	1620	1343	1149	1006	895	806	734
240	5655	3119	2238	1764	1462	1251	1095	974	878	799
250	6136	3385	2428	1914	1586	1358	1188	1057	952	867
260	6437	3661	2626	2070	1716	1469	1285	1143	1030	938
270	7157	3946	2832	2232	1850	1584	1386	1233	1111	1011
280	7697	4246	3046	2401	1990	1703	1490	1326	1195	1087
290	8256	4555	3267	2575	2135	1827	1599	1422	1281	1166
300	8836	4874	3496	2756	2284	1955	1711	1522	1371	1248

This table can be used to estimate the area (acres) from estimates of total spread distance (rate of spread x time) and effective windspeed. When the effective windspeed is an even number or when spread distance is not broken out, estimations can be made or interpolation may be necessary.

DIAGRAM 2—Approximate Fire Shapes for Various Effective Windspeeds

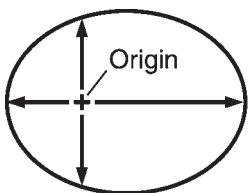

1 mph

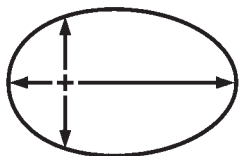

3 mph

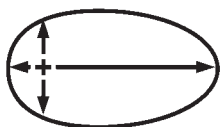

5 mph

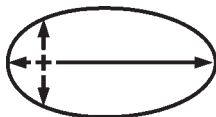

7 mph



9 mph



11 mph



13 mph

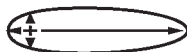

15 mph

OUTPUT 8: Maximum Spotting Distance (SPOT), mi

The Spotting Worksheet is used to predict the distance a firebrand will travel from the originating torching tree. It does not apply to firebrands resulting from a running crown fire, but may be considered as a first approximation in such situations. Use the Spotting Worksheet and Nomograms 1 through 4 to determine Maximum Spotting Distance. **Enter Maximum Spotting Distance on the Spotting Worksheet and as Output 8 on the Fire Behavior Worksheet on page B-5.**

INPUT

- 1 (Torching Tree Height)—Actual height of torching tree.
- 2 (Torching Tree Species)—When species is not provided, select species based on crown shape and knowledge of firebrand production.
- 3 (Torching Tree DBH)—Diameter at breast height.
- 4 (Average Tree Cover Height)—Estimate average tree cover height downwind from the torching tree.
- 5 (Windspeed at 20-foot Height)—Use the forecasted 20-foot windspeed. When gusts are indicated, using the maximum gust would provide the worst case distance.

OUTPUT

(Maximum Spotting distance)—Enter maximum spotting distance on the Spotting Worksheet.

Convert spotting distance to map distance using the Map-Spot Worksheet as outlined on page B-49.

Map-Spot Worksheet

Use the Map-Spot Worksheet on page B-9 and complete the following Input and Output Items to determine map-spot distance. **Enter the map-spot distance as Output 1 on the Map-Spot Worksheet and under Output 8 on the Fire Behavior Worksheet on page B-5.**

INPUT

- 0 (Projection Point)—Record the number of the projection point for which a fire behavior prediction is to be made.
- 1 (Spotting Distance, mi)—Record the Output from the Spotting Worksheet.
- 2 (Spotting Distance, ft)—Multiply mile distance in Input 1 by 5,280 to obtain feet.
- 3 (Map Scale)—Record the map scale taken from the map being used; e.g., 1:24,000.
- 4 (Conversion Factor)—See Table 9 on page B-36 for correct conversion factor; e.g., 2000.

OUTPUT

- 1 (Map Distance Spot)—Input 2 divided by Input 4.

NOMOGRAM 1—Flame Height

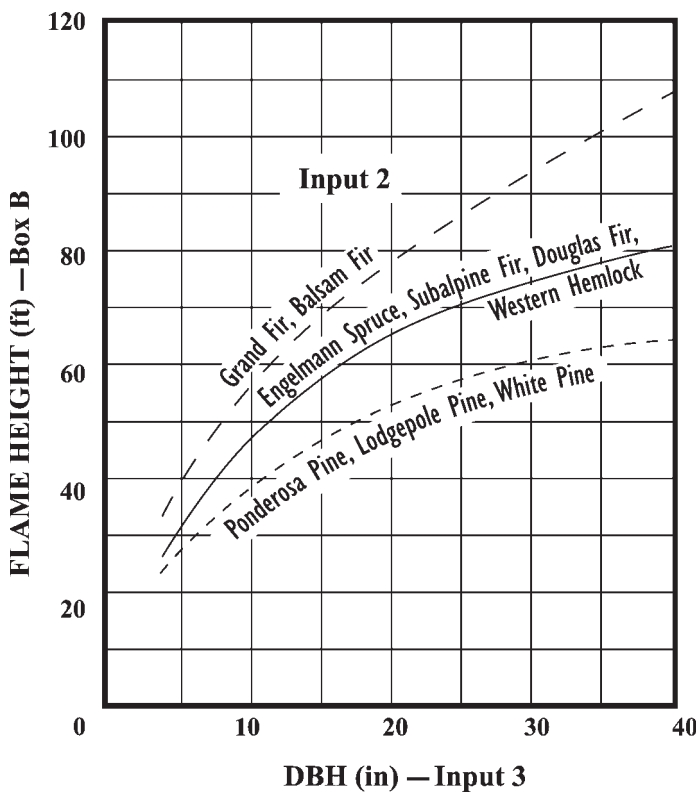

From Nomogram 1, determine flame height by using DBH and torching tree species. **Enter flame height in Box B on the Spotting Worksheet.**

NOMOGRAM 2—Flame Duration

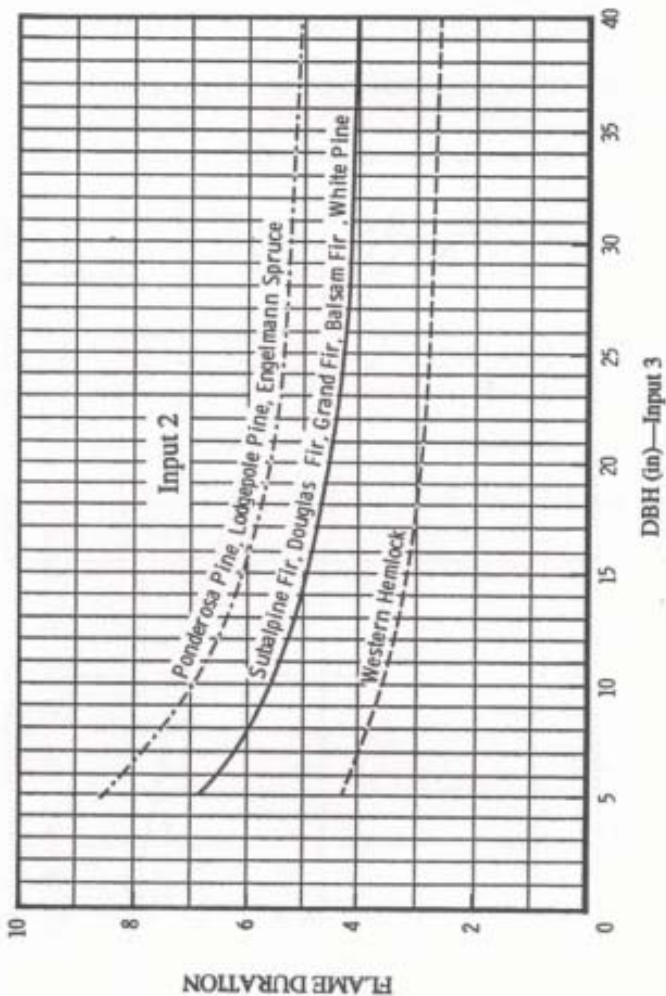

From Nomogram 2, determine flame duration by using DBH and tree species. **Enter flame duration on the Spotting Worksheet.**

NOMOGRAM 3—Ratio of Lofted Firebrand Height to Flame Height

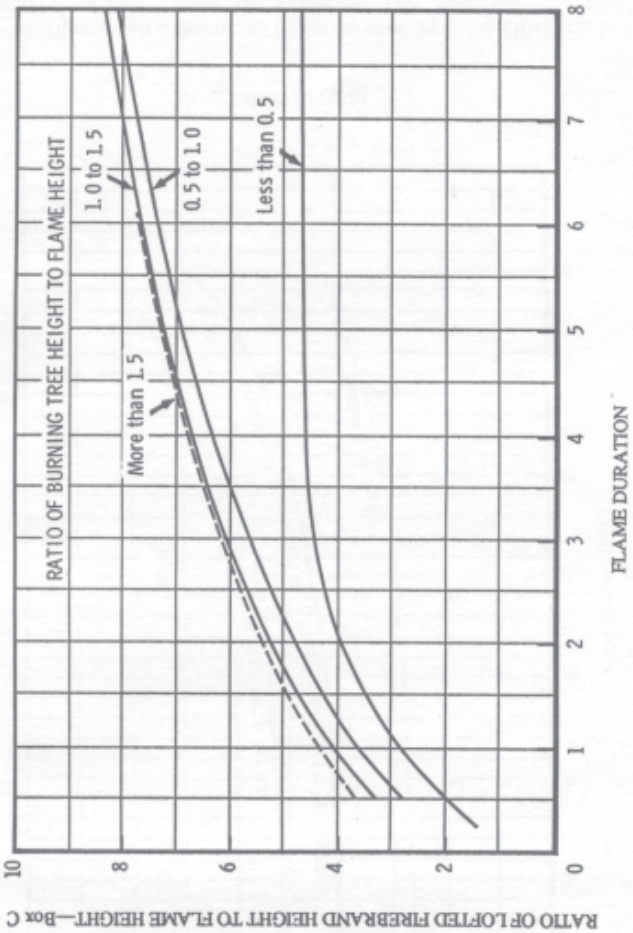

From Nomogram 3, determine ratio of lofted firebrand height to flame height. Use flame duration and ratio of tree height to flame height as inputs. **Enter ratio of lofted firebrand height to flame height in Box C on the Spotting Worksheet.**

NOMOGRAM 4—Maximum Spotting Distance

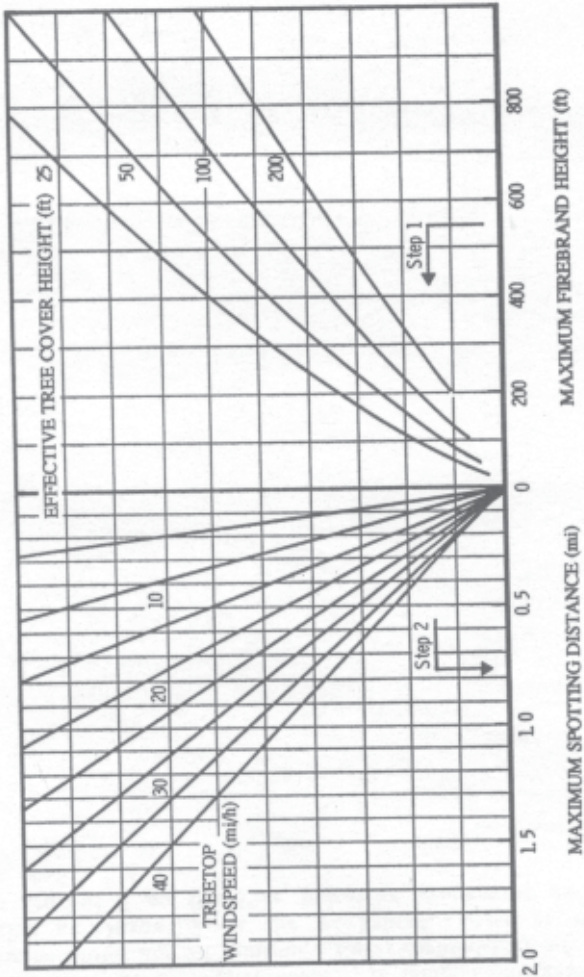

On the lower right-hand edge of Nomogram 4, locate the firebrand height. Proceed vertically to the effective tree cover height. Move left horizontally until you reach the treetop windspeed; move vertically down to the bottom axis and read the maximum spotting distance. **Enter the maximum spotting distance on the Spotting Worksheet.**

OUTPUT 9: Probability of Ignition (PIG), %

Use Table 12 on page B-55 and the dry bulb temperature (Input 2), shading (Input 8) and the fine dead fuel moisture (Output 1) from the Fine Dead Fuel Moisture/Probability of Ignition Worksheet to determine probability of ignition.

Enter probability of ignition as Output 2 on the worksheet. Also record it as Output 9 on the Fire Behavior Worksheet on page B-5.

TABLE 12: Probability of Ignition Table

Shading (Percent)	Dry-Bulb Temp. (°F)	FINE DEAD FUEL MOISTURE (PERCENT)																
		2	3	4	5	6	7	8	9	10	11	12	13	14	15	16	17	
Unshaded <50%	110+	100	100	80	70	60	60	60	50	40	40	30	30	20	20	20	20	10
	100-109	100	90	80	70	60	60	60	50	40	40	30	30	20	20	20	20	10
	90-99	100	90	80	70	60	60	60	50	40	40	30	30	20	20	20	20	10
	80-89	100	90	80	70	60	60	60	50	40	40	30	30	20	20	20	20	10
	70-79	100	80	70	60	60	60	60	50	40	40	30	30	20	20	20	20	10
	60-69	90	80	70	60	60	60	60	50	40	40	30	30	20	20	20	20	10
	50-59	90	80	70	60	60	60	60	50	40	40	30	30	20	20	20	20	10
	40-49	90	80	70	60	60	60	60	50	40	40	30	30	20	20	20	20	10
	30-39	80	70	60	50	50	50	50	40	30	30	20	20	20	10	10	10	10
Shaded >50%	110+	100	90	80	70	60	60	60	50	40	40	30	30	20	20	20	20	10
	100-109	100	90	80	70	60	60	60	50	40	40	30	30	20	20	20	20	10
	90-99	100	90	80	70	60	60	60	50	40	40	30	30	20	20	20	20	10
	80-89	100	80	70	60	60	60	60	50	40	40	30	30	20	20	20	20	10
	70-79	90	80	70	60	60	60	60	50	40	40	30	30	20	20	20	20	10
	60-69	90	80	70	60	60	60	60	50	40	40	30	30	20	20	20	20	10
	50-59	90	80	70	60	60	60	60	50	40	40	30	30	20	20	20	20	10
	40-49	90	80	60	50	50	50	50	40	30	30	20	20	20	20	20	20	10
	30-39	80	80	60	50	50	50	50	40	30	30	20	20	20	10	10	10	10

TABLE 13—Fire Severity Related to Fuel Moisture Chart

Relative Humidity	Fuel Moisture	Fuel Moisture	Relative ease of chance ignition and spotting, general burning conditions.
>60	>20	>15	Very little ignition; some spotting may occur with winds above 9 mi/h.
45-60	15-19	12-15	Low ignition hazard – campfires become dangerous; glowing brands cause ignition when relative humidity is <50 percent.
30-45	11-14	10-12	Medium ignition hazard – matches become dangerous; “easy” burning conditions.
26-40	8-10	8-9	High ignition hazard – matches are dangerous; occasional crowning, spotting caused by gusty winds: “moderate” burning conditions.
15-30	5-7	5-7	Quick ignition, rapid buildup, extensive crowning; any increase in wind causes increased spotting, crowning, loss of control; fire moves up bark of trees igniting aerial fuels; long distance spotting in pine stands; dangerous burning conditions.
<15	<5	<5	All sources of ignition dangerous; aggressive burning, spot fires occur often and spread rapidly, extreme fire behavior probable; critical burning conditions.

DIAGRAM 3—Fire Behavior Characteristics Chart (Light Fuel)

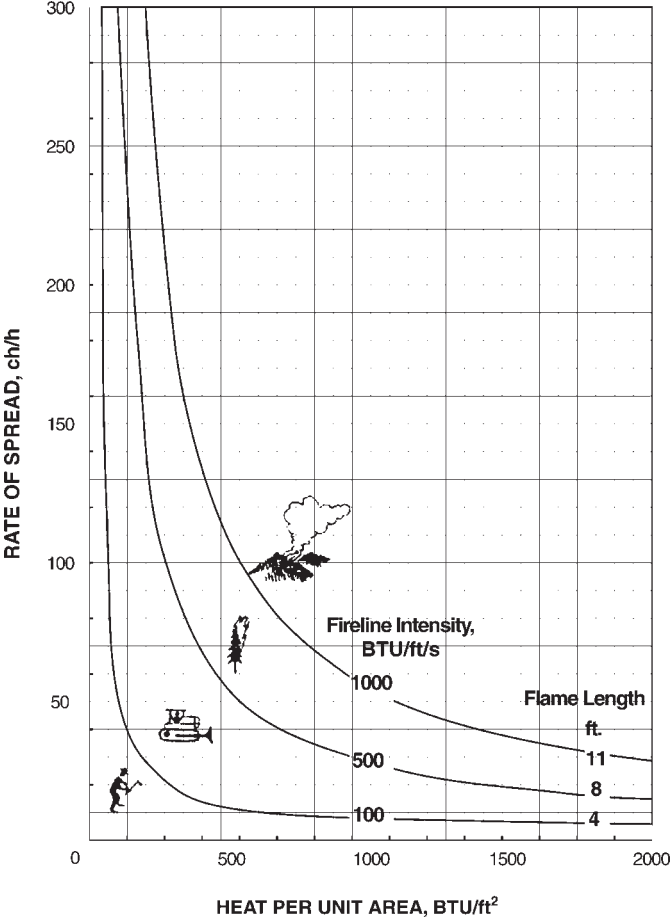

DIAGRAM 4—Fire Behavior Characteristics Chart (Heavy Fuel)

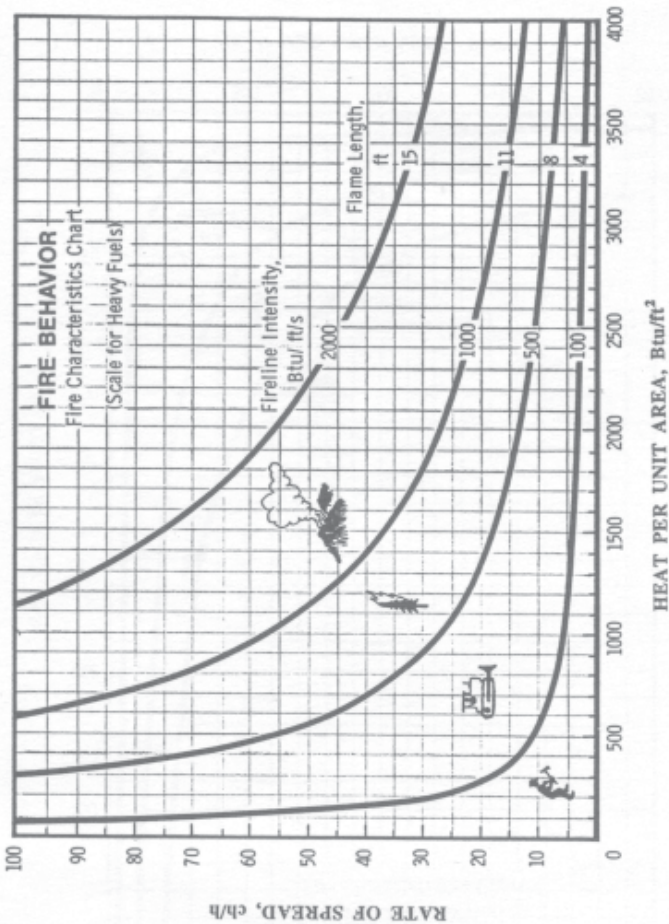

TABLE 14—Fire Suppression Interpretations¹

CAUTION: These are not guides to personal safety. Fires can be dangerous at any level of intensity. Wilson (1977) has shown that most fatalities occur in light fuels on small fires or isolated sections of large fires.

Flame Length (ft)	Fireline Intensity (Btu/ft/s)	Interpretations
0-4	0-100	Fires can generally be attacked at the head or flanks by persons using hand tools. Handline should hold the fire.
4-8	100-500	Fires are too intense for direct attack on the head by persons using hand tools. Handline cannot be relied on to hold fire. Equipment such as dozers, engines, and retardant aircraft can be effective.
8-11	500-1,000	Fires may present serious control problems – torching out, crowning, and spotting Control efforts at the head of the fire will probably be ineffective.
11+	1,000+	Crowning, spotting, and major runs are common. Control efforts at the head of the fire are ineffective.

¹ Help in Making Fuel Management Decisions, 1975; Research Paper NC-112, USDA: Forest Service.

SAFETY AND FIRE BEHAVIOR

- Probably the most important aspect of predicting fire behavior is to identify potentially dangerous fireline conditions.
- Be alert to all potentially dangerous situations and communicate the danger to all affected personnel.
- Know, remember, and use:
 - THE STANDARD ORDERS (Inside Cover)
 - THE 18 WATCHOUT SITUATIONS (Inside Cover)
 - THE FOUR COMMON DENOMINATORS OF FIRE BEHAVIOR ON TRAGEDY AND NEAR-MISS FIRES (Inside Cover)
 - DOWNHILL/INDIRECT LINE CONSTRUCTION GUIDELINES (Chapter 4)
 - THE 9 URBAN WILDLAND “WATCHOUTS”
 - LCES (LOOK OUTS, COMMUNICATIONS, ESCAPE ROUTES, AND SAFETY ZONES)
 - LOOK UP, LOOK DOWN, LOOK AROUND

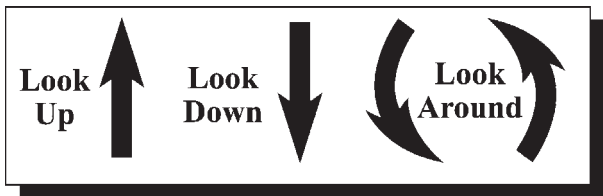

**FIRE ENVIRONMENT
FACTORS**

INDICATORS

Fuel Characteristics
Assess

Continuous fine fuels CARRIER!
Heavy loading of dead and down
Ladder Fuels
Tight crown spacing (<20 ft.)
Special Conditions:
 Firebrand sources
 Numerous snags
 Preheated canopy
 Frost and bug kill
 Unusual fine fuels
 High dead-to-live ratio
 Urban/Wildland

Fuel Moisture
Feel & Measure

Low RH (Dangerous <25%)
Low 10 hr FMC (Dangerous <6%)
Drought conditions
Seasonal drying

Fuel Temperature
Feel & Measure

High temps (above 85 °F)
High % of fuels with direct sun
Aspect with increasing fuel temps.

Terrain
Scout

Steep slopes (>50%)
Chutes
Saddles
Narrow canyons

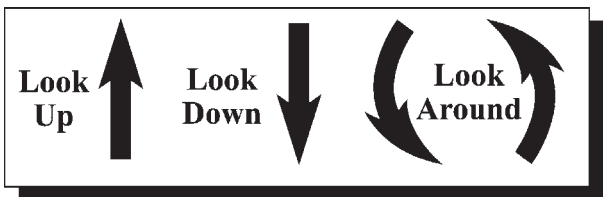

**FIRE ENVIRONMENT
FACTORS**

INDICATORS

Wind
Observe

Surface winds above 10 mi/h
Lenticular clouds
High, fast moving clouds
Approaching cold front
Cumulonimbus development
Sudden calm
Battling winds

Stability
Observe

Clear visibility
Gusty winds and dust devils
Cumulus clouds
Castellatus clouds in the a.m.
Smoke rises straight up
Inversion beginning to lift
Thermal belt

Fire Behavior
Watch

Leaning column
Sheared column
Well developed column
Trees torching
Smoldering fires picking up
Small firewhirls beginning
Frequent spot fires

Remember to Expect Diurnal Changes!

•RH•
•Temperature•

•Winds•
•Stability•

- Indicators may vary in different regions and fuel types.
- Ask questions in unfamiliar situations.

Tables 15 through 78—Rate of Spread and Flame Length Tables by Fuel Type and Percent Slope

NOTE: Tables 15 through 78 for ROS and FL (Output Items 1 and 4) on the Fire Behavior Worksheet reflect slope classes 0, 30, 45, 60 and 90 percent. You may use the slope class closest to the actual slope recorded (for Input Item 5) or interpolate between the slope class.

TABLE 15: FUEL MODEL 1—0% SLOPE

Fuel Moisture (1-Hour)	Midflame Wind, mi/h						
	0.	2.	4.	6.	8.	10.	12.
	Rate of Spread/Chains per Hour						
3.0	5	22	77	172	307	•446	•446
6.0	4	18	61	135	242	•270	•270
9.0	3	13	45	101	•136	•136	•136
12.0+	0	0	0	0	0	0	0
	Flame Length/Feet						
3.0	1.3	2.5	4.5	6.4	8.4	•10.0	•10.0
6.0	1.1	2.1	3.8	5.4	7.1	•7.5	•7.5
9.0	0.9	1.7	3.0	4.3	•5.0	•5.0	•5.0
12.0+	0.0	0.0	0.0	0.0	0.0	0.0	0.0
	•MEANS YOU HIT THE WIND LIMIT.						

TABLE 16: FUEL MODEL 1—30% SLOPE

Fuel Moisture (1-Hour)	Midflame Wind, mi/h						
	0.	2.	4.	6.	8.	10.	12.
	Rate of Spread/Chains per Hour						
3.0	25	42	97	191	327	446•	446•
6.0	20	33	76	151	257	270•	270•
9.0	15	25	57	112	136•	136•	136•
12.0+	0	0	0	0	0	0	0
	Flame Length/Feet						
3.0	2.7	3.4	4.9	6.8	8.6	10.0•	10.0•
6.0	2.2	2.8	4.2	5.7	7.3	7.5•	7.5•
9.0	1.8	2.3	3.3	4.6	5.0•	5.0•	5.0•
12.0+	0.0	0.0	0.0	0.0	0.0	0.0	0.0
•MEANS YOU HIT THE WIND LIMIT.							

TABLE 17: FUEL MODEL 1—45% SLOPE

Fuel Moisture (1-Hour)	Midflame Wind, mi/h						
	0.	2.	4.	6.	8.	10.	12.
	Rate of Spread/Chains per Hour						
3.0	50	67	122	216	352	446•	446•
6.0	39	53	96	170	270•	270•	270•
9.0	29	39	71	127	136•	136•	136•
12.0+	0	0	0	0	0	0	0
	Flame Length/Feet						
3.0	3.6	4.2	5.5	7.1	8.9	10.0•	10.0•
6.0	3.1	3.5	4.6	6.0	7.5•	7.5•	7.5•
9.0	2.5	2.8	3.7	4.8	5.0•	5.0•	5.0•
12.0+	0.0	0.0	0.0	0.0	0.0	0.0	0.0
•MEANS YOU HIT THE WIND LIMIT.							

TABLE 18: FUEL MODEL 1—60% SLOPE

Fuel Moisture (1-Hour)	Midflame Wind, mi/h						
	0.	2.	4.	6.	8.	10.	12.
	Rate of Spread/Chains per Hour						
3.0	84	101	156	251	386	446*	446*
6.0	66	80	123	197	270*	270*	270*
9.0	49	59	91	136*	136*	136*	136*
12.0+	0	0	0	0	0	0	0
	Flame Length/Feet						
3.0	4.6	5.0	6.2	7.7	9.3	10.0*	10.0*
6.0	3.9	4.3	5.2	6.5	7.5*	7.5*	7.5*
9.0	3.1	3.4	4.1	5.9*	5.0*	5.0*	5.0*
12.0+	0.0	0.0	0.0	0.0	0.0	0.0	0.0

*MEANS YOU HIT THE WIND LIMIT.

TABLE 19: FUEL MODEL 1—90% SLOPE

Fuel Moisture (1-Hour)	Midflame Wind, mi/h						
	0.	2.	4.	6.	8.	10.	12.
	Rate of Spread/Chains per Hour						
3.0	183	200	255	251	349	446*	446*
6.0	144	157	200	197	270*	270*	270*
9.0	107	117	136*	136*	136*	136*	136*
12.0+	0	0	0	0	0	0	0
	Flame Length/Feet						
3.0	6.6	6.9	7.7	8.9	10.0*	10.0*	10.0*
6.0	5.6	5.8	6.5	7.5*	7.5*	7.5*	7.5*
9.0	4.5	4.7	5.0*	5.0*	5.0*	5.0*	5.0*
12.0+	0.0	0.0	0.0	0.0	0.0	0.0	0.0

*MEANS YOU HIT THE WIND LIMIT.

TABLE 20: FUEL MODEL 2—0% SLOPE

Fuel Moisture % (1-Hour)	Midflame Wind, mi/h						
	0.	2.	4.	6.	8.	10.	12.
	Rate of Spread/Chains per Hour						
3.0 120-90	3	11	28-31	56-62	92-102	138-152	191-211
6.0 120-90	2	9	23-25	45-50	75-83	112-124	156-172
9.0 120-90	2	8	20-22	40-44	66-73	99-109	137-151
12.0 120-90	2	6	16	30-33	49-54	73-81	102-112
15.0 120-90	*0	*0	*3	*3	*3	*3	*3
18.0+ 120-90	0	0	0	0	0	0	0
	Flame Length/Feet						
3.0 120-90	2.1	3.8	6.2	8.4	10.7	12.8	14.9
6.0 120-90	1.8	3.2	5.3	7.2	9.1	11.0	12.8
9.0 120-90	1.7	3.0	4.8	6.6	8.4	10.0	11.6
12.0 120-90	1.3	2.3	3.7	5.2	6.5	7.8	9.1
15.0 120-90	*0.2	*0.3	*0.4	*0.5	*0.5	*0.5	*0.5
18.0+ 120-90	0.0	0.0	0.0	0.0	0.0	0.0	0.0

*MEANS YOU HIT THE WIND LIMIT.

TABLE 21: FUEL MODEL 2—30% SLOPE

Fuel Moisture % (1-Hour)	Midflame Wind, mi/h						
	0.	2.	4.	6.	8.	10.	12.
	Rate of Spread/Chains per Hour						
3.0 120-90	9	15-17	34-37	61-68	98-109	144-159	197-218
6.0 120-90	8	14	27-30	50-55	80-88	117-129	161-177
9.0 120-90	7	12	24-27	44-49	70-78	103-113	141-156
12.0 120-90	5	9	18-20	33-36	52-57	76-84	105-115
15.0 120-90	*1	*1	*2	*2	*2	*2	*2
18.0+ 120-90	0	0	0	0	0	0	0
	Flame Length/Feet						
3.0 120-90	3.5	4.7	6.7	8.8	10.9	13.0	15.1
6.0 120-90	3.0	4.0	5.8	7.5	9.4	11.2	12.9
9.0 120-90	2.8	3.7	5.3	6.9	8.6	10.2	11.8
12.0 120-90	2.2	2.9	4.1	5.4	6.7	8.0	9.3
15.0 120-90	*0.3	*0.3	*0.5	*0.5	*0.5	*0.5	*0.5
18.0+ 120-90	0.0	0.0	0.0	0.0	0.0	0.0	0.0

*MEANS YOU HIT THE WIND LIMIT.

TABLE 22: FUEL MODEL 2—45% SLOPE

Fuel Moisture % (1-Hour)	Midflame Wind, mi/h						
	0.	2.	4.	6.	8.	10.	12.
	Rate of Spread/Chains per Hour						
3.0 120-90	17	23-25	41-45	69-76	105-117	151-167	204-226
6.0 120-90	14	20	33-37	56-62	86-95	123-136	167-184
9.0 120-90	12	16-18	29-32	49-54	76-83	108-119	147-161
12.0 120-90	9	13	22-24	37-40	56-62	80-88	109-129
15.0 120-90	*1	*1	*2	*2	*2	*2	*2
18.0+ 120-90	0	0	0	0	0	0	0
	Flame Length/Feet						
3.0 120-90	4.7	5.6	7.3	9.3	11.3	13.4	15.3
6.0 120-90	4.0	4.8	6.3	7.9	9.7	11.4	13.2
9.0 120-90	3.7	4.4	5.8	7.3	8.9	10.5	12.0
12.0 120-90	2.9	3.4	4.5	5.7	6.9	8.2	9.4
15.0 120-90	*0.3	*0.4	*0.5	*0.5	*0.5	*0.5	*0.5
18.0+ 120-90	0.0	0.0	0.0	0.0	0.0	0.0	0.0
	*MEANS YOU HIT THE WIND LIMIT.						

TABLE 23: FUEL MODEL 2—60% SLOPE

Fuel Moisture % (1-Hour)	Midflame Wind, mi/h						
	0.	2.	4.	6.	8.	10.	12.
	Rate of Spread/Chains per Hour						
3.0 120-90	26-28	33-36	51-56	79-87	116-128	161-178	214-237
6.0 120-90	21-23	27-30	42-46	64-71	94-104	131-145	175-193
9.0 120-90	18-20	24-26	37-40	57-62	83-91	115-127	154-169
12.0 120-90	15	17-19	27-30	42-46	62-68	86-94	114-126
15.0 120-90	*1	*2	*2	*2	*2	*0	*0
18.0+ 120-90	0	0	0	0	0	0	0
	Flame Length/Feet						
3.0 120-90	5.9	6.6	8.1	9.9	11.8	13.8	15.7
6.0 120-90	5.1	5.7	6.9	8.5	10.1	11.8	13.5
9.0 120-90	4.6	5.2	6.4	7.7	9.3	10.8	12.3
12.0 120-90	3.6	4.1	5.0	6.1	7.2	8.4	9.6
15.0 120-90	*0.4	*0.5	*0.5	*0.5	*0.5	*0.5	*0.5
18.0+ 120-90	0.0	0.0	0.0	0.0	0.0	0.0	0.0
	*MEANS YOU HIT THE WIND LIMIT.						

TABLE 24: FUEL MODEL 2—90% SLOPE

Fuel Moisture % (1-Hour)	Midflame Wind, mi/h						
	0.	2.	4.	6.	8.	10.	12.
	Rate of Spread/Chains per Hour						
3.0 120-90	55-60	63-68	80-88	108-119	144-160	190-210	243-269
6.0 120-90	45-49	50-56	65-72	88-97	118-130	155-171	199-219
9.0 120-90	39-43	44-49	57-63	77-85	104-114	136-150	175-192
12.0 120-90	29-32	33-36	43-47	57-63	77-85	101-111	130-142
15.0 120-90	*2	*2	*2	*2	*2	*2	*2
18.0+ 120-90	0	0	0	0	0	0	0
	Flame Length/Feet						
3.0 120-90	8.4	8.9	10.0	11.4	13.1	14.8	16.6
6.0 120-90	7.2	7.6	8.5	9.8	11.3	12.7	14.2
9.0 120-90	6.6	6.9	7.8	9.0	10.3	11.6	13.0
12.0 120-90	5.1	5.5	6.1	7.0	8.0	9.1	10.2
15.0 120-90	*0.5	*0.5	*0.5	*0.5	*0.5	*0.5	*0.5
18.0+ 120-90	0.0	0.0	0.0	0.0	0.0	0.0	0.0
	*MEANS YOU HIT THE WIND LIMIT.						

TABLE 25: FUEL MODEL 3—0% SLOPE

Fuel Moisture (1-Hour)	Midflame Wind, mi/h						
	0.	2.	4.	6.	8.	10.	12.
	Rate of Spread/Chains per Hour						
3.0	6	52	121	201	290	387	490
6.0	5	39	89	148	214	286	361
9.0	4	32	73	122	176	234	296
12.0	3	28	64	107	154	206	260
15.0	3	25	57	95	137	182	213
18.0	2	20	47	79	114	151	191
21.0	2	14	32	53	77	103	130
	Flame Length/Feet						
3.0	3.8	10.1	14.8	18.7	22.2	25.3	28.2
6.0	3.0	8.0	11.8	14.9	17.7	20.2	22.5
9.0	2.6	7.0	10.3	13.0	15.4	17.6	19.6
12.0	2.4	6.5	9.5	12.1	14.3	16.3	18.2
15.0	2.2	6.0	8.9	11.2	13.3	15.2	16.9
18.0	2.0	5.3	7.7	9.8	11.6	13.2	14.7
21.0	1.4	3.8	5.6	7.1	8.4	9.6	10.7

TABLE 26: FUEL MODEL 3—30% SLOPE

Fuel Moisture (1-Hour)	Midflame Wind, mi/h						
	0.	2.	4.	6.	8.	10.	12.
	Rate of Spread/Chains per Hour						
3.0	26	72	140	221	310	407	510
6.0	19	53	103	163	229	300	376
9.0	16	43	85	133	187	246	308
12.0	14	38	75	117	165	216	271
15.0	12	34	66	104	146	192	240
18.0	10	28	55	86	121	159	199
21.0	7	19	37	59	82	108	135
	Flame Length/Feet						
3.0	7.3	11.7	15.9	19.6	22.9	25.9	28.7
6.0	5.8	9.3	12.6	15.6	18.2	20.6	22.9
9.0	5.0	8.1	11.0	13.6	15.9	18.0	19.9
12.0	4.7	7.5	10.2	12.6	14.7	16.7	18.5
15.0	4.4	7.0	9.5	11.7	13.7	15.5	17.2
18.0	3.8	6.1	8.3	10.2	11.9	13.5	15.0
21.0	2.7	4.4	6.0	7.4	8.6	9.8	10.9

TABLE 27: FUEL MODEL 3—45% SLOPE

Fuel Moisture (1-Hour)	Midflame Wind, mi/h						
	0.	2.	4.	6.	8.	10.	12.
	Rate of Spread/Chains per Hour						
3.0	50	96	165	245	334	431	534
6.0	37	71	122	181	247	318	394
9.0	30	58	100	148	202	261	323
12.0	27	51	88	130	178	229	284
15.0	24	45	78	116	158	203	252
18.0	20	38	64	96	131	168	209
21.0	13	26	44	65	89	115	142
	Flame Length/Feet						
3.0	9.9	13.4	17.1	20.5	23.7	26.6	29.4
6.0	7.9	10.6	13.6	16.3	18.8	21.2	23.4
9.0	6.9	9.3	11.9	14.2	16.4	18.5	20.4
12.0	6.4	8.6	11.0	13.2	15.2	17.1	18.9
15.0	5.9	8.0	10.2	12.3	14.2	15.9	17.6
18.0	5.2	7.0	8.9	10.7	12.4	13.9	15.3
21.0	3.7	5.1	6.5	7.8	9.0	10.1	11.1

TABLE 28: FUEL MODEL3—60% SLOPE

Fuel Moisture (1-Hour)	Midflame Wind, mi/h						
	0.	2.	4.	6.	8.	10.	12.
	Rate of Spread/Chains per Hour						
3.0	84	131	199	279	369	465	568
6.0	62	96	147	206	272	343	419
9.0	51	79	120	169	223	281	344
12.0	45	69	106	149	196	247	302
15.0	40	62	94	132	174	219	268
18.0	33	51	78	109	144	182	222
21.0	22	35	53	74	98	124	151
	Flame Length/Feet						
3.0	12.6	15.4	18.7	21.8	24.8	27.6	30.2
6.0	10.0	12.2	14.8	17.3	19.7	21.9	24.0
9.0	8.7	10.7	12.9	15.1	17.2	19.1	21.0
12.0	8.1	9.9	12.0	14.0	15.9	17.7	19.4
15.0	7.5	9.2	11.2	13.0	14.8	16.5	18.1
18.0	6.6	8.0	0.76	11.4	12.9	14.4	15.8
21.0	4.8	5.8	7.1	8.2	9.4	10.4	11.4

TABLE 29: FUEL MODEL 3—90% SLOPE

Fuel Moisture (1-Hour)	Midflame Wind, mi/h						
	0.	2.	4.	6.	8.	10.	12.
	Rate of Spread/Chains per Hour						
3.0	182	228	297	377	467	563	666
6.0	134	168	219	278	344	415	491
9.0	110	138	179	228	282	341	403
12.0	97	121	158	201	248	299	354
15.0	86	108	140	178	220	266	314
18.0	71	89	116	147	182	220	260
21.0	48	61	79	100	124	150	177
	Flame Length/Feet						
3.0	17.9	19.9	22.4	25.0	27.6	30.1	32.5
6.0	14.3	15.8	17.8	19.9	22.0	23.9	25.9
9.0	12.4	13.8	15.6	17.4	19.2	20.9	22.6
12.0	11.5	12.8	14.4	16.1	17.7	19.4	20.9
15.0	10.7	11.9	13.4	15.0	16.5	18.0	19.5
18.0	9.3	10.4	11.7	13.1	14.4	15.7	17.0
21.0	6.8	7.5	8.5	9.5	10.4	11.4	12.3

TABLE 30: FUEL MODEL 4—0% SLOPE

Fuel Moisture % (1-Hour)	Midflame Wind, mi/h							
	0.	2.	4.	6.	8.	10.	12.	
	Rate of Spread/Chains per Hour							
3.0 120-90	5	24-29	56-70	97-120	143-178	195-243	252-313	
6.0 120-90	4	21-25	49-61	85-104	126-155	171-211	221-272	
9.0 120-90	4	19-23	46-56	79-96	117-143	160-194	206-250	
12.0 120-90	4	18-22	43-53	74-90	110-134	149-183	192-235	
15.0 120-90	3	12-19	28-46	47-78	70-116	96-158	124-204	
18.0+ 120-90	1	6	11-13	19-23	29-34	39-46	51-60	
21.0 120-90	0	0	0	0	0	0	0	
	Flame Length/Feet							
3.0 120-90	5.7	12-13	18-20	23-25	27-31	32-35	35-40	
6.0 120-90	5.1	11-12	16-18	20-23	25-27	28-32	32-35	
9.0 120-90	4.8	10-11	15-17	19-21	23-26	27-30	30-33	
12.0 120-90	4.6	10-11	14-16	18-20	22-24	25-28	28-32	
15.0 120-90	3-4	6-10	10-14	12-18	15-22	17-25	19-28	
18.0+ 120-90	1	3	4-5	6	7	8	9	
21.0 120-90	0	0	0	0	0	0	0	

TABLE 31: FUEL MODEL 4—30% SLOPE

Fuel Moisture % (1-Hour)	Midflame Wind, mi/h							
	0.	2.	4.	6.	8.	10.	12.	
Rate of Spread/Chains per Hour								
3.0 120-90	15-18	34-42	67-83	107-133	154-191	206-256	262-326	
6.0 120-90	13-16	30-37	58-72	94-116	135-166	180-222	230-283	
9.0 120-90	12-14	28-34	55-66	88-107	126-153	168-205	215-261	
12.0 120-90	11-14	26-32	51-62	82-100	118-144	157-192	200-245	
15.0 120-90	7-12	17-28	33-54	53-87	76-125	101-167	129-213	
18.0+ 120-90	3	8	13-16	22-25	31-37	41-49	53-62	
21.0 120-90	0	0	0	0	0	0	0	
Flame Length/Feet								
3.0 120-90	10-11	14-16	19-22	24-27	28-32	32-36	36-40	
6.0 120-90	9	13-14	17-19	21-24	25-28	29-32	32-36	
9.0 120-90	8-9	12-13	16-18	20-22	24-26	28-30	31-34	
12.0 120-90	8	11-13	16-17	19-21	23-25	26-29	29-32	
15.0 120-90	5-8	8-11	10-15	13-19	15-22	18-26	20-29	
18.0+ 120-90	2	4	5	6	7	8	9	
21.0 120-90	0	0	0	0	0	0	0	

TABLE 32: FUEL MODEL 4—45% SLOPE

Fuel Moisture % (1-Hour)	Midflame Wind, mi/h							
	0.	2.	4.	6.	8.	10.	12.	
	Rate of Spread/Chains per Hour							
3.0 120-90	27-34	47-58	80-99	120-149	167-207	219-272	275-342	
6.0 120-90	24-30	41-51	70-86	105-130	146-180	192-236	241-297	
9.0 120-90	23-27	38-47	65-79	98-119	137-166	179-218	225-274	
12.0 120-90	21-26	36-44	61-74	92-112	127-156	167-204	210-257	
15.0 120-90	14-22	23-38	39-65	59-97	82-135	107-177	135-223	
18.0+ 120-90	7	9-11	16-19	24-29	34-40	44-52	55-65	
21.0 120-90	0	0	0	0	0	0	0	
	Flame Length/Feet							
3.0 120-90	13-14	16-18	21-23	25-28	29-33	33-37	37-41	
6.0 120-90	12-13	15-16	19-21	23-25	26-29	30-33	33-37	
9.0 120-90	11-12	14-15	18-20	21-24	25-28	28-31	31-35	
12.0 120-90	10-11	13-15	17-19	20-13	24-26	27-30	30-33	
15.0 120-90	7-10	9-13	11-17	14-20	16-23	18-26	20-28	
18.0+ 120-90	3	4	5	6	7	8	8-9	
21.0 120-90	0	0	0	0	0	0	0	

TABLE 33: FUEL MODEL 4—60% SLOPE

Fuel Moisture % (1-Hour)	Midflame Wind, mi/h							
	0.	2.	4.	6.	8.	10.	12.	
	Rate of Spread/Chains per Hour							
3.0 120-90	26-57	65-81	98-121	138-172	185-230	237-294	293-365	
6.0 120-90	40-49	57-70	86-105	121-149	162-200	207-256	257-316	
9.0 120-90	37-45	53-65	80-97	113-138	151-184	194-236	240-292	
12.0 120-90	35-43	50-61	75-91	106-129	141-173	181-221	224-274	
15.0 120-90	22-37	32-53	48-79	68-112	91-150	116-192	144-238	
18.0+ 120-90	9-11	13-15	20-23	28-33	37-44	48-56	59-70	
21.0 120-90	0	0	0	0	0	0	0	
	Flame Length/Feet							
3.0 120-90	16-18	19-21	23-26	27-30	31-34	34-39	38-43	
6.0 120-90	14-16	17-19	20-23	24-27	28-31	31-34	34-38	
9.0 120-90	14-15	16-18	20-22	23-25	26-29	20-32	32-36	
12.0 120-90	13-14	15-17	18-20	22-24	25-28	28-31	31-34	
15.0 120-90	9-13	10-15	12-18	15-21	17-24	19-27	21-30	
18.0+ 120-90	4	5	6	7	8	9	9	
21.0 120-90	0	0	0	0	0	0	0	

TABLE 34: FUEL MODEL 4—90% SLOPE

Fuel Moisture % (1-Hour)	Midflame Wind, mi/h						
	0.	2.	4.	6.	8.	10.	12.
	Rate of Spread/Chains per Hour						
3.0 120-90	98-121	117-146	150-186	190-236	237-294	238-359	345-429
6.0 120-90	86-105	103-126	131-162	167-205	208-256	253-312	302-373
9.0 120-90	80-97	96-117	123-149	156-189	194-236	237-287	283-344
12.0 120-90	75-91	90-109	114-140	145-178	181-221	221-270	264-323
15.0 120-90	48-79	58-95	74-122	93-154	116-192	142-234	170-280
18.0+ 120-90	20-23	24-28	30-36	38-45	48-56	58-69	70-82
21.0 120-90	0	0	0	0	0	0	0
	Flame Length/Feet						
3.0 120-90	23-26	25-28	28-31	31-35	34-39	38-42	41-46
6.0 120-90	20-23	22-25	25-28	28-31	31-34	34-38	37-41
9.0 120-90	20-22	21-23	24-26	26-29	29-32	32-35	35-38
12.0 120-90	18-20	20-22	23-25	25-28	28-31	30-34	33-37
15.0 120-90	12-18	14-20	15-22	17-25	19-27	20-30	22-33
18.0+ 120-90	6	6	7	8	0	8-9	10-11
21.0 120-90	0	0	0	0	0	0	0

TABLE 35: FUEL MODEL 5—0% SLOPE

Fuel Moisture % (1-Hour)		Midflame Wind, mi/h						
		0.	2.	4.	6.	8.	10.	12.
		Rate of Spread/Chains per Hour						
3.0	120-90	1	7-10	16-23	28-39	42-58	56-78	72-100
6.0	120-90	1	4-8	9-20	16-34	24-50	32-67	42-87
9.0	120-90	1	2-5	6-13	10-22	14-32	19-44	*20-56
12.0	120-90	0	2-3	5-6	9-11	13-16	*18-22	*18-22
15.0	120-90	0	2	4-5	8-9	11-14	*12-15	*12-15
18.0+	120-90	0	1	3	*4	*4	*4	*4
21.0	120-90	0	0	0	0	0	0	0
		Flame Length/Feet						
3.0	120-90	1-2	3-4	5-6	7-8	8-10	9-11	10-12
6.0	120-90	1	2-4	3-6	4-7	5-8	6-10	6-11
9.0	120-90	1	1-2	2-4	2-5	3-6	3-7	*3-7
12.0	120-90	1	1	2	2	3	*3	*3-4
15.0	120-90	1	1	2	2	3	*3	*3
18.0+	120-90	<1	1	1	*1	*1	*1	*1
21.0	120-90	0	0	0	0	0	0	0
* MEANS YOU HIT THE WIND LIMIT								

TABLE 36: FUEL MODEL 5—30% SLOPE

Fuel Moisture % (1-Hour)	Midflame Wind, mi/h							
	0.	2.	4.	6.	8.	10.	12.	
	Rate of Spread/Chains per Hour							
3.0 120-90	4-5	10-14	19-27	31-43	44-62	59-82	75-104	
6.0 120-90	2-5	6-12	11-23	18-37	26-53	34-71	43-90	
9.0 120-90	1-3	3-8	7-15	10-24	15-35	*20-46	*20-59	
12.0 120-90	1-2	3-4	6-8	10-12	14-17	*18-22	*18-22	
15.0 120-90	1	3	5-6	9-10	*12-15	*12-15	*12-15	
18.0+ 120-90	1	2	*3-4	*4	*4	*4	*4	
21.0 120-90	0	0	0	0	0	0	0	
	Flame Length/Feet							
3.0 120-90	3	4-5	6-7	7-8	8-10	9-11	10-13	
6.0 120-90	2-3	2-4	3-6	4-7	5-9	6-10	6-11	
9.0 120-90	1-2	2-3	2-4	3-5	3-6	*3-7	*3-8	
12.0 120-90	1	1-2	2	3	3	*3	*3	
15.0 120-90	1	1	2	2	*3	*3	*3	
18.0+ 120-90	1	1	*1	*1	*1	*1	*1	
21.0 120-90	0	0	0	0	0	0	0	
	* MEANS YOU HIT THE WIND LIMIT							

TABLE 37: FUEL MODEL 5—45% SLOPE

Fuel Moisture % (1-Hour)	Midflame Wind, mi/h							
	0.	2.	4.	6.	8.	10.	12.	
	Rate of Spread/Chains per Hour							
3.0 120-90	8-11	13-19	23-32	35-48	48-67	63-87	79-109	
6.0 120-90	4-9	8-16	13-28	20-42	28-58	36-75	45-94	
9.0 120-90	3-6	5-10	8-18	12-27	16-37	*20-49	*20-61	
12.0 120-90	2-3	4-5	7-9	11-14	15-19	*18-22	*18-22	
15.0 120-90	2-3	4	6-8	10-12	*12-15	*12-15	*12-15	
18.0+ 120-90	1	2-3	*4	*4	*4	*4	*4	
21.0 120-90	0	0	0	0	0	0	0	
	Flame Length/Feet							
3.0 120-90	4	5	6-7	7-9	8-10	10-12	11-13	
6.0 120-90	2-4	3-5	4-6	4-8	5-9	6-10	6-11	
9.0 120-90	1-3	2-3	2-4	3-5	3-6	*3-7	*3-8	
12.0 120-90	1	2	2	3	3	*3	*3	
15.0 120-90	1	2	2	2	*2	*2	*2	
18.0+ 120-90	1	1	*1	*1	*1	*1	*1	
21.0 120-90	0	0	0	0	0	0	0	
	* MEANS YOU HIT THE WIND LIMIT							

TABLE 38: FUEL MODEL 5—60% SLOPE

Fuel Moisture % (1-Hour)	Midflame Wind, mi/h						
	0.	2.	4.	6.	8.	10.	12.
	Rate of Spread/Chains per Hour						
3.0 120-90	13-18	19-26	28-39	40-55	53-74	68-94	84-117
6.0 120-90	7-15	11-22	16-34	23-48	31-64	39-81	48-101
9.0 120-90	4-10	6-14	10-22	13-31	18-41	*20-53	*20-65
12.0 120-90	4-5	6-7	9-11	13-16	17-21	*18-22	*18-22
15.0 120-90	3-4	5-6	8-9	11-13	*12-15	*12-15	*12-15
18.0+ 120-90	2	*4	*4	*4	*4	*4	*4
21.0 120-90	0	0	0	0	0	0	0
	Flame Length/Feet						
3.0 120-90	5-6	5-7	7-10	8-10	9-11	10-12	11-13
6.0 120-90	3-5	3-6	4-7	5-8	5-10	6-11	7-12
9.0 120-90	2-3	2-4	2-5	3-6	3-6	*3-7	*3-8
12.0 120-90	2	2	2-3	3	*4	*4	*4
15.0 120-90	1-2	2	2	2-3	*3	*3	*3
18.0+ 120-90	1	1	*1	*1	*1	*1	*1
21.0 120-90	0	0	0	0	0	0	0
	* MEANS YOU HIT THE WIND LIMIT						

TABLE 39: FUEL MODEL 5—90% SLOPE

Fuel Moisture % (1-Hour)	Midflame Wind, mi/h						
	0.	2.	4.	6.	8.	10.	12.
	Rate of Spread/Chains per Hour						
3.0 120-90	27-38	33-46	43-59	54-76	68-94	83-115	99-137
6.0 120-90	16-33	19-40	25-51	31-65	39-81	48-99	57-118
9.0 120-90	9-21	11-26	14-33	18-42	*20-53	*20-64	*20-77
12.0 120-90	9-11	11-13	14-17	17-21	*18-22	*18-22	*18-22
15.0 120-90	7-9	9-11	*12-14	*12-15	*12-15	*12-15	*12-15
18.0+ 120-90	*4	*4	*4	*4	*4	*4	*4
21.0 120-90	0	0	0	0	0	0	0
	Flame Length/Feet						
3.0 120-90	7-8	7-9	8-10	9-11	10-12	11-13	12-14
6.0 120-90	4-7	4-8	5-9	5-10	6-11	6-12	7-13
9.0 120-90	2-5	3-5	3-6	3-6	*3-7	*3-8	*3-9
12.0 120-90	2	2-3	3	*4	*4	*4	*4
15.0 120-90	2	2	*3	*3	*3	*3	*3
18.0+ 120-90	*1	*1	*1	*1	*1	*1	*1
21.0 120-90	0	0	0	0	0	0	0
	* MEANS YOU HIT THE WIND LIMIT						

TABLE 40a: FUEL MODEL 6—0% SLOPE

Fuel Moisture (1-Hour)	Midflame Wind, mi/h						
	0.	2.	4.	6.	8.	10.	12.
	Rate of Spread/Chains per Hour						
3.0	2	15	33	56	81	109	138
6.0	2	11	25	43	62	83	105
9.0	1	9	21	35	52	69	88
12.0	1	8	19	31	45	61	77
15.0	1	7	17	28	41	55	69
18.0	1	6	15	24	35	47	60
21.0	1	6	11	19	28	37	47
	Flame Length/Feet						
3.0	1.9	4.5	6.5	8.3	9.8	11.3	12.6
6.0	1.6	3.7	5.4	6.8	8.1	9.2	10.3
9.0	1.4	3.2	4.7	6.0	7.1	8.2	9.1
12.0	1.3	3.0	4.4	5.6	6.6	7.6	8.5
15.0	1.2	2.8	4.1	5.2	6.2	7.1	7.9
18.0	1.1	2.6	3.8	4.8	5.7	6.5	7.2
21.0	0.9	2.1	3.1	3.9	4.7	5.3	6.0

TABLE 40b: FUEL MODEL 6—30% SLOPE

Fuel Moisture (1-Hour)	Midflame Wind, mi/h						
	0.	2.	4.	6.	8.	10.	12.
	Rate of Spread/Chains per Hour						
3.0	8	21	40	62	88	115	145
6.0	6	16	30	47	67	88	111
9.0	5	13	25	39	55	73	92
12.0	5	11	22	35	49	64	81
15.0	4	10	20	31	44	58	72
18.0	4	9	17	27	38	50	63
21.0	3	7	14	21	30	40	57
	Flame Length/Feet						
3.0	3.4	5.3	7.1	8.8	10.3	11.6	12.9
6.0	2.8	4.3	5.8	7.2	8.4	9.5	10.6
9.0	2.5	3.8	5.1	6.3	7.4	8.4	9.3
12.0	2.3	3.5	4.8	5.8	6.8	7.8	8.6
15.0	2.2	3.3	4.5	5.5	6.4	7.3	8.1
18.0	2.0	3.0	4.1	5.0	5.9	6.7	7.4
21.0	1.6	2.5	3.4	4.2	4.9	5.5	6.1

TABLE 41: FUEL MODEL 6—45% SLOPE

Fuel Moisture (1-Hour)	Midflame Wind, mi/h						
	0.	2.	4.	6.	8.	10.	12.
	Rate of Spread/Chains per Hour						
3.0	15	28	47	69	94	122	151
6.0	12	21	36	53	72	93	115
9.0	10	18	30	44	60	77	96
12.0	9	16	26	49	53	68	85
15.0	8	14	23	35	47	61	76
18.0	7	12	20	30	41	53	66
21.0	5	9	16	24	32	42	52
	Flame Length/Feet						
3.0	4.6	6.0	7.6	9.1	10.6	11.9	13.1
6.0	3.8	4.9	6.3	7.5	8.7	9.7	10.8
9.0	3.3	4.4	5.5	6.6	7.6	8.6	9.5
12.0	3.1	4.0	5.1	6.2	7.1	8.0	8.8
15.0	2.9	3.8	4.8	5.8	6.7	7.5	8.3
18.0	2.6	3.5	4.4	5.3	6.1	6.8	7.5
21.0	2.2	2.8	3.6	4.3	5.0	5.6	6.2

TABLE 42: FUEL MODEL 6—60% SLOPE

Fuel Moisture (1-Hour)	Midflame Wind, mi/h						
	0.	2.	4.	6.	8.	10.	12.
	Rate of Spread/Chains per Hour						
3.0	26	38	57	79	105	132	161
6.0	20	29	43	61	80	101	123
9.0	16	24	36	50	66	84	103
12.0	14	21	32	44	59	74	91
15.0	13	19	29	30	53	66	81
18.0	11	17	25	35	46	58	70
21.0	9	13	19	27	36	45	54*
	Flame Length/Feet						
3.0	5.8	7.0	8.4	9.8	11.1	12.3	13.5
6.0	4.8	5.7	6.9	8.0	9.1	10.1	11.1
9.0	4.2	5.0	6.1	7.1	8.0	8.9	9.8
12.0	3.9	4.7	5.6	6.6	7.4	8.3	9.1
15.0	3.7	4.4	5.3	6.2	7.0	7.8	8.5
18.0	3.3	4.0	4.8	5.6	6.4	7.1	7.8
21.0	2.8	3.3	4.0	4.6	5.2	5.8	6.3*
	*MEANS YOU HIT THE WIND LIMIT.						

TABLE 43: FUEL MODEL 6—90% SLOPE

Fuel Moisture (1-Hour)	Midflame Wind, mi/h						
	0.	2.	4.	6.	8.	10.	12.
	Rate of Spread/Chains per Hour						
3.0	55	67	86	109	134	161	191
6.0	42	51	66	83	102	123	146
9.0	35	43	55	69	85	103	121
12.0	31	38	48	61	75	90	107
15.0	28	34	43	55	67	81	96
18.0	24	29	38	47	58	70	83
21.0	19	23	29	37	46	54*	54*
	Flame Length/Feet						
3.0	8.2	9.0	10.1	11.3	12.4	13.5	14.6
6.0	6.8	7.4	8.3	9.2	10.2	11.1	12.0
9.0	6.0	6.6	7.3	8.2	9.0	9.8	10.6
12.0	5.5	6.1	6.8	7.6	8.3	9.1	9.8
15.0	5.2	5.7	6.4	7.1	7.8	8.5	9.2
18.0	4.7	5.2	5.8	6.5	7.1	7.8	8.4
21.0	3.9	4.3	4.8	5.3	5.9	6.5*	6.3*
	*MEANS YOU HIT THE WIND LIMIT.						

TABLE 44: FUEL MODEL 7—0% SLOPE

Fuel Moisture % (1-Hour)	Midflame Wind, mi/h							
	0.	2.	4.	6.	8.	10.	12.	
	Rate of Spread/Chains per Hour							
3.0 120-90	1-2	10-11	23-26	38-44	55-64	74-85	94-109	
6.0 120-90	1	9-10	20-23	33-38	48-55	64-73	81-93	
9.0 120-90	1	8-9	17-20	29-33	42-48	56-65	72-82	
12.0 120-90	1	7-8	16-18	26-30	38-44	51-59	65-74	
15.0 120-90	1	6-7	15-17	24-28	35-40	47-54	60-69	
18.0+ 120-90	1	6-7	14-16	23-26	33-38	45-51	57-64	
21.0 120-90	1	6	13-15	22-25	32-36	42-48	54-61	
	Flame Length/Feet							
3.0 120-90	2	4	6	7-8	8-9	10	11-12	
6.0 120-90	1	3-4	5	6-7	8	9	10	
9.0 120-90	1	3	5	6	7	8	9	
12.0 120-90	1	3	4-5	5-6	6-7	7-8	8-9	
15.0 120-90	1	3	4	5-6	6-7	7	8	
18.0+ 120-90	1	3	4	5	6	7	8	
21.0 120-90	1	3	4	5	6	7	7-8	

TABLE 45: FUEL MODEL 7—30% SLOPE

Fuel Moisture % (1-Hour)	Midflame Wind, mi/h						
	0.	2.	4.	6.	8.	10.	12.
	Rate of Spread/Chains per Hour						
3.0 120-90	5-6	14-16	27-31	42-49	59-68	78-90	98-113
6.0 120-90	5	12-14	23-26	36-42	51-59	67-77	84-97
9.0 120-90	4-5	11-12	20-23	32-37	45-52	59-68	75-86
12.0 120-90	4	10-11	18-21	29-33	41-47	54-62	68-77
15.0 120-90	3-4	9-10	17-20	27-31	38-43	50-57	63-72
18.0+ 120-90	3-4	8-9	16-18	25-29	36-41	47-53	59-67
21.0 120-90	3	8-9	15-17	24-27	34-38	45-50	56-63
	Flame Length/Feet						
3.0 120-90	3	4-5	6	7-8	9	10-11	11-12
6.0 120-90	3	4	5-6	7	8	9-10	10
9.0 120-90	2	4	5	6	7-8	8-9	9-10
12.0 120-90	2	4	5	6	7	8	9
15.0 120-90	2	3	4-5	5-6	6-7	7-8	8
18.0+ 120-90	2	3	4	5-6	6	7	8
21.0 120-90	2	3	4	5	6	7	7-8

TABLE 46: FUEL MODEL 7—45% SLOPE

Fuel Moisture % (1-Hour)		Midflame Wind, mi/h						
		0.	2.	4.	6.	8.	10.	12.
		Rate of Spread/Chains per Hour						
3.0	120-90	10-12	19-22	32-37	47-54	64-74	83-96	103-119
6.0	120-90	9-10	16-19	27-31	40-47	55-64	71-82	89-102
9.0	120-90	8-9	16-14	24-28	36-41	49-56	63-72	78-90
12.0	120-90	7-8	13-15	22-25	33-37	44-51	57-66	71-81
15.0	120-90	7	12-14	20-23	30-34	41-47	53-61	66-75
18.0+	120-90	6-7	11-13	19-22	28-32	39-44	50-57	62-70
21.0	120-90	6-7	11-12	18-20	27-30	37-42	47-54	59-67
		Flame Length/Feet						
3.0	120-90	4	5-6	6-7	8	9-10	10-11	11-12
6.0	120-90	4	5	6	7-8	8-9	9-10	10-11
9.0	120-90	3	4	5-6	6-7	7-8	8-9	9-10
12.0	120-90	3	4	5	6	7	8	9
15.0	120-90	3	4	5	6	7	7-8	8-9
18.0+	120-90	3	4	5	5-6	6-7	7-8	8
21.0	120-90	3	3-4	4-5	5-6	6	7	8

TABLE 47: FUEL MODEL 7—60% SLOPE

Fuel Moisture % (1-Hour)		Midflame Wind, mi/h						
		0.	2.	4.	6.	8.	10.	12.
		Rate of Spread/Chains per Hour						
3.0	120-90	17-20	26-30	38-44	54-62	71-82	90-104	109-127
6.0	120-90	15-17	22-25	33-38	46-53	61-70	77-89	95-109
9.0	120-90	13-15	20-22	29-34	41-47	54-62	68-79	84-96
12.0	120-90	12-14	18-20	27-30	37-43	49-56	62-71	76-87
15.0	120-90	11-13	16-19	25-28	35-36	46-52	58-66	70-80
18.0+	120-90	10-12	15-18	23-26	32-37	43-49	54-61	66-75
21.0	120-90	10-11	15-17	22-25	31-35	41-46	51-58	63-71
		Flame Length/Feet						
3.0	120-90	5	6	7-8	8-9	10	11	12
6.0	120-90	4-5	5-6	6-7	7-8	8-9	9-10	10-11
9.0	120-90	4	5	6	7	8	9	9-10
12.0	120-90	4	4-5	5-6	6-7	7-8	8-9	9
15.0	120-90	4	4-5	5-6	6	7	8	8-9
18.0+	120-90	3-4	4	5	6	7	7-8	8-9
21.0	120-90	3-4	4	5	6	6-7	7-8	8

TABLE 48: FUEL MODEL 7—90% SLOPE

Fuel Moisture % (1-Hour)	Midflame Wind, mi/h							
	0.	2.	4.	6.	8.	10.	12.	
	Rate of Spread/Chains per Hour							
3.0 120-90	37-42	45-51	58-67	73-85	90-105	109-126	129-149	
6.0 120-90	32-36	39-45	50-58	63-73	78-90	94-109	111-128	
9.0 120-90	28-32	35-40	44-51	56-64	69-79	83-96	99-113	
12.0 120-90	25-29	31-36	40-46	51-58	63-72	76-87	90-102	
15.0 120-90	24-27	29-33	37-42	47-54	58-66	70-80	83-94	
18.0+ 120-90	22-25	27-31	35-40	44-50	55-62	66-75	78-89	
21.0 120-90	21-24	26-29	33-38	42-48	52-59	63-71	74-84	
	Flame Length/Feet							
3.0 120-90	7-8	8	9	10	11	12	12-13	
6.0 120-90	6-7	7	8	9	9-10	10-11	11-12	
9.0 120-90	6	6-7	7-8	8	9	9-10	10-11	
12.0 120-90	5-6	6	6-7	7-8	8-9	9	10	
15.0 120-90	5	6	6-7	7	8	8-9	9-10	
18.0+ 120-90	5	5-6	6	7	7-8	8	9	
21.0 120-90	5	5-6	6	6-7	7-8	8	8-9	

TABLE 49: FUEL MODEL 8—0% SLOPE

Fuel Moisture (1-Hour)	Midflame Wind, mi/h						
	0.	2.	4.	6.	8.	10.	12.
	Rate of Spread/Chains per Hour						
3.0	0	1	2	3	5	7	8
6.0	0	1	2	3	4•	5•	5•
9.0	0	1	1	2	3•	3•	3•
12.0	0	0	1	2	3•	3•	3•
15.0	0	0	1	2	2•	2•	2•
18.0	0	0	1	1	2•	2•	2•
21.0	0	0	1	1	2•	2•	2•
	Flame Length/Feet						
3.0	0.5	0.8	1.2	1.5	1.8	2.1	2.2•
6.0	0.4	0.7	1.0	1.2	1.5	1.6•	1.6•
9.0	0.4	0.6	0.8	1.1	1.3•	1.3•	1.3•
12.0	0.3	0.5	0.8	1.0	1.2•	1.2•	1.2•
15.0	0.3	0.5	0.7	0.9	1.1•	1.1•	1.1•
18.0	0.3	0.5	0.7	0.9	1.0•	1.0•	1.0•
21.0	0.3	0.4	0.6	0.8	0.9•	0.9•	0.9•
	•MEANS YOU HIT THE WIND LIMIT.						

TABLE 50: FUEL MODEL 8—30% SLOPE

Fuel Moisture (1-Hour)	Midflame Wind, mi/h						
	0.	2.	4.	6.	8.	10.	12.
	Rate of Spread/Chains per Hour						
3.0	1	1	2	4	5	7	8*
6.0	1	1	2	3	4	5*	5*
9.0	0	1	1	2	3*	3*	3*
12.0	0	1	1	2*	3*	3*	3*
15.0	0	1	1	2*	2*	2*	2*
18.0	0	1	1	2	2*	2*	2*
21.0	0	0	1	1	2*	2*	2*
	Flame Length/Feet						
3.0	0.7	1.0	1.3	1.6	1.9	2.1	2.2*
6.0	0.6	0.8	1.0	1.3	1.5	1.6*	1.6*
9.0	0.5	0.7	0.9	1.1	1.3*	1.3*	1.3*
12.0	0.5	0.6	0.8	1.0	1.2*	1.2*	1.2*
15.0	0.4	0.6	0.8	1.0	1.1*	1.1*	1.1*
18.0	0.4	0.6	0.7	0.9	1.0*	1.0*	1.0*
21.0	0.4	0.5	0.7	0.8	0.9*	0.9*	0.9*
	*MEANS YOU HIT THE WIND LIMIT.						

TABLE 51: FUEL MODEL 8—45% SLOPE

Fuel Moisture (1-Hour)	Midflame Wind, mi/h						
	0.	2.	4.	6.	8.	10.	12.
	Rate of Spread/Chains per Hour						
3.0	1	2	3	4	6	8•	8•
6.0	1	1	2	3	5	5•	5•
9.0	1	1	2	3•	3•	3•	3•
12.0	1	1	2	2	3•	3•	3•
15.0	1	1	1	2•	2•	2•	2•
18.0	1	1	1	2•	2•	2•	2•
21.0	0	1	1	2•	2•	2•	2•
	Flame Length/Feet						
3.0	0.9	1.1	1.4	1.7	1.9	2.2•	2.2•
6.0	0.8	0.9	1.1	1.4	1.6•	1.6•	1.6•
9.0	0.7	0.8	1.0	1.2	1.3•	1.3•	1.3•
12.0	0.6	0.7	0.9	1.1	1.2•	1.2•	1.2•
15.0	0.6	0.7	0.9	1.0	1.1•	1.1•	1.1•
18.0	0.5	0.6	0.8	1.0•	1.0•	1.0•	1.0•
21.0	0.5	0.6	0.7	0.9•	0.9•	0.9•	0.9•
	•MEANS YOU HIT THE WIND LIMIT.						

TABLE 52: FUEL MODEL 8—60% SLOPE

Fuel Moisture (1-Hour)	Midflame Wind, mi/h						
	0.	2.	4.	6.	8.	10.	12.
	Rate of Spread/Chains per Hour						
3.0	2	3	4	5	7	8•	8•
6.0	1	2	3	4	5•	5•	5•
9.0	1	2	2	3•	3•	3•	3•
12.0	1	1	2	3•	3•	3•	3•
15.0	1	1	2•	2•	2•	2•	2•
18.0	1	1	2•	2•	2•	2•	2•
21.0	1	1	1	2•	2•	2•	2•
	Flame Length/Feet						
3.0	1.2	1.3	1.5	1.8	2.1	2.2•	2.2•
6.0	0.9	1.1	1.3	1.5	1.6•	1.6•	1.6•
9.0	0.8	0.9	1.1	1.3•	1.3•	1.3•	1.3•
12.0	0.7	0.8	1.0	1.2•	1.2•	1.2•	1.2•
15.0	0.7	0.8	0.9	1.1•	1.1•	1.1•	1.1•
18.0	0.7	0.8	0.9	1.0•	1.0•	1.0•	1.0•
21.0	0.6	0.7	0.8	0.9•	0.9•	0.9•	0.9•
	•MEANS YOU HIT THE WIND LIMIT.						

TABLE 53: FUEL MODEL 8—90% SLOPE

Fuel Moisture (1-Hour)	Midflame Wind, mi/h						
	0.	2.	4.	6.	8.	10.	12.
	Rate of Spread/Chains per Hour						
3.0	4	5	6	7	8•	8•	8•
6.0	3	3	4	5•	5•	5•	5•
9.0	2	3•	3•	3•	3•	3•	3•
12.0	2	2	3•	3•	3•	3•	3•
15.0	2	2•	2•	2•	2•	2•	2•
18.0	2•	2•	2•	2•	2•	2•	2•
21.0	1	2•	2•	2•	2•	2•	2•
	Flame Length/Feet						
3.0	1.6	1.7	1.9	2.1	2.2•	2.2•	2.2•
6.0	1.3	1.4	1.5	1.6	1.6•	1.6•	1.6•
9.0	1.1	1.2	1.3•	1.3•	1.3•	1.3•	1.3•
12.0	1.0	1.1	1.2•	1.2•	1.2•	1.2•	1.2•
15.0	1.0	1.0	1.1•	1.1•	1.1•	1.1•	1.1•
18.0	0.9	1.0•	1.0•	1.0•	1.0•	1.0•	1.0•
21.0	0.9	0.9•	0.9•	0.9•	0.9•	0.9•	0.9•
	•MEANS YOU HIT THE WIND LIMIT.						

TABLE 54: FUEL MODEL 9—0% SLOPE

Fuel Moisture (1-Hour)	Midflame Wind, mi/h						
	0.	2.	4.	6.	8.	10.	12.
	Rate of Spread/Chains per Hour						
3.0	1	3	8	16	25	36	49
6.0	1	2	6	12	19	27	37
9.0	1	2	5	10	15	22	30
12.0	1	2	4	8	13	19	26
15.0	1	2	4	7	12	17	23
18.0	0	1	3	6	10	14	19
21.0	0	1	2	4	7	10	13
	Flame Length/Feet						
3.0	1.3	2.1	3.2	4.2	5.2	6.2	7.1
6.0	1.0	1.6	2.5	3.4	4.2	4.9	5.7
9.0	0.9	1.4	2.2	2.9	3.6	4.3	5.0
12.0	0.8	1.3	2.0	2.7	3.4	4.0	4.6
15.0	0.8	1.2	1.9	2.5	3.1	3.7	4.3
18.0	0.7	1.1	1.7	2.2	2.7	3.3	3.7
21.0	0.5	0.8	1.2	1.6	2.0	2.4	2.7

TABLE 55: FUEL MODEL 9—30% SLOPE

Fuel Moisture (1-Hour)	Midflame Wind, mi/h						
	0.	2.	4.	6.	8.	10.	12.
	Rate of Spread/Chains per Hour						
3.0	3	5	10	17	27	38	51
6.0	2	4	7	13	20	28	38
9.0	2	3	6	11	16	23	31
12.0	1	3	5	9	14	20	27
15.0	1	2	5	8	13	18	24
18.0	1	2	4	7	11	15	20
21.0	1	1	3	5	7	10	14
	Flame Length/Feet						
3.0	1.9	2.5	3.4	4.4	5.4	6.3	7.2
6.0	1.5	2.0	2.7	3.5	4.3	5.0	5.8
9.0	1.3	1.7	2.4	3.1	3.7	4.4	5.0
12.0	1.2	1.6	2.2	2.8	3.5	4.1	4.7
15.0	1.1	1.5	2.1	2.6	3.2	3.8	4.3
18.0	1.0	1.3	1.8	2.3	2.8	3.3	3.8
21.0	0.7	1.0	1.3	1.7	2.1	2.4	2.8

TABLE 56: FUEL MODEL 9—45% SLOPE

Fuel Moisture (1-Hour)	Midflame Wind, mi/h						
	0.	2.	4.	6.	8.	10.	12.
	Rate of Spread/Chains per Hour						
3.0	5	7	12	19	29	40	53
6.0	4	5	9	14	21	30	39
9.0	3	4	7	12	17	24	32
12.0	3	4	6	10	15	21	28
15.0	2	3	6	9	14	19	25
18.0	2	3	5	8	11	16	21
21.0	1	2	3	5	8	11	14
	Flame Length/Feet						
3.0	2.4	2.9	3.7	4.6	5.6	6.5	7.4
6.0	1.9	2.3	3.0	3.7	4.4	5.2	5.9
9.0	1.7	2.0	2.6	3.2	3.9	4.5	5.1
12.0	1.6	1.9	2.4	3.0	3.6	4.2	4.7
15.0	1.5	1.7	2.2	2.8	3.3	3.9	4.4
18.0	1.3	1.5	2.0	2.4	2.9	3.74	3.9
21.0	0.9	1.1	1.4	1.8	2.2	2.5	2.8

TABLE 57: FUEL MODEL 9—60% SLOPE

Fuel Moisture (1-Hour)	Midflame Wind, mi/h						
	0.	2.	4.	6.	8.	10.	12.
	Rate of Spread/Chains per Hour						
3.0	8	10	15	22	32	43	56
6.0	6	7	11	16	23	32	41
9.0	5	6	9	14	19	26	34
12.0	4	5	8	12	17	23	30
15.0	4	5	7	11	15	20	26
18.0	3	4	6	9	12	17	22
21.0	2	3	4	6	9	12	15
	Flame Length/Feet						
3.0	3.0	3.4	4.1	4.9	5.8	6.7	7.5
6.0	2.4	2.7	3.3	3.9	4.6	5.3	6.0
9.0	2.1	2.4	2.9	3.4	4.0	4.6	5.2
12.0	1.9	2.2	2.6	3.2	3.7	4.3	4.9
15.0	1.8	2.0	2.5	3.0	3.5	4.0	4.5
18.0	1.6	1.8	2.2	2.6	3.0	3.5	4.0
21.0	1.2	1.3	1.6	1.9	2.2	2.6	2.9

TABLE 58: FUEL MODEL 9—90% SLOPE

Fuel Moisture (1-Hour)	Midflame Wind, mi/h						
	0.	2.	4.	6.	8.	10.	12.
	Rate of Spread/Chains per Hour						
3.0	16	18	23	30	40	51	64
6.0	12	13	17	22	29	38	47
9.0	10	11	14	18	24	31	39
12.0	8	10	12	16	21	27	34
15.0	7	9	11	14	19	24	30
18.0	6	7	9	12	16	20	25
21.0	4	5	6	8	11	14	17*
	Flame Length/Feet						
3.0	4.2	4.5	5.0	5.7	6.5	7.2	8.0
6.0	3.4	3.6	4.0	4.5	5.1	5.8	6.4
9.0	2.9	3.1	3.5	4.0	4.5	5.0	5.6
12.0	2.7	2.9	3.2	3.7	4.2	4.7	5.2
15.0	2.5	2.7	3.0	3.4	3.9	4.3	4.8
18.0	2.2	2.3	2.6	3.0	3.4	3.8	4.2
21.0	1.6	1.7	1.9	2.2	2.5	2.8	3.0*
	*MEANS YOU HIT THE WIND LIMIT.						

TABLE 59: FUEL MODEL 10—0% SLOPE

Fuel Moisture % (1-Hour)	Midflame Wind, mi/h						
	0.	2.	4.	6.	8.	10.	12.
	Rate of Spread/Chains per Hour						
3.0 120-90	1	4	8	11-13	16-20	22-27	28-35
6.0 120-90	1	3	7	9-12	14-17	19-23	24-30
9.0 120-90	1	3	6	9-10	13-15	17-21	22-27
12.0 120-90	1	3	6	8-10	12-14	16-19	21-25
15.0 120-90	1	2	5	9	11-13	15-18	19-23
18.0+ 120-90	1	2	5	8	10-12	14-16	18-21
21.0 120-90	0	2	4	6	8-10	11-13	14-17
	Flame Length/Feet						
3.0 120-90	2.0	3.5	5.0	6.4	7.7	8.9	10.0
6.0 120-90	1.7	3.1	4.5	5.6	6.8	7.8	8.9
9.0 120-90	1.6	2.9	4.2	5.3	6.2	7.2	8.2
12.0 120-90	1.5	2.7	4.0	5.1	6.0	6.9	7.8
15.0 120-90	1.5	2.6	3.8	4.8	5.7	6.6	7.5
18.0+ 120-90	1.4	2.4	3.5	4.4	5.3	6.0	6.8
21.0 120-90	1.2	2.0	2.9	3.7	4.4	5.1	5.8

TABLE 60: FUEL MODEL 10—30% SLOPE

Fuel Moisture % (1-Hour)	Midflame Wind, mi/h							
	0.	2.	4.	6.	8.	10.	12.	
	Rate of Spread/Chains per Hour							
3.0 120-90	3	5	8-10	12-15	18-21	23-29	30-36	
6.0 120-90	2	4	8	11-13	15-18	20-24	26-31	
9.0 120-90	2	4	7	10-12	14-17	18-22	23-28	
12.0 120-90	2	3	6	9-11	13-15	17-20	22-26	
15.0 120-90	2	3	6	8-10	12-14	16-19	20-24	
18.0+ 120-90	2	3	5	8	11-13	15-17	19-20	
21.0 120-90	1	2	4	7	8-11	11-14	14-18	
	Flame Length/Feet							
3.0 120-90	3.0	4.2	5.6	6.8	8.0	9.2	10.3	
6.0 120-90	2.7	3.7	4.9	6.0	7.1	8.1	9.0	
9.0 120-90	2.5	3.4	4.5	5.6	6.6	7.5	8.3	
12.0 120-90	2.3	3.2	4.3	5.3	6.2	7.0	7.9	
15.0 120-90	2.2	3.0	4.1	5.0	5.9	6.7	7.5	
18.0+ 120-90	2.1	2.8	3.8	4.7	5.5	6.2	7.0	
21.0 120-90	1.7	2.4	3.2	3.9	4.6	5.3	5.9	

TABLE 61: FUEL MODEL 10—45% SLOPE

Fuel Moisture % (1-Hour)		Midflame Wind, mi/h						
		0.	2.	4.	6.	8.	10.	12.
		Rate of Spread/Chains per Hour						
3.0	120-90	5	7	9-12	14-17	19-23	25-31	31-38
6.0	120-90	4	6	8-10	12-15	16-20	21-26	27-33
9.0	120-90	4	6	7-9	11-13	15-18	19-23	24-29
12.0	120-90	3	5	8	10-12	14-17	18-22	23-27
15.0	120-90	3	5	6-8	11	13-16	17-20	21-25
18.0+	120-90	3	4	7	10	13-14	16-18	20-23
21.0	120-90	2	4	6	7-9	9-12	12-15	15-19
		Flame Length/Feet						
3.0	120-90	3.9	4.8	6.0	7.2	8.3	9.3	10.4
6.0	120-90	3.4	4.2	5.3	6.3	7.3	8.3	9.1
9.0	120-90	3.2	3.9	4.9	5.8	6.8	7.6	8.4
12.0	120-90	3.0	3.7	4.6	5.5	6.4	7.2	8.0
15.0	120-90	2.9	3.6	4.4	5.3	6.1	6.9	7.6
18.0+	120-90	2.7	3.3	4.1	4.9	5.7	6.4	7.1
21.0	120-90	2.2	2.7	3.4	4.0	4.7	5.3	5.9

TABLE 62: FUEL MODEL 10—60% SLOPE

Fuel Moisture % (1-Hour)		Midflame Wind, mi/h						
		0.	2.	4.	6.	8.	10.	12.
		Rate of Spread/Chains per Hour						
3.0	120-90	7	8-10	12-14	16-20	21-26	27-33	34-41
6.0	120-90	6	8	10-12	14-17	18-22	23-28	29-35
9.0	120-90	6	6-8	9-11	13-15	17-20	21-26	26-32
12.0	120-90	5	7	10	12-14	16-19	20-24	24-29
15.0	120-90	5	7	9	11-13	15-17	19-22	23-27
18.0+	120-90	4	6	7-9	10-12	13-16	17-20	21-25
21.0	120-90	4	5	7	8-10	10-13	12-17	16-20
		Flame Length/Feet						
3.0	120-90	4.9	5.6	6.6	7.6	8.7	9.7	10.7
6.0	120-90	4.3	2.9	5.8	6.8	7.7	8.6	9.4
9.0	120-90	3.9	4.6	5.4	6.3	7.1	7.9	8.7
12.0	120-90	3.8	4.3	5.1	5.9	6.7	7.5	8.3
15.0	120-90	3.6	4.1	4.9	5.7	6.4	7.2	7.9
18.0+	120-90	3.3	3.8	4.5	5.2	6.0	6.7	7.3
21.0	120-90	2.7	3.2	3.8	4.4	5.0	5.5	6.1

TABLE 63: FUEL MODEL 10—90% SLOPE

Fuel Moisture % (1-Hour)	Midflame Wind, mi/h						
	0.	2.	4.	6.	8.	10.	12.
	Rate of Spread/Chains per Hour						
3.0 120-90	13-15	15-18	18-22	23-28	28-34	34-41	40-49
6.0 120-90	11-13	13-15	16-19	20-24	24-29	29-35	34-42
9.0 120-90	10-12	11-14	14-17	18-21	22-26	26-32	31-38
12.0 120-90	9-11	11-13	13-16	17-21	20-24	25-29	29-35
15.0 120-90	10	10-12	12-15	16-18	19-23	23-27	27-32
18.0+ 120-90	9	9-11	11-13	14-17	17-20	21-25	25-29
21.0 120-90	6-8	7-9	9-11	11-14	13-17	16-21	19-24
	Flame Length/Feet						
3.0 120-90	6.8	7.3	8.1	9.0	9.8	10.7	11.6
6.0 120-90	6.0	6.5	7.1	7.9	8.7	9.4	10.3
9.0 120-90	5.5	5.9	6.6	7.3	8.0	8.8	9.4
12.0 120-90	5.3	5.7	6.2	6.9	7.6	8.3	9.0
15.0 120-90	5.0	5.4	6.0	6.6	7.2	7.9	8.6
18.0+ 120-90	4.6	5.0	5.5	6.1	6.7	7.3	7.9
21.0 120-90	3.9	4.1	4.6	5.1	5.6	6.1	6.6

TABLE 64: FUEL MODEL 11—0% SLOPE

Fuel Moisture (1-Hour)	Midflame Wind, mi/h						
	0.	2.	4.	6.	8.	10.	12.
	Rate of Spread/Chains per Hour						
3.0	1	3	6	9	12	16	19
6.0	1	2	5	7	10	13	16
9.0	0	2	4	6	9	11	14
12.0	0	2	3	5	7	9	11
15.0	0	1	2	3	4	•5	•5
18.0+	0	0	0	0	0	0	0
	Flame Length/Feet						
3.0	1.3	2.6	3.6	4.3	5.0	5.6	6.1
6.0	1.2	2.3	3.1	3.8	4.4	4.9	5.4
9.0	1.1	2.1	2.9	3.5	4.0	4.5	5.0
12.0	0.9	1.8	2.4	2.9	3.4	3.8	4.2
15.0	0.5	1.0	1.4	1.7	1.9	2.2	•2.3
18.0+	0.0	0.0	0.0	0.0	0.0	0.0	0.0
	• MEANS YOU HIT THE WIND LIMIT.						

TABLE 65: FUEL MODEL 11—30% SLOPE

Fuel Moisture (1-Hour)	Midflame Wind, mi/h						
	0.	2.	4.	6.	8.	10.	12.
	Rate of Spread/Chains per Hour						
3.0	2	4	7	10	13	17	20
6.0	1	3	6	8	11	14	17
9.0	1	3	5	7	10	12	15
12.0	1	2	4	6	8	10	12
15.0	1	1	2	3	4	•5	•5
18.0+	0	0	0	0	0	0	0
	Flame Length/Feet						
3.0	2.1	3.0	3.8	4.6	5.2	5.8	6.3
6.0	1.8	2.7	3.4	4.0	4.6	5.1	5.5
9.0	1.7	2.4	3.1	3.7	4.2	4.7	5.1
12.0	1.4	2.1	2.6	3.1	3.5	3.9	4.3
15.0	0.8	1.2	1.5	1.8	2.0	2.2	•2.3
18.0+	0.0	0.0	0.0	0.0	0.0	0.0	0.0
	•MEANS YOU HIT THE WIND LIMIT.						

TABLE 66: FUEL MODEL 11—45% SLOPE

Fuel Moisture (1-Hour)	Midflame Wind, mi/h						
	0.	2.	4.	6.	8.	10.	12.
	Rate of Spread/Chains per Hour						
3.0	3	6	8	11	15	18	22
6.0	3	5	7	9	12	15	18
9.0	2	4	6	8	11	13	16
12.0	2	3	5	7	8	10	12
15.0	1	2	3	3	4	•5	•5
18.0+	0	0	0	0	0	0	0
	Flame Length/Feet						
3.0	2.7	3.5	4.2	4.8	5.4	6.0	6.5
6.0	2.4	3.0	3.7	4.2	4.8	5.2	5.7
9.0	2.2	2.8	3.4	3.9	4.4	4.8	5.2
12.0	1.8	2.4	2.9	3.3	3.7	4.1	4.4
15.0	1.0	1.3	1.6	1.9	2.1	•2.3	•2.3
18.0+	0.0	0.0	0.0	0.0	0.0	0.0	0.0
	•MEANS YOU HIT THE WIND LIMIT.						

TABLE 67: FUEL MODEL 11—60% SLOPE

Fuel Moisture (1-Hour)	Midflame Wind, mi/h						
	0.	2.	4.	6.	8.	10.	12.
	Rate of Spread/Chains per Hour						
3.0	5	7	10	13-	17	20	24
6.0	4	6	9	11-	14	17	19
9.0	4	5	7	10	12	14	17
12.0	3	4	6	8	10	11	13
15.0	2	2	3	4	•5	•5	•5
18.0+	0	0	0	0	0	0	0
	Flame Length/Feet						
3.0	3.3	4.0	4.6	5.2	5.7	6.3	6.7
6.0	2.9	3.5	4.0	4.6	5.0	5.5	5.9
9.0	2.7	3.2	3.7	4.2	4.7	5.1	5.5
12.0	2.3	3.7	3.1	3.5	3.9	4.3	4.6
15.0	1.3	1.5	1.8	2.0	2.2	•2.3	•2.3
18.0+	0.0	0.0	0.0	0.0	0.0	0.0	0.0
	•MEANS YOU HIT THE WIND LIMIT.						

TABLE 68: FUEL MODEL 11—90% SLOPE

Fuel Moisture (1-Hour)	Midflame Wind, mi/h						
	0.	2.	4.	6.	8.	10.	12.
	Rate of Spread/Chains per Hour						
3.0	11	13	16	19	22	26	29
6.0	9	11	13	16	18	21	24
9.0	8	9	11	14	16	18	21
12.0	6	7	9	11	13	15	17
15.0	3	4	•5	•5	•5	•5	•5
18.0+	0	0	0	0	0	0	0
	Flame Length/Feet						
3.0	4.7	5.1	5.6	6.1	6.6	7.0	7.4
6.0	4.1	4.5	4.9	5.4	5.8	6.1	6.5
9.0	3.8	4.1	4.5	4.9	5.3	5.7	6.0
12.0	3.2	3.5	3.8	4.2	4.5	4.8	5.1
15.0	1.8	2.0	2.2	•2.3	•2.3	2.3•	•2.3
18.0+	0.0	0.0	0.0	0.0	0.0	0.0	0.0
	•MEANS YOU HIT THE WIND LIMIT.						

TABLE 69: FUEL MODEL 12—0% SLOPE

Fuel Moisture (1-Hour)	Midflame Wind, mi/h						
	0.	2.	4.	6.	8.	10.	12.
	Rate of Spread/Chains per Hour						
3.0	2	7	13	20	27	34	42
6.0	1	6	11	16	22	27	33
9.0	1	5	9	14	19	24	29
12.0	1	4	8	12	17	21	26
15.0	1	4	7	11	15	19	23
18.0	1	3	6	8	11	15	18
21.0	0	2	3	5	7	9	11
	Flame Length/Feet						
3.0	3.3	6.3	8.5	10.3	11.8	13.2	14.4
6.0	2.8	5.4	7.3	8.8	10.1	11.3	12.4
9.0	2.6	5.0	6.7	8.1	9.3	10.3	11.3
12.0	2.4	4.7	6.3	7.6	8.7	9.7	10.6
15.0	2.2	4.3	5.7	6.9	7.9	8.9	9.7
18.0	1.9	3.5	4.7	5.7	6.6	7.4	8.1
21.0	1.2	2.3	3.1	3.7	4.2	4.7	5.2

TABLE 70: FUEL MODEL 12—30% SLOPE

Fuel Moisture (1-Hour)	Midflame Wind, mi/h						
	0.	2.	4.	6.	8.	10.	12.
	Rate of Spread/Chains per Hour						
3.0	4	9	16	22	29	37	44
6.0	3	8	13	18	24	29	35
9.0	3	7	11	16	21	26	31
12.0	3	6	10	14	18	23	27
15.0	2	5	9	12	16	20	24
18.0	2	4	7	10	13	16	19
21.0	1	2	4	8	8	9	11
	Flame Length/Feet						
3.0	5.1	7.3	9.2	10.9	12.3	13.6	14.8
6.0	4.3	6.3	7.9	9.3	10.6	11.7	12.7
9.0	4.0	5.7	7.2	8.5	9.7	10.7	11.6
12.0	3.7	5.4	6.8	8.0	9.1	10.0	10.9
15.0	3.4	4.9	6.2	7.3	8.3	9.2	10.1
18.0	2.8	4.1	5.2	6.1	6.9	7.6	8.3
21.0	1.8	2.6	3.3	3.9	4.4	4.9	5.3

TABLE 71: FUEL MODEL 12—45% SLOPE

Fuel Moisture (1-Hour)	Midflame Wind, mi/h						
	0.	2.	4.	6.	8.	10.	12.
	Rate of Spread/Chains per Hour						
3.0	7	13	19	26	33	40	47
6.0	6	10	15	21	26	32	38
9.0	5	9	13	18	23	28	33
12.0	5	8	12	16	20	25	29
15.0	4	7	10	14	18	22	26
18.0	3	5	8	11	14	17	20
21.0	2	3	5	7	8	10	12
	Flame Length/Feet						
3.0	6.5	8.3	10.0	11.5	12.9	14.1	15.3
6.0	5.6	7.2	8.6	9.9	11.1	12.1	13.1
9.0	5.1	6.6	7.9	9.1	10.0	11.1	12.0
12.0	4.8	6.2	7.4	8.5	9.5	10.4	11.3
15.0	4.4	5.6	6.8	7.8	8.7	9.5	10.3
18.0	3.6	4.7	5.6	6.4	7.2	7.9	8.5
21.0	2.3	3.0	3.6	4.1	4.6	5.1	5.5

TABLE 72: FUEL MODEL 12—60% SLOPE

Fuel Moisture (1-Hour)	Midflame Wind, mi/h						
	0.	2.	4.	6.	8.	10.	12.
	Rate of Spread/Chains per Hour						
3.0	12	17	23	30	37	44	52
6.0	10	14	19	24	30	36	42
9.0	8	12	16	21	26	31	36
12.0	7	11	15	19	23	28	32
15.0	6	9	13	16	20	24	28
18.0	5	7	10	13	16	19	22
21.0	3	4	6	8	9	11	13
	Flame Length/Feet						
3.0	8.1	9.5	11.1	12.4	13.7	14.9	16.0
6.0	7.0	8.2	9.5	10.7	11.7	12.7	13.7
9.0	6.4	7.5	8.7	9.8	10.7	11.7	12.5
12.0	6.0	7.1	8.2	9.2	10.1	10.9	11.8
15.0	5.5	6.5	7.4	8.4	9.2	10.0	10.7
18.0	4.5	5.4	6.2	6.9	7.6	8.3	8.9
21.0	2.9	3.4	4.0	4.5	4.9	5.3	5.7

TABEL 73: FUEL MODEL 12—90% SLOPE

Fuel Moisture (1-Hour)	Midflame Wind, mi/h						
	0.	2.	4.	6.	8.	10.	12.
	Rate of Spread/Chains per Hour						
3.0	25	30	36	43	50	57	64
6.0	20	24	29	34	40	46	52
9.0	17	21	25	30	35	40	45
12.0	15	19	23	27	31	36	40
15.0	13	16	20	23	27	31	35
18.0	11	13	15	18	21	24	28
21.0	6	8	9	11	13	15	17
	Flame Length/Feet						
3.0	11.3	12.4	13.5	14.6	15.7	16.7	17.7
6.0	9.7	10.6	11.6	12.5	13.4	14.3	15.1
9.0	8.9	9.7	10.6	11.5	12.3	13.1	13.9
12.0	8.4	9.1	10.0	10.8	11.6	12.3	13.0
15.0	7.6	8.3	9.1	9.8	10.5	11.2	11.9
18.0	6.3	6.9	7.5	8.2	8.8	9.3	9.9
21.0	4.1	4.5	4.9	5.3	5.6	6.0	6.3

TABLE 74: FUEL MODEL 13—0% SLOPE

Fuel Moisture (1-Hour)	Midflame Wind, mi/h						
	0.	2.	4.	6.	8.	10.	12.
	Rate of Spread/Chains per Hour						
3.0	2	9	16	24	33	42	51
6.0	2	7	13	19	26	33	40
9.0	2	6	11	16	22	28	34
12.0	1	5	10	14	20	25	30
15.0	1	5	9	13	18	22	27
18.0	1	4	8	12	16	20	24
21.0	1	3	6	9	13	17	21
	Flame Length/Feet						
3.0	4.6	8.4	11.2	13.5	15.5	17.3	18.9
6.0	3.9	7.1	9.5	11.5	13.2	14.7	16.1
9.0	3.5	6.4	8.5	10.3	11.8	13.2	14.4
12.0	3.2	5.9	7.9	9.6	11.0	12.3	13.4
15.0	3.1	5.6	7.5	9.0	10.4	11.6	12.7
18.0	2.9	5.2	7.0	8.5	9.7	10.8	11.9
21.0	2.6	4.7	6.3	7.6	8.7	9.7	10.6

TABLE 75: FUEL MODEL 13—30% SLOPE

Fuel Moisture (1-Hour)	Midflame Wind, mi/h						
	0.	2.	4.	6.	8.	10.	12.
	Rate of Spread/Chains per Hour						
3.0	6	12	19	27	36	45	54
6.0	4	9	15	22	29	36	43
9.0	4	8	13	18	24	30	36
12.0	3	7	12	16	21	27	32
15.0	3	6	10	15	19	24	29
18.0	3	6	9	13	17	22	26
21.0	2	5	8	11	15	19	22
	Flame Length/Feet						
3.0	6.8	9.7	12.2	14.3	16.2	17.9	19.5
6.0	5.8	8.2	10.3	12.1	13.7	15.2	16.5
9.0	5.2	7.4	9.2	10.9	12.3	13.6	14.8
12.0	4.8	6.9	8.6	10.1	11.5	12.7	13.8
15.0	4.6	6.5	8.2	9.6	10.8	12.0	13.1
18.0	4.3	6.1	7.6	9.0	10.1	11.2	12.2
21.0	3.8	5.4	6.8	8.0	9.1	10.0	10.9

TABLE 76: FUEL MODEL 13—45% SLOPE

Fuel Moisture (1-Hour)	Midflame Wind, mi/h						
	0.	2.	4.	6.	8.	10.	12.
	Rate of Spread/Chains per Hour						
3.0	10	16	23	31	40	49	58
6.0	8	13	19	25	32	39	46
9.0	6	11	16	21	27	33	39
12.0	6	9	14	19	24	29	35
15.0	5	9	13	17	22	26	31
18.0	5	8	11	15	19	24	28
21.0	4	7	10	13	17	20	24
	Flame Length/Feet						
3.0	8.8	11.1	13.3	15.2	17.0	18.6	20.1
6.0	7.5	9.4	11.3	12.9	14.4	15.8	17.1
9.0	6.7	8.4	10.1	11.6	12.9	14.2	15.3
12.0	6.2	7.9	9.4	10.8	10.8	13.2	14.3
15.0	5.9	7.4	8.9	10.2	11.4	12.5	13.5
18.0	5.5	6.9	8.3	9.5	10.6	11.7	12.6
21.0	4.9	6.2	7.4	8.5	9.5	10.4	11.3

TABLE 77: FUEL MODEL 13—60% SLOPE

Fuel Moisture (1-Hour)	Midflame Wind, mi/h						
	0.	2.	4.	6.	8.	10.	12.
	Rate of Spread/Chains per Hour						
3.0	15	21	29	37	46	54	63
6.0	12	17	23	29	36	43	50
9.0	10	14	19	25	31	37	43
12.0	9	13	17	22	27	32	38
15.0	8	12	16	20	25	29	34
18.0	7	10	14	18	22	26	31
21.0	6	9	12	15	19	23	26
	Flame Length/Feet						
3.0	10.9	12.8	14.7	16.4	18.1	19.6	21.0
6.0	9.2	10.8	12.4	13.9	15.3	16.6	17.8
9.0	8.3	9.7	11.1	12.5	13.7	14.9	16.0
12.0	7.7	9.0	10.4	11.6	12.8	13.9	14.9
15.0	7.3	8.5	9.8	11.0	12.1	13.1	14.1
18.0	6.8	8.0	9.2	10.3	11.3	12.3	13.2
21.0	6.1	7.1	8.2	9.2	10.1	11.0	11.8

TABLE 78: FUEL MODEL 13—90% SLOPE

Fuel Moisture (1-Hour)	Midflame Wind, mi/h						
	0.	2.	4.	6.	8.	10.	12.
	Rate of Spread/Chains per Hour						
3.0	31	37	45	53	62	70	79
6.0	25	30	36	42	49	56	63
9.0	21	25	30	36	41	47	53
12.0	19	22	27	32	37	42	47
15.0	17	20	24	29	33	38	43
18.0	115	18	22	26	30	34	38
21.0	13	16	19	22	26	29	33
	Flame Length/Feet						
3.0	15.2	16.5	17.9	9.4	20.7	22.1	23.3
6.0	12.9	14.0	15.2	16.4	17.6	18.7	19.8
9.0	11.5	12.5	13.6	14.7	15.8	16.8	17.7
12.0	10.7	11.7	12.7	13.7	14.7	15.6	16.5
15.0	10.2	11.1	12.0	13.0	13.9	14.8	15.6
18.0	9.5	10.3	11.2	12.1	13.0	13.8	14.6
21.0	8.5	9.2	10.1	10.9	11.6	12.4	13.1

