

UNITED STATES DEPARTMENT OF AGRICULTURE
Rural Utilities Service

BULLETIN 1751F-643

SUBJECT: Underground Plant Design

TO: All Telecommunications Borrowers
RUS Telecommunications Staff

EFFECTIVE DATE: August 28, 2002

OFFICE OF PRIMARY INTEREST: Outside Plant Branch,
Telecommunications Standards Division

INSTRUCTIONS: This bulletin supersedes RUS Bulletin 1751F-643,
"Underground Plant Design," issued May 14, 1998.

AVAILABILITY: This bulletin is available on the Internet at
<http://www.usda.gov/rus/telecom/publications/bulletins.htm>

PURPOSE: This bulletin provides RUS borrowers, consulting
engineers, contractors and other interested parties with
information on the design and construction of underground plant
facilities. This bulletin also provides information on the
design of poured-in-place underground cable vaults.

Roberta D. Purcell
Roberta D. Purcell
Assistant Administrator
Telecommunications Program

8/28/02
Date

TABLE OF CONTENTS

Abbreviations	4
Definitions	4
1. General	7
2. Application	8
3. Construction Materials	11
4. Conduit Types and Usage	11
5. Conduit Formations and Curves	13
6. Conduit Section Lengths	14
7. Conduit Protection	15
8. UCV Types	15
9. Cable Racks, Rack Supports, and Pulling Irons	22
10. UCV and Conduit Locations	24
11. Determination of Installation Length and Pulling Tension of Filled Copper Cables	25
12. Determination of Installation Length and Pulling Tension of Filled Fiber Optic Cables	28
13. Design Considerations	29

TABLES & FIGURES

Table 1	Conduit Formations	14
Table 2	Minimum Headroom - Poured-In-Place UCVs	16
Table 3	Floor Thicknesses and Reinforcing Rod Spacings Rectangular Poured-In-Place UCVs in Fluid Soils	17
Table 4	Floor Thicknesses and Reinforcing Rod Spacings Type UM-V Poured-In-Place UCVs in Fluid Soils	17
Table 5	Wall Construction - Poured-In-Place UCVs in Firm Soils	19
Table 6	Wall Construction - Poured-In-Place UCVs in Fluid Soils	20
Table 7	Roof Thicknesses and Reinforcing Rod Diameters Rectangular Poured-In-Place UCVs	21
Table 8	Roof Thicknesses and Reinforcing Rod Diameters Type UM-V Poured-In-Place UCVs	21
Table 9	UCV Opening Forms for UCV Frame Types and Sizes Poured-In-Place UCVs	21
Table 10	Number and Size of Cable Racks Versus Headroom Poured-In-Place UCVs	23
Table 11	Coefficient of Friction Conduit Versus Cable Jacket Material	25

TABLES & FIGURES - Continued

Table 12	Cross-sectional Area of Copper Conductors	27
Figure 1	Overall Design Layout - Poured-In-Place UCVs	31
Figure 2	Floor Construction Poured-In-Place UCVs In Fluid Soils	32
Figure 3	Sump and Drain Construction Poured-In-Place UCVs	33
Figure 4	Wall Construction - Poured-In-Place UCVs	34
Figure 5	Roof Construction - Poured-In-Place UCVs	35
Figure 6	Conduit Entrances and Recesses Poured-In-Place UCVs	36
Figure 7	Frame and Cover Types - Poured-In-Place UCVs	37
Figure 8	Brick Collar Construction - Poured-In-Place UCVs .	38
Figure 9	Typical Installation of Cable Racks Poured-In-Place UCVs	39
Figure 10	Arrangement and Installation of Pulling-In Irons Poured-In-Place UCVs	40
Figure 11	Example of Underground Cable Vault and Conduit Route Construction Drawing	41
Figure 12	Underground Plant Construction Abbreviations and Symbols	42
Figure 12A	Underground Plant Construction Abbreviations and Symbols (Continued)	43
Figure 12B	Underground Plant Construction Abbreviations and Symbols (Continued)	44
Figure 12C	Underground Plant Construction Abbreviations and Symbols (Continued)	45
Figure 13	Example of Underground Filled Copper Cable Installation in a Conduit and UCV System Containing Multiple Bends	46
Figure 13A	Example of Underground Filled Copper Cable Installation in a Conduit and UCV System Containing Multiple Bends (Continued)	47

TABLES & FIGURES - Continued

Figure 13B Example of Underground Filled Copper Cable Installation in a Conduit and UCV System Containing Multiple Bends (Continued) 48

Figure 14 Example of Determining the Cable Sidewall Pressure at Conduit Bends in a Conduit and UCV System 49

Figure 14A Example of Determining the Cable Sidewall Pressure at Conduit Bends in a Conduit and UCV System (Continued) 50

INDEX:

Outside Plant
Design, Underground
Telecommunications

ABBREVIATIONS

AWG	American Wire Gauge
CFR	Code of Federal Regulations
cm	Centimeters
ft	Foot or Feet
in.	Inches
kgs	Kilograms
kgs/m	Kilograms per meter
kgs/mm ²	Kilograms per square millimeter
lbs	Pounds
lbs/ft	Pounds per foot
LD	Loan Design
m	Meter
mm	Millimeters
mm ²	Square Millimeters
R/W	Rights-of-way
RUS	Rural Utilities Service
SAVE	Serving Area Value Engineering
TE&CM	Telecommunications Engineering and Construction Manual
UCV	Underground Cable Vault
UCVS	Underground Cable Vaults
UM	Underground Manhole

DEFINITIONS

Cable Rack: A device usually secured to the wall of an underground cable vault, cable raceway, or building to provide support for cables.

Conduit: A tubular raceway for holding wires or cables, which is designed expressly for, and used solely for, this purpose.

DEFINITIONS - Continued

Construction Drawings: The drawings developed through the staking process and used to guide the construction of outside plant facilities.

Eligible Country: Any country that applies with respect to the United States an agreement ensuring reciprocal access for United States products and services and United States suppliers to the market of that country, as determined by the United States Trade Representative.

Loan Design: A comprehensive engineering plan for the project supporting a loan application to RUS.

Underground Cable Vault (UCV): A subsurface chamber, large enough for a person to enter for the purpose of installing cables and other devices, and for making connections and tests.

Underground Cable Vault (UCV) Cover: A removable lid which closes the opening to an underground cable vault or similar subsurface enclosure.

Underground Cable Vault (UCV) Frame: A structure that caps the roof opening of the underground cable vault at ground level and supports the cover.

Pulling Iron: An anchor secured in the wall, ceiling, or floor of an underground cable vault to attach rigging used to pull cable.

Resident: The qualified representative of the Engineer who is delegated full time "on site" Construction Administration responsibilities of the Engineer.

Right-of-way: The strip of land over which facilities such as highways, railroads, power lines, other utilities, or telecommunication lines are constructed.

DEFINITIONS - Continued

RUS Accepted (Material and Equipment): Equipment which RUS has reviewed and determined that:

- a. Final assembly or manufacture of the equipment is completed in the United States, its territories and possessions, or in an eligible country;
- b. The cost of components within the material or equipment manufactured in the United States, its territories and possessions, or in an eligible country is more than 50 percent of the total cost of all components used in the material or equipment; and
- c. The material or equipment is suitable for use on systems of RUS telecommunications borrowers.

RUS Technically Accepted (Material and Equipment): Equipment which RUS has reviewed and determined that the material or equipment is suitable for use on systems of RUS telecommunications borrowers but the material or equipment does not satisfy both paragraph (a) and (b) of this definition:

- a. Final assembly or manufacture of the equipment is not completed in the United States, its territories and possessions, or in an eligible country; and
- b. The cost of components within the material or equipment manufactured in the United States, its territories and possessions, or in an eligible country is 50 percent or less than the total cost of all components used in the material or equipment.

1. GENERAL

1.1 This bulletin discusses in particular the design of underground plant using filled copper or fiber optic cables. This bulletin also provides information on the design and construction of poured-in-place underground cable vaults (UCVS). The information and recommendations in this bulletin are advisory.

1.2 Underground plant consists of a conduit and an underground cable vault (UCV) system and the telecommunications copper or fiber optic cables installed in the conduit and UCV system.

1.3 Additional information for the use in the design and construction of underground plant facilities can be found in the following Rural Utilities Service (RUS) documents:

- a. Telecommunications Engineering and Construction Manual (TE&CM) Section 116, Plant Engineering and Record System;
- b. TE&CM Section 204, Telephone System Design;
- c. TE&CM Section 210, Telephone System Design - Sizing Criteria;
- d. TE&CM Section 218, Plant Annual Cost Data for System Design Purposes;
- e. TE&CM Section 219, Present Worth of Annual Charge Studies for System Design;
- f. TE&CM Section 230, General Principles of Feeder-Distribution Cable Engineering [Serving Area Value Engineering (SAVE)];
- g. TE&CM Section 231, Design Techniques of Feeder-Distribution Cable Engineering (SAVE);
- h. TE&CM Section 232, Transmission Design and Costs Considerations of Feeder-Distribution Cable Engineering (SAVE);
- i. TE&CM Section 628, Plastic-Insulated Cable Plant Layout;
- j. TE&CM Section 629, Cable Plant Layout - Serving Area Value Concept for Rural Systems;
- k. RUS Bulletin 344-3, "Buy American" Requirement, as amended by the Notice published in the Federal Register, Volume 66, Number 222, dated November 16, 2001;
- l. RUS Bulletin 1751F-644, Underground Plant Construction;

- m. RUS Bulletin 1751F-670, Outside Plant Corrosion Considerations;
- n. RUS Bulletin 1751F-801, Electrical Protection Fundamentals;
- o. RUS Bulletin 1751F-815, Electrical Protection of Outside Plant;
- p. RUS Bulletin 1751H-601, Lightwave Fundamentals, Systems, and Application;
- q. RUS Bulletin 1753F-151, Specifications and Drawings for Construction of Underground Plant, Form 515b;
- r. RUS Bulletin 1753F-205(PE-39), RUS Specification for Filled Telephone Cables;
- s. RUS Bulletin 1753F-208(PE-89), RUS Specification for Filled Telephone Cables with Expanded Insulation;
- t. RUS Bulletin 1753F-402(PC-2), RUS Standard for Splicing Copper and Fiber Optic Cables;
- u. RUS Bulletin 1753F-601(PE-90), RUS Specification for Filled Fiber Optic Cables;
- v. 7 Code of Federal Regulations (CFR) § 1753.6, Standards, specifications, and general requirements.

2. APPLICATION

2.1 Underground plant facilities should be considered for the following conditions:

- a. In urban or suburban areas;
- b. Where public authorities object to aerial plant construction;
- c. Where direct buried plant is inadvisable;
- d. Where alternative aerial or buried routes are not practicable;
- e. Where the appearance of an aerial entrance cable to a central office building would be objectionable; or
- f. Where department of transportation officials prohibit aerial crossings over roads, streets, highways, etc.

2.2 Since underground plant facilities are usually exposed to less physical damage than aerial or buried facilities, fewer cable faults should be associated with underground plant facilities. This lower fault rate should result in long periods of maintenance-free operation and greater subscriber satisfaction. Underground plant facilities could be used in areas susceptible to frequent ice storms and/or high wind velocities.

2.3 Permission from appropriate authorities needs to be obtained before installing underground plant facilities, which include conduits, UCVs, and copper or fiber optic cables, in public rights-of-way (R/W) or travel lanes of roadways, streets, etc. In most circumstances cooperation with appropriate authorities can be obtained when underground plant construction techniques are fully explained. A comprehensive investigation of the public R/W or travel portions of roadways, streets, etc. should be made as to possible roadway, street, etc. improvements, such as widening or changing grade elevations, before the installation of underground plant facilities to eliminate costly future rearrangements and rerouting. When installing underground plant facilities at railroad crossings, on bridges, and the crossing of facilities owned by other utilities, the need for permits should be thoroughly investigated.

2.4 In urban and suburban areas, other buried or underground facilities such as water lines, gas lines, sewer lines, Community Antenna Television lines, electric and/or telecommunications lines present obstacles to the installation of the conduit and UCV components of underground plant facilities. When the above buried or underground obstacles are anticipated, detailed information should be obtained from the other utilities on present and proposed buried or underground facilities locations. Where it is known that buried or underground obstacles will be encountered during construction of the conduit and UCV components of underground plant facilities, those areas should be identified separately in the Loan Design (LD).

2.5 The physical location of the conduit and UCV components of the underground plant facilities should be determined in conjunction with federal, state, county, and local authorities, as applicable. Special attention should also be given to the type and size of equipment that will be required to perform the conduit, UCV, and cable installation of underground plant facilities.

2.6 Some of the considerations that can affect the physical locations of the conduit and UCV components of underground plant facilities are:

- a. Width of road shoulders;
- b. Type of road and road surface;

- c. Easements;
- d. Required number of conduits and UCVs;
- e. Public R/W;
- f. Railroad crossings;
- g. Bridge crossings;
- h. Buried or underground obstacles of other utilities; and
- i. Environmentally sensitive areas.

2.7 When conduit and UCV components of underground plant facilities are to be installed in public R/W or travel lanes of roadways, streets, etc. discussions with department of transportation authorities should be held to inform the authorities as to locations and depths of conduits and UCVs in the R/W or travel lanes of roadways, streets, etc.

2.8 The same procedure as outlined in paragraph 2.7 of this section should be followed in coordination with town and development areas where conduit and UCV components of underground plant facilities are to be installed. Assistance should be given to town planning authorities, land, industrial, and commercial developers by either identifying on existing construction drawings or in the preparation of new construction drawings, the locations and depths of all conduits and UCVs. Here again, these organizations should be informed that the borrower will provide identification and location of its existing underground plant facilities when requested.

2.9 Proposed underground plant construction activities should be coordinated with other utilities. This coordination is necessary to properly develop a working relationship among the various utilities on future planning of all utility plant. Construction drawings of underground plant to be constructed should be provided to each of the utility companies whose plant is, or may be placed, within the area of the borrower's underground plant facilities.

2.10 RUS Bulletin 1753F-151, Specifications and Drawings for Construction of Underground Plant, RUS Form 515b, provides assistance to either the resident, consulting engineer, or borrower's engineering staff in the design and construction of underground plant facilities. The resident, consulting engineer, or borrower's engineering staff should check with Federal, State, county, and local authorities in regard to any existing and proposed land development programs which would require special design considerations to be taken into account in the design and construction of underground plant facilities.

2.11 In the design of conduit and UCV systems of underground plant facilities, more conduits than initially needed should be provided to eliminate the added expense of reopening trenches and adding additional conduits to existing conduit systems.

2.12 The resident, consulting engineer, or borrower's engineering staff should keep in mind during the design of underground filled copper or fiber optic cable components of underground plant facilities that flexibility of underground cable components depend to a great extent on the physical arrangement of the cables and associated equipment in the conduit and UCV systems of underground plant facilities. Correct assignments and arrangements of underground copper or fiber optic cables should provide economical advantages by decreasing the cost of future rearrangements.

2.13 Prior to the design layout of the underground filled copper or fiber optic cables, the resident, consulting engineer, or borrower's engineering staff should make an on-site field survey of all UCVs, riser poles, building conduits, etc.

2.14 Where underground filled copper or fiber optic cables are pulled through UCVs without splicing, duct selections should be the same at both ends of UCVs. Changes in duct selections, especially in elevations, should be considered carefully to avoid damage to underground cable sheaths and to keep the pulling tensions as low as possible.

3. CONSTRUCTION MATERIALS

3.1 For all underground plant construction projects financed with RUS loan funds, RUS regulation 7 CFR 1753.6 requires that only RUS accepted materials be used.

3.2 RUS technically accepted, nondomestic manufactured materials, may also be used on underground plant construction projects. Before technically accepted materials can be used on underground plant construction projects, permission is required from the RUS borrower. In addition, borrower's are required to ensure that the cost of the technically accepted materials are at least 6 percent less than the cost of the RUS accepted materials, as specified in RUS Bulletin 344-3, "Buy American" Requirement, as amended by the Notice published in the Federal Register, Volume 66, Number 222, dated November 16, 2001.

4. CONDUIT TYPES AND USAGE

4.1 Conduit types most frequently used in underground plant facilities are as follows:

- a. Multi-duct concrete;

- b. Multi-duct plastic;
- c. Fiberglass/epoxy;
- d. Plastic;
- e. Flexible plastic; and
- f. Plastic fiber optic cable duct.

4.2 Multi-duct concrete conduits are available in 3.5 inch (in.) [89 millimeters (mm)] and 4 in. (102 mm) bore sizes and two design types. The first design consists of a bell and spigot with joint seals utilizing rubber gaskets and/or joint sealing compound. The second design utilizes a polyethylene sleeve with dowel pins for alignment. Conduits are available in 4-way, 6-way, and 9-way configurations. Short joints, miters, split conduits, and special adapters; such as concrete-to-steel, concrete-to-concrete, and concrete-to-plastic, are standard stock items for both designs which are available from manufacturers.

4.3 Multi-duct plastic conduits are available in bore sizes of 4 in. (102 mm) in bell and spigot designs. Joint seals are made using rubber gaskets and spring clips. Conduits are available in 4-way, 6-way, and 9-way configurations supplied in 42 in. [107 centimeters (cm)] sections. Miters, double bells, spigots, etc. are standard stock items available from manufacturers. Short joint sections can be made in the field by cutting conduits with a hacksaw.

4.4 Fiberglass/epoxy conduits are available in 2 in. (51 mm), 3 in. (76 mm), 4 in. (102 mm), and 6 in. (152 mm) bore sizes and three design types. The first design is a bell and spigot with joint seals utilizing joint sealing compound. The second design is a bell and spigot with joint seals utilizing joint sealing compound and a mechanical thread to ensure proper make up. The last design uses threaded mechanical connectors to ensure positive joint seals. Sweeps, elbows, bends, expansion joints, etc. are standard stock items available from manufacturers.

4.5 Plastic conduits are available in bore sizes of 2 in. (51 mm), 3 in. (76 mm), 4 in. (102 mm), and 6 in. (152 mm) and five design types. The five design types are B, C, D, EB, and DB. Design types B and EB are used for concrete encasement. Types C and DB are used for direct burial. Type D is used for exposed installations, such as on bridges, viaducts, etc. Jointing is accomplished with plastic couplings and solvent cements. Sweeps, elbows, adapters, plugs, bell ends, etc. are standard stock items available from manufacturers. Conduits can be cut with a hacksaw in the field to provide short joint sections. Plastic spacers are available for building conduit formations. The conduits are usually supplied in 20 foot (ft)

[6 meter (m)] lengths. Because plastic conduits are somewhat flexible, gradual changes in widths and heights of conduit banks can be made without special miter fittings. Plastic conduits also have low coefficients of friction which allow longer conduit runs.

4.6 Flexible plastic conduits are available in bore sizes of 2 in. (51 mm), 3 in. (76 mm), 3.5 in. (89 mm), 4 in. (102 mm), and 6 in. (152 mm) and two design types. The first type is a smooth wall finish. The second design is a corrugated wall finish. Jointing is accomplished by heat fusion with caps, ells, etc. which are standard stock items from manufacturers. The conduits are usually supplied in 500 ft (152 m) coiled lengths. Because of the conduit's flexibility, the conduit may be bent in radii as sharp as 4 ft (1.2 m) without kinking. Special fittings necessary to make turns, dips, and bends are not usually needed with flexible plastic conduits. Flexible plastic conduits can be installed either by trenching or plowing. Smooth wall flexible conduits may be installed in multiple configurations. Corrugated wall flexible conduits should only be used on subsidiary conduit routes. Corrugated wall flexible conduits should only be placed on horizontal planes (side by side).

4.7 Plastic fiber optic cable ducts are small diameter flexible plastic conduits available in bore sizes of 0.5 in. (13 mm), 1 in. (25 mm), and 1.5 in. (38 mm). These type ducts are available in either smooth or corrugated wall finishes. The ducts can be supplied in 1650 ft (502 m) coiled lengths. The primary usage of this type duct is for installation in existing conduits. This duct may also be used for direct burial. Placement of filled fiber optic cables in these type ducts provide clean, low friction, low hazard environment for fiber optic cable installations.

4.8 Steel pipes may be used as conduits where special conditions prohibit the use of conduit types listed in paragraph 4.1 of this section. Such conditions may include locations where trenching could not be performed or where pipe pushes are required. Steel pipes are available in all commercial sizes and can be obtained with threaded ends and couplings or with plain ends.

4.9 Sewer tiles, which are available in all commercial sizes, should be used as drains or sumps for poured-in-place UCVs.

5. CONDUIT FORMATIONS AND CURVES

5.1 Conduit formations consisting of four or more ducts should not be less than two, nor greater than four, ducts wide. Table 1 of this section lists various conduit formations based on trench sizes and UCV vault racking diagrams.

TABLE 1
Conduit Formations

Number of Ducts	Duct Width
4, 6, 8, and 10 ducts	2 wide
9, 12, 15, and 18 ducts	3 wide

5.2 Conduit sections containing curves should be avoided whenever possible. When curves are required in conduit sections, angles of curves should be less than 90 degrees. Curves with angles greater than 90 degrees or curves with extremely small radii should not be used because of possible damage to conduits or cables.

6. CONDUIT SECTION LENGTHS

6.1 Conduit section lengths should depend on diameters and types of conduits and types of filled copper or fiber optic cables to be installed in conduits. Conduit sections should be as long as practicable to reduce the number of UCVs, splices, and set-ups for cable pulling.

6.2 Conduit sections should not exceed 1500 ft (457 m). Typical conduit sections range from 600 to 1,000 ft (183 to 305 m). Achieving the 600 to 1,000 ft (183 to 305 m) distance may be restricted by junction points, offsets, or degrees of curvature in conduit sections. An offset is defined as the displacement of one portion of a straight conduit section run relative to the remainder of the conduit run. Displacements (offsets) may occur in any plane. If offset distances are 5 ft (1.5 m) or less, offsets may be disregarded in determining maximum section lengths. If offsets in otherwise straight conduit sections are greater than 5 ft (1.5 m) or radii of sweeps in offsets are less than 1200 ft (366 m), conduit section lengths should be shortened proportionately (up to one-third for extreme conditions). Conduit sections containing offsets should normally not exceed 600 ft (183 m).

6.3 Bends, twists, or curves in conduit runs should be used to change the general direction of conduit runs at street corners or to avoid underground obstructions. For conduit sections containing bends or curves, maximum conduit section lengths should be determined by angles between straight conduit runs on each side of curves and radii of curves.

6.4 Actual lengths of conduit runs should be obtained and verified from existing conduit system records to ensure that cable lengths will be correct. Distances, such as UCV wall-to-wall, UCV-to-riser pole, or UCV-to-building, should be measured and added to the length of cable required in each UCV for pulling-in, setting-up, splicing, and testing. The sum of the

distance measurements mentioned above and the cable lengths for pulling-in, setting-up, splicing, and testing is known as the cable "cut lengths." Cable "cut lengths" should be indicated on construction drawings. The excess length of copper cable normally required for splicing, testing, and pulling usually amounts to 3 ft (one meter) per cable or 6 ft (2 m) per section. The excess length of fiber optic cable normally required for splicing, testing, and pulling should be based on the LD.

7. CONDUIT PROTECTION

7.1 Conduits should be protected against mechanical damage due to settlement of the ducts, excavating equipment, etc. by use of either treated wood planks or concrete. Protection may consist of top protection only, base only, top and sides only, or complete encasement. The type of protection should depend on the particular circumstances of the project. Where no hazards are likely to be encountered, protection of conduits should not be required.

7.2 Top protection should be provided where conduits are to be installed under roadways which may be paved at later dates. Concrete bases should be used whenever the ground is spongy or yielding, such as swamps or marshlands, or where bases are desirable as leveling mediums under conditions where sand base trenches are subjected to washing out. Conduits within railroad R/W should be protected if required by regulations.

7.3 Concrete encasement of conduits should be considered for the following conditions:

- a. Road or street crossings having earth covers that are equal to or less than 30 in. (76 cm);
- b. Railroad crossings;
- c. Earth covers parallel to and within street, highway, or road travel areas that are less than 30 in. (76 cm);
- d. Stream crossings, storm canals, ditches, etc.; and
- e. Bend angles of 20° or greater in conduit lengths equal to or greater than 550 ft (168 m).

8. UCV TYPES

8.1 Precast and poured-in-place UCVs should be designed to provide sufficient and suitable space for installation of cables and associated equipment. Precast and poured-in-place UCV types and sizes that are normally used within the RUS program are shown in the construction guide drawings of RUS Bulletin 1753F-151,

Specifications and Drawings for Construction of Underground Plant, Form 515b, listed below:

- a. Guide drawing Underground Manhole (UM) UM-A,-L,-T,-J;
- b. Guide drawing UM-V; and
- c. Guide drawing UM-X,-Y.

8.2 Headroom, floor, wall, and roof thicknesses, openings, wall recesses, frames, covers, collars, sumps, or drains of precast UCVs should be designed in accordance with the manufacturers' recommendations.

8.3 Headroom, floor, wall, and roof thicknesses, openings, wall recesses, frames, covers, collars, sumps, or drains of poured-in-place UCVs should be designed in accordance with the engineer's specifications. Figure 1 of this bulletin provides an example of the poured-in-place UCV overall design layout.

8.4 Sufficient headroom should be provided in poured-in-place UCVs to allow for racking of cables plus a clear space of 12 in. (305 mm) just above the floor and below the UCV roof. Table 2 of this section indicates the minimum headroom recommended for the various types of poured-in-place UCVs.

TABLE 2
Minimum Headroom
Poured-In-Place UCVs

UCV Types	Minimum Headroom in. (cm)
UM-X	42 (107)
UM-Y	48 (122)
UM-A	66 (168)
UM-L	66 (168)
UM-T	66 (168)
UM-V	66 (168)
UM-J	66 (168)

8.5 Unreinforced concrete should be used for floors of poured-in-place UCVs that are to be constructed in firm soils. Floor thicknesses should be 4 in. (102 mm) for poured-in-place UCVs with unreinforced concrete walls. For poured-in-place UCVs with reinforced concrete walls, floors should be 6 in. (152 mm) thick.

8.6 Reinforced concrete should be used for floors of poured-in-place UCVs that are to be constructed in fluid soils. The reinforcing members should be 5/8 in. (16 mm) diameter deformed bars. Table 3 of this section and Figure 2 of this bulletin provide design information on the floor thicknesses and reinforcing bar spacings of all rectangular poured-in-place UCVs

in fluid soils. Floor thicknesses of UM-V type poured-in-place UCVs vary with depths of finished floors below grade. Table 4 of this section and Figure 2 of this bulletin provide design information on the floor thicknesses and reinforcing bar spacings of UM-V type UCVs in fluid soil.

TABLE 3
 Floor Thicknesses and Reinforcing Rod Spacings
 Rectangular Poured-In-Place UCVs in Fluid Soils

Depth of UCV Floor Below Grade Ft (m)	Floor Thickness In. (mm)	Spacing of Reinforcing Rods	
		in. (mm) (See Note)	
8 (2.4)	6 (152)	8 (203)	
9 (2.7)	6 (152)	8 (203)	
10 (3.0)	6 (152)	8 (203)	
11 (3.4)	6 (152)	8 (203)	
12 (3.7)	6 (152)	8 (203)	
13 (4.0)	6 (152)	8 (203)	
14 (4.3)	6 (152)	7 (178)	
15 (4.6)	6 (152)	6.5 (165)	
16 (4.9)	6 (152)	6.5 (165)	

TABLE 4
 Floor Thicknesses and Reinforcing Rod Spacings
 Type UM-V Poured-In-Place UCVs in Fluid Soils

Depth of UCV Floor Below Grade ft (m)	Floor Thickness in. (mm)	Spacing of Reinforcing Rods		
		In. (mm) (See Note)		
		Spacing A	Spacing B	Spacing C
8 (2.4)	6 (152)	8 (203)	9 (229)	11 (279)
9 (2.7)	6 (152)	8 (203)	9 (229)	11 (279)
10 (3.0)	6 (152)	8 (203)	9 (229)	11 (279)
11 (3.4)	6 (152)	8 (203)	9 (229)	11 (279)
12 (3.7)	6 (152)	8 (203)	9 (229)	11 (279)
13 (4.0)	6 (152)	8 (203)	9 (229)	11 (279)
14 (4.3)	6.5 (165)	7 (178)	8 (203)	10 (254)
15 (4.6)	7 (178)	6.5 (165)	8 (203)	10 (254)
16 (4.9)	7 (178)	6.5 (165)	8 (203)	10 (254)

Note: See Figure 2 of this bulletin for diagrams of reinforcing rod spacings.

8.7 Sumps or drains for poured-in-place UCVs should be located directly under UCV covers and at depths such that finished floor surfaces should be graded toward the sumps or drains. Sumps or drains should be at least 8 in. (203 mm) in diameter or 8 in. (203 mm) square. Sumps or drains should be constructed using

12 in. (305 mm) lengths of 8 in. (203 mm) sewer tiles. Figure 3 of this bulletin provides information on two types of sump or drain designs.

8.8 Table 5 of this section and Figure 4 of this bulletin provide design information on wall thicknesses and vertical reinforcement spacings, if any, for concrete walls of poured-in-place UCVs in firm soils. Table 6 of this section and Figure 4 of this bulletin provide design information on wall thicknesses and vertical reinforcement spacings, if any, for concrete walls of poured-in-place UCVs in fluid soils. It should be noted in Tables 5 and 6 of this section that the variations in concrete wall thickness and the quantity of vertical reinforcement required varies only with the depths of the poured-in-place UCV walls. Vertical reinforcing bars should be of sufficient lengths to extend 1 in. (25 mm) from the bottoms of concrete floors to within 1 in. (25 mm) of the tops of UCV roofs. In addition to vertical reinforcement, UCV walls should also contain horizontal reinforcement. For UCV walls that are 12 in. (305 mm) or less in thickness, horizontal reinforcement should consist of 3/8 in. (10 mm) or larger diameter round bars spaced 12 in. (305 mm) on centers. UCV walls that are greater than 12 in. (305 mm) thick should be horizontally reinforced using 5/8 in. (16 mm) or larger diameter round bars spaced 12 in (305 mm) on centers. Horizontal reinforcing bars should be of sufficient lengths to extend within 1 in. (25.4 mm) of outside surfaces of the two adjacent walls.

TABLE 5
Wall Construction
Poured-In-Place UCVs in Firm Soils

		Reinforced Walls				
		Plain Walls		Vertical Reinforcement Using Deformed Bars		
Category	Depth of UCV Floor Below Surface of Street in. (cm)	Wall Thickness in. (mm)	Wall Thickness in. (mm)	Size In. (mm)	Deformed Bar Types	Spacing On Center in. (mm)
8.0	96 (244) or less	6 (152)	6 (152)	None	None	None
8.5	102 (259)	7 (178)	6 (152)	3/8 (10) 1/2 (13)	Round Round	8 (203) 12 (305)
9.0	108 (274)	7.5 (190)	6 (152)	3/8 (10) 1/2 (13)	Round Round	6 (152) 10 (254)
9.5	114 (289)	8 (203)	6 (152)	3/8 (10) 1/2 (13)	Round Round	5.5 (140) 9 (229)
10.0	120 (305)	8.5 (216)	6 (152)	3/8 (10) 1/2 (13)	Round Round	4 (102) 8 (203)
10.5	126 (320)	9 (229)	6 (152)	3/8 (10) 1/2 (13)	Round Round	4 (102) 7 (178)
11.0	132 (335)	10 (254)	6 (152)	1/2 (13)	Round	6 (152)
11.5	138 (350)	10.5 (267)	6 (152)	1/2 (13)	Round	5 (127)
12.0	144 (366)	11 (279)	6.5 (165)	1/2 (13)	Round	5 (127)
12.5	150 (381)	12 (305)	6.5 (165)	1/2 (13) 5/8 (16)	Round Round	4.5 (114) 7 (178)
13.0	156 (396)	12.5 (317)	7 (178)	1/2 (13) 5/8 (16)	Round Round	4.5 (114) 7 (178)
13.5	162 (411)	13 (330)	7 (178)	5/8 (16)	Round	6.5 (165)
14.0	168 (427)	14 (356)	7.5 (190)	5/8 (16)	Round	6.5 (165)
14.5	174 (442)	14.5 (368)	7.5 (190)	5/8 (10) 3/4 (19)	Round Round	5.5 (140) 8 (203)
15.0	180 (457)	15 (381)	8 (203)	5/8 (10) 3/4 (19)	Round Round	5.5 (140) 8 (203)
16.0	192 (488)	Reinforcement Required	9 (229)	5/8 (10) 3/4 (19)	Round Round	5.5 (140) 7.5 (190)
17.0	204 (518)	Reinforcement Required	9.5 (241)	5/8 (10) 3/4 (19)	Round Round	4.5 (114) 7 (178)
18.0	216 (549)	Reinforcement Required	10 (254)	5/8 (10) 3/4 (19)	Round Round	4 (102) 6 (152)
19.0	228 (579)	Reinforcement Required	11 (279)	5/8 (10) 3/4 (19)	Round Round	4 (102) 5.5 (140)
20.0	240 (610)	Reinforcement Required	11.5 (292)	5/8 (10) 3/4 (19)	Round Round	3.5 (89) 5.5 (140)

TABLE 6
Wall Construction
Poured-In-Place UCVs in Fluid Soils

		Reinforced Walls				
		Plain Walls	Vertical Reinforcement Using Deformed Bars			
Category	Depth of UCV Floor Below Surface of Street In. (cm)	Wall Thickness in. (mm)	Wall Thickness In. (mm)	Size In. (mm)	Deformed Bar Types	Spacing On Center in. (mm)
8.0A	96 (244) or less	9 (229)	6 (152)	½ (13)	Round	6 (152)
8.5A	102 (259)	10 (254)	6.5 (165)	½ (13)	Round	6 (152)
9.0A	108 (274)	11 (279)	7 (178)	½ (13)	Round	5.5 (140)
9.5A	114 (289)	12 (305)	7.5 (190)	½ (13)	Round	5 (127)
10.0A	120 (305)	13 (330)	8 (203)	½ (13)	Round	4.5 (114)
10.5A	126 (320)	14 (356)	8.5 (216)	½ (13)	Round	4 (102)
11.0A	132 (335)	15 (381)	9 (229)	5/8 (16)	Round	6 (152)
11.5A	138 (350)	16 (406)	9.5 (241)	5/8 (16)	Round	5.5 (140)
12.0A	144 (366)	Reinforcement Required	10 (254)	5/8 (16)	Round	5.5 (140)
12.5A	150 (381)	Reinforcement Required	10.5 (267)	5/8 (16)	Round	5 (127)
13.0A	156 (396)	Reinforcement Required	11 (279)	5/8 (16) ¾ (19)	Round Round	4.5 (114) 6 (152)
13.5A	162 (411)	Reinforcement Required	11.5 (292)	5/8 (16) ¾ (19)	Round Round	4 (102) 6.5 (165)
14.0A	168 (427)	Reinforcement Required	12 (305)	¾ (19)	Round	5.5 (140)
14.5A	174 (442)	Reinforcement Required	12.5 (317)	¾ (13)	Round	5.5 (140)
15.0A	180 (457)	Reinforcement Required	13 (330)	¾ (13)	Round	5 (127)
16.0A	192 (488)	Reinforcement Required	14 (356)	¾ (13)	Round	4.5 (114)

8.9 Roofs of poured-in-place UCVs should be designed using reinforced concrete. Table 7 of this section provides design information on UCV roofs regarding thicknesses and reinforcing rod diameters for all rectangular poured-in-place UCVs. Table 8 of this section provides design information on UCV roofs regarding thicknesses and reinforcing rod diameters for UM-V type poured-in-place UCVs. Figure 5 of this bulletin provides design information on center-to-center spacings of reinforcing rods for both rectangular and UM-V type poured-in-place UCV roofs.

TABLE 7
Roof Thicknesses and Reinforcing Rod Diameters
Rectangular Poured-In-Place UCVs

Inside Width of UCV in. (cm)	Roof Thickness In. (mm)	Reinforcing Rod Diameter in. (mm)
36 (91)	6 (152)	1/2 (13)
42 (107)	6 (152)	1/2 (13)
48 (122)	7 (178)	1/2 (13)
54 (137)	7.5 (190)	1/2 (13)

TABLE 8
Roof Thicknesses and Reinforcing Rod Diameters
Type UM-V Poured-In-Place UCVs

Inside Width or Length of UCV Whichever is Greater ft (m)	Roof Thickness In. (mm)	Reinforcing Rod Diameter in. (mm)
8 (2.4)	11 (279)	3/4 (19)
9 (2.7)	11.5 (292)	3/4 (19)
10 (3.0)	12 (305)	3/4 (19)
11 (3.3)	12.5 (317)	3/4 (19)
12 (3.7)	13 (330)	3/4 (19)

8.10 Openings of poured-in-place UCVs should be determined by the types and sizes of UCV frames. Diameters of frame openings at bases of frames should be equal to diameters of UCV roof openings. Table 9 of this section provides design information on the sizes of UCV opening forms to be used with various types and sizes of UCV frames.

TABLE 9
UCV Opening Forms
for UCV Frame Types and Sizes
Poured-In-Place UCVs

Frame Types	Frame Sizes In. (cm)	UCV Opening Form Sizes in. (cm)
B	24 (61)	35 (89)
B	27 (69)	38 (96)
B	30 (76)	41 (104)
R	27 (69)	28 (71)
R	30 (76)	31 (79)

8.11 When poured-in-place UCVs require wall recesses at conduit entrances, concrete should be placed between the faces of the recesses and the excavation walls to provide watertight bonds. Concrete thicknesses should be equal to at least one-half of UCV

wall thicknesses. Figure 6 of this bulletin provides additional design information concerning wall recesses. When conduits entering UCVs are splayed, recessing of conduit banks should not be required.

8.12 Type B frames should be used with poured-in-place UCVs installed in areas subjected to vehicular traffic. Type R frames should be used with poured-in-place UCVs that are installed in areas not subjected to vehicular traffic such as sidewalks, median strips, etc. Figure 7 of this bulletin provides additional design information on Types B and R frames. Thirty inch (30 in.) (76 cm) frames should be used in areas subjected to vehicular traffic. Twenty-seven inch (27 in.) (69 cm) frames should be used in areas not subjected to vehicular traffic. Poured-in-place UM-X and UM-Y type UCVs normally use 24 in. (61 cm) frames.

8.13 Frames of poured-in-place UCVs should be supported with either brick or concrete collars. Brick or concrete collars should be of sufficient heights to bring UCV covers flush with grades of travel surfaces. Figure 8 of this bulletin provides additional design information on brick collars.

8.14 Solid covers should be used with all types of poured-in-place UCVs except when light and ventilation of UCVs are required. Heavy duty covers should be used on all types of poured-in-place UCVs that are subjected to vehicular traffic.

9. CABLE RACKS, RACK SUPPORTS, and PULLING IRONS

9.1 The number of cable racks and rack supports, spacing of cable racks, and placement of pulling irons for precast UCVs should be designed in accordance with manufacturers' recommendations.

9.2 For poured-in-place UCVs, the number and size of vertical cable racks should be based on headroom within UCVs as shown in Table 10 of this section. Additional design information that may be used to assist in the installation of cable racks within poured-in-place UCVs may be found in Figure 9 of this bulletin.

TABLE 10
Number and Size of Cable Racks Versus Headroom
Poured-In-Place UCVs

Headroom In. (cm)	Number of Racks		
	14 Hole Rack Size	18 Hole Rack Size	37 Hole Rack Size
60 (152) ⁽¹⁾	1	1	1
66 (168) ⁽²⁾	-	2	1
72 (183) ⁽²⁾	-	2	1
78 (198)	3	-	-
84 (213)	2	1	-
90 (229)	1	2	-
96 (244)	-	3	-
102 (259)	4	-	-
108 (274)	3	1	-
114 (290)	2	2	-
120 (305)	1	3	-
126 (320)	4	1	-
132 (335)	4	1	-

Note (1): UCVs may contain either one 14 and one 18 hole rack or one 14 and one 37 hole rack

Note (2): UCVs may contain either two 18 hole racks or one 37 hole rack.

9.3 UCV racking diagrams for poured-in-place UCVs should include all hardware items needed for supporting cables within UCVs along with all additional work such as drilling holes, etc.

9.4 The spacing of cable racks within poured-in-place UCVs should be specified on the construction drawings.

9.5 Cable racking diagrams should be made for central office vaults, cable troughs, and central office building walls showing locations of all existing cables, stubs, load coil cases, if any, and ducts in use. Using this information vacant ducts should be selected that would allow new cables to be installed without crossing over existing cables or blocking other vacant ducts. Trunk and special cables, which require protection, should be assigned lower conduits because these type cables usually do not require replacement. Cable duct assignments should be the same in each UCV, whenever possible. However, each duct should be chosen section-by-section, since the same relative position in each UCV may not always provide the best cable arrangement.

9.6 Cables and stubs should be arranged in UCVs to allow accessibility to cable splices. The number of branch cables from ends of mainline splices should be limited to two. Stub cables may be necessary to maintain this arrangement. At locations requiring cable stubs, racking of main cables should be based on

pair counts, gauge sizes, and intended use stub cables. Where stub cables are used to connect branch feeder or distribution cables entering UCVs from branch circuits, terminal ends of stub cables should be racked on UCV walls opposite branch conduits.

9.7 For pull-through UCVs (no splice), cable lengths necessary for racking should be added to wall-to-wall lengths of conduit sections on both sides of UCVs.

9.8 Figure 10 of this bulletin should be used in the design of pulling irons for poured-in-place UCVs.

10. UCV AND CONDUIT LOCATIONS

10.1 Locations of UCVs and conduit routes between UCVs should be indicated on construction drawings. An example of a construction drawing indicating UCV locations and conduit routes is shown in Figure 11 of this bulletin. The construction symbols and abbreviations used in preparing construction drawings are shown in Figures 12 through 12C of this bulletin. Poured-in-place or precast UCVs should be located to avoid unnecessary hazards and to ensure that future work in UCVs will cause minimum interference with the normal flow of vehicular traffic. Poured-in-place or precast UCVs should be located in public R/W wherever possible. When poured-in-place or precast UCVs are located in the travel portion of roads, streets, etc., intersection locations should be avoided wherever possible. In congested areas where the possibility of undisclosed subsurface conditions exist, test holes may be required to verify that construction can be carried out as planned to avoid useless excavation. Test holes should be dug 12 in. (305 mm) deeper than the depth of the proposed UCV excavation. If foreign pipes or other structures are encountered in the test holes, steps should be taken to determine ownership of the foreign structures. If the structures can not be readily removed, a decision should be made as to the practicability of either shifting the UCV, arranging with the owning company for a change in the route of their plant, or include the structure in the UCV. Penalties or costs associated with each of the above mentioned alternatives should be carefully considered before reaching a decision. Poured-in-place or precast UCVs should not be located near springs or underground streams.

10.2 Main conduits entering poured-in-place or precast UCVs should be located equidistant between the floors and roofs and centered between end walls. For UM-L, UM-J, and UM-T poured-in-place or precast UCVs, conduits entering side walls should be located 4 in. (102 mm) from end walls which are located farthest from central offices. Clearances of 12 in. (305 mm) should be maintained between main conduit formations and roofs or floors of UCVs. Unless indicated on the construction drawings, wall

recesses should be provided at conduit entrances. Subsidiary conduits entering UCVs should be located to provide clearances of 4 in. (102 mm) from roofs and adjacent walls.

11. DETERMINATION OF INSTALLATION LENGTH AND PULLING TENSION OF FILLED COPPER CABLES

11.1 Mechanical stresses placed on copper cables during installations should be held to absolute minimums to avoid excessive twisting, stretching, or flexing of cables. Therefore to avoid excessive twisting, stretching, or flexing of copper cables during installations, maximum pulling tensions for copper cables should be calculated to ensure that copper cables can be placed in conduit and UCV systems without damage.

11.2 One of the factors to consider in determining copper cable pulling tensions is the coefficient of friction between various conduit and cable jacket materials. Table 11 of this section provides both dry and lubricated coefficient of friction values between various conduit and cable jacket materials which may be used in determining pulling tensions of cables. The information in Table 11 of this section is based on conduit interior surfaces being free of dirt, gravel, etc. Interior conduit surfaces that are considered dirty, could result in increased coefficient of friction values. Therefore interior conduit surfaces should be cleaned before installation of cables.

TABLE 11
Coefficient of Friction
Conduit Versus Cable Jacket Materials

Conduit Material	Coefficient of Friction (Sliding)			
	High Density Polyethylene		Low Density Polyethylene	
	Dry	Lubricated	Dry	Lubricated
Polyvinyl Chloride	0.31	0.13	0.36	0.16
Concrete	0.48	0.37	0.57	0.41
Corrugated Plastic	0.22	0.13	0.40	0.13

As the table indicates lubricated coefficient of friction values are generally one-half or less of the dry coefficient of friction values. The lower lubricated coefficient of friction values should allow for lower cable pulling tensions which in turn would allow the installation of longer cable lengths in conduit and UCV systems. For purposes of safety, maximum pulling tension calculations for copper cables should be computed using the dry coefficient of friction values. The effectiveness of lubricants is dependent to a large extent on the thoroughness of its application to copper cables. In addition, conduit surface conditions can contribute significantly to the actual coefficient of friction.

11.3 The factors that should be used in determining the lengths of copper cables that may be safely installed in conduit systems are as follows:

- a. Cable size and conductor gauge;
- b. Maximum pulling strain allowed on conductors;
- c. Cable pulling method (pulling eye or basket weave grip);
- d. Number of bends in conduit system;
- e. Bend radii;
- f. Bend angles;
- g. Coefficient of friction; and
- h. Cables pulled dry or lubricated.

11.4 Equation #1 of this section listed below should be used for calculating maximum pulling tensions of copper cables equipped with factory installed pulling eyes:

$$T = ANK \text{ (Equation \#1)}$$

Where:

T = Maximum allowable pulling tension in pounds (lbs) [kilograms (kgs)].

A = Cross-sectional area of copper conductors in circular mils [square millimeters (mm²)].

N = Number of conductors terminated in factory installed pulling eyes. Typical all conductors in cables are terminated in factory installed pulling eyes.

K = 0.008 lbs/circular mils (7.2 kgs/mm²) for copper.

The cross-sectional areas of copper conductors designated by the letter "A" in equation #1 of this section are listed in Table 12 of this section:

TABLE 12
Cross-sectional Area of Copper Conductors

Conductor Size American Wire Gauge (AWG)	Cross-sectional Area Circular Mils (mm ²)
19	1290 (0.653)
22	642 (0.324)
24	404 (0.205)
26	254 (0.128)

11.5 After calculating maximum pulling tensions of copper cables, maximum allowable pulling lengths of cables should be calculated using equation #2 of this section listed below:

$$L = T/Wf \text{ (Equation \#2)}$$

Where:

L = Maximum allowable pulling length in ft (m).

T = Maximum allowable pulling tension in lbs (kgs).

W = Cable weight in lbs/ft (kgs/m).

f = Coefficient of friction for type of conduit used in installation.

11.6 Another factor that should be considered in calculating cable pulling tensions is the number and effects of bends in conduit systems. For conduit systems containing bends, pulling tensions of copper cables should be calculated on cumulative basis using equations #3 and #4 of this section listed below:

$$T = LWf \text{ (Equation \#3)}$$

$$T = T_1 e^{fa} \text{ (Equation \#4)}$$

Where:

T = Pulling tension in lbs (kgs).

L = Cable length in ft (m).

W = Cable weight in lbs/ft (kgs/m).

T₁ = Accumulated tension to start of bend in lbs (kgs).

e = Napierian logarithm equal to 2.718.

f = Coefficient of friction for type of conduit used in installation.

a = Bend angle in radians (1 radian = 57.3 degrees).

11.7 Another factor that should be considered is the maximum allowable sidewall pressure. Sidewall pressures are radial forces exerted on cable sheaths at bend points when cables are under tension. Sidewall pressures at bend points should be calculated using equation #5 of this section listed below:

$$P = T/R \text{ (Equation \#5)}$$

Where:

P = Sidewall Pressure in lbs/ft (kgs/m).

T = Pulling tension in lbs (kgs).

R = Bend radius in ft (m).

The maximum allowable sidewall pressure for copper cables should not exceed 100 lbs/ft (149 kgs/m). In conduit systems containing multiple bends, the last bend in the system would develop the greatest sidewall pressure on the cable. Therefore during the design of conduit systems, bends with the severest radii should be installed at the start of conduit systems.

11.8 Figures 13 through 13B of this bulletin provide an example of an underground filled copper cable installation that may be used for calculating maximum cable pulling tensions for conduit and UCV systems containing multiple conduit bends. Figures 14 and 14A of this bulletin provide an example of an underground filled copper cable installation that may be used for calculating the maximum sidewall pressures for conduit and UCV systems containing multiple conduit bends.

12. DETERMINATION OF INSTALLATION LENGTH AND PULLING TENSION OF FILLED FIBER OPTIC CABLES

12.1 Factors that should be considered in determining the installation lengths and pulling tensions of fiber optic cables to ensure that fiber optic cables can be placed in conduit and UCV systems without damage are listed below:

- a. Maximum allowable pulling tension;
- a. Minimum allowable bending radius during installation;
- b. Minimum allowable bending radius after installation;
- c. Construction and dimensions of pulling end;

- d. Cable weight and diameter;
- e. Supply length of cable; and
- f. Excess cable length at each splice location.

12.2 Fiber optic cable manufacturers should be contacted to determine the appropriate values for the items listed in paragraph 12.1 of this section to ensure that fiber optic cables can be placed in conduit and UCV systems without damage.

12.3 In addition to the factors listed in paragraph 12.1 of this section, fiber optic cable manufacturers should also be contacted to determine the maximum allowable sidewall pressure that may be exerted on fiber optic cable sheaths at bend points when cables are under tension.

13. DESIGN CONSIDERATIONS

13.1 For outside plant underground facilities using copper cables, circuit requirements should be thoroughly evaluated to provide sufficient margin in the sizing of underground feeder cables. The sizing of the copper cables should be based on the recommendations listed in RUS TE&CM Section 210, Telephone System Design - Sizing Criteria. The assigning of cable pairs should be based on the recommendations included in RUS TE&CM Section 629, Cable Plant Layout - Serving Area Value Engineering for Rural Systems.

13.2 For outside plant underground facilities using fiber optic cables, circuit requirements should be thoroughly evaluated to provide sufficient margin in the sizing of the cables. The sizing of the fiber optic cables should be based on circuit requirements of the LD plus the number of circuits needed for future growth.

13.3 Local characteristics of the project area should be thoroughly studied to determine whether normal or extraordinary construction conditions exist before making comparative cost studies. In addition, the determination should be made as to whether or not protection of conduits would be required so that the increase in the incremental cost associated with the protection of the conduits can be evaluated.

13.4 For copper underground plant, the design should provide for the optimum use of fine gauge cable (22 and 24 American Wire Gauge (AWG) conductors). Care should be exercised in the design to ensure that transmission requirements will be met.

13.5 For copper underground plant, the choice of the proper gauge conductors should depend on the transmission and signaling requirements. Care should be exercised in selecting the cables

since initial cost differentials between the various cable types, sizes, and conductor gauges can be appreciable. Where economic costs indicate the use of digital carrier and other types of electronic equipment over physical circuits, the electronic equipment should be designed.

13.6 For optical fiber underground plant, the design should provide for the use of either dispersion-unshifted single mode fibers (operate at both the 1310 and 1550 nanometer windows) or dispersion-shifted single mode fibers (operate at the 1550 nanometer window). The choice as to which single mode fiber to use should depend on the optical system's length and the transmission and signaling requirements.

13.7 The optical fiber design should be prepared in accordance with the recommendations in RUS Bulletin 1751H-601, Lightwave Fundamentals, Systems, and Application.

FIGURE 1
OVERALL DESIGN LAYOUT
POURED-IN-PLACE UCVS

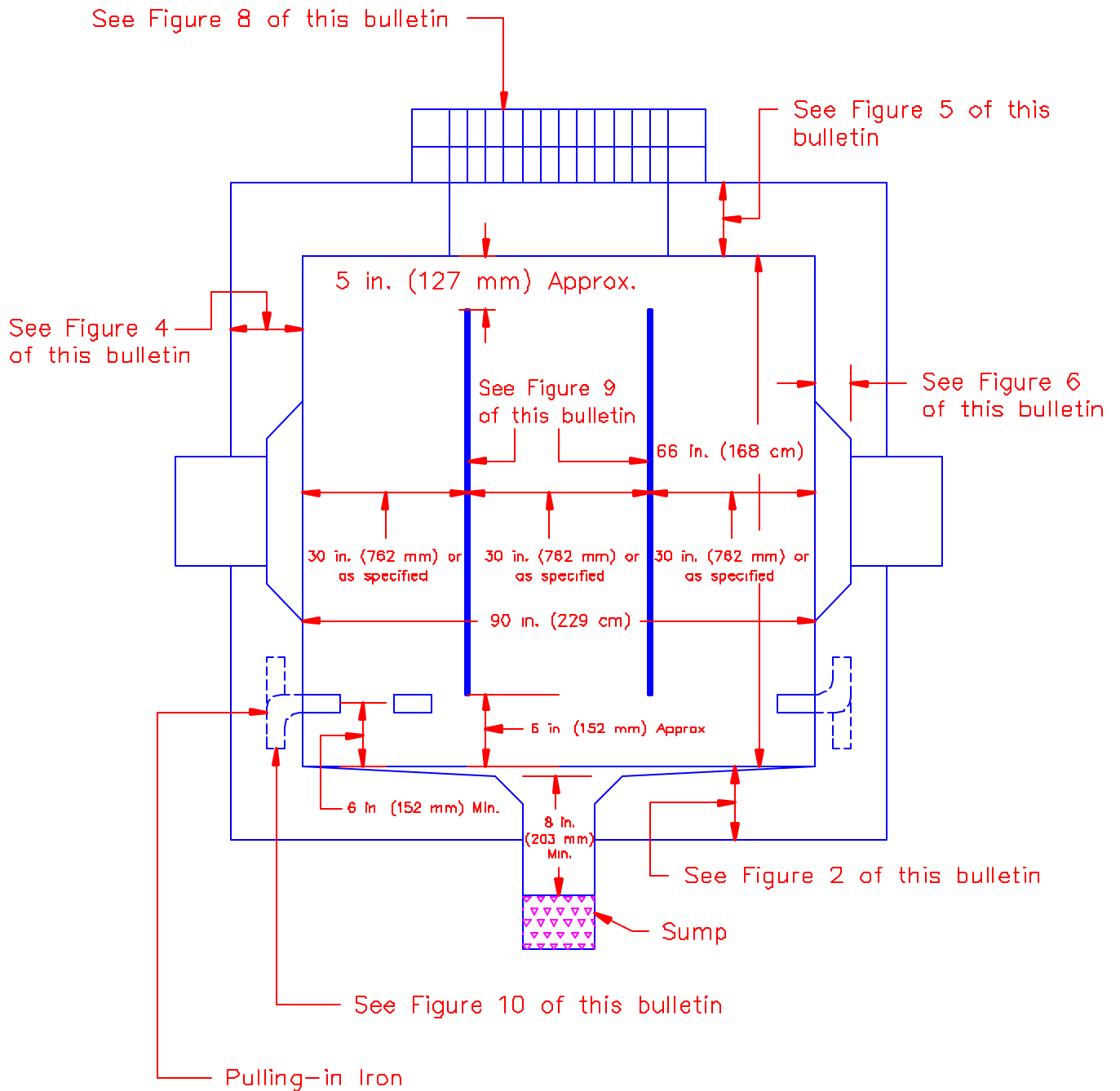
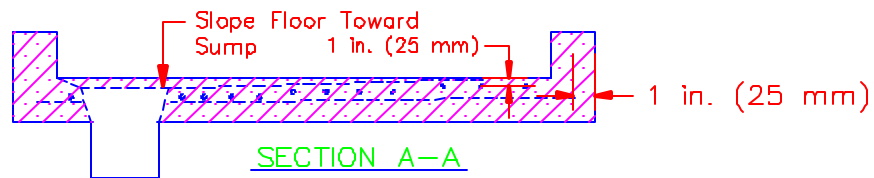
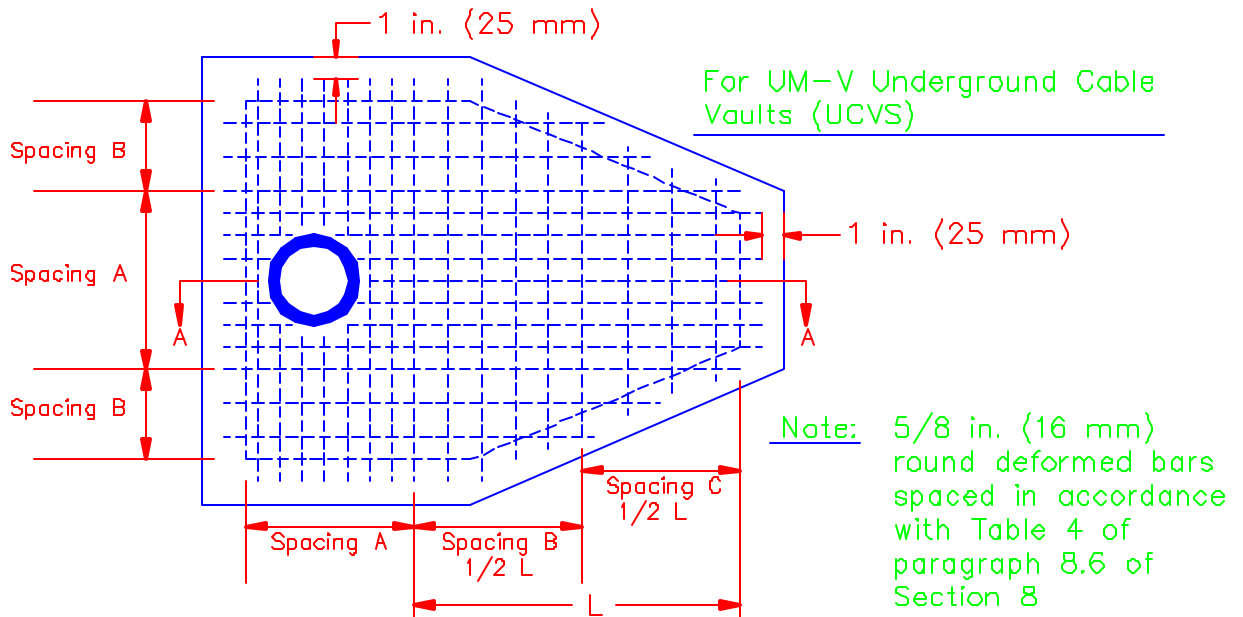
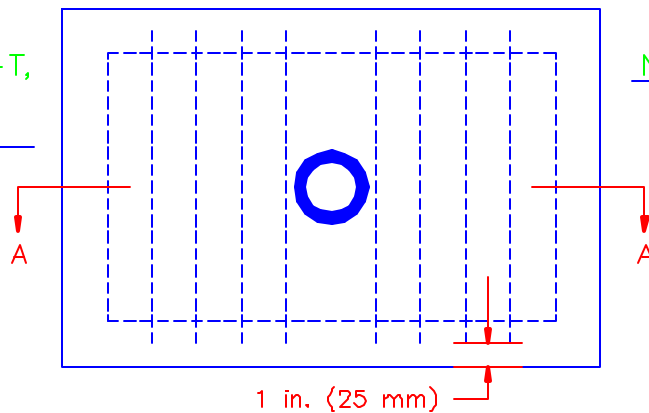


FIGURE 2
FLOOR CONSTRUCTION
POURED-IN-PLACE UCVS IN FLUID SOILS



For UM-A, -L, -T, -J, -X and -Y UCVS



Note: 5/8 in. (16 mm) round deformed bars spaced in accordance with Table 3 of paragraph 8.6 of Section 8.

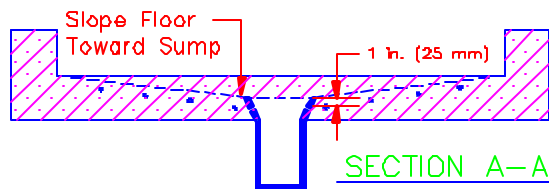
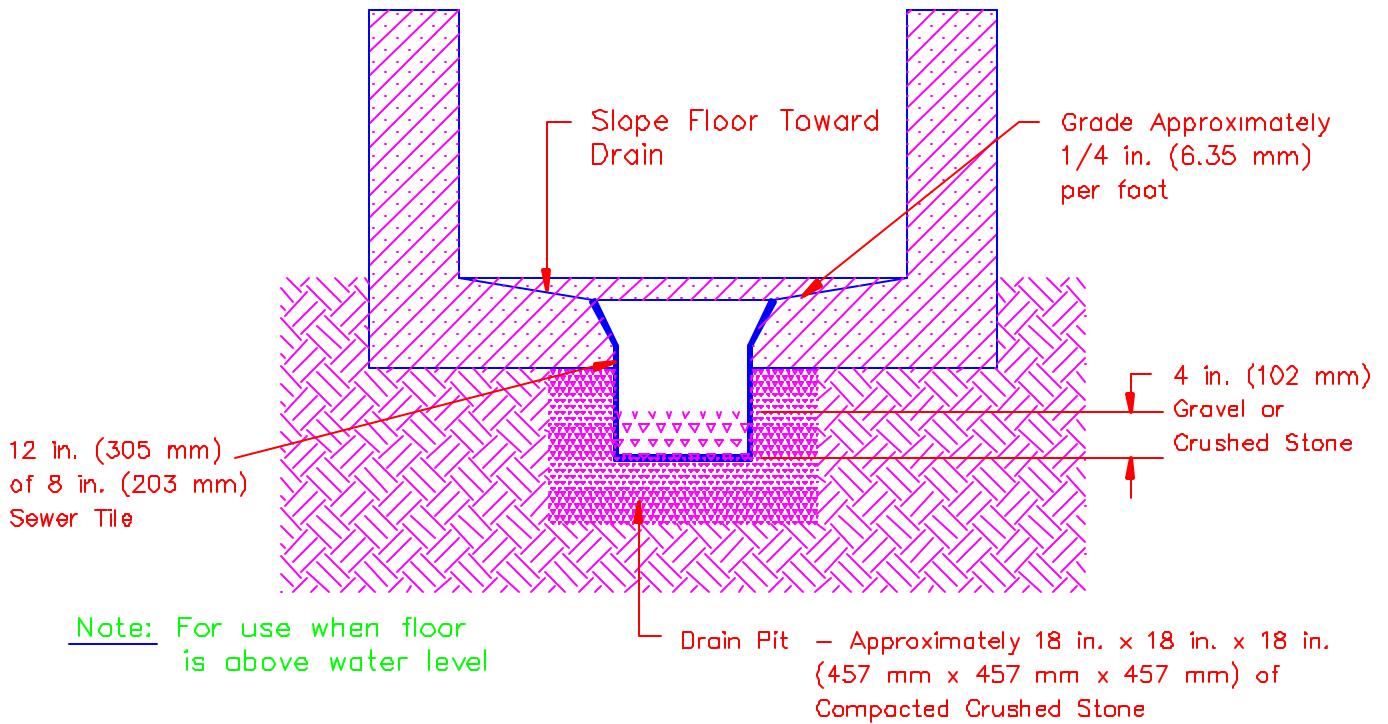


FIGURE 3 SUMP AND DRAIN CONSTRUCTION POURED-IN-PLACE UCVS

OPTION C



OPTION S

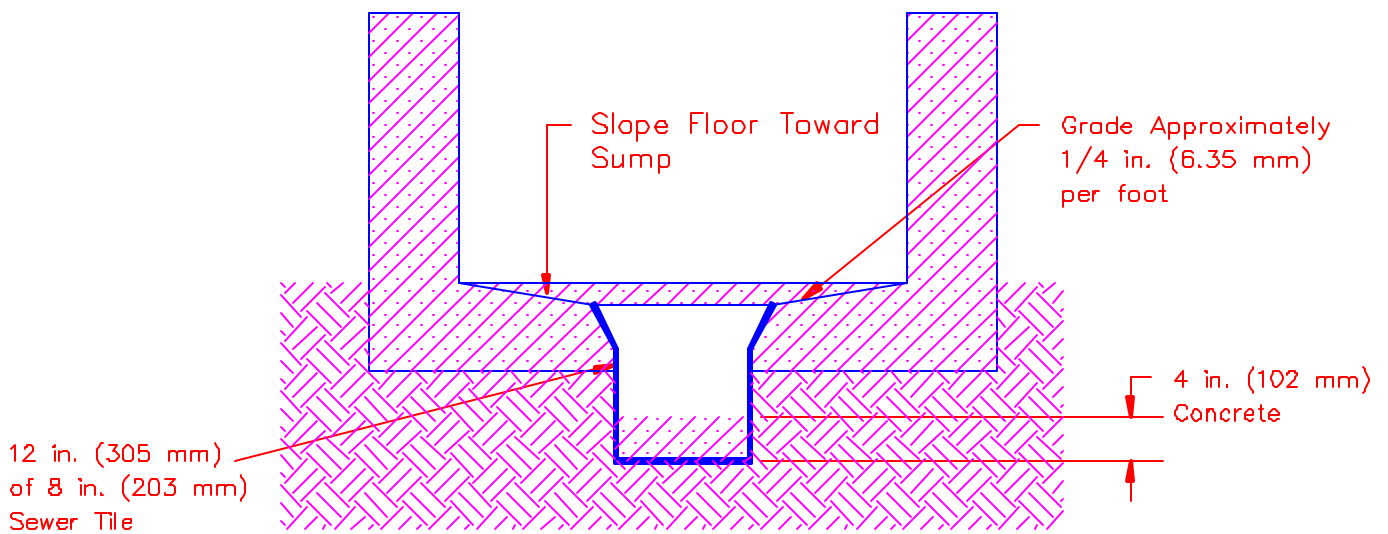
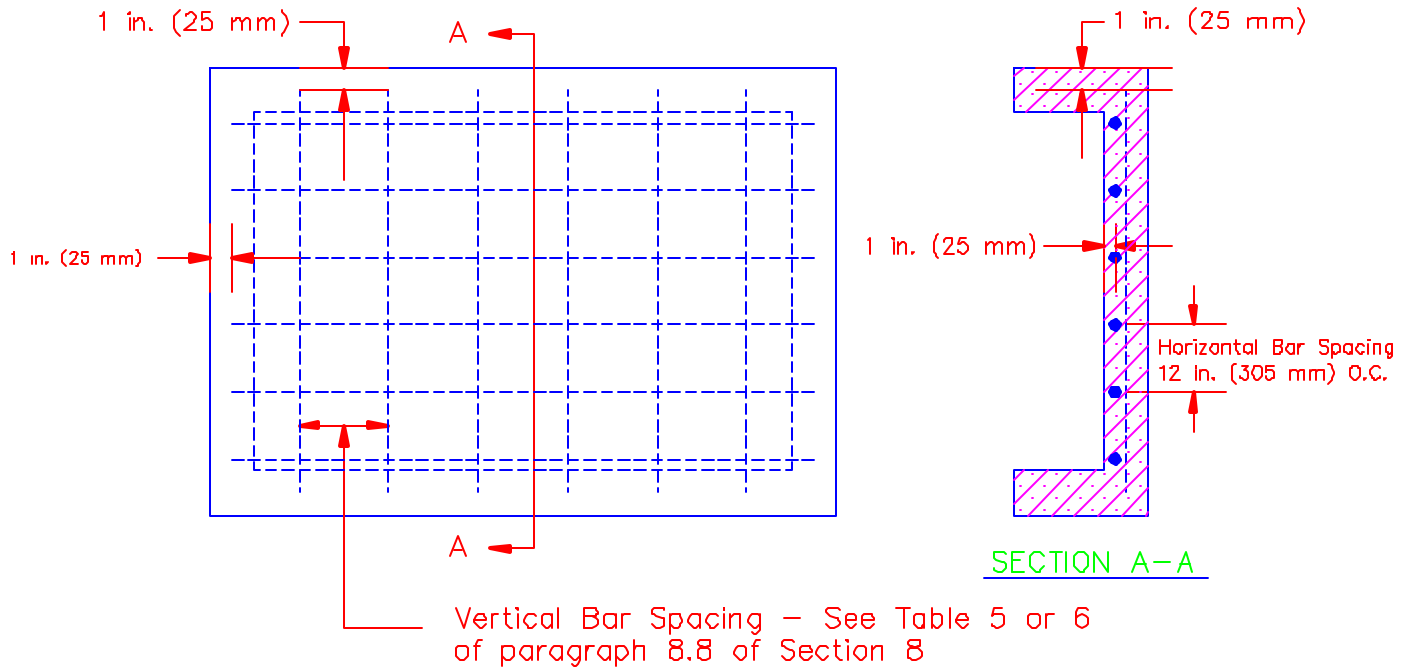
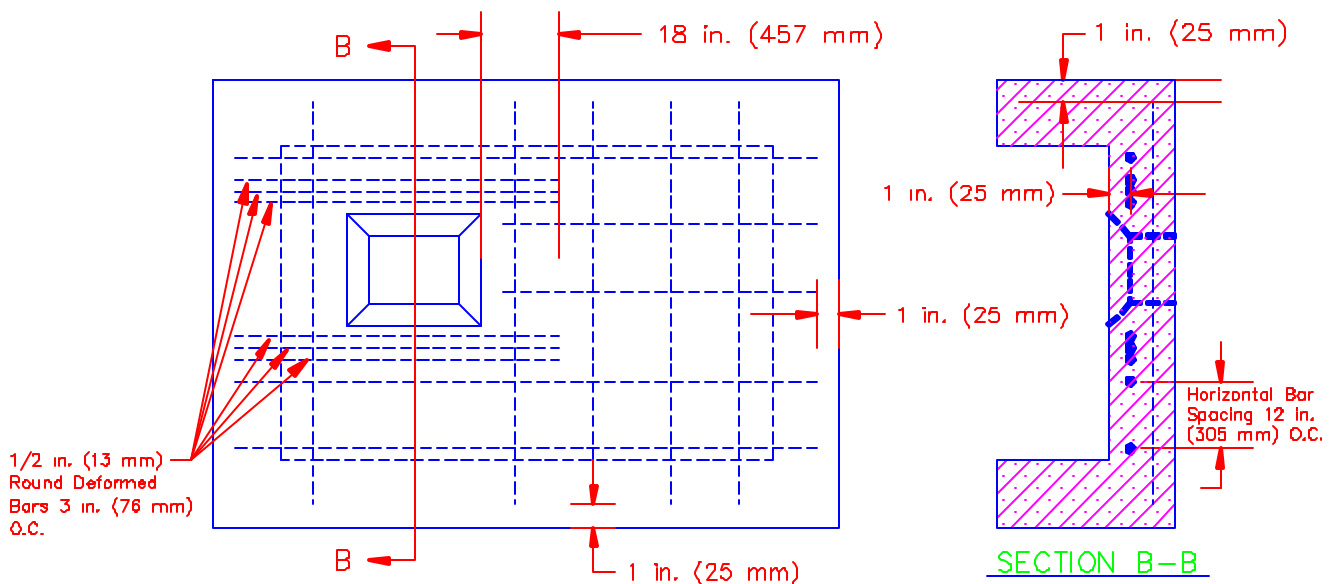


FIGURE 4
WALL CONSTRUCTION
POURED-IN-PLACED UCVS

Typical Wall Reinforcing Without Conduit Window



Typical Wall Reinforcing With Conduit Window



Note: O.C. means "On Center"

FIGURE 5
ROOF CONSTRUCTION
POURED-IN-PLACE UCVS

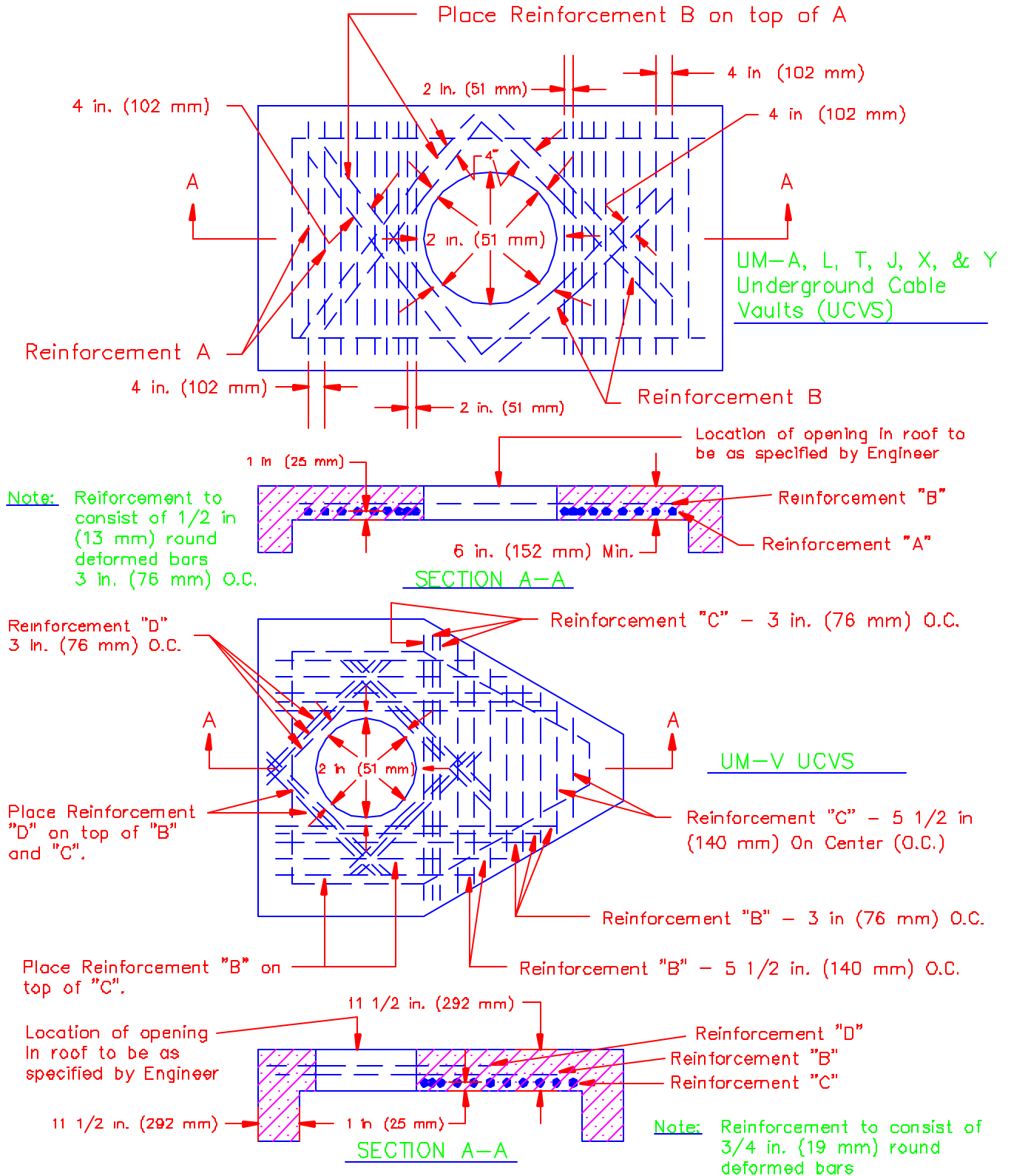
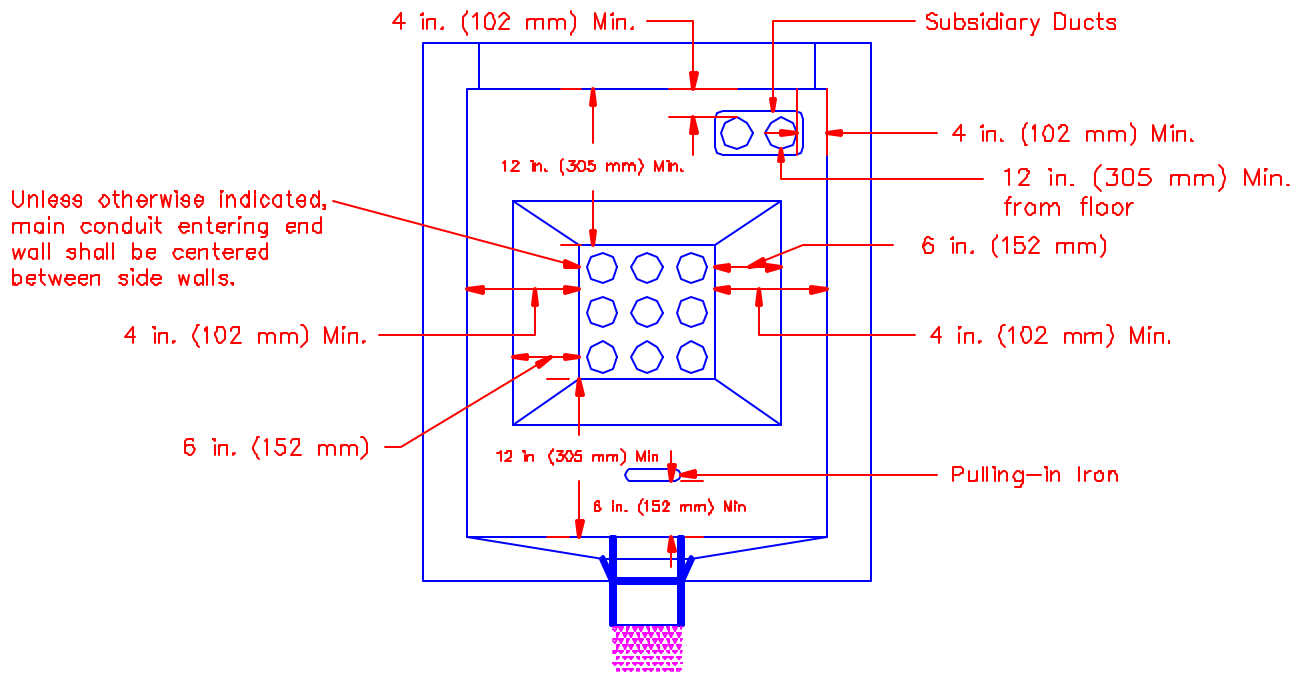
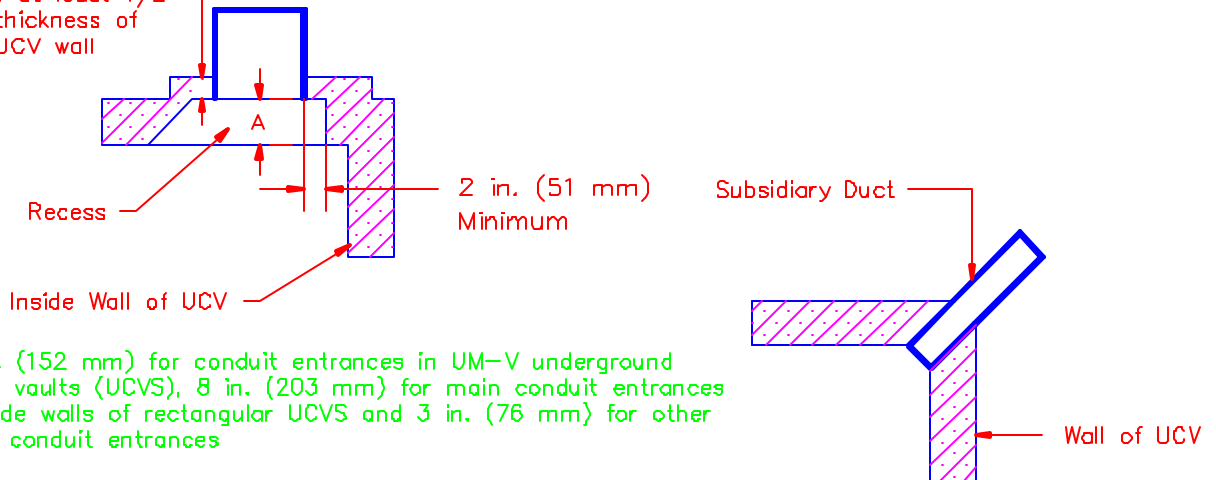


FIGURE 6
CONDUIT ENTRANCES AND RECESSES
POURED-IN-PLACE UCVS



PLAN VIEW

Thickness of the concrete here to equal at least 1/2 the thickness of the UCV wall



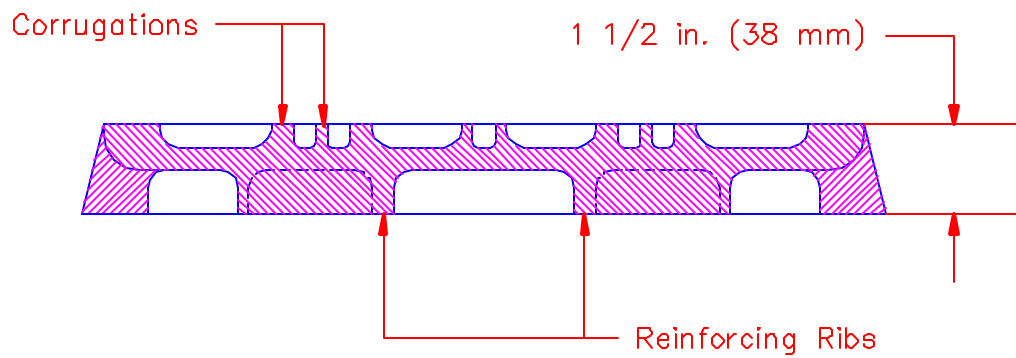
A = 6 in. (152 mm) for conduit entrances in UM-V underground cable vaults (UCVS), 8 in. (203 mm) for main conduit entrances on side walls of rectangular UCVS and 3 in. (76 mm) for other main conduit entrances

Note: When recesses are desired for future duct the Engineer should specify the size and location of such recesses.

Alternate Arrangement for Subsidiary Ducts

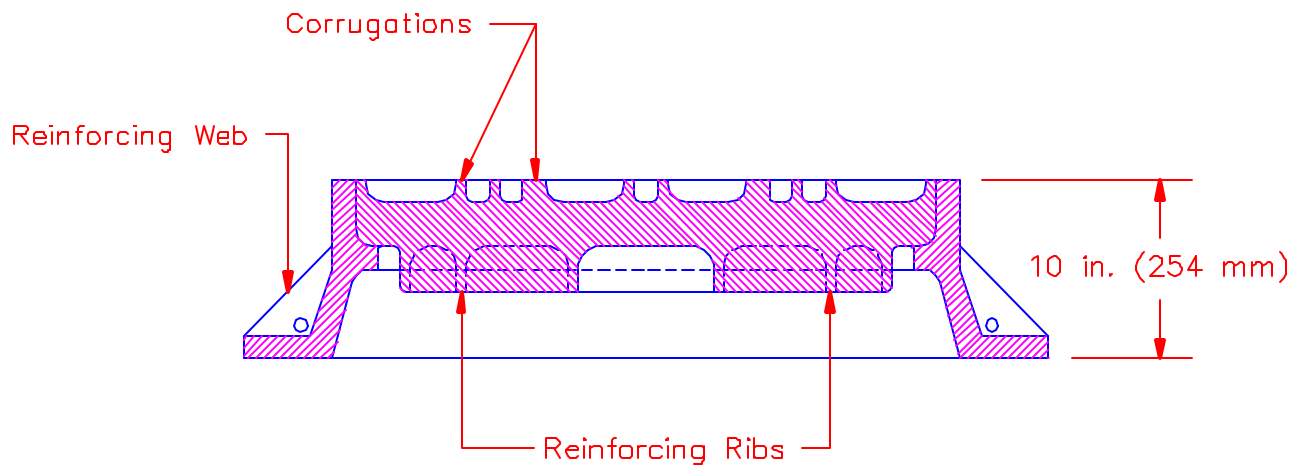
FIGURE 7
FRAME AND COVER TYPES
POURED-IN-PLACE UCVS

Type R Frame and Cover



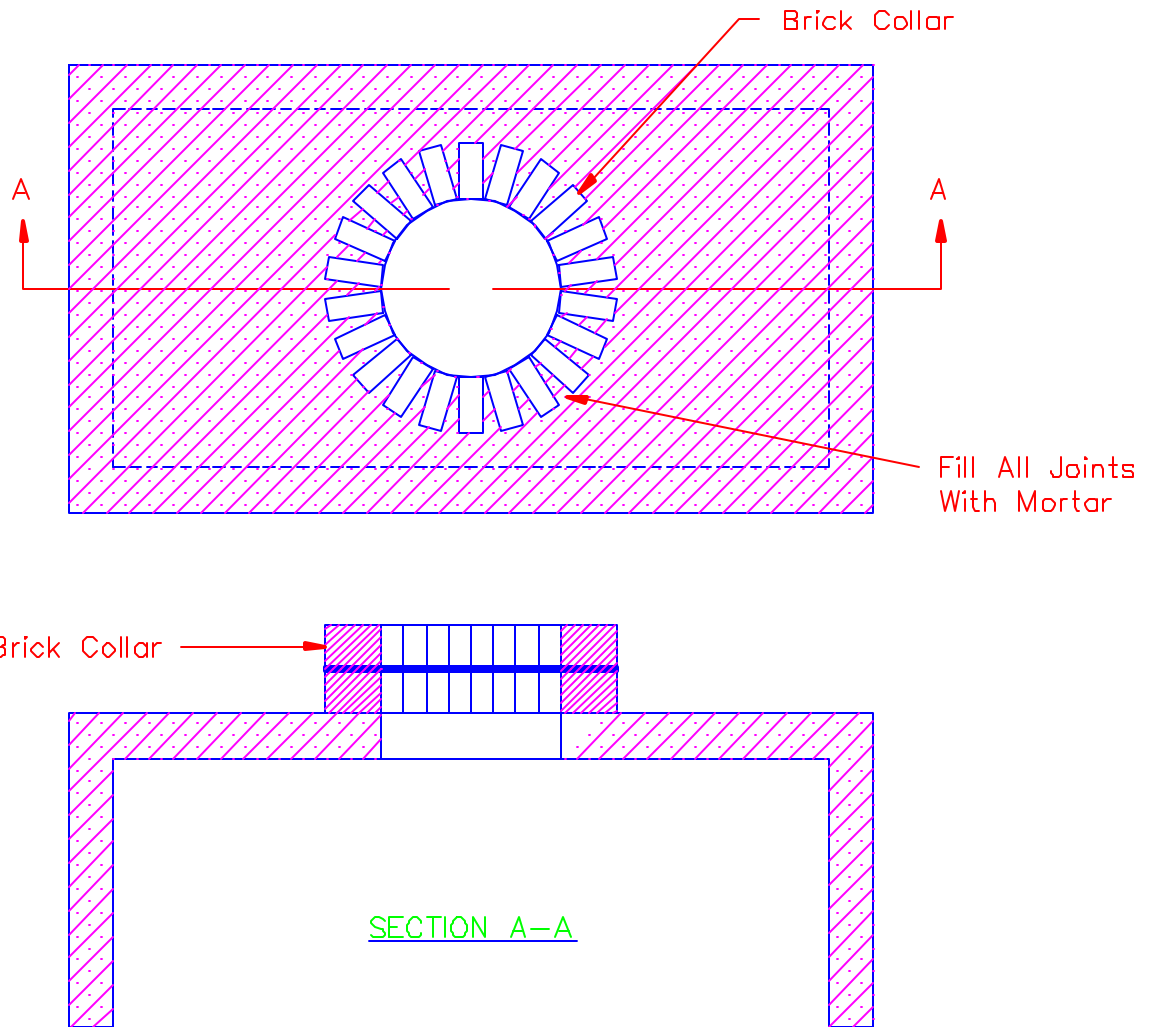
Note: Type R frame and cover for use only in locations not subject to the loads of vehicular traffic

Type B Frame and Cover



Note: Type B frame and cover for use in locations subject to the loads of vehicular traffic.

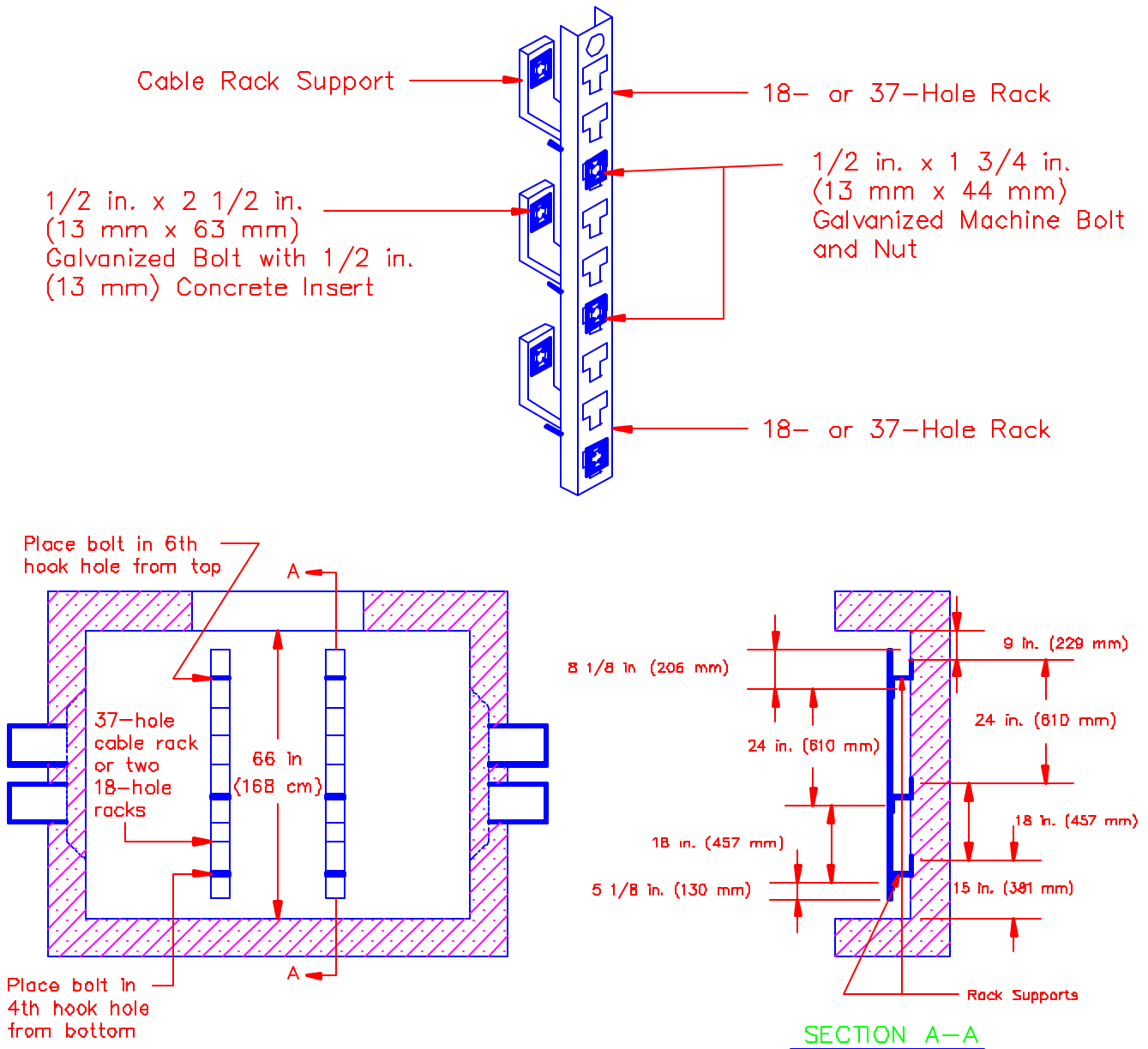
FIGURE 8
BRICK COLLAR CONSTRUCTION
POURED-IN-PLACE UCVS



Notes:

- ① Use 2 in. x 4 in. x 8 in. (51 mm x 102 mm x 203 mm) common brick for the UCV collar.
- ② Broken bricks are not to be used as a means of adjusting the frame to grade.
- ③ Top the upper course of bricks with a layer of mortar to embed the UCV frame.
- ④ Thoroughly fill all joints with mortar both inside and outside the collar.
- ⑤ The brick collar shall have a minimum of two courses of bricks.

FIGURE 9
TYPICAL INSTALLATION OF CABLE RACKS
POURED-IN-PLACE UCVS



Notes:

- ① Changes in locations of cable racks, additional racks, or different type cable racks will be specified by the Engineer when required.
- ② Before mounting cable rack supports on wall, chip away any projections on the wall which might prevent even bearing of the support against the wall.

FIGURE 10
ARRANGEMENT AND INSTALLATION OF PULLING-IN IRONS
POURED-IN-PLACED UCVS

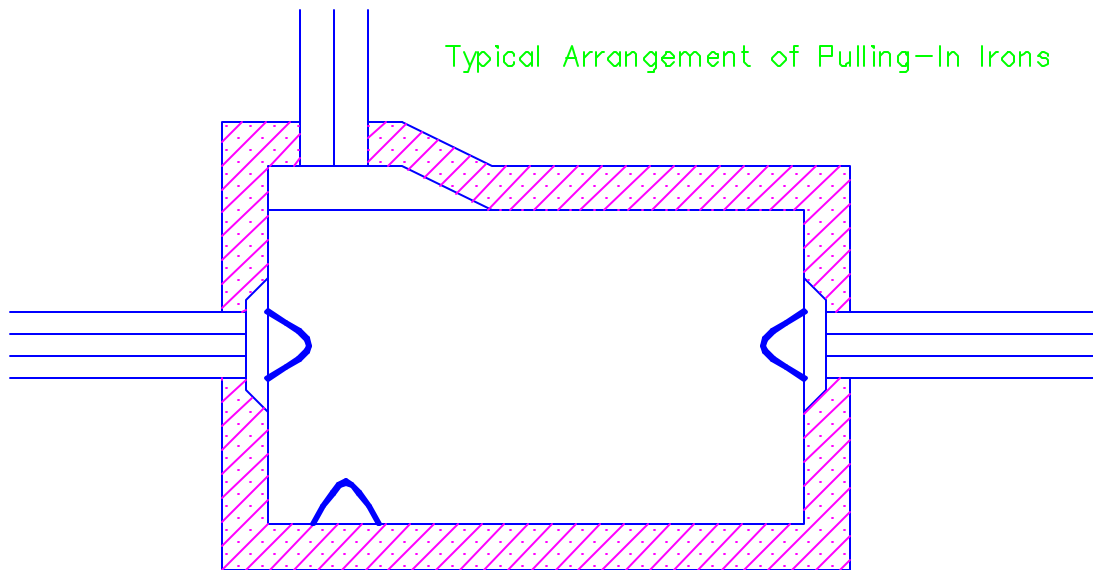
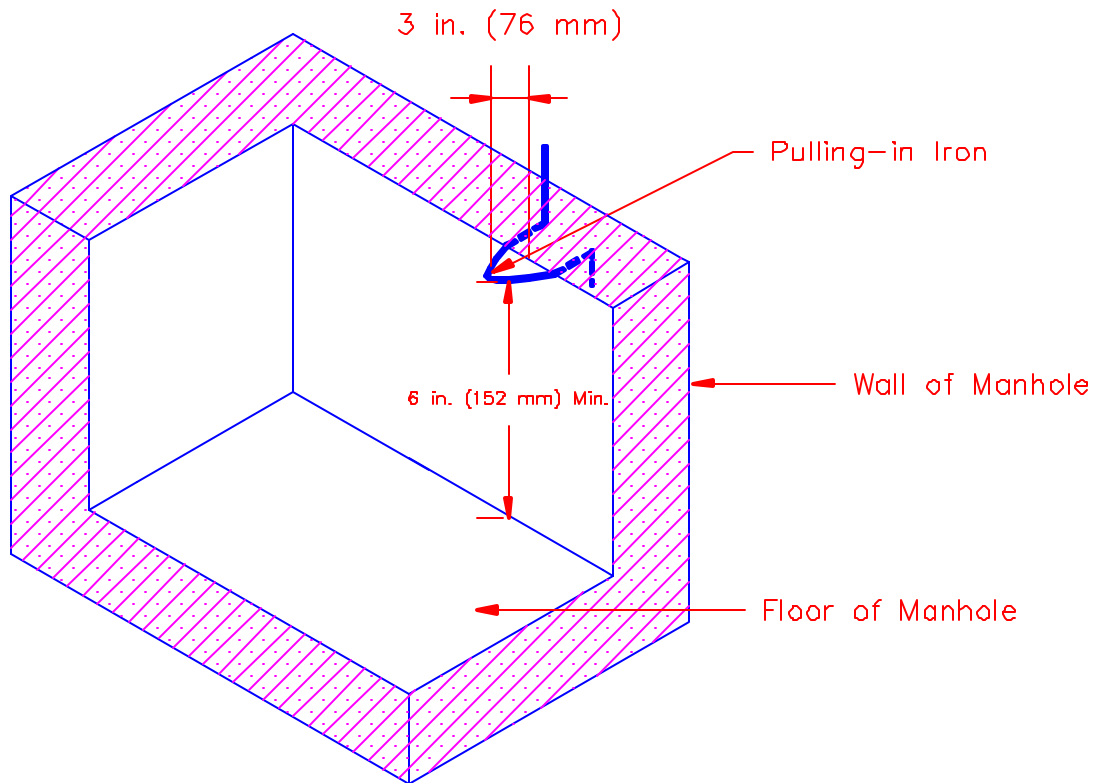


FIGURE 11
EXAMPLE OF UNDERGROUND CABLE VAULT AND
CONDUIT ROUTE CONSTRUCTION DRAWING

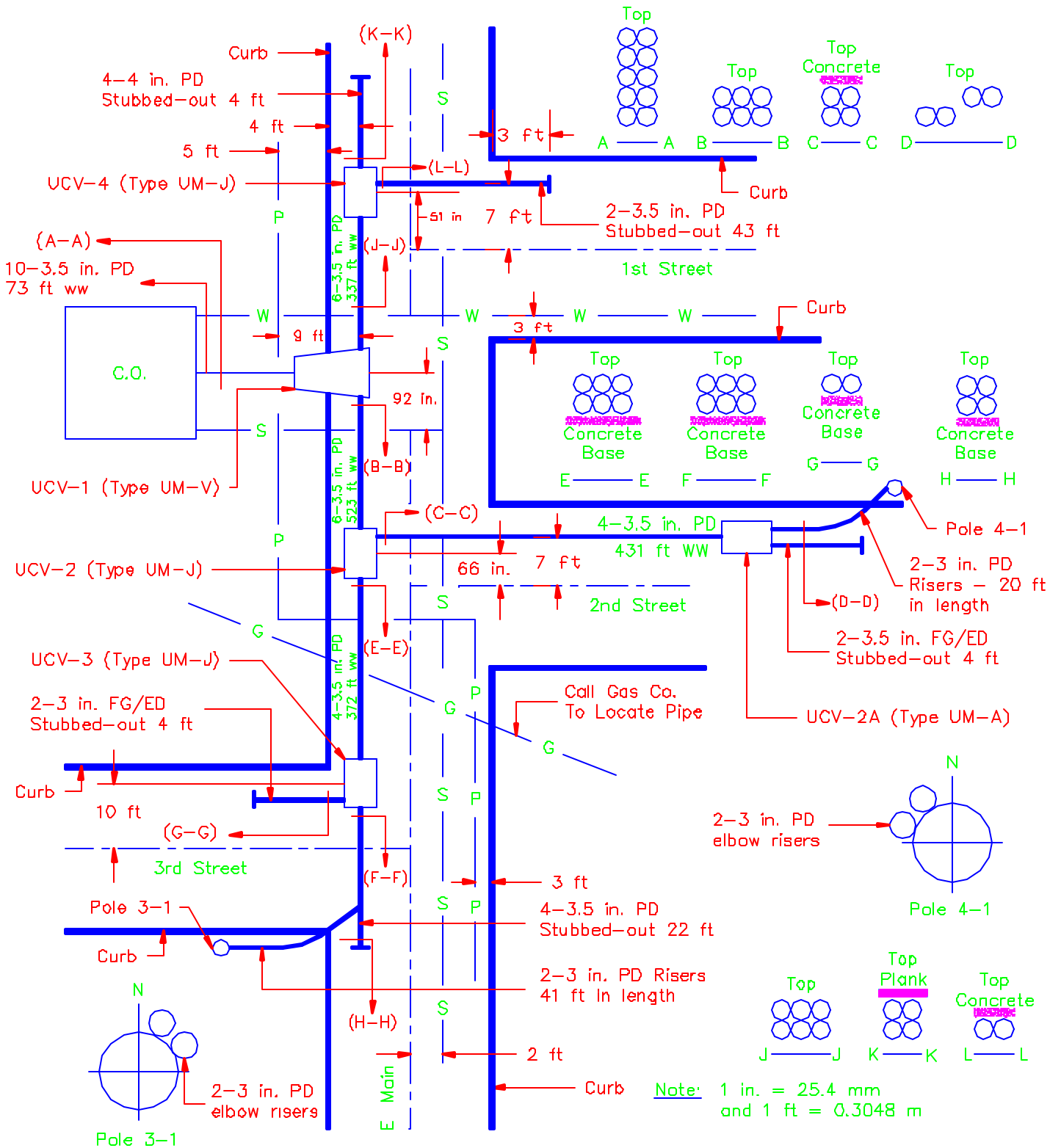


FIGURE 12 UNDERGROUND PLANT CONSTRUCTION ABBREVIATIONS AND SYMBOLS

Abbreviations

<p>BW – Building to Underground Cable Vault Wall Distance</p> <p>CC – Center to Center Distances Between Underground Cable Vaults</p> <p>C.O. – Central Office</p> <p>CONC – Concrete</p> <p>FG/ED – Fiberglass/Epoxy Duct</p> <p>FLXPD – Flexible Plastic Duct</p> <p>ft – Feet</p> <p>HH – Handholes</p> <p>Hwy. – Highway</p> <p>I.D. – Inside Diameter</p> <p>in. – Inches</p> <p>m – Meters</p>	<p>MCD – Multiple Concrete Duct</p> <p>mm – Millimeters</p> <p>MPD – Multiple Plastic Duct</p> <p>O.D. – Outside Diameter</p> <p>PD – Plastic Duct</p> <p>PINDCT – Plastic Innerduct</p> <p>Rd – Road</p> <p>R/W – Right-of-Way</p> <p>St. – Street</p> <p>UCV – Underground Cable Vault</p> <p>WW – Underground Cable Vault Wall to Underground Cable Vault Wall Distance</p>
--	--

Symbols




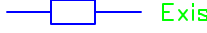
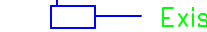






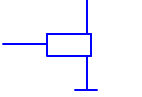
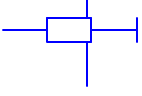
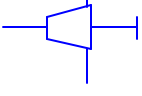




<p> Existing conduit</p> <p> Proposed conduit</p> <p> Proposed (future) conduit</p> <p> Existing Type UM-A UCV</p> <p> Existing Type UM-L UCV</p> <p> Existing Type UM-T UCV</p> <p> Existing Type UM-J UCV</p> <p> Existing Type UM-V UCV</p> <p> Existing Type UM-X or UM-Y UCV</p> <p> Existing Type UM-A UCV With Stubbed-Out Duct</p> <p> Existing Type UM-L UCV With Stubbed-Out Duct</p>	<p> Existing Type UM-T UCV With Stubbed-Out Duct</p> <p> Existing Type UM-J UCV With Stubbed-Out Duct</p> <p> Existing Type UM-V UCV With Stubbed-Out Duct</p> <p> Proposed Type UM-A UCV</p> <p> Proposed Type UM-L UCV</p> <p> Proposed Type UM-T UCV</p> <p> Proposed Type UM-J UCV</p>
--	---

FIGURE 12B UNDERGROUND PLANT CONSTRUCTION ABBREVIATIONS AND SYMBOLS (CONTINUED)

Symbols

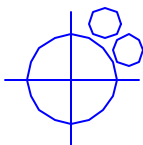
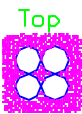
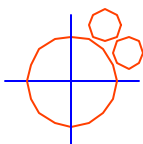

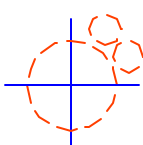


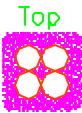
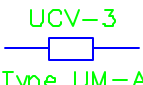



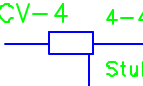
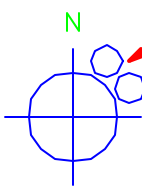
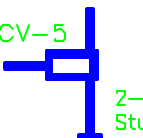
	<p>Existing Riser Conduit Termination Showing Pole Quadrant</p>		<p>Top 4-3.5 in. PD</p>	<p>Existing Concrete Encased Conduit Configuration Looking Back Toward Central Office Showing 4-3.5 in. Plastic Ducts</p>
	<p>Proposed Riser Conduit Termination Showing Pole Quadrant</p>		<p>Top 2-3.5 in. FG/ED</p>	<p>Existing Direct Buried Conduit Configuration Looking Back Toward Central Office With Treated Plank Top Protection Showing 2-3.5 in. Fiberglass/Epoxy Ducts</p>
	<p>Proposed Riser Conduit Termination Showing Pole Quadrant</p>		<p>Top 4-3.5 in. FG/ED</p>	<p>Existing Direct Buried Conduit Configuration Looking Back Toward Central Office With Concrete Base Showing 4-3.5 in. Fiberglass/Epoxy Ducts</p>
<p><u>4 in. MPD</u></p>	<p>Existing 4 way 4 in. Multi-Plastic Duct</p>		<p>Top 4-4 in. PD</p>	<p>Proposed Direct Buried Conduit Configuration Looking Back Toward Central Office Showing 4-4 in. Plastic Ducts</p>
<p><u>6-3.5 in. FG/ED</u></p>	<p>Proposed 6-3.5 in. Fiberglass/Epoxy Ducts</p>		<p>Top 4-3.5 in. PD</p>	<p>Proposed Concrete Encased Conduit Configuration Looking Back Toward Central Office Showing 4-3.5 in. Plastic Ducts</p>
	<p>UCV-3 Existing Type UM-A UCV No. 3</p>		<p>Top 2-3.5 in. FG/ED</p>	<p>Proposed Direct Buried Conduit Configuration Looking Back Toward Central Office With Treated Plank Top Protection Showing 2-3.5 in. Fiberglass/Epoxy Ducts</p>
	<p>UCV-6 Proposed Type UM-A UCV No. 6</p>		<p>Top 4-3.5 in. FG/ED</p>	<p>Proposed Direct Buried Conduit Configuration Looking Back Toward Central Office With Concrete Base Showing 4-3.5 in. Fiberglass/Epoxy Ducts</p>
	<p>UCV-4 4-4 in. PD Stub-out 5 ft Existing Type UM-J UCV No. 4 With 4-4 in. Plastic Ducts Stubbed-Out 5 ft</p>		<p>2-2 in. PD Risers</p>	<p>Existing Riser Conduit Termination Showing Pole Quadrant and 2-2 in. Plastic Duct Risers</p>
	<p>UCV-5 2-4 in. FG/ED Stub-out 4 ft Proposed Type UM-T UCV No. 5 With 2-4 in. Fiberglass/Epoxy Ducts Stubbed-Out 4 ft</p>	<p>Top 4-4 in. PD</p>	<p>Existing Direct Buried Conduit Configuration Looking Back Toward Central Office Showing 4-4 in. Plastic Ducts</p>	<p>Pole 4-6</p>
<p>Top</p>	<p>Existing Direct Buried Conduit Configuration Looking Back Toward Central Office Showing 4-4 in. Plastic Ducts</p>			

FIGURE 12C UNDERGROUND PLANT CONSTRUCTION ABBREVIATIONS AND SYMBOLS (CONTINUED)

Symbols

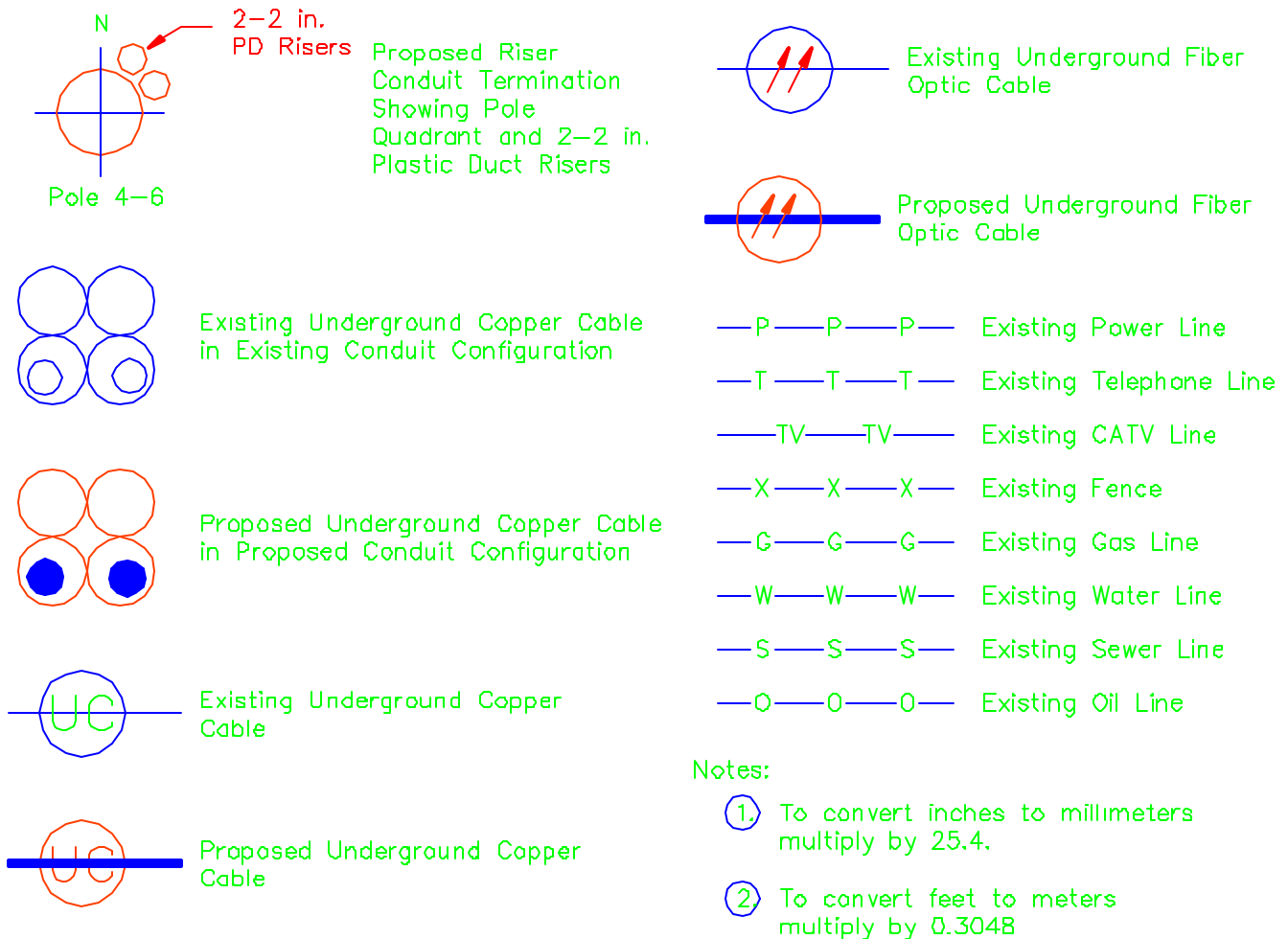
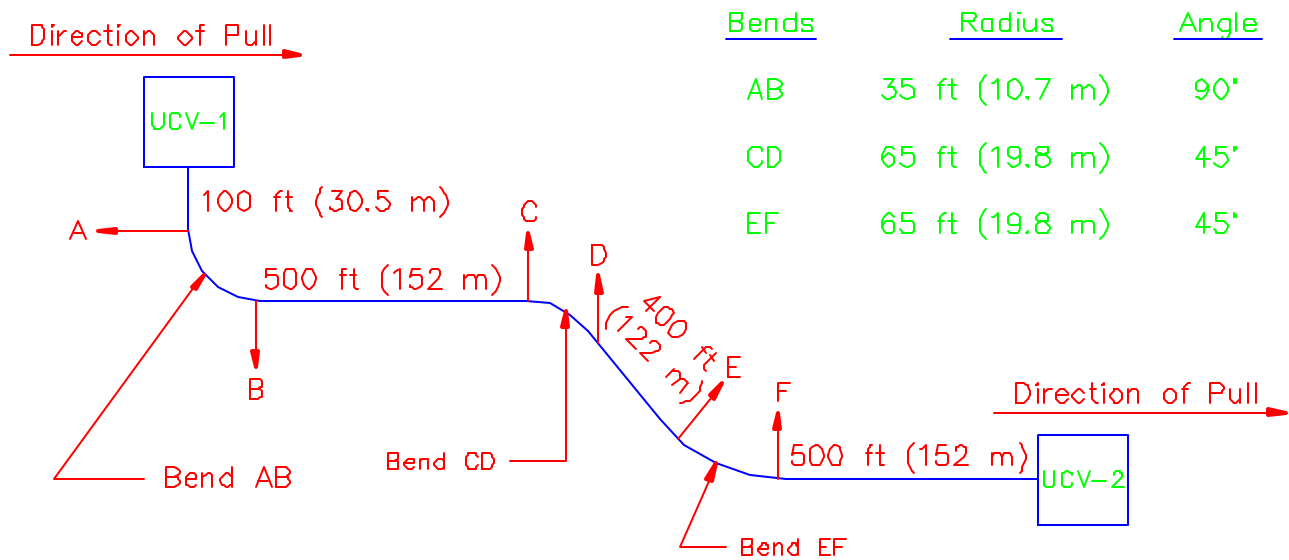


FIGURE 13
 EXAMPLE OF UNDERGROUND FILLED COPPER CABLE
 INSTALLATION IN A CONDUIT AND UCV SYSTEM CONTAINING
 MULTIPLE CONDUIT BENDS



Assume that a 900/24 filled cable using solid polyethylene insulation is to be pulled from UCV-1 to UCV-2. The cable has a low density polyethylene outer jacket and the conduit is polyvinyl chloride (PVC).

Procedure

- Determine the maximum allowable pulling tension for the 900/24 filled cable by the formula $T = ANK$.

Where: $T =$ Maximum Pulling Tension in lbs (kgs)

$A =$ Cross-sectional area of copper conductors in circular mils (mm^2) taken from Table 10

$N =$ Number of Conductors Terminated in Factory Installed Pulling Eyes

$K =$ 0.008 lbs/circular mils (7.2 kgs/mm^2)

English Units

$$T = ANK$$

$$T = 404 \times 1800 \times 0.008$$

$$T = ANK = 5818 \text{ lbs}$$

Metric Units

$$T = ANK$$

$$T = 0.205 \times 1800 \times 7.2$$

$$T = ANK = 2657 \text{ kgs}$$

FIGURE 13A
EXAMPLE OF UNDERGROUND FILLED COPPER CABLE
INSTALLATION IN A CONDUIT AND UCV SYSTEM CONTAINING
MULTIPLE CONDUIT BENDS (CONTINUED)

Procedure - Continued

2. Next determine the pulling tension from UCV-1 to Point A by using the following formula $T = LWf$.

Where: T = Pulling Tension in lbs (kgs) L = Cable Length in ft (m)
 W = Cable Weight in lbs/ft (kgs/m) f = Coefficient of Friction for Type of Installed Conduit

English Units

$$\begin{aligned} T &= LWf \\ T &= 100 \times 4.51 \times 0.36 \\ T &= LWf = 162 \text{ lbs} \end{aligned}$$

Metric Units

$$\begin{aligned} T &= LWf \\ T &= 30.5 \times 6.72 \times 0.36 \\ T &= LWf = 74 \text{ kgs} \end{aligned}$$

3. Then determine the pulling tension at Point B by substituting the tension calculated in Step 2 above as T_1 in the following formula $T = T_1 e^{fa}$.

Where: T = Pulling Tension in lbs (kgs) T_1 = Accumulated Tension to Start of Bend in lbs (kgs)
 e = Napierian Logarithm equal to 2.718 a = Bend Angle in Radians (1 radian = 57.3 degrees)
 f = Coefficient of Friction for Type of Installed Conduit

English Units

$$\begin{aligned} T &= T_1 e^{fa} \\ T &= 162 \times 2.718^{(0.36 \times 1.57)} \\ T &= T_1 e^{fa} = 285 \text{ lbs} \end{aligned}$$

Metric Units

$$\begin{aligned} T &= T_1 e^{fa} \\ T &= 74 \times 2.718^{(0.36 \times 1.57)} \\ T &= T_1 e^{fa} = 130 \text{ kgs} \end{aligned}$$

4. Next determine the pulling tension at Point C by adding the tension found at Point B (Step 3) to the tension for the 500 ft (152 m) straight section by the following formula $T = T_1 e^{fa} + LWf$.

English Units

$$\begin{aligned} T &= T_1 e^{fa} + LWf \\ T &= 285 + (500 \times 4.51 \times 0.36) \\ T &= T_1 e^{fa} + LWf = 1097 \text{ lbs} \end{aligned}$$

Metric Units

$$\begin{aligned} T &= T_1 e^{fa} + LWf \\ T &= 130 + (152 \times 6.72 \times 0.36) \\ T &= T_1 e^{fa} + LWf = 498 \text{ kgs} \end{aligned}$$

FIGURE 13B
 EXAMPLE OF UNDERGROUND FILLED COPPER CABLE
 INSTALLATION IN A CONDUIT AND UCV SYSTEM CONTAINING
 MULTIPLE CONDUIT BENDS (CONTINUED)

Procedure – Continued

5. Then determine the pulling tension at Point D by substituting the tension calculated at Point C (Step 4) as T_1 in the following formula $T = T_1 e^{fa}$.

<u>English Units</u>	<u>Metric Units</u>
$T = T_1 e^{fa}$	$T = T_1 e^{fa}$
$T = 1097 \times 2.718^{(0.36 \times 0.79)}$	$T = 498 \times 2.718^{(0.36 \times 0.79)}$
$T = T_1 e^{fa} = 1457 \text{ lbs}$	$T = T_1 e^{fa} = 662 \text{ kgs}$

6. Next determine the pulling tension at Point E by adding the tension found at Point D (Step 5) to the tension for the 400 ft (122 m) straight section by the following formula $T = T_1 e^{fa} + LWf$.

<u>English Units</u>	<u>Metric Units</u>
$T = T_1 e^{fa} + LWf$	$T = T_1 e^{fa} + LWf$
$T = 1457 + (400 \times 4.51 \times 0.36)$	$T = 662 + (122 \times 6.72 \times 0.36)$
$T = T_1 e^{fa} + LWf = 2106 \text{ lbs}$	$T = T_1 e^{fa} + LWf = 957 \text{ kgs}$

7. Then determine the pulling tension at Point F by substituting the tension calculated at Point E (Step 6) as T_1 in the following formula $T = T_1 e^{fa}$.

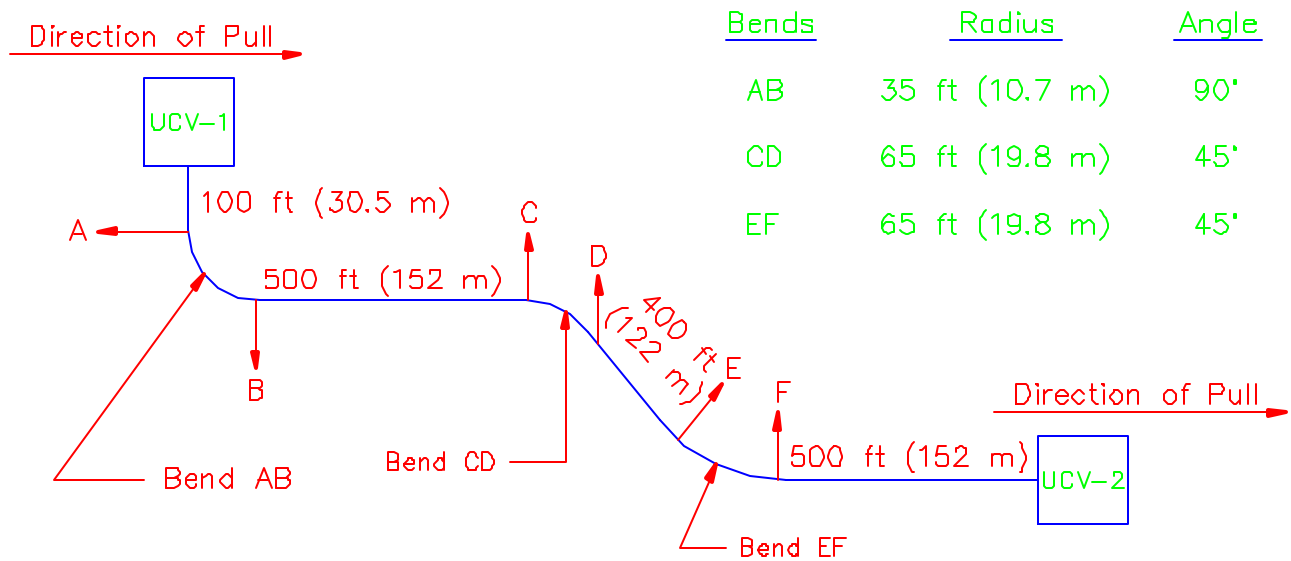
<u>English Units</u>	<u>Metric Units</u>
$T = T_1 e^{fa}$	$T = T_1 e^{fa}$
$T = 2106 \times 2.718^{(0.36 \times 0.79)}$	$T = 957 \times 2.718^{(0.36 \times 0.79)}$
$T = T_1 e^{fa} = 2799 \text{ lbs}$	$T = T_1 e^{fa} = 1272 \text{ kgs}$

8. Lastly determine the pulling tension at UCV-2 by adding the tension found at Point F (Step 7) to the tension for the 500 ft (152 m) straight section by the following formula $T = T_1 e^{fa} + LWf$.

<u>English Units</u>	<u>Metric Units</u>
$T = T_1 e^{fa} + LWf$	$T = T_1 e^{fa} + LWf$
$T = 2799 + (500 \times 4.51 \times 0.36)$	$T = 1272 + (152 \times 6.72 \times 0.36)$
$T = T_1 e^{fa} + LWf = 3611 \text{ lbs}$	$T = T_1 e^{fa} + LWf = 1640 \text{ kgs}$

9. Since the maximum pulling tension to pull the 900/24 filled cable from UCV-1 to UCV-2 was calculated to be 3611 lbs. (1640 kgs), the 900/24 filled cable can be pulled from UCV-1 to UCV-2 because the calculated pulling tension for the conduit and UCV system does not exceed the 5818 lbs. (2657 kgs) maximum allowable cable pulling tension calculated in Step 1 of Figure 13. Since the pulling calculations were for unlubricated cable, lubrication of the cable should provide a substantial safety margin.

FIGURE 14
 EXAMPLE OF DETERMINING THE CABLE SIDEWALL PRESSURE
 AT CONDUIT BENDS IN A CONDUIT AND UCV SYSTEM



Determine the sidewall pressure of a 900/24 filled cable at the conduit bends in the UCV-1 to UCV-2 underground system.

Procedure

1. Determine the maximum allowable sidewall pressures for the 900/24 filled cable at the conduit bends using the formula $P = T/R$.

Where: P = Sidewall Pressure in lbs/ft (kgs/m) T = Pulling Tension in lbs (kgs)
 R = Bend Radius in ft (m)

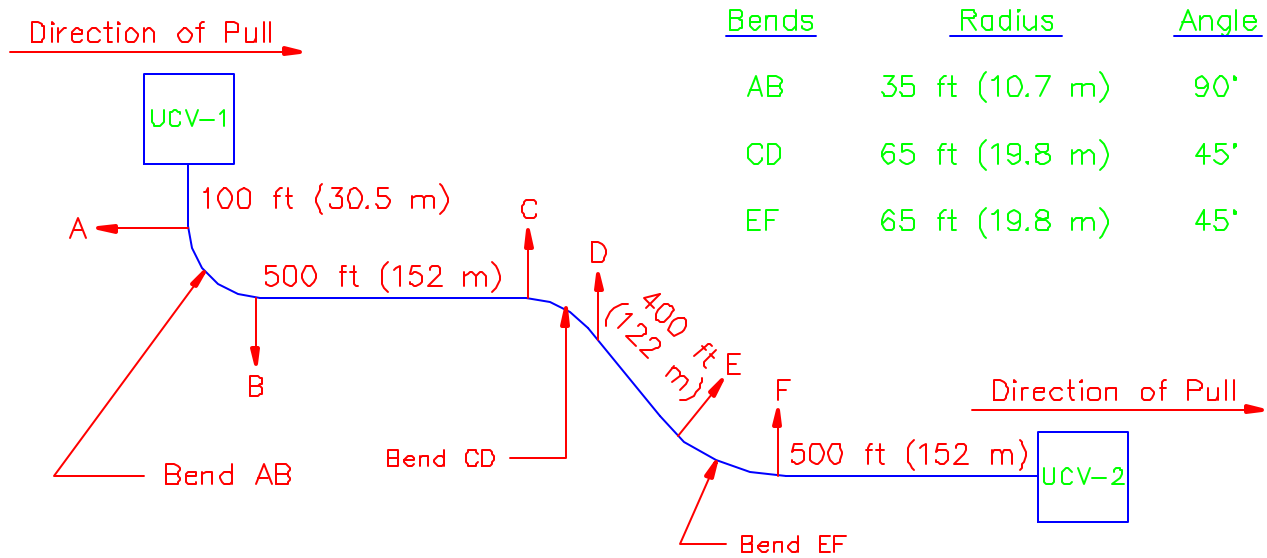
2. Determine the sidewall pressure for conduit bend "AB" having a 35 ft (10.7 m) radius and a pulling tension of 285 lbs (130 kgs) taken from Step 3 of Figure 13A.

<u>English Units</u>	<u>Metric Units</u>
$P = T/R$	$P = T/R$
$P = 285/35 = 8 \text{ lbs/ft}$	$P = 130/10.7 = 12 \text{ kgs/m}$

3. Determine the sidewall pressure for conduit bend "CD" having a 65 ft (19.8 m) radius and a pulling tension of 1457 lbs (662 kgs) taken from Step 5 of Figure 13B.

<u>English Units</u>	<u>Metric Units</u>
$P = T/R$	$P = T/R$
$P = 1457/65 = 22 \text{ lbs/ft}$	$P = 662/19.8 = 33 \text{ kgs/m}$

FIGURE 14A
 EXAMPLE OF DETERMINING THE CABLE SIDEWALL PRESSURE AT
 CONDUIT BENDS IN A CONDUIT AND UCV SYSTEM (CONTINUED)



Determine the sidewall pressure of a 900/24 filled cable at the conduit bends in the UCV-1 to UCV-2 underground system.

Procedure

- Determine the sidewall pressure for conduit bend "EF" having a 65 ft (19.8 m) radius and a pulling tension of 2799 lbs (1272 kgs) taken from Step 7 of Figure 13B.

English Units

$$P = T/R$$

$$P = 2799/65 = 43 \text{ lbs/ft}$$

Metric Units

$$P = T/R$$

$$P = 1272/19.8 = 64 \text{ kgs/m}$$

- Since the sidewall pressures of conduit bends "AB," "CD," and "EF" calculated in Steps 2 and 3 of Figure 14, and Step 4 above do not exceed the maximum allowable sidewall pressure of 100 lbs/ft (149 kgs/m), the 900/24 filled cable can be installed from UCV-1 to UCV-2.