

Ensuring a Sustainable Future: An Energy Management Guidebook for Wastewater and Water Utilities



JANUARY 2008



Table of Contents

FOREWORD	1
OVERVIEW	2 to 4
How This Guidebook is Organized	5 to 9
Characterization of Your Utility	
Crosswalk of Plan-Do-Check-Act Approach	
PLAN	
SESSION 1: Getting Ready	10 to 18
Module 1: Establish your utility's energy improvement goals	
Module 2: Secure and maintain management commitment, involvement, and visibility	
Module 3: Choose an energy "fenceline"	
Module 4: Establish energy improvement program leadership	
Module 5: Secure and maintain employee buy-in	
Module 6: Communicate results	
SESSION 2: Assessing Current Energy Baseline Status	19 to 33
Module 1: Benchmark energy efficiency information	
Module 2: Conduct an energy assessment or baseline audit	
Module 3: Review legal and other requirements and establish a compliance baseline	
SESSION 3: Establishing an Energy Vision and Priorities for Improvement	34 to 43
Module 1: Develop an energy policy	
Module 2: Identify activities and operations that consume energy	
Module 3: Prioritize activities/operations and potential energy improvement efforts	
SESSION 4: Identifying Energy Objectives and Targets	44 to 50
Module 1: Establish energy objectives and targets	
Module 2: Define performance indicators	
DO	
SESSION 5: Implementing Energy Improvement Programs and Building a Management System to Support Them	51 to 62
Module 1: Develop action plans to implement energy improvements	
Module 2: Develop management system 'operating controls' to support energy improvements	
CHECK & ACT	
SESSION 6: Monitoring and Measuring Your Energy Improvement Management Programs	63 to 71
Module 1: Review what you currently monitor and measure for energy	
Module 2: Determine what else you need to monitor and measure for your priority energy improvement operations	
Module 3: Develop a plan for maintaining the efficiency of energy equipment	
Module 4: Review the progress of your energy targets	
Module 5: Implement actions to adjust or correct when you are not progressing toward your energy goals	
Module 6: Monitor/reassess compliance status	
SESSION 7: Maintaining Your Energy Improvement Programs	72 to 76
Module 1: Continue to align energy goals with business/operational goals	
Module 2: Apply lessons learned	
Module 3: Expand involvement of management and staff	
Module 4: Communicate success	
CONCLUSION	77
Resources/Tools	78
APPENDICES	

FOREWORD

Providing wastewater and drinking water service to citizens requires energy – and a lot of it. The twin problems of steadily rising energy costs and climate change have therefore made the issue of energy management one of the most salient issues facing wastewater and water utilities today. Energy management is also at the heart of efforts across the entire sector to ensure that utility operations are sustainable in the future. More and more utilities are realizing that a systematic approach for managing the full range of energy challenges they face is the best way to ensure that these issues are addressed on an ongoing basis in order to reduce climate impacts, save money, and remain sustainable. Working closely with a number of utilities and others, the Office of Water at the U.S. Environmental Protection Agency (EPA) is proactively addressing this issue by developing this *Energy Management Guidebook for Wastewater and Water Utilities* that provides a systematic approach to reducing energy consumption and energy cost.

This *Guidebook* was specifically written to provide water and wastewater utility managers with a step-by-step method, based on a Plan-Do-Check-Act management system approach, to identify, implement, measure, and improve energy efficiency and renewable opportunities at their utilities.

To accomplish these objectives, water and wastewater practitioners with experience in implementing energy efficiency improvements played a major role in developing the *Guidebook*, serving as Steering Committee members, along with EPA staff. Their experiences and insights were instrumental in the development of this guide.

U.S. EPA Project Officer

Jim Horne

Office of Wastewater Management
Washington, DC

Steering Committee Members

Bob Bois

Environmental Compliance Officer
Springvale Water Treatment Plant
Natick, Massachusetts

Katie Jordan

Environmental/Safety Specialist
Osram Sylvania Products Inc.
Hillsborough, New Hampshire

Andy Kricun

Deputy Executive Director
Camden County Municipal Utilities Authority (CCMUA)
Camden, New Jersey

Jim Newton

Environmental Program Manager
Kent County Public Works Department
Dover, Delaware

Tom Pedersen

Vice President
Camp Dresser & McKee
Cambridge, Massachusetts

Mark Young

Executive Director
Regional Wastewater Utility
Lowell, Massachusetts

Anne Leiby

U.S. EPA Region 1

Gina Snyder

U.S. EPA Region 1

EPA also would like to thank the following individuals that provided comments throughout the *Guidebook's* development:

Linda Benevides

Massachusetts Executive Office of Energy and
Environmental Affairs

Leah Bowe

U.S. EPA Region 1

Catherine Hatcher

U.S. EPA, ENERGY STAR

Jean Holbrook

U.S. EPA Region 1

Jackie LeClair

U.S. EPA Region 1

Jason Turgeon

U.S. EPA Region 1

Ensuring a Sustainable Future: AN ENERGY MANAGEMENT GUIDEBOOK FOR WASTEWATER AND WATER UTILITIES

As a water or wastewater utility manager, you are facing unprecedented challenges that include ever increasing:

- ☑ Public expectations for holding rates/taxes while maintaining service standards.
- ☑ Population shifts/increases.
- ☑ Number and complexity of regulatory requirements.
- ☑ Maintenance and replacement of aging systems/infrastructure.
- ☑ Concerns about security and emergency preparedness.
- ☑ Changing work force demographics.
- ☑ Challenges in managing personnel, operations, and budgets.

Overlaying all these issues are steadily rising energy costs for your utility. Dealing with these rising costs will require utilities to better manage their energy consumption and identify areas for improvement. Water and wastewater utility energy consumption is generally on the order of 30-60% of a city's energy bill.¹

The graphs below further illustrate the challenges faced by the water and wastewater utility industry. The first illustrates the trend in electricity costs/kWh in New England from 1990 to 2007 and second characterizes operational energy use from a National Association of Clean Water Agencies (NACWA) survey of water and wastewater utilities.²

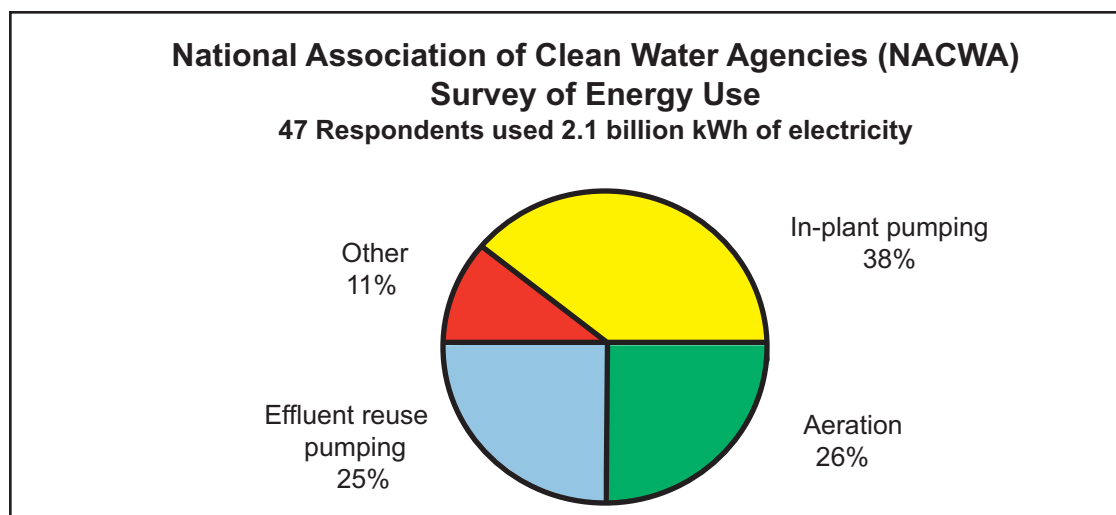
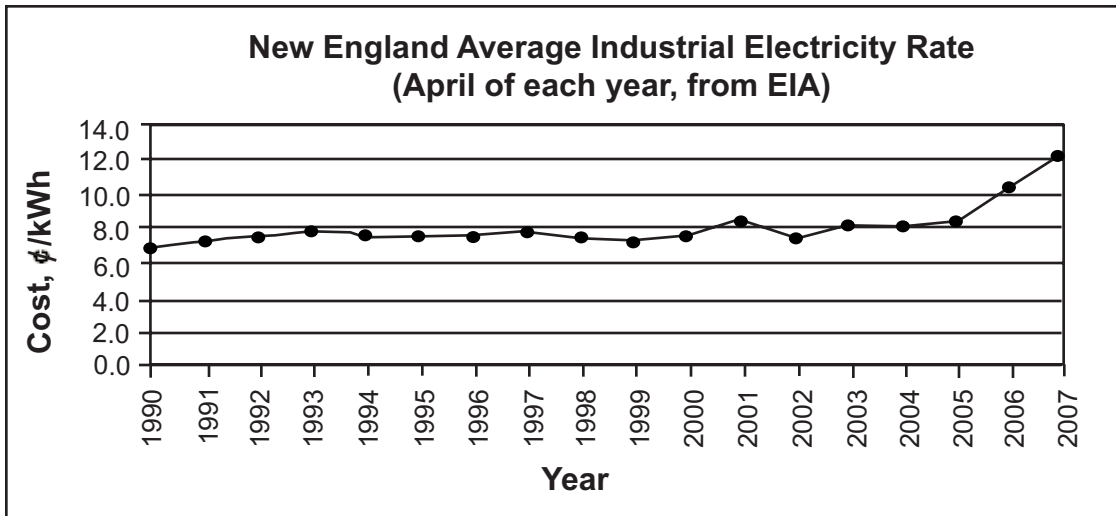

1 - Data from Energy Information Administration, "The Current and Historical Monthly Retail Sales, Revenues and Average Revenue per Kilowatt hour by State and by Sector," EIA-826. Available online at http://www.eia.doe.gov/cneaf/electricity/page/sales_revenue.xls.

2 - T. Jones, "Water-Wastewater Committee: Program Opportunities in the Municipal Sector: Priorities for 2006," presentation to CEE June Program Meeting, June 14, 2006, Boston, MA. Available online at http://www.cce1.org/cee/mtg/6-06_ppt/jones.pdf.

Energy represents the largest controllable cost of providing water or wastewater services to the public. Most facilities were designed and built when energy costs were not a major concern. With large pumps, drives, motors, and other equipment operating 24 hours a day, water and wastewater utilities can be among the largest individual energy users in a community.

In addition, a review of a facility's energy performance may also identify other areas for operational improvements and cost savings such as labor, chemicals, maintenance, and disposal costs. Finally, a thorough assessment of a facility's energy performance may alert managers to other issues. An unexplained increase in energy consumption may be indicative of equipment failure, an obstruction, or some other problem within facility operations.

Given these challenges, it is imperative for water and wastewater utilities to investigate implementing systematic programs to minimize energy usage and cost, without sacrificing performance.

The purpose of this *Energy Management Guidebook* is to demonstrate to utility managers that it makes sound business and environmental sense to utilize a management system approach to optimize energy conservation efforts. Specifically, this *Guidebook* will present a management system approach for energy conservation, based on the successful Plan-Do-Check-Act process, that enables utilities to establish and prioritize energy conservation targets (Plan), implement specific practices to meet these targets (Do), monitor and measure energy performance improvements and cost savings (Check), and periodically review progress and make adjustments to energy programs (Act). The *Guidebook* will also provide real life examples of water and wastewater utilities who have already realized significant benefits through use of an energy management program and provide a step-by-step process to show how to achieve the same benefits for your utility.

Similar to an operations plan, the *Guidebook* goes through the steps that a facility would take to understand their energy use and set reduction goals, take actions, and make progress on achieving energy reduction targets.

By making a commitment to saving energy at your water or wastewater utility, you will also help maintain the confidence of the public in the operations providing community services. In addition, by capitalizing on energy saving opportunities, a municipality or county utility can exert some control over rising costs for ratepayers of utility services as well as free up resources for other civic investments such as schools, police, or fire protection.

"Controlling our energy use saves money and creates budget capacity."

James L. Jutras

Water Quality Superintendent
Essex Junction, Vermont

"Energy production and usage have many areas of impact. Energy production is a major source of environmental impact and includes impacts to air and water pollution and the depletion of natural resources. Energy usage takes costs from a facility's budget that could be better spent on employee wages/benefits or to stabilize a utility's rate. A well thought out and implemented energy management program will minimize the energy production and usage impacts and strengthen the position of your utility."

Andy Kricun

Camden County Municipal Utility Authority
Camden, New Jersey

"A plan-do-check-act process is good for business and good for the environment. We can't do much about the weather and the outside factors that drive bulk energy costs but we can commit to competitive volume purchases of energy and to employ energy conservation efforts to effectively hold down the ever increasing costs and impacts of fossil fuel-based energy usage. This process can help identify energy conservation opportunities."

Bob Bois

Springvale Water Treatment Plant
Natick, Massachusetts

Total Estimated Annual Electricity Consumption - Wastewater and Water Treatment Facilities in Massachusetts³

	Estimated kWh/Mgal	kWh	Water and Wastewater as % of all MA industrial sectors	Costs
Wastewater treatment (not including distribution)	11,750	707,735,000	7.37%	\$91,439,362
Water treatment and distribution estimated	1,500	386,137,500	4.03%	\$49,888,965
Totals for MA Water and Wastewater Utilities	13,250	1,093,872,500	11.40%	\$141,328,327

Note: Total kWh of all MA Industrial Sectors equals 9,602,457,000.

Total estimated annual emissions from energy consumption at Massachusetts wastewater and water facilities⁴

- 957,138 CO₂ (tons)
- 4,190,045 SO₂ (tons)
- 1,415,471 NO_x (pounds)

FAST FACTS⁵

Drinking Water and Wastewater Utility Energy

- * Water and wastewater industries account for an estimated 75 billion kWh of overall U.S. electricity demand.
- * Drinking water and wastewater systems in the U.S. spend about \$4 billion a year on energy to pump, treat, deliver, collect, and clean water.
- * Energy efficiency investments often have outstanding rates of return and can reduce costs at a facility by 5%, 10%, 25%, or more.
- * Loads expected to increase by 20% in next 15 years due to increased populations and more stringent regulations.
- * Energy costs for water and wastewater can be 1/3 of a municipality's total energy bill.
- * If drinking water and wastewater systems reduce energy use by just 10% through cost-effective investments, collectively they could save approximately \$400 million and 5 billion kWh annually.

Wastewater Utility

- * There are 15,000 wastewater systems, including 6,000 Publicly Owned Treatment Works (POTWs) in the U.S.
- * Majority of energy use: treatment process (aeration) and pumping.
- * Energy use affected by: population, influent loading, effluent quality, process type, size, and age.
- * Major processes: collection systems (sewers and pumping stations), wastewater treatment (primary, secondary, and/or tertiary/advanced), bio-solids processing, disposal, or re-use.

Note: Reduction in greenhouse gases can also be realized through improvements in energy efficiency. The U.S. Climate Technology Cooperation Gateway website's (<http://www.usctcgateway.net/tool>) Greenhouse Gas Equivalencies Calculator is designed to enable users to quickly and easily translate greenhouse gas reductions from units that are typically used to report reductions (e.g., metric tons of carbon dioxide equivalent) into terms that are easier to conceptualize (e.g., equivalent number of cars not driven for one year).

Drinking Water Utility

- * There are 60,000 community drinking water systems in the U.S.
- * Majority of energy use: pumping.
- * Energy use affected by: water source, quality, storage, elevation, distance, age, and process.
- * Major processes: production, treatment (disinfection), and distribution.

3- MassDEP, 9/07. It should be noted that some states are exploring ways to integrate energy efficiency, renewable energy, and green building into State Revolving Funds that provide low-interest loans for wastewater and drinking water projects. See the work that MassDEP is doing to promote the integration of renewable energy and energy conservation into new or upgraded construction projects at <http://www.mass.gov/dep/energy.htm>.

4- Ibid.

5- See <http://www.eere.energy.gov/industry/saveenergynow/partners/results.cfm> for a list of industrial energy efficiency improvements; several case studies discuss return on investment, often identifying measures with payback of 1-4 years. Some individual measures, such as changing incandescent lights to compact fluorescent, often have a rate of return of 100% or more. An example of a wastewater utility implementing a comprehensive package of improvements for a similar return on investment is the Metropolitan Syracuse Wastewater Treatment Plant in Onondaga County, NY. See <http://www.nrel.gov/docs/fy06osti/38076.pdf>. The payback period was 13 months.

How This Guidebook is Organized

Now that you have some information on energy costs and the potential energy efficiency savings for your water or wastewater utility, you may be asking:

- * What resources are available for me as a utility manager interested in pursuing energy efficiency at my facility?
- * How do I set and measure energy efficiency and renewable energy targets?
- * Are there tools available to help me set and achieve energy goals?
- * How do I align my energy goals with current programs already in place such as health and safety or quality programs, Capacity, Management, Operations, and Maintenance (CMOM), and/or asset management plans?

This *Energy Management Guidebook* will help you answer these and many other questions by taking you through the steps necessary to set, manage, and achieve energy efficiency goals for your utility through the development and implementation of a focused energy management program. These management programs can help you document annual energy savings, decrease air emissions, and earn a return on their capital investment. The steps outlined in the *Guidebook* are replicable and based on a Plan-Do-Check-Act process that will assist you in:

1. Benchmarking and tracking monthly and annual energy use;
2. Identifying and prioritizing energy operations and issues that can increase efficiency;
3. Identifying energy efficiency objectives and targets;
4. Defining the performance indicator(s) to use to measure progress towards your energy targets;
5. Establishing energy management programs (i.e., action plans to meet your goals);
6. Monitoring and measuring the performance of your established target(s);
7. Documenting and communicating success; and
8. Reviewing your progress periodically and making adjustments as necessary.

As you begin to make the important decisions for your utility on energy efficiency and renewable opportunities, keep in mind that there are a number of resources and management tools that are available to you as a water and wastewater utility manager. This *Guidebook* will define and link you to those resources and tools, as well as identify how you can align your energy efficiency plans with current management programs and tools that you use or may be implementing at your utility.

Throughout this *Guidebook*, you will see step-by-step sessions, modules, and exercises along with real life examples from water and wastewater organizations, so that you can successfully implement energy efficiency and renewable goals for your utility. Each module will define objectives, provide an overview of the main concepts, have the user complete exercises where applicable, and finally review the important takeaways specific to each module.

This *Guidebook* has been developed with significant input from water and wastewater utility professionals like you. They face the same energy challenges and are committed to addressing these issues based on the step-by-step approach described in the *Guidebook*.

Thank you for taking the first steps toward improved energy management at your utility.



Jim Horne
Office of Wastewater Management
U.S. EPA



You'll find the following icon symbols in each session:



Keys to Success indicates important takeaways to successful energy management implementation as identified by water and wastewater practitioners.



Consider This highlights a point or concept important to energy management implementation.



Reminders are key points to keep in mind.

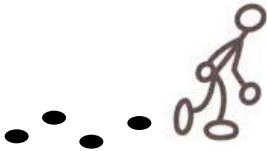

Moving to the Next Session identifies key concepts for the next session and the end of the current session.



TIP! identifies an important concept.

Not sure how this *Guidebook* can help you? Review the table below to see what statement best characterizes your utility's situation and find out what you should focus on and with what tools. Sessions referred to in the table below can be found in this *Guidebook*.

Characterization of your Utility

If this characterizes your situation...	Then focus on:	Use these tools:
<p>“We are starting to think about ways to improve energy management but don’t know where to start.”</p>	<p>Developing an energy management program</p>	<p>Portfolio Manager Overview (http://www.energystar.gov/index.cfm?c=evaluate_performance.bus_portfolio.manager); EPA's Performance Track (www.epa.gov/perftrac/); Session 1: Getting Ready</p>
<p>“We have completed the benchmarking tool and want to set priorities for energy improvement efforts.”</p>	<p>Conducting an energy audit</p>	<p>Session 2: Assessing Current Energy Baseline Status; Session 3: Establishing an Energy Vision and Priorities for Improvement</p>
<p>“We are a member of EPA's Performance Track Program, committed to reduce energy consumption and reduce greenhouse gas emissions.”</p>	<p>Establishing targets; developing action plans; measuring and monitoring results; evaluating progress; aligning program with operational goals</p>	<p>Portfolio Manager Overview (http://www.energystar.gov/index.cfm?c=evaluate_performance.bus_portfolio.manager); Greenhouse Gas Equivalencies Calculator (http://www.usctcgateway.net/tool/); Session 3: Establishing an Energy Vision and Priorities for Improvement; Session 4: Identifying Energy Objectives and Targets</p>
<p>“We are using ENERGY STAR's Portfolio Manager and have identified specific areas for improvement.”</p>	<p>Establishing targets; developing action plans</p>	<p>Session 3: Establishing an Energy Vision and Priorities for Improvement; Session 4: Identifying Energy Objectives and Targets</p>
<p>“We have completed an energy audit and want to set priorities for energy improvement efforts.”</p>	<p>Prioritizing activities; establishing targets</p>	<p>Session 3: Establishing an Energy Vision and Priorities for Improvement</p>
<p>“We have implemented some great energy improvement projects but they don’t necessarily:</p> <ul style="list-style-type: none"> • connect to each other, • get managed as well as they could be, • measure for results, and/or • have procedures or systems to ensure they continue.” 	<p>Measuring and monitoring results; evaluating progress; aligning program with operational goals</p>	<p>Portfolio Manager (https://www.energystar.gov/istar/pmp/am/); Session 5: Implementing Energy Improvement Programs and Building a Management System to Support Them; Session 6: Monitoring and Measuring Your Energy Improvement Management Programs</p>

If this characterizes your situation...	Then focus on:	Use these tools:
<p>“We are part of an EPA, state, regional or municipal program to reduce energy consumption greenhouse gas emissions.”</p>	<p>Assessing emission footprint</p>	<p>Portfolio Manager (https://www.energystar.gov/istar/pmpam/); NEPOOL emission factors (www.iso-ne.com); Session 6: Monitoring and Measuring Your Energy Improvement Management Programs; Session 7: Maintaining Your Energy Improvement Programs</p>
<p>“We have ideas or proposals for energy improvements including renewables.”</p>	<p>Developing action plans, identifying resources</p>	<p>Portfolio Manager (https://www.energystar.gov/istar/pmpam/); NEPOOL emission factors (www.iso-ne.com); DSIRE (www.dsireusa.org); Session 1: Getting Ready; Session 3: Establishing an Energy Vision and Priorities for Improvement; Session 4: Identifying Energy Objectives and Targets</p>
<p>“We have an asset management system and want to look at ways to improve energy management.”</p>	<p>Reviewing Crosswalk Table page 9; Incorporating energy aspects into the management system</p>	<p>Session 1: Getting Ready; Session 2: Assessing Current Energy Baseline Status</p>
<p>“We are developing an Environmental Management System and want to incorporate energy improvements into its development.”</p>	<p>Reviewing Crosswalk Table page 9; Incorporating energy aspects into the management system</p>	<p>U.S. EPA’s PEER Center (www.peercenter.net); Session 3: Establishing an Energy Vision and Priorities for Improvement</p>
<p>“We have a functioning Environmental Management System and want to add in energy improvements and/or renewables.”</p>	<p>Reviewing Crosswalk Table page 9; Incorporating energy aspects into the management system</p>	<p>DSIRE (www.dsireusa.org); Session 4: Identifying Energy Objectives and Targets; Session 5: Implementing Energy Improvement Programs and Building a Management System to Support Them</p>
<p>“We have ISO 14001 certification and want to add in energy improvements and/or renewables.”</p>	<p>Reviewing Crosswalk Table page 9; Incorporating energy aspects into the management system</p>	<p>EPA’s Performance Track (www.epa.gov/perfrac/); Session 3: Establishing an Energy Vision and Priorities for Improvement; Session 4: Identifying Energy Objectives and Targets; Session 5: Implementing Energy Improvement Programs and Building a Management System to Support Them</p>
<p>“We have set energy targets and want to measure performance and communicate our results.”</p>	<p>Measuring and monitoring results; evaluating progress; developing communication strategy</p>	<p>Session 6: Monitoring and Measuring Your Energy Improvement Management Programs; Session 7: Maintaining Your Energy Improvement Programs</p>

The Plan-Do-Check Act approach in this *Guidebook* corresponds to the guidelines or other approaches such as ENERGY STAR. This means that if you are already using another process, this *Guidebook* will support your efforts as well as give you additional tools and assistance in focusing on energy improvements.

Crosswalk of Plan-Do-Check-Act Approach

Guidebook Section	ENERGY STAR	Asset Management	ISO 14001 Environmental Management Systems	ANSI/MSE 2000: A Management System for Energy
1. Getting Ready	Step 1: Make Commitment	Make a commitment (e.g., establish a policy) and determine asset management planning needs and prepare management and staff through early and on-going communication and training	Make a commitment (e.g., establish a policy) and determine environmental management planning needs and prepare management and staff through early and on-going communication and training	4.0 Management Systems for Energy 5.0 Management Responsibility 5.1 Management Commitment 5.3 Strategic Planning 5.4 Responsibility and Authority
2. Assessing Current Energy Baseline Status	Step 2: Assess Performance	Step 1: Taking an inventory of assets	4.3.1 Environmental Aspects and Impacts 4.3.2 Legal and Other Requirements 4.5.2 Evaluation of Compliance	6.0 Energy Management Planning 6.1 Energy Profile 6.2 External information 6.3 Energy Assessment
3. Energy Vision and Priorities for Improvement	Step 1.3: Institute an Energy Policy	Step 1: Taking an inventory of assets Step 2: Prioritizing assets	4.2 Environmental Policy 4.3.1 Environmental Aspects and Impacts	5.2 Energy Policy
4. Objectives and Targets	Step 3: Set Goals		4.3.3 Objectives and Targets and Environmental Management Programs	
5. Energy Improvement Management Plans	Step 4: Create Action Plan Step 5: Implement Action Plan	Step 3: Developing an asset management plan Step 4: Implementing an asset management plan	4.3.3 Objectives and Targets and Environmental Management Programs 4.4.1 Resources, Roles, Responsibility, and Authority 4.4.2 Training, Awareness, Competence 4.4.3 Communication 4.4.6 Operational Control 4.4.7 Emergency Preparedness and Response	7.0 Implementation and Operation 7.1 Purchasing 7.2 Facility, Equipment, and Process Control 7.3 Energy management projects 7.4 Control of outsourced energy services 7.5 Communication 7.6 Training, Competence, and Awareness
6. Monitoring and Measuring	Step 6: Evaluate Progress	Step 5: Reviewing and revising asset management plans	4.5.1 Monitoring and Measuring 4.5.2 Evaluation of Compliance 4.5.3 Nonconformance and Corrective Action and Preventive Action 4.5.5 EMS Audits 4.6 Management Review	8.0 Checking and Evaluation 9.0 Management Review
7. Maintaining Energy Improvement Programs	Step 7: Recognize Achievements			

SESSION 1: Getting Ready

You may be eager to plunge directly into starting energy programs, but before you do, it is important that you prepare your utility for the effort. Take the time to lay the foundation for energy improvement programs using a systematic Plan-Do-Check-Act management system approach. Investing the time and effort now will make a difference later on.

To successfully implement programs that improve energy efficiency, conservation, and use of alternative or renewable sources of energy, you will need to:

1. Establish your utility's energy improvement goals;
2. Secure and maintain management commitment, involvement, and visibility;
3. Choose an energy "fenceline";
4. Establish energy improvement program leadership;
5. Secure and maintain employee buy-in; and
6. Communicate results.

First let's review a few terms that you will need to understand.

Energy Program Manager: The person who has the responsibility and management authority for implementing your energy improvement programs from start to finish.

Energy Improvement Goal: A quantifiable energy efficiency objective that your utility has made a decision to achieve.

Energy Fenceline: The scope of your operations where you will focus your energy improvement goals and where they will be implemented. For example, across all utility operations, within a particular operation (e.g. biosolids), or for one utility component (e.g. pumps).

Energy Team: A core team made up of individuals at your facility that will help facilitate and implement energy improvement programs. These are the people within your utility with knowledge of utility processes and energy usage and will help communicate the importance of energy improvement to utility staff.

Generally, the Energy Team is composed of employees from various levels and functions who will assist in the design, implementation, and evaluation of your energy improvement programs. The Energy Team is made up of employees and staff who are closest to the actual work in the operations of your scope or fenceline and who can bring a huge amount of institutional expertise and operational experience that is critical to a strong energy improvement program.

The Energy Team plays an important leadership role in planning, delegating tasks, establishing deadlines, collecting and evaluating work, and providing training, guidance, and assistance as needed. The Energy Program Manager heads the Team, and together they become the organization's energy experts and champions.





Keys to Success

- Management commitment and support
- Active and meaningful engagement of staff
- Ability to build on existing processes and projects
- Effective leader and team
- Balancing the need for 'quick hits' with longer term changes
- Communication of meaningful results

Energy Team members should possess the following qualities:

- Knowledge of their operational and functional areas,
- Good communication and listening skills,
- Enthusiasm and commitment, and
- Respect and trust by employees and managers.

You may be able to use existing teams or groups that have been created in your utility or municipality. Some organizations enlist volunteers for their team, others delegate and assign members. Keep in mind that the Energy Team needs the authority as well as the responsibility to drive energy improvement programs and support their implementation.

Working as a Team

There are many ways to start work as an Energy Team. Try these training exercises to build an effective Energy Team within your organization.

- Identify and make a list of all the policies, standard operating procedures, and/or training related to energy currently in place in your utility.
- Identify and list all the management systems or programs your utility has developed [e.g., CMOM, Asset Management, National Biosolids Partnership].
- Identify and list all the energy projects your utility is currently undertaking.

MODULE 1: Establish Your Utility's Energy Improvement Goals

Module Objective: Identify how to align energy improvement goals with your current management, operations, and/or maintenance plans and policies.

In developing energy improvement programs, take the time to understand how they fit in with your utility's mission, goals, and strategic direction. Does your utility, board of directors, municipality, rate-payers, and general public want to:

- * **Reduce (control) energy costs by reducing/controlling energy use?**
- * **Set an example for other public entities?**
- * **Demonstrate leadership in sustainability or energy conservation initiatives and do the right thing for the environment?**
- * **Help your state or community implement its Climate Change Action Plan and contribute to reducing greenhouse gas generation and other air pollution?**
- * **Increase the use of renewable energy and alternative fuels, leading towards energy independence from foreign fuel sources?**
- * **Enhance the utility's or municipality's public image?**

If the answer to any of these questions is "yes," you're on the right path to identifying energy improvement goals that will align with your utility's objectives and plans.

Also, you may want to check to see if your community has a Climate Change Action Plan (<http://www.iclei.org/index.php?id=1387®ion=NA>) and coordinate your activities with the municipal lead or committee that is implementing the plan.



CONSIDER THIS...

Ensure that your energy improvement goals align with and build on your current and/or planned utility management programs and plans.

MODULE 2: Secure and Maintain Management Commitment, Involvement, and Visibility

Module Objective: To learn how to obtain and sustain management support for your energy improvement goals.

One of the most important steps in planning energy improvement programs is to gain top management's commitment and support. It is critical that commitment and support comes from both local (municipal) leadership and your organization's top and middle management as well as the union leaders. In fact, experience has shown that public organizations who attempt to implement energy improvement programs without top management support are unsuccessful.

During your preliminary discussions with management, you'll want them to clarify their specific goals and expectations. Find out what really motivates decision makers. Is it cost savings? Avoiding rate increases? Other pressures or aspirations?



Remember

Just like the rest of the employees, senior managers will need training to increase their awareness and understanding. Short, frequent sessions that address managers' concerns and provide examples of the benefits other utilities have realized in energy improvement programs are the most successful ways to keep management up-to-date, interested, and involved.

Confirm that senior managers at your utility understand:

- The implementation strategy and schedule you are using,
- The estimated direct labor commitment involved,
- When, how, and what to communicate to employees on a regular basis, and
- How your energy program aligns with current management plans and programs.

Role of management:

- Demonstrate real commitment to energy improvements,
- Provide appropriate responsibility and authority designations, and
- Ensure that operators are recognized for their efforts and contributions.



CONSIDER THIS...

Every organization implementing a new energy initiative or a management program has come to the same conclusion about management – visibility, commitment, and involvement are the keys to success. Be sure your energy improvement programs include regular and frequent dialogue with management. They are more likely to stay visible and involved if they have regular updates about the benefits and improvements your energy programs are providing your utility.

MODULE 3: Choose an Energy “Fenceline”

Module Objective: To learn how to determine which operations and processes will be the focus of your energy improvement programs (i.e., your “fenceline”).

You may not want to work on all energy opportunities in all buildings, locations, processes, and/or operations at once. Which ones should you work on first?

Consider selecting one operation or department as an energy pilot, gaining confidence and experience as you develop improvement programs. Personnel in the original fenceline can then become mentors, trainers, or leaders as new areas of the organization implement energy improvement programs.

Example Energy Fencelines for Water and Wastewater Utilities:

Water Supply or Wastewater Operations:

- Collection
- Treatment
- Distribution

Aspect of Operations:

- Pumping
- Sludge handling
- Heating, ventilation, air conditioning
(all buildings or a subset of buildings)
- Lighting
(all buildings or a subset of buildings)

Departments:

- Administration
- Electrical maintenance
- Structural maintenance
- Mechanical maintenance

Once top management has confirmed the fenceline selection, it's time to pay a visit to the managers and supervisors in your energy fenceline divisions. You'll certainly want to include all types of employees (e.g., union stewards, contractors, temporary staff) in your discussions right from the start. The time you invest now in promoting awareness, understanding, and buy-in, especially among managers and supervisors, will be time saved later in the process.

Questions to Consider When Selecting Your Fenceline:

- 1) Which of your operations consumes the most energy use and costs the most?
- 2) Which operations might get results that could be replicated to other operations?
- 3) Which of your operations has the most receptive management? Line supervisors? Employees?
- 4) Is there any place in the system where you are losing energy to gravity?
- 5) Where could you get some quick improvements and create success stories to share?



Remember

Remember the rule: keep it super simple (KISS). Starting with smaller, more manageable operations (or redundant operations), then expanding and transferring the lessons learned and knowledge to other departments is an option for your utility and a good way to build momentum.



CONSIDER THIS...

Your energy improvement program scope or fenceline should be manageable so that people don't get overwhelmed or paralyzed, but noteworthy enough to document and build on success.

The Fenceline Golden Rule: Don't bite off more than you can chew.

MODULE 4: Establish Energy Improvement Program Leadership

Module Objective: To establish effective leadership for energy improvement programs.

“Leadership comes in many forms and at different times. Be prepared to jump on it when it raises its head.”

Bob Bois
Springvale Water Treatment Plant
Natick, Massachusetts

Selecting an Energy Program Manager

For any initiative or program to be successful, you need a person who is effective at leading projects, someone who can take the responsibility and be trusted with the authority for developing, implementing, and maintaining your energy improvement programs. This person must have the designated authority from management to get the job done and have a level of management authority themselves – this is pivotal to drive the success of your energy programs.⁶

You have all been members of a team at some point in time. You may also have been the leader of a project or team. Leading initiatives and programs requires:

- Knowledge of operations,
- Good project management, organizational, and communication skills,
- Trust and respect of staff,
- Commitment and enthusiasm, and
- The ability to listen to others who have different perspectives and ideas.

Your Energy Program Manager will assume new responsibilities in addition to existing ones. Be sure the Energy Program Manager and town and/or plant management understand the scope of the work, including the number of hours you expect will be involved. All will need to be willing at times to redistribute some responsibilities to others in the organization.

In addition to typical project manager responsibilities, the Energy Program Manager will:

- Build and lead the Energy Team,
- Plan the project and implementation schedule,
- Gather, organize, and disseminate information,
- Delegate tasks and establish deadlines,
- Facilitate top management visibility and involvement,
- Obtain cross-functional support and buy-in, and
- Regularly meet and communicate with top management about the benefits and status of implementation.



TIP!

An Energy Team can include people from across your utility or municipal departments (e.g., engineering, finance, human resources, operations, municipal electric department, etc.) and include members from all levels of the organization. Members can even be pulled in from operations outside the scope of the fenceline. If your municipality already has an energy team or committee, connect with them.



Remember

Your water or wastewater utility may already have managers and staff that understand energy issues and are leaders in managing teams and programs. It is extremely beneficial to have senior management designate one or two people from these groups to become leaders in developing and managing your energy programs.

6 - To review a useful guide on team building from King County, WA, follow this link: (<http://www.resourcesaver.com/file/toolmanager/CustomO73C230F53915.pdf>)

Apply Your Knowledge

Sit down with your Energy Team and fill out the table below to identify and document energy programs and information that your utility has implemented.

Worksheet of Previously Implemented and Planned Energy Improvement Projects

Energy Use [type]	Projects completed	Results (\$, gallons, kWh, normalized if possible)	Who did you communicate results to?	Were there associated SOPs, training, records?	Current activities in planning	How will you measure results?	Who could you communicate results to?	What SOPs, training and records will be needed?



CONSIDER THIS...

Your energy improvement program scope or fenceline should be significant enough to document success and build on that success and momentum, but manageable enough that people don't get overwhelmed or paralyzed. It's important to keep things moving, so remember to remain flexible and fluid. Keep it super simple. The management system approach relies on checking and acting to continually review your work, so there will be many opportunities along the way to make improvements and course corrections.

MODULE 5: Secure and Maintain Employee Buy-In

Module Objective: Establish employee buy-in for your energy improvement programs.

The same methods that you used for gaining management support can be applied to gaining employee buy-in.

Get key employees involved early and often. It's important to get employee support from the beginning through ongoing, consistent, and open dialogue. Employees should understand what the organization wants to accomplish through its energy improvement programs. This can go a long way toward gaining support and answering the questions "what's in it for me" and "what will be required of me?" Communicate and ask employees for their interests and concerns during the planning stages and throughout implementation.

Ultimately, your organization will want to institutionalize energy conservation, efficiency, and energy renewable efforts and create an atmosphere or culture where looking for energy improvement opportunities becomes business as usual.



Remember

Involving a cross section of employees from departments across the organization early in program planning is the best way to promote short and long-term commitment throughout the organization. Plus, it's a great way to gain support and ensure buy-in for your energy improvement programs and the management system that supports them.

"It is important to identify how each person's fulfillment of their individual role connects to the utility's ability to realize the overall goals of the program. It is critical that everyone understands why it is important for them to do things in a certain way and how that contributes to the utility's overall success. That, I have found, is the best way to get employee buy-in, because they take ownership in the process."

Andy Kricun

Camden County Municipal Utility Authority
Camden, New Jersey

Ideas for building a team approach and involving employees from the very beginning include:

- Holding a kick-off meeting and inviting top management (this helps everyone see this effort as a priority).
- Talking this effort up with employees, union stewards, middle managers, 2nd shifters, etc.
- Spending time talking with your operators and plant staff.
- Having one-on-one conversations with team members can identify their needs, concerns, and problem areas.
- Asking employees on the front-line what changes they might like to see in their operations as a result of this effort.
- Posting signs and information on bulletin boards in lunch-rooms and near coffee and copy machines to familiarize staff with energy issues.
- Advertising early successes to keep management and employees aware and interested.



CONSIDER THIS...

Employee dialogue, buy-in, and involvement will help ensure that your efforts to improve energy efficiency are realistic, practical, and add value.

MODULE 6: Communicate Results

Module Objective: To learn effective ways to communicate your energy improvement goals.

“It’s important to be flexible, to listen, and adapt to the needs of staff and the organization.”

Bob Bois

Springvale Water Treatment Plant
Natick, Massachusetts

People are too often hesitant to communicate the status of an effort until something “big” happens or they have achieved huge results. Make the time to communicate the status of the efforts to develop energy improvement programs, including small milestones, quick updates, or findings. As an example, the Energy Team could package and communicate its initial inventory of energy projects (from the exercise on page 16) and use the communication as an opportunity to confirm that all current projects have been captured.

Mark your calendar to make sure that you are communicating something every month at a minimum, and preferably twice a month.



CONSIDER THIS...

Communicate your energy improvement goals frequently with staff. This will help ensure involvement and buy-in to your goals.

Session 1 Resources & Tools

Public Entity EMS Resource Center: <http://www.peercenter.net>

EMS Handbook for Wastewater Utilities: <http://www.peercenter.net/ewebeditpro/items/O11F10698.pdf>

ENERGY STAR Challenge Toolkit: http://www.energystar.gov/index.cfm?c=implement_plan.communication_plan

Moving to the Next Session

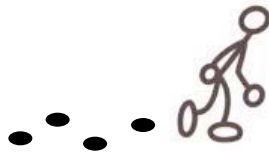

In *Getting Ready*, you developed the key to early success for any energy program initiative: **identification and alignment of goals** with your utility’s or municipality’s overall management strategy. **Frequent communication and involvement of management and staff** builds credibility and ensures senior management visibility and commitment throughout the program. Having established a communications process should ensure that the team will be getting feedback and continued resources to do its job.

In the next Session, the Energy Team, with the help of utility staff, will begin to determine your utility’s **current energy program status** by benchmarking your utility and conducting an energy audit and compliance review to baseline data.

SESSION 2: Assessing Current Energy Baseline Status

Before identifying areas for improvement, a water or wastewater utility will need to understand its current energy management programs, energy consumption, and its compliance with relevant regulations.

Key questions that will have to be answered include:

- How much energy is currently used overall for each process and what are the associated costs?
- How does your utility compare to the typical energy consumption for similar facilities?
- Do emissions from direct energy use fall within the permitted amounts?
- What other legal requirements related to energy (e.g., emissions) should be considered?

A *baseline energy evaluation* is the central element used for assessing your energy consumption status. You may have already conducted energy audits in the past. If so, you will be familiar with the process and should already have a good amount of data.

To successfully implement programs to improve energy efficiency, conservation and the use of alternative or renewable sources of energy, you will need to:

1. Benchmark energy efficiency information
 - Step 1) Collect baseline data
 - Step 2) Track monthly and annual energy use
2. Conduct an energy assessment or baseline evaluation
 - Step 3) Conduct a field investigation
 - Step 4) Create equipment inventory and distribution of demand and energy
3. Review legal and other requirements and establish a compliance baseline

Let's first review a few key terms that will help you as you conduct the energy audit.

Baseline Data: The starting point from which to track the achievement of an energy improvement target. By establishing "normalized" baselines, you can accurately measure how your utility's energy management and consumption change over time due to seasonal and other variations. This is particularly important since energy consumption may be affected by changes in production, flow, load, weather, or other related factors.

For example, if you were measuring energy consumed for your facility's HVAC system, you might want to establish a weather-normalized baseline because the energy demand of this system will depend on the amount of heating or cooling needed. The ENERGY STAR benchmarking tool described on the subsequent pages does this automatically.



Keys to Success

- What gets measured gets managed
- Keep data organized
- Ensure consistent units and timeframes
- Be creative in assessing processes and potential changes
- Focus on the biggest opportunities first
- Be ready to move on or estimate if data doesn't exist or can't be readily obtained

For pumps and other treatment equipment, consider comparing your energy use per million gallons of water treated to normalize your data.

For more information on normalizing data, review EPA's *Choosing a Normalizing Factor Basis and Performance Track's Normalization Guidance* (<http://www.epa.gov/perfrac/apps/normalization.htm>).

Design Specifications: A pump, fan, motor, or other system is designed to draw a given amount of electricity and do a corresponding amount of work. Design specifications provide this information. By comparing the power draw and the actual performance to the design specifications, you can see if your system is working as it should.

Energy Conservation: A general term for measures to reduce energy consumption. Energy efficiency, most often used to mean achieving the same results with less energy or getting the most out of every watt includes many types of technologies. Other types of energy conservation measures might include eliminating or changing certain processes or behavioral changes that do not involve a technology solution (e.g., turning off lights).

Energy Audit: A procedure undertaken to assess the current energy performance and to identify opportunities for energy savings. An equipment audit focuses on one type of system, such as pumps, HVAC systems, or lighting. A process audit refers to wastewater treatment processes and focuses on either one sub-set (such as aeration) or the overall treatment process. A walk-through audit provides an initial and very general overview of opportunities.

Intermittent Process: Many systems and processes do not run continuously but rather only at specific times. In some cases, processes can be scheduled to run during the night-time hours when grid power demand is low.

Load Profile: A variation of your energy demand over time that can be used to plan how much power a facility will need to generate at any given time. While most end users consume more power during the daytime, some users such as water utilities can shift high-energy demand processes to off-peak hours.

MODULE 1: Benchmark Energy Efficiency Information

Module Objective: To compare your energy performance to similar utilities.

Information on comparable wastewater treatment utilities is likely to be available through ENERGY STAR's Benchmarking Tool (see text box). Local utilities of similar size and design are excellent points of comparison. Broadening the search, one can find several resources discussing the "typical" energy consumption across the U.S. for a water or wastewater utility of a particular size and design.

Some utilities will have an inherently higher or lower energy demand due to factors beyond their control. For example, larger plants will, in general, have a lower energy demand per million gallons treated due to economies of scale. A plant that is large relative to its typical load is going to have a higher energy demand per million gallons treated. Some secondary treatment processes require greater energy consumption than others. Still, benchmarking allows a rough estimate of the utility's relative energy performance. Benchmarking of individual components is also useful. A survey of one's peers may identify what level of performance can realistically be expected from, say, a combined heat and power system or a specific model of methane-fueled microturbine.

Apply Your Knowledge

Using EPA's Portfolio Manager, track energy use over time and compare your utility to others in your region and across the nation. EPA's energy performance rating, which is accessible online through Portfolio Manager (see below), will rate the energy efficiency of your wastewater treatment plant on a scale from 1 to 100. EPA's energy performance rating is normalized for location and the impacts of year-to-year weather variations. The rating system also allows you to manage facility flow rate, level of treatment, and other operating characteristics.

In addition to tracking and rating energy use, Portfolio Manager allows you to measure and track energy costs and carbon emissions associated with the operation of your plant over time.

Available Resources for Benchmarking

- The ENERGY STAR program, administered by the U.S. Environmental Protection Agency (EPA) has developed an Energy Benchmarking Tool for Wastewater Utilities along with a series of Best Practices. These are available at www.energystar.gov/benchmark. For water utilities, the ability to measure and track energy use, energy cost, and carbon emission and corresponding reductions will be available in 2008.
- Several reports on wastewater utility energy demand have been developed for the California Energy Commission (<http://www.energy.ca.gov/process/water/>).
- The American Water Works Association (AWWA) Research Foundation has also developed a guide to Best Practices for Energy Management (<http://www.awwarf.org/research/topicsandprojects/execSum/2621B.aspx>).

Establish a user account in Portfolio Manager

- Go to <http://www.energystar.gov/benchmark> and login. If you do not already have a user account in Portfolio Manager, click the New User link on the login page and follow the instructions.
- Portfolio Manager allows you to import facility data into Portfolio Manager using a downloadable Excel template. This minimizes manual data entry of large sets of facility data. This Excel-based upload template (sample next page) is also useful as you gather and track your monthly energy use and costs. After downloading the import template, carefully review the instructions as well as the Tips for a Successful Import. Make sure your data is complete, particularly with regard to data that is required by Portfolio Manager for rating purposes. When you have populated the import template, send it to buildings@energystar.gov and upon review, your data will be uploaded into your account.
- To allow other organizations access to your portfolio with either read-only or administrative rights, you can share facility access with your Portfolio Manager account.

ENERGY STAR Criteria for Operating Characteristics for Wastewater Treatment Plant Requirements

- Average daily wastewater flow in MGD ≥ 0.6
- Average influent BOD5 (biological oxygen demand) level $30 \leq \text{mg/liter} \leq 1000$
- Average effluent BOD5 (mg/liter) level ≥ 0

The template below provides an example of energy data from a wastewater utility that can be uploaded and tracked using the Portfolio Manager tool.

Sample Portfolio Manager Upload Template

Facility Name	Energy Meter ID	Energy Type	Start Date	End Date	Energy Consumption	Energy Cost
Wastewater	E223-455	Electricity	2/1/2007	2/28/2007	83,489 kWh	\$3,520
Wastewater	E223-455	Electricity	1/1/2007	1/31/2007	83,826 kWh	\$3,580
Wastewater	E223-455	Electricity	12/1/2006	12/31/2006	83,456 kWh	\$3,485
Wastewater	E223-455	Electricity	11/1/2006	11/30/2006	83,623 kWh	\$3,259
Wastewater	E223-455	Electricity	10/1/2006	10/31/2006	83,518 kWh	\$3,325
Wastewater	E223-455	Electricity	9/1/2006	9/30/2006	83,794 kWh	\$3,450
Wastewater	E223-455	Electricity	8/1/2006	8/31/2006	83,725 kWh	\$3,440
Wastewater	E223-455	Electricity	7/1/2006	7/31/2006	83,676 kWh	\$3,250
Wastewater	E223-455	Electricity	6/1/2006	6/30/2006	80,942 kWh	\$3,350



CONSIDER THIS...

Benchmarking can be useful, but no two utilities are ever exactly the same. You'll have some characteristics that affect your relative performance and are beyond a utility's control.

STEP 1: Collect Baseline Data

Step Objective: To learn how to identify, locate, and assemble the information that can help you determine what you'll need to improve your energy performance.

The first step in collecting baseline data for your utility is to determine what data you already have available. At a minimum, have one full year of monthly data for consumption of electricity, natural gas, and other fuels – if you can get three years of data, even better. However, if you don't have data going this far back, use what you have or can easily collect. In addition, if you can get the data at daily or hourly intervals, you may be able to identify a wider range of energy opportunities.



Remember

ENERGY STAR's Portfolio Manager can help your water or wastewater treatment plant track and assess energy consumption across your entire utility. Follow this link (http://www.energystar.gov/ia/business/government/wastewater_fs.pdf) to view an ENERGY STAR Water and Wastewater Focus Fact Sheet.

STEP 1 Continued...

Here are several data elements to document and track for your utility in order to review energy improvement opportunities.

- **Water and/or wastewater flows** are key to determining your energy performance per gallon treated. For drinking water, the distance of travel and number of pumps are also key factors.
- **Electricity data** includes overall electricity consumption (kWh) as well as peak demand (kW) and load profiles if available.
- **Other energy data** includes purchases of diesel fuel, natural gas, or other energy sources including renewables.
- **Design specifications** can help you identify how much energy a given process or piece of equipment should be using.
- **Operating schedules** for intermittent processes will help you make sense of your load profile and possibly plan an energy-saving or cost-saving alternative.

Keep in mind that energy units may vary. For example, captured methane or purchased natural gas may be measured in 100 cubic feet (Ccf) or millions of British Thermal Units (MMBTU). Develop a table like the one below to document and track your data needs.

Data Need	Units
Wastewater flow	MGD
Electricity consumption	kWh
Peak demand	kW
Methane capture *	MMBTU
Microturbine generation	kWh
Natural gas consumed	MMBTU
Fuel oil consumed	Gallons
Diesel fuel consumed	Gallons
Design specifications	N/A
Operating schedules	N/A
Grease trap waste collected **	Gallons
Other (based on your utility)	TBD

Note:

* Methane capture will apply only to plants that digest their sludge.

** Collecting this type of data may provide you with a future renewable fuel source that could serve as a potential feedstock for biodiesel and some locations can use it to generate electricity on site.

Tools to Collect Baseline Data

There are many software programs for energy tracking (also known as utility management, energy accounting, or utility accounting). Some of these programs can accept automatic data entry directly from your utility. ENERGY STAR Portfolio Manager is useful not only for tracking your energy data, but also for comparing to similar facilities.

Remember your existing accounting system may already be tracking energy costs.



Remember

Keep units consistent!

STEP 1 Continued...

Consider any other quantities that you'll want to measure. Is there anything you would add to the list on the previous page? Select units that your Energy Team is comfortable with and that your data is typically available in. If the data is reported using the wrong units, you may have some conflicting or confusing results.

Units by themselves are not that informative; to be placed in proper context, they need to be associated with an interval of time. Therefore, for the next step add another column to your table: "Desired Frequency of Data."

Remember, while knowing your utility's energy consumption per month is useful, knowing it in kWh per day is better. With hourly consumption data, you can develop a "load profile" or a breakdown of your energy demand during the day. If your load profile is relatively flat, or if your energy demand is greater in the off-peak hours (overnight and early morning) than in the peak hours (daytime and early evening), your utility may qualify for special pricing plans from your energy provider.

Typically, water and wastewater utilities have a predictable diurnal variation. Usage is most heavy during the early morning, lags during the afternoon, has a second, less intensive peak in the early evening, and hits the lowest point overnight. Normally, energy use for water and wastewater utilities could be expected to follow a pattern of water flows. However, this effect can be delayed by the travel time from the sources, through the collection system, to the plant, or by storage tanks within the distribution system to customers. A larger system will have varying travel times, whereas a smaller system will have lower variability. Moreover, this effect can be totally eliminated if the plant has an equalization tank.

If your utility is paying a great deal of money for peak demand charges, you might consider the capital investment of an equalization tank. Demand charges can be significant for wastewater utilities, as they are generally about 25% of the utility's electricity bill.⁷

Adding a column for Desired Frequency of Data, the updated table would look like this:

Data Need	Units	Desired Frequency of Data
Wastewater flow	Million gallons	Daily
Electricity consumption	kWh	Hourly if possible or daily if not
Peak demand	kW	Monthly (if electric utility bills for peak monthly demand)
Methane capture	MMBTU	Monthly
Microturbine generation	kWh	Monthly
Natural gas consumed	MMBTU	Monthly
Fuel oil consumed	Gallons	Monthly
Diesel fuel consumed	Gallons	Monthly
Design specifications	N/A	N/A
Operating schedules	N/A	N/A

⁷ Water Environment Federation (1997), Energy Conservation in Wastewater Treatment Facilities, Water Environment Federation, Manual of Practice No. MFD-2, Alexandria, VA.

STEP 1 Continued...

Next, determine how you will collect baseline data. Energy data is recorded by your energy provider (e.g. electric utility, natural gas utility, or heating oil company). A monthly energy bill contains the total consumption for that month, as well as the peak demand. In some cases, your local utilities will record the demand on every meter for every fifteen-minute interval of the year. Similar data may be available if you have a system at your utility that monitors energy performance. Sources of energy data include the following:

- **Monthly energy bills** vary in detail but all contain the most essential elements. The scope of the analysis is in this case limited to a collection of one or more meters. If different systems are all on one meter, the fenceline must be defined to include all of the systems.
- **The energy provider** may be able to provide more detailed information. It will still be limited to meters (and not broken out by sub-systems behind the meters), but it may include greater resolution of hourly or quarter-hourly energy demand.
- **An energy management program** (e.g., Supervisory Control and Data Acquisition - SCADA) automatically tracks energy data, often with sub-meters to identify the load on individual components. If such a system is in place at your utility, you will have a large and detailed data set on hand.

Other data needs may also have a range of sources. Design specifications for equipment may be in manuals at your utility but you may still need to contact the manufacturers for specific items. Add a column for “Data Source” and “Availability” in your table.

Your energy provider can, in addition to providing raw data, offer you extensive expertise on energy-saving technologies, practices, and programs as well as contractors who can help you implement certain types of improvements. It is recommended that you meet early and often with your energy provider as you seek to improve your energy performance.

Example

Suppose that your utility has readily accessible data for its wastewater flow, microturbine generation, most of its design specifications, and its operating schedules. The Energy Team has a contact at the electric utility that can provide detailed information on electricity consumption and demand as well as a contact at the natural gas utility. No heating oil is used and diesel fuel consumption is negligible so these rows are removed. However, the utility doesn’t have a reliable record of exactly how much methane is captured by its system. In this example, the table will look as follows.

Data Need	Units	Desired Frequency of Data	Data Source	Availability of Data
Wastewater flow	Million gallons	Daily	Pump records	On-hand
Electricity consumption	kWh	Hourly if possible, daily if not	Electric utility and SCADA	Contact at utility
Peak demand	kW	Monthly (if electric utility bills for peak monthly demand)	Electric utility	Contact at utility
Methane capture	MMBTU	Monthly	Plant	Internal
Microturbine generation	kWh	Monthly	Meter attached to unit	On-hand
Natural gas consumed	MMBTU	Monthly	Natural gas utility	Contact at utility
Design specifications	N/A	N/A	Equipment manuals, nameplate ratings	Most on-hand, some will have to contact manufacturer
Operating schedules	N/A	N/A	Plant handbook	On-hand

STEP 1 Continued...

Without data on methane capture however, the utility will be unable to determine the microturbine's efficiency. They'll know how much electricity is produced but not how much fuel goes into the system in the form of methane. Although this calculation may be important, you can revisit it at a later time, when more data becomes available.

Normalized Baselines

Remember, to accurately measure how your utility performance is changing over time, establish "normalized" baselines where appropriate. Normalized baselines will measure your energy performance changes rather than changes in production, customer demand, or other non-environmental related factors.

Utility Case Study: Village of Essex Junction Wastewater Treatment Facility (Appendix A)

The Village of Essex Junction, Vermont, with the support of Efficiency Vermont, has successfully implemented microturbine technology at its 2.0 million gallons per day (MGD) average-flow, municipal wastewater treatment facility, and has firsthand information on its financial benefits. To review more information on how Essex Junction reduced energy and achieved cost savings from installing two microturbines at their 2.0 MGD wastewater utility, go to Appendix A.

Apply Your Knowledge

Develop energy baseline data using the blank tables in Appendix B. Consider your list of data needs. Where will you look to find the information you need? Is the data readily available or will you have to do some digging?

Once the data collection has been completed, your Energy Team will develop a final table, changing "Desired Frequency of Data" to "Frequency of Data." Also, since all of the data is now on-hand, you can remove the "Accessibility" column and our example table would look like this.

Data Need	Units	Frequency of Data	Source
Wastewater flow	Million gallons	Daily	Pump records
Electricity consumption	kWh	Hourly	Electric utility
Peak demand	kW	Monthly	Electric utility
Methane capture	MMBTU	Monthly	New gas meter attached to unit
Microturbine generation	kWh	Monthly	Electric meter attached to unit
Natural gas consumed	MMBTU	Monthly	Natural gas utility
Design specifications	N/A	N/A	Equipment manuals, nameplate ratings
Operating schedules	N/A	N/A	Plant handbook



CONSIDER THIS...

More information can be helpful, but only to a point. Keep your data organized and don't get overwhelmed or stuck looking for minor details. Be ready to move on and estimate if data doesn't exist or can't be easily obtained. Remember that the systems that use the most energy will have the greatest impact on your baseline and often have the greatest potential for energy savings.

STEP 2: Track Monthly and Annual Energy Use

Step Objective: To learn how to conduct a preliminary analysis to look for trends in energy data.

Now that you have your data, take a look at it and see what patterns emerge. Determine the energy demand per gallon of water or wastewater treated and see if this has changed over the baseline period. If you have annual energy consumption data for the last few years, then that can be analyzed for trends as well. Are there changes attributable to the replacement or installation of some piece of equipment? Are there seasonal variations in energy demand and in energy cost? What about daily variations?

Putting the data into graphical form may help your utility perceive any trends and may be particularly helpful for presenting results to those outside of the Energy Team. Make one graph of average daily energy consumption over time and one graph of energy consumption per gallon of water or wastewater treated. You may also want to make a third graph of energy costs over time, including purchased fuels as well as electricity. In addition, if greenhouse gas emissions (GHG) are a consideration for your utility or municipality, you may want to take this time to track your energy-related GHG emissions (direct emissions from fuel use and indirect emissions from energy).

Below is an example table indicating how you can track your monthly energy consumption. You can measure energy usage in kWh per day or kWh per month; just remember to be consistent. Consider using the same time unit as you use for treated water or wastewater flow so that you can see your energy demand per gallon treated. In the tables below, days are used as the increment.

2006 Energy Consumption	Average Daily Consumption (kWh)	Peak Demand (kW)	Cost (¢/kWh)	Daily Flow (million gallons)
January				
February				
March				
April				
May				
June				
July				
August				
September				
October				
November				
December				

STEP 2 Continued...

Apply Your Knowledge

Use the table on the previous page – or a similar one based on your needs – to document and track the monthly and annual energy use at your utility.

You may also wish to track overall energy demand per gallon of water or wastewater treated, especially if non-electricity energy sources such as natural gas play a significant role in your treatment process. In this case, you will need a metric that allows you to combine electricity and natural gas into a single measurement. Cost (in dollars) is one option, but cost is heavily influenced by external market forces. Energy can be expressed in scientific units, such as megajoules (MJ) or British Thermal Units (BTU), and it is possible to convert electricity, natural gas, and other fuel consumption into these units. Alternatively, you can track each energy source separately. Be advised that this may give a misleading picture of energy performance if you changed from one energy source to another such as replacing a natural gas heating system with a ground-source heat pump powered by electricity).⁸

If you have the data, tracking annual energy consumption can show long-term trends. Here is an example tracking table.

Year	Average Daily Consumption (kWh)	Peak Demand (kW)	Cost (¢/kWh in 2007)	Daily Flow (million gallons)
2000				
2001				
2002				
2003				
2004				
2005				
2006				



CONSIDER THIS...

Look for unusual trends in energy data and seek explanations.⁹ Rising energy expenditures may be due to rising electricity prices, increased water flow, unusually cold winters, or equipment failures. All of which can decrease your energy efficiency. Present your results in a way that conveys an explanation. In addition, remember that specific analysis of energy and energy-related data is a key activity in developing an effective energy management program.

⁸ - The Portfolio Manager tool will accept any unit and produce a normalized energy source intensity figure in kbtu/million gallons.

⁹ - ENERGY STAR'S Benchmarking tool will use zip code and weather data to normalize for heating and cooling degree days.

MODULE 2: Conduct an Energy Assessment or Baseline Audit

Module Objective: To learn the basics of conducting an energy audit.

The energy audit is an essential step in energy conservation and energy management efforts. Your utility or municipality may have had an energy audit or energy program review conducted at some point. If so, find the final report and have your Energy Team review it. How long did the process take? Who participated in it—your team, the electric utility, independent contractors? What measures were suggested to improve energy efficiency? What measures were actually implemented and did they meet expectations? Were there lessons learned from the process that should be applied to future audits? In addition, if your facility's previous energy audit had recommended measures, determine if they are still viable.

In many cases, electric utilities offer audits as part of their energy conservation programs. Independent energy service companies also provide these services. An outside review from an electric utility or an engineering company can provide useful input but it is important to ensure that any third party is familiar with water and wastewater systems.

Some energy audits focus on specific types of equipment such as lighting, HVAC, or pumps. Others look at the processes used and take a more systematic approach. Audits focused on individual components, as well as in-depth process audits, will include testing equipment. For example, in conducting the baseline energy audit, the Energy Team may compare the nameplate efficiency of a motor or pump to its actual efficiency.

In a process approach, a preliminary walk-through audit is often used as a first step to determine if there are likely to be opportunities to save energy. If such opportunities exist, then a detailed process audit is conducted. This may include auditing the performance of the individual components as well as considering how they work together as a whole. Much like an environmental management system initial assessment that reviews current status of regulatory requirements, training, communication, operating conditions, and current practices and processes, a preliminary energy audit or energy program review will provide your utility with a baseline of what your energy consumption is at that point in time.

Once you have collected your utility's baseline data and tracked monthly and annual energy use, there are two additional steps to completing your energy assessment or baseline energy audit:

Step 3) Conduct a Field Investigation

Step 4) Create an Equipment Inventory and Distribution of Demand and Energy

For Your Information

States often maintain programs to assist municipalities and local agencies with energy management. For example, the Massachusetts Division of Energy Resources (DOER) has an Energy Audit Program to support municipal wastewater districts. The Audit Program provides each project participant with a list of energy conservation projects, their costs, and estimated energy savings. For more information, visit DOER's Energy Grant informational website at http://www.mass.gov/doer/pub_info/grant-eap.pdf.

Several other states have similar programs. California has had remarkable success in funding energy audits at municipal wastewater utilities. For example, an energy audit of the Eureka, California water and wastewater system cost the state \$15,800 and the identified capital improvements cost \$56,800. However, the annual savings were \$91,900 and the improvements reduced the city's electricity bill by 34%.¹⁰

At the federal level, the U.S. Department of Energy offers free 1-day walkthroughs for smaller facilities through its Save Energy Now Program (<http://www1.eere.energy.gov/industry/saveenergynow>).

¹⁰ - California Energy Commission (1990), The Second Report to the Legislature on Programs Funded Through Senate Bill 880, Sacramento, CA, cited in Water Environment Federation (1997), Energy Conservation in Wastewater Treatment Facilities, Water Environment Federation, Manual of Practice No. MFD-2, Alexandria, VA.

STEP 3: Conduct a Field Investigation

The field investigation is the heart of an energy audit. It will include obtaining information for an equipment inventory, discussing process operations with the individuals responsible for each operation, discussing the impacts of specific energy conservation ideas, soliciting ideas from your Energy Team, and identifying the energy profiles of individual system components. The Electric Power Research Institute (EPRI) recommends evaluating how each process or piece of equipment could otherwise be used. For example, it might be possible for a given system to be replaced or complemented for normal operation by one of lower capacity; to run fewer hours; to run during off-peak hours; to employ a variable speed drive; and/or to be replaced by a newer or more efficient system. Depending on the situation, one or more of these changes might be appropriate.

STEP 4: Create Equipment Inventory and Distribution of Demand and Energy

This is a record of your facility's equipment, equipment names, nameplate horsepower (if applicable), hours of operation per year, measured power consumption, and total kilowatt-hours (kWh) of electrical consumption per year. Other criteria such as age may also be included. In addition, different data may be appropriate for other types of systems such as methane-fired combined heat and power systems.

You may find that you already have much of this information in your maintenance management system (if applicable). A detailed approach for developing an equipment inventory and identifying the energy demand of each piece of equipment is provided in the 1997 book *Energy Conservation in Wastewater Treatment Facilities: Manual of Practice No. MFD-2*, Water Environment Federation. The basics are presented here, but readers are encouraged to review the *Manual of Practice* for a more thorough explanation.

Example utility equipment inventories and the relevant energy data to collect could include the following.

Motors and Related Equipment

- Start at each motor control center (MCC) and itemize each piece of equipment in order as listed on the MCC.
- Itemize all electric meters on MCCs and local control panels.
- Have a qualified electrician check the power draw of each major piece of equipment.

Pumps

- From the equipment manufacturer's literature, determine the pump's power ratio (this may be expressed in kW/mgd).
- Multiply horsepower by 0.746 to obtain kilowatts.
- Compare the manufacturer's data with field-obtained data.

Aeration Equipment

- Power draw of aeration equipment is difficult to estimate and should be measured.
- Measure aspects related to biological oxygen demand (BOD) loading, food-to-microorganism ratio, and oxygen-transfer efficiency (OTE). Note that OTE levels depend on type and condition of aeration equipment. Actual OTE levels are often considerably lower than described in the literature or in manufacturers' materials.

STEP 4 Continued...

Below is an equipment inventory example for pumps:

Pump Designation	Installed	Nameplate Rating	Hours of Operation Per Year	Measured Power Consumption	kWh per Year
Pump #1	1992	200 horsepower	2,000	200 kW	400,000
Pump #2	1994	150 horsepower	4,000	120 kW	480,000
Pump #3	1995	80 horsepower	4,000	70 kW	280,000
Pump #4	2002	40 horsepower	5,000	32 kW	160,000

Utility Case Study: Camden County (New Jersey) Municipal Utilities Authority (CCMUA)

By carefully reviewing their plant operations, the CCMUA developed a computerized system that shaved the peaks by avoiding simultaneous use of energy-intensive process units and staggering the use, thereby minimizing the peak charge from the energy company.

Apply Your Knowledge

Using the table above as an example, complete equipment inventory worksheets for your utility using the blank equipment inventory worksheets (or similar ones based on your needs) in Appendix C.

Although you can use the inventory worksheets in Appendix C, in practice, you might find that you use several different types of inventory methods, depending on the types of equipment that you are examining. Try to look at each process or piece of equipment from a fresh perspective. Why is each process run a certain way? Is it a stated requirement? Is it the best way? Is it just tradition? Consider how processes interact with each other and look at the overall system. Also, consider having a third party (e.g., local energy utility) work with the Energy Team as you conduct your field investigation for a fresh perspective and review of your energy consumption and management.

Resources & Tools

New England Power Pool (NEPOOL) has the emission factors for the New England grid. The 2005 report is available at: http://www.iso-ne.com/genrtion_resrcs/reports/emission/2005_mea_report.pdf. Check your states website for information related to your locality.



Remember

Determining your utility's carbon footprint is also a method of establishing a baseline. Carbon emissions are affected by energy consumption (electricity, natural gas, and fuel oil) as well as by process emissions such as methane. If your municipality or state requires you to participate in a determination of a carbon footprint or if you have a goal of reducing greenhouse gas emissions, you may need to know some conversion factors. Your municipality or state should be able to tell you what sort of methodology they use to assess emissions from electricity. Marginal emissions factors consider what sort of resource will be dispatched to meet increased load or cut back to respond to decreased load. Grid average emission factors assign an equal portion of the overall emissions to each kWh consumed.¹¹

¹¹ - ENERGY STAR's Benchmarking Tool will give estimates of reduction of CO₂ usage based on national averages but won't provide an initial baseline.

MODULE 3: Review Legal and Other Requirements and Establish a Compliance Baseline

Module Objective: To identify legal and other requirements that affect your operations and your compliance status.

There are additional metrics for a utility to review besides what has been covered thus far. One of the most important aspects is compliance with legal and other requirements. While this is a fundamental goal for any utility, these requirements can also significantly affect the nature and scope of your energy management program.

What are the requirements that utilities must follow? A few examples are:

- Attaining a certain quality of discharged effluent or treated water,
- Maintaining a stated degree of reliability,
- Having capacity to handle unusually large flows or demands,
- Ensuring worker safety,
- Environmental monitoring and reporting and documenting compliance, and
- Limiting air pollutant emissions based on permitted amounts.

Municipalities could apply additional (“other”) requirements, such as:

- Limiting growth in costs of energy, chemicals, and/or labor,
- Enacting load reductions during times of peak power demand (since grid reliability is a concern), and
- Limiting or reducing greenhouse gas emissions (direct and indirect).

Apply Your Knowledge

Make a list of your most relevant requirements. Then, for each one, ask the following:

- What is required of our facility?
- What agency or entity has enacted this requirement?
- Is our understanding of this requirement current and accurate?
- Do the relevant agencies consider our utility to be fully in compliance?
- Do we consider our utility to be fully in compliance? What could we do to better achieve compliance?
- How does this requirement affect the scope or type of energy conservation measures that we may consider? Does it encourage or discourage specific types of measures?
- Are we in compliance? If yes, what will we have to do to maintain that status? If not, what can we do to achieve compliance?

In the example table on the next page, a wastewater utility has a combined heat and power system that is permitted for nitrous oxides (NO_x) emissions. The utility gathered the information as part of their legal and other requirements review on NO_x emissions.

Requirement Name: NOx Emissions	
Requirement	Our combined heat and power (CHP) system is permitted at a rate of 200 pounds of NOx per year.
Relevant agencies (federal, state, local)	State Department of Environment Quality, contact _____ email _____ phone # _____
Effective date of requirement including revision date(s) as applicable	Date _____
Are applicable regulations changing or being updated?	Yes, the state is changing regulations due to CAIR rule but we expect no change in our permitted amount as it is a very small rate per MWh.
Are we in compliance according to agencies?	Yes, emissions are slightly under our permitted amount.
Could we improve our performance?	Possibly, because NOx is a precursor to ground-level ozone, which causes urban smog, we would like to reduce emissions if possible. We are looking at changing the fuel/air mix to reduce emissions. Another option is to evaluate the cost of verified retrofit technologies.
How does this affect the proposed energy conservation measures?	Measures to improve the plant's energy efficiency would enable us to stay under our permitted amount even if the flow rates increase.
Are we in compliance?	Yes, however, if the electricity demand continues to grow as flow rates increase, our emissions would surpass the cap and we would need a new permit.

Apply Your Knowledge

Using the example table above and the blank regulatory requirements table in Appendix D, fill in the information for your utility.

Note: New energy generation systems will often have a number of regulatory mandates. Air emission permitting requirements may limit the use of on-site generation unless the system is exceptionally clean. Demands for system reliability may place limitations on the use of on-site generation. Interconnection protocols require close cooperation with the energy provider to ensure that the generator is properly aligned with the grid.

CONSIDER THIS...



Consider how the energy improvements you will prioritize may affect your compliance status. Also, consider whether the improvements will create additional regulating requirements of their own.

Session 2 Resources & Tools

ENERGY STAR's Benchmarking Tool:

(http://www.energystar.gov/index.cfm?c=evaluate_performance.bus_portfoliomanager)

ENERGY STAR's Portfolio Manager: (<https://www.energystar.gov/istar/pmpam/>)

For more information on auditing protocols, use this link

(<http://cfpub.epa.gov/compliance/resources/policies/incentives/auditing/>).

Converting your energy use to greenhouse gas:

<http://www.cleanerandgreener.org/resources/pollutioncalculator.htm>

Carbon Dioxide Emissions from the Generation of Electric Power in the United States:

http://www.eia.doe.gov/cneaf/electricity/page/co2_report/co2report.html

Greenhouse Gas Equivalency Calculator:

<http://www.usctcgateway.net/tool>



Moving to the Next Session

In *Assessing Current Energy Baseline Status*, you developed **baseline data**, conducted an **energy audit**, completed some **benchmarking**, and did a review of **legal and other compliance requirements**. This information will be used in the next sessions to determine your utility's potential **priority energy improvements**.

SESSION 3: Establishing an Energy Vision and Priorities for Improvement

Now that you have secured management's commitment, selected an energy program manager to put an Energy Team together, benchmarked your utility, and completed an Energy Audit, it is time to decide what energy improvement priorities to work on first.

In this session, you will:

1. Develop an energy policy.
2. Identify activities and operations that consume energy, using information from your Energy Audit (equipment inventory worksheets) and other data collection efforts you completed in Session 2.
3. Prioritize activities/operations and potential energy improvement efforts.

Let's first review a few key terms that will help you as you establish an Energy Vision and Priorities for Improvement.

Energy Policy: An organization's formal statement defining its intentions and principles in relation to its overall management of energy resources. It provides a framework for action and setting specific energy improvement goals and milestones.

Energy Fenceline: The scope of your operations where you will focus your energy improvement goals and where they will be implemented. For example, your fenceline may include all of your operations, be within a particular operation (e.g., biosolids), include particular utility components (e.g., pumps), or a particular building.

Continual Improvement: The process of ongoing efforts to improve. It is the basic principle of the Plan-Do-Check-Act approach.



Keys to Success

- Align your energy policy with your utility goals**
- Involve employees in the energy review process**
- Remember the Keep It Super Simple (KISS) Rule**
- Communicate status regularly and frequently**
- Document recurring processes and how decisions are made**

MODULE 1: Develop an Energy Policy

Module Objective: To learn how to develop a strong Energy Policy.

An Energy Policy is your utility's statement of commitment to improve its use and management of energy resources. It should include a commitment to continual improvement and compliance. Signed by top management, the Energy Policy provides a vision for the entire utility and serves as a foundation document for energy improvement management programs. Everyone, including contractors and vendors, should understand the policy and what is expected of them in order to achieve your energy goals. Use your Energy Policy as a framework for planning, action, and continual improvement.

The Energy Policy should also include a commitment to explore and increase the use of renewable fuels or renewable energy technology. Renewable resources not only can improve the environmental impacts of a utility's activities, their appropriate use can also save money.

As you develop your Energy Policy, ensure that it is consistent with other strategic business priorities you may have established through strategic plans or other similar efforts. Don't make the mistake of having your Energy Policy "exist in a vacuum." For example, you may have already embarked on a major effort to improve the management of your capital assets through a formal asset management program, or your municipality's or facility's master planning document may already have goals on water conservation or energy use that you can incorporate. These types of programs make use of many of the same tools and data gathering efforts, so it makes sense to reflect these commitments in your Energy Policy to become part of your improvement and management programs.

Have a focus meeting with your Energy Team to brainstorm what should be included in your Policy. Designate a couple of Energy Team members to draft the text of the Energy Policy. Get input from top management and seek input from employees. Also, review your current business or level of service commitments and/or organizational and energy goals. It is important that your policy reflect your organizational culture and that it is appropriate to all levels of your operations and services.

Methods used to communicate your Energy Policy:

- Posting the Energy Policy at various sites throughout your utility (e.g., in lunchrooms) so there is a visual reminder of the statement and its importance;
- Using paycheck stuffers, identification badges, and/or wallet cards, so that employees can carry the Energy Policy with them;
- Incorporating the Energy Policy into existing training opportunities and materials;
- Referring to the Energy Policy at staff or all-hands meetings; and
- Posting the Energy Policy on the facility's Internet/Intranet site.

After you've received input, finalize your Policy by having top management sign, date, post, and communicate it to employees. Make sure that all employees understand the Energy Policy and how it relates to their work. The policy should also be communicated to vendors and contractors as they may also have a role in meeting your energy improvement goals.

Apply Your Knowledge

Develop an Energy Policy for your utility, building on current program policies (e.g., asset management, environmental) already in place.



Remember

Avoid developing an Energy Policy that is vague or so generic that it could apply to any organization.

Your Energy Policy should be specific to the goals your utility wants to accomplish.



CONSIDER THIS...

Keep your Energy Policy simple. A simple policy written with specific expectations provides employees with a straight-forward and realistic view of your commitments to energy improvements.

MODULE 2: Identify Activities and Operations that Consume Energy

Module Objective: To learn how to identify the activities and operations at your utility that consume energy.

This module will help you define your utility's energy "footprint" (i.e., how your operations and activities affect energy use) and develop measurable goals for energy improvements. This process can be challenging and requires focus and teamwork. However, this is the opportunity for your utility to:

1. Take a hard look at your individual operations and activities.
2. Identify how these positively and negatively affect energy use.
3. Better understand the unique role that each of you, individually and collectively, play in managing your utility's energy consumption. The result of this effort will be a list of activities and operations you can use to decide where to invest time, effort, and resources.

Following the step-by-step approach will make it manageable and you will quickly realize the benefits of this approach.

STEP 1: Pull Together Information Previously Collected

Review information from your previously planned and implemented energy improvement project, baseline information, energy audits, and any other additional sources that might be useful in developing this concise list of activities and operations.

STEP 2: Develop a List of Activities and Operations

Employees within your energy fenceline will most likely be the best source of information as you develop a list of activities and operations, where they are located, the type of energy used, and the current use and costs. The table below will serve as a helpful example as your utility's Energy Team begins populating a table with activities and operations specific to your facility.

Example List of Activities and Operations

Activity	Operation or Location	Type of Energy Used	Current Use and Costs
Heating, Ventilation, and Air Conditioning (HVAC)	Operations Building (Heating)	Natural Gas	<ul style="list-style-type: none"> • 150 MMBTU/year • \$1,500/year
	Operations Building (Cooling, Ventilation)	Electricity	<ul style="list-style-type: none"> • 10,000 kWh/year • \$1,000/year
Lighting	Operations Building	Electricity	<ul style="list-style-type: none"> • 24,000 kWh/year (4 kWh/ft², 6,000 ft²) • \$2,400/year
Vehicle Use	Service Trucks	Diesel Fuel	<ul style="list-style-type: none"> • 1,000 gallons/year • \$2,500/year
Equipment			
Pump #1	Treatment Building	Electricity	<ul style="list-style-type: none"> • 400,000 kWh/year • \$40,000/year
Pump #2	Treatment Building	Electricity	<ul style="list-style-type: none"> • 480,000 kWh/year • \$48,000/year
Pump #3	Treatment Building	Electricity	<ul style="list-style-type: none"> • 280,000 kWh/year • \$28,000/year
Pump #4	Treatment Building	Electricity	<ul style="list-style-type: none"> • 160,000 kWh/year • \$16,000/year

Apply Your Knowledge

Using the table on the previous page as an example and the blank table in Appendix E, work with your Energy Team and complete a list of activities and operations, their locations, the type of energy they use, and the current use and costs for energy at your utility.

Typical Water and Wastewater High-Use Energy Operations and Associated Potential Energy Saving Measures¹²

High Energy Using Operations	Energy Saving Measures
Pumping	<ul style="list-style-type: none"> • Reduce load • Manage load • Water to wire efficiency • Pump selection • Motor and drive selection • Automated control
Aeration	<ul style="list-style-type: none"> • Fine bubble • Improved surface aerators • Premium motors • High efficiency motor drive • Blower Variable Frequency Drives (VFDs) • Automatic DO control
Dewatering	<ul style="list-style-type: none"> • Replace vacuum systems • Premium motors • VFDs for plant water pump
Lighting	<ul style="list-style-type: none"> • Motion sensors • T5 low and high bay fixtures • Pulse start metal halide • Indirect fluorescent • Super efficient T8s • Comprehensive control for large buildings
Heating, Ventilation, Air Conditioning (HVAC)	<ul style="list-style-type: none"> • Water source heat pumps • Prescriptive incentives for RTUs • Custom incentives for larger units • Low volume fume hood • Occupancy controls • Heat pump for generator oil sump

Appendix F outlines additional energy saving information for typical water and wastewater equipment and systems including motors, pumps, aeration systems, lighting, and HVAC.



CONSIDER THIS...

Keep the level of detail meaningful without getting stuck in too many details. It is more important to compile a reasonable list with relevant information in order to make decisions about what energy consuming activities and operations your utility should focus on first.

¹²- An Overview of Utility Efficiency Programs, Massachusetts Electric, NEWEA Conference, 2004.

MODULE 3: Prioritize Activities/Operations and Potential Energy Improvement Efforts

Module Objective: To develop a method to prioritize energy improvements.

You've created a large list of activities and operations where energy efficiency could be improved. Don't worry, you do not have to make all the improvements at once. The next step of the process is to prioritize the list to identify a manageable number of improvements that are the most important to your utility.

You can narrow your list of activities and operations to focus on what is most significant by:

1. Defining a group of criteria that help focus on your energy goals and developing a scoring system;
2. Applying the criteria to each of the energy related-activities or operations to achieve a total rank or number; and
3. Establishing a threshold score above which an activity or operation will become a priority for energy improvement.

STEP 1: Define Criteria to Prioritize Opportunities for Energy Improvements

Experience has shown that a simple system for developing priorities generates the same results as a more complex one, but in a much shorter period of time and with more satisfied team members. There is not a magic number in terms of how many criteria you should use; it really depends on what factors are important within your utility and what allows you to simply and effectively rank opportunities for energy improvements. Refer back to your Energy Policy for ideas when selecting your criteria.



Remember

Criteria can be variable. Develop the unique and individual combination of criteria that will work best for your water or wastewater utility.

For energy issues, criteria might include:

- Current or projected costs;
- Feasibility of efficiency projects or the use of renewable sources;
- Potential for energy use reduction;
- Availability of funding;
- Existing need for equipment upgrade;
- Renewable source of energy, particularly for facilities in states that are pushing for climate change mitigation (e.g., Massachusetts and Connecticut);
- Return on investment;
- Regulatory requirement; and
- Support of other priorities (e.g., asset management goals).

Apply your Knowledge

Work with your Energy Team to select approximately four or five criteria for your utility.

Criterion 1: _____

Criterion 2: _____

Criterion 3: _____

Criterion 4: _____

Criterion 5: _____

STEP 2: Decide How to Use the Criteria

Once you have selected your criteria for ranking your energy activities and operations, apply the criteria to each of the entries on your list using a quantitative ranking method. A simple 1 for low impact; 3 for medium impact; and 5 for high impact works well and avoids long discussions about the difference between a 2 and 3 or a 3 and 4. Remember that your evaluation of the energy impact is based on your expertise and experience. It is basically an educated guess.

Take the time to document the process you used to determine your potential energy improvement priorities. This can be as simple as a memo that outlines the process that was used or as formal as a management system procedure. Documenting how you developed your priorities will help you support requests for resources and will also help in the future when the process is repeated.

Remember, this is a subjective analysis. Make sure that when you finish your scoring, you do a reality check with staff that work within your energy fence line to verify that your selected operations and activities are feasible priorities.

See the examples on the next two pages.



Remember

Documenting procedures and processes captures your utility's institutional knowledge and allows for continual improvement at your utility.



TIP!

If rate of return is one of the factors in deciding what to work on first, consider using ENERGY STAR's financial evaluation tools (financial value calculator, building upgrade value calculator, cash flow opportunity calculator, etc.) at http://www.energystar.gov/index.cfm?c=assess_value.financial_tools.

Example of Energy Priority Ranking Table

Activity	Operation or Location	Type of Energy	Current Costs	Ranking Criteria to Set Priorities (Examples only)							
				Current/ Projected Costs 1= L 3= M 5= H	Feasibility of Energy Efficiency Projects 1= not feasible 3= feasible 5= Very feasible	Feasibility of Alternative, Renewable sources? 1= L 3= M 5= H	Costs to implement 1= H 3= M 5= L	Availability of Funding 1=Capital funds required 3=potential or not known 5=Funding options available	Rate of Return on Investment 1= More than____ years 3= ____ years 5= Less than____ years	Regulated? 0=No 3=Yes 5=Yes and compliance issues exist	Total Score
Heating, Ventilation, and Air Conditioning											
	Operations Building (Heating)	Natural Gas	\$1,500/year	1	3	1	3	1	1	0	10
	Operations Building (Cooling, Ventilation)	Electricity	\$1,000/year	1	3	1	3	1	1	0	10
Lighting											
	Operations Building	Electricity	\$3,000/yr	1	5	1	1	5	5	0	18
Vehicle Use											
	Service Trucks	Diesel Fuel	\$2,500/yr	1	5	1	3	1	1	3	15
	Service Trucks	Diesel Fuel	\$2,500/yr	1	1	5	3	3	1	3	17
Equipment											
	Pump #1	Electricity	\$40,000/yr	5	3	1	3	1	3	3	19
	Pump #2	Electricity	\$48,000/yr	5	3	1	3	1	1	3	17

Example: Now, sort from highest to lowest score to determine the potential priority energy improvements.

Activity	Operation or Location	Type of Energy	Current Costs	Ranking Criteria to Set Priorities (Examples only)							
				Current/Projected Costs 1= L 3= M 5= H	Feasibility of Energy Efficiency Projects 1= not feasible 3= feasible 5= Very feasible	Feasibility of Alternative, Renewable sources? 1= L 3= M 5= H	Costs to implement 1= H 3= M 5= L	Availability of Funding 1=Capital funds required 3=potential or not known 5=Funding options available	Rate of Return on Investment 1= More than____ years 3= ____ years 5= Less than____ years	Regulated? 0=No 3=Yes 5=Yes and compliance issues exist	Total Score
Equipment	Pump #1	Electricity	\$40,000/yr	5	3	1	3	1	3	3	19
Lighting	Operations Building	Electricity	\$3,000/yr	1	5	1	1	5	5	0	18
Vehicle Use	Service Trucks	Diesel Fuel	\$2,500/yr	1	1	5	3	3	1	3	17
Equipment	Pump #2	Electricity	\$48,000/yr	5	3	1	3	1	1	3	17
Vehicle Use	Service Trucks	Diesel Fuel	\$2,500/yr	1	5	1	3	1	1	3	15
Heating, Ventilation and Air Conditioning	Operations Building (Heating)	Natural Gas	\$1,500/year	1	3	1	3	1	1	0	10
	Operations Building (Heating)	Electricity	\$1,000/year	1	3	1	3	1	1	0	10

STEP 3: Establish a Threshold Score

In the example on the previous pages, the total score was 19 for pump #1. What does this score mean? Once you've determined all your potential priority energy improvements and their associated scores for the operations/activities, you will need to establish a priority threshold based on what your organization can reasonably manage. For instance, anything with a total score of 18 and above could be considered an energy management priority in the example above.

Keep in mind that your utility has the flexibility, consistent with its business, technical, legal, operational, and stakeholder concerns and requirements to set what it considers to be a priority threshold value for energy management.

Utility Case Study: Renewable Opportunities in Anaerobic Digestion

If biogas is available from anaerobic digestion, the gas produced is primarily composed of methane, which can be used to run an engine generator or microturbine. In a combined heat and power (or cogeneration) system, waste heat can be captured and used to provide for space heating, sludge drying, or other needs. The fuel source is basically wastewater – a renewable resource – and a facility that employs this technology may be eligible to sell “green power credits” to a broker.¹³

Water and wastewater utilities have excellent opportunities for energy generation from renewable sources. There are numerous case studies of wastewater utilities installing energy generation systems based on methane capture. A number of these are included in Appendix G. For further information, see the December 2006 EPA report, *Opportunities for and Benefits of Combined Heat and Power at Wastewater Treatment Facilities*.¹⁴

Cogeneration from wastewater-derived methane has several advantages including:

- Utilizing a renewable resource;
- Minimizing greenhouse gas emissions;¹⁵
- Creating efficiency by utilizing heat that would otherwise be wasted;
- Locating the electricity production at the point of demand (distributed generator); and
- Reducing peak demand, easing the load on the electric utility's transmission and distribution system.

Such a system might benefit from incentives designed to support renewable energy, cogeneration, distributed generation, or energy efficiency. Two good directories of incentive programs are DSIRE, the Database of State Incentives for Renewable Energy,¹⁶ and the EPA's Combined Heat and Power Partnership Funding Resources page.¹⁷

Utility Case Study: Renewable Opportunities in Wind Turbines

Small wind turbines have been installed at wastewater facilities in Saco, ME; Bellevue, OH; Dimondale, MI; and Browning, MT. Photovoltaic (PV) systems of all sizes have been installed at wastewater treatment plants, producing electricity from sunlight. The 14.5-kW system in Charlemont, MA is of modest size, about three to four times the size of a large household PV system. Wastewater facilities have also seen many of the nation's largest PV arrays, including the 500-kW system in Somerset, NJ, the 520-kW system in Oroville, CA, and the 770-kW system in Yuba City, AZ.

In addition, the Atlantic County, New Jersey Utility Authority (ACUA) has a wind farm project and has implemented a number of other alternative energy projects, including geothermal and solar. To review ACUA's alternative energy projects, use this link (http://www.acua.com/alternative/a_projects.cfm).



Remember

Each energy activity or operation that is identified as a priority (i.e., a total score equal to or over your determined threshold) will require some kind of operational or equipment control measure, training, recordkeeping and other relevant required management practice.

Remember, this is a continuous process, so you don't need to be perfect the first time around!

13- See <http://www.eere.energy.gov/greenpower/markets/certificates.shtml?page=0> for a list of vendors of “Renewable Energy Credits”; some such vendors may be willing to buy the credits resulting from a renewable energy project at a wastewater facility.

14- Available online at http://www.epa.gov/chp/documents/wwtf_opportunities.pdf.

15- The CO₂ emissions from the CHP system contribute much less to global warming than the biogas would produce if vented.

16- <http://www.dsireusa.org>.

17- <http://www.epa.gov/chp/funding/index.html>

Apply Your Knowledge

Use the tables on pages 40 and 41 as examples and the blank one in Appendix H. Determine your most important (priority) energy improvement opportunities for the fenceline energy activities and operations of your utility.



CONSIDER THIS...

Keep It Super Simple [KISS]

Don't have too many criteria or over analyze. A very complicated scoring system will discourage those involved and make this process more difficult than necessary. Your rankings are more of an educated assessment rather than a mathematical computation.

Session 3 Resources & Tools

EMS Handbook for Wastewater Utilities: http://www.peercenter.net/toolkit/Step_By_Step.cfm

EMS Aspects Identification and Prioritization Workbook: <http://www.peercenter.net/toolkit/Aspects.cfm>

To try an EPA biodiesel calculator to determine the emissions benefits of switching to alternative fuels, use this link <http://www.epa.gov/otaq/retrofit/techlist-biodiesel.htm>

Solar Photovoltaic Installation FAQs: http://www.mass.gov/doer/pub_info/solar-tip.pdf

Solar Photovoltaic Site Selection Survey: <http://mass.gov/doer/programs/renew/renew.htm>

Massachusetts Division of Energy Resources (DOER) Renewable Energy Programs: http://www.mass.gov/envir/Sustainable/documents/pv_site_selection_survey.doc

Massachusetts Technology Collaborative, Small Renewables Initiative:

http://www.masstech.org/renewableenergy/small_renewables.htm

Massachusetts Technology Collaborative, Large Onsite Renewables Initiative:

http://masstech.org/renewableenergy/large_renewables.htm

Moving to the Next Session

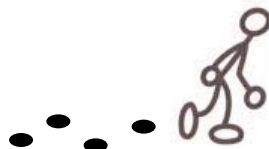

In *Establishing an Energy Vision and Priorities for Improvement*, you crafted an **Energy Policy**, developed a list of **energy-consuming activities and operations**, and identified **energy improvement priorities**. In the next Session, you will establish **energy improvement goals, objectives, and targets** for the priority energy improvement opportunities that scored above the threshold you established.

SESSION 4: Identify Energy Objectives and Targets

You have now assembled your team, evaluated your energy performance, and identified priority areas for improvement. The next steps are to set objectives and establish targets to measure your progress. These targets can relate to activities – such as your progress in implementing energy conservation measures – or to the results you achieve from these measures.

In this session, you will:

1. Establish energy objectives and targets.
2. Define performance indicators.

Let's first review a few key terms that will help as you develop your energy objectives and targets.

Objective: The internal goal your utility establishes to improve its energy performance. Example: reduce facility energy use.

Target: A measurable performance requirement that arises from your objective. Example: reduce utility energy use by 25% from 2006 levels by 2011.

Performance Indicator: What exactly you will measure to evaluate and verify performance improvements in relation to a specific target. For example, measuring electricity cost or consumption per gallon of wastewater treated (\$ or kWh/gallon). Performance indicators can be adjusted to meet specific management needs or as necessary to ensure progress toward reaching specific energy targets.



Keys to Success

- ☑ Align utility objectives and targets with your energy policy
- ☑ Communicate objectives and targets to staff
- ☑ Identify energy improvement targets that can be measured
- ☑ Measure early and often

MODULE 1: Establish Energy Objectives and Targets

Module Objective: To learn how to set objectives and targets for your priority energy activities and operations.

Your utility may have many energy improvement goals. However, you may find that you can't do everything all at once and that some types of energy improvement goals may work towards one objective at the expense of another. For example, purchasing green power may increase cost, but decrease greenhouse gas (GHG) emissions. While all of the objectives may seem appealing, it's best to start with a limited number so that you can focus your efforts, get experience, and track, document, and verify results.

Although there are a number of example objectives and targets from water and wastewater facilities that have implemented energy improvement programs, there are no standard energy objectives and targets that make sense for all utilities in all locations. Your objectives and targets should reflect what your utility does, how well it is currently performing, and what it wants to achieve.

A water or wastewater utility might have the following example energy objectives:

- Reduce energy cost;
- Reduce petroleum consumption;
- Reduce peak energy demand;
- Reduce GHG emissions;
- Improve reliability;
- Increase use of renewable fuels;
- Evaluate the installation or improve performance of renewable energy technologies; and
- Reduce vehicle fuel use.

What do you hope to accomplish in the next few years? Set energy targets that are realistic enough to get accomplished yet significant enough to get noticed and motivate change. Remember that your ability to measure and document progress towards your targets is important.

In the example from Session 3, the utility's priority fenceline activities/operations had a total significance score of 18 for equipment (pump #1) and a score of 19 for lighting (operations building). As detailed in Module 3 of Session 3, these measures scored higher than the HVAC systems, vehicle use, and other pumps and equipment. Pump #1 and lighting were therefore identified as potential focus areas where goals could be set based on factors such as capital cost, payback period, GHG emissions, and other factors that are important to your utility and your Energy Policy.

What objectives and targets do pump #1 and lighting support? While they will likely reduce peak electricity demand and reduce GHG emissions, the selection of these energy improvement opportunities was based on the goal of reducing overall energy cost – an important driver for utilities. The utility determines that, by establishing a normalized baseline first, these energy improvement opportunities can be implemented, along with certain operational changes, within 12 months and achieve a 10% overall reduction in energy costs.



Remember

Baseline data is the starting point from which to track the achievement of an energy objective. "Normalized" baselines accurately measure how your utility's energy consumption could change over time due to seasonal and other variations. Normalized baselines will take into account how your energy consumption may be affected by changes in flow, load, or other related factors.

"Sometimes behavior-based targets (e.g., learning a systems-based management approach) are not the biggest gains in performance measures related to your targets, but they are very important in terms of culture change and should be considered."

Donna Adams
Wastewater Division
Eugene, Oregon

Below is an example of an energy improvement objective and target that a utility could select – based on Session 3’s examples of pump #1 and lighting as potential priority areas for energy improvement. In addition, a utility could consider increasing renewable energy sources as an opportunity. Therefore, a renewable energy objective and target has been included as a potential longer-term opportunity in the example.

Objective and Target	Timeframe
Reduce overall energy cost by 10% by 2009	12 months
Increase energy purchased or generated from renewable energy sources by 10% by 2012	4 years

Apply your Knowledge

Now choose energy improvement objectives and targets for your utility with staff and your Energy Team using the Objective and Target worksheet provided in Appendix I.

Utility Case Study: Kent County, Delaware Wastewater – Renewable Energy

The Kent County Department of Public Works (KCDPW) operates a 16 MGD wastewater treatment plant that treats most of the wastewater in the county with over sixty pump stations and nearly 70 miles of gravity sewer and force main, and management of county-owned buildings. The wastewater that enters the Kent County regional system comes from five municipal contract users and seven significant industrial users. Operations serve 70% of the county’s population.

KCDPW has a certified ISO 14001 and OHSAS 18001 Environmental, Health, and Safety Management System (EHS-MS), as well as a National Biosolids Partnership certification. As part of their EHS-MS, Kent County committed to:

- Reducing energy usage by 20% from 2002 levels; and
- Reviewing renewable energy alternatives (e.g., wind).

Kent County started with some easy fixes (e.g., swapping lights to more energy efficient alternatives and replacing older pumps and other assets with more energy efficient models). Additionally, their action plan included researching energy alternatives and new technologies that could help them accomplish their targets.

Researching and Implementing New Energy Technologies

At a regional conference, Kent County saw a technology that guaranteed a 15% reduction in energy costs by reducing the number of air blowers needed in the treatment process. Kent County, at the time, used about 4 MW of power to consistently run 4-5 air blowers in their process, and their energy costs were about \$10,000-20,000 per month. The process adds fine bubble diffused air to one of two parallel basins to provide oxygen for the microorganisms. The prior process relied on a dissolved oxygen meter at the end of the basin to allow the operators to control the number of air blowers feeding the basin. This system was highly inefficient and was reactive to conditions in the basins. The new system automatically measures the amount of oxygen being released from the basin using floating hoods and feeds this information to an automatic control system. With the new technology Kent County now runs 2-2 ½ air blowers rather than 4-5 before the technology, an almost 50% reduction in their energy requirements. Within a year, Kent County has recouped the cost of the technology (about \$100,000).



Remember

Focus your energy goals on areas that will have the most impact on your energy footprint and your water or wastewater operations. You may want to review your priority energy improvement impacts and the Energy Policy that your utility drafted before you finalize your goals.

Creating an Energy Park of Renewable Energy Sources

Kent County began to investigate four renewable energy alternatives: wind, biomass, solar, and hydroelectric power. The utility's senior executive saw some wind powered utilities in Germany and believed that they would work at the Kent County facility. They hired a consultant to conduct wind studies in 2003 and determined that the turbines would be operational with winds at 9 miles per hour. The study cited a lack of on-site wind data and suggested that additional data was required and that with certain energy credits, the facility would be feasible. The utility installed a wind monitoring system on a 115 foot tall radio tower located at the facility in 2004. The studies showed that at 115 feet the winds were at 8 ½ to 9 miles per hour – marginally sufficient. Further studies were ordered at 200 feet and projections indicate that the wind energy has the potential to provide about 60% of the facility's energy needs. Wind towers will be installed in the energy park at the facility sometime before the end of 2010 if the additional wind survey proves that there is sufficient wind available at the 200 foot level to support turbines. The cost of the wind installation is \$10-12 million which does not include any maintenance costs. The utility does not anticipate any additional capital costs. However, since delivery of the equipment is several years out there may be an inflation factor that has not been considered. The actual cost to the county will depend upon what available grants they can obtain.

"The energy projects are an outgrowth of the facility's EHS-MS. The main goal of our EHS-MS is to reduce the environmental footprint of the facility. Energy usage and generation are key components of this effort."

Jim Newton
Environmental Program Manager
Kent County Public Works Department
Dover, Delaware

Currently, biomass stabilization processes at the facility use lime addition with heat drying to produce a quality Class A biosolids containing 60% solids. The facility is investigating the use of anaerobic digestion of fats, greases, and the utility's sludge to create methane gas which would then be used in the fuel cells to create sufficient energy production to account for about one third of the utility's energy needs. The estimated cost of the system would be \$3-5 million.

The facility is working with a contractor to design and build the combined system. Under the proposed agreement, the contractor would design, build, and operate the renewable energy park and charge the county for the electricity generated. In order to reduce the unit cost of electricity, the county will pay \$3-5 million to the contractor over the next 3 years. In addition, the county will charge the FOG haulers a treatment fee to help offset the costs. The remaining 80% will be paid to

the contract, with the utility repaying over a 20-year period. After that the utility will own the wind turbines. It is estimated that the life expectancy of the turbine is greater than 30 years. The cost of electricity to be paid by the county will include the recovery of the capital expenses, the facility operations and maintenance, and the profit for the energy company. The actual costs will be determined as each new unit comes on line.

Apply your Knowledge

Once your utility has determined the energy objectives and targets, use EPA's Portfolio Manager to calculate reductions in energy cost, consumption, and emissions and to track progress towards your goals. Results from EPA's energy performance rating system can help facility managers make decisions about commissioning equipment, changing operations and maintenance procedures, and investing in future energy efficiency projects. Organizations have learned that EPA's rating provides valuable information to managers at all levels, empowering them to make sound decisions about energy management.

The following summary table is from ENERGY STAR's Portfolio Manager and contains examples for three sample wastewater treatment plants showing:

1. Current source energy per flow;
2. Annual energy cost;
3. Baseline and current performance rating;
4. Adjusted energy reduction; and
5. Pounds of carbon emissions reduced over time.

Facility Name	Current Source Energy per Flow (kBtu/gallons per day)	Annual Energy Cost (US Dollars (\$))	Baseline Rating (1-100)	Current Rating (1-100)	Adjusted Energy Reduction (kBtu (thousand Btu))	Adjusted Percent Energy Reduction	CO2 Reduced (pounds)
Wastewater Example Facility 1	5.8483	\$165,486.48	87	85	97,126.97	No Reduction	22,701.89
Wastewater Example Facility 2	4.9614	\$148,550.64	87	92	930,247.68	13.8%	213,784.10
Wastewater Example Facility 3	4.1018	\$133,831.08	87	96	2,175,012.06	27.9%	507,943.71

Factors to consider in setting objectives and targets:

- Ability to control;
- Ability to track/measure;
- Cost to track/measure;
- Progress reporting; and
- Linkages to your Energy Policy.



CONSIDER THIS...

Start with one or two manageable energy objectives and targets that you will be able to monitor. The best targets are those that can be measured and that are meaningful to employees. Communicate your objectives and targets to staff. Make sure everybody knows what you seek to accomplish and by when.

MODULE 2: Define Performance Indicators

Module Objective: To learn how to measure progress towards your energy targets.

As noted previously, energy improvements lend themselves to quantitative measurement. Your electricity bill, natural gas bill, or similar invoices and data sources provide a ready reference for energy consumption, peak demand, and energy cost.

Energy performance indicators will include the measured quantity, a unit, and, if applicable, a time interval. For example, a utility might use one or more of the following performance indicators for energy at their facility:

- Electricity consumption, in kWh per month;
- Peak electricity demand, in kW;
- Natural gas, in therms per month;
- Energy cost, in dollars per month;
- Electricity consumption per gallon of water or wastewater treated (kWh per gallon); and
- Energy cost or consumption per gallon of water or wastewater treated (\$ or kBTU/MGD).

Performance Indicators: Measuring Your Progress

When you establish quantifiable objectives and targets you may first need to establish a (normalized) baseline. This baseline serves as the starting point from which you will measure your progress. For example, you may measure your equipment's electricity use (for motors, pumps, fans, and the like) in kilowatt-hours per million gallons treated (kWh/MG) for each month. Or, you may use "weather normalization" to adjust your HVAC energy demand each year. If your facility has increased in size, you may have increased energy demand for lighting, HVAC, and other loads. You can also "normalize" your demand to the size of your facility, defining your energy use per square foot for these loads.

ENERGY STAR's Benchmarking Tool, (http://www.energystar.gov/index.cfm?c=evaluate_performance.bus_portfoliomanager), is designed to handle this situation. For example, if your building footprint changes, how would you enter the change without losing data? ENERGY STAR's Benchmarking Tool and its training components can help you answer this question and others.

ENERGY STAR offers plant energy performance indicators (EPIs) to enable energy managers to evaluate the energy efficiency of their plants relative to that of the industry.

Do you have all the data and information to set an energy target and establish an applicable, measurable performance indicator? If not, what level of effort is necessary to define the baseline data you require? You may find that no baseline data exist. If so, do not let this stop you from moving forward. Set a plan to determine your baseline as a first step.

Apply Your Knowledge

Following the examples below and the blank performance indicator worksheet in Appendix I and complete the information that you will need to determine an applicable performance indicator to measure progress toward the energy targets that you set in Session 4, Module 1. Include where you can find the information (i.e., data source).

Target	Performance Indicator	Data Source
Reduce overall energy cost by 10% by 2009	Pump #1: Electricity consumption per gallon of water or wastewater treated (kWh per gallon) Lighting: kWh per square foot/year	Automatic Energy Management System
Increase energy purchased or generated from renewable energy sources by 10% by 2012	Solar or wind energy purchased or generated per gallon of water or wastewater treated (kWh/gallon)	Energy Consumption Invoices/energy meter

Remember



Don't hesitate to be ambitious in selecting your energy objectives and targets. Many organizations have found that improvements in energy efficiency offer great potential for cost savings and continued improvement even after the "low-hanging fruit" has been collected. Also, remember to try and use data you already collect and can count when establishing your energy performance indicators.

Automatic Energy Management Systems

The worksheet on the previous page notes “automatic energy management system” as a potential data source for electricity consumption. “Energy management system” in this usage does not mean a set of practices, but rather a system of hardware and software that is used to track and manage energy consumption. It may include a set of sub-meters, a connection to the main utility meter, controls for certain systems, and a program to display energy consumption and adjust certain parameters. These systems vary considerably in their complexity and capability but many facilities use some systems of this type. Supervisory Control and Data Acquisition (SCADA) systems in particular are widely used to help utilities reduce energy costs and save money.

SCADA systems can be used to optimize system performance, adjust for time-of-day electrical rates, and warn of mechanical problems. They can be programmed to respond to changing conditions, make it easier to monitor and control a water or wastewater system, and provide comprehensive information to the utility managers.

SCADA systems can be very cost-effective as seen by the following examples from water utilities.¹⁸

- Fresno, CA estimates the annual savings from its SCADA system at \$725,000. The system was installed for a cost of \$3.2 million, giving it a simple payback period of 4.4 years.
- The California Water Service Company installed a SCADA system in its Westlake District at a cost of \$100,000, for annual savings of \$47,000, a simple payback period of 2.1 years.

Even if a utility already has a SCADA system, additional functionality could improve its performance, or a newer system might offer the potential for additional cost savings.

Below are additional examples of energy performance indicators for your utility Energy Team to consider.

Target	Performance Indicator	Data Source
Reduce peak electricity demand by 10% from 2006 levels	Peak electricity demand (kW)	Automatic Energy Management System, SCADA
Increase share of biodiesel to 20% of fuel purchases	Biodiesel purchased (gallons per month) and diesel fuel purchased (gallons per month)	Energy Consumption Invoices
Increase on-site generation from microturbine by 20% from 2006 levels	Electricity generation (kWh/month)	Meter on microturbine
Reduce electricity demand per gallon treated by 10% from 2006 levels	Electricity consumption per gallon of wastewater treated (kWh/gallon)	Automatic energy management system (kWh), pump records (gallons treated)



CONSIDER THIS...

Make sure that your performance indicators are meaningful given the context in which you operate. If changes in your energy cost are driven largely by external market forces and not by changes in your energy consumption, then energy cost might not be a metric that properly conveys your progress on energy management.

Session 4 Resources & Tools

ENERGY STAR’s Portfolio Manager: (<https://www.energystar.gov/istar/pmpam/>)

ENERGY STAR Plant Energy Performance Indicators (EPIs):

(http://www.energystar.gov/index.cfm?c=in_focus.bus_industries_focus)

Moving to the Next Session



In *Identifying Energy Objectives and Targets*, you selected **objectives and targets** you want to achieve for your priority energy-consuming activities and operations. In the next session, you will establish action plans or **energy improvement management programs** to meet your objectives and targets. These will include the specific tasks needed to reach your energy goals, staff responsible for accomplishing the tasks, the resources required, and a timeline for implementation. In addition, you will determine what you have in place and what is needed to control or manage your priority operations.

¹⁸ - National Renewable Energy Laboratory, Cities Cut Water System Energy Costs, document DOE/CH10093-262, February 1994.

SESSION 5: Implementing Energy Improvement Programs and Building a Management System to Support Them

Now that your utility has established energy objectives and targets to identify what they would like to accomplish for energy improvement, it is time to take action to implement energy improvement priorities and build an infrastructure of training, communication, and management system controls.

In this session you will:

1. Develop action plans to implement energy improvements.
2. Develop management system operating control (e.g. training, communication, records, system procedures) to support energy improvements.

Let's first review a few key terms that will help as you implement your energy improvement programs.

Energy Improvement Management Program: A structured program with a set of specific identifiable actions providing the direction for energy objectives and targets to be tracked and accomplished. Your program plan should assign responsibilities, tasks, timeframes, and resources (**who, what, by when and how much**) for achieving your objectives and targets.

Operating Controls: Documents that specify the way to execute a certain activity or operation. Operating controls are assigned to activities and operations involving priority energy improvement opportunities and are documented through the use of work instructions, standard operating procedures (SOPs), manuals, and programs. Examples of where these controls are used would include HVAC, equipment maintenance, calibration, and automatic lighting.

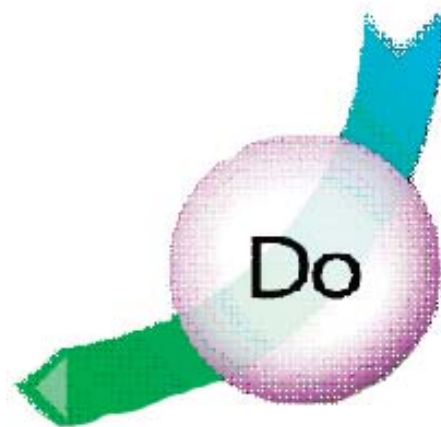

Keys to Success

- Build on what has worked in the past but promote creative thinking about new and innovative approaches**
- Develop meaningful measures to assess and communicate progress**
- Communicate what you are doing, what you need, and the results**
- Use energy improvements to motivate and inspire**
- Support energy improvements with training and procedures to help support and reach your energy goals**

MODULE 1: Develop Action Plans To Implement Energy Improvements

Module Objective: To learn how to develop Energy Improvement Management Programs.

Action plans or Energy Improvement Management Programs are “roadmaps” that define how your utility intends to reach its energy improvement objectives and targets. They describe how your organization will translate its goals into concrete action plans so that energy objectives and targets are achieved.

In this module, you will:

- Step 1. Establish Energy Improvement Management Programs.
- Step 2. Get top management commitment and approval.
- Step 3. Communicate your objectives and targets and Energy Improvement Management Programs.



Remember

Refer back to the Typical High Use Energy Operations and Their Associated Potential Energy Saving Measures Table (pages 40-41) to help you develop potential objectives and targets and subsequent Energy Improvement Management Program.

Step 1: Establish Energy Improvement Management Programs

Now that you have set energy objectives and targets (in Session 4), how will you achieve them and accomplish your goals? Your plan should be to:

1. List the individual tasks (**What:** Step-by-step guide of what individual activities will be undertaken to meet your energy improvement objectives and targets).
2. Assign responsibility for achieving energy improvement goals (**Who:** Assign all levels of staff responsibility for both the overall plan and for the individual tasks). Make sure you communicate and confirm this with the managers and staff in responsible areas.
3. Establish deadlines for individual target tasks (**When:** Set intermediate deadlines for your plans). Incorporating deadlines give those responsible a sense that this is important and needs to be accomplished in a timely manner.
4. Estimate staff time and costs * (**How much:** Confirm with managers that the resources [financial and staff time] are consistent with what was described in the approved budget.) Are there other direct costs for materials? Equipment? Outside services?

** Note: Estimating your staff time and resources is an optional step. Management may want to understand the resource commitment before approving your objectives and targets. Many organizations therefore incorporate this information in their written plans.*

Let's use our lighting and pumps energy improvement objectives and target examples (below from Session 4) to outline the step-by-step approach to develop an Energy Improvement Management Program.

Objective	Target	Timeframe
Reduce Energy Cost	Reduce overall energy cost by 10% by 2009	12 months
Increase energy purchased or generated from renewable energy sources	Increase energy purchased or generated from renewable energy sources by 10% by 2012	4 years

The table on the next page presents an Energy Improvement Management Program developed as an example to increase the efficiency of a utility's lighting and pumps. The table on page 54 shows an example of an Energy Improvement Management Program with increasing renewable energy sources as the objective.

Energy Improvement Priority Activities/Operations: Lighting and pumps

Objective: Reduce Energy Cost

Target: Reduce overall energy cost by 10% by 2009

Start Date: January 1, 2008

Completion Date: January 30, 2009

Energy Improvement Management Program Lead: Jones

Tasks	Staff	Timeline	Estimated Time	Estimated Costs
			(Person Hours or FTEs)	(e.g., equipment)
Task: Establish month-to-month normalized baseline data on energy use and cost for (calendar year) 2008 Deliverable: Monthly report of gross and normalized energy consumption and cost ¹⁹	Jones	January 1 to December 31, 2008	8 hours to establish normalization protocol; 1 hour per month to update	
Task: Post 2008 monthly energy consumption data in public area Deliverable: Spreadsheet	Smith	Each month's data posted within 30 days of end of month; complete 2008 data posted by 01/30/09	2 hours (10 minutes per month)	
Install Automatic Lighting Controls in Operations Building *				
Task: List of electrical contractors with recommendations Deliverable: Annotated memo	Purchasing (Anderson)	By January 15, 2008	4 hours	
Task: Issue RFQ Deliverable: RFQ	Contracts (Grant)	By January 31, 2008	4 hours	
Task: Review responses to RFQ Deliverable: Memo with contractors ranked	Contracts (Grant)	Responses due by February 21, 2008; review complete by March 7, 2008	8 hours	
Task: Enlist contractor Deliverable: Signed contract with electrician	Contracts (Grant)	By March 15, 2008	4 hours	
Task: Install automatic lighting controls Deliverable: Installed system	Johnson	By April 30, 2009	4 hours	\$3,000 capital cost (estimated)
Replace Pump # 1 with more efficient pump*				
Task: Determine optimal pump size using PSAT software tool Deliverable: Memo, with analysis reviewed by engineering	Engineering (Clark)	By January 31, 2008	32 hours	
Task: Research pump manufacturers Deliverable: Annotated memo	Purchasing	By February 28, 2008	8 hours	
Task: Purchase pump(s) Deliverable: Completed transaction	Purchasing	By April 15, 2008	20 hours	\$60,000 (estimated)
Task: Install replacement pump(s) Deliverable: Installed pump(s)	Engineering (Taylor)	By May 31, 2008	20 hours	
Monitor, measure, and communicate 2009 data on energy cost from 2008 baseline				
Task: Present current status relative to target 10% reduction Deliverable: Presentation to staff on year-to-year change in energy costs	Jones	January 31, 2008	12 hours	

*Note: The pump #1 and lighting examples identified as priority areas for energy improvement in Session 3 become tasks (i.e., replace pump #1 and install automatic lighting) in our target to reach a 10% reduction in energy costs by 2009.

¹⁹ ENERGY STAR's Benchmarking Tool

Energy Improvement Priority Activities/Operations: Utility wide

Objective: Increase energy from renewable energy sources

Target: Increase energy purchased from renewable energy sources by 10% by 2012

Start Date: January 1, 2008

Completion Date: January 30, 2012

Energy Improvement Management Program Lead: Smith

Tasks	Staff	Timeline	Estimated Time (Person Hours or FTEs)	Estimated Costs (e.g., equipment)
Task: Establish baseline information on existing purchases of renewable energy as a percent of 2007 overall purchases Deliverable: Memo or spreadsheet	Smith	By January 8, 2008	4 hours	
Task: Identify potential sources of renewable energy and make recommendations Deliverable: Memo	Smith, Jones	By February 8, 2008	12 hours	
Task: Adopt recommendation(s) and purchase renewable energy Deliverable: Contracts to purchase renewable energy	Jones	First purchase by April 15, 2008	20 hours	Cost premium of no greater than 1.5 cents per kWh
Task: Monitor, measure, and communicate on 2009 purchases as a percent of annual 2009 purchases Deliverable: Presentation to staff	Jones	January 31, 2009	20 hours	

Provide a reality check on your plans with line managers, department heads, and supervisors whose operational staff and management are involved.

- Are the appropriate staff members responsible?
- Does the timing conflict with other operational priorities?
- Do the tasks seem logical and sufficient to accomplish the target?

Now that you have drafted your utility’s Energy Improvement Management Programs, you need to get top management’s commitment and approval and communicate your objectives and targets and programs to utility staff.

Step 2: Get Top Management’s Commitment and Approval

Top management needs to ensure that your Energy Improvement Management Programs are integrated with other organizational goals and are consistent with the overall mission of your utility or municipality. Management also needs to know what the efforts of achieving these goals will cost in terms of staff time and capital expenditures, the length of time needed to accomplish this effort, how it will interface with periods of high operational priority, and who will be involved in the tasks. This information will help top management prepare and approve budgets for the projects and assign project managers.



Remember

Refer back to the Typical Water and Wastewater High-Use Energy Operations and Associated Potential Energy Saving Measures table (page 37) to help you develop potential objectives and targets and subsequent Energy Improvement Management Programs.

Step 3: Communicate Your Objectives and Targets and Energy Improvement Management Programs

Communicate your objectives and targets and action plans to employees, suppliers, contractors, and external stakeholders. Open communication will increase buy-in of your energy goals and what you are trying to accomplish. In addition, communication of your goals and plans will keep the utility's energy improvements on everyone's radar and ensure that your organization is on the path to continuous improvement.

Involving Contractors and Temporary Staff

On-site contractors and temporary staff may work in areas in which objectives and targets have been set. Communicating your objectives and targets and Energy Improvement Management Programs to contractors and temporary staff is important and can get you needed buy-in on what you are trying to accomplish. Also, keep in mind that your suppliers can help you in meeting your objectives and targets (e.g., by providing information on more energy efficient technology or equipment and/or opportunities for renewable energy).

Apply Your Knowledge

Using the objectives and targets developed by the Energy Team and the example Energy Improvement Management Programs on pages 53 and 54, develop action plans for your water or wastewater utility. Attached in Appendix J is a blank Energy Improvement Management Program table that you can use with your Energy Team.



CONSIDER THIS...

Begin with one or two objectives and targets and make sure they are attainable and feasible for your utility. Your utility can build on the original objectives and targets once you have experience and buy-in from staff on implementing energy improvements. Don't forget to report progress regularly as you move toward your goal!

MODULE 2: Develop Management System ‘Operating Controls’ to Support Energy Improvements

Module Objective: To learn how to review, identify, and implement operating controls for your priority energy management activities and operations.

You’ve just completed an energy efficiency review of your utility, established objectives and targets, and set up energy action plans to implement your targets. So what’s next?

Remember from Session 3, Module 3 – for every energy activity or operation you determine to be a priority (above the threshold you established in the example – pump #1 and lighting), your utility will need to verify current controls (e.g., records, procedures, training) or implement new or additional controls to manage your priority energy issues.

Operating controls include:

- Training;
- Communication;
- Controlling documents and managing records; and
- Work instructions/SOPs and operations/equipment manuals for energy improvements.

TRAINING

Why train employees about energy management and your utility’s efforts to improve efficiency and reduce cost?

- Every employee can have potential impacts on energy demand and use; and
- Any employee can identify positive ways in which to improve energy management.

To improve your energy management training and awareness, include the following steps.

Step 1. Assess energy management training needs, develop the training, and integrate energy training with current training and methods your utility already has in place.

Step 2. Conduct energy management training and document and maintain training records.

Step 3. Develop a system procedure/plan for maintaining energy management training and awareness and/or integrate into ongoing and future training plans.

Assessing energy management training needs – ask yourself:

- What activities affect our utility’s demand and use of energy?
- What activities involve an identified priority for energy improvements?
- What types of training do we currently conduct for these areas?
- Can energy management roles/responsibilities/controls be included in this training?
- Can we tweak current training material or ask our training provider to include energy issues or do we need to develop new materials?
- How do we currently maintain training records?



Remember

Build on what you have in place and what currently works. Do you have an existing training procedure or plan? Or do you do a lot of on-the-job training? If so, build your energy management training on what you have. If you rely on an outside provider, contact them to see what they are doing in terms of including energy topics in their programs.

STEP 1: Assess Energy Management Training Needs

Training relating to energy improvements should be tailored to the different needs of employees and to various levels or functions in your utility. Who needs to receive energy management training at your facility? In assessing training needs for your utility, consider both general and specific needs. For example:

- “What broad understanding of energy issues does a particular employee need?”
- “What operating controls associated with energy management affect their daily work, and what happens if they aren’t followed?”
- “What type of training does the employee currently receive?”

STEP 2: Conduct, Document, and Maintain Training Records

Just like any other training you conduct, you should document and maintain (for verification purposes) your energy management training. Consider how you currently track training and participation.

Energy Management and Competence

Implementing and maintaining energy management improvements at your utility may mean that employees in certain jobs, particularly operations that affect or are associated with energy need to have a combination of education, training, and experience to do their day-to-day tasks and ensure that your utility is meeting its energy management commitments. Make sure you maintain records of their experience and training (e.g., certifications, education, and previous job records) just as you would any other verifiable training records at your utility.

STEP 3: Develop a Training Plan/Procedure and/or Integrate Energy Management Training and Awareness into Current Training Plans

When you’re satisfied that your process for implementing an energy management training program is sufficient, document what you want to do in your current training plans/programs. This will help ensure that your employees stay current with your organization’s energy controls and commitments now and in the future.



Remember

Most organizations already have some type of training in place before they begin implementing energy management programs. Build off your existing training procedures and plans.

COMMUNICATION

Proactive communication is crucial for the effective implementation of your utility’s energy management program and goals.

The actions in this portion include:

- Step 1. Determine what energy issues need to be communicated internally and externally.
- Step 2. Determine who has an interest and who has a potential to influence your energy management goals.
- Step 3. Develop internal and external communications plans.

STEP 1: Determine What Energy Issues Need to be Communicated Internally and Externally

A good place to start in developing a communication strategy is to look at how your utility currently communicates messages internally and externally and to whom. How do managers currently get information to employees and receive information and communication back from employees? Leverage effective strategies that are already in place, especially those that are familiar to personnel such as an emergency communications plan.

Internal Communication Vehicles:

- Employee meetings
- Environmental, health, and safety training
- Working lunches
- Newsletters
- Pay stub inserts
- Intranet postings
- Bulletin boards
- “Tool box” meetings



Remember

Most organizations have some type of communication process in place before they begin implementing energy management programs. Build off your existing communication vehicles and plans.

Once you have an internal communication strategy in place, the next step is to determine your external communication strategy and with whom you are currently communicating. As an organization that regularly reports to the public, you probably already have external stakeholders that you communicate with, including city commissioners or town boards, local citizens and citizen groups, the mayor or town manager, local energy utilities, contractors and vendors, and regulatory agencies.

It will benefit your utility to have a proactive internal and external communication program. Reach out internally as well as to key external stakeholders about why you have chosen to implement energy management programs and what you want to achieve.

Common Water and Wastewater Utility External Interested Parties (i.e. Stakeholders):

- Local citizen/community groups
- Regulatory agencies
- Energy advisory groups
- Local officials
- Contractors and vendors
- Energy utilities

Internally Communicate Your:

- Energy Policy
- ENERGY STAR benchmarking results
- Energy audit results
- Energy improvement priorities
- Energy Improvement Management Programs
- Objectives and targets
- Energy savings progress and success stories

Externally Communicate Your:

- Energy Policy
- ENERGY STAR benchmarking results
- Energy audit results
- Energy improvement priorities
- Energy objectives and targets
- Requirements to suppliers and contractors
- Annual reports including energy highlights and successes
(e.g., Drinking Water Consumer Confidence Report)

STEP 2: Determine Who has an Interest and Who has the Potential to Influence Your Energy Management Goals

Once you've determined your current audience, identify additional external stakeholders or new methods of communicating by determining: who potentially has a vested interest and who potentially has an effect on energy management improvements. In determining what to communicate to your external interested parties, your organization will need to assess the extent to which your strategy will be proactive. Ask:

- What is your current level of public acceptance?
- What are your external stakeholders' concerns?
- Have you had public relations issues in the past that require certain strategies or cautions?
- Since communication is most effective when it's a two-way dialogue, what type of input from them would interest you most and be most useful?
- What will be the return on investment of a proactive approach?

STEP 3: Develop Internal and External Communications Plans

When you've determined what and to whom you will communicate, integrate the information with your current communication plans and procedures. For help with your communications plan(s), review U.S. EPA's "Getting in Step: A Guide for Conducting Watershed Outreach Campaigns" using the following link: (www.epa.gov/owow/watershed/outreach/documents/getnstep.pdf).

CONTROLLING DOCUMENTS AND MANAGING RECORDS

Have you ever come across a document (e.g., a policy, procedure) and found that you couldn't tell whether it was current, revised, approved, or obsolete? If your utility wants to make sure that everyone is working from the most current and approved documents, then documents must be "controlled" and records managed so that they can be easily located, periodically reviewed, updated as needed, and removed when obsolete and replaced with current versions.

The steps to manage your documents and records include:

Step 1. Review current document control and records procedures.

Step 2. Develop a format and procedure(s) for controlling documents and managing records.

STEP 1: Review Current Document Control and Records Procedures

Review what procedures/systems you have in place to control documents and manage records and those that will work best for your utility, including:

- Will a paper or electronic process or maybe a combination of both, work best?
- Who has the responsibility and authority for creating and revising documents?
- Which documents should be controlled so to ensure that employees refer to the correct version?
- Does your organization currently employ a standard document format and numbering system?



TIP!

What's the difference between a document and a record?

Documents are written instruments used to keep a management system functioning. These may be revised or changed as your management system develops.

Records provide evidence or proof that the organization is actually implementing the management system as designed and the procedures and work instructions are being carried out.

STEP 2: Develop a Format and Procedure(s) for Controlling Documents and Managing Records

When you've developed a process for managing and controlling your documents and records, integrate that process with your current systems. Identify and assign responsibility for preparing documents associated with your utility's energy management programs and procedures, making necessary changes, and ensuring that documents are kept current. In other words, your utility should have a clearly defined system that designates authority for review and approval of documentation at various levels.

Records Management Check

- Have you identified what records need to be maintained?
- Have you determined the period of time necessary for retaining your records?
- How are your records stored and retrieved (electronic vs. hard copy)?
- Are you maintaining all the records needed to support your utility's energy improvement priorities?
- Are records easily accessible?

For samples of Document Control and Records procedure(s) from water and wastewater facilities, use this link (<http://www.peercenter.net/ewebeditpro/items/O11F10697.pdf>) and refer to Section VIII. Also, additional procedures from utilities can be found here: <http://www.peercenter.net/sector/wastewater/emstoolbox.cfm>, under sample Environmental Management System (EMS) Documentation.

WORK INSTRUCTIONS/SOPs AND OPERATIONS/EQUIPMENT MANUALS FOR ENERGY IMPROVEMENTS

Operating Controls

Documents that specify the way to execute a certain activity or operation are considered operating controls. Operating controls are assigned to activities and operations involving priority energy improvement opportunities and are documented through the use of work instructions, standard operating procedures (SOPs), manuals, and other programs. Examples include HVAC, equipment maintenance and calibration procedures, and automatic lighting and equipment documents or programs.

Achieving energy management improvements requires managing or "controlling" the utility's operations associated with your utility's energy improvement priorities, objectives and targets, and regulatory requirements. What are your operating controls and how do you document them? You probably already have procedures, work instructions, permits, maintenance manuals, and similar in place for many of your operations and services.

The following steps will allow your organization to determine which energy operations should be covered by documented procedures and work instructions and how those operations should be controlled.

The steps to manage your energy improvement operations include:

- Step 1. Review, improve, or draft energy specific operating controls.
- Step 2. Review maintenance and calibration requirements.
- Step 3. Check operating controls.
- Step 4. Communicate operating controls.

STEP 1: Review, Improve, or Draft Energy Specific Operating Controls

Once you have a list of operations and services that require documented operating controls, look at what you already have in place to manage these activities. Do your current procedures reflect what is actually being done at your facility? How do you control the operations now and are the controls adequate? Can the employees, whose work the procedures describe, easily understand them? What improvements to the current procedures do they suggest?

One method to consider when developing or modifying your operating controls is to have someone observe a task being conducted. The person would write down the steps, photograph key meters, valves, etc., and put together the operating control (or work instruction) in written form. The writer should ask: Why are we doing the task in that particular way? Has the work instruction been reviewed by everyone who completes the task? This will allow the best practices to be used and ensure that all shifts will perform the task in the same way.

STEP 2: Review Maintenance and Calibration Requirements

Once you have identified operations that require control and have documented your procedures and work instructions, determine the maintenance and calibration requirements for these operations and services, and then document and maintain these records. Don't ignore the maintenance manuals that come with your energy and energy related equipment (e.g., HVAC or pump manuals).

Review the maintenance activities you are currently conducting. Are they sufficient? Timely? Preventive or reactive? Some organizations place critical monitoring equipment under a special calibration and preventive maintenance program. This can help to ensure accurate monitoring and make your employees aware of which instruments are most critical for energy monitoring purposes.

STEP 3: Check Operating Controls

About two or three months after you have documented and implemented your operating controls, check if they are working according to your plan. Here are some questions to focus on:

- Have you identified all operations and activities associated with energy improvement priorities?
- Are these operations and activities under control through programs, documented procedures, work instructions, etc.?
- Have you communicated and trained your employees, suppliers, vendors, and contractors on applicable procedures, work instructions, and policies?
- What benefits/improvements are you experiencing?
- What adjustments need to be made?

STEP 4: Communicate Operating Controls

Review your energy-related documented procedures and work instructions with all applicable employees. Discussing your procedures with the people who will implement them will help secure buy-in. Also remember to communicate operating controls with applicable vendors, contractors, suppliers, and temporary staff.

Examples of energy operations and services that may require operating controls:

- Equipment/tool calibration;
- Pump maintenance; and
- Management of contractors.

For many types of water and wastewater equipment, operating controls make a real difference in energy consumption. For example, pumps and motors are most efficient at particular settings.

Note: As you update or develop homeland security and/or incident response and emergency preparedness and response plans, procedures for potential power failures could also be developed. Consider what connections these procedures might have with energy improvement programs.



CONSIDER THIS...

Build your energy plans, programs, and documentation on what you already have in place. Employees closest to the operations needing control should be involved in developing improved work instructions and SOPs.

For examples of operating controls for energy operations, review Appendix K.

Session 5 Resources & Tools

EMS Handbook for Wastewater Utilities: http://www.peercenter.net/toolkit/Step_By_Step.cfm

Moving to the Next Session



In *Implementing Energy Improvement Programs and Building a Management System to Support Them*, you completed **action plans** for your energy objectives and targets and developed **operating controls** for the energy activities that you determined were priorities. In the next session, you will **measure the progress of your energy targets**, establish periodic energy audits, a corrective action program, and a process to continually review legal and other requirements and your energy goals with management.

SESSION 6: Monitoring and Measuring Your Energy Improvement Management Programs

So far, you've identified your current status on energy performance, identified priority areas for improvement, set objectives and targets, and developed energy action plans or Energy Management Improvement Programs. You have also put procedures, work instructions, operating controls, and training in place to ensure that your priority energy improvements are managed.

The next step is to monitor and measure your progress in meeting your energy objectives and targets and assess your compliance toward meeting your regulatory requirements. Monitoring and measuring allows you to track your performance and improve efficiency by managing what you do. The results of your objectives and targets and other efforts are easier to demonstrate when current and reliable performance data are available and referenced against a defined baseline. This data can help you demonstrate the value of your energy management activities to top management and to other vested parties such as utility staff and your local community.

In this Session on Monitoring and Measuring, you will develop ways to:

1. Review what you currently monitor and measure for energy.
2. Determine what else you need to monitor and measure for your priority energy improvement operations.
3. Develop a plan for maintaining the efficiency of energy equipment.
4. Review the progress of your energy targets.
5. Implement actions to adjust or correct when you are not progressing toward your energy goals.
6. Monitor/Reassess compliance status.

Let's first review a few key terms that will help as you determine what to monitor and measure for energy targets.

Key Characteristic: An element of an energy target, operation, or activity that can be measured or evaluated for energy performance.

Performance Indicator: What exactly you will measure to evaluate and verify performance improvements in relation to a specific target. For example, measuring the direct and indirect emissions of carbon dioxide (CO₂) per year from established baselines to check the progress in meeting your target of 25% CO₂ reduction from 2006 levels.

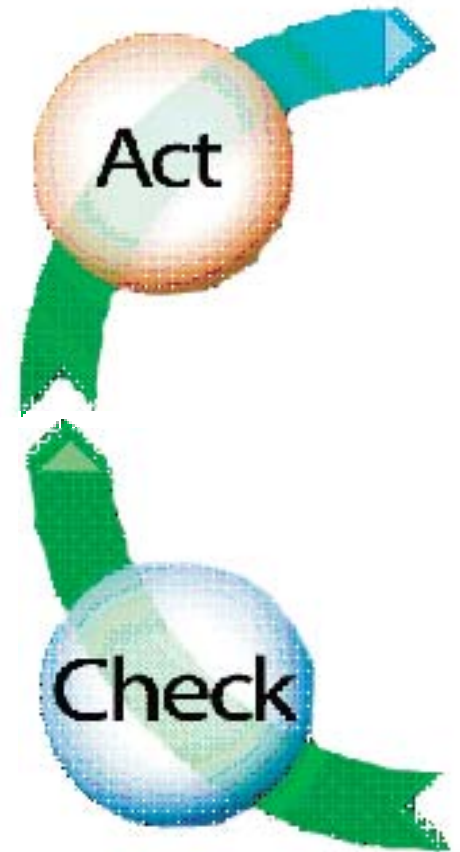

Keys to Success

- Make sure the data you collect is useful and has meaning for what you want to accomplish**
- Hold regular progress reviews of the Energy Improvement Management Programs to ensure you are on track to meet your targets**
- Communicate the status and progress of your energy targets to staff, management, and other stakeholders**

MODULE 1: Review What you Currently Monitor and Measure for Energy

Module Objective: To review the energy and energy-related data and information you currently collect.

In Session 2, you identified your current status on energy consumption and energy performance. This required identifying a number of data elements and sources. In Session 4, you established energy targets and identified performance indicators that could be used to measure your progress. Therefore, you've compiled many of the methods and tools you'll need to monitor and measure your energy management progress.

Apply Your Knowledge

Using the example below and the blank worksheet in Appendix L to document what you are currently measuring and from where you obtain this data. Refer back to Session 2 as applicable.

A water or wastewater utility might want to record the following:

Data Element	Units	Data Source
Overall electricity consumption	kWh per month	Utility bills, Automatic Energy Management System
Peak electricity demand	kW	Utility bills, Automatic energy management system
Electricity demand by system (HVAC, lighting, pumps, other)	kWh per day	Automatic Energy Management System
Wastewater treated	Million gallons per day	Pump records
Natural gas consumption	Million BTU per month	Utility bills
Methane captured	Million BTU per month	Combined Heat and Power (CHP) system
Electricity generated	kWh per month	CHP system
Steam supplied	Million BTU per month	CHP system
NOx Emissions	Pounds per day	CEM on CHP system
Gasoline purchased	Gallons per month	Energy Consumption Invoices
Diesel fuel purchased	Gallons per month	Energy Consumption Invoices
Biodiesel fuel purchased	Gallons per month	Energy Consumption Invoices



CONSIDER THIS...

When you have two sources for data, list both. It can be useful to cross-check your data.

Module 2: Determine What Else you Need to Monitor and Measure for Your Priority Energy Improvement Operations

Module Objective: To determine what data your utility will need to collect to achieve its energy targets and to manage energy improvements.

Information collected by monitoring and measuring your key energy issues can help you determine what you need and answer the questions:

- Is your energy improvement program being carried out as planned?
- Is your utility achieving its energy commitments and its objectives and targets?
- What information is most valuable?

Look back at your energy objectives and targets and energy plans from Sessions 4 and 5. What energy data and information needs to be collected for you to achieve your energy targets? What are the key characteristics of the operations and related equipment and how do you measure these characteristics to ensure proper energy performance?

Referring back to the pump (#1) and lighting energy opportunity examples, let's make a sample list of the operating controls, key characteristics, monitoring and measurement methods, and calibration needs for operating and maintaining pumps and lighting.

Energy-Related Operation	Energy-Related Impacts	Operational Controls	Key Characteristics of Operation or Activity	Monitoring or Measurement Methods	Equipment & System Calibration Needs
Operate and Maintain Utility Pumps	Overall energy cost (\$)	Pump maintenance manual	Energy (kWh) per million gallons	Track energy consumption	Flow meters
	Electricity consumption (kWh)	Time-of-day pricing	Load profile	Track volume pumped	Electric Meters
	Peak electricity demand (kW)	Pump schedule (operations deferred to off-peak hours when possible)	Cost of energy (\$/kWh)	Note changes in electricity cost	SCADA
		Float settings	Peak demand charges (\$/kW)	Calculate kWh/MG Chart daily and monthly load profile Monthly energy report	
Lighting for Operations Building	Overall energy cost (\$)	Automatic lighting control system	Energy (kWh) per month	Track energy consumption	Automatic lighting control system
	Electricity consumption (kWh)	Work instructions on turning off unneeded task lighting	Cost of energy (\$/kWh)	Note changes in electricity cost	
		Work instructions on limiting overrides of automatic controls		Include in monthly energy report	

Apply Your Knowledge

Using the sample table on the previous page and the blank worksheet in Appendix M, draft a list of the operating controls, key characteristics, monitoring and measurement methods, and calibration needs for the priority energy opportunities your Energy Team came up with in Session 3.

Calibration

Calibration of your systems is an extremely important aspect of maintenance. Your equipment may have calibration procedures set by the manufacturer that must be followed. You may need to document calibration requirements and dates for equipment that affect your targets or your compliance requirements. Example of calibrated equipment could include flow, pH, chlorine monitors, or thermostats used by the HVAC system. Make sure a regular schedule is in place to calibrate the equipment and make sure you retain your calibration records. Remember, some equipment may be calibrated off-site, so make sure the vendor supplies you with a copy of the records.



Remember

Don't forget about the maintenance manuals that come with your energy operations equipment. They may contain calibration and/or measurement methods for your equipment. In addition, your equipment may have calibration procedures set by the manufacturer, and often equipment comes with annual maintenance provided by the vendor.

“Monitoring and measurement takes the pulse of an organization. Their application can be the most important tools in a manager’s toolbox with regard to setting goals, objectives and targets, and improving overall operations.”

Rick Bickerstaff

Commissioners of Public Work
Charleston, South Carolina

Think about what else you might want to monitor and measure. Your performance indicators help you measure progress towards your energy goals and help you demonstrate compliance with legal and other requirements.

In the course of establishing the tasks needed to meet your energy goals, you may have identified additional data needs. Add those as applicable as well. For example, reducing NOx emissions may not be a priority objective if your utility is well below its limit but you need to monitor and measure the quantity of NOx as a regulatory parameter.

Review the worksheet below for example utility requirements, their associated performance indicators, and potential data sources.

Requirement	Performance Indicator	Data Source
Keep NOx emissions under 1 ton per ozone season	NOx emissions (lbs per ozone season)	Continuous Emission Monitor on CHP system
Ensure fewer than 5 power outages of one hour or more each year	Number of power outages exceeding one hour	Automatic Energy Management System
Ensure fewer than 3 unscheduled service calls for CHP system per year	Service calls for CHP system	Energy Consumption Invoices



CONSIDER THIS...

If you are going to spend the time and resources to collect information, make sure that it is useful and meaningful to your utility.

MODULE 3: Develop a Plan for Maintaining the Efficiency of Energy Equipment

Module Objective: To ensure that energy-related equipment is properly maintained.

Energy equipment can be a substantial investment for your organization. A methane capture system feeding a combined heat and power system, a back-up generator, and an automatic energy management system are significant capital investments. Proper maintenance can ensure that these systems operate smoothly and reliably. Neglecting maintenance can lead to system failures and possibly dangerous situations. The details of the necessary maintenance will vary from system to system but will typically be provided by the vendor.

For your energy equipment or system, note the following.

- Who is responsible for maintenance? With new equipment, does the vendor provide maintenance for the first year?
- What is the schedule of maintenance actions?
- Are all the necessary resources available for maintenance (e.g., fuel, spare parts, filters, etc.)?
- Are there specific outside contractors brought in to perform maintenance, or is there a process for finding such contractors?
- Is performance evaluated on a regular basis?
- Where are the maintenance records and performance evaluations of the equipment or system recorded?

Energy equipment performance will vary depending on what type of system is included. For example, performance indicators for a back-up engine generator might include the following:

- Start-up time;
- Fuel consumption;
- Electricity generation; and/or
- NOx emissions.

For an energy system maintenance check, an example performance indicator for an automatic energy management system (meters and a software program) would be very different and might include the following:

- Degree of agreement with utility meters;
- Number of manual adjustments/overrides needed to automatic controls; and
- Number of technical support calls needed in past quarter.



CONSIDER THIS...

Proper energy equipment and system preventive maintenance can save repair costs and improve performance and reliability.

MODULE 4: Review the Progress of your Energy Targets

Module Objective: To develop a plan for regular, periodic reviews of your Energy Improvement Management Programs.

You now have the information you need to measure progress and use the information in regular, periodic reviews of your Energy Improvement Management Programs. This will help you get a clear picture of your performance and progress relative to your established energy targets.

In developing your review plan, consider the following.

- When is the review conducted?
- How is progress measured?
- Who is responsible for the review? Are they sufficiently trained?
- What will be done with the outcome of the review?

The bullets below provide a sample method for a utility to periodically review the progress of their energy targets.

- Review your Energy Improvement Management Programs within six months after initial implementation.
- Assess your energy targets using the performance indicators you developed for each task in the Energy Improvement Management Programs.
- The status and progress of each task can be reported by the applicable staff listed in your plans.
- Use the outcome of the review as a scorecard for each target indicating the progress, the next steps, and any corrective actions recommended.

Apply Your Knowledge

Using the example Energy Improvement Management Programs Progress Review* on the next page and the blank worksheet in Appendix N, sit down with your Energy Team and develop a Progress Scorecard based on the energy target(s) you set with your utility in Sessions 4 and 5.

* Note: Your utility may wish to consider a different method to evaluate the energy target's performance.

Conducting Periodic Energy Audits

Conducting a periodic energy audit is another type of review or status check you could consider for your energy management plans and programs. Remember from Session 2 that you conducted a baseline energy audit for your utility. With periodic, follow-up energy audits, you can have a clear before and after characterization of your energy management activities. This is particularly important if you are installing a number of new systems or changing operational practices. Remember, you'll want to ensure that you actually achieve or exceed the energy savings you set out to accomplish. Not every periodic review needs to be a full-scale energy audit, but audits should be a regular part of assessing your performance.



TIP!

It is sometimes beneficial to consider a third party performance contract to implement some or all of your energy-related initiatives.

A useful tool to see if you are a good candidate for guaranteed energy performance can be found at: <http://www.energyservicescoalition.org/resources/5steps.htm>.

"I wish we had documented costs and cost savings earlier. Measuring and monitoring are the most important things you can show rate payers and tax payers the actual money you have saved."

Mark Young

Director, Lowell Regional Wastewater Utility
Lowell, MA

Energy Improvement Management Programs Sample Progress Review Table

Objective	Reduce Energy Costs
Target for 12/31/08	Reduce overall energy cost by 10% from 2006 levels by 2009
Status at 12/31/07	Energy cost reduced by 6% from 2006 levels
Tasks Identified	Install automatic lighting controls
	Replace pump #1
	Replace windows and improve insulation around doors
	Increase CHP generation by 10%
	Evaluate potential for participation in demand response program
Tasks Accomplished	Automatic lighting controls installed
	Replaced windows and improved insulation around doors
	Increased CHP generation by 12%
Observations	New pump purchased but not yet installed due to contractor delays
	Better insulation allows for down-sizing of HVAC system – which is in need of replacement
	Efficiency of pump from ABC judged to be not compatible with operational and energy efficiency requirements
Corrective Actions Needed	Have purchasing review pump suppliers to find pump with appropriate operational and energy efficiency requirements
Next Steps	Replace HVAC system with ground-source heat pump

What do you do if your utility progress report or energy audit status check shows that your energy targets are not performing as intended? In this case, first determine the reason or cause of why the targets are off course, and then implement a corrective action to get your energy target back on course. The subsequent module and Session will provide further information on this topic.



CONSIDER THIS...

You've put a lot of effort into developing your Energy Improvement Management Programs and collecting the necessary information to monitor and measure your performance and progress towards your energy targets. Regular reviews will make sure these efforts will pay off. In addition, have regular checks on the progress of your energy objectives and targets and report the results to top management and staff.

MODULE 5: Implement Actions to Adjust or Correct When You Are Not Progressing Toward Your Energy Goals

Module Objective: To identify measures to meet energy targets when current efforts are not as successful as originally planned.

If you have set ambitious targets, it's possible that one or more may not have been attained by the time the review is conducted. Weather patterns, electricity markets, contractor schedules, budget cycles, and other factors may have prevented your utility from achieving everything you set out to accomplish. Use the review to identify why your target was not met and what can be done to achieve that target in the future. The following are some helpful questions to pose.

Was the target realistic?

An overly ambitious target may be simply unattainable. If a utility set a goal of reducing energy expenditures, but faced a "perfect storm" of increasing energy prices, increasing volume of water treated, and a particularly cold winter, even the most ambitious energy management program may be unable to provide a net reduction in energy costs. If your organization did everything it set out to do but couldn't meet the target, consider revising the target based on this information.

Were the identified tasks sufficient to achieve the target?

Your organization may have identified tasks to meet the target and accomplished all of these tasks but yet did not achieve the target. For example, a utility's target may have been to reduce peak energy demand by 20 kW and the identified measures are estimated to provide that peak reduction. Some measures have uncertain benefits that are estimated based on experience of similar organizations. Once implemented, the actual demand reduction may turn out to be 17 kW. The utility may have done almost everything right, but the identified tasks were insufficient to meet the target. The utility can resolve to add in extra measures next time for a margin of error.

Were some tasks not completed?

A likely reason for targets being unmet is that one or more tasks was not completed. There may be any number of reasons for this. The team responsible for that task should be prepared to explain the reasons for the delay or omission. Was the task deemed not feasible? Were there delays due to factors beyond the organization's control? Was the original estimate on the timing of the task unrealistic?

Did anything change?

As mentioned above, wet and dry flows, weather patterns, electricity markets, contractor schedules, budget cycles, personnel changes, and other factors may affect how your utility attempts to achieve its energy goals.

Once you've identified why the targets have not been met, identify an appropriate response. This may include revising the targets, modifying the task list, or providing additional resources to the team implementing a specific task.

If all of your targets have been met with relative ease, take time to applaud your efforts, and then consider setting more ambitious targets for the next phase of your energy management program.



CONSIDER THIS...

There will be "lessons learned" throughout the process of setting targets and identifying tasks. Listen to your Energy Team as they discuss any difficulties encountered.

MODULE 6: Monitor/Reassess Compliance Status

Module Objective: To learn how to check your compliance with your energy-related legal requirements.

You evaluated your compliance with legal and other requirements in Session 2. Since your energy targets could involve some changes to your equipment or operations, it is important to repeat this evaluation at regular intervals.

It's time to check if reducing your energy consumption has affected your compliance requirements. From the example, did installing a new pump, installing automated lighting, or utilizing renewables affect your compliance requirements? Refer back to Session 2, Module 6 and the compliance baseline review you conducted. Ask the following questions once you've implemented your energy improvement programs.

- How has compliance been affected by your energy conservation measures?
- Have any regulations been affected? If so, which one(s)?
- Is the regulation up-to-date?
- Are we still in compliance according to all pertinent agencies?
- Do we expect to remain in compliance?
- Are there opportunities to go beyond compliance?



CONSIDER THIS...

Priorities may shift with new budget cycles or new regulations. While energy management will be beneficial to your utility and your community, the scope of measures that you are able to employ may shift with changing requirements.

Session 6 Resources & Tools

ENERGY STAR's Portfolio Manager: (<https://www.energystar.gov/istar/pmpam/>)

Moving to the Next Session

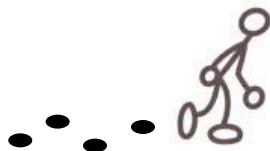

In *Monitoring and Measuring Your Energy Improvement Management Programs*, you determined what you currently do as well as need to do to **monitor and measure** and develop an **equipment maintenance plan**. You also developed a way to regularly **review progress**, take **corrective action** if needed, **monitor compliance**, and **communicate progress**. In the next and final session, you will learn to effectively **maintain your energy improvement programs** by continuing to align energy goals with your utility's priorities, apply lessons learned, expand involvement of management and staff, and ultimately communicate success.

SESSION 7: Maintaining Your Energy Improvement Programs

In this *Guidebook*, we have demonstrated that it makes good operational and business sense to utilize a systematic approach to optimize your energy efficiency and conservation efforts. Through a replicable Plan-Do-Check-Act approach, the *Guidebook* has provided step-by-step Sessions and modules necessary to translate and prioritize your energy improvement areas and cost savings opportunities into achievable, quantifiable targets. This *Guidebook* has also provided real life examples and case studies from water and wastewater utilities that have already realized the benefits of setting and achieving energy improvement goals. In addition, don't forget about the energy tools and resources provided throughout the *Guidebook* and the utility practitioners who have experience in systematic approaches and in implementing successful energy improvement programs.

In this session you will:

1. Continue to align your energy goals with business/operational goals.
2. Apply lessons learned.
3. Expand involvement of management and staff.
4. Communicate success.

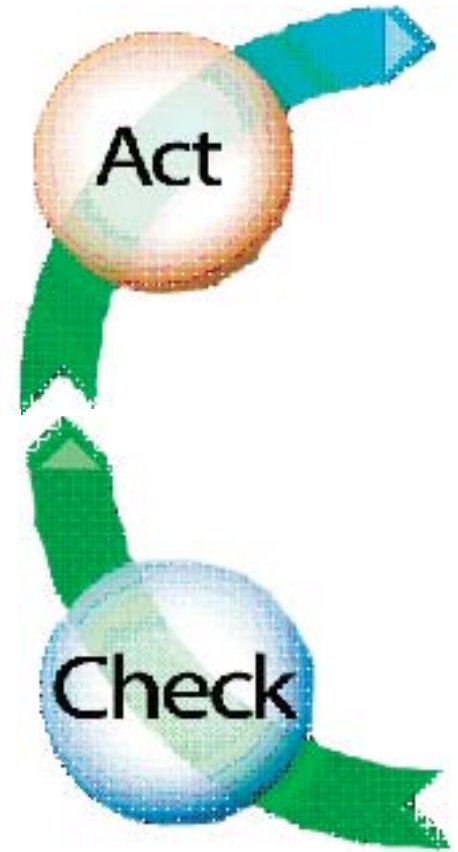

Keys to Success

- Communicate energy achievements and build on successes
- Encourage further staff involvement
- Aligning energy goals with operational objectives and mission

MODULE 1: Continue to Align Energy Goals with Business/Operational Goals

Module Objective: To align your energy efficiency and energy cost savings goals with your current or planned business and operational systems/programs.

As your utility plans and implements its energy improvement opportunities, it is important to ensure that your energy goals are aligned with your organization's overall business and operational management practices. Here are some questions you may wish to consider at each of your energy program reviews.

- Have our priority objectives changed?
- Has the business or policy environment changed in such a way that the targets need revision?
- Have new resources or funding assistance programs become available that would support setting additional objectives or targets?
- In terms of setting targets and identifying tasks for energy performance, do we feel that our current process is sound and efficient?

As an example, consider the replacement of aged infrastructure at your utility through an asset management program. If you choose to replace older pumps with newer, more energy efficient ones through an energy management program, this aligns well with your asset management goals.

Utility Case Study: Lowell, MA Regional Wastewater Utility

The following is an example of activities Lowell Regional Wastewater District implemented over time to meet business and operational goals.

- Installed motion sensors and have achieved payback of \$20,000/year.
- Adopted purchasing and bidding procedures to specify that when equipment needs to be replaced, it will be replaced with energy efficient equipment.
- Installed energy efficient pump motors (VFDs) with payback of 2 years, estimated annual energy costs savings of \$145,538; lifetime reduction of 953 tons of CO₂, 2 tons of SO₂, and 1 ton of NO_x.
- Currently exploring potential for on-site generation of energy using effluent flow and microturbines.
- Currently directing consultants who are developing a comprehensive upgrade plan to incorporate energy efficient systems and equipment early and throughout the planning process.

For examples of how Camden County (New Jersey) Municipal Utility Authority has reduced their energy consumption, review Appendix O. Other examples can be found at:

(<http://www.nyserda.org/Programs/Environment/muniwaterwwtTDDComplete.asp>) to view a series of water and wastewater utility case studies from the New York State Energy Research and Development Authority.

"Energy management investment is an asset management tool that provides daily operational savings with increased process control."

James L. Jutras
Water Quality Superintendent
Essex Junction, Vermont



CONSIDER THIS...

By aligning your energy improvement opportunities with your utility's business/operational goals, your utility will focus its attention on the priorities that matter most to facility management and the local community.

MODULE 2: Apply Lessons Learned

Module Objective: To successfully apply what you've learned through implementation of your utility's energy targets and the examples from your utility peers that have successfully developed energy improvement programs.

Throughout this *Guidebook*, there are energy tools and resources, as well as case studies and working examples of energy improvements from water and wastewater utilities that can further assist you as you plan, prioritize, and implement your utility's energy objectives and targets. Keep the following lessons, provided by water and wastewater utilities, in mind as you develop the energy goals for your utility.

- Communicate success, including the progress of your energy improvement targets, early and often to help motivate management and employees to the benefits of your energy programs.
- Clearly define roles and responsibilities for energy management.
- Remember the KISS rule. Keep the methods to review your priority energy improvement opportunities straight forward and flexible. Remember, this process is not set in stone. If you do not feel the criteria selected are right or the analysis is working as intended, make a change.
- Choose targets that are realistic and quantifiable and that come from your "low hanging fruit" or quick win energy improvement opportunities.
- Contact water and wastewater treatment facilities that have implemented energy improvement programs and benefit from their knowledge. Members of the Steering Committee that participated in the development of this *Guidebook* are eager to share their insights as well.



CONSIDER THIS...

Build on the successes and learn from the plans and procedures that did not work that well when developing and maintaining your utility's energy plans, programs, and goals.

MODULE 3: Expand Involvement of Management and Staff

Module Objective: To learn how to expand the involvement of utility staff in planning and implementing Energy Improvement Management Programs.

Regardless of the size of your utility or the scope of your energy fenceline, it is easy to allow energy improvement programs to become “Steve’s” or “Megan’s” or “the Energy Team’s” program. If a particular person or group writes your energy management plans/procedures, does all the training, and is responsible for implementing most of your energy objectives and targets, what happens if Steve or Megan or some members of your Energy Team move on? The investment your utility has made in your energy improvement program could be in jeopardy.



Remember

Your Energy Team and other cross-functional teams can also help the integration of your energy programs into other utility systems such as environmental, quality assurance, conservation, security, or asset management.

One solution that has proven successful is to expand the involvement of management and staff at your utility. Not only should your Energy Team be cross-functional, with representation from across the utility, but you should also have different levels of staff involved including management on your Energy Team. Management’s input is critical to the success of your energy improvement goals and will help ensure buy-in and commitment from your entire staff.

In addition, transferring the experience and knowledge throughout your utility will help capture and maintain institutional knowledge of the energy program as utility staff retire or move on to other locations and positions. Your incorporation of energy efficiency/conservation maintenance, calibration, and other requirements into your training programs will also help keep your energy improvement programs going strong.

Remember, recognizing the accomplishments of individuals or teams is a key to sustaining support and momentum. Rewarding effort sets the example for what constitutes success and helps motivate employees through increased job satisfaction. To review a few ideas for ways to recognize personnel for their efforts, use this link http://www.energystar.gov/index.cfm?c=recognize_achievements.internal_recognition.



CONSIDER THIS

Involving management and staff from all levels and functions will deepen the experience and knowledge base for your energy programs. Continue to communicate the message indicating the importance of energy goals from top management to operations and throughout your utility.

MODULE 4: Communicate Success

Module Objective: To communicate the on-going successes of your utility's energy management plans.

Now that you've developed your utility's Energy Improvement Management Programs, make sure that your employees, your management, and your community know what you want to accomplish with regard to energy improvement and how you're doing against your goals.

You may wish to consider attending conferences sponsored by the U.S. Environmental Protection Agency (EPA), by the Water Environment Federation (WEF), the American Water Works Association (AWWA) or participating on their energy committees. The National Association of Clean Water Agencies (NACWA) is another organization involved in promoting sustainable infrastructure. Through these and other trade associations, you can share the benefit of your experiences with your peers and in turn learn from their experiences.

The ENERGY STAR Program, supported by the U.S. Department of Energy and U.S. EPA, is one opportunity for demonstrating superior performance in energy management. In addition, many states have a municipal energy challenge that you can join and enter your water or wastewater treatment plant to reduce your energy consumption. Also, your electric or gas utility may have a program for recognizing peak demand reductions in the summer months. There are also many entities that recognize organizations that reduce greenhouse gas emissions.



CONSIDER THIS...

Remember, employees and external stakeholders respond best to information that is meaningful to them. Putting energy performance information in a form that is relevant to each internal and external stakeholder will increase the likelihood they will act on the information.

CONCLUSION

Energy production and energy use can impact your utility in many areas of operation. Energy production is a major source of environmental impact that affects air quality, water quality, the depletion of natural resources, and climate change, while energy usage takes costs from a facility's budget that could be better spent on employee wages/benefits or to stabilize utility rates. A well thought out and implemented Plan-Do-Check-Act process will conserve energy, reduce or avoid costs, and reduce the depletion of non-renewable sources of energy as well as minimize the energy production and usage impacts, strengthening the position of the utility.

As you utilize the information in this *Guidebook* for your water and wastewater utility, remember the following.

- Energy production and use affects air quality, water quality, the depletion of natural resources, and the generation of greenhouse gases that contribute to climate change.
- Wastewater and water utilities' challenges in meeting energy needs and costs are increasing.
- Every dollar spent on energy is a dollar that it is not available for employee wages/benefits or to stabilize utility rates.
- Proactively and systematically looking for ways to reduce energy consumption and costs is a critical part of managing operations.
- Tools and resources are available for utilities interested in conserving energy, reducing costs, and increasing the use of renewable sources of energy.
- Many utilities have had great success in improving their energy management but the most effective are those that integrate energy projects into a sustainable Plan-Do-Check-Act process.
- A better managed, more efficient utility enjoys an improved image, position, and relationships with regulatory agencies as well as tax or rate payers.

RESOURCES/TOOLS

Best Practices for Energy Management, AWWA Research Foundation, 2003.

[The Cleaner and Greener Emission Reduction Calculator](#)

[Combined Heat and Power Partnership](#); U.S. EPA

Energy Audit Manual for Water/Wastewater Facilities, published by EPRI, 1994.

Energy Conservation in Wastewater Treatment Facilities - MOP FD-2, published by WEF, hardcover, 1997.

[ENERGY STAR's Benchmarking Tool](#)

[ENERGY STAR's Portfolio Manager](#)

[ENERGY STAR Guidelines for Energy Management](#)

EPA's National Environmental Performance Track Program: www.epa.gov/performance-track

Opportunities for and Benefits of Combined Heat and Power at Wastewater Treatment Facilities, by Eastern Research Group for EPA, April 2007. Very good on CHP options.

[Roadmap for the Wisconsin Municipal Water and Wastewater Industry](#); funded through [Focus on Energy](#), this roadmap addresses four key areas of concern that industry representatives have identified: energy use and supply, aging plants and infrastructure, sustainable water supply, and waste-product reuse.

Roadmap to Energy in the Water and Wastewater Industry, ACEEE, 2005; focused on what industry stakeholders think would benefit them.

Wastewater Management Fact Sheet: Energy Conservation, U.S. EPA, July 2006; discusses energy audits, renewable energy, and other options.

Water & Sustainability (Volume 4): U.S. Electricity Consumption for Water Supply & Treatment – the Next Half Century, EPRI Topical Report, March 2002.

Water-Energy Relationship, CEC staff paper, June 2005. This document focuses more on water treatment but has a fair amount of (California-specific) material on energy demands for wastewater treatment, including figures of kWh per million gallons. This document also has a great list of references.

Watergy: Taking Advantage of Untapped Energy and Water Efficiency Opportunities in Municipal Water Systems, Alliance to Save Energy, 2002. Very much its own sort of management approach, with case studies from all over the world.

APPENDICES

**Ensuring a Sustainable Future:
An Energy Management Guidebook
for Wastewater and Water Utilities**

SESSION 2: Appendices

Appendix A

Utility Case Study: Essex Junction, Vermont Wastewater Treatment Facility

Turning Methane into Money: Cost-Effective Methane Co-Generation Using Microturbines at a Small Wastewater Plant -- Paper

Village of Essex Junction Wastewater Treatment Facility

Project Summary

In an effort to cut operating expenses and keep wastewater rates stable, the Village of Essex Junction partnered with Efficiency Vermont, Northern Power Systems, and Hallam Associates, Inc. to incorporate methane-fueled co-generation using microturbine technology into the wastewater treatment process. Methane-fueled co-generation has been implemented at many large wastewater facilities in the United States, but is often not considered cost effective for smaller plants. The Essex Junction facility is the first of its kind in New England, confirming the viability of small-scale application of this process.

While treating wastewater, the waste sludge is processed in an anaerobic digestion tank, meaning the tank has no oxygen. This part of the process stabilizes the sludge and reduces its volume. Methane gas is produced from the anaerobic digestion. In the past, the methane gas was collected and burned in a flare. Now, methane-fueled co-generation allows nearly 100% of the methane to be used as fuel for two microturbines that generate electricity. The heat emitted from this process is then captured and used to heat the anaerobic digestion tanks.

Methane-fueled co-generation is a method of producing electricity and creating usable heat that enables the facility to save energy and money. It is also a great example of renewable and distributed generation efforts.

The Village of Essex Junction and Efficiency Vermont were honored with a 2003 Vermont Governor's Award for Environmental Excellence and Pollution Prevention.

Project Facts

The need: To reduce operating costs of the wastewater treatment facility.

The solution: Use waste methane gas that is already collected on-site to generate electricity, thereby reducing the need for commercial energy.



www.encyvermont.com

Essex Junction, VT



Project Partners

Owner:
Village of Essex Junction
(802) 878-6943

Design/Build:
Northern Power Systems
Waitsfield, VT
(802) 496-2955

Engineer:
Hallam Associates, Inc.
South Burlington, VT
(802) 658-4891

Additional Funding Support:
Biomass Energy Resource
Center
Montpelier, VT
(802) 223-7770

NativeEnergy
Charlotte, VT
(800) 924-6826

United States Department of
Energy
<http://www.energy.gov>

Energy efficiency upgrade costs	\$303,000
Estimated first year utility bill savings	\$37,000
Energy efficiency investment payback (after incentives paid)	About 7 years
Estimated lifetime customer savings (15 years)	\$555,000

Efficiency Vermont was created by the Vermont Legislature and the Vermont Public Service Board to help all Vermonters save energy, reduce energy costs, strengthen the economy and protect Vermont's environment. Efficiency Vermont is currently operated by Vermont Energy Investment Corporation (VEIC), an independent non-profit organization under contract to the Vermont Public Service Board. VEIC is a Vermont based organization, founded in 1986.

Turning Methane into Money: Cost-Effective Methane Co-Generation Using Microturbines at a Small Wastewater Plant

*Gillian Eaton, Vermont Energy Investment Corporation
James L. Jutras, Village of Essex Junction, Vermont*

ABSTRACT

Application of microturbines for methane-fueled combined heat and power generation represents an innovative, renewable energy technology. While methane-based co-generation has been widely implemented at large wastewater facilities, it is generally not considered to be cost-effective for smaller plants. The Village of Essex Junction, with the support of Efficiency Vermont, has successfully implemented microturbine technology at its 2.0 million gallon per day (MGD) average-flow, municipal wastewater treatment facility, and can provide firsthand information on its financial benefits. The Essex Junction facility design is 3.3 MGD with flows at 2.0 MGD.

The Essex Junction co-generation project installed two, 30 kilowatt (kW) microturbines that combust waste methane gas to generate electricity. Waste heat from the microturbines is used to maintain 100-degree Fahrenheit temperatures for the site's anaerobic digestion process. Total system efficiency of electricity and heat generation is greater than 80%. With nearly 100% use of its waste methane, the facility now saves approximately 412,000 kilowatt-hours (kWh) (36% of annual usage) and \$37,000 in electricity costs per year. As a result, more than 600,000 pounds of carbon dioxide emissions from power plants will be prevented because of this project.

The Essex Junction project is the first of its kind at a small New England wastewater facility. Similar projects could likely be implemented at 5-15% of the nation's 16,000 publicly-owned wastewater treatment facilities. Efforts to expand methane-based co-generation at wastewater facilities would yield significant energy savings, while also supporting pollution prevention, renewable energy, and distributed generation efforts. This paper will describe the benefits of methane-fueled microturbine co-generation, provide lessons learned from the experience of a 2.0 MGD facility, and show the cost-effectiveness of this innovative technology.

Introduction

The Village of Essex Junction, Efficiency Vermont, and other project partners were able to leverage each other's technical and financial resources to complete a project that will help Essex Junction's rate payers for years to come. While many municipalities are struggling with maintaining infrastructure in the face of increasing costs, there are innovative and effective ways to increase efficiency, conserve energy resources, and reduce operating costs. Methane-fueled microturbine co-generation provides such an opportunity at Essex Junction.

The Village of Essex Junction is in northwestern Vermont with a land area of 4.6 square miles and a population of approximately 8,700 people. It is located approximately 10 miles from Burlington, Vermont, which is the State's largest city with 38,000 people. Both

Essex Junction and Burlington are in Vermont's most populous county, Chittenden County, which is home to approximately 100,000 residents. The total population of Vermont is roughly 620,000. Given the small size and rural nature of the state, it is difficult for individual municipalities to cover the cost of large projects with high initial capital costs and maintain user rate stability (even when projects achieve long-term operating cost reductions).

Efficiency Vermont, the nation's first energy efficiency utility, was created by the Vermont legislature and the Vermont Public Service Board in 1999 to help all Vermonters save energy, reduce energy costs, and protect Vermont's environment. Efficiency Vermont is operated by Vermont Energy Investment Corporation, an independent, non-profit organization under contract to the Vermont Public Service Board. Efficiency Vermont administers virtually all system-wide, electric-ratepayer funded energy efficiency at a statewide level. The Efficiency Vermont contract is a multi-year, competitively bid, performance-based contract that includes a great deal of freedom and flexibility to achieve clearly specified, quantitative energy savings. While commercial and industrial customers have access to prescriptive incentives for simple efficiency measures¹, the large majority of electric energy savings are achieved through custom projects and services. Typical services that may be provided by Efficiency Vermont include project-specific technical assistance (e.g., electric and cost savings analyses, economic analyses, technical recommendations, etc.), education and training, and financial incentives.

Anaerobic Digestion and Methane

Methane is produced as a by-product of a process known as anaerobic (i.e., without oxygen) digestion, which decomposes organic material. At wastewater plants, anaerobic digestion is used to stabilize wastewater sludge, reduce sludge volume, and eliminate pathogens. Volume reduction of sludge results in smaller disposal quantities and lower disposal costs. The methane generated from anaerobic digestion at wastewater facilities is typically considered a "waste." In fact, methane gas can be a troublesome waste since it is also a "greenhouse gas" that contributes to global warming. Most wastewater plants with anaerobic digestion are required to collect the resulting methane gas and burn it (usually with a flare), rather than letting it discharge directly to the atmosphere, in order to control and reduce the emission of greenhouse gases². Many do burn a portion for heating the digester.

Based on information collected by the US EPA in its Clean Watersheds Needs Survey in 2000, there are approximately 16,000 public wastewater facilities in the U.S., referred to as publicly owned treatment works (POTWs). Anaerobic digestion is a process that is used at roughly 20% of these POTWs (EPA 2003a). Many of these facilities use their waste methane gas as a fuel to provide process heat for the anaerobic digesters, which are typically maintained at 95 degrees Fahrenheit; the rest is often flared. Few use the methane to generate electricity on-site. In fact, the possibility of using methane gas to produce electricity is mentioned only briefly in the Water Environment Federation (WEF) 2003 edition of

¹ Prescriptive incentives are currently available to Vermont businesses from Efficiency Vermont for some lighting products, LED traffic signals, vending machine controllers, energy star transformers, some refrigeration equipment, premium efficient motors, and "tier 2" air conditioning units.

² The by-products of methane combustion are carbon dioxide and water. Although carbon dioxide is also a greenhouse gas, it is 20 times less effective at trapping heat than methane.

Wastewater Treatment Plant Design, and then indicated only for “larger treatment plants.” (Vesilind et al. 2003, 15-1)

Methane is a renewable energy source, specifically, a biofuel. As a fuel, methane contains approximately half the energy content of natural gas on a per unit basis. That is, a cubic foot of waste methane gas typically has 500-600 British Thermal Units (Btu), whereas a cubic foot of natural gas contains 1,000-1,100 Btu.

Essex Junction Wastewater Facility Background

The Village of Essex Junction upgraded its Wastewater Treatment Facility (WWTF) in 1985 to a secondary conventional activated sludge plant with advanced treatment using mesophilic anaerobic digestion. The Village constructed its new plant to serve a “tri-town” area in Vermont that includes the Village of Essex Junction, the Town of Essex, and the Town of Williston. The WWTF has a design flow of 3.3 million gallons per day (MGD) and an average flow of 2.0 MGD. Although a plant of this size is considered small by national standards, the Essex Junction WWTF is one of the ten largest municipal wastewater plants in the state of Vermont.

As a municipal wastewater facility, the Essex Junction WWTF is challenged to meet its budget needs without increasing sewer rates. Building budget capacity when much of the WWTF’s annual operating budget consists of fixed costs that escalate with inflation is a difficult objective, but one that the WWTF pursues vigorously. Of the WWTF’s \$750,000 annual operating budget, 90.5% is made up of only five categories.

Figure 1: Major Budget Categories for WWTF annual operating budget

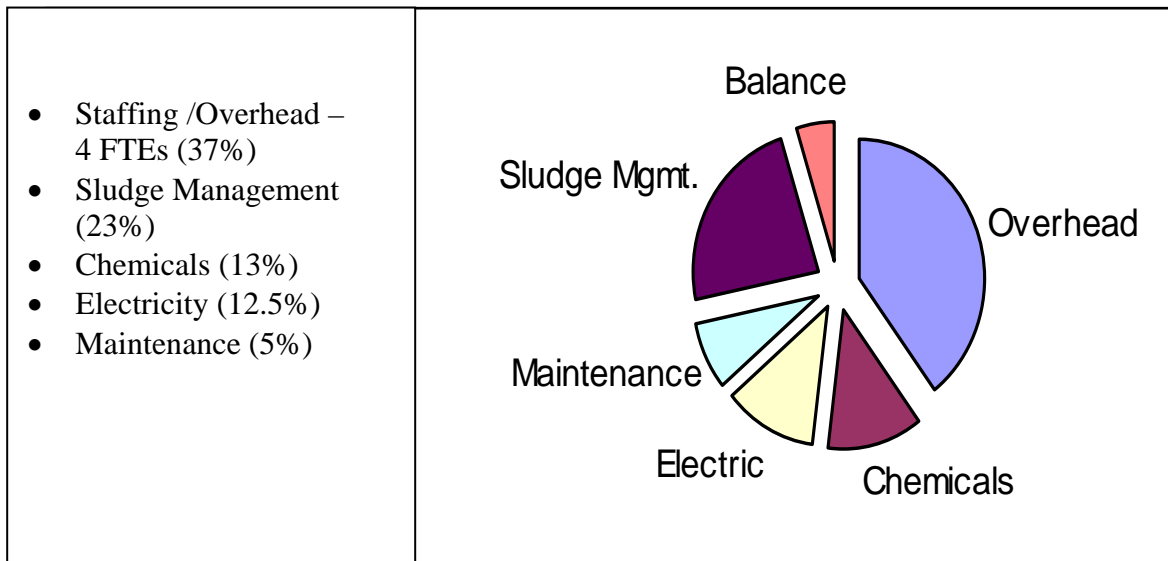

Electric power demand for the WWTF is typically between 120-240kW. Prior to co-generation, electric usage was approximately 1,100,000 kWh each year, representing approximately \$100,000 in annual electric utility costs. As with most municipalities, the WWTF is the most energy intensive facility it owns and operates.

The Essex Junction WWTF seeks continuous improvement in all aspects of its business. In 1985, the plant was upgraded to remove phosphorus to 0.8 mg/L and provide seasonal nitrification. A 1998 upgrade was to provide for flow equalization and reduce peak hydraulic demand on the affected treatment operations. This project was a funding priority to protect the water quality of Lake Champlain. Current work is focused on meeting new federal and state regulations regarding storm water collection and management. In addition to required process upgrades over the years, WWTF personnel were seeking energy conservation and efficiency projects to build budget capacity through reduced operating costs. As with most wastewater facilities, there are constant competing priorities for time and financial resources. By 2000, the WWTF was able to complete most of the energy efficiency recommendations made to the facility in a 1993 report, even while improving operations and treatment at the plant. Some examples of efficiency projects include

- T8 lighting upgrades
- Hot water management
- Load shifting
- Load shedding
- Aeration blower variable frequency drive (VFD)
- 3 Phase power conversion (VFD conversion from single phase to three phase power at point of application).

Now the challenge became – how to achieve more cost savings beyond standard efficiency measures?

Making the Case for Co-Generation

Essex Junction WWTF personnel had been considering implementing a combined heat and power (CHP) system since 1992. Given the high initial capital cost, it simply wasn't deemed cost-effective for the Village to pursue CHP at that time. The sewer facility governing board has a requirement that any energy-saving/cost-saving proposal have a simple payback of no more than 7 years in order to proceed. Moreover, since the project would be expending taxpayer dollars, municipal decision makers had to feel confident that the project would deliver the estimated savings. On the whole, municipalities tend to be highly risk-averse when making project and budget decisions, as they have to defend their decisions to entire communities.

The Essex Junction WWTF used the waste methane gas to fire a boiler that provided process heat to the anaerobic digesters and flared any remaining methane. On an annual basis, only about 50% of the methane gas produced was utilized. Could the facility increase its overall efficiency by using more of its methane to generate power and heat, rather than flaring it as a waste? In order to estimate a payback period for the project, the Village of Essex Junction needed to know how much electricity generation they could achieve, given the facility's treatment flow, amount of methane produced, and need for digester process heat. When methane is used as fuel for a CHP project, an important consideration is whether the process heat available after combusting the methane will be sufficient to maintain digester temperatures. Given Vermont's cold climate, special attention had to be paid to the lower methane production rates in winter, coupled with the greater need for process heat in the winter.

The WWTF hired an engineer to perform initial design work, cost estimates, and feasibility analyses. One of the first questions to consider was what type of electric generator to use: engine, microturbine, fuel cell, etc. While engines were considered, the microturbine was a preferred alternative since municipal personnel wanted to be sure that emissions from any new system would be at least as “clean” as existed before installation of the system. The basic plan for the system was to combust collected methane in a microturbine to generate electricity. The waste heat from the combustion would then be used to provide process heat to the anaerobic digesters. The 18-year old dual-fuel boiler currently used for process heat would be kept as a backup heating source. Figure 2 shows the system process.

Figure 2: Essex Junction methane-fueled cogeneration preliminary design process diagram

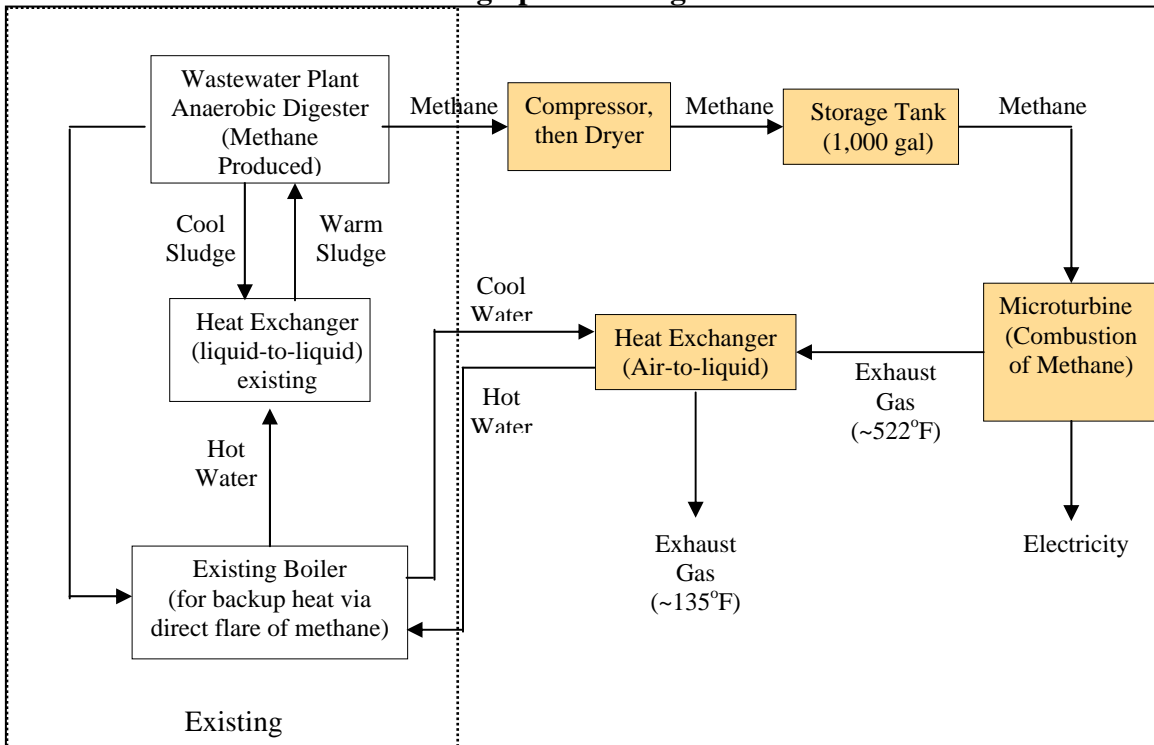

During initial investigations, it became clear that methane-fueled cogeneration at a facility the size of Essex Junction was not typical. In fact, no such system existed in New England. The closest, similar facility was in Lewiston, NY. During conversations with Lewiston plant personnel, and a site visit to the Lewiston facility, a variety of “lessons learned” were discussed and incorporated into initial design work. In particular, the issue of siloxanes was raised. Siloxanes are silica-based compounds, typically found in shampoo, that can glassify when subjected to high temperatures. Glassified materials can reduce the effectiveness of heat exchangers, and can create imbalance in microturbines, potentially causing failure. It was determined that a siloxane removal strategy would need to be part of any cogeneration system. As knowledge grew regarding all the required elements for a successful cogeneration project, the estimated initial capital cost grew. In order to meet the 7-year payback requirement from the sewer board, it became critical to identify additional funding sources and leverage outside resources. The local electric utility was supportive of the

project since reduced demand from the WWTF would assist in a transmission and distribution (T&D) constrained area. Unfortunately, there was no funding available from them. Efficiency Vermont was able to commit funding to the project, and help with economic and savings analyses. Efficiency Vermont also helped to “spread the word” about the project, soliciting additional support for it. Ultimately, a project team was put together with 5 different funding sources; a creative solution that made this project a reality.

Project Design, Contractor Selection, and Construction

Preliminary design work was performed by a local engineer. The focus of the effort was to determine if implementation of CHP would be cost-effective for the WWTF, given the existing electric rate structure, capital costs, and the required maximum payback period. The initial basis of design included the following components:

- Two – 30 kW micro-turbines
- Continuous generation for 1 microturbine
- Additional peak shaving for 2nd microturbine
- Natural gas and methane blending option
- 3 Phase 480 volt generation
- Operate parallel to the utility, reduce purchased electricity
- UL 1741 protection for voltage & Grid

Although the municipality had completed initial design work, the RFP was structured to allow for alternate designs. It included a large amount of information for potential bidders in order to solicit the best possible performance and allowed a bidder to propose a system based on the preliminary design, or to propose an alternate design. The RFP was written such that the selected contractor would enter into a performance-based, design/build contract. In order to generate quality system designs, the following facility background information was provided in the RFP:

- The WWTF generates an average of 30,300 cu.ft./day of methane
- The facility’s methane has a typical energy content of 520 btu/cu.ft.

Additional RFP content included system requirements and evaluation priorities.

- The system should emit no additional pollutants (i.e., SO_x, NO_x, methane) compared to the current practice of flaring methane
- The system must remove siloxanes to protect equipment operation and life (e.g., heat exchanger, microturbines)
- The electrical system interconnect must meet utility requirements and safety protocols (e.g., no power feed onto grid during power outages)
- Generated power must be line-synchronized with grid-supplied power to maintain power quality.
- The system must not exceed facility maximum allowed noise levels, based on nearby residences and neighborhood park.
- The system must be highly reliable and require minimal maintenance that can be performed by facility personnel at reasonable cost.
- The system must meet all relevant permit and other federal, state and local requirements

Bids came in more than \$90,000 higher than expected (low bid cost of \$275,000 v. estimated cost of \$184,000). The higher initial cost meant that the project did not meet the sewer facility governing board 7-year payback requirement to move forward. Many projects may have simply been abandoned at this point. The key difference in the Essex Junction project is that project champions actively solicited additional financial support in order to make the project a reality. Efficiency Vermont increased its incentive offer from \$25,000 to \$40,000. Other key contributors also stepped forward. The Vermont-based Biomass Energy Resource Center (BERC) committed \$25,000 toward the project. Another Vermont-based organization, NativeEnergy offered \$10,000 toward the carbon credits that would be created from the project as a result of onsite generation and the reduction in demand for power plant generation. The Department of Energy, Region 1 provided \$5,000 toward the project to assure data collection and dissemination, so that other facilities could benefit from the knowledge gained from the Essex Junction experience. And negotiations with the low bidder, Vermont-based company Northern Power Systems, provided important technical insight to optimize system performance while containing costs. Without the financial support and personal dedication of all of these organizations, and especially the commitment of Essex Junction personnel, the WWTF's methane-fueled cogeneration system would not have materialized.

The final, installed system is based on a design/build approach with performance standards and includes the following characteristics.

- 480 Volt – 3 Phase Power
- 3% Maximum Voltage Distortion
- 5% Maximum Harmonics Distortion, and compliance with IEEE 519-1992
- Full compliance with IEEE interconnect standards
- Dual-fuel microturbines (with natural gas/methane blending capability)

Start-Up and Ongoing Operations

Project start up included several activities prior to “going live” with the system. The local electric utility was subcontracted to perform the electrical installation. This ensured that all utility requirements were met during the installation. An area of some difficulty was enabling a smooth transition from methane-fueled cogeneration to natural gas-fueled cogeneration and back again. Although a dual fuel microturbine was specified, the actual control and sequencing of switching from one fuel source to another was not a trivial matter. Contractor personnel ultimately developed a successful proprietary protocol that provided methane/natural gas blending during transitions from one fuel to the other without fuel fault to the generators. Another activity included the need to update the supervisory control and data acquisition (SCADA) system with new screen views and monitoring/control capabilities. Computer programming was necessary to integrate the monitor and control functions with the actual equipment. Recent condensation and cooling work has built on initial system, pre-compression moisture removal capabilities.

Preliminary design work estimated that the level of methane generated at the WWTF would be sufficient to operate two 30kW microturbines an average of approximately 40 total hours each day. Since installation of the system in October 2003, there has been sufficient methane generation to run the two microturbines 48 total hours each day. One reason for consistently high methane production is that, prior to the cogeneration installation, the WWTF

had its two anaerobic digesters cleaned to ensure proper process heating and to maximize methane gas generation. These extra 8 hours of run time each day represent more than 80,000 kWh of electricity each year. And now that methane is a valuable energy resource for the WWTF, it is monitored and managed more carefully than when it was simply a waste by-product. In addition, the WWTF has also now installed two utility-grade sub-meters to more definitively document the net power generation and net purchased power.

Results

To date, all aspects of the cogeneration system have operated as well or better than anticipated, with the exception of the methane compressors (These are the compressors that raise the 0.5 pounds per square inch (psi) methane to 100 psi prior to drying and combustion in the microturbines.). Over the first year of operation, the system achieved 90% reliability. While actual maintenance costs for the siloxane removal system (filter media, etc.) are lower than anticipated, the compressor maintenance cost is presently anticipated to be higher. The presence of moisture in the compressors has been the single largest reason for equipment downtime and failure to date. An effective strategy for moisture removal from methane and keeping moisture out of the methane compressors is key to successful system operation and maximizing system run time. When a compressor is not working, the down time has a direct impact on the daily electrical generation and subsequent facility cost savings. Table 1 provides information on the power demand from the electric utility after startup of the 60kW of microturbines. One item of interest is that the facility power factor decreased since installation of the microturbines. Facility personnel are working to pinpoint the cause and ensure that plant-wide power factors remain above 90% to avoid power factor penalty fees from the electric utility. Table 2 compares pre-installation cost estimates and post-installation actual costs.

Table 1: Facility Power Information Before and After System Installation

	Before (Oct 2002 –Sept 2003)	After Oct 2003-Sept 2004)
On Peak Demand	134-235 kW	110-215 kW ³
Off Peak Demand	130-226 kW	94-226 kW ⁴
Monthly Avg. Usage	93,000 kWh	61,000 kWh
Power Factor	96	87

³ Oct 2003 value is 215 kW. With out start up month 203 kW is maximum

⁴ Oct 2003 value is 226 kW. With out start up month 190 kW is maximum

Table 2: Estimated and Actual Project Payback Analysis

	Pre-Construction (estimates)	Post-Construction (actuals)
System capital cost	\$184,000	\$303,000
Incentives and grants	\$25,000	\$80,000
Net customer cost	\$159,000	\$223,000
Electric generation	396,000 kWh/yr	412,000 kWh/yr
Electric cost savings	\$26,600/yr ⁵	\$37,000/yr ⁶
Maintenance costs	\$3,700/yr	\$4,000/yr
Net annual savings	\$22,900	\$33,000
Payback without incentives	8.0 yrs	9.2 yrs
Payback with incentives	6.9 yrs	6.8 yrs

Figure 3 illustrates the amount of on-site electrical generation compared to purchased electricity at the WWTF.

Figure 3: Electric usage at the Essex Junction WWTF

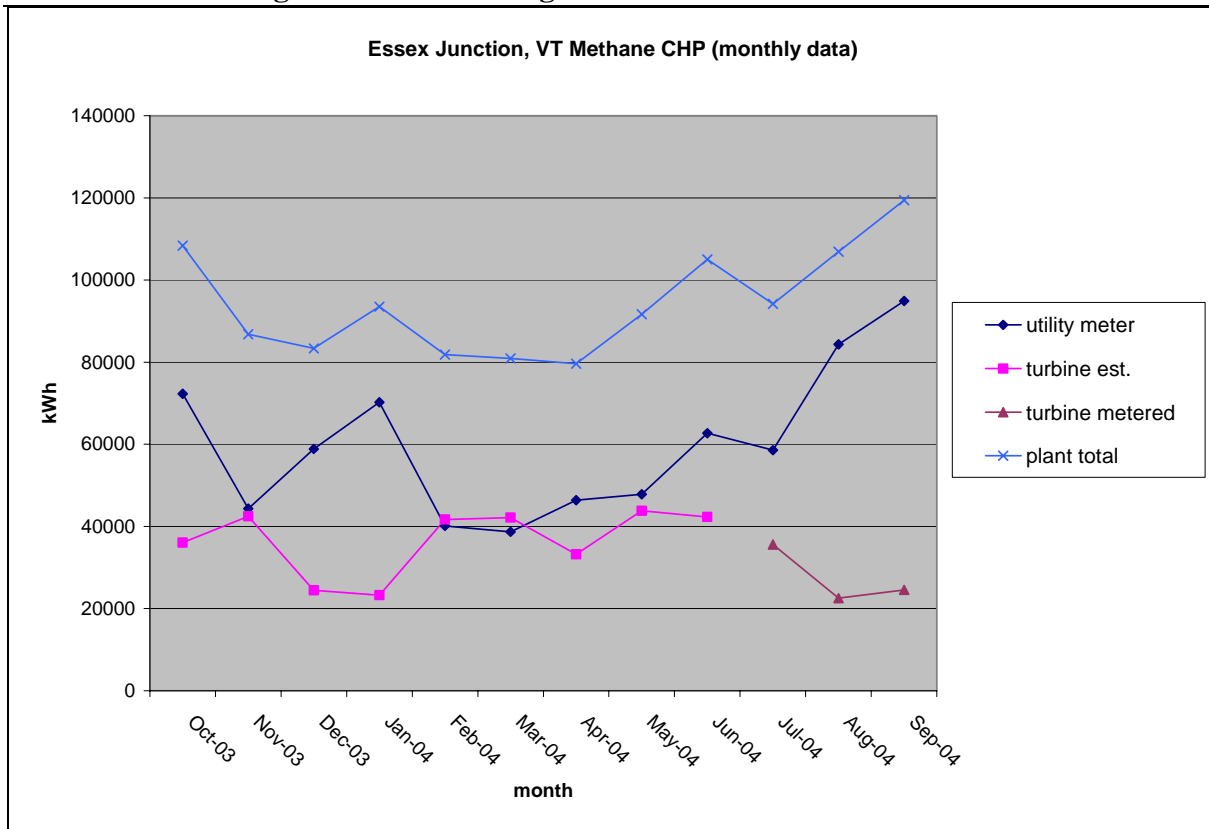

⁵ Demand rate savings were not included in original estimates to be conservative

⁶ Actual blended rate of electricity Oct 2003-Sept 2004 \$0.09/kWh

Recommendations to Other Facilities

For those facilities that may be interested in implementing a CHP project, there are several things to keep in mind while designing and installing a system. The first step is to talk with others who are involved in CHP operations. Their experiences and lessons learned can prove vital for project success. They can also provide input on whether you should pursue a performance-based, design/build project, or cost plus materials for installation of an engineered system. For those who use a design/build request for proposals (RFP) based on performance requirements, it is important to specify the outcomes you require and provide potential bidders data to use for design purposes. For instance, the chemical composition of the methane gas should be analyzed, including Btu content, chemical content, and moisture content, and this information should be provided with the RFP. Assumptions should be stated regarding methane production rates, weather/temperature conditions, indoor v. outdoor siting (and/or maximum noise levels), historical electric kWh and kW quantities, electric rate structure, interconnect requirements, permit requirements, and power quality requirements. When evaluating bid proposals, include a knowledgeable engineer on the review team to assist in “fatal flaw analysis,” so that significant issues or omissions can be caught as early as possible. The RFP should also require that the following items are clearly identified for proposed systems.

- Process for siloxane removal from methane
- Process for moisture removal from methane
- Life expectancy of compressors and microturbines
- Warrantees and service obligations/protocols
- Dual-fuel capability (methane and natural gas), including blending options
- Total kWh generated, parasitic loads, net kWh generation
- Sequencing strategy (e.g., base load constant operation, peak shaving, etc.)
- Equipment efficiency and total system efficiency
- Anticipated maintenance and related costs
- Emissions/ air quality
- Material costs associated with backup (i.e., spare) equipment to be kept on hand (e.g., extra compressor)

Beyond technical considerations, probably the most important requirement is to have project “champions” that will advocate for the project throughout the many obstacles that are sure to arise. The Essex Junction project had many! Without champions who are committed to overcome implementation barriers, many projects that are cost-effective will not secure funding, community support, and decision-maker approval.

Conclusions

The Essex Junction WWTF’s methane-fueled microturbine CHP installation was presented with a 2003 Vermont Governor’s Award for Environmental Excellence and Pollution Prevention. These awards are given for projects that reduce or eliminate the generation of pollutants and wastes at the source. Selection criteria include benefits to the environment, use of innovative approaches, economic efficiency, and the ability of an activity to serve as a model for other efforts. Awardees were recognized as having “chosen to see the world of possibilities and achieved excellence in pursuit of a preferred future.”

The project is noteworthy and successful for numerous reasons.

- The facility now uses nearly 100% of a former “waste” as fuel. This waste was only about 50% utilized before.
- The Essex Junction community is now using a renewable energy source to reduce costs and prevent pollution.
- A small municipality has been able to implement innovative microturbine technology while maintaining community confidence and rate stability.
- Implementation of distributed generation reduces power demand and helps ensure power availability in a local electric utility T&D constrained area.
- The facility, and its ratepayers, are saving 40% off their electric bills each year.
- Many other wastewater facilities can install similar systems and achieve similar results.

Of the 16,000 POTWs in the country, approximately 20% of these facilities use anaerobic digestion, and roughly 1,100 use anaerobic digestion and have average flows of 2 MGD or more. In addition to POTWs, there are also industrial and private wastewater facilities for which CHP would be applicable and cost-effective. By recognizing that methane-fueled microturbines can be cost-effective at small wastewater plants, and not just larger facilities, an entire new segment of the wastewater market is now open to distributed generation opportunities. For efficiency organizations, and other potential funding sources, this is what you can do to facilitate implementation of wastewater CHP projects. Show that it's been done before to reduce the perception of taxpayer risk. Understand the economic requirements of your customer (e.g., payback requirements, ROI requirements, etc.). Provide funding when possible. Help the facility find other funding sources. Spread the news to generate support and excitement for the project. Let others know about your experience. The technology continues to improve, the costs continue to come down, and methane can mean money for wastewater facilities.

References

[EPA] U.S. Environmental Protection Agency, 2003a. *Clean Watersheds Needs Survey (CWNS) 2000 Process Report*. Available online:
<http://cfpub.epa.gov/cwns/process.cfm>

[EPA] U.S. Environmental Protection Agency, 2003b. *Clean Watersheds Needs Survey (CWNS) Report to Congress*. Available online:
<http://www.epa.gov/owm/mtb/cwns/2000rtc/toc.htm>

Vesilind, P.A. et. al., ed. 2003. *Wastewater Treatment Plant Design*, Alexandria, Virg.: Water Environment Federation.

Bishop, J. 2004. “Digester Gas Unpopular as Power Fuel” *Water Environment & Technology*. July.

Allentown, City of. 2001. City of Allentown, Pennsylvania web site. Available online:
www.allentownwater.org

Water and Wastewater Newsletter, Oct.8, 2001, TXU Energy Services, Available online:
http://www.waterandwastewater.com/www_services/newsletter/october_8_2001.htm

GHR Consulting Services Inc., 1993. *Energy Analysis Study*, Essex Junction Waste Water Treatment Plant, May.

SESSION 2: Appendices Continued

Appendix C

Equipment Inventory Worksheets

Process or Equipment	Nameplate HP or Measured kW	Load Factor	Hours of Operation Per Year	kWh/Year

Pump Designation	Installed	Nameplate Rating	Hours of Operation Per Year	Measured Power Consumption	kWh/Year

SESSION 2: Appendices Continued

Appendix D

Regulatory Requirements Table

Requirement Name:	
Requirement	
Relevant Agency	
Is regulation up to date?	
Are we in compliance according to agencies?	
Could we improve our performance?	
How does this affect the proposed energy conservation measures?	
Do we expect to remain in compliance?	

SESSION 3: Appendices

Appendix E

List of Activities and Operations Table

Activity	Operation or Location	Type of Energy Used	Current Use and Costs
Activity 1			
Activity 2			
Activity 3			
Activity 4			

SESSION 3: Appendices Continued

Appendix F

Energy savings information for typical water and wastewater equipment and systems, including motors, pumps, aeration systems, lighting and HVAC

Motors

Motors represent a major capital investment, a recurring maintenance requirement, and a significant energy demand. Proper selection and proper maintenance will help reduce energy costs and improve reliability.

Motors are often available in standard and high-efficiency models. The difference in efficiency is greater for smaller motors than for larger ones,²⁰ although even a 1-2% difference in efficiency can make a major difference in energy cost for a large motor that is run continuously. The New England Interstate Water Pollution Control Commission recommends using high-efficiency motors in all cases except for very small motors that are used frequently.²¹ The Commission also recommends incorporating power factor correction into all designs.

The Hampton Roads Sanitation District implemented an extensive motor policy in 1996. Some of the most important elements are as follows:²²

- Motors must meet or exceed the efficiency levels set by the Energy Policy Act of 1992;
- Efficiency is determined by test standards set by IEEE Standard 112-1984;
- Motors must be sized properly for load, with a service factor of 1.15;
- The guidelines specify 13 parameters to be noted, including horsepower, voltage, full load amps, speed, maximum starts per hour and more; and
- When deciding to repair or replace an old motor, the District will purchase a new energy-efficient motor if the simple payback period is 5 years or less, or if the cost of repair is more than 50% of the cost of a new energy-efficient motor.

Proper maintenance can extend a motor's lifetime and improve its energy efficiency. Motors should be operated as close to nameplate voltage as practical; any deviation in voltage will impair efficiency. Connections and switches on all major power-driven equipment should be checked at least once per year.²³ The major cause of motor failure is neglected maintenance of either mechanical or electrical components.

Pumps

Although aeration is typically the largest single energy demand in a WWTP, influent pumping can also be a significant demand, depending on site elevation and sewer elevation. Pumps operate nearly all the time and are often over-designed. Variable-frequency drives can improve pump efficiency.²⁴

Ideally, a pump would always operate at or near its Best Efficiency Point, although varying system requirements may make this impractical at times. Proper maintenance will keep a pump at or near its original design efficiency rating. Friction losses caused by piping components (such as valves) can increase the energy required for pumping and have a significant impact on energy costs.²⁵

20- Water Environment Federation (1997), Energy Conservation in Wastewater Treatment Facilities, Manual of Practice No. MFD-2, Alexandria, VA, 1997.

21- New England Interstate Water Pollution Control Commission (1998), Guides for the Design of Wastewater Treatment Works, Technical Report #16.

22- Water Environment Research Foundation (1999), Improving Wastewater Treatment Plant Operations Efficiency and Effectiveness, Project 97-CTS-1.

23- Water Environment Federation (1997), Energy Conservation in Wastewater Treatment Facilities, Manual of Practice No. MFD-2, Alexandria, VA, 1997.

24- Maine Department of Environmental Protection (2002), Bureau of Land & Water Quality, O&M Newsletter, February 2002.

25- J. Oliver and C. Putnam (1997), "Energy Efficiency: Learning How to Avoid Taking a Bath on Energy Costs," WATER/Engineering and Management, July 1997.

SESSION 3: Appendices Continued

Appendix F Continued

Aeration Systems

Aeration is typically the largest single energy user in the treatment process,²⁶ typically ranging from 45% to 75% of the wastewater utility's total electricity consumption.²⁷ Like pumps, aeration equipment operates nearly all of the time.²⁸ Possible energy-saving measures may include any of the following:

Blowers

- Variable and multiple staged single-speed blowers
- Efficient, properly-sized blowers operating at or near best efficiency point
- Using digester gas to fuel engine-driven blowers

Aeration System

- Two-speed mechanical aerators where mechanical aeration is used
- Fine bubble diffusers where diffusion aeration is used
- In some cases, a combination of mechanical mixing and diffused aeration may be the most efficient

Controls

- Continuous dissolved oxygen (DO) monitoring
- Lowest DO concentration consistent with stable operation and treatment objectives
- Automatically controlled variable air flow based on oxygen demand

The type of aeration impacts the energy demand. Energy Conservation in Wastewater Treatment Facilities, Manual of Practice No. MFD-2 from the Water Environment Federation, includes a number of case studies on fine-pore diffusers. In general, the system improves Oxygen Transfer Efficiency (OTE), and often shows a significant economic advantage. A few examples are highlighted below:

- Glastonbury, CT switched from coarse-bubble diffusers to fine-pore diffusers. OTE improved from 4-4.5% to 6.5-7%. Blower energy savings resulted in a simple payback period of approximately 2 years, although this calculation does not include increased cleaning cost.
- Hartford, CT switched from a coarse-bubble spiral roll system to a fine-pore dome diffuser system, improving OTE from 4.4% to 10%. Operating savings of \$200,000 per year resulted in a simple payback period of less than 3 years.
- Ridgewood, NJ switched from a coarse-bubble aeration system to a dome fine-pore aeration system, improving OTE from 4.8% to 9.5%. The facility saw a 30% decrease in blower energy use (saving about 30 MWh per month), but increased maintenance resulted in the simple payback period being approximately 10 to 11 years.

In some cases, increased cleaning and maintenance costs extended the time required for fine-pore diffusers to repay their cost in energy savings; in other cases, cleaning costs had relatively little effect.

Control systems are particularly important. An accurate aeration control system can reduce plant energy consumption by as much as 25%, for a system payback of less than three years.²⁹ Such a system requires accurate mass flow meters. Control systems can continuously and automatically adjust the air consumption to the optimal required amount, thereby reducing the demand on blower motors.

²⁶ New England Interstate Water Pollution Control Commission (1998), Guides for the Design of Wastewater Treatment Works, Technical Report #16.

²⁷ EPRI Industrial Program (1993), "Energy-Efficient Aeration Systems for Wastewater Treatment," Environment & Energy Management, Vol. 1, No. 3; WEF's 1997 Manual of Practice cites a very similar figure of 40-70% for activated-sludge WWTP facilities.

²⁸ Maine Department of Environmental Protection (2002), Bureau of Land & Water Quality, O&M Newsletter, February 2002.

²⁹ C. Hewitt (1996), "Programmable Aeration Control System Reduces Plant Energy Costs," WATER/Engineering and Management, May 1996.

SESSION 3: Appendices Continued

Appendix F Continued

Lighting

Lighting is a major category of energy consumption for commercial buildings. It is not as significant for industrial facilities – and a wastewater treatment plant is essentially an industrial facility – but it remains one of the energy costs most easily addressed. Fluorescent bulb technology has continued to improve, offering higher-quality lighting at lower energy demand than previous versions; if a facility has old fluorescent lights, newer versions can improve the work environment and reduce energy costs. There exists a wealth of resources for information on energy-efficient lighting options, such as ENERGY STAR’s Building Upgrade Manual.³⁰

Lights that are on for most of the workday are the best candidates for replacement with new energy-efficient models. For more intermittent loads, occupancy sensors may be a wise choice. These controls will switch off lights in unoccupied rooms after a period of time, automatically turning them on again if a person enters the room. Suitable areas might include warehouses, storage rooms, restrooms, small offices, lunch, copy, and utility rooms.³¹

Heating, Ventilation, and Air Conditioning

Heating, ventilation, and air conditioning (HVAC) are similar to lighting in that they are not as relatively important as energy demand for WWTPs as they are for typical commercial facilities, they are still a significant energy demand that can be managed effectively.

Because HVAC is such a major energy user for commercial facilities, there are many resources and many contractors able to improve the energy efficiency of a building’s HVAC system. Improving insulation, sealing leaks, properly sizing the system, and selecting an energy-efficient system (such as a ground-source heat pump) can help reduce energy costs and provide a good return on investment.

30- U.S. Environmental Protection Agency (2004), ENERGY STAR Building Upgrade Manual, online at <http://www.energystar.gov/ia/business/BUM.pdf>. The section on lighting begins on page 48.

31- J. Null and J. Hoggard (1998), “Occupancy Sensors Can Lead to Savings,” Engineered Systems, July 1998.

SESSION 3: Appendices Continued

Appendix G

Case studies of wastewater utilities installing energy generation systems based on methane capture

Facility: Wastewater Treatment Facility, Town of Amherst, NY

Daily Volume: 25 million gallons

Improvements Made: energy efficiency, methane capture

Implemented: 2004

Annual Savings: \$500,000; 7.5 million kWh

Description: This project was implemented by Siemens Building Services, an energy service company. Typically, an energy service company (ESCO) contracts with a facility owner to install energy efficiency improvements. The ESCO's costs and fees are paid from the energy savings. In this case, the New York State Energy Research and Development Authority (NYSERDA) also contributed to the costs of the improvements. The facility's new system captures approximately 77,000 cubic feet of methane per day. This gas is used to run a compressor for oxygenating the waste stream. Other improvements included a heat recovery unit, an additional natural gas engine, a new control system, lighting dimmer switches, and high-efficiency motors.

Source: NYSERDA press release: http://www.nyserda.org/Press_Releases/PressRelease.asp?i=55&d=2004

Facility: Wastewater Treatment Facility, Essex Junction, VT

Daily Volume: 3.1 million gallons

Improvements Made: Methane capture, microturbine generators

Implemented: 2003

Annual Savings: \$37,000; 412,000 kWh, or about 36% of purchased electricity

Description: The facility's anaerobic digester produces about 30,300 cubic feet of methane per day. Prior to 2003, the facility captured approximately half of this and used it in a boiler to heat the digester. The remainder was flared. In 2003, the facility installed two 30-kW microturbines in a combined heat and power system. The methane is now used to produce power, and a heat recovery system channels waste heat from the electricity generation to warm the digester. The overall efficiency of the system is about 80%. Methane-based cogeneration is normally not cost-effective for a facility of relatively small size, like this one. However, with the assistance of state agencies, federal agencies, and non-governmental organizations, the facility was able to bring the cost down to the point where it met its own requirement of a seven-year simple payback period.

Source: Northeast CHP Application Center:

<http://www.northeastchp.org/uploads/Essex%20Junction%20Project%20Profile.pdf>

Facility: Wastewater Treatment Facility, Nashua, NH

Daily Volume: 12.5 million gallons

Improvements Made: anaerobic digester, gas engine

Implemented: 2001

Annual Savings: \$750,000

Description: The City of Nashua undertook a major project, adding a \$9 to \$10 million anaerobic digester to its wastewater treatment facility. The system includes methane capture to fuel a 365-kW internal combustion engine generator. The anaerobic digester reduces the sludge to a state where it can be used as compost. This lowers sludge disposal costs by over \$1 million per year. The process also lowers chemical costs, purchased electricity costs, and other expenses. Even after accounting for the repayments to the state's revolving loan fund (one source of financing for this project) and the O&M expenses on the digester, the net savings are \$750,000 per year. Energy improvements were one part of the solution here. The overall cost savings far exceeded the energy savings alone.

Sources: Presentation for APWA Congress & Exposition, September 15, 2004:

<https://www.apwa.net/meetings/congress/2004/handouts/documents/1001.pdf>. Also see *Waukesha Power Connection*, Winter 2001, from www.dresser.com.

SESSION 3: Appendices Continued

Appendix G Continued

Case studies of wastewater utilities installing energy generation systems based on methane capture

Facility: Gloversville-Johnstown Joint Wastewater Treatment Facilities, NY

Daily Volume: design capacity 13 million gallons

Improvements Recommended: Improvements to methane capture system and possible replacement of engine generators

Implemented: 2004-2006

Annual Savings: Potential savings: \$175,000 for improvements to methane capture system; \$21,000-166,000 for improvements to or replacements of engine generators

Description: This facility already has an effective energy system in place. Methane is captured from an anaerobic digester and used to power two 150-kW engine generators. NYSERDA made its recommendations in October 2004, and generation has since increased from 1.3 million kWh to 1.8 million kWh. While the facility does not specify exactly which improvements were made, the incremental annual savings of 500,000 kWh would be about \$75,000 per year. Current total energy generation represents 42% of the site's energy consumption, for overall annual savings of \$273,000. The anaerobic digester produces about 4.1 million cubic feet of biogas per month (biogas is a mixture of methane, CO₂, and other gases).

Source: NYSERDA recommendations (October 2004) at

http://www.nyserda.org/programs/Technical_Assistance/Success/Gloversville_Johnstown_WWTF.pdf, and facility's annual report at <http://www.g-jwastewater.com/annual-report.html>.

Facility: Metropolitan Syracuse Wastewater Treatment Plant, Onondaga County, NY

Daily Volume: 80 million gallons

Improvements Made: Process optimization, energy efficiency upgrades

Implemented: 2004-2005

Annual Savings: \$207,500; 2.8 million kWh and 270 MMBTU of natural gas

Description: This is a very large wastewater facility. Improvements beginning in 2004 included retrofitting pumps, changing some operational processes, maximizing waste gas usage, and installing new equipment. Best practices tools developed by the U.S. Department of Energy were used to assess potential areas of improvement. A wide range of operational changes were made in a systematic approach. A recently-installed biological aeration filtration system allowed the facility to stop wastewater nitrification in the aeration tanks. This process change, combined with equipment upgrades, allowed the facility to reduce the number of 100-horsepower blowers from 21 to 13. In all, the improvements cost approximately \$233,000, for a payback period of 13 months.

Source: National Renewable Energy Laboratory at: <http://www.nrel.gov/docs/fy06osti/38076.pdf>.

SESSION 4: Appendices

Appendix I

Objective and Target Worksheet

Objective	Target	Timeframe

Performance Indicator Worksheet

Target	Performance Indicator	Data Source

SESSION 5: Appendices Continued

Appendix K

Examples of Operating Controls for Energy Operations

Opportunity for Energy Improvement	Associated Operations	Examples of Operating Controls
NOx Emissions	CHP system	<ul style="list-style-type: none"> • Note values from Continuous Emissions Monitor (CEM) on system • Compare measured rate to power output on system meter – should be less than 0.5 pounds per MWh
Methane Emissions	Anaerobic Digestion	<ul style="list-style-type: none"> • Check valves and pipe fittings for leaks every week • Compare measured generation from system to estimated methane content of sludge – should be 13,000 BTU per kWh • Track system generation as a function of sludge volume
Electricity Consumption	Lighting	<ul style="list-style-type: none"> • Ensure that automatic lighting control system is working as designed – note any manual overrides • Turn off task lighting when not in use
Electricity Consumption	HVAC	<ul style="list-style-type: none"> • Replace filters every 3 months • Calibrate system every 3 months – measure outlet temperature and compare to system settings • Clean area around air intakes every 6 months • Clean evaporator and condenser coils every 6 months • Note any manual overrides to settings – try to minimize if possible
Electricity Consumption	Computers	<ul style="list-style-type: none"> • Activate power-saving features on all computers; screensavers to activate after 5 minutes, screen to standby after 10 minutes, hard disks to standby after 2 hours • Communicate that employees are to shut down computers when leaving

SESSION 6: Appendices Continued

Appendix M

List of the operational controls, key characteristics, monitoring and measurement methods, and calibration needs for the priority energy opportunities

Energy-Related Operation	Energy-Related Impacts	Operational Controls	Key Characteristics of Operation or Activity	Monitoring and Measurement Methods	Equipment and System Calibration Needs

SESSION 6: Appendices Continued

Appendix N

Energy Improvement Management Programs Progress Review Worksheet

Objective	
Target date	
Status at (6 months)	
Tasks Identified	
Tasks Accomplished	
Observations	
Corrective Actions Needed	
Next Steps	

SESSION 7: Appendices

Appendix O

Utility Case Study: Camden County Municipal Utility Authority (CCMUA)

The Camden County Municipal Utilities Authority (CCMUA) operates an 80 million gallon per day (MGD) secondary, pure oxygen activated sludge wastewater treatment plant in Camden, NJ. It also operates a regional interceptor system with 100 miles of sewer, ranging in size from 24 inches in diameter to 96 inches, 25 pumping stations, ranging in size from 1 MGD to 54 MGD, and 16 metering stations.

In 1999, the CCMUA implemented an Environmental Management System (EMS) in order to optimize its environmental performance and minimize its costs. The results were excellent. As part of its Management System, the CCMUA sought to reduce energy consumption and, correspondingly, energy costs, using the systematic, continuous improvement process inherent to an EMS. Specifically, the CCMUA looked at every function/process that used a significant amount of energy and attempted to implement projects that would reduce energy consumption and energy costs. The following is a list of some of the most important energy reduction projects undertaken, to date:

1) Elimination of Infiltration/Inflow: Infiltration/Inflow (I/I), the leaking of groundwater and rainfall into a sewer collection system, results in unnecessary increases in pumping and treatment costs. In addition, water is wasted. Simply put, when one gallon of sewage is mixed with one gallon of clean groundwater through infiltration, two gallons of sewage must now be pumped and treated. Eliminating I/I through repair of leaky lines, especially those in the vicinity of high groundwater tables, grouting of leaky manholes, implementation of watertight manhole covers, can significantly reduce I/I and thereby reduce energy costs. (It also reduces the potential for flooding and overflows, which have their own economic and social costs).

The CCMUA's strategy was to meter member municipalities for both dry weather and wet weather flow. When significant differences were noted, the municipality was charged with the responsibility to undertake a trackback analysis to identify the major sources of I/I within their system and to take steps, via a best management practices approach, to reduce I/I correspondingly.

2) Elimination of Pump Stations via Direct Connections: In a system like the CCMUA's, where smaller municipal collection systems connect into a larger regional interceptor system that then conveys the total flow to a regional treatment plant, there were several opportunities to eliminate municipal pumping stations and connect them directly into the regional sewer system. The CCMUA was able to eliminate over 20 pumping stations that were pumping right past its regional sewer system to the main collection point for the municipality and then that same flow would be pumped right back to the same point. By allowing the municipal pump station to tie into the regional system right there, the station could be eliminated, as was the double pumping, thereby resulting in reduced energy costs, and reduced operations and maintenance costs for the municipality.

3) Optimization of Primary Sedimentation Tanks: The main driving force for a primary sedimentation tank is the force of gravity, as the solids/sediment settle to the bottom of the tank where they are collected as primary sludge. Conversely, the secondary system is much more energy intensive, especially pure oxygen activated sludge plants like the CCMUA's, Philadelphia's, and many other large cities where space is at a premium. Therefore, since the CCMUA's goal is to maximize solids removal prior to discharge to the receiving water body, it optimized the operations and maintenance of its primary sedimentation tanks in order to maximize the percentage of solids removed via the primary sedimentation tanks using the free force of gravity as the removal agent, rather than the costly, energy intensive secondary aeration process.

SESSION 7: Appendices Continued

Appendix O Continued

Utility Case Study: Camden County Municipal Utility Authority (CCMUA)

4) Heating loops: The use of heating loops and heat exchangers is well known in water and wastewater treatment plants, and other facilities as well, capturing excess heat from process units and reusing said heat downstream in other processes. The CCMUA has just completed the design of a heating loop that will capture excess heat from large natural gas engines and preserve it for use elsewhere in the plant.

5) Use of energy efficient equipment/lighting: There are many examples throughout many industries of more energy efficient equipment and lighting. The CCMUA realized savings of about \$100,000 per year when it switched light bulbs throughout the plant to a more efficient brand. Also, checking energy usage on a regular basis can identify under-performing equipment, such as pumps that may need new wear rings, or may be on the verge of failure.

6) Retrofitting of diesel vehicles to use ultra low sulfur fuel: The CCMUA obtained an EPA grant to retrofit its diesel vehicles to use ultra low sulfur fuel. Although there was no operational cost savings realized through this project, the CCMUA was able to reduce sulfur emissions from its diesel vehicles by over 95%, without any capital expenditure whatsoever.

7) Use of catalytic converter to reduce NO_x and CO emissions: Similarly, the CCMUA installed catalytic converters on both of its large natural gas engines, thereby reducing NO_x and CO emissions from those engines by over 90%. Since this enabled the CCMUA to remain below the Title V threshold, the result was a significant net savings in operational and permitting costs.

The Camden County (NJ) Municipal Utilities Authority used its EMS to implement several projects that reduced energy consumption and, correspondingly, reduced its energy costs. In accordance with an EMS' systematic approach that strives toward continual improvement, the CCMUA is continuing to look for additional opportunities to reduce its energy consumption.