

Improving Pavements With Long-Term Pavement Performance: *Products for Today and Tomorrow*

*Papers From the 2003–2004 International Contest on
Long-Term Pavement Performance Data Analysis*

Sponsored by the Federal Highway Administration
and the American Society of Civil Engineers

PUBLICATION NO. HRT-06-109
SEPTEMBER 2006



U.S. Department of Transportation
Federal Highway Administration

FOREWORD

In 1998, the Federal Highway Administration (FHWA), Long-Term Pavement Performance (LTPP) Program and the Highway Division Pavements Committee of the American Society of Civil Engineers (ASCE) initiated a program to organize an international contest on the use of LTPP data. The competition was designed to promote the use of LTPP data and involve the future pavement engineers in university in the analysis of data from the LTPP database. The program has been in operation for 5 years with four contests completed. The papers contained in this document are the result of the 2003–2004 contest.

Gary L. Henderson
Director, Office of Infrastructure
Research and Development

Notice

This document is disseminated under the sponsorship of the U.S. Department of Transportation in the interest of information exchange. The U.S. Government assumes no liability for the use of the information contained in this document. This report does not constitute a standard, specification, or regulation.

The U.S. Government does not endorse products or manufacturers. Trademarks or manufacturers' names appear in this report only because they are considered essential to the objective of the document.

Quality Assurance Statement

The Federal Highway Administration (FHWA) provides high-quality information to serve Government, industry, and the public in a manner that promotes public understanding. Standards and policies are used to ensure and maximize the quality, objectivity, utility, and integrity of its information. FHWA periodically reviews quality issues and adjusts its programs and processes to ensure continuous quality improvement.

Technical Report Documentation Page

1. Report No. FHWA-HRT-06-109		2. Government Accession No.		3. Recipient's Catalog No.	
4. Title and Subtitle Improving Pavements With Long-Term Pavement Performance: Products for Today and Tomorrow Papers From the 2003–2004 International Contest on Long-Term Pavement Performance Data Analysis				5. Report Date September 2006	
				6. Performing Organization Code	
7. Author(s) J.Arellano, M.M. de Farias, R.O. de Souza, V.P.K. Ganesan, M.P. McDonald, D. Morian, S.D. Neto, J.T. Smith, S.M. Stoffels, S.L. Tighe				8. Performing Organization Report No.	
9. Performing Organization Name and Address Office of Infrastructure Research and Development Federal Highway Administration 6300 Georgetown Pike, HRDI-13 McLean, VA 22101-2296				10. Work Unit No.	
				11. Contract or Grant No.	
12. Sponsoring Agency Name and Address American Society of Civil Engineers (ASCE) Transportation and Development Institute (T&DI) Federal Highway Administration Long-Term Pavement Performance (LTPP) Program				13. Type of Report and Period Covered 2003–2004	
				14. Sponsoring Agency Code	
15. Supplementary Notes The Contract Officer's Technical Representative (COTR) was Antonio Nieves—HRDI-13.					
16. Abstract This report is a compilation of award-winning technical papers from the Third Annual International Contest on LTPP Data Analysis 2003–2004, various authors.					
17. Key Words LTPP, pavement performance, DataPave contest, DataPave			18. Distribution Statement No restrictions. This document is available to the public through the National Technical Information Service, Springfield, VA 22161.		
19. Security Classif. (of this report) Unclassified		20. Security Classif. (of this page) Unclassified	21. No of Pages 100	22. Price	

SI* (MODERN METRIC) CONVERSION FACTORS

APPROXIMATE CONVERSIONS TO SI UNITS

Symbol	When You Know	Multiply By	To Find	Symbol
LENGTH				
in	inches	25.4	millimeters	mm
ft	feet	0.305	meters	m
yd	yards	0.914	meters	m
mi	miles	1.61	kilometers	km
AREA				
in ²	square inches	645.2	square millimeters	mm ²
ft ²	square feet	0.093	square meters	m ²
yd ²	square yard	0.836	square meters	m ²
ac	acres	0.405	hectares	ha
mi ²	square miles	2.59	square kilometers	km ²
VOLUME				
fl oz	fluid ounces	29.57	milliliters	mL
gal	gallons	3.785	liters	L
ft ³	cubic feet	0.028	cubic meters	m ³
yd ³	cubic yards	0.765	cubic meters	m ³
NOTE: volumes greater than 1000 L shall be shown in m ³				
MASS				
oz	ounces	28.35	grams	g
lb	pounds	0.454	kilograms	kg
T	short tons (2000 lb)	0.907	megagrams (or "metric ton")	Mg (or "t")
TEMPERATURE (exact degrees)				
°F	Fahrenheit	5 (F-32)/9 or (F-32)/1.8	Celsius	°C
ILLUMINATION				
fc	foot-candles	10.76	lux	lx
fl	foot-Lamberts	3.426	candela/m ²	cd/m ²
FORCE and PRESSURE or STRESS				
lbf	poundforce	4.45	newtons	N
lbf/in ²	poundforce per square inch	6.89	kilopascals	kPa

APPROXIMATE CONVERSIONS FROM SI UNITS

Symbol	When You Know	Multiply By	To Find	Symbol
LENGTH				
mm	millimeters	0.039	inches	in
m	meters	3.28	feet	ft
m	meters	1.09	yards	yd
km	kilometers	0.621	miles	mi
AREA				
mm ²	square millimeters	0.0016	square inches	in ²
m ²	square meters	10.764	square feet	ft ²
m ²	square meters	1.195	square yards	yd ²
ha	hectares	2.47	acres	ac
km ²	square kilometers	0.386	square miles	mi ²
VOLUME				
mL	milliliters	0.034	fluid ounces	fl oz
L	liters	0.264	gallons	gal
m ³	cubic meters	35.314	cubic feet	ft ³
m ³	cubic meters	1.307	cubic yards	yd ³
MASS				
g	grams	0.035	ounces	oz
kg	kilograms	2.202	pounds	lb
Mg (or "t")	megagrams (or "metric ton")	1.103	short tons (2000 lb)	T
TEMPERATURE (exact degrees)				
°C	Celsius	1.8C+32	Fahrenheit	°F
ILLUMINATION				
lx	lux	0.0929	foot-candles	fc
cd/m ²	candela/m ²	0.2919	foot-Lamberts	fl
FORCE and PRESSURE or STRESS				
N	newtons	0.225	poundforce	lbf
kPa	kilopascals	0.145	poundforce per square inch	lbf/in ²

*SI is the symbol for the International System of Units. Appropriate rounding should be made to comply with Section 4 of ASTM E380.
(Revised March 2003)

Table of Contents

PAPER 1: STATISTICAL ANALYSIS BETWEEN ROUGHNESS INDICES AND ROUGHNESS PREDICTION MODEL USING NEURAL NETWORKS

ABSTRACT	1
INTRODUCTION	2
LONGITUDINAL PROFILE STATISTICS	3
International Roughness Index (IRI)	3
Standard Deviation of Longitudinal Roughness (σ)	5
NEURAL NETWORKS	6
THE LTPP PROFILE DATABASE	8
DATA ANALYSES	9
International Roughness Index (IRI) Versus Standard Deviation of Longitudinal Roughness (σ)	9
Comparative Analysis Between the Rejected Sections Using the IRI and σ Statistics	11
Prediction of Longitudinal Roughness	13
CONCLUSIONS	16
ACKNOWLEDGMENTS	17
REFERENCES	17

PAPER 2: USE OF LTPP DATA TO VERIFY THE ACCEPTANCE LIMITS DEVELOPED
FOR PENNDOT PAVEMENT DISTRESS DATA

ABSTRACT	21
INTRODUCTION	22
Background	22
Motivation	22
LITERATURE REVIEW	23
Types of Pavement Condition Data	23
Methods of Pavement Data Collection	23
Distress Variability	23
PENNDOT QA PLAN	24
Sensitivity Analysis	25
CONTROL SECTIONS	27
Recommended Use of Control Sections	27
Blind Verification Sites	27
Acceptance Testing	28
Proposed Initial Values for Acceptance Criteria	28
Discussion of Proposed PennDOT QA Plan	30
LTPP DATA ANALYSIS	30
LTPP Data Collection	30
LTPP Data Analysis	31
RESULTS	36
CONCLUSIONS AND RECOMMENDATIONS	36
REFERENCES	37
BIBLIOGRAPHY	37

PAPER 3: INVESTIGATION OF SEASONAL VARIATION IN PAVEMENT FRICTION
USING THE DATAPAVE 3.0 DATABASE

ABSTRACT	39
INTRODUCTION	40
BACKGROUND AND LITERATURE REVIEW	40
CONCEPTUAL MODEL	42
DATA COLLECTION AND MANAGEMENT	43
RESEARCH METHODOLOGY	45
VISUAL ANALYSIS	46
NUMERICAL RESULTS	50
MODEL VALIDATION	51
CONCLUSIONS AND SUGGESTIONS.....	55
REFERENCES	55

PAPER 4: ASSESSMENT OF OVERLAY ROUGHNESS IN THE LTPP—A CANADIAN
CASE STUDY

ABSTRACT.....	57
INTRODUCTION	58
SCOPE AND OBJECTIVES.....	59
IMPORTANCE OF IRI AS A PAVEMENT INDICATOR.....	60
METHODOLOGY FOR ANALYSIS.....	60
NATIONAL ROUGHNESS TREND.....	60
PROVINCIAL ROUGHNESS TREND.....	61
OVERLAY THICKNESS EFFECTS.....	62
CLIMATIC ZONE EFFECTS.....	63
SUBGRADE EFFECTS	64
ROUGHNESS AND C-SHRP	65
CONCLUSIONS.....	67
RECOMMENDATIONS.....	68
REFERENCES	68

PAPER 5: ASSIGNMENTS WITH PURPOSE: USING LTPP FOR EDUCATING
TOMORROW’S ENGINEER

ABSTRACT	69
INTRODUCTION	70
Key Issues and Questions	70
Scope and Objectives	70
BACKGROUND: UNIVERSITIES AS THE UPSTREAM COMPONENT	71
Supply and Demand Chain	71
Required Skill Sets for Transportation Professionals	71
EDUCATOR TOOLS	74
ASSIGNMENTS WITH PURPOSE	74
Undergraduate Transportation Course	74
Undergraduate Challenge Problems	77
Undergraduate Project Courses	79
Senior-Level Pavement Course	80
Graduate-Level Pavement Course	81
CONTEXT	84
CONCLUSIONS	85
ACKNOWLEDGMENTS	85
REFERENCES	85
PROGRAM ACKNOWLEDGMENTS	87

List of Figures

Paper 1

Figure 1. Quarter car simulation.	3
Figure 2. IRI thresholds adopted in different countries.	4
Figure 3. Roughness measurement.	5
Figure 4. Three-meter-long straightedge profilometer.	5
Figure 5. Regression analysis between the IRI and σ	10
Figure 6. Adopted neural network model.	14
Figure 7. Learning stage.	14
Figure 8. Validation stage.	15
Figure 9. Computed-versus-target IRI values for both statistical models.	16

Paper 2

Figure 1. Recommended use of statistical sampling for acceptance testing of each deliverable.	29
Figure 2. Within limits, total joint spalling, all regions, 1=yes, -1=no.	32
Figure 3. Within initial limits, total fatigue cracking, all regions, 1=yes, -1=no.	33
Figure 4. Percent within limits, all regions, GPS sections, JPC pavements (all severities).	33
Figure 5. Percent within limits, all regions, GPS sections, JPC pavements (medium and high severities).	34
Figure 6. Percent within limits, all regions, GPS sections, individual distresses, AC pavements.	34
Figure 7. Percent within limits, all regions, GPS sections, total distress values, AC pavements.	35
Figure 8. PWL for limits 20 percent and 40 percent, AC, all regions.	36

Paper 3

Figure 1. Conceptual model of frictional processes.	43
Figure 2. Skid number frequency distribution.	45
Figure 3. Contour plot of skid number versus air temperature and 180-day snowfall.	47
Figure 4. Skid number versus 180-day snowfall.	48
Figure 5. Skid number versus air temperature.	48
Figure 6. Post plot of skid number versus air temperature and minimum temperature minus air temperature.	49
Figure 7. Contour plot of skid number versus air temperature and minimum temperature minus air temperature.	49
Figure 8. "Temperature alone" structural equations model.	50
Figure 9. "Temperature and snowfall" structural equations model.	50

List of Figures, *continued*

Paper 4

Figure 1. Distribution of LTPP test sites.	59
Figure 2. National IRI trends.	61
Figure 3. Ontario IRI trends.	62
Figure 4. Effect of overlay thickness on roughness progression in wet-freeze climatic zones with fine-grained subgrades.	62
Figure 5. Effect of climatic zone on roughness progression in thin overlays with coarse-grained subgrades.	63
Figure 6. Effect of subgrade type on roughness progression in medium overlays with wet-freeze climatic zones.	65
Figure 7. Roughness progression of thin overlays in wet-freeze climatic zones with fine-grained subgrades.	66
Figure 8. Roughness progression of medium overlays in wet-freeze climatic zones with fine-grained subgrades.	67
Figure 9. roughness progression of thick overlays in wet-freeze climatic zones with fine-grained subgrades.	67

Paper 5

Figure 1. Effect of overlay thickness.	75
Figure 2. Effect of climatic zone.	76
Figure 3. Roughness trends for thin overlays (30 to 60 m) in high traffic.	76
Figure 4. Roughness trends for thin overlays in wet, low-freeze zones.	77
Figure 5. Observed roughness trends on sections in Saskatchewan.	79
Figure 6. Transverse crack analysis.	80
Figure 7. Rut depth analysis.	81
Figure 8. Needs analysis based on LTPP data.	81

List of Tables

Paper 1

Table 1. Summary of database values.....	9
Table 2. Threshold values for σ as a function of the IRI.....	10
Table 3. Pavement sections rejected.....	12
Table 4. Relative contribution of input parameters for the final IRI value.....	15
Table 5. Linear and nonlinear multivariate statistical models.....	16

Paper 2

Table 1. Proposed initial values for acceptance criteria and suggested actions.....	30
Table 2. LTPP data collection.....	31
Table 3. Comparison of LTPP and PennDOT distress data.....	32
Table 4. Initial criteria and PWL for JPC pavements all regions.....	36

Paper 3

Table 1. “Temperature alone” structural equations model.....	52
Table 2. “Temperature and snowfall” structural equations model.....	53
Table 3. Calculated skid number reductions.....	54

Paper 4

Table 1. LTPP test site identification numbers.....	59
Table 2. Overlay regression analysis.....	63
Table 3. Overlay thickness ANOVA analysis.....	63
Table 4. Climatic zone regression analysis.....	64
Table 5. Climatic zone ANOVA analysis.....	64
Table 6. Subgrade regression analysis.....	65
Table 7. Subgrade ANOVA analysis.....	65

Paper 5

Table 1. Required skills for transportation professionals.....	72
Table 2. Changes in average IRI for individual Provinces.....	78
Table 3. Comparison of predicted and observed IRI using mean values.....	79
Table 4. Senior-level student ANOVA comparison.....	80
Table 5. Students responsible for Provinces and States.....	84

PREFACE

BACKGROUND

In 1998, the Federal Highway Administration (FHWA), the Long-Term Pavement Performance (LTPP) program, and the Transportation and Development Institute (T&DI) of the American Society of Civil Engineers (ASCE) initiated a program to organize an international contest on the use of LTPP pavement performance data. The competition was designed to promote the use of LTPP data and involve students, academicians, and pavement engineers in the analysis of data from the LTPP database. The program has been in operation for 5 years with 4 contests. The papers in this document are the winners of the 2003–2004 contest.

DATA ANALYSIS CONTEST

The contest has been expanded to cover four categories:

Category 1—Undergraduate students (individual or team entry).

Category 2—Graduate students (individual or team entry).

Category 3—Partnership.

Category 4—Curriculum.

The contest involves participants from universities, State highway agencies, and industry. T&DI continues to provide oversight of the contest with strong support from FHWA.

Experts from academia, industry, and highway agencies reviewed the 20 papers submitted for the 2003–2004 contest and gave awards for the best paper in each category. The following are the winners:

Category 1

Prize	Name	Faculty Advisor
1st Place	James T. Smith	Susan L. Tighe
2nd Place	Ricardo Oliveira de Souza Silvrano Dantas Neto	Márcio Muniz de Farias

Category 2

Prize	Name	Faculty Advisor
1st Place	Mark P. MacDonald	Larry C. Crowley Rod E. Turochy

Category 3

Prize	Name	Faculty Advisor
1st Place	Venkatesa Prasanna Kumar Ganesan	Shelly M. Stoffels Janice Arellano Dennis Morian

Category 4

Prize	Name
1st Place	Susan L. Tighe

For more information on the contest, visit the LTPP Data Analysis Contest Web site at <http://www.tfhrc.gov/pavement/ltp/contest.htm>.



The people photographed are (left to right) T. Paul Teng, FHWA; Kumares C. Sinha, ASCE/T&DI; James T. Smith, first place winner, category 1; Susan L. Tighe, first place winner, category 4; Venkatesa Prasanna Kumar Ganesan, first place winner, category 3; and Ricardo Oliveira de Sousa, second place winner, category 1.

PAPER 1: STATISTICAL ANALYSIS BETWEEN ROUGHNESS INDICES AND ROUGHNESS PREDICTION MODEL USING NEURAL NETWORKS

Ricardo Oliveira de Souza

University of Brasilia,
Brasilia, Distrito Federal Brazil

Silvrano Dantas Neto

University of Brasilia,
Brasilia, Distrito Federal Brazil

Faculty Advisor

Márcio Muniz de Farias

University of Brasilia, Brasilia,
Distrito Federal Brazil

ABSTRACT

This paper presents an analysis between the International Roughness Index (IRI) and the standard deviation of longitudinal roughness (σ), as well as a neural network study developed to predict the critical level of roughness. Measured longitudinal profiles available in the Long-Term Pavement Performance (LTPP) program database were used. A total of 207 pavement sections in 42 States of the United States were used to do this analysis. Using a suitable software, the International Roughness Index (IRI) and the standard deviation of longitudinal roughness (σ) values were computed for every longitudinal pavement profile measured. Afterwards, these values were used in regression analysis and a high correlation was found between them ($R^2=0.93$). Neural network analysis correlated the IRI-computed values with the type of subgrade soil, pavement structure (layer thickness), climate, and traffic data of 157 pavement sections. The neural network could forecast the IRI with an extremely high correlation factor ($R^2=0.99$). Besides, the neural network provided a sensitivity analysis indicating the relative contribution of factors related to the structural number (49 percent), climate (31 percent), and traffic (20 percent). Multivariate linear and nonlinear statistic regressions were also performed to predict IRI, but no correlation was found.

INTRODUCTION

Longitudinal surface roughness is defined as the deviations over the pavement surface compared to the designed surface grade. These deviations affect the ride quality, the vehicle dynamics, and the effect of dynamic loads over the surface. The difference between the theoretical surface heights and actual surface heights in a longitudinal profile may occur as a result of the construction process, road use, or in some cases a combination of both factors.⁽¹⁾

The importance of longitudinal surface roughness in users' comfort perception has been considered since 1960. During the American Association of State Highway Officials (AASHO) Road Test, it was observed that 95 percent of pavement serviceability was related exclusively to the deviations of surface profiles.⁽²⁾

The longitudinal roughness is composed of waves whose wavelengths vary as a result of the permanent deformation of the pavement or subgrade under the action of repeated traffic loads. These deviations are presented as waves with intermediate length and amplitude, between 0.5 and 50 meters (m). They are the main source of vehicle dynamic excitation and are responsible for the user's feeling of discomfort.

Statistics have been developed to represent the longitudinal roughness for measured pavement profiles. A statistic is a numeric value representing the surface deviations for a pavement section. Among them are the slope variance (SV), root-mean square of vertical accelerations (RMSVA), International Roughness Index (IRI), and standard deviation of longitudinal roughness (σ).⁽³⁾

LONGITUDINAL PROFILE STATISTICS

The longitudinal profiles can be represented by statistics. Some statistics, such as the slope variance (SV) and the standard deviation of longitudinal roughness (σ), can be applied directly to the measured longitudinal profile. In other cases, these statistics may apply to imaginary profiles. These imaginary profiles try to represent the relative movement between the rear axle and the vehicle body while the vehicle moves at a certain speed. The longitudinal profiles measured in the field are the input (or dynamic response agent). Through the use of mathematical simulations for the dynamic problem, imaginary profiles can be determined.

Different simulators were developed over the years, such as the quarter car simulator, half car simulator, and whole car simulator. The quarter car simulator, also known as the quarter car system, is the most widely used.⁽⁴⁾

International Roughness Index (IRI)

The IRI is a statistic index that summarizes the surface deviations for just one wheel track. This mathematical simulation uses the quarter car system to generate an imaginary profile. As shown in figure 1, the quarter car system is composed of two parts: a sprung mass representing the vehicle body (where the user is seated) and an unsprung mass representing the set of wheel/tire and half axle/suspension. The sprung mass is connected to the unsprung mass by the suspension, which is simulated by a damper and a spring. The sprung mass is in contact with the real pavement surface by another spring.

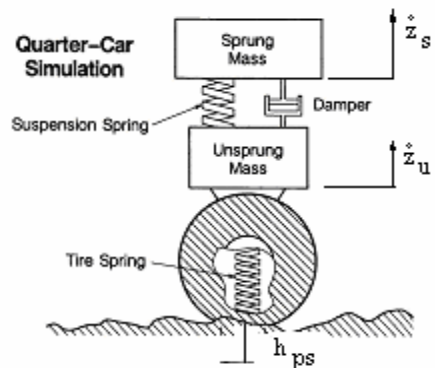

Figure 1. Quarter car simulation.⁽⁵⁾

During the simulation, the quarter car system runs over the longitudinal profile, measured in the field at a constant speed of 80 kilometers per hour (km/h). The roughness over this surface induces dynamic excitation to the quarter car system, generating different vertical speeds (\dot{z}_s and \dot{z}_u) or accelerations (\ddot{z}_s and \ddot{z}_u) in the sprung and unsprung masses. As a result, a relative movement is produced between the chassis and the axle of the imaginary vehicle. The IRI value for a given section length (e.g., 100 m) is computed according to equation 1.

$$IRI = \frac{1}{L} \int_0^{x/V} |\dot{z}_s - \dot{z}_u| dt \quad (1)$$

Where:

IRI = International Roughness Index (in mm/m or m/km).

L = length of the section (m).

x = longitudinal distance (m).

V = speed of the quarter-car model (m/s).

x/V = time the model takes to run a certain distance x .

dt = time increment.

\dot{z}_s = vertical speed of the sprung mass.

\dot{z}_u = vertical speed of the unsprung mass.

The IRI represents the rectified average slope, or the absolute sum of the relative vertical displacement experienced by the user when driving a fictitious model car over a section (L) of the road at a constant speed of 80 km/h.

A perfectly smooth road results in an IRI value of 0, roads with moderate roughness give IRI values of around 6 meters per kilometer (m/km), and in extreme cases a very bumpy unpaved road can result in IRI values up to 20 m/km.⁽⁶⁾ Maintenance intervention threshold varies according to the country, road type, etc. For instance, limit values of 2.7 m/km in the United States, 3.5 m/km in Brazil, 4.0 m/km in Chile, Uruguay, and Spain, and 6.0 m/km in Honduras have been reported.⁽⁷⁾ Figure 2 illustrates these threshold differences.

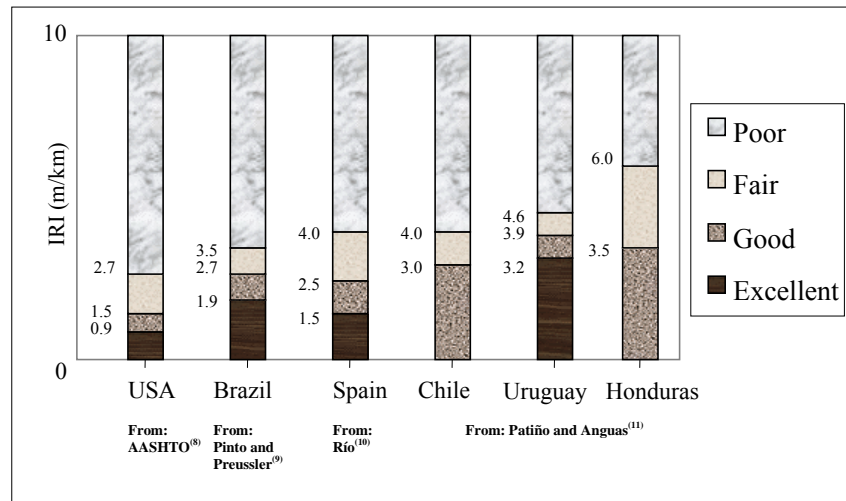

Figure 2. IRI thresholds adopted in different countries.

Standard Deviation of Longitudinal Roughness (σ)

In Japan, the standard deviation of longitudinal roughness (σ) is used to summarize surface deviations. Initially, as illustrates figure 3, the relative difference height “ d_i ” (roughness) is measured every 1.5 m, considering an imaginary reference line.⁽¹²⁾

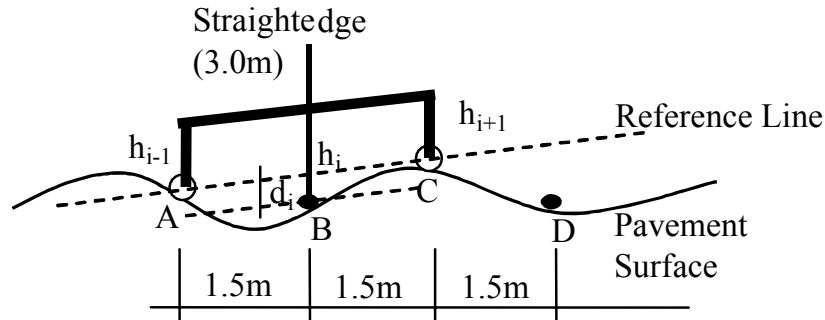

Figure 3. Roughness measurement.⁽¹²⁾

The surface roughness can be measured using a 3-m-long straightedge profilometer (figure 4). Nowadays, laser profilometers are the most used devices. The laser readings are coincident with the desired intervals.

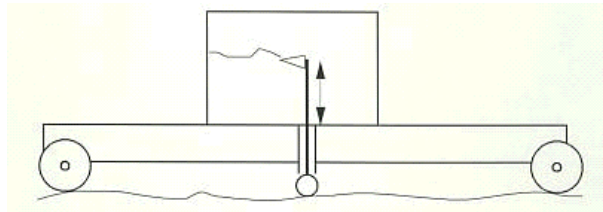

Figure 4. Three-meter-long straightedge profilometer.⁽¹³⁾

During the measurement, hundreds of elevations are registered, thus the heights “ d_i ” can be computed according to equation 2.

$$d_i = h_i - \frac{1}{2}(h_{i-1} + h_{i+1}) \quad (2)$$

Where:

d_i = Registered profile heights.

h_i, h_{i-1}, h_{i+1} = Surface elevations.

According to figure 3a, after measuring the height “ d_i ” at point B, the beam is displaced to point D, where the heights h_i, h_{i-1}, h_{i+1} are measured at points B, C, and D, respectively. The reference line becomes the line linking points B, C, and D. Using the equation 2 once more, the height “ d_i ” at point C can be calculated. When a pavement section is measured continuously, a profile with

positive and negative elevations is obtained. These elevations are the relative difference height “ d_i ” considering the reference line every 1.5 m.⁽¹²⁾

The longitudinal roughness (σ) is computed through the standard deviation of “ d_i ” values, as shown in equation 3.

$$\sigma = \sqrt{\frac{n_r \sum d_i^2 - (\sum d_i)^2}{n_r (n_r - 1)}} \quad (3)$$

Where:

σ = Standard deviation of longitudinal roughness (mm).

d_i = Registered profile heights.

n_r = Number of registered data.

The Japan Road Association recommends pavement sections 100 m long to calculate σ , whereas the Japan Highway Public Corporation suggests pavement sections 150 m long.⁽¹⁴⁾

NEURAL NETWORKS

According to Anderson, the neural network concept started with the work of McCulloch and Pitts in 1943.⁽¹⁵⁾ They developed computational elements based on the physiological properties of biological neurons. Later, Widrow-Hoff developed a linear model called ADALINE (ADaptive LINear Element), which was then generalized for multiple layers and called MADALINE (Multiple ADALINE).⁽¹⁶⁾ The next important development came in 1950 with the work of Rosenblatt, who proposed neural networks known as perceptrons. In this model, the network can learn when fed with examples and the responses can assume continuous values, whereas the original neurons of McCulloch-Pitts operated with only binary numbers.⁽¹⁷⁾

Artificial neural networks (NN) can be understood as a computational technique that helps to develop nonparametric mathematical models. Different from usual statistics techniques, the models do not explicitly exhibit a set of fitting coefficients or parameters (although they are somehow embedded in the model).

The term “neural network” is a little presumptuous and derives from the fact that earlier models were inspired in the neuronal structure of intelligent organisms. However, the technique is rather simple and easy to use. From a mathematical point of view, a neural network is a simple set of points, called nodes or neurons, arranged in a few consecutive layers. There is necessarily an input layer, one or more intermediate layers, and an output layer. The number of input and output neurons depends on the available data and type of problem, whereas the number of intermediate layers and nodes (the NN architecture) is generally a matter of empirical investigation for each case under study. However, there are recent developments in adaptive NN in which the network architecture is iteratively modified during the learning stage.

The neurons of a given layer are generally linked to all neurons of the next layer, although some connections (called synapses) may be disabled and layers may be bypassed. Information is

generally processed from the input layer to the output layer in the feed-forward process. A node or neuron (i) of a given layer ($t+1$) performs very simple mathematical operations. It multiplies each entry $S_j(t)$ from a neuron (j) of the previous (t) layer by some coefficient (w_{ij}) and computes the sum (S) of all entries thus modified.

$$S = \sum w_{ij} S_j(t) \quad (4)$$

The coefficients (w_{ij}) are known as synaptic weights and store the main model characteristics during the learning process.

Later, the previous sum (S) is compared to limit value (θ_i), known as threshold, for each layer.

$$x = \sum w_{ij} S_j(t) - \theta_i \quad (5)$$

The value x above will be the argument of function, $f(x)$, known as activation function. The output of this function will be the entry of the neuron for the next layer.

$$S_i(t+1) = f\left(\sum w_{ij} S_j(t) - \theta_i\right) \quad (6)$$

Different activation functions may be tried during the development of a model. The most common are the step function and the sigmoid function.

The development of an NN model involves two stages: learning and validation. For that purpose, a sufficiently large number of experimental data must be available. The data with known input and output values are divided into two sets. The first and larger set is used to train the NN and the validation set is used to test the generalization capacity of the trained NN.

The learning stage consists of finding the appropriate synaptic weights (w_{ij}) to reproduce the desired output values. The weights are initialized randomly and the computed output values are compared to the desired output values. A root-mean square (RMS) error between computed and desired output values is calculated. Neural networks generally use a learning algorithm known as backpropagation of error. In the backpropagation method, the weights are recalculated from the output layer to the input layer to minimize the RMS error. The process is repeated during several iterations, until a specified error is achieved. This algorithm, also known as the generalized delta rule, is a modification of Widrow-Hoff's ADALINE, but considers nonlinear activation functions and the entries may assume continuous values. It was developed by Rummerlhart, Hinton, and Williams, and is extremely efficient in minimizing the quadratic error, RMS.⁽¹⁸⁾ Other algorithms are also available.

Once an NN is trained, the validation data set, which was not used in the learning stage, is used to test the forecasting capacity of the model developed. An NN has the property of generalization.

Neural networks are easy to implement, robust even when treating data with some noise, and very efficient, especially when dealing with problems for which a specific knowledge of the underlying mechanisms is not totally available and when analytical formulations are too complicated to be obtained. The use of NN depends on the ability to adapt it to the desired problem by means of appropriate changes in its synaptic weights to enhance its efficiency.

Several commercial and academic programs are available to help develop neural network models. Basically, the user prepares the appropriate input and output files, decides the appropriate NN architecture, and defines a few other analysis parameters. For the analyses in this paper, the authors used a multilayered neural network program called Qnet. The program uses a backpropagation algorithm.

THE LTPP PROFILE DATABASE

The profile database of the Long-Term Pavement Performance (LTPP) program was used in this study. This program was established in 1984 by the U.S. government as part of the Strategic Highway Research Program (SHRP). The LTPP program consists of two study groups: General Pavement Studies (GPS) and Specific Pavement Studies (SPS). The main objective of GPS is to study the performance of existing pavements constructed by different State departments of transportation in the United States. The selected roads reflect typical materials and structures used in the current practice design in the United States and Canada.⁽¹⁹⁾ The GPS program is divided into 10 subgroups according to the type of pavement structure. Subgroup GPS-1 studies pavements made of asphalt concrete surface course over granular bases. Its database was used for this paper.

The GPS program divided the United States into four main regions and studied sections 152 m long in all States. The LTPP database includes inventory data, climatic data, materials data, maintenance data, rehabilitation data, traffic data, and pavement monitoring data.

In 1992, responsibility for the LTPP program was transferred to the Federal Highway Administration (FHWA), which started to analyze the collected data in 1994. As a result, the first major report was published in 1997. Since then the database has been updated and is available in a CD-ROM software called DataPave, as well as online on the FHWA Web site.

Souza studied the DataPave database, extracting information provided by GPS-1 on about 207 pavement sections in 42 States in the United States.⁽⁷⁾ Pavement profiles, obtained with laser profilometers between 1989 and 1996, were retrieved and roughness indices (e.g., IRI and σ) were computed using a modified version of the University of Michigan Transportation Research Institute's (UMTRI) RoadRuf computer program. Each section was surveyed at least once a year and in each instance the measurements were repeated five times. Souza analyzed 6,329 of these profiles and computed thousands of roughness indices, which were later statistically related.⁽⁷⁾

The neural network analysis was done by selecting 57 pavement sections from the 207 sections studied by Souza.⁽⁷⁾ These sections contained all of the relevant information, such as layer thickness, climate, and traffic data. Table 1 shows a summary of the minimum, maximum, average, and standard deviation values for the thickness of surface layer course, thickness of

binder layer, thickness of base layer, thickness of subbase layer, freezing index, average annual precipitation, number of days with temperature above 32 °C, age of the pavement, average daily volume of heavy vehicles, and computed IRI values. On average, the pavements showed a total asphalt layer course of 15.2 centimeters (cm) and a total granular layer of 32.2 cm. The average climatic conditions show rainfall precipitation of 877 millimeters (mm) per year, with a freezing index of 235 days and 49 days with temperature above 32 °C. The roads were about 18.3 years old and submitted to an average daily volume of 675 heavy vehicles. As to the subgrade conditions, 2 percent of the pavement structures were laid over rock ground, 44 percent on sandy soils, 24 percent on clay soils, 20 percent on gravel, and 10 percent on silt soils.

Table 1. Summary of database values.

	Surface Course (cm)	Binder (cm)	Base (cm)	Subbase (cm)	Freeze (F-days)	Rain (mm)	T>32 °C (days)	Age (years)	Traffic Volume	IRI (m/km)
Minimum	1.0	0.0	0.0	0.0	0.0	123.0	0.0	7.0	4.0	0.62
Maximum	23.6	36.8	65.5	108.2	1530.0	2020.0	177.0	40.0	5498.0	3.20
Average	5.6	9.6	21.5	10.7	235.4	877.0	48.8	18.3	675.0	1.45
Deviation	4.3	9.4	12.4	18.3	323.8	415.0	44.4	6.1	827.2	0.55

DATA ANALYSES

International Roughness Index (IRI) Versus Standard Deviation of Longitudinal Roughness (σ)

The analysis of pavement sections was done using a modified version of the UMTRI RoadRuf software. RoadRuf includes several tools developed to interpret the data obtained through longitudinal roughness field measurements. Among these tools are the International Roughness Index (IRI), ride number (RN), and standard filters.⁽¹³⁾ Two subroutines were added to the original algorithm to compute the standard deviation of longitudinal roughness (σ) and the slope variance (SV).⁽⁷⁾

As illustrated in figure 5, when the computed values of IRI and σ were statistically related, a high correlation was observed between them ($R^2=0.93$). The regression model developed (equation 7) can explain 93 percent of the σ variation values.

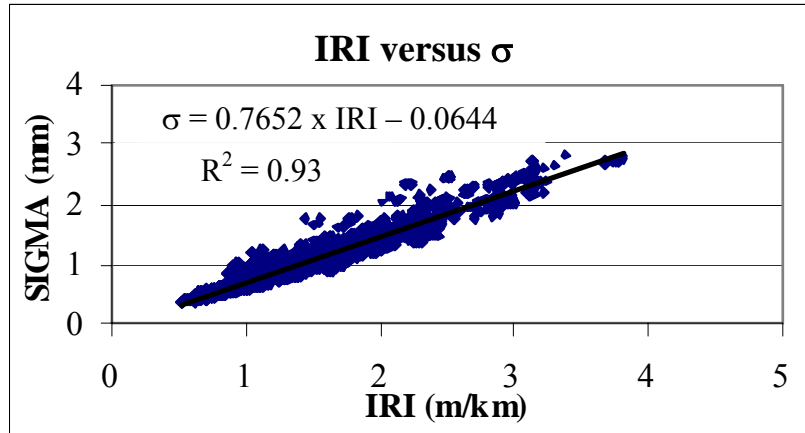

Figure 5. Regression analysis between the IRI and σ .

This correlation is impressive since the IRI is computed using a dynamic simulation, whereas σ interprets just the geometric characteristics of the pavement surface. This fact refutes the increasing criticisms against the use of indices based exclusively on geometric characteristics.

$$\sigma = 0.7652 \times IRI - 0.0644 \quad R^2 = 0.93 \quad (7)$$

Where:

σ = standard deviation of longitudinal roughness (mm).

IRI = International Roughness Index (m/km).

In Japan, the threshold values for the standard deviation of longitudinal roughness (σ) varies according to the highway agencies in charge of pavement maintenance. Table 2 illustrates these threshold values and their respective values converted to IRI. The IRI values were computed using the model shown by equation 7.

To analyze the surface condition, IRI and σ values were computed for every pavement section to determine the unacceptability of each pavement stretch.

Table 2. Threshold values for σ as a function of the IRI.

Highway Agency	Pavement Condition	
	Recently built pavements (just after construction)	Pavements in operation (maintenance, conservation)
Japan Highway Public Corporation	1.3 mm (IRI=1.8 m/km)	2.4 mm (IRI=3.2 m/km)
Prefectures (Provinces)	3.5 mm (IRI=4.7 m/km)	4.7 mm (IRI=6.2 m/km)

From: Takashi⁽²⁰⁾

Comparative Analysis Between the Rejected Sections Using the IRI and σ Statistics

According to figure 1, the IRI critical value used by the American Association of State Highway and Transportation Officials (AASHTO) is 2.7 millimeters per kilometer (mm/km), whereas the critical value σ adopted by Japan Highway Public Corporation is 2.4 mm (table 2). The IRI and σ values computed by the software to each pavement section were compared with admissible values of IRI and σ . It was found that of the 207 pavement sections, just 6 presented σ values greater than the σ critical value. Considering the IRI, it was observed that 8 pavement sections presented index values greater than the critical IRI. Table 3 illustrates the pavement sections whose statistics computed values were greater than the admissible values.

A preliminary comparison between these rejected sections could suggest that the IRI statistic is the most severe because it rejected more pavement sections when compared to the σ statistic. However, the higher number of rejected sections may not reflect just the index influence itself, but a difference of strictness between the threshold values considered admissible in the United States (IRI < 2.7 m/km) and Japan (σ < 2.4 mm).

Table 3. Pavement sections rejected.

State	Section	$\sigma \geq 2.4$ mm	IRI ≥ 2.7 m/km	$\sigma \geq 2.0$ mm
Alaska	1004	2.45	2.51	2.51
Arizona	1036		2.01	2.01
	1037		2.27	2.27
Colorado	1029		2.50	2.47
Illinois	1003	2.40	3.16	3.16
Kansas	1005	2.40	3.00	3.00
Kentucky	1014		2.23	2.23
Minnesota	1016		2.26	2.26
	1018		2.08	2.08
	1023		2.28	2.28
	1028		2.44	2.44
	1029		2.02	2.02
	1085	2.40	3.18	3.18
Nevada	1021		2.00	2.00
New Jersey	1033	2.40	3.20	3.20
New York	1643		2.07	2.07
Pennsylvania	1597		2.70	2.65
Texas	1048		1.99	2.00
	1049		2.70	2.67
	1056		2.01	2.01
	1065		2.16	2.16
	1096		2.33	2.33
	1111		2.14	2.14
	1178	2.43	3.12	3.12
	1181		2.39	2.39
	1183		2.44	2.44
Utah	1004		2.94	2.94
Vermont	1004		2.13	2.13
Virginia	1002		2.41	2.41
	1423		2.07	2.07
Sum total		6	8	30

This kind of comparison is trustworthy only if the roughness statistics are analyzed considering the same admissible values references. Using the regression model developed (equation 7), the σ computed values were converted to the IRI index. The admissible IRI (IRI=2.7 m/km) is equivalent to a critical σ value of 2 mm. The pavement sections whose σ values are greater than 2 mm are also included in table 3.

Of the 207 pavement sections, just 30 sections presented σ roughness values higher than 2 mm. Thus, 30 sections would be rejected according to this criterion. These rejected pavement sections now can be compared to the sections rejected by the IRI statistic, since both use the same reference (IRI=2.7 m/km and σ (converted to IRI)=2 mm). Since the number of σ rejected

sections is higher than the IRI rejected sections, the σ statistic is more strict or rigorous than the IRI statistic.

Using the regression model presented by equation 7, an analysis of the σ acceptance threshold was achieved. It was noted that the admissible ($\sigma=2.4$ mm) value is equivalent to a critical IRI of 3.2 m/km. This shows that the acceptance threshold values are stricter in the United States.

Prediction of Longitudinal Roughness

Prediction of Longitudinal Roughness Using Neural Networks

The previously described IRI data was initially analyzed using the Qnet neural network modeling system with the objective of finding an NN model as function of the available input parameters. A single output layer for IRI value was used. The input layer consisted of 10 data neurons as follows:

- Input 1 (AS): thickness of the asphalt surface course layer (cm).
- Input 2 (AB): thickness of the asphalt binder layer (cm).
- Input 3 (Ba): thickness of the granular base layer (cm).
- Input 4 (SB): thickness of the granular subbase layer (cm).
- Input 5 (SG): code for the type of subgrade soil.
- Input 6 (FD): freezing index in equivalent freezing days.
- Input 7 (RF): average annual rainfall (mm).
- Input 8 (HD): number of hot days with temperature above 32 oC.
- Input 9 (TV): average traffic volume of heavy vehicles daily.
- Input 10 (Age): age of the pavement (years).

The subgrade soil was divided in 14 types according to the Unified Soil Classification System (SUCS), plus rock foundation. The following codes were attributed to input 5 (SG): Rock=0, SC=1, SW-SM=2, SP=3, SP-SM=4, SM=5, CL=6, CL-CM=7, GC=8, GP=9, GP-GM=10, GC-GM=11, GM=12, GW=13, and MH=14.

A few neural network architectures were tried to find the best configuration for the intermediate layers. The best results were obtained for the configuration illustrated in figure 6, with three intermediate layers of eight, five, and three neurons, respectively. All neurons of a given layer are connected to all neurons of the subsequent layer. A sigmoid activation function was used.

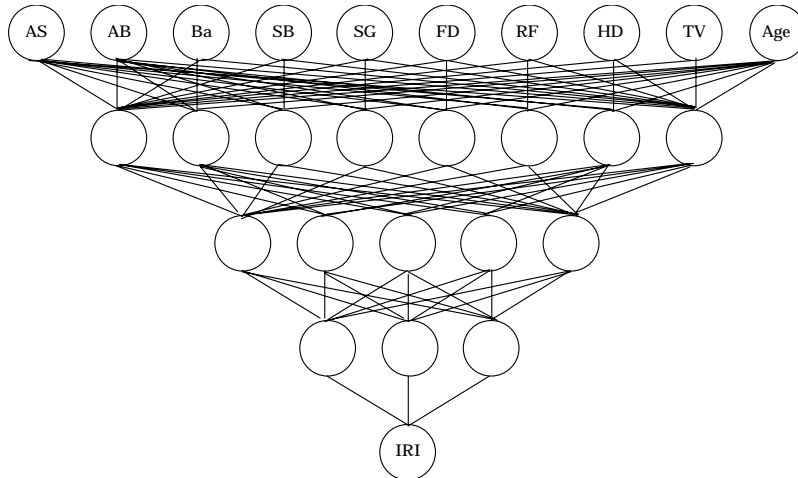

Figure 6. Adopted neural network model.

A training data set comprising 140 random sections out of 157 available (89 percent) was initially chosen for the learning stage. The NN of figure 6 produced excellent results, as illustrated in figure 7, which shows the training targets (measured IRI values) in the abscissa and the network outputs (computed IRI values) in the ordinate. The correlation coefficient for the learning stage was very high with $R^2=0.992$. The root-mean square error was $RMS=0.017$.

After the training stage, the remaining 17 sections were used to validate the model. Predictions were also good, despite a higher dispersion than in the learning stage (figure 8). The correlation coefficient for the validation stage was $R^2=0.80$ with a standard deviation of IRI values equal to 0.28. The lower correlation of the validation stage may be attributed to the relatively small number of sections available or to an overfitting during the learning stage.

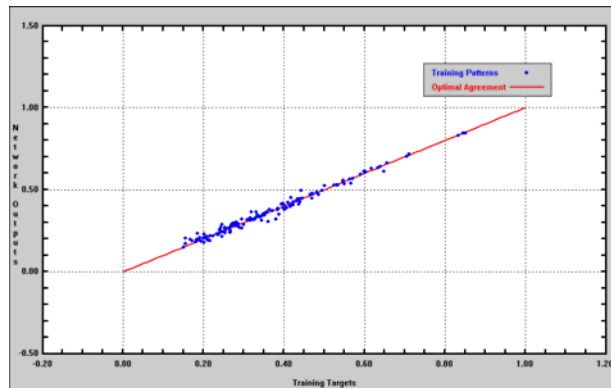

Figure 7. Learning stage.

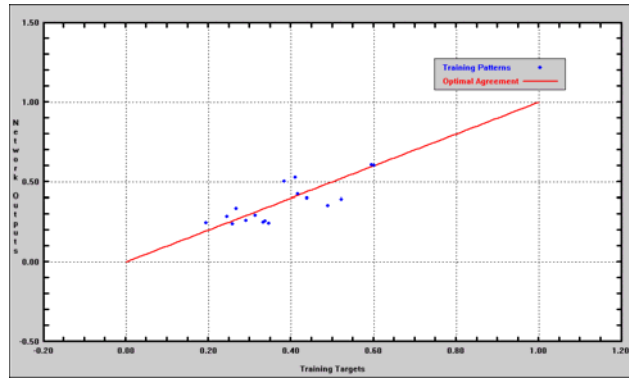

Figure 8. Validation stage.

An important feature of the Qnet program is that it allows quantification of the relative contribution of each input neuron to the computed output value. Hence, it is possible to investigate the most relevant factors affecting roughness in a flexible pavement. Individual contributions of each input are shown in table 4. In the same table, the contributions were grouped for the pavement structure (38.1 percent), climatic factors (31.2 percent), and traffic conditions (20.4 percent), besides subgrade type (10.3 percent).

Table 4. Relative contribution of input parameters for the final IRI value.

Input	1	2	3	4	5	6	7	8	9	10
	SC	AB	Ba	SB	SG	FD	RF	HD	TV	Age
Contribution (%)	10.44	9.46	10.81	7.39	10.3	11.39	7.94	11.86	10.22	10.18
	Structure				Subgrade	Climate			Traffic	
Contribution (%)	38.1				10.3	31.2			20.4	

Prediction of Longitudinal Roughness Using Multivariate Statistical Models

The same IRI data values were used to try to establish statistical models using SYSTAT® software. The user defines a priori the type of model to be tried. In this paper, multivariate linear and nonlinear (exponential) models were tested. The model constants and correlation coefficients are shown in table 5. A plot of computed-versus-target IRI values for both models is shown in figure 9. Dispersion is complete and no correlation at all could be found with $R^2=0.15$ and $R^2=0.21$ at best for the linear and nonlinear models, respectively.

Table 5. Linear and nonlinear multivariate statistical models.

		Linear $IRI = \sum_{j=1}^{10} A_j x_j + 11,944$	Nonlinear $IRI = \sum_{i=1}^{10} A_i e^{B_i x_i}$	
Input	x_i	A_i	A_i	B_i
SC	1	-0.229	1.138	-0.237
AB	2	0.033	0.735	-0.119
Ba	3	0.006	1.287	-27.130
SB	4	-0.015	0.414	-0.117
SG	5	-0.151	0.376	-0.277
FD	6	-0.004	1.598	-0.228
RF	7	-0.005	22.355	-0.479
HD	8	-0.037	0.682	-0.156
TV	9	-0.001	2.229	-0.058
Age	10	0.019	11.390	-960.900

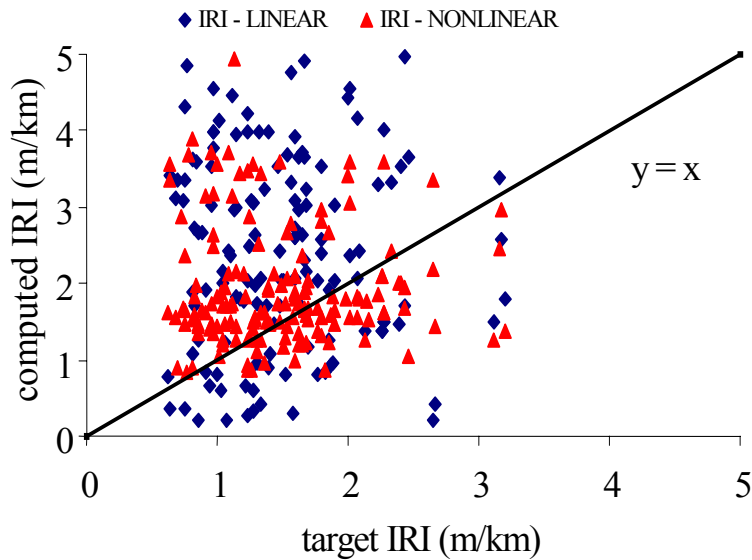

Figure 9. Computed-versus-target IRI values for both statistical models.

CONCLUSIONS

The International Roughness Index (IRI) and the standard deviation of longitudinal roughness (σ) were correlated for 6,329 pavement longitudinal profiles measured on 207 pavement sections of the LTPP program. A high correlation was found between the IRI and σ statistics ($R^2=0.93$).

When the IRI and σ statistics were compared under different references, it was observed that the IRI rejected a higher number of pavement sections. However, when the IRI and σ statistics were equated using the regression model developed in this study, it was found that the σ statistic

rejected more pavement sections than the IRI. Therefore, the σ statistic is stricter than the IRI statistic.

Using the regression model developed in this study, it was also found that the roughness acceptance threshold values are stricter in the United States than in Japan.

Neural network and multivariate statistics regression were used to try modeling the computed IRI values. Out of 207 pavement sections, 157 sections were selected to achieve this study. A complete set of subgrade, pavement structure, climate, and traffic data and IRI computed values for each pavement measured profile were available.

An extremely accurate model using Qnet neural network software was developed. This NN model gave a coefficient of correlation of 0.992 during the learning stage. Despite a lower correlation during the validation stage, it is believed that this feature can be improved as more data become available. On the other hand, it was not possible to model the data using multivariate linear and nonlinear (exponential) statistics models.

The studied database (GPS-1) comprised concrete asphalt pavements with granular base and subbase over most U.S. States, covering a wide range of subgrade soils and climatic and traffic conditions. The NN model allowed quantification of the relative contributions of these factors on IRI values and credited most of the pavement roughness (around 49 percent) to structural factors (subgrade soil and pavement layer thickness), followed by climatic factors (31 percent) and traffic conditions (20 percent). The most important structural factor was the overall thickness of the asphalt layers (including binder), responsible for almost 20 percent of the roughness index. However, these numbers should not be extrapolated to other countries with different engineering practices and less rigorous traffic weight control.

The neural network proved to be an extremely powerful tool to predict pavement roughness. Similar NN models may be developed for other databases of LTPP's GPS program to include other types of pavement structures.

ACKNOWLEDGMENTS

The authors acknowledge the financial support of Brazilian agencies Conselho Nacional de Desenvolvimento Científico e Tecnológico (CNPq) and Coordenação de Aperfeiçoamento de Pessoal de Nível Superior (CAPES).

REFERENCES

1. Río, R.C. (1999). "Tread quality." *Jornadas sobre la calidad en el proyecto y la construcción de carreteras*. AEPO Ingenieros Consultores, Barcelona, Spain. (In Spanish). At <http://www.aepo.es/aepo-old/ausc/publ/calidad.pdf>.
2. Haas, R., Hudson, W.R., and Zaniewski, J. (1994). *Modern Pavement Management*. Melbourne, FL: Krieger Publishing Co.

3. Farias, M.M., and Souza, R.O. (2002). "Longitudinal roughness and its influence on pavement functional evaluation." *Proceedings VII National Meeting for Highways Conservation*. CD-ROM. Vitória, Brazil. (In Portuguese).
4. Melis, M., and Río, R.C. (1992). "IRI computation through highway longitudinal profile. The IRI once more. The IRI equation for a sinusoidal profile." *Cuaderno AEPO No 1*. AEPO Ingenieros Consultores, Madrid, Spain. (In Spanish).
5. Shahin, M.Y. (1994). *Pavement Management for Airports, Roads and Parking Lots*. Norwell, MA: Kluwer Academic Publishers.
6. Paterson, W.D.O. (1987). *Road Deterioration and Maintenance Effects: Models for Planning and Management*. Highway Design and Maintenance Standard Series. Baltimore, MD: The John Hopkins University Press.
7. Souza, R.O. (2002). "Influence of Longitudinal Roughness on the Evaluation of Pavement." M.S. Dissertation. Publication 625.8(043) S729i. University of Brasilia, Brasilia, Brazil. (In Portuguese).
8. U.S. Department of Transportation. (1999). *Status of the Nation's Highways, Bridges, and Transit: Conditions and Performance*. Report to the U.S. Congress. Washington, DC. At <http://www.fhwa.dot.gov/policy/1999cpr/report.htm>.
9. Pinto, S., and Preussler, E. (2001). "Pavimentação Rodoviária. Conceitos fundamentais sobre pavimentos flexíveis." Copiarte, Copiadora e Artes Gráficas Ltda. Rio de Janeiro, Brazil. (In Portuguese).
10. Río, R.C. (1997). "Introduction to pavements sounding." *Cuaderno AEPO No. 4*. AEPO Ingenieros Consultores, Madrid, Spain. (In Spanish).
At <http://www.aepo.es/aepo-old/ausc/publ/auscultacion.pdf>.
11. Patiño, M.C.A., and Anguas, P.G. (1998). "International Roughness Index, application to the Mexican highway network." *Publicación Técnica No. 108*. Instituto Mexicano del Transporte, Sanfandila, Querétaro, Mexico. (In Spanish).
12. Suzuki, K. (2001). Personal Communication. Japan Highway Public Corporation, Tokyo, Japan.
13. Sayers, M., and Karamihas, S.M. (1996). *The Little Book of Profiling: Basic Information about Measuring and Interpreting Road Profiles*. University of Michigan Transportation Research Institute, Ann Arbor, MI.
14. Japan Road Association (1989). *Manual for asphalt pavement*. Second Edition. Tokyo, Japan.
15. Anderson, A.J. (1995). *An Introduction to Neural Networks*. Cambridge, MA: MIT Press.

16. Kovács, L.Z. (1997). *Artificial Neural Networks: Fundamentals and Applications* (20 ed.). Editora Collegium Cognitio e Edição Acadêmica. (In Portuguese).
17. Fausett, L. (1994). *Fundamentals of Neural Networks: Architectures, Algorithms, and Applications*. Englewood, NJ: Prentice-Hall.
18. Hertz, J.A., Krogh, A., and Palmer, R. G. (1991). *Introduction to the Theory of Neural Computation*. New York: Addison-Wesley Publishing Co.
19. Federal Highway Administration. (2001). DataPaveVersion 3.0. Washington, DC. At <http://www.datapave.com/>.
20. Takahashi, S. (2001). Personal Communication. Japan Highway Public Corporation, Tokyo, Japan.

PAPER 2: USE OF LTPP DATA TO VERIFY THE ACCEPTANCE LIMITS DEVELOPED FOR PENNDOT PAVEMENT DISTRESS DATA

Venkatesa Prasanna Kumar Ganesan
The Pennsylvania State University

Faculty Advisor
Shelley M. Stoffels, D.E., P.E.,
The Pennsylvania State University

Agency Liaison
Janice Arellano, P.E.,
Pennsylvania Department of Transportation

Project Consultant
Dennis Morian, P.E.,
Conneaut Lake, PA

ABSTRACT

State transportation agencies use various methods of pavement data collection. The major methods are manual, film-based, semiautomated, and automated collection. The Federal Highway Administration (FHWA) Long-Term Pavement Performance (LTPP) program has used both the manual method and the Pavement Distress Analysis System (PADIAS) film-based survey for its pavement data collection.⁽¹⁾ The Pennsylvania Department of Transportation (PennDOT) replaced its former manual method with a semiautomated method. The project team at the Pennsylvania Transportation Institute developed a quality assurance plan for PennDOT for pavement data collection and rating. Initial acceptance limits were developed by the project team with the assistance of PennDOT. The manual distress data are compared with the PADIAS 4.2 distress data. This paper also summarizes the PennDOT quality assurance plan. The sources of variability affecting surface distress are also discussed. In this paper, the LTPP distress data are used to verify the PennDOT acceptance limits. The findings indicate that the proposed limits may require modification. Two types of modifications are attempted with the LTPP data, providing input to PennDOT's future decisions.

INTRODUCTION

Background

State transportation agencies follow various treatment or decision matrices in their pavement management systems. Some agencies consider individual distress and severity levels and others consider composite indices, such as pavement condition index and pavement distress index, for their treatments. The Pennsylvania Department of Transportation (PennDOT) considers individual distress and severity level treatments for its treatment methodology.

The methods of data collection for pavement surface distress can be categorized as manual, film-based, semiautomated (remote survey), and automated. Transverse profile data are collected to determine the rut depth. Longitudinal profile data are collected to determine pavement roughness.

This paper emerged from the “Videologging—QA Plan, Development, Implementation, and Analysis” project (Work Order 117) performed for PennDOT. The project was conducted at the Pennsylvania Transportation Institute (PTI).⁽²⁾ In this project, a quality assurance (QA) plan was developed for PennDOT to monitor the collection of quality pavement condition data. In 1997, PennDOT replaced the manual method with a semiautomated method of pavement condition data collection. At that time, the distress definitions and decisionmaking methodologies were significantly altered, but PennDOT did not perform sensitivity analyses. Hence, as part of research under Work Order 117, detailed analyses were conducted to determine the impacts of individual distresses for the existing pavement conditions in Pennsylvania.

From the comprehensive literature review and the results of the sensitivity analysis, the team proposed the initial acceptance limits for pavement condition data. The acceptance limits are based on the PennDOT method of data collection. PennDOT contracts to vendors the digital imaging and interpretation of pavement distress. Control and acceptance will be performed with PennDOT’s own equipment and personnel, resulting in different equipment manufacturers, software, and raters. While the Long-Term Pavement Performance (LTPP) program methodologies differ, this paper verifies the acceptance limits by comparing the manual distress data with the Pavement Distress Analysis System (PADIAS 4.2) data, thus simulating the control of one data stream with the use of another, nonidentical distress data methodology.

Motivation

The project team at PTI proposed initial acceptance limits for PennDOT pavement data collection. The limits were set based on the experts’ opinion and comprehensive literature review. The results from this paper will help PennDOT refine or broaden the limits, in combination with the first-year application of the methodology. Success by PennDOT may enable other agencies to establish formal acceptance methodologies for contracted pavement distress data collection.

LITERATURE REVIEW

This section documents a literature review of recent studies about the types of data, pavement data collection, and distress data variability.

Types of Pavement Condition Data

Pavement condition data include surface distress and longitudinal profile data. Surface distresses in asphalt concrete include fatigue cracking, transverse cracking, longitudinal cracking, edge deterioration, raveling and weathering, bituminous patching, and rut depth. Surface distresses in jointed concrete pavements include transverse joint spalling, longitudinal joint spalling, longitudinal cracking, transverse cracking, bituminous patching, and concrete patching. Longitudinal profile data are collected for both asphalt concrete (AC) and jointed concrete pavements (JCP) to compute a parameter known as the International Roughness Index (IRI). While the QA plan developed for PennDOT also includes IRI, the analysis using LTPP data in this paper addresses surface distress only.

Methods of Pavement Data Collection

The methods of data collection for pavement surface distress can be categorized as manual, film-based, semiautomated (remote survey), and automated. For manual data collection, the pavement raters travel to each site and rate pavement distresses. The film-based method uses 35-millimeter (mm) black-and-white photography to obtain images of pavement test sections.⁽³⁾ Both the manual and film-based methods are used in distress data collection for the Federal Highway Administration (FHWA) LTPP program. In a semiautomated method, the pavement images are collected digitally using a camera mounted on a van by a process sometimes called videologging and are visually rated. In a fully automated method, the images are collected and then rated automatically using crack detection software. Most State transportation agencies are shifting their methods of data collection from manual to semiautomated or automated for their network-level pavement management systems. Primary reasons for the change include safety and improved possibilities for consistency and quality control.

Distress Variability

The variability of pavement condition data is an important factor to be considered in a pavement management system. Pavement condition data collected can include variability from a number of sources.⁽²⁾ These sources include the following:

- **Method of data collection.** State agencies are shifting their methods of data collection from manual to semiautomated or automated methods. This may affect the quality of distress data and the consistency of the data over time.
- **Pavement condition.** Pavement condition also affects the variability of the data. An LTPP study showed that the variability increases as the quantity of the distress increases.
- **Repeatability (within group variability).** Repeatability is another important factor in assessing the condition data. Repeatability is the ability of the raters to get the same results if they rate the same section using the same software.

- **Reproducibility (between group variability).** Reproducibility is the ability of different pools of raters to produce the same result when rating the same section using different software. This is an important source of variability for an agency that contracts out pavement data collection.

A study of LTTP distress data variability discussed the variability that affects the pavement condition data.⁽³⁾ In that study, statistical analyses were performed to quantify the precision and bias between the raters by comparing with a reference value. The manual distress survey was compared with the PADIAS film-based survey. LTTP sections were rated by experts, individual raters, and teams. Statistical analyses were performed to determine the variability of the raters.

The following observations were made from that study:

- No significant negative or positive bias existed between the raters (i.e., there was no tendency of the raters to rate consistently low or high severity).
- The variability increased as the quantity of distress increased.
- The variability and the bias decreased tremendously when individual severity ratings were converted into a pavement condition index.
- A coefficient of variation (COV) of 30 percent is common in manual distress surveys.
- Statistical analysis showed that the between-rater variability was greater than the within-rater variability.
- For AC pavements, for total distress quantities, the average COV was the following:
 - Between-rater variability for experts, individual raters, and teams was 26.8, 33.9, and 22.1 percent, respectively.
 - Within-rater variability for experts, individual raters, and teams was 16.4, 28.1, and 16.8 percent, respectively.
- For portland cement concrete (PCC) pavements, for total distress quantities, the average COV was the following:
 - Between-rater variability for experts, individual raters, and teams was 13.3, 29.4, and 26.3 percent, respectively.
 - Within-rater variability for experts, individual raters, and teams was 24.9, 100.1, and 20.0 percent, respectively.
- There was no bias for AC pavement and PCC pavement distresses, except for fatigue cracking in AC and transverse joint spalling in PCC.
- For PCC, PADIAS surveys showed greater variability than the manual surveys.

PENNDOT QA PLAN

In 1997, PennDOT replaced the manual method with a semiautomated method of pavement condition data collection in its network-level pavement management systems. PennDOT contracts out pavement data collection to vendors for its network-level pavement management systems. PennDOT currently contracts out pavement data collection to a private vendor. PennDOT and the vendor use different equipment and software for pavement condition data collection and rating.

The impacts of distress variability on pavement modeling and decisionmaking depend on the type of treatment methodology used by the agency. Therefore, the sensitivity analyses results were considered in developing the PennDOT QA plan.

Sensitivity Analysis

Sensitivity analyses are generally defined as statistical studies to determine the sensitivity of a dependent variable to variations in independent variables over reasonable ranges. There are several reasons for doing sensitivity analysis of the treatment matrices. First, it shows the impact of a distress on determination of the final treatments for a pavement. It also helps to find out where to concentrate resources in the collection of quality pavement condition data. The IRI frequency ranges that represent most of the network conditions were used in the sensitivity analysis. The sensitivity analysis was used for the following:

- Identify the critical variables (distresses) so that they may be given more careful consideration in the quality assurance plan.
- Identify the critical conditions (values) so that they may be given more emphasis in the quality assurance plan.
- Identify areas of potential improvements in the treatment matrices.

Sensitivity analyses were performed on PennDOT's treatment matrices, using roadway management system (RMS) 2001 data for both AC and JCP pavements. These analyses were performed in spreadsheets, using the treatment matrices.

Sensitivity Analysis for Asphalt Concrete Pavements

IRI frequency distributions were plotted for AC and JCP pavements. The IRI range for sensitivity analysis was selected by considering both the frequency in the network condition and the effects of IRI on the treatments. From the treatment matrices, for interstate pavements, for the value $IRI > 21$, there is a trigger or an effect in the treatments; hence the IRI 121–160 that also has significant frequency was selected for the sensitivity analyses. To study the effect of IRI, sensitivity analyses were performed for IRI 81–120 and IRI 121–160 for interstates. For National Highway System (NHS) noninterstate, and non-NHS pavements, sensitivity analyses were done for the range IRI 121–160.

There were seven independent variables including IRI; the dependent variable for this analysis was the treatment result.

Sensitivity analysis was performed by keeping the following:

- All distress values at minimum and varying one distress at a time to maximum.
- All distress values at average and varying one distress at a time to maximum.
- All distress values at average and varying one distress at a time to minimum.

The sensitivity analyses were performed for all roadway categories and conditions (minimum to maximum, average to maximum, and average to maximum).

The results of the sensitivity analysis for asphalt concrete pavements are the following:

- Fatigue cracking and rut depth are the two independent variables that are most sensitive when the value changes from minimum to maximum and average to minimum. In the former case, the treatments increase and in the latter, the treatments decrease. In any case, the change in values seriously affects the treatment results. Hence, fatigue cracking has to be considered an important independent variable in the quality assurance process.
- Transverse cracking is the second most significant distress that is sensitive to the treatments.
- All other distresses have similar effects on treatments.

To illustrate how the sensitivities may differ from one highway type to another, the sensitivity analysis were performed for interstate, NHS noninterstate, and non-NHS pavements. The following are the results are:

- Transverse cracking, raveling and weathering, and rut depth have significant effects for IRI 121–160, interstate pavements.
- Fatigue cracking, transverse cracking, and edge deterioration have significant effects for IRI 81–120, interstate pavements.
- All distresses (fatigue cracking, transverse cracking, miscellaneous cracking, edge deterioration, raveling and weathering, and rut depth) have a similar effect on noninterstate and non-NHS pavements.

Sensitivity Analysis for Jointed Concrete Pavements

Sensitivity analysis was performed for all types of highways under different annual average daily traffic (AADT) conditions using the PennDOT treatment matrices ⁽⁵⁾ for jointed concrete pavements. Sensitivity can be observed if there is any change in the treatments by varying the particular distress value to maximum or minimum from the average. For jointed concrete pavements, IRI 81–120 has the greatest percent frequency.⁽⁷⁾ Only the data from this IRI 81–120 range was used for sensitivity analysis. There were eight independent variables or distresses.

The results of the sensitivity analysis for jointed concrete pavements are the following:

- Transverse joint spalling is the independent variable that is most sensitive when the distress value changes from minimum to maximum and average to minimum, irrespective of conditions.⁽⁷⁾ In the former case, the treatments increase and in the latter, the treatments decrease. In any case, the change in values frequently affects the treatment results. Hence, transverse joint spalling has to be considered an important independent variable in the quality assurance process for pavement condition data.
- Longitudinal joint spalling is the second most sensitive distress that affects the treatment results when the distress value changes from minimum to maximum and average to minimum.

To illustrate how the sensitivities may differ from one highway type to another, the sensitivity analyses for interstate, NHS noninterstate, and non-NHS pavements were compared. As before,

the transverse joint spalling and longitudinal joint spalling distresses play a major role in determining the final treatments. The following are the results:

- Transverse joint spalling and longitudinal joint spalling are the two critical distresses that are the most sensitive distresses for all categories (interstate, noninterstate, and non-NHS).⁽⁷⁾
- Transverse cracking is more sensitive for interstate and noninterstate NHS than non-NHS.
- Rut depths, left and right, are not sensitive for interstate and non-NHS for existing conditions. Rut depth, right, is a little sensitive on NHS noninterstate.
- Longitudinal cracking is not sensitive for non-NHS, and has little sensitivity for interstate and NHS noninterstate.

The project team reviewed the literature, treatment results, sensitivity analyses results, and variability studies and developed the QA plan for PennDOT pavement data collection and rating. This plan was then modified for implementation by PennDOT. The following sections summarize the QA plan developed by the project team.

CONTROL SECTIONS

Recommended Use of Control Sections

Control sections are used to determine the repeatability and reproducibility between the agency and vendor. The control sections should be selected so that the sections represent the network pavement condition distribution. The project team made the following recommendations to PennDOT:

For IRI, the repeatability for a single equipment/operator combination on immediately repeated runs on the same day should be less than plus or minus 5 percent, 95 percent of the time. Ten runs for each control site should be performed. The average for each equipment/operator combination should be within 3 percent of the reference value.

The repeatability should be less than plus or minus 5 percent on the extent of each rutting severity. Bias can be quantified using manual profiling measurements as the reference value. It is recommended that the bias on actual rut depth be less than plus or minus 15 percent.

The repeatability of each vendor and PennDOT rater should be within plus or minus 10 percent for each distress and severity combination. The average rating by each vendor and quality assurance rater should be within plus or minus 15 percent of the pooled average rating.

Blind Verification Sites

The project team recommended the use of blind verification sites in the PennDOT QA plan. About 100 segments should be selected based on geographic and anticipated pavement condition. Multiple runs and ratings should be performed by PennDOT before the vendor's production schedule. The location of the segments should not be disclosed to the vendor. The vendor should provide the distress ratings and IRI of each blind verification site immediately upon the agency's request. PennDOT should determine if the vendor's reported values are within

the 95 percent prediction interval from the repeated runs. The vendor should be informed immediately if the results are not within 95 percent confidence. Investigation and possible recalibration will then be necessary. The use of the blind verification sites provides timely and confident checks with tighter control limits, and also allows immediate corrections rather than ultimate rejection of entire deliverables.

Acceptance Testing

Five percent of segments by highway types (interstate, NHS, and non-NHS) and by anticipated conditions should be selected based on stratified sampling by geographical distribution and anticipated condition. The anticipated conditions can be determined from the previous RMS ⁽⁶⁾ condition data.

A greater concentration of acceptance samples should be chosen near critical condition values. For example, for interstate, for both AC and JCP pavements, an IRI of 120 is the breakpoint between routine maintenance and major treatments. Therefore, the segments should be selected near these critical conditions. Figure 1 shows the recommended use of the statistical sampling plan for acceptance testing.

Proposed Initial Values for Acceptance Criteria

Table 1 shows the proposed initial values for acceptance criteria and recommended actions if these criteria are not met. These initial criteria and limits were taken from the literature review and from the suggestions of experienced members of the project team.

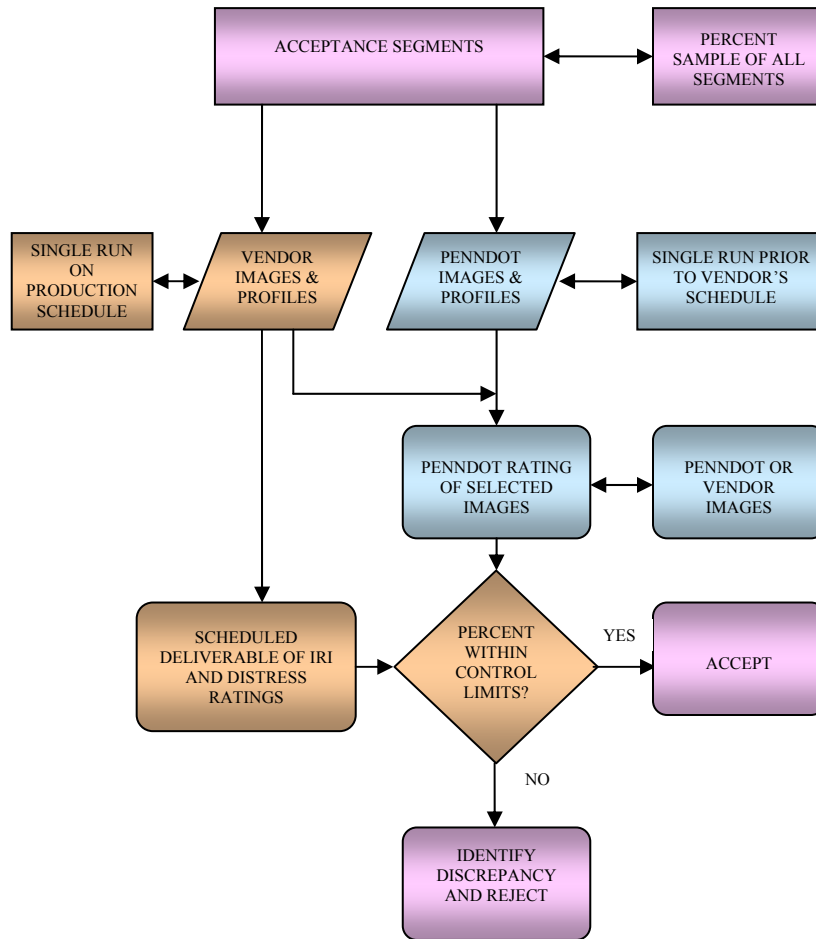

Figure 1. Recommended use of statistical sampling for acceptance testing of each deliverable.⁽²⁾

Proposed Initial Values for Acceptance Criteria

Table 1 shows the proposed initial values for acceptance criteria and recommended actions if these criteria are not met. These initial criteria and limits were taken from the literature review and from the suggestions of experienced members of the project team.

From the sensitivity analyses results, the project team developed three types of distress criteria for AC and JCP pavements. The individual distress and severity combinations are considered for both AC and JCP pavements. Total fatigue cracking is the sum of all severity level values (low, medium, and high severity). Other sensitive distresses (miscellaneous cracking, transverse cracking, and edge deterioration) are combined to obtain total nonfatigue cracking. For JCP pavements, total transverse cracking and total joint spalling (transverse and longitudinal joint spalling) are used as distress criteria for acceptance.

Discussion of Proposed PennDOT QA Plan

Rating results and IRI values for control sections should be checked for the initial criteria proposed in table 1. PennDOT will review the results for control sections and decide the final acceptance criteria for the production sites. Increasing or decreasing the proposed limits or percent within limits (PWL) should be considered by reviewing the control section results. If the control sections results are well within the proposed limits, then PennDOT may consider tightening the initial values to get the desired final acceptance criteria. However, PennDOT should not assume that the vendors may produce the same results for production sites. Therefore, before tightening the control limits, PennDOT may consider 1,000 segments of production site results to check whether the vendors are still producing results well within limits. If the variability for some distress is higher than expected, careful investigations should be performed to check if there are any outliers. If so, retraining of raters should be conducted to eliminate the outliers.

Table 1. Proposed initial values for acceptance criteria and suggested actions.⁽²⁾

Reported Value	Initial Criteria	Percent Within Limits (PWL)	Recommended Action if Criteria Not Met
IRI	+/- 25%	95%	Reject deliverable.
Individual Distress Severity Combination	+/- 30%	90%	Feedback on potential bias or drift in ratings. Retrain on definitions.
Total Fatigue Cracking	+/-20%	90%	Reject deliverable.
Total Nonfatigue Cracking	+/-20%	90%	Reject deliverable.
Total Joint Spalling	+/-20%	90%	Reject deliverable.
Transverse Cracking, JCP	+/-20%	90%	Reject deliverable.
Location Reference—Segment/Offset	Correct Segment	All	Return deliverable for correction.
Location Reference—Section Begin	+/- 10 feet	95%	Return deliverable for correction and system check.
Panoramic Images	Legible signs	80%	Report problem. Reject subsequent deliverables.

LTTP DATA ANALYSIS

LTTP Data Collection

The LTTP manual distress data were extracted from the DataPave Web site.⁽⁴⁾ Table 2 shows the table names descriptions. Only the distress data that represent PennDOT distress type and

severity were considered in the analysis. The survey dates for manual and PADIAS 4.2 were compared and only the data that were within 6 months' difference between the two dates were considered.

Table 2. LTPP data collection.

Table Name	IMS Module	Description
Mon_Dis_AC_Rev	Monitoring	AC Manual Distress Data Revised
Mon_Dis_JPCC_Rev	Monitoring	JPCC Manual Distress Data
Mon_Dis_PADIAS42_AC	Monitoring	AC PADIAS 4.2 Distress Data
Mon_Dis_PADIAS42_JPCC	Monitoring	JPCC PADIAS 4.2 Distress Data

LTPP Data Analysis

Manual distress data and PADIAS 4.2 data for all regions for GPS sections were extracted from the DataPave Web site. The LTPP distress data were categorized into different types, as shown in table 3. The total fatigue cracking is in length for PennDOT and it is in area for LTPP. PennDOT considers longitudinal cracking between wheelpaths as the only longitudinal cracking; LTPP considers longitudinal cracking wheelpath, nonwheelpath, sealed, and unsealed as longitudinal cracking. The LTPP data for analysis were selected to approximate the PennDOT distress types.

The minimum and maximum manual distress values (for example, for total fatigue cracking, minus 20 percent, and plus 20 percent of the manual distress values) were calculated and compared with the PADIAS 4.2 distress values. For example, in figures 2 and 3, “1” represents “within limits” and “-1” represents “not within limits.” In agreement with findings that the variability increases as the quantity of the distress increases, only lower values meet the criteria proposed in table 1.⁽³⁾

Table 3. Comparison of LTPP and PennDOT distress data.

Pavement Type	PennDOT Distress Type	Corresponding LTPP Distress	Comments
AC	Total fatigue cracking, in length: (low+medium+high) severity	Total fatigue cracking, in area (L+M+H)	PennDOT considers longitudinal wheelpath cracking as low-severity fatigue cracking.
	Total nonfatigue cracking: miscellaneous cracking (longitudinal cracking between wheelpath), transverse cracking, edge deterioration	Longitudinal cracking (sealed, WP, NWP, reflection cracking), transverse cracking (sealed, reflection cracking)	
JPC	Total joint spalling: (transverse joint spalling and longitudinal joint spalling)		In PennDOT rating manual, sealed cracks are considered as low transverse cracking.
	Total transverse cracking	Total transverse cracking (transverse cracking + transverse cracking sealed)	
	Total longitudinal cracking	Total longitudinal cracking (sealed)	

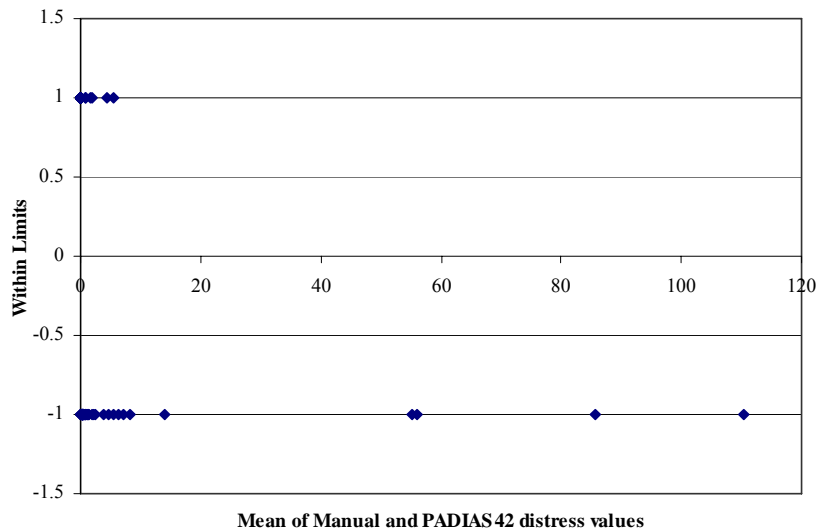

Figure 2. Within limits, total joint spalling, all regions, 1–yes, -1–no.

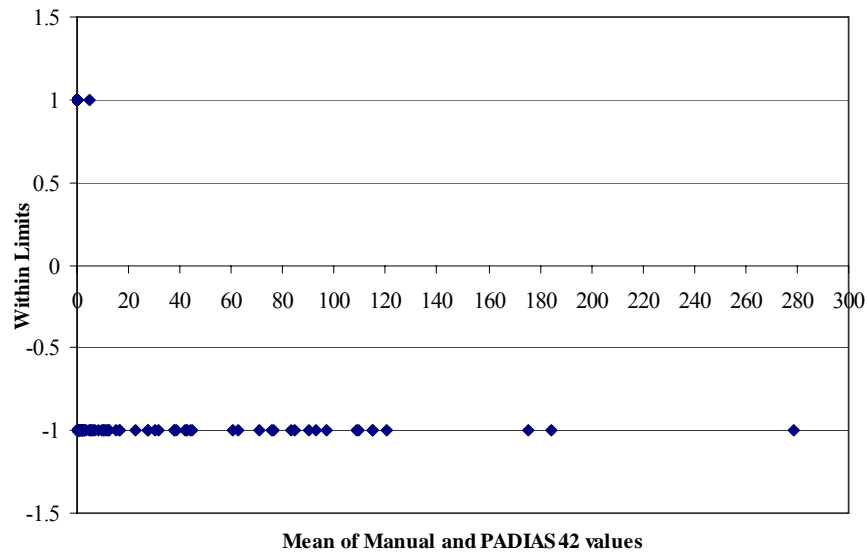

Figure 3. Within initial limits, total fatigue cracking, all regions, 1=yes, -1=no.

Figures 4 to 7 show the PWL for all regions for both AC and JPC pavements for the initial criteria proposed in table 1. The PennDOT acceptance limits were developed based on the semiautomated method (videologging). The PADIAS 4.2 distress survey method showed significant variation in low-severity cracking when compared to manual surveys. There may not be as much variation between the two semiautomated systems used by PennDOT and its vendor, as both systems are of similar resolution and are more likely to distinguish similar quantities of low-severity cracking. Therefore, only medium and high severities were considered for this comparison.

Figure 4 shows the PWL with all severities for all regions and figure 5 shows the PWL with only medium and high severities. From these figures, it is clear that after excluding low severity, the PWL has increased significantly. Because the PWL was less, the low-severity fatigue cracking was not included in the total fatigue cracking and checked for PWL. There was a significant increase in PWL after removing the low severities for all distresses.

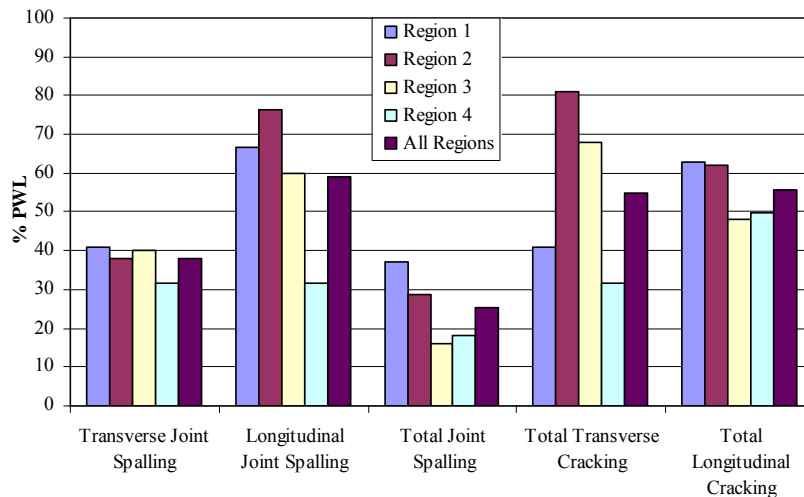

Figure 4. Percent within limits, all regions, GPS sections, JPC pavements (all severities).

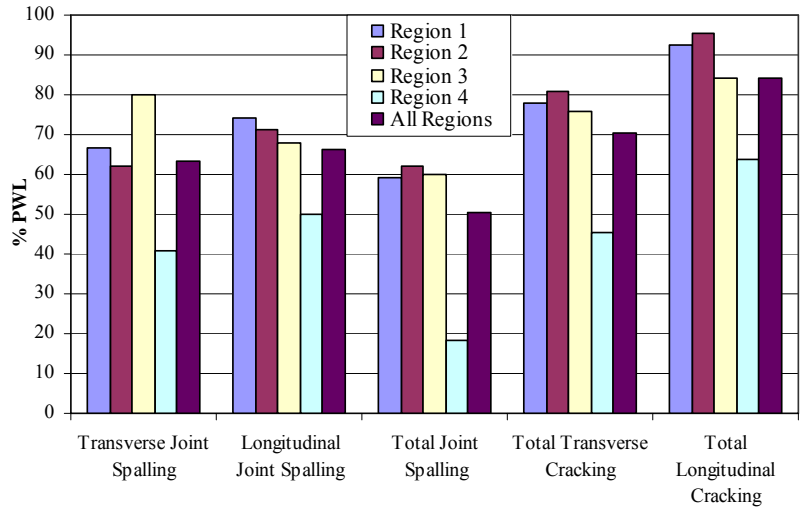

Figure 5. Percent within limits, all regions, GPS sections, JPC pavements (medium and high severities).

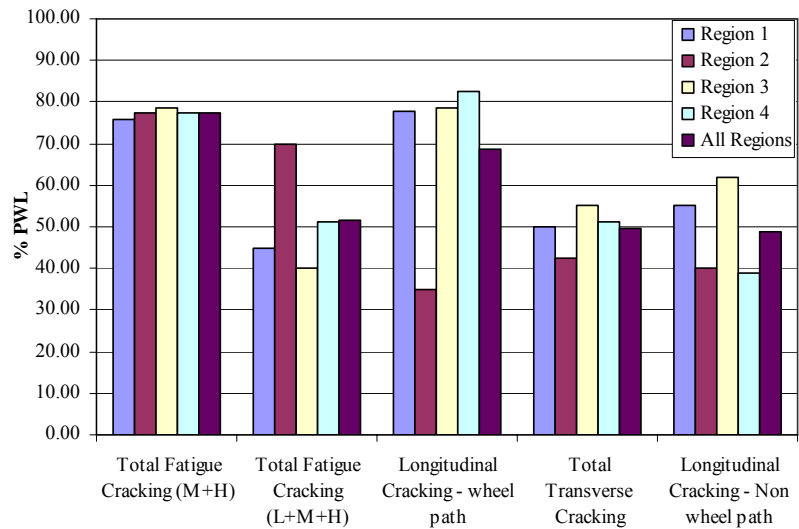

Figure 6. Percent within limits, all regions, GPS sections, individual distresses, AC pavements.

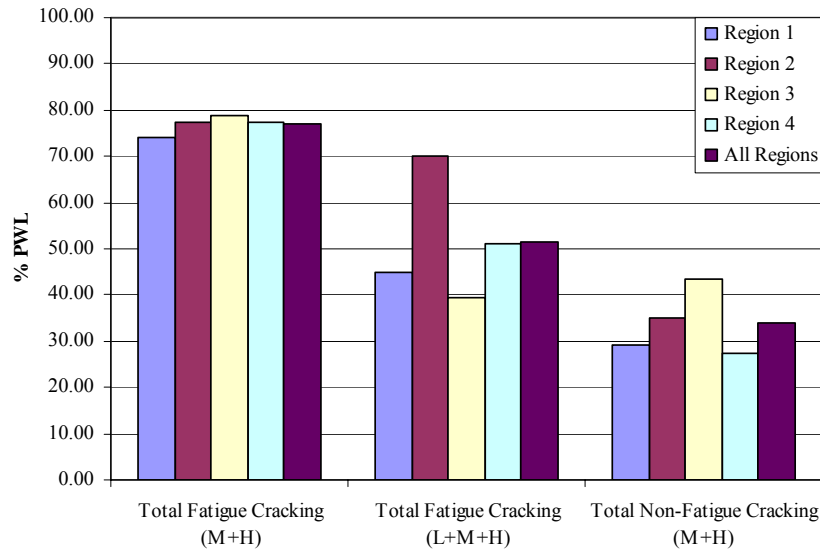

Figure 7. Percent within limits, all regions, GPS sections, total distress values, AC pavements.

From the results above, it is clear that the most of the data are not within limits. This may occur for PennDOT pavement data collection; on the other hand, PennDOT data variability may be less than for PADIAS 4.2 survey data. As the control sites and initial blind verification and acceptance segments are tested, PennDOT may consider increasing the initial criteria or decreasing the PWL or both to achieve the reasonable acceptance data.

Therefore, the initial criteria were increased to plus or minus 40 percent as a trial. There was no significant increase in PWL values. This implies that when a difference occurs, it is typically a very large difference. Another approach would be to decrease the minimum PWL required for each criterion. PWL was still less than 80 percent for all distress types, except longitudinal cracking in jointed portland cement concrete (JPCC). This can be illustrated by figure 8 and table 4. Figure 8 shows the PWL for AC pavements for all regions and table 4 shows the PWL and initial criteria for JPCC pavements for all regions.

Therefore, an agency must consider carefully the impact on its decision methodology of having over 20 percent of the data variable by a high amount. The initial criteria proposed for PennDOT may be modified by either changing the limits or the PWL values. However, the impacts of the modifications on pavement management outcomes must be carefully considered.

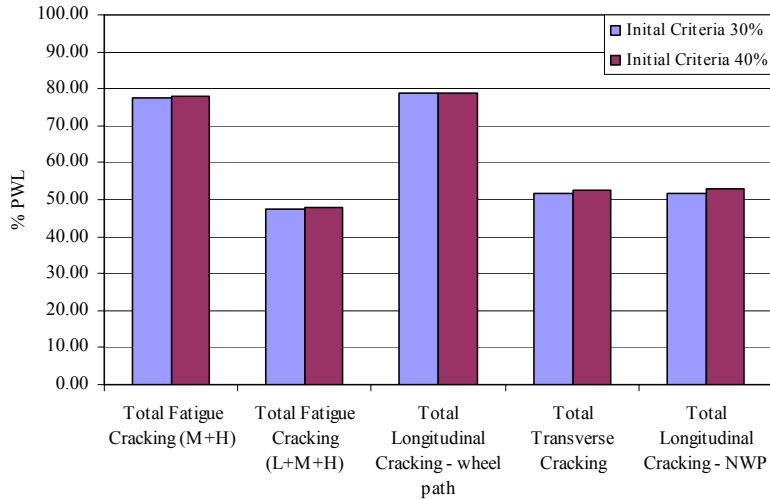

Figure 8. PWL for limits 20 percent and 40 percent, AC, all regions.

Table 4. Initial criteria and PWL for JPC pavements all regions.

Distress Type	Initial Trial		Revised Trial	
	Criteria (limits)	PWL	Criteria (limits)	PWL
Transverse Joint Spalling	30%	63%	40%	63%
Longitudinal Joint Spalling	30%	66%	40%	67%
Total Joint Spalling	20%	51%	40%	53%
Total Transverse Cracking	30%	71%	40%	72%
Total Longitudinal Cracking	30%	84%	40%	85%

RESULTS

- For AC pavements, no distress categories met the proposed limits (90 percent PWL) developed for PennDOT.
- For JPC pavements, only total longitudinal cracking (for Region 1 and Region 2) met the limits specified for PennDOT.
- Only lower distress values fall within the limits for both AC and JPCC pavements.
- Increase in initial criteria does not significantly affect the PWL for the PADIAS 4.2 surveys, as controlled by the manual surveys.

CONCLUSIONS AND RECOMMENDATIONS

- The PADIAS 4.2 distress data does not fall within the initial limits proposed for PennDOT when compared with manual distress data.
- Excluding low-severity cracking in both AC and JPCC greatly increases the PWL.
- PennDOT may consider increasing the initial criteria or decreasing the PWL, depending on the results from the control sections. Based on the results of this LTPP data analysis, it is

anticipated that increasing the PWL will be a more effective approach. However, the agency must realize that a significant portion of the data outside the limits may lie outside the established criteria by a large percentage.

REFERENCES

1. Federal Highway Administration, Long-Term Pavement Performance Program, at <http://www.tfhr.gov/pavement/ltp/ltp.htm>.
2. Stoffels, S., Ganesan, V., Morian, D., Antle, C., and Sinha, S.K. (2003). *Videologging QA—Development, Implementation and Analysis*. Pennsylvania Transportation Institute Internal Report. Pennsylvania Transportation Institute, University Park, PA.
3. Rada, G.R., Wu, C.L., Bhandari, R.K., Shekharan, A.R., Elkins, G.E., and Miller, J.S. (1999). *Study of LTPP Distress Data Variability*. FHWA-RD-99-074. Federal Highway Administration, Washington, DC.
4. Federal Highway Administration, DataPave Online, Long-Term Pavement Performance Program, at <http://www.datapave.com>.
5. Pennsylvania Department of Transportation. *Pennsylvania Department of Transportation Treatment Matrices Manual*. Roadway Management Division, Bureau of Maintenance and Operations, Pennsylvania Department of Transportation, Harrisburg, PA.
6. Pennsylvania Department of Transportation. *Automated Pavement Condition Surveying Field Manual*. Publication 336-2002. Roadway Management Division, Bureau of Maintenance and Operations, Pennsylvania Department of Transportation, Harrisburg, PA.
7. Ganesan, V., (2003). *Impacts of Pavement Condition Data Variability on State Agency Pavement Management Decisions*, Masters Thesis, Pennsylvania State University, PA.

BIBLIOGRAPHY

- Anderson, D.A., Luhr, D.R., and Antle, C.E. (1990). *Framework for Development of Performance-Related Specifications for Hot-Mix Asphaltic Concrete*. National Cooperative Highway Research Program Report 332. Transportation Research Board, Washington, DC.
- Daleiden, J.F., and Simpson, A.L. (1998). “‘Off-the-Wall’ Pavement Distress Variability Study.” *Transportation Research Record 1643*. Transportation Research Board, Washington, DC, 62–70.
- Evans, D.L., and Eltahan, A. (2000). *LTPP Profile Variability*. FHWA-RD-00-113. Federal Highway Administration, Washington, DC.
- Federal Highway Administration. (1996). *Long-Term Pavement Performance Program Reference Guide: Version 1.0*. Pavement Performance Division, Federal Highway Administration, Washington, DC.

Hadley, W.O. (1994). *SHRP-LTTP Data Analysis Studies: Five Year Report*. Strategic Highway Research Program, Federal Highway Administration, Washington, DC.

Huang, H.Y. (1993). *Pavement Analysis and Design*. Upper Saddle River, NJ: Prentice Hall, Inc.

Marshall, H.E. (1999). "Sensitivity Analysis." In R.C. Dorf (Ed.) *The Technology Management Handbook* (8-59 and 8-63). Boca Raton, FL: CRC Press.

Morian, D., Stoffels, S., and Frith, D. (2002). "Quality Management of Pavement Performance Data." *Proceedings of the Pavement Evaluation 2002 Conference*, Roanoke, VA.

Rada, G.R., Wu, C.L., Elkins, G.E., Bhandari, R.K., and Bellinger, W.Y. (1998). "Update of Long-Term Pavement Performance Manual Distress Data Variability: Bias and Precision." *Transportation Research Record 164*. Transportation Research Board, Washington, DC, 71–79.

Stoffels, S., Morian, D., Larsen, D., and Frith, D. (2001). "Quality Analysis Methods for Pavement Distress Data," Transportation Research Board Annual Meeting presentation. Transportation Research Board, Washington, DC.

PAPER 3: INVESTIGATION OF SEASONAL VARIATION IN PAVEMENT FRICTION USING THE DATAPAVE 3.0 DATABASE

Mark P. McDonald
Auburn University
Albertville, AL

Faculty Advisor:
Larry G. Crowley
Auburn University
Albertville, AL

Faculty Advisor:
Rod E. Turochy
Auburn University
Albertville, AL

ABSTRACT

The nature of seasonal variations in highway skid resistance is investigated through use of the DataPave 3.0 friction data. The investigation is approached using the first principle of the conservation of energy. Two common theories explaining seasonal variation in skid resistance are considered, one stating that the seasonal variations in skid resistance occur as snowfall removal operations increase microtexture, which is then worn away throughout the summer. The other states that seasonal variations are caused by seasonal differences in pavement temperature.

This research also demonstrates a methodology that can be adapted to analyze general multivariate statistical systems and specifically the DataPave pavement structural data. The study uses visually oriented observational study techniques to assess the validity of the hypothesized factor structure in the data and to express it visually. After the visual analysis, structural equations modeling is used to express the structure numerically. The results indicate that snowfall did not organize the data; however, temperature did begin to organize the data. This suggests a temperature effect on skid resistance and indicates that seasonal variations in pavement friction depend on factors not related to surface texture.

Using the developed model, monthly adjustments for skid numbers were calculated and compared with those used by the Virginia Department of Transportation. This comparison showed significant agreement between the developed model and in-place practices.

INTRODUCTION

An understanding of how and why pavements behave as they do is crucial in the effective management of highway infrastructure systems. For this reason, the Federal Highway Administration (FHWA) began work on the Long-Term Pavement Performance (LTPP) program in 1984 to examine the behavior of pavements. These experiments fall into two categories, General Pavement Studies (GPS) and Specific Pavement Studies (SPS). The GPS studies focus on the most commonly used pavement designs, while the SPS studies focus on specific pavement design factors.⁽¹⁾

As the data collection and management phase of the LTPP program comes to a close, a long and difficult data analysis process begins. Unfortunately, the analysis task is very complex as the data result from a factorial design. The many confounding effects of the factors result in significant “noise” in the data and weaken the strength of correlations in the data. This investigation will demonstrate a methodology for exploring the database using visually oriented observational study techniques.

Highway skid resistance is a very important component of traffic safety. In Alabama, 22 percent of all accidents and 15 percent of all fatal accidents occur on wet pavements, although Alabama’s highways are wet only 4 percent of the time. While the benefits associated with wet-weather traction are very great, the costs associated with providing it are great as well.

Although much money is spent to provide wet-weather traction, the nature of the mechanics of tire friction is still poorly characterized. A better understanding of friction mechanics would allow researchers to understand the nature of seasonal and short-term variations in skid resistance that have been observed for more than 40 years. The purpose of this research is to explain the nature of seasonal variation in skid resistance.

BACKGROUND AND LITERATURE REVIEW

The law of conservation of energy has been chosen as the focal point of this investigation because friction is an energy conversion process. The conservation of energy is one of the most fundamental truths of physics. To begin an investigation of friction from any other perspective is to risk the development of a theory of friction that may not be consistent with the fundamental laws of nature.

Richard Feynman explains that the law of conservation of energy is a fundamental law of nature for which we have no known exception.⁽²⁾ We do not know exactly what energy is, but we do know the basic forms it takes. Feynman enumerates these as gravitational potential energy, kinetic energy, heat, sound, radiant energy, elastic energy, chemical energy, nuclear energy, and mass energy. He explains that while energy can be converted from one form to another, their sum is constant in a closed system.

Frictional phenomena have played a central role in the discovery of this law of energy. In the classic physics experiment, Count Rumford noticed that as horses did work to bore holes in cannon barrels, an equivalent amount of heat was generated. This experiment shows that friction is a process by which energy is converted to waste forms at an interface between two surfaces. A

surface with good frictional properties suggests an improved rate at which energy can be converted to its waste forms.

While friction has played a central role in the discovery of the laws of energy, it is also interesting to note that until 40 years ago there was no attempt to explain friction mechanics in an energy context. Kummer was the first to attempt to explain the mechanics of the tire-pavement interface in such a context.⁽³⁾ He examines several theories of friction before presenting his unified theory. First, he examines the classical Coulomb theory of friction, which stipulates that friction is caused by the interlock of two surfaces. He dismisses the theory on the basis that the kinetic energy lost as an object is lifted over the tops of the asperities is regained when the object is lowered.

After dismissing the Coulomb theory, Kummer considers the idea of an abrasive theory, in which energy is lost through the mechanical wear of the surfaces at the interface. In the well-known Fermi estimation problem, one realizes that for every revolution of a tire, a layer of atoms approximately one atom thick is worn. When Kummer considers the small amount of matter lost in abrasion, he seriously questions whether abrasion alone can account for the amount of energy lost in a braking maneuver.

Next, Kummer considers the possibility of friction resulting from a static electrical attraction. He experimented by applying an electrical potential difference across the interface, but he found that the voltage had no effect on the friction coefficient. After dismissing the impact of static electrical forces, his attention turns to the cyclical deformation and release of the rubber. He proposes that there are two types of deformations occurring simultaneously. He proposes that the macrotexture of the pavement creates bulk material deformations that agitate the polymer chains in the bulk rubber of the tire. This phenomenon is termed hysteresis. He further proposes that a similar adhesive phenomenon exists at the interface.

Kummer proposes that friction is the sum of adhesion and hysteresis, both of which depend strongly on temperature and velocity. He also proposed that adhesion comprised approximately 80 percent of friction and proposed a mathematical model for adhesion:

$$F_a = As \tag{1}$$

Where:

F_a is the adhesive force on the tire.

A is the actual contact patch area.

s is the effective junction strength.

The adhesion model is important because it explains the importance of aggregate microtexture in the frictional process. More microtexture results in a greater contact patch area and greater adhesive force.

Kummer's observations tend to defy conventional wisdom on the topic of friction, which states that friction is the function of the normal weight and the ability of the surfaces to interlock. There are, however, some recent observations of the Tokay Gecko that also defy the conventional wisdom. The gecko's toes have been shown to be able to cling to micromechanically smooth surfaces because of van der Waals forces generated in the millions of hairs on its toes.⁽⁴⁾ These van der Waals forces produce what Rabinowicz terms surface energy, or the energy of a free

surface.⁽⁵⁾ He explains that this phenomenon is also the cause of surface tension in water and causes capillary rise.

In addition to his observations about surface energy and the adhesive mechanism, Rabinowicz also makes some important observations on the temperature of the surfaces in contact. He comments that when an object slides rapidly over a cooler substrate, much more waste energy will enter the substrate. This is because the sliding object keeps the same hot contact patch at the interface while the contact patch continually moves over fresh substrate.

Burchett and Rizenbergs have found that seasonal variations in skid resistance exhibit an annual sinusoidal cycle.⁽⁶⁾ The changes in asphalt concrete surfaces were generally greater than the changes in portland cement concrete (PCC). They found that the correlation between skid number and the combination of traffic volume and temperature was as good as the correlation between skid number and day of year. It is likely that Burchett and Rizenbergs observed greater changes in asphalt surfaces because asphalt surfaces are very nearly a black body and are much more sensitive to solar radiation than are PCC pavements. They are thus less receptive to energy vented in heat through frictional processes in hotter weather.

Henry has also made some important observations on seasonal and short-term changes in the nature of the tire-pavement interface.⁽⁷⁾ He has observed particularly dramatic seasonal variations in the northern climates. He has observed that snow removal and winter weather highway operations cause increased microtexture in the winter and early spring. Furthermore, Henry has observed that summertime operations wear the aggregate and reduce the microtexture. It is logical to conclude that not only would these wintertime operations increase microtexture and actual contact area, but they would also provide fresh, high-energy surfaces.

Henry has also observed that poor friction performance often results after a long lack of rain. Surface contamination would likely bind the surface energy of the aggregate and tend to lubricate the interface. Henry has also observed temperature-related changes in skid resistance.

CONCEPTUAL MODEL

As discussed earlier, friction can be conceived as a rate-based measure of energy transfer across an interface. Consider the path diagram in figure 1 for a general braking maneuver with a locked wheel. In figure 1, K_1 and K_2 are properties of the interface, and the model is specified by the equations:

$$\text{Final Mechanical Energy} = K_1 * \text{Initial Mechanical Energy} \quad (2)$$

$$\text{Waste Energy Generated} = K_2 * \text{Initial Mechanical Energy} \quad (3)$$

The relationship between K_1 and K_2 is defined as follows:

$$K_1 + K_2 = 1 \text{ (by conservation of energy)} \quad (4)$$

The relationship of K_1 to K_2 is governed by the properties of the interface, but for the general system, it is expected that K_2 is highly correlated with the 64 kilometers-per-hour (km/h) (40 miles-per-hour (mi/h)) skid number.

K_2 is obviously a function of many variables, including but not limited to coarse and fine aggregate properties and gradations, traffic loading, pavement age, geometric conditions such as grade and degree of curve, surface contamination, mixture-related problems such as bleeding and stripping, sliding velocity, and tire properties.

However, the variables listed above are not expected to be the primary causes of seasonal variations. It is expected that intense winter weather operations will increase frictional performance as snowplows and snow tires roughen the surface, exposing newer, cleaner surfaces and increasing microtexture.

In a locked-wheel test, assuming that all kinetic energy is converted to heat at the tire-pavement interface, it follows that energy will be vented directly into the pavement or into the tire as junctions formed at the interface rupture. If the pavement is cool, heat can enter the pavement at a rapid rate, but if the pavement is hot, more heat must enter the tire. The damping properties of the rubber (particularly at the interface) will change so that less energy is dissipated in straining and releasing the tire, lessening the ability of the tire to accept energy throughout the remainder of the test. This phenomenon is observed in time plots of friction tests with initially high peak performance that degrades as the test continues. If there is less heat sink available in the pavement and in the tire, then more energy will be forced to stay in the form of vehicular kinetic energy. Reduced friction performance should then be observed.

For these reasons, the investigation will explain only the effects of snow removal and other winter weather operations and the effects of temperature on the frictional system.

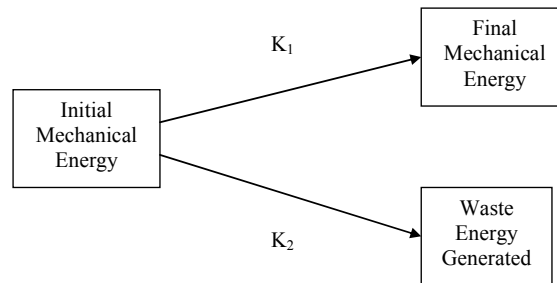

Figure 1. Conceptual model of frictional processes.

DATA COLLECTION AND MANAGEMENT

The benefit of DataPave to the research effort is tremendous. It allows researchers to conduct investigations of their choosing without spending time, money, and effort to design and execute a controlled experiment. For this reason, the investigation will use the DataPave 3.0 data.

The sections included in the study are found in the GPS-1, GPS-2, and GPS-6 studies in the DataPave 3.0 database because they contain only conventional and full-depth asphalt concrete pavement sections. Because strains are distributed much differently in an asphalt concrete

overlay of PCC pavements, overlays have been excluded from the study. PCC sections, which have very different surface and mechanical properties, have also been excluded.

Because very little petrographical data existed for these sections, the data were parsed by coarse aggregate bulk specific gravity with hopes of excluding aggregates that do not have high silica content. Crowley has noticed the importance of the chain-like structure of silica tetrahedra to good frictional performance.⁽⁸⁾ He speculates that the release of the adhesive bonds at the tire-pavement interface not only excites the polymer chains of the tire, but also likely excites the silica chains in the aggregate as well. For this reason, the bulk specific gravity of the uppermost layer was required to be between 2.60 and 2.70, as found in the DataPave INV_PMA module. The parsing process may still allow for the inclusion of some nonsiliceous material in the sample, but should exclude pure calcite with a bulk specific gravity of 2.72 and also exclude dolostones with a specific gravity of approximately 2.85. These are the two most common nonsiliceous materials used in highway construction.

The skid test information for the sections selected was extracted from the MON_FRICTION module, and latitude and longitude for each section was extracted from the INV_ID module. The information in the MON_FRICTION module included the skid number at the beginning and end of each section. Most records provided ambient air temperature. Skid tests that were not performed according to ASTM E274, *Standard Test Method for Skid Resistance of Paved Surfaces Using a Full-Scale Tire*, with the standard ribbed tire were excluded, as were any tests for which the exact day was not known. Tests not performed at 64 km/h (40 mi/h) are excluded from consideration. Only the skid numbers taken at the beginning of each section are used.

The nearest National Oceanic and Atmospheric Administration weather station in operation during the testing time period was selected for each site. The corresponding weather data for the 6 months before the test day were extracted from the National Climatic Data Center's National Virtual Data System for each skid test. The information missing from the nearest weather station was either assumed on the basis of other information available or inferred from another nearby weather station. The variables extracted from the National Virtual Data System include 180-day snowfall, maximum temperature on the day of the test, and minimum temperature on the day of the test.

The 78 sites selected are in 28 States. Together, 263 skid tests were used in the analysis. The maximum skid number reported was 74 and the minimum was 16. The 25th percentile skid number was 44 and the 75th percentile skid number was 51. The mean and median skid number was 47, with a standard deviation of 8.25. The mode was 46. The skid numbers have a symmetric distribution. Figure 2 shows the distribution of the skid numbers.

Skid Number Frequency Distribution

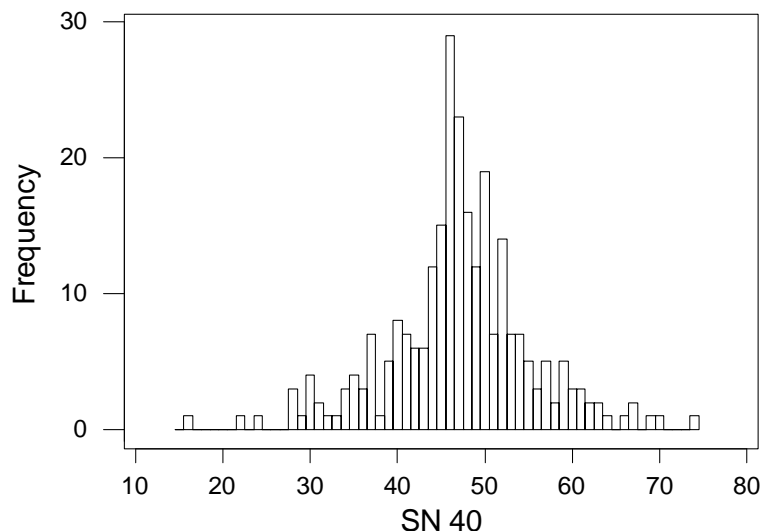

Figure 2. Skid number frequency distribution.

RESEARCH METHODOLOGY

The problem of highway skid resistance is highly multidimensional. Many factors are expected to contribute to the frictional performance; some of these factors are naturally correlated with each other. For instance, heavy snowfall is expected to occur in colder climates. For this reason, if one were to examine the correlation between the skid number and snowfall as well as the correlation between the skid number and temperature, both might be significant. But whether either is causal is left unresolved. Numerically, it is difficult to assess the causality of the system, but if one uses graphical techniques, it is possible to quickly and easily distinguish whether one of these effects is not causal.

This research includes two analyses of the data compiled. First, the data were examined visually by use of contour plots to see which, if any, of the factors are significant. In the visual procedure, two plots have been used. The first plot is a post plot, which shows the location of the data points under consideration. The purpose of the post plot is to indicate contours that lie in an unpopulated region and are based on dispersed information; they are thus less stable indicators of underlying trends.

The second plot is a contour plot in which the elevations of the contour lines correspond with the skid number. The purpose of the contour plot is to enable the researcher to discern subtleties in the data. A main effect of a variable is shown by the slope of the plot in the direction of its axis. Slope in a direction not along either axis signifies a joint effect of two variables. The researcher may also find points that are unusually high or low relative to their respective cohort groups. These points are likely outliers on axes not included in the factor pairing. The outliers are not a problem, but rather the most informative points. As an aid in visually identifying the trends and outliers, contours corresponding to skid numbers of 40 and below are colored red, and contours

corresponding to skid numbers of 50 and above are colored blue. Contours between 40 and 50 are colored green. These techniques allow the researcher to find patterns too complex for a computer to find.

After a thorough visual exploration, the data were numerically modeled using structural equations modeling (SEM). SEM is a tool developed by social scientists needing the ability to model the effects of concepts that they could not measure directly and is applicable to problems in scientific data analysis. SEM explains the covariance structure observed in the manifest variables with the use of latent variables. Latent variables are hypothetical constructs for which no operational methods for direct measurement exist. The purpose of SEM is to see whether the causal structure seen in several manifest variables can be described as the product of a few latent variables. SEM allows researchers to test hypotheses on causal processes.⁽⁹⁾

SEM involves creating a mathematical model to explain the covariance structure in the data. These models can be summarized with the equation:

$$data = model + residual \quad (5)$$

Structural equations models depend on the assumption of conditional independence, which states that given the values of the latent variables, the manifest variables are independent of one another. The assumption of conditional independence implies that the latent variables produce the observed relationships among the manifest variables.⁽⁹⁾

Structural equations models can be represented by path diagrams on which manifest variables are shown as rectangles and latent variables are shown as ovals. Arrows, or paths, show the relationships between the variables. The value associated with each path is the value of Pearson's r for the correlation, which is also the standardized regression weight. Disturbance terms are added to the manifest variables to represent the residuals unexplained by the model. The values of the regression slopes and the variances of the disturbance terms can be estimated using software such as Amos™.

It is possible to test the significance of the regression parameters. In this process, Amos uses a bootstrap method in which the data set is sampled with replacement and the model is fit to the samples generated. From these samples, Amos can estimate the standard error of the regression slope and can return a critical ratio, which is the slope divided by its standard error. The critical ratio is a t -statistic for which the area of the tail of the t -distribution for the N minus p degrees of freedom is the probability that the regression slope is zero. In this test, N is the number of observations and p is the number of manifest variables. The area under the tail is commonly referred to as the P -value.

In this case, Amos was required to perform an analysis with incomplete data. Incomplete cases were excluded in pairs, meaning that the covariance of any two variables is computed using only the complete pairs of data common to the two variables.

VISUAL ANALYSIS

The two types of factor pairings examined were the pairing of 180-day snowfall and temperature measures, and the pairing of ambient air temperature and deviations from temperature extremes.

The plot of air temperature and 180-day snowfall in figure 3 shows that no main effect is associated with the snowfall axis. A main effect, however, is associated with the temperature axis. The absence of the effect of snowfall is further shown by the profile of the response surface of figure 4, taken at 15.56 °C (60 °F). On the other hand, the presence of a temperature effect is shown in figure 5, a profile of the same response surface taken at 2.7 centimeters (cm) (5 inches) of 180-day snowfall.

Significant organization of the data is also associated with plots of air temperature and minimum temperature on the day of the test minus air temperature, shown in figures 6 and 7. On these plots, lines of constant minimum temperature run from the upper left corner to the lower right corner, creating minimum temperature axes running from the lower left corner to the upper right corner. The plots segregate the points of poor and excellent performance along these minimum temperature axes. The poor performers have accumulated largely on the upper right side of the graphs, in the direction of higher minimum temperatures, and the excellent performers have accumulated largely on the lower left side.

The visual analysis of the data reveals no evidence of seasonal variations in skid resistance associated with snowfall removal operations and gives evidence of the existence of an independent temperature effect.

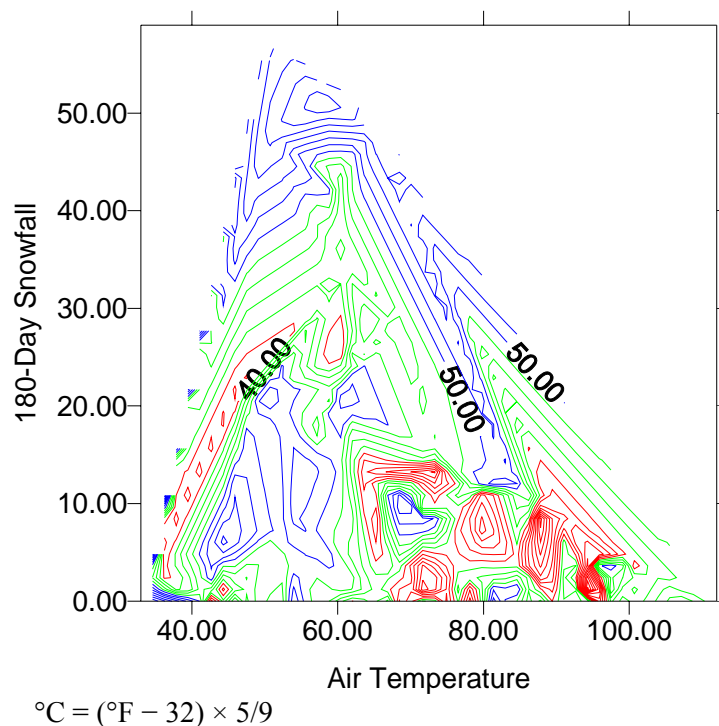
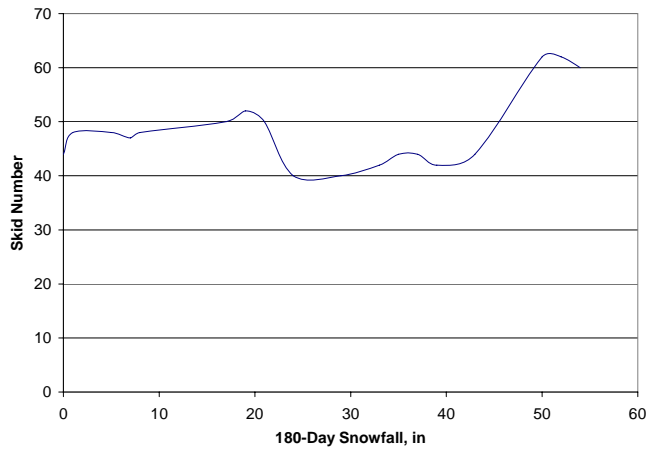
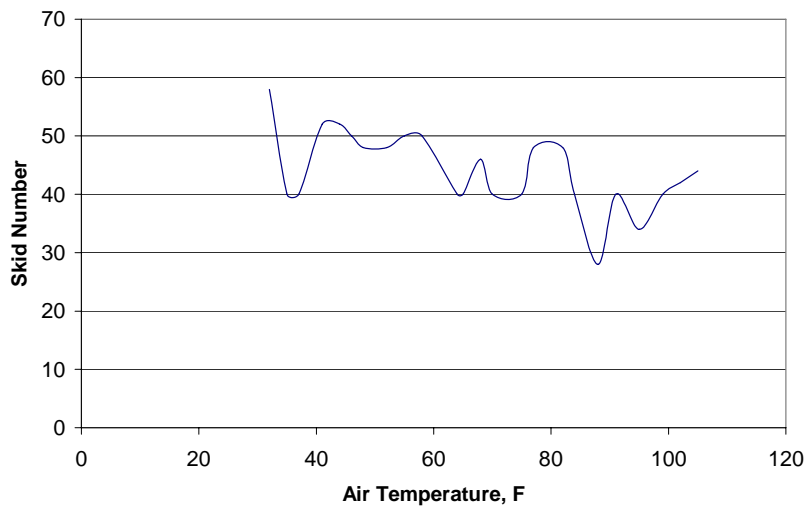

Figure 3. Contour plot of skid number versus air temperature and 180-day snowfall.



1 inch = 2.54 cm

Figure 4. Skid number versus 180-day snowfall.



$$^{\circ}\text{C} = (^{\circ}\text{F} - 32) \times 5/9$$

Figure 5. Skid number versus air temperature.

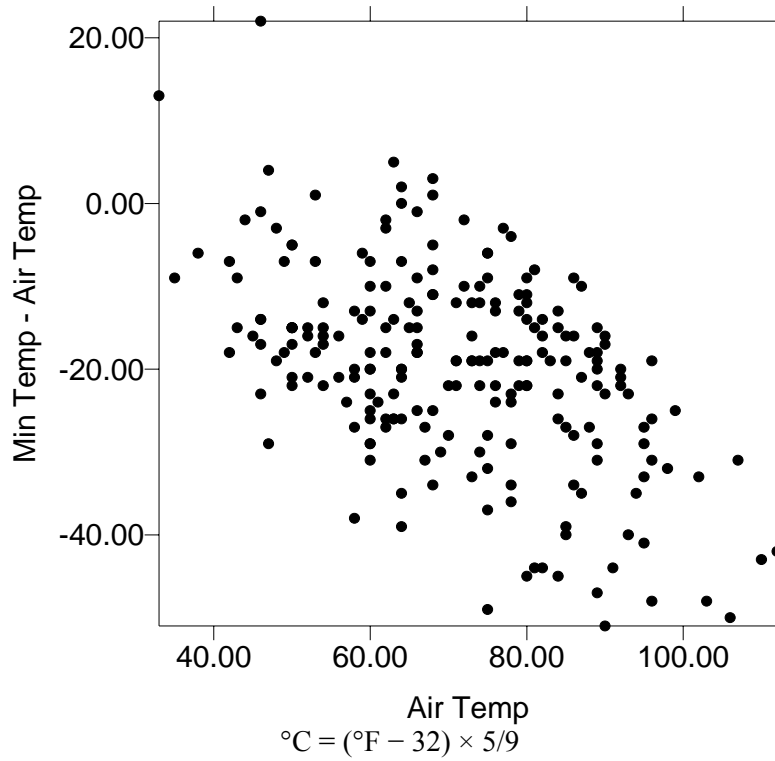

Figure 6. Post plot of skid number versus air temperature and minimum temperature minus air temperature.

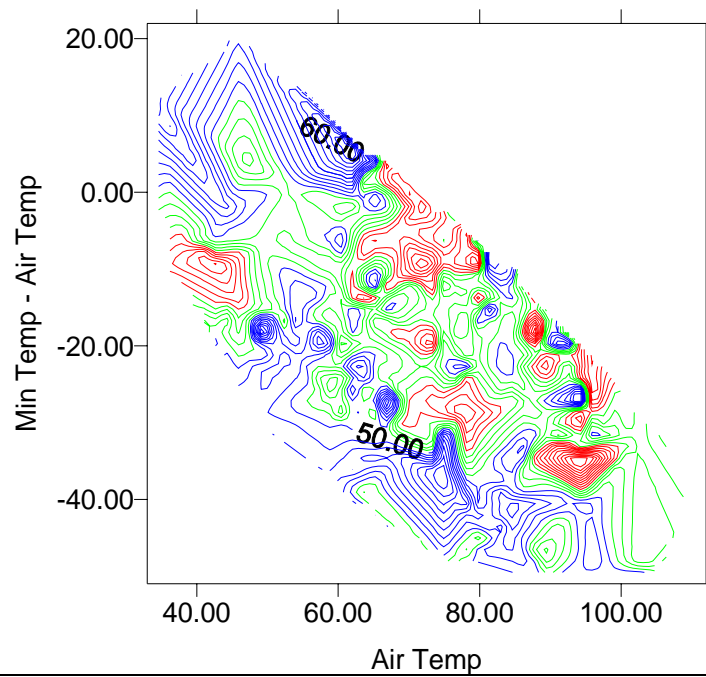

Figure 7. Contour plot of skid number versus air temperature and minimum temperature minus air temperature.

NUMERICAL RESULTS

The numerical exploration process involved fitting two structural equations models in light of the results of the visual analysis. The two structural equations models involved one latent variable called “energy transfer.” The manifest variables are assumed to be a reflection of this latent variable. The first structural equations model specified the skid number, maximum temperature, minimum temperature, and air temperature as linear functions of the single latent variable. The second model specified the same variables as the first, but included 180-day snowfall. The path diagrams for the structural equations models are shown in figures 8 and 9.

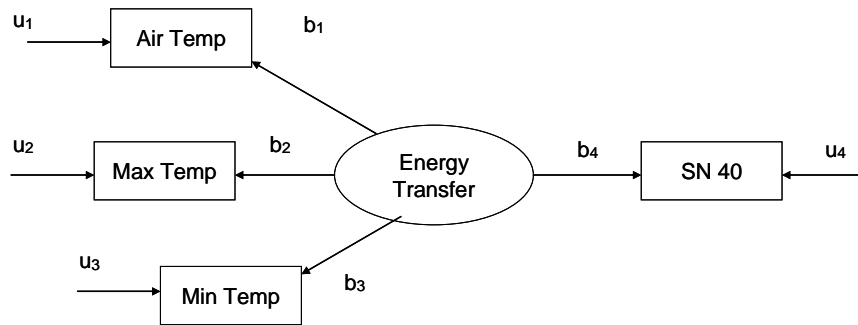

Figure 8. “Temperature alone” structural equations model.

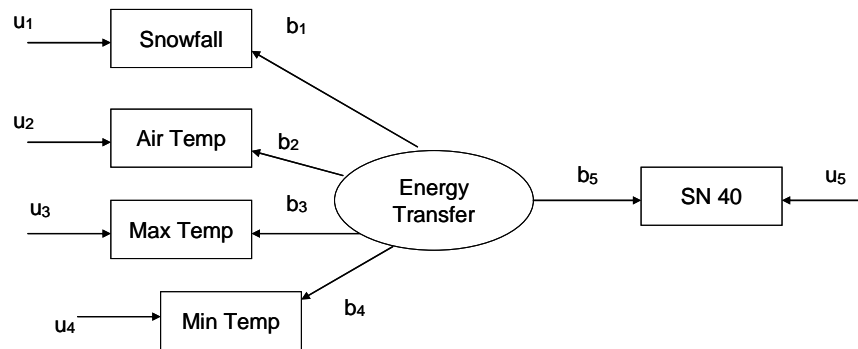

Figure 9. “Temperature and snowfall” structural equations model.

The results of the modeling process are shown in tables 1 and 2. The structural equations model without snowfall yielded path coefficients that were all significant beyond the 99.9 percent confidence level. Although the path between energy transfer and skid number is negative, the paths between the energy transfer and the temperature variables were all positive, indicating an inverse relationship between temperature and skid number.

The model could account for 5.7 percent of the variance in skid number. This means a central construct is reflected in the manifest variables and is a part of a much larger factor structure. This construct is a measure of the ability of the pavement to accept energy in the frictional process.

The addition of the snowfall variable did not increase the correlation between the latent variable energy transfer and the skid number. Although all paths were significant in the model, the correlation between the skid number and the 180-day snowfall was 0.055 and the R-square of the model for the skid number was still 0.057. This means that the addition of the snowfall variable added no descriptive power to the model. These results reaffirm the previous observations made in the contour plots and previous structural equations models that snowfall does not account for the organization in the data.

MODEL VALIDATION

The Virginia Department of Transportation (VDOT) currently applies a seasonal deduction to the skid test measurements it takes.⁽¹⁰⁾ To validate the model developed through the investigation of the DataPave data, monthly correction factors for Richmond, VA, have been developed and compared with the seasonal adjustments VDOT now uses.

From the defining structural equations of the model in figure 9 and the results in table 1, the following relationship with standardized slope is derived between temperature and skid number:

$$SN\ 40 = 0.247 (Max\ Temp) \quad (6)$$

In unstandardized form:

$$Change\ in\ SN\ 40 = 0.138 (Max\ Temp) \quad (7)$$

with *SN 40* in skid numbers and *Max Temp* in degrees Fahrenheit.

Using this relationship and climate normals for Richmond, a set of seasonal deductions is developed.⁽¹¹⁾ These deductions and the VDOT deductions are shown in table 3. There is agreement between the two sets of correction factors, signifying that the model is able to replicate the currently used seasonal corrections. The calculated corrections are somewhat higher than the in-place VDOT corrections. This is likely because of the exclusion of PCC pavements from the data used to develop the model.

Table 1. “Temperature alone” structural equations model.

Regression Weights							
			Estimate	S.E.	C.R.	P	Label
Max		Energy					
Temp	←	Transfer	14.21	0.71	20.025	0.000	b2
		Energy					
SN 40	←	Transfer	-1.965	0.515	-3.816	0.000	b4
Air		Energy					
Temp	←	Transfer	11.926	0.878	13.582	0.000	b1
Min		Energy					
Temp	←	Transfer	12.348	0.706	17.484	0.000	b3
Standardized Regression Weights							
			Estimate				
Max		Energy					
Temp	←	Transfer	0.964				
		Energy					
SN 40	←	Transfer	-0.239				
Air		Energy					
Temp	←	Transfer	0.768				
Min		Energy					
Temp	←	Transfer	0.884				
Intercepts							
			Estimate	S.E.	C.R.	P	
		Air Temp	70.909	1	70.921	0.000	
		Min Temp	51.133	0.863	59.236	0.000	
		SN 40	47.027	0.508	92.498	0.000	
		Max Temp	74.46	0.911	81.728	0.000	
Variances							
			Estimate	S.E.	C.R.	P	
		Energy					
		Transfer	1				
		u1	98.805	10.643	9.283	0.000	
		u3	42.763	6.415	6.666	0.000	
		u4	63.861	5.599	11.406	0.000	
		u2	15.54	7.029	2.211	0.027	
Squared Multiple Correlations							
			Estimate				
		Air Temp	0.590				
		Max Temp	0.929				
		Min Temp	0.781				
		SN 40	0.057				

S.E. – Standard Error

C.R. – Critical Ratio

P – P-Value

Table 2. “Temperature and snowfall” structural equations model.

Regression Weights							
			Estimate	S.E	C.R.	P	Label
Max Temp	←	Energy Transfer	14.15	0.709	19.946	0.000	b2
SN 40	←	Energy Transfer	-1.967	0.516	-3.813	0.000	b5
Air Temp	←	Energy Transfer	11.963	0.876	13.65	0.000	b1
Min Temp	←	Energy Transfer	12.396	0.703	17.625	0.000	b3
Snowfall	←	Energy Transfer	-2.321	0.629	-3.693	0.000	b4
Standardized Regression Weights							
			Estimate				
Max Temp	←	Energy Transfer	0.960				
SN 40	←	Energy Transfer	-0.239				
Air Temp	←	Energy Transfer	0.771				
Min Temp	←	Energy Transfer	0.887				
Snowfall	←	Energy Transfer	-0.232				
Intercepts							
			Estimate	S.E.	C.R.	P	
		Air Temp	70.917	1	70.94	0.000	
		Min Temp	51.133	0.863	59.236	0.000	
		SN 40	47.027	0.508	92.498	0.000	
		Max Temp	74.460	0.911	81.728	0.000	
		Snowfall	3.932	0.619	6.351	0.000	
Variances							
			Estimate	S.E.	C.R.	P	
		Energy Transfer	1				
		u1	97.878	10.55	9.278	0.000	
		u3	41.573	6.28	6.620	0.000	
		u5	63.853	5.60	11.403	0.000	
		u2	17.256	6.824	2.529	0.011	
		u4	95.008	8.33	11.406	0.000	
Squared Multiple Correlations							
			Estimate				
		Snowfall	0.054				
		Air Temp	0.594				
		Max Temp	0.921				
		Min Temp	0.787				
		SN 40	0.057				

Table 3. Calculated skid number reductions.

Month	Model	VDOT
January	5.8	3.7
February	5.2	3.7
March	4.0	3.1
April	2.6	1.7
May	1.6	0.7
June	0.5	0.3
July	0.0	0.0
August	0.2	0.0
September	1.1	0.6
October	2.5	1.7
November	3.8	3.1
December	5.2	3.7

CONCLUSIONS AND SUGGESTIONS

The investigation of the friction data selected has shown that the seasonal variations in the data set cannot be attributed to snowfall removal and winter weather highway operations. However, it is likely that temperature-related effects create the seasonal variations observed in the data set. This result is significant because it implies that seasonal variations in pavement friction depend on variables not related to surface texture. The observations support prior assertions that the release of energy through hysteresis and adhesion is the principal cause of tire friction.

Temperature-related effects accounted for approximately 5.7 percent of the total variance in the skid numbers, and these effects are statistically significant. These results imply that temperature effects are part of a much larger factor structure. Further investigations performed in a similar manner should reveal more fully the impact of factors such as aggregate size and properties, wear, rainfall and surface contamination, tire properties, and the amount of water present. These investigatory techniques can also be applied to DataPave structural data with good result.

REFERENCES

1. Transportation Research Board Long-Term Pavement Performance Committee. (2001). *Fulfilling the Promise of Better Roads: A Report of the TRB Long-Term Pavement Performance Committee*. Transportation Research Board, Washington, DC.
2. Feynman, R. (1995). *Six Easy Pieces: Essentials of Physics Explained by its Most Brilliant Teacher*. Originally prepared for publication by Robert B. Leighton and Matthew Sands, new introduction by Paul Davies. Reading, MA: Helix Books.
3. Kummer, H. (1966). *Unified Theory of Rubber and Tire Friction: Engineering Research Bulletin B-94*. Pennsylvania State University, State College, PA.
4. Autumn, K., Sitti, M., Liang, Y., et al. (2002). "Evidence for van der Waals Adhesion in Gecko Setae." *Proceedings of the National Academy of Sciences*, vol. 99, no.19. Washington, DC.
5. Rabinowicz, E.R. (1995). *Friction and Wear of Materials* (2nd ed.). New York: John Wiley and Sons.
6. Burchett, J. and Rizenbergs R. (1980). "Seasonal Variations in the Skid Resistance of Pavements in Kentucky." *Transportation Research Record*, Transportation Research Board, Washington, DC. 788, 6–14.
7. Henry, J., and Saito, K. (1983). "Mechanistic Model for Seasonal Variations in Skid Resistance." *Transportation Research Record*, Transportation Research Board, Washington, DC. 946, 29-38.
8. Crowley, L. (2001). *Skid Resistance of Asphalt Wearing Courses Made With Limestone Aggregates*. Alabama Department of Transportation, Montgomery, AL.
9. Everitt, B. (1984). *An Introduction to Latent Variable Models*. London: Chapman and Hall.

10. Henry, J. (2000). *National Cooperative Highway Research Program Synthesis 291: Evaluation of Pavement Friction Characteristics*. Transportation Research Board, Washington, DC.
11. National Climatic Data Center. (2002). "Monthly Station Normals of Temperature, Precipitation, and Heating and Cooling Degree Days 1971–2000." *Climatology of the United States No. 81, 44 Virginia*. Asheville, NC.

PAPER 4: ASSESSMENT OF OVERLAY ROUGHNESS IN THE LTPP—A CANADIAN CASE STUDY

James T. Smith, B.A.Sc.
University of Waterloo
Waterloo, Ontario, Canada,

Faculty Advisor
Susan L. Tighe, Ph.D., P.E.
University of Waterloo
Waterloo, Ontario, Canada

ABSTRACT

This paper studies asphalt pavement overlay performance in the Canadian environment. It investigates the impact of asphalt overlay thickness, climatic zone, and subgrade type on the progression of roughness as described by the International Roughness Index (IRI). Data from the Canadian Long-Term Pavement Performance (LTPP) program test sites were analyzed. Through the investigation, pavement factors that significantly impact overlay performance in the Canadian environment can be identified.

Data collected over the first 13 years of study were used to show national and provincial roughness trends from 53 test sites. The IRI data were statistically summarized (mean, standard deviation) for each category by the age of the overlay section. Using the summarized data, regression analysis was used to determine an equation that best describes the progression of roughness. Two-factor analysis of variance was used to determine any significant differences within specific categories. The results of the regression analysis were compared to the Canadian Strategic Highway Research Program (C-SHRP) LTPP data to confirm the validity of the roughness progression equations.

Results show that overlay thickness and climatic zones significantly impact roughness, while subgrade type has little influence on the IRI values. The roughness progression equations achieved squared correlation coefficients (R^2) between 0.93 and 0.39, demonstrating the accuracy of the model equations.

INTRODUCTION

In 1987, as part of a comprehensive 20-year study of inservice pavements, the Long-Term Pavement Performance (LTPP) program was initiated. The purpose of this program was to develop an understanding of why some pavements perform better than others and how to maintain a cost-effective highway system.⁽¹⁾ The LTPP program monitors 107 test sections in Canada. At each site, data on distress, roughness, structural capacity, traffic, and other pavement performance measures were collected.

The individual test sites are identified by a climatic zone, overlay thickness, and subgrade. Figure 1 and Table 1 shows the distribution and identification numbers of the 53 test sites in the LTPP study that have overlays and are included in the data analysis for this paper.

The International Roughness Index (IRI) is a measurement scale to evaluate pavement roughness. The index is based on the result from a response-type road roughness measuring system (RTRRMS) to the longitudinal profile of the road surface. The profile captures the movement between the axle and vehicle body in response to the motion of the vehicle traveling down the pavement surface at 80 kilometers per hour (km/h).⁽²⁾

IRI is measured in units of meters per kilometer (m/km). An absolutely perfect pavement profile, one with no vertical displacements, has an IRI value equal to 0 m/km. As the index value increases, the smoothness of the road decreases. There is no maximum limit to the scale; however, IRI values greater than 8 m/km are classified as damaged pavements or rough, unpaved roads. At an IRI value greater than 2.15 m/km, pavements are in poor condition and become uncomfortable at speeds greater than 80 km/h.

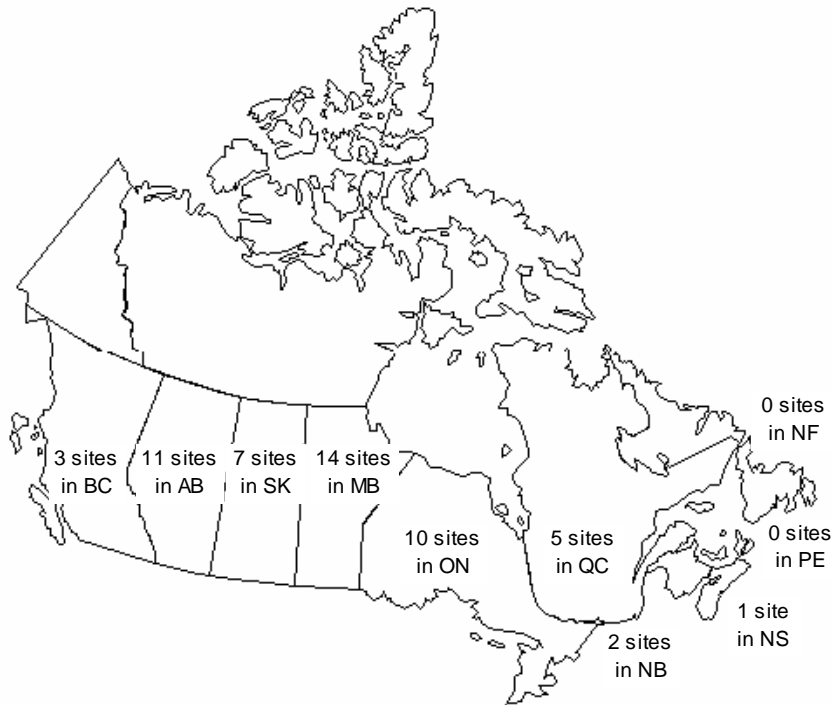

Figure 1. Distribution of LTPP test sites.

Table 1. LTPP test site identification numbers.

BC	AB	SK	MB	ON	QC	NB	PE	NS	NF
82-1005	81-502	90-6405	83-502	87-1620	89-1021	84-1684		86-6802	
82-6006	81-503	90-6410	83-503	87-1622	89-1125	84-6804			
82-6007	81-504	90-6412	83-504	87-1680	89-1127				
	81-505	90-6420	83-505	87-1806	89-9018				
	81-506	90-6801	83-506	87-2811	89-A310				
	81-507	90-A310	83-507	87-2812					
	81-508	90-B310	83-508	87-A310					
	81-509		83-509	87-A311					
	81-1804		83-3802	87-B310					
	81-1895		83-6450	87-B311					
	81-8529		83-6451						
			83-6452						
			83-6454						
			83-A310						

SCOPE AND OBJECTIVES

This paper analyzes the relationship between pavement performance measured by IRI and the age of the asphalt pavement overlay. All data used in the analysis was extracted from the LTPP Information Management System’s DataPave Online Release 15.

Based on this extraction, the following analysis was carried out:

- National and provincial roughness trends were summarized.

- The effect of climatic zones (wet-freeze, wet-no freeze, and dry-freeze) on roughness progression was analyzed.
- The effect of overlay thicknesses (30 to 60 millimeters (mm), 60 to 100 mm, and 100 to 185 mm) on roughness progression was analyzed.
- The effect of subgrade types (coarse and fine) on roughness progression was analyzed.
- The LTPP results were compared to the Canadian Strategic Highway Research Program (C-SHRP) LTPP study.

Overall, the paper is directed at determining the pavement factors with the most significant impact on overlay performance in the Canadian environment.

IMPORTANCE OF IRI AS A PAVEMENT INDICATOR

Pavement roughness is the primary measure most transportation agencies use to establish the need for rehabilitation. Pavement roughness affects driving comfort, vehicle operating costs, and safety.⁽³⁾ ASTM International (originally known as the American Society for Testing and Materials) defines pavement roughness as “the deviation of the surface from a true planar surface with characteristic dimensions that affect vehicle dynamic, ride quality, dynamic loads, and drainage.”

METHODOLOGY FOR ANALYSIS

Two-way analysis of variance (ANOVA) was used to compare population means based on a simple random sample (SRS). Each population is assumed to be normal, possibly with different means and the same standard deviation. ANOVA separates the total variation of the data into variation between group means and variation within groups. The null hypothesis (H_0) states that the population means are equal. The alternative hypothesis (H_a) is true if there is any difference between the population means. If the variation between groups is large compared to the variation within the groups, there is evidence against the null hypothesis.⁽⁴⁾

Analysis was conducted using a four-step process:

1. Sample means and standard deviations were calculated for all groups.
2. Plots were made to provide an overview of the data. These plots were observed for any extreme deviations from normal.
3. Null and alternative hypotheses were formulated for each option.
4. ANOVA analysis was conducted and H_0 was accepted if $F_{\text{Calc}} \leq F_{\text{Crit}}$ or rejected if $F_{\text{Calc}} > F_{\text{Crit}}$.

NATIONAL ROUGHNESS TREND

Figure 2 is a boxplot that shows the national roughness trend from 1989 to 2002 for all Canadian test site overlays in the LTPP program. For each year, six measures are used to describe roughness. Minimum and maximum IRI values are used to illustrate the best and worst performing test sections. The mean and median are also given to describe the IRI distribution.

The first and third quartiles, which capture 50 percent of the test population, are provided to show the divergence of IRI values from the median value.

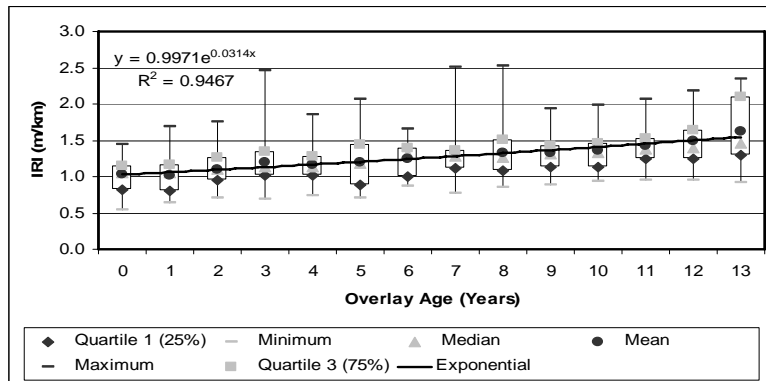

Figure 2. National IRI trends.

Figure 2 shows an increase in the overlay roughness during the study period. Over the period, the average IRI measured increased from 1.031 m/km to 1.630 m/km, representing a pavement that is still smooth and functioning properly. The difference between the first and third quartiles remained fairly constant, approximately 0.4 m/km. National roughness progression is best explained using an exponential regression, as shown by equation 1, and accurately predicts the LTPP IRI data as evidence of the squared correlation coefficient (R^2) equal to 0.9467. Using an IRI trigger level of 2.15 m/km for maintenance, rehabilitation, and reconstruction (MR&R), the average lifespan for overlays in Canada is 25 years. Note that all factors have been aggregated in this analysis. However, the results show that overlays can provide good performance.

$$IRI = 0.9971e^{0.0314(Age)} \quad (1)$$

PROVINCIAL ROUGHNESS TREND

Figure 3 shows the boxplot roughness trends for the province of Ontario. There are 6 sites and 10 test sections included in this analysis.

The provincial roughness trend shows a constant increase in the average IRI value similar to the national roughness trend. The average IRI changed from 1.076 m/km to 1.852 m/km in 8 years. The difference between the first and third quartiles did not remain constant over the study period, varying between 0.055 m/km to 0.676. Ontario roughness progression is best explained using an exponential regression equation shown by equation 2. The high R^2 value of 0.9195 shows that equation 2 accurately predicts the LTPP IRI data. An overlay in the province of Ontario has a useful life of approximately 12 years. This significantly lower service life compared to the national value could be attributed to Ontario's high traffic loads and extreme climate. Both factors could result in decreased service life because of traffic- and environment-related distresses.

$$IRI = 0.9621e^{0.0671(Age)} \quad (2)$$

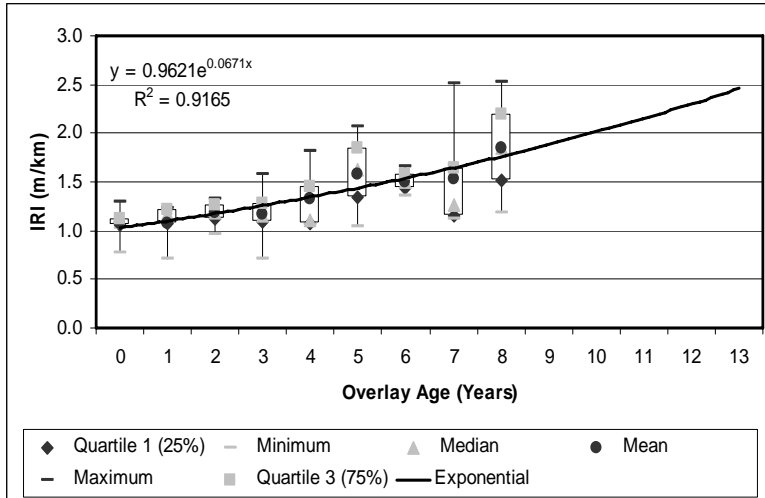

Figure 3. Ontario IRI trends.

OVERLAY THICKNESS EFFECTS

Overlay thickness is a primary consideration for pavement designers. Figure 4 illustrates the effects of overlay thickness on the progression of roughness. The overlays were divided into three categories, thin (30 to 60 mm), medium (60 to 100 mm), and thick (100 to 185 mm). Overall, this resulted in six thin overlays, two medium overlays, and three thick overlays.

During the first 8 years, the thin overlay had the greatest increase in roughness, while the changes for moderate and thick overlays remained almost identical. After the eighth year, the deterioration rate for the moderate overlay thickness was accelerated while the thick overlay increased gradually. Table 2 presents the results of the regression analysis and approximate lifespan of the overlay for all three overlay categories.

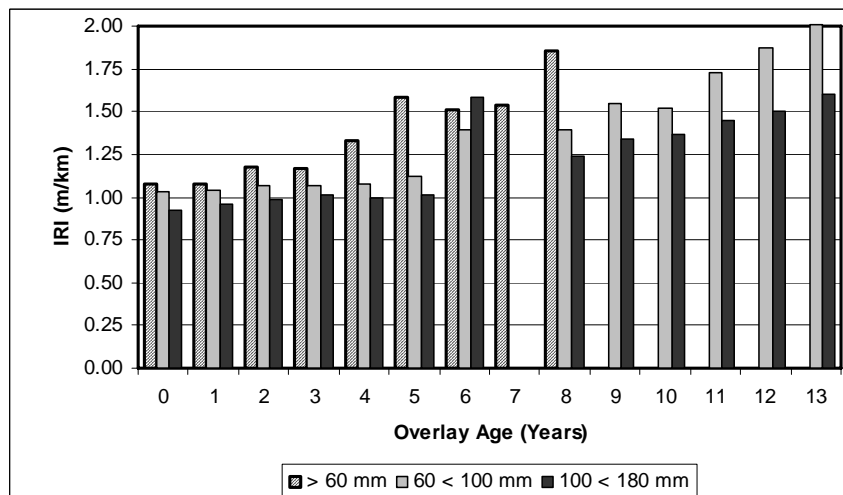

Figure 4. Effect of overlay thickness on roughness progression in wet-freeze climatic zones with fine-grained subgrades.

As the thickness of the overlay increases, the structural capacity of the pavement increases. This allows the pavement to resist deterioration and produce lower roughness values. The results must be interpreted with caution, however, because thickness cannot increase indefinitely. Correct compaction cannot be achieved if the overlay thickness becomes excessive, resulting in accelerated roughness progression due to early failure of the pavement structure.

Table 2. Overlay regression analysis.

Pavement Class	Regression Equation	R ²	N _{OBS.}	Life (Years)
Wet-freeze / Fine grained / Thin	$y = 0.0059x^2 + 0.033x + 1.0147$	0.9124	41	12
Wet-freeze / Fine grained / Medium	$y = 0.0059x^2 + 0.033x + 1.0147$	0.9719	25	16
Wet-freeze / Fine grained / Thick	$y = 0.8732e^{0.0429x}$	0.7949	37	21

A two-factor ANOVA analysis conducted at an α level of 0.05 or 95 percent showed a significant change in the IRI values over time for all overlay thicknesses. The results from the ANOVA analysis are presented in table 3.

Table 3. Overlay thickness ANOVA analysis.

Overlay Thickness	df	F _{Calculated}	F _{Critical}	Significant
Thin and Medium	1,6	7.74	5.99	Yes
Thin and Thick	1,5	13.66	6.61	Yes
Medium and Thick	1,12	12.62	4.75	Yes

CLIMATIC ZONE EFFECTS

The three climatic zones presented on the LTPP sites are wet-freeze (WF), wet-no freeze (WNF), and dry-freeze (DF). This analysis is intended to isolate the impact of climatic zone on performance. Overall, this resulted in 10 wet-freeze climatic zones, 2 wet-no freeze climatic zones, and 2 dry-freeze climatic zones. Figure 5 presents the relationship between climatic zone and roughness progression.

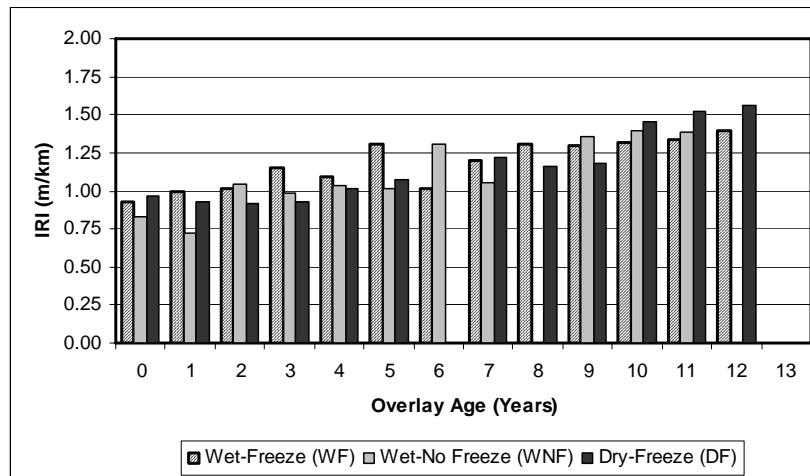

Figure 5. Effect of climatic zone on roughness progression in thin overlays with coarse-grained subgrades.

The roughness values varied widely from one year to another. This is possibly explained by the time of year the roughness data were collected. However, regardless of the time of year, dry-freeze zones exhibited the poorest performance in this study. Table 4 presents the results of the regression analysis and approximate lifespan of the overlay for the three climatic zone categories.

Roughness progression is accelerated by freeze-thaw effects and trapped water. This effect is shown by the wet-no freeze zone being the best performing zone. The presence of water did not affect roughness progression because it does not freeze in this zone and cause additional stress to and deterioration of the pavement structure.

Table 4. Climatic zone regression analysis.

Pavement Class	Regression Equation	R ²	NOBS.	Life (Years)
Wet-freeze / Coarse grained / Thin	$y = 0.0355x + 0.9319$	0.7789	72	34
Wet-no freeze / Coarse grained / Thin	$y = -0.0007x^2 + 0.0651x + 0.7301$	0.8218	17	35
Dry-freeze / Coarse grained / Thin	$y = 0.0050x^2 - 0.0156x + 0.9474$	0.9475	22	18

A two-factor ANOVA was performed to determine if the differences between the climatic zones for thin overlays on coarse-grained subgrade were statistically significant. Two-factor ANOVA analysis conducted at an α level of 0.05 showed a significant change in the IRI values over time between the wet-freeze and wet-no freeze, dry-freeze and wet-freeze climatic zones. The difference between the wet-no freeze and dry-freeze climatic zones is not statistically significant. The results from the ANOVA analysis are presented in table 5.

Table 5. Climatic zone ANOVA analysis.

Climatic Zone	df	F _{Calculated}	F _{Critical}	Significant
Wet-freeze and Wet-no freeze	1,5	8.13	6.61	Yes
Wet-freeze and Dry-freeze	1,5	7.19	6.61	Yes
Wet-no freeze and Dry-freeze	1,9	0.81	5.12	No

SUBGRADE EFFECTS

The next analysis in this research focused on examining subgrade type on pavement performance. Two categories of subgrade were used, coarse and fine. Coarse-grained subgrades are composed of sands and gravels, whereas fine-grained subgrades are composed of silts and clays.⁽⁵⁾ Overall, this resulted in two fine-grained subgrades and four coarse-grained subgrades. Figure 6 compares the effect that the roadway subgrade has on the progression of roughness.

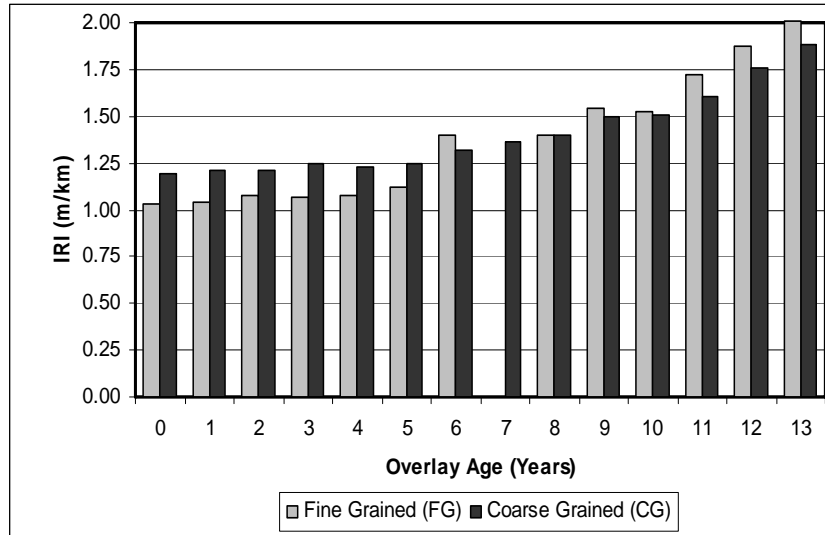

Figure 6. Effect of subgrade type on roughness progression in medium overlays with wet-freeze climatic zones.

The progression of roughness for both coarse and fine subgrades is similar. During the first 8 years, the overlay with fine-grained subgrades performed better than coarse-grained subgrades. This trend was reversed during the second half of the life cycle. Table 6 presents the results of the regression analysis and approximate lifespan of the overlay for the two subgrade categories.

Table 6. Subgrade regression analysis.

Pavement Class	Regression Equation	R ²	N _{Obs.}	Life (Years)
Wet-freeze / Fine grained / Medium	$y = 0.0054x^2 - 0.0061x + 1.0273$	0.9719	25	15
Wet-freeze / Coarse grained / Medium	$y = 0.0050x^2 - 0.0254x + 1.2357$	0.9862	41	17

Although the effect of subgrade type produced similar results for pavements in a wet-freeze climatic zone and with medium overlay thickness, special attention must be made to match the subgrade to the environmental conditions. Pavements in areas susceptible to frost should avoid fine-grained subgrades because of the problems associated with continuous freeze-thaw effects.

Two-factor ANOVA analysis conducted at an α level of 0.05 showed no significant change in the IRI values over time when comparing coarse- and fine-grained subgrades. The results from the ANOVA analysis are presented in table 7.

Table 7. Subgrade ANOVA analysis.

Subgrade Type	df	F _{Calculated}	F _{Critical}	Significant
Fine grained and Coarse grained	1,12	0.87	4.75	No

ROUGHNESS AND C-SHRP

The Canadian Strategic Highway Research Program (C-SHRP) LTPP program began in 1989, 2 years after the start of the LTPP program. The goal of the C-SHRP LTPP experiment was to

build on the LTPP program, focusing on inservice pavement performance of rehabilitated pavements over 15 years at the national and provincial levels.⁽⁶⁾

The roughness deterioration equations from the LTPP study were validated by comparing them to the roughness data taken from the C-SHRP LTPP study and the R^2 calculated.⁽⁷⁾

Figure 7 presents the comparison between the two LTPP studies for thin overlays in a wet-freeze fine-grained subgrade. The second-degree polynomial regression equation accurately predicts the C-SHRP roughness deterioration with a R^2 of 0.9346.

$$IRI = 0.0059(Age)^2 + 0.033(Age) + 1.0147 \quad (3)$$

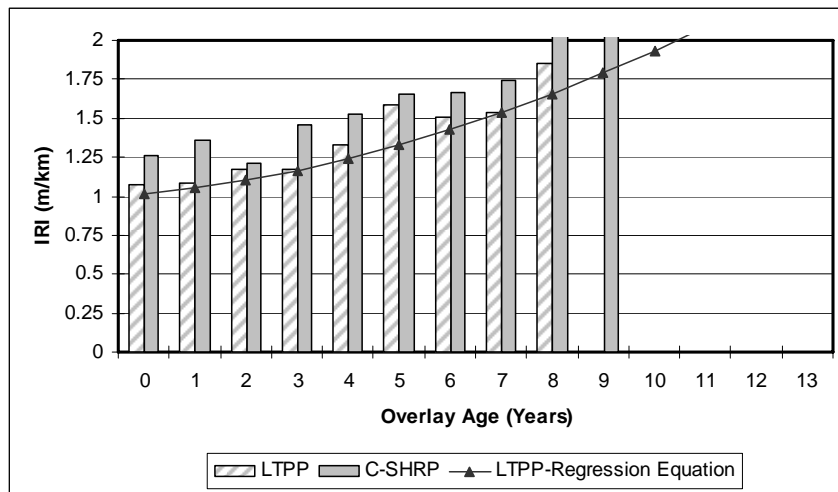

Figure 7. Roughness progression of thin overlays in wet-freeze climatic zones with fine-grained subgrades.

Figure 8 illustrates the comparison between the two LTPP studies for moderate overlays in a wet-freeze fine-grained subgrade. The second-degree polynomial regression equation accurately predicts the C-SHRP roughness deterioration with a R^2 of 0.7676.

$$IRI = 0.0054(Age)^2 - 0.0061(Age) + 1.0273 \quad (4)$$

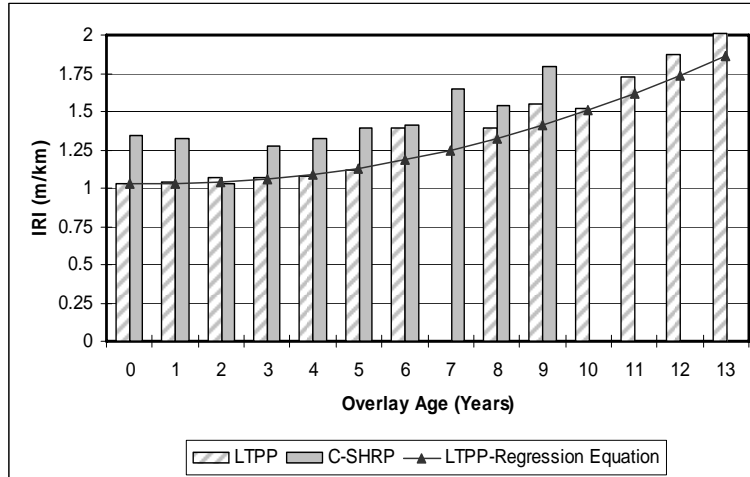

Figure 8. Roughness progression of medium overlays in wet-freeze climatic zones with fine-grained subgrades.

Figure 9 shows the comparison between the two LTPP studies for moderate overlays in a wet-freeze fine-grained subgrade. The second-degree polynomial regression equation moderately predicts the C-SHRP roughness deterioration with a R^2 of 0.3879.

$$IRI = 0.8732e^{0.0429(Age)} \quad (5)$$

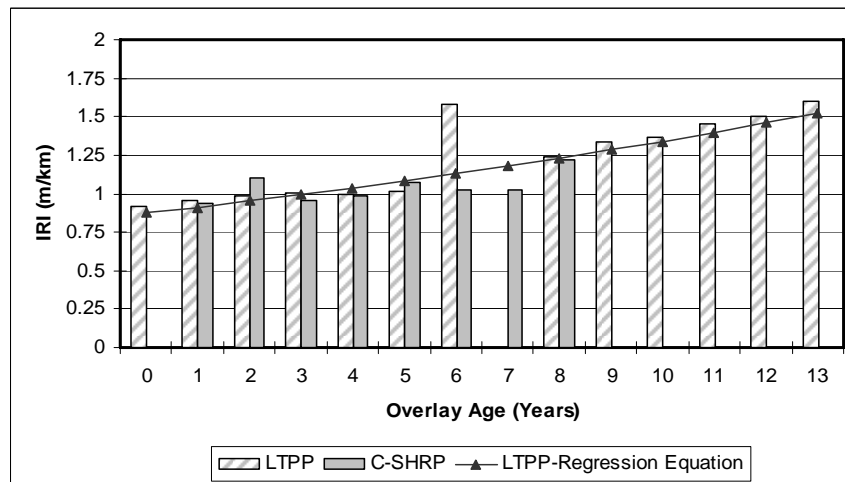

Figure 9. roughness progression of thick overlays in wet-freeze climatic zones with fine-grained subgrades.

CONCLUSIONS

The LTPP experiment data represents only the first 13 years of testing. The major conclusions and findings to date can be summarized as follows:

1. The progression of roughness on a national level increases steadily over time and is best explained using an exponential regression equation.
2. Provincial trends follow the same trends as the national average.

3. Overlay thickness and climatic zones significantly affect roughness.
 - a. As the thickness of the overlay increased, the pavement performance increased in areas characterized by wet-freeze climates and fine-grained subgrade.
 - b. Wet-no freeze climatic regions had the best pavement performance, while dry-freeze regions performed the worst for test sections with a thin overlay and coarse-grained subgrade.
4. Subgrade type has little influence on the IRI values for asphalt overlays.
5. Asphalt overlays in Canada should have a lifespan of 12 to 35 years.
6. LTPP regression equations adequately explain roughness progression for the C–SHRP sites.

RECOMMENDATIONS

This study gives an initial look at the performance of overlay roughness for Canadian LTPP test sites. Further study would be beneficial in the following areas:

1. Continue study for the remaining study period.
2. Create smaller subcategories to better describe the test section properties.
3. Investigate the potential for other performance factors (overlay type, traffic level, etc.) influencing roughness.
4. Develop a single equation to explain roughness progression that accounts for all performance factors.

REFERENCES

1. Federal Highway Administration. (2003). DataPave Online, Long-Term Pavement Performance Program, at <http://www.datapave.com>.
2. Sayers, M.W., Gillespie, T.D., and Patterson, W.D. (1986). *Guidelines for the Conduct and Calibration of Road Roughness Measurement*. World Bank Technical Paper 46. The World Bank, Washington, DC.
3. Transportation Association of Canada. (1997). *Pavement Design and Management Guide*. Ottawa, Canada.
4. Moore, D., and McCabe, G. (1996). *Introduction to the Practice of Statistics* (2nd ed.). New York: W.H. Freeman & Co.
5. Craig, R.F. (1997). *Craig's Soil Mechanics* (6th ed.). New York: E & FN Spon.
6. Tighe, S., Haas, R., and Li, N. (2001). *Overlay Performance in the Canadian Strategic Highway Program's LTPP Study*. Transportation Research Board, Washington, DC.
7. Haas, R., Li, N., and Tighe, S. (1999). *Roughness Trends at C–SHRP LTPP Sites*. Canadian Strategic Highway Research Program, Ottawa, Canada.

PAPER 5: ASSIGNMENTS WITH PURPOSE: USING LTPP FOR EDUCATING TOMORROW'S ENGINEER

Susan L. Tighe, Ph.D., P.E.
University of Waterloo
Waterloo, Ontario, Canada

ABSTRACT

The overall scope of this paper involves a university perspective on how the Long-Term Pavement Performance (LTPP) program can be used to educate and train skilled engineers in the pavement sector.

Building on a presentation at the 2003 Transportation Research Board Annual Meeting, this paper first presents a context for using the LTPP data. In formulating and addressing the use of the data, the following main points are discussed: education and training using LTPP, development of assignments with purpose, discussion of using LTPP to develop pavement research themes, and conclusions. The paper is directed primarily at academics. However, it does have relevance to the public and private sectors, as it directs assignments that will result in highly qualified people and potential leaders in the field of pavement engineering. It also recognizes the competing demands that face academics, so the assignments are intended to be straightforward and are designed for academics with limited preparation time. Overall there is a need to produce intelligent engineers with good problem-solving skills. Thus, the primary focus is to encourage independence and creativity through inquiry-based learning.

In summary, the basic premise of this paper is that good design, construction, and maintenance of long-life pavements can be realized most effectively in education and training through inquiry-based learning with LTPP.

INTRODUCTION

The broad issue of transportation education and training and the associated issues of supply and demand have existed for decades. A key motivating factor for training and educating future engineers in the transportation sector is concern about whether the transportation sector is and will be adequately served in terms of education and training, supply of skilled people, availability of resources, and future demands and commitment by both public and private agencies.

Overall, the transportation sector has many dimensions. It can be viewed by modal type, public versus private versus academic, professionals versus technologists/technicians versus operators, function ranging from engineering to financial or accounting to planning to administrative or management, supply sources, skill sets needed, breakdown of demand, remuneration levels—and the list goes on.

This paper recognizes the many dimensions of the needs of the transportation sector, while the focus remains on the academic perspective and the use of the Long-Term Pavement Performance (LTPP) program to promote transportation and more specifically to attract highly qualified people to the pavement sector.

Key Issues and Questions

The key issues related to the people side of the pavement engineering sector and the associated education and training needs can be categorized as follows:

1. Supply- and demand-related issues: adequacy of supply of trained professionals, subsector specifics, cyclic nature and cyclic offset of supply and demand, influence of the U.S. economy, remuneration and demand, incentives to pursue transportation, and succession planning.
2. Education-, training-, and skills-related issues: basic versus advanced training and education and research support, continuity of training and education, discipline choice or background, specific skill sets (technical and nontechnical) needed, and faculty resources.

Scope and Objectives

The overall scope of this paper involves a university perspective on how the LTPP program can be used to educate and train skilled engineers in the pavement sector.

This paper builds on an earlier presentation at the 2003 Transportation Research Board Annual Meeting by first presenting a context for using the LTPP data. In formulating and addressing use of the data, the following main points are discussed: education and training using LTPP, development of assignments with purpose, discussion of using LTPP to develop pavement research themes, and conclusions. The paper is directed primarily at academics. However, it does have relevance to the public and private sectors as it directs assignments that will result in highly qualified people and potential leaders in the field of pavement engineering. It also recognizes the competing demands academics face, so the assignments are intended to be straightforward and

are designed for academics with limited preparation time. Overall there is a need to produce intelligent engineers with good problem-solving skills. Thus, the primary focus is to encourage independence and creativity through inquiry-based learning.

In summary, the basic premise of this paper is that good design, construction, and maintenance of long-life pavements can be realized most effectively in education and training through inquiry-based learning with LTPP.

BACKGROUND: UNIVERSITIES AS THE UPSTREAM COMPONENT

Supply and Demand Chain

A 1972 study noted that the major supply source for skilled professionals in the transport sector and thus pavement sector was civil engineering graduates.⁽¹⁾ Since then, the number of graduates has continued to be cyclic and out of phase with economic cycles and the marketplace. The enrollments and production of civil engineers declined by about one-third over the past decade. This has occurred during a generally increasing economy, a sharply increasing infrastructure backlog that includes roads, an aging cohort of professionals in public agencies and industry, and an era of downsizing, surplus, reengineering, and strategic repositioning (all buzzwords used to try to soften the reality that layoffs, early retirements, and dismissals were involved) by transport departments. The net effect is supply and skills shortages, which already exist in a number of transport subsectors. Unfortunately, there is no magic tap to turn on or off in these situations and, even more unfortunately, the transport sector has not learned from history. Whether we will now enter a new and more enlightened era of human resource planning, including the critical component of succession planning as subsequently discussed, is at least a case for optimism.⁽²⁾

The decline in the production of civil engineers (the primary supply source for transportation professionals) has been alarming, not only in absolute numbers but also in comparison to computer, mechanical, and electrical engineers. It is also noteworthy that in 1972 civil engineering graduates composed about 21 percent of the total but now, 30 years later, that has shrunk to about 14 percent.⁽²⁾ It is also notable that civil engineering now enjoys close to 100 percent placement during its undergraduate programs. At the University of Waterloo, for example, civil engineering during the past 2 years has received work term job placements ahead of the other disciplines.

Required Skill Sets for Transportation Professionals

It is important to recognize that transportation professionals need to possess a number of skills. Again, the universities are the upstream component in equipping their students with the initial skill sets. Table 1 lists the key nontechnical, basic, and technical and special skills professionals require to carry out their work at both the network/systemwide level and the project/site-specific level. Of course, the depth of any individual skill required will vary with a number of factors, such as type of transportation network or project, size and complexity, environmental impacts, and financing.

Table 1. Required skills for transportation professionals.⁽³⁾

NETWORK/SYSTEM WIDE LEVEL		NON-TECHNICAL SKILLS					BASIC SKILLS				
		Financial Planning	Public Policy	Business Admin.	Personnel Manag.	Engineering Law	Public Relations	Computing	Data base design & manag	Statistics	Math Models
Data	Locational reference system						X	X			
	Facilities Inventory				X						
	Field monitoring & other data				X		X	X			
	Data processing						X	X	X		
	Present status reports						X	X	X		
Deficiency/ Needs	Min. levels of service		X			X					
	Max user costs		X								
	Max program costs	X	X	X							
	Needs now/future						X	X			
	Deter.predictions						X	X	X	X	
Alternative Strategies and Life Cycle Costing	Maint & rehab alternatives										
	Selection Criteria		X								
	Eng.anal.&perf.predictions						X	X	X	X	
	Life Cycle costs						X				X
	Priority analysis						X			X	X
Priorities, Programs, Schedules	Funding Levels			X			X				
	Final Capital Program	X	X	X							
	Final Maint. Program	X	X	X							
	Construct schedule	X		X			X				
	Maint. schedule						X				
	Program monitoring			X	X		X				
	Budget & financial planning	X		X			X				
PROJECT/SITE SPECIFIC LEVEL											
Data	Detailed site and other data				X		X	X	X		
	Subdivision of project						X	X	X		
	Data processing						X	X	X		
Detailed Design	Specifications								X		X
	Max. project cost	X	X								X
	Min. interruptions to service		X			X					
	Selection criteria		X								
	Alternatives & Analysis										
Construction	Lifecycle analysis & best alt.						X		X		
	Activities, control, records				X	X	X	X	X	X	
Maintenance	Built to within specifications						X				
	Maint. Activities and records					X			X	X	X
	Budget and schedule updates	X		X			X				

Table 1. Required skills for transportation professionals, *continued*.⁽³⁾

NETWORK/SYSTEM WIDE LEVEL		TECHNICAL AND SPECIAL SKILLS										
		Geotechnical Geology	Building Materials	Construction Material	Materials Testing	Field Testing	Traffic Analysis	Pavement Engineering	Bridge Engineering	Structural Engineering	Concrete Design	Construction Manag.
Data	Locational reference system	X					X	X	X			
	Facilities Inventory											
	Field monitoring & other data				X	X						
	Data processing											
	Present status reports											
Deficiency/ Needs	Min. levels of service											
	Max user costs											
	Max program costs											
	Needs now/future						X	X	X			
	Deter. predictions	X		X	X		X	X	X			
Alternative Strategies and Life Cycle Costing	Maint & rehab alternatives	X		X	X		X	X	X	X	X	X
	Selection Criteria											
	Eng. anal. & perf. predictions			X	X	X	X	X	X	X		
	Life Cycle costs							X	X			
	Priority analysis							X	X			X
Priorities, Programs, Schedules	Funding Levels							X	X			
	Final Capital Program							X	X			
	Final Maint. Program							X	X			
	Construct schedule											X
	Maint. schedule											
	Program monitoring											X
	Budget & financial planning											X
PROJECT/SITE SPECIFIC LEVEL												
Data	Detailed site and other data	X										
	Subdivision of project	X										
	Data processing											
Detailed Design	Specifications			X	X	X	X	X	X	X	X	X
	Max. project cost											
	Min. interruptions to service											
	Selection criteria											
	Alternatives & Analysis	X		X	X	X	X	X	X	X		
Construction	Lifecycle analysis & best alt.											
	Activities, control, records			X	X	X						X
Maintenance	Built to within specifications	X	X	X		X						X
	Maint. Activities and records											
	Budget and schedule updates											X

EDUCATOR TOOLS

In general, academics tend to rely on textbooks or course notes to assist with lecturing material. However, CDs, labs, computers, and various software programs can assist in the delivery of material. The advantage of using these latter forums is that it can provide students with exposure to the state of the practice. It also can enable students to work with real-world data and provide them with hands-on experience. In addition, with specific reference to the LTPP data, it provides an unlimited ability to manufacture questions. From an instructor's point of view, it allows for creativity. More specifically, students can be directed to analyze data in various ways to reinforce basic engineering concepts. Both straightforward and challenge-type questions can be developed using the extensive LTPP database. Another big advantage to incorporating LTPP into a curriculum is that it can challenge students and, if presented properly, can plant the seed for graduate studies. In the author's experience, if students are challenged it serves as a beacon for attracting the intelligent students to the area. Lastly, the use of LTPP data can be a marketing tool for pavement engineering as a profession.

ASSIGNMENTS WITH PURPOSE

Assignments using LTPP data in this paper are directed at the following courses in a typical civil engineering program:

- Introductory undergraduate transportation course assignment problems.
- Undergraduate "challenge" problems.
- Undergraduate student projects.
- Senior-level undergraduate pavement course assignment problems.
- Graduate pavement course assignment problems.

Undergraduate Transportation Course

Every civil engineering program has at least one mandatory course in transportation engineering. Ideally, this course should be delivered in a manner that attracts students to the transportation sector. It is notable that at many universities the bright students in civil engineering tend to pursue structural engineering because they believe it is a more challenging field. This further reinforces the need to present transportation in a way that sparks student interest. The challenge with the mandatory transportation course is that it covers all of the basic concepts (i.e., traffic analysis, transportation planning, geometric design, pavement engineering, etc.). Consequently, the time spent on pavement engineering is limited. However, assignment problems can be developed so that students can easily carry out an analysis. For example, if the instructor provides the LTPP Web site address with detailed instructions as shown later in this paper and sets clear expectations of what needs to be done, these problems can be both challenging and interesting. The tasks in the problem should highlight major design features, major distresses, and/or data needs for design. Ultimately, these problems can also be used to provide magnitude checks so that once engineers graduate, they will have an appreciation for typical pavement thicknesses, distresses, and various other practical aspects of pavement design and management.

For example, the following assignment problems have been developed using data from the Canadian LTPP (C-LTPP) program. This experiment, which is complementary to the LTPP program, focuses on the following design factors:

- Overlay thickness (three levels).
- Climatic zones (four types).
- Subgrade types (two types).
- Traffic levels (two levels).
- Asphalt concrete (AC) types (two types).

In one assignment, students are asked to analyze roughness progression on the various sites, as shown in figures 1 through 4. Students are given the data and asked to prepare the figures and tables that explain performance. The problems presented are built on a study carried on in 2001.⁽⁴⁾ Students are asked to comment on what the trends mean. For example, figure 1 compares the thickness effects on roughness progression among the three levels of overlay thickness. This is for the two levels of traffic, the two types of subgrade (fine and coarse), and the three types of climatic zones combined. It is clear that the thinner overlays are deteriorating at a significantly higher rate than the medium and thick overlays. The highest International Roughness Index (IRI) values after 8 years, about 1.8 meters per kilometer (m/km), occur for the lowest overlay thickness level of 30 to 60 millimeters (mm) for both high and low traffic, while the lowest IRIs after 8 years, about 1.4 m/km, occur for the highest overlay thickness level of 100 to 185 mm. However, the average IRI difference between the medium and high thickness overlays after 8 years is only 0.1 m/km. The students should provide a recommendation on the need for continued observations so that future trends can also be monitored.

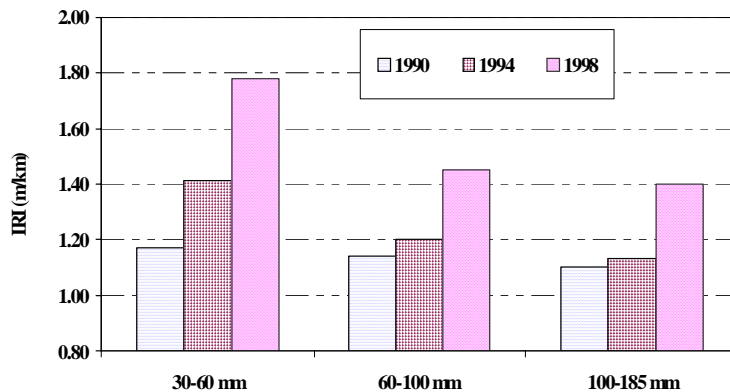

Figure 1. Effect of overlay thickness.

Figure 2 presents the overall trends of roughness progression in the three climatic zones (all levels of overlay thickness, traffic level, subgrade type, and overlay material combined). It reveals that a relatively higher rate of roughness progression takes place in wet, low-freeze zones. Roughness trends for pavements in dry, high-freeze zones are relatively flat.

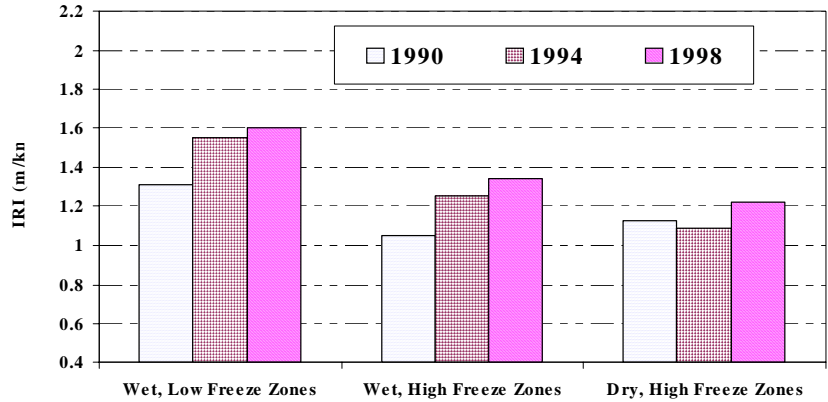

Figure 2. Effect of climatic zone.

It is apparent that the pavements with thin overlays (figure 3) deteriorate the fastest in the wet, low-freeze zones. However, the thickness effect on roughness is substantially reduced in dry, high-freeze zones. For pavements in wet, high-freeze zones, roughness levels are intermediate between the other two zones.

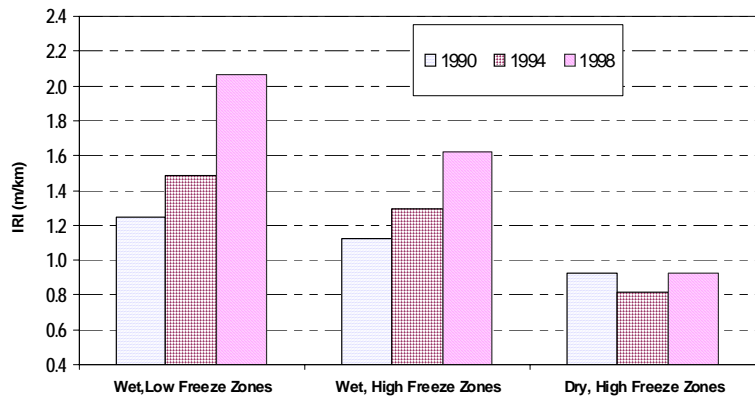

Figure 3. Roughness trends for thin overlays (30 to 60 mm) in high traffic.

Further explanation in the student's response should elaborate on the trends. More specifically, the average IRI of the thin overlays in wet, low-freeze zones increased from about 1.3 m/km (as-built in 1990) to 2.1 m/km (observed in 1998), for a net IRI increase of 0.8 m/km in 8 years. On the other hand, there is no increase in average IRI for these low-thickness overlays in dry, high-freeze zones. The average IRI of the pavements in wet, high-freeze zones increased from about 1.1 m/km (as-built in 1990) to about 1.6 m/km (observed in 1998), for a net IRI increase of about 0.5 m/km in 8 years.

Another assignment problem examines the subgrade influences on pavement performance. According to the database codes of the Canadian Strategic Highway Research Program (C-SHRP), subgrade soils are classified into two categories: fine grained and coarse grained. The coarse-grained subgrade soils include sands and gravels, while the fine-grained subgrade soils are composed mainly of silts and clays. Analyzing

the factor effects on roughness trends under various traffic, thickness, and climate conditions has shown that pavement deterioration is influenced to a considerable extent by the type of subgrade soil on which the pavement is built. Generally, pavements on fine-grained subgrade soils will deteriorate significantly faster than pavements on coarse-grained subgrade soils in terms of average IRI progression in the same time period. This factor effect is significant when examining thin overlays.

Figure 4 shows the roughness trends for thin overlays (30 to 60 mm) in wet, low-freeze zones. The effect of fine subgrade for either level of traffic is quite apparent. This might be expected because in this type of climatic zone with more moisture and freeze-thaw cycles and a lower depth of frost penetration, a thin overlay on a fine subgrade should deteriorate more rapidly. Similarly, at the high traffic level, pavements with fine-grained subgrade soils increased their average IRI by 2.5 times, compared with the pavements with coarse subgrade soils. On the other hand, the coarse subgrade sections showed comparatively less deterioration, but the rate of deterioration would still suggest (recognizing the risk of extrapolation) that even in this case a relatively short overlay life might be expected.

Overall, these questions would be directed in such a way that students could analyze data and comment on what the trends mean.

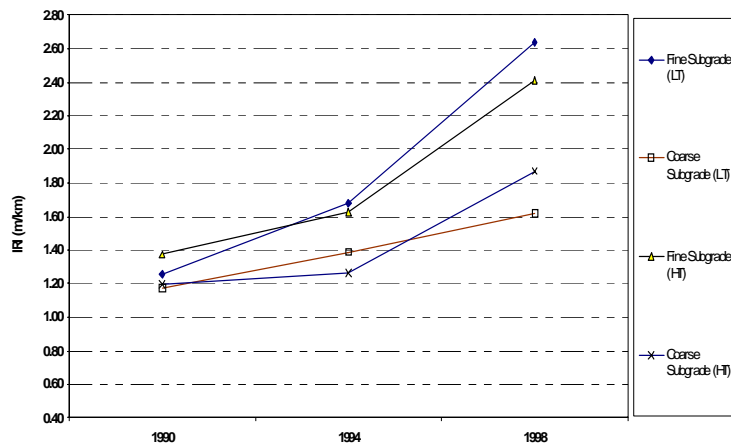

Figure 4. Roughness trends for thin overlays in wet, low-freeze zones.

Undergraduate Challenge Problems

Challenge problems also can be easily developed by using the LTPP data. These problems would be directed specifically at the top students. They involve analysis of data and must be accompanied with design recommendations and the use of statistical analysis. The students would use the data and be asked to articulate linkages to design factors. The advantage of using LTPP is that it enables the instructor to develop unlimited questions and unique problems aimed specifically at the top students in the course with the intention of planting a seed for graduate studies. For example, 2 of 87 students correctly answered an LTPP problem developed in 2002. It involved data analysis that required students to isolate design factors and come up with the

best pavement design for various climates, subgrades, pavement thicknesses, and traffic levels. It is interesting to note that the students had a very positive reaction despite the challenge.

An example of a challenge problem assignment is shown in table 2. It uses roughness data from the C-LTPP study. In this case, students are asked to determine a regression relationship between roughness progression versus time for all of the Canadian Provinces over a given time period. Table 2 summarizes the roughness trends over 8 years for the individual Provinces. It appears that climate has an influence on roughness progression in terms of the amount of IRI increase. Among the 24 test sites or 65 sections, all in Quebec and two in Ontario are classified as being in wet, high-freeze zones; all in the three prairie Provinces (Alberta, Manitoba, and Saskatchewan) are in dry, high-freeze zones; the rest are in wet, low-freeze zones.

Table 2. Changes in average IRI for individual Provinces.

Location and Climatic Zone	IRI As-built in 1989/1990			IRI in 1997			IRI in 1998			Δ IRI	
	Q ₁ ⁽²⁾	Q ₃ ⁽³⁾	Mean	Q ₁ ⁽²⁾	Q ₃ ⁽³⁾	Mean	Q ₁ ⁽²⁾	Q ₃ ⁽³⁾	Mean	In 7 Yrs.	In 8 Yrs.
AB (III)	1.148	1.281	1.220	1.240	1.386	1.344	—	—	—	0.120	—
BC (I)	0.880	1.219	1.056	1.170	1.229	1.250	—	—	—	0.190	—
MB (III)	0.876	1.262	1.103	1.264	1.436	1.336	0.976	1.180	1.179	0.233	0.076
NB (I)	1.187	1.389	1.270	1.442	1.729	1.652	1.238	1.749	1.541	0.382	0.271
NF (I)	0.930	1.531	1.231	1.134	1.544	1.320	1.044	1.566	1.350	0.089	0.119
NS (I)	1.367	1.666	1.554	1.350	1.996	1.877	1.398	2.071	1.859	0.323	0.305
ON (I, II)	0.827	1.045	0.978	1.114	1.681	1.492	1.798	2.347	2.072	0.514	1.094
PE (I)	1.108	1.203	1.158	1.330	1.735	1.546	—	—	—	0.390	—
QC (II)	1.109	1.254	1.181	1.183	1.420	1.333	2.145	3.280	2.708	0.152	1.527
SK (III)	0.882	1.127	1.002	0.964	1.184	1.162	1.046	1.329	1.273	0.160	0.271

Table 3 is provided to compare predicted and observed IRIs for seven Provinces in 1998 and three Provinces in 1999. Predicted values are determined using regression. In the case of figure 5 for Saskatchewan, the relationship is based on a (exponential) form of roughness progression data using data from 1989 to 1997 for each Province. The predicted values using the equation are then compared to the observed. The point of this exercise is to incorporate statistics and have the students examine the accelerating trends in roughness progression. Ultimately, the point is to demonstrate that the models should be recalibrated when future data becomes available.

Generally, table 3 shows that predicted and observed values are relatively close. However, there are some relatively large differences (e.g., Quebec), and this implies that continued observation of performance prediction is most important, particularly if performance prediction models for overlay design are to be developed in the future.

Table 3. Comparison of predicted and observed IRI using mean values.

Location	Predicted 1998	Observed 1998	Predicted 1999	Observed 1999
MB	1.15	1.28	1.16	1.22
NB	1.37	1.54	—	—
NF	1.38	1.35	—	—
NS	1.80	1.86	1.84	1.99
ON	1.76	2.07	—	—
QB	1.44	2.71	—	—
SK	1.27	1.24	1.4	1.27

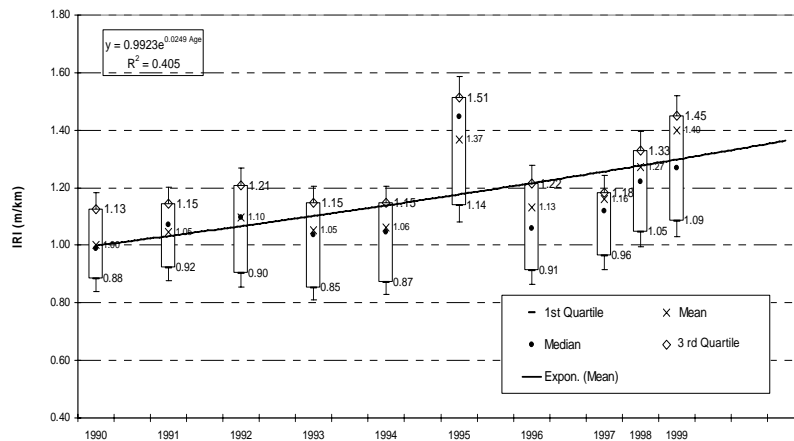

Figure 5. Observed roughness trends on sections in Saskatchewan.

Undergraduate Project Courses

These courses typically require students to work in groups on an engineering problem (junior and senior years). For example, at the University of Waterloo, two of these courses are included in the engineering curriculum. The instructor provides basic instructions for using the DataPave Online Web site. Students are required to provide a detailed proposal of how they plan to use the data and what they plan to analyze.

One project at the University of Waterloo involved a safety project in which skid numbers were assessed for selected flexible and rigid pavements. The students developed relationships between various factors in $SN=f(\text{time})$ and $IRI=f(\text{time})$. In another project course, one senior-level student validated IRI models developed for C-LTPP using LTPP data. The student used the analysis of variance (ANOVA) technique to determine if the C-LTPP data and the LTPP data were statistically different. As shown in table 4, significant differences were observed in 6 of 10 Provinces at a 95 percent confidence level between groups. This student ended up pursuing graduate studies in pavement engineering. Another aspect of this project involved identifying sources of error in the prediction model.

Table 4. Senior-level student ANOVA comparison.

	BC	AB	SK	MB	ON	QC	NB	PE	NS	NF
F_{calc}	1.30	0.76	4.06	33.68	40.14	6.46	1.12	1.20	6.78	170.42
F_{crit}	3.99	3.88	3.92	3.87	3.89	3.95	3.99	4.01	4.41	3.11
Significant	N	N	Y	Y	Y	Y	N	N	Y	Y

Senior-Level Pavement Course

A senior-level course in pavement engineering is also offered at the University of Waterloo. At this level, the students have used the data in various capacities. For example, one assignment involved comparing pavements in Ontario to pavements in California. The problem was directed at examining climatic performance, distress data, and relationship to IRI, traffic data, falling weight deflectometer (FWD) data, and environmental data. This senior-level engineering analysis included a core thickness assignment that involved calculating the variability of pavement thickness throughout a section and how this would impact the long-term performance. Then students were asked how additional traffic loads would impact the performance and ultimately how this variation would affect the structural soundness of the pavement.

Another example of an assignment related to pavement management is presented in figures 6, 7, and 8. Various sections are analyzed based on all available data with particular emphasis on distress data, roughness data, and structural data. In this case, figures 6 and 7 show the amount of transverse cracking and the extent of rut depths on the Ontario sections. Using the data, students are required to develop a needs analysis for all of the Ontario sections. The summary is presented in figure 8. Other assignment problems require students to examine the impact of poor soil conditions. As part of the assignment, students are always required to provide charts and table that reinforce their conclusions.

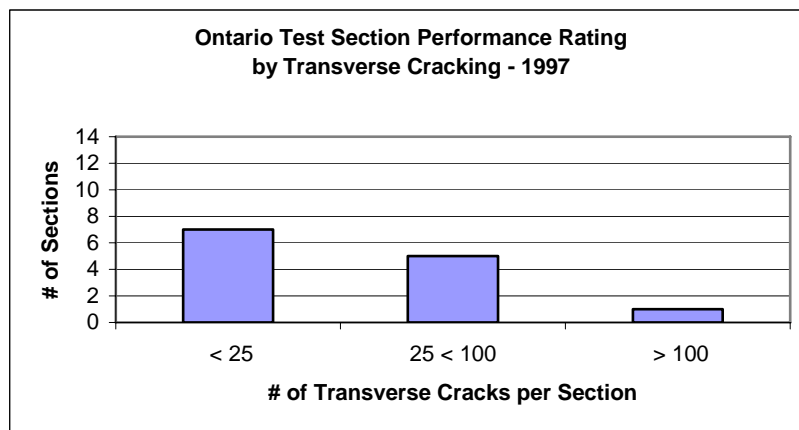

Figure 6. Transverse crack analysis.

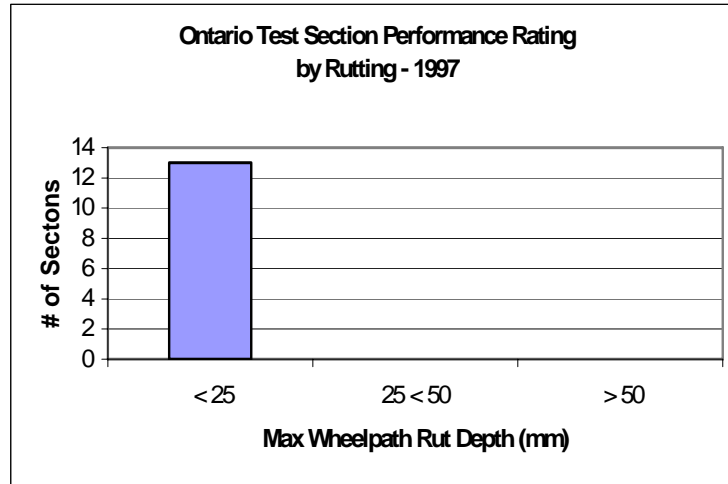

Figure 7. Rut depth analysis.

		Ranking	Section ID
Needs	Now	1	B340
		2	A310
		3	2811
		3	2812
		5	1621
Future	Needs	6	B330
		7	1622
		8	1620
		8	B320
		10	1680
		10	B310

Figure 8. Needs analysis based on LTPP data.

Graduate-Level Pavement Course

The LTPP data has been used as part of a major course assignment in a graduate-level pavement course at the University of Waterloo. This assignment has been modified based on an initial discussion with Professor Norb Delatte.⁽⁵⁾ This assignment problem is known as the “Pathfinder” assignment because there is no defined route for the students. Each student assigned a different Province or State. The student must use the LTPP data to provide senior management for that State’s or Province’s department of transportation with pavement design and management recommendations. Students are asked to address the following factors:

- Determine whether current designs are working.
- Compare designs to standards.
- Carry out statistical analysis to prove their points.
- Conduct regression, distribution, and cluster analyses.

- Provide recommendations on pavement management system (PMS) needs.
- Develop policy with the data.

The following is the actual question that was used in the 2003 Graduate-Level Pavement Engineering Course at the University of Waterloo.

This question will require you to use data available through the U.S. Long-Term Pavement Performance Program. Data is available online at www.datapave.com.

For this project you will need to analyze the performance of three LTPP sections. Analyze three sections (you select them) in the Province or State next to your name in the table below. If you have difficulty, you may use an alternative section from another Province or State. If you analyze more than three sections, bonus marks will be given.

Consider this as a consulting effort for assessing distresses. Is there a rutting problem on this section? Is there a roughness concern? If so, what is causing these problems?

The first step in using DataPave is to select the LTPP test sections of interest to the user. There are two ways of accomplishing this, by using either the visualization by location or the criteria method.⁽⁶⁾

By Location (Using Online Map)

1. Select the appropriate experiment type: general pavement studies (GPS), specific pavement studies (SPS), or seasonal monitoring program (SMP).
2. Then select the specific experiment: GPS-1, SPS-5, or SMP.
3. Then select the site-specific experiment and its State location.

Note: This selection will provide performance data for the selected LTPP section(s).

By Criteria

1. Select first the State(s) or LTPP region.
2. Select the experiment type.
3. Select parameters for climatic region, subgrade type, and other filter criteria.

Note: This selection will provide performance data for the selected LTPP section(s).

Performance trends and detailed information can be obtained using either method.

Table Export

Data extraction is possible by conducting the following steps:

1. Select “Tools/Table Export” from the menu items.
2. Select the “IMS Module” and “Table” that you want to extract data from.
3. Select the test site(s) (multiple selections are allowed by using standard keystrokes) that you want data from.
4. Click on “export.”

5. Click on “download.”

Note: A summary of the requested information is displayed in the following screen. Three additional documents can be downloaded at this time as well.

- “LTPP Data Disclaimer.”
- “LTPP Data Dictionary.”
- “LTPP Data Codes.”

You should include the following in your analysis:

- Construction (compare inventory data on layer thickness to actual layer).
- Pavement age and traffic carried.
- Current damage and roughness, including cracking as well as rutting.
- Subgrade classification and compaction (compare moisture content and density to γ_{max} , optimum moisture content (OMC)).
- Properties of each layer.
- An 8-to-10-page summary of your analysis, including appropriate figures and tables.

You must provide your analysis electronically in addition to a hard copy.

You may also want to consider the following questions:

- How does the magnitude of distress vary over the length of the section?
- How has the extent of distress varied with time?
- Do plots of transverse profiles provide any insight into what may be going on?
- Do the aggregate gradations for the AC layers avoid the Superpave® restricted zone?

The following table provides a summary of which student is responsible for each Province and State.

Table 5. Students responsible for Provinces and States.

Name	Province/State	Sections
Ishtiaque Tunio	Alberta	81
Syed Javed Iqbal	British Columbia	82
Khalid Manzar	Manitoba	84
Kehui Zhang	New Brunswick	85
Fayyaz Khan	Nova Scotia	86
Ahmad Shah	Ontario	87
Saeed Ahmad	Quebec	89
Hamid S. Mohmand	Saskatchewan	90
Iram Burhari	Colorado	8
Ignacio Davila Pazmino	Florida	12
Liaquat Ali	Georgia	13
Rafi Uddin Ahmed	Illinois	17
Syed Aqeel Ahmed	Indiana	18
Muhammad (Tariq) Mahmood	Maryland	24
Muhammad Shoaib Kiani	Massachusetts	25
Bo Lan	Michigan	26
Haroon Raza	New York	36
Rickenson Daniel	Ohio	39
Gary Tang	Oklahoma	40
Javed Iqbal	Pennsylvania	42
Aamer Shakoor	Virginia	51
	Washington	53
	Wisconsin	55

In summary, this assignment is a course highlight because it forces students to think. They are required to use the data to develop design, construction, maintenance, and inservice pavement needs. It highlights the complex nature of pavement engineering and the need to examine multiple factors to develop a construction and maintenance program.

CONTEXT

The current asset value of North American roads and pavements is huge. Protecting this investment is critically important to the movement of goods and the mobility of people. However, competing pressure for funding from other segments of society and the need to cope with more costly and diminishing materials resources, requirements for zero-waste management, and sustainability present real threats to our ability to protect the investment and offer the level of service society expects. At the same time, there is both an opportunity and a critical need to carry out the research and technology development that will advance the planning, design, construction, and operation of our roads to a new level over the coming decades.⁽⁷⁾

The LTPP data can be used to provide effective and long-term partnerships among researchers, public sector agencies, and private industry. It can be used to help promote key areas for research such as the following:

- Innovative structural and materials technologies for pavements.
- Advanced computer applications related to roads.
- Pavement construction, preservation, and sustainable development.
- Pavement and roadway safety.

CONCLUSIONS

This paper has presented several assignments for using the LTPP data in a typical civil engineering curriculum. The experiences and problems presented have been used at the University of Waterloo over the past 3 years. Overall, the following comments can be made:

- LTPP data forces students to think.
- It provides an endless source of unique problems.
- It allows for instructor and student creativity.
- It provides an opportunity to increase the talent pool of highly qualified people.
- It exposes students to the state of the practice in pavement engineering.
- It teaches critical thinking, which is an important skill for graduating engineers.
- It provides data that results in avoiding cookie-cutter assignments
- It provides students with appreciation for real-world data.

Overall, there is a need for highly qualified people in this industry. Ultimately, educators play an important role in training and educating tomorrow's engineers. Thus, there is a need to be responsible and ensure that graduates have the tools to handle technically complex problems. LTPP provides a great resource to academics to accomplish this task.

ACKNOWLEDGMENTS

The author gratefully acknowledges the students in her classes who take on these assignments with great enthusiasm. Their interest and feedback make the preparation time to develop problems worthwhile. In addition, special appreciation is extended to the LTPP staff for maintaining the Web site and making the data so readily available.

REFERENCES

1. Haas, R. (1972). *Skilled Manpower Requirements for the Canadian Transportation Industry*. Report prepared for Department of Manpower and Immigration, Ottawa, Canada.
2. Tighe, S. (2003). "Succession Planning: Is the Civil Engineering Community Up For The Challenge?" *Canadian Civil Engineer*. Toronto, Canada, April–May, 20–23.
3. Tighe, S.L., Patel, A., Haas, R., and Hudson, W. R. (1997). "Education and Training Needs for Road Infrastructure Renewal." *Proceedings of the X-III IRF World Meeting*. Toronto, Canada.

4. Tighe, S., Haas, R., and Li, N. (2001). "Overlay Performance in the Canadian Strategic Highway Research Program's LTPP Study." *Transportation Research Record No. 1778*. Transportation Research Board, Washington, DC, 191–200.
5. Delatte, N. (2001, July). Personal communication on Using LTPP in graduate courses at the University of Alabama at Birmingham. Birmingham, AL.
6. Federal Highway Administration. (2003). "LTPP Guidelines for the Fourth International Contest on Using LTPP Data Analysis." Washington, DC.
7. Haas, R. (2001). "Reinventing the (Pavement Management) Wheel." Distinguished Lecture, *Proceedings of the Fifth International Conference on Managing Pavements*. Seattle, WA.

PROGRAM ACKNOWLEDGMENTS

We are grateful for the efforts of the American Society of Civil Engineers/Transportation and Development Institute (ASCE/T&DI) task committee that oversaw the contest activities. In particular, we would like to recognize the contributions of the contest review board in charge of administering the contest:

Karim Chatti, Michigan State University, Acting Chair
Fouad M. Bayomy, University of Idaho, Past Chair
Antonio Nieves Torres, Federal Highway Administration, Co-Chair
Andrea Baker, Transportation and Development Institute, ASCE Liaison

In addition, we would like to recognize the technical support of the ASCE/T&DI task committee members who helped review the contest papers:

Imad L. Al-Qadi, University of Illinois at Urbana-Champaign (formerly at Virginia Polytechnic Institute and State University)
Neeraj J. Buch, Michigan State University
Armando J. De La Rocha, Western Technologies, Inc.
Norbert J. Delatte, Cleveland State University (formerly at the University of Alabama at Birmingham)
Gerardo W. Flintsch, Virginia Polytechnic Institute and State University
Paul T. Foxworthy, ERES Consultants
Andrew J. Gisi, Kansas Department of Transportation
Roger M. Larson, Applied Pavement Technology, Inc.
K. Wayne Lee, University of Rhode Island
Tom T. Papagiannakis, Washington State University
Olga L. Selezneva, ERES Consultants
Ali A. Selim, South Dakota State University
Robert E. Smith, MACTEC, Inc.
Roger E. Smith, Texas A&M University
Nabil J. Suleiman, University of North Dakota
Waheed Uddin, University of Mississippi

We would also like to give special recognition to the technical reviewers who are not members of the task committee for their voluntary effort in reviewing the contest papers:

Ghassan Abu-Lebdeh, Michigan State University
Adrian R Archilla, University of Hawaii
Gilbert Y. Baladi, Michigan State University
Don Fohs, Federal Highway Administration
Keith Herbold, Federal Highway Administration
Haiming Huang, ERES Consultants
Newton Jackson, Nichols Consulting Engineers
Sean Lin, Federal Highway Administration
Walid Nassar, Bradley University

Jorge Prozzi, University of Texas at Austin
Stefan Romanoschi, Kansas State University
Monte Symons, Federal Highway Administration

Finally, we would like to acknowledge the participants in the contest, who included students and their advisors (categories 1 and 2), pavement engineering professionals (category 3), and university professors (categories 3 and 4). They have taken their valuable time to make an important contribution. In all, 20 papers were submitted, including 3 in category 1 (undergraduate students), 14 in category 2 (graduate students), 1 in category 3 (partnership between industry and academia), and 3 in category 4 (curriculum development). The winning papers from each category for the 2003–2004 contest are included in this volume.

