

United States
Department of
Agriculture

Marketing and
Regulatory
Programs

Animal and
Plant Health
Inspection
Service

Plant Protection
and Quarantine



Biological Control of Pink Hibiscus Mealybug Project Manual

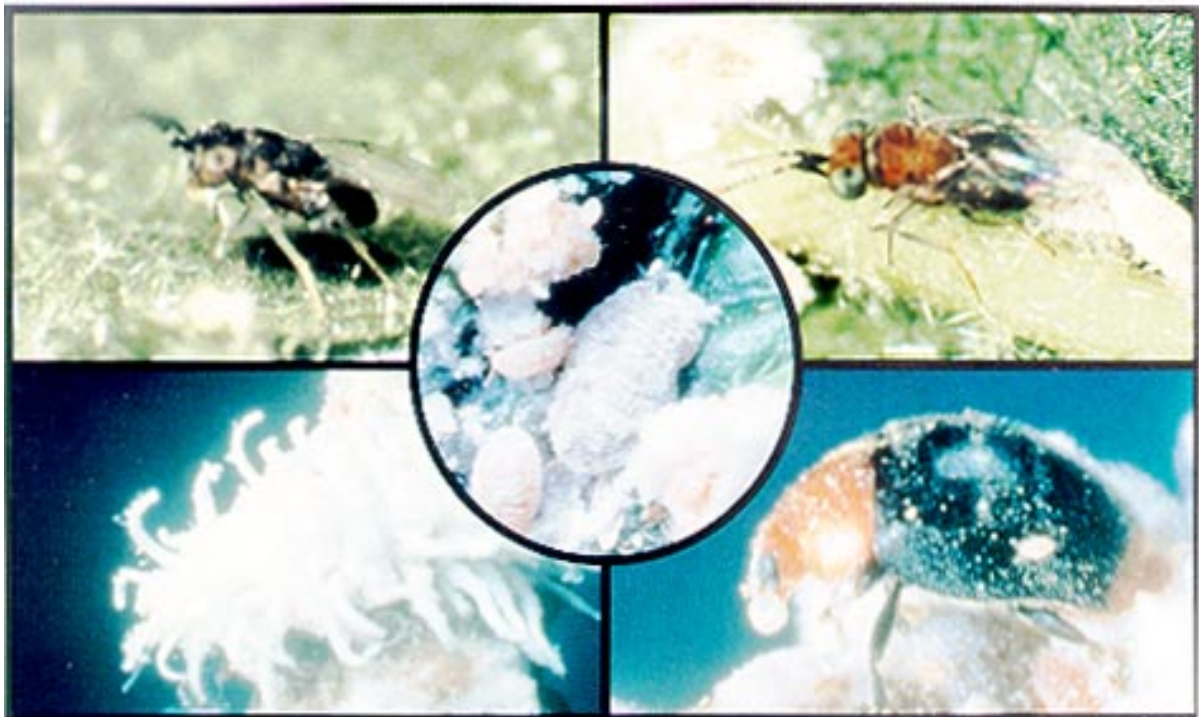

**United States
Department of
Agriculture**

Marketing and
Regulatory
Programs

Animal and
Plant Health
Inspection
Service

Plant Protection
and Quarantine



Biological Control of Pink Hibiscus Mealybug Project Manual

D. E. Meyerdirk, R. Warkentin¹, B. Attavian², E. Gersabeck³, A. Francis, M.Adams, and G. Francis⁴

1 United States Department of Agriculture (USDA), Animal and Plant Health Inspection Service (APHIS), Plant Protection and Quarantine (PPQ) & International Services (IS), Riverdale, MD 20737-1236
2 USDA, APHIS, PPQ, Frederick, MD 21702
3 USDA, APHIS, IS, Riverdale, MD 20737-1233
4 St. Kitts Department of Agriculture, Basseterre, St. Kitts, W.I.

Contents

Figures

LOF-iii

Introduction

Orientation 1-1

Who's Involved 1-11

How to Use This Manual 1-13

Surveying for PHM

Introduction 2-1

Visual 2-3

Sex Pheromone Traps 2-5

Distinguishing Field Characters 2-9

Preparing Slides and Identifying Characters 2-17

Operating the Insectary

Introduction 3-1

Host Plant Material 3-5

Pink Hibiscus Mealybug (PHM) Culture 3-13

Exotic Natural Enemy Shipments 3-25

Natural Enemy Culture: Parasites 3-27

Natural Enemy Culture: Predators 3-37

Releasing Natural Enemies

Introduction 4-1

Procedures for Parasites 4-3

Procedures for Predators 4-9

Evaluating Results

Introduction 5-1

Establishment of Natural Enemies 5-3

Impact of Released Natural Enemies 5-9

Appendix A

Host Plants of Pink Hibiscus Mealybug (PHM) A-1

Appendix B

Geographic Distribution of PHM B-1

Appendix C

Natural Enemies Reported Attacking Pink Hibiscus Mealybug (PHM)
C-1

Appendix D

List of Key PHM Cooperators D-1

Appendix E

Sources of Natural Enemies E-1

Appendix F

Environmental Assessments *F-1*

Appendix G

References *G-1*

Appendix H

Forms *H-1*

Appendix I

Supplemental Information *I-1*

Index

TABLE 1-1 : Summary of PHJM biological data (Mani, 1989) *page*4
TABLE 4-1 : Releasing *Cryptolaemus* beetles on PHM-infested host plants *page* 10
u Form PHM-1 *page*3

:

Figures

- FIGURE 1-1: Development Cycle of Pink Hibiscus Mealybug (PHM) *page 1-5*
- FIGURE 1-2: Infected hibiscus twig. Note mealybugs and egg masses *page 1-7*
- FIGURE 1-3: "Bunchy top" on citrus. Note stunted, distorted leaves *page 1-7*
- FIGURE 1-4: Hibiscus defoliated by PHM *page 1-7*
- FIGURE 1-5: Dead saman tree *page 1-8*
- FIGURE 2-1: Male pink hibiscus mealybug mating with female *page 2-5*
- FIGURE 2-2: Paper carton type sex pheromone trap with potato *page 2-6*
- FIGURE 2-3: Sex pheromone trap showing trap holder and white sticky card *page 2-7*
- FIGURE 2-4: Servicing sex pheromone trap on tree branch of host plant *page 2-7*
- FIGURE 2-5: Pink hibiscus mealybug nymphal instars (arrows). *page 2-9*
- FIGURE 2-6: Adult female pink hibiscus mealybug (arrow). *page 2-10*
- FIGURE 2-7: Male mealybug puparium. Note white filaments. *page 2-11*
- FIGURE 2-8: Adult male pink hibiscus mealybug. Note caudal filaments. *page 2-12*
- FIGURE 2-9: Female ovisac. Note white, waxy mass with pink colored eggs. *page 2-13*
- FIGURE 2-10: Eggs. Note small cottony filaments forming ovisac. *page 2-13*
- FIGURE 2-11: General morphology of an adult female mealybug (from Williams, 1996) *page 2-20*
- FIGURE 2-12: Pink hibiscus mealybug, *Maconellicoccus hirsutus* (Green) (from Williams, 1996) *page 2-21*
- FIGURE 3-1: Japanese pumpkin, *Curcubita moschata* (Duchesne) var. *chirimen* *page 3-5*
- FIGURE 3-2: Growing Japanese pumpkin seedlings in flats for greater production. *page 3-6*
- FIGURE 3-3: Japanese pumpkins with short stems attached in wooden crates *page 3-9*
- FIGURE 3-4: Open rack system for sprouting potatoes *page 3-11*
- FIGURE 3-6: Potato sprouts (foreground) infested with PHM crawlers *page 3-12*

- FIGURE 3-8: Wooden shelves supporting plastic trays with infested pumpkins page 3-13
- FIGURE 3-9: Night lamp wrapped in aluminum foil in crawler collection box page 3-16
- FIGURE 3-10: Crawler collection box covered with heavy black cloth page 3-17
- FIGURE 3-11: Rack used in the hot wire barrier system holding five shelves of pumpkins page 3-19
- FIGURE 3-12: Removable five-sided shelf used in hot wire barrier system page 3-20
- FIGURE 3-13: Rheostat used to heat the wire to a temperature of 115°F (46°C) page 3-20
- FIGURE 3-13: Adult male *Anagyrus kamali* page 3-27
- FIGURE 3-14: Adult female *Anagyrus kamali* page 3-27
- FIGURE 3-15: Development cycle of the parasite *Anagyrus kamali* page 3-28
- FIGURE 3-16: Pink hibiscus mealybug mummies showing parasite emergence holes page 3-29
- FIGURE 3-17: Portable aluminum cage for rearing parasites page 3-30
- FIGURE 3-18: Aspirator assembly showing vacuum pump and latex tubing page 3-31
- FIGURE 3-19: Clear styrene tubes with snap-on caps page 3-32
- FIGURE 3-20: *Cryptolaemus montrouzieri* larva page 3-37
- FIGURE 3-21: *Cryptolaemus montrouzieri* adult page 3-37
- FIGURE 4-1: Characteristics for identification of *Anagyrus kamali* (from Moursi, 1948) page 4-4
- FIGURE 4-2: Characteristics for identification of *Leptomastix* spp. (from Moursi, 1948) page 4-5
- FIGURE B-1: World Distribution of Pink Hibiscus Mealybug (from C.A.B International Institute of Entomology Distribution Maps of Pests Map No. 100 – December 1987) page B-1
- FIGURE B-2: Western Hemisphere Infestations of Pink Hibiscus Mealybug page B-2
- FIGURE B-3: Countries Known to be Infested with Pink Hibiscus Mealybug page B-3
- FIGURE I-1: Pink Hibiscus Mealybug Culture Rack page I-2
- FIGURE I-2: Parasite Cage Rack page I-3
- FIGURE I-3: Double Hole Sleeve Cage page I-4

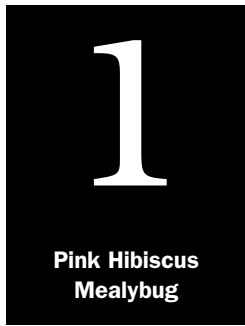

Introduction

Orientation

Contents

- Background [1-1](#)
- Biological Control Project Against PHM [1-2](#)
- Description of the Insect [1-2](#)
- Systematic Position [1-2](#)
- Biology/Ecology [1-3](#)
 - Natural Protection [1-6](#)
 - Reproduction and Development [1-6](#)
- Damage [1-7](#)
- Economic Losses [1-9](#)
- Geographic Distribution [1-9](#)
- Host Range [1-9](#)
- Biological Control [1-10](#)
 - Types of Natural Enemies [1-10](#)

Background

The pink hibiscus mealybug (PHM), *Maconellicoccus hirsutus* (Green), is a serious economic threat to agriculture, forestry, and the nursery industry. This pest attacks many plants, trees, and shrubs. It infests hibiscus, citrus, coffee, sugar cane, annonas, plums, guava, mango, okra, sorrel, teak, mora, pigeon pea, peanut, grape, maize, asparagus, chrysanthemum, beans, cotton, soybean, and cocoa, just to name a few of its hosts. For a comprehensive list of host plants, see [Appendix A](#).

This pest occurs in most tropical areas of the world including Asia, the Middle East, Africa, Australia, and Oceania. PHM arrived in Egypt from India in 1912 and in Hawaii in 1984. Finally, it appeared in Grenada, Trinidad, and St. Kitts in the early 1990's. It is now a very serious pest in the Caribbean, found on at least 16 islands including the U.S. Virgin Islands, where it attacks many economically important hosts and disrupts Caribbean agricultural trade and commerce.

Biological Control Project Against PHM

The Animal and Plant Health Inspection Service (APHIS) of the U.S. Department of Agriculture (USDA) is charged with protecting American agriculture from exotic plant pests like PHM. APHIS considers PHM a pest of extremely serious quarantine importance that has the potential to expand its geographical distribution to North, Central, and South America. Two units of APHIS, Plant Protection and Quarantine (PPQ), and International Services (IS), are cooperating in a biological control project aimed at controlling PHM in the Caribbean. This project will serve as a model to start a biological control program in the mainland U.S. when PHM arrives. The purpose of this manual is to guide USDA personnel and cooperators (see [page 1-12](#)) in setting up and maintaining these biological control programs.

Description of the Insect

The adult PHM is about 2-3 mm long. Females are oval shaped, wingless, and covered by a mass of white mealy wax. Males have one pair of wings, two long waxy tails, and can fly. For a more detailed description (Hall, 1921) modified for field use, refer to the subsection Distinguishing Field Characters on [page 2-9](#). See also the insert following page 2.8 for color photographs of PHM.

Systematic Position

The taxonomic classification of PHM is summarized as follows:

Phylum: Arthropoda

Class: Insecta

Order: Homoptera

Family: Pseudococcidae

Genus: *Maconellicoccus*

Species: *Maconellicoccus hirsutus* (Green)

Williams (1996) has recently reviewed *M. hirsutus* taxonomically. Ezzat (1958) separates the genus *Maconellicoccus* from *Paracoccus*, the closest known relatives, by the following features in the adult female:

- ◆ Pseudo articulation in the 9th (terminal) antennal joint
- ◆ Anterior leg with unequal tarsal digitules
- ◆ Small oral collar tubular ducts present on both the dorsal and ventral sides of the body

PHM is one of apparently nine species in *Maconellicoccus*. The genus is probably Far Eastern, possibly of tropical Australian origin, as five of nine species are found there. Of those five species, three have become adapted to a more moderate subtropical climate, especially *M. tasmaniae*, found only in temperate Tasmania. In Africa, there are only two species, including the PHM, which may have spread there recently. The other species, *M. ugandae*, has a strictly tropical African distribution (Williams, 1985 and 1986). *M. australiensis* (Green & Lidgett), *M. lanigerus* (Fuller), *M. leptospermi* Williams, *M. hirsutus* (Green) and *M. tasmaniae* Williams all occur in Australia; *M. multipori* (Takahashi) in Malaysia and *M. ramchensis* sp. n. *M. pasaniae* in Nepal (Williams, 1996).

PHM is the only species with a worldwide distribution. It probably spread to Africa along tropical routes from the oriental region. Some of this spread is recent: Egypt, 1908 (Williams, 1986); Hawaii, 1984 (NPAG, 1984); and the West Indies in 1994 (Pollard, 1995).

Biology/Ecology

PHM is a small, soft-bodied insect with a nonflying female and a flying male. The intermediate life stages, illustrated in **Figure 1-1 on page 1-5**, are eggs and three (female) or four (male) nymphal instars. The female lays its eggs in ovisacs, which it deposits on the host, sometimes in great numbers and visible as a whitish covering over the terminal parts or even main areas of the host. The female, the nymphal stages and the male, if present, are very visible on the host as well. All stages are reddish to pink in color, but covered in white mealy wax, with the body color showing through. For that reason it is often called the pink hibiscus mealybug.

Many researchers have studied the life cycle of PHM. **Table 1-1** (from Mani, 1989) summarizes their findings.

TABLE 1-1: Summary of PHJM biological data (Mani, 1989)

Particulars	Misra 191)	Hall (1921)	Dutt et al. (1951)	Singh and Ghosh (1970)	Ghose (1970)	Mani (1986)	Reddy and Lakshmi Narayana (1986)
Egg length (mm)	0.36- 0.39	-	0.29- 0.32	-	0.357- 0.398	0.34- 0.38	-
Egg width (mm)	0.15- 0.21	-	0.17	-	0.178- 0.206	0.17- 0.20	-
Incubation (days)	5-8	6-9	7	6-7	3-8	4-7	3-4
Nymph (days)	-	-	-	22	10-19	19-22	20-22
Egg to adult (days)	24- 29	35	-	-	23-29	24-27	30
Adult length (mm)	2.52	-	3	-	-	2.65- 2.80	-
Preoviposition (days)	-	-	-	3-5	0.5-6	4-5	-
Oviposition (days)	-	-	5-8	4-5	-	6-8	-
Fecundity (no. eggs /female)	232	150- 300	194	-	84- 654	386- 540	500

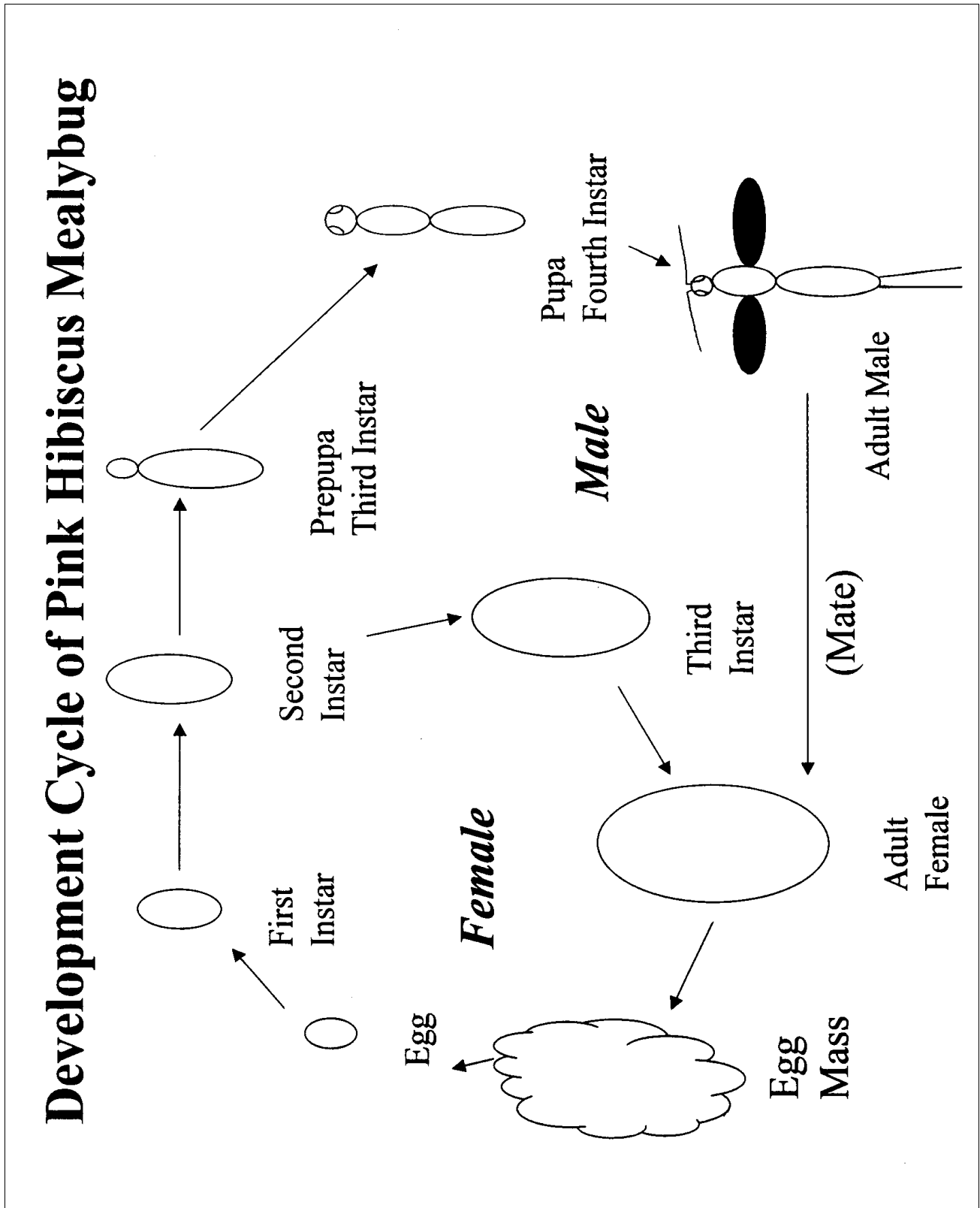

FIGURE 1-1: Development Cycle of Pink Hibiscus Mealybug (PHM)

Natural Protection

The natural wax coating covering the various stages of the PHM provides some protection from pesticides. This is especially true of the egg stage, which is protected by a white, waxy ovisac. The ovisac is almost impossible to penetrate with many pesticides (McKenzie, 1967).

The PHM's ability to hide in cracks and crevices is probably the most important means by which it protects itself. Once hidden, reaching it by both natural enemies and humans is difficult (McKenzie, 1967).

Some sugar-loving ants will protect the PHM from parasites and predators. The ant, *Monomorium indicum*, was observed in India attending the nymphs and maturing females for their honeydew. They do not attend to male nymphs in the last nymphal stage nor to gravid females that have begun laying eggs because they no longer produce honeydew (Misra, 1920).

Reproduction and Development

Mani (1989) reports that males are very common, but parthenogenetic reproduction has been reported in the literature. Overall, researchers assume reproduction is restricted to the sexual form with the sex ratio approximately 1:1. From 84 to 654 mealybug eggs are laid in a loose cottony terminal white ovisac. They are in close contact with each other within the ovisac. Eggs turn pink before they hatch, 3–8 days after being laid.

Newly hatched mealybugs (crawlers or first instar nymphs) are mobile. They settle on the host and start their development, which lasts 10 to 22 days. Although they prefer the apical and tender regions of the host, under field conditions the older plant parts, including stems, leaves, petioles, roots, tubers, and even the pods, may harbor large populations of the crawlers (Ghose, 1972). Male and female nymphs are distinguishable by the end of the second instar. The male has four instars of 6.60 ± 0.50 days, 6.51 ± 0.51 days, one day, and 5.59 ± 0.69 days each, while the females have three instars of 6.71 ± 0.47 days, 6.55 ± 0.52 days and 7.9 ± 0.79 days. At the end of the second instar, males produce cottony cocoons (puparia) (Mani 1989).

Females are wingless and dark pink. They migrate to the lower parts of the host as the affected apical portions wither away (Ghose, 1972). Preoviposition is from 0.5 to 6 days, followed by an ovipositional period of 4 to 8 days. Oviposition normally occurs in the terminal areas of the host, but when the weather gets cooler, the females search for shelter to oviposit. These include crevices in the bark (of a tree) or other shelter on the host (Hall, 1926). Activity on roots has been reported in a few cases, but the circumstances are not clear (Rao & Srinivasan, 1987; Hall, 1921; Hosny, 1939).

There are about 10 generations a year in the subtropics. If there is a winter season, PHM will hibernate or remain quiescent in any or all of its stages until food plants are again available. The pest may overwinter in protected parts of the host such as the capsules of kenaf or sorrel, cracks and crevices of bark, inside fruit bunches or in the soil. Maximum populations are reached in late summer and early fall.

Although PHM by itself is not greatly mobile, the crawlers, ovisacs, and males may migrate by means of air currents. The females, crawlers, and nymphs are mobile and can walk from host to host in the infested area. Males are probably attracted to the female over several hundred meters at best (Misra, 1920) and seem to stay within the infested area as well.

Damage

The PHM's toxic saliva and direct feeding may cause various symptoms in the host plants. These symptoms are generally severe malformation of shoots and leaves. Leaves become twisted and crinkled. Growth becomes stunted and shoot tips have a bushy appearance. Infested flowers dry and drop and fruits are not produced. Infested fruits are small and abnormally shaped, and may drop early, thus reducing production and marketability (Francis-Ellis, 1995).

Specific hosts may exhibit symptoms as in the following examples:

- ◆ In **hibiscus**, PHM usually infests young twigs (**Figure 1-2**), causing gall-like deformations of the terminal growth. This is characterized by internode shortening or "Bunchy Top" (**Figure 1-3**), deformed leaves and thickened twigs (Veni, et al, 1973; Beardsley, 1985). Heavy infestations can result in leaf defoliation, stunted leaves, and death of the plant (**Figure 1-4**).



FIGURE 1-2: Infected hibiscus twig. Note mealybugs and egg masses

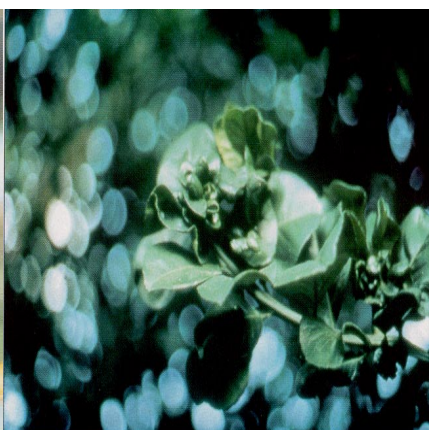

FIGURE 1-3: "Bunchy top" on citrus. Note stunted, distorted leaves



FIGURE 1-4: Hibiscus defoliated by PHM

- ◆ In **mulberry**, the shoots of the affected plant first turn coppery-green, then pale-yellow and finally become so hard, compact, and brittle that they cannot be opened without breaking. The lower lateral leaves become seared and fall off prematurely. In severe attacks, nothing but the bare stems of plants remain in the field (Misra, 1920).
- ◆ In **roselle**, floral branching is suppressed, the tips are gradually withered and the floral buds are reduced and distorted. This results in a drastic reduction in seed loss—about 21–43 percent of normal production, due to a reduction in the number and quality of the pods (Ghose, 1971).
- ◆ In **cotton**, the growing parts are attacked resulting in bunched-type symptoms. Attacked plants remain stunted and produce fewer bolls of a smaller size. Boll opening is adversely affected and yield reduction ranges from 58–73 percent (Dhawan, 1980). It is recorded, but rare on the roots of cotton plants under severely attacked trees (Hosny, 1939).
- ◆ In **grapevine**, PHM feeds on the developing sprouts after pruning and stunts their growth. The growing shoots and the leaves are malformed due to sticky honeydew produced by the pest, predisposing them to moldy growth and bunching. Heavily infested bunches shrivel and drop. Damage can be as much as 90 percent occasionally (Babu & Azam, 1987).
- ◆ In **peanut**, PHM feeds on the underground parts of the roots, pods, and pegs of the plant. This results in stunted growth and poorly developed pegs and pods (Rao & Srinivasan, 1987).
- ◆ In **trees**, PHM feeds on tender young growth, although this can change to older growth if the infestation is high. This results in malformed leaves and shoots, which become gnarled and form compact heads. As a result, dieback of young shoots and limbs may occur resulting in eventual death of the tree. Some trees may be very obviously infected and covered with PHM, emitting a distinctive odor (Hall, 1921; ANON., 1995; Hall, 1926).
- ◆ In **other hosts**, symptoms may vary, but dieback of attacked areas often results. Death of the host, including large trees, is very common (**Figure 1-5**).



FIGURE 1-5: Dead saman tree

Economic Losses

In many countries, this pest is chiefly restricted to *Hibiscus* and is not of concern, possibly because it is kept in check by natural enemies. In some areas of India and Egypt, however, it is a serious pest of some important crops, especially where no natural controls are present. In these countries it does seem to have many hosts, but of these hosts few are heavily attacked. When this mealybug turned up in Hawaii in 1984, it did not become a problem because natural enemies were apparently fortuitously introduced with it. In the Caribbean islands where natural enemies were absent, it became a very serious problem, attacking many plants and disrupting the agricultural sector to a major extent causing significant financial losses. Grenada reported economic losses of \$3.5 to \$10 million for the 1996/97 season, and Trinidad and Tobago estimate potential losses exceeding \$125 million/year if infestations continue to escalate.

Geographic Distribution

PHM seems native to southern Asia (Williams, 1996) as based on its distribution and that of members of the genus *Maconellicoccus*. It is the only species with a virtually worldwide distribution in tropical areas of the world from Australia through Southeast Asia, the Middle East and central Africa. It has recently spread to Guam, Hawaii, and the Caribbean. Since its discovery in Grenada in November 1994, it has been found in Trinidad in August 1995, and St. Kitts & Nevis in November 1995. For maps showing world and Caribbean distribution, and a list of infested islands and countries in the Caribbean, see [Introduction](#).

Host Range

PHM attacks more than 200 genera of plants in 70 different families. Many of these are economically important representatives of the following groups:

- ◆ Forest trees
- ◆ Fruit trees
- ◆ Ornamentals
- ◆ Root crops
- ◆ Vegetables

For an extensive list of hosts recorded with damaging populations of PHM, see [Appendix A](#).

Any local survey needs to take into account both the host list given in [Appendix A](#), and local plant species that may be hosts. PHM changes host preferences by locality, perhaps as a reflection of changes in habitat, environment, and interactions with the local flora/fauna/predator/parasite complex. Surveyors should design a local host list based on actual local finds.

Biological Control

Biological control, when considered from the ecological viewpoint as a phase of natural control, can be defined as “the action of parasites, predators, or pathogens in maintaining another organism’s population density at a lower average than would occur in their absence” (DeBach, 1964). Biological control of PHM is the best long-term solution, since pesticides are not effective. Natural enemies can control the pest in a way that is safe to humans and the environment.

Types of Natural Enemies

Overall, natural enemies are classified as one of the following types based on how they control the target pest:

- ◆ Parasite: Completes its growth and development on or in a single host, killing that host in the process
- ◆ Predator: Finds and kills a number of prey to complete growth and development
- ◆ Pathogen: Controls the pest by causing a fatal disease that spreads to other host individuals (includes bacteria, fungi, and viruses)

Many exotic natural enemies have been reported in the literature and are under consideration for importation and release to regulate PHM in the Caribbean (see [Appendix C](#)).

These four natural enemies have been released in St. Kitts and Nevis:

Parasites (tiny wasps)

- ◆ *Anagyrus kamali* (Hymenoptera: Encyrtidae)
- ◆ *Gyranusoidea indica* (Hymenoptera: Encyrtidae)

Predators (lady beetles)

- ◆ *Cryptolaemus montrouzieri* (Coleoptera: Coccinellidae)
- ◆ *Scymnus coccivora* (Coleoptera: Coccinellidae)

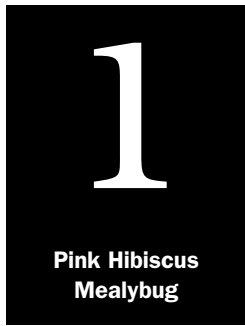

Introduction

Who's Involved

Project Leader

The Project Leader is Dr. Dale E. Meyerdirk, Senior Staff Officer. You can contact Dale at the following address:

Dale Meyerdirk
USDA, APHIS, PPQ
4700 River Road, Unit 135
Riverdale, MD 20737-1236
Telephone: (301) 734-5667
Fax: (301) 734-8192
E-Mail: dale.e.meyerdirk@aphis.usda.gov

International Contacts

Foreign governments may request assistance from these contacts:

Dale Meyerdirk
USDA, APHIS, PPQ
4700 River Road, Unit 135
Riverdale, MD 20737-1236
Telephone: (301) 734-5667
Fax: (301) 734-8192
E-Mail: dale.e.meyerdirk@aphis.usda.gov

Farouk Hamdy, Regional Director
USDA, APHIS, IS, Region VII
U. S. Embassy Guatemala
4 Avenida 12-62 Zona 10
Guatemala City, Guatemala, C. A.
Telephone: (502) 331-2036
Fax: (502) 333-5446

Jim Mackley, Regional Director
USDA, APHIS, IS, Region II
American Embassy Santiago
Merced 230, 2nd Floor
Santiago, Chile
Telephone: (562) 638-1989, 633-8448
Fax: (562) 639-8463

Carolyn Cohen
USDA, APHIS, IS, Region VII, Area 4
American Embassy
Calle Leopoldo Navarro No. 1
Santo Domingo, Dominican Republic
Telephone: (809) 685-9780, 688-3184
Fax: (809) 686-0979 (Attention: USDA:APHIS:IS)

Cooperators

PPQ and IS are directing the biological control project with the assistance of many cooperators including the following:

- ◆ Belize Ministry of Agriculture and Fisheries
- ◆ California Department of Food and Agriculture
- ◆ Egypt Ministry of Agriculture
- ◆ Florida Department of Agriculture
- ◆ Grenada Ministry of Agriculture
- ◆ International Institute for Biological Control (IIBC), CABI¹
- ◆ Puerto Rico Ministry of Agriculture
- ◆ St. Kitts Ministry of Agriculture
- ◆ Trinidad and Tobago Ministry of Agriculture
- ◆ University of Florida
- ◆ University of Hawaii
- ◆ University of the Virgin Islands
- ◆ USDA, Agricultural Research Service (ARS)
- ◆ U.S. Virgin Islands Ministry of Agriculture

The St. Kitts Ministry of Agriculture has been extremely cooperative in providing assistance in the development of a biological control technology. Ministry of Agriculture personnel have helped administratively and provided necessary transportation, staff, facilities, and host material as needed, during the first year of the program. For a list of key cooperators in the United States, the Caribbean, and elsewhere, see [Appendix D](#).

¹ Center for Agriculture and Bioscience International.



Introduction

How to Use This Manual

Use the PHM Manual as an on-the-job reference for general information and for detailed information on these topics:

- ◆ Surveying for PHM
- ◆ Developing a biological control program
- ◆ Setting up an insectary
- ◆ Releasing natural enemies
- ◆ Evaluating the establishment and impact of natural enemies

Each tabbed section is independent, containing step-by-step procedures.

Each section has an Introduction that contains general information relating to the section's main content.

Use the Appendixes as they relate to the other sections of the Manual. In some places, the Manual will refer you to an Appendix; in other places you may need to go directly to an Appendix to get the necessary information.

If the table of contents is not specific enough, use the index to find a topic and its page number.

2

Pink Hibiscus
Mealybug

Surveying for PHM

Introduction

Contents

Introduction	2-1
Purpose	2-1
Visual	2-3
Introduction	2-3
Procedure	2-3
Sex Pheromone Traps	2-5
Introduction	2-5
Procedure	2-6
Distinguishing Field Characters	2-9
Introduction	2-9
Identifying Life Stages	2-9
Preparing Slides and Identifying Characters	2-17
Introduction	2-17
Preparing Slides	2-17
Identifying Characters	2-18

Purpose

The purpose of surveying for PHM is to decide if a local population of the pest is present. If you detect the presence of PHM either by visual survey or by pheromone trapping, you should plan to begin releasing natural enemies. First, follow the procedures in this section for surveying. If the results of your survey are positive, then refer to the sections on insectary operation and releasing natural enemies. Detailed survey techniques are also discussed by Jeffrey Stibick (1997) in the New Pest Response Guidelines for the Pink Hibiscus Mealybug.

2

Pink Hibiscus
Mealybug

Surveying for PHM

Visual

Introduction

Visual survey is the most effective style of survey at this time. The most common hosts found infested in the Caribbean are *Acacia* spp., cotton, hibiscus, seaside grape, and soursop. By examining these common hosts at residential sites, hotels, other commercial property or open fields and along the seashore, you will easily see PHM on these plants if infested.

Procedure

Look closely at the terminals on hibiscus, *Acacia* spp. and cotton, the fruit on soursop, and the junction of leaves and stem and leaf veins on seaside grape. To help identify PHM, refer to the following inserts for keys and color photographs. The white waxy covering of the various mealybug instars and white waxy filaments in the egg mass allow for easy detection. Rolling the terminal stem over sometimes reveals protective niches in which the mealybug may be residing. In heavy infestations, large quantities of egg masses may be present on the bark and main trunk of host plants such as saman, soursop, and hibiscus.

When surveyors find suspicious mealybugs that appear to have the typical field characteristics discussed in the subsection beginning on [page 2-14](#), send the specimens to a qualified taxonomist for positive identification. If the taxonomist confirms that the specimens are PHM, appropriate authorities will then announce a formal country (county or state) notification of positive identification.

Step 1—Fill a screw-cap vial with 70 percent ethyl or isopropyl alcohol.

Step 2—Remove adult female mealybugs (and other instars if present) from the infested terminals, twigs, or branches using a small brush or probe.

Step 3—Place the mealybugs in the vial containing 70 percent alcohol.

Step 4—On [Form PHM-1 \(Appendix H\)](#) or a small paper label, record **in pencil** the date, location, host plant from which you collected the mealybugs, your name, and the tentative identification. Place the label inside the vial and cap the vial. **Do not use ink**—most inks dissolve in alcohol.

2

Pink Hibiscus
Mealybug

Surveying for PHM

Sex Pheromone Traps

Introduction

The female PHM releases a sex pheromone to attract the male for mating (**Figure 2-1**). Sex pheromone traps lure the male PHM by releasing a chemical attractant (sex pheromone), either natural or synthetic, into the air. These traps may be two types:

- ◆ A trap that uses live virgin females
- ◆ A trap that uses a synthetic sex pheromone

These traps can be useful in indexing the population density of PHM in a local area. They can also be used for delimiting surveys to show presence or absence of PHM, but this requires the laborious task of identifying trapped males.



FIGURE 2-1: Male pink hibiscus mealybug mating with female

Procedure

Virgin Female Trap

If sex pheromone traps with live virgin females are available, a delimiting survey could consist of setting 32 to 36 traps/mi² (12 to 14 traps/km²) in the core host plant areas in places where the traps will be safe. Trained survey personnel must have access to a key (currently under development) for identifying male PHM.

Use one trap per study site to determine the relative population density index at that site and average with other sites as appropriate.

These traps may consist of a pint-size (½-liter) paper carton modified to hold a sprouted potato with 10 or more new virgin females (**Figure 2-2**). The trap has a vented top made of fine mesh cloth, allowing movement of the sex pheromone out of the trap to attract adult males.

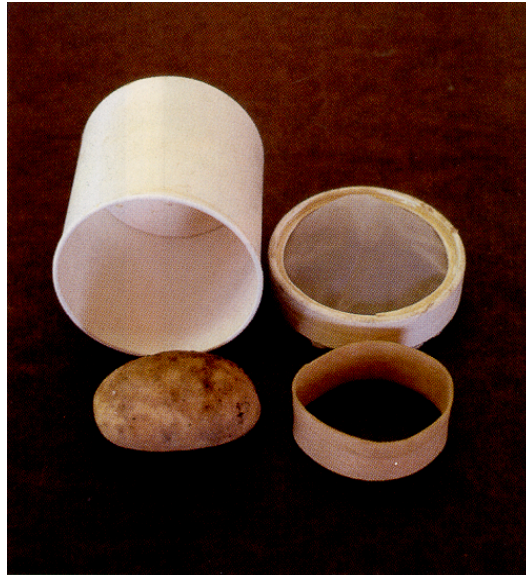

FIGURE 2-2: Paper carton type sex pheromone trap with potato

A wire clip and trap holder (**Figure 2-3**) support a 3 in x 5 in (7.6 cm x 12.7 cm) white plastic sticky card covered with tangle foot. Suspend the trap about 4–6 ft (1.2–1.8 m) above the ground close to the host plants (**Figure 2-4**). You can leave the trap in the field for 4 weeks and change the trap card weekly. Count male PHM on each card. This count represents a relative index of the population density of PHM at that site.

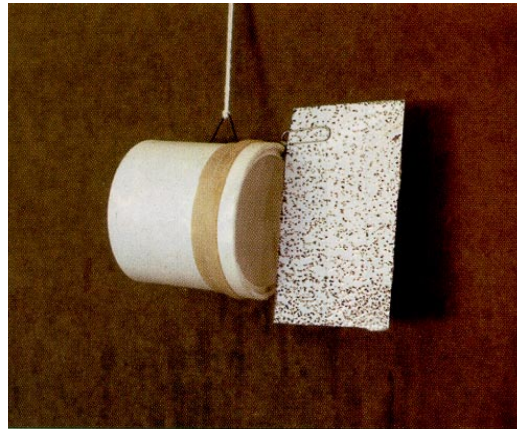

FIGURE 2-3: Sex pheromone trap showing trap holder and white sticky card



FIGURE 2-4: Servicing sex pheromone trap on tree branch of host plant

Synthetic Sex Pheromone Trap

Although not currently available for PHM, synthetic sex pheromones have been developed for the citrus mealybug and Comstock mealybug.

If a synthetic sex pheromone becomes available for PHM, set the traps out in a standard grid pattern within core and buffer areas. Service the traps weekly by changing the sticky card, and replace the traps monthly.

Using a dissecting microscope, count all males on each card and record data weekly on **Form PHM-2 (Appendix H)**. The data will serve as a population density index for PHM. Keeping weekly counts of trapped males is an excellent way to track population trends and impact of natural enemies over time from their initial release.

2

Pink Hibiscus
Mealybug

Surveying for PHM

Distinguishing Field Characters

Introduction

Use the following description (Hall, 1921) of the life stages of PHM to help identify the insect in the field. Refer also to the color photographs and the **MEALYBUG (MB) KEY Identification of Gross Field Characteristics of Adult Females** in the following inserts.

Identifying Life Stages

Nymphal Instars (Crawlers)

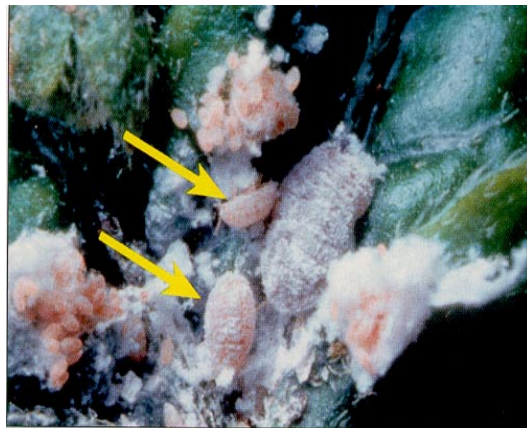

FIGURE 2-5: Pink hibiscus mealybug nymphal instars (arrows).

- ◆ Elongate and ovate
- ◆ Light pink color
- ◆ Well-developed legs and 6-jointed antennae
- ◆ No marginal appendages, but occasionally a little posterior cottony secretion
- ◆ Anal lobes more prominent than in the adult

Adult Female

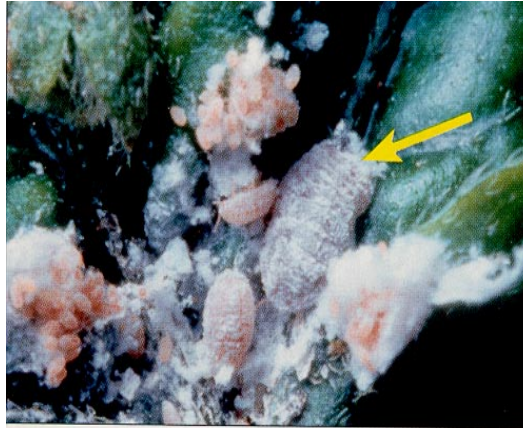

FIGURE 2-6: Adult female pink hibiscus mealybug (arrow).

- ◆ Length 2–3.5 mm; width 0.9–2 mm
- ◆ Reddish color, sparsely covered with white mealy wax with body color showing through
- ◆ Cottony secretion at the posterior extremity may be present
- ◆ Antennae 9-jointed, last segment pseudo-jointed, with prominent stout hair on last three segments
- ◆ Wings absent, body slightly elongate and ovate
- ◆ No lateral wax fringe
- ◆ No distinct caudal filaments

Male puparium



FIGURE 2-7: Male mealybug puparium.
Note white filaments.

This photograph of a Comstock mealybug male puparium shows features also characteristic of PHM.

- ◆ Somewhat elongated
- ◆ Formed of a very loose mass of fine white filaments
- ◆ Length 1.1–1.5 mm; width 0.35–0.45 mm

Male 4th Instar (Pupa)

- ◆ Brownish color
- ◆ Wing sheaths developed
- ◆ Antennae directed backwards and held down close to the margin of the head and thorax
- ◆ Length 1.25 mm; width 0.4 mm

Adult Male



**FIGURE 2-8: Adult male pink hibiscus mealybug.
Note caudal filaments.**

- ◆ Pinkish color
- ◆ Eyes and ocelli black; the lower ocelli slightly larger
- ◆ Two wings present, iridescent
- ◆ Caudal filaments present, white, rather stout and as long as the rest of the insect, each filament supported by two hairs half the length of the filament
- ◆ Antennae 10 jointed, hairy, last three joints with a stout, prominent hair at the end of last three segments
- ◆ Two long waxy caudal filaments, about as long as the body, at the posterior end of the abdomen on each side of the 9th abdominal segment

Female Ovisac



FIGURE 2-9: Female ovisac. Note white, waxy mass with pink colored eggs.

- ◆ White, about twice as long as wide, rounded at ends and roughly semicircular in cross section
- ◆ The outer shell is of matted fibers, and inside, many eggs are arranged in a loose network of fibers.

Eggs







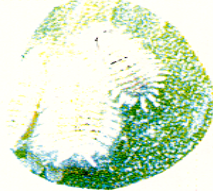

FIGURE 2-10: Eggs. Note small cottony filaments forming ovisac.

- ◆ Very light pink color, with a decidedly pink cap at one end
- ◆ Surface apparently somewhat pitted or mottled with small cottony filaments from the ovisac generally attached
- ◆ Length 0.35 mm; width 0.2 mm

MEALYBUG (MB) KEY

Identification of Gross Field Characteristics of Adult Females

<p><i>Pseudococcus maritimus</i>—Grape MB</p>  <ul style="list-style-type: none"> ◆ Color light pink ◆ No longitudinal depressions ◆ Fringe present ◆ Body fluid reddish-brown ◆ Egg sac irregular ◆ Anal filaments present <p>Hosts: Nursery stock, grape, <i>Malus</i>, <i>Pyrus</i>, etc.</p>	<p><i>Phenacoccus gossypii</i>—Mexican MB</p>  <ul style="list-style-type: none"> ◆ Color slate grey ◆ 4 longitudinal depressions ◆ Fringe present ◆ Body fluid pale greenish ◆ Egg sac very regular ◆ Anal filaments present <p>Hosts: Fuchsias, Pelargoniums, Lantanas</p>
<p><i>Pseudococcus fragilis</i>—Citrophilus MB</p>  <ul style="list-style-type: none"> ◆ Color pink ◆ 4 longitudinal depressions (2 faint & 2 apparent) ◆ Fringe heavy & wedge-shaped ◆ Body fluid wine-purple color ◆ Egg sac none ◆ Anal filaments long <p>Hosts: General nursery stock</p>	<p><i>Ferrisia virgata</i>—Striped MB</p>  <ul style="list-style-type: none"> ◆ Color white ◆ 2 longitudinal depressions (broken) ◆ Fringe heavy & wedge-shaped ◆ Body fluid light color ◆ Egg sac none ◆ Anal filaments present ◆ Long, waxy dorsal threads <p>Hosts: Greenhouse plants</p>
<p><i>Pseudococcus longispinus</i>—Longtailed MB</p>  <ul style="list-style-type: none"> ◆ Color yellow-white ◆ 1 longitudinal depression ◆ Fringe present ◆ Body fluid light clear ◆ Egg sac none ◆ Anal filaments long <p>Hosts: Greenhouse plants, <i>Pittosporum</i>, <i>Eugenia</i>, <i>Myrtus</i>, etc.</p>	<p><i>Maconellicoccus hirsutus</i>—Pink Hibiscus MB</p>  <ul style="list-style-type: none"> ◆ Color reddish brown ◆ No longitudinal depressions ◆ Fringe absent ◆ Body fluid dark red ◆ Anal filaments short ◆ Egg sac irregular ◆ Flocculent wax on dorsum <p>Hosts: Hibiscus, cotton, soursop, citrus, teak, pigeon pea, guava, peanut, asparagus, beans, cocoa, etc.</p>
<p><i>Pseudococcus affinis</i>—Obscure MB</p>  <ul style="list-style-type: none"> ◆ Color light pink ◆ No longitudinal depressions ◆ Fringe present ◆ Body fluid reddish-orange ◆ Egg sac irregular ◆ Anal filaments present <p>Hosts: Nursery stock, grape, prickly pear, <i>Begonia</i>, etc.</p>	<p><i>Planococcus citri</i>—Citrus MB</p>  <ul style="list-style-type: none"> ◆ Color white ◆ 1 longitudinal depression (faint) ◆ Fringe present ◆ Body fluid clear ◆ Egg sac irregular ◆ Anal filaments short <p>Hosts: Citrus and very polyphagous</p>

Revised: June 18, 1998

Citrus Mealybug
Planococcus citri

- ◆ color pink
- ◆ 1 stripe in middle of back
- ◆ short, slightly curved filaments around body, caudal filaments less than one-eighth length of body
- ◆ ovisac under body of female

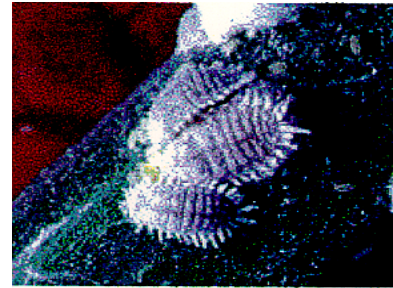

Solenopsis Mealybug
Phenacoccus solenopsis

- ◆ color dark green
- ◆ with wax removed with 2 stripes on back
- ◆ short filaments around body, caudal filaments about one-fourth length of body

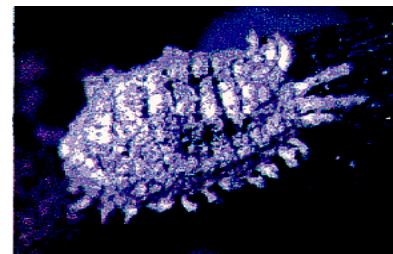

Jack Beardsley Mealybug
Pseudococcus jackbeardsleyi

- ◆ color gray
- ◆ without stripes on back
- ◆ thin filaments around body, caudal pair about one-half length of body or more
- ◆ ovisac covering hind part of body



Longtailed Mealybug
Pseudococcus longispinus

- ◆ color grayish
- ◆ 1 stripe in middle of back
- ◆ thin filaments around body, caudal pair longer than body, second pair also long
- ◆ without an ovisac



Obscure Mealybug
Pseudococcus viburni

- ◆ color pink
- ◆ without stripes on back
- ◆ thin filaments around body, caudal pair about one-half length of body or more
- ◆ ovisac covering hind part of body

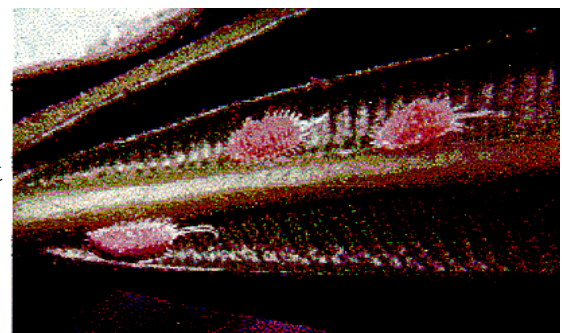

Compiled by Douglass Miller, Systematic Entomology Laboratory, USDA, ARS
National Museum of Natural History, Washington, DC 20506-0168

Pink Hibiscus Mealybug
Maconellicoccus hirsutus

- ◆ color reddish brown or pink
- ◆ no markings on back
- ◆ usually without lateral filaments, sometimes with 1 or 2
- ◆ egg sac beneath body



Pineapple Mealybug
Dysmicoccus brevipes

- ◆ color pink
- ◆ no markings on back
- ◆ with 17 pairs of lateral filaments, hind filament one-fourth length of body
- ◆ without egg sac



Striped Mealybug
Ferrisia virgata

- ◆ color dark gray
- ◆ with 2 conspicuous dark stripes on back
- ◆ with 1 pair of lateral filaments, hind filament one-half length of body
- ◆ with long glassy rods on back

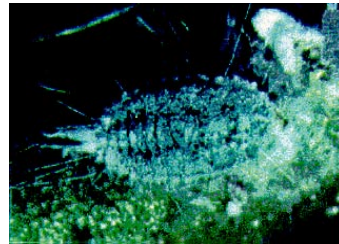

Coconut Mealybug
Nipaecoccus nipae

- ◆ color dark red
- ◆ without markings on back
- ◆ filament not only around margin but on back also
- ◆ without egg sac

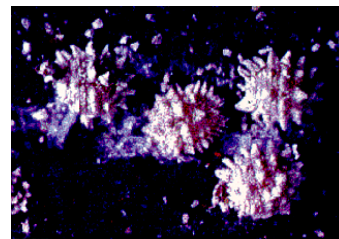

Papaya Mealybug
Paracoccus marginatus

- ◆ color yellow
- ◆ without markings on back
- ◆ hind filament about one-fourth length of body
- ◆ egg sac under body of female



Mexican and Madeira Mealybugs
Phenacoccus gossypii & *P. madeirensis*

- ◆ color gray
- ◆ with 2 dark stripes on back
- ◆ short filaments around body, caudal filaments about one-fourth length of body
- ◆ ovisac covering body except head



2

Pink Hibiscus
Mealybug

Surveying for PHM

Preparing Slides and Identifying Characters

Introduction

For accurate identification of PHM, use the following procedure developed by Doug Odermatt, Coccoidea specialist, PPQ. While this is not the only method, it provides a permanent mount, and may be the fastest way to clear, stain, and mount a specimen. For better clearing, boil the mealybugs in water or ethanol before preserving in ethanol.

Preparing Slides

Step 1—To clear, heat in a 10 percent potassium hydroxide (KOH) solution at 140 °–150 °F (60 °–66 °C) for about 15 minutes. Puncture larger specimens with an insect pin or make a small slit on the side of the abdomen before heating. Premix the KOH in a ratio of about 14 pellets per 50 ml of distilled water. If time is not critical, clear the specimen in cold KOH overnight. Check the calibration of your hot plate with a thermometer in a water bath.

Step 2—Use a spatula to pump out the body contents of the specimen until it is transparent. This is the most critical step. Briefly reheat in KOH if needed. Also, try a higher temperature if needed.

Step 3—Rinse in distilled water.

Step 4—Stain in acid fuchsin or double stain (with lignin pink). Leave specimens in stain at least 15 minutes (much longer is acceptable). Another recommended fluid for clearing/staining is Essig's aphid fluid containing stain.

Step 5—Rinse in 70 percent ethanol, then 95 percent ethanol.

Step 6—Transfer to clove oil until clear. Any remaining wax should disappear during this step. You may leave specimens in clove oil overnight.

Step 7—Place the specimen on a slide in a drop of Canada Balsam. Histoclear is a safe thinner for balsam. Arrange the specimens with anterior end toward you. Cover with a cover slip.

Step 8—Properly label each slide with the following information:

- ◆ *Maconellicoccus hirsutus* (Green)
- ◆ Collector's name
- ◆ Date collected
- ◆ Location
- ◆ Host plant

Identifying Characters

Refer to **Figure 2-11** for an illustration of the general morphology of an adult female mealybug (from Williams, 1996). Compare this illustration to **Figure 2-12**, *Maconellicoccus hirsutus*, and the following description of the adult female PHM (also from Williams, 1996):

Description

Adult female. Appearance in life described as orange pink to reddish, sparsely covered with white mealy wax but the insects become completely buried in the white ovisac material. Slide-mounted specimens up to 3.8 mm long, 2.1 mm wide; anal lobes poorly to moderately developed, each with a ventral anal lobe bar expanding towards apex and an apical seta 250–330 μm long. Antennae each usually 380–470 μm long with 9 segments. Legs well developed; hind trochanter+femur usually 300–350 μm long, rarely reduced to 280–290 μm long, hind tibia+tarsus normally 310–370 μm long, rarely only 280–300 μm long, claw stout, 35.0–37.5 μm long. Ratio of lengths of hind tibia+tarsus to hind trochanter+femur 1.00–1.16. Ratio of lengths of hind tibia to tarsus 2.30–2.60. Translucent pores present on hind femur and hind tibia, those on hind femur sometimes few and not easily apparent. Labium 150–165 μm long, about same length as clypeolabral shield. Circulus normally 85–150 μm wide, varying considerably in shape from almost quadrate to oval, usually with weak constrictions laterally and sometimes divided by an intersegmental line but this line not apparent in many specimens. Ostioles well developed, the inner edges of lips moderately sclerotized, each lip with 1–3 setae and a few trilocular pores but with marked variation. Anal ring 80–95 μm wide with 6 setae, each 125–150 μm long. Cerarii usually numbering 4–6 pairs, rarely 7 pairs. Anal lobe cerarii each with 2 conical setae, each seta about 20 μm long, and a few trilocular pores all situated on a membranous area. Anterior cerarii often similar but anteriormost cerarii sometimes reduced to a single seta or one or both setae replaced by flagellate setae.

Dorsal surface with thick flagellate setae. Multilocular disc pores absent. Trilocular pores evenly distributed. Discoidal pores minute, sparse. Oral rim tubular ducts numerous, usually each 4–5 μm in diameter, but sometimes narrower, 3.75 μm wide, 7.5–8.5 μm long, the rim about 10 μm in diameter. Oral collar tubular ducts each narrower than a trilocular pore and about 7.5 μm long, present across the middle of segments in more or less single rows but sometimes reduced to only one or two on each segment.

Description (continued)

Ventral surface with normal flagellate setae, similar to those on dorsum but usually longer. Multilocular disc pores each about 8.75 μm in diameter, distributed across the anterior and posterior edges of abdominal segment IV and posterior segments, often reaching submargins; sometimes present on abdominal segment III and rarely on medial area of head. Trilocular pores present in an even distribution. Discoidal pores sparse. Oral rim tubular ducts similar to those on dorsum, present around margins of thorax and anterior abdominal segments. Oral collar tubular ducts of two sizes. A large type, narrower than a trilocular pore and about 10 μm long, is present in transverse rows on abdominal segments III–VI and around lateral margins of all abdominal segments; others are scattered in medial and marginal areas of the thorax. A small type of duct, similar to those on the dorsum, is distributed mainly across middle of abdominal segments and mingled with the large type on margins; others are present in small numbers on head and thorax.

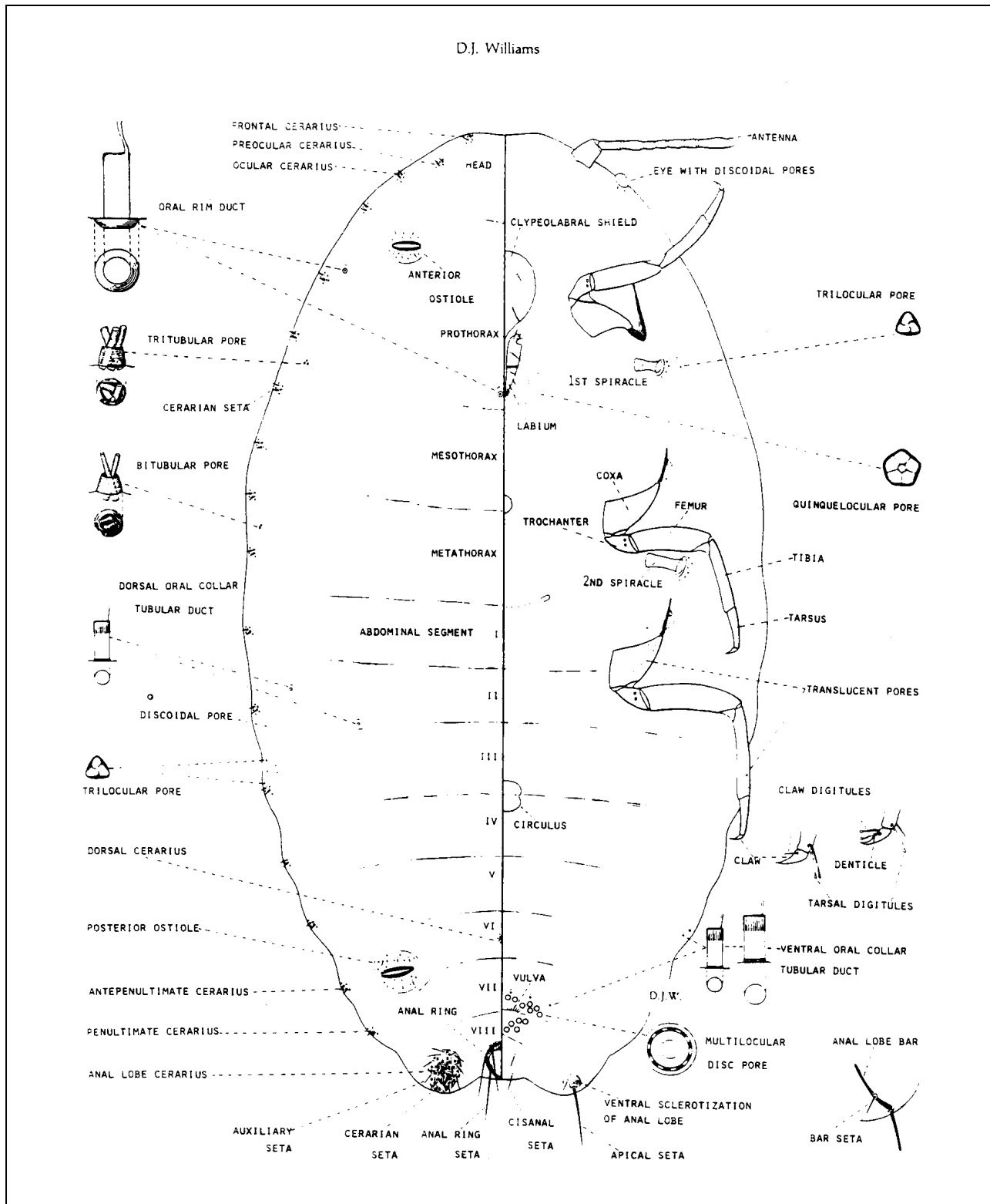

FIGURE 2-11: General morphology of an adult female mealybug (from Williams, 1996)

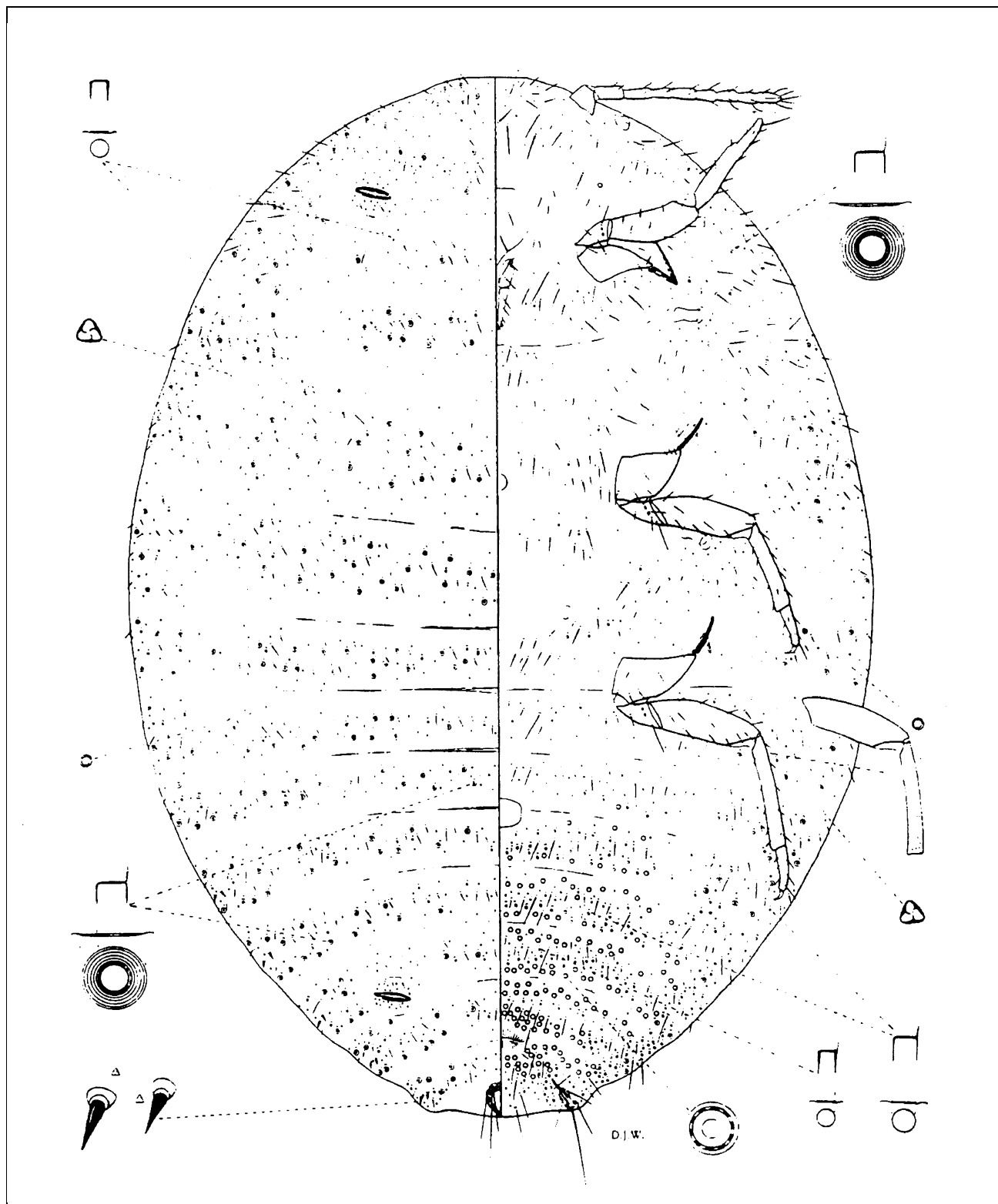

FIGURE 2-12: Pink hibiscus mealybug, *Maconellicoccus hirsutus* (Green) (from Williams, 1996)

3

Pink Hibiscus
Mealybug

Operating the Insectary

Introduction

Contents

Introduction	3-1
Purpose	3-2
Following the Mandatory Work Pathway Protocol	3-2
Host Plant Material	3-5
Introduction	3-5
Using Japanese Pumpkins as Host Plants	3-5
Using Potatoes as Host Plants	3-11
Using Potted Plants as Host Plants	3-12
Pink Hibiscus Mealybug (PHM) Culture	3-13
Introduction	3-13
Sanitizing the Insectary	3-13
Preparing the Room for Pumpkins	3-13
Preparing the Room for Potatoes	3-14
Transferring Pumpkins or Potatoes	3-15
Starting the PHM Culture on Laboratory Host Plant Material	3-15
Establishing a Crawler Collection System	3-16
Culturing PHM	3-22
Examining Pumpkins	3-23
Selecting PHM-Infested Pumpkins for the Parasite, Predator, or PHM Cultures	3-23
Cleaning the Host Culture Room	3-24
Exotic Natural Enemy Shipments	3-25
Introduction	3-25
Keeping Records	3-25
Starting the Parasite Culture	3-26
Natural Enemy Culture: Parasites	3-27
Introduction	3-27
Life Cycle	3-27
Housing the Cultures	3-29
Constructing the Cages	3-30
Setting Up the Aspirator	3-31
Establishing Weekly Parasite Oviposition Cages	3-33
Maintaining the Parasite Cultures	3-34
Natural Enemy Culture: Predators	3-37
Introduction	3-37
Life Cycle	3-37
Determining Production Capacity	3-38
Maintaining the Cryptolaemus Culture	3-38
Using Suitable Rearing Cages	3-38
Using Preferred Host Material	3-38
Setting Up the Oviposition Units	3-39
Aiding Larval Development	3-39
Monitoring Pupation	3-40
Providing Food and Water at Emergence	3-40
Collecting Beetles for Field Release	3-40

Purpose

To rear parasites and predators, it is a necessity to propagate or acquire the optimum host plant for rearing the mealybug in a laboratory. You can use suitable potted plants that are hosts to PHM, but propagating and maintaining these types of plants requires considerable greenhouse space, special lighting inside the laboratory, and a sizable workforce. Occasionally, a fruit or vegetable can be substituted as the host plant substrate of choice for an insectary operation for mass producing an insect. The Japanese pumpkin (*chirimen* variety) is such a host and is the host of choice for this program. You can also use Russet or other white potatoes as a backup host if sprouts can be grown and maintained for several months. These host plants are easy to maintain and manipulate. Potatoes are held in the dark for storage and sprouting, and both potatoes and pumpkins are held in the dark to effectively rear the mealybug. These infested hosts are then placed in a single- or double-holed sleeve cage for predator and parasite mass production in the insectary.

Insectary operators must understand that they have to deal with a total of three trophic levels in this insectary operation:

- ◆ The host plant
- ◆ The mealybug
- ◆ The predators or parasites that feed on or parasitize the mealybug

To successfully rear and release adequate numbers of natural enemies, you must adequately produce and maintain all three trophic levels. Keeping these trophic levels free from contamination is an important aspect of operating the insectary. To prevent contamination, be sure to follow the procedures in the next subsection, **Following the Mandatory Work Pathway Protocol**. Locate the insectary site in an infested area if possible, to prevent establishment of this pest in uninfested regions.

Following the Mandatory Work Pathway Protocol

To prevent premature contamination of the host plant material with PHM and contamination of the PHM culture with natural enemies, you must carefully define the work pathway and follow a specific protocol.

Host Plant Material

The first work of the day should be with the host plant material. This may consist of the following activities:

- ◆ Working in the field harvesting pumpkins and transporting them for treatment and storage
- ◆ Examining the host plant material in storage and culling host material that is decaying
- ◆ Selecting host plant material for the week and/or day's use



Important

Do NOT work with the PHM or natural enemy cultures before working with uninfested host plant material!

Some staff may need to dedicate half a day to the host plant material while others may only help for an hour and go on to the next level of activity, which would be working with the PHM culture. Anyone who has worked with the PHM culture **never returns** to work on the pumpkins or potatoes for that day and **never enters** the host plant storage area.

PHM Culture

Once workers finish the host plant work for the day, they may go on to work at the next trophic level, such as working with the PHM culture. **Do not work on natural enemy cultures** before working in the PHM insectary. To avoid contamination, do not enter the natural enemy insectary, handle field releases, or allow exposure to field material before working with the PHM culture. Open the natural enemy culture room **only after** completing all PHM culture work and securing and locking the rooms.

Natural Enemies

The last events of the day consist of working with the natural enemy cultures and/or field work. New cultures need to be set up, old cultures cleaned, and host material properly discarded. Put all material in heavy black plastic bags, seal tightly, and take to an appropriate disposal site a safe distance from the insectary facilities. You may need to collect natural enemies from cages for release that day. Once you have worked in the natural enemy insectary, or have handled or released natural enemies, **never reenter** the PHM insectary or host plant storage area, and **never handle** uninfested host plant material.

Field Work

Field work should follow the natural enemy culture work. Do **not** work on field samples in the parasite insectary or mealybug culture room. A separate room is ideal for holding and examining field material to avoid contaminating the pure cultures. Keeping this room at a constant temperature of approximately 80°F (27°C), you can hold samples up to 30 days for parasite emergence.

3

Pink Hibiscus
Mealybug

Operating the Insectary

Host Plant Material

Introduction

Two host plants suitable for use in propagating PHM in the insectary are the Japanese pumpkin (*Cucurbita moschata* (Duchesne) var. *chirimen*) and potatoes. The following subsection discusses the use of these artificial host plants.

Using Japanese Pumpkins as Host Plants

The Japanese pumpkin, (**Figure 3-1**), is a product of Takii Seed Company (Parent Company is in Kyoto, Japan). It has been successfully used as an artificial host plant to mass produce three other species of mealybugs including: Comstock mealybug, *Pseudococcus comstocki* (Kuwana) (Meyerdirk and Newell 1979), spherical mealybug, *Nipaeococcus viridis* (Newstead) (Meyerdirk, et al. 1988), and citrus mealybug, *Planococcus citri* (Risso) (Chandler et al. 1980).



FIGURE 3-1: Japanese pumpkin, *Cucurbita moschata* (Duchesne) var. *chirimen*

Description

The fruit is a flat globe, distinctly ribbed and warty. The rind is dark green, turning to buff yellow when fully ripe. The flesh is cream yellow and thick, with a sweet, nutty flavor. While the plants are easy to grow and set fruit prolifically in temperate climates, they are not so easily grown in tropical, wet climates. Results may be poor during the rainy season. Since this pumpkin is a hybrid, it is not possible to save seed from harvested pumpkins to use for next year's planting needs.

Acquisition of Seed

Listed below are two sources of seed. The following list is for information only and does not constitute endorsement by APHIS.

- 1. Stokes**
P.O. Box 548
Buffalo, New York 14240-0548
Phone: 716-695-6980
FAX: 716-695-9649

Reference: The personal contact representing Stokes is Joel Butwin, 905-684-3022 or 1-800-263-7233; FAX 905-684-8499

- 2. American Takii, Inc.**
301 Natividad Rd.
Salinas, California 93906
Phone: 408-443-4901

Cost

Approximately \$75.00/lb. (1996)

Field Production

Since the pumpkin is susceptible to frost, planting the seeds in a greenhouse with controlled temperatures of greater than 70°F (21°C) will allow the earliest planting and harvest in temperate climates. Growing the seedlings in flats and transplanting in tropical climates will maximize production (**Figure 3-2**). In temperate climates, plant approximately 2,500 seedlings in flats about 3-4 weeks before transplanting; in tropical climates, plant 1,000 seeds every 60 days.



FIGURE 3-2: Growing Japanese pumpkin seedlings in flats for greater production.

Transplanting: Transplant seedlings to the field at the 2–4 leaf stage and use hot-caps if necessary in temperate climates, depending on outside temperatures. Have the following supplies ready:

- ◆ Hand trowels (10–12)
- ◆ Hoes (4–5)
- ◆ Sticks cut to 4 ft. (1.2 m) in length (6)

Space the seedlings 4 ft. (1.2 m) apart in the row, with approximately 6.7 ft. (2.0 m) between rows. If using 40-in. (1.0-m) furrows, plant the pumpkin seedlings in every other row. Depending on irrigation systems, you may plant the seedlings on the edge of the furrow. To accomplish this operation most efficiently, divide duties up according to the number of workers available. Caution workers not to trample down the furrows during transplanting activities.

1. Send workers down the rows measuring off exactly 4 feet (1.2 m), using the 4-ft. sticks. Have the workers dig a small hole for the seedlings every 4 feet.
2. Send another set of workers down the rows placing bunches of seedlings alongside each hole.



Important

To prevent the root system from drying out, do not lay out too many plants ahead of time before planting!

3. Send a third set of workers behind the above to put plants in the holes. Cover the roots with soil and tap down gently.
4. Apply a 10-10-10 (NPK) fertilizer about 4 weeks after planting.
5. Continue watering as needed.
6. Record planting data on **Form PHM-3 (Appendix H)**.

Greenhouse Production

These same pumpkins have been grown in greenhouses in central California during the winter. The following are guidelines for greenhouse production based on past growing experience in California.

Regulating temperature and spacing: At the time of planting, the soil temperature should be about 50°F (10°C) and the air temperature should be between 58°F (14°C) and 80°F (27°C). Transplant seedlings the second week in January when you observe the first main leaf. Plant seedlings in groups of two's and pinch off the weaker plant 2 weeks later. Space each plant 2 feet (0.6 m) apart within rows bedded with straw. Train the vines to grow up when they reach 12 to 15 inches (30 to 38 cm) and attach them to overhead wires with nylon twine suspended from steel rods at each end of the rows.

Controlling disease: To prevent pathogen damage, remove all laterals and leaves touching the ground except the main lateral. Pathogens likely to be encountered include *Botrytis*, which attacks the blossom ends of the fruit and causes deterioration, and *Sclerotinia* which attacks open wounds on the plant and multiplies in decaying debris on the ground. To prevent damage by these organisms, good sanitation is important. Hand pick infected leaves and apply a mixture of Boltran and Benlate with baby powder as a carrier. Water the plants once a week in the early stages of growth and up to 3 times a week in later growth. Use straw to bed the plants, retain moisture, and build up carbon dioxide in the air.

Fertilizing: Apply fertilizer early and during the middle of the growth stages to promote leaf and lateral growth. Use 15-30-15 NPK to start and shift to 26-16-6 NPK toward the middle when pumpkins are being formed. A supplemental application of nitrogen may improve fruit set. Use urea (46-0-0) and some potash to retain leaves and force pumpkin production. As pumpkins ripen, support them in the air with a netting.

Harvesting Pumpkins

The preferred stage for harvesting the Japanese pumpkins is in between the green and orange stages, when the pumpkins are dark green or black and very dull—no longer shiny. When the pumpkins have become dull the skin should have hardened. At this stage the pumpkins are fully ripe. This is the stage preferred by PHM and also the stage which will give the longest shelf life. When harvesting, leave a short stem attached to the pumpkin (**Figure 3-3**), and pack in straw to prevent bruising. Wooden crates may be useful in transporting the pumpkins from the field. Handle the pumpkins carefully to avoid injury to the skin (do not throw or drop pumpkins). Bacteria will enter injured areas, and the pumpkins will break down. Discard cracked pumpkins.



FIGURE 3-3: Japanese pumpkins with short stems attached in wooden crates

Record the following data on **Form PHM-3 (Appendix H)**:

- ◆ Date the pumpkins were planted
- ◆ Location of the field
- ◆ Number of plants seeded or transplanted
- ◆ Date you harvested the pumpkins
- ◆ Total number of pumpkins harvested
- ◆ Total weight of pumpkins if possible to measure

Preparing Pumpkins for Storage

After harvest and before storage, wash the pumpkins in 5 percent bleach solution. Brush off all dirt and insect life with a soft bristle brush. Add specific fungicide and miticide **with no insecticidal properties** to the wash water as available.

These chemicals were available in St. Kitts:

- ◆ Fungicide: Manzate
- ◆ Miticide: Dicofol

Storing Pumpkins

Shelf life of the pumpkin can span 3 months, but by that time they are past the stage where PHM will settle, feed, and develop. If rodents are present, build a wire cage to keep them out. Store the harvested and washed pumpkins on open shelves in a large, open room, or on shelves outside under a roof shelter, to allow for air circulation. Air conditioning may not be necessary, but the pumpkins should remain dry and should get plenty of air flow from windows or other openings. Use a dehumidifier to reduce moisture levels if necessary. Ideally, the pumpkins should not touch each other during storage. Each week, examine all stored pumpkins for rot and insects. Discard rotting pumpkins and brush mealybugs or other pests from the pumpkins.

Using Potatoes as Host Plants

Potatoes have served as a useful host for many different species of mealybugs. It is not the potato itself that the mealybug feeds upon, but the blanched sprout of the potato. You can sprout potatoes without soil and water on an open rack system ([Figure 3-4](#)) or partially submerged in a box containing soil ([Figure 3-5](#)) that is occasionally watered. The latter requires more care and maintenance of the potatoes and room conditions. In both systems, the potatoes are grown **TOTALLY** in the **DARK** to keep the sprout from producing chlorophyll and turning green, which is not desirable to the mealybug. The mealybug crawlers and various instars will feed directly on the potato sprout. Russet or other white seed potatoes have worked well in the past. This is a backup host plant in case the pumpkins are not available, or to be used in small test containers, or to supplement the pumpkin culture of the mealybug.



FIGURE 3-4: Open rack system for sprouting potatoes



FIGURE 3-5: Sprouted potatoes partially submerged in a box containing soil

Seed potatoes are best to purchase in 100-lb. (45 kg) bags, because they are not treated with sprouting inhibitors. You can buy these bags in large quantities and refrigerate at 37°F (3°C) to 45°F (7°C) for long periods. Sometimes, cutting the tip of the potato can stimulate sprouting. Sprouting of last seasons' potatoes may take 4–6 weeks.

Wash, dry, and lay the potatoes out on trays. Place the potatoes in a dark room for sprouting at room temperature. When sprouts are at least ½–1 inch (1.3–2.5 cm) long, lightly infest the sprouts with crawlers (**Figure 3-6**) and return them to a room with **NO LIGHT** except for temporary maintenance.



FIGURE 3-6: Potato sprouts (foreground) infested with PHM crawlers

Potatoes potted in soil and kept watered require more care and are subject to diseases. Partially submerge these potatoes in the soil, with half the potato lying flat above the surface. Boxes must be able to drain off excess water through the bottom of the box. These sprouts become thick and long, reaching 12 inches (30.5 cm) or more in height.

Using Potted Plants as Host Plants

You can also use plants like hibiscus potted in 1-gallon (3.8-liter) containers as host material, but this will require propagation or purchase. If grown inside, plants will require adequate space, overhead lighting (for example, grow-lux lights), and large cages to confine the PHM on the plants and prevent predators or parasites from entering. These same cages in turn will serve to contain the natural enemies for propagation.

3

Pink Hibiscus
Mealybug

Operating the Insectary

Pink Hibiscus Mealybug (PHM) Culture

Introduction

The PHM insectary should consist of two rooms (approximately 150 ft² or 14 m² each) plus another room (approximately 100 ft² or 9.3 m²) to collect crawlers. Depending on the size of the insectary, the crawler collection system can be isolated in a large cardboard box in a separate room (see [Establishing a Crawler Collection System](#)). When room #1 of the mealybug insectary is filled with PHM-infested pumpkins, begin filling room #2. As room #2 is being filled, begin to empty room #1 by transferring host material to parasite and predator cultures, or to the crawler collection system for the PHM stock culture.

Sanitizing the Insectary

Each room should remain empty for 1 week to allow time for cleaning and decontamination. Sweep the rooms and then mop with 10 percent bleach solution. Wipe shelves with 10 percent bleach solution.

Preparing the Room for Pumpkins

The PHM insectary room should be at least 150 ft² (14 m²), with wooden shelves approximately 18 in (46 cm) deep at 1-ft (30 cm) intervals above each other along the walls of the room ([Figure 3-8](#)).



FIGURE 3-8: Wooden shelves supporting plastic trays with infested pumpkins

Use at least five shelves per wall to support plastic (cafeteria-style) trays of infested host plant material (pumpkins or potatoes).



If possible, use free-standing racks, preferably on rollers, rather than shelves attached to walls. The racks can be removed from the insectary room for cleaning and sterilizing.

Curtains made of heavy black cloth, hung from the top shelves and draped to the floor, help eliminate all light from the PHM culture. These curtains will cover newly infested pumpkins or potatoes and prevent light from attracting the crawlers while people are working in the room each day. All light sources are **OFF** and **NO** outside light should penetrate the room. Since light attracts crawlers, rear the PHM cultures in **TOTAL DARKNESS** to prevent crawlers from walking off the pumpkins. Turn on lights and throw back the black curtains only when technicians are working in the culture for short periods of time. **Do NOT take work breaks and leave the lights on!**

Supply the two host rooms with air-conditioning units and industrial grade portable fans, to maintain room temperatures between 75°F (24°C) and 85°F (30°C), and to provide adequate air circulation. If necessary, use a dehumidifier to keep relative humidity at approximately 60 percent. The door to the rooms should open to the outside. Construct a small cubicle to provide another small entry door, also opening to the outside, to prevent entry of foreign insects and parasites to the room inside. A sink with running water is desirable to wash trays and tables. Use plastic serving trays lined with paper towels as a portable substrate, which allows workers to move the pumpkins from place to place as needed. The paper towels will absorb honeydew excreted by the mealybugs.

Preparing the Room for Potatoes

When pumpkins are scarce, you can use sprouted potatoes for host material. A room, **kept dark** to prevent greening of the sprouts, will provide for adequate storage of potatoes and will allow the potatoes to sprout over time. Line the room walls with wooden shelves, and spread out potatoes on plastic trays on the shelves. Temperatures may fluctuate between 75°F (24°C) and 90°F (32°C), and a relative humidity of 70 percent is ideal.

Transferring Pumpkins or Potatoes

Each weekday morning, select 5 to 10 pumpkins from the storage area for use in host culture, depending on the number of pumpkins available for future use. Before infesting, examine the pumpkins and brush off or remove any mealybugs or other contaminants. Place the pumpkins on a piece of paper towel on a plastic tray and transfer them to the host culture room. Depending on the length of time in storage, another dip treatment of bleach, miticide, and fungicide may be necessary. Make sure the pumpkins are dry before infesting with PHM and placing in PHM culture.

Starting the PHM Culture on Laboratory Host Plant Material

To initiate a pure culture of PHM, you will need to carefully transfer single, gravid adult PHM females from field material to insectary host material. The females must be confirmed as PHM. Take care not to transfer other species of mealybugs. When the females begin laying ovisacs (egg sacs) on the pumpkins, transfer these ovisacs to new pumpkins daily to maintain the culture. The following steps describe the egg sac transfer system.

Step 1—Select from the mealybug host culture one PHM-infested pumpkin that has adult females with ovisacs containing eggs.

Step 2—With a 0000-size camel hair brush and using a 2¼ X magnificuser, carefully transfer 50–100 ovisacs onto each of the five pumpkins to be infested. Dampening the brush with water may help the ovisacs stick to the brush during the transfer process, if necessary. Take care not to transfer ovisacs from any contaminant species of mealybugs. During the transfer process, place ovisacs within the grooves of the pumpkin over the entire upper half surface of the pumpkin.

Step 3—Place a paper tag showing the date of infestation on the tray with the pumpkins. Store the pumpkins on shelves behind a black curtain that drapes over the rack and excludes light from the room.

Establishing a Crawler Collection System

You will eventually need a crawler collection system to make the insectary operation more efficient at collecting 1-2 day old PHM crawlers as they hatch from the egg masses. Such a system will allow a more even distribution of the developmental stages in the mealybug culture on each pumpkin and allow specific stages to be selected for the parasite production with minimal overlap of other stages. You can use a crawler collection **box** or dedicate a total **room** (see [page 3-18](#)) to this system, depending on the size of your facility and the PHM culture.

Crawler Collection Box

Construct a **crawler collection box** using a large, heavy cardboard box, approximately 30 in (76 cm) x 30 in x 30 in. To modify the box, follow these steps:

Step 1—Close the box. Tape the lid with duct tape to prevent light entry.

Step 2—Cut a door flap, 14 in (36 cm) x 14 in, into the side of the box, leaving the top side uncut. This uncut top side will serve as a hinge, allowing the door to swing upward.

Step 3—Tape manila folders to the bottom with a 6-in (15-cm) square cut out of the front section and not taped. Cut a second manila folder section 12 in (30 cm) square to serve as a paper tray that slides under the folder taped to the box.

Step 4—Plug a small (7-watt) night lamp into a 12-ft (4-m) extension cord ([Figure 3-9](#)). Push the lamp through a small hole in the top front section of the box so that the light hangs in the center of the small paper tray on the bottom of the box. Position the light to hang just 4 in (10 cm) off the bottom of the tray with light focused on the paper tray. Wrap aluminum foil around the lamp to reduce the light and focus it on the paper tray below.



FIGURE 3-9: Night lamp wrapped in aluminum foil in crawler collection box

Step 5—Place infested host plant material (pumpkins or potatoes) inside the box and around the outer edge. Use small wire trays to hold the host material off the paper to allow crawlers to walk underneath if they fall behind the host material. You can use additional wire racks to hold a second level of host plant material inside the box along the back edge.

Step 6—Seal the box and leave the light turned on continuously. Close and tape the door. The hatching crawlers will be attracted to the small light inside the box and will gather in large numbers on the removable paper tray. Cover the box with a heavy black cloth large enough to wrap around the box and over the top to prevent any light from penetrating the box (**Figure 3-10**). Tuck the end of the cloth under the box.

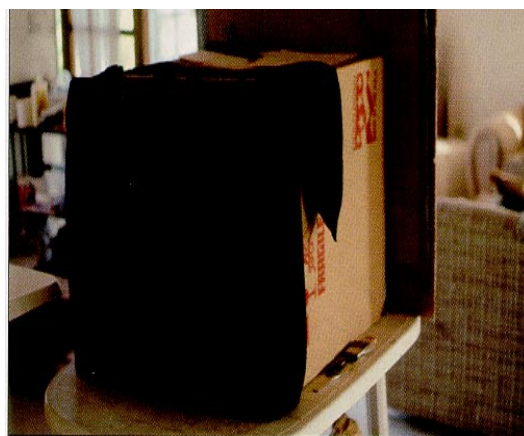

FIGURE 3-10: Crawler collection box covered with heavy black cloth

Step 7—Check the box and collect crawlers daily. Remove crawlers by curling the paper tray. Tap the crawlers into a large plastic vial for transport to the mealybug culture room where you will infest new pumpkins or potatoes. Using **Form PHM-4 (Appendix H)**, record the date you collected the crawlers, the volume or weight of crawlers collected, the number of host plants infested, and the total host units infested. Use **Form PHM-5** to keep a copy of the host infestation record on each tray of host material as it moves through each level of production.

Step 8—Rotate old pumpkins and potatoes out of the crawler collection box. Keep the box as clean as possible, supplying new paper trays as needed.

Crawler Collection Room

If the insectary is large enough to warrant the use of a large crawler collection system, then a room (approximately 100 ft² or 9.3 m²) can become the crawler collection “box” only on a larger scale. This room needs an appropriate air-conditioning system to control temperatures near 80°F (27°C). The room must be totally darkened so no outside light can penetrate, including light from under functioning doors. All windows need to be blocked from incoming light.

You can use two different types of crawler collection room systems:

- ◆ Hot wire barrier system
- ◆ Light only system

The first type uses a hot wire barrier that stops the advancement of crawlers toward an open light in the room. The second type uses only a small light source to attract and hold the crawlers in place. Set up the room using one of these systems, described in detail below.

Hot Wire Barrier System

This is the most efficient crawler collection system, but it requires more equipment and is more complicated to set up than the light only system. Use this system if you have the resources and expertise to put it in place.

Step 1—Build three to four racks to hold four to five shelves of pumpkins. The racks should be approximately 3 ft (1 m) wide x 2 ft (0.6 m) deep x 6 ft (2 m) high. A room with four racks can then hold about 20 trays (**Figure 3-11**) each with approximately 12 pumpkins. See **Appendix I** for an illustration showing dimensions of the PHM culture racks.



FIGURE 3-11: Rack used in the hot wire barrier system holding five shelves of pumpkins

Step 2—Mount in a vertical position a 36-in (92-cm), 20-watt fluorescent light on a wooden stand about 4 ft (1.2 m) high. Place the light in the corner of the room facing the racks that will hold the pumpkins infested with egg masses. This crawler collection light should be the only light in the room. Leave this light on continuously and be prepared to replace the light when necessary to avoid loss of crawler production if the light burns out.

Step 3—Cut 30-in (76-cm) wide pieces of plywood tapered to the front (**Figure 3-12**), to make removable five-sided shelves that will fit in the rack on the shelf holder cross member. Glue a smooth layer of white formica to the surface of each shelf. Place shelves on the racks about 12–16 in (30–40 cm) apart.

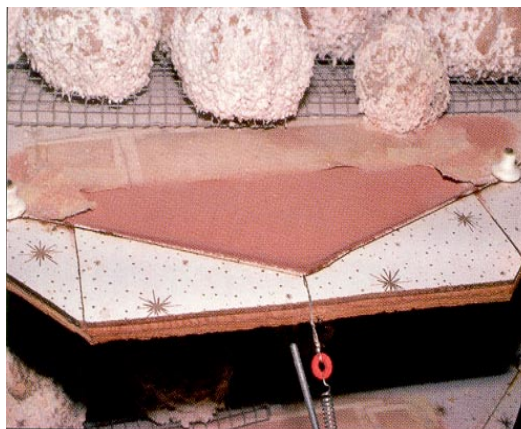

FIGURE 3-12: Removable five-sided shelf used in hot wire barrier system

Step 4—Secure on insulators a wire (heating wire found in toasters) $\frac{1}{4}$ in (6 mm) off the formica, running from the back of the shelf all around the front, then returning to the back.

Step 5—Connect a rheostat (**Figure 3-13**) to the wires on each tray of the rack and adjust to heat the wire to a temperature of 115°F (46°C). Avoid higher temperatures, which will kill the crawlers. Crawlers, actually remaining about 1 in (25 mm) behind the wire, will not cross this hot wire barrier, even though they are attracted to the light ahead of them.

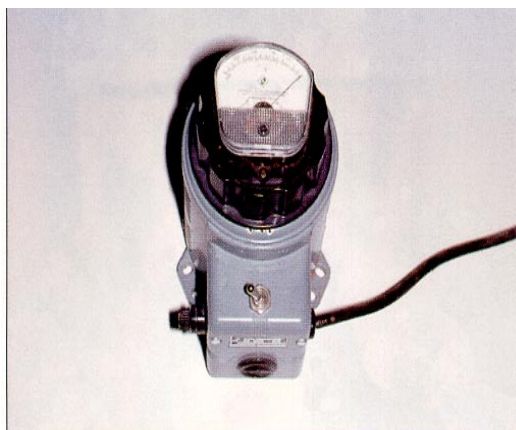

FIGURE 3-13: Rheostat used to heat the wire to a temperature of 115°F (46°C)

Step 6—Equip each crawler collection tray with a removable section about 6 in (15 cm) deep x 10 in (25 cm) wide in front of the tray. This section is a piece of white formica that slips under a small overlapping paper lip attached to the main tray. This construction will allow the crawlers to walk across to the removable tray without falling into the crack. Place four or five of these trays from which to collect crawlers on each rack.

Step 7—Position another insulated wire and a spring to hold the front end of the heated wire that straddles the removable tray. You should be able to lift this spring up to remove the tray with live crawlers.

Step 8—Place pumpkins or other host material infested with egg masses on small wire trays to keep the host material from directly contacting the formica tray. Place larger wire tray stands on each tray to stack the pumpkins on the trays two layers high if necessary.

Step 9—Tap the crawlers collected from each tray onto a manila folder and transfer them to a large vial. Measure and/or weigh the vial to determine the quantity of PHM crawler material produced that day.

Step 10—Discard the pumpkins after all crawlers have emerged (about 2 weeks).

Light Only System

You can use another crawler collection system similar to the crawler collection box that is less complicated than the **hot wire barrier system**. Again, the room is substituted for the box.

Step 1—Center a large table (4–5 ft² or 0.4–0.5 m²) in the room. You can use a sheet of plywood on top of a smaller table.

Step 2—Glue a covering of white formica onto the table top.

Step 3—Attach two 7-watt night lights to an extension cord to form a small light system. Hang the lights down from the ceiling just over the center of the table, about 4–5 in (10–13 cm) above the table top. Cover each light with aluminum foil to focus the light on the table below. The extra light is a precaution in case one light burns out overnight; the other will still attract the crawlers, and you will not lose a day's worth of crawlers.

Step 4—Develop the same type of tray system as described above in the hot wire barrier system. Crawlers moving from the perimeter of the table will approach the light in the center of the table and walk into the removable tray system. To construct this tray system, tape a manila folder on three sides and cut out a 12-in (30-cm) section in the center to form a “U” shape. Use another manila folder as the tray, which slides underneath the taped top folder.

Step 5—Place infested pumpkins or potatoes with egg masses around the perimeter of the table on three sides. Set the host material on small wire trays that will hold the pumpkins or potatoes about 1 in (2.5 cm) off the substrate. Doing this will allow the crawlers to fall to the table top and walk under the host material freely without being obstructed. You can place pumpkins on the wire trays two deep. Leave one side of the table open to work freely on the table top and to permit moving the tray in and out of its holder for crawler collection.

Step 6—Rotate in infested pumpkins and potatoes with egg masses weekly; take out and discard old material. Use each side of the table to represent a new set of host material to exchange in about a 2–3 week period. Collect crawlers daily and use them to infest new host material for the PHM stock culture. Remove decaying host material as necessary.

Culturing PHM

Quantify the amount of PHM crawlers collected daily either by weighing or by measuring the volume of crawlers. Log daily records of crawler production for future use to determine the relative production levels for comparative purposes and to alert the insectary operator when production declines.

Gently sprinkle crawlers widely over the upper surface of the pumpkins or above the potato sprouts. The actual amount may vary depending on crawler production. Place no more than one ¼-dram vial of crawlers on an average sized pumpkin (2–3 lbs or 0.9–1.4 kg).

Set pumpkins on paper towels on a cafeteria type tray, which may hold four to six pumpkins. The paper towels will help absorb the honeydew excreted by the mealybugs. Separate the pumpkins by several inches (5–10 cm) to prevent contact by honeydew from mealybugs on other pumpkins and to help prevent the spread of fruit rot when it occurs.

Place all newly infested pumpkins on an appropriate shelf in the PHM culture room. Cover the pumpkins with a heavy black cloth draped over the rack holding the pumpkins to reduce the room light contacting the crawlers while you are working. The crawlers are highly attracted to light. Keep work in the PHM culture room at a minimum to reduce the influence of light on the crawlers' movement off the pumpkins. When the PHM culture room light is off, you should see **no light** in the room, including light from under a door. **Total darkness** is the optimal system. Anything less will influence the crawlers to move off the pumpkins. Check around window air conditioners and windows to eliminate small pockets of light. You can move infested pumpkins 15 days old out from under the black cloth onto another rack, but they **must** remain in the PHM culture room in **total darkness**. Keep the PHM culture room at a constant temperature of 80°F (27°C) with relative humidity of 60 percent.

Always retain half of the PHM culture in all stages to maintain the stock culture of PHM. **Do not remove more than half of the infested material per day for natural enemy production.** Keep a record on each tray of when the tray was infested and when material was removed for natural enemies, or disposed of, because of rotting pumpkins.

Infested pumpkins may remain in this room from 30 to 45 days before they are transferred to a crawler collection system or used for natural enemy production. *Anagyrus kamali* and *Gyranusoidea indica* production will require mostly third instars of PHM and *Cryptolaemus montrouzieri* will need fresh egg mass material for ovipositioning.

Examining Pumpkins

Examine all infested pumpkins in the host culture weekly. Search for the following:

- ◆ Decaying host material (discard as necessary)
- ◆ Contaminant species of mealybugs
- ◆ Predator larvae
- ◆ Signs of parasite activity

Kill any contaminant mealybugs and remove any decaying pumpkins and pumpkins showing signs of parasites (mummified mealybugs). If this occurs, you will need to start a new PHM culture in another protected rearing room. Use these infested pumpkins in this room for predator production only; do not use them for pure parasite cultures. To limit future spread of PHM, properly dispose of all infested material at a site within the infested area.

Selecting PHM-Infested Pumpkins for the Parasite, Predator, or PHM Cultures

To select PHM-infested pumpkins for parasite and predator cultures, follow these steps:

Step 1—Select appropriate numbers of pumpkins or potatoes with late second or third instar PHM for new parasite cultures. Transport them to the parasite rearing lab as needed for setting up parasite stings.

Step 2—Select infested pumpkins with older adult female PHM with a majority of ovisacs for the predator culture each week.

Step 3—Select infested pumpkins with mostly young egg masses for the crawler collection system weekly and transport as needed.

Cleaning the Host Culture Room

Once per week, clean the host culture room as follows:

Step 1—Sweep the floor, then mop with 5 percent bleach solution.

Step 2—Wipe down the shelves with 5 percent bleach solution.

Step 3—Examine all pumpkins for signs of decay; discard rotting pumpkins or potatoes.

Step 4—Dust the floor and shelves with a light coating of boric acid crystals for ant and cockroach control.

3

Pink Hibiscus
Mealybug

Operating the Insectary

Exotic Natural Enemy Shipments

Introduction

Each exotic natural enemy culture will start by receiving a shipment of insects from abroad. Proper processing and recording is very important, so be sure to carefully handle and record the contents of each shipment.

Keeping Records

Each shipment must have been previously cleared through a quarantine facility or must be known to be a pure laboratory culture of a specific species of natural enemy previously cleared through quarantine, unless the material can be screened through a local quarantine facility.

When you receive the shipment, take care in recording the contents of the shipment. Using **Form PHM-6 (Appendix H)**, properly document the shipment by recording the following data:

- ◆ Vial or packet number
- ◆ Host insect (P_1)
- ◆ Entomophagous species
- ◆ Number of natural enemies found alive and dead
- ◆ Total number of females and males present or later emerged
- ◆ Number of natural enemies propagated (F_1) on target mealybugs in laboratory

Identify and number each vial or container. Use a special numbering system for each shipment and container within, for example: 98 (year)-1 (number of the shipment for the year)-1 (number of container in shipment). Identify, properly label, and send voucher specimens to the appropriate museum curator.

Starting the Parasite Culture

Carefully transfer each species of imported natural enemy to a separate cage containing various instars of PHM, which should be mostly late second and third instars. If you do not know the mealybug host stage, expose the parasites to first, second, third, and adult female stages. Properly label each cage with the shipment number and record the number of individual natural enemies (P_1) placed in the cage. Record the number of individuals (F_1) propagated from the parents (P_1) on PHM in your laboratory. Continue to track and record on the cage's label the number of F_1 individuals that emerge. You will later tally this number on a summary sheet. Monitor and record the production of the F_2 and F_3 generations until you put each species into a mass production system.

3

Pink Hibiscus
Mealybug

Operating the Insectary

Natural Enemy Culture: Parasites

Introduction

The parasites presently available for biological control of PHM are two small wasps, *Anagyrus kamali* and *Gyranusoidea indica*. Procedures for rearing these parasites follow.

Life Cycle

Anagyrus kamali is a primary, solitary endoparasitoid; one adult parasitoid is produced from each PHM parasitized, with the entire immature development occurring within the PHM host (Cross and Noyes, 1995). For a diagrammatic illustration of the development cycle of *A. kamali*, see [Figure 3-15](#); for color photographs of male and female adults, see [Figure 3-13](#) and [Figure 3-14](#).



FIGURE 3-13: Adult male *Anagyrus kamali*



FIGURE 3-14: Adult female *Anagyrus kamali*

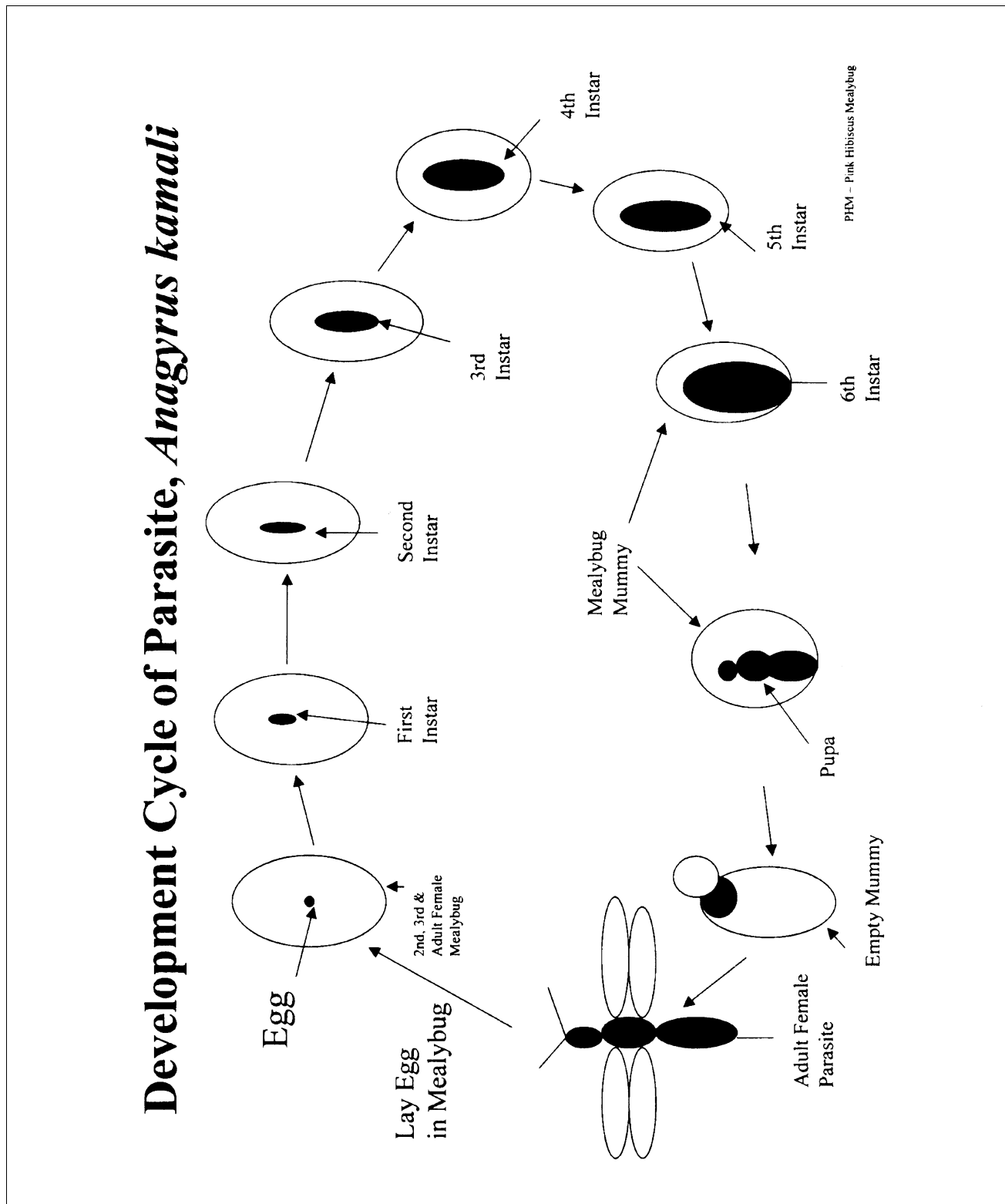

FIGURE 3-15: Development cycle of the parasite *Anagyrus kamali*

The adult leaves a characteristic emergence hole (**Figure 3-16**) after breaking through the carcass of the mealybug mummy.



FIGURE 3-16: Pink hibiscus mealybug mummies showing parasite emergence holes

Housing the Cultures

House the parasite cultures in a room of at least 144 ft² (13.4 m²) provided with air conditioning and portable floor fans. The temperature can fluctuate between 75°F (24°C) and 85°F (30°C). Provide light by overhead lighting and windows. Line the walls with shelves (see **Appendix I** for dimensions) to hold rearing cages and supplies. A table in the center of the room will provide a working surface for aspirating parasites and microscope work. Record minimum and maximum temperatures and relative humidity each day on **Form PHM-7 (Appendix H)**.

Constructing the Cages

The most common commercially available portable cage has a light-weight aluminum frame with dimensions of 12 in (30 cm) x 12 in x 12 in (**Figure 3-17**). The cages are hinged for collapsing and storage, and can be disassembled for cleaning. Some commercially available cages may not be suitable for rearing small Hymenoptera.



FIGURE 3-17: Portable aluminum cage for rearing parasites

To make sure that the cages will be acceptable for rearing the parasites, you may need to alter the cages as follows:

- ◆ Remove the screen panels from sides, back, and top of the cage.
- ◆ Replace the sides and back with fine-mesh organdy cloth fabric.
- ◆ Cover the top of the cage with a clear plexiglas panel held in place with silicone.
- ◆ Remove the loose weave sleeve from the front of the cage and replace with a close weave, unbleached muslin sleeve panel. The new sleeve must be long enough to tie in a knot and to open and insert your hand for aspirating parasites.
- ◆ Seal all surfaces of the aluminum frame where the sides of the cage meet the top with foam self-sticking weather strips. Seal the metal bottom with silicone caulking.

Large Aluminum Cage

With some modifications, you can also use a larger commercially available aluminum cage, 12 in (30.5 cm) x 12 in x 24 in (61 cm), that folds flat, for parasite production. Remove the door screen and replace it with two muslin cloth sleeves, held in by the rubber spline material around the frame. Replace the screen material at the top of the cage with a solid piece of plexiglas attached with silicone glue. To support the pumpkins when moving the cage, attach the bottom of the cage to a 3/8-in (1-cm) thick piece of plywood or Plexiglas using silicone glue. Seal the door with 1/2-in (1.3-cm) thick weather stripping.

Single and Double Hole Wooden Cages

Single and double hole wooden cages are optimum for rearing mealybugs on pumpkins for these reasons:

- ◆ They are sturdy
- ◆ They are durable
- ◆ They can be easily washed and maintained
- ◆ They can last a long time

If you have the time and materials, construct these cages using 5/8-in (1.6-cm) thick marine plywood. The double hole sleeve cage (see [Appendix I](#) for dimensions) is more suitable for six to eight pumpkins, while the single hole cage is good for experiments, sprouted potatoes, or one to two pumpkins.

Setting Up the Aspirator

To aspirate parasites for transfer to sting cages and to the field for release, use an aspirator attached to a vacuum pump ([Figure 3-18](#)).

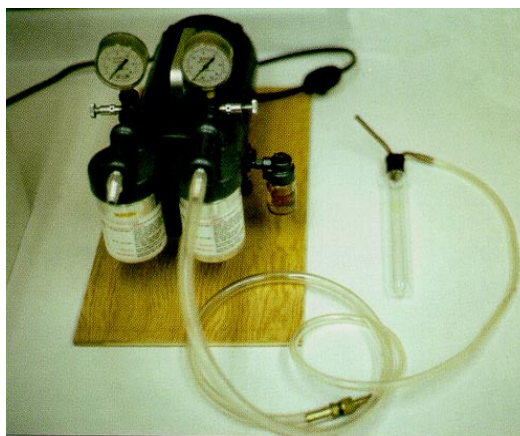

FIGURE 3-18: Aspirator assembly showing vacuum pump and latex tubing

Recommended specifications for the aspirator and vacuum pump follow:

Aspirator

Fit the aspirator with intake and exhaust tubes of aluminum or copper, and a mouth piece of ¼-in (0.6-cm) natural latex tubing. To limit inhalation of foreign matter, protect the exhaust tube with fine 220 mesh nylon. Use 9-dram, 1-in (2.5-cm) x 2¾-in (7-cm) clear styrene tubes (**Figure 3-19**) with snap-on caps as containers.



FIGURE 3-19: Clear styrene tubes with snap-on caps

Vacuum pump

The vacuum pump should have these specifications:

- ◆ Free-air capacity = 4.5 cfm
- ◆ Maximum vacuum = 26" Hg
- ◆ Maximum pressure = 20 psi
- ◆ HP = 1/3
- ◆ Amps = 2.2
- ◆ VAC/Hz = 115/80
- ◆ Watts = 528

Also equip the pump with a transformer to convert power from a 220-V source when needed.

Establishing Weekly Parasite Oviposition Cages

Providing Parasite Sting Cages with Host Material

Prepare a clean, empty parasite rearing cage with paper toweling placed on the cage floor. Paint thin honey streaks inside the top of the cage, and position a petri dish containing water-soaked absorbent cotton in one corner of the cage floor. Place in the prepared rearing cage four pumpkins from the host culture infested with third-instar PHM.

Selecting Cages for Aspirating Parasites

Check for adult emergence in cages set up 16 days previously. Look for cages with a new emergence of adult parasites. Males will emerge first, followed by the females. Choose a cage with approximately a 50:50 sex ratio of emerged parasites for aspirating.

Aspirating Parasites for the Sting Cage

When you find an appropriate cage, untie and open the sleeve of the cage and shake the sleeve gently to dislodge any parasites sitting inside the sleeve. Aspirate parasites from these cages. For sting cages with approximately four well-infested pumpkins, use 500 parasites per cage. For sting cages with approximately six to eight pumpkins, use 1,000 parasites per cage. To do this, use the aspirator, vacuum pump, and 9-dram vial described above in the [Setting Up the Aspirator](#) subsection. Working through the opened cloth sleeve of the new cage with unstung PHM, place the vial with the aspirated parasites on the floor of the newly prepared cage. Remove the lids from the vials and leave the vials upright on the cage bottom. Allow the parasites to leave the vials on their own and find the PHM-infested host material provided. Close the sleeve by tying it in an overhand knot.

Using [Form PHM-8](#) in [Appendix H](#), record the species, cage number, date of sting, number released in sting, host plant material, number of host plant units, date progeny collected, and number of progeny collected. Attach a form to each cage that remains, tracking production until you clean the cage. Transfer the data to summary [Form PHM-9](#) and [Form PHM-10](#).

Labeling the Sting Cage

Tape a paper label on one corner of the cage top for recording the date of cage set up, number of parasites (P_1), species of parasite, and its origin. Use this label for recording the dates and numbers of F_1 parasites emerged and aspirated for field release or for setting up new sting cages. You may take many collections over several weeks from each cage.

Maintaining the Parasite Cultures

Check the parasite rearing cages daily for the following conditions:

- ◆ The need to renew honey streaks
- ◆ The need to renew water-soaked cotton
- ◆ Invasion of ants in the cage
- ◆ Rotting pumpkins (remove if necessary)
- ◆ Contaminants—either parasite or predator
- ◆ F₁ parasite emergence (can be held another 16–21 days for F₂ emergence and collection when necessary)

After checking the cages for these conditions, continue with the routine maintenance tasks described in detail below.

Providing Honey Streaks and Water-Soaked Cotton

Renew honey streaks and water-soaked cotton as needed throughout the life of the parasite sting within the cage.

Controlling Ants/Cockroaches

Treat for ants and cockroaches as needed by applying a thin film of boric acid crystals to the floor, racks, and shelves in the parasite laboratory. Do **not** use liquid pesticides, such as in a spray or bait, which may volatilize or contact the parasites. For ant control on free-standing racks holding cages, put each leg of the rack in vegetable oil in a small pan or lid. To protect cages on table tops, place the cages on small legs and position the legs in shallow pans containing vegetable oil.

Removing Rotting Pumpkins

Working through the cage sleeve, carefully brush all mealybugs and mummies from the rotting pumpkin. Remove the pumpkin from the cage and discard it in a sealed plastic bag.

Aspirating Contaminants

If you notice contaminants, aspirate them from the cage into a 9-dram vial. Positive identification will require microscopic examination. Examine the cage carefully to find any possible leaks where the contaminants might have entered. Make temporary repairs with tape. Record the incidence of contamination on the cage label provided.

Recording Adult Emergence

When daily observations reveal F₁ parasite emergence, record the date of first emergence on the cage label. Examine the cage carefully each day after that to learn when both sexes have emerged.

Using Emerged Adults for Culture Reproduction and Field Colonization

After adequate F₁ emergence with a 1:1 sex ratio, you may use the cage to supply parasites for setting up new weekly sting cages. After removing enough parasites for use in new sting units for the week, you can aspirate the remainder of the parasites from the cage for field release. F₁ emergence will take place over approximately a 1-week period. As the F₁ parasites emerge, they will parasitize any unparasitized PHM in second instar through early adult stages in the cage. Therefore, you may wish to hold the cage an additional 2½ to 3 weeks to allow for a second generation (F₂) of emergence. Holding cages for F₂ and F₃ emergence has on occasion led to serious *sugar mite* contamination. Hold cages in the insectary for prolonged periods of time only as an emergency measure.

Cleaning-Up and Repairing the Cages

After emergence is completed and you have removed all parasites from the cage, discard the pumpkins in sealed plastic bags. Scrub and clean the cage with soap and water. Examine the cage carefully and make any necessary repairs.

Performing Weekly Laboratory Maintenance

Each Friday, sweep the laboratory and mop with a dilute (5 percent) bleach solution. Wipe down all racks, shelves, table tops, and counter tops with 5 percent bleach solution. After the floor is dry, spread boric acid crystals again throughout the lab.

3

Pink Hibiscus
Mealybug

Operating the Insectary

Natural Enemy Culture: Predators

Introduction

The preferred predator to use as a biological pesticide for the control of PHM is the lady bird beetle, *Cryptolaemus montrouzieri*, known as the “Mealybug Destroyer.” This predator is available commercially (Hunter, 1997). For color photographs of larval and adult life stages, see [Figure 3-20](#) and [Figure 3-21](#).

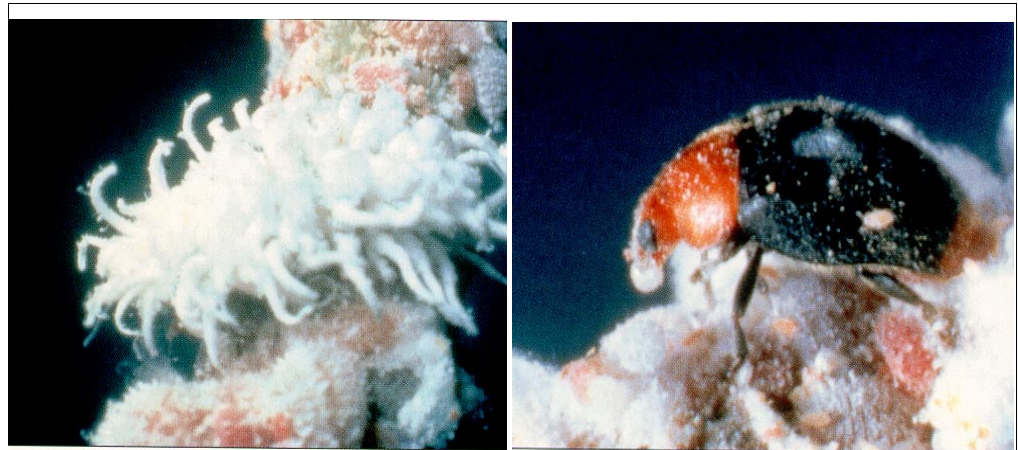

FIGURE 3-20: *Cryptolaemus montrouzieri* larva

FIGURE 3-21: *Cryptolaemus montrouzieri* adult

Procedures for rearing *Cryptolaemus* follow.

Life Cycle

The following is a description of the life cycle of *C. montrouzieri* in the St. Kitts insectary. At temperatures fluctuating between 74°F (23°C) and 80°F (27°C), the entire life cycle is completed in 30 days.

- A.** Insectary workers allow adult female beetles to lay eggs for 7 days.
- B.** Larvae develop over a 14-day period.
- C.** Larvae complete development, pupate, and remain in pupal stage for 7 days.
- D.** Adult beetles begin emerging and continue to emerge over a period of 7 days.

Determining Production Capacity

Setting 17 cages will yield between 4,000 and 6,000 *Cryptolaemus* per month for field release. The limiting factor is the availability of PHM-infested Japanese pumpkins from the PHM insectary culture.

Maintaining the *Cryptolaemus* Culture

Maintain the *Cryptolaemus* culture in a lighted room approximately 100 ft² (9.3 m²), with air conditioning holding the temperature at 80°F (27°C). Choose pumpkins that have mostly young egg masses from the PHM host culture once per week. If necessary to hold for a time, keep in a darkened room until needed for *Cryptolaemus* culture. Holding the host material in a darkened room prevents PHM crawlers from leaving the surface of the pumpkins and traveling toward the light source.

Using Suitable Rearing Cages

The *Cryptolaemus* culture with a production capacity of 4,000–6,000 per month can use up to 17 plastic rearing cages with the following specifications:

- ◆ Detachable
- ◆ Polypropylene
- ◆ External dimensions: 30 cm x 30 cm x 30 cm
- ◆ Weight: 930 g
- ◆ Mesh size: 24 mesh

Using Preferred Host Material

Host material used for propagating *Cryptolaemus*, in order of preference, is as follows:

- A. PHM-infested (egg mass) Japanese pumpkins from lab culture
- B. PHM-infested local variety of pumpkin from lab culture
- C. PHM-infested sprouted potatoes from lab culture
- D. Field-collected, PHM-infested soursop fruit
- E. Field-collected, PHM-infested hibiscus cuttings

Use field-collected, PHM-infested host material only when the lab-reared host material is scarce. Contaminants will be common in these cages.

Setting Up the Oviposition Units

Set up the oviposition units every 2 weeks using these procedures:

Step 1—Set up three rearing cages and add three infested pumpkins from host culture to each cage. The mealybug life stage offered should be adult PHM females with ovisacs.

Step 2—Streak honey on the undersides of the cage tops. Place a petri dish containing water-soaked absorbent cotton in each cage.

Step 3—Place 100 adult *Cryptolaemus* (50 female and 50 male) in each of the three cages. Allow the *Cryptolaemus* adults to remain in the oviposition cage for an egg laying period of 7 days. After the seventh day, aspirate the adults into a plastic vial and transfer them to a second cage. Divide the host material in the original cage into three parts by removing two of the three pumpkins and placing each in a separate cage. This will prevent overcrowding of the small cages. At the end of another 7 days, transfer the ovipositing adults to a third cage. After the third 7-day oviposition period, remove them and use these older beetles for field releases. Divide the host material from the second and third oviposition cages in the same manner as with the first cage. This produces a total of nine propagation cages.

Aiding Larval Development

During the next 2 weeks, when the *Cryptolaemus* larvae are developing, add one to two PHM-infested pumpkins to each cage twice a week. The mealybug life stage offered is adult females with ovisacs.

Step 1—Once a week, brush larvae from the oldest pumpkins in each cage and remove the oldest pumpkin(s) to make room for new host material. Add PHM-infested pumpkins containing mealybug stages described above.

Step 2—Place pumpkins removed from cages on a plastic tray and store on a shelf in the lab for 1 week.

Step 3—At the end of the week, use a size 0000 camel hair artist's brush to brush any developing larvae off the pumpkins into a petri dish. Return the larvae to the cage and discard the pumpkins on the plastic tray.

Monitoring Pupation

After the 2-week larval development period, the larvae begin to pupate. At this point, stop adding host material to the cages. The *Cryptolaemus* will remain in pupal stage for 1 week, after which adult beetles begin to emerge.

Providing Food and Water at Emergence

As beetles begin emerging, streak honey stripes on the underside of the cage top and place a petri dish containing water-soaked cotton in the cage. Adult beetles will continue to emerge for approximately 1 week. After the first flush of emergence, remove and sex the beetles for use in setting up the next set of oviposition cages. To remove the adult beetles, use a portable electric vacuum pump attached to a flexible tube and aspirator with a plastic vial.

Collecting Beetles for Field Release

As beetles continue to emerge, aspirate them into plastic vials every other day for field release. Place shredded paper inside each vial and stripes of honey inside the lids. Take vials of 100 beetles each to the field in a styrofoam ice chest containing a reusable frozen ice pack (blue ice) to keep the package cool during the release period. Wrap the ice pack in paper towels to prevent the vials from directly contacting it.



Do not leave beetles in closed cars where temperatures can exceed 100°F (38°C).

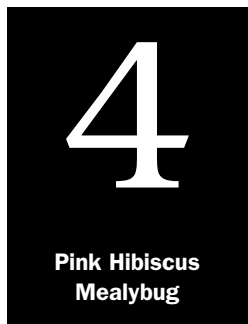

Releasing Natural Enemies

Introduction

Contents

Introduction	4-1
Purpose	4-1
Effectiveness of Parasites and Predators	4-1
Procedures for Parasites	4-3
Introduction	4-3
Aspirating Parasites	4-3
Transporting Parasites	4-6
Releasing Parasites	4-6
Procedures for Predators	4-9
Introduction	4-9
Transporting Predators	4-9
Releasing Predators	4-9

Purpose

The purpose of releasing natural enemies of PHM onto infested host plants is to allow the natural enemies to control local populations of the pest. This section is divided into two main subsections:

- ◆ Procedure for Parasites
- ◆ Procedure for Predators

The first subsection, Procedure for Parasites, deals with release procedures for parasitic wasps. Use these procedures for long-term control of PHM.

The second subsection, Procedure for Predators, deals with release procedures for lady bird beetles. Use these procedures for a quick knock down of PHM on moderately to heavily infested plants.

Effectiveness of Parasites and Predators

Exotic parasites are the long term solution to the PHM pest problem, while use of the predaceous beetle will only serve as a short term solution. The major thrust of the program is to mass produce and widely distribute PHM parasites as soon as possible. The predaceous beetle functions as a biopesticide—use only when major economic losses may occur if more immediate control is not attained within a 6-week period.

Using the beetle will delay the effective establishment and impact of the parasites. The beetle will feed on parasitized mealybugs and significantly reduce the parasites' population density if released at the same time and place. At sites where predaceous beetles are released, beetle populations eventually begin to decline in 6 to 9 months. If parasites are then introduced for establishment at those sites, they will continue to reduce mealybug populations, creating an environment unfavorable for beetle reproduction. The parasites may displace the beetles after some time.

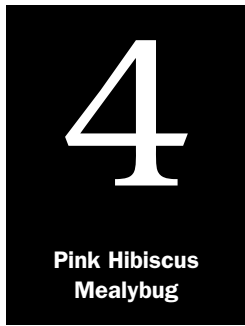

Releasing Natural Enemies

Procedures for Parasites

Introduction

Releasing parasites is an extremely important component of the PHM biological control program. You must try to release healthy parasites on suitable host plants infested with PHM. The parasites you may release are stingless wasps, *Anagyrus kamali* (Figure 4-1), *Gyranusoidea indica*, *Leptomastix* sp. (Figure 4-2), and possibly others. For color photographs and identifying characteristics of these parasites, refer to Figure 3-13 and Figure 3-14 in the previous section and to page 4-8.

Aspirating Parasites

These wasps are small, delicate insects. Be sure to use only a very gentle suction when you operate the aspirator pump.

Step 1—Select a cage from which to collect parasites.

Step 2—Place the aspirator assembly on a 9-dram plastic snap-cap vial and turn on the aspirator. Check the suction by placing it on your cheek. You should feel just a slight suction of the skin. **Do not use a hard suction because this will kill the parasites.**

Step 3—Untie and shake the sleeve to make sure the parasites are off the inside of the sleeve and back in the cage.

Step 4—Take the aspirator tube in your hand and insert the tube into the cage through the sleeve.

Step 5—Using the aspirator tube, carefully suction adult parasites into the plastic vial. Aspirate approximately 50 female and 50 male parasites in the plastic vial.

Step 6—Pull the aspirator assembly out of the sleeve.

Dr. A. A. Moursi

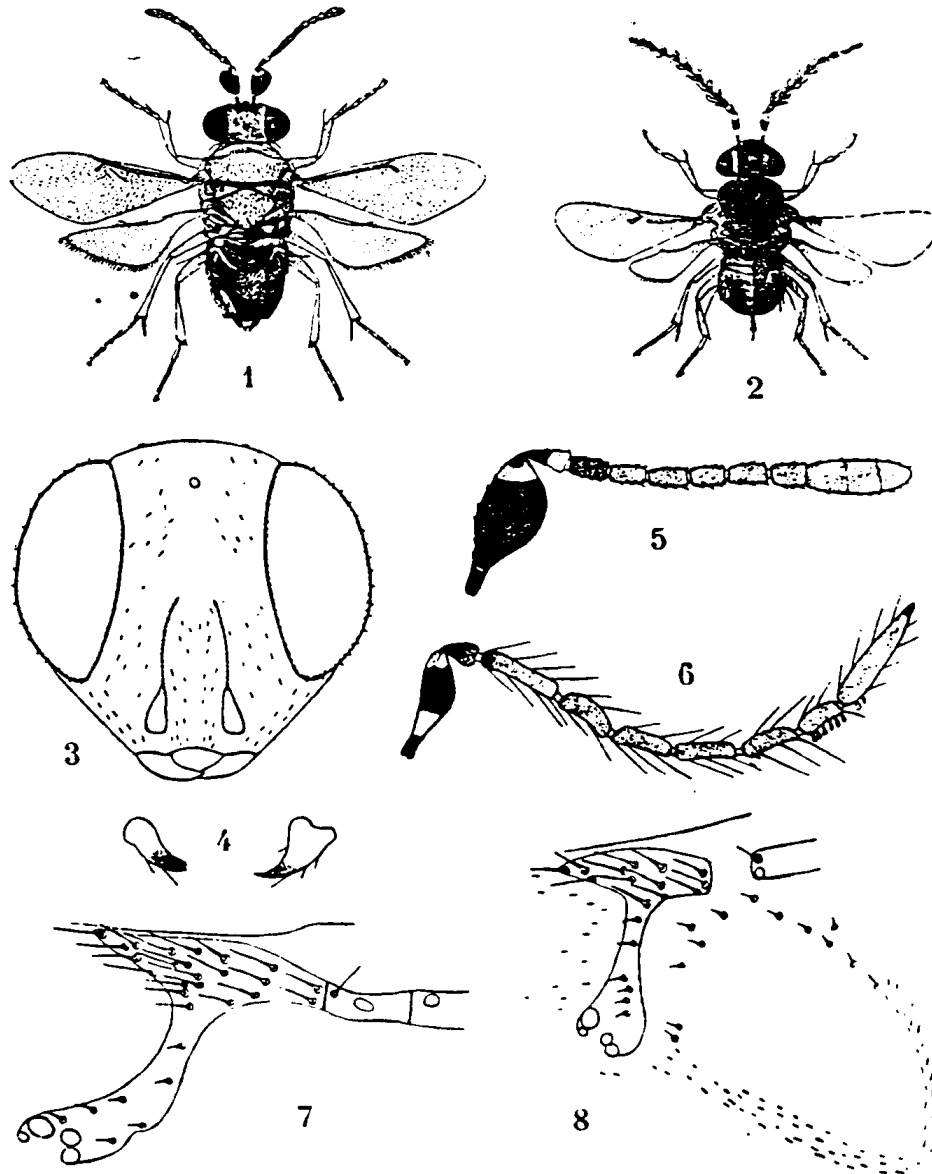

Anagyrus kamali nov. spec.

Fig. 1 : Adult female, $\times 15$. — Fig. 2: Adult male, $\times 15$. — Fig. 3: Head, frontal view. — Fig. 4: Mandibles. — Fig. 5: Female antenna. — Fig. 6: Male antenna. — Fig. 7: Venation of female forewing. — Fig. 8: Venation of male forewing.

FIGURE 4-1: Characteristics for identification of *Anagyrus kamali* (from Moursi, 1948)

Dr. A. A. Moursi

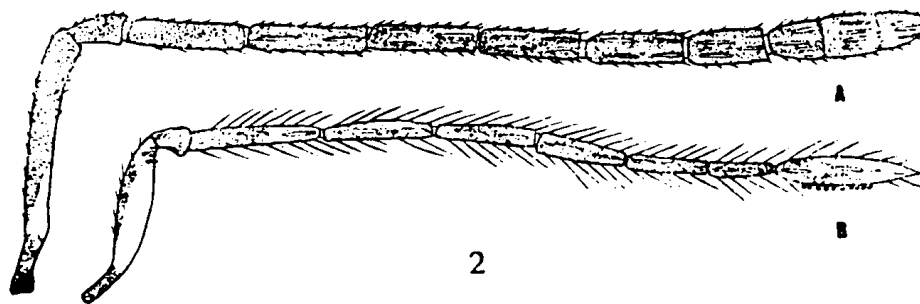
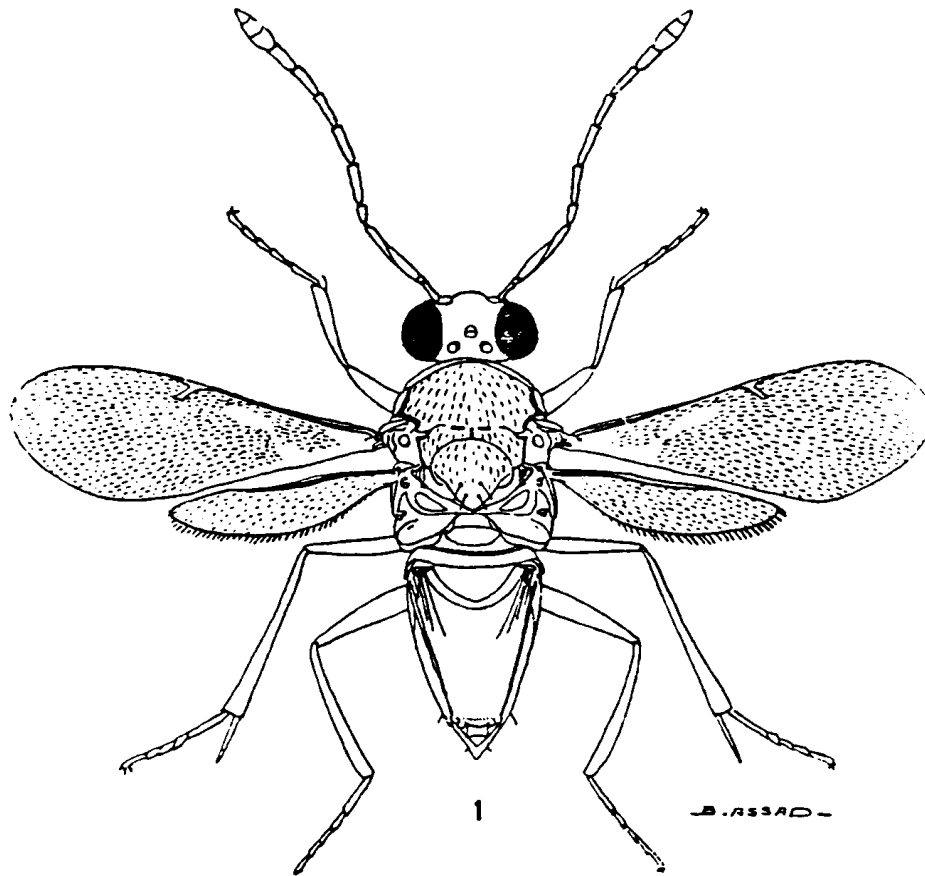

Leptomastix phenacocci Compere

Fig. 1 : Adult female, $\times 30$. — Fig. 2 : A, female antenna; B, male antenna.

FIGURE 4-2: Characteristics for identification of *Leptomastix* spp. (from Moursi, 1948)

Step 7—Shake the sleeve to make sure the remaining parasites are back in the cage. Twist and retie the sleeve.

Step 8—Gently tap the vial on the table top, quickly remove the aspirator, and cap the vial. If parasites are to remain in the vial for any length of time (as in shipping) place two **very small** droplets of honey inside the vial lid.

Transporting Parasites

When transporting parasites from the rearing facility to the field, keep them cool (about 55°F or 13°C is ideal) but not cold. If you use frozen gel packs in an insulated box, be sure to separate the parasites from the gel packs with foam or another material so the vials do not directly contact the gel packs.

Releasing Parasites

Selecting a good release site will increase the likelihood of the parasites' colonization and survival. Look for suitable host plant material infested with PHM on which to release the parasites.

Step 1—After finding infested host plants, get the property owner's permission to release the parasites in advance. Explain to the property owner how the biological control program works and **stress the importance of not cutting (pruning), spraying, or destroying the plants**. Give a program brochure and/or flier to the homeowner.

Step 2—Release the parasites directly onto the plants by removing the vial's cap and wiring the vial tightly to a main branch or wedging it between twigs.

Step 3—Using **Form PHM-11 (Appendix H)**, record the following information:

- ◆ Date released
- ◆ Species released (*Anagyrus*, *Gyranusoidea*, or *Leptomastix*)
- ◆ Name of owner
- ◆ Releaser's name (initials)
- ◆ Address of release site (street number, name, county, State)
- ◆ Name of host plant
- ◆ Number of parasites released

Step 4—On your first visit, thank the property owner for cooperating in the biological control program. Leave appropriate information and a business card with your name, address, and phone number so the owner can contact you (or the Department of Agriculture) if necessary. Leave also a copy of the tri-fold brochure titled “HELP DEFEAT OUR NEW INSECT PEST: THE PINK HIBISCUS MEALYBUG” (see [Appendix I](#)).

Step 5—Summarize parasites released monthly on [Form PHM-12](#). Record the following data:

- ◆ Dates released
- ◆ Total number of properties
- ◆ Total number of each parasite released

**Parasitoids of Pink Hibiscus Mealybug
 (*Maconellicoccus hirsutus* (Green))**

Primary Parasitoids

Gyranusoidea indica



Body with dorsal thorax orange, white laterally. Head orange dorsally and becoming white ventrally, with dark spot between eye margin and toruli. Antenna with scape expanded, black except white at tip, pedicel black basally, becoming white apically, flagellum dark basally, becoming white apically. Sculpture at top of head openly reticulate.

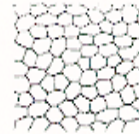

vertex sculpture

Anagyrus kamali

Body mostly orange including face and lateral thorax; mouth margin and interantennal prominence dark. Antennal scape expanded, similar to above. sculpture on top of head finer than above, reticulations not as open.

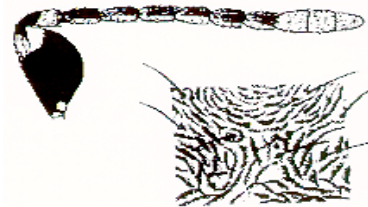

Anagyrus dactylopii

Body mostly orange; antennal scape swollen and mostly black (similar to *A. kamali*), but first funicle distinctly darker than others which are white.



Leptomastix dactylopii

Body orange, back of head dark brown. Scape long and cylindrical with dorsal margin darker than venter, flagellum with all funicles longer than wide and generally brownish.



Compiled by Michael E. Schauff, Systematic Entomology Laboratory, USDA, ARS,
 National Museum of Natural History, Washington, DC 20560-0168

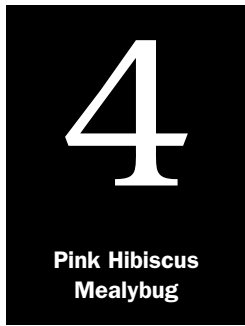

Releasing Natural Enemies

Procedures for Predators

Introduction

Releasing predators is another important component of the PHM biological control program. Predators work well on moderately to heavily infested host plants where a **quick knock down** of the pest population is **necessary**. They are useful as a biological pesticide where the natural enemy will provide dramatic short-term results. As with releasing parasites, try to release healthy predators on suitable host plants infested with PHM. The most common predator you will release is a small beetle, *Cryptolaemus montrouzieri*.

Transporting Predators

When transporting predators to the field, keep them cool. If you use frozen gel packs, separate the beetles from the gel pack with foam or other suitable material. Small slits in the plastic lids will allow for some circulation of air.

Releasing Predators

Predators will be most effective when released on host plants with high pest populations. Therefore, try to reserve your available predators for stands of plants heavily infested with PHM.

Step 1—Get the property owner's permission to search for PHM and potentially release the predators. Explain to the property owner how the biological control program works and **stress the importance of not spraying, pruning, or destroying the plants**.

Step 2—Determine the number of predators to release based on the number of infested host plants and the level of infestation. As a general guide, release approximately 500 beetles per acre (1,250 beetles per hectare) or 250–500 beetles per home property. When purchasing *Cryptolaemus* beetles from a commercial supplier, check the number of beetles per shipping container. Normally, these beetles are shipped at the rate of 500 adults per vial. If your release site is a hotel or commercial property where the landscape is extremely valuable, you may need to release 1,000–5,000 beetles at once.

Step 3—Use **Table 4-1** as a guide when releasing *Cryptolaemus* beetles:

TABLE 4-1: Releasing *Cryptolaemus* beetles on PHM-infested host plants

If:	Then:
Many infested host plants are close together, as in a hedge	Shake out about 25 beetles per plant directly onto the foliage near PHM egg masses.
Individual host plants are widely separated	Try to place 50–100 beetles in the interior of the plants.

Step 4—Using **Form PHM-13 (Appendix H)**, record the following information:

- ◆ Date released
- ◆ Name of owner
- ◆ Releaser’s name (initials)
- ◆ Address of release site (street number, name, county, State)
- ◆ Name of host plant
- ◆ Number of predators released

Step 5—On your first visit, thank the property owner for cooperating in the biological control program. Leave appropriate information and a business card with your name, address, and phone number so the owner can contact you (or the Department of Agriculture) if necessary. Leave also a copy of the tri-fold brochure titled “HELP DEFEAT OUR NEW INSECT PEST: THE PINK HIBISCUS MEALYBUG” and a flier on *Cryptolaemus* (see **Appendix I**).

Step 6—Summarize predator release monthly on **Form PHM-12**. Record the following data:

- ◆ Dates released
- ◆ Total number of properties
- ◆ Total number of predators released

5

Pink Hibiscus
Mealybug

Evaluating Results

Introduction

Contents

Introduction	5-1
Purpose	5-1
Establishment of Natural Enemies	5-3
Introduction	5-3
Equipment and Supplies	5-3
Evaluating Colonization and Establishment	5-4
Recovering Parasites	5-4
Sampling to Determine Percent Parasitization	5-4
Collecting a Quick Sample for “Field Presence” of Parasites	5-6
Monitoring Hyperparasites	5-6
Recovering Predators	5-7
Impact of Released Natural Enemies	5-9
Introduction	5-9
Selecting a Field Study Site	5-9
Collecting Samples	5-9

Purpose

The purpose of evaluating results is to measure the success of the program. Three principal types of evaluation can be accomplished in a biological control program:

1. Colonization and establishment of the released exotic natural enemies
2. Impact of released natural enemies
3. Economic evaluation, including the actual and potential losses by the target pest and the cost of the biological control program, which can be used to develop a cost/benefit ratio.

This manual will address the first two forms of evaluation.

5

Pink Hibiscus
Mealybug

Evaluating Results

Establishment of Natural Enemies

Introduction

For a biological control program to be successful, the natural enemies must become established. The following sampling procedures described in this subsection will help you determine if previously released natural enemies have become colonized and established. This evaluation will consist of collecting and holding a percent parasitization sample for a period of time.

Equipment and Supplies

To evaluate the establishment and impact of natural enemies, you will need the following equipment and supplies:

- ◆ Beat sheet, 2 ft (60 cm) x 2 ft, made of white fabric
- ◆ Beat sheet stick, 12 in (30 cm) x 1½ in (3.8 cm), doweling
- ◆ Brush, small (approximately size 0)
- ◆ Cooler and blue ice
- ◆ Two counters, each with four digits
- ◆ Dissecting microscope and light source
- ◆ Forceps
- ◆ Hand counter
- ◆ Hand magnifying lens (10x)
- ◆ Pharmaceutical gelatin capsules (size 0)
- ◆ Plant shears
- ◆ Probe
- ◆ Record keeping forms
- ◆ Sacks, large plastic and paper
- ◆ Standard table forms

Evaluating Colonization and Establishment

To determine the *colonization* (development of one or more generations in the field) and *establishment* (ability to persist for at least 3 years in the field) of released exotic natural enemies, sampling procedures were developed for both parasites and predators. These sampling procedures can also be used to determine dispersal of exotic natural enemies at various distances away from release sites. It is normally used in association with the PHM Population Density Counts, but can stand alone if just colonization, establishment or dispersal information is needed for a specific field site.

Recovering Parasites

The recovery of parasites from live PHM during a window of time will reflect the percent parasitization of PHM at the time of collection. It will indicate the presence or absence of parasites (colonization and establishment), the ratio of parasite species collected, and their abundance. Percent parasitization can be calculated based on the total number of live mealybugs collected.

Primary Parasite—The primary parasite is the “good” parasite that kills the PHM by laying an egg inside the mealybug. This egg develops into a maggot-type larva and feeds internally, killing the mealybug. These same primary parasites also feed on other individual mealybugs by piercing the PHM body and feeding on its body fluid, which also results in the death of the mealybug. Hyperparasites (secondary parasites) also exist in nature. These are other species of parasites that can usually be found in the local fauna attacking native mealybug primary parasites. Hyperparasites attack the primary parasite and are considered the “bad” parasite (Note: Hyperparasites).

Sampling to Determine Percent Parasitization

To determine percent parasitization, follow these steps:

Step 1—From the same “field study” sites where host plant samples were taken for the PHM Population Density Counts, randomly collect at least four additional infested twigs, place in a paper sack, and label “Percent Parasitization.” Include the following information:

- ◆ Collector’s name
- ◆ Date collected
- ◆ Host plant
- ◆ Address (street number and name, county, and State)
- ◆ Name of owner
- ◆ Initial records (should indicate location of plant sampled—include simple map)

Collect these samples **monthly** at the PHM Population Density Count sites.

Step 2—Keep the samples cool by placing in a cooler box with blue ice (ice block) and do **not** allow exposure to high temperatures. **Do not leave in a closed car.** These specimens must be kept alive and returned to the laboratory for additional developmental time.

Step 3—In the laboratory, remove the twigs from the paper sack and begin to examine under a dissecting microscope. With a brush, carefully remove the live late second and third instar and adult mealybugs individually and place each one in a gelatin capsule (size 0). From each twig, transfer approximately 25 PHM individuals into a capsule. Encapsulate a total of 100 individual PHMs per field site per date. If the sample contains less than 100 PHM and all four samples have been processed, the number may be low, but will represent the relative percent parasitization with less than 100 individuals. You can also use the PHM Population Density Sample twigs if you need more PHM individuals. Place each capsule in a paper carton or sack and label with the specific location information and date collected. All mummies without exit holes will also be encapsulated and placed in a separate container (**Note: Hyperparasitization**).

Step 4—Hold these sacks (or cartons) holding live PHM in gelatin capsules in the laboratory under controlled temperatures of 70°F (21°C) to 85°F (30°C) for 30 days and then examine under the dissecting microscope. All PHMs that were parasitized will normally have parasites emerge in the capsule. Record the number of mealybugs sampled, the number of parasites per capsule, parasite species identified, and the sex of all specimens in the capsules on **Form PHM-14 (Part 1) (Appendix H)** for each field site per date collected.

Step 5—Divide the total number of live mealybugs collected and encapsulated into the number of capsules that have emerged parasites, and multiply by 100 to calculate the percent parasitization. If a hyperparasite emerges from the sample, still count it as a parasitized PHM capsule. Record summarization of field data on **Form PHM-15**.

Divide the number of parasitized PHM attacked by one species of parasite by the total number of PHM parasitized and multiply by 100 to give the percentage of that species present in the parasite complex. Divide the number of capsules parasitized by one species of parasite by the total number of PHM parasitized and multiply by 100 to give the percent parasitization by that species.

Collecting a Quick Sample for “Field Presence” of Parasites

By using a hand magnifying lens (10x) examine the terminals of the host plants looking for the presence of new and/or old egg mass and live mealybugs. Other host plants can be examined by looking through the lens at the fruit, and midrib veins of the leaves and bark of the tree. Advanced stages of PHM parasitization, appearing as mummies (**Figure 3-16**), can usually be seen associated with the egg mass. The mummies appear as brownish colored, swollen PHM bodies (like Rice Crispy kernels) oblong in shape. If parasites have emerged from the mummy, an exit hole will be apparent at one end of the mummy. The mummy is the hardened exoskeleton of the mealybug which is swollen, but the legs can usually be seen through a magnifying lens. The presence of these mummies and exit holes is an excellent indicator that the PHM is being parasitized and the parasites are active at that field site.

Monitoring Hyperparasites

Hyperparasites are parasites that attack the primary parasite. They can be found attacking other species of parasites on other mealybug species in the local habitat. Occasionally, they could attack the PHM and its parasites. They normally parasitize late-developing primary parasites, such as the mummy stage. To determine the impact of these local hyperparasites on the primary parasites attacking the PHM, you will need to establish a monitoring system. These hyperparasites can attack the primary parasite within the mealybug at different stages of development, but many attack the primary parasite pupa. All hyperparasites will emerge from the mummy of PHM similar to the primary parasites. Therefore, collect all PHM mummies **without exit holes** that you find on twigs being sampled to determine the percent parasitization or PHM population density. Encapsulate these mummies with no exit holes, place them in a separate paper carton or sack, and label “% **HYPERPARASITIZATION**” sample.

Percent Hyperparasitization Sampling Procedure:

Step 1—Encapsulate all PHM mummies (all mealybug mummies with no exit holes on hibiscus sampled) that you find during percent parasitization samples and mealybug density counts. Collect these from the hibiscus twigs and place in a separate, appropriately labeled paper carton or sack.

Step 2—Properly label as percent hyperparasitization, with the collector’s name, date collected, address (street number and name, county, State), host plant, etc.

Step 3—Hold in the laboratory under controlled temperatures of 70°F (21°C) to 85°F (30°C). Examine and record these capsules 30 days after their encapsulation.

Step 4—Record the number of individual parasites, species, and sex on **Form PHM-16 (Part 1) (Appendix H)**. If the hyperparasite has not been identified or confirmed, hold each parasite and mealybug mummy within the capsule for later identification. Confirmation of the mealybug species and the parasite may be required. If required, send the mealybug mummy in for mealybug identification and the hyperparasite to the appropriate taxonomist for identification.

Recovering Predators

Using the beat sheet

Predators like *Cryptolaemus montrouzieri* can be sampled by using a beat sheet that catches adults and larvae as they fall from the host plant when the plant is gently hit with a stick. At each percent parasitization site, use the beat sheet to sample the presence of predators like *Cryptolaemus*, as desired.

Step 1—Place the white 2 ft (60 cm) x 2 ft beat sheet directly under a hibiscus shrub. Using a stick 12 in (30 cm) long x 1½ in (3.8 cm) diameter, strike the shrub's main branches overhead four times. Quickly pull out the beat sheet, count all larvae and adults, and record the counts.

Step 2—Clean off the beat sheet by turning it over and tapping with the stick to dislodge debris and insects under the hibiscus plant sampled.

Step 3—Repeat **Steps 1** and **2** three more times at different locations under the shrub or hedge, making a total of four samples per site.

Step 4—Record each sample separately on **Form PHM-17**, including total and average per location.

Step 5—Properly label the table with collector's name, date collected, address, and host plant, etc.

5

Pink Hibiscus
Mealybug

Evaluating Results

Impact of Released Natural Enemies

Introduction

To determine the impact of releasing exotic natural enemies of PHM, a procedure has been developed that will sample the PHM population density at preselected field study sites before the release of the natural enemies and at quarterly (every 3 months) intervals. In addition, the population density of the parasites will be monitored by calculating the percent parasitization, and the population density of the predators will be monitored by using a beat sheet sampling technique. Hibiscus plants have been selected as the standard host plant for sampling, and all sampling techniques discussed in this manual apply to hibiscus plants. Other host plants can be sampled, but specific sampling techniques should be modified to suit the plant and behavior of the PHM on that host plant.

Selecting a Field Study Site

Residential properties usually are the best field sites where you can interact with the owner as needed. Hotel properties normally use a wide range of pesticides at various times and may not be appropriate for initial field releases. The hotel properties often are also under several layers of management, which makes communications difficult.

Step 1—Select hibiscus shrubs **moderately** infested with PHM (heavily infested plants may be in decline and may not recover and die). For example, you could select one large shrub, 4–6 ft (1–2 m) high and 2–4 ft (0.6–1 m) wide, or several shrubs forming a hedge.

Step 2—Get the property owner to agree **not to apply any pesticides** on or near the study host plant and **not to trim the plants**. The owner will also allow workers to trim the plants as needed, which may be monthly. This procedure will require workers to enter the property on a regular basis with the owner's permission.

Collecting Samples

Step 1—At the center (outer surface) of the hedge or on the single plant, collect a single twig tip at random, cutting it 6 inches from the tip of the woody portion of the twig.

Step 2—Repeat this procedure three more times around the single plant or every 2 feet along the hedge to get a representative sample. Collect a total of four terminals per single plant or hedge per field site.

Step 3—Place each twig terminal into a single paper sack, close, and label with this information:

- ◆ Collector's name
- ◆ Date collected
- ◆ Host plant
- ◆ Address (street number, name, county, State, and name of owner if available)

Take a photograph (using slide film) to document the site and the plant's condition at the beginning of the release program. Label and date the slide and save it in a slide-holder album. Tie a colored ribbon on a large branch of the hibiscus plant to tag the plant sampled for future reference.

Step 4—Keep the sample in a cool location or in a cooler box with blue ice (ice block) until it can be examined in the laboratory. **Do not leave samples in a vehicle with the windows rolled up**, because high temperatures can damage the specimens.

Step 5—Remove the sample from the bag in the laboratory. Carefully measure 6 inches from the terminal tip of each sample; cut and discard the remaining twig.

Step 6—Examine each twig under a dissecting microscope, working your way up from the bottom of the terminal. Gently turning the twig, count and remove all egg sacs as necessary. Examine the egg sacs to determine the presence or absence of eggs or crawlers. You may need to remove and examine separately leaves and other smaller twigs. Count and record all second and third instars, adult males and females, predaceous larvae and adults (*Cryptolaemus* sp., *Scymnus* sp., and *Chrysoperla* sp.), and mummies (parasitized mealybugs), noting those with emergence holes and those unemerged. Use **Form PHM-18 (Appendix H)** for tallying data. Table counters are very useful for this counting process, with each bank labeled with the appropriate instar being counted. Tweezers, probe, and small brush are tools that are useful during this process.

Step 7—Use **Form PHM-19** to summarize the PHM population density counts.

Step 8—Clear the counter before proceeding to the next terminal count.

Step 9—Collect samples quarterly (every 3 months) for monitoring the PHM population's density at field study sites and as needed at other locations.



Appendix A

Host Plants of Pink Hibiscus Mealybug (PHM)

Introduction

Those hosts recorded with damaging populations of PHM are denoted with a number after the scientific name. They may or may not be economic hosts. The number corresponds to the reference in which the host was stated to bear large numbers of the mealybug, and this reference is given after the host list (Stibick, 1997; Chang and Miller, 1996).

Any local survey needs to take into account not only the list given here, but also those local plant species which may prove to be hosts. Since PHM demonstrates apparent changes in host preferences by locality, perhaps as a reflection of changes in habitat, environment, and interactions with the local flora/fauna/predator/parasite complex, a local host list should be designed, based on actual local finds, with this list of value only as a guide in the search for preferred and other local hosts.

Notes

1. Some hosts are reported to be attacked at their roots (potatoes, peanuts, beans, cotton, some grasses).
2. Symptoms may vary depending on the host (See Biology).
3. When reviewing this list, keep in mind that the literature may have misidentifications of PHM.

Hosts by Scientific and Common Names

Scientific Name	Common Name	Reference
<i>Abelmoschus esculentus</i> ⁵	Okra	Mani, 1989
<i>Aberia</i> sp.	N/A	Chang & Miller, 1996
<i>Abutilon theophrasti</i> (= <i>avicennae</i>)	Velvetleaf	Hall, 1921
<i>Acacia</i> sp.	Acacia	Williams, 1986
<i>Acacia nilotica</i> (= <i>arabica</i>) ²	Babul	Hall, 1921
<i>Acacia farnesiana</i>	Huisache	Hall, 1921

Appendix A: Host Plants of Pink Hibiscus Mealybug (PHM)
Hosts by Scientific and Common Names

Scientific Name	Common Name	Reference
<i>Acalypha</i> sp.	A copperleaf	Mani, 1989
<i>Acalypha hispida</i> ⁴	Cat's tail	Anon., 1996
<i>Acalypha indica</i>	Indian nettle	Hall, 1921
<i>Acalypha marginata</i>	N/A	Hall, 1921
<i>Acanthus ilicifolius</i>	N/A	Mani, 1989
<i>Achyranthes indica</i>	Man better man	Anon., 1996
<i>Aegle marmelos</i>	Bael	Anon., 1996
<i>Aglaonema</i> sp.	Silver Queen	Anon., 1996
<i>Albizia caribaea</i> ⁴	Tantakayo	Persad, 1995
<i>Albizia lebbek</i> ²	Lebbekh	Williams, 1986
<i>Albizia niopoides</i> ⁵	Tantakayo	Chang & Miller, 1996
<i>Albizia saman</i> (= <i>Samanea saman</i>) ⁴	Saman	Anon., 1996
<i>Allamanda</i> sp.	Allamanda	Anon., 1996
<i>Allamanda cathartica</i>	Yellow buttercup	Anon., 1996
<i>Alocasia cucullata</i>	Heart shae dasheen	Anon., 1996
<i>Alpinia</i> spp. ⁴	Ginger lily	Anon., 1996
<i>Althaea</i> sp.	N/A	Chang & Miller, 1996
<i>Amaranthus</i> sp.	Bhagi	Anon., 1996
<i>Annona</i> spp. ⁵	Atemoya	Williams, 1986
<i>Annona cherimolia</i>	Cherimoya	Hall, 1921
<i>Annona muricata</i> ⁴	Soursop	Williams, 1986
<i>Annona reticulata</i> ⁴	Custard apple	Williams, 1986
<i>Annona squamosa</i> ⁴	Sugar apple	Mani, 1989
<i>Anthurium andraeanum</i> ⁴	Anthurium	Anon., 1996
<i>Arachis hypogaea</i>	Peanut	Mani, 1989
<i>Aralia</i> sp. ⁴	Angelica	Williams, 1986
<i>Artocarpus altilis</i> ⁴	Breadfruit	Anon., 1996
<i>Artocarpus communis</i> ⁴	Breadnut	Anon., 1996
<i>Asparagus</i> sp. ⁴	Asparagus fern	Anon., 1996
<i>Asparagus densiflorus</i>	Rice fern	Anon., 1996
<i>Asparagus officinalis</i>	Asparagus	Chang & Miller, 1996
<i>Asparagus setaceus</i>	Bridel fern	Anon., 1996
<i>Averrhoa carambola</i> ⁴	Carambola	Anon., 1996
<i>Azadirachta indica</i>	Neem	Williams, 1986
<i>Basella alba</i> ⁴	Poi spinach	Anon., 1996
<i>Bauhinia</i> sp.	A bean	Mani, 1989
<i>Bauhinia acuminata</i>	N/A	Hall, 1921
<i>Bauhinia forficata pruinosa</i> ² (= <i>candicans</i>)	Bauhinia	Hall, 1921
<i>Bauhinia racemosa</i>	N/A	Hall, 1921
<i>Bauhinia vahlii</i>	N/A	Hall, 1921

Appendix A: Host Plants of Pink Hibiscus Mealybug (PHM)
Hosts by Scientific and Common Names

Scientific Name	Common Name	Reference
<i>Bauhinia variegata</i> ^{2,4}	Orchid tree	Anon., 1996
<i>Begonia</i> sp.	Begonia	Anon., 1996
<i>Beta vulgaris</i> ⁴	Beetroot	Anon., 1996
<i>Bidens pilea</i>	Railway daisy	Anon., 1996
<i>Bignonia</i> sp.	N/A	Williams, 1986
<i>Blighia sapida</i>	Ackee	Anon., 1996
<i>Boehmeria nivea</i> ¹	Ramie	Mani, 1989
<i>Bougainvillea</i> spp.	Bougainvillea	Anon., 1996
<i>Bougainvillea spectabilis</i>	N/A	Hall, 1921
<i>Brassaia actinophylla</i>	Octopus tree	Anon., 1996
<i>Caesalpinia coriaria</i> ⁴	Divi divi	Anon., 1996
<i>Caesalpinia decapetala</i> (=sepiaria)	N/A	Hall, 1921
<i>Caesalpinia pulcherrima</i>	Pride of Barbados	Anon., 1996
<i>Cajanus cajan</i> (Syn.= <i>C. indicus</i>) ⁴	Pigeon pea	Anon., 1996
<i>Cajanus indicus</i> ²	Pigeon pea	Mani, 1989
<i>Calliandra</i> sp.	Powder puff	Anon., 1996
<i>Cananga odorata</i> ⁴	Ylang-Ylang	Persad, 1995
<i>Callistemon</i> sp.	Bottle brush tree	Anon., 1996
<i>Capsicum</i> sp.	Seasoning pepper	Anon., 1996
<i>Capsicum annum</i> ⁴	Sweet pepper	Anon., 1996
<i>Capsicum frutescens</i> ⁵	Hot pepper	Anon., 1996
<i>Carica papaya</i> ⁴	Papaya	Anon., 1996
<i>Carissa acuminata</i>	N/A	Hall, 1921
<i>Carissa macrocarpa</i> (=grandiflora)	Natal plum	Hall, 1921
<i>Carissa ovata</i>	N/A	Hall, 1921
<i>Cassia</i> spp.	N/A	Hall, 1921
<i>Cassia glauca</i>	N/A	Hall, 1921
<i>Cassia renigera</i>	N/A	Hall, 1921
<i>Casuarina</i> sp.	Casuarina	Anon., 1996
<i>Catharanthus roseus</i>	Old maid	Anon., 1996
<i>Ceiba pentandra</i>	Kapok	Williams, 1986
<i>Celosia cristata</i>	Cox comb	Anon., 1996
<i>Ceratonia siliqua</i> ²	Carob	Hall, 1921
<i>Cestrum nocturnum</i> ⁴	Ladies of the Night	Anon., 1996
<i>Chaleas paniculata</i> ⁴	Sweet lime	Anon., 1996
<i>Chenopodium album</i>	Lambsquarters	Williams, 1986
<i>Chrysanthemum</i> sp.	N/A	Ezzat, 1958
<i>Chrysanthemum coronarium</i>	Crown daisy	Chang & Miller, 1996
<i>Chrysothemis pulchella</i>	Generiad	Chang & Miller, 1996
<i>Cissus verticillata</i>	Snake vine	Anon., 1996
<i>Citrus paradisi</i>	Grapefruit	Williams, 1986

Appendix A: Host Plants of Pink Hibiscus Mealybug (PHM)
Hosts by Scientific and Common Names

Scientific Name	Common Name	Reference
<i>Citrus</i> spp. ⁴	All citrus spp	Maui, 1989; Anon., 1996
<i>Citrus aurantifolia</i>	Lime	Williams, 1985
<i>Citrus aurantium</i> (=bigarradia)	Sour orange	Hall, 1921
<i>Citrus medica</i>	Citron	Hall, 1921
<i>Citrus reticulata</i> (=nobilis)	Tangerine	Hall, 1921
<i>Citrus sinensis</i>	Sweet orange	Hall, 1921
<i>Clerodendron infortunatum</i>	N/A	Maui, 1989
<i>Clerodendrum aculeatum</i>	Bitter fence	Anon., 1996
<i>Clitoria ternatea</i>	Butterfly pea	Mani, 1989
<i>Coccoloba uvifera</i> ⁴	Seaside grape	Anon., 1996
<i>Cocos nucifera</i>	Coconut	Anon., 1996
<i>Codiaeum</i> spp.	Croton	Anon., 1996
<i>Codiaeum</i> spp. ⁴	Croton	Persad, 1995
<i>Coffea</i> spp.	Coffee	Mani, 1989; Anon., 1996
<i>Coffea arabica</i>	Arabica coffee	Williams, 1989
<i>Colocasia esculenta</i>	Eddoe & dasheen	Anon., 1996
<i>Colubrina arborescens</i> ⁴	Mauby	Anon., 1996
<i>Corchorus</i> sp.	A jute	Mani, 1989
<i>Corchorus olitorius</i>	N/A	Hall, 1921
<i>Cordia curassavica</i> ⁴	Black sage	Anon., 1996
<i>Cosmos</i> spp. ⁴	Cosmos	Anon., 1996
<i>Couroupita guianensis</i> ⁴	Cannonball tree	Anon., 1996
<i>Crataegus</i> spp.	Hawthorn	Hall, 1921
<i>Crescentia cujete</i>	Calabush tree	Anon., 1996
<i>Croton</i> sp.	N/A	Chang & Miller, 1996
<i>Croton flavens</i> ⁴	Broom	Anon., 1996
<i>Cucumis sativus</i> ⁴	Cucumber	Anon., 1996
<i>Cucurbita maxima</i> ⁴	Pumpkin	Anon., 1996
<i>Cucurbita moschata</i>	Pumpkin	Chang & Miller, 1996
<i>Cucurbita pepo</i> ⁴	Squash	Anon., 1996
<i>Cydonia</i> (=Pyrus) <i>oblonga</i>	Quince	Hall, 1921
<i>Cynara scolymus</i>	Artichoke	Hall, 1921
<i>Cyperus</i> sp.	Sedges	Anon., 1996
<i>Daucus carota</i> ⁴	Carrot	Anon., 1996
<i>Daradixa</i> sp.	A grass	Hall, 1921
<i>Dahlia</i> sp.	N/A	Chang & Miller, 1996
<i>Datura</i> spp.	Datura	Chang & Miller, 1996
<i>Delonix</i> (=Poinciana) <i>regia</i>	Royal poinciana	Hall, 1921
<i>Dendrobium</i> cultivars	Orchid	Persad, 1995

Appendix A: Host Plants of Pink Hibiscus Mealybug (PHM)
Hosts by Scientific and Common Names

Scientific Name	Common Name	Reference
<i>Dieffenbachia</i> spp.	Dieffenbachia	Anon., 1996
<i>Dioscorea</i> spp.	Yam	Anon., 1996
<i>Diospyros kaki</i>	Japanese persimmon	Hall, 1921
<i>Dizygotheca elegantissima</i>	N/A	Anon., 1996
<i>Dracaena</i> sp.	Dracaena	Anon., 1996
<i>Duranta</i> sp.	Datur	Williams, 1986
<i>Duranta plumieri</i>	N/A	Hall, 1921
<i>Duranta repens</i> ⁴	Duranta	Anon., 1996
<i>Elaeagnus</i> sp.	N/A	Chang & Miller, 1996
<i>Emilia</i> spp.	A weed	Anon., 1996
<i>Equisetum arvense</i>	Bottle bush weed	Anon., 1996
<i>Eranthemum pulchellum (=nervosum)</i>	N/A	Anon., 1996
<i>Eriobotrya japonica</i>	Loquat	Hall, 192 ⁴
<i>Erthrina variegata</i>	Variegated immortelle	Anon., 1996
<i>Ervatamia coronaria</i>	Chamelie	Anon., 1996
<i>Eryngium foetidum</i>	Shadow beni	Anon., 1996
<i>Erythrina</i> sp.A	bean	Mani, 1989
<i>Erythrina corallodendron</i> ²	N/A	Hall, 1921
<i>Erythrina crista-galli</i> ²	N/A	Hall, 1921
<i>Erythrina resinifera</i> ²	N/A	Hall, 1921
<i>Erythrina speciosa (=reticulata)</i> ²	N/A	Hall, 1921
<i>Erythrina stricta (=indica)</i> ²	N/A	Hall, 1921
<i>Erythrina variegata</i> ⁵	Variegated immortelle	Mani, 1989
<i>Erythrina vespertilio</i> ²	N/A	Hall, 1921
<i>Erythroxyllum</i> sp.	Coca	Williams, 1989
<i>Eugenia</i> spp. ⁴	Wax apple	Anon., 1996
<i>Eugenia jambolana</i> Java	plum	Mani, 1989
<i>Eugenia malaccensis</i>	Pommerac	Anon., 1996
<i>Euphorbia</i> spp.	Milkweed	Anon., 1996
<i>Euphorbia pulcherrima</i>	Poinsettia	Anon., 1996
<i>Ficus benghalensis</i>	Indian banyan	Williams, 1986
<i>Ficus benjamin</i>	Banyan tree	Anon., 1996
<i>Ficus benjamina (=nitida)</i>	Weeping fig	Hall, 1921
<i>Ficus carica</i>	Common fig	Hall, 1921
<i>Ficus cunia</i>	N/A	Mani, 1989
<i>Ficus elastica</i>	Rubber plant	Hall, 1921
<i>Ficus indica</i>	N/A	Mani, 1989
<i>Ficus laurifolia</i>	N/A	Ezzat, 1958
<i>Ficus platyphylla</i>	N/A	Hall, 1921
<i>Ficus religiosa</i>	Peepul tree	Mani, 1989
<i>Ficus sycomorus</i>	Sycamore fig	Hall, 1921

Appendix A: Host Plants of Pink Hibiscus Mealybug (PHM)
Hosts by Scientific and Common Names

Scientific Name	Common Name	Reference
<i>Ficus virens</i> (=infectoria)	N/A	Hall, 1921
<i>Flacourtia indica</i>	Series	Anon., 1996
<i>Gerbera</i> sp.	Gerbera	Anon., 1996
<i>Glycine max</i> ⁴	Soyabean	Williams, 1985
<i>Glyricidia sepium</i> ⁴	Glyricidia	Anon., 1996
<i>Gossypium</i> sp. ²	A cotton	Williams, 1985
<i>Gossypium arboreum</i>	Tree cotton	Mani, 1989
<i>Gossypium herbaceum</i>	Levant cotton	Mani, 1989
<i>Grevillea robusta</i> ²	Silk-oak	Mani, 1989
<i>Grewia</i> sp.	N/A	Williams, 1986
<i>Haldina cordifolia</i>	N/A	Chang & Miller, 1996
<i>Hamelia</i> sp.	N/A	Anon., 1996
<i>Heliconia</i> spp. ⁴	Heliconia	Anon., 1996
<i>Hibiscus</i> spp.	A hibiscus	Mani, 1989
<i>Hibiscus acetosella</i>	N/A	Mani, 1989
<i>Hibiscus boryanus</i>	N/A	Williams, 1986
<i>Hibiscus cannabinus</i> ^{1,2}	Kenaf	Mani, 1989
<i>Hibiscus elatus</i> ⁴	Blue mahoe	Anon., 1996
<i>Hibiscus esculentus</i> ^{2,4}	Okra	Williams, 1986
<i>Hibiscus manihot</i>	N/A	Chang & Miller, 1996
<i>Hibiscus mutabilis</i> ²	Cotton-rose	Mani, 1989
<i>Hibiscus rosa-sinensis</i> ^{2,4}	Hibiscus	Mani, 1989
<i>Hibiscus sabdariffa</i> ²	Roselle	Mani, 1989
<i>H. sabdariffa</i> var. <i>altissimus</i> ¹	Roselle	
<i>H. sabdariffa</i> var. <i>sabdariffa</i> ⁴	Sorrel	Anon., 1996
<i>Hibiscus schizopetalus</i> ²	Coral hibiscus	Williams, 1986
<i>Hibiscus surattensis</i>	N/A	Williams, 1986
<i>Hibiscus syriacus</i> ²	Shrub althea	Hall, 1921
<i>Hibiscus tiliaceus</i>	N/A	Chang & Miller, 1996
<i>Holmskia sanguinea</i> ⁴	Chinese hat	Anon., 1996
<i>Inga</i> sp.	N/A	Hall, 1921
<i>Ipomoea</i> sp.	Morning glory tree	Anon., 1996
<i>Ipomoea batatas</i> ⁴	Sweet potato	Anon., 1996
<i>Ixora</i> spp. ⁴	Ixora	Anon., 1996
<i>Jacaranda mimosifolia</i> Jac	aranda	Hall, 1921
<i>Jasminum</i> sp.	Lady of the night	Anon., 1996
<i>Jasminum</i> sp.	Jasmine	Anon., 1996
<i>Jasminum sambac</i>	Aiton	Mani, 1989
<i>Kalanchoe</i> spp.	Wonder of the world	Anon., 1996
<i>Kigelia</i> spp.	N/A	Chang & Miller, 1996
<i>Lactuca sativa</i> ⁴	Lettuce	Anon., 1996

Appendix A: Host Plants of Pink Hibiscus Mealybug (PHM)
Hosts by Scientific and Common Names

Scientific Name	Common Name	Reference
<i>Lagerstroemia speciosa</i> ⁴	Queen of flowers	Anon., 1996
<i>Lantana camara</i>	Lantana	Anon., 1996
<i>Laportea aestuans</i>	Stinging nettle	Anon., 1996
<i>Leonotis nepetifolia</i> ⁴	Honeysuckle	Anon., 1996
<i>Leuceana glauca</i> ⁴	Leuceana	Anon., 1996
<i>Lighia sapida</i>	Ackee	Anon., 1996
<i>Lycopersicon esculentum</i> ⁴	Tomato	Anon., 1996
<i>Malpighia glabra</i> (=punicifolia) ⁴	West Indies cherry	Anon., 1996
<i>Malvaviscus arboreus</i>	N/A	Hall, 1921
<i>Mangifera indica</i> ⁴	Mango	Mani, 1989
<i>Manihot esculenta</i>	Cassava	Williams, 1986
<i>Manilkara zapota</i> ⁴	Sapodilla	Anon., 1996
<i>Medicago sativa</i>	Alfalfa	Williams, 1986
<i>Melia azederach</i>	Chinaberry	Hall, 1921
<i>Melicocca bijugatus</i> (=bijuga) ⁴	Genip	Anon., 1996
<i>Miconia cornifolia</i> ⁴	Malestomac	Anon., 1996
<i>Mikania cordata</i>	hempweed	Mani, 1989
<i>Mimosa pudica</i>	Sensitive plant	Anon., 1996
<i>Mimosa rubicaulis</i> ¹	N/A	Ghose, 1972
<i>Morus</i> sp. ¹	A mulberry	Williams, 1986
<i>Morus alba</i> ²	White mulberry	Mani, 1989
<i>Morus nigra</i>	Black mulberry	Hall, 1921
<i>Murraya exotica</i>	Sweet lime	Anon., 1996
<i>Murraya koenigii</i>	Curry leaf	Anon., 1996
<i>Murraya paniculata</i> ⁵	Sweetlime	Chang & Miller, 1996
<i>Musa</i> spp. ⁴	Banana	Williams, 1985
<i>Mussaenda</i> spp. ⁴	Mussaenda	Anon., 1996
<i>Myrtus communis</i>	Myrtle	Hall, 1921
<i>Nephrolepis biserrata furcans</i>	Fish tail fern	Anon., 1996
<i>Nephrolepis exaltata</i>	Boston fern	Anon., 1996
<i>Nerium odorum</i>	An oleander	Mani, 1989
<i>Nerium oleander</i>	Oleander	Anon., 1996
<i>Opuntia</i> sp.	Prickly pear	Ezzat, 1958
<i>Pachystachys lutea</i>	Shrimp plant	Anon., 1996
<i>Paritium</i> sp.	N/A	Chang & Miller, 1996
<i>Parkinsonia</i> sp.	A bean	Williams, 1985
<i>Parkinsonia aculeata</i> ²	Horsebean	Mani, 1989
<i>Parthenium hysterophorus</i> ⁴	White head	Williams, 1985
<i>Passiflora edulis</i> var. <i>edulis</i> ⁴	Passion fruit	Anon., 1996
<i>Passiflora granadilla</i>	Barbadeen	Anon., 1996
<i>Passiflora quadrangularis</i>	Giant granadilla	Hall, 1921

Appendix A: Host Plants of Pink Hibiscus Mealybug (PHM)
Hosts by Scientific and Common Names

Scientific Name	Common Name	Reference
<i>Passiflora quadrangularis</i>	Giant granadilla	Hall, 1921
<i>Pavonia</i> sp.	N/A	Chang & Miller, 1996
<i>Peperomia pellucida</i>	Shining bush	Chang & Miller, 1996
<i>Pereskia bleo</i>	African rose	Anon., 1996
<i>Persea americana</i> ⁴	Avocado	Anon., 1996
<i>Petiveria alliacea</i> ⁴	Maouipoui	Anon., 1996
<i>Petrea arborea</i> ⁴	Petrea	Anon., 1996
<i>Phaseolus mungo</i>	Mung bean	Chang & Miller, 1996
<i>Phaseolus vulgaris</i> ⁴	String bean	Anon., 1996
<i>Philodendron</i> spp.	Philodendron	Anon., 1996
<i>Phoenix dactylifera</i>	Date palm	Hall, 1921
<i>Phoenix sylvestris</i>	Wild date palm	Mani, 1989
<i>Phyllanthus acidus</i> ⁴	Damson	Anon., 1996
<i>Prunus persica</i>	Peach	Hall, 1921
<i>Psidium guajava</i> ²	⁴ Guava	Mani, 1989
<i>Punica granatum</i>	Pomegranate	Williams, 1986
<i>Pyrus communis</i>	Pear	Hall, 1921
<i>Quisqualis</i> sp.	N/A	Chang & Miller, 1996
<i>Rhoeo</i> sp.	Boundary plant	Anon., 1996
<i>Ricinus communis</i>	Castor bean	Hall, 1921
<i>Rivinia humilis</i> ⁴	Cats' blood	Anon., 1996
<i>Robinia pseudoacacia</i> ²	Black locust	Mani, 1989
<i>Rosa</i> spp.	Rose	Anon., 1996
<i>Russelia equisetifolia</i> ⁴	Antigua heath	Anon., 1996
<i>Saccharum officinarum</i>	Sugarcane	Mani, 1989
<i>Salix</i> sp.	Willow	Chang & Miller, 1996
<i>Schefflera</i> sp.	Schefflera	Anon., 1996
<i>Schefflera actinophylla</i>	Octopus tree	Chang & Miller, 1996
<i>Schefflera elegantissima</i>	False aralia	Chang & Miller, 1996
<i>Schinus molle</i>	California peppertree	Hall, 1921
<i>Schinus terebenthifolius</i>	Brazilian peppertree	Hall, 1921
<i>Sciadophyllum pulchrum</i>	N/A	Hall, 1921
<i>Scindapsus aureus</i>	Devil's ivy	Anon., 1996
<i>Scoparia dulcis</i>	Sweet broom	Anon., 1996
<i>Senna italica</i>	N/A	Chang & Miller, 1996
<i>Senna obtusifolia</i> ⁴	Wild senna	Anon., 1996
<i>Senna siamea</i>	Cassia	Mani, 1989
<i>Senna sulfurea</i>	N/A	Chang & Miller, 1996
<i>Sesbania sesban</i> (=aegyptiaca)	N/A	Hall, 1921
<i>Sida acuta</i>	Broom weed	Williams, 1985
<i>Solanum aethiopicum</i>	N/A	Williams, 1986

Appendix A: Host Plants of Pink Hibiscus Mealybug (PHM)
Hosts by Scientific and Common Names

Scientific Name	Common Name	Reference
<i>Solanum bicolor</i>	An ornamental	Anon., 1996
<i>Solanum melongena</i>	Eggplant	Anon., 1996
<i>Solanum tuberosum</i>	Potato	Hall, 1921
<i>Spondias chili</i>	Plum	Chang & Miller, 1996
<i>Spondias cytherea</i> (=dulcis)	Golden apple	Mani, 1989
<i>Spondias mombin</i> ⁴	Hog plum	Williams, 1986
<i>Spondias purpurea</i> ⁴	Red plum	Anon., 1996
<i>S. purpurea</i> var. <i>lutea</i> ⁴	Yellow plum	Anon., 1996
<i>Stachytarpheta jamaicensis</i>	Vervine	Anon., 1996
<i>Symedrella nodiflora</i>	A weed	Anon., 1996
<i>Syngonium podophyllum</i>	N/A	Anon., 1996
<i>Syzygium cumini</i> ⁴	Jamoon	Anon., 1996
<i>Syzygium malaccense</i> ⁴	French cashew	Anon., 1996
<i>Tabebuia</i> sp.	Poui	Anon., 1996
<i>Tabebuia heterophylla</i> ⁴	White cedar	Anon., 1996
<i>Tabernaemontana divaricata</i>	Chamelie	Chang & Miller, 1996
<i>Tamarindus indica</i>	Tamarind	Anon., 1996
<i>Tecoma capensis</i> ³	N/A	Hall, 1921
<i>Tecoma grandiflora</i>	N/A	Mani, 1989
<i>Tecoma stans</i>	Trumpet flower	Hall, 1921
<i>Tectona grandis</i> ⁴	Teak	Williams, 1986
<i>Templetonia</i> sp.	N/A	Chang & Miller, 1996
<i>Terminalia</i> spp.	N/A	Chang & Miller, 1996
<i>Terminalia catappa</i>	Tropical almond	Williams, 1986
<i>Terminalia mantaly</i>	N/A	Williams, 1986
<i>Theobroma cacao</i> ⁴	Cocoa	Anon., 1996
<i>Thunbergia erecta</i>	Thunbergia	Anon., 1996
<i>Tithonia urticifolia</i>	N/A	Williams, 1986
<i>Vigna unguiculata</i> ⁴	Cowpea	Anon., 1996
<i>Vinca minor</i>	Common periwinkle	Chang & Miller, 1996
<i>Vitis vinifera</i>	⁴ Grape	Mani, 1989
<i>Xanthosoma</i> spp.	Tannia	Anon., 1996
<i>Zea mays</i>	Corn	Ezzat, 1958
<i>Zizyphus</i> sp.	N/A	Mani, 1989
<i>Zizyphus jujuba</i> (=vulgaris) ²	N/A	Hall, 1921
<i>Zizyphus mauritiana</i> ⁴	Indian jujube	Anon., 1996
<i>Zizyphus mucronata</i>	N/A	Williams, 1986
<i>Zizyphus spina-christi</i> ²	N/A	Hall, 1921

Hosts Known Only by Common Name or Vague Designation

Common Name	Reference
Orengo thyme	Anon., 1996
Pon-pom	Anon., 1996
Palm (Family-Palmae)	Anon., 1996
Numerous grass weeds	Anon., 1996
Leguminous weeds	Anon., 1996

1. Ghose, 1972
2. Hall, 1921
3. Hall, 1926
4. Persad, 1995
5. Chang & Miller, 1996

B

Pink Hibiscus
Mealybug

Appendix B

Geographic Distribution of PHM

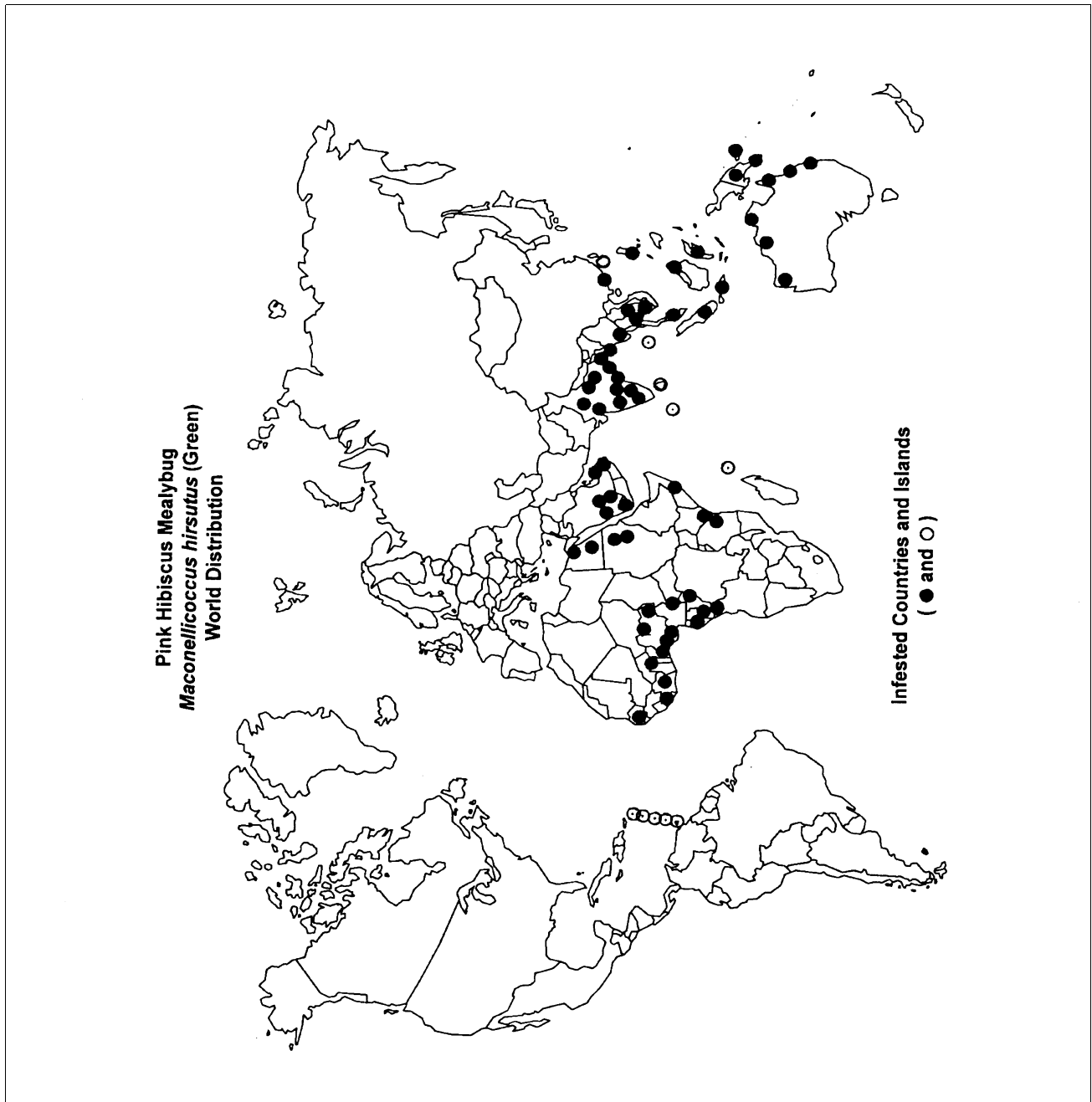

FIGURE B-1: World Distribution of Pink Hibiscus Mealybug (from C-A-B International Institute of Entomology Distribution Maps of Pests Map No. 100 – December 1987)

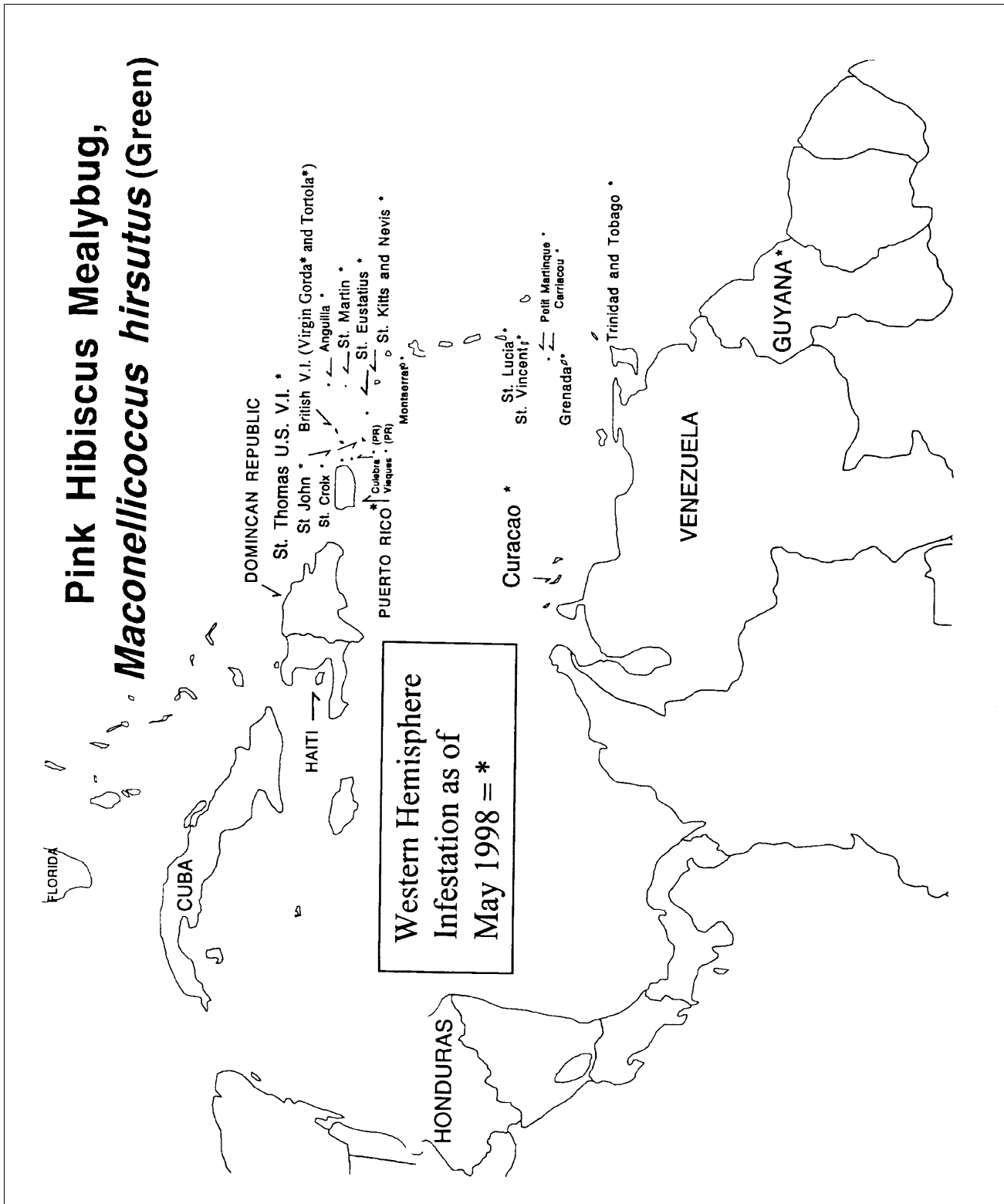

FIGURE B-2: Western Hemisphere Infestations of Pink Hibiscus Mealybug

Countries Known to be Infested with Pink Hibiscus Mealybug			
Africa	Asia	Australasia/Pacific Islands	Caribbean
Benin	Andaman Island	Australia	Anguilla
Burkina Faso	Bangladesh	◆ Northern Territory	British Virgin Islands
Cameroon	Brunei	◆ Queensland	◆ Virgin Gorda
Central African Republic	Burma	◆ Western Australia	Grenada
Chad	China	Papua New Guinea	Montserrat
Congo	Hong Kong		Netherlands Antilles
Côte d'Ivoire	India		◆ Curaçao
Egypt	◆ Andhra Pradesh		◆ Saint Eustatius
Gabon	◆ Assam		◆ Saint Maarten
Kenya	◆ Bihar		Saint Kitts and Nevis
Liberia	◆ Delhi		Saint Lucia
Niger	◆ Karnataka		Saint Vincent and the Grenadines
Nigeria	◆ Kerala		◆ Saint Vincent
Senegal	◆ Madhya Pradesh		Trinidad and Tobago
Seychelles	◆ Maharashtra		United States Territories
Somalia	◆ Orissa		◆ Puerto Rico
Sudan	◆ Punjab		❖ Culebra
Tanzania	◆ Tamil Nadu		❖ Vieques
Zaire	◆ Tripura		◆ U.S. Virgin Islands
	◆ Uttar Pradesh		❖ Saint Croix
	◆ West Bengal		❖ Saint John
	Indonesia		❖ Saint Thomas
	◆ Java		
	◆ Sumatra		North America
	◆ Salawesi		United States
	Kampuchea		◆ Hawaii
	Laos		
	Malaysia		South America
	◆ Malaya		Guyana
	Maldiv Island		
	Nepal		
	Oman		
	Pakistan		
	Philippines		
	Saudi Arabia		
	Sri Lanka		
	Taiwan		
	Thailand		
	United Arab Emirates		
	Yemen		

FIGURE B-3: Countries Known to be Infested with Pink Hibiscus Mealybug



Appendix C

Natural Enemies Reported Attacking Pink Hibiscus Mealybug (PHM)

Introduction

Numerous natural enemies have been reported in the literature and are under consideration for importation and release to regulate PHM in the Caribbean. The following is a list of those natural enemies (Stibick, 1997):

Parasites

Hymenopterous Parasites

Alamella flava (Encyrtidae) (Mani, 1989)

From India. Of minor importance (Mani, et al., 1987).

Allotropia citri (Platygasteridae) (Mani, 1989)

From India.

Allotropia sp. nr. japonica (Platygasteridae) (Mani, 1989)

From India. Of minor importance (Mani, et al., 1987).

Anagyrus sp. (Encyrtidae) (Mani, 1989)

From India. Found to parasitize 19-47% of the mealybug on fibre crops. (Mani, 1989)

Anagyrus sp. (Encyrtidae) (Beardsley, 1985)

From Hawaii. Less plentiful than *A. kamali*, with which it was associated.

Anagyrus agraisensis (Encyrtidae) (Cross & Noyes, 1995)

From the Oriental region. Sympatric to *A. dactylopii* and *A. kamali*.

Anagyrus dactylopii (Encyrtidae) (Mani, 1989)

A Hong Kong parasitoid (Noyes & Hayet, 1994) introduced into India from Brazil in 1984 for control of the mealybug *Planococcus citri* (Mani, 1994). Found to parasitize up to 70% of the third instar and adult female of the Hibiscus mealybug on grapes. A generation is completed in about 15 days. Dichlorvos is apparently non-toxic to this parasitoid. (Mani, 1989) Available in the USA (Acosta, 1996).

Anagyrus fusciventris (Encyrtidae) (Noyes & Hayat, 1994)
An Australian/New Zealand parasitoid introduced into Hawaii, California, Florida, Bermuda, Trinidad, Puerto Rico, Ghana, Italy, and Israel for control of several mealybugs (but not the Hibiscus mealybug). It may have been introduced into Hong Kong, where a specimen was reared from the Hibiscus mealybug on Oleander.

Anagyrus greeni (Encyrtidae) (Mani, 1989)
From India.

Anagyrus kamali (Encyrtidae) (Mani, 1989)
From Java. Introduced to Egypt and may have caused a decline in the Hibiscus mealybug population, which was parasitized from 66 to 100%. In many places the mealybug disappeared completely (Mani, 1989). Accidently introduced into Hawaii (Beardsley, 1985).

Anagyrus mirzai (Encyrtidae) (Noyes & Hayat, 1994)
From India. Not a well known parasitoid of this mealybug.

Anagyrus pseudococci (Encyrtidae) (Noyes & Hayat, 1994)
From Egypt, Saudi Arabia.

Aphelinus sp. (Aphelinidae) (Mani, 1989)
From India.

Chartocerus sp. nr. walkeri (Signiphoridae) (Mani, 1989)
From India. Of minor importance (Mani, et al., 1987).

Cheiloneurus sp. (Encyrtidae) (Mani, 1989)
From India.

Erioporus aphelinoides (Aphelinidae) (Mani, 1989)
From India.

Gyranusoidea mirzai (Encyrtidae) (Mani, 1989)
From India. Of minor importance (Mani, et al., 1987)

Leptomastix phenacocci (Encyrtidae) (Mani, 1989)
From Java. Introduced to Egypt, but may be hyperparasitized by *Achrysoiphagus javanicus*, *A. annulatus*, and *Erioporus aphelinoides*. (Mani, 1989)

Leptopilina sp. (Eucoilidae) (Mani, 1989)
From India. Of minor importance (Mani, et al., 1987).

Phanerotoma dentata (Braconidae) (Mani, 1989)
From Egypt.

Procheiloneurus annulatus (Encyrtidae) (Noyes & Hayat, 1994)
From Indonesia.

Procheiloneurus javanicus (Encyrtidae) (Noyes & Hayat, 1994)
From Indonesia.

Prochiloneurus (=Achrysopophagus) sp. (Encyrtidae) (Mani, 1989)
From India. With *Anagyrus kamali*, said to obtain outstanding control of the mealybug. (Mani, 1989)

Rhopus longiclavatus (Encyrtidae) (Noyes & Hayat, 1994)
From India. May eventually prove to be synonymous with *R. nigriclavus* (not listed here).

Predators

Coleopterous Predators

Brumus suturalis (Coccinellidae) (Mani, 1989)
From India.

Cryptolaemus affinis (Coccinellidae) (Greve & Ismay, 1983)
From Papua New Guinea.

Cryptolaemus montrouzieri (Coccinellidae) (Mani, 1989)
From France. This predator was not effective in Egypt, probably due to poor overwintering, but it was effective in India at the rate of 1000/ha. At 1500 per acre, it gave effective control within 75 days in vineyards. The predatory larva may eat up to 1500 nymphs of the mealybug during its development. May be adversely affected by low temperatures. Dichlorvos and chlorpyrifos are relatively nontoxic to this species. (Mani, 1989) Available in the U.S. (Acosta, 1996).

Hippodamia convergens (Coccinellidae) (Acosta, 1996)
From U.S. Easily available predators by mail order. Shipped in the adult stage in quantities depending on the area to be covered, ie., ¼ pt (650 ft²; 2,300 ladybugs) to 1 gal. (10-20 acres; 72,000 ladybugs). Ideal conditions are 61-72°F. May be stored for 1-3 weeks at 35-45°F.

Hyperaspis maindronii (Coccinellidae) (Mani, 1989)
From India. A different species (*H. miles*) is available in the U.S. (Hunter, 1994).

Melanophthalma carinulata (Lathridiidae) (Mani, 1989)
From Egypt.

Menochilus sexmaculata (Coccinellidae) (Mani, 1989)
From India.

Nephus regularis (Coccinellidae) (RAPCPM, 1995)
From India.

Oxynychus erythrocephalus (Coccinellidae) (Mani, 1989)
From Egypt.

Pullus ? salomonis (Coccinellidae) (Greve & Ismay, 1983)
From India.

Rodolia cardinalis (Coccinellidae) (Mani, 1989)
From Egypt.

Scymnus sp. (Coccinellidae) (Greve & Ismay, 1983)
From Papua New Guinea.

Scymnus biverrucata (Coccinellidae) (Mani, 1989)
From Egypt.

Scymnus coccivora (Coccinellidae) (Mani, 1989)
Recommended for control in India, since *Scymnus* species can survive at low population levels of Hibiscus mealybug and are not adversely affected by low temperatures. A single predatory larva consumes about 60-70 mealybug nymphs during a developmental period of about 20 days (Mani, 1989). This species has been imported from India to Trinidad and Tobago and St. Kitts in 1995 and 1996 (Dale Meyerdirk, per. comm.)

Scymnus gratiozus (Coccinellidae) (Mani, 1989)
Recommended for control in India, since *Scymnus* species can survive at low population levels of Hibiscus mealybug and is not adversely affected by low temperatures (Mani, 1989).

Scymnus nubilus (Coccinellidae) (Mani, 1989)
From India.

Scymnus sp. nr. nubilus (Coccinellidae) (Mani, 1989)
From India.

Scymnus pallidicollis (Coccinellidae) (Mani, 1989)
From India.

Scymnus pyrocheilus (Coccinellidae) (Mani, 1989)
From India.

Scymnus seriacus (Coccinellidae) (Mani, 1989)
From Egypt.

Sericoderus percikanus corylophidae (Coccinellidae) (Mani, 1989)
From Egypt.

Dipterous Predators

Cacoxenus perpicaux (Drosophilidae) (Mani, 1989)

From India.

Coccodiplosis smithi (Cecidomyiidae)

From Papua New Guinea. (Greve & Ismay, 1983)

Diadiplosia sp. (Cecidomyiidae) (Mani, 1989)

From Egypt.

Diadiplosia indica (Cecidomyiidae) (Mani, 1989)

From India. Larvae eat eggs, nymphs, and gravid females. Eggs are laid loosely on the ovisac of the mealybug. (Misra, 1920)

Triommata coccidivora (Cecidomyiidae) (Mani, 1989)

From India.

Hemipteran Predators

Geocoris tricolor (Coreidae) (Mani, 1989)

From India.

Lepidopterous Predators

Autoba silicula (Noctuidae) (Mani, 1989)

From India.

Eublemma sp. (Noctuidae) (Mani, 1989)

From Egypt.

Eublemma geyri (Noctuidae) (Mani, 1989)

From Egypt.

Eublemma sp. nr. trifaciata (Noctuidae) (Mani, 1989)

From India. The caterpillars are predaceous on the nymphs and females, which they devour avidly, and pupate in the midst of mealybug colonies, but fall prey to Drosophilid flies in turn. (Misra, 1920)

Spalgisepius (Lycaenidae) (Pushpaveni, et al., 1974)

From India. The caterpillars feed voraciously on young nymphs of the mealybug. Each full-grown caterpillar is capable of eating as many as 300 nymphs per day.

Neuropterous Predators

Brinckochrysa scelestes (Chrysopidae) (Mani, 1989)
From India.

Chrysopa sp. (= *Chrysoperla*) (Chrysopidae) (Mani, et al., 1987)
From India. Three species of this genus are available in the U.S.
(Hunter, 1997).

Chrysopa sp. (= *Chrysoperla*) (Chrysopidae) (Mani, 1989)
From India.

Chrysopa scelestes (Chrysopidae) (Rao, et al., 1984)
From India.

Chrysoperla carnea (Chrysopidae) (Mani, 1989)
From Egypt. Available in the U.S. (Hunter, 1994)

***Chrysoperla* spp.** (= *Chrysopa*) (Chrysopidae)
From U.S. These are available year-round in any life stage from
suppliers. They are released in the egg stage at the rate of 1,000 eggs
per 200 sq. ft. Repeated releases may be necessary. (Acosta, 1996)
Three species, including the above, are listed by Hunter, 1994.

Conwentzia psociformis (Coniopterygidae) (Mani, 1989)
From Egypt.

Mallada boninensis (Chrysopidae) (Mani, 1989)
From India.

Symphorobius pygmaeus (Hemerobiidae) (Mani, 1989)
From Egypt.

Pathogens

A Sporozoean, ***Laterospora phenacocca***, was recently described from
the Hibiscus mealybug. (Haldar, et al., 1988)



Appendix D

List of Key PHM Cooperators

The following is a list of key PHM cooperators in the Caribbean, the United States, and elsewhere. If you have questions about the PHM Program in the Virgin Islands of the United States, or the PHM Biological Control Program, contact the appropriate cooperator.

<p>Dr. Shaban Abd-Rabou Scale Insects and Mealybugs Research Department Plant Protection Research Institute Nadi El Said Street Dokki, Giza 12618 EGYPT Tel. (202) 348-6163 FAX: (202) 335-6175</p>	<p>Dr. Harold Browning University of Florida IFASCREC 700 Experiment Station Rd. Lake Alfred, Florida 33850 UNITED STATES Tel. (941) 956-1151 FAX: (941) 956-4631</p>
<p>Crispin Blanco USDA, APHIS, IS P. O. Box 61 National Agriculture Trade Showgrounds Belmopan BELIZE, CENTRAL AMERICA Tel. (501) 82-30-85 FAX: (501) 82-01-95</p>	<p>Carolyn Cohen USDA, APHIS, IS Santo Domingo DOMINICAN REPUBLIC Mail: Unit 5527, APO, AA 34041 US Comser Building Pedro Enrique Urena 133, SADQ Tel. (809) 277-0111 FAX: (809) 277-1948</p>
<p>Dr. Theodore Boratynski USDA, APHIS, PPQ P. O. Box 37 Brawley, California 92227 UNITED STATES Tel. (760) 344-1152 FAX: (760) 344-1971</p>	<p>Dr. Tony Cross IIBC, Headquarters Silwood Park, Buckhurst Rd., Ascot Berks, SL5 7TA UNITED KINGDOM Tel. (44) 0-1344-872999 FAX: (44) 0-1344-875-007</p>

<p>Mr. Elvett Elliot Assistant Commissioner, and Dr. Ashley George Virgin Islands Dept. of Agriculture 7944 Estate Dorothea St. Thomas U. S. VIRGIN ISLANDS 00802 Tel. (809) 774-5182 FAX: (809) 774-1823</p>	<p>Dr. Ed Gersabeck USDA, APHIS, IS 4700 River Road, Unit 67 Riverdale, Maryland 20737-1233 UNITED STATES Tel. (301) 734-8892 FAX: (301) 734-8318</p>
<p>Dr. Larry Ertle Kenneth Swan Beneficial Insects Introduction Research Laboratory USDA, ARS 501 South Chapel Street Newark, Delaware 19713-3814 UNITED STATES Tel. (302) 731-7330 FAX: (302) 737-6780</p>	<p>Dr. Marjorie Hoy Dept. of Entomology & Nematology Bldg. 976, Hull Road University of Florida Gainesville, Florida 32611 UNITED STATES Tel. (904) 392-1901 FAX: (904) 392-0190</p>
<p>Everest Ferguson Pest Management Unit Ministry of Agriculture Lowthers Lane St. George's GRENADA Tel. (809) 440-0019 FAX: (809) 440-8866</p>	<p>Dr. Marshall W. Johnson College of Tropical Agriculture & Human Resources University of Hawaii at Manoa Gilmore Hall 202 3050 Maile Way Honolulu, Hawaii UNITED STATES Tel. (808) 956-8432 FAX: (808) 956-2428</p>
<p>Dan Fieselmann USDA, APHIS, PPQ 1017 Main Campus Drive Suite 2500 Raleigh, North Carolina 27606 UNITED STATES Tel. (919) 513-2126 FAX: (919) 513-1995</p>	<p>William (Dennis) Jones USDA, APHIS, PPQ Federal Building, Room 141 Veterans Drive St. Thomas U.S. VIRGIN ISLANDS 00801 Tel. (809) 776-2787 Cell Phone: (809) 690-6651 FAX: (809) 774-0796</p>
<p>Mrs. Dale Francis-Ellis Pest Management Officer Pest Management Unit Ministry of Agriculture Lowthers Lane St. George's GRENADA Tel. (809) 440-0019 FAX: (809) 440-8866</p>	<p>Dr. Moses Kairo Scientist in Charge International Institute of Biological Control Gordon Street, Curepe TRINIDAD Tel. (868) 662-4173 FAX: (868) 663-2859 Email: CABI-IIBC-CLAS@CABI.ORG</p>

<p>Dr. William Kauffman USDA, APHIS, PPQ 2534 South 11th Street Niles, Michigan 49120-4315 UNITED STATES Tel. (616) 683-3563 FAX: (616) 683-9608</p>	<p>Dr. Dale E. Meyerdirk USDA, APHIS, PPQ 4700 River Rd. Unit 135 Riverdale, Maryland 20737-1236 UNITED STATES Tel. (301) 734-5667 FAX: (301) 734-8192</p>
<p>Dr. Jeff Keularts University of the Virgin Islands Cooperative Extension Service St. Croix, U.S. Virgin Islands 00821 Tel. (809) 778-9491 FAX: (809) 778-8866</p>	<p>Dr. Douglass Miller Systematic Entomology Lab. USDA, ARS-BARC-W Bldg. 0054, Rm. 137 Beltsville, Maryland 20705 UNITED STATES Tel. (301) 503-5895 FAX: (301) 504-6482</p>
<p>Dr. Alan Kirk European Biological Control Laboratory USDA, ARS Campus International de Baillarguet CS. 90013 Montferrier sur Lez 34980 St. Gely du Fesc CEDEX, FRANCE Tel. (33) 499-62-30-01 FAX: (33) 499-62-30-49</p>	<p>Terry Nelson Oxnard Pest Control Association 666 Pacific Avenue P. O. Box 1187 Oxnard, California 93032 UNITED STATES Tel. (805) 483-1024 FAX: (805) 487-6867</p>
<p>Dr. Stephen L. Lapointe USDA, ARS U. S. Horticultural Research Laboratory 2001 South Rock Road Ft. Pierce, Florida 34945 UNITED STATES Tel. (561) 462-5914 FAX: (561) 462-5986</p>	<p>Dr. Lance Osborne University of Florida 2807 Binion Road Apopka, Florida 32703 UNITED STATES Tel. (407) 889-4161 FAX: (352) 392-9359</p>

<p>Nilda Perez Aixa Ramirez Lourdes Siez Ministry of Agriculture, Sanidad Vegetal Calle Tadeo Rivera Esq. Sur. Estroda A. Muelle 13 Purerto De Teirra San Juan, Puerto Rico 00901 Tel. (787) 724-4672 FAX: (787) 722-3447</p>	<p>Senator Holland L. Redfield, II Republican Charge d'Affaires to Washington, DC National Committeeman for the Virgin Islands Republican National Committee Post Office Box 631 Christiansted, St. Croix U.S. VIRGIN ISLANDS 00820-0631 Tel.(809) 773-2424 Ext. 2279 (809) 772-2830 FAX: (809) 772-2843</p>
<p>Ms. Cynthra Persad Hibiscus Mealybug Management Coordinator Central Experimental Station Ministry of Agriculture, Land & Marine Resources Centeno, Via Arima P. O. TRINIDAD & TOBAGO WEST INDIES Tel. (809) 646-4335 FAX: (809) 622-4246</p>	<p>Dr. Carlos Robless University of the Virgin Islands Cooperative Extension Service St. Thomas U.S. VIRGIN ISLANDS 00802 Tel. (809) 693-1083 FAX: (809) 693-1085</p>
<p>Dr. Arthur C. Petersen, Jr., Commissioner, and Dr. Lawrence Lewis, Deputy Commissioner Department of Agriculture Virgin Islands of the United States Estate Lower Love, Kingshill St. Croix U.S. VIRGIN ISLANDS 00850 Tel. (809) 778-0997 (778-0998) FAX: (809) 778-3101</p>	<p>Josephine L. Roller Deputy Commissioner Department of Agriculture Virgin Islands of the United States Estate Carolina Coral Bay St. John U.S. VIRGIN ISLANDS 00830 Tel. (809) 776-6274</p>
<p>Dr. Gene V. Pollard Regional Plant Protection Officer Food and Agricultural Organization of the United Nations P. O. Box 631-C Bridgetown BARBADOS Tel. (246) 426-7110 FAX: (246) 427-6075 Email: Gene.Pollard@field.fao.org</p>	<p>Dr. William Roltsch California Department of Food & Agriculture Biological Control Program 3288 Meadowview Road Sacramento, CA 95832 UNITED STATES Tel. (916) 262-2055</p>

<p>Dr. Michael Schauff U. S. National Museum Systematic Entomology Lab Nhb 168 Washington, DC 20560-0001 UNITED STATES Tel. (202) 382-1784 FAX: (202) 786-9422</p>	<p>State Plant Health Director USDA, APHIS, PPQ GSA Center 651 Federal Drive, Suite 321-16 Guaynabo, Puerto Rico 00965 Tel.(787) 749-4471 (787) 749-4472 FAX: (787) 749-4473</p>
<p>Dr. Miguel Serrano USDA, ARS Tropical Agriculture Research Station 2200 Pedro Albizu Campos Ave. Suite 201 Mayaguez PUERTO RICO 00680 Tel. (787) 831-3435 FAX: (787) 831-3386</p>	<p>Dr. Jerome Thomas Earl Thomas Department of Agriculture La Guerite Basseterre ST. KITTS & NEVIS WEST INDIES Tel. (809) 465-2335 FAX: (809) 465-2635</p>
<p>Mr. Carl Francis Smith Bahamas Director of Agriculture Valerie Outten Deputy Director Department of Agriculture P. O. Box N-3028 Nassau BAHAMAS Tel. (242) 356-3919 FAX: (242) 325-3960</p>	<p>Gary Timmons USDA, APHIS, IS Nassau International Airport Nassau, BAHAMAS Tel. (242) 377-7127 FAX: (242) 377-1791</p>
<p>Orlando Solsa Belize National Plant Protection Service Ministry of Agriculture and Fisheries Central Farm Cayo District BELIZE, CENTRAL AMERICA Tel. (501) 92-2131 Ext. 122 FAX: (501) 92-3773</p>	<p>Richard Warkentin USDA, APHIS, PPQ c/o USDA, ARS Subtropical Horticulture Research Station 13601 Old Cutler Road Miami, Florida 33158 UNITED STATES Tel. & FAX: (305) 234-2540</p>



Appendix E

Sources of Natural Enemies

The following organizations are currently producing natural enemies of pink hibiscus mealybug:

- ◆ International Institute of Biological Control
Gordon Street, Curepe
TRINIDAD
Tel. (868) 662-4173
FAX: (868) 663-2859
Email: CABI-IIBC-CLAS@CABI.ORG
Contact: Dr. Moses Kairo
Scientist in Charge
- ◆ Central Experimental Station
Ministry of Agriculture, Land & Marine Resources
Centeno, Via Arima P. O.
TRINIDAD & TOBAGO
WEST INDIES
Tel. (809) 646-4335
FAX: (809) 622-4246
Contact: Ms. Cynthra Persad
Hibiscus Mealybug Management Coordinator
- ◆ Pest Management Unit
Ministry of Agriculture
Lowthers Lane
St. George's
GRENADA
Tel. (809) 440-0019
FAX: (809) 440-8866
Contact: Mrs. Dale Francis-Ellis
Pest Management Officer
- ◆ Department of Agriculture
La Guerite
Basseterre
ST. KITTS & NEVIS
WEST INDIES
Tel. (809) 465-2335
FAX: (809) 465-2635
Contacts: Dr. Jerome Thomas; Antonio Francis

- ◆ Department of Agriculture
Virgin Islands of the United States
Estate Lower Love, Kingshill
St. Croix, U.S. VIRGIN ISLANDS 00850
Tel. (809) 778-0997 (778-0998)
FAX: (809) 778-3101
Contacts: Henry Schuster, Commissioner;
Dr. Lawrence Lewis, Deputy Commissioner
- ◆ Ministry of Agriculture, Sanidad Vegetal
Calle Tadeo Rivera Esq. Sur.
Estroda A. Muelle 13
Purerto De Teirra
San Juan, PUERTO RICO 00901
Tel. (787) 724-4672
FAX: (787) 722-3447
Contact: Nilda Perez
- ◆ California Department of Food & Agriculture
Biological Control Program
3288 Meadowview Road
Sacramento, CA 95832
UNITED STATES
Tel. (916) 262-2055
Contact: Dr. William Roltsch

You can find other sources of *Cryptolaemus montrouzieri* in the following reference publication:

- ◆ Hunter, Charles D., 1997. Suppliers of beneficial organisms in North America.

To request a copy of this pamphlet, contact the following agency:

- ◆ California Environmental Protection Agency
Department of Pesticide Regulation
Environmental Monitoring and Pest Management Branch
1020 N Street, Room 161
Sacramento, California 95814-5624
Telephone: (916) 324-4100



Appendix F

Environmental Assessments

Field Releases of Nonindigenous Species of *Anagyrus* and *Gyranusoidea* (Hymenoptera: Encyrtidae) for Biological Control of Pink Hibiscus Mealybug, *Maconellicoccus hirsutus* (Homoptera: Pseudococcidae)

Environmental Assessment

June 1997

Agency Contact:

Dale E. Meyerdirk, Ph.D.
Center for Plant Health Science and Technology
Plant Protection and Quarantine
U.S. Department of Agriculture
4700 River Road
Riverdale, MD 20737-1236

I. Description of the Proposed Action

The Animal and Plant Health Inspection Service (APHIS) of the U.S. Department of Agriculture (USDA) proposes to release nonindigenous wasps in the genus *Anagyrus* and *Gyranusoidea* (Hymenoptera: Encyrtidae) in the continental United States and its Caribbean territories as part of a biological control project against pink hibiscus mealybug (PHM), *Maconellicoccus hirsutus* (Green) (Homoptera: Pseudococcidae). PHM is a devastating pest of cocoa, grapes, fiber crops, hibiscus, and many other field crops and ornamental plants. *Anagyrus* wasps are of interest because they controlled PHM in Egypt, India, and Hawaii (Cross and Noyes, 1995; Beardsley, 1985). *Gyranusoidea* wasps are closely related to *Anagyrus*, and they offer similar potential as biological control agents. *G. tebygi* controlled *Rastrococcus invadens* on mango and citrus in West and Central Africa (Willick and Moore, 1988). *G. indica*, a PHM parasite of Egyptian origin, is now being studied in quarantine in St. Kitts preparatory to its introduction into the United States.

The applicant plans to import *Anagyrus* and *Gyranusoidea* from worldwide locations into USDA-certified insect quarantine facilities (e.g., Florida Division of Plant Industry in Gainesville, Florida). Laboratory colonies will be established, species identifications will be confirmed, and undesirable organisms such as hyperparasites will be screened out. The wasps will then be released in areas invaded by PHM. Since PHM already occurs in the Caribbean area, the first U.S. infestations (other than Hawaii) are expected to appear in Puerto Rico and Florida. It is expected that the wasps will become established and reproduce naturally without further human intervention.

Specimens of *Anagyrus* and *Gyranusoidea* will be identified by recognized experts, and voucher specimens will be deposited in collections of recognized museums and universities.

This environmental assessment (EA) was prepared in compliance with the National Environmental Policy Act (NEPA) (42 USC 4321 *et seq.*) as described in implementing regulations adopted by the Council on Environmental Quality (40 CFR 1500-1509), by the USDA (7 CFR 1b), and by APHIS (7 CFR 372).

II. Purpose of and Need for the Proposed Action

The purpose of the proposed action, i.e., the release of parasitic wasps in the genera *Anagyrus* and *Gyranusoidea*, is to suppress PHM infestations throughout the eventual U.S. distribution of the pest. PHM does not yet occur in Puerto Rico or the continental United States, but it is expected soon to enter Puerto Rico and Florida from infestations in the Caribbean area. From Florida PHM could spread

rapidly through the Gulf states and eventually on to Texas and California. The limits of its spread northward cannot be accurately predicted, but certain greenhouse crops would be at risk even in cold regions.

PHM attacks at least 346 host plants. In Grenada, cocoa production decreased by 30% after PHM was introduced (Meyerdirk, pers. comm.), losses in all crops were estimated at \$1.8 million/year during 1996 and 1997, and total economic losses were estimated to be between \$3.5 and \$10 million. Trinidad forecast losses exceeding \$125 million/year if infestations continued to escalate. In India, PHM caused from 50–100% losses in grapes, and up to 75% reduction of the sorrel crop, *Hibiscus sabdariffa*. This pest has also caused severe losses in various fiber crops.

III. Alternatives to the Proposed Action

The no-action alternative to releasing *Anagyrus* spp. and *Gyranusoidea* spp. is to forego the biological control project. In this case, insecticides will be used against the pest. Alternatively, other types of biological control agents such as the lady beetle *Cryptolaemus montrouzieri* might be used in place of parasitic wasps.

IV. Environmental Consequences of the Proposed Action and Alternative

A. Impacts of the proposed action

Intended impact of the release

The intended environmental impact of the proposed action is to reduce the severity of PHM infestations without resort to the use of insecticides.

Area affected by the releases

Biological control agents such as parasitic wasps generally spread even without the agency of man. In principle, therefore, release of an *Anagyrus* or *Gyranusoidea* species at even one site in the continental United States must be considered equivalent to release over the entire area of the United States in which potential hosts occur and in which the climate is suitable. Eventually the wasps might establish self-sustaining populations throughout the pest's entire area of distribution. Although that area cannot now be predicted with confidence, Florida, Hawaii (PHM is already present there), Puerto Rico, and the Virgin Islands are considered as the minimal limits.

Environmental safety of releases

The proposed introductions of *Anagyrus* and *Gyranusoidea* raise the question of environmental safety since the wasps conceivably might attack nontarget insects. Most *Anagyrus* species attack only mealybugs, either Pseudococcidae or Eriococcidae. A very few attack only larvae of certain lady beetles (Noyes & Hayat, 1994). Mealybugs are the only known hosts of *Gyranusoidea* species.

Mealybugs are not considered beneficial to agriculture, nor is there evidence that indigenous mealybugs play a critical role in noncrop systems since native mealybugs usually occur at very low population levels.

The following list indicates the range of mealybugs attacked by various species of *Anagyrus* parasitic on PHM (Cross & Noyes, 1995; Noyes & Hayat, 1994) (laboratory hosts possibly not attacked in nature are marked with an asterisk):

Anagyrus dactylopii (introduced into HI): *Cerococcus* sp.?, *Ceroplastes* sp.?, *Ferrisia virgata* (striped mealybug), *Nipaecoccus viridis* (lebbek mealybug), *Planococcus citri* (citrus mealybug), *Pseudococcus* sp., *Rastrococcus capparidae*, *R. iceryoides*?

Anagyrus fusciventris (introduced into HI, CA, FL): *Eragrostis variabilis*, *Ferrisia virgata**, *Phenacoccus njalensis** (cacao mealybug), *P. gossypii** (Mexican mealybug), *Planococcus citri**, *Pseudococcus gallicola*, *P. montanus*, *P. calceolariae*, *P. longispinus** (long-tailed mealybug), *Ripersia palmarum*, *Vryburgia lounsburyi**.

Anagyrus kamali (introduced into HI, CA, and TX): *Ferrisia virgata*, *Nipaecoccus viridis*, *Planococcoides robustus*?, *Pseudococcus* sp.

Anagyrus pseudococci (introduced into CA and TX): *Dysmicoccus brevipes**, *Phenacoccus herreni*, *Planococcus citri*, *P. vovae*, *P. sp. nr. ficus*, *Pseudococcus affinis**, *P. calceolariae**, *P. comstocki* (Comstock mealybug), *P. cryptus* (= *P. citriulus*), *P. longispinus**, *P. njalensis**.

The following list indicates the range of mealybugs attacked by various species of *Gyranusoidea* (Noyes & Hayat, 1994; Meyerdirk, pers. comm.):

Gyranusoidea albiclavata: *Dysmicoccus ryani*, *Pseudococcus* sp.
Gyranusoidea ceroplastis: *Ceroplastes rubens*?.
Gyranusoidea cinga: *Rastrococcus invadens*?.
Gyranusoidea epos: *Rastrococcus spinosus*.
Gyranusoidea flava: *Cataenococcus hispidus*,
Nipaecoccus viridis, *Planococcoides robustus*, *Planococcus citri*.
Gyranusoidea tebygi: *Rastrococcus invadens*.

Risk to threatened and endangered species

Mealybugs are the only known hosts of the species of *Anagyrus* and *Gyranusoidea* that are candidates for introduction into the United States. No mealybug species are federally listed as threatened or endangered, and, in fact, no members of the order (Homoptera) to which mealybugs belong are so listed (U.S. Fish and Wildlife Service, 1996). Mealybugs often are important items in the diet of certain encyrtid wasps, and at times they may be important in the diet of lady beetles, lacewings, and certain lycaenid butterflies. However, no such insects are federally listed as threatened or endangered.

Risk to other biological control agents

All known *Anagyrus* and *Gyranusoidea* wasps are obligate primary parasites rather than hyperparasites (i.e., they do not parasitize other parasites). Hence, there is no danger that introduced species of *Anagyrus* and *Gyranusoidea* might cause harm by attacking parasites of pest insects.

Impact on health of humans and animals

The status of *Anagyrus* and *Gyranusoidea* wasps as obligate parasites of mealybugs precludes any adverse effects on human or animal health. People who handle insects in confinement may develop allergic reactions. However, the greater risk is presented by scales from the bodies of moths. It would not be expected that tiny wasps would pose a significant risk.

Impact from previous releases of *Anagyrus* and *Gyranusoidea* wasps against pest mealybugs

No adverse impacts were reported after releases of *Anagyrus pseudococci* in California and Texas for control of *Planococcus citri* (Noyes & Hayat, 1994), *Anagyrus fusciventris* in California and Florida for control of *Pseudococcus longispinus*, *Anagyrus* spp. in California for control of *Pseudococcus comstocki* (Meyerdirk & Newell, 1979), and *Gyranusoidea tebygi* in West and Central Africa for control of *Rastrococcus invadens*.

B. Impact of the “no-action” alternative

If *Anagyrus* or *Gyranusoidea* wasps are not released, chemical pesticides will likely be the primary means of control. Repeated, increasingly costly applications will be required as the mealybug develops resistance. Eventually, when satisfactory control becomes impossible, severe infestations may have major economic and social impacts in the continental United States as they did in the Caribbean. Chemical treatments may exacerbate mealybug damage by destroying indigenous natural enemies of PHM. Wildlife may suffer from environmental pollution. Human health might suffer from

contamination of groundwater sources and possibly contamination of air, soil, and food. Large-scale unemployment in agricultural areas is highly probable.

C. Impact of the use of alternative types of biological control agents

Nonindigenous lady beetles, lacewings, and other predatory insects might be used in place of parasitic wasps. However, predators probably would yield less effective control than parasitic wasps, raising again the need for insecticidal treatments with all the concomitant risks discussed in the preceding paragraph.

In conclusion, releases of nonindigenous wasps in the genera *Anagyrus* and *Gyranusoidea* offer an environmentally safe, preferred alternative to the use of insecticides in controlling pink hibiscus mealybug.

V. Agencies and Persons Consulted

This environmental assessment was prepared by USDA, APHIS, Environmental Analysis and Documentation, and Plant Protection and Quarantine Units (all at USDA, APHIS, Riverdale, MD).

VI. References

- Beardsley, J.W.** 1985. *Maconellicoccus hirsutus* (Green). Proc. Hawaiian Entomol. Soc. 25: 27–28.
- Cross, A.E., and Noyes, J.S.** 1995. Dossier on *Anagyrus kamali*, biological control agent for the pink mealybug, *Maconellicoccus hirsutus*, in Trinidad and Tobago. Commonwealth Agricultural Bureau (CAB) International, UK: 16 pp.
- Meyerdirk, D.E., and Newell, I.M.** 1979. Importation, colonization, and establishment of natural enemies on the Comstock mealybug in California. Jour. Econ. Entomol. 72(1): 70–73.
- Noyes, J.S., and Hayat, M.** 1994. Oriental Mealybug Parasitoids of the Anagyrini. CAB International, Oxon, UK: 554 pp.
- U.S. Fish and Wildlife Service.** 1996. Endangered and Threatened Wildlife and Plants. Code of Federal Regulations, Title 50, Parts 17.11 and 17.12, October 31, 1996, 46 pp.
- Willick, E., and Moore, D.** 1988. Aspects of the biology of *Rastrococcus invadens* Williams (Hemiptera: Pseudococcidae), a pest of fruit crops in West Africa, and one of its primary parasitoids, *Gyranusoidea tebygi* Noyes (Hymenoptera, Encyrtidae). Bull. Entomol. Res. 78: 709–715.

FINDING OF NO SIGNIFICANT IMPACT

The Animal and Plant Health Inspection Service of the United States Department of Agriculture proposes to release nonindigenous species of parasitic wasps in the genera *Anagyrus* and *Gyranusoidea* (Hymenoptera: Encyrtidae) in the continental United States and U.S. territories in the Caribbean. These wasps are potentially useful for the biological control of the pink hibiscus mealybug, *Maconellicoccus hirsutus* (Homoptera: Pseudococcidae), a devastating pest of field and tree crops, ornamentals, and native vegetation in certain Caribbean countries. It is nearly certain that the mealybug pest eventually will invade the United States and its Caribbean territories. Subsequent releases of *Anagyrus* spp. and *Gyranusoidea* spp. are expected to have no significant adverse impacts on the quality of the human environment. This conclusion is based on the following considerations:

—The species of wasps to be released attack only a few species of mealybugs, some of which are serious agricultural pests.

—Indigenous mealybugs are not known to play a critical role in natural ecosystems, and in any case, indigenous mealybugs are expected to escape heavy attack by the wasps, because these mealybugs generally exist at low population levels.

Release of *Anagyrus* spp. and *Gyranusoidea* spp. at various points in the United States, including Caribbean possessions, will have no effect on federally-listed endangered or threatened species or critical habitat.

—Over a period of decades, several species of *Anagyrus* have been successfully introduced into the continental United States for effective control of pest mealybugs, and two species of *Anagyrus* were established in the Hawaiian Islands to control pink hibiscus mealybug. No adverse impacts have ever been reported from these introductions.

—The biological characteristics of wasps in the genera *Anagyrus* and *Gyranusoidea* preclude any possibility of harmful effects on human health.



Matthew Royer

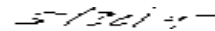

Date

Plant Protection and Quarantine
Animal and Plant Health Inspection Service
United States Department of Agriculture

Field Releases of Nonindigenous Species of *Leptomastix* (Hymenoptera: Encyrtidae) for Biological Control of Pink Hibiscus Mealybug, *Maconellicoccus hirsutus* (Homoptera: Pseudococcidae)

Environmental Assessment

June 1997

Agency Contact:

Dale E. Meyerdirk, Ph.D.
Center for Plant Health Science and Technology
Plant Protection and Quarantine
U.S. Department of Agriculture
4700 River Road
Riverdale, MD 20737-1236

I. Description of the Proposed Action

The Animal and Plant Health Inspection Service (APHIS) of the U.S. Department of Agriculture (USDA) proposes to release nonindigenous wasps in the genus *Leptomastix* in the continental United States and its Caribbean territories as part of a biological control project against pink hibiscus mealybug (PHM), *Maconellicoccus hirsutus* (Green) (Homoptera, Pseudococcidae).

PHM is reported attacking over 200 plant genera, which include diverse crops such as cocoa, grapes, fiber crops, garden and ornamental hibiscus, and many other crops and ornamental plants. *Leptomastix* wasps are of interest because they are primary, solitary endoparasitoids (internal parasites) of mealybugs. All *Leptomastix* species appear to be associated with mealybugs and eriococcoid scales on trees and bushes, except for a few which parasitize mealybugs on grasses. Available information indicates that most species of *Leptomastix* species are able to develop in several different mealybug hosts. *L. phenacocci* is known to parasitize in PHM in Egypt. Other *Leptomastix* species with similar biological potential are: *L. nigrocoxalis* Compere (India), *L. gunturensis* Shafee (India), *L. flava* Mercet (Egypt), *L. dactylopii* (Cosmopolitan) and *L. salemensis* Hyat (India).

Leptomastix species will be imported from worldwide locations into USDA-certified insect quarantine facilities (e.g., Florida Division of Plant Industry in Gainesville, Florida). Laboratory colonies will be established on PHM to confirm that this mealybug is a reproductive host species (that is, the chosen *Leptomastix* spp. will complete its life cycle on this host), that identifications will be confirmed, and that undesirable organisms such as hyperparasites will be screened out.

The species of *Leptomastix* that appear to be most promising as biological control agents will then be reared in a laboratory and released in areas of the United States and U.S. Territories invaded by PHM. Species most likely to be found attacking PHM are *L. dactylopii*, *L. phenacocci* and *L. flava*. Releases will usually be by hand, from vials in units of 50-100 parasites per release. Other exotic parasitoid species (if available) will be released separately, but more than one species may be released at the same site. Occasionally, however, different agents may be released in different areas for comparative purposes. Those *Leptomastix* species released may be used in combination with various cultural practices and releases of other exotic parasitoid species and commercially produced predators.

Since PHM already occurs in the Caribbean area, the first U.S. releases will be in Vieques, Puerto Rico, and the U.S. Virgin Islands. PHM is expected to appear in Florida and other states soon. The released exotic *Leptomastix* spp. will become established and reproduce naturally without further human intervention.

Specimens of *Leptomastix* will be identified by recognized experts, and voucher specimens will be deposited in collection of recognized museums and universities.

This environmental assessment (EA) was prepared in compliance with the National Environmental Policy Act (NEPA) (42 USC 4321 *et seq.*) As described in implementing regulations adopted by the Council on Environmental Quality (40 CFR 1500-1509), by the USDA (7 CFR 372).

II. Purpose of and Need for the Proposed Action

The purpose of the proposed action, i.e., the release of parasitic wasps in the genus *Leptomastix*, is to suppress PHM infestations throughout the eventual U.S. distribution of the pest. PHM does not occur yet in Puerto Rico (except for the off shore island of Vieques) or the continental United States, but it is expected to soon enter Puerto Rico and Florida from infestations in the Caribbean area. It has already infested three islands in the U.S. Virgin Islands, including St. Thomas, St. Croix, and St. John. From Florida, PHM could spread rapidly through the Gulf states and eventually to Texas and California. The limits of its spread northward cannot be accurately predicted, but certain greenhouse crops would be at risk even in cold regions.

PHM attacks at least 346 host plants. In Grenada, cocoa production decreased by 30% after PHM was introduced (Meyerdirk, pers. comm.), losses in all crops was estimated at \$1.8 million/year during 1996 and 1997, and total economic losses were estimated to be between \$3.5 and \$10 million. Trinidad forecast losses exceeding \$125 million/year if infestations continued to escalate. In India, PHM caused losses of 50 - 100% in grapes and up to 75% in sorrel, *Hibiscus sabdariffa*. Losses in various fiber crops have also been severe.

III. Alternatives to the Proposed Action

The no-action alternative to releasing *Leptomastix* spp. is to limit the biological control potential for this pest. In this case, insecticides will be used against the pest. Alternatively, other types of biological control agents, such as the use of related exotic species of *Anagyrus* and *Gyranusoidea* (USDA, APHIS, 1997) and the lady beetle, *Cryptolaemus montrouzieri*, might be used in place of *Leptomastix* spp.

IV. Environmental Consequences of the Proposed Action and Alternative

A. Impacts of the proposed action

Intended impact of the release of the agent

The intended environmental impact of the proposed action is to reduce the severity of PHM infestations without resort to the continuous use of insecticides.

Area affected by releases

Biological control agents such as parasitic wasps generally spread even without the agency of man. In principle, therefore, release of an *Leptomastix* species at even one site in the continental United States must be considered equivalent to release over the entire area of the United States in which potential hosts occur and in which the climate is suitable. Eventually, the wasp might establish self-sustaining populations throughout the pest's entire area of distribution. Although that area cannot now be predicted with confidence, Florida, Hawaii (PHM is already present there), Puerto Rico (already on the offshore island of Vieques), and the U.S. Virgin Islands (where it is already established) are considered as the minimal limits.

Environmental safety of releases

The proposed introductions of *Leptomastix* spp. raise the question of environmental safety, since the wasps might conceivably attack nontarget hosts. *Leptomastix* spp. attack either Pseudococcidae or Eriococcidae. Mealybugs and certain scales are the only known hosts.

Mealybugs and eriococcid scales are not considered beneficial to agriculture, nor is there evidence that indigenous mealybugs or eriococcid scales play a critical role in noncrop systems, since native mealybugs and scales usually occur at very low population levels.

The following list indicates the range of mealybugs attacked by various species of *Leptomastix* species that are known to be parasitic on PHM and *Nipaecoccus viridis*, a closely related species of mealybug (Noyes & Hayat, 1994).

Leptomastix flava (introduced into California): *Nipaecoccus viridis*, *Peliococcus mesasiaticus*, *Planococcus citri* (citrus mealybug), *Planococcus* sp. nr. *ficus*, *Pseudococcus comstocki* (Comstock mealybug), *Pseudococcus* nr. *cryptus*, *Trionymus multivorus*.

Leptomastix dactylopii (California, Texas, Florida): *Birendracoccus saccharifolii*, *Dysmicoccus brevipes*, *Ferrisa virgata*, *Planococcoides njalensis*, *Phenacoccus madeirensis*, *Planococcus aemulor*, *Planococcus citri*, *Planococcus ficus*, *Planococcus kraunhiae*,

Planococciodes lamabokensi, *Planococcus vovae* *Pseudococcus*
bukbensis, *Pseudococcus concavocerarii*, *Pseudococcus*
longispinus, *Pseudococcus occiduus*.

Leptomastix gunturensis: *Nipaeococcus viridis*

Leptomastix nigrocoxalis: *Nipaeococcus* sp., *Nipaeococcus graminis*,
Nipaeococcus viridis *Coccidohystrix* sp., *Coccidohystrix insolitus*,
Icerya aegyptica, *Planococcus citri*, *Pseudococcus* sp., *Rastrococcus*
cappariae, *Rastrococcus iceryoides*.

Leptomastix phenacocci: *Maconellicoccus hirsutus*, *Nipaeococcus viridis*.

Leptomastix salemensis: *Chorizococcus* sp., *Nipaeococcus* sp.,
Rastrococcus sp.

Risk to threatened and endangered species

Mealybugs and eriococcid scales are the only known hosts of the species of *Leptomastix* that are candidates for introduction into the United States. No mealybug species or eriococcid scales are federally listed as threatened or endangered, and, in fact, no members of the order (Homoptera) to which mealybugs belong, are so listed (U.S. Fish and Wildlife Service, 1996). Mealybugs often are important items in the diet of lady beetles, lacewings, and certain lycaenid butterflies. However, no such insects are federally listed as threatened or endangered.

Risks to other biological control agents

All known *Leptomastix* wasps are obligate primary parasites rather than hyperparasites (i.e., they do not parasitize other parasites). Hence, there is no danger that introduced species of *Leptomastix* might cause harm by attacking parasites of pest insects.

Impacts on health of humans and animals

The status of *Leptomastix* wasps as obligate parasites of mealybugs precludes any adverse effects on human or animal health. People who handle insects in confinement may develop allergic reactions. However, the greatest risk is presented by scales from the bodies of moths. It would not be expected that tiny wasps would pose a significant risk.

Impacts from previous releases of *Leptomastix*

No adverse impacts were reported after releases of *Leptomastix flava* in California for control of *Pseudococcus comstocki* in California (Meyerdirk & Newell, 1979) or of *Leptomastix dactylopii* in California, Texas and Florida for control of *Planococcus citri* and to Hawaii for control of *Dysmicoccus brevipes* (Noyes & Hayat, 1994). In fact, *Leptomastix dactylopii* are commercially reared and sold in the United States and other countries for biological control purposes at the rate of 2 wasps/sq. meter or 5/heavily infested plant (Arbico, 1996).

B. Impact of the “no-action” alternative

If *Leptomastix* and related species (i.e., *Anagyrus*, *Gyranusoidea*) of wasps are not released, chemical pesticides will likely be the primary means of control (USDA, APHIS, 1997). Repeated, increasingly costly applications will be required as the mealybug develops resistance. Eventually, when satisfactory control becomes impossible, severe infestations may have major economic and social impacts in the continental United States as they did in the Caribbean. Chemical treatments may exacerbate mealybug damage by destroying indigenous natural enemies of PHM. Wildlife may suffer from environmental pollution. Human health might suffer from contamination of groundwater sources and possibly contamination of air, soil, and food. Large-scale unemployment in agricultural areas is highly probable.

C. Impact of the use of alternative types of biological control agents

Nonindigenous lady beetles, lacewings, and other predatory insects might be used in place of parasitic wasps. However, predators probably would yield less effective control than parasitic wasps, raising again the need for insecticidal treatments with all the concomitant risks discussed in the preceding paragraph.

In conclusion, releases of nonindigenous wasps in the genus *Leptomastix* offer an environmentally safe, preferred alternative to the use of insecticides in controlling pink hibiscus mealybug.

V. Agencies and Persons Consulted

This environmental assessment was prepared by USDA, APHIS, Environmental Analysis and Documentation, and Plant Protection and Quarantine Units (all at USDA, APHIS, Riverdale, MD).

VI. References

- ARBICO/BICONET.** 1995/1996. Beneficial Specialists 2.
<http://www.usit.net/hp/bionet/BS2.html>
- Meyerdirk, D.E. and Newell, I.M.** 1979. Importation, colonization, and establishment of natural enemies on the Comstock mealybug in California. *Jour. Econ. Entomol.* 72(1):#70-73.
- Noyes, J.S. and Hayat, M.** 1994. Oriental Mealybug Parasitoids of the Anagyrini. CAB International, Oxon, UK: 554 pp.

USDA, APHIS. 1997. Field Releases of Nonindigenous Species of *Anagyrus* and *Gyranusoidea* for Biological Control of Pink Hibiscus Mealybug, *Maconellicoccus hirsutus*. Environmental Assessment, June, 1997. Federal Register, 62(121):34043.

U.S. Fish and Wildlife Service. 1996. Endangered and Threatened Wildlife and Plants. Code of Federal Regulations, Title 50, parts 17.11 and 17.12, October 31, 1996, 46 pp.

FINDING OF NO SIGNIFICANT IMPACT

The Animal and Plant Health Inspection Service of the United States Department of Agriculture proposes to release Nonindigenous species of parasitic wasps in the genus *Leptomastix* (Hymenoptera: Encyrtidae) in the continental United States and U.S. territories in the Caribbean. These wasps are potentially useful for the biological control of the pink hibiscus mealybug, *Maconellicoccus hirsutus* (Homoptera: Pseudococcidae), a devastating pest of field and tree crops, ornamentals, and native vegetation in certain Caribbean countries. It is nearly certain that the mealybug pest eventually will invade the United States and its Caribbean territories. Subsequent releases of *Leptomastix* spp. are expected to have no significant adverse impacts on the quality of the human environment. This conclusion is based on the following considerations:

—The species of wasps to be released attack only a few species of mealybugs, some of which are serious agricultural pests.

—Indigenous mealybugs are not known to play a critical role in natural ecosystems, and in any case, indigenous mealybugs are expected to escape heavy attack by the wasps, because these mealybugs generally exist at low population levels.

—Release of *Leptomastix* spp. at various points in the United States, including Caribbean possessions, will have no effect on federally-listed endangered or threatened species or critical habitat.

—Over a period of decades, several species of *Leptomastix* have been successfully introduced into the continental United States for effective control of pest mealybugs. One species is in commercial use as a biological control agent. No adverse impacts have ever been reported from these introductions.

—The biological characteristics of wasps in the genus *Leptomastix* preclude any possibility of harmful effects on human health.



Matthew Royer



Date

Plant Protection and Quarantine
Animal and Plant Health Inspection Service
United States Department of Agriculture



Appendix G

References

- Babu, T. R., and Azam, K. M.**, 1987. Studies on biology, host spectrum, and seasonal population fluctuation of the mealybug, *Maconellicoccus hirsutus* on grapevine. *Indian J. Hortic.*, 44: 284-288.
- Beardsley, J. W.**, 1985. *Maconellicoccus hirsutus*. *Proc. Hawaiian Ent. Soc.*, 25: p. 27.
- Chandler, L. D., Meyerdirk, D. E., Hart, W. G., and Garcia, R. G.**, 1980. Laboratory studies of the development of the parasite *Anagyrus pseudococci* (Girault) on insectary-reared *Planococcus citri* (Risso). *Southwest. Entomol.* 5: 99-103.
- Chang, L. W. H., and Miller, C. E.**, 1996. Pathway risk assessment: Pink mealybug from the Caribbean. 61 pp.
- Cross, A. E., and Noyes, J. S.**, 1995. Dossier on *Anagyrus kamali* Moursi biological control agent for the pink mealybug, *Maconellicoccus hirsutus*, in Trinidad and Tobago. CABI, UK: 16 pp.
- Dhawan, A. K.**, 1980. *Maconellicoccus* sp. attacking *arboreum* cotton in Punjab. *Science and Culture*, 46: p. 258.
- Ezzat, Y. M.**, 1958. *Maconellicoccus hirsutus*, a new genus with redescription of the species. *Bull. Soc. Entomol. Egypte*, 42: 377-383.
- Francis-Ellis, D.**, 1995. Paper on background and status of mealybug *Maconellicoccus hirsutus* in Grenada. Ministry of Agriculture, Grenada, 7 pp.
- Gautam, R. D.**, 1996. Dossier on *Cryptolaemus montrouzieri* Mulsant, biocontrol agent for the hibiscus mealybug, *Maconellicoccus hirsutus* (Green) in Trinidad and Tobago, West Indies. 12 pp.
- Gautam, R. D.**, 1996. Multiplication and use of exotic coccinellids. CARDI, Technical Manual, Series TB9626-T03. 34 pp.

- Ghose, S. K.**, 1971. Morphology of various instars of both sexes of the mealy-bug, *Maconellicoccus hirsutus* (Green). Indian J. Agric. Sci., 41 (7): 602-611.
- Ghose, S. K.**, 1972. Biology of the mealybug, *Maconellicoccus hirsutus*. Indian Agric., 16 (4): 323-332.
- Hall, W. J.**, 1921. The hibiscus mealy bug. Ministry of Agric., Egypt, Tech. & Sci. Ser., Entomo. Sec., Bull. 17: 1-28.
- Hall, W. J.**, 1926. The hibiscus mealy bug in Egypt in 1925 with notes on the introduction of *Cryptolaemus montrouzieri*. Ministry of Agric., Egypt, Tech. & Sci. Service, 70: 1-15.
- Hosny, M.**, 1939. On coccids found on roots of plants in Egypt. Bull. Min. Agric., Egypt, 237: p. 2.
- Hunter, C. D.**, 1997. Suppliers of beneficial organisms in North America. California Environmental Protection Agency, Department of Pesticide Regulation, Environmental Monitoring and Pest Management Branch. 32 pp.
- Jorge, P.**, and Castleton, C. W., 1996. Risk analysis for the West Indies to import Caribbean produce infested with the pink mealybug *Maconellicoccus hirsutus* (Green). 17 pp.
- Kairo, M. T. K., Cross, A. E., Lopes, V. F., Peterkin, D. D., and Ram, P.**, 1997. Rearing the hibiscus mealybug, *Maconellicoccus hirsutus*, and the parasite *Anagyrus kamali* Moursi. International Institute of Biological Control, CAB International. 33 pp.
- Mani, M.**, 1987. Role of parasitoids and predators in the biological control of fruit and vegetable crop pests in India. Proc. seminar cum workshop. Biol. Control Crop Pests and Weeds. Tech. Doc. No. 19, 108-119.
- Mani, M.**, 1989. A review of the pink mealybug – *Maconellicoccus hirsutus* Green. Insect Sci. Applic., 10 (2): 157-167.
- McKenzie, H. L.**, 1967. Mealybugs of California. Univ. of Calif. Press, Berkeley & L. A., pp. 32-33.
- Meyerdirk, D. E., and Newell, I. M.**, 1979. Season development and flight activity of *Pseudococcus comstock* (Kuw.) in California. Ann. Entomol. Soc. Am. 72: 492-4.

- Meyerdirk, D. E., Khasimuddin, S., and Bishar, M.**, 1988. Importation, colonization, and establishment of *Anagyrus indicus* (Hymenoptera: Encyrtidae) on *Nipaecoccus viridis* (Newstead) (Homoptera: Pseudococcidae) in Jordan. *Entomophaga* 33: 229-237.
- Misra, C. S.**, 1920. Turka, disease of mulberry. Proc. 3rd Ento. Meeting, Pusa, 1919, 25: 609-618.
- Moursi, A. A.**, 1948. Contribution to the knowledge of natural enemies of mealybugs. 1. Description of two new species of *Anagyrus* (Hymenoptera: Encyrtidae). *Bull. Soc. Foud. Ent.* 32: 1-7.
- Moursi, A. A.**, 1948. Contribution to the knowledge of natural enemies of mealybugs. 2. *Anagyrus kamali* Moursi. A parasite of the hibiscus mealybug *Phenacoccus hirsutus* Green (Hymenoptera: Encyrtidae). *Bull. Soc. Foud. Ent.* 32: 9-16.
- Moursi, A. A.**, 1948. Contribution to the knowledge of natural enemies of mealybugs. 4. *Leptomastix phenacocci* Compere, a parasite of the lebbek mealybug *Phenacoccus filamentosus* Ckll. (Hymenoptera: Encyrtidae). *Bull. Soc. Foud. Ent.* 32: 33-40.
- NPAG**, 1984. New Pest Advisory Group data sheet. *Maconellicoccus hirsutus*, hibiscus mealybug. 3 pp.
- Pollard, G. V.**, 1995. Update on new pest introductions – Continuing spread of pink mealybug, *Maconellicoccus hirsutus*. FAO Regional Office for Latin America and the Caribbean, FAO Circular letter, No. 4/95.
- Rao, V. S., and Srinivasan, S.**, 1987. *Maconellicoccus hirsutus*, a new pest of groundnut in Andhra Pradesh. *Entomon.*, 12 (2): 115.
- Stibick, J. N. L.**, 1997. Pink hibiscus mealybug, new pest response guidelines. 104 pp.
- Veni, et al.**, 1973. A note on the biology and control of mealybugs (*Maconellicoccus hirsutus*) on Mesta. *Jute Bull.*, 36 (1/2): 25-28.
- Williams, D. J.**, 1985. Australian mealybugs. British Museum (Natural History), London, England, Publication #953: 190-201.
- Williams, D. J.**, 1986. The identity and distribution of the genus *Maconellicoccus* in Africa. *Bull. Ent. Res.*, 76: 351-357.

Williams, D. J., 1996. A brief account of the hibiscus mealybug *Maconellicoccus hirsutus*, a pest of agriculture and horticulture, with descriptions of two related species from southern Asia. Bull. Ent. Res., 86: 617-628.



Appendix H

Forms

Included in this Appendix are the standard forms you will use to keep a record of the activities comprising the PHM biological control program. For guidance in using the forms, refer to the appropriate section of the manual.

The following pages in this Appendix have been printed without headers, footers, or page numbers so that you can reproduce the forms locally as needed. Note: To make sure that you maintain a complete set of blank master forms, **copy the forms as you need them and leave the originals in your binder!**

The following is a list of included forms:

- ◆ **Form PHM-1:** Mealybug Survey: Visual—Collection of Adult Females and Various Instars
- ◆ **Form PHM-2:** Mealybug Survey: Sex Pheromone Trap—Adult Males
- ◆ **Form PHM-3:** Japanese Pumpkin Harvest Records
- ◆ **Form PHM-4:** Pink Hibiscus Mealybug Insectary Culture: Daily Operation
- ◆ **Form PHM-5:** Host Infestation Records
- ◆ **Form PHM-6:** Natural Enemy Foreign Shipment Receiver's Report
- ◆ **Form PHM-7:** Laboratory Temperature and Relative Humidity Daily Records
- ◆ **Form PHM-8:** Parasite/Predator Production Records/Cage
- ◆ **Form PHM-9:** Summary of Parasite/Predator Production Records/ Cage
- ◆ **Form PHM-10:** Summary of Monthly Parasite/Predator Production Records/Species
- ◆ **Form PHM-11:** Parasite Release Data
- ◆ **Form PHM-12:** Summary of Monthly Parasite/Predator Releases on Pink Hibiscus Mealybug
- ◆ **Form PHM-13:** Predator Release Data: *Cryptolaemus montrouzieri*

- ◆ **Form PHM-14 (Part 1)** and **Form PHM-14 (Part 2)**: Percent Parasitization Data
- ◆ **Form PHM-15**: Summary: Percent Parasitization of Pink Hibiscus Mealybug
- ◆ **Form PHM-16 (Part 1)**: Percent Hyper-parasitization Data
- ◆ **Form PHM-17**: Beat-Sheet Field Samples: *Cryptolaemus montrouzieri*
- ◆ **Form PHM-18**: Pink Hibiscus Mealybug: Population Density Count Data
- ◆ **Form PHM-19**: Summary of Pink Hibiscus Mealybug Population Density Counts

Mealybug Survey
Visual—Collection of Adult Females and Various Instars

Date	Location	Host Plant	Collector's Name	Tentative Identification (species)	Positive Identification (species)

Mealybug Survey

Sex Pheromone Trap—Adult Males

Date Trap Placed in Field	Date Trap Removed from Field	Location	Host Plant	Collector's Name	Number of Males

Japanese Pumpkin Harvest Records

Date Planted	Location	No. of Plants Seeded/ Transplanted	Date Harvested	Total No. Harvested	Total Weight (optional)
Total					

Pink Hibiscus Mealybug Insectary Culture Daily Operation

Date	Vol./Weight Crawlers Collected	Number of Host Plants Infested			(species) Total Host Units
		Potatoes	Japanese Pumpkin	Local Squash	

HOST INFESTATION RECORDS

Host (Check)

Pumpkin Potato Squash

Event	Date
Host infested with crawlers (or eggs)	
Host removed for crawler or parasite/ predator production	

HOST INFESTATION RECORDS

Host (Check)

Pumpkin Potato Squash

Event	Date
Host infested with crawlers (or eggs)	
Host removed for crawler or parasite/ predator production	

HOST INFESTATION RECORDS

Host (Check)

Pumpkin Potato Squash

Event	Date
Host infested with crawlers (or eggs)	
Host removed for crawler or parasite/ predator production	

HOST INFESTATION RECORDS

Host (Check)

Pumpkin Potato Squash

Event	Date
Host infested with crawlers (or eggs)	
Host removed for crawler or parasite/ predator production	

HOST INFESTATION RECORDS

Host (Check)

Pumpkin Potato Squash

Event	Date
Host infested with crawlers (or eggs)	
Host removed for crawler or parasite/ predator production	

HOST INFESTATION RECORDS

Host (Check)

Pumpkin Potato Squash

Event	Date
Host infested with crawlers (or eggs)	
Host removed for crawler or parasite/ predator production	

HOST INFESTATION RECORDS

Host (Check)

Pumpkin Potato Squash

Event	Date
Host infested with crawlers (or eggs)	
Host removed for crawler or parasite/ predator production	

HOST INFESTATION RECORDS

Host (Check)

Pumpkin Potato Squash

Event	Date
Host infested with crawlers (or eggs)	
Host removed for crawler or parasite/ predator production	

Natural Enemy Foreign Shipment Receiver's Report

Date received _____ Condition of Shipment _____

Examined by _____ Source of material (name) _____

Source location _____

Vial or Packet #	Host Insect	Entomophagous Species	Number Received		Total Emergence		Propagated	Consignment
			Alive	Dead	Female	Male		

**Laboratory
Temperature and Relative Humidity
Daily Records**

Room: _____

Date	Time	Temperature			Relative Humidity
		Current	Minimum	Maximum	

Summary of Parasite/Predator Production Records/Cage

Sting Date	Cage Unit No.	Parasite/ Predator Species	No. Parasite/ Predator per Sting	No. of Hosts with:				No. Parasites Collected	Range of Dates Collected
				Potatoes	Pumpkins	Local Squash	Hibiscus (stems)		
Total									

Summary of Monthly Parasite/Predator Production Records/Species

Species: _____ Origin: _____ Month: _____

Date of Sting	Cage #	Number Released in Sting	Host Material	Total Number of Progeny Collected	Date Range of Emergence

Summary of Monthly Parasite/Predator Releases on Pink Hibiscus Mealybug

Country _____

Month _____ Year _____

Biocontrol Agent	Dates Released	Total Number of Properties	Total Number Released
<i>Anagyrus kamali</i> (China)			
<i>Anagyrus kamali</i> (Hawaii)			
<i>Gyranusoidea indica</i> (Egypt)			
<i>Leptomastix</i> sp.			
<i>Anagyrus dactylopi</i> (China)			
<i>Cryptolaemus montrouzieri</i>			
Total			

Percent Parasitization Data (Encapsulated Live 2nd, 3rd, and Adult Female Mealybugs)

Site No: _____ Location: _____

Date Collected: _____ Date Released: _____

Cap No.	Species	Unemerged Mummy	Number Emerged Parasites		Cap No.	Species	Unemerged Mummy	Number Emerged Parasites	
			♀	♂				♀	♂
1					26				
2					27				
3					28				
4					29				
5					30				
6					31				
7					32				
8					33				
9					34				
10					35				
11					36				
12					37				
13					38				
14					39				
15					40				
16					41				
17					42				
18					43				
19					44				
20					45				
21					46				
22					47				
23					48				
24					49				
25					50				

Percent Parasitization Data (continued)

Site No: _____ Location: _____

Date Collected: _____ Date Released: _____

Cap No.	Species	Unemerged Mummy	Number Emerged Parasites		Cap No.	Species	Unemerged Mummy	Number Emerged Parasites	
			♀	♂				♀	♂
51					76				
52					77				
53					78				
54					79				
55					80				
56					81				
57					82				
58					83				
59					84				
60					85				
61					86				
62					87				
63					88				
64					89				
65					90				
66					91				
67					92				
68					93				
69					94				
70					95				
71					96				
72					97				
73					98				
74					99				
75					100				
Total									

Percent Hyper-Parasitization Data (Encapsulated Mealybug Mummies Only)

Site No: _____

Location: _____

Date Collected: _____

Date Released: _____

Cap No.	Species	Unemerged Mummy	Number Emerged Parasites		Cap No.	Species	Unemerged Mummy	Number Emerged Parasites	
			♀	♂				♀	♂
1					26				
2					27				
3					28				
4					29				
5					30				
6					31				
7					32				
8					33				
9					34				
10					35				
11					36				
12					37				
13					38				
14					39				
15					40				
16					41				
17					42				
18					43				
19					44				
20					45				
21					46				
22					47				
23					48				
24					49				
25					50				

Percent Hyper-Parasitization Data (continued)

Site No: _____ Location: _____
 Date Collected: _____ Date Released: _____

Cap No.	Species	Unemerged Mummy	Number Emerged Parasites		Cap No.	Species	Unemerged Mummy	Number Emerged Parasites	
			♀	♂				♀	♂
51					76				
52					77				
53					78				
54					79				
55					80				
56					81				
57					82				
58					83				
59					84				
60					85				
61					86				
62					87				
63					88				
64					89				
65					90				
66					91				
67					92				
68					93				
69					94				
70					95				
71					96				
72					97				
73					98				
74					99				
75					100				
Total									

**Pink Hibiscus Mealybug—Population Density Count Data
(6" Hibiscus Terminals)**

Location	Date	Twig Sample No (1-4)	Egg Mass		# 2nds	# 3rds	# Adults ♀	# Adult ♂	Total # Egg Mass	Total # 2nd to Adult	Cryptolaemus		No. Mummies	
			Eggs	Eggs + Crawlers							Larvae	Adults	Exit Holes	No Exit Holes
		1												
		2												
		3												
		4												
Total		↑												
Average		↑												
		1												
		2												
		3												
		4												
Total		↑												
Average		↑												
		1												
		2												
		3												
		4												
Total		↑												
Average		↑												

**Summary of Pink Hibiscus Mealybug
Population Density Counts**

Host Plant: _____ **Location:** _____

Date	Location	Egg Sacs				2nd to Adult		<i>Crpt. No.</i> Adult + Larva	No. Mummies	
		Eggs	Crawlers	Total	Avg.	Total	Avg.		Exit Hole	No Exit Hole



Appendix I

Supplemental Information

This Appendix provides you with the following supplemental information for the PHM Project:

- ◆ Figure I-1: Pink Hibiscus Mealybug Culture Racks
- ◆ Figure I-2: Parasite Cage Rack
- ◆ Figure I-3: Double Hole Sleeve Cage
- ◆ Tri-fold brochure titled “Help Defeat Our New Insect Pest: The Pink Hibiscus Mealybug”
- ◆ Flier titled “*Cryptolaemus montrouzieri* The Mealybug Destroyer”

You may reproduce the brochure and flier locally for handouts.

Remember to keep the originals in your manual!

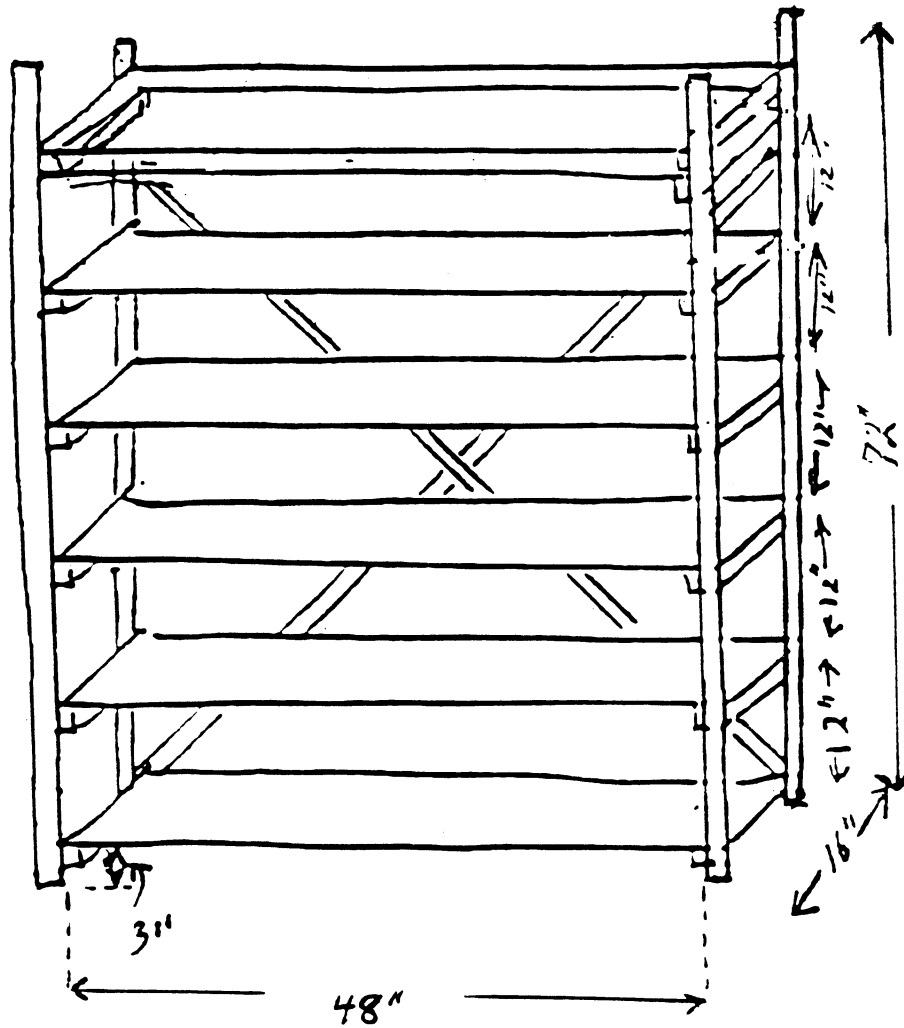

Front View

Specifications:

1. Make the legs from 2" x 3" or 2" x 4" wood.
2. Use plywood (1/2" thick) for shelves.

FIGURE I-1: Pink Hibiscus Mealybug Culture Rack

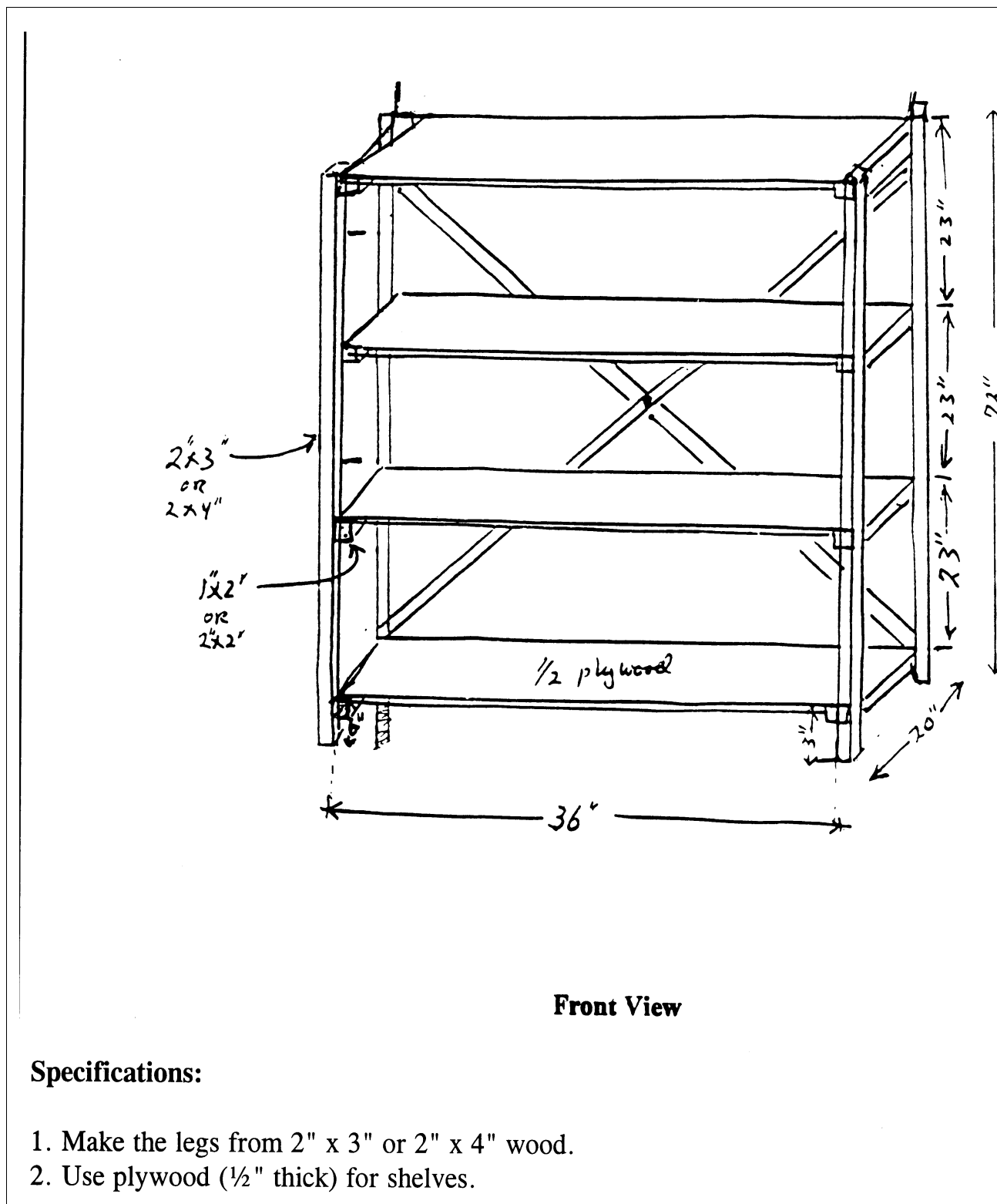

FIGURE I-2: Parasite Cage Rack

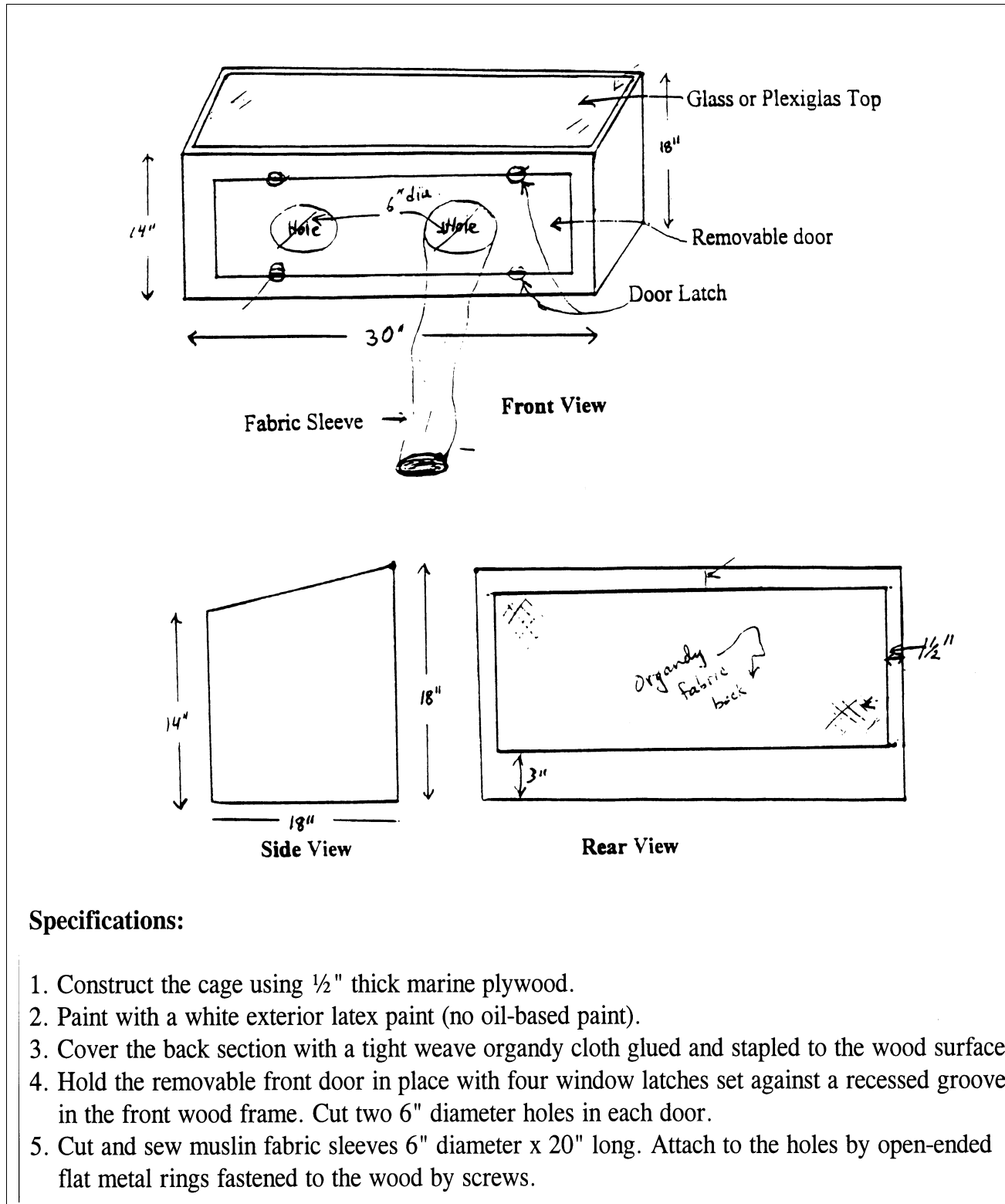

FIGURE I-3: Double Hole Sleeve Cage

Index

A

Acacia spp. [2-3](#)

acid fuchsin [2-17](#)

Africa [1-1](#) to [1-3](#), [1-9](#), [B-3](#)

Agricultural Research Service (ARS) [1-12](#)

air circulation [3-10](#), [3-14](#)

air conditioning [3-10](#), [3-29](#), [3-38](#)

alcohol
ethyl [2-3](#)
isopropyl [2-3](#)

aluminum foil [3-16](#), [3-21](#)

Anagyrus
environmental assessment [F-1](#), [F-6](#)
finding of no significant impact [F-7](#)

Anagyrus dactylopii [4-8](#)

Anagyrus kamali
adult female [3-27](#), [3-28](#)
adult male [3-27](#)
characteristics for identification [4-4](#)
culture [3-27](#)
description and photo [4-8](#)
development cycle [3-28](#)
eggs [3-28](#)
in St. Kitts and Nevis [1-10](#)
instars [3-28](#)
life cycle [3-27](#)
production [3-23](#)
reported attacking PHM [C-2](#)

anal lobes [2-9](#), [2-18](#)

Animal and Plant Health Inspection Service (APHIS) [1-2](#), [F-2](#), [F-10](#)

annona [1-1](#), [A-2](#)

antennae [2-9](#) to [2-11](#), [2-12](#), [2-18](#)

ants
control of [3-34](#)
invasion of [3-34](#)
sugar-loving [1-6](#)

APHIS, See Animal and Plant Health Inspection Service

appendages, marginal [2-9](#)

ARS, See Agricultural Research Service

Arthropoda [1-2](#)

Asia [1-1](#), [1-9](#), [B-3](#)

asparagus [1-1](#), [2-14](#), [A-2](#)

aspirator [3-31](#), [3-33](#), [3-40](#), [4-3](#)

Australia [1-1](#), [1-3](#), [1-9](#), [B-3](#)

B

background [1-1](#)

bacteria [1-10](#), [3-9](#)

bags, plastic [3-3](#), [3-35](#)

bait [3-34](#)

bark [1-6](#), [1-7](#), [2-3](#), [5-6](#)

beans [1-1](#), [2-14](#), [A-1](#)

beat sheet [5-3](#), [5-7](#), [5-9](#)
stick [5-3](#)

Begonia [2-14](#)

Belize Ministry of Agriculture and Fisheries [1-12](#)

Benlate [3-8](#)

biological control
definition of [1-10](#)
project against PHM [1-2](#)
technology [1-12](#)

biopesticide [4-1](#)

bleach [3-10](#), [3-13](#), [3-15](#), [3-24](#), [3-35](#)

blue ice [3-40](#), [5-3](#), [5-5](#), [5-10](#)

Boltran 3-8

boric acid 3-24, 3-34, 3-35

Botrytis 3-8

box, crawler collection 3-16 to 3-18

brochure, tri-fold 4-7, 4-10, I-1

brush
 camel hair 3-15, 3-39
 small 5-3

buffer areas 2-7

bunchy top 1-7

C

CABI, *See* Center for Agriculture and Bioscience International

cages
 aluminum 3-30
 parasite oviposition 3-33 to 3-35
 portable 3-30
 propagation 3-39
 rearing 3-29, 3-30, 3-31, 3-33, 3-34, 3-38
 repairing 3-35
 sting 3-31, 3-33, 3-35
 wooden
 double hole 3-31, I-1
 single hole 3-31

California Department of Food and Agriculture 1-12

camel hair brush 3-15

Canada Balsam 2-17

caps, snap-on 3-32

capsules 1-7, 5-5
 pharmaceutical gelatin 5-3

card, white plastic sticky 2-7

Caribbean
 biological control in 1-10
 common PHM hosts 2-3
 cooperators 1-12
 countries known to be infested with PHM B-3
 economic losses from PHM 1-9
 environmental assessments F-2, F-10, F-11, F-14
 finding of no significant impact F-7, F-16
 list of PHM cooperators D-1
 natural enemies of PHM for importation and release C-1
 PHM a serious pest in 1-1
 PHM distribution 1-9
 PHM spread to 1-9
 source of PHM infestation F-2

carton, paper 2-6, 5-5

caudal filaments 2-10, 2-12

Center for Agriculture and Bioscience International (CABI) 1-12

Chile 1-11

chlorophyll 3-11

chrysanthemum 1-1

Chrysoperla 5-10, C-6

Citrus A-3

citrus 1-1, 2-7, 2-14, F-2

citrus mealybug 3-5

cloth
 black 3-14, 3-17, 3-22
 fine mesh 2-6
 organdy 3-30

clove oil 2-17

Coccinellidae 1-10

Coccoidea 2-17

cockroach control 3-24, 3-34

cocoa 1-1, 2-14, A-9, F-2, F-3, F-10, F-11

cocoons 1-6

coffee 1-1, A-4

Coleoptera 1-10

coleopterous predators C-3 to C-4

- Comstock mealybug
 environmental assessment [F-4](#), [F-12](#)
 Japanese pumpkins as host plants [3-5](#)
 male puparium [2-11](#)
 natural enemies of [F-6](#), [F-14](#)
 sex pheromones [2-7](#)
- contacts, international [1-11](#)
- contaminants [3-15](#), [3-34](#), [3-39](#)
- cooler [5-3](#), [5-5](#), [5-10](#)
- cooperators [1-2](#), [1-12](#), [D-1](#) to [D-5](#)
- copper exhaust tubes [3-32](#)
- copper intake tubes [3-32](#)
- cord, extension [3-16](#)
- core host plant area [2-6](#)
- cotton [2-3](#)
 host attacked at its roots [A-1](#)
 host plant of PHM [2-14](#), [A-6](#)
 PHM as a serious economic threat to [1-1](#)
 symptoms of PHM infestation [1-8](#)
 used in oviposition cages [3-39](#), [3-40](#)
 used in parasite rearing cages [3-33](#), [3-34](#)
 visual survey for PHM [2-3](#)
- cottony secretion [2-9](#)
- counters [5-3](#), [5-10](#)
- cover slip [2-17](#)
- crawler collection box [3-16](#), [3-17](#)
- crawler collection system [3-13](#), [3-16](#), [3-18](#), [3-19](#),
[3-21](#), [3-23](#)
- crawler collection tray [3-21](#)
- crawlers, PHM
 feeding on potato sprouts [3-11](#)
 migration by air currents [1-7](#)
- Cryptolaemus montrouzieri*
 adults [3-37](#), [5-7](#)
 aiding larval development [3-39](#)
 collecting beetles for field release [3-40](#)
 determining production capacity [3-38](#)
 eggs [3-37](#)
 larvae [3-37](#)
 life cycle of [3-37](#)
 maintaining the culture [3-38](#)
 monitoring pupation [3-40](#)
 predator of PHM [1-10](#)
 providing food and water at emergence [3-40](#)
 recovering [5-7](#)
 releasing [4-9](#) to [4-10](#)
 setting up oviposition units [3-39](#)
 transporting [4-9](#)
 using preferred host material [3-38](#)
 using suitable rearing cages [3-38](#)
- Cucurbita moschata* (Duchesne) var. *chirimen* [3-5](#)
- curator, museum [3-25](#)
- curtains [3-14](#)
-
- ## D
- dehumidifier [3-10](#), [3-14](#)
- description of the insect [1-2](#)
- development cycle
 of *Anagyrus kamali* [3-27](#)
 of pink hibiscus mealybug [1-5](#)
- development of PHM [1-5](#)
- dipterous predators [C-5](#)
- dissecting microscope [2-7](#), [5-3](#), [5-5](#)
- distilled water [2-17](#)
- distinguishing field characteristics [2-9](#)
- distinguishing field characteristics of PHM [2-3](#), [2-9](#)
- distribution of PHM [1-2](#), [B-1](#)
- Dominican Republic [1-12](#)
- duct tape [3-16](#)
- Dysmicoccus brevipes* [2-16](#)

E

economic losses [1-9](#), [4-1](#), [F-3](#), [F-11](#)

egg masses
 on pumpkins for the crawler collection system [3-23](#)
 on pumpkins for the *Cryptolaemus* culture [3-38](#)
 surveying for [2-3](#)
 used in establishing a crawler collection system [3-16](#)
 used in hot wire barrier system [3-19](#), [3-21](#)
 used in light only system [3-22](#)

Egypt [1-1](#), [1-3](#), [1-9](#), [1-12](#)
 Ministry of Agriculture [1-12](#)

emergence hole [3-29](#)

Encyrtidae [1-10](#)

endoparasitoid [3-27](#), [F-10](#)

environmental assessments
Anagyrus and *Gyranusoidea* [F-1](#) to [F-7](#)
Leptomastix [F-9](#) to [F-15](#)

Essig's aphid fluid [2-17](#)

ethanol [2-17](#)

ethyl alcohol [2-3](#)

Eugenia [2-14](#)

exhaust tubes [3-32](#)

exit holes [5-5](#), [5-6](#)

extension cord [3-16](#)

F

fans [3-14](#), [3-29](#)

Ferrisia virgata [2-14](#), [2-16](#)

fertilizer [3-7](#), [3-8](#)

field work [3-3](#)

filaments, caudal [2-10](#), [2-12](#)

finding of no significant impact
Anagyrus and *Gyranusoidea* [F-7](#)
Leptomastix [F-16](#)

Florida Department of Agriculture [1-12](#)

fluorescent lights [3-19](#)

foam
 packing material [4-6](#), [4-9](#)
 weather strips [3-30](#)

foil, aluminum [3-16](#), [3-21](#)

folders, manila [3-16](#)

forceps [5-3](#)

forest trees [1-9](#)

formica [3-20](#), [3-21](#)

forms, record keeping [5-3](#)

frames, aluminum [3-30](#)

fruit
 as PHM host plant substrate [3-2](#)
 controlling disease of [3-8](#)
 of Japanese pumpkin [3-5](#)
 PHM overwintering inside bunches of [1-7](#)
 rot [3-22](#)
 soursop [3-38](#)
 trees as PHM host [1-9](#)

Fuchsia [2-14](#)

fungicide [3-10](#), [3-15](#)

G

gel packs [4-6](#), [4-9](#)

gelatin capsules [5-3](#), [5-5](#)

generations [1-7](#), [3-26](#), [5-4](#), [C-1](#)

geographic distribution of PHM [1-9](#), [B-1](#)

Gersabeck, Edward [D-2](#)

glue, silicone [3-31](#)

grape
 as a crop attacked by PHM [F-10](#)
 as a host of grape mealybug [2-14](#)
 as a host of obscure mealybug [2-14](#)
 as a host recorded with damaging populations of PHM [A-9](#)
 losses caused by PHM [F-11](#)
 parasitization of mealybugs on [C-1](#)
 percent losses caused by PHM [F-3](#)
 PHM as a devastating pest of [F-2](#)
 PHM as an economic threat to [1-1](#)

grapevine [1-8](#)

- greenhouse plants [2-14](#)
- Grenada [1-1](#), [1-9](#), [F-11](#)
- Grenada Ministry of Agriculture [1-12](#)
- Guam [1-9](#)
- Guatemala [1-11](#)
- guava [1-1](#), [2-14](#), [A-8](#)
- Gyranusoidea*
 environmental assessment [F-1](#) to [F-8](#)
 finding of no significant impact [F-7](#)
- Gyranusoidea indica*
 culture [3-27](#), [3-29](#)
 description and photo [4-8](#)
 in St. Kitts and Nevis [1-10](#)
 production [3-23](#)
 releasing [4-3](#)
- histoclear [2-17](#)
- hole, emergence [3-29](#)
- Homoptera [1-2](#)
- honey [3-33](#), [3-34](#), [3-39](#), [3-40](#)
- honeydew [1-6](#), [1-8](#), [3-14](#), [3-22](#)
- host culture room [3-15](#)
- host plants [3-3](#), [3-5](#) to [3-12](#), [5-6](#), [5-9](#), [A-1](#) to [A-10](#)
- host range [1-9](#)
- hot wire barrier system [3-18](#) to [3-21](#)
- Hymenoptera [1-10](#)
- hymenopterous parasites [C-1](#) to [C-3](#)
- hyperparasites [5-4](#), [5-6](#) to [5-7](#)
 monitoring [5-6](#)

H

- Hamdy, Farouk [1-11](#)
- hand counter [5-3](#)
- hand magnifying lens [5-3](#), [5-6](#)
- Hawaii
 affected by releases of biological control agents [F-12](#)
Anagyrus fusciventris introduced into [C-2](#)
Anagyrus sp. from [C-1](#)
 impacts from previous releases of *Leptomastix dactylopii* [F-13](#)
 natural enemies introduced with PHM [1-9](#)
 PHM controlled by *Anagyrus* wasps in [F-2](#)
 PHM in [1-1](#), [1-3](#)
 PHM present in [F-3](#)
 PHM spread to [1-9](#)
 state known to be infested with PHM [B-3](#)
- head [2-11](#), [2-19](#)
- hemipteran predators [C-5](#)
- hibiscus [1-9](#), [2-3](#)
 as a host of PHM [2-14](#)
 attacked by PHM [1-1](#)
 infested with [1-7](#)
 potted host plant of PHM [3-12](#)
 preferred PHM host material [3-38](#)
 recovering predators from [5-7](#)
 use in determining impact of released natural enemies [5-9](#)
 use in surveying for PHM [2-3](#)

I

- ice chests
 reusable [3-40](#)
 styrofoam [3-40](#)
- ice, blue [5-3](#), [5-5](#), [5-10](#)
- IIBC. See International Institute for Biological Control
- India [1-1](#), [1-6](#) to [1-9](#)
- Insecta [1-2](#)
- insectary operation [3-1](#) to [3-40](#)
- instars [1-3](#)
 collection of [H-1](#)
 detection of [2-3](#)
 morphology of [G-2](#)
 newly hatched crawlers [1-6](#)
 of PHM [1-3](#)
 on potato sprouts [3-11](#)
 second and third [3-26](#), [5-10](#)
 third [3-23](#)
- insulators [3-20](#)
- intake tubes [3-32](#)
- international contacts [1-11](#) to [1-12](#)
- International Institute for Biological Control (IIBC) [1-12](#)

International Services (IS) [1-2](#)
irrigation systems [3-7](#)
isopropyl alcohol [2-3](#)

J

Japanese pumpkins
 acquisition of seed [3-6](#)
 as host plants [3-5](#) to [3-10](#)
 controlling disease [3-8](#)
 cost [3-6](#)
 description [3-5](#)
 fertilizing [3-8](#)
 field production [3-6](#)
 greenhouse production [3-8](#)
 harvesting [3-9](#)
 photograph [3-6](#), [3-9](#)
 preparing for storage [3-10](#)
 regulating temperature [3-8](#)
 seedlings [3-6](#)
 spacing [3-7](#)
 storing [3-10](#)
 transplanting [3-7](#)
 transporting [3-9](#)

K

kenaf [1-7](#)
knot, overhand [3-33](#)
KOH [2-17](#)

L

lamp, night [3-16](#)
lantana [2-14](#)
larvae
 Cryptolaemus montrouzieri [3-37](#), [5-7](#)
 Diadiplosia indica [C-5](#)
 of lady beetles [F-4](#)
 predator [3-23](#)
latex tubing [3-32](#)
leaves [5-6](#), [5-10](#)
lens, hand magnifying [5-3](#), [5-6](#)

lepidopterous predators [C-5](#)

Leptomastix [F-9](#), [F-10](#), [F-11](#)

Leptomastix
 dactylopii [4-8](#)
 phenacocci [C-2](#)

levels, trophic [3-2](#)

life cycle, of *Cryptolaemus montrouzieri* [3-37](#)

light source [5-3](#)

lignin pink [2-17](#)

M

Mackley Jim [1-11](#)

Maconellicoccus
 australiensis [1-3](#)
 hirsutus [1-1](#), [1-2](#), [2-14](#), [2-16](#), [2-18](#), [4-8](#)
 lanigerus [1-3](#)
 leptospermi [1-3](#)
 multiporti [1-3](#)
 pasaniae [1-3](#)
 ramchensis [1-3](#)
 tasmaniae [1-3](#)
 ugandae [1-3](#)

magnificuser [3-15](#)

magnifying lens, hand [5-3](#)

maize [1-1](#)

male mealybug puparium [2-11](#)

malformation [1-7](#)

Malus [2-14](#)

mandatory work pathway protocol [3-2](#) to [3-3](#)

mango [1-1](#)

manila folders [3-16](#), [3-21](#)

marketability [1-7](#)

mealybugs
 citrophilus 2-14
 citrus 2-14, 2-15, 3-5
 coconut 2-16
 comstock 2-7, 2-11, 3-5
 contaminants 3-15
 general morphology 2-20
 grape 2-14
 Jack Beardsley 2-15
 longtailed 2-14, 2-15
 Mexican 2-14
 Mexican and Madeira 2-16
 mummies 3-34, 5-5 to 5-6, 5-10
 mummified 3-23
 obscure 2-14, 2-15
 papaya 2-16
 parasitized 4-2
 pineapple 2-16
 pink hibiscus 2-14, 2-16
 See pink hibiscus mealybug
 solenopsis 2-15
 spherical 3-5
 striped 2-14, 2-16

Meyerdirk, Dale 1-11

microscope, dissecting 2-7, 5-3, 5-5, 5-10

Middle East 1-1, 1-9

midrib veins 5-6

miticide 3-10, 3-15

moisture levels 3-10

Monomorium indicum 1-6

mora 1-1

mulberry 1-8

mummies 3-34, 5-5, 5-6

museum curator 3-25

muslin sleeve 3-30, 3-31

Myrtus 2-14

N

natural enemies
 cages for containing 3-12
 colonization of 5-1
 dispersal of 5-4
 establishment of 5-3 to 5-7
 impact of released 5-9 to 5-10
 keeping records of 3-25
 list of C-1
 PHM culture for 3-23
 PHM protected from 1-6
 rearing 3-2, 3-3
 releasing 4-1
 starting culture of 3-26
 types of 1-10

neuropterous predators C-6

night lamp 3-16

Nipaecoccus
nipae 2-16
viridis 3-5

North America B-3

nylon 3-8

nymphal instars 1-3, 2-9

nymphs 1-6

O

Oceania 1-1

ocelli 2-12

Odermatt, Doug 2-17

oil
 clove 2-17
 vegetable 3-34

okra 1-1

open rack system 3-11

organdy cloth 3-30

ornamentals 1-9

oviposition 1-4, 1-6

ovisacs, PHM
description of 3-15
eggs within 1-3, 1-6
migration by air currents 1-7
transferring to start PHM culture 3-15
use in culturing *Cryptolaemus* 3-39

pesticides
biological 4-9
liquid 3-34
PHM protection from 1-6
used by hotels 5-9

petri dish 3-33, 3-39

pharmaceutical gelatin capsules 5-3

P

packs, gel 4-6, 4-9

panel, clear plexiglas 3-30

paper towels 3-33, 3-40

paper, shredded 3-40

Paracoccus 1-2

Paracoccus
marginatus 2-16

parasites
aspirating 3-31 to 3-32, 4-3
biological control of 1-10
colonization 4-6
culture 3-26, 3-27, 3-34 to 3-35
effectiveness of 4-1
oviposition cages 3-33 to 3-35, 3-39
population density 5-4
preventing entry of 3-12, 3-14
primary 5-4, 5-6
procedures for 4-3
rearing 3-2
recovering 5-4
releasing 4-6 to 4-7, 4-9 to 4-10
secondary 5-4
survival 4-6
transporting 4-9

parasitization, percent 5-4 to 5-5

parasitoids 3-27, 4-8

parthenogenetic reproduction 1-6

pathogens 1-10, C-6

pathway protocol, mandatory work 3-2 to 3-4

peanut 1-1, 1-8, 2-14

pelargonium 2-14

percent
hyperparasitization 5-6
parasitization 5-4 to 5-5

Phenacoccus
gossypii 2-14, 2-16
madeirensis 2-16
solenopsis 2-15

pheromone trapping 2-1

pigeon pea 1-1, 2-14

- pink hibiscus mealybug (PHM)
 adult females 2-9, 2-10, 2-14
 adult males 2-6, 2-12
 biological control project against 1-2
 biological data, summary of 1-4
 biology/ ecology 1-3
 cocoons 1-6
 crawlers
 determining presence of 5-10
 distinguishing field characteristics 2-9
 migration by air currents 1-7
 where found on host plant 2-3
 damage from 1-7 to 1-8
 description of the insect 1-2
 development cycle of 1-5
 distinguishing field characteristics 2-3
 eggs
 contained in ovisacs used to start PHM culture 3-15
 description of 2-13
 laid in ovisacs 1-3
 length and width 1-4
 protected by wax coating 1-6
 general morphology 2-21
 hosts 1-1, 1-9
 identifying characters 2-17, 2-18
 life stages of 1-5
 mummies 3-23, 3-34, 5-6 to 5-7
 natural protection 1-6
 nymphal instars
 See also crawlers
 ovisacs
 description of 1-6
 eggs within 1-6
 migration by air currents 1-7
 transferring to start PHM culture 3-15
 use in culturing *Cryptolaemus* 3-39
 population density of 2-5
 preparing slides 2-17 to 2-18
 puparia 1-6
 reproduction and development 1-6
 saliva 1-7
 sex pheromone traps
 synthetic 2-7
 virgin female 2-6
 summary of biological data 1-4
 symptoms in specific hosts 1-7 to 1-8
 systematic position 1-2
 visual survey 2-3
- Pittosporum* 2-14
- Planococcus*
citri 2-14, 2-15, 3-5
- Plant Protection and Quarantine (PPQ) 1-2, 1-12
- plant shears 5-3
- plastic bags 3-35
- plastic sticky card, white 2-7
- plastic tray 3-39
- plastic trays 3-12, 3-13, 3-14
- plexiglas 3-30, 3-31
- plums 1-1
- plywood 3-20, 3-21, 3-31
- polypropylene 3-38
- population density
 of parasites 5-9
 of PHM 2-5, 5-4, 5-9
- potassium hydroxide 2-17
- potatoes
 as host plants 3-2, 3-5, 3-11, 3-14, 3-38
 open rack system for sprouting 3-11
 sprouted 3-12
 used in paper carton sex pheromone trap 2-6
 sprouts 3-12
- potted plants
 as host plants 3-12
- PPQ. See Plant Protection and Quarantine
- predators
 coleopterous C-3 to C-4
 dipterous C-5
 effectiveness of 4-1
 hemipteran C-5
 in definition of biological control 1-10
 lepidopterous C-5
 list of C-3 to C-6
 neuropterous C-6
 PHM protected from 1-6
 preferred for control of PHM 3-37
 preventing entry of 3-12
 rearing 3-2
 releasing 4-9, 4-9 to 4-10
 transporting 4-9
- preoviposition 1-4
- prepupa 1-5
- prickly pear 2-14
- probe 5-3
- production 1-7
- progeny 3-33
- project leader 1-11
- properties
 hotel 5-9
 residential 5-9

protocol, mandatory work pathway 3-2 to 3-4

Pseudococcidae 1-2

Pseudococcus

affinis 2-14

comstocki 3-5

fragilis 2-14

jackbeardsleyi 2-15

longispinus 2-14, 2-15

maritimus 2-14

viburni 2-15

Puerto Rico Ministry of Agriculture 1-12

pump, vacuum 3-31, 3-32, 3-40

pumpkins, Japanese. See Japanese pumpkins

pupae 1-5

puparia 1-6

Pyrus 2-14

R

racks, parasite cage 1-3

record keeping forms 5-3

rheostat 3-20

rodents 3-10

root crops 1-9

roselle 1-8

rubber spline 3-31

S

sacks

paper 5-3, 5-4

plastic 5-3

saman 2-3

tree killed by PHM 1-8

Sclerotinia 3-8

screen panels 3-30

Scymnus

coccivora 1-10

sp. 5-10

seaside grape 2-3, A-4

secondary parasites 5-4

sex pheromone traps 2-5

shears, plant 5-3

shelves

removable five-sided 3-20

wooden 3-13

shredded paper 3-40

silicone 3-30

silicone glue 3-31

sink 3-14

snap-on caps 3-32

sorrel 1-1

soursop 2-3, 2-14, 3-38

South America 1-2, B-3

soybean 1-1

spatula 2-17

spline, rubber 3-31

sporozoean C-6

spray 3-34

sprouts, potato 3-2

St. Kitts 1-1, 3-10

St. Kitts & Nevis 1-9, 1-10

St. Kitts Ministry of Agriculture 1-12

sting cages 3-31

strips, foam weather 3-30

styrene tubes 3-32

sugar cane 1-1

synthetic sex pheromone 2-5

T

tangle foot [2-7](#)

tape, duct [3-16](#)

Tasmania [1-3](#)

taxonomists [2-3](#), [5-7](#)

teak [1-1](#), [2-14](#)

terminals [2-3](#), [5-6](#), [5-9](#)

thorax [2-11](#)

transformer [3-32](#)

trap holder [2-7](#)

traps, sex pheromone
 synthetic sex pheromone [2-7](#)
 virgin female [2-6](#)

trees [1-8](#)

Trinidad [1-1](#), [1-9](#)

Trinidad and Tobago [1-9](#)

Trinidad and Tobago Ministry of Agriculture [1-12](#)

trophic levels [3-2](#)

tubes
 exhaust [3-32](#)
 intake [3-32](#)
 latex [3-32](#)
 styrene [3-32](#)

U

U.S. Virgin Islands [1-1](#)

U.S. Virgin Islands Ministry of Agriculture [1-12](#)

United States [1-12](#)

University of Florida [1-12](#)

University of Hawaii [1-12](#)

University of the Virgin Islands [1-12](#)

update record for the manual [1-2](#)

V

vacuum pump [3-31](#), [3-33](#), [3-40](#)

vegetables [1-9](#)

vials
 1/4-dram [3-22](#)
 9-dram [3-33](#) to [3-34](#), [4-3](#)
 for aspirating *Cryptolaemus* beetles [3-39](#) to [3-40](#)
 for collecting crawlers [3-21](#)
 for field release of *Cryptolaemus* beetles [3-40](#)
 for transporting natural enemies [3-25](#)
 large plastic [3-17](#)
 screw-cap [2-3](#)

virgin female trap [2-6](#)

visual survey [2-1](#)

W

wasps [4-1](#), [4-3](#), [F-2](#)

wax fringe [2-10](#)

weather stripping [3-31](#)

wing sheaths [2-11](#)

wire clip [2-7](#)

wooden shelves [3-13](#)

