

The U.S. Department of Agriculture (USDA) prohibits discrimination in all its programs and activities on the basis of race, color, national origin, age, disability, and where applicable, sex, marital status, familial status, parental status, religion, sexual orientation, genetic information, political beliefs, reprisal, or because all or part of an individual's income is derived from any public assistance program. (Not all prohibited bases apply to all programs.) Persons with disabilities who require alternative means for communication of program information (Braille, large print, audiotape, etc.) should contact USDA's TARGET Center at (202) 720-2600 (voice and TDD). To file a complaint of discrimination, write to USDA, Director, Office of Civil Rights, 1400 Independence Avenue, S.W., Washington, D.C. 20250-9410, or call (800) 795-3272 (voice) or (202) 720-6382 (TDD). USDA is an equal opportunity provider and employer.

Mention of companies or commercial products does not imply recommendation or endorsement by the U.S. Department of Agriculture over others not mentioned. USDA neither guarantees nor warrants the standard of any product mentioned. Product names are mentioned solely to report factually on available data and to provide specific information.

This publication reports research involving pesticides. All uses of pesticides must be registered by appropriate State and/or Federal agencies before they can be recommended.

CAUTION: Pesticides can be injurious to humans, domestic animals, desirable plants, fish, or other wildlife—if they are not handled or applied properly. Use all pesticides selectively and carefully. Follow recommended practices for the disposal of surplus pesticides and pesticide containers.

Contents

Cut Flowers and Greenery Import Manual

Introduction *page 1-1*

Procedures *page 2-1*

Reference *page 3-1*

Appendix A—Use of Permits and Phytosanitary Certificates in
Regulating Imported Articles *page A-1*

Appendix B—Maintaining Import Manuals *page B-1*

Glossary *page Glossary-1*

Index *page Index-1*

Comment Sheet

List of Tables

- TABLE 1-1: Where To Report Problems with the *Cut Flowers and Greenery Import Manual* page 1-10
- TABLE 1-2: How to Use Decision Tables page 1-12
- TABLE 2-1: Where to Collect Information Needed page 2-3
- TABLE 2-2: Categories of Shipments page 2-8
- TABLE 2-3: Screen for Prohibitions of Cut Articles Listed in the *Reference* page 2-10
- TABLE 2-4: Screen for Prohibitions of Cut Articles Not Listed in the *Reference* page 2-11
- TABLE 2-5: Residue Cargo Handling page 2-12
- TABLE 2-6: Guide to the Pest Risk Level of Cut Flowers page 2-16
- TABLE 2-7: Determine the Inspectional Unit page 2-22
- TABLE 2-8: Determine the Inspectional Unit For Shipments That Have Different Genera page 2-23
- TABLE 2-9: Determine the Sample Size of Each Inspectional Unit page 2-23
- TABLE 2-10: Preparation of Cut Flowers for Inspection page 2-25
- TABLE 2-11: Action to Take When Inspecting Cut Flowers for Presence of Fruits page 2-26
- TABLE 2-12: Quarantine Action to Take Based on Pest Findings page 2-27
- TABLE 2-13: Determining Eligibility for Cut Flower Release page 2-29
- TABLE 3-1: *Aegilops* spp. and Its Intergeneric Crosses (goatgrass) Poaceae page 3-6
- TABLE 3-2: *Ajania pacifica*—a monotypic genus (yellow splash) Asteraceae page 3-7
- TABLE 3-3: *Ananas* spp. (pineapple) Bromeliaceae page 3-8
- TABLE 3-4: Arecaceae (palm leaves and fronds) page 3-10
- TABLE 3-5: *Capsicum* spp. (pepper—bell, bird, chili, green, paprika, tabasco) Solanaceae page 3-13
- TABLE 3-6: *Chamaedorea* spp. (palm fronds) Arecaceae page 3-15
- TABLE 3-7: *Chrysanthemum x morifolium* (florist's chrysanthemum, mum) Asteraceae page 3-16
- TABLE 3-8: *Coffea* spp. (coffee) Rubiaceae page 3-18

- TABLE 3-9: *Cordyline* spp., Agavaceae (includes cabbage tree and ti plants) page 3-24
- TABLE 3-10: *Cotoneaster* spp., Rosaceae page 3-26
- TABLE 3-11: *Crocasmia* spp. (autumn-gold, garden montbretia, montbretia) page 3-27
- TABLE 3-12: Cycadaceae/Zamiaceae (cycads) page 3-28
- TABLE 3-13: *Cynara* spp. (artichoke) Asteraceae page 3-30
- TABLE 3-14: *Dendranthema* spp. (florist's mum, florist's chrysanthemum, cultivated mum) Asteraceae page 3-31
- TABLE 3-15: *Dracaena* spp., Agavaceae (includes cabbage tree and ti plants) page 3-32
- TABLE 3-16: *Gladiolus* spp. (gladiolus, gladiola, glad, sword-lily) page 3-34
- TABLE 3-17: *Gossypium* spp. (cotton) Malvaceae page 3-35
- TABLE 3-18: *Hibiscus* spp., Malvaceae page 3-37
- TABLE 3-19: *Hippophae* spp. (sea buckthorn) Elaeagnaceae page 3-38
- TABLE 3-20: *Ilex* spp. (holly) Aquifoliaceae page 3-40
- TABLE 3-21: *Leucanthemella* spp. (high daisy, giant-daisy) Asteraceae page 3-41
- TABLE 3-22: Loranthaceae (all genera of mistletoe) page 3-43
- TABLE 3-23: *Musa* spp. (banana, plantain) Musaceae page 3-45
- TABLE 3-24: *Nepenthes* spp. (pitcher plant) Nepenthaceae page 3-46
- TABLE 3-25: *Nipponanthemum* spp. (nippon-daisy, nipon-chrysanthemum) Asteraceae page 3-48
- TABLE 3-26: *Oryza sativa* (rice) Poaceae page 3-50
- TABLE 3-27: *Phoenix* spp. (date palm) Arecaceae page 3-52
- TABLE 3-28: *Physalis* spp. (ground cherry, Chinese-lantern plant, Japanese-lantern) Solanaceae page 3-53
- TABLE 3-29: Pinaceae (all genera of conifers) page 3-54
- TABLE 3-30: Pinaceae from Mexico page 3-55
- TABLE 3-31: Pinaceae from Canada page 3-55
- TABLE 3-32: Cut Christmas Trees or Branches of *Pinus* spp. From Canada page 3-56
- TABLE 3-33: Cut Christmas Trees or Branches of *Pinus* spp. from Ontario or Quebec—Gypsy Moth Requirements page 3-57
- TABLE 3-34: Cut Christmas Trees or Branches of *Pinus* spp. from Ontario or Quebec—Pine Shoot Beetle Requirements page 3-58
- TABLE 3-35: Cut Christmas Trees or Branches of *Pinus* spp. from New Brunswick or Nova Scotia page 3-59

-
- TABLE 3-36: Cut Christmas Trees or Branches Other Than *Pinus* spp. from Canada page 3-60
- TABLE 3-37: Poaceae (all genera and species of grasses) page 3-61
- TABLE 3-38: Polypodiophyta (Ferns) page 3-62
- TABLE 3-39: Proteaceae (protea) page 3-63
- TABLE 3-40: *Ricinus communis* (castor, ricin) Euphorbiaceae page 3-67
- TABLE 3-41: Rutaceae (all genera and species of the citrus subfamilies Aurantioideae, Rutoideae, and Toddalioideae) page 3-69
- TABLE 3-42: *Salix* spp. (willow, pussy willow) Salicaceae page 3-71
- TABLE 3-43: *Sarracenia* spp. (pitcher plant) Sarraceniaceae page 3-72
- TABLE 3-44: *Sorghum bicolor* (broomcorn) Poaceae page 3-73
- TABLE 3-45: *Triticum* spp. (wheat and intergeneric crosses) Poaceae page 3-76
- TABLE 3-46: *Tritonia* spp. (blazing star) page 3-77
- TABLE 3-47: *Viburnum* spp. (nannyberry, snowball, viburnum)—branches with botanical fruit or with foliage only page 3-78
- TABLE 3-48: *Watsonia* spp. (bugle lily, Merians bugle lily, pink watsonia, watsonia) page 3-79
- TABLE 3-49: Zamiaceae (cycads) page 3-80
- TABLE 3-50: *Zea mays* (corn and closely related plants) Poaceae page 3-81
- TABLE 1-1: How to Process Red and White (PPQ Form 599) Labeled Packages page A-4
- TABLE 1-2: How to Process Green and Yellow (PPQ Form 505) Labeled Packages page A-7
- TABLE 1-3: Obtain a Copy of the Departmental Permit (PPQ Form 597) page A-8
- TABLE 1-4: Processing Departmental Permits page A-9

List of Tables

List of Figures

- FIGURE 2-1: Diagram of a General Inspection Table *page 2-4*
- FIGURE 2-2: Overview of the General Inspection Procedures for Clearing
Fresh, Cut Articles *page 2-8*
- FIGURE 2-3: Flower and Country of Origin Combinations Eligible for
Release *page 2-28*
- FIGURE B-1: Example of Control Data *page B-3*

List of Figures

1

Cut Flowers and
Greenery

Introduction

Contents

Purpose	page-1-1
Scope	page-1-2
Users	page-1-3
Related Documents	page-1-4
Convention for International Trade in the Endangered Species of Wild Fauna and Flora	page-1-4
Endangered Species Act	page-1-5
Plant Protection Act	page-1-5
Code of Federal Regulations	page-1-5
Treatment Manual	page-1-10
Application	page-1-10
Reporting Problems	page-1-10
Conventions	page-1-10
Advisories	page-1-10
Boldface	page-1-11
Bullets	page-1-11
Contents	page-1-11
Control Data	page-1-11
Decision Tables	page-1-12
Examples	page-1-12
Footnotes	page-1-12
Heading Levels	page-1-12
Hypertext Links (Highlighting) to Tables, Figures, and Headings	page-1-13
Indentions	page-1-13
Italics	page-1-13
Numbering Scheme	page-1-13

Purpose

The *Cut Flowers and Greenery Import Manual* provides the background, procedures, and reference tables for regulating the fresh, cut portion of the plant when it is imported for decoration or ornamentation, and for protecting plants that are threatened with extinction due to trade in those plants or their derivatives.

The articles from the countries of origin listed in this manual are regulated because just one destructive pest might be enough to start a pest outbreak that can cause millions of dollars of damage to crops, trees, flowers, or lawns. By their destructiveness, pests can increase the price and reduce the quality of food, lower property values, and ruin recreational areas. The extinction of just one plant species does away with the aesthetic, ecological, educational, historical, recreational, commercial, and scientific value of our world.

Scope

The *Cut Flowers and Greenery Import Manual* covers the fresh, cut portion of the plant including the cut flower and greenery (including branches or stems and any fruits attached) to be used for decoration or ornamentation, and are **not** intended for eating or growing.

The manual is divided into the following chapters:

1. *Introduction*
2. *Procedures*
3. *Reference*

The manual also includes two *Appendixes*, a *Glossary*, and an *Index*.

The *Introduction* contains basic information about the *Cut Flowers and Greenery Import Manual*. This chapter includes the manual's purpose, scope, users, and application; a list of related documents that provide the authority for the manual's content; directions about how to use the manual; and the conventions (unfamiliar or unique symbols and highlighting) that appear throughout the manual.

The *Procedures* provides the prerequisites and general directions for sampling, inspecting, determining pest risk, and regulating fresh, cut articles; and the protocol for the National Cut Flower Release Program.

The *Reference* identifies the prohibitions and restrictions that apply to the admissibility of fresh, cut articles and provides the authority for the regulatory action.

The *Appendixes* contain supplementary information which is **not** appropriate for other components of topics, explanations and elaborations **not** essential to the manual but helpful to the user, and information that interrupts the application of the information or makes the information more difficult to follow.

The *Glossary* defines specialized words, abbreviations, and acronyms associated with regulating fresh, cut articles. The *Index* contains topics and links or page numbers for quick reference.

The *Cut Flowers and Greenery Import Manual* does **not** cover plant material intended for planting or growing, unprocessed seeds intended for food or animal feed, fresh fruits, herbs, or vegetables, or processed plant material and articles manufactured from plants or plant products. Plant material **not** covered by this manual are listed below with a reference where information can be found about inspecting, regulating, and clearing such commodities.

- ◆ Fresh, cut articles in quarters on carriers

- ◆ Fresh, cut articles in transit to Canada
- ◆ Fresh, cut articles moving interstate (see the territorial regulations for regulatory actions)
- ◆ Fresh, cut flowers, fronds, fruits, fruit pods, leaves, roots, seed heads, seed pods, and stems for food (human consumption) or utilized as herbs¹ (see *Fresh Fruits and Vegetables Import Manual*)
- ◆ Fresh fruits, herbs, or vegetables for food (human consumption) (see *Fruits and Vegetables Import Manual*)
- ◆ Plant material imported for planting or growing, including forced bulbs, potted plants, or rooted plants (see MCFR 319.37, *Port of Entry Manual*)
- ◆ Processed (bleached, chemically treated, dried, or dyed) plant material² and articles (decorative or ornamental) manufactured from plants or plant products (see *Miscellaneous and Processed Products Import Manual*)
- ◆ Unprocessed seeds for food (human consumption) (see *Unprocessed Seeds Import Manual*)
- ◆ Unprocessed seeds for animal feed (see *Animal Products Manual*)

Users

The *Cut Flowers and Greenery Import Manual* is written for use by regulatory officials working at airports, seaports, and land borders:

- ◆ Customs and Border Protection (CBP) officers
- ◆ CBP agricultural specialists
- ◆ Plant Protection and Quarantine (PPQ) officers

The experience levels of users will vary, but the assumption is that regulatory officials minimally have a working knowledge of using PPQ's import manuals to make regulatory decisions.

Regulatory functions are shared between CBP and PPQ at ports of entry. Therefore, the responsibility for final clearance of cargo are divided depending on the situation at hand. For example, in situations where fumigation is required, then PPQ is the responsible agency to give final clearance of cut flower shipments after treatments are officially monitored and validated. Conversely, CBP is responsible for final regulatory action and disposition when cut flower shipments are destroyed or re-exported.

1 For example, banana flowers, chrysanthemum greens, cockscomb inflorescences, fiddle heads, roselle calyxes, and squash flowers.
2 For example, cones, flowers, fronds, fruits, fruit pods, leaves, roots, seed heads, seed pods, and stems.

Domestic and international PPQ officers and other regulatory officials reference this manual to answer questions related to importations that are asked by the public, importers, brokers, and other interested parties.

Related Documents

Enabling legislation provides the authority to carry out the mission of protecting American agriculture from plant pests. Legislative acts are the fundamental authority granted by Congress to the Secretary of Agriculture to promulgate regulations to protect American agriculture. The regulatory authority for taking the actions listed in this manual is contained in the following legislative acts and multi-national treaty:

- ◆ [Convention for International Trade in the Endangered Species of Wild Fauna and Flora](#)
- ◆ [Endangered Species Act](#)
- ◆ [Plant Protection Act](#)

Other documents which include information related to the importation of fresh, cut articles are listed below and followed by their details:

- ◆ [Code of Federal Regulations](#)
- ◆ [Treatment Manual](#)

Convention for International Trade in the Endangered Species of Wild Fauna and Flora

The Convention for International Trade in the Endangered Species of Wild Fauna and Flora (CITES) is a multi-national treaty that regulates the importation of listed species of wild fauna and flora. CITES provides three appendixes for listing plants. These appendixes, in order of their restrictiveness, are as follows:

1. CITES Appendix I—any genus, species, subspecies, or variety, globally threatened with extinction through trade.
2. CITES Appendix II—any taxon (the entire family—all genera and all species) that **must** be regulated in order to avoid the threat of extinction through trade.
3. CITES Appendix III—any species, subspecies, or variety listed by one country in order to enlist the cooperation of other countries to re-enforce domestic conservation measures by regulating trade.

Trade in protected species of CITES plants is monitored. More specifically, commercial trade in CITES Appendix I plants taken from the wild is **prohibited**, and commercial trade in CITES Appendix II plants is allowed **only** if that trade is **not** detrimental to the survival of the species in the wild.

Endangered Species Act

The Endangered Species Act (ESA) provides for the protection of listed species in two categories. These categories, listed in order of their restrictiveness, are as follows:

1. Endangered—any species, subspecies, or variety that is in danger of extinction throughout all or a significant portion of its range.
2. Threatened—any species, subspecies, or variety that is likely to become endangered within the foreseeable future throughout all or a significant portion of its range.

In general, ESA **prohibits** the trade in endangered and threatened species. The importation of threatened species may be allowed for scientific research, enhancement of propagation, enhancement of survival, educational exhibition, display at botanical gardens and arboretums, and other activities consistent with the purposes or policy of ESA.

Plant Protection Act

The Plant Protection Act of 2000 (PPA) provides the authority to prohibit or restrict imports, exports, or interstate movement of plant pests, plants, plant products, noxious weeds, biological control agents, and means of conveyance.

Code of Federal Regulations

The Code of Federal Regulations (CFRs) provide the authority for the regulatory action taken and are enforced by CBP and PPQ. The restrictions and prohibitions listed in this manual are covered by the following Title 7 and Title 50 parts:

7CFR 318.13

7CFR 318.13 Subpart—Hawaiian Fruits and Vegetables provides the following:

- ◆ Restricts and prohibits the movement of fresh fruits, vegetables, cactus, cut flowers, mango seed, and rice straw from Hawaii to other parts of the continental United States, Guam, Puerto Rico, or the U.S. Virgin Islands
- ◆ Gives instructions on the clearance of carriers, cargo, passenger baggage, and mail

- ◆ Pests of concern—green coffee scale (*Coccus viridis*), Mediterranean fruit fly (*Ceratitidis capitata*), melon fly (*Bactrocera cucurbitae*), oriental fruit fly (*Bactrocera dorsalis*), bean pod borer (*Maruca testulalis*), bean butterfly (*Lampides boeticus*), Asiatic rice borer (*Chilo suppressalis*), mango weevil (*Sternochetus mangiferae*), Chinese rose beetle (*Adoretus sinicus*), cactus borer (*Cactoblastis cactorum*)

7CFR 318.82

7CFR 318.82 Subpart—Guam provides the following:

- ◆ Prohibits and restricts the movement of fresh fruits and vegetables, cotton and cotton covers, sugarcane, cereals, cut flowers, and packing materials from Guam to the United States, Puerto Rico, and the U.S. Virgin Islands
- ◆ Pests of concern—Egyptian fluted scale (*Icerya aegyptiaca*), orange spiny whitefly (*Aleurocanthus spiniferus*), citrus leafminer (*Phyllocnistis citrella*), chafer (*Anomala sulcatula*), green coffee scale (*Coccus viridis*), red coconut scale (*Furcaspis oceanica*), coffee bean borer (*Stephanoderes hampei*), pink spotted bollworm (*Pectinophora scutigera*), oriental fruit fly (*Bactrocera dorsalis*), melon fly (*Bactrocera cucurbitae*), bean pod borer (*Maruca testulalis*), bean butterfly (*Lampides boeticus*), citrus pock caterpillar (*Prays endocarpa*), Asian cutworm (*Prodenia litura*), West Indian sweet potato weevil (*Euscepes postfasciatus*), northern rough bollworm (*Earias fabia*), New Guinea sugarcane weevil (*Rhabdoscelus obscurus*), whitefly on grasses (*Neomaskellia bergii*), European corn borer (*Pyrausta nubilalis*), scentless plant bug (*Leptocorisia acuta*), Chinese rose beetle (*Adoretus sinicus*), *Holotrichia mindanaona*.
- ◆ Disease of concern—citrus canker (*Xanthomonas citri*), sweet potato scab (*Elsinoe batatas*), rust of yam (*Uredo dioscoreae-alatae*), sweet potato leafspot (*Cercospora batatae*), *Coniothyrium* sp., *Phyllosticta colocasiophila*, sugarcane gummosis (*Xanthomonas vasculorum*), corn brown spot (*Physoderma zeae-maydis*)

7CFR 319.8

7CFR 319.8 Subpart—Foreign Cotton and Covers provides the following:

- ◆ Prohibits cottonseed, seed cotton, and fresh cut articles of cotton
- ◆ Restricts the entry of all unmanufactured parts of the cotton plant (lint, linters; cottonseed cake, hulls and meal; cotton gin and thread waste); secondhand burlap, covers, and other fabrics that have held cotton, grain, field seed, underground crops, and meats
- ◆ Pests of concern—pink bollworm (*Pectinophora gossypiella*) and golden nematode (*Heterodera rostochiensis*)
- ◆ Diseases of concern—flag smut (*Urocystis triticia*)

- 7CFR 319.15** 7CFR 319.15 Subpart—Sugarcane provides the following: Prohibits from all countries sugarcane and its related products including cuttings, canes, leaves, and bagasse; restricts bagasse and related sugarcane products into Guam.
- 7CFR 319.19** 7CFR 319.19 Subpart—Citrus Canker and Other Citrus Diseases provides the following:
- ◆ Prohibits all plant parts of citrus and related genera except fruits and seeds
 - ◆ Disease of concern—citrus canker (*Xanthomonas citri*)
- 7CFR 319.24** 7CFR 319.24 Subpart—Corn Diseases provides the following:
- ◆ Prohibits and restricts all parts of corn and corn relatives (including seeds) from specific countries
 - ◆ Disease of concern—*Peronospora maydis*, downy mildew (*Sclerospora sacchari*), *Physoderma* diseases of maize, *Physoderma zea-maydis*, corn brown spot (*Physoderma maydis*)
- 7CFR 319.37** 7CFR 319.37 Subpart—Nursery Stock, Plants, Roots, Bulbs, Seed and Other Plant Products provides the following:
- ◆ Regulates plants and plant parts capable of propagation, including branches with or without flowers imported as cut flowers, greenery, or decorative materials such as wreaths from the following genera or family: *Chaenomeles*, *Cydonia*, *Eucalyptus*, *Malus*, Poaceae, *Prunus*, *Pyrus*, *Salix*, and *Vitis*
 - ◆ Lists the approved growing media for propagative materials
- 7CFR 319.41** 7CFR 319.41 Subpart—Indian Corn or Maize, Broomcorn, and Related Plants provides the following:
- ◆ Prohibits or restricts the entry of corn, broomcorn, and related plants
 - ◆ Pest of concern—European corn borer (*Ostrinia nubilalis*)
- 7CFR 319.55** 7CFR 319.55 Subpart—Rice provides the following:
- ◆ Prohibits or restricts rice seeds, paddy rice, rice straw, and rice hulls
 - ◆ Diseases of concern—downy mildew (*Sclerospora macrospora*), leaf smut (*Entyloma oryzae*), blight (*Oospora oryzaetorum*), glume blotch (*Melanomma glumarum*)
- 7CFR 319.56** 7CFR 319.56 Subpart—Fruits and Vegetables provides the following:

- ◆ Restricts or prohibits fresh fruits and vegetables (including herbs) from all countries
- ◆ Restricts frozen fruits and vegetables
- ◆ Includes fresh, cut articles imported for decoration when fresh fruits are attached, e.g. pineapples (*Ananas* spp.) that are used as decorative articles
- ◆ Pests of concern—fruit and melon flies (Tephritidae)

7CFR 319.59

7CFR 319.59 Subpart—Wheat Diseases provides the following:

- ◆ Prohibits and restricts plants, plant parts and products of wheat and wheat relatives from countries infested with Karnal bunt or flag smut
- ◆ Includes products of the milling process, articles which have been manufactured from wheat plants or plant parts if their use could serve to disseminate the spores of Karnal bunt or flag smut, and fresh, cut plant parts for decorative purposes
- ◆ Pests of concern—foreign strain of Karnal bunt (*Teilletia indica*) and flag smut (*Urocystis agropyri*)

7CFR 319.73

7CFR 319.73 Subpart—Coffee provides the following:

- ◆ Prohibits green (unroasted) and insufficiently roasted coffee beans and empty sacks previously used for unroasted coffee from all areas of the world into Hawaii and Puerto Rico
- ◆ Pest of concern—coffee berry borer (*Hypothenemus hampei*)
- ◆ Disease of concern—rust disease caused by coffee leaf rust (*Hemileia vastatrix*)

7CFR 319.74

7CFR 319.74 Subpart—Cut Flowers provides the following: Restricts or prohibits the importation of fresh, cut flowers, but exempts dried, bleached, dyed, or chemically treated decorative plant materials from the definition of cut flowers.

7CFR 330

7CFR 330 Subpart—Federal Plant Pest Regulations provides the following:

- ◆ Restricts the entry of miscellaneous cargo, garbage, plants, carriers, or any item which is or may act as a carrier of plant pests
- ◆ Restricts the movement of soil from Hawaii, Puerto Rico, and the U.S. Virgin Islands to the United States
- ◆ Pest of concern which means any living stage of any insects, mites, nematodes, slugs, snails, protozoa, or other invertebrate animals, bacteria, fungi, other parasitic plants or reproductive parts thereof, viruses, or any organisms similar to or allied with

any of the foregoing, or any infectious substances which can directly or indirectly injure or cause disease or damage in any plants or parts thereof, or any processed, manufactured, or other products of plants; or any living stage of insects, mites, nematodes, slugs, snails, protozoa, or other invertebrate animals, bacteria, fungi, other parasitic plants or reproductive parts thereof, viruses, or any organisms similar to or allied with any of the foregoing, or any infectious substances of the aforementioned which are not genetically engineered as defined in 7CFR 340.1 which can directly or indirectly injure or cause disease or damage in any plants or parts thereof, or any processed, manufactured, or other products of plants

7CFR 352

7CFR 352 Subpart—Safeguard Regulations provides the following: Restricts the importation of all items which are either prohibited or restricted by Subparts 319 or 330 and are subject to safeguard regulations when:

- ◆ Brought in for a temporary stay and unloading is not intended, i.e., ships' stores
- ◆ Unloaded for transshipment and direct exportation
- ◆ Unloaded for transportation and exportation (T&E)
- ◆ Unloading and entry at a subsequent port is intended (residue cargo)
- ◆ Refused entry under Subparts 319 or 330

7CFR 360

7CFR 360 Subpart—Noxious Weed Regulation provides the following: Lists weeds that are noxious and allows the importation of seed of listed weeds only under an import permit.

If you are unsure whether a plant is a Federal noxious weed, see [Identification of Protected Plants and Genera of Taxa Regulated Higher Than Genus](#) in the *Reference*.

50CFR 17.12

50CFR 17.12 Subpart—Endangered and threatened plants, provides the following: Lists all species of plants that have been determined by the United States Fish and Wildlife Service, Department of the Interior, to be endangered or threatened.

50CFR 23.23

50CFR 23.23 Subpart—Endangered Species Convention provides the following: Lists all species of plants and animals that have been placed in Appendix I, Appendix II, or Appendix III.

50CFR 24.12

50CFR 24.12 Section—Designated ports, provides the following: List of U.S. Department of Agriculture ports that are designated for the import, export, or re-export of plants listed in 50CFR 17.12 or 50CFR 23.23.

Treatment Manual

The *Treatment Manual* provides the details of treatments when a commodity must be treated as a condition of entry or based on pest findings.

Application

The *Cut Flowers and Greenery Import Manual* informs CBP officials and PPQ officers about how to regulate commercial and noncommercial shipments of fresh, cut articles of the florist trade.

Reporting Problems

Use [Table 1-1](#) to determine where to report problems with the *Cut Flowers and Greenery Import Manual*.

TABLE 1-1: Where To Report Problems with the *Cut Flowers and Greenery Import Manual*

If you:	Then:
Are unable to access the on-line manual	CONTACT PPQ's Manuals Unit. If the situation warrants immediate action, call 240-629-1934 OR e-mail < john.l.patterson@aphis.usda.gov >. Otherwise, print, complete, and mail a <i>Comment Sheet</i> (located at the end of the manual) to PPQ's Manuals Unit
Have a suggestion for improving the formatting (design, layout, composition), grammar, or spelling	CONTACT PPQ's Permits, Registrations, Imports & Manuals staff through proper channels if the situation warrants an immediate response. Otherwise, print, complete, and mail a <i>Comment Sheet</i> (located at the end of the manual) to PPQ's Manuals Unit
Disagree with the admissibility of a commodity	CONTACT PPQ's Quarantine Policy, Analysis, and Support through proper channels with the reason for the disagreement and a recommendation
Disagree with policy or procedures	CONTACT PPQ's Quarantine Policy, Analysis, and Support through proper channels with the reason for the disagreement and a recommendation

Conventions

Conventions are established by custom and are widely recognized and accepted. Major conventions used in this manual follow.

Advisories

Advisories are used throughout the *Cut Flowers and Greenery Import Manual* to bring important information to your attention. Please carefully review each advisory. The definitions coincide with American National Standards Institute (ANSI), and are in the format shown below.



DANGEROUS indicates that people could easily be hurt or killed.



WARNING indicates that people could possibly be hurt or killed.



CAUTION indicates that people could possibly be endangered and slightly hurt.



NOTICE indicates a possibly dangerous situation where goods might be damaged.



IMPORTANT indicates helpful information.

Boldface

Boldface type is used to emphasize important words throughout this manual. These words include: **do not, except, never, not, only, other than.**

Bullets

Bulleted lists indicate that there is no order to the information listed.

Chapters

This manual contains the following chapters: *Introduction, Procedures, and Reference.*

Contents

Most every chapter has a table of contents that lists the heading titles, and is located at the beginning of the chapter to help facilitate finding information.

Control Data

Information placed at the top and bottom of each page helps users keep track of where they are in the manual and manual updates. At the top of the page is the chapter, section, and first-level heading. At the bottom of the page is the month, year, manual transmittal number, manual title, page number, and USDA-APHIS work unit responsible for content.

Decision Tables

Many of the tables in this manual are called decision tables. Read decision tables from left to right, beginning with the column headings and moving right one column at a time. Each column represents a condition with the last column on the right representing the action to take once all the conditions are met. When using [Table 1-2](#) if you are a 28 year old female, you would schedule a physical.

TABLE 1-2: How to Use Decision Tables

If you are a:	And your age is:	Then:
Male	Under 30	Do not schedule a physical
	30 or over	Schedule a physical
Female	Under 25	Do not schedule a physical
	25 or over	Schedule a physical

Examples

Examples are used to clarify a point by applying it to a real-world situation. Examples always appear in boxes as a means of visually separating them from the other information contained on the page.

EXAMPLE	Examples are graphically placed boxes within the text as a means of visually separating information from other information contained on the page. Examples will always appear in a box.
----------------	---

Footnotes

Footnotes are notes usually placed at the bottom of a page that comments on or cites a reference for a designated part of the text. Two types of footnotes are used in the *Cut Flowers and Greenery Import Manual*.

- ◆ General text footnotes that are located at the bottom of the page
- ◆ Table or figure footnotes that are located directly below the associated table or figure. If a table or figure continues beyond one page, the associated footnotes will appear on the last page below the table or figure.

Heading Levels

Within each chapter and section there are three heading levels. The first heading is indicated by a horizontal line followed by the title which continues across both the left and right columns. The second heading is in the right-hand column with the text beginning below it. The third heading is in the left-hand column and is used to easily scan topics.

Hypertext Links (Highlighting) to Tables, Figures, and Headings

Tables, figures, and headings are highlighted using bold print. Hypertext links within the on-line manual are also highlighted using bold print and the print color is blue. Headings are highlighted using italic print.

EXAMPLE	Refer to Table 1-1 in the <i>Introduction</i> to determine where to report problems with this manual.
----------------	--

Indentions

Entry requirements which are summarized from CFRs, import permits, or policies are indented on the page.

Italics

The following items are italicized throughout the *Cut Flowers and Greenery Import Manual*:

- ◆ Cross-references to headings
- ◆ Publication names
- ◆ Scientific names of commodities

Numbering Scheme

A two-level numbering scheme is used in this manual for pages, tables, and figures. The first number represents the chapter. The second number represented the page, table, or figure. This numbering scheme allows for easier updating and adding pages without having to reprint an entire chapter. Dashes are used in page numbering to differentiate page numbers from decimal points.

2

Cut Flowers and
Greenery

Procedures

Contents

Introduction	page 2-1
Preparation	page 2-1
Information Needed	page 2-2
Inspectional Area Needed	page 2-3
Materials Needed	page 2-5
PPQ Inspection Station Facilities for Fumigating Commercial Shipments	page 2-5
Regulatory Action	page 2-6
General Inspection Procedures for Clearing Fresh, Cut Articles	page 2-7
Step 1: Determine if Articles Are Admissible, Precleared, or Prohibited	page 2-9
Step 2: Determine Whether to Inspect or Authorize Movement	page 2-12
Step 3: Check for Import Permit Requirements	page 2-13
Step 4: Identify the Level of Pest Risk	page 2-14
Step 5: Determine the Sample Size	page 2-21
Step 6: Inspect the Cut Flowers and Foliage	page 2-24
Step 7: Take Regulatory Actions Based on Inspection Results	page 2-27
Protocol for The National Cut Flower Release Program	page 2-28
Purpose	page 2-28
Participating Ports	page 2-28
Flower/Country Combinations Eligible for Release	page 2-28
Limitations	page 2-29
Procedures	page 2-29
Documentation	page 2-30
Adding or Deleting Flowers Eligible for Release and Program Review	page 2-30

Introduction

The information presented in *Procedures* chapter includes the prerequisites and general inspection procedures for sampling, inspecting, determining pest risk, and regulating fresh, cut articles; and the protocol for the National Cut Flower Release Program.

Preparation

The information presented under *Preparation* is a prerequisite to the *General Inspection Procedures*. Be sure to complete the preparatory tasks described below.

Information Needed

Do some solid investigating and be creative when collecting the necessary information which can be obtained from a variety of sources. Refer to [Table 2-1 on page 2-3](#) for sources of information. HOLD all shipments until you have the needed information.

- ◆ Scientific or common name of the cut articles
- ◆ Origin of the cut articles (where they were grown or harvested, **not** the port of lading)
- ◆ Destination of the cut articles where they will be used (**not** always the port of entry)
- ◆ Size and kind of shipment: commercial or noncommercial
 - ❖ Commercial or larger quantity shipments are imported for resale or for profit
 - ❖ Noncommercial or smaller quantity shipments are imported for personal use and not for profit (usually enter as passenger baggage, trade samples, household goods, and mail)
- ◆ Presence or absence of required import permits and foreign phytosanitary certificates
- ◆ Presence of preclearance form (PPQ Form 203)



Currently only Chile and Jamaica have preclearance programs for cut flowers and greenery

- ◆ Intended use of cut articles (how the fresh, cut articles are to be used determines what restrictions apply. For example, Chrysanthemum stems could be used as greenery or cut flowers, as herbs or vegetables, or as parts to grow the plants. When the intended use of fresh, cut articles is unknown, regulate them as if they were intended for planting or growing and use MCFR 319.37, *Port of Entry Manual*.

Make sure that the information is accurate. Manifests often show the port or airport of lading, but **not** the origin of the articles; therefore, you may need to check other documents for the country of origin. Consult reference materials and PPQ specialists (botanist, entomologist, and plant pathologist) through proper channels when you are **not** sure what is being imported.

EXAMPLE
An air waybill of lading shows 15 boxes of daffodils, <i>Narcissus</i> spp., being imported from the Netherlands; but when you inspect the flowers, you notice the boxes have printing that says the flowers were grown in Israel.

TABLE 2-1: Where to Collect Information Needed

If the shipment is:	Then get information from:
Commercial (for resale or for profit)	<ul style="list-style-type: none"> ◆ Carrier documents (air waybills and shipping papers) ◆ Computers and computer printouts ◆ Foreign phytosanitary certificates ◆ Interviews with importers, brokers, freight forwarders, or other representatives of the importer ◆ Invoices (obtained from importer or broker) ◆ Labels ◆ Manifests and other U.S. Customs forms ◆ Notices of arrival ◆ Packing lists ◆ Permits (PPQ, Convention on International Trade in Endangered Species of Fauna and Flora (CITES), Endangered Species (ESA))
Noncommercial (not for sale nor profit)	<ul style="list-style-type: none"> ◆ Declarations (oral or written U.S. Customs declaration) ◆ Documents (such as a sales receipt) ◆ Foreign phytosanitary certificates ◆ Labels (information written on the packaging) ◆ Interviews with importers ◆ Permits

Inspectional Area Needed

In order to inspect effectively, you need the following inspection area and operational supports:

- ◆ **Designated Inspection Area**
- ◆ **Inspection Surface**
- ◆ **Lighting**

Designated Inspection Area

Ports of entry where cut flower shipments are received regularly should have a designated area for inspectional operations. The designated area should be as follows:

- ◆ Inspection surface (table) **must** be located outside the flow of warehouse traffic, i.e., pedestrians, forklifts, pallet jacks, etc.
- ◆ Inspection surface (table) **must not** be used for cargo storage or any purpose **other than** agricultural inspection and **must** be kept clean and dry
- ◆ Adequately ventilated with fans; wherever possible, fans should be permanently mounted either on the floor or wall
- ◆ Easily accessible for inspectors, i.e., **not** blocked by cargo or equipment

- ◆ Secure area capable of being locked with a USDA-APHIS seal for storing quarantined cut flowers, ideally located within the warehouse or cooler¹
- ◆ Designated USDA-APHIS office space, with a secured door, telephone, desk, chair, and sufficient space for USDA-APHIS files; USDA-APHIS shall be provided keys for access to the inspection area

Inspection Surface

The inspection surface used to inspect cut flowers should be smooth and cleanable. The surface should be painted white or covered with white laminate to provide the greatest visibility. A sturdy, large table that is 36 to 40 inches high is ideal. The minimum width and length of the table should be 48 x 96 inches. The table may be greater than the minimum standards, if a company or warehouse desires. Also, the table surface edges **should not** have any raised edges. See [Figure 2-1](#) for a diagram of a general inspection table.

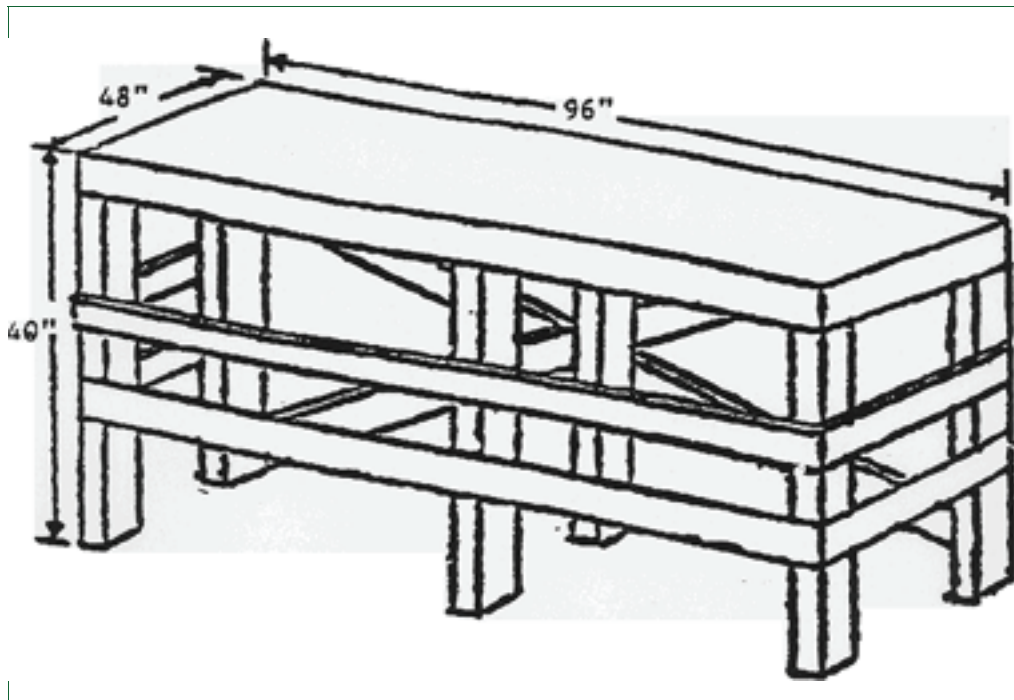

FIGURE 2-1: Diagram of a General Inspection Table

Lighting

Good, strong lighting is necessary to inspect cut flowers. Fluorescent lighting is the best. Where possible, supplement the overhead fluorescent lighting with a table lamp with magnifier. See the following optimum lighting for inspecting cut flowers:

1 When a secure area **is not** feasible, arrangements may be made to seal infested material in another manner and/or location.

- ◆ Two 96 inch fluorescent bulbs centered directly over each 48 x 96 inch section of inspection surface
- ◆ Install light fixtures 44 to 56 inches above the inspection surface; **do not** install light fixtures more than 8 feet above the floor surface

Materials Needed

When inspecting, have the following materials available:

- ◆ Alcohol (for insect preservation)
- ◆ Bags, small brown paper
- ◆ Brush (a small one) and probe (for picking up insects)
- ◆ Flash light
- ◆ Gloves, plastic or rubber for inspecting treated flowers and foliage
- ◆ Hand lens
- ◆ Knife
- ◆ Manuals
- ◆ Regulatory stamps (Hold, Released, Treated & Released, Authorize Shipment to, Released for Export, and Inspected & Released)
- ◆ Vials, PPQ Forms 309, paper clips (for interceptions)

PPQ Inspection Station Facilities for Fumigating Commercial Shipments

PPQ inspection stations may fumigate commercial shipments of cut flowers **only** when the following criteria are met²:

- ◆ Facility is **not** being used to fumigate nursery stock; fumigation of propagative material takes precedence over the fumigation of cut flowers
- ◆ Size of the inspectional unit must be small enough to fit into the chamber so that the entire inspectional unit can be treated in a single fumigation
- ◆ USDA-APHIS-PPQ will benefit from fumigating the cut flowers in the inspection station. Program costs for fumigating in the inspection station require less manpower than monitoring a commercial fumigation, which may involve regulatory officials traveling long distances

² If such criteria **do not** exist at the point of entry, then other means of fumigation should take place in order to satisfy and bring into compliance the regulatory action of treatments.

- ◆ USDA-APHIS-PPQ Regional Office **must** approve the procedure (The option to use the inspection station facilities for fumigating commercial shipments of cut flowers **must** have the support of local management, considering the available manpower and facilities availability)

Regulatory Action

Once you have all the information needed to make a regulatory decision, take one of the following actions:

- ◆ **AUTHORIZE SHIPMENT**
- ◆ **HOLD**
- ◆ **PROHIBIT ENTRY**
- ◆ **RELEASE**

AUTHORIZE SHIPMENT

The regulatory action to AUTHORIZE SHIPMENT may be authorized under Customs bond (also called in-transit) and allows the item to move to another port where CBP or PPQ have personnel to inspect or treat the item. Authorize shipment if:

- ◆ The receiving CBP or PPQ office agrees to clear the cargo
- ◆ The cargo is moving to an approved treatment facility when you would prescribe proper safeguards to prevent any pests escape
- ◆ The cargo remains aboard the carrier as residue cargo and the destination is authorized for the regulated cargo
- ◆ The conditions of the import permit require that the regulated cargo be cleared or treated at a specific port of entry, e.g., Departmental permit material authorized shipment to the National Plant Germplasm and Biotechnology Laboratory in Beltsville, Maryland

HOLD

The regulatory action to HOLD maintains control of the cargo while:

- ◆ Collecting information to make a regulatory decision
- ◆ Awaiting inspection of the cargo
- ◆ Awaiting importer or representative to make cargo accessible for inspection
- ◆ Awaiting the identification of an “urgent interception”³

3 If a commercial shipment requires treatment or if the shipment is being held pending the identification of a pest, allow the importer to have the commodity treated or re-exported, or arrange for its destruction. In general, it is impractical to treat articles intercepted in baggage; therefore, seize and destroy such articles. On occasion, because of the high value of fresh, cut articles, you may have to defer a decision to a higher authority. In this instance, safeguard the articles and refrigerate if necessary. Tell the passengers that they must arrange for the pick up or the forwarding of the articles if they are found to be admissible.

- ◆ Awaiting decision by importer to apply for required import permit, to treat³, or to re-export
- ◆ Awaiting a copy of an approved import permit

PROHIBIT ENTRY

Take the regulatory action PROHIBIT ENTRY if the plants or plant products are:

- ◆ Prohibited and **not** authorized by a Departmental permit
- ◆ Infested with plant pests and the importer refuses to treat the commodities
- ◆ Imported and the importer refuses to comply with the conditions of entry
- ◆ Infested with a pest for which a treatment **does not** exist or **is not** feasible

RELEASE

Take the regulatory action to RELEASE⁴ after ensuring:

- ◆ The material is admissible after inspection
- ◆ All import permit requirements have been met
- ◆ Quarantine pests have **not** been found
- ◆ Required treatments, if any, have been completed
- ◆ All required documents are in order (CITES, import permits, foreign phytosanitary certificates)

RELEASED UNDER THE CUT FLOWER RELEASE PROGRAM—take the regulatory action to release under the National Cut Flower Release Program when a flower and country of origin combination that is eligible for release is **not** selected as the flower of the day. This regulatory action is only used at participating ports of entry for importation of high volume, low risk cut flowers. (See [“Protocol for The National Cut Flower Release Program”](#) on [page 2-28](#).)

General Inspection Procedures for Clearing Fresh, Cut Articles

[Figure 2-2](#) is an overview of the steps involved in sampling, inspecting, determining pest risk, and regulating fresh, cut articles and greenery. Details of each step follow the overview.

⁴ The cut flowers or greenery may have been precleared. Currently only Chile and Jamaica have preclearance programs for cut flowers and greenery.

Procedures

General Inspection Procedures for Clearing Fresh, Cut Articles

- Step 1: Determine if Articles Are Admissible, Precleared, or Prohibited**
- Step 2: Determine Whether to Inspect or Authorize Movement**
- Step 3: Check for Import Permit Requirements**
- Step 4: Identify the Level of Pest Risk**
- Step 5: Determine the Sample Size**
- Step 6: Inspect the Cut Flowers and Foliage**
- Step 7: Take Regulatory Actions Based on Inspection Results**

FIGURE 2-2: Overview of the General Inspection Procedures for Clearing Fresh, Cut Articles

Use [Table 2-2](#) to determine if the commercial shipment of cut flowers is one that falls under the protocol of the National Cut Flower Release Program.

TABLE 2-2: Categories of Shipments

If the shipment is entering:	And the flower and country of origin combination is:	Then:
<ul style="list-style-type: none"> ◆ Atlanta, Georgia ◆ Chicago, Illinois ◆ Houston, Texas ◆ JFK, New York ◆ Los Angeles, California ◆ Miami, Florida ◆ Port Hueneme, California ◆ San Juan, Puerto Rico 	Included in the list eligible for release under the National Cut Flower Release Program (See Figure 2-3)	GO to “Protocol for The National Cut Flower Release Program” on page 2-28
	Not eligible for release under the National Cut Flower Release Program	GO to “Step 1: Determine if Articles Are Admissible, Precleared, or Prohibited” on page 2-9
Port of entry other than listed above	—————→	

Step 1: Determine if Articles Are Admissible, Precleared, or Prohibited

After collecting and reviewing the documents accompanying the shipment, determine the admissibility of each kind of cut article using the *Reference* to identify if the articles are restricted or prohibited by USDA-APHIS-PPQ regulations.

The articles may have been precleared as evidenced by being accompanied by a PPQ Form 203. Currently only Chile and Jamaica have preclearance programs for cut flowers and greenery. RELEASE precleared articles from these to countries. For detailed information on preclearance, see “[Prcleared Flowers and Greenery](#)” on [page 3-3](#)

Initially screen for prohibitions using [Table 2-3 on page 2-10](#) if the cut articles were listed in the *Reference*, or using [Table 2-4 on page 2-11](#) if the cut articles were **not** listed in the *Reference*.

The *Index* is another quick source to look up cut articles of concern. The *Index* will list those cut articles that are in the *Reference* as well as those that are enterable but with an assigned pest risk level, which you will determine in “[Step 4: Identify the Level of Pest Risk](#)” on [page 2-14](#).

The more common importations of cut articles usually:

- ◆ Will **not** be from protected plants
- ◆ Will **not** be listed in the *Reference* as restricted or prohibited
- ◆ Will **not** be residue cargo (“[Step 2: Determine Whether to Inspect or Authorize Movement](#)” on [page 2-12](#))
- ◆ Will **not** require a permit (“[Step 3: Check for Import Permit Requirements](#)” on [page 2-13](#))
- ◆ Will **not** have fruits attached

Therefore, for more common importations of cut articles you may be able to skip from the *Index* directly to “[Step 4: Identify the Level of Pest Risk](#)” on [page 2-14](#) to identify the level of pest risk for inspecting non-precleared shipments.

Procedures

General Inspection Procedures for Clearing Fresh, Cut Articles

TABLE 2-3: Screen for Prohibitions of Cut Articles Listed in the Reference

If the cut articles are:	And the regulatory action listed is to:	And you find:	Then:
Protected by CITES or ESA, or are from Federal noxious weeds or parasitic plants ¹		→	FOLLOW the directions provided in the <i>Reference</i>
Not from protected plants, noxious weeds, or parasitic plants	INSPECT and RELEASE	→	GO to “ Step 2: Determine Whether to Inspect or Authorize Movement ” on page 2-12
	REQUIRE a treatment	→	<ol style="list-style-type: none"> 1. HOLD shipment 2. CONTACT a PPQ Officer through proper channels
	PROHIBIT ENTRY	<p>Prohibited articles mixed with admissible articles</p> <p>Only prohibited articles</p>	<ol style="list-style-type: none"> 1. Depending upon local policy and the situation at hand (shipment size, workload, packaging of individual stems or varieties), either: HOLD the shipment until a 100 percent inspection can be performed, OR PROHIBIT ENTRY to the shipment 1. If unaccompanied by a Departmental permit issued by PPQ’s Permit Services, then ALLOW the importer to re-export or destroy the shipment 2. If in baggage or the mail, then PROHIBIT ENTRY 3. EXIT this manual

1 If you are unsure whether the articles are protected by CITES or ESA, or are from Federal noxious weeds or parasitic plants, refer to [Identification of Protected Plants and Genera of Taxa Regulated Higher Than Genus](#) in the *Reference* for directions about how to access GRIN and other databases.

TABLE 2-4: Screen for Prohibitions of Cut Articles Not Listed in the Reference

If the cut articles are:	And the cut articles are:	And they were cut in:	Then:
Protected by CITES or ESA, or are from Federal noxious weeds or parasitic plants ¹	CITES or ESA protected plants	→	<ol style="list-style-type: none"> 1. HOLD shipment 2. CONTACT a CBP agricultural specialist to determine if you are a CITES designated port for the cut articles being imported. 3. If you are a CITES designated port for the cut articles being imported: TAKE regulatory action under plant quarantines and plant pest regulations REGULATE as CITES or ESA as appropriate 4. If you are not a CITES designated port for the cut articles being imported: SAFEGUARD under plant quarantines and plant pest regulations GIVE the importer one of the following options: Reexport the cut articles to the country of origin Reroute the cut articles to a CITES designated port NOTE: Shipping and handling charges are the responsibility of the importer
	Federal noxious weeds	→	<ol style="list-style-type: none"> 1. HOLD shipment 2. CONTACT a PPQ botanist at the nearest Plant Inspection Station or a CBP agricultural specialist²
	Parasitic plants	→	PROHIBIT ENTRY
Not from protected plants, noxious weeds, or parasitic plants	With fruits attached	Canada or New Zealand	INSPECT AND RELEASE
		Other than Canada or New Zealand	PROHIBIT ENTRY to prevent the establishment of fruit flies
	Without fruits	For personal use	INSPECT AND RELEASE
		Commercial	INSPECT 5% of all cut flower shipments

1 If you are unsure whether the articles are protected by CITES or ESA, or are from Federal noxious weeds or parasitic plants, refer to **Identification of Protected Plants and Genera of Taxa Regulated Higher Than Genus** in the *Reference* for directions about how to access GRIN and other databases.

2 These local specialists will consult with PPQ's Biological and Technical Services as decisions are made on a case-by-case basis.

Procedures

General Inspection Procedures for Clearing Fresh, Cut Articles

Step 2: Determine Whether to Inspect or Authorize Movement

Use [Table 2-5](#) to determine if you will authorize movement to another port staffed by CBP and equipped to complete the inspection.

TABLE 2-5: Residue Cargo Handling

If the cut flowers are:	And the other port is:	And the cut flowers are with:	Then:
Remaining on board a carrier that is destined to another port	Equipped to complete the inspection	Stems, leaves, or inflorescences only—never with fruits	1. STAMP the air waybill or bill of lading as SHIPMENT AUTHORIZED TO: 2. RELEASE the inbound manifest
		Botanical fruits	1. REQUIRE a transit permit under 7CFR 352 2. REFER to <i>Appendix A</i> , “Permits and Foreign Phytosanitary Certificates” on page A-1
	Not equipped to complete the inspection	—————→	1. INSPECT the shipment at the port of first arrival 2. GO to “Step 3: Check for Import Permit Requirements” on page 2-13
Removed at the first port of arrival	—————→	—————→	

Step 3: Check for Import Permit Requirements

Except where noted in the *Reference*, most cut flowers **do not** require an import permit.

Phytosanitary certificates may or may **not** be required. The Reference Section will alert you when certificates are required.

Specified cut flowers and greenery may be precleared when from Chile or Jamaica. Precleared shipments from these countries will be accompanied by a signed PPQ Form 203. Precleared shipments may be RELEASED without inspection.

REQUIRE a USDA-APHIS-PPQ issued Protected Plant Permit (formerly General Permit) for CITES or ESA regulated cut articles being imported by individuals or companies trading for gain or profit. If the importer lacks a General Permit when one is required, then the importer must apply for one. Importers apply for General Permits by completing PPQ Form 621, Application for General Permit to Engage in the Business of Importing, Exporting, or Reexporting Terrestrial Plants. Importers may call USDA-APHIS-PPQ Permit Services toll free at 1-877-770-5990 or go to the following web site address (follow the links for CITES and ESA):

[<http://www.aphis.usda.gov/ppq/permits>](http://www.aphis.usda.gov/ppq/permits)

If the importer has an import permit, then follow the instructions on the import permit. If the importer lacks an import permit when one is required, then the importer must apply for one with USDA-APHIS-PPQ Permit Services. Refer to *Appendix A*, “[Permits and Foreign Phytosanitary Certificates](#)” on **page A-1** for instructions and information on processing import permits.

Otherwise, proceed to “[Step 4: Identify the Level of Pest Risk](#)” on **page 2-14**.

Step 4: Identify the Level of Pest Risk

The level of pest risk helps determine the extent to which you should inspect cut flowers for significant pests. The pest risk level of cut flowers differs depending on the genera and where the cut flowers were grown. There are three levels of pest risk: **high**, **moderate**, and **low**. The levels are determined for genera of cut flowers based on previous imports and interceptions.

Cut flowers that are **high** risk or **low** risk are listed in [Table 2-6 on page 2-16](#), *Guide to the Pest Risk Level of Cut Flowers*. Cut flowers **not** listed in the guide are a **moderate** level of pest risk. The guide is **only** an aid in determining the thoroughness of inspection. Inspect all non-precleared shipments of cut flowers regardless of whether they are high risk, moderate risk, or low risk. Low risk flowers entering under the Cut Flower Release Program will be inspected using the schedule established for those flowers (see “[Protocol for The National Cut Flower Release Program](#)” on [page 2-28](#)). Also, inspection techniques and sampling rates are the same for domestic products entering as foreign origin moving from Hawaii and Puerto Rico to the mainland.

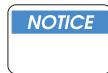

If you feel that the level of pest risk in the guide is either excessive or too lenient for a particular kind of flower from a specific country or region of the world, then notify USDA-APHIS-PPQ through proper channels. PPQ periodically reevaluates the levels of pest risk and makes appropriate changes based on new interceptions, field input, or other pest information.

Using [Table 2-6 on page 2-16](#) and follow these steps to identify the level of pest risk:

1. Consider **all** cut flowers, garlands, wreaths, and greenery from Australia, Ireland, New Caledonia, New Zealand, and the United Kingdom as high risk. These countries are **high risk** because of their being infested with the the light brown apple moth (*Epiphyas postvittana*).
2. If the articles came from **other than** Australia, Ireland, New Caledonia, New Zealand, or the United Kingdom, then look up the genus name of the cut flower in [Table 2-6 on page 2-16](#). The genera are listed in alphabetical order, down the left column. All genera are **not** listed. If the genus is **not** listed, then the level of pest risk is moderate.

3. Identify the country where the flowers were grown. The foreign phytosanitary certificate may list the country of origin next to the flower entry. The boxes or containers may also contain markings that identify the country of origin.
4. Once you find the genus listed, then look in the center column for the country where the flowers were grown. If the country is **not** listed, then the level of pest risk is moderate.
5. Identify the level of pest risk listed in the right column next to the cut flower and country entries.
6. Make a note next to the flower entry on the invoice or the foreign phytosanitary certificate as to the inspection level—high, moderate, or low.
7. Go to [“Step 5: Determine the Sample Size” on page 2-21](#), and continue with your inspection.

Procedures

General Inspection Procedures for Clearing Fresh, Cut Articles

TABLE 2-6: Guide to the Pest Risk Level of Cut Flowers

If the cut flowers are:	And the country or region where the flowers were grown is:	Then identify the pest risk level as:
<i>Achillea</i> (yarrow)	Netherlands	Low
<i>Alstroemeria</i> (Peruvian lily)	Eastern Hemisphere (Africa, Asia, Australia, Europe)	High
	Ecuador	Low
<i>Amaryllis</i> (belladonna)	Netherlands	Low
	South Africa	Low
<i>Anemone</i> (windflower)	Israel	Low
	Netherlands	Low
<i>Anthurium</i> (tailflower)	Colombia	Low
	Costa Rica	Low
	Jamaica	Low
<i>Antirrhinum</i> (snapdragon)	Colombia	Low
<i>Aster</i> (aster)	Colombia	High
	Costa Rica	Low
	Dominica Republic	Low
<i>Brodiaea</i> (= <i>Triteleia</i> , = <i>Ipheion</i>) (spring starflower)	Netherlands	High
<i>Centaurea</i> (cornflower)	Netherlands	Low
<i>Chamaelaucium</i> (waxflower)	Israel	High
<i>Chrysanthemum</i> (mum) ¹	Africa	High
	Colombia	High
	Chile	High
	Dominican Republic	Low
	Ecuador	High
	Europe	High

TABLE 2-6: Guide to the Pest Risk Level of Cut Flowers (continued)

If the cut flowers are:	And the country or region where the flowers were grown is:	Then identify the pest risk level as:
<i>Crocasmia</i> (autumn gold, garden montbretia)	All countries	High
<i>Cytisus</i> (scotch broom)	Italy	High
<i>Delphinium</i> (= <i>Consolida</i>) (larkspur)	Netherlands	High
<i>Dianthus</i> (carnation, pinks)	Chile	Low
	Costa Rica	Low
	Dominican Republic	Low
	Guatemala	Low
	Panama	Low
	Peru	Low
<i>Eryngium</i> (button snake-root, sea holly, spirit weed)	Netherlands	High
<i>Euphorbia</i> (spurge, poinsettia)	Netherlands	Low
<i>Eustoma grandiflora</i> (<i>Lisianthus</i>)	Colombia	Low
	Ecuador	Low
<i>Forsythia</i> (golden-bells)	Netherlands	Low
<i>Freesia</i>	Colombia	Low
	Netherlands	Low
<i>Gerbera</i> (Transvaal daisy, Barberton daisy)	Costa Rica	Low
	Ecuador	Low
	Israel	Low
<i>Gladiolus</i> (sword lily)	All countries	High
<i>Gloriosa</i> (glory lily)	Netherlands	Low
<i>Gypsophila</i> (baby's-breath)	Colombia	Low
	Eastern Hemisphere (Africa, Asia, Australia, Europe)	High

Procedures

General Inspection Procedures for Clearing Fresh, Cut Articles

TABLE 2-6: Guide to the Pest Risk Level of Cut Flowers (continued)

If the cut flowers are:	And the country or region where the flowers were grown is:	Then identify the pest risk level as:
<i>Hippeastrum</i>	Netherlands	Low
	South Africa	Low
<i>Hyacinthus</i> (hyacinth)	Netherlands	Low
<i>Hypericum</i> (St. John's wort)	All countries	High
<i>Ixia</i> (African corn lily)	Netherlands	Low
<i>Liatrix</i> (blazing star, button snakeroot, gay-feather)	Dominican Republic	Low
	Ecuador	Low
	Netherlands	High
<i>Lilium</i> (lily)	Colombia	Low
	Costa Rica	Low
	Dominican Republic	Low
	Ecuador	Low
	New Zealand	Low
	South Africa	Low
<i>Limonium</i> (sea lavender, statice)	Ecuador	Low
<i>Montbretia</i> (= <i>Tritonia</i>)	Netherlands	Low
<i>Muscari</i> (grape-hyacinth)	Netherlands	Low
<i>Narcissus</i> (daffodil)	Great Britain	Low
	Israel	Low
	Netherlands	Low
<i>Nerine</i> (Guernsey lily)	Netherlands	Low

TABLE 2-6: Guide to the Pest Risk Level of Cut Flowers (continued)

If the cut flowers are:	And the country or region where the flowers were grown is:	Then identify the pest risk level as:
Orchid	Australia	Low
	Netherlands	Low
	New Zealand	Low
	Singapore	High
	Thailand	High
<i>Ornithogalum</i> (chincerinchee, star-of-Bethlehem)	Colombia	Low
	Netherlands	Low
<i>Physostegia</i> (false dragonhead, obedient plant)	Netherlands	High
<i>Ranunculus</i> (Persian buttercup)	Israel	Low
<i>Rosa</i> (rose) ²	Bolivia	Low
	Chile	Low
	Colombia	Low
	Costa Rica	Low
	Dominican Republic	Low
	Ecuador	Low
	Panama	Low
	Peru	Low
Rose Bouquets ³	Colombia	Low
	Costa Rica	Low
	Ecuador	Low
	Guatemala	Low
<i>Rudbeckia</i> (coneflower, black-eyed Susan)	Netherlands	High
<i>Ruscus</i> (butcher's broom, box holly)	Israel	Low
<i>Scabiosa</i> (scabious, pincushion flower)	Netherlands	High
<i>Spiraea</i> (spirea, bridal-wreath)	Netherlands	High

Procedures

General Inspection Procedures for Clearing Fresh, Cut Articles

TABLE 2-6: Guide to the Pest Risk Level of Cut Flowers (continued)

If the cut flowers are:	And the country or region where the flowers were grown is:	Then identify the pest risk level as:
<i>Strelitzia</i> (bird of paradise)	Costa Rica	Low
	Guatemala	Low
<i>Triteleia</i> (= <i>Brodiaea</i>)	Netherlands	Low
<i>Tritonia</i> (= <i>Montbretia</i>) (blazing star)	All countries	High
<i>Tulipa</i> (tulip)	Netherlands	Low
<i>Zantedeschia</i> (arum lily, calla)	Colombia	Low
	Netherlands	Low
	New Zealand	Low

- 1 Carefully inspect for Chrysanthemum White Rust. Look on the upper and lower surface of leaves and flower bracts for whitish or yellowish- to light-green (water-soaked) lesions (early symptoms). Also look on the underside of leaves, flower bracts, and along the stem for whitish- to caramel-colored raised, velvety pustules (infectious spores).
- 2 If inspecting *Rosa* spp. in Puerto Rico, then assign a moderate risk level. If *Phragmidium* is found, then HOLD the shipment and CONTACT a PPQ officer through proper channels.
- 3 If 75 percent of the stems in a bouquet are roses (excluding greenery), then identify the bouquet as a Rose Bouquet.

Step 5: Determine the Sample Size

To determine the sample size, do as follows:

1. Use [Table 2-7 on page 2-22](#) and [Table 2-8 on page 2-23](#) to determine what constitutes an inspectional unit.
2. Use [Table 2-9 on page 2-23](#) to determine the sample size. A sample size is how many boxes you should open and how many flowers you should examine from each inspectional unit. This table is **only** a guide. If any of the following situations present themselves, then increase the number of boxes to open or the amount of flowers to examine:
 - A. Shipment has been transshipped (pest risk increases because of the possibility of infestation at the transshipment point)
 - B. Symptoms or signs of pests are found in the sample
 - C. Time of year alerts you to seasonal pests
 - D. Recent pest findings indicate a higher level of pest risk than listed in the guide to the level of pest risk (see [Table 2-6 on page 2-16](#))

Procedures

General Inspection Procedures for Clearing Fresh, Cut Articles

TABLE 2-7: Determine the Inspectional Unit

If there:	And are imported by:	And the cut articles are:	And the boxes contain:	Then:
Is one bill of lading		→	Same genus ²	1. CONSIDER all the boxes as one inspectional unit 2. GO to Table 2-9 on page 2-23
			Different genera	GO to Table 2-8 on page 2-23
Are two or more bills of lading ¹	One consignee	Certain to have been grown at the same location that can be identified	Same genus	1. CONSIDER all the boxes as one inspectional unit 2. GO to Table 2-9 on page 2-23
			Different genera	GO to Table 2-8 on page 2-23
		Uncertain to have been grown at the same location (the grower cannot be identified)	Different genera	1. CONSIDER those boxes on the one bill of lading as one inspectional unit 2. GO to Table 2-9 on page 2-23
	Same genus ²			
	More than one consignee	Uncertain to have been grown at the same location (the grower cannot be identified)	Same genus ²	1. CONSIDER all the boxes on one bill of lading as one inspectional unit 2. GO to Table 2-9 on page 2-23
			Different genera	GO to Table 2-8 on page 2-23
Certain to have been grown at the same location that can be identified		Different genera	1. If operationally feasible, then CONSIDER all boxes as one unit. If not , then CONSIDER the boxes on one bill of lading as one inspection unit 2. GO to Table 2-9 on page 2-23	
Same genus				

- 1 Includes a bill of lading for one consignee and a house air waybill for one consignee; **does not** include a consolidated air waybill.
- 2 Flowers of the same genus that appear to be grown at different locations or under different conditions may be considered as a separate inspectional unit

TABLE 2-8: Determine the Inspectional Unit For Shipments That Have Different Genera

If the boxes contain:	And each box contains:	Then consider all boxes:
One genus per box	—————→	CONSIDER all boxes containing the same genus as one inspectional unit (one inspectional unit for each genus)
Mixed flowers (more than one genus per box)	Same mixture	CONSIDER all boxes one inspectional unit
	Different mixtures	CONSIDER all boxes containing common contents (genera) grouped into one inspectional unit

TABLE 2-9: Determine the Sample Size of Each Inspectional Unit

If the boxes contain:	And the pest risk level is:	And the number of boxes is:	Then:	
One genus per box	High	—————→	<ol style="list-style-type: none"> 1. OPEN and EXAMINE at least two boxes of each genus 2. INSPECT 100 percent of the contents 3. GO to “Step 6: Inspect the Cut Flowers and Foliage” on page 2-24 	
	Moderate	—————→	<ol style="list-style-type: none"> 1. OPEN and EXAMINE at least one box of each genus 2. INSPECT 100 percent of the contents 3. GO to “Step 6: Inspect the Cut Flowers and Foliage” on page 2-24 	
	Low		Less than 50	<ol style="list-style-type: none"> 1. OPEN and EXAMINE at least one box of each genus 2. INSPECT between 25 and 50 percent of the contents 3. GO to “Step 6: Inspect the Cut Flowers and Foliage” on page 2-24
			50 or more	<ol style="list-style-type: none"> 1. OPEN and EXAMINE at least one box of each genus 2. INSPECT 100 percent of the contents 3. GO to “Step 6: Inspect the Cut Flowers and Foliage” on page 2-24
Two or more genera per box		—————→	<ol style="list-style-type: none"> 1. OPEN and EXAMINE enough boxes to inspect two bunches of each genus, placing emphasis on those flowers of high risk and moderate risk 2. GO to “Step 6: Inspect the Cut Flowers and Foliage” on page 2-24 	

Step 6: Inspect the Cut Flowers and Foliage

Follow these steps to inspect the cut flowers and foliage:

1. Put on gloves (plastic or rubber) before handling the flowers or foliage to protect yourself against articles that have been treated with a pesticide.



Take appropriate cautions as fresh, cut flowers and foliage may have pesticide residue. Check accompanying documents, container markings and labels to learn if the contents were treated. If you detect a chemical odor, then suspect that the contents were treated.

2. Tell the importer or importer's representative which boxes or containers they need to pull out of the shipment, open for inspection, and aerate if treated.
3. Prepare the stems or bunches of flowers and foliage for inspection. The techniques used differ for articles packed in bunches than for those packed as loose stems. Usually loose stems are of a lower risk than those tied in bunches. See [Table 2-10 on page 2-25](#).
4. Examine the flowers and foliage by selectively:
 - A. Spreading apart inflorescences (petals of the flowers)
 - B. Opening the calyx at the base of the flower
 - C. Breaking apart bracteal heads (leaf-like plant part at the base of the flowers)
 - D. Cutting open stems
5. Look for the following:
 - A. Freedom from roots and soil. If roots are attached to fresh, cut articles as sometimes occurs with lily-of-the-valley, then regulate them as if they were intended for planting or growing. When it is practical, give the importer the option of cutting off the roots and entering the cut articles under 7CFR 319.74. Otherwise, HOLD the shipment and CONTACT a PPQ officer through proper channels.
 - B. Presence of fruits. If fruits are present, follow [Table 2-11 on page 2-26](#).
 - C. Packing material. Have unauthorized material removed and destroyed.
 - D. Pests. When found, use [Table 2-12 on page 2-27](#) to determine the quarantine action to take.



Carefully but thoroughly inspect flowers that are delicately packed.

- i. Shake or tap each flower or bunch while holding over the inspection surface. Tap with enough force to dislodge any crawling insect larvae, adult flying insects that cling to the article, or fecal material.
 - ii. Closely examine the inspection surface to catch the smaller pests such as thrips, aphids, and early instar larvae. Look for anything that moves and fecal material that may have been dislodged.
- 6. Examine the leaves and stems for the following:
 - A. Signs of feeding (discolored tunneling in the leaves made by insects that feed internally)
 - B. Symptoms of diseases (discolored sections, rust, or black spots)
 - C. Snails, larvae, and/or insects
- 7. Inspect the bottom of the box for larvae, insects, snails, or evidence of these pests.
- 8. Once you complete the inspection, then appropriately discard the gloves. Wash your hands with soap and water.
- 9. If the shipment shows evidence of having been treated but was **not** so marked, then mark the documents and container to alert others who may handle the shipment.
- 10. GO to “[Step 7: Take Regulatory Actions Based on Inspection Results](#)” on [page 2-27](#).

TABLE 2-10: Preparation of Cut Flowers for Inspection

If the cut articles are packed as:	Then:
Bunches	1. REMOVE the bunches one at a time from the box 2. If the bunches are individually wrapped, then: <ul style="list-style-type: none"> a. TAKE off an end or side of the wrapping b. REMOVE the wrapping over the inspection surface 3. CUT strings or bands to free the leaves and flowers
Loose stems	1. If the articles have a high-level of pest risk, then REMOVE all the stems from the box 2. If the articles have a low- or moderate-level of pest risk, then: <ul style="list-style-type: none"> a. REMOVE only the first layer of articles from the box b. INSPECT the remaining flowers in the box

Procedures

General Inspection Procedures for Clearing Fresh, Cut Articles

TABLE 2-11: Action to Take When Inspecting Cut Flowers for Presence of Fruits

If fruits are:	And the genus:	Then:
Present	Was listed in the <i>Reference</i> as admissible with fruits (for example <i>Ilex</i> spp. from Canada)	CONTINUE with your inspection
	Was not listed in the <i>Reference</i> as admissible with fruits	PROHIBIT ENTRY (such fruits may be hosts to fruit flies)
Absent		CONTINUE with your inspection

Step 7: Take Regulatory Actions Based on Inspection Results

To determine the action to take based on pest findings, then do as follows:

1. If you find pests (insects, mollusks, pathogens; then HOLD the shipment and SEND the interception for identification to the nearest PPQ Plant Inspection Station through proper channels. If you find contaminants (inadmissible plant parts, plant debris, soil), then HOLD the shipment and REQUIRE removal and disposal of contaminant or PROHIBIT ENTRY.
2. CONSULT with PPQ to decide the regulatory action to take based on pest findings and whether the pests can be destroyed by an effective and authorized treatment. Provide the importer or broker with the following options:
 - A. Treat the inspectional unit under PPQ monitoring
 - B. Destroy the inspectional unit under CBP supervision at the owner's expense
 - C. Reexport the inspectional unit under proper safeguarding measures
3. When quarantine significant pests are found, then use [Table 2-12 on page 2-27](#) to determine the inspectional unit that requires quarantine action.

TABLE 2-12: Quarantine Action to Take Based on Pest Findings

If pests are found in an inspectional unit containing:	And the pests found are:	Then:
Same genus in all the boxes	—————→	TAKE quarantine action on the whole inspection unit
Mixed varieties and genera with more than one genus per box	On or closely associated with one genus of cut articles (scale, insects, leafminers, or pathogens)	TAKE quarantine action on all the boxes containing the same genus that are found infested or infected
	Not on or closely associated with one genus of cut articles (mobile pests such as lepidopteras, thrips, and snails)	TAKE quarantine action on the whole inspectional unit

Protocol for The National Cut Flower Release Program

Use these special procedures for clearing commercial shipments of cut flowers that are imported under the protocol of the National Cut Flower Release Program (Release Program).

Purpose

The purpose of the Release Program is to use pest risk analysis in processing agricultural cargo more effectively and efficiently by expediting the release of high volume, low risk cut flowers.

Participating Ports

The following ports of entry are participating in the Release Program:

- ◆ Atlanta, Georgia
- ◆ Chicago, Illinois
- ◆ Houston, Texas
- ◆ JFK, New York
- ◆ Los Angeles, California
- ◆ Miami, Florida
- ◆ Port Hueneme, California
- ◆ San Juan, Puerto Rico

Flower/Country Combinations Eligible for Release

Figure 2-3 identifies the combinations of flower type and country of origin that are eligible for release.

Flower Type:	Country of Origin:
<i>Alstroemeria</i> spp. (Peruvian lily) Liliaceae	Ecuador
<i>Dianthus</i> spp. (carnation) Caryophyllaceae	Guatemala
<i>Gerbera</i> spp. (transvaal daisy) Asteraceae	Costa Rica, Ecuador
<i>Liatis</i> spp. (blazing star) Asteraceae	Dominican Republic, Ecuador
<i>Lilium</i> spp. (lily) Liliaceae	Colombia, Costa Rica, Dominican Republic, Ecuador
<i>Limonium</i> spp. (sea lavender) Plumbaginaceae	Ecuador
<i>Lisianthus</i> spp. (<i>Eustoma</i> spp.)	Ecuador
<i>Rosa</i> spp., Rosaceae	Colombia, Costa Rica, Ecuador
Rose bouquets ¹	Colombia, Costa Rica, Ecuador
<i>Zantedeschia</i> spp. (calla lily) Araceae	Colombia, Costa Rica, Ecuador

FIGURE 2-3: Flower and Country of Origin Combinations Eligible for Release

1 Any bouquet that 75 percent of the stems in the bouquet, excluding greenery, are *Rosa* spp.

Limitations

Only commercial shipments of the cut flowers from the countries of origin listed in [Figure 2-3 on page 2-28](#) are eligible for release under the protocol of the Release Program.

Procedures

Regulatory officials working at the participating ports of entry will follow these procedures when clearing commercial shipments of the cut flowers from the countries of origin that are listed in [Figure 2-3 on page 2-28](#) as eligible for release.

1. Use [Table 2-13](#) to determine eligibility for cut flower release. All commercial importations of the cut flowers from the countries of origin are inspected on randomly selected days each month.

TABLE 2-13: Determining Eligibility for Cut Flower Release

If the flower/country combination is:	Then:
Selected as the flower of the day	INSPECT the entire contents of one box of each flower/country combination from each grower
Not selected as the flower of the day	<ol style="list-style-type: none"> 1. RELEASE without inspection 2. GO to “Documentation” on page 2-30

2. USDA-APHIS-PPQ Headquarters will provide an annual schedule to CBP agricultural specialists detailing which, if any, flower/country combinations will be inspected each day.
3. Local operations desk will advise the warehouse, airline, or importer which low risk flower type (flower of the day), if any, will be inspected on that particular day.
4. If all flowers appearing on the air waybill or bill of lading can be released without inspection, the importer may do one of the following:
 - A. Present all required paperwork at the operations desk for release, or
 - B. Present the required paperwork to the CBP agricultural specialist at the warehouse or airline for release.
5. The local port is responsible for keeping USDA-APHIS-PPQ Headquarters advised of significant findings associated with flowers on the Release Program. CBP is responsible for notifying USDA-APHIS-PPQ Headquarters of smuggling of flowers or other prohibited agricultural commodities associated with flowers on the Release Program. USDA-APHIS-PPQ identifiers are responsible for notifying USDA-APHIS-PPQ Headquarters of any significant pest findings associated with flowers on the Release Program.

Documentation

If a flower/country combination eligible for release is not selected as the flower of the day, stamp the paperwork RELEASED UNDER THE CUT FLOWER RELEASE PROGRAM. Record the number of stems and/or boxes of all cut flower types imported under the Release Program must be entered in the PPQ Form 280 database using appropriate codes for the Cargo Release Program. These codes will be either IRBC or REBC. Consult the 280 User Guide for definitions of these codes.

Adding or Deleting Flowers Eligible for Release and Program Review

The risks associated with the importation of cut flowers are subject to change for a variety of reasons such as:

- ◆ The volume of flowers fluctuates annually
- ◆ The number and species of pests intercepted and population levels in growing areas are subject to change

For these reasons, the Release Program will be reviewed annually. The Release Program will also be subject to further evaluation as problems, i.e., significant pest findings or incidents of smuggling, etc., occur.

3

Cut Flowers and
Greenery

Reference

Contents

Introduction **page 3-1**

Precleared Flowers and Greenery **page 3-3**

Chile **page 3-3**

Jamaica **page 3-4**

Identification of Protected Plants and Genera of Taxa Regulated Higher Than Genus
page 3-4

Reference Tables **page 3-5**

Introduction

When all the available information is gathered, then determine the admissibility of the fresh, cut article by finding any prohibitions or restrictions that apply. Some cut flowers are **not** listed in the Reference Section. If such is the case, use the table that follows.

If you are:	And the stem was cut in:	And the consignment is:	And there is:	Then:
Sure the plant is not an endangered species, nor a noxious weed, nor a parasitic plant	Canada	—————→	—————→	INSPECT AND RELEASE regardless of whether there is fruit attached to the articles
	New Zealand	Accompanied by phytosanitary certification with the additional declaration “The cut flowers/garlands/wreaths/greenery in this shipment have been inspected and found free of all life stages of <i>Epiphyas postvittana</i> .”	—————→	
		Lacks the above certification	—————→	PROHIBIT ENTRY ¹
	Australia, Ireland, New Caledonia, or the United Kingdom	Accompanied by phytosanitary certification with the additional declaration “The cut flowers/garlands/wreaths/greenery in this shipment have been inspected and found free of all life stages of <i>Epiphyas postvittana</i> .”	Fruit (including capsules and pods) is attached to the cut article	PROHIBIT ENTRY to prevent the establishment of fruit flies
			No fruit is attached to the article	INSPECT AND RELEASE
			Lacks the above certification	—————→
	A country other than one listed in the cells above	—————→	Fruit (including capsules and pods) is attached to the cut article	PROHIBIT ENTRY to prevent the establishment of fruit flies
			No fruit is attached to the article	INSPECT AND RELEASE
Unsure whether the plant fits in one of the categories listed in the cell above	—————→	—————→	—————→	SEE the “List of Regulated Propagative Material” in the Nursery Stock Restrictions that lists protected plants, noxious weeds, and parasitic plants

1 Your authority to prohibit is emergency measures effective August 4, 2008.

In this reference, most entries are by genus. Infrequently, higher taxa are used (Bambusaceae, Coniferae, Loranthaceae, Poaceae, Proteaceae, and Rutaceae). Common names and groups of plants listed by taxa higher than genus (except Poaceae) are cross-referenced in the Index. The decision tables include:

- ◆ Prohibition or restriction to be met
- ◆ Action to be taken
- ◆ Authority for the action

Prohibited plant material may be imported for research or experimental purposes under a Departmental permit issued by Permit Services in Riverdale. Plant pests, including noxious weeds, may also be imported for research or experimental purposes under a “Permit to Move Live Plant Pests and Noxious Weeds” issued by Permit Services of the Biological & Technical Services in Riverdale. Go to http://www.aphis.usda.gov/plant_health/permits/index.shtml for directions on handling material moving under **other than** plant pest permits.

Applicability to Guam and the CNMI

The regulatory actions listed in the following decision tables also apply to Guam and the Commonwealth of the Northern Mariana Islands.

Precleared Flowers and Greenery

This topic includes information about certain cut flowers that have been approved for preclearance from Chile and Jamaica, external databases used to identify protected plants and genera of taxa regulated higher than genus, and decision tables that provide the regulatory action to take on importations of fresh, cut articles.

Cut flowers and greenery have been approved for preclearance in Chile. Such shipments will be accompanied by a PPQ Form 203 endorsed by APHIS inspectors there.



Not all shipments will be precleared.

Chile

All cut flowers and greenery admissible into the United States are approved for preclearance from Chile.

Reference

Identification of Protected Plants and Genera of Taxa Regulated Higher Than Genus

Jamaica

The flowers and greenery approved for USDA preclearance in Jamaica are as follows:

- ◆ *Alpinia purpurata* (red ginger) Zingiberaceae
- ◆ *Anthurium* spp. (anthurium) Araceae
- ◆ *Codiaeum variegatum* (croton leaves) Euphorbiaceae
- ◆ *Cordyline terminalis* (ti leaves) Liliaceae
- ◆ *Cyperus* spp. (papyrus) Cyperaceae
- ◆ *Dracaena* spp. (dracaena) Liliaceae
- ◆ *Gerbera* spp. (gerbera) Asteraceae
- ◆ *Gladiolus* spp. (gladiolus) Iridaceae
- ◆ *Heliconia* spp. (heliconia) Heliconiaceae
- ◆ Orchidaceae family (orchid)
- ◆ *Pandanus* spp. (pandanus) Pandanaceae
- ◆ *Phaeomeria* (= *Nicolaia*) *speciosa* (torch ginger) Zingiberaceae
- ◆ *Rosa* spp. (rose) Rosaceae
- ◆ *Rumohra adiantiformis* (leather leaf fern) Dryopteridaceae
- ◆ *Strelitzia reginae* (bird-of-paradise) Strelitziaceae

Identification of Protected Plants and Genera of Taxa Regulated Higher Than Genus

Infrequently, higher taxa are used in the *Reference*, such as Bambusoideae, Loranthaceae, Pinaceae, Poaceae, Proteaceae, and Rutaceae. Therefore, if you are unsure whether the cut articles are:

- ◆ Protected by CITES or ESA, are Federal noxious weeds or parasitic plants
- ◆ Regulated by taxa higher than genus (as the family, subfamily, and tribe)

Access external databases in the following order:

1. GRIN (a taxonomic database that also identifies CITES-listed plants, ESA-listed plants, and Federal noxious weeds)
<<http://www.ars-grin.gov/npgs/tax/>>
2. Parasitic plant database
<http://www.omnisterra.com/bot/pp_home.cgi>

3. CITES database
<<http://www.cites.org/eng/resources/species.html>>
4. Federal noxious weed list
<<http://www.aphis.usda.gov/ppq/permits/fnwsbycat-e.PDF>>
5. List of plants protected by ESA
<http://ecos.fws.gov/tess_public/TESSWebpage>

Reference Tables

The reference tables are listed alphabetically by genus, family, or subfamily and include restrictions to be met, regulatory actions to take, and authorities for the regulatory actions. The regulatory actions also apply to fresh, cut articles arriving from Guam and Northern Mariana Islands.

After collecting and reviewing the documents accompanying a shipment, then determine the admissibility of each kind of cut article using the reference tables. (Refer to “[Step 1: Determine if Articles Are Admissible, Precleared, or Prohibited](#)” on [page 2-9](#) in the *Procedures* chapter of this manual.) Some cut articles are **not** listed in the reference tables. If the article is **not** listed, then use [Table 2-4 on page 2-11](#) of the *Procedures* chapter to determine admissibility.

Prohibited plant material may be imported for research or experimental purposes **only** under a Departmental permit issued by PPQ’s Permit Services. Plant pests, including noxious weeds, may be imported for research or experimental purposes **only** under a PPQ Form 526, Application to Move Live Plant Pests and Noxious Weeds, that has been validated by PPQ’s Permit Services. (See [Appendix A, “Permits and Foreign Phytosanitary Certificates” on page A-1.](#))

**A Special Note
on Articles from
Countries
Infested with
the Light Brown
Apple Moth
(*Epiphyas
postvittana*)**

- ◆ All cut flowers, garlands, wreaths, and greenery arriving from Australia, Ireland, New Caledonia, and the United Kingdom must be accompanied by a phytosanitary certificate with the additional declaration “The cut flowers/garlands/wreaths/greenery in this shipment have been inspected and found free of all life stages of *Epiphyas postvittana*.” PROHIBIT ENTRY to consignments **lacking** this certification. Your authority to prohibit entry is emergency measures effective August 4, 2008.
- ◆ Phytosanitary certificates issued on or after November 1, 2008 for cut flowers, garlands, wreaths, and greenery arriving from **New Zealand** must have one of the following Additional Declarations (AD):
 - ❖ “The flowers were grown in greenhouses or screenhouses inspected and found free of light brown apple moth (*Epiphyas postvittana*) and the consignment was inspected and found free of LBAM, **or**
 - ❖ “The cut flowers/greenery in this shipment were produced under the MAF BNZ Exports Phytosanitary Compliance Program for light brown apple moth for the export of cut flowers and foliage to the United States.”

Aegilops spp. (goatgrass) Poaceae

Use **Table 3-1** to regulate fresh, cut articles of *Aegilops* spp. and its intergeneric crosses.

If the articles are dried, then GO to the *Miscellaneous and Processed Products Import Manual*.

TABLE 3-1: Aegilops spp. and Its Intergeneric Crosses (goatgrass) Poaceae

If grown in:	Then:	Authority:
Afghanistan, Algeria, Armenia, Australia, Azerbaijan, Bangladesh, Belarus, Bulgaria, Chile, China, Cyprus, Egypt, Estonia, Falkland Islands, Georgia, Greece, Guatemala, Hungary, India, Iran, Iraq, Israel, Italy, Japan, Kazakhstan, Korea (Republic of and Democratic People’s Republic of), Kyrgyzstan, Latvia, Libya, Lithuania, Mexico, Moldova, Morocco, Nepal, Oman, Pakistan, Portugal, Romania, Russia, South Africa, Spain, Tajikistan, Tanzania, Tunisia, Turkmenistan, Turkey, Ukraine, Uzbekistan, or Venezuela	PROHIBIT ENTRY	7CFR 319.59
Canada	INSPECT and RELEASE	7CFR 330.105
Country other than listed above	PROHIBIT ENTRY	7CFR 319.37

Reference

Reference Tables

***Ajania pacifica* (yellow splash) Asteraceae**

Ajania pacifica is a monotypic genus. Use **Table 3-2** to regulate fresh, cut articles of *Ajania pacifica*.

TABLE 3-2: *Ajania pacifica*—a monotypic genus (yellow splash) Asteraceae

If the flowers were harvested in:	And the consignment is:	And:	Then:	Authority:
Andorra, Argentina, Australia, Austria, Belarus, Belgium, Bosnia and Herzegovina, Brazil, Brunei, Bulgaria, Canary Islands, Chile, China, Colombia, Croatia, Cyprus, Czech Republic, Denmark, Ecuador, Estonia, Finland, France, Germany, Greece, Hungary, Iceland, Ireland, Italy, Japan, Korea, Latvia, Liechtenstein, Lithuania, Luxembourg, Macedonia, Malaysia, Malta, Mexico, Moldova, Monaco, New Zealand, Norway, Peru, Poland, Portugal, Republic of South Africa, Romania, Russia, San Marino, Slovakia, Slovenia, Spain, Sweden, Switzerland, Taiwan, Thailand, Tunisia, Ukraine, United Kingdom, Uruguay, Venezuela, Yugoslavia and all countries, territories, and possessions of countries located in part or entirely between 90° and 180° East longitude	Accompanied by a phytosanitary certificate or equivalent documentation ¹ , issued by the National Plant Protection Organization of the country of origin or its designee, that contains an additional declaration stating that “The place of production as well as the consignment have been inspected and found free of <i>Puccinia horiana</i> ²	The box labels and other documents accompanying consignments of cut flowers must be marked with the identity of the registered production site.	INSPECT AND RELEASE	7CFR 330.105 7CFR 319.74
		The identification information described above is absent	PROHIBIT ENTRY	
Netherlands ³	Lacking either the certificate or the certification specified in the cell above	→		
		→		
Other than a country listed in the cells above		→	INSPECT AND RELEASE	

- 1 Documentation may be written in Spanish. A legible photocopy, facsimile, or scanned copy of an original phytosanitary certificate is acceptable.
- 2 Statement does **not** need to be word-for-word but must indicate that both production site and the consignment have been inspected and found free of *Puccinia horiana*.
- 3 The Netherlands has been suspended from the program. When the suspension is lifted, you will be notified in ample time.

Ananas spp. (pineapple) Bromeliaceae

Fruits of *Ananas* spp. are regulated to prevent the entry of exotic fruit flies. Use [Table 3-3](#) to regulate fresh, cut articles of *Ananas* spp.

TABLE 3-3: *Ananas* spp. (pineapple) Bromeliaceae

If entering:	And with:	And grown in:	Then:	Authority:
State or territory other than Hawaii	Botanical fruits	Algeria, Angola, Antigua and Barbuda, Argentina, Bahamas, Barbados, Belize, Bolivia, Brazil, Burkina Faso, Cayman Islands, Chile, China, Colombia, Congo, Costa Rica, Côte d'Ivoire, Dominica, Dominican Republic, Ecuador, Egypt, El Salvador, Fiji, French Guiana, French Polynesia, Ghana, Grenada, Guadalupe, Guatemala, Guinea, Guyana, Haiti, Honduras, Italy, Jamaica, Kenya, Liberia, Mali, Martinique, Mauritania, Mexico, Montserrat, Morocco, The Netherlands Antilles, Nicaragua, Niger, Nigeria, Panama, Paraguay, Peru, Portugal, Saint Kitts and Nevis, Saint Lucia, Saint Vincent and the Grenadines, Senegal, Sierra Leone, South Africa, Spain, Sri Lanka, Trinidad and Tobago, Tunisia, Turkey, Uruguay, and Venezuela	1. REQUIRE an import permit ¹ 2. INSPECT and RELEASE	7CFR 319.56
		New Zealand	INSPECT and RELEASE	7CFR 319.74
		Country other than listed above	PROHIBIT ENTRY	7CFR 319.56
	Stems, leaves, or inflorescences only—never with fruits		INSPECT and RELEASE	7CFR 319.74
Hawaii			PROHIBIT ENTRY	7CFR 319.56

- 1 If the importer lacks an import permit and the shipment is noncommercial that can be inspected 100 percent, then the permit requirement may be waived. Otherwise, HOLD the shipment and direct the importer to apply for a permit. Refer to *Appendix A*, “Permits and Foreign Phytosanitary Certificates” on [page A-1](#) for instructions and information about permits.

Reference

Reference Tables

Arecaceae (alt. Palmae) (palms)

Arecaceae is a family that includes all genera and species of palms. A list of all genera and species of Arecaceae is provided in the GRIN database. For directions for how to access GRIN and other related databases, see “Identification of Protected Plants and Genera of Taxa Regulated Higher Than Genus” on page 3-4.

Use Table 3-4 to regulate palm leaves and fronds.

TABLE 3-4: Arecaceae (palm leaves and fronds)

If the taxa is:	And are:	And are:	Then:	Authority:
<i>Chamaedorea</i> spp.			GO to “ <i>Chamaedorea</i> spp. (palm fronds) Arecaceae” on page 3-16	
<i>Phoenix</i> spp.			GO to “ <i>Phoenix</i> spp. (date palm) Arecaceae” on page 3-53	
Listed in CITES Appendix I or II, includes the following genera: <ul style="list-style-type: none"> ◆ <i>Beccariophoenix madagascariensis</i> (II) ◆ <i>Chrysalidocarpus decipiens</i> (I) ◆ <i>Lemurophoenix halleuxii</i> (II) ◆ <i>Marojejya darianii</i> (II) ◆ <i>Neodypsis decaryi</i> (II) ◆ <i>Ravenea louvelii</i> (II) ◆ <i>Ravenea rivularis</i> (II) ◆ <i>Satranala decussilvae</i> (II) ◆ <i>Voanioala gerardii</i> (II) 	Entering at a CITES designated port ¹		<ol style="list-style-type: none"> 1. REGULATE as CITES Appendix I or II as appropriate 2. REQUIRE a valid <ul style="list-style-type: none"> ◆ CITES export permit from the country of export and; ◆ A Protected Plant Permit (formerly General Permit which is still valid until expired) from USDA APHIS 	7CFR 355 50CFR 23
	Not entering at a CITES designated port	Accompanied by CITES documents	<ol style="list-style-type: none"> 1. SAFEGUARD under plant quarantines and plant pest regulations 2. GIVE the importer one of the following options: <ul style="list-style-type: none"> Re-export the articles to the country of origin Reroute the articles to a CITES designated port <p>NOTE: Shipping and handling charges are the responsibility of the importer.</p>	
		Not accompanied by CITES documents	<ol style="list-style-type: none"> 1. HOLD shipment 2. CONTACT a CBP agricultural specialist at the nearest CITES designated port for instructions on initiating seizure and forfeiture actions 	
Palm other than listed above			INSPECT ² and RELEASE	7CFR 330.105

- 1 If the importer lacks an import permit and the shipment is noncommercial that can be inspected 100 percent, then the permit requirement may be waived. Otherwise, HOLD the shipment and direct the importer to apply for a permit. Refer to http://www.aphis.usda.gov/plant_health/permits/index.shtml for instructions and information about permits.
- 2 Look for very small but visible, bright-red, mites (red palm mite). Also look for colonies of mites along the midrib of the leaves. Look for evidence of the mites feeding: green leaves having bright green to pale green, to yellow, and finally copper-brown streaking or spots. Look for webbing and cast skins of the mites

Reference

Reference Tables

Bambusoideae (bamboo)

Bambusoideae is a subfamily of Poaceae and its tribes Bambuseae and Brachyelytreae, which include the genera and species of bamboo. A list of all genera and species of bamboo is provided in the GRIN database. For directions for how to access GRIN and other related databases, see [“Identification of Protected Plants and Genera of Taxa Regulated Higher Than Genus”](#) on [page 3-4](#).

Fresh, cut articles of bamboo are regulated from all countries to prevent the entry of bamboo smut, *Ustilago shiraiana*, and other exotic pathogens. Therefore, PROHIBIT ENTRY to fresh, cut articles of Bambusoideae. Your authority is 7CFR 319.37.

If the cut articles are dried, then GO to the *Miscellaneous and Processed Products Import Manual*.

***Callicarpa* spp. (mulberry, beautyberry) Lamiaceae**

INSPECT and RELEASE stems, leaves, or inflorescences, including cut flowers with fruits attached, of *Callicarpa* spp. *Callicarpa* is **not** a known host for fruit flies. For cut flowers with fruits, your authority is 7CFR 319.56; for cut flowers free from fruits, your authority is 7CFR 319.74.

Reference

Reference Tables

Capsicum spp. (pepper) Solanaceae

Capsicum spp. includes bell pepper, bird pepper, chili pepper, paprika pepper, and tabasco pepper. Fruits of capsicums are regulated to prevent the entry of the Mediterranean fruit fly, *Ceratitis capitata*. Use [Table 3-5](#) to regulate fresh, cut articles of *Capsicum* spp.

TABLE 3-5: *Capsicum* spp. (pepper—bell, bird, chili, green, paprika, tabasco) Solanaceae

If with:	And:	Then:	Authority:
Stems, leaves, or inflorescences only—never with fruits	→	INSPECT and RELEASE	7CFR 319.74
Botanical fruits	After using the <i>Fresh Fruits and Vegetables Import Manual</i> , you determine that the fruits are admissible without treatment or without special requirements by 7CFR 319.56	1. REQUIRE an import permit ¹ 2. INSPECT and RELEASE	7CFR 319.56
	After using the <i>Fresh Fruits and Vegetables Import Manual</i> , you determine that the fruits are inadmissible , admissible with treatment, or has special requirements by 7CFR 319.56	PROHIBIT ENTRY	

1 If the importer lacks an import permit and the shipment is noncommercial that can be inspected 100 percent, then the permit requirement may be waived. Otherwise, HOLD the shipment and direct the importer to apply for a permit. See *Appendix A, “Permits and Foreign Phytosanitary Certificates”* on [page A-1](#) for instructions and information about permits.

***Chaenomeles* spp. (flowering quince) Rosaceae**

Chaenomeles spp. are regulated because they are host to a diversity of exotic diseases. Therefore, PROHIBIT ENTRY to branches with or without foliage or blooms of *Chaenomeles* spp. Your authority is 7CFR 319.37.

Reference

Reference Tables

Chamaedorea spp. (palm fronds) Arecaceae

Begin at **Table 3-6** to regulate fresh, cut articles of *Chamaedorea* spp.

TABLE 3-6: *Chamaedorea* spp. (palm fronds) Arecaceae

If a pest is found that:	And the fronds are destined to:	And are consigned to an importer who is:	Then:	Authority:
Requires action by USDA, APHIS, PPQ		→	1. HOLD shipment 2. CONTACT a PPQ officer through proper channels	7CFR330.105
Does not require action by USDA, APHIS, PPQ	Florida	Not under a compliance agreement ¹	CONTACT your District Field Office ²	
		Under a compliance agreement ¹	RELEASE; notification is not required	
	Hawaii, Puerto Rico, or U.S. Virgin Islands	→	CONTACT your District Field Office ²	
	State or region other than listed above	→	RELEASE; notification is not required	

1 All *Chamaedorea* spp. fronds imported for distribution in Florida must include a fumigation certificate of treatment. Below are importers under compliance in Florida:

Best of Latin Greens, Inc. 4141 NW 36th Ave. Miami, FL	Bonderun & Adam P.O. Box 7423 Miami, FL	Florida Green Distributors 4621 NW 74 Ave. Miami, FL	J. A. Flower Services 2003 NW 70 Ave. Miami, FL	Lima Flowers 3100 NW 72 Ave. Miami, FL
Simpson's Greens and Floral Dist 8301 NW 30th Terrace Doral FL	Southern Distributing 7221 NW 43 St. Miami, FL	Uniflora Overseas, Inc. P.O. Box 56 Okahumpka, FL	W.F.R., Inc. P.O. Box 605 Zellwood, FL	Scarlet Farms It. 9391 NW 13 St Miami FL

2 The District Field Office Agricultural Inspection Policy and Programs (AIPP) staff will notify the appropriate CBP Office of Field Operations Headquarters AIPP contact for further action regarding notification to PPQ.

***Chrysanthemum x morifolium* (florist' chrysanthemum, mum) Asteraceae**

Use **Table 3-7** to regulate fresh, cut articles of *Chrysanthemum x morifolium* and other species susceptible to Chrysanthemum white rust. After the decision table, is a list of the other species susceptible to Chrysanthemum while rust.

TABLE 3-7: *Chrysanthemum x morifolium* (florist's chrysanthemum, mum) Asteraceae

If the flowers were harvested in:	And the consignment is:	And:	Then:	Authority:
Andorra, Argentina, Australia, Austria, Belarus, Belgium, Bosnia and Herzegovina, Brazil, Brunei, Bulgaria, Canary Islands, Chile, China, Colombia, Croatia, Cyprus, Czech Republic, Denmark, Ecuador, Estonia, Finland, France, Germany, Greece, Hungary, Iceland, Ireland, Italy, Japan, Korea, Latvia, Liechtenstein, Lithuania, Luxembourg, Macedonia, Malaysia, Malta, Mexico, Moldova, Monaco, New Zealand, Norway, Peru, Poland, Portugal, Republic of South Africa, Romania, Russia, San Marino, Slovakia, Slovenia, Spain, Sweden, Switzerland, Taiwan, Thailand, Tunisia, Ukraine, United Kingdom, Uruguay, Venezuela, Yugoslavia and all countries, territories, and possessions of countries located in part or entirely between 90° and 180° East longitude	Accompanied by a phytosanitary certificate or equivalent documentation ¹ , issued by the National Plant Protection Organization of the country of origin or its designee, that contains an additional declaration stating that "The place of production as well as the consignment have been inspected and found free of <i>Puccinia horiana</i> ²	The box labels and other documents accompanying consignments of cut flowers must be marked with the identity of the registered production site.	INSPECT AND RELEASE	7CFR 330.105 7CFR 319.74
		The identification information described above is absent	PROHIBIT ENTRY	
Netherlands ³		→		
Other than a country listed in the cells above		→	INSPECT AND RELEASE	

- 1 Documentation may be written in Spanish. A legible photocopy, facsimile, or scanned copy of an original phytosanitary certificate is acceptable.
- 2 Statement does **not** need to be word-for-word but must indicate that both production site and the consignment have been inspected and found free of *Puccinia horiana*.
- 3 The Netherlands has been suspended from the program. When the suspension is lifted, you will be notified in ample time.

Following is a list of other species susceptible to Chrysanthemum white rust:

- ◆ *Chrysanthemum arcticum* (=Arctanthemum arcticum, Dendranthema arcticum)
- ◆ *Chrysanthemum boreale* (=Chrysanthemum indicum var. boreale, Dendranthema boreale)
- ◆ *Chrysanthemum indicum* (=Dendranthema indicum)
- ◆ *Chrysanthemum japonense* (=Dendranthema japonense, Dendranthema occidentalijaponense)
- ◆ *Chrysanthemum japonicum* (=Chrysanthemum makinoi, Dendranthema japonicum)

Reference

Reference Tables

- ◆ *Chrysanthemum* × *morifolium* (= *Anthemis grandiflorum*, *Anthemis stipulacea*, *Chrysanthemum sinense*, *Chrysanthemum stipulaceum*, *Dendranthema* × *grandiflorum*, *Dendranthema* × *morifolium*, *Matricaria morifolia*)
- ◆ *Chrysanthemum pacificum* (= *Ajania pacifica*, *Dendranthema pacificum*)
- ◆ *Chrysanthemum shiwogiku* (= *Ajania shiwogiku*, *Dendranthema shiwogiku*)
- ◆ *Chrysanthemum yoshinaganthum* (= *Dendranthema yoshinaganthum*)
- ◆ *Chrysanthemum zawadskii* subsp. *yezoense* (= *Chrysanthemum arcticum* subsp. *Maekawanum*, *Chrysanthemum arcticum* var. *yezoense*, *Chrysanthemum yezoense*, *Dendranthema yezoense*, *Leucanthemum yezoense*)
- ◆ *Chrysanthemum zawadskii* subsp. *Zawadskii* (= *Chrysanthemum sibiricum*, *Dendranthema zawadskii*, *Dendranthema zawadskii* var. *zawadskii*)
- ◆ *Leucanthemella serotina* (= *Chrysanthemum serotinum*, *Chrysanthemum uliginosum*, *Pyrethrum uliginosum*)
- ◆ *Nipponanthemum nipponicum* (= *Chrysanthemum nipponicum*, *Leucanthemum nipponicum*)

Coffea spp. (coffee) Rubiaceae

Coffea spp. are regulated to prevent the entry of Mediterranean fruit fly, *Ceratitis capitata*, coffeeberry borer, *Hypothenemus hampei*, and *Hemileia vastatrix* that is an injurious rust disease of coffee. Use [Table 3-8](#) to regulate fresh, cut articles of *Coffea* spp.

TABLE 3-8: *Coffea* spp. (coffee) Rubiaceae

If moving to:	And with:	And:	Then:	Authority:
Hawaii or Puerto Rico		→	PROHIBIT ENTRY	7CFR 319.73
State or territory other than Hawaii or Puerto Rico	Stems, leaves, or inflorescences only—never with fruits	→	INSPECT and RELEASE	7CFR 319.74
	Botanical fruits	After using the <i>Fresh Fruits and Vegetables Import Manual</i> you determine that the fruits are admissible without treatment or without special requirements by 7CFR 319.56	1. REQUIRE an import permit ¹ 2. INSPECT and RELEASE	7CFR 319.56
		After using the <i>Fresh Fruits and Vegetables Import Manual</i> you determine that the fruits are inadmissible , admissible with treatment, or has special requirements by 7CFR 319.56	PROHIBIT ENTRY	

- 1 If the importer lacks an import permit and the shipment is noncommercial that can be inspected 100 percent, then the permit requirement may be waived. Otherwise, HOLD the shipment and direct the importer to apply for a permit. Refer to *Appendix A*, “Permits and Foreign Phytosanitary Certificates” on [page A-1](#) for instructions and information about permits.

Reference

Reference Tables

Coniferae, all genera of (conifers)—Includes cut Christmas trees

Conifers are regulated to prevent the entry of a wide variety of insect pests (from defoliators to borers) and various pathogens (cankers and rusts, for example).

Coniferae, all genera of (conifers) — Includes cut Christmas trees

If cut in:	And:	And:	And:	Then:	Authority
Canada			→	Use Table 4	
Mexico	From the State of Baja California Norte, Chihuahua, Coahuila, Nuevo León, Sonora, or Tamaulipas	Pinus	Two or three needles in a fascicle	PROHIBIT ENTRY	7CFR 319.37
			Five needles in a fascicle	INSPECT AND RELEASE	7CFR 330.105
		<i>Abies, Cedrus, Juniperus, Larix, Picea, Pseudolarix, or Pseudotsuga</i>	→	PROHIBIT ENTRY	7CFR 319.37
	From a State other than one listed in the cell above	A coniferous genus other than the one listed in the cells above	→	INSPECT AND RELEASE	7CFR 319.37
			→	PROHIBIT ENTRY	7CFR 319.37
Other than Canada or Mexico	Cut trees		→		
	Cut branches or wreaths	Pinus	Two or three needles in a fascicle		
			Five needles in a fascicle	INSPECT AND RELEASE	7CFR 330.105
		<i>Abies, Cedrus, Juniperus, Larix, Picea, Pseudolarix, or Pseudotsuga</i>	→	PROHIBIT ENTRY	7CFR 319.37
	A coniferous genus other than the one listed in the cells above	→	INSPECT AND RELEASE	7CFR 319.37	

TABLE 4—Canadian origin cut flowers and greenery

If:	Then:
Christmas trees or conifer wreaths	GO to Table 5 below
Other than Christmas trees or conifer wreaths	GO to Table 10

TABLE 5—Cut Christmas trees (including boughs and wreaths)

If the article is:	And cut from:	And made from:	And originated in:	Then:
Boughs or wreaths	Douglas-fir (<i>Pseudotsuga menziesii</i>), hemlock (<i>Tsuga</i> spp.) or fir (<i>Abies</i> spp.)	Branches less than 15 mm (1/2 inch) in diameter	—————→	INSPECT AND RELEASE
		Branches 15 mm (1/2 inch) or greater in diameter	The Province of Ontario or Quebec	GO to Table 6
			The Province of British Columbia, New Brunswick or Nova Scotia	GO to Table 7
	Other than one of the trees listed in the cell above	—————→	A province other than Ontario, Quebec, British Columbia, New Brunswick, or Nova Scotia	GO to Table 8
			The Province of Ontario or Quebec	GO to Table 6
			The Province of British Columbia, New Brunswick or Nova Scotia	GO to Table 7
Other than boughs or wreaths	—————→	The Province of Ontario or Quebec	GO to Table 6	
	—————→	The Province of British Columbia, New Brunswick or Nova Scotia	GO to Table 7	
	—————→	A province other than Ontario, Quebec, British Columbia, New Brunswick, or Nova Scotia	GO to Table 8	

Reference

Reference Tables

TABLE 6—Cut Christmas trees (including boughs and wreaths) from Ontario or Quebec

If:	And destined to:	And:	Then:
A pine species	CT, DE, DC, ME, MD, MA, NH, NJ, NY, PA, RI, or VT	Accompanied by a Canadian Phytosanitary Certificate with Additional Declaration stating that “The trees were inspected and found free from <i>Tomicus piniperda</i> , pine shoot beetle” or “The trees were grown in an area not known to be infested by <i>Tomicus piniperda</i> , pine shoot beetle.” The certificate must also state the county or MRC ¹ , and province where the trees were grown.	INSPECT AND RELEASE
		Lacks a Canadian Phytosanitary Certificate with the above statement	REQUIRE T313
	CA or OR	Accompanied by a Canadian Phytosanitary Certificate with Additional Declaration stating that “The trees were inspected and found free from <i>Tomicus piniperda</i> , pine shoot beetle and <i>Lymantria dispar</i> , gypsy moth” or The trees were grown in an area not known to be infested by <i>Tomicus piniperda</i> , pine shoot beetle and <i>Lymantria dispar</i> , gypsy moth.” The certificate must also state the county or MRC ¹ , and province where the trees were grown.	GO to Table 9
		Lacks a Canadian Phytosanitary Certificate with the above statement	REQUIRE T313
	Other than a State listed above	Accompanied by a Canadian Phytosanitary Certificate with Additional Declaration stating that “The trees were inspected and found free from <i>Tomicus piniperda</i> , pine shoot beetle and <i>Lymantria dispar</i> , gypsy moth” or The trees were grown in an area not known to be infested by <i>Tomicus piniperda</i> , pine shoot beetle and <i>Lymantria dispar</i> , gypsy moth.” The certificate must also state the county or MRC ¹ , and province where the trees were grown.	INSPECT AND RELEASE
		Lacks a Canadian Phytosanitary Certificate with the above statement	REQUIRE T313
Not a pine species	CT, DE, DC, MD, MA, NH, NJ, NY, PA, RI, or VT	→	INSPECT AND RELEASE
	West Virginia or other areas in the United States infested with pine shoot beetle (<i>Tomicus piniperda</i>) ²	Both of the following conditions are met: 1. The trees are accompanied by a certification of origin and movement ³ that specifies the province or provinces where the trees were grown, and if applicable, moved through, if different from the province or provinces where grown 2. The U.S. destination (including State and county) of the trees is plainly indicated on the trees or on the outer container (if in a container)	RELEASE
		The conditions described above are not met	PROHIBIT ENTRY

- 1 MRC = Municipalité régionale de comté. This is a level of local government body located in the province of Quebec.
- 2 For a list of infested areas, refer to the following web site address: <http://www.aphis.usda.gov/ppq/manuals/pdf_files/CB%20in%20PDF/AppendixG.pdf>.
- 3 The certification of origin and movement for pine shoot beetle is a signed, accurate statement certifying the area in which the trees were grown and moved through, and stating that the trees were produced and moved through areas of Canada not considered to be infested with pine shoot beetle. The statement may be printed directly on the documents accompanying the shipment, or may be provided on a separate document. The certification **does not** require the signature of a CFIA inspector; exporters may sign the statement.

TABLE 7—Cut Christmas trees (including boughs and wreaths) from British Columbia, New Brunswick or Nova Scotia

If:	And destined to:	And:	Then:
A pine species	CT, DE, DC, MD, MA, NH, NJ, NY, PA, RI, or VT	—————→	INSPECT AND RELEASE
	CA or OR	Accompanied by either a Canadian Phytosanitary Certificate with Additional Declaration stating that “The trees were inspected and found free from <i>Lymantria dispar</i> , gypsy moth.” OR a Canadian certification of origin stating that “The trees were grown in an area not known to be infested by gypsy moth.” The certificates must also state the county and province where the trees were grown.	GO to Table 9
		Lacks the documents described above	REQUIRE T313
	Other than a State listed above	Accompanied by either a Canadian Phytosanitary Certificate with Additional Declaration stating that “The trees were inspected and found free from <i>Lymantria dispar</i> , gypsy moth.” OR a Canadian certification of origin stating that “The trees were grown in an area not known to be infested by gypsy moth.” The certificates must also state the county and province where the trees were grown.	INSPECT AND RELEASE
		Lacks the documents described above	REQUIRE T313
Not a pine species	CT, DE, DC, MD, MA, NH, NJ, NY, PA, RI, or VT	—————→	INSPECT AND RELEASE
	Other than a State listed above	Accompanied by either a Canadian Phytosanitary Certificate with Additional Declaration stating that “The trees were inspected and found free from <i>Lymantria dispar</i> , gypsy moth.” OR a Canadian certification of origin stating that “The trees were grown in an area not known to be infested by gypsy moth.” The certificates must also state the county and province where the trees were grown.	
		Lacks the documents described above	REQUIRE T313



TABLE 8—Cut Christmas trees (including boughs and wreaths) from a province OTHER THAN Ontario, Quebec, British Columbia, New Brunswick, or Nova Scotia

If:	Then:
Accompanied by a Canadian certification of origin	RELEASE
Lacks a Canadian certification of origin	REQUIRE T313

Reference

Reference Tables

TABLE 9—Cut PINE Christmas trees (including boughs and wreaths) destined to CA or OR¹, free from gypsy moth and pine shoot beetle

If destined to:	And the date of entry falls between:	And the shipment is:	Then:
CA		Commercial	REQUIRE T313
		Non-commercial	PROHIBIT ENTRY
OR	January 1 and October 19	Commercial	REQUIRE T313
		Non-commercial	PROHIBIT ENTRY
	October 20 and December 31		INSPECT AND RELEASE

1 In addition to regulating the importation of pine trees, boughs, and wreaths for gypsy moth and pine shoot beetle, the States of California and Oregon regulate importation of pine trees to exclude the European pine shoot moth, *Rhyacionia buoliana*.

TABLE 10—Cut flowers and greenery of Canadian origin OTHER THAN Christmas trees and conifer wreaths

If a flower or branch (stem) from:	Then:
Almond (<i>Prunus</i> spp.), Apple (<i>Malus</i> spp.), Apricot (<i>Prunus</i> spp.), Cherry (<i>Prunus</i> spp.), Cherry laurel (<i>Prunus</i> spp.), Cotton (<i>Gossypium</i> spp.), Crabapple (<i>Malus</i> spp.), English laurel (<i>Prunus</i> spp.), Flowering quince (<i>Chaenomeles</i> spp.), Grape (<i>Vitis</i> spp.), Nectarine (<i>Prunus</i> spp.), Peach (<i>Prunus</i> spp.), Pear (<i>Pyrus</i> spp.), Prune (<i>Prunus</i> spp.), or Quince (<i>Cydonia</i> spp.)	PROHIBIT ENTRY
Other than a plant listed above	INSPECT AND RELEASE

Cordyline spp., Agavaceae

Cordyline spp. includes cabbage tree and ti plants. Use [Table 3-9](#) to regulate fresh, cut articles of *Cordyline* spp.

TABLE 3-9: *Cordyline* spp., Agavaceae (includes cabbage tree and ti plants)

If the cut articles are:	And the canes are:	And there are:	And the consignment is:	And the consignment:	Then:	Authority:
With panicles of flowers				→	INSPECT and RELEASE	7CFR 319.74
Canes, with or without leaves or roots	In a ready made bouquet	7 or fewer canes in the bouquet		→		
		More than 7 canes in the bouquet	Accompanied by a foreign phytosanitary certificate	Consists of 8 to 12 canes	INSPECT AND RELEASE as a propagative entry ¹	7CFR 319.37
			Consists of 13 or more canes ²	1. HOLD shipment 2. CONTACT a PPQ Officer through proper channels (this commodity is a propagative entry and must move to a Plant Inspection Station)		
				Lacks a foreign phytosanitary certificate	→	PROHIBIT ENTRY
Single, not in a ready made bouquet		→	Accompanied by a foreign phytosanitary certificate	12 or fewer canes in the shipment	INSPECT AND RELEASE as a propagative entry ¹	
				13 or more canes in the consignment ²	1. HOLD shipment 2. CONTACT a PPQ Officer through proper channels (this commodity is regulated as a propagative entry and must move to a Plant Inspection Station)	
			Lacks a foreign phytosanitary certificate	Lacks a foreign phytosanitary certificate	PROHIBIT ENTRY	

¹ CBP Agriculture Specialists may clear consignments of generally admissible nursery stock that consist of 12 or fewer units.

Reference

Reference Tables

- 2 Canes are subject to size/age limitations. If the canes have leaves and/or roots and are **more than** 18 inches from the soil line to the farthest growing point, PROHIBIT ENTRY. If the canes are stem cuttings and **without** roots and leaves and are **longer than** 6 feet (1.83 meters), PROHIBIT ENTRY.

Cotoneaster spp., Rosaceae

Fruits of Cotoneaster are regulated to prevent the entry of exotic fruit flies. Use [Table 3-10](#) to regulate fresh, cut articles of *Cotoneaster* spp.

TABLE 3-10: Cotoneaster spp., Rosaceae

If the cut articles are with:	And are grown in:	And the shipment:	Then:	Authority:
Stems, leaves, or inflorescences only—never with fruits	_____ →	_____ →	INSPECT and RELEASE	7CFR 319.74
Botanical fruits	Canada or New Zealand	_____ →		
	The Netherlands	Is accompanied by a foreign phytosanitary certificate that shows the name and address of the grower in The Netherlands ¹	1. REQUIRE an import permit ² 2. INSPECT and RELEASE	7CFR 319.56
		Lacks a foreign phytosanitary certificate or the grower is not clearly indicated as in The Netherlands	PROHIBIT ENTRY	
Country other than listed above	_____ →	_____ →	PROHIBIT ENTRY	

- 1 The name of the grower's village satisfies the address requirement.
- 2 If the importer lacks an import permit and the shipment is noncommercial that can be inspected 100 percent, then the permit requirement may be waived. Otherwise, HOLD the shipment and direct the importer to apply for a permit. Refer to *Appendix A*, "Permits and Foreign Phytosanitary Certificates" on [page A-1](#) for instructions and information about permits.

Reference

Reference Tables

***Crocasmia* spp. (autumn-gold, garden montbretia, montbretia) Iridaceae**

Crocasmia are regulated because they are host to the gladiolus rust, *Uromyces transversalis*, a rust that is considered of plant quarantine importance in Europe and the United States. Use [Table 3-11](#) to regulate fresh, cut articles of *Crocasmia*.

TABLE 3-11: *Crocasmia* spp. (autumn-gold, garden montbretia, montbretia)

If grown in:	And a:	Then:	Authority:
Colombia or Mexico	Personal shipment	PROHIBIT ENTRY	7CFR 330
	Commercial shipment	INSPECT AND RELEASE ¹	7CFR 319.74
Other than one of the countries listed in the cell above			

1 Look carefully for single or aggregated yellowish-brown or blackish-brown pustules on the leaves. These may be symptoms of gladiolus rust, a disease not known to occur in the U.S.

Cycadaceae/Zamiaceae (cycads)

All taxa of cycads are listed in CITES Appendix II, except those specifically listed in CITES Appendix I. A list of all genera and species of cycads is provided in the GRIN database. For directions for how to access GRIN and other related databases, refer to “Identification of Protected Plants and Genera of Taxa Regulated Higher Than Genus” on page 3-4.

Cycad leaves and fronds are regulated because unrestricted trade could threaten them with extinction. Use Table 3-12 to regulate the fresh, cut leaves and fronds of Cycadaceae and Zamiaceae. (See also “Zamiaceae/Cycadaceae (cycads)” on page 3-81.)

TABLE 3-12: Cycadaceae/Zamiaceae (cycads)

If the leaves/ fronds are:	And the taxa:	Then:	Authority:
Entering at a CITES designated port ¹	Is listed in CITES Appendix I, includes the following genera: ◆ <i>Ceratozamia</i> spp. ◆ <i>Chigua</i> spp. ◆ <i>Cycas beddomei</i> ◆ <i>Encephalartos</i> spp. ◆ <i>Microcycas calocoma</i>	1. REGULATE as CITES Appendix I 2. REQUIRE a CITES import permit from U.S. Fish and Wildlife, a valid CITES export permit from country of export, and a General Permit from USDA APHIS	50CFR 23
	Is a cycad other than those listed in CITES Appendix I	1. REGULATE as CITES Appendix II 2. REQUIRE a valid CITES export permit from the country of export and a General Permit from USDA APHIS	
Not entering at a CITES designated port	Is accompanied by CITES documents	1. SAFEGUARD under plant quarantines and plant pest regulations 2. GIVE the importer one of the following options: Reexport the articles to the country of origin, or Reroute the articles to a CITES designated port NOTE: Shipping and handling charges are the responsibility of the importer.	7CFR 355 50CFR 23
	Not accompanied by CITES documents	1. HOLD shipment 2. CONTACT a CBP agricultural specialist at the nearest CITES designated port for instructions on initiating seizure and forfeiture actions	

1 A list of the CITES designated ports is available at the following web site address: <<http://www.aphis.usda.gov/ppq/permits/cites>>.

ReferenceReference Tables

***Cydonia* spp. (quince) Rosaceae**

Cydonia spp. are regulated because they are host to a diversity of exotic diseases. Therefore, PROHIBIT ENTRY to branches with or without foliage or blooms of *Cydonia* spp. Your authority is 7CFR 319.37.

Cynara spp. (artichoke) Asteraceae

Flowers of *Cynara* spp. are regulated to prevent the entry of exotic fruit flies. Use **Table 3-13** to regulate fresh, cut articles of *Cynara* spp.

TABLE 3-13: *Cynara* spp. (artichoke) Asteraceae

If the cut articles are:	And are grown in:	And:	Then:	Authority:
Leaves and stems only		→	INSPECT and RELEASE	7CFR 330.105
Mature or immature floral heads	Canada	→		
	Country other than Canada	After using the <i>Fresh Fruits and Vegetables Import Manual</i> you determine that the floral heads are admissible as immature floral heads by 7CFR 319.56	1. REQUIRE an import permit ¹ 2. INSPECT and RELEASE	7CFR 319.56
		After using the <i>Fresh Fruits and Vegetables Import Manual</i> you determine that the floral heads are inadmissible as immature floral heads by 7CFR 319.56	PROHIBIT ENTRY	

- 1 If the importer lacks an import permit and the shipment is noncommercial that can be inspected 100 percent, then the permit requirement may be waived. Otherwise, HOLD the shipment and direct the importer to apply for a permit. Refer to *Appendix A*, “Permits and Foreign Phytosanitary Certificates” on **page A-1** for instructions and information about permits.

Reference

Reference Tables

Dendranthema spp. (florist’s mum, florist’s chrysanthemum, cultivated mum)
Asteraceae

Use **Table 3-14** to regulate cut articles of *Dendranthema* spp.

TABLE 3-14 *Dendranthema* spp. (florist’s mum, florist’s chrysanthemum, cultivated mum) Asteraceae

If the flowers were harvested in:	And the consignment is:	And:	Then:	Authority:
Andorra, Argentina, Australia, Austria, Belarus, Belgium, Bosnia and Herzegovina, Brazil, Brunei, Bulgaria, Canary Islands, Chile, China, Colombia, Croatia, Cyprus, Czech Republic, Denmark, Ecuador, Estonia, Finland, France, Germany, Greece, Hungary, Iceland, Ireland, Italy, Japan, Korea, Latvia, Liechtenstein, Lithuania, Luxembourg, Macedonia, Malaysia, Malta, Mexico, Moldova, Monaco, New Zealand, Norway, Peru, Poland, Portugal, Republic of South Africa, Romania, Russia, San Marino, Slovakia, Slovenia, Spain, Sweden, Switzerland, Taiwan, Thailand, Tunisia, Ukraine, United Kingdom, Uruguay, Venezuela, Yugoslavia and all countries, territories, and possessions of countries located in part or entirely between 90° and 180° East longitude	Accompanied by a phytosanitary certificate or equivalent documentation ¹ , issued by the National Plant Protection Organization of the country of origin or its designee, that contains an additional declaration stating that “The place of production as well as the consignment have been inspected and found free of <i>Puccinia horiana</i> ²	The box labels and other documents accompanying consignments of cut flowers must be marked with the identity of the registered production site.	INSPECT AND RELEASE	7CFR 330.105 7CFR 319.74
	Lacking either the certificate or the certification specified in the cell above	—————→	PROHIBIT ENTRY	
Netherlands ³	—————→	—————→		
Other than a country listed in the cells above	—————→	—————→	INSPECT AND RELEASE	

- 1 Documentation may be written in Spanish. A legible photocopy, facsimile, or scanned copy of an original phytosanitary certificate is acceptable.
- 2 Statement does **not** need to be word-for-word but must indicate that both production site and the consignment have been inspected and found free of *Puccinia horiana*.
- 3 The Netherlands has been suspended from the program. When the suspension is lifted, you will be notified in ample time.

Dracaena spp., Agavaceae

Dracaena spp. includes dragon tree, isikonkwane, lucky bamboo, palmillo, and son-of-India. Centers for Disease Control embargoes the importation of *Dracaena* shipments in standing water which could introduce mosquito species not widely seen in the United States. Shipments of *Dracaena* in dry containers are not affected by this embargo. Use [Table 3-15](#) to regulate fresh, cut articles of *Dracaena* spp.

TABLE 3-15: *Dracaena* spp., Agavaceae (includes cabbage tree and ti plants)

If the cut articles are:	And the canes are:	And there are:	And the consignment is:	And the consignment:	Then:	Authority:	
With panicles of flowers				→	INSPECT and RELEASE	7CFR 319.74	
Canes, with or without leaves or roots	In a ready made bouquet	7 or fewer canes in the bouquet		→		7CFR 319.37	
		More than 7 canes in the bouquet	Accompanied by a foreign phytosanitary certificate	Consists of 8 to 12 canes Consists of 13 or more canes ²	INSPECT AND RELEASE as a propagative entry ¹ 1. HOLD shipment 2. CONTACT a PPQ Officer through proper channels (this commodity is a propagative entry and must move to a Plant Inspection Station)		
	Single, not in a ready made bouquet	→		Accompanied by a foreign phytosanitary certificate		PROHIBIT ENTRY	
					Lacks a foreign phytosanitary certificate	→	
				12 or fewer canes in the shipment	INSPECT AND RELEASE as a propagative entry ¹		
				13 or more canes in the consignment ²	1. HOLD shipment 2. CONTACT a PPQ Officer through proper channels (this commodity is regulated as a propagative entry and must move to a Plant Inspection Station)		
			Lacks a foreign phytosanitary certificate	Lacks a foreign phytosanitary certificate	PROHIBIT ENTRY		

Reference

Reference Tables

- 1 CBP Agriculture Specialists may clear consignments of generally admissible nursery stock that consist of 12 or fewer units.
- 2 Canes are subject to size/age limitations. If the canes have leaves and/or roots and are **more than** 18 inches from the soil line to the farthest growing point, PROHIBIT ENTRY. If the canes are stem cuttings and **without** roots and leaves and are **longer than** 6 feet (1.83 meters), PROHIBIT ENTRY.

Gladiolus spp. (Iridaceae)

Gladiolas are regulated from many countries to prevent the entry of gladiolus rust, *Uromyces transversalis*, a rust that is considered of plant quarantine importance in Europe and the United States. Use [Table 3-16](#) to regulate fresh, cut articles of Gladiolus.

TABLE 3-16: *Gladiolus* spp. (gladiolus, gladiola, glad, sword-lily)

If grown in:	And a:	And leaves are:	And:	Then:	Authority:
Colombia	Personal shipment	—————→		PROHIBIT ENTRY	7CFR 330
	Commercial shipment		Appropriately certified by the National Plant Protection Organization of the country of origin ¹	INSPECT ² AND RELEASE	7CFR 319.74
			Lacks the required certification ¹		PROHIBIT ENTRY
Mexico	Personal shipment	—————→		PROHIBIT ENTRY	7CFR 330
	Commercial shipment	Present ³	—————→		
		Absent	Appropriately certified by the National Plant Protection Organization of the country of origin ¹	INSPECT ² AND RELEASE	7CFR 319.74
			Lacks the required certification ¹	PROHIBIT ENTRY	7CFR 330
Other than Colombia or Mexico	—————→			INSPECT ² AND RELEASE	7CFR 319.74

- 1 Accompanied by a phytosanitary certificate with the following additional declaration: "The gladiolus in this shipment have been inspected and found free of *Uromyces transversalis*."
- 2 Look carefully for single or aggregated yellowish-brown or blackish-brown pustules on the leaves. These may be symptoms of gladiolus rust, a disease not known to occur in the U.S.
- 3 The gladiolus must arrive at the port defoliated. Do **not** allow the removal of the leaves at the port of arrival.

Reference

Reference Tables

Gossypium spp. (cotton) Malvaceae

Cotton is regulated from all countries to prevent the entry of pink bollworm, *Pectinophora gossypiella*. Use [Table 3-17](#) to regulate fresh, cut articles of *Gossypium* spp.

TABLE 3-17: *Gossypium* spp. (cotton) Malvaceae

If destined to:	Then:	Authority:
Guam or the Northern Mariana Islands	INSPECT and RELEASE	7CFR 319.8
State or territory other than Guam or the Northern Mariana Islands	PROHIBIT ENTRY	

***Helleborus* spp. (black helleborus, Christmas-rose, green hellebore, lenten-rose, stinking hellebore): Ranunculaceae**

INSPECT AND RELEASE stems, leaves, or inflorescences, including cut flowers with fruits attached, of *Helleborus* spp. *Helleborus* is not a known host for fruit flies. For cut flowers with fruits, your authority is 7CFR 319.56; for cut flowers free from fruits, your authority is 7CFR 319.74.

Reference

Reference Tables

***Hibiscus* spp., Malvaceae**

Hibiscus is regulated from all countries to prevent the entry of pink bollworm, *Pectinophora gossypiella*. Use **Table 3-18** to regulate fresh, decorative pods of *Hibiscus* spp.

TABLE 3-18: *Hibiscus* spp., Malvaceae

If the shipment:	And the pods are:	Then:	Authority:
Is accompanied by certification that the pods were treated by T203(c)(5), or its equivalent		INSPECT and RELEASE	7CFR 319.37
Lacks the above certification	Processed to the extent that pests would be destroyed (for example, bleached, boiled, or dyed)		
	Unprocessed	1. REQUIRE T203-g-1, T203-g-2, T203-g-3, or their equivalent 2. HOLD shipment 3. CONTACT a PPQ officer through proper channels	

***Hippophae* spp. (sea buckthorn) Elaeagnaceae**

Fruits of *Hippophae* spp. are regulated to prevent the entry of exotic fruit flies. Use [Table 3-19](#) to regulate fresh, cut articles of *Hippophae* spp.

TABLE 3-19: *Hippophae* spp. (sea buckthorn) Elaeagnaceae

If the cut articles are with:	And were grown in:	Then:	Authority:
Stems, leaves, or inflorescences only—never with fruits	—————→	INSPECT and RELEASE	7CFR 319.74
Botanical fruits	◆ Canada	INSPECT and RELEASE	7CFR 319.56
	◆ New Zealand		
	◆ The Netherlands		
	Country other than listed above	PROHIBIT ENTRY	

ReferenceReference Tables

***Hypericum* spp. (St. John's wort) Clusiaceae**

INSPECT and RELEASE stems, leaves, or inflorescences, including cut flowers with fruits attached, of *Hypericum* spp. *Hypericum* is **not** a known host for fruit flies. For cut flowers with fruits, your authority is 7CFR 319.56; for cut flowers free from fruits, your authority is 7CFR 319.74.

***Ilex* spp. (holly) Aquifoliaceae**

Use [Table 3-20](#) to regulate botanical fruits (berries) with stems and leaves of *Ilex* spp. Fruits of *Ilex* are regulated to prevent the entry of exotic fruit flies.

TABLE 3-20: *Ilex* spp. (holly) Aquifoliaceae

If the stems are:	And were grown in:	And the shipment:	Then:	Authority:
With berries	Canada or New Zealand	—————→	INSPECT and RELEASE	7CFR 319.56
	The Netherlands	Is accompanied by a foreign phytosanitary certificate ¹ that shows the name and address of the grower in The Netherlands ²	1. REQUIRE an import permit ³ 2. INSPECT and RELEASE	
		Lacks a foreign phytosanitary certificate or the grower is not clearly indicated as in The Netherlands	PROHIBIT ENTRY	
	Country other than listed above	—————→	PROHIBIT ENTRY	
Without berries		—————→	INSPECT and RELEASE	7CFR 319.74

- 1 A foreign phytosanitary certificate is required to ensure that *Ilex* spp. are grown in a country free from Mediterranean fruit fly, *Ceratitis capitata*.
- 2 The name of the grower's village satisfies the address requirement.
- 3 If the importer lacks an import permit and the shipment is noncommercial that can be inspected 100 percent, then the permit requirement may be waived. Otherwise, HOLD the shipment and direct the importer to apply for a permit. Refer to *Appendix A*, "Permits and Foreign Phytosanitary Certificates" on [page A-1](#) for instructions and information about permits.

Reference

Reference Tables

Leucanthemella spp. (high daisy, giant daisy, max-chrysanthemum, Shasta daisy)
Asteraceae

Use **Table 3-21** to regulate fresh, cut articles of *Leucanthemella* spp.

TABLE 3-21 *Leucanthemella* spp. (high daisy, giant-daisy, max-chrysanthemum, Shasta daisy) Asteraceae

If the flowers were harvested in:	And the consignment is:	And:	Then:	Authority:
Andorra, Argentina, Australia, Austria, Belarus, Belgium, Bosnia and Herzegovina, Brazil, Brunei, Bulgaria, Canary Islands, Chile, China, Colombia, Croatia, Cyprus, Czech Republic, Denmark, Ecuador, Estonia, Finland, France, Germany, Greece, Hungary, Iceland, Ireland, Italy, Japan, Korea, Latvia, Liechtenstein, Lithuania, Luxembourg, Macedonia, Malaysia, Malta, Mexico, Moldova, Monaco, New Zealand, Norway, Peru, Poland, Portugal, Republic of South Africa, Romania, Russia, San Marino, Slovakia, Slovenia, Spain, Sweden, Switzerland, Taiwan, Thailand, Tunisia, Ukraine, United Kingdom, Uruguay, Venezuela, Yugoslavia and all countries, territories, and possessions of countries located in part or entirely between 90° and 180° East longitude	Accompanied by a phytosanitary certificate or equivalent documentation ¹ , issued by the National Plant Protection Organization of the country of origin or its designee, that contains an additional declaration stating that “The place of production as well as the consignment have been inspected and found free of <i>Puccinia horiana</i> ²	The box labels and other documents accompanying consignments of cut flowers must be marked with the identity of the registered production site.	INSPECT AND RELEASE	7CFR 330.105 7CFR 319.74
	Lacking either the certificate or the certification specified in the cell above	→	PROHIBIT ENTRY	
Netherlands ³	→	→	→	
Other than a country listed in the cells above	→	→	INSPECT AND RELEASE	

- Documentation may be written in Spanish. A legible photocopy, facsimile, or scanned copy of an original phytosanitary certificate is acceptable.
- Statement does **not** need to be word-for-word but must indicate that both production site and the consignment have been inspected and found free of *Puccinia horiana*.
- The Netherlands has been suspended from the program. When the suspension is lifted, you will be notified in ample time.

***Ligustrum* spp. (privet) Oleaceae**

INSPECT and RELEASE stems, leaves, or inflorescences, including cut flowers with fruits attached, of *Ligustrum* spp. *Ligustrum* is **not** a known host for fruit flies. For cut flowers with fruits, your authority is 7CFR 319.56; for cut flowers free from fruits, your authority is 7CFR 319.74.

Reference

Reference Tables

Loranthaceae (all genera of mistletoe)

Loranthaceae is a plant family that includes the genera and species of mistletoe. Mistletoe is a parasitic plant. A list of all genera and species of Loranthaceae is provided in the GRIN database. For directions for how to access GRIN and other related databases, see [“Identification of Protected Plants and Genera of Taxa Regulated Higher Than Genus” on page 3-4.](#)

Use **Table 3-22** to regulate fresh, cut articles of Loranthaceae.

TABLE 3-22: Loranthaceae (all genera of mistletoe)

If the stems are:	And grown in:	Then:	Authority:
With berries		PROHIBIT ENTRY	7CFR 319.56
Without berries	Canada	INSPECT and RELEASE	7CFR 319.74
	Country other than Canada	1. HOLD shipment 2. CONTACT a PPQ botanist at the nearest PPQ Plant Inspection Station; if unavailable then 3. CONTACT a CBP agricultural specialist ¹	7CFR 330

1 The CBP agricultural specialist will contact a botanist with PPQ’s Permits, Registrations, Imports & Manuals Staff. as decisions are made on a case-by-case basis.

***Malus* spp. (apple) Rosaceae**

Malus spp. are regulated because they are host to a diversity of exotic diseases. Therefore, PROHIBIT ENTRY to branches with or without foliage or blooms of *Malus* spp. Your authority is 7CFR 319.37.

***Musa* spp. (banana, dwarf banana, flowering banana, Japanese banana, plantain) Musaceae**

Fruits of *Musa* spp. are regulated to prevent the entry of exotic fruit flies. Use [Table 3-23](#) to regulate fresh, cut articles of *Musa* spp.

TABLE 3-23: *Musa* spp. (banana, plantain) Musaceae

If entering:	And grown in:	And with:	Then:	Authority:
State or territory other than Hawaii	Algeria, Antigua and Barbuda, Argentina, Bahamas, Barbados, Belize, Bermuda, Bolivia, Brazil, Burkina Faso, Cameroon, Canary Islands, Cayman Islands, Chile, Colombia, Congo, Costa Rica, Côte d'Ivoire, Dominica, Dominican Republic, Ecuador, Egypt, El Salvador, Fiji, Ghana, Grenada, Guadalupe, Guatemala, Guinea, Guyana, Haiti, Honduras, Italy, Jamaica, Liberia, Mali, Martinique, Mauritania, Mexico, Montserrat, Morocco, The Netherlands Antilles, Nicaragua, Niger, Nigeria, Panama, Paraguay, Peru, Saint Kitts and Nevis, Saint Lucia, Saint Vincent and the Grenadines, Senegal, Sierra Leone, Tonga, Trinidad and Tobago, Tunisia, Uruguay, Vanatu, and Venezuela	Immature (green) bananas	1. REQUIRE an import permit ¹ 2. INSPECT ² and RELEASE	7CFR 319.56
		Mature (ripe) bananas	PROHIBIT ENTRY	7CFR 319.56
		Stems, leaves, or inflorescences only—never with fruits	INSPECT ² and RELEASE	7CFR 319.74
	Country other than listed above	Bananas	PROHIBIT ENTRY	7CFR 319.56
		Stems, leaves, or inflorescences only—never with fruits	INSPECT ² and RELEASE	7CFR 319.74
Hawaii		→	PROHIBIT ENTRY	7CFR 319.56

- 1 If the importer lacks an import permit and the shipment is noncommercial that can be inspected 100 percent, then the permit requirement may be waived. Otherwise, HOLD the shipment and direct the importer to apply for a permit. Refer to http://www.aphis.usda.gov/plant_health/permits/index.shtml for instructions and information about permits.
- 2 Look for very small but visible, bright-red, mites (red palm mite). Also look for colonies of mites along the midrib of the leaves. Look for evidence of the mites feeding: green leaves having bright green to pale green, to yellow, and finally copper-brown streaking or spots. Look for webbing and cast skins of the mites

***Nepenthes* spp. (pitcher plant) Nepenthaceae**

Nepenthes spp. plants are regulated because unrestricted trade could threaten them with extinction. Use **Table 3-24** to regulate the fresh, cut pitchers (modified leaves) of *Nepenthes* spp.

TABLE 3-24: *Nepenthes* spp.¹ (pitcher plant) Nepenthaceae

If the cut articles are:	And the species is:	Then:	Authority:
Entering at a CITES designated port ²	<i>Khasiana</i> or <i>raja</i> (giant pitcher plants)	<ol style="list-style-type: none"> 1. HOLD shipment 2. TAKE regulatory action under plant quarantines and plant pest regulations, then 3. REGULATE as CITES Appendix I 4. REQUIRE a CITES import permit from U.S. Fish and Wildlife, a valid CITES export permit from the country of export, and a General Permit from USDA APHIS 	50CFR 23
	Other than <i>Khasiana</i> or <i>Raja</i>	<ol style="list-style-type: none"> 1. HOLD shipment 2. TAKE regulatory action under plant quarantines and plant pest regulations, then 3. REGULATE as CITES Appendix II 4. REQUIRE a valid CITES export permit from the country of export and a General Permit from USDA APHIS 	
Not entering at a CITES designated port	Accompanied by CITES documents	<ol style="list-style-type: none"> 1. SAFEGUARD under plant quarantines and plant pests regulations 2. GIVE the importer one of the following options: Re-export the articles to the country of origin Reroute the articles to a CITES designated port. NOTE: Shipping and handling charges are the responsibility of the importer. 	7CFR 319.74 or if from Canada, 7CFR 330.105 7CFR 355 50CFR 23 50CFR 24
	Not accompanied by CITES documents	<ol style="list-style-type: none"> 1. HOLD shipment 2. CONTACT a CBP agricultural specialist at the nearest CITES designated port for instructions on initiating seizure and forfeiture actions 	

1 Refers to the pitcher

2 A list of the CITES designated ports is available at the following web site address: <<http://www.aphis.usda.gov/ppq/permits/cites>>.

ReferenceReference Tables





Nigella* spp. (fennel-flower, jack-in-the-green, love-in-a-mist, nutmeg-flower)*Ranunculaceae**

INSPECT and RELEASE stems, leaves, or inflorescences, including cut branches with seed capsules attached, of *Nigella* spp. For cut branches with seed capsules, your authority is 7CFR 319.56; for cut flowers free from seed capsules, your authority is 7CFR 319.74.

***Nipponanthemum* spp. (nippon-daisy, nipon-chrysanthemum) Asteraceae**

Use [Table 3-25](#) to regulate fresh, cut articles of *Nipponanthemum* spp.

TABLE 3-25 *Nipponanthemum* spp. (nippon-daisy, nipon-chrysanthemum) Asteraceae

If the flowers were harvested in:	And the consignment is:	And:	Then:	Authority:
Andorra, Argentina, Australia, Austria, Belarus, Belgium, Bosnia and Herzegovina, Brazil, Brunei, Bulgaria, Canary Islands, Chile, China, Colombia, Croatia, Cyprus, Czech Republic, Denmark, Ecuador, Estonia, Finland, France, Germany, Greece, Hungary, Iceland, Ireland, Italy, Japan, Korea, Latvia, Liechtenstein, Lithuania, Luxembourg, Macedonia, Malaysia, Malta, Mexico, Moldova, Monaco, New Zealand, Norway, Peru, Poland, Portugal, Republic of South Africa, Romania, Russia, San Marino, Slovakia, Slovenia, Spain, Sweden, Switzerland, Taiwan, Thailand, Tunisia, Ukraine, United Kingdom, Uruguay, Venezuela, Yugoslavia and all countries, territories, and possessions of countries located in part or entirely between 90° and 180° East longitude	Accompanied by a phytosanitary certificate or equivalent documentation ¹ , issued by the National Plant Protection Organization of the country of origin or its designee, that contains an additional declaration stating that “The place of production as well as the consignment have been inspected and found free of <i>Puccinia horiana</i> ²	The box labels and other documents accompanying consignments of cut flowers must be marked with the identity of the registered production site.	INSPECT AND RELEASE	7CFR 330.105 7CFR 319.74
	Lacking either the certificate or the certification specified in the cell above		PROHIBIT ENTRY	
Netherlands ³				
Other than a country listed in the cells above			INSPECT AND RELEASE	

- 1 Documentation may be written in Spanish. A legible photocopy, facsimile, or scanned copy of an original phytosanitary certificate is acceptable.
- 2 Statement does **not** need to be word-for-word but must indicate that both production site and the consignment have been inspected and found free of *Puccinia horiana*.
- 3 The Netherlands has been suspended from the program. When the suspension is lifted, you will be notified in ample time.

Orchidaceae (orchids)

The great majority of orchids encountered in the trade are from artificially propagated plants and therefore **fall outside the scope** of the CITES Regulations.

Therefore, INSPECT and RELEASE commercial shipments of cut orchids unless you have convincing proof that the orchids were collected in the wild¹. **Neither permits nor** certificates are necessary for orchid blossoms from artificially propagated plants.

A list of all genera and species of orchids is provided in the GRIN database. For directions for how to access GRIN and other related databases, see [“Identification of Protected Plants and Genera of Taxa Regulated Higher Than Genus” on page 3-4](#).

If you have convincing proof that the orchids were wild collected, then:

1. HOLD shipment
2. CONTACT a PPQ botanist at the nearest PPQ Plant Inspection Station; if unavailable then
3. CONTACT a CBP agricultural specialist

1 Artificially propagated orchids are very clean and consistent in quality and professionally packaged, usually having small water vials on the cut end of the blossom to keep them fresh, rarely having pests or any other quarantine concerns. Wild collected orchids would show signs of wilting and browning or discoloration, insect or handling damage, missing the water vials, probably not in clean consistent packages, and typically in poor condition overall.

***Oryza sativa* (rice) Poaceae**

Oryza sativa is regulated from all countries to prevent the entry of rice pathogens and insect pests. Use [Table 3-26](#) to regulate fresh, cut articles of *Oryza sativa*.

If the articles are dried, then GO to the *Miscellaneous and Processed Products Import Manual*.

TABLE 3-26: *Oryza sativa* (rice) Poaceae

If destined to:	Then:	Authority:
Guam or the Northern Mariana Islands	INSPECT and RELEASE	7CFR 319.55
Territory or State other than Guam or the Northern Mariana Islands	PROHIBIT ENTRY	

ReferenceReference Tables

***Pernettya* spp. (pernettya) Eriaceae**

INSPECT and RELEASE stems, leaves, or inflorescences, including cut flowers with fruits attached, of *Pernettya* spp. *Pernettya* is **not** a known host for fruit flies. For cut flowers with fruits, your authority is 7CFR 319.56; for cut flowers free from fruits, your authority is 7CFR 319.74.

Phoenix spp. (date palm) Arecaceae

Leaves of *Phoenix* spp. are regulated because they could be a means of introducing Bayoud disease of date palms caused by *Fusarium oxysporum* var. *albedinis*. Use [Table 3-27](#) to regulate fresh, cut leaves of *Phoenix* spp.

TABLE 3-27: Phoenix spp. (date palm) Arecaceae

If the leaves were grown in:	And the shipment:	Then:	Authority:
Algeria or Morocco		PROHIBIT ENTRY	7CFR 330.105
Country other than listed above	Is accompanied by a certificate of origin or phytosanitary certificate issued by the national plant protection organization of the country in which the palm leaves were cut	INSPECT and RELEASE	
	Lacks the certification described above	PROHIBIT ENTRY	

Reference

Reference Tables

***Physalis* spp. (ground cherry, Chinese-lantern plant, Japanese-lantern) Solanaceae**

Fruits of *Physalis* spp. are regulated to prevent the entry of the Mediterranean fruit fly, *Ceratitis capitata*. Use **Table 3-28** to regulate fresh, cut articles of *Physalis* spp.

TABLE 3-28: *Physalis* spp. (ground cherry, Chinese-lantern plant, Japanese-lantern) Solanaceae

If with:	And:	Then:	Authority:
Stems, leaves, or inflorescences only—never with fruits	—————→	INSPECT and RELEASE	7CFR 319.74
Botanical fruits	After using the <i>Fruits and Vegetables Import Manual</i> you determine that the fruits are admissible without treatment or without special requirements by 7CFR 319.56	1. REQUIRE an import permit ¹ 2. INSPECT and RELEASE	7CFR 319.56
	After using the <i>Fruits and Vegetables Import Manual</i> you determine that the fruits are inadmissible , admissible with treatment, or has special requirements by 7CFR 391.56	PROHIBIT ENTRY	

1 If the importer lacks an import permit and the shipment is noncommercial that can be inspected 100 percent, then the permit requirement may be waived. Otherwise, HOLD the shipment and direct the importer to apply for a permit. Refer to *Appendix A*, “Permits and Foreign Phytosanitary Certificates” on **page A-1** for instructions and information about permits.

Pinaceae (conifers)

Pinaceae is the family for conifers that are host to a wide variety of exotic insect pests and diseases, especially needle rusts, as well as gypsy moth and pine shoot beetle. A list of all general and species of Pinaceae is provided in the GRIN database. For directions for how to access GRIN and other related databases, see “[Identification of Protected Plants and Genera of Taxa Regulated Higher Than Genus](#)” on [page 3-4](#).

Begin at [Table 3-29](#) to regulate fresh, cut articles of all conifers including cut Christmas trees of pine, fir, cedar, juniper, larch, and spruce.

TABLE 3-29: Pinaceae (all genera of conifers)

If the articles were cut in:	And the cut articles are:	And the coniferous genus is:	And there are in a fascicle:	Then:	Authority:	
Canada	Commercially produced wreaths or garlands		→	INSPECT and RELEASE	7CFR 330.105	
	Other than described above		→	GO to Table 3-31 on page 3-56		
Mexico			→	GO to Table 3-30 on page 3-56		
Country other than Canada or Mexico	Coniferous trees		→	PROHIBIT ENTRY	7CFR 319.37	
	Coniferous branches or wreaths	<i>Pinus</i> (pine)	Two or three needles			
			Five needles		INSPECT and RELEASE	7CFR 330.105
		<i>Abies</i> (fir) <i>Cathaya</i> <i>Cedrus</i> (cedar) <i>Juniperus</i> (juniper) <i>Keteleeria</i> <i>Larix</i> (larch) <i>Picea</i> (spruce) <i>Pseudolarix</i> <i>Pseudotsuga</i> <i>Tsuga</i>	→	PROHIBIT ENTRY	7CFR 319.37	
Other than one listed above		→	INSPECT and RELEASE	7CFR 319.37		

Reference

Reference Tables

TABLE 3-30: Pinaceae from Mexico



If the cut articles are from the Mexican State of:	And the coniferous genus is:	And there are in a fascicle:	Then:	Authority:
Baja California Norte, Chihuahua, Coahuila, Nuevo León, Sonora, or Tamaulipas	<i>Pinus</i> (pine)	Two or three needles	PROHIBIT ENTRY	7CFR 319.37
		Five needles	INSPECT and RELEASE	7CFR 330.105
	<i>Abies</i> (fir) <i>Cathaya</i> <i>Cedrus</i> (cedar) <i>Juniperus</i> (juniper) <i>Keteleeria</i> <i>Larix</i> (larch) <i>Picea</i> (spruce) <i>Pseudolarix</i> <i>Pseudotsuga</i> <i>Tsuga</i>	→	PROHIBIT ENTRY	7CFR 319.37
	Other than one listed above	→	INSPECT and RELEASE	7CFR 330.105
State other than listed above		→	PROHIBIT ENTRY	7CFR 319.37

TABLE 3-31: Pinaceae from Canada¹

If the cut articles are:	And are of:	Then:	Authority:
Conifer Christmas trees or branches ²	The <i>Pinus</i> (pine) genus (white pine, Scotch or Scots pine)	GO to Table 3-32 on page 3-57	
	Other than the <i>Pinus</i> genus (fir, spruce, hemlock, Douglas fir) ³	GO to Table 3-36 on page 3-61	
Other than conifer Christmas trees or branches, such as flowers or stems	One of the following genera: <i>Chaenomeles</i> spp. (flowering quince) <i>Cydonia</i> spp. (quince) <i>Gossypium</i> spp. (cotton) <i>Malus</i> spp. (apple, crabapple) <i>Prunus</i> spp. (almond, apricot, cherry, cherry laurel, English laurel, nectarine, peach, prune) <i>Pyrus</i> spp. (pear) <i>Vitis</i> spp. (grape)	PROHIBIT ENTRY	7CFR 319.37
	Other than a genus listed above	RELEASE	7CFR 330.105

- 1 Other than commercially produced wreaths or garlands, which may be RELEASED.
- 2 The term conifer refers to cone-bearing trees. Common examples include pine (*Pinus* spp.), fir (*Abies* spp.), spruce (*Picea* spp.), hemlock (*Tsuga* spp.) and Douglas fir (*Pseudotsuga menziesii*).
- 3 Coniferous branches from species other than pine and less than 15 mm (1/2 inch) in diameter are exempt from certification requirements and may be RELEASED.

TABLE 3-32: Cut Christmas Trees or Branches¹ of *Pinus* spp. From Canada

If from the Canadian Province of:	And the shipment:	Then:	Authority:
New Brunswick or Nova Scotia		GO to Table 3-35 on page 3-60	
Ontario or Quebec		GO to Table 3-33 on page 3-58	
Province other than listed above	Is accompanied by both of these documents: <ul style="list-style-type: none"> ◆ A certificate of origin² stating that the trees were produced in an area of Canada where gypsy moth (<i>Lymantria dispar</i>) is not known to occur ◆ A certificate of origin and movement³ stating that the trees were produced in and moved through an area of Canada where pine shoot beetle (<i>Tomicus piniperda</i>) is not known to occur⁴ 	RELEASE	7CFR 330.105
	Lacks the documents described above	PROHIBIT ENTRY	

- 1 Cut pine Christmas trees or branches of Canadian origin are subject to requirements for both gypsy moth (*Lymantria dispar*) and pine shoot beetle (*Tomicus piniperda*). Because the entry requirements are complex and are based on place of origin in Canada as well as place of destination in the United States, first determine the requirements for gypsy moth, then determine the requirements for pine shoot beetle.
- 2 The certificate of origin for gypsy moth is a signed, accurate statement certifying the area in which the trees were grown. The statement may be provided directly on the documents accompanying the tree shipment, or may be provided on a separate certificate. The certification **does not** require the signature of a CFIA inspector; exporters may sign the statement.
- 3 The certification of origin and movement for pine shoot beetle is a signed, accurate statement certifying the area in which the trees were grown and moved through, and stating that the trees were produced and moved through areas of Canada not considered to be infested with pine shoot beetle. The statement may be printed directly on the documents accompanying the shipment, or may be provided on a separate document. The certificate **does not** require the signature of a CFIA inspector; exporters may sign the statement.
- 4 A current list of infested areas can be found at the following web site address: <http://www.aphis.usda.gov/ppq/manuals/pdf_files/CB%20in%20PDF/AppendixG.pdf>.

Reference

Reference Tables

TABLE 3-33: Cut Christmas Trees or Branches of *Pinus* spp. from Ontario or Quebec—Gypsy Moth Requirements

If the shipment is from:	And is destined to:	And the shipment:	Then:
Canadian area infested with gypsy moth (<i>Lymantria dispar</i>) ¹	Connecticut, Delaware, District of Columbia, Maryland, Massachusetts, Michigan, New Hampshire, New Jersey, New York, Pennsylvania, Rhode Island, Vermont, or other areas in the United States infested with gypsy moth ^{1, 2}	→	GO to Table 3-34 on page 3-59
		Is accompanied by a Canadian phytosanitary certificate with one of the following additional declarations: 1. “The trees have been inspected and found free of gypsy moth.” OR 2. “The trees have been treated for gypsy moth in accordance with the Plant Protection and Quarantine Treatment Manual.”	
		Lacks the above certification	
Canadian area not infested with gypsy moth (<i>Lymantria dispar</i>)	Connecticut, Delaware, District of Columbia, Maryland, Massachusetts, Michigan, New Hampshire, New Jersey, New York, Pennsylvania, Rhode Island, Vermont or other areas in the United States infested with gypsy moth ^{1, 2}	→	GO to Table 3-34 on page 3-59
		Is accompanied by a certificate of origin ³ stating that the trees were produced in an area of Canada where gypsy moth is not known to occur	
		Lacks the above certification	

- 1 For a list of infested areas, refer to the following web site address: <http://www.aphis.usda.gov/ppq/manuals/pdf_files/CB%20in%20PDF/AppendixG.pdf>.
- 2 Trees destined to a gypsy moth infested area, but moving through a U.S. noninfested area (other than noninfested areas in the counties of Aroostock, Franklin, Oxford, Penobscot, Piscataquis, and Somerset, Maine) **must** meet entry requirements for trees destined to gypsy moth noninfested areas.
- 3 The certificate of origin is a signed, accurate statement certifying the area in which the trees were grown, and stating that the trees were produced in an area of Canada where gypsy moth is not known to occur. The statement may be provided directly on the documents accompanying the tree shipment, or may be provided on a separate certificate. The certificate **does not** require the signature of a CFIA inspector; exporters may sign the statement.

TABLE 3-34: Cut Christmas Trees or Branches of *Pinus* spp. from Ontario or Quebec—Pine Shoot Beetle Requirements

If the shipment is destined to:	And:	Then:
West Virginia or other areas in the United States infested with pine shoot beetle (<i>Tomicus piniperda</i>) ¹	Both of the following conditions are met: 1. The trees are accompanied by a certification of origin and movement ² that specifies the province or provinces where the trees were grown, and if applicable, moved through, if different from the province or provinces where grown 2. The U.S. destination (including State and county) of the trees is plainly indicated on the trees or on the outer container (if in a container)	RELEASE
	The conditions described above are not met	PROHIBIT ENTRY
Area in the United States not infested with pine shoot beetle (<i>Tomicus piniperda</i>)	Both of the following conditions are met: 1. The U.S. destination (including State and county) of the trees is plainly indicated on the trees or on the outer container (if in a container) 2. The trees are accompanied by a Canadian phytosanitary certificate that specifies the province or provinces where the trees were grown, and, if applicable, moved through, if different from the province or provinces where grown. The treatment section of the certificate must indicate that the trees have been treated with methyl bromide to kill the pine shoot beetle (<i>Tomicus piniperda</i>). Alternatively, in lieu of methyl bromide treatment, the certificate must contain one of the following additional declarations: ◆ “These articles were produced on a plantation that has a program to control or eradicate pine shoot beetle (<i>Tomicus piniperda</i>) and have been inspected and are considered to be free from pine shoot beetle (<i>Tomicus piniperda</i>).” OR ◆ “These articles were produced in an area where pine shoot beetle (<i>Tomicus piniperda</i>) is not considered to be present, as determined by the CFIA.” OR ◆ “These articles have been 100 percent inspected and found to be free from pine shoot beetle (<i>Tomicus piniperda</i>).”	RELEASE
	The conditions described above are not met	PROHIBIT ENTRY

- 1 For a list of infested areas, refer to the following web site address: <http://www.aphis.usda.gov/ppq/manuals/pdf_files/CB%20in%20PDF/AppendixG.pdf>.
- 2 The certification of origin and movement for pine shoot beetle is a signed, accurate statement certifying the area in which the trees were grown and moved through, and stating that the trees were produced and moved through areas of Canada not considered to be infested with pine shoot beetle. The statement may be printed directly on the documents accompanying the shipment, or may be provided on a separate document. The certification **does not** require the signature of a CFIA inspector; exporters may sign the statement.

Reference

Reference Tables

TABLE 3-35: Cut Christmas Trees or Branches of *Pinus* spp. from New Brunswick or Nova Scotia

If the shipment is from:	And is destined to:	And the shipment:	Then:
A Canadian area infested with gypsy moth (<i>Lymantria dispar</i>) ¹	Connecticut, Delaware, District of Columbia, Maryland, Massachusetts, Michigan, New Hampshire, New Jersey, New York, Pennsylvania, Rhode Island, Vermont, or other areas in the United States infested with gypsy moth ^{1, 2}	→	RELEASE
		Is accompanied by a Canadian phytosanitary certificate with one of the following additional declarations: 1. "The trees have been inspected and found free from gypsy moth." OR 2. "The trees have been treated for gypsy moth in accordance with the Plant Protection and Quarantine Treatment Manual."	
	An area in the United States not infested with gypsy moth	Lacks the above certification	PROHIBIT ENTRY
A Canadian area not infested with gypsy moth (<i>Lymantria dispar</i>)	Connecticut, Delaware, District of Columbia, Maryland, Massachusetts, Michigan, New Hampshire, New Jersey, New York, Pennsylvania, Rhode Island, Vermont, or other areas in the United States infested with gypsy moth ^{1, 2}	→	RELEASE
		Is accompanied by a certificate or origin ³ stating that the trees were produced in an area of Canada where gypsy moth is not known to occur	
	Area in the United States not infested with gypsy moth	Lacks the above certification	PROHIBIT ENTRY

- 1 For a list of infested areas, refer to the following web site address: <http://www.aphis.usda.gov/ppq/manuals/pdf_files/CB%20in%20PDF/AppendixG.pdf>.
- 2 Trees destined to a gypsy moth infested area, but moving through a U.S. noninfested area (other than noninfested areas in the counties of Aroostock, Franklin, Oxford, Penobscot, Piscataquis, and Somerset, Maine) **must** meet entry requirements for trees destined to gypsy moth noninfested areas.
- 3 The certificate of origin is a signed, accurate statement certifying the area in which the trees were grown, and stating that the trees were produced in an area of Canada where gypsy moth is not known to occur. The statement may be provided directly on the documents accompanying the tree shipment, or may be provided on a separate certificate. The certification **does not** require the signature of a CFIA inspector; exporters may sign the statement.

TABLE 3-36: Cut Christmas Trees or Branches Other Than *Pinus* spp. from Canada

If the shipment is from:	And is destined to:	And the shipment:	Then:
Canadian area infested with gypsy moth (<i>Lymantria dispar</i>) ¹	Connecticut, Delaware, District of Columbia, Maryland, Massachusetts, Michigan, New Hampshire, New Jersey, New York, Pennsylvania, Rhode Island, Vermont, or other areas in the United States infested with gypsy moth ^{1, 2}	→	RELEASE
		Is accompanied by a Canadian phytosanitary certificate with one of the following additional declarations: 1. "The trees have been inspected and found free from gypsy moth." OR 2. "The trees have been treated for gypsy moth in accordance with the Plant Protection and Quarantine Treatment Manual."	
	Lacks the above certification	PROHIBIT ENTRY	
Canadian area not infested with gypsy moth (<i>Lymantria dispar</i>)	Connecticut, Delaware, District of Columbia, Maryland, Massachusetts, Michigan, New Hampshire, New Jersey, New York, Pennsylvania, Rhode Island, Vermont, or other areas in the United States infested with gypsy moth ^{1, 2}	→	RELEASE
		Is accompanied by a certificate or origin ³ stating that the trees were produced in an area of Canada where gypsy moth is not known to occur	
	Lacks the above certification	PROHIBIT ENTRY	

1 For a list of infested areas, refer to the following web site address: <http://www.aphis.usda.gov/ppq/manuals/pdf_files/CB%20in%20PDF/AppendixG.pdf>.

2 Trees destined to a gypsy moth infested area, but moving through a U.S. noninfested area (other than noninfested areas in the counties of Aroostock, Franklin, Oxford, Penobscot, Piscataquis, and Somerset, Maine) **must** meet entry requirements for trees destined to gypsy moth noninfested areas.

3 The certificate of origin is a signed, accurate statement certifying the area in which the trees were grown, and stating that the trees were produced in an area of Canada where gypsy moth is not known to occur. The statement may be provided directly on the documents accompanying the tree shipment, or may be provided on a separate certificate. The certification **does not** require the signature of a CFIA inspector; exporters may sign the statement.

Reference

Reference Tables

Poaceae (grasses)

Poaceae is a family that includes all genera and species of grasses. A list of all genera and species of Poaceae is provided in the GRIN database. For directions for how to access GRIN and other related databases, refer to “[Identification of Protected Plants and Genera of Taxa Regulated Higher Than Genus](#)” on [page 3-4](#). Grasses are regulated to prevent the entry of a wide diversity of plant diseases, primarily viruses and rusts.

Use [Table 3-37](#) to regulate fresh, cut articles of Poaceae.

If the grasses are dried, then GO to the *Miscellaneous and Processed Products Import Manual*.

TABLE 3-37: Poaceae (all genera and species of grasses)

If the grasses are grown in:	And the grasses are:	And the shipment is destined to:	And the grasses:	Then:	Authority:	
Canada	Bamboo or rice	Guam or the Commonwealth of the Northern Mariana Islands (CNMI)	→	INSPECT and RELEASE	7CFR 318.82	
		Territory of State other than Guam or CNMI	→	PROHIBIT ENTRY	7CFR 319.37 (bamboo) 7CFR 319.55 (rice)	
	Broomcorn or corn and related genera	→	→	For <i>Sorghum bicolor</i> (broomcorn), GO to Table 3-44 on page 3-74 For <i>Zea mays</i> (corn and closely related plants), GO to Table 3-50 on page 3-82		
	Sugarcane	→	→	PROHIBIT ENTRY	7CFR 319.15	
	Federal noxious weeds	→	→	Have seeds	1. HOLD shipment 2. CONTACT a PPQ botanist at the nearest PPQ Plant Inspection Station; if unavailable then 3. CONTACT a CBP agricultural specialist ¹	
				Lack seeds	INSPECT and RELEASE	7CFR 330.105
Other than listed above	→	→	→			
Country other than Canada				PROHIBIT ENTRY	7CFR 319.37	

1 The CBP agricultural specialist will contact a botanist with PPQ’s Permits, Registrations, Imports & Manuals Staff, as decisions are made on a case-by-case basis.

Polypodiophyta (Ferns)

Two species of fern are regulated because they are noxious weeds and have the potential to cause serious environmental and economic damage to some areas of the United States. Use [Table 3-28](#) to regulate fresh, cut articles of ferns:

TABLE 3-38: *Polypodiophyta (Ferns)*

If the ferns are:	Then:	Authority:
<i>Lygodium flexuosum</i> (maidenhair creeper) or <i>Lygodium microphyllum</i> (Old World climbing fern)	PROHIBIT ENTRY	Federal Import Quarantine Order—May 30, 2008
Other than one of the two ferns listed above	INSPECT and RELEASE	7CFR 319.74

Reference

Reference Tables

Proteaceae (protea)

Proteaceae is a plant family that includes all genera of protea. A list of all genera and species of Proteaceae is provided in the GRIN database. For directions for how to access GRIN and other related databases, see “[Identification of Protected Plants and Genera of Taxa Regulated Higher Than Genus](#)” on [page 3-4](#).

Proteaceae are regulated primarily because of diseases for which there are **not** approved treatments. Use [Table 3-39](#) to regulate fresh, cut articles of all genera of Proteaceae.

TABLE 3-39: Proteaceae (protea)

If the articles were cut in:	And the shipment:	And the shipment:	Then:	Authority:
South Africa	◆ Arrived directly from South Africa	Is accompanied by a foreign phytosanitary certificate issued by the Republic of South Africa	INSPECT and RELEASE	7CFR 319.74
	◆ Re-exported from a country other than The Netherlands	Lacks a foreign phytosanitary certificate	PROHIBIT ENTRY	7CFR 330.106
	Re-exported from The Netherlands	—————→	INSPECT and RELEASE	7CFR 319.74
Swaziland	—————→	—————→	PROHIBIT ENTRY	7CFR 330.106
Country other than listed above	—————→	—————→	INSPECT and RELEASE	7CFR 319.74; if from Canada, 7CFR 330.106

***Prunus* spp. (almonds, apricots, cherries, cherry laurels, English laurel, nectarines, peaches, plums, prunes) Rosaceae**

Prunus spp. are regulated because they are host to a diversity of exotic diseases. Therefore, PROHIBIT ENTRY to branches with or without foliage or blooms of *Prunus* spp. Your authority is 7CFR 319.37.

Reference

Reference Tables

***Pyracantha* spp. (firethorn) Rosaceae**

INSPECT and RELEASE stems, leaves, or inflorescences, including cut flowers with fruits attached, of *Pyracantha* spp. *Pyracantha* is **not** a known host for fruit flies. For cut flowers with fruits, your authority is 7CFR 319.56; for cut flowers free from fruits, your authority is 7CFR 319.74.

***Pyrus* spp. (pear) Rosaceae**

Pyrus spp. are regulated because they are host to a diversity of exotic diseases. Therefore, PROHIBIT ENTRY to branches with or without foliage or blooms of *Pyrus* spp. Your authority is 7CFR 319.37.

Reference

Reference Tables

***Ricinus communis* (castor, ricin) Euphorbiaceae**

Use **Table 3-40** to regulate botanical fruits (pods) with stems and leaves of *Ricinus* spp. Fruits of *Ricinus* are regulated to prevent the entry of exotic fruit flies including the guava fruit fly (*Bactrocera correcta*).

TABLE 3-40: *Ricinus communis* (castor, ricin) Euphorbiaceae

If the stems are:	And were grown in:	And the shipment:	Then:	Authority:
With fruit pods	Canada or New Zealand		INSPECT and RELEASE	7CFR 319.56
	The Netherlands	Is accompanied by a foreign phytosanitary certificate ¹ that shows the name and address of the grower in The Netherlands ²	1. REQUIRE an import permit ³ 2. INSPECT and RELEASE	
		Lacks a foreign phytosanitary certificate or the grower is not clearly indicated as in The Netherlands	PROHIBIT ENTRY	
	Country other than listed above			
Without fruit pods			INSPECT and RELEASE	7CFR 319.74

- 1 A foreign phytosanitary certificate is required to ensure that *Ricinus* spp. are grown in a country free from fruit flies.
- 2 The name of the grower’s village satisfies the address requirement.
- 3 If the importer lacks an import permit and the shipment is noncommercial that can be inspected 100 percent, then the permit requirement may be waived. Otherwise, HOLD the shipment and direct the importer to apply for a permit. Refer to *Appendix A*, “Permits and Foreign Phytosanitary Certificates” on [page A-1](#) for instructions and information about permits.

***Ruscus* (box-holly, butcher's-broom, horse-tongue, spineless butcher's-broom)**

Ruscaceae. Also placed in: Liliaceae

INSPECT and RELEASE stems, leaves, or inflorescences, including cut flowers with fruits attached, of *Ruscus* spp. *Ruscus* is not a known host for fruit flies. For cut flowers with fruits, your authority is 7CFR 319.56; for cut flowers free from fruits, your authority is 7CFR 319.74.

Reference

Reference Tables

Rutaceae (citrus)

Rutaceae includes all genera and species of the citrus subfamilies Aurantioideae, Rutoideae, and Toddalioideae. A list of all genera and species of citrus is provided in the GRIN database. For directions for how to access GRIN and other related databases, see “[Identification of Protected Plants and Genera of Taxa Regulated Higher Than Genus](#)” on [page 3-4](#).

Rutaceae are regulated from all countries to prevent the entry of citrus canker and other citrus diseases. Use [Table 3-41](#) to regulate fresh, cut articles of Rutaceae.

TABLE 3-41: Rutaceae (all genera and species of the citrus subfamilies Aurantioideae, Rutoideae, and Toddalioideae)

If destined to:	Then:	Authority:
◆ Guam	INSPECT and RELEASE	7CFR 319.19
◆ The Northern Mariana Islands		
Territory of State other than Guam or the Northern Mariana Islands	PROHIBIT ENTRY	

Saccharum spp. (sugarcane) Poaceae

Saccharum spp. are regulated to prevent the introduction of certain injurious insects and fungi that attack sugarcane. Therefore, PROHIBIT ENTRY to fresh, cut articles of *Saccharum* spp. Your authority is 7CFR 319.15.

If the articles are dried, then GO to the *Miscellaneous and Processed Products Import Manual*.

Reference

Reference Tables

Salix spp. (willow, pussy willow) Salicaceae

Salix spp. are regulated from Europe to prevent the entry of *Erwinia salicis*, watermark disease. Use [Table 3-42](#) to regulate fresh, cut branches with or without foliage or blooms of *Salix* spp.

TABLE 3-42: *Salix* spp. (willow, pussy willow) Salicaceae

If the cut articles were grown in:	Then:	Authority:
Europe ¹	PROHIBIT ENTRY	7CFR 319.37
Other than Europe	INSPECT and RELEASE	7CFR 319.74

- 1 The recognized countries of Europe, **not** dependencies and/or territories are as follows: Albania, Andorra, Armenia, Austria, Azerbaijan, Belarus, Belgium, Bosnia and Herzegovina, Bulgaria, Croatia, Cyprus, Czech Republic, Denmark, Estonia, Finland, France, Georgia, Germany, Greece, Hungary, Iceland, Ireland, Italy, Latvia, Liechtenstein, Lithuania, Luxembourg, Macedonia, Malta, Moldova, Monaco, Netherlands (The), Norway, Poland, Portugal, Romania, San Marino, Serbia and Montenegro (Yugoslavia), Slovakia, Slovenia, Spain, Sweden, Switzerland, Ukraine, United Kingdom, Vatican City.

Sarracenia spp. (Sarraceniaceae)

Sarracenia spp. plants are regulated because unrestricted trade could threaten them with extinction. Use [Table 3-43](#) to regulate fresh, cut pitchers (modified leaves) of *Sarracenia* spp.

TABLE 3-43: *Sarracenia*¹ spp. (pitcher plant) Sarraceniaceae

If the cut articles are:	And the species is:	Then:	Authority:
Entering at a CITES designated port ²	<i>oreophila</i> (green pitcher plant) or <i>rubra</i>	1. REGULATE as CITES Appendix I and ESA-E 2. REQUIRE a CITES import permit from U.S. Fish and Wildlife, a valid CITES export permit from country of export, and a General Permit from USDA APHIS	50CFR 17 50CFR 23
	Other than <i>oreophila</i> or <i>rubra</i>	1. REGULATE as CITES Appendix II 2. REQUIRE a valid CITES export permit from the country of export and a General Permit from USDA APHIS	
Not entering at a CITES designated port	Accompanied by CITES documents	1. SAEGUARD under plant quarantines and plant pest regulations 2. GIVE the importer one of the following options: Reexport the articles to the country of origin Reroute the articles to a CITES designated port NOTE: Shipping and handling charges are the responsibility of the importer.	7CFR 355 50CFR 23
	Not accompanied by CITES documents	1. HOLD shipment 2. CONTACT a CBP agricultural specialist at the nearest CITES designated port for instructions on initiating seizure and forfeiture actions	

- 1 Pitchers are regulated. Cut flowers of artificially propagated *Sarracenia* spp. that are listed in CITES Appendix II are exempt from CITES regulations.
- 2 A list of the CITES designated ports is available at the following web site address: <<http://www.aphis.usda.gov/ppq/permit/cites>>

Reference

Reference Tables

***Sorghum bicolor* (broomcorn) Poaceae**

Use **Table 3-44** to regulate fresh, cut articles of *Sorghum bicolor*.

If the broomcorn is dried, then GO to the *Miscellaneous and Processed Products Import Manual*.

TABLE 3-44: *Sorghum bicolor* (broomcorn) Poaceae

If grown in:	And is destined to:	And the shipment:	Then:	Authority:
Canada	◆ Arizona	Is accompanied by a Canadian phytosanitary certificate declaring that the broomcorn was vacuum fumigated in Canada	INSPECT and RELEASE	7CFR 330.105
	◆ California			
	◆ Colorado	Lacks a certificate that declares the broomcorn was vacuum fumigated in Canada	PROHIBIT ENTRY	7CFR 319.41
	◆ South Carolina			
◆ Texas				
◆ Utah	State other than one listed above	Is accompanied by a Canadian phytosanitary certificate	INSPECT and RELEASE	7CFR 330.105
◆ Washington		Lacks a Canadian phytosanitary certificate	PROHIBIT ENTRY	7CFR 319.41
Country other than Canada		→		

***Striga* spp. (witchweed) Scrophulariaceae**

Striga spp. are regulated from all countries because they are both parasitic and noxious weeds. Therefore, PROHIBIT ENTRY to fresh, cut articles of *Striga* spp. Your authority is 7CFR 360 and 7CFR 330.

ReferenceReference Tables

***Symphoricarpos* (coralberry, snowberry) Caprifoliaceae**

INSPECT and RELEASE stems, leaves, or inflorescences, including cut flowers with fruits attached, of *Symphoricarpos* spp. *Symphoricarpos* is **not** a known host for fruit flies. For cut flowers with fruits, your authority is 7CFR 319.56; for cut flowers free from fruits, your authority is 7CFR 319.74.

***Triticum* spp. (wheat and intergeneric crosses) Poaceae**

Triticum spp. are regulated from some countries to prevent the entry of flag smut (*Urocystis agropyri*) and Karnal bunt (*Tilletia indica*). Use [Table 3-45](#) to regulate fresh, cut articles of *Triticum* spp. and its intergeneric crosses.

If the wheat is dried, then GO to the *Miscellaneous and Processed Products Import Manual*.

TABLE 3-45: *Triticum* spp. (wheat and intergeneric crosses) Poaceae

If the cut articles were grown in:	Then:	Authority:
Afghanistan, Algeria, Armenia, Australia, Azerbaijan, Bangladesh, Belarus, Bulgaria, Chile, China, Cyprus, Egypt, Estonia, Falkland Islands, Georgia, Greece, Guatemala, Hungary, India, Iran, Iraq, Israel, Italy, Japan, Kazakhstan, Korea (Republic of and Democratic People's Republic of), Kyrgyzstan, Latvia, Libya, Lithuania, Mexico, Moldova, Morocco, Nepal, Oman, Pakistan, Portugal, Romania, Russia, South Africa, Spain, Tajikistan, Tanzania, Tunisia, Turkmenistan, Turkey, Ukraine, Uzbekistan, or Venezuela	PROHIBIT ENTRY	7CFR 319.59
Canada	INSPECT and RELEASE	7CFR 330.105
Country other than listed above	PROHIBIT ENTRY	7CFR 319.37

Reference

Reference Tables

***Tritonia* spp. (blazing star) Iridaceae**

Blazing star are regulated from many countries to prevent the entry of gladiolus rust, *Uromyces transversalis*, a rust that is considered of plant quarantine importance in Europe and the United States. Use [Table 3-46](#) to regulate fresh, cut articles of *Tritonia*.

TABLE 3-46: *Tritonia* spp. (blazing star)

If grown in:	And a:	Then:	Authority:
Colombia or Mexico	Personal shipment	PROHIBIT ENTRY	7CFR 330
	Commercial shipment	INSPECT AND RELEASE ¹	7CFR 319.74
Other than one of the countries listed in the cell above			

1 Look carefully for single or aggregated yellowish-brown or blackish-brown pustules on the leaves. These may be symptoms of gladiolus rust, a disease not known to occur in the U.S.

Viburnum spp. (Guelder-rose, Japanese snowball, laurustine, snowball, summer snowflake) Caprifoliaceae

Viburnum spp. are regulated to prevent the entry of fruit flies and other exotic pests and pathogens. Use [Table 3-47](#) to regulate fresh, cut articles of *Viburnum* spp.

TABLE 3-47: *Viburnum* spp. (nannyberry, snowball, viburnum)—branches with botanical fruit or with foliage only

If branches are:	And:	And:	And the symptoms are on:	Then:	Authority:
With berries	Were grown in Canada or New Zealand	—————→	—————→	INSPECT AND RELEASE	7CFR 319.74
	Were grown in the Netherlands	Paperwork shows a Dutch grower	—————→	1. REQUIRE a permit, and 2. INSPECT AND RELEASE	7CFR 319.56
		Paperwork does not show a Dutch grower	—————→	PROHIBIT ENTRY	
	Were grown in other than Canada, the Netherlands, or New Zealand	With a foreign phytosanitary certificate ¹	—————→	—————→	1. REQUIRE a permit, and 2. INSPECT AND RELEASE
Lacks a foreign phytosanitary certificate		—————→	—————→	PROHIBIT ENTRY	
Solely the inflorescence or inflorescence with foliage (no fruit)	Were grown in The Netherlands	No pests and no pathogens are found	—————→	RELEASE	7CFR 319.74
		Solely disease symptoms are found	The stems	1. SUBMIT THE DISEASE as a prompt interception, and 2. RELEASE	7 CFR 330.105
			Other than the stems	1. SUBMIT THE PEST as an urgent interception, and 2. HOLD the shipment pending final determination	
	Insects or other arthropods are found or insects in combination with disease symptoms	—————→	2. HOLD the shipment pending final determination		
Were grown in other than The Netherlands	—————→	—————→	—————→	INSPECT AND RELEASE ²	7CFR 319.74

1 A foreign phytosanitary certificate that shows the *Viburnum* spp. are grown in a country free from Mediterranean fruit fly (*Ceratitis capitata*)

2 If arthropod pests or diseases are found, submit as an **urgent** interception.

Fruits of viburnum are regulated to prevent the entry of exotic fruit flies.

Reference

Reference Tables

Watsonia spp. (Iridaceae)

Watsonia are regulated because they are host to the gladiolus rust, *Uromyces transversalis*, a rust that is considered of plant quarantine importance in Europe and the United States. Use [Table 3-48](#) to regulate fresh, cut articles of *Watsonia*.

TABLE 3-48: *Watsonia* spp. (bugle lily, Merians bugle lily, pink watsonia, watsonia)

If grown in:	And a:	Then:	Authority:
Colombia or Mexico	Personal shipment	PROHIBIT ENTRY	7CFR 330
	Commercial shipment	INSPECT AND RELEASE ¹	7CFR 319.74
Other than one of the countries listed in the cell above			

1 Look carefully for single or aggregated yellowish-brown or blackish-brown pustules on the leaves. These may be symptoms of gladiolus rust, a disease not known to occur in the U.S.

Zamiaceae/Cycadaceae (cycads)

All taxa of cycads are listed in CITES Appendix II, except those specifically listed in CITES Appendix I. A list of all genera and species of cycads is provided in the GRIN database. For directions for how to access GRIN and other related database, see “[Identification of Protected Plants and Genera of Taxa Regulated Higher Than Genus](#)” on [page 3-4](#).

Cycad leaves and fronds are regulated because unrestricted trade could threaten them with extinction. Use [Table 3-49](#) to regulate the fresh, cut leaves and fronds of Zamiaceae and Cycadaceae. (See also “[Cycadaceae/Zamiaceae \(cycads\)](#)” on [page 3-29](#).)

TABLE 3-49: Zamiaceae (cycads)

If the leaves/fronds are:	And the taxa is:	Then:	Authority:
Entering at a CITES designated port ¹	Listed in CITES Appendix I, includes the following genera: <ul style="list-style-type: none"> ◆ <i>Ceratozamia</i> spp. ◆ <i>Chigua</i> spp. ◆ <i>Cycas beddomei</i> ◆ <i>Encephalartos</i> spp. ◆ <i>Microcycas calocoma</i> 	<ol style="list-style-type: none"> 1. REGULATE as CITES Appendix I 2. REQUIRE a CITES import permit from U.S. Fish and Wildlife, a valid CITES export permit from country of export, and a General Permit from USDA APHIS 	50CFR 23
	Cycad other than those listed in CITES Appendix I	<ol style="list-style-type: none"> 1. REGULATE as CITES Appendix II 2. REQUIRE a valid CITES export permit from the country of export and a General Permit from USDA APHIS 	
Not entering at a CITES designated port	Accompanied by CITES documents	<ol style="list-style-type: none"> 1. SAFEGUARD under plant quarantines and plant pest regulations 2. GIVE the importer one of the following options: Re-export the articles to the country of origin Reroute the articles to a CITES designated port NOTE: Shipping and handling charges are the responsibility of the importer. 	7CFR 355 50CFR 23
	Not accompanied by CITES documents	<ol style="list-style-type: none"> 1. HOLD shipment 2. CONTACT a CBP agricultural specialist at the nearest CITES designated port for instructions on initiating seizure and forfeiture actions 	

1 A list of the CITES designated ports is available at the following web site address: <<http://www.aphis.usda.gov/ppq/permits/cites>>

Reference

Reference Tables

Zea mays (corn and closely related plants) Poaceae

Zea mays is regulated because of the European corn borer, *Ostrinia nubilalis*, and other insects and plant diseases. Use [Table 3-50](#) to regulated fresh, cut articles of *Zea mays*.

If the cut articles are dried, then GO to the *Miscellaneous and Processed Products Import Manual*.

TABLE 3-50: *Zea mays* (corn and closely related plants) Poaceae

If the cut articles were grown in:	And the shipment is destined to:	And the shipment:	Then:	Authority:
The Canadian Provinces of: ◆ Alberta ◆ Manitoba ◆ New Brunswick ◆ Newfoundland ◆ Nova Scotia ◆ Ontario ◆ Prince Edward Island ◆ Quebec ◆ Saskatchewan	◆ Arizona	Is accompanied by a Canadian certificate that states the articles were fumigated to eliminate European corn borer Lacks the certification described above	RELEASE	7CFR 330.105
	◆ California		PROHIBIT ENTRY	7CFR 319.41
	◆ Florida	—————→	RELEASE	7CFR 330.105
	◆ Idaho			
	◆ Nevada	—————→	PROHIBIT ENTRY	7CFR 319.24 7CFR 319.41
	◆ New Mexico			
	◆ Oregon	—————→	PROHIBIT ENTRY	7CFR 319.24 7CFR 319.41
	◆ Texas			
	◆ Utah	—————→	PROHIBIT ENTRY	7CFR 319.24 7CFR 319.41
	◆ Washington			
	State other than listed above	—————→	RELEASE	7CFR 330.105
Canadian Province of British Columbia	—————→	—————→	PROHIBIT ENTRY	7CFR 319.24 7CFR 319.41
Country other than Canada	—————→	—————→	PROHIBIT ENTRY	7CFR 319.24 7CFR 319.41



Appendix A

Permits and Foreign Phytosanitary Certificates

Contents

Introduction	page A-1
PPQ Permits	page A-1
Oral Permission	page A-2
Written Permits	page A-2
Departmental Permits	page A-7
Transit Permits	page A-9
VS Permits	page A-10
CITES Permits	page A-10
Phytosanitary Certificates	page A-11

Introduction

This appendix provides administrative and operational policies regarding permits and foreign phytosanitary certificates that are encountered when regulating agricultural products imported for other than planting purposes.

This appendix **does not** cover the following topics:

- ◆ Permits and foreign phytosanitary certificates for plants and plant products imported for planting purposes (see MCFR 319.37, *Port of Entry Manual*)
- ◆ Animal product certificates (see the *Animal Product Manual*)

The three kinds of permits encountered in agricultural quarantine inspections are as follows:

- ◆ **PPQ Permits**
- ◆ **VS Permits**
- ◆ **CITES Permits**

PPQ Permits

PPQ permits are either oral or written permission to import plant material. PPQ permits are issued by USDA-APHIS-PPQ and are authorized by the Plant Protection Act.

The purposes of PPQ permits are as follows:

- ◆ Provide contact with importers in order to exchange information
- ◆ Inform importers of agricultural regulations and conditions of entry that must be met, such as treatments or designated ports of entry
- ◆ Inform PPQ and CBP of the importers' intentions
- ◆ Strengthen the ability to exclude prohibited material and thereby keep out plant pests
- ◆ Verify that importers had prior knowledge of agricultural regulations

Oral Permission

PPQ or CBP regulatory officials provide oral permission at the time of inspection. The regulatory official's oral permission is appropriate for noncommercial importations of admissible plant material. Noncommercial means for personal use, **not** for resale or other commercial use, and admissible material are items that are generally unrestricted. If a plant product is admissible, then in the *Reference* of this manual the regulatory action listed is to INSPECT and RELEASE. Therefore, when all import requirements are met based on a regulatory inspection, then oral permission is adequate for noncommercial importations of admissible plant material.

Written Permits

USDA-APHIS-PPQ Permits, Registrations, Imports, and Manuals (PRIM) issue written permits for commercial importations of admissible plant material and for the movement of live plants pests, pathogens, and Federal noxious weeds. The written permits covered in this appendix are as follows:

- ◆ **PPQ Form 526** (Application for Permit to Move Live Plant Pests or Noxious Weeds)
- ◆ **PPQ Form 597** (Import Permit for Plant and Plant Products)

Although in general, commercial shipments of cut flowers do not require a written permit¹, permits are important. Written permits instruct the importer to purchase and to handle agricultural plant material in a manner that minimizes pest risk. Additionally, written permits allow PPQ to fully enforce the regulations with fewer complications because written permits verify that importers are aware of the conditions of entry.

1 Cut flowers which are covered under quarantines **other than** 7CFR 319.74, may require a written permit. Examples include articles with decorative fruits (regulated by 7CFR 319.56) and *Triticum* spp. (regulated by 7CFR 319.59).

Written permits **do not** automatically authorize entry. PPQ and CBP regulatory officials **must** validate the accuracy of permits matching them with the shipments and importers to confirm that the conditions of entry are met. Most importations accompanied by a written permit are referred to secondary to be cleared by a CBP agricultural specialist. Live plants, covered by both import permits and phytosanitary certificates, are referred to the nearest PPQ Plant Inspection Station for inspection and processing.

PPQ Form 526



PPQ Form 526, Application for Permit to Move Live Plant Pests or Noxious Weeds, is the application as well as the permit that authorizes movement of live plant pests, Federal noxious weeds or parasitic plants imported for scientific and educational research. USDA-APHIS-PPQ Permit Services completes and validates these permits for Federal noxious weeds and parasitic plants under the Plant Protection Act, bees and bee related articles (like pollen and honey utilized as bee feed) under the authority of 7CFR 319.76, butterflies, moths, and earthworms under the authority of 7CFR 330.

Section C of PPQ Form 526 becomes the permission to move the live plant pests, pathogens, or Federal noxious weeds described. Section C of PPQ Form 526 will list or attach the conditions that must be met to mitigate the pest risk. Also, standard safeguards are printed on the reverse side of the permit. To be valid, permits must be signed by an authorized official of USDA-APHIS-PPQ (either in Block 24 of Section C or at the end of the attached sheets describing the permit conditions).

Since November 1, 2003, importers can no longer hand carry materials authorized on a PPQ Form 526. All importations of such materials must enter the United States by bonded carrier. If organisms authorized by a PPQ Form 526 are found on an individual or in baggage, then seized the package and authorize its movement to the nearest PPQ Plant Inspection Station for destruction, unless **explicitly** authorized to hand carry by a permit issued after August 1, 2003.

Along with the PPQ Form 526, USDA-APHIS-PPQ Permit Services generally issues a supply of red and white labels, PPQ Form 599, for the importer to affix to packages of live plant pests and pathogens. (See [Table 1-1](#) for instructions about how to process red and white labeled packages.)

TABLE 1-1: How to Process Red and White (PPQ Form 599) Labeled Packages

If a package with an affixed red and white label is encountered in:	Then REFER the package to:
Cargo under bonded carrier	<p data-bbox="786 436 906 506"></p> <p data-bbox="938 426 1424 520">Do not open the package!</p> <p data-bbox="786 541 1162 569">CBP agricultural specialist, who will:</p> <ol data-bbox="786 585 1424 737" style="list-style-type: none"> 1. CONFIRM that the conditions of the permit have been met 2. INSPECT the package without opening to ensure that it is not damaged or leaking 3. RE-LABEL and SEND the package directly to the nearest PPQ Plant Inspection Station
Passenger baggage hand carried by the importer	<p data-bbox="786 795 906 865"></p> <p data-bbox="938 785 1424 879">Do not open the package!</p> <p data-bbox="786 900 1313 928">Secondary where a CBP agricultural specialist will:</p> <ol data-bbox="786 945 1424 1096" style="list-style-type: none"> 1. SEIZE the package 2. SEND the package to the nearest PPQ Plant Inspection Station for destruction, unless the permit (issued after August 1, 2003) explicitly authorizes the importer to hand carry the plant pests or noxious weeds <p data-bbox="800 1127 911 1245"> Important</p> <p data-bbox="938 1117 1424 1253">All live plant pests and pathogens and noxious weeds imported under written permit must enter the United States by bonded carrier.</p>

Importers apply for a permit to move live plant pests, pathogens, or Federal noxious weeds by completing Section A of PPQ Form 526, Application for Permit to Move Live Plants Pests or Noxious Weeds. Importers may call USDA-APHIS-PPQ Permit Services toll free at 1-877-770-5990 or go to the following web site address:

<http://www.aphis.usda.gov/ppq/permits>

PPQ Form 597

PPQ Form 597, Import Permit for Plant and Plant Products, is a written permit issued by USDA-APHIS-PPQ Permit Services to authorize the importation of regulated plants and plant products for a specified period. General guidelines for handling written permits are described in this appendix. Following the general guidelines are those for handling the following special categories of written permit:

◆ **Departmental Permits**

◆ Transit Permits

PPQ Form 597 are issued and numbered using the specific subpart of the Code of Federal Regulations in Block 4, under which the plants or plant products are regulated. Similarly, if a plant product requires a written permit as a condition of entry, that plant product is listed in the *Reference* chapter of this manual as requiring an import permit along with the regulatory authority (see examples below).

EXAMPLE	<ol style="list-style-type: none"> 1. Foreign cotton and covers are regulated by subpart 8 of 7CFR 319. The regulatory authority in Block 4 is 7CFR 319.8 and the permit number in Block 1 is 8 followed by a number representing an issuance scheme. 2. Sugarcane products and by-products such as sugarcane juice (including parts of the sugarcane plant) are regulated by subpart 15 of 7CFR 319. The regulatory authority in Block 4 is 7CFR 319.15 and the permit number in Block 1 is 15 followed by a number representing an issuance scheme. 3. Logs, lumber, and other unmanufactured wood products are regulated by subpart 40 of 7CFR 319. The regulatory authority in Block 4 is 7CFR 319.40 and the permit number in Block 1 is 40 followed by a number representing an issuance scheme. 4. Corn or maize, broomcorn, and related plants of corn are regulated by subpart 41 of 7CFR 319. The regulatory authority in Block 4 is 7CFR 319.41 and the permit number in Block 1 is 41 followed by a number representing an issuance scheme. 5. Rice and rice related articles such as tatami mats made from rice straw are regulated by subpart 55 of 7CFR 319. The regulatory authority in Block 4 is 7CFR 319.55 and the permit number in Block 1 is 55 followed by a number representing an issuance scheme. 6. Approved, fresh fruits and vegetables (including fresh herb and sprouts) are regulated by subpart 56 of 7CFR 319. The regulatory authority in Block 4 is 7CFR 319.56 and the permit number in Block 1 is 56 followed by a number representing an issuance scheme.
----------------	--

For many generally admissible plant material (inspect and release), a one-time-only written permit may be issued at the time of inspection by a PPQ or CBP regulatory official. These situations are rare when an importer plans **no** more than one commercial importation of plant material that **does not** require post entry growing.

If an importer presents an expired permit (refer to Block 2), then the PPQ or CBP regulatory official may allow the importer to complete an application for a new permit using PPQ Form 587, Application for Permit to Import Plants or Plant Products. Once the permit application is approved, the importation can be cleared provided all entry conditions and requirements are met. Because this is a time

consuming effort, usually importations awaiting approval are referred to secondary and then authorized movement to the nearest PPQ Plant Inspection Station for processing.

If the importer lacks an import permit when one is required and the shipment is noncommercial that can be inspected 100 percent, then the import permit requirement may be waived. Otherwise, HOLD the shipment and direct the importer to apply for a permit by completing PPQ Form 587, Application for Permit to Import Plants or Plant Products. For wood products, the importer completes PPQ Form 585, Application for Permit to Import Timber or Timber Products. For soil, the importer completes PPQ Form 525A, Application for Permit to Receive Soil. Importers may call USDA-APHIS-PPQ Permit Services toll free at 1-877-770-5990 or go to the following web site address:

<<http://www.aphis.usda.gov/ppq/permits>>

Processing Written (Import) Permits

If an importation of plant products requiring a written permit is encountered in cargo, then REFER the importation to a CBP agricultural specialist. If an importation of plant products requiring written permit is encountered in passenger baggage, then REFER the importation to secondary.

CBP agricultural specialist will do the following:

1. CONFIRM that the permit is valid (not expired) and appropriate for the plant products being imported
2. HOLD the shipment and direct the importer to apply for a permit if the permit is expired or inappropriate²
3. CONFIRM that the conditions of the permit have been met
4. If the conditions and requirements have been met, then RELEASE or CONTROL as specified on the permit

Along with the PPQ Form 597, USDA-APHIS-PPQ Permit Services sometimes issues a supply of green and yellow labels, PPQ Form 505, for the importer to affix to packages of quarantine plant material that constitute a higher risk. (See [Table 1-2](#) for instructions about how to process green and yellow labeled packages.)

² Importers may call USDA-APHIS-PPQ Permit Services toll free at 1-877-770-5990 or go to the following web site address: <<http://www.aphis.usda.gov/ppq/permits>>.

TABLE 1-2: How to Process Green and Yellow (PPQ Form 505) Labeled Packages

If a package with an affixed green and yellow Label is encountered in:	Then REFER the package to:
Cargo	<div data-bbox="846 432 951 506" style="border: 1px solid black; background-color: yellow; padding: 2px; display: inline-block;">CAUTION</div> <div data-bbox="976 417 1471 520" style="background-color: #e0f2f1; padding: 5px; display: inline-block;">Do not open the package!</div> <p data-bbox="833 539 1211 567">CBP agricultural specialist, who will:</p> <ol data-bbox="833 583 1471 737" style="list-style-type: none"> 1. CONFIRM that the conditions of the permit have been met 2. INSPECT the package without opening to ensure that it is not damaged or leaking 3. RE-LABEL and SEND the package directly to the nearest PPQ Plant Inspection Station
Passenger baggage	<div data-bbox="846 791 951 865" style="border: 1px solid black; background-color: yellow; padding: 2px; display: inline-block;">CAUTION</div> <div data-bbox="976 777 1471 879" style="background-color: #e0f2f1; padding: 5px; display: inline-block;">Do not open the package!</div> <p data-bbox="833 898 1362 926">Secondary where a CBP agricultural specialist will:</p> <ol data-bbox="833 942 1471 1096" style="list-style-type: none"> 1. CONFIRM that the conditions of the permit have been met 2. INSPECT the package without opening to ensure that it is not damaged or leaking 3. RE-LABEL and SEND the package directly to the nearest PPQ Plant Inspection Station

Departmental Permits

USDA-APHIS-PPQ, Permits, Registrations, Imports & Manuals, Permit Services, issue Departmental permits, which is a special category of written permit for the importation of small research samples of prohibited plants or plant products intended for experimental purposes. Departmental permits supersede the requirements in the import manuals and direct the regulatory official on how to proceed when clearing the importation at ports of entry.



The pest risk involved with importing prohibited plants and plant products under Departmental permit is relatively great because these plants or plant products are attacked by serious plant pests and diseases in the country of origin. Therefore, Departmental permits will **always** list specific safeguards or conditions tailored for the intended importation, which the importer **must** meet as a condition of entry.

Unlike other written permits, Departmental permits are issued **only** by USDA-APHIS-PPQ Permit Services.

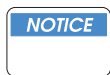

PPQ or CBP regulatory officials at ports of entry are **never** authorized to issue permits for prohibited plants and plant products.

Importers apply for Departmental permits by completing PPQ Form 588, Application for Permit to Import Prohibited Plants or Plant Products for Experimental Purposes. Importers may call USDA-APHIS-PPQ Permit Services toll free at 1-877-770-5990 or go to the following web site address:

<http://www.aphis.usda.gov/ppq/permits>

Departmental permits are issued using PPQ Form 597, Import Permit for Plants and Plant Products. Written in Block 1 will be “DEPARTMENTAL PERMIT” followed by a series of numbers.

Processing Departmental Permits

1. Obtain a copy of the Departmental permit (see [Table 1-3](#)).

TABLE 1-3: Obtain a Copy of the Departmental Permit (PPQ Form 597)

If the:	And the plants or plant products are:	Then:
Importer or the port of entry office (local files or national databases) has a copy of the permit		GO to Step 2 below
Importer applied for a permit, but there is no copy at the port of entry		CONTACT USDA-APHIS-PPQ Permit Services through proper channels
Importer did not apply for a permit	Destine to a research facility or educational institution	1. CONTACT USDA-APHIS-PPQ Permit Services through proper channels 2. If the prohibited material presents an imminent pest hazard, then ORDER the material DESTROYED or REEXPORTED
	Not destine to a research facility or an educational institution	ORDER the material DESTROYED or REEXPORTED with the concurrence of the port supervisor or officer-in-charge

2. Ensure that the prohibited plants or plants products being imported are authorized by the Departmental permit.
 - A. If there is a discrepancy, then HOLD the importation under appropriate safeguards and CONTACT USDA-APHIS-PPQ Permit Services through proper channels.
 - B. If the importer is hand carrying the prohibited plants or plant products, then ensure that the permit authorizes hand carrying to the final destination. If authorized, then ALLOW the importer to hand carry the prohibited material in accordance with the conditions listed on the permit. If **not** authorized, then CONTACT USDA-APHIS-PPQ Permit Services through proper channels.

3. If the package must be sent to USDA-APHIS-PPQ National Plant Germplasm and Biotechnology Laboratory, then ensure that the package is secure and has sufficient postage. Mail the package to the following address:

USDA-APHIS-PPQ
Center for Plant Health Science and Technology
National Plant Germplasm and Biotechnology Laboratory
Building 580, BARC-EAST
Beltsville, Maryland 20705

4. Follow the directions printed on the Departmental permit. Check that all conditions on the permit are met (see [Table 1-4](#)).

EXAMPLE	Some conditions of entry on Departmental permits are as follows: <ul style="list-style-type: none"> ◆ Treat by USDA-APHIS-PPQ at port of entry ◆ Inspect by a plant specialist named on the permit ◆ Dispose of by autoclaving, incinerating, or grinding
----------------	--

TABLE 1-4: Processing Departmental Permits

If the shipment:	Then:
Meets the stated conditions of entry	Proceed as directed by the Departmental permit
Does not meet the stated conditions	<ol style="list-style-type: none"> 1. HOLD the plants or plant products under appropriate safeguards 2. REFRIGERATE the plants or plant products, if necessary 3. REQUEST instructions from USDA-APHIS-PPQ Permit Services through proper channels

Transit Permits

USDA-APHIS-PPQ Permits, Registrations, Imports & Manuals, Permit Services, issues transit permits for the unloading, landing, or other movement of plants and plant products in cargo and passenger baggage through the United States to ensure they are adequately safeguarded and re-exported in the specified time frame. Transit permits prescribe all required safeguarding or mitigation measures for the shipment based on a risk analysis. Transit permits are issued in accordance with 7CFR 352.

Only agricultural shipments moving as transportation and exportation (TE) cargo or immediate export (IE) cargo require a transit permit. Most shipments moving under Customs bond as in-transit (IT) cargo and as residue cargo are covered by other authorization mechanisms, except for shipments of avocados from Mexico moving IT to inland-approved states which require a transit permit.

Importers apply for transit permits by completing PPQ Form 586, Application for Permit to Transit Plants and/or Plant Products through the United States. Importers may call USDA-APHIS-PPQ Permit Services toll free at 1-877-770-5990 or go to the following web site address:

<http://www.aphis.usda.gov/ppq/permits>

VS Permits

Veterinary Services (VS) permits are written permission to import prohibited or restricted animal products or by-products such as manure, eggs for food and hatching, egg by-products for research or other inedible purposes, dry milk products, blood, organs, organisms, and vectors imported for biological use and research. VS permits are issued by USDA-APHIS-VS to identify conditions of entry (that take precedence over those listed in the *Animal Product Manual*), to inform the importer of the conditions of entry, and to allow regulators to verify that importers had prior knowledge of VS requirements.

VS Form 16-6, United States Veterinary Permit for Importation and Transportation of Controlled Materials and Organisms and Vectors, is used mainly for commercial importations of restricted or prohibited animal products and by-products. VS Form 16-6A is used mainly for animal products and by-products imported for research, such as organisms and vectors.

When a VS permit authorizes the entry of an animal product or by-product, PPQ or CBP regulatory officials at the port of entry review the permit to verify the identifying number, expiration date, and destination address. Three asterisks will precede restrictions and precautions that must be confirmed as being met.

Refer to the *Animal Product Manual* for the background, procedures, and regulatory actions to enforce the regulations governing the import and export of animals products and by-products.

CITES Permits

While the Convention on International Trade in Endangered Species (CITES) is a multi-national treaty regulated by the U.S. Fish and Wildlife Service, PPQ and CBP are designated to inspect protected plants and plant products moving in international commerce. The importation, exportation, and re-exportation of protected plants and

plant products are restricted to designated ports (usually with PPQ Plant Inspection Stations) with qualified specialists, such as botanist, to process such shipments.

PPQ Form 622, General Permit, is issued by USDA-APHIS-PPQ Permit Services for all commercial importations, exportations, and re-exportations of plants and plant products that are regulated under the Endangered Species Action (50CFR 17) and CITES (50CFR 23). USDA regulation 7CFR 355 requires that importers possess a valid General Permit, which is valid for 2 years. A General Permit **does not** authorize entry into the United States, and are rarely seen in passenger baggage that typically does not involve commercial shipments.

In addition to a General Permit, importations of CITES Appendix I and CITES Appendix II plant material must be accompanied by an export certificate from the country of origin. Also, importations of CITES Appendix I plant material must have an import permit from the U.S. Fish and Wildlife Service, issued first then sent to the origin country, so they can issue the export permit. These shipments of rare, wild-collected specimens are for scientific research purposes only; no commercial trade is allowed. Exceptions can be made for some artificially propagated specimens of CITES Appendix I species or hybrids, allowing them to be traded legally as though they are CITES Appendix II specimens.

Importers apply for General Permits by completing PPQ Form 621, Application for General Permit to Engage in the Business of Importing, Exporting, or Reexporting Terrestrial Plants. Importers may call USDA-APHIS-PPQ Permit Services toll free at 1-877-770-5990 or go to the following web site address:

<<http://www.aphis.usda.gov/ppq/permits>>

Phytosanitary Certificates

Phytosanitary certificates are documents issued by an official of an exporting country, or country of re-export, attesting to freedom from pests and admissibility into the destination country for specific plants or plant products.

Phytosanitary certificates can be valid and accurate, yet still be insufficient to meet conditions of entry. Therefore, even when plants or plant products are accompanied by a phytosanitary certificate, PPQ and CBP regulatory officials inspect the importations to confirm admissibility.

In general, PPQ and CBP regulatory officials use phytosanitary certificates to perform the following tasks at the port of entry:

- ◆ Identify type of plants or plant products
- ◆ Identify area where plants or plant products were grown
- ◆ Determine if the plants or plant products were treated in country of origin and if so, identify the treatment
- ◆ Determine if quarantine requirements are met (growing season, preclearance)
- ◆ Confirm that plants or plant products meet specific certification requirements
- ◆ Determine how much of the shipment to inspect

Do **not** confuse foreign issued phytosanitary certificates with PPQ issued import permits. A phytosanitary certificate is issued by the foreign plant protection organization and is a statement of fact (certifies the inspection), while an import permit is issued by USDA-APHIS-PPQ as an authorization to import or transit a commodity. In most instances, the lack of either document alone is **not** sufficient reason to deny entry to a shipment. Therefore, unless the *Reference* section of this manual instructs differently, PPQ and CBP regulatory officials should do the following when clearing an importation accompanied by a phytosanitary certificate:

1. If an importation **only** lacks a phytosanitary certificate, then do **not** prohibit entry to the shipment (refer to the *Reference* chapter of this manual for exceptions)
2. Inspect **all** importations of plants and plant products, except for those from Canada accompanied by a phytosanitary certificate
3. If there is an operational preclearance program for the imported plants or plant products in the country of origin, then inspection may be waived for precleared shipments bearing a U.S. Department of Agriculture release stamp on the foreign document. Occasionally spot check precleared shipments.



Appendix B

Maintaining Import Manuals

Contents

Introduction	page-B-1
Revisions to the Manual	page-B-1
Advance Notice	page-B-1
Immediate Update	page-B-2
New Editions	page-B-2
Supersede Statements	page-B-2
Keeping the Cut Flowers and Greenery Import Manual Current	page-B-3
Transmittal Memorandums	page-B-3
Control Data	page-B-3
Update Record	page-B-3
Knowing Responsibilities of Manual Users	page-B-3

Introduction

This appendix contains the procedures and the users' responsibilities for maintaining the *Cut Flowers and Greenery Import Manual*. The USDA-APHIS-PPQ Manuals Unit issues and maintains manuals electronically on the Manuals Unit Web site. The on-line manuals contain the most up-to-date information. In addition, some manuals are also issued in hard copy that must manually be kept current.

Revisions to the Manual

Changes in policy, regulations, and any error in a manual that would lead to an incorrect action are immediately corrected and updated. Revisions are **not** issued solely to correct a minor typographical error.

The USDA-APHIS-PPQ Manuals Unit issues transmittals for advance notice for manual updates, advance notice of new editions, and immediate manual updates by e-mail.

Advance Notice

An advance notice is issued based on the urgency of the updated information and the size of the revision. Information that is **not** urgent or is extensive (more than 6 pages) will be updated in the on-line manual posted on the Manuals Unit Web site at the following address:

<http://www.aphis.usda.gov/ppq/manuals/online_manuals.html>

The advance notice e-mail contains the following information:

- ◆ Alert to users that the on-line manual has been updated
- ◆ Purpose of the revision
- ◆ List of updated pages to be removed and replaced (for paper copies of the manuals)
- ◆ Instructions to access the Manuals Unit Web site to download a specific chapter section, an appendix, or the entire manual

Immediate Update

Updated information that is urgently needed and covers 6 pages or less will be transmitted via e-mail as an immediate update.

The immediate update e-mail contains the following information:

- ◆ Transmittal number (used to track revisions)
- ◆ Change or purpose for the update
- ◆ List of the updated pages by page number
- ◆ Instructions to remove old pages and replace with new pages or additional pages to add
- ◆ Attached Adobe Acrobat Portable Document Format (PDF) file containing the updated pages along with the reverse side of the updated page

New Editions

Advance notice transmittal memorandums are issued by e-mail for newly-published manuals issued in hard copy (paper).

A new edition of a manual is generally scheduled when the percentage of revised pages exceeds 30 percent of the entire manual.

Supersede Statements

When a revision has superseded existing documents, then a supersede statement is included in the transmittal e-mail and transmittal memorandum.

USDA-APHIS-PPQ's Manuals Unit is obligated to identify all existing documents that contain outdated information and are no longer valid or accurate. If a manual user accessed outdated information that was **not** formally superseded, our agency may be liable. Therefore, supersede statements are critical from a legal standpoint.

Keeping the *Cut Flowers and Greenery Import Manual Current*

Transmittal Memorandums

Each new edition issued in hard copy is accompanied by a transmittal memorandum that contains the following information:

- ◆ Transmittal number (in the subject line)
- ◆ Supersede statement
- ◆ Instructions to remove all pages from the binder and place new pages in the binder, or instructions to destroy all old pages, tabs, and binders and immediately
- ◆ Instructions to file transmittal memos and e-mails to ensure that they have receive all revisions

Control Data

To track revisions to the *Cut Flowers and Greenery Import Manual*, use the control data located at the bottom of most pages. The control data contains the month, year, and transmittal number for that page (see [Figure B-1](#)).

06/2004-01	<ul style="list-style-type: none"> ◆ 06/2004 is the month and year when the new edition or revision was issued ◆ -01 is the transmittal number
------------	--

FIGURE B-1: Example of Control Data

New editions of manuals **always** start with a transmittal number of -01 and increase by one for each revision to the manual for the life of the edition.

Update Record

An Update Record is located either on the page following (on-line manuals) or on the reverse side of the manual's title page (hard copy manuals). Use the Update Record to record each transmittal number and the date each transmittal memo or e-mail was received. Keeping track of transmittal numbers helps identify missing revisions, especially if users find that they are out-of-sequence.

Knowing Responsibilities of Manual Users

Those who maintain a hard copy of the manual should continue below to know their responsibilities in keeping their manual up to date. Otherwise, the on-line manual is maintained by USDA-APHIS-PPQ's Manuals Unit and resides on PPQ's Manuals Unit Web Site.

The *Cut Flowers and Greenery Import Manual* must be kept up-to-date in order to effectively maintain the hard copy and to enhance professionalism. When you use an outdated manual, you risk making a decision that provides the opportunity for an outbreak of an exotic disease. Your diligence is a crucial part of maintaining a manual.

When you receive each revision, do the following:

- 1.** Read the transmittal e-mail or memo to understand the purpose of the revision. Except for changes to the indexes, all revisions will be marked with a change bar as located to the left of this sentence.
- 2.** Record the transmittal number and date received in the Update Record. If you have missed a revision, check USDA-APHIS-PPQ's Manuals Unit Web site.
- 3.** Add or remove and replace the revised pages in the manual on the same day they are received.
- 4.** File the transmittal e-mail or memo.
- 5.** Communicate, through proper channels, changes to addresses and copy counts on the mailing label, if applicable.

Glossary

Introduction

Use this *Glossary* to find the meaning of specialized words, abbreviations, acronyms, and terms used in regulating the fresh, cut articles imported for decoration or ornamentation. To locate where in the manual a given definition, term, or abbreviation is mentioned, use the [Index](#).

Definitions, Terms, and Abbreviations

Additional declaration—statement that is required by an importing country to be entered on a foreign phytosanitary certificate and that provides specific additional information pertinent to the phytosanitary condition of a shipment.

Branch—a cut portion of a woody plant, with or without foliage or blooms.

Broomcorn—a grass (*Sorghum bicolor* var. *technicus*) having flower clusters with stiff, branching stalks that are used to make brooms and brushes.

Certificate—authorization to move a regulated item, most often indicated by stamping “Released” or “Treated and Released” on documents or containers.

Commercial shipment—goods that are imported for resale purposes or for profit; **not** for personal use.

Contaminants—an undesirable impurity, e.g., soil, animal manure, and weed seeds.

Culm—the jointed stem of a grass or sedge.

Cut flower—the fresh, cut portion of a plant which is highly perishable, including the inflorescence, and any parts of the plant attached to the cut portion. A cut flower can take different forms, such as a single stem with the inflorescence, a lei made of many inflorescences threaded on a string like beads, or a bouquet consisting of a mixtures of flowers like carnations, lilies, and roses. This definition does **not** include decorative plant material that has been

dried, bleached, dyed, or chemically treated; or filler and greenery. Compare to the definition for “[Filler and greenery](#)” on [page-Glossary-7-2](#).

Decorative fruit—fruit which is intended to be used for ornamental purposes and not to be eaten or grown.

Disease—the interaction between a pathogen and the plant resulting in damage to the plant. The damage caused is referred to as a symptom.

Dried—a category of processing whereby water is removed or reduced by exposure to heat or air.

Endemic—common and/or widespread in a particular place.

Filler and greenery—fresh foliage used for decoration, such as fern and palm fronds, asparagus (fern) plumes, pine sprays, chamaedorea fronds, willow branches, *Ruscus*, *Papyrus*, *Euonymus*, and other greens. Compare cut flowers.

Foreign phytosanitary certificate—an official document issued by an employee of the national plant protection organization of the exporting country attesting to the phytosanitary condition of plants or plant products. (See also “[Phytosanitary certificate](#)” on [page-Glossary-7-3](#).)

Fruit—the ripened ovary of a seed-bearing plant. Examples commonly encountered in the florist trade are peppers (*Capsicum* spp.) and holly branches (*Ilex* spp.) with berries.

Hitchhiking pest—insects or other pests which are **not** directly associated with their host material and which move with cargo, in baggage, or at large in carriers.

Import permit—official document issued by the importing country authorizing the importation of a commodity in accordance with specified phytosanitary requirements.

Inflorescence—a characteristic arrangement of flowers on a stalk or in a cluster.

Inspectional unit—the portion of a shipment used to determine what size sample should be inspected. Also, quarantine action is taken on the inspectional unit.

Intergeneric—existing or occurring between genera (hybridization).

Noncommercial—goods that are **not** imported for profit or resale, generally for personal consumption.

Noxious weeds—an undesirable plant as specified by the Federal Noxious Weed Regulations. As defined by the Federal Noxious Weed Regulations, noxious weeds are “Any living stage (including, but **not** limited to seed and reproductive parts) of any parasitic or other plant or a kind, which is of foreign origin, is new to or not widely prevalent in the United States, and can directly or indirectly injure crops, other useful plants, livestock or poultry or other interests of agriculture, including irrigation or navigation or the fish or wildlife resources of the United States or the public health.”

Packing material—a covering, stuffing, or holding apparatus used to protect, cushion, or brace goods during shipment, e.g., straw, plant litter, paper, vermiculite.

Panicle—any pyramidal inflorescence with a main axis and subdivided branches as in oats, rice, and sorghum.

Pathogen—an organism that is capable of causing disease in a particular host or range of hosts, and obtains its nutrients wholly or in part from another living organism, e.g., a microorganism such as a bacterium or fungus.

Pest Risk Level Guide—an aid to determine the extent of inspection of cut flowers based on pest risk. A risk level is given to kinds of flowers from specific countries. See [Table 2-6 on page-2-3-16](#) in the *Procedures* chapter of this manual.

Phytosanitary certificate—an official document issued by an employee of the national plant protection organization of the exporting country attesting to the phytosanitary condition of plants or plant products. (See also, “[Foreign phytosanitary certificate](#)” on [page-Glossary-7-2](#).)

Plant or portions of a plant—leaves, twigs, or other portions of plants or plant litter or debris as distinguished from clean fruits, vegetables, herbs, or other commercial articles.

Preclearance—inspection and/or treatment of commodities by or under the supervision of PPQ officers in foreign countries and U.S. offshore locations in accordance with PPQ-approved phytosanitary requirements.

Glossary

Definitions, Terms, and Abbreviations

Precleared—articles which are inspected and/or treated under PPQ monitoring/approval at origin and are in compliance with PPQ regulations prior to U.S. arrival. Precleared shipments are **always** accompanied by a PPQ Form 203.

Propagative structure—any plant part which is capable of reproduction or growth by itself.

Sample—a portion that is representative of the whole; a specimen.

Smut—any of various destructive diseases of cereal grasses caused by parasitic fungi characterized by the transformation of various plant organs into dark brown or black often dusty masses of spores.

Transit permit—a document required in advance of arrival for the unloading, landing or other movement of plants and plant products in cargo into and immediately through the United States, which lists specific conditions that must be met during the transit period.—

Treatment

a chemical or physical procedure used to kill pests; for example, fumigation, cold treatment, hot water dip, application of fungicide, vapor heat.

Index

Numerics

- 50CFR 17.12
 - description 1-9
- 50CFR 23.23
 - description 1-9
- 50CFR 24.12
 - description 1-9
- 7CFR 318.13
 - description 1-5
- 7CFR 318.82
 - description 1-6
- 7CFR 319.15
 - description 1-7
- 7CFR 319.19
 - description 1-7
- 7CFR 319.24
 - description 1-7
- 7CFR 319.37
 - description 1-7
- 7CFR 319.41
 - description 1-7
- 7CFR 319.55
 - description 1-7
- 7CFR 319.56
 - description 1-7
- 7CFR 319.59
 - description 1-8
- 7CFR 319.73
 - description 1-8
- 7CFR 319.74
 - description 1-8
- 7CFR 319.8
 - description 1-6
- 7CFR 330
 - description 1-8
- 7CFR 352
 - description 1-9
- 7CFR 360
 - description 1-9

A

- Abies*
 - regulatory action 3-53
- Achillea*
 - pest risk level 2-16
- Additional declaration
 - definition of Glossary-1
- Admissible or prohibited
 - determine 2-9
- Advisories
 - manual convention 1-10
- Aegilops*
 - regulatory action 3-5
- Aegilops* 3-75
- African corn lily (*Ixia maculata*)
 - pest risk level 2-18
- Agavaceae
 - Cordyline spp.*
 - regulatory action 3-23
 - Dracaena spp.*
 - regulatory action 3-31
- Ajania pacifica*
 - regulatory action 3-6
- Almond
 - regulating 3-22
- Almond (*Prunus spp.*)
 - regulatory action 3-63

Alpinia purpurata
Jamaica preclearance 3-2

Alstroemeria
pest risk level 2-16

Amaryllis
pest risk level 2-16

Ananas 3-7, 3-44

Ananas spp.
regulatory action 3-7

Anemone
pest risk level 2-16

Anthurium
pest risk level 2-16

*Anthurium*spp.
Jamaica preclearance 3-2

Antirrhinum majus
pest risk level 2-16

Apple
regulating 3-22

Apple (*Malus* spp.)
regulatory action 3-43

Application
manual 1-10

Apricot
cut flowers and greenery, 3-22

Apricot (*Prunus* spp.)
regulatory action 3-63

Aquifoliaceae
Ilex spp.
regulatory action 3-39

Arecaceae
Chamaedorea spp.
regulatory action 3-14
Phoenix spp.
regulatory action 3-51

Artichoke (*Cynara*spp.)
regulatory action 3-29

Arum lily (*Zantedeschia aethiopica*)
pest risk level 2-20

Aster
pest risk level 2-16

Asteraceae
Ajania pacifica
regulatory action 3-6

Chrysanthemum x morifolium
regulatory action 3-15

Cynara spp.
regulatory action 3-29

Dendranthema spp.
regulatory action 3-30

Leucanthemella spp.
regulatory action 3-40

Nipponanthemum spp.
regulatory action 3-47

Aurantioidae 3-68

Aurantioidae (citrus)
regulatory action 3-68

Authorize movement
when to allow 2-12

Authorize movement or inspect
determine 2-12

Authorize shipment
regulatory action 2-6

Autumn-gold (*Crocasmia* spp.)
regulatory action 3-26

B

Baby's-breath (*Galium sylvaticum*, *Gypsophila elegans*, *G. paniculata*)
pest risk level 2-18

Bamboo (Bambusoideae)
regulatory action 3-10

Bamboo smut (*Ustilago shiraiana*) 3-10

Bambuseae
regulatory action 3-10

Bambusoideae
regulatory action 3-10

Banana 3-44

Barberton daisy (*Gerbera jamesonii*)
pest risk level 2-17

Bayoud disease 3-51

Beautyberry (*Callicarpa* spp.)
regulatory action 3-11

Beccariophoenix madagascariensis 3-9

Bell pepper (*Capsicum* spp.)
regulatory action 3-12

- Belladonna (*Amaryllis*)
pest risk level 2-16
- Bird of Paradise (*Strelitzia reginae*)
pest risk level 2-20
- Bird pepper (*Capsicum* spp.)
regulatory action 3-12
- Bird-of-paradise (*Strelitzia reginae*) 3-3
- black helleborus 3-35
- Black-eyed Susan (*Rudbeckia hirta*)
pest risk level 2-19
- Blazing star (*Liatris*)
pest risk level 2-18
- Boldface
manual convention 1-11
- Boughs, Christmas tree, 3-19 to 3-22
- Bouquet
pest risk level 2-20
- Box holly (*Ruscus*)
pest risk level 2-19
- Box-holly 3-67
- Brachyelytrae
regulatory action 3-10
- Branch
definition of Glossary-1
- Bridal-wreath (*Spiraea*)
pest risk level 2-19
- British Columbia
Christmas trees from, 3-21
- Brodiaea* (= *Triteleia*)
pest risk level 2-16
- Broomcorn
7CFR 319.41 description 1-7
definition of Glossary-1
- Broomcorn (*Sorghum bicolor*) regulatory action 3-72
- Broomcorn (*Sorghum vulgare* var. *technicum*) 3-72
- Buckthorn (*Rhamnus cathartica* L.) 3-37
- Bugle lily (*Watsonia* spp.)
regulatory action 3-78
- Bulbs
planting or growing 1-3
- Bullets
manual convention 1-11
- Bunches
inspecting 2-25
- butcher's-broom 3-67
- Butcher's broom (*Ruscus*)
pest risk level 2-19
- Buttercup
Persian (*Ranunculus*)
pest risk level 2-19
- Button snake-root (*Eryngium yuccifolium*)
pest risk level 2-17
- Button snakeroot (*Liatris*)
pest risk level 2-18
-
- ## C
- Cabbage tree 3-23, 3-31
- Cabbage tree (*Cordyline* spp.)
regulatory action 3-23
- Calla lily (*Zantedeschia*)
pest risk level 2-20
- Callicarpa spp.
regulatory action 3-11
- Caprifoliaceae
Viburnum spp.
regulatory action 3-77
- Caprifoliaceae 3-74
- Capsicum* spp.
regulatory action 3-12
- Carnation (*Dianthus*)
pest risk level 2-17
- Cathaya*
regulatory action 3-53
- Caution advisories
manual convention 1-11
- Cedar (*Cedrus*)
regulatory action 3-53
- Cedrus*
regulatory action 3-53
- Centaurea*
pest risk level 2-16

- Ceratitis capitata* 3-12
- Ceratitis capitata* 3-52
- Certificate
definition of [Glossary-1](#)
of origin, Canadian, 3-21
- CFRs
description 1-5
- Chaenomeles*
cut flowers and greenery, 3-22
- Chaenomeles* spp.
regulatory action 3-13
- Chamaedorea* 3-14
- Chamaedorea* spp.
regulatory action 3-14
- Chamaelaucium*
pest risk level 2-16
- Changes to the manual B-1
- Chapters
manual convention 1-11
- Cherry
cut flowers and greenery, 3-22
- Cherry (*Prunus* spp.)
regulatory action 3-63
- Cherry (*Prunus*) 3-52
- Cherry Laurel (*Prunus laurocerasus*) 3-22
- Cherry laurel (*Prunus* spp.)
regulatory action 3-63
- Chile
precleared flowers and greenery 3-2
- Chili pepper (*Capsicum* spp.)
regulatory action 3-12
- Chincherinchee*
pest risk level 2-19
- Chinese-lantern plant (*Physalis* spp.)
regulatory action 3-52
- Chinese-lantern Plant *Physalis alkekengi* 3-52
- Christmas Trees 3-18
- Christmas trees
Canadian origin, 3-18 to 3-22
regulatory action 3-53
- Christmas-rose 3-35
- Chrysalidocarpus decipiens* 3-9
- Chrysanthemum*
arcticum (=Arctanthemum arcticum, Dendranthema arcticum) 3-15
boreale (=Chrysanthemum indicum var. boreale, Dendranthema boreale) 3-15
indicum (=Dendranthema indicum) 3-15
japonense (=Dendranthema japonense, Dendranthema occidentalijaponense) 3-15
japonicum (=Chrysanthemum makinoi, Dendranthema japonicum) 3-15
pacificum (=Ajanía pacífica, Dendranthema pacificum) 3-16
pest risk level 2-16
shiwogiku (=Ajanía shiwogiku, Dendranthema shiwogiku) 3-16
x morifolium (=Anthemis grandiflorum, Anthemis stipulacea, Chrysanthemum sinense, Chrysanthemum stipulaceum, Dendranthema x grandiflorum, Dendranthema x morifolium, Matricaria morifolia) 3-16
yoshinaganthum (=Dendranthema yoshinaganthum) 3-16
zawadskii subsp. yezoense (=Chrysanthemum arcticum subsp. Maekawanum, Chrysanthemum arcticum var. yezoense, Chrysanthemum yezoense, Dendranthema yezoense, Leucanthemum yezoense) 3-16
zawadskii subsp. Zawadskii (=Chrysanthemum sibiricum, Dendranthema zawadskii, Dendranthema zawadskii var. zawadskii) 3-16
- Chrysanthemum white rust*
inspection technique 2-20
list of other species susceptible to 3-15
- Chrysanthemum x morifolium*
regulatory action 3-15
- CITES
check for permit requirements 2-13
description 1-4
Web site address for 3-3
- CITES protected palm 3-9
- Citrus (*Rutaceae*)
regulatory action 3-68
- Citrus Canker
7CFR 319.19 description 1-7
- Climbing ferns 3-61
- Clusiaceae
Hypericum spp.
regulatory action 3-38
- Code of Federal Regulations
description 1-5

- Codiaeum variegatum*
Jamaica preclearance 3-2
- Coffea* 3-17
- Coffea* spp.
regulatory action 3-17
- Coffee
7CFR 319.73 description 1-8
- Coffee (*Coffea* spp.)
regulatory action 3-17
- Coffee (*Coffea*) 3-17
- Coffeeberry borer (*Hypothenemus hampei*) 3-17
- Collecting information
general inspection procedures 2-2
- Commercial shipment
definition of Glossary-1
- Commercial shipments
fumigating at PPQ Inspection Stations 2-5
- Coneflower (*Rudbeckia*)
pest risk level 2-19
- Conifer 3-18
- Conifer wreaths
Canadian origin, 3-18 to 3-22
- Coniferae 3-18
- Conifers (Pinaceae)
regulatory action 3-53
- Contaminants
definition of Glossary-1
- Contents
manual convention 1-11
- Control data
manual convention 1-11
- Convention for Interantional Trade in the
Endangered Species of Wild Fauna and Flora
description 1-4
- Conventions
manual 1-10
- Coralberry 3-74
- Cordyline* spp. 3-23, 3-31
- Cordyline* spp.
regulatory action 3-23
- Cordyline terminalis*
Jamaica preclearance 3-2
- Corn 3-80
7CFR 319.41 description 1-7
- Corn (*Zea mays*)
regulatory action 3-80
- Corn Diseases
7CFR 319.24 description 1-7
- Cornflower (*Centaurea*)
pest risk level 2-16
- Cotoneaster* 3-25
- Cotoneaster* spp.
regulatory action 3-25
- Cotton
cut flowers and greenery, 3-22
- Cotton (*Gossypium* spp.)
regulatory action 3-34
- Crabapple 3-22
- Croton leaves *Codiaeum variegatum*
Jamaica preclearance 3-2
- Culm
definition of Glossary-1
- Cut flower
definition of Glossary-1
- Cut Flower Release Program
determine if commercial shipment falls under 2-8
- Cut Flowers
7CFR 319.74 description 1-8
eligible for release under the National Release
Program 2-28
- Cut flowers
Canadian origin, ?? to 3-18
eligible for release
adding or deleting under the National Release
Program 2-30
inspecting 2-24
- Cut flowers and greenery
approved for preclearance 3-2
precleared 3-2
- Cycadaceae
regulatory action 3-27
- Cycads
regulatory action 3-27
- Cycads (Zamiaceae)

regulatory action 3-79

Cydonia
cut flowers and greenery, 3-22

Cydonia spp.
regulatory action 3-28

Cynara 3-29

Cynara spp.
regulatory action 3-29

*Cyperus*spp.
Jamaica preclearance 3-3

Cytisus
pest risk level 2-17

D

Daffodil (*Narcissus*)
pest risk level 2-18

Dangerous advisories
manual convention 1-11

Databases
CITES 3-3
Federal noxious weeds 3-3
GRIN 3-3
parasitic plants 3-3

Date Palm (*Phoenix dactylifera*) 3-51

Date palm (*Phoenix* spp.)
regulatory action 3-51

Decision tables
manual convention 1-12

Decorative Articles 3-34

Decorative fruit
definition of Glossary-2

Decorative Pods 3-36

Delphinium (=Consolida)
pest risk level 2-17

Dendranthema 3-15

Dendranthema spp.
regulatory action 3-30

Dianthus
pest risk level 2-17

Disease
definition of Glossary-2

Documentation
National Cut Flower Release Program 2-30

Dracaena spp.
regulatory action 3-31

Dracaenaspp.
Jamaica preclearance 3-3

Dragon tree (*Dracaena* spp.)
regulatory action 3-31

Dried
definition of Glossary-2

Dwarf banana 3-44

E

Elaeagnaceae
Hippophae spp.
regulatory action 3-37

Enabling legislation
manual 1-4

Endangered Species Act
description 1-5

Endangered Species Convention
50CFR 23.23 description 1-9

Endemic
definition of Glossary-2

English laurel 3-22

English laurel (*Prunus* spp.)
regulatory action 3-63

Eriaceae
Pernettya spp.
regulatory action 3-50

Erwinia salicis 3-70

Eryngium
pest risk level 2-17

ESA
check for permit requirements 2-13
description 1-5

ESA protected plants
Web site address for
Databases
ESA protected plants 3-4

- Euphorbia*
pest risk level [2-17](#)
- European corn borer (*Ostrinia nubilalis*) [3-80](#)
- European pine shoot moth, [3-22](#)
- Eustoma grandiflora*
pest risk level [2-17](#)
- Examples
manual convention [1-12](#)
-
- F**
- False dragonhead (*Physostegia*)
pest risk level [2-19](#)
- Federal noxious weeds
Web site address for [3-3](#)
- Federal Plant Pest Regulations
7CFR 330 description [1-8](#)
- Fennel-flower (*Nigella* spp.)
regulatory action [3-46](#)
- Ferns [3-61](#)
- Filler and greenery
definition of [Glossary-2](#)
- Fir (*Abies*)
regulatory action [3-53](#)
- Firethorn (*Pyracantha* spp.)
regulatory action [3-64](#)
- Flag smut (*Urocystis agropyri*) [3-75](#)
- Florist' chrysanthemum (*Chrysanthemum x morifolium*)
regulatory action [3-15](#)
- Flowering banana [3-44](#)
- Flowering quince
cut flowers and greenery, [3-22](#)
- Flowering quince (*Chaenomeles* spp.)
regulatory action [3-13](#)
- Flowers
as herbs [1-3](#)
human consumption [1-3](#)
inspecting [2-24](#)
processed or manufactured [1-3](#)
- Flowers and greenery
precleared [3-2](#)
- Foliage
inspecting [2-24](#)
- Footnotes
manual convention [1-12](#)
- Forced bulbs
planting or growing [1-3](#)
- Foreign Cotton and Covers
7CFR 319.8 description [1-6](#)
- Foreign phytosanitary certificate [Glossary-2](#)
- Forsythia*
pest risk level [2-17](#)
- Freesia*
pest risk level [2-17](#)
- Fresh cut articles
quarters on carriers [1-2](#)
- Fresh, cut articles
moving interstate [1-3](#)
planting or growing [1-3](#)
transit to Canada [1-3](#)
- Fronds
as herbs [1-3](#)
human consumption [1-3](#)
- Fronds, palm (*Chamaedorea* spp.)
regulatory action [3-14](#)
- Fruit
definition of [Glossary-2](#)
- Fruit pods
as herbs [1-3](#)
human consumption [1-3](#)
- Fruits
human consumption [1-3](#)
- Fruits and Vegetables
7CFR 319.56 description [1-7](#)
- Fumigating commercial shipments
policy on [2-5](#)
PPQ Inspection Station [2-5](#)
- Fusarium oxysporum* var. *albedinis* [3-51](#)
-
- G**
- Garden montbretia (*Crocasmia* spp.)
regulatory action [3-26](#)
- Gay-feather (*Liatris*)

pest risk level 2-18

General inspection procedures 2-7
information needed 2-2

Gerbera
pest risk level 2-17

Gerberaspp.
Jamaica preclearance 3-3

Giant daisy (*Leucanthemella* spp.)
regulatory action 3-40

Ginger
red (*Alpinia purpurata*)
Jamaica preclearance 3-2

Gladiolus 2-17

Gladiolus spp.
Jamaica preclearance 3-3

Gloriosa
pest risk level 2-17

Glory lily (*Gloriosa*)
pest risk level 2-17

Goatgrass (*Aegilops* spp.)
regulatory action 3-5

Goatgrass *Aegilops* 3-75

Golden-bells (*Forsythia*)
pest risk level 2-17

Gossypium 3-34

Gossypium spp.
regulatory action 3-34

Gossypium, 3-22

Grape
cut flowers and greenery, 3-22

Grape-hyacinth (*Muscari*)
pest risk level 2-18

Grasses (Poaceae)
regulatory action 3-60

green hellebore 3-35

Greenery
approved for preclearance 3-2
precleared 3-2

greenery
Canadian origin, 3-18 to 3-22

GRIN

Web site address for 3-3

Ground cherry (*Physalis* spp.)
regulatory action 3-52

Guam
7CFR 318.82 description 1-6

Guelder-rose (*Viburnum* spp.)
regulatory action 3-77

Guernsey lily (*Nerine*)
pest risk level 2-18

Gypsophila
pest risk level 2-18

Gypsy moth 3-53

Gypsy moth, 3-20 to 3-22

H

Hawaiian Fruits and Vegetables
7CFR 318.13 description 1-5

Heading levels
manual convention 1-12

Heliconia spp.
Jamaica preclearance 3-3

Helleborus
regulatory action 3-35

Hemileia vastatrix 3-17

Herbs
human consumption 1-3

Hibiscus *Hibiscus moscheutos* 3-36

Hibiscus spp.
regulatory action 3-36

High daisy (*Leucanthemella* spp.)
regulatory action 3-40

Highlighting
manual convention
Links
highlighting
manual convention 1-13

Hippeastrum
pest risk level 2-18

Hippophae 3-37

Hippophae spp.

- regulatory action 3-37
- Hitchhiking pest
definition of [Glossary-2](#)
- Hold
regulatory action 2-6
- Holly (*Ilex* spp.)
regulatory action 3-39
- Holly (*Ilex*) 3-39
- horse-tongue 3-67
- Hyacinth (*Hyacinthus*)
pest risk level 2-18
- Hyacinthus*
pest risk level 2-18
- Hypericum*
pest risk level 2-18
- Hypericum* spp.
regulatory action 3-38
- Hypertext links
manual convention 1-13
- Hypothenemus hampei 3-17
-
- I**
- Ilex* 3-39, 3-66
- Ilex* spp.
regulatory action 3-39
- Import permit
definition of [Glossary-2](#)
- Important advisories
manual convention 1-11
- Intentions
manual convention 1-13
- Indian Corn
7CFR 319.41 description 1-7
- Inflorescence
definition of [Glossary-2](#)
- Inspect or authorize movement
determine 2-12
- Inspecting
bunches 2-25
loose stems 2-25
- Inspecting cut flowers
equipment 2-5
procedures For 2-7
what Is Needed 2-3
- Inspecting cut flowers and foliage
general inspection procedures
Inspection procedures
inspecting cut flowers and foliage 2-24
- inspecting loose 2-25
- Inspection area
general inspection procedures 2-3
- Inspection of cut flowers
preparation of 2-25
- Inspection procedures 2-7
actions to take based on pest findings
Procedures
general inspection
actions to take based on pest findings 2-27
determining inspectional unit 2-21
determining sample size 2-21
information needed 2-2
inspection area 2-3
inspection surface 2-4
lighting 2-4
materials needed 2-5
regulatory action 2-6
- Inspection Surface
description 2-4
- Inspection surface
general inspection procedures 2-4
- Inspectional unit
definition of [Glossary-2](#)
general inspection procedures 2-21
- Intergeneric
definition of [Glossary-2](#)
- Isikonkwane (*Dracaena* spp.)
regulatory action 3-31
- Italics
manual convention 1-13
- Ixia*
pest risk level 2-18
-
- J**
- Jack-in-the-green (*Nigella* spp.)
regulatory action 3-46
- Japanese banana 3-44

Japanese snowball (*Viburnum* spp.)
regulatory action 3-77

Japanese-lantern (*Physalis alkekengi*) 3-52

Japanese-lantern (*Physalis* spp.)
regulatory action 3-52

Juniper (*Juniperus*)
regulatory action 3-53

Juniperus
regulatory action 3-53

K

Karnal bunt (*Tilletia indica*) 3-75

Keteleeria
regulatory action 3-53

L

Lamiaceae
Callicarpa spp. 3-11

Larch (*Larix*)
regulatory action 3-53

Larix
regulatory action 3-53

Larkspur (*Delphinium* (= *Consolida*))
pest risk level 2-17

Laurustine (*Viburnum* spp.)
regulatory action 3-77

Leather leaf fern (*Rumohra adiantiformis*)
Jamaica preclearance 3-3

Leaves
as herbs 1-3
human consumption 1-3

Legislative acts 1-4

Lemurophoenix halleuxii 3-9

lenten-rose 3-35

Leucanthemella serotina (= *Chrysanthemum serotinum*, *Chrysanthemum uliginosum*, *Pyrethrum uliginosum*) 3-16

Leucanthemella spp.
regulatory action 3-40

Level of pest risk
determining 2-14
identify 2-14

Liatris
pest risk level 2-18

Lighting
description 2-4
general inspection procedures 2-4

Ligustrum spp.
regulatory action 3-41

Lilium
pest risk level 2-18

Lily
African corn (*Ixia maculata*)
pest risk level 2-18
arum (*Zantedeschia*)
pest risk level 2-20
calla (*Zantedeschia*)
pest risk level 2-20
glory (*Gloriosa*)
pest risk level 2-17
Guernsey (*Nerine*)
pest risk level 2-18
Peruvian (*Alstroemeria*)
pest risk level 2-16

Lily (*Lilium*)
pest risk level 2-18

Limitations
National Cut Flower Release Program 2-29

Limonium
pest risk level 2-18

Lisianthus
pest risk level 2-17

Loranthaceae
regulatory action 3-42

Loranthaceae 3-42

Love-in-a-mist (*Nigella* spp.)
regulatory action 3-46

Lucky bamboo (*Dracaena* spp.)
regulatory action 3-31

Lygodium flexuosum 3-61

Lygodium microphyllum 3-61

Lymantria dispar, 3-20, 3-21

M

Maidenhair creeper 3-61

Maize

7CFR 319.41 description 1-7

Malus

cut flowers and greenery, 3-22

Malus spp.

regulatory action 3-43

Malvaceae

Gossypium spp.

regulatory action 3-34

Hibiscus spp.

regulatory action 3-36

Manual

application 1-10

conventions 1-10

enabling legislation 1-4

numbering scheme 1-13

purpose 1-1

related documents 1-4

reporting problems 1-10

revisions B-1

user responsibilities B-3

users 1-3

what's not covered 1-2

Marojejya darianii 3-9

Materials needed

general inspection procedures 2-5

Mediterranean fruit fly (*Ceratitis capitata*) 3-12

Mediterranean fruit fly (*Ceratitis capitata*)

Ceratitis capitata 3-17

Mediterranean fruit fly (*Ceratitis capitata*) 3-52

Merians bugle lily (*Watsonia* spp.)

regulatory action 3-78

Mistletoe (Loranthaceae)

regulatory action 3-42

Mistletoe (*Phoradendron*) 3-42

Montbretia (=Tritonia)

pest risk level 2-18

Montbretia (*Crocsmia* spp.)

regulatory action 3-26

MRC (Municipalité régionale de comté), 3-20

Mulberry <Scientific Name>(Callicapa spp.)

regulatory action 3-11

Mum (*Chrysanthemum x morifolium*)

regulatory action 3-15

Mum (*Chrysanthemum*)

pest risk level 2-16

Municipalité régionale de comté (MRC), 3-20

Musa 3-44

Musaceae 3-44

Muscari

pest risk level 2-18

N

Narcissus

pest risk level 2-18

National Cut Flower Release Program

adding or deleting flowers 2-30

cut flowers eligible for release 2-28

determine if commercial shipment falls under 2-8

documentation 2-30

limitations 2-29

participating ports 2-28

procedures 2-29

protocol 2-28

purpose of protocol 2-28

Nectarine

cut flowers and greenery, 3-22

Nectarines (*Prunus* spp.)

regulatory action 3-63

Nepenthaceae

Nepenthes spp.

regulatory action 3-45

Nepenthes 3-45

Nepenthes spp.

regulatory action 3-45

Nerine

pest risk level 2-18

New Brunswick

Christmas trees from, 3-21, 3-58

Nigella spp.

regulatory action 3-46

Nipon-chrysanthemum (*Nipponanthemum* spp.)

regulatory action 3-47

Nipponanthemum nipponicum (=Chrysanthemum nipponicu, Leucanthemum nipponicum) 3-16

Nipponanthemum spp.
regulatory action 3-47

Nippon-daisy (*Nipponanthemum* spp.)
regulatory action 3-47

Noncommercial
definition of Glossary-3

Notice advisories
manual convention 1-11

Nova Scotia
Christmas trees from, 3-21, 3-58

Noxious Weed Regulation
7CFR 360 description 1-9

Noxious weeds
definition of Glossary-3

Numbering scheme
manual convention 1-13

Nursery stock
7CFR 319.37 description 1-7

Nutmeg-flower (*Nigella* spp.)
regulatory action 3-46

O

Obedient plant (*Physostegia*)
pest risk level 2-19

Ochids (Orchidaceae)
regulatory action 3-48

Old World climbing fern 3-61

Oleaceae
Ligustrum spp.
regulatory action 3-41

Ontario
Christmas trees from, 3-20, 3-56, 3-57

Orchid
pest risk level 2-19

Orchidaceae
Jamaica preclearance 3-3
regulatory action 3-48

Ornithogalum
pest risk level 2-19

Oryza Sativa 3-49

Oryza sativa

regulatory action 3-49

Ostrinia nubilalis 3-80

P

Packing material
definition of Glossary-3

Palm Fronds 3-14

Palm fronds (*Chamaedorea* spp.)
regulatory action 3-14

Palmae
regulatory action 3-9

Palmillo (*Dracaena* spp.)
regulatory action 3-31

Palms 3-9

Palms (Palmae)
regulatory action 3-9

Pandanusspp.
Jamaica preclearance 3-3

Panicle
definition of Glossary-3

Paprika pepper (*Capsicum* spp.)
regulatory action 3-12

Papyrus (*Cyperus*)spp.
Jamaica preclearance 3-3

Parasitic plant database
Web site address for 3-3

Participating ports
National Cut Flower Release Program 2-28

Pathogen
definition of Glossary-3

Peach
(*Prunus persica*)cut flowers and greenery, 3-22

Peaches (*Prunus* spp.)
regulatory action 3-63

Pear (*Pyrus communis*)
cut flowers and greenery, 3-22

Pear (*Pyrus* spp.)
regulatory action 3-65

Pectinophora gossypiella 3-34, 3-36

- Pepper (*Capsicum* spp.)
regulatory action 3-12
- Pepper—Bell, Green, Paprika, Chili, Bird, Tabasco
(*Capsicum*) 3-12
- Permit requirements
check 2-13
- Pernettya* spp.
regulatory action 3-50
- Persian buttercup (*Ranunculus*)
pest risk level 2-19
- Peruvian lily (*Alstroemeria*)
pest risk level 2-16
- Pest findings
action to take 2-27
- Pest risk level
identify 2-14
- Pest Risk Level Guide
definition of Glossary-3
- Pesticide residue 2-24
- Pests
quarantine significant
regulatory action 2-27
- Pests intercepted
regulatory actions 2-27
- Phaeomeria* (= *Nicolaia*) *speciosa*
Jamaica preclearance 3-3
- Phoenix (*Firmiana simplex*) 3-51
- Phoenix* spp.
regulatory action 3-51
- Phragmidium*
when found on *Rosa* spp. 2-20
- Physalis* 3-52, 3-61
- Physalis* spp.
regulatory action 3-52
- Physostegia*
pest risk level 2-19
- Phytosanitary certificate
definition of Glossary-3
- Picea*
regulatory action 3-53
- Pinaceae
regulatory action 3-53
- Pincushion flower (*Scabiosa*)
pest risk level 2-19
- Pine
cut Christmas trees, 3-20 to 3-22
- Pine shoot beetle 3-20, 3-22, 3-53
- Pineapple (*Ananas comosus*) 3-7
- Pineapple (*Ananas* spp.)
regulatory action 3-7
- pineless butcher's-broom 3-67
- Pink bollworm (*Pectinophora gossypiella*) 3-34,
3-36
- Pink watsonia (*Watsonia* spp.)
regulatory action 3-78
- Pinks (*Dianthus*)
pest risk level 2-17
- Pinus* 3-53
- Pitcher plant (*Nepenthes* spp.)
regulatory action 3-45
- Pitcher Plant (*Sarracenia purpurea*) 3-45, 3-71
- Plant or portions of a plant
definition of Glossary-3
- Plant Protection Act of 2000
description 1-5
- Plantain 3-44
- Plants
for growing 1-3
- Plums (*Prunus* spp.)
regulatory action 3-63
- Poaceae
Aegilops spp.
regulatory action 3-5
Oryza sativa
regulatory action 3-49
regulatory action 3-60
Saccharum spp.
regulatory action 3-69
Sorghum bicolor
regulatory action 3-72
Triticum spp.
regulatory action 3-75
Zea mays
regulatory action 3-80
- Poinsettia
pest risk level 2-17

- Polypodiophyta (Ferns) 3-61
 - Ports
 - participating in the National Cut Flower Release Program 2-28
 - Potted plants
 - planting or growing 1-3
 - PPA
 - description 1-5
 - PPQ Inspection Station
 - fumigating commercial shipments 2-5
 - Preclearance
 - definition of Glossary-3
 - Precleared
 - definition of Glossary-4
 - Precleared flowers and greenery 3-2
 - Privet (*Ligustrum spp.*)
 - regulatory action 3-41
 - Problems
 - reporting manual 1-10
 - Procedures
 - general inspection 2-7
 - inspection area 2-3
 - inspection surface 2-4
 - lighting 2-4
 - materials needed 2-5
 - regulatory action 2-6
 - general inspection procedures
 - determining inspectional unit
 - Sample size
 - determining 2-21
 - determining sample size 2-21
 - inspecting cut flowers and foliage 2-24
 - Prohibit entry
 - regulatory action 2-7
 - Prohibited or admissible
 - determine 2-9
 - Promeliaceae
 - Ananas spp.*
 - regulatory action 3-7
 - Propagative structure
 - definition of Glossary-4
 - Protea (Proteaceae)
 - regulatory action 3-62
 - Proteaceae 3-62
 - regulatory action 3-62
 - Protocol
 - National Cut Flower Release Program 2-28
 - Prune
 - cut flowers and greenery, 3-22
 - Prune (*Prunus spp.*)
 - regulatory action 3-63
 - Prunus*
 - cut flowers and greenery 3-22
 - Prunus spp.*
 - regulatory action 3-63
 - Pseudolarix*
 - regulatory action 3-53
 - Pseudotsuga*
 - regulatory action 3-53
 - Purpose
 - manual 1-1
 - National Cut Flower Release Program 2-28
 - Pussy Willow (*Salix discolor*) 3-70
 - Pussy willow (*Salix spp.*)
 - regulatory action 3-70
 - Pyracantha spp.*
 - regulatory action 3-64
 - Pyrus*
 - cut flowers and greenery, 3-22
 - Pyrus spp.*
 - regulatory action 3-65
-
- ## Q
- Quarantine significant pests
 - regulatory action 2-27
 - Quebec
 - Christmas trees from, 3-20, 3-56, 3-57
 - Quince
 - cut flowers and greenery, 3-22
 - Quince (*Cydonia spp.*)
 - regulatory action 3-28
-
- ## R
- Ranunculaceae 3-35
 - Ranunculus*

- pest risk level 2-19
- Ravenea louvelii 3-9
- Ravenea rivularis 3-9
- Red ginger (*Alpinia purpurata*)
 - Jamaica preclearance 3-2
- Red palm mite 3-9
- regulatory 3-9
- Regulatory action
 - based on pest findings 2-27
 - general inspection procedures 2-6
- Regulatory actions
 - based on pest findings 2-27
- Related documents
 - manual 1-4
- Release
 - regulatory action 2-7
- Release Program
 - determine if commercial shipment falls under national protocol 2-8
 - national cut flower protocol 2-28
- Released under the Cut Flower Release Program 2-7
- Reporting problems
 - manual 1-10
- Residue cargo
 - handling 2-12
- Rhyacionia buoliana*, 3-22
- Rice
 - 7CFR 319.55 description 1-7
- Rice (*Oryza sativa*)
 - regulatory action 3-49
- Rice (*Oryza sativa*) 3-49
- Risk level
 - identify pest 2-14
- Rooted plants
 - planting or growing 1-3
- Roots
 - as herbs 1-3
 - human consumption 1-3
- Rosa
 - pest risk level 2-19
- Rosa spp.
 - If Phragmidium is found 2-20
- Rosaceae
 - Chaenomeles* spp. 3-13
 - Cotoneaster* spp.
 - regulatory action 3-25
 - Cydonia* spp.
 - regulatory action 3-28
 - Malus* spp.
 - regulatory action 3-43
 - Prunus* spp.
 - regulatory action 3-63
 - Pyracantha* spp.
 - regulatory action 3-64
 - Pyrus* spp.
 - regulatory action 3-65
- Rosasp.
 - Jamaica preclearance 3-3
- Rose (*Rosa*)
 - pest risk level 2-19
- Rubiaceae
 - Coffea* spp.
 - regulatory action 3-17
- Rudbeckia*
 - pest risk level 2-19
- Rumohra adiantiformis*
 - Jamaica preclearance 3-3
- Ruscus 3-67
- Ruscus*
 - pest risk level 2-19
 - regulatory action 3-67
- Rutaceae 3-68
- Rutaceae (citrus)
 - regulatory action 3-68
- Rutoideae 3-68
- Rutoideae (citrus)
 - regulatory action 3-68

S

- Saccharum* spp.
 - regulatory action 3-69
- Safeguard Regulations
 - 7CFR 352 description 1-9
- Salicaceae
 - Salix* spp.

- regulatory action 3-70
- Salix* 3-70, 3-77
- Salix* spp.
 - regulatory action 3-70
- Sample
 - definition of Glossary-4
- Sample size
 - general inspection procedures 2-21
- Sarracenia* 3-71
- Sarracenia* spp.
 - regulatory action 3-71
- Sarraceniaceae
 - Sarracenia* spp.
 - regulatory action 3-71
- Satranala decussilvae* 3-9
- Scabiosa*
 - pest risk level 2-19
- Scabious (*Scabiosa*)
 - pest risk level 2-19
- Scotch Broom (*Cytisus scoparius*)
 - pest risk level 2-17
- Scrophulariaceae
 - Striga* spp.
 - regulatory action 3-73
- Sea buckthorn (*Hippophae* spp.)
 - regulatory action 3-37
- Sea Holly (*Eryngium maritimum*)
 - pest risk level 2-17
- Sea lavender (*Limonium*)
 - pest risk level 2-18
- Seed heads
 - as herbs 1-3
 - human consumption 1-3
- Seed pods
 - as herbs 1-3
 - human consumption 1-3
- Seeds
 - animal feed 1-3
 - human consumption 1-3
- Shipment authorized
 - regulatory action 2-6
- Smut
 - definition of Glossary-4
- Snapdragon (*Antirrhinum*)
 - pest risk level 2-16
- Snowball (*Viburnum* spp.)
 - regulatory action 3-77
- Snowberry 3-74
- Solanaceae
 - Capsicum* spp.
 - regulatory action 3-12
 - Physalis* spp.
 - regulatory action 3-52
- Son-of-India (*Dracaena* spp.)
 - regulatory action 3-31
- Sorghum* 3-72
- Sorghum bicolor*
 - regulatory action 3-72
- Specialized words
 - meaning
 - See Glossary
- Spiraea*
 - pest risk level 2-19
- Spirea (*Spiraea*)
 - pest risk level 2-19
- Spirit weed (*Lachnanthes tinctoria*)
 - pest risk level 2-17
- Spring starflower (*Brodiaea uniflorum*)
 - pest risk level 2-16
- Spruce (*Picea*)
 - regulatory action 3-53
- Spurge (*Euphorbia*)
 - pest risk level 2-17
- St. John's wort (*Hypericum perforatum*)
 - pest risk level 2-18
- St. John's wort (*Hypericum* spp.)
 - regulatory action 3-38
- Star-of-Bethlehem (*Ornithogalum umbellatum*)
 - pest risk level 2-19
- Statice (*Limnium*)
 - pest risk level 2-18
- Stems 2-25
 - as herbs 1-3
 - human consumption 1-3
- stinking hellebore 3-35
- Strelitzia*

- pest risk level 2-20
- Strelitzia reginae*
Jamaica preclearance 3-3
- Striga* spp.
regulatory action 3-73
- Sugarcane
7CFR 319.15 description 1-7
- Sugarcane (*Saccharum* spp.)
regulatory action 3-69
- Summer snowflake (*Viburnum* spp.)
regulatory action 3-77
- Symphoricarpos 3-74
-
- T**
- Tabasco pepper (*Capsicum* spp.)
regulatory action 3-12
- Tables
decision
manual convention 1-12
- Tailflower (*Anthurium*)
pest risk level 2-16
- Terms
See Glossary
- Ti leaves (*Cordyline terminalis*)
Jamaica preclearance 3-2
- Ti plant (*Cordyline* spp.)
regulatory action 3-23
- ti plants 3-23, 3-31
- Tilletia indica* 3-75
- Toddalioideae 3-68
- Toddalioideae (citrus)
regulatory action 3-68
- Tomocus piniperda*, 3-20
- Torch ginger *Phaeomeria* (= *Nicolaia*) *speciosa*
Jamaica preclearance 3-3
- Transit permit
definition of Glossary-4
- Transvaal daisy (*Gerbera*)
pest risk level 2-17
- Treated cut flowers and foliage 2-24
- Treatment
definition of Glossary-4
- Treatment Manual
description 1-10
- Trees
Christmas
regulatory action 3-53
- Triticum* 3-75
- Triteleia* (= *Brodiaea*)
pest risk level 2-20
- Triticum* spp.
regulatory action 3-75
- Tritonia* (= *Montbretia*)
pest risk level 2-20
- Tsuga*
regulatory action 3-53
- Tulip (*Tulipa*)
pest risk level 2-20
- Tulipa*
pest risk level 2-20
-
- U**
- Urocystis agropyri* 3-75
- Users
manual 1-3
- Ustilago shiraiana* 3-10
-
- V**
- Vegetables
human consumption 1-3
- Viburnum* spp.
regulatory action 3-77
- Vitis*
cut flowers and greenery, 3-22
- Voanioala gerardii* 3-9

W

Warning advisories
manual convention 1-11

Watermark disease 3-70

Watsonia (*Watsonia* spp.)
regulatory action 3-78

Waxflower (*Chimphila*)
pest risk level 2-16

What this manual doesn't cover 1-2

what to look for 3-9

Wheat (*Triticum aestivum*) 3-75

Wheat (*Triticum* spp.)
regulatory action 3-75

Wheat Diseases
7CFR 319.59 description 1-8

Willow (*Salix* spp.)
regulatory action 3-70

Willow (*Salix*) 3-70

Windflower *Anemone*
pest risk level 2-16

Witchweed (*Striga* spp.)
regulatory action 3-73

Words
specialized meaning
See Glossary

Wreaths, 3-19 to 3-22

Y

Yarrow (*Achillea millefolium*)
pest risk level 2-16

Yellow splash
approved growers in Mexico 3-6

Yellow splash *Ajanía pacífica*
regulatory action 3-6

Z

Zamiaceae
regulatory action 3-79

Zantedeschia
pest risk level 2-20

Zea mays
regulatory action 3-80

Zea mays 3-80

Comment Sheet

Directions

Use this sheet if you have a suggestion for improving the formatting (design, layout, composition), grammar, or spelling in the manual. **Do not** use this sheet to order manuals or change the number of manuals you receive or your mailing address (see *Appendix B, Maintaining Import Manuals*).

Description of the problem, error, inconsistency, missing or insufficient information

Description of the suggested improvement or recommended change

Reason for improvement or change

Fold this sheet in thirds so that your comments are on the inside and the Manuals Unit's address is in the center. Tape, stamp and mail.

USDA-APHIS-PPQ MANUALS UNIT
Attn: Cut Flowers and Greenery Import Manual Comment Sheet
69 Thomas Johnson Drive, Suite 100
Frederick, MD 21702
