

aquaculture

magazine

July-August 2007, Volume 33, Number 4



PERIODICAL RATE PAID

2007
12th Annual

Products Issue

World's Largest Selection of Aquatic Tools

Satisfaction Is Our Number One Goal

Don't waste your time shopping all over town. Get all your aquatic supplies from one place: Aquatic Eco-Systems. Backed by the largest inventory in the industry and 29 years of experience, AES is uniquely qualified to make your aquatic ecosystem flourish. Got a question? Call our technicians and ask for advice.

AES offers:

- Over 13,000 products.
- Wholesale pricing to qualified customers.
- Same-day shipping.
- 20+ aquatic and marine biologists on staff.

Shopping and Services at aquaticeco.com

Get up-to-date availability and pricing. Search our entire inventory and get a heads-up on new products. Shop online with fast, secure checkout. Read dozens of technical articles. Discuss your system with our team of aquatic experts in the new Aquatic Eco Forum. Visit us today at aquaticeco.com!

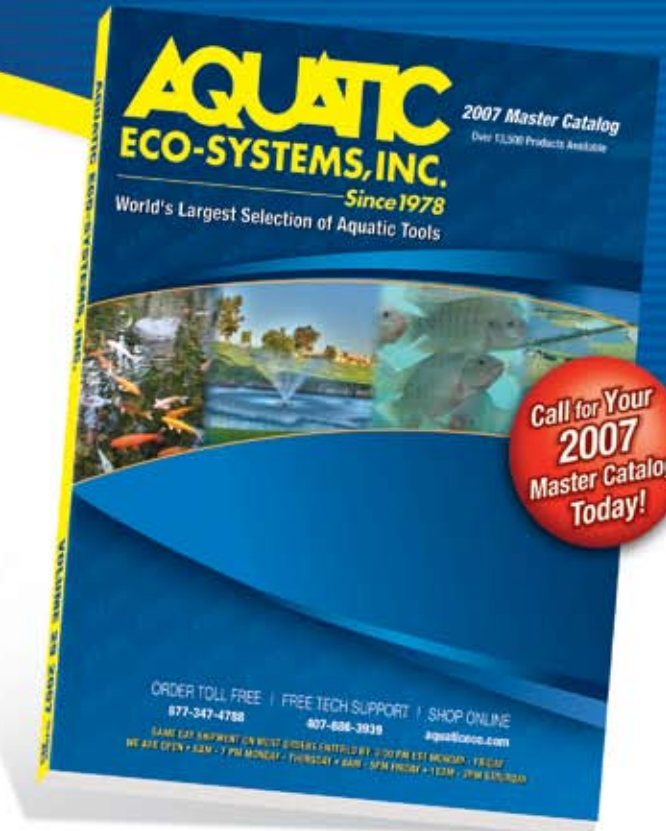

Quick Search

Educational
Tech Talks

Forum



Secure Shopping

New Products

Splash!
E-Newsletter

Free service on all factory warranties,
low rates on all YSI® meters we carry,
full inventory of replacement parts.



AQUATIC ECO-SYSTEMS, INC.

Since 1978

See it all on the Web at: aquaticeco.com

RS No. 252

Toll Free Order Line: 877-347-4788 Free Tech Support: 407-598-1401 Email: aes@aquaticeco.com

AquaMax[®]

Brand

FISH DIETS



AQUAMAX[®] STARTER

Highly digestible, high energy nutrient dense diet excellent for starters and fingerlings.

AQUAMAX[®] CARNIVOROUS SPECIES

High protein, nutrient dense diets that promote growth and maintain good health in carnivorous fish.



AQUAMAX[®] OMNIVOROUS SPECIES

Nutritionally complete diets with moderate amounts of nutrients for warm water animals.

*Formulated for
Max Digestibility
and Performance*

*From Fry Powder to
1/4" Floating Diets*

*Available One Bag
at a Time,
or by the Truckload*

*Call Toll Free 1.800.227.8941
for the Dealer Nearest you
or for more Information
Visit www.PurinaMills.com*

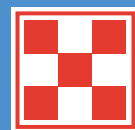

Purina Mills

aquaculture

magazine

July/August - Products 2007 Issue

HEADLINERS		PRODUCTS	14
Leaders Ask Congress To Endorse Aquaculture Legislation	7	COLUMNS	
Exchange Rate Hurts New Zealand Seafood Industry	8	Genetics & Breeding By Greg Lutz	78
A Substitute For Wheat In Fish Feed	8	Fish Feed By Ron Hardy	81
Congressional Appropriations For VHS	10	Shellfish By Ken Chew	84
Wary Diners Ask: Is Fish From China	10	Research Report By James Avault	86
NMFS Sees Kona Blue As A Model For Open Ocean Aquaculture	12	MISC	
		Catfish Report	88
		Calendar Of Events	89
		Advertisers Index	90

AQUACULTURE MAGAZINE (ISSN 0199-1388) is published bimonthly, Products Issue/July, and Buyer's Guide/December by Achill River Corporation, 55 Buck Shoals Rd., Arden, NC 28704. Telephone: (828) 687-0011, Fax (828) 681-0601, Email: editor@aquaculturemag.com, Website: www.aquaculturemag.com.

All material in this magazine are copy righted by Achill River Corporation. All rights reserved. Copyright 2007, all rights reserved including mechanical and electronic reproduction, Achill River Corporation.

SUBSCRIPTIONS: Rates are \$24 per year inside USA and \$30 Canada and Mexico surface mail. \$60 foreign air mail, per year. No air mail to Canada or Mexico. Single copy price is \$5 USA, \$8 foreign. Annual Buyer's Guide is \$25 USA, \$30 foreign.

ALL FOREIGN ORDERS MUST BE IN U.S. DOLLARS PAYABLE ON U.S. BANKS.

Mail all subscriptions and correspondence to:

AQUACULTURE MAGAZINE

P.O. BOX 1409

Arden, NC 28704

USA

POSTMASTER: Please send form 3579 to P.O. Box 1409, Arden, NC 28704. Periodicals postage paid at Arden, NC, and at additional mailing offices.

Products Issue 2006 Articles Index

Advanced Aquaculture	63
AlgaeControl.US	66
Alita	40
All Star Products	29
Aqua Logic	61
Aquaculture Systems	74
Aquanate.com	66
Aquatic Eco-Systems	19
Artesian Trout Farm	71
Auburn University	54
AVA Publishing	53
B&K Installations	53
BL Mitchell	48
Cantrell Creek Trout Farm	73
Cargill	28
Cleveland Process Corporation CLEPCO	39
Common Sensing Inc.	73
Crystal Lake Fisheries	14
Decotex Inc.	48
Delstar Inc	33
Delta Hydronics	59
Emperor Aquatics	32
Environmental Technologies Inc	68
Firestone Specialty Products	51
Florida Fish Farms	20
Fresh Flo Corporation	65
Frigid Units Inc.	15
I.A.S. Products	41
International Ingredients	75
Internet Inc.	72
J.M. Malone	26
Kens Hatchery & Fish Farm.	38
Lantec Products	57
Marisource	31
Memphis Net & Twine	38
Mid Water Systems	53
Mossy Oak Properties	67
MTI Inc.	69
Myron L. Company	24
Norvatis Animal Health	30
Octaform	34
Owen & Williams Fish Farm	72
Pacific Coast Imports	66
Pacific Ozone Technology	70
Pentair Aquatics	28
Plast-O-Matic Valves	16
Process Technology	62
Purina Mills	21
Reef Industries	48
Schering Plough	36
Shivers Real Estate	41

Solar Components	16
South Santee Aquaculture	66
Sterling Net & Twine	20
Superior Aquaculture	68
Texas A&M	23
The Roan Group	54
Troutlodge	45
United Country	18
Universal Marine	43
University of Arkansas	55
Valterra Products	15
Western Chemical	49
Wisconsin Flowgate & Culvert	64
Zeigler Brothers	23



Please note that articles in this publication are the opinions of individual authors, and are not necessarily those of Aquaculture Magazine. While we hope that the information is useful for your business, the publisher can assume no responsibility.

*Your source for
BioSecurity supplies*

VIRKON® AQUATIC

Disinfectant & Virucide



EPA & Health Canada approved for disinfection of vehicles, nets, boots, waders, dive suits, hoses, brushes and other equipment. Also great for use in foot baths.



OVADINE® PVP IODINE

Buffered Povidone Iodine
solution for Fish Egg
disinfection

**BIOSECURITY
SIGNAGE,
DISINFECTION
MATS, AND MORE...**



Download our new BioSecurity
brochure at www.wchemical.com

An Aquatic Life Sciences Company

World Leader In Fish Health Products



Tel: +1.360.384.5898 • Fax: +1.360.384.0270
1.800.283.5292 • info@wchemical.com • www.wchemical.com
Ferndale, WA, USA

RS No. 330

Editors Notebook

The 37th edition of Aquaculture Magazine's Buyers Guide and Industry Directory will be published this December. It has been in preparation for several months. We are currently doing research for the "Status of the Industry Report." Several authors are preparing feature articles for the Buyer's Guide which will enhance its worth to our subscribers. If you are subscriber or advertiser, you have been sent a listing form. If you have not been sent a listing form, please go to www.aquaculturemag.com and fill out your information online.

Advertisers should not miss putting an advertisement in the Buyers Guide 2008. The Guide is sold year round and is considered "the Yellow Pages of the industry."

Fish farmers use it extensively.

You will be pleased with this year's Buyers Guide, which will be the most comprehensive ever. Aquaculture Magazine's Buyers Guide is undeniably second to none.

Staff

Richard V. Gallagher
Publisher

Gregory J. Gallagher
Editor

Tom Parsons
Production Manager

Russel Burtner
Advertising

Doinita Corciovei
Circulation Manager

Brent Garren
Website Designer

Headliners

Leaders Ask Congress to Endorse Aquaculture Legislation

This summer, Commerce Secretary Carlos M. Gutierrez convened seafood industry leaders in Washington, D.C., to heighten awareness of offshore aquaculture legislation. The bill, HR2010 in the House and S1609 in the Senate, will give the National Oceanic and Atmospheric Administration authority to regulate and monitor aquaculture growth into federal waters off U.S. coasts.

On balance, summit panelists overwhelmingly sent a message to Congress that industry is poised and ready to develop a new, ecologically responsible offshore aquaculture industry. The new industry would create jobs and revenue for coastal communities and provide American consumers with more homegrown seafood choices.

“Aquaculture can be a great, new source of innovation, but we need a framework that fosters innovation, investment and prosperity,” Gutierrez said. “As a major growth engine, aquaculture can help preserve the historic ties that fishing communities have to the oceans and create a new and vibrant means for job creation.”

Gutierrez said that while demand for seafood is growing, the United States is working to ensure its wild fisheries remain among the most productive and best managed in the world. But he cautioned that the domestic wild harvest is insufficient to meet new demands, and global competitors have seized the market opportunity of aquaculture while the United States has fallen behind.

A number of economic drivers prompted the Administration to develop and propose the legislation, including a desire to increase domestic production to close the \$8 billion seafood trade deficit and to give American seafood farmers and investors greater opportunity to participate in the \$70 billion global industry. U.S. aquaculture accounts for only about 1.5

percent of global aquaculture production. Fish and shellfish consumption continues to rise in the United States, causing government officials to raise a warning flag that without this legislation there will be a major shortfall in supply in the next 25 years. New government figures show that seafood consumption in the United States rose in 2006 from 16.2 pounds per person to 16.5 pounds per person.

James L. Connaughton, chairman of the White House Council on Environmental Quality, yesterday reiterated President Bush’s commitment to passage of the legislation.

“There is absolutely no reason why this Congress cannot adopt this bipartisan aquaculture legislation,” Connaughton said. “We have engaged the public, held a national dialogue, and now it is time to act to develop regulatory certainty for industry, ensure ecological integrity, and allow the United States to become a beacon for the world in responsible aquaculture development. The stage is set and pre-wired for action.”

Citing statistics from government health experts advising more seafood

IT'S NOT JUST A GREENHOUSE
It's an Advantage!

Hurricane-Tested Structures
Offering Value, Durability and Profitability.

B&K Installations' greenhouses and pond covers are not just engineered to stand up to the harshest weather conditions; they're engineered to give you an advantage every day for your investment.

- ★ Affordable
- ★ Custom designs
- ★ Superior Strength
- ★ State-of-the-art materials

B&K
INSTALLATIONS, INC.
RS No. 874

VALUE THROUGH ENGINEERING

Tel (Homestead, Fla.) 305.245.6968
Toll Free-USA 1.800.523.3870 • Toll Free-Florida 1.800.624.7612
Visit us on the web: www.bkinstall.com

GREENHOUSES • POND COVERS • HEATING • COOLING • EQUIPMENT • COVERINGS • HARDWARE

consumption for health benefits, Connaughton noted that aquaculture ranks on the list of the Administration's highest legislative priorities because seafood safety and availability is a food security and human welfare issue.

During the summit, seafood industry leaders provided a wealth of information that will help guide Congressional discussion about the legislation. Summit participants agreed that the legislation should provide for the development of an environmentally responsible and sustainable aquaculture industry, while also providing the framework for regulatory certainty that will aid development and growth of new business.

Exchange Rate Hurts New Zealand Seafood Industry

Failure to address the overvalued dollar effectively is causing huge financial losses for the industry

and the country, says the New Zealand Seafood Industry Council's General Manager Trade Alastair Macfarlane.

"The overnight increase in the dollar has cost the sector the equivalent of the net returns of the entire Pacific Oyster production for this year," Mr Macfarlane said. "It's an appalling situation for export dependent industries such as ours. Every one cent rise in the exchange rate equates to a loss of NZ\$20 million."

Another rise in the OCR (Official Cash Rate) will only increase the financial pain for the sector, Mr Macfarlane said.

"Lifting the OCR has proven ineffective. The New Zealand dollar has simply become a magnet for currency speculators and they have benefited from ever increasing interest rates at the expense of exporters."

The combination of high exchange rates and growing business and compliance costs is disastrous for the seafood sector, he said.

"Good people have lost their jobs or businesses already, and sadly more will follow. Dr Bollard and the New Zealand government need to re-think their

approach to inflation."

A Substitute For Wheat In Fish Feed?

Increases in the prices of ingredients such as wheat or corn can cause the price of fish feed to climb, so use of replacement ingredients could help keep feed costs at a minimum. Cuphea is a new oil seed crop that is currently under domestication by plant breeders. Seed shattering has been one problem that has kept cuphea from commercialization, but new research shows promise for overcoming unfavorable traits. Post-doctoral research associate Dr. Todd Sink and Dr. Rebecca Lochmann conducted an 8-week study in which channel catfish fingerlings were fed a control diet (with wheat) or experimental diets with 7.5% or 12.5% cuphea meal. There were no differences in growth or survival among the diets, but fish fed the cuphea meal did have significantly higher whole-body protein levels.

Bottom Line: Cuphea meal shows

FEEDMASTER™

Ask Us About The World's
First Centralized Shrimp Farm
Feeding System

Now Operating in Mexico

RS No. 823



SHRIMP FARM AUTOMATIC FEEDERS & HARVESTERS

ETI • 219 Frontage Rd. N., Suite A • Pacific, WA USA 98047

Tel: 253-804-2507 • Fax: 253-804-2581

www.transvac.com • e-mail: transvac@aol.com

AQUACULTURE 2008 AMERICA



February 9 – 12, 2008

**Disney's Coronado Springs Resort
Lake Buena Vista, Florida
(near Orlando)**

THE NATIONAL CONFERENCE & EXPOSITION OF

NATIONAL
Aquaculture
ASSOCIATION



HOSTED BY: THE FLORIDA AQUACULTURE ASSOCIATION

***For More Information Contact:
Conference Manager***

**P.O. Box 2302 • Valley Center, CA 92082 USA
Tel: +1.760.751.5005 • Fax: +1.760.751.5003
Email: worldaqua@aol.com
www.was.org**

Associate Sponsors

American Tilapia Association
American Veterinary Medical Association
Aquacultural Engineering Society
Aquaculture Association of Canada
Caribbean Aquaculture Association
Catfish Farmers of America

Global Aquaculture Alliance
Latin American Chapter WAS
National Aquaculture Council
Striped Bass Growers Association
US Shrimp Farming Association
US Trout Farmers Association

promise as a substitute ingredient in catfish feeds. For more information on this research project, contact Dr. Sink at tsink@uaex.edu or (870) 575-8174.

Article comes from the University of Arkansas - Pine Bluff.

Congressional Appropriations For VHS

The House and the Senate FY 2008 Appropriations Bill include two line items for Viral Hemorrhagic Septicemia (VHS). The House includes \$5.6 million for VHS in the Animal Health Monitoring and Surveillance line item (new money). The Senate includes an increase of \$1.8 million, specifically for VHS, in the aquaculture line item.

Because of the recent decision by the Office of Management and Budget (OMB) denying the USDA request for emergency funds to conduct VHS surveillance and education, it is imperative that industry contact their congressional members immediately, requesting support of the House and Senate Appropriations mark-ups. Please refer specifically to the amounts, noting that they are included in the FY 2008 Appropriation Bills.

If you need addresses or contact information for your Congressional members, please contact the NAA office

for assistance.

Wary Diners Ask: Is Fish From China?

BY RON SCHERER

After the FDA voices safety concerns about certain Chinese exports, some Americans are beginning to look more closely at restaurant selections.

A few weeks ago, restaurateur Martin Sheridan discovered his famed “hot and spicy” shrimp came from China.

The owner of the Ear Inn, the second-oldest tavern in New York, quickly asked his fish purveyor to “get them from anywhere but China.” Last month, the US Food and Drug Administration announced that some Chinese seafood tested positive for banned substances.

Because of those findings, which led the FDA to restrict certain seafood from China, some Americans are beginning to look more closely at ocean selections in restaurants – from Hayes Street Grill in San Francisco to Cucina D’Angelo in Boca Raton, Fla., to the Ear Inn in New York. Diners are asking: Where did the tilapia special come from? Who caught the all-you-can-eat shrimp? Is the salmon farm-raised or wild?

It’s too early to know if Americans will permanently change their eating patterns because of concerns about Chinese seafood. But fisheries experts

worry that more Americans will opt for barbecued beef or chicken instead of barbecued salmon.

This could reverse the trend of rising seafood consumption, up 11 percent since 2001. The average American now consumes 16.5 pounds of seafood per year, up from 14.8 pounds six years ago. Shrimp is the top choice, representing almost a quarter of the seafood that Americans eat.

And these days, most of America’s seafood arrives from foreign shores. According to the National Fisheries Institute, a seafood trade organization, 75 to 80 percent of fish is imported. In addition, some 40 percent of all seafood comes from domestic and overseas fish farms.

It’s those fish farms, particularly in China, that are raising the most eyebrows. Late last month, the FDA announced that Chinese-farmed eel, dace, basa, catfish, and shrimp must be tested and shown to be residue-free before they are allowed in the United States. The FDA found that samples of those fish had unacceptable levels of antibiotics, as well as drugs that are banned in the US.

And so now, awareness at local restaurants is growing – and fisheries experts worry that consumers are having more doubts about finned species.

The contamination concern “definitely adds to the confusion since we are so globally dependent on the seafood supply and don’t know the quality,” says Usha

PROTEIN FRACTIONATION

Do you Maintain, Propagate, Research or Grow Out Finfish, Mollusks, Crustaceans or Larvae?
 Do you want Clean Water, Low in Dissolved Organics, and Low in Proteins and Bacteria?
 Do you Want “Quality Water” High in Dissolved Oxygen With Exceptional Clarity?
 Do you want Healthier and Faster Growing Animals?

RK2 FRACTIONATORS DO ALL OF THE ABOVE AND MORE !



“Quality Water”

Distributors			
USA (Eastern)	Aquatic Eco-Systems	Tel. 1-800-422-3939	aes@aquaticeco.com
USA (Western)	Custom Aquatic	Tel. 1-760-599-6838	info@customaquatic.com
USA (Central)	R&B Aquatic Dist.	Tel. 1-830-995-3767	brian@rbaquatic.com
Australasia	Aquasonic	Tel. 02-9605-2999	sales@aquasonic.com.au
Europe	Tecno Aquarium	Tel. +34-95-541-1129	info@tecnoaquarium.com
UK & Scandinavia	Tropical Marine Center	Tel. +44-1923-284-151	tmc@tmc-ltd.co.uk



RS No. 372

Varanasi, science and research director for the Northwest Fisheries Science Center in Seattle. Her organization is part of the National Oceanic and Atmospheric Administration.

She adds, "It's important to identify the sources of fish and make sure we have good data and easily accessible information."

That, however, has been a highly controversial issue. Consumer advocates were successful at getting country-of-origin labeling for fish into the last farm bill. But it only applies to large grocery stores.

"The problem is that companies that import seafood don't want consumers to know where their seafood comes from," says Wenonah Hauter, executive director of Food & Water Watch, a consumer advocacy organization in Washington. "Most of the big seafood chains are almost entirely serving imported seafood."

CATFISH AND POLITICS

Just back from a trip to China, seafood importer Matt Fass, president of Maritime Products International in Newport News, Va., says the issues surrounding safe-

to-eat fish have a heavy dose of politics in them. For example, he blames the domestic catfish lobby for trying to stifle competition. "The issue is not necessarily health and safety," he maintains. "I know not everything is perfect in China, but we know what a great job they are trying to do."

No doubt for consumers, much of this is confusing.

Mark Wolfe, a resident and frequent restaurant patron in the nation's capital, says he never considered the lineage of the piscine course. "I'm thinking about it now," he says. "You know that farm-raised salmon is questionable. Now, what are we supposed to do?"

That type of confusion is causing diners to avoid the ocean side of the menu at Cucina D'Angelo in Boca Raton, reports chef Angelo Morenilli. Patrons are not ordering as many shrimp dishes because of concerns about Chinese seafood, he says. "The big news has stuck in their minds, and now they ask where the fish came from," Mr. Morenilli adds.

Over in San Francisco, Susan Nagy

says she's horrified at how many times she and her husband may have eaten shrimp from China. (Only 7 percent of shrimp sold in the US is imported from China.)

"Now, I have to think twice before I will purchase or order it," she writes in an e-mail. "I am wary of shrimp now even if it's not from China."

Ms. Nagy notes that it's becoming more common for restaurants to inform diners of where fish were swimming when they were caught.

That's the case at Hayes Street Grill, where a recent menu included the local catch, "Steve Fitz's Half Moon Bay Sand Dabs." The menu notes that the item was caught using a Scottish seine, which is supposed to create the least disturbance to the ocean floor.

San Francisco restaurants "are the pioneers of the informational menu," says Patricia Unterman, chef and co-owner.

AMERICANS 'DON'T PAY ATTENTION'

Yet for the most part, "We usually don't pay attention to where our food comes from," says nutrition professor Carol



South Santee Aquaculture, Inc.

AlgaeControl.us Division

- * Fountains * Aerators
- * Circulators * De-icers
- * High Oxygen Transfer *
- * Aquaculture Ponds/Raceways
- * Agriculture Irrigation
- * Reservoirs, Lakes, Ponds
- * Dive Facilities
- * Swimming Pools, Watergardens

1-888-ALGAE-US

www.AlgaeControl.US

Authorized
Kasco
Service
Center



- * Wastewater Treatment Plants
- * Municipal Waterworks
- * Impoundments, Lagoons
- * Sand Filters, Clarifiers
- * Storage Tanks, Cooling Towers

The LG Sonic unit transmits a complex pattern of ultrasonic vibrations through the water in an all around radius of 176° causing the vacuoles inside the algae cells to resonate and break, much like a glass breaking from a high pitched sound. These vibrations are harmless to humans, animals, fish and aquatic plants. Your water systems will become clearer and healthier without harmful chemicals. This Is True Algae Control!





Healthy



Dying



Dead

RS No. 322

Ultrasonic Algae Control Without Chemicals

100% Environmentally Safe!

Johnston of Arizona State University.

That's the case in New York, where John Southerland, a visitor from Huntsville, Ala., had a shrimp cocktail at Spark's Steak House. He didn't ask where the shrimp came from, but he remembers the restaurant "as the place where the mobster got shot out front."

Even restaurant personnel may need some prompting on fish origins. Take Hale and Hearty Soups, a chain in New York City. At one of its locations in Manhattan, it has a shrimp creole soup on the menu. One of the staff says she has no idea where the shrimp came from since the soup is made in a central location.

The website for Hale and Hearty gives the calorie content of the shrimp soup, but no indication of where the shrimp came from. "Good question," says Simon Jacobs, CEO of the company. "I don't know, but I'll call our supplier to find out."

A day later, Mr. Jacobs e-mailed that his purchaser believes the shrimp come from Ecuador, which is one of the largest sources of farmed shrimp in the West.

On a recent day, the Ear Inn had a

shrimp dish on its blackboard of specials. "Where do the shrimp come from?" the bartender is asked. "The purveyor," she replies.

"No, what body of water?"

"Oh, who knows," she answers.

"Maybe the chef?" the other suggests.

"He wouldn't have a clue, I guarantee it," she declares.

The shrimp are from Thailand, says the owner, Mr. Sheridan

This article comes from the July 25, 2007 issue of Christian Science Monitor

NMFS Sees Kona Blue As A Model For Open Ocean Aquaculture

Can Kona Blue's open ocean Kona Kampachi@operation become a model for sustainable aquaculture in Federal waters? That was the question in the minds of officials from the National Oceanic and Atmospheric Administration

(NOAA) and the National Marine Fisheries Service, who visited Kona

Blue Water Farms last Friday for a firsthand look at America's leading environmentally sound open ocean fish culture operation.

"We're here to see and learn," said Dr. William Hogarth, Director for the National Marine Fisheries Service. "Kona Blue is pioneering open ocean aquaculture, and we feel that their infrastructure and commitment to environmental sustainability can be replicated in Federal waters offshore."

NOAA is currently sponsoring a bill before Congress, the Offshore Aquaculture Act, which would promote the development of open ocean aquaculture in federal waters, providing economic incentives and establishing environmental safeguards.

"Some environmental organizations have concerns about the bill," said Neil Anthony Sims, President of Kona Blue and Founding Board Member of the Ocean Stewards Institute, a trade organization advocating for open ocean aquaculture. These concerns include the

DOES MESSY HEATER WIRING SCARE YOU?

Don't be intimidated by complicated heater installations - Process Technology's **EASYPLUG** heaters make it simple! Just plug them in and you're done. Available in stainless steel for fresh water applications or titanium for salt water, our systems are designed with safety in mind.

Process Technology's extensive line of aquaculture heaters and precise temperature controls offers you the reliability you need from a name you can trust. Rely on the best for your aquaculture needs - Process Technology.

PROCESS TECHNOLOGY

www.process-technology.com
Eastern USA/CAN: 800-621-1998
Western USA/CAN: 800-621-1999
International: 440-674-1300

AUSTIN BROS. FISHERIES INCORPORATED

Hybrid Striped Bass

Hatchery / Live Fish Terminal / Food Fish Supplier

RS No. 174

We Deliver
Fingerlings / Phase II / Live Food Fish

Austin Bros. Fisheries, Inc.
P.O. Box 844 Aurora, North Carolina 27806
(252) 322-7271

use of fishmeal and fish oil in feed, the potential for escapes, and the potential for effluent water impact.

“At Kona Blue, we are addressing all of these issues in a responsible, responsive manner, said Sims. “They are not insolvable; we just need the opportunity and the incentive to work towards sustainable solutions. Federal legislation can provide that. We see our Kona Kampachi® operation as an exemplar of how open ocean aquaculture can provide jobs, and a healthful, delicious product, while at the same time alleviating pressure on ocean resources.”

Currently, over 40 percent of all seafood consumed in the United States is imported from overseas aquaculture farms. “Developing an emerging aquaculture industry in U.S waters is key to ensuring a safe supply of healthful seafood grown in a sustainable manner,” said Hogarth. “We know that this can be done... we’ve seen it here at Kona Blue.”

Kona Blue is the first sustainable operation in the United States to grow



*From right to left Neil Anthony Sims, President of Kona Blue
William Robinson, Pacific Islands Regional Administrator of NOAA
Dr. William Hogarth, Director of the National Marine Fisheries Service*

fish in the open ocean from an integrated hatchery. Six years ago, the company began culturing Kona Kampachi® (or *Seriola rivoliana*), a delicious Hawaiian yellowtail fish. This fish is nurtured from hatch-to-harvest, fed sustainable feed and grown in some of the cleanest water on Earth. Kona Kampachi® is healthy, pure and rich in healthy omega-3 fatty acids

with no detectable mercury.

Kona Blue is committed to building an environmentally sustainable future through marine fish hatchery technology, sustainable feeds, and deep-ocean aquaculture.

For more information on Kona Kampachi® and Kona Blue visit our website at www.kona-blue.com.

Looking for an indestructible pond liner?

Heavy Dura+Skrim J-Series....Unmatched



Dura+Skrim J-Series 30 to 45 mil reinforced polyethylene outperforms other reinforced geomembranes with unequalled tear resistance ranging from 75 to 100 pounds and outstanding longevity.

- ◆ Super Stabilized for Demanding UV Exposure
- ◆ Tear Resistant 1300 Denier Reinforcement
- ◆ Remains Flexible Below -40° F
- ◆ Outer Layer Formulation Provides Ease of Field Welding
- ◆ Low Creep for Slopes or Floating Covers
- ◆ Custom Colors Available

Typical Applications: Fish Pond & Lake Liners, Waste Containment Liners, Floating Covers, Canal Linings, Tank Liners



RS No. 726



800-635-3456
www.dura-skrim.com



Products

Crystal Lake Fisheries

Crystal Lake Fisheries, Inc. has been a family operated business for over 57 years. Our facility is fed by the constant flow of a clear Ozark Mountain spring, which produces about 10 million gallons per day. Beautiful, healthy rainbow trout fill 47 compartmentalized raceways at the farm, where rainbows range in size from fry to fingerlings to large adults. Crystal Lake Fisheries, Inc. selects and maintains its own high performance brood stock. The Emerson Strain rainbow trout is registered with the National Trout Registry.

Recently there has been an increased demand for trout as bass feed. Pond owners are stocking rainbow trout during the winter months as a supplemental food



source. The omega 3's and oils in the rainbows provide a nutritional boost for bass during their slow feeding times. In the spring, the bass appear to be larger, healthier and more vigorous.

DEPENDABLE LIVE DELIVERY

Our trout are produced for live

delivery to markets up to twelve hundred miles away. They are sold to resorts, private estates, other fish farms and to city, county and state recreational parks and hatcheries. Our goal at Crystal Lake Fisheries is to supply live rainbow trout to your stream, pond or lake, providing

Firestone
Pond Gard
RUBBER LINERS

Firestone Specialty Products
www.firestonesp.com • 1.800.428.4442

I Love What You've Done With The Place...

RS No. 266

CAROLINA FISHERIES

HOME OF THE FIRST POND-RAISED

WE SPECIALIZE IN HYBRID STRIPED BASS

ANY SIZE

- FRY
- PHASE II
- FINGERLINGS
- FOOD FISH

Live Haul Specialist
LEE BROTHERS, OWNER
AURORA, NC 27806
PHONE 252-322-7117
FAX 252-322-4687

RS No 918

you with a wholesome family oriented activity - trout fishing - where one can experience the success of really catching a trout, taking it home and eating it.

- For more information
- Crystal Lake Fisheries, Inc.
Route 2 Box 528
Ava, Missouri 65608
- Telephone 417-683-2301
- Fax 417-683-6565.
- E-mail: info@crystallakefisheries.com
- Website: www.crystallakefisheries.com

SEE AD PAGE 68

Frigid Units Inc

Frigid Units, Inc. has been in the industry since the early 1950's and is dedicated to supplying a top quality product. Equipment is used wherever a controlled environment is required, ie: research and development, aquatic life, hydroponics and bait dealers. Such locations as College and Universities, Government Installations (Fish and Wildlife Service, NHS, EPA,

Food & Drug Administration, Corps of Engineers, etc..) Marine and Industrial Labs throughout the world.

Frigid Units takes great pride in the quality and finish of our products. • tanks have a satin smooth interior surface, which requires minimum effort for maintenance. A large election of tanks molds are readily available including our "LIVING STREAM", MIN-O-COOL, and our versatile patented STREAM MODULES that are attractive to labs where space is limited. Also, we have the flexibility to manufacture to special needs.

Our WATER CHILLED UNITS cool, aerate and circulate in one operation. Units are available in three sizes for use in fresh &/or salt water. Chiggers can be used with our tanks or : adapted to your own equipment. They are now available with 1000W to 3000W heating elements (P t Pending). A dual digital thermostat is used to select required temperature using a single power sour . Control has choice of Fahrenheit or Celsius and will

maintain about +/- 1 degree Fahrenheit from 35 -100 degrees.

- If you have any questions, please contact our office
- Telephone (419)-478-4000,
- Fax, 419/478-4019.
- website at www.frigidunits.com
- e-mail us at frigidunits@a wast.net

SEE AD PAGE 33

Valterra Products, Inc.

Valterra Products, Inc. manufactures a complete line of gate valves. With over 26 years experience, Valterra produces inexpensive, quality gate valves, ideal for quick shut-off in low pressure or vacuum lines. They are also well suited for a drain valve for tanks and ponds.

Valves are constructed of quality ABS and PVC material and are easily disassembled for in line servicing. Sizes range from 1-1/2" through 8". Stainless steel paddles are available on 4", 6" and 8" models. 1-1/2", 2" and 3" models come in several connection fittings to



"AquaOptima has chosen to use the Octaform™ product in our system due to its smooth inside surface, easy maintenance and long lasting material. It is easy to install and has a cost advantage for medium and large tanks."

*Idar Schei
Managing director of AquaOptima, Norway AS*

OCTAFORM™

The New Generation of Aquaculture Tank Technology

Industrial strength PVC encapsulates the structural concrete walls. You get the best of both worlds: The strength of protected concrete and the sanitary shell of PVC. The result is a highly effective fish growing environment.



OCTAFORM™ – The Better Way To Build

- Unlimited size and shape.
- Creates a smooth fish friendly environment.
- Easy clean sanitary finish minimizes bacteria.
- Low transportation costs through compact shipping of components.
- Solid walls allow for equipment mounting.
- Suitable for warm, cold, or salt water fish.

RS No. 777

CONTACT US @ 1-888-786-OCTA (6282)

www.octaformtanks.com • www.octaform.com



Valterra Valves

- website at www.valterra.com
 - Contact Valterra at 818-898-1671
- SEE AD PAGE 61**

Corrosion Resistant Manual Shut-off Valve

Plast-O-Matic Valves Inc. has introduced a 1/2" size palm or foot operated shut-off valve with no metals or external fasteners for high-purity or corrosive environments. These balanced, compact valves are designed for liquid service to 150 PSI. The balanced aspect means that the valve outlet pressure, commonly known as back pressure, can be as high as the inlet pressure without affecting performance. The normally-closed design has a spring return, and will automatically close "fail safe" when hand or foot force is removed. Series MFR is offered in Grade 1 Type 1 PVC or natural polypropylene for heavy duty applications.

- For More information:
- Plast-O-Matic Valves, Inc.,



- 1384 Pompton Ave.,
Cedar Grove, NJ 07009
- Telephone 973-256-3000
 - Website; www.plastomatic.com
- SEE AD PAGE 80**

Solar Components Aquaculture Tanks & Tubes

Made from corrosion-free, fiberglass-reinforced polymer sheeting, bio-filter columns from Solar Components are completely maintenance-free and have no moving parts. They are ideal for ammonia

meet a variety of needs.

Valterra's valves are suitable for Aquaculture, Agriculture, Commercial and Industrial markets.

- For more information



TROUTLODGE

THE WORLD'S LEADING SUPPLIER OF
Eyed Salmonid Eggs

Rainbow trout eggs

Silver steelhead eggs

Atlantic salmon eggs

Arctic charr eggs

All female eggs

Triploid eggs



Comprehensive genetic selection program



Personalized customer and technical services



Internationally accepted independent disease-free certifications



Eggs are available every week of the year

Since 1945 www.troutlodge.com

T +1 (253) 863-0446 F +1 (253) 863-4715 E trout@troutlodge.com

PO Box 1290, Sumner, WA 98390 USA

RS No. 319

Open-Channel or Pressurized

Reliable UV protection demands equipment integrity, supported by accurate performance recommendations. Emperor Aquatics, Inc. offers you the most economical UV solutions available for a large variety of applications.

Protect your valuable livestock with proven Emperor Aquatics, Inc. UV performance!



UV Sterilizers with optional clamps



Premium HighOutput Multi Lamp UV

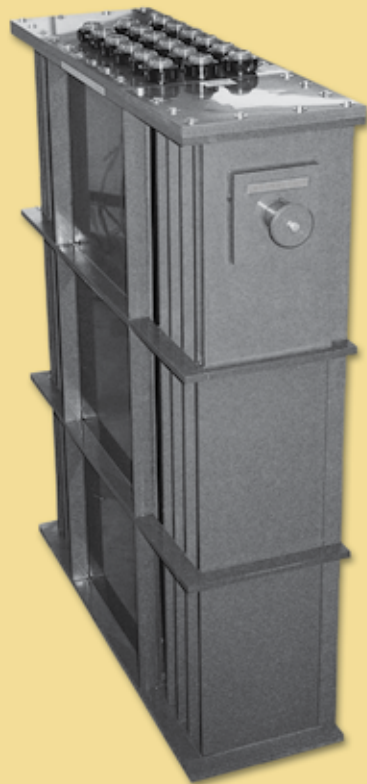

Rack System / Channel UV

Ultraviolet Sterilization

Models Available

- * Pressurized Single lamp models up to 150 Watts
- * Pressurized Multi-lamp models up to 2,000 Watts
- * Open-channel models

Standard Features

- * Cost efficient heavy wall plastic construction
- * Easy installation
- * Water tight design
- * Protective remote power enclosures
- * Efficient low-pressure lamps

Optional Touch Screen Control System

- * Individual UV lamp status indicators (displays individual lamp operating hours)
- * Re-settable lamp run-time hour meter "password protected".
- * Main Power Indicator Status (displays the input voltage).
- * Output data/alarm port
- * Safety Power Shut-off (disconnects input power to the lamps while vessel lid is opened, available with open-channel units only)
- * Automatic/manual operating mode selection control
- * UV intensity monitor w/ set-point alarm for use with output data/alarm port
- * Temperature monitor w/ set-point alarm for use with output data/alarm port

 **EMPEROR AQUATICS, INC.**

www.emperoraquatics.com

RS No. 332



removal, oxygenation, or degassing of closed loop recirculating aquaculture systems.

With 90 percent of visual light transmission, these unique tanks allow you to observe activity within the tank. The specially formulated bio-medium is maintenance-free and a proven performer. It provides over 165 square feet of surface area per cubic foot.

Bio-filter tanks from Solar Components are the most affordable and natural way to maintain water quality in your aquaculture operation.

Other products include flat bottom algae tanks, conical bottom tanks, knock down tanks, upwellers, and protein skimmers. Standard and custom sizes available.

Many of our products have been used worldwide since 1973.

- For information, please contact: Solar Components,
121 Valley Street,
Manchester, NH 03103.
- Telephone: 603-668-8186,
- Fax: 603-668-1783
- website at www.solar-components.com

SEE AD PAGE 56

Fish Farms For Sale

United Country is offering two properties for sale in Mississippi. Here is your chance to enter the aquaculture industry.

MISSISSIPPI OPERATION

The farm has 14 plus acres with 4 ponds with public utilities and deep well for maintenance. The farm has a home on the premises. The house has 3 bedrooms, 2 bath rooms, and a 24x24 outside building with apartment. No state tax on retirement income! **\$89,500!**

RAISE FISH!

36 acre former catfish farm with 4 ponds & pumps. Fenced & x-fenced. House on premises with 3 bedrooms, 2 Baths. Farm is near lake. **\$94,500.**

- For More Information
- United Country, 1-800-999-1020, Ext.99
- www.unitedcountry.com

SEE AD PAGE 60

Ozone Superstore!



ICSo60
60 gpm with 1.6 lbs/day ozone in a compact high performance skid



LAB Series
Up to 3 lbs/day of ozone on your desktop



Dual G Series
Two ozone outputs with discreet control for two ozone applications in one box—up to 6 lbs/day



Super SGA Series
Ozone/oxygen system NEMA4 stainless steel—ideal for harsh environments—3 lbs/day ozone with oxygen system

Pacific Ozone Technology is the ozone superstore with everything you need!



PACIFIC
OZONE
TECHNOLOGY

RS No. 241

tel. 707-747-9600 / fax 707-747-9209 / sales@pacificozone.com / www.pacificozone.com

Florida Fish Farms, Inc.



Florida Largemouth Bass
Bluegill and Redear Sunfish
Channel Catfish
Tripliod Grass Carp
Koi

9684 CR 705
Center Hill, Florida 33514
352-793-4224
Fax: 352-793-6898
www.floridafishfarms.com
Email: ronslay@sum.net

RS No 531

Aquatic Eco-Systems: An Industry Leader For 30 Years

Aquatic Eco-Systems has been serving the aquaculture industry for almost thirty years. Our experienced staff of 20+ marine and aquatic biologists is led by a PhD Professional Engineer. We're prepared to answer your questions and make your aquatic ecosystem flourish.

With AES, get everything you need from one place. Backed by the largest inventory in the industry, we're able to provide an unmatched level of service. Call our technicians today to order our 500-page Master Catalog or ask for a few minutes of free advice. Visit aquaticceco.com 24/7 to see our extensive selection of products. In our catalog and on our website, you'll find our helpful Tech Talks, which explain an assortment of aquatic principles in easy-to-understand

terms. If you live outside the US, call and ask for our International Department.

If you're looking for more than just products and advice, we have a division that can help. Waterlife Design Group is a design, engineering and consulting team servicing the aquaculture, public zoo and aquarium industries. We have assembled a talented staff of system designers and biologists with over 50 years of combined academic and field experience. They can provide components to your design specifications or work with you to design complete systems from scratch. They will coordinate with owners, architects, engineers and contractors to provide integrated, coherent and economical solutions for the aquatics industries. Call Waterlife Design Group today for a free introductory consultation.

AQUATIC ECO-SYSTEMS, INC.

—Since 1978

- Aquatic Eco-Systems, Inc.
2395 Apopka Blvd.
Apopka, FL 32703
- Phone: 877-347-4788
- Fax: 407-886-6787
- Email: aes@aquaticceco.com
- Web: aquaticceco.com

- Waterlife Design Group
2395 Apopka Blvd.
Apopka, FL 32703
- Phone: 407-472-0525
- Fax: 407-886-6787
- Email: info@waterlifedesign.com
- Web: waterlifedesign.com

SEE AD PAGE: IFC

Easily & Accurately Maintain Water Quality of your Ponds, Aquariums, and Farms

Myron L Water Quality Instrumentation

Monitor & Control:

pH
Temperature
Mineral/Salt
ORP
Conductivity
TDS



720II pH
Monitor/controller



Waterproof POOLPRO™



RS No. 803



**MYRON L
COMPANY**
Water Quality Instrumentation
Accuracy • Reliability • Simplicity

See our complete line of water quality instrumentation at:

www.myronl.com

1-760-438-2021

Sterling Net & Twine

Sterling Net & Twine Co., Inc. offers the widest range of aquacultural, marine biological research and commercial fishing nets and net products. Sterling has served the global community since 1949. In 1974 thru 1977 Sterling, along with the N.M.F.S., pioneered the Pacific Northwest Salmon pen business and Ocean Engineering.

With 53 years of experience in the netting industry, Sterling is the choice supplier of your net products. A large sampling of our product lines have been placed on the web to browse at www.sterlingnets.com. We offer a large variety of seines, trawls, gill nets and trap nets as well as rope & twine for the customers who want to make their own fish nets. Sterling also manufactures special "Shark Barrier Nets" and provides fyke nets, cutlery, fish holding boxes, dip nets and a wide variety of marine products for aquaculture, marine biological research and fish applications. Everything from the best quality brands and materials, along with the most competitive prices

in the market, a must see!

We hope you find what you are looking for, but if you don't - Sterling will custom manufacture any netting product. We look forward to being your netting source. For a free catalog, call our toll-free number: 800-342-0316 or E-mail us a request at custsvc@sterlingnets.com.

SEE AD PAGE 85

Florida Fish Farms

With facilities located approximately forty miles west of Orlando, Florida Fish Farms, Inc. is perfectly situated for the production and distribution of aquaculture products on a year-round basis.

The species of fish we produce include Florida largemouth bass, bluegill, redear sunfish, channel catfish, koi (ornamental carp) and triploid grass carp.

The proximity to two international airports enables us to air ship our products to markets worldwide. Because the subspecies of game fish we sell evolved in Florida, their distribution is generally limited to the U. S. Southeast and

Southwest, or similar warm climates. Koi are suitable in all climates.

Triploid grass carp sales are limited to properly permitted individuals and companies within the State of Florida.

Current projects include the development of a Florida largemouth bass certification program. This procedure will provide additional assurance of the genetic integrity of our broodstock and fingerlings. We do not maintain any northern strain largemouth bass on our farm. Moreover, our being located in the center of the zoogeographic range of the Florida largemouth bass minimizes the accidental contamination of our broodstock by the introduction of "wild stocks".

Florida Fish Farms, Inc. has also committed additional acreage and tank space to the production of koi. The increasing popularity of backyard ponds and water gardens presents new opportunities in this area. Both regular and long fin varieties are available.

- For further information, please contact
- Florida Fish Farms, Inc.
- (352) 793-4224



Feeding Systems
Norcan Electrical Systems Inc.

THE FUTURE OF FEEDING...

Automated Feeding Systems for Fish Farms & Hatcheries



RS No. 894



- Hatcheries: 1", 1.5" and 2" Systems
- Grow Out Sites 2" 3" or 4" Systems
- Pre Assembled Skid and Container Systems
- Integrated Concrete or Steel Barge Systems

Norcan Electrical Systems Inc.
6296 Cherry Creek Road, Port Alberni, BC, Canada, V9Y 8S9
Tel: +01 (250) 723-7523 • Fax: +01 (250) 723-7531 • info@feeding-systems.com
www.feeding-systems.com

Practical Aquaculture from A to Z

First There Was
Fundamentals of Aquaculture:



Over 900 Pages
Over 280 Photos
Over 50 Illustrations

NOW GET the New
Companion Aquaculture Manual For Teaching and Extension:



A comprehensive guide for teachers using Fundamentals of Aquaculture

Fundamentals of Aquaculture
by James Avault, Jr. is a **Step-By-Step Guide To Commercial Aquaculture**

Everyday problems worked on pond construction, feeding, disease control, and more!
Extensive Reference and Study Questions included at the end of each Chapter
For everyone involved in Aquaculture - From student to the experienced fish farmer

Fundamentals of Aquaculture & Companion Manual:
Order Both Today for: \$79.90!

Fundamentals of Aquaculture \$69.95 -
Add \$6.00 for shipping (\$12.00 Outside the US)
Companion Manual alone: \$9.95
Add \$2.00 for shipping (\$3.00 Outside the US)

To order or for more information:
Call: 225-763-9656 - Fax: 225-766-0728
Email: AVApub@cox.net - Website: www.AVApub.com

AVA Publishing Company, Inc.
PO Box 84060
Baton Rouge, LA 70884-4060 USA

Mastercard & Visa Accepted ~ Please send Checks in US Funds
Louisiana Residents add 9% sales tax

RS No. 175

- fax us at (352) 793-6898.
- website at www.floridafishfarms.com.

SEE AD PAGE 18

AquaMax Fish Diets

AquaMax™ brand fish diets are 100% nutritionally complete diets that have been collaboratively developed by our nutritionists and fish experts. These products have been formulated for optimum nutrient delivery to a wide number of fish species. With complete nutrition, fish have better performance and maintain good health and resistance to disease.

AquaMax™ products are formulated to be high energy, nutrient dense diets. These highly digestible diets enable fish to more efficiently utilize nutrients which in turn reduces fecal waste and biological load in water. A precision manufacturing process reduces the amount of fine feed dust material which helps maintain water quality by minimizing feed waste. Excessive feed fines in water can lodge in fish gills in some species and attract bacteria and fungus. By reducing these

feed fines, AquaMax provides an added health benefit to fish.

Using that latest information available on ingredient nutrient contents combined with a broad based knowledge of nutritional requirements, AquaMax fish diets have been created to feed two major groups of species.

1. **Carnivorous Species** - Trout, Hybrid Striped Bass, Yellow Perch, and Red Drum are major carnivorous species that are fed manufactured diets. These fish require high protein, nutrient dense diets that promote growth and maintain good health.

2. **Omnivorous Species** - Catfish and Tilapia are the major species for this category of diets. These two species do not require the protein levels nor the nutrient density of carnivorous fish but do require more moderate amounts of nutrients. Omnivorous species are usually warm water animals.

For starting fish and early growth phases, use AquaMax carnivorous starting diets for both species groups. AquaMax starting diets are all sinking diets. For fish that have reached the fingerling

stage, the product line separates into diet formulations most appropriate to the species group. Recommended growing diets are floating diets.

FEATURES AND BENEFITS **100% NUTRITIONALLY COMPLETE**

Optimum Nutrition...Your fish get a complete, balanced diet for optimum growth, overall health and better performance.

Resistance to disease through balanced nutrition.

PALATABLE

Readily accepted by a wide variety of species.

Helps in proper diet intake for growth and health.

CONTAINS STABILIZED VITAMIN C

Improves shelf life of the diet and the stabilized form of this essential nutrient gives extra assurance that it will be in the diet when fed to the fish.

HIGH DIGESTIBILITY AND BIO-AVAILABILITY

Less undigested material is passed into the water because fish utilize and

TOP QUALITY AQUARIUM SUPPLIES

PACIFIC COAST IMPORTS

P.O. BOX 378
WOODBURN, OR 97071
PH: 503-982-6700 FAX: 503-982-0760
www.pacificcoastimports.com

RS No. 105

The advertisement features a central logo for Pacific Coast Imports, surrounded by various aquarium equipment including blue and grey pumps, heaters, and a water test kit. Two bags of Pacific Coast Marine Mix fish food are also shown. The background is a vibrant underwater scene with colorful clownfish and coral.



absorb more of the diet nutrients.

Fish better absorb nutrients for maintenance and growth.

Helps maintain overall health because protein and energy sources are highly available to the fish, especially the amino acids lysine, methionine and Cystine, which are of key importance in fish nutrition.

Growth and biological functions enhanced since protein comes from high quality fish meals rich in amino acids. Carnivorous diets contain high quality fish oil containing a high level of fatty acids including Omega 3 fatty acids.

STARTER DIETS SINK

Diet is well dispersed throughout the water column to assure intake when fish are small and more densely stocked in starting tanks or raceways. Small fish at all levels in the water column get the opportunity to consume the diet.

GROWER DIETS FLOAT

Visible management tool to see how much, as well as how well, fish are eating.

Helps prevent overfeeding because

you can see excess on the surface.

Less waste because you can see if you are overfeeding and adjust accordingly.

Improve water quality because floating diets are less likely to accumulate on bottom where they can decay, take up oxygen and provide a medium for bacteria and fungus which can cause disease.

Allows more time for all fish to eat because the feed remains on the surface and available rather than settling to the bottom.

FEW FEED FINES

Less waste. Fish do not consume feed fines in the grower stages.

Feed conversion improves because more feed is being consumed by the fish and less is dispersed into the water as waste.

Helps maintain good water quality by decreasing the biological load in the water. Feed fines decay and release soluble materials into the water, as well as create suspended solids that eventually settle out.

Helps maintain fish health because there are fewer particles to lodge



LANTEC PRODUCTS

New & Innovative Bio Media

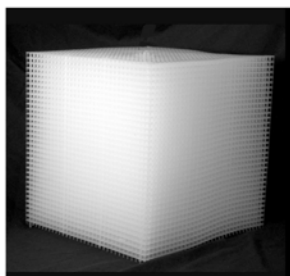

HD Q-PAC® is advanced technology media for use in:

- Biotowers
- DeAerators
- Protein Skimmer Sumps

HD Q-PAC® is the new generation in bio media:

- 132-300 ft²/ft³ specific surface area
- 75,000 drip points per ft³
- 20% greater efficiency than corrugated biomedica
- Durable, easy to handle 1 ft³ blocks
- Excellent resistance to plugging and fouling
- Rounded surface supports active growth
- Better control of life support systems

RS No. 119

To learn more, call 617-265-2171

sales@lantecp.com

www.lantecp.com

in gills which can cause disease in some species.

Available in a variety of sizes to meet virtually all needs

Enables complete feeding and management programs. Sized for each stage of growth for most commercial species.

PRODUCT

- 5D00 AquaMax Fry Powder
 - 5D01 AquaMax Fry Starter 100
 - 5D02 AquaMax Fry Starter 200
 - 5D03 AquaMax Fingerling Starter 300
 - 5D04 AquaMax Grower 400
 - 5D05 AquaMax Grower 500
 - 5D06 AquaMax Grower 600
 - 5D07 AquaMax Pond 2000
 - 5D08 AquaMax Plus 3000
 - 5D09 AquaMax Dense 4000
- More information: 800-227-8941

SEE AD PAGE 3

Texas A&M - Corpus Christi

The mission of the Master of Science in Mariculture degree program is to assist students in developing leadership roles at public/private sector aquaculture facilities through advanced or specialized education and training. The program and the students will play a vital role in the growth of the aquaculture industry in south Texas, and at the state and national levels. The Mariculture Program at TAMU-CC began in 1990

when 6 graduate students were admitted. To date, 59 students have graduated from the program conducting research in various aspects of marine fish and shrimp culture. Many graduates from the program hold key positions around the world in the field of aquaculture.

The student wishing to obtain a Master of Science degree in Mariculture may do so by following one of two 36-hour program options. Graduate students in the mariculture program can select between research and internship options. Selection of an option depends on a student's interests and objectives for doing graduate work. Option 1 focuses on the development of the student's managerial skills and techniques through a broad hands-on internship. Students choose the internship option if they prefer exposure to a wide range of areas in mariculture. Option 2 places greater emphasis on in-depth research in one or more areas of mariculture specialization, a prerequisite for other graduate studies. Students who intend to further their graduate study and undertake a doctoral degree are advised to select the research option, as successful completion of a master's thesis (or equivalent) is generally required for entrance into most doctoral programs. The purpose of the research option is to demonstrate a student's competence in investigating a research topic and to report the findings with full documentation in a scientific format. This affords the student the

opportunity to gain expertise in a specific area of mariculture/aquaculture and to produce research results of publishable quality. Through such research a student generally develops a better appreciation of what constitutes valid research design, methodology, statistical analysis, and conclusions.

The M.S. in Mariculture degree requires 20 semester hours of biology and mariculture courses, 6 semester hours of support (business) courses; 10 semester hours each for the internship or research options with one of those semester hours required for the oral exam and seminar. Additionally, Option 2 requires 3 semester hours of graduate-level statistics. For more information, visit our website: <http://sci.tamucc.edu/pals/maric/Index/WEBPAGE/mari1.htm>, or contact Dr. David McKee at dmckee@falcon.tamucc.edu.

SEE AD PAGE 61

Zeigler Vpak™: Economical Feed

Zeigler® Vpak™ is an all-natural, highly purified nutritional additive that has been shown to improve survival and production yields in aquatic animals. Both field and laboratory tests have demonstrated decreased mortality rates and boosted production yields when fish were fed a diet supplemented with Vpak™.

POND AND TANK LINERS

by Reef Industries, Inc.

9209 Alameda Genoa Rd. • Houston, TX 77075 • P: 713.507.4251 • F: 713.507.4295
Email: info@reefindustries.com • All Major Credit Cards Accepted



- Alloyed high-density polyethylene laminate resists punctures and tears for a more secure system.
- Lightweight and easy to handle for a quick, easy, installation.
- UV stabilized for durability during extended exposure to the elements.
- Cold crack tested to -60°F for continuous performance in extreme temperatures.
- Custom engineered fabrication and sizes up to an acre available.

TOLLFREE 1.800.231.6074
www.reefindustries.com

RS No. 887

**You've seen this
fish a thousand
times...**



**...but have you ever
wondered why?**

**It's because
Naltex® Netting
is the premier
Aquaculture netting
in the industry.
And he wouldn't
still be swimming
without it.**

*Contact us to learn more about
our complete collection of
cost-effective outdoor products:*

- Heavy-Duty plastic mesh with strand spacings ranging from 200 micron to 2.5 inches
- Eight lightweight to heavy gauge polyethylene nets, stocked in a variety of widths and lengths
- Bait Bags, stocked in 3 sizes

*All Naltex Aquaculture products
are long lasting, easy to install,
safe for the environment,
and safe for fish.*

RS No. 435

DelStar
TECHNOLOGIES, INC.

220 East Saint Elmo Road
Austin, Texas 78745-1218
Tel: 512-447-7000
Fax: 512-447-7444

www.delstarinc.com • 800.531.5112

Based on principles of nutritional immunology, Vpak™ utilizes a unique blend of selected nutrients and natural ingredients formulated at optimal levels to help overcome stress situations. This supplement is not a therapeutic, but rather a completely non-toxic activator of the non-specific immune system.

Reports from the field indicate that when fed prior to acute or chronic stress neutrophil function was enhanced, potentially increasing disease resistance and survival rates. Improved immune response such as this is critical during periods of handling, transportation or exposure to poor water quality.

Results suggested that routine incorporation into the feed for Snapper during winter may enhance macrophage function and growth rates at a time of increased disease susceptibility and little or no growth. Other reports indicated reduced mortality in Rainbow Trout under the stressful conditions of high temperature and low water flow. In addition, the incidence of "Strawberry Disease" in Rainbow Trout was also minimized.

Vpak™ contains nutrients and extracts of natural ingredient and does not include any drugs or antibiotics. It is safe, biodegradable and residue free. Vpak™ is reactive and proactive in fighting viruses and bacterial pathogens.

Vpak™ is formulated for use with any finfish or shrimp feed and is highly economical. As with all Zeigler® products, Vpak™ is manufactured according to ISO-9001:2000 quality guidelines to help assure consistent, high quality and traceability.

For more information, please contact us at 1-800-841-6800, or email: sales@zeiglerfeed.com or visit our website at www.zeiglerfeed.com.

SEE AD PAGE IBC

Myron L. Company: Water Quality Instrumentation

Founded in 1957, The Myron L Company is a privately owned and operated California Corporation dedicated to the manufacture of accurate,



reliable and simple to operate water quality instrumentation.

Increasing regulation and the demand for precise treatment of wastewater has created the need for an accurate, reliable and economical multi-parameter instrument. This industry request was the driving force behind the development and re-design of the Ultrameter multi-parameter series of handheld instrumentation.

The feature packed Ultrameter II is Myron L Company's latest in an increasing line of instruments utilizing advanced microprocessor-based circuitry. This circuitry makes the instrument extremely accurate, reliable and easy to use. The Ultrameter II is a prime example of how hi-tech application driven engineering and design can greatly simplify and streamline a task. Whether in the lab or in the field, simply:

1. Rinse & fill the cell cup
2. Push the desired parameter key
3. Observe and store the reading

Temperature compensation and range selection are rapid and automatic.

Two Ultrameter II models are currently available: the model 4P (Conductivity/TDS/Resistivity and Temperature) and the popular model 6P (Conductivity/TDS/Resistivity/pH/ORP and Temperature). Two instrument models capable of measuring up to six water quality parameters.

Handy Polaris

Dissolved Oxygen Meter



New Probe design!



OxyGuard CO2

Direct measurement of free dissolved CO₂

Commander

Measuring, monitoring and total control...



of the entire farm!

Dissolved Oxygen - Water Level - pH
CO₂ - Temperature - Ozone - Pumps
Filter Motors - Artificial Daylight Control
Feed Systems - Alarms - Data Logging
Remote Access - LAN - wireless LAN

Commander does it better!

Convoy

For monitoring and control during live fish transport

Very close control of DO levels etc.



Full control from cab
Print-out of data after journey



OxyGuard International A/S,
Blokken 59, DK 3460 Denmark

Phone +45 4582 2094
Fax +45 4582 1994

www.oxyguard.com
oxyguard@oxyguard.com

OxyGuard® 

- For more information, contact
- Myron L Company
www.myronl.com
2450 Impala Drive
Carlsbad, CA 92010
- info@myronl.com

SEE AD PAGE 19

J.M. Malone And Son, Inc. Specializes In Triploid Grass Carp

Triploid grass carp have proven themselves to be the safest and most cost effective control for aquatic vegetation on the market today. With 35 years experience producing and stocking grass carp for vegetation control, J.M. Malone and Son knows a successful aquatic vegetation control program utilizing Triploid Grass Carp must take into account the unique biology of grass carp and the production cycle with which they are produced. Accordingly our business and our record revolves around the Triploid Grass Carp production cycle.

The triploid grass carp production cycle at J.M. Malone and Son begins in May and June when diploid brood fish are artificially spawned in a controlled hatchery environment. Shortly after fertilization the grass carp embryos are shocked to induce the retention of a naturally occurring third polar body

which is normally discarded. Embryos that retain this third polar body are triploid. Approximately 24 hours after fertilization the semi-bouyant grass carp fry hatch and are incubated in an upwelling environment to prevent suffocation.

The shock treatment used to induce triploidy is not 100% effective, therefore every batch of fry produced in the hatchery is tested at four days post hatch to determine the percentage of triploid fry in the population. Only groups of fry which are better than 90% triploids are stocked into nursery ponds for fingerling production. The grass carp fry grow rapidly reaching 3 to 4 inches in length by August. The fingerling grass carp are then harvested and brought to our holding facility prior to stocking in production ponds. While in the holding facility the fish are graded to a uniform size and tested again to determine the percentage of triploid fish in each population. Only groups of fingerlings which are better than 95% triploid are stocked for grow out.

By October the grass carp have grown to 8 to 12 inches in length and are ready for sale. Grass carp are harvested according to pending shipments and held in our modern 30,000 square foot live fish holding facility. After three days of purging and hardening the grass carp are transferred to our state of the art blood testing laboratory where each grass carp is individually blood tested using a coulter counter to determine its

ploidy. Diploid fish are removed from the population and triploids are isolated for sale. Our full time seven person blood analysis crew can individually test 3000 grass carp per day using the most efficient methods and newest equipment in the industry.

Once all triploids have been isolated for a given shipment, an inspector from the USFWS Triploid Grass Carp Verification Program visits the farm and randomly selects 120 fish from the group of tested triploids. These 120 fish are re-tested by the inspector to verify that all fish isolated for shipment are triploids. If all 120 fish are triploids the inspection is passed and a certification is issued declaring the group of grass carp consists of 100% Triploid fish. If even one diploid is found during the inspection process the inspection is failed and all fish isolated for shipment must be individually re-tested and then pass another random 120 fish inspection before a certificate can be issued by the USFWS. J.M. Malone and Son, Inc. takes great pride in the fact that we have the lowest failure rate by volume in the USFWS Triploid Grass Carp Verification Program.

The main goal of J.M. Malone and Son, Inc. is to ensure customer satisfaction by supplying a superior product and introducing it at the proper time frame to guarantee the best performance for years to come. Accordingly the best time to purchase and stock triploid grass carp from J.M. Malone and Son, Inc.



J. M. Malone and Son, Inc. *A Leader in Fisheries.....Since 1952*



World's Largest Hatchery of Chinese Fish

- Pioneer of the Triploid Grass Carp
- 100% Certified Triploid Grass Carp
 - Bighead Carp
 - Silver Carp
 - Black Carp

Your One Stop Source For:

- | | | |
|-------------------------------|---------------|------------|
| Channel Catfish | Redear | |
| Native Bluegill | Black Crappie | |
| Coppernose Bluegill | Shiners | |
| Hybrid Bluegill | Fatheads | RS No. 302 |
| Largemouth Bass- Feed Trained | | |

Biological Solutions for Water Management

PO Box 158
Hwy 31 South
Lonoke, Arkansas 72086
Office (501) 676-2800

(501) 676-6554

Delivery Available
Live, Healthy Fish
Volume Dealers Welcomed
Fax (501) 676-2910



Visit ALEARN to discover more about water and the plants and animals that live in and on the water.

Let ALEARN be your source of information on

- Pond design, construction and repair, and recreational fish pond management
- Public fishing
- Aquatic weeds identification
- Recipes
- Weather
- Photo resources
- Lesson plans and activities
- Grant opportunities
- And much, much more



COLLEGE OF AGRICULTURE



Your Experts for Life

ALEARN.info is a cooperative effort by the Auburn University Department of Fisheries and Allied Aquaculture, and the Alabama Cooperative Extension System to help aquaculture producers, students, anglers, teachers and other citizen groups conserve, enjoy, and gain economic benefit from Alabama's rich aquatic resources.

Department of Fisheries & Allied Aquacultures • 203 Swingle Hall • Auburn, Alabama 36849

Phone: (334) 844-4786 E-mail: fish@auburn.edu

Auburn University is an equal opportunity educational institution/employer. www.auburn.edu

is between the months of November and March. Triploid grass carp purchased at this time of year are robust after completing a full growing season and dormant from cool water temperatures. This allows for improved handling and stocking, ultimately resulting in more effective vegetation control. Once water temperatures begin to rise in the spring the fish will emerge unscathed from their dormant state with a racing metabolism and a need to consume an abundance of aquatic vegetation. Triploid grass carp purchased and stocked during late spring and summer do not handle as well due to their high metabolism. Stocking triploid grass carp during this time period is often unsuccessful due to high water temperatures, low oxygen concentrations and dense aquatic vegetation resulting in poor aquatic vegetation control.

J.M. Malone and Son, Inc. remains the World's Largest Producer of Triploid Grass Carp and continues to set the standard for quality in the industry. Whether you need 100 fish for your Lake Management Company or 100,000 fish for your Irrigation District Project, J.M. Malone and Son, Inc. is ready to meet your needs.

- For more information, contact
- J.M. Malone and Son, Inc.
Highway 31 South, P.O. Box 158, Lonoke, AR. 72086
- Phone: 501-676-2800 or 501-676-6554
- Fax: 501-676-2910

SEE AD ON PAGE 26

Cargill Aquaxcel™ Starter Feeds For Shrimp & Fish

Cargill Animal Nutrition's AQUAXCEL™ starter feeds, which provides aquaculture customers with a high concentration of nutrients in a water-stable formulation to cost-effectively facilitate shrimp and fish survival and growth.

Nutrient delivery is key to aquaculture profitability. The technology used in AQUAXCEL™ starter feeds precisely controls temperature, humidity, pressure, and other variables – to deliver small, nutrient-dense particles sized to the shrimp or fish species. The stability of these particles facilitates consumption, helping to achieve a more uniform growth rate.

The highly available amino acids and balanced energy sources help ensure that protein is used for growth and development. The proper balance of vitamins and other nutrients helps to improve survival rates.

For shrimp, AQUAXCEL™ starter feeds provide essential nutrients for survival, growth and molting, and they are extruded in 0.8, 1.5 and 2.0 mm sizes, then packaged in 25 kg bags.

The AQUAXCEL™ product line offers specialized feed portfolios for

warm-water fish, cold-water and marine species. Floating or slow-sinking extruded micro-particles come as small as 0.8, 1.5 and 2.2 mm, sizes which are easily consumed.

AQUAXCEL™ starter feeds are available globally.

• For more information, please contact one of the following locations:

- United States: 1-800-928-AQUA;
- Latin America: 52 644 410-62-35;
- Asia: 84 61 836528;
- visit us online at www.aquaxcel.com
- Contacts: Elizabeth Becklin (952) 984-0115
- elizabeth_becklin@cargill.com
- David Feider, (952) 742-6910
- david_feider@cargill.com

SEE AD ON PAGE BC

Pentair Aquatics Relocates World Headquarters

Pentair Aquatics, manufacturers of Aquarium, Pond and Aquaculture Products has relocated their world headquarters from El Monte, CA to Chino, CA located near the Ontario California airport. The new address is now 13950 Mountain Avenue, Chino, CA 91710 and new phone numbers are 909-287-7850 and Fax 909-287-7895. E-mail remains info@pentairaquatics.com.

All-Star® Regenerative Blowers

- Lower Initial Cost
Special Aquaculture pricing
- Lower Maintenance
External bearing eliminates overhung impeller loads
- Longer Service-Free Life
High temperature (180 Deg C) rated Class H motor insulation provides greater safety margin than competitive blowers
- Deliveries From Stock
2500 blowers on the shelf for immediate shipment
- Local Repair Service
Warranty and non-warranty service available through 2000 local service centers
RS No. 236



1/4 to 150 HP
Flows to 2500 SCFM
Pressure to 11.5 psi

For the past 10 years All-Star Products has been supplying the largest regenerative blowers in North America - to 150HP.

These high quality, industrial rated blowers meet the rugged duty of aquaculture farms. Call today for the details on the All-Star Aquaculture Special Offer

<http://www.all-star-usa.com>
or call us at 800-431-8258



com and web site is www.pentairaquatics.com. Pentair Aquatics, formerly Rainbow Lifeguard Products is a division of Pentair Water Pool and Spa, Inc

SEE AD ON PAGE 29

All Star Regenerative Blowers

Aeration requires a reliable and rugged duty blower that can withstand harsh environmental conditions and reliably provide 24 x 7 service. All-Star regenerative blowers have been meeting these challenges for the past twenty-five years in North America and around the world.

Aquaculture farms find the All-Star blower provides higher air flows and greater pressures than competitive blowers. All-Star is the only company to certify their blower performance by testing according to an ANSI (American National Standards Institute) and AMCA Standard 210-85. When you purchase an All-Star blower, you are guaranteed you receive what you paid for - the published flow and pressure capacities. Other manufacturers performance test to their own standards which are all different. This means you can not compare the performance differences between manufacturers so you can purchase the best product based on performance and cost. Ask your present blower supplier what is their test standard support their published performance data curves. Then ask him (or her), why don't they use an ANSI test standard so you can compare their blower's performance with other manufacturers.

Testing standards are important because they tell you what you are getting when you purchase a blower. After all, you are not purchasing a blower, you are purchasing the blower's performance, eg: flow and pressure. To most aquaculture farms, the important blower features pertain to reliability, minimal service and long-term life. No manufacture can guarantee their blower will provide the best service in your particular installation. Therefore you need to evaluate the blower design and materials.

DESIGN

The area of most concern in a regenerative blower is the bearing normally located between the motor and the blower housing. This bearing is exposed to the highest heat - heat created by the motor and the blower. Sandwiched between the motor and the blower, this bearing is unable to get any cooling air. In addition, the entire blower has to be disassembled to lubricate or replace this bearing.

The All-Star design is different. This bearing is located in the outside cover of the blower housing. This means the bearing is not exposed to the high heat from the motor. It is runs cooler because it is exposed to the cooler air temperature. Another important factor is that by locating the blower cover, the impeller is supported on both sides by a bearing. The All-Star bearing design eliminates what is referred to as an overhung load condition

LIFEGARD® COMMERCIAL FILTERS & PUMPS

Pentair Aquatics, manufacturers of the popular Lifeguard® Modular and M-Series Mechanical, Chemical and UV Sterilizers also offers the Pentair line of one piece Fiberglass High Rate Sand Filters and High Performance Energy Efficient Pumps.

This complete selection offers a proven source of quality products designed to satisfy life support requirements for water treatment in aquaculture, mariculture, large aquariums, central filtration systems and large Koi ponds requiring higher flow rates.

Choose from Lifeguard's Modular Mechanical, Chemical and Ultraviolet Sterilizers, Fluidized Bed Biological Filters or Tarpon and Marlin High Rate Sand Filters. Pumps include among others, the Sea Horse, Sea Flow, IntelliFlo Variable Drive, EQ Series with 6" suction and 4" discharge for high flow rates plus a complete selection of Quiet One® submersible pumps for unlimited applications. Pentair can also fill your needs for Automatic Fish Feeders, Bulkhead Fittings, Valves and many other accessories.

Contact Pentair Aquatics at 800-628-8771 or fax your requirements to 800-424-1445 for a no obligation system quotation.

Tarpon Sand Filter

Marlin Sand Filter

EPA Est. No. 72974-CA-1



Pentair Aquatics®

Aquarium, Pond & Aquaculture Products

Division of Pentair Water Pool and Spa, Inc.

Email: info@pentairaquatics.com

Website: www.pentairaquatics.com

RS No. 798



Commercial Filtration System

(a side load caused by high pressure loads that can actually bend the impeller shaft, causing the impeller to rub against the side of the blower housing).

In the All-Star blower, this bearing is much easier to lubricate and in some models, an external grease fitting is supplied so this bearing can be lubricated without disassembly of the blower.

MATERIALS

The All-Star blower parts are cast aluminum except for the mounting base and the motor cooling fan. Aluminum is a preferred material in aeration applications due to its resistance to rust and corrosion. Some manufacturers are using steel and cast iron blower and motor housings which require more maintenance.

MOTOR INSULATION

The thermal life of a motor depends upon the maximum temperature rating of the motor insulation. Motor insulation thermal capacities are rated by classes and temperatures. Class B insulation is rated 130 Deg C; Class F insulation is rated 155 Deg C; and Class H insulation is rated 180 Deg C. In general, the higher the motor

thermal capacity, the longer the motor will last. As a rule-of-thumb, every 10 Deg C lower temperature the motor operates below the insulation maximum temperature, the insulation rated life doubles. The typical thermal design life of a motor's insulation is 20,000 operation hours. This means that if the motor operates ten (10) degrees C below the insulation temperature rating, the life rating doubles to 40,000 hours. If the motor operate at twenty (20) degrees C below the insulation temperature rating the life doubles again - to 80,000 hours. To receive the longest motor life, purchase a blower with the highest insulation class.

BLOWER REPAIR SERVICE

Local warranty and non-warranty service of the blower should be available. All-Star has over 2000 service centers in the USA.

SUMMARY

When purchasing a regenerative blower, follow these simple steps to insure you are receiving the best performance blower for your investment.

1. Be sure the blower's published

performance data is tested according to a national standardize test such as ANSI or AMCA Standard.

2. Select a blower where the bearing in NOT between the motor and the blower.

3. Select a blower that features as much aluminum materials as possible.

4. Select a blower with a Class H rated motor insulation to obtain the longest motor life.

5. Select a blower supplier that can provide the best local service.

SEE AD PAGE 28

Novartis Provides High Quality Medications

Novartis was created in 1996 through the merger of Ciba-Geigy and Sandoz. Our name, derived from the latin novae artes, means "new skills" and reflects our commitment to bringing new aquaculture products to fish farmers worldwide.

Common SENSING Inc
 INTRODUCES...
 the **TBO-DL6 series**
 Including 20 foot Probe **RS No. 464**

Portability
 ..Logging
Respirometry
Alarms
Automatic Calibration in
Fresh Water and Salt Water
 *New TDGP/Temp probe for 695.00
 The TBO-F still available for \$2950.00 in the 1200 Series waterproof Pelican case.

USER INSTALLED SOFTWARE
IDEAL FOR RECIRC SYSTEMS

Phone (208)266-1541
 Fax (208)266-1428
 Box 130, Clark Fork
 Idaho, USA 83811
 e-mail: sales@comsen.com
 website: www.comsen.com

Technical Representatives:
POINT FOUR SYSTEMS
 (604) 273-9939 or 1-800-267-9936
 #100-13720 Mayfield Place,
 Richmond, BC
 e-mail: sales@pointfour.com
 website: www.pointfour.com

**Master of Science
 Aquaculture/Fisheries**
 University of Arkansas at Pine Bluff

Arkansas, the birthplace of U.S.
 warmwater aquaculture, is second
 in U.S. aquaculture production.

UAPB is offering assistantships in:

1. Fish health
2. Fish nutrition
3. Catfish product marketing
4. Baitfish production
5. Catfish farm computer modeling

Come join a dynamic program dedicated to solving industry problems!

RS No. 000
 Visit us at: www.uaex.edu/aqfi
 E-mail us at: fisheries@uaex.edu

Novartis Animal Health is dedicated to maintaining and improving the health and welfare of farm animals. We research, develop and commercialize leading animal treatments that meet the needs of farmers and veterinarians. Scientists at Novartis Animal Health are striving for improved animal care by searching for new therapies and novel delivery technologies.

Here are the products that we offer in the United States:

Renogen - for the prevention of Bacterial Kidney Disease

- Aeromonas Salmonicida Bacterin Vaccine

- Aeromonas Salmonicida Bacterin Immersion Vaccine

- Aeromonas Salmonicida Bacterin Injectable Vaccine

- Autogenous Bacterin Vaccine

- Enteric Redmouth Bacterin Vaccine

- Infectious Salmon Anemia Virus Vaccine

- Vibriosis Erm/Furogen Vaccine

- Vaccination Equipment

Headquartered in Basel, Switzerland and present in almost 40 countries, Novartis Animal Health employs approximately 2300 associates worldwide.

- In the United States,
- Please contact Jerry Zinn.
- Here is the contact information:
- Novartis Animal Health
4316 Carter Pack Road
Buhl, ID 83316
- Telephone: 208-543-5369
- Fax: 208-543-5369
- Email: jerry.zinn@novartis.com

SEE AD PAGE 32

Vertical Incubators

MariSource

MariSource is the world's provider of vertical incubators. 4-tray, 8-tray, & 16-tray vertical incubators are available in various combinations to maximize use of manpower, floor space, and water supply. The design and construction of these vertical incubators offers several advantages:

Vertical flow: Fresh water enters the rear of a water tray, at the top of the

cabinet, upwells through the egg tray and flows over the front wall inside the water tray into a channel which feeds the next lower water tray unit. This flow allows aeration to occur naturally, ensuring ample oxygenation even for bottom trays.

Accessibility: Each water tray is designed to slide easily forward on level tracks from the front of the cabinet, enabling eggs to be worked on and returned to the tray without removing

it from the vertical incubator cabinet. Hatchery personnel can remove individual egg trays entirely to monitor the progress of eggs and fry without disturbing the remaining trays in the stack.

Versatility: MariSource cabinets may be used in single 8-tray or 4-tray applications or may be stacked atop each other to form 16-tray or 12-tray configurations without consuming additional floor space. In the stacked application, a second water source

ENCAPCELL®

GREATER GROWTH = GREATER PROFIT

Microencapsulated Nucleotides

- Patented micronencapsulated nucleotides
- ENCAPCELL® does not leech out like nonencapsulated nucleotide products

WHAT'S IN IT FOR YOU?

Bottom Line: Increased Profits

For The Grower

Increases Growth Rates
Promotes Healthier Animals
Reduces Mortalities
Improves FCR



For The Mill

Limited Distribution Provides Competitive Advantage
Improve Your Products' Performance
Reach new customers



RS No. 357

The ROAN Group, Inc.
Corporate Office
600 W. Taddei Rd.
Acampo, CA 95220
209-333-9680

Sales Office
112 Gardenside Court
Fallbrook, CA 92028
760-451-2255
www.encapcell.com

ENCAPCELL®



incubator. MariSource also manufactures a 4-tray incubation unit for small quantity applications such as educational or laboratory environments for segregated batch incubation of hybrid eggs.

Materials: The cabinet itself is constructed of a one-piece welded aluminum frame for lightweight convenience in stackability, corrosion resistance, and a long, useful life. Interior components are molded of plastic, which may be easily cleaned and disinfected after or prior to each use, and are resistant to corrosion. Materials will neither rust nor attack eggs chemically. All incubation components will float.

Species specific: MariSource incubation units are delivered fully assembled with screening material specified by the hatchery for the desired species. Proper screen mesh size allows eggshells to pass through while retaining alevin or fry.

• For more information on MariSource's vertical incubation systems or other hatchery supplies:

- Telephone: Toll Free 800.851.1510 Ext. 116 or 253.922.2700;
- fax, 253.284.9112 or
- Write to PO Box 580, Milton, WA 98354.
- You may also view the catalog line at
- www.marisource.com.

SEE AD PAGE 51

Quality Replacement UV Lamps And More!

Qualityuvlamps.com offers an assortment of replacement UV lamps and quartz sleeves for a wide variety of UV Sterilizer/Clarifier brands. With customer satisfaction as our top priority, the website is very secure, easy to navigate and takes all the guess work out of purchasing the proper UV lamp or quartz sleeve for your equipment. Please visit us at: www.qualityuvlamps.com to make Qualityuvlamps.com your UV Lamp source... you won't be disappointed.

- Emperor Aquatics

may be introduced to the lower units, thus insuring ample oxygen for each

Netting Protection



Above
and
Below
Water

Aquaculture Uses

Clam beds, cages, traps, barriers, screens, standpipe filters, tubes and more.

Choose from a wide range of aperture sizes and products in rolls, sheets, tubes, cut-to-size.

•Rolls to 17' wide •Immediate shipment
RS No. 211



INDUSTRIAL NETTING
Formerly InterNet



1-800-328-8456 www.industrialnetting.net

NOVARTIS

The Leaders In Fish Vaccine Development

IT'S ALL ABOUT PRODUCTION COSTS AND RISKS. . .WE CAN HELP!

USDA - LICENCED VACCINES FOR YOUR FISH AND FARM.

FOR MORE INFORMATION
Toll Free: 1-877-544-4966
Inside the US: 208-543-5369
Outside the US and Canada: 902-566-4966

RS No. 342



DelStar Technologies Introduces TPX™ Methylpentene Delnet Apertured Films

DelStar Technologies, Inc. has announced that they now manufacture Delnet® apertured films from TPX™, a 4-methylpentene-1 based polyolefin.

DelStar Technologies chose to develop this new TPX Delnet product because it displays a unique combination of physical properties and characteristics that will benefit their existing markets. The TPX Delnet films will provide safe and non-toxic advantages in medical, food-grade, and other applications requiring high heat resistance, transparency, light weight, good release, or good chemical and hydrolysis resistance.

DelStar Technologies can produce their new TPX Delnet apertured films in a multitude of configurations.

Further, this new product will have

improved processing characteristics over traditional polypropylene and polyethylene Delnet products due to the inherent properties of the TPX copolymer.

TPX Delnet apertured films will provide increased heat resistance and can be used at more intense service temperatures than those of polypropylene. The melting point of TPX is 240°C (460°F).

TPX Delnet apertured films will be more transparent than traditional Delnet products. The TPX methylpentene grade is colorless, with a visible light transmittance of 90 percent, plus it is superior to other transparent resins in ultraviolet (UV) and infrared (IR) transmittance.

TPX Delnet apertured films will exhibit exceptional release properties. The surface tension of TPX methylpentene is second only to flouropolymers, at 24 dyne/cm.

TPX Delnet apertured films will not absorb water, nor will hydrolysis cause dimensional changes or physical property deterioration. With a very

2229 Sanatoga Station Road
Pottstown, PA 19464

- Telephone (610) 970-0440
- Fax: (610) 970-0443

SEE AD PAGE 17

the "Living Stream"® System provides a controlled environment for aquatic life.

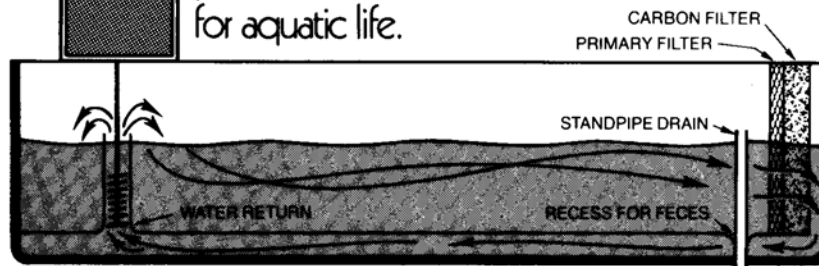

The "Living Stream"® is a new revolutionary design for recirculating water in a closed system. All water in the tank makes a complete cycle through the primary and charcoal filters every 90 seconds, thus providing filtered water with equal amounts of dissolved oxygen . . . and the desired temperature throughout the tank. A 13" x 55" thermopane/plexiglass viewing window is optional. Circular Tanks (3', 4', 6' & 8' diameter) are also available, both regular and insulated.

Water Chiller Units cool, aerate and circulate the water in one operation. They are available in 1/6, 1/3, and 1 hp units with a capacity to cool up to 1,000 gallons of water in a temperature range from 35°-70°F (2-21°C).

NOW AVAILABLE WITH HEATING
ELEMENTS & DUAL THERMOSTAT
350 - 1000 Patent Pending

We take great pride in the quality and finish of our products. All tanks have a satin smooth interior surface, which requires minimum effort for maintenance . . . plus hand applied fiberglass for uniformity in wall thickness. This custom fabrication also gives us the flexibility to manufacture to your special needs.

For more information please write, phone or fax for our brochure and current price list. Also, you can visit us at :
www.frigidunits.com

RS No 258

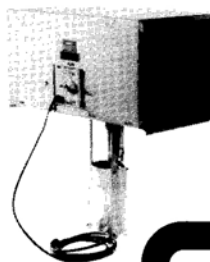

frigid units, inc.
5072 Lewis Avenue
Toledo, Ohio 43612
419/478-4000
Fax: 419/478-4019

low water absorption (0.01%), TPX methylpentene is highly resistant to water and steam. Plus, TPX methylpentene shows excellent chemical resistance in comparison to other transparent resins.

DelStar Technologies is currently sampling a TPX Delnet product with a six mil (150 micron) thickness and a 65 percent open area. DelStar also invites you to present your specific requirements for the development of a unique structure.

DelStar Technologies, Inc., headquartered in Middletown, DE, has manufacturing operations at that location, as well as in Austin, TX, Richland, PA, El Cajon, CA, and Suzhou, China. DelStar Technologies also has international sales offices in Bristol, England and Shanghai, China. For more information, visit DelStar Technologies on the internet at www.delstarinc.com.

For additional information on TPX Delnet Apertured Film, contact Marjorie E. Wilcox, Corporate Marketing Manager for DelStar Technologies, Inc.

DelStar Technologies, Inc. is a portfolio company of American Capital

Strategies, Ltd., (NASDAQ: ACAS.)

Copyright © 2007 Delnet is a registered trademark of DelStar Technologies, Inc.

TPX is a trademark of Mitsui Chemicals, Inc.

SEE AD ON PAGE 24

Octaform Systems Inc. Reports New Aquaculture Developments In Norway

Innovative technology from Canada has recently found its way into the aquaculture industry in Norway, which is one of the most advanced countries in the world in terms of fish farming.

AquaOptima, a Norwegian company that provides onshore hatcheries and growout farms for cold and warm water production, selected Octaform's innovative PVC stay-in-place concrete

forming system in order to meet the demanding needs of one of Norway's oldest aquaculture companies.

Octaform Systems Inc. markets its patented forming system throughout North America and internationally for applications in numerous industries including agricultural, industrial building construction and liquid containment, where the demand for large capacity tanks is growing rapidly.

Octaform's product offers versatility in construction design to meet the demands of contemporary fish farm applications for tanks and buildings. This applies to small tanks through to large structures, which cannot practically be built with any other method. PVC lined structural concrete tanks offer numerous advantages for the aquaculture industry, including ease of sanitation and cleaning, reduced bacterial growth and better water quality.

Unique engineering design requirements for the Norway project called for octagonal tanks nested in a confined area, which provided an ideal opportunity for Octaform to demonstrate its versatility. The tanks were 14 meters

D&T Fiberglass Inc.
Your WEST COAST Leader!
 Since 1987
For Fiberglass Aquaculture Tanks



30' Panel Tanks
Stolt Sea Farms - Sacramento, CA



Transport Tanks



Round Tanks



Raceways



Square Tanks

D&T Fiberglass, Inc.
 8900 Osage Avenue
 Sacramento, CA 95828
 Tel: 916.383.9012
 Fax: 916.383.1851

RS No. 101

www.dtfiberglass.com

Graham's Hand-Tite® Pipe Plug

Check these features and applications!

- Available in 4, 5, 6, 8, 12 and 15 inch sizes
- No metal parts (except 15" Pipe Plug)
- Easily installed—no tools are required!
- Nearly 30 years of satisfactory service
- Pressure rated 5psi/ 12 feet head pressure
- Lightweight; made of nylon, high-impact plastic, (approximately 8# for 12") with proven polyisoprene rubber gasket
- Plugs tank openings
- Ideal for use on portable tanks
- Large diameter make tanks more accessible



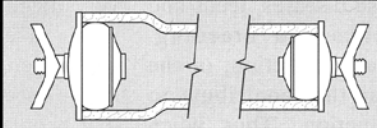

Seals both ends of PVC pipe

For more information contact: R.C. Graham Co.
 118 W. Streetsboro Rd., Suite 114 • Hudson, OH 44236
 1-800-466-9051 • Fax: 330-650-5074
 visit us on the web www.hand-tite.com
*Ship Internationally

RS No. 255



environment

- Ease of installation and maintenance of tanks with ancillary equipment mounting on structural walls
- Insulated wall options for temperature controlled growth environments
- Hygienic easy -clean environment means improved economics and profits (meets Canadian Food Inspection certification standards).
- For more information on our tanks
- Octaform Tanks
Suite 520
885 Dunsmuir Street
Vancouver, BC
Canada V6C 1N5
- Call toll-free: 1-888-786-OCTA (6282)
- Telephone: 604-408-0558
- Fax: 604-408-0595
- Website: www.octaformtanks.com
- Website: www.octaform.com

SEE AD PAGE 15

in diameter, 3.8 meters in depth with a wall thickness of 300 millimeters. The versatility of the Octaform system allowed for rapid construction and wall completion of phase one in a period of

9 days.

Octaform offers key benefits to the aquaculture industry:

- Smooth wall surface, which offers a safe abrasion- free growing

The NEW TRAC-LOCK™ Microbubble Diffuser

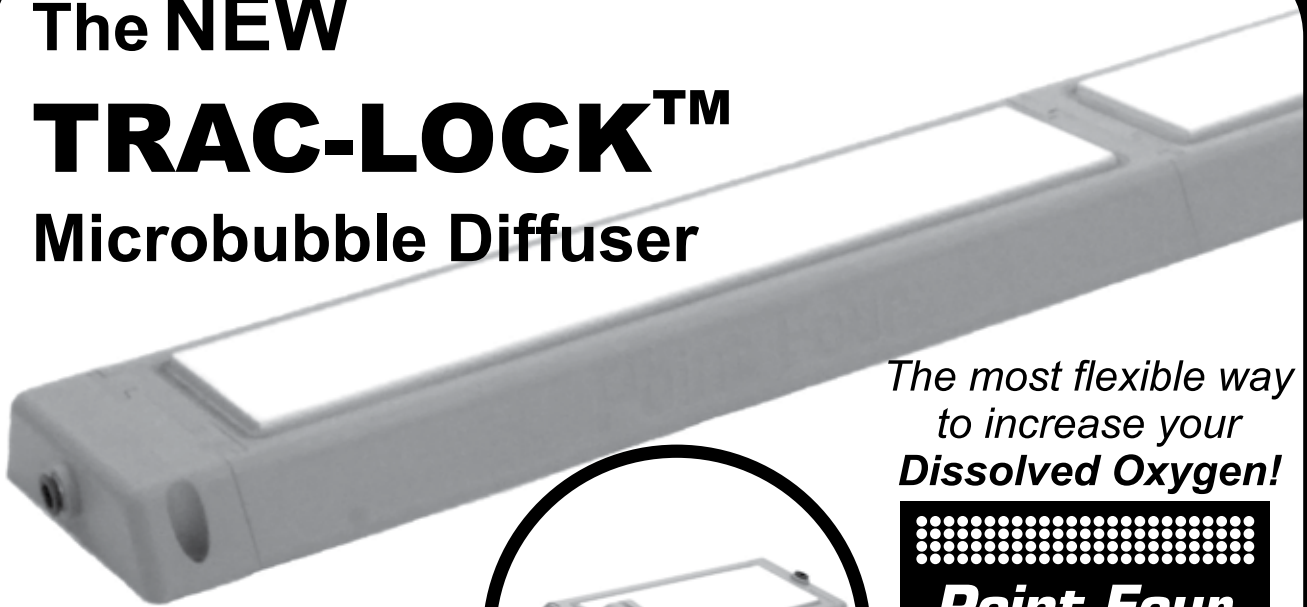

*Same quality
More flexibility
Volume discounts*

*The most flexible way
to increase your
Dissolved Oxygen!*



Making your water better!

Tel: 1-800-267-9936
sales@pointfour.com
www.pointfour.com

RS No. 149

Aquaflor® (Florfenicol) Approved For Freshwater-Reared Salmonids First And Only Antibiotic In U.S. For Coldwater Disease

AQUAFLO[®] (florfenicol), the first new in-feed antibiotic licensed for U.S. aquaculture in more than two decades, has become the first and only antibiotic approved for controlling mortality in freshwater-reared salmonids due to *Flavobacterium psychrophilum* (coldwater disease), which causes mortality rates of 30 to 45 percent annually in hatchery-reared trout and salmon.

"The new claim for AQUAFLO[®] is really big news for our industry," said John Bechtel, president of the U.S. Trout Farmers Association. "It's been a long, long time since we've had a new antibiotic - and we desperately need one. We really appreciate the effort and investment that Schering-Plough Animal Health has made to bring this product to our producers."

Developed by Schering-Plough Animal Health Corporation, AQUAFLO[®] Type A Medicated Article has been proven

worldwide to be effective against a wide range of bacteria in several aquatic species. It is also highly palatable and has an excellent safety profile for fish, human food and the environment.

Unlike sulfa drugs and tetracyclines, this unique antibiotic was developed specifically for use in food animal species. Studies have shown that AQUAFLO[®] can be used in trout and other freshwater-reared salmonids, from sac fry to food fish, with no reduction in feed consumption or growth. The product's short, 15-day withdrawal period gives producers ample flexibility when marketing fish.

EFFECTIVE AGAINST COLDWATER DISEASE

Trials conducted with the U.S. Fish and Wildlife Service have shown AQUAFLO[®] to be highly effective against coldwater disease. In steelhead trout, for example, fingerlings treated with AQUAFLO[®] had 60 percent less mortality than untreated controls, even though initiation of treatment was delayed far beyond what would be typical in most field situations.

"Coldwater disease often results in prolonged, chronic mortality and is one of the most economically significant diseases of salmonid aquaculture - not just in the U.S., but also worldwide," says Richard Endris, Ph.D., aquaculture research program manager for Schering-Plough Animal Health.

"In fingerlings and food fish, the disease produces lethargy, poor appetite and dark coloration," he adds. "Infected fish can also develop spinal deformities, which reduce their value."

Trials have also shown that fish consume feed medicated with AQUAFLO[®] at the same rate as unmedicated feed - even when AQUAFLO[®] is used at 10 times the recommended dose rate.*

"The palatability of an antibiotic is extremely important because it ensures optimum feed and antibiotic intake during the critical treatment period," Dr. Endris says. "It also helps fish stay on feed in the face of a severe disease challenge."

AQUAFLO[®] is a highly stable product, both as a packaged premix and in feed following high-temperature extrusion. For salmonid feeds, it can be incorporated prior to pelleting or coated onto pellets. Schering-Plough Animal Health recommends using feed medicated with AQUAFLO[®] as the sole ration for 10 consecutive days. Treatments should be discontinued 15 days before marketing. AQUAFLO[®] is not approved for use in breeding stock.

VFD ENSURES CORRECT USAGE

AQUAFLO[®] is the first in-feed antibiotic in aquaculture and the second for all food-animal species to be classified by the FDA as a Veterinary Feed Directive (VFD) drug. VFD is a category



Is pleased to announce their **FDA approval** of
FORMACIDE-B
(37% Aqueous solution of formaldehyde)
In 1 gal. containers, 5 gal. containers and 55 gal. drums

B. L. Mitchell, Inc. has many other fine products for your use:

BAYLUSCIDE®-M is an EPA registered product of B. L. Mitchell, Inc., which is a Molluscicide for control of snail populations in aquaculture ponds

AQUASHADE
ACTAMIDE (CHLORAMINE-T)
(Under FDA INAD)
AMQUEL, PURE DRY (CLORAM-X)

COPPER SULFATE
FISH HAUL
LIQUID COPPERS
NON-FOAMER

POTASSIUM PERMANGANATE
SODIUM THIOSULFATE
AURUDYNE (PVP IODINE)
ROTENONE

OXYTETRACYCLINE HCl SOLUBLE POWDER-343 for the marking of skeletal tissues in Finfish Fry and Fingerlings as an aid in identification and many other products for your use!!

B.L. Mitchell, Inc. • 103 U.S. Highway 82 E., Leland, MS 38756 • Tel: 662-686-9002; Fax: 9020
E-mail: blmitch@bellsouth.net

RS No. 353

established in 1996 to help the agency more closely control new therapeutic products, primarily antimicrobials, and their use in food animals. The VFD classification applies only to new in-feed therapeutics approved by FDA after 2000. Fish farmers may obtain VFD drugs through normal feed distribution channels, but they will require a signed Veterinary Feed Directive from a licensed veterinarian.

Dr. Dave Erdahl, fisheries biologist and Branch Chief of the Aquatic Animal Drug Approval Partnership (AADAP) Program of the U.S. Fish and Wildlife Service, Bozeman, Mont., doesn't think the VFD process will be a major issue for most producers raising trout and other freshwater-reared salmonids.

"The role of veterinarians in aquaculture is expanding," he says. "There are already a considerable number of operations working directly with consulting veterinarians or veterinarians on staff with state and federal agencies.

"Like anything new, it may be a bit problematic at first," he adds, "but I

look at the VFD process as a 'growing pain' for our industry. If we want new products to maintain fish health, we have to comply with the new regulations. It's that simple."

While AQUAFLO® is relatively new to the U.S. market, it has been used successfully for more than 15 years in other major aquaculture markets, including Japan, Europe and Latin America, to treat diseases in other farm-raised aquatic species. Since October 2005, AQUAFLO® has been approved for control of mortality in catfish due to enteric septicemia (ESC) associated with *Edwardsiella ictaluri*. Schering-Plough Animal Health is actively seeking claims for other disease-causing pathogens in freshwater-reared salmonids, catfish and other species.

NUFLOR® (florfenicol), a sister product to AQUAFLO®, has been used successfully in the United States since 1996 to treat respiratory disease in beef and non-lactating dairy cattle. More recently, NUFLOR® (florfenicol) Oral Solution and NUFLOR® (florfenicol)

Premix were approved for use in swine.

For more information on AQUAFLO®, producers should contact their fish health specialists, veterinarians, diagnosticians, extension representatives, feed mills or Schering-Plough Animal Health at 1-800-521-5767.

Website: www.AQUAFLO-USA.com.

ABOUT SCHERING-PLOUGH CORPORATION

Schering-Plough Animal Health Corporation is the worldwide animal health business of Schering-Plough Corporation (NYSE: SGP) of Kenilworth, N.J. Schering-Plough is a global science-based health care company with leading prescription, consumer and animal health products. Through internal research and collaborations with partners, Schering-Plough discovers, develops, manufactures and markets advanced drug therapies to meet important medical needs. Schering-Plough's vision is to earn the trust of the physicians, patients and customers served by its more than 32,000 people around the world. The company is based

Compendia

interactive encyclopedias



www.cabicompendium.org/ac



The **Aquaculture Compendium** is an encyclopediac mixed-media resource which covers all aspects of aquaculture. It addresses issues of aquatic animal production, diseases, natural resources and environment, biodiversity, trade, food security and safety, poverty alleviation, livelihoods and much more.

the support you need... right at your fingertips.

FREE TRIAL!

Email publishing@cabi.org for a free two week trial of the Aquaculture Compendium, and also receive a free 256Mb memory stick. Quote **NIF** in the subject line of your email.

RS No. 352

essential information for aquaculture professionals...

KNOWLEDGE FOR LIFE

in Kenilworth, N.J., and its Web site is <http://www.schering-plough.com>.

AQUAFLO is a registered trademark of Schering-Plough Animal Health Corporation.

* SPAH Experiment X00-241-01 and SPAH Experiment V-079.

SEE AD PAGE 46-47

Memphis Net & Twine

Offering the widest array of commercial fishing and aquaculture nets and netting in North America, Memphis Net & Twine is featured on the World Wide Web at www.memphisnet.net. For more than 46 years, Memphis Net & Twine has served the interests of the commercial fishing and aquaculture industry by offering a wide range of custom made trammel and gill nets, knotless and knotted seines, hoop nets and turtle nets... all competitively priced. We furnish a variety of monofilament, multifilament and seine nettings sold in bulk, as well as ropes, twines, cast nets, leads and floats for the do-it-yourself customer. Holding Boxes, Live Cars, heavy-duty dip nets and plastic netting are available for a variety of applications. Our extended line includes Kasco, Power House, and Mino-Saver aerators and fountains, Dexter-Russell cutlery, Detecto, Chatillon and Viking/Hanson scales, Helly-Hansen and Grundens rain wear, AquaPro fish feeders, Privacy Screening, and LaCrosse, Servus and Muck boots.

For a free 64 page catalog, call our toll-free number: 800.238.6380 or email us a request at: info@memphisnet.net.

SEE AD PAGE 51

Ken's Fish Hatchery

Ken's Fish Hatchery has one of the largest fish operations in North America. With over 40 patents on his products, Ken and his staff have both the knowledge and the dedication to help you with all of your pond needs.

There are a multitude of ways to have a successful pond, but only if you start it the right way. Do you dream of that trophy bass? Or is it that plate size Georgia Giant bream that tugs at your heart strings, hmm? Know your goals



Judye, Ken and Jason Holyoake of Ken's Fish Hatchery

and then let Ken's help you fulfill your wildest and wettest pond dreams.

AQUARIUS 1 AERATOR

Inadequate concentration of dissolved oxygen has long been recognized as a limiting factor in intensive fish production. It is also important to note that the solubility of oxygen, or the water's carrying capacity of oxygen, decreases as the temperature increases. The hotter it gets, the less oxygen can be carried in the water. Aeration is the key here, and the Aquarius 1 Aerator is the very best on the market for the money! It is designed to bring the water from approximately three feet deep and charge it with life-giving oxygen. Most other aerators draw water from only the surface.

BUG-O-MATIC

The Bug-O-Matic attracts all kinds of night flying insects, cripples them and distributes them "live" in a 6 foot to 8 foot circle which gives all the fish an opportunity to feed. With a Bug-O-Matic your fish or frogs can feed silently and automatically while you sleep.

SOLAR FISH FEEDER

The Solar Fish and Game Feeder is completely programmable for up to six feeding times each 24 hour period. It is the most economical feeder available. With a 50 lb. capacity not only is this feeder inexpensive, but it requires no electricity to run and it will sling feed in a 6 to 8 foot circle.

BREAM CAGE

This cage is a specially designed cage to grow bream in. You can also grow

Hybrid Stripe Sun Bass and Rainbow Trout in this cage. This cage has been tested and proven to be very successful in growing bream. It is made of soft mesh that will not be rough on the bream's scales.

It is not made to grow catfish. Catfish will get tangled in this material. For proper results in raising bream in a cage, feed them "Ken's Special Cage Bream Feed."

EZ FLOATING FISH CAGE

Cage culture is one of the most profitable, convenient methods of raising fish to a harvestable size. You will find our floating fish cage the easiest!

Use EZ cage in stocking ponds already populated by raising fingerlings until they can be released into the pond or until they are edible size. You have the advantage of actually watching your fish grow.

Increase your yield! Increase your profits!

FISH,FISH,FISH ...

1. Georgia Giant Hybrid Bream
2. Channel Catfish
3. Largemouth Bass
4. New Hybrid Largemouth Bass
5. Hybrid Stripe Sun Bass
6. Rainbow Trout
7. Hy-Tech Speck (Hybrid Crappie)
8. Gambusia minnows (mosquito fish)
9. Giant Bullfrog Tadpoles
10. Bullfrogs
11. Koi
12. White Amur Sterile Grass Carp
13. Catalpa Trees and Worms
14. Super Worms

EQUIPMENT ...

1. Aquarius 1 Aerator
2. Bream Cage
3. Bug-O-Matic
4. EZ Floating Fish Cage
5. Chain Reefs
6. Fish and Wildlife Feeders
7. Solar Feeders
8. Lifetime Fish Trap
9. Commercial Super Trap
10. Pond Liner
11. Purple Martin Condominiums
12. Electric Scale-O-Matic Fish Scaler
13. Mini Jet Electric Fish Skinner
14. Seines
15. Snake Guard
16. Solar Trap-O-Matic Turtle Trap
17. Hoop Turtle Trap
18. Heavy Duty Plastic Mesh
19. Aquanet Stretch Mesh
20. Tank Aerators

CHEMICALS ...

1. K-Tea Algaecide
2. Leak B Gone pond sealant
3. Microbelift HC
4. Mud Buster

5. Navigate
6. Ocean Blue, Shadow Blue, Back Out
7. Potassium Permanganate
8. Reward
9. Rotonone
10. Sodium Thiosulfate

HOG HUNTING

River Oaks Plantation is a subsidiary of Ken's Hatchery, and it offers year round hog hunting as well as seasonal deer and turkey hunting. Remember Hogzilla? Well that mammoth creature was brought down right here on our very own land. If your gun finger is twitching then give us a call and book a hunt soon. We have the best prices around, and with over 5000 hogs killed here in the past 7 years you won't be disappointed.

And we offer so much more Ken's Fish Hatchery has been working very hard for the past 46 years studying and researching all the latest developments in the world of Aquaculture. From a simple pond stocking to an intense dedication into the ever changing world of biogenetics, we spend endless hours

devoted to this passion that has turned obsession for us. Our customers are our friends, and we invite you to join our family.

CONTACT INFORMATION

- Ken's Farms Inc.
P.O. Box 449
24533 Hwy 129 North
Alapaha, Georgia 31622-0449
- Telephone: (229) 532-6135
or (229) 532-5395
- Order line: 1-877-Ken-Fish
- Fax: (229) 532-7220
- Email: kensfish@usa.com
- Website: www.kens-fishfarm.com

SEE AD PAGE 39

CLEPCO: Heat Smart – Heat Right

CLEPCO is your submersible Aquatic heater specialist. CLEPCO – Cleveland Process Corporation has over 50 years experience in building heavy – duty industrial grade immersion heater products. During the



Georgia Giant Bream

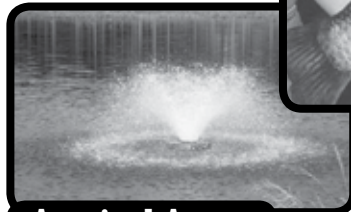

Aquarius 1 Aerator



Bug-O-Matic

We offer a complete line of fish & fish farming equipment, pond aerators, supplies, management, feed, feeders, floating cages, Bug-O-Matics, turtle and fish traps, scalers, many other items for commercial or hobby interests and a hog hunting plantation. Call for reservations.

• FREE Full Color Catalog for pond owners. •

RIVER OAKS PLANTATION
Home of
HOGZILLA



Ken's Hatchery & Fish Farm, Inc.

24533 Hwy 129 North, P.O. Box 449 • Alapaha, Ga. 31622-0449

Telephone: **229-532-6135** • Toll Free: **877-KEN-FISH**

Fax: **229-532-7220** • Email: **kensfish@usa.com**

RS No. 741

Hopper-Stephens Hatcheries, Inc

989 Johnson Road
Lonoke, AR 72086

501-676-2435 ~ 501-676-5491
Fax: 501-676-7776

"Quality creates its own demand"



NOW AVAILABLE!

Our gamefish fingerlings in small, medium, and large. Call for size availability.

Catfish Fingerlings
Largemouth Bass
Triploid/Diploid White Amur
Triploid Black Carp
Bighead Amur
Hybrid Bluegill
Coppernose Bluegill
Regular Bluegill
Fathead Minnows
Black Crappie
Red Ear Sunfish

RS No. 324

Quality Fish
Quality Service
Expanded Facilities

**Competitively Priced
Delivered - Graded
Treated - Guaranteed**

 **DOLPHIN**
FIBERGLASS PRODUCTS, INC.
26800 SW 202 Ave. • Homestead, FL 33031

Manufacturer of Aquaculture Tanks



Phone 305-247-1748
Fax 305-247-8750
www.aquaculturetanks.com

RS No 845

last 20 years we have applied and refined this technology to the Aquatic market.

In recent years we have developed **Submersible Heater** products for use in Aquaculture applications. These heater systems include a companion temperature control with an attached float switch and require no special tank mounting. As our technical skill evolved, we have introduced additional specialized Submersible products – such as the **Adaptable** system, and the **Floating Buoy. Adaptable** is a convertible heater and control system that permits you to install the heater as a horizontal bottom heater, or it can be vertically side-mounted. **Floating Buoy** is a heater and control system that has a vertically suspended heater from a float (**BUOY**) and allows you to adjust the heater submersion depth to your tank or pond requirements.

Multi-Submersible, a new multiple submersible heater and control system is targeted for heating larger tanks and ponds. **Multi-Submersible** incorporates a common temperature control with float switch and your choice for different heater size components to build systems from 6 KW to 24 KW. Each component consists of one Submersible Heater with a 20 ft. cord. Longer cords are available. Build Multi-Submersible up or down depending upon your heater requirements by adding or removing heaters as needed. The detachable component heaters are easy to remove and to re attach. This system allows you to strategically place heaters in your pond or tank for best results. This higher output heater system may help prevent **KOI Virus** by allowing you to maintain a constant 85 degree F^o temperature as suggested by Koi experts.

CLEPCO Heat Smart – Heat Right!
Visit our web site to see our complete produce line. www.clepc.com

SEE AD PAGE 41

Alita Industries, Inc.

Alita Industries is pleased to introduce three new DC powered linear air compressors with adjustable flow control. Compatible with 12V, 24V or 48V DC solar power or wind power electric systems, these

three models offer adjustable air flow in range from 6 liter/min to over 120 liter/min. Automatic flow adjustment can be performed by interfacing the pump with microprocessor control device.

Alita Industries, Inc. designs and manufactures a complete line of compact, high flow and easily maintained AC and DC linear air compressors for aquaculture aeration applications. The main features are:

- Durable and reliable continuous operation
- Oil-less components, no lubrication necessary
- Compact design
- Low noise output
- Simple maintenance
- cULus outdoor rated AC air pumps
- EU's RoHS compliant - "Green" environmental friendly pumps
- DC pump models compatible with battery banks, solar power or wind power electric systems

In addition to aeration pumps, Alita Industries also manufacture and supply sintered air stones, membrane diffuser hose, tubes and discs designed to increase dissolved oxygen levels. Available membrane materials include EPDM, Polyurethane and Silicone elastomers. These diffusers offer low or no maintenance, good chemical resistance and exceptionally long service life for variety of water conditions. Diffuser lengths range from 4 inches to 50 feet or longer (10 to 1500 cm) and can be customized on site to develop a variety of aeration patterns.

• For more information on our products please contact:

- Alita Industries, Inc.,
PO Box 660923,
Arcadia, CA 91066-0923, USA,



- Telephone: 626-962-2116
- Fax: 626-962-2177
- email: info@alita.com,
- visit our website at www.alita.com

SEE AD PAGE 70

Catfish Farm For Sale

Shivers Real Estate Investments, Inc., is offering for sale a 357 acre commercial catfish fingerling farm with hatchery. This state-of-the-art facility is fully operational and located in Jefferson County, Georgia. It includes 15 ponds totaling 113 acres of water surface. The ponds are supplied by a 16 inch well powered by a three phase electric, 200 hp pump with a 2300 gallon/minute capacity. 12 ponds are monitored by an automated oxygen monitoring system.

The 27ft x 80ft hatchery building includes 45 hatching troughs and all equipment. It is supplied by (2) 4 inch, 65 gallon/minute wells providing 68 degree F water, and has a

10-12 million head/year hatching capacity.

A 110ft x 30ft pole barn has an enclosed maintenance shop and an enclosed office plus a 16ft extension for equipment storage.

(3) 15 ton capacity feed bins are used for catfish feed storage.

All farm equipment, including tractors, implements, trucks, and more are included. Go to our website, www.GeorgiaLand.com, for a detailed equipment list.

The brood fish and current fingerling inventory may also be purchased.

The ponds, hatchery, and other improvements are located on 189 acres. The adjoining 168 acres is optional and consists of 112 acres of cultivation with 65 acres irrigated under center pivot and a 17 acre sport fishing pond. This portion of the property is currently generating lease income, but it also offers plenty of space for expansion of the fish farm.

The farm is very well designed, constructed, and maintained. It is a unique opportunity as a hatchery/fingerling operation or could be easily converted to a food fish farm. It is 1 of only 2 commercial hatcheries on the east coast and has an excellent market presence, an established customer base,

and tremendous opportunity for growth in the fingerling market. It is being offered at \$1,660,000 for 189 acres with fish farm ponds, improvements & equipment; \$520,000 for the additional 168 acres (optional).

- Please see our website,
- www.GeorgiaLand.com,
- for more information, photos, and maps;
- call Chad Shivers at
- Shivers Real Estate Investments, Inc., Waynesboro, Georgia,
- Telephone: 706-833-9114.

SEE AD PAGE 41

I.A.S. Products Serving The Aquaculture Industry For Over 20 Years

Since 1986 I.A.S. Products Ltd has designed and manufactured innovative feed handling, feed monitoring, and feed control equipment to improve feed conversion rates and bottom line profitability. We are proud to present our family of dry pellet feed broadcasting systems to include the HydroSpreader™ a subsurface feed broadcast system that mixes feed pellets with water and distributes feed out into the surrounding water at depth. The timer controlled AutoSpreader™ is a center less auger system designed for hatchery tanks where a slow, continuous, and even flow of feed pellets across a broad face is preferred. The AeroSpreader™ line of air driven feed broadcasters using our range of Aerite™ static blowers and annular venturi feed eductors to broadcast feed pellets out over the waters surface. Whether using our smallest 30-kilogram or largest 6,000-kilogram capacity feed hoppers, IAS can best match operating requirements offering a choice of feed broadcasting rates from 1 to over 90 kilograms per minute with a range of broadcast distances from under 1 to over 25 meters. We handle feed sizes from crushed to over 12 mm and by mixing and matching any number of feed broadcast methods from our simplest operator held broadcast nozzles, automatic oscillating systems, and Aerite™ Feed Spinner

CLEPCO

Electric Immersion Heaters & Temperature Controls

Business As Usual



Improved Lead Times

Cleveland Process Corp

127 SW 5th Ave
Homestead, FL 33030
800-241-0412 • 305-248-4312
Fax: 305-2484371
www.clepc.com

RS No. 070

FOR SALE: Catfish Fingerling Farm



357 acre fully operational, commercial catfish fingerling farm with hatchery, Jefferson County, Georgia. 15 ponds totaling 113 acres of water surface. Very well constructed and maintained. Great for fingerling/hatchery operation or as a food fish farm. \$1,660,000 for 189 acres with fish farm ponds, improvements, and equipment. \$520,000 for adjoining 168 acres (optional). Fish inventory may also be purchased (optional).

Go to www.GeorgiaLand.com for details and photos.

Shivers Real Estate
Waynesboro, Georgia.
Chad Shivers 706-833-9114
Paul Shivers 706-833-9115

RS No. 290

Heads, to our latest in 'broad face' timed augers IAS can address best possible feed broadcast coverage.

To assist in feed movement around the farm IAS offers the Bulk Feed Loader™. By incorporating a self-loading hydraulic lift system with a fast moving feed conveyor centrally stored bulk feed bags are lifted over a collection cone, dumped and conveyor loaded into any walkway operated mobile hopper or vessel positioned feed hopper. When the bulk bag-loading portion of the Bulk Feed Loader™ is combined with our Aerite™ Feed Transporter a cost effective self-loading centralized feed system is created. This product uses a positive displacement blower, matched with the appropriate number of HDPE pipe diverter valves to move feed pellets from a central location to assigned cages. By adding cyclonic decelerators feed pellets may be gently dropped into individual AeroSpreader™ pen side hoppers for simultaneous farm feeding using any number of our Aerite™ gas, diesel, or electric powered blowers.

The best-feed handling, delivery and broadcast systems can quickly fall short without reliable feed event observation and systems control. Our full range of SeeMate™ b&w and colour underwater camera systems allow for real time

observation of underwater fish feed and fish behavior during feeding. IAS offers a range of camera cable lengths, lense configurations from wide angle to focused image, and low light capabilities to best suit your site conditions. Our underwater camera housings have been carefully designed to work with our soon to be released SeeView™ Pellet Detection System - a networked video camera system designed to detect and alarm when an operator set threshold of uneaten feed pellets are observed in the water column. We offer our WireLess W.A.V.E.™ camera network systems for sites where wiring is too costly or time consuming to install and maintain. This wireless network system provides 60 addressed locations each with 4 cameras, offering a network of 240 cameras all accessed using a handheld remote control. Whether wired or wireless all camera images may be viewed on CRT or LCD video monitors housed in weatherproof carry cases or as fully self-contained cart systems with 4 to 30 hour battery packs.

IAS manufactures a full line of SeeBrite™ Underwater Lighting Systems for hatchery, live haul, and grow out site applications. Specific site operating needs are addressed using any number of fluorescent, metal halide and halogen

underwater lights with outputs ranging from 30-watts to 1000-watts and power requirements from 12-volt DC through to 120/240 VAC 50/60 hz. We are able to best match lighting requirements to your hatchery or site growth needs with colour temperature selections ranging from 4,000 to over 10,000 Kelvin. To insure the optimum underwater lighting levels are reached and maintained we offer the SeeBrite™ Underwater Illumination Intensity Meter. This underwater light meter is specifically designed with a 340-degree light gathering sensor dome to accurately record all light in the surrounding water that fish are responding to. Using proprietary software the gathered light level readings are recorded and may be plotted with comments added for review, evaluation, and documentation purposes.

- For more information
- IAS Products,
1415 Dominion Street
North Vancouver, B.C.
Canada V7J 1B3
- Telephone (604) 924-1844
- Fax (604) 9241848
- E-mail info@iasproducts.com

SEE AD PAGE 45

**AST Has Dedicated More Than 10 Years
To The Evolution & Perfection
Of Bead Technology For
Mechanical & Biological Filtration.**



Reliable & Hassle Free





Healthy Fish Environment



Propeller-Washed
Bead Filter



Bubble-Washed
Bead Filter

AST's Newest Innovation...
The PolyGeyser Bead Filters



RS No. 414

AQUACULTURE
SYSTEMS TECHNOLOGIES, L.L.C.
Bead Filter Specialists
1.800.939.3659
Info@BeadFilters.com • www.BeadFilters.com
(504)837.5575 • fax: (504)837.5585

Universal Marine Industries

Inter Ocean Enterprises now doing business as Universal Marine Industries grew out of a need for reliable, industrial heat exchangers.

The President of Universal Marine, Ken McHale, was born in Vancouver British Columbia and the Vice President, Edward Keating, is from Ireland. Like most entrepreneurs, McHale got his start by recognizing an opportunity to fill a demand in live seafood industry.

In 1980, while working as an engineer for the International Seafood Company in Gloucester Massachusetts, McHale met some engineers from the Woods Hole Oceanographic Institute in Martha's Vineyard who has just purchased some large industrial heat exchangers composed of stainless steel tubing. After a short time the units began to fail and it was discovered that the stainless steel parts were pitting and holes were forming as a result of the corrosive nature of salt water. It was then that McHale sought to build a heat exchanger that could withstand the corrosive environment of salt water and reliably support aquatic life in artificial habitats.

Working after hours McHale developed a prototype heat exchanger composed of titanium tubing. Titanium, being an element not alloyed with another material, resists electrolysis, which is the process by which corrosion takes place. After developing the prototype, McHale applied this unit to the field he was working in and landed an order to install 12 live lobster systems around the U.S.A. To fill this order, McHale, and Keating drove a tractor-trailer around the country as a mobile production unit. This first trip would launch Universal Marine Industries but its first big break would come from David Powell at the Monterey Bay Aquarium in California.

The Monterey Bay Aquarium had just collected a large number of species from the sea of Cortez and had purchased heat exchangers from a company who used anodized aluminum tubing, a technique common in those days. After a short time the salt water corroded the tubing and oil from the refrigeration system leached into

the tanks and killed the organisms. David Powell, working with the Monterey Bay Aquarium, approached McHale and Keating and asked them to build heat exchangers that could withstand the salt water. Although titanium was not an industry standard at the time, McHale had already used titanium in the lobster systems they had installed for various seafood markets around the United States. Since then, Titanium has become an industry standard.

In 1984, Universal Marine Industries was incorporated and the first factory was established in San Leandro California. In 1992, Keating took over the management of the California operation and McHale moved back to his hometown to set up another branch. In 1992, Inter-Ocean Enterprises what incorporated in Canada and expanded the business to include refrigeration equipment for the research and bioassay industry, live seafood holding and display systems

FOR SALE:

CANTRELL CREEK TROUT FARM & HATCHERY

in North Carolina

**APPROXIMATELY 10 ACRES LOCATED
ON THE PRISTINE HEADWATERS
OF THE FRENCH BROAD RIVER**

PRICE: \$1,500,000





House On Property
16 years old • 2500 square feet living space • Brick and vinyl
4 Bedrooms, 2 1/2 Baths • Solar, Gas & Heat Pump • 2 1/2 Car Garage

Farm Hatchery & Equipment (14 X 30')
30 gpm from well and 50 gpm from creek • 360,000 3" Fingerlings per year
Emergency Power backup – Battery operated • Recirculation Pump and generator for power outage • Ice Machine • 2 Fish Hauling Trucks • 40 Bramlett feeders and stands • 10 – 12 hour Belt Feeders • 4 hp Honda gas water pump for Filling Trucks 150 gpm • 8 hp Gas Recirc pump 300 gpm • 5 hp Electric Pump 400 gpm • 3 hp Sta Rite Electric Fresh water pump 80 gpm • 5 hp Electric agitation pump for 30,000 gal waste storage tank • 10 hp Electric irrigation pump for 30,000 gal waste storage tank • 20 – 6' x 48' Paired Concrete Raceways (LHO's in 18) • 2 – 5 x 12' Concrete Fingerling Tanks near hatchery • 40' x 100' Catch-out pond • 16' x 32' Greenhouses–Propane Heated • Annual production for the farm is over 100,000 lbs./year.

Water Source
Jane Cantrell Creek (Avg. Flow 1,000 gpm) RS No. 358

Business Advantages
\$250,000 market in place, customer list, & website • NPDES General Permit No. NCG530000 • NC Aquaculture Permit No. 593

FOR MORE INFORMATION:

Cantrell Trout Farm P.O. Box 478 Pisgah Forest, North Carolina 28768
Home: 828-884-9890 • Cell: 828-553-3551
Website: www.stockrainbow.com • Email: cselle@citcom.net



and industrial water chillers for marine mammal tanks.

Since our first facility in San Leandro California, Universal Marine Industries has steadily supported the water chilling industry and cultivated relationships with clients by producing quality units at fair prices. Universal Marine Industries

continues to respond to the needs of the aquatic industry through innovation and quality control and we do this by focusing on what we do best: building *custom* environments for aquatic life.

In the summer of 2007, Universal Marine Industries has re-launched its website to showcase a redesigned U-Tube

exchangers. For over twenty years, UMI has been filling orders for clients all over the world with needs, ranging from 160 hp units for marine mammal tanks down to ¼ hp units for salmon enhancement programs at elementary schools. UMI is committed to manufacturing quality products at competitive prices and to do this we have continually been reducing our overhead and increasing quality control by purchasing American titanium and producing our coils and U-Tubes in house. At our facility, we believe in the quality of North American products and produce the finest industrial titanium heat exchangers and stand by our product.

Universal marine has also developed one of the most reliable heat pumps in the world. Heat pumps are an efficient way to heat water but due to the demands placed on the fittings by the heat, they have been expensive to repair and lacked the reliability needed to be cost effective. UMI uses titanium fittings welded to a solid titanium plate, which greatly increases the life of the unit and its cost effectiveness over time. We continue to expand our product line to include larger



Owen
&
Williams
FISH FARM, INC.

Grandkids spoiled yet?

We can help.

Custom pond stocking • Specializing in Southern Sportfish

478-892-3144
www.owenandwilliams.com

Producers of quality fish
for recreation and aquaculture

RS No. 716

Fish FOOD

Complete Feed Formulas for all Types of Pond Fish
• Floating • Sinking • Fingerling

**Catfish • Trout
Bass • Tilapia
Shrimp • Koi**

ALSO AVAILABLE
• Custom Formulas
• Medicated Feeds

*Star Milling
Company has over
30 years of experience in
manufacturing a complete line of aquaculture feeds.*

1-800-733-6455

Iva Gaglione - aquaculture representative: 951-255-1600
email iva_gaglione@starmilling.com



RS No. 203



Star Milling Co.

AQUACULTURE SPECIALISTS

units and has developed a large capacity heat exchanger up to 160 hp and made it more efficient in terms of dimensions and cost. We can offer our clients large capacity exchangers for a fraction of the cost of traditional industrial exchangers used in the chemical industry.

- For More Information:
- Universal Marine Industries
2790 Sunnyside Road
Anmore, BC V3H 3C8
Canada
- Telephone: 604-469-6427
- Fax: 604-469-6437
- Email: umi@telus.net
- Website: www.universalmarine.com

SEE AD PAGE 71

Troutlodge Expands Their Business

Troutlodge, Inc. expands into commercial marine aquaculture with the purchase of Unlimited Aquaculture LLC. Marine Aqua, a Washington limited liability company formed by the owners of Troutlodge, Inc., has purchased Unlimited Aquaculture LLC (UA). UA was founded in 2004 by Don MacQuarrie and Ian Shand to produce sablefish and halibut in a land-based marine environment at the NELHA facility in Kona, Hawaii. With the purchase, Marine Aqua will expand upon the work of its predecessors, seeking to

commercially develop coldwater marine finfish for both food and enhancement purposes. Its long-term goals also include the production and sale of high-quality marine fish juveniles to service the growing marine aquaculture industry.

“Troutlodge has been engaged in marine finfish research for many years, largely in cooperation with the National Marines Fisheries Service. We are thrilled to have this opportunity to now leverage this expertise on a commercial scale. The NELHA facility provides us with a unique opportunity to produce coldwater marine species in a pathogen-free environment and in truly environmentally-sustainable manner,” states Marine Aqua Managing Partner Steve Brown.

NELHA (Natural Energy Laboratory of Hawaii Authority), located in Kona, Hawaii, is home to nearly 30 tenants in various industries, including aquaculture. This unique facility provides UA with cold, pathogen-free seawater by pumping it from depths of both 2,000 and 3,000 feet. By mixing this cold water with warm surface seawater also pumped by NELHA, UA is able to achieve the optimal temperatures for hatching and grow-out of its products. Located adjacent to the Kona International Airport, the facility allows for easy access for delivery of fresh product to markets around the world.

Unlimited Aquaculture has not yet set a timetable on when product will be

commercially available, but does state that it will aim to first serve the Hawaiian seafood markets and then expand to serve the remaining Pacific Rim markets.

ABOUT MARINE AQUA / UNLIMITED AQUACULTURE

Marine Aqua is a Washington limited liability company (LLC) formed by the owners of Troutlodge, Inc. of Sumner, WA. Troutlodge is the world’s leading producer of eyed salmonid eggs, and Marine Aqua represents the company’s expansion into commercial marine aquaculture. Unlimited Aquaculture LLC was founded in 2004 and is engaged in land-based marine aquaculture at the NELHA facility in Kona, Hawaii.

ABOUT NELHA

NELHA is a unique facility in the world, producing the only deep seawater from depths of 3,000 feet. This water is used by over 20 companies producing commercial aquaculture crops and 4 water bottling companies making desalinated, mineralized deep sea drinking water. This water is the highest value export from the state of Hawaii. NELHA is actively pursuing several very large alternative energy projects that will benefit its tenants and the people of Hawaii.

- For More Information on Troutlodge
- Andrew Barfoot
- Troutlodge, Inc.+
- Telephone: 1 (253) 863-0446
- Email: abarfoot@troutlodge.com
- For more information on NELHA

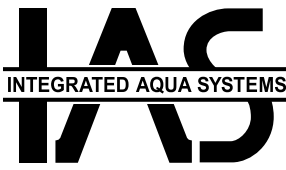

I.A.S. Products Ltd.
1415 Dominion Street
North Vancouver, BC, V7J 1B3
Tel: (604) 924 1844
Fax: (604) 924 1848
Email: info@iasproducts.com
www.iasproducts.com

FEED HANDLING, DELIVERY AND CONTROL SPECIALIST.

MANUFACTURING AND SELLING INTERNATIONALLY SINCE 1986
RS No. 724



AeroSpreader™ Bulk Feeding Systems



Aerite™ Feed Delivery Systems



SeeBrite™ Underwater Lighting Systems



Aerite™ Series of Feed Blowers



AeroSpreader™ Feed Broadcasters



SeeMate™ Underwater Video and Camera Systems

Aquaculture Magazine July/August-Products 2007 Issue

45



Get ready
to reach
new highs

AQUAFLO[®]
(FLORFENICOL) TYPE A MEDICATED ARTICLE

This year even more fish farmers will scale new heights in performance and profitability. Will you be one of them?

Talk with your veterinarian, extension agent or feed supplier today about AQUAFLO[®] — the fast-acting, new-generation antibiotic that will take your fish health program to a whole new level.

It's safe and highly palatable, too.

NOW APPROVED FOR:

- Furunculosis and Coldwater disease in freshwater-reared salmonids¹
- Enteric septicemia² (ESC) in catfish
- Columnaris in catfish using AQUAFLO[®]-CA1³

WWW.AQUAFLO-USA.COM
1-800-521-5767

 Schering-Plough

¹ For the control of mortality in freshwater-reared salmonids due to coldwater disease associated with *Flavobacterium psychrophilum* and furunculosis associated with *Aeromonas salmonicida*.

² For the control of mortality in catfish due to enteric septicemia of catfish associated with *Edwardsiella ictaluri*.

³ AQUAFLO-CA1 is conditionally approved for the control of mortality in catfish due to columnaris disease associated with *Flavobacterium columnare*. Conditionally approved by FDA pending a full demonstration of effectiveness under application number 141-259.

WHERE CAN I BUY

AQUAFLO[®]

[F L O R F E N I C O L]

At press time,
the following feed
suppliers were
helping growers
of catfish and
freshwater-reared
salmonids reach
new highs with
AQUAFLO[®].

**Alabama Catfish
Feedmill LLC**
Uniontown, AL
(334) 628-6446

Arkat Nutrition
Dumas, AR
(870) 382-2600
(800) 874-9395

Clay County Co-op
West Point, MS
(662) 494-4676

C. R. Brown Feeds
Andrews, NC
(800) 722-9477
(828) 321-3335

Delta Western
Indianola, MS
(800) 426-1226
(662) 887-1226

**Escambia Grain
Corporation**
Walnut Hill, FL
(850) 327-4292

**Farmers Co-op of
El Campo**
El Campo, TX
(979) 543-7756

Fishbelt Feeds, Inc.
Moorhead, MS
(662) 246-5065

**Greensboro Farmers
Co-op**
Greensboro, AL
(334) 624-8351

Land O'Lakes Purina
Macon, MS
(800) 737-4262

Melick Aquafeed, Inc.
Catawissa, PA
(800) 358-6595
(570) 356-2522

**Monroe County
Co-op**
Aberdeen, MS
(877) 785-7359
(662) 369-8175

**Nelson & Sons /
Silver Cup Fish Feed**
Murray, UT
(800) 521-9092

Rangen Inc.
Buhl, ID
(800) 657-6446

Rangen Inc.
Angleton, TX
(800) 272-6436
(210) 695-1354

Skretting
Vancouver, B.C.,
Canada
(604) 325-0302

Skretting
New Brunswick,
Canada
(506) 529-5499

Star Milling Co.
Perris, CA
(951) 657-3143

Topwater Feed Mill
Wisner, LA
(318) 724-6133

Tri County Co-op
Aliceville, AL
(800) 851-8365

 Schering-Plough

For the latest list and more information about the product:

WWW.AQUAFLO-USA.COM / 1.800.521.5767

AQUAFLO[®] is a registered trademark of Schering-Plough Animal Health Corporation.
Copyright ©2007. Schering-Plough Animal Health Corporation. All rights reserved.
SPAH-AQF-41R.

CAUTION: Federal law limits this drug to use under the professional supervision of a licensed veterinarian. Animal feed bearing or containing this veterinary feed directive drug shall be fed to animals only by or upon a lawful Veterinary Feed Directive (VFD) issued by a licensed veterinarian in the course of the veterinarian's professional practice.

- Ron Baird
- Natural Energy Laboratory of Hawaii Authority
- Telephone: +1 (808) 329-7341 ext 225
- email ronb@nelha.org

SEE AD PAGE 16

Permalon® Tank And Pond Liners

When your project requires a great deal of a liner and a special material to offer a balance of properties necessary to best meet those needs, specify Reef Industries' Permalon tank and pond liners. Reef Industries' Permalon Liners is the ultimate containment membrane available on the market today. The alloyed high-density polyethylene laminate resists punctures and tears for a more secure system. Designed to be lightweight and very easily handled, Permalon always ensures a cost efficient installation.

Permalon is also available in heavy-duty, internally scrim reinforced construction and with a geotextile composite for difficult site conditions. Custom fabrication is available for your specific project requirements. Custom engineered fabrication and sizes up to 200' x 200' available to minimize in-field seaming and includes three dimensional shapes for box and container liners. Individual panels of an acre in size are

readily done, always minimizing and often eliminating the need for expensive field installation crews. Permalon is a non-toxic material so it will not affect the health of your crop. If value can be defined as the optimal relationship between cost and benefit, then get real value in your containment membrane and specify Permalon. Whatever your project requires, Permalon products offer answers in support of your efforts.

For more information on Permalon®, please contact us at

- 800-231-6074
- Visit us at www.reefindustries.com
- email: gquevedo@reefindustries.com
- Telephone: 713-507-4251.

SEE AD PAGE 23

Shrimp And Fish Swimming In Dirty Water

Decotex has been supplying fabrics since 1985 to industry for filtration and industrial end uses.

Aquaculture Nettings for farm ponds, such as Shrimp and Fish has been Decotex's main focus for many years.

Decotex nylon cloth is woven and/or knitted from strong, heavy duty yarns.

Micron ranges from 1 micron to 2000 micron to suit your farming needs.

(supplied in raw goods form).

Micron rated nylons endure heat and sunlight very well. Meets outdoor weathering criteria nicely. Ask us about micron rated cloth for your dividers, raceways, pond separators, screens and filtration needs.

- For more information
- DECOTEX, INC.
63 East Main Street
Pawling, NY 12564 USA
- Telephone: 845-855-1863
- Fax: 845-855-1865
- Contact: Karen@decotex.com
- www.decotexinc.com

SEE AD PAGE 63

B.L. Mitchell Inc.

B.L. Mitchell is pleased to announce their FDA approval of Formacide-B (37% Aqueous Solution of Formaldehyde) in 1 gallon containers, 5 gallon containers and 55 gallon drums.

Remember the good things Bayliscide can do for your ponds!

OTHER PRODUCTS FOR YOUR AQUACULTURE NEEDS:

- Aquashade
- Actamide (Chloramine-T)
- Amquel, Pure Dry (Cloram-X)
- Calcium Chloride
- Copper Sulfate
- Fish Haul
- Liquid Coppers

 MOSSY OAK. PROPERTIES LAND EXCHANGE	<h1>ATTENTION!</h1> <h2>Investors, Farmers Fish Retailers...</h2> <p>Looking for your own farm operation? Selling out?</p>	 MOSSY OAK. PROPERTIES LAND EXCHANGE
<h2>BUYING?</h2> <p>Arkansas Rice, Fish & Sod Farms</p>	<div style="border: 1px solid black; padding: 10px;"> <h2>LAND EXCHANGE</h2> <h3>Wants to help you!</h3> </div>	<h2>SELLING?</h2> <p>St. Francis River 1057 +/- ac of Great Hunting!</p>
Broker/Agent <i>Randall Page</i> Little Rock, AR (501)454-4943	<h2>Traditional or Auction</h2>	Broker/Auctioneer <i>Bruce Colbert</i> Marion, AR (901)517-8383 <small>RS No. 364</small>

- Non Foamer
- Potassium Permanganate
- And Many Others
- For More Information
- B.L Mitchell Inc.
103 U.S. Highway 82 E
Leland, MS 38756 USA
- Telephone: 662-686-9002
- Fax: 662-686-9020
- Email: blmitch@bellsouth.net

SEE AD PAGE 36

Your Trusted Source For Hatchery Products

Western Chemical Inc. has been in business for over 30 years as a supplier to fish hatcheries, aquaculture facilities, and research institutions. The company is best known for its TRICAINE-S (MS 222, TMS) fish anaesthetic which is manufactured at the company's Washington state manufacturing facility. TRICIANE-S is a high purity MS 222 which obtained FDA approval in 1998 and has since become the best selling MS-222 in North America. Another popular company product is PARASITE-S which is an FDA approved Formalin for use as a parasiticide on fish and penaeid shrimp, as well as a fungicide on fish eggs.

Growth & New Partners - In 2006 Western Chemical merged with Syndel Laboratories of Canada under the parent

company Aquatic Life Sciences. Western has long been a leader in the manufacture of FDA approved products while Syndel has been a leader in spawning agents, biosecurity products, and fish health products. Combined, the two companies are in the forefront of developing aquaculture pharmaceutical products for distribution worldwide. The companies are expanding by introducing new products and pursuing new aquaculture drug approvals.

New Product - 35% PEROX-AID® was approved by the FDA on January 11, 2007 and it is the first new waterborne drug approved for a disease claim for any aquatic species in more than twenty years. 35% PEROX-AID® is a specially formulated hydrogen peroxide product and is the only hydrogen peroxide product with FDA approval for use in aquaculture. It is intended for use as an external microbicide for the control of mortality in freshwater-reared finfish eggs due to saprolegniasis, in freshwater-reared salmonids due to bacterial gill disease (associated with *Flavobacterium branchiophilum*), and in freshwater-reared coolwater finfish and channel catfish due to external columnaris disease (associated with *Flavobacterium columnare* [*Flexibacter columnaris*]).

The FDA Center for Veterinary Medicine has indicated that the Low Regulatory Priority (LRP) Drug status

for hydrogen peroxide is rescinded. Prior to the approval of 35%PEROX-AID® facilities could purchase and use most any brand of hydrogen peroxide that was consistent with the FDA's policy. This has changed and the only hydrogen peroxide product that can legally be purchased and used is 35%PEROX-AID® and it is for the approved label claims. More information is available at: www.fda.gov/cvm/CVM_Updates/hydrogenperoxide.htm

New Line of Biosecurity Products – The recent outbreak of VHS in the Great Lakes region has highlighted the need for effective BioSecurity programs at all levels. Western Chemical, with its sister company Syndel Laboratories, has been working with fishermen, fish culturists, veterinarians and government agencies to help design and implement practical and effective BioSecurity programs.

New Biosecurity Product - VIRKON® AQUATIC is a disinfectant and virucide that is effective against viruses, bacteria, and fungi. It is intended to disinfect environmental surfaces associated with aquaculture including vehicles, nets, boots, waders, dive suits, hoses, brushes, and other similar equipment. It is also very effective in foot baths.

Virkon® Aquatic is formulated to work with comparatively short contact times and in the presence of organic materials. The product is specifically designed for



www.praqua.com

Trusted for our knowledge... **Appreciated** for our expertise... **Chosen** for our experience...

CONSERVE	ENHANCE	GROW
<p>Water Treatment Solutions</p> <ul style="list-style-type: none"> ◆ Rotofilter™ drum filters ◆ Fiberglass tanks & raceways ◆ Degassing, Aeration & Oxygenation ◆ Ozone & UV ◆ Belt filters 	<p>Fish-Friendly Solutions</p> <ul style="list-style-type: none"> ◆ Heathro™ Live Fish Pumps ◆ Pescalator™ fish elevators ◆ Mobile Fish Transfer Station ◆ Fish graders ◆ Vaki® counters and biomass scanners 	<p>Engineering & Equipment Supply Packages</p> <ul style="list-style-type: none"> ◆ Experts in recirc/reuse design & technology integration

RS No. 125

Contact us: Email: info@praqua.com or Tel: 250-714-0141 Toll Free: 866-714-0141

aquatic applications and it has met the stringent requirements of the US EPA and Health Canada. Virkon® Aquatic is unique in having label indications and instructions specifically for aquatic applications in both countries. There are many disinfectants on the market, but there are few that are specifically formulated for and approved for use in Aquaculture.

More Biosecurity Products - Western carries a full line of BioSecurity products including OVADINE (PVP Iodine) which is a buffered Povidone iodine solution for fish egg disinfection. This product is widely used in salmonid hatcheries to help prevent the spread of disease between generations. Other Biosecurity products include: Biosecurity signs, disinfection mats, hand wash stations and antibacterial cleansers. The company is continually expanding its product offerings and on-line ordering will be available soon. A complete BioSecurity brochure can be downloaded at: www.wchemical.com.

Environmental Stewardship - Western Chemical's respect for the

environment is unwavering and is reflected in both its products and its record of compliance with environmental laws. The company consistently meets or exceeds all environmental regulations as set forth by the U.S. Environmental Protection Agency (EPA), Washington Department of Ecology, US Food and Drug Administration (FDA), as well as other regulatory agencies. Western takes pride in its people, facilities, and products while being respected for its ethics and commitment to the environment. When purchasing products from Western Chemical, you can be assured that they are manufactured in an environmentally responsible manner.

Product Purity - Western's production facilities operate under the standards of Good Manufacturing Practices (GMP) as well as Good Laboratory Practices (GLP). These guidelines provide a system of processes, procedures, and documentation to assure all products have the identity, strength, composition, quality, and purity that it is appropriate for their intended use. You can trust the quality of Western Chemical's

products.

- For more information:
- Western Chemical, Inc.
1269 Lattimore Road
Ferndale, WA. 98248, USA
- Toll Free 800-283-5292
- Phone 360-384-5898
- FAX 360-384-0270
- Email: info@wchemical.com
- www.wchemical.com

- Syndel Laboratories, Ltd.
958 Chatsworth Road
Qualicum Beach, BC V9K 1V5
Canada
- Toll Free 800-663-2282
- Phone 250-752-5256
- Fax 250-752-5188
- Email: info@syndel.com
- www.syndel.com

SEE AD PAGE 6

Jelliquarium™
Jellyfish Display Systems and
Tank-Raised Jellyfish



Reseller Pricing Available.

Learn to Produce Your Own Jellyfish.

Home Business Opportunity.

RS No. 362

Midwater Systems
www.jelliquarium.com
805-241-7140



Minnie Tanks. Many Tanks.
(Minnows, Fry, etc.) (Polytanks) (Lots and Lots) (Polytanks)



Conical or Flat-Bottom Cylindrical Tanks, and Rectangular Tanks available in many sizes

Semi-Square Tanks 4 sizes available



Conical Bottom Tanks from 250 up to 1500 gallons

Boy, have we got tanks! All shapes and sizes. With stands or self-supported. Filter tanks and drain kits too. And very inexpensive. If we don't have it—we can make it. Give us a call, or visit us on-line at www.polytankco.com.

Polytank Inc.
62824 250th Street (320) 693-8370
Litchfield, MN 55355 1-800-328-7659

RS No. 776

Firestone Specialty Products Provides Aquaculture Professionals With An Outstanding Geomembrane Option

For more than 10 years, Firestone Specialty Products has been involved in a myriad of aquaculture installations featuring Firestone PondGard EPDM Geomembrane throughout the world. Developed by the premier name in rubber polymer technology and innovation, PondGard offers a high-quality, durable, and user-friendly option for aquaculture professionals.

PondGard provides low application costs, ease and speed of installation and is beneficial to contractors working in remote areas because there is no need for utilities for thermal welding, providing a cost savings. PondGard geomembranes



Officials at Dexter NFH&TC selected an EPDM liner because they wanted a lining material with excellent lay flat characteristics to prevent wrinkling and ensure fish safety.

are also available in a variety of sizes to suit the needs of all project sizes and reduce field seaming. With outstanding resilience to

FREE 64-PAGE CATALOG!
 Call Toll-Free 24 hours a day
 1-800-238-6380
 Web Site: www.memphisnet.net
 E-mail: memnet@memphisnet.net

- Standard and Custom Built Seines, Nets
- Bulk Knotted and Knotless Nettings
- Aquaculture Nettings & PVC Coated Wire
- Wooden Fish Traps & Wire traps
- Fish Hatchery Supplies
- Fish Scales & Cutlery
- Fish Hooks & Swivels
- Aerators & Agitators
- Ropes & Twines
- Rainwear & Boots

OVER 5,000 stock items!!

JOIN OUR 100,000 CUSTOMERS

MEMPHIS NET & TWINE CO.
WWW.MemphisNet.Net

CALL TOLL-FREE 24 HOURS A DAY
1-800-238-6380

MariSource

Vertical incubation systems for the hatchery industry

INCUBATION TRAYS provide superior

- use of space
- water utilization
- survival rates
- egg segregation
- labor efficiencies
- durability

MariSource also supplies hatchery accessories

Spawning Knives

Egg Counters

Egg Pickers

Measuring Boards

call toll-free (866) 447-5967 • (253) 922-2700 • www.marisource.com
a division of Flex-a-lite Consolidated, Fife, Washington 98424 RS No. 409

DELMARVA AQUATICS

256 Brick Store Landing Rd
Smyrna, DE 19977

**HYBRID & PURE
STRIPED BASS
FRY
FINGERLINGS
KOI**

CHESAPEAKE - DELAWARE STRAINS
ORIGINAL CROSS

**YELLOW PERCH
SMALLMOUTH BASS**

OTHER SPECIES TOO

****DISCOUNT PRICES****

**SMALL or SPECIAL
SCIENTIFIC ORDERS OK**

EXPERIMENTAL CROSSES
AVAILABLE
WORLDWIDE SHIPPING EXPERIENCE

**CHINA, ISRAEL
ITALY, TAIWAN, USA**

**CALL FOR INFO.
PH: 302-653-8652**

www.delmarvaaquatics.com

RS No. 692

LIVE FISH



- Albino Catfish
- Big Head Carp
- Black Fathead Minnow
- Catfish
- Catfish Fingerlings
- Gold Fish
- Hybrid Striped Bass
- Koi
- Large Mouth Bass
- Rosey Red Minnow
- Tilapia
- Specialized Hauling

Call or Write:

Farm Cat Inc.

PO Box 317
Lonoke, AR 72086
1-800-530-7931

Tele: 501-676-2686 • Fax: 501-676-3742

E-mail: farmcat96@aol.com

RS No 348

UV rays, exceptional weathering characteristics, and superior puncture and tear resistance, Firestone PondGard geomembranes sustain the health and beauty of aquaculture projects and provide superior resistance to microbial and algae attack. PondGard also provides lay flat and conformance characteristics, no flap seams and little to no maintenance once installed. PondGard is also specially formulated to be used safely in the presence of fish and plant life.

Recently, PondGard was installed at the Dexter National Fish Hatchery and Technology Center (Dexter NFH&TC) in Dexter, N.M. Faced with the possibility of losing up to 3,000 gallons of water per day in each of its 25 threatened and endangered fish species holding ponds, Dexter NFH&TC wanted to install a cost-effective lining material with excellent lay flat characteristics to prevent wrinkling.

"Many of our holding ponds contain tiny fry or fingerling fish that can easily get trapped in a wrinkled pond geomembrane," said Manuel Ulibarri, center director, Dexter NFH&TC. "Our original plan had been to leave these new ponds unlined because our experience with lining materials was that they wrinkle easily and that's a threat to our fingerlings."

His search led him to visit friends who work for a large warm water fish hatchery in San Marcos, Texas, and who were in the middle of a large relining project using an unreinforced PondGard EPDM Geomembrane from Firestone Specialty Products Company. "I really liked what I saw and chose to use the same product at Dexter. The only thing we did differently was select the scrim-reinforced option, because it enhanced durability," Ulibarri said.

Using 10-foot-wide panels of PondGard, the crew deployed the material and taped all the seams at a rate of one pond per day, with each pond being 10,000 square feet, or approximately ¼-acre in size. The 200-foot-long rolls were cut as needed to fit each pond.

"Watching the EPDM being rolled out and moved into place, I knew we had selected the right product for our fish," said Ulibarri. "Once all the seams were taped and the edges were secured

into the trenches around the perimeter of the ponds, there was not a wrinkle to be found. This is so important to our operation."

Another unique characteristic of PondGard is that it can be used in not only fresh water applications, but also in saltwater applications. In two recent fish hatchery installations in Florida and Texas, sea water from the Gulf of Mexico was used in the ponds. Products such as High Density Polyethylene (HDPE) become un-repairable after two to three years in salt water applications due to oxidation of the material expedited by the salt. The repair-ability of PondGard made it the membrane of choice for these projects.

In keeping with Firestone's commitment to provide eco-friendly, quality products, PondGard geomembrane is manufactured at a facility that has been certified to both the ISO 9001:2000 Quality Management Standard, which recognizes the quality process, and also to the ISO 14001:2004 Environmental Management Standard.

Firestone provides aquaculture professionals with unmatched technical, logistic and design support. With more than 70 years of experience combined, Firestone representatives are on hand to answer all technical questions. Firestone also offers assistance to engineers and designers with specifications, details and technical information. To assist aquaculture professionals during the bid process, Firestone provides qualified trained approved applicators with panel layouts and bill of materials.

In addition to impeccable service, Firestone is also committed to providing unsurpassed product availability. With a worldwide network of distributors and job site delivery available for the commercial and industrial markets, Firestone provides aquaculture professionals with outstanding products and services. For more information about Firestone Specialty Products, please visit our Web site at www.firestonesp.com.

SEE AD PAGE 14

Are Jellyfish The Next Market In The Marine Aquarium Hobby?

In the search for aquaculture alternatives the Jelliquarium and tank raised jellyfish they are the ultimate alternative!

Midwater Systems set out four years ago to design a display system for jellyfish. It was realized quite quickly that since there was no source for live jellyfish it was going to be very difficult to sell a jellyfish tank. That's when Jim Stime decided he needed to learn how to grow his own jellyfish.

Four years later Midwater Systems has designed the Jelliquarium, a stand-alone turn-key jellyfish display system, is a producer of tank-raised Moon jellyfish and has developed a line of tanks specific to producing jellyfish.

Moon jellyfish are the easiest to raise, but they are a cold water species raised at 60 degrees. Properly stimulated polyps can produce many free-swimming Ephyra. Fed freshly hatched brine shrimp, twice daily, within 60+ days will produce saleable 2" jellyfish. These can be boxed and shipped Fed Ex Next Day Air. Grow-out foods are frozen planktonic foods fed twice daily. Moon jellyfish typically do not involve a sting, but care should always be taken when handling jellyfish.

For more information on the producing of jellyfish see my article on-line at <http://www.aquarium-design.com/invert/moon-jellyfish.html>.

The key to a proper jellyfish tank design is to create a means where the water enters and exits the tank, as well as, suspends its inhabitants weightlessly within the center, all without being visually obvious and without damaging the soft gelatinous bodies of its jellyfish inhabitants. The Jelliquarium has been designed specifically for this.

We offer four sizes of the Jelliquarium, the Mini-Jelliquarium (24"), the 30 and 48 inch Jelliquarium In-Wall and Cabinet systems and a monstrous 60 inch Jelliquarium in a tank-only version.

The Mini-Jelliquarium is our compact hobbyist system as it incorporates its filter

system into its backside. This is available as a complete tank-only system or with a sexy black acrylic stand and canopy. We also offer an attractive wooden cabinet. The Mini-Jelliquarium does not include a chiller but we do offer an optional Chiller Pump Assembly allowing you to easily install your favorite brand of chiller alongside the tank.

The 30" and 48" Jelliquarium systems all include component style wet-dry trickle filter technology, a reliable and silent water pump, Euro-Reef brand protein skimmer, AquaLogic brand titanium chiller (2 year warranty), digital thermostat and a GFI Power Center with digital timer. Both sizes are available within a wooden cabinet or the collective components to be installed as an In-Wall system.

The first consumer turn-key jellyfish display system and tank raised livestock with no impact on the ocean. Maricultured jellyfish, along with fish bred in captivity, are a growth industry. In a world that is quickly becoming ecologically sensitive, or Green, tank raised jellyfish means low impact, year round availability and sustainable, which is reliable and Eco-smart.

- For more information;
- Contact – Jim Stime
- Midwater Systems
2925 Calle Quebracho
Thousand Oaks, CA. 91360 – USA
- Phone – 805-241-7140
- Fax – 805-241-7150
- E-Mail - jellyfish@aquarium-design.com
- Website – www.jelliquarium.com

SEE AD PAGE 50

B&K Installations

B&K Installations, Inc. is located in Homestead; Fl. Homestead is famous for being the land fall point of hurricane Andrew a category 5 class hurricane with wind gusts and wind shears in excess off 220 mph. As survivors of hurricane Andrew and other major storms B&K has witnessed first hand the devastation and destructive effects high winds have on structures of all types.

This experience has helped to develop B&K into a premiere designer and manufacturer of severe weather structures

for both high winds and snow loads as well. The picture accompanying this editorial is the University of Miami, Rosenthal School of Marine & Atmospheric science located on Virginia Key in Miami, FL. This structure was at ground zero of the land fall point of hurricane Katrina; this structure experienced no physical damage at all in sustained winds of 75 mph plus gusts of over 100 mph. B&K's sale and engineering staff can design a structure to your specific needs whether it is a high wind or snow load structure a long span or tall structure or a simple basic economical structure or pond cover.

B&K also has a full service metals fabrication and machine shop facility able to fabricate, weld or machine stainless steel, steel, aluminum etc. B&K can build new or repair old parts for your existing equipment or build new equipment to your specifications.

- You can contact us
- Telephone 305-245-6968
- Fax 305-245-8119
- e mail bkinstall@aol.com.

SEE AD PAGE 7

Fundamentals Of Aquaculture A Step-By-Step Guide

The book, Fundamentals of Aquaculture: A Step-by-Step Guide to Commercial Aquaculture has been heralded as one of the best written, most readable, and complete books on commercial aquaculture - a real masterpiece at a bargain price. It is being used in countries throughout the world, and numerous universities and colleges have adopted it as their textbook. The chapters include: getting started; aquatic food production and people; which species to culture; social and legal considerations; site selection and culture systems; water requirements; water management; fertilization, liming and pond muds; feeds and nutrition; maintaining health of a culture species; predators and pests; aquatic plants and weeds; seed production and stock improvement; maximizing production and profit; harvesting and processing; marketing; and your business

Heating Your Pond

www.heatingyourpond.com

sales@heatingyourpond.com

Aquaculture tank heaters
Floating pond deicers
Inline heat exchangers

Heaters that dont burn
out from low liquid

It's time for new
heater technology

NON - METALIC HEATERS

RS No. 361

ASK ABOUT "ENERGY EFFICIENT"
POND HEATERS

848 N RAINBOW BLVD
LAS VEGAS, NV 89107
phone: 702-508-4427

CASTLE HAYNE FISHERIES, INC

FINGERLING & FRY
HYBRID STRIPED BASS
FOOD FISH & PHASE II'S
OTHER SPECIES AVAILABLE



NANCY SUGG
MANAGER
252-943-1116 (CELL)
REFERENCES SUPPLIED
ON REQUEST

6950 SPRING CREEK RD.
AURORA, NC 27806
252-322-5936
FAX: 252-322-7377
chfisherieshsb@aol.com

RS No. 179



*Dr. James Avault, columnist for
Aquaculture Magazine and author
of Fundamentals Of Aquaculture.*

Instructors can now thoroughly enjoy teaching the subject of aquaculture with this well organized manual. It has been designed to fit the needs of individual teachers. The manual contains an outline for teaching an introductory course in aquaculture, complete with lectures, laboratories, home work assignments, sample tests, and growing fish as a class project. There are examples of short courses and guidance in developing your own short course.

- For more information contact:
- AVA Publishing Company Inc.,
PO Box 84060,
Baton Rouge, LA 70884-4060
USA.
- Tel: 225.763.9656;
- Fax: 225.766.0728;
- E-mail: AVApub@cox.com.

SEE AD PAGE 20

You Will Love ALEARN

Let ALEARN to discover more about water and the plants and animals that live in and on the water.

Let ALEARN be your source of information on pond design, construction and repair, and recreational fish pond management.

ALEARN provides information on:

- Aquatic weeds identification
- Recipes
- Weather
- Photo Resources
- Lesson plans and activities

- Grant opportunities
- And much, much more
- For information:
- Department of Fisheries & Allied
Aquacultures
203 Swingle Hall
Auburn, AL 36849
- Telephone: 334-844-4786
- Email: fish@auburn.edu

SEE AD PAGE 27

The Roan Group (TRG) Releases New Encapsulated Nucleotide Product For Improved Disease Resistance And Growth

ENCAPCELL®, a new, patented encapsulated nucleotide formula for preventing disease and enhancing growth, is now available through The ROAN Group, Inc. (TRG).

TRG, manufacturer of ENCAPCELL®, an encapsulated nucleotide based formula that reduces and/or eliminates symptoms of disease, has recently launched their product into the aquaculture marketplace. ENCAPCELL® aids in cell proliferation to combat disease stressors that may lead to less profitable crops and/or crop loss. The product, when included in the normal diet from first feeding until harvest, dramatically aids in reducing disease and improves growth rates. ENCAPCELL® may be incorporated into extruded feed without any degradation or destruction of potency and the same results can be expected.

When an animal is attacked by disease it requires both time and energy to mount a significant defense. During this time, symptoms of the disease appear and are likely to produce mortalities. The oral supplementation of ENCAPCELL®, prior to the onset of disease, is an effective preventative measure to ensure healthy crops. This effect reduces both energy and

the time it takes for cell proliferation in the organism and accelerates the antibody production. The effect of the encapsulated nucleotides found in ENCAPCELL®, on the cellular immunity, is to accelerate the production of antibodies which contributes to the overall health of the animal.

ENCAPCELL® also aids in the general development and growth of the animal by maintaining a healthier gastrointestinal tract. Further, ENCAPCELL® aids in the feed conversion ratio to lower crop costs and improve water quality, which promotes higher crop yields and increased profits.

ABOUT THE ROAN GROUP, INC.

TRG, founded in 2004, is the world's only provider of encapsulated nucleotide based health solutions. With ongoing research and testing aimed at combating various mortality producing diseases, ENCAPCELL®, the first product released from TRG, targets the aquaculture market. ENCAPCELL® allows those crops that are normally stricken with these disease conditions to better resist disease and enhance growth rates at the same time.

- For more information,
- The ROAN Group, Inc.
600 W. Taddei Rd.
Acampo, CA 95220
- Telephone: (209) 333-9680
- website: www.theroangroup.net

SEE AD PAGE 31

Graduates Of UAPB's M.S. Program In Aquaculture/Fisheries Landing Great Jobs

Students graduating with M.S. degrees in Aquaculture/Fisheries from the University of Arkansas at Pine Bluff (UAPB) are having an impact throughout the U.S. in the private sector, in state and federal agencies, and in Ph.D. programs. Private aquaculture companies seek out UAPB's graduates because they are skilled in managing aquaculture ponds and have in-depth experience with every aspect of fish farm management from spawning to growout to financial analysis. Other recent graduates have stepped into state and federal positions in fish health. Their UAPB training in fish disease detection and management and hands-on experience in diagnostics, aquaculture, and natural fisheries provides them with the comprehensive background to excel. Some M.S. graduates from UAPB have chosen to move on to Ph.D. programs at other institutions and their new departments have been impressed with the ability of UAPB's graduates to tackle and solve problems and to develop applied recommendations derived from sound science.

The UAPB Aquaculture/Fisheries

Center of Excellence was created in 1988 by the University of Arkansas Board of Trustees, and has become a nationally and internationally-renowned source of research-based information in the areas of aquaculture and fisheries. The Center is charged with providing the teaching, research, and extension support to the aquaculture industry and to fisheries managers in the state. Academic programs in aquaculture/fisheries extend theory into practical applications and solutions to problems faced by stakeholders in the state and across the country.

Arkansas plays a unique role in aquaculture and fisheries in the United States. It is the birthplace of US warmwater aquaculture, is the second-leading aquaculture-producing state, and is home to many national leaders in aquaculture and fisheries science. Aquaculture and fisheries have had significant impacts on the rural economies of the Delta, through the multiplier effects of expenditures in local communities by aquaculture businesses, and through expenditures by anglers who enjoy the excellent recreational fishing opportunities in the Natural State. Advancements in aquaculture production technologies and in understanding and managing the natural fisheries resources of the state have driven the growth and competitiveness of these sectors.

Specific areas of study for UAPB graduate students training for careers in



Just Add Water

Integrator

AT Last! An AFFORDABLE WIRELESS Oxygen Monitoring System that works for YOU!

RS No. 225



User Setup - Modular, Plug-In Parts

Wireless Monitoring & Control

Reduce Operating Costs

More Efficient Use of Resources

Available Extras:

- Telephone Alerts
- Remote Access
- Interactive Voice Response

And MORE!

For More Info Contact:

Integrator Aqua Systems
21 Main St., PO Box 842
Lake Village, AR 71653
Tel: 704-907-2059



www.jwhiteassoc.com

Email: jwassoc@sprynet.com



**Free-Standing,
Conical Bottom Tanks**

- 90% Transparent.
- High light transmission.
- You can see inside!
- Standard and custom sizes.

Call us at 603-668-8186
or visit our website at
solar-components.com

(Other products include: flat-bottom algae tanks, biofilters and protein skimmers.)

Many of our products have been in use worldwide since 1973.

SOLAR COMPONENTS CORP.

121 Valley Street, Dept. AQ
Manchester, NH 03103 RS No.399



UAPB graduate student Neil Pugliese strips channel catfish eggs while working with a commercial producer to develop better ways to produce hybrid catfish.



AQUANATE

www.aquanate.com

Online Data Management

- Tank Inventory Tracking
- Feed Purchasing
- Feed Inventory Tracking
- Feed Conversion
- Tagged Fish Management
- Mobile PDA Interface
- Customization Included

info@aquanate.com
206-841-3023 RS No. 315

aquaculture include emphasis in ...

1. Fish pathology
2. Fish nutrition
3. Hatchery production systems
4. Pond management systems
5. Water quality
6. Fish physiology
7. Aquaculture effluents
8. Aquaculture engineering
9. Aquaculture economics
10. Aquaculture marketing
11. Aquaculture extension

UAPB also offers classes and graduate programs that emphasize management of natural fisheries. Some very successful graduates have crafted programs that include aspects of both study areas. The location of UAPB in the center of a major aquaculture state with diverse natural fisheries provides unparalleled opportunities for research in both of these closely allied fields. UAPB students and faculty spend part of their time in modern

laboratories, but are just as often found on farms and in the field working in the real world with to solve real problems.

In addition to their classroom and research responsibilities, UAPB graduate students are frequently seen presenting their work at regional and national scientific meetings. These meeting provide career-building opportunities to be seen and to establish contacts with others in the field. The UAPB students also have a very active chapter of the American Fisheries Society and were the first student sub chapter chartered by the US Aquaculture Association. Participation in these groups provides additional opportunities for networking and public service.

The greatest strength of the MS program at UAPB is its close ties to fish producers and fisheries managers, and the opportunity for students to be involved in research projects and training hands-on,

in the real world, with real fish. Those experiences make UAPB graduates uniquely qualified and immediately useful to aquaculture industries, state and federal agencies, and Ph.D. programs.

If you are interested in graduate study at UAPB, visit their web sites at www.uaex.edu/aqfi.

Graduate assistantships (earn while you learn!) are available now and can be found on the web or by contacting Dr. Carole Engle at cengle@uaex.edu.

SEE AD PAGE 30

HD Q-PAC® Biomedica Improves Operating Parameters In Aquarium Water Treatment System: Ph, Dissolved Oxygen, And Turbidity Improved Significantly

BY KATY FITZGERALD

The Newport Aquarium needed to improve the clarity and quality of sea water in its large fish exhibit. After evaluating alternatives with independent consultant Dave LaBonne, Jeff Gibula (Husbandry Operations Manager) decided to use HD Q-PAC® media in his one of his life support systems. HD Q-PAC® is an excellent choice for use in aquarium water treatment, both for newly constructed systems, and for replacement of corrugated media in existing systems.

HD Q-PAC® (see photo) has the following characteristics, making it ideally suited for aquarium and aquaculture applications:

- 132 ft²/ft³ specific surface area (up to 300 ft²/ft³ effective surface area)
- 75,000 drip points per ft³ form additional droplet surface
- durable, easy to handle 1 ft³ blocks, rigid enough to walk on
- excellent resistance to fouling and

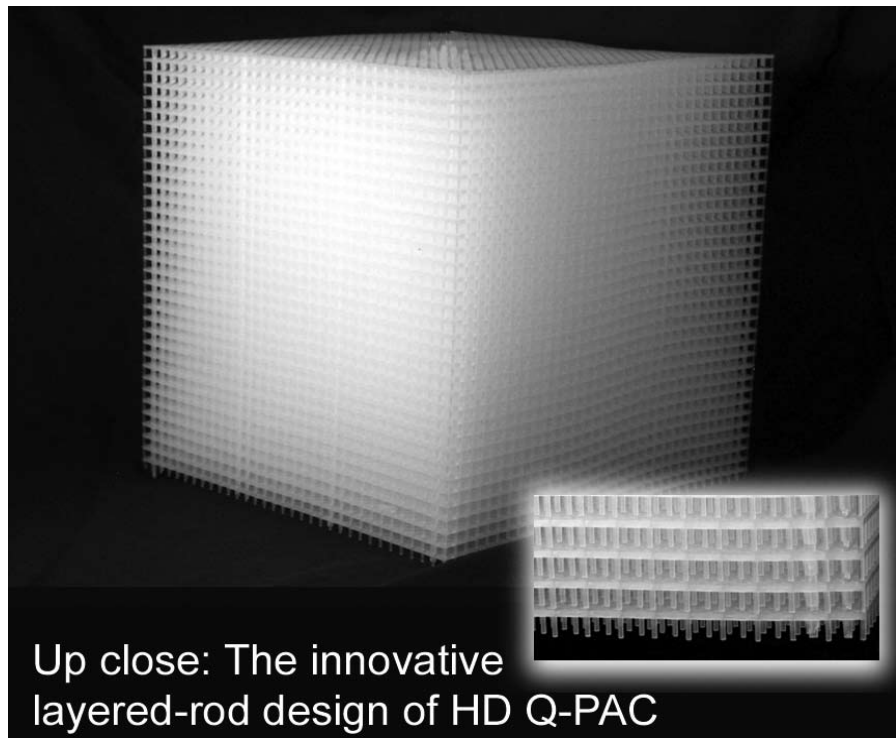

plugging

- none of the harmful extractables found in PVC and CPVC media

• rounded surfaces support active

growth

- good distribution of applied water

Building environments for life.

TITANIUM WATER CHILLERS AND HEAT PUMPS SINCE 1989

- Delta Star® and Cyclone® Chillers
- Multi Temp Water Chillers and Titan Heat Pumps
- Titanium Tube Sheet and Plate Heat Exchangers
- Temperature Controlled Tank Systems
- Insulated PVC/ABS Tanks and Sumps
- UV Sterilizers, Pumps and a whole lot more

Call the industry source today and experience the benefit of American made products, ingenuity and value.

AQUACULTURE DUTY TOUGH RESEARCH LAB RELIABLE

Chillers

Heat Exchangers

Tank Systems

UV Sterilizers

8268 Clairemont Mesa Blvd., Suite 302, San Diego, CA 92111
T: 858.292.4773 F: 858.279.0537

RS No. 950 Visit us at: aqualogicinc.com and aquaneticsparts.com

Parameter	Goal	Previous	w/ HD Q-PAC®	Comments
pH	> 8.0	7.96	7.99	Consistent gain with HD Q-PAC.
DO	6.8 mg/L, or 90 – 100%	6.59 mg/L, 94%	6.63 mg/L, 94.6%	DO concentration expected to continue increasing as organic load decreases.
Turbidity	Reduction of NTU value	0.7 – 1.2 NTU	0.20 NTU, less fluctuation	Reduction in turbidity is especially important, since it relates to the clarity and viewer enjoyment of the exhibit.
Coliform	< 100 cfu	Inconsistent	41 cfu	Except for major variations likely due to other testing, the coliform value has stabilized near 41 cfu.
NO3 Conc.	< 50 ppm	78.33 ppm	76.29 ppm	This parameter is expected to decrease further over time.
NO2 Conc.	< 0.04 ppm	0.05 ppm	0.04 ppm	This parameter is expected to decrease further over time.

In October 2003, it was decided that HD Q-PAC® would be installed in the existing protein skimmer sump of a large fish exhibit. The block media was easily cut to fit the round tower, and was installed on top of a fibergrate sub-floor. On Nov. 14, 2003, Mr. Gibula and his team started recording new

data points for the following system parameters: pH, dissolved oxygen, turbidity, coliform count, and nitrite and nitrate concentrations. The results were excellent.

THE DISPLAY

The HD Q-PAC® media was installed as an upgrade to the treatment system

connected to the 385,000 gallon, saltwater Surrounded by Sharks exhibit. The depth of the exhibit was from ten to 24 feet. It contained the following creatures: seven large sharks (6 – 9 ft), 11 small sharks (2 – 5 ft), two large loggerhead sea turtles (150+ lbs each), three large Southern stingrays (4 – 5 ft), 500 jacks (1 – 3 ft),



F&L Anderson Fish Farm

**KOI ~ FATHEADS ~ LARGEMOUTH BASS
SHUBUNKINS ~ SHINERS ~ COPPER NOSE
BLUEGILL ~ GOLDFISH**

OUR FISH AND FARM ARE CERTIFIED FREE OF SVCV, IHN, VHS, IPN, KHU, AND CARP ERYTURODERMATITIS BY USDA/APHIS ACCREDITED VETERINARIAN ACCORDING TO INTERNATIONAL, OIE, AND USDA/APHIS STANDARDS.

WE CAN FURNISH CERTIFICATES FOR LMBV VIRUS AND OTHER DISEASES AS REQUESTED.

**35 YEARS OF
EXPERIENCE**

F&L Anderson Fish Farm - Lonoke, Arkansas
RS No. 670 **501-676-2035**



Optimal Water Temperature means PRODUCTION!

Delta Hydronics will provide a custom heating or cooling solution for your specific aquaculture application and needs. We provide complete design and build services including engineering, equipment and installation.

Our New Product Catalog Includes:

- Gas fired Boilers/Heaters
- Air cooled chillers
- Polypropylene exchangers
- Titanium heat exchangers
- Pumps/Filters
- Temperature controls
- Electric water heaters

Delta will preplumb and skid mount systems for customer installation and export

1011 E. Lemon Street, Tarpon Springs, FL 34689
Office: (727) 938-2225 Fax: (727) 938-2311
Email: deltahydro@aol.com

RS No. 429

100 Atlantic blue tangs (8 – 10 inches), 150 spade fish (5 – 8 inches), 300 grunt species (6 – 12 inches), one Goliath grouper (4 ft), two red groupers (2 ft), 1 Nassau grouper (3 ft), one moray eel (5 ft), and one red drum (3 ft).

The life support system contained no dedicated biological filtration system other than an 8" thick under-gravel filter. Mechanical filtration consisted of seven rapid sand filters, and contact/degasification chambers for ozone injection. The system upgrade added three ozone injected protein skimmers, with HD Q-PAC® as the degasification and biological treatment media. The HD Q-PAC® media was installed to a depth of 1 foot.

TESTING

The chart below reflects testing of HD Q-PAC® that took place over the course of two months, from mid November 2003 to mid January 2004. The results, for all parameters, were excellent.

The Newport Aquarium was so pleased with the results of the HD Q-PAC® installation, they installed the media in two additional systems: the sump downstream of the ozone contactor chamber for the otter display, and the bio-tower for one of the snake displays.

CONCLUSION

HD Q-PAC® media is ideal for use in aquarium and aquaculture water treatment applications. It is a marked improvement over the current media being used in bio-towers, and in degasification systems for protein skimmer and ozone contact chamber sumps. HD Q-PAC® has the highest effective surface area of any bio-media on the market (132 - 300 ft²/ft³), and by far the highest number of drip points (75,000/ft³). Its unique air-liquid interface design allows for excellent aeration and contaminant removal performance. With its open construction and rounded rod structure, HD Q-PAC® exhibits low pressure drop and excellent support of microorganisms.

CONTACT LANTEC

HD Q-PAC® prices are comparable to competitive bio-media, so the decision to use HD Q-PAC® in aquarium and aquaculture water treatment applications is a no-brainer!

- Please contact Lantec.
- Lantec Products Inc

50 Redfield, Ste. 207
Boston, MA 02122

- Tel: 617-265-2171
- E-mail: sales@lantec.com
- Web Site: www.lantec.com.

SEE AD PAGE 22

Commercial Aquatic Heating & Cooling Solutions

Delta Hydronics provides commercial heating and cooling solutions for aquaculture, hydroponics and zoo habitats. Since 1988, Delta has been building turnkey systems on site as well as shipping preplumbed heating/cooling packaged systems for end user installation in commercial aquatic operations, institutional research facilities and public aquarium systems.

Traditional Designs: Delta's heating and cooling systems are designed using commercial chiller and boiler equipment

in conjunction with properly sized heat transfer systems. Typically plate heat exchangers (PHE) or immersion grid coil (IGC) designs are selected based on corrosion resistance, adaptability to filtration piping systems, cost and maintainability. Delta's heat transfer skids are preplumbed using nonmetallic pumps, CPVC piping, NEMA-4 electrical enclosures and assembled on noncorrosive fiberglass reinforced polyester skids.

Efficient Heating: Over the past twenty years natural gas and propane fired commercial heating systems offered our clients the most efficient and reliable solution. Utilizing dual centralized high efficiency boilers servicing multiple IGC or PHE heat exchangers provides the client with redundancy and energy efficiency.

Efficient Cooling: Large volume and multi-tank aquatic systems are excellent applications for commercial multi-compressor 3/PH centralized chiller systems as an alternative to multiple single compressor 1/PH chillers. Staging

SAVING FISH IS WHAT FRESH-FLO DOES BEST

SAVING ENERGY IS A NEW TALENT

■ New Line of Watt saver Aerators Can Save Up To 43% In Energy Use.

■ Same Outstanding Design Proven for Adding Oxygen To Lakes, Ponds, Raceways.

Keep your fish healthy—and your operating costs down. Fresh-Flo now offers a new, optional line of aerators equipped with Watt saver motors on 1/3, 1/2 and 1 hp. models. Choose standard Fresh-Flo aerators, or new Watt saver models, and experience the long term dependability and big time efficiency only Fresh-Flo aeration can provide.

RS No. 209

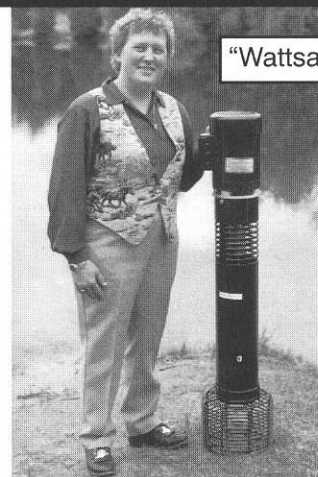

"Wattsaver"

12-VOLT transport aerator --



has new long life Leeson-built motor. Fresh-flo's unit is best in business.

FRESH-FLO CORP.

3037 Weeden Creek Rd., Sheboygan, WI 53081 U.S.A.
Ph: 920-208-1500, Fax: 920-208-6533
E-Mail: freshflo@excel.net; Web site: www.freshflo.com

of multi-compressor centralized chillers compared with concurrent cycling of multiple single stage chillers significantly reduces the clients kW demand charges resulting in utility cost savings.

New Cooling Tower Product: Delta's new Aquatic Cooling Tower is designed for large indoor or outdoor tanks providing evaporative cooling, degasification and aeration where pond style aerators are not suitable. This low cost efficient cooling system is effective where moderate cooling is needed to maintain system temperatures; the aquatic tower is designed with large fill PVC media, optional particle screens, noncorrosive fiberglass basin and FRP panel construction. Performance is location specific based on wet bulb temperatures.

Efficient PHE Heat Transfer: In seawater systems titanium heat exchangers are typically utilized due to its noncorrosive and high thermal heat transfer properties. Titanium PHE units are inherently the most thermally efficient and are utilized for cooling and heating applications. The limitation

of PHE applications is system water quality as plates tend to foul over time in minimal filtration and natural aquatic system designs. All PHE's will require annual cleanings and eventually complete regasketing based on operating environment. The benefit for clients using PHE units is that they can be 100% reconditioned at a fraction of replacement cost. Delta Hydronics offers complete plate regasketing and reconditioning services for all model heat exchanger manufacturers.

Efficient IGC Heat Transfer: Immersion grid coils are fabricated in 316ss for freshwater and titanium for seawater and a suitable for individual in-tank aquatic heating and cooling applications or utilized in a common filtration sump. These efficient exchangers are durable, providing long life spans and are perfect for smaller (< 100,000 BTU) heat transfer loads.

Material Scarcity: Historically heat exchangers have been constructed of copper, stainless steel and titanium all of which raw material costs have increased over the last two years. Worldwide

demand for metals from developing nations will keep inventories low and prices high for the long-term. The use of polyethylene or polypropylene heat exchangers are becoming a viable economic alternative to traditional heat transfer metals pending application.

Energy Inflation: Worldwide demand for energy will require existing aquatics entrepreneurs and new start-ups to invest more capital upfront in the foreseeable future for energy efficient building designs and higher efficiency mechanical systems (pump motors, heat exchangers, boilers, chillers, energy management) to safeguard against energy costs relentlessly outpacing historical 2-4% annual inflation.

Renewable Energy: Solar based heating systems desired by aquatic system designers have not been economically justifiable based on traditional ROI criteria and projected length of ownership. Additionally, solar based energy systems did not accomplish the intended job 100% of the time. Solar assisted designs were often dismissed as a noble green idea but not a sound business decision. However, energy economics, climate change and efficient designs of flat panel solar collectors now make solar assist a viable option in union with traditional mechanical systems.

Future Energy Hybrid Solutions: Aggressive engineering of traditional commercial chiller, boiler and heat exchanger systems in conjunction with purposefully sized solar collection and small natural gas fired cogeneration systems will be a way for future aquatics entrepreneurs.

Delta Hydronics can furnish engineered turnkey solutions for commercial aquatic heating and cooling applications from traditional fuel fired system to hybrid renewable energy designs incorporating economically viable alternatives.

- Contact Information
- Visit www.deltahydro.com
- Telephone:(727) 938-2225
- e-mail info@deltahydronics.com

SEE AD PAGE 58

WISCONSIN FLOWGATE & CULVERT

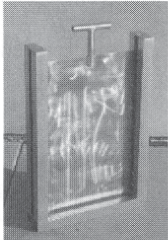

Watertight Gate

Tele: 1-866-FLOGATE (356-4283)
FAX: 715-325-6213
E-Mail: wisflow@tzn.net

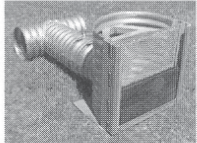

Flowgate with Screen

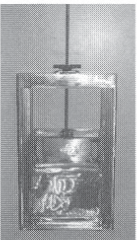

Dual Purpose Slide Gate

RS No. 281

Custom Aluminum Fabrication, aluminum flow gates, culverts, liftgates, fish ladders, lift pump structures, full circle risers, bottom draw gates, water tight gates, screens, trash racks, anti-swirl racks, security covers, anti-sweep collars, and custom angle elbows and tees.

Fish Farms For Sale

MS OPERATION – 14+ acres w/4 ponds w/public utilities & deep well for maintenance. 3 BR, 2 BA home, 24x24 outbldg w/apartment. No state tax on retirement income! **\$89,500**

RAISE FISH! – 36 acre former catfish farm w/4 ponds & pumps. Fenced & x-fenced. 3 BR, 2 BA MH. Near lake. **\$94,500.**

UNITED COUNTRY, 1-800-999-1020, Ext. 99.
www.unitedcountry.com

RS No. 329

New UVS And Heaters From Aqua Logic® Building Environments For Life

Since 1989, Aqua Logic, Inc. has been designing, producing and servicing aquatic system requirements of Universities, Research Labs, Public Zoos & Aquariums, Aquaculture, Seafood Industry, and Hydroponics around the world. Our sales and design staff have extensive experience in designing, developing, and refining aquatic life support components and systems. We offer a broad range of standard and customized products that have an excellent reputation for usability, reliability, and support before and after the sale.

Our product line includes both air cooled and water cooled Delta Star® table top inline chillers (1/5hp-1.5hp),



Master of Science in Mariculture

A degree program offered by Texas A & M University - Corpus Christi

The program will provide students with courses specifically designed to emphasize mariculture as both a science and a business. Students in the program will have access to aquaculture/mariculture facilities in the Corpus Christi area in addition to others at the state, national and international levels.

The Master of Science in Mariculture degree requires satisfactory completion of a minimum of 36 semester hours and an oral comprehensive final examination. Students may select an internship (Option 1) or research track (Option 2) according to their interests.

For more information, please contact:

Dr. David McKee

College of Science and Technology
Texas A&M University - Corpus Christi
Corpus Christi, Texas 78412
361-825-2676 Fax 361-825-3719

www.sci.tamucc.edu/pals/mari.html

RS No 061

Reliable & Easy to Use Knife Gate Valves

Perfect for drain, low pressure or vacuum line applications. Built using our 25+ years of experience.

- Quick draining - simple pull/push motion
- Complete drain - full port opening
- Water tight seal - knife paddle with seals on both sides
- Versatile - available in popular sizes: 1", 2", 3", 4", 6" and 8"



RS No. 973



Call 818-898-1671, ext. 15 to see how easily Valterra Gate Valves will work for you.

Cyclone® drop in coil chillers (1/5hp-1/2hp), Multi-Temp skid mount inline chillers (2-25hp), Titan heat pumps 1/4-20hp) all manufactured with titanium heat exchangers. Our **TITANIUM** heat exchangers are completely saltwater compatible and provide maximum heat transfer. We have established a solid, reputable name by building the best water chillers available in the industry.

Aqua Logic's **NEW** Compact Mega Watt UV Sterilizers (see picture) pack the most UV killing power in a minimal amount of space. Its unique design also allows for higher kill rates with less wattage than competitor brands. The large inlet and outlet connection, and large "dwell" chamber maximizes the lamps killing power at high flow rate.

All models use quartz sleeves for more convenient changing of lamps and for use in any water temperature. Easy to maintain; the only tool you need is a Phillips screwdriver. Single ended access from the top of the unit makes for easy and quick lamp changes, requiring only 22" of clearance. A large viewing window allows for visual inspection of each lamp operation.

Electronic ballasts allow for cooler, more reliable operation and enclosed in a NEMA4X housing. Standard units operate on 100-120vac/50-60Hz electrical supply. 220vac.50-60Hz models are also available

Aqua Logic's **NEW** in line titanium heater is the latest addition to our growing product range. Pure Titanium flow tube and elements ensure its stability for use in all aquatic systems, including salt water. All units come fully equipped with Digital thermostat for precise temperature control demanded by professional fish keepers, breeders, and researchers. Engineered for safety and efficiency each unit includes a highly sensitive flow switch, high limiting safety thermostat and integral contactor / relay. Available from 1.5 - 8 kW.

Aqua Logic also offers a wide range of Titanium Heat Exchangers. Many styles are available and include tube in shell, plate and frame, water to water packs, refrigerant to water packs, and direct immersion coils.

Aqua Logic's complete tank systems include the water chiller with temperature

controller, water pump, biological / particulate filter cells, venturi aeration, lids and removable dividers. These tanks are made of insulated ABS plastic and thermal pane acrylic windows to prevent water condensation on the outside viewing windows. All systems are compatible for both Fresh and Saltwater. **CUSTOM** fabricated insulated tanks systems and PVC tanks are also available.

Visit our **NEW WEBSITE** www.aqualogicinc.com for information on our complete product line of aquatic products.

Call the industry source today and experience the benefit of American made products, ingenuity and value contact.

- For More Information
- Aqua Logic Inc.,
8268 Clairemont Mesa Blvd.
Suite#302,
San Diego, California USA.
- Telephone: 858-292-4773
- Fax: 858-279-0537
- E-mail: info@aqualogicinc.com
- Web site: www.aqualogicinc.com

SEE AD PAGE 57

Process Technology

Process Technology strives to be a symbol of quality, safety, and innovative product design. We've met this goal by manufacturing an unparalleled line of electric immersion heaters, heat exchangers, in-line heaters, and temperature and liquid level controls.

Established in 1978, we have set the benchmark for industrial fluid heating and cooling products. We service a variety of industries including metal finishing, pharmaceutical, and printed circuit board. We've serviced the aquaculture industry for over 20 years, and we found a need for quality industrial heating products specifically designed for aquaculture. As a result, Process Technology developed an extensive line of electric heaters and controls to meet the precise requirements of the aquaculture industry.

Heating water is relatively simple compared to heating industrial chemicals. Heating chemicals requires expensive corrosion resistant materials. Our aquaculture heater line is built to the same exacting standards as our

industrial product line, but with materials appropriate for fresh and salt water heating requirements (titanium for saltwater applications, and stainless steel for freshwater).

Process Technology was the first company in the world to incorporate thermal protection devices as a standard feature in our immersion heaters to provide the utmost in safety to our customers. This safety device acts as an emergency shut off for the heater in the event it is turned on without being immersed in water. An immersion heater run "dry" can be a significant safety hazard. Please note that immersion heaters should never be "submerged" completely in water. They should be installed so that the "hot zone" of the heater is always immersed in the water and the head of the heater is mounted out of the water.

Our aquaculture products include electric immersion heaters sized from 1,000 watts for small tanks, up to 36,000 watts for large volume applications. We manufacture both over-the-side and bottom style heaters in a variety of configurations to match most any requirement. For superior service life, we utilize higher quality 316L stainless steel instead of the traditional 304 stainless. The standard line of heaters also offers innovative design features including unique screw cap heads, ten-foot electrical leads and compact size.

Thermostats to regulate the electric immersion heaters are offered in two different versions: digital display and non-indicating. Our popular digital control has LCD readout with a temperature scale that reads in either Celsius or Fahrenheit. It is accurate to +/- 1 degree.

For steam or hot water heating systems, Process Technology manufactures heating and cooling coils in stainless and titanium, and also offers temperature controls, solenoid valves and strainers. Our product line also includes immersion heat exchangers, in-line heat exchangers and in-line electric heaters. Standard and custom configurations are available.

Process Technology aquaculture heater products also include EASYPLUG(tm) heaters and controls. These heaters are designed for standard electrical circuits up to 30 amps. The heater simply plugs



into the temperature control and the control plugs into an electrical outlet. Hardwiring the heater and control is eliminated, so installation is fast and easy. Our entire line of products is cUL listed (conforms to UL and CSA standards). The heaters are fully grounded. As with any electrical device used near water, however, a GFP in the circuit is recommended for additional safety.

EASYPLUG™ highlights:

- Plugs in easily. No complicated or messy wiring.
- Heater head is o-ring sealed for moisture resistance.
- Compact heavy-duty construction.
- Titanium for saltwater or stainless steel (316L) for freshwater.
- Ample wattage selection (1000-3500 watts).
- Sized for up to 30 amp breaker electrical service.
- Available in 120 or 240 volts.
- Digital thermostat with LED read-out.
- Precise temperature control, (1°F). cUL listed, CE compliant.

Standard catalog items as well as custom-engineered products make this the most complete heating product line available in the aquaculture industry today. Proudly celebrating its 30th

anniversary in 2008, Process Technology will continue to offer customers the best in design, quality, manufacture, performance, and safety.

- For More Information
- Process Technology
7010 Lindsay Drive
Mentor, Ohio 44060
- Phone: (440) 974-1300
- Fax: (440) 974-9561
- Eastern U.S./Canada: 1-800-621-1998
- Western U.S./Canada: 1-800-621-1999
- www.process-technology.com
- E-mail: info@process-technology.com
- Editorial contact:
Christine L. Venaleck, Advertising
Manager
- Telephone: (440-974-1300 ext. 326)
- email at cvenaleck@process-technology.com.

SEE AD PAGE 12

Advanced Aquaculture Systems

Advanced Aquaculture Systems, Inc. specializes in the design of simple, dependable and energy efficient aquaculture systems to meet your exact site and budget requirements. Since 1984, Advanced

SHRIMP & FISH Swimming in DIRTY WATER?



DECOTEX Netting and Micron Rated Mesh

Decotex has been supplying fabrics since 1985 to industry for filtration and industrial end uses.

Aquaculture Nettings for farm ponds, such as Shrimp and Fish has been one of Decotex main focus for many years.

Decotex nylon cloth is woven and/or knitted from strong, heavy duty yarns. Micron ranges from 1 micron to 2000 micron to suit your farming needs. (supplied in raw goods form).

Micron rated nylons endure heat and sunlight very well. Meets outdoor weathering criteria nicely. Ask us about micron rated cloth for your dividers, raceways, pond separators, screens and filtration needs.

DECOTEX, INC.

63 East Main Street Pawling, NY 12564

Ph: **845-855-1863**

Fax: **845-855-1865**

Contact: Karen@decotex.com

www.decotexinc.com

RS No. 310

PUNGO FISHERIES

Producer of Hybrid Striped Bass

**We Can Load or Ship
Chilled Water for
Summer Shipping**

**Pungo Fisheries Emphasizes
Customer Service**

and

**We Produce the Best Hybrid
Striped Bass**



For more information, contact:

Archie Cook or George Sugg

Pungo Fisheries

334 Shirley Farm Road

Pinetown, NC 27865

252-943-6921

252-943-6925 (fax)

RS No. 333



Aquaculture Systems, Inc. has developed many proprietary products and system designs specifically for aquaculture production applications. In addition to our extensive line of AQUACUBES® and Perma-Bead™ media and filters, we also have hundreds of models of energy efficient regenerative blowers, swirl separators, drum micro screen filters, UV sterilizers, water pumps, tanks, and many other quality proven and dependable components all at factory direct prices. Best of all we provide professional systems design and technical support services for all types of aquaculture projects based on over 25 years of experience.

Advanced Aquaculture Systems, Inc. is now offering an expanded product line of proprietary, innovative components including our NEW Perma-Bead™ media that replaces sand in any rapid sand filter and eliminates clogging and channeling. Autobackwash Perma-Bead™ filters with optional UV sterilizers are also available in a range of flow rates to meet your project requirements. We also offer our NEW Directional AQUACUBES® that produce a directed, adjustable current of aerated, degassed and bio-filtered water in any tank or pond system. Both our Directional and Standard AQUACUBES® operate maintenance free and provide complete aerations, degassing, biological filtration, circulation, and foam fractionation to any recirculating system or pond. The air powered, energy efficient AQUACUBE® is available in four standard sizes and processes large volumes of water without water pumps, submerged electrical wires, chemicals or replacement parts and are guaranteed for five years of trouble free operation.

Applications for Directional

AQUACUBES® are numerous and include circular tanks where they produce a rotational flow end in rectangular tanks, raceways and large outdoor ponds to produce directed linear flows. In all of these sites they produce a vigorous current of processed water that simultaneously aerates, strips carbon dioxide and other gases and provides biological filtration. As with our standard AQUACUBES®, the flow rates through our new Directional AQUACUBES® are individually adjustable. This allows you to “fine tune” the flow pattern in your tank or pond to create the ideal circulation pattern to meet changing environmental or production requirements.

For further product information and more about our complete professional system design and technical support services for simple, maintenance free aquaculture systems, please contact:

- Advanced Aquaculture Systems, Inc.,
4509 Hickory Creek Lane,
Brandon, FL 33511,
- Tel: 813.653.2823,
- Fax: 813).684.777,
- Website: www.advancedaquaculture.com.

SEE AD PAGE 65

Wisconsin Flowgate & Culvert

Wisconsin Flowgate & Culvert (WFG) has been in business since 1955. Their specialty is design and fabrication of water control devices which include single, double, and triple log flowgates, culverts, liftgates, fish ladders, lift pump structures, full circle risers, bottom draw gates and Gottschik valves. These products are used to regulate water levels for wetlands, cranberry farming, aquaculture and waste disposal projects to name a few. The majority of these products are manufactured from aluminum to resist corrosion and provide a lifetime of service.

Accessories and options for the above products include; trash racks and screens to keep debris, animals, and fish from entering the flowgates, security covers to prevent vandalism, anti-seep collars to prevent washouts or animals burrowing

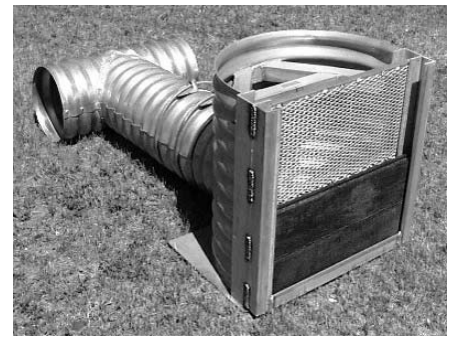

parallel to culverts, and anti-swirl collars to reduced whirl pooling at full circle risers. Liftgates are available sized to your requirements with a gearbox for motorized operations or handwheels for manual operation.

Aluminum flowgates are available in widths from 24 inches to 96 inches and heights up to 25 feet. Culverts are available in aluminum or galvanized steel in standard diameters from 12 inches to 72 inches. Full circle risers come in standard diameters from 24 inches through 120 inches and heights to fit the customer's requirements. Aluminum products are designed and manufactured to fulfill the customer's needs. WFG also manufactures perforated galvanized culverts for aeration of stored potatoes, campfire rings, roofs for fuel containments, and aluminum window wells. Plastic culverts and drain tile along with the fittings and accessories are also part of WFG's product lines. Floating spill containment booms in 50 feet and 100 feet lengths are also available.

Wisconsin Flowgate & Culvert has manufactured a variety of products for the U.S. Fish and Wildlife Service, Wisconsin Department of Natural Resources, Duck's Unlimited, various cranberry growers and the aquaculture industry.

WFG takes pride in the quality of the products they manufacture and constantly strives to fulfill the needs of their customers. If you have any questions or require further information please contact

- WFG
- Telephone: 715.325.3302
- Toll Free 866.356.4283
- Fax: 715.325.6213
- Email: wisflow@tznet.com

SEE AD PAGE 60

Helping Fish Is What Fresh-Flo Is All About

A healthy body of water with the proper amount of oxygen is the sign of another Fresh-Flo aerator working to save fish. A steady supply of live insects to a pond surface is the sign of another Bug Lite Fish Feeder, today's latest success story for Fresh-Flo Corporation, Sheboygan, Wisconsin. "Like our aerators, the Bug Lite has become known for its success at doing the job for which it was designed. As a result, Bug Lite sales have increased steadily and we project a 15% increase this year," say Barb Ziegelbauer, President of Fresh-Flo.

Normally installed on a pole set a convenient distance from shore, Fresh-Flo's fish feeder utilizes a black light and a heavy duty fan to attract and stun swarms of insects especially during the nighttime hours. It has become an important source of live insects as protein



rich fish food.

In a period of high energy costs, the Fresh-Flo Wattsaver line of aerators draws special interest with its capacity to save up to 40% in energy use. Featuring an efficient aeration process of sandwiching air between layers of

water, all Fresh-Flo aerators are available in 1/3, 1/2, and 1 hp. Models. Their long term dependability has been proven over the years in fish-saving operations for fish farmers, fish hatcheries, lake property owners, and industrial, commercial, and private ponds.

SUPERIOR raceway systems

Patented*

Flexible to your aquaculture needs.

Environmentally responsible, financially friendly, and simple, this system provides a unique and flexible mechanism for high-density fish rearing. The floating flow-through application shown below uses the economy of air lift pumps for water movement and removes most solids before discharging into pond, which easily handles denitrification, dissolved nutrients and further aeration.

WHY IS THIS DESIGN SUPERIOR?

- Floating or in-ground use
- Virtually indestructible plastic
- All climate, year-round use
- Ease of cleaning
- Superior observation of fish
- Radically customizable
- Economy of operation
- Flow-through, recirc, or hybrid
- Affordable initial cost
- Easily moved
- Sold as a "kit" with or without docks or as turnkey operation
- Professional technical support

Please visit: superiorraceways.com



Floating raceways surrounded by ice.

THE SUPERIOR SYSTEM PERMITS:

- Improved biosecurity
- Predator control
- Use in ponds, marshes, quarries, etc.
- High density stocking
- Variety of fish species
- Polyculture
- Observation of fish health and feeding
- Ease of cleaning
- Water temperature modification
- Grading and sorting
- Disease and parasite control
- Water quality monitoring
- Divisions within a raceway
- Easy movement; raceways rollup
- Very long life (all plastic and stainless)
- Back-up alarms, telephone alerts, etc.
- Greenhouse erection
- Boat dockage/entertainment
- Professional technical support options

Corporate office: 715.340.0932

* Manufactured under one or more patents, including U.S. Patent #7069875. RS No. 227
Designed, manufactured, sold, and supported by Superior Aquaculture LLC ©2006 Superior Aquaculture LLC

WHICH AQUACULTURE SYSTEM DO YOU NEED?

- ✓ High density recirculating systems?
- ✓ Extensive pond systems?
- ✓ Research systems?
- ✓ Ornamental systems?
- ✓ Patented, low energy, minimal maintenance products!
- ✓ AQUACUBES[®], Non-clogging Perma-Bead[™] media, Preassembled autobackwash Perma-Bead/UV Filter Systems, UV Sterilizers, Drum Filters, Swirl Separators, Regenerative Blowers, Silent Air Pumps and more...
- ✓ Professional Service Since 1984!
- ✓ Free System Design and Technical Support Services!



Call us to discuss your project requirements!

ADVANCED AQUACULTURE SYSTEMS, INC.
4509 Hickory Creek Lane • Brandon, FL 33511
Phone (813) 653-2823 • Fax (813) 684-7773
www.advancedaquaculture.com/aquaculture

RS No. 111

In transport aerators, the best known single unit is probably the Fresh-Flo Model TT. Here, the importance of high efficiency aeration becomes most important on those long hauls. That's why when you see a large fish delivery truck making its rounds, there are probably nine or ten Fresh-Flo aerators inside - all doing their thing.

Termed "absolutely the most convenient adjustable fish grader," Fresh-Flo's "Mag" speeds accurate grading by width. The easy-to-use grader is well liked because it promotes regular grading, which stimulates growth, and helps prevent cannibalism.

In addition to league leading products, Fresh-Flo also offers top shelf service from its headquarters in Sheboygan. It's here that fast, pleasant help delivers the products and information and parts you need to keep fish-producing operations in full gear.

• Call, write, fax, or e-mail for more information:

- Fresh-Flo Corp.,
3037 Weeden Creek Road,
Sheboygan, WI 53081.USA
- Phone: 800-493-3040,
- Fax: 920-208-6533,
- e-mail: freshflo@excel.net.

SEE AD PAGE 59

Algaecontrol.US Announces New Version Of LG Sonic

AlgaeControl.US has announced that an updated version of the LG Sonic product has arrived in the United States for immediate distribution. The new product revision includes up to sixteen different ultrasound waves, an upgrade from eight different sound waves in previous products. The LG Sonic product provides the widest range of frequencies available to kill the widest variety of algae without the use of chemicals.

"The LG Sonic ultrasonic algae control devices have had a significant impact in all market segments since first introduced to the US market in 2006", stated Kevin Hutchinson, CEO of South Santee Aquaculture, Inc., the parent



company of AlgaeControl.US. "We are excited with the new product revision which will allow the technology to have an even greater impact on algae control with double the frequencies."

The units transmit a series of ultrasonic vibrations through the water in a beam shaped much like a tear drop. The maximum range is 150 meters for green roaming algae and up to 400 meters for blue-green algae. The vibrations match critical resonance frequencies of vital algae membranes causing them to tear or break and ultimately causing the algae to die.

The devices are available in various ranges for different kinds of applications including lakes, ponds, potable water and waste water systems, aquaculture raceways, pools, and Koi gardens. The ultrasound vibrations are harmless to humans, animals, fish and aquatic plants. Ultrasound technology is the easiest and most effective way to kill nearly every form of algae without chemicals.

ABOUT ALGAECONTROL.US:

AlgaeControl.US is a division of South Santee Aquaculture, Inc. created as the exclusive US distributor of the LG Sonic product line of ultrasonic algae control products with complimentary eco-friendly pond management products and services.

AlgaeControl.US products are currently offered through an authorized dealer network in the United States. Their territory encompasses continental North, Central, and South Americas and Caribbean Islands.

ABOUT SOUTH SANTEE AQUACULTURE, INC.:

South Santee Aquaculture, Inc. began as a commercial pond management company servicing the east coast of South Carolina. The company expanded

seventeen years later in 2006 by forming the AlgaeControl.US division as the exclusive US distributor for the LG Sonic ultrasound algae control devices. In 2007 the company expanded further by merging with Swimming Rock Fish Farms to expand their existing aquaculture operations to include a wide variety of aquaculture species. Currently the company is providing consulting services based around "green solutions" for algae control, aquaculture, and pond management to clients worldwide.

• Contact:

- D. Laureen Earnest
- Business Development Manager
AlgaeControl.US
- Telephone: 888-2542387
- Telephone: 888-Algae-US
- website: <http://www.algaecontrol.us>

SEE AD PAGE 11

Aquanate.com

Aquanate.com provides online data management for aquaculture companies.

- Tank Inventory Tracking
- Feed Purchasing
- Feed Inventory Tracking
- Feed Conversion
- Tagged Fish Management
- Mobile PDA Interface
- Customization Included
- For More Information
- info@aquanate.com
- Telephone: 206-841-3023

SEE AD PAGE 56

Pacific Coast Imports

Sea Line Aquatics 2007 Platinum Series chiller represents a significant step forward in water cooler engineering, offering state-of-the-art technology at highly competitive prices. With five models available, you can chill up to 1250 gallons quickly and efficiently with reliability you can count on. The heat exchanger is made from high-quality pure titanium and is suitable for both fresh and saltwater applications. It is sleek and durable in design with a strong steel chassis, yet its contemporary look will not look out of place. The digital thermostat is accurate and will retain the temperature set,



even after a power outage. Our chillers are the quietest on the market and use environmentally friendly refrigerant.

Sea Line chiller specs
 SL150 1/10HP
 LWH 16.5x9.8x14 33lbs
 1/2" 5/8" hose connection
 BTU 1200
 10 degree 85 gallons
 30 degree 40 gallons
 Flow rate - 200 min-350 max

SL300A 1/4HP
 LWH 18.7x14x19 44lbs
 3/4" hose connection
 BTU 3000
 10 degree 180 gallons
 30 degree 100 gallons
 Flow rate - 350 min-700 max

SL500A 1/2HP
 LWH 18.7x14x19 48lbs
 3/4" hose connection
 BTU 6000
 10 degree 400 gallons
 30 degree 200 gallons
 Flow rate - 400 min-800 max

SL1000B 1HP 71lbs
 20x15.6x18.7
 1" hose connection
 BTU 12,000
 10 degree 1000 gallons
 30 degree 600 gallons
 Flow rate - 500 min-900 max

SL1000BH 1HP Heater/Chiller
 72lbs
 20x15.6x18.7
 1" hose connection
 BTU 12,000
 10 degree 1000 gallons
 30 degree 600 gallons
 Flow rate - 500 min-900 max

To find the correct chiller size or pump for your application, please contact us at (503) 982-6700. One of our friendly sales associates will assist you!

Also try our new Sea Line Pumps, five sizes now available.

The pumps are super silent. They can be mounted externally or submerged. They have an energy saving electric motor, polished ceramic shaft and ceramic bearings. All these qualities ensure a high jet, large flow and a long durable life.

SEE AD PAGE 21

Mossy Oak Properties Land Exchange

What a great opportunity to introduce our real estate company to the world of aquaculture. We are excited to have been introduced to this publication, and expect to meet lots of great folks through our association here.

Mossy Oak Properties, LAND EXCHANGE, located on I-55 in Crawfordsville, Arkansas, is in the midst of preparing it's corporate headquarters for the busy times ahead. Ultimately, the facility will house the corporate offices, the company's Crittenden County real estate offices, a hospitality area, and an auction facility.

YES, you read it right!!
 "AUCTION FACILITY"

The man with the vision, and the founder of this organization is none other than Bruce Colbert, of Marion, which is just minutes away from "the place that is to be". His credentials include:

Principal Broker; A A R E
 CES; BAS; CAI & Director, Ark.
 Auctioneer Assn.

Being licensed as both a broker and auctioneer in the States of ARKANSAS, ALABAMA, FLORIDA, LOUISIANA, MISSISSIPPI, TENNESSEE and soon to be OKLAHOMA,

Bruce has a vision of bringing the traditional service of real estate agencies together with the growing and dynamic move to the auction block for various specialty marketing needs, thereby, providing the real and personal property

communities with optional methods of procurement, as well as liquidation.

LAND EXCHANGE

A Mossy Oak Properties franchise agency with a vision. Numerous franchise locations are being targeted, to establish LAND EXCHANGE across the south as the agency folks know about.

The corporate facility will not only be used for typical "office" operations, but will also be the center for many activities, which include multiple property auctions, from real estate to vintage guns and sporting equipment.

The LAND EXCHANGE AUCTIONS will be on site or at the Crawfordsville facility, whichever is deemed best for the interest of the sellers, and while the physical location may vary, there is one thing that can remain constant.

THE WORLD WILL BE IN ATTENDANCE!

That's right,,,CyberSpace will be alive with online bidding!

At this writing, it's all coming together. New franchises, new brokers and agents, new staff with credentials and the personal commitment to supply the public with professional, timely, and loyal representation, assisting them in their efforts to adjust their real and personal property holdings.

The Grand Opening of our newly renovated facility is expected this Fall, with the date(s) yet to be announced, however, in the mean time.

WE ARE "AT YOUR SERVICE NOW"

For fabulous St Francis River hunting land(below), or what may be the croplands/fishery of your dreams.

GIVE US A CALL!

1057+/- acres of ducks & deer!

\$1350 per acre

Farms: row crop/fish/sod

Recreational and Income Producing Properties

- For More Information
- President & CEO
- Bruce Colbert
- Telephone: 901-517-8383
- bcolbert@mossyoakproperties.com
- Executive Broker
- Randall Page
- Telephone: 501-454-4943
- rpage@mossyoakproperties.com

SEE AD PAGE 48

**FOR SALE:
TROUT FARM & BULK
WATER HAULING
STATION**



21 acres with large clay ponds and hatchery tanks, state inspected processing building. Unbelievable quality artesian water from three wells that free flow 500-gpm each (one potable). All permits and zoning are in place to haul bulk or bottled water. Almost tanker ready with brand new quality building.

Price includes newer ranch home, farm with all fish inventory, and equipment. Located five miles from Interstate 39, sixty miles north of Madison, Wisconsin. Conveniently located between Chicago, Milwaukee, and Twin Cities. Very beautiful recreational area with creek frontage, towering oaks, wildlife, and great deer hunting opportunities. Only serious inquires. RS No. 365

PRICE: \$799,000

Contact Chuck or Jenny Anderson
608-296-2834
Westfield, Wisconsin family run
business for 27 years.
witrou@maqs.net

**EMERSON'S
RAINBOW TROUT**

Over 50 years of Live Delivery
Most Sizes Available Year Round



CRYSTAL LAKE

Fisheries, Inc.
RS No. 269

Rt. 2 Box 528, Ava, MO, 65608
Ph: 417-683-2301

www.crystallakefisheries.com
e-mail: info@crystallakefisheries.com



ETI's Silkstream

ETI's Silkstream

ETI's new 10 Inch Diameter SILKSTREAM™ continues to enjoy success in the aquaculture market with recent sales to salmon farmers in Canada, Scotland and the US, with additional deliveries to Cobia farmers at two different sites in the Caribbean. The new larger SILKSTREAM is being successfully used to pump fish of over 10 Kg, without damage to the fish. ETI has over 200 of its 8 Inch and 10 Inch Silkstream fish pumping systems in operation around the world.

ETI has also recently delivered its new FEEDMASTER(tm) systems to shrimp and fish farms in the Arabian Sea and for feeding underwater cages in Hawaii. The new FEEDMASTER is able to feed up to 200 acres of shrimp or tilapia ponds with a single feeding system and can feed up to 30 floating or underwater cages per system. ETI's new TRANSVAC(r) shrimp harvest pump has been delivered to 8 different shrimp producers in the last few months. ETI has over 1200 TRANSVAC fish transfer systems in operation on six continents around the world.

- Additional information on ETI
- ETI Inc.
219 Frontage Rd.,
N. Suite A,
Pacific, WA 98047 USA,

- Telephone: 253. 804.2507
- Fax: 253.804.2581
- email: transvac@aol.com
- web site: www.transvac.com

SEE AD PAGE 8

**New "In-Pond RAS"™
Technology Available**

New adaptations of the recently patented Superior Raceways have enabled new, economically feasible projects that previously have been unrealistic. Thousands of acres of U.S. waters, including marshes, estuaries, and quarries are now "farmable". The chart below and the picture poster (elsewhere in this issue) show some comparisons. The units are available, as cost-saving "kits", in any size desired.

As biosecurity and environmental concerns continue to pose significant challenges for aquaculture world-wide, the Superior Floating Raceway system is an excellent response to challenging conditions. As a well-studied and proven technology, the features outlined on the picture poster may be unmatched by any other system.

Fingerling production is especially effective in the smooth, virtually indestructible, flexible, HDPE raceways. Slime removal and mouth fungus associated with abrasion on rough concrete surfaces is significantly reduced,



Superior Raceways

as is tank cleaning. Autoimmune systems of fingerlings are greatly enhanced via the “free”, wild plankton that are “caught” in the raceways when pond water flows through them. For those interested in imprinting their fingerlings, the portability, durability, and inexpensive purchase price make these units an excellent choice.

If you’ve ever experienced “AWOL” (absent without leave) fish, you’re in good company. With Superior Raceways, you will find that pesky predators like birds and otters will be a thing of the past, and your fish will thank you. Content, non-stressed fish grow healthier and faster.

Whether you are a beginning hobby-farmer or an established saltwater “rancher”, the Superior Raceways team of experienced professionals can show you how this very flexible system (physically limited only by your imagination) can work for you.

SEE AD PAGE 65

Mariculture Technologies Inc. Announces A New Division

Mariculture Technologies International, Inc. (Founded 1984) (www.MaricultureTechnology.com) announces

the formation of a new division, Pompano Farms, LLC (www.PompanoFarms.com). During the last five years MTI, Inc. has been engaged in two research and development projects: (1) low salinity earthen pond farming of the Florida Pompano (*Trachinotus carolinus*) and (2) successive strain enhancement of hatchery produced Florida Pompano. Through selection of preferred physical characteristics such as accelerated growth rate, uniformity in body form and decreased variation in growth rate (size uniformity) the company currently has F-2 generation fish in its broodstock center. Within a few months the best performing F-2 fish will be crossed in

order to produce the next selected F-3 generation. The result of these artificial spawnings and selection has given rise to a pronouncedly improved strain of the Florida Pompano for use in farming this species.

The company has established and reported on the successful farming of this species in low salinity water (12 to 19 ppt.) from saline ground water aquifers pumped up from a 460 foot deep well in central Florida. In part, these experiments were to determine if this species could survive and grow normally in this type of ground water. The company has learned many important factors from these pond experiments and is ready to proceed to commercialization using this farming method.

Northeast Brine Shrimp (DBA) of MTI, Inc. celebrates its 12th year in business. This commercial division (www.LiveBrineShrimp.com) supplies farm grown and wild captured live food organisms to the national Pet, Zoo, and Aquaculture industries. With a growing selection of new products, NEBS is looking forward to being of greater service to our industry in the years ahead.

Please see our ad for further product and contact information.

- Contact:
- Mariculture Technologies International, Inc.
- P.O. Box 1020

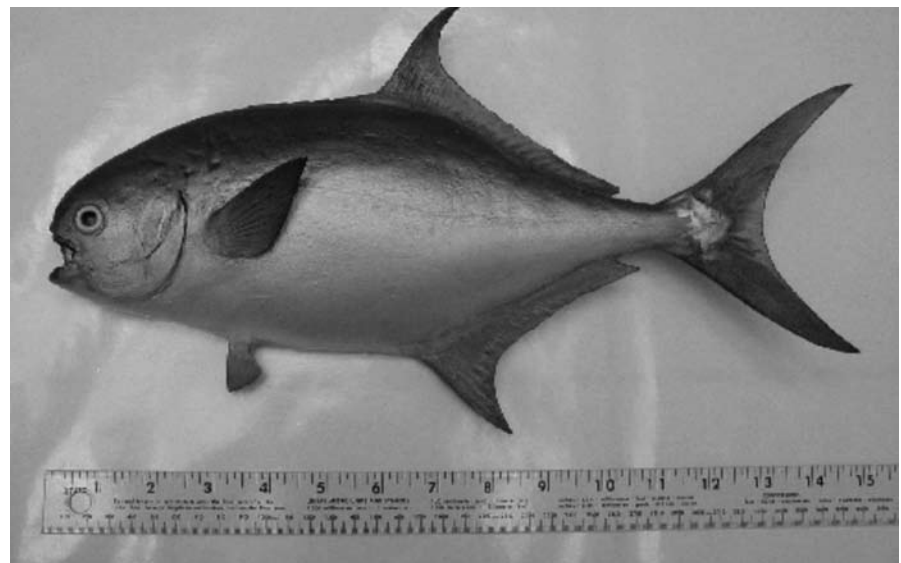

Mariculture Technologies Inc. produces Florida Pompano.



**ALITA LINEAR
AIR PUMP &
AIR DIFFUSERS**

*Efficient, Quiet & Durable
Aeration Pumps*



**3 Years
Limited Warranty**

Compact and Dependable Air Source
for Aquaculture Business

Durable Air Diffuser Hose

NEW!

- Uniform Air Distribution
- Low Loss for any length
- None Clog & Self Cleaning
- pH & Ozone Resistant
- Versatile & Extra Long Life!

ALITA INDUSTRIES, INC.
PO Box 660923, Arcadia, CA 91066-0923, USA
Tel: (626) 962-2116 Fax: (626) 962-2177
E-mail: sales@alita.com RS No. 206

www.alita.com

**SPECIALTY
LIVE FOODS**

LIVE BRINE SHRIMP

FROZEN BRINE SHRIMP

Farm Grown and Nutritionally Enhanced

MANY OTHER PRODUCTS INCLUDING:

- **Live Feeder Shrimp**
(Freshwater & Saltwater)
- **Live Feeder Fish**
(Freshwater & Saltwater)
- **Live Rotifer Cultures**
- **Live Phytoplankton Cultures**
- **Mysid Shrimp**
(Live & Frozen) RS No. 311

WWW.LIVEBRINESHRIMP.COM
386-345-3333

*Celebrating over 30 years
in the mariculture industry!*

**Farm raised Florida
Pompano fry available**
WWW.POMPANOFARMS.COM

Oak Hill, Florida 32759 USA
• Email: Sales@MaricultureTechnology.com
• Telephone (386) 345-3337
SEE AD PAGE 70

**Pacific Ozone
Technology :Ozone
SuperStore**

The Ozone SuperStore™ and new Dual G™ Series Ozone Generators are two new developments for Aquaculture from Pacific Ozone Technology, the world's leading supplier of OEM air-cooled, corona discharge ozone generators and integrated ozone/oxygen systems and process controls.

OZONE SUPERSTORE™

Selecting the proper components is critical to the long lasting performance of an Aquaculture ozone system and installation. Pacific Ozone's engineers continually search the world for the best ozone resistant fittings and accessories for the wide variety of ozone system configurations and installations found in Aquaculture. Now this huge selection of ozone specialty components and accessories are available to Aquaculture operators everywhere.

Contact the ozone experts at Pacific Ozone to help you select the right ozone components, monitors and accessories for a safe and reliable Aquaculture ozone installation. Dustin Sudweeks, in Technical Support, has helped hundreds of ozone users worldwide with their technical ozone needs and can help you with yours. He will assist you in the



**PACIFIC
OZONE
TECHNOLOGY**



selection of the right ozone component solution for your needs. He can offer the most reliable and complete line of components, fittings, and specialty products needed to design, install and maintain your Aquaculture ozone contact or delivery system. Having access to the hundreds of ozone specific parts and accessories as well as Pacific Ozone's technical expertise to support it, is a service you'll appreciate once you try.

**DUAL G™ OZONE
GENERATORS**

The new Dual G™ Ozone Generators are unique in that each unit contains two discrete PID controlled ozone generators that deliver two precise ozone doses for two individual application points with complete individual control of ozone concentration and gas flow. The new Dual-Output and modular Dual G™ Ozone Generator essentially contains dual ozone generators with dual control, combined within a single enclosure. A single power and oxygen connection with two ozone output connections makes them easy to install. The standard NEMA4 enclosure can accommodate two independently controlled robust Pacific Ozone G-Series Generators each operating at different ozone production rates. Each injection (application) site can therefore receive ozone at an operator-specified flow rate and concentration. With each generator having an independent outlet, no downstream control is required, reducing distribution system costs and complexity.

Additionally, with a single power connection and oxygen gas feed port, the installation costs are lower than for a similar number of independent generators.

In a typical Aquaculture recirculation

system, that efficiently uses ozone for filter enhancement and disinfection, about 25% - 33% of the ozone gas flow would be delivered to a foam fractionator and the remainder to the LHO, diffusers or injector for disinfection. Normally such an arrangement would require two separate ozone generators or costly and hard to use multiple ozone-resistant flowmeters and valves to manage and control the delivery of ozone gas to each location. Controlling ozone gas in this manner is complex and does not guarantee that the concentration and volume of ozone gas delivered to each location is consistent with the right strength to consistently do the job.

The dual ozone output and control features of the new Dual G™ are truly distinctive and a great value. The Dual G™ will cost less than two generators and will give you complete control over two separate points of delivery that you don't have with an unreliable and complex splitting arrangement. The Dual G™ can also be used as built-in ozone redundancy in critical life support installations where minimum ozone

down-time is crucial.

Pacific Ozone Technology is recognized as the standard reference for quality ozone air-cooled generators and integrated contact systems. They've developed clean, effective ozone solutions for their customers since 1987, and their knowledge of systems, applications, and ozone technology is unsurpassed. Pacific Ozone Technology hardware is powered by a highly efficient Ti-ceramic and titanium reactor cells that features patented Floating Plate Technology™ (FPT). Available only from Pacific Ozone Technology, FPT offers tremendous performance benefits to any ozone application. Air cooled ozone generators offer distinct advantages as well; ease of installation, reliability, durability and simple system integration. The complete line of ozone generators, integrated feed gas and ozone contacting systems, monitors, controls, and now more ozone specialty parts and accessory items than ever, will ensure that your ozone system will deliver the precise ozone treatment it was designed for. Offering every possible advantage for your ozone

application is what makes Pacific Ozone Technology the only name in ozone that matters. It's no accident that Pacific Ozone Technology is the worldwide leader in ozone generators and system integration.

- Contact Information
- Pacific Ozone Technology, Inc.
6160 Egret Court
Benicia, CA 94510
- Telephone: 707-747-9600
- Email: sales@pacificozone.com
- Fax: 707-747-9209
- Website: www.pacificozone.com

SEE AD PAGE 18

Tremendous Business Opportunity In Wisconsin

Beautiful trout farm and bulk water filling station is being offered for sale. Artesian Trout Farm, which is family owned, is located in a pristine area of Wisconsin. It is also located conveniently near the large seafood



UMI
INTER-OCEAN ENTERPRISE, INC.

Trusted around the world since 1984



***Titanium heat exchangers**
True U-tube design to 40HP

***Titanium Chillers**
up to 160 HP

*** Heat Pumps**
All titanium front ends for long life

***Culture Systems**

***Live Seafood Displays**



**Universal Marine Inc, 2790 Sunnyside Rd.
Anmore, BC V3H3C8 Canada.**

Ph:604-469-6427 Fax:604-469-6437
Email: umi@telus.net
Visit our Web: universalmarine.com

RS No. 356

*World's Largest
Hybrid Striped Bass Fry and
Fingerling Producer*



**Also, we are a major producer of:
Triploid Grass Carp**

KEO FISH FARMS, INC
PO Box 166, Highway 165 N.
Keo, AR 72083

RS No. 737

Tel: 501-842-2872
Fax: 501-842-2156
Email: keoff@futura.net



Artesian Aquafarm is located in Westfield, Wisconsin.

markets of Madison, Chicago, and the Twin Cities just off Interstate 39.

Included in the price is the farm, fish inventory, equipment, newer nice ranch home with walk-out basement, and bulk hauling filling station. This is a very beautiful recreational area with creek frontage and towering oak trees. Three (500+gpm each) artesian wells feed the trout ponds with constant 49 degree pure water flowing from deep beneath the surface. With room to expand the farm produces the highest quality trout in the markets at a premium price. We have hatching and growing facilities with a state inspected processing building (24x30x10). We also smoke fish and do live hauling.

Also included in the price and near completion is a bulk water fill station with all permits in place. The artesian water is superior quality. A brand new (28x40x10) processing building with a small bottling machine is almost complete and ready for inspection.

This is really one of a kind property that can be expanded, with limitless possibilities. Artesian Trout Farms offers you an excellent business opportunity if you are a small businessman or a large seafood company. We will soon be retiring and we are looking for someone to continue the fine business tradition that is Artesian Trout Farm. Only serious inquires please. Financial references will be checked.

- For more information contact:
- Chuck or Jenny Anderson
P.O. Box 111
Westfield, WI 53964 USA

- Telephone:608-296-2834
- witrou@maqs.net .

SEE AD PAGE 68

Owen & Williams Fish Farm Inc.

We are celebrating our 26th anniversary this year. In 1981 we began when Paul Williams and his business partner, the late Ed Owen, started producing channel catfish fingerlings for local growers. Since then we have grown to be the only producer of triploid grass carp and hybrid striped bass in Georgia. Today, Owen and Williams specializes in providing fish for stocking lakes and ponds. Our trucks deliver fish all over the Southeast and we can ship live fish anywhere in the world. Our farm has 10 full-time employees, with two fisheries biologist on staff, and we also have part-time employees in the summer. Owen & Williams has two locations with our main office located in Hawkinsville, Georgia and our grow out ponds are located in Newton, Georgia. We have approximately 300 acres of water, with 80 ponds. Owen & Williams sells several million commercial catfish fingerlings and recreational fingerlings every year. We offer consulting services, pond spraying, pond shocking and aquaculture equipment. Owen & Williams believes that word of mouth is our best advertising and we strive to make every customer happy.

- For more information contact:

- Owen & Williams Fish Farm, Inc.
RR 5 Box 22390,
Hawkinsville, Georgia 31036,
- Telephone: 478-892-3144,
- e-mail- fishsales@owenandwilliams.com .
- website:www.owenandwilliams.com

SEE AD PAGE 44

17 Foot Wide Netting Protects Against Predators

InterNet, Inc. features extra wide 17 foot wide plastic Aquaculture Netting rolls to help protect shell and finfish from predators. The added flexibility and convenience of the wider rolls can ease installation over ponds and raceways as well as other applications. Strong and lightweight netting is easy to work with and is available in lengths up to 5000 feet. 12 foot, 14 foot and other roll widths in a variety of mesh sizes are also offered.

The company has been serving the industry for 26 years with their broad inventory of in-stock products while always offering netting custom sized to meet customer needs. Aquaculture Netting from InterNet, Inc. also includes heavier weight, more rigid netting for a host of applications ranging from cages, pens, traps, grow out bags and more, to plastic tubing for stand pipe filters. Formed, open mesh netting tubes and tubular nets are also available to expand potential aquaculture applications.

Extensive converting and fabrication capabilities at InterNet allow customers to get products to meet their specific requirements. They include slitting, sheeting, die cutting, sonic welding, and packaging to meet customer needs -while still shipping orders promptly.

- To learn more, contact
- InterNet, Inc.,
7681 Setzler Parkway North
Brooklyn Park, MN 55445 USA
- Phone 800-328-8456/763-504-4360
- fax 763-971-0872.
- E mail: info@internetmesh.net.
- website at www.internetmesh.net

SEE AD PAGE 32

Calibrated Air Saturation-Temperature Probe

Aquaculture facilities - particularly those with recirculation capability requiring quality control monitoring of TDGP can now add to their semi-automated systems a compact, simple, calibrated sensor that provides a scaled millivolt output proportional to the Total Dissolved Gas Pressure (TDGP) and also features a temperature sensor. Developed by Common Sensing Inc., the compact probe, which can accept a 6-24 volt DC supply and uses only 2.5 mA, can be directly connected to any computer or data logging device with 0-1.0 volt input. Since it provides a scaled output of 1.00 mV/mm Hg and 10.0 mV/°C, it can be read accurately by any digital voltmeter or can be provided with its own digital display allowing both a dedicated display of TDGP/TEMP and sensor input for control of automated systems. Custom scaling in other pressure units is also available. Common Sensing Inc. first developed probes suitable for measuring TDGP electronically in the late 1970s (1), and this direct sensing method has now become a standard method used extensively in aquaculture, environmental, and industrial applications (2-4). The new probe has been redesigned

with SOIC technology to provide a compact TDGP/TEMPERATURE sensor for "plug and read" applications and is available either as a stand alone probe or with a simple digital display. Precision is better than .3% - more than adequate for most purposes. Membrane replacement is simple and quick and less expensive than previous models.

1. D'Aoust, B. G.; White, R.; Siebold, H. Direct measurement of total dissolved gas pressure. Undersea Biomed. Res. 1975, 2, 141.

2. Dissolved Gas Supersaturation. In Standard Methods for the Examination of Water and Wastewater, 17th ed.; Clesceri, L. S., Greenberg, A. E., Trussell, R. R., Eds.; Am. Public Health Assoc.: Washington, DC, 1989; Section 2810A, pp 2-94.

3. D'Aoust, B. G.; Clark, M. J. R. Analysis of Supersaturated Air in Natural Waters and Reservoirs. Trans. Amer. Fisheries Soc. 1980, 109 (6), 708-724.3.

4. D'Aoust, B. 1989 Gas Bubble Disease- An Appraisal Fish Farmer, May June 1989.

- For More Information
- Common Sensing Inc.
P.O. Box 130
Clark Fork, ID 83811
- Telephone:(208) 266 1541
- FAX: (208) 266 1428
- www.comsen.com
- sales@comsen.com

SEE AD PAGE 30



For Sale Cantrell Creek Trout Farm

Approximately 10 acres located on the pristine headwaters of the French Broad River. The property is located in Pisgah Forest, North Carolina.

HOUSE ON PROPERTY

16 years old house with 2500 square feet of living space. House has 4 bedrooms, 2 1/2 baths .

FARM HATCHERY & EQUIPMENT (14 X 30')

- 30 gpm from well and 50 gpm from creek
- 360,000 3" Fingerlings per year
- Emergency Power backup
- Recirculation Pump and generator for power outage
- Ice Machine
- 2 Fish Hauling Trucks
- 40 Bramlett feeders and stands
- 10 - 12 hour Belt Feeders
- 4 hp Honda gas water pump for Filling Trucks 150 gpm
- 8 hp Gas Recirc pump 300 gpm
- 5 hp Electric Pump 400 gpm
- 3 hp Sta Rite Electric Fresh water pump 80 gpm
- 5 hp Electric agitation pump for 30,000 gal waste storage tank
- 10 hp Electric irrigation pump for 30,000 gal waste storage tank
- 20 - 6' x 48' Paired Concrete Raceways (LHO's in 18)
- 2 - 5 x 12' Concrete Fingerling Tanks
- 40' x 100' Catch-out pond
- 16' x 32' Greenhouses-Heated

WATER SOURCE

Jane Cantrell Creek (Avg. Flow 1,000 gpm)

BUSINESS ADVANTAGES

\$250,000 market in place, annual production for the farm is over 100,000 lbs./year.

FOR MORE INFORMATION:

- Cantrell Trout Farm
P.O. Box 478
Pisgah Forest, North Carolina 28768
- Home: 828-884-9890
- Cell: 828-553-3551
- Website: www.stockrainbow.com
- Email: cselle@citcom.net

SEE AD PAGE 43

Aquaculture Systems Technologies Introduces NEW PolyGeyser “Pneumatically Washed” Drop Bead Filters

Bead Filter Specialists, Aquaculture Systems Technologies, L.L.C. has introduced a new patented PolyGeyser bead filter for the hatchery and aquarium sectors. This is the newest addition to their line of bead filter technologies and the first to exploit the biofilm protection offered by their Enhanced Nitrification (EN) bead media. Designed as “bioclarifiers” capable of performing both biological and mechanical filtration, these filter systems are capable of handling biological loads of 50% to 100% higher than the bubble-washed or propeller-washed bead filters equipped with standard bead media. Additionally, the PolyGeyser Bead Filters offer a very high degree of reliability and are virtually immune to clogging and caking because they backwash automatically/spontaneously using no moving parts or electronics.

OPERATION

The PolyGeyser Drop Filter stands apart from AST’s other Bead Filter technologies primarily through its automatic/spontaneous pneumatic backwash mechanism. Water is introduced below a bed of packed EN bead media and travels upward through the filtration chamber where mechanical and biological filtration takes place. Simultaneously, air is introduced into the air charge chamber at a constant, predetermined rate to achieve the desired backwash frequency. Once the charge chamber has reached capacity, the pneumatic trigger fires, releasing the entrapped air from the charge chamber into the filter chamber below the media bed. The sudden release of air from the charge chamber causes the beads to mix, roll and “drop” as the air agitates the beads.

The circulation pump/airlift operates continually, which ensures that the filter chamber begins refilling immediately after a backwash, causing the beads to float upward and the filtration bed to reform. During the recharge cycle, suspended solids in the captured backwash waters settle into the sludge storage chamber for later disposal via the sludge drain valve (usually every 2-3 days). At the same time, the backwash water is slowly passed through the bead bed again as the air charge chamber is slowly recharged with air.

The pneumatic backwash system breaks the linkage between backwash frequency and water loss and allows the nitrification capacity of the unit to be fully utilized. The elimination of water loss associated with an individual backwash event is also a key element in this new technology. This is particularly advantageous in marine systems where the loss of saltwater is minimized and operating costs are decreased.

Frequent backwash sequences have proven advantageous for optimizing the nitrification capacity of the unit. Numerous gentle scouring routines promote high rates of nitrification by maintaining a healthy thin biofilm on the bead surfaces. Typical backwash frequencies are every three to six hours. In recirculating bioclarifier applications, where the PolyGeyser Drop Filter operates concurrently as a clarifier and biofilter, total ammonia nitrogen (TAN) levels below 0.3, 0.5 and 1.0 mg-N/l can be expected at feed loading rates of 0.5, 1.0 and 1.5 pounds feed per cubic foot of EN media per day (8, 16 and 24 kg of feed per cubic meter of EN media per day), respectively.

POLYGEYSERS IN ACTION

To date AST has PolyGeyser Drop Filters operating in a wide range of applications across the US and in Europe. The largest units built to date are 50 ft³ PolyGeyser Drop Filter units operating at Mote Aquaculture Park in Sarasota, FL on their Sturgeon grow-out. Also, AST has a 25 ft³ PolyGeyser Drop Filter providing bioclarification at Hubbs SeaWorld Research Center in San Diego, CA, on their yellow tail broodstock system. Additionally, AST has produced hundreds of 3 ft³ Drop Filters which



PolyGeyser “Pneumatically Washed” Drop Bead Filter, Model DF-15. This filter contains 6 ft³ of Enhanced Nitrification (EN) Bead Media and is designed to provide complete biofiltration and clarification for systems being fed up to 9 lbs of 35% protein feed per day.

are being used in applications ranging from marine broodstock and fingerling production systems to ornamental Koi ponds and water gardens. AST is now please to announce the addition of the NEW 6 ft³ DF-6 PolyGeyser into its product line. The DF-6 is capable of handling the biological and mechanical filtration needs for a 12,000 gallon koi pond. The DF-6 contains 6 ft³ of EN media and is capable of handling a maximum flow rate of 90 gpm. Full details for this exciting new product are available by visiting our website (www.BeadFilters.com) or calling 800-939-3659.

COMPANY BACKGROUND

In October 2006 AST will celebrate its 11th year in business. Founded in 1995, by Douglas Drennan, Aquaculture Systems Technologies, LLC is both a manufacturing company, and a cutting edge research company that is continually seeking to improve its patented Bead Filter Technologies. For ten years Aquaculture Systems Technologies has lead the world in the development and marketing of bead filter technologies. Most notable is our commitment to

research and furthering the science of bioclarification. Our efforts are supported by the numerous SBIR grants awarded to our research department from both the United States Department of Agriculture and the United States Department of Commerce.

Technologies which AST has been able to bring to market as a direct result of these grants include a computer automated system for producing algae for feeding larval shrimp, oysters and zooplankton, automated bead filter backwash controllers and the enhanced nitrification bead media which can increase the nitrifying capacity of a bead filter by up to 50%. Ongoing research is focused on improving single pass solids capture of particles in the 5-10 micron range in bead filters by manipulating bead size and shape and developing cost effective and reliable denitrification technologies.

AST's bead filter technologies are currently in use by some of the largest and most prestigious facilities around the world. These include ADM's Tilapia Farm, one of the largest indoor fish farms in the US, Miami Metro Zoo's new Asian Aviary, the new Sea Lion exhibit at the Buffalo Zoo, Kent SeaTech's hybrid striped bass operation, Tiltech Aquaculture's tilapia hatchery, the Koi Pond at the City of Phoenix, AZ's Japanese Friendship Garden, Audubon Zoo, Hubbs SeaWorld Research Centers in San Diego and Carlsbad, CA, numerous zebra fish research facilities around the world thanks to the efforts of Aquaneering, Inc. of San Diego, CA, and

Harbor Branch Oceanographic Institute--to name a few. AST also built three huge 450 cubic foot PBF filters that were 16' diameter x 22' tall for the U.S. Fish and Wildlife Service to be used at a cold water salmonid hatchery in New Mexico.

Our most popular filters continue to be our Propeller-Washed Bead Filters, some of which have been successfully operating on aquaculture systems for over a decade. Our Bubble-Washed Bead Filters also remain an excellent choice for bioclarification on research systems, broodstock holding systems as well as for koi ponds, and ornamental systems all over the world. The Bead Filters we manufacture provide a reliable and valuable resource to maintain healthy, clean water quality for aquatic life.

Aquaculture Systems Technologies is a proud member of the World Aquaculture Society, United States Aquaculture Society, National Aquaculture Association, the Aquaculture Engineering Society, the American Tilapia Association, the American Zoo and Aquarium Association, the Associated Koi Clubs of America, and the Mid-Atlantic Koi Clubs.

- For More Information:
- Aquaculture Systems Technology LLC
108 Industrial Ave.
Jefferson, LA 70121 USA
- Telephone: 504-837-5575
- Fax: 504-837-5585
- Email: info@beadfilters.com
- www.Beadfilters.com

SEE AD PAGE 42

International Ingredients Corporation

International Ingredient Corporation (IIC) manufactures and sells specialty ingredients for the aquaculture industry. GroBiotic®-A is an all-natural prebiotic and immunostimulant with research-proven benefits on growth performance and survivability in warm and cold-water fish and shrimp. Significant and economically-important advantages to GroBiotic®-A have been consistently demonstrated in hybrid striped bass, tilapia, red drum, trout, and shrimp.

Enhanced survivability was shown under a variety of stress conditions, including bacterial infection, viral infection, crowding, poor water quality, low salinity (shrimp), and commercial industry conditions. Up-regulation of the immune system and shifts in gut microflora populations have been demonstrated. IIC also provides a unique cheese-based product called Cheese Plus Cheese that provides quality nutrition and cheese palatability to aquatic diets.

- For More Information
- International Ingredients
150 Larkin Williams
Box 26377
Fenton, MO 63026
- Telephone: 636-343-4111
- Fax: 636-349-4845
- Website: www.iicag.com

SEE AD PAGE 83

Get Your Advertisement in The Buyer's Guide 2008

**Our readers reach for the Buyer's Guide
when they want to buy your products!**

**To Reserve Ad Space:
Call: 828-687-0011 Fax: 828-681-0601
Or Email us at: advertising@aquaculturemag.com**



Get The Buyer's Guide

**1700 companies with
over 30,000 listings of
Products And Services.**

2007!

Included In The Buyers Guide 2007:

Aquaculture Outlook
World • United States
Canada

Aquatic Species • Baits
Consultants • Feeds
Medications/Chemicals
Products • Services

Aquaculture Associations
International & National
Regional & State

- Aquaculture Resources
- Extension Contacts
- Aquaculture Coordinators
- Sea Grant
- Federal Fish Health Biologists & Fish Health Centers
- Federal Fishery Assistance
- USDA APHIS Veterinarian In Charge
- Diagnostic Services Available
- Universities & Institutions Offering Aquaculture Courses
- Additional Sources Of Information For Aquaculturists
- USDA APHIS Wildlife Services: State Directors
- US Regional Aquaculture Centers

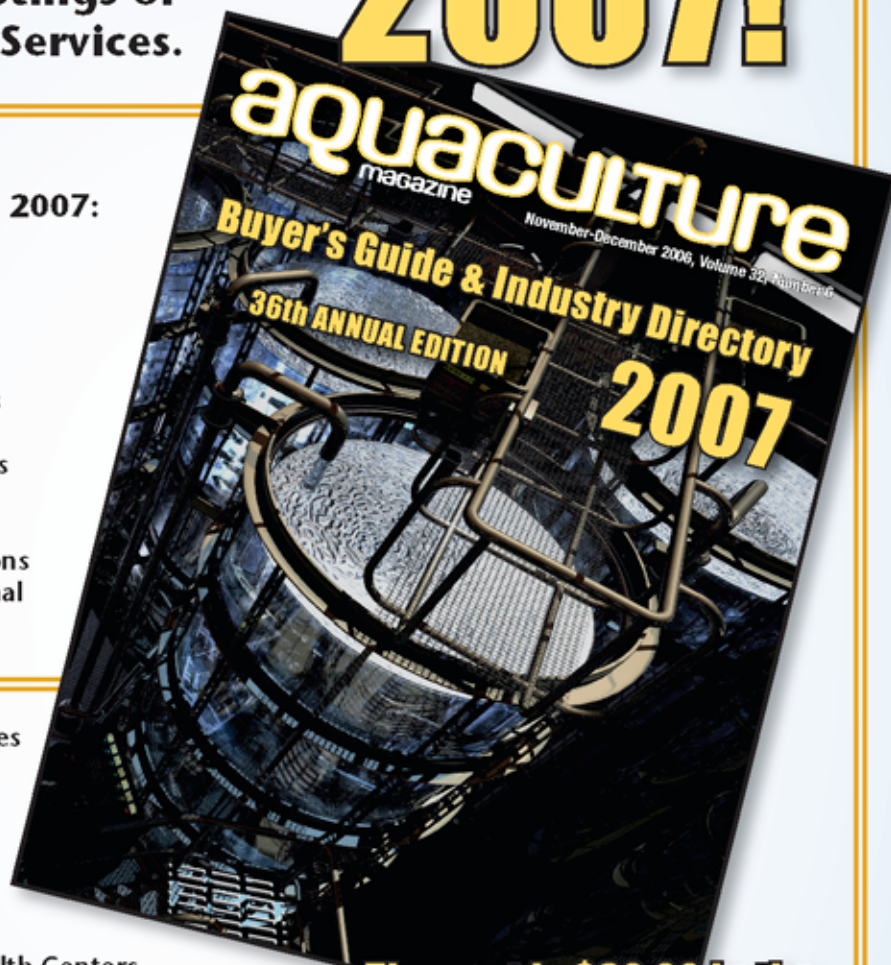

**The cost is \$30.00 in the
United States and \$35.00
Outside the USA**

**Order Online at www.aquaculturemag.com
or by Phone at 828-687-0011**



Back Issues

- MAY/JUNE 2007**
Hybrid Striped Bass In North Carolina
Never Let Your Guard Down
- MARCH/APRIL 2007**
Marketing For Small Scale Aquaculture
Producers
Fish Farmers: Are You in the Business
to make money
- JANUARY/FEBRUARY 2007**
Organic Aquaculture
The Evolution Of Aquaculture: Part 2
- JULY/AUGUST 2006**
Current Status on Crawfish Farming
in Louisiana
- MAY/JUNE 2006**
Still Evolving: Global Shrimp
Farming Continues To Set A Course
In Pursuit Of Sustainability; The
Role For Recirculating Aquaculture
Systems (RAS) Part I; An Overview
Of Aquaculture Insurance Part III: The
Americas, Other Than the United States
- MARCH/APRIL 2006**
U.S. Senate Hearing On Offshore
Aquaculture Act; An Overview Of
Aquaculture Insurance - Part 2: Europe,
Asia, Africa and Australia; Aquaculture
in Europe
- JANUARY/FEBRUARY 2006**
Where The United States Aquaculture
Industry Is Headed; An Overview Of
Aquaculture Insurance Part I: The US;
Tides Of Change In British Columbia's
Salmon Farming Industry
- SEPTEMBER/OCTOBER 2005**
Vietnam: A Potential Giant in Asia
for Aquaculture; China's Giant
Aquaculture Industry Experiences
- Canada's Aquaculture Industry:
Unlimited Potential
- MARCH/APRIL 2005**
Marketing Options For Small
Aquaculture Producers; FY 2006
Budget Cuts - History And Future Of
Aquaculture Research
- JANUARY/FEBRUARY 2005**
Yerseke Fish Farm: A Pioneer of Dutch
Fish Farming; Tsunami Update - Impact
on Aquaculture
- NOVEMBER/DECEMBER 2004**
United States Trout Farmers
Association: 50 Years
- SEPTEMBER/OCTOBER 2004**
FAO Focuses On China; An Overview
Of Largemouth Bass Breeding And
Culture - Part 2
- JULY/AUGUST 2004**
An Overview Of Largemouth Bass;
Breeding And Culture - Part 1;
Pompano Mariculture
- 2004 MAY/JUNE 2004**
Setting a Course for Sustainable Marine
Aquaculture; Domestic Aquaculture
Production Higher and Imports Up;
Recent Observation for Aquaculture
Along the Nile and Other Regions In
Egypt
- MARCH/APRIL 2004**
What Else Can Happen? Other
Problems For Fish Production; A
Critical Review of a New Information
Resource for Aquaculture; Freshwater
Pearl Culture Development in India
- JANUARY/FEBRUARY 2004**
Acvares: Romania's New Ventures
- Growing Pains Cyst Production of
Brine Shrimp Artemia in Salt Ponds
After Inoculation
- JULY/AUGUST 2005**
The National Offshore Aquaculture Act
Of 2005
Frequently Asked Questions: The
National Aquaculture Act
- MAY/JUNE 2005**
Aquaculture Outlook 2005: U.S.;
Aquaculture Production Higher;
quaculture; Two Environmental
Groups Sue Salmon Farmers; Workers
Compensation: Protecting Your
Fish Farm
- NOVEMBER/DECEMBER 2003**
Other Ectoparasites Infesting Fish;
Copepads, Branchiurans, Isopods,
Mites, And Bivalves; A Survey Of
Attitudes On College Aquaculture
Education
- SEPTEMBER/OCTOBER 2003**
Aquaculture Development In Iran; The
Promise Of A Blue Revolution; The
Emerging Silver Catfish Culture
- JULY/AUGUST 2003**
Strategic Planning For Aquaculture
Development In Honduras;
Aquaculture Outlook
- MAY/JUNE 2003**
Asian Oysters In The Chesapeake Bay -
A New Beginning; Past-Present-Future:
Catfish in the US And Vietnam
- NOVEMBER/DECEMBER 2002**
Fungi, Algae, And Tumors Of Fish
International Symposium On Viruses
Held; Polyculture Of Striped Bass And
Summer Flounder In RAS's

Check the box next to each issue you would like to order (or attach a separate list) Send Check payments to: Aquaculture Magazine P.O. Box 1409 Arden, NC, USA 28704 Credit Card payments may fax orders to (828) 687-0011 or email circulations@aquaculturemag.com	No. of Issues:	at \$5.00 each (\$8.00 each Outside U.S.)	
	Amount Enclosed: \$		
	Card Type (circle one): VISA Diner's Club MasterCard		
	Card Number:		
	Expiration Date:		
	Name/Company:		
	Address:		
	City:	State:	Zip:
	Country:		
	Phone:		



C. Greg Lutz

Genetics & Breeding

Advances in Tripoidy

By Greg Lutz
Specialist & Professor,
Louisiana State University
Agricultural Center

The key feature of gamete formation in virtually all the aquatic species one might wish to culture is a halving of the number of chromosomes (and therefore the genetic material) through a process called meiosis. This halving is necessary so that when eggs (1N) and sperm (1N) combine to form new individuals, the offspring possess the same total number of chromosomes (2N) as their parents. As a general rule, the process of meiosis involves two cell divisions, which result in the formation of four 1N sperm cells in males, or one

egg and two (or in some cases three) "polar bodies" in females. During egg maturation or activation, the first polar body (typically 2N) may be expelled directly from the egg, as is the case in many fishes, but in some species it may divide at the time of the first meiotic division. Subsequently, the second polar body (1N) is lost, leaving a 1N set of chromosomes in the egg pronucleus to pair up with those from the sperm cell.

Over the years, many researchers have expended significant effort searching for ways to disrupt this process by creating organisms that have an odd number of chromosome sets, say 3N. Simply put, a 3N set of chromosomes cannot be divided equally, resulting in functional sterility. The ultimate goal of this type of research is to develop organisms that are biologically viable in every respect

except gamete formation.

The gametes of many fish and shellfish can be manipulated to produce triploid offspring. Sometimes the goal may be faster growth, with energy normally designated for maturation and spawning becoming available for weight gain. Sometimes enhanced survival is possible due to reduction in the physiological stress normally associated with the spawning season. In other cases, it may be desirable for fish to be sterile in order to protect intellectual property or to preclude the establishment of populations by animals which may inadvertently escape from production facilities.

From a production standpoint, the bio-economics of triploidy depend greatly on the relationship between an organism's natural life history and the production cycle in question. If the species being cultured is typically harvested prior to the onset of sexual maturity, then few if any benefits (and occasionally a number of deficiencies) may be accrued from a triploid state. However, if market size is not reached until after one or two spawning seasons, the improved growth efficiency realized from sterility may be significant.

Liu et al. (2006) found no differences in growth (as measured by shell length and/or body weight) between diploid and triploid blacklip abalone over a 50-day grow-out period. Although food intake was significantly higher in triploids, their conversion efficiency was significantly lower. Diploid abalone converted 1 g of dry food into 0.58 g of body weight, as compared to only 0.44 g for triploids.

Mori et al. (2006) evaluated the performance of triploid barfin flounder (*Verasper moseri*) and found that both males and females appeared to be functionally sterile. However, triploid males grew more slowly than male diploids, and triploid females exhibited similar or slower growth than female diploids. Similarly, over an experimental period of 76 days, Segato et al. (2006)

DRIED CARP PITUITARIES For Spawning Fish

Whole or in powdered form
Used in spring spawning of fish



For injection into female fish
for more roe, more rapidly

STOLLER FISHERIES

Box B

Spirit Lake, Iowa 51360

Tel: 712-336-1750

Fax: 712-336-4681

www.stollerfisheries.com

RS No 234

found that juvenile shi drum (*Umbrina cirrosa*) triploids performed poorly when compared to diploid controls. Triploids exhibited reduced protein retention, with significantly lower specific growth rates and final body weights. Compared to diploids, triploids had larger amounts of coelomatic fat, higher liver lipid content and lower crude protein content.

Xiang et al. (2006) evaluated the physiology and performance of triploid Chinese shrimp, *Penaeus chinensis*, produced by heat shock. They found that although these triploids did not exhibit improved growth during early life history, at the onset of maturation they began to grow faster than their diploid counterparts. Triploids appeared to be sterile based on the status of their reproductive organs. Similarly, Cal et al. (2006) found that growth of triploid turbot was similar to that of diploids for the first year of life, but thereafter triploids out-grew diploids, with weights that were 10 to 12 percent higher from 24 to 48 months of age. During this same period, survival of diploids was 92 percent, as compared to 100 percent for triploids. The authors surmised this difference was attributable to a lack of spawning-associated stress and mortality. While diploids exhibited a sex ratio of 1 male to 0.6 females at 47 months, there were 3.3 female triploids for every male. This combined with a significant dress-out advantage for triploid females (14.3

percent over their diploid counterparts) indicated that commercial production of large turbot could benefit substantially from the use of triploids.

Some aquatic species begin life as one gender and then change to the other after maturing. Such is the case with the protandrous hermaphroditic fish known as the gilthead seabream. This species is widely cultured throughout the Mediterranean, south-west Europe and other regions. Haffray et al. examined the effects of triploidy in this species and found no differences in growth between triploids and diploids until roughly 17 months of age, at which point both groups were all males, with an overall average weight of 484 g, the commonly accepted marketable size. By 42 months of age, triploid fish had exhibited reduced growth, with a final weight that was 15.3 percent lower than that of diploids. Triploids remained male, while a significant portion of diploid fish shifted to females, exhibiting faster growth. At sizes greater than 484 g, triploids grew more slowly, but they did exhibit better dress-out percentage and leaner body composition. No spawning occurred, even among diploids, because the study was undertaken in tanks, but the authors stressed the need to perform similar comparisons in sea cages, where diploid gilthead would be inclined to spend 3 or 4 months each year in spawning.

Triploid organisms generally have larger, but fewer, cells than their diploid counterparts – throughout all types of body tissues. The immune function of triploids is often influenced in different ways as a result. In the Xiang et al (2006) study cited above, triploid shrimp had fewer, but larger haemocytes. Budino et al. (2006) produced triploid turbot to study their immune systems. In this case as well, triploid individuals had larger immune cells, but the numbers of erythrocytes, leucocytes and thrombocytes were lower than in diploids. Since the larger size of these blood components in triploids was offset by reduced numbers, total respiratory burst and phagocytosis activities were similar in diploids and triploids.

Vetesntk et al. (2006) found similar patterns in the erythrocyte profiles of diploid and triploid crucian carp. Erythrocyte counts were lower in triploids, but mean corpuscular volume and haemoglobin content increased in triploids. As a result, overall haematocrit values and corpuscular haemoglobin did not differ significantly between triploids and diploids. Beyea et al. (2005) reported similar observations in triploid shortnose sturgeon.

There are several approaches to inducing triploidy in aquatic organisms. In general, more techniques are available for mollusks than for finfish. Induction of “meiotic” triploidy, a typical approach

Nothing Protects Like AquaNet Grids and Netting

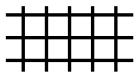

AquaNet® Is Now Available In Square Or Rectangular Grids, As Well As Our Popular Hexagonal Netting.

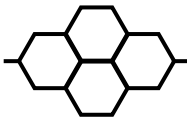

Soft, Flexible Grids Are Durable And Easy to Use. Cages, Traps, Screens, Barriers from 1/6” to 2” Hole Openings. Longer Life, Better Protection for Clams, Mussels and Oysters. Grids Up to 8’ Wide, Netting Up to 50’ Wide. Convenient Size Rolls of 100’ Length.

“Servicing The Aqua Farm Industry For Over 35 Years.”

Call For Free Samples and Brochure



J.A. CISSEL MFG. CO.

1995 Rutgers University Blvd. Lakewood, New Jersey 08701
Phone 732-901-0300 • Fax 732-901-1166 Toll Free 800-631-2234
Email: info@jacissel.net Website: jacissel.net

RS No. 678

for finfish, involves applying thermal, pressure or chemical ‘shocks’ to newly-fertilized eggs, with the resultant disruption of the mechanisms that would otherwise force the second polar body out of the egg. The sperm contributes 1N to the soon-to-be-developing zygote, as do both the egg pro-nucleus and the second polar body. In this way, 3 sets of chromosomes (one paternal, two maternal) combine within the nucleus of the fertilized egg, and all 3 sets replicate with each cell division as the zygote begins its development.

The fact that the triploid offspring produced in this way have unequal inheritance, with two maternal sets of chromosomes as opposed to one paternal set, has led to some interesting observations in recent years. Park et al. (2006) examined diploid and triploid reciprocal hybrids between the Mud Loach and the Cyprinid Loach and found that although diploid hybrids were intermediate to the parental species in terms of body weight, growth of triploid hybrids was similar to that of their maternal parents. Similar relationships

were apparent in terms of body proportions, with diploid hybrids being somewhat intermediate in form and triploid hybrids resembling their maternal species. Triploid hybrids were sterile, while diploids were not.

Johnson et al. (2007) reported on differences in heritability and maternal effects in diploid and triploid Chinook salmon resulting from “dosage effects.” They found that triploidy resulted in significantly higher levels of phenotypic variance for growth and survival-related traits. Triploidy also appeared to alter the variation patterns for these traits, but the opposite was true for lysozyme activity. This increased fitness-related trait might be accounted for by an increased level of heterozygosity. Duchemin et al. (2007) reported a similar reduction in environmental sensitivity in triploid Pacific oysters when compared to diploid counterparts.

In numerous studies, performance of triploid organisms has been inferior to that of diploid controls, at least during early life stages. Many studies suggest that the shocks applied to newly-fertilized eggs in

order to induce triploidy may be partially to blame. Alternately, interploidy triploids can sometimes be produced without the use of physiological shocks, by crossing tetraploid (4N) individuals with normal diploids. Tetraploids, which typically produce 2N gametes, have been produced in a variety of aquatic organisms. In the production of tetraploids, normal (1N) eggs and sperm combine to form a normal, viable 2N diploid zygote. The 2N chromosomes then replicate in preparation for the first cell division, or “first cleavage”, but temperature, pressure or chemical shocks are applied at the precise moment to prevent this division, leaving a 4N chromosomal complement in the cell. From this point on, chromosomal replication and cell division proceed normally, but each cell will now contain a 4N complement of chromosomes: 2N of paternal origin and 2N of maternal origin.

Li et al. (2006) reported on the production of interploidy triploids in the blunt snout bream (*Megalobrama amblycephala*). Two types of interploids were produced: 2N female by 4N male, and the reciprocal 4N female by 2N male. The authors referred to these as “negative” and “positive” interploids, respectively. Negative interploids exhibited similar fertilization, embryonic development, hatching rates and post-hatching growth and survival as diploid controls, while the positive interploids were inferior in all these characteristics. In a novel approach to inducing triploidy, David and Pandian (2006) incubated Buenos Aires Tetra semen in 2.5% polyethylene glycol to facilitate entry of two sperm cells into the eggs of Widow Tetras. At hatching, survival for these “paternal” triploids was 5 percent. Survival decreased, however, over time.

The bottom line? The number of species evaluated for triploidy continues to increase, as does our understanding of methods and techniques for inducing triploidy. Nonetheless, this approach to genetic manipulation often results in reduced performance, at least until a size and age at which sexual maturation would normally take place.





Corrosion Resistant VALVES & CONTROLS

- Manual & Actuated Valves
- Pressure & Flow Control
 - Solenoid Valves
- Strainers & Sight Glasses
- Experts In Custom Design

Engineered valves feature 100% individual testing to ensure performance and longevity. Rugged thermoplastic designs provide multi-million cycle life, provide excellent corrosion resistance and maintain high water purity.



FREE CATALOG

RS No. 033

PLAST-MATIC
VALVES, INC.

1384 Pompton Avenue, Cedar Grove, NJ 07009
(973) 256-3000 • FAX (973) 256-4745 • www.plastomatic.com

**Mill Technology's
Altima Multipact™ Pulverizer**

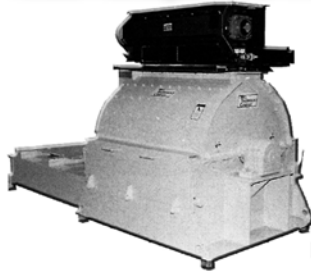

Highest Quality Post Grind
of Aquaculture Feedstuffs

**The Altima is the BEST, used by most of the Major
Feed manufacturers.**

**Producers, ask what equipment is processing
your feeds.**

**Particle reduces to 97% minus 40, 85% minus
60 & 50% minus 140 mesh, capacity to 15 MTPH
(Results may vary somewhat with ration)**

50 & 60 cycle from 40 to 400 HP

Contact Mill Technology Company, Inc.
Phone (763) 553-7416
Fax (763) 553-7417
Email: gary@mill-technology.com
www.mill-technology.com

RS No. 940



Ronald W. Hardy

Fish Feeds & Nutrition

Zebrafish As A Model Fish In Nutrition Research

By Ron Hardy
Professor and Director
Aquaculture Research Institute
University of Idaho

Zebrafish (*Danio rerio*) are a common species in the ornamental fish sector, and many schoolchildren who pass through a stage at which they are interested in having a home aquarium purchase zebrafish at one time or another. Zebrafish are a small, active schooling fish that are easy

to rear and fun to watch. Zebrafish have become a major research organism over the past decade, and are now widely used in medical research. Zebrafish have a short life-cycle, becoming mature within weeks compared to months for mice, plus zebrafish are relatively easy to spawn, producing 100-200 eggs per spawning. Zebrafish eggs are transparent and large enough to allow genetic manipulations, such as replacing the nucleus. Many strains of zebrafish have been developed, and approximately 10,000 single gene mutants are available, allowing researchers to make numerous crosses to determine the effects of single or multiple gene mutations on cell development. The entire zebrafish genome has been sequenced, and most

functional genes have been identified, further enhancing the value of zebrafish in research. Zebrafish are widely used in drug development and testing, and are fast becoming valuable research animals in aquatic toxicology research. Naturally, it has occurred to researchers that zebrafish might be an interesting model organism in fish nutrition research. However, this potential has not yet been realized.

ZEBRAFISH HUSBANDRY

An excellent review of zebrafish husbandry has recently been published by Lawrence (2007), and the most striking aspect of this review is that there is almost a complete lack of information on the nutritional requirements of zebrafish. This means that researchers

Because there's more than one hungry mouth to feed.

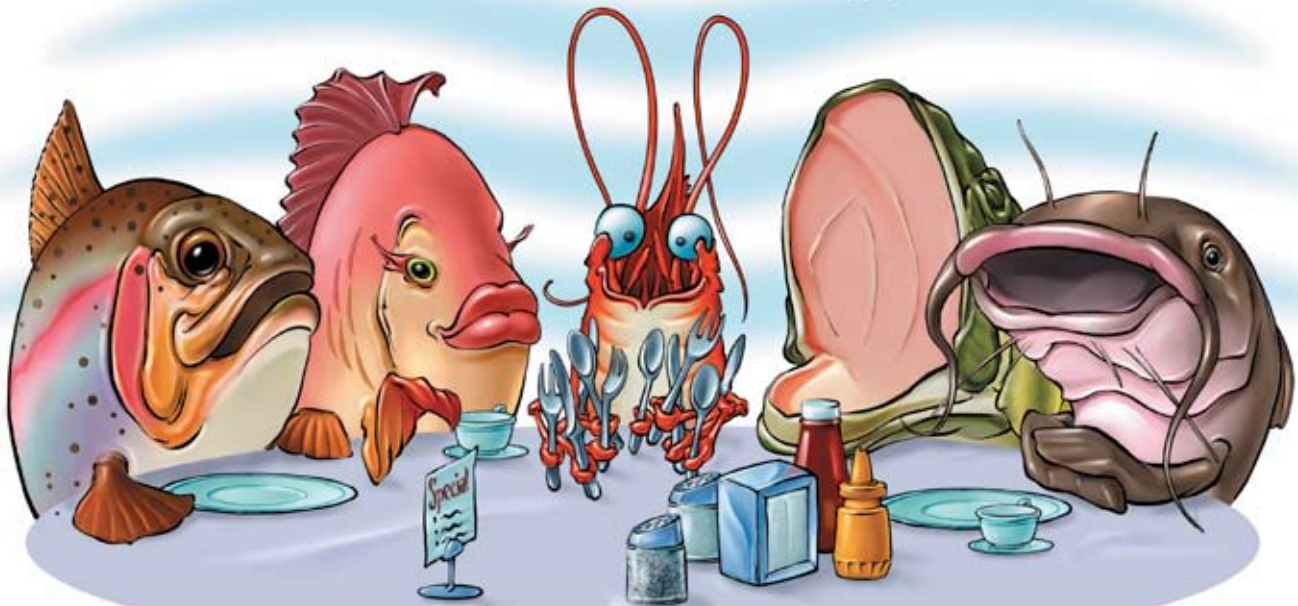

Cold water or warm water, floating foods or sinking foods, Rangen has the Aquaculture diet specially formulated for your exact species. Each formula has been pre-tested to increase size and weight and

produce higher yields. Plus, diets can be made to your specifications. Because Rangen knows in this business, there's more than one hungry mouth to feed.



Aquaculture Feeds Division
www.rangen.com

(800) 657-6446 Idaho (800) 272-6436 Texas
(208) 543-4698 fax (979) 849-6943 fax

RS No. 726

are conducting studies on behavior, physiology, reproduction, toxicology and so on without having any idea if their experimental animal, our zebrafish, is being fed a diet that meets its nutritional requirements. How can credible research be conducted using zebrafish when researchers have no idea if the effects they are seeking to study might be influenced by a nutritional deficiency or imbalance, or if their fish is performing up to its potential because it may not be receiving an optimum diet?

Researchers are not operating completely in the dark, nutritionally-speaking. Lawrence points out that several studies have been carried out to describe the natural habitat of zebrafish (India, Bangladesh, Nepal, Myanmar and Pakistan), including their natural food. Zebrafish are opportunistic feeders that consume benthic and planktonic crustaceans, worms and insect larvae. Stomach samples indicate that terrestrial insects constitute a major part of zebrafish diets in their natural habitats, which are ponds, rice paddies, and pools and shorelines of streams. This information suggests that the diets of zebrafish are similar to that of young trout, although as in the case of trout, differences in food intake are often associated with different habitats. In other words, fish take advantage of prey that are available in different habitats, or that change in abundance with season, weather or other environmental factors. Sometimes their natural diet is good, but sometimes it may not be.

NUTRITIONAL REQUIREMENTS OF ZEBRAFISH

Even though there are no published

studies of the nutritional requirements of zebrafish, we know that zebrafish will require 10 essential amino acids, 11 vitamins, minerals (both macro and micro minerals), and essential fatty acids. How do we know this? Because all fish studied to date require these nutrients. Zebrafish are cyprinids, and the nutritional requirements of several cyprinid species have been studied to some extent. The nutritional information collected thus far is in line with expectations, meaning that there have not been any surprises. However, the cyprinid species studied thus far are baitfish that are typically reared in ponds where a significant proportion of their requirements for specific nutrients is supplied by natural food within the pond. The point is that we do not know are the optimum dietary levels of the 40 or so essential nutrients, especially for fish raised in aquaria where all of their nutrition is supplied via the feed. Of the essential nutrients, the dietary requirements for omega-3 or omega-6 fatty acids are most critical in terms of supporting the endocrine system, immune response and reproductive performance. Determining these should be among the highest priority items in our list of dietary requirements of zebrafish. In addition, we do not know the minimum or maximum levels of dietary starch that zebrafish can tolerate, nor do we know the optimum protein: energy level that supports maximum growth and feed efficiency ratio in zebrafish. Currently several companies sell zebrafish research feeds. Formulation of these feeds seems to be based on a combination of conventional pond fish formulation coupled with ornamental

fish diet formulation. This means that conventional ingredients make up the bulk of the formulation but there are a number of exotic ingredients (worm meal, etc.) that producers include just to be sure that all nutritional bases are covered. So far, this seems to be working well enough, but maybe not for some potential research uses of zebrafish.

FEEDING LEVELS

The Zebrafish Book (Westerfield, 1995) is the standard guide to zebrafish culture. If you are conducting a nutrient requirement study with zebrafish and base feeding level on the guidelines in this book, your chances of seeing differences among treatments are relatively low because the feeding level is about 5x lower than the intake capacity of the fish. This is not a surprise, given the aim of feeding zebrafish in most laboratories is maintenance, not maximum growth. To see differences in growth performance associated with diet, one must adjust feeding level to the maximum intake level of the fish rather than base feeding level on a percentage of body weight of the fish. One must also feed to apparent satiation so that fish fed diets that promote maximum growth can achieve high growth rates. Feeding to a percentage of fish body weight in all treatment groups eliminates the possibility of detecting faster growth in treatment groups receiving optimum supplementation levels of essential nutrients. With continuous feeding of a commercial diet, zebrafish are reported to grow at a rate of 0.33 mm/day, compared to half that rate when fed 3x per day, even using very high quality prepared diets such as Microfeast L-10, Kyowa fry feed or Tetramin Baby Fish Food "E". According to information presented in the review by Lawrence, zebrafish appear to be grazers and may require frequent or almost continuous exposure to feed to achieve maximum growth.

RESEARCH OPPORTUNITIES

Given the importance of breeding in zebrafish research, the lack of information on the effects of diet on reproductive performance in this species is astonishing. It is well known that in batch spawners like zebrafish, diet composition has a profound effect on fecundity and hatchability. Similar issues exist with



Aeration Pumps

The Most Durable Linear Diaphragm Pumps on the Planet

*From the **Original** Linear Diaphragm Air Pump Company: over 35 years of engineering and manufacturing innovation.*

- Extremely efficient compared to motor driven pumps
- Smooth, pulsation-free air delivery
- Oil-less design delivers contamination-free air
- U.L. OUTDOOR Rated
- Thermal Protection
- Competitively priced
- Professional and genuinely friendly customer service



RS No. 076

1300 Tefft Court, Suite 8 • Saline, Michigan 48176 • 734 944 5032 • FX: 734 944 5163 • www.hiblow-usa.com

zebrafish fry, which are too small to be fed on prepared feed, are generally fed *Paramecium* or rotifers at first feeding, and then moved onto *Artemia* nauplii as they grow. However, recent advances in larval diet production appear not to have reached the zebrafish world. While it is certainly not difficult to feed zebrafish larvae live prey, it is well known that live prey can serve as disease vectors and also that live prey vary considerably in nutritional quality. Developing a zebrafish larval feed seems like the answer to these problems, plus such a development would open opportunities to explore nutrient-gene interactions in developing larvae.

ZEBRAFISH AS A MODEL ORGANISM FOR FARMED FISH

Given the well characterized genomic information on zebrafish, they would seem to be a valuable research tool for researchers looking at the effects of nutrition on the immune system, endocrine system, reproductive system, and for those interested in general metabolism. However, there is a catch. Zebrafish have a relatively short growth

period that is not confounded by sexual maturation. Therefore, it is difficult to conduct growth studies with zebrafish that might be relevant to grow-out stages of farmed fish. The answer to this problem might be the giant danio, *Davario aequipinnatus*. This species resembles the zebrafish (sometimes called the Zebra danio) but grows more to a much larger size, up to six inches, over a longer period of time. In fact, the giant danio appears to be capable of continuous growth, also known as indeterminate growth, unlike the zebrafish, which exhibits determinate growth, meaning that once it reaches a certain size, it stops growing. Studies by Biga and Goetz (2006) show that the giant danio continues to recruit new muscle cells throughout its life, making it an interesting model fish for farmed species. The key will be to determine if the giant danio genome is similar to the zebrafish genome. If so, this fish has a future in aquaculture research.

REFERENCES:

Biga, P.R. and F.W. Goetz. (2006) Zebrafish and giant danio as models for muscle growth: Determinate versus indeterminate growth as

determined by morphometric analysis. *American Journal of Physiology – regulatory, integrative and comparative physiology*. 291: R1327-R1337.

Westerfield, M. (1995) *The Zebrafish Book: A Guide for the Laboratory Use of Zebrafish (Danio rerio)*, 3rd Edition. University of Oregon Press, Eugene, OR. 385 pp.

Aquaculture Fact

In South America more than 65 percent of the aquaculture production was achieved solely with introduced species in 2004. This includes large production of salmon, trout, tilapia, and carps.

The top species produced by Chile were atlantic salmon (349,329 metric tons), rainbow trout (126,265 metric tons), and coho salmon (90,160 metric tons). Chile is beginning to see large production numbers in shellfish. According to FAO in 2004, Chile produced 77,248 metric tons of mussels and 24,242 metric tons of Peruvian calico scallops.

BURRIS

Aquaculture



Feeding the World's Aquaculture Species!

Tuna	Trout	Macrobrachium rosenbergii
Cobia	Catfish	Penaeus Vannamei
Pompano	Tilapia	Penaeus Monodon
Red Drum	Barramundi	Abalone
Yellow Perch	Sturgeon	Conch
Mutton Snapper	Turtle	Eel
Large Mouth Bass	Alligator	
Hybrid Striped Bass	Frog	

Just To Name a Few!

Contact:
1012 Pearl Street
Franklinton, LA 70438 USA
800-928-2782
985-839-3400
Fax: 985-839-3404
www.burrismill.com



RS No. 001

GroBiotic®-A

Research Proven for Aquaculture

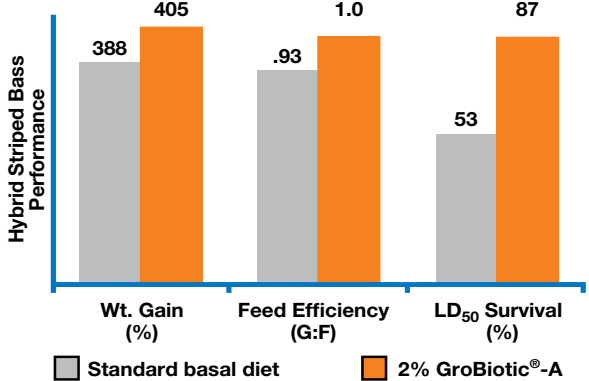

Performance Metric	Standard basal diet	2% GroBiotic®-A
Wt. Gain (%)	388	405
Feed Efficiency (G:F)	.93	1.0
LD ₅₀ Survival (%)	53	87

GroBiotic®-A enhanced growth performance of hybrid striped bass and significantly improved survivability in a bacterial challenge study.



INTERNATIONAL INGREDIENT CORPORATION
Fenton, MO • Ph: 636-343-4111
iicag@iicag.com • www.iicag.com

RS No. 022



Shellfish Settlement Between Washington Tribes and Commercial Growers Becomes Major Breakthrough After Years of Dispute Over Harvest on Private Lands

By Ken Chew
 Professor Emeritus
 School of Aquatic and Fishery
 Science
 College of Ocean and Fishery Sciences
 University of Washington,
 Seattle, Washington

On July 6, 2007, the Washington State's Puget Sound tribes and the commercial shellfish growers signed a settlement that ends the dispute over tribal shellfish harvesting from the grower's private tideland. The United States and Washington State were signatories to the agreement as well. This has been a long drawn out concern following the ruling on December 20, 1994 by Judge Edward Rafeedie of the U.S. District in Los Angeles on the shellfish subproceedings (89-3) of U.S. vs. Washington (also known as the Bolt Decision). This is a spin-off of the landmark 1974 Bolt ruling—where U.S. District Judge George Bolt declared treaties reserved the tribes right to half the salmon catch.

I wrote about this issue ten years ago in my shellfish column in **Aquaculture Magazine** (*January/February 1997 issue*) entitled "Shellfish Fishing Rights For Native Americans In The State

Of Washington." Reference can be made to this 1997 column article; but for the benefit of the readers to this column, a brief historical account leading to this notable settlement would be appropriate.

As background information, Rafeedie's decision regarding tribal fishing rights for shellfish (called the Shellfish Proviso of the Stevens Treaties) was an interpretation of five treaties, including the Point Elliott Treaty of 1855. In his decision, Judge Rafeedie stated that:

- shellfish are included in rights to fish reserved to the tribes in their original accustomed fishing grounds;
- rights extend to all natural and native beds, even those on privately owned land;
- provided, however, that shellfish may not be taken from beds that may be staked or cultivated by citizens;
- but this proviso only applies to artificial beds that may be staked or cultivated.

On August 25, 1995, Judge Rafeedie issued an order regarding the implementation of the Shellfish Proviso. The objective was to establish a framework under which the tribes' fishing rights could be exercised. This original order addressed:

- definitions of natural and artificial shellfish beds
- principles for sustainable development and equitable sharing of the shellfish resource
- interim and permanent management plans governing state and tribal harvests from public lands and waters
- special rules regarding cases where a tribe wishes to harvest shellfish on property owned or controlled by a shellfish "grower"
- location population estimates and management plans for harvesting shellfish from privately owned lands not being used for commercial shellfish production
- use of a Special Master for dispute

settlement.

I should mention that well before the ruling by Judge Rafeedie in 1994, and about three years after the Bolt decision on salmon in 1974, The Seattle Times (newspaper) on July 19, 1977 had an article by Warren King with a heading "New Dispute Brewing: will there be a Bolt Decision on clams?" So as far back as then, the news media had already picked up on the beginning of concerns for sharing the natural shellfish already being commercially cultivated and harvested, and sooner or later this issue would be brought up under the original Bolt decision for salmon.

Although once the Rafeedie order was made, further clarification and additional information was needed by the shellfish farmers as clam and oyster seed from hatcheries were utilized over cultivated beds that also had wild shellfish stocks. All parties involved agreed the court ruling would be difficult, if not impossible, to implement without disrupting the commercial growing areas. What this means is that though the tribes had the right to wild harvest of shellfish, the ruling specifically said they had no right to the fruits of the commercial growers labor. There was no way to tell wild shellfish from farmed clams and oysters on the same beds. And even if they could, how could tribal harvesters collect the wild shellfish without damaging the farmed clams and oysters right next to them? As noted in an article by Lynda V. Mapes ("Shellfish Settlement Ends Years Of Rancor") in the July 6, 2007 Seattle Times, "tribes and shellfish growers saw they had a choice: Spend years battling it out in court, or negotiate a settlement that would give the sides what they both wanted—reliable access to productive shellfish beds. Thus, years of on again, off again negotiations between tribes and commercial shellfish growers, hammered out the agreement recently signed."

"The significance is huge," said Bill Dewey, a spokesman for a group of

more than 60 Puget Sound commercial shellfish growers who have been fighting the issue in court. "It ends 18 –some-odd years of litigation and fighting with the tribes," states Dewey, "and allows us to mend our relationships with the people who are our neighbors."

Briefly, for tribes, this agreement means giving up rights to harvest shellfish worth \$2 million a year from commercial shellfish beds in Puget Sound. But they get \$33 million in federal and state money to buy and lease tidelands for their exclusive use. "Both sides can have economic prosperity," said U.S. Rep. Norm Dicks, D-Bremerton, WA who helped negotiate the agreement and get money for the settlement. He noted \$22 million is from federal money and Gov. Christine Gregoire of Washington was able to come up with another \$11 million to fund agreement. Dicks also stated "What is good here is tribes now have another way to go out and earn money, and it allows commercial growers to grow and expand their businesses." Several shellfish growers noted to me they can now have some relief from this agreement and provide some peace after all these years since the Refeedie ruling more than ten years ago.

The settlement also requires the Puget Sound shellfish growers to provide \$500,000 over the next 10 years for shellfish seeding of public tidelands of the state's choosing, which will provide more harvest opportunities for the public.

The settlement covers shellfish beds that were commercially cultivated prior to Rafeedie's August 28, 1995 Order. Growers cultivating new areas are required to notify effected tribes. If there are natural beds of the species proposed for cultivation where the new beds are proposed, the tribes are entitled to 50% of the natural production from the bed. If a natural bed is present it does not preclude creating an artificial bed, but provides for a periodic tribal harvest for their share. Tribes are not entitled to any of the increased production as a result of grower's cultivation efforts. The densities of shellfish that must be present to constitute a natural bed were established earlier this year in negotiations facilitated by Federal



Bill Taylor, President, Puget Sound Shellfish Growers Legal Defense Fund signing the agreement, with Washington Governor Christine Gregoire looking on behind him. Photo credit to Northwest Indian Fisheries Commission

District Court Judge Robert Lasnik. The negotiations between the Puget sound Tribes, commercial shellfish growers, and Washington State established natural bed densities for oysters and Manila, native littleneck, and geoduck clams. Densities vary by species and four designed regions. As examples, a density of one or more geoduck per hundred square feet constitutes a natural bed; for oysters it is 0.33 oysters per square foot; and for manilas it ranges from 0.07 to 0.14 pounds per square foot depending on the region of the Sound you are in.

In a joint "Guess Columnists" article in the Seattle Post Intelligencer by Bill Taylor, president of Taylor Shellfish Farms, and Billy Frank, Jr, chairman of the Northwest Indian Fisheries Commission, they stated "This agreement is a win for the tribes, growers and everyone else who lives in this state. Perhaps just as important, it is proof that through the spirit of cooperation we can solve most of our problems all by ourselves, as long as we are willing to talk, neighbor to neighbor." This is the way it should be and is well stated by the both of them!

For more information on this agreement, visit the website of the Puget Sound Shellfish Growers Legal Defense Fund www.pssgldf.org or contact Bill Dewey at billd@taylorshellfish.com.



visit our website at:
sterlingnets.com



or call for your free
2007 Sterling
Marine Catalog

STERLING NET & TWINE CO., INC.
18 Label St. Montclair, NJ 07042
1-800-342-0316

RS. No. 912



James Research Report

Increasing Fish Farming Profits, Try Something New

In past columns, we noted that from time to time the fish farming industry in the United States has had difficulty competing in the marketplace with imports from other countries. We suggested that other species could be considered for farming. In this column we offer other ideas.

Example one: Rice-crawfish double cropping. In 1978 LSU reported on the double cropping of rice and crawfish at the International Crawfish Conference in France. The cycle goes like this: Rice is planted in March; in June adult crawfish are seeded in the ricefield at a rate of 40 pounds per acre. The crawfish mate and burrow underground. In August water is drained off the field and the grain harvested. In mid October water is added back to the rice stubble. Crawfish emerge from their burrows, and females release young into the water. Crawfish feed on the decaying rice stubble. Their sustenance comes from bacteria and other organisms associated with decomposition of rice straw. Crawfish may be harvested as early as Thanksgiving until the following March at which time the field is drained and rice is replanted. Thus two crops -rice and crawfish - can be grown in 1 year's time.

This knowledge sat on the shelf for a number of years. During this time rice farmers were making good money. Why should they try something new? It was too much trouble. Traps and bait were needed along with labor to run traps. Then there was possible theft of crawfish from traps. And on top of that farmers wanted some down time to duck hunt and relax. Further, March and April are prime months for crawfish production, but this conflicts with rice planting.

This all changed sometime during

the 1980s. The price of rice dropped to \$4.00 a bushel, which at that time was below the break even price. Many rice farmers wanted something, anything, to improve their bottom line. Some tried rice-crawfish double cropping. It worked. Today roughly 80,000 acres of rice fields are used for crawfish production in Louisiana.

The crawfish crop is perceived by some as the primary crop. This market shift has dictated that the rice-crawfish cycle be modified. Instead of terminating the crawfish harvest in March and replanting rice, crawfish harvest continues until May or June. The water is then removed, and the land lays fallow from June until March of the following year at which time rice is planted again. In a second scenario, the chronology of events is basically the same. However, once crawfish trapping is over, say around June, rice is replanted rather than waiting until March. There is no layout time. Rice production is relatively low because rice is planted late. In a less common scenario, crawfish is the only crop of interest. Rice may be planted as late as August. In this instance, rice is

grown for crawfish forage, and rice grain is not harvested.

Example two: Grow fish for zoos. Jason L. Jenkins writes in a University of Missouri newsletter (Momentum Fall 2006) that there is potential for Asian carps as food for zoo animals. He notes that the St. Louis zoo purchases more than 60 tons of fish to feed its animals each year. These fish are mostly marine species, such as mackerel and herring, which range in price from 30 to 70 cents per pound. Duane Chapman with the U.S. Geological Survey Service and Rob Hayward with the University of Missouri are looking into the use of silver carp and other carp species as food for use at zoos.

Ellen Dierenfeld, a staff nutritionist at the St. Louis zoo, feels that around 25% of the current fish usage could be replaced with carp. She further noted that with more than 200 accredited zoos in the U.S. the potential for Asian carp products is substantial. Researchers are experimenting with "carp cakes." Vitamin and mineral supplements can be added to the carp cakes, so it is not necessary to

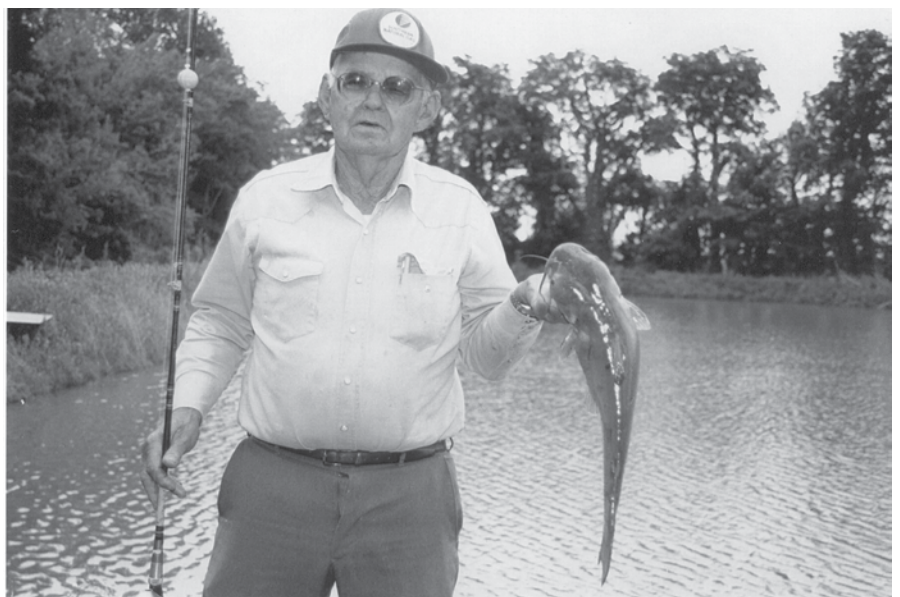

Mr. J.C. Tyson of Mer Rouge, LA with a catfish he caught from a stocked pond.



The crawfish, double cropped with rice, helped farmers survive low prices for rice

feed these separately. Penguins are one of three animals that are to be used in a carp cake feeding study at the St. Louis zoo.

Could this apply to catfish farmers? The bighead carp at one time was grown in Mississippi catfish ponds with the idea of canning the product like tuna. Use of Asian carps could pose a legal problem in certain states. Perhaps use of the common carp and buffalo fish (*Ictiobus spp.*) would be worth considering.

Catfish farmers typically harvest fish by topping off. This method would seem to be compatible with harvest of carp spp. Perhaps existing processing plants could produce ground fish. Then there is the possibly of alligator farmers using crab cakes or some modification. Can you add to these ideas?

Example three: Consider fee-fishing ponds. Old timers in the catfish farming industry will remember that the industry took off around the mid 1960s. Pioneer farmers, such as Edgar Farmer of Dumas, AR and Pete Haring of Wisner, LA, felt their way into a new type of farming for them. Louisiana got into catfish farming in a big way around the mid 1960s. Only one problem, the infrastructure was not in place. There were no feed mills, processing plants, or other ancillary businesses that are needed. Virtually all of the catfish grown during the early years in Louisiana and elsewhere went to pay lakes where people pay to fish. That's right, and because processing plants were lacking some catfish farmers opened their own restaurants to sell the fish they had

grown. Nathan Cormie of Louisiana, opened a restaurant near Lake Charles, LA solely for the purpose of marketing his pond production of catfish. It was some years later that the catfish was marketed mostly for food.

Auburn University has years of experience in research of pay lakes. Some may say that pay lakes won't work in certain states. It has been pointed out that in Louisiana numerous natural lakes and rivers are available to fish. However, not all citizens have a boat or even the time to fish. Picture this with a pay lake, a family, including wife and kids, fishing from mowed grass with rented fishing gear, and having their fish cleaned. If you wit further, the fish could be cooked at the pond area. Go all the way, and provide a play area for the children. Fee-fishing ponds have one big advantage over imported fish from other countries. Fish from overseas are shipped in fresh or frozen. Either way they are not alive to take the hook.



Southland Fisheries Corporation

FRY & FINGERLINGS AVAILABLE

HYBRID STRIPED BASS

REDEAR

BLUEGILL

LARGEMOUTH BASS

STERILE GRASS CARP

OTHERS ON REQUEST

Quantity Discount on
Advanced Booking.
Specialized in International Shipping

600 Old Bluff Road
Hopkins, SC 29061
803-776-4923
Fax 803-776-4975

RS No. 169



Various carp species may show promise as food for zoo animals.

the Catfish Report

Catfish Processing Down 14 Percent from Last Year

Farm-raised catfish processed during July 2007 totaled 39.2 million pounds round weight, down 14 percent from July 2006. This total is the lowest reported July round weight processed since July 1996 when 39.0 million pounds were processed. The average price paid to producers was 76.2 cents per pound for July 2007, down 5.5 cents from last month and 5.0 cents below a year ago.

Net pounds of processed fish sold during July 2007 totaled 20.4 million pounds, down 8 percent from the comparable month in 2006. The total end of the month inventory decreased 10 percent from last month but was up 49 percent from a year ago. Sales of fresh

fish, at 7.25 million pounds, were down 8 percent from July 2006 and represented 36 percent of total sales.

Frozen fish sales, at 13.1 million pounds, were down 8 percent from a year ago and accounted for the remaining 64 percent of total fish sales. Sales of whole fish represented 16 percent of the total fish sold, fillets accounted for 63 percent, and the remaining 21 percent were mostly steaks, nuggets, and value added products.

The July 2007 average price received by processors for total fresh fish was \$2.53 per pound, unchanged from last year. Prices for fresh whole fish were \$1.73 per pound, up 1 cent from July 2006.

Prices for fresh fillets were unchanged from a year ago at \$3.18 per pound. Total frozen fish averaged \$2.48 per pound, down 12 cents from July 2006. Prices for frozen whole dressed fish were down 5 cents at \$2.19 and frozen fillets at \$2.93

per pound were down 8 cents from a year ago.

Freshwater imports of *Ictalurus* spp., *Pangasius* spp., and other catfish of the order Siluriformes for June 2007 totaled 5.47 million pounds, up 24 percent from the amount imported in June 2006. Imports were from Brazil, Canada, Chile, China, China-Taipei, Indonesia, Philippines, Spain, Thailand, and Vietnam. The *Ictalurus* spp. imports totaled 388 thousand pounds, which were from Brazil, Canada, China, China-Taipei, and Philippines.

Fresh boneless catfish fillet exports totaled 69.3 thousand pounds, with 54.3 thousand pounds going to Canada and the rest going to the Bahamas and the Netherlands. Exports of frozen, boneless catfish fillets reported for June 2007 totaled 24.3 thousand pounds, which all went to China.

Import and export data are compiled by the U.S. Census Bureau.

Farm-Raised Catfish: Quantity Processed by Major Processors, United States, 2005-2006						
Month	Round Weight Processed					
	Monthly		Percent of Previous Year	Cumulative		Percent of Previous Year
	2006	2007		2006	2007	
1,000 Pounds	1,000 Pounds	Percent	1,000 Pounds	1,000 Pounds	Percent	
Jan	50,703	46,957	93	50,703	46,957	93
Feb	49,145	44,439	90	99,848	91,396	92
Mar	56,315	44,397	79	156,163	135,793	87
Apr	43,126	37,954	88	199,289	173,747	87
May	42,865	38,867	91	242,154	212,673	88
Jun	41,214	37,275	90	283,368	249,889	88
Jul	45,528	39,168	86	328,896	289,057	88
Aug	51,736			380,632		
Sep	47,296			427,928		
Oct	50,788			478,716		
Nov	45,680			524,396		
Dec	41,735			566,131		

Farm-Raised Catfish: Prices Paid to Producers by Processors and Imports, United States, 2005-2006						
Month	Price Per Pound ¹		Change from Prev Year	Imports ²		Percent of Previous Year
	2005	2006		2006	2007	
	Dollars	Dollars	Dollars	1,000 Pounds	1,000 Pounds	Percent
Jan	0.727	0.838	0.111	2,644	12,056	456
Feb	0.729	0.838	0.109	2,491	7,582	304
Mar	0.745	0.838	0.093	3,267	6,430	197
Apr	0.785	0.841	0.056	3,119	5,097	163
May	0.796	0.840	0.044	3,306	5,434	164
Jun	0.807	0.817	0.010	4,424	5,469	124
Jul	0.812	0.762	-0.050	5,232		
Aug	0.811			8,991		
Sep	0.832			9,091		
Oct	0.836			10,672		
Nov	0.837			12,830		
Dec	0.838			8,897		

¹Price for fish delivered to the processing plant door. Price includes charges for any services provided by the processing plant, such as seining and hauling, but does not include adjustments based on year-end settlements

²Pounds of frozen boneless fillets. Includes *Ictalurus*, *Pangasius* and Siluriformes catfish. Data furnished by the U.S. Bureau of Census

CALENDAR OF EVENTS

OCTOBER 2007

OCTOBER 15- 18

IX Ecuadorian Aquaculture Conference & AquaExpo 2007
Guayaquil, Ecuador
Tel: 593-4-2-269494
Email: cparra@cna-ecuador.com

OCTOBER 24 - 26

Fish Africa
Capetown, South Africa
Tel:44 (0) 20 7017 4661
Email: leonard.field@informa.com

OCTOBER 24 - 26

Aquaculture Africa
Capetown, South Africa
Tel: 27 (0)-11-7983-7250
Fax: 27 (0)-11-783-7269

OCTOBER 24 - 27

Aquaculture Europe 2007
Istanbul, Turkey
Tel:32-59-32-3859
Fax: 32-59-32-1005
Email: mario.stael@scarlet.be

NOVEMBER 2007

NOVEMBER 6 - 8

China Fisheries & Seafood Expo 2007
Dalian, China
Tel: 206-789-5741
Fax: 206-789-0504
Email: seafoodchina@seafare.com

NOVEMBER 6 - 9

Caribbean & Latin America Aquaculture 2007
San Juan, Puerto Rico
Tel: 760-751-5005
Fax: 760-751-5003
Email: worldaqua@aol.com

NOVEMBER 12 - 16

10th International Conference On Shellfish Restoration (ICSR)
Wageningen, The Netherlands
Tel: +31 317 477477
Fax: +31 317 484884

NOVEMBER 14 -16

VI Aquamar Internacional
Vera Cruz, Mexico
Tel: 52-55-51355697
Fax: 52-55-51356128
Email: aquamarineinternacional.com

NOVEMBER 15 - 17

Expo Pesca
Lima, Peru
Tel: 511-344-4386
Fax: 511-344-4389
Email: thais@amauta.rcp.net.pe

NOVEMBER 16-17

Virginia Aquaculture Conference
Williamsburg, Virginia, USA
Tel: 804-684-7165
Email: mike@vims.edu

NOVEMBER 22 - 25

Agadir Fish Morocco Agadir, Morocco
Tel: 212-(0)-22-47-0600
Fax: 212-(0)-22-47-0601
Email: afm@eme-morocco.com

NOVEMBER 27 - 30

Iran's Fifth International Fisheries, Aquaculture & Seafood Exhibition
Kish Island, Iran
Tel: 98 21 66482281-2
Fax: 98 21 66970742
Email : info@persianfedfund.com
Website: www.iranseafoodexpo.ir/

FEBRUARY 2008

FEBRUARY 8-10

Aquaculture America 2008
Lake Buena Vista, Florida, USA
Tel: 760-751-5005
Fax: 760-751-5003
Email: worldaqua@aol.com
See Ad Page 9

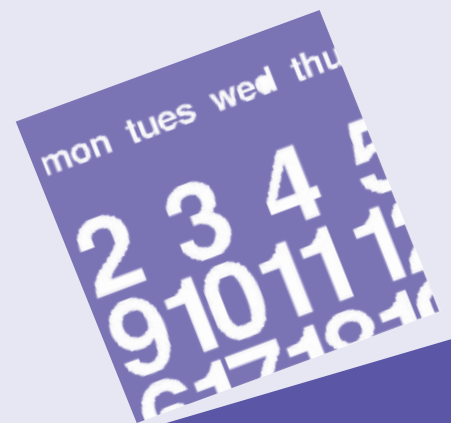

Advertisers Index

Advanced Aquaculture.....	111	65	Feeding Systems	894	20	Point Four Systems	149	35
Alita Industries.....	206	70	Firestone.....	266	14	Polytank	776	50
All Star Products	236	28	Florida Fish Farms	531	18	PRAqua Supplies	125	49
Aqua Logic.....	950	57	Fresh Flo Corp.	209	59	Process Tech.....	382	12
Aquaculture Systems	414	42	Frigid Units	258	33	Pungo Fisheries.....	333	63
Aquanate	217	56	Heating Your Pond.....	361	54	Purina Mills.....	665	03
Aquatic Eco-Systems	252	IFC	Hiblow USA.....	076	82	Rangen	726	81
Artesian Trout Farm	365	68	Hopper-Stephens.....	324	40	Raven Industries.....	032	13
Auburn University	359	27	IAS Products	724	45	RC Graham	255	34
Austin Bros. Fisheries.....	174	12	Integrator Aqua Systems	225	55	Reef Industries.....	887	23
AVA Publishing	175	20	International Ingredients	022	83	RK2 Systems.....	372	10
B & K Installations	874	7	InterNet	211	32	Schering Plough	314	46
B.L. Mitchell.....	353	36	J.A. Cissel	678	79	Schering Plough	314	47
Burriss Aquaculture	001	83	J.M. Malone & Son Inc.....	302	26	Shivers Real Estate	290	41
CABI	352	37	Ken's Hatchery.....	741	39	Solar Components.....	399	56
Cantrell Trout Farm.....	358	43	Keo Fish Farms	737	71	South Santee Aquaculture	322	11
Cargill.....	152	BC	Lantec Products.....	119	22	Southland Fisheries.....	169	87
Carolina Fisheries	918	14	MariSource.....	409	51	Star Milling Company.....	203	44
Castle Hayne Fisheries.....	179	54	Memphis Net & Twine.....	213	51	Sterling Net & Twine.....	912	85
Cleveland Process	070	41	Midwater Systems.....	362	50	Stoller Fisheries	234	74
Common Sensing	464	30	Mill Technology Co	940	80	Superior Aquaculture	227	65
Crystal Lake Fishereis.....	269	68	Mossy Oak Properties	364	48	Texas A & M	061	61
D&T Fiberglass.....	101	34	MTI Inc.	311	70	The Roan Group.....	357	31
Decotex	310	63	Myron L. Company.....	803	19	Troutlodge Inc.....	319	16
Delmarva Aquatics.....	692	52	Novartis Aniaml Health	342	32	United Country.....	329	60
Delstar Technologies.....	435	24	Octaform	777	15	Universal Marine	356	71
Delta Hydronics	429	58	Oxyguard.....	349	25	University of Arkansas.....	000	30
Dolphin Fiberglass.....	845	40	Owen & Williams	716	44	Valterra Products	973	61
Emperor Aquatics.....	332	17	Pacific Coast Imports	106	21	Western Chemical	330	6
ETI	823	8	Pacific Ozone Tech.....	241	18	Wisconsin Flowgate.....	281	60
F&L Anderson.....	670	58	Pentair Aquatics	798	29	World Aquaculture	238	9
Farm Cat.....	348	52	Plast-O-Matic Valves	033	80	Zeigler	569	IBC

aquaculture
magazine

IS ONLINE AT

WWW.AQUACULTUREMAG.COM



V*pak*[™] is an all-natural, highly-purified nutritional additive designed to improve vitality and survivability in cultured species. Field trials have demonstrated increased disease resistance rates when fish were fed diets supplemented with **V***pak*[™].

As with all Zeigler fish diets, **V***pak*[™] is formulated to contain no antibiotics.



Zeigler Bros., Inc.
P.O. Box 95, Gardners, PA 17324 USA
717-677-6181 Toll Free: 800-841-6800 Fax: 717-677-6826
www.zeiglerfeed.com



Product of U.S.A.

RS No. 569



Customer Success.

It's the very reason we do what we do.

"We were losing biomass by not feeding during the winter months. With Cargill's help, we reviewed and analyzed feeding patterns and identified what we needed to change. Now we're optimizing our feed conversion by varying rations and making seasonal changes.

The relationship with our Cargill rep Jason is key to the success of our business. Day or night, he's ready to help with the right solutions."

*Bubba Groves
Biologist/Assistant Manager
Nature's Catch, Inc., Clarksdale, MS*



> We look forward to your success.

www.cargillaquaculture.com

CargillTM