

Life Cycle Inventory of Biodiesel and Petroleum Diesel for Use in an Urban Bus



A Joint Study Sponsored by:

**U.S. Department of Agriculture and
U.S. Department of Energy
Final Report
May 1998**

NOTICE

NOTICE: This report was prepared as an account of work sponsored by an agency of the United States government. Neither the United States government nor any agency thereof, nor any of their employees, makes any warranty, express or implied, or assumes any legal liability or responsibility for the accuracy, completeness, or usefulness of any information, apparatus, product, or process disclosed, or represents that its use would not infringe privately owned rights. Reference herein to any specific commercial product, process, or service by trade name, trademark, manufacturer, or otherwise does not necessarily constitute or imply its endorsement, recommendation, or favoring by the United States government or any agency thereof. The views and opinions of authors expressed herein do not necessarily state or reflect those of the United States government or any agency thereof.

Printed in the United States of America

Available to DOE and DOE contractors from:

Office of Scientific and Technical Information (OSTI)

P.O. Box 62

Oak Ridge, TN 37831

Prices available by calling (423) 576-8401

Available to the public from:

National Technical Information Service (NTIS)

U.S. Department of Commerce

5285 Port Royal Road

Springfield, VA 22161

(703) 487-4650

A limited supply is also available from Sally Evans

National Renewable Energy Laboratory

1617 Cole Boulevard

Golden, CO 80125

(303) 275-4363

Printed with renewable source ink on paper containing at least 50% wastepaper, including 20% postconsumer waste



Life Cycle Inventory of Biodiesel and Petroleum Diesel for Use in an Urban Bus

Final Report

May 1998

by

John Sheehan
Vince Camobreco
James Duffield
Michael Graboski
Housein Shapouri

Prepared for:

U.S. Department of Energy's
Office of Fuels Development

and

U.S. Department of Agriculture's
Office of Energy

Prepared by: the
National Renewable Energy Laboratory
1617 Cole Boulevard
Golden, Colorado 80401-3393
A national laboratory of the U.S. Department of Energy
Operated by Midwest Research Institute
Under Contract No. DE-AC02-83CH10093
Prepared under Task No. BF886002

Acknowledgements

Life cycle studies require a lot of thoughtfulness, hard work and patience. We have been fortunate enough to have all of these. The core team of workers comes from a variety of organizations. The ability to pull off this kind of collaboration among so many groups is a tribute to each of the individual organizations.

From the U.S. Department of Energy’s National Renewable Energy Laboratory...

- ❑ John Sheehan, who initiated and organized this whole effort at the start, provided detailed process modeling for the soybean crushing and biodiesel production technologies.
- ❑ K. Shaine Tyson, NREL Project Manager for DOE’s Biodiesel Program, provided overview and management for the work (and, more importantly, shared her insights based her experience conducting a life cycle study for ethanol).

From the U.S. Department of Agriculture’s Office of Energy...

- ❑ Jim Duffield, who coordinated this study for USDA, was the lead contributor to the soybean agriculture portion of the model.
- ❑ Housein Shapouri, a co-author of the soybean agriculture section, provided invaluable support in collecting and analyzing USDA’s data on soybean farm practices.

From Ecobalance, Inc. and the the Colorado Institute for Fuels and High Altitude Engine Research (CIFER) at the Colorado School of Mines...

- ❑ CIFER’s Mike Graboski, through the support of USDA’s Office of Energy, took the lead in collecting and analyzing all of the available data on biodiesel and petroleum diesel performance in bus engines.

From Ecobalance, Inc.

- ❑ Ecobalance’s Vince Camobreco, who coordinated this study for Ecobalance with support from the U.S. Department of Energy, tirelessly lead the effort to construct the life cycle models for petroleum diesel and biodiesel using Ecobalance’s invaluable software tools designed for this type oif work. Remi Coulon and Jacques Besnainou provided technical oversight of the model development, also provided invaluable insight on life cycle modeling

We would be remiss if we did not recognize the hours of volunteer time put in by our stakeholders and peer reviewers. It is their efforts who lend real credibility to this work. Finally, we want to thank the leadership at the U.S. Department of Energy and the U.S. Department of Agriculture for their support and patience during this long and trying effort. In particular, we would like to thank....

- ❑ Roger Conway, USDA Office of Energy
- ❑ John Ferrell and Mike Voorhies, USDOE Office of Fuels Development

Executive Summary

What is biodiesel?

Biodiesel is a renewable diesel fuel substitute. It can be made from a variety of natural oils and fats. Biodiesel is made by chemically combining any natural oil or fat with an alcohol such as methanol or ethanol. Methanol has been the most commonly used alcohol in the commercial production of biodiesel. In Europe, biodiesel is widely available in both its neat form (100% biodiesel, also known as B100) and in blends with petroleum diesel. European biodiesel is made predominantly from rapeseed oil (a cousin of canola oil). In the United States, initial interest in producing and using biodiesel has focused on the use of soybean oil as the primary feedstock mainly because the United States is the largest producer of soybean oil in the world.

Why biodiesel?

Proponents of biodiesel as a substitute for diesel fuel (in blends or in its neat form) can point to a number of potential advantages for biodiesel that could support a number of strategies for addressing national issues.

✓ ***Reducing dependence on foreign petroleum...***

Petroleum imports are at record levels in the United States, and will continue to rise as domestic supplies of oil shrink. Our transportation sector relies almost exclusively on petroleum as a source of energy. This is due to the high level of demand for gasoline and diesel fuel. Biodiesel can be produced domestically from agricultural oils and from waste fats and oils. With its ability to be used directly in existing diesel engines, biodiesel offers the immediate potential to reduce our demand for petroleum in the transportation sector.

✓ ***Leveraging limited supplies of fossil fuels....***

Regardless of whose perspective one chooses to believe on the future supply of coal, oil and natural gas, it is indisputable that the supply of these fuels is, ultimately, limited. Biodiesel has the potential to leverage our use of limited supplies of fossil fuels.

✓ ***Mitigating greenhouse gas emissions....***

The burning of fossil fuels over the past century has dramatically increased the levels of carbon dioxide (CO₂) and other “greenhouse gases” that trap heat in our atmosphere. The implications of the increasing levels of these greenhouse gases are a matter of serious debate. What is not questioned is that the levels of these greenhouse gases have risen at unprecedented rates in the context of geological time¹. To the extent that biodiesel is truly renewable, it could play a role in reducing greenhouse gas emissions from the transportation sector.

¹Revelle published the groundbreaking work on atmospheric CO₂ build-up during the International Geophysical Year of 1957, in which he stated the problem of greenhouse gases more clearly than any researcher before or since. He stated that “Human beings are carrying out a large-scale geophysical experiment of a kind that could not have happened in the past nor be produced in the future. Within a few centuries, we are returning to the atmosphere and

✓ ***Reducing Air Pollution and Related Public Health Risks....***

One of EPA's primary charges is to reduce public health risks associated with environmental pollution. Biodiesel can play a role in reducing emissions of many air pollutants, especially those targeted by EPA in urban areas. These include emissions of particulate matter (PM), carbon monoxide (CO), hydrocarbons (HC), sulfur oxides (SO_x), nitrogen oxides (NO_x) and air toxics.

✓ ***Benefiting our domestic economy....*** Spending on foreign imports of petroleum send dollars out of our economy. Biodiesel offers the potential to shift this spending from foreign imports to domestically produced energy. It also offers new energy-related markets to farmers.

Why a life cycle study?

The purpose of this study is to quantify, to the extent possible, some of the benefits listed above. In this study, we have focused on those benefits related to biodiesel energy's balance, its effect on emissions of greenhouse gases, and its effects on the generation of air, water and solid waste pollutants. We have made no attempt to quantify domestic economic benefits of using biodiesel.

The effect of biodiesel on overall consumption of petroleum and other fossil fuels can only be understood in the context of this fuel's "life cycle"—the sequence of steps involved in making and using the fuel from the extraction of all raw materials from the environment to the final end-use of the fuel in an urban bus. Similarly, the accumulation of CO₂ in the atmosphere is a global effect that requires a comprehensive life cycle analysis. Furthermore, understanding the benefits of biodiesel means understanding how its life cycle emissions compare to those of petroleum diesel.

This study provides a life cycle inventory of environmental and energy flows to and from the environment for both petroleum diesel and biodiesel, as well as for blends of biodiesel with petroleum diesel.

The scope of this study

Life cycle analysis is a complex science. The level of detail required in such a study forces a high degree of specificity in the scope and application of the products being studied. A substantial amount of information from engine tests and fuel demonstrations of soybean-derived biodiesel in urban buses is available. We relied on this recent data and experience to characterize the performance of soybean-derived biodiesel in this application.

Findings

Conducting life cycle inventories is fraught with difficulties. Incomplete data is the rule rather than the exception. There are varying degrees of confidence in the results that we present in this report. The most reliable conclusions of this study are for overall energy balance and carbon dioxide emissions. For these two measures, our data is the most complete. More importantly, our sensitivity studies show that the estimates of carbon dioxide emissions and energy requirements are very robust-- that is, these results show little change in response to changes in key assumptions.

the oceans the concentrated organic carbon stored in sedimentary rocks over hundreds of millions of years.”
Revelle, R.; Suess, H. *Tellus*, Volume 9, No. 11, pp 18-21. 1957.

Reductions in Petroleum and Fossil Energy Consumption

As one component of a strategy for reducing petroleum oil dependence and minimizing fossil fuel consumption, the use of biodiesel offers tremendous potential.

Substituting 100% biodiesel (B100) for petroleum diesel in buses reduces the life cycle consumption of petroleum by 95%. This benefit is proportionate with the blend level of biodiesel used. When a 20% blend of biodiesel and petroleum diesel (B20) is used as a substitute for petroleum diesel in urban buses, the life cycle consumption of petroleum drops 19%.

In our study, we found that the production processes for biodiesel and petroleum diesel are almost identical in their efficiency of converting a raw energy source (in this case, petroleum and soybean oil) into a fuel product. The difference between these two fuels is in the ability of biodiesel to utilize a renewable energy source.

Biodiesel yields 3.2 units of fuel product energy for every unit of fossil energy consumed in its life cycle. The production of B20 yields 0.98 units of fuel product energy for every unit of fossil energy consumed.

By contrast, petroleum diesel's life cycle yields only 0.83 units of fuel product energy per unit of fossil energy consumed. Such measures confirm the "renewable" nature of biodiesel.

Reductions in CO₂ Emissions

Given the low demand for fossil energy associated with biodiesel, it is not surprising that biodiesel's life cycle emissions of CO₂ are substantially lower than those of petroleum diesel.

Biodiesel reduces net emissions of CO₂ by 78.45% compared to petroleum diesel. For B20, CO₂ emissions from urban buses drop 15.66%.

In addition, biodiesel provides modest reductions in total methane emissions, compared to petroleum diesel. Methane is another, even more potent, greenhouse gas. Thus, use of biodiesel to displace petroleum diesel in urban buses is an extremely effective strategy for reducing CO₂ emissions.

Changes in Air Pollutant Emissions

The effect of biodiesel on air quality is more complex. Biodiesel, as it is available today, offers substantial improvements in some air pollutants, while it leads to increases in others.

Reductions in Particulates, Carbon Monoxide and Sulfur Oxides...

The use of B100 in urban buses results in substantial reductions in life cycle emissions of total particulate matter, carbon monoxide and sulfur oxides (32%, 35% and 8% reductions, respectively, relative to petroleum diesel's life cycle).

All three of these pollutants have been targeted by EPA because of the important role they play in public health risks, especially in urban areas where the acute effects of these pollutants may be greater. Given the concern over urban air quality, it is important to note that most of these reductions occur because of lower emissions at the tailpipe. For buses operating in urban areas, this translates to an even greater potential benefit:

Tailpipe emissions of particulates less than 10 microns in size are 68% lower for buses run on biodiesel (compared to petroleum diesel). In addition, tailpipe emissions of carbon monoxide are 46% lower for buses run on biodiesel (compared to petroleum diesel). Biodiesel completely eliminates emissions of sulfur oxides at the tailpipe.

Tailpipe emissions of particulates that are smaller than 10 microns in size are specifically regulated by EPA because of the tendency for fine particulate matter to remain trapped in the lungs.

The reductions in air emissions reported here are proportional to the amount of biodiesel present in the fuel. Thus, for B20, users can expect to see 20% of the reductions reported for biodiesel used in its neat form (B100).

Increased Emissions of Nitrogen Oxides (NO_x)...

NO_x is one of three pollutants implicated in the formation of ground level ozone and smog in urban areas (NO_x, CO and hydrocarbons).

The use of B100 in urban buses increases life cycle emissions of NO_x by 13.35%. Blending biodiesel with petroleum proportionately lowers NO_x emission. B20 exhibits a 2.67% increase in life cycle emissions of NO_x. Most of this increase is directly attributable to increases in tailpipe emissions of NO_x. B100, for example, increases tailpipe levels of NO_x by 8.89%.

Our results are presented for fuel and engine technology as they exist today. Our study points out the need for research on both engine design and biodiesel fuel formulation to address this problem.

Hydrocarbons—higher on a life cycle basis, but lower at the tailpipe...

The increase in hydrocarbon emissions is due to release of hexane in the processing of soybeans and volatilization of agrochemicals applied on the farm.

Total life cycle emissions of hydrocarbons are 35% higher for B100, compared to petroleum diesel. However, emissions of hydrocarbons at the tailpipe are actually 37% lower.

These results point out opportunities for improving the life cycle of biodiesel. Future biodiesel research should focus on ways of reducing hexane releases from today's current levels in soybean crushing plants. Improvements in use of agrochemicals on the farm would have similarly beneficial effects.

Next Steps

At the outset, we designed this study to identify and quantify the advantages of biodiesel as a substitute for petroleum diesel. These advantages are substantial, especially in the area of energy security and control of greenhouse gases. We have also identified weaknesses or areas of concern for biodiesel—such as its emissions of NO_x and hydrocarbons. We see these as opportunities for further research to resolve these concerns. We hope that our findings will be used to focus future biodiesel research on these critical issues.

There is much that could be done to build on and improve the work we have done here. Appropriate next steps for this work include the following:

- **Use the life cycle inventory to assess the relative effects of petroleum diesel and biodiesel on our environment and on public health risks in order to gain an understanding of the benefits associated with biodiesel.**
- **Quantify the costs and benefits of biodiesel.**
- **Assess the economic impact of biodiesel as an alternative fuel (e.g., its effects on jobs, trade deficit, etc.)**
- **Evaluate other feedstock sources.**
- **Incorporate new health effects data on hydrocarbon emissions from biodiesel and petroleum diesel.**
- **Develop regional life cycle models for biodiesel use.**
- **Evaluate performance of newer diesel engines and new fuel production technologies.**

Table of Contents

1	<i>How To Use This Report</i>	1
2	<i>Technical Overview</i>	3
2.1	Stakeholder Involvement	3
2.2	Scope of the Life Cycle Study	4
2.2.1	Purpose	4
2.2.2	What Is “Biodiesel?”	4
2.2.3	What Is “Petroleum Diesel?”	5
2.2.4	Defining the Product Application.....	5
2.2.5	What Is Included in the Life Cycle Systems?.....	5
2.2.6	What Are the Geographical Boundaries?.....	6
2.2.7	What Is the Time Frame?.....	6
2.2.8	Basis for Comparing the Life Cycles.....	6
2.3	Key Assumptions	8
2.4	Findings	8
2.4.1	Results of the Base Case Study	9
2.4.1.1	Life Cycle Energy Balance.....	10
2.4.1.1.1	Types of Life Cycle Energy Inputs	10
2.4.1.1.2	Defining Energy Efficiency	11
2.4.1.1.3	Petroleum Diesel Life Cycle Energy Consumption	11
2.4.1.1.4	Biodiesel Life Cycle Energy Demand.....	13
2.4.1.1.5	Effect of Biodiesel on Life Cycle Energy Demands	17
2.4.1.2	CO ₂ Emissions.....	18
2.4.1.2.1	Accounting for Biomass-Derived Carbon	18
2.4.1.2.2	Comparison of CO ₂ Emissions for Biodiesel and Petroleum Diesel	18
2.4.1.3	Primary Resource Consumption for Biodiesel and Petroleum Diesel	19
2.4.1.4	Life Cycle Emissions of Regulated and Nonregulated Air Pollutants.....	22
2.4.1.4.1	Comparison of Life Cycle Air Emissions for Biodiesel and Petroleum Diesel	23
2.4.1.5	Life Cycle Emissions of Water Effluents	25
2.4.1.6	Comparison of Solid Waste Life Cycle Flows	26
2.4.2	Sensitivity Studies	27
2.4.2.1	The Effect of Enhanced Location for Biodiesel Production and Use	27
2.4.2.2	The Effect of Energy Requirements for Conversion of Soybean Oil to Biodiesel	30
2.5	Conclusions	33
2.5.1	Life Cycle Energy and Environmental Flows	33
2.5.2	Next Steps.....	34
3	<i>Life Cycle Scope and Methodology</i>	35
3.1	Background	35
3.1.1	Life Cycle Assessment Overview.....	35
3.1.2	Biodiesel and Petroleum Diesel Fuels	36
3.2	Purpose of this Study	37
3.3	Project Scope	37
3.3.1	Project Parameters	37
3.3.1.1	Environmental Issues Considered.....	37
3.3.1.2	Temporal Scope	39
3.3.1.3	Geographical Scope	39

3.3.2	Product Parameters.....	40
3.3.2.1	Fuels Studied.....	40
3.3.2.2	End-Use.....	41
3.3.2.3	Functional Unit.....	41
3.3.3	Process Parameters.....	41
3.3.3.1	Biodiesel.....	41
3.3.3.2	Petroleum Diesel Fuel.....	42
3.3.4	LCA-Specific Parameters.....	42
3.4	System Boundaries.....	43
3.4.1	LCA Principle for Setting System Boundaries.....	43
3.4.2	How Allocation Rules are Used in Our Study.....	45
4	Petroleum Diesel Fuel Modeling.....	53
4.1	Petroleum Diesel Fuel General Modeling Assumptions.....	53
4.1.1	Geographic Boundaries.....	53
4.2	Crude Oil Extraction.....	54
4.2.1	Conventional Onshore Extraction.....	55
4.2.1.1	Material Use.....	55
4.2.1.2	Energy/Equipment Use.....	56
4.2.1.3	Process Emissions.....	57
4.2.1.4	Crude Oil Separation.....	58
4.2.1.5	Crude Oil and Natural Gas Allocations – Conventional Onshore.....	59
4.2.2	Conventional Offshore Extraction.....	61
4.2.2.1	Material Use.....	61
4.2.2.2	Energy/Equipment Use.....	61
4.2.2.3	Process Emissions.....	62
4.2.2.4	Crude Oil Separation.....	64
4.2.2.5	Crude Oil and Natural Gas Allocations – Conventional Offshore.....	64
4.2.3	Advanced Onshore Extraction (Steam Injection).....	65
4.2.3.1	Material Use.....	66
4.2.3.2	Energy/Equipment Use.....	66
4.2.3.3	Process Emissions.....	66
4.2.3.4	Crude Oil and Natural Gas Allocation-Steam Injection Extraction.....	67
4.2.4	Advanced Onshore Extraction (CO ₂ Injection).....	67
4.2.4.1	Material Use.....	67
4.2.4.2	Energy/Equipment Use.....	68
4.2.4.3	Process Emissions.....	68
4.2.4.4	Crude Oil and Natural Gas Allocations - CO ₂ injection.....	69
4.2.5	Crude Oil Extraction Results.....	69
4.3	Crude Oil Transport to Refinery.....	72
4.3.1	Transportation Regionalization.....	72
4.3.2	Transportation Distances.....	73
4.3.3	Transportation Models.....	75
4.3.4	Energy and Fugitive Emissions from Storage and Handling.....	75
4.3.5	Crude Oil Transportation Results.....	80
4.4	Crude Oil Refining.....	83
4.4.1	Material Use.....	85
4.4.2	Energy/Equipment Use.....	86
4.4.3	Process Emissions.....	87
4.4.3.1	Air Emissions.....	87
4.4.3.2	Water Effluents.....	88
4.4.3.3	Solid Waste.....	88
4.4.4	Diesel Fuel Production.....	90

4.4.5	Crude Oil Refining Results.....	91
4.5	Diesel Fuel Transport.....	93
4.5.1	Modes of Transport and Distance Transported	93
4.5.2	Energy and Fugitive Emissions from Storage and Handling	94
4.5.3	Diesel Fuel Transportation Results.....	94
5	Biodiesel Fuel Modeling.....	97
5.1	Soybean Agriculture.....	97
5.1.1	Soybean Agriculture General Modeling Assumptions	98
5.1.2	Soybean Agriculture Materials Consumption	99
5.1.2.1	Fertilizers and Agrochemicals	99
5.1.2.2	Water Use.....	102
5.1.3	Soybean Agriculture Energy and Equipment Use	102
5.1.3.1	Energy Use and Soybean Yield	102
5.1.3.2	Energy Emissions	105
5.1.4	Soybean Agriculture Biological Interactions/Field Emissions.....	105
5.1.4.1	Soil Erosion—National Resource Inventory.....	106
5.1.4.2	Other Nutrients and Fertilizers Carried off the Field by Erosion	107
5.1.4.3	Agrochemicals in Waterways	109
5.1.4.4	Agrochemicals in the Atmosphere	111
5.1.4.5	NO _x and N ₂ O Emissions from Soil.....	114
5.1.5	Soybean Agriculture LCI Results.....	115
5.2	Soybean Transport to Crusher	117
5.2.1	Modes of Transport and Distance Transported	117
5.2.2	Energy and Fugitive Emissions from Storage and Handling	117
5.2.3	Soybean Transportation Results.....	117
5.3	Soybean Crushing	119
5.3.1	Process Description for Soybean Crushing.....	119
5.3.1.1	Soybean Receiving and Storage.....	121
5.3.1.2	Bean Preparation.....	122
5.3.1.3	Soybean Oil Extraction	124
5.3.1.4	Meal Processing.....	125
5.3.1.5	Soybean Oil Recovery.....	127
5.3.1.6	Solvent Recovery	128
5.3.1.7	Oil Degumming	128
5.3.1.8	Waste Treatment.....	130
5.3.2	Analysis of Yields and Energy Balance.....	131
5.3.3	Overall Inputs to Soybean Crushing.....	133
5.3.4	Overall Soybean Crushing Outputs	134
5.3.5	Allocation of Life Cycle Flows for Soybean Crushing.....	136
5.3.6	Soybean Crushing Results	136
5.4	Soybean Oil Transport.....	138
5.4.1	Where Do We Locate the Biodiesel Conversion Facilities?	138
5.4.2	Modes of Transport and Distance Transported	139
5.4.3	Energy and Fugitive Emissions from Storage and Handling	139
5.4.4	Soybean Oil Transport Results.....	140
5.5	Soybean Oil Conversion.....	142
5.5.1	Process Overview for Conversion of Soybean Oil to Biodiesel	142
5.5.1.1	Alkali Refining of Crude Soybean Oil.....	144
5.5.1.2	Transesterification	147
5.5.1.3	Methyl Ester Purification	148
5.5.1.4	Glycerine Recovery.....	150

5.5.1.5	Methanol Recovery	154
5.5.1.6	Waste Treatment	157
5.5.2	Analysis of Yields and Energy Balance	158
5.5.3	Overall Inputs to the Soybean Oil Conversion Facility	163
5.5.4	Overall Soybean Oil Conversion Outputs	164
5.5.5	Allocation of Life Cycle Flows for Soy Oil Conversion to Biodiesel	165
5.5.6	Soybean Conversion Results	165
5.6	Biodiesel Transport	167
5.6.1	Modes of Transport and Distance Transported	167
5.6.2	Energy and Fugitive Emissions from Storage and Handling	167
5.6.3	Biodiesel Transportation Results	167
6	Urban Bus Operation	171
6.1	Biodiesel Fuel Combustion	171
6.1.1	Comparison of Fuel Properties of Petroleum Diesel and Biodiesel	171
6.1.1.1	Cetane Number	174
6.1.1.2	Flash Point	174
6.1.1.3	Distillation	175
6.1.1.4	Specific Gravity	175
6.1.1.5	Energy Content	175
6.1.1.6	Flow Properties (Cold Temperature Sensitivity)	175
6.1.1.7	Viscosity and Surface Tension	176
6.1.1.8	Oxidative Stability	176
6.1.1.9	Sulfur, Aromatic, Ash, Sediments, Water, Methanol, Glycerine, and Glyceride Content	177
6.1.1.10	Biodiesel Composition	177
6.1.2	Biodiesel Fuel Economy	177
6.1.3	Biodiesel Tailpipe Emissions	181
6.1.4	The Fate of Biomass Carbon Leaving the Tailpipe of the Bus	184
6.1.5	Biodiesel Combustion Results	186
6.2	Diesel Fuel Combustion	187
6.2.1	Diesel Fuel Economy	187
6.2.2	Tailpipe Emissions	187
6.3	Combustion End-use Results	187
7	Software Modeling Tools	189
7.1	Description of the TEAM™ Model	189
1.2	Description of the Database Used	189
1.2.1	Electricity	189
1.2.1.1	Electricity from Coal	190
1.1.1.1.1	Coal Mining	190
1.1.1.1.2	Cleaning and Preparation	191
1.1.1.1.3	Transportation from Site of Extraction to Power Plant	191
1.1.1.1.4	Coal–Rail	191
1.1.1.1.5	Coal–Truck	191
1.1.1.1.6	Coal–Ship	192
1.1.1.1.7	Coal Slurry Pipeline	192
1.1.1.1.8	Water Effluents	192
1.1.1.2	Coal Combustion	192
1.1.1.2.1	Emissions Control Technology	194
1.1.1.2.2	Water Effluents	194
1.1.1.3	Post-Combustion Products of Coal	194
1.1.1.3.1	Transportation to the Landfill from the Silo	195
1.1.1.4	Electricity from Heavy Fuel Oil	195

1.1.1.5	Electricity from Natural Gas.....	195
1.1.1.6	Natural Gas Production.....	195
1.1.1.6.1	Mining and Cleaning Natural Gas.....	195
1.1.1.6.2	Gas Sweetening.....	196
1.1.1.6.3	Transportation.....	196
1.1.1.7	Natural Gas Combustion.....	196
1.1.1.8	Electricity from Nuclear Energy.....	197
1.1.1.9	Electricity from Hydroelectric Power.....	197
1.1.1.10	Electricity per Geographical Zone.....	197
1.1.2	Fertilizers and Agrochemicals.....	199
8	<i>Data Quality</i>	203
9	<i>Results and Discussion</i>	205
9.1	Base Case Results	206
9.1.1	Life Cycle Energy Balance.....	206
9.1.1.1.1	Types of Life Cycle Energy Inputs.....	206
9.1.1.1.2	Defining Energy Efficiency.....	207
9.1.1.2	Petroleum Diesel Life Cycle Energy Consumption.....	208
9.1.1.3	Biodiesel Life Cycle Energy Demand.....	211
9.1.1.4	Effect of Biodiesel on Life Cycle Energy Demands.....	213
9.1.2	CO ₂ Emissions.....	215
9.1.2.1	Accounting for Biomass-Derived Carbon.....	215
9.1.2.2	Petroleum Diesel Life Cycle Emissions of CO ₂	217
9.1.2.3	Biodiesel Life Cycle Emissions of CO ₂	220
9.1.2.4	The Effect of Biodiesel on CO ₂ Emissions from Urban Buses.....	221
9.1.3	Life Cycle Consumption of Primary Resources.....	222
9.1.3.1	Life Cycle Consumption of Primary Resources for Petroleum Diesel.....	222
9.1.3.2	Life Cycle Consumption of Primary Resources for Biodiesel.....	225
9.1.3.3	The Effect of Biodiesel on Primary Resource Consumption.....	228
9.1.4	Life Cycle Emissions of Regulated and Nonregulated Air Pollutants.....	231
9.1.4.1	Life Cycle Air Emissions from Petroleum Diesel Life Cycle.....	231
9.1.4.2	Life Cycle Emissions of Air Pollutants for Biodiesel.....	239
9.1.4.3	Comparison of Life Cycle Air Emissions from Biodiesel and Petroleum Diesel.....	251
9.1.4.4	Potential Effects of Biodiesel as a Diesel Substitute on Life Cycle Air Emissions.....	256
9.1.4.5	Tailpipe Emissions for Petroleum Diesel and Biodiesel.....	258
9.1.5	Life Cycle Emissions of Water Effluents.....	261
9.1.6	Life Cycle Flows of Solid Waste.....	263
9.2	Sensitivity Studies	267
9.2.1	The Effect of an Enhanced Location for Biodiesel Production and Use.....	268
9.2.2	The Effect of Energy Requirements for Conversion of Soybean Oil to Biodiesel.....	272
10	<i>Appendix A: Emission Factors</i>	277
11	<i>Appendix B: References</i>	279
	Life Cycle Scope and Approach	279
	Petroleum Diesel Fuel Production	280
	Soybean Agriculture	281
	Soybean Crushing	282
	Soybean Oil Conversion	282
	Combustion	284

Tables

Table 1: Geographic Scope of the Petroleum Diesel Life Cycle	7
Table 2: Geographic Scope of the Biodiesel Life Cycle	7
Table 3: Primary Energy Requirements for the Petroleum Diesel Life Cycle	12
Table 4: Fossil Energy Requirements for the Petroleum Diesel Life Cycle	14
Table 5: Primary Energy Requirements for Biodiesel Life Cycle	15
Table 6: Fossil Energy Requirements for the Biodiesel Life Cycle	17
Table 7: Tailpipe Contribution to Total Life Cycle CO ₂ for Petroleum Diesel and Biodiesel (g CO ₂ /bhp-h)	19
Table 8: Model Parameters for the Chicago Area Biodiesel Scenario	28
Table 9: Range of Energy Inputs for Soybean Oil Conversion Tested in LCI Model	30
Table 10: LCI Items Considered	38
Table 11: Geographic Scope of Petroleum Diesel Fuel Modeling	40
Table 12: Geographic Scope of Biodiesel Modeling	40
Table 13: Environmental Inflows and Outflows for the Biodiesel Conversion Process	45
Table 14: Mass Percent of the Various Conversion Co-Products	45
Table 15: Mass Allocated Conversion Results for Biodiesel	46
Table 16: Mass Allocated Conversion Results for Glycerine (not used in this study)	47
Table 17: Biodiesel Conversion Process Flows per Coproduct	47
Table 18: Production of Crude Oil by Technology Type and Origin	55
Table 19: Crude Oil Production Wastewater Constituents and Concentrations	57
Table 20: Natural Gas Venting and Flaring from Onshore Crude Oil Wells	58
Table 21: VOC Emissions for Onshore Crude Oil Wells	59
Table 22: Speciated VOC Data for Onshore Crude Oil Wells	59
Table 23: Natural Gas Venting, Flaring, and Coproduct Production from Onshore Crude Oil Wells	60
Table 24: Production of Typical Domestic Conventional Onshore Crude Oil Well	60
Table 25: Production of Typical Foreign Conventional Onshore Crude Oil Well	60
Table 26: Natural Gas Venting and Flaring from Offshore Crude Oil Wells	63
Table 27: Speciated VOC Emissions for Offshore Crude Oil Production	63
Table 28: Natural Gas Venting, Flaring, and Coproduct Production from Offshore Crude Oil Wells	64
Table 29: Production of Typical Domestic Conventional Offshore Crude Oil Well	65
Table 30: Production of Typical Foreign Conventional Offshore Crude Oil Well	65
Table 31: LCI Results for Domestic Crude Oil Extraction (for 1 kg of crude oil)	70
Table 32: LCI Results for Foreign Crude Oil Extraction (for 1 kg of crude oil)	71
Table 33: Refinery Receipts of Crude Oil by Source and by PADD (1993)	72

Table 34: Refinery Receipts of Crude Oil by Method of Transportation and by PADD (1993).....	73
Table 35: LCI Results for Domestic Crude Oil Transportation (for 1 kg of crude oil)	81
Table 36: LCI Results for Foreign Crude Oil Transportation (for 1 kg of crude oil)	82
Table 37: Mass and Energy Balance Calculations for an Average U.S. Refinery.....	84
Table 38: Material Requirements for an Average U.S. Refinery	85
Table 39: Material Requirements for an Average U.S. Refinery	86
Table 40: Internal Energy Use for an Average U.S. Refinery.....	86
Table 41: Petroleum Refining Process Emissions	88
Table 42: Refinery Process Flows	88
Table 43: Wastewater Production in Crude Oil Refineries	89
Table 44: Crude Oil Refinery Wastewater Composition	89
Table 45: Solid Waste Produced from Crude Oil Refining.....	89
Table 46: Total U.S. Refinery Production (1994)	90
Table 47: LCI Results for Crude Oil Refining (for 1 kg of diesel produced)	92
Table 48: LCI Results for Diesel Fuel Transportation (for 1 kg of diesel fuel)	96
Table 49: Soybean Agriculture System Inputs.....	101
Table 50: Irrigation Water Used on Soybeans by State per Year (1994).....	102
Table 51: Average Soybean Yield (Bu/acre/yr)	103
Table 52: Soybean Production by State	104
Table 53: Emission Factors for Diesel Fuel Combustion in a Farming Tractor.....	105
Table 54: Emission Factors for Gasoline Combustion in a Farming Tractor.....	105
Table 55: Estimated Annual Average Sheet and Rill Erosion on Total Cropland and Soybean Cropland—1992	107
Table 56: Estimated Annual Average Wind Erosion on Total Cropland and Soybean Cropland—1992	108
Table 57: Annual Erosion and Discharge of TSS, TKN, and TP on Soybean Acreage.....	109
Table 58: Amounts and Types of Herbicides Applied to Soybean Agriculture	112
Table 59: Weighted Average Vapor Pressure of Surface-Applied Agrochemicals.....	113
Table 60: VOC Emission Factors for Soil-Incorporated Agrochemicals.....	113
Table 61: VOC Emission Factors for Surface-Applied Agrochemicals	114
Table 62: LCI Results for Soybean Agriculture (for 1 kg of soybeans)	116
Table 63: LCI Results for Soybean Transport (for 1 kg of soybeans).....	118
Table 64: Bean Composition.....	121
Table 65: Soybean Oil Composition.....	122
Table 66: Energy Requirements for Receiving and Storage in a Soybean Crushing Facility (normalized to 1 metric ton of beans).....	123

Table 67: Energy Requirements for Bean Preparation in a Soybean Crushing Facility (normalized per metric ton beans).....	124
Table 68: Electricity Requirements for Meal Processing in a Soybean Crushing Facility (kWh per metric ton of beans)	126
Table 69: Steam Requirements for Meal Processing in a Soybean Crushing Facility (kcal per metric ton of beans).....	126
Table 70: Electricity Requirements for Oil Recovery in a Soybean Crushing Facility (kWh per metric ton of beans).....	128
Table 71: Steam Requirements for Oil Recovery in a Soybean Crushing Facility (kcal per metric ton of beans).....	128
Table 72: Final Composition of Crude, Degummed Oil.....	129
Table 73: Electricity Requirements for Degumming in a Soybean Crushing Facility (kWh per metric ton of beans).....	129
Table 74: Steam Requirements for Degumming in a Soybean Crushing Facility (kcal per metric ton of beans).....	130
Table 75: Steam Requirements for Waste Treatment in a Soybean Crushing Facility (kcal per metric ton of beans).....	131
Table 76: Summary of Electricity Requirements for Soybean Crushing (kWh per metric ton of beans).	132
Table 77: Raw Material Inputs to Soybean Crushing Facility	134
Table 78: Energy Inputs to Soybean Crushing Process	134
Table 79: Products from Soybean Crushing Facility.....	134
Table 80: Air Emissions from Soybean Crushing Facility (Excluding Combustion).....	135
Table 81: Water Emissions from a Soybean Crushing Facility.....	135
Table 82: Production of a Generic Soybean Crushing Facility	136
Table 83: LCI Results for Soybean Crushing (for 1 kg of soybean oil)	137
Table 84: LCI Assumptions for Soy Oil Transportation.....	140
Table 85: LCI Results for Soybean Oil Transport (for kg soybean oil).....	141
Table 86: Tentative Biodiesel Fuel Specifications Proposed by The National Biodiesel Board.....	144
Table 87: Composition of Crude, Degummed Oil from Crushing Operation	145
Table 88: Losses Associated with Alkaline Refining of Crude, Degummed Soybean Oil.....	146
Table 89: Steam Requirements for Alkaline Refining of Crude, Degummed Oil (per metric ton of Biodiesel Produced).....	146
Table 90: Steam Requirements for Transesterification (Normalized per Metric Ton of Biodiesel Produced).....	148
Table 91: Composition of Final Biodiesel Product Based on Material Balance	150
Table 92: Steam Requirements for Methyl Ester Purification (normalized per metric ton of biodiesel produced).....	150

Table 93: Steam Requirements for Glycerine By-Product Recovery (normalized per metric ton of biodiesel produced).....	154
Table 94: Steam Requirements for Methanol Recovery (normalized per metric ton of biodiesel produced)	157
Table 95: Electricity Requirements for Conversion of Crude Degummed Soybean Oil to Biodiesel.....	159
Table 96: Summary of Steam Requirements for Biodiesel Production (normalized per metric ton of biodiesel produced).....	159
Table 97: Reported Steam Usage in Kansas City Facility Used as a Starting Point for Our Model	160
Table 98: Comparison of Steam Requirements for Our Process Design Model and Other Available Technologies (kcal steam per metric ton of biodiesel).....	161
Table 99: Comparison of Electricity Requirements for Our Process Model and for Current European Technologies.....	162
Table 100: Raw Material Inputs to Biodiesel Production Facility	163
Table 101: Energy Inputs to a Biodiesel Production Facility.....	164
Table 102: Products from a Biodiesel Production Facility	164
Table 103: Water and Solid Waste Emissions from a Biodiesel Production Facility.....	164
Table 104: Production of a Generic Soybean Conversion Facility.....	165
Table 105: LCI Results for Soybean Oil Conversion (for 1 kg of biodiesel).....	166
Table 106: LCI Results for Biodiesel Transportation (for kg of biodiesel)	169
Table 107: Glossary of Terms for Fuel Properties	172
Table 108: Summary of Properties of Diesel and Various Biodiesel Esters	173
Table 109: Elemental Composition of Biodiesel and Petroleum Diesel	177
Table 110: Economy Data for Biodiesel Fuels in a Modern Series 60 Engine	178
Table 111: Fuel Economy Data for a Series of Engines Operating with Catalysts and Timing Changes	178
Table 112: Chassis Dynamometer-Based Fuel Economy Data.....	180
Table 113: Analytical Data for Soy Methyl Ester	185
Table 114: Percent Soot as a Function of Percent Oxygen in Fuel	185
Table 115: Effect of Biodiesel on Tailpipe Emissions (g/bhp-h)	186
Table 116: 1994 U.S. EPA Emission Standards for Diesel Engines versus Engine Certification Data for Two Common Urban Bus Engines (g/bhp-h).....	188
Table 117: Coal Fire Configurations Provided by the Interim Inventory (1994).....	193
Table 118: Coal Carbon and CO ₂ Emissions Factors	194
Table 119: Percent Horsepower for Pipeline Power in 1989	196
Table 120: Share of Power Generation Source by Region in North America.....	198
Table 121: Energy Content of Fertilizers and Agrochemicals	202
Table 122: Primary Energy Demand for the Petroleum Diesel Life Cycle Inventory	208

Table 123: Fossil Energy Requirements for the Petroleum Diesel Life Cycle.....	211
Table 124: Primary Energy Requirements for Biodiesel Life Cycle.....	212
Table 125: Fossil Energy Requirements for the Biodiesel Life Cycle.....	214
Table 126: Biomass Carbon Balance for Biodiesel Life Cycle (g/bhp-h).....	216
Table 127: LCI Inventory of Raw Material Consumption for Petroleum Diesel (kg/bhp-h).....	223
Table 128: Life Cycle Consumption of Primary Resources for Biodiesel.....	226
Table 129: LCI of Air Emissions for Petroleum Diesel (g/bhp-h).....	232
Table 130: LCI Air Emissions for Biodiesel (g/bhp-h).....	240
Table 131: Air Emissions for Petroleum Diesel, B20, and B100 (g/bhp-h).....	251
Table 132: Relative Change in Life Cycle Air Emissions for Fuels Containing 20% and 100% Biodiesel	256
Table 133: Baseline Diesel Engine Emissions for Low-Sulfur Petroleum Diesel.....	259
Table 134: Model Parameters for the Chicago Area Biodiesel Scenario.....	268
Table 135: Chicago Scenario Life Cycle Resource Demands for Biodiesel (kg/bhp-h).....	269
Table 136: Life Cycle Air Emissions for Chicago Area Biodiesel Scenario.....	270
Table 137: Life Cycle Water and Solid Emissions for the Chicago Area Biodiesel Scenario.....	271
Table 138: Range of Energy Inputs for Soybean Oil Conversion Tested in LCI Model.....	272
Table 139: The Effect of Soy Oil Conversion Energy Demands on Life Cycle Consumption of Raw Materials.....	273
Table 140: The Effect of Soybean Oil Conversion Energy Demands on Air Emissions from Biodiesel.....	274
Table 141: The Effect of Soybean Oil Conversion Energy Demands on Water and Solid Waste Emissions for Biodiesel (kg/bhp-h).....	275
Table 142: Emission Factors for Natural Gas Combustion in an Industrial Boiler.....	277
Table 143: Emission Factors for Natural Gas Combustion in a Turbine.....	277
Table 144: Emission Factors for LPG Combustion in an Industrial Boiler.....	277
Table 145: Emission Factors for Coal Combustion in an Industrial Boiler.....	277
Table 146: Emission Factors for Diesel Oil Combustion in an Industrial Boiler.....	278
Table 147: Emission Factors for Heavy Fuel Oil Combustion in an Industrial Boiler.....	278
Table 148: Emission Factors for Natural Gas Combustion in an Industrial Flare.....	278

Figures

Figure 1: Ranking of Primary Energy Demand for the Stages of Petroleum Diesel Production.....	12
Figure 2: Process Energy Demand for Petroleum Diesel Life Cycle.....	13
Figure 3: Ranking of Fossil Energy Demand for Stages of the Petroleum Diesel Life Cycle	15
Figure 4: Ranking of Primary Energy Demand for Stages of the Biodiesel Life Cycle	16
Figure 5: Process Energy Requirements for Biodiesel Life Cycle	16
Figure 6: Fossil Energy Requirements versus Fuel Product Energy for the Biodiesel Life Cycle.....	17
Figure 7: Biomass Carbon Balance for Biodiesel Life Cycle (g carbon/bhp-h).....	20
Figure 8: Comparison of Net CO ₂ Life Cycle Emissions for Petroleum Diesel and Biodiesel Blends.....	21
Figure 9: Petroleum Consumption for Petroleum Diesel, B20, and B100	21
Figure 10: Coal and Natural Gas Consumption for Petroleum Diesel, B20, and B100.....	22
Figure 11: Water Use for Petroleum Diesel, B20, and B100	22
Figure 12: Life Cycle Air Emissions for B100 and B20 Compared to Petroleum Diesel Life Cycle Air Emissions	24
Figure 13: Comparison of Total Wastewater Flows for Petroleum Diesel and Biodiesel Life Cycles.....	26
Figure 14: Hazardous Waste Generation for Petroleum Diesel, B20, and B100.....	27
Figure 15: Nonhazardous Waste Generation for Petroleum Diesel, B20, and B100.....	27
Figure 16: The Effect of an Enhanced Location for Biodiesel on Life Cycle Consumption of Primary Energy Resources.....	29
Figure 17 : Reductions in Life Cycle Air Emissions for the Chicago Area Biodiesel Scenario	29
Figure 18: Water and Solid Waste Emissions Reductions for the Chicago Area Biodiesel Scenario	30
Figure 19: The Effect of Conversion Energy Requirements on Primary Energy Resource Demands for Biodiesel.....	31
Figure 20: The Effect of Soybean Oil Conversion Energy Demands on Air Emissions for Biodiesel.....	32
Figure 21: The Effect of Soybean Oil Conversion Energy Demands on Water and Solid Waste Emissions for Biodiesel	32
Figure 22: Elements of the Scoping Phase for LCA.....	38
Figure 23: LCA System Boundary Principles	44
Figure 24: Primary Energy Balance for the Petroleum Diesel Fuel Life Cycle (with Mass Allocation)....	48
Figure 25: Primary Energy Balance for Petroleum Diesel Fuel Life Cycle (No Mass Allocation).....	49
Figure 26: Primary Energy Balance for Biodiesel Fuel Life Cycle (with Mass Allocation)	50
Figure 27: Primary Energy Balance for Biodiesel Fuel Life Cycle (No Mass Allocation).....	51
Figure 28: U.S. Crude Oil Production, Imports and Input to Refineries (1983-1994).....	54
Figure 29: Petroleum Process Areas Modeled in this Project	55
Figure 30: Conventional Onshore Crude Oil Extraction.....	56
Figure 31: Conventional Offshore Crude Oil Extraction	61

Figure 32: Advanced Onshore (Steam Injection) Crude Oil Extraction	65
Figure 33: Advanced Onshore (CO ₂ Injection) Crude Oil Extraction	67
Figure 34: Schematic of Crude Oil Production System Modeled in TEAM™	69
Figure 35: Modes of Transport and Distances for Crude Oil	76
Figure 36: Contributions to Life Cycle Flows for Transport and Handling of Crude Oil.....	79
Figure 37: Schematic of TEAM™ Model Inputs to Domestic Oil Transport	80
Figure 38: Schematic of TEAM Model Inputs to Foreign Oil Transport	80
Figure 39: Petroleum Refining System Description	83
Figure 40: Diesel Fuel Transportation Modeling	93
Figure 41: Diesel Fuel Transportation Modeling	95
Figure 42: Soybean Agriculture System Modeling	98
Figure 43: Schematic of TEAM™ Model Inputs to Soybean Agriculture	115
Figure 44: Soybean Crushing System Description	119
Figure 45: Overview of Soybean Crushing Process	120
Figure 46: Receiving and Storage in Soybean Crushing Facility	121
Figure 47: Bean Preparation in Soybean Crushing Facility	123
Figure 48: Oil Extraction in Soybean Crushing Facility	125
Figure 49: Meal Processing in Soybean Crushing Facility	126
Figure 50: Oil Recovery in Soybean Crushing Facility	127
Figure 51: Solvent Recovery in Soybean Crushing Facility	129
Figure 52: Oil Degumming Process for Soybean Crushing Facility	130
Figure 53: Waste Treatment for Soybean Crushing Facility	131
Figure 54: Yield of Oil and Triglycerides in a Soybean Crushing Facility.....	132
Figure 55: Distribution of Electricity Requirements in a Soybean Crushing Facility (kWh per metric ton of beans).....	133
Figure 56: Steam and Natural Gas Consumption in a Soybean Crushing Facility (kcal per metric ton of beans)	133
Figure 57: Overview of Process for Conversion of Soybean Oil to Biodiesel (Flows in kg/h)	143
Figure 58: Alkali Refining of Crude Soybean Oil to Remove Free Fatty Acids.....	145
Figure 59: Transesterification Section of Biodiesel Production Facility	148
Figure 60: Methyl Ester Purification	149
Figure 61: Recovery of Crude Glycerine By-Product	151
Figure 62: ASPEN PLUS™ Sensitivity Study Results:.....	152
Figure 63: ASPEN PLUS™ Simulation Input Summary for Crude Glycerine Column.....	153
Figure 64: ASPEN PLUS™ Simulation Results for Crude Glycerine Column	153

Figure 65: Methanol Recovery	154
Figure 66: Selection of Optimum Reflux Ratio for Methanol Drying Column.....	155
Figure 67: Input Summary for 20-Tray Methanol Dryer ASPEN PLUS™ Simulation.....	156
Figure 68: Results of ASPEN PLUS™ Simulation for Methanol Dryer	157
Figure 69: Wastewater Treatment for Conversion of Soybean Oil to Biodiesel	158
Figure 70: Yield Analysis for Conversion of Soybean Oil to Biodiesel	159
Figure 71: Distribution of Steam Requirements for Conversion of Soybean Oil to Biodiesel (normalized per metric ton of biodiesel produced)	160
Figure 72: Ranking of Steam Requirements for Our Process Design Model and Reported Estimates for Commercial Technologies (kcal/metric ton of biodiesel)	162
Figure 73: Ranking of Electricity Requirements for Our Process Design Model and for Current Comparable Technology	163
Figure 74: Schematic of Inputs to TEAM™ Model for Conversion of Soybean Oil to Biodiesel	165
Figure 75: Biodiesel Transportation Modeling	168
Figure 76: Energy Economy for Biodiesel-Fueled Engines.....	179
Figure 77: Effect of Biodiesel Blend Level on NO _x Emissions for Four-Stroke Diesel Engines.....	182
Figure 78: Effect of Biodiesel Blend Level on PM10 Emissions for Four-Stroke Engines.....	182
Figure 79: Effect of Biodiesel Blend Level on CO Emissions for Four-Stroke Engines.....	183
Figure 80: Effect of Biodiesel Blend Level on NMHC for Four-Stroke Engines	183
Figure 81: Correlation for Soot Content in PM as a Function of Oxygen Content	186
Figure 82: Example of TEAM™ Interface	190
Figure 83. Map of the NERC regions in the United States and Canada	199
Figure 84: Nitrogen Fertilizer Modeling.....	200
Figure 85: Phosphorous Fertilizer Modeling.....	201
Figure 86: Potassium Fertilizer Modeling.....	202
Figure 87: Ranking of Primary Energy Demand for the Stages of Petroleum Diesel Production.....	209
Figure 88: Process Energy Demand for Petroleum Diesel Life Cycle.....	209
Figure 89: Transport Distances for Domestic and Foreign Crude Oil (kg-km).....	210
Figure 90: Primary Energy Demand of Advanced versus Conventional Crude Recovery	211
Figure 91: Process Energy Requirements of Advanced versus Crude Oil Extraction	211
Figure 92: Ranking of the Fossil Energy Demand for Stages of the Petroleum Diesel Life Cycle.....	212
Figure 93: Ranking of Primary Energy Demand for the Stages of Biodiesel Production.....	213
Figure 94: Process Energy Requirements for Biodiesel Life Cycle	214
Figure 95: Fossil Energy Requirements versus Fuel Product Energy for the Biodiesel Life Cycle	215
Figure 96: Carbon Dioxide Emissions for Petroleum Diesel Life Cycle	217

Figure 97: Biomass Carbon Balance for Biodiesel Life Cycle.....	218
Figure 98: Comparison of CO ₂ Emissions for Domestic and Foreign Crude Production.....	219
Figure 99: CO ₂ Emissions for Biodiesel Life Cycle.....	220
Figure 100: Comparison of Net CO ₂ Life Cycle Emissions for Petroleum Diesel and Biodiesel Blends (g CO ₂ /bhp-h).....	221
Figure 101: Effect of Biodiesel Blend Level on CO ₂ Emissions.....	222
Figure 102: Life Cycle Consumption of Coal and Natural Gas for Petroleum Diesel.....	223
Figure 103: Life Cycle Consumption of Uranium for Petroleum Diesel.....	224
Figure 104: Life Cycle Consumption of Limestone for Petroleum Diesel.....	225
Figure 105: Life Cycle Consumption of Water for Petroleum Diesel.....	225
Figure 106: Life Cycle Consumption of Coal and Oil for Biodiesel.....	226
Figure 107: Life Cycle Consumption of Natural Gas for Biodiesel.....	227
Figure 108: Life Cycle Consumption of Uranium for Biodiesel.....	228
Figure 109: Life Cycle Consumption of Limestone for Biodiesel.....	229
Figure 110: Petroleum Consumption for Petroleum Diesel, B20, and B100.....	229
Figure 111: Coal and Natural Gas Consumption for Petroleum Diesel, B20, and B100.....	230
Figure 112: Water Use for Petroleum Diesel, B20, and B100.....	230
Figure 113: THC Emissions from Petroleum Diesel Life Cycle.....	233
Figure 114: CH ₄ Emissions from Petroleum Diesel Life Cycle.....	234
Figure 115: CO Emissions for Petroleum Diesel Life Cycle.....	234
Figure 116: CO Emissions from the Petroleum Life Cycle (Excluding End-Use Combustion of the Fuel).....	235
Figure 117: TPM Emissions from Petroleum Diesel Life Cycle.....	236
Figure 118: SO _x Emissions from Petroleum Diesel Life Cycle.....	236
Figure 119: NO _x Emissions from Petroleum Diesel Life Cycle (Reported as NO ₂).....	237
Figure 120: NO _x Emissions from Petroleum Diesel Life Cycle Excluding End-use Combustion (Reported as NO ₂).....	238
Figure 121: Life Cycle Emissions of HCl for Petroleum Diesel.....	238
Figure 122: Life Cycle Emissions of HF for Petroleum Diesel.....	239
Figure 123: THC Emissions from Biodiesel Life Cycle.....	241
Figure 124: Sources of THC and CH ₄ in Soybean Crushing.....	242
Figure 125: Sources of THC and CH ₄ in Soybean Agriculture.....	242
Figure 126: CH ₄ Emissions from the Biodiesel Life Cycle.....	243
Figure 127: Sources of CH ₄ Emissions from the Biodiesel Production Step.....	243
Figure 128: CO Emissions from the Biodiesel Life Cycle.....	244
Figure 129: CO Emissions from the Biodiesel Life Cycle (Excluding End-use).....	244

Figure 130: TPM Emissions from Biodiesel LCA	245
Figure 131: Sources of TPM in Soybean Agriculture.....	245
Figure 132: SO _x Emissions from Biodiesel Life Cycle (Reported as SO ₂).....	246
Figure 133: Sources of SO _x Emissions from Soy Oil Conversion Step.....	247
Figure 134: Source of SO _x from Soybean Crushing.....	247
Figure 135: Sources of SO _x Emissions from Soybean Agriculture	248
Figure 136: NO _x Emissions from Biodiesel Life Cycle.....	248
Figure 137: HCl Emissions from Biodiesel Life Cycle	249
Figure 138: HF Emissions from Biodiesel Life Cycle.....	249
Figure 139: Sources of HCl and HF in Soybean Crushing	250
Figure 140: Sources of HCl and HF in Soy Oil Conversion	250
Figure 141: Life Cycle Emissions of THC for Petroleum Diesel, B20, and B100.....	252
Figure 142: Life Cycle Emissions of CH ₄ for Petroleum Diesel, B20, and B100.....	252
Figure 143: Life Cycle Emissions of CO for Petroleum Diesel, B20, and B100	253
Figure 144: Life Cycle Particulate Matter Emissions for Petroleum Diesel, B20, and B100	253
Figure 145: Life Cycle SO _x Emissions for Petroleum Diesel, B20, and B100.....	254
Figure 146: Life Cycle NO _x Emissions for Petroleum Diesel, B20, and B100.....	254
Figure 147: Life Cycle HF Emissions for Petroleum Diesel, B20, and B100.....	255
Figure 148: Life Cycle HCl Emissions for Petroleum Diesel, B20, and B100	255
Figure 149: Effect of Biodiesel Blend on Life Cycle Air Emissions of CH ₄ , SO _x , HF, PM10, and CO ..	256
Figure 150: Effect of Biodiesel Blend Level on Air Emissions of NO _x , NMHC and HCl	257
Figure 151: Tailpipe Emissions of CO and NO _x for Petroleum Diesel and Biodiesel.....	260
Figure 152: Tailpipe Emissions of PM10, NMHC and SO _x for Petroleum Diesel and Biodiesel.....	260
Figure 153: Effect of Biodiesel on Tailpipe Emissions of Soot	261
Figure 154: Wastewater Flows for Petroleum Diesel Life Cycle.....	262
Figure 155: Wastewater Flows for Biodiesel Life Cycle	262
Figure 156: Comparison of Life Cycle Wastewater Flows for Petroleum Diesel and Biodiesel Life Cycles	263
Figure 157: Life Cycle Emissions of Solid Hazardous Waste for Petroleum Diesel.....	264
Figure 158: Life Cycle Flows of Nonhazardous Waste for Petroleum Diesel	264
Figure 159: Life Cycle Flows of Hazardous Solid Waste for Biodiesel	265
Figure 160: Life Cycle Flows of Nonhazardous Solid Waste for Biodiesel	265
Figure 161: Sources of Hazardous Waste in Soybean Agriculture.....	266
Figure 162: Hazardous Waste Generation for Petroleum Diesel, B20, and B100 Life Cycles	266
Figure 163: Nonhazardous Waste Generation for Petroleum Diesel, B20, and B100 Life Cycles	267

Figure 164: The Effect of an Ideal Location for Biodiesel on Life Cycle Consumption of Primary Energy Resources 269

Figure 165: Sources of Energy Savings in the Chicago Area Biodiesel Scenario..... 270

Figure 166 : Reductions in Life Cycle Air Emissions for the Chicago Area Biodiesel Scenario 271

Figure 167: Water and Solid Waste Emissions Reductions for the Chicago Area Biodiesel Scenario 272

Figure 168: The Effect of Conversion Energy Requirements on Primary Energy Resource Demands for Biodiesel..... 273

Figure 169: The Effect of Soybean Oil Conversion Energy Demands on Air Emissions for Biodiesel... 275

Figure 170: The Effect of Soybean Oil Conversion Energy Demands on Water and Solid Waste Emissions for Biodiesel..... 276

This page intentionally left blank

1 How To Use This Report

Reporting on the results of a life cycle study is at best an awkward process. The complexity of such a study can lead to the necessary, but sometimes tedious, reporting of much detail. For life cycle analysis, the devil is truly in the details.

We recognize, however, that there are many types of readers who may find an interest in the results of our work. Therefore, we have presented our study at three different levels of detail: one for the policymaker interested in “cutting to the quick,” one for the more technically oriented staff often supporting policy decisions, and one for the “hard core” life cycle practitioner. This approach has undoubtedly led to some redundancy in our presentation. We apologize for any inconvenience that this may cause, but hope that (at least for those who bothered to stop here first before diving into the report) most will find this approach more economical in targeting the appropriate level of detail needed.

Here is a road map for finding your way around this report:

For a quick and concise description of the study and its results, see...

- Executive Summary (starting on page iii)

For the 2nd level of detail providing more information on how we conducted the study and a more detailed discussion of results, see...

- Section 1.0 Technical Overview. This overview is can be read without any need to reference later sections (including the bibliography at the end).

For the “hard core” details of our modeling and a detailed discussion of the results see...

- Section 2.0 through Section 11.0. The reader can start from section 2.0 to get a complete and detailed description of the study.

Each of the three levels described above is essentially free standing and can be read independently to get a full perspective on the study.

This page left intentionally blank

2 Technical Overview

This report presents the findings from a study of the life cycle inventories (LCIs) for petroleum diesel and biodiesel. An LCI is a comprehensive quantification of all the energy and environmental flows associated with a product from “cradle to grave.” It provides information on:

- Raw materials extracted from the environment
- Energy resources consumed
- Air, water, and solid waste emissions generated.

By “cradle to grave,” we mean all the steps from the first extraction of raw materials from the environment to the final end-use of the product. LCIs are invaluable tools for assessing and comparing the overall environmental impacts of various products. One purpose for conducting this study is to assess overall greenhouse gas emissions from these two fuels. Because of the global nature of greenhouse gas effects, these emissions lend themselves very well to life cycle assessment (LCA). We also considered other environmental emissions; particularly regulated air emissions such as carbon monoxide, hydrocarbons, nitrogen oxides, sulfur oxides and particulate matter. The purpose of this study is to provide LCI data that can be used by industry and government decision-makers considering biodiesel as an alternative fuel. This study is the product of a highly effective partnership between the U.S. Department of Agriculture (USDA) and the U.S. Department of Energy (DOE), which has brought together the agricultural and energy expertise needed to adequately address an LCI of biodiesel.

2.1 Stakeholder Involvement

Any good life cycle study makes use of every opportunity to obtain input from all who have a stake in the final outcome. This is especially true for those life cycle studies being conducted to support important government policy decisions. Many of the early decisions made in setting the scope of the study (see section 2.2) can have a profound effect on the outcome of the study. This makes it crucial that all stakeholders have an opportunity to discuss the key assumptions and options for the analysis. But stakeholder involvement cannot stop there. Input throughout the major steps of the project is useful for ensuring the proper use and interpretation of the best available data. Finally, as results from the LCI model become available, offering the opportunity to have stakeholders provide their perspective helps to avoid “tunnel vision.” The most important reason for stakeholder involvement in the study is *credibility*. When such studies are done in a vacuum, they stand little chance of getting buy-in from the industries involved. In the end, LCI results are only as good as the “buy-in” or level of credibility they engender.

We made stakeholder involvement a top priority in our study. The following is a list of the groups that provided input to us during the project:

- Petroleum Industry
- Oilseed Processing Industry
- Animal Renderers and Recyclers
- Chemical Process Industry

- Biodiesel Producers
- Engine Manufacturers
- U.S. Department of Agriculture
- U.S. Department of Energy
- U.S. Environmental Protection Agency
- State and Local Governments
- Environmental Public Interest Groups.

Outlined below is a brief description of the process used to continually check in with stakeholders. Throughout this process, we provided opportunities to communicate with us in writing, by phone, and by e-mail, as well as in our face-to-face meetings.

1. Before pen was put to paper, USDA and DOE brought together a consortium of stakeholders at a meeting hosted by USDA in Washington, DC, to discuss the need and goals of our study.
2. Based on input from this group, a preliminary scoping document was put together and distributed for review.
3. A second face-to-face meeting with stakeholders was held to work out the details of the project scope.
4. Once the basic data had been collected on all aspects of the petroleum diesel and biodiesel life cycles, the stakeholders reconvened to review the data. Feedback from this meeting resulted in our updating data sources and filling in gaps in available data.
5. Finally, once results from the LCI model were available, we sought detailed comments from a representative group of stakeholders (that is, those willing to put in the time to study our results). They were given a first draft of this report. Their comments have been carefully compiled. Wherever possible, we have made changes to the model and the report to reflect concerns and criticisms raised by this group. This document is a product of that final review.

The quality of our results is much the better for the input of these groups. We are indebted to the individuals who took the time to participate in this process.

2.2 Scope of the Life Cycle Study

2.2.1 Purpose

The purpose of this study is to conduct an LCI to quantify and compare the comprehensive sets of environmental flows (to and from the environment) associated with both biodiesel and petroleum-based diesel, over their entire life cycles. In addition to the purpose stated, this LCA was initiated to provide the necessary information that could be used to answer the following questions that have been posed by policy makers:

2.2.2 What Is “Biodiesel?”

In its most general sense, “biodiesel” has been used to refer to any diesel fuel substitute that is derived from renewable biomass. In the past few years, biodiesel has taken on a more specific definition and currently refers to a family of products made from vegetable oils or animal fats and alcohol, such as methanol or ethanol. These are called alkyl esters of fatty acids. In order for these alkyl esters of fatty acids to be considered as viable transportation fuels, they must meet stringent quality standards, otherwise they become standard industrial chemicals that are not suitable for diesel applications. Thus, alkyl esters

of fatty acids that meet transportation fuel standards are called “biodiesel.” One popular process for producing biodiesel is known as “transesterification.” This is the technology modeled in this report.

Today, biodiesel is made from a variety of natural oils. Chief among these are soybean oil and rapeseed oil. Rapeseed oil, a close cousin of canola oil, dominates the growing biodiesel industry in Europe. In the United States, biodiesel is being made from soybean oil because more soybean oil is produced than all other sources of fats and oil combined. There are many candidates for feedstocks, including recycled cooking oils, animal fats, and a variety of other oilseed crops. We selected soybean oil as the feedstock used for biodiesel production because of the vast number of data that have been generated about biodiesel from soybean oil.

Today, the most widely used alcohol for biodiesel production is methanol, mostly because of its ease of processing and its relatively low cost. We have chosen to model biodiesel production using methanol. Thus, the working definition of biodiesel in our study is a diesel fuel substitute made via the transesterification of soybean oil with methanol. In industry parlance, this biodiesel product is referred to as soy methyl ester or methyl soyate.

2.2.3 What Is “Petroleum Diesel?”

We defined petroleum diesel as “on-highway” low-sulfur diesel made from crude oil. Recent regulations promulgated by the U.S. Environmental Protection Agency (EPA) as part of its enforcement of the 1990 Clean Air Act Amendments set tougher restrictions on diesel used on the road versus diesel used off the road. The “on highway” diesel must now meet new limits for sulfur content that are an order of magnitude lower than previously allowed (0.05 wt% versus 0.5% sulfur). We restrict our evaluation of petroleum diesel to this new low-sulfur diesel¹.

2.2.4 Defining the Product Application

The choice of the fuels’ end-use can greatly affect the life cycle flows. Potential markets for biodiesel cover a wide range of diesel applications, including most truck operations, stationary generation, mining equipment, marine diesel engines, and bus fleets. In this study, we compare the use of petroleum diesel and biodiesel in urban buses. This choice was based on the availability of end-use data. The urban bus market was identified by the nascent U.S. biodiesel industry early on as a near-term opportunity, and a large number of data are available on the performance of diesel bus engines.

2.2.5 What Is Included in the Life Cycle Systems?

Major operations included within the boundary of the petroleum diesel system are:

- Extraction of crude oil from the ground
- Transport of crude oil to an oil refinery
- Refining of crude oil to diesel fuel
- Transport of diesel fuel to its point of use
- Use of the fuel in a diesel bus engine.

¹ One important clarification should be made about our characterization of petroleum diesel. In our analysis, low-sulfur diesel fuel is used in the product application (urban buses). This is not true for agricultural use of diesel fuel in the production of soybeans. Data for “off highway” diesel-powered tractors were used to characterize performance and emissions of these engines. This off-highway diesel is not held to the same strict standard for sulfur content.

For the biodiesel system, major operations include:

- Produce soybeans
- Transport soybeans to a soy crushing facility
- Recover soybean oil at the crusher
- Transport soybean oil to a biodiesel manufacturing facility
- Conversion of soybean oil to biodiesel
- Transport biodiesel fuel to the point of use
- Use the fuel in a diesel bus engine.
- These operations are not a comprehensive list of what has been modeled in our analysis. These operations include within them detailed processes described elsewhere in this report. For example, extraction of crude oil includes flows from a number of operations such as onshore and offshore drilling and natural gas separation. Onshore drilling is further characterized as either conventional or advanced technology.

We include more than just the energy and environmental flows that occur directly in each of these steps. Energy and environmental inputs from the production of any raw materials used in each step are also included. Generally, life cycle flows are characterized for all raw materials from the point of extracting their primary components from the environment. For example, methanol use in the biodiesel manufacturing facility contributes life cycle flows that go back to the extraction of natural gas used as a feedstock. Likewise, life cycle flows from intermediate energy sources such as electricity are included—back to extraction of coal, oil, natural gas, limestone, and any other primary resources needed.

2.2.6 What Are the Geographical Boundaries?

The LCA is limited to the use of petroleum diesel and biodiesel in the United States. This does not mean that all the steps involved in the life cycles are restricted to domestic boundaries. Petroleum diesel's life cycle, in particular, expands its geographic limits to include foreign crude oil production simply because half the crude oil used in the United States is imported. Other aspects of the geographic limits of the study involve the choice of national versus regional or even site-specific assessment. For domestic operations, we rely on national average data. For foreign operations, we rely on industry average data. Electricity generation is modeled on a national basis. Table 1 and Table 2 present specific information on the geographical scope of the analysis for each stage of the petroleum diesel and biodiesel life cycles.

2.2.7 What Is the Time Frame?

We were faced with two basic options: 1) model technology and markets as they are today; and 2) model a futuristic scenario based on projected technology and markets. We chose to focus on a current time frame. Thus, we consider production and end-use technologies that are available today for both petroleum diesel and biodiesel. This approach ignores future advances in production efficiency and end-use engine technology. By limiting the analysis to the present, it is far more “grounded” and objective because it relies on documented data rather than on potentially optimistic projections. Results from this study provide a baseline for considering future scenarios.

2.2.8 Basis for Comparing the Life Cycles

Common sense suggests that any comparison of two fuel products must be done on the same basis. In the lexicon of LCA, two industrial systems are compared on the same “functional basis.” In other words, the fuels are compared based on identical services they provide. Once this shared function is defined, a unit

has to be chosen in order to compare the systems on the same quantitative basis. For example, a comparison of fuel life cycles for passenger vehicles might characterize all life cycle flows per mile of travel delivered by the vehicle.

The unit used to normalize all life cycle flows is known as the “functional unit.” For a more detailed discussion of the definition and protocols established for LCIs, refer to publications from the Society of Environmental Toxicology and Chemistry (SETAC)² and EPA³. Medium- and heavy-duty diesel engines are typically evaluated on the basis of actual work delivered by the engine. This approach is used because of the variability (or even the irrelevance) of mileage among the various applications for diesel engines. Therefore, we have chosen to compare the life cycle flows of biodiesel and petroleum diesel on the basis of 1 brake horsepower-hour (bhp-h) of work delivered by the bus engine.

Table 1: Geographic Scope of the Petroleum Diesel Life Cycle

Life Cycle Stage	Geographic Scope
Crude Oil Extraction	International average based on the consumption of crude oil in the United States
Crude Oil Transportation	International average transportation distances to the United States
Crude Oil Refining	U.S. national average
Diesel Fuel Transportation	U.S. national average
Diesel Fuel Use	U.S. national average based on urban bus use

Table 2: Geographic Scope of the Biodiesel Life Cycle

Life Cycle Stage	Geographic Scope
Soybean Agriculture	Average based on data from the 14 key soybean-producing states
Soybean Transportation	U.S. national average
Soybean Crushing	U.S. national average based on modeling of a generic U.S. crushing facility
Soybean Oil Transport	U.S. national average
Soybean Oil Conversion	U.S. average based on modeling of a generic biodiesel facility
Biodiesel Transportation	U.S. national average
Biodiesel Fuel Use	U.S. national average based on urban bus use

² SETAC, *A Technical Framework for Life-Cycle Assessments*, Society of Environmental Toxicology and Chemistry, Washington DC, 1991; SETAC, *Guidelines for Life-Cycle Assessment: A “Code of Practice,”* Society of Environmental Toxicology and Chemistry, Washington, DC, 1993; SETAC, *A Conceptual Framework for Life-Cycle Impact Assessment*, Society of Environmental Toxicology and Chemistry, Washington, DC, 1993; SETAC, *Life Cycle Assessment Data Quality: A Conceptual Framework*, Society of Environmental Toxicology and Chemistry, Washington, DC, 1994.

³ EPA: *Life Cycle Design Manual: Environmental Requirements and the Product System*, EPA/600/R-92/226, 1993; U.S. Environmental Protection Agency, *Life-Cycle Assessment: Inventory Guidelines and Principles*, EPA/600-R-92-245, 1993; U.S. Environmental Protection Agency, *Guidelines for Assessing the Quality of Life-Cycle Inventory Analysis*, EPA/530-R-95-010, 1995.

2.3 Key Assumptions

The details of the assumptions and modeling steps of the life cycle are presented in subsequent sections of this report, although two general assumptions applied in the modeling should be highlighted. First, national average distances were used for transport of all feedstocks, intermediates, and products. The effect of this assumption was tested in a sensitivity analysis. Second, both fuels are assumed to be used in “current” diesel engines, defined as engines calibrated to meet 1994 EPA regulations for diesel exhaust when operated on low-sulfur petroleum diesel. Other assumptions worth noting include:

- Crude oil delivery from domestic and foreign sources are split almost evenly
- Best available refinery data for extant facilities were used to model a “generic” refinery
- Emissions from petroleum diesel are assumed to meet 1994 engine emissions standards.
- Biodiesel assumptions worth noting include:
 - Agriculture practices and yields are based on weighted averages for 14 soybean-producing states
 - Emissions are based on actual engine data for biodiesel emissions that are then modeled as changes in the oxygen content⁴ in the fuel
 - Energy efficiencies of biodiesel-fueled engines are identical to those of petroleum diesel-fueled engines⁵
 - Biomass-derived carbon dioxide (CO₂) in the fuel emissions is recycled in soybean production.

For details on the bases for these assumptions, refer to the sections describing each stage of the life cycles.

2.4 Findings

LCI results are presented for 100% biodiesel (known as “B100”), a 20% blend of biodiesel with petroleum diesel (known as “B20”), and petroleum diesel. These results include estimates of:

- Overall energy requirements
- CO₂ emissions
- Other regulated and non-regulated air emissions. Regulated pollutants include carbon monoxide (CO), particulate matter less than 10 microns in size (PM₁₀), non-methane hydrocarbons (NMHC), and nitrogen oxides (NO_x). Non-regulated air emissions include methane (CH₄), formaldehyde, benzene, total hydrocarbons (THC), and total particulate matter (TPM).
- Water emissions
- Solid wastes.

These life cycle flows are presented for the base-case scenarios and for two sensitivity studies. The base case describes petroleum diesel and biodiesel life cycle flows for “national average” scenarios.

The purpose of conducting sensitivity studies on the life cycle of biodiesel was to establish the potential range for improvement in the fuel, as well as to establish the range of possible error associated with the

⁴ Diesel fuel contains no oxygen. The amount of oxygen is a measure of biodiesel content in the fuel. In addition, percent oxygen proves to be a good basis for predicting emissions.

⁵ This is substantiated with an analysis of engine performance data.

assumptions made in the model. The LCI assumes a “current” time frame—that is, we are looking at options for improvement of agriculture, soybean oil recovery, conversion technology, and engine technology within a short-term horizon. This sets realistic limitations on the assumptions used in the model.

In each life cycle step we considered the potential for near-term improvement. Two main areas were identified. First, we felt it was important to understand the impact of location on biodiesel production. This allows us to consider the benefits of the best agricultural productivity available in the United States and the shortest distances for transport of fuel and materials. This sets an upper bound on biodiesel benefits from the perspective of current agricultural practices and transportation logistics.

Second, we identified the conversion of soybean oil to biodiesel as an aspect of the life cycle that has significant impact on energy use and emissions and that has a broad range of efficiencies, depending on the commercial technology used. Our base case estimate of the energy requirements for soy oil conversion is based on a preliminary engineering design prepared for this study. The design was loosely based on data from an extant transesterification plant in Kansas City, Missouri. Our energy budget proved to be much lower than that reported for the facility in Kansas City. A review of the literature on recent transesterification technology revealed that our design estimate is at the high end of the range of recently published literature values. To deal with this disparity in energy estimates for conversion of soy oil to biodiesel, we decided to look at the range of reported energy budgets as a sensitivity study.

Changes in engine technology may also be an avenue for improving biodiesel on a life cycle basis. We opted to forego this area in our sensitivity analysis because of limited data. Thus, we present in this report the results of two sensitivity studies:

- The base case for B100 is compared with the LCI for an optimal biodiesel location (Chicago). The choice of an optimal location is based on an evaluation of regions with the most efficient production of soybeans, local concentration of soybean producers, and large end-use markets for urban buses.
- Results for a range of high and low energy demands for soybean conversion to biodiesel are compared to determine the impact of this stage of the biodiesel life cycle on overall emissions and energy flows. Low and high values for energy consumption were based on a survey of technical literature on the most recent technologies commercially available.

2.4.1 Results of the Base Case Study

The results provided here allow the reader to make a nominal comparison of biodiesel and petroleum diesel. By nominal, we mean that the LCIs calculated for each fuel reflect generic “national average” models. The only exception to this statement is soybean agriculture data, which are provided on a state-by-state basis for the 14 key soybean-producing states. Implicit in such a nominal comparison is that there are no regional differences that could affect any of the stages of each fuel’s life cycle. There will, of course, be differences that will affect each fuel.

In most cases, biodiesel is interchangeable with petroleum diesel without any need to modify today’s diesel engine. However, one key issue for biodiesel use that should be explicitly is the effect of regional climate on the performance of the fuel. This fuel’s cold flow properties may limit its use in certain parts of the country during the winter. This caveat should be kept in mind. Means of mitigating biodiesel’s cold flow properties are being evaluated by researchers, though no clear solution is at hand. Low-sulfur #2 diesel fuel has similar limitations that are currently addressed with the use of additives and by blending this fuel with #1 diesel fuel.

2.4.1.1 Life Cycle Energy Balance

LCIs provide an opportunity to quantify the total energy demands and the overall energy efficiencies of processes and products. Understanding the overall energy requirements of biodiesel is key to our understanding the extent to which biodiesel made from soybean oil is a “renewable energy” source. Put quite simply, the more fossil energy required to make a fuel, the less we can say that this fuel is “renewable”. Thus, the renewable nature of a fuel can vary across the spectrum of “completely renewable.” (i.e., no fossil energy input) to nonrenewable (i.e., fossil energy inputs as much or more than the energy output of the fuel)⁶. Energy efficiency estimates help us to determine how much additional energy must be expended to convert the energy available in raw materials used in the fuel’s life cycle to a useful transportation fuel. The following sections describe these basic concepts in more detail, as well as the results of our analysis of the life cycle energy balances for biodiesel and petroleum diesel.

2.4.1.1.1 Types of Life Cycle Energy Inputs

In this study, we track several types of energy flows through each fuel life cycle. For clarity, each of these energy flows is defined below.

- *Total Primary Energy.* All raw materials extracted from the environment can contain⁷ energy. In estimating the total primary energy inputs to each fuel’s life cycle, we consider the cumulative energy content of all resources extracted from the environment.
- *Feedstock Energy.* Energy contained in raw materials that end up directly in the final fuel product is termed “feedstock energy.” For biodiesel production, feedstock energy includes the energy contained in the soybean oil and methanol feedstocks that are converted to biodiesel. Likewise, the petroleum directly converted to diesel in a refinery contains primary energy that is considered a feedstock energy input for petroleum diesel. Feedstock energy is a subset of the primary energy inputs.
- *Process Energy.* The second major subset of primary energy is “process energy.” This is limited to energy inputs in the life cycle exclusive of the energy contained in the feedstock (as defined in the previous bullet). It is the energy contained in raw materials extracted from the environment that does not contribute to the energy of the fuel product itself, but is needed in the processing of feedstock energy into its final fuel product form. Process energy consists primarily of coal, natural gas, uranium, and hydroelectric power sources consumed directly or indirectly in the fuel’s life cycle.
- *Fossil Energy.* Because we are concerned about the renewable nature of biodiesel, we also track the primary energy that comes from fossil sources specifically (coal, oil, and natural gas). All three of the previously defined energy flows can be categorized as fossil or nonfossil energy.
- *Fuel Product Energy.* The energy contained in the final fuel product, which is available to do work in an engine, is what we refer to as the “fuel product energy”. All other things being equal, fuel product energy is a function of the energy density of each fuel.

⁶ This last statement is an oversimplification. We consider the energy trapped in soybean oil to be renewable because it is solar energy stored in liquid form through biological processes that are much more rapid than the geologic time frame associated with fossil energy formation. Also, other forms of nonrenewable energy besides fossil fuel exist.

⁷ The energy “contained” in a raw material is the amount of energy that would be released by the complete combustion of that raw material. This “heat of combustion” can be measured in two ways: as a higher heating value or a lower heating value. Combustion results in the formation of CO₂ and water. Higher heating values consider the amount of energy released when the final combustion products are gaseous CO₂ and liquid water. Lower heating values take into account the loss of energy associated with the vaporization of the liquid water combustion product. Our energy content is based on the lower heating values for each material.

2.4.1.1.2 Defining Energy Efficiency

We report two types of energy efficiency. The first is the overall “life cycle energy efficiency”. The second is what we refer to as the “fossil energy ratio”. Each elucidates a different aspect of the life cycle energy balance for the fuels studied.

The calculation of the life cycle energy efficiency is simply the ratio of fuel product energy to total primary energy:

$$\text{Life Cycle Energy Efficiency} = \text{Fuel Product Energy} / \text{Total Primary Energy}$$

It is a measure of the amount of energy that goes into a fuel cycle, which actually ends up in the fuel product. This efficiency accounts for losses of feedstock energy and additional process energy needed to make the fuel.

The fossil energy ratio tells us something about the degree to which a given fuel is or is not renewable. It is defined simply as the ratio of the final fuel product energy to the amount of fossil energy required to make the fuel:

$$\text{Fossil Energy Ratio} = \text{Fuel Energy} / \text{Fossil Energy Inputs}$$

If the fossil energy ratio has a value of zero, then a fuel is not only completely nonrenewable, but it provides no useable fuel product energy as a result of the fossil energy consumed to make the fuel. If the fossil energy ratio is equal to 1, then this fuel is still nonrenewable. A fossil energy ratio of one means that no loss of energy occurs in the process of converting the fossil energy to a useable fuel. For fossil energy ratios greater than 1, the fuel actually begins to provide a leveraging of the fossil energy required to make the fuel available for transportation. As a fuel approaches being “completely” renewable, its fossil energy ratio approaches “infinity.” In other words, a completely renewable fuel has no requirements for fossil energy.

From a policy perspective, these are important considerations. Policymakers want to understand the extent to which a fuel increases the renewability of our energy supply. Another implication of the fossil energy ratio is the question of climate change. Higher fossil energy ratios imply lower net CO₂ emissions. This is a secondary aspect of the ratio, as we are explicitly estimating total CO₂ emissions from each fuel’s life cycle. Nevertheless, the fossil energy ratio serves as a check on our calculation of CO₂ life cycle flows (since the two should be correlated).

2.4.1.1.3 Petroleum Diesel Life Cycle Energy Consumption

Table 3 and Figure 1 show the total primary energy requirements for the key steps in the production and use of petroleum diesel. The LCI model shows that 1.2007 MJ of primary energy is used to make 1 MJ of petroleum diesel fuel. This corresponds to a life cycle energy efficiency of 83.28%⁸.

The distribution of the primary energy requirements for each stage of the petroleum diesel life cycle is shown in Table 3. In Figure 1, the stages of petroleum diesel production are ranked from highest to lowest in terms of primary energy demand. Ninety-three percent of the primary energy demand is for extracting crude oil from the ground. About 88% of the energy shown for crude oil extraction is associated with the energy value of the crude oil itself. The crude oil refinery step for making diesel fuel dominates the remaining 7% of the primary energy use.

Removing the feedstock energy of the crude itself from the primary energy total allows us to analyze the relative contributions of the process energy used in each life cycle. Process energy used in each stage of the petroleum life cycle is shown in Figure 2. Process energy demand represents 20% of the energy

⁸ Using the total primary energy reported in Table 3, Life Cycle Energy Efficiency = 1 MJ of Fuel Product Energy / 1.2007 MJ of Primary Energy Input = 0.8328.

ultimately available in the petroleum diesel fuel product. About 90% of the total process energy is in refining (60%) and extraction (29%). The next largest contribution to total process energy is for transporting foreign crude oil to domestic petroleum refiners.

Table 3: Primary Energy Requirements for the Petroleum Diesel Life Cycle

Stage	Primary Energy (MJ per MJ of Fuel)	Percent
Domestic Crude Production	0.5731	47.73%
Foreign Crude Oil Production	0.5400	44.97%
Domestic Crude Transport	0.0033	0.28%
Foreign Crude Transport	0.0131	1.09%
Crude Oil Refining	0.0650	5.41%
Diesel Fuel Transport	0.0063	0.52%
Total	1.2007	100.00%

There are some significant implications in the process energy results shown in Figure 2 regarding trends for foreign and domestic crude oil production and use. Transportation of foreign crude oil carries with it a fourfold penalty for energy consumption compared to domestic petroleum transport because the overseas transport of foreign oil by tanker increases the travel distance for foreign oil by roughly a factor of four.

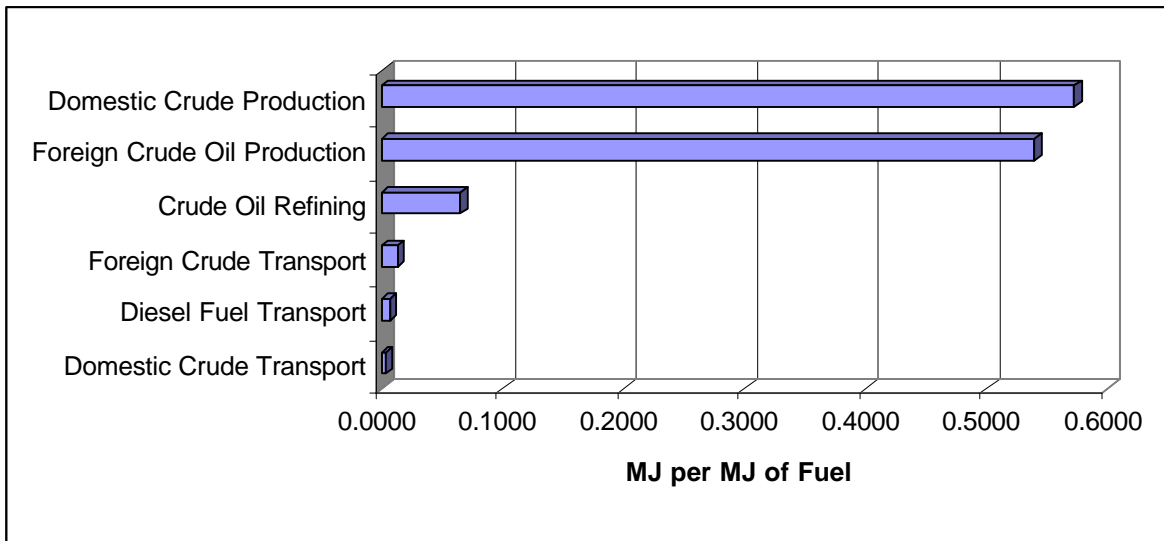

Figure 1: Ranking of Primary Energy Demand for the Stages of Petroleum Diesel Production

At the same time, domestic crude oil extraction is more energy intensive than foreign crude oil production. Advanced oil recovery practices in the United States represent 11% of the total production volume, compared to 3% for foreign oil extraction. Advanced oil recovery uses twice as much primary energy per kilogram of oil compared to conventional extraction. Per kilogram of oil out of the ground, advanced crude oil extraction requires almost 20 times more process energy than onshore domestic crude oil extraction because the processes employed are energy intensive and the amount of oil recovered is low

compared to other practices. Domestic crude oil supply is essentially equal to foreign oil supply (50.26% versus 49.74%, respectively) in our model, but its process energy requirement is 62% higher than that of foreign crude oil production (see Figure 2).

If our present trend of increased dependence on foreign oil continues, we can expect the life cycle energy efficiency of petroleum diesel to worsen because of the higher energy costs of transporting foreign crude to the United States. In addition, with declining domestic oil supplies, we may well see increased energy penalties for domestic crude oil extraction, as the practice of advanced oil recovery increases.

Table 4 and Figure 3 summarize the fossil energy inputs with respect to petroleum diesel’s energy output. Petroleum diesel uses 1.1995 MJ of fossil energy to produce 1 MJ of fuel product energy. This corresponds to a fossil energy ratio of 0.8337⁹. Because the main feedstock for diesel production is itself a fossil fuel, it is not surprising that this ratio is almost identical to the life cycle energy efficiency of 83.28%. In fact, fossil energy associated with the crude oil feedstock accounts for 93% of the total fossil energy consumed in the life cycle. The fossil energy ratio is slightly less than the life cycle energy ratio because there is a very small contribution to the total primary energy demand, which is met through hydroelectric and nuclear power supplies related to electricity generation.

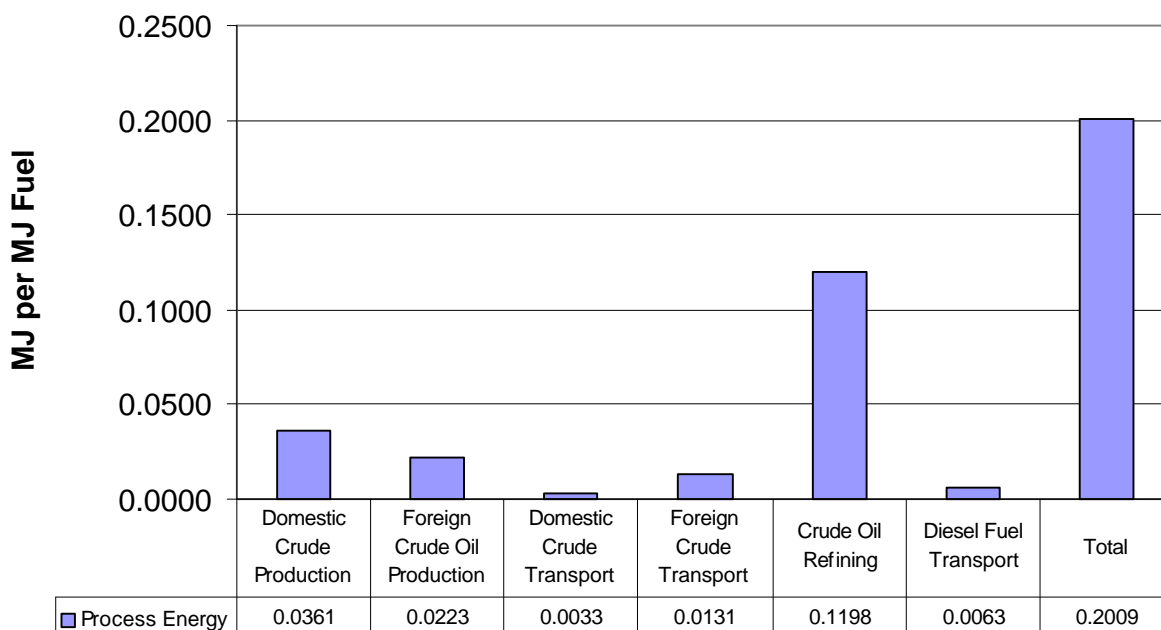

Figure 2: Process Energy Demand for Petroleum Diesel Life Cycle

2.4.1.1.4 Biodiesel Life Cycle Energy Demand

Table 5 and Figure 4 present the total primary energy demand used in each stage of the biodiesel life cycle. One MJ of biodiesel requires an input of 1.2414 MJ of primary energy, resulting in a life cycle energy efficiency of 80.55%. Biodiesel is comparable to petroleum diesel in the conversion of primary energy to fuel product energy (80.55% versus 83.28%). The largest contribution to primary energy (87%) is the soybean oil conversion step because this is where we have chosen to include the feedstock energy

⁹ Fossil Energy Ratio = 1 MJ Fuel Energy/1.1995 MJ of Fossil Energy Input = 0.8337.

associated with the soybean oil itself¹⁰. As with the petroleum life cycle, the stages of the life cycle that are burdened with the feedstock energy overwhelm all other stages. Had the soybean oil energy been included with the farming operation, then soybean agriculture would have been the dominant consumer of primary energy. This is analogous to placing the crude oil feedstock energy in the extraction stage for petroleum diesel fuel. The next two largest primary energy demands are for soybean crushing and soybean oil conversion. They account for most of the remaining 13% of the total demand.

Table 4: Fossil Energy Requirements for the Petroleum Diesel Life Cycle

Stage	Fossil Energy (MJ per MJ of Fuel)	Percent
Domestic Crude Production	0.572809	47.75%
Foreign Crude Oil Production	0.539784	45.00%
Domestic Crude Transport	0.003235	0.27%
Foreign Crude Transport	0.013021	1.09%
Crude Oil Refining	0.064499	5.38%
Diesel Fuel Transport	0.006174	0.51%
Total	1.199522	100.00%

When we look at process energy separately from primary energy, we see that energy demands in the biodiesel life cycle are not dominated by soybean oil conversion (Figure 5). The soybean crushing and soy oil conversion to biodiesel demand the most process energy (34.25 and 34.55%, respectively, of the total demand). Agriculture accounts for most of the remaining process energy consumed in life cycle for biodiesel (almost 25% of total demand). Each transportation step is only 2%-3% of the process energy used in the life cycle.

¹⁰ Energy contained in the soybean oil itself represents, in effect, the one place in the biodiesel life cycle where input of solar energy is accounted for. Total radiant energy available to soybean crops is essentially viewed as “free” in the life cycle calculations. It becomes an accountable element of the life cycle only after it has been incorporated in the soybean oil itself. This is analogous to counting the feedstock energy of crude petroleum as the point in its life cycle where solar energy input occurs. Petroleum is essentially stored solar energy. The difference between petroleum and soybean oil as sinks for solar energy is their time scale. While soybean oil traps solar energy on a rapid (“real time”) basis, petroleum storage represents a process that occurs on a geologic time scale. This difference in the dynamic nature of solar energy utilization is the key to our definitions of renewable and nonrenewable energy.

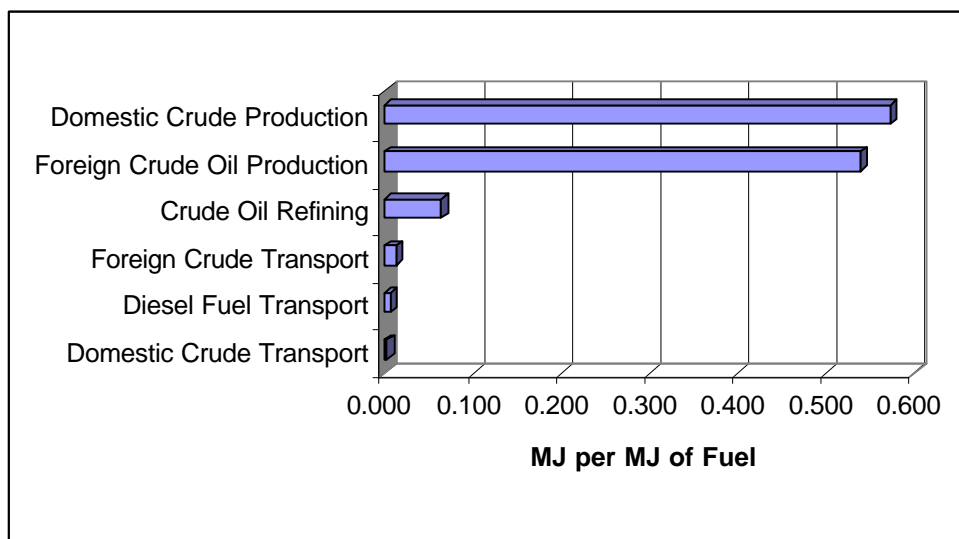

Figure 3: Ranking of Fossil Energy Demand for Stages of the Petroleum Diesel Life Cycle

Table 5: Primary Energy Requirements for Biodiesel Life Cycle

Stage	Primary Energy (MJ per MJ of Fuel)	Percent
Soybean Agriculture	0.0660	5.32%
Soybean Transport	0.0034	0.27%
Soybean Crushing	0.0803	6.47%
Soy Oil Transport	0.0072	0.58%
Soy Oil Conversion	1.0801	87.01%
Biodiesel Transport	0.0044	0.35%
Total	1.2414	100.00%

Table 6 and Figure 6 summarize the fossil energy requirements for the biodiesel life cycle. Because 90% of its feedstock requirements are renewable (that is, soybean oil), biodiesel's fossil energy ratio is favorable. Biodiesel uses 0.3110 MJ of fossil energy to produce one MJ of fuel product; this equates to a fossil energy ratio of 3.215. In other words, the biodiesel life cycle produces more than three times as much energy in its final fuel product as it uses in fossil energy. Fossil energy demand for the conversion step is almost twice that of its process energy demand, making this stage of the life cycle the largest contributor to fossil energy demand. The use of methanol as a feedstock in the production of biodiesel accounts for this high fossil energy demand. We have counted the feedstock energy of methanol coming into the life cycle at this point, assuming that the methanol is produced from natural gas. This points out an opportunity for further improvement of the fossil energy ratio by substituting natural gas-derived methanol with renewable sources of methanol, ethanol or other alcohols.

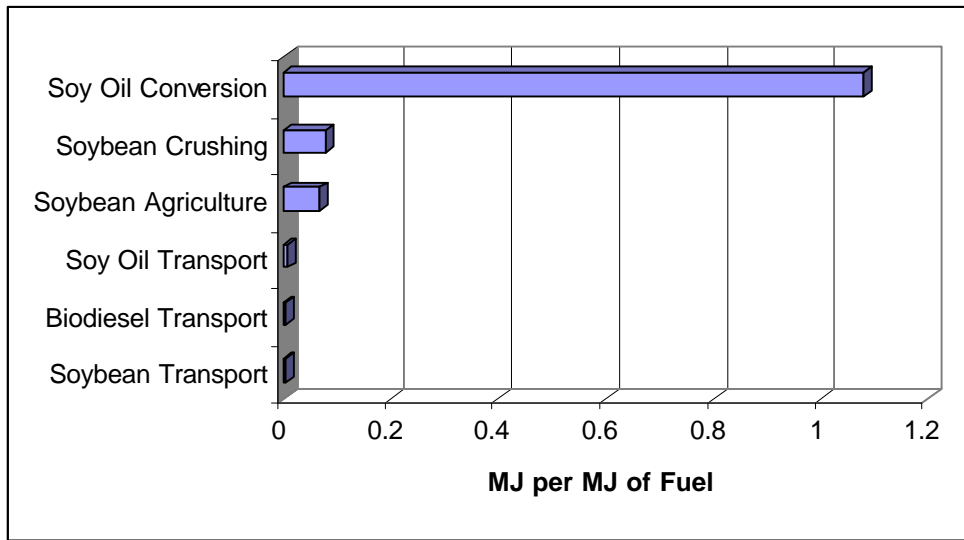

Figure 4: Ranking of Primary Energy Demand for Stages of the Biodiesel Life Cycle

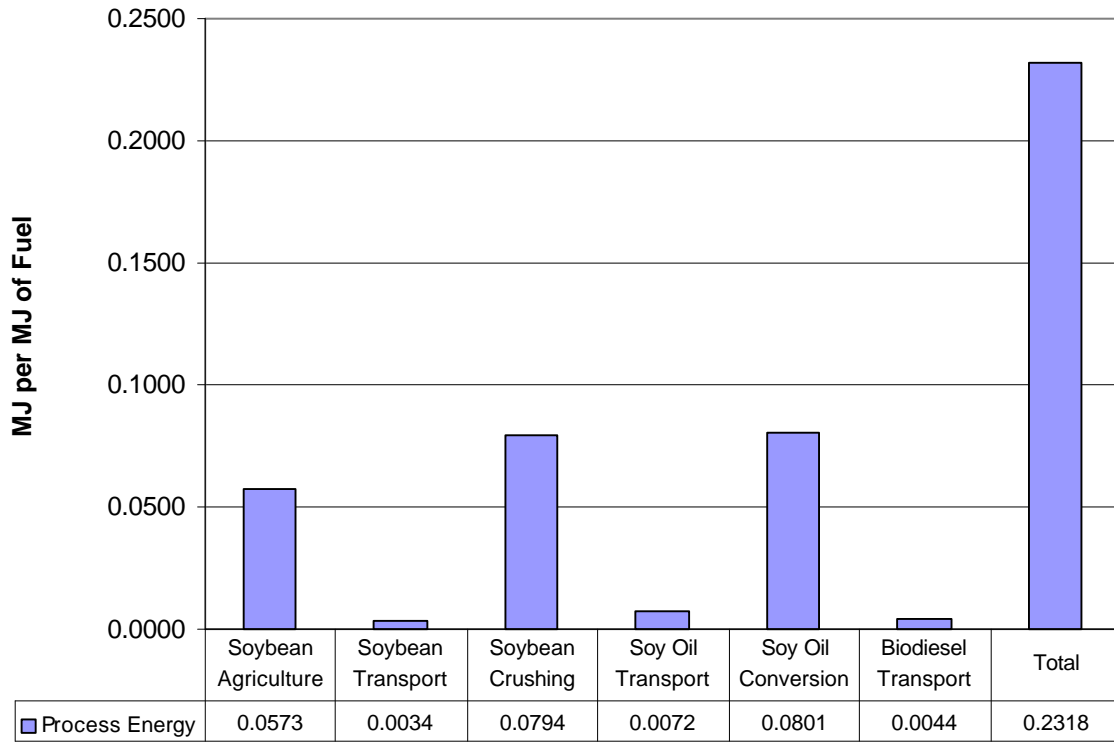

Figure 5: Process Energy Requirements for Biodiesel Life Cycle

Table 6: Fossil Energy Requirements for the Biodiesel Life Cycle

Stage	Fossil Energy (MJ per MJ of Fuel)	Percent
Soybean Agriculture	0.0656	21.08%
Soybean Transport	0.0034	1.09%
Soybean Crushing	0.0796	25.61%
Soy Oil Transport	0.0072	2.31%
Soy Oil Conversion	0.1508	48.49%
Biodiesel Transport	0.0044	1.41%
Total	0.3110	100.00%

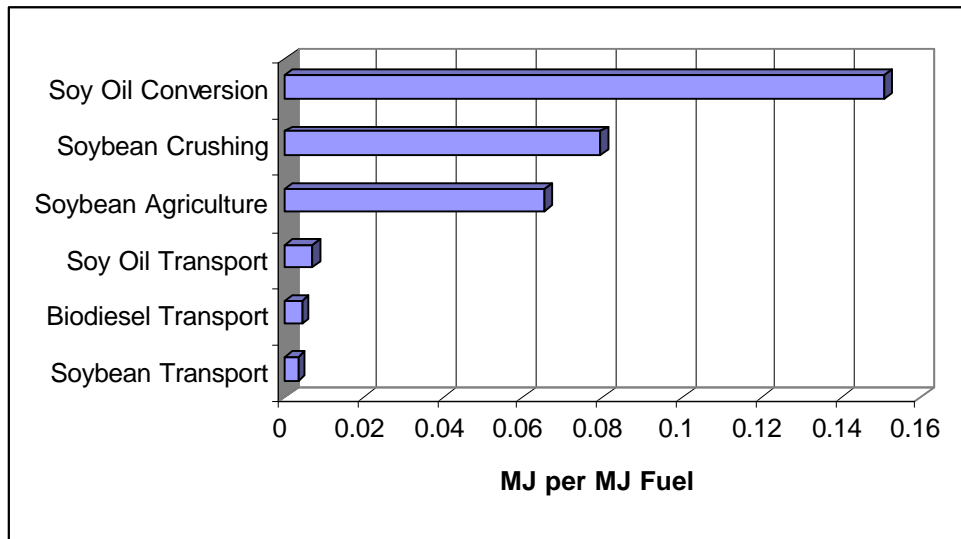

Figure 6: Fossil Energy Requirements versus Fuel Product Energy for the Biodiesel Life Cycle

2.4.1.1.5 Effect of Biodiesel on Life Cycle Energy Demands

Compared on the basis of primary energy inputs, biodiesel and petroleum diesel are essentially equivalent. Biodiesel has a life cycle energy efficiency of 80.55%, compared to 83.28% for petroleum diesel. The slightly lower efficiency reflects a slightly higher demand for process energy across the life of cycle for biodiesel. On the basis of fossil energy inputs, biodiesel enhances the effective use of this finite energy resource. Biodiesel leverages fossil energy inputs by more than three to one.

2.4.1.2 CO₂ Emissions

2.4.1.2.1 Accounting for Biomass-Derived Carbon

Biomass plays a unique role in the dynamics of carbon flow in our biosphere. Biological cycling of carbon occurs when plants (biomass such as soybean crops) convert atmospheric CO₂ to carbon-based compounds through photosynthesis. This carbon is eventually returned to the atmosphere as organisms consume the biological carbon compounds and respire. Biomass derived fuels reduce the net atmospheric carbon in two ways. First, they participate in the relatively rapid biological cycling of carbon to the atmosphere (via engine tailpipe emissions) and from the atmosphere (via photosynthesis). Second, these fuels displace the use of fossil fuels. Combustion of fossil fuels releases carbon that took millions of years to be removed from the atmosphere, while combustion of biomass fuels participates in a process that allows rapid recycle of CO₂ to fuel. The net effect of shifting from fossil fuels to biomass-derived fuels is, thus, to reduce the amount of CO₂ present in the atmosphere.

Because of the differences in the dynamics of fossil carbon flow and biomass carbon flow to and from the atmosphere, biomass carbon must be accounted for separately from fossil-derived carbon. The LCI model tracks carbon from the point at which it is taken up as biomass via photosynthesis to its final combustion as biodiesel used in an urban bus. The biomass-derived carbon that ends up as CO₂ leaving the tailpipe of the bus is subtracted from the total CO₂ emitted by the bus because it is ultimately reused in the production of new soybean oil. In order to ensure that we accurately credit the biodiesel LCI for the amount of recycled CO₂, we provide a material balance on biomass carbon.

The material balance shows all the biomass carbon flows associated with the delivery of 1 bhp-h of engine work (Figure 7). For illustration purposes, only the case of 100% biodiesel is shown. Lower blend rates proportionately lower the amount of biomass carbon credited as part of the recycled CO₂. Carbon incorporated in the meal fraction of the soybeans is not included in the carbon balance. Only carbon in the fatty acids and triglycerides that are used in biodiesel production are tracked. Not all the carbon incorporated in fatty acids and triglycerides ends up as CO₂ after combustion of biodiesel. Some oil loss occurs in the meal by-product. Glycerol is removed from the triglycerides as a by-product. Fatty acids are removed as soaps and waste. Finally, carbon released in combustion ends up in the form of CO₂, CO, THC, and TPM. Of the 169.34 grams of carbon absorbed in the soybean agriculture stage, only 148.39 grams (87%) end up in biodiesel. After accounting for carbon that ends up in other combustion products, 148.05 grams of carbon end up as 543.34 grams of tailpipe CO₂. This CO₂ is subtracted from the diesel engine emissions as part of the biological recycle of carbon. No credit is taken for the 13% of the carbon that ends up in various by-products and waste streams.

2.4.1.2.2 Comparison of CO₂ Emissions for Biodiesel and Petroleum Diesel

Table 7 summarizes CO₂ flows from the total life cycles of biodiesel and petroleum diesel and the total CO₂ released at the tailpipe for each fuel. The dominant sources of CO₂ for both the petroleum diesel life cycle and the biodiesel life cycle is the combustion of fuel in the bus. For petroleum diesel, CO₂ emitted from the tailpipe of the bus represents 86.54% of the total CO₂ emitted across the entire life cycle of the fuel. Most remaining CO₂ comes from emissions at the oil refinery, which contributes 9.6% of the total CO₂ emissions. For biodiesel, 84.43% of the CO₂ emissions occur at the tailpipe. The remaining CO₂ comes almost equally from soybean agriculture, soybean crushing, and conversion of soy oil to biodiesel.

At the tailpipe, biodiesel emits 4.7% more CO₂ than petroleum diesel, most of which is renewable. The nonrenewable portion comes from the methanol. Biodiesel generates 573.96 g/bhp-h compared with 548.02 g/bhp-h for petroleum diesel. The higher CO₂ levels result from more complete combustion and the concomitant reductions in other carbon-containing tailpipe emissions. As Figure 8 shows, the overall life cycle emissions of CO₂ from B100 are 78.45% lower than those of petroleum diesel. The reduction is

a direct result of carbon recycling in soybean plants. B20, the most commonly used form of biodiesel in the US, reduces net CO₂ emissions by 15.66% per gallon of fuel used.

Table 7: Tailpipe Contribution to Total Life Cycle CO₂ for Petroleum Diesel and Biodiesel (g CO₂/bhp-h)

Fuel	Total Life Cycle Fossil CO ₂	Total Life Cycle Biomass CO ₂	Total Life Cycle CO ₂	Tailpipe Fossil CO ₂	Tailpipe Biomass CO ₂	Total Tailpipe CO ₂	% of Total CO ₂ from Tailpipe
Petroleum Diesel	633.28	0.00	633.28	548.02	0.00	548.02	86.54%
B100	136.45	543.34	679.78	30.62	543.34	573.96	84.43%

2.4.1.3 Primary Resource Consumption for Biodiesel and Petroleum Diesel

The use of B100 as a substitute for petroleum diesel effects a 95% reduction in life cycle consumption of petroleum. Figure 9 compares petroleum oil consumption for petroleum diesel, B20, and B100. The 20% blend of biodiesel provides a proportionate reduction of 19%.

Consumption of coal and natural gas is a different story (Figure 10). The use of B100 increases life cycle consumption of coal by 19%. This reflects the higher overall demand for electricity in the biodiesel life cycle, relative to petroleum diesel. Electricity demand for soybean crushing is the dominant factor in electricity consumption for biodiesel because of the mechanical processing and solids handling equipment involved in this step. Life cycle consumption of natural gas increases by 77% for biodiesel versus petroleum diesel. Two factors contribute to this increase: 1) the assumed use of natural gas for the supply of steam and process heat in soybean crushing and soy oil conversion, and 2) the use of natural gas to produce methanol used in the conversion step.

The biodiesel life cycle imposes a higher burden on water resources than the petroleum diesel life cycle. Water use for petroleum diesel is not even visible on a plot scaled to show biodiesel use (Figure 11). That is because the biodiesel life cycle uses water at a rate that is three orders of magnitude higher than that of petroleum diesel. The impact of this water use is not addressed in this report. We offer no simple way to compare water use between the two life cycles because there is no simple equivalency in its use and final disposition.

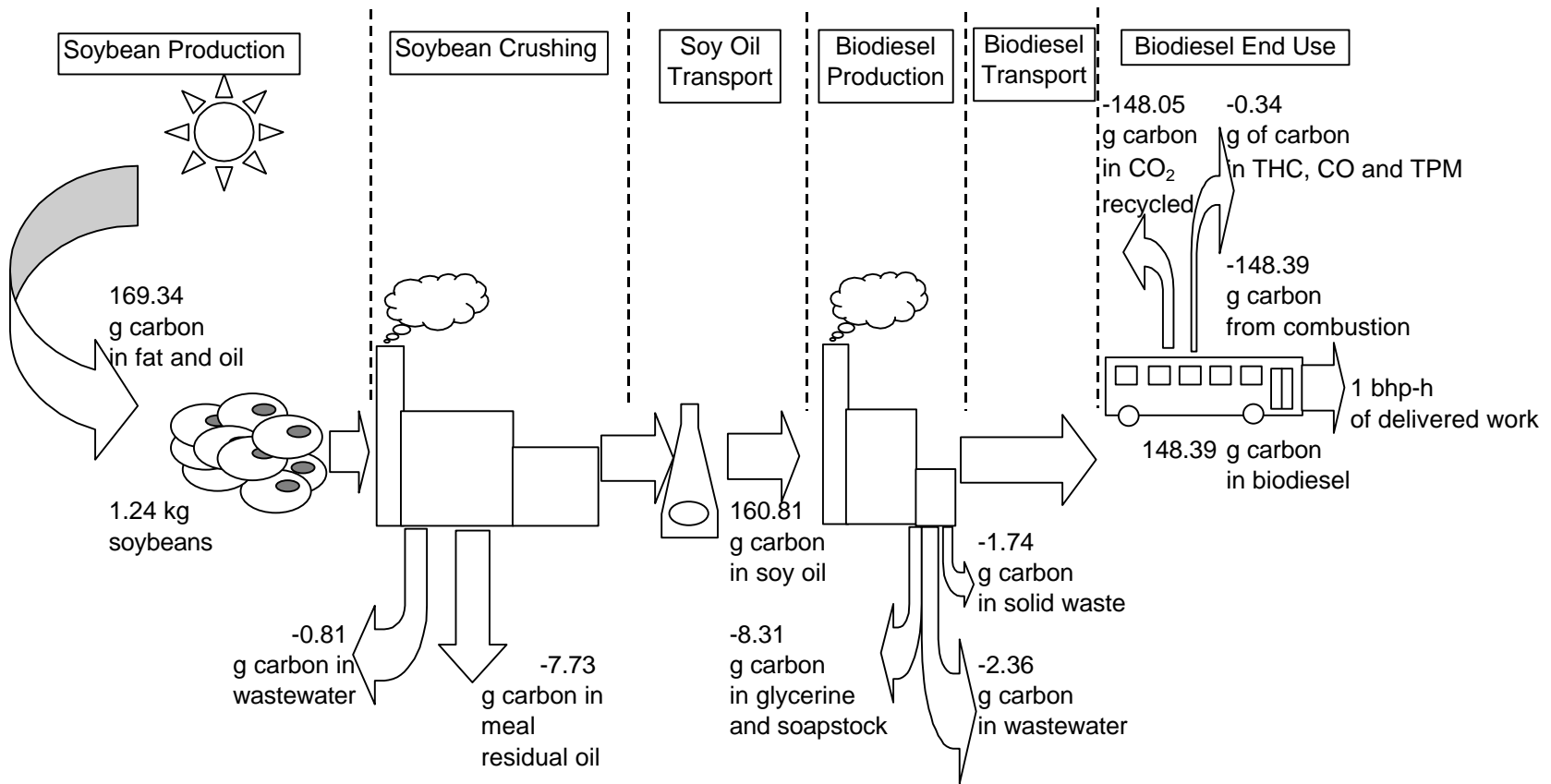

Figure 7: Biomass Carbon Balance for Biodiesel Life Cycle (g carbon/bhp-h)¹¹

¹¹ All numbers presented as carbon equivalent. To calculate actual CO₂ emissions, multiply carbon equivalent numbers by 3.67 (the ratio of the molecular weight of CO₂ divided by the molecular weight of carbon).

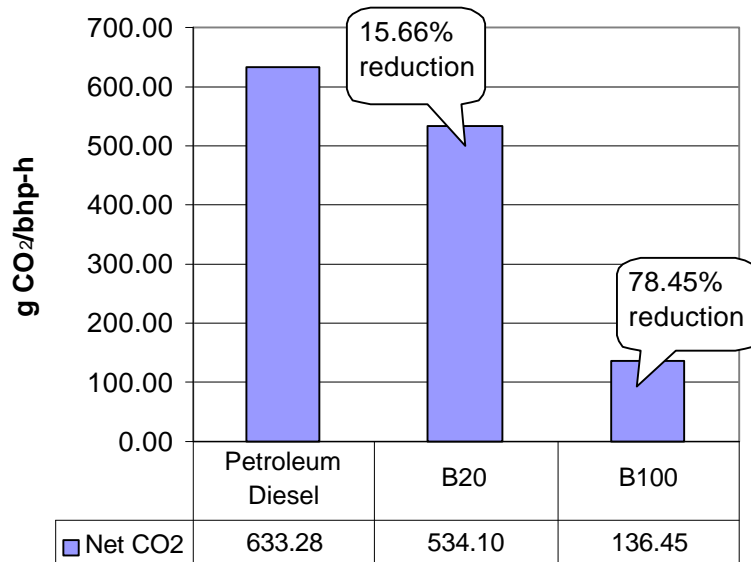

Figure 8: Comparison of Net CO₂ Life Cycle Emissions for Petroleum Diesel and Biodiesel Blends¹²

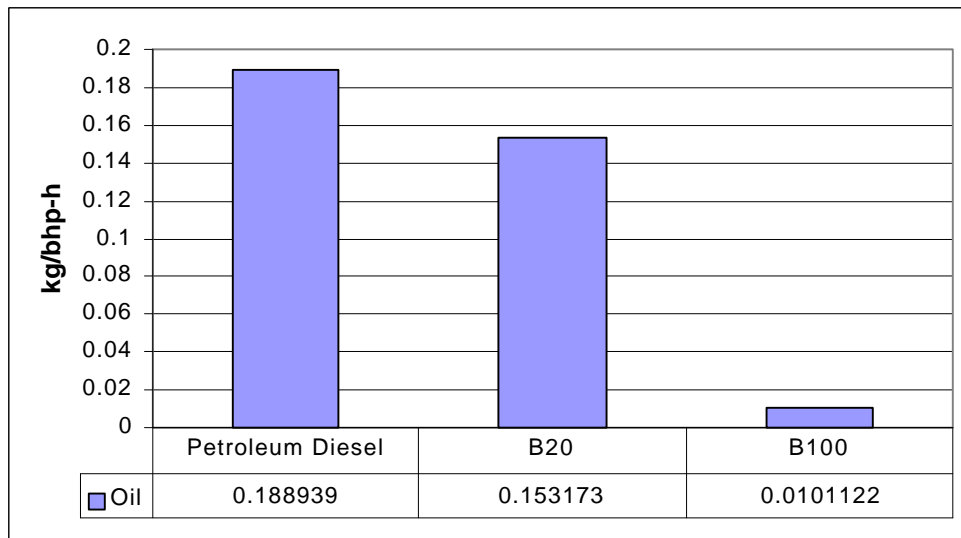

Figure 9: Petroleum Consumption for Petroleum Diesel, B20, and B100

¹² Net CO₂ calculated by setting biomass CO₂ emissions from the tailpipe to zero.

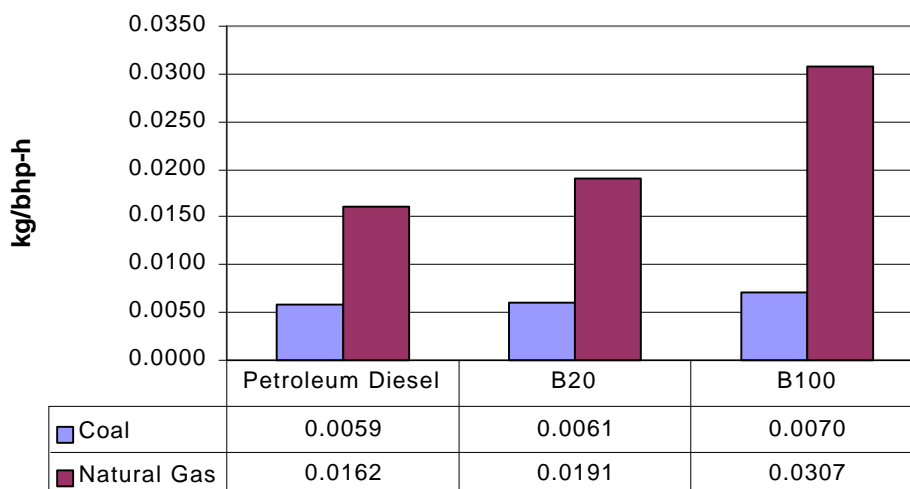

Figure 10: Coal and Natural Gas Consumption for Petroleum Diesel, B20, and B100

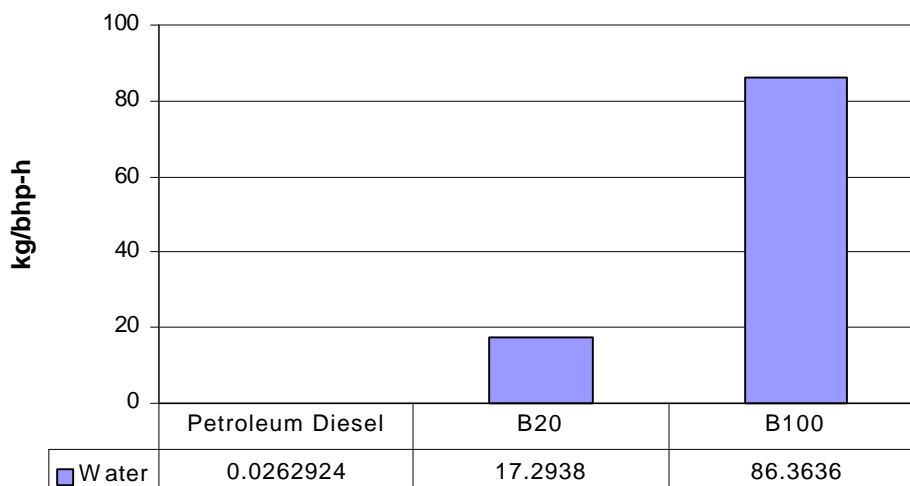

Figure 11: Water Use for Petroleum Diesel, B20, and B100

2.4.1.4 Life Cycle Emissions of Regulated and Nonregulated Air Pollutants

Regulated air pollutants include the following:

- Carbon Monoxide (CO)
- Nitrogen Oxides (NO_x)
- Particulate Matter Less Than 10 Microns (PM10)
- Sulfur Oxides (SO_x)
- Non Methane Hydrocarbons (NMHC)

The emissions of these air pollutants are regulated at the tailpipe for diesel engines. Sulfur dioxide (SO_x) does not have specific tailpipe limits, but it is controlled through sulfur content of the fuel. Other air emissions included in this study are methane (CH₄), benzene, formaldehyde, nitrous oxide (N₂O), hydrochloric acid (HCl), hydrofluoric acid (HF), and ammonia. N₂O is associated with agricultural field emissions. HCl and HF are associated with coal combustion in electric power stations. Ammonia is released primarily during fertilizer production.

2.4.1.4.1 Comparison of Life Cycle Air Emissions for Biodiesel and Petroleum Diesel

Figure 12 summarizes the differences in life cycle air emissions for B100 and B20 versus petroleum diesel fuel. In this section, we discuss overall differences in the emissions of the biodiesel and petroleum life cycles. More detail on the sources of the differences is presented in section 9.1.4 Life Cycle Emissions of Regulated and Nonregulated Air Pollutants.

We report particulate matter and hydrocarbons differently from the definitions used by EPA in their regulations. This difference in reporting is due to variations in how different data sources for the stages of the life cycle report these emissions. Benzene and formaldehyde emissions are not consistently reported. Some sources explicitly define emissions for non-methane hydrocarbons (NMHC), while others do not specify this distinction. Hydrocarbon data are reported as THC, defined as:

$$THC = (CH_4 + Benzene + formaldehyde + HC_{unspecified} + HC_{noCH_4})$$

where:

THC = total hydrocarbons

CH₄ = methane

HC_{unspecified} = unspecified hydrocarbons

HC_{noCH₄} = hydrocarbons excluding methane

Likewise, particulates are combined as a single category according to the following formula:

$$TPM = (PM_{10} + PM_{unspecified})$$

where:

TPM = total particulate matter

PM₁₀ = particulate matter less than 10 micron

PM_{unspecified} = unspecified particulate matter

The replacement of petroleum diesel with biodiesel in an urban bus reduces life cycle air emissions for all but three of the pollutants we tracked. The largest reduction in air emissions that occurs when B100 or B20 are used as a substitute for petroleum diesel is for CO. Reductions in CO reach 34.5% when using B100. The effectiveness of B20 in reducing life cycle emissions of CO drops proportionately with the blend level. Biodiesel could, therefore, be an effective tool for mitigating CO in EPA's designated CO non-attainment areas¹³.

¹³ These are urban areas in the U.S. identified as not currently meeting National Ambient Air Quality Standards for levels of carbon monoxide.

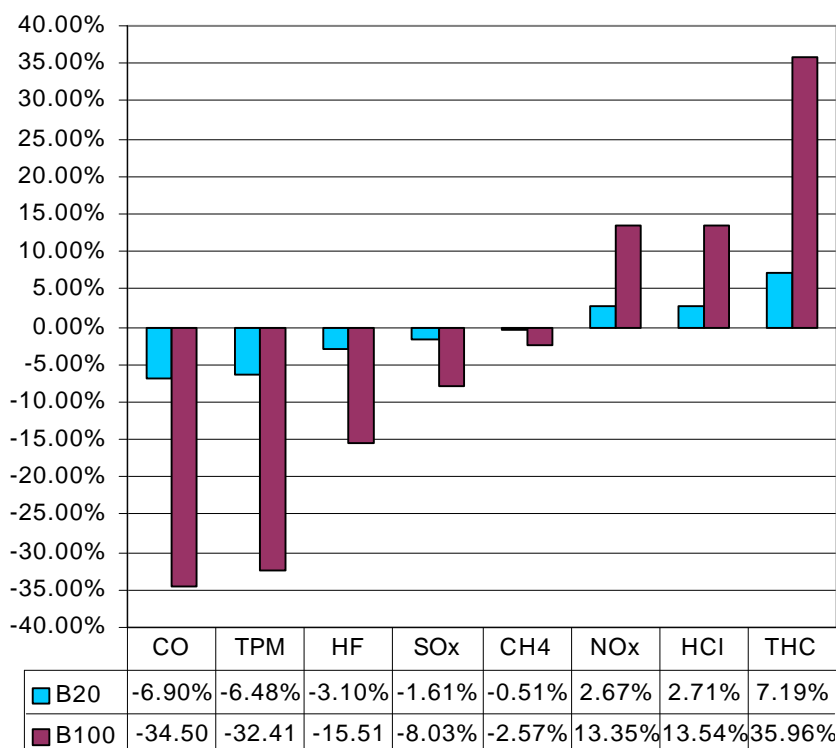

Figure 12: Life Cycle Air Emissions for B100 and B20 Compared to Petroleum Diesel Life Cycle Air Emissions

B100 exhibits life cycle emissions of total particulates (TPM) that are 32.41% lower than those of the petroleum diesel life cycle. As with CO, the effectiveness of biodiesel in reducing TPM drops proportionately with blend level. This improvement in TPM emissions is a direct result of reductions in PM10 at the tailpipe of the bus. Tailpipe emissions of PM10 are 68% lower for urban buses operating on B100 versus petroleum diesel. PM10 emitted from mobile sources is a major EPA target because of its role in respiratory disease. Urban areas represent the greatest risk in terms of numbers of people exposed and level of PM10 present. Use of biodiesel in urban buses is potentially a viable option for controlling both life cycle emissions of TPM and tailpipe emissions of PM10¹⁴.

Biodiesel's life cycle produces 35% more THC than petroleum diesel's life cycle. This is in spite of the fact that tailpipe emissions of THC for B100 are 37% lower. The level of emissions of hexane that occur in the soybean crushing stage overshadows the tailpipe benefits¹⁵. In understanding the implications of the higher life cycle emissions, it is important to remember that emissions of hydrocarbons, as with all of the air pollutants discussed, have localized effects. In other words, it makes a difference *where* these emissions occur. The fact that biodiesel's hydrocarbon emissions at the tailpipe are lower may mean that

¹⁴ Among the options under consideration by EPA are regulations that would control levels of PM2.5, as opposed to PM10. PM2.5 includes particles of 2.5 microns or less in diameter. That is, EPA is focusing its attention on the very smallest particles in ambient air. Data collected in this study focus on PM10. While our results bode well for lowering levels of PM10, no information is available on the effect of biodiesel on this new class of smaller particles.

¹⁵ See section 9.1.4.3 Comparison of Life Cycle Air Emissions from Biodiesel and Petroleum Diesel for more details.

the biodiesel life cycle has beneficial effects on urban area pollution. We offer no judgement in this report regarding the impacts of these emissions because that discussion is beyond the scope of this report.

CH₄ emissions are 25% and 32% of the life cycle emissions of THC for B100 and B20, respectively. All these CH₄ emissions occur in the fuel production and utilization steps. Life cycle emissions of CH₄ are 2.57% and 0.51% lower for B100 and B20, respectively, compared to petroleum diesel. Though the reductions achieved with biodiesel are small, they could be significant when estimated on the basis of its “CO₂ equivalent”-warming potential.¹⁶

Perhaps the next most critical pollutant from the perspective of human health and environmental quality is NO_x. The triumvirate of CO, THC, and NO_x is the key to controlling ground-level ozone and smog in urban areas. The relative importance of each of these precursors is not at all clear because they interact in a complex set of chemical reactions catalyzed by sunlight¹⁷. Biodiesel effectively reduces tailpipe emissions of two of the three smog precursors (CO and THC). However, both B100 and B20 have life cycle *and* tailpipe emissions of NO_x that are higher than those of petroleum diesel. B100 and B20 exhibit 13.35% and 2.67% higher life cycle emissions, respectively, compared to petroleum diesel. It is almost an aphorism in the engine industry that TPM and NO_x emissions are two sides of a technology trade-off. Biodiesel seems to fit this observation. Dealing with this trade-off involves a combination of fuel research and engine technology research. Within these two arenas, solutions are potentially achievable that meet the tougher future standards for NO_x without sacrificing the other benefits of this fuel.

B100 and B20 life cycle emissions of SO_x are lower than those of petroleum diesel (8.03% and 1.61%, respectively). This is a relatively low reduction given that biodiesel completely eliminates SO_x at the tailpipe. The amount of SO_x in the emissions from a diesel engine is a function of sulfur content in the fuel. With this in mind, EPA regulates diesel fuel’s sulfur content, rather than tailpipe SO_x emissions. The latest requirements for diesel fuel include 0.05 wt% sulfur for on-highway fuel. Biodiesel can eliminate SO_x emissions because it is sulfur-free. The complete elimination of SO_x at the tailpipe is offset by emissions of SO_x associated with the higher demand for electricity in the biodiesel life cycle versus the petroleum diesel life cycle¹⁸

HCl and HF emissions are emitted in very low levels as a part of the life cycles of both petroleum diesel and biodiesel. They are tracked in this study because of their potential contribution to acidification effects in the environment. Both pollutants occur as a result of coal combustion in electric power generation. HF levels drop with biodiesel in proportion to the amount of electricity consumed over the life cycle of the fuel. This amounts to 15.51% reductions for B100. HCl emissions, on the other hand, increase with biodiesel blend. Biodiesel has additional sources of HCl associated with the production and use of inorganic acids and bases used in the conversion step. B100 increases emissions of HCl by 13.54%.

2.4.1.5 Life Cycle Emissions of Water Effluents

We tracked a number of waterborne effluents through the life cycles for petroleum diesel and biodiesel such as BOD (biological oxygen demand) and COD (chemical oxygen demand). However, relatively few data were consistently available. Therefore, the comparisons of the two life cycles are limited to total

¹⁶ Although CH₄ is a more potent greenhouse gas, its half-life in the atmosphere is less than that of CO₂. These complications in understanding the impact of each pollutant illustrate why we have avoided making quantitative judgements about the life cycle impacts of biodiesel. We leave it to others to evaluate the comparative inventories of biodiesel and diesel in terms of their positive and negative impacts.

¹⁷ For an excellent discussion of the complexities of urban air pollution, see Seinfeld, John H., “Urban Air Pollution: State of the Science” in *Science*, Vol 243, pp 745-752.

¹⁸ See section 9.1.4.3 for a more thorough discussion of sources of SO_x in the two fuel life cycles.

flow of wastewater. Foreign and domestic crude oil extraction account for 78% of the total wastewater flow in the petroleum diesel life cycle. Only about 12% is associated with the refinery. Two-thirds of the total wastewater flows in the life cycle for biodiesel come from the soy oil conversion process. This step in the life cycle generates relatively dilute wastewater containing oil and soap from the processing of the soybean oil. A comparison of total wastewater flows from the life cycles for petroleum diesel and biodiesel is shown in Figure 13. Petroleum diesel generates roughly five times as much wastewater flow as biodiesel.

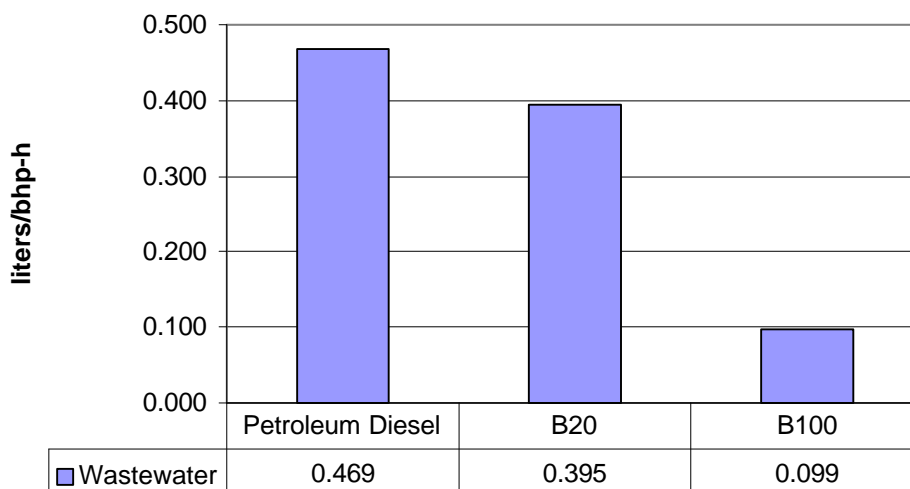

Figure 13: Comparison of Total Wastewater Flows for Petroleum Diesel and Biodiesel Life Cycles

2.4.1.6 Comparison of Solid Waste Life Cycle Flows

Solid waste from the two life cycles is classified as hazardous or nonhazardous. In the petroleum diesel life cycle, hazardous waste is derived almost entirely from the crude oil refining process. The minor levels of solid waste that show up in foreign crude transport and diesel fuel transport are indirect flows of solid waste attributable to production of diesel fuel and gasoline used in the transportation process. Total hazardous waste generation amounts to 0.41 g/bhp-h of engine work. About half the nonhazardous waste is generated by petroleum diesel is in the crude oil refining step. Another one-third is generated in the foreign and domestic crude oil extraction steps. Total nonhazardous waste generation in the petroleum diesel life cycle is 2.8 g/bhp-h.

Hazardous waste from the biodiesel life cycle amounts to only 0.018 g/bhp-h of engine work. Soybean agriculture contributes 70% of the hazardous waste from the entire life cycle, but these flows are indirect charges against agriculture for hazardous waste flows associated with the production of diesel fuel and gasoline used on the farm. Nonhazardous solid waste generated in the biodiesel life cycle 12.7 g/bhp-h of engine work. This waste is primarily trash and tramp metals removed from soybeans brought into the soybean crushing stage. Figure 14 and Figure 15 show hazardous and nonhazardous solid waste generation for petroleum diesel and biodiesel. The B100 life cycle produces 96% less hazardous waste compared to petroleum diesel life cycle. Nonhazardous waste, on the other hand, is twice as high for B100.

2.4.2 Sensitivity Studies

2.4.2.1 The Effect of Enhanced Location for Biodiesel Production and Use

We studied the effect of placing biodiesel production and use in a more optimal location, which mimics how similar renewable fuels industries, such as ethanol, have developed. To that end, we chose to model biodiesel production and use in the Chicago area. This location provides a good outlet for biodiesel sales for the urban bus end-use. More importantly, it allows us to consider near-term access to some of the best soybean farmland in the United States. This scenario reduces the distances required to move beans, oil, and biodiesel, and allows us to take advantage of high-yield soybean agriculture.

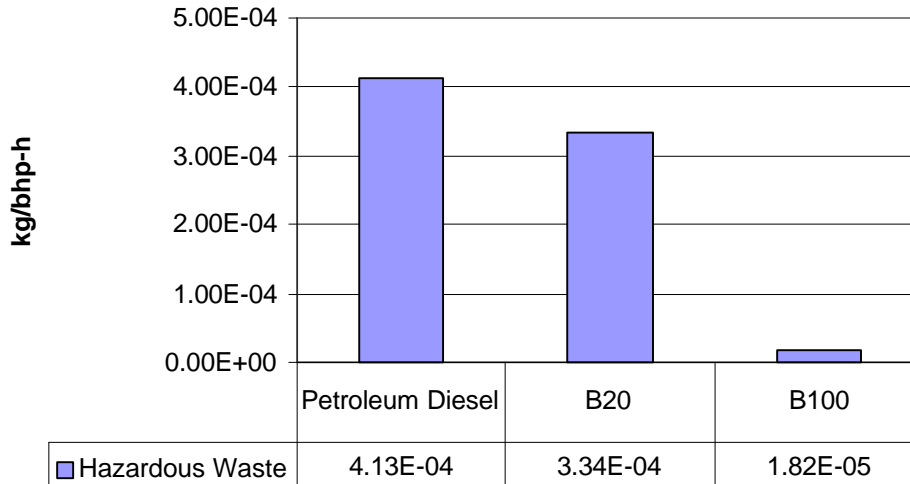

Figure 14: Hazardous Waste Generation for Petroleum Diesel, B20, and B100

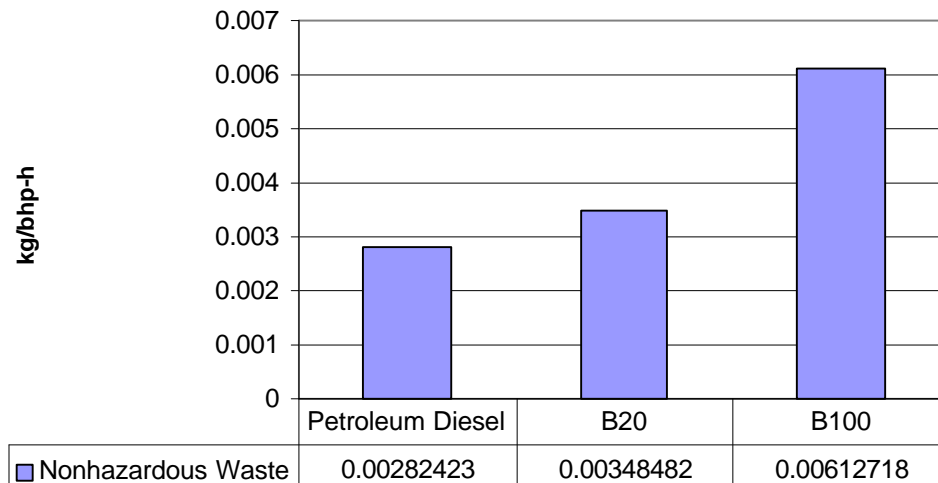

Figure 15: Nonhazardous Waste Generation for Petroleum Diesel, B20, and B100

Basic changes to the model are shown in Table 8. The reduced distance for shipping soybean oil is based on an evaluation of the location of crushing facilities to potential market locations. The results of the model with these assumptions is presented for B100, with the understanding that the improvements or worsening in life cycle emissions relative to petroleum diesel are proportional to the blend level.

Table 8: Model Parameters for the Chicago Area Biodiesel Scenario

Model Parameter	Baseline Scenario	Chicago Area Scenario
Soybean Agriculture	Yields and inputs based on national average (14 key soybean-producing states)	Yields and inputs based on production of soybeans from Illinois and Iowa. 50% of soybean supply is taken from each state.
Transport Distances	National average distance for soy oil of 571 miles	Reduced travel distance of 248 miles.

Placing biodiesel production and use in the Chicago area has benefits for energy consumption (see Figure 16). Impacts on natural gas and coal consumption are minor (2% and 5% savings, respectively). Petroleum consumption, on the other hand, drops by 23.53% from the national average base case. This leads to a slight increase in life cycle energy efficiency from the base case value of 80.55% to 81.84%. Biodiesel’s fossil energy ratio increases from 3.22 to 3.43. The energy savings occur primarily on the farm. Process energy requirements for farming drop by 22%. Energy savings of 56% are also realized in the soy oil transport step, but this impact is smaller because of the relatively small contribution to energy demand made by this step. Water use drops dramatically in the Chicago area scenario. Biodiesel consumes 31% less water in this scenario.

The percent reductions of key air pollutants are tabulated in Figure 17. The change to a more favorable location has, with one exception, modest benefits for air emissions. The exception is for ammonia emissions, which drop by 45%. Ammonia emissions occur as a result of nitrogen fertilizer use. The large drop in life cycle ammonia emissions is due to improved yields and lower nitrogen fertilizer usage rates per kg of soybeans produced. The next largest saving is for PM10 emissions, which drop 10% from the base case. This is consistent with the reductions in petroleum consumption associated with diesel fuel use on the farm. The Chicago scenario provides an additional savings of 7% in CO₂ emissions. All other emissions savings are less than 5%, compared to the base case.

Reductions in life cycle waste emissions are shown in Figure 18. Hazardous waste emissions are reduced dramatically. The 28% reduction corresponds to lower levels of diesel fuel use in the farming of soybeans. Wastewater and nonhazardous solid waste reductions are 5.79% and 2.72%, respectively.

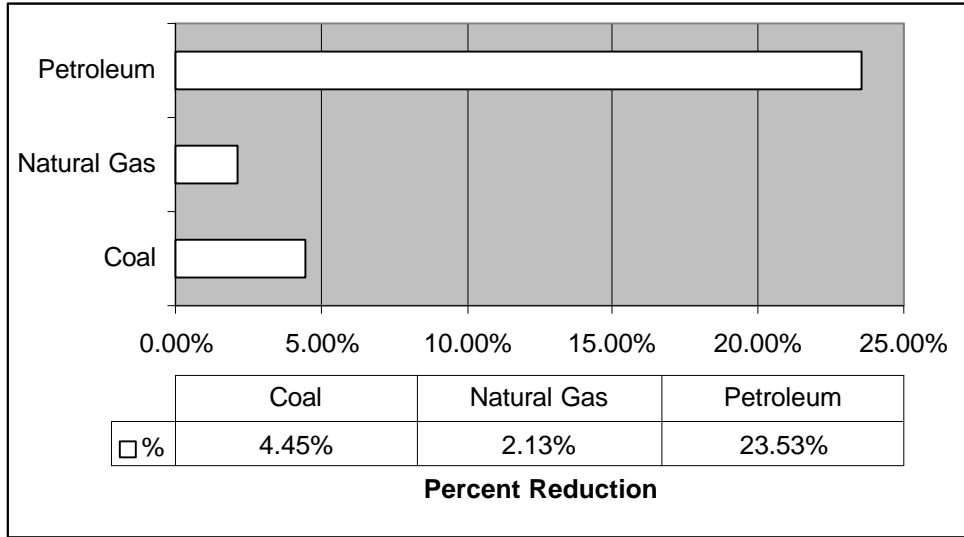

Figure 16: The Effect of an Enhanced Location for Biodiesel on Life Cycle Consumption of Primary Energy Resources

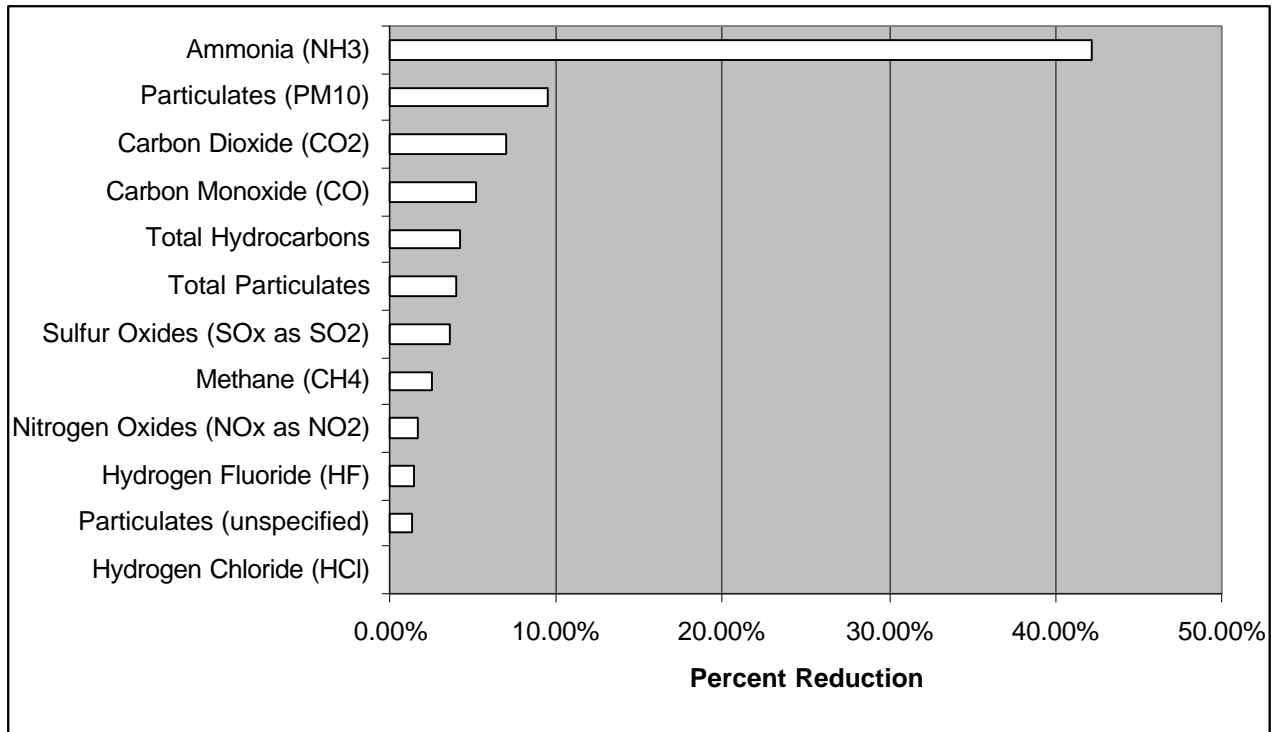

Figure 17 : Reductions in Life Cycle Air Emissions for the Chicago Area Biodiesel Scenario

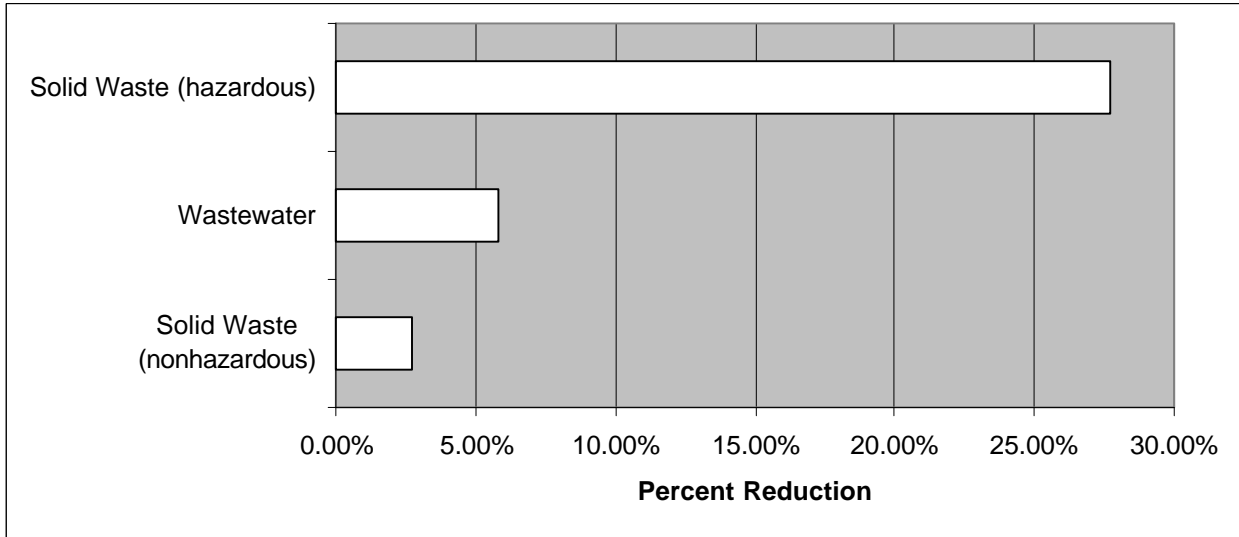

Figure 18: Water and Solid Waste Emissions Reductions for the Chicago Area Biodiesel Scenario

2.4.2.2 The Effect of Energy Requirements for Conversion of Soybean Oil to Biodiesel

A range of energy inputs for converting soybean oil to biodiesel was used in the LCI model to test the effect of these modeling assumptions on the overall LCI of biodiesel. A survey of current commercial technology for biodiesel reveals a high degree of variation on reported steam and electricity requirements for the transesterification process. High and low estimates for both steam and electricity used in the model are indicated in Table 9.

Table 9: Range of Energy Inputs for Soybean Oil Conversion Tested in LCI Model

Energy Use	Low Value	Baseline Scenario	High Value
Steam (kcal/metric ton of biodiesel produced)	95,022.7	329,793.5	617,922.2
Electricity (kWh/metric ton of biodiesel produced)	9.0	28.9	40.0

Steam requirements vary 3.5-fold from the lowest to the highest value. Electricity varies 4.4-fold. This high degree of variability warrants testing the range of these assumptions in our model in order to assess the uncertainty of our overall results related to this assumption. Furthermore, energy inputs for soybean oil conversion are a substantial part of the life cycle, making this variability even more important.

The effect of conversion energy variability on the demand for primary energy resources is shown in Figure 19. Overall effects on primary energy are considerably smaller than the range of variation in energy inputs. Oil consumption is not affected at all. Because natural gas is the sole source of process energy in the conversion model, it is the most affected by the energy requirements assumed for this stage. Natural gas consumption increases 16.41% for the high energy inputs and decreases by 13.5% for the low energy inputs. Coal consumption ranges from +6.55% to -11.7% of the base case.

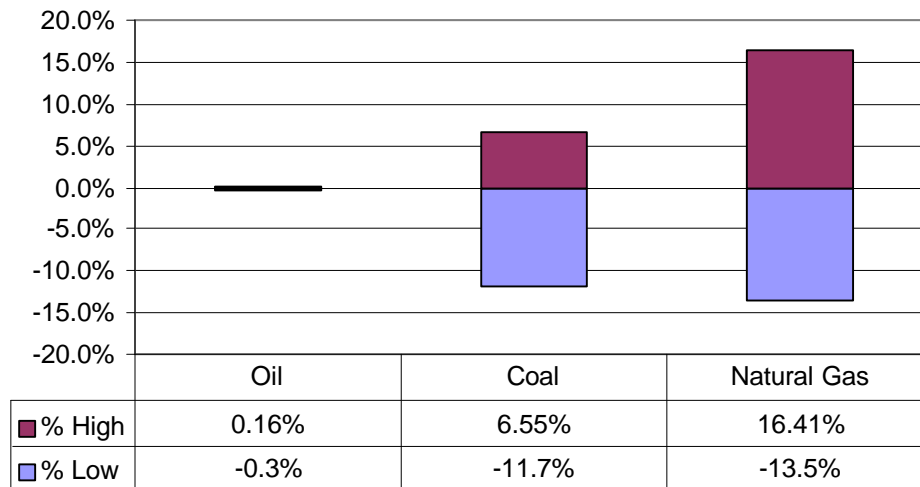

Figure 19: The Effect of Conversion Energy Requirements on Primary Energy Resource Demands for Biodiesel

Figure 20 presents changes in biodiesel’s life cycle air emissions across the range of assumed energy requirements for conversion of soybean oil. Life cycle emissions are listed in order of increasing sensitivity to energy requirement assumptions. Changes in steam requirements (and hence natural gas consumption) have a large effect on CH₄ emissions, which can vary by 14% in both directions. From a greenhouse gas perspective, this is probably the most significant change observed in this sensitivity study. CO₂ shows similar responses. Unspecified PM and SO_x emissions are also affected significantly, reflecting emissions from combustion for electricity generation. No other emissions show much response to the energy inputs for soy oil conversion.

The relative changes in solid waste and wastewater emissions are presented in Figure 21. Wastewater and hazardous solid waste emissions hardly change at all across the range of assumed energy requirements. Nonhazardous solid waste does show a moderate response.

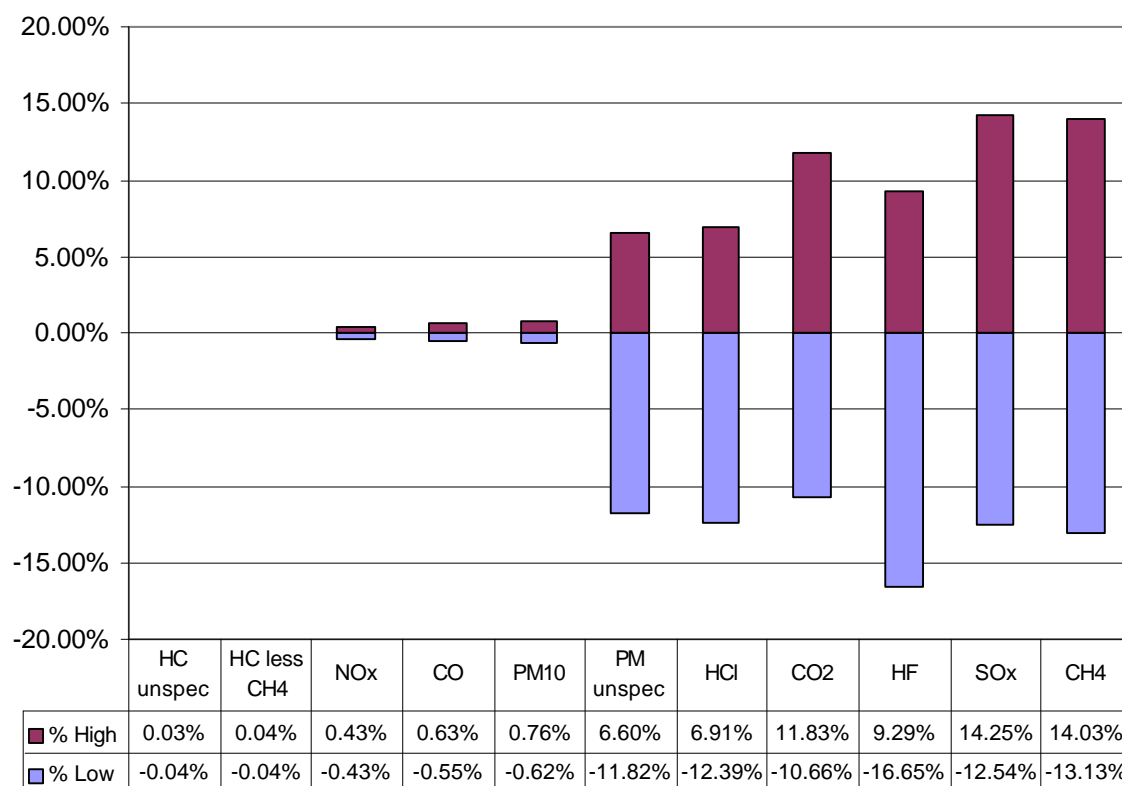

Figure 20: The Effect of Soybean Oil Conversion Energy Demands on Air Emissions for Biodiesel

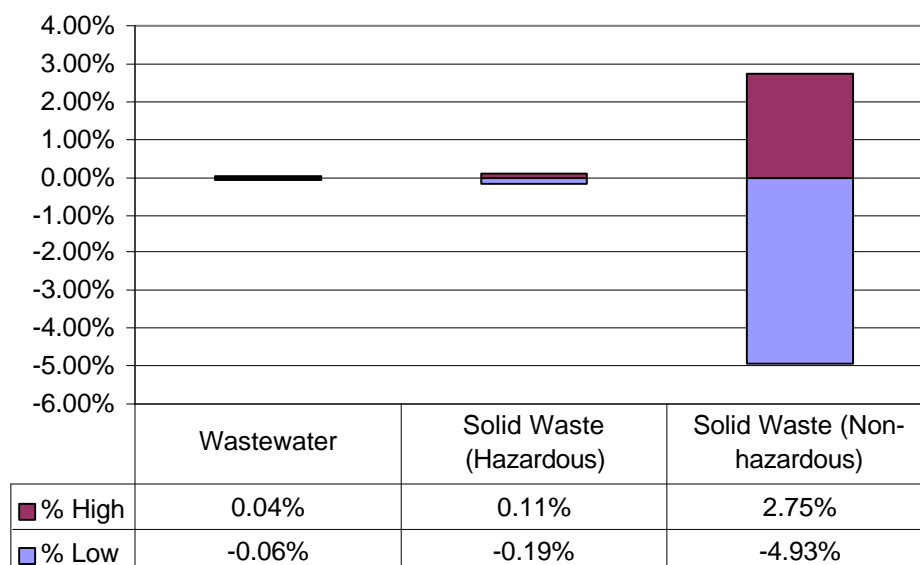

Figure 21: The Effect of Soybean Oil Conversion Energy Demands on Water and Solid Waste Emissions for Biodiesel

2.5 Conclusions

Conducting LCIs is fraught with difficulties. Incomplete data are the rule rather than the exception. We have varying degrees of confidence in the results we present in this report. The most reliable conclusions of this study are for overall energy balance and CO₂ emissions. For these two measures, our data are the most complete. More importantly, our sensitivity studies show that the estimates of CO₂ emissions and energy requirements are very robust; that is, these results show little change in response to changes in key assumptions.

2.5.1 Life Cycle Energy and Environmental Flows

Major analytical results are presented below in order of decreasing confidence:

- **Energy Balance.** Biodiesel and petroleum diesel have very similar energy efficiencies. The base case model estimates life cycle energy efficiencies of 80.55% for biodiesel versus 83.28% for petroleum diesel. The lower efficiency for biodiesel reflects slightly higher process energy requirements for converting the energy contained in soybean oil to fuel. In terms of effective use of fossil energy resources, biodiesel yields around 3.2 units of fuel product energy for every unit of fossil energy consumed in the life cycle. By contrast, petroleum diesel's life cycle yields only 0.83 units of fuel product energy per unit of fossil energy consumed. Such measures confirm the "renewable" nature of biodiesel. The life cycle for B20 has a proportionately lower fossil energy ratio (0.98 units of fuel product energy for every unit of fossil energy consumed). B20's fossil energy ratio reflects the impact of adding petroleum diesel into the blend.
- **CO₂ Emissions.** Given the low demand for fossil energy associated with biodiesel, it is not surprising that biodiesel's life cycle emissions of CO₂ are substantially lower. Per unit of work delivered by a bus engine, B100 reduces net emissions of by 78.45% compared to petroleum diesel. B20's life cycle CO₂ emissions of CO₂ are 15.66% lower than those of petroleum diesel. Thus, use of biodiesel to displace petroleum diesel in urban buses is an extremely effective strategy for reducing CO₂ emissions.
- **Total Particulate Matter (TPM) and Carbon Monoxide (CO) Emissions.** The biodiesel (B100) life cycle produces less TPM and CO (32% and 35% reductions, respectively) than the petroleum diesel life cycle. Most of these reductions occur because of lower emissions at the tailpipe. PM10 emissions from an urban bus operating on biodiesel are 63% lower than the emissions from an urban bus operating on petroleum diesel. Biodiesel reduces tailpipe emissions of CO by 46%.
- **NO_x Emissions.** At the same time, NO_x emissions are 13% higher for the B100 life cycle compared to the petroleum diesel life cycle. B20 has 2.67% higher life cycle emissions of NO_x. Again, this increase is attributed to higher NO_x emissions that occur at the tailpipe. An urban bus run on B100 has NO_x emissions that are 8.89% higher than a bus operated on petroleum diesel.
- **Total Hydrocarbons (THC).** We also report 35% higher life cycle emissions of THC compared to petroleum diesel. Tailpipe emissions of THC are actually 37% lower for B100, compared to petroleum diesel. The increase in hydrocarbon emissions is due to release of hexane during soybean processing and to volatilization of agrochemicals applied on the farm. We have less confidence in the hydrocarbon air emissions results from this study. Air emissions data are often not reported on the same basis. For example, data run the gamut from specific hydrocarbon compounds such as CH₄ or benzene to broad measures of total hydrocarbons. The latter are not measured consistently, as well. Our data set includes numbers reported as "unspecified

hydrocarbons” and as “non-methane hydrocarbons” (NMHC). Given these kinds of ambiguities in the data, results on hydrocarbon emissions need to be viewed with caution.

- **Water and Solid Waste.** We report total wastewater and solid waste flows. Our results show that biodiesel has life cycle wastewater flows that are almost 80% lower than those of petroleum diesel. Hazardous waste generation is also much lower for biodiesel. Biodiesel generates only 5% of the amount of hazardous waste generated by petroleum diesel. However, we do not have a consistent basis for comparing these flows because their final disposition and composition are so different.
- **Water consumption.** B100 uses water at a level that is three orders of magnitude higher than petroleum diesel, on a life cycle basis.

2.5.2 Next Steps

At the outset, we designed this study to identify and quantify the advantages of biodiesel as a substitute for petroleum diesel. These advantages are substantial, especially in the area of energy security and control of greenhouse gases. We have also identified weaknesses or areas of concern for biodiesel—such as its emissions of NO_x and THC. We see these as opportunities for further research to resolve these concerns. We hope that our findings will be used to focus future biodiesel research on these critical issues.

Much that could be done to build on and improve the work we have done here. Appropriate next steps for this work include the following:

- ✓ Use the LCI to assess the relative effects of petroleum diesel and biodiesel on our environment and on public health risks in order to gain an understanding of the benefits associated with biodiesel.
- ✓ Quantify the costs and benefits of biodiesel.
- ✓ Assess the economic impact of biodiesel as an alternative fuel (e.g., its effects on jobs, trade deficit, etc.).
- ✓ Evaluate other feedstock sources.
- ✓ Incorporate new health effects data on emissions from biodiesel and petroleum diesel.
- ✓ Develop regional life cycle models for biodiesel use.
- ✓ Evaluate performance of newer diesel engines and new fuel production technologies.

This study provides the building blocks for others to assess the relative merits of this fuel under a wide variety of circumstances, to which this country could be exposed. On a smaller scale, it provides the type of information that local regulators always seek when developing approaches to solving our air, water, and solid waste problems. We leave it to these individuals to use this information to customize their evaluations of their particular questions. We ask only that it be used wisely.

3 Life Cycle Scope and Methodology

This section provides an overview of the biodiesel and petroleum diesel life cycle project. It describes the background, the approach taken for conducting the study, the selection of models and methodologies, and describes major components of LCAs and includes subsections on:

- **3.1 Background:** Defines and describes LCAs and the two fuels are analyzed in this report.
- **3.2 Purpose of this Study:** Describes why an LCA was necessary to answer specific questions.
- **3.3 Project Scope:** Describes the temporal and geographic assumptions used in the study. It also describes the type of information collected on energy and environmental flows. Also, some major assumptions are highlighted here.
- **3.4 System Boundaries:** Describes in more detail how data were manipulated. Specifically, this section describes how allocation decisions were made and handled.
- *Error! Reference source not found. Error! Reference source not found.:* Outlines the partners involved in this study and the tools used for completing the analysis.

3.1 Background

3.1.1 Life Cycle Assessment Overview

LCA is an analytical tool used to comprehensively quantify (within the limits of available data) and interpret the flows to and from the environment. These include air emissions, water effluents, solid waste, toxicity, and the consumption/depletion of energy and other resources, over the entire life cycle of a product or process, commonly referred to as “cradle-to-grave.” LCAs can include production and extraction of raw materials, intermediate products manufacturing, transportation, distribution, use, and a final “end-of-life” stage, which often includes multiple parallel paths such as recycling, incineration, or landfilling.

An LCA involves two main steps: (1) the *Inventory*, in which the material and energy inputs and outputs from a life cycle are calculated and tabulated; and (2) the *Interpretation*, which describes the implications to decision makers that may be gleaned from an analysis of the inventory data. The methodology of LCI analysis can be standardized and its practitioners and users commonly accept these standardized approaches. Approaches to the interpretation step are much more varied.

In the most straightforward and transparent approach to LCI interpretation, the LCI results may be used *as-is* to help identify and prioritize opportunities for pollution prevention or increases in material and energy efficiency for processes within the life cycle. A particular advantage of LCI applied in this way is its comprehensiveness. LCAs help detect the shifting of environmental burdens from one life cycle stage to another (e.g., lower energy consumption during use, achieved at the cost of much higher manufacturing energy consumption), or from one medium to another (e.g., lower air emissions at the cost of increased solid waste).

Because the resulting number of flows calculated during an LCI analysis often exceeds 100, subsets of the flows are sometimes consolidated or aggregated into stages, such as production or transportation, to

facilitate interpretation, especially when two or more products or processes are being compared using LCA.

Finally, because the results of an LCI are influenced by a significant number of assumptions and uncertainties, the interpretation phase should include some sensitivity analyses to assess the robustness of the baseline results and conclusions. Sensitivities can also highlight potentially influential assumptions, methodological choices, future scenarios, and uncertainties.

Further information about LCA methodology is provided in a number of publications from SETAC (SETAC, 1991, 1993a, 1993b, 1994), EPA (USEPA, 1993a, 1993b, 1995) and a variety of European sources (Heijungs, et al., 1992 and SETAC-Europe, 1992).

3.1.2 Biodiesel and Petroleum Diesel Fuels

This life cycle study evaluates changes in energy, resource use, emissions, and wastes resulting from the use of new diesel fuel substitutes and additives in the U.S. transportation sector. Developing new fuels can provide a wide range of potential social benefits, such as diversifying fuels that have few current substitutes, reducing dependence of the transportation sector on vulnerable fuel supplies, improving the environmental characteristics of the transportation sector, or improving its energy efficiency. This study compares the life cycle flows of material, energy, and outputs of biodiesel, a renewable transportation fuel, with petroleum diesel from fossil crude oil supplies.

In the early stages of developing the diesel engine one century ago, Rudolf Diesel tested vegetable oils as a fuel. In the 1930s and 1940s vegetable oils were occasionally used as diesel fuels, generally in emergency situations (Shay, 1993). However, unmodified vegetable oils are glycerol esters, and when used in engines designed for petroleum diesel fuel, the glycerol poses engine wear and performance problems caused by higher viscosity and lower volatility (Biomass Digest, 1993)¹⁹.

To mitigate these problems numerous processes have been researched and demonstrated for converting oil glycerides to molecular forms more similar to petroleum-based diesel fuels, including thermal and catalytic cracking, transesterification, and electrolysis (Shay, 1993). During the past couple of years, biodiesel has become defined as the mono alkyl esters of long chain fatty acids derived from renewable lipid feedstocks, such as vegetable oils or animal fats, for use in compression ignition (diesel) engines. In other words, biodiesel is composed of an ester of a fatty acid chain from vegetable oil or animal fats and an alcohol molecule. However, not all alkyl esters can be used as transportation fuels. In order for the alkyl ester product to be considered a “biodiesel” for transportation fuel, it should meet proposed quality standards from the National Biodiesel Board (NBB). There are many challenges for the biodiesel industry in distinguishing itself from the industrial chemical alkyl ester industries. In this study we examine the processes necessary to make a transportation fuel quality biodiesel.

A variety of biodiesels (various fats and oils and several types of alcohol) has been demonstrated in numerous road transport applications worldwide countries (EC Directorate, 1994; Hemmerlein, 1991; NBB, 1994). In the United States, biodiesel has been tested in nearly 8 million miles of use involving more than 1,500 vehicles in fleets, particularly in urban buses. Much greater use of biodiesel occurs currently in Europe, where a methyl ester made from rapeseed oil receives near-total exemption from highway-use taxes in several European Community (EC) countries (NBB, 1994). The use of biodiesel in aquatic transportation applications has been suggested as a result of tests demonstrating that biodiesel fuels biodegrade relatively rapidly in aquatic environments (Zhang, et al, 1995). There are other potential markets for biodiesel (stationary power, industrial equipment, aviation fuel), but this study compares the relative merits of biodiesel as an on-road transportation fuel with those of petroleum diesel.

¹⁹ See discussion in section 5.5 for additional references on the problems of using unmodified fats and oils in diesel engines.

3.2 Purpose of this Study

Several potential environmental benefits of biodiesel have been cited in the literature, including:

- Reduced (or zero) emissions of SO_x at the point of end-use
- More rapid biodegradability in aquatic environments
- Low or negative flows of CO₂ to the environment over the full product life cycle (when accounting for the CO₂ uptake during the feedstock growing stage).

Solving one problem can unintentionally create others. A life cycle analysis can provide a holistic view of environmental issues.

The purpose of this study is to conduct an LCI to quantify and compare the comprehensive sets of environmental flows (to and from the environment) associated with both biodiesel and petroleum-based diesel, over their entire life cycles.

In addition to the purpose stated, this LCA was initiated to provide the necessary information that could be used to answer the following questions that have been posed by policy makers:

- What are the carbon balances for biodiesel and petroleum diesel fuels? Does one fuel provide a benefit over the other?
- What are the energy efficiencies of biodiesel and petroleum diesel fuels? Does one fuel provide a benefit over the other?
- What are the total contributions of regulated emissions to the environment from producing and using biodiesel and petroleum diesel? Does one fuel provide a benefit over the other?
- Are there potential benefits in some life stages of these fuels that are offset by potential burdens in other stages?
- Can the benefits or burdens of specific life cycle stages, which are created by using biodiesel and diesel fuel, be altered without increasing the net burdens of the entire life cycle?

3.3 Project Scope

This section defines the parameters considered during the scoping phase of the project. This phase had significant stakeholder input. We followed the sequence shown in Figure 22. The outcome of the scoping process was summarized in a report made available to all stakeholders (NREL, 1995).

3.3.1 Project Parameters

3.3.1.1 Environmental Issues Considered

This report will describe only the LCI flows of biodiesel and petroleum-based diesel fuels and discuss the implications of the data. The actual environmental impacts created by these flows depend on site-specific conditions and are best considered in models designed for those purposes. As a result, this report will not consider environmental damages, economic impacts, or long-term environmental consequences of using biodiesel or petroleum diesel fuel. Table 10 presents the list of LCI flows considered in this project.

The inventory flows shown in Table 10 were selected because they were common to both biodiesel and petroleum diesel fuel life cycles; for example, natural resources used during the life cycle of either biodiesel, petroleum diesel fuel, or both. Specific air emissions and water effluents are also found in both life cycles. In addition, these data are most often collected and reported by regulatory agencies and thus,

provide a common framework for the inventories. Input from stakeholders was used early in the process to identify important emissions and life cycle flows that needed to be included in our study.

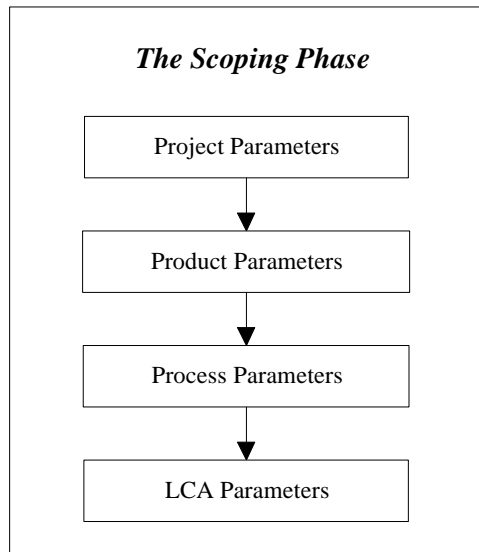

Figure 22: Elements of the Scoping Phase for LCA

Table 10: LCI Items Considered

Natural Resources	Air Emissions
Coal	Fossil Carbon Dioxide (CO ₂ fossil)
Oil	Biomass Carbon Dioxide (CO ₂ biomass)
Natural Gas	Methane (CH ₄)
Iron (Fe, ore)	Nitrous Oxide (N ₂ O)
Phosphate Rock	Nitrogen Oxides (NO _x)
Potash (K ₂ O)	Sulfur Oxides (SO _x)
Uranium (U, ore)	Ammonia (NH ₃)
Limestone (CaCO ₃)	Hydrogen Chloride (HCl)
Sand	Hydrogen Fluoride (HF)
Sodium Chloride (NaCl)	Particulate Matter (PM)
Water Used (total)	Hydrocarbons (HC)
Water Effluents	Carbon Monoxide (CO)
Chemical Oxygen Demand (COD)	Benzene
Nitrates	Formaldehyde
Biochemical Oxygen Demand (BOD)	Solid Waste
Agrochemicals	Hazardous
Ammonia (as N)	Nonhazardous
Metals	

The list of air emissions selected was also based on the potential harm to the environment. Trace emissions of benzene and formaldehyde were included in the inventory list because of their potentially toxic nature, and some of the acid gas emissions (HCl, HF) were chosen because of their potential contribution to acid deposition. However, the inventory information on these flows is not consistent throughout the life cycle. Trace HC emissions of benzene and formaldehyde are only known for volatile emissions during crude oil extraction; data on these emissions from other combustion sources are sparse.

These, and other similar types of data, should be used with care because some sources may not be accounted for because of data gaps.

Energy use is tracked throughout the life cycle of both biodiesel and petroleum-based diesel fuel. Total energy efficiency, process energy efficiency, and fossil energy efficiency ratios are calculated in the section presenting results. The ratios are used to evaluate the consumption of nonrenewable energy resources. The carbon balance for each fuel cycle is also modeled and evaluated to estimate the impact, if any, on controversial greenhouse gas and global warming issues.

Some of the values estimated for inventory flows are highly uncertain for a variety of reasons: scarce data, poorly characterized processes or natural systems, proprietary data, etc. When the uncertainty of the data characterizing a particular inventory flow is large, the results are not included in the final inventory tabulation to prevent compromising reliable data and misinterpreting the results. However, the data and their quality are discussed in detail in the relevant sections describing specific life cycle stages.

3.3.1.2 Temporal Scope

A near-term time frame has been selected for this study. Because of capital stock lifetimes, a study reflecting current technologies should remain relevant into the next decade. Also, a study of current end-use technologies based on empirical data provides a robust LCI that becomes the most logical starting point for future projections or extrapolations.

The biodiesel LCA required us to postulate a hypothetical biodiesel industry in its infancy, based on today's soybean production and crushing industries, U.S. and European methyl ester transesterification technology, and methyl ester and diesel fuel transportation infrastructure. The details that describe the basis for these and other assumptions are provided in the sections describing the details of the biodiesel life cycle stages.

3.3.1.3 Geographical Scope

The focus of the project is, in generic terms, to “evaluate biodiesel and petroleum diesel applications in the United States.” However, the geographic scope of particular data or product life cycle stages will depend on the locations dictated by actual plant locations, feedstock origins, sources of electricity, and end-uses. Often, our choice of using site-specific, industry, or national average data is limited by the completeness of each type of data set available, and whether the choice of data made for one stage of the life cycle can be followed through into the sequential stages of the life cycle. Because most firm and industry data are proprietary, LCAs are often limited to national public data, which generally consist of national, regional, or industry averages. Table 11 outlines the geographic scope and types of data sets available for each petroleum diesel fuel life cycle stage modeled in this study. International crude oil extraction is included because almost half the crude oil used in the United States is of foreign origin. Table 12 outlines the geographic scope and type of data sets used for each biodiesel fuel life cycle stage modeled in this study.

U.S. national averages for soybean oil conversion and biodiesel production were based on modeled engineering systems because little industry specific information was available. Biodiesel transportation and storage systems had to be modeled as well, because biodiesel distribution infrastructure has not yet been developed.

The relevance of data is explained in each section of this report. Whenever possible data are regionalized to allow for more detailed site-specific comparisons. For example, crude oil transportation distances and methods are separated by Petroleum Administration for Defense District (PADD), and soybean agriculture is separated by state.

Table 11: Geographic Scope of Petroleum Diesel Fuel Modeling

<i>Life Cycle Stage</i>	<i>Geographic Scope</i>
Crude Oil Extraction	International average based on the consumption of crude oil in the United States
Crude Oil Transportation	International average transportation distances to the United States
Crude Oil Refining	U.S. national average
Diesel Fuel Transportation	U.S. national average
Diesel Fuel Use	U.S. national average based on urban bus use

Table 12: Geographic Scope of Biodiesel Modeling

<i>Life Cycle Stage</i>	<i>Geographic Scope</i>
Soybean Agriculture	Average based on the 14 states growing soybeans
Soybean Transportation	U.S. national average
Soybean Crushing	U.S. average based on modeled data
Soybean Oil Transport	U.S. national average
Soybean Oil Conversion	U.S. average based on modeled data
Biodiesel Transportation	U.S. national average
Biodiesel Fuel Use	U.S. national average based on urban bus use

3.3.2 Product Parameters

3.3.2.1 Fuels Studied

The petroleum diesel studied is low-sulfur #2 diesel. A comparison with 100% biodiesel is selected as the baseline for this study. However, among biodiesel blend ratios, 20% biodiesel blend with #2 diesel has been extensively studied and has been recommended by industry groups as a fuel blend that provides reasonable environmental benefits for a reasonable cost (NBB, 1994). This type of study is an appropriate venue for quantifying some of those environmental flows. The three fuels studies in this report are:

- Low-sulfur #2 diesel for on-road applications (often referred to simply as petroleum diesel)
- 100% biodiesel made from soybean oil and methanol using transesterification technology (referred to as B100)
- A blend of 20% biodiesel 80% low-sulfur #2 diesel fuel (referred to as B20).

3.3.2.2 End-Use

The end-uses of the fuels modeled in this study are characterized by the following:

- Use of biodiesel and low-sulfur diesel fuel in modern urban diesel buses
- Fleet use only (a consequence of the previous assumption)
- Engine-specific comparisons.

It is important to limit the end-uses of the fuels to a single application. Transit bus applications are among the most heavily studied biodiesel applications in the United States to date. Limiting the end-use to bus applications allows us to introduce the best-characterized empirical database on biodiesel available. Urban buses operations are characterized as “fleets” and establishes the use of central fueling in the modeling.

Engine-specific comparisons of the two fuel alternatives (biodiesel and petroleum diesel) are highly important. Data on engine performance for diesel and biodiesel have shown considerable variability in emissions and performance characteristics among different engine designs. Therefore, comparisons must pertain to a given engine, and must clearly state the engines to which the results correspond.

Many bus fleets use four-stroke engines (e.g., the Detroit Diesel Series 60) today to meet particulate emission rules imposed by EPA. No one specific engine is chosen as the representative urban bus engine, because of the variability in emissions and performance among engines, *all engines suitable for transit buses for which reliable emissions test data are available for both fuels are included in the study.*

3.3.2.3 Functional Unit

Different industrial systems can be compared only if they perform the same function or service to society. In this case, that service is to provide bus transportation to an urban population.

Once this shared function is defined, a unit has to be chosen to compare the systems on the same quantitative basis. End-use emissions data are generally available in terms of grams of emissions per brake-horsepower-hour (g/bhp-h), as the result of standardized EPA transient cycle testing procedures, designed to characterize emissions from real driving. Therefore, the functional unit to be used in this study is *brake-horsepower-hour*. By using this functional unit, the LCA will compare the two fuels in terms of actually delivered work from combustion within real engines under tests designed to reflect realistic operating conditions.

All the energy and mass flows in the inventory are normalized to this functional unit. In other words, the LCI data will be tabulated and reported as units of environmental flows per brake-horsepower-hour.

3.3.3 Process Parameters

The establishment of project and product parameters leads logically to the development of the process parameters, which describe the fuel technologies chosen.

3.3.3.1 Biodiesel

We assume that the LCIs will be based on current data and technology; this dictates some of the assumptions concerning fuel production and feedstock supplies. The primary feedstock for biodiesel production is soybeans because soybean oil supplies exceed the total combined supply of all other oils and fats produced in the United States today. Based on its dominant supply position and widespread availability, it is the most likely biodiesel fuel to dominate the U.S. market in the near term. Other oil seed crops would require a significant amount of time to expand production and achieve dominance, which eliminates them from consideration in the near term. Animal fats used for biodiesel have yet to

establish their market acceptance, and that too eliminates them from near-term consideration. In addition, most of the research and data available for characterizing biodiesel are based on a soy oil methyl ester. Therefore, soy oil and soybean feedstock production were logical choices for characterizing near-term biodiesel production.

USDA data characterizing the chemical, land, energy, water, and other inputs to soybean production in the United States are used to establish current performance characteristics for soybean production and harvesting. Also, to the maximum extent supportable by reliable data, outflows of the agricultural system will include the use, production, and fates of chemicals used, including fertilizers, herbicides, etc.

Soybean crushing and soy oil production technologies are widespread, although characterization data were not easily found in the literature. Cooperation with industrial partners allowed NREL engineers to recreate an engineering model of this technology. Sources and distribution of soybean oil are identified for each region studied. Available end-use data on soy-derived biodiesel are based on refined oils.

The most popular current biodiesel production technology is transesterification using methanol as the alcohol input. The U.S. capacity dedicated to biodiesel production for the transportation market (excluding methyl ester industry chemical producers) is approximately 30 million annual gallons, most of which use some variation of the transesterification process. This technology also dominates the European market for biodiesel. Methanol is the most common alcohol used because it provides some process efficiencies and is relatively inexpensive compared to its second most common alternative, ethanol.

3.3.3.2 Petroleum Diesel Fuel

Petroleum diesel produced domestically from U.S. and foreign sources of crude oil is the second largest source of transportation fuel in the U.S. Energy Information Administration data characterizing the split between foreign and domestic crude oil supplies are used to characterize diesel fuel feedstocks. Oil production technologies are characterized by public data, as is crude oil transportation. Regional differences in crude oil supplies, refined product production, and product distribution modes are taken into account where data are available. National average data supplied by the EPA are used to characterize refining technologies. Some of these data may be out of date given the large advances in refining technology demonstrated by the industry in recent years. Industry and government studies characterizing refining and other petroleum life cycle flows were sought out and provided valuable data for assumptions and environmental flows. Mass and energy balances were developed for these stages to give confidence to the analysis, similar to the same effort conducted for biodiesel life cycle stages.

3.3.4 LCA-Specific Parameters

Biomass carbon in this study is a specific case that requires special attention when performing an LCI. The carbon content of the biomass portion of the biodiesel is derived from the CO₂ absorbed by plants while growing (photosynthesis). These carbon atoms are released as CO₂, CO, HC, or particulate emissions during biodiesel combustion. The biomass-derived CO₂ releases are offset by the CO₂ uptake or sequestering during plant growth²⁰.

A portion of the biodiesel consists of methanol that is derived from natural gas, a fossil fuel source. The total CO₂ emitted from the bus tailpipe consists of both fossil and biomass CO₂; therefore, these two

²⁰ Implicit in this discussion is the fact that we have ignored the dynamic effect of carbon sequestration in the soil on the level of atmospheric carbon. A significant amount of carbon can be stored in the soybean plant root systems. Soil microorganisms eventually return this carbon to the atmosphere, but at a relatively slow rate. We have chosen not to take credit for any of this additional sequestering of carbon. See sections 9.1.2.1 for a more detailed description of how we account for biological cycling of carbon.

sources of CO₂ are reported and tracked separately throughout the biodiesel life cycle. Actually, a carbon balance is calculated for the biodiesel life cycle showing all the sources and final deposition of both fossil and biomass carbon.

3.4 System Boundaries

3.4.1 LCA Principle for Setting System Boundaries

System boundaries define the relevant processes to be included or excluded from the LCA. The common ones that are generally considered are construction and disposition stages, the flows associated with producing the inputs consumed in life cycle stages, accounting for duplicate stages common to both life cycles, and the rules for allocating life cycle contributions between coproducts of production processes. Arguments associated with each of the three common system boundary decisions are provided below.

- The LCA theoretical principle implies that *each* material and constituent be studied and traced *back* to natural resources, and *forward* through final disposal. The strict application of this principle would lead to the study of almost every industrial process, as all industrial operations work within a complex network. To keep the LCA focused on the primary flows that provide significant contributions to the LCI, quantitative rules are applied to exclude the constituents and ancillary materials whose impacts are estimated to be negligible compared to those of the overall studied system.
- As the project focuses on a comparison, steps that are functionally equivalent for the compared products could be excluded from both systems. On the other hand, steps or operations that are not functionally equivalent for the compared products should be taken into account, i.e., included in the system boundaries. If the life cycle is to prepare a comprehensive inventory rather than a comparison, common activities to both life cycles should be included.
- Economic activities that result in more than one product that are subsequently introduced into commerce (i.e., not disposed of) should allocate the environmental flows associated with those processes between the coproducts in a rational or equitable manner. A wide variety of “rational and equitable” approaches is available and each has its particular impact on the results of an LCA. Whatever choice is made for one life cycle should be applied to another if the two are being compared. In addition, whatever choice is made for one stage or process in an LCA should be carried through to other processes and stages. In practice, these rules of consistency create difficult choices and unintentional trade-offs.

The principle for defining the system boundaries within an LCA study is illustrated in Figure 23.

For this study, the life cycle environmental flows associated with producing capital equipment and facilities used to extract, transport, and refine crude oil are excluded based on results from prior studies that suggest their contribution is small. Likewise, the life cycle environmental flows associated with producing capital equipment and facilities used to grow, transport, crush, and convert soybeans are excluded.²¹

The energy used in the construct large energy facilities and other equipment used in fuel cycles (including electric power plants, oil wells, oil tankers, and hydroelectric plants) is negligible (less than 1%)

²¹ See, for example, Boustead, 1997. Boustead states that the flows from large equipment and facilities construction are less than 0.01% for any product. He does suggest two exceptions to this—oil well construction and road transport. Delucchi suggests that oil well contributions are small (Delucchi, 1993). The complexity of modeling road transport equipment production necessitated our ignoring this effect in our analysis. Quantification of life cycle flows from capital equipment production should be considered as a future area of study for improving the quality of our results.

compared with the energy produced or carried by that equipment over its useful life (DeLucchi 1993). These results indicate that, for the petroleum fuel cycle in this study, the life cycle flows associated with capital equipment and facilities are negligible²².

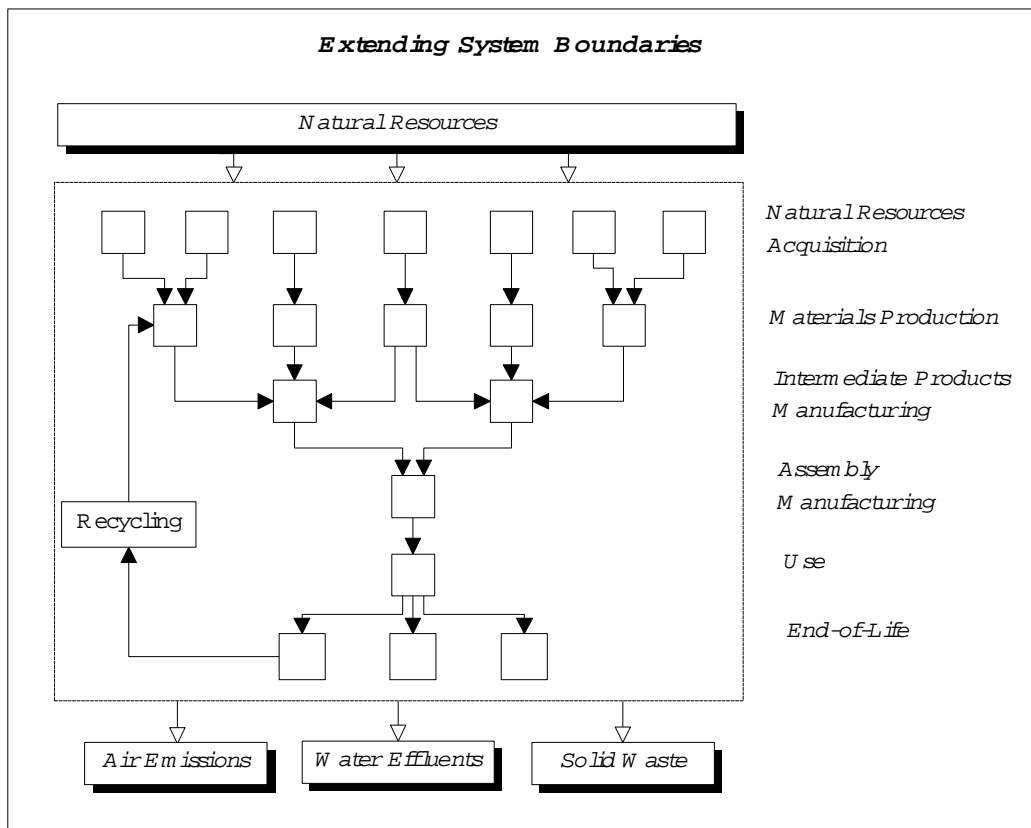

Figure 23: LCA System Boundary Principles

This may not be the case, however, for the biodiesel life cycle. The biomass resources used to produce biodiesel are often less energy dense and less concentrated than fossil fuels. They also often require more transportation and processing equipment and facilities. In some cases, the energy embodied in the construction of equipment used in biofuels compared with the energy produced or carried by that equipment over its useful life is an order of magnitude higher than petroleum fuel cycles (~10%) (DeLucchi 1993). However, to be consistent with the petroleum fuel cycle, the life cycle flows associated with construction of capital equipment and facilities used in biodiesel life cycle are excluded from this study.

The environmental flows associated with inputs consumed in the life cycle stages are traced back to their original components and their production and extraction wherever possible.

Both the biodiesel and the petroleum diesel life cycles employ a mass balance allocation rule throughout.²³ A number of alternatives were considered and discarded because they introduced major practical problems in their implementation or interpretation.

²² The only case for which this may not be negligible is offshore oil platform construction.

3.4.2 How Allocation Rules are Used in Our Study

Several processes within the biodiesel and the petroleum diesel life cycles produce more than one product. This life cycle study is concerned only with the portion of the environmental flows that is attributable to the biodiesel or petroleum-based diesel LCIs. Therefore, the original LCI flows of a process (emissions, energy and material requirements, etc.) that produce more than one coproduct are split between the various products produced. As previously discussed, a mass based allocation is used for the baseline comparison of biodiesel and petroleum-based diesel fuel.

The following example shows how a mass allocation works in the case of allocating the soybean conversion into biodiesel environmental flows between multiple coproducts:

First, the overall environmental flows are determined for a specific process, as shown in Table 13 for soybean conversion into biodiesel.

Table 13: Environmental Inflows and Outflows for the Biodiesel Conversion Process

	<i>Environmental Flow</i>	<i>Units</i>	<i>Value</i>
IN:	Soybean Oil (degummed)	kg	1.04
	Sodium Hydroxide (NaOH, 100%)	kg	0.0023
	Methanol (CH ₃ OH)	kg	0.096
	Electricity	MJ elec	0.23
	Steam	kg	1.03
	Water Used (total)	L	0.36
	Sodium Methoxide (CH ₃ ONa)	kg	0.024
OUT:	Biodiesel (neat, kg)	kg	1
	Crude Glycerine	kg	0.15
	Soapstock	kg	0.00054
	Water (chemically polluted)	L	0.38
	Waste (total)	kg	0.012

Next, the mass percent of each coproduct produced is calculated, as shown in Table 14:

Table 14: Mass Percent of the Various Conversion Co-Products

<i>Coproducts</i>	<i>Units</i>	<i>Value</i>	<i>Mass Percent of Total</i>
Biodiesel (neat, kg)	kg	1	87%
Crude Glycerine	kg	0.15	13%
Soapstock	kg	0.00054	0% (negligible)
Total:	kg	1.15	100%

²³The choice of allocation rules can be quite controversial. The assumption of a mass allocation rule applied to multi-product processes was a subject of real debate among the stakeholders. The mass allocation approach was seen as the least problematic approach to use.

Finally, the overall environmental flows are allocated to only the production of biodiesel, as shown in Table 15.

Table 15: Mass Allocated Conversion Results for Biodiesel

<i>Environmental Flow</i>		<i>Units</i>	<i>Total Process</i>	<i>Biodiesel Only</i>	<i>Biodiesel Only</i>
			<i>Values</i>	<i>Allocation</i>	<i>Results</i>
IN:	Soybean Oil (degummed)	kg	1.04	x 0.87 =	0.90
	Sodium Hydroxide (NaOH, 100%)	kg	0.0023	x 0.87 =	0.0020
	Methanol (CH ₃ OH)	kg	0.096	x 0.87 =	0.083
	Electricity	MJ	0.23	x 0.87 =	0.20
	Steam	kg	1.03	x 0.87 =	0.89
	Water Used (total)	kg	0.36	x 0.87 =	0.31
	Sodium Methoxide (CH ₃ ONa)	kg	0.024	x 0.87 =	0.021
OUT:	Biodiesel (neat, kg)	kg	1	x 1 =	1
	Crude Glycerine	kg	0.15	x 0 =	0
	Soapstock	kg	0.00054	x 0 =	0
	Water (chemically polluted)	kg	0.38	x 0.87 =	0.33
	Waste (total)	kg	0.012	x 0.87 =	0.010

Similarly, a mass based allocation can be performed for the production of crude glycerine, as shown in Table 16. We don't actually carry out the calculations for allocation of life cycle flows to glycerine in our model because our analysis is concerned with those flows allocated only to biodiesel. We show this calculation to demonstrate that the mass balance for all flows is not violated by the application of allocation factors, as long as all coproducts are treated the same way when flows are allocated to them. In this example, in other words, combining the final columns of Table 15 and Table 16 will yield the overall results for biodiesel conversion as shown in Table 17.

Figure 24 through Figure 27 show the allocated and unallocated mass and energy balances for the two systems considered in this study. These figures demonstrate the complexity of the systems we are modeling. A comparison of the allocated and unallocated primary energy inputs for both of these fuels shows that, without allocation, the energy consumption assigned to make each fuel is much higher than the value of the fuel. This is due to the fact that the energy inputs that occur in each life cycle contribute to production of many other products besides petroleum diesel and biodiesel. The application of allocation rules provides an approximate means for assigning energy inputs in the life cycle among all of the products involved.

Table 16: Mass Allocated Conversion Results for Glycerine (not used in this study)

<i>Environmental Flow</i>	<i>Units</i>	<i>Total Process</i>		<i>Glycerine Only</i>	<i>Glycerine Only</i>
		<i>Values</i>	<i>Allocation</i>	<i>Results</i>	<i>Results</i>
IN: Soybean Oil (degummed)	kg	1.04	x 0.13 =		0.14
Sodium Hydroxide (NaOH, 100%)	kg	0.0023	x 0.13 =		0.00030
Methanol (CH ₃ OH)	kg	0.096	x 0.13 =		0.013
Electricity	MJ	0.23	x 0.13 =		0.030
Steam	kg	1.03	x 0.13 =		0.14
Water Used (total)	kg	0.36	x 0.13 =		0.047
Sodium Methoxide (CH ₃ ONa)	kg	0.024	x 0.13 =		0.0032
OUT: Biodiesel (neat, kg)	kg	1	x 0 =		0
Crude Glycerine	kg	0.15	x 1 =		0.15
Soapstock	kg	0.00054	x 0 =		0
Water (chemically polluted)	kg	0.38	x 0.13 =		0.051
Waste (total)	kg	0.012	x 0.13 =		0.0016

Table 17: Biodiesel Conversion Process Flows per Coproduct

<i>Environmental Flow</i>	<i>Units</i>	<i>Biodiesel Only</i>		<i>Glycerine Only</i>		<i>Total Process</i>
		<i>Results</i>		<i>Results</i>		<i>Values</i>
IN: Soybean Oil (degummed)	kg	0.90	+	0.14	=	1.04
Sodium Hydroxide (NaOH, 100%)	kg	0.0020	+	0.00030	=	0.0023
Methanol (CH ₃ OH)	kg	0.083	+	0.013	=	0.096
Electricity	MJ	0.20	+	0.030	=	0.23
Steam	kg	0.89	+	0.14	=	1.03
Water Used (total)	kg	0.31	+	0.047	=	0.36
Sodium Methoxide (CH ₃ ONa)	kg	0.021	+	0.0032	=	0.024
OUT: Biodiesel (neat, kg)	kg	1	+	0	=	1
Crude Glycerine	kg	0	+	0.15	=	0.15
Water (chemically polluted)	kg	0.33	+	0.051	=	0.38
Waste (total)	kg	0.010	+	0.0016	=	0.012

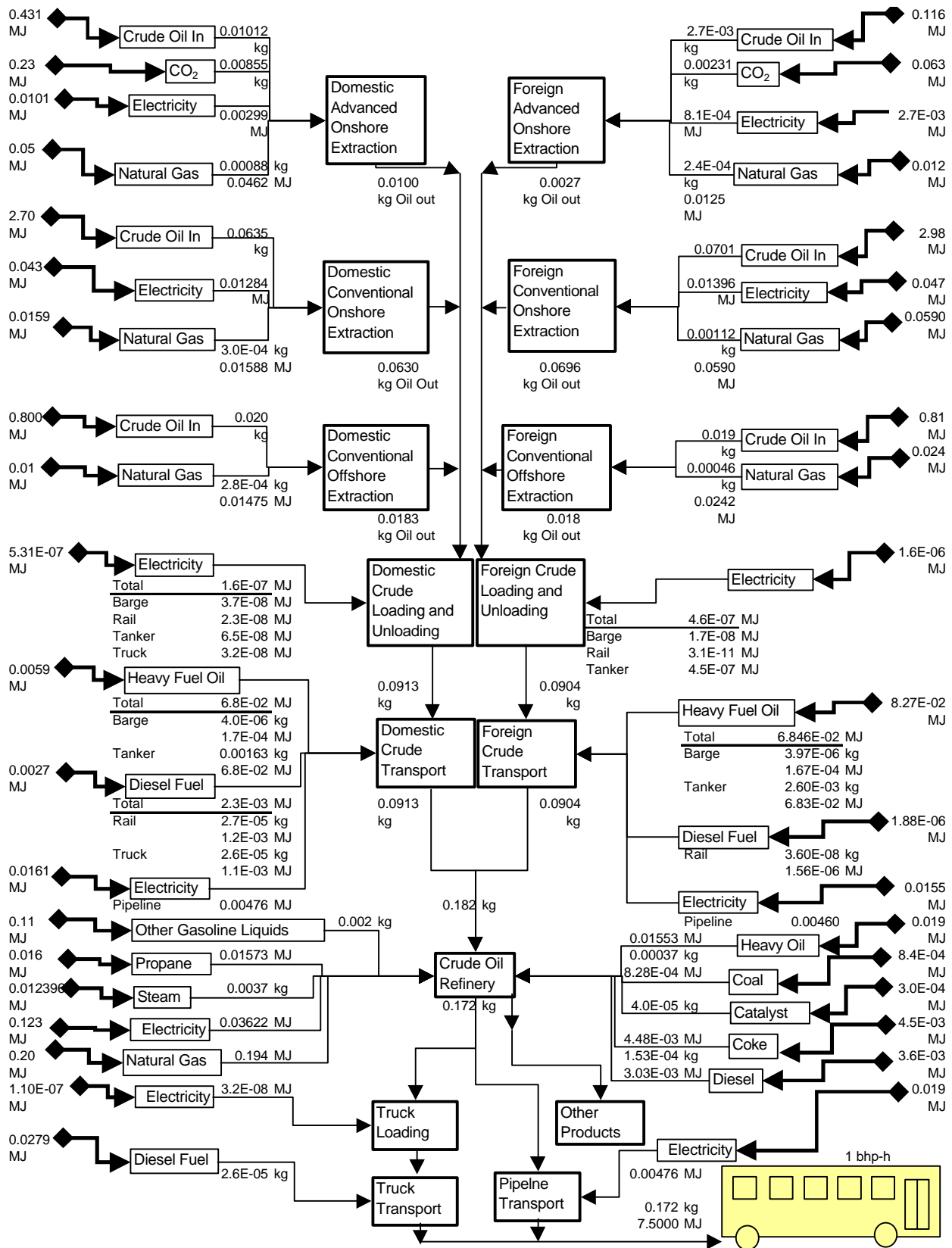

Figure 24: Primary Energy Balance for the Petroleum Diesel Fuel Life Cycle (with Mass Allocation)

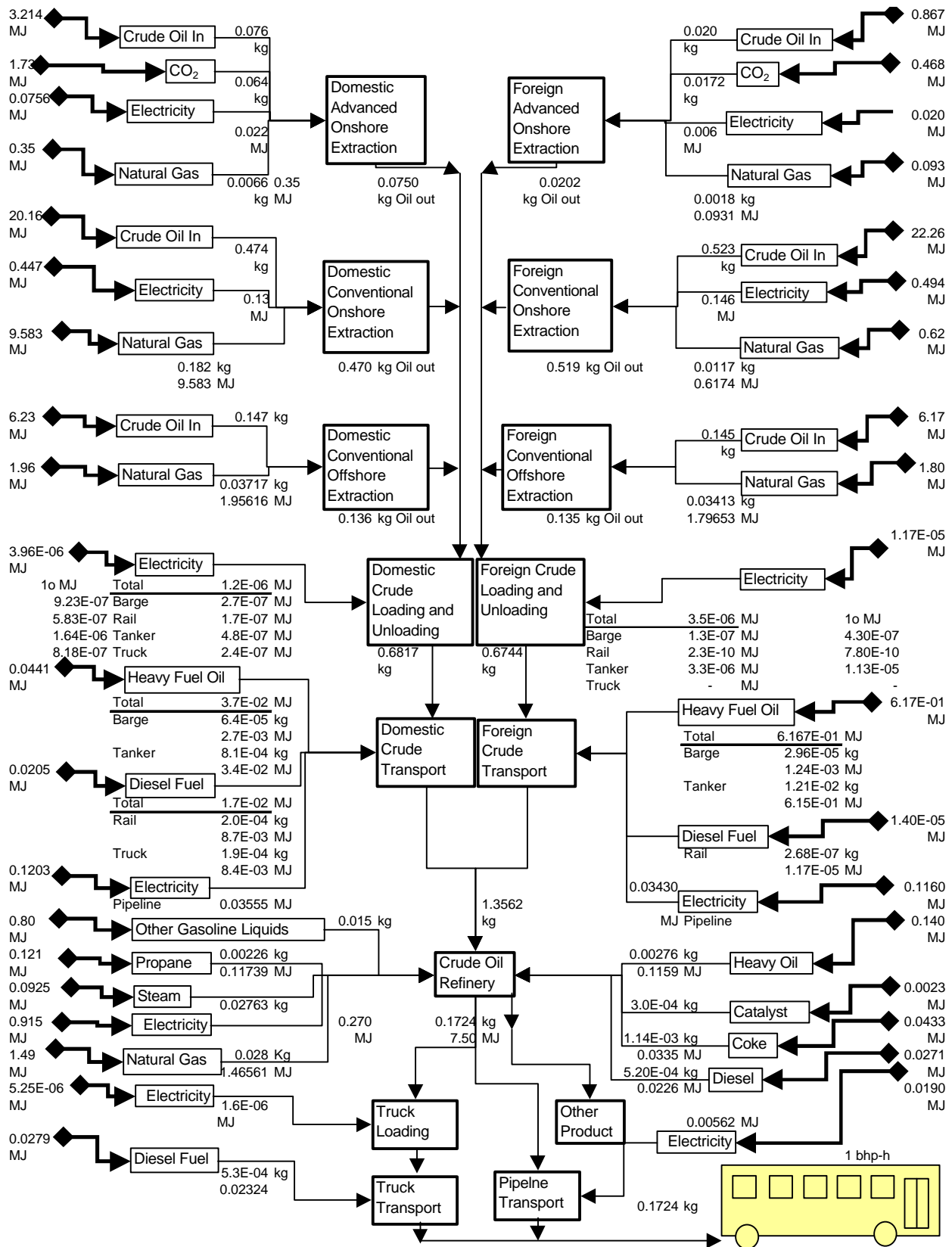

Figure 25: Primary Energy Balance for Petroleum Diesel Fuel Life Cycle (No Mass Allocation)

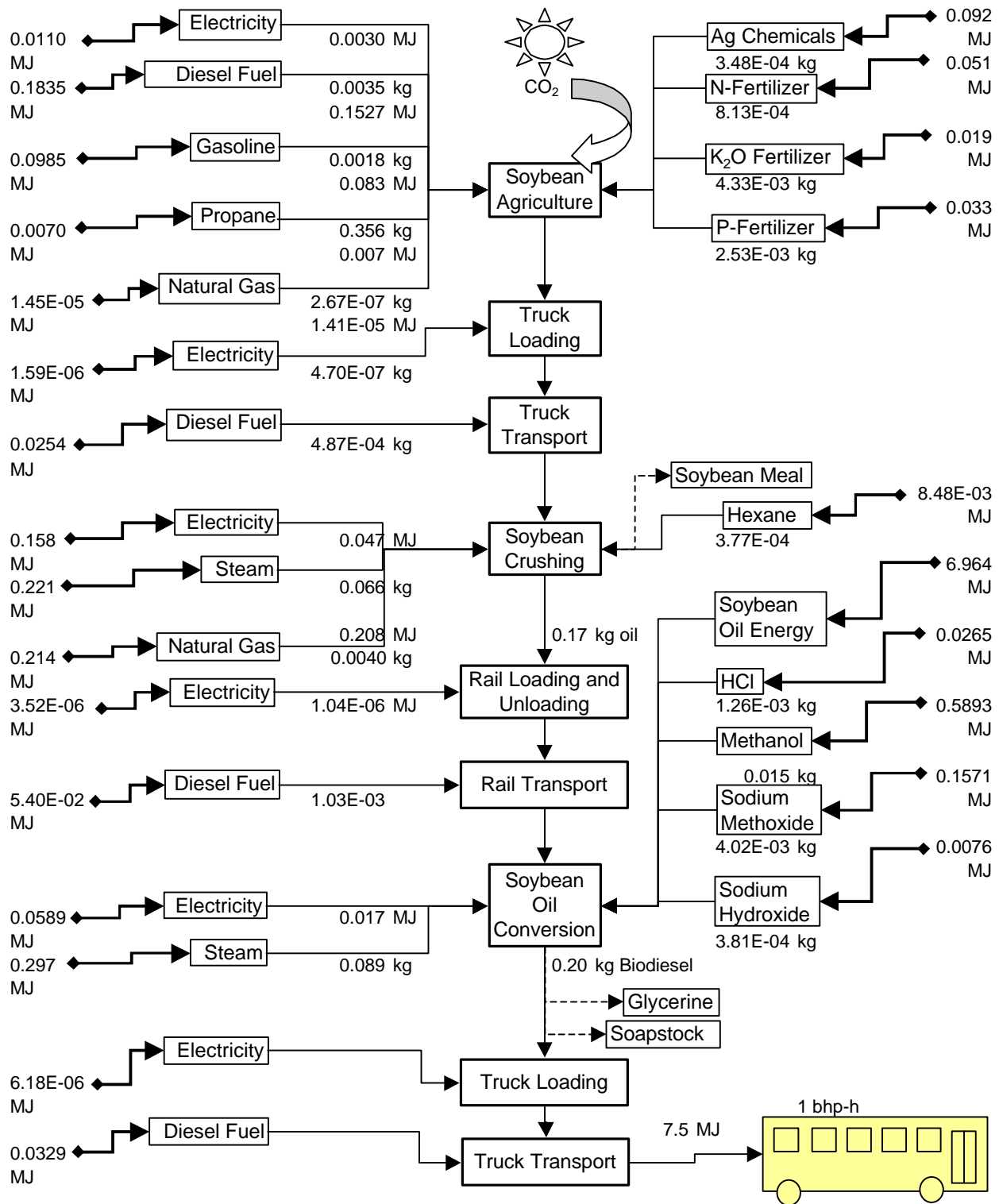

Figure 26: Primary Energy Balance for Biodiesel Fuel Life Cycle (with Mass Allocation)

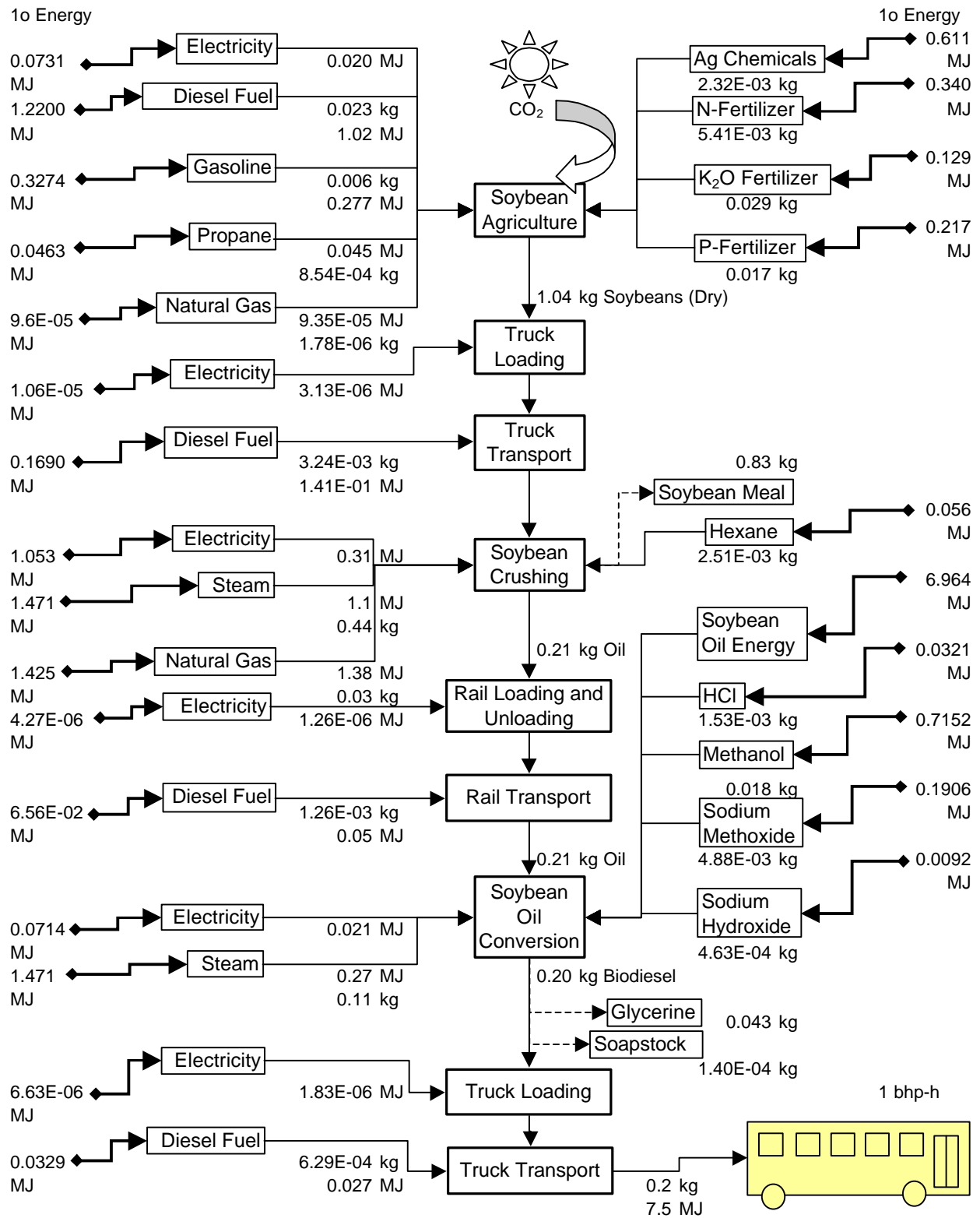

Figure 27: Primary Energy Balance for Biodiesel Fuel Life Cycle (No Mass Allocation)

This page left intentionally blank.

4 Petroleum Diesel Fuel Modeling

This section describes each phase of the life cycle for petroleum diesel. Data and assumptions used in this life cycle are based on the current U.S. petroleum industry.

- **4.1 Petroleum Diesel Fuel General Modeling Assumptions:** This section outlines the boundaries of this study (i.e., which data are included and omitted). This refers to physical geographic boundary assumptions as well as to the exclusion of secondary sources of data such as the production of capital equipment.
- **4.2 Crude Oil Extraction:** This section describes the process flows associated with crude oil extraction from the ground and subsequent upgrading before transportation. This section explains the assumptions that went into modeling these processes.
- **4.3 Crude Oil Transport to Refinery:** This section explains how transportation is regionalized by the five PADDs. It also explains how transportation distances were calculated and describes the various transportation models used to depict the transport of crude oil.
- **4.4 Crude Oil Refining:** This section details the assumptions concerning refinery operations, including allocation principles and methodologies used to designate total refinery process flows specifically to diesel fuel.
- **4.5: Diesel Fuel Transport:** This section defines how diesel is stored and transported to point of use. The final point-of-use locations are described in section 2 of this report.

4.1 Petroleum Diesel Fuel General Modeling Assumptions

4.1.1 Geographic Boundaries

The modeling of petroleum-based diesel fuel production includes worldwide crude oil extraction but not foreign refinery operations or transport of foreign intermediate refinery products or diesel fuel to the United States. Foreign crude oil extraction and transportation to the United States is modeled because half the U.S. supply of crude oil is imported. Total crude oil input to U.S. refineries has been slowly rising over the past decade, and has exceeded 50% of U.S. consumption since 1994 (Figure 28) (EIA Historical Monthly Energy Review 1973 - 1992 & EIA, 1995a).

Foreign diesel fuel production and transportation are not included in this study because diesel fuel imports represent only 4% of the total diesel fuel used in the United States (EIA 1995a). In addition, imports of intermediate refinery products (products used in the production of diesel fuel, such as Fischer-Tropsch diesel) are also small (approximately 3% of total U.S. use) and are not included in this analysis (EIA 1995a).

Imported crude oil comes from all parts of the world, and limited data are available on foreign crude oil extraction techniques, input requirements, and characteristics. The lack of data makes it difficult to model foreign crude oil extraction and upgrading before transportation. Therefore, U.S. production data are sometimes used to estimate foreign crude oil production parameters, even though such data may not accurately reflect foreign oil production characteristics. Given the size of the crude oil contribution to U.S. refinery inputs, this approach was considered the most cost effective.

Figure 29 outlines the petroleum industry process areas that are considered in this project.

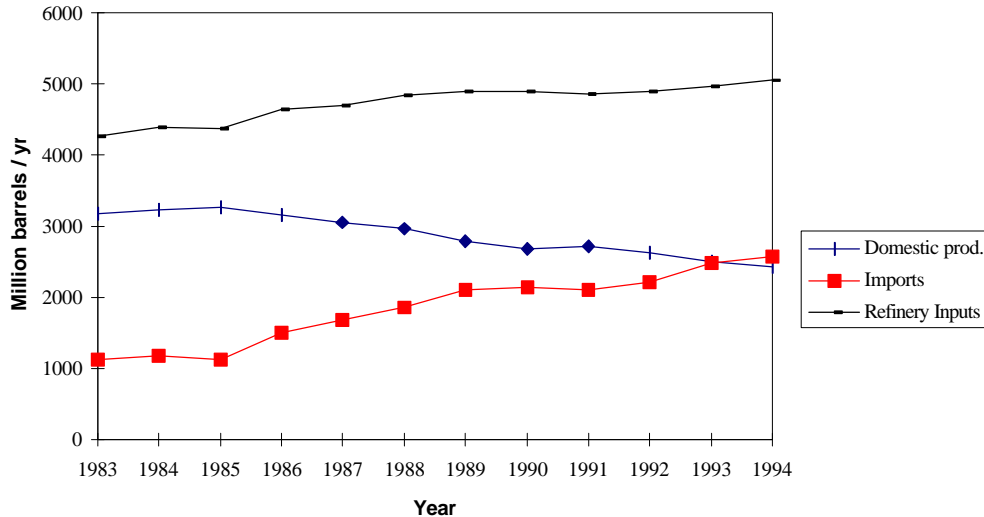

Figure 28: U.S. Crude Oil Production, Imports and Input to Refineries (1983-1994)

4.2 Crude Oil Extraction

Three separate types of processes for extracting crude oil are modeled in the petroleum extraction system, all based on a recent life cycle study of U.S. petroleum production processes (Tyson et al. 1993). The three processes are onshore production, offshore production, and enhanced recovery. Enhanced recovery entails the underground injection of steam (produced by natural gas boilers) and CO₂ to force the crude oil to the surface. The shares of total crude oil recovered by each process, for domestic and foreign production, are shown in Table 18²⁴.

Within the enhanced/advanced crude oil extraction category, two processes are typically used with different energy and material requirements: steam injection and CO₂ injection. Steam injection is assumed to account for 63% of the enhanced/advanced extraction, and CO₂ injection is assumed to account for the remaining 37%. Each of these production types will be considered in more detail in the following sections.

²⁴ Source: Shares of each production type were obtained from the Oil & Gas Journal Database, using numbers obtained in 1994. The Enhanced/Advanced category includes all advanced crude oil extraction techniques except water flooding. It is assumed that steam flooding and CO₂ injection will represent the largest portion of the Enhanced/Advanced techniques obtained from the Oil & Gas Journal Database.

Table 18: Production of Crude Oil by Technology Type and Origin

Technology Type	Domestic Crude Oil Production	Foreign Crude Oil Production
Conventional Onshore	69%	77%
Conventional Offshore	20%	20%
Enhanced/Advanced	11%	3%

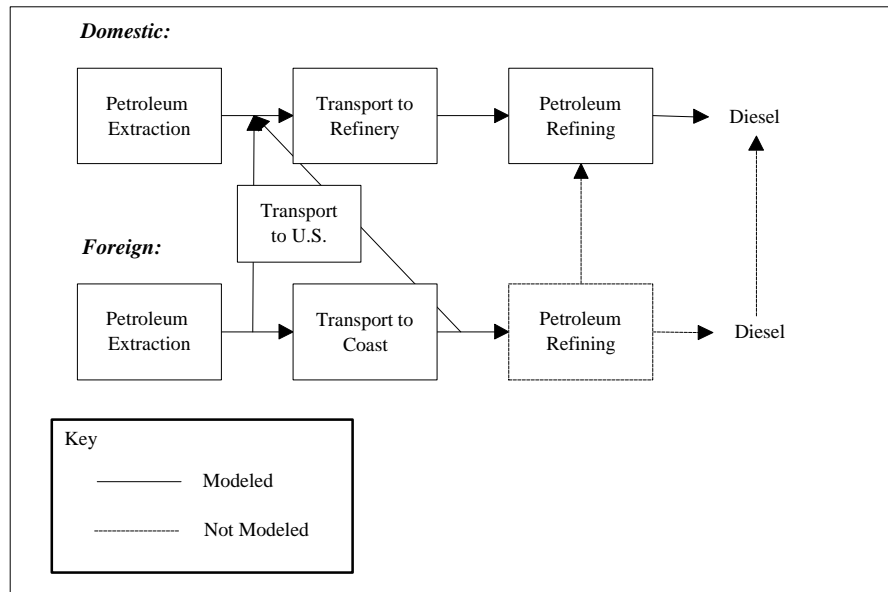

Figure 29: Petroleum Process Areas Modeled in this Project

4.2.1 Conventional Onshore Extraction

Figure 30 shows the system process diagram associated with conventional onshore crude oil extraction. It demonstrates the system boundaries and process flows modeled for conventional onshore crude oil extraction in this study.

4.2.1.1 Material Use

The only raw material inputs required for conventional onshore crude oil extraction accounted for in this study are the actual crude oil and natural gas in the ground. We assumed that there is no loss of crude oil once it is extracted from the well.

The life cycle environmental flows associated with producing capital equipment and the facilities used to extract crude oil are excluded from this study. However, the energy required for drilling and exploration are included. The energy required to explore and drill for conventional onshore crude oil represents approximately 0.75% of the energy contained in the oil produced (Delucchi 1993). This energy is primarily used for drilling, and is accounted for by increasing the amount of crude oil in the ground needed to produce 1 kg of crude oil. Therefore, conventional onshore crude oil extraction requires 1.0075

kg of crude oil in the ground to produce 1 kg of crude oil. The material requirements for both domestic and foreign conventional onshore crude oil extraction are assumed to be the same.

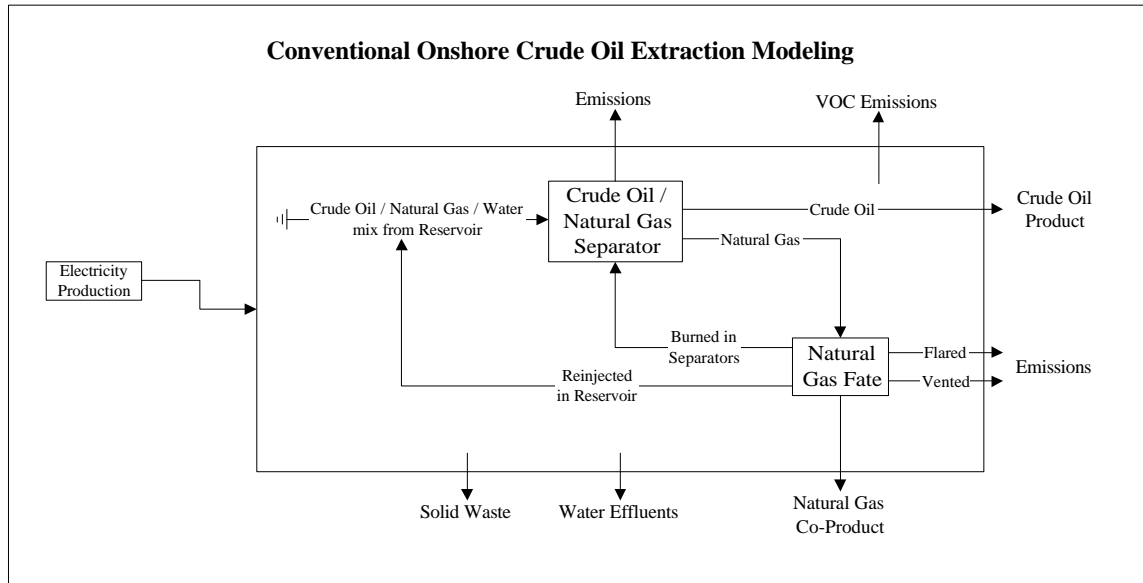

Figure 30: Conventional Onshore Crude Oil Extraction

4.2.1.2 Energy/Equipment Use

Energy requirements for both domestic and foreign conventional onshore crude oil production are based on a 400-well production field (195 unproductive wells) located in the lower 48 states producing 4.98×10^9 kg/yr (3.65×10^7 bbl/yr) of crude oil (DOE 1983) as follows:

Electricity:	10.7 kWh/bbl	(used in pumping)
Natural Gas:	5.2 MJ/bbl	(used in recovery)

Electricity is assumed to come from a generic (national average) U.S. grid; natural gas is assumed to come from gross production of the well. The national average grid was used because our modeling of crude oil production is generic to the U.S., and is not broken down regionally. The LCI model converts all secondary energy inputs, such as electricity, into their primary or original raw energy inputs for reporting purposes²⁵.

The electricity used in foreign crude oil extraction was based on the standard U.S. grid, even though it is not an accurate representation of the foreign electricity used in foreign oil fields. This assumption was necessary because of the lack of data describing foreign electricity production and its use in foreign oil extraction²⁶. This assumption will result in conservative estimates of electricity use impacts because

²⁵ Fuels can be divided into two groups: primary and secondary. Primary fuels are those, such as coal, oil, and gas, which are directly extracted from the earth and liberate energy when burned. Secondary fuels are those such as electricity, coke, and manufactured gas, which are produced from primary fuels. This conversion is based on modeled secondary energy sectors in the Ecobalance database DEAMTM

²⁶ Actually, each U.S. crude oil production field would have its own mix of electricity use. However, the standard U.S. grid was used to represent an average situation.

foreign electricity production sources may not meet the same strict emission guidelines as those in the United States.

4.2.1.3 Process Emissions

Air, water, and solid waste emissions are emitted from conventional onshore crude oil extraction.

Water effluents are based on the amount of wastewater produced and its estimated average composition. The EPA (1997) estimated that 0.7 L of wastewater are produced for every kg of crude oil produced by conventional onshore crude oil extraction. The total wastewater produced is actually higher than this estimate, but only 0.7 L are released to the environment. The rest is treated on site through reinjection, evaporation, etc. The compositions of the wastewater contaminants are shown in Table 19 (EPA 1987). In addition to those contaminants shown by the EPA, DOE (1983) estimated total oil and grease contained in the wastewater released to be 1×10^{-4} kg/kg crude oil produced.

Table 19: Crude Oil Production Wastewater Constituents and Concentrations

Constituent	Median Concentration (mg/L)
Arsenic	0.02
Benzene	0.47
Boron	9.9
Sodium	9,400
Chloride	7,300
Mobile ions	23,000

The emission factor for the production of solid waste is calculated as 0.0098 of solid waste are produced for every kg of crude oil (Tyson et al., 1993).

Air emissions from conventional onshore crude oil extraction come from the combustion of natural gas in the crude oil/natural gas separators, venting and flaring of natural gas, and from volatilization (fugitive) emissions of crude oil.

The emission factors for natural gas combustion of the crude oil/natural gas separators were assumed to be the same as industrial boilers (shown in Appendix A). This may be conservative because many of these burners are located in remote sites where requirements for emissions may be less stringent.

Natural gas venting/flaring emissions from crude oil extraction have been calculated based on a percentage of the gross natural gas production of the well based on the following data and assumptions. DOE estimates of the gross extraction of associated natural gas from crude oil wells in the United States (EIA Natural Gas Annual 1994) were divided by the amount of crude oil produced in 1994 (EIA Petroleum Supply Annual 1997). The resulting estimate, 0.47 kg of associated natural gas produced per kg of crude oil produced, was used to characterize domestic and foreign crude oil wells.

DOE then estimated the amount of natural gas vented and flared for natural gas extraction (EIA Natural Gas Annual 1994). We assumed the percentage of natural gas flared and vented is the same for total natural gas as for associated natural gas from crude oil wells because the authors did not distinguish between these two sources. For foreign venting and flaring practices, DOE estimated the amount of natural gas flared and vented in 1994 (EIA International Energy Annual 1995). Once again, the percentage of natural gas flared and vented is assumed to be the same for total natural gas as for natural

gas from crude oil wells. Based on previous research by DeLucchi (1993) we assumed that 97.5% of the total amount of natural gas vented and flared was actually flared; only 2.5% is vented. Table 20 shows the net result of these assumptions and calculations for natural gas venting and flaring from conventional onshore crude oil extraction.

Based on the amount of gas produced, these proportions can be used to estimate a constant factor for kg of natural gas flared and vented per kg of crude oil extracted. In this study, 0.0057 kg of natural gas is flared and 0.00014 kg of natural gas is vented per kg of domestic onshore crude oil extracted.

Table 20: Natural Gas Venting and Flaring from Onshore Crude Oil Wells

	Conventional Onshore Extraction
Gross Natural Gas extracted (kg/kg crude)	0.47
Domestic % Flared	1.22%
Domestic % Vented	0.03%
Foreign % Flared	4.53%
Foreign % Vented	0.12%

The amount of foreign natural gas flared and vented per kg of crude oil extracted is calculated in a similar manner, resulting in an assumption of 0.021 kg of natural gas flared and 0.00056 kg of natural gas vented per kg of foreign onshore crude oil extracted.

The amount that is vented is assumed to be released as CH₄, although it is well known that the actual gas contains numerous other constituents of varying proportions. Data reflecting national averages of these constituents could be not found. The emissions from the amount that is flared are based on the emission factors for industrial flares shown in Appendix A.

The EPA provided estimates of volatile organic compound (VOC) emissions from onshore crude oil extraction (shown in Table 21) (EPA 1990). The EPA also provided some speciated estimates of the gross emissions (shown in Table 22). In 1994 the average productivity of U.S. crude oil production wells was 1,555 kg of crude oil/day per well (11.4 bbl/day per well) (EIA 1995b). Using this estimate, VOC emissions data were converted into kg of speciated VOCs per kg of crude oil produced and used in subsequent modeling.

4.2.1.4 Crude Oil Separation

The extracted crude oil must undergo an additional step before it is ready to be shipped to refineries; it must be separated from the natural gas and water. These field separators are assumed to operate on natural gas produced at the site, as explained in the previous sections. The combustion of natural gas leads to air emissions, which are based on emissions from industrial boilers described in Appendix A.

Table 21: VOC Emissions for Onshore Crude Oil Wells

Component	Emission Factor (g/well-yr.)
Fugitive Emissions	180,000
Crude Oil Sumps	4,000
Crude Oil Pits	4,000
Total	188,000

Table 22: Speciated VOC Data for Onshore Crude Oil Wells

Compound	Wt %
Isomers of Hexane	9.9
Isomers of Heptane	11.6
Isomers of Octane	8.7
C-7 Cycloparaffins	1.6
C-8 Cycloparaffins	0.6
Isomers of Pentane	5.6
Methane	38.0
Ethane	6.4
Propane	10.0
n-Butane	7.4
iso-Butane	0.4
Benzene	0.1

4.2.1.5 Crude Oil and Natural Gas Allocations – Conventional Onshore

Because associated natural gas is a coproduct of crude oil production, the emissions associated with the crude oil extraction and separation need to be allocated between crude oil and natural gas production. In order to arrive at a reasonable allocation methodology, the natural gas that is reinjected, flared, and vented must be taken into account because only the natural gas that is transported offsite is considered a coproduct. The onsite uses of natural gas must be netted out of the total gross natural gas produced.

According to DOE, 17.8% of the associated natural gas produced in 1994 was reinjected during onshore crude oil extraction (EIA Natural Gas Annual 1994). An estimated 9.98% of the associated natural gas extracted during foreign crude oil recovery was reinjected (EIA International Energy Annual 1995). This fraction was assumed to reflect practices of onshore and offshore crude oil recovery because the data did not reflect production technology characteristics.

The fraction of associated natural gas produced that is flared and vented during domestic and foreign conventional crude oil recovery was discussed in a previous section, and is reproduced in Table 23. Using the previous assumption that 0.47 kg of natural gas is extracted for every kg of crude oil extracted, the calculation of the amount of natural gas produced as a coproduct is shown in Table 23.

Using these raw estimates of the mass of natural gas and crude oil produced, mass allocation ratios can be calculated for domestic (Table 24) and foreign (Table 25) conventional onshore crude oil extraction. These ratios are used to allocate the inputs and emissions associated with crude oil extraction between the crude oil and the associated natural gas produced. For example, 72% of the emissions from flaring and venting, operating separators, fugitive emissions, and raw materials and energy consumed during conventional onshore crude oil extraction are assigned to the crude oil produced; the remaining 28% are assigned to the coproduct natural gas.

Table 23: Natural Gas Venting, Flaring, and Coproduct Production from Onshore Crude Oil Wells

	Onshore Extraction
Gross NG extracted (kg/kg crude)	0.47
Domestic % Reinjectd	17.8 %
Domestic % Flared/Vented	1.25 %
Foreign % Reinjectd	9.98 %
Foreign % Flared/Vented	4.65 %
Co-Product Domestic	80.95 % x 0.47 = 0.38 kg
Co-Product Foreign	85.37 % x 0.47 = 0.40 kg

Table 24: Production of Typical Domestic Conventional Onshore Crude Oil Well

	Mass (kg)	Mass (%)
Crude Oil	1	72 %
Natural Gas	0.38	28 %
Total	1.38	

Table 25: Production of Typical Foreign Conventional Onshore Crude Oil Well

	Mass (kg)	Mass (%)
Crude Oil	1	71 %
Natural Gas	0.40	29 %
Total	1.40	

4.2.2 Conventional Offshore Extraction

Figure 31 shows the system process diagram associated with conventional offshore crude oil extraction. It demonstrates the system boundaries and process flows modeled for conventional offshore crude oil extraction in this study.

4.2.2.1 Material Use

The only raw material inputs required for conventional offshore crude oil extraction accounted for in this study, is the actual crude oil and natural gas in the ground. We assumed that there is no loss of crude oil once it is extracted from the well.

The life cycle environmental flows associated with producing capital equipment and the facilities for extracting crude oil are excluded from this study. However, the energy required for drilling and exploration are included. For conventional offshore crude oil production, exploration, and drilling energy represents approximately 7%-8% of the energy in the produced crude oil (DeLucchi 1993). The average, or 7.5%, is used in this study. This energy is primarily used for drilling. This energy is accounted for by increasing the amount of crude oil in the ground needed to produce 1 kg of crude oil. Therefore, conventional offshore crude oil extraction would require 1.075 kg of crude oil in the ground to produce 1 kg of crude oil. The material requirements for domestic and foreign conventional offshore crude oil extraction are assumed to be the same.

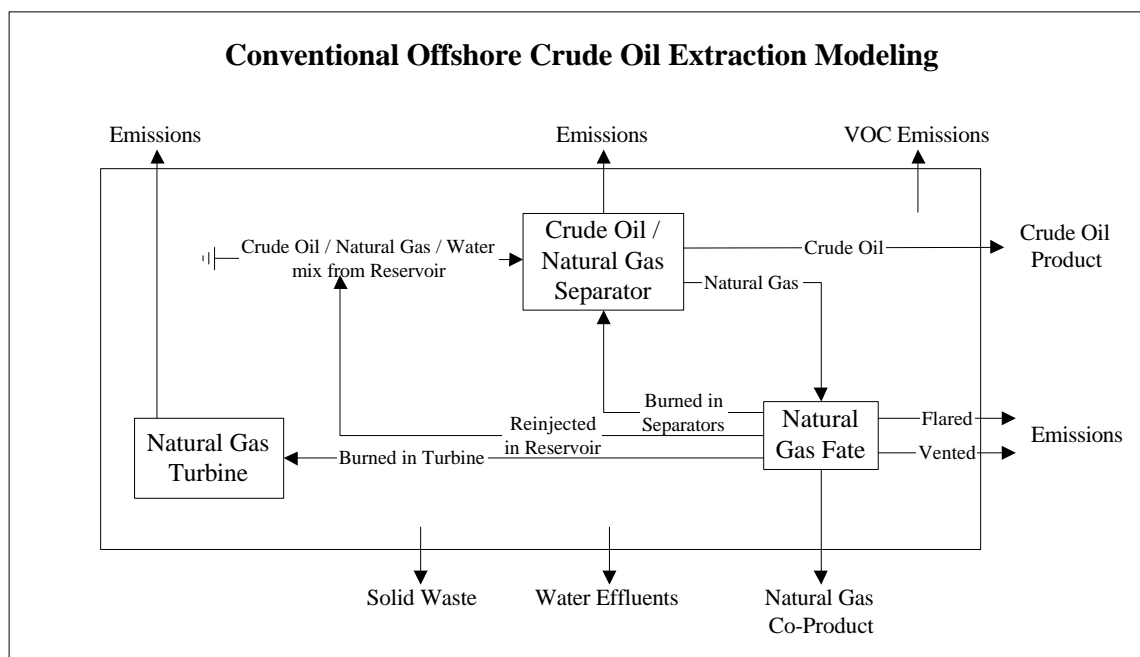

Figure 31: Conventional Offshore Crude Oil Extraction

4.2.2.2 Energy/Equipment Use

Energy used to extract crude oil is assumed to come from the gross production of the well. Energy requirements for both foreign and domestic conventional offshore crude oil production are based on an

18-well offshore platform producing 1.97×10^8 kg of crude oil/yr (1.46×10^6 bbl/yr) (DOE 1983) as follows²⁷:

Natural Gas (used in recovery): 38.8 MJ/bbl

Natural Gas (used for electricity, pumping, etc.): 96.6 MJ/bbl

Unlike conventional onshore crude oil production, natural gas is used for the separators and for producing electricity for pumping and other uses.

4.2.2.3 Process Emissions

Air, water, and solid waste emissions are produced during conventional offshore crude oil extraction.

Water effluents are based on the amount of wastewater produced and its estimated average composition. The U.S. Department of Interior (DOI) estimates that 10.14 L of wastewater are released for every kg of crude oil produced (DOI 1991). All the wastewater produced is assumed to be released to the surrounding environment.

The EPA estimates of the wastewater constituents and concentrations are shown in Table 19 (EPA 1987). In addition, DOI estimates that 2.8×10^{-4} kg of oil and grease are included in the wastewater for every kg crude oil produced (DOI 1990).

The emission factor for the production of solid waste is calculated as 0.0098 g of solid waste generated for every kg of crude oil (Tyson et al. 1993).

Air emissions from conventional offshore crude oil extraction come from the combustion of natural gas in the crude oil/natural gas separators and natural gas turbine, venting, and flaring of natural gas as well as from volatilization (i.e., fugitive) emissions of crude oil.

The emission factors for natural gas combustion from operating the separators were assumed to be the same as industrial boilers. This may be conservative because many of these burners are located in remote sites where requirements for emissions may be less stringent. The emission factors for natural gas combustion used to produce electricity are based on natural gas emission factors from a gas turbine (shown in Appendix A).

Natural gas venting and flaring emissions from offshore crude oil extraction are calculated based on a percentage of the gross natural gas production of the well and a variety of assumptions shown in Table 26. DOE estimates of gross natural gas extracted from offshore wells (EIA Natural Gas Annual 1994) were divided by DOE estimates of gross crude oil production from offshore wells in 1994 (EIA Petroleum Supply Annual 1997) to arrive at an estimated 0.26 kg of associated natural gas produced for every kg of crude oil extracted from offshore oil wells. Lacking any information on foreign offshore associated natural gas production, U.S. offshore estimates were used for both.

DOE provides estimates of the total amount of natural gas vented and flared from offshore extraction activities (EIA Natural Gas Annual 1994). The percentage of natural gas flared and vented offshore is used to estimate the total amount of associated natural gas produced in offshore oil wells that is vented and flared. DOE estimates of foreign natural gas flaring and venting for 1994 do not distinguish between onshore and off, and the number provide is used for both activities. (EIA International Energy Annual 1995). Based on a previous assumption by Delucchi (1993), 75% of the associated natural gas produced offshore is assumed to be flared and 25% is assumed to be vented.

²⁷ Electrical energy requirements are assumed to be met through the use of natural gas turbines.

Table 26: Natural Gas Venting and Flaring from Offshore Crude Oil Wells

	Conventional Offshore Extraction
Gross Natural Gas Extracted (kg/kg crude)	0.26
Domestic % Flared	0.067%
Domestic % Vented	0.022%
Foreign % Flared	3.49%
Foreign % Vented	1.16%

The assumptions presented in Table 26 are used to calculate fixed factors of natural gas flaring and venting per kg of crude oil produced from offshore wells. Based on the total natural gas produced by the well, 0.00017 kg of natural gas is flared and 0.000057 kg of natural gas is vented per kg of domestic offshore crude oil extracted. Similarly, 0.0091 kg of foreign natural gas is flared and 0.0030 kg of foreign natural gas are vented per kg of foreign offshore crude oil extracted.

The amount that is vented is assumed to be released as CH₄, although the actual composition of the gases flared and vented is more complex. The emissions from the flared natural gas are based on the emission factors for industrial flares shown in Appendix A.

A study by Tyson et al. (1993) provides estimates of VOC emissions released during conventional offshore crude oil production (Table 27), which are used in this study.

Table 27: Speciated VOC Emissions for Offshore Crude Oil Production

Pollutant	Emission rate (kg/kg crude oil produced)
Methane	5.6×10^{-5}
Formaldehyde	1.9×10^{-5}
Isomers of Hexane	3.0×10^{-6}
Isomers of Heptane	2.3×10^{-5}
Isomers of Octane	2.6×10^{-6}
C-7 Cycloparaffins	3.2×10^{-6}
C-8 Cycloparaffins	1.2×10^{-6}
Isomers of Pentane	1.1×10^{-5}
Ethane	1.3×10^{-5}
Propane	2.0×10^{-5}
n-Butane	1.5×10^{-5}
iso-Butane	8.0×10^{-7}
Benzene	2.0×10^{-7}

4.2.2.4 Crude Oil Separation

Directly after extraction and before shipping the crude oil produced offshore, the crude oil is separated from the contained gases (natural gas), water, and wastes using field separators. These separators are assumed to be operated by burning some of the associated natural gas as explained in the previous sections. The combustion of this natural gas leads to air emissions, which are assumed to be similar to industrial boiler emissions.

4.2.2.5 Crude Oil and Natural Gas Allocations – Conventional Offshore

Because natural gas is a coproduct of crude oil production, the energy and emissions associated with its production need to be allocated between crude oil and natural gas production. To arrive at a reasonable allocation method, the natural gas that is reinjected, vented, and flared needs to be deducted from the total amount of associated natural gas produced. Only the natural gas that is transported from the offshore production facilities is considered a coproduct of the crude oil produced.

The amount of natural gas vented and flared during offshore production has already been discussed. The amount of natural gas reinjected during domestic offshore crude oil extraction is estimated at 2.46% (EIA Natural Gas Annual 1994). The previous estimate of reinjected natural gas for foreign crude oil production is used for offshore and onshore production, because the data did not distinguish between crude oil extraction activities.

Based on the data provided, 97.45% of the total natural gas extracted is considered a coproduct of domestic offshore crude oil production, and 85.37% of the foreign associated natural gas is considered a coproduct to foreign offshore crude oil production (Table 28). Applying these estimates to the mass of natural gas produced per kg of domestic (Table 29) and foreign (Table 30) offshore crude oil produced, yields the coproduct allocation ratios. These ratios are applied to the inputs and emissions associated with offshore crude oil production. For example, with conventional domestic offshore crude oil production, 80% of the total emissions, raw materials, and energy use are allocated to crude oil and 20% are allocated to the coproduct natural gas.

Table 28: Natural Gas Venting, Flaring, and Coproduct Production from Offshore Crude Oil Wells

	Offshore Extraction
Gross Natural Gas Extracted (kg/kg crude)	0.26
Domestic % Reinjected	2.46%
Domestic % Flared/Vented	0.089%
Foreign % Reinjected	9.98%
Foreign % Flared/Vented	4.65%
Coproduct Domestic	$97.45\% \times 0.26 = 0.25 \text{ kg}$
Coproduct Foreign	$85.37\% \times 0.26 = 0.22 \text{ kg}$

Table 29: Production of Typical Domestic Conventional Offshore Crude Oil Well

	Mass (kg)	Mass (%)
Crude Oil	1	80%
Natural Gas	0.25	20%
Total	1.25	

Table 30: Production of Typical Foreign Conventional Offshore Crude Oil Well

	Mass (kg)	Mass (%)
Crude Oil	1	82%
Natural Gas	0.22	18%
Total	1.22	

4.2.3 Advanced Onshore Extraction (Steam Injection)

Figure 32 shows the system process diagram associated with advanced onshore crude oil extraction through the use of steam injection. It demonstrates the system boundaries and process flows modeled for advanced steam injection onshore crude oil extraction in this study. All steam injection is assumed to occur onshore.

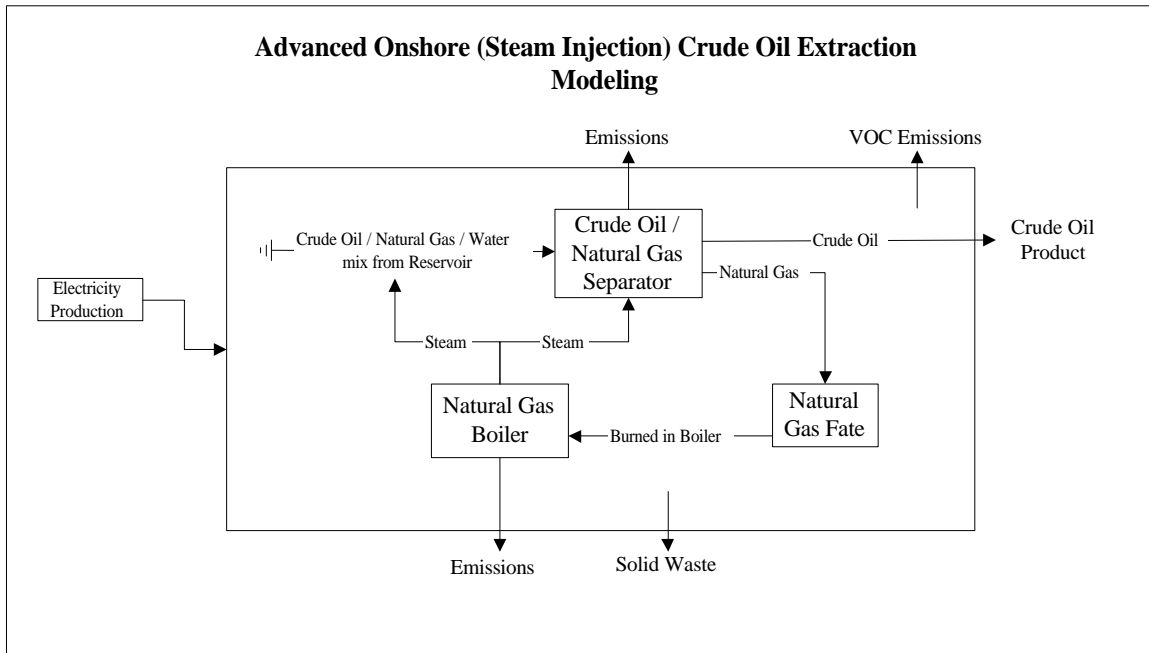

Figure 32: Advanced Onshore (Steam Injection) Crude Oil Extraction

4.2.3.1 Material Use

The raw material inputs required for advanced steam injection onshore crude oil extraction, accounted for in this study, include the crude oil and natural gas in the ground and water used to produce steam. It is assumed that there is no loss of crude oil once it is extracted from the well.

The life cycle environmental flows associated with producing capital equipment and the facilities used to extract crude oil are excluded from this study. However, the energy required for drilling and exploration is included in the study and is assumed to be the same as onshore crude oil production exploration and drilling energy, or 0.75% of the energy in the produced crude oil (Delucchi 1993). This energy is accounted for by increasing the amount of crude oil in the ground needed to produce 1 kg of crude oil. Therefore, advanced steam injection onshore crude oil extraction would require 1.0075 kg of crude oil in the ground to produce 1 kg of crude oil.

The material requirements for both domestic and foreign advanced steam injection onshore crude oil extraction are assumed to be the same.

4.2.3.2 Energy/Equipment Use

Energy used to extract the crude oil is assumed to come from the gross natural gas production of the well and from purchased electricity. Energy requirements for both domestic and foreign advanced steam injection onshore crude oil production are based on a steam injection site located in the lower 48 states producing 4.7×10^9 kg/yr (3.45×10^7 bbl/yr) of crude oil (DOE 1983) as follows:

Electricity:	11.3 kWh/bbl	(used in pumping)
Natural Gas:	986 MJ/bbl	(used in recovery and steam boiler)

This site is assumed to require the same amount of electricity as the conventional onshore crude oil extraction site modeled in Section 4.2.1. (we assumed that no electricity is used for steam or injecting steam). However, because the amount of oil produced from the steam injection site is less than that of the conventional site, more electricity is required per barrel of oil extracted.

We assumed that all steam is produced by natural gas-fired boilers using associated gas, although several large sites in the United States use purchased natural gas. The estimate of steam use per year is based on the amount of water used by the site (1.06×10^{10} L/yr). The energy necessary to convert this water to steam is based on the enthalpy of the steam (2.6 MJ/kg @ approximately 150 psi and 177°C) and a boiler efficiency of 80%. The energy required to run the separators (separating the crude oil, natural gas, and water from each other) is assumed to be included in this estimate.

Electricity is assumed to come from a generic (national average) U.S. grid as previously described in Section 4.2.1.2. See this same section for assumptions concerning foreign electricity production and use in crude oil extraction.

4.2.3.3 Process Emissions

The process emissions from advanced steam injection onshore crude oil extraction include air emissions and solid waste emissions.

No wastewater is assumed to be produced by advanced steam injection onshore crude oil extraction because it is assumed to be reused for steam production. Advanced steam injection onshore extraction is actually a net user of water. Advanced steam injection onshore crude oil extraction is assumed to produce 1×10^{-4} kg of waste oil and grease per kg of crude oil produced although no wastewater is produced (DOE 1983).

The emission factor for the production of solid waste is calculated as 0.0098 g of solid waste produced for every kg of crude oil (Tyson et al., 1993).

Air emissions from advanced steam injection onshore crude oil extraction come from the combustion of natural gas in a boiler (see Appendix A) and volatilization (i.e., fugitive) emissions of crude oil. VOC emissions from onshore crude oil extraction (Table 21) are assumed to reflect those from steam injection extraction. The speciation of these emissions are assumed to be the same as in Table 22, as other data are not available. The VOC emissions, and the speciation data, are handled as described in Section 4.2.1.3.

4.2.3.4 Crude Oil and Natural Gas Allocation-Steam Injection Extraction

Advanced onshore crude oil extraction is assumed to burn all of the natural gas produced by the well in order to generate the steam needed for injection. Therefore, no natural gas is produced as a coproduct of advanced steam injection onshore crude oil extraction. Emissions from natural gas boilers and fugitive emissions as well as raw materials, and energy use are allocated completely to crude oil production for advanced steam injection onshore crude oil extraction.

4.2.4 Advanced Onshore Extraction (CO₂ Injection)

Figure 33 shows the system process diagram associated with advanced onshore crude oil extraction through the use of CO₂ injection. It demonstrates the system boundaries and process flows modeled for advanced CO₂ injection onshore crude oil extraction in this study.

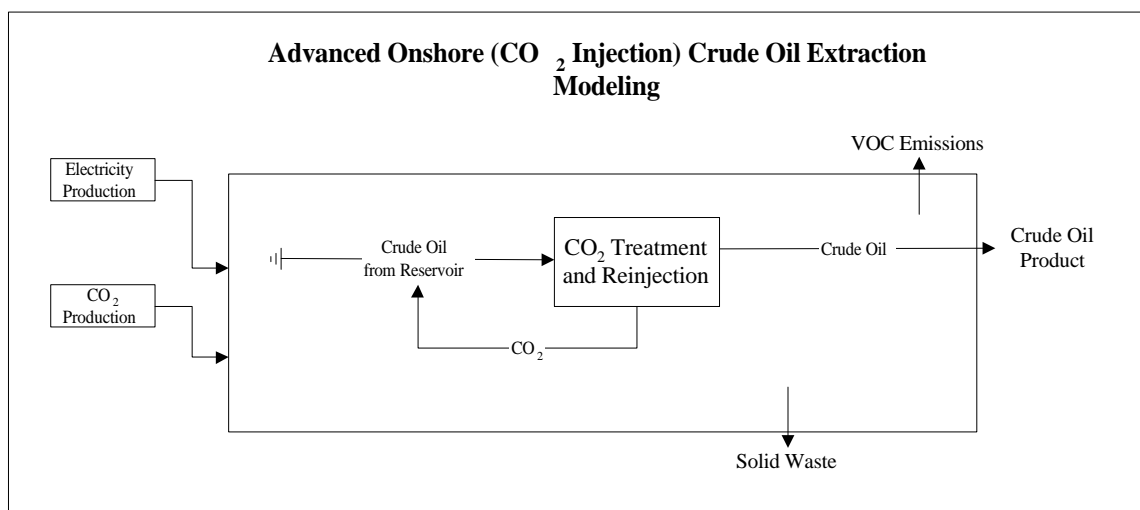

Figure 33: Advanced Onshore (CO₂ Injection) Crude Oil Extraction

4.2.4.1 Material Use

The material inputs required for advanced CO₂ injection onshore crude oil extraction, accounted for in this study, include the crude oil in the ground and the CO₂ required for injection. A CO₂ gas injection well is assumed to require 4.6 kg of CO₂ to be injected for every 1 kg of crude oil produced (15,000 scf of CO₂ per barrel of crude oil) (AOSTRA 1993). Of this CO₂ injected, half is assumed to be produced with the crude oil extracted, which is subsequently removed and reinjected. The remaining 2.3 kg of CO₂ gas

(per kg of crude oil extracted) is manufactured and injected²⁸. The production of the CO₂ gas is taken from Ecobalance's database DEAMTM.

We assumed that there is no loss of crude oil once it is extracted from the well. Only the energy required for drilling and exploration are included in the study; capital equipment and facilities are assumed to be outside the study boundaries as previously discussed. The assumption for energy consumed for onshore crude oil exploration and drilling from section 4.2.1.1, 0.75% of the energy in the produced crude oil, is assumed for CO₂ injection. This energy is accounted for by increasing the amount of crude oil in the ground needed to produce 1 kg of crude oil. Therefore, advanced CO₂ injection onshore crude oil extraction would require 1.0075 kg of crude oil in the ground to produce 1 kg of crude oil. The material requirements for both domestic and foreign advanced CO₂ injection onshore crude oil extraction are assumed to be the same.

4.2.4.2 Energy/Equipment Use

Because we lacked specific energy data describing enhanced/advanced crude oil extraction by CO₂ injection, we assumed that CO₂ injection required the same amount of electricity as the steam injection enhanced/advanced crude oil extraction (section 4.2.3). It is also assumed that this electricity is used to separate, dry, compress, and inject the CO₂ gas.

Electricity: 11.3 kWh/bbl (Used in pumping)

Electricity for foreign and domestic advanced CO₂ injection processes is assumed to come from a generic (national average) U.S. grid. See section 4.2.1.2 for more information.

4.2.4.3 Process Emissions

The process emissions from advanced CO₂ injection onshore crude oil extraction include air emissions and solid waste emissions.

No wastewater is assumed to be produced by advanced CO₂ injection onshore crude oil extraction. However, advanced CO₂ injection onshore crude oil extraction is assumed to produce oil and grease, estimated to be 1×10^{-4} kg/kg crude oil produced (DOE 1983).

The emission factor for the production of solid waste is calculated as 0.0098 g of solid waste are produced for every kg of crude oil (Tyson et al. 1993).

Air emissions from advanced CO₂ injection onshore crude oil extraction come from volatilization (i.e., fugitive) emissions of crude oil. VOC emissions are assumed to be the same as those from conventional onshore crude oil extraction (Table 21 and Table 22). In 1994 the average productivity of U.S. crude oil production wells was 1,555 kg of crude oil/day per well (11.4 bbl/day per well) (EIA 1995b). Using this number, VOC emission data can be calculated per kg of crude oil produced.

The use of CO₂ injection to enhance the production of crude oil is assumed to result in some sequestration of the injected CO₂. We assumed that half the injected CO₂ is sequestered and, therefore, is accounted for as a negative flow in the life cycle.

²⁸ This sequestered CO₂ is accounted for as a negative flow in the model.

4.2.4.4 Crude Oil and Natural Gas Allocations - CO₂ injection

It is assumed that advanced CO₂ injection onshore crude oil extraction does not produce natural gas as a coproduct of crude oil extraction. Fugitive emissions as well as raw materials and energy use are allocated completely to crude oil production for advanced CO₂ injection onshore crude oil extraction.

4.2.5 Crude Oil Extraction Results

A schematic of the system model for both foreign and domestic crude oil production is shown in Figure 34. The corresponding life cycle flows calculated by the TEAMTM model for domestic and foreign oil production and the three modules which feed into oil production are shown in Table 31 and Table 32.

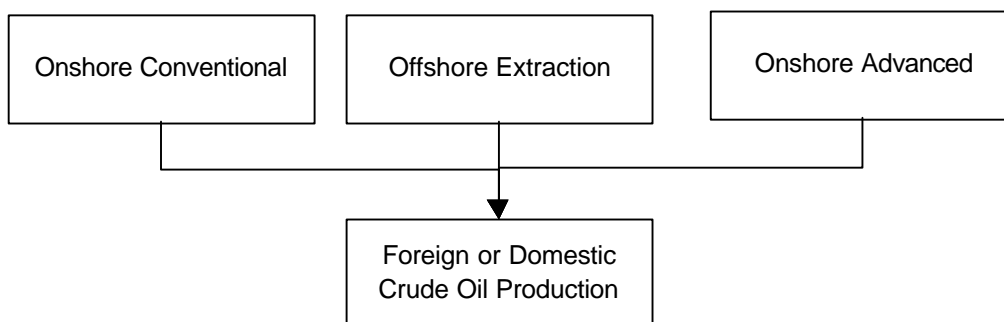

Figure 34: Schematic of Crude Oil Production System Modeled in TEAMTM

Table 31: LCI Results for Domestic Crude Oil Extraction (for 1 kg of crude oil)

	Units	Domestic Crude Oil Production	Onshore Conventional Extraction	Conventional Offshore Extraction	Onshore Advanced Extraction
Raw Materials					
Coal (in ground)	kg	0.01306	0.00968	0.00000	0.00338
Oil (in ground)	kg	1.02145	0.69551	0.21500	0.11094
Natural Gas (in ground)	kg	0.06525	0.00436	0.00307	0.05782
Uranium (U, ore)	kg	0.00000	0.00000	0.00000	0.00000
Phosphate Rock (in ground)	kg	0.00000	0.00000	0.00000	0.00000
Potash (K ₂ O, in ground)	kg	0.00000	0.00000	0.00000	0.00000
Perlite (SiO ₂ , ore)	kg	0.00000	0.00000	0.00000	0.00000
Limestone (CaCO ₃ , in ground)	kg	0.00249	0.00184	0.00000	0.00065
Sodium Chloride (NaCl)	kg	0.00000	0.00000	0.00000	0.00000
Water Used (total)	liter	0.22170	0.00030	0.00000	0.22140
Air Emissions					
Carbon Dioxide (CO ₂ , fossil)	g	46.63270	38.93490	8.98844	-1.29060
Carbon Dioxide (CO ₂ , biomass)	g	0.00000	0.00000	0.00000	0.00000
Methane (CH ₄)	g	0.49569	0.20565	0.01859	0.27145
Nitrous Oxide (N ₂ O)	g	0.04432	0.00056	0.00022	0.04354
Carbon Monoxide (CO)	g	0.06668	0.02833	0.00883	0.02953
Hydrocarbons (except methane)	g	0.14941	0.11073	0.01510	0.02357
Hydrocarbons (unspecified)	g	0.00107	0.00079	0.00000	0.00028
Benzene	g	0.00023	0.00017	0.00003	0.00004
Formaldehyde	g	0.00303	0.00000	0.00303	0.00000
Particulates (PM10)	g	0.00212	0.00003	0.00017	0.00192
Particulates (unspecified)	g	0.18387	0.13616	0.00000	0.04771
Sulfur Oxides (SO _x as SO ₂)	g	1.40728	0.26233	0.00093	1.14402
Nitrogen Oxides (NO _x as NO ₂)	g	0.26273	0.09849	0.00977	0.15447
Hydrogen Chloride (HCl)	g	0.00705	0.00522	0.00000	0.00183
Hydrogen Fluoride (HF)	g	0.00088	0.00065	0.00000	0.00023
Ammonia (NH ₃)	g	0.00000	0.00000	0.00000	0.00000
Agrochemicals (unspecified)	g	0.00000	0.00000	0.00000	0.00000
BOD5 (Biochemical Oxygen Demand)	g	0.00017	0.00013	0.00000	0.00004
COD (Chemical Oxygen Demand)	g	0.00143	0.00106	0.00000	0.00037
Metals (unspecified)	g	0.01953	0.00348	0.01605	0.00000
Ammonia (NH ₄ + NH ₃ as N)	g	0.00004	0.00003	0.00000	0.00001
Nitrates (NO ₃ -)	g	0.00001	0.00001	0.00000	0.00000
Solid Waste (hazardous)	kg	0.00000	0.00000	0.00000	0.00000
Solid Waste (non-hazardous)	kg	0.00479	0.00355	0.00000	0.00124
Total Primary Energy	MJ	47.04950	30.00660	9.17476	7.86822
Fossil Energy	MJ	47.02950	29.99170	9.17476	7.86304
Fuel Energy	MJ	2.96633	0.65396	0.66676	1.64561

Table 32: LCI Results for Foreign Crude Oil Extraction (for 1 kg of crude oil)

	Units	Foreign Crude Oil Production (Total)	Onshore Conventional	Conventional Offshore Extraction	Onshore Advanced
Raw Materials					
Coal (in ground)	kg	0.01156	0.01064	0.00000	0.00092
Oil (in ground)	kg	1.02140	0.77614	0.21500	0.03026
Natural Gas (in ground)	kg	0.03444	0.01358	0.00509	0.01577
Uranium (U, ore)	kg	0.00000	0.00000	0.00000	0.00000
Phosphate Rock (in ground)	kg	0.00000	0.00000	0.00000	0.00000
Potash (K ₂ O, in ground)	kg	0.00000	0.00000	0.00000	0.00000
Perlite (SiO ₂ , ore)	kg	0.00000	0.00000	0.00000	0.00000
Limestone (CaCO ₃ , in ground)	kg	0.00220	0.00203	0.00000	0.00018
Sodium Chloride (NaCl, in ground or in sea)	kg	0.00000	0.00000	0.00000	0.00000
Water Used (total)	liter	0.06071	0.00033	0.00000	0.06038
Air Emissions					
Carbon Dioxide (CO ₂ , fossil)	g	79.18740	66.31410	13.22530	-0.35198
Carbon Dioxide (CO ₂ , biomass)	g	0.00000	0.00000	0.00000	0.00000
Methane (CH ₄)	g	1.03591	0.45854	0.50334	0.07403
Nitrous Oxide (N ₂ O)	g	0.01272	0.00061	0.00023	0.01187
Carbon Monoxide (CO)	g	0.12269	0.09475	0.01989	0.00805
Hydrocarbons (except methane)	g	0.17158	0.14559	0.01956	0.00643
Hydrocarbons (unspecified)	g	0.00094	0.00087	0.00000	0.00008
Benzene	g	0.00022	0.00018	0.00003	0.00001
Formaldehyde	g	0.00311	0.00000	0.00311	0.00000
Particulates (PM10)	g	0.00073	0.00003	0.00018	0.00052
Particulates (unspecified)	g	0.16270	0.14969	0.00000	0.01301
Sulfur Oxides (SO _x as SO ₂)	g	0.92057	0.56113	0.04743	0.31201
Nitrogen Oxides (NO _x as NO ₂)	g	0.17394	0.11982	0.01199	0.04213
Hydrogen Chloride (HCl)	g	0.00624	0.00574	0.00000	0.00050
Hydrogen Fluoride (HF)	g	0.00078	0.00072	0.00000	0.00006
Ammonia (NH ₃)	g	0.00000	0.00000	0.00000	0.00000
Agrochemicals (unspecified)	g	0.00000	0.00000	0.00000	0.00000
BOD5 (Biochemical Oxygen Demand)	g	0.00015	0.00014	0.00000	0.00001
COD (Chemical Oxygen Demand)	g	0.00126	0.00116	0.00000	0.00010
Metals (unspecified)	g	0.02029	0.00382	0.01646	0.00000
Ammonia (NH ₄ ⁺ , NH ₃ , as N)	g	0.00004	0.00003	0.00000	0.00000
Nitrates (NO ₃ ⁻)	g	0.00001	0.00001	0.00000	0.00000
Solid Waste (hazardous)	kg	0.00000	0.00000	0.00000	0.00000
Solid Waste (nonhazardous)	kg	0.00424	0.00390	0.00000	0.00034
Total Primary Energy	MJ	44.81250	33.47480	9.19190	2.14588
Fossil Energy	MJ	44.79480	33.45850	9.19190	2.14446
Fuel Energy per kg of Crude Oil	MJ	42.54	-	-	-

4.3 Crude Oil Transport to Refinery

The United States is divided into PADDs to ensure that each region or PADD is supplied with enough petroleum for strategic defense reasons. The transportation distances used in this report are regionalized by these PADDs. However, no specific ton-mile information is available for crude oil transportation per PADD. Therefore, certain assumptions have to be made regarding crude oil transportation as described in the following sections:

- **Section 4.3.1:** This section describes how the modes of transportation are regionalized per PADD.
- **Section 4.3.2:** This section explains how transportation distances for each PADD are based on U.S. average distances.
- **Section 4.3.3:** This section explains the various transportation models used to represent the modes of transportation.
- **Section 4.3.4:** This section describes how the pumping and fugitive emissions of transportation are taken into account.
- **Section 4.3.5:** This section provides the LCI results for transporting 1 bbl of crude oil.

4.3.1 Transportation Regionalization

The amount of foreign and domestic crude oil transported into each PADD is estimated from refinery receipts of crude oil which is known for each PADD.²⁹ Table 33 and Table 34 describe refinery receipt of crude oil for 11 methods of transport and two sources, foreign and domestic.

Table 33: Refinery Receipts of Crude Oil by Source and by PADD (1993)

Source	Petroleum Administration for Defense District					Total U.S.
	I	II	III	IV	V	
Total:	(%)	(%)	(%)	(%)	(%)	(%)
Domestic	2.68	56.03	39.37	81.33	90.12	50.41
Foreign	97.32	43.97	60.63	18.67	9.88	49.59
Total	100	100	100	100	100	100

Pipeline transportation for Canadian and other foreign sources are estimated separately. This is done to account for the fact that foreign oil, other than Canadian, must travel via tanker to the United States before it enters a domestic pipeline³⁰.

²⁹ Source: EIA Petroleum Supply Annual 1993, Vol. 1. 1993 data were used because that was the latest year for which information used to calculate transportation distances could be found.

³⁰ Note: Transportation of crude oil within foreign countries is limited to pipelines. This seems to be a fair estimate considering the small amount of crude oil shipped by alternate methods in the United States. 15% of all foreign oil (excluding Canada) will travel in a foreign pipeline before being shipped to the United States (DeLucchi, 1993).

Table 34: Refinery Receipts of Crude Oil by Method of Transportation and by PADD (1993)

Method	Petroleum Administration for Defense District					Total U.S.
	I	II	III	IV	V	
Pipeline:	(%)	(%)	(%)	(%)	(%)	(%)
Domestic	13.3	96.9	84.4	86.8	38.6	71.9
Foreign	0.17	51.8	22.9	0	0	23.2
Canadian	4.59	48.2	0.31	99.8	18.1	12.5
Tanker:						
Domestic	1.73	0	0.78	0	59.5	20.2
Foreign	90.7	0	75.7	0	70.5	62.4
Barge:						
Domestic	10.7	0.19	11.8	0	0.67	4.57
Foreign	4.57	0	1.12	0	11.4	1.92
Tank Cars:						
Domestic	41.2	0	0.08	0.65	0.21	0.34
Foreign	0	0	0	0.19	0	0
Trucks:						
Domestic	33.1	2.93	2.99	13.1	0.98	2.98
Foreign	0	0	0	0	0	0
Total:						
Domestic	100	100	100	100	100	100
Foreign	100	100	100	100	100	100

4.3.2 Transportation Distances

Crude oil transportation distances are based on national average distances according to the amount of crude transported by each mode. The data and assumptions are described below.

Crude oil transported via domestic tankers and domestic barges was based on data provided by the Army Corp of Engineer's Report *Waterborne Commerce of the United States, Calendar Year 1993, Part 5 - National Summaries*. The Army report lists tons and ton-miles of crude oil transported by tanker and barge on all U.S. waterways. The data listed are not just for refinery receipts, but include all transport (including any transport to storage facilities). Average miles are calculated by dividing total ton-miles traveled by total tons transported. This is done separately for both tanker and barge.

Crude oil transported through domestic pipelines are characterized by the Association of Oil Pipelines, using data from Annual Report (Form 6) of oil pipeline companies to the Federal Energy Regulatory Commission (EIA Petroleum Supply Annual 1993, vol. 1). The Association of Oil Pipelines provides estimates of total ton-miles of crude oil carried in domestic pipelines. Petroleum Supply Annual Table 46

provides estimates of refinery receipts of barrels of crude oil by PADD, by method, and source of transportation. The data in Table 46 are converted to tons.³¹ Average miles are calculated by dividing total ton-miles of crude oil, carried in domestic pipelines, by the tons of crude oil received at refineries via pipeline.

Crude oil transported by domestic rail is characterized by the Association of Oil Pipelines, using data from *Carload Way Bill Statistics*, Report TD-1 (U.S. Department of Transportation); the *Federal Railroad Administration Annual*; and the *Freight Commodity Statistics*, Association of American Railroads Annual as reported by the EIA (Petroleum Supply Annual, 1993, vol. 1). The Association of Oil Pipelines provides estimates of total ton-miles of crude oil carried by rail in the United States. Petroleum Supply Annual Table 46 provides estimated refinery receipts of barrels of crude oil by PADD, by method, and by source of transportation. Table 46 gives crude oil receipts in barrels, which are converted to tons. Average miles are calculated by dividing total ton-miles of crude oil, carried by rail, by tons of crude oil received at refineries via railroad tank cars.

Crude oil transported by domestic trucking firms is also provided by the Association of Oil Pipelines, using data from *Financial and Operating Statistics* American Trucking Association, Inc. as reported by the EIA (Petroleum Supply Annual, 1993, Vol. 1). The Association of Oil Pipelines provides estimated total ton-miles of crude oil transported by motor carriers in the United States. Petroleum Supply Annual Table 46 provides estimates of refinery receipts of barrels of crude oil by PADD, by method, and by source of transportation. Table 46 gives crude oil receipts in barrels, which are converted to tons. Average miles are calculated by dividing total ton-miles of crude oil, transported by motor carriers, by tons of crude oil received at refineries via truck.

The estimated average miles per ton that were calculated for domestic pipelines were used for characterizing crude oil transported via foreign pipeline from the field to the coast and for moving crude oil within Canadian pipelines to the United States.

Information describing crude oil transported via foreign tankers was taken from a previous study by Delucchi (1993) and DOE (EIA, Petroleum Supply Annual, 1994, vol. 1). The DOE report provided estimates of imported crude oil by country for each PADD in barrels. PADD I crude oil is assumed to all arrive at New York. PADD II and III oil is assumed to arrive at Houston. (PADD II oil arrives at Houston and then is transported by pipeline, barge, etc. to its final destination). PADD V oil is assumed to arrive at Los Angeles. PADD IV receives no foreign oil except from Canada.

The nautical miles between ports of origin and U.S. ports (New York, Houston, and Los Angeles) are given in Delucchi's study, based on information from the Defense Mapping Agency³². From this information a weighted average is calculated for each PADD, by multiplying barrels imported from each country by the distance from that country to the specified U.S. port of entry. These results, in barrel-miles for each PADD, are added together and then divided by the total number of barrels imported to get an average distance traveled by the foreign tankers (in miles). Average mileage values for all modes of transportation are then converted into kilometers.

³¹ Conversion of crude oil from barrels to tons is done using the conversion factor of 6.62 bbl equals one ton (EIA, 1994).

³² Defense Mapping Agency, Hydrographic/Topographic Center, Distance Between Ports, Fifth edition, Publication 151, Washington, DC (1995).

4.3.3 Transportation Models

Ecobalance maintains a database of transportation methods and environmental impacts associated with those methods. This database, DEAM™ is used to account for the environmental impacts of transporting crude oil from extraction sites to refinery locations.

Transporting crude via pipelines consumes electricity drawn from the U.S. average power mix. In this study 0.0184 kWh electricity per ton-mile was assumed³³. Rail and truck transportation was estimated assuming that #2 diesel fuel was used. Ocean tankers and barges were assumed to use #6 fuel oil.

To make the diesel fuel consumed in the rail and truck sector consistent with the results of this analysis (which estimates #2 diesel life cycle impacts), the DEAM™ model was run in a reiterating mode. The model was run the first time with values for production of #2 diesel fuel based on Ecobalance's database. Those results were then used to replace the original factors in DEAM™, then the model was run a second time with the new values to obtain the final result. Empty backhauls were taken into account for truck transportation.

Figure 35 demonstrates graphically how crude oil transportation is regionalized in this study. Example percentages for mode of transport are given for PADD II to clarify how the information is used.

4.3.4 Energy and Fugitive Emissions from Storage and Handling

In addition to the energy requirements and subsequent emissions from the actual modes of transportation (e.g., truck diesel use and emissions, pipeline electricity requirements, and emissions from electricity production), energy and emissions are also created during the loading and unloading of the crude oil.

The loading and unloading of crude oil is assumed to require electricity for pumping. The amount of electricity used is based on the electricity required for pipeline transport. Pipelines are assumed to require 5.8×10^{-5} MJ of electricity per 1 kg transported 1 km. For loading and unloading, we assumed that the distance fuel would be pumped is 50 meters and that the energy required for pumping is linear with distance pumped. Therefore, 2.9×10^{-6} MJ of electricity are required for loading and unloading 1 kg of fuel. Life cycle flows for electricity used in this stage are based on a generic (national average) U.S. grid.

The emissions associated with loading and unloading trucks and rail cars were based on the following formula (US EPA AP-42):

$$L_L = 12.46 \frac{SPM}{T} \left(1 - \frac{eff}{100}\right)$$

Equation 1: Estimating Emissions from Loading and Unloading Trucks and Rail Cars

Where:

- L_L = loading loss in pounds per 1000 gallons
- S = saturation factor
- P = true vapor pressure of fuel transported (psia)
- M = molecular weight of fuel vapors (lb/lb-mole)
- T = temperature of the fuel ($^{\circ}R(^{\circ}F + 460)$)
- eff = overall reduction efficiency (%)

³³ Banks, W. F., Energy Consumption in the Pipeline Industry, SAN-1171-1/3, Systems, Science, and Software, La Jolla, CA, for the U.S. Department of Energy, December (1977).

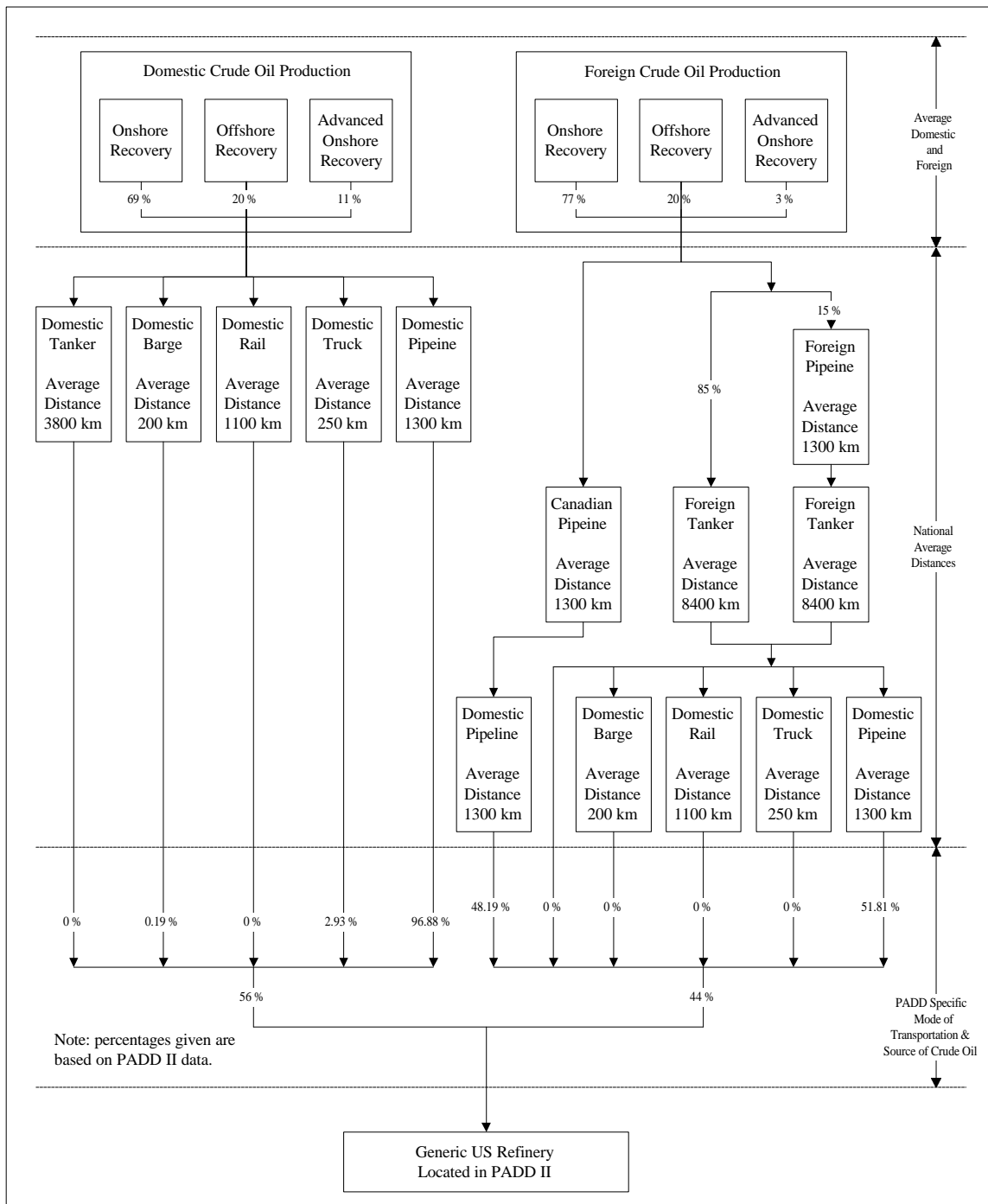

Figure 35: Modes of Transport and Distances for Crude Oil

The saturation factor is based on the type of carrier and the mode of operation³⁴. For this project an average S value is used that is the straight average of all possible operation modes.

The vapor pressure of the fuel (in this case, crude oil) is estimated at 160°F based on information in AP-42. The M (or molecular weight of the crude oil vapors) is also taken from information in AP-42. The temperature is assumed to be 160°F to match the vapor pressure and molecular weight data.

The reduction efficiency is a measure of how much of the vapors are collected, then subsequently controlled. In this case it is assumed that 70% of the vapors were collected and then 90% of those collected vapors were controlled to yield an overall efficiency of 63%³⁵.

The emissions associated with loading and unloading tankers and barges were based on the following formula (US EPA AP-42):

$$C_L = (C_A + 1.84(0.44P - 0.42) \frac{MG}{T})$$

Equation 2: Estimating Emissions from Loading and Unloading Tankers and Barges

Where:

C_L = total loading loss in pounds per 1000 gallons

C_A = arrival emission factor (lb/1000 gal.)

P = true vapor pressure of fuel transported (psia)

M = molecular weight of fuel vapors (lb/lb-mole)

G = vapor growth factor = 1.02 (dimensionless)

T = temperature of the vapors (°R (°F + 460))

eff = overall reduction efficiency (%)

The arrival emission factor is based on information in AP-42 and is determined by the condition of the transportation vessel upon arrival. In this project it is assumed to be an uncleaned vessel³⁶.

The vapor pressure of the fuel (in this case, crude oil) is estimated at 160°F based on information in AP-42. The M (or molecular weight of the crude oil vapors) is also taken from information in AP-42. The temperature is assumed to be 160°F to match the vapor pressure and molecular weight data.

In addition to loading and unloading fugitive emissions there are also fugitive emissions associated with transit of the fuel. The emissions associated with truck, train, tanker, and barge transit were based on the following formula (US EPA AP-42):

$$L_T = 0.1PW$$

Equation 3: Estimating Fuel Transit Emissions

³⁴ The different types of carriers include normal service and vapor balance service in which the cargo truck retrieves the vapors displaced during product unloading and transports them back to the loading terminal. Modes of operation include submerged and splash loading.

³⁵ Both the 70% collection efficiency and 90% control efficiency are the low range of values reported in AP-42.

³⁶ Therefore, no ballast emissions are accounted for.

Where:

L_T = transit losses in pounds per 1000 gal/wk

P = true vapor pressure of fuel transported (psia)

W = density of the condensed vapors (lb/gal)

The vapor pressure of the fuel (in this case, crude oil) is estimated at 160°C based on information in AP-42. The W (or density of the condensed crude oil vapors) is also taken from information in AP-42.

The value obtained for L_T can be converted to pounds per 1000 gal/km based on the speed of the modes of transportation used. The following conversion factors are computed from average speeds for the modes of transport:

Tanker - 1 week = 4,317.6 km

Rail - 1 week = 10,752 km

Barge - 1 week = 2,167.2 km

Truck³⁷ - 1 week = 5,792 km

Figure 36 shows how crude oil transportation was modeled in this project. Note that fugitive tank emissions from the storage of crude oil at the oil field are accounted for in crude oil extraction modeling. Also, fugitive tank emissions from the storage of crude oil at the refinery are accounted for in the crude oil refining model.

³⁷ Assuming the truck is running at 60 mph for 10 hours a day and 6 days a week.

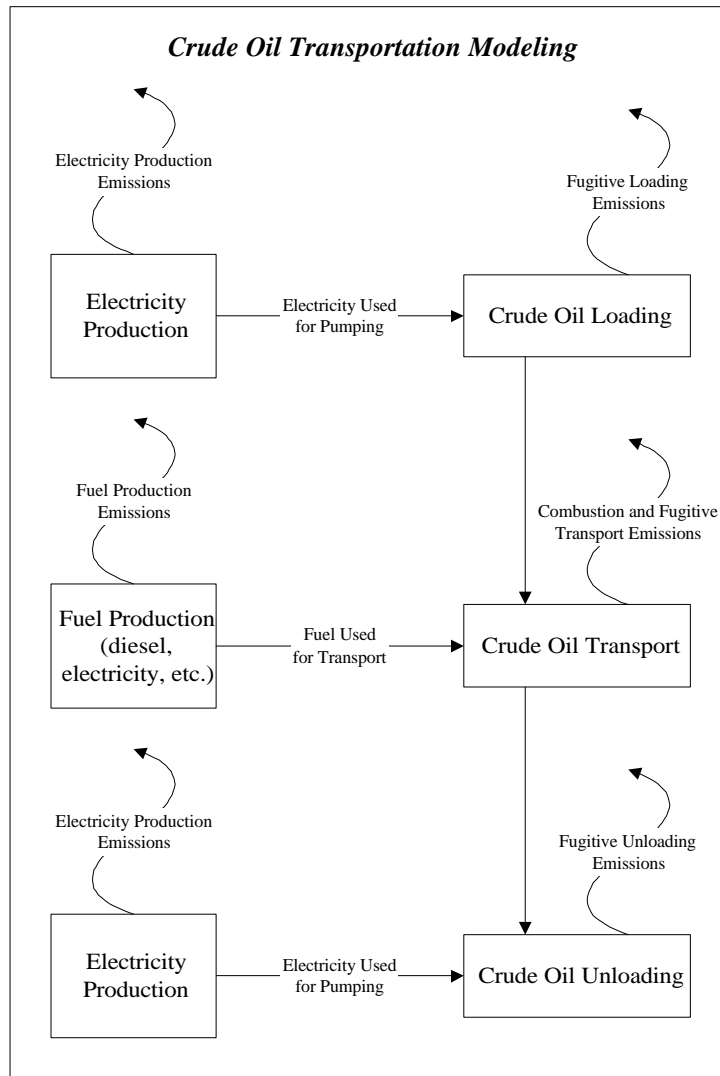

Figure 36: Contributions to Life Cycle Flows for Transport and Handling of Crude Oil

4.3.5 Crude Oil Transportation Results

Figure 37 and Figure 38 present schematics of the system modeled in the TEAM™ software for domestic and foreign crude oil transport, respectively. Table 35 and Table 36 show the corresponding LCI results for domestic and foreign crude oil, respectively, for the transport of 1 kg of crude oil to a generic U.S. refinery location.

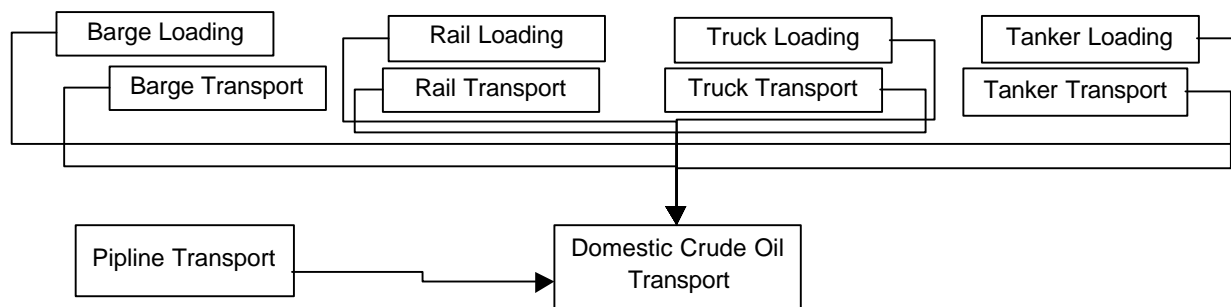

Figure 37: Schematic of TEAM™ Model Inputs to Domestic Oil Transport

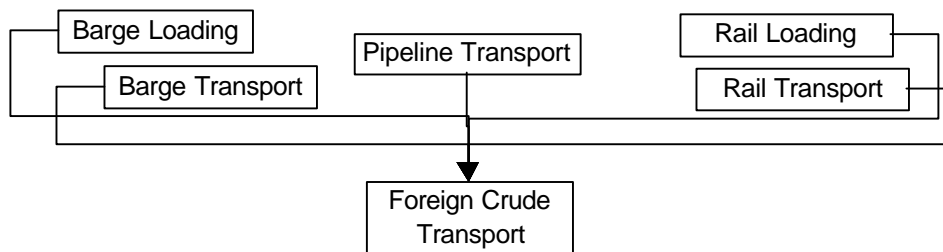

Figure 38: Schematic of TEAM Model Inputs to Foreign Oil Transport

Table 35: LCI Results for Domestic Crude Oil Transportation (for 1 kg of crude oil)

	Units	Domestic Crude Oil Transport (Total)	Tanker Loading	Tanker Transport	Barge Loading	Barge Transport	Railcar Loading	Rail Transport	Truck Loading	Truck Transport	Pipeline Transport
Raw Materials											
Coal (in ground)	kg	0.003654	4.89E-08	4.03E-05	2.75E-08	3.18E-06	1.74E-08	1.00E-05	2.44E-08	9.63E-06	0.003591
Oil (in ground)	kg	0.002149	1.68E-09	0.001292	9.48E-10	0.000102	5.99E-10	0.000322	8.40E-10	0.000309	0.000124
Natural Gas (in ground)	kg	0.000568	5.37E-09	0.000111	3.02E-09	8.76E-06	1.91E-09	2.77E-05	2.68E-09	2.65E-05	0.000394
Uranium (U, ore)	kg	8.76E-08	1.17E-12	9.61E-10	6.60E-13	7.59E-11	4.17E-13	2.39E-10	5.85E-13	2.30E-10	8.61E-08
Phosphate Rock (in ground)	kg	0	0	0	0	0	0	0	0	0	0
Potash (K ₂ O, in ground)	kg	0	0	0	0	0	0	0	0	0	0
Perlite (SiO ₂ , ore)	kg	4.60E-07	0	2.94E-07	0	2.32E-08	0	7.32E-08	0	7.02E-08	0
Limestone (CaCO ₃ , in ground)	kg	0.000697	9.33E-09	7.65E-06	5.25E-09	6.04E-07	3.32E-09	1.91E-06	4.66E-09	1.83E-06	0.000685
Sodium Chloride (NaCl)	kg	0	0	0	0	0	0	0	0	0	0
Water Used (total)	liter	0.000392	1.50E-09	0.000180	8.46E-10	1.42E-05	5.34E-10	4.48E-05	7.50E-10	4.30E-05	0.000110
Air Emissions											
Carbon Dioxide (CO ₂ , fossil)	g	17.8928	0.000152	4.31102	8.53E-05	0.343858	5.39E-05	1.08413	7.56E-05	1.02877	11.1247
Carbon Dioxide (CO ₂ , biomass)	g	0	0	0	0	0	0	0	0	0	0
Methane (CH ₄)	g	0.029077	3.65E-07	0.001388	2.06E-07	0.000110	1.30E-07	0.000390	1.82E-07	0.000369	0.026820
Nitrous Oxide (N ₂ O)	g	0.000369	2.80E-09	4.64E-05	1.58E-09	3.66E-06	9.95E-10	1.16E-05	1.40E-09	0.000102	0.000205
Carbon Monoxide (CO)	g	0.011651	3.36E-08	0.000930	1.89E-08	0.001148	1.19E-08	0.003618	1.68E-08	0.003490	0.002465
Hydrocarbons (except	g	0.001129	1.23E-09	0.000216	6.92E-10	1.71E-05	4.37E-10	5.40E-05	6.13E-10	0.000751	0.000090
Hydrocarbons (unspecified)	g	0.111550	0.033145	0.020609	0.018665	0.001493	0.014540	0.001995	0.020402	0.000407	0.000293
Benzene	g	4.54E-07	0	2.90E-07	0	2.29E-08	0	7.22E-08	0	6.93E-08	0
Formaldehyde	g	6.08E-06	7.89E-18	3.88E-06	4.44E-18	3.06E-07	2.81E-18	9.67E-07	3.94E-18	9.28E-07	5.79E-13
Particulates (PM10)	g	0.001744	0	0	0	0.000139	0	0.000438	0	0.001167	0
Particulates (unspecified)	g	0.054249	6.88E-07	0.003192	3.88E-07	7.25E-05	2.45E-07	0.000229	3.44E-07	0.000220	0.050534
Sulfur Oxides (SO _x as SO ₂)	g	0.121741	8.64E-07	0.054722	4.87E-07	0.000500	3.07E-07	0.001578	4.31E-07	0.001515	0.063424
Nitrogen Oxides (NO _x)	g	0.072804	4.70E-07	0.005058	2.65E-07	0.005673	1.67E-07	0.017883	2.35E-07	0.009680	0.034510
Hydrogen Chloride (HCl)	g	0.001972	2.64E-08	2.16E-05	1.49E-08	1.71E-06	9.39E-09	5.39E-06	1.32E-08	5.17E-06	0.001938
Hydrogen Fluoride (HF)	g	0.000246	3.30E-09	2.71E-06	1.86E-09	2.14E-07	1.17E-09	6.74E-07	1.65E-09	6.46E-07	0.000242
Ammonia (NH ₃)	g	2.02E-08	1.80E-13	4.01E-09	1.01E-13	3.17E-10	6.40E-14	1.37E-09	8.98E-14	1.32E-09	1.32E-08
Water Emissions											
Agrochemicals (unspecified)	g	0	0	0	0	0	0	0	0	0	0
BOD5 (Biochemical Oxygen Demand)	g	0.001405	6.32E-10	0.000867	3.56E-10	6.84E-05	2.25E-10	0.000216	3.15E-10	0.000207	4.64E-05
COD (Chemical Oxygen Demand)	g	0.011886	5.35E-09	0.007335	3.01E-09	0.000579	1.90E-09	0.001828	2.67E-09	0.001753	0.000393
Metals (unspecified)	g	5.91E-05	3.99E-11	3.58E-05	2.25E-11	2.83E-06	1.42E-11	8.93E-06	1.99E-11	8.57E-06	2.93E-06
Ammonia (NH ₄ ⁺ , NH ₃ , as N)	g	0.000210	1.56E-10	0.000127	8.80E-11	1.00E-05	5.56E-11	3.16E-05	7.80E-11	3.03E-05	1.15E-05
Nitrates (NO ₃ ⁻)	g	3.12E-06	4.18E-11	3.43E-08	2.35E-11	2.71E-09	1.49E-11	8.54E-09	2.09E-11	8.19E-09	3.07E-06
Solid Waste (hazardous)	kg	4.57E-06	2.06E-12	2.82E-06	1.16E-12	2.23E-07	7.32E-13	7.03E-07	1.03E-12	6.74E-07	1.51E-07
Solid Waste (non-hazardous)	kg	0.001345	1.79E-08	1.93E-05	1.01E-08	1.52E-06	6.37E-09	4.81E-06	8.94E-09	4.62E-06	0.001314
Total Primary Energy	MJ	0.271239	2.40E-06	0.059959	1.35E-06	0.004732	8.55E-07	0.015362	1.20E-06	0.014732	0.176448
Fossil Energy	MJ	0.265639	2.33E-06	0.059897	1.31E-06	0.004727	8.28E-07	0.015347	1.16E-06	0.014718	0.170944
Fuel Energy per kg of Crude Oil	MJ	42.54	-	-	-	-	-	-	-	-	-

Table 36: LCI Results for Foreign Crude Oil Transportation (for 1 kg of crude oil)

	Units	Foreign Crude Oil Transport (Total)	Tanker Loading	Tanker Transport	Barge Loading	Barge Transport	Railcar Loading	Rail Transport	Pipeline Transport
Raw Materials									
Coal (in ground)	kg	0.0041165	3.40E-07	0.0006134	1.30E-08	1.50E-06	2.35E-11	1.36E-08	0.0035012
Oil (in ground)	kg	0.0198367	1.17E-08	0.0196678	4.46E-10	4.80E-05	8.10E-13	4.36E-07	0.0001205
Natural Gas (in ground)	kg	0.0020772	3.73E-08	0.0016889	1.42E-09	4.12E-06	2.58E-12	3.74E-08	0.000384
Uranium (U, ore)	kg	9.86E-08	8.15E-12	1.46E-08	3.11E-13	3.57E-11	5.64E-16	3.24E-13	8.39E-08
Phosphate Rock (in ground)	kg	0	0	0	0	0	0	0	0
Potash (K ₂ O, in ground)	kg	0	0	0	0	0	0	0	0
Perlite (SiO ₂ , ore)	kg	4.48E-06	0	4.47E-06	0	1.09E-08	0	9.91E-11	0
Limestone (CaCO ₃ , in ground)	kg	0.0007844	6.49E-08	0.0001164	2.47E-09	2.84E-07	4.49E-12	2.58E-09	0.0006676
Sodium Chloride (NaCl)	kg	0	0	0	0	0	0	0	0
Water Used (total)	liter	0.0028514	1.04E-08	0.0027371	3.98E-10	6.68E-06	7.23E-13	6.06E-08	0.0001075
Air Emissions									
Carbon Dioxide (CO ₂ , fossil)	g	76.6231	0.0010541	65.6117	4.02E-05	0.161937	7.30E-08	0.0014671	10.8469
Carbon Dioxide (CO ₂ , biomass)	g	0	0	0	0	0	0	0	0
Methane (CH ₄)	g	0.0473333	2.54E-06	0.0211286	9.69E-08	5.16E-05	1.76E-10	5.27E-07	0.02615
Nitrous Oxide (N ₂ O)	g	0.0009081	1.95E-08	0.000706	7.42E-10	1.72E-06	1.35E-12	1.56E-08	0.0002003
Carbon Monoxide (CO)	g	0.0171105	2.34E-07	0.0141615	8.90E-09	0.0005406	1.62E-11	4.90E-06	0.0024033
Hydrocarbons (except methane)	g	0.0033896	8.55E-09	0.0032936	3.26E-10	8.04E-06	5.92E-13	7.31E-08	8.80E-05
Hydrocarbons (unspecified)	g	0.61238	0.230553	0.371922	0.0087901	0.000806	1.97E-05	2.93E-06	0.0002861
Benzene	g	4.42E-06	0	4.41E-06	0	1.08E-08	0	9.77E-11	0
Formaldehyde	g	5.92E-05	5.49E-17	5.91E-05	2.09E-18	1.44E-07	3.80E-21	1.31E-09	5.65E-13
Particulates (PM10)	g	6.61E-05	0	0	0	6.55E-05	0	5.93E-07	0
Particulates (unspecified)	g	0.0978977	4.79E-06	0.0485863	1.83E-07	3.42E-05	3.31E-10	3.10E-07	0.0492719
Sulfur Oxides (SO _x as SO ₂)	g	0.894921	6.01E-06	0.832837	2.29E-07	0.0002354	4.16E-10	2.14E-06	0.06184
Nitrogen Oxides (NO _x as NO ₂)	g	0.113323	3.27E-06	0.0769758	1.25E-07	0.0026716	2.26E-10	2.42E-05	0.0336481
Hydrogen Chloride (HCl)	g	0.0022197	1.84E-07	0.0003294	7.00E-09	8.04E-07	1.27E-11	7.30E-09	0.0018893
Hydrogen Fluoride (HF)	g	0.0002775	2.30E-08	4.12E-05	8.75E-10	1.01E-07	1.59E-12	9.12E-10	0.0002362
Ammonia (NH ₃)	g	7.41E-08	1.25E-12	6.10E-08	4.77E-14	1.49E-10	8.66E-17	1.86E-12	1.29E-08
Water Emissions									
Agrochemicals (unspecified)	g	0	0	0	0	0	0	0	0
BOD5 (Biochemical Oxygen Demand)	g	0.0132701	4.40E-09	0.0131924	1.68E-10	3.22E-05	3.04E-13	2.92E-07	4.52E-05
COD (Chemical Oxygen Demand)	g	0.112286	3.72E-08	0.111628	1.42E-09	0.0002726	2.57E-12	2.47E-06	0.0003828
Metals (unspecified)	g	0.0005498	2.78E-10	0.0005456	1.06E-11	1.33E-06	1.92E-14	1.21E-08	2.86E-06
Ammonia (NH ₄ ⁺ , NH ₃ , as N)	g	0.0019448	1.09E-09	0.0019289	4.14E-11	4.71E-06	7.52E-14	4.27E-08	1.12E-05
Nitrates (NO ₃ ⁻)	g	3.52E-06	2.91E-10	5.22E-07	1.11E-11	1.27E-09	2.01E-14	1.16E-11	2.99E-06
Solid Waste (hazardous)	kg	4.32E-05	1.43E-11	4.29E-05	5.45E-13	1.05E-07	9.90E-16	9.51E-10	1.47E-07
Solid Waste (non-hazardous)	kg	0.0015762	1.25E-07	0.000294	4.75E-09	7.18E-07	8.62E-12	6.51E-09	0.0012814
Total Primary Energy	MJ	1.08685	1.67E-05	0.912542	6.37E-07	0.0022286	1.16E-09	2.08E-05	0.172042
Fossil Energy	MJ	1.08055	1.62E-05	0.911607	6.18E-07	0.0022263	1.12E-09	2.08E-05	0.166676
Fuel Energy per kg of Crude Oil	MJ	42.54	-	-	-	-	-	-	-

4.4 Crude Oil Refining

The modeling of crude oil production and transportation to a refinery have been described in the previous sections. This section describes the system of refining crude oil into #2 low-sulfur diesel fuel as shown in Figure 39:

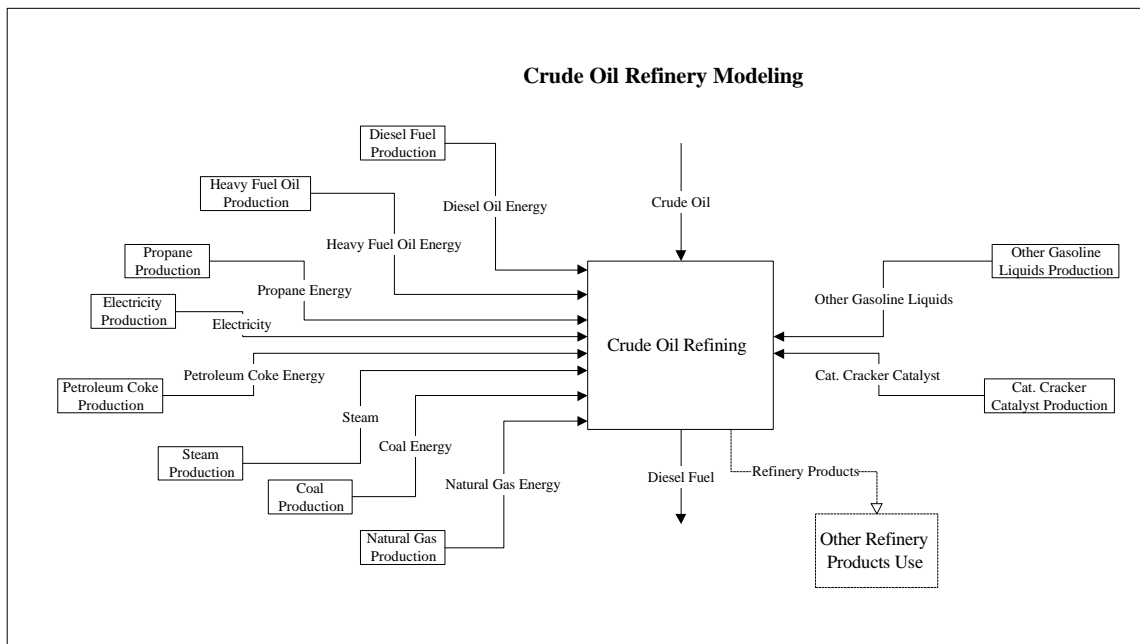

Figure 39: Petroleum Refining System Description

The model of petroleum refining is based on the U.S. refining averaged performance as opposed to a PADD-specific refinery. Therefore, the size and complexity of various refineries in various PADDs are not taken into account.

EIA data from Table 2 (U.S. Supply, Disposition, and Ending Stocks of Crude Oil and Petroleum Products 1994) of the Petroleum Supply Annual 1994, vol. 1, were used to establish the volumetric flows for the U.S. refining industry. The assumed specific gravities were used to close the mass balance. The energy of the streams were estimated and cooling water loss was calculated. The closure of the energy balance was checked. The crude efficiency and thermal efficiency were calculated.

Table 37 presents the assumptions and calculations used to close the mass and energy balance for the U.S. 1994 EIA refining data. To accomplish this, the EIA volumetric data were converted to masses using input and product densities obtained from the literature for the streams. The energy flows were estimated from the same densities. Heat rejection to cooling water was based on published literature values.

Table 37: Mass and Energy Balance Calculations for an Average U.S. Refinery

M.S. Graboski								
1994 EIA Based U.S. Refinery Mass and Energy Balance Spreadsheet Model								
Sep-97								
Energy Contents of Fuels on a HHV Basis. Adjusted to LHV								
			Refinery Production			Refinery Inputs		
	spg	MJ/liter	Liters	kg	MJ	Liters	kg	MJ
Crude	0.87	39	0	0	0	8.0 E+11	7.0 E+11	3.2 E+13
Imported Energy								1.4 E+12
Natural gas liquids	0.55	25	3.5 E+10	2.0 E+10	8.9 E+11	2.7 E+10	1.5 E+10	6.8 E+11
Other Liquids	0.72	28	0	0	0	4.0 E+10	2.9 E+10	1.1 E+12
Gasoline	0.72	34	4.2 E+11	3.0 E+11	1.4 E+13	0	0	0
Jet + Kerosene	0.81	37	8.7 E+10	7.1 E+10	3.3 E+12	0	0	0
Low sulfur distillate	0.86	39	1.1 E+11	9.1 E+10	4.1 E+12	0	0	0
High sulfur distillate	0.86	39	8.0 E+10	6.9 E+10	3.1 E+12	0	0	0
Residual fuel oil	0.88	40	4.8 E+10	4.2 E+10	1.9 E+12	0	0	0
Coke		40	3.6 E+10	4.1 E+10	1.4 E+12	0	0	0
Special Oils & Lubes	0.90	40	3.7 E+10	3.3 E+10	1.5 E+12		0	0
Waxes, Asphalt, Road Oils	1.0	43	3.0 E+10	3.0 E+10	1.3 E+12		0	0
Miscellaneous	0.90	40	2.8 E+09	2.5 E+09	1.1 E+11		0	0
			8.8 E+11	7.0 E+11	3.2 E+13	8.7 E+11		
Still gas	0.73	40	3.8 E+10	2.8 E+10	1.5 E+12			
Catalyst Carbon		40	1.3 E+10	1.5 E+10	5.1 E+11			
Heat loss, cooling water					8.4 E+11			
Grand Total Inputs & Outputs			9.2 E+11	7.4 E+11	3.5 E+13		7.4 E+11	3.5 E+13
% Thermal inputs, output basis					10.6%			
% Losses, output basis				5.72%	13.2%			
Energy loss MJ/liter product					5.2			
Net product (less pass through)				7.0 E+11				
Process Energy Inputs								
	Liters							
LPG	1.6 E+09							
Distillate	7.9 E+07							
Resid	1.5 E+09							
Still Gas	3.7 E+10							
Coke	4.4 E+08							
Catalyst Carbon	1.3 E+10							
Natural Gas	1.9 E+10							
Coal	8.2 E+07							
Electricity	1.1 E+10							
Steam	9.5 E+08							
Hydrogen	0							
Other	2.2 E+08							
Energy Imports	3.5 E+10							
Total Energy	8.5 E+10							
Energy Imports MJ	1.4 E+12							
Total Energy MJ	3.4 E+12							
Total Cooling Water liter/bbl crude	4738.82							
MJ/BB1 crude @ 15F rise	165							

Crude gravity was assumed to be 32° API from Bonner and Moore, Refinery Economics Short Course Text, Feb 1994. Product densities were estimated for all streams from Bonner and Moore except coke, where the EIA definition of 5 bbl/ton was used. The heating value of a fuel oil equivalent of 6 MM Btu/bbl was used for refinery energy consumption data. Natural gas was assumed to have 1012 Btu/scf. Coal was assumed to be 24 MM Btu/ton. NBS Misc Pub 97 was used to estimate the heats of all petroleum materials below 50° API. Gasoline heating value was estimated from ANL/ESD-28 table 3.5 adjusted for higher heating value for summer reformulated gasoline. Other liquids, oxygenates and

natural gasoline were assumed to have a gravity equal to gasoline and a heating value typical of oxygenates. Unfinished oils were assumed to be fuel oil. Still gas mass was estimated assuming 23,500 Btu/lb for the gas (about 75% CH₄), using 19350 Btu/lb and 0.887 spg for the fuel oil equivalent barrel. The plant heat loss to cooling water was estimated from Gary and Handwerk, Petroleum Refining Technology and Economics, 3rd Edition, Marcel Dekker, NY, 1994. The authors provide a case study for a 100,000 bbl/day refinery of moderate complexity. The total reported cooling water duty is 1,252 gal/bbl crude fed at 30°F temperature rise. Fifty percent of the duty is used for boiler feed water heating. It is assumed that plant convective and radiation heat losses are negligible. Electricity was charged at 3413 Btu/kWh.

The mass balance closes to within 0.5%. Still gas and catalyst coke are burned in the plant and thus do not show up as useful products. The indicated crude in is 105.56% of the products on a fuel oil equivalent basis.

The energy balance closes to within 0.3%. The energy inputs plus recycled still gas and coke amount to about 9.7 % of the energy of the useful products out. The energy balance suggests that an additional 2.6% is heat losses from the plant in cooling water. Thus the amount of energy consumed per gallon of low-sulfur diesel is 17,292 Btu.

As a result of this analysis, the amount of crude to the refinery needs to be increased by 5.56% to cover mass losses in still gas and catalyst coke. This affects upstream recovery and transportation.

Using energy consumption data, thermal inputs to the plant amounted to about 9.7% of the distillate product. Counting losses, the total energy is 12.3% of the distillate product.

4.4.1 Material Use

The material requirements assumed in this study of petroleum refining include the crude oil plus other petroleum based feedstocks, purchased energy inputs, and process catalysts. Process catalysts are limited to cracking catalyst as shown in Figure 39³⁸.

The amounts of crude oil and other petroleum based feedstocks required are taken from the total inputs to all U.S. refineries from EIA, Petroleum Supply Annual (1994) as shown in the mass balance. The EIA report lists the total U.S. refinery inputs of crude oil, other gasoline liquids, and unfinished oils for 1994. Table 38 provides the estimated materials input to all U.S. refineries. Unfinished oils are added to the total for crude oil input in this analysis. The LCI results for the production of the other gasoline liquids are from Ecobalance's database and assumed to be produced from natural gas. The amount of crude to the refinery is increased by 5.56% to cover mass losses in still gas and catalyst coke.

Table 38: Material Requirements for an Average U.S. Refinery

<i>Flow Name</i>	<i>Units</i>	<i>Value per Year</i>
Crude Oil	kg	6.95E+11
Other Gasoline Liquids	kg	7.90E+09
Unfinished Oils	kg	2.24E+10

³⁸ Import of hydrogen is not accounted for in this model. It is assumed that all of the hydrogen used is produced within the refinery. Therefore, the energy required by the refinery accounts for this hydrogen production.

The amount of cracking catalyst required is based on the uncontrolled particulate emissions from the catalytic cracker. It is assumed that all the particulate produced by the catalytic cracker results from the loss of the catalyst. Therefore, the lost catalyst needs to be made up with additional inputs. Based EPA AP-42 data for uncontrolled particulate emissions from catalytic cracking, 0.566 g of catalyst is required per liter of crude oil through the catalytic cracking units. Other catalyst inputs are much smaller than the cracking catalyst and are ignored in this analysis. The LCI associated with producing cracking catalyst is taken from Ecobalance's database based on a Zeolite catalyst.

4.4.2 Energy/Equipment Use

Petroleum refineries draw most of their energy from the crude oil stream. However, additional energy requirements and process needs are fulfilled through the following inputs summarized in Table 39. The same inputs are also shown in Figure 39 and the mass and energy balance in Table 37.

Table 39: Material Requirements for an Average U.S. Refinery

<i>Flow Name</i>	<i>Units</i>	<i>Value per Year</i>
Natural Gas	MJ	7.66E+11
Coal	MJ	3.27E+09
Steam	MJ	3.8E+10
Electricity	MJ elec.	1.43E+11
Propane (C ₃ H ₈ , kg)	MJ	6.21E+10
Diesel Oil (kg)	MJ	3.16E+09
Heavy Fuel Oil	MJ	6.13E+10
Coke	MJ	1.77E+10
Other	MJ	8.8E+09

The numbers shown are averages based on the total U.S. consumption of fuels at all refineries. Consistent with this generic approach to describing a U.S. refinery, we assume that electricity is supplied by a generic (national average) U.S. grid. The production of propane, diesel oil, heavy fuel oil, and coke could actually happen inside the refinery from the crude oil stream. However, EIA reports them as if they are imported. This approach accounts for the energy and emissions needed to produce the fuels. In addition to the fuels listed in the table above, the refinery also draws energy directly from the crude oil stream as shown in Table 40. The production of these fuels is assumed to be accounted for in the emissions and energy requirements of the refinery modeled here.

Table 40: Internal Energy Use for an Average U.S. Refinery

<i>Flow Name</i>	<i>Units</i>	<i>Value per Year</i>
Still Gas	MJ	1.52E+12
Catalyst Coke	MJ	5.14E+11

4.4.3 Process Emissions

Emissions from crude oil refining include air emissions, water effluents, and solid waste. The following sections describe how each is modeled from crude oil refining.

4.4.3.1 Air Emissions

Air emissions from crude oil refining are assumed to come from three sources:

- Fuel combustion
- Process emissions
- Fugitive emissions.

Fuel combustion emissions are based on the amount and types of fuels consumed (as shown in Section 4.4.2) and emission factors for specific combustion devices. All the fuels used in the refinery are assumed to be combusted in industrial boilers³⁹. The associated emission factors that were assumed for an industrial boiler burning each type of fuels used in a generic U.S. refinery are shown in Appendix A.

The emissions for electricity production are based on Ecobalance's database DEAMTM for the standard U.S. electricity grid. Emissions for purchased steam production are based on Ecobalance's database DEAMTM for the production of steam from natural gas.

Process emissions for a petroleum refinery are based on emission factors published in EPA AP-42 fifth edition (Air Chief 1995). The emission factors for petroleum refining processes are shown in Table 41.

Some assumptions have been made to arrive at the numbers shown in Table 41. Catalytic cracking input is assumed to be a 80/20 split between fluid catalytic cracking (FCC) and moving bed catalytic cracking units. All catalytic cracking units are assumed to have a CO boiler and electrostatic precipitator installed. CO and HC burned in the CO boiler are assumed to be converted to CO₂. A vapor recovery and flaring system is assumed to be installed to control the emissions from the blowdown system. Blowdown HC emissions are assumed to be converted to CO₂. The amount of HC produced is based on the emissions from one refinery in Yorktown, Virginia (Amoco/EPA 1992). Based on the Amoco/EPA study, 1.86 g of HC emissions are produced per kg of crude oil into the refinery. If a 75% carbon content is assumed for the HC emissions, 5.11 g of CO₂ is produced per kg of crude oil into the refinery

Emissions from the vacuum distillation column are assumed to be negligible. A Claus recovery plant is assumed to recover 98.6% of sulfur in tail gas and have controlled emissions. This is the highest rate listed by EPA AP-42 fifth edition (Air Chief 1995) for sulfur recovery this corresponds to an emission factor of 29 g of SO_x per kg of sulfur produced.

Flows associated with the petroleum refinery processes are taken from EIA Petroleum Supply Annual (1994), and are shown in Table 42.

Fugitive emissions for a petroleum refinery are based on the emissions from one refinery in Yorktown, Virginia (Amoco/EPA 1992)⁴⁰. Based on the Amoco/EPA study, 0.97 g of THC emissions are produced per kg of crude oil into the refinery. .

³⁹ Some of the natural gas imported to the refinery is used to produce hydrogen. Therefore, assuming the emissions from combustion of all the natural gas in an industrial boiler may overestimate the emissions of the refinery somewhat. This will only affect the combustion-related emissions of NO_x, CO, TPM, and THC as hydrogen production still produces CO₂.

⁴⁰ Basing fugitive emissions on only one site is admittedly a problem. We were unable to find any other data on fugitive emissions. This is an area where future work is needed to improve the quality of the model.

Table 41: Petroleum Refining Process Emissions

Process	Emission Factors					
	Particulate	SO ₂	CO	Non-Methane Hydrocarbons	NO ₂	CO ₂
Catalytic Cracking (g/L crackers feed)	0.052	0.79	--	--	0.11	40.7
Fluid Coking (g/L cokers feed)	1.5	--	--	--	--	--
Vapor Recovery/Flare (g/L refinery feed)	--	0.077	0.012	0.002	0.054	--
Sulfur Recovery (g/kg sulfur produced)	--	29	--	--	--	--

Table 42: Refinery Process Flows

Process	Associated flow
Catalytic Cracking	2.8 x 10 ¹¹ (L feed/yr)
Fluid Coking	8.9 x 10 ¹⁰ (L feed/yr)
Vapor Recovery/Flare	8.4 x 10 ¹¹ (L refinery feed/yr)
Sulfur Recovery	8.2 x 10 ⁹ (kg sulfur produced/yr)

4.4.3.2 Water Effluents

Water effluents from the refinery are based on the total amount of wastewater produced and the composition of the wastewater.

Wastewater volume produced by the refinery is calculated using Table 43 (EPA 1985). Wastewater composition in milligram per liter (mg/L) is given in Table 44 (DOE 1988).

4.4.3.3 Solid Waste

Solid waste is computed from factors given in a recent study of refinery generation of solid waste (API 1991). The study gave totals for hazardous and nonhazardous wastes as shown in Table 45.

Table 43: Wastewater Production in Crude Oil Refineries

Wastewater Source	Emission Factor (gal/bbl)	Crude oil (bbl/yr)	Gal/yr	L/yr
Crude Oil Storage, Desalting, and Atmospheric Distillation	4.4	5.06×10^9	2.23×10^{10}	8.43×10^{10}
Gases Water Wash	3.3	5.06×10^9	1.67×10^{10}	6.32×10^{10}
Vacuum Distillation	7.3	2.53×10^9	1.85×10^{10}	6.99×10^{10}
Light Hydrocarbon Hydrodesulfurization	1.9	9.49×10^8	1.80×10^9	6.82×10^9
Middle Distillates Hydrotreating	5.2	3.58×10^9	1.86×10^{10}	7.04×10^{10}
Catalytic Cracking	9.5	1.77×10^9	1.68×10^{10}	6.37×10^{10}
Hydrocracking	4.5	3.67×10^8	1.65×10^9	6.25×10^9
Coking	6.4	5.62×10^8	3.60×10^9	1.36×10^{10}

Table 44: Crude Oil Refinery Wastewater Composition

Pollutant	Concentration (mg/L)
BOD	1,300
COD	11,000
TOC	9,200
TSS	5,900
Ammonia Nitrogen	190
Phenols	25
Sulfides	--
Oil and Grease	500
Total Chromium	16

Table 45: Solid Waste Produced from Crude Oil Refining

Type of Waste	Amount of Waste (kg/yr)
Hazardous	1.6×10^9
Nonhazardous	2.6×10^9

4.4.4 Diesel Fuel Production

Petroleum refineries produce a number of products from the crude oil they receive. This study is concerned with one specific product, #2 low-sulfur diesel fuel. Therefore, a method of allocating total refinery energy use and total refinery emissions between #2 low-sulfur diesel fuel and the other products needs to be developed.

The simplest allocation procedure (and the baseline case for this study) is to allocate total refinery inputs and releases among the products on a mass output basis. Table 46 outlines how this was done, based on the output of all U.S. refineries.

Table 46: Total U.S. Refinery Production (1994)

<i>Refinery Flow</i>	<i>Mass (kg/yr)</i>	<i>Mass (%)</i>
Diesel Oil (< 0.05% Sulfur, kg)	9.12E+10	13.4%
Diesel Oil (> 0.05% Sulfur, kg)	6.91E+10	10.1%
Gasoline	3.00E+11	44.0%
Heavy Fuel Oil	4.21E+10	6.17%
Jet Fuel (kg)	6.79E+10	9.95%
Kerosene (kg)	2.72E+09	0.40%
Misc. Refinery Products (kg)	2.50E+09	0.37%
Petroleum Coke (kg)	4.12E+10	6.04%
Liquefied Petroleum Gas	4.65E+09	0.68%
Asphalt (kg)	2.62E+10	3.83%
Lubricants (kg)	8.87E+09	1.30%
Petrochemical Feedstocks (kg)	2.18E+10	3.19%
Petroleum Waxes (kg)	1.21E+09	0.18%
Naphthas (kg)	2.76E+09	0.41%
Total:	6.83E+11	100%

Based on this table for crude oil refining, 13.4% of the total emissions, raw materials, and energy use required by the refinery are allocated to the production of low-sulfur diesel fuel. This approach ignores issues such as determining the contribution of inputs and releases that are uniquely associated with diesel versus the other refinery products, but it is consistent with the use of U.S. average data on refineries used in this analysis.

4.4.5 Crude Oil Refining Results

The schematic of the crude oil refinery system shown in Figure 39 corresponds to the system modeled using TEAM™. Table 47 shows the corresponding LCI results for crude oil refining for the production of 1 kg of diesel fuel.

Table 47: LCI Results for Crude Oil Refining (for 1 kg of diesel produced)

	Units	Diesel Fuel Production (Total)	Coal Use	Diesel Oil Use	Heavy Fuel Oil Use	Natural Gas Use	Petroleum Coke Use	Propane Use	Steam Production	Electricity Production: US Average	Catalytic Cracking Catalyst:	Other Gasoline Liquids:	Crude Oil Refining
Raw Materials													
Coal (in ground)	kg	0.01475	0.000164	1.38E-05	7.31E-05	3.94E-08	2.83E-05	3.19E-09	2.44E-09	0.0144671	8.03E-06	2.11E-08	0
Oil (in ground)	kg	0.00426	4.68E-07	0.000442	0.002344	5.13E-08	0.000970	4.16E-09	3.18E-09	0.0004977	5.55E-07	2.75E-08	0
Natural Gas (in ground)	kg	0.03938	5.71E-08	3.80E-05	0.000201	0.022298	8.31E-05	0.00180773	0.001383	0.0015869	2.69E-05	0.011958	0
Uranium (U, ore)	kg	3.50E-07	9.10E-12	3.29E-10	1.74E-09	9.43E-13	6.74E-10	7.65E-14	5.85E-14	3.47E-07	1.93E-10	5.06E-13	0
Phosphate Rock (in ground)	kg	0	0	0	0	0	0	0	0	0	0	0	0
Potash (K ₂ O, in ground)	kg	0	0	0	0	0	0	0	0	0	0	0	0
Perlite (SiO ₂ , ore)	kg	0.000246	0	1.01E-07	5.33E-07	0	2.21E-07	0	0	0	0.000245	0	0
Limestone (CaCO ₃ , in ground)	kg	0.002782	7.21E-08	2.62E-06	1.39E-05	7.46E-09	5.36E-06	6.05E-10	4.63E-10	0.002759	1.53E-06	4.00E-09	0
Sodium Chloride (NaCl)	kg	0	0	0	0	0	0	0	0	0	0	0	0
Water Used (total)	liter	0.000967	5.80E-08	6.16E-05	0.000326	6.33E-09	0.000135	5.13E-10	3.92E-10	0.000444	2.77E-07	3.39E-09	0
Air Emissions													
Carbon Dioxide (CO ₂ , fossil)	kg	360.415	0.435057	1.52636	8.09235	65.6713	2.7725	5.52474	4.07231	44.8195	0.088355	1.05594	226.357
Carbon Dioxide (CO ₂ , biomass)	kg	0	0	0	0	0	0	0	0	0	0	0	0
Methane (CH ₄)	kg	0.30982	0.001213	0.00048	0.00280	0.10837	0.001470	0.008808	0.0067200	0.10805	0.000187	0.058040	0.013687
Nitrous Oxide (N ₂ O)	kg	0.00728	9.17E-06	2.22E-05	0.00011	0.00030	8.41E-05	0.000179464	1.86E-05	0.00083	3.46E-06	4.04E-05	0.005678
Carbon Monoxide (CO)	kg	0.25025	0.001126	0.00046	0.00230	0.02192	0.006338	0.000755271	0.0013593	0.00993	3.22E-05	0.000288	0.205737
Hydrocarbons (except methane)	kg	0.00272	0.000130	8.60E-05	0.00047	0.00075	0.000864	1.54E-06	4.65E-05	0.00036	9.94E-07	1.02E-05	0
Hydrocarbons (unspecified)	kg	1.05653	2.46E-06	0.00058	0.00309	4.48E-07	0.001279	0.0002007	2.78E-08	0.00118	2.10E-06	2.40E-07	1.05019
Benzene	kg	8.43E-07	0	9.92E-08	5.26E-07	0	2.18E-07	0	0	0	0	0	0
Formaldehyde	kg	1.13E-05	5.44E-16	1.33E-06	7.04E-06	6.25E-17	2.92E-06	5.07E-18	3.88E-18	2.33E-12	1.30E-15	3.35E-17	0
Particulates (PM10)	kg	0.008464	0.000207	5.97E-05	0.00522	0.00158	0.001118	0.000182	9.77E-05	0	0	0	0
Particulates (unspecified)	kg	0.458895	6.80E-06	0.00031	0.00167	0.00004	0.00066	3.24E-06	2.48E-06	0.203592	0.000116	2.14E-05	0.2525
Sulfur Oxides (SO _x as SO ₂)	kg	2.554930	0.002509	0.00388	0.09925	0.50559	0.01736	0.041236	0.031352	0.255523	0.000734	0.270969	1.3265
Nitrogen Oxides (NO _x as NO ₂)	kg	0.753419	0.001269	0.00166	0.01789	0.08923	0.00781	0.006697	0.005533	0.139034	0.000377	0.0038615	0.4801
Hydrogen Chloride (HCl)	kg	0.007873	2.05E-07	7.41E-06	3.93E-05	2.12E-08	1.52E-05	1.72E-09	1.32E-09	0.007807	4.34E-06	1.14E-08	0
Hydrogen Fluoride (HF)	kg	0.000984	2.56E-08	9.26E-07	4.91E-06	2.65E-09	1.90E-06	2.15E-10	1.65E-10	0.000976	5.42E-07	1.42E-09	0
Ammonia (NH ₃)	kg	6.27E-08	1.09E-10	1.89E-09	7.28E-09	1.22E-11	1.72E-10	9.92E-13	7.59E-13	5.32E-08	2.97E-11	6.56E-12	0
Water Emissions													
Agrochemicals (unspecified)	kg	0	0	0	0	0	0	0	0	0	0	0	0
BOD5 (Biochemical Oxygen Demand)	kg	0.725045	1.92E-07	0.00030	0.001572	2.66E-08	0.00065	2.15E-09	1.65E-09	0.000187	2.08E-07	1.42E-08	0.72234
COD (Chemical Oxygen Demand)	kg	6.135	1.62E-06	0.00251	0.013305	2.25E-07	0.00551	1.82E-08	1.39E-08	0.001582	1.76E-06	1.21E-07	6.11209
Metals (unspecified)	kg	0.009006	1.13E-08	1.23E-05	6.50E-05	1.30E-09	2.69E-05	1.06E-10	8.09E-11	1.18E-05	1.32E-08	7.00E-10	0.00889
Ammonia (NH ₄ ⁺ , NH ₃ , as N)	kg	0.105987	2.85E-08	4.34E-05	0.000230	3.93E-09	9.52E-05	3.19E-10	2.44E-10	4.62E-05	4.08E-08	2.11E-09	0.10557
Nitrates (NO ₃ ⁻)	kg	1.25E-05	3.25E-10	1.17E-08	6.22E-08	3.36E-11	2.40E-08	2.73E-12	2.09E-12	1.24E-05	6.87E-09	1.80E-11	0
Solid Waste (hazardous)	kg	0.002360	6.23E-10	9.65E-07	5.12E-06	8.64E-11	2.12E-06	7.01E-12	5.36E-12	6.08E-07	6.76E-10	4.64E-11	0.00235
Solid Waste (non-hazardous)	kg	0.009212	3.86E-05	6.61E-06	3.50E-05	9.12E-08	1.38E-05	7.39E-09	5.65E-09	0.005295	3.37E-06	4.89E-08	0.00382
Total Primary Energy	MJ	2.828260	0.004846	0.02110	0.108766	1.15951	0.033651	0.094002	0.071902	0.710879	0.00176039	0.621839	0
Fossil Energy	MJ	2.805900	0.004845	0.02108	0.108655	1.15951	0.033608	0.094002	0.071902	0.688705	0.00174808	0.621839	0
Fuel Energy	MJ	43.5	-	-	-	-	-	-	-	-	-	-	-

4.5 Diesel Fuel Transport

Modeling the transportation of #2 low-sulfur diesel fuel to the point of use location (in this case the central fueling location of an urban bus fleet) is shown in Figure 40.

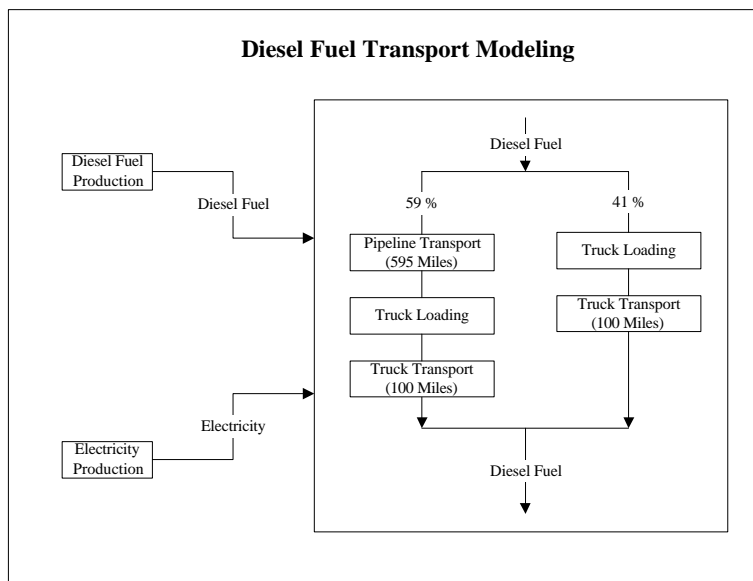

Figure 40: Diesel Fuel Transportation Modeling

4.5.1 Modes of Transport and Distance Transported

Diesel fuel is often transported from the refinery via trucks into the surrounding communities and shipped longer distances using product pipelines. The fraction of low-sulfur diesel fuel consumed locally was assumed to travel an average distance of 100 miles. The remaining fraction is shipped via pipeline to a tank farm, where it is in turn shipped by truck 100 miles to a point-of-use location.

The fraction of diesel fuel shipped via pipeline is based on Association of Oil Pipelines, using data from Annual Report (Form 6) of oil pipeline companies to the Federal Energy Regulatory Commission (FERC). The report lists the percentage of total finished petroleum products that are shipped by pipelines, water carriers, motor carriers, and railroads. The report states that 59% of the finished petroleum products are shipped via pipeline. The remaining 41% is assumed to be transported by truck.

The Association of Oil Pipelines report also provides estimates of the total ton-miles of finished petroleum products carried in domestic pipelines. Table 46 lists the total amount of petroleum products produced in the United States. It is assumed that 59% of these petroleum products are shipped via pipeline. Average pipeline transportation miles are calculated by dividing total ton-miles of petroleum products, carried in domestic pipelines, by tons of petroleum products shipped via pipeline. The result is 595 miles of pipeline transport.

The transportation models from DEAMTM are used to model energy requirements and emissions from the two types of transportation.

4.5.2 Energy and Fugitive Emissions from Storage and Handling

In addition to the energy requirements and subsequent emissions from the actual modes of transportation (e.g., truck diesel use and emissions, pipeline electricity requirements, and emissions from electricity production), energy and emissions are also caused by loading and unloading the diesel fuel.

The pumping requirements for diesel oil are calculated in the same method as for crude oil pumping (outlined in Section 4.3.4).

The fugitive emissions from loading, unloading, and transporting the diesel fuel are calculated using the same formulas as for the crude oil fugitive emissions (described in Section 4.3.4). The formulas are modified based on the diesel fuel properties (true vapor pressure, molecular weight of the vapors, etc.) as outlined in AP-42. Fugitive tank emissions from diesel fuel storage at the refinery are accounted for in the refinery model. Also, fugitive tank emissions from diesel fuel storage at the urban bus refueling location are assumed to be negligible.

Figure 41 represents how the emissions from diesel fuel transportation are modeled in this project.

4.5.3 Diesel Fuel Transportation Results

Table 48 shows the LCI results for diesel fuel transportation for the transport of 1 kg of diesel fuel.

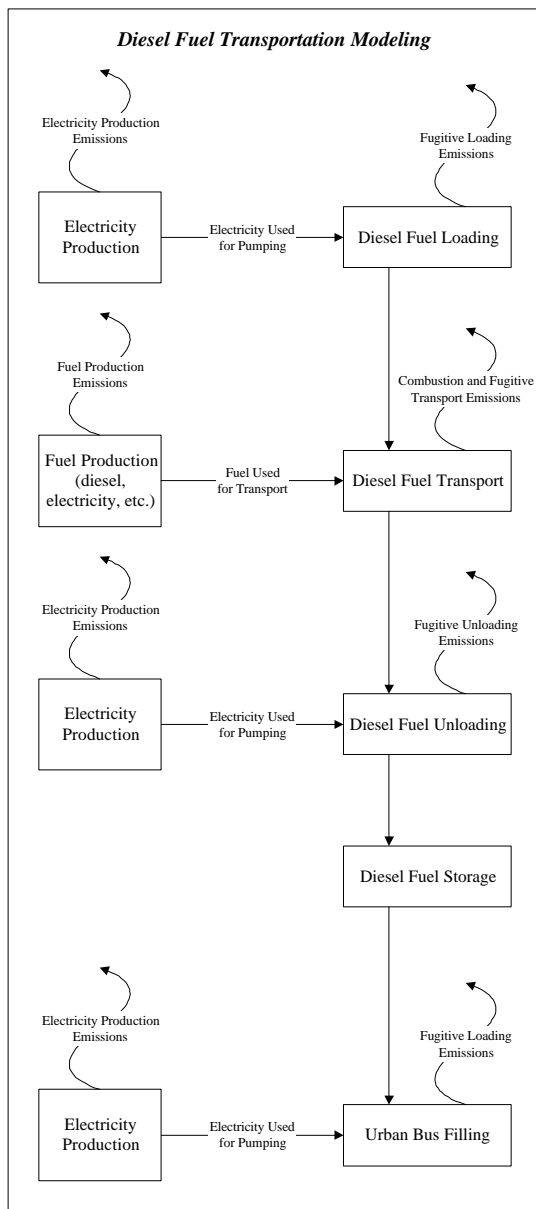

Figure 41: Diesel Fuel Transportation Modeling

Table 48: LCI Results for Diesel Fuel Transportation (for 1 kg of diesel fuel)

	Units	Diesel Fuel Transport (Total)	Truck Loading	Truck Transport	Pipeline Transport
Raw Materials					
Coal (in ground)	kg	0.00235	6.20E-07	0.00011	0.00224
Oil (in ground)	kg	0.00347	2.13E-08	0.00339	7.72E-05
Natural Gas (in ground)	kg	0.00054	6.80E-08	0.00029	0.00025
Uranium (U, ore)	kg	5.63E-08	1.49E-11	2.52E-09	5.38E-08
Phosphate Rock (in ground)	kg	0	0	0	0
Potash (K ₂ O, in ground)	kg	0	0	0	0
Perlite (SiO ₂ , ore)	kg	7.71E-07	0	7.71E-07	0
Limestone (CaCO ₃ , in ground)	kg	0.000448	1.18E-07	2.01E-05	0.000428
Sodium Chloride (NaCl)	kg	0	0	0	0
Water Used (total)	liter	0.000541	1.90E-08	0.000472	6.89E-05
Air Emissions					
Carbon Dioxide (CO ₂ , fossil)	g	18.259	0.001920	11.3028	6.95429
Carbon Dioxide (CO ₂ , biomass)	g	0	0	0	0
Methane (CH ₄)	g	0.020819	4.63E-06	0.00405	0.01677
Nitrous Oxide (N ₂ O)	g	0.001252	3.54E-08	0.00112	0.00013
Carbon Monoxide (CO)	g	0.039881	4.25E-07	0.03834	0.00154
Hydrocarbons (except methane)	g	0.008311	1.56E-08	0.00826	5.64E-05
Hydrocarbons (unspecified)	g	0.006885	0.002223	0.00448	0.0001834
Benzene	g	7.61E-07	0	7.61E-07	0
Formaldehyde	g	1.02E-05	1.00E-16	1.02E-05	3.62E-13
Particulates (PM10)	g	0.012817	0	0.012817	0
Particulates (unspecified)	g	0.034011	8.72E-06	0.002412	0.0315897
Sulfur Oxides (SO _x as SO ₂)	g	0.056308	1.09E-05	0.01665	0.0396474
Nitrogen Oxides (NO _x as NO ₂)	g	0.127928	5.96E-06	0.106349	0.0215728
Hydrogen Chloride (HCl)	g	0.001268	3.34E-07	5.68E-05	0.0012113
Hydrogen Fluoride (HF)	g	0.000159	4.18E-08	7.10E-06	0.0001514
Ammonia (NH ₃)	g	2.27E-08	2.28E-12	1.45E-08	8.26E-09
Water Emissions					
Agrochemicals (unspecified)	g	0	0	0	0
BOD5 (Biochemical Oxygen Demand)	g	0.002305	8.01E-09	0.002276	2.90E-05
COD (Chemical Oxygen Demand)	g	0.019501	6.77E-08	0.019255	0.0002454
Metals (unspecified)	g	9.59E-05	5.06E-10	9.41E-05	1.83E-06
Ammonia (NH ₄ ⁺ , NH ₃ , as N)	g	0.000340	1.98E-09	0.00033272	7.17E-06
Nitrates (NO ₃ ⁻)	g	2.01E-06	5.30E-10	9.00E-08	1.92E-06
Solid Waste (hazardous)	kg	7.50E-06	2.61E-11	7.41E-06	9.44E-08
Solid Waste (non-hazardous)	kg	0.00087	2.27E-07	5.07E-05	0.0008215
Total Primary Energy	MJ	0.27219	3.05E-05	0.161859	0.110301
Fossil Energy	MJ	0.26859	2.95E-05	0.161698	0.106861
Fuel Energy per kg of Diesel	MJ	42.5	-	-	-

5 Biodiesel Fuel Modeling

This section describes each phase of the life cycle for biodiesel production. Data and assumptions are described in the following sections:

- **5.1 Soybean Agriculture:** This section outlines the boundaries of this study, i.e., which data are included and omitted. This refers to the physical and geographic assumptions, as well as to the exclusion of secondary sources of data such as the production of capital equipment and data with high uncertainties.
- **5.2 Soybean Transport to Crusher:** This section describes the process flows associated with transporting soybeans to regional crushers.
- **5.3 Soybean Crushing:** This section explains how soybean crushing was modeled in the analysis. It includes assumptions and descriptions of process flows for soybean crushing.
- **5.4 Soybean Oil Transport:** This section explains how soybean oil and the biodiesel production and distribution industries are organized. It also includes assumptions and descriptions of process flows associated with soybean oil transportation.
- **5.5 Soybean Oil Conversion:** This section describes the modeling of soybean oil conversion to biodiesel.
- **5.6 Biodiesel Transport:** This section includes assumptions and descriptions of process flows associated with biodiesel transportation.

5.1 Soybean Agriculture

The agriculture part of this LCI study involves identifying the complete environmental flows associated with soybean production. This includes the amounts of chemicals and fuels used on the farm and their associated emissions, as well as the manufacturing, packaging, and processing of the inputs used to grow soybeans. For example, the energy required to mine, process, and transport potash fertilizer to the field is estimated. Also, the environmental flows and energy requirements involved in making and transporting pesticides, seed, and all other farm inputs are accounted for. These upstream environmental flows are combined with the flows associated with the actual soybean growing and harvesting to calculate the total emissions associated with soybean agriculture.

Figure 42 describes the modeling of soybean agriculture within the context of this LCA study.

The soybean agriculture block shown in Figure 42 represents the actual field or farm where soybeans are grown. The remaining 10 blocks represent the upstream flows associated with production of the agricultural inputs used to produce soybeans.

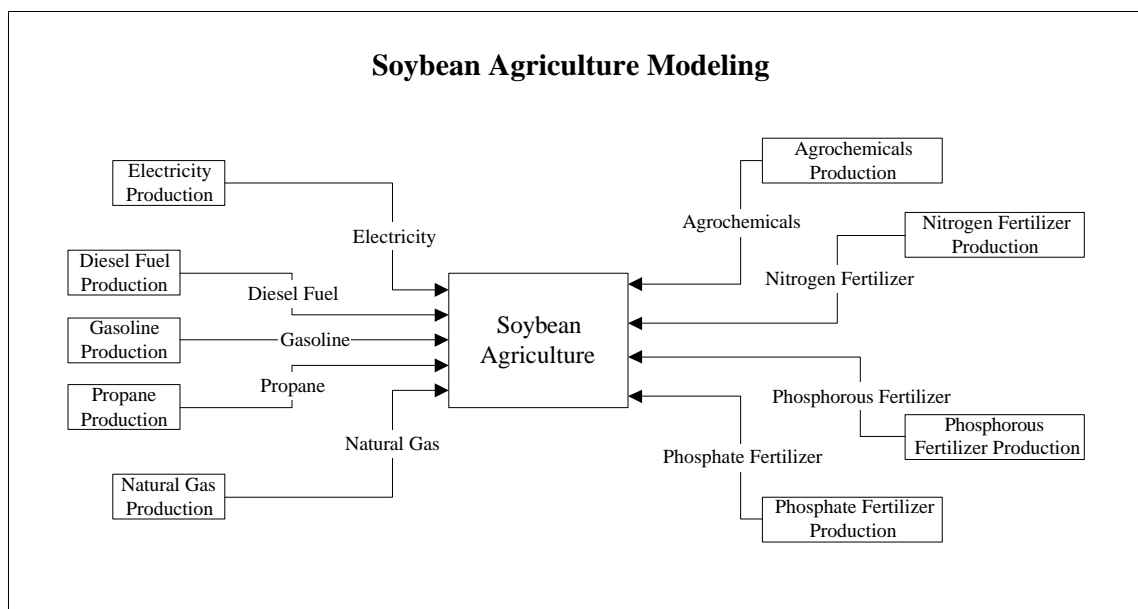

Figure 42: Soybean Agriculture System Modeling

5.1.1 Soybean Agriculture General Modeling Assumptions

The LCI models an agricultural system using current practices in agriculture. We assume that producing biodiesel from soybeans does not alter this baseline, i.e., near-term biodiesel production is too small to have any significant effect on soybean production, prices, or resource allocation. Soybeans are generally rotated with other crops, such as corn. Crop rotations help maintain soil moisture and fertility, reduce farm-level demand for fertilizer (Lin et al. 1995), and control insects, diseases, and weeds. However, our analysis is limited to a single growing season and adjustments related to the rotation sequence are *not* factored into input usage.

Another modeling assumption is made regarding plant uptake of CO₂. Plants use solar energy to fix carbon from CO₂ during photosynthesis. Soil insects (e.g., worms, mites, and centipedes) that feed on plant material or on other animals consume the biomass carbon. They eventually die and are added to the soil with the waste material of animals. All forms of dead organic materials are attacked by decomposers, mainly bacteria and fungi. Through enzymatic digestion, the carbon is returned to the atmosphere as CO₂ and energy is released as heat. Without decomposers to release fixed carbon, the atmosphere would become depleted of CO₂, life would cease, and the cycle would stop (Foth 1984).

In a sustainable agricultural system, there is no net CO₂ flux to the atmosphere from the soybean but there is a net CO₂ influx caused by the fossil-fuel inputs currently used to produce and process soybeans (Marland and Turhollow 1991).

We assumed that CO₂ uptake by the soybean plant is released back to the environment through decomposition of plant residue, left in the field after harvesting, or through the combustion of biodiesel made from soybeans. Thus, the net biomass-derived CO₂ balance for growing and burning soybean biodiesel is zero. CO₂ sequestered in the beans is carried through the LCA as CO₂ (biomass) versus CO₂ (fossil), which results from the combustion of petroleum resources, such as the methanol component of the biodiesel. Emissions and CO₂ releases from processing and producing farm inputs are accounted for separately (fossil CO₂) from the CO₂ sequestered and subsequently released from burning the biomass fraction of the biodiesel made from soybeans (biomass CO₂).

Process flows (energy requirements and environmental outflows) associated with the production of capital equipment used on soybean farms are not included in the LCI. This is consistent with the modeling of the petroleum fuel system in which capital equipment was excluded.

5.1.2 Soybean Agriculture Materials Consumption

Reliable data on farm inputs are required to estimate the LCI; current data must be used because U.S. agriculture is very dynamic. The most current source of farm input data for soybean production is from USDA's 1990 Farm Costs and Returns Survey (FCRS).

The FCRS is conducted annually by USDA's Economic Research Service (ERS) and USDA's National Agricultural Statistical Service (NASS). The commodity cost-of-production version of FCRS has questions about whole-farm expenses and detailed information about input use, field operations, and production costs of a particular crop.

A special soybean production questionnaire was included in the 1990 FCRS for 20 soybean-production states. The 1990 FCRS represents about 272,000 farms that planted soybeans on 44 million acres and produced 1.4 billion bushels, accounting for approximately 75% of the U.S. production of soybeans.

Data on inputs used to grow soybeans such as fertilizers, chemicals, liquid fuels, electricity, and natural gas are published by ERS (Ali and McBride). The yield data used in this study come from NASS. Ali and McBride report FCRS data on input use of soybean farms for the major soybean-producing states: Alabama, Arkansas, Georgia, Illinois, Indiana, Iowa, Kansas, Minnesota, Mississippi, Missouri, Nebraska, Ohio, South Carolina, and South Dakota. These 14 states account for 86% of soybean production. Soybeans produced in another 15 states account for most of the remaining soybean production in the United States.

Each of the 14 soybean-producing states considered in this study uses a certain amount of the materials and energy inputs (shown in Figure 42) to grow an amount of soybeans. Table 49 shows each input to the soybean agriculture system and associated yields for each of the 14 states considered in this study based on a per acre, per year consumption, and a weighted average.

5.1.2.1 Fertilizers and Agrochemicals

Soybeans remove essential minerals from the soil which must be replaced to maintain soil productivity. As a rule, soybeans remove about 0.9 lb (408 g) of phosphorus per bushel of beans harvested (Chapman and Carter 1976). Soybeans also use large amounts of potassium, removing about 1.2 lb (545 g) of potassium from the soil for each bushel of beans harvested (Chapman and Carter 1976). Nitrogen fertilizer is seldom required for successful soybean production because, like all members of the legume family, soybeans fix atmospheric nitrogen if the proper strain of *Rhizobium* bacteria is present in the soil or if the seed is properly inoculated (Chapman and Carter 1976). Thus, only small amounts of nitrogen fertilizer are used on U.S. soybeans.

The amount of fertilizer used per acre is given in the report by Ali and McBride for the 14 soybean-producing states considered in this study for the year 1990. The values are given in pounds of N, P₂O₅, and K₂O per acre for nitrogen, phosphorous, and potassium fertilizers, respectively. These values are then converted to kg per acre per year.

The small amount of nitrogen applied to soybeans is assumed to be in the form of ammonium nitrate (NH₄NO₃), phosphorous applied is assumed to be in the form of triple superphosphate (TSP), and potassium applied is assumed to be in the form of K₂O (Phosphate and Potash Institute 1996).

The production of these fertilizers (including energy requirements and emissions) is based on Ecobalance's LCA database DEAMTM as outlined in section 7.2.2 Fertilizers and Agrochemicals.

The actual amount of chemicals (e.g., pesticides and insecticides) applied to soybean acreage is not provided by Ali and McBride. However, they do report information on chemical expenditures as collected from the FCRS. These expenditures were converted to lb and then kg of agrochemicals used per acre for 1990, based on percentage of acreage treated and composite farm pesticide prices (weighted average cost of all chemicals). The production of agrochemicals (including energy requirements and emissions) is based on Ecobalance's LCA database DEAMTM as outlined in section 7.2.2 Fertilizers and Agrochemicals.

Table 49: Soybean Agriculture System Inputs

Item	Unit	AL	AR	GA	IL	IN	IA	KS	MN	MS	MO	NE	OH	SC	SD	14-State weighted average
Seed	lbs/acre	56	69	55	61	62	62	63	64	55	58	62	81	41	60	62.66
Fertilizer:																
Nitrogen	lbs/acre	8	13	13	5	8	12	41	10	19	6	6	5	3	5	9.89
Phosphate	lbs/acre	41	31	44	41	44	18	41	19	44	33	22	25	40	20	31.02
Potash	lbs/acre	54	44	85	86	47	60	7	31	70	50	5	56	84	7	52.80
Energy:																
Gasoline	Gal./acre	4.27	4.18	3.4	2.72	2.95	2.77	3.95	3.03	2.52	2.97	4.09	3.6	2.55	2.76	3.11
Diesel	Gal./acre	6.75	9.19	6.84	4.1	4.49	4.35	3.98	5.68	7.44	3.84	9.63	4.41	8.54	4.85	5.29
LP	Gal./acre	0.02	0.07	0.11	0.35	0.01	0	0	0	0.24	0.41	4.96	0.03	0.01	0.12	0.38
Electricity	kWh/acre	0	6.81	21.83	0	0.51	0	1.98	0.21	4.3	0	50.44	0.82	0.08	18.93	4.60
Natural Gas	C.F./acre	0	0.01	0	0	0	0	0.28	0	0.02	0	1.15	0	0	0	0.07
Custom operations	\$/acre	1.15	1.74	4.03	1.69	2.67	5.15	2.99	4.89	4.85	7.3	3.72	6.24	0.81	1.71	3.82
Chemicals	\$/acre	14.51	16.15	13.95	19.24	24.76	24.11	14	21.87	20.49	19.99	18.87	23.57	21.35	17.06	20.58
Soybean yield																
Avg. (89-91)	Bu/acre	20	26	22	39	39	40	25	38	22	29	33	36	21	27	34
Avg. (90-92)	Bu/acre	23	29	23	40	41	42	28	36	27	33	37	38	21	28	36
Avg. (92-94)	Bu/acre	28	31	26	44	45	42	34	32	29	36	42	41	21	30	38
Ag. Chemical Application:																
Herbicides	Percent	100	100	82	100	100	100	100	100	100	100	96	100	100	100	99
Insecticides	Percent	0	0	18	0	0	0	0	0	0	0	4	0	0	0	1
Composite Farm Pesticide Prices:																
Herbicides	\$/lb															5.04
Insecticides	\$/lb															12.33
Chemicals	lbs/acre	2.88	3.20	2.47	3.82	4.91	4.78	2.78	4.34	4.07	3.97	3.66	4.68	4.24	3.38	4.06
Custom operations (diesel fuel use)	Gal/acre	0.21	0.32	0.73	0.31	0.49	0.94	0.54	0.89	0.88	1.33	0.68	1.14	0.15	0.31	0.70
Lubricants (motor oil)	gal./acre	0.34	0.41	0.32	0.21	0.23	0.22	0.24	0.27	0.31	0.21	0.42	0.25	0.34	0.23	0.26

Table 50: Irrigation Water Used on Soybeans by State per Year (1994)

State	Liters/Hectare/year	Gallons/Acre/year	Inches/Acre/year
Arkansas	2.4 x 10 ⁶	260,720	9.6
Georgia	1.2 x 10 ⁶	130,360	4.8
Illinois	1.8 x 10 ⁶	195,540	7.2
Kansas	3.3 x 10 ⁶	358,490	13.2
Minnesota	1.2 x 10 ⁶	130,360	4.8
Mississippi	2.1 x 10 ⁶	228,130	8.4
Missouri	1.5 x 10 ⁶	162,950	6.0
Nebraska	1.8 x 10 ⁶	195,540	7.2
South Dakota	1.8 x 10 ⁶	195,540	7.2

5.1.2.2 Water Use

The U.S. Department of Commerce has published a Census of Agriculture on agriculture-related topics.⁴¹ The 1994 Farm and Ranch Irrigation Survey is part of this census and lists the estimated quantity of water applied to various types of crops. Information was obtained on irrigation water applied to soybean production by state. Of the 14 soybean-producing states considered in this project, only the states listed in Table 50.

5.1.3 Soybean Agriculture Energy and Equipment Use

5.1.3.1 Energy Use and Soybean Yield

Energy inputs for soybean production include gasoline, diesel fuel, liquefied petroleum gas (LPG), natural gas, and electricity. These energy sources are required for field equipment (e.g., tractors and combines), as well as such activities as pumping irrigation water to soybean fields. The source of farm energy requirements is the FCRS produced for soybeans and reported by Ali and McBride. This survey lists the amounts of the different energy sources used per acre for each soybean-producing state in 1990.

The gallons of diesel fuel and gasoline used per acre of soybeans for 1990 is reported by the survey. Also, when a farmer hires machinery and labor to perform a farming operation, the FCRS refers to these expenses as custom operations. The fuel portion of custom operations for soybeans is not provided by the FCRS. We assumed that the fuel share of custom operations accounts for 16.4%⁴² of total cost, which is converted to gallons of diesel oil per acre of soybean based on prices of diesel fuel paid by farmers. The gallons of fuel used are then converted to liters for use in the model.

The LCI modeling of the production of diesel fuel and gasoline is an output of this study. Therefore, a loop for diesel fuel and gasoline is created in the model. The model was run the first time with values for production of #2 diesel fuel and gasoline based on Ecobalance's database. Then the new results of the model were taken and reinserted into the model to replace the previously used values for production of the refinery products. The model was rerun with the new values to obtain the final result.

⁴¹ This responsibility has since moved to the National Agricultural statistical Service within USDA.

⁴² Percentage is based on communications with the authors of the Farm Costs and Returns Survey.

Electricity use is given by the 1990 survey in terms of kWh used per acre of soybeans. This can then be converted to MJ of electricity used per acre for 1990. Electricity production is based on Ecobalance's database DEAM™ and is regionalized based on the electricity grid in the soybean producing states considered in this study.

LPG use is given in terms of gallons used per acre for 1990. This gallon amount is converted to an energy value based on the heating value of the LPG (95.3 MJ/gal). The same is true for natural gas use, which was reported as thousands of cubic feet of natural gas per acre. This is converted to an energy value based on the heating value of the natural gas (1.05 MJ/ft³). The production of natural gas and LPG is based on Ecobalance's database.

The energy value of growing seed is assumed to be equal to 150% of the energy required to grow soybeans. Soybean seed uses more energy than regular soybeans because of additional storage and packaging cost. Also, it takes more energy to haul the seed from a local seed company to retailers and from retailers to soybean farmers. This is accounted for in the model by adjusting the yield of the soybeans per acre. The yield of soybeans shown in Table 51 in bushels is converted to a weight based on a conversion factor of 27.2 kg/bushel of soybeans (USDA, ERS "Weights, Measures, and Conversion Factors for Agricultural Commodities and Their Products"). The amount of soybean seed used per acre is known from the FCRS. This value is multiplied by 1.5 and subtracted from the soybean yield to give an adjusted yield value that accounts for seed production.

Table 51: Average Soybean Yield (Bu/acre/yr)

<i>State</i>	<i>Three Year Average (bushels per acre per year)</i>		
	<i>1989-1991</i>	<i>1990- 992</i>	<i>1992-1994</i>
Alabama	20	23	28
Arkansas	26	29	31
Georgia	22	23	26
Illinois	39	40	44
Indiana	39	41	45
Iowa	40	42	42
Kansas	25	28	34
Minnesota	38	36	32
Mississippi	22	27	29
Missouri	29	33	36
Nebraska	33	37	42
Ohio	36	38	41
South Carolina	21	21	21
South Dakota	27	28	30

An example of how this is done for Alabama is shown as follows:

- 1 Bushels per acre per year (from Table 51) is multiplied by 27.2 (conversion factor) to give 761.6 kg of soybeans produced per acre per year in Alabama.
- 2 Seed used in Alabama per acre per year is 56 lb or 25.4 kg (FCRS). Multiplied by 1.5 to account for the extra energy of packaging, transport, etc. gives 38.1 kg of seed used per acre per year.
- 3 Subtract seed used from the yield to get 723.5 kg/acre per year.

Average annual soybean yields for 1989-1991, 1990-1992, and 1992-1994 are shown in Table 51 for each of the 14 major soybean-producing states (crop production annual summary). The 1992-1994 3-year average yield is used for this study to account for variation caused by weather and to reflect yield rate based on current farming technology. The 1992-1994 average soybean yield per acre, compared to the 1989-1991 average yield increased for every state except Minnesota. Minnesota's average yield declined by 16%. The largest increase occurred in Alabama—40%.

The energy information on soybean inputs recorded for the 14 soybean-producing are weighted by the fraction of the total soybean output produced from each state. Table 52 shows the soybean production of the 14 states used in this study for the years 1993, 1994, and 1995 as well as the average for those 3 years and the fraction of the total coming from each state.

The soybean production and inputs for each state were multiplied by the fraction of the total soybean production produced by that specific state (the final column of Table 52). This yields an estimate for the average U.S. production of soybeans.

Table 52: Soybean Production by State

<i>State</i>	<i>Production (1,000 bushels)</i>				<i>Fraction of Total</i>
	<i>1993</i>	<i>1994</i>	<i>1995</i>	<i>3 Year Avg.</i>	
Alabama	7,080	9,145	5,400	7,208	0.0038
Arkansas	92,300	115,600	86,700	98,200	0.052
Georgia	8,160	15,500	8,370	10,677	0.0057
Illinois	387,000	429,065	373,450	396,505	0.21
Indiana	223,100	215,260	194,220	210,860	0.11
Iowa	257,300	442,885	398,180	366,122	0.20
Kansas	53,200	73,500	51,250	59,317	0.032
Minnesota	115,000	224,000	232,000	190,333	0.10
Mississippi	42,900	57,035	37,800	45,912	0.024
Missouri	118,800	173,280	130,500	140,860	0.075
Nebraska	90,000	134,420	99,450	107,957	0.058
Ohio	156,180	173,565	153,140	160,962	0.086
South Carolina	7,800	15,660	12,720	12,060	0.0064
South Dakota	38,500	91,200	75,000	68,233	0.036
Total:				1,875,205	1.000

5.1.3.2 Energy Emissions

The emissions associated with farm equipment use are derived from data reported in the FCRS and in the Ali and McBride report describing soybean production. The survey reports gallons of diesel oil and gasoline used. We assumed that all the diesel oil is used in a diesel tractor, and that half the gasoline is used in a gasoline tractor and half is used in a truck. The emissions from the truck are based on Ecobalance's database DEAMTM. The emissions from the two types of tractors are shown in Table 53 and Table 54⁴³.

We assume natural gas is combusted in an internal combustion engine and LPG is assumed to be combusted in a commercial boiler. The emission factors for these combustion sources are shown in Appendix A.

Table 53: Emission Factors for Diesel Fuel Combustion in a Farming Tractor

Tractor Type	Emission Factors (g/MJ diesel fuel burned)							
	Hydrocarbons	CO	NO _x	PM10	SO ₂	CH ₄	N ₂ O	CO ₂
Diesel	0.085	0.32	0.89	0.041	0.12	0.0042	0.0019	75.5

Table 54: Emission Factors for Gasoline Combustion in a Farming Tractor

Tractor Type	Emission Factors (g/MJ gasoline burned)							
	Hydrocarbons	CO	NO _x	PM10	SO ₂	CH ₄	N ₂ O	CO ₂
Gasoline	0.20	1.14	0.63	0.0074	0.0046	0.032	0.0019	67.7

5.1.4 Soybean Agriculture Biological Interactions/Field Emissions

Fertilizers and pesticides applied to agricultural land are distributed between the plants in the field, soil, water, and air. Some of the chemicals applied to improve soybean productivity are absorbed by the soybean plant and soybean through the root system. Chemicals that go into the soybean move to the next phase of the LCA and are not a concern here. Chemicals absorbed by the plant or applied directly to the foliage (e.g., herbicides) eventually reach the soil during rainfall or when the soybeans are harvested. Most soybean crops are harvested with grain combines that separate the bean from the rest of the plant, leaving the residue on the field. In the Fall or early Spring, the crop residue is plowed into the soil, then disked and harrowed to prepare a firm seedbed for planting. Pesticides left in the field dissipate from the soil or enter the air through volatilization. Pesticides can also be carried away from the field by soil erosion.

Although farmers generally use soil tests to avoid over-fertilization and to determine precise fertilizer application rates that ensure good yields, not all the fertilizer is used by the plants. Unused fertilizer will degrade in the soil and some will completely dissipate. Some attaches to soil particles and moves off the field through soil erosion. Also, some of the applied fertilizer transforms into gases such as N₂O and NO_x and enters the atmosphere.

⁴³ Emission factors for fuel combustion are based on a project done by the Argonne National Laboratory (Argonne 1996). SO_x releases are based on burning high-sulfur diesel fuel, which is an acceptable fuel quality for farm equipment (off road vehicles). Only on road vehicles are required to use low-sulfur diesel fuel.

5.1.4.1 Soil Erosion^{3/4}National Resource Inventory

Soil erosion not only moves large amounts of soil away from the field, but it also is the main driver for removing unused farm chemicals and natural nutrients. Soil erosion data are available from USDA's National Resources Inventory (NRI). The NRI is an inventory of land use and soil erosion on prime farmland, wetlands, and other nonfederal rural land in the United States. The NRI erosion trends are reported by state and land use, e.g., cultivated cropland, non-cultivated cropland, pasture land, and range land. Inventories are conducted every 5 years by the National Resources Conservation Service (NRCS—formerly the Soil Conservation Service).

Data for the most recent survey, 1992, were collected for more than 800,000 locations. NRI data are statistically reliable for national, regional, state, and sub-state analysis (NRCS 1995).

In order to obtain erosion estimates for our 14 soybean states, the 1992 NRI data set was downloaded into an statistical analysis software file. Erosion estimates were averaged for land where soybeans were produced during the 1992 growing season. Missouri has the highest soil loss of 8.1 tons per acre of soybeans and South Dakota has the lowest, 2.8 tons per acre (Table 55). Alabama had the highest soil erosion overall, but Missouri had the highest soil erosion specifically associated with soybean production.

Sheet erosion occurs when there is a little water at the soil surface and it runs over the soil as a thin sheet. Rill erosion is due to the energy of water that has concentrated and is moving downslope. As water concentrates, it forms small channels called rills. Water collected into small rills coalesces to form large channels and produce gully erosion (Foth 1984).

In addition to erosion caused by water, Table 56 shows wind erosion on soybean cropland. Only seven of the 14 states studied reported wind erosion, which varied from 4.2 tons per acre in Minnesota to 0.20 tons per acre in Ohio.

The Universal Soil Loss Equation (USLE) is used to predict water erosion on agricultural land. It was designed to predict the long-term erosion rates on farmland so that management systems could be devised that result in acceptable levels of erosion. It is a complex equation that uses information on the quantity and intensity of rainfall, soil erodibility, slope length, slope gradient, cropping management practices, and erosion control practices.

The cropping management factor looks at vegetative cover, types of tillage (moldboard plow, minimum till, or no till), and crop rotation. Detailed tables are used to obtain information from the farmer to determine how management practices affect erosion. Information is collected on past years because crop rotation sequences, tilling practices, and other factors in previous years have a direct effect on current erosion rates. Thus, even though this project focuses on a single growing season for soybeans, the soil loss estimates for a given year depend on factors that occur in previous years.

Erosion control factors include contour tillage, strip cropping on the contour, and terrace systems. Since the 1920s federal legislation and government programs, such as USDA's Conservation Reserve Program (CRP) have provided incentives for farmers to use conservation practices. Even though soil loss is still considered a major problem, it has been declining in recent years. Soil loss from erosion on cropland dropped from a total of 3.1 billion tons on 421 million acres in 1982 to 2.1 tons on 382 million acres in 1992 (NRCS 1995).

Table 55: Estimated Annual Average Sheet and Rill Erosion on Total Cropland and Soybean Cropland—1992

State	Total Cropland ⁴⁴ (tons/acre)	Std Dev.	Soybeans (tons/acre)	Std Dev.
Alabama	6.5	6.53	6.6	5.05
Arkansas	3.4	2.52	3.7	2.65
Georgia	5.1	6.10	6.9	6.58
Illinois	4.8	6.22	4.4	6.06
Indiana	3.4	4.83	3.4	4.62
Iowa	5.4	7.97	5.2	7.49
Kansas	2.6	4.55	5.4	7.99
Minnesota	2.8	4.37	3.2	4.61
Missouri	6.0	9.64	8.1	11.94
Mississippi	5.4	7.22	4.8	5.60
Nebraska	3.5	5.70	6.0	7.53
Ohio	3.0	4.48	3.2	4.18
South Carolina	3.4	4.44	3.8	4.75
South Dakota	2.0	2.94	2.8	3.98

5.1.4.2 Other Nutrients and Fertilizers Carried off the Field by Erosion

As pointed out earlier, soil is not the only item carried off a field by erosion. Fertilizers, pesticides, and soil nutrients are also transported. A large part of the soil erosion reported in Table 55 and Table 56 include natural nutrients such as nitrogen, phosphorus, and potassium. The Earth's crust contains about 0.1% phosphorus and 2.6% potassium (Foth 1984).

The atmosphere is made up of 79% nitrogen, which plants bring into the soil through nitrogen fixation. Soybeans fix as little as 15 kg of nitrogen/ha (13 lb/acre) and as much as 310 kg of nitrogen/ha (275 lb/acre) (NRC). Thus, the amounts of applied fertilizer and agrochemicals are relatively small compared to nutrients already in the soil. For example, on average soybeans receive only about 10 lb of nitrogen per acre and 4 lb of agrochemicals per acre.

⁴⁴ Excludes CRP land

Table 56: Estimated Annual Average Wind Erosion on Total Cropland and Soybean Cropland—1992

State	Total cropland* (tons/acre)	Std Dev.	Soybeans (tons/acre)	Std Dev.
Alabama	0	NA	0	NA
Arkansas	0	NA	0	NA
Georgia	0	NA	0	NA
Illinois	0	NA	0	NA
Indiana	0.35	1.43	0.26	1.22
Iowa	1.3	2.23	1.8	2.59
Kansas	1.9	4.55	0.30	1.80
Minnesota	4.4	5.37	4.2	4.23
Missouri	0	NA	0	NA
Mississippi	0	NA	0	0
Nebraska	1.4	3.18	0.90	2.40
Ohio	0.10	0.509	0.20	0.689
South Carolina	0	NA	0	0
South Dakota	2.1	3.97	1.4	2.67

* Excludes CRP land.

The next question is: How much of the soil, fertilizer, and agrochemicals carried away from the field go to natural or constructed waterways? Ribaudo (Ribaudo 1989) shows how soil erosion and fertilizer affect the amounts of sediment and nutrients discharged into waterways. His estimates are based on levels of total suspended sediment (TSS), total Kjeldahl nitrogen (TKN), and total phosphorus (TP) that are discharged into waterways each year as estimated by Resources for the Future (RFF, Gianessi). RFF estimated the discharge of materials associated with soil particles by estimating sediment delivery ratios and attached pollutant coefficients, then applying them to soil erosion data (excluding wind erosion). Sediment delivery ratios are a function of stream density and soil type. Attached pollutant coefficients are the ratios of the weight of the nutrients attached to soil particles to the weight of soil particles (Ribaudo 1989).

RFF used a nutrient simulation model to estimate the amount of materials dissolved in runoff from cropland. Information on discharges came from EPA discharge permits. Estimates of annual discharge of TSS, TKN, and TP were made for 99 Aggregated Subareas (ASAs). ASAs are hydrologic units, usually the basins of major rivers, for which there are data on the discharge of TSS, TKN, and TP. Ribaudo provided sediment delivery ratios and attached pollutant coefficients for TKN and TP for regions in which our 14 states are located. Multiplying sediment delivery ratios from each state times the estimated soil erosion from each state gives TSS. The sediment delivery ratio times the nitrogen coefficient, times the erosion estimate, gives the amount of TKN carried away with the sediment. And the sediment delivery ratio times the phosphorus coefficient, times the state erosion estimate, gives the amount of TP carried away with the sediment for each state.

Table 57 shows the expected amounts of soil sediment, nitrogen and phosphorus that move from the field and into the nearby water system. The nitrogen and phosphorus runoff includes natural nutrients and applied fertilizer. For example, the annual soil that is dislodged by water and carried to the edge of the field in Alabama is 6.6 tons per acre. Of this 6.6 tons of soil, 2.55 tons are sediment, 0.043 tons are nitrogen, and 0.005 tons are phosphorus that move from the edge of the field and into the local waterway. These estimates represent land in our 14 states where soybeans are grown. As discussed earlier, erosion estimates are for a single growing season but data from previous years related to crop rotations and other management practices are included in the calculations.

Table 57: Annual Erosion and Discharge of TSS, TKN, and TP on Soybean Acreage

<i>State</i>	<i>Erosion*</i> <i>(tons/ac/yr)</i>	<i>Sediment</i> <i>Delivery Ratio</i>	<i>TSS</i> <i>(tons/ac/yr)</i>	<i>Nitrogen</i> <i>Coefficient</i>	<i>Phosphorus</i> <i>Coefficient</i>	<i>TKN</i> <i>(tons/ac/yr)</i>	<i>TP</i> <i>(tons/ac/yr)</i>
Alabama	6.6	0.387	2.55	0.017	0.002	0.043	0.0051
Arkansas	3.7	0.548	2.03	0.011	0.002	0.022	0.0041
Georgia	6.9	0.387	2.67	0.017	0.002	0.045	0.0053
Illinois	4.4	0.512	2.25	0.038	0.006	0.086	0.0135
Indiana	3.4	0.512	1.74	0.038	0.006	0.066	0.0104
Iowa	5.2	0.512	2.66	0.038	0.006	0.101	0.0160
Kansas	5.4	0.473	2.55	0.021	0.004	0.054	0.0102
Minnesota	3.2	0.369	1.18	0.041	0.004	0.048	0.0047
Mississippi	4.8	0.548	2.63	0.011	0.002	0.029	0.0053
Missouri	8.1	0.512	4.15	0.038	0.006	0.158	0.0249
Nebraska	6.0	0.473	2.84	0.040	0.004	0.114	0.0114
Ohio	3.2	0.512	1.64	0.038	0.006	0.062	0.0098
South Carolina	3.8	0.387	1.47	0.017	0.002	0.025	0.0029
South Dakota	2.8	0.473	1.32	0.021	0.004	0.028	0.0053

* Includes sheet and rill erosion.

5.1.4.3 Agrochemicals in Waterways

Pesticides include herbicides, insecticides, and fungicides. Most soybean acreage received pesticides in 1992, but nearly all pesticides used on soybeans (99%) were herbicides (Lin et al. 1995). Pesticides contribute to increased productivity, but their use has received increased scrutiny because of human health and environmental risks. Federally funded programs began in the early 1970s developed an “Integrated Pest Management” (IPM) approach to controlling pests (Vandeman et al. 1994). IPM encourages natural control of pest populations by anticipating pest problems and preventing pests from reaching economically damaging levels.

Control techniques include enhancing natural enemies, planting pest-resistant crops, adapting cultural management, and using pesticides judiciously (Agricultural Research Service 1993). The Clinton Administration has made IPM an important part of its legislative reform proposals. In September 1993, the Administration committed to research and education efforts necessary to achieve the adoption of IPM on 75% of the nation’s crop acreage by the year 2000.

Recent information collected by USDA on the adoption of IPM techniques shows significant progress in the adoption of IPM on U.S. farms (Vandeman et al. 1994). For example, results from the USDA survey reflect the greater availability of post-emergence herbicides for use in soybean production (Vandeman et al 1994). Post-emergence herbicides are better than pre-emergence herbicides (applied before planting) because they have little or no soil residual activity and are applied only when needed. There is a trend toward more use of post-emergence herbicides, which is expected to accelerate in the future for two reasons (Kapusta 1992). First, the cost of some post-emergence herbicides has been declining; Second, conservation tillage has increased, which limits the option of incorporating pre-emergence herbicides into the soil.

Another example of IPM on soybeans is using crop rotations and leaving crop residues. Crop residues can decrease pesticide runoff, and crop rotation can effectively interrupt the development of the disease and weed life cycle. See Lin et al.1995 and Vandeman et al.1994 for a further description of IPM adoption.

Generally, herbicide runoff is much smaller than fertilizer runoff because application rates are much smaller—the application rate for herbicides per planted acre of soybeans was 4.06 lb in 1992. This compares to about 31 lb/acre for phosphate and 53 lb/acre for potash as shown in Table 49. Herbicides leaving a treated area in runoff constitute only a small percentage of that applied because most of the applied herbicide is dissipated by other processes (Leonard 1988). Once an herbicide reaches either the plant or soil surface, it is degraded or transformed by chemical, biological, and photochemical processes and subjected to volatilization losses. Runoff is worse when there is heavy rainfall shortly after application but as discussed previously, the adoption of IPM has placed increased emphasis on the correct timing of pesticide application.

Wauchope (Wauchope 1978) conducted an extensive review of available data and proposed a rule-of-thumb pesticide classification with estimates of average or reasonably expected edge-of-field runoff losses. Estimated seasonal losses were 1% of the amount applied for foliar-applied organochlorine insecticides, 2% to 5 % for wettable powder, depending on slope and hydrologic response, and 0.3% or less for the remaining pesticides. Runoff losses in the range of 1% to 2% are not uncommon for a wide range of pesticides. He defined “catastrophic” events as those in which runoff losses exceed 2% of application. These are usually with the first storms after recent application.

There is a great deal of variation in herbicide runoff depending on crop stage; type of herbicide; whether it is a powder, granular, or spray application method; soil texture, and weather conditions. Calculating an average runoff for our 14 states would be an arduous task. For example, USDA reported 38 types of herbicides used on soybeans in 1995, with each state using various combinations and quantities of these herbicides. In addition, when variability in weather and other factors among the 14 states are considered, it is not clear what an average runoff level would represent.

Pesticides can also reach waterways by leaching into groundwater basins. The tendency of a pesticide to leach depends on solubility, sorption, and persistence. Sorption is commonly evaluated by use of a sorption coefficient based on the organic carbon content of soils. Persistence is commonly evaluated in terms of half-life, which is the time that it takes for 50% of a chemical to be degraded or transformed. Pesticides with low sorption coefficients, long half-lives, and high water solubility are likely to leach and contaminate groundwater (NRC).

The travel time of a pesticide to the water table may only be a few days to a week; if the soil is permeable, rainfall exceeds water-holding capacity of the soil and if the depth to the water table is shallow. In contrast, the travel time may be decades in arid regions where the water table is far below the land surface (NRC). The further the pesticide must travel to reach the water table, the more it is subject to degradation and immobilization mechanisms. Thus, in cases where it takes years for pesticides to leach into the water table, only a minuscule amount of contaminant may reach the water supply.

This is not to say that small amounts of pesticides in the water system are not hazardous, but quantifying these contaminants is extremely difficult. Transformations and transport of pesticides are strongly influenced by site-specific conditions and management practices (NRC). In addition, pesticides include a broad class of agrochemicals with widely ranging properties that defy generalizations. Computer simulation models are being developed to evaluate more fully the fate and transport of pesticides. But at this time, there are no appropriate estimates available to calculate the amount of pesticides that may leach into the groundwater in the production of soybeans.

For this study, pesticides and herbicides are grouped into one agrochemicals category that represents all the chemicals applied to the soybeans during planting and growing. Of these agrochemicals, a runoff coefficient of 3% of the weight of the chemicals applied is used to estimate the amount of agrochemicals lost to runoff (which is the average of the reported range 1%-5%).

5.1.4.4 Agrochemicals in the Atmosphere

Spray application is the major source of atmospheric contamination by pesticides because of drift and vaporization (Lewis and Lee 1976). Studies have found that large amounts of aerially applied pesticides miss their agricultural targets. Drift loss depends on factors such as wind, size, and height at which the material is released. However, most soybean acreage receives herbicides by ground broadcast (90%) and IPM application timing recommendations help to minimize drift. Only about 2% is applied by aerial broadcast and about 8% by band treatment (ERS, AREI 1994). Banded treatment is applying pesticides over, or next to, each row of plants in a field.

Majewski and Capel (Majewski and Capel 1995) showed that drift for ground-rig applications ranged from less than 0.5% to 8% of the nominal application and was dependent on the nozzle type, hydraulic pressure, and wind speed. The drift from aircraft applications ranged from 1% to 31%.

In addition to application drift, pesticide residues can be transported into the atmosphere attached to dust particles disturbed during tilling operations. This represents a secondary form of off-target pesticide drift that takes place over a much longer period. No-till or minimum till can help minimize soil disturbances.

Another major route of entry of pesticides into the atmosphere is through volatilization from treated agricultural soils and plant foliage. Volatilization occurs when herbicides reach the plant or soil surface and are degraded or transformed by chemical, biological, and photochemical processes and enter the atmosphere.

Volatilization is a major cause of disappearance of herbicides from target areas, particularly where they are surface applied, and the rate of this loss can exceed that of chemical degradation (Taylor and Glotfelty 1988). The rate of volatilization will depend the moisture content of the soil (wet is worse than dry), temperature, the relative humidity, wind velocity, and soil type (Lewis and Lee 1976)⁴⁵. Volatilization is continuous, even though the rate is variable. Peak periods of volatilization occur during the application phase, following a rain event or during irrigation. When spray application is used, loss from volatilization ranges from 3% to 25% for most pesticides, but for some pesticides it may be as great as 20% to 90%, depending on weather conditions. In contrast, pesticide losses from soil-incorporated application methods are usually much lower.

The total amounts of chemicals applied to soybean agriculture are shown in Table 49 for each of the 14 states considered in this study and for the 14-state weighted average. It is also seen that 99% of the applied chemicals are herbicides. The exact types of chemicals applied are found in the USDA study "Pesticide and Fertilizer Use Trends in U.S. Agriculture." Table 58 shows the chemicals used.

⁴⁵ Volatilization is often too variable to make generalizations. The range of loss is listed as somewhere between 0 and 90 percent depending on time, moisture, soil, type of compound, application method, etc. (Grover). There are equations that can be used to estimate volatilization rates, but they require very site-specific information.

Table 58: Amounts and Types of Herbicides Applied to Soybean Agriculture

<i>Herbicide:</i>	<i>Million Pounds Active Ingredient/Acre</i>				<i>Percent of Total</i>
	<i>1990</i>	<i>1991</i>	<i>1992</i>	<i>3 yr Avg.</i>	
Actifluorfen	1.1	0.9	1.1	1.0	1.6%
Alachlor	14.7	12.8	10.2	12.6	20%
Bentazon	6.1	4.2	4.8	5.0	8.0%
Chloramben	0.7	0.2		0.3	0.47%
Chlorimuron	0.3	0.2	0.2	0.2	0.37%
Clomazon	2.7	1.9	1.4	2.0	3.2%
Ethalfluralin	2.4	1.4	0.9	1.6	2.5%
Glyphosate	2.7	2.4	2.4	2.5	4.0%
Imazaquin	1.0	0.8	0.9	0.9	1.4%
Imazethapyr	0.4	0.7	0.9	0.7	1.1%
Linuron	2.0	1.0	0.5	1.2	1.8%
Metolachlor	9.9	7.6	5.9	7.8	12%
Metribuzin	3.6	2.7	2.2	2.8	4.5%
Pendimethalin	6.8	7.9	9.7	8.1	13%
Trifuralin	17.6	16.3	15.6	16.5	26%
Total:	72	61	56.7	63.2	100%

Of these herbicides, the Pesticide and Fertilizer Use Trends report states that Trifuralin is applied through soil incorporation, the remaining herbicides are assumed to be applied through surface application.

The EPA AP-42 document provides emission factors for the volatilization of agrochemicals based on the method of application (soil incorporation versus surface application) and on the vapor pressure of the chemicals. AP-42 also provides a factor for estimating the VOC content of the inert portion of the chemicals applied. The Pesticide and Fertilizer Use Trends report supplies an estimate of the average amount of herbicide active ingredient applied per treated acre of soybeans. The 3-year average (1990-1992) is 1.23 lb/treated acre. This value is adjusted based on the amount of treated acres (96 %) to give an average per acre of soybeans (1.29 lb/acre soybeans). The total amount of chemicals applied is known to be 4.06 pounds per acre of soybeans (shown in Table 49). Therefore, the percentage of inert ingredients in the chemicals applied is 68%.

The amount of herbicides volatilized is calculated based on the vapor pressures of the active ingredients and the application method, as well as the VOC content of the inert ingredients (assumed to be 32% based on an average value from AP-42). Trifuralin, which represents 26% of the total chemicals applied, is assumed to be soil incorporated and have a vapor pressure of 1.1 E-04 mm Hg at 20°C. The remaining chemicals are assumed to be surface applied and a weighed average vapor pressure is used as shown in Table 59.

Table 59: Weighted Average Vapor Pressure of Surface-Applied Agrochemicals

<i>Herbicide</i>	<i>3 yr Avg.</i>	<i>Percent of Total</i>	<i>Vapor Pressure (mm Hg)</i>	<i>Weighted Average Vapor Pressure (mm Hg)</i>
Actifluorfen	1.0	2.2%	4.9 E-09	1.1 E-10
Alachlor	12.6	26.9%	1.4 E-05	3.8 E-06
Bentazon	5.0	10.8%	3.8 E-09	4.1 E-10
Chloramben	0.3	0.6%	7.0 E-03	4.5 E-05
Chlorimuron	0.2	0.5%	3.7 E-12	1.8 E-14
Clomazon	2.0	4.3%	1.4 E-04	6.0 E-06
Ethalfuralin	1.6	3.4%	8.8 E-05	3.0 E-06
Glyphosate	2.5	5.3%	3.8 E-08	2.0 E-09
Imazaquin	0.9	1.9%	4.9 E-08	9.4 E-10
Imazethapyr	0.7	1.4%	4.9 E-08	7.0 E-10
Linuron	1.2	2.5%	1.7 E-05	4.2 E-07
Metolachlor	7.8	16.7%	3.1 E-05	5.2 E-06
Metribuzin	2.8	6.1%	5.0 E-06	3.0 E-07
Pendimethalin	8.1	17.4%	9.4 E-06	1.6 E-06
Total	46.7	100.0%		6.5 E-05

The calculation of the emissions from chemical applications for soybean production is shown as follows:

- Of the 4.06 lb of chemicals applied per acre of soybeans per year, 68% is inert material. This comes to 2.76 lb. From AP-42, the average VOC content of the inert ingredients of agrochemicals is 32%. This leads to **0.88 lb of VOC** per acre of soybeans per year due to the inert ingredients of the chemicals applied.
- Of the active ingredients of chemicals applied per acre of soybeans per year (4.06 - 2.76 = 1.3 lb), 26% of it is applied through soil incorporation or 0.34 lb. Table 60 from AP-42 shows the emission factors for soil-incorporated chemicals based on their vapor pressure.
-

Table 60: VOC Emission Factors for Soil-Incorporated Agrochemicals

<i>Vapor Pressure Range (mm HG at 20° to 25°C)</i>	<i>Emission Factor (% of applied chemical)</i>
< 1 x 10 ⁻⁶	0.27 %
1 x 10 ⁻⁴ to 1 x 10 ⁻⁶	2.1 %
> 1 x 10 ⁻⁴	5.2 %

- The soil-incorporated chemical in this case has a vapor pressure of 1.1×10^{-4} mm Hg at 20°C. Therefore, the emission factor of 5.2% is applied to the amount of active ingredient applied: $0.34 \times 5.2\% = \mathbf{0.017 \text{ lb of VOC}}$ per acre of soybeans per year.
- The remaining active ingredients of chemicals applied per acre of soybeans per year ($1.3 - 0.34 = 0.96$ lb) are surface applied. Table 61 from AP-42 shows the emission factors for surface-applied chemicals based on their vapor pressure.

Table 61: VOC Emission Factors for Surface-Applied Agrochemicals

<i>Vapor Pressure Range (mm HG at 20° to 25°C)</i>	<i>Emission Factor(% of applied chemical)</i>
1×10^{-4} to 1×10^{-6}	35 %
$> 1 \times 10^{-4}$	58 %

- The surface-applied chemical in this case has a vapor pressure of 6.5×10^{-5} mm Hg at 20°C. Therefore, the emission factor of 35% is applied to the amount of active ingredient applied: $0.96 \times 35\% = \mathbf{0.34 \text{ lb of VOC}}$ per acre of soybeans per year.

Based on these calculations, for every 4.06 lb of chemicals applied 1.24 lb are lost to the atmosphere through volatilization ($0.88 + 0.017 + 0.34$). This represents 31% of the total amount of chemicals applied.

Therefore, for this model it is assumed that 31% (by weight) of the agrochemicals applied to soybean agriculture are volatilized. This results in a release of unspecified HC air emissions from soybean agriculture.

5.1.4.5 NO_x and N₂O Emissions from Soil

It is possible for the nitrogen applied to soil as fertilizer to be released into the atmosphere as N₂O, and NO_x (NO + NO₂ = NO_x). The amount depends on the quantity and type of fertilizer, soil conditions and water content, crop type, agricultural practices, and weather conditions, particularly rainfall. A review of field experiments on *corn* found that about 0%-1.8% (average 1.3%) of the nitrogen in the fertilizer had evolved to the atmosphere as nitrogen in N₂O during the study period (Eichner 1990). Mosier (Mosier 1986) found 1.5% for corn but only 0.4% for barley.

It is expected that fertilizers continue to produce N₂O after the study period and some evolves off the site. Researchers have doubled the N₂O estimate to account for these other effects. Thus, about 2.6% of the nitrogen in the fertilizer applied to cornfields ends up as nitrogen in N₂O in the air.

Although soybeans don't generally need nitrogen fertilizer (10 lb of nitrogen/acre compared to 123 lb/acre for corn), they contribute to nitrogen emissions indirectly. Soybean production systems produce soybeans and nitrogen fertilizer for the next growing season through nitrogen fixation. That nitrogen fixation leads to nitrogen emissions in the following year when decomposition occurs. Brenner et al. sampled sites cropped with soybeans in six different soil types. Emissions ranged from 0.34 to 1.97 kg N₂O-N ha⁻¹yr⁻¹ with an average of 1.2 kg N₂O-N ha⁻¹yr⁻¹. Comparisons to non-legumes crops or to uncultivated soil were not included in the study; thus, these values include natural emissions, emissions associated with cultivation, and emissions from N fixed by the legume crop. However, on a relative basis, the N₂O emissions from soybeans appear to be much lower than the N₂O from growing corn. Estimates of total N₂O emissions on two corn fields were 3.60 kg N₂O-N ha⁻¹ and 5.20 kg N₂O-N ha⁻¹ (Cates and Kenney 1987).

It is generally agreed that the preponderance of NO_x emitted by soil is NO, with direct soil emission of NO₂ accounting for less than 10% of the total (Williams et al. 1992). Williams et al. (Williams et al. 1992) review current literature on soil emissions, including a field study that estimates the emissions of NO in a soybean/corn rotation (Anderson and Levine). During the soybean cycle, field measurements of NO ranged from 0.7 ngN/m²/s to 9.4 ngN/m²/s with a mean of 4 ngN/m²/s. During the corn cycle, with nitrogen fertilizer added, emissions of NO ranged from 6 ngN/m²/s to 67 ngN/m²/s with a mean of 25 ngN/m²/s.

Emissions of N₂O and NO_x from soil to the atmosphere have thus far been calculated from a very small database obtained under a very limited variety of conditions. A summary of study results indicates considerable spatial and temporal variability in emission estimates. Given the large degree of variability in the data, extrapolation is highly uncertain (Williams, et al. 1992). In addition, field tests on soybeans did not include a sample of emissions from an uncultivated soil control site. Consequently, the soybean-derived emissions cannot be distinguished from natural sources of N₂O and NO_x. Available studies agree that soil emissions are associated with crop production, including soybeans, and that adding fertilizer to these crops can increase these emissions appreciably (Eichner 1990). However, the lack of consistent data and high degree of variability in soil emission measurements prevents us from deriving a meaningful expected soil emission estimate for soybeans.

Therefore, although the range of values for possible N₂O and NO_x emissions is available, the uncertainty involved is too great to determine a meaningful estimate. For this model the field emissions for N₂O and NO_x will not be reported to prevent any misinterpretation of the overall results.

5.1.5 Soybean Agriculture LCI Results

Figure 43 presents a schematic of the TEAM™ model for soybean agriculture. Table 62 shows the corresponding LCI results for soybean agriculture for the production of 1 kg soybeans.

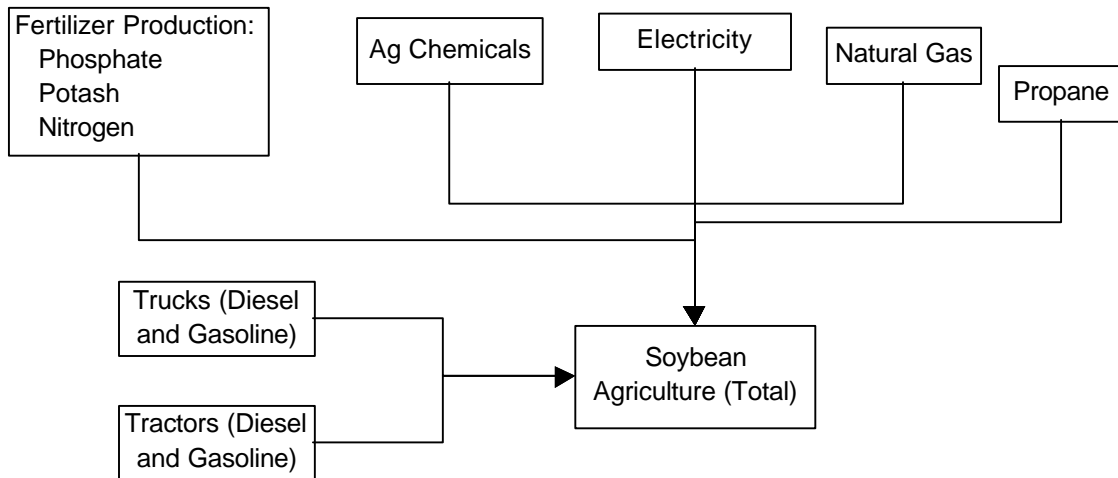

Figure 43: Schematic of TEAM™ Model Inputs to Soybean Agriculture

Table 62: LCI Results for Soybean Agriculture (for 1 kg of soybeans)

	Units	Soybean Agriculture (total)	Diesel Tractor	Gasoline Tractor	Gasoline Truck	Natural Gas Use	Propane Use	Electricity Use	Nitrogen Fertilizer Production	Phosphate Fertilizer Production	Potash Fertilizer Production	Agrochemicals Production	Soybean Agriculture
Raw Materials													
Coal (in ground)	kg	0.008471	0.00076	0.0002	0.0002	3.14E-12	1.51E-	0.001978	0.000640	0.00218	0.001812	0.000699	0
Oil (in ground)	kg	0.043558	0.02453	0.0064	0.0064	4.09E-12	1.97E-	4.61E-05	2.20E-05	0.00057	6.30E-05	0.005527	0
Natural Gas (in ground)	kg	0.016584	0.00210	0.00055	0.00055	1.78E-06	0.00085	9.00E-05	0.005744	0.00179	0.000864	0.004028	0
Uranium (U, ore)	kg	4.65E-07	1.82E-	4.76E-09	4.76E-09	7.52E-17	3.62E-	3.25E-08	1.53E-08	5.12E-08	4.34E-08	2.95E-07	0
Phosphate Rock (in ground)	kg	0.059960	0	0	0	0	0	0	0	0.05996	0	0	0
Potash (K ₂ O, in ground)	kg	0.028182	0	0	0	0	0	0	0	0	0.02818	0	0
Perlite (SiO ₂ , ore)	kg	8.49E-06	5.58E-	1.45E-06	1.45E-06	0	0	0	0	0	0	0	0
Limestone (CaCO ₃ , in ground)	kg	0.001096	0.00014	3.79E-05	3.79E-05	5.95E-13	2.86E-	0	0.00012	0.00041	0.00035	0	0
Sodium Chloride (NaCl)	kg	0	0	0	0	0	0	0	0	0	0	0	0
Water Used (total)	liter	550.35	0.00341	0.00089	0.00089	5.05E-13	2.43E-	4.04E-05	0.0069	0.00615	5.57E-05	0.005210	550.329
Air Emissions													
Carbon Dioxide (CO ₂ , fossil)	g	182.87	84.6843	20.7032	21.328	0.00497	2.61254	4.40514	17.9255	11.9934	7.5756	11.6376	0
Carbon Dioxide (CO ₂ , biomass)	g	-1832.98	0	0	0	0	0	0	0	0	0	0	-1832.98
Methane (CH ₄)	g	0.18082	0.03045	0.01529	0.00810	3.65E-05	0.00417	0.00064	0.032338	0.03139	0.01677	0.041635	0
Nitrous Oxide (N ₂ O)	g	0.00835	0.00273	0.00073	0.00243	1.77E-07	8.49E-	0.00035	8.04E-05	0.00041	0.00011	0.001414	0
Carbon Monoxide (CO)	g	0.87327	0.32102	0.29183	0.18872	3.24E-05	0.00071	0.00073	0.057599	0.00590	0.00191	0.004821	0
Hydrocarbons (except methane)	g	0.34422	0.08699	0.05370	0.02437	4.76E-05	7.29E-	0.03987	3.01E-05	0.02505	6.80E-05	0.114106	0
Hydrocarbons (unspecified)	g	0.73962	0.03234	0.00843	0.00843	3.57E-11	9.49E-	0	5.24E-05	0.00084	0.000152	0	0.68928
Benzene	g	8.38E-06	5.50E-	1.44E-06	1.44E-06	0	0	0	0	0	0	0	0
Formaldehyde	g	0.000113	7.37E-	1.92E-05	1.92E-05	4.99E-21	2.40E-	0	1.03E-13	1.20E-06	2.11E-09	0	0
Particulates (PM10)	g	0.087500	0.03997	0.00195	0.02822	9.87E-07	0.00012	0	0.01115	0.00609	0	0	0
Particulates (unspecified)	g	0.098765	0.01745	0.00455	0.00455	3.19E-09	1.53E-	0.00366	0.00919	0.03181	0.02555	0.002003	0
Sulfur Oxides (SO _x as SO ₂)	g	0.599564	0.21008	0.02676	0.03140	4.03E-05	0.0195	0.03826	0.14005	0.04713	0.04710	0.039243	0
Nitrogen Oxides (NO _x as NO ₂)	g	1.283880	0.89468	0.17282	0.03759	9.03E-05	0.00416	0.01924	0.06889	0.03897	0.02011	0.027327	0
Hydrogen Chloride (HCl)	g	0.001799	0.00041	0.00011	0.00011	1.69E-12	8.14E-	0	0	0.00117	0	0	0
Hydrogen Fluoride (HF)	g	7.83E-05	5.14E-	1.34E-05	1.34E-05	2.12E-13	1.02E-	0	0	0	0	1.02E-07	0
Ammonia (NH ₃)	g	0.46877	1.05E-	1.18E-09	1.18E-09	9.76E-16	4.69E-	1.18E-07	0.46867	5.78E-07	6.67E-09	9.85E-05	0
Water Emissions													
Agrochemicals (unspecified)	g	0.06670	0	0	0	0	0	0	0	0	0	0	0.06670
BOD5 (Biochemical Oxygen Demand)	g	0.03391	0.01646	0.00429	0.00429	2.12E-12	1.02E-09	3.54E-08	0.00852	0.00030	2.39E-05	2.95E-05	0
COD (Chemical Oxygen Demand)	g	0.24044	0.13927	0.03632	0.03632	1.79E-11	8.62E-	1.06E-07	0.02568	0.00250	0.00020	0.000165	0
Metals (unspecified)	g	0.00104	0.00068	0.00018	0.00018	1.04E-13	5.00E-	0	0	0	0	0	0
Ammonia (NH ₄ ⁺ , NH ₃ , as N)	g	0.00402	0.00241	0.00063	0.00063	3.14E-13	1.51E-	2.28E-06	0.00028	4.70E-05	5.86E-06	2.05E-05	0
Nitrates (NO ₃ ⁻)	g	1.71E-05	6.51E-	1.70E-07	1.70E-07	2.68E-15	1.29E-	1.16E-06	5.47E-07	2.40E-06	1.55E-06	1.04E-05	0
Solid Waste (hazardous)	kg	8.15E-05	5.36E-	1.40E-05	1.40E-05	6.89E-15	3.31E-	0	0	0	0	0	0
Solid Waste (non-hazardous)	kg	0.003681	0.00036	9.56E-05	9.56E-05	7.27E-12	3.49E-	0.00101	0.00023	0.00081	0.00066	0.000414	0
Total Primary Energy	MJ	3.158330	1.17068	0.31419	0.31419	9.25E-05	0.04445	0.07011	0.32653	0.20804	0.12367	0.586382	0
Fossil Energy	MJ	3.137950	1.16951	0.31388	0.31388	9.25E-05	0.04445	0.06874	0.32554	0.20421	0.12089	0.576736	0

5.2 Soybean Transport to Crusher

The transport of soybeans from the field to the crusher is based on current practices in the soybean farming and soybean crushing sectors. The actual data used in this study were based on a combination of conversations with industry representatives and modeled data. We ignored transporting soybeans for the export market, which represents most of the longest transportation distances in the industry.

5.2.1 Modes of Transport and Distance Transported

Most soybean crushers are located in or near major soybean-producing regions in the 14 major soybean producing states we are modeling in this LCA. According to at least one expert, most crushing locations will receive soybeans from within a 75-mile radius⁴⁶. The average transportation distance for a radius is typically the value of the radius because of road networks and variations in terrain. We assumed that the average distance soybeans are transported from the field to a crushing location is 75 miles.

We assumed that most of the transported soybeans that move 75 miles from the field to the crusher are moved by heavy-duty trucks. No other modes were assumed to be used for these short distances. Longer distance modes such as barges and trains, are assumed to move soybeans to export markets, but would not logically be used to move soybeans 75 miles. The transportation model from DEAMTM was used to model energy requirements and emissions from truck transportation.

The moisture content of the beans being transported is 16%, based on data for beans delivered directly from the field to the crusher during the Fall harvest. In reality beans may be stored by cooperatives for extended periods of time. In this case, the beans would be dried to around 11% moisture. We consolidated all energy demand for drying at the site of the crusher. Thus, instead of receiving beans already dried to 11%, the crusher has to dry the raw beans from its harvest moisture level of 16%. From an energy balance perspective, where we take the penalty for drying has no impact.

5.2.2 Energy and Fugitive Emissions from Storage and Handling

Energy and emissions result from loading and unloading the soybeans. The loading requirements are based on the electricity required to pump 1 kg of liquid. We assumed that the same electricity is required to load 1 kg of soybeans. The energy required for unloading the soybeans is included in the soybean crushing model.

Fugitive emissions from loading, unloading, and transporting of the soybeans from the field to the crusher are not included in the model, even though they may exist. We could not find data that described these emissions.

5.2.3 Soybean Transportation Results

Table 63 shows the LCI results for soybean transportation for the transport of 1 kg of soybeans to a generic U.S. crushing location.

⁴⁶ Communications with Phil Baumel of Iowa State University.

Table 63: LCI Results for Soybean Transport (for 1 kg of soybeans)

	Units	Transport of Soybeans to Crusher	Truck Loading	Truck Transport
Raw Materials				
Coal (in ground)	kg	0.0001062	2.07E-07	0.000106
Oil (in ground)	kg	0.0033994	7.11E-09	0.0033994
Natural Gas (in ground)	kg	0.0002919	2.27E-08	0.0002919
Uranium (U, ore)	kg	2.53E-09	4.95E-12	2.53E-09
Phosphate Rock (in ground)	kg	0	0	0
Potash (K ₂ O, in ground)	kg	0	0	0
Perlite (SiO ₂ , ore)	kg	7.73E-07	0	7.73E-07
Limestone (CaCO ₃ , in ground)	kg	2.02E-05	3.94E-08	2.01E-05
Sodium Chloride (NaCl)	kg	0	0	0
Water Used (total)	liter	0.0004731	6.34E-09	0.0004731
Air Emissions				
Carbon Dioxide (CO ₂ , fossil)	g	11.3255	0.000640	11.3249
Carbon Dioxide (CO ₂ , biomass)	g	0	0	0
Methane (CH ₄)	g	0.0040585	1.54E-06	0.0040569
Nitrous Oxide (N ₂ O)	g	0.0011253	1.18E-08	0.0011253
Carbon Monoxide (CO)	g	0.0384142	1.42E-07	0.0384141
Hydrocarbons (except methane)	g	0.0082712	5.19E-09	0.0082712
Hydrocarbons (unspecified)	g	0.00448	1.69E-08	0.00448
Benzene	g	7.63E-07	0	7.63E-07
Formaldehyde	g	1.02E-05	3.33E-17	1.02E-05
Particulates (PM10)	g	0.0128418	0	0.0128418
Particulates (unspecified)	g	0.00242	2.91E-06	0.0024171
Sulfur Oxides (SO _x as SO ₂)	g	0.0166862	3.65E-06	0.0166825
Nitrogen Oxides (NO _x as NO ₂)	g	0.106559	1.99E-06	0.106557
Hydrogen Chloride (HCl)	g	5.70E-05	1.11E-07	5.69E-05
Hydrogen Fluoride (HF)	g	7.13E-06	1.39E-08	7.12E-06
Ammonia (NH ₃)	g	1.45E-08	7.60E-13	1.45E-08
Water Emissions				
Agrochemicals (unspecified)	g	0	0	0
BOD5 (Biochemical Oxygen Demand)	g	0.0022801	2.67E-09	0.0022801
COD (Chemical Oxygen Demand)	g	0.0192927	2.26E-08	0.0192927
Metals (unspecified)	g	9.43E-05	1.69E-10	9.43E-05
Ammonia (NH ₄ ⁺ , NH ₃ , as N)	g	0.0003334	6.60E-10	0.0003334
Nitrates (NO ₃ ⁻)	g	9.03E-08	1.77E-10	9.02E-08
Solid Waste (hazardous)	kg	7.42E-06	8.69E-12	7.42E-06
Solid Waste (non-hazardous)	kg	5.09E-05	7.56E-08	5.08E-05
Total Primary Energy	MJ	0.162186	1.02E-05	0.162175
Fossil Energy	MJ	0.162023	9.83E-06	0.162014

5.3 Soybean Crushing

The modeling of soybean agriculture and soybean transportation to a crushing location have been described in previous sections. This section of the report describes the system of crushing soybeans into oil and meal as shown in Figure 44:

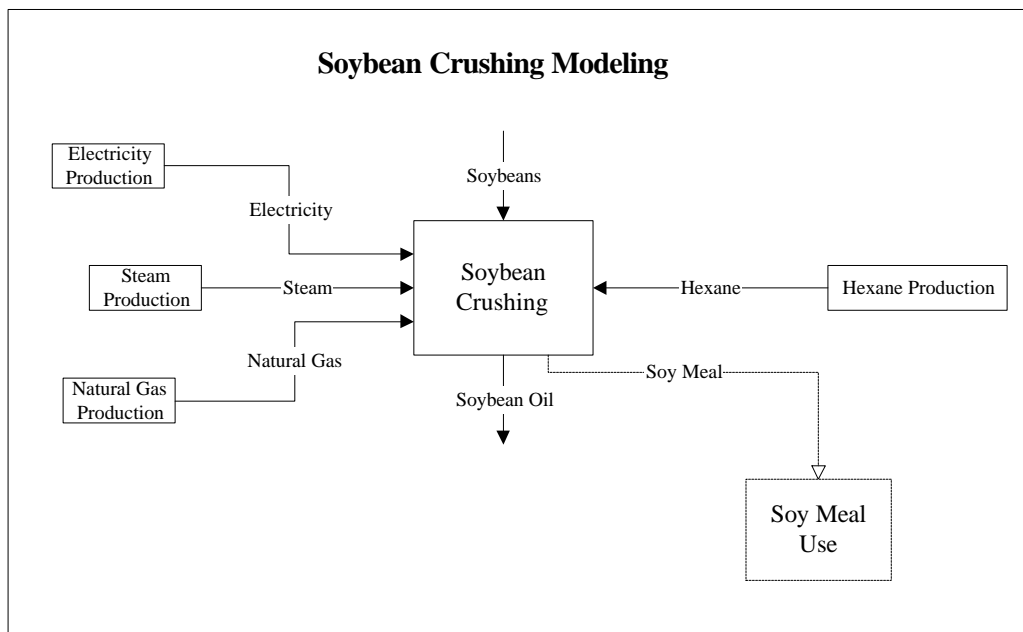

Figure 44: Soybean Crushing System Description

We modeled the soybean crushing process using, as a starting point, a detailed engineering study of a crushing facility located in the southeastern region of the United States (Adams et al 1981). The data available from this study are 17 years old. Furthermore, this study, though detailed in its analysis, represents performance of a single facility. To compensate for these limitations in the original data, an Excel® spreadsheet was developed that uses specific data from this facility in conjunction with basic engineering principles to establish a consistent set of material and energy balances for the overall process and for each of its unit operations. The result is a soybean crushing model with greater accuracy and robustness. To further ensure that our results reflect current crushing industry practice, the model output was reviewed by the National Oil Processors' Association (NOPA), the trade group representing soybean and oilseed crushers. We did, as a result of NOPA's review, adjust our estimate of a key performance parameters in the model—the thermal efficiency of the soybean dryers (discussed in more detail later in this section).

5.3.1 Process Description for Soybean Crushing

Figure 45 shows actual output from the spreadsheet model for a soybean crushing facility. The crushing process is fairly uniform throughout the industry; thus, the process modeled in this study is assumed to be representative of typical soybean crushing operations in the United States. The major distinguishing feature among the types of processes used in the U.S. crushing plants is in the oil extraction method. Our model facility uses solvent extraction to recover the oil. The alternative to solvent extraction is mechanical extraction (or some combination of mechanical and solvent extraction). Only 1% to 2% of

the soybeans processed in the United States are recovered via mechanical extraction methods⁴⁷. The model is broken out into eight separate sections. In the model's overview output in each section of the plant has total mass flow inputs and outputs shown. Logical output statements are shown as tags below each section box that indicate whether total mass balance closure is achieved for each section. This serves as a diagnostic tool for checking the validity of the model's output. In addition, at the bottom left corner in this figure, a box shows the output of a logical "if" statement, which checks for overall closure of the total plant material balance.

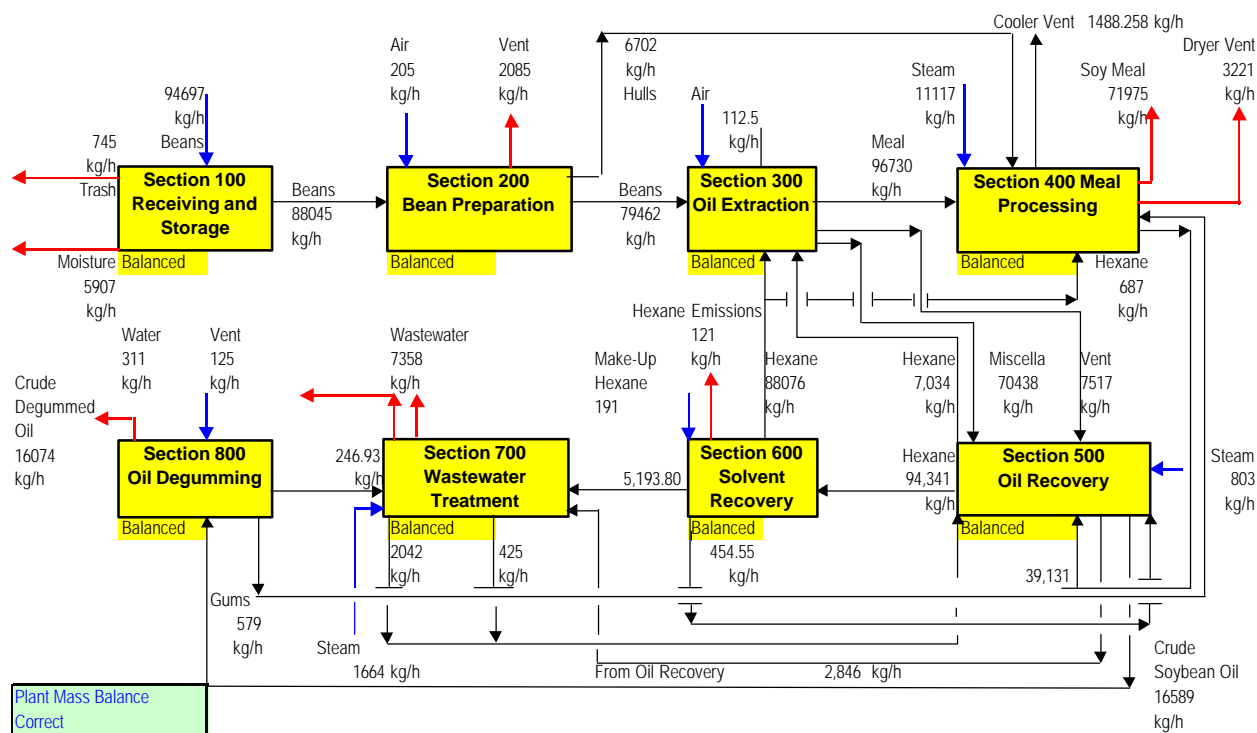

Figure 45: Overview of Soybean Crushing Process

The model assumes a facility that handles, on average, around 95,000 kg/h of soybeans (or 2,273 metric tons/day). This corresponds to almost 400 metric tons/day of crude, degummed soybean oil produced by the plant. Input to and through the receiving and storage section of the plant varies widely around the average flow of soybeans because delivery of beans to the plant is not uniform

Preparation of beans involves removal of the beans' hulls, as well as grinding and flaking. Flaked beans are then subjected to an extraction step in which hexane is used to remove the soybean oil. The extracted beans are dried and ground to produce a marketable meal product. Oil-containing hexane is then processed to separate the volatile hexane phase from the oil. Hexane solvent is recovered and recycled as much as possible. Finally the oil product is washed with water to remove gums before the final oil product is stored or shipped. Specific details for each section of the process follow.

⁴⁷ Erickson, D.R. "Chapter 5: Overview of Modern Soybean Processing," *Practical Handbook of Soybean Processing and Utilization*. AOCS Press, Champlain, IL 1995. Mechanical extraction involves use of continuous screw presses to expel oil from the beans. This approach is more energy intensive and generally more appropriate for oil seeds with higher oil contents.

5.3.1.1 Soybean Receiving and Storage

Figure 46 provides a process flow diagram for the receiving and storage section of the bean crushing plant. Once again, this diagram is actual output from the spreadsheet model. This part of the process includes conveyors for moving the beans, dryers, screens, and storage bins. Beans are received by truck. Barge access is used for moving soybean meal out of the plant. Note that the shipping of meal is not included in our LCI. The composition of the beans received is shown in Table 64 (Adams et al. 1981). Basic composition of the oil contained in the beans is shown in Table 65.

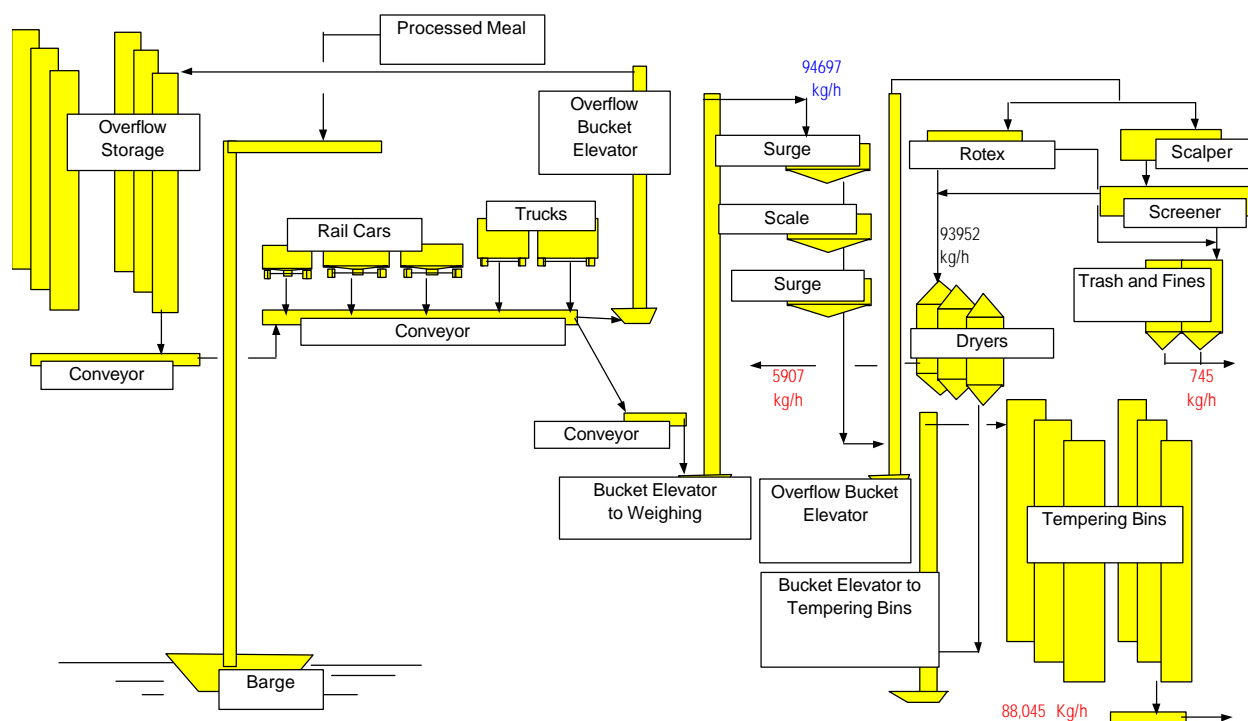

Figure 46: Receiving and Storage in Soybean Crushing Facility

Table 64: Bean Composition

Percent Oil in Beans	18.4%
Percent “Other Solids” in Beans	0.8%
Percent Hulls in Beans	7.4%
Percent Moisture in Beans	16.0%
Percent Meal in Beans	57.4%
Total	100.00%

The beans contain only 18.4% oil. The “other solids” are dirt and trash that are screened out of the beans and disposed of as waste. The triglycerides are the component of the oil that can be transesterified to

biodiesel. Free fatty acids are hydrolyzed forms of fats that are not converted to biodiesel by transesterification and that must be removed before biodiesel production. Phosphatides in the beans are more commonly referred to as “gums.” In our modeling of oil recovery and refining, we assume that these gums must also be removed before shipment to a biodiesel plant.

Moisture content of the beans can range from 14% to 18% in the Fall harvest delivered to the facility. The beans in our model facility are dried from a moisture content of 16% to a level of 10.5%. This moisture level is optimal for cracking the beans later in the process, and ensures that, under conditions of extended storage, the beans will not deteriorate appreciably.

Table 65: Soybean Oil Composition⁴⁸

Triglycerides	95.20%
Phosphatides (Gums)	2.50%
Unsaponifiable Matter	1.60%
Free Fatty Acids	0.70%
Total	100.00%

Figure 46 provides mass flows in and out of all major equipment in this section of the crushing operation. Of the 94,697 kg/h of beans delivered to the plant, 88,045 kg/h (or 93%) remain after dirt, trash, and moisture are removed. Energy requirements for this part of the plant are based on equipment power ratings and percent on-line times reported for the southeast U.S. facility (Adams et al. 1981). In addition, energy requirements for removing moisture are calculated for the air drying systems. Heat is supplied to the dryers by combustion of natural gas. The dryer is assumed to require 1940 kcal/kg (3500 Btu/lb) of water removed⁴⁹. The latent heat of vaporization is only 610 kcal/kg (1100 Btu/lb). This corresponds to an efficiency of 31% for the dryer.

Energy requirements are summarized in Table 66. Drying of the beans is one of the most energy-intensive parts of the process.

5.3.1.2 Bean Preparation

Mechanical processing of beans before extraction involves cracking of the beans followed by dehulling, cracking, conditioning and flaking (Figure 47). The five cracking rollers break up the beans into six to eight pieces. Dehulling does not provide a perfect separation between what the industry calls the “meats” of the beans and the hulls. Meats include the meal, oil, and moisture. One percent of the hulls remains with the meats. Seven percent of the meats is lost with the separated hulls. After dehulling, aspirators pneumatically carry hulls to the meal processing part of the plant. Conditioning the beans adjusts their temperature and moisture to make them more plastic and pliable before flaking. Indirect heating with steam and addition of air reduces the moisture content to 9% and raises their temperature from 21°C to

⁴⁸ Adapted from Perkins, E. “Chapter 2: Composition of Soybeans and Soybean Products,” In Erickson, DR., ed., *Practical Handbook of Soybean Processing and Utilization*, AOCS Press, Champlain, IL, 1995. This composition is for what is referred to as “crude oil”, the product of solvent extraction without any further refining.

⁴⁹ Woerfel reports that “reasonably efficient” dryers will require 830 kcal/kg (1500 Btu/lb) to 890 kcal/kg (1,600 Btu/lb) for whole bean drying (Woerfel 1995). We found higher numbers reported for drying soybean meal in Perry and Chilton 1975. However, after review of this report by the National Oil Processors’ Association (NOPA), we selected an energy demand of 1940 kcal/kg (3500 Btu/l). NOPA felt that colder temperatures often reduce the energy efficiency of these dryers to this level of 31%.

74°C. The moisture content of 9% is at the low end of the required range of 9% to 11% reported in the literature. Flaking is a critical step. Properly flaked beans must be 0.3 to 0.4 mm in thickness. Average diameter of the flakes must be such that 80% of the flakes are retained by a number 8 screen. Proper sizing of the flakes is critical to optimal extraction of the oil.

Table 66: Energy Requirements for Receiving and Storage in a Soybean Crushing Facility (normalized to 1 metric ton of beans)

Electricity (kWh)	
Rail and Truck	1.86
Cleaning	3.98
Drying	15.5
Total Electricity	21.3
Natural Gas (kcal)	
Drying	266,275

As the mass flow data show, 90% of the incoming mass of beans are sent on to extraction; 7.6% of the mass leaves with the hulls sent to the meal processing section of the plant. This is the first step where oil losses occur. Approximately 0.58% of the incoming triglycerides is lost at this stage because of the carryover of the “meats” with the hulls. The remainder of the mass balance is accounted for in additional moisture removal.

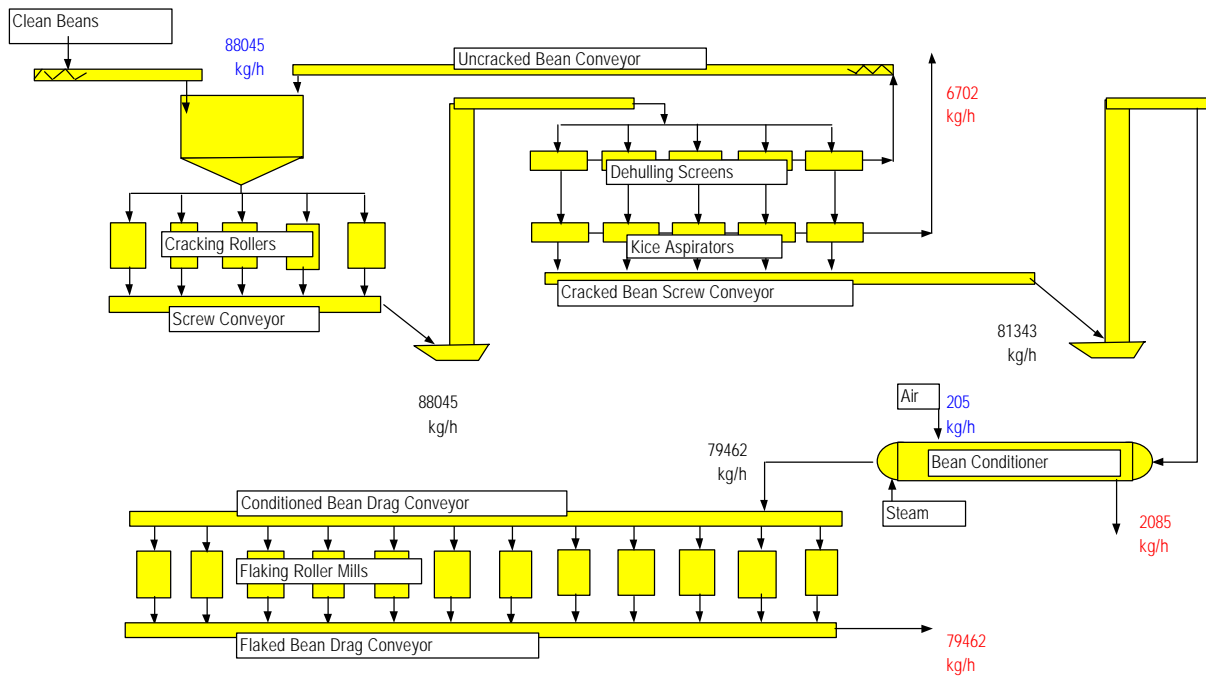

Figure 47: Bean Preparation in Soybean Crushing Facility

As in the receiving and storage section of the plant, energy requirements are estimated using the power ratings and percent on-line times from the southeastern U.S. facility. Steam requirements for bean conditioning are based on sensible heat and latent heats of vaporization for the beans, water, and air. Energy requirements are summarized in Table 67.

Table 67: Energy Requirements for Bean Preparation in a Soybean Crushing Facility (normalized per metric ton beans)

Electricity (kWh)	
Cracking	4.14
Dehulling	2.36
Conditioning	1.13
Flaking	13.96
Total Electricity	21.59
Steam (kcal)	
Conditioning	41,431

5.3.1.3 Soybean Oil Extraction

Figure 48 shows the process flow diagram for the oil extraction section of the crushing facility. The heart of this part of the process is the extractor. Four types of extractors are marketed in the industry: Rotary or deep-bed, horizontal belt, continuous loop extractors, and a miscellaneous collection of designs. The extractor used in our model is based on the one used in the southeast U.S. facility (Adams et al. 1981), and is known as a “stationary basket extractor.” It is manufactured and sold by the French Oil Mill Machinery company. It falls into the rotary bed design category. Flaked beans are dropped into a series of baskets. Miscella (the hexane/oil mixture) and hexane are pumped to the baskets to achieve a countercurrent scheme. It provides a countercurrent extraction scheme by rotating the solvent and solvent/oil mixture around the series of baskets. Each basket is washed by successively less concentrated oil/solvent mixtures, until each is ultimately washed with fresh solvent. The full miscella leaving the extractor can contain 19% to 24% oil. From our material balance, we calculate an oil content of 23.5%.

The full miscella is sent through a liquid cyclone that uses fresh hexane to remove entrained fines so that a clear miscella can then be sent on to the recovery section of the plant. The yield of oil recovered across the extraction section is 96%, providing a cumulative yield (up to this point in the plant) of 95.4% for oil. The yield of triglycerides is the same as for total oil. The rate of solvent addition is assumed to be 1.2 kg of solvent for every kg of flaked beans. Most of this solvent is recovered and recycled, so that actual make-up hexane usage is only 0.0024 kg/kg of flaked beans. Extracted flakes are dropped into a screw conveyor for subsequent removal of solvent.

Energy requirements for this section of the plant are low. Extensive heat integration is used so that heating of the solvent can be achieved using steam and energy from other parts of the plant. Electricity use amounts to a total of 3.6 kWh/metric ton of beans coming into the plant.

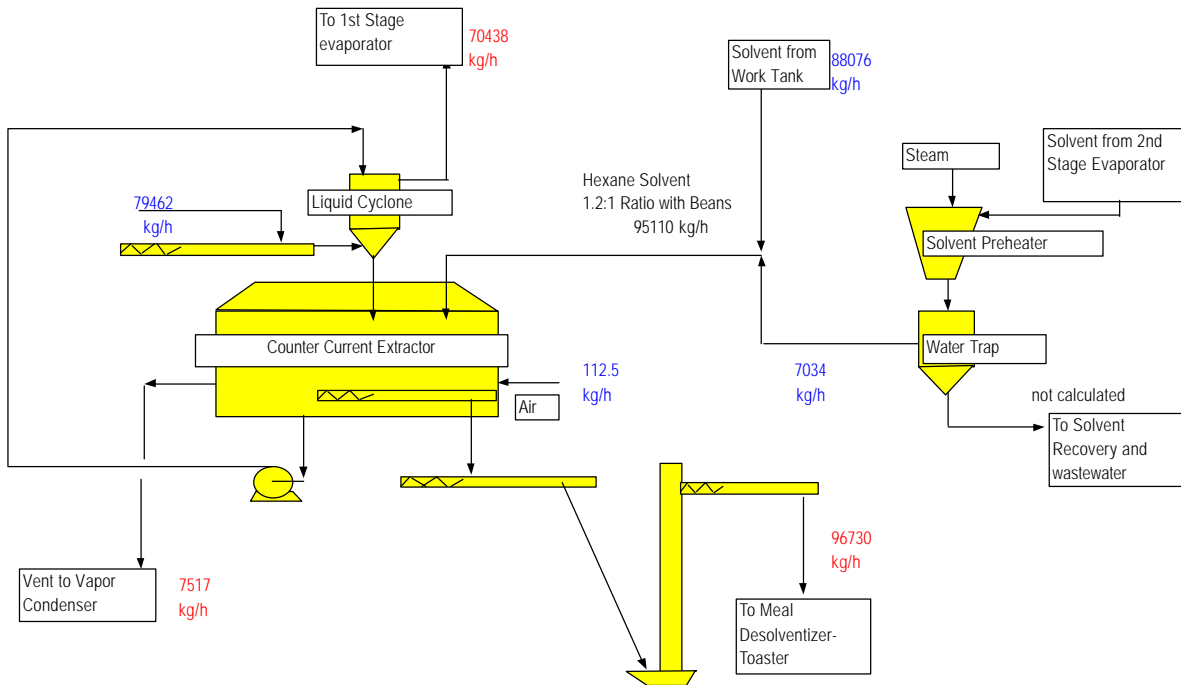

Figure 48: Oil Extraction in Soybean Crushing Facility

5.3.1.4 Meal Processing

Figure 49 shows the process flow diagram for the meal processing part of the plant. Wet solvent-containing flakes are reported to be as much as 40% hexane by weight in the southeast U.S. plant used as a starting point for our model. For the solvent application rate assumed, we calculated a hexane content of 35% by weight. These flakes are sent to a desolventizer-toaster, which does exactly what its name implies. This piece of equipment is designed to remove hexane by contacting the flakes with open steam. The flakes are toasted by contact with a series of high-temperature trays heated indirectly with high-pressure steam. Careful control of time, temperature, and moisture content in this unit is required to produce a meal essentially free of hexane and to inactivate urease and trypsin inhibitor enzymes present in the meal. Open steam is used to raise the moisture content to 20% on one of the trays; but final moisture content leaving the unit is 18%. Hexane concentration leaving the desolventizer-toaster is 995 ppm. The meal dryer uses indirect steam to reduce moisture content to a level of 14% and hexane to a level of 500 ppm. The meal is then cooled with air. Moisture content is further reduced at this point to 12%. Residual hexane is 400 ppm. The meal is then ground and conveyed to final storage and shipment. This part of the facility receives the hulls from the bean preparation part of the plant. The hulls are also toasted to inactivate the urease and trypsin enzymes. After grinding, the hulls are combined with the meal.

This part of the plant is the most energy intensive. Heating requirements for solvent removal and drying of the meal are the main contributors. All heat for this part of the plant is supplied by steam (both directly and indirectly through heat exchangers). The energy requirements are summarized in Table 68 and Table 69.

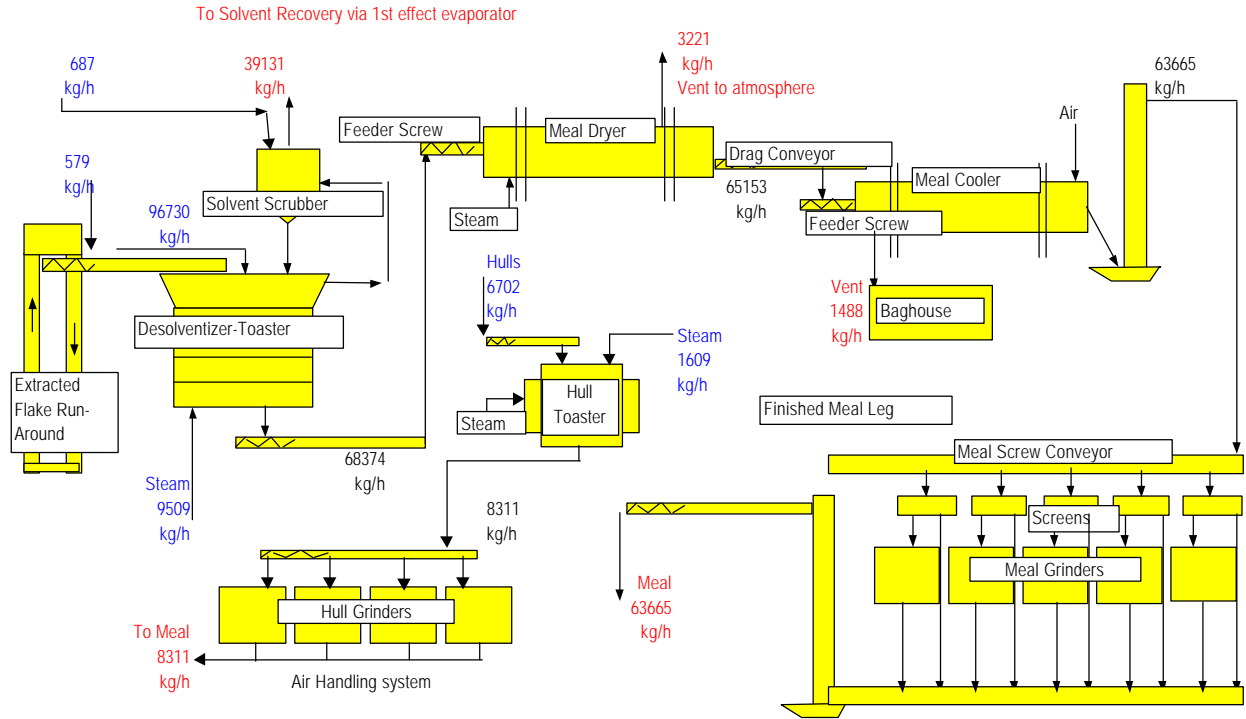

Figure 49: Meal Processing in Soybean Crushing Facility

Table 68: Electricity Requirements for Meal Processing in a Soybean Crushing Facility (kWh per metric ton of beans)

Desolventizer-Toaster	4.14
Meal Dryer	0.64
Meal Cooler	2.54
Meal Grinding	7.24
Hull Grinding	5.40
Total Electricity	19.96

Table 69: Steam Requirements for Meal Processing in a Soybean Crushing Facility (kcal per metric ton of beans)

Desolventizer-Toaster	100,824
Meal Dryer	20,546
Hull Toaster	11,704
Total Steam	133,074

5.3.1.5 Soybean Oil Recovery

Multiple effect evaporators are used to concentrate the oil in the miscella exiting the countercurrent extractor. Because of the complexity of designing the multiple effect evaporators, we used the conditions for oil concentration and temperature indicated for the system used in the southeast U.S. facility. Given these conditions, we then calculated all material and energy balances. No oil losses occur in this section of the facility. It is in this part of the facility that some of the heat integration opportunities can be recognized.

For example, hexane vapor coming from the first desolventizer-toaster in the meal processing section provides all the heat to the first stage evaporator. Most heat required for the extractor is, in turn, provided directly from the hexane vapor exiting the second stage evaporator. Steam used in the second stage evaporator and the final oil stripper are the original sources of heat that drive the extraction process. Because of environmental and economic reasons, hexane is recovered extensively from vents throughout the facility. Most of these come together at the excess vapor condenser shown in Figure 50. No appreciable oil losses occur in this section. Direct injection of steam reduces hexane content of the soybean oil to 120 ppm. Energy requirements are summarized in Table 70 and Table 71.

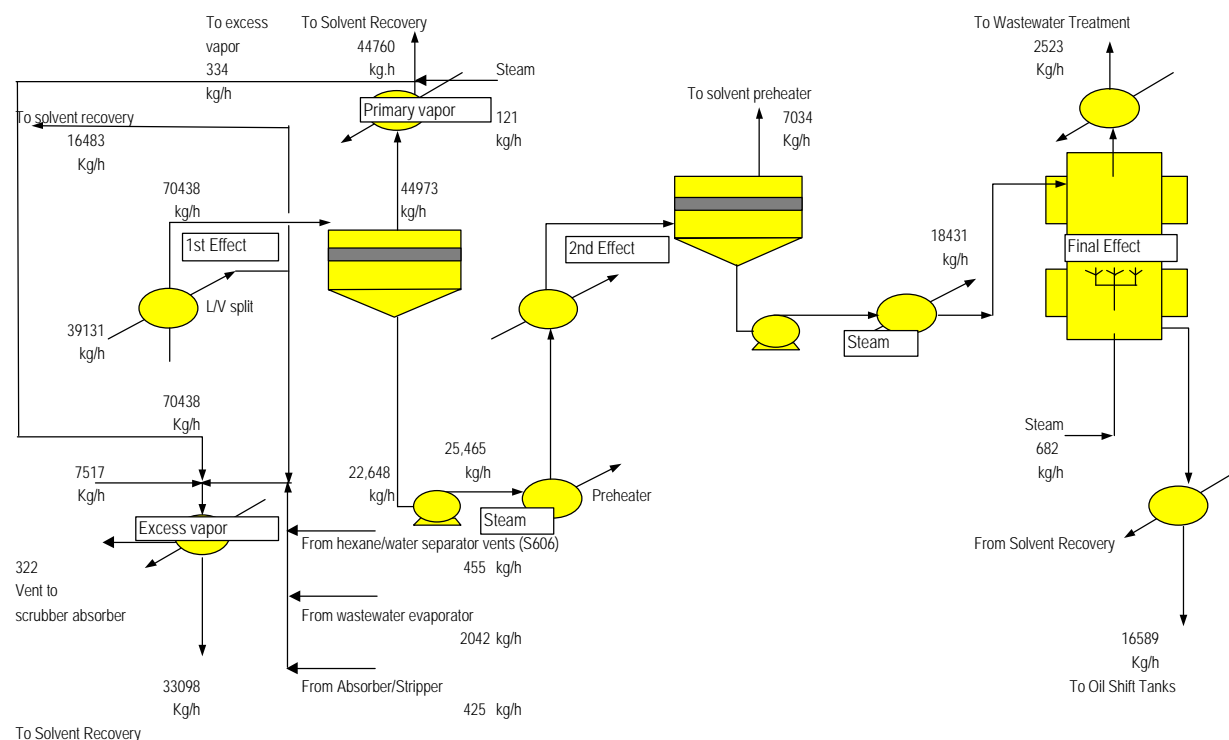

Figure 50: Oil Recovery in Soybean Crushing Facility

**Table 70: Electricity Requirements for Oil Recovery in a Soybean Crushing Facility
(kWh per metric ton of beans)**

First Effect Evaporator	0.15
Second Effect Evaporator	0.15
Final Effect Evaporator	0.08
Total Electricity	0.38

**Table 71: Steam Requirements for Oil Recovery in a Soybean Crushing Facility
(kcal per metric ton of beans)**

First Effect Evaporator	0
Second Effect Evaporator	9,978
Final Effect Evaporator	10,836
Total Steam	20,814

5.3.1.6 Solvent Recovery

Figure 51 shows the process flow diagram for recovery and recycle of hexane. Hexane and hexane/water condensate from the excess vapor condenser and other parts of the oil recovery system are sent to a settling tank. Solvent is continuously drawn off the top phase and pumped back to extraction section of the plant. The water phase is pumped to the waste treatment section of the facility. A small amount of hexane is pumped to the scrubber above the desolventizer-toaster, where it is used to remove entrained fines. Energy requirements for this section of the plant are only 0.52 kWh/metric ton of soybeans.

5.3.1.7 Oil Degumming

Degumming removes phosphatides and some of the unsaponifiable matter from the crude oil (Figure 52). This is done simply by mixing the oil with hot water. As the gums are hydrated they swell and can be separated from the oil by the difference in density. Water is added at a rate of 75% of the level of phosphatides present in the oil. A centrifuge is used to separate the hydrated gums from the oil. The oil is vacuum dried and sent to storage for shipment. The gums collected in the aqueous phase are separated from the water and sent to meal processing, where they are added to the desolventizer-toaster. Oil losses in this section of the plant are 3.11%; but only 0.5% loss of triglycerides occurs. The final yield of crude, degummed oil is 92.5% of the oil contained in the delivered beans. The yield of triglycerides is 95%. Final composition of the crude, degummed oil is shown in Table 72. The energy requirements for degumming are shown in Table 73 and Table 74.

Table 72: Final Composition of Crude, Degummed Oil

Triglycerides	97.43%
Unaponified Matter	1.500%
Free Fatty Acids	0.750%
Other	0.300%
Phosphatides (Gums)	0.0200%
Total	100.00%

Table 73: Electricity Requirements for Degumming in a Soybean Crushing Facility (kWh per metric ton of beans)

Hydration	0.24
Centrifuge	0.68
Vacuum Dryer	0.77
Total Electricity	1.69

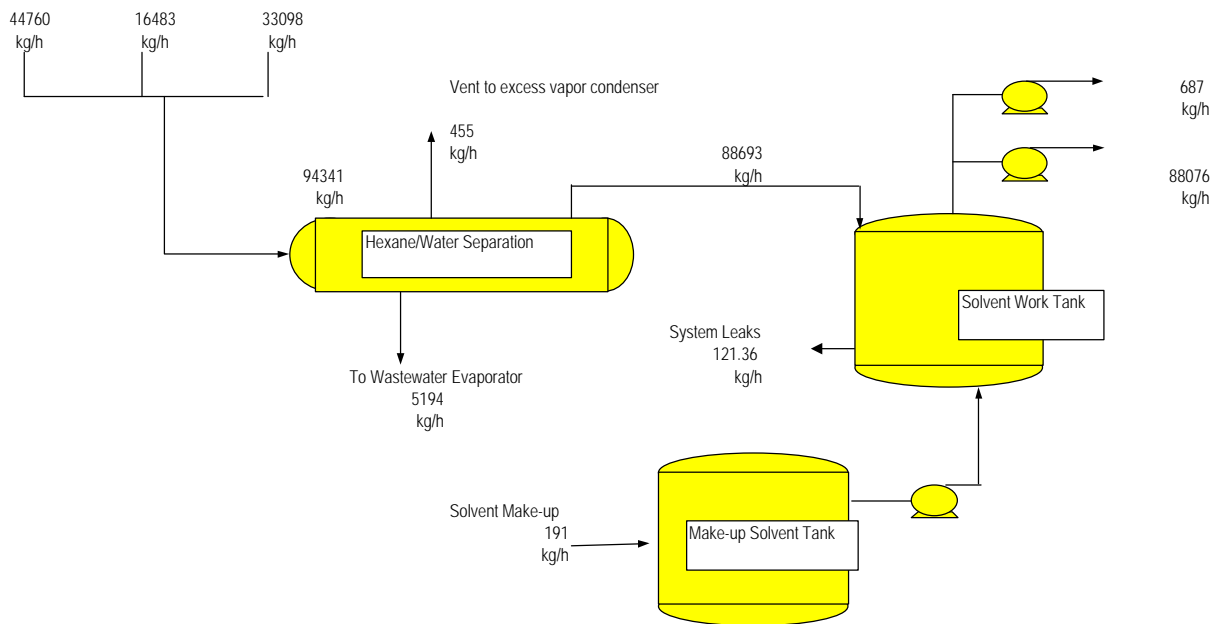

Figure 51: Solvent Recovery in Soybean Crushing Facility

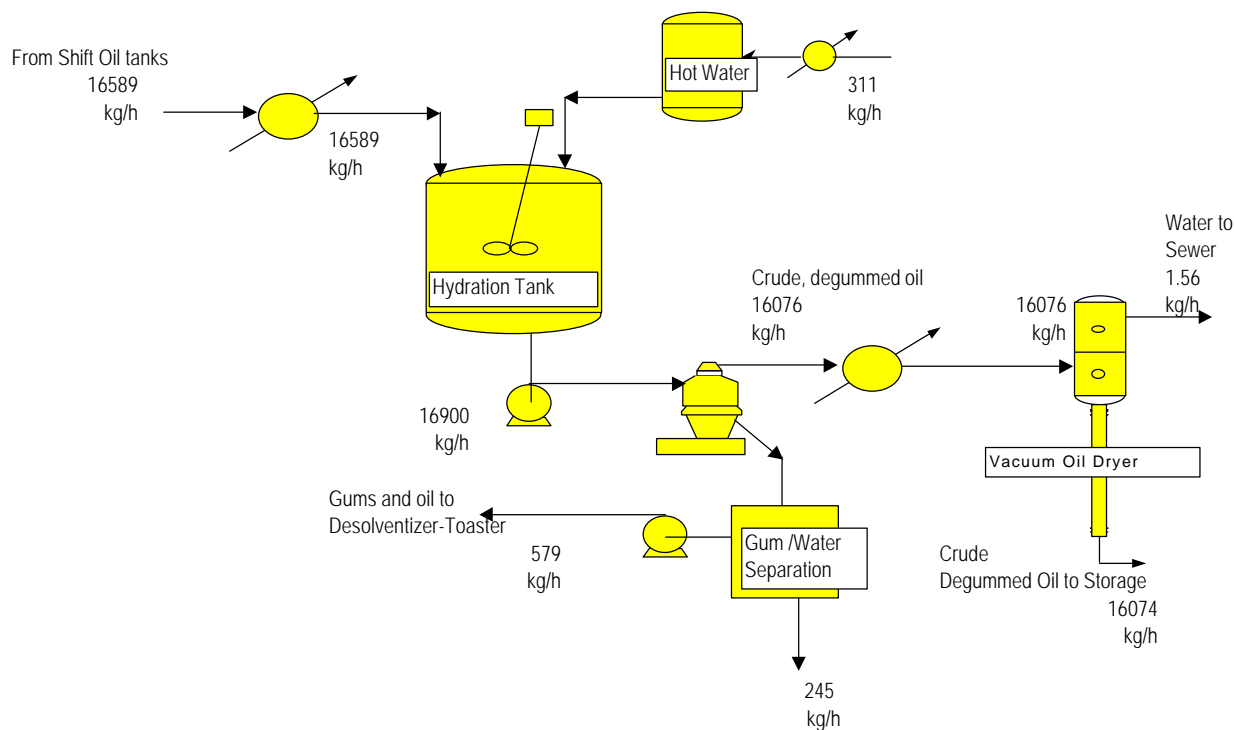

Figure 52: Oil Degumming Process for Soybean Crushing Facility

**Table 74: Steam Requirements for Degumming in a Soybean Crushing Facility
(kcal per metric ton of beans)**

Hydration	8,611
Dryer	7,743
Total Steam	16,354

5.3.1.8 Waste Treatment

Waste treatment is focused primarily on recovery of residual hexane (Figure 53). To this end, a steam stripper is used to remove evaporated hexane that is then recovered in the excess vapor condenser in the solvent recovery section of the plant. The wastewater from the evaporator contains low levels of oil from the degumming operation. The vapor that remains from the excess vapor condenser is sent to an absorber to capture any residual hexane before venting. Hexane is recovered from the absorbent by steam stripping.

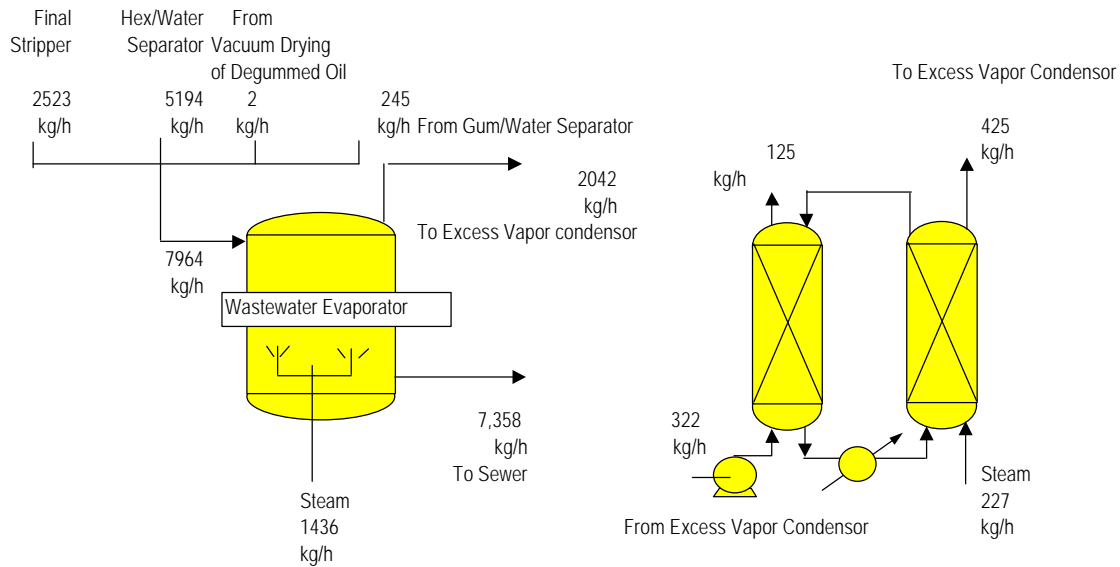

Figure 53: Waste Treatment for Soybean Crushing Facility

Electricity requirements for this section of the plant are 0.52 kWh/metric ton of beans delivered to the plant. Steam requirements are shown in Table 75.

Table 75: Steam Requirements for Waste Treatment in a Soybean Crushing Facility (kcal per metric ton of beans)

Hexane Absorption	7,207
Wastewater Evaporator	1,591
Total Steam	8,798

5.3.2 Analysis of Yields and Energy Balance

Yield results for each section of the plant are shown in Figure 54. Crude oil and triglycerides are shown. The most significant for biodiesel production is the yield of triglycerides, because these are the components of the oil that are transesterified.

As Figure 54 shows, the performance of the extractor is the most critical part of the process in determining yield of triglycerides from soybeans. Minor losses occur in the bean preparation and in the oil degumming steps. The difference between 95% yield of triglycerides and the 92% yield of total oil from the facility is due to the removal of gums and unsaponifiable matter.

A comparison of electricity demands in various parts of the crushing operation is shown in Table 76 and Figure 55. Electricity demand is dominated by solids handling and size reduction equipment. These occur in the receiving and storage, bean preparation, and meal processing sections of the plants. Steam and natural gas demand, used primarily for heating, are summarized in Figure 56.

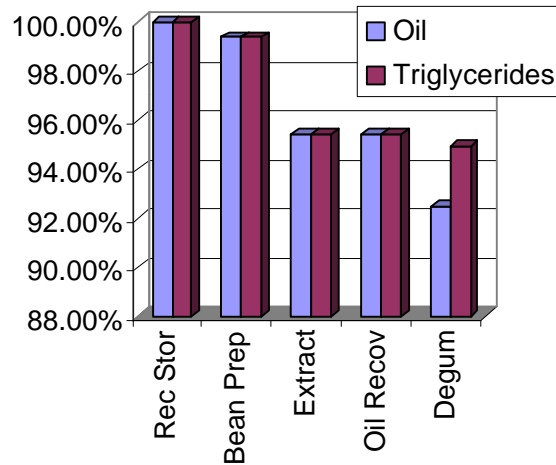

Figure 54: Yield of Oil and Triglycerides in a Soybean Crushing Facility

Table 76: Summary of Electricity Requirements for Soybean Crushing (kWh per metric ton of beans)

Section	Electricity Requirements
Oil Recovery	0.38
Solvent Recovery	0.52
Waste Treatment	0.57
Degumming	1.69
Oil Extraction	3.60
Meal Processing	19.95
Receiving and Storage	21.35
Bean Preparation	21.59
Total	69.65

All the energy shown in Figure 56 is for steam usage except for the receiving and storage number, which includes only the energy used in burning natural gas to dry beans before storage. Once again, receiving and storage, bean preparation, and meal processing are the dominant consumers of energy from steam and natural gas. Oil recovery and oil degumming also use significant amounts of energy.

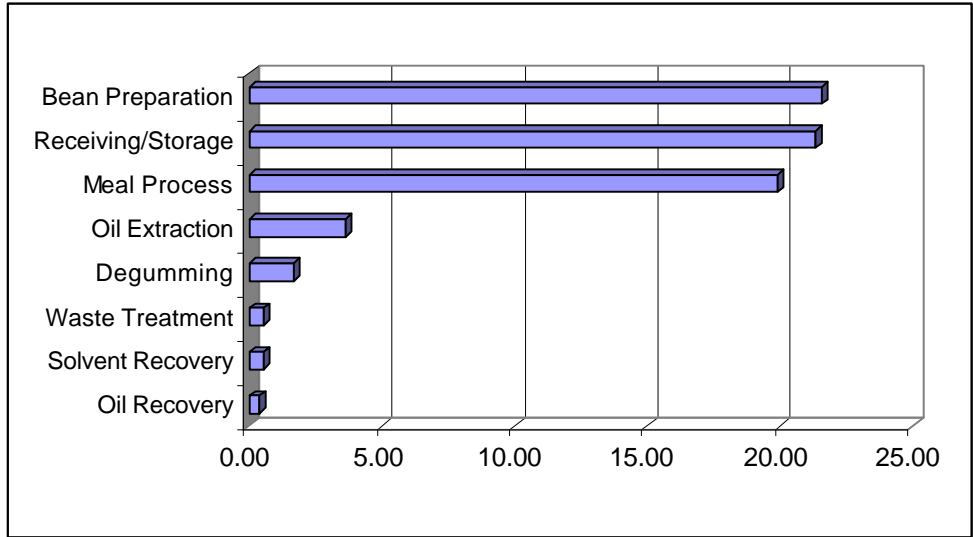

Figure 55: Distribution of Electricity Requirements in a Soybean Crushing Facility (kWh per metric ton of beans)

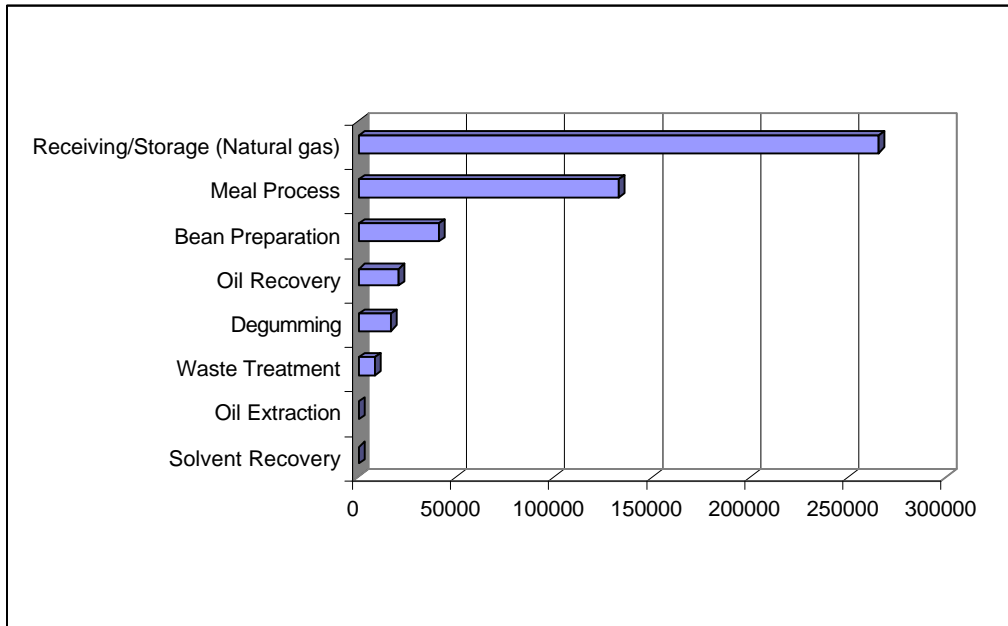

Figure 56: Steam and Natural Gas Consumption in a Soybean Crushing Facility (kcal per metric ton of beans)

5.3.3 Overall Inputs to Soybean Crushing

The soybean crushing facility has only three raw material inputs (see Table 77): soybeans, hexane, and water. The inputs are shown below for actual hourly flow of the model crushing facility, as well as in normalized units (per metric ton of beans delivered and oil produced).

Table 77: Raw Material Inputs to Soybean Crushing Facility

Component	Hourly Flow (kg/h)	kg/Metric Ton of Beans Delivered	kg/Metric Ton of Oil Produced
Soybeans	94,697	1,000	5,891.27
Hexane	191.	2.02	11.90
Water	311	3.28	19.35

Energy inputs to the soybean crushing facility are summarized in Table 78. They are listed according to the form of energy used and normalized to the amount of delivered beans and oil produced. In our Ecobalance model, the electricity demand presented here is tied back to an electricity model describing electricity produced on a generic (national average) U.S. grid. Similarly, steam demand is tied back to an Ecobalance module describing a natural gas-fired industrial boiler. National average data for natural gas production are used to model life cycle flows from production and distribution of natural gas.

Table 78: Energy Inputs to Soybean Crushing Process

Energy Source	Energy per Metric Ton of Beans Delivered	Energy per Metric Ton of Oil Produced
Electricity (kWh)	69.66	410.45
Natural Gas (kcal)	266,275	1,568,858.71
Steam (kcal)	220,020	1,296,331.52

5.3.4 Overall Soybean Crushing Outputs

Products from the crushing facility are indicated in Table 79. The only two products from this operation are soybean meal and soybean oil. Of 1,000 kg of beans going into the process, 760 kg end up as meal and 170 kg end up as crude, degummed soybean oil. The remaining 70 kg is accounted for in air, solid, and liquid waste streams.

Table 79: Products from Soybean Crushing Facility

Product	Hourly Flow (kg/h)	Kg per Metric Ton of Beans Delivered	Kg per Metric Ton of Oil Produced
Crude, Degummed Soybean Oil	16,072.45	169.73	1,000.00
Soybean Meal	71,975.40	760.06	4,478.19

Air emissions from the facility are summarized in Table 80. Hexane emissions come from vent losses in meal processing and solvent recovery. Soybean crushing facilities assiduously recycle the hexane used in the process. The need for hexane make-up reflects the small losses that occur in these plants. The hexane shown as an air emission in Table 80 accounts for 163 kg/h of the 191 kg/h required as make-up feed to the process. The remaining 28 kg/h of hexane loss can be accounted for in low levels of residual hexane contained in the oil and meal products. Water vapor leaving in vents is almost exclusively the result of

drying steps to remove moisture contained in the beans. Emissions from combustion are estimated using data from the DEAM™ database. These emissions are associated with combustion of natural gas to produce steam and hot air for drying.

Table 80: Air Emissions from Soybean Crushing Facility (Excluding Combustion)

Component	Hourly Flow (kg/h)	kg per Metric Ton of Beans Delivered	kg per Metric Ton of Oil Produced
Moisture	6,561	69.28	408.19
Air	317	3.35	19.73
Hexane	163	1.72	10.15

Water emissions are indicated in Table 81. An explicit material balance for water in and out of the process has not been shown (though a complete material balance has been achieved for the crushing process). For example, a quick inspection of the water input shown in Table 77 and water leaving as waste in Table 81 reveals that water leaving as waste is much greater than the amount of process water brought in. The added flow of water is due to the use of steam injected directly into the process streams. This steam condenses and ultimately ends up as wastewater. The steam flows presented in the energy inputs (Table 78) include steam used for indirect heat exchange as well as steam directly injected into the process. The detailed spreadsheet model for crushing correctly accounts for steam, which becomes part of the process flows in the material balance. The primary contaminant of the wastewater is soybean oil. The oil is present at a level of 1.1% by weight of the total wastewater flow. In section 5.3.2, we indicated that the total yield of oil from the crushing process is 92.5%. Approximately 0.5% of the oil contained in the beans is lost as part of the wastewater discharge. The remaining 7% of the oil present in the beans can be accounted for as residual oil in the meal product.

Table 81: Water Emissions from a Soybean Crushing Facility

Component	Wastewater kg/h	kg per Metric Ton of Beans Delivered	kg per Metric Ton of Soybean Oil Produced
Total Wastewater	7,358.26	77.70	457.77
Soybean Oil	80.77	0.85	5.02
Triglycerides	78.96	0.83	4.91
Phosphatides	0.02	0.0002	0.00
Unsaponifiable Matter	1.21	0.01	0.08
Free Fatty Acids	0.58	0.01	0.04
Moisture	7,277.50	76.85	452.75

The only solid waste generated in the soybean crushing operation is from trash and tramp metals removed from the raw beans. This amounts to 745 kg/h of total flow (0.008 kg/kg of raw beans delivered or 0.046 kg per kg of degummed oil produced). In the LCI, this trash is categorized as nonhazardous waste.

5.3.5 Allocation of Life Cycle Flows for Soybean Crushing

Soybean crushing facilities produce both soybean oil and soybean meal. This study is concerned only with the production of soybean oil. Therefore, there needs to be a method of allocating total crushing energy use and total crushing emissions to the production of soybean oil only.

An allocation technique based on the mass output of soybean crushing is used as the baseline for this study. In order to allocate total soybean crushing environmental flows among the products on a mass output basis, the mass percent of each coproduct must be known. Table 82 outlines how this would be done, based on the output of a generic soybean crushing facility. The percentages are based on the product outputs described in section 5.3.4.

Table 82: Production of a Generic Soybean Crushing Facility

	Mass (kg/h)	Mass (%)
Soybean Oil	16,072	18 %
Soybean Meal	71,975	82 %
Total	88,047	100%

5.3.6 Soybean Crushing Results

Table 83 shows the LCI results for soybean crushing for the production of 1 kg of soybean oil. These results are output from the Ecobalance model. Thus, the emissions and flows shown in the first column reflect indirect flows coming from intermediate raw material and energy inputs to the crushing operation, as well as the direct flows discussed in sections 5.3.1 through 5.3.5. This subtle distinction becomes apparent when you consider some of the water and solid waste flows listed in this table. For example BOD₅ and COD numbers appear, even though no estimates for these flows are provided in our model for soybean crushing. These components enter the LCI as a result of electricity generation and the production of other raw materials used in the crushing operation. Similarly, no hazardous waste is generated in the crushing facility. The small amount shown in Table 83 is the result of indirect contributions from other processes.

Table 83: LCI Results for Soybean Crushing (for 1 kg of soybean oil)

	Units	Total Soybean Crushing	Natural Gas Use	Steam Production	Electricity Production	Hexane Production	Direct from Crushing
Raw Materials							
Coal (in ground)	kg	0.018566	4.19E-08	4.33E-08	0.0185663	1.82E-09	0
Oil (in ground)	kg	0.002991	5.47E-08	5.65E-08	0.0006388	0.0023523	0
Natural Gas (in ground)	kg	0.050306	0.02374	0.0245249	0.0020365	1.50E-08	0
Uranium (U, ore)	kg	4.45E-07	1.00E-12	1.04E-12	4.45E-07	0	0
Phosphate Rock (in ground)	kg	0	0	0	0	0	0
Potash (K ₂ O, in ground)	kg	0	0	0	0	0	0
Perlite (SiO ₂ , ore)	kg	0	0	0	0	0	0
Limestone (CaCO ₃ , in ground)	kg	0.00354	7.95E-09	8.21E-09	0.0035403	0	0
Sodium Chloride (NaCl)	kg	0	0	0	0	0	0
Water Used (total)	liter	0.004097	6.74E-09	6.96E-09	0.0005701	0	0.00353
Air Emissions							
Carbon Dioxide (CO ₂ , fossil)	g	200.328	69.9311	72.2291	57.519	0.649155	0
Carbon Dioxide (CO ₂ , biomass)	g	na	na	na	na	na	na
Methane (CH ₄)	g	0.37326	0.1154	0.119192	0.138668	9.77E-08	0
Nitrous Oxide (N ₂ O)	g	0.001814	0.00032	0.0003303	0.0010621	0.0001015	0
Carbon Monoxide (CO)	g	0.060743	0.02334	0.0241107	0.0127441	0.0005446	0
Hydrocarbons (except methane)	g	1.86624	0.0008	0.0008255	0.0004664	0.0147412	1.84941
Hydrocarbons (unspecified)	g	0.001518	4.77E-07	4.93E-07	0.0015171	0	0
Benzene	g	0	0	0	0	0	0
Formaldehyde	g	3.00E-12	6.66E-17	6.88E-17	3.00E-12	0	0
Particulates (PM10)	g	0.003411	0.00168	0.001733	0	0	0
Particulates (unspecified)	g	0.261845	4.26E-05	4.40E-05	0.261279	0.00048	0
Sulfur Oxides (SO _x as SO ₂)	g	1.43078	0.53839	0.556078	0.327924	0.0083909	0
Nitrogen Oxides (NO _x as NO ₂)	g	0.375724	0.09502	0.0981413	0.178429	0.0041355	0
Hydrogen Chloride (HCl)	g	0.010019	2.26E-08	2.34E-08	0.0100188	0	0
Hydrogen Fluoride (HF)	g	0.001252	2.83E-09	2.92E-09	0.0012524	0	0
Ammonia (NH ₃)	g	4.62E-05	1.30E-11	1.35E-11	6.83E-08	4.62E-05	0
Water Emissions							
Agrochemicals (unspecified)	g	0	0	0	0	0	0
BOD5 (Biochemical Oxygen Demand)	g	0.000253	2.83E-08	2.92E-08	0.0002399	1.30E-05	0
COD (Chemical Oxygen Demand)	g	0.002069	2.39E-07	2.47E-07	0.0020298	3.91E-05	0
Metals (unspecified)	g	1.52E-05	1.39E-09	1.43E-09	1.52E-05	0	0
Ammonia (NH ₄ ⁺ , NH ₃ , as N)	g	5.93E-05	4.19E-09	4.33E-09	5.93E-05	0	0
Nitrates (NO ₃ ⁻)	g	1.59E-05	3.58E-11	3.70E-11	1.59E-05	0	0
Solid Waste (hazardous)	kg	7.81E-07	9.20E-11	9.51E-11	7.81E-07	0	0
Solid Waste (nonhazardous)	kg	0.015261	9.71E-08	1.00E-07	0.0067949	3.41E-06	0.00846
Total Primary Energy	MJ	3.47122	1.23473	1.2753	0.912304	0.048883	0
Fossil Energy	MJ	3.44276	1.23473	1.2753	0.883847	0.048883	0

5.4 Soybean Oil Transport

This section describes the assumptions behind determining the distances and locations soy oil is transported, and discusses the data used to model the environmental flows associated with these activities.

5.4.1 Where Do We Locate the Biodiesel Conversion Facilities?

In order to model the transport of soybean oil to the biodiesel production facility, we needed to postulate the location of these biodiesel facilities in the near future. Our basic choices were: (1) move soy oil to the retail market where biodiesel is made, (2) make the biodiesel at the crushing plant and move biodiesel to the retail market, or (3) transport soy oil to a biodiesel plant located some where between the crusher and the retail market. Regardless of the scenario we choose, we still model the transport of the same liquid mass over the same total distance⁵⁰. This is an important assumption on our part, but it appears to be fairly robust.⁵¹ Transportation modes are the same for oil and biodiesel (truck, tanker and rail car).

In this study we hypothesized that biodiesel is available neat (100% biodiesel) or in blends of B20 for urban bus fleets. Neat use would tend to be supported by federal regulations that include neat biodiesel as an alternative fuel, and provide incentives to fleet managers to use neat biodiesel. Therefore, biodiesel must be available in a neat form in relatively large volumes near the retail users.

B20 is a popular alternative that bears closer examination. The biodiesel blended into diesel to make B20 will likely occur at the distribution level, similar to how ethanol is blended today with gasoline. Therefore, the biodiesel will probably be stored and blended in the retail market, probably at a tank farm where other petroleum products are stored, and again, stored in a neat form at the tank farm and blended just before delivery.

Moving very small amounts of biodiesel into markets poses some infrastructure problems. Most storage facilities for petroleum have been designed for large volumes. Also, the economies of scale associated with liquid transportation tend to show that transportation costs decline and energy efficiency improves as larger volumes of fuel are moved. Therefore, to capture economies of transportation and storage, biodiesel will tend to be moved neat in large volumes.

Most urban bus fleets are located in relatively large urban areas, which provide more opportunities for marketing biodiesel to other users. More users would tend to support larger demand and provide the opportunity to capture the economies of scale. Some biodiesel producers are targeting market development in larger cities by trying to attract large fleet customers and using those positions to expand their market sales to other customers. Blending biodiesel at refineries would not work in this study because we are examining an end use that requires neat biodiesel. Therefore, large urban markets appear to be supportable destinations for the biodiesel.

⁵⁰ The number of gallons of soy oil required to make a gallon of biodiesel is roughly the same because the glycerine component of the oil is replaced with a methanol molecule, but the volume doesn't change. Some processing losses are incurred but they are small. See the next section for more detail.

⁵¹ This hypothesis does not change even if we assume that all diesel fuel is blended with 5% biodiesel at the refinery before the blended biodiesel is moved through the existing diesel fuel distribution network. Then we may have assumed that the soy oil or biodiesel moves from the Midwest, where the soybean industry is located into regional refineries and down the river systems to Gulf coast refineries. But again, either the soy oil would have moved to the biodiesel facilities located near the refineries, or the biodiesel would have been made near the crushing plants and moved to the refineries.

This does not mean that biodiesel plants are located in the urban markets. Some biodiesel producers are part of integrated agricultural industries, owning crushing and biodiesel production facilities. Those biodiesel plants tend to be located in the soybean-producing regions. Some biodiesel producers are not associated with agricultural interests, making biodiesel out of recycled grease and other feedstocks. Those producers tend to be exploring some of the economic benefits of urban redevelopment, brown field development benefits, and similar synergies. Urban locations will also provide opportunities to reduce feedstock cost by blending soy oil and recycled grease. If we relied primarily on this distribution of biodiesel producers, we would say the industry is evenly split.

One other piece of information that may determine the balance of development is that the urban bus fleets tend to be owned and operated by local governments; those same local governments who have economic and political interests in urban redevelopment. Obtaining the supply contracts for those bus fleet customers may require a physical production presence in the urban area that leads to job creation and a stable tax base. And because those urban bus contracts may be integral components for developing a market position that provides access to other urban customers (and ultimately economies of scale), there appears to be a strong motivating force that would favor locating biodiesel facilities in urban communities.

So, having said all that, we chose to model soy oil transportation to biodiesel facilities located in urban communities, even though the future biodiesel industry may be more complex. Transportation distances are the same with either choice.

5.4.2 Modes of Transport and Distance Transported

The soy oil is being produced in the 14 major soybean-producing states. We based soybean oil transportation on a calculated U.S. average distance from the soybean crushers/soybean production regions to 14 major metropolitan areas. Fourteen metropolitan sites were chosen based on U.S. non-attainment areas of more than one million people. The 14 urban areas selected represent an average geographical distribution of U.S. cities.

National average transportation distance for soy oil transportation was calculated in a three-step process.

1. Two distances were calculated: one from the closest soybean crushing facilities to the nearest urban area; the other was based on the centroid of the major soybean-producing region to the same urban area.
2. The two distances were averaged together for each urban area.
3. The averaged urban distances were averaged together to determine a national average transportation distance for any urban area.

The information used for these calculations and the results are shown in Table 84.

The mode of transportation for the soybean oil is calculated by assuming that all the oil would be transported by train, because train transportation is more efficient than truck for distances longer than 300 miles. An additional advantage of train transportation is that the train cars themselves are used for storing the oil at the conversion facility. This practice is common in many industries.

5.4.3 Energy and Fugitive Emissions from Storage and Handling

Energy and emissions are created while loading and unloading the soybean oil.

The loading requirements are based on the electricity required to pump 1 kg of liquid as outlined in crude oil transportation modeling. We assumed that the soybean oil needs to be loaded and unloaded because the unloading is not included in the biodiesel conversion model.

We assumed that there are no fugitive emissions from loading, unloading, and transporting the soybean oil from the crusher to the biodiesel conversion facility.

Table 84: LCI Assumptions for Soy Oil Transportation

<i>City Using Biodiesel</i>	<i>Transport Distances (miles)</i>			<i>Mode of Transport (%)</i>
	<i>From Site 1</i>	<i>From Site 2</i>	<i>Avg.</i>	<i>Train</i>
	<u>Arkansas</u>	<u>Kansas</u>		
Phoenix	1260	1170	1215	100%
	<u>Iowa</u>	<u>Arkansas</u>		
LA/San Diego	1480	1470	1475	100%
	<u>Iowa</u>	<u>Arkansas</u>		
San Francisco/Sacramento	1640	1840	1740	100%
	<u>Kansas</u>	<u>Iowa</u>		
Denver	400	650	525	100%
	<u>Arkansas</u>	<u>Dallas</u>		
Dallas	300	50	175	100%
	<u>Louisiana</u>	<u>Mississippi</u>		
Houston	300	400	350	100%
	<u>Minnesota</u>	<u>Iowa</u>		
Minneapolis/St. Paul	120	240	180	100%
	<u>Illinois</u>	<u>Iowa</u>		
Chicago	175	320	247.5	100%
	<u>Ohio</u>	<u>Illinois</u>		
Cincinnati	140	320	230	100%
	<u>Ohio</u>	<u>Illinois</u>		
Cleveland	100	475	287.5	100%
	<u>Alabama</u>	<u>South Carolina</u>		
Atlanta	150	160	155	100%
	<u>Delaware</u>	<u>South Carolina</u>		
Baltimore/Washington	100	300	200	100%
	<u>Delaware</u>	<u>Illinois</u>		
New York	200	860	530	100%
	<u>Delaware</u>	<u>Illinois</u>		
Boston	360	1000	680	100%
		US Average:	571	100%

5.4.4 Soybean Oil Transport Results

Table 85 shows the LCI results for soybean oil transportation for the transport of 1 kg of soybean oil from the crushing facility to the conversion facility.

Table 85: LCI Results for Soybean Oil Transport (for kg soybean oil)

	Units	Soy Oil Transport (Total)	Railcar Loading	Rail Transportation
Raw Materials				
Coal (in ground)	kg	0.000203966	4.13E-07	0.000203553
Oil (in ground)	kg	0.00652741	1.42E-08	0.0065274
Natural Gas (in ground)	kg	0.000560541	4.53E-08	0.000560496
Uranium (U, ore)	kg	4.86E-09	9.90E-12	4.85E-09
Phosphate Rock (in ground)	kg	0	0	0
Potash (K ₂ O, in ground)	kg	0	0	0
Perlite (SiO ₂ , ore)	kg	1.48E-06	0	1.48E-06
Limestone (CaCO ₃ , in ground)	kg	3.87E-05	7.88E-08	3.86E-05
Sodium Chloride (NaCl)	kg	0	0	0
Water Used (total)	liter	0.000908433	1.27E-08	0.00090842
Air Emissions				
Carbon Dioxide (CO ₂ , fossil)	g	21.9774	0.00127989	21.9761
Carbon Dioxide (CO ₂ , biomass)	g	0	0	0
Methane (CH ₄)	g	0.00790308	3.09E-06	0.0079
Nitrous Oxide (N ₂ O)	g	0.000234333	2.36E-08	0.000234309
Carbon Monoxide (CO)	g	0.0733493	2.84E-07	0.073349
Hydrocarbons (except methane)	g	0.00109545	1.04E-08	0.00109544
Hydrocarbons (unspecified)	g	0.0254744	3.38E-08	0.0254744
Benzene	g	1.46E-06	0	1.46E-06
Formaldehyde	g	1.96E-05	6.67E-17	1.96E-05
Particulates (PM10)	g	0.00888317	0	0.00888317
Particulates (unspecified)	g	0.00464701	5.81E-06	0.00464119
Sulfur Oxides (SO _x as SO ₂)	g	0.0319926	7.30E-06	0.0319853
Nitrogen Oxides (NO _x as NO ₂)	g	0.362504	3.97E-06	0.3625
Hydrogen Chloride (HCl)	g	0.000109523	2.23E-07	0.000109301
Hydrogen Fluoride (HF)	g	1.37E-05	2.79E-08	1.37E-05
Ammonia (NH ₃)	g	2.79E-08	1.52E-12	2.79E-08
Water Emissions				
Agrochemicals (unspecified)	g	0	0	0
BOD5 (Biochemical Oxygen Demand)	g	0.00437806	5.34E-09	0.00437805
COD (Chemical Oxygen Demand)	g	0.0370451	4.52E-08	0.037045
Metals (unspecified)	g	0.000181066	3.37E-10	0.000181066
Ammonia (NH ₄ ⁺ , NH ₃ , as N)	g	0.000640132	1.32E-09	0.000640131
Nitrates (NO ₃ ⁻)	g	1.73E-07	3.53E-10	1.73E-07
Solid Waste (hazardous)	kg	1.42E-05	1.74E-11	1.42E-05
Solid Waste (nonhazardous)	kg	9.77E-05	1.51E-07	9.76E-05
Total Primary Energy	MJ	0.311422	2.03E-05	0.311402
Fossil Energy	MJ	0.311111	1.97E-05	0.311091

5.5 Soybean Oil Conversion

In modeling biodiesel production, the heart of the process for converting soybean oil to biodiesel is assumed to be a reaction known as transesterification. In this reaction, a simple alcohol such as methanol is reacted with the triglycerides in soybean oil to produce a fatty acid methyl ester (biodiesel) and glycerol. This modification of the soybean oil to make it suitable as a diesel fuel was originally proposed by researchers in South Africa (Bruwer et al. 1980). Formation of the ester was seen as a way to dramatically reduce viscosity, eliminating many of the early problems identified with the use of raw vegetable oil in diesel engines (Bruwer et al. 1980; Walton 1938; Martinez de Vedia 1944). Other approaches to producing a diesel fuel from vegetable oils and other forms of biomass exist (Shay 1993; Fleisch et al. 1995; Wong et al. 1994), but production of the fatty acid methyl ester is the only approach considered in this model.

Transesterification is not the only route to production of fatty acid methyl esters. Nor is the methyl ester the only form of ester that can be used as a fuel. An alternative approach to transesterification is to completely hydrolyze all the triglycerides to free fatty acids, and then to directly esterify these fatty acids with methanol. Transesterification has been selected for this model because it is the process of choice in all the commercial biodiesel production facilities that have come on line in Europe over the past 4 years (Korbitz 1994; Gosse 1994; Riva 1994). A number of simple alcohols have been used to produce the esters. Alcohols such as ethanol, butanol, and isopropanol have been used to make the ethyl, butyl, and isopropyl esters of the fatty acids (Kusy 1982; Nye et al. 1983; Freedman et al. 1984; Korus et al. 1993; Drown et al. 1995). However, the bulk of industrial experience, especially for fuel production, is with the use of methanol to produce methyl esters via transesterification (Korbitz 1994; Howell et al. 1995).

To ensure a realistic description of biodiesel production from soybean oil, an extensive review of available data on conversion kinetics, reactor conditions, and yields was conducted to determine assumptions for all unit operations. This review shows that ester production is old technology, whether we are talking about direct esterification of fatty acids or transesterification of triglycerides (Eckley 1954; Markley 1961; Swern 1982; Formo 1954; Eisenhard 1989). Yields of biodiesel from triglycerides are commonly in excess of 90%. Methyl esters are produced commercially today for a variety of applications, especially as intermediates in the production of detergent products. In fact, the design of the transesterification plant in our model is based on an older commercial facility located in Kansas City, Missouri. Because this facility is being offered for sale, information on the basic unit operations, mass balance, and energy requirements were available, though only in fairly sketchy form (Proctor and Gamble 1994). Practices and approaches used in this plant may not reflect the latest innovations in the industry (especially those in Europe), but they do reflect conventional practices for methyl ester in the United States. They represent a conservative basis for evaluating the energy efficiency and environmental inputs and outputs associated with this part of the biodiesel life cycle.

As we did in modeling the soybean crushing operation described in the previous section, we augmented available data from the Kansas City facility with design calculations based on chemical engineering principles. This provides for a more robust model, but it is also necessary to fill in gaps in the mass and energy balance information available from the Kansas City facility.

The mass and energy balances for production of biodiesel from soybean oil are in the form of an Excel® workbook. Mass and energy balances for each section of the plant are in interlinked worksheets. Output from the spreadsheet model is presented in the subsequent sections on soybean oil conversion.

5.5.1 Process Overview for Conversion of Soybean Oil to Biodiesel

Figure 57 shows actual output from the spreadsheet model for a soybean oil conversion facility. The model plant is broken out into six major processing sections. Tags below each section block in Figure 57

show output from a logical test indicating whether closure is achieved for the mass balance in each section. The overall material balance for the entire plant is also checked as indicated in the block at the top of the figure.

The chemistry of transesterification should yield almost exactly 1 kg of biodiesel per kg of crude soybean oil. This model facility produces 10,504 kg/h of biodiesel (equivalent to 25 million gallons per year) from 10,897 kg/h of crude oil, corresponding to a mass yield of biodiesel from oil of 96.4%. Crude oil received from the crushing operation is taken through a caustic refining step to remove free fatty acids. The soaps generated in this step are removed by washing the oil with hot water. This wash is sent to wastewater treatment. Before sending the oil to the transesterification reactor, the oil is dried to remove water, which can be detrimental to yield in the reactors. Dry, caustic-refined oil is combined with a 2:1 stoichiometric excess of methanol and a small amount of catalyst. The reaction produces methyl ester and glycerine. Unreacted methanol is recovered as extensively as possible and recycled to the reactors. A crude glycerine product (80% glycerol) is sold as a by-product.

The plant design does not include purification to USP-grade glycerine. The steps for purification of the methyl ester include countercurrent water washing to remove glycerine and methanol. The Kansas City plant used as the basis for the spreadsheet model includes a distillation step to remove unreacted and partially reacted glycerides from the product. This distillation step is not included in the model. The material balance shows that, given the assumptions for yield from the reactors, unconverted glycerides are already below the level needed to meet the proposed biodiesel fuel specification being developed by the NBB (Howell 1997).

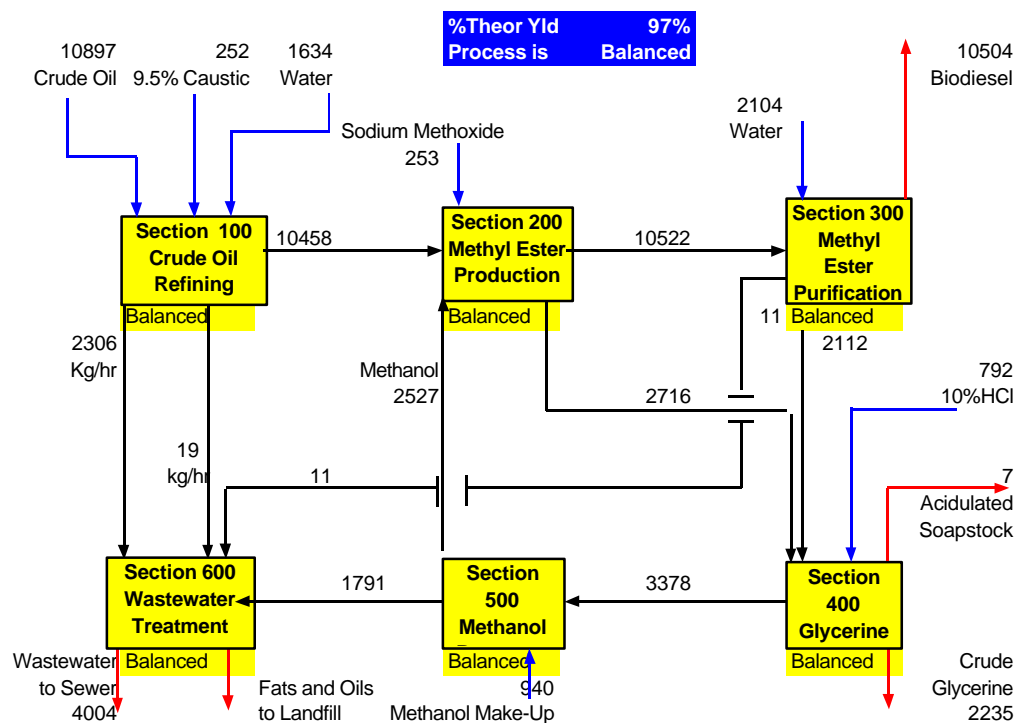
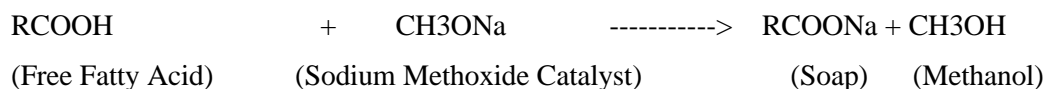

Figure 57: Overview of Process for Conversion of Soybean Oil to Biodiesel (Flows in kg/h)

The NBB's specifications are listed in Table 86. Other critical factors in the specification directly affected by processing of the crude oil are the water and sediment levels and flash point. The latter is a sensitive measure of methanol left in the fuel. Proper drying of the ester controls the former. Excessive levels of free fatty acids can affect the acid number level as well. As mentioned earlier, viscosity limits are the motivation for the chemical conversion of the soybean oil to the methyl ester.

5.5.1.1 Alkali Refining of Crude Soybean Oil

The characteristics of the crude, degummed soybean oil are taken directly from the spreadsheet model of the crushing operation (Figure 58). Content of the oil is shown in Table 87. The free fatty acids present in the oil are detrimental to the chemistry of transesterification because they can tie up catalyst through the formation of soaps, as shown in the reaction below.



In addition, soap formation can result in a more difficult phase separation of methyl ester and glycerol. To prevent this, caustic and water are added to the degummed soybean oil before carrying out the transesterification step in a process known as alkali refining. This is a well-established practice in the soybean processing industry. The conditions for this process step are based on typical industry practice (Swern 1982; Erickson 1995). The soybean oil is heated to 70°C and mixed with 14° *Baume* (9.5 wt%) caustic solution to form soap and free fatty acids.

Table 86: Tentative Biodiesel Fuel Specifications Proposed by The National Biodiesel Board

Property	ASTM Method	Limits	Units
Flash Point	93	100.0 minimum	Degrees Celsius
Water and Sediment	1796	0.050 maximum	Volume %
Carbon Residue, 100% sample	4530	0.050	Weight %
Sulfated Ash	874	0.020	Weight %
Kinematic Viscosity at 40 °C	445	1.9-1.6	Millimeter squared per second
Sulfur	2622	0.05 maximum	Weight %
Cetane	613	40 minimum	
Cloud Point	2500	By customer	Degrees Celsius
Copper Strip Corrosion	130	No 3b maximum	
Acid Number	664	0.80 maximum	Mg KOH/gm
Free Glycerine	Austrian update of GC method developed by USDA	0.020 maximum	Weight %
Total Glycerine	Same as free glycerine	0.240 maximum	Weight %

Table 87: Composition of Crude, Degummed Oil from Crushing Operation

Component	Weight %
Triglycerides	97.761%
Phosphatides	0.020%
Unsaponifiable Matter	1.5%
Free Fatty Acids	0.719%
Total	100.00%

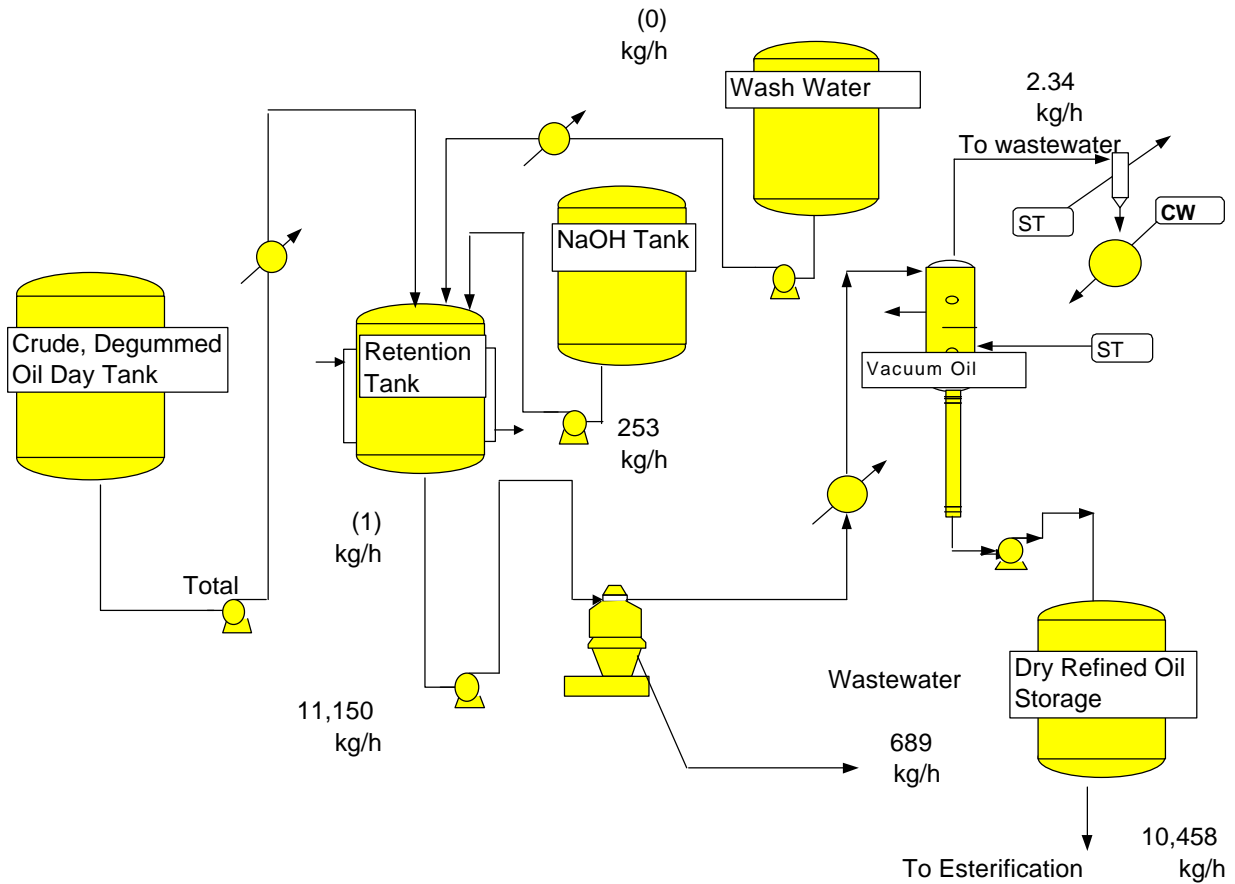
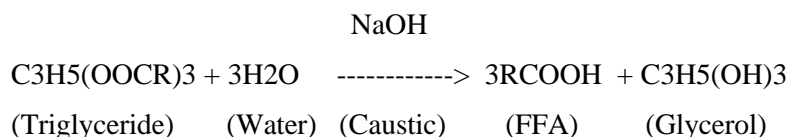

Figure 58: Alkali Refining of Crude Soybean Oil to Remove Free Fatty Acids

The measured level of free fatty acids in the oil determines the addition rate of caustic. Typically, caustic is added at a rate equivalent to a 113% stoichiometric excess.⁵² Wash water, also heated to 70°C, is added

⁵² Definition of this excess rate can be confusing. Conventions for measuring this vary. According to Erickson. (1995), this excess is defined as the amount of caustic required to neutralize the free fatty acids plus 113% of this amount. This is the convention used in the model.

at a rate of 15% of the crude soybean oil mass flow rate. Some yield loss is assumed to result from the saponification of triglycerides according to the follow reaction:



The mixture of oil, soap, and wash water is sent to a centrifuge to separate soap and water from the oil. One percent of the oil phase is assumed to be lost with the soap and water.⁵³

Of the 10,897 kg/h of soybean oil entering the refining section, 10,458 kg/h are sent to the transesterification section. This represents a total yield of 96%. A breakdown of the source of the losses is shown in Table 88. A little more than half the losses are due to removal of unwanted components (the free fatty acids and unsaponifiable matter). The remainder is loss of triglyceride. About half the triglyceride loss is due to the 1% carryover of oil in the wash water, and half is due to saponification.

Table 88: Losses Associated with Alkaline Refining of Crude, Degummed Soybean Oil

Component	Losses
Free Fatty Acids	0.719%
Triglyceride Losses	1.799%
Unsaponifiable Matter	1.485%
Total	4.00%

Steam requirements for heating and drying are summarized in Table 89. Heating of the crude oil represents three-quarters of the steam demand. All steam requirements in this report are indicated as Kcal of available latent heat⁵⁴.

Table 89: Steam Requirements for Alkaline Refining of Crude, Degummed Oil (per metric ton of Biodiesel Produced)

Unit	kcal
Crude Oil Heater	25,935.61
Wash Water Heater	7,780.68
Preheater for Vacuum Dryer	2,338.37
Vacuum Dryer	959.21
Total	37,013.87

⁵³ This is a reasonable estimate. No data were available to support this estimate. We assumed that the centrifuge is operated to maximize removal of soaps and unsaponified matter, at the expense of a small loss of triglyceride.

⁵⁴ The plant uses 150 psi steam with a latent heat content of 475.1 kcal per kg.

5.5.1.2 Transesterification

Figure 59 presents output of the transesterification section of the model. Assumptions for reactor conditions were based on a review of the literature on transesterification of vegetable oils and fats (Swern 1982; Peterson et al. 1995; Erickson 1995; Kusy 1982; Nye et al. 1983; Freedman et al. 1984; Korus et al. 1993; Drown et al. 1995). The chemistry of the reaction is as follows:

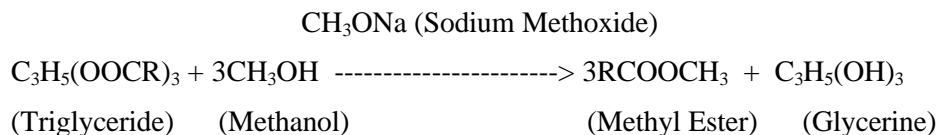

The stoichiometry of the reaction requires three molecules of methanol for every molecule of triglyceride reacted. On a weight basis, this corresponds to adding methanol at a rate of about 10% by weight per mass of oil processed. However, to obtain high yields and reasonable reaction times, an excess of methanol is usually used. In our model, this excess is assumed to be twice the stoichiometric requirement. This translates to six molecules of methanol for every molecule of triglyceride in the oil. Excess methanol remaining after the reaction is recovered later in the process. In commercial practice, a variety of base catalysts has been used to for this reaction. These include sodium hydroxide and potassium hydroxide, as well as sodium methoxide. The Kansas City facility used as a framework for our model reports the use of sodium methoxide. For consistency with this plant, we also used sodium methoxide in the model. The catalyst is present at a level of 10% in the methanol added to the reactors. For the 6:1 molar ratio of methanol to glycerides, this corresponds to a catalyst concentration in the reactor of 2.2%.

Yields of 98% have been reported for this reaction. Consistent with the Kansas City facility design, our model assumes a two-stage reactor scheme, in which 90% yields are achieved at each stage. This corresponds to an overall yield of 99%. Reported temperatures in the reactors vary from 50° to 120°C. We selected a temperature of 60°C. because the lower end of the temperature range is typical of more modern commercial facilities. These reactors require considerable mixing to achieve good contact between the methanol and oil phases. The two-phase product streams from each stage are sent to settling tanks. The oil phase containing the ester product is lighter than the aqueous phase containing the glycerol and methanol. The aqueous phase is drawn off from the bottoms of both settling tanks and sent to methanol and glycerol recovery. The oil phase from the first-stage settler is sent to the second reactor. The oil phase from the second reactor is sent to the methyl ester purification section of the plant.

The 10,455 kg/h of triglycerides entering the reactors produce 10,397 kg/h of methyl ester. This corresponds exactly to a 99% yield of ester from triglyceride on a molar basis. No other losses of oil or product occur. Potential losses can occur in the settling tanks if some of the oil phase is carried over with the aqueous phase. This design assumes that the settling tanks are being operated for maximum recovery of product, at the expense of some carryover of aqueous phase in the oil.⁵⁵ Purification of the ester removes the glycerine, methanol, and water carried over.

Steam requirements for this part of the plant are for heating of reactants to the reactor temperature of 60°C (see Table 90).

⁵⁵ We assume that 5% of the aqueous phase in the settlers is carried over with the product. This is a reasonable estimate, though no specific data were available.

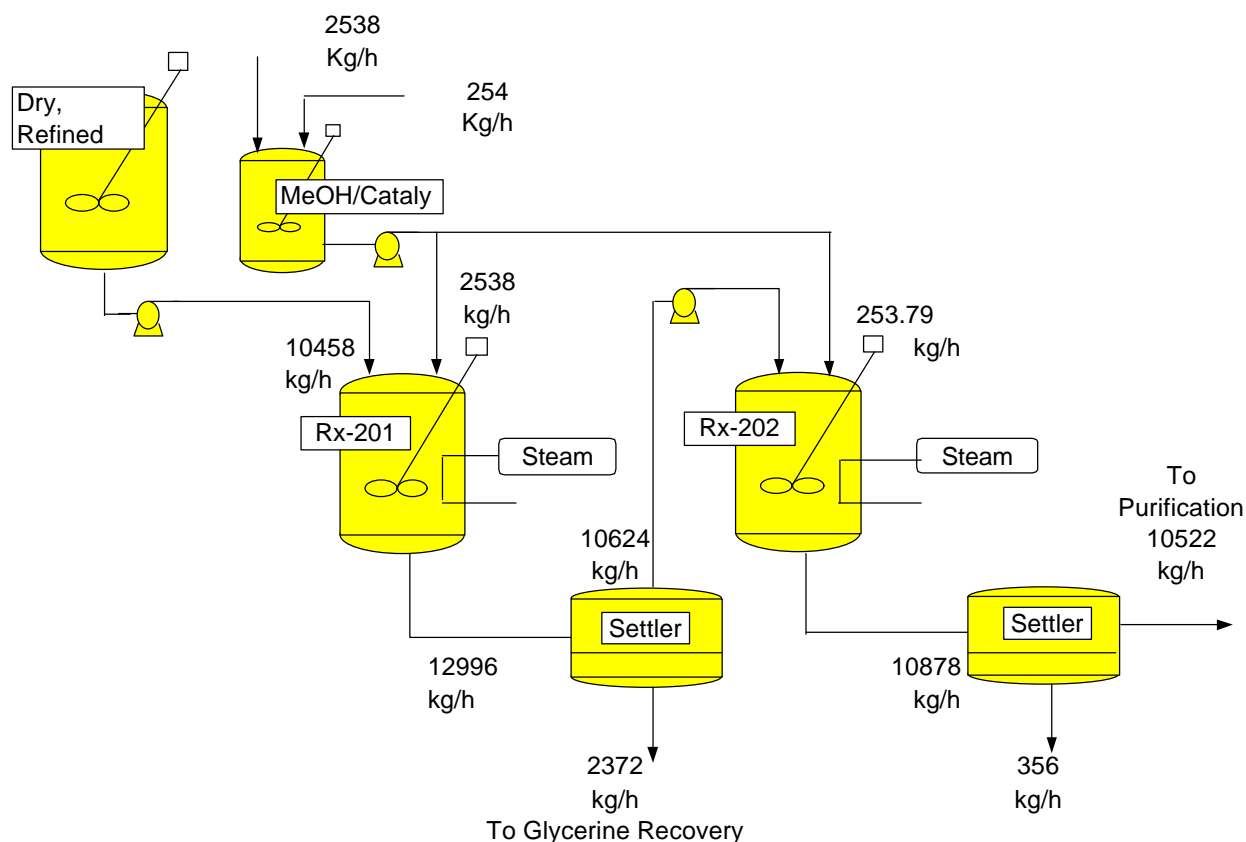

Figure 59: Transesterification Section of Biodiesel Production Facility

5.5.1.3 Methyl Ester Purification

Figure 60 shows the process steps assumed for purification of the methyl ester product. The methyl ester rich phase from the reactors is washed with water to remove glycerol, methanol, and other water-soluble components. This is done in countercurrent wash columns. Water is fed to the tops of the columns, while the methyl ester product is fed in from the bottom.

Table 90: Steam Requirements for Transesterification (Normalized per Metric Ton of Biodiesel Produced)

Unit	Kcal
First Stage Transesterification Reactor	23,186.46
Second Stage Transesterification Reactor	2,418.56
Total Steam Demand for Transesterification	25,605.02

No specific data are available for the operation of these wash columns. Information on the approach to batch water washing of methyl esters is used as a basis for establishing conditions for these columns. The steps involved in the batch process are as follows:

1. 5%-10% hot water wash. Then settle.
2. Add another 5-10% hot water wash.
3. Possible third wash if aqueous bottom layer is not clear.
4. Add another 10% hot water wash with agitation. Settle and decant.

In total, the batch process uses a water addition rate of 30%-40% of the mass flow rate of methyl ester product. For the countercurrent continuous wash, we assume complete washing can be done with only half the water addition (20%). Water enters the columns at 70°C. We assume that 10% of the wash water is entrained with the ester product, while none of the ester product is lost with the wash water. Water exiting the bottoms of the columns goes to glycerine recovery. Washed ester product is sent to a settler to separate the aqueous phase, which is also sent on to the glycerine recovery section. This settler is operated to maximize ester recovery. We assume that recovery of the ester phase is 100%, while 5% of the aqueous phase is lost to the ester phase. The ester is then vacuum dried to remove the residual water.

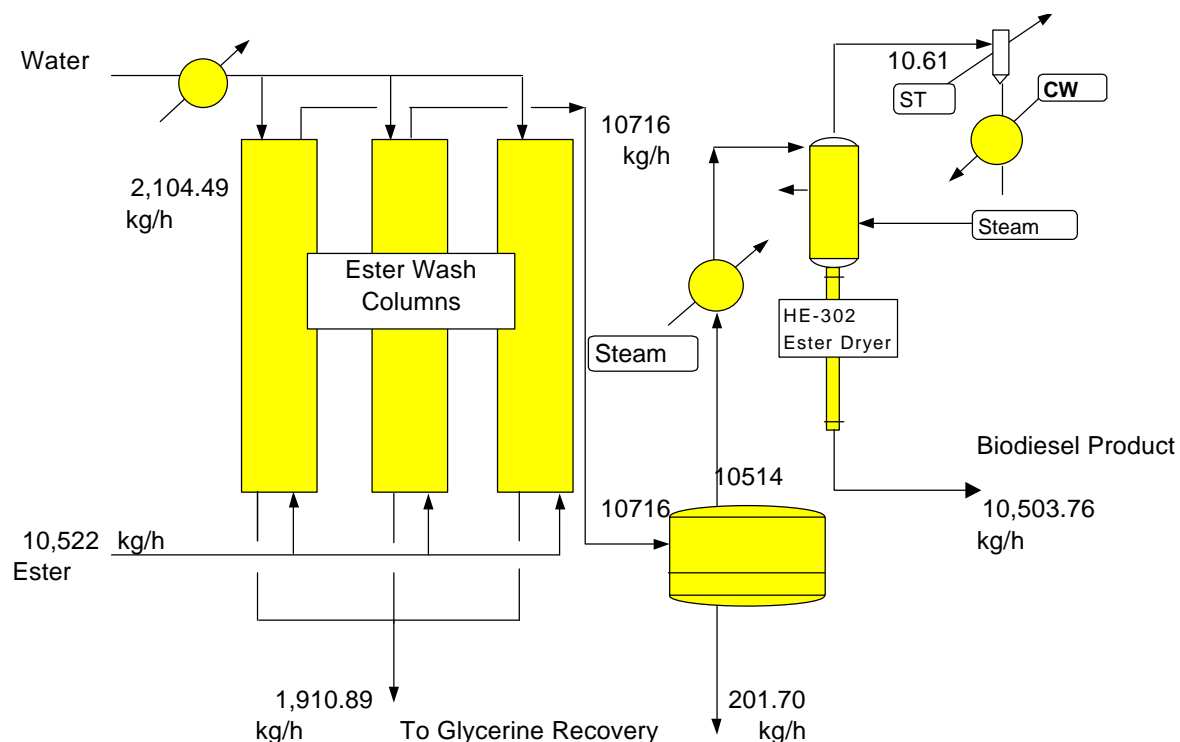

Figure 60: Methyl Ester Purification

No ester product is lost in the purification steps. Composition of the product coming out of the vacuum dryer is shown in Table 91. This composition is based on the material balance calculations for the purification section of the plant. These calculations were done to verify that the levels of glycerine (both free and total) are within the proposed limits developed by NBB.

Table 91: Composition of Final Biodiesel Product Based on Material Balance

Component	Weight %
Triglycerides	1.00%
Phosphatides	0.00%
Unsaponifiable Matter	0.02%
Methyl Ester	98.99%
Total	100.0%

The final level of glycerides is 1% by weight. The NBB standard for total glycerine is 0.24%, but this limit is glycerides measured as glycerine. When the mass fraction of total glycerides is converted to a glycerine basis, the weight percent is 0.105%, well within the limit of 0.24%.⁵⁶ Free glycerine and methanol are assumed to be removed by the vacuum dryer. Vapor condensed from the dryer is sent to wastewater treatment.

Steam requirements for purification are summarized in Table 92. Steam is used in heating the ester and water before the wash columns, as well as in drying of the final product.

**Table 92: Steam Requirements for Methyl Ester Purification
(normalized per metric ton of biodiesel produced)**

Unit	Kcal
Wash Water Heater	10,017.74
Ester Heater	25,044.34
Dryer Preheater	20,040.24
Vacuum Dryer	546.12
Total	55,648.44

5.5.1.4 Glycerine Recovery

Figure 61 shows the glycerine recovery steps in the model. Glycerine-containing streams from the transesterification settlers, ester purification wash columns, and ester dryer condensate are all collected, heated, and fed to the glycerine distillation column. The design information provided for the Kansas City plant that serves as the starting point of this model indicates that this column produces a crude glycerine stream that contains 80% glycerol.

A material balance across the column is used to determine the concentration of methanol in the vapor leaving the top of the column based on the 80% glycerine composition required for the bottoms. This

⁵⁶ Converting the glyceride concentration to equivalent units of glycerine on a mass basis is done by multiplying the weight percent of glycerides times the ratio of the molecular weight of glycerine to molecular weight of triglycerides. To obtain an average molecular weight of triglycerides in soybean oil, a weighted average of the fatty acid composition of soybean oil was used. The molecular weight of glycerine is 92. The average molecular weight of triglycerides in soybean oil is 874.

translates to an overhead stream containing 47% methanol on a weight basis. In addition, the crude glycerine must be essentially methanol-free.

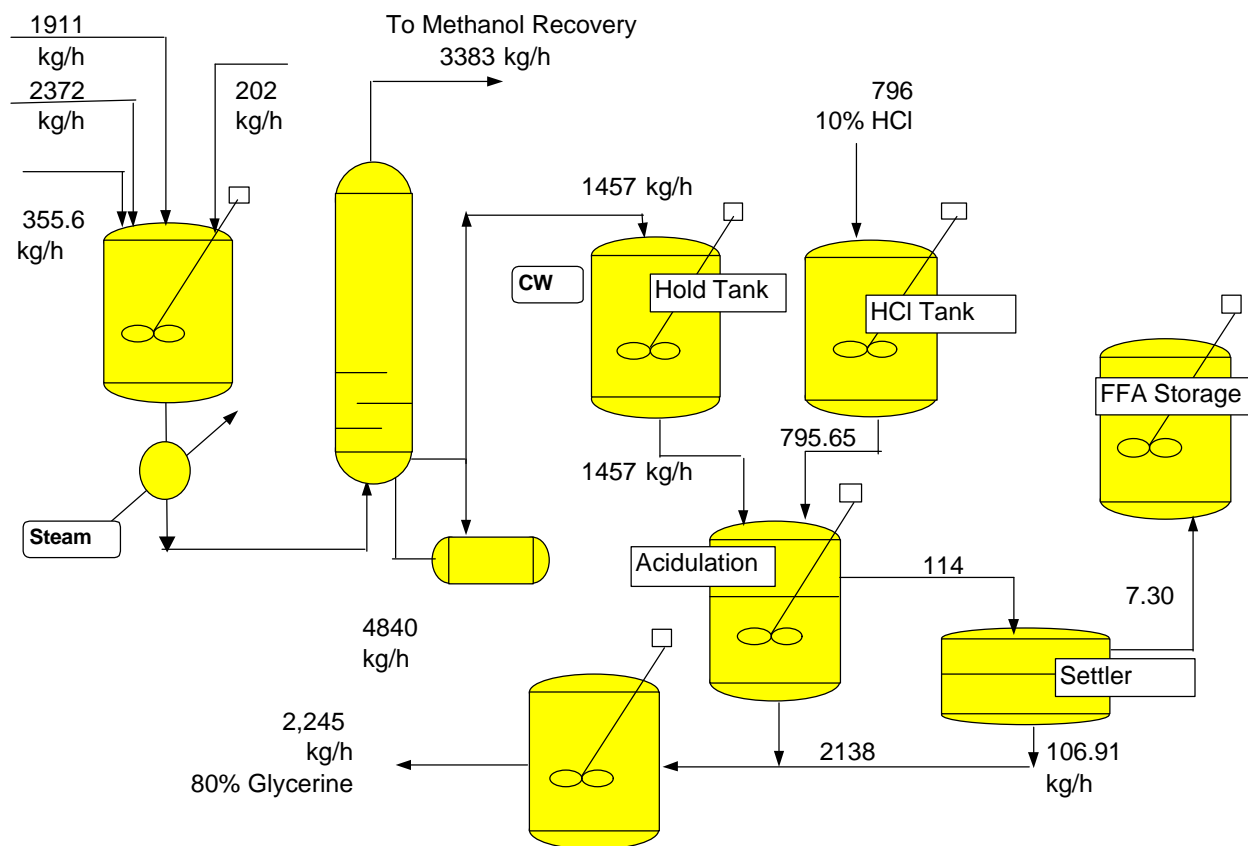

Figure 61: Recovery of Crude Glycerine By-Product

With the composition of the feed, column bottoms, and distillate set, we designed a column that operates at atmospheric pressure. ASPEN PLUS™ process simulation software was used to design the glycerine recovery column. We used the process simulator's RADFRAC™ routine to carry out rigorous tray-by-tray calculations for mass and energy balance. The software requires making an assumption for the number of theoretical trays. The design is constrained by the requirements for a crude glycerine product leaving the bottom of the column at 80% glycerine concentration. We used the number of theoretical trays to set the residual methanol concentration. A sensitivity study is done to determine the number of trays required to ensure an essentially methanol-free crude glycerine. The results of this analysis are shown in Figure 62. This figure shows that, for a column with six trays or more, methanol in the column bottoms is essentially zero.

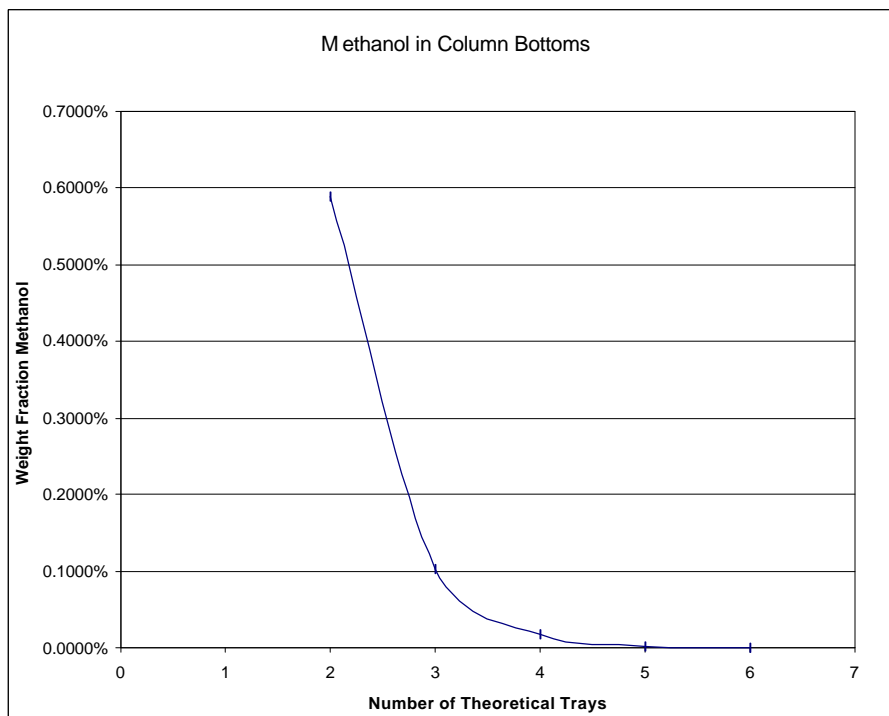

Figure 62: ASPEN PLUS™ Sensitivity Study Results:

The Effect of Column Size on Residual Methanol Concentration

Input and output summaries for the ASPEN PLUS™ six-tray column design are shown in Figure 63 and Figure 64. Steam requirements for the column’s reboiler and for the preheater are both indicated in Table 93. Preheater steam requirements are based on the sensible heat requirements for bringing the glycerine/methanol streams up to saturated liquid conditions. Distillation steam requirements are based on the calculated reboiler duty shown in Figure 64.

```

*****
**** INPUT DATA ****
*****

**** INPUT PARAMETERS ****
NUMBER OF STAGES                                6
ALGORITHM OPTION                                STANDARD
ABSORBER OPTION                                 NO
INITIALIZATION OPTION                          STANDARD
HYDRAULIC PARAMETER CALCULATIONS              NO
INSIDE LOOP CONVERGENCE METHOD                 BROYDEN
DESIGN SPECIFICATION METHOD                    NESTED
MAXIMUM NO. OF OUTSIDE LOOP ITERATIONS        25
MAXIMUM NO. OF INSIDE LOOP ITERATIONS         10
MAXIMUM NUMBER OF FLASH ITERATIONS           50
FLASH TOLERANCE                               0.0001
OUTSIDE LOOP CONVERGENCE TOLERANCE           0.0001
**** COL-SPECS ****
MOLAR VAPOR DIST / TOTAL DIST                 1
CONDENSER DUTY (W/O SUBCOOL) MMKCAL/H        0
MASS DISTILLATE RATE      KG/HR              3,378.00

```

Figure 63: ASPEN PLUS™ Simulation Input Summary for Crude Glycerine Column

```

*****
**** RESULTS ****
*****

*** SUMMARY OF KEY RESULTS ***

TOP STAGE TEMPERATURE      C      92.7281
BOTTOM STAGE TEMPERATURE  C      122.459
TOP STAGE LIQUID FLOW      KMOL/HR  173.216
BOTTOM STAGE LIQUID FLOW  KMOL/HR   26.937
TOP STAGE VAPOR FLOW      KMOL/HR  148.747
BOTTOM STAGE VAPOR FLOW  KMOL/HR  145.042
MOLAR BOILUP RATIO        5.38448
CONDENSER DUTY (W/O SUBCOOL) MMKCAL/H    0
REBOILER DUTY             MMKCAL/H  1.44917

```

Figure 64: ASPEN PLUS™ Simulation Results for Crude Glycerine Column

Table 93: Steam Requirements for Glycerine By-Product Recovery (normalized per metric ton of biodiesel produced)

Unit	Kcal
Glycerine Preheater	18,066.71
Distillation Columns Reboiler	137,969.48
Total	156,036.19

5.5.1.5 Methanol Recovery

The methanol and water vapor from the glycerine column are sent to a second distillation column for methanol recovery (see Figure 65). A simple graphical method is used to determine preliminary estimates for the major design parameters for the column, including reflux ratio and the number of theoretical stages in the column (Van Winkle 1967; McCabe and Smith 1976). The column is designed based on the feed conditions as specified for the vapor leaving the glycerine column. The column bottoms should contain less than 0.5% methanol; the distillate should contain less than 0.05% moisture.

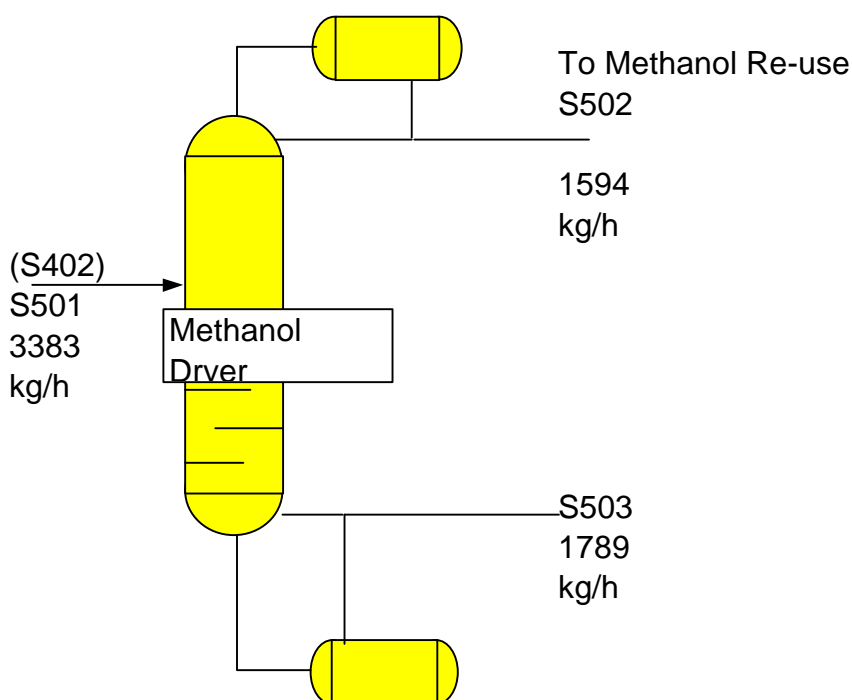

Figure 65: Methanol Recovery

To establish a more accurate optimization of reflux ratio, the estimates of reflux ratio and the number of theoretical stages from this graphical design were used as a starting point for a sensitivity study conducted using the ASPEN PLUS™ process simulation package. The results of this study are shown in Figure 66.

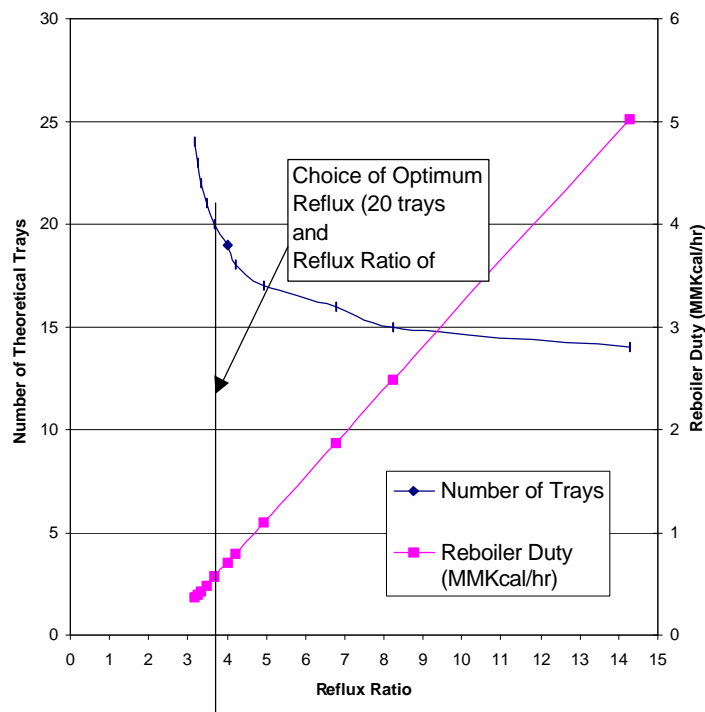

Figure 66: Selection of Optimum Reflux Ratio for Methanol Drying Column

The choice of reflux ratio strongly affects the energy requirements for the column. Larger values of reflux ratio lead to larger energy requirements, while reducing the size (and capital cost) of the column. Larger columns will reduce energy cost up to a point. At around 20 trays, increasing the column size has diminishing effect. Based on this analysis, a 20-tray column is selected. Figure 67 and Figure 68 show input and results from the ASPEN PLUS™ simulation of this column for the 20-tray case.

*** INPUT DATA ***		

*** INPUT PARAMETERS ***		
NUMBER OF STAGES		20
ALGORITHM OPTION	STANDARD	
ABSORBER OPTION	NO	
INITIALIZATION OPTION	STANDARD	
HYDRAULIC PARAMETER CALCULATIONS	NO	
INSIDE LOOP CONVERGENCE METHOD	BROYDEN	
DESIGN SPECIFICATION METHOD	NESTED	
MAXIMUM NO. OF OUTSIDE LOOP ITERATIONS		25
MAXIMUM NO. OF INSIDE LOOP ITERATIONS		10
MAXIMUM NUMBER OF FLASH ITERATIONS		50
FLASH TOLERANCE		0.0001
OUTSIDE LOOP CONVERGENCE TOLERANCE		0.0001
*** COL-SPECS ***		
MOLAR VAPOR DIST / TOTAL DIST		0
MOLAR REFLUX RATIO		6
MASS DISTILLATE RATE	KG/HR	1,587.00

Figure 67: Input Summary for 20-Tray Methanol Dryer ASPEN PLUS™ Simulation

Heating requirements for the methanol drying column are associated with the reboiler at the bottom of the column. No heat is required to treat the feed to the column, since the feed is already a saturated vapor coming from the glycerine recovery column. The steam requirements for methanol recovery are shown in Table 94.

*** SUMMARY OF KEY RESULTS ***					
TOP STAGE TEMPERATURE	C		64.4948		
BOTTOM STAGE TEMPERATURE	C		100.008		
TOP STAGE LIQUID FLOW	KMOL/HR		182.569		
BOTTOM STAGE LIQUID FLOW	KMOL/HR		98.9299		
TOP STAGE VAPOR FLOW	KMOL/HR		0		
BOTTOM STAGE VAPOR FLOW	KMOL/HR		57.8518		
MOLAR REFLUX RATIO			3.66481		
MOLAR BOILUP RATIO			0.58478		
CONDENSER DUTY (W/O SUBCOOL)	MMKCAL/H		-1.95791		
REBOILER DUTY	MMKCAL/H		0.56379		
**** MANIPULATED VARIABLES ****					
	BOUNDS		CALCULATED		
	LOWER	UPPER	VALUE		
MASS DISTILLATE RATE KG/HR	1500	2000	1595.6		
MOLAR REFLUX RATIO	1	100	3.6648		
**** DESIGN SPECIFICATIONS ****					
NO	SPEC-TYPE	QUALIFIERS	UNIT	SPECIFIED	CALCULATED
				VALUE	VALUE
1	MASS-FRAC	STREAMS: 4		5.00E-04	5.00E-04
		COMPS: WATER			
2	MASS-FRAC	STREAMS: 5		1.00E-04	1.00E-04
		COMPS: METHANOL			

Figure 68: Results of ASPEN PLUS™ Simulation for Methanol Dryer

The column bottoms are sent to waste treatment. Methanol from the top of the column is combined the fresh methanol make-up for use in the transesterification reactors.

**Table 94: Steam Requirements for Methanol Recovery
(normalized per metric ton of biodiesel produced)**

Unit	Kcal
Methanol Dryer	53,676
Total	53,676

5.5.1.6 Waste Treatment

Figure 69 shows the process flow diagram for wastewater treatment. Wastes collected from alkali refining, methyl ester purification, and methanol recovery are sent to clarifiers for removal of oil and grease. The oil and grease skimmed off the wastewater is landfilled; the remaining wastewater is sent to the municipal sewer system.

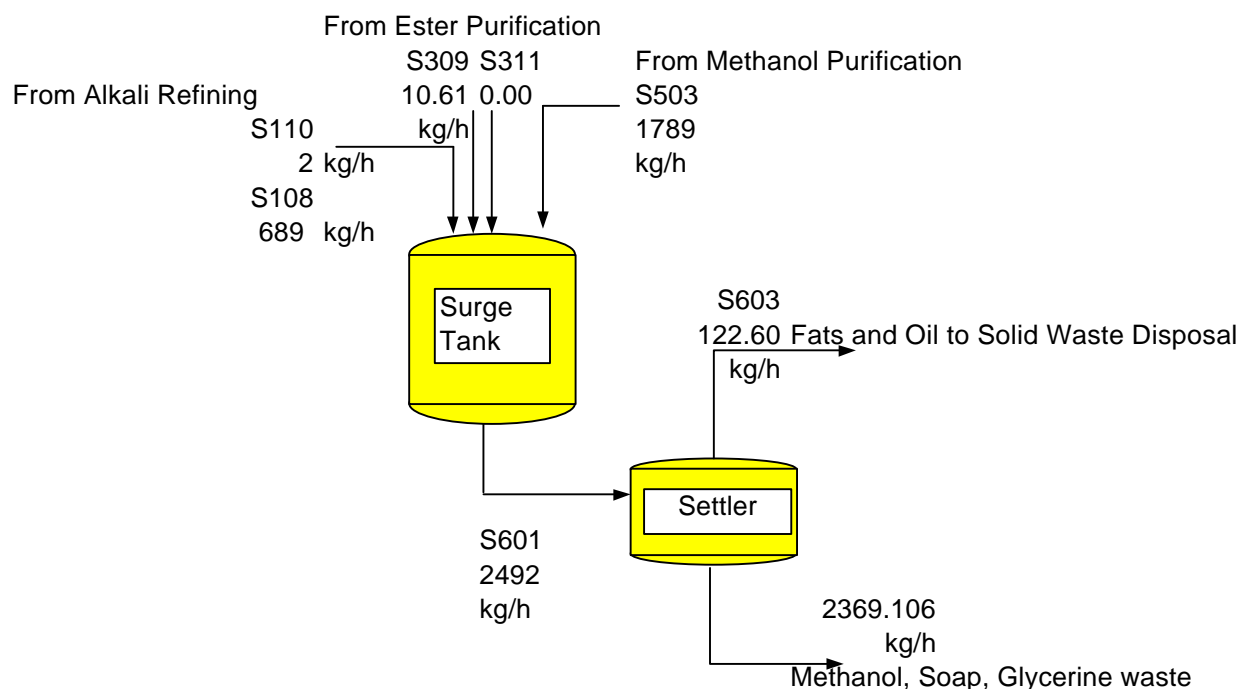

Figure 69: Wastewater Treatment for Conversion of Soybean Oil to Biodiesel

5.5.2 Analysis of Yields and Energy Balance

Figure 70 indicates yields across the major production steps for biodiesel. Losses in this process are very low. A little more than 2% of the losses occur as a result of triglycerides lost in alkali refining. Methyl ester production achieves 99% conversion of available triglycerides. Finally, no losses are seen in methyl ester purification, which involves a simple washing step

Energy requirements for the conversion of soybean oil to biodiesel include steam and electricity. Electricity requirements are taken directly from the utility demand indicated for the Kansas City facility used as the basis for our model. Electricity use is shown in Table 95. Electricity production is modeled using a generic (national average) U.S. grid.

A summary of steam requirements is shown in Table 96 and Figure 71. Steam is assumed to be produced using a natural gas-fired industrial boiler. Steam demand is greatest for glycerine recovery. Both the methanol and glycerine columns separate and recover methanol from the aqueous reactor product streams. When the energy of glycerine recovery is included with the energy requirements for methanol recovery, recycle of methanol represents 64% of the total energy demand for the conversion facility.

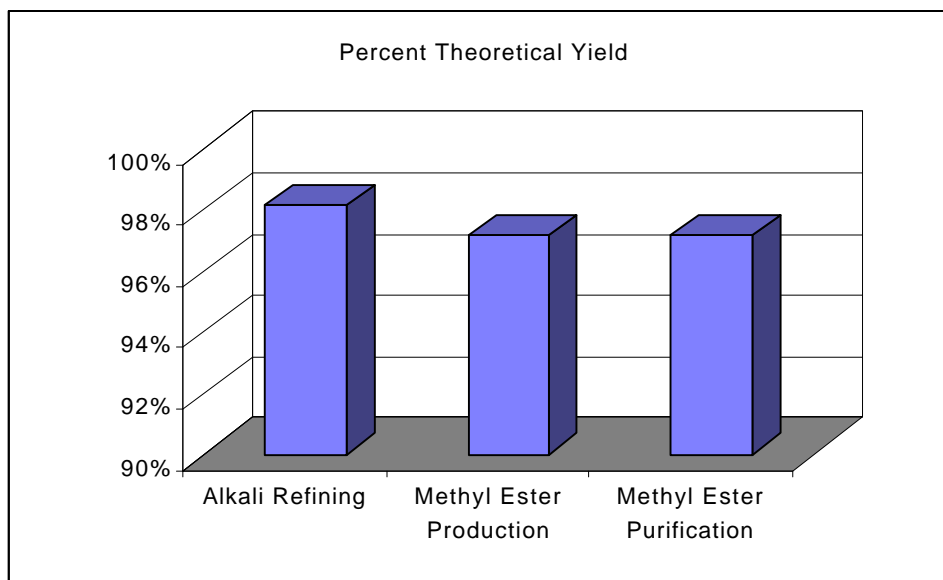

Figure 70: Yield Analysis for Conversion of Soybean Oil to Biodiesel

Table 95: Electricity Requirements for Conversion of Crude Degummed Soybean Oil to Biodiesel

Reported Annual Consumption of Electricity	5,000	MWh/yr
Reported Biodiesel Production Capacity	173	Million lb/yr
Electricity Requirements per Metric Ton Biodiesel	28.90	kWh/metric ton product

Table 96: Summary of Steam Requirements for Biodiesel Production (normalized per metric ton of biodiesel produced)

Section	Kcal
Alkaline Refining	37,013.87
Methyl Ester Production (Transesterification)	25,605.02
Methyl Ester Purification	55,648.43
Glycerine Recovery	156,036.19
Methanol Recovery	53,676.11
Waste Treatment	0.00
Total	327,979.62

The consumption of steam reported by the Kansas City facility used as a starting point for our model is shown in Table 97.

Table 97: Reported Steam Usage in Kansas City Facility Used as a Starting Point for Our Model

Mass Flow of Steam Used	225 million lb/yr
Energy Utilized in Steam	48,591,158.18 kcal/yr
Biodiesel Produced	173 million lb/yr
Steam Energy per Metric Ton of Biodiesel	617,922.24 kcal/metric ton

Our model predicts only one-half the steam demand that is indicated for the Kansas City facility. The fact that our energy balance does not match indicates that we did not have very much detail on the reactor conditions used in the facility. Nor are data on yields available. Therefore, the process design in our study used conditions and yields based on current practice as reported in the literature.

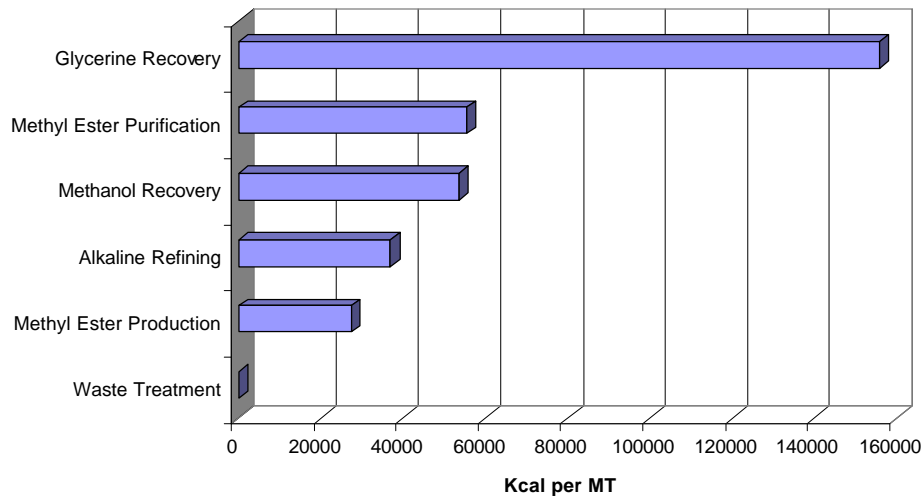

Figure 71: Distribution of Steam Requirements for Conversion of Soybean Oil to Biodiesel (normalized per metric ton of biodiesel produced)

To assess which of these numbers may best represent energy requirements for conversion of soybean oil to biodiesel, we surveyed available data on other commercial operations for biodiesel production. Most of these operations are European facilities. In order to compare these numbers on an apples-to-apples basis, we need to understand the basic process characteristics for the other commercial technologies (see Table 98 and Figure 72).

Ballestra S.p.A.'s technology⁵⁷ involves a three-step reaction using a 2:1 stoichiometric excess of methanol. They operate the reactors under vacuum at temperatures colder than 50°C. Outputs from the facility include a crude glycerine (80 wt%) coproduct and a biodiesel product made from rapeseed and

⁵⁷ "Ballestra Continuous Transesterification Process," In *Ballestra News*, November 1995. Ballestra, S.p.A., Milano, Italy, 1995.

sunflower oil. Florys S.p.A. technology⁵⁸ is a continuous production system operating at 100°C and 2.5 bar. It also produces a crude glycerine by-product. The Institut Francais du Petrole (IFP)⁵⁹ offers a commercial process that converts rapeseed to biodiesel and a crude glycerine product using mild reactor conditions of 50°C and atmospheric pressure, with sodium methoxide as the catalyst. Both Fina⁶⁰ and DeSmet⁶¹ offer high-pressure and high-temperature process technology packages.

Table 98: Comparison of Steam Requirements for Our Process Design Model and Other Available Technologies (kcal steam per metric ton of biodiesel)

Technology Source	Steam Use (kcal/metric ton)	Reactor conditions
Ballestra	96,022.71	< 50°C, atmospheric pressure, sodium methylate catalyst
Florys	166,289.74	100°C, 2.5 atm pressure, sodium methoxide catalyst
Institut Francais du Petrole	237,556.77	50° to 70°C, base catalyst
De Smet	365,837.43	High-pressure and high-temperature reactors
Fina	495,923.52	High-pressure and high-temperature reactors
NREL Model Results	327,979.62	90°C, atmospheric pressure, sodium methoxide catalyst
Kansas City Plant	617,922.24	Unspecified reactor conditions, sodium methoxide catalyst

Figure 72 ranks the process design model results relative to the technologies which operate under similar conditions and relative to the Kansas City plant data. The DeSmet and Fina steam requirements are not included because they both use high-temperature and high-pressure reactor designs.

Though the steam requirement for biodiesel production in our model is only half that of the Kansas City plant, it seems reasonable to use our model results. As Figure 72 shows, our model results are double the average of the reported steam requirements for today’s European transesterification technology.

Furthermore, details about the operation of the Kansas City facility are sparse. It seems prudent, therefore, to use the energy results for the process model since we know which assumptions support these estimates.

Table 99 presents a comparison of electricity requirements for the process design model with data available for the comparable technologies.

⁵⁸ *Process Description and Specific Consumption of Raw Materials and Utilities for the Production of Vegetable Oil Methyl-Esters (Biodiesel)*. Florys, S.p.A. brochure. Florys, S.p.A., Milano, Italy (undated).

⁵⁹ *Esterfip Process for Diese Fuel Extenders*. Institute Francais du Petrole Brochure. Institut Francais du Petrole, France (undated).

⁶⁰ *Fina Research Methanolysis Process*. Fina Research Brochure. Final Research, S.A. (undated).

⁶¹ See Howell, S. *Multi-Feedstock Biodiesel Project Phase II Final Report*, NREL Report 1997.

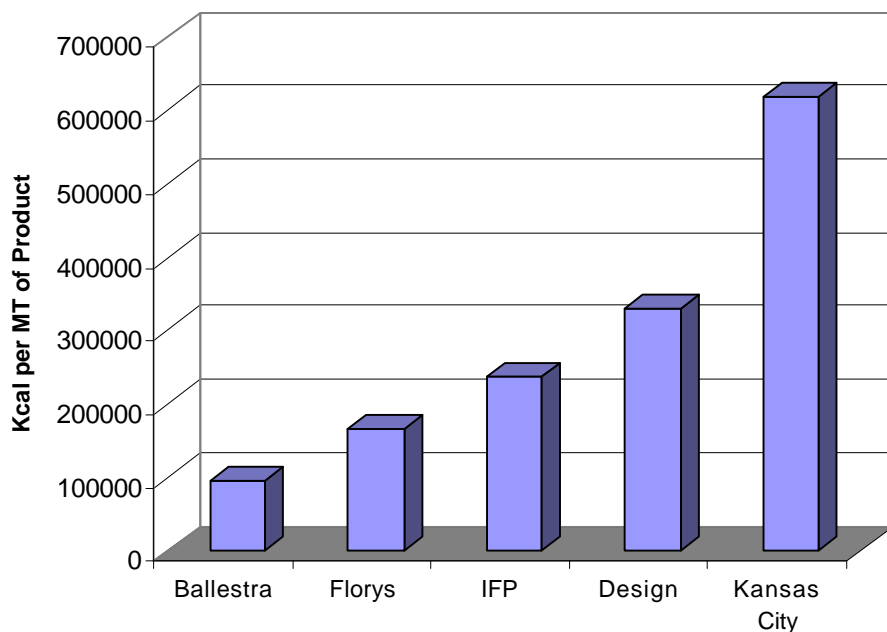

Figure 72: Ranking of Steam Requirements for Our Process Design Model and Reported Estimates for Commercial Technologies (kcal/metric ton of biodiesel)

Table 99: Comparison of Electricity Requirements for Our Process Model and for Current European Technologies

Technology Source	kWh/metric ton of Biodiesel
Ballestra	30
Florys	40
Institut Francais du Petrole	9
NREL Model	28.9

The ranking of reported electricity demand against our estimate suggests we are being reasonably conservative.

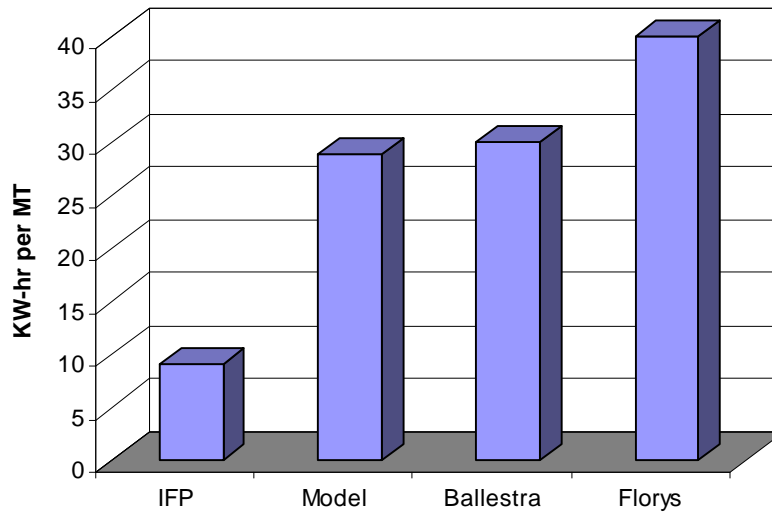

Figure 73: Ranking of Electricity Requirements for Our Process Design Model and for Current Comparable Technology

5.5.3 Overall Inputs to the Soybean Oil Conversion Facility

The biodiesel production facility has six raw material inputs, as shown in Table 100. For every 1,000 kg of biodiesel produced, 1,037 kg of crude degummed oil is required as feedstock. Approximately 90 kg of methanol is added to the system. Though methanol is added to the reactors at twice the required stoichiometric ratio, most of this excess methanol is recovered. Typically, the literature reports 100 kg of methanol for every 1,000 kg of biodiesel.

The apparently lower methanol usage shown in our inputs is due to the fact that methanol from the sodium methoxide catalyst is recovered as well. The primary use of sodium hydroxide is in alkaline refining. Hydrochloric acid (HCl) is required in acidulation of the glycerin coproduct.

Table 100: Raw Material Inputs to Biodiesel Production Facility

Material	Hourly Flow (kg/h)	Normalized Flow (kg/metric ton of Biodiesel)
Crude, Degummed Soybean Oil	10,896.64	1,037.42
Sodium Methoxide	252.71	24.06
Sodium Hydroxide (9.5%)	252.09	24.00
Hydrochloric Acid (10%)	792.26	75.43
Methanol	940.17	89.51
Water	3,738.93	355.97

Energy inputs to the facility are summarized in Table 101.

Table 101: Energy Inputs to a Biodiesel Production Facility

Type	Rate	Normalized Consumption
Electricity	303.57 kW	28.90 kWh/metric ton biodiesel
Steam	3,464,004.46 kcal/h	329,793.54 kcal

5.5.4 Overall Soybean Oil Conversion Outputs

Products from the biodiesel production facility are indicated in Table 102. The two main products are biodiesel and crude glycerine. A small amount of acidulated soapstock is produced as a result of the neutralization of fatty acids contained in the crude glycerine recovered.

Table 102: Products from a Biodiesel Production Facility

Product	Hourly Flow (kg/h)	Normalized Flow (kg/metric ton biodiesel)
Biodiesel	10,503.55	1,000.00
Acidulated Soapstock	7.27	0.69
Crude Glycerine (80% wt)	2,235.47	212.83

No air emissions are predicted in our process model, because these do not include emissions associated with combustion for steam generation. Emissions from combustion are estimated using data from the DEAM™ database.

Water and solid waste emissions are summarized in Table 103.

Table 103: Water and Solid Waste Emissions from a Biodiesel Production Facility

Classification	Component	Hourly Flow (kg/h)	Normalized Flow (kg/metric ton biodiesel)
Solid Waste	Oil and Grease	122.55	11.667
Liquid Waste	Total Wastewater	4,003.96	381.200
	Methanol	9.00	0.8572
	Water	3,660.03	348.457
	Phosphatides	2.16	0.20541
	Unsaponifiable Matter	161.82	15.4058
	Soap	160.39	15.2701
	Glycerides	10.56	1.00539

5.5.5 Allocation of Life Cycle Flows for Soy Oil Conversion to Biodiesel

Soybean conversion into biodiesel produces biodiesel, glycerol, and some soapstock products. This study is concerned only with the production of biodiesel. Therefore, there needs to be a method of allocating total crushing energy use and total crushing emissions to only the production of biodiesel.

An allocation technique based on the mass output of soybean conversion is used as the baseline for this study. In order to allocate total soybean conversion environmental flows among the products on a mass output basis, the mass percent of each coproduct must be known. Table 104 outlines how this would be done, based on the output of a generic soybean conversion facility:

Table 104: Production of a Generic Soybean Conversion Facility

	Mass (k/h)	Mass (%)
Biodiesel:	10,503.5	82 %
Glycerine:	7.3	0.06 %
Soapstock:	2,235.5	18 %
Total:	12,746.3	

5.5.6 Soybean Conversion Results

Figure 74 presents a schematic of the system for conversion of soybean oil to biodiesel modeled with TEAM™. Table 105 shows the LCI results for soybean oil conversion for the production of 1 kg of biodiesel.

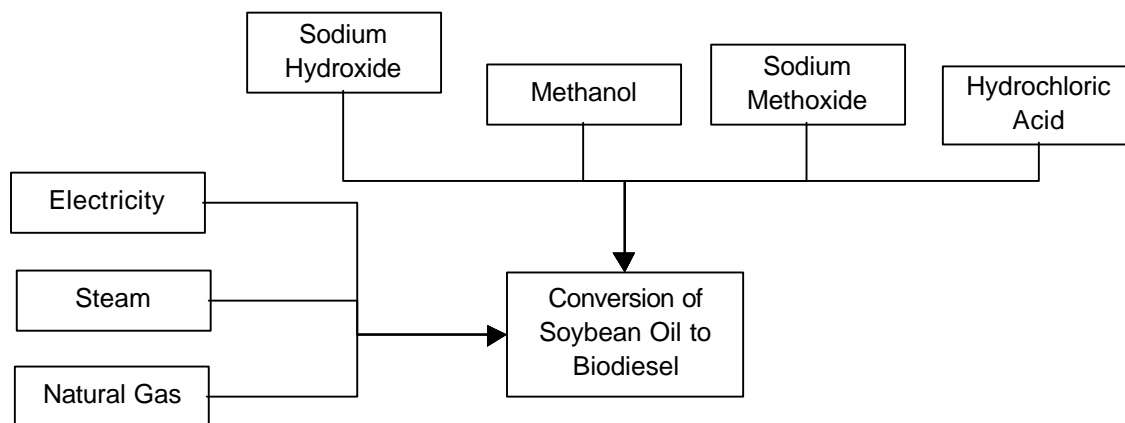

Figure 74: Schematic of Inputs to TEAM™ Model for Conversion of Soybean Oil to Biodiesel

Table 105: LCI Results for Soybean Oil Conversion (for 1 kg of biodiesel)

	Units	Soybean Oil Conversion	Steam Production	Electricity Production: US Average	Methanol Production	Sodium Methoxide Production	Sodium Hydroxide Production	Hydrogen Chloride Production	Soybean Conversion
Raw Materials									
Coal (in ground)	kg	0.0118507	4.97E-08	0.00590285	0.00118846	0.00300157	0.00035979	0.00139796	0
Oil (in ground)	kg	0.00203498	6.48E-08	0.000203089	4.10E-05	0.00114872	0.00014613	0.00049597	0
Natural Gas (in ground)	kg	0.0946834	0.0281715	0.000647469	0.05484	0.0103907	0.00016527	0.00046848	0
Uranium (U, ore)	kg	1.74E-07	1.19E-12	1.41E-07	2.85E-08	4.54E-09	0	0	0
Phosphate Rock (in ground)	kg	0	0	0	0	0	0	0	0
Potash (K ₂ O, in ground)	kg	0	0	0	0	0	0	0	0
Perlite (SiO ₂ , ore)	kg	0	0	0	0	0	0	0	0
Limestone (CaCO ₃ , in ground)	kg	0.00167708	9.43E-09	0.00112559	0.000226621	0.000190292	1.97E-05	0.00011485	0
Sodium Chloride (NaCl)	kg	0.0172361	0	0	0	0.00866427	0.00110847	0.0074634	0
Water Used (total)	liter	0.558377	7.99E-09	0.000181251	0.147549	0.101334	0.00995741	0.00603847	0.293318
Air Emissions									
Carbon Dioxide (CO ₂ , fossil)	g	170.082	82.9689	18.2873	35.8645	23.2311	2.10421	7.62574	0
Carbon Dioxide (CO ₂ , biomass)	g	0	0	0	0	0	0	0	0
Methane (CH ₄)	g	0.500959	0.136914	0.0440873	0.274471	0.0454863	0	0	0
Nitrous Oxide (N ₂ O)	g	0.00112695	0.000379465	0.000337674	0.000349276	6.05E-05	0	0	0
Carbon Monoxide (CO)	g	0.0618712	0.0276957	0.00405177	0.0113161	0.0124397	0.00131513	0.0050528	0
Hydrocarbons (except methane)	g	0.00156164	0.000948278	0.000148282	0.000390616	7.45E-05	0	0	0
Hydrocarbons (unspecified)	g	0.14588	5.66E-07	0.000482341	9.82E-05	0.0954694	0.0122119	0.0376176	0
Benzene	g	0	0	0	0	0	0	0	0
Formaldehyde	g	1.17E-12	7.90E-17	9.52E-13	1.92E-13	3.06E-14	0	0	0
Particulates (PM10)	g	0.00280072	0.0019907	0	0.000676549	0.000133463	0	0	0
Particulates (unspecified)	g	0.17608	5.05E-05	0.0830695	0.0168216	0.0482042	0.00582414	0.0221103	0
Sulfur Oxides (SO _x as SO ₂)	g	2.45438	0.638761	0.104258	1.26082	0.355926	0.0187876	0.0758267	0
Nitrogen Oxides (NO _x as NO ₂)	g	0.408812	0.112734	0.0567286	0.0643086	0.117432	0.013527	0.0440815	0
Hydrogen Chloride (HCl)	g	0.00755151	2.68E-08	0.00318532	0.000641319	0.00230493	0.00028181	0.0011381	0
Hydrogen Fluoride (HF)	g	0.000491102	3.35E-09	0.000398165	8.02E-05	1.28E-05	0	0	0
Ammonia (NH ₃)	g	2.68E-08	1.55E-11	2.17E-08	4.40E-09	7.01E-10	0	0	0
Water Emissions									
Agrochemicals (unspecified)	g	0	0	0	0	0	0	0	0
BOD5 (Biochemical Oxygen Demand)	g	0.000162724	3.36E-08	7.63E-05	1.54E-05	4.65E-05	5.64E-06	1.89E-05	0
COD (Chemical Oxygen Demand)	g	0.0010744	2.84E-07	0.000645328	0.000130469	0.000211693	2.44E-05	6.22E-05	0
Metals (unspecified)	g	0.00173099	1.65E-09	4.82E-06	9.73E-07	0.00102812	0.00013151	0.00056557	0
Ammonia (NH ₄ ⁺ , NH ₃ , as N)	g	2.33E-05	4.97E-09	1.88E-05	3.80E-06	6.06E-07	0	0	0
Nitrates (NO ₃ ⁻)	g	6.22E-06	4.25E-11	5.05E-06	1.02E-06	1.62E-07	0	0	0
Solid Waste (hazardous)	kg	7.64E-07	1.09E-10	2.48E-07	5.02E-08	3.02E-07	3.76E-08	1.26E-07	0
Solid Waste (nonhazardous)	kg	0.0141251	1.15E-07	0.00216033	0.000435141	0.00115602	0.00013903	0.00062043	0.00961401
Total Primary Energy	MJ	39.9088	1.46493	0.290053	2.90332	0.773746	0.037406	0.13045	34.3089
Fossil Energy	MJ	5.57241	1.46493	0.281005	2.9015	0.763029	0.0360721	0.125884	0
Fuel Energy per kg of Biodiesel	MJ	2.95884	1.46493	0.290053	0.625141	0.410869	0.037406	0.13045	0

5.6 Biodiesel Transport

The transport of biodiesel from the conversion facility to the point of use is estimated assuming the conversion facility is located close to the point-of-use. For more information, see the previous section on soy oil transportation. This section contains the assumptions and descriptions of the data used to model biodiesel transportation to end-use.

5.6.1 Modes of Transport and Distance Transported

We assumed that both B100 and B20 were transported a maximum distance of 100 miles by heavy-duty tank trucks from the production facility to the point of end-use, in this case the storage facility at the bus fleet refueling site. We felt that this distance was long enough to encompass situations in which the biodiesel facility may be located on the opposite side of a very large urban area from the bus refueling site. This distance is also long enough to encompass transporting biodiesel to a tank farm and moving the B20 to the bus refueling site.

In addition, 100 miles is consistent with the distance used to transport diesel fuel from the refinery to the urban bus refueling center. The transportation models from DEAM™ are used to model truck transportation energy requirements and emissions.

5.6.2 Energy and Fugitive Emissions from Storage and Handling

In addition to the energy requirements and subsequent emissions from the actual modes of transportation (truck diesel use and emissions), energy and emissions are also created while loading and unloading the biodiesel.

The pumping requirements for biodiesel are calculated in the same method as for crude oil pumping. We assumed that the electricity requirements are the same for different types of liquids. Electricity is assumed to come from a generic (national average) U.S. grid. The physical characteristics of biodiesel and diesel fuel are very similar so no significant biases are expected to be introduced here.

The fugitive emissions from loading, unloading, and transporting the biodiesel are calculated using the same formulas as for the crude oil fugitive emissions. The formulas are modified based on the biodiesel properties. The vapor pressure of the biodiesel at 160°C is estimated based on the vapor pressure of methyl oleate which is one of a variety of fatty acid compounds in biodiesel. The fatty acid profile of biodiesel is determined by the feedstock oil, and soy oil contains oleic acids as well as other fatty acids.

Fugitive tank emissions from the storage of biodiesel at the conversion facility are included in the biodiesel conversion model. Fugitive tank emissions from the storage of biodiesel at the urban bus refueling location are assumed to be negligible. Biodiesel has a higher flash point compared to diesel fuel, and thus is less volatile. Actual volatile emissions have not been documented for biodiesel.

Figure 75 represents how the emissions from biodiesel transportation are modeled in this project.

5.6.3 Biodiesel Transportation Results

Table 106 shows the LCI results for the transporting 1 kg of biodiesel from the conversion facility to the point of use.

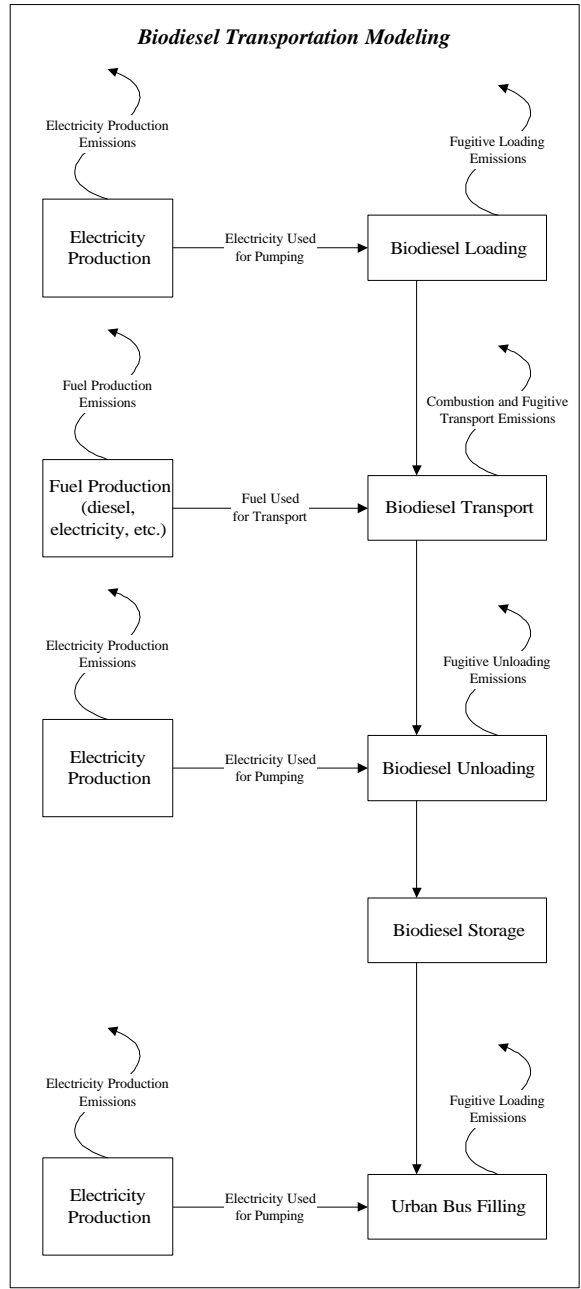

Figure 75: Biodiesel Transportation Modeling

Table 106: LCI Results for Biodiesel Transportation (for kg of biodiesel)

	Units	Biodiesel Transportation	Truck Loading	Truck Transport
Raw Materials				
Coal (in ground)	kg	0.000106422	6.20E-07	0.000105802
Oil (in ground)	kg	0.00339281	2.13E-08	0.00339279
Natural Gas (in ground)	kg	0.0002914	6.80E-08	0.000291332
Uranium (U, ore)	kg	2.54E-09	1.49E-11	2.52E-09
Phosphate Rock (in ground)	kg	0	0	0
Potash (K ₂ O, in ground)	kg	0	0	0
Perlite (SiO ₂ , ore)	kg	7.71E-07	0	7.71E-07
Limestone (CaCO ₃ , in ground)	kg	2.02E-05	1.18E-07	2.01E-05
Sodium Chloride (NaCl)	kg	0	0	0
Water Used (total)	liter	0.000472194	1.90E-08	0.000472175
Air Emissions				
Carbon Dioxide (CO ₂ , fossil)	g	11.3047	0.00191984	11.3028
Carbon Dioxide (CO ₂ , biomass)	g	0	0	0
Methane (CH ₄)	g	0.00405364	4.63E-06	0.00404901
Nitrous Oxide (N ₂ O)	g	0.00112314	3.54E-08	0.0011231
Carbon Monoxide (CO)	g	0.0383396	4.25E-07	0.0383392
Hydrocarbons (except methane)	g	0.00825505	1.56E-08	0.00825503
Hydrocarbons (unspecified)	g	0.00447132	5.18E-08	0.00447127
Benzene	g	7.61E-07	0	7.61E-07
Formaldehyde	g	1.02E-05	1.00E-16	1.02E-05
Particulates (PM10)	g	0.0128168	0	0.0128168
Particulates (unspecified)	g	0.0024211	8.72E-06	0.00241238
Sulfur Oxides (SO _x as SO ₂)	g	0.0166609	1.09E-05	0.01665
Nitrogen Oxides (NO _x as NO ₂)	g	0.106355	5.96E-06	0.106349
Hydrogen Chloride (HCl)	g	5.71E-05	3.34E-07	5.68E-05
Hydrogen Fluoride (HF)	g	7.14E-06	4.18E-08	7.10E-06
Ammonia (NH ₃)	g	1.45E-08	2.28E-12	1.45E-08
Water Emissions				
Agrochemicals (unspecified)	g	0	0	0
BOD5 (Biochemical Oxygen Demand)	g	0.00227562	8.01E-09	0.00227561
COD (Chemical Oxygen Demand)	g	0.0192552	6.77E-08	0.0192551
Metals (unspecified)	g	9.41E-05	5.06E-10	9.41E-05
Ammonia (NH ₄ ⁺ , NH ₃ , as N)	g	0.000332726	1.98E-09	0.000332725
Nitrates (NO ₃ ⁻)	g	9.05E-08	5.30E-10	9.00E-08
Solid Waste (hazardous)	kg	7.41E-06	2.61E-11	7.41E-06
Solid Waste (nonhazardous)	kg	5.09E-05	2.27E-07	5.07E-05
Total Primary Energy	MJ	0.16189	3.05E-05	0.161859
Fossil Energy	MJ	0.161727	2.95E-05	0.161698

This page intentionally left blank

6 Urban Bus Operation

The life cycles for biodiesel and petroleum diesel come together at the end-use stage in an urban bus. Thus, the combustion modeling for both fuels is described here in one section. This section includes two main subsections:

- **6.1 Biodiesel Fuel Combustion:** This section provides a review of published data on the use of biodiesel in blends and in neat form. It includes information on general fuel properties, fuel economy, and emissions for petroleum diesel and blends of petroleum diesel and biodiesel.
- **6.2 Petroleum Diesel:** This section includes basic data on fuel economy and emissions for low-sulfur petroleum diesel.

6.1 Biodiesel Fuel Combustion

The LCI modeling of biodiesel combustion in an urban bus is based on of the amount of biodiesel required to supply the functional unit of this study (1 bhp-h), and the emissions from the tailpipe of the bus. The amount of biodiesel required is dependent on the fuel economy of the bus engine, and the emissions are dependent on many factors, including the type of engine. The following sections outline how biodiesel combustion is modeled.

6.1.1 Comparison of Fuel Properties of Petroleum Diesel and Biodiesel

An implicit assumption in our modeling of biodiesel use is that biodiesel and its blends with petroleum diesel can be used directly in diesel engines with no impact on engine performance and engine life. This point is sufficiently critical that we felt it was worthwhile to review the literature on this question. What the literature shows is that, overall, biodiesel is compatible with current engines, with certain caveats. The most important of these are:

- Biodiesel exhibits cold weather problems
- Some types of biodiesel have exhibited storage instability that could lead to engine problems
- Diesel additives may not provide the same benefits when used with biodiesel.
- This literature review also shows that biodiesel has some significant advantages over petroleum, such as:
 - Zero aromatic content (currently being regulated more stringently by EPA and the California Air Resources Board)
 - Higher cetane numbers
 - Zero sulfur content
 - Low flash point.

Specific fuel characteristics and differences are not always captured in the LCI model. Some discussion is offered in the following sections to provide useful information to the reader.

NBB has been developing a fuel standard for biodiesel. The U.S. diesel engine manufacturers deem this standard as absolutely necessary for any manufacturer to extend warranty coverage to biodiesel-fueled

engines. The NBB task force on biodiesel took the various European biodiesel standards as starting points.

Chemical and physical fuel properties are important. Table 108 summarizes reported fuel data for #2 diesel and a variety of biodiesels from a selection of biodiesel studies. The #2 diesel fuel analyses are provided to show the variation in fuel properties used in engine testing. The predominant ester studied is soy methyl ester, but other oils and alcohol combinations have been documented and continue to be studied. Table 107 provides a brief glossary for the items listed in Table 108. Many of these parameters are discussed in more detail in the subsequent section.

Table 107: Glossary of Terms for Fuel Properties

Iodine #	Standard natural oil assay to measure the degree of unsaturation (or the number of double bonds present) in vegetable oils and fats.
Cetane Number	Measure of fuel ignition characteristics. Like the octane number used for gasoline, the higher the value, the better the fuel performance. EPA also uses this parameter as a measure of aromatic content in fuel.
SPG	Specific gravity (density of the oil normalized to that of water).
Flash	Flash point. The temperature at which the vapor/air mixture above the fuel ignites.
IBP	Initial boiling point. The first data point measured on a standard ASTM distillation curve. This is the temperature at which the first vapor appears when heating the fuel.
T10, T50 and T90	Interim points on the standard ASTM distillation curve for diesel fuel. They correspond to the temperatures at which 10%, 50%, and 90% of the fuel vaporizes.
EP	End point. The final temperature measured in an ASTM distillation curve at which point all of the fuel has vaporized.
Cloud	Cloud point. The temperature at which the first wax crystals appear. Standardized ASTM test protocol is used to determine this temperature.
Pour	Pour point. The temperature at which the fuel is no longer pumpable. Standardized ASTM protocols are used to determine this temperature.
CFPP	Cold filter plugging point. An alternative to the cloud and pour point tests to assay cold flow properties of fuels.
HHV	Energy content of the fuel designated as the “higher heating value.” This measure ignores energy lost to vaporization of water formed during combustion.
LHV	Energy content of the fuel designated as the “lower heating value.” This measure accounts for energy used to vaporize water formed during combustion.
Carbon %	Amount of carbon in the fuel.
Gum Number	Measure of the tendency of a fuel to form gums via oxidation.

Table 108: Summary of Properties of Diesel and Various Biodiesel Esters

Author	Ester	IODINE #	CETANE NUMBER	SPG	FLASH (°F)	IBP (°F)	T10 (°F)	T50 (°F)	T90 (°F)	EP (°F)	Cloud (°F)	Pour (°F)	CFPP (°F)	HHV (BTU/LB)	LHV (BTU/LB)	Carbon %	GUM NUMBER	Viscosity @40°C	Surface Tension
Ali, Hanna, Cuppett(1995)	DIESEL			0.8383	130	355	414	504	619	619	5	-18		19578		0.18		2.07	
Clark et al(1984)	DIESEL		48.2	0.8470	172.4				565		-2.2	-9.4		19446			6	2.39	
FEV(1994)	DIESEL		52	0.8296										18533				2.49	
Geyer,Jacobus,Lestz(1984)	DIESEL		48	0.8500	125.6										19214				
Graboski et al(1994)	DIESEL		46.2	0.8468		387	429	527	632	677									
McDonnald, et al(1995)	DIESEL		43.2	0.8591	215.6						-4				18499			3	
Peterson et al(1995)	DIESEL	8.6	49.2	0.8495	165.2						10.4	-9.4		19540	18456	0.16		2.98	
Marshall(March,1994)	DIESEL			0.8370	148		404	479	582		-12	-25			18400			2.1	
Reece and Peterson(1993)	DIESEL		47.8	0.8520	176						10	-20		19443				3.2	22.5
AVERAGE	DIESEL	8.6	47.8	0.8455	162	371	416	503	599	648	1	-16		19308	18642	0.17	6	2.6	22.5
Ali & Hanna(1994)	METHYLTALLOWATE			0.8745		411		613		620									
Ali, Hanna, Cuppett(1995)	METHYLTALLOWATE			0.8772	205	424	613	629	667	669	54	48		17186		1.83		4.11	
Sims (1985)	METHYLTALLOWATE			0.8750		220		621	640				42.8	17380		0.01			
AVERAGE	METHYLTALLOWATE			0.8756	205	352	613	621	654	644	54	45		17283		0.92		4.11	
Ali, Hanna, Cuppett(1995)	METHYLSOYATE			0.8870	260	509	625	635		639	37	19		17243		1.74		4.06	
Clark et al(1983)	METHYLSOYATE	135.1	46.2	0.8840	285.8				648		35.6	33.8		17122			16,400	4.08	
FEV(1994)	METHYLSOYATE		48	0.8831										17991				3.77	
Graboski et al(1994)	METHYLSOYATE		56.4																
McDonnald, et al(1995)	METHYLSOYATE		54.7	0.8855	345.2						23				15961			3.9	
Marshall(1994)	METHYLSOYATE			0.8810							28	25			15700				
Schmaucher (1994)	METHYLSOYATE		45.8	0.8844	355						30	20	24	17650				4.06	
Stotler(1995)	METHYLSOYATE	130.5	56.9	0.8880			610(7%)									0.14		4.23	34.9
FSD(July 1994)	METHYLSOYATE		51.4	0.8855							29	32		17176	16000			3.97	
AVERAGE	METHYLSOYATE	133	51.34	0.8848	312	509	617	635	648	639	30	26	24	17437	15887	0.94	16400	4.01	34.9
Geyer,Jacobus,Lestz(1984)	METHYLSUNFLOWER	125.5	49	0.8800	361.4							19.4			16580				
Geyer,Jacobus,Lestz(1984)	METHYLCOTTONSEED	105.7	51.2	0.8800	230							37.4			16735				
Reece and Peterson(1993)	METHYLRAPSE		54.4	0.8738	183						28	15		17930		0.044		6	25.4
Clark et al(1983)	ETHYLSOYATE	123	48.2	0.8810	320				651		30.2	24.8		17208			19,200	4.41	
Peterson et al(1995)	ETHYLFRYATE	63.5	61	0.8716	255.2						48.2	46.4		17428	16004	0.06		5.78	
Sims (1985)	ETHYLTALLOWATE			0.8710		210		635	660			42.8		17940		0.007			
Sims (1985)	BUTYLTALLOWATE			0.8680		236		655	668			42.8		17733		0.051			

6.1.1.1 Cetane Number

The cetane *number* of the fuel, specified by ASTM D-613, is a measure of its ignition quality. The cetane number of biodiesel exceeds that of #2 diesel, which implies that biodiesel may provide cetane enhancement when used neat or in blends, and may provide emission benefits that have been correlated to cetane number. Higher cetane numbers (as high as 55 to 60) generally improve diesel emissions, but above that level little improvement is demonstrated.

The cetane *index* is a calculated property that correlates well with cetane number for natural petroleum stocks, and is defined by ASTM D-976. Cetane index is also a measure of fuel aromaticity⁶². It is not relevant to biodiesel.

The cetane number of biodiesel depends on the oil or fat feedstock. Fatty acids consist of long chains of carbon atoms attached to carbonyl groups. Fats and oils contain a distribution of carbon chains of varying lengths, typically ranging from 10 to 18 carbons (referred to as C10 to C18 chains). Some carbon chains contain 0, 1, 2, or more double bonds between the carbons, and have carbonyl groups in different locations. Cetane number increases with chain length, decreases with number and location of double bonds, and changes with various locations of the carbonyl group. As bonds or carbonyl move toward the center of the chain, the cetane number decreases. Cetane numbers increases from 47.9 to 75.6 when the number of carbons in the fatty acids in biodiesel increases (Freedman and Bagby 1990). When the number of carbons in the fatty acid chains exceeds C12, the cetane number exceeds 60. For soy methyl ester, reported cetane numbers range from 45.8 to 56.9. The variation is due to the distribution of carbon chain lengths in each fuel tested. The average of the available data presented in Table 108 is 51.3.

Generally, the cetane number for a blend of biodiesel and either #1 or #2 diesel fuel is a nearly linear function equal to the average of the cetane numbers for the fuels (Midwest Biofuels 1993; Graboski 1994). This implies that the neat cetane numbers for diesel and biodiesel can be used to estimate the cetane number over the entire range of mixtures of biodiesel with diesel fuel.

6.1.1.2 Flash Point

Flash point, as defined by ASTM D-93, is a measure of the temperature to which a fuel must be heated such that a mixture of the vapor and air above the fuel can be ignited. All #2 diesel fuels have high flash points (54°C, minimum; 71°C, typical). The flash point of neat biodiesel is typically greater than 93°C (Interchem Industries Inc. 1992). The U.S. Department of Transportation considers a material with a flash point of 93°C or higher to be nonhazardous. From the perspective of storage and fire hazard, biodiesel is much safer than diesel. In blends, the diesel flash point will prevail.

The Engine Manufacturers' Association (EMA 1995) expressed concern that the oxidative instability of some types of biodiesel may result in fuels that have unacceptably low flash points after storage. Some biodiesels have excellent storage histories; others have tended to oxidize rapidly. An ASTM test method on oxidative stability of biodiesel is under development to help researchers test biodiesel and determine its storage characteristics.

The number and location of the double bonds have been identified as possibly contributing to the instability of biodiesel fuels. Fatty acid chains can be saturated (adding hydrogen or alcohol) to reduce the number of double bonds, and it may be possible to remove the fatty acids with excessive double bonds if indeed, these characteristics are confirmed as sources of the problem. In addition, soy oil contains natural antioxidants, which can be added back to the fuel if removed during processing. And a number of

⁶² EPA uses cetane number and cetane index as indirect measures for controlling the aromatic content of diesel fuel. The current minimum cetane number of 40 is intended to regulate the aromatic content in diesel fuel.

antioxidants have been identified that significantly reduce the amount of oxidation that occurs during storage. Research is continuing in this area.

6.1.1.3 Distillation

Biodiesel fuels have a narrow range of boiling points from 327°C to 346°C. Some B20 blends have met the ASTM T-90 distillation specification, using ASTM D-86. However, EMA (1995) and others have reported that intake valve deposit formation is a problem with soy methyl esters at light load, which may be related to the large percentage of olefinic content in the B20 mixtures. Excess glycerine and glycerides in the fuel have also been associated with deposits. Quality control on biodiesel fuel standards was not evident before 1997 and remains an industry problem today; off spec fuel may also contribute to some of the fuel problems identified in past studies.

6.1.1.4 Specific Gravity

Specific gravity is determined by ASTM D-287. Diesel #2 exhibits a specific gravity of 0.85. Biodiesel specific gravity is reported to vary between 0.86 and 0.90 depending on the feedstock used. The average gravity in Table 108 is 0.885 for soy methyl esters. The specific gravities of biodiesel and #2 diesel are very similar.

6.1.1.5 Energy Content

Generally, fuel consumption is proportional to the volumetric energy density of the fuel based on the lower or net heating value. Based on Table 108, #2 diesel contains about 131,295 Btu/gal while biodiesel contains approximately 117,093 Btu/gal. The ratio is 0.892. If biodiesel has no impact on engine efficiency, volumetric fuel economy would be approximately 10% lower for biodiesel compared to petroleum diesel. However, fuel efficiency and fuel economy of biodiesel tend to be only 2%-3% less than that of #2 diesel. The reasons behind this unexpected difference have not been established.

6.1.1.6 Flow Properties (Cold Temperature Sensitivity)

The key flow properties for Winter fuel specification are cloud and pour point. These are static tests that indicate first wax and non-flow temperatures for the fuel. Cloud point, as defined by ASTM D-2500, is a measure of the temperature at which the first wax crystals form, and is related to the warmest temperature at which these will form in the fuel. Wax crystals cause fuel filter plugging. Pour point is a measure of the fuel gelling temperature, at which point the fuel can no longer be pumped. The pour point, as defined by ASTM D-97, is always lower than the cloud point.

Additives called flow improvers do not generally affect the cloud point of conventional diesel fuel; however, they do reduce the size of the wax crystallites that form when the fuel cools. Additives tend to allow the fuel filters to operate at lower temperatures. Diesel #1 and kerosene are common pour point additives that reduce the fuel gelling temperature significantly when mixed with #2 diesel. Refiners and marketers vary fuel cloud and pour points to meet local climatic conditions, and ASTM provides recommended fuel characteristics by season and by degree of latitude.

The cloud point of soy methyl ester, used in this study, can be 30°C higher than that for diesel #2. The difference in pour points may be 10°C higher for soy methyl ester. The relevant structural properties of biodiesel that affect freezing point are degree of unsaturation, chain length, and degree of branching. Fully saturated fatty acid chains tend to become solids at relatively high temperatures (tallow, hydrogenated soy oil, palm oil). Rape and canola methyl esters have lower cloud and pour points than soy methyl ester (Peterson et al. 1997). Tallow methyl ester has a cloud point of 16°C and a pour point of 10°C. Producing biodiesel with ethanol instead of methanol tends to reduce the cloud and pour points by

a few degrees. Rape ethyl esters have cloud points of 10°C and a pour point of 15°C. Isopropyl alcohol has been used to make a biodiesel with a pour point 90°C lower than methanol-based biodiesel; pour point temperature was reduced by 30°C (Foglia et al, 1997). Other solutions, such as customizing the fatty acid profiles of the fuel, remain possible but unexplored.

Traditionally, cloud and pour points of biodiesel blends have been modified by changing the amount of biodiesel in the blends. Biodiesel blends with #1 and #2 diesel #1 show that cloud and pour points increased as the amount of biodiesel increased. The effect was stronger with #1 diesel than with #2 diesel. Blends of more than 35% biodiesel demonstrate significant Winter problems in the Midwest, even when the base diesel as a 50-50 mix of #1 and #2 diesel fuels (AEP 1997).

In Europe, cold weather additives have been identified for use with rape methyl esters, but they are not effective with soy methyl esters. Several studies have shown that a number of diesel flow improvers do not work for biodiesel blends (Midwest Biofuels 1993; Clark et al. 1984).

The biodiesel industry continues to fund research in this critical area. Currently, solutions are limited to recommending lower blends of biodiesel in the Winter compared to Summer, blending with #1 diesel or kerosene, and using heated storage tanks and in-line fuel heating systems in vehicles. There are at least two field demonstrations this Winter (1997-1998) using biodiesel blends of 20% to 35% in heavy-duty, on-road vehicles (Iowa and Idaho), but the precautions discussed earlier have been taken.

An approach being considered by the industry is marketing specific types of biodiesel to meet cold temperature by altering the types of alcohol and oil feedstocks used. By customizing seasonal fuel compositions, similar to diesel producers, more acceptance in cold weather could be established. Additives may still be necessary. A lot of research remains to be done in this area.

6.1.1.7 Viscosity and Surface Tension

The ASTM D-445 specification for viscosity at 40°C of 4 centistokes is generally met by biodiesel and biodiesel blends. However, the viscosity of biodiesel and its blends is higher than for #2 diesel. Soy methyl ester is reported to have a viscosity ranging from 3.8 to 4.1 centistokes at 40°C (Scholl and Sorenson 1993). Glycerine contamination will cause biodiesel viscosity to increase, among other problems. Estimates of the surface tension of biodiesel suggest that it may be two to three times as great as that for #2 diesel. These properties affect the fuel droplet size during injection. Biodiesel has both larger viscosity and surface tension, resulting in larger droplets, one of a number of contributing factors that have been identified as possible causes for higher NO_x emissions.

6.1.1.8 Oxidative Stability

Oxidative stability is a major industry issue for diesel and biodiesel fuels. Oxidative stability is measured by ASTM D2274. EMA (1995) reported that compared to #2 diesel, biodiesel fuels were far more prone to oxidation. The degree of saturation of the fatty acid chains tends to be correlated with its stability. Oxidation products formed in biodiesel will affect fuel life and contribute to deposit formation in tanks, fuel systems, and filters. Gum number is one of several possible measures of oxidative stability of a fuel, iodine value is another. Fuels with high iodine numbers may possess high gum numbers. Thermal and oxidative instability, and fuel oxidation during storage can lead to deposit formation and other potential engine problems. A recent draft report by Southwest Research Institute prepared for NREL evaluates this complex issue and recommends test methods and levels that correlate fuel oxidative characteristics with engine performance goals. No oxidative stability test method for biodiesel has been established by ASTM.

6.1.1.9 Sulfur, Aromatic, Ash, Sediments, Water, Methanol, Glycerine, and Glyceride Content

These contaminants, if they exist at all, are limited less than 2% in the biodiesel, in total. The ester content of a fuel-grade biodiesel generally exceeds 98%. Biodiesel is nonaromatic and does not contain sulfur. Sodium and potassium containing ash may be present because of contamination from catalysts used in transesterification. Phosphorous may be present from inferior oil refining (poor gum removal). Water and sediments may be by-products of long-term storage. Glycerine and methanol in the biodiesel may scavenge water. Glycerine, glycerides, and excess alcohol are major fuel contamination problems, and newly developed industry standards have taken aim at controlling these contaminants. Sediment may result from oxidation of esters and reactive glycerides in the fuel. Algae growth may also produce sediment.

6.1.1.10 Biodiesel Composition

Table 109 presents analytical data for soy methyl ester. These data, along with the energy density data presented in this section, are useful for estimating energy-based fuel economies for the various fuels and engine platforms investigated. The data of Graboski (1994) are important for quality checking the other sources because the oxygen weight percent reported was directly determined as opposed to determined by difference.

Table 109: Elemental Composition of Biodiesel and Petroleum Diesel

Source	WT%		
	Carbon	Hydrogen	Oxygen
FEV (1994)	78	11.5	10
Graboski (1994)	77.22	11.56	11.03
Schumacher (1994)	76.5	12.5	11
McDonald (1995)	77.55	11.56	10.88
Marshall (1994)	76.91	12.11	10.97
AVERAGE	77.24	11.85	10.78
STDEV	0.58	0.44	0.44
Low-sulfur #2 diesel	87	13	0

6.1.2 Biodiesel Fuel Economy

The fuel economy of the bus burning biodiesel is based on combustion data in a modern four-stroke diesel engine. Table 110 presents fuel economy data for the same four-stroke diesel engine used to calculate the fuel economy of the diesel fuel (Graboski 1997). The root mean square (RMS) error in fuel economy by each method is approximately 1.5%. The data clearly show the following:

- The energy efficiency determined by both methods (based on CO₂ and on fuel use) for each blend are the same within experimental error. Thus, the fuel composition and lower heating value data used to estimate fuel economy from CO₂ and fuel flow data are internally consistent.

- Within experimental error, the energy efficiency is independent of biodiesel content. The neat biodiesel actually shows a better fuel economy of around 3%. This is thought to be insignificant within the experimental error of the data.

Table 110: Economy Data for Biodiesel Fuels in a Modern Series 60 Engine

% Biodiesel by Volume in Diesel Fuel	Engine Efficiency (Btu/bhp-h)	
	Calculated from Measurements of CO ₂ Emissions	Calculated from Fuel Consumption Data
0%	7176	7326
20%	7040	7192
35%	7080	7130
65%	7006	7133
100%	7038	7038
avg/stdv	7116	97(1.4%)

As discussed later in this section, biodiesel increases emissions of NO_x and decreases emissions of PM10 in urban bus engines. One approach often used to mitigate the NO_x increase associated with biodiesel is to change the timing of the engine. Retarding the timing of these engines tends to reduce NO_x emissions at the expense of increasing PM10. An oxidation catalyst can be added to the engine to bring PM10 emissions down again. Researchers have tested the effect of both the timing change and the catalyst on engine performance. Table 111 shows the effect that these two engine modifications can have on fuel economy for low-sulfur #2 diesel and for B20 blends. The data show that they have no measurable effect on fuel economy. The average amount of energy required to deliver 1 bhp-h of engine work increases by only 0.6% when both the timing change and the catalyst were applied in tests done on six different engines.

Table 111: Fuel Economy Data for a Series of Engines Operating with Catalysts and Timing Changes

FUEL	SETUP	DDEC 6V-92-TA 1991	MUI 6V-71N 1977	DDEC 6V-92TA 1988	MUI 6V-92 - 1981/1989	MECH-L-10 1987	MUI-6V-92TA 1987
DF-2	STOCK	8593	8374	8426	8735	7252	8911
B20	STOCK	8529	8439	8258	8759	7192	8837
B20	TIMING	8599	8375	8475	8874	7066	8873
B20	TIMING + CAT	8589	8835	8421	8835	7138	8819
	TIMING DEG	3	4	1	2	?	?
RATIO	TIME+CAT/ STOCK DF-2	0.9985	1.0551	0.9994	1.0115	0.9842	0.9897
AVG/S TDEV	1.0064	0.0256					

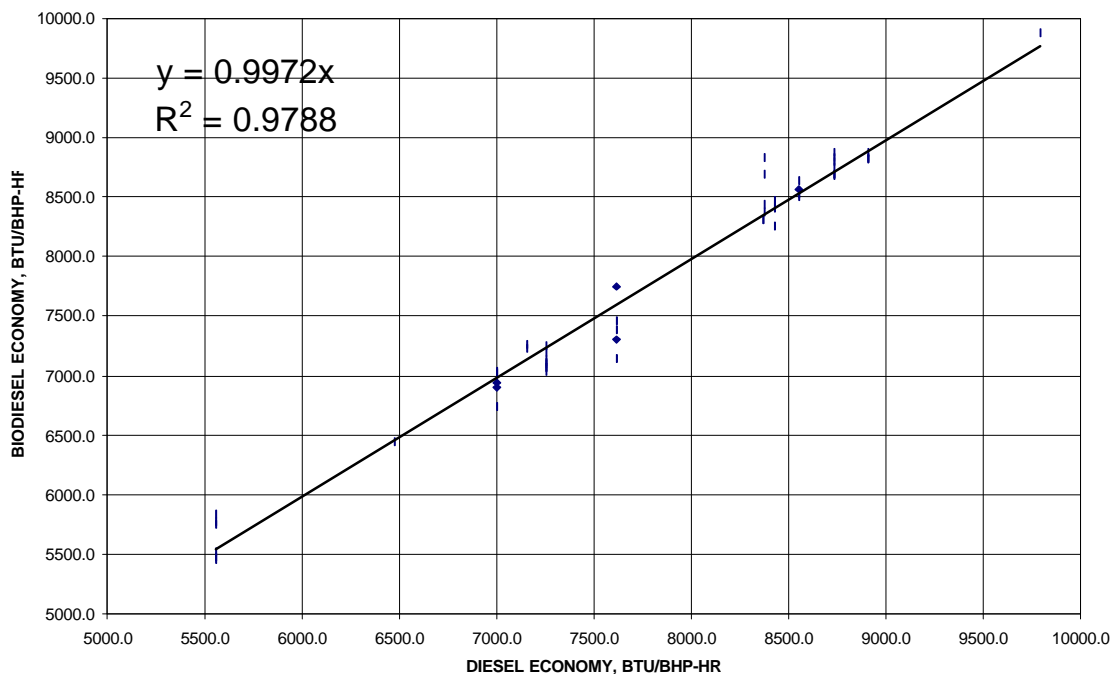

Figure 76: Energy Economy for Biodiesel-Fueled Engines

In addition to transient testing, energy fuel economy data are available for steady-state and multimode steady-state testing. Figure 76 presents energy economy data for biodiesel and biodiesel blends compared to #2 diesel for steady-state and transient testing and covering a broad range of engine models and vintages. Biodiesel blends vary from 10% to neat, and include methyl, ethyl, and butyl esters. As Figure 76 shows, the energy fuel economy is independent of the fuel mixture fed to the engine. Thus, the crude oil replacement benefits of biodiesel depend on the total quantity used but not the blend concentration.

Several road tests support the conclusions from engine testing. Battelle (1995) reported on the B20 bus experiment carried out at Bi-State Development Agency in St. Louis, where five buses each were run on B20 and control diesel. Approximately 200,000 miles were accumulated with each fleet. The diesel buses were run 7 days per week; the biodiesel buses were operated 5 days per week. The measured fuel economy was 3.76 mpg for B20 and 4.01 mpg for control diesel, a 6% reduction. A 1% to 3% loss was expected based on fuel property estimates, and no explanation was provided for the discrepancy. The fuels were not interchanged for a given bus; the fleet size was so small that hardware differences may have a significant effect on mileage. Data on passenger loading, driver assignment, and routes were not provided.

ATE Management and Service Company, Inc. (1994) reported on a study conducted by Cincinnati Metro. Six buses were tested. Four were equipped with 1987 MUI and two with 1989 Electronic DDC two-stroke power plants. Before the test all engines were tuned up and received new injectors. B30 was used. Each bus was power baselined on a chassis dynamometer with #2 diesel. The buses were not assigned to fixed routes and experienced a variety of driving situations. Fuel mileage data were given for each bus. Mileage was on average 5% lower with B30. The expected loss in mileage based on energy use is 3.2%.

The agreement is excellent and the author indicated that the difference could be due to route bias for hill testing trials.

Daniel (1994) reported on the Link Transit 1 month 104,000-mile demonstration on B20 (soy). The base diesel was not defined. They saw no significant change in fuel economy for 1991 and 1993 6V-92TA DDEC II engines in Orion 1 Coaches. The expected change would have been a 2.2% loss in mileage.

Yost (1994) reported on a 6-month field test by Spokane Transit on #1 diesel blended with 30% soy methyl ester and 6 months on #1 diesel blended with 20% soy methyl ester. Eighteen bus coaches were used (six each 6V-71, 6V-92, and 6L-71; 1974 to 1992 vintage). The fuel mileage was 0.5 mpg better than with #1 diesel. The lower heating value of #1 diesel is approximately the same as for soy methyl ester. Thus, fuel economy may have been better for biodiesel blends. However, it is not known how fuel economy differences were actually computed and whether there was any control of properties on the #1 diesel employed.

Howes and Rideout (1995 a,b) investigated emissions and fuel economy for two urban buses using three bus chassis cycles for diesel; they examined B20 alone, then with timing changes and catalyst. Table 111 shows that the fuel economy in mpg. No data on fuel composition were given and it was not stated whether the B20 was produced with the diesel reference fuel. Three cycles of varying load were driven. Table 112 shows that there was no significant effect of B20 on mileage without or with a 1.5° timing change. This suggests a higher thermal efficiency for B20; the confidence limits on the data encompass the expected 2.2% loss in mileage. Addition of a catalyst caused a 6.2% and 8.3% loss in mileage for the 6V-92 and 8V-71, respectively. This probably points out the importance of backpressure on vehicle performance regardless of the fuel.

Table 112: Chassis Dynamometer-Based Fuel Economy Data

CYCLE		%Biodiesel	mpg	
			1988 6V-92TA	1981 DDC 8V-71
CBD	STOCK	0%	3.69	3.59
ARTERIAL	STOCK	0%	4.67	3.92
COMPOSITE	STOCK	0%	3.70	3.66
CBD	STOCK	20%	3.68	3.63
ARTERIAL	STOCK	20%	4.72	3.91
COMPOSITE	STOCK	20%	3.63	3.52
CBD	TIMING	20%	3.54	3.59
ARTERIAL	TIMING	20%	4.89	3.93
COMPOSITE	TIMING	20%	3.50	3.63
CBD	CAT	20%	3.35	3.18
ARTERIAL	CAT	20%	4.64	3.40
COMPOSITE	CAT	20%	3.34	3.21
CBD	TIMING+CAT	20%	3.26	3.30
ARTERIAL	TIMING+CAT	20%	4.56	3.84
COMPOSITE	TIMING+CAT	20%	3.33	3.43

Clark et al. (1984) studied diesel, soy methyl ester, and soy ethyl ester in a John Deere 4239TF direct-injected turbocharged diesel engine attached to an eddy current dynamometer. Fuel economy, torque, and horsepower were all directly related to volumetric heating value of the fuels.

Klopfenstein and Walker (1983) reported on an investigation of thermal efficiency of nine pure esters and eight whole oils using a Fairbanks Morse one-cylinder direct-injection engine rated at 5.25 bhp at 1800 rpm. Methyl esters made from lauric acid (C12), myristic acid (C14), palmitic acid (C16), stearic acid, oleic acid (C18, one double bond), linoleic acid (C18, two double bonds), and linolenic acid (C18, three double bonds) were tested. Ethyl and butyl esters of oleic acid were examined. The heats of combustion were measured using a bomb calorimeter. Thermal efficiency was reported to increase with decreasing fatty acid chain length from 20% at C18 to 24.4% at C12. The ethyl ester also yielded a high thermal efficiency of 24.8%. The butyl ester gave a low efficiency of 20.3%. No explanation is given for the trend and no description of the possible error in measurement, repeatability, or repeated diesel testing for control purposes is given. The diesel fuel gave 21.7% efficiency. The cetane number for the diesel fuel was not reported.

Based on these data, neat biodiesel and biodiesel blends should exhibit a fuel economy proportional to the lower heating value of the blend. No improvement in energy efficiency is expected. Therefore, the fuel economy of the biodiesel bus is assumed to be the same as for a conventional diesel fueled bus — 7.5 MJ/bhp-h.

The lower heating value of biodiesel is used to determine the amount of fuel needed per functional unit. The lower heating value of biodiesel is assumed to be 36.95 MJ/kg. Therefore, 0.203 kg of biodiesel are required per brake horsepower hour of engine use.

6.1.3 Biodiesel Tailpipe Emissions

The regulated emissions data, NO_x, CO, NMHC, PM10, and SO_x, from engines fueled with biodiesel can be separated into data for older two-stroke engines embodied as various DDC-6V-71 and 92 engines and for modern four-stroke engines embodied as the DDC Series 50 and 60 engines. We focus our attention on these newer four-stroke engines to be consistent with the “current” timeframe of our study.

Figure 77 and Figure 78 show how biodiesel emissions of NO_x and PM10 change with blend level in four-stroke engines. Figure 79 and Figure 80 show the effect of biodiesel on CO and NMHC emissions in four-stroke engines. These results are from four independent studies (Sharp 1994; Ross 1994; Graboski, 1994; and Ortech, 1995). The emissions tests were done on at least three Series 60 engines, and three calibrations (1991, 1994, 1998). Data for a Cummins N-14 engine (Ortech 1995) are also included. Figure 77 shows that the newer four-stroke engines have emissions of NO_x that increase with the blend level of biodiesel. PM10, on the other hand, drops significantly with increasing blend levels of biodiesel (see Figure 78). Both CO and NMHC decrease as the blend level of biodiesel increases.

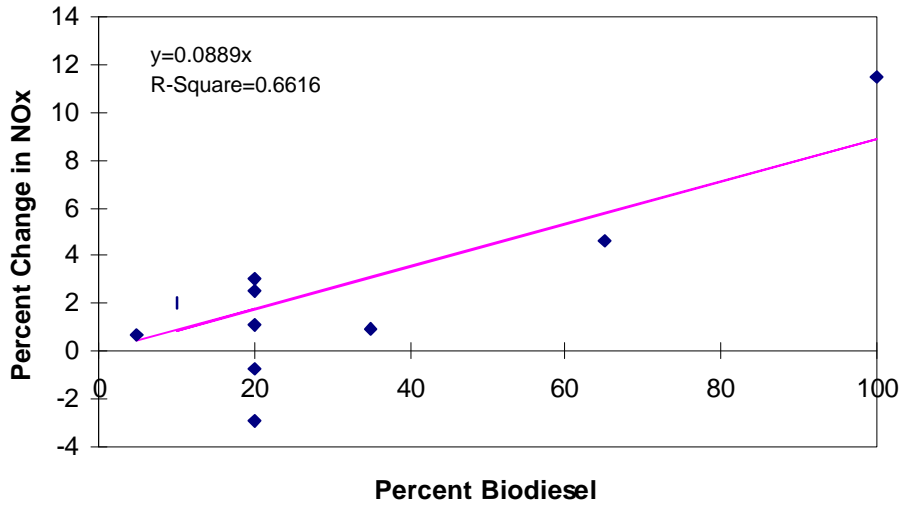

Figure 77: Effect of Biodiesel Blend Level on NO_x Emissions for Four-Stroke Diesel Engines

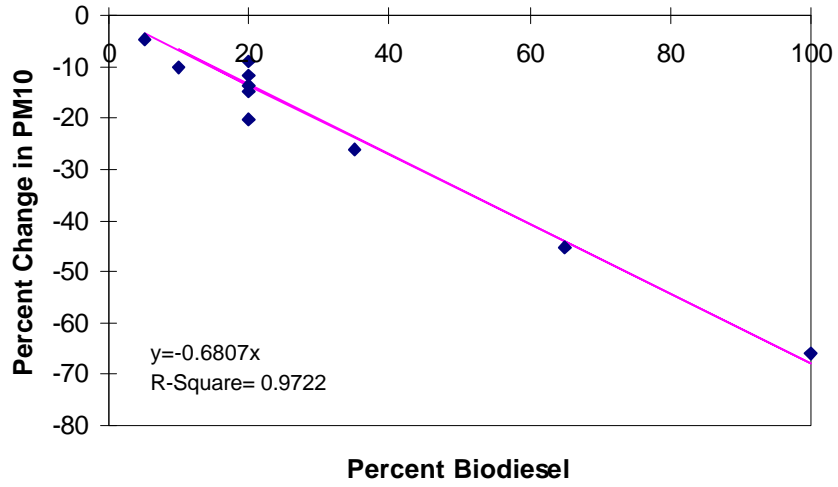

Figure 78: Effect of Biodiesel Blend Level on PM10 Emissions for Four-Stroke Engines

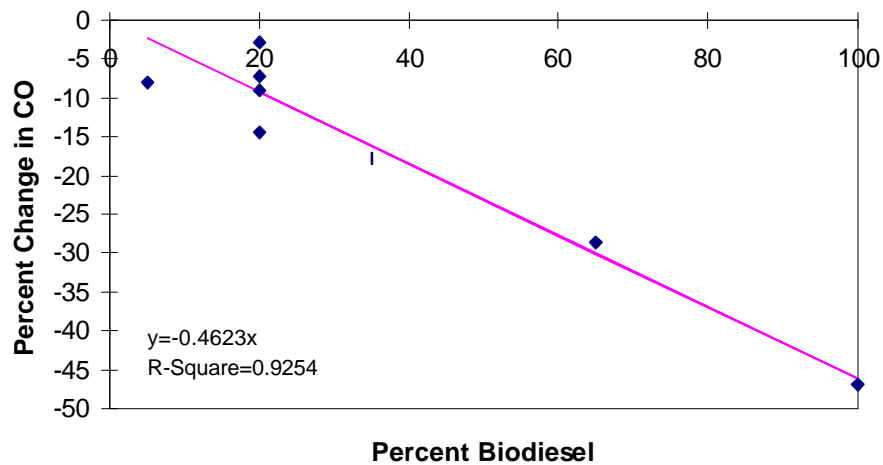

Figure 79: Effect of Biodiesel Blend Level on CO Emissions for Four-Stroke Engines

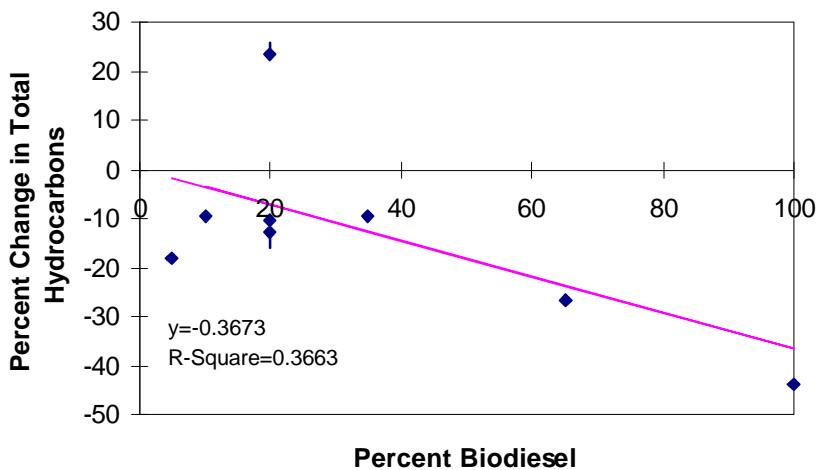

Figure 80: Effect of Biodiesel Blend Level on NMHC for Four-Stroke Engines

These figures suggest that the regulated emissions change nearly linearly with biodiesel content. If linearity is assumed, the specific emissions effect of biodiesel is independent of its concentration in #2 diesel fuel. This is an important result because it allows us to predict the tailpipe emissions for any blend of biodiesel and #2 diesel. The assumption of linearity is quite reasonable for CO and PM10 emissions, each of which exhibit correlations with R-squares of 0.9722 and 0.9254, respectively. This strong correlation supports the widely held view that oxygenates in diesel fuel lead to lower CO and PM emissions by improving the degree of complete combustion (Liotta 1993). The linear correlation between biodiesel blend level and NO_x is weaker (R-square=0.6616), though a visual inspection of the data supports the conclusion that high blend levels of biodiesel result in higher NO_x emissions in four-stroke engines. The issue is whether or not this trend is linear. The variability of the data makes more sophisticated interpretations of the trend meaningless. The rate of increase in NO_x with blend level may

be lower at lower blend levels. Better data are needed to evaluate this possibility. For the purposes of this study, we assume a linear response across the full range of blend levels from 0% to 100% biodiesel. NMHC emissions show the weakest correlation with biodiesel blend level (R-square of 0.3663). This is due to the high degree of variability in data reported on the 20% blend level. Once again, for our purposes, we model emissions of HC from the engine as a linear function of biodiesel blend level.

The following formulas are used to represent the relationship between the oxygen content of the fuel and the emissions:

- $\text{NO}_x \rightarrow y = 0.0889x$
- $\text{PM} \rightarrow y = -0.6807x$
- $\text{CO} \rightarrow y = -0.4623x$
- $\text{NMHC} \rightarrow y = -0.3673x$ Where:

y = the percent change in the emissions relative to standard low-sulfur #2 diesel fuel

x = the biodiesel blend level expressed as a volume percent in the fuel

The baseline emissions for which the percent of change (y) is applied are the same baseline emissions that are used for the diesel fuel combustion emissions (see section 6.2.2).

We assumed that there is no sulfur in the biodiesel. Therefore, there are no SO_x emissions from the combustion of neat biodiesel (B100). The level of SO_x emissions for biodiesel blends is assumed to decrease linearly with the level of biodiesel present in the fuel.

6.1.4 The Fate of Biomass Carbon Leaving the Tailpipe of the Bus

Table 113 indicates actual measurements of carbon in biodiesel. The average carbon content is 77.2%. Biodiesel combusted in the bus engine contains carbon that is derived from biomass and from fossil fuels. Methanol chemically coupled to the fatty acids from soybean oil contains fossil carbon. The fatty acid portion of the methyl ester contains only biomass-derived carbon. The distinction is important in identifying the amount of CO_2 derived from biomass. This portion of the CO_2 emissions does not contribute to total CO_2 in the atmosphere because of its recycle in the production of soybean oil. As discussed in the section describing biodiesel production, biodiesel contains 73.2% biomass carbon and 4% fossil-derived carbon. Thus, 73.2% of the total CO_2 emitted at the tailpipe is recycled in the agriculture step of the life cycle for biodiesel⁶³.

In an engine that completely combusts the carbon in the fuel, all the carbon would end up in CO_2 . As discussed in section 6.1.3, the emissions from diesel engines include PM10, CO, and NMHC, as well as CO_2 . The carbon is partitioned among all four components. The carbon partitioned in CO is estimated as the product of the total mass of CO times the percent carbon in each molecule. The percent carbon in CO is 42.9%⁶⁴. The complex natures of the CH and PM make this calculation more difficult. We used data from Sharp (1996) to estimate the composition of these components⁶⁵.

⁶³ This assumes that biomass carbon and fossil carbon partition equally among the carbon containing combustion products.

⁶⁴ %C in CO = $\text{MW}_C/\text{MW}_{\text{CO}} = 12/(12+16) = 42.9\%$.

⁶⁵ Sharp, Christopher A. *Emissions and Lubricity Evaluation of Rapeseed Derived Biodiesel Fuels*. Report SwRI #7507. Southwest Research Institute, San Antonio, TX, December 1996.

Table 113: Analytical Data for Soy Methyl Ester

Study	wt%		
	C	H	O
FEV (1994)	78	11.5	10
GRABOSKI (1994)	77.22	11.56	11.03
SCHUMACHER (?)	76.5	12.5	11
MCDONALD (1995)	77.55	11.56	10.88
MARSHALL (1994)	76.91	12.11	10.97
AVERAGE	77.24	11.85	10.78
STDEV	0.58	0.44	0.44
DIESEL	87	13	0

PM contains two basic components: soot and the volatile organic fraction (VOF). Soot is essentially 100% carbon resulting from pyrolysis reactions during combustion. The amount of soot present in the particulates is strongly affected by the amount of biodiesel-derived oxygen in the fuel. Sharp (1996) includes data on the relative soot content of particulates for a range of biodiesel blends. The data from this study were used to develop a predictive correlation for soot content (see Figure 81). The parameters for the linear model developed using these data are shown in Table 114. The model predicts that 100% petroleum diesel emits PM containing 54% carbon as soot. B100 emits PM with only 30% carbon as soot, while blends contain soot at levels between the values for each neat fuel.

Table 114: Percent Soot as a Function of Percent Oxygen in Fuel

Parameter	Value
Slope	-2.437
Intercept	54.179
R-Square	0.933

Sharp reports that the VOF is dominated by long-chain alkanes and alkenes. We estimated the carbon content of these compounds to be 85%.⁶⁶ Sharp also reports speciated data for the HC from the tailpipe. The analytical results were quantitative for HC with a carbon number of 12 or lower. An evaluation of the distribution of C1 through C12 paraffins, olefins, and aldehydes reported in this study indicates an average carbon content of around 72%. The higher carbon number compounds were assumed to be 85% carbon.

Using the emission correlations in Figure 78, Figure 79, and Figure 80, in conjunction with the carbon content estimates for each pollutant, we calculated the amount of carbon that is tied up in CO, PM, and

⁶⁶ Based on molecular weight, alkanes from C10 to C18 contain 85% carbon. Long chain alkenes with one double bond contain 86% carbon.

HC. The remainder of the carbon is assumed to be CO₂. The carbon balanced closed within 1.5%, which provides an estimate of robustness to this analysis.

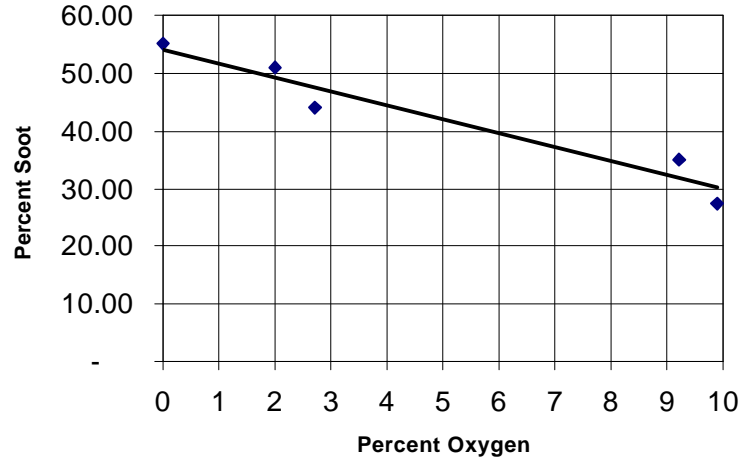

Figure 81: Correlation for Soot Content in PM as a Function of Oxygen Content

6.1.5 Biodiesel Combustion Results

Table 115 shows estimates from the LCI model for emissions from petroleum diesel and biodiesel blends based on the linear models described in section 6.1.4. The diesel fuel baseline emissions are outlined in Section 6.2.2, the biodiesel emissions are based on the formulas described earlier. The change in tailpipe emissions resulting from the biodiesel use is assumed to be linear. Therefore, emissions for other biodiesel blends can be extrapolated from the results shown in Table 115.

Table 115: Effect of Biodiesel on Tailpipe Emissions (g/bhp-h)

Emission	Diesel Fuel Baseline	20% Biodiesel Blend	100% Neat Biodiesel
Carbon Dioxide (fossil)	633.28	534.10	136.45
Carbon Dioxide (biomass)	0	108.7	543.34
Carbon Monoxide	1.2	1.089	0.6452
Hydrocarbons	0.1	0.09265	0.06327
Particulate Matter (PM10)	0.08	0.0691	0.02554
Sulfur Oxides (as SO ₂)	0.17	0.14	0
Nitrogen Oxides (as NO ₂)	4.8	4.885	5.227

6.2 Diesel Fuel Combustion

The LCI modeling of combustion of diesel fuel in an urban bus is composed of the amount of diesel fuel required to supply 1 bhp-h, and the emissions from the tailpipe of the bus. The amount of diesel fuel required depends on the fuel economy of the bus engine. The emissions depend on many factors, including the type of engine, but in this study we have assumed that they equal the EPA standards for diesel emissions from heavy duty vehicles. The following sections outline how this diesel combustion is modeled.

6.2.1 Diesel Fuel Economy

The fuel economy of the diesel bus is based on combustion in a modern four-stroke diesel engine. The fuel economy for petroleum diesel is based on data collected by Graboski (1997). Fuel economy was determined for a four-stroke diesel engine operating on a range of fuels including low-sulfur diesel and blends of biodiesel from 20% to 100%. A more specific discussion of the data analysis for fuel economy is presented in section 6.1.2. The work by Graboski demonstrates that fuel economy does not vary as a function of biodiesel blended in the fuel. We use an average of the data collected from this study as the fuel economy for the diesel engine independent of fuel choice. Fuel economy can vary from engine to engine. This approach allows us to compare relative performance of the two fuels using the same engine data for fuel economy. These were by fuel mass and by the emissions-based carbon balance for EPA transient testing. The fuel economy for our combustion model is 7,250 Btu/bhp-h, or 7.5 MJ/bhp-h.

The lower heating value of #2 low-sulfur diesel fuel is used to determine the amount of fuel needed per functional unit. The lower heating value of diesel fuel is assumed to be 43.5 MJ/kg. Therefore, 0.172 kg of diesel fuel are required per brake horsepower hour of engine use.

6.2.2 Tailpipe Emissions

Our early modeling of the emissions from diesel engines was based on EPA's 1994 standards for diesel engines. Based on feedback during the final review process, we switched from the 1994 standards to actual data for 1994 engines as certified by the engine manufacturers with EPA. It turns out that emissions from 1994 engines were, for some pollutants, much lower than what was allowed under the standards.

Table 116 compares certification data for the Series 50 and Series 60 engines to the 1994 standards. These engines actually have much lower emissions of NMHC and CO. They are almost identical in emission performance. The Series 50 engine data was used as the basis for comparing low-sulfur #2 diesel fuel and biodiesel blends. SO_x emissions are calculated by assuming all the sulfur in the diesel fuel is converted to SO₂. The sulfur content of #2 low-sulfur diesel fuel is assumed to be 0.05 % by weight.

6.3 Combustion End-use Results

The only environmental flows tracked in the end-use system of the TEAM™, model are the air emissions. Refer to Table 115 for a summary of the emissions for petroleum diesel, B20, and B100. All emissions are reported on the basis of 1 bhp-h.

Table 116: 1994 U.S. EPA Emission Standards for Diesel Engines versus Engine Certification Data⁶⁷ for Two Common Urban Bus Engines (g/bhp-h)

Pollutant	1994 EPA Emission Standards for Diesel Engines	1994 Engine Certification Data for Detroit Diesel Series 60 (11.1 liter) Engine	1994 Engine Certification Data for Detroit Diesel Series 50 (8.5 liter) Engine
NMHC	1.3	0.1	0.1
CO	15.5	1.2	1.1
NO _x	5.0	4.9	4.8
PM10	0.05	0.06	0.08

⁶⁷ U.S. Environmental Protection Agency. *1994 Summary Report: Diesel Heavy Duty Engines*. August 24, 1994. Downloaded from the EPA Office of Mobile Sources web site at www.epa.gov/omswww/gopher.

7 Software Modeling Tools

7.1 Description of the TEAM™ Model

The LCI uses information modules contained in the TEAM™ software. These modules allow an LCA to be streamlined, one of TEAM™'s special features that allow several processes to be gathered into a single subsystem that may be reused at a higher level. The user may therefore:

- Build complex systems while keeping the interface simple. All the complex processes may be hidden; the main system is simplified on the interface. The user would be able to access any of the subsystems for more process details.
- Model the various life cycle phases within TEAM™ allowing for easy identification of the contribution of each phase.
- Import data from other databases. For example, update the soybean crushing model, and automatically update the TEAM™ model through an import procedure.
- Easily reuse large blocks of information. For instance, a subsystem made for a specific product can be copied, pasted, and instantly reused in another system, yielding significant savings in terms of data collection and calculation.

Figure 73 shows an example of the graphical interface taken directly from TEAM™. An unlimited number of subsystems can be created to organize the information collected. At the reporting stage, the contribution of any given subsystem can be calculated instantly.

NREL researchers use a copy of the TEAM™ model containing the biodiesel and petroleum diesel life cycles, so they can run simulations, update the model, and refine any assumptions. It has also been used for other renewable energy processes being evaluated at NREL.

7.2 Description of the Database Used

LCI data for energy production and ancillary materials used in this model came from DEAM™, Ecobalance's database on materials and processes, and literature searches. The DEAM™ database is continuously updated and is one of the most extensive LCI databases of environmental impacts associated with products and processes. The following sections describe the type of data in DEAM™.

7.2.1 Electricity

Ecobalance has developed a model of the production of electricity for the various regions of the United States, based on primary data sources and EPA AP-42. Wherever possible, the model details precisely the various technologies involved in producing electricity, and relies on weighted averages. For electricity produced from coal combustion, for example, five major groups of boilers were considered, corresponding to various technologies. The models describing the various fuels, as well as how the specific mix of fuels for each zone is taken into account in the model, are described later.

7.2.1.1 Electricity from Coal

Electricity from coal includes all coal that is burned in utility plants with a total steam-electric and combined nameplate capacity of 50 or more MW. Types of coal include bituminous, subbituminous, lignite, and anthracite. Coal pre-combustion life cycle steps include coal mining, cleaning and preparation for use at utility plants, and transportation to the utilities.

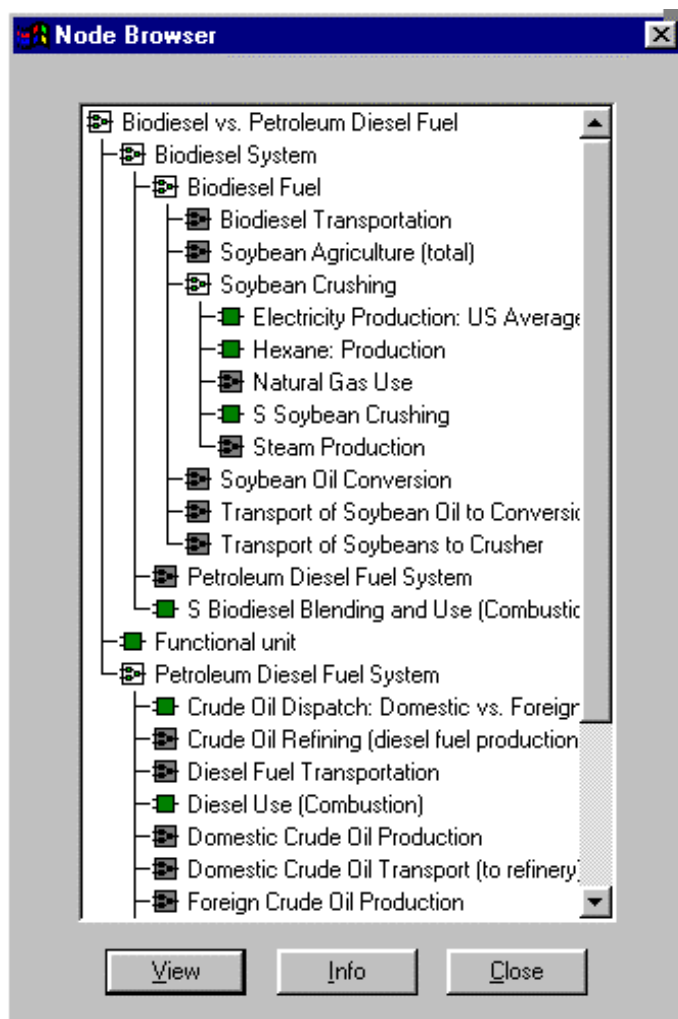

Figure 82: Example of TEAM™ Interface

7.2.1.1.1 Coal Mining

Materials and energy consumed in mining and cleaning coal comes from 1987 Census Bureau data (DeLucchi, 1993). Emissions from coal mining are from the combustion of diesel oil of mining equipment and methane released directly from the mine. All emissions factors come from AP-42 Mobile Sources vol. II, January 1991. DOE states that water effluents from mining are unquantifiable, and concludes that water effluents from this type of operation generally do not have global impacts⁶⁸; however the local and regional impacts can be significant.

⁶⁸ DOE, 1983. Energy Technology Characterizations Handbook section on "Coal Technologies."

7.2.1.1.2 *Cleaning and Preparation*

Cleaning and preparing coal may involve many processes, including beneficiation, which remove sulfur and mineral matter so that stringent federal emissions limits during combustion are met. However, there are not enough specific data as to the percentage of coal that goes through these processes; and the amount of energy consumed in these processes is negligible compared to the amount of energy generated from coal combustion⁶⁹. Therefore, coal cleaning and preparation steps are omitted from the model.

7.2.1.1.3 *Transportation from Site of Extraction to Power Plant*

Coal may be transported by various transportation means, including rail, road, pipeline, and barge. The expression used to describe the energy intensity of transporting coal (or any other material) is Btu/ton-mile. This is calculated as:

$$\frac{E}{T * M} \quad (\text{see note } 70)$$

where:

E is total Btu used by the mode of transport and the energy used for the backhaul (assuming the return trip is empty)

T is total tonnage of the transported material

M is the distance the material is carried.

It is safe to assume that the carrier usually returns empty. For example, 91% of the unit train cars that carry coal return empty to the mine (DeLucchi 1993), and trucks return empty unless they can find a similar product to transport back. Therefore, all transportation data will assume a one-way haul and an empty return trip.

7.2.1.1.4 *Coal-Rail*

The 1987 national average length of haul for coal by rail is 490 miles⁷¹. We assumed that diesel fuel is used for rail transportation⁷². DeLucchi (1993) presents energy consumed in coal transportation by rail from a few sources (DOE 1983), U.S. Congressional Research Service (CRS) (1977), and Argonne National Laboratory (ANL) (1982). The energy consumed is averaged out to be 589 Btu/ton-mile.

7.2.1.1.5 *Coal-Truck*

DeLucchi (1993) is in accordance with the DOE *Energy Technology Characterizations Handbook* (1983) on an average haul distance of 60 miles for a round trip of coal delivery. It is assumed that diesel fuel is used for truck transportation. DeLucchi estimates energy consumed in coal transportation by truck from a few sources: DOE (1983); CRS (1977); ANL (1982); and Rose (1979). The energy consumed is averaged out to be 2,349 Btu/ton-mile.

⁶⁹ DeLucchi 1993. *Emissions of Greenhouse Gases from the Use of Transportation Fuels and Electricity*, Appendix F.

⁷⁰ DeLucchi 1993. *Emissions of Greenhouse Gases from the Use of Transportation Fuels and Electricity*, Appendix E.

⁷¹ DeLucchi 1993. *Emissions of Greenhouse Gases from the Use of Transportation Fuels and Electricity*. EIA, 1988. *Coal Distribution*.

⁷² DeLucchi 1993. *Emissions of Greenhouse Gases from the Use of Transportation Fuels and Electricity*, Appendix F.

7.2.1.1.6 Coal–Ship

The national average length of haul for coal via water is 450 miles⁷³. DeLucchi (1993) estimates energy consumed in coal transportation by ship from a few sources DOE (1983); CRS (1977); ANL (1982); and Rose (1979). The energy consumed is averaged 539 Btu/ton-mile.

7.2.1.1.7 Coal Slurry Pipeline

In general, coal slurry pipeline is a highly reliable (99%) source of transportation, and can last longer than 20 or 30 years. It is the cleanest and safest coal delivery system to power plants. Data for energy consumed in coal transportation by slurry pipeline are presented in *Emissions of Greenhouse Gases from the Use of Transportation Fuels and Electricity*⁷⁴ (1993) over a few sources: DOE (1983); Banks (1977); and ANL (1982). The energy consumed for this mode of transport averages 668 Btu/ton-mile. Included in this average is energy used for slurry preparation, pipeline pumping, dewatering facilities, and specifically, energy used in the Black Mesa Pipeline, which runs 273 miles from the Black Mesa Coal Mine in Arizona to the Mohave Power Plant in Laughlin, Nevada. DeLucchi estimates that the average length of haul for a pipeline is 300 miles, including the pipeline, tramway transportation, and conveyor belts.

7.2.1.1.8 Water Effluents

Water effluents coming from precombustion processes are considered negligible for this study. In general, the only water effluents coming from precombustion are those from mining the fuels used to transport materials and refinery processes.

7.2.1.2 Coal Combustion

Energy consumed and emissions associated with coal combustion in utility boilers come from a variety of sources. Emissions and total coal burned were obtained from the 1994 Interim Inventory based on the Form EIA-767 data⁷⁵. Emissions factors for pollutants not provided in the Interim Inventory are obtained from AP-42 (1995).

Emissions are presented for each individual firing configuration. Because firing configurations have varying combustion requirements (coal burning temperatures, firing methods, emissions control equipment, etc.), they emit varying amounts of pollutants.

The firing configurations included in the model are:

- Pulverized coal fired, dry bottom and wall fired
- Pulverized coal fired, dry bottom and tangentially fired
- Pulverized coal-fired and wet bottom
- Spreader stoker
- Fluidized bed combustor
- Cyclone furnace.

⁷³ DeLucchi 1993. *Emissions of Greenhouse Gases from the Use of Transportation Fuels and Electricity*. U.S. Department of Army 1988, 1989. *Waterborne Commerce of the United States*,

⁷⁴ DeLucchi 1993. *Emissions of Greenhouse Gases from the Use of Transportation Fuels and Electricity*.

⁷⁵ Database provided by EPA.

The Interim Inventory provides actual air emissions (VOCs, NO_x, CO, SO_x, and PM10) by specific type of coal (bituminous, subbituminous, and lignite) and by furnace type. The firing types provided are also identified by a Source Classification Code (SCC). Each firing type is placed into a broader category of firing configurations (identified in AP-42), using SCC numbers. Table 117 presents the firing types provided by the Interim Inventory, and how they were placed in the firing configuration category, based on SCC numbers.

Several steps were taken to obtain actual emissions in pounds per ton of each type of coal. The tonnage for each emission provided by the Interim Inventory database is summed for each firing configuration. This number is divided by the total amount of coal consumed for each firing configuration, to obtain actual emissions per firing configuration, per type of coal.

Table 117: Coal Fire Configurations Provided by the Interim Inventory (1994)

Firing Configuration (AP-42 1995)	Firing Types (Interim Inventory 1994)
Pulverized coal fired, dry bottom, wall fired	Front Furnace Arch Furnace (50%) ⁷⁶ Rear Furnace Spreader Stoker (80%) ⁷⁷ Opposed Furnace Vertical Furnace
Pulverized coal fired, dry bottom and tangentially fired	Tangential Furnace
Pulverized coal-fired, wet bottom	Arch Furnace (50%)
Spreader stoker	Spreader Stoker (20%)
Fluidized bed combustor	Fluidized Bed
Cyclone furnace	Cyclone

Where actual emissions data were not available, such as for N₂O, CH₄, and trace elements, emissions factors were obtained from AP-42 (1995). A weighted average is used for each firing configuration.

The model also takes into account all CO₂ emissions, which are calculated by multiplying 36.7 by the percent weight of carbon content in coal. Fixed carbon content percentages of various coal samples are given in provided Babcock and Wilcox⁷⁸ for anthracite, bituminous coal, subbituminous coal, and lignite. Averaged values and CO₂ emissions factors (in g/kg coal) are provided in Table 118.

Finally, the model takes the weighted average of each of the firing configurations for each type of coal. For example, the emissions from the spreader stoker for bituminous coal combustion are omitted from the

⁷⁶ About half of the arch furnace boilers had SCC numbers for dry-bottom wall-fired units and the other half for wet-bottom units.

⁷⁷ An estimated 80% of the spreader stoker boilers had SCC numbers for dry-bottom wall-fired units and the other 20% belonged in the spreader stoker category of firing configurations.

⁷⁸ Babcock and Wilcox 1992. *Steam*, 40th ed. Babcock and Wilcox Company, Barberton, OH.

model because bituminous coal combusted in the spreader stoker is a negligible representation of all of the bituminous coal fed into the firing configurations.

7.2.1.2.1 Emissions Control Technology

Because there are actual plant data for VOCs, NO_x, CO, SO₂, and PM, emission control technologies for some of the major pollutants of concern, such as NO_x and SO_x, are already taken into account.

Lime and limestone, used for flue gas desulfurization (FGD), are modeled. Coal utility plants use different methods for scrubbing, such as limestone slurries and dry spraying, and use as the primary FGD materials lime and limestone. Quantities of lime and limestone vary, depending on the type of coal, the molar ratio needed to scrub the SO_x, and the percentage of SO_x (by weight) in the coal. Each type of coal is modeled according to the general scrubbing material for that type of coal and based on its percentage by weight of SO_x. Data on scrubbing, molar ratios, and technologies were collected from a source at a coal utility plant in North America (1996), a source at American Electric Power Company (1997) and from the EIA *Electric Power Annual* 1994, vol. II, November 1995.

Table 118: Coal Carbon and CO₂ Emissions Factors

	Fixed Carbon Content %	CO ₂ Emissions Factor (g/kg)
Anthracite	(see footnote ⁷⁹)	2,840
Bituminous	85	3,120
Subbituminous	75	2,753
Lignite	70	2,569

7.2.1.2.2 Water Effluents

Coal combustors use water for boiler makeup, treatment of fumes, and slag cooling. However, we assumed that most of the water is recycled in the facility. Therefore, water effluents generated as a result of combustion of coal are negligible in this model.

7.2.1.3 Post-Combustion Products of Coal

The coal combustion process produces waste that must be disposed of off-site, including coal ash, resulting from coal combustion, and sludge, resulting from FGD. In 1984, 69x10⁶ tons and 16x10⁶ tons of coal ash and FGD sludge, respectively, were generated from electrical facilities⁸⁰. Energy and emissions to remove coal ash and FGD sludge are modeled. Because the quantity of FGD sludge is approximately 25% the amount of coal ash, all energy and emissions to remove and dispose of FGD sludge are considered to be about 25% of those found for the disposal of coal ash.

Energy to transport FGD sludge and coal ash from the plant to their respective storage locations is modeled. The moisture content of coal ash (in % weight of ash) at the point it is removed from the silo is

⁷⁹ Carbon content for anthracite is not needed for the calculation because the EPA Air Emissions Factors provided the emission factor directly.

⁸⁰ U.S. EPA 1987. *Wastes from the Combustion of Coal by Electric Utility Power Plants* (taken from DeLucchi 1993. *Emissions of Greenhouse Gases from the Use of Transportation Fuels and Electricity*, Appendix F).

assumed to be approximately 17% (moisture content may be 8% to 25%)⁸¹. The average energy consumed to place ash from the silo into the truck, 0.143 kWh⁸²/ton, is very minimal, as most of the work is due to gravitational force (ash falling from the shoot).

7.2.1.3.1 Transportation to the Landfill from the Silo

The distance from the power plant to the coal ash and FGD sludge landfills is assumed to be 1 mile⁸³. The trucks used to transport the materials are tandem trucks, filled based on weight of the material. The tandem truck carries an actual payload of about 27.6 short tons, and consumes 0.038 gallons of diesel fuel per short ton⁸⁴ of material.

7.2.1.4 Electricity from Heavy Fuel Oil

Heavy fuel oil, or residual oil, is the fuel oil used in power utilities. This type of oil is produced from the residue remaining after the lighter fractions of oils, such as gasoline, kerosene, and distillate oils have been removed from the crude oil. The major source of data for the combustion of fuel oil is EPA AP-42. As described in detail for the coal combustion, various technologies of fuel combustion have been averaged, according to their relative weight on the market.

7.2.1.5 Electricity from Natural Gas

Raw natural gas is a mixture of HC, N₂, CO₂, sulfur compounds, and water. It may have any range of compounds from mostly CH₄ to inert gases, such as nitrogen, CO₂, and helium, and smaller amounts of ethane, propane, and butane. Natural gas may be mined onshore, offshore, and in conjunction with petroleum processes. The average gross heating value is assumed to be approximately 8,900 kcal/scf (AP-42 1995).

7.2.1.6 Natural Gas Production

7.2.1.6.1 Mining and Cleaning Natural Gas

The energy used to produce natural gas is provided by EIA *Natural Gas Annual*⁸⁵ and U.S. Bureau of Census⁸⁶. The process energy is apportioned out by Delucchi (1993) among petroleum, natural gas, and natural gas liquids based on the following assumptions:

- Almost all the natural gas consumed, according to the Census Bureau, is used in field operations—natural gas lifting and reinjecting. These data correspond with data provided by EIA.
- Any energy used to reinject natural gas into wells is excluded from the natural gas precombustion processes, because reinjection is mainly used in oil wells; and the amount of electricity used for field equipment and processing plants is little relative to the amount of gas they produce.

⁸¹ From American Power Plant Data 1996. Power plant information is confidential data collected by Ecobalance.

⁸² From American Power Plant Data 1996.

⁸³ From American Power Plant Data 1996.

⁸⁴ At an average of 4 L of diesel fuel to transport 28 metric tons per load to the coal ash monofill, from American Power Plant Data 1996.

⁸⁵ EIA 1990. *Natural Gas Annual 1989, Volume 1*.

⁸⁶ U.S. Department of Commerce 1990. *Census of Mineral Industries, Fuels, and Electrical Energy Consumed*.

Thus, energy in this model excludes gas reinjection energy requirements.

7.2.1.6.2 Gas Sweetening

The amine process, or gas sweetening removes and recovers hydrogen sulfide (H₂S). The recovered H₂S gas is either (1) vented, (2) flared in waste gas flares or modern smokeless flares, (3) incinerated, or (4) used to produce elemental sulfur or sulfuric acid. Emissions from venting the gas into the environment are covered in the model. Vented gas is usually passed to a tail gas incinerator in which the H₂S is oxidized to SO₂ and is then passed to the atmosphere out a stack. Emissions are mostly SO₂ due to the 100% conversion of H₂S to SO₂. Very little particulate and NO_x are emitted from this process. Emissions factors for the amine process come from AP-42 (1995).

7.2.1.6.3 Transportation

Natural gas is transported via high-pressure transmission lines. Compressors along these lines may be powered from various sources: gas-fueled reciprocating engines and gas turbines, and electric motors. Emissions are all different because of the various sources of power in the compressors: the turbines, the engines, and the electric motors, so all these sources are modeled in this study.

The total amount of gas consumed in the compressors is averaged over the various sources of power. However, most pipeline compressor units are reciprocating engines, as reciprocating engines are more efficient when they operate under a large load. And because many of the compressors operate under a large load, we assume that there are more reciprocating engines in the compressors than turbines (DeLucchi 1993). To obtain a breakdown of energy sources for compressors in transmission pipelines, actual pipeline company data are used (Table 119).

Table 119: Percent Horsepower for Pipeline Power in 1989⁸⁷

Turbines	24.2%
Engines	73.4%
Electric	2.5%

Horsepower hours by type of compressor and the associated fuel combustion per horsepower-hour are used to obtain a weighted percent of energy and emissions caused by each type of compressor in transmission pipelines. Because electric power is so little relative to the other compressors (2.5%), it is averaged into the other two categories.

AP-42 (1995) provides emissions data for gas turbines and reciprocating engines. For both gas turbines and reciprocating engines, we used an average of emission factors for NO_x-controlled and NO_x uncontrolled scenarios. These emissions factors include NO_x, CO, TOC, NMHC, CH₄, and PM10.

7.2.1.7 Natural Gas Combustion

Natural gas is combusted in gas boilers. Emissions from natural gas combustion are primarily from improper operating conditions, such as inefficient mixing of fuel and air in the boiler, or an insufficient amount of air, etc. Emissions vary by the type and size of combustor and operating conditions.

⁸⁷ DeLucchi 1993. *Emissions of Greenhouse Gases from the Use of Transportation Fuels and Electricity*, Vol. 2, Appendix G.

Emissions factors for gas boilers were obtained from EPA AP-42 (1995) for NO_x, CO, SO_x, PM, CO, and TOCs. NO_x control technologies are required for many boilers to comply with strict NO_x emissions standards, so it is assumed that most boilers have NO_x control technologies. Therefore, emissions factors for NO_x in AP-42 (1995) use the factors for boilers with NO_x control technologies.

7.2.1.8 Electricity from Nuclear Energy

Uranium contains two various isotopes—238U and 235U. 235U is used as a fuel for nuclear reactors because it is fissionable, so the atoms can be split, releasing large amounts of heat. However, natural uranium consists of more than 99% 238U and less than 1% 235U. To be used as a fuel, its 235U content must be enriched to 3%-5%.

The data included in the model are uranium hexafluoride (UF₆) manufacturing, enrichment of 235U, and fuel rods manufacturing⁸⁸. No data on waste disposal, plant construction, or emissions of radionuclides are included in the nuclear electricity production model.

7.2.1.9 Electricity from Hydroelectric Power

Hydroelectric power generation refers to water used to generate electricity at plants in which turbine generators are driven by falling water. The hydroelectric power production model includes greenhouse gas emissions (CO₂ and CH₄) from operating a hydroelectric plant (flooded biomass decomposition). We have not included emissions from capital equipment and facilities construction in order to be consistent with the system boundaries discussed for petroleum diesel and biodiesel. There is some research that suggests that the life cycle flows from equipment and facilities construction are not negligible⁸⁹. FERC⁹⁰ provides U.S. hydroelectric plant information such as average annual generation, plant capacity, and reservoir area and depth.

Explosives are excluded from the hydroelectric plant model, which encompass less than 5% of total energy consumed (Chamberlain et al). The data obtained on greenhouse gases emissions do not distinguish flooded biomass decomposition from new biomass decomposition and are assumed to refer only to flooded biomass.

7.2.1.10 Electricity per Geographical Zone

Table 120 shows the electricity *production* percentages for the North American Electric Reliability Council (NERC) regions in the North America⁹¹.

Some regions shown in Table 120 are split between Canada and the United States (WSCC for example); however, the electricity production percentages shown are only for the U.S. portion. The NERC regions are described in Figure 83.

⁸⁸Swiss Federal Office of Environment, Forests and Landscape (FOEFL or BUWAL). Environmental Series No. 132. p A15. Berne, February 1991, and E.E. El-Hinnawi: Environmental Impacts of Production and Use of Energy. Tycooli International 1981.

⁸⁹ Chamberlain et al provide life cycle data on construction materials and energy (Chamberland, Andre, and Levesque, S. Hydroelectricity, an Option to Reduce Greenhouse Gas Emissions from Thermal Power Plants. *Energy Cons. Mgmt* Vol. 37, Nos. 6-8, pp. 885-890). Chamberland's life cycle study is based on a group of facilities in northern Canada whose average life span is 100 years and produces 62,200 GWh of electricity annually.

⁹⁰ FERC database 1996.

⁹¹ Electricity source percentages from: EIA-759, U.S. Department of Energy, 1995 Electric Utility Net Generation by NERC Region and Fuel Type.

Table 120: Share of Power Generation Source by Region in North America

<i>Fuel Type</i>	<i>NERC Region</i>				
	<i>NPCC</i>	<i>ECAR</i>	<i>WSCC</i>	<i>ERCOT</i>	<i>SERC</i>
HFO	10.7%	0.3%	0.1%	0.1%	3.4%
Hydro	15.4%	0.5%	40.6%	0.3%	4.6%
NG	18.3%	0.5%	10.2%	37.4%	5.9%
Nuclear	35.1%	10.4%	12.8%	17.1%	29.5%
Coal	20.5%	88.3%	36.3%	45.2%	56.6%

<i>Fuel Type</i>	<i>NERC Region</i>				
	<i>MAAC</i>	<i>MAPP</i>	<i>MAIN</i>	<i>SPP</i>	<i>U.S. Average</i>
HFO	3.1%	0.5%	0.5%	0.3%	2%
Hydro	0.8%	8.4%	1.4%	2.9%	9.8%
NG	5.3%	0.9%	1.7%	28.3%	10.2%
Nuclear	40.8%	15.9%	42.4%	15.7%	23%
Coal	50%	74.3%	54%	52.8%	55%



Figure 83. Map of the NERC regions in the United States and Canada

7.2.2 Fertilizers and Agrochemicals

Nitrogen applied to soybeans is assumed to be in the form of ammonium nitrate (NH_4NO_3), which is produced by neutralizing nitric acid (HNO_3) with NH_3 . The process involves several operations including solution formation and concentration, solids formation, finishing, screening, and coating, and product bagging.

The modeling of nitrogen fertilizer production is shown in Figure 84.

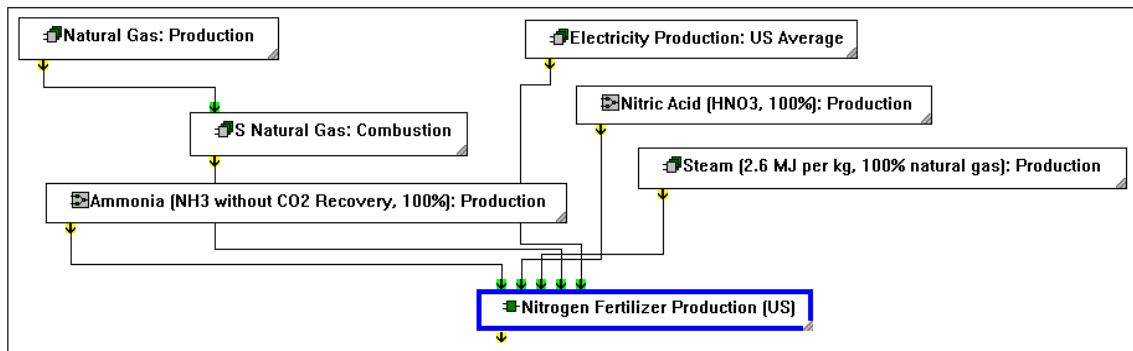

Figure 84: Nitrogen Fertilizer Modeling

As shown in Figure 84, inputs to the process include HNO_3 , NH_3 , and energy (electricity, natural gas, and steam). The amounts of HNO_3 and NH_3 used are based on the stoichiometry of the reaction and accounting for a 98% yield. The amount of energy used is based on contact with representatives from the Fertilizer Institute. Emissions released from the production of ammonium nitrate include particulate matter and ammonia (Air Chief, 1995).

Process flows associated with nitric acid and ammonia production are also taken into account. These are modeled based on Ecobalance's database DEAMTM. The production of electricity, steam, and natural gas are also based on data from DEAMTM.

Phosphorous applied is assumed to be in the form of TSP. In the granular process method used to produce TSP, ground phosphate rock or limestone is reacted with phosphoric acid in one or two reactors in series. Figure 85 describes the modeling of phosphorous fertilizer production.

The process requirements for TSP production are described in a survey done by the Fertilizer Institute on production costs. It lists a weighted average of inputs per ton of TSP produced. Thirteen phosphate fertilizer companies were surveyed for the report. The inputs required are phosphoric acid, phosphate rock, electricity, natural gas, and fuel oil. Emissions associated with TSP production include fluoride and particulate (Air Chief 1995).

Phosphoric acid is produced by reacting sulfuric acid (H_2SO_4) with naturally occurring phosphate rock. The phosphate rock is dried, crushed, and then continuously fed into the reactor along with H_2SO_4 . The reaction also combines calcium from the phosphate rock with sulfate, forming calcium sulfate (CaSO_4), commonly referred to as gypsum. A weighted average of process inputs for 18 North American facilities is listed in the production cost survey produced by the Fertilizer Institute. It lists H_2SO_4 ⁹², phosphate rock, and electricity as process inputs. Emissions include air emissions of fluoride and fluorine as well as possible leaching from cooling ponds (Air Chief 1995).

⁹² Process flows associated with sulfuric acid will also be included in TSP production. Process inputs are listed by the Fertilizer Institute (1995) as a weighted average for 18 North American facilities. Emissions are based on EPA AP-42.

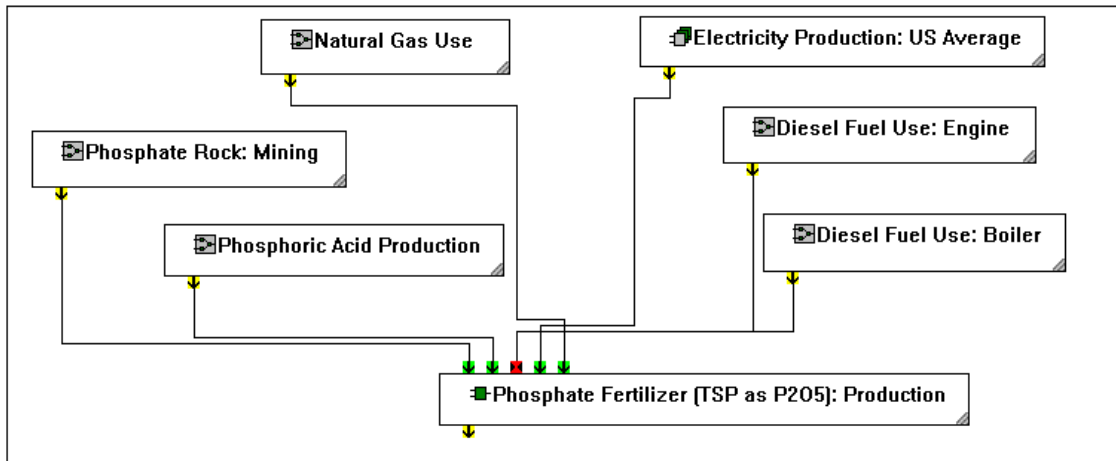

Figure 85: Phosphorous Fertilizer Modeling

Phosphate rock is mined primarily in Florida and North Carolina. Electricity use and overburden are given as weighted averages for 13 mines in the Fertilizer Institute’s Production Cost Survey. Emissions include particulate and emissions from diesel mining equipment.

Potassium applied is assumed to be in the form of K_2O (Phosphate and Potash Institute 1996). The modeling of potassium fertilizer production is shown in Figure 86.

Potassium fertilizer production involves the potash mining. The amount of energy used in the mining process is based on information in *The Fertilizer Handbook* (The Fertilizer Institute 1982). The values reported in *The Fertilizer Handbook* were based on a 1980 study. Therefore, the values have been reduced by 15% to account for energy efficiencies over time. Emissions released from the mining of potash include particulate matter (Air Chief 1995).

The modeling of agrochemical production is based on Ecobalance’s database DEAM™, with aggregated data on the production of chemicals primarily taken from *Energy in World Agriculture* (Elsevier 1987). Energy consumed per kg of agrochemicals produced:

- Natural gas: 0.64 kg/kg
- Coke: 0.045 kg/kg
- Light fuel: 1.89 kg/kg
- Steam: 16.5 kg/kg
- Electricity: 24.4 MJ/kg.

Distances associated with transporting fertilizer and chemicals are assumed to be 500 miles by train and 50 miles by truck (Delucchi 1993). The energy associated with this transport is assumed to be included in the energy required to produce the fertilizer. Table 121 shows the energy required to produce the fertilizer and agrochemicals used in this study.

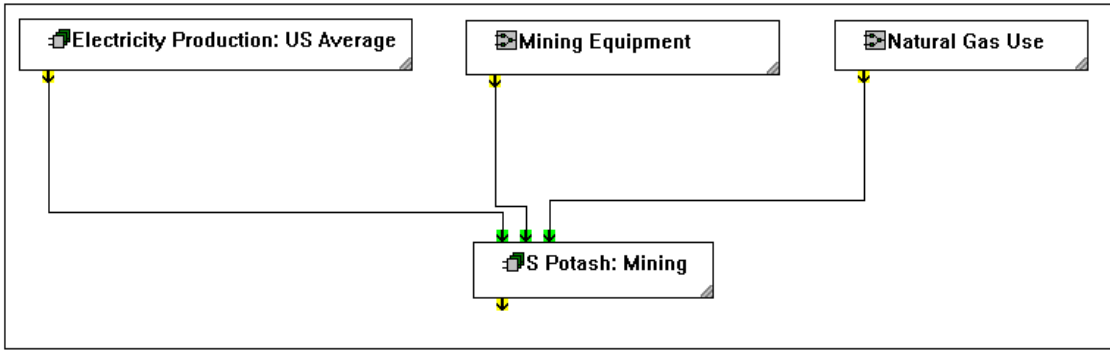

Figure 86: Potassium Fertilizer Modeling

Table 121: Energy Content of Fertilizers and Agrochemicals

<i>Material</i>	<i>Total Energy (MJ/kg)</i>
Nitrogen Fertilizer (NH ₄ NO ₃ as N)	66.8
Phosphorous Fertilizer (TSP as P ₂ O ₅)	12.8
Potash Fertilizer (K ₂ O)	4.6
Agrochemicals	263.7

8 Data Quality

The quality of the collected data has been carefully assessed. The data are individually recorded in the software model for each process description, and can be described in terms of their precision, completeness, accurate representation of physical systems, consistency, and quality of their source or origin.

Precision Different levels of precision were achieved, depending on the origin of the data. The soybean agriculture model contains measured data, with a high level of precision. The emissions data for the biodiesel also come from measured data with a high level of precision. The remaining data consist of secondary and estimated data, with a poor level of precision (see Origin of the data below).

Completeness The completeness, as defined by International Standards Organization (ISO)⁹³, is very good for the soybean agriculture modeling. Also, the petroleum refining model contains averaged data for all U.S. refining operations. The data describing soybean crushing and conversion to biodiesel are based on data describing specific facilities and may not represent the average data of a diversified industry.

Representativeness No attempt has been made to precisely estimate the representativeness of the systems under study. However, the representativeness for the agriculture modeling is good except that it is for 1990 data. The soybean crushing data are thought to represent a typical crushing facility. The same is true for crude oil extraction (although the data are from 1983). Soybean oil conversion is felt to represent an average facility, as are the crude oil refining data.

Consistency The data for individual processes have been collected by different members of the project team. All data, however, have been captured into the software by one person on the project team who went over all these data individually, double checking with other persons of the team as needed. These procedures help ensure a certain degree of consistency among collected data. However, each source of data is different, and some interpretation had to be done.

Origin of the data The soybean agriculture and petroleum refining data come from actual measured data that were aggregated and presented in secondary sources. Also, the emissions for biodiesel use are from engine testing measured data. The soybean crushing and soybean oil conversion data are a mix of measured and modeled data. The remaining data are from secondary sources and modeled data. Nevertheless, whenever actual data were available, they have been preferred to modeled data. In any case, the origin of the data, including whether the data are measured, calculated, or estimated, is recorded in the software model.

⁹³ ISO/DIS 14041: 1997(E), Version 05/03/97.

This page left intentionally blank

9 Results and Discussion

LCI results are presented for B100, B20, and petroleum diesel. These results allow the reader to make a nominal comparison of biodiesel and petroleum diesel. By nominal, we mean that LCIs calculated for each fuel reflect generic “national average” models. The only exception to this statement is soybean agriculture data, which are provided state-by-state basis for the 14 key soybean-producing states. Implicit in such a nominal comparison is that there are no regional differences that could affect any stage of each fuel’s life cycle. There will, of course, be differences that will affect each fuel.

In most cases, biodiesel is interchangeable with petroleum diesel without any need to modify today’s diesel engine. However, one key issue for biodiesel use that should be explicitly stated up front is the effect of regional climate on the performance of the fuel. This fuel’s cold flow properties may limit its use in certain parts of the country during Winter. This caveat should be kept in mind. Means of mitigating biodiesel’s cold flow properties are being evaluated by researchers, though no clear solution is at hand. Low-sulfur #2 diesel fuel has similar limitations that are currently addressed today with the use of additives and by blending this fuel with #1 diesel fuel.

These results include estimates of:

- Overall energy requirements
- CO₂ emissions
- Other regulated and nonregulated air emissions
- Water emissions
- Solid wastes.

This section is divided into two main subsections: base case results and sensitivity analyses.

Base Case Results: A comparison of petroleum diesel and biodiesel is presented using the base-case assumptions for each fuel described in the previous sections.

Sensitivity Studies: The purpose of conducting sensitivity studies on the life cycle of biodiesel is to establish the potential range for improvement in the fuel and to establish the range of possible error associated with the assumptions made in the model. The LCI assumes a “current” time frame—that is, we are looking at the extant structure of agriculture, soybean oil recovery, conversion technology, and engine technology within a short-term horizon. This sets realistic limitations on the bounds of the assumptions used in the model. In each step in the life cycle, we have considered where the potential for near-term improvement is. Two main areas were identified. First, we felt it was important to understand the impact of location on biodiesel production. This allows us to consider the benefits of the best of agricultural productivity available in the United States and the shortest distances for transport of fuel and materials. This sets an upper bound on biodiesel benefits from the perspective of current agricultural practices and transportation logistics. Second, we identified the conversion of soybean oil to biodiesel as an aspect of the life cycle that has significant impact on energy use and emissions and that has a broad range of efficiencies, depending on the commercial technology used. Changes in engine technology may also be an avenue for improving biodiesel on a life cycle basis. We opted to forego this area in our sensitivity analysis. Thus, we present in this report the results of two sensitivity studies.

- The base case for B100 is compared with the LCI for an optimal biodiesel location (Chicago). The choice of optimal location is based on an evaluation of regions with the most efficient production of soybeans and with close access to soybean production and end-use markets for urban buses.
- Results for a range of high and low energy demands for soybean conversion to biodiesel are compared to determine the impact of this stage of the biodiesel life cycle on overall emissions and energy flows. Low and high values for energy consumption were based on a survey of technical literature on the most recent technology commercially available.

9.1 Base Case Results

The LCIs for B100, B20, and 100% petroleum diesel are summarized in the following subsections. All of the energy and environmental flows for these fuels are allocated on a mass basis among the various coproducts that result from each process in the fuels' life cycles. For a more detailed discussion of the mass allocation rule used in this study, see section 3.4. For a comparison of the total primary energy flows of biodiesel and petroleum diesel with and without application of the allocation rules, see the results presented in Figure 24 through Figure 27 in section 3.4.2.

9.1.1 Life Cycle Energy Balance

LCIs provide an opportunity to quantify the total primary energy requirements and the overall energy efficiencies of processes and products. Understanding the overall energy requirements of biodiesel is key to our understanding the extent to which biodiesel made from soybean oil is a “renewable energy” source. Put quite simply, the more fossil energy required to make a fuel, the less we can say that this fuel is renewable. Thus, the renewable nature of a fuel can vary across the spectrum of “completely renewable” (i.e., no fossil energy input) to nonrenewable (i.e., fossil energy inputs as much or more than the energy output of the fuel)⁹⁴. Energy efficiency estimates help us to determine how much additional energy must be expended to convert the energy available in raw materials used in the fuel's life cycle to a useful transportation fuel. The following sections describe these basic concepts in more detail, as well as the results of our analysis of the life cycle energy balances for biodiesel and petroleum diesel.

9.1.1.1.1 Types of Life Cycle Energy Inputs

In this study, we track several types of energy flows through each fuel life cycle. For clarity, each is defined below.

- *Total Primary Energy.* All raw materials extracted from the environment can contain⁹⁵ energy. In estimating the total primary energy inputs to each fuel's life cycle, we consider the cumulative energy content of all resources extracted from the environment.

⁹⁴ This last statement is an oversimplification. We consider the energy trapped in soybean oil to be renewable because it is solar energy stored in liquid form through biological processes that are much more rapid than the geologic time frame associated with fossil energy formation. Also, other forms of nonrenewable energy besides fossil fuel exist.

⁹⁵ The energy “contained” in a raw material is the amount of energy that would be released by the complete combustion of that raw material. This “heat of combustion” can be measured in two ways: as a higher heating value or a lower heating value. Combustion results in the formation of CO₂ and water. Higher heating values consider the amount of energy released when the final combustion products are gaseous CO₂ and liquid water. Lower heating values take into account the loss of energy associated with the vaporization of the liquid water combustion product. Our energy content is based on the lower heating values for each material.

- *Feedstock Energy.* Energy contained in raw materials that end up directly in the final fuel product is termed “feedstock energy.” For biodiesel production, feedstock energy includes the energy contained in the soybean oil and methanol feedstocks that are converted to biodiesel. Likewise, the petroleum directly converted to diesel in a refinery contains primary energy that is considered a feedstock energy input for petroleum diesel. Feedstock energy is a subset of the primary energy inputs.
- *Process Energy.* The second major subset of primary energy is “process energy.” This is limited to energy inputs in the life cycle exclusive of the energy contained in the feedstock (as defined in the previous bullet). It is the energy contained in raw materials extracted from the environment that does not contribute to the energy of the fuel product itself, but is needed in the processing of feedstock energy into its final fuel product form. Process energy consists primarily of coal, natural gas, uranium, and hydroelectric power sources consumed directly or indirectly in the fuel’s life cycle.
- *Fossil Energy.* Because we are concerned about the renewable nature of biodiesel, we also track the primary energy that comes from fossil sources specifically (coal, oil, and natural gas). All three of the previously defined energy flows can be categorized as fossil or nonfossil energy.
- *Fuel Product Energy.* The energy contained in the final fuel product, which is available to do work in an engine, is what we refer to as the “fuel product energy.” All other things being equal, fuel product energy is a function of the energy density of each fuel.

9.1.1.1.2 Defining Energy Efficiency

We report two types of energy efficiency. The first is the overall “life cycle energy efficiency.” The second is what we refer to as the “fossil energy ratio.” Each elucidates a different aspect of the life cycle energy balance for the fuels studied.

The calculation of the life cycle energy efficiency is simply the ratio of fuel product energy to total primary energy:

$$\text{Life Cycle Energy Efficiency} = \text{Fuel Product Energy} / \text{Total Primary Energy}$$

It is a measure of the amount of energy that goes into a fuel cycle, which actually ends up in the fuel product. This efficiency accounts for losses of feedstock energy and additional process energy needed to make the fuel.

The fossil energy ratio tells us something about the degree to which a given fuel is or is not renewable. It is defined simply as the ratio of the final fuel product energy to the amount of fossil energy required to make the fuel:

$$\text{Fossil Energy Ratio} = \text{Fuel Energy} / \text{Fossil Energy Inputs}$$

If the fossil energy ratio has a value of zero, then a fuel is not only completely nonrenewable, but it provides no useable fuel product energy as a result of the fossil energy consumed to make the fuel. If the fossil energy ratio is equal to 1, then this fuel is still nonrenewable. A fossil energy ratio of one indicates that no loss of energy occurs in the process of converting the fossil energy to a useable fuel. For fossil energy ratios greater than 1, the fuel actually begins to provide a leveraging of the fossil energy required to make the fuel available for transportation. As a fuel approaches being “completely” renewable, its fossil energy ratio approaches “infinity.” In other words, a completely renewable fuel has no requirements for fossil energy.

From a policy perspective, these are important considerations. Policy makers want to understand the extent to which a fuel increases the renewability of our energy supply. Another implication of the fossil energy ratio is the question of climate change. Higher fossil energy ratios imply lower net CO₂ emissions. This is a secondary aspect of the ratio, because we are explicitly estimating total CO₂

emissions from each fuel’s life cycle. Nevertheless, the fossil energy ratio serves as a check on our calculation of CO₂ life cycle flows (since the two should be correlated).

9.1.1.2 Petroleum Diesel Life Cycle Energy Consumption

Table 122 and Figure 87 show the total primary energy requirements for all the key steps in the production and use of petroleum diesel. The LCI model shows that 1.2007 MJ of primary energy is used to make 1 MJ of petroleum diesel fuel. This corresponds to a life cycle energy efficiency of 83.28%.

The distribution of the primary energy requirements for each stage of the petroleum diesel life cycle is shown in Table 122. In Figure 87 stages of petroleum diesel production are ranked from highest to lowest in terms of primary energy requirements. 93% of the total primary energy is for the extraction of crude oil from the ground. About 88% of the energy shown for crude oil extraction is associated with the energy value of the crude oil itself. The crude oil refinery step for making diesel fuel dominates the remaining 7% of the primary energy usage.

Table 122: Primary Energy Demand for the Petroleum Diesel Life Cycle Inventory

Stage	Primary Energy (MJ per MJ of Fuel)	Percent
Domestic Crude Production	0.5731	47.73%
Foreign Crude Oil Production	0.5400	44.97%
Domestic Crude Transport	0.0033	0.28%
Foreign Crude Transport	0.0131	1.09%
Crude Oil Refining	0.0650	5.41%
Diesel Fuel Transport	0.0063	0.52%
Total	1.2007	100.00%

Removing the feedstock energy (of the crude oil) from the total primary energy demand allows us to analyze the relative contributions of the remaining process energy from each step of the life cycle. Process energy used in each stage of the petroleum life cycle is shown in Figure 88. Process energy demand represents 20.1% of the energy ultimately available in the petroleum diesel fuel product. About 90% of the process energy consumed is in refining (60%) and extraction (29%). The next largest contribution to process energy demand is for transport of foreign crude oil to domestic petroleum refiners.

There are some significant implications in the process energy results shown in Figure 88 regarding trends for foreign and domestic crude oil production and use. Transportation of foreign crude oil carries with it a fourfold penalty for energy consumption compared to domestic petroleum transport. The reason for this is overseas transport of foreign oil by tanker increases the travel distance for foreign oil by roughly a factor of four, relative to the distances required for transport of domestic fuel (see Figure 89).

At the same time, domestic crude oil extraction is more energy intensive than foreign crude oil production. Advanced oil recovery practices in the United States represent 11% of the total production volume, compared to 3% for foreign oil extraction. Figure 90 shows the overall contributions of advanced and conventional oil extraction to primary energy demand for domestic crude oil production. Advanced oil recovery uses twice as much primary energy per kg of oil compared to conventional extraction. Advanced crude oil extraction requires almost 20 times more process energy than onshore domestic crude oil extraction per kg of oil out of the ground (Figure 91) because the processes employed are energy intensive and the amount of oil recovered is low compared to other practices. Domestic crude

oil supply is essentially equal to foreign oil supply (50.26% versus 49.74%, respectively) in our model, but its process energy requirement is 62% higher than that of foreign crude oil production.

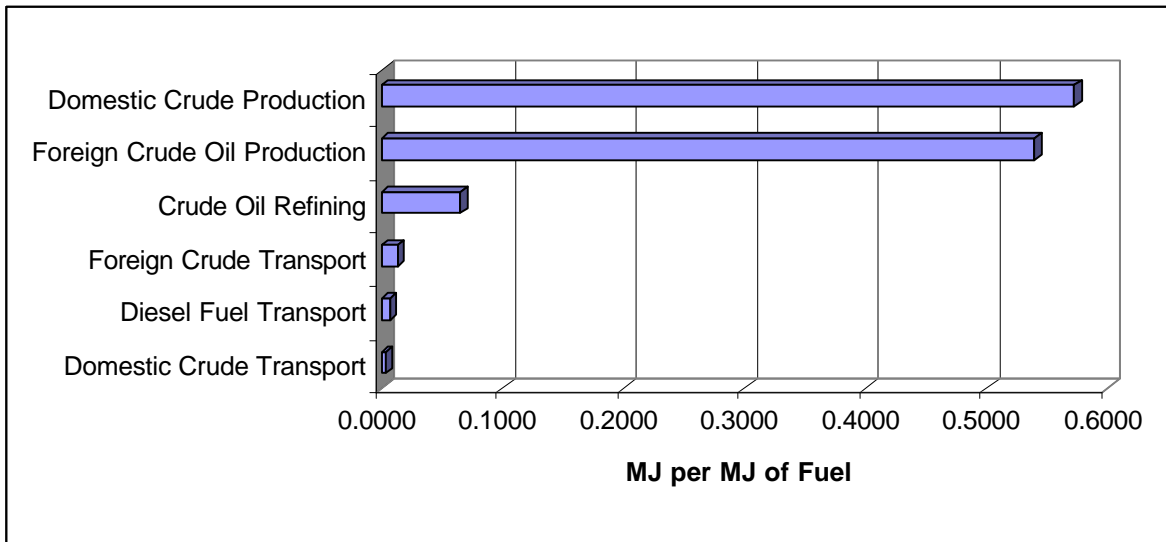

Figure 87: Ranking of Primary Energy Demand for the Stages of Petroleum Diesel Production

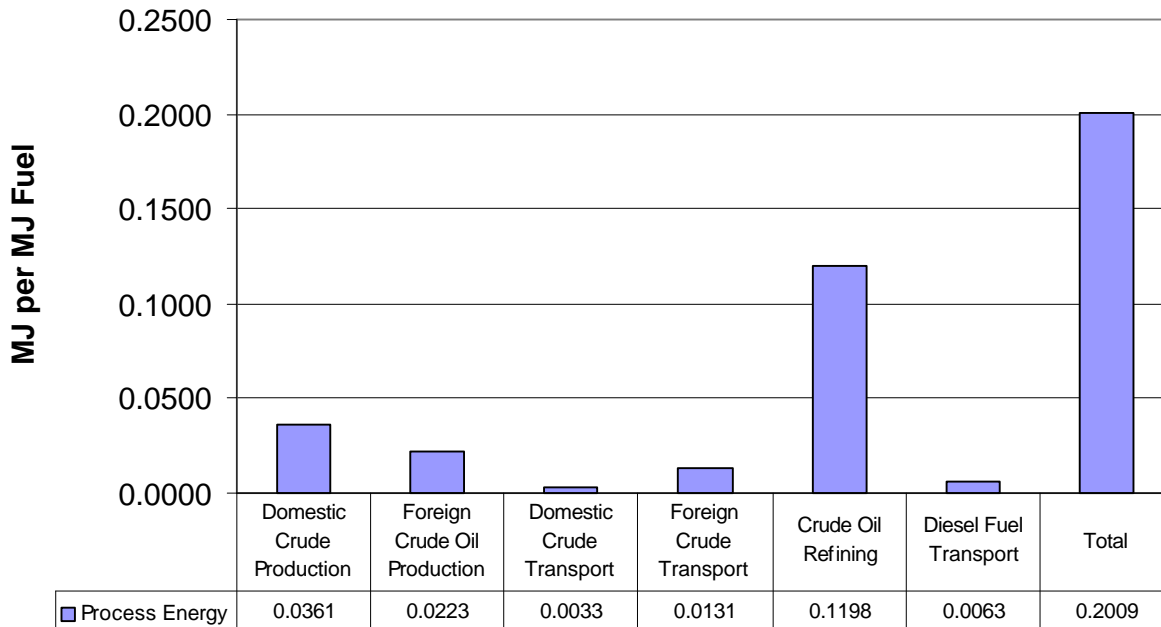

Figure 88: Process Energy Demand for Petroleum Diesel Life Cycle

If our present trend of increased dependence on foreign oil continues, we can expect the life cycle energy efficiency of petroleum diesel to worsen due to the higher energy costs of transporting foreign crude to the United States. In addition, as the practice of advanced oil recovery increases in the United States, domestic crude oil extraction may become less energy efficient.

Table 123 and Figure 92 summarize the fossil energy inputs with respect to fuel product energy output. Petroleum diesel uses 1.1995 MJ of fossil energy to produce 1 MJ of fuel product energy. This corresponds to a fossil energy ratio of 0.8337⁹⁶. Because the main feedstock for diesel production is itself a fossil fuel, this ratio is almost identical to the life cycle energy efficiency of 83.28%. In fact, fossil energy associated with the crude oil feedstock accounts for 93% of the total fossil energy consumed in the life cycle. Fossil fuel use is slightly less than the total primary energy consumption because there is a very small contribution to the total primary energy that is met through hydroelectric and nuclear power supplies related to electricity generation.

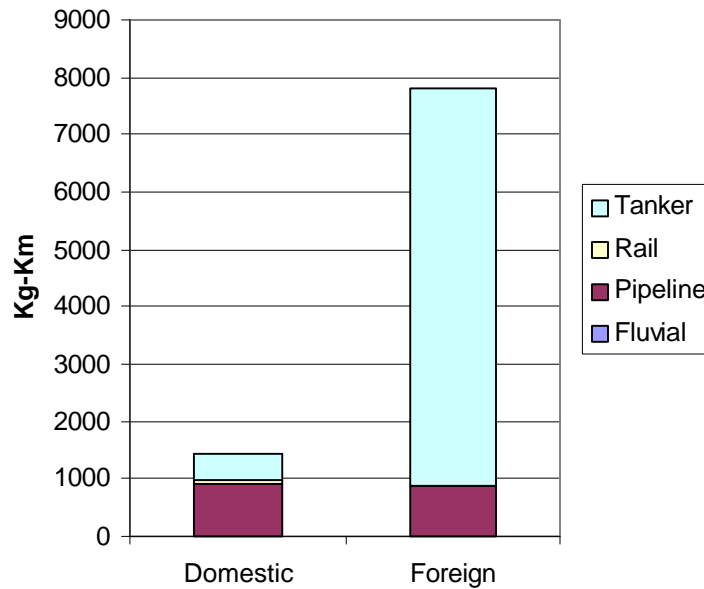
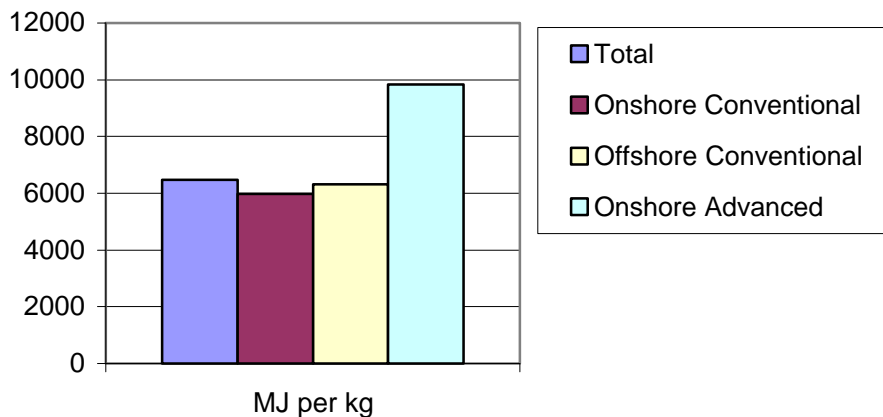

Figure 89: Transport Distances for Domestic and Foreign Crude Oil (kg-km)⁹⁷



⁹⁶ Fossil Energy Ratio = 1 MJ of Fuel Product Energy/1.1995 MJ of Fossil Energy Input.

⁹⁷ The transport distances are calculated in the LCI model using PADD data for modes of transportation and distances.

Figure 90: Primary Energy Demand of Advanced versus Conventional Crude Recovery

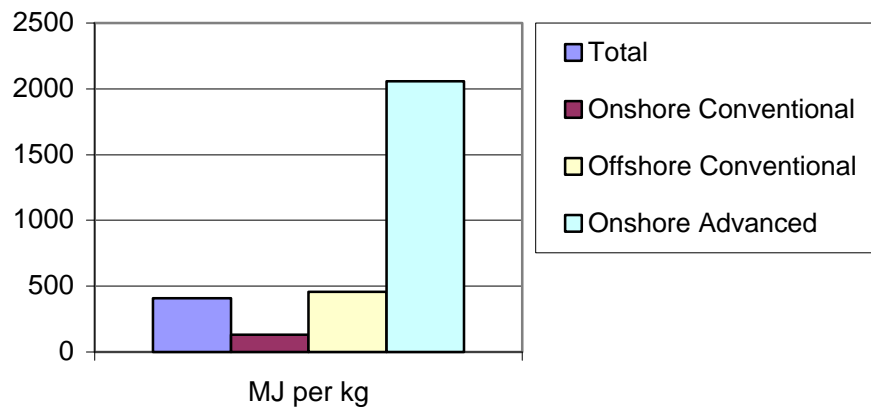

Figure 91: Process Energy Requirements of Advanced versus Crude Oil Extraction

Table 123: Fossil Energy Requirements for the Petroleum Diesel Life Cycle

Stage	Fossil Energy (MJ per MJ of Fuel)	Percent
Domestic Crude Production	0.572809	47.75%
Foreign Crude Oil Production	0.539784	45.00%
Domestic Crude Transport	0.003235	0.27%
Foreign Crude Transport	0.013021	1.09%
Crude Oil Refining	0.064499	5.38%
Diesel Fuel Transport	0.006174	0.51%
Total	1.199522	100.00%

9.1.1.3 Biodiesel Life Cycle Energy Demand

Table 124 and Figure 93 present LCI results for the total primary energy requirements of each stage of the biodiesel life cycle. One MJ of biodiesel requires an input of 1.2414 MJ of primary energy, resulting in a life cycle energy efficiency of 80.55%. Biodiesel is only slightly less efficient than petroleum diesel in the conversion of primary energy to fuel product energy (80.55% versus 83.28%). The largest contribution to primary energy is the soybean oil conversion step because this is where we have chosen to include the feedstock energy associated with the soybean oil itself⁹⁸. The conversion step consumes 87%

⁹⁸ Energy contained in the soybean oil itself represents, in effect, the one place in the biodiesel life cycle where input of solar energy is accounted for. Total radiant energy available to soybean crops is essentially viewed as “free” in the life cycle calculations. It becomes an accountable element of the life cycle only after it has been incorporated in the soybean oil itself. This is analogous to counting the feedstock energy of crude petroleum as the point in its life cycle where solar energy input occurs. Petroleum is essentially stored solar energy. The difference between petroleum and soybean oil as sinks for solar energy is their time scale. While soybean oil traps solar energy on a rapid (“real time”) basis, petroleum storage represents a process that occurs on a geologic time scale. This

of the total primary energy in the biodiesel life cycle. As with the petroleum life cycle, the stages of the life cycle that are burdened with the feedstock energy overwhelm all other stages. Had the soybean oil energy been included with the farming operation, soybean agriculture would have been the dominant consumer of primary energy. This is analogous to placing the crude oil feedstock energy in the extraction stage for petroleum diesel fuel. The next two largest uses of primary energy are for soybean crushing and soybean oil conversion. They account for most of the remaining 13% of the total demand.

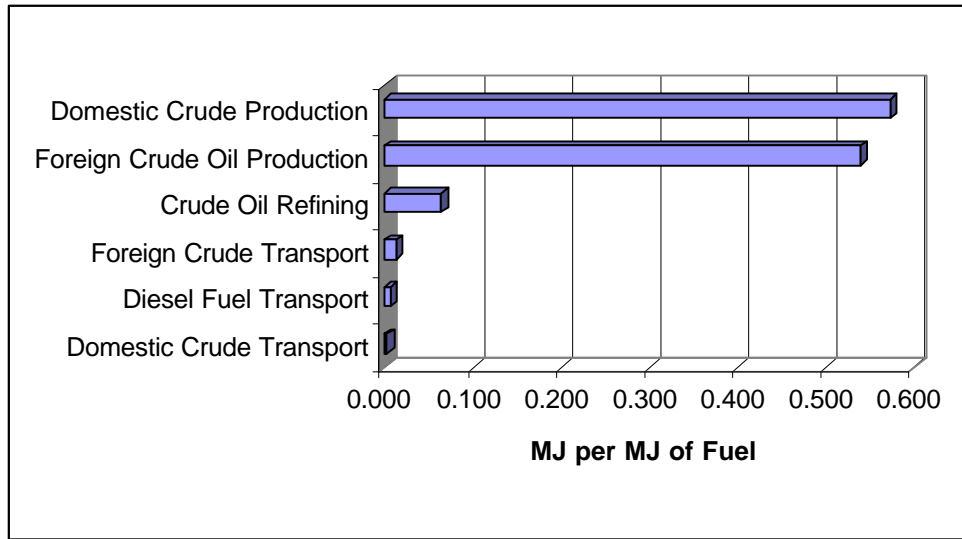

Figure 92: Ranking of the Fossil Energy Demand for Stages of the Petroleum Diesel Life Cycle

Table 124: Primary Energy Requirements for Biodiesel Life Cycle

Stage	Primary Energy (MJ per MJ of Fuel)	Percent
Soybean Agriculture	0.0660	5.32%
Soybean Transport	0.0034	0.27%
Soybean Crushing	0.0803	6.47%
Soy Oil Transport	0.0072	0.58%
Soy Oil Conversion	1.0801	87.01%
Biodiesel Transport	0.0044	0.35%
Total	1.2414	100.00%

difference in the dynamic nature of solar energy utilization is the key to our definitions of renewable and nonrenewable energy. See section 2.4.1.2.1 for an analogous discussion of carbon utilization dynamics for soybean oil versus fossil fuels.

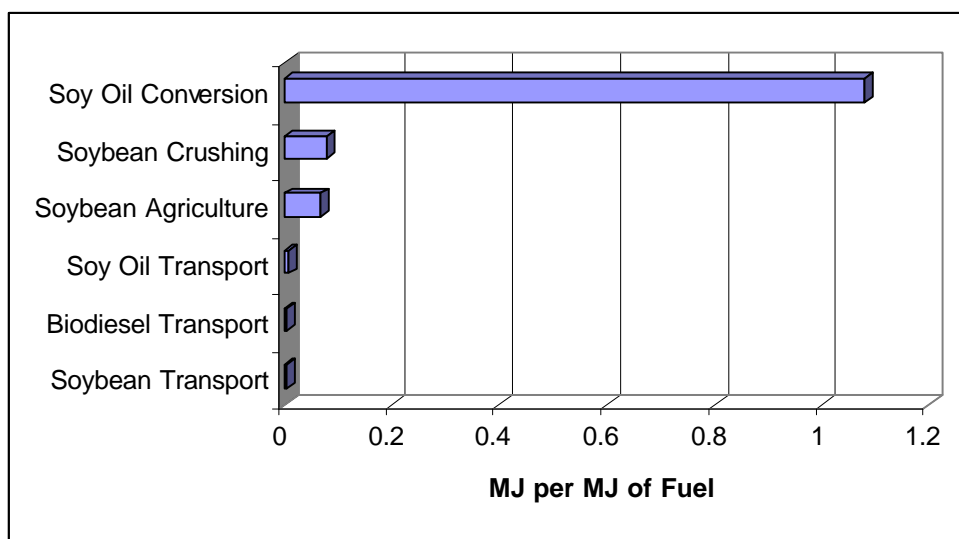

Figure 93: Ranking of Primary Energy Demand for the Stages of Biodiesel Production

When we look at process energy separately from primary energy, we see that process energy demands is not dominated by soybean oil conversion (Figure 94). The soybean crushing and soy oil conversion steps use the most process energy (34.25 and 34.55%, respectively, of the total). Agriculture accounts for the most of the remaining process energy consumed in life cycle for biodiesel (almost 25% of total demand). Each transportation step is only 2%-3% of the process energy used in the life cycle.

Table 125 and Figure 95 summarize the fossil energy requirements for the biodiesel life cycle. Because 90% of its feedstock requirements are renewable (that is, soybean oil), biodiesel's fossil energy ratio is favorable. Biodiesel uses 0.3110 MJ of fossil energy to produce one MJ of fuel product; this equates to a fossil energy ratio of 3.215. In other words, the biodiesel life cycle produces more than three times as much energy in its final fuel product as it uses in fossil energy. Fossil energy used for the conversion step is almost twice that of its process energy consumption, making this stage of the life cycle the largest contributor to fossil energy demand. The use of methanol as a feedstock in the production of biodiesel accounts for this high fossil energy use⁹⁹. We have counted the feedstock energy of methanol coming into the life cycle at this point, assuming that the methanol is produced from natural gas. This points out an opportunity for further improvement of the fossil energy ratio by substituting natural gas-derived methanol with renewable sources of methanol, ethanol or other alcohols.

9.1.1.4 Effect of Biodiesel on Life Cycle Energy Demands

Compared on the basis of primary energy inputs, biodiesel and petroleum diesel are essentially equivalent. Biodiesel has a life cycle energy efficiency of 80.55%, compared to 83.28% for petroleum diesel. The slightly lower efficiency reflects a slightly higher demand for process energy across the life of cycle for biodiesel. On the basis of fossil energy inputs, biodiesel enhances the effective use of this finite energy resource. Biodiesel leverages fossil energy inputs by more than three to one.

⁹⁹ Fossil energy can be used in the form of feedstock energy or process energy. Generally, for biodiesel production, process energy is the main consumer of fossil energy. However, methanol used in the conversion process energy which contains fossil energy that shows up as feedstock energy. Thus, the usage of fossil energy in the conversion step is much higher than the total process energy consumed in this step.

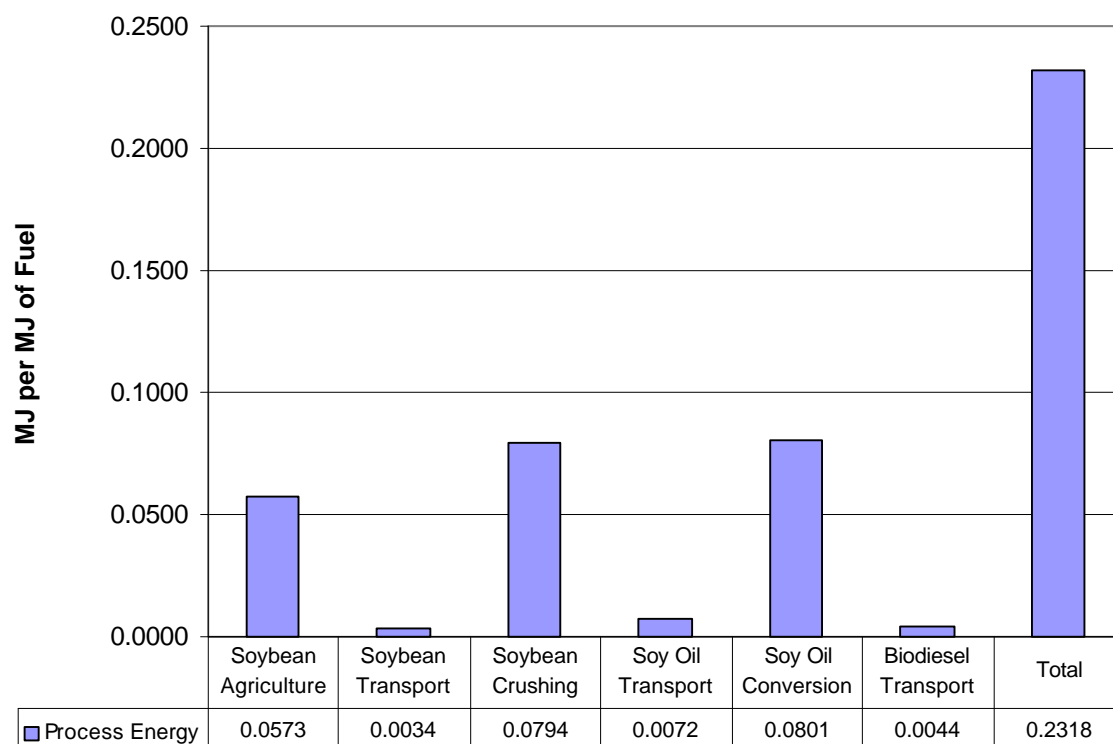

Figure 94: Process Energy Requirements for Biodiesel Life Cycle

Table 125: Fossil Energy Requirements for the Biodiesel Life Cycle

Stage	Fossil Energy (MJ per MJ of Fuel)	Percent
Soybean Agriculture	0.0656	21.08%
Soybean Transport	0.0034	1.09%
Soybean Crushing	0.0796	25.61%
Soy Oil Transport	0.0072	2.31%
Soy Oil Conversion	0.1508	48.49%
Biodiesel Transport	0.0044	1.41%
Total	0.3110	100.00%

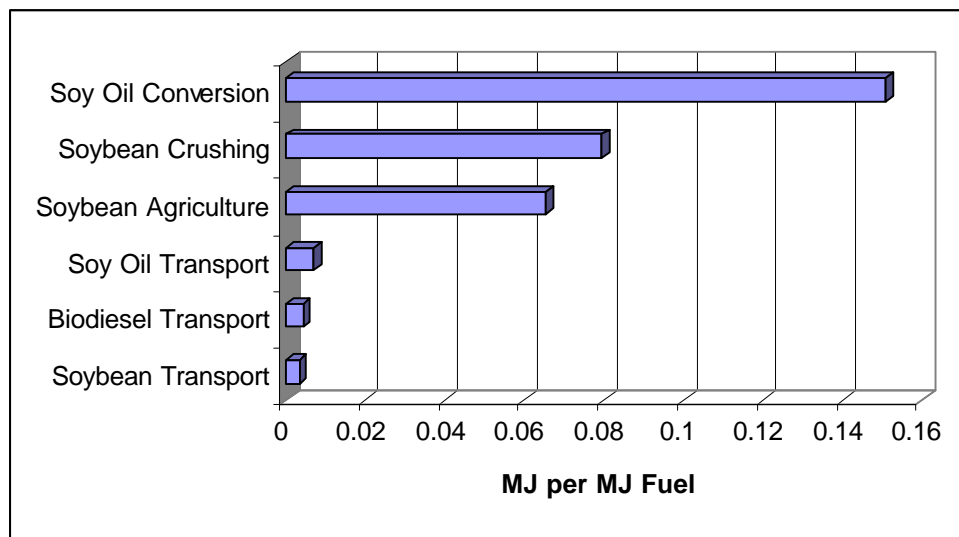

Figure 95: Fossil Energy Requirements versus Fuel Product Energy for the Biodiesel Life Cycle

9.1.2 CO₂ Emissions

9.1.2.1 Accounting for Biomass-Derived Carbon

Biomass plays a unique role in the dynamics of carbon flow in our biosphere. Biological cycling of carbon occurs when plants (biomass such as soybean crops) convert atmospheric CO₂ to carbon-based compounds through photosynthesis. This carbon is eventually returned to the atmosphere as organisms consume the biological carbon compounds and respire. Biomass derived fuels reduce the net atmospheric carbon in two ways. First, they participate in the relatively rapid cycling of carbon to the atmosphere (via engine tailpipe emissions) and from the atmosphere (via photosynthesis). Second, these fuels displace the use of fossil fuels. Combustion of fossil fuels releases carbon that took millions of years to be removed from the atmosphere, while combustion of biomass fuels participates in a process that allows rapid recycle of CO₂ to fuel. The net effect of shifting from fossil fuels to biomass-derived fuels is, thus, to reduce the amount of CO₂ in the atmosphere.

Because of the differences in the dynamics of fossil carbon flow and biomass carbon flow to and from the atmosphere, biomass carbon must be accounted for separately from fossil-derived carbon. The LCI model tracks carbon from the point at which it is taken up as biomass via photosynthesis to its final combustion as biodiesel used in an urban bus. The biomass-derived carbon that ends up as CO₂ leaving the tailpipe of the bus is subtracted from the total CO₂ emitted by the bus because it is ultimately reused to produce new soybean oil. In order to ensure that we accurately credit the biodiesel LCI for the amount of recycled CO₂, we provide a material balance on biomass carbon.

The material balance (Table 126 and Figure 97) shows all the biomass carbon flows associated with the delivery of 1 bhp-h of engine work. For illustration purposes, only the case of 100% biodiesel is shown. Lower blend rates proportionately lower the amount of biomass carbon credited as part of the recycled CO₂. Carbon incorporated in the meal fraction of the soybeans is not included in the carbon balance. Only carbon in the fatty acids and triglycerides that are used in biodiesel production are tracked. The

calculation of the carbon content of the fatty acids and triglycerides is based on average composition data for soybean oil¹⁰⁰.

Table 126: Biomass Carbon Balance for Biodiesel Life Cycle (g/bhp-h)¹⁰¹

Life Cycle Stage	g carbon per bhp-h	g CO ₂ /bhp-h
Soybean Production	169.34	621.48
Uptake of carbon in triglycerides and fatty acids	169.34	621.48
Soybean Crushing	160.81	590.16
Release of carbon via residual oil in meal	(7.73)	(28.36)
Release of carbon via waste	(0.81)	(2.97)
Biodiesel Production	148.39	544.60
Release of carbon via glycerine	(8.26)	(30.32)
Release of carbon via wastewater	(2.36)	(8.67)
Release of carbon via solid waste	(1.74)	(6.40)
Release of carbon in soapstock	(0.05)	(0.17)
Combustion in bus		-
Release of carbon in biodiesel (total)	(148.39)	(544.60)
Release of carbon in CO ₂	(148.05)	(543.34)
Release of carbon in HC	(0.04)	(0.16)
Release of carbon in CO	(0.28)	(1.01)
Release of carbon in PM	(0.02)	(0.08)
Release of carbon in HC, CO, and PM	(0.34)	(1.26)

Not all the carbon incorporated in fatty acids and triglycerides ends up as CO₂ after combustion of biodiesel. Some oil loss occurs in the meal by-product. Glycerol is removed from the triglycerides as a by-product. Finally, fatty acids are removed as soaps and waste. The calculation of carbon released as residual oil in the meal after crushing is described in the section on soybean crushing. Calculation of the carbon released as by-products and waste from biodiesel production is described in the section on soybean oil conversion. Finally, carbon released in combustion ends up as CO₂, CO, HC, and PM. The detailed calculations of carbon distribution in combustion products are discussed in the section on urban bus operations.

¹⁰⁰ Based on data from Perkins, E., "Composition of Soybeans and Soybean Products," in *Practical Handbook of Soybean Processing and Utilization* (Erickson, D.R., ed.). AOCS Press, Champlain, Illinois, 1995.

¹⁰¹ Highlighted life cycle stages show cumulative carbon moving through the life cycle. Soybean production shows a net inflow of 169 grams of carbon for 1 bhp-h of engine work. Each subsequent stage consumes carbon, so that, at the point of end-use combustion, the carbon which remains is zero. Inflows of carbon are shown as positive numbers and outflows are shown as negative numbers (in parentheses).

Of the 169.34 grams of carbon absorbed in the soybean agriculture stage, only 148.39 grams (87%) end up in biodiesel. After accounting for carbon that ends up in other combustion products, 148.05 grams of carbon end up as 543.34 grams of tailpipe CO₂. This CO₂ is subtracted from the diesel engine emissions as part of the biological recycle of carbon. No credit is taken for the 13% of the carbon that ends up in various by-products and waste streams.

9.1.2.2 Petroleum Diesel Life Cycle Emissions of CO₂

CO₂ emissions for the petroleum life cycle are shown in Figure 96. CO₂ is shown for biomass- and fossil-derived sources. In the petroleum life cycle, the contribution of CO₂ from biomass is zero. Only combustion of fossil fuel-derived carbon generates CO₂.

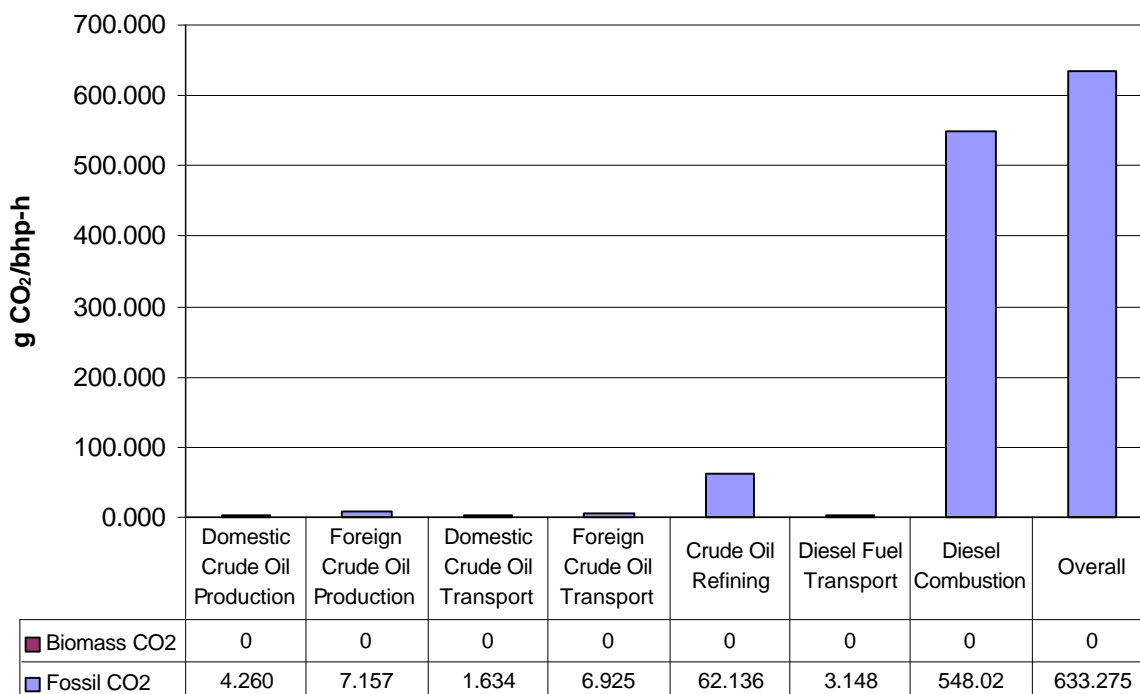

Figure 96: Carbon Dioxide Emissions for Petroleum Diesel Life Cycle

The dominant source of CO₂ is the combustion of petroleum diesel in the bus. CO₂ emitted from the tailpipe of the bus represents 86.5% of the total CO₂ emitted across the entire life cycle of the fuel. Most remaining CO₂ comes from emissions at the oil refinery, which contributes 9.8% of the total CO₂ emissions.

Foreign crude oil production and foreign crude oil transport represent the third largest sources of CO₂ emissions (2.22%). As we saw with the energy numbers, transport of foreign crude generates roughly four times the amount of CO₂ emitted by domestic crude transport.

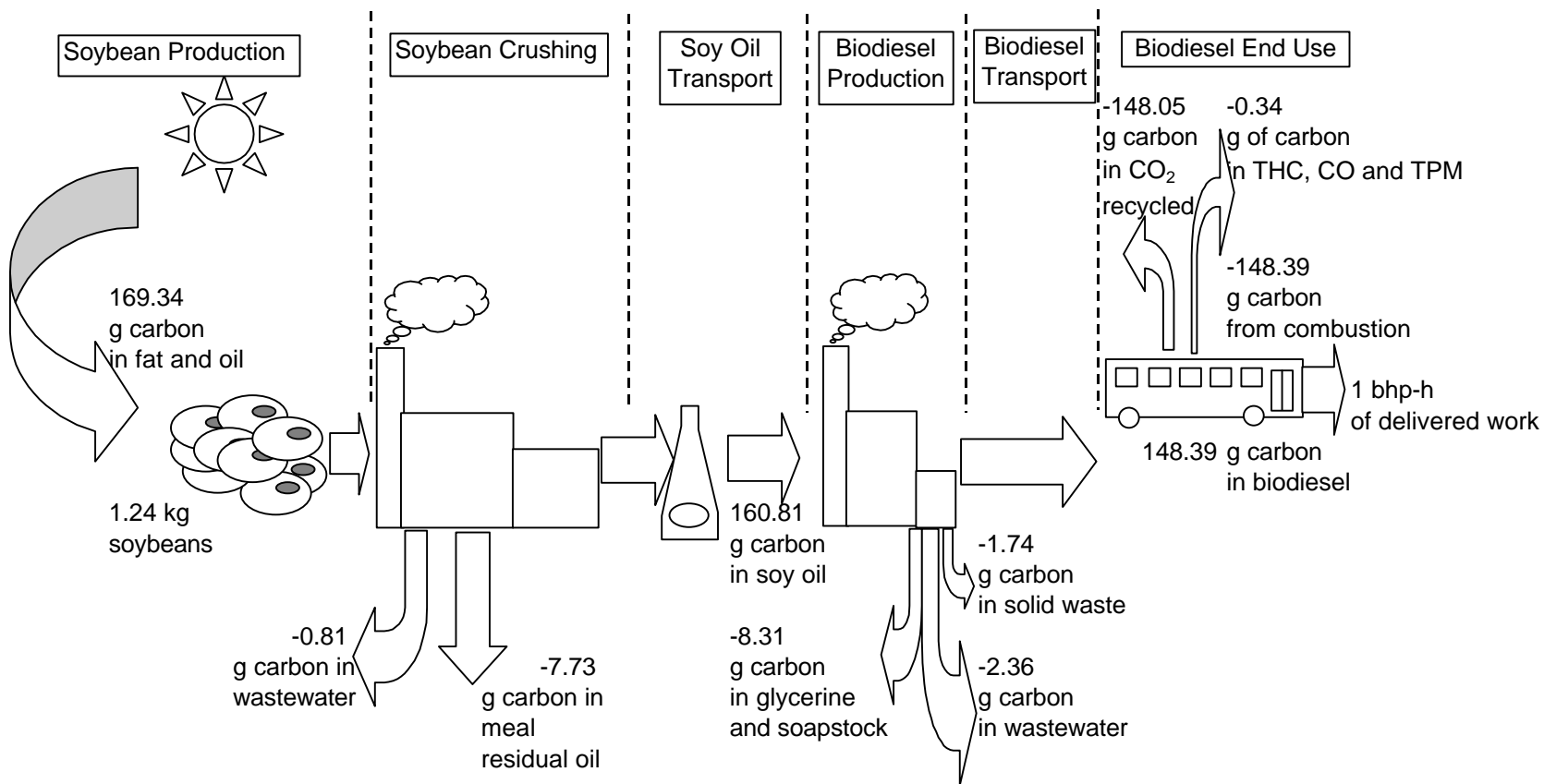

Figure 97: Biomass Carbon Balance for Biodiesel Life Cycle¹⁰²

¹⁰² All numbers presented as carbon equivalent. To calculate actual CO₂ emissions, multiply carbon equivalent numbers by 3.67 (the ratio of the molecular weight of CO₂ divided by the molecular weight of carbon).

Foreign oil production generates 68% higher emissions of CO₂ than domestic crude oil production. This is contrary to what might be expected based on the energy consumption numbers presented in the previous section. Domestic crude oil production uses 68% more energy than foreign crude oil production because of the greater reliance on more energy intensive advanced oil recovery technologies used in the United States. The increased CO₂ emissions resulting from the higher energy consumption of advanced oil recovery are offset by the practice of CO₂ reinjection, which effectively sequesters carbon.¹⁰³

A second factor leads to higher CO₂ emissions in foreign oil production: the flaring of natural gas at the well head. Figure 98 demonstrates this point. Conventional crude oil extraction for foreign production generates 50% more CO₂ than does its domestic counterpart. This is true for both onshore and offshore production. The key difference appears to be the fact that foreign oil producers, on average, flare four times as much natural gas as domestic producers because there are fewer market opportunities for this gas. To test the effect of this practice, we ran the LCI model with an assumption of no flaring of natural gas in foreign operations. As Figure 98 shows, this scenario leads to CO₂ emissions from foreign oil production that are almost the same as from domestic oil production.

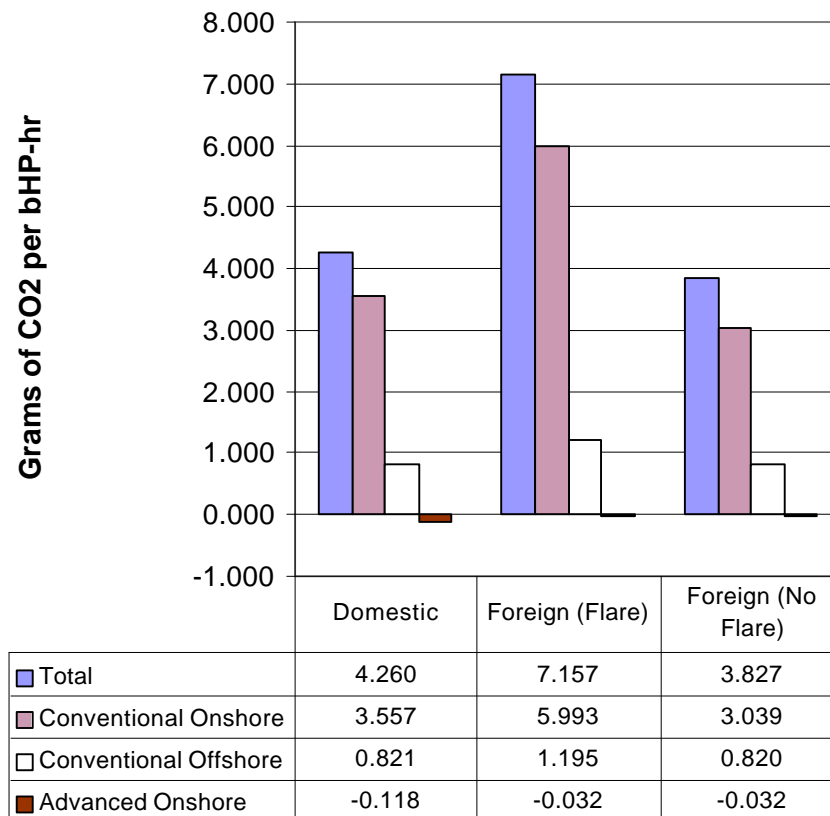

Figure 98: Comparison of CO₂ Emissions for Domestic and Foreign Crude Production

As with the energy efficiency results, we can see that there are significant implications of our CO₂ results for projections of foreign oil dependence. Foreign oil production introduces two penalties for CO₂

the review process. They suggested the idea of allowing for sequestration of carbon in advanced oil recovery based on estimates which they provided. Their comments indicate that 0.75 metric tons of CO₂ are injected in the well per metric ton of oil recovered, and that half of this CO₂ remains sequestered in the oil reservoir.

emissions: 1) CO₂ emissions due to well head flaring practices and CO₂ emissions from the transport of oil. Thus, the CO₂ emissions from petroleum diesel can be expected to increase as our reliance on foreign oil increases.

9.1.2.3 Biodiesel Life Cycle Emissions of CO₂

Figure 99 shows results of the LCI model for CO₂ emissions in the biodiesel life cycle. The biomass carbon mass balance described in section 9.1.2.1 was used to account for the carbon taken up in the production of soybeans and subsequently released in the combustion of biodiesel. Of the 169 grams of carbon taken up by the soybean plants in the agriculture stage, we take credit for only 148.05 grams of carbon (see Figure 97). This is equivalent to 543.34 grams of CO₂ removed from the atmosphere for every brake horsepower-hour of delivered biodiesel engine work. The remaining uptake of CO₂ is associated with by-products and waste streams in the soybean crushing and conversion stages of the life cycle for biodiesel. We did not feel it was appropriate to take credit for this carbon.

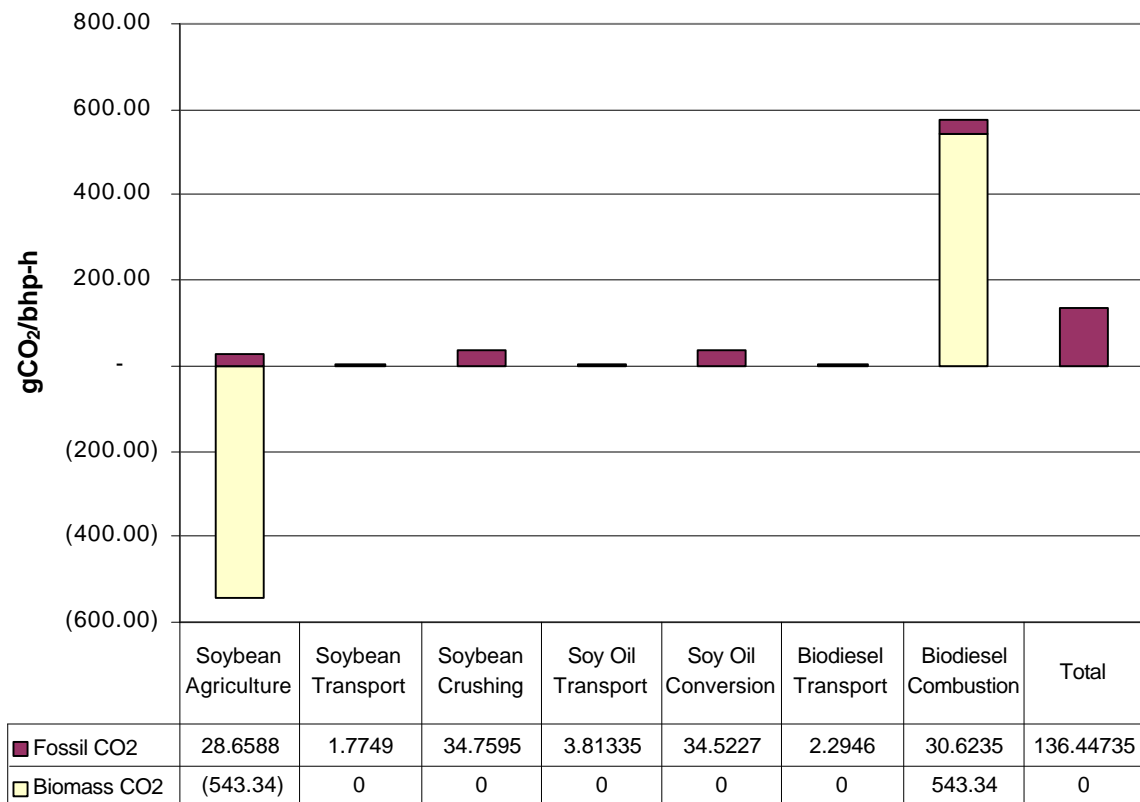

Figure 99: CO₂ Emissions for Biodiesel Life Cycle

As with the petroleum diesel life cycle, most of the CO₂ emissions are from the diesel engine tailpipe; 85% of the emissions occur at this point. The remaining CO₂ comes almost equally from soybean agriculture, soybean crushing, and conversion of soy oil to biodiesel.

9.1.2.4 The Effect of Biodiesel on CO₂ Emissions from Urban Buses

At the tailpipe, biodiesel emits almost 10% more CO₂ than petroleum diesel, most of which is renewable¹⁰⁴. Biodiesel generates 573.96 gCO₂/bhp-h, compared with 548.02 gCO₂/bhp-h for petroleum diesel (see combustion estimates in Figure 96 and Figure 99). The higher CO₂ levels result from more complete combustion and the concomitant reductions in other carbon-containing tailpipe emissions. As Figure 100 shows, the overall life cycle emissions of CO₂ from 100% biodiesel are 78.45% lower than those of petroleum diesel. The reduction is a direct result of carbon recycling in soybean plants.

B20, the most commonly used form of biodiesel in the United States today, provides a 15.66% reduction in net CO₂ emissions compared to petroleum diesel. When biodiesel is blended with diesel fuel, reductions in CO₂ emissions are proportional to the amount of biodiesel. Figure 101 plots results for LCI runs conducted for a range of biodiesel blends from zero to 100%. Our LCI model indicates that CO₂ emission reductions vary linearly from the maximum of 79% for pure biodiesel to zero for the case of normal petroleum diesel.

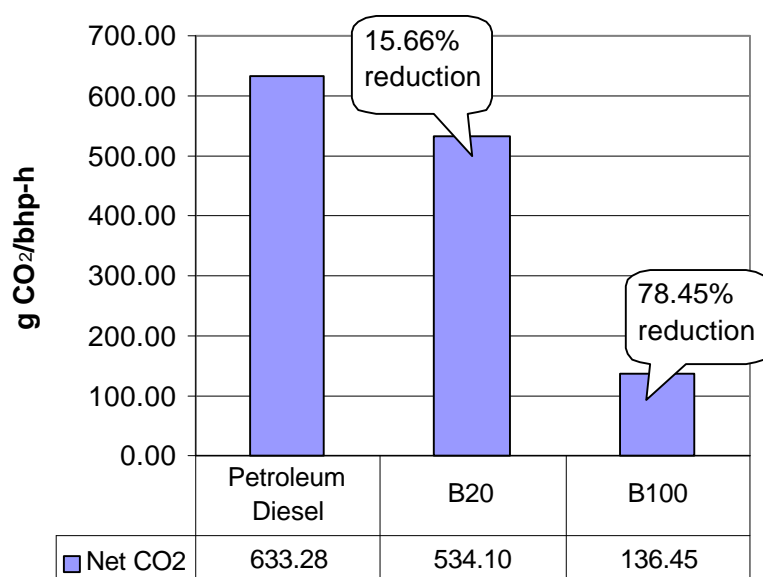

Figure 100: Comparison of Net CO₂ Life Cycle Emissions for Petroleum Diesel and Biodiesel Blends (g CO₂/bhp-h)

¹⁰⁴ The methanol component of biodiesel is fossil based.

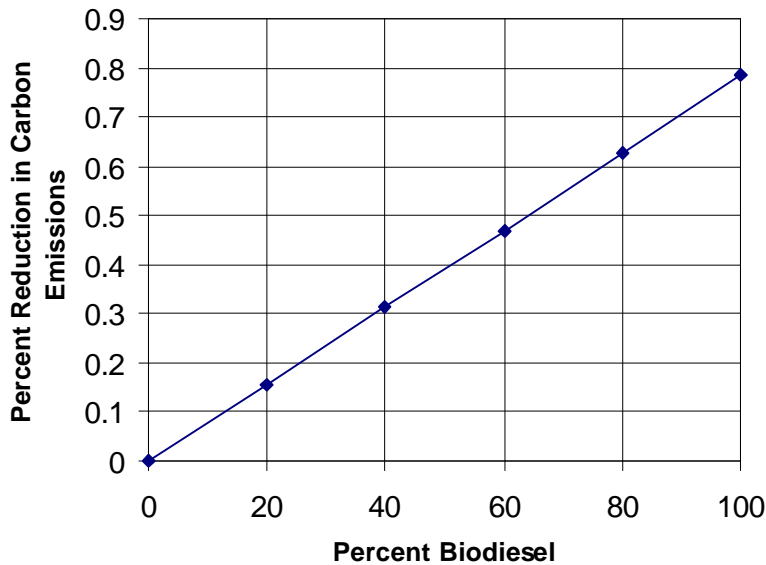

Figure 101: Effect of Biodiesel Blend Level on CO₂ Emissions

9.1.3 Life Cycle Consumption of Primary Resources

Primary resources consist of raw materials that are extracted from the environment. Because these resources are finite, it is important to understand the kinds of demands that are placed on these resources by each fuel. LCIs provide a way to quantify the total impact of these fuels on natural resources. The raw materials included in the LCI model are:

- Primary energy resources (coal, oil, natural gas and uranium)
- Phosphate rock
- Potash
- Perlite (silicon oxide ore)
- Limestone
- Sodium chloride
- Water.

9.1.3.1 Life Cycle Consumption of Primary Resources for Petroleum Diesel

Table 127 summarizes the raw material inventory for key steps in the life cycle of petroleum diesel. Analysis of raw material consumption summarized in this table is provided in this section.

As the primary energy feedstock for diesel production, petroleum consumption is, by definition, almost exclusively reflected in crude oil extraction. Foreign and domestic crude production are 98.2% of the total oil use. A small amount of petroleum consumption is associated with refining, where crude oil is used directly as an energy source as well as a feedstock for diesel production. A small consumption of crude oil is also associated with diesel fuel used in transport steps.

Table 127: LCI Inventory of Raw Material Consumption for Petroleum Diesel (kg/bhp-h)

Raw Material	Domestic Crude Oil Production	Foreign Crude Oil Production	Domestic Crude Oil Transport	Foreign Crude Oil Transport	Crude Oil Refining	Diesel Fuel Transport	Total
Coal	0.00119	0.00104	0.000334	0.000372	0.002544	0.000405	0.00589
Limestone	0.00023	0.00020	6.36E-05	7.09E-05	0.00048	7.73E-05	0.00112
Natural Gas	0.00596	0.00311	5.19E-05	0.000188	0.00679	9.27E-05	0.01620
Oil	0.09331	0.09231	0.000196	0.001793	0.000734	0.000598	0.18894
Perlite	0	0	4.21E-08	4.05E-07	4.24E-05	1.33E-07	0.00004
Phosphate Rock	0	0	0	0	0	0	0
Potash	0	0	0	0	0	0	0
Sodium Chloride	0	0	0	0	0	0	0
Uranium	2.86E-08	2.50E-08	8.00E-09	8.91E-09	6.03E-08	9.71E-09	1.41E-07
Water Used	0.02025	0.00549	3.58E-05	0.000258	0.000167	9.33E-05	0.02629

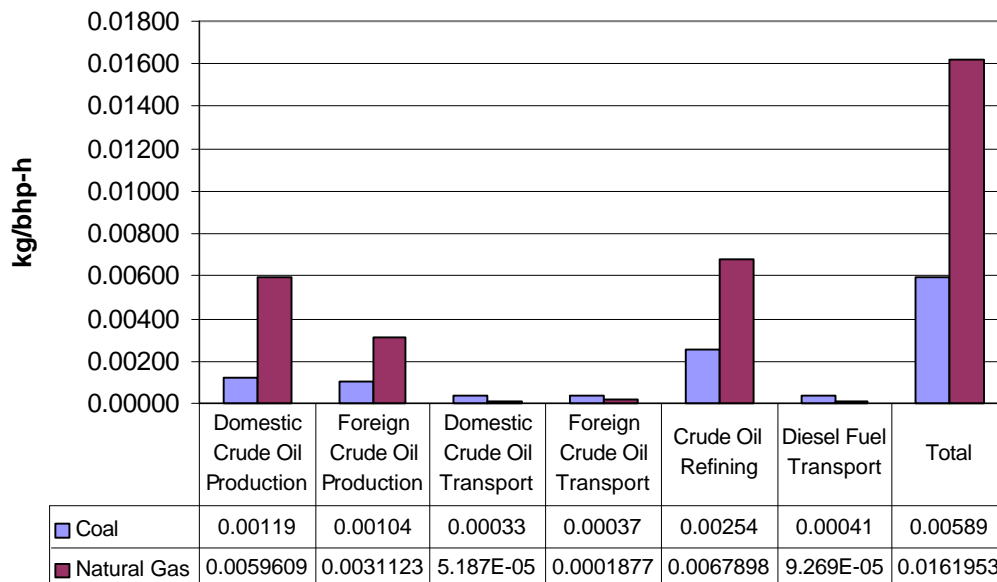

Figure 102: Life Cycle Consumption of Coal and Natural Gas for Petroleum Diesel

Figure 102 summarizes coal and natural gas consumption for petroleum diesel. Refining and extraction account for 98% of the natural gas consumption. These two parts of the life cycle almost split the demand for natural gas (56% for extraction and 42% for refining). Natural gas is used directly in these steps as a

source of process energy. There is also indirect consumption of natural gas associated with electricity purchased off the grid. Domestic crude production uses twice as much natural gas as foreign crude production, reflecting its greater reliance on energy-intensive advanced recovery schemes. The distribution of coal consumption tracks with electricity demand. Again, crude oil extraction and refining consume the larger amount of coal, in total representing 81% of the life cycle use of coal. Refining accounts for 43% of the coal use; extraction accounts for 38%¹⁰⁵.

Figure 103 summarizes uranium consumption. Both uranium and coal use are indicators of electricity demand in this model. The distribution of uranium use shown here is identical to the distribution of coal shown in Figure 102. Refining uses 38% of the total uranium demand; extraction accounts for 43%.¹⁰⁶

Figure 104 shows limestone consumption for petroleum diesel. Limestone is consumed as part of electricity production, where it is used in flue gas desulfurization. The distribution of its use tracks identically with coal, uranium, and electricity.

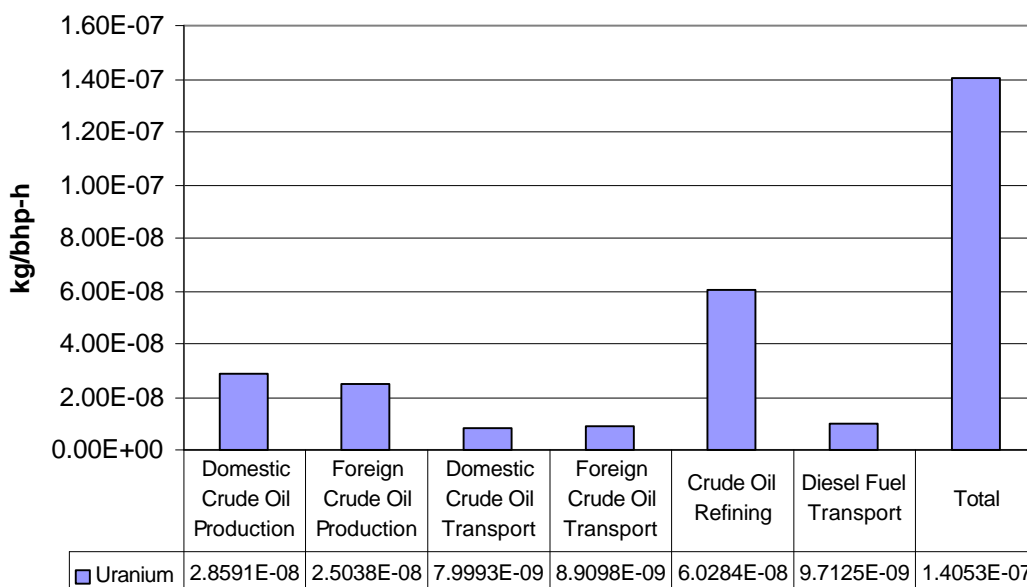

Figure 103: Life Cycle Consumption of Uranium for Petroleum Diesel

Figure 105 shows that 98% of the demand for water is in crude production. Water use is four times higher for domestic crude production than for foreign crude production because of a higher reliance on advanced recovery processes in the United States. A very small amount of water is required for offshore conventional oil recovery. None is required for onshore conventional recovery.

Table 127 shows consumption of perlite, a silicon oxide mineral. Perlite is used for catalyst production in the oil refining step. Thus, it shows up primarily in the refinery, and secondarily as an indirect consumption associated with diesel fuel used in transport steps.

¹⁰⁵The consumption of coal is affected by our simplifying assumption that the mix of primary energy sources for electricity generation is the same for foreign oil production as it is for U.S. oil production.

¹⁰⁶ The same caution applies for uranium consumption as was discussed for coal.

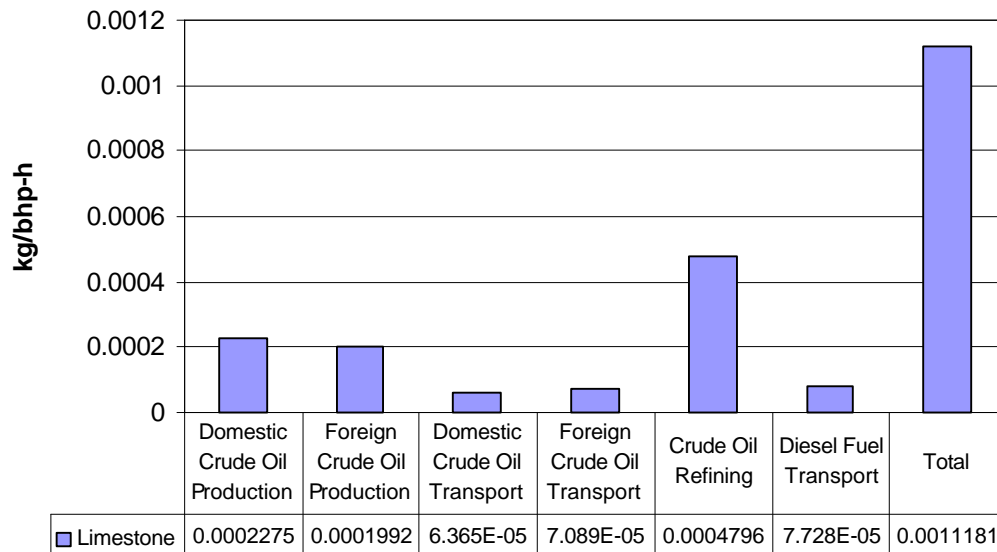

Figure 104: Life Cycle Consumption of Limestone for Petroleum Diesel

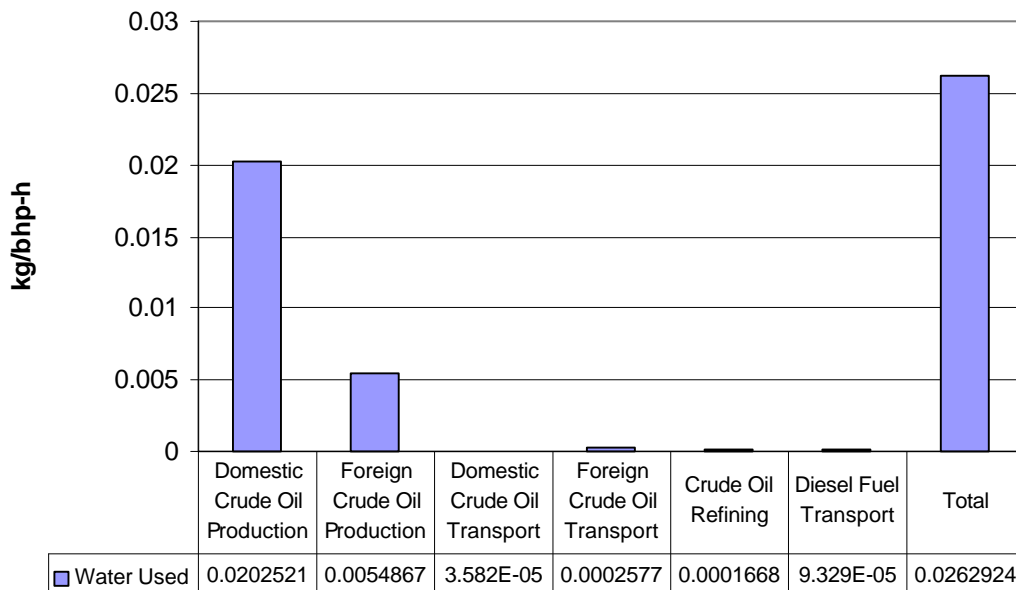

Figure 105: Life Cycle Consumption of Water for Petroleum Diesel

9.1.3.2 Life Cycle Consumption of Primary Resources for Biodiesel

Table 128 summarizes the resource demands across the life cycle for biodiesel. Analysis of the LCI shown in this table follows immediately in this section.

Coal and oil consumption for biodiesel are shown in Figure 106. As with the petroleum diesel life cycle, coal consumption tracks electricity usage. The coal and oil estimates for soybean crushing and soy oil conversion are both related to electricity. Petroleum oil consumption in the other parts of the life cycle

reflect the use of diesel and gasoline. The use of tractors, trucks and other farm equipment makes agriculture the largest consumer of petroleum oil. Agriculture represents 67.6% of the petroleum oil used in the biodiesel life cycle.

Table 128: Life Cycle Consumption of Primary Resources for Biodiesel

Raw Material	Soybean Agriculture	Soybean Transport	Soybean Crushing	Soybean Oil Transport	Soybean Oil Conversion	Biodiesel Transport	Total
Coal	0.001328	0.000017	0.003221	0.000035	0.002405	0.000022	0.00703
Limestone	0.000172	0.000003	0.000614	0.000007	0.000340	0.000004	0.00114
Natural Gas	0.002599	0.000046	0.008729	0.000097	0.019219	0.000059	0.03075
Oil	0.006826	0.000533	0.000519	0.001133	0.000413	0.000689	0.01011
Perlite	1.330E-06	1.211E-07	0.000E+00	2.575E-07	0.000E+00	1.566E-07	1.87E-06
Phosphate Rock	0.009397	0	0	0	0	0	0.00940
Potash	0.004417	0	0	0	0	0	0.00442
Sodium Chloride	0	0	0	0	0.00350	0	0.00350
Uranium	7.293E-08	3.97E-10	7.721E-08	8.44E-10	3.542E-08	5.15E-10	1.87E-07
Water Used	86.2493	7.41E-05	0.0007109	0.000158	0.113338	9.58E-05	86.364

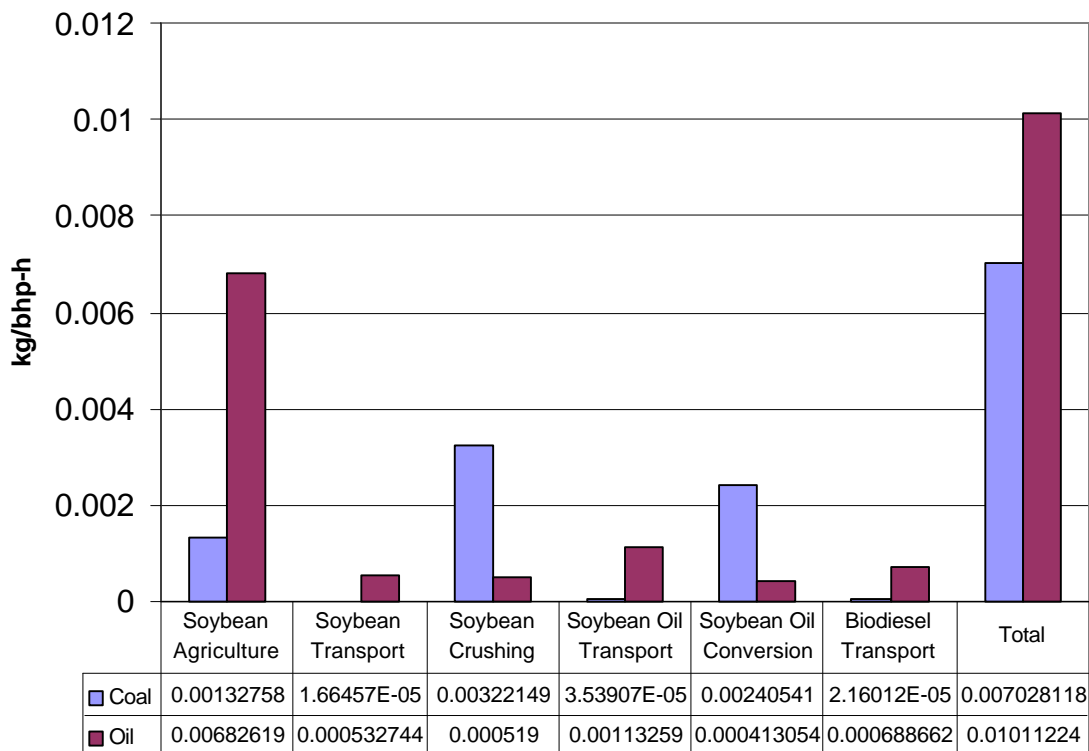

Figure 106: Life Cycle Consumption of Coal and Oil for Biodiesel

Figure 107 shows the amounts of natural gas used in the key steps in the life cycle of biodiesel. Use of natural gas includes the production of process energy used directly in each step, as well as natural gas used to produce electricity and methanol. The combination of soy oil conversion and soybean crushing represents the greatest requirement for use of natural gas, consuming 91% of the total life cycle input of natural gas. The conversion step alone accounts for almost two-thirds of the natural gas used in the life cycle. The use of methanol as a feedstock in conversion of soy oil to biodiesel makes the conversion step the highest consumer of natural gas on a life cycle basis¹⁰⁷.

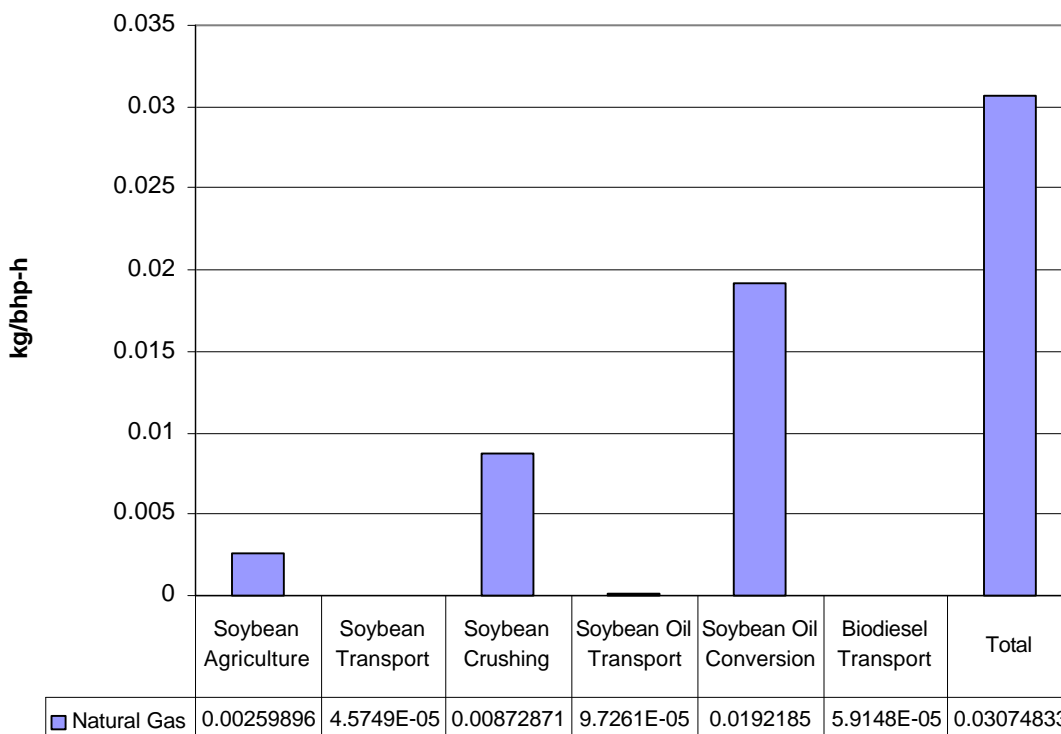

Figure 107: Life Cycle Consumption of Natural Gas for Biodiesel

Uranium consumption is shown in Figure 108. Because uranium is used to produce, the pattern of uranium use across the life cycle should track with coal consumption. The model shows almost twice the level of uranium consumption expected for farming. The unusually high uranium consumption can be traced back to the use of a data source for the production of agrochemicals. This data source is based on a plant located in France, where the electricity supply is predominantly nuclear. The electricity inputs were integrated into the Ecobalance data for this facility, and were not readily separated. The uranium consumption estimates for farming are artifacts of this problem with the data. Figure 109 shows the limestone consumption for each stage of biodiesel. It is in agreement with the distribution of consumption shown for coal in Figure 102.

A number of primary resources listed in Table 128 are associated with specific steps in the life cycle. Water is the largest of these. Its consumption for biodiesel is dominated by the use of water for agriculture. Farming accounts for 99.87% of the water consumed in the life cycle. The phosphate rock

¹⁰⁷ On the basis of natural gas used directly in each stage, the soybean crushing and conversion steps use similar amounts of natural gas. In the life cycle calculation, however, natural used to make the methanol is an indirect consumption associated with the conversion step.

and potash are also exclusively used in farming. Sodium chloride is an indirect input to soy oil conversion via HCl acid production.

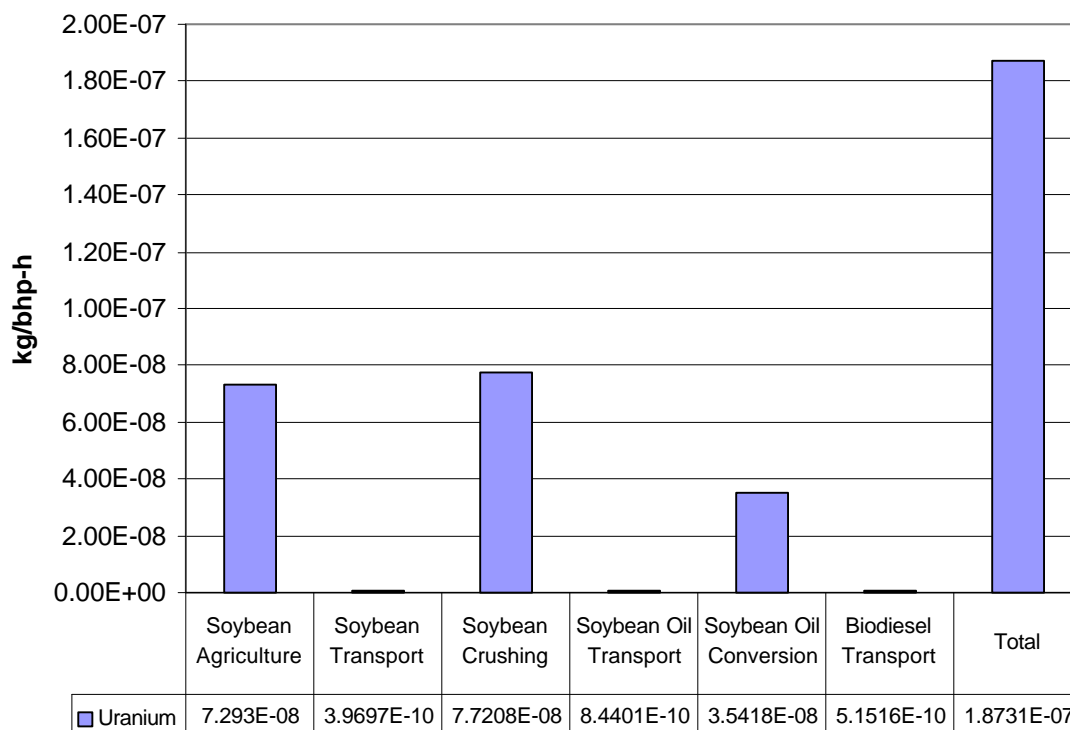

Figure 108: Life Cycle Consumption of Uranium for Biodiesel

9.1.3.3 The Effect of Biodiesel on Primary Resource Consumption

Figure 110 compares petroleum oil consumption for petroleum diesel, B20, and B100. The use of B100 as a substitute for petroleum diesel effects a 95% reduction in life cycle consumption of petroleum. The 20% blend of biodiesel provides a proportionate reduction of 19%.

Consumption of coal and natural gas is a different story (see Figure 111). The use of B100 increases coal consumption by 18.6%. This reflects the higher overall use of electricity in the biodiesel life cycle, relative to petroleum diesel. Electricity consumption in the soybean crushing stage is the dominant factor for biodiesel because of the mechanical processing and solids handling equipment involved. Natural gas use increases by 89.5% for B100 versus petroleum diesel. Two factors contribute to this increase: 1) the assumed use of natural gas for the supply of steam and process heat in soybean crushing and soy oil conversion, and 2) the use of natural gas to produce methanol used on the conversion step.

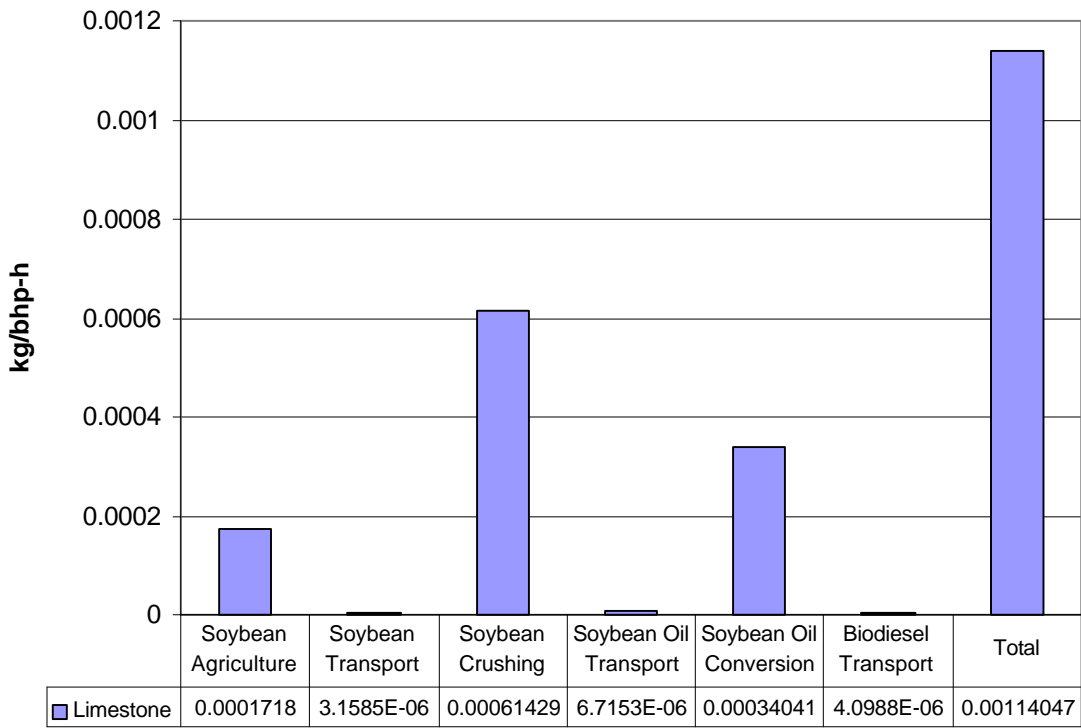

Figure 109: Life Cycle Consumption of Limestone for Biodiesel

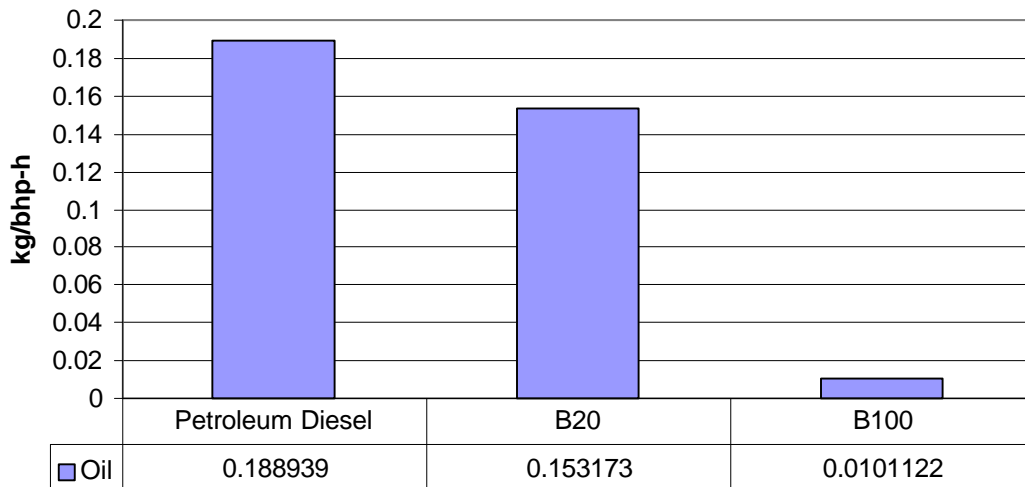

Figure 110: Petroleum Consumption for Petroleum Diesel, B20, and B100

Water consumption is higher for biodiesel, than for petroleum diesel. Water use for petroleum diesel is not even visible on a plot scaled to show biodiesel use (see Figure 112). That is because the biodiesel life cycle uses water at a rate that is three orders of magnitude higher than that of petroleum diesel. The

impact of this water use is not clear. For instance, when water use is compared to total wastewater generated, it appears that the biodiesel life cycle generates far less wastewater. Although water designated as waste is produced in crude oil production, it can also be used to increase oil recovery by well reinjection. In the biodiesel life cycle it is consumed during agriculture, and is generally recycled into the environment for other uses. We offer no simple way to compare water use between the two life cycles because no simple equivalency exists in its use and final disposition.

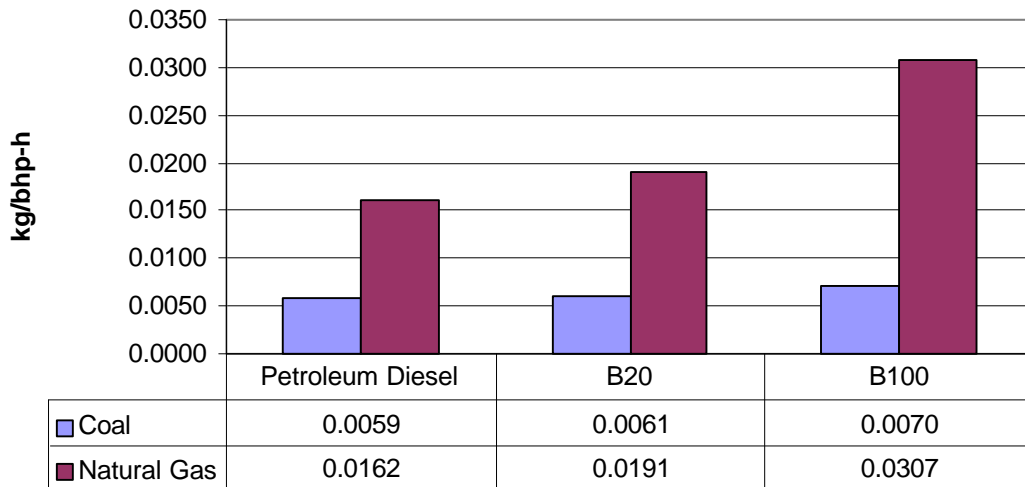

Figure 111: Coal and Natural Gas Consumption for Petroleum Diesel, B20, and B100

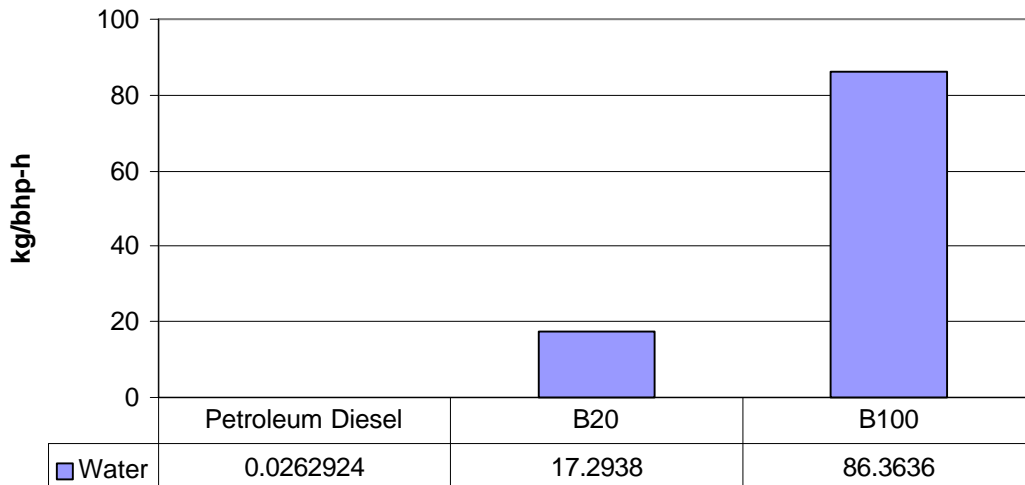

Figure 112: Water Use for Petroleum Diesel, B20, and B100

9.1.4 Life Cycle Emissions of Regulated and Nonregulated Air Pollutants

Regulated air pollutants include the following:

- CO
- NO_x
- PM10
- NMHC

The emissions of these air pollutants are regulated at the tailpipe for diesel engines. SO_x does not have specific tailpipe limits, but it is controlled through sulfur content of the fuel. Other air emissions included in this study are CH₄, benzene, formaldehyde, N₂O, HCl, HF, and NH₃. N₂O is associated with agricultural field emissions. HCl and HF are associated with coal combustion in electric power stations. NH₃ release occurs primarily in fertilizer production.

In this section, we discuss only those pollutants for which the most comprehensive and consistent data are available. These include the regulated air pollutants listed above. PM and HC are reported in different forms, depending on the data sources available. Benzene and formaldehyde emissions are not consistently reported. In some cases, we have combined pollutants into categories. HC data are reported as THC, defined as:

$$THC = (CH_4 + Benzene + formaldehyde + HC_{unspecified} + HC_{noCH_4})$$

where:

THC = total hydrocarbons

CH₄ = methane

HC_{unspecified} = unspecified hydrocarbons

HC_{noCH₄} = hydrocarbons excluding methane

Likewise, particulates are combined as a single category according to the following formula:

$$TPM = (PM10 + PM_{unspecified})$$

where:

TPM = total particulate matter

PM10 = particulate matter less than 10 micron

PM_{unspecified} = unspecified particulate matter

9.1.4.1 Life Cycle Air Emissions from Petroleum Diesel Life Cycle

Table 129 presents a summary of the air emissions LCI for petroleum diesel. The steps of the life cycle included in these results are:

- Foreign and domestic crude oil extraction
- Transport of crude oil to the refinery (for both foreign and domestic oil)
- Production of diesel fuel from crude oil at a domestic oil refinery
- Transport of the diesel fuel to bus fleet operators
- Diesel fuel use.

Analysis of the inventory for specific pollutants or groups of pollutants shown in Table 129 is presented in this section.

THC emissions from the life cycle for petroleum diesel are summarized in Figure 113. We found that CO₂ emissions from the petroleum life cycle were dominated by emissions at the tailpipe, but this was not true for THC. The largest contributor of THC is the oil refinery, which emits 40.4% of the total life cycle flow. Domestic and foreign crude production represent the next largest contribution, at 29%. Tailpipe emissions account for 17% of the total. Transport of foreign crude oil is also a significant contributor, accounting for 10% of the THC released in the life cycle.

Table 129: LCI of Air Emissions for Petroleum Diesel (g/bhp-h)¹⁰⁸

Air Pollutant	Domestic Crude Oil Production	Foreign Crude Oil Production	Domestic Crude Transport	Foreign Crude Transport	Crude Oil Refining	Diesel Fuel Transport	Diesel Use	Total
NH ₃	4.39E-09	3.84E-09	1.85E-09	6.69E-09	1.08E-08	3.92E-09	0.00E+00	3.15E-08
Benzene	2.14E-05	2.03E-05	4.15E-08	4.00E-07	1.45E-07	1.31E-07	0.00E+00	4.24E-05
CO	0.006091	0.011088	0.001064	0.001546	0.043144	0.006875	1.200000	1.269810
Formaldehyde	0.000277	0.000281	0.000001	0.000005	0.000002	0.000002	0.000000	0.000568
NMHC	0.013648	0.015506	0.000103	0.000306	0.000470	0.001433	0.100000	0.131467
Hydrocarbons (unspecified) ¹⁰⁹	9.76E-05	8.54E-05	1.02E-02	5.53E-02	1.82E-01	1.19E-03	0.00E+00	2.49E-01
Hydrogen Chloride	0.000644	0.000564	0.000180	0.000201	0.001357	0.000219	0.000000	0.003164
Hydrogen Fluoride (HF)	8.05E-05	7.05E-05	2.25E-05	2.51E-05	1.70E-04	2.73E-05	0.00E+00	3.96E-04
CH ₄	0.045281	0.093621	0.002656	0.004278	0.053414	0.003589	0.000000	0.202839
NO _x	0.024000	0.015720	0.006651	0.010242	0.129891	0.022055	4.800000	5.008558
N ₂ O	0.004049	0.001149	0.000034	0.000082	0.001255	0.000216	0.000000	0.006784
PM10	0.000194	0.000066	0.000159	0.000006	0.001459	0.002210	0.080000	0.084094
Particulates (unspecified)	0.016796	0.014704	0.004956	0.008848	0.079114	0.005864	0.000000	0.130281
SO _x	0.128553	0.083197	0.011121	0.080880	0.440475	0.009708	0.172402	0.926335

¹⁰⁸ Note that THC (not listed in the table) is the sum of benzene, formaldehyde, hydrocarbons (unspecified), NMHC (Non Methane Hydrocarbons), and CH₄. Similarly, data we report in other parts of this study for TPM (total particulate matter) represent the sum of PM10 and Particulates (unspecified). This latter category represents data in which the type of particulates measured was not specified.

¹⁰⁹ Unspecified hydrocarbons are *not* the sum of NMHC and CH₄. This is because the unspecified category of emissions is ambiguous. We do not know if original data sources were referring to total hydrocarbons or NMHC. This ambiguity is a common problem in life cycle analysis because of the need to use data collected across a wide range of sources.

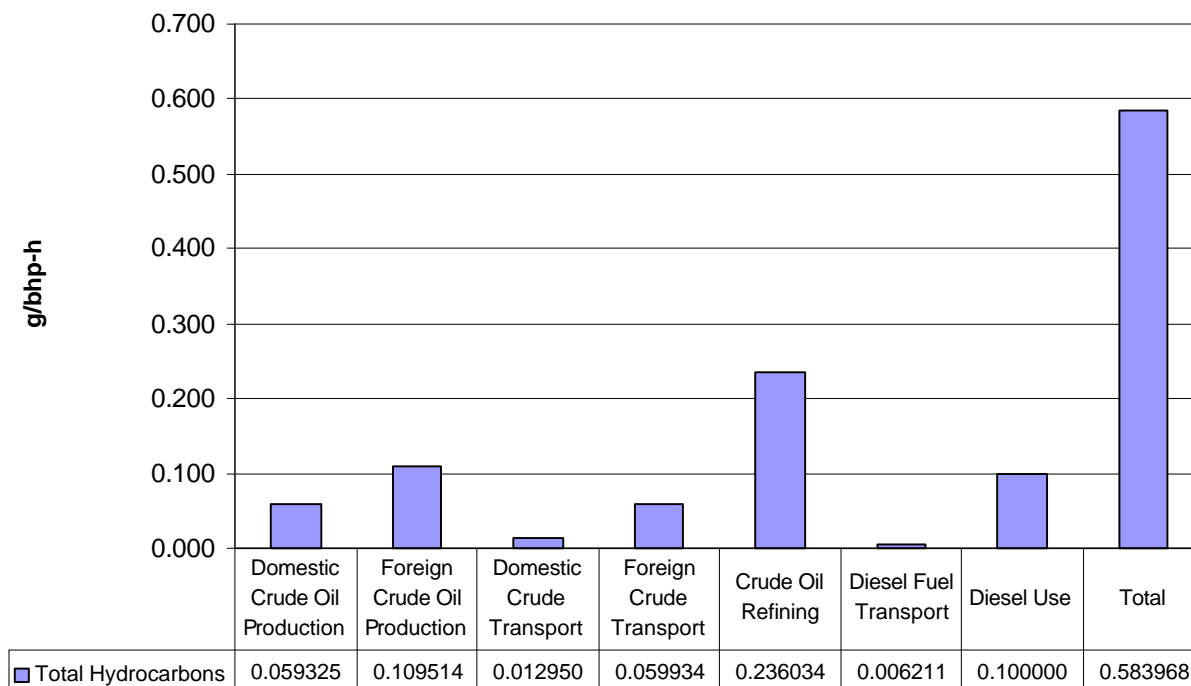

Figure 113: THC Emissions from Petroleum Diesel Life Cycle

The THC emissions that occur before the fuel’s end-use contain a significant amount of CH₄, which comprises 42% of the THC emissions that occur in the diesel fuel production and distribution steps. Sources of CH₄ in the petroleum diesel life cycle are shown in Figure 114. Life cycle CH₄ releases are credited to oil extraction and oil refining activities. CH₄ emissions in foreign crude oil extraction account for 85.5% of the THC released during this step. Domestic oil production is similar, with CH₄ making up 76% of its THC emissions. The rather high percentage of CH₄ in the THC emissions of crude oil extraction reflects the practice of natural gas venting, which is done to a greater extent in foreign oil production than it is in domestic oil production. There are two major sources of CH₄ emissions for the oil refinery: the direct use of natural gas and electricity. Both sources involve indirect emissions of CH₄ are associated with the production of natural gas. In total, CH₄ represents 34% of the THC released throughout the life cycle.

CO emissions for the petroleum diesel life cycle are shown in Figure 115. Emissions from the end-use of the fuel overwhelm the contributions of CO from any other part of the life cycle. CO from the combustion of diesel in the bus represents 94.5% of the total life cycle emissions.

Figure 116 shows the CO emissions for all steps but combustion. This expanded scale allows visual inspection of the relative contributions of these steps to the remaining 5.5% of CO emissions. The relative size of the contributions from these steps is similar to what has been shown for THC. Refining is the next largest contributor after combustion, representing two-thirds of the non-end-use CO. Total CO emitted from foreign and domestic crude oil extraction is about half the level of refinery emissions.

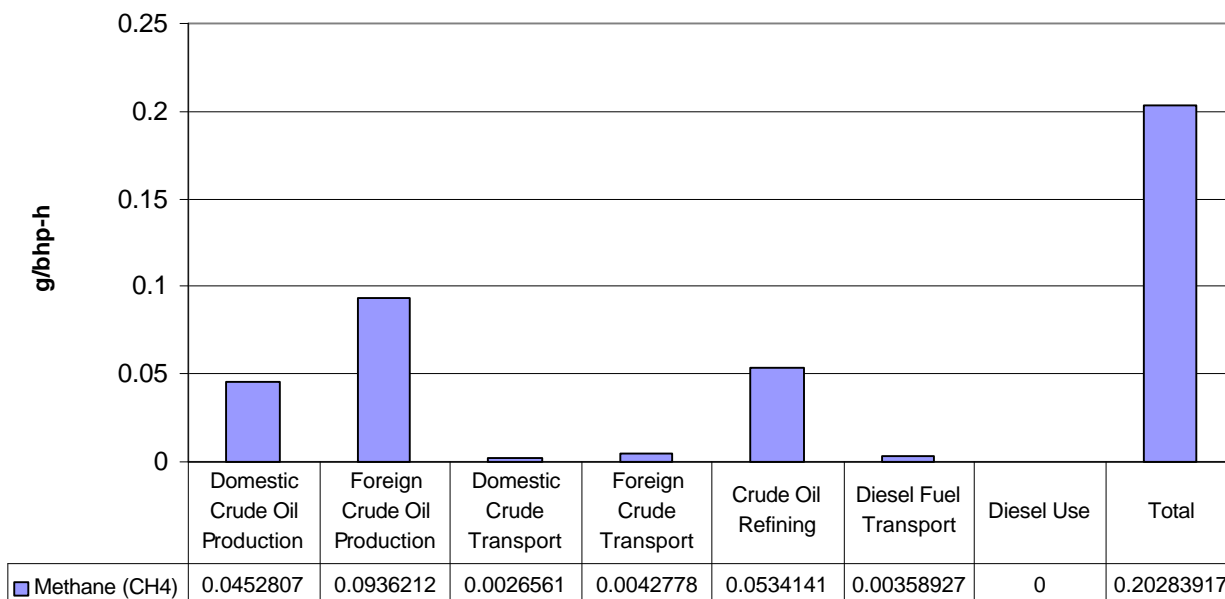

Figure 114: CH₄ Emissions from Petroleum Diesel Life Cycle

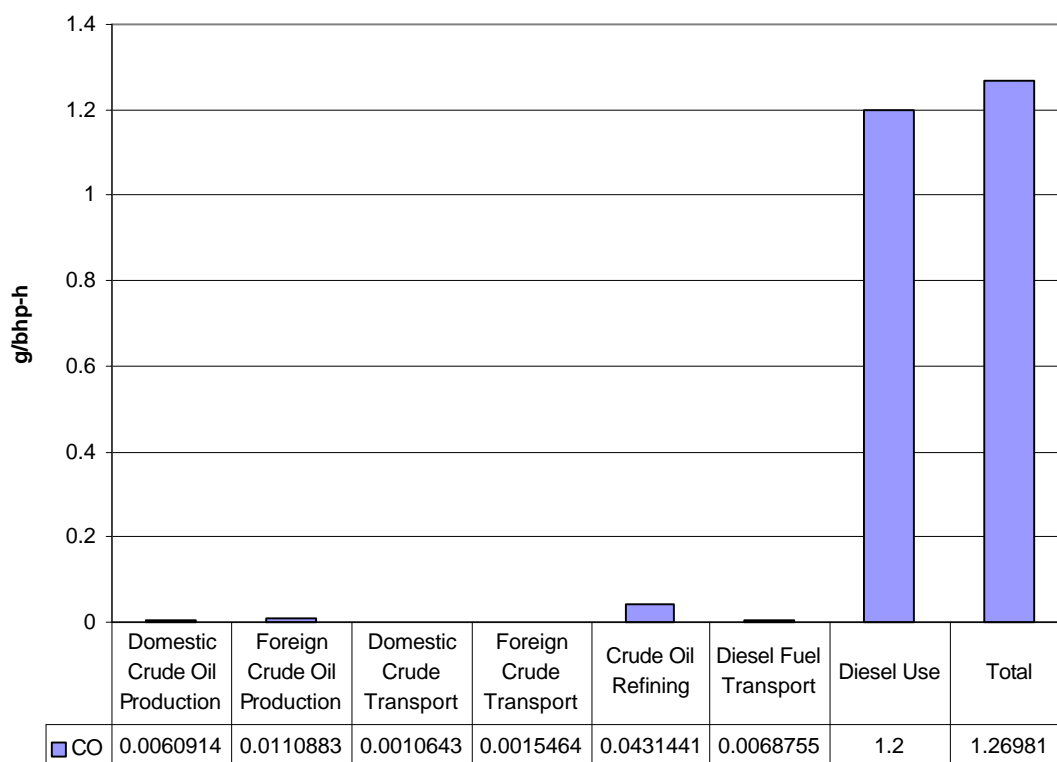
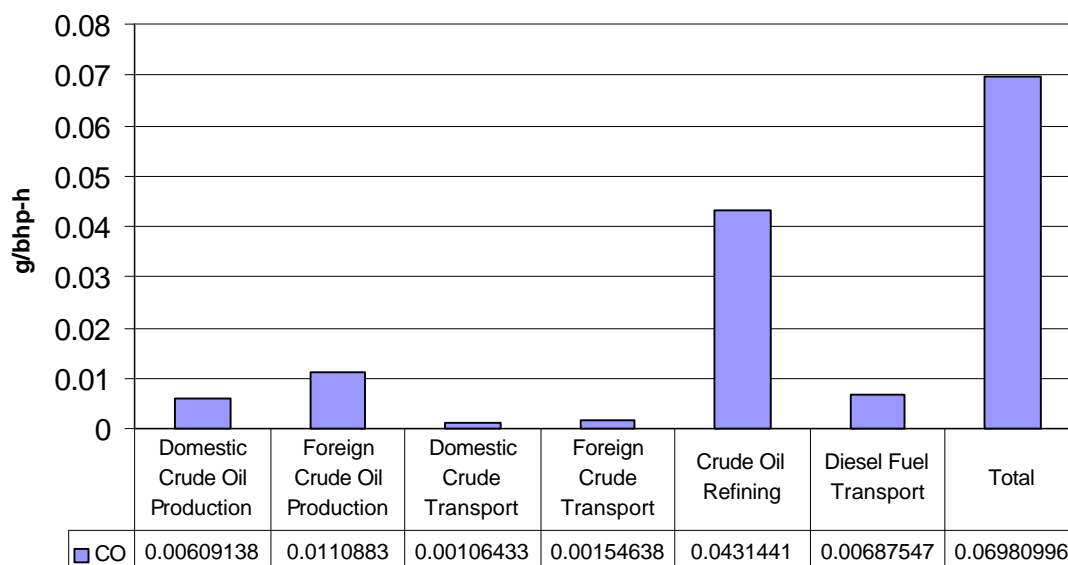

Figure 115: CO Emissions for Petroleum Diesel Life Cycle



**Figure 116: CO Emissions from the Petroleum Life Cycle
(Excluding End-Use Combustion of the Fuel)**

TPM emissions for the petroleum diesel life cycle are summarized in Figure 117. Both unspecified PM and PM10 are shown cumulatively for each step of the life cycle. Some care has to be taken in interpreting these results because of the differences in reporting among the various data sources. Most of the sources did not indicate what type (or size range) of particulates was measured. In the case of the diesel fuel emissions, the TPM includes only PM10, and thus does not reflect emissions of coarser particulates. The engine tailpipe and the oil refinery are the two dominant sources of TPM (37% and 38% of the TPM emissions for the life cycle, respectively). Foreign and domestic crude oil production together contributes 15% of the life cycle TPM emissions.

A comparison of the TPM emissions and SO_x emissions for the petroleum diesel life cycle reveals that these emissions seem to track each other very closely. The relative contributions for each of these pollutants are similar, especially for the fuel production and distribution parts of the life cycle. This close tracking of SO_x and PM emissions is not surprising because sulfates are major contributors to the formation of particulates. The largest contribution of SO_x emissions comes from the oil refinery, which accounts for 48% of the total. Crude oil production contributes another 23%. The distribution of SO_x emissions in the production and distribution stages closely mirrors that of the process energy requirements for petroleum diesel shown in Figure 88. Diesel fuel combustion accounts for only 19% of the total SO_x emissions.

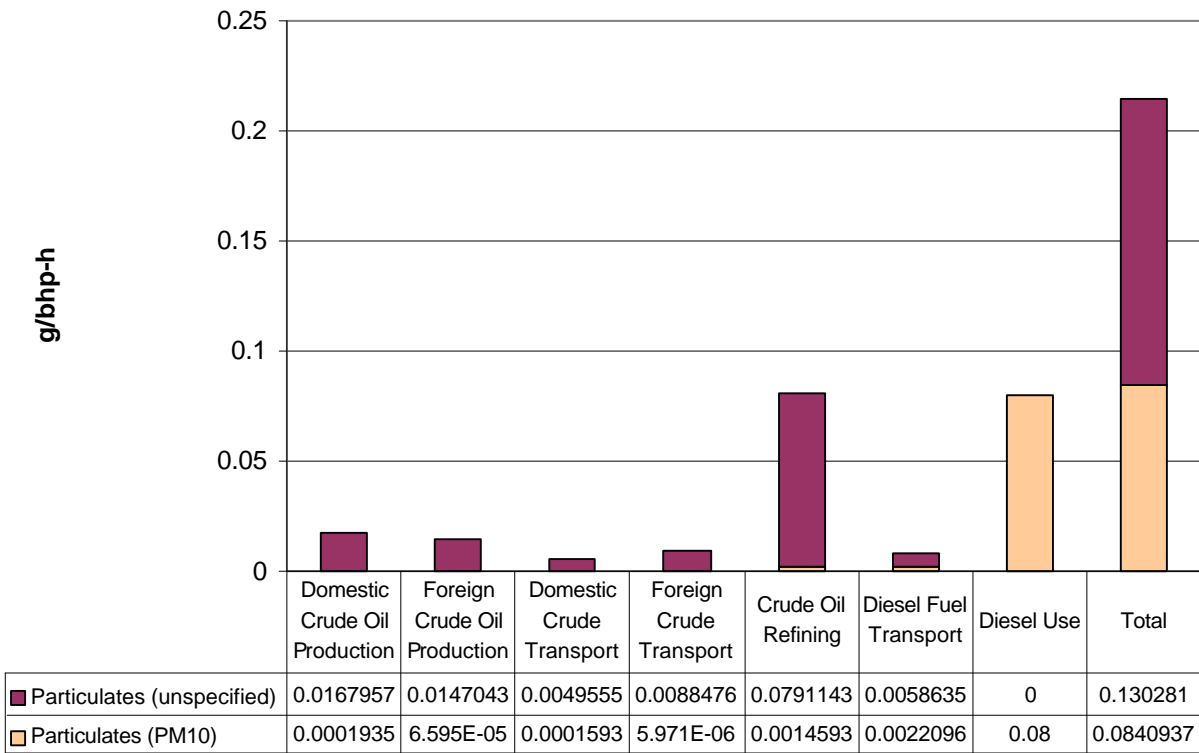

Figure 117: TPM Emissions from Petroleum Diesel Life Cycle

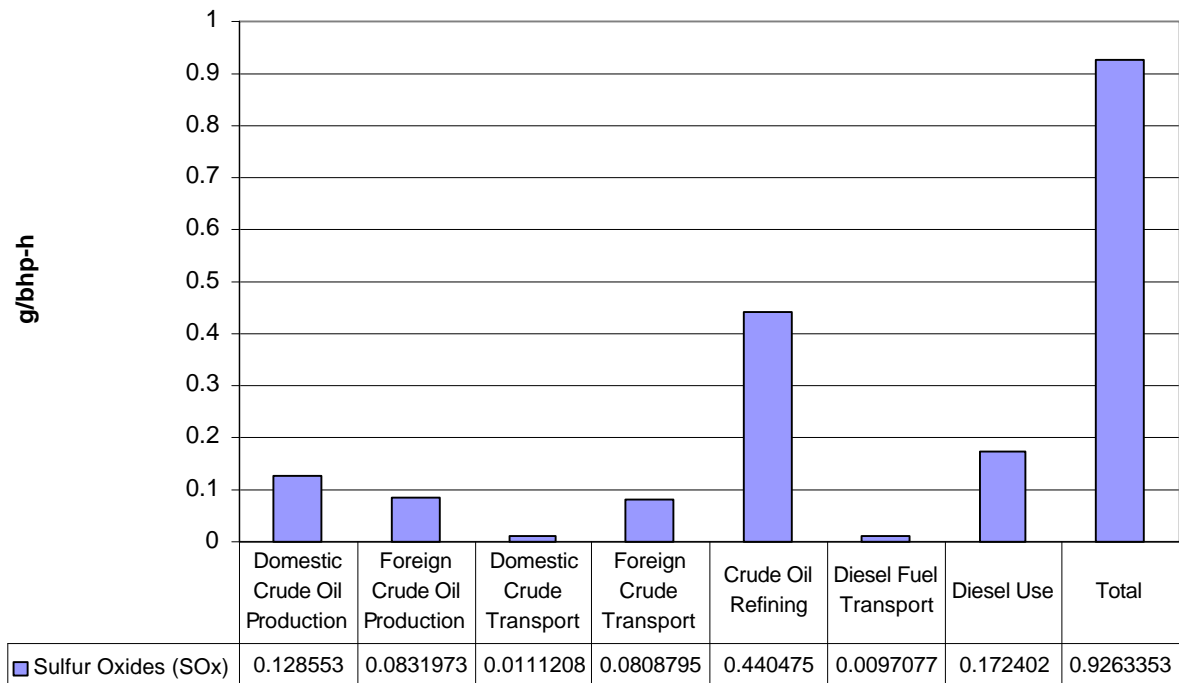

Figure 118: SO_x Emissions from Petroleum Diesel Life Cycle

NO_x emissions for the petroleum diesel life cycle are reported in Figure 119 and Figure 120. As with the CO emissions, NO_x emissions are overwhelmed by the impact of the fuel's end-use. NO_x emissions from the tailpipe of the bus are 96% of the total. Oil refining makes up the bulk of the remaining 4% of NO_x emissions.

In order to better show the relative distribution of NO_x emissions for the fuel production and distribution steps, the emissions are shown in an expanded scale without diesel fuel combustion in Figure 120. The distribution of emissions is similar to that of CO. Oil refining is the dominant source of emissions, accounting for 62% of the non-end-use combustion emissions of NO_x. The importance of NO_x emissions from diesel fuel combustion in diesel engines again increases the impact of diesel fuel transport. This same effect was observed with CO emissions (Figure 116).

HCl and HF emissions for the petroleum diesel life cycle are presented in Figure 121 and Figure 122. The relative contributions of HCl and HF from each step in the life cycle track each other exactly. These emissions result from the combustion of coal used in electric power generation. These emissions are indicators of electricity consumption in each step of the life cycle. Most (81%) of the emissions occurs in crude oil refining and crude oil production, split almost equally between the two.

No discussion is presented on the emissions of N₂O, benzene, formaldehyde, and NH₃ because few consistent data were available on these pollutants across the life cycle of petroleum diesel.

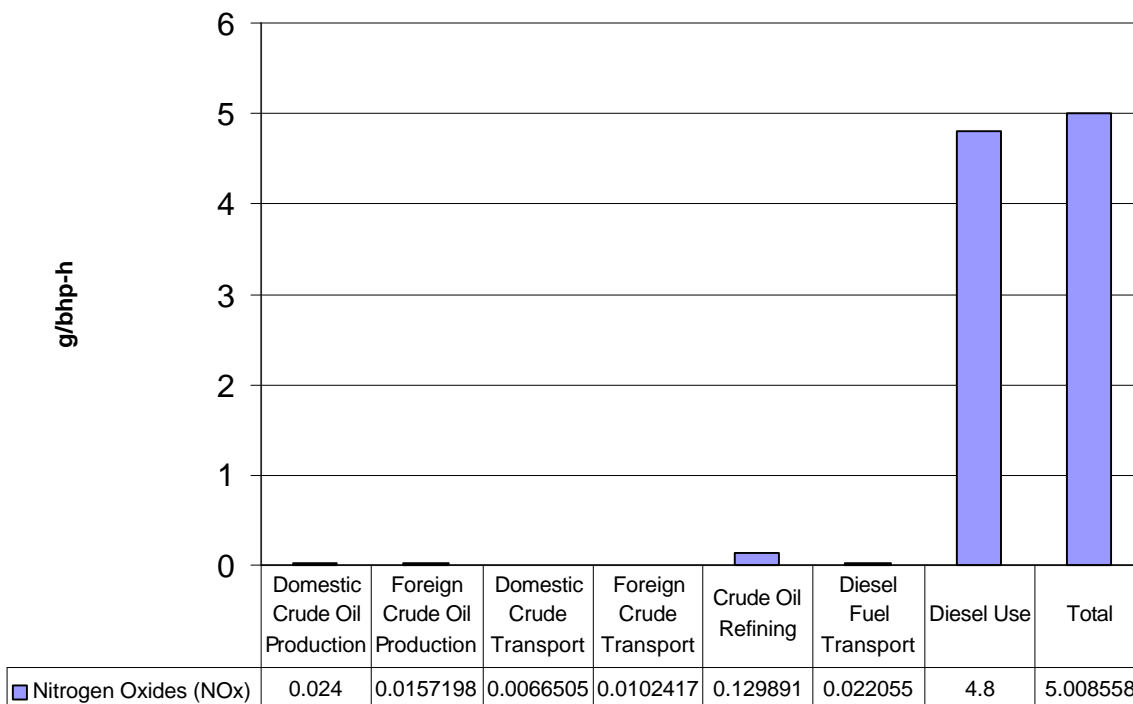

Figure 119: NO_x Emissions from Petroleum Diesel Life Cycle (Reported as NO₂)

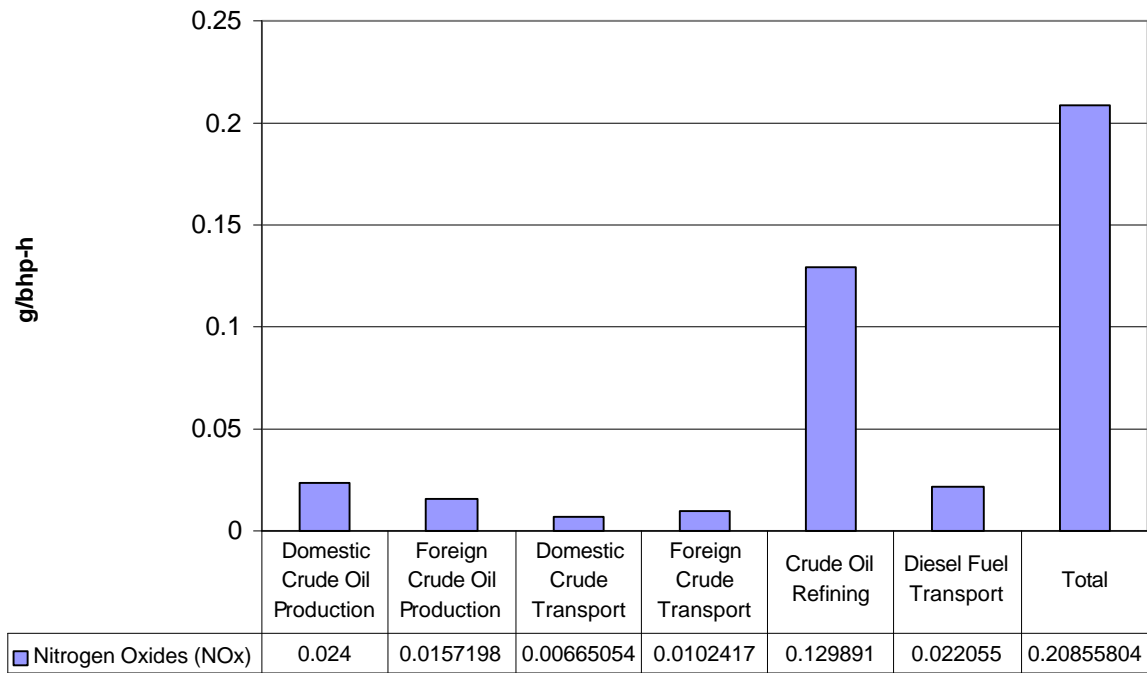

Figure 120: NO_x Emissions from Petroleum Diesel Life Cycle Excluding End-use Combustion (Reported as NO₂)

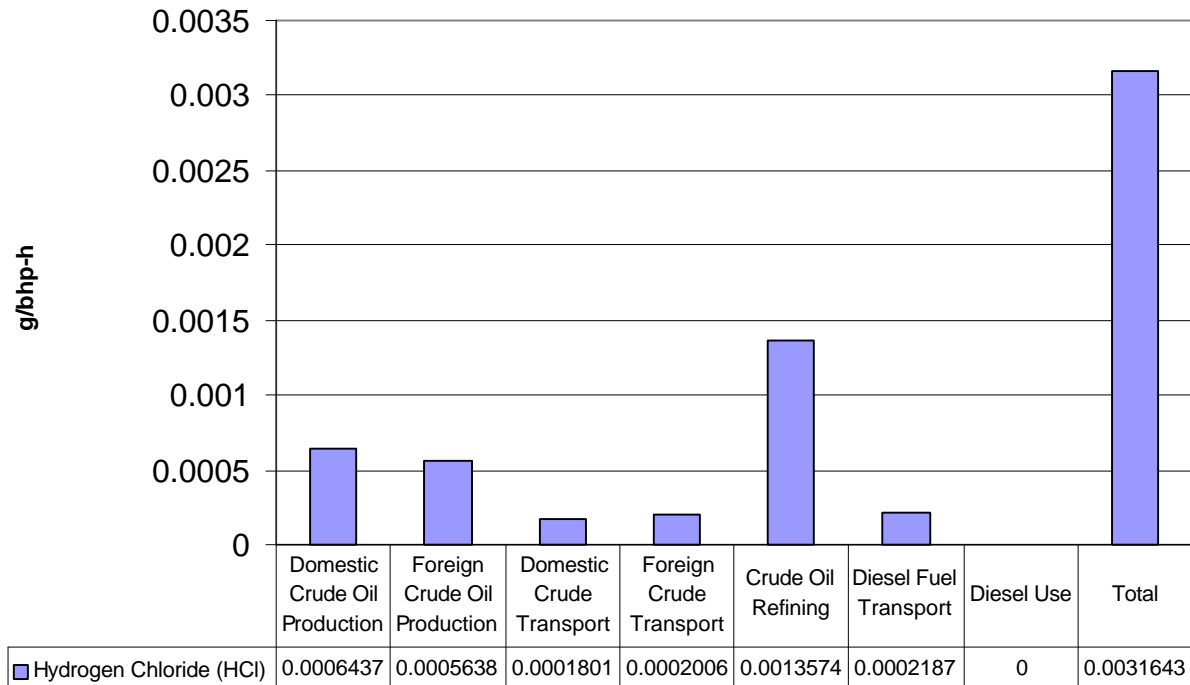

Figure 121: Life Cycle Emissions of HCl for Petroleum Diesel

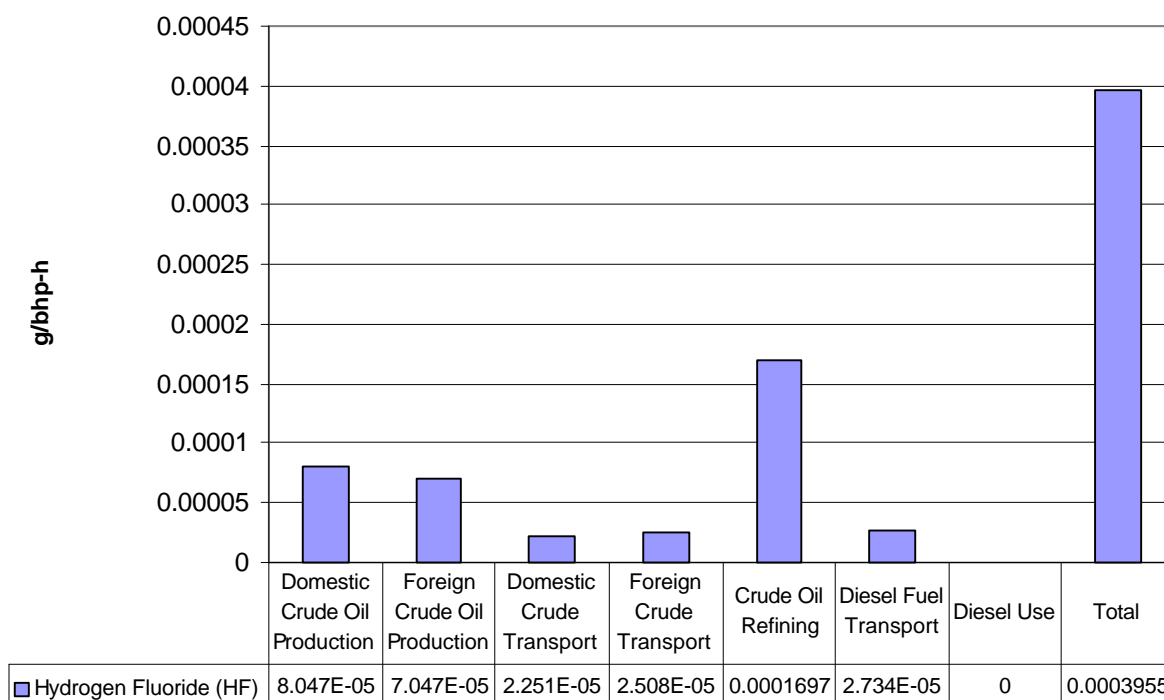

Figure 122: Life Cycle Emissions of HF for Petroleum Diesel

9.1.4.2 Life Cycle Emissions of Air Pollutants for Biodiesel

Table 130 provides a summary of all of the life cycle air emissions inventories for biodiesel. The basic steps included are:

- Soybean agriculture
- Transport of beans to soybean processor (crushing facility)
- Soy oil recovery (at the crusher)
- Transport of soy oil to a biodiesel facility
- Conversion of soy oil at a biodiesel facility
- Transport of biodiesel
- Use of biodiesel in an urban bus.

The results presented in Table 130 are for B100. Blends of biodiesel and petroleum diesel such as B20 will have emissions that lie between those of diesel and biodiesel, in proportion to the percentage of biodiesel included. Overall emissions for the B20 blend are discussed in the next section on comparisons of emissions for petroleum diesel and biodiesel blends. As with the petroleum life cycle discussion, results are analyzed for those pollutants or groups of pollutants for which a consistent and comprehensive set of data is available.

Table 130: LCI Air Emissions for Biodiesel (g/bhp-h)¹¹⁰

Air Pollutant	Soybean Agriculture	Soybean Transport	Soybean Crushing	Soybean Oil Transport	Soybean Oil Conversion	Biodiesel Transport	Biodiesel Use	Total
NH ₃	0.0734632	2.2735E-09	8.02E-06	4.83E-09	5.4472E-09	2.94E-09	0	0.073471
Benzene	1.313E-06	1.195E-07	0	2.54E-07	0	1.54E-07	0	1.84E-06
CO	0.136856	0.00602014	0.01054	0.012727	0.0125584	0.007782	0.64524	0.831723
Formaldehyde	1.78E-05	1.60E-06	5.20E-13	3.40E-06	2.38E-13	2.07E-06	0	2.48E-05
NMHC)	0.0539448	0.00129623	0.323816	0.00019	0.00031698	0.001676	0.06327	0.44451
Hydrocarbons (unspecified) ¹¹¹	0.11591	0.00070209	0.000263	0.00442	0.0296103	0.000908	0	0.151813
HCl	0.000282	8.9382E-06	0.001738	1.9E-05	0.00153278	1.16E-05	0	0.003593
HF	1.23E-05	1.12E-06	2.17E-04	2.38E-06	9.97E-05	1.45E-06	0	0.000334
CH ₄	0.0283374	0.00063603	0.064765	0.001371	0.101683	0.000823	0	0.197616
NO _x	0.201205	0.0166995	0.065193	0.062899	0.0829794	0.021588	5.22672	5.677283
N ₂ O	0.0013084	0.00017635	0.000315	4.07E-05	0.00022874	0.000228	0	0.002297
PM10	0.0137127	0.00201252	0.000592	0.001541	0.00056848	0.002602	0.025544	0.046572
Particulates (unspecified)	0.0154781	0.00037925	0.045433	0.000806	0.0357402	0.000491	0	0.098329
SO _x	0.0939614	0.00261499	0.248258	0.005551	0.498182	0.003382	0	0.851949

Figure 123 presents THC emissions for the life cycle of biodiesel. Combustion of biodiesel accounts for only 8% of the THC emissions. The soybean crushing operation contributes 49% of the THC emissions. Soybean agriculture contributes 25% of the total life cycle emissions of THC. The next largest contributor to THC emissions is the soy oil conversion step, representing 17% of the total. Transportation of beans, soy oil and biodiesel contribute very little to the overall life cycle emissions of THC (totaling around 1.5%).

Though we would expect THC emissions to track energy consumption through the life cycle, this is not the case for soybean crushing. Even though energy consumption in the soybean crushing operation is less than that of biodiesel conversion (Figure 94), soybean crushing has emissions of THC that are more than

¹¹⁰ Note that THC (not listed in the table) is the sum of benzene, formaldehyde, hydrocarbons (unspecified), NMHC (Non Methane Hydrocarbons), and CH₄. Similarly, data we report in other parts of this study for TPM (total particulate matter) represent the sum of PM10 and Particulates (unspecified). This latter category represents data in which the type of particulates measured was not specified.

¹¹¹ Unspecified hydrocarbons are *not* the sum of NMHC and CH₄. This is because the unspecified category of emissions is ambiguous. We do not know if original data sources were referring to total hydrocarbons or NMHC. This ambiguity is a common problem in life cycle analysis because of the need to use data collected across a wide range of sources.

double those of conversion. Figure 124 shows the sources of THC from the crushing operation. The steps shown indicate emissions associated with the production of steam, electricity, natural gas, and hexane, in addition to the actual crushing operation itself. The crushing operation is directly responsible for 85% of the THC emissions. Virtually all these emissions are attributable to the loss of hexane through vents and leaks in the crushing operation.

THC from soybean agriculture is predominantly from volatilization of applied chemicals during farming, which represent 54% of the THC (see Figure 125). The combustion products from gasoline and diesel equipment represent the next largest contributions to THC emissions from farming. Tractor and truck operations produce 21% of the THC emissions from the farm. The remaining 25% of farm emissions of THC come from indirect emissions associated with production of fertilizers and agrochemicals.

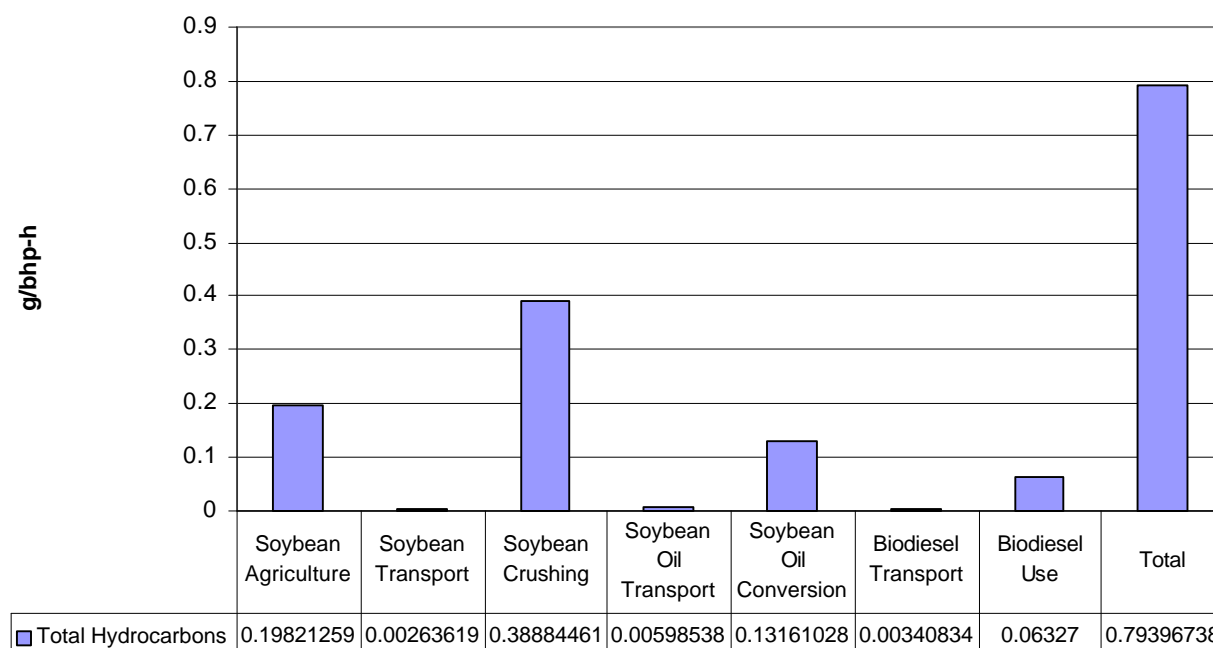

Figure 123: THC Emissions from Biodiesel Life Cycle

CH₄ emissions for the biodiesel life cycle are shown in Figure 126. CH₄ is 25% of the THC emissions from the life cycle for biodiesel, and makes up 27% of the THC emissions from the fuel production and distribution steps. The biodiesel conversion step is responsible for 51% of all of the CH₄ emissions. The reason for this large contribution can be seen in Figure 127. Almost all the THC from the conversion step are CH₄. This step introduces indirect emissions of CH₄ associated with the production of methanol, which is used as a co-reactant with soybean oil in the production of biodiesel. Methanol usage accounts for 64% of the CH₄ emissions from this step. Steam and electricity account for the rest (27% and 9%, respectively). The relatively large contribution from steam is because steam production is assumed to use natural gas as its primary energy source. The sources of CH₄ emissions for methanol and steam production are indirect emissions of natural gas associated with extracting and recovering of natural gas itself.

Figure 128 shows CO emissions from the biodiesel life cycle. As with petroleum diesel, biodiesel life cycle emissions of CO are dominated by end-use combustion of the fuel, which accounts for 77.6% of the total. As Figure 129 indicates, 73% of the remaining CO is generated in the soybean agriculture step, related to the operation of diesel- and gasoline-powered vehicles.

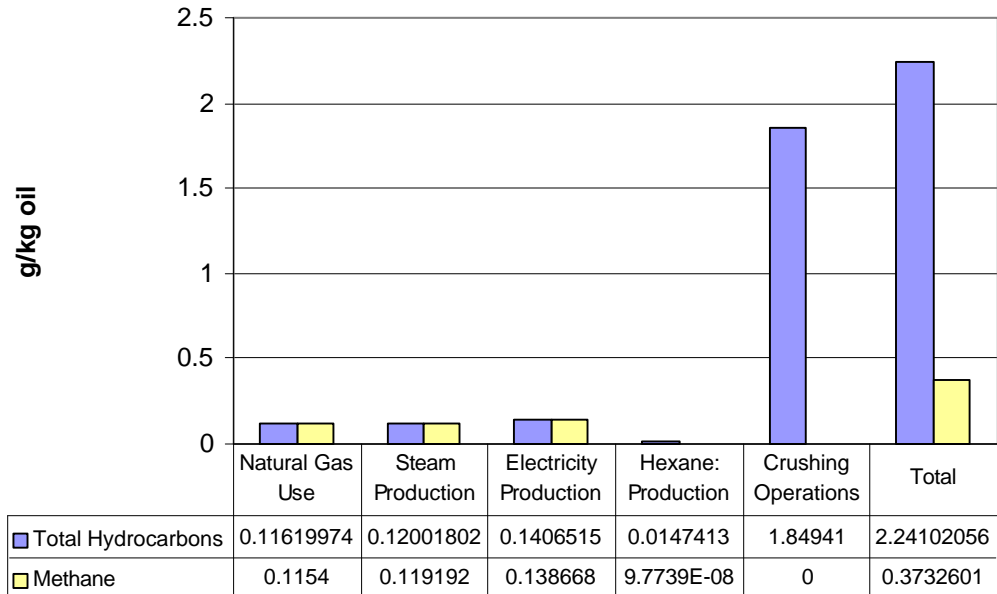

Figure 124: Sources of THC and CH₄ in Soybean Crushing

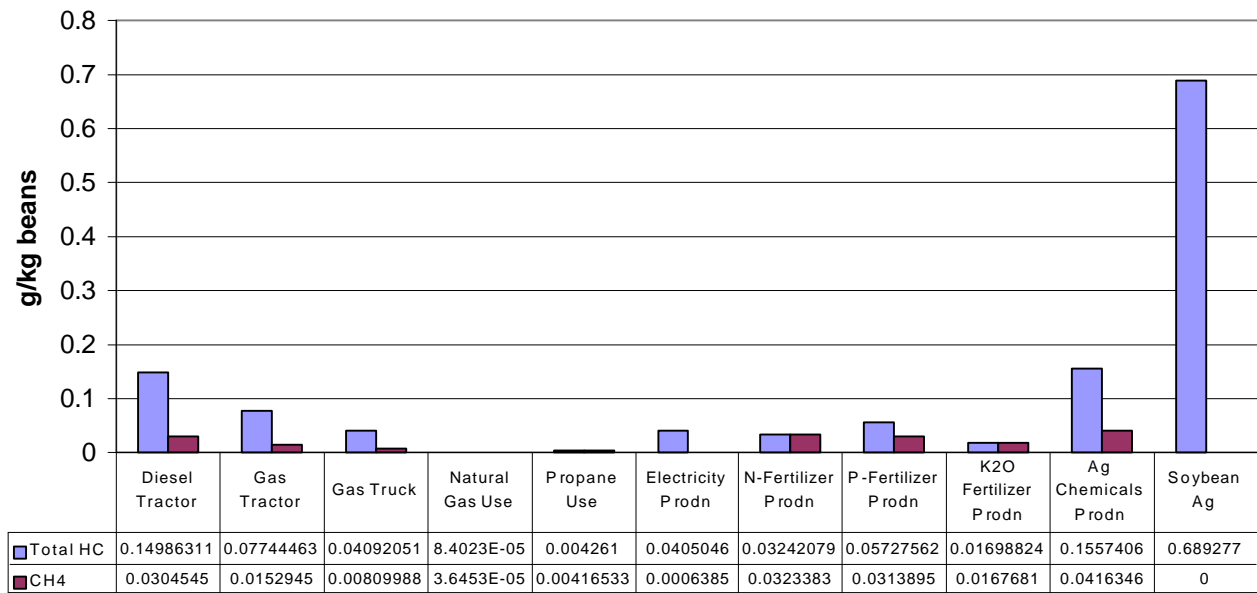

Figure 125: Sources of THC and CH₄ in Soybean Agriculture

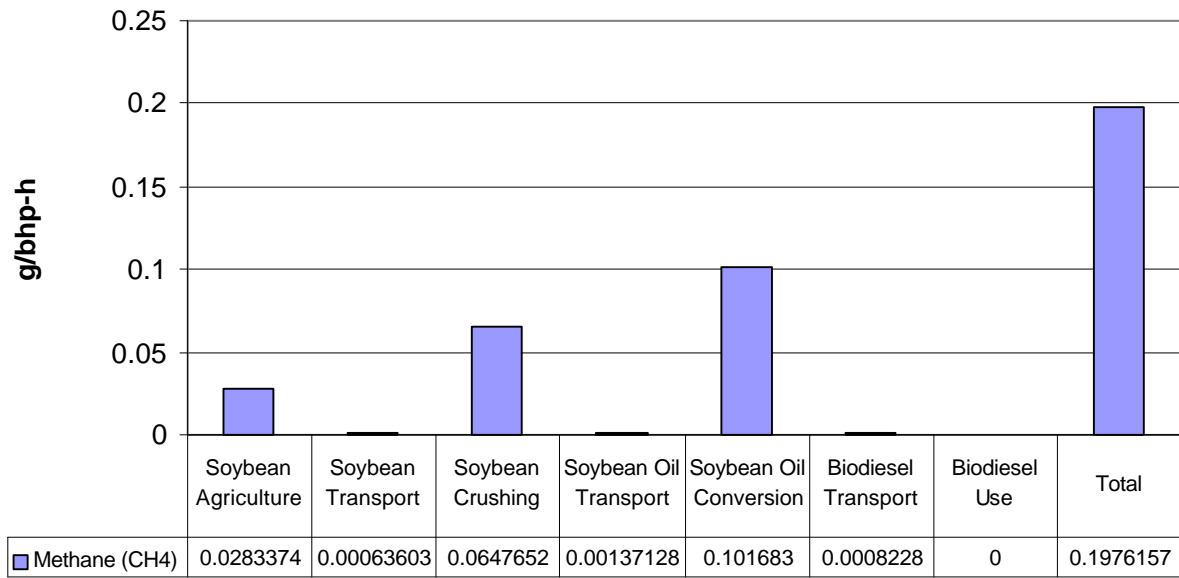

Figure 126: CH₄ Emissions from the Biodiesel Life Cycle

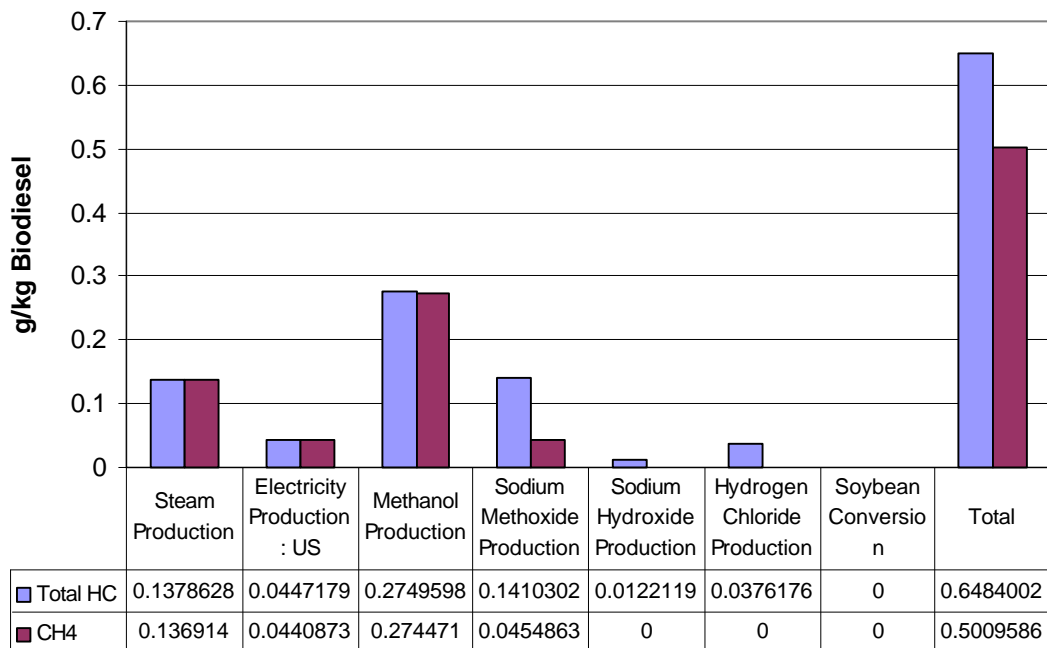

Figure 127: Sources of CH₄ Emissions from the Biodiesel Production Step

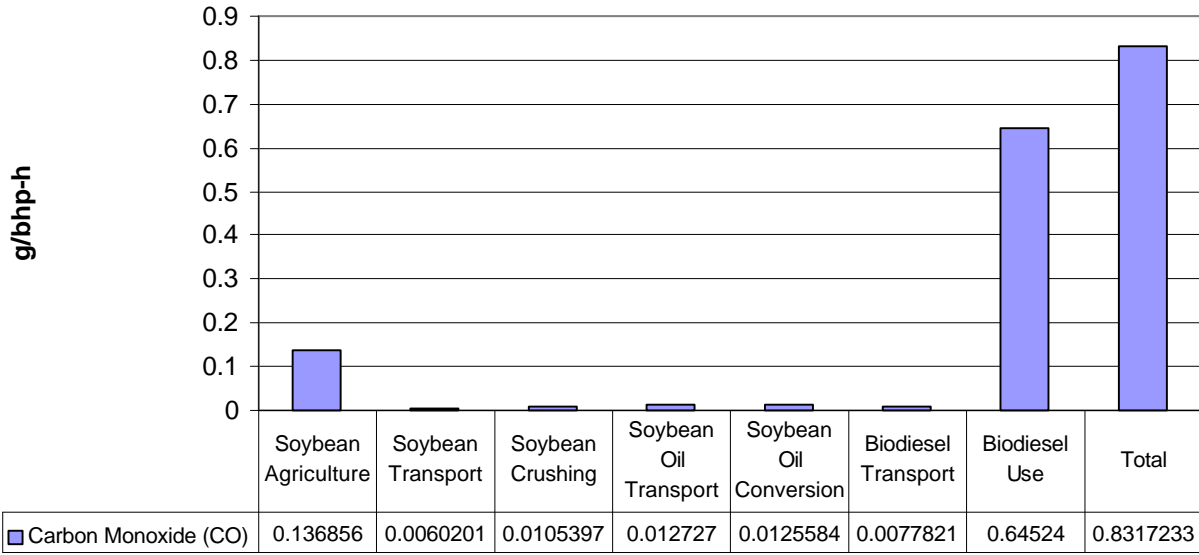

Figure 128: CO Emissions from the Biodiesel Life Cycle

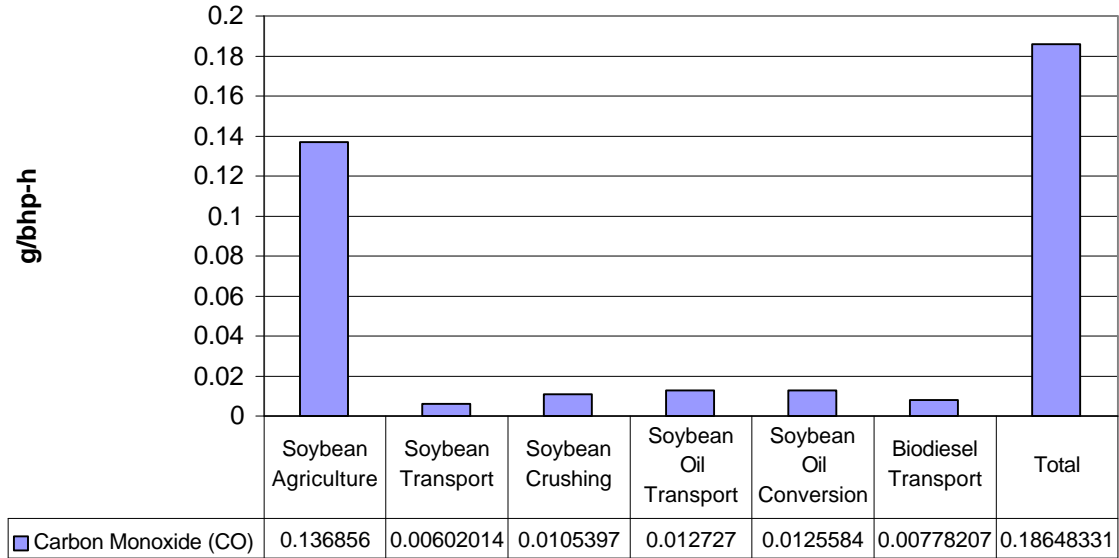

Figure 129: CO Emissions from the Biodiesel Life Cycle (Excluding End-use)

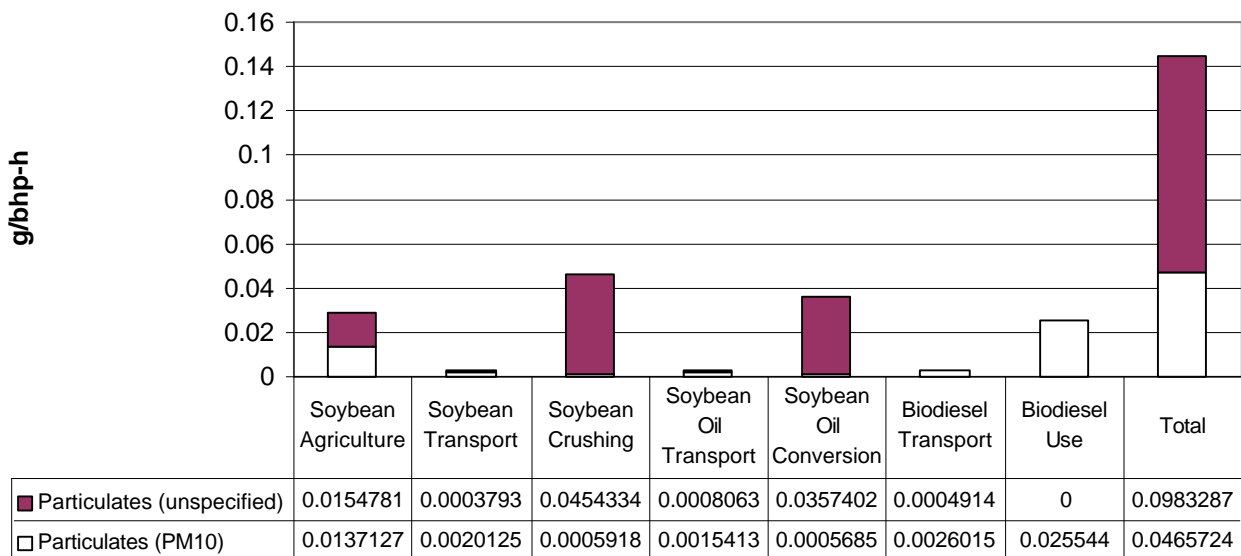

Figure 130: TPM Emissions from Biodiesel LCA

TPM emissions from the life cycle of biodiesel are shown in Figure 130. The bar graph shows cumulative levels for PM10 and unspecified particulates. Two-thirds of the TPM are in the unspecified category. PM10 from the end-use combustion of biodiesel represent only 18% of the total emissions. Soybean agriculture emissions are split half-and-half between PM10 and unspecified particulates. Figure 131 shows the distribution of TPM emissions from the farm. Half the particulates are from vehicle use and half are associated with the production of fertilizers used on the farm. Unspecified particulates from soybean crushing and soy oil conversion are a result of electricity and steam consumption. Of the two, electricity production introduces the bulk of the particulates. This is because steam production is modeled assuming only natural gas as the primary energy source; electricity from the grid is based on a national average mix of coal, oil, gas, nuclear, and hydroelectric sources.

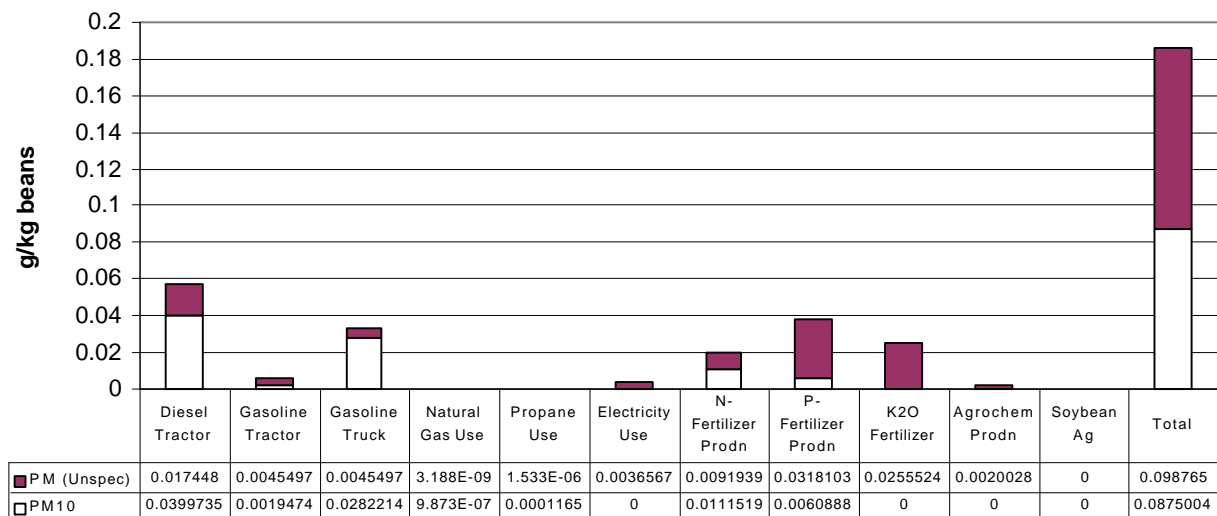

Figure 131: Sources of TPM in Soybean Agriculture

Figure 132 shows SO_x emissions from the life cycle for biodiesel. Soy oil conversion to biodiesel is responsible for 58% of the emissions. The large contribution of SO_x from this step is related to steam production and indirect emissions associated with methanol production. As indicated in Figure 133, the use of methanol accounts for 66% of the SO_x emissions from this step. The soybean crushing step generates SO_x through the consumption of steam, natural gas, and electricity (see Figure 134). Farming introduces SO_x primarily through consumption of diesel fuel in tractors and consumption of nitrogen fertilizer (see Figure 135).

Figure 136 shows NO_x emissions for biodiesel. The life cycle emissions are dominated by emissions from end-use combustion of the fuel. This represents 92% of the total. The remaining emissions track energy consumption for each step, except the agriculture step. Emissions on the farm are disproportionately higher because of the contribution of NO_x from diesel tractor emissions.

Figure 137 and Figure 138 show emissions for HCl and HF, respectively. In the case of petroleum diesel, both of these emissions tracked precisely with electricity consumption. For biodiesel, this is not the case. HF emissions track very well with electricity. HCl emissions for soy oil conversion do not track electricity. As can be seen in Figure 139 and Figure 140, HCl emissions occur as part of sodium methoxide, sodium hydroxide, and HCl production. These emissions are not related to electricity, but are specific to the production processes for these raw materials.

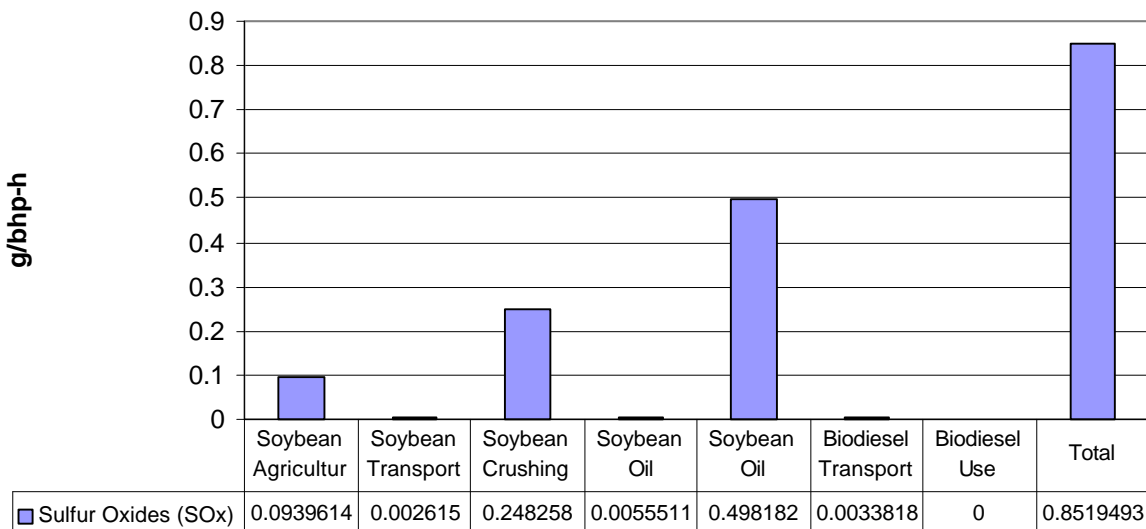

Figure 132: SO_x Emissions from Biodiesel Life Cycle (Reported as SO₂)

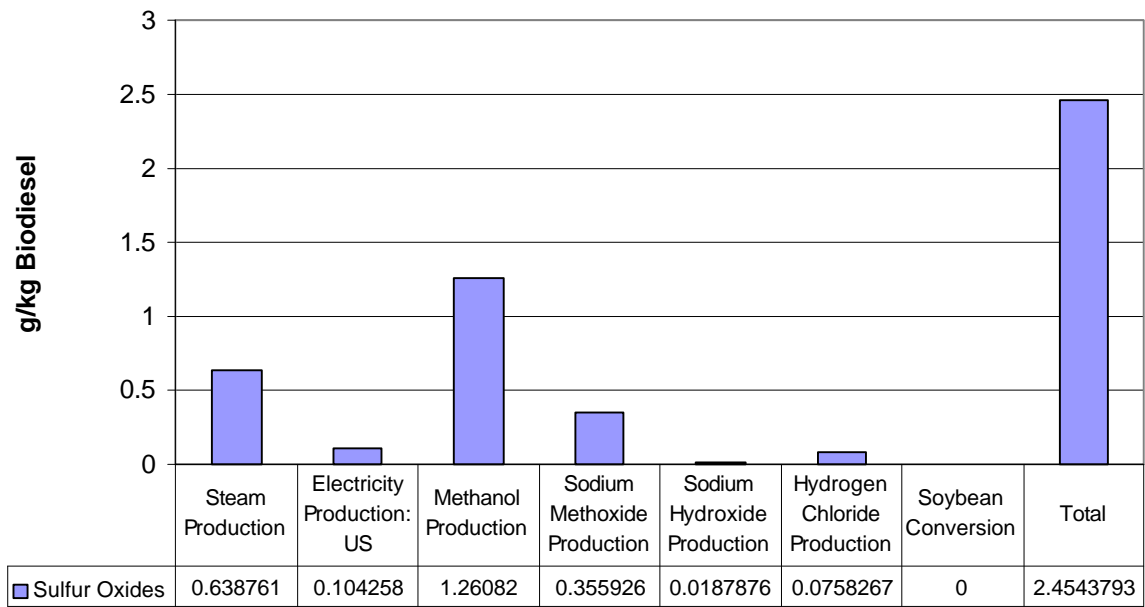

Figure 133: Sources of SO_x Emissions from Soy Oil Conversion Step

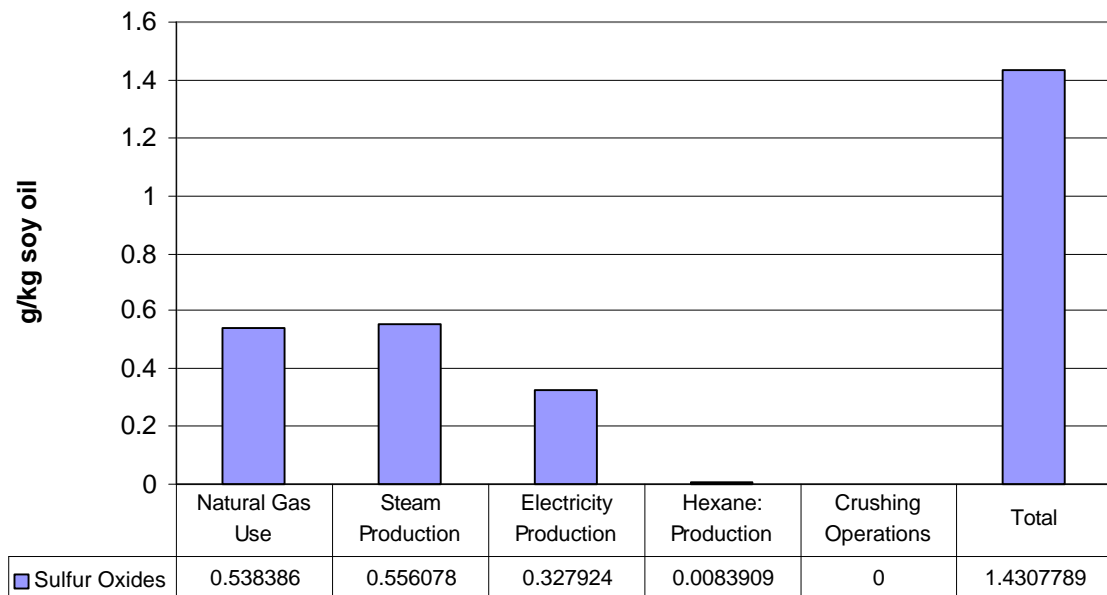

Figure 134: Source of SO_x from Soybean Crushing

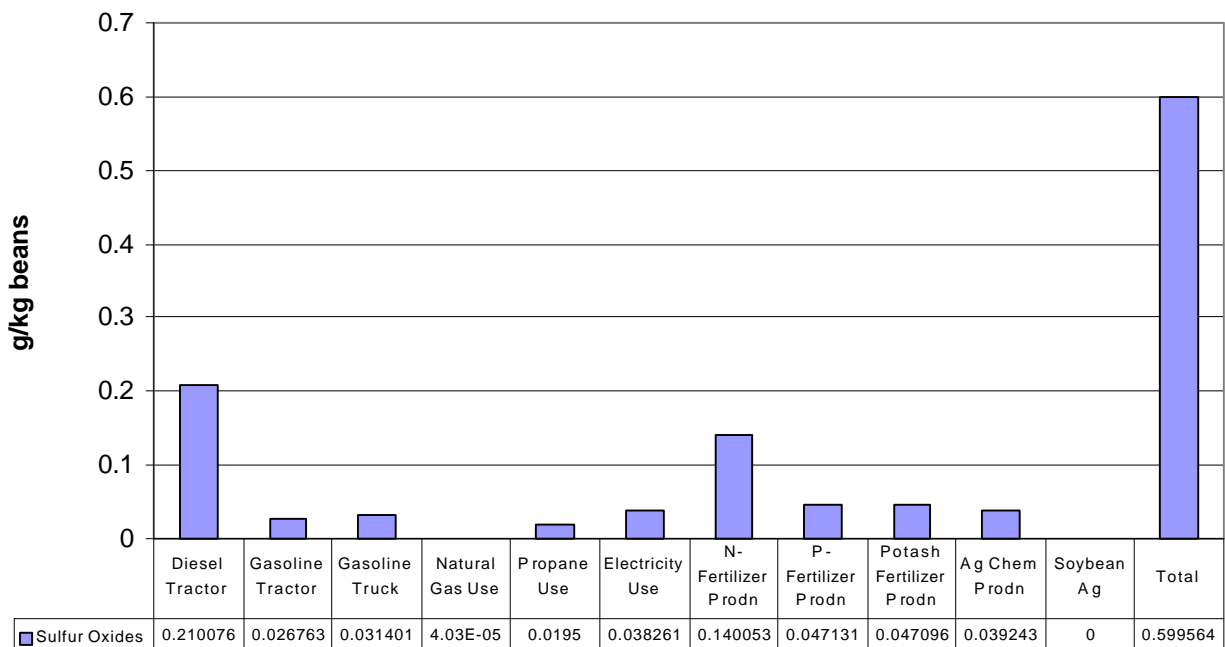

Figure 135: Sources of SO_x Emissions from Soybean Agriculture

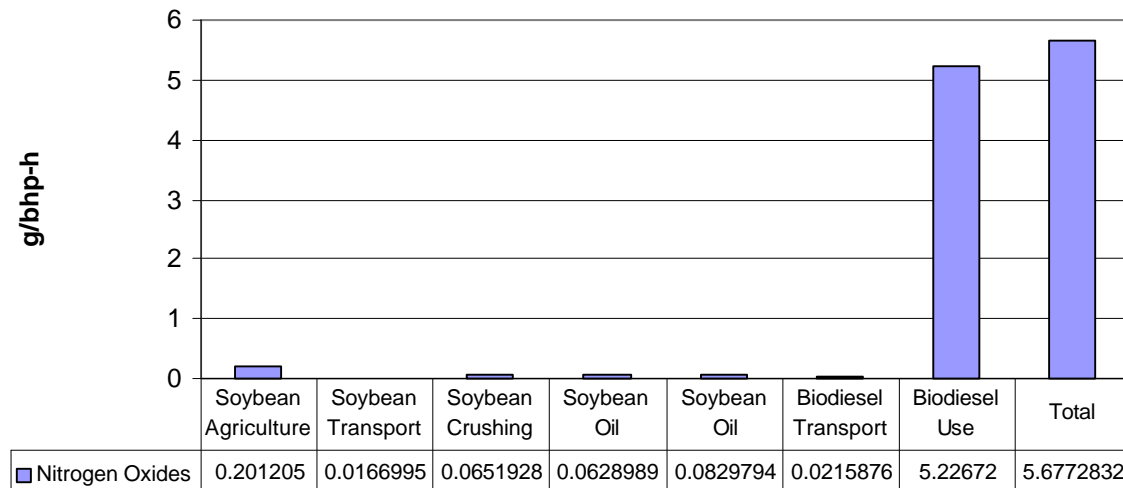

Figure 136: NO_x Emissions from Biodiesel Life Cycle

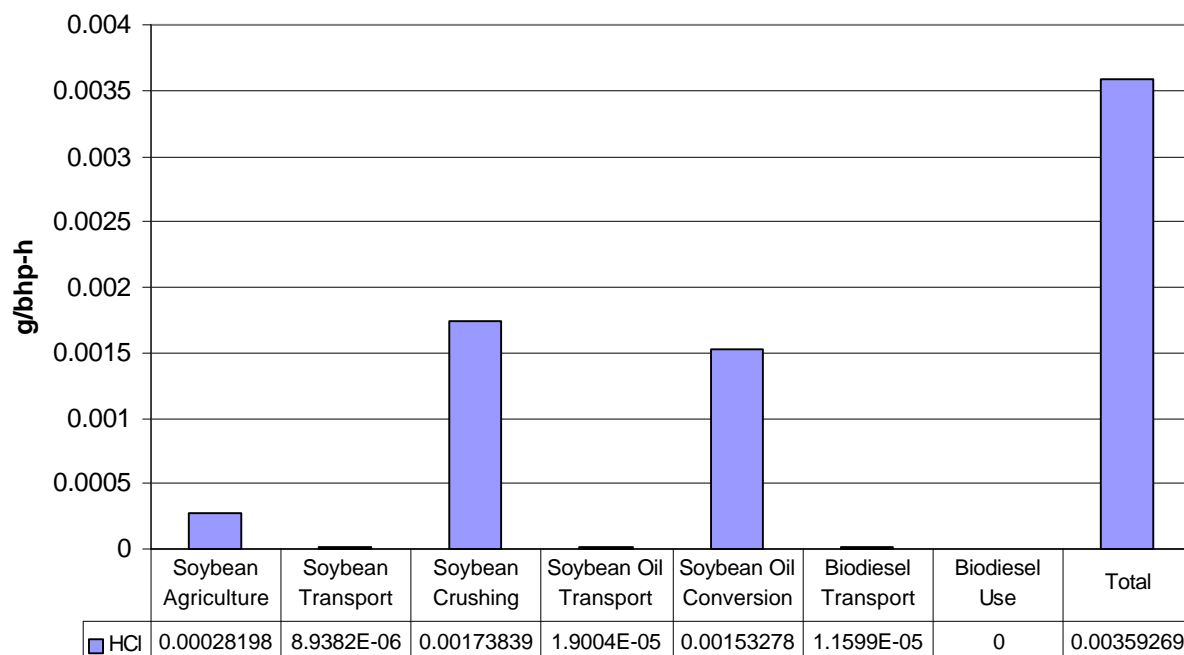

Figure 137: HCl Emissions from Biodiesel Life Cycle

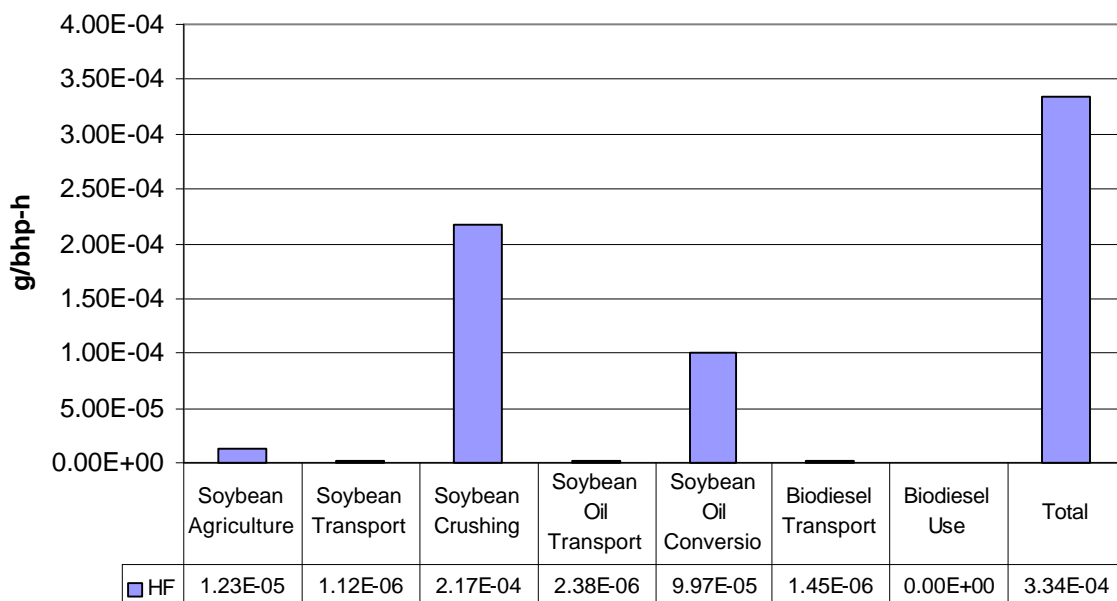

Figure 138: HF Emissions from Biodiesel Life Cycle

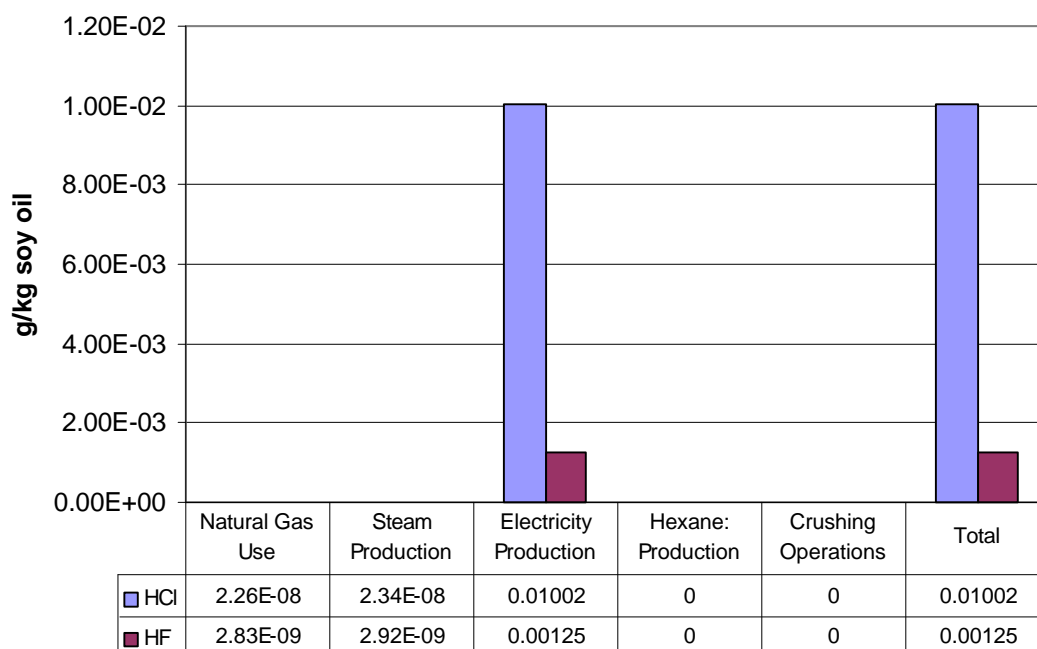

Figure 139: Sources of HCl and HF in Soybean Crushing

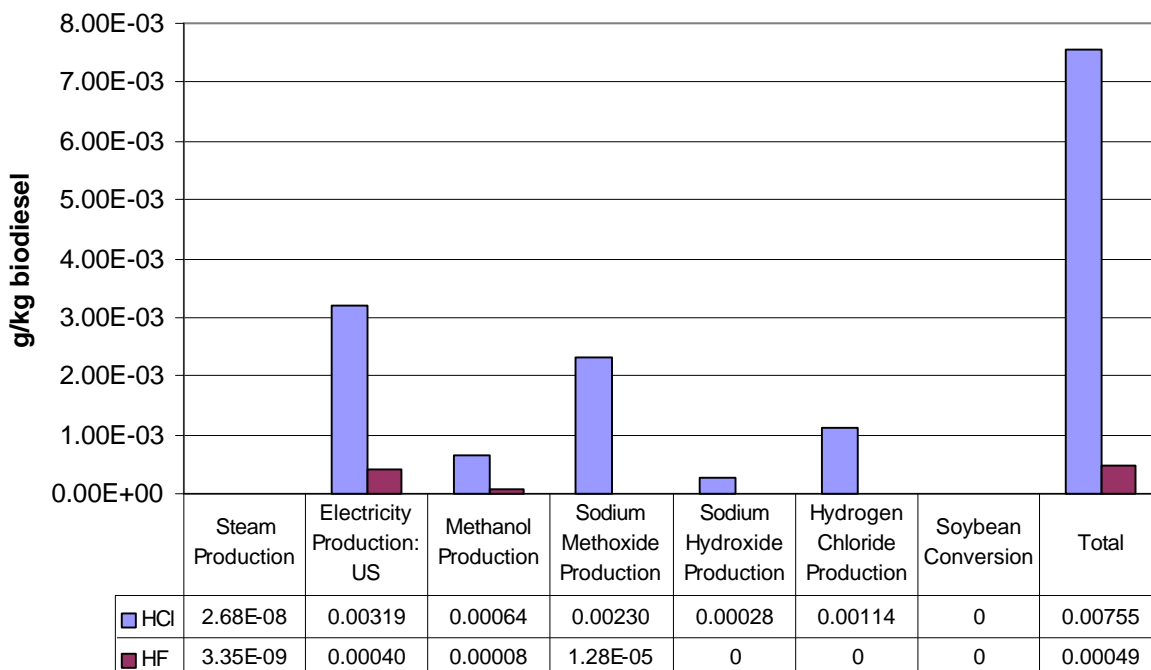

Figure 140: Sources of HCl and HF in Soy Oil Conversion

9.1.4.3 Comparison of Life Cycle Air Emissions from Biodiesel and Petroleum Diesel

Table 131 summarizes the overall life cycle air emissions for petroleum diesel, B20, and B100. This section provides a discussion of the relative differences in emissions for these three fuels.

Table 131: Air Emissions for Petroleum Diesel, B20, and B100 (g/bhp-h)¹¹²

Pollutant	Petroleum Diesel	B20	B100
CH ₄	0.202839	0.201795	0.197616
NO _x	0.006784	0.005887	0.002297
CO	1.26981	1.18219	0.831723
NMHC	0.131467	0.194075	0.44451
Hydrocarbons (unspecified) ¹¹³	0.249053	0.229605	0.151814
Benzene	4.24E-05	3.43E-05	1.84E-06
Formaldehyde	0.000568	0.000459	2.48E-05
PM10	0.084094	0.076589	0.046572
Particulates (Unspecified)	0.130281	0.123891	0.098329
SO _x	0.926335	0.911458	0.851949
NO _x	5.00856	5.1423	5.67728
HCl	0.003164	0.00325	0.003593
HF	0.000396	0.000383	0.000334
NH ₃	3.15E-08	0.014694	0.073471

Figure 141 displays THC emissions for these three systems. B100 increases THC emissions by 36%. The effect of blending is linear. Thus, increases in HCs for B20 are around 7%. The THC include CH₄. Figure 142 shows that CH₄ emissions for B100 and B20 actually drop slightly (2.56% and 0.5%, respectively). All the CH₄ savings occur in the fuel production and distribution steps. The largest contributor to CH₄ emissions in the biodiesel life cycle is the production of methanol required in the transesterification. Thus, another opportunity for reducing emissions is to substitute current methanol technology with a renewable process that does not start with natural gas as a feedstock. Likewise, substituting ethanol for methanol would reduce this source of CH₄ emissions. The effect of using ethanol or renewable methanol is not clear, however. A better understanding of life cycle flows for these alcohols

¹¹² Note that THC (not listed in the table) is the sum of benzene, formaldehyde, hydrocarbons (unspecified), NMHC (Non Methane Hydrocarbons), and CH₄. Similarly, data we report in other parts of this study for TPM (total particulate matter) represent the sum of PM10 and Particulates (unspecified). This latter category represents data in which the type of particulates measured was not specified.

¹¹³ Unspecified hydrocarbons are *not* the sum of NMHC and CH₄. This is because the unspecified category of emissions is ambiguous. We do not know if original data sources were referring to total hydrocarbons or NMHC. This ambiguity is a common problem in life cycle analysis because of the need to use data collected across a wide range of sources.

is needed. Furthermore, ethanol has other effects on the conversion technology for biodiesel that would have to be assessed.

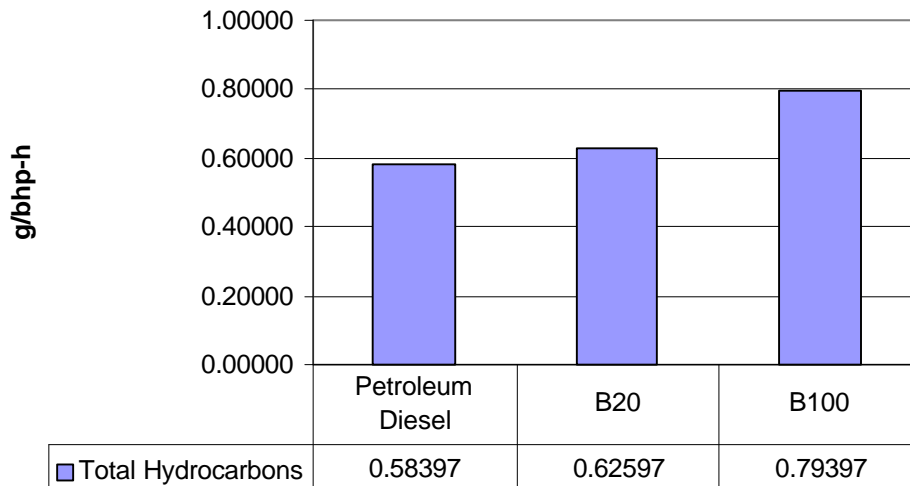

Figure 141: Life Cycle Emissions of THC for Petroleum Diesel, B20, and B100

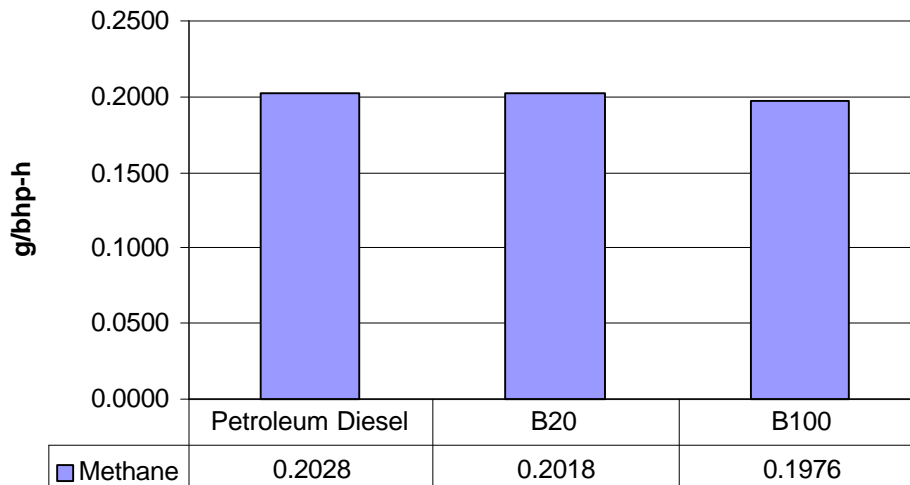

Figure 142: Life Cycle Emissions of CH₄ for Petroleum Diesel, B20, and B100

CO emissions for petroleum diesel, B20, and B100 show dramatic differences in life cycle emissions (see Figure 143). B100 has 34.5% lower emissions of CO on a life cycle basis. Because tailpipe emissions dominate both petroleum and biodiesel life cycles, the reductions in CO that occur at the end-use step are key factors in establishing life cycle emissions.

Interpreting the results of the TPM emissions inventories is complicated by the nature of the data collected. As indicated in the previous two sections, TPM data have been reported as PM₁₀ (particulate matter of 10 microns or less) and unspecified particulates. The most prudent way to compare these inventories is on the basis of TPM, which is the sum of both these types of PM. All three measures of TPM are shown in Figure 144. TPM drop 32.41% for B100 compared to petroleum diesel. Reductions in

PM10 look better. B100 provides a 44.6% reduction in PM10, though this result is ambiguous because of the lack of consistent data on PM10 throughout the life cycles of both petroleum diesel and biodiesel.

Figure 145 compares SO_x emissions for petroleum diesel and biodiesel blends. Even though biodiesel completely eliminates SO_x emissions from the tailpipe, its impact on life cycle emissions is not that great. B100 reduces SO_x emissions by 8.03% compared to petroleum diesel. There are two reasons for this. First, the relative contribution of SO_x emissions from the tailpipe in the petroleum life cycle is small (see Figure 118). Second, SO_x emissions in the fuel production and distribution steps for all these fuels very much depend on process energy consumption. Biodiesel and petroleum diesel have very similar process energy demands; thus, they exhibit relatively similar levels of SO_x emissions.

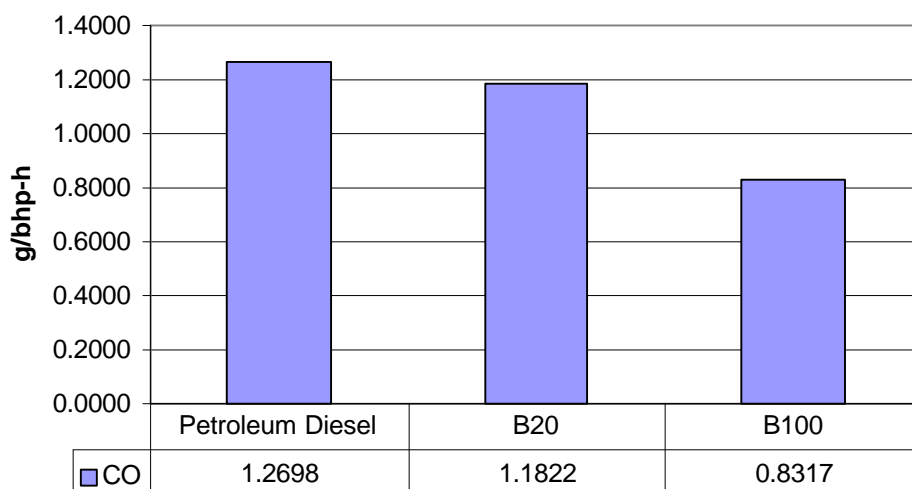

Figure 143: Life Cycle Emissions of CO for Petroleum Diesel, B20, and B100

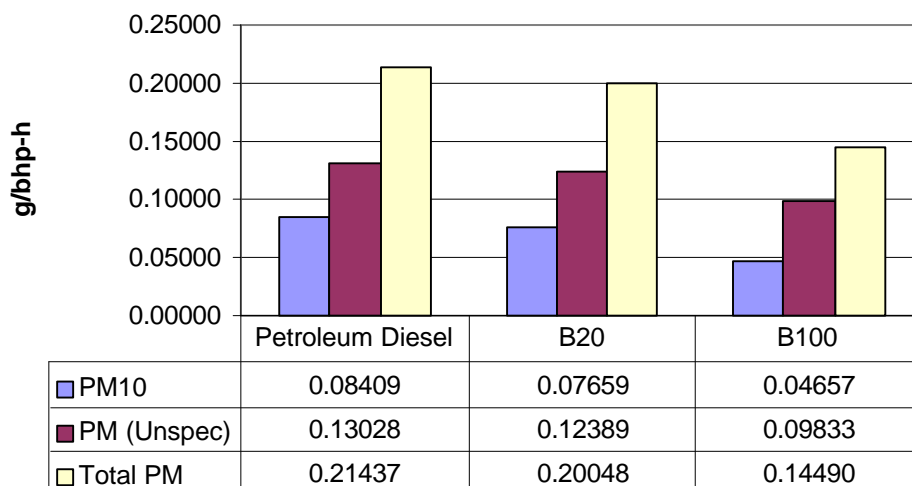

Figure 144: Life Cycle Particulate Matter Emissions for Petroleum Diesel, B20, and B100

NO_x emissions for all three fuels are presented in Figure 146. As discussed previously, biodiesel increases NO_x emissions in diesel engines¹¹⁴ unless adjustments are made to the engine, such as retarding of engine timing. Research is already underway to understand what causes NO_x to increase when biodiesel is used and to develop changes to the fuel to eliminate this problem. The results of this study underscore the importance of this kind of research for biodiesel. Our engine combustion model predicts a 8.89% increase in NO_x at the tailpipe when B100 is used, but the life cycle emissions for this fuel increase by 13.35%. The increased level of NO_x emissions for the life cycle versus the tailpipe emissions is caused by diesel fuel use in the agriculture step. Blending biodiesel with petroleum diesel mitigates NO_x emissions. B20 has life cycle emissions of NO_x that are 2.67% higher than petroleum diesel.

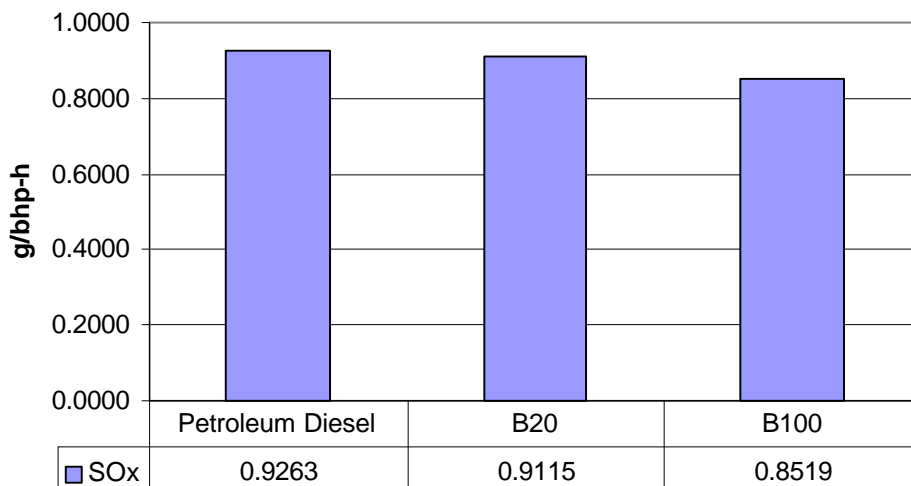

Figure 145: Life Cycle SO_x Emissions for Petroleum Diesel, B20, and B100

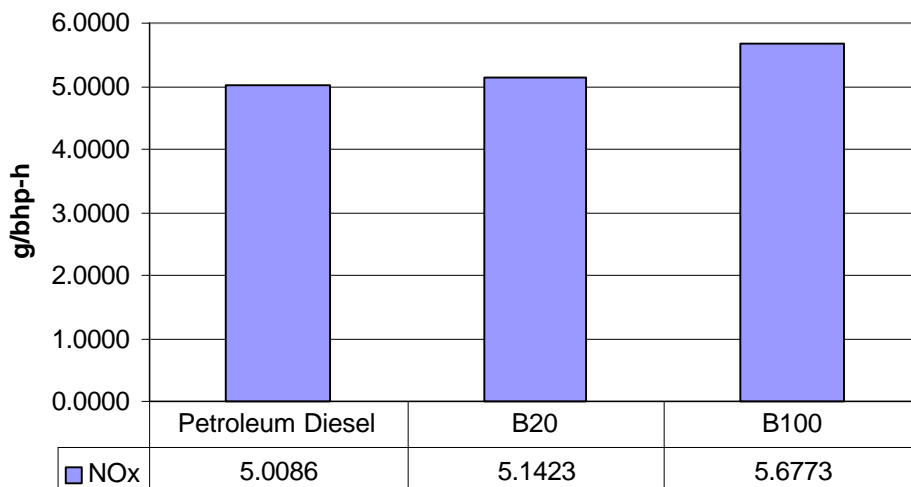

Figure 146: Life Cycle NO_x Emissions for Petroleum Diesel, B20, and B100

¹¹⁴ This affect appears to be smaller based on testing with newer engines. If most new engines demonstrate the same trend , life cycle NOx emissions for biodiesel may approach those of petroleum diesel.

Figure 147 shows life cycle emissions of HF for petroleum diesel, B20, and B100. Biodiesel reduces HF emissions; by 15.5% for B100 and 3.1% for B20. HF emissions correlate strongly with electricity consumption. The reduced emissions result from a reduction in electricity usage compared to petroleum diesel.

Figure 148 shows HCl emissions for petroleum diesel and the two biodiesel fuels. Biodiesel has 13.54% higher emissions of HCl on a life cycle basis than petroleum diesel. In the case of petroleum, HCl emissions correlated with electricity consumption, but biodiesel's emissions did not. The use of sodium methoxide, sodium hydroxide, and HCl increases emissions for biodiesel above those normally associated with power generation.

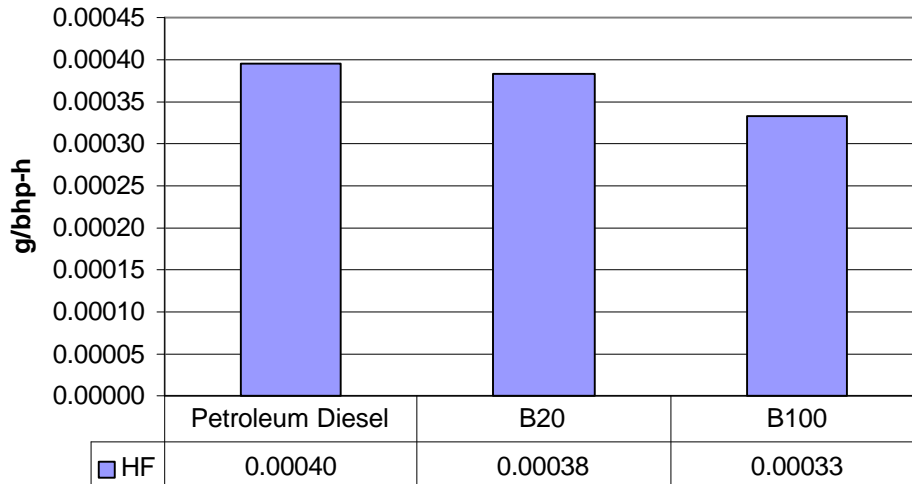

Figure 147: Life Cycle HF Emissions for Petroleum Diesel, B20, and B100

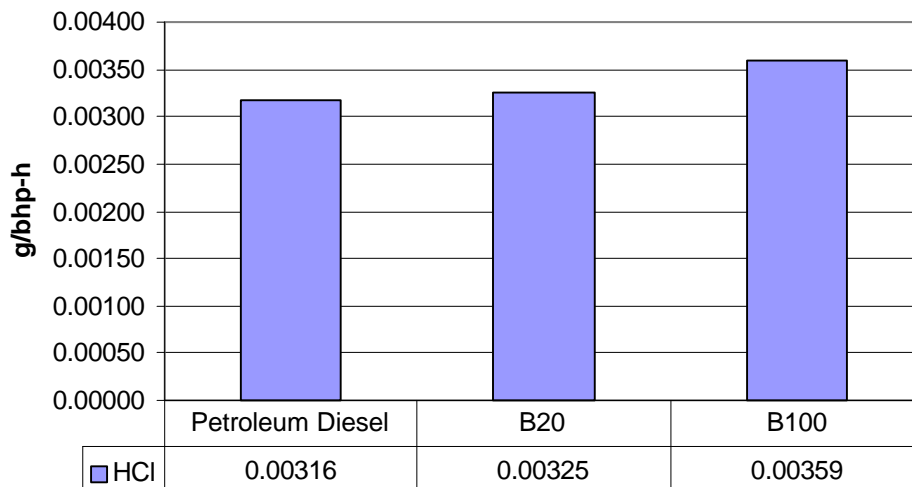

Figure 148: Life Cycle HCl Emissions for Petroleum Diesel, B20, and B100

9.1.4.4 Potential Effects of Biodiesel as a Diesel Substitute on Life Cycle Air Emissions

One way to summarize the comparison of biodiesel and petroleum diesel life cycle air emissions is to consider the relative change in life cycle emissions for each of the two biodiesel fuels, B20 and B100, using petroleum diesel as a baseline. These changes are shown in Table 132, Figure 149, and Figure 150.

The plots in Figure 149 and Figure 150 demonstrate that all the trends for life cycle emissions predicted by the LCI model are linear functions of biodiesel blend rate. This should be the case, because the emissions were modeled independently for each fuel, and no interacting effects associated with blending of the fuels was assumed. The most important assumption in this regard is for air emissions. The engine emission tests analyzed for this study support the assumption of linearity (see section 6.1.3 on tailpipe emissions for biodiesel and diesel fuel).

Table 132: Relative Change in Life Cycle Air Emissions for Fuels Containing 20% and 100% Biodiesel

Pollutant	B20	B100
CO	-6.90%	-34.50%
PM	-6.48%	-32.41%
HF	-3.10%	-15.51%
SO _x	-1.61%	-8.03%
CH ₄	-0.51%	-2.57%
NO _x	2.67%	13.35%
HCl	2.71%	13.54%
HC	7.19%	35.96%

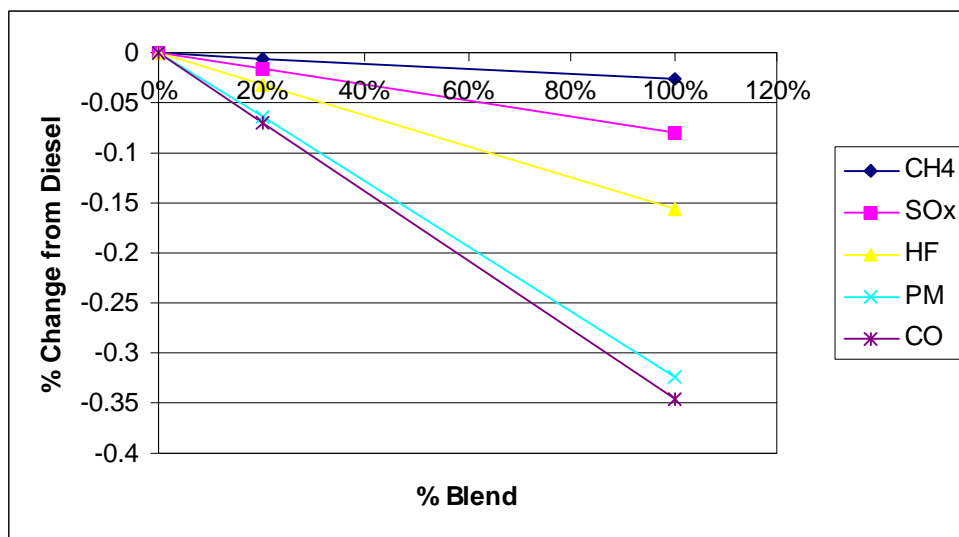

Figure 149: Effect of Biodiesel Blend on Life Cycle Air Emissions of CH₄, SO_x, HF, PM₁₀, and CO

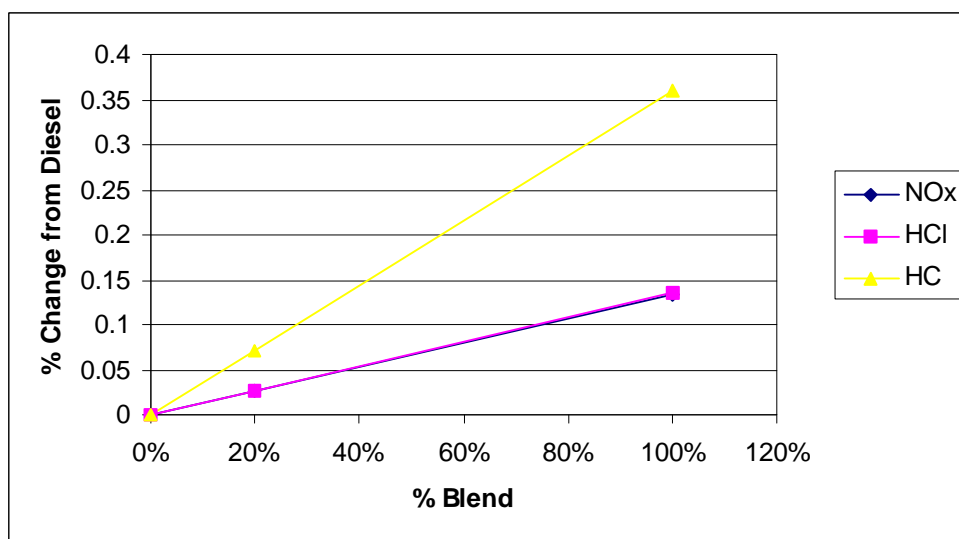

Figure 150: Effect of Biodiesel Blend Level on Air Emissions of NO_x, NMHC and HCl

The largest difference in air emissions for the two life cycles is for CO. Reductions in CO reach 34.5% when using B100. In terms of total emissions from diesel fuels, CO is also the second largest of all the air emissions on a mass basis. CO is a major target of EPA air quality standards because of its inherent health-related impacts in urban areas. It also plays a role in smog formation. Biodiesel could, therefore, be an effective tool for mitigating CO in EPA’s designated CO non-attainment areas¹¹⁵.

The next largest difference in air emissions for the two life cycles is for TPM. B100 exhibits life cycle emissions of TPM that are 32.41% lower than those of petroleum diesel. This improvement is a direct result of reductions in PM10 at the tailpipe of the bus. PM10 emitted from mobile sources is also a major EPA target because of its role in respiratory disease. Urban areas represent the greatest risk in terms of numbers of people exposed and level of PM10 present. Use of biodiesel in urban buses is potentially a viable option for controlling the emissions of PM10.¹¹⁶

On a life cycle basis, B100 increases life cycle THC emissions substantially, compared to petroleum diesel. The major cause of this increase is the release of hexane at the soybean crushing facility. It is important to keep in mind that tailpipe emissions of THC are lower for biodiesel-fueled buses than those for petroleum diesel-fueled buses. Where localized effects such as ground level ozone formation are concerned, biodiesel may prove to be beneficial because of its ability to reduce THC emissions that may contribute to smog in urban areas. Our results point out the need for research and development on soybean processing to look for ways to reduce or eliminate the emissions of hexane.

Life cycle emissions of CH₄ emissions are slightly lower for biodiesel, compared to petroleum diesel. All these emissions occur in the fuel production and utilization steps. As indicated in Figure 149 and Table 132, B100 has life cycle emissions of CH₄ that are 2.56% lower than those of petroleum diesel. CH₄ has

¹¹⁵ These are urban areas in the U.S. identified as not currently meeting National Ambient Air Quality Standards for levels of CO.

¹¹⁶ Among the options under consideration by EPA are regulations that would control levels of PM2.5, as opposed to PM10. PM2.5 includes particles of 2.5 microns or less in diameter. That is, EPA is focusing its attention on the very smallest particles in ambient air. Data collected in this study focus on PM10. While our results bode well for lowering levels of PM10, no information is available on the effect of biodiesel on this new class of smaller particles.

long been recognized as a greenhouse gas, with much greater greenhouse gas potential than CO₂. Thus, even though the relative reductions of CH₄ are small, the benefits of biodiesel's impact on greenhouse gas effects could be substantial¹¹⁷.

Perhaps the next most critical pollutant from the perspective of human health and environmental quality is NO_x. The triumvirate of CO, THC, and NO_x is the key to controlling smog in urban areas. The relative importance of each of these precursors is not at all clear, because they interact in a complex set of chemical reactions catalyzed by sunlight.¹¹⁸ When biodiesel is used as a substitute for petroleum diesel, it effectively reduces tailpipe emissions of two of the three smog precursors (CO and THC). However, it increases NO_x emissions. B100 exhibits 13.35% higher emissions of NO_x than petroleum diesel on a life cycle basis, mostly due to increases of NO_x that occur at the tailpipe. It is almost an aphorism in the engine industry that PM10 and NO_x emissions are two sides of a technology trade-off. Biodiesel seems to fit this observation. Dealing with this trade-off involves a combination of fuel research and engine technology research. With these two degrees of freedom, solutions are potentially achievable that meet the tougher future standards for NO_x without sacrificing the other benefits of this fuel.

Life cycle emissions of SO_x are reduced by only 8% when B100 is used as a diesel fuel substitute. This is a relatively low reduction given that biodiesel completely eliminates SO_x at the tailpipe. The amount of SO_x in the emissions from a diesel engine is a function of sulfur content in the fuel. With this in mind, EPA regulates sulfur content in diesel fuel, rather than regulating the tailpipe emissions. The latest requirements for diesel fuel include 0.05 wt% sulfur for on-highway fuel. Biodiesel can eliminate SO_x emissions because it is sulfur-free.

HCl and HF are emitted in very low levels as a part of the life cycles of both petroleum diesel. Both occur as a result of coal combustion in electric power generation. HF levels drop with biodiesel in proportion to the amount of electricity consumed over the life cycle of the fuel. This amounts to 15.51% reductions for B100. HCl emissions, on the other hand, increase with biodiesel blend. Biodiesel has additional sources of HCl associated with the production and use of inorganic acids and bases used in the conversion step. B100 increases emissions of HCl by 13.54%.

9.1.4.5 Tailpipe Emissions for Petroleum Diesel and Biodiesel

Unlike CO₂ emissions, the air pollutants from diesel engines that are regulated by EPA tend to have more localized effects. Effects of CO, THC, NO_x, and TPM (particularly PM10) are acutely important in localized urban areas. Therefore, it is important to understand emission levels at the engine tailpipe as well as on a life cycle basis. Furthermore, as the previous discussion illustrates, life cycle emissions of the regulated air pollutants are substantially different from what is seen at the tailpipe. With these points in mind, we present in this section a discussion centered on a comparison of the tailpipe emissions from biodiesel and petroleum diesel. We contrast life cycle and tailpipe emissions for each pollutant, with some indication of the relative importance of one versus the other. The tailpipe emissions presented here are based entirely on the extensive review of engine performance and engine emissions data for petroleum diesel and biodiesel, as presented in the section on urban bus operations.

Table 133 summarizes typical diesel exhaust emissions for 1994 bus engines. These emissions were used as a baseline for modeling diesel engine emissions for petroleum diesel and biodiesel. The emissions of

¹¹⁷ While methane is a more potent greenhouse gas, its half-life in the atmosphere is less than that of carbon dioxide. These complications in understanding the impact of each pollutant illustrate why we have avoided making quantitative judgements about the life cycle impacts of biodiesel. We leave it to others to evaluate the comparative inventories of biodiesel and diesel in terms of their positive and negative impacts.

¹¹⁸ For an excellent discussion of the complexities of urban air pollution, see Seinfeld, John H., "Urban Air Pollution: State of the Science" in *Science*, Vol 243, pp 745-752.

NMHC, PM10, CO and NO_x are actually monitored by EPA on a normalized basis of 1 bhp-h of delivered work (the same functional basis used in the LCI for this study). The SO_x emission shown in this table is based on diesel engine performance for current low-sulfur diesel as designated for on-highway use.

Table 133: Baseline Diesel Engine Emissions for Low-Sulfur Petroleum Diesel¹¹⁹

Air Pollutant	g/bhp-h
CO	1.1
NMHC (Hydrocarbons except methane)	0.1
PM10)	0.08
SO _x	0.17
NO _x	4.8

In this study, bus engines were assumed to be calibrated to the 1994 engine emissions listed in Table 133. Changes in performance for the engines when operated on biodiesel were predicted using generalized correlations of engine emissions data to predict relative changes for a given engine. The results of the LCI model should only be used to evaluate comparative performance of diesel engines operating petroleum diesel and biodiesel. Emission results presented here should not be used to judge absolute performance of engines operating on these fuels against EPA regulations, because they do not reflect emission levels of specific engines.

Tailpipe emissions for these regulated pollutants are shown in Figure 151 and Figure 152 for petroleum diesel, B20, and B100. Biodiesel's greatest impacts are, in order of importance, on SO_x, PM10, NMHC, and CO emissions.

SO_x emissions are completely eliminated when neat biodiesel is used because biodiesel is sulfur free. By contrast, the life cycle reductions of SO_x for B100 are only 8%. B20 provides a 20% reduction in sulfur. B100 and B20 reduce tailpipe emissions of PM10 by 68% and 13.6%, respectively. NMHC is reduced by 36.70% when B100 is used, and by 7.3% when B20 is used. CO emissions from the tailpipe drop by 46.23% and 9.3%, respectively, when B100 and B20 are used. Biodiesel's effects on CO, NMHC, and PM10 are due to the fact that this fuel contains molecular oxygen, and thus improves overall combustion.

Biodiesel actually causes an increase in NO_x emissions. B100 has tailpipe emissions that are 8.89% higher than those of petroleum diesel. At the lower level of biodiesel in B20, this effect is reduced to about 2%. Changes in engine timing can effect a trade-off between TPM and NO_x emissions on current engines. Smaller changes in NO_x emissions for B100 and B20 have been observed in current research programs on new engine models, but it is still too early to predict whether all or just a few future engines will display this characteristic.

¹¹⁹ CO, NO_x, NMHC and PM10 emissions are based on 1994 calibration data from the U.S. Environmental Protection Agency's report *1994 Summary Report: Diesel Heavy Duty Engines*. August 24, 1994. Downloaded from the EPA Office of Mobile Sources website at www.epa.gov/omswwww/gopher. SO_x is based on emissions from engines using .05 wt% sulfur diesel fuel.

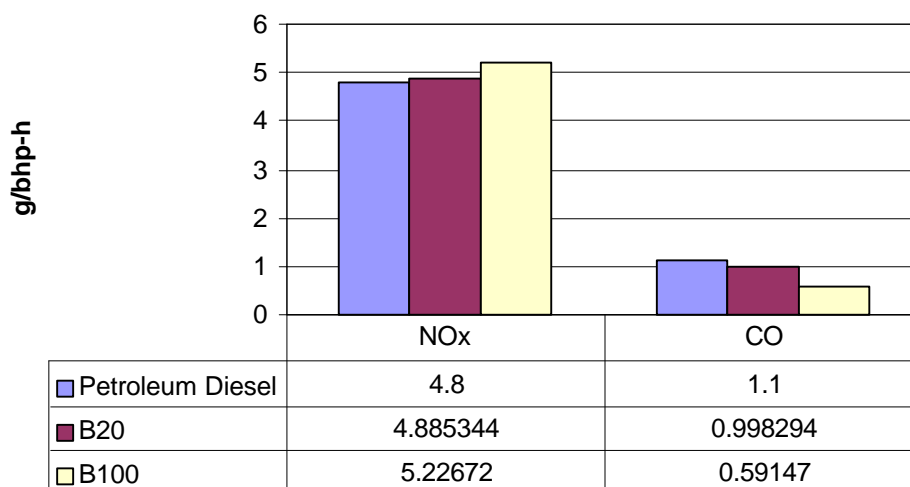

Figure 151: Tailpipe Emissions of CO and NO_x for Petroleum Diesel and Biodiesel

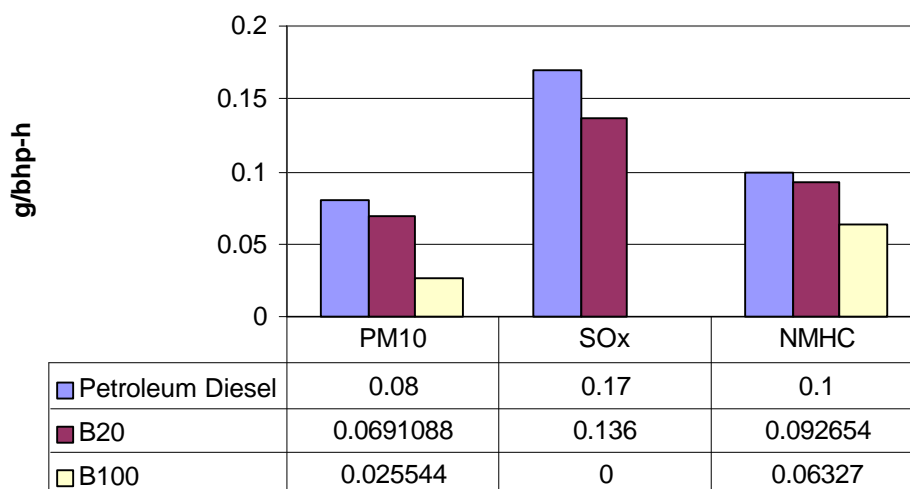

Figure 152: Tailpipe Emissions of PM10, NMHC and SO_x for Petroleum Diesel and Biodiesel

Not only does biodiesel reduce the total level of particulates emitted at the tailpipe of a diesel engine, but it also changes the character of the particulates emitted. As discussed in the section on urban bus operations, PM10 consists of a soot fraction and a VOF. The soot, which is carbon produced by pyrolysis reactions during combustion, drops dramatically as biodiesel is added to the fuel blend. Figure 153 shows the emissions of soot for petroleum diesel, B20, and B100. Biodiesel has a greater impact on soot. B100 emits 83.6% less soot than petroleum diesel. B20 reduces soot by 22%. Although the environmental impacts of reducing soot versus TPM are not clear¹²⁰, there is an aesthetic benefit associated with

¹²⁰ Mauderly, in a recent paper from Lovelace Laboratories, a leading research firm in health effects of diesel and biodiesel particulate matter, provides a theory and data that claim soot leads to cancerous growths in mice populations. The effect on human populations is under debate.

significantly less visible smoke observed from the tailpipe. For urban bus operators, this translates to improved public relations.

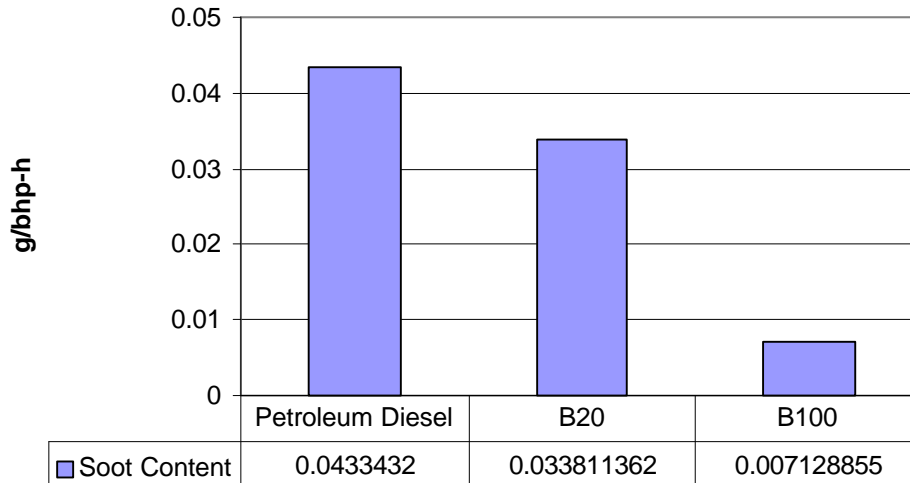

Figure 153: Effect of Biodiesel on Tailpipe Emissions of Soot

9.1.5 Life Cycle Emissions of Water Effluents

We tracked a number of waterborne effluents through the life cycles for petroleum diesel and biodiesel such as BOD and COD. Specific data are presented for each part of the life cycles in the previous sections. However, relatively few data were consistently available. Therefore, the comparisons of the two life cycles are limited to total flow of wastewater. Figure 154 summarizes wastewater flows associated with petroleum diesel. Foreign and domestic crude oil extraction account for 78% of the total wastewater flow. Only about 12% is associated with the refinery. Figure 155 shows the distribution of wastewater flows for the biodiesel life cycle. Two-thirds of the total wastewater flows in the life cycle for biodiesel come from the soy oil conversion process. This step in the life cycle generates relatively dilute wastewater containing oil and soap from the processing of the soybean oil. A comparison of total wastewater flows from the life cycles for petroleum diesel and biodiesel is shown in Figure 13. Petroleum diesel generates roughly five times as much wastewater flow as biodiesel.

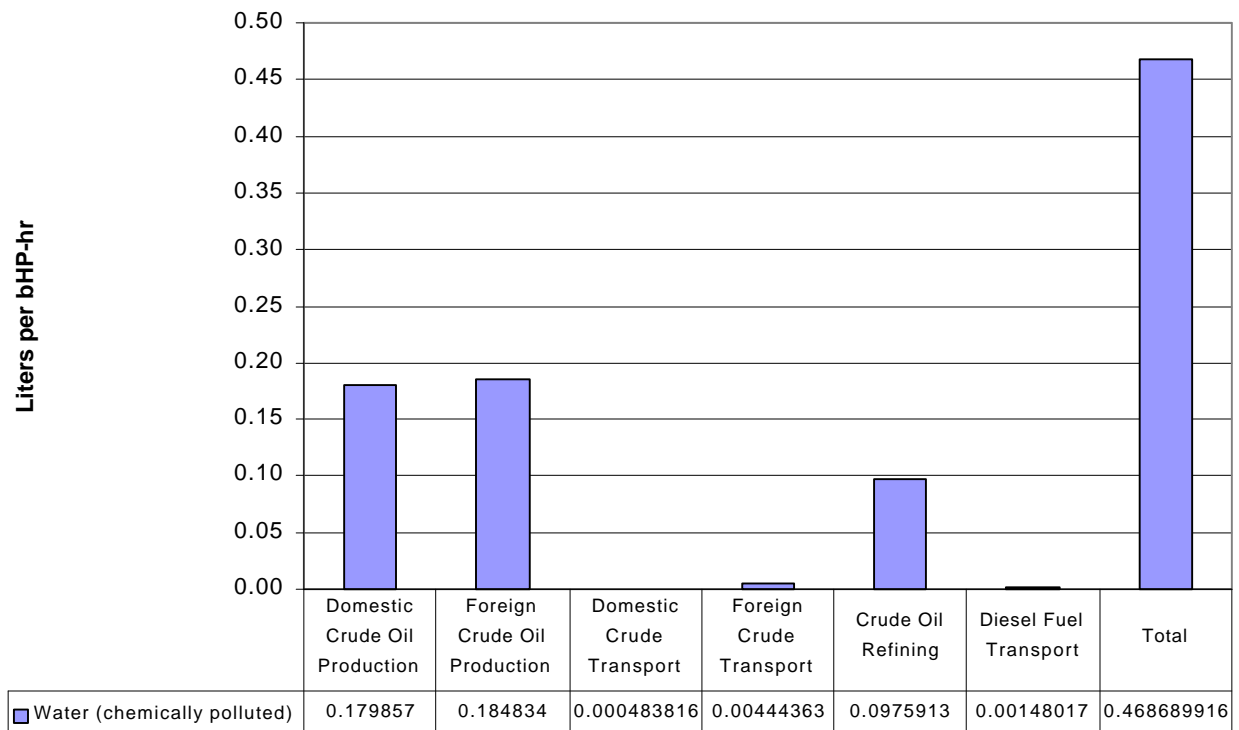

Figure 154: Wastewater Flows for Petroleum Diesel Life Cycle

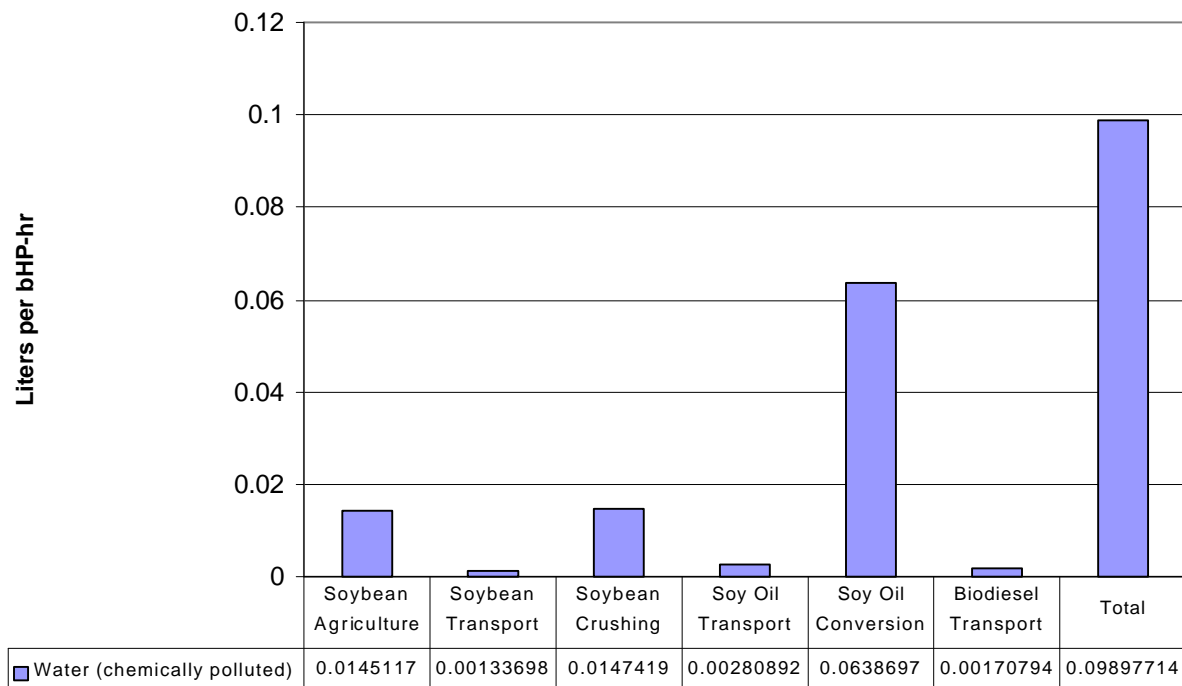

Figure 155: Wastewater Flows for Biodiesel Life Cycle

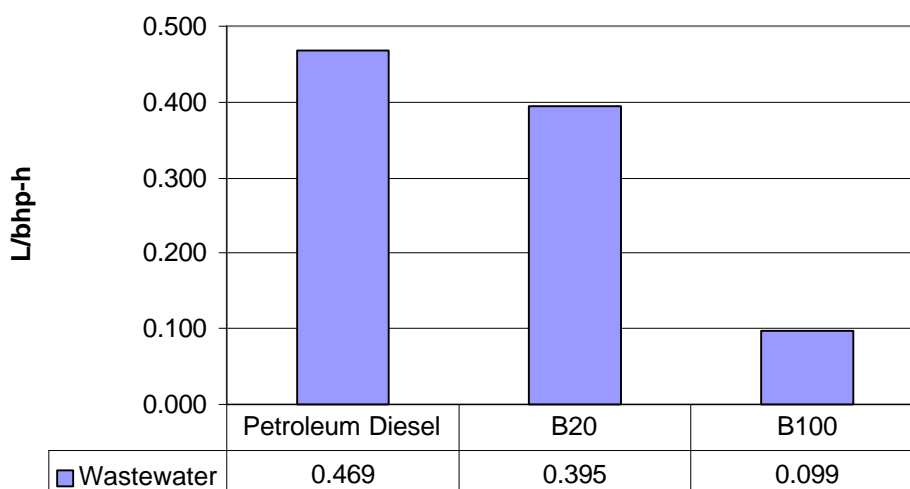

Figure 156: Comparison of Life Cycle Wastewater Flows for Petroleum Diesel and Biodiesel Life Cycles

9.1.6 Life Cycle Flows of Solid Waste

Solid waste from the two life cycles is classified as hazardous or nonhazardous. Figure 157 shows the life cycle contributions to solid waste for petroleum diesel. Hazardous waste is derived almost entirely from the crude oil refining process. The minor levels of solid waste that show up in foreign crude transport and diesel fuel transport are indirect flows of solid waste attributable to diesel fuel consumption in the transportation process. Total hazardous waste generation amounts to 0.41 g/bhp-h of engine work. Nonhazardous waste flows are shown in Figure 158. Just over half of the non-hazardous waste is generated in the crude oil refining step. Another one-third is generated in the foreign and domestic crude oil extraction steps. Total nonhazardous waste generation is 2.8 g/bhp-h.

Figure 159 presents data on hazardous waste generation from the biodiesel life cycle. Hazardous waste amounts to only 0.018 g/bhp-h of engine work. Surprisingly, the most significant source of this hazardous waste is farming. Soybean agriculture produces 70% of the hazardous waste from the entire life cycle. An inspection of the sources of hazardous waste from farming (as shown in Figure 161) reveals that these flows are indirect charges against agriculture for hazardous waste flows associated with the production of diesel and gasoline used on the farm. Likewise, the remaining hazardous waste in the life cycle for biodiesel stems from fuel use for transport of materials. Nonhazardous solid waste from the biodiesel life cycle is summarized in Figure 160. Biodiesel generates 6.1 grams of nonhazardous waste per brake horsepower-hour of engine work. Figure 162 and Figure 163 compare hazardous and nonhazardous solid waste generation for petroleum diesel and biodiesel. B100 reduces hazardous waste by 96% compared to petroleum diesel. Nonhazardous waste, on the other hand, is twice as high for B100. Given the more severe impact of hazardous versus nonhazardous waste disposal, this is a reasonable trade-off.

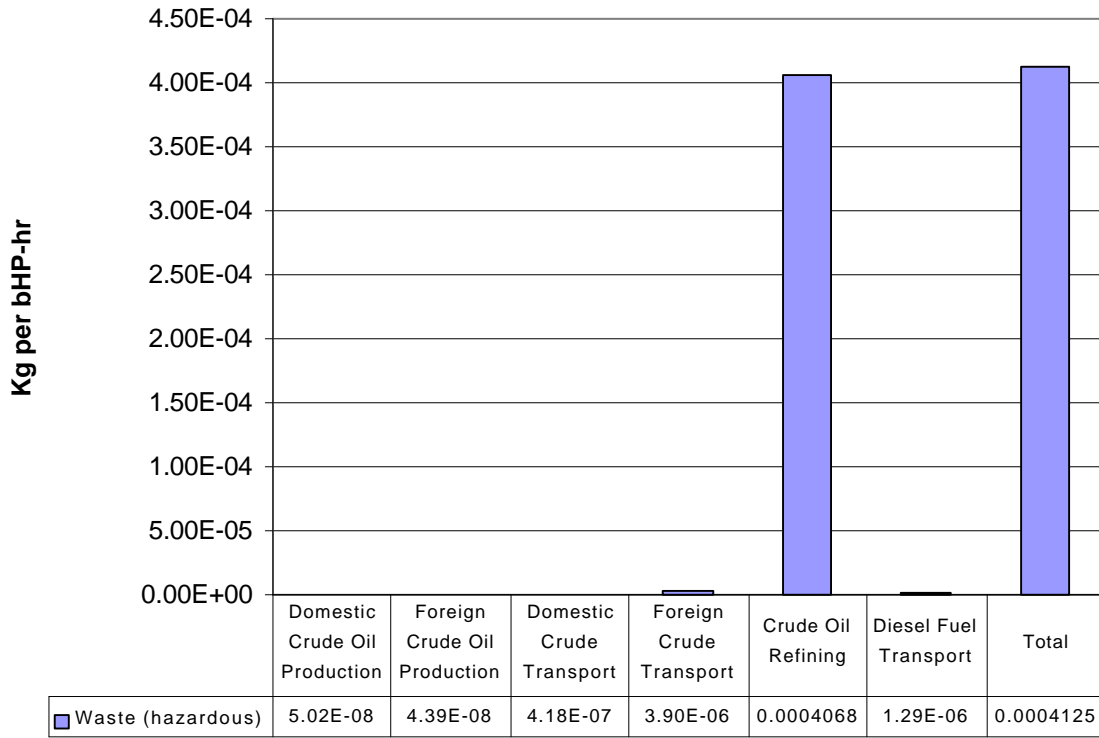

Figure 157: Life Cycle Emissions of Solid Hazardous Waste for Petroleum Diesel

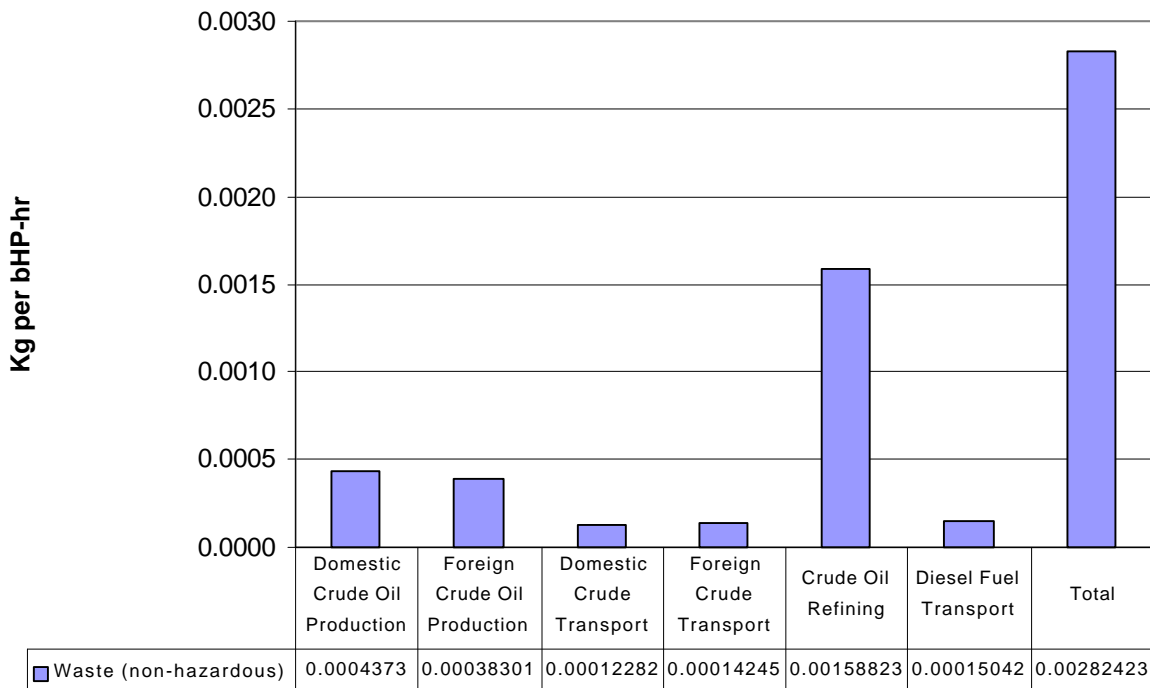

Figure 158: Life Cycle Flows of Nonhazardous Waste for Petroleum Diesel

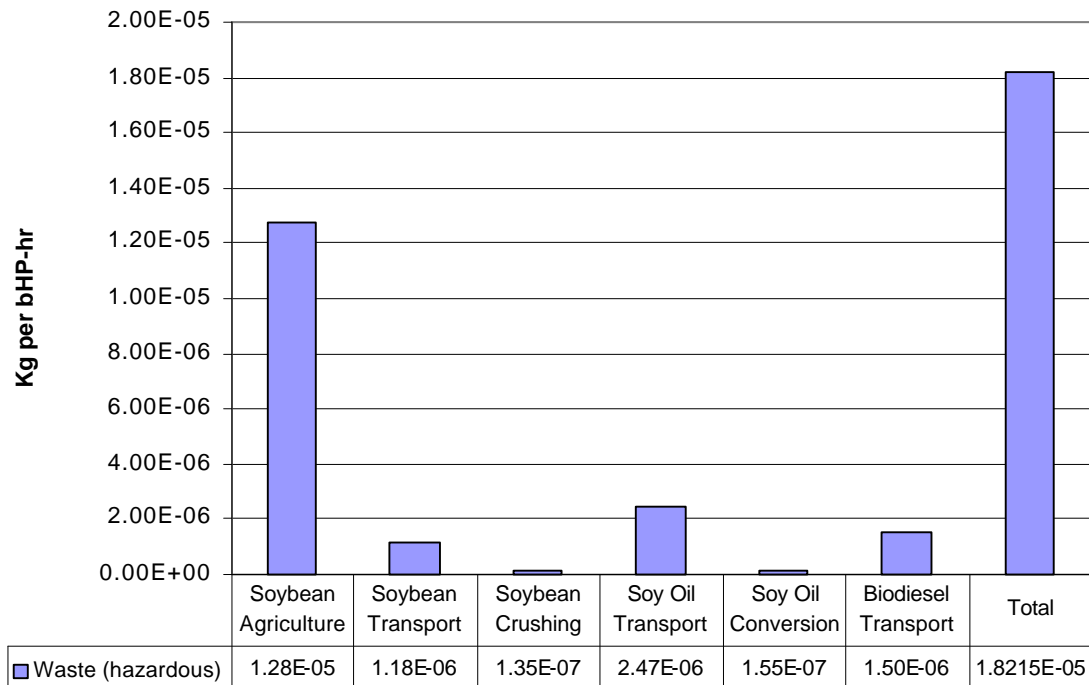

Figure 159: Life Cycle Flows of Hazardous Solid Waste for Biodiesel

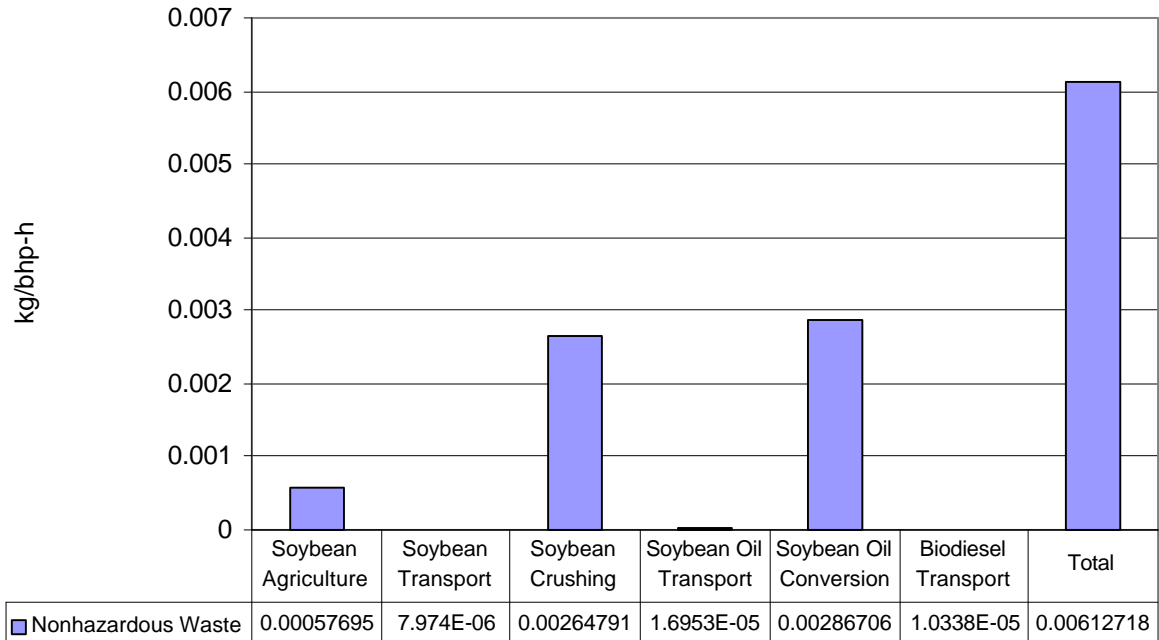

Figure 160: Life Cycle Flows of Nonhazardous Solid Waste for Biodiesel

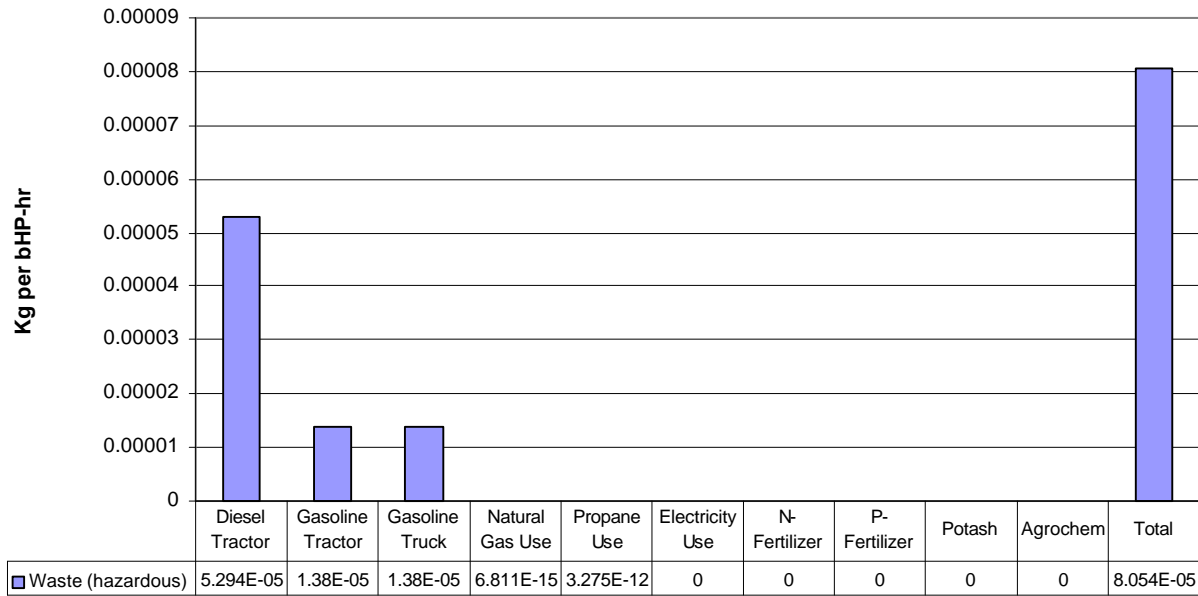

Figure 161: Sources of Hazardous Waste in Soybean Agriculture

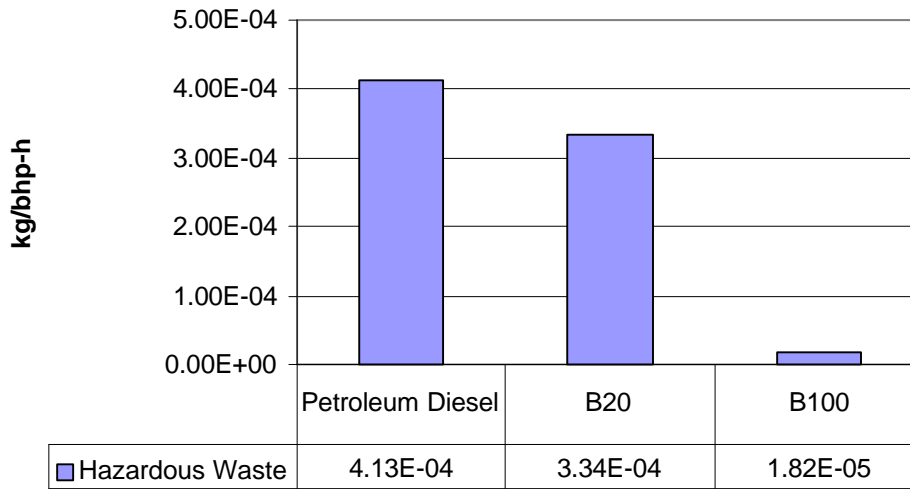

Figure 162: Hazardous Waste Generation for Petroleum Diesel, B20, and B100 Life Cycles

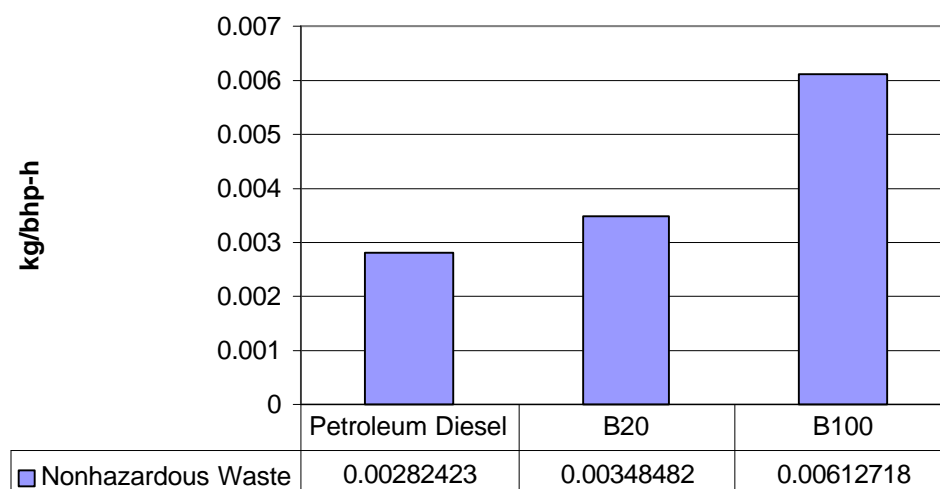

Figure 163: Nonhazardous Waste Generation for Petroleum Diesel, B20, and B100 Life Cycles

9.2 Sensitivity Studies

The purpose of conducting sensitivity studies on the life cycle of biodiesel is to establish the potential range for improvement in the fuel, and to establish the range of possible error associated with the assumptions made in the model. The LCI assumes a “current” time frame—that is, we are looking at existing agriculture, conversion technology, and engine technology within a short-term horizon. This sets realistic limitations on the bounds of the assumptions used in the model. In each step in the life cycle, we have considered where the potential for near-term improvements is.

In agriculture, there is certainly the possibility of genetic engineering designed to improve the per acre yield of oil in soybeans. The potential for such improvements is probably outside the time frame of this study, especially because any such changes in the soybean will be carefully considered against the risk of reducing meal productivity. Meal is the primary product from soybeans, and any alterations that switch the product mix from beans toward oil may not be desirable to the economics of the crop. In looking at the range of potential improvements in agriculture, we therefore limited ourselves to the range of possible efficiencies in soybean farming today in the United States. We chose to study the effect of producing and selling biodiesel in an optimal soybean-growing region. We selected a scenario in which Chicago is the target market for fuel sales to urban bus operators. This puts the marketplace close to one of the most efficient soybean-growing regions in the United States

Soybean crushing operations are based on well-established technology. Our model for soybean crushing is based on detailed operating information on a current soybean processor. Our results compare well with other published data on material and energy balances for this type facility. We did not consider any scenarios for improving the soybean crushing process. Future efforts in evaluating the life cycle of biodiesel production should look at this part of the life cycle. Alternatives to current hexane-based technology exist. These alternatives, as well as strategies for controlling hexane emissions from existing plants, should be explored since hexane emissions represent the bulk of the life cycle THC emissions.

Biodiesel conversion technology is also quite old. The commercial facility used in the LCI model is more than 40 years old. The technology developments for transesterification of soybean oil date back to the early part of this century. At first glance, it would appear that there is little potential variation for this part of the biodiesel life cycle. This turns out not to be the case. The recent interest in transesterification technology for biodiesel production has spurred a great deal of technology development in the past 15

years. Much of this activity has occurred in Europe, where new biodiesel production facilities have come on line in great numbers¹²¹. Therefore, we decided that this area warranted further evaluation because if the industry expands, we assume investors and developers will choose to use the most efficient technologies available compared to the older technology currently in place in the United States.

Like biodiesel production technology, diesel engine technology has gone through rapid change in the past decade, driven for the most part by the demand for improved emissions. We nevertheless chose not to evaluate this area. A great deal of new information is soon to be available on the performance of new engines designed to meet stricter standards for PM10 and NO_x. Rather than try to predict where this technology is going, and what its impact on biodiesel might be, we simply state here that new engines are being tested that may solve the problem of increased NO_x emissions, as identified in this study.

9.2.1 The Effect of an Enhanced Location for Biodiesel Production and Use

As indicated in the previous section, we studied the effect of placing biodiesel production and use in an ideal location, in lieu of the assumed national average conditions used in the base case inventory. To that end, we chose to model biodiesel production and use in the Chicago area. This location provides a good outlet for biodiesel sales for the urban bus end-use we modeled. More importantly, it allows us to consider near-term access to some of the best soybean farmland in the United States. This scenario reduces the distances required to move beans, oil, and biodiesel, and allows us to take advantage of high-yield soybean agriculture.

Basic changes to the model are shown in Table 134. The reduced distance for shipping of soybean oil is based on an evaluation of the location of crushing facilities to potential market locations. The results of the model with these assumptions is presented for B100, with the understanding that the improvements or worsening in life cycle emissions relative to petroleum diesel are proportional to the blend level.

Table 134: Model Parameters for the Chicago Area Biodiesel Scenario

Model Parameter	Baseline Scenario	Chicago Area Scenario
Soybean Agriculture	Yields and inputs based on national average (14 key soybean-producing states)	Yields and inputs based on production of soybeans from Illinois and Iowa. 50% of soybean supply is taken from each state.
Transport distances	National average distance for soy oil of 571 miles	Reduced distance of travel of 248 miles.

Changes in resource demands for this scenario are summarized in Table 135. Highlights of these results are presented immediately following this table. Placing biodiesel production and use in the Chicago area has positive benefits on energy consumption (see Figure 16). Impacts on natural gas and coal consumption are minor (2% and 4% savings, respectively). Petroleum consumption, on the other hand, drops by 24% from the national average base case. This leads to a slight increase in life cycle energy efficiency from the base case value of 81.5% to 82.7%. Biodiesel's fossil energy ratio increases from 3.216 to 3.430. The energy savings occur primarily on the farm. Figure 165 shows that process energy requirements for farming drops by 24%. Energy savings of 57% are also realized in the soy oil transport step; but this impact is smaller because of the relatively small contribution to energy demand made by this step. Water use drops dramatically in the Chicago area scenario. Biodiesel consumes 31% less water in this scenario.

¹²¹ As early as 1993, capacity in Europe for biodiesel production had reached levels of 376,000 metric tons per year (*Chemical Engineering*, February 1993).

**Table 135: Chicago Scenario Life Cycle Resource Demands for Biodiesel
(kg/bhp-h)**

Primary Resources	Petroleum Diesel	Biodiesel Base Case	Biodiesel Chicago
Coal (in ground)	0.00589	0.007028	0.006716
Limestone (CaCO ₃ , in ground)	0.00112	0.001140	0.001139
Natural Gas (in ground)	0.01620	0.030748	0.030095
Oil (in ground)	0.18894	0.010112	0.007733
Perlite (SiO ₂ , ore)	4.30E-05	1.87E-06	1.34E-06
Phosphate Rock (in ground)	0	0.009397	0.011447
Potash (K ₂ O, in ground)	0	0.004417	0.004931
Sodium Chloride (NaCl)	0	0.003499	0.003499
Uranium (U, ore)	1.41E-07	1.87E-07	1.78E-07
Water Used (total)	0.02629	86.3636	59.8778

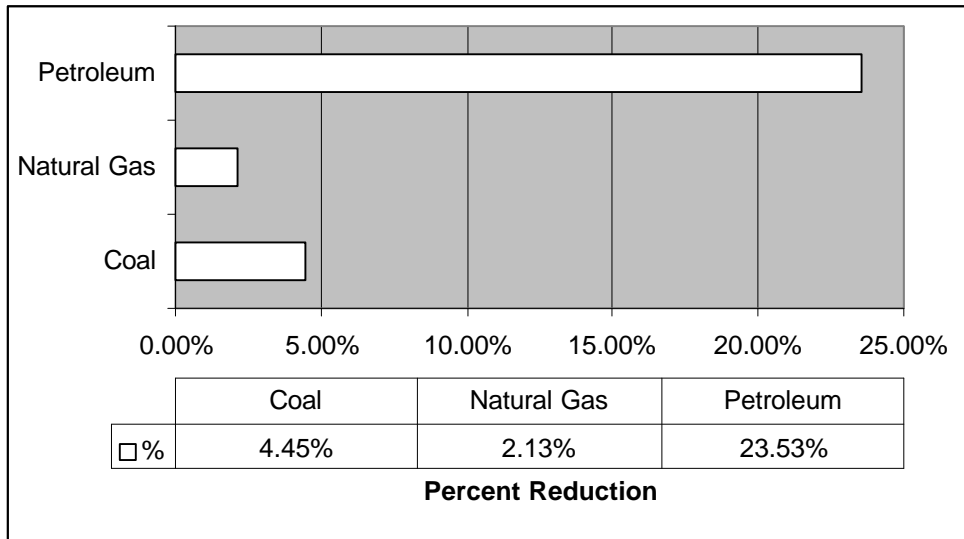

**Figure 164: The Effect of an Ideal Location for Biodiesel on
Life Cycle Consumption of Primary Energy Resources**

Air emissions for the Chicago area scenario are summarized in Table 136. The percent reductions of key pollutants are tabulated in Figure 166. The largest saving is for ammonia, which drops by 42%. The drop of 10% in PM10 emissions is consistent with the reductions in petroleum consumption associated with diesel fuel use on the farm. The Chicago scenario provides additional savings of 7% in CO₂ emissions. All other emissions savings are less than 4%.

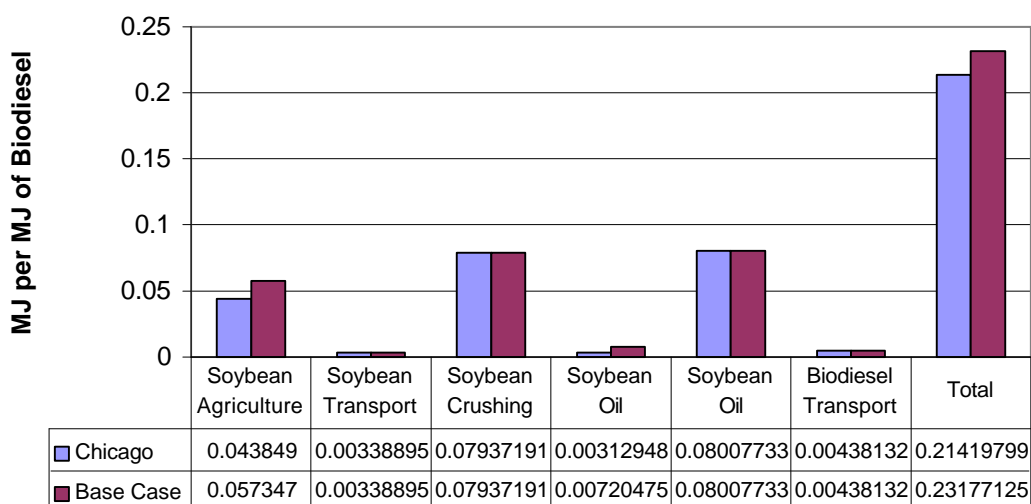

Figure 165: Sources of Energy Savings in the Chicago Area Biodiesel Scenario

Table 136: Life Cycle Air Emissions for Chicago Area Biodiesel Scenario

Air Pollutant	Petroleum Diesel	Biodiesel Base Case	Biodiesel Chicago	% Change from Biodiesel Baseline
Ammonia (NH ₃)	3.15E-08	0.07347	0.04243	-42%
Benzene	4.24E-05	1.84E-06	1.32E-06	-28%
Carbon Dioxide (CO ₂)	633.275	136.447	126.892	-7%
Carbon Monoxide (CO)	1.2698	0.831723	0.7883	-5%
Formaldehyde	0.000568	2.48E-05	1.79E-05	-28%
Hydrocarbons (except CH ₄)	0.1315	0.44451	0.4306	-3%
Hydrocarbons (unspecified)	0.249053	0.15181	0.13698	-10%
Hydrogen Chloride (HCl)	0.003164	0.00359	0.00359	0%
Hydrogen Fluoride (HF)	0.0003955	0.000334	0.000329	-1%
Methane (CH ₄)	0.2028	0.197616	0.19265	-3%
Nitrogen Oxides (NO _x as NO ₂)	5.00856	5.67728	5.58294	-2%
Particulates (PM10)	0.0841	0.04657	0.0421258	-10%
Particulates (unspecified)	0.1303	0.09833	0.0970565	-1%
Sulfur Oxides (SO _x as SO ₂)	0.9263	0.851949	0.821351	-4%

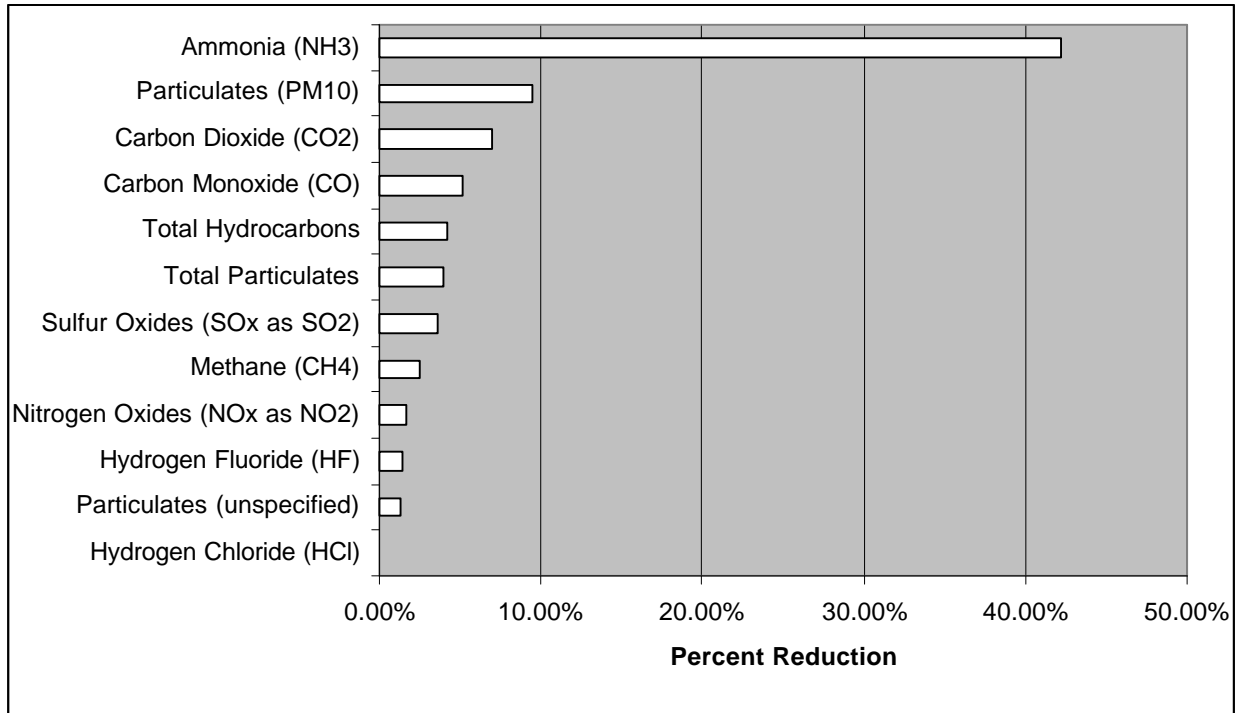

Figure 166 : Reductions in Life Cycle Air Emissions for the Chicago Area Biodiesel Scenario

Wastewater and solid waste emissions for the Chicago area scenario are presented in Table 137. Reductions in life cycle waste emissions are shown in Figure 167. Hazardous waste emissions are reduced dramatically. The 28% reduction corresponds to reductions in diesel fuel use in the farming of soybeans. Wastewater and nonhazardous solid waste reductions are 5.79% and 2.72% respectively.

Table 137: Life Cycle Water and Solid Emissions for the Chicago Area Biodiesel Scenario

Emission	Petroleum Diesel	Biodiesel Baseline	Biodiesel Chicago	% Change from Biodiesel Baseline
Solid Waste (hazardous)	0.000412523	1.82E-05	1.32E-05	27.70%
Solid Waste (nonhazardous)	0.00282423	0.00612718	0.00596055	2.72%
Wastewater	0.46869	0.0989614	0.0932325	5.79%

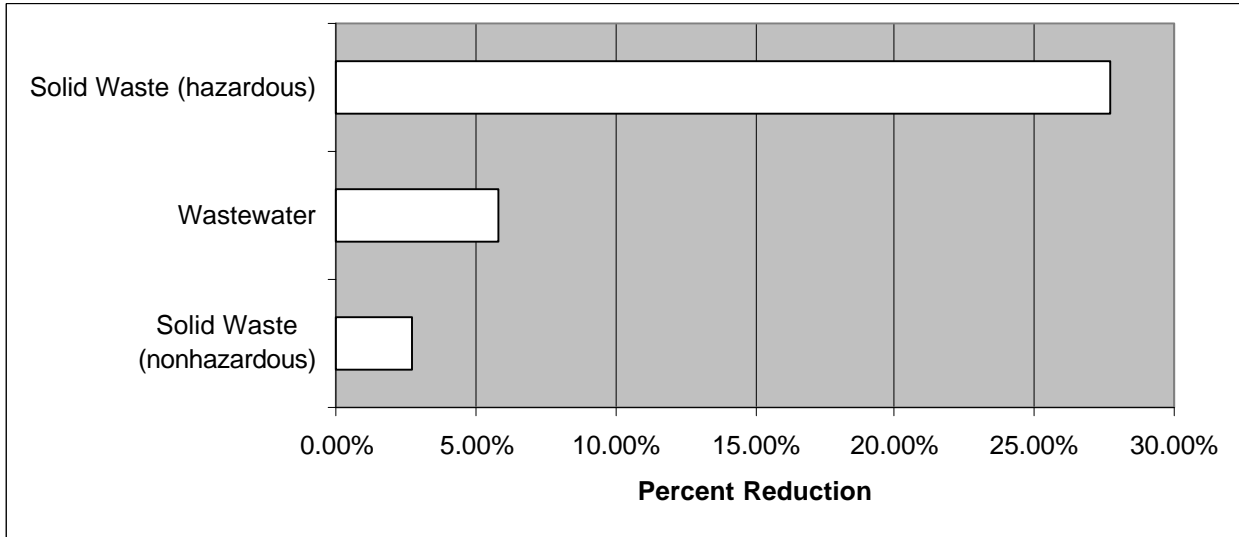

Figure 167: Water and Solid Waste Emissions Reductions for the Chicago Area Biodiesel Scenario

9.2.2 The Effect of Energy Requirements for Conversion of Soybean Oil to Biodiesel

A range of energy inputs for the conversion of soybean oil to biodiesel were used in the LCI model to test the effects of these modeling assumptions on the overall LCI of biodiesel. A survey of commercial technology for biodiesel reveals that there is high degree of variation on reported steam and electricity requirements for the transesterification process. High and low estimates for both steam and electricity used in the model are indicated in Table 138.

Table 138: Range of Energy Inputs for Soybean Oil Conversion Tested in LCI Model

Energy Use	Low Value	Baseline Scenario	High Value
Steam (kcal/metric ton of biodiesel produced)	95,022.7	329,793.5	617,922.2
Electricity (kWh/metric ton of biodiesel produced)	9.0	28.9	40.0

Steam requirements vary 3.5-fold from the lowest to the highest value. Electricity varies 4.4-fold. This high degree of variability warrants testing the range of these assumptions in our model to assess the uncertainty of our overall results related to this assumption. Furthermore, energy inputs for soybean oil conversion are a substantial part of the life cycle, making this variability even more important.

Resource requirements for petroleum diesel and the three cases for conversion energy inputs are presented in Table 139.

Table 139: The Effect of Soy Oil Conversion Energy Demands on Life Cycle Consumption of Raw Materials

Primary Resources	Petroleum Diesel	B100 High Energy Conversion	Biodiesel Base Case	B100 Low Conversion Energy
Coal (in ground)	0.005893	0.007488	0.007028	0.006203
Limestone (CaCO ₃ , in ground)	0.001118	0.001228	0.001140	0.000983
Natural Gas (in ground)	0.016195	0.035795	0.030748	0.026587
Oil (in ground)	0.188939	0.010128	0.010112	0.010084
Perlite (SiO ₂ , ore)	4.297E-05	1.87E-06	1.866E-06	1.87E-06
Phosphate Rock (in ground)	0	0.009397	0.009397	0.009397
Potash (K ₂ O, in ground)	0	0.004417	0.004417	0.004417
Sodium Chloride (NaCl)	0	0.003499	0.003499	0.003499
Uranium (U, ore)	1.405E-07	1.98E-07	1.873E-07	1.68E-07
Water Used (total)	0.026292	86.3637	86.3636	86.3636

The effect of conversion energy variability on primary energy resources is shown in Figure 168. Overall effects on primary energy are considerably smaller than the range of variation in energy inputs. Oil consumption is not affected at all. Because natural gas is the sole source of process energy in the conversion model, it is the most impacted by the assumptions for this step. Natural gas consumption increases 16.41% for the high energy inputs and decreases by 13.5% for the low energy inputs. Coal consumption ranges from +6.55% to -11.7% of the base case.

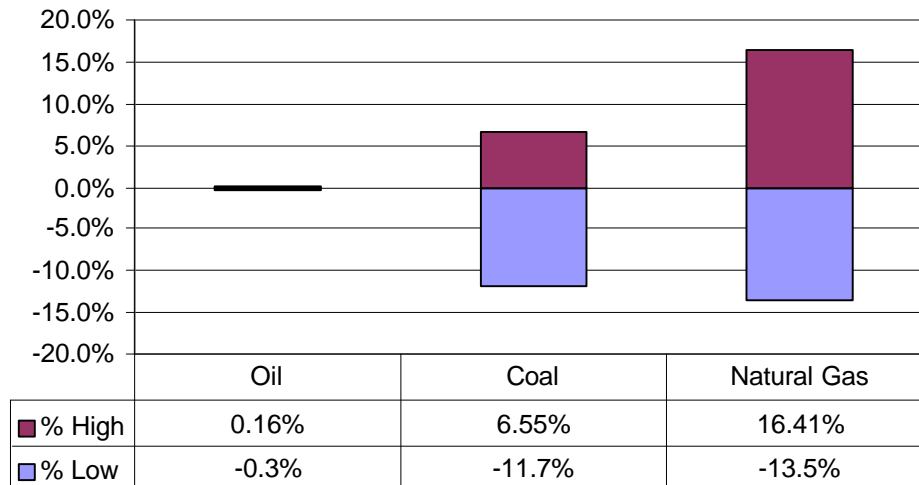

Figure 168: The Effect of Conversion Energy Requirements on Primary Energy Resource Demands for Biodiesel

The only other raw material affected in this sensitivity study is limestone, which tracks the changes for coal consumption. Both coal and limestone reflect changes in electricity demand.

Air emissions for this sensitivity study are presented in Table 140. Significant changes in the emissions related to variation of energy demands for soybean oil conversion can be identified in Figure 169. Changes in steam requirements (and hence natural gas consumption) have a large effect on CH₄ emissions, which can vary by 14% in both directions. From a greenhouse gas perspective, this is probably the most significant change observed in this sensitivity study. CO₂ shows similar responses. PM and SO_x emissions are also affected significantly, probably because of the effect of combustion for electricity generation. No other emissions show much response to the energy inputs for soy oil conversion.

Table 140: The Effect of Soybean Oil Conversion Energy Demands on Air Emissions from Biodiesel

Air Pollutant	Petroleum Diesel	B100 High Conversion Energy	Biodiesel Base Case	B100 Low Conversion Energy
Ammonia (NH ₃)	3.15E-08	0.073471	0.0734713	0.073471
Benzene	4.24E-05	1.84E-06	1.84E-06	1.84E-06
Carbon Dioxide (CO ₂)	633.275	152.586	136.447	121.903
Carbon Monoxide (CO)	1.26981	0.83695	0.831723	0.827155
Formaldehyde	0.00056761	2.48E-05	2.48E-05	2.48E-05
Hydrocarbons (except CH ₄)	0.131467	0.444689	0.44451	0.444352
Hydrocarbons (unspecified)	0.249053	0.151852	0.151814	0.151746
Hydrogen Chloride (HCl)	0.00316426	0.003841	0.0035927	0.003148
Hydrogen Fluoride (HF)	0.000395532	0.000365	0.000334188	0.000279
Methane (CH ₄)	0.202839	0.225332	0.197616	0.171671
Nitrogen Oxides (NO _x as NO ₂)	5.00856	5.7017	5.67728	5.65307
Particulates (PM10)	0.0840937	0.046925	0.0465724	0.046285
Particulates (unspecified)	0.130281	0.104814	0.0983287	0.086711
Sulfur Oxides (SO _x as SO ₂)	0.926335	0.973351	0.851949	0.745081

Model results for water and solid waste emissions are presented in Table 141 for the range of energy inputs considered in this sensitivity study. The relative changes in emissions are presented in Figure 170. Wastewater and hazardous solid waste emissions are hardly affected. Nonhazardous solid waste does show a moderate response.

Table 141: The Effect of Soybean Oil Conversion Energy Demands on Water and Solid Waste Emissions for Biodiesel (kg/bhp-h)

	Base	Low	High
Wastewater	0.098961	0.098899	0.098997
Solid Waste (Hazardous)	1.82E-05	1.82E-05	1.82E-05
Solid Waste (Non-hazardous)	0.012704	0.012402	0.012873

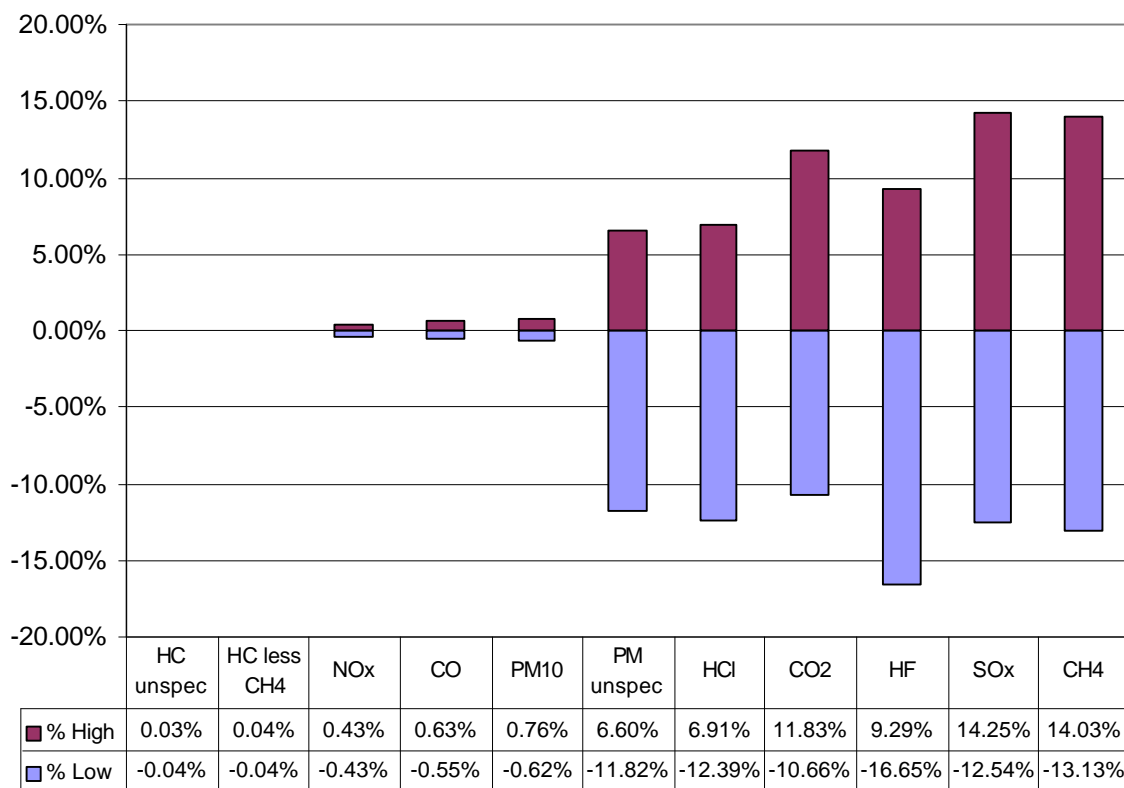

Figure 169: The Effect of Soybean Oil Conversion Energy Demands on Air Emissions for Biodiesel

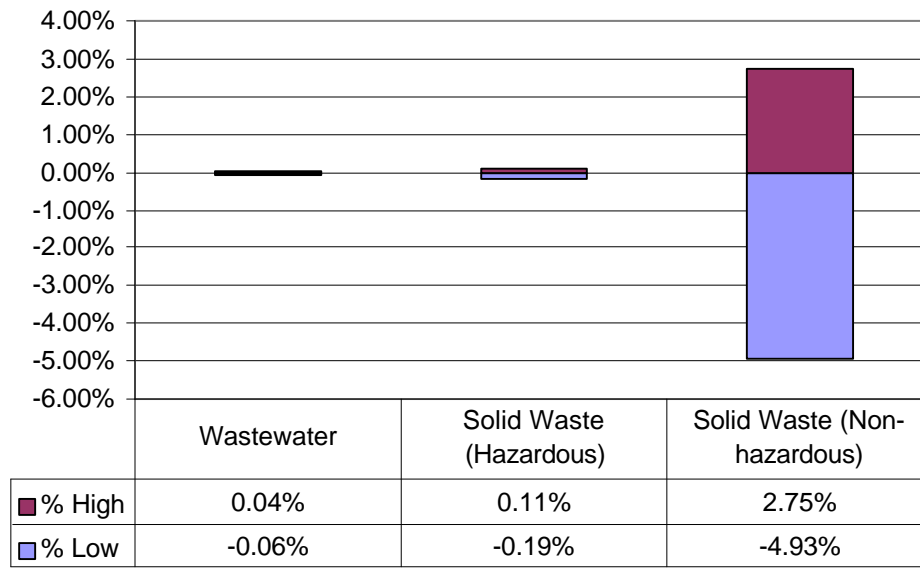

Figure 170: The Effect of Soybean Oil Conversion Energy Demands on Water and Solid Waste Emissions for Biodiesel

10 Appendix A: Emission Factors

This appendix lists the emission factors for various fuel combustion modules that were used throughout this project. Most of the emission factors were obtained from the EPA document, "Compilation Of Air Pollutant Emission Factors," Volume I, Fifth Edition, Point Sources AP-42, which were recompiled for a project done by Argonne National Laboratory (Argonne 1996) as follows:

Table 142: Emission Factors for Natural Gas Combustion in an Industrial Boiler

Boiler Type	Emission Factors (g/MJ natural gas fired)							
	Hydrocarbons	CO	NO _x	PM10	SO ₂	CH ₄	N ₂ O	CO ₂
Utility/Industrial Boiler	6.5 x 10 ⁻⁴	0.019	0.086	0.0014	2.9 x 10 ⁻⁴	1.3 x 10 ⁻⁴	2.0 x 10 ⁻⁴	56.6

Table 143: Emission Factors for Natural Gas Combustion in a Turbine

Turbine Type	Emission Factors (g/MJ natural gas fired)							
	Hydrocarbons	CO	NO _x	PM10	SO ₂	CH ₄	N ₂ O	CO ₂
Large Gas Turbine	0.0014	0.069	0.052	9.7 x 10 ⁻⁴	2.9 x 10 ⁻⁴	0.0046	0.0019	56.5

Table 144: Emission Factors for LPG Combustion in an Industrial Boiler

Boiler Type	Emission Factors (g/MJ LPG fired)							
	Hydrocarbons	CO	NO _x	PM10	SO ₂	CH ₄	N ₂ O	CO ₂
Industrial Boiler	0.0022	0.016	0.039	0.0031	2.9 x 10 ⁻⁴	3.8 x 10 ⁻⁴	0.0019	67.8

Table 145: Emission Factors for Coal Combustion in an Industrial Boiler

Boiler Type	Emission Factors (g/MJ coal fired)							
	Hydrocarbons	CO	NO _x	PM10	SO ₂	CH ₄	N ₂ O	CO ₂
Industrial Boiler	0.027	0.23	0.26	0.043	0.52	0.017	0.0019	90

Table 146: Emission Factors for Diesel Oil Combustion in an Industrial Boiler

Boiler Type	Emission Factors (g/MJ diesel oil fired)							
	Hydrocarbons	CO	NO _x	PM10	SO ₂	CH ₄	N ₂ O	CO ₂
Industrial Boiler	6.7 x 10 ⁻⁴	0.017	0.020	0.0033	0.0065	8.3 x 10 ⁻⁵	3.7 x 10 ⁻⁴	76.2

Table 147: Emission Factors for Heavy Fuel Oil Combustion in an Industrial Boiler

Boiler Type	Emission Factors (g/MJ heavy fuel oil fired)							
	Hydrocarbons	CO	NO _x	PM10	SO ₂	CH ₄	N ₂ O	CO ₂
Industrial Boiler	8.6 x 10 ⁻⁴	0.015	0.051	0.0058	0.15	0.0031	3.4 x 10 ⁻⁴	78.4

Table 148: Emission Factors for Natural Gas Combustion in an Industrial Flare

Boiler Type	Emission Factors (g/MJ natural gas fired)							
	Hydrocarbons	CO	NO _x	PM10	SO ₂	CH ₄	N ₂ O	CO ₂
Utility/Industrial Boiler	0.06	0.16	0.029	0	0.68	--	--	56.5

11 Appendix B: References

Life Cycle Scope and Approach

“Transesterification process converts vegetable oil, tallow to biodiesel.” *Biomass Digest*, Vol. 2, No. 3, Western Regional Biomass Energy Program, Kansas State University, Spring 1993.

Biofuels: Application of Biologically Derived Products as Fuels or Additives in Combustion Engines.” European Commission Directorate, Brussels, Belgium, 1994.

Boustead, I. *Eco-Profiles of the European Plastics Industry. Report #15: Nylon 66.* Association of Plastics Manufacturers in Europe. October 1997

Delucchi, M. A., “Emissions of Greenhouse Gases from the Use of Transportation Fuels and Electricity,” Center for Transportation Research, Energy Systems Division, Argonne National Laboratory, Argonne, Illinois, ANL/ESD/TM-22, 1993.

Heijungs, R., et al. (eds), *Environmental Life Cycle Assessment of Products, Center of Environmental Science*, University of Leiden, Netherlands, 1992.

Hemmerlein et al., “Performance, Exhaust Emissions and Durability of Modern Diesel Engines Running on Rapeseed Oil.” SAE Technical Paper 910848, Society of Automotive Engineers, Warrendale, PA, 1991.

NBB, *Biodiesel: A Technology, Performance, and Regulatory Overview.* National Biodiesel Board (NBB, formerly the National SoyDiesel Development Board), Jefferson City, MO, 1994.

NREL, *Life Cycle Assessment of Petroleum-Based Diesel Fuel and Biodiesel: Final Scoping Document*, National Renewable Energy Laboratory, Golden, CO, December 1995.

SETAC Europe, *Life-Cycle Assessment, Society of Environmental Toxicology and Chemistry - Europe*, Brussels, Belgium, 1992.

SETAC, *A Conceptual Framework for Life-Cycle Impact Assessment*, Society of Environmental Toxicology and Chemistry, Washington, DC, 1993.

SETAC, *A Technical Framework for Life-Cycle Assessments*, Society of Environmental Toxicology and Chemistry, Washington, DC, January 1991.

SETAC, *Guidelines for Life-Cycle Assessment: A “Code of Practice.”* Society of Environmental Toxicology and Chemistry, Washington, DC, 1993.

SETAC, *Life-Cycle Assessment Data Quality: A Conceptual Framework.* Society of Environmental Toxicology and Chemistry, Washington, DC, 1994.

Shay, E. Griffin, “Diesel Fuel from Vegetable Oils: Status and Opportunities.” *Biomass and Bioenergy*, Vol. 4, No. 4, pp. 227-242, 1993.

U.S. Environmental Protection Agency, *Guidelines for Assessing the Quality of Life-Cycle Inventory Analysis*, EPA/530-R-95-010, 1995.

U.S. Environmental Protection Agency, *Life Cycle Design Manual: Environmental Requirements and the Product System*, EPA/600/R-92/226, 1993.

U.S. Environmental Protection Agency, *Life-Cycle Assessment: Inventory Guidelines and Principles*. EPA/600-R-92-245, 1993.

Zhang, X., et al., 1995. "Biodegradability of Biodiesel in the Aquatic Environment," presented at the 1995 ASAE Meeting, June 18-23, Chicago, IL, American Society of Agricultural Engineers, St. Joseph, MI, paper # 956742.

Petroleum Diesel Fuel Production

Air Chief, "Clearinghouse for Inventories and Emission Factors," Version 4.0, EPA-454/c-95-001, CD-ROM, July 1995.

The American Petroleum Institute (API), "The Generation of Wastes and Secondary Materials in the Petroleum Refining Industry," 1991, total United States

Bartus, D., "Effects of Fuel Ethanol Production and Use on CO₂ production and Global Warming, United States Environmental Protection Agency, Washington D.C., June, 1989.

DeLucchi, M. A., "Emissions of Greenhouse Gases from the Use of Transportation Fuels and Electricity," Center for Transportation Research, Energy Systems Division, Argonne National Laboratory, Argonne, Illinois, ANL/ESD/TM-22, 1993.

Energy Information Administration (EIA, 1994) International Energy Annual 1992. Report No. DOE/EIA-0219 (92) (94/01) (January, 1994). Numbers used were for 1993.

Energy Information Administration (EIA, 1995a) Petroleum Supply Annual 1994. Report No. DOE/EIA-0340(94)/1 (May, 1995).

Energy Information Administration (EIA, 1995b) Annual Energy Review 1994. Report No. DOE/EIA-0384(94) (July, 1995).

Kaplan, E., et. al, "Assessment of Environmental Problems Associated with Increased Enhanced Oil Recovery in the United States: 1980-2000," Report No. BNL 51528, prepared for United States Department of Energy, Washington, D.C., November 1981.

Marland, G. and A. Turhollow. "CO₂ Emissions From the Production and Combustion of Fuel Ethanol From Corn." Environmental Sciences Division and Energy Division, Oak Ridge National Laboratory, Oak Ridge Tenn, Feb, 1991.

Tyson, Dr. K. S., C. J. Riley, and K. K. Humphreys, National Renewable Energy Laboratory, "Fuel Cycle Evaluations of Biomass-Ethanol and Reformulated Gasoline," Golden, CO, Report No. NREL/TP-463-4950, DE94000227, November 1993.

The United States Department of Energy, "Energy Technologies and the Environment," Report No. DOE/EH-0077, Washington, DC, October 1988.

The United States Department of Energy, Assistant Secretary for Environmental Protection, Safety, and Emergency Preparedness, "Energy Technology Characterizations Handbook, Environmental Pollution and Control Factors," Third edition, DOE/EP-0093, Washington, D.C., March 1983.

The United States Department of the Interior, Alaska Outer Continental Shelf - Chukchi Sea Oil & Gas Lease Sale 126 Draft Environmental Impact Statement Volume I, Report No. MMS 90-0035, Minerals, Management Service, Herndon, Virginia, July 1990 and DOI 1991.

The United States Environmental Protection Agency (EPA), "VOC Emissions From Petroleum Refinery Wastewater Systems - Background Information for Proposed Standards," Report No. EPA 450/3-85-001a, 1985.

The United States Environmental Protection Agency (EPA), "Volatile Organic Compound (VOC)/Particulate Matter (PM) Speciation Data System," Version 1-32a, Air Quality Management Division, Office of Air Quality Planning and Standards, Research Triangle Park, North Carolina, September 1990.

The United States Environmental Protection Agency, Report to Congress: "Management of Wastes from the Exploration, Development, and Production of Crude Oil, Natural Gas, and Geothermal Energy," Report NO. EPA/530-SW-88-003, PB88-14622, Office of Solid Waste and Emergency Response, Washington, D.C., December 1987.

Soybean Agriculture

Anderson, I., and J. Levine. ASimultaneous Field Measurements of Biogenic Emissions of Nitric Oxide and Nitrous Oxide. *Journal of Geophysical Research*, Vol. 92, 965-976 (1987).

Cates, R and D Keeney. ANitrous Oxide Production Throughout the Year Form Fertilized and Manured Maize Fields. *Journal of Environmental Quality*, 16: 443-447 (1987).

Chapman, S. and L.Carter. *Crop Production: Principles and Practices*. W.H. Freeman and Company, San Francisco, 1976.

Eichner, M. ANitrous Oxide Emissions from Fertilized Soils: Summary of Available Data. *Journal of Environmental Quality*, 19:272-280 (1990).

Foth, H. Fundamentals of Soil Science, 7th ed. John Wiley, New York 1984.

Kapusta G. APost-Emerge Herbicide Programs Proliferate. *Solutions*, May/June, 22 and 26 (1992).

Leonard, R. AHerbicides in Surface Water. Chapter 3, p 45. Environmental Chemistry of Herbicides, Volume I, Editor R. Grover, CRC Press, Inc. Boca Raton, Florida, 1988.

Lewis, R. and R. Lee. AAir Pollution from Pesticides: Sources, Occurrence, and Dispersion. Air Pollution from Pesticides and Agricultural Processes, p 5-50. Editor, R. Lee, CRS Press, Cleveland, 1976.

Lin, B.H., Padgitt, M., Bull, L., Herman, D., Shank, D., and H. Taylor. APesticide and Fertilizer Use and Trends in U.S. Agriculture. Economic Research Service, USDA, AER Number 717, May, 1995.

Majewski, M. and P. Cabal. Environmental Chemistry of Herbicides. Ann Arbor Press, 1995.

Marland, G. and A. Turhollow. "CO₂ Emissions From the Production and Combustion of Fuel Ethanol From Corn." Environmental Sciences Division and Energy Division, Oak Ridge National Laboratory, Oak Ridge Tenn, Feb, 1991.

Mosier, A. ASoil Losses of Dinitrogen and Nitrous Oxide from Irrigated Crops in Northeastern Colorado. *Soil Science Society American Journal*, Vol. 50: 344-348 (1986).

National Research Council. Soil and Water Quality: An Agenda for Agriculture. National Academy Press, Washington, D.C. 1993.

Ribaudo, M. AWater Quality Benefits from the Conservation Reserve Program. Economic Research Service, USDA, AER No 606, February 1989.

Taylor, A., and D. Glotfelty. AEvaporation from Soils and Crops.≡ Chapter 4, p 89. Environmental Chemistry of Herbicides, Volume I, Editor R. Grover, CRC Press, Inc. Boca Raton, Florida. 1988

U.S. Department of Agriculture, Agricultural Research Service. 1993. A USDA Programs Related to Integrated Pest Management≡. USDA Program Aid 1506.

U.S. Department of Agriculture, Economic Research Service. Agricultural Resources and Environmental Indicators, pp. 86-105. Agricultural Handbook No. 705, December 1994.

U.S. Department of Agriculture, Economic Research Service. Weights, Measures, and Conversion Factors for Agricultural Commodities and Their Products. Agricultural Handbook No 697, June 1992.

U.S. Department of Agriculture, National Agricultural Statistics Service (NASS). Crop Production Summary, Cr Pr 2-1(95), January 1995.

U.S. Department of Agriculture, Natural Resources Conservation Service. Summary Report 1992 National Resources Inventory. Issued July 1994 (Revised January 1995).

U.S. Department of Agriculture, Natural Resources Conservation Service. National Resources Inventory, Graphic Highlights of Natural Resource Trends in the United States Between 1982 and 1992, April 1995.

Vandeman, A., Fernandez-Cornejo, J., Jans, S., and Biing-Hwan, L. AAdoption of Integrated Pest Management in U.S. Agriculture≡. Economic Research Service, USDA, AIB No. 707, September 1994.

Wauchope, R. AThe Pesticide Content of Surface Water Draining from Agricultural Field: A Review≡. *Journal of Environmental Quality*, Vol. 7, 459-472 (1978).

Williams, E., Hutchinson, G., and F. Fehsenfeld. ANO_x and N₂O Emissions From Soil≡. *Global Biogeochemical Cycles*, Vol.6, No. 4, 351-388, December 1992.

Soybean Crushing

Perkins, E. “Composition of Soybeans and Soybean Products.” In *Practical Handbook of Soybean Processing and Utilization*. (Erickson, D.R., ed). AOCS Press, Champlain, Illinois, 1995.

Erickson, D.R., “Overview of Modern Soybean Processing and Links Between Processes.” In *Practical Handbook of Soybean Processing and Utilization*. (Erickson, D.R., ed). AOCS Press, Champlain, Illinois, 1995.

Woerfel, J.B. “Harvest, Storage, Handling, and Trading of Soybeans.” In *Practical Handbook of Soybean Processing and Utilization*. (Erickson, D.R., ed). AOCS Press, Champlain, Illinois, 1995.

Adams, C. H.; Luttges, W.E.; Mullen, M.; Rand, M.C.; Peters, J.F.; Schroer, B.J.; Ziemke, M.C. *Study on Production, Marketing, and Utilization of Degummed Soybean Oil as a Diesel Fuel Extender*. UAH Report No. 297. University of Alabama in Huntsville, 1981.

Perry and Chilton (eds). *Chemical Engineers' Handbook, Fifth Edition*. McGraw-Hill, MY, 1973.

Soybean Oil Conversion

“Ballestra Continuous Transesterification Process.” In *Ballestra News*. November, 1995. Ballestra, S.p.A., Milano, Italy, 1995.

Adams, C. H.; Luttges, W.E.; Mullen, M.; Rand, M.C.; Peters, J.F.; Schroer, B.J.; Ziemke, M.C. *Study on Production, Marketing, and Utilization of Degummed Soybean Oil as a Diesel Fuel Extender*. UAH Report No. 297. University of Alabama in Huntsville, 1981.

Balzhiser, R.; Samuels, M.; Eliassen, J. *Chemical Engineering Thermodynamics: The Study of Energy, Entropy, and Equilibrium*. Prentice-Hall, New York, 1972.

Bruwer, J.J., *et al.* "Sunflower Seed Oil as an Extender for Diesel Fuel in Agricultural Tractors." In *Symposium of the South African Institute of Agricultural Engineers*. June 11, 1980.

Drown, D.; Cox, J.; Wood, B. *Hydrogenated Soy Ethyl Ester (HySEE) Process Refinement*. Idaho Department of Natural Resources, Boise, Idaho, 1995.

Eisenhard, W. "Chapter 6: Esterification." In *Fatty Acids in Industry* (Fritz, E.; Johnson, R., eds). Marcel Dekker, Inc., pp 139-152. 1989.

Erickson, D.R., "Alkaline Refining." In *Practical Handbook of Soybean Processing and Utilization*. (Erickson, D.R., ed). AOCS Press, Champlain, Illinois, 1995.

Erickson, D.R., "Interesterification." In *Practical Handbook of Soybean Processing and Utilization*. (Erickson, D.R., ed). AOCS Press, Champlain, Illinois, 1995.

Erickson, D.R., "Overview of Modern Soybean Processing and Links Between Processes." In *Practical Handbook of Soybean Processing and Utilization*. (Erickson, D.R., ed). AOCS Press, Champlain, Illinois, 1995.

Esterification Process for Diesel Fuel Extenders. Institute Francais du Petrole Brochure. Institut Francais du Petrole, France (undated).

Fina research Methanolysis Process. Fina Research Brochure. Final Research, S.A. (undated).

Fleisch, T.; McCarthy, C.; Basu, A.; Udovich, C.; Charbonneau, P.; Mikkelsen, S.; McCandless, J. A New Clean Diesel Technology: Demonstration of ULEV Emissions on a Navistar Diesel Engine Fueled with Dimethyl Ether." SAE Technical Paper Series #950061. SAE International, Warrendale, PA, 1995

Formo, M. "Ester Reactions of Fatty Materials." *Journal Oil Chemists' Society*, 31/11, pp 548-559, 1954.

Freedman, B.; Pryde, E.H.; Mounts, T.L. "Variables Affecting the Yields of Fatty Esters from Transesterified vegetables." *Journal American Oil Chemists' Society*, 61/10, pp 1638-1643.

Genereaux, R.; O'Neill, P.; Webb, W.; Nolan, R. "Section 6. Transport and Storage of Fluids." In *Chemical Engineers' Handbook, Fifth Edition*. (Perry and Chilton, eds). McGraw-Hill, New York, 1973.

Gosse, G, "The French Diester Programme." *Seminar on Vegetable Oils as Transport Fuels, Pisa, Italy, May 1993* (Caserta, G., Ed.). International Energy Agency, 1994.

Hirata, M.; Ohe, S.; Nagahama, K. *Computer Aided Data Book of Vapor-Liquid Equilibria*. Kodansha Limited Elsevier Scientific Publishing Company, New York, 1975.

Howell, S. *Multi-Feedstock Biodiesel Project Phase II Final Report*. Prepared for the National Renewable Energy Laboratory under Subcontract No. ACF-5-14418-01, National Renewable Energy Laboratory, Golden, CO, 1997.

Howell, S.; Weber, J. "U.S. Biodiesel Overview." In *Proceedings: Second Biomass Conference of the Americas*. National Renewable Energy Laboratory, Golden, CO, 1995.

Korbitz, W., "Status of BioDiesel Production In Europe." Presented at the Bio-Oils Symposium, Saskatoon, Saskatchewan. Saskatchewan Agriculture and Food, Saskatchewan, CANADA, 1994.

Korus, R.; Hoffman, D.; Bam, N.; Peterson, C.; Drown, D. "Transesterification Process to Manufacture Ethyl Ester of Rape Oil" In *Proceedings: First Biomass Conference of the Americas*. National Renewable Energy Laboratory, Golden, CO, 1993.

Kusy, P. "Transesterification of Vegetable Oils for Fuels." In *Vegetable Oil fuels: Proceedings of the International Conference on Plant and Vegetable Oils as Fuels*. American Society of Agricultural Engineers, St. Joseph, MI, 1982.

Martines de Vedia,. "Vegetable Oils as Diesel Fuels." Diesel Power and Diesel Transportation, Volume 22, pp 1298-1304, 1944.

McCabe, W.; Smith, J. *Unit Operations of Chemical Engineering*. Third Edition. McGraw-Hill, New York, 1976.

Nye, M.J.; Willimson, T.W.; S. Deshpande; Schrader, J.H.; Snively, W.H.; Yurkewich, T.P; French, C.L. "Conversion of Used Frying Oil to Diesel Fuel by Transesterification: Preliminary Tests." *Journal American Oil Chemists' Society*, 60/8, pp1598-1601, 1983.

Perkins, E. "Composition of Soybeans and Soybean Products." In *Practical Handbook of Soybean Processing and Utilization*. (Erickson, D.R., ed). AOCS Press, Champlain, Illinois, 1995.

Peterson, C.; Reece, D.; Hammond, B.; Thompson, J.; Beck, S. *HySee Preliminary Processing and*

Porter, H.; McCormick, P.; Lucas, R.; Wells, D. "Section 20. Gas-Solid Systems." In *Chemical Engineers' Handbook, Fifth Edition*. (Perry and Chilton, eds). McGraw-Hill, New York, 1973.

Process Description and Specific Consumption of Raw Materials and Utilities for the Production of Vegetable Oil Methyl-Esters (Biodiesel). Florys, S.p.A. brochure. Florys, S.p.A., Milano, Italy (undated).

Screening: Making and Testing a Biodiesel Fuel Made from Ethanol and Waste French-Fry Oil. Idaho Department of Water Resources Energy Division Boise, Idaho, 1995.

Shay, E.G., "Diesel Fuel from Vegetable Oils: Status and Opportunities." *Biomass and Bioenergy*, 4/4, pp 227-242, 1993.

Swern, D. "Chapter 2: Chapter 2: Fat Splitting, Esterification and Interesterification." In *Bailey's Industrial Oil and Fat Products Volume 2 (4th Edition)*. Wiley-InterScience, New York, 1982.

Swern, D. "Chapter 4" In *Bailey's Industrial Oil and Fat Products Volume 2 (4th Edition)*. Wiley-InterScience, New York, 1982.

Van Winkle, M. *Distillation*, McGraw Hill, New York, 1967

Walton, J. "The Fuel Possibilities of Vegetable Oils: An Examination of the Technical Problems Associated with the Use of Bean and Seed Oils." *Gas and Oil Power*, July 1938, pp 167-168. Whitehall Press, London, U.K.

Woerfel, J.B. "Harvest, Storage, Handling, and Trading of Soybeans." In *Practical Handbook of Soybean Processing and Utilization*. (Erickson, D.R., ed). AOCS Press, Champlain, Illinois, 1995.

Wong, A.; Monnier, J.; Stumborg, M.; Hogan, E. "Technical and Economic Aspects of Manufacturing Cetane-Enhanced Diesel Fuel from Canola Oil." Presented at the Bio-Oils Symposium, Saskatoon, Saskatchewan. Saskatchewan Agriculture and Food, Saskatchewan, CANADA, 1994.

Combustion

Ali, Y, Hanna, M, "Physical Properties of Tallow Ester and Diesel Fuel Blends," *Bioresource Technology* v47, P131, 1994.

Ali, Y, Hanna, M, Cuppett, S, "Fuel Properties of Tallow and Soybean Oil Esters," *JAACS* V72,no 12,p J7654-1, 1995

Chandler, J , Horneck, F, Brown, G, "The Effect of Cold Flow Additives on Low Temperature Operability of Diesel Fuels," SAE 922186, 1992.

Clark, S.J., Wagner, L, Schrock, M.D., Piennaar, P.G., "Methyl and Ethyl Soybean Esters as renewable Fuels for Diesel Engines," JAOCS 61(10), p1632(1984).

EMA, "Biodiesel Fuels and Their Use in Diesel Engine Applications," Chicago Illinois, August, 1995.

FEV Engine Technology, Inc, "Emissions and Performance Characteristics of the Navistar T444E DI Engine Fueled with Blends of Biodiesel and Low-sulfur Diesel Phase 1 Final Report," for the NBB, Dec 6, 1994.

Fosseen Manufacturing & Development, "Emission Testing on Diesel & Biodiesel Blend- 1977 DDC 6V-71N Coach," Report NSDB4F15, July, 1994.

Freedman B ,Bagby M,O, "Predicting Cetane Numbers of N-Alcohols and Methyl Esters from their Physical properties," JAOCS 67(9), p 565, Sept. 1990.

Geyer, S.M., Jacobus, M,J, Lestz, S.S., "Comparison of Diesel Engine performance and Emissions from Neat and Transesterified Vegetable Oils," Trans ASAE, p375, 1984.

Graboski, M, "Biodiesel Bus #4882," 1993.

Graboski, M.S., "Emissions from Biodiesel Blends and Neat Biodiesel from a 1991 Model Series 60 Engine Operating at High Altitude," Final Report to NREL, 1994.

Harrington, K, "Chemical and Physical Properties of Vegetable Oil Esters and their Effect on Diesel Fuel Performance," Biomass V9, P1,(1986).

Hemmerlein, N, Korte, V, Richter, H, Schroder, G, "Performance, Exhaust, Emissions, and Durability of Modern Diesel Engines Running on Rapeseed Oil" ,SAE 910848,1991.

Interchem Industries, "Soydiesel Quality Specification," 1992.

Liotta Jr., F, Montalvo, D, "The Effect of Oxygenated Fuels on Emissions from a Modern Heavy Duty Engine," SAE 932734, 1993.

Marshall, W., "Improved Control of NOx Emissions with Biodiesel Fuels," DOE Contract DE-AC22-94PC91008, March 1994.

McDonald, J, Purcell, D, McClure, B, Kittelson, D, "Emission Characteristics of Soy Methyl Ester Fuels in an IDI Compression Ignition Engine," SAE 950400, 1995.

Midwest Biofuels Inc., "Biodiesel Cetane Number Engine Testing Comparison to Calculated Cetane Index Number," 1993.

Midwest Biofuels Inc., "Biodiesel Pour Point and Cold Flow Study," Report to NSDB, Sept. 30,1993.

National Biodiesel Board,"1000 Hour Durability Testing DDC 6V-92TA DDEC II Engine," January 27, 1995.

Ortech International, " Operation of Cummins N14 Diesel on Biodiesel; Performance, Emissions, Durability," Report 95-E11-B004524, December 20, 1995.

Peterson, C, Reece, D, Hammond, B, Thompson, J, Beck, S, "Making and Testing a Biodiesel Fuel Made from Ethanol and Waste French Fry Oil," Idaho Department of Water Resources Report, July, 1995.

Reece, D , Peterson, C.L., "Progress report Idaho On-Road Test with Vegetable Oil as a Diesel Fuel," Proceedings, First Biomass Conference of the Americas,P891.

Ross, JD, "Emissions Study of Oxygenated Diesel Fuels," Colorado School of Mines M.S. Thesis T-4641, 1995.

Ryan, III, T, Dodge, L.G., Gallahan, T.J., "The Effect of vegetable Oil Properties on Injection and Combustion in Two Different Diesel Engines," JAOCS vol., No 10, p1610,1984.

Scholl, K W, Sorenson, S C, "Combustion of Soybean Oil Methylester in a Direct Injection Diesel Engine," SAE 930934, 1993.

Schumacher, L, Borgelt, S, Hires, W, "Fueling Diesel Engines with Blends of Methylester Soybean Oil and Diesel Fuel," ????

Shafer, A, "Biodiesel Research - Mercedes Benz- Engine Warranty Policy," Presented at Commercialization of Biodiesel: Establishment of Engine Warranties, U Idaho National Center for Advanced Transportation Technology, p125-141, 1994.

Sharp, C.A., "Transient Emissions Testing of Biodiesel and Other Additives in a DDC Series 60 Engine," by SWRI for NBB, December, 1994.

Sims, R, "Tallow Esters as an Alternative Diesel Fuel," Trans ASAE V29(3)m p716, 1985.

Spreen, K, Ullman, T, Mason, R, "Effects of Fuel Oxygenates, Cetane Number, and Aromatic Content on Emissions from 1994 and 1998 Prototype Heavy Duty Diesel Engines," CRC Project VE-10, May, 1995.

Stotler, R, Human, D, "Transient Emission Evaluation of Biodiesel Fuel Blend in a 1987 Cummins L-10 and DDC 6V-92-TA," ETS Report to NBB, 11/30/95.

REPORT DOCUMENTATION PAGE

Form Approved
OMB NO. 0704-0188

Public reporting burden for this collection of information is estimated to average 1 hour per response, including the time for reviewing instructions, searching existing data sources, gathering and maintaining the data needed, and completing and reviewing the collection of information. Send comments regarding this burden estimate or any other aspect of this collection of information, including suggestions for reducing this burden, to Washington Headquarters Services, Directorate for Information Operations and Reports, 1215 Jefferson Davis Highway, Suite 1204, Arlington, VA 22202-4302, and to the Office of Management and Budget, Paperwork Reduction Project (0704-0188), Washington, DC 20503.

1. AGENCY USE ONLY (Leave blank)		2. REPORT DATE May 1998	3. REPORT TYPE AND DATES COVERED Subcontract Report	
4. TITLE AND SUBTITLE Life Cycle Inventory of Biodiesel and Petroleum Diesel for Use in an Urban Bus			5. FUNDING NUMBERS BF886002	
6. AUTHOR(S) John Sheehan, James Duffield, Housein Shapouri, Michael Graboski, Vince Camobreco				
7. PERFORMING ORGANIZATION NAME(S) AND ADDRESS(ES) National Renewable Energy Laboratory 1617 Cole Boulevard Golden, CO 80401-3393 U.S. Department of Energy U.S. Department of Agriculture Ecobalance, Inc. Colorado School of Mines, Colorado Institute for Fuels and Engine Research			8. PERFORMING ORGANIZATION REPORT NUMBER	
9. SPONSORING/MONITORING AGENCY NAME(S) AND ADDRESS(ES) National Renewable Energy Laboratory 1617 Cole Blvd. Golden, CO 80401-3393			10. SPONSORING/MONITORING AGENCY REPORT NUMBER NREL/SR-580-24089	
11. SUPPLEMENTARY NOTES				
12a. DISTRIBUTION/AVAILABILITY STATEMENT National Technical Information Service U.S. Department of Commerce 5285 Port Royal Road Springfield, VA 22161			12b. DISTRIBUTION CODE UC-1503	
13. ABSTRACT (<i>Maximum 200 words</i>) This report presents findings from a study of the life cycle inventories for petroleum diesel and Biodiesel. It presents information on raw materials extracted from the environment, energy resources consumed, and air, water, and solid waste emissions generated.				
14. SUBJECT TERMS biodiesel, life cycle inventory, petroleum diesel			15. NUMBER OF PAGES 300	
			16. PRICE CODE	
17. SECURITY CLASSIFICATION OF REPORT	18. SECURITY CLASSIFICATION OF THIS PAGE	19. SECURITY CLASSIFICATION OF ABSTRACT	20. LIMITATION OF ABSTRACT	

For more information, contact:

Michael Voorhies, Program Manager
Office of Fuels Development
U.S. Department of Energy
Forrestal Building
1000 Independence Avenue, SW
Washington, D.C. 20585-0121

K. Shaine Tyson, Manager
Biodiesel Project
National Renewable Energy Laboratory
1617 Cole Boulevard
Golden, CO 80401-3393

James Duffield
Office of Energy
U.S. Department of Agriculture
1800 M. Street, NW
Washington, D.C. 20036

John Sheehan
Biotechnology Center for Fuels and
Chemicals
National Renewable Energy Laboratory
1617 Cole Boulevard
Golden, CO 80401-3393

Prepared for the
U.S. Department of Energy (DOE)



and the U.S. Department of Agriculture (USDA)

by the National Renewable Energy Laboratory
a U.S. Department of Energy national laboratory



Printed with renewable source ink on paper containing at least
50% wastepaper, including 20% postconsumer waste.