

IC 9320

BUREAU OF MINES
INFORMATION CIRCULAR/1992

Examination of Design and Operation Practices for Longwall Shields

By Thomas M. Barczak



UNITED STATES DEPARTMENT OF THE INTERIOR

Library of Congress Cataloging in Publication Data:

Barczak, Thomas M.

Examination of design and operation practices for longwall shields / by Thomas M. Barczak.

p. cm. — (Information circular / Bureau of Mines; 9320)

Includes bibliographical references (p. 14).

Supt. of Docs. no.: I 28.27:9320

1. Mine roof control. 2. Longwall mining. I. Title. II. Series: Information circular (United States. Bureau of Mines); 9320.

TN295.U4 [TN288] 622 S—dc20 [622'.28] 92-8898 CIP

CONTENTS

	<i>Page</i>
Abstract	1
Introduction	2
Trends in shield design and operation	3
Design requirements	6
Consequences of design and operating practices	7
Optimization of support utilization	10
Conclusions	14
References	14

ILLUSTRATIONS

1. Bending of leg cylinders in chock support	2
2. Horizontal stiffness provided in early shield design by mechanically connecting canopy with base	2
3. Contribution of shield support to longwall mining.	3
4. Comparison of caliper and lemniscate-guided shield designs illustrating tip-to-face movement of canopy ...	4
5. Electrohydraulic shield control system	4
6. Trend in U.S. longwall support capacity	4
7. Rigid canopy design compared with extensible canopy design	4
8. Split caving shield design abandoned because of stability problems	5
9. Base-lifting device	5
10. Shearer-initiated electrohydraulic shield control system	5
11. Examples of setting pressure inefficiency from two mines using electrohydraulic shield control systems ..	5
12. Horizontal and vertical shield loading produced from support and strata interactions	6
13. Mechanics of roof behavior and manifestation of shield loading	6
14. Maximum caving height that can be supported with designated shield capacity assuming free block formation directly above shield	7
15. Comparison of setting force and total shield capacity for three shields of different capacities	8
16. Comparison of load development for 500-ton and 800-ton shield for same load condition of 0.5 in of convergence	8
17. Active horizontal force provided by two-leg shield designs	9
18. Comparison of resultant force locations for two-leg and four-leg shields	9
19. Four-leg shield operation in cavity-prone conditions illustrating problems of canopy control	9
20. Controlling cavities in roof with opposing leg reactions using four-leg shields	10
21. High toe loading caused by rotational moment in two-leg shields	10
22. Selection of two-leg and four-leg shields as function of seam height, panel width, and depth of cover ...	10
23. Four general categories of strata behavior pertaining to shield loading	12
24. Increased moment of inertia of roof beam caused by shield forces	13

UNIT OF MEASURE ABBREVIATIONS USED IN THIS REPORT

ft	foot	pct	percent
in	inch	psi	pound per square inch
lb/ft ³	pound per cubic foot	ton/in	ton per inch
m	meter		

EXAMINATION OF DESIGN AND OPERATION PRACTICES FOR LONGWALL SHIELDS

By Thomas M. Barczak¹

ABSTRACT

The success of longwall mining can largely be traced to the development of powered roof support systems. The most significant improvement in powered support design has been the shield support, which improved kinematic stability and promoted the application of longwall mining in difficult-to-control caving conditions where chock and frame supports were inadequate. The most obvious trend in shield design has been an increase in shield size and capacity. This U.S. Bureau of Mines report examines shield design and operation practices and their consequences for the utilization of high-capacity shield support systems. An optimization goal is to minimize support loading by selecting an active shield setting force that is compatible with strata behavior and shield loading characteristics. Shield stiffness is an important design parameter that is often overlooked. A consequence of increasing shield capacity by incorporating larger diameter leg cylinders is a proportional increase in shield stiffness. Setting forces have also increased in direct proportion to the increase in shield capacity. The increased stiffness and higher setting force cause the available capacity to be consumed more quickly, severely limiting the ability of high-capacity supports to last longer and provide reserve capacity for difficult mining conditions.

¹Research physicist, Pittsburgh Research Center, U.S. Bureau of Mines, Pittsburgh, PA.

INTRODUCTION

Throughout the history of longwall mining, the design of the roof support system has been critical to the success of the mining operation. Early forms of longwall mining used wood props for face support and packwalls made from roof and floor rock to control caving of the immediate roof (1).² These systems were replaced by powered roof supports that could be advanced easily while allowing the strata to cave behind them. The first powered roof supports were simple frame and chock structures. These designs were poor in their ability to resist horizontal displacements and moment loading caused by the strata dynamics during the caving process. They often experienced difficulty and failure (see figure 1) (2).

A major improvement in support design occurred with the introduction of the shield support. The shield greatly improved kinematic stability by providing a horizontal

²Italic numbers in parentheses refer to items in the list of references at the end of this report.

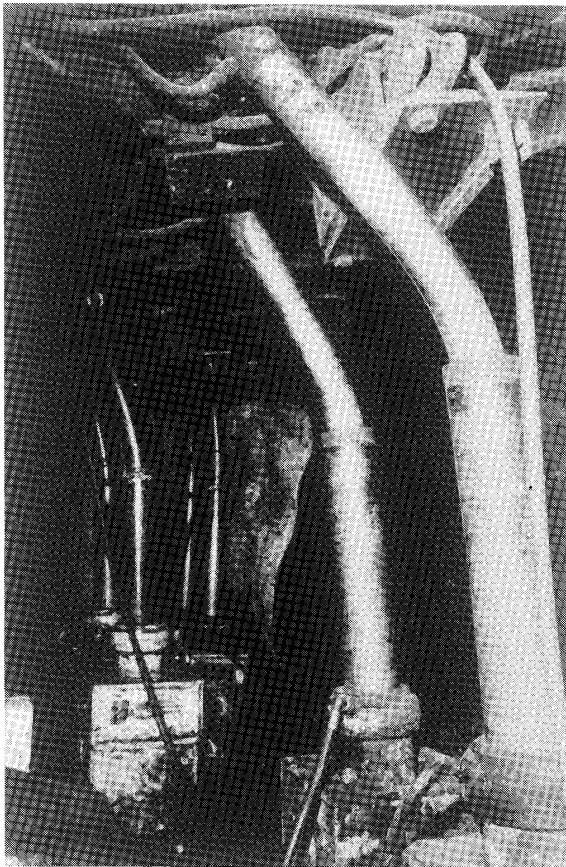

Figure 1.—Bending of leg cylinders in chock support.

stiffness between the canopy and base that was lacking in other support designs. This was accomplished by mechanically connecting the canopy to the base in a truss-like fashion as shown in figure 2. The success of the shield support promoted the application of the longwall mining method in highly faulted and massive strata conditions where caving was difficult to control and where chock and frame supports were inadequate. The contribution of the shield support to longwall mining can be seen in figure 3, which compares U.S. longwall utilization and productivity before and after the introduction of the shield support system in 1975. Today, longwall mining accounts for approximately one-third of the coal mined underground, and the average annual production per face is about 1.3 million tons. Longwall mining is employed in a wide variety of geological conditions and is the most productive and safest underground mining system used worldwide (3).

The primary design consideration for longwall shields is their capacity. If load conditions were well defined, the required capacity would be easily determined and the design of the support structure would be straightforward using standard structural engineering principles. Unfortunately, load conditions in longwall mining are not well defined, and a margin of safety is employed by providing a capacity for expected worst-load conditions. An even more debatable issue is the utilization of the support capacity. Since the shield is actively set against the roof and floor with a setting force chosen by the operator, proper setting force is necessary to realize the most efficient utilization of the available shield capacity.

Motivations for optimizing shield design are to minimize support costs and maximize shield life and at the same time to provide effective ground control in all mining conditions. This report examines these motivations in relation to current shield design and operation practices in support of the Bureau's goal to reduce accidents and improve ground control in underground coal mines.

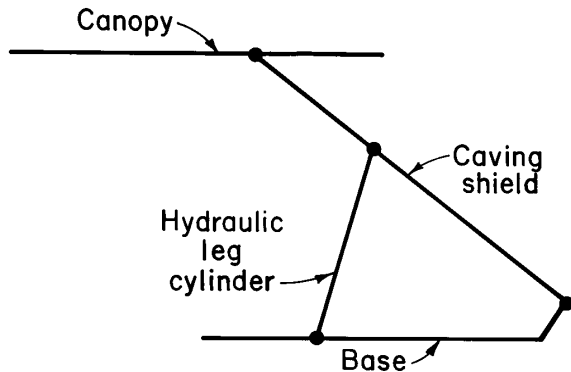

Figure 2.—Horizontal stiffness provided in early shield design by mechanically connecting canopy with base.

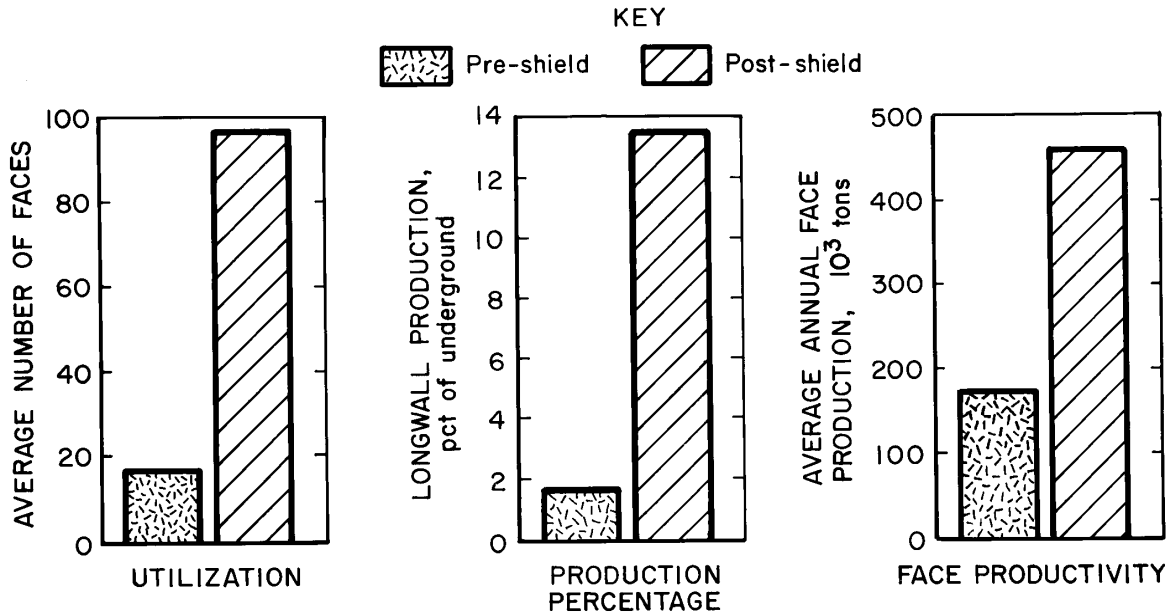

Figure 3.—Contribution of shield support to longwall mining.

TRENDS IN SHIELD DESIGN AND OPERATION

Two fundamental changes in design and operation have been made since the introduction of shields: (1) The caliper design was replaced with a lemniscate-guided caving shield that maintains a constant tip-to-face distance throughout its operating range (see figure 4); and (2) Electrohydraulic control systems have replaced manual systems to permit remote and automated operation of the shield (see figure 5). Current trends in shield design are summarized as follows:

Capacity.—Support capacity has continued to increase throughout the history of U.S. longwall mining as shown in figure 6 (4). Support capacities in the United States have increased by 25 pct since 1980 to an average support capacity at yield of 579 tons for the 96 longwalls operating in 1990. Thirteen installations employ shields with capacities greater than 700 tons, and 44 installations use shields with capacities equal to or greater than 600 tons. The highest capacity shield used in the United States is 900 tons (5).

Size.—Shields have increased in size, principally mass and length, to accommodate higher capacities and increased face spans required by the increase in the size of haulage and extraction equipment. For example, 11-ft canopy lengths were typical with the 400- to 600-ton supports used prior to 1980, and these lengths have increased to

13 ft for the higher capacity 600- to 800-ton shields used in 1990. Likewise, the weights of supports have typically increased from 12 to 15 tons during the past decade, although the weights do not always correspond well with capacity. The most recent trend in shield design is an increase in the width of the canopy from 1.5 m to 2 m. Since fracture developments in the roof tend to parallel the face, roof control should not be affected by the increase in shield width nor should a substantial increase in support capacity be required. The potential benefit of wider supports is less cost, since much of the cost is due to the machining of the hydraulic leg cylinders and since fewer legs per unit of supported face are required with wider shields. The wider supports may also be more stable in thick-seam operations. Some decrease in move time might also be realized, since fewer supports are employed on a face. Two wide-canopy shield-supported faces are currently operating in the United States, while there are approximately 30 systems operating in Germany.

Setting forces.—Differences of opinions in regard to setting forces have developed through the evolution of longwall mining. The British initially favored low setting forces (25 pct of yield capacity), while the Germans and Americans have generally favored higher setting forces (60 to 80 pct of yield capacity). Setting forces have increased in proportion to the increase in yield capacity, because the

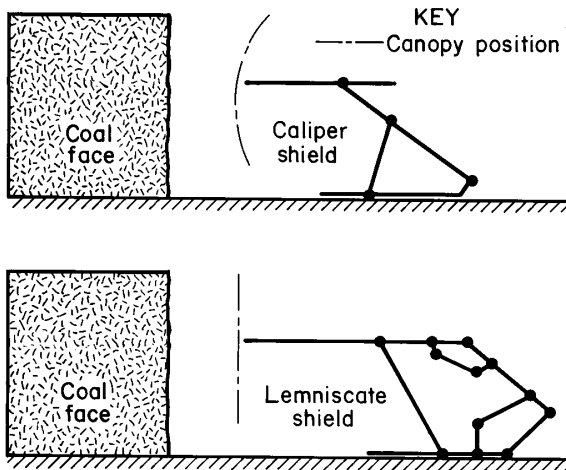

Figure 4.—Comparison of caliper and lemniscate-guided shield designs illustrating tip-to-face movement of canopy.

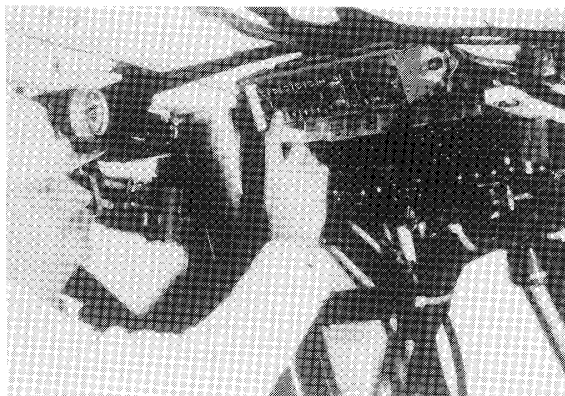

Figure 5.—Electrohydraulic shield control system.

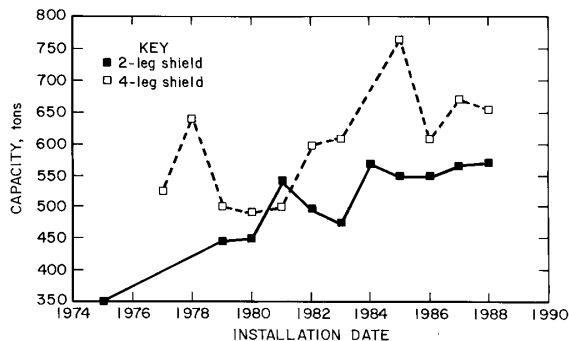

Figure 6.—Trend in U.S. longwall support capacity.

hydraulic setting pressures in the leg cylinders have remained constant while the size (area) of the leg cylinders has increased to accommodate the higher yield capacities. Optimum setting forces as a function of strata interaction and overall support loading are not pursued by longwall operators.

Component constructions.—Component constructions have remained similar since the development of the lemniscate linkage design; however, there have been some design improvements incorporated in recent years.

The component that has changed the most is the canopy. Extensible canopy designs as shown in figure 7 are becoming popular in Europe, where friable roof geologies must be controlled (6). These designs have yet to be utilized extensively in the United States, where more competent roof geologies are typically found. Canopy tips have been curved upward to promote tip contact. However, the force generated at the tip is typically about 10 pct of the leg force and is mostly a function of the distance of the tip from the leg cylinders. The distribution of loading on the canopy and base is also dependent upon the stiffness of these components and the deformation characteristics of the immediate strata.

Structurally, several failures have occurred with canopy constructions in which the front portion is fabricated as a separate unit and welded in cantilever fashion to the rear section of the canopy. These designs are being replaced by designs that incorporate beams that longitudinally traverse the length of the canopy. Split caving shield designs as shown in figure 8 have also been abandoned because of stability problems. Little has been done to change the design of the pin joints in the caving shield, but these remain a source of failure, particularly when the shields are in service for long periods of time. Failure of leg

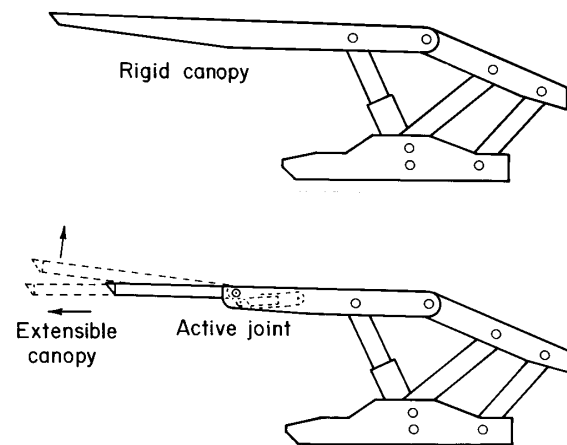

Figure 7.—Rigid canopy design (top) compared with extensible canopy design (bottom). Extensible canopy design is used to control friable immediate roof geologies.

sockets continues to be a problem when the canopy or base is highly flexed. Most structural failures are fatigue related and occur after many thousands of cycles (7).

Base-lifting devices (see figure 9) have been a popular design feature in soft floor conditions. Some of these designs are poor in that they exacerbate the inherent high toe loading of two-leg shields by promoting two-point contact at the toe and rear of the base.

Control systems.—Dramatic improvements in shield control have been made with the incorporation of electrohydraulic control systems that automate the support function. The most recent development is a shearer-initiated system, whereby the shearer emits a signal (usually infrared) that is sensed by a receiver on the shield and activates the advance cycle automatically (see figure 10). These systems are currently used more extensively in U.S. longwall operations than in European operations, but this technology is certain to be a worldwide standard. One reported advantage of the electrohydraulic control is its ability to provide programmable and consistent setting forces across the face. However, recent studies show that consistent setting

forces are not routinely achieved. Examples of setting pressure inefficiency are shown in figure 11 for two state-of-the-art electrohydraulic U.S. longwall operations. Apparently, the demand placed upon these systems is greater than the capability of the hydraulic distribution system to provide sufficient hydraulic fluid at the required pressure. This problem is presently being addressed by the equipment manufacturers, who are trying to avoid time-dependent setting algorithms in which the pump pressure is available to the shield for only a brief amount of time following the support advance.

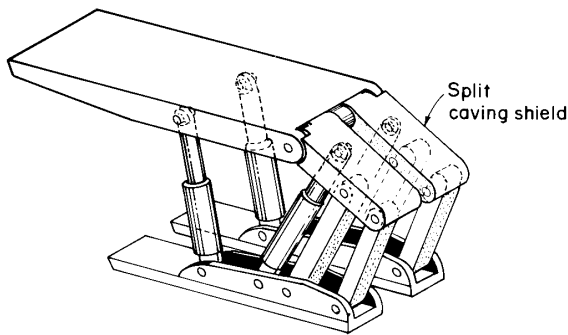

Figure 8.—Split caving shield design abandoned because of stability problems.

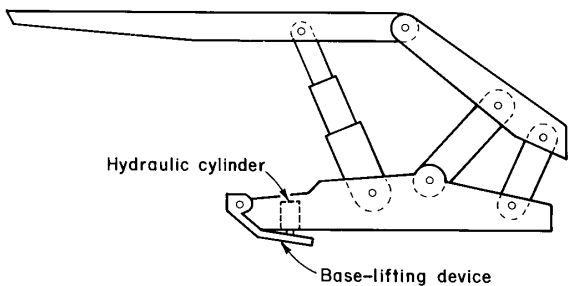

Figure 9.—Base-lifting device.

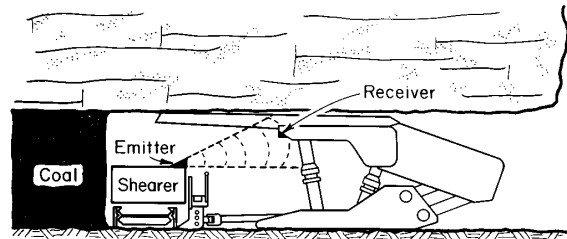

Figure 10.—Shearer-initiated electrohydraulic shield control system.

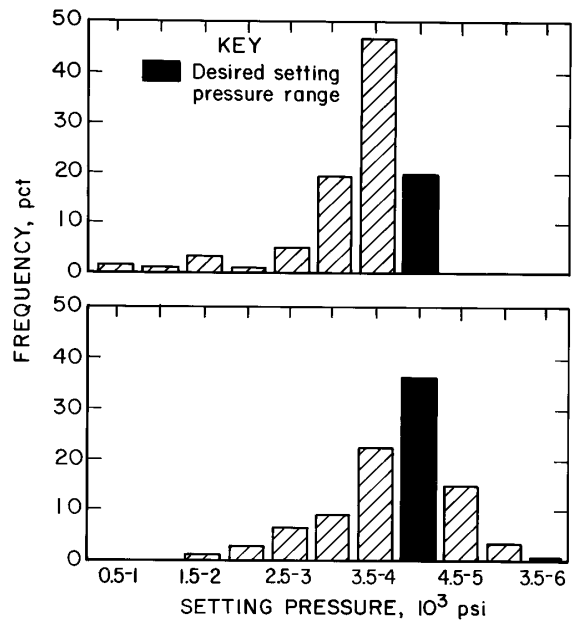

Figure 11.—Examples of setting pressure inefficiency from two mines using electrohydraulic shield control systems.

DESIGN REQUIREMENTS

The selection and design of longwall roof supports are predicated by strata deformations during the extraction of the longwall panel. The nature of these strata deformations is largely dependent upon the thickness and stability of the structures formed by the roof and floor geology and the stiffness of the ground supporting elements. Most of the roof structure is capable of maintaining a dynamic equilibrium as the longwall face advances by transferring its weight primarily to the solid coal in front of the face and the compressed portion of the gob beyond the face. The powered supports develop load in response to the deformation of this rock mass when deformation produces convergence of the mine roof and floor that contacts the shield canopy and base. The immediate strata are less stable and cave after the supports are advanced. The powered support must also carry the weight of immediate strata that become separated from the overlying roof structure and are not supported by the coal or the gob. Both vertical and horizontal loading are induced on the supports by the strata dynamics (see figure 12).

Figure 13 depicts the mechanics of roof behavior and the manifestation of support loading. In general, the distribution of loading on the coal, the powered supports, and the gob is dependent upon the relative stiffness of these support elements (8). From the perspective of strata control, it should be recognized that the shield stiffness is at least an order of magnitude less than the coal and the gob stiffness, which indicates that the shield is not the dominant supporting element. Load distribution among the supporting elements must comply with conservation of energy requirements in such a way that the combined work of the coal, the powered supports, and the gob must equal the loading imposed by the overlying rock mass. This means that if the coalbed is very strong and the immediate roof is sufficiently thick to provide a gob foundation for

support of the main roof, the loading on the powered supports will be considerably less than if the coalbed is weak and deformed, or if the gob stiffness is so low that the gob must be highly compacted before it provides much resistance.

The required support capacity is generally determined by estimating the height of the caving zone. A caving zone occurs when a portion of the immediate roof is fractured by the overburden abutment pressure, causing that portion to separate from the overlying rock mass and cave behind the supports once the supports are advanced. Upon caving, these strata consume a larger volume by bulking to fill

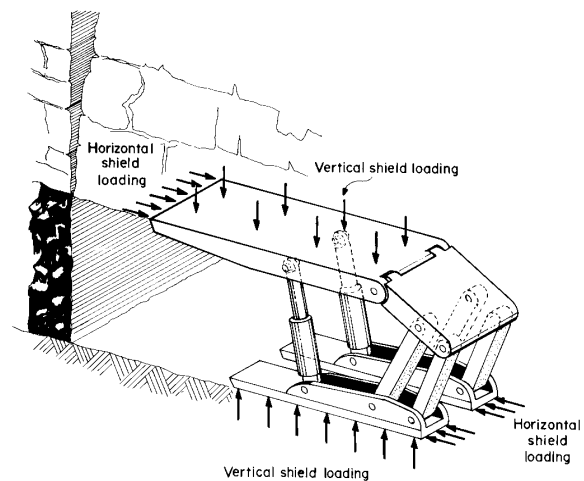

Figure 12.—Horizontal and vertical shield loading produced from support and strata interactions.

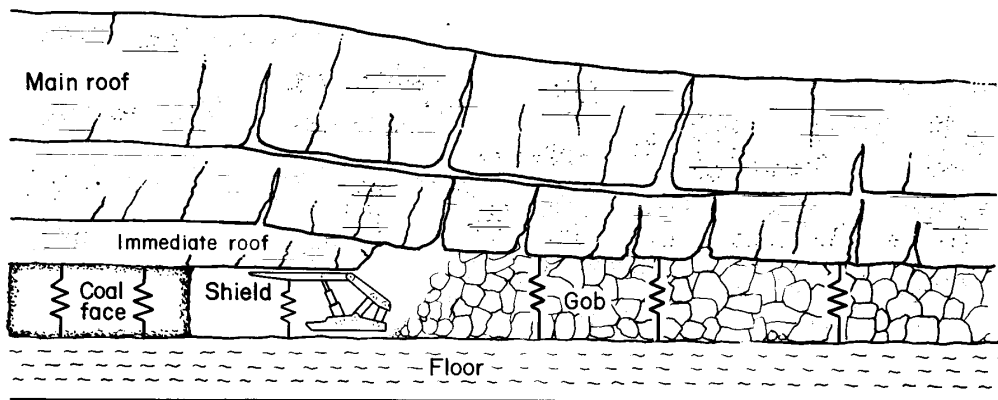

Figure 13.—Mechanics of roof behavior and manifestation of shield loading.

the void created by the extraction of the coal seam and the caved roof. This typically establishes a caving height of four to six times the mining height for weak- to moderate-strength immediate roof geologies. More competent strata, which are less likely to be rubblized by the overburden pressure, tend to fail along well-defined parting planes and to cave in larger, blocky pieces with considerably less bulking than weaker strata. Caving heights of up to 12 times the mining height are typical for these competent roof geologies that are frequently encountered in the United States. As a worst-case load condition, it is then assumed that the entire weight of the rock mass in the caving zone must be carried by the shield support. This establishes a conservative design capacity for the support. Figure 14 indicates the maximum caving height that can be supported by the indicated shield capacity, assuming an isolated rock mass 15 ft long and 5 ft wide with a caving angle of 30° to vertical at the rear of the support. A rock density of 165 lb/ft³ was also assumed in these calculations.

However, gravity loading by isolated rock masses in the immediate roof is generally not the typical load condition imposed on the shield. Under most circumstances, the immediate roof maintains some stability and often acts as a disjointed cantilevered beam. Shield loading is produced in response to deflection of the immediate roof beam and the convergence induced by the deformation of the main roof structure. The purpose of the support is not to *prevent* these strata deformations. It is not necessary, nor is it desirable, to utilize more support resistance than is needed to maintain the stability of the immediate roof. Higher-than-needed support resistance unnecessarily stresses the support structure and the surrounding strata, leading to a reduction in shield life and a potential degradation of roof and floor conditions.

These interactions of the support with the strata impose the following design requirements for the shield:

1. Adequate capacity to provide equilibrium of the immediate rock mass that is not supported by the coal face or caved gob material;
2. Vertical stiffness and hydraulic yield capacity compatible with the imposed displacement of the overburden to avoid excessive yielding of the leg cylinders;
3. Horizontal stiffness to provide resistance to horizontal displacements and rotations that compromise the

CONSEQUENCES OF DESIGN AND OPERATING PRACTICES

Historically, a "bigger the better" philosophy has been pursued in longwall shield design. As shown in figure 6, support capacities have generally increased throughout the history of longwall mining. Two motivations for this increase in support capacity are (1) to enhance support life

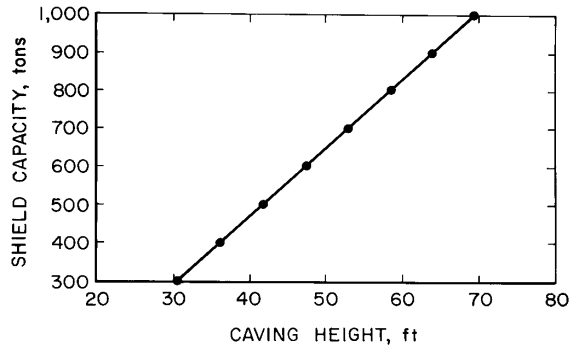

Figure 14.—Maximum caving height that can be supported with designated shield capacity assuming free block formation directly above shield.

integrity of the immediate strata or the stability of the support structure;

4. Sufficient lateral stiffness to maintain stability against loading parallel to the face line that may occur for eccentric contact conditions or pitching seam operations;

5. Adequate bearing areas at the roof and floor interface to effectively distribute the leg forces and to avoid further fracturing, compacting, or movement of the strata that would compromise ground control or support stability;

6. Ability to provide adequate roof and gob cover to avoid the hazardous infiltration of roof material into the working area;

7. Structural components designed to maintain elastic response for load conditions induced by vertical and horizontal strata displacements under full and partial contact configurations established at the roof and floor. Well-engineered mechanics should be employed to avoid critical load conditions, such as standing the support on the toe of the base; and

8. Ability to provide adequate ground control and to accommodate changes in operating height of 100 pct or greater in some cases. Changes in support capacity, stiffness, and load distribution on the canopy and base should be determined as a function of operating height as part of the design and performance testing procedure (9).

and (2) to provide reserve capacity for insurance against difficult ground conditions. However, an examination shows recent shield design and operating practices to be counterproductive to achieving these goals.

An analysis of shield mechanics indicates that the vertical load capacity of a shield is almost totally provided by the hydraulic leg cylinders. The caving shield-lemniscate assembly has very little vertical stiffness and provides less than 5 pct of the shield capacity (10). The purpose of the assembly is to provide horizontal stiffness and stability to the canopy and base. Therefore, if the support capacity is to be increased, it must be done through the leg cylinders. Three options are available: (1) The hydraulic yield pressure can be increased, (2) The size (area) of the leg cylinders can be increased, and (3) The number of legs can be increased. Historically, the design practice has been to increase shield capacity by increasing the diameter of the legs, while keeping the yield pressure constant at about 6,500 psi. The larger leg area then provides a corresponding increase in leg force. Hydraulic setting pressures have also remained constant at about 4,500 psi, which means setting forces have increased in direct proportion to the increase in shield capacity. An important consequence of the increased leg area is a corresponding increase in shield stiffness. For example, a 500-ton shield has a vertical stiffness of about 400 ton/in of vertical displacement, while an 800-ton shield has a stiffness of 600 ton/in of displacement.

The consequences of these design practices can be seen by examination of figures 15 and 16. Figure 15 illustrates setting forces and available capacity after setting for three shields of different capacities: (1) 360 tons, representative of 1980; (2) 500 tons, representative of 1985; and (3) 700 tons, representative of 1990. As seen in the figure, setting forces have increased with the increase in support capacity to remain constant at 60 pct of the total support capacity. Hence, while there is some increase in reserve capacity after setting with the higher capacity shields, the setting forces represent the majority of the shield loading,

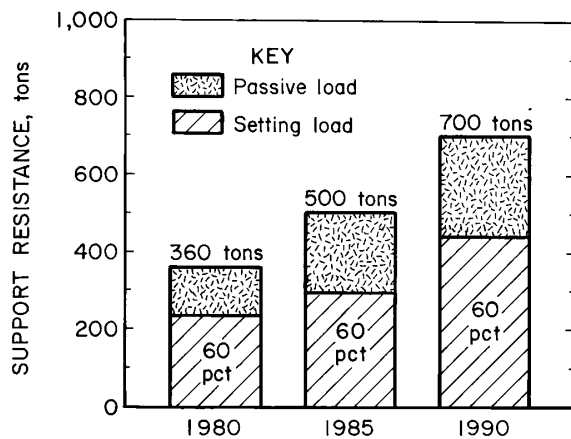

Figure 15.—Comparison of setting force and total shield capacity for three shields of different capacities.

and the increase in setting forces causes all three shields to be stressed to nearly the same level. Since structures fail from being stressed, this analysis suggests that the 700-ton shield will not last much longer than the 360-ton shield despite having twice the capacity.

This argument is further reinforced by examination of load development in the support after it is actively set against the roof and floor. After the shield is set against the roof and floor, it acts totally as a passive support and develops resistance through the hydraulic leg cylinders only by displacement of the canopy relative to the base. Figure 16 compares load development for a 500-ton shield and an 800-ton shield for the same load condition: 0.5 in of roof convergence. Since the stiffness of the 800-ton shield (600 ton/in) is 50 pct greater than that of the 500-ton shield (400 ton/in), the 500-ton shield reacts 200 tons of load in response to the 0.5 in of convergence, while the 800-ton shield reacts 300 tons of load in response to this convergence. With a setting force of 60 pct of the shield capacity, the full 500 tons of capacity is used in the 500-ton shield and all but 20 tons is used in the 800-ton shield. Hence, both supports were essentially loaded to their full capacity and stressed to the same degree for the identical load condition, despite the 800-ton shield's having 300 additional tons of capacity initially. Based upon this analysis, longer shield life and additional reserve capacity to accommodate difficult ground conditions should not be expected with higher capacity shields.

Differences in two-leg and four-leg shield design also provide for different strata interactions. The primary difference is the ability of the two-leg shield to provide an

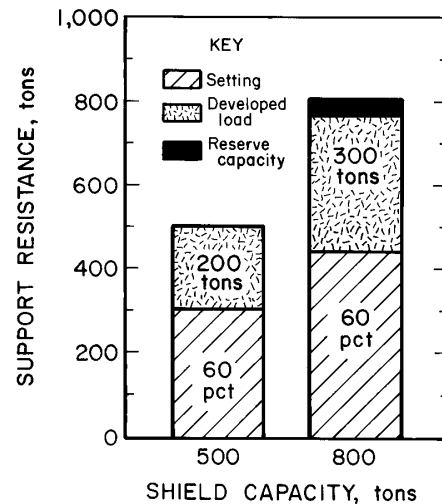

Figure 16.—Comparison of load development for 500-ton and 800-ton shield for same load condition of 0.5 in of convergence.

active horizontal force (11). Since the leg cylinder in a two-leg shield is inclined toward the face, horizontal components of the leg force push the canopy toward the coal face as shown in figure 17. This induces a force into the immediate strata that tends to maintain the strata in a state of compression. In comparison, the legs of a four-leg shield are inclined in opposite directions to one another and the horizontal components of leg force cancel one another out and do not produce an active horizontal force. In conclusion, two-leg shields are more effective in controlling highly jointed or friable immediate roof geologies, since the active horizontal force arrests slippage along fracture planes and improves overall strata stability.

A reported advantage of the four-leg shield is that it provides a resultant vertical force farther from the coal face than does a two-leg shield (see figure 18). This is supposed to be more effective in controlling cantilevered strata, since the support force acts at a mechanically more efficient location. However, laboratory and field data suggest that this advantage is highly overrated for two reasons. First, the difference in resultant locations and the corresponding load profile on the canopy are too small to make a significant difference. Second, there is typically an imbalance in load distribution between the front and rear legs of a four-leg shield, so that the resultant force location is similar to that of a two-leg shield.

The unbalanced distribution of loading between the front and rear legs also makes the four-leg shield less effective in cavity-prone strata. As the example in figure 19 illustrates, the force in the rear legs causes the canopy to rotate up into the cavity, which causes a loss of roof contact at the canopy tip. This condition ultimately results in further cavity formation and requires the front legs to do all of the supporting work. Since the front legs of a four-leg shield are considerably smaller than they would be in a two-leg shield of equivalent support capacity, the four-leg shield provides much less supporting force than would a comparable two-leg design. If the legs are double-acting cylinders, four-leg shields can be effective in controlling cavities in the immediate roof by having one set

of legs act in the opposite direction of the other as illustrated in figure 20. This action controls the rotation of the canopy about one set of legs and can ensure contact loading at the tip or rear of the canopy. However, opposing leg reactions greatly diminishes the capacity of the shield and is not an efficient utilization of the support system.

The primary disadvantage of a two-leg shield is generally higher contact pressure on the canopy and base. High toe loading, caused by the moment created by the line of action of the resultant vertical forces acting on the canopy and base (see figure 21), can be a problem in high-capacity two-leg shields and should be a primary consideration in the support design. This behavior is alleviated in four-leg designs since the two sets of legs provide a canopy resultant force more coincident with the base resultant and provide for a more uniform load distribution. However, if a two-leg shield of the required support capacity can be obtained, it is the preferred support in most applications. Figure 22 illustrates two-leg and four-leg shield utilization as a function of seam height, panel width, and depth of cover.

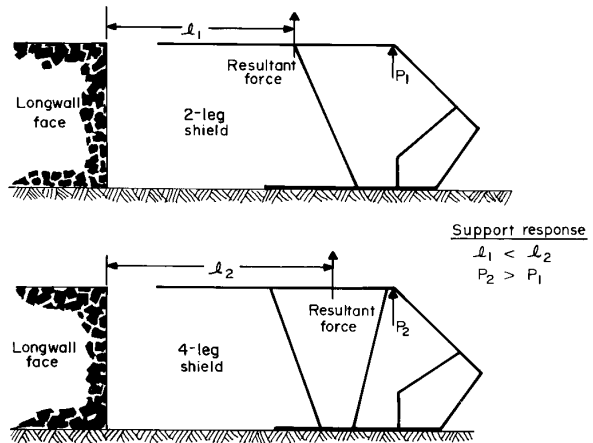

Figure 18.—Comparison of resultant force locations for two-leg and four-leg shields.

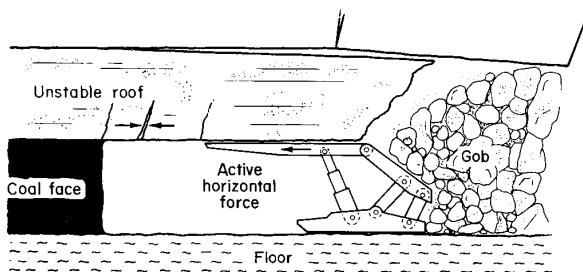

Figure 17.—Active horizontal force provided by two-leg shield designs.

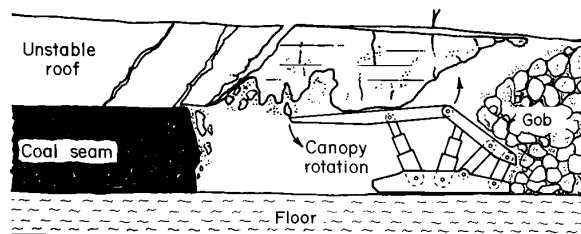

Figure 19.—Four-leg shield operation in cavity-prone conditions illustrating problems of canopy control.

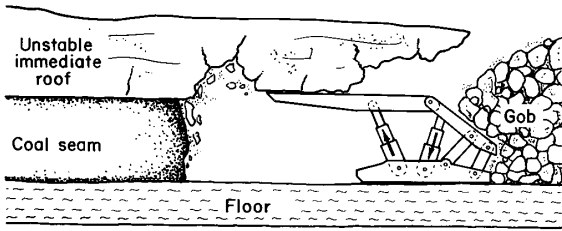

Figure 20.—Controlling cavities in roof with opposing leg reactions using four-leg shields.

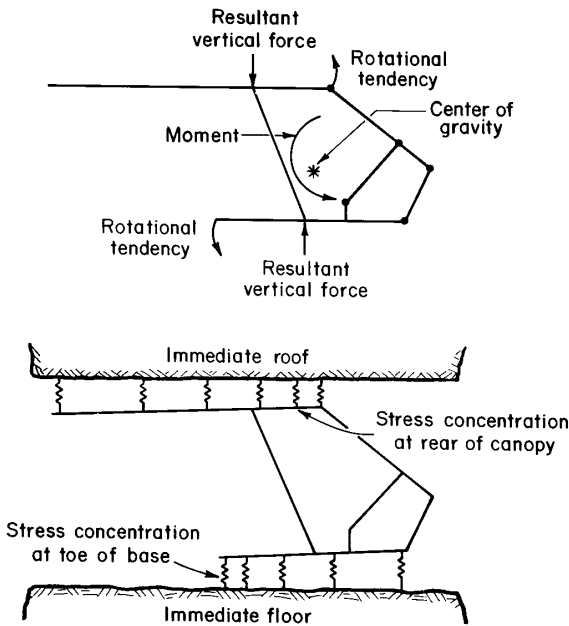

Figure 21.—High toe loading caused by rotational moment in two-leg shields.

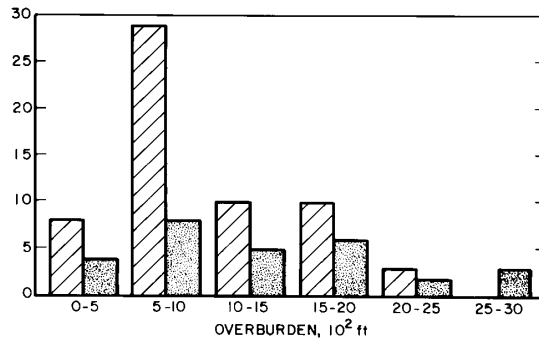
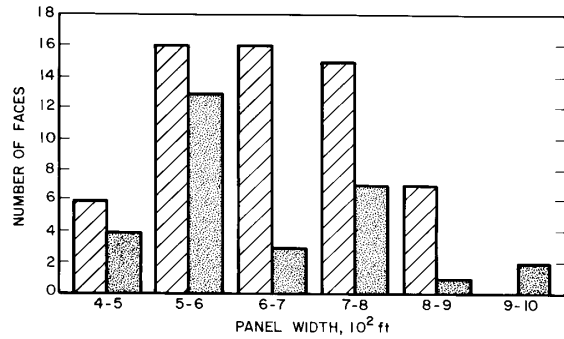
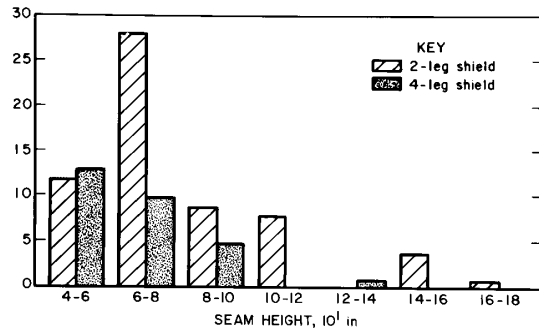

Figure 22.—Selection of two-leg and four-leg shields as function of seam height, panel width, and depth of cover.

OPTIMIZATION OF SUPPORT UTILIZATION

The primary purpose of the support system is to provide a safe working place for the personnel and equipment to extract coal. An optimization goal in terms of support utilization is to minimize support loading during a mining cycle. Since ground control problems generally manifest

themselves in terms of support loading, minimizing support loading provides effective ground control with the most efficient use of the support system. Because the operator does not have control over the shield stiffness (10), an optimum setting force must be provided to minimize

support loading. Therefore, setting pressures should be adjusted until total support loading is minimized. A less stringent optimization goal is to avoid yielding. Again, this can be accomplished by minimizing the setting force, since doing so provides the maximum reserve capacity to be utilized in response to the roof activity. If the support resistance has no influence on strata behavior, then an active setting force is not required. The shield can be raised to the point where roof contact is first established, and then used as a passive support to develop load as needed in response to the uncontrollable roof activity. Only if the shield resistance influences the strata behavior is an active setting force justified, and then the setting force should be examined in reference to the total load developed during the mining cycle.

An examination of strata behavior is provided to evaluate the interaction of the shield with the strata. Strata behavior from the perspective of support loading can be classified into four general categories as illustrated in figure 23: (1) main roof convergence, (2) periodic weighting from the main roof and partial caving zone, (3) free block formation in the immediate roof, and (4) deflection of the immediate roof beam. An assessment of the shield influence on these load conditions follows. Setting pressure recommendations are made in reference to the current practice of setting pressures at 60 pct of yield pressure.

Main roof convergence.—The convergence of the main roof is irresistible in terms of any shield capacity that conceivably could be provided. Hence, it is concluded that the shield has no influence on main roof convergence. Where the main roof behavior is dominant, setting pressures should be reduced to provide the necessary capacity to accommodate the main roof convergence.

Periodic weighting.—Periodic weighting is most likely to develop in the main roof and in the partial caving zone several tens or hundreds of feet from the coal seam. The support does not generate sufficient force to significantly affect the state of stress in the rock mass at this level. Hence, it is unlikely that the magnitude of the shield resistance will have much effect on controlling periodic weighting. Again, reduced setting pressures are recommended to maximize the available support capacity to absorb the load intensities developed from periodic weighting.

Formation of a free block in the immediate strata.—The front abutment pressure creates fissures in the immediate strata and the potential for free block formation once

the strata become distressed as the coal is removed. The shield may act to equilibrate these strata, but it is unlikely that it will prevent formation of the free block. If it is critical to keep this isolated block from converging to prevent separation from the overlying strata, then an active setting force equal to the weight of the block is required. Obviously, the required setting force would change from cycle to cycle unpredictably. Therefore, only a nominal setting force is recommended to avoid wasting available capacity. It should also be remembered that if separation of the strata does not manifest itself in higher support loading or threaten strata stability, the active setting force is not justified.

Deflection of the immediate roof beam.—Of the four types of loading discussed, the shield resistance is most likely to influence the deflection of the immediate roof beam. Structural mechanics indicates that the deflection of the immediate roof beam decreases with increased shield stiffness. The deflection of the roof beam may also be dependent upon the magnitude of the shield resistance, if the support resistance acts to prevent bed separation by binding the strata layers together or if it prevents slippage along bedding planes by increasing the frictional restraint between layers. The effect of these actions is to increase the bending stiffness of the roof beam by increasing its moment of inertia (see figure 24). The increased bending stiffness of the roof beam reduces its deflection and subsequent shield loading. While a stronger roof beam is more likely to cantilever beyond the face, it is unlikely that the increased shield resistance significantly influences cantilevering beyond the supports since the roof beyond the supports is likely to relax as the support is removed.

Shield load development is also dependent upon the stiffness of the immediate roof and floor structure. Stiffer strata transfer more of the overlying roof convergence into the shield, causing higher shield loading. Hence, if there is debris on the canopy or under the base, it is likely that this debris will be more compacted for higher setting forces and will cause an increase in shield load development.

In summary, the shield is most likely to influence strata behavior by increasing the bending and axial stiffness of the immediate roof or floor through higher setting forces. However, the increased bending stiffness is likely to reduce shield loading during the mining cycle, while the increase in axial stiffness increases shield loading. The benefit of this active setting force must then be examined on the basis of overall support loading and strata stability.

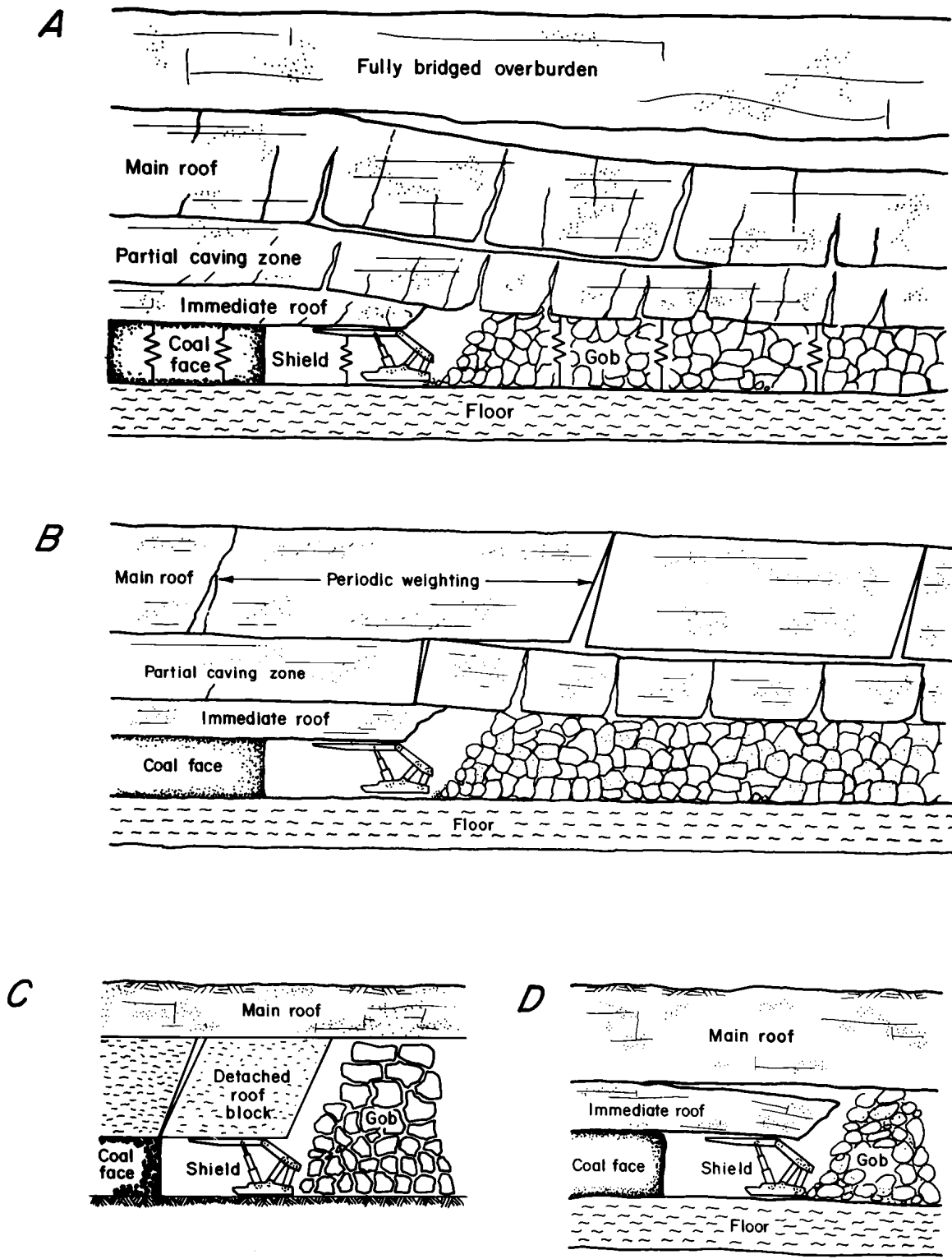
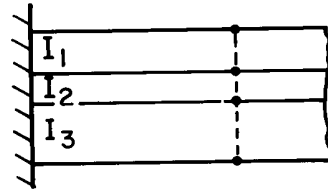

Figure 23.—Four general categories of strata behavior pertaining to shield loading. A, Main roof convergence; B, periodic weighting; C, detached immediate roof; D, deflection of immediate roof.

UNDEFORMED IMMEDIATE ROOF



NO FRICTIONAL INTERACTION

Layers slip

$$I_{\text{Slip}} = I_1 + I_2 + I_3$$

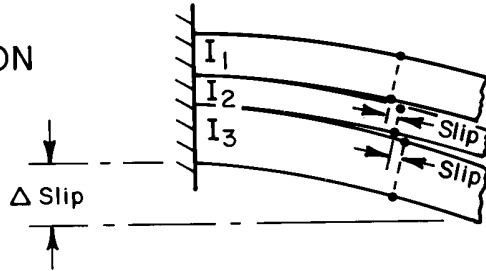

FULL FRICTIONAL INTERACTION

No slip

$$I_{\text{No slip}} = I_1 + I_2 + I_3 + \sum_{x=1}^3 A_x d_x^2$$

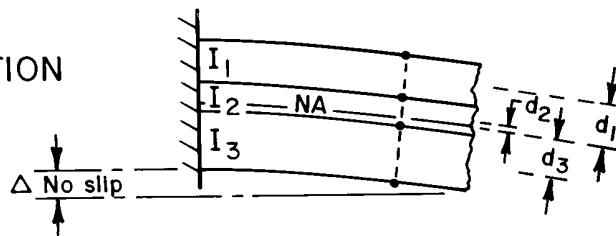

KEY

A_1, A_2, A_3 Layer area

d_1, d_2, d_3 Distance from layer neutral axis to composite neutral axis

I_1, I_2, I_3 Moment of inertia of each layer

NA Neutral axis of composite beam

$$I_{\text{NO SLIP}} > I_{\text{SLIP}}$$

$$\Delta_{\text{NO SLIP}} < \Delta_{\text{SLIP}}$$

Figure 24.—Increased moment of inertia of roof beam caused by shield forces.

CONCLUSIONS

The full potential of longwall mining was not realized until powered roof supports, particularly shield support systems, were developed. The stability of the shield permitted the application of longwall mining in conditions where caving was difficult to control and where chock and frame supports were inadequate.

Lemniscate-guided caving shield designs quickly replaced caliper designs to provide a constant tip-to-face distance throughout the shield's operating range, and electrohydraulic control systems now provide remote and automated shield operation. The next major change in shield design is likely to be an increase in shield width from 1.5 to 2.0 m in an effort to reduce support costs and improve stability in thick-seam operations.

Shield capacities continue to increase. Several 700- and 800-ton shield systems are now in operation in U.S. coal mines. Justifications for this increase in capacity in terms of shield life and reserve capacity for difficult ground conditions are being questioned in light of current design and utilization practices. An often overlooked consequence of the increase in shield capacity is an increase in shield stiffness. Since longwall strata do not reach a full state of equilibrium and much of the displacement of these strata is irresistible from the perspective of shield capacities,

the stiffness of the shield is an important design consideration. Higher capacity (stiffer) supports react a larger load to the roof-to-floor convergence, and therefore use up their available capacity as a passive support more quickly than lower capacity (less stiff) supports do.

A closer examination of setting forces is suggested for the high-capacity support systems being used today. Setting forces greater than the yield forces of past-generation shields are routinely used. Since many of these old faces were not yielding excessively, the use of the high setting force with the high-capacity supports is questioned. The proportional increase in setting force with increases in shield capacity causes the high-capacity supports to be stressed to nearly the same degree as the low-capacity systems they replaced and severely limits their ability to last longer.

Powered roof supports currently represent about 70 pct of the equipment cost required for longwall mining. The shield design provides an effective system that can be used in a wide variety of ground conditions and is likely to remain the support design for the foreseeable future. In order to optimize shield design and utilization and to reduce failures and extend shield life, the Bureau continues to investigate shield design and its interaction with mine strata.

REFERENCES

1. Peele, R. *Mining Engineering Handbook*. Wiley, v. 1, 3d ed., 1941, pp. 10-5-5 to 10-5-11.
2. Mason, R. H. The First Longwalls Were Primitive Compared to the Ones Now in Use. *Coal Min. and Process.*, v. 13, December 1976, pp. 59-64.
3. Combs, T. H. Longwall Productivity Continues Upward Trend, Jumps 30 pct in Year's Time. *Coal*, v. 25, August 1988, pp. 40-41.
4. Barczak, T. M. Practical Considerations in Longwall Support Selection. Paper in Proceedings, Ninth International Conference on Ground Control in Mining. WV Univ., 1990, pp. 128-134.
5. Coal. Longwall Census '90. June 1990, pp. 40-49.
6. Adam, R. A., T. M. Barczak, and H. Irresberger. Strata Dynamics in Underground Coal Mines. Paper in Proceedings: Longwall USA Conference Papers. MacLean Hunter, 1991, pp. 285-313.
7. Barczak, T. M. Safety Evaluations of Longwall Roof Supports. BuMines IC 9221, 1989, 17 pp.
8. Barczak, T. M., and D. C. Oyler. A Model of Shield-Strata Interaction and Its Impact on Active Shield Setting Requirements. Paper in Proceedings, Tenth International Conference on Ground Control in Mining. WV Univ., 1991, pp. 35-42.
9. Barczak, T. M. Advanced Guidelines for Performance Testing of Two-Legged Longwall Shields. BuMines IC 9231, 1989, 149 pp.
10. Barczak, T. M., and D. E. Schwemmer. Stiffness Characteristics of Longwall Shields. BuMines RI 9154, 1988, 14 pp.
11. Barczak, T. M. Selection of the Right Shield Support. *Coal Min.*, v. 96, June 1990, pp. 63-67.