

The Californium Source Upgrade

Based on Material presented at the
ATLAS Operation's Review
December 8-10, 2003

by

Guy Savard

Argonne National Laboratory

&

University of Chicago

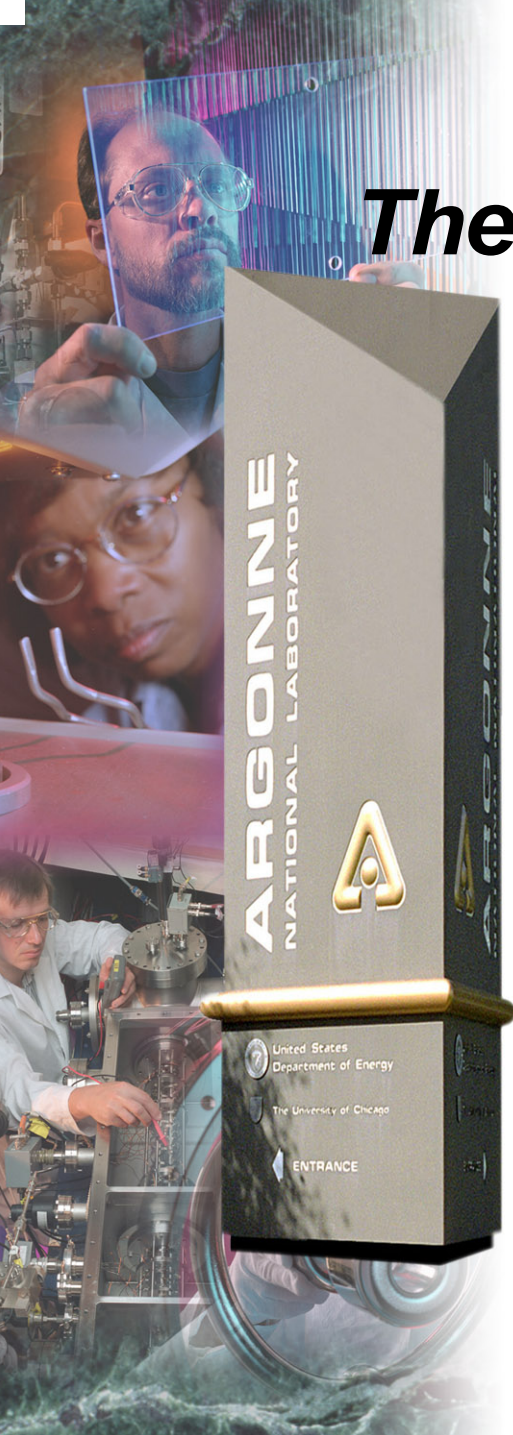

*A U.S. Department of Energy
Office of Science Laboratory
Operated by The University of Chicago*



ATLAS Status

- **ATLAS** → **only low-energy accelerator for stable ions operating as a User Facility**
with well documented characteristics (reliability, beam quality, transmission, timing,...)
- **Excellent and varied physics program with a large User community**
- **What lies ahead for ATLAS**
 - Maintain position as premier low-energy heavy ion accelerator
 - Address open physics/technical questions leading to RIA
 - Help the community in the “pre-RIA” phase with stable beams
 - Help the community with exotic beams hand in hand (i.e. complementary) with HRIBF and NSCL

Where the field is going ... big picture

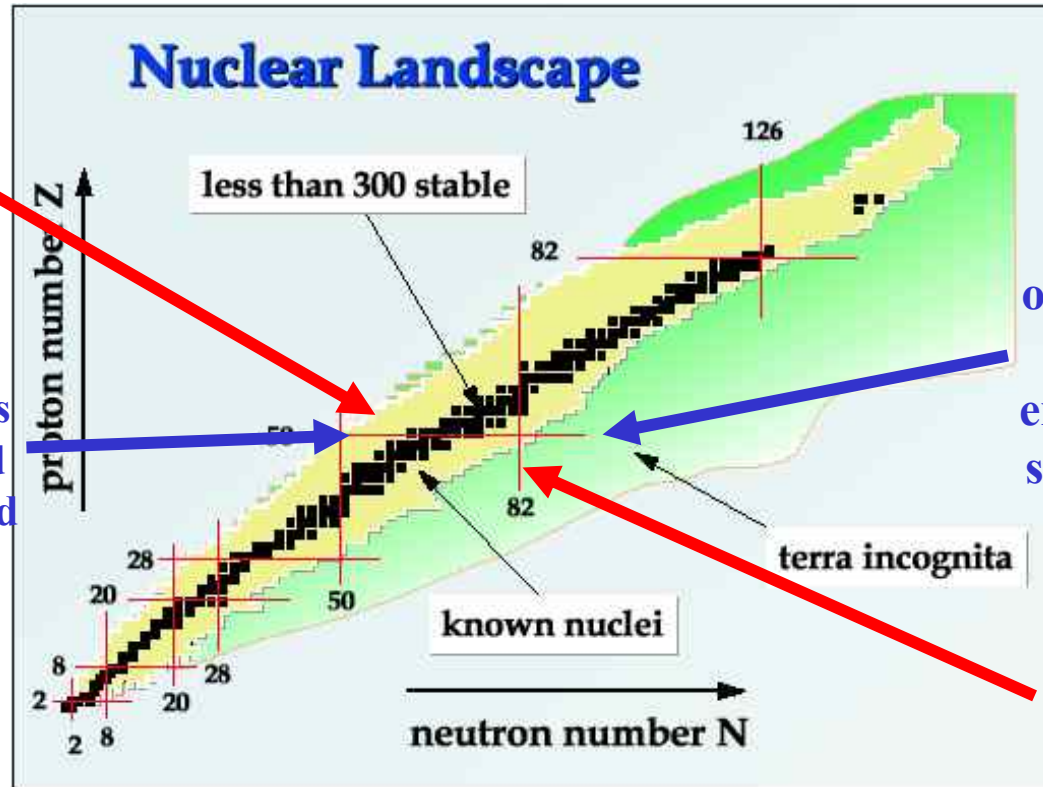

**Fusion-evaporation
& fragmentation**

If changes are to occur, they will take place here and existing facilities are starting exploration

We have been there, lots of great physics left and we know how to proceed

Fission + ???

n-rich region is the next frontier and the exploration has started

Important physics questions

- **modification of nuclear structure in neutron rich systems**
 - *shell-structure quenching*
 - *single particle structure near n-rich magic nuclei*
 - *pairing interaction in weakly bound systems*
- **collective behavior in neutron-rich systems**
- **r-process path**
 - *ground-state information*
 - mass
 - lifetime
 - beta-delayed neutron branching ratio
 - *neutron capture rate*
 - *fissionability of very heavy n-rich isotopes*



Answering physics questions (I): Nucleon transfer reaction ... single particle state

- Single particle/hole states around magic nuclei
 - ^{132}Sn
 - ^{78}Ni
- (d,p) reactions
 - Best done well above Coulomb barrier in both entrance and exit channels ... i.e. about 7.5 MeV/u around ^{132}Sn
 - requires 10^4 per second to get information on angular distribution
- ($^3\text{He}, \alpha$), (α, t) reactions
 - similar requirements

(d,p) reactions can also be important to determine (n, γ) rates close to r-process path.

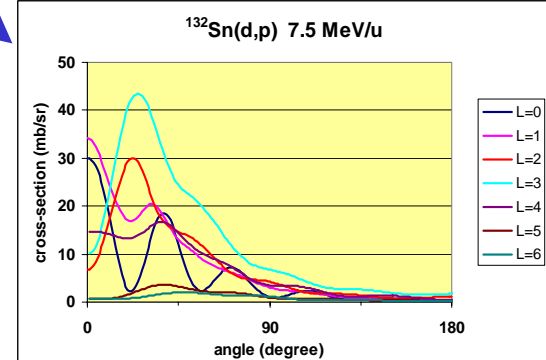
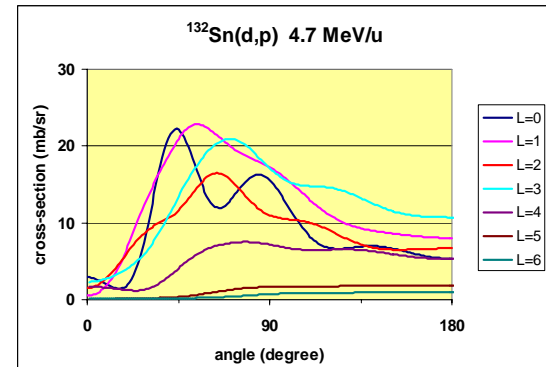
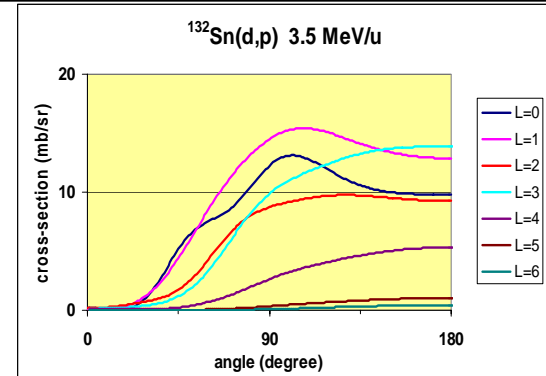

Answering physics questions (II): Multinucleon transfer ... pairing interaction

- (p,t) and (t,p) reactions ... 2-neutron pairing in weakly bound n-rich nuclei
- energy and strength of excited 0+ states (paired neutron particles/holes)
- Q-value and Coulomb barrier set required energy
 - (t,p) reactions can be done with energies available at ATLAS, some (p,t) require on-going energy upgrade

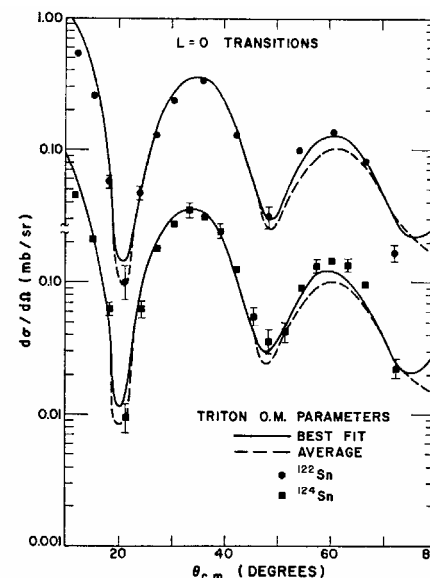
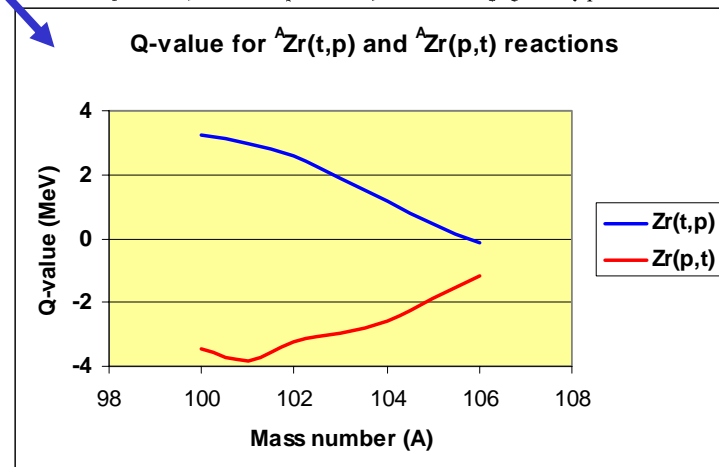

Fig. 1. $L = 0$ transitions. Distorted wave calculations are shown for two cases of optical-model potentials, the best fit parameters, and the average geometry parameters.

A	Current ATLAS		UPGRADE I		UPGRADE II	
	No Strip	Strip	No Strip	Strip	No Strip	Strip
1	24.08	24.08	38.50	38.50	54.84	54.84
2	15.71	15.71	23.20	23.20	31.57	31.57
16	12.98	15.66	18.50	21.48	24.52	29.79
40	12.37	13.35	17.49	19.91	23.00	27.28
58	9.94	11.79	13.49	17.87	17.04	24.75
78	9.49	11.19	12.78	16.71	15.98	22.90
132	7.96	9.33	10.37	13.38	12.40	15.23
197	6.65	7.89	8.37	10.94	9.43	13.88
238	6.36	7.39	7.94	10.04	8.79	12.40



Answering physics questions (III): Coulomb excitation ... collective properties

- TRS calculations show low lying superdeformed minima for neutron rich Mo-Ru nuclei.
- To access these structures, one needs to excite these nuclides to $I \sim 30\hbar$.
- This can be accomplished using Coulomb excitation of the beam at energies $\sim 25\%$ above the barrier.
- With beams $> 1 \times 10^5$, studies such as these using Gammasphere should be possible.

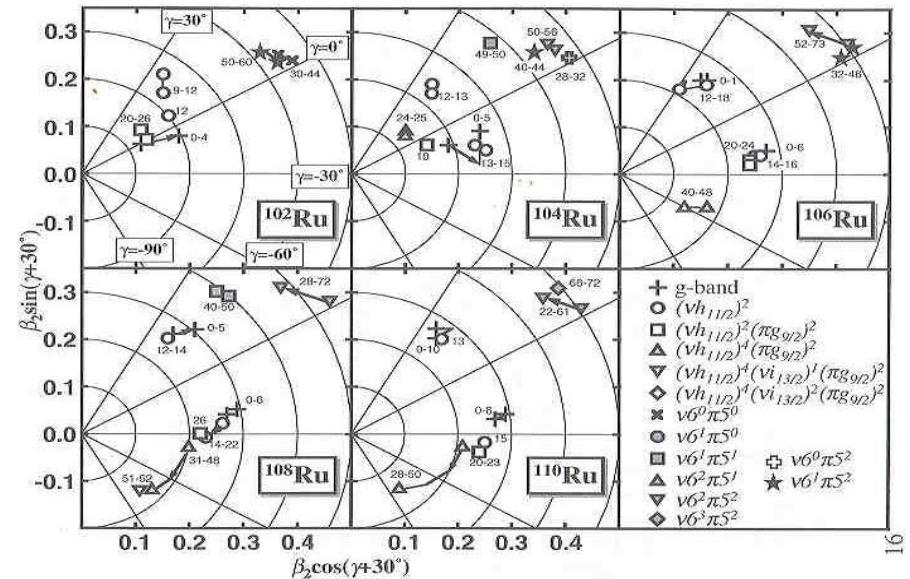

J. Skalski *et al.*, Nucl. Phys. A617 (1997) 282

Calculations predict best cases are ^{100}Mo ($N=58$) and $^{110,112}\text{Ru}$ ($N=66,68$) where SD bands predicted to be yrast at $I \sim 20$.

Answering Physics questions (IV): Ground state properties close to r-process path

- r-process path determined by nuclear masses
- r-process evolution dominated by nuclear lifetimes
- beta-delayed neutrons affect final isotope distribution
- very little information in the refractory element region around Mo, Zr, Tc, ...
- need **element independent technique** to access these regions

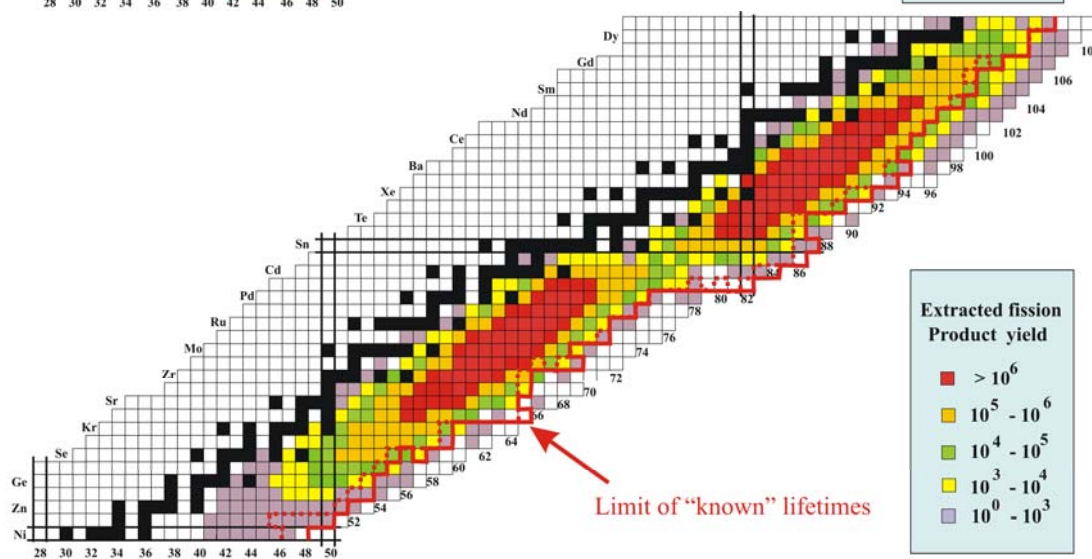
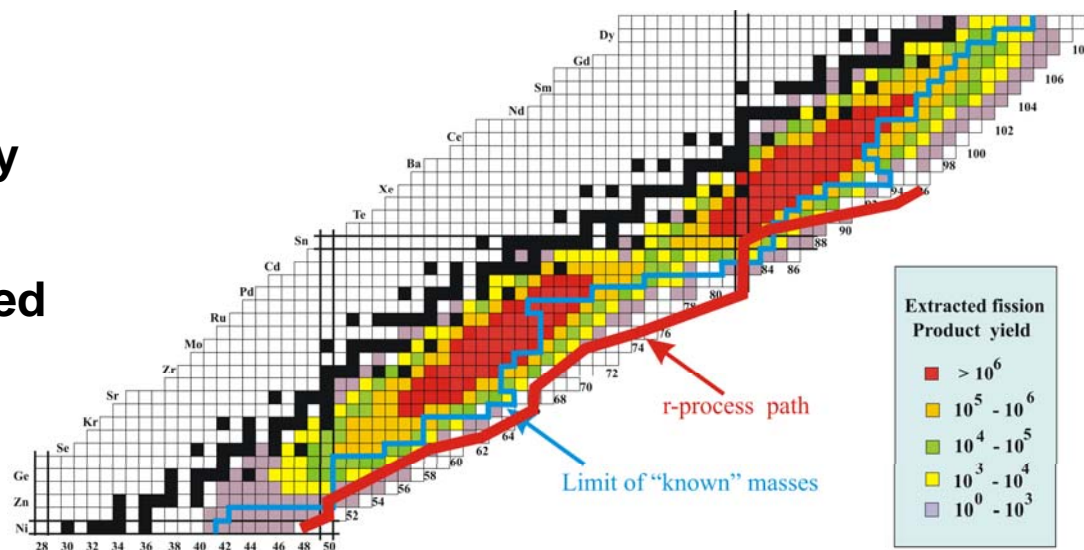

What does ATLAS have to offer for n-rich beams?

- **New target/source approaches**
→ **gas catcher, charge breeder** ←

can be used to efficiently turn a non-conventional source of n-rich isotopes such as a spontaneous fission source into a low-energy beam

- **Very high post-acceleration efficiency**
→ **RIA post-accelerator based on ATLAS** ←

Accelerated Neutron-rich Radioactive Ion Beams

(over 100 beams with intensities $\geq 10^3$ ions/sec)

Yields for

E/A = 3 MeV/amu

From HRIBF web site

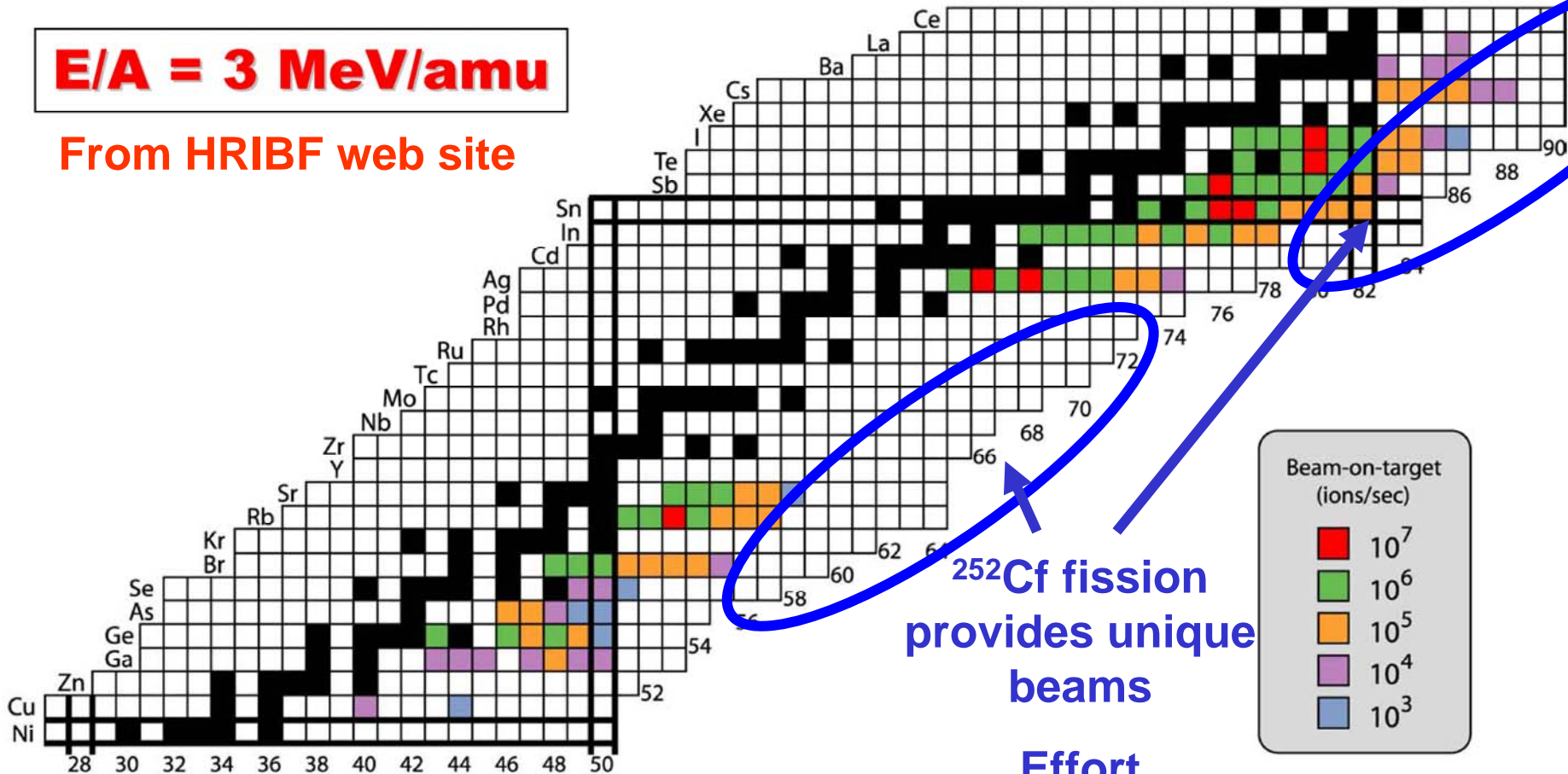

Effort complementary to HRIBF

OAK RIDGE NATIONAL LABORATORY
U.S. DEPARTMENT OF ENERGY

UT-BATTELLE

New opportunity: ^{252}Cf source + large gas catcher as neutron-rich isotope source

- Shortened version of RIA gas catcher can efficiently stop fission products from a fission source
 - ~ 50% stopped in gas for backed source
- About 45% of those can be extracted as charged ions
- Very efficient and fast source, provides cooled bunched beams for post-acceleration
- Production peaks in new regions and extraction is element independent ...
new isotopes available



Gas catcher technology developed, tested and now routinely used at ATLAS for CPT and RIA programs

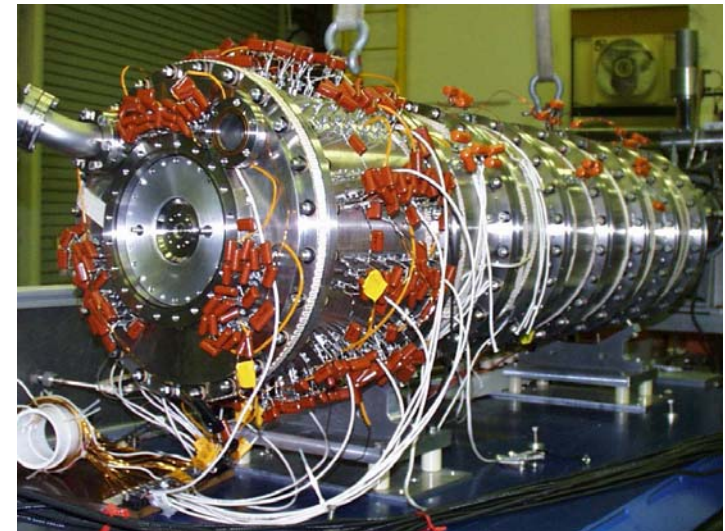

Extracted isotope yield at low energy

- 1 Ci ^{252}Cf source
- about 20% of total activity extracted as ions
- works for all species
- large improvement over existing ISOL based facilities

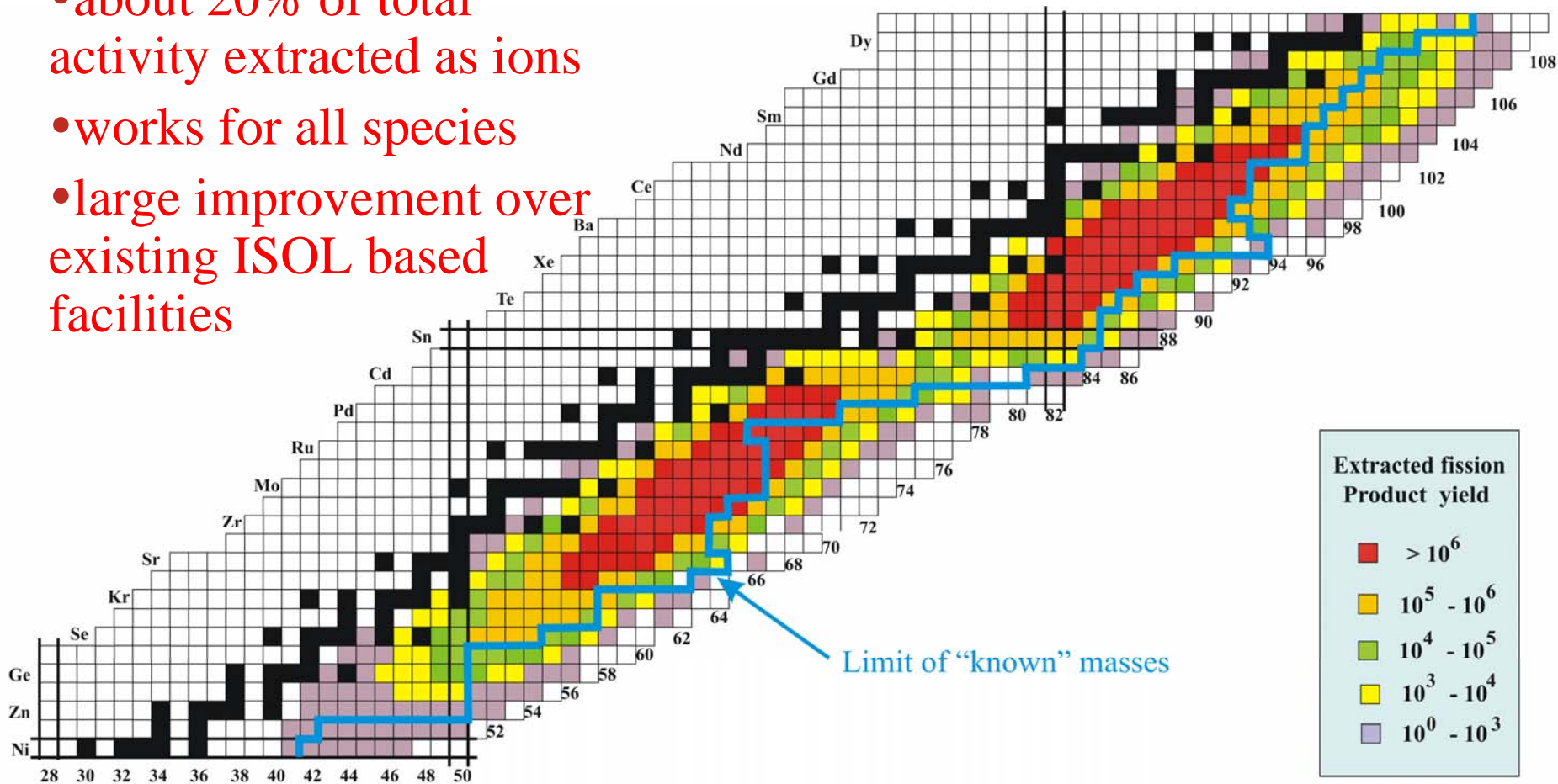

Phoenix ECR Charge Breeder

ISN Grenoble

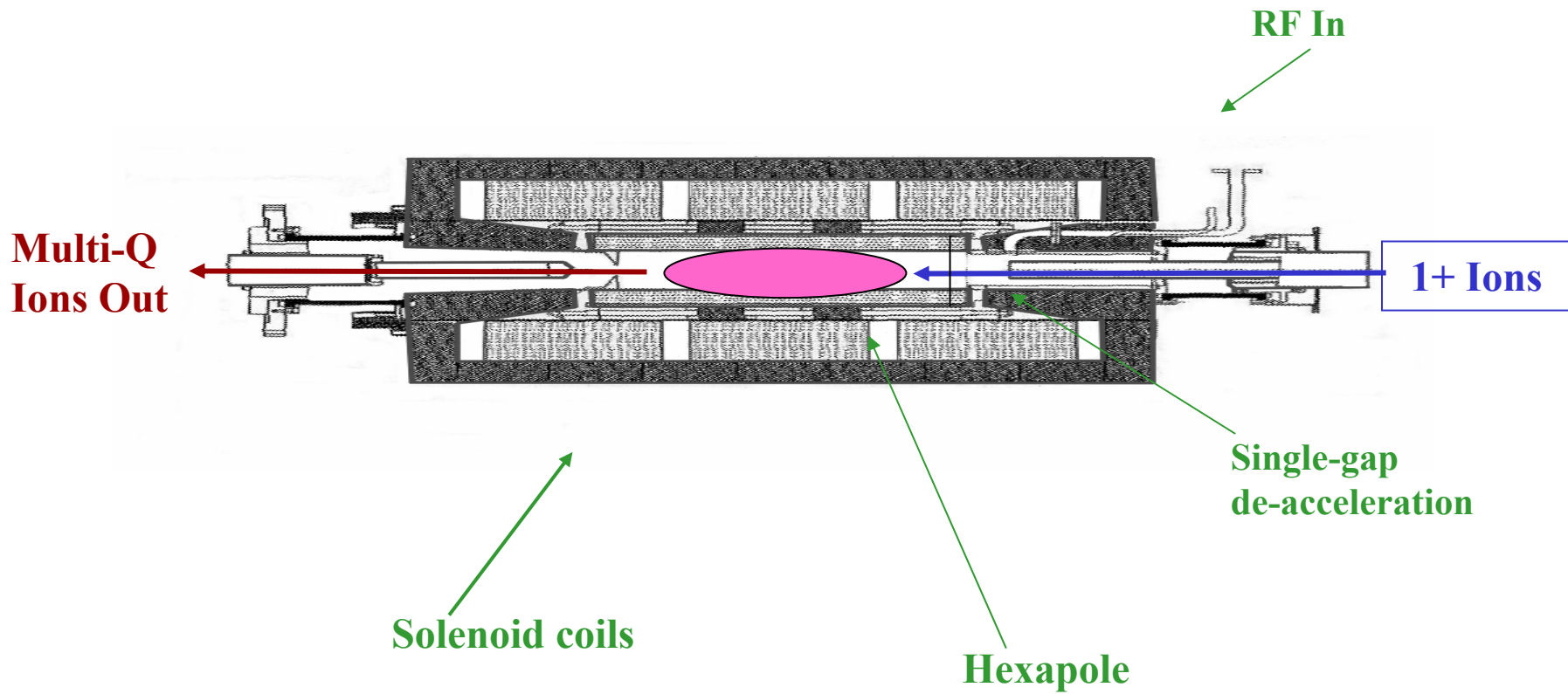

Phoenix Ionization Efficiency vs. RIA Stripping Scenario

ISN/TRIUMF

- **Gases**

	Efficiency	A/Q	Time(ms)	RIA Strip. Eff.
- $^{40}\text{Ar}^{9+}$:	11.9%	4.4	25	33%
- $^{84}\text{Kr}^{14+}$:	10.3%	6.0	60	12%

- **Solids**

- $^{115}\text{In}^{18+}$:	4.6%	5.8		9.5%
- $^{109}\text{Ag}^{19+}$:	3.9%	5.7	25	9.5%
- $^{120}\text{Sn}^{22+}$:	4.0%	5.5	20(19+)	9.5%

- **1+ beam emittance used: 55π mm•mr**

Emittance extracted from gas catcher system is below 5π mm mr and one can expect even higher charge breeding efficiency for solids

Proposed location for neutron-rich isotope source

ATLAS

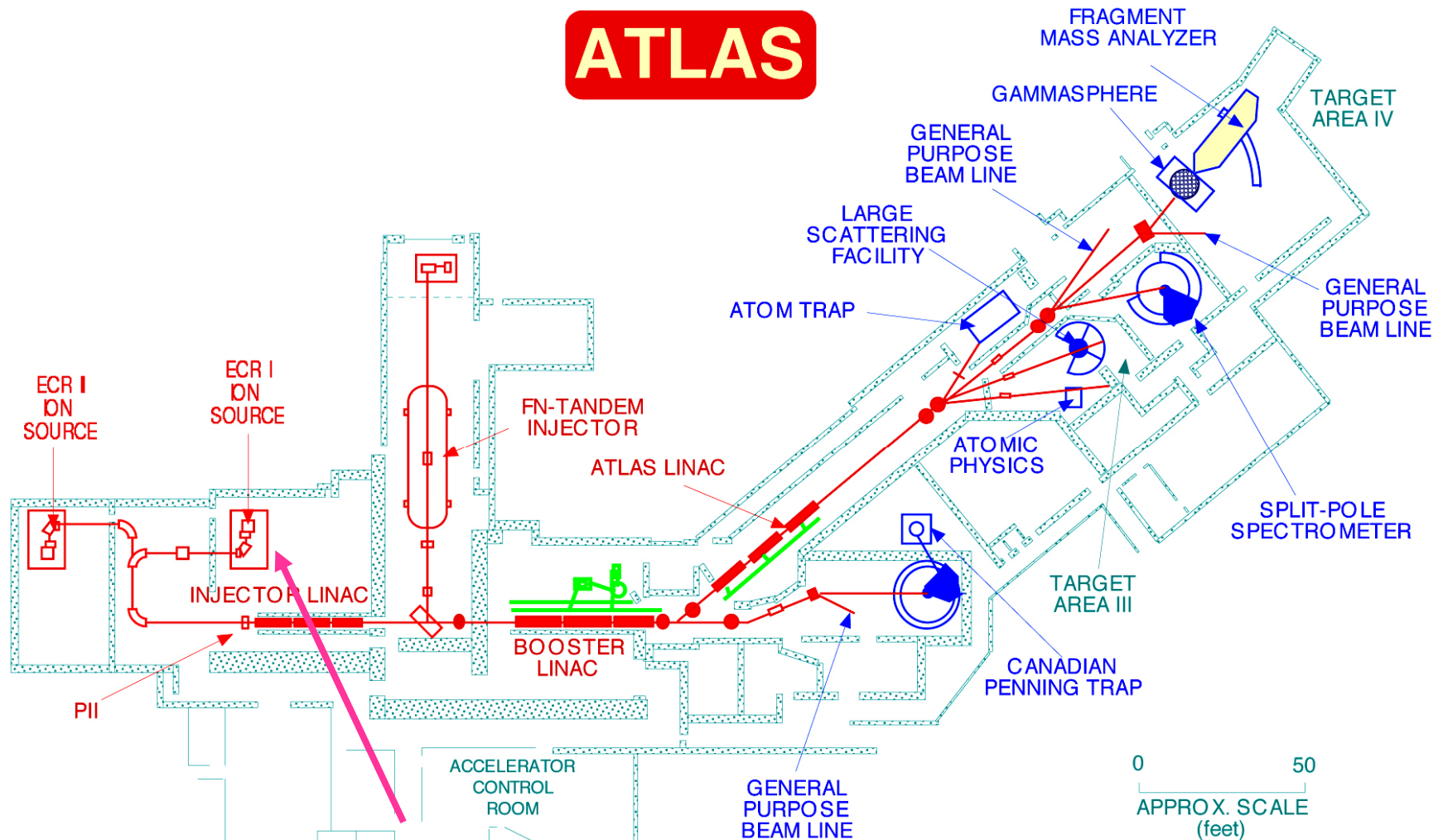

“fat boy” gas catcher + fission source

Proposed Charge-Breeder Scheme

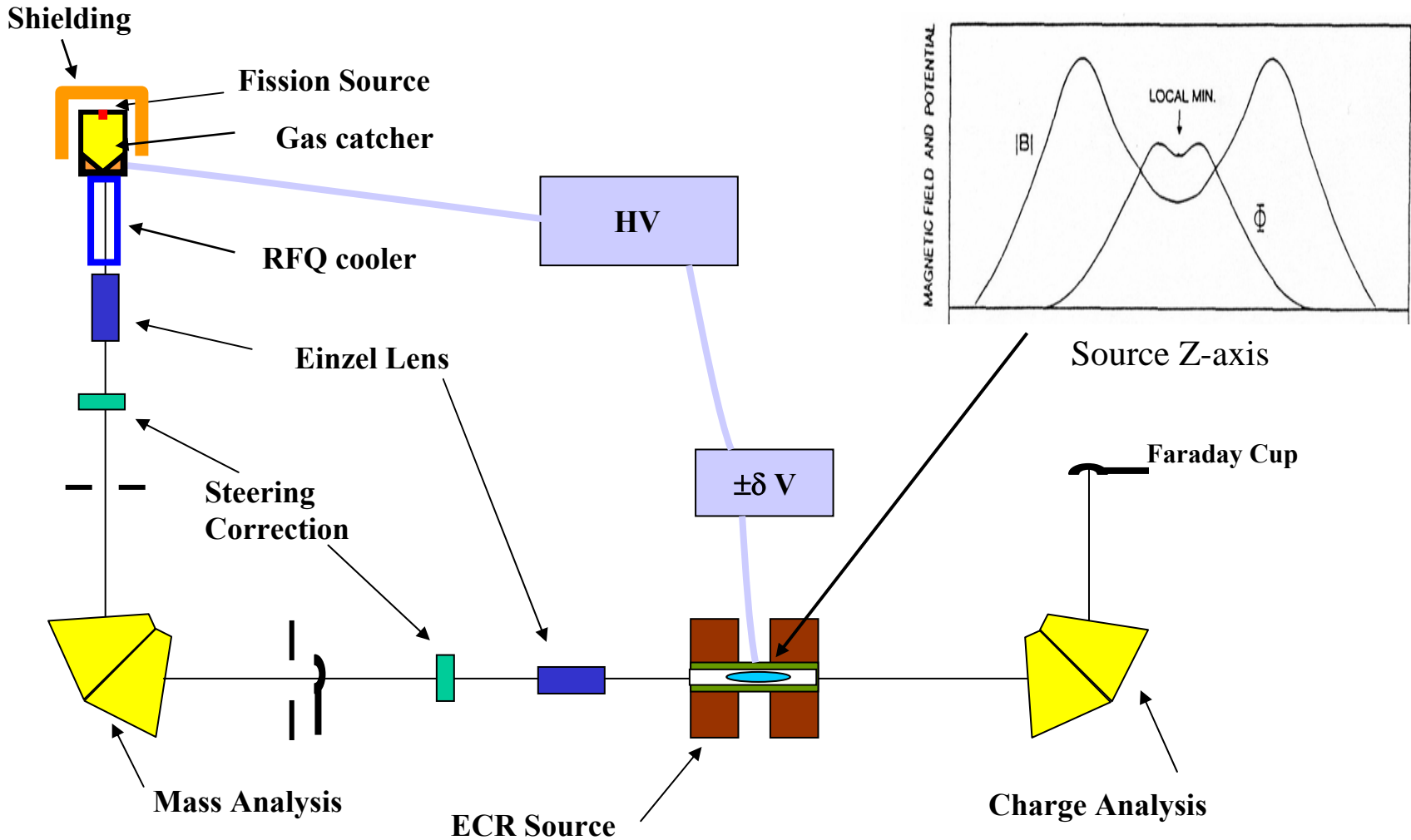

Proposed layout for fission source and breeder upgrade

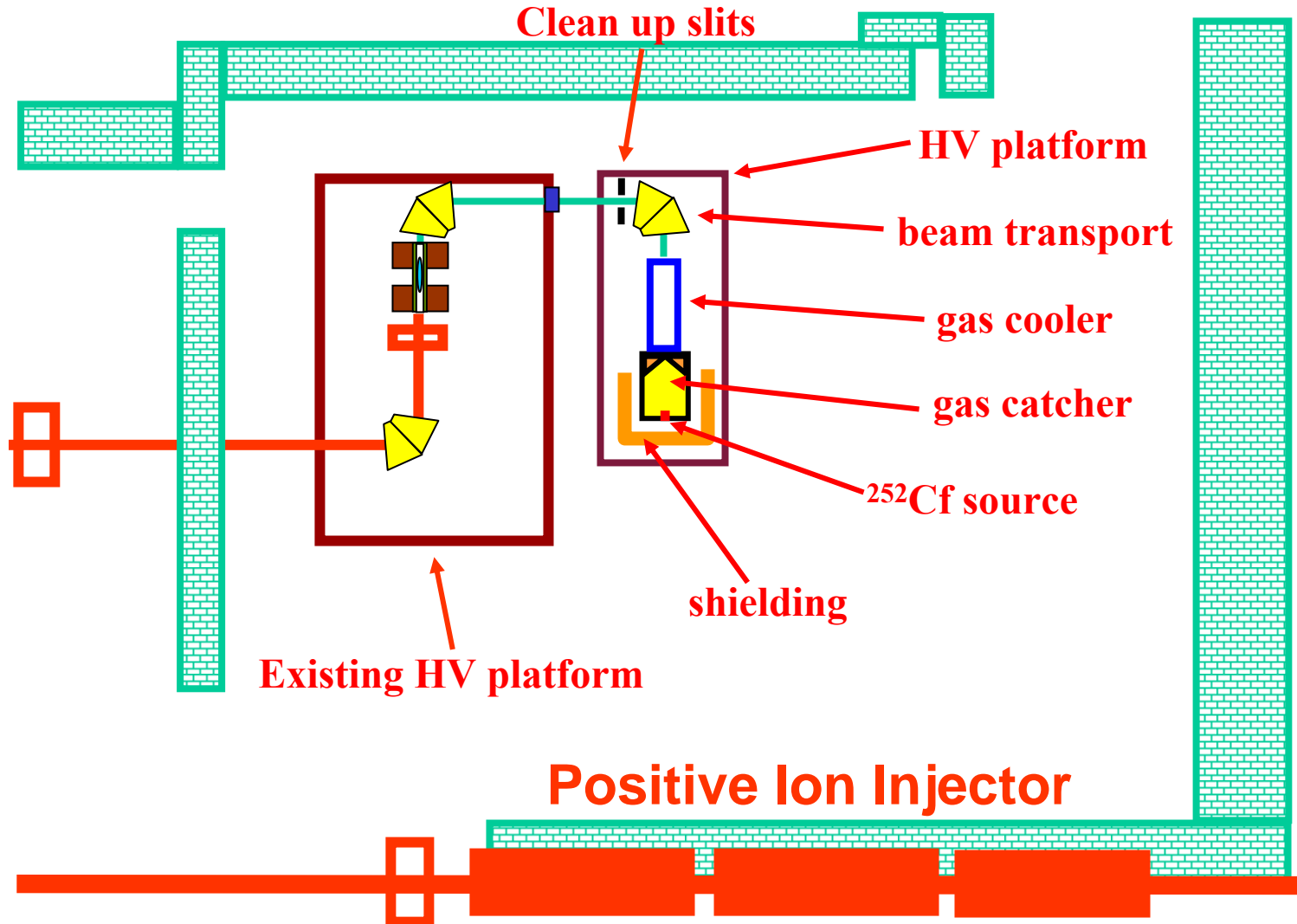

Required developments overlap RIA R&D and ATLAS experimental programs

- Spare parts from RIA gas catcher will be used to build the required large gas catcher ... in the near term it will be used with stronger and stronger sources for more n-rich masses at CPT and RIA R&D purposes
- ECR breeder R&D is ongoing for RIA and ATLAS is involved
- Some experiments would be done optimally at a higher energy than currently available. An initial upgrade is AIP funded (replacing last cryostat with RIA type cryostat and resonators) and will be completed in 2005. An additional cryostat might be added in a second stage.

	Current ATLAS		UPGRADE I		UPGRADE II	
	No Strip	Strip	No Strip	Strip	No Strip	Strip
A						
1	24.08	24.08	38.50	38.50	54.84	54.84
2	15.71	15.71	23.20	23.20	31.57	31.57
16	12.98	15.66	18.50	21.48	24.52	29.79
40	12.37	13.35	17.49	19.91	23.00	27.28
58	9.94	11.79	13.49	17.87	17.04	24.75
78	9.49	11.19	12.78	16.71	15.98	22.90
132	7.96	9.33	10.37	13.38	12.40	15.23
197	6.65	7.89	8.37	10.94	9.43	13.88
238	6.36	7.39	7.94	10.04	8.79	12.40

- New instruments would improve some of the proposed experiments.

Why this scenario?

- Provides unique capabilities with **Coulomb-barrier n-rich beams** of sufficient intensity to access important new physics
 - energy reach
 - refractory region
 - timing, beam properties
 - makes ATLAS unique for some n-rich beams until RIA and complementary to HRIBF and NSCL
- Demonstrates operation of gas catcher in battle conditions with RIA-like ionization intensities
- Can be implemented in a timely manner
- All of this at low cost.

Conclusions

- A number of open physics questions leading towards RIA program cannot be properly addressed with the capabilities currently available worldwide
- Unique technologies and expertise available at ATLAS can provide the necessary capabilities in a timely manner and at low cost
- The proposed upgrade has great synergy to RIA on both the technical and physics fronts
- This upgrade will help keep the US competitive in radioactive beam physics until RIA