



**US Army Corps
of Engineers®**
Engineer Research and
Development Center

Technical Guidelines for Environmental Dredging of Contaminated Sediments

Michael R. Palermo, Paul R. Schroeder, Trudy J. Estes,
and Norman R. Francingues

September 2008



Technical Guidelines for Environmental Dredging of Contaminated Sediments

Michael R. Palermo, Paul R. Schroeder, Trudy J. Estes, and Norman R. Francingues

*Environmental Laboratory
U.S. Army Engineer Research and Development Center
3909 Halls Ferry Road
Vicksburg, MS 39180-6199*

Final report

Approved for public release; distribution is unlimited.

Prepared for U.S. Environmental Protection Agency
Office of Solid Waste and Emergency Response
Washington, DC 20314-1000

Abstract: This report provides technical guidelines for evaluating environmental dredging as a sediment remedy component. This document supports the *Contaminated Sediment Remediation Guidance for Hazardous Waste Sites*, released by the U.S. Environmental Protection Agency (USEPA) in 2005, by providing detailed information regarding evaluation of environmental dredging as a remedy component. This document is intended to be applicable to contaminated sediment sites evaluated under various environmental laws and regulatory programs. The intended audience for this report includes all stakeholders potentially involved in evaluating environmental dredging for purposes of a feasibility study, remedial design, and implementation.

The scope of this document is limited to the technical aspects of the environmental dredging process itself, but it is important that environmental dredging be integrated with other components such as transport, dewatering, treatment, and rehandling and disposal options. This report covers initial evaluation, pertinent site conditions and sediment characteristics, environmental dredging performance standards, equipment capabilities and selection, evaluation of production, duration, and transport, methods for estimating resuspension, residuals and release, control measures, operating methods and strategies, and monitoring.

DISCLAIMER: The contents of this report are not to be used for advertising, publication, or promotional purposes. Citation of trade names does not constitute an official endorsement or approval of the use of such commercial products. All product names and trademarks cited are the property of their respective owners. The findings of this report are not to be construed as an official Department of the Army position unless so designated by other authorized documents.

DESTROY THIS REPORT WHEN NO LONGER NEEDED. DO NOT RETURN IT TO THE ORIGINATOR.

Contents

| | |
|---|-------------|
| Figures and Tables | viii |
| Preface | x |
| Unit Conversion Factors | xii |
| 1 Introduction | 1 |
| 1.1 Background | 1 |
| 1.2. Purpose, scope, and applicability | 2 |
| 1.3. Environmental dredging objectives and processes | 3 |
| 1.4. Evaluation sequence for environmental dredging..... | 5 |
| 2 Initial Evaluation | 17 |
| 2.1. Conditions conducive to dredging..... | 17 |
| 2.2. Potential advantages and limitations of dredging..... | 18 |
| 2.3. Environmental dredging as a component of a sediment removal remedy..... | 20 |
| 2.4. Evaluation of project requirements and constraints | 22 |
| 2.5. Preliminary evaluation of dredging feasibility | 23 |
| 2.6. Pilot studies | 24 |
| 3 Evaluating Site Conditions and Sediment Characteristics | 26 |
| 3.1. Identifying and filling data gaps | 27 |
| 3.1.1. <i>General considerations for site and sediment characterization</i> | 27 |
| 3.1.2. <i>Conceptual site model</i> | 29 |
| 3.2. Site conditions | 30 |
| 3.2.1. <i>Project setting and sources of contamination</i> | 31 |
| 3.2.2. <i>Positioning and survey control</i> | 31 |
| 3.2.3. <i>Access to the water body</i> | 32 |
| 3.2.4. <i>Waterway uses and infrastructure</i> | 32 |
| 3.2.5. <i>Siting for transport, rehandling, treatment, and disposal</i> | 34 |
| 3.2.6. <i>Water depths and bathymetry</i> | 35 |
| 3.2.7. <i>Hydrodynamics</i> | 36 |
| 3.2.8. <i>Elevation and nature of bedrock or hard bottom</i> | 37 |
| 3.2.9. <i>Shoreline stability</i> | 38 |
| 3.2.10. <i>Presence and extent of debris</i> | 39 |
| 3.2.11. <i>Habitat considerations and seasonal dredging restrictions</i> | 42 |
| 3.2.12. <i>Winter icing conditions</i> | 43 |
| 3.2.13. <i>Ambient water and air quality</i> | 43 |
| 3.3. Sediment characterization | 44 |
| 3.3.1. <i>Sampling plans and data quality</i> | 44 |
| 3.3.2. <i>Positioning and vertical survey control for sampling</i> | 46 |
| 3.3.3. <i>Sediment sampling equipment and techniques</i> | 47 |
| 3.3.4. <i>Core compression, segmentation, and compositing</i> | 48 |

| | |
|--|-----------|
| 3.3.5. Sediment physical properties | 50 |
| 3.3.6. Sediment contaminant concentrations | 52 |
| 3.4. Removal requirements | 53 |
| 3.4.1. Debris removal | 53 |
| 3.4.2. Dredgeability..... | 55 |
| 3.4.3. Volume to be dredged..... | 56 |
| 4 Environmental Dredging Performance Standards | 58 |
| 4.1. Goals, objectives, and performance standards | 58 |
| 4.2 Performance standards related to production and implementation time..... | 61 |
| 4.2.1. Time of project completion | 61 |
| 4.2.2. Limits on solids content and volume throughput..... | 62 |
| 4.3. Performance standards related to resuspension and release | 63 |
| 4.3.1. Sediment resuspension | 63 |
| 4.3.2. Water quality standards..... | 63 |
| 4.3.3. Air quality standards | 64 |
| 4.4. Performance standards related to dredging effectiveness..... | 65 |
| 5 Equipment Capabilities and Selection..... | 66 |
| 5.1. Dredging equipment types and methods | 66 |
| 5.1.1. Hydraulic dredging..... | 68 |
| 5.1.2. Mechanical dredging | 80 |
| 5.1.3. Equipment combinations and hybrid approaches | 85 |
| 5.2. Considerations for equipment selection | 85 |
| 5.3. Equipment capabilities and selection factors..... | 87 |
| 5.3.1. Production rates | 93 |
| 5.3.2. Percent solids by weight (solids concentration) | 95 |
| 5.3.3. Vertical operating accuracy | 96 |
| 5.3.4. Horizontal operating accuracy..... | 101 |
| 5.3.5. Maximum dredging depth..... | 104 |
| 5.3.6. Minimum dredging depth | 104 |
| 5.3.7. Sediment resuspension control..... | 105 |
| 5.3.8. Contaminant release control..... | 107 |
| 5.3.9. Residual sediment control and cleanup levels..... | 112 |
| 5.3.10. Transport by pipeline | 114 |
| 5.3.11. Transport by barge..... | 116 |
| 5.3.12. Positioning control | 117 |
| 5.3.13. Maneuverability..... | 118 |
| 5.3.14. Portability/Access | 119 |
| 5.3.15. Availability | 120 |
| 5.3.16. Debris/Loose Rock/Vegetation..... | 120 |
| 5.3.17. Hardpan/Rock Bottom | 121 |
| 5.3.18. Sloping bottom..... | 123 |
| 5.3.19. Flexibility for varying conditions | 124 |
| 5.3.20. Thin lift/residuals removal | 126 |

| | |
|--|------------|
| 5.4. Summary of considerations in selection of equipment..... | 127 |
| 5.5. Case studies | 128 |
| 6 Evaluating Production, Project Duration, and Transport..... | 131 |
| 6.1. General considerations for evaluation of production | 131 |
| 6.1.1. Approach..... | 131 |
| 6.1.2. Factors affecting production for environmental dredging | 135 |
| 6.2. Selection of dredge size(s) for evaluation | 137 |
| 6.2.1. Dredge size related to transport, rehandling, and disposal constraints..... | 138 |
| 6.2.2. Dredge size as related to cut thickness | 139 |
| 6.2.3. Dredge size related to site characteristics | 140 |
| 6.2.4. Dredge size related to dredgeability | 140 |
| 6.3. Estimate of operating production rates..... | 141 |
| 6.3.1. Methods for estimating operating production rate | 143 |
| 6.3.2. Mechanical production rates based on operating parameters..... | 145 |
| 6.3.3. Hydraulic production rates based on operating parameters..... | 146 |
| 6.4. Estimate of sustained production rate | 149 |
| 6.5. Project duration and needed dredge sizes and number of dredges | 151 |
| 6.6. Considerations for sediment transportation..... | 151 |
| 7 Methods for Estimating Resuspension, Residuals, and Release | 156 |
| 7.1. Sediment resuspension | 158 |
| 7.1.1. Characteristic resuspension factors | 159 |
| 7.1.2. Adjustments to characteristic resuspension factors..... | 161 |
| 7.1.3. Nakai TGU method | 162 |
| 7.1.4. Collins (1995) resuspension correlations for open clamshells | 163 |
| 7.1.5. Hayes et al. (2000) cutterhead correlation method | 165 |
| 7.1.6. USACE DREDGE model | 167 |
| 7.1.7. EPA ARCS guidance | 168 |
| 7.1.8. Fate and transport models | 168 |
| 7.1.9. Resuspension controls..... | 169 |
| 7.2. Residuals | 170 |
| 7.2.1. Residuals characteristics..... | 172 |
| 7.2.2. Factors affecting dredging residuals..... | 175 |
| 7.2.3. Predicting dredging residuals | 177 |
| 7.2.4. Example calculation of generated residuals | 178 |
| 7.3. Contaminant release | 180 |
| 7.3.1. Particulate contaminant releases from resuspension | 182 |
| 7.3.2. Dissolved contaminant releases from resuspension | 184 |
| 7.3.3. Dissolved contaminant releases from residuals | 188 |
| 7.3.4. DRET test..... | 189 |
| 7.3.5. Contaminant volatilization to air | 191 |
| 7.3.6. Volatilization flux test | 192 |
| 7.3.7. Fate and transport models | 192 |
| 7.3.8. Release controls..... | 193 |
| 7.4. Summary of predictive methods for resuspension, residuals, and release | 194 |

| | | |
|-----------|---|------------|
| 8 | Control Measures | 195 |
| 8.1. | Control measures for sediment resuspension | 195 |
| 8.1.1. | Operational control measures for sediment resuspension | 196 |
| 8.1.2. | Engineered control measures for resuspension | 197 |
| 8.1.3. | Silt curtains/screens | 199 |
| 8.1.4. | Sheet-pile enclosures and other structural barriers | 204 |
| 8.2. | Control measures for contaminant release | 206 |
| 8.2.1. | Control of NAPL releases and floatable materials | 206 |
| 8.2.2. | Control of particulate contaminant releases | 206 |
| 8.2.3. | Control of dissolved contaminant releases | 207 |
| 8.2.4. | Control of volatile emissions | 207 |
| 8.3. | Control of residuals | 208 |
| 8.3.1. | Operational controls for residuals | 209 |
| 8.3.2. | Post-dredging control measures for residuals | 210 |
| 8.4. | Summary | 213 |
| 8.5. | Case studies | 213 |
| 8.5.1. | Examples of structural controls | 214 |
| 8.5.2. | Examples of operational controls | 215 |
| 8.5.3. | Monitoring effectiveness of controls | 216 |
| 8.5.4. | Reported costs and production rates | 216 |
| 9 | Operating Methods and Strategies | 219 |
| 9.1. | Management units and dredging prisms | 219 |
| 9.1.1. | Sediment management unit | 219 |
| 9.1.2. | Neat line prism and neat line volume | 220 |
| 9.1.3. | Dredging prism or dredging prism volume | 221 |
| 9.1.4. | Dredging management unit | 224 |
| 9.1.5. | Compliance demonstration areas | 227 |
| 9.2. | Dredge cuts and cleanup passes | 227 |
| 9.2.1. | Cuts | 227 |
| 9.2.2. | Overdredging | 230 |
| 9.2.3. | Cleanup passes | 231 |
| 9.3. | Sequence of work | 233 |
| 9.4. | Operations plan | 235 |
| 10 | Monitoring | 236 |
| 10.1. | General monitoring considerations | 236 |
| 10.1.1. | Monitoring framework and the six-step process | 236 |
| 10.1.2. | Short-term versus long-term monitoring | 237 |
| 10.1.3. | Monitoring objectives and elements for environmental dredging | 238 |
| 10.2. | Monitoring for removal accuracy, production, and times of completion | 239 |
| 10.3. | Monitoring for sediment resuspension and water column contaminant release | 240 |
| 10.3.1. | Points of compliance and sampling locations | 240 |
| 10.3.2. | Total suspended solids versus turbidity | 242 |
| 10.3.3. | Plume definition | 242 |

| | |
|---|------------|
| 10.3.4. Water column sampling..... | 243 |
| 10.4. Monitoring for volatile contaminant release | 243 |
| 10.5. Monitoring for dredging effectiveness..... | 244 |
| 10.5.1. Lag times and points of compliance..... | 245 |
| 10.5.2. Thickness of residuals | 246 |
| 10.5.3. Sampling for residuals..... | 247 |
| 10.5.4. Engineering/operational evaluation of post-dredging conditions..... | 249 |
| 10.6. Monitoring plans..... | 250 |
| 10.7. Management actions..... | 251 |
| 10.7.1. Management actions for production | 251 |
| 10.7.2. Management actions for resuspension and contaminant release..... | 252 |
| 10.7.3. Management actions for residuals | 252 |
| 10.8. Monitoring for adaptive management..... | 253 |
| 11 Summary, Integration, and Conclusions | 255 |
| 11.1 Summary and integration | 255 |
| 11.2. Conclusions | 255 |
| References..... | 259 |
| Bibliography..... | 273 |
| Appendix A: Dredging Elutriate Test Procedure | 278 |
| Introduction | 278 |
| Dredging elutriate tests for water quality evaluation | 278 |
| Apparatus | 279 |
| Dredging elutriate test procedure | 280 |
| Chemical analyses | 283 |
| Released contaminant concentrations..... | 283 |
| Dredging elutriate for water column toxicity | 286 |
| Elutriate apparatus | 286 |
| Dredging elutriate procedure | 287 |
| Dredging elutriate toxicity evaluation | 287 |
| References..... | 288 |

Figures and Tables

Figures

| | |
|--|-----|
| Figure 1. Conceptual illustration of environmental dredging and processes..... | 4 |
| Figure 2. Flowchart illustrating environmental evaluation/design sequence..... | 7 |
| Figure 3. Example flow diagram of the possible steps in a dredging or excavation alternative..... | 22 |
| Figure 4. Example of an acoustic survey track..... | 36 |
| Figure 5. Example of a sub-bottom profile image. (Graphics courtesy of CR Environmental and Parsons). | 38 |
| Figure 6. Example guideline for shoreline structure stability (Otten 2006)..... | 39 |
| Figure 7. Example of side-scan sonar (a) mosaic, (b) side-scan image showing debris at base of a mooring dolphin, (c) side-scan image showing unidentified cylindrical object (13 ft long). (Graphics courtesy of CR Environmental and Parsons)..... | 41 |
| Figure 8. Examples of magnetic survey results (a) magnetic contours and (b) magnetic anomalies. (Graphics courtesy of CR Environmental and Parsons). | 42 |
| Figure 9. Photos of sediment sampling equipment..... | 48 |
| Figure 10. Debris fouling of cutterhead by cables. | 54 |
| Figure 11. Photos of basic dredging equipment. | 69 |
| Figure 12. Photos of specialty dredging equipment. | 70 |
| Figure 13. Components of a hydraulic dredge. | 72 |
| Figure 14. Vic Vac® hydraulic dredgehead for residuals. | 77 |
| Figure 15. Mouth of suction pipe and conventional basket cutterhead..... | 78 |
| Figure 16. Spillage layer from conventional hydraulic cutterhead dredge. | 79 |
| Figure 17. Components of a mechanical bucket dredge..... | 81 |
| Figure 18. Components of a wire-supported clamshell dredge. | 82 |
| Figure 19. Cross section showing required dredging elevation vs. target dredging elevation as a function of vertical accuracy of dredge. | 98 |
| Figure 20. Variation of percent solids from cutterhead hydraulic dredge during dredging cycles..... | 148 |
| Figure 21. Schematic of dredging residuals..... | 157 |
| Figure 22. Example of DREDGE model graphical output. | 168 |
| Figure 23. Multiple dredge passes, each lift not to exceed 3 to 5 ft. (Source: Dalton, Olmsted & Fuglevand). | 172 |
| Figure 24. Photo of resuspension, generated residuals and undisturbed residuals/sediment (Z-layer) (Patmont 2006). | 173 |
| Figure 25. Sampling data for Hylebos Segment 4 (Patmont 2006). | 178 |
| Figure 26. Schematic of DRET test procedure. | 181 |
| Figure 27. Control measures. | 198 |
| Figure 28. Silt curtain installation at Black Lagoon, Detroit River, Trenton, Michigan. | 204 |

| | |
|---|-----|
| Figure 29. Illustration of sediment management units (SMU) for the Onondaga Lake, NY site..... | 220 |
| Figure 30. Conceptual illustration comparing neat line prism and dredge cut prism. Source: Weber et al. (2003)..... | 222 |
| Figure 31. Fox River example illustrating use of Thiessen polygons to define a neat line prism. | 223 |
| Figure 32. Puget Sound Naval Station example illustrating dredge cut prism. Source: Elmer and Lally (EPA Forum)..... | 224 |
| Figure 33. Dredging management units, New Bedford example. | 225 |
| Figure 34. Dredging management units, Head of Hylebos example. Reference Dredge Management Areas (RDMAs). | 226 |
| Figure 35. Example of a two-pass dredge cut plan, Lockheed example. | 228 |
| Figure 36. Illustration of dredging box cuts. Source: USACE Dredging Fundamentals (EM 1110-2-5025 In publication). | 229 |
| Figure 37. Compliance monitoring..... | 241 |

Tables

| | |
|---|-----|
| Table 1. Environmental dredging equipment operational characteristics. | 88 |
| Table 2. Summary of reported data on operational characteristics for environmental dredging. | 89 |
| Table 3. Environmental dredging equipment selection factors. | 91 |
| Table 4. Typical operating limits for cutterhead dredges..... | 140 |

Preface

This technical resource document, Technical Guidelines for Environmental Dredging of Contaminated Sediments, was developed by the Center for Contaminated Sediments at the U.S. Army Corps of Engineers (USACE) Engineer Research and Development Center (ERDC), Environmental Laboratory (EL), Vicksburg, MS. This document provides technical guidelines for planning, designing, implementing, and monitoring environmental dredging operations for purposes of contaminated sediment remediation. The document was prepared for the U.S. Environmental Protection Agency (EPA), Office of Solid Waste and Emergency Response, Washington, DC, under agreement No. DW96921926.

This report was written by Dr. Michael R. Palermo, formerly of the Environmental Processes and Engineering Division (EPED), EL, ERDC and presently with Mike Palermo Consulting, Inc.; Dr. Paul R. Schroeder, and Dr. Trudy J. Estes, both of the EPED, EL, ERDC; and Norman R. Francingues, formerly of EPED, EL, ERDC and presently with OA Systems Corporation. The contributions of Daniel E. Averett, formerly of ERDC, and Dr. Karl Gustavson, EPED, EL, ERDC, are also acknowledged.

Dr. Todd S. Bridges, Senior Scientist, EL; Director, Center for Contaminated Sediments; and Technical Lead for ERDC's support to USEPA's Superfund Sediment Resource Center, provided program oversight for ERDC. The EPA project manager was Stephen Ells, Sediments Team Leader, Office of Site Remediation and Technology Innovation.

The EPA Office of Site Remediation and Technology Innovation, in conjunction with the U.S. Army Corps of Engineers, selected a diverse group of peer reviewers to provide input and comment on this document. Reviewers included EPA Regions, USACE Districts, consulting firms with environmental dredging design experience, and dredging contractors with field experience in implementing projects. The document greatly benefited from the peer review, and the contributions of the reviewers are gratefully acknowledged. Peer reviewers included: Steve Ells, EPA HQ; Pam Tames, EPA Region 2; Allison Hiltner, Sean Sheldrake, Jonathan Williams, and Ed Moreen, all of EPA Region 10; Tom Fredette, USACE New England

District; John Wakeman, USACE Seattle District; Larry McShea, Alcoa; Steve Garbaciak, Arcadis BBL; Jennifer Kahler, Natural Resources Technology; Paul Fuglevand, Greg Hartman, and Rob Webb, all of Dalton, Olmsted & Fuglevand, Inc.; and Glenn Green, J. F. Brennan.

Director of ERDC-EL was Dr. Elizabeth C. Fleming. Commander and Executive Director of ERDC was COL Gary E. Johnston. Director was Dr. James R. Houston.

Unit Conversion Factors

| Multiply | By | To Obtain |
|----------------------|------------|---------------|
| acres | 4,046.873 | square meters |
| acre-feet | 1,233.5 | cubic meters |
| cubic feet | 0.02831685 | cubic meters |
| cubic yards | 0.7645549 | cubic meters |
| feet | 0.3048 | meters |
| inches | 0.0254 | meters |
| microns | 1.0 E-06 | meters |
| miles (U.S. statute) | 1,609.347 | meters |
| square yards | 0.8361274 | square meters |
| yards | 0.9144 | meters |

1 Introduction

1.1 Background

Contaminated sediments pose potential risks to human health and the environment at many sites nationwide, and the problem has received growing attention in recent years (U.S. Environmental Protection Agency (USEPA) 1998a; National Research Council (NRC) 1989, 1997, 2001, 2007). Sediment cleanup is being actively pursued by the USEPA under Comprehensive Environmental Response, Compensation and Liability Act (CERCLA) authority, and by other Federal and state agencies under a variety of other authorities. Contaminated sediment is now being viewed in many ways as a “fourth environmental medium,” with concerns over sediment impacts on a par with those for water, air, and land-disposed waste (Palermo and Wilson 2000).

Options commonly considered for remediation of contaminated sediments include monitored natural recovery (MNR), in situ capping, and environmental dredging followed by treatment or disposal.¹ For purposes of this report, environmental dredging is defined as follows:

Environmental dredging — the removal of contaminated sediments from a waterbody for purposes of sediment remediation.

Environmental dredging using several equipment types and approaches, followed by treatment and disposal of the contaminated material and residuals management, has been the most frequent cleanup method for sediment used by the Superfund program. Dredging or dry excavation² has been selected as the cleanup method for contaminated sediment or a component of the remedy at more than 100 Superfund sites (some as an

¹ *Contaminated Sediment Remediation Guidance for Hazardous Waste Sites* (USEPA 2005) contains information and guidance on sediment remediation to include monitored natural recovery, in situ capping, environmental dredging, and treatment and disposal following environmental dredging.

² Dry excavation of contaminated sediment generally involves isolating the contaminated sediment from the waterbody by pumping water from or diverting water around the area and using conventional excavation equipment to remove the sediment. Dry excavation is compared to dredging in some sections of this report, but detailed guidance on dry excavation is beyond the scope of this report. *Contaminated Sediment Remediation Guidance for Hazardous Waste Sites* (USEPA 2005) contains additional information on dry excavation (see Section 6-4 of USEPA 2005).

initial removal action), and nearly all of the larger sites. At about one-third of these sites, monitored natural recovery or in situ capping were also selected as components of the remedy (USEPA 2005). Environmental dredging is now being used or considered for some of the largest contaminated sediment projects in the United States, such as the Hudson River, Fox River, Housatonic River, Kalamazoo River, and Lower Passaic River. With rare exceptions, contaminated sediment projects will need to consider environmental dredging or dry excavation as a potential alternative.

Although dredging has been conducted for centuries to increase and maintain navigation depths in harbors and waterways, the concept of environmental dredging is a relatively new one. Much of the publicly available information on environmental dredging based on cleanup experience has been developed within the past 15 to 20 years. The EPA, in cooperation with the U.S. Army Corps of Engineers (USACE), published general guidance on environmental dredging as early as 1994 (USEPA 1994), and EPA issued guidance in 2002 and 2005 (USEPA 2002a, 2005). The Permanent International Association of Navigation Congresses (PIANC) and the U.S. National Research Council of the National Academy of Sciences have also published reports dealing with contaminated sediments, all of which included general recommendations on environmental dredging (PIANC 1996; NRC 1997, 2001, and 2007). But to date, detailed information for planning, selecting equipment, designing operational strategies, and predicting effectiveness has been largely site-specific (many of the projects are described in documents listed as references for this report), and no comprehensive technical guidelines on environmental dredging existed. This report is intended to fill that gap.

1.2. Purpose, scope, and applicability

The purpose of this report is to provide technical guidelines for evaluating environmental dredging as a sediment remedy component. This document is compatible with and supports the *Contaminated Sediment Remediation Guidance for Hazardous Waste Sites* (USEPA 2005) by providing detailed information regarding evaluation of environmental dredging as a remedy component. The intended audience for this report includes all stakeholders potentially involved in evaluating environmental dredging for purposes of a feasibility study, remedial design, and implementation. The scope of this document is limited to the technical aspects of the environmental dredging process itself, the transport of the dredged

sediment (i.e., by barge or pipeline), and those processes and activities directly related to the dredging (e.g., associated monitoring). It is important that the environmental dredging component of a remedy be integrated with other components such as the subsequent transport of sediment by other means (such as truck or rail), sediment dewatering, sediment and water treatment, and rehandling and disposal options for dredged sediment. Considerations for integration of these remedy components are discussed in Section 2.3, but are not addressed in any detail by this document.

This document is intended to be applicable to contaminated sediment sites evaluated under various environmental laws and regulatory programs, e.g., the Comprehensive Environmental Response, Compensation and Liability Act (CERCLA); the Resource Conservation and Recovery Act (RCRA); and the Clean Water Act (CWA). However, the terminology used in this report is generally based on the CERCLA framework. Details regarding the regulatory aspects of the CERCLA framework or other frameworks are not covered in any detail by this document.

The information provided in this document can be applied at any of several phases of a sediment remediation project including the Remedial Investigation (RI), Feasibility Study (FS), and Remedial Design (RD) phases under the CERCLA framework, or similar phases under other remedial frameworks. For example, dredging equipment and approaches are normally evaluated in the FS phase so that implementability and effectiveness of the dredging component can be evaluated and cost estimates can be developed for purposes of remedy selection. In the RD phase, more detailed evaluations of dredging equipment and approaches are conducted so that designs and cost estimates can be refined and plans and specifications can be developed for project implementation. The dredging contractor usually makes the final selection of specific equipment and approaches for the project execution phase.

1.3. Environmental dredging objectives and processes

The objectives of an environmental dredging operation normally include:

1. Dredge with sufficient accuracy such that contaminated sediment is removed and sediment cleanup levels are met without excessive removal of clean sediment;

2. Dredge the sediments in a reasonable period of time and in a condition compatible with subsequent transport for treatment or disposal;
3. Reduce and/or control resuspension of contaminated sediments, downstream transport of resuspended sediments, and releases of contaminants of concern (COCs) to water and air; and
4. Dredge the sediments such that generation of residuals is reduced and/or controlled.

A number of factors and processes must be appropriately considered and evaluated to ensure that an environmental dredging operation achieves the above objectives, as well as the objectives of the remedy. Figure 1 is a conceptual illustration of environmental dredging and related processes of importance. These processes are defined as follows (Bridges et al. 2008).

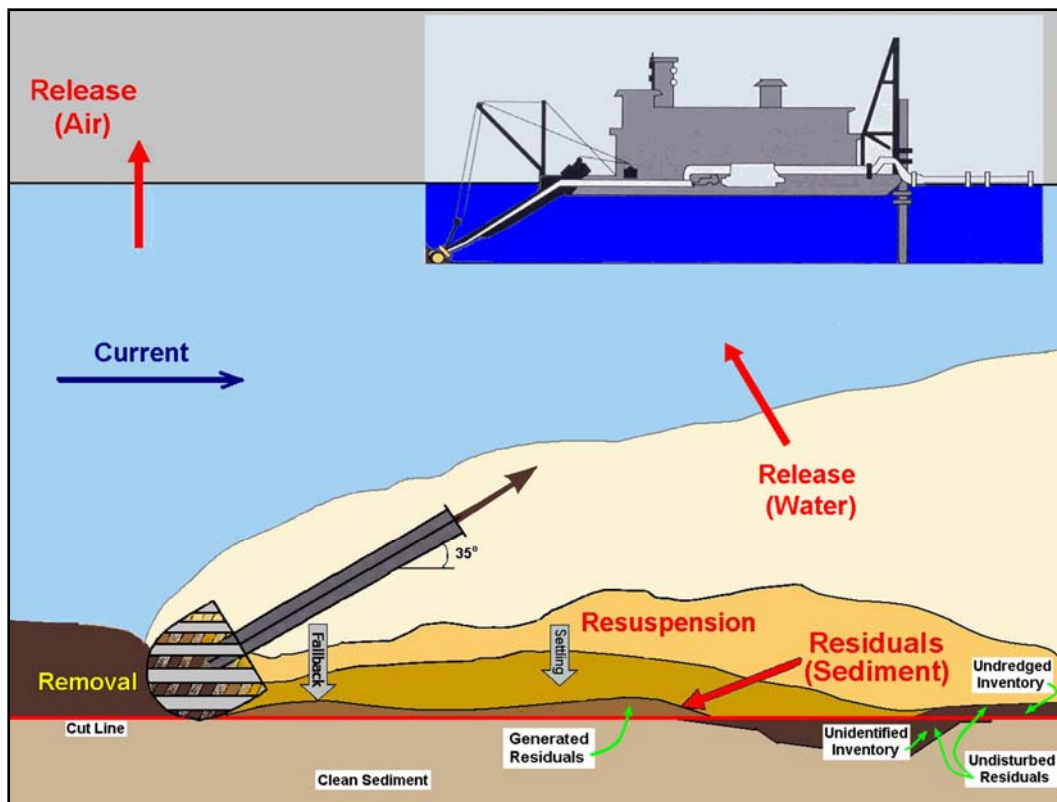

Figure 1. Conceptual illustration of environmental dredging and processes.

- **Removal** is the process by which sediments are dislodged from the sediment bed and lifted or transported out of the dredge cut. Dredges dislodge sediment by mechanically and/or pneumatically penetrating, grabbing, raking, cutting, or hydraulically suctioning and/or scouring the sediment bed. Once dislodged, the sediment is lifted out of the

- dredge cut either hydraulically through a pipe or mechanically, as with buckets. Dredges can therefore be categorized as either mechanical or hydraulic depending on the basic means of transporting the dredged material from the sediment bed.
- **Resuspension** is the process whereby bedded sediments are dislodged and dispersed in the water column by the dredging operation. The resuspended sediment particles may settle in the dredging area or be transported downstream.
 - **Release** is the process by which the dredging operation results in the loss of contaminants from the pore water of the sediment bed or from contaminants sorbed to resuspended sediment into the water column or air. The dissolved and colloidal contaminants that are released to the water column are typically transported farther downstream than contaminants sorbed to resuspended sediment.
 - **Residuals** are contaminated sediments remaining in or adjacent to the dredging footprint after completion of the removal/dredging operation. There are numerous potential causes for residual sediment contamination, but residuals can be broadly grouped into two categories: 1) undisturbed residuals (also commonly termed undredged inventory), and 2) generated residuals. Undisturbed residuals are contaminated sediments found at the post-dredge sediment surface that have been uncovered by dredging but not fully removed. These residuals may have been unidentified during characterization and therefore located below the cut line or may result from dredging inaccuracies or other factors such as the presence of structures, debris, or irregular hard bottom features. Generated residuals are defined as sediment dislodged, but not removed, by dredging which falls back, spills, sloughs, or settles in or near the dredging footprint and forms a new sediment layer. The level of concern associated with the residuals depends on both the concentration and bioavailability of the contamination in the sediment and the density and thickness of the contaminated surface layer.

Additional details on removal, resuspension, release, and residuals processes are presented in Chapters 6 and 7.

1.4. Evaluation sequence for environmental dredging

Environmental dredging is a complex process. A technically sound evaluation of environmental dredging as a remedy component therefore requires a comprehensive evaluation of many steps. This section describes

an evaluation/design sequence for environmental dredging (Palermo 2006) that mirrors the chapter sequence of this document.

Figure 2 is a flowchart illustrating the major steps in the evaluation/design process. The flowchart illustrates the recommended sequence and relationship between the various processes and the major decision points in evaluating environmental dredging.

The environmental dredging evaluation sequence described here assumes that a decision has been made to evaluate environmental dredging as a potential remedy component for the project under consideration. The sequence also assumes that other components of a dredging remedy normally considered critical to success (e.g., source control, rehandling and transport, disposal and/or treatment, etc.) will be appropriately considered and will be appropriately integrated with the environmental dredging component. The evaluation sequence therefore focuses on the environmental dredging process itself, the transport of the dredged sediment normally considered as an integral part of the dredging process (e.g., by barge or pipeline), and those processes and activities directly related to the dredging (e.g., debris removal and associated monitoring).

Evaluation of environmental dredging involves an engineering and environmental assessment of site and sediment conditions, the selection of equipment and operational approach, evaluation of complex processes such as sediment resuspension, contaminant release, and residual sediment generation, and development of monitoring and management plans for implementation. There is a strong interdependence between all these components of an environmental dredging project.

The steps shown in the flowchart span both the conceptual level of design and evaluation normally developed for a feasibility evaluation and the more detailed evaluations needed for a remedial design. Evaluation approaches and tools ranging from the simple to the more complex are available for many of the steps in the evaluation process. For example, conceptual level evaluations requiring minimal data and computational effort may be used in the FS phase evaluations, while more detailed evaluations should be used for the RD phase evaluations under CERCLA (or equivalent phases under other regulatory programs). The level of effort should be commensurate with the scale and complexity of the specific project and the consequences (outcome, financial, schedule) of the degree

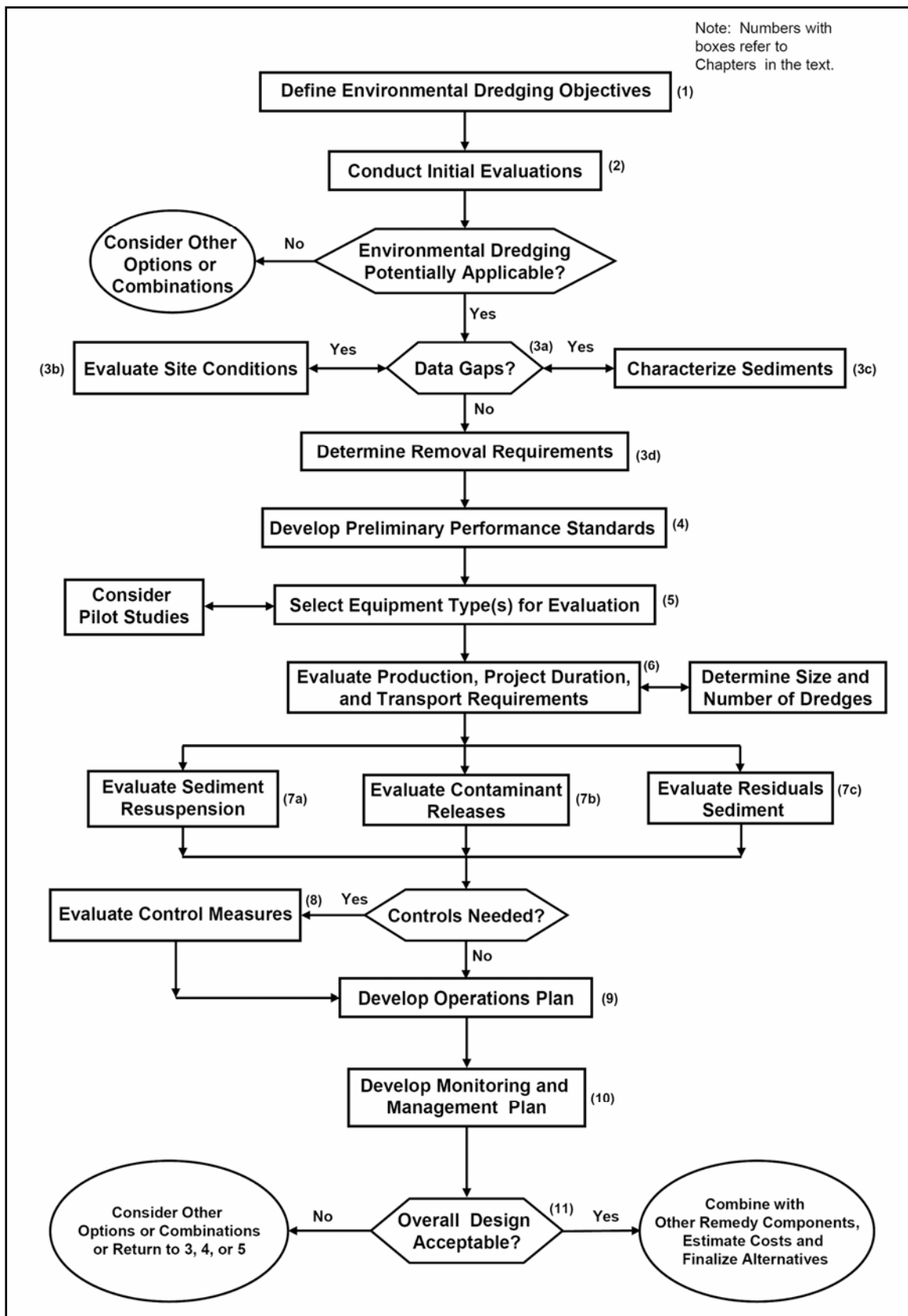

Figure 2. Flowchart illustrating environmental evaluation/design sequence.

of uncertainty tied to these topics. One of the major lessons learned from completed projects is that simplifying assumptions made in the FS phase can at times result in unrealistic assessments and may not provide for informed decisions to be made regarding project outcomes.

Determining an appropriate level of detail in the FS stage vs. the RD stage may be difficult, but each of these steps in the evaluation/design sequence should be performed in a logical progression with an appropriate level of detail to progress to and through decision points as illustrated in Figure 2. These steps are interrelated, so the evaluation or design sequence cannot be followed in a purely linear fashion. The progression sequence therefore includes several decision points and allows for iteration of evaluations as needed to arrive at an efficient design that meets the project objectives.

It should also be noted that the design process may be performed for multiple dredge types, dredge sizes, dredge ancillary equipment (e.g., positioning equipment, boosters, cutterhead or suction head) and operational approaches to allow for comparisons to determine the best combination of equipment for the project-specific sediment, site, and performance criteria. Evaluations should also be conducted in the context of available equipment and the availability of qualified contractors who have experience in the operation of the equipment. The process can also be evaluated for various dredging options, e.g., removal of the total area/volume requiring remediation or a partial removal of specific areas and/or depths to allow for optimizing the effectiveness or implementability of dredging as a remedy component.

General descriptions of the various steps in the environmental dredging evaluation sequence are given in the following sub-sections. Each block in the flowchart in Figure 2 is numbered, with each block referenced to the number in parentheses in the sub-section headings that follow. The block numbers also correspond to the chapter numbers in this document, where more detailed information for each step in the evaluation sequence is found. Terms referred to in the various steps below are defined in the chapters of this document pertaining to each step.

- **Define Environmental Dredging Objectives (1)** — The initial step in the evaluation or design is to identify the processes of importance for the site and define the objectives of the environmental dredging operation. The important processes would normally include

- sediment removal, resuspension of sediments, release of contaminants, and generation of residuals. Objectives normally relate to sufficient accuracy, reasonable time for completion, safety impact on public during operations, meeting cleanup levels, compatibility with transport for treatment or disposal, quantity and rate of resuspension of contaminated sediments and releases to water and air, and quantity and quality of residual sediment. Additional information on the processes of importance and environmental dredging objectives is found earlier in this chapter.
- **Conduct Initial Evaluations (2)** — Initial evaluations could be done as part of the screening of alternatives in the Feasibility Study. However, the initial evaluations could be conducted early as part of the remedial investigation (RI) phase. An early initial evaluation of the potential feasibility of dredging would allow for tailoring the site and sediment investigations in the RI phase to collect necessary data for further evaluation of dredging in the subsequent FS phase. The initial evaluations include a comparison of known site conditions, sediment characteristics, and project requirements to those conducive to a dredging remedy; consideration of the advantages and disadvantages of environmental dredging as compared to other remedy approaches or combinations of approaches; consideration of environmental dredging as a component of a complete dredging and treatment/disposal remedy approach; and identification of significant project requirements and constraints. If environmental dredging is feasible for the site, more detailed evaluations can then be conducted. It is particularly important to identify major constraints at this stage, such as the non-availability of on-site disposal, bedrock or hard substrate, boulders, debris, etc. If site conditions or institutional constraints indicate that a full dredging remedy is not a potentially feasible option, other remediation options or combined remedies such as partial dredging followed by capping and/or monitored natural recovery could be considered. More detailed information on these initial evaluations is found in Chapter 2.
 - **Identify Data Gaps (3a)** — The initial evaluations provide a basis for determining any data gaps pertaining to the feasibility of environmental dredging, which should be filled to complete the evaluations. A conceptual site model of the physical, chemical, and/or biological processes at the site provides the basis for identifying data gaps and designing subsequent site and sediment investigations. This step will be considered differently for the RI, FS, or RD phases. At the

- RI phase, this step will entail design of the field and laboratory investigations that will be essential to evaluation of dredging in the FS phase. At the FS phase, this step will entail identification of data gaps in the RI for those aspects needed for dredging feasibility evaluations and cost estimates. At the RD phase, this step may entail identification of dredging-specific laboratory or field tests and modeling efforts needed for detailed design of a selected environmental dredging remedy. Data gaps can be identified by comparing the needed site and sediment characterization data with the existing information. More detailed information on identifying data gaps is found in Chapter 3.
- **Understand Site Conditions (3b)** — Depending on the data gaps identified at a particular phase of evaluation, additional data collection efforts may be required. These efforts may include collection of data on physical characteristics of the water body (water depths, bathymetry, slopes, currents, wave energies, etc), water body uses (navigation, recreation, drinking water supply, wastewater discharge, etc), the presence and nature of major infrastructure (bulkheads, piers, abandoned pilings, bridges, utility crossings, pipelines, etc.); the presence and nature of debris in the sediments; information on geotechnical conditions (stratification of underlying sediment layers, depth to bedrock, physical properties of foundation layers, etc); and sources of contamination. It is particularly important to identify site conditions critical to dredging implementability such as potential to undermine the shoreline or shoreline structures. The process of filling data gaps on site conditions may be iterative in that several tiers or phases of investigation may be warranted. More detailed information on site characterization for environmental dredging is found in Chapter 3.
 - **Characterize Sediments (3c)** — In a similar manner, the contaminated sediments under consideration for dredging and any sediment layers above or below the contaminated sediments should be characterized and any data gaps critical to evaluating environmental dredging should be filled. This includes the physical and chemical characteristics of the sediments, which should be determined both horizontally and vertically. The results of the characterization, in concert with the cleanup level proposed or selected for the remedy, will determine the potential areal extent and depths to be dredged. As with the evaluation of site conditions, the process may be iterative. More detailed information on sediment characterization for environmental dredging is found in Chapter 3.

- **Determine Dredgeability and Removal Requirements (3d)** — Once data gaps are appropriately filled, the dredgeability and dredging prism can be determined. Dredgeability evaluations focus on the ability of various equipment types to effectively remove the sediments and include consideration of factors such as the presence and extent of debris, the shear strength and density of the sediments, the presence of underlying hardpan or rock bottoms, etc. At this stage, the presence of debris may be considered in planning for separate debris removal operations if needed. The removal requirements include accurately defining the areas slated for dredging; thicknesses of sediment layers requiring dredging; consideration of factors such as water and sediment depths, overburden, slopes, need for step cuts, layback slopes, and overdredge allowances; limits on precision of removal; and an estimate of the total volume of material to be dredged. In the FS stage, the anticipated dredging prism size and shape, together with the available data and initial consideration of operational factors, can be used to compute estimates of volume to be dredged. For the RD, the dredge prism must be defined in detail and a final estimate of dredging volumes determined. More detailed information on determining dredgeability and removal requirements is found in Chapter 3.
- **Develop Preliminary Performance Standards (4)** — The ability of a given dredging design to meet any performance standards that are established must be considered. Performance standards may include applicable water quality and air quality standards, limitations on or minimum requirements for production, limitations related to quality of life considerations, limitations on resuspension, and goals for dredging effectiveness (usually defined in terms of meeting a cleanup level). Goals and objectives of the project may be initially defined in the FS phase in, at least, general terms, and then be refined and finalized in more specific terms in the RD phase. More detailed information on development of performance goals is found in Chapter 4.
- **Select Equipment Type(s) for Evaluation (5)** — With site conditions and sediment characterization data available and performance standards defined, dredge equipment type(s) and size(s) can be selected for evaluation. Selection should be made considering pertinent equipment capabilities and selection factors related to the capabilities of equipment and the compatibility of equipment with site and sediment conditions, transport and rehandling requirements, and disposal options. A preliminary operational strategy (to include a dredging sequence, depths of cuts, cut slopes, consideration of

- allowable overdredging, etc.) can be developed at the FS stage. Both mechanical and hydraulic dredging approaches should be evaluated and compared. Multiple dredge types and operational approaches may be selected for evaluation in the FS phase, but the selection is narrowed for more detailed evaluations in the RD phase. In some cases, pilot studies can be performed to confirm the evaluations for the site-specific conditions. Detailed information on selection of dredging equipment for subsequent evaluation is found in Chapter 5.
- **Evaluate Production Rate, Project Duration, and Transport Needs (6)** — An evaluation of production rates will determine the required size and numbers of dredges needed to meet the project needs, the duration of the project, and transport needs (such as the need for booster pumps or the required number of transport barges). Dredging production refers to the rate of sediment volume removed, usually measured in in situ volume of sediment removed per unit time. Production can be considered and defined in several ways, and it is important to distinguish between average operating production rate (the average production rate during dredging shifts while removing full production cuts) and overall or sustained production rate (the average production rate across a full operating season). Estimates of the average operating production rate will depend on the equipment characteristics, site conditions, sediment properties, thickness or face of material to be removed, continuity of sediment removal areas, location and type of disposal or rehandling facilities, etc. Sustained production rates are driven by a number of factors to include the need for both production and partial or “cleanup” passes, constraints on allowable times for dredging due to operational and quality of life issues, environmental windows or other seasonal constraints, resuspension controls, residuals management, sediment dewatering requirements, and possible transport, treatment, or disposal-related constraints. It should be recognized that timely completion of the project; the need to meet performance standards for resuspension, release, and residuals; and compatibility among dredging, transport, treatment, and disposal requirements are not always mutually achievable. These considerations should therefore be appropriately balanced in the project design. A range of production rates may be calculated for a range of dredge sizes, and then the numbers and sizes of dredges can be selected to meet the performance standards or desired project duration. If there are no specific production-related performance standards, the project duration can be evaluated in terms

- of a reasonable timeframe for completion, and for small projects, possible completion of the work in a single dredging season. Detailed information on production and related aspects is found in Chapter 6.
- **Evaluate Sediment Resuspension (7a)** — Once the needed size and number of dredges are selected for the design, an evaluation of sediment resuspension, contaminant release, and generated residuals is possible. These evaluations may be needed in order to predict the potential short-term effectiveness and long-term effectiveness of environmental dredging for the site. Presently available methods for evaluating resuspension usually rely on an estimate of the resuspension sources and “source strengths,” which are based on the estimated production rate, sediment characteristics, dredge size and type, type of removal mechanism (bucket, cutterhead, or open suction), and operating characteristics. The source strength is expressed as the mass of sediment resuspended per unit time throughout the water column. The source strengths are coupled with a model for prediction of suspended solids concentrations in the water column as a function of distance and time. Results can then be compared to performance standards for resuspension or water quality standards for suspended sediments or turbidity. The need for control measures (such as restrictions on the rate and timing of operations or deployment of silt curtain containments) can then be determined. Detailed information on methods for evaluation of sediment resuspension and transport of resuspended sediments is found in Chapter 7.
 - **Evaluate Contaminant Releases (7b)** — Releases of contaminants of concern in dissolved phase to water and releases of volatile contaminants to air are directly related to sediment resuspension. Contaminant release rates have a direct impact on meeting water quality standards, and control of contaminant release can greatly impact production rates and project costs. At the FS stage, evaluations of contaminant release may be based on simple partitioning models. In the RD phase, this evaluation could be based on laboratory tests such as the Dredging Elutriate Test (DRET) or flux chamber tests for volatilization. Results of both release evaluations and sediment resuspension evaluations can be used in combination to estimate concentrations of contaminants in the water column or volatilized to air, and these can be compared to water quality standards or air quality limits established for the project. As with sediment resuspension, these comparisons will determine the need for control measures. Detailed

- information on methods for evaluation of contaminant releases to water and air are found in Chapter 7.
- **Evaluate Residuals (7c)** — Residuals refer to the mass (thickness and density) and concentration of contaminated sediments left in or adjacent to the dredging footprint at the completion of a dredging operation. The residuals can be generated by the dredging operation as “fallback,” sloughing from the dredge cutface, and/or resettlement of resuspended sediments. Undisturbed residuals, commonly referred to as “undredged inventory,” can also be left due to dredging inaccuracies, incomplete or inadequate sediment characterization, inability of the dredge to access the targeted sediments (irregular hard bottom, presence of debris, protection of shoreline structures) or other factors. Undredged inventory resulting from incomplete or inadequate sediment characterization is sometimes termed “unidentified inventory.” The thicknesses of residual sediment left behind and the concentration of contaminants in the residuals determine both the short-term and long-term effectiveness of environmental dredging in meeting remediation goals (RGs) and remedial action objectives (RAOs). Although there are presently no standardized methods for prediction of the thickness or contaminant concentration in the generated residuals and in the undredged inventory, predictions can be based on field experience at other similar sites and with similar dredging operations and the characteristics of the sediment profile to be dredged. An estimate of residuals will determine the potential need for cleanup passes or placement of post-dredging residuals caps as residuals management alternatives. Detailed information on methods for evaluation of generated residuals is found in Chapter 7.
 - **Determine Need for and Effectiveness of Control Measures (8)** — The results of the evaluations of sediment resuspension, contaminant releases, and residual sediments should be compared with any pertinent performance standards to determine if control measures are needed. If needed, operational controls or engineered controls can be evaluated for their potential effectiveness based on site and sediment conditions. Operational controls include those associated with the dredging operation itself, such as selection of a different dredge type or size, addition of controls such as wash tanks for buckets, changes in the rate of operation or advancement of the dredge, etc. Engineered controls include structural containments such as sheet pile enclosures or silt curtain containments for control of sediment transport and deposition. If controls are deemed necessary and

- potentially effective, such controls would be included in the design and the potential impacts to the operational plan and schedule appropriately considered. Detailed information on evaluation of control measures is found in Chapter 8.
- **Develop Operations Strategy (9)** — Once the removal requirements are determined, the dredge type and size are selected, production rates are evaluated, and the need for additional controls for resuspension, release, and residuals are established, all information should be available to develop an operations strategy or plan. At the FS stage, the strategy may be developed only to a conceptual stage, and may include only a basic description of how the dredge will operate (e.g., a general description of the dredging prism, the number of production cuts, consideration of overdredging allowance, and a general concept of removal sequence). But at the RD stage, a more formal Operations Plan should be developed in detail as a written document. The plan should include a detailed dredging prism or sediment layer trace; delineation of dredging management units; description of dredge cuts, layback slopes, and box cuts; a sequence of operations; detailed mobilization-demobilization and construction timeline; complete descriptions of all equipment to be used; design and use of control measures; and methods for monitoring progress and payment, etc. Detailed information on operational considerations for environmental dredging and development of Operations Plans are found in Chapter 9.
 - **Develop Monitoring and Management Plan (10)** — A dredging Monitoring and Management Plan should be developed to determine if the various performance standards are met. Elements of the plan should address processes related to both short-term effectiveness (e.g., meeting limits on production and project duration, resuspension, and releases) and long-term effectiveness (e.g., meeting limits on residuals and cleanup levels). At the FS stage, the Monitoring Plan may be developed only to a conceptual stage with general monitoring approaches established for purposes of developing conceptual level cost estimates. For the RD stage, the Monitoring Plan should be developed in detail as a written document. The detailed Monitoring Plan should include the monitoring equipment and techniques to be used (e.g., specific instruments, sampling devices); the protocols for sampling, handling and testing of samples (e.g., numbers and locations for sampling, compositing schemes, and testing procedures); and a description of how the monitoring data will be interpreted. A

Management Plan should also be established in advance, describing specific actions to be taken based on the results of the monitoring. Management actions would typically be developed in a tiered fashion, depending on the monitoring results, and may include provisions for additional or more intensive monitoring, a slow-down or cessation of operations, or implementation of control measures. Chapter 10 contains detailed information on developing monitoring objectives, monitoring tools and techniques, and monitoring and management plans.

- **Summary and Integration (11)** — Once all aspects are evaluated (Steps 1-10 above), the overall acceptability of the environmental dredging design can be evaluated in terms of providing environmental protection, meeting performance standards, being implementable, and providing remedial effectiveness. If the evaluations indicate that the dredging design is not feasible, other dredging designs or options should be evaluated or other remediation alternatives should be considered. If the environmental dredging design is found to be feasible, it can be combined with other dredging remedy components (such as long distance transport, rehandling and treatment, and disposal) to form a complete removal remedy alternative. Considerations to determine overall acceptability of the design are found in Chapter 11.

2 Initial Evaluation

This chapter includes information on conducting initial evaluations of environmental dredging as a potential remedy component for a contaminated sediment site.

Initial evaluations should include the following:

- Compare known site conditions and sediment characteristics to those conducive to a dredging remedy.
- Consider the advantages and disadvantages of dredging as compared to other remedy approaches or combinations of approaches for the site.
- Consider environmental dredging as a component of a complete dredging and treatment/disposal remedy approach.
- Identify significant project requirements and constraints that may impact the effectiveness of the environmental dredging remedy component.
- Determine the potential feasibility of environmental dredging to meet RAO's for the site under consideration.

Additional details on each of these aspects of the initial evaluation are described in the following sections.

2.1. Conditions conducive to dredging

The first step in evaluating environmental dredging as a potential remedy is to gather all available site information and compare those data with the site conditions and sediment characteristics conducive to environmental dredging and subsequent treatment/disposal as a remedy approach. The information presented in this section on site conditions amenable to environmental dredging (or removal by dry excavation) as a remedial approach and the advantages and disadvantages of environmental dredging presented in Section 2.2 was taken directly from USEPA (2005) and is presented in this document for completeness. These considerations are important in determining the potential feasibility of environmental dredging at the conceptual level, and in deciding if a more detailed evaluation is warranted for the project under consideration.

In most cases, detailed information on the site and sediments will be available from the RI phase of investigation for the site. The RI should also contain data needed for subsequent evaluations of environmental dredging and, if it does not, this information needs to be obtained during the FS.

Site conditions especially conducive to environmental dredging or excavation are (USEPA 2005):

- Suitable disposal site(s) is available and nearby.
- Suitable area is available for staging and handling of dredged material.
- Existing shoreline areas and infrastructure can accommodate dredging or excavation needs; maneuverability and access not unduly impeded by piers, pilings, or other structures.
- Navigational dredging is scheduled or planned.
- Water depth is adequate to accommodate dredge but not so great as to be infeasible; or excavation in the dry is feasible.
- Long-term risk reduction of sediment removal outweighs sediment disturbance and habitat disruption.
- Water diversion is practical, or current velocity is low or can be minimized, to reduce resuspension and downstream transport during dredging.
- Contaminated sediment overlies clean or much cleaner sediment (so that over-dredging is feasible).
- Sediment contains low incidence of debris (e.g., logs, boulders, scrap material) or is amenable to effective debris removal prior to dredging or excavation.
- High contaminant concentrations cover discrete areas of sediment.
- Contaminants are highly correlated with sediment grain size (to facilitate separation and minimize disposal costs).

2.2. Potential advantages and limitations of dredging

The advantages of environmental dredging (or removal by dry excavation) as a remedy approach include (USEPA 2005):

- If the operation achieves cleanup levels for the site, it may result in the least uncertainty about long-term effectiveness of the cleanup, particularly regarding future environmental exposure to contaminated sediment. Removal of contaminated sediment can minimize the uncertainty associated with predictions of sediment bed or in situ cap

- stability and the potential for future exposure and transport of contaminants.
- Removal of the contaminated material provides flexibility for future use of the water body. In situ cleanup methods such as monitored natural recovery and capping frequently need institutional controls that limit water body uses. Although remedies at sites with bioaccumulative contaminants usually require the development or continuation of fish consumption advisories for a period after removal, other types of institutional controls might be necessary to protect a cap or layer of natural sedimentation. If dredging residuals are low, sediment removal may reduce risk quickly and achieve remedial action objectives faster than would be achieved by natural recovery.
 - Sediment removal is presently the only cleanup method that can allow for treatment and/or beneficial reuse of dredged or excavated material (although sediment treatment is not often cost-effective and therefore not often selected).

There are also significant potential limitations to sediment removal (USEPA 2005):

- Implementation is usually more complex and costly than MNR or in situ capping because of the removal technologies themselves (especially in the case of dredging) and the need for transport, staging, treatment (where applicable), and disposal of the dredged sediment. Treatment technologies for contaminated sediment frequently offer implementation challenges because of limited full-scale experience and high cost. In some parts of the country, disposal capacity may be limited in existing municipal or hazardous waste landfills and it may be difficult to locate new local disposal facilities. Dredging or excavation may also be more complex and costly than other approaches due to accommodation of equipment maneuverability and portability/site access. Operations and effectiveness may be affected by utilities and other infrastructure, surface and submerged structures (e.g., piers, bridges, docks, bulkheads, or pilings), overhead restrictions, and narrow channel widths.
- There is a level of uncertainty associated with estimating the extent of residual contamination left following removal. Residual contamination is likely to be greater in the presence of cobbles, boulders, or buried debris, in high energy environments, at greater water depths, and where contaminated sediment directly overlies bedrock or a hard

bottom. Residuals may also be greater in very shallow waters and when dredging sediments with high water contents. These complicating factors can make the sediment removal process and achievement of risk-based remediation goals difficult and costly. The continued bioaccumulation of residual contaminants can also affect the achievement of risk-based remediation goals. Dredging residuals have been underestimated at many existing sites, even when obvious complicating factors were not present. For some sites, this has resulted in not meeting cleanup levels or remedial action objectives.

- There is potential for significant contaminant losses through resuspension and, generally to a lesser extent, through volatilization. Resuspension of sediment from dredging normally results in both dissolved and particle-associated releases of contaminants to the water column. Resuspended particulate material can be redeposited at the dredging site or, if not controlled, transported to other locations in the water body downstream. Some resuspended contaminants can also dissolve into the water column where they are more available for uptake by biota. While aqueous resuspension generally is much less of a concern during excavation, there may be increased concern with releases to air. Losses en route to and/or at the disposal or treatment site might include effluent or runoff discharges to surface water, leachate discharges to groundwater, or volatile emissions to air. Each component of a sediment removal alternative typically necessitates additional handling of the material and presents a possibility of contaminant loss, as well as other potential risks to workers and communities.
- As for in situ capping, disruption of the benthic environment normally is unavoidable during dredging or excavation and usually includes at least a temporary destruction of the aquatic community and habitat within the remediation area.
- Removal of sediments near shoreline structures such as existing bank protection, retaining walls, wharfs, etc. has the potential to undermine the shoreline and/or structures, creating foundation instability and limiting the depth of sediment removal near these features.

2.3. Environmental dredging as a component of a sediment removal remedy

One of the most important considerations related to environmental dredging is that once the dredge removes sediment from the water body, something must be done with that contaminated sediment. Although the

physical act of sediment removal and its effectiveness considering resuspension, release, and residuals are the focus of this technical resource document, they represent only a part of the concerns for a sediment remediation project involving environmental dredging. Much of the cost and complexity for a dredging/disposal remedy is inherent to the disposal/treatment components as opposed to the dredging component.

Environmental dredging must be viewed as one component of a dredging/disposal remedy. The environmental dredging process must be fully integrated with and compatible with other components such as transportation of the dredged sediment and the subsequent treatment and/or disposal or reuse of the sediment. Further, environmental dredging may be a component of a combined remedy or a remedy involving other actions within the water body itself (NRC 2001 and USEPA 2005). For example, dredging may be selected as a remedy component to ensure navigational depth is maintained or to remove the most highly contaminated sediments, then combined with capping or MNR to achieve the final cleanup level.

A remedy involving dredging (or dry excavation) must include a number of components forming a “treatment or process train.” The key components include removal (the environmental dredging component); transport and storage (rehandling); treatment (pretreatment, treatment of decant and/or dewatering effluents and sediment, and potentially separate handling and treatment requirements for different materials (e.g., Toxic Substances Control Act (TSCA) versus Non-TSCA)); and disposal (liquids and solids) (USEPA 2002a). Figure 3 provides an example flow diagram of the possible steps in a dredging or excavation alternative. The availability of disposal capacity on-site versus off-site is a major consideration in developing options for such process trains. The simplest dredging or excavation projects may consist of as few as three of the components shown in Figure 3. Complex projects may include most or all of these components. Efficient coordination of each component is very important for a cost-effective and time-efficient cleanup. Project managers should recognize that, in general, fewer sediment rehandling steps leads to lower implementation risks, greater production rates, and lower cost (USEPA 2005). Additional guidance on the rehandling and subsequent treatment and disposal of contaminated sediments is found in USEPA (1994, 2005).

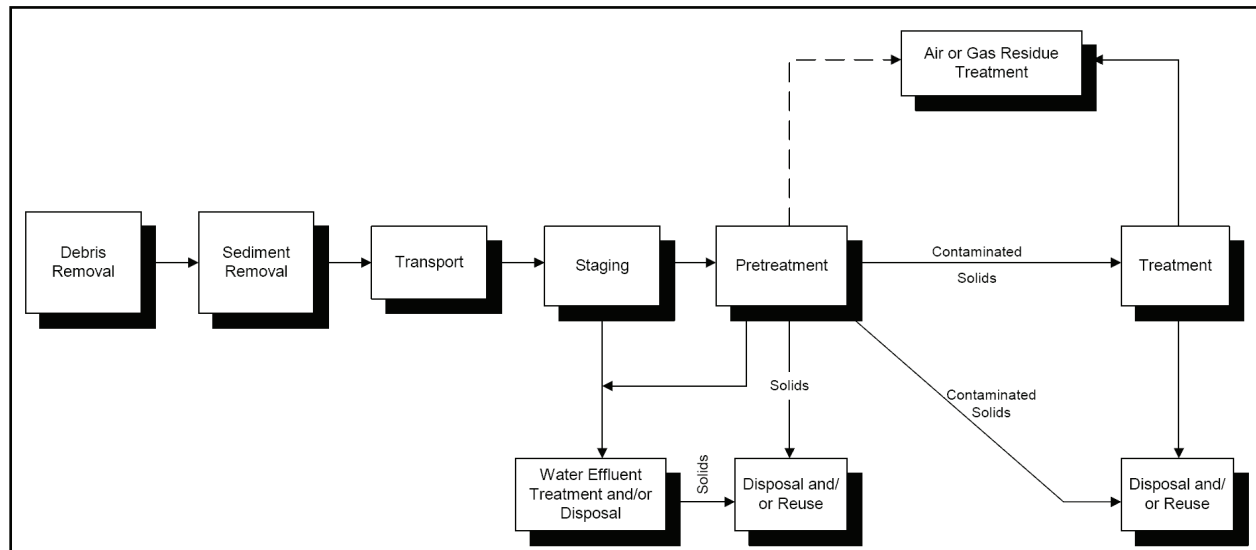

Figure 3. Example flow diagram of the possible steps in a dredging or excavation alternative.

The dredging component must be compatible with the components subsequent to the removal operation. The treatment and disposal options under consideration, size and capacity of disposal sites, distance from dredging site to treatment or disposal sites, and constraints associated with throughput for transport, storage, rehandling, treatment, or disposal will be major factors in selecting compatible dredging equipment and approaches. In many cases, the inefficiencies experienced at environmental dredging projects result from constraints associated with components of the remedy other than the dredging itself.

2.4. Evaluation of project requirements and constraints

Project requirements and constraints may be technical, regulatory, institutional, and/or logistical, and may be major factors in limiting the effectiveness or efficiency of dredging. Such constraints may change through the phases of evaluation, i.e., the potential options may be wide open in the RI and FS phases, but the Record of Decision (ROD) may specify certain constraints that apply to the RD phase.

Examples of project requirements and constraints with potential to greatly influence the evaluation include the following:

- Constraints on the maximum allowable time period for implementation.
- Water quality criteria.
- Quality of life considerations related to light, noise, traffic, etc.

- Availability (or non-availability) of on-site or nearby disposal capacity.
- Shoreline and infrastructure stability issues that would limit the depth of dredging.

Such constraints would be major drivers in determining the type and number of dredges, dredge size, the need for control measures associated with dredging operations, etc.

2.5. Preliminary evaluation of dredging feasibility

At the FS stage, a preliminary evaluation of dredging feasibility should be done to determine if dredging should be carried forward for more detailed evaluation. Site conditions conducive to dredging are given in Section 2.1, advantages and disadvantages of dredging are given in Section 2.2, considerations relating to dredging as a removal remedy component are given in Section 2.3, and major project constraints are given in Section 2.4. These factors should be evaluated to determine if environmental dredging is a feasible alternative for the site. Only rarely would environmental dredging not be carried forward for more detailed evaluation in the FS.

The preliminary evaluation should determine whether dredging is potentially feasible at the site, whether a full dredging remedy should be considered, whether a combination remedy with partial dredging (e.g., to a set elevation) should be considered, what areas and volumes should be considered, and whether mechanical dredging, hydraulic dredging, or both approaches, should be evaluated. It is important to note that the preliminary evaluation is comparable to the screening evaluation in an FS and is not intended as an additional report or requirement. Again, only rarely would environmental dredging not be carried forward for more detailed evaluation in the FS.

It is important to note that multiple possibilities are normally evaluated at the FS stage, and the preliminary evaluation step here can serve to identify potential remedy options involving full dredging, partial dredging, etc. and to narrow the range of options evaluated. If site and sediment conditions and project requirements and constraints indicate that dredging is potentially feasible, evaluations should proceed for dredging as the remedial approach or component of the remedial approach.

2.6. Pilot studies

Field pilot studies have been conducted at a number of contaminated sediment sites to develop data on performance of various dredging equipment types, control measures, and monitoring tools, etc. Pilot studies should be considered when field monitoring data for a full-scale operation is needed for purposes of feasibility determination or for confirmation of project design assumptions. The primary goal of any pilot study is to reduce uncertainties in dredging effectiveness. Specific reasons to consider a pilot study may include:

- Developing and testing adequacy of instruments.
- Assessing the feasibility of a piece of equipment or technique at full scale.
- Designing an operations or monitoring protocol and assessing whether the protocol is realistic and workable.
- Establishing whether the sampling strategy and techniques are effective.
- Developing site-specific information on expected residuals, resuspension and release, and limitations related to implementation constraints (i.e., water quality standards) that can affect project outcome, schedule, and cost.
- Assessing the likely success of proposed engineering and operational approaches.
- Identifying logistical problems that might occur using proposed methods or protocols.
- Estimating variability in outcomes to help determine sample sizes for monitoring.
- Verifying that assumptions based on experience at other projects hold true under site-specific conditions.
- Collecting data for design.
- Assessing the proposed data analysis techniques to uncover potential problems.
- Defining field information to determine what resources (people, time, money) are needed for the full-scale project.
- Training a project team in as many elements of the project processes as possible.
- Demonstrating that the project is feasible and worth funding.
- Demonstrating to other stakeholders (community) what the project will entail and is worth supporting.

- Uncovering local politics that may affect the project acceptance and community outreach.

Pilot studies should be conducted using full-scale equipment and should be performed on site in conditions expected for the full-scale remediation. Conducting the work under these conditions will reduce physical and geometric effects of process equipment on equipment performance. An especially useful pilot program would use multiple equipment types, etc. at the same site and under the same conditions. This type of pilot study provides a direct comparison of equipment or technique, and the data can show the advantages of one option versus another.

The size of the area to be used for a pilot study or the volume of material to be dredged for a pilot would depend on the project conditions and the specific objectives of the project. However, the area and/or volume should be large enough for full-scale operations of the equipment for a sufficient period to observe potential changes (e.g., tidal influences, river discharge rates, etc.) which would occur for the full-scale remediation.

3 Evaluating Site Conditions and Sediment Characteristics

This chapter identifies and describes the important site conditions and sediment characteristics relative to evaluating dredging along with the tools and techniques normally applicable for gathering and evaluating these data, and the limitations and considerations in applying those tools. This chapter also describes considerations for determining the need for separate debris removal operations, the overall dredgeability of the sediments, and the neat line dredging volume for the target sediments.

Knowledge of site conditions and sediment characteristics is critical to the evaluation of environmental dredging as a potential remedy component. Inadequate site and sediment characterization is one of the major causes for problems associated with implementation of environmental dredging and can potentially cause delays, higher costs, unacceptable environmental impacts, and failure to meet cleanup levels and remediation goals.

Site conditions are the overall characteristics of the water body, sediment deposits, and surrounding areas. Site conditions are normally evaluated by general information gathering and field site surveys. The information gained from evaluation of site conditions can usually be displayed in a map-type format using a Geographic Information System (GIS).

Sediment characteristics include specific physical, chemical, or biological properties of the sediments, e.g., grain-size distribution and concentrations of COCs in sediments. Sediment characterization data are obtained by collecting borings or grab samples in the field and then testing and analyzing them in the laboratory. The information gained from evaluation of sediment characteristics is essentially point data and can be displayed in geotechnical cross sections showing the boring logs in tabular format or in GIS. Profiles of sediment characteristics are very important for defining the dredging prism and refining the Conceptual Site Model (CSM). Site-specific conditions can greatly impact the ability of site characterization efforts to fully understand the nature of a given site. Specific examples include high degree of variability in contaminant distribution, difficult/variable site bottom conditions, and sediment characteristics, which are not conducive to subsurface profiling technologies.

Site and sediment characterization occurs throughout the Remedial Investigation (RI) and Feasibility Study (FS). Information is gathered for developing the site conceptual model and identifying remedial alternatives. Much of this information is useful for designing the environmental dredging alternative during Remedial Design (RD); however, the data are not usually sufficient and additional data quality objectives may be formulated and fulfilled to evaluate and design environmental dredging. Site characterization data are also used to compare to post-remediation monitoring data to ascertain the effect of the dredging operation. In this regard, consistency, to the extent feasible, between pre- and post-dredging monitoring techniques, locations, and characteristics (e.g., time of year, depths of sampling, etc.) is essential to permit reliable comparisons of site conditions between time points. The considerations for site and sediment characterization for other remedial approaches (e.g., monitored natural recovery or in situ capping) or those related to evaluation of rehandling, treatment, or disposal of dredged sediment may differ. When these alternatives are also under consideration, the site and sediment characterization effort should be designed to evaluate these remedial options in addition to those described here for dredging.

3.1. Identifying and filling data gaps

The process of site and sediment characterization involves identifying and filling data gaps. Sediment sites and contaminated sediment deposits at these sites are often complex. Rarely can a contaminated sediment site be adequately characterized in a single surveying and sampling effort. The data gaps can be identified by comparing all available data, project constraints, and requirements with the data requirements described in the following sections.

3.1.1. General considerations for site and sediment characterization

Site and sediment data are needed to (USEPA 2005):

- Develop and refine the conceptual site model.
- Evaluate sediment and contaminant fate and transport.
- Conduct the human health and ecological risk assessments.
- Evaluate the need for and effectiveness of source control.
- Evaluate potential remedies.
- Document baseline conditions prior to implementation of the remedy.
- Design and implement the selected remedy.

- Serve as the basis for post-remedial evaluations of dredging effectiveness.

The nature and extent of the data gaps associated with these data needs will largely depend on the stage of evaluation. The site and sediment characterization effort needed for environmental dredging also feeds the data needs in the above list.

A sediment investigation is initiated in response to an identified problem, such as the presence of contaminants above screening levels or observed impacts to human or ecological receptors that signal the presence of contaminants in a given area. There is usually some level of knowledge of the site and the sediments that can serve as the basis of an initial evaluation of dredging feasibility as described in Chapter 2. The initial evaluation of dredging feasibility also provides a basis for an early identification of data gaps for site conditions and sediment characteristics.

Detailed evaluations of site conditions and sediment properties, based on site surveys and sediment sampling and testing, are normally done as a part of the RI phase under the CERCLA evaluation framework. Although it is not always possible, the RI should be conducted with potential remedial alternatives in mind. In this way, much information critical to the evaluation of environmental dredging can be obtained early in the process. The information in this chapter is therefore applicable to developing the sampling plans, etc., needed for conducting an RI, if dredging is a potential remedial approach and should be used in conjunction with *Contaminated Sediment Remediation Guidance for Hazardous Waste Sites* (USEPA 2005).

Evaluations of environmental dredging as a remedial option are conducted during the FS and RD phases of evaluation. Ideally, the RI for the site should provide nearly all of the data needed to perform the FS; in reality, this is rarely the case. As shown in the flowchart in Figure 2, if data gaps exist (which will normally be the case in both the FS and RD phases), additional field data collection and laboratory testing efforts should be planned and designed. These efforts should be consistent with the guidelines in Sections 3.2 and 3.3. The level of detail of the information forming the basis of the evaluations should be substantially greater as the evaluations progress from the FS phase to the RD phase.

Depending upon the site, an environmental dredging project may involve one or more regulatory and resource agencies, as well as other stakeholders, such as potentially responsible parties (PRPs). Multiple users may be using the characterization data for multiple purposes (e.g., human health and ecological risk, resource damage assessments, remedy selection, and remedy design). It is therefore important to consult as many data users as possible (e.g., risk assessors, modelers, QA/QC experts, designers, etc.) Preliminary project objectives and information needs may be evaluated by a working group composed of representatives from the various agencies and other stakeholders. One of the first objectives of a working group should be to develop a conceptual site model that defines the problem by evaluating available information, and supplementing that information as needed with appropriate site and sediment characterization. This may involve review of data held by different agencies or private concerns, in order to establish first what is known about the site and possible contaminant sources. There may also be other ongoing or planned actions for the site, which will have to be taken into consideration. Once all available information has been assimilated, data gaps can be identified. A systematic plan can then be developed to obtain critical information needed in order to enable decision-making. This will likely involve a multi-disciplinary effort in order to design testing and sampling plan requirements, interpret results, and develop an action plan for the site. A tiered approach to site evaluation and sediment characterization will ensure maximum benefit from finite resources.

3.1.2. Conceptual site model

EPA has published *Principles for Managing Contaminated Sediment Risks at Hazardous Waste Sites* (USEPA 2002a). Risk Management Principle Number 4 is:

“Develop and refine a conceptual site model that considers sediment stability.”

A conceptual site model should identify all known and suspected sources of contamination, the types of contaminants and affected media, existing and potential exposure pathways, and the known or potential human and ecological receptors that may be threatened. The CSM should include the physical, chemical, and/or biological processes at the site within the context of the problem formulation. It defines the relationship of site contaminants of potential concern (COPCs) with known or suspected sources of

contamination, release and transport mechanisms, affected media, existing and potential exposure pathways, and known or potential human and ecological receptors that may be at risk. The CSM will rely on compiled historical data, data collected during the RI, and predictive tools and models to describe important processes and to make predictions about future conditions at the site. This information is frequently summarized in a written format, often supplemented in pictorial or graphical form, backed up by site-specific data.

Once the CSM is initially constructed, data gaps are identified and filled through data collection. The CSM should therefore be considered a living document and should be refined as new data become available. In this way, the CSM can be used as a mechanism for integration of site and sediment data and evaluation of the project in a comprehensive manner. Any data collected to fill data gaps related to environmental dredging evaluations should also serve to update and refine the CSM. The CSM also provides the basis for developing data needs to evaluate the effectiveness of dredging at the site.

3.2. Site conditions

Several aspects of the physical environment may make sediment removal more or less difficult to implement. In the remedial investigation, the following types of information should be collected, as they can affect the type of dredging equipment selected and potentially the feasibility of sediment removal:

- General project setting and sources of contamination.
- Positioning and land-based survey control, etc.
- Access to water body.
- Water body uses and presence of infrastructure (bulkheads, piers, bridges, stormwater and CSO outfalls, utility crossings, etc.).
- Siting for transport, rehandling, treatment and disposal facilities.
- Water depths, bathymetry, and slopes of the sediment surface.
- Hydrodynamics (currents, waves, tides, etc.) and seasonal variations.
- Elevation and nature of bedrock or hard bottom (e.g., stiff glacial till).
- Shoreline stability.
- Presence and extent of debris in the sediments (to include large buried objects, loose rock, etc. within the sediment bed).
- Habitat considerations and seasonal dredging restrictions.
- Winter icing conditions.

- Ambient water and air quality.

Many of these considerations can be evaluated by site inspections and researching general site information from Federal, state, and local government sources, permit records, etc. (USEPA/U.S. Army Corps of Engineers (USEPA/USACE) 1998) contains a detailed list of possible information sources for this purpose. Other aspects of site characterization require site-specific surveys using a variety of geophysical assessment approaches. Considerations for evaluation of each of these types of site characterization information and tools commonly used for the evaluations are described in the following subsections.

3.2.1. Project setting and sources of contamination

Site characterization begins with an assessment of the general character of the potentially impacted area, including existing and historical land uses adjacent to and upstream of the site, industrial, sewage, and stormflow outfalls (existing and historical), and other possible sources of contamination, such as navigation activities and atmospheric contributions.

All potential sources of contaminants should be identified and their possible importance with respect to the identified problem should be considered. The source of contamination should be removed or controlled before any active remediation begins. The industrial outfalls that were sources of contaminants may have long since been addressed. Sources more difficult to control are groundwater discharges and the contaminated sediment itself, which may become more widely distributed by tidal action or storm events. The relative contributions of these contaminant transport pathways, both current and historic, need to be estimated so that the long-term efficacy of dredging and other types of remedial action can be evaluated.

3.2.2. Positioning and survey control

Evaluation of dredging requires site and sediment data that are tied to a location (in three dimensions) at an acceptable level of precision. Electronic positioning based on satellite-based Differential Global Positioning Systems (DGPS) and/or survey control should therefore be a central part of all field data collection efforts. If the site is located sufficiently near a shoreline (which is usually the case), shore-based survey controls should be established early in the site and sediment characterization process. Installation of tide gauges or pool elevation is needed in areas subject to

fluctuating water levels. It is desirable to input all site characterization data into a Geographic Information System (GIS) for purposes of data interpretation.

The vertical position of sediment samples should be reported as depth below mudline, as well as referenced to the elevation of the mudline based on a standard vertical datum. The vertical datum in coastal areas under tidal influence is often referenced to Mean Lower Low Water (MLLW), while inland waterways often report vertical elevations referenced to a Low Water Reference Plane (LWRP), and vertical elevations in the Great Lakes might use the International Great Lakes Datum (IGLD) of 1985. The elevation of the mudline is established by measuring the elevation of the water surface to a known vertical datum, and then measuring the depth of water to the mudline to calculate elevation. Failure to report mudline elevation for sediment samples (reporting only depth below mudline) can result in erroneous application of the sediment data and may make the data unusable in the future if erosion or sedimentation occurs.

3.2.3. Access to the water body

Dredges and necessary support equipment must be able to access the contaminated site. Larger dredges can reach the site by use of navigation channels, etc., although bridges or undersized locks may present constraints. Smaller dredges are truck-transportable and can be deployed if suitable launching sites are available. There may also be a need to identify areas for booster pumps and sampling support boat access. Remote landlocked sites may require construction of new access roads or other methods such as air transport. Therefore, water and land access should be evaluated; some access points may need to be away from the main unloading and rehandling area.

3.2.4. Waterway uses and infrastructure

The uses of the waterway or water body or the presence of infrastructure within and adjacent to the water body may result in constraints on the nature of dredging equipment that can be used at the site and the allowable time periods for operation of the equipment. Quality of life considerations or other concerns can also pose similar constraints. Waterway uses and infrastructure that may need to be considered when evaluating environmental dredging include the following:

- **Navigation** - The presence of commercial navigation channels or turning basins within or adjacent to the project area is an important consideration and can have an impact on selection of material transport options, locations of pipelines, control measures, etc. The potential impact of navigation traffic on environmental dredging operations should also be assessed. Navigation traffic has the right of way in federally authorized navigation channels, which means that environmental dredging will have to cease and dredges must move out of the navigation channel when they are blocking navigation traffic.
- **Recreation** - Recreational use of the waterway may influence the locations of hydraulic dredge pipelines or dictate the need for submerged pipelines, or control hours of operation.
- **Residential** – The presence of private homes, piers, etc. may require special consideration of quality of life issues (noise, light, odors) and potential for contaminant exposures of nearby residents due to contaminant releases, etc. It is not uncommon to restrict environmental dredging to normal daylight hours in residential areas to reduce the impacts of the work on the local community.
- **In-water Structures** - Bridges, piers, locks and dams, or other in-water structures may present obstacles to certain dredge types and dictate equipment selection as well as impact ability to remove sediment without negatively affecting these structures. Many contaminated sites have not been dredged before or for many years and dredging can adversely impact structures that are stable under existing conditions but fail when large volumes of sediment are removed.
- **Shoreline/Structure Stability** – Removal of sediments near shoreline structures such as existing bank protection, retaining walls, wharfs, etc. may require use of certain dredge types. In addition, the potential for undermining the shoreline and structures may effectively limit the depth of sediment removal near these features.
- **Utility Crossings** - Buried cables, pipelines, etc. may present obstacles to dredging or may require expensive relocations prior to dredging.
- **Water Supply Intakes and Discharge Outfalls** – Water supply intakes located near the project area may require additional controls for sediment resuspension and contaminant release; discharge outfalls may constrain the use of silt curtain or sheet pile controls for resuspension.
- **Anchorage** – Moorage and anchorage areas may be affected during the implementation. Alternative anchorages may be required.

- **Habitat** – The presence of endangered species and associated environmental windows to protect environmental resources may preclude work in some areas; the destruction of critical or sensitive aquatic habitat may require mitigation; and physical changes to the water body due to dredging may influence habitat type or quality.

3.2.5. Siting for transport, rehandling, treatment, and disposal

The interface between the dredging process and subsequent transport, rehandling, treatment, and disposal is critical for selection of dredging equipment and overall evaluation of a removal remedy. For this reason, the site characterization should include a survey of site conditions related to potential transport and disposal interfaces.

The potential locations of sites for rehandling and/or disposal of dredged sediments are key considerations in the selection of hydraulic or mechanical dredging approaches. For example, large tracts of existing land near the dredging areas (such as brownfields, abandoned industrial sites, or vacant lands) may hold potential for rehandling, dewatering, treatment or disposal sites, making hydraulic dredging with pipeline transport more feasible. Conversely, use of mechanical dredges with barge transport may be more advantageous in the absence of larger land space, although even mechanically dredged sediments can require substantial upland space for transferring the sediment to upland transport equipment and to provide buffer capacity between dredging and off-site transport.

Distance to the disposal site or staging area may also influence dredge selection. Potential locations for offloading facilities for barges, potential hydraulic dredge pipeline routes, and potential truck routes should be identified. If the dredging operation is to interface with an upland treatment system, the feed requirements of that system must be taken into consideration in selecting dredging equipment. Dewatering operations, for example, require a consistent feed rate and slurry solids content, while hydraulic dredges deliver a widely varying solids content over the course of a single pass, as well as over the course of a project. In addition, under the best of conditions, some dredge idle time can be expected due to processing disruptions, depending upon buffering capability between the systems. This will be more costly for some equipment than for others.

3.2.6. Water depths and bathymetry

Bathymetry is a key requirement for site characterization and is needed to establish water depths, bottom slopes, variability in bottom features, etc. Water depths are a factor in selection of dredging equipment and approach.

Bathymetry surveys will likely be needed at several stages during project evaluation and a final bathymetry survey should be conducted prior to project implementation (for purposes of final plans and specs and the bidding process). Since sediment deposits might not be physically stable under periodic or episodic hydrological events and contaminated sediment sites are frequently depositional areas, surveys taken shortly in advance of the start of dredging can reduce uncertainties with respect to initial conditions as they relate to calculation of removal quantities. Alternatively, projections can be made, if necessary, to predict the future profile at the time of dredging. During the actual dredging process, bathymetric surveys will also play a role in tracking the progress of the dredging.

Although several methods are available to determine water depths and thereby bathymetry, the use of acoustic instruments is the most common approach. Acoustic survey instruments may use a single-beam echo sounder hung from the survey vessel, multiple transducers arrayed on a boom extending from the survey vessel, or multibeam equipment. The single beam method provides depth data along the track line of the survey boat. The multiple-transducer provides parallel track lines of data associated with each transducer, and the multibeam, with multiple transducers in the same head (array) provides a swath of closely spaced data points (on the order of a foot) over a swath width equivalent to 2.5 to as much as 7 times the water depth. The multibeam devices provide a more detailed survey and allow for mapping of individual bucket placements, ridges left between bucket and cutterhead passes, slope sloughing features, rock outcrops and ridges, and other factors that relate to the successful completion of environmental dredging. The multibeam devices provide a more detailed survey and allow for a determination of a “fluff” layer above the more consolidated sediment surface. Single-beam equipment would be acceptable when additional resolution is not needed or when surveying areas where multibeam surveys do not provide additional value, such as homogeneous areas of consolidated sands.

The accuracy of acoustic surveys is a function of water depth, among other things. An example of an acoustic survey track is shown in Figure 4. The width of the survey lanes is a key parameter for acoustic surveys.

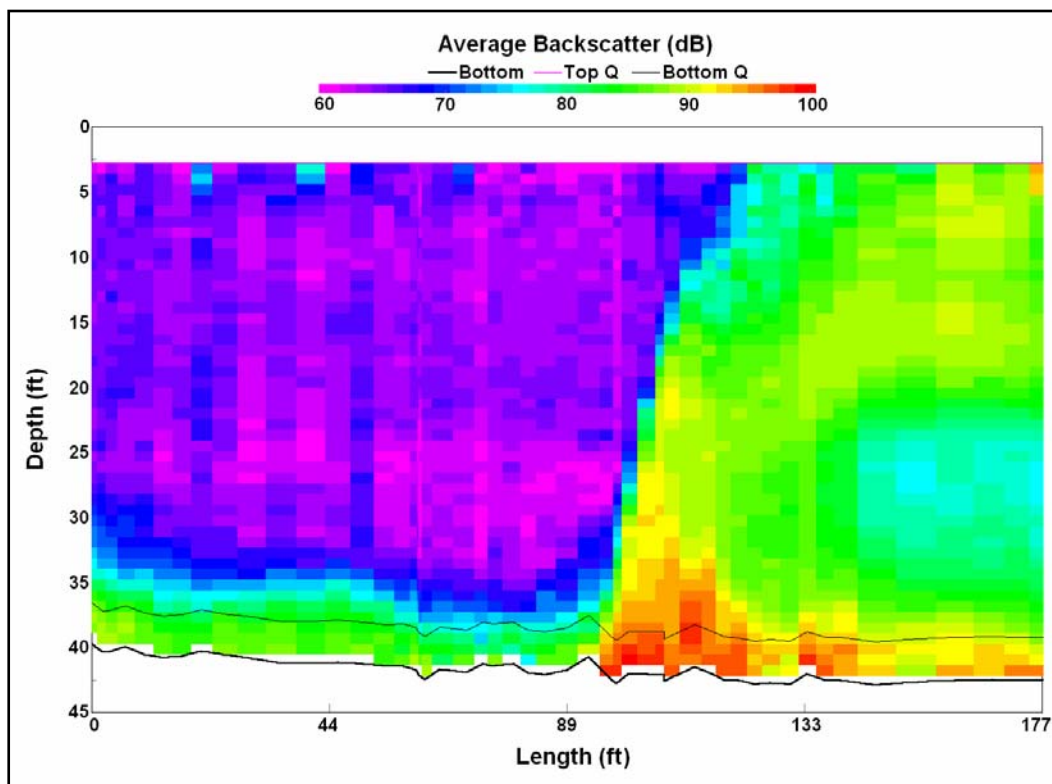

Figure 4. Example of an acoustic survey track.

USACE has published an Engineer Manual with detailed guidance on hydrographic surveying (USACE 2002). It sets forth performance standards for hydrographic surveys with resultant elevation/depth accuracy of ± 0.5 ft for acoustic measurements in water depths of 15 ft or less, and ± 1.0 ft for acoustic measurements in water depths greater than 15 ft. Detailed information on hydrographic surveying equipment is also available from instrument manufacturers.

3.2.7. Hydrodynamics

The hydrodynamics of the site should be characterized with respect to waves, currents, and fluctuating water levels to determine whether dredging is feasible or whether constraints should be imposed on equipment selection. Evaluations of dispersion of resuspended sediment and subsequent contaminant release will require hydrodynamic data. The potential

for episodic events will also affect the design of control measures such as sheet pile enclosures or silt curtains.

Data on currents, tides, river stages, and waves may be obtained from USACE, U.S. Geological Survey, and NOAA's National Ocean Service records. In many cases, site-specific data collection and hydrodynamic modeling may be needed to evaluate local conditions and the potential impact of episodic events at the site. The *Contaminated Sediment Remediation Guidance for Hazardous Waste Sites* (USEPA 2005) contains a discussion of modeling considerations. The potential change in hydrodynamics following completion of dredging should also be considered (this is especially important if an environmental dredging remedy component is combined with a capping component).

3.2.8. Elevation and nature of bedrock or hard bottom

Contaminated sediments are usually silts and clays with some fraction of sand. In many cases, the sediment deposits were contaminated over a timescale of decades and are relatively shallow deposits; as such, the sediments are not geologically compacted, cemented, or consolidated due to overlying layers. However, the underlying layers can be highly consolidated or composed of so-called hardpan materials such as glacial till or bedrock. The proximity of hard bottom to the contamination layer is of critical interest. One of the most difficult conditions for environmental dredging is soft contaminated sediment immediately overlying such a hard layer, since the absence of a clean softer underlying layer prevents any overdredging to help ensure efficient removal of all targeted sediment or dilution of the residuals. New advances in equipment are improving the ability to work effectively in these conditions. For example, open suction dredge attachments have shown promise in effectively removing fine-grained sediment layers and fluffy residuals over hard bottom surfaces (Weber et al. 2008).

The elevation of underlying bedrock or hardpan layers is therefore an important parameter for evaluating the effectiveness of dredging, selection of dredging equipment, development of an operational approach for dredging, and the determination of necessary overdepth dredging. Of equal importance is the nature of the hard-bottom surface. Blasted rock surfaces are common for sites where navigation channels have been constructed in bedrock; loose rock and uneven surfaces at such locations can present difficult conditions for efficient sediment removal.

Data from borings or probings can be used to estimate elevations of hardpan, but such data are for specific stations in the water body only. A more general evaluation might be done using sub-bottom profiling surveys, provided that confounding factors such as gas in the sediment can be accounted for. These surveys rely on towed geophysical instruments that reflect signals from the layers of differing densities and can provide a visual profile showing relative vertical locations of layers. Figure 5 is an example of a sub-bottom profile image.

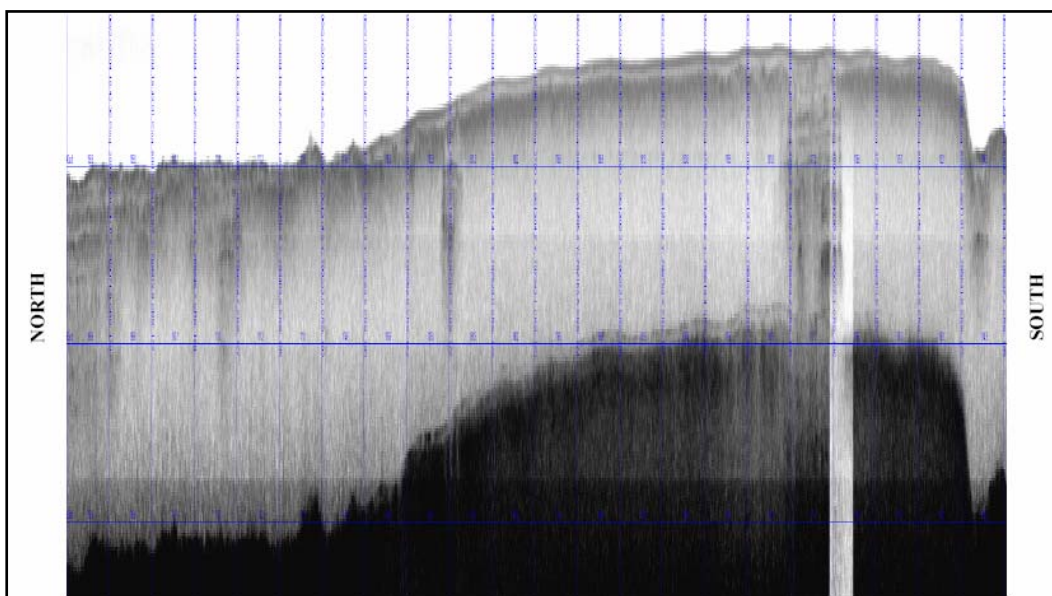

Figure 5. Example of a sub-bottom profile image. (Graphics courtesy of CR Environmental and Parsons).

3.2.9. Shoreline stability

Sediment removal by dredging may change the slope stability or erosion potential of the remediation area. These changes should be evaluated to ensure that the sediment removal does not increase the potential for bank erosion or structural instability of shoreline facilities, or other adverse effects that may be unacceptable. Evaluation of the feasibility of a sediment removal project should include an analysis of whether impacts to these potential uses may be avoided or minimized both during construction and in the long term. A geotechnical engineering evaluation of shoreline slope and/or shoreline infrastructure stability may need to be conducted for determining limitations on nearshore sediment removal.

An example guideline for assessing the potential impact of dredging adjacent to shoreline structures is shown in Figure 6 (Otten 2006). Any

dredging within the Critical and Caution Zones will first require a detailed engineering (geotechnical and structural) evaluation to address the stability of the existing structures, and the impact of dredging on the stability of those structures. Removing dredged material from the toe of a slope or from the toe of a bulkhead will reduce the resistance to sliding of the slope or wall.

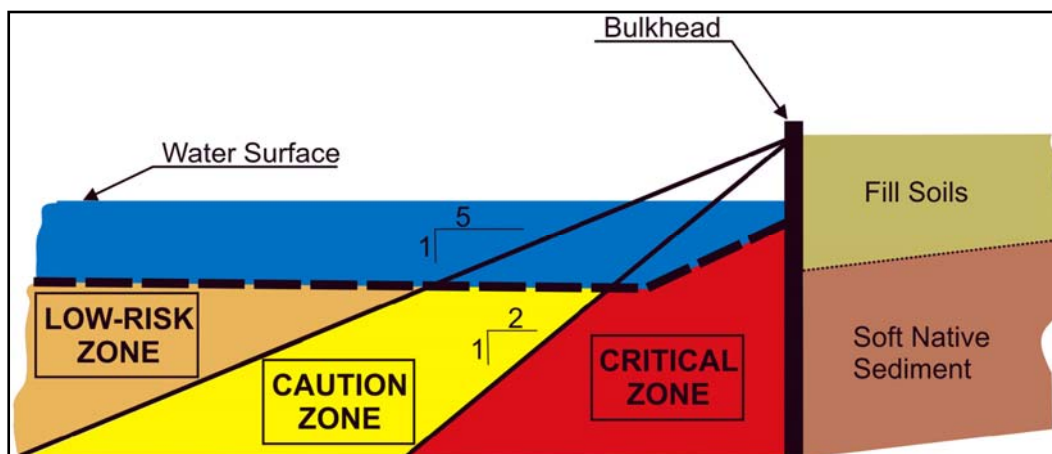

Figure 6. Example guideline for shoreline structure stability (Otten 2006).

Because contaminated sediment often is accumulated adjacent to older industrial facilities, it is quite possible that many of the structures (bulkheads, piers, walls) will be found to be marginally stable in their existing condition (some on the verge of failure). These structures are subject to damage from any significant dredging in the Critical Zone and possible damage from significant dredging in the Caution Zone. Consequently dredging along the slopes near established structures may require extensive slope reinforcement to protect existing facilities from damage. Dredging within the Low-Risk Zone can usually be done without slope reinforcement.

3.2.10. Presence and extent of debris

The extent and nature of any debris are key considerations for dredge selection. Debris could be considered a sediment characteristic, but is normally evaluated on a site-wide basis because debris is often larger than the size of sediment samples, and is therefore considered here as a site condition. A debris survey should be conducted and, if necessary, a debris management plan should be developed for debris removal, decontamination, and disposal that is consistent with and supports the plan/equipment for removing and handling contaminated sediment. For example, mechanical

dredging might accommodate a wide range of debris encountered during dredging with the mechanical dredge, while the same debris (rocks, boulders, cables, chains, stumps, etc.) might all but shut down a smaller hydraulic dredge used for environmental remediation. The presence and nature of debris may be the determining factor in the selection of dredging equipment.

Potential staging areas to receive, decontaminate, and load debris for transport to a disposal area should be identified. Materials that cannot be decontaminated may have to be disposed of in a permitted facility, and additional measures may have to be taken to prevent release of contaminated water and sediment from the materials. Several methods are available to assess the nature and extent of debris, including side scan sonar, sector scan sonar, magnetometry, metal detector surveys, diver surveys, shoreline inspections, and physical probes. In addition, observations of current waterway usage and research on historical usage can provide significant insight on debris that can be expected. For example, in former log handling or log rafting areas, debris such as logs, chokers, and chains should be expected.

Side scan sonar and sector scan images provide a photograph-like image of the sediment surface, and surficial debris objects can be identified on the images. Side scan images can also provide information on the texture of the surface sediments. The main limitation of side scan surveys is the fact that only surface features can be distinguished and the extent of debris below the sediment surface cannot be determined. Examples of side scan sonar images showing both large and small debris are shown in Figure 7.

Magnetometers provide data on the intensity of magnetic return. The return is indicative of both surficial and buried ferrous metal objects. Maps of overall magnetic intensity can be developed, and individual magnetic targets can be identified. In some cases, data for non-ferrous metal debris may be desirable, and a metal detector survey can be conducted. Examples of magnetometer intensity maps and distribution of individual magnetic targets are shown in Figures 8a and 8b. However, the presence of metal piling near docks and other structures can overwhelm the signal from debris, making the data relatively unusable.

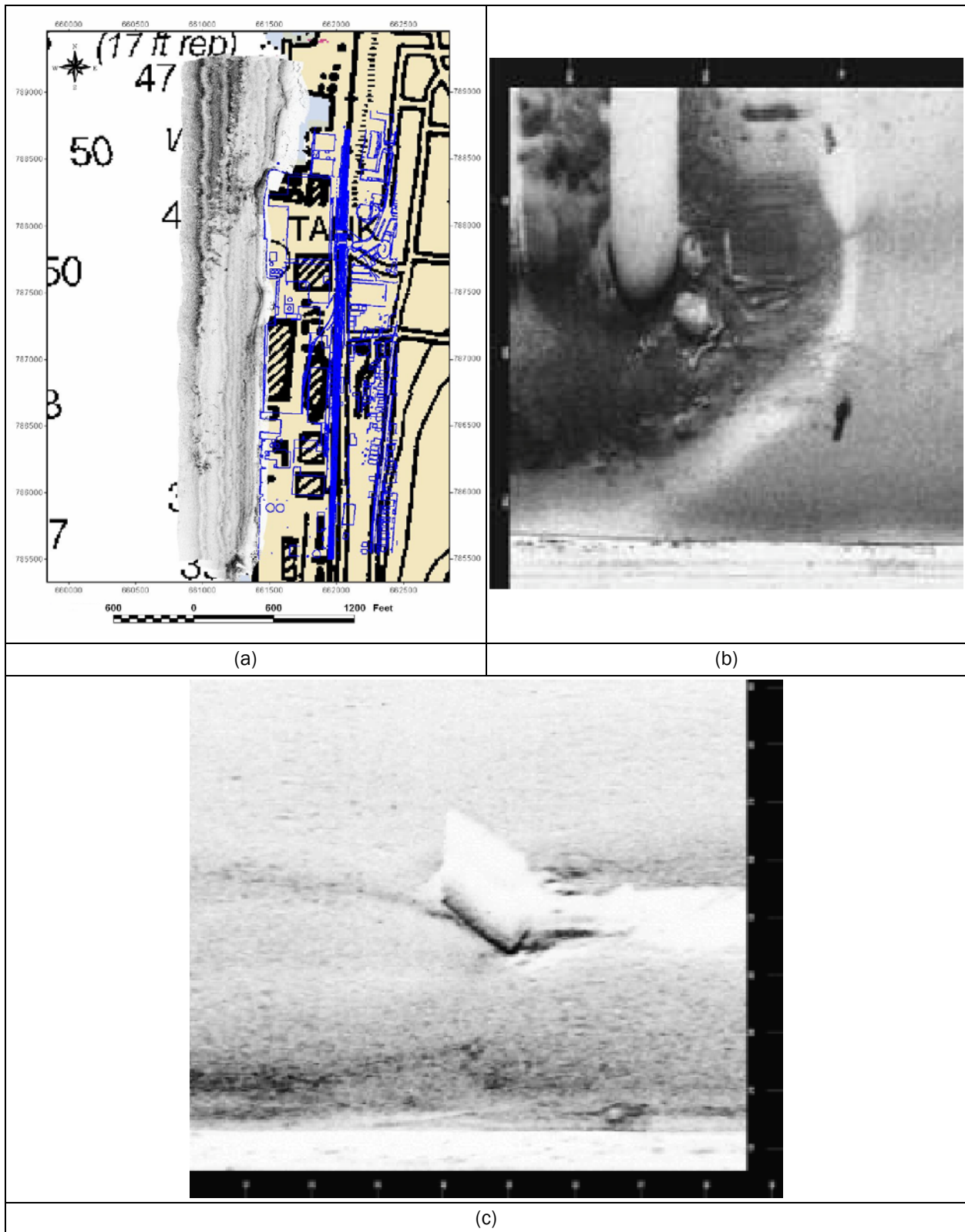

Figure 7. Example of side-scan sonar (a) mosaic, (b) side-scan image showing debris at base of a mooring dolphin, (c) side-scan image showing unidentified cylindrical object (13 ft long). (Graphics courtesy of CR Environmental and Parsons).

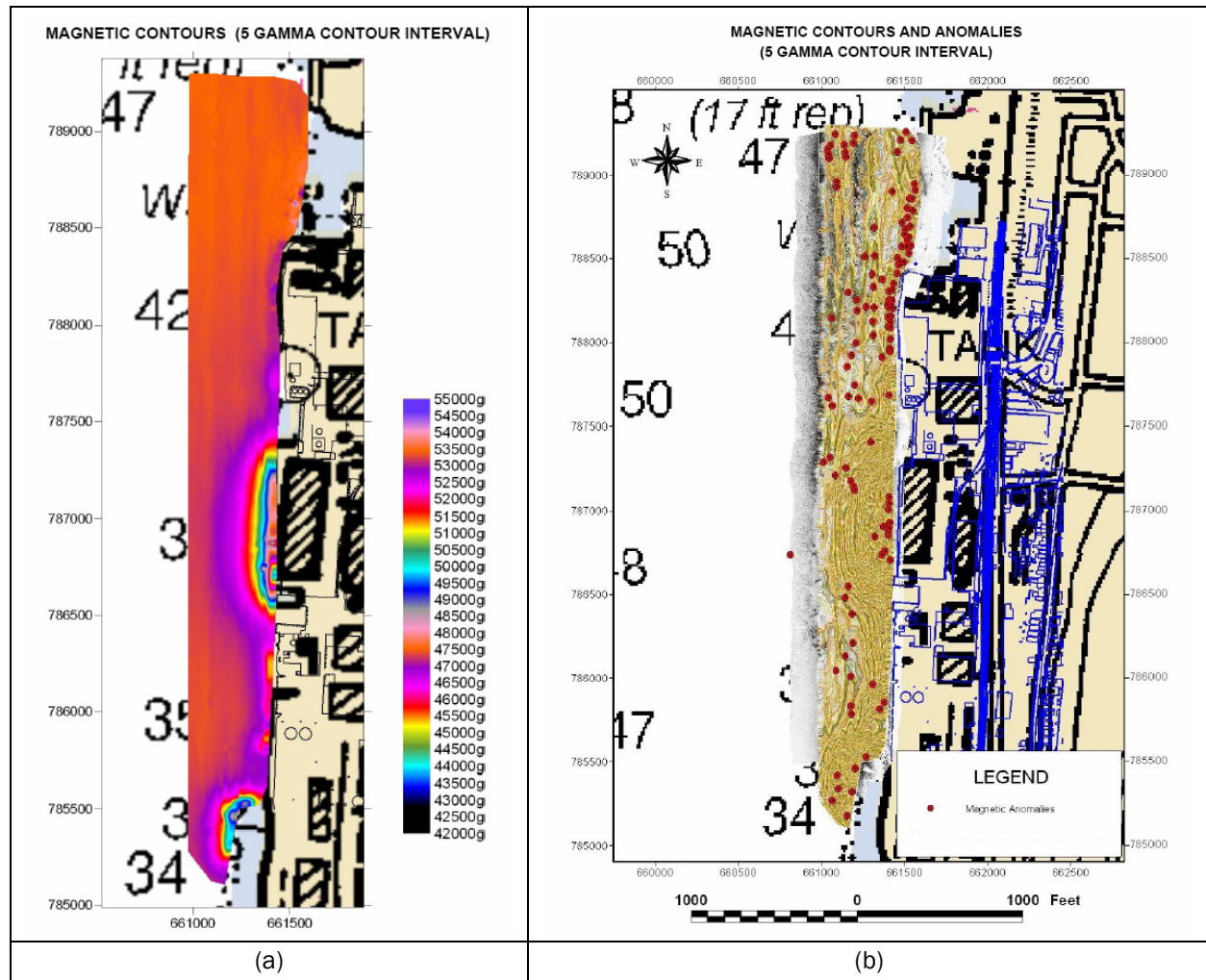

Figure 8. Examples of magnetic survey results (a) magnetic contours and (b) magnetic anomalies. (Graphics courtesy of CR Environmental and Parsons).

Physical probe surveys can also be used to determine the depth of burial of debris. The utility of probes is a function of the spacing of the probing stations. One potential problem with probes is that the size of an object cannot be determined, and a “hit” can be registered by encountering a relatively small object. Multiple probings at each station can be used in an attempt to distinguish the size of the object. Another problem with probes is that it may be difficult to distinguish a “hit” from an outcropping of a hard bottom.

3.2.11. Habitat considerations and seasonal dredging restrictions

The potential for loss of aquatic organisms, destruction of aquatic habitat, impacts on organisms due to dredging, and the long-term physical changes to the water body should be considered during the evaluation of

environmental dredging. In some cases, these considerations may influence the selection of dredging equipment, the method of operations, or the need for control measures.

Seasonal restrictions (or Environmental Windows) are commonly placed on dredging operations for navigation dredging (Reine et al. 1998), and similar seasonal restrictions can be placed on dredging for sediment remediation. The potential for restrictions should be determined in the early stages of the investigation or evaluation by consultation with Federal and State resource agencies. Seasonal restrictions due to environmental concerns will restrict the length of the dredging season and can have a significant impact on sustained production and the total required duration of the project.

The impact of habitat loss or alteration is another consideration. While a project may be designed to minimize habitat loss, or even enhance habitat, sediment removal and disposal, as well as sediment capping, alter the environment. It is important to balance the loss of a contaminated habitat against the benefit of providing a new, modified, but less contaminated habitat.

Another consideration is avoidance of short-term ecological impacts during dredging. This might involve timing the project to avoid water quality impacts during migration and breeding periods of sensitive species or designing the dredging project to minimize suspended sediment during dredging and disposal.

3.2.12. Winter icing conditions

Winter ice-over will effectively shut down dredging operations. Ice-over will determine the length of the dredging season and can have a significant impact on sustained production and the total required duration of the project. The average date for ice-over and spring breakup should be determined and used in setting a projected dredging season.

3.2.13. Ambient water and air quality

Characterization of background water samples may be appropriate for evaluation of potential impacts from sediment resuspension and contaminant releases due to dredging. Methods for sampling, handling, and analysis of water are spelled out in detail in several EPA and USACE

manuals (USEPA 2001a; USEPA/USACE 1991; 1995; 1998). In some cases, background surveys using instruments such as Acoustic Doppler Current Profilers (ADCP) for turbidity/total suspended solids (TSS) conditions may be conducted. Deposition of sediment from the water column can also be evaluated with sediment traps for concentration based and loading analysis. For purposes of environmental dredging, it is important to establish ambient water quality conditions and the potential for variability in those conditions. These data should be considered in setting appropriate performance standards related to sediment resuspension and contaminant releases to water and air (see Chapter 4), and in determining the ability to meet restrictions or requirements related to sediment resuspension and contaminant releases to water and air (see Chapter 7).

3.3. Sediment characterization

The objective of sediment characterization efforts is to determine the volume, thickness, location, and physical and chemical character of impacted sediments and the magnitude of contamination present. Standard procedures for sediment sampling and characterization have been developed by the EPA and USACE (see USEPA 2001a. *Methods for Collection, Storage and Manipulation of Sediments for Chemical and Toxicological Analysis*; and USEPA/USACE 1991; 1998). This section summarizes principles and considerations for sediment and water sampling and testing important for evaluation of environmental dredging.

3.3.1. Sampling plans and data quality

The overall goal of the sampling plan is to define a sampling effort that will provide sufficient data to address all anticipated data requirements. An iterative approach to this may be the most efficient use of resources even though additional mobilization costs will be incurred for multiple sampling efforts. The goal of the initial sampling effort should be to define the boundaries of the impacted area, to assess the general variability of the materials and contaminant distribution, and to identify areas that should be sampled more intensively. The area to be sampled can be subdivided into discrete management units based on hydrodynamics (USEPA/USACE 1998), expected level of contamination, or other relevant site-specific characteristics. The initial sampling effort might provide, as appropriate, sufficient replication in each management unit to permit calculation of basic summary statistics. A second sampling effort may be needed to

address inconsistencies in the data, refine compositing intervals or sampling locations, sample critical areas more intensively, improve the confidence level associated with certain parameters, or more completely define the boundaries of the impacted area.

Some key elements of the sampling plan include:

- Project background.
- Existing data summary and evaluation.
- Proposed management units.
- Sample locations and contingency locations.
- Sample coordinates, compatible with GPS navigation systems.
- Positioning method and accuracy (vertical and horizontal).
- Method of establishing water surface elevation during sampling.
- Method of establishing depth of water to mudline during sampling.
- Number of samples.
- Sampling method (cores or grab samples) and equipment.
- Method to establish elevation of mud line during sampling.
- Sample containers and preservation.
- Depth and/or length of samples.
- Decontamination procedures.
- Compositing intervals and method.
- Packaging, labeling, shipping and handling, and chain of custody.
- Chemical analytes.
- Physical and engineering properties to be tested.
- Analytical procedures, sample clean-up, extraction methods, holding times, and required detection limits.
- Applicable environmental criteria (for determination of DL requirements and comparison of resulting data).
- Data analysis and reporting.
- Management and disposal of residuals.

Comprehensive guidance into the development of sampling plans is provided by the USEPA (2002c). The sampling plan may also specify lab selection procedures. The use of certified laboratories is strongly recommended. In addition, it may be desirable to have several candidate laboratories demonstrate their ability to analyze test samples from the site, since cleanup procedures and analytical interferences may be somewhat site-specific. In addition, candidate labs should provide “level IV-like” documentation with the test sample results, in order to demonstrate the

adequacy of their standard lab practices. Results and data validation should be reviewed by a qualified chemist and that evaluation should weigh heavily in final lab selection.

Comprehensive guidance regarding development of data quality objectives can be found in *Guidance on Systematic Planning Using the Data Quality Objectives Process (EPA QA/G-4)* (USEPA 2006b). The specific purpose of the guidance in USEPA (2006a) is to ensure that “data collected for the characterization of environmental processes and conditions are of the appropriate type and quality for their intended use. It is customary to develop a Quality Assurance Project Plan (QAPP EPA QA/G-5) (USEPA 2002c) for all data prepared for EPA review. Additional documents providing guidance relevant to data quality objectives include (USEPA 2006a):

- *Data Quality Objectives: Decision Error Feasibility Trials (DEFT) Software – USER’S GUIDE (EPA QA/G-4D)* (USEPA 2001b).
- *Data Quality Objectives Process for Hazardous Waste Site Investigations (EPA QA/G-4HW)* (USEPA 2000).
- *Guidance for the Preparing Standard Operating Procedures (SOPs) (EPA QA/G-6)* (USEPA 2007).
- *Data Quality Assessment: A Reviewer’s Guide (EPA QA/G-9R)* (USEPA 2006).

3.3.2. Positioning and vertical survey control for sampling

As with site conditions, electronic positioning and/or survey control should be a central part of all field sampling efforts. Differential Global Positioning Systems (DGPS), Real-time Kinematic GPS (RTK-GPS), or shore-based surveys should be used, depending on the accuracy required for the sampling program. It is desirable to input all sediment characterization data into a Geographic Information System (GIS) or three-dimensional spatial model for purposes of data interpretation. The real time horizontal accuracy of DGPS using USCG or commercially broadcast corrections can be approximately ± 1 m, while the horizontal accuracy of RTK-GPS is approximately ± 2 to 5 cm. DGPS accuracy depends upon the type of equipment used (recreational grade vs. mapping grade), as well as the length of time that a station is occupied and whether post processing is used.

Horizontal positioning accuracy can be especially important when sampling a sloping bottom, otherwise conflicts may arise between the mapped elevation at a sampling point and the measured elevation at a sampling point. For example, if the bottom is sloped at 3-horizontal to 1-vertical (3:1), a 2-m error in plan location (extreme of ± 1 m) would equate to a 2-ft error in the mudline elevation, since moving 6 ft horizontally down the fall line will result in a 2-ft change in mudline elevation. When the sample is plotted on a cross section, it will appear that the mudline of the sample is above or below the mapped mudline. Chapter 5 contains additional discussion of positioning accuracy, especially related to dredge positioning.

Considering the fact that environmental dredging projects now routinely plan dredge cuts to a half foot, the vertical accuracy of coring is extremely important. This is especially true since sediment sampling occurs below a sediment/water interface (mudline), which is subject to changes in elevation due to scour or accretion of sediment. It may seem an obvious requirement, but it deserves emphasis here, that all sediment characterization data should be tied to elevation. Presentation of data below the “mudline” is simply not acceptable because the mudline elevation can change considerably during the timeframe of site studies and remedy implementation. Installation of tide gauges or pool elevation is needed in areas subject to fluctuating water levels. Most contaminated sediment sites are relatively nearshore, where land-based survey control can be established.

3.3.3. Sediment sampling equipment and techniques

Surficial sediments can be collected for analysis by using grab samplers. This sampling approach is commonly used in reconnaissance studies, and for investigations at the RI phase. However, for FS and RD evaluations, core samples are usually required to obtain samples with depth and allow for characterization of the sediments to the potential full depth of dredging. Core samples can be taken with conventional soil sampling equipment (such as push tube or rotary drill sampling approaches). The use of long-tube samplers such as vibracore and impact core devices has proven to be a relatively low-cost method to collect sediment cores. One example of long-tube sampling involves driving a 4-in. diameter by 20-ft-long piece of aluminum pipe into the sediment by application of vibration to the top of the pipe. USEPA (2001a) contains descriptions of both grab and core sampling equipment and considerations in obtaining

and handling sediment samples. Photos of typical sediment sampling devices are shown in Figure 9.

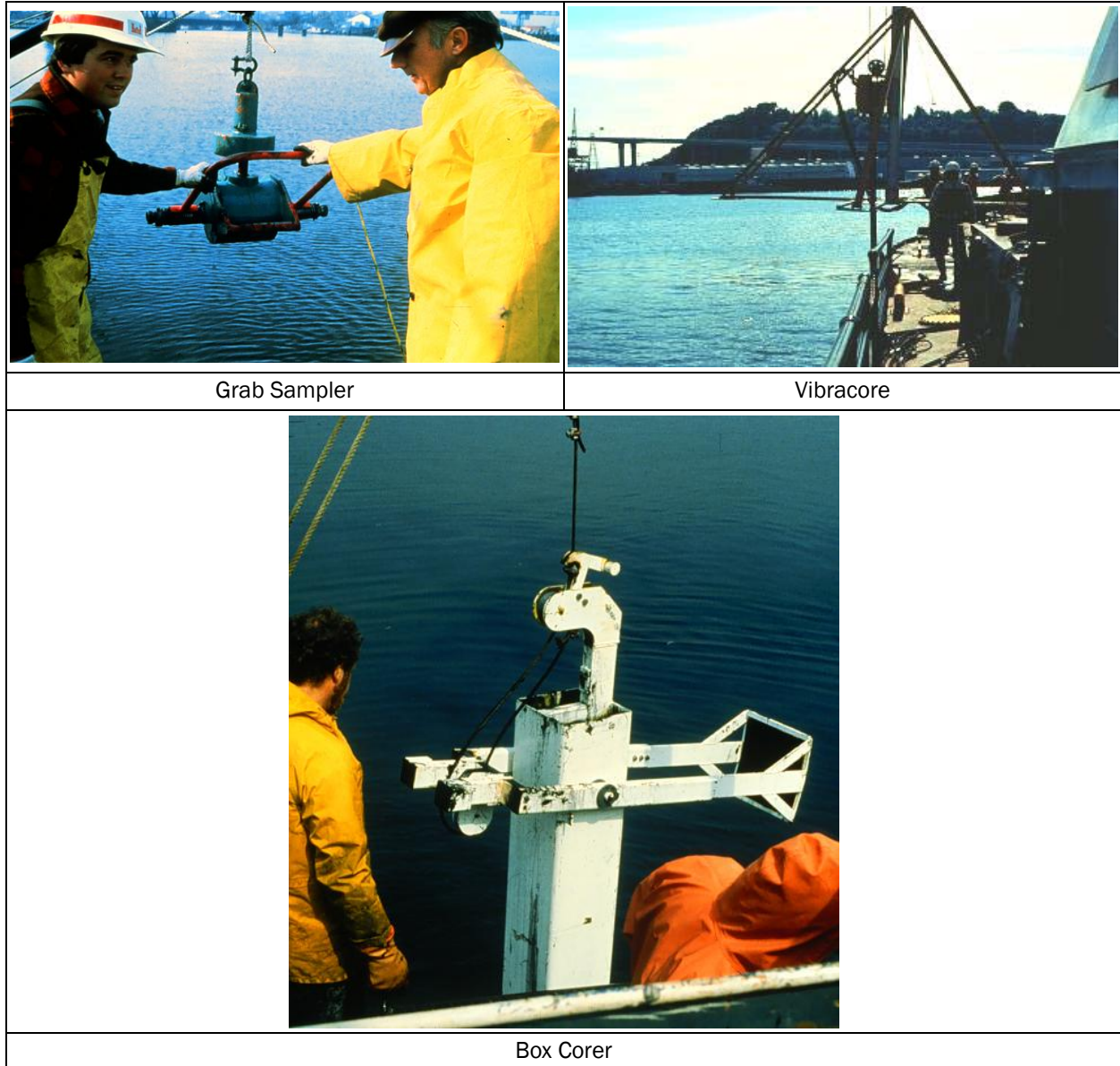

Figure 9. Photos of sediment sampling equipment.

3.3.4. Core compression, segmentation, and compositing

While long-tube sampling provides a relatively cost-effective method for collecting subsurface sediment samples, it often results in uncertainty of the actual depth profile of the sampled sediment. For example, it is not uncommon in long-tube sampling to find that the length of recovered sediment is only a fraction of the distance the tube was driven into the sediment (50 to 100 percent), with recovery of about 60 to 80 percent of

the driven length not out of the ordinary. For example, a long-tube sample driven 16 ft with 12 ft of sediment recovery would represent a 75-percent recovery ($12/16 = 75$ percent).

The difficulty arises in deciding how to account for the lost portion of the core sample. Possible explanations are that: 1) it fell out the bottom of the tube as it was retrieved; 2) the sediment in the tube was compacted during driving; 3) after some distance of driving, the sediment in the tube formed a plug that prevented more sediment from entering the tube; 4) debris initially plugged the end of the tube and prevented the first few feet of sediment from entering the tube until the plug was punched through by the driving action; 5) a combination of the above. Experience has shown that all are reasonable explanations and that it is very difficult to determine how to allocate the factors to each long-tube sample. Therefore, with 75-percent recovery from a 16-ft tube, there is an approximately 4-ft uncertainty on the position of the contact elevation between the contaminated sediment layer and the clean sediment. Without other more precise data, this uncertainty remains unresolved.

Recent coring equipment has been developed to measure the actual incremental recovery during driving of long-tube samples, which allows for the determination of the relationship of sediment in the tube to the actual site conditions. Alternatively, more controlled sampling can be employed instead of long-tube samples, such as collecting sediment with land-based drilling equipment (hollow stem auger, mud rotary, etc.) deployed from a barge. The presence of light fluffy material at the sediment-water interface also may not be adequately sampled by some corers, because the core tube will simply push through such layers without recovering a representative sample.

Once core samples are taken, the cores should be vertically segmented for laboratory testing, with each segment separately analyzed. It is generally good practice to not composite samples for laboratory testing across boundaries between sediment types (stratigraphy). Establishing the potential depth of dredging is an important objective of an investigation for environmental dredging because each increment of dredging depth is costly not only for dredging but for subsequent treatment and/or disposal. Segmentation of cores in 6-in. intervals is common. There are pros and cons of longer versus shorter core intervals. If 6-in. intervals are used exclusively, cost per core can mount quickly, which will likely result in

fewer cores (and poorer horizontal delineation of contamination). A combination of other core intervals, e.g., 2 ft, 1 ft, and 6 in., may be appropriate for initial characterization, with finer intervals in the design phase as needed. Other strategies are to use changes in grain size, color, or other composition characteristics to determine the core interval analyzed; analyze only a portion of the core intervals and archive the rest to be analyzed if finer delineation is needed; and look for relationships between sediment characteristics (particularly visual cues) and contamination.

Some consideration should be given to pairing tests for physical and chemical sediment characterization. Paired physical and chemical data can be particularly useful for interpretation of the extent and nature of contamination and for design of environmental dredging and treatment and disposal components of a remedy. Co-located core pairs or split cores can be used to obtain paired samples for testing. Use of 4-in. or larger diameter tubes can provide sufficient volume for testing, depending upon the sampling interval. Using sampling intervals shorter than 6 in. to 1 ft does not match actual dredging accuracy, but is often useful at the surface for characterizing risk.

Composite samples of the same strata across cores are also used for some analyses for dredging and/or disposal evaluations. Long tube column settling tests (LTCSTs) and contaminant pathway tests such as elutriates or leachate tests are commonly conducted on composite samples.

3.3.5. Sediment physical properties

Information on sediment physical properties is needed for equipment selection, production estimates, dredgeability determinations, and design of hydraulic dredging systems. Physical property data are also critical for evaluation of slope stability, sediment treatment, and disposal options. The physical properties are subdivided into two categories, index properties and engineering properties.

Physical index parameters of particular interest to dredging include:

- In situ sediment solids concentration and its variability; solids concentration can be expressed as percent solids by weight, water content, wet or dry bulk density, and possibly as void ratios or porosities.
- Atterberg limits (plasticity).

- Specific gravity of solids.
- Grain-size distribution (including hydrometer range) and variability.
- Organic content, oily phase (e.g., dense nonaqueous phase liquid (DNAPL) content), and volatiles.
- Presence of large debris and dispersed debris (determined by drill action, visual observations of shoreline activities, and sample recovery).

Physical engineering parameters of particular interest to dredging include:

- Shear strength and/or bearing strength.
- Compressibility, consolidation characteristics.
- Erosional characteristics (Sedflume, Gust chamber, etc.).
- Dewatering characteristics (settling, filtering, consolidation, permeability, response to flocculating agents, etc.).
- Gas production.

Considerations for conducting tests for sediment physical characterization are found in USEPA (2001a) and USEPA/USACE (1991, 1998). Detailed procedures for conducting soils tests (which are generally applicable to physical characterization of sediments) are available in the USACE Engineer Manual on Laboratory Soils Testing (USACE 1970). USACE has also published a series of technical notes providing additional information regarding physical and engineering tests for sediments and the interpretation of physical data for evaluation of dredging projects (Lee 2001a; 2001b; 2004).

The solids concentration of the sediments (in situ water content or in situ percent solids or in situ density) is a critical physical sediment parameter for evaluating dredging (see further discussion in Chapters 5, 6, and 7). Since different dredging techniques and equipment remove sediments at differing percent solids (due to varying degrees of added water), an accurate determination of the mass of sediment solids in the dredging prism is essential to selection of dredging equipment, design of transport systems, and estimation of production rates and project duration. The solids concentration of the sediments should be determined on an adequate number of samples throughout the area being evaluated.

Sediment grain-size distribution (GSD) is commonly determined by mechanical analysis for sand and larger fractions, and by hydrometer for

the fine-grained fraction. The GSD is determined by measurement of the dry weight of various size fractions in the sediments. The laboratory test procedures for this test were developed with soils analysis in mind, where all particle fractions are primarily mineral materials, but sediments may contain particle fractions that are not mineral materials. For example, some contaminated sediments contain high percentages of fine wood chip materials, which if analyzed and reported for GSD, can give misleading results. Measurement of total organic content for the sample as well as by size fraction can provide additional information on whether this is the case.

3.3.6. Sediment contaminant concentrations

The determination of so-called “bulk sediment chemistry,” the concentration of contaminants of concern (COCs) in the sediments on a dry-weight basis, or on an organic-carbon normalized basis are important components for determining volumes of sediments to be dredged (target sediments) for a contaminated sediment site. Measurement of contaminant fractionation by particle size, density, or organic content can provide additional information for processing the sediment.

Sediment chemistry parameters potentially of interest include:

- Surface and near-surface contaminant concentrations in sediment.
- Contaminant profiles in sediment cores. Contaminant concentrations in biota tissue.
- Dissolved and total contaminant concentrations in surface water.
- Contaminant concentrations in groundwater for fate and transport.
- Total organic carbon (TOC) and dissolved organic carbon (DOC) concentration profiles in surface sediments and sediment cores.
- Total organic carbon (TOC) and dissolved organic carbon (DOC) concentrations in surface water.
- Total suspended solids concentration in surface water.
- Presence and nature of non-aqueous phase liquids (NAPL) in collected sediments.
- Acid volatile sulfide (AVS) and simultaneously extracted metals (SEM) in sediment.
- Other chemical species that may affect contaminant mobility.
- Oxidation-reduction potential and pH profile of sediment cores.
- Carbon/nitrogen/phosphorus ratio.

- Non-ionized ammonia concentration.
- Salinity.

Although the near-surface concentrations of COCs are important for purposes of risk assessment, the contaminant concentration profile with depth is the basis for selecting cut-line elevations for meeting a given cleanup level (CUL). Procedures for determining sediment chemical concentrations have been developed by the EPA and USACE (USEPA 2001a; USEPA/USACE 1991, 1998). Parameters such as AVS/SEM, TOC, and presence of NAPL are related to interpreting the potential mobility of COCs due to sediment resuspension.

3.4. Removal requirements

As data gaps are filled, the removal requirements for the project can be determined. The removal requirements would include any requirements related to separate removal of debris; the overall dredgeability of the sediments to be removed; and an initial computation of the neat-line volume to be dredged.

3.4.1. Debris removal

The need for and potential success of a separate debris removal operation or pass should be determined based on debris surveys, probings, and other information related to the presence, nature, and extent of debris. The evaluation should consider resuspension and impacts on sediment properties and dredgeability.

The presence of debris can have an adverse impact on the success of the smaller hydraulic dredges often used for sediment remediation. Relatively small debris, on the order of 6 to 10 in. in diameter, can plug the dredge intake. Cable and chain can wrap around the cutter head and render it ineffective (see Figure 10), and other debris can block the swing path of the cutterhead. If an auger engages large debris, rocks, or trees, the turning auger will walk along the obstruction, pulling the dredge off the intended path.



Figure 10. Debris fouling of cutterhead by cables.

Infrastructure requiring removal, such as pilings embedded in the sediment, will require a separate removal operation. Large debris such as automobiles, large metal objects, etc. may require a separate debris removal operation regardless of the dredge type potentially used for sediment removal (there are no set guidelines on debris size that would dictate a separate debris removal operation). Miscellaneous debris such as shopping carts, cable, welding rods, detached pilings, pieces of timbers, rubber tires, boulders, etc., may all be removed with a mechanical dredge if the bucket size is adequate. Some debris such as plant life, branches, and other shearable material can be effectively dealt with in the dredging operation by using debris chopping plates behind hydraulic cutterheads. However, even small debris can be problematic for some dredging operations and necessitate equipment modifications or separate removal operations.

Once the method of debris management is established, this item should be separately considered in production estimates, overall schedule for completion of the project, and cost estimating. One of the adverse consequences of conducting a separate debris removal pass prior to initiating dredging is the potential destruction of the inherent soil structure from the shearing action of debris removal. If the sediment is significantly disturbed or water is entrained in the sediment during debris removal, the sediment may lose shear strength and become more like a thick liquid. Fluid sediment is more difficult to capture during the dredging operation and increases residual generation.

3.4.2. Dredgeability

The term dredgeability refers to that part of the production rate and energy required for removal by a given dredge type that is directly influenced by the properties of the sediment (Spigolon 1993a). Dredgeability refers to the ease in which sediments can be removed by a given dredge type and is closely related to the shear strength of the sediments. For example, unconsolidated sediments such as recently deposited clays, silts, and sands are highly dredgeable, while highly consolidated clays, cemented materials, or rock are more difficult to dredge. The production rate and efficiency of removal of sediment is a function of site conditions, sediment properties and thickness, as well as equipment type. Theoretically, any sediment material can be removed by dredging, up to and including hard rock, if the right dredging equipment is used. However, environmental dredging requires a balancing of removal efficiency with other processes and should be evaluated in the context of all the processes of importance.

In most cases, contaminated sediments are associated with fine fractions of recently deposited sediments (clays, silts and sands) that have low shear strength and present no problems with respect to dredgeability. However, there may be other size fractions or materials in the sediment mass, e.g., debris, boulders, wood chip fractions, etc., that may be of larger grain size and more difficult to remove. In some cases, the contamination may be associated with more consolidated sediments, cemented materials, etc. (e.g., contamination due to upwelling of contaminated groundwater or NAPL into a sediment bed), and dredgeability may be an issue. Clean layers of materials underlying the contaminated sediments may also factor into dredgeability determinations (such as underlying till or bedrock) due to the inability to achieve a clean exposed face or clean residuals. The issue

of debris in the sediments is related to dredgeability, and may require the development of a separate debris management plan as discussed above.

USACE has developed a knowledge base concerning dredgeability that can be used to address dredgeability issues if they are an issue for the site (Hales 1995; Spigolon 1993 a-d, 1995 a-c; Spigolon and Baaker 1994 a-b). These resources can be used in conducting a detailed assessment of dredgeability if needed for the site. If dredgeability is determined to be a factor, the difficulty of cutting and removing the material might influence dredge type and/or dredge size.

3.4.3. Volume to be dredged

An initial estimate of the volume to be dredged should be calculated from the site and sediment characterization data and the CUL as described in Chapter 4. At first glance, the computation of the dredging volume for a project would seem straightforward. For an RI, this volume to be dredged is often understated based on a straight area-volume computation based on the sediment concentrations exceeding a CUL at specific points. This volume is defined as the neat line prism volume. However, a neat line prism volume is not appropriate for use in selecting dredge sizes, treatment and disposal requirements, and other project requirements related to production, because the actual volumes requiring removal will always be greater than the neat line prism volume.

For FS level evaluations, a preliminary dredge plan is an appropriate basis for defining the dredging volume carried forward in the evaluations of remedial alternatives. The preliminary dredge plan should account for operational considerations such as non-target overburden, allowable dredging overdepth, allowances for box cuts for slopes, and layback slopes for deeper excavations. These allowances, plus considerations of the method of dredge operation, are normally considered in developing a dredge prism (see Chapter 9).

In instances where site characterization data are limited, the ratio of the dredge prism (including allowable overdepth) to the neat line prism may be significant. For example, the U.S. Navy Homeporting project in Everett, Washington estimated that dredging 3 million yd³ of sediment would be required to capture a neat line estimate of 1 million yd³ of impacted sediment (a factor of 3).

More recently, at the Head of Hylebos Waterway, where advanced sediment characterization and precision dredging technologies were employed, 400,000 yd³ of sediment was dredged to capture an estimated 270,000 yd³ of impacted sediment (a 1.5 factor). For FS level considerations, an adjustment factor of 50 percent (i.e., an estimated dredge prism volume equal to 1.5 times the neat line prism volume) is appropriate for typical site conditions.

For site conditions dictating very thin cuts over large areas (on the order of 1-ft cuts), a higher adjustment factor would be appropriate, since the allowable overdredge would be 6 in. at a minimum (see Chapter 9). In addition, a higher adjustment factor would be appropriate for sites requiring deep excavations relative to their area, since the layback slopes would require removal of significant additional volumes (see Chapter 9). If the possibility of exceeding available disposal site capacity is a critical issue, a more precise volume adjustment may be appropriate.

For the RD level of evaluation, the dredging volume should be based on a more rigorous development of the dredge prism volume, considering all factors related to dredge operation, box cuts, layback slopes, etc. The dredge prism may be refined as the RD progresses through 30-percent and 60-percent designs, and the final dredge prism volume should be based on a dredge plan that lays out the detailed prism configuration to be included in the project plans and specifications (see Chapter 9 for details).

4 Environmental Dredging Performance Standards

The terms “design standard” or “performance standard” are often used in the context of sediment remediation, and a variety of standards have been applied to various projects. At some sites, it may be appropriate to set goals, instead of enforceable standards that must be reached. For purposes of this report, the term “performance standard” as it relates to environmental dredging is defined as follows:

Performance Standard – Numeric limits or criteria related to environmental dredging processes or operations defined in the ROD.

Such performance standards are sometimes needed to satisfy project objectives related to short-term and long-term effectiveness, environmental protection, project duration, and overall costs, forming the basis for determining feasibility, costs, and needs for controls. Performance standards may also be used to evaluate the execution of the environmental dredging component of the remedy. Therefore, identifying or determining appropriate performance standards is sometimes a necessary early step in conducting feasibility evaluations or developing remedial designs and controls for environmental dredging. This chapter describes the considerations in developing performance standards for environmental dredging.

4.1. Goals, objectives, and performance standards

As defined in USEPA (2005), a hierarchy of objectives for most contaminated sediment remediation projects can be described in terms of Remedial Action Objectives, Remediation Goals, and Cleanup Levels (RAOs, RGs, and CULs) (USEPA 2005).

The RAOs, RGs, and CULs for a contaminated sediment remediation project must be clearly defined before a remedy approach can be selected, designed, and implemented. RAOs, RGs, and CULs also provide a means by which success of the remediation can ultimately be measured. Further, these terms are normally all related to achieving risk reduction. For

example, an RAO may be to reduce risk to humans from ingestion of fish, while the resulting sediment cleanup level may be based on achieving an acceptable cleanup level or remediation goal in fish tissue concentration of a given COC.

Cleanup levels are the key performance standards that are normally set in RODs and are developed by weighing a number of factors related to uncertainty, exposure, and technical feasibility related to effectiveness, implementability, and cost for potential remedies. It is important to recognize that, from an engineering standpoint, active remedies for contaminated sediment sites (such as environmental dredging) are formulated and designed to achieve sediment CULs, not fish tissue CULs.

The sediment CUL may be used to define areas where active remediation is required, and to set performance standards related to dredging effectiveness. Of course, other performance standards that are not related to the CUL may be developed for environmental dredging.

The success of an environmental dredging project can be defined as the degree to which the project RAOs, CULs, and other performance standards are met by dredging, capping, MNR, or combination remedies. A successful environmental dredging project should reduce risk by removing contaminated sediments, thereby reducing areas of exposure and bioavailable contaminant concentrations in those areas. Performance standards in addition to sediment and/or tissue CULs are often needed.

For most projects, the regulatory agencies do not finalize CULs or other performance standards until the ROD is issued. In these situations, the designers should base evaluations during the remedy evaluation phase on assumed CULs and performance standards. Precedents at other sites, especially within the same region or state, can be used for assumed CULs and assumed performance standards can be based on desired results that are deemed effective and implementable for the site conditions and sediment characteristics.

Environmental dredging performance standards may include or be based on some combination of the following:

- Removal of all sediment having contaminant concentrations above a specific action level).

- Reduction of the surface-weighted average concentration (SWAC) to achieve the sediment cleanup level.
- Removal of sediments to a specified elevation within specified areas.
- Limits on the surficial contaminated sediment mass remaining as residuals following dredging.
- Limits on sediment resuspension generated by the operation.
- Limits on the release of dissolved contaminants reaching some distance downstream from the dredging operation.
- Limits on contaminant releases to air.
- Limits on solids content and/or volume throughput for subsequent treatment or disposal.
- Constraints on allowable time for project completion.

The above list shows that there is an inherent conflict in setting performance standards for environmental dredging, with the desire to achieve an economically efficient remedy through efficient production and timely project completion potentially conflicting with the desire to minimize resuspension, release, and residuals. The setting of performance standards therefore requires a balance between multiple needs.

General considerations in developing performance standards for environmental dredging include the following:

- Performance standards should be directly related to achieving the RAOs and all CULs for the remediation project, not to the expected capabilities of the dredging operations for the given site conditions and sediment characteristics.
- It should be noted that performance standards cannot be determined (at least in final form) until the CULs often based on site conditions, sediment characteristics, and project constraints, have been determined. For example, it makes little sense to set a sediment or fish tissue CUL at or below the surrounding “background” concentrations.
- Performance standards (what the environmental dredging process is designed and expected to achieve) versus operational efficiency (what the process can efficiently do for the given project conditions) is a major issue. Conversely, the way in which performance standards are set is a major factor in determining the efficiency and potential for success of an environmental dredging project.

- It is not appropriate to propose generic design standards for any aspect of a sediment remediation project, without considering the project, site, and sediment specifics.
- When performance standards cannot be met without controls, the controls may require consideration as an integral part of the environmental dredging for the purpose of determining feasibility and establishing performance/design specifications.
- Performance standards should be developed at a sufficient level of detail that contracting needs are served.

Studies of completed projects (General Electric 2004; ReTec 2001; and Cushing and Hammaker 2001) found that the objectives and performance standards varied considerably, with many focused solely on achieving mass sediment removal or removal to a specified cut line elevation. Others included goals related to a residual sediment concentration. The field experience to date indicates that projects with standards set in terms of mass removal or set cut elevations have been largely successful in meeting those standards, but the projects might not have met their remediation goals and might require controls on resuspension and residuals. Success has been mixed for projects with standards set in terms of a low residual surface contaminant concentration and mass. Further, the overall experience base with larger scale projects is limited (Francingues 2001). The limitations of the environmental dredging process should therefore be considered carefully in selecting removal as a remedy or remedy component for a given project and in developing performance standards (Palermo 2003). At the same time, goals for future performance should not be based solely on limited success achieved on many projects in the past. The use of newly developed equipment, adaptive management, etc. should result in improved performance and reduced release, resuspension, residuals, and risk associated with environmental dredging.

4.2 Performance standards related to production and implementation time

4.2.1. Time of project completion

Constraints on allowable time for project completion are often linked to stakeholders' perceptions of a reasonable time period for remedy implementation. An allowable time for completion of smaller projects may be a function of the normal construction season, since work in colder climates may be limited to only a part of the year. Environmental

windows, limiting the size of the construction season or dividing it into multiple periods throughout the year, can also be a significant factor. Efficiency considerations would dictate that the number of dredges, dredge sizes, and production rates be selected such that smaller projects could be completed in a single dredging season; larger projects would normally require multiple construction seasons. In such cases, the allowable time for completion is not usually stated as an explicit time, but the selection of a remedy alternative and/or dredging equipment may be determined by the perception of a reasonable time line for project completion.

Additional performance standards that relate to time of completion may be imposed for “quality of life considerations” such as minimizing noise or light, or restricting operations to specific times of the day or days of the week. In order for the dredge to meet the performance standards in an efficient manner, the environmental and operational trade-offs should be clearly identified and appropriately balanced taking into account the above factors.

4.2.2. Limits on solids content and volume throughput

Limitations on solids content and/or volume throughput may be considered if there are constraints on the capacity of rehandling and treatment facilities or disposal sites for receiving dredged sediments. Under most conditions, it is not economically justifiable to have dredging equipment lie idle for extended periods while waiting for rehandling and treatment throughput. The design criteria related to this issue require a thorough evaluation of compatibility of the dredging and rehandling/treatment/disposal components of the remedy alternative under consideration. In most cases, it can be assumed that throughput can be adequately designed such that the dredging operation is not constrained and standards related to time of project completion can be met. Redundancy in critical components related to throughput (such as parallel treatment units or spare rehandling equipment) or adding surge tanks or basins between dredging and processing with intermediate storage can reduce potential for bottlenecks, but these measures may be costly. In cases where a constraint on available space, etc., presents an insurmountable limit on throughput, the type, size, or total number of dredges may be limited. Examples of the types of bottlenecks that may require evaluation include:

- Insufficient numbers of barges for shuttling mechanically dredged material from the dredging site to offloading facilities.
- Limited capacity of ship locks to pass sediment barges.
- Undersized offloading or transport capacity for mechanically dredged sediments.
- Limited footprint for rehandling/ treatment facilities.
- Undersized treatment facilities (in any one step of the treatment train).
- Limitations on size of trucks or time of day for trucking material.
- Inadequate access to or availability of roads and docks.
- Undersized confined disposal facilities for settling in the case of direct pipeline placement from hydraulic dredges.
- Regional limitations on rail transportation infrastructure.

4.3. Performance standards related to resuspension and release

Depending on the location and regulatory agencies within the state, performance standards for resuspension and release may be established. These are related to the short-term effectiveness of an environmental dredging remedy, environmental protection of specific species, compliance with applicable or relevant and appropriate requirements (ARARs), and/or potentially long-term effectiveness due to the generation of residuals. Since the areas requiring environmental dredging are contaminated and present a risk to human health and/or the environment, project managers should acknowledge and accept that some short-term impacts resulting from environmental dredging may be unavoidable to reap the long-term benefits of the remedy. This is consistent with EPA's Sediment Management Principles (USEPA 2002a).

4.3.1. Sediment resuspension

Performance standards related to sediment resuspension may be developed as necessary to meet project goals, particularly goals for water quality and consequently for contaminant release since the effects of the resuspended sediment itself are usually minor.

4.3.2. Water quality standards

Water quality standards are normally applied in the context of environmental dredging as a limit on contaminant release to water. The water quality standards are normally identified as ARARs and must be achieved or waived. The *Contaminated Sediment Remediation Guidance*

for Hazardous Waste Sites (USEPA 2005) contains more information on ARARs.

4.3.3. Air quality standards

The volatile emission of contaminants to the atmosphere directly from the water surface surrounding an operating dredge and directly from sediments exposed to the air during the dredging and transport process can be an issue related to environmental dredging at some sites. Some classes of contaminants, such as volatile organics, are of more concern with respect to releases to air than others are. Therefore, meeting air quality standards may be required for only some COCs at a specific project. In addition, the concentrations of COCs must normally be quite high for releases to air to be of concern. Exposure of workers on site (both at the dredge and at the rehandling or disposal site), and the public in close proximity to the site are the receptors of concern for releases to air. USACE has developed testing and evaluation approaches for volatile emissions at confined disposal facilities (CDFs) (USACE 2003), and these procedures are generally applicable for volatile emissions at the point of dredging.

Exhaust emissions from the engines of dredges are regulated by the Clean Air Act (CAA), but this issue is not considered in this document as a part of environmental dredging evaluations. Volatile emissions of contaminants from water and sediment resulting from a dredging operation are not regulated under the CAA, since the CAA regulates point and mobile sources; neither are emissions from water or exposed sediment. In most cases, air quality is regulated under the CAA only for gaseous emissions that could be sampled from a waste stream, not for volatilization from an areal source. Air quality from areal sources is more typically regulated, considering the resulting quality at a point of compliance or at the nearest receptor. Moreover, there have been no documented CAA concerns with volatile emission from dredging operations anywhere in the nation. However, the Occupational Safety and Health Administration (OSHA) air quality standards apply when workers are exposed to inhalation or dermal contact with vapors containing certain volatile organic compounds. When volatile emissions are of concern, evaluations may be performed and predicted emission concentrations may be compared to OSHA standards to determine compliance (USACE 2003).

4.4. Performance standards related to dredging effectiveness

Environmental dredging is an active remedy approach, and as such, the dredging must be developed to achieve and maintain CULs, not RGs and RAOs directly. The engineering basis of a remedy design (in the case of environmental dredging, where, how, and what to dredge) is therefore based on meeting a sediment CUL, since this will result in a reduction in exposure and therefore a reduction in risk (Palermo and Ells 2005). Although sediment CULs for environmental dredging can be defined in several ways, a limiting sediment concentration is the most likely case. Even this basic concept has many possible variations, including use of ranges of CULs at the feasibility study stage, various area-weighted schemes, etc. Regardless of how they are defined, some form of sediment CUL, usually a limiting concentration of COC, will determine the basis for evaluation of alternatives and design of an active remedy (Palermo 2005a,b).

Since attaining the CUL is the primary basis for the decision of where to actively remediate, the CUL should logically serve as the basis for design standards for the project related to remedy effectiveness. Under this concept, a design standard for remedy effectiveness can be defined as a specific limiting sediment concentration of a COC, which is 1) equal to or directly related to the CUL, and 2) defined within a specified point of compliance, usually that portion of the sediment profile corresponding to the “biologically active zone.” The most common examples of such a design standard may include maximum and/or surface area-weighted average sediment concentrations in post-dredging residual sediment or in the upper layers of an isolation cap. The design standards must also be developed such that they can be monitored using accepted tools and techniques and within acceptable levels of potential error or uncertainty.

Performance standards for mass removal and residuals are related to long-term effectiveness of the remedy, and should be attainable in an operationally efficient manner if dredging and controls are feasible. For example, in difficult-to-dredge areas, the most cost-effective option may be to include a contingency in the performance standards that allows for placement of an engineered cap if cleanup standards are not initially met. This brings more certainty into the process of cost estimating and bidding (Palermo 2003).

5 Equipment Capabilities and Selection

Once initial feasibility of dredging is established, data gaps on site conditions and sediment characteristics are appropriately addressed, and performance standards are determined (Chapters 1 to 4), the dredging equipment types may be selected for evaluation. This chapter presents descriptions of the dredging equipment types and dredging methods commonly employed for environmental dredging, a description of the capabilities of dredge types, and the ranking of dredge types in meeting a range of selection factors.

In addition to providing background information, the descriptive information in this section is useful for project managers in developing the project-specific process descriptions for feasibility studies and remedial designs. The information summarized in this section is based on project experience, USACE and EPA guidance documents, recent studies, and reviews of the environmental dredging literature (USACE 1983, in publication; USEPA 1991, 1994, 2005; NRC 1997; Palermo et al. 2004; and Major Contaminated Sediment Sites database <http://www.ge.com/ge/hudson/>).

5.1. Dredging equipment types and methods

This section provides a basic description of dredging equipment types and methods normally considered for environmental dredging projects. It is not the intention here to attempt to list all dredge equipment types that may be appropriate for environmental dredging projects. More extensive equipment descriptions are available (USEPA 1996, USACE 1983). Further, new equipment innovations are becoming increasingly available as vendors respond to evolving project needs.

The following equipment types with definitions were developed based on review of the available published literature, and are most commonly used for environmental dredging projects in the United States (Palermo et al. 2004):

- **Conventional Clamshell** – conventional wire-supported, open clamshell bucket.

- **Enclosed Bucket** – wire-supported, near watertight or sealed bucket as compared to conventional open bucket. Recent designs also incorporate a level cut capability as compared to a circular-shaped cut for conventional buckets (e.g., the Cable Arm™ and Boskalis Horizontal Closing Environmental Grab).
- **Articulated Bucket** – backhoe designs, clam-type enclosed buckets, hydraulic closing mechanisms, all supported by articulated fixed arm (e.g., Ham Visor Grab, Bean Hydraulic Profiling Grab (HPG), Young Manufacturing rehandling bucket, Toa High Density Transport, and the Dry Dredge).
- **Conventional Cutterhead** – conventional hydraulic pipeline dredge with rotating cutterhead at end of a ladder that moves only up and down; ladder swing controlled using cable and anchors; ladder may be articulated (e.g., models by Ellicott, Dredging Supply Company, etc.); and dredge advanced by pivoting on spuds using cable and anchors.
- **Swinging Ladder Cutterhead** – hydraulic pipeline dredge with rotating cutterhead; ladder that moves both vertically and horizontally, swinging on pivot; ladders may be articulated (e.g., models by Ellicott, Dredging Supply Company, etc.); and dredge advanced by kicker spud or traveling spud carriage.
- **Horizontal Auger** – hydraulic pipeline dredge (e.g., Mudcat) with horizontal auger dredgehead; advance controlled by cable and anchors.
- **Plain Suction** -- other hydraulic pipeline dredges using plain suction often with specialty dredgeheads (e.g., Matchbox dredgehead, articulated Slope Cleaner, Brennan Vic Vac®, Tornado Motion), often on the same types of floating dredge plants as conventional or swinging ladder cutterheads.
- **Diver-Assisted** – plain hand-held flexible hydraulic suction pipeline with a small hydraulic dredge plant for transport.
- **Pneumatic** -- air-operated dredges (e.g., Japanese Oozer, Italian Pneuma, Dutch “d,” Japanese Refresher, etc.) that entrain little water.
- **Specialty Dredges and Dredgeheads** – other pipeline dredges using specialty dredgeheads or pumping systems (e.g., Boskalis Environmental Disc Cutter, Scoop-Dredge BRABO, Water Refresher, Brennan Vic Vac®, Tornado Motion, etc.).
- **Dry Excavation** – conventional excavation equipment operating within dewatered containments such as sheet-pile enclosures or cofferdams.

Figure 11 includes photographs of some of the basic dredge types, and Figure 12 shows photographs of some specialty dredges. This list is not inclusive of all available dredge types. Dredge types such as hopper dredges, dustpan dredges, bucket-ladder dredges, etc., are not included here since they are primarily used for navigation dredging. Within given dredge types, specific designs may also differ and may have varying capability. New equipment designed specifically for environmental dredging continues to be developed, allowing better performance for remediation than equipment originally designed for navigation dredging. In general, the dredge types listed above reflect equipment that is readily available and used for environmental dredging projects in the United States.

Importantly, the equipment used for environmental dredging is usually smaller than that commonly used for navigation dredging, because the removal volumes tend to be smaller, dredging cut depths tend to be shallower, and the operation may be coupled with other processes of limited capacity, such as a dewatering plant. Larger dredges are sometimes used; however, they often must operate at less than full capacity or intermittently and/or with less precision, decreasing their cost-effectiveness. For this reason, the information presented in this chapter is generally tailored for mechanical bucket sizes from about 2 to 8 m³ (3 to 10 yd³) and hydraulic pump sizes from about 15 to 30 cm (6 to 12 in.). Of course, larger dredge sizes are available for both mechanical and hydraulic equipment types and, if needed, can be used for environmental dredging.

5.1.1. Hydraulic dredging

The description of hydraulic dredging in this section is adapted from USACE (1983 and in publication) and USEPA (1994). Hydraulic dredges remove and transport sediments with entrained water in the form of a slurry. Hydraulic dredges most commonly considered for environmental dredging are the cutterhead and horizontal auger dredges. Hydraulic dredges provide an economical means of removing large quantities of contaminated sediments and are widely used for both navigation dredging and, more recently, environmental dredging. Some dredges employ pneumatic systems, and for purposes of this section, pneumatic dredges are considered a subset of specialty dredges (USEPA 1994).



Conventional Clamshell



Enclosed Bucket



Plain Suction



Excavator



Cutterhead (Source: Ellicott Dredge)



Horizontal Auger

Figure 11. Photos of basic dredging equipment.



Vertical Cutterhead



Shrouded Cutterhead



Diver-Assisted



Articulated Bucket

Figure 12. Photos of specialty dredging equipment.

Fundamentally, there are five key components of a hydraulic dredge (see Figure 13):

- The **dredgehead** is the part of the dredge that is actually submerged in the sediment, often applying a force to dislodge the sediment from the bed. Dredgehead types include the cutterhead, the auger, and other plain suction and specialty dredgeheads.
- The **dredgehead support** is usually a **ladder** as shown in Figure 11, but may instead be a simple cable or a sophisticated hydraulic arm. Ladders can be a straight structural member, or in more recent designs, can be articulated.
- The **hydraulic pump** provides suction at the dredgehead, draws the sediment slurry into the pipeline, and then propels the slurry to the discharge point. (It may be submerged or deck-mounted.) The diameter of the discharge pipeline from the pump defines the size of the hydraulic dredge. For example, a hydraulic pump with a 12-in.-diameter discharge pipe would be classified as a 12-in. hydraulic dredge. Many larger dredges are also equipped with a ladder pump to allow for dredging in waters exceeding about 15 m (about 50 ft).
- The **pipeline** carries the sediment in a pressurized slurry away from the dredgehead to the receiving barge, storage tank, or disposal area and is classified as the high pressure or discharge side of the dredge.
- Most hydraulic dredges use **spuds** (essentially movable structural members similar to pilings) that are lowered into the sediment and used to support and steady the dredge as it operates. The spuds may be designed as “traveling” or “kicker” spuds and used to advance the dredge. A series of **cables and anchors** may also be used to steady and advance the dredge during operations.

Hydraulic dredges range in size from 4 in. to over 36 in., although only the smaller sizes are normally considered for environmental dredging. The smaller hydraulic dredges used for environmental dredging are much more susceptible to complications due to debris as compared to larger navigation dredges. The smaller hydraulic dredges are also capable of removing only relatively soft to medium stiff sediment, as compared to the greater digging capability of larger and heavier navigation dredges. The advantage of these smaller hydraulic dredges is that they can work in relatively shallow water and transport the dredged material directly to a process or disposal site via pipeline. These dredges can work in shallow

water depths that might not normally be accessible to larger hydraulic dredges or sediment barges associated with mechanical dredging.

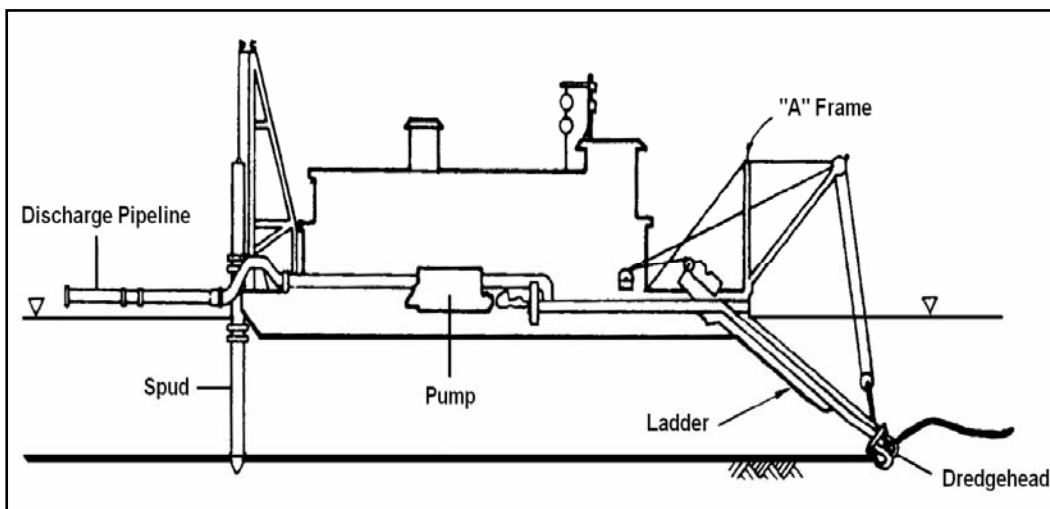

Figure 13. Components of a hydraulic dredge.

The dredged material removed by hydraulic dredges is usually pumped directly to a storage or disposal area through a pipeline. Pipeline lengths of about a mile can be used with the dredge alone; longer pumping distances are possible with the addition of booster pumps in the line. The hydraulics of the dredge and pipeline system must be evaluated for each project, since it is dependent on pumping distance, sediment grain size, amount of debris, elevation change, and other factors.

For navigation dredging, the solids content of the slurry is typically 10-20 percent by weight (Herbich and Brahme 1991), but lower concentrations are common for environmental dredging because operators lower production rates in an attempt to reduce resuspension and residuals (Palermo 2003; Palermo et al. 2004). To form a slurry at 10- to 20-percent solids by weight, approximately 4 volumes of “make-up” water is entrained and transported with every volume of in situ sediment removed (which would include sediment solids plus in situ pore water). The large quantity of excess water generated by hydraulic dredging has a major impact on the design of dewatering, treatment, and disposal facilities.

Souder et al. (1978) indicated that slurry concentrations are a function of the suction pipeline inlet velocity, the physical characteristics of the in situ sediment, and effective operational controls. The slurry uniformity is controlled by the cutterhead (if one is employed) and suction intake design

and operation. The cutterhead (both conventional and innovative) should be designed to dislodge/grind/shear and entrain and direct the sediment to the suction intake with minimal hydraulic losses. Water jets can also be used to loosen the in situ material and provide a uniform slurry concentration. The dredgehead and intake suction pipeline should be designed to maintain velocities that are capable of breaking the in situ sediment into pieces that the pump can handle while minimizing entrance and friction losses (USEPA 1994). Hydraulic dredges are particularly adept at dredging very soft, silty, and organic sediments that can be readily drawn into the suction intake with little resuspension or loss when the dredgehead is well-designed and carefully operated, matching the advance of the dredgehead with dredge pumping rate.

The dredge pump and dredgehead (e.g., cutterhead) should work in tandem so that the entire volume of contaminated sediment comes into the system, while maintaining a slurry concentration that the dredge pump is capable of handling. The pump must impart enough energy to the slurry so that the velocities in the pipeline prevent the solids from settling out in the line prior to reaching the discharge point. A properly designed and operated dredgehead, suction intake and pipe, pump, and discharge pipeline system can reduce sediment resuspension while significantly reducing system maintenance and the likelihood of pump failure.

Conventional cutterhead dredges

The conventional cutterhead dredge is generally equipped with two stern spuds used to hold the dredge in working position and to advance the dredge into the cut or excavating area. During operation, the cutterhead dredge swings from side to side alternately using the port and starboard spuds as a pivot. Cables attached to anchors on each side of the dredge control lateral movement. Forward movement is achieved by lowering the starboard spud after the port swing is made and then raising the port spud. The dredge is then swung back to the starboard side of the cut centerline. The port spud is lowered and the starboard spud is lifted to advance the dredge (USACE 1983; in publication). The method of operation of conventional cutterhead dredges results in a zigzag pattern of arcs across the bottom, which tends to leave windrows of material on the bottom (Herbich and Brahme 1991). Innovative operating techniques, including overlapping dredge or step cuts, or using spud carriages to advance the dredge, can reduce or eliminate windrows. Cutterhead dredges can be operated to reduce resuspension or losses of volatile

contaminants using additional equipment such as sediment shields and gas collection systems, or by using underwater cameras and bottom sensors. The cables used to swing and advance conventional cutterheads can cause safety concerns for boaters on the water and limit the ability of the dredge to operate in confined spaces.

Swinging ladder cutterhead dredges

The swinging ladder dredge is a more recent version of the cutterhead dredge. Like the conventional cutterhead, the swinging ladder dredge utilizes a rotating cutterhead at the end of the ladder to dislodge sediment for capture by the suction pipe; but instead of using anchors and wires to pivot the dredge on spuds, the ladder itself swings on a pivot located on the dredge at the top of the ladder. This allows the dredge to operate without anchors and cables, and the swinging ladder dredge is therefore able to work in more confined areas than a conventional hydraulic dredge. The dredge is held in place by spuds set in the bottom sediment. Once set in place, the swinging ladder sweeps an arc in front of the dredge removing sediment through the action of the cutterhead and suction pipe. Once a sweep is completed, the dredge moves itself ahead a few feet by pushing off its spuds (traveling spud or kicker spud). The dredge then resets its spuds and completes another dredging sweep.

The swinging ladder can easily be lifted up and over large debris encountered in the sediment, such as trees and rocks. However, smaller rocks and large branches can plug the suction line or the pump, requiring cleanout actions that interrupt dredging. Although generally intended for work on a level bottom, some swinging ladder cutterhead dredges have been adapted to work on sloping bottoms using digital navigation and dredge positioning systems. Because of its improved ability to work around large debris, more uniform pattern of sediment removal (reduction of zigzag pattern of arcs and windrowing of sediment), and ability to work in confined areas and near navigation, the swinging ladder cutterhead dredge is better matched for environmental dredging than larger conventional hydraulic cutterhead dredges. In addition, some swinging ladder dredges have incorporated an articulated ladder that allows the cutterhead to be positioned parallel to the bottom, resulting in closer proximity of the suction head to the cut, which reduces the fallback contribution to generated residuals.

Horizontal auger dredges

Horizontal auger dredges are operated differently than cutterheads. They are equipped with a wide dredgehead consisting of an auger that rotates and moves the sediment toward the center of the auger where the hydraulic intake is located. Auger dredges are advanced in a straight-ahead fashion, along the length of a cable anchored forward and aft of the dredge. No spuds are used with the auger dredge. Under ideal conditions, horizontal auger dredges are capable of removing thin lifts with relatively high precision. The bathymetry of the water body will affect the performance of the dredge; however, windrowing of sediments can be problematic when operating on an uneven surface or in a debris field.

The auger dredge was originally developed to remove sludge from sewage lagoons where there is little debris and a level bottom where the dredge can move along a set horizontal elevation. The auger dredge is usually about 8 ft wide, and the auger head is a rotating pipe 1 to 2 ft in diameter, and 6 to 10 ft long. An auger blade is attached to the rotating pipe, with the blades moving the sediment to the center of the cutterhead where the suction pipe is located. The sediment is then picked up and transported by the suction pipe.

The auger dredge moves ahead while the horizontal auger is turning and the suction line is pumping to remove sediment in its path. The path of the auger dredge is controlled by cables strung from shore to shore along the direction of travel. If the auger engages stiff sediment, large debris, rocks or trees in the sediment, the turning auger will tend to walk along the obstruction, pulling the dredge off the intended path. On sites with soft material over hard, this tendency for the dredge to move itself offline can result in undredged areas.

In addition, the horizontally orientated auger is not designed to readily remove material located along a sloping surface. The auger dredge is not considered an optimal piece of dredging equipment where there is an abundance of debris, harder underlying material, and sloping bottom conditions.

Plain suction

Plain suction dredges are hydraulic dredges that operate without a mechanical action to loosen the sediment (i.e., no cutterhead or auger).

For example, simply removing the cutter basket from a conventional cutterhead dredge allows it to be used as a plain suction dredge. Some dredges are specifically designed as plain suction dredges. In addition, specially designed plain suction dredgeheads can be used with hydraulic dredges.

Pneumatic

Pneumatic dredges operate with submerged air-actuated pumps and are designed to entrain little water during the removal process. Some pneumatic dredges are suspended with wire cable, similar to bucket dredges, but the pumps may also be mounted on a ladder, and the dredge operated similar to the hydraulic dredges. Due to the nature of the air-actuated pumps, pneumatic dredges operate more efficiently in deeper water, and cannot be used in very shallow water. Pneumatic dredges are not commonly used in the United States, and are usually considered a subset of specialty dredges.

Specialty dredges and dredgeheads

Commonly available dredges, including those used for navigation dredging, are generally called “conventional” dredges. These dredges can be successfully used for environmental projects, but a number of specialty designs, including dredges or dredgeheads specifically designed for environmental dredging, are now available. These “specialty” dredges can provide benefits with respect to reductions in sediment resuspension, contaminant release, and carrier water volume. Additionally, specialty dredges can increase operational efficiency for removal and transportation, depending on the sediment and project conditions and the performance standards. Some of these specialty designs originated outside the U.S. (PIANC 1996), but several U.S. companies have now formed partnerships that allow the use of specialty equipment from a number of countries. More recently, specialty dredgeheads have been developed in the United States for environmental dredging applications. An example is the Vic Vac® dredgehead, shown in Figure 14, designed for cleanup passes and applied at the Fox River site and Ashtabula site (Greene et al. 2007, Weber et al. 2008). For purposes of this report, specialty dredges refer to dredges or dredgeheads that are designed for a specific purpose related to environmental dredging, such as removal with high solids content, low sediment resuspension, low generated residuals, or removal of residuals using cleanup passes.



Figure 14. Vic Vac® hydraulic dredgehead for residuals.

Resuspension and release by hydraulic dredges

The operation of hydraulic dredges (cutterheads, augers, or some specialty dredges) will resuspend some of the sediment dislodged by the cutterhead that escapes the suction pipe. Both the mechanical force of the rotating cutterhead or auger and the plowing action of the swinging ladder or the advancing auger will result in some resuspension of sediments. The depth of cut and the speed of advance of the dredgehead are important factors. The depth of cut for a full production cut would ideally be approximately the diameter of the cutterhead or auger. Overburial of the cutterhead or auger will usually result in increased sediment resuspension and contaminant release, since sediment would tend to ride over the top of the dredgehead. In addition, excessive ladder swing speed or excessive rotation speed of the cutterhead may also result in increased resuspension and release. If the rate of advance of the ladder swing or auger advance exceeds the capability of the suction to remove dislodged material, the dredgehead is essentially plowing through the sediment, with increased resuspension and release. Sediments resuspended by hydraulic dredges are usually more concentrated in the lower portion of the water column, where the dredgehead encounters the sediments.

Residuals generation by hydraulic dredges

The shearing action of a cutterhead or auger dredge through sediment, in combination with the positioning of the suction pipe for the dredge, results in the formation of a fallback layer (sometimes referred to as a spillage layer) unique to hydraulic dredging. As material is disturbed by the action of the cutterhead/auger, it falls down and away from the bank. This fallback or spillage layer is a major component of the generated residuals layer for a hydraulic dredge.

In a conventional cutterhead, the mouth of the suction pipe is located at the backside of the dredgehead and above the depth of the cutting action made by the basket cutterhead at the cutline. In an auger dredge, the suction pipe is located at the center of a wide auger. Consequently, not all of the material dislodged by the cutterhead or auger is captured in the suction pipe, but is left behind in the spillage layer, as shown in Figures 15 and 16.

The spillage layer is a blend of the material removed in the cut face. If the cut face consists of both contaminated sediment and underlying clean sediment, the spillage layer will contain a blend of contaminated and clean sediment. Consequently, the spillage layer can be contaminated even though the dredge was advanced well into underlying native non-contaminated sediment.



Figure 15. Mouth of suction pipe and conventional basket cutterhead.

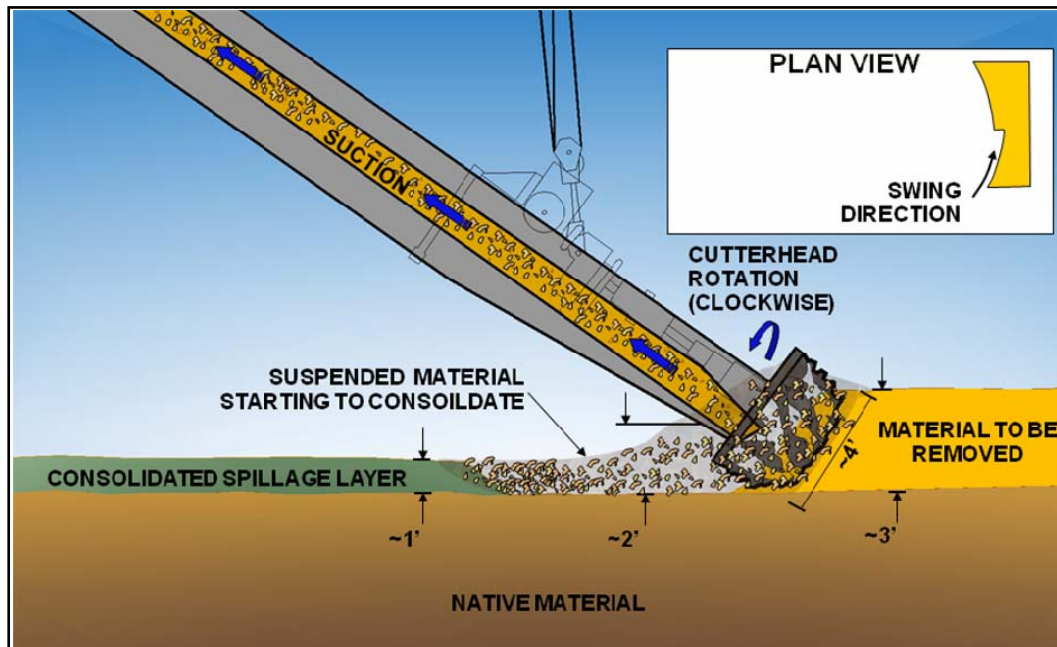

Figure 16. Spillage layer from conventional hydraulic cutterhead dredge.

The thickness of the spillage layer is a function of the dredged material type, the configuration of the cutterhead and suction pipe, velocity within the flowfield around the cutterhead and intake pipe, cutterhead revolution speed and the method in which the dredge is operated. As a rule of thumb, the thickness of the spillage layer for a conventional cutterhead dredge can be about 0.2 times the cutterhead diameter or 0.5 times the discharge pipe diameter. For dredges with articulated ladders, the suction pipe can be located closer to the cutline, with a resulting decrease in the spillage layer thickness (perhaps half of the spillage of a conventional ladder). Further research is needed to better understand the formation of the spillage layer and the associated generation of post-dredging residuals.

Summary

Advantages common to hydraulic dredges normally associated with environmental dredging include the following:

- Capable of excavating most types of materials with higher production rates than comparably sized mechanical dredges.
- Capable of dredging on a practically continuous basis with higher production than similarly sized mechanical dredges.
- Capable of pumping material directly by pipeline to confined disposal facilities, geotubes, or mechanical dewatering and treatment facilities.

- Capable of switching dredgeheads for different sediment types and generated residuals.

Disadvantages common to all hydraulic dredges normally associated with environmental dredging are:

- Difficulty with debris (plugging, inability to capture, pushed off location).
- A large quantity of excess water is generated, with potentially high cost of sediment dewatering and water treatment.

5.1.2. Mechanical dredging

The description of mechanical dredging in this section is adapted from USACE (1983) and USEPA (1994). The basic components of a mechanical bucket dredge are shown in Figure 17. Mechanical dredges remove bottom sediment through the direct application of mechanical force to dislodge and excavate the material. The dredged material is then lifted mechanically to the surface at nearly in situ densities (Averett et al. 1990). As noted above, this advantage is significant because it limits the amount of excess water to be handled and subsequently treated and reduces dewatering requirements for certain treatment and disposal options. This is dependent upon bucket size, cut depth, and the bucket fill factor. In very shallow cuts, fill factors can be low, increasing water production. Mechanical dredges can be particularly effective for those locations where dredged sediment must be transported by a barge to a disposal or treatment facility (Zappi and Hayes 1991).

Production rates for mechanical dredges are typically lower than rates for comparably sized hydraulic dredges. However, high productivity is typically not the main priority for environmental dredging projects. Mechanical dredges can operate in constricted areas and do not interfere with navigation or recreational boat traffic to the same extent as conventional cutterhead dredges (Zappi and Hayes 1991). Mechanical dredges are often selected for small dredging projects in confined areas such as docks and piers. They provide one of the few effective methods for removing large debris (Averett et al. 1990) and are adaptable to land-based operations.

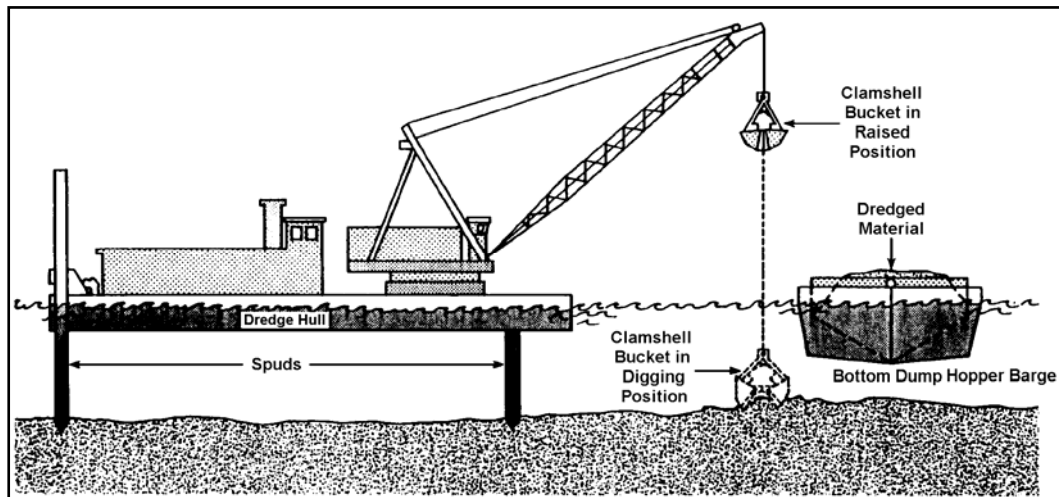

Figure 17. Components of a mechanical bucket dredge.

The most common mechanical dredges considered for environmental dredging are the wire-supported clamshell dredge (with conventional or enclosed buckets) and the articulated fixed-arm backhoe and bucket dredges.

Wire-supported bucket

The main components of a wire-supported clamshell dredge are shown in Figure 18. This dredge may consist simply of a crane mounted on a spud barge, although most bucket dredges have a crane/barge system specifically designed and constructed for dredging (Figure 17) (Zappi and Hayes 1991). Buckets are classified by their capacities, which range from <1 to over 50 yd³.

A bucket dredge is operated in the same manner as a land-based crane and bucket. The crane operator lowers the bucket through the water column, using the lifting line of the crane, allowing it to sink into the sediment. The bucket is closed with the second line from the crane (closing line), and is raised through the water column. Once above the water surface, the operator swings the bucket over the receiving container (usually a barge) and releases the closing line to open the bucket and discharge the load (Zappi and Hayes 1991).

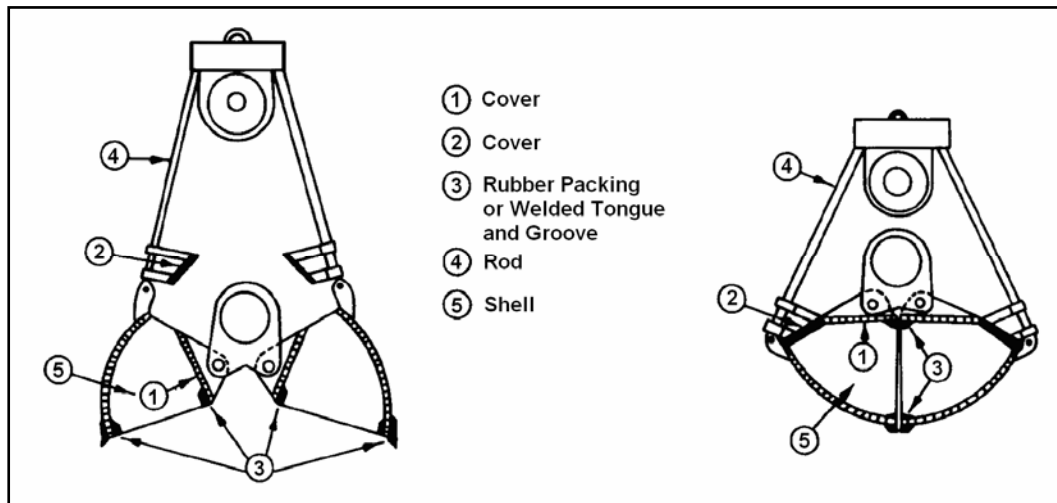

Figure 18. Components of a wire-supported clamshell dredge.

Conventional clamshell bucket

The conventional clamshell bucket dredge usually leaves an irregular, cratered sediment surface (Herbich and Brahme 1991) and releases some sediment throughout the depth of the water column. In addition, as the bucket breaks the water surface, the clamshell bucket tends to lose much of the entrained water and some of the loose sediment captured by the bucket during closure. Consequently, more turbidity is visible at the surface of the water than is evident with a hydraulic dredge, where the resuspension is limited to the bottom of the water column. Conventional clamshell buckets are heavy and can penetrate into consolidated sediments, and can remove both large debris and debris-laden sediments. However, when removing larger debris, the jaws of the bucket may not completely close, resulting in higher sediment resuspension.

Enclosed buckets

A variation of the conventional dredge bucket, the enclosed dredge bucket, has been developed to reduce spillage and leakage from the bucket. The operation and deployment of the enclosed dredge bucket is identical to that of the conventional clamshell bucket discussed above. Earlier designs for enclosed dredge buckets featured covers designed to prevent material from spilling out of the bucket while being raised through the water column and rubber gaskets or tongue-in-groove joints to reduce leakage through the jaws and pass the cutting edges of the closed bucket. Newer designs (e.g., the Cable Arm bucket) include provisions for drainage of excess water prior to release of the sediment load and a level-cutting

operation, which results in a relatively flat sediment surface. Environmental buckets might not effectively penetrate highly consolidated sediments. However, consolidated sediments are also less susceptible to resuspension and, therefore, there may be little benefit in using an environmental bucket for consolidated sediments.

Articulated bucket with fixed arm

Articulated mechanical dredges use an excavating bucket with a fixed-arm support. These include backhoes and similar buckets with fixed-arm supports and hydraulic closing mechanisms. Backhoes, although normally thought of as excavating rather than dredging equipment, can be used for removing contaminated sediments under certain circumstances. Backhoes are normally land based, but may be operated from a barge. Long-reach excavators may remove sediment to depths of about 50 ft, but the bucket size is restricted as the length of the arm is increased. Recent innovations of articulated dredges include buckets with hydraulic closing mechanisms and a level-cut capability (e.g., the Young Manufacturing rehandling bucket and Bean Horizontal Profiling Grab dredge). Articulated mechanical dredges offer an advantage of more controlled penetration depth as compared to wire-supported buckets, which depend upon bucket weight and momentum to penetrate the sediment. The articulated feature allows the bucket to be rotated on the vertical axis, which provides better control of bucket location and overlap as compared to a wire-supported bucket.

Resuspension and release by mechanical dredges

Resuspension and contaminant release by mechanical dredges may result from dynamic impact of the bucket with the bottom sediment (for wire-supported buckets), sloughing of material into the cut, washing of sediment from the bucket exterior as the bucket is raised through the water column, and leakage from the bucket (either from the top of an open bucket or from the lips of the bucket if closure is not complete due to debris). All these mechanisms result in a pattern of resuspension and contaminant release that may be exhibited both near bottom and in the full depth of the water column.

Enclosed buckets prevent the release of sediment from the bucket as it is pulled up through the water column, reducing contribution to resuspension and contaminant release throughout the depth of the water

column. Use of enclosed buckets also decreases the loss of captured water from the bucket after breaking the water surface during sloughing to the barge, reducing the resuspension and contaminant release at the water surface. This captured water increases the generation of water into the sediment barge. If the turbid water is allowed to discharge over the sides of the barge, it can become a source of resuspension and contaminant release that offsets the part of the advantages of using an enclosed bucket (Fuglevand and Webb 2006).

Residual generation by mechanical dredges

Once a bucket has penetrated the sediment and is closed, the subsequent raising action as the bucket is pulled from the sediment will result in some fallback and sloughing of sediment that has been dislodged along the cutface. As the bucket is raised up into the water column, sediment “chucks” clinging to the exterior of the bucket will tend to fall back to the surface. With open buckets, spillage and wash-out from the bucket may occur during lifting. If bucket closure is not complete, chucks of sediment leaking from the bucket will also contribute to fallback.

Enclosed buckets are designed to prevent the release of sediment from the bucket as it is pulled up through and out of the water column, reducing contribution to a residual layer. Level cut buckets plow and remold the sediment, increasing the potential for the formation of a sediment slurry that is difficult to capture in the bucket, increasing the residual layer. Rehandling buckets with offset pivots slice through the sediment, reducing the formation of remolded/liquid residual material. Wire-rope deployed buckets are difficult to hold on station on slopes and may actually contribute to the formation of residual layers.

Summary

Advantages common to all types of mechanical dredging normally used for environmental dredging include the following:

- Rugged; can remove hard-packed materials.
- Can remove debris and debris-laden sediments.
- Can work in tight areas.
- Efficient for transport by barge for long haul distances.
- Can remove sediments at nearly in situ density, with minimal requirements for managing excess water.

- Can operate in deep water.
- Can switch from box cut buckets, to toothed buckets, to smaller buckets, etc.

Disadvantages common to all mechanical dredges normally used for environmental dredging include the following:

- Production rates for mechanical dredges are lower than comparably sized hydraulic dredges.
- Normally require barges for transport of the dredged sediments.
- May require re-slurry of sediment prior to treatment.

5.1.3. Equipment combinations and hybrid approaches

Mechanical dredges remove sediments at nearly in situ density and normally place the sediments in barges for transport. Hydraulic dredges remove the sediments as a slurry and normally pump the slurry directly to a treatment or disposal site. Some hybrids of these approaches have been developed that mix the traditional excavation and transport approaches. The hybrid mechanical dredge directly places sediments into a hopper to which water is added, and the resulting slurry is then pumped to shore for treatment or disposal. This approach offers some advantages in that barging and mechanical offloading is eliminated, although debris may still require barge transport. Additionally, the approach might allow mechanical dredging in circumstances where direct access to the disposal area is not possible; however, it loses the advantage of limiting entrained water requiring management during treatment or disposal. Mechanical dredging with subsequent hydraulic offloading of the barges is another form of hybrid operation. In some cases, hydraulic dredges are used to pump slurried sediment into barges for transport to distant points for offloading and subsequent treatment and/or disposal. However, given the high volumes of slurry relative to in situ volume, this is generally considered impractical if other transport alternatives are available.

5.2. Considerations for equipment selection

Dredging equipment selection is an important consideration for the feasibility evaluation, alternative selection, and design phases of an environmental dredging project. In the Feasibility Study stage, project managers must evaluate the effectiveness and implementability of remedial alternatives. For those alternatives involving environmental

dredging, the project manager should develop a number of conceptual dredging operations using generalized types of dredging and transport equipment (hydraulic and mechanical) and then evaluate the feasibility of these broad operational approaches based on logistics, complexity, treatment and disposal requirements, reliability, production, and costs. In the equipment selection process, specific types of dredgeheads or attachments should also be evaluated (e.g., cutterhead shrouds, open suction vac systems, etc.).

Next, select dredging equipment for the feasible operational approaches so that the implementability and effectiveness of the operation can be evaluated and planning-level cost estimates can be prepared. For detailed design, plans and specifications must be prepared, and cost estimates must be refined. The project manager may develop performance-based specifications, and in some cases, the type of equipment may be specified. Once a project is advertised, contractors usually evaluate and choose the specific equipment most appropriate for the job, and, depending on the design and contract specifications, selection may be subject to approval of the project manager. At each of these steps, the suitability of equipment must be evaluated, and specific equipment must be selected.

The major considerations in selecting equipment for environmental dredging include: removal efficiency, production rate, resuspension of sediment and contaminant release during the dredging process, residual sediment left in place following dredging, compatibility with transport, treatment, and disposal options, and costs. Cost is just one of a number of balancing criteria that is considered after providing environmental protection and compliance with ARARs. Selection of the proper equipment type and operational approach for a given site usually requires a balancing of these considerations. Field experience and monitoring data for an increasing number of sites are providing the basis for more informed decisions for equipment selection.

Factors that affect the selection of the type and size of dredge for a given project include volume to be dredged; site conditions such as water depth, sloping vs. flat bottom, and current and wave climate; physical and chemical characteristics of the sediment; presence of debris, vegetation, loose rock, or underlying bedrock; physical site constraints such as bridges or waterway widths; distance to the disposal site; treatment and disposal methods; availability and cost of equipment; and the performance

standards for the operation. Specifically, removal efficiency, resuspension of sediment, and contaminant release during the dredging process, residual contaminated sediment left in place following the operation, the need for multiple cuts or cleanup passes, the need to reduce overdredge volumes, and compatibility with transport, treatment, and disposal options must be considered with respect to these factors.

5.3. Equipment capabilities and selection factors

This section provides an evaluation of the capabilities and advantages and disadvantages of various equipment types commonly considered for environmental dredging, using published data and best professional judgment. The information described in this section builds on earlier referenced summaries of equipment capability and selection factors (Palermo et al. 2004). A list of specific factors related to removal efficiency, resuspension and release, residual sediment, and compatibility with disposal is provided along with discussion of the relative effectiveness of the various equipment types in addressing each of the factors.

Table 1 summarizes the information on operational characteristics and contains *quantitative* entries related to specific operational characteristics (both capabilities and limitations) for the dredge types listed and defined above for conditions likely to be encountered for many environmental dredging projects. These operational characteristics reflect what the given dredge type is capable of doing and are largely a function of the equipment itself. The numbers are not representative of all dredge designs and sizes. Earlier versions of such information were developed for specific projects or specific purposes (Hand et al. 1978; Philips and Malek 1984; Palermo and Pankow 1988). These earlier tables included information on dredge types and larger dredge sizes commonly used for navigational dredging. Several literature reviews and summaries of such information have also been developed for environmental dredging (Averett et al. 1990; Herbich and Brahme 1991, Herbich 1995, 2000). Versions of this information focusing solely on the smaller sizes and types of dredges more commonly used for environmental dredging were included in the EPA Assessment and Remediation of Contaminated Sediments (ARCS) Remediation Guidance Document (USEPA 1994) and *Contaminated Sediment Remediation Guidance for Hazardous Waste Sites* (USEPA 2005).

Table 1. Environmental dredging equipment operational characteristics.

| Operational Characteristics ⁽¹³⁾ | Equipment Type ⁽²⁾ | | | | | | | | | | |
|--|--|---------------------------------------|---|---|----------------------------|---------------------------------|------------------------------|--------------------------|---------------------------|-----------------------|---------------------------------------|
| | Mechanical Dredges (2 to 8 m ³ buckets) | | | Hydraulic/Pneumatic Dredges (15 to 30 cm pump sizes) | | | | | | | Dry Excavation |
| | Conventional Clamshell (Wire) ⁽³⁾ | Enclosed Bucket (Wire) ⁽⁴⁾ | Articulated Bucket (Fixed-arm) ⁽⁵⁾ | Conventional Cutterhead ⁽⁶⁾ | Swinging Ladder Cutterhead | Horizontal Auger ⁽⁷⁾ | Plain Suction ⁽⁸⁾ | Pneumatic ⁽⁹⁾ | Specialty ⁽¹⁰⁾ | Diver ⁽¹¹⁾ | Mechanical Excavators ⁽¹²⁾ |
| Operating Production Rate (m ³ /hr) ⁽¹⁴⁾ | 50 (2 m ³ bucket) 95 (4 m ³ bucket) 145 (6 m ³ bucket) 190 (8 m ³ bucket) | | | 70 (15 cm pump) 145 (20 cm pump) 200 (25 cm pump) 285 (30 cm pump) | | | | Site-specific | Equipment Specific | 15 | Site-specific |
| Percent Solids (by weight) ⁽¹⁵⁾ | 90% In situ | 80% In situ | 80% In situ | 10 | 10 | 10 | 10 | 15 | Equipment Specific | <5 | In situ |
| Vertical Operating Accuracy (cm) ⁽¹⁶⁾ | ± 15 | ± 15 | ± 10 | ± 10 | ± 10 | ± 10 | ± 10 | ± 15 | ± 10 | – | ± 5 |
| Horizontal Operating Accuracy (cm) ⁽¹⁷⁾ | ± 10 | ± 10 | ± 10 | ± 10 | ± 10 | ± 10 | ± 10 | ± 10 | ± 10 | – | ± 5 |
| Maximum Dredging Depth (m) ⁽¹⁸⁾ | NA | NA | 15 | 15 | 15 | 5 | 15 | 45 | 15 | 30 | Stability Limited |
| Minimum Dredging Depth (m) ⁽¹⁹⁾ | – | – | – | 1 | 1 | 0.5 | 1 | 5 | 1 | 0.5 | – |

This table summarizes OPERATIONAL CHARACTERISTICS shown as quantitative entries, reflecting capabilities and limitations of equipment types for environmental dredging, and are solely a function of the equipment itself. The information in this table should be applied only after consideration of the details on the definitions of the various dredge types, operational characteristics, and the technical basis for the entries in this table as described in: Palermo, M. R., P. R. Schroeder, T. J. Estes, and N. R. Francingues. 2008. "Technical Guidelines for Environmental Dredging of Contaminated Sediments," Technical Report ERDC/EL TR-08-29, U.S. Army Engineer Research and Development Center, Vicksburg, MS. This information is intended to help project managers initially assess dredge capabilities, and screen and select equipment types for evaluation at the feasibility study stage or for pilot field testing. This table is NOT intended as a guide for final equipment selection for remedy implementation. There are many site-specific, sediment-specific, and project-specific circumstances that will dictate which equipment is most appropriate for any given situation, and each equipment type can be applied in different ways to adapt to site and sediment conditions. In addition, because new equipment is being continuously developed, project managers will need to consult with experts who are familiar with the latest technologies.

Table 2 summarizes reported data on *quantitative* dredge operational characteristics with supporting references. This table includes citations from the readily available literature, but should not be considered comprehensive in that proprietary information or data from specific projects in dredging contractor files and client reports were not available for this review. In addition, many of the projects cited in Table 2 were field pilot projects and might not reflect the efficiencies that may be gained for a full-scale project. Even with these constraints, the information in Table 2 attempts to provide a technical basis for the dredge operational capabilities and limitations shown in Table 1. The quantitative dredge

operational characteristics in Table 1 are essentially bracketed by the range of values based on field experience.

Table 2. Summary of reported data on operational characteristics for environmental dredging.

| Reference | Mechanical Dredges | | | Hydraulic Dredges – Pneumatic Dredges | | | | | | | Dry Excavation |
|--------------------------------------|---|----------------------------------|------------------------------------|---------------------------------------|----------------------------|---------------------------|---------------------|---------------------------|-----------------------|-------------------------|----------------------|
| | Conventional Clamshell (Wire-supported) | Enclosed Bucket (Wire-supported) | Articulated Mechanical (Fixed-arm) | Conventional Cutterhead | Swinging Ladder Cutterhead | Horizontal Auger | Plain Suction | Pneumatic | Specialty Dredges | Diver Assisted | Mechanical Excavator |
| Production Rate (m ³ /hr) | | | | | | | | | | | |
| Herbich (1995) | | | | | | 15.3 to 61 ⁽¹⁾ | | | | | |
| Herbich (1995) | | | | 12.3 | | 31.3 ⁽²⁾ | 18.7 ⁽³⁾ | | | | |
| Hornsby (1995) | 8 | | | | | | | | | | |
| Cushing and Hammaker (2001) | 31 | 31 | | | | | | | | | |
| Wang et al. (2000) | | 32 to 64 | | | | | | | | | |
| Cushing and Hammaker (2002) | | | | 19.1 to 38.2 | | | | | | | |
| Hayes and Wu (2001) | | | | 28-56 ⁽⁴⁾ | | | | | | | |
| Pelletier (1995) | | | | | | | | 25 to 45 ⁽⁵⁾ | | | |
| Herbich (1995) | | | | | | | | 240 to 300 ⁽⁶⁾ | 85 to 103 | | |
| Herbich (2000) | | | | | | | | | | 15 to 35 ⁽⁷⁾ | |
| Mohan (1998) | | | | | | | | | | 12 to 36 ⁽⁸⁾ | |
| Pound (2000) | | | | | | | | | | 48 | |
| Bennett and Hill (1994) | | | | | | | | | 2 to 7 ⁽⁹⁾ | | |

| Reference | Mechanical Dredges | | | Hydraulic Dredges – Pneumatic Dredges | | | | | | | Dry Excavation |
|---------------------------------|---|----------------------------------|------------------------------------|---------------------------------------|----------------------------|--|---------------|--|--------------------------|------------------------|----------------------|
| | Conventional Clamshell (Wire-supported) | Enclosed Bucket (Wire-supported) | Articulated Mechanical (Fixed-arm) | Conventional Cutterhead | Swinging Ladder Cutterhead | Horizontal Auger | Plain Suction | Pneumatic | Specialty Dredges | Diver Assisted | Mechanical Excavator |
| Percent Solids (by wt) | | | | | | | | | | | |
| Herbich (1995) | | 44 to 48 ⁽¹⁰⁾ | | | | 8 to 22 ⁽¹¹⁾ | | 40 to 50 ⁽¹²⁾ | | | |
| Mohan (1998) | | | | | | | | | | 2 to 4 ⁽¹³⁾ | |
| Pelletier (1995) | | | | | | | | 17 to 31 ⁽¹⁴⁾ 20 to 40 ⁽¹⁵⁾ | | | |
| Appel and Jeroense (2001) | | | | | | | | | 15 to 20 ⁽¹⁶⁾ | | |
| VanRaalte (1986) | | | | | | | | | 70 ⁽¹⁷⁾ | | |
| Vertical Accuracy (cm) | | | | | | | | | | | |
| Scott et al. (2002) | 20 | | | | | | | | | | 10 ⁽¹⁸⁾ |
| Blanchard and Priore (2002) | | 2.5 | | | | | | | | | |
| Herbich (2000) | | | | | | 8 ⁽¹⁹⁾ 3 ⁽²⁰⁾ | | | | | |
| DeRuggeris and Nilson (2000) | | | | | | 15 | | | | | |
| Seagren 2002 | | | | | | | 5.1 | | | | |
| Esterline et al. 2002 | | 5.1 | | | | | | | | | |
| Horizontal Accuracy (cm) | | | | | | | | | | | |
| DeRuggeris and Nilsen (2000) | | | | 20 | | 20 ⁽²¹⁾ | | | | | |

| Reference | Mechanical Dredges | | | Hydraulic Dredges – Pneumatic Dredges | | | | | | | Dry Excavation |
|---|---|----------------------------------|------------------------------------|---------------------------------------|----------------------------|------------------|--------------------|--|--|----------------|----------------------|
| | Conventional Clamshell (Wire-supported) | Enclosed Bucket (Wire-supported) | Articulated Mechanical (Fixed-arm) | Conventional Cutterhead | Swinging Ladder Cutterhead | Horizontal Auger | Plain Suction | Pneumatic | Specialty Dredges | Diver Assisted | Mechanical Excavator |
| Maximum Digging Depth (m) | | | | | | | | | | | |
| Herbich (1995, 2000) | 9 to 12 | 9 to 12 | | 12 | | 5 to 8 | 26 ⁽²²⁾ | 60 ⁽²³⁾ 18 ⁽²⁴⁾ | 21 ⁽²⁵⁾ 18 to 35 ⁽²⁶⁾ 31 ⁽²⁷⁾ | | |
| (1) Marathon Battery Custom auger, (2) Mudcat New Bedford Pilot Study, (3) Mudcat New Bedford Pilot Study, (4) Calumet, Acushnet, Lavaca Bay, (5) Pneuma 150 Collingwood Harbor, (6) Pneuma 450 Gibraltar Lake, (7) Manistique, (8) LTV Steel, (9) Vacuum Clam, (10) Cablearm - Hamilton Harbor, (11) Mudcat Welland River, (12) Pneuma 450 Gibraltar Lake, (13) Manistique, (14) Pneuma, (15) Collingwood Harbor, (16) ICH Dredging Wheel, (17) Disk Cutter, (18) Mallee 2002, (19) Bayou Bonfouca p. 18.23, (20) Marathon Battery, (21) Lake Capri, NY, (22) Matchbox, (23) Pneuma, (24) Oozer, (25) Cleanup, (26) Refresher, (27) Wide Sweeper | | | | | | | | | | | |

Table 3 contains a matrix of *qualitative* selection factors for each dredge type. These selection factors reflect the potential performance of a given dredge type, but are a function of both the capability of the equipment type, the site and/or sediment conditions. As with the dredge operational characteristics, there were earlier efforts to develop environmental dredging selection factors (Palermo 1991, Mohan and Thomas 1997, Mohan 1998). For example, Mohan (1998) presented a significant overview of remedial dredging and factors that could influence the selection of a remedial dredging alternative.

Table 3. Environmental dredging equipment selection factors.

| Equipment Selection Factors ⁽¹³⁾ | Equipment Type ⁽²⁾ | | | | | | | | | | |
|---|--|---------------------------------------|---|--|----------------------------|---------------------------------|------------------------------|--------------------------|---------------------------|-----------------------|---------------------------------------|
| | Mechanical Dredges (2 to 8 m ³ buckets) | | | Hydraulic / Pneumatic Dredges (15 to 30 cm pump sizes) | | | | | | | Dry Excavation |
| | Conventional Clamshell (Wire) ⁽³⁾ | Enclosed Bucket (Wire) ⁽⁴⁾ | Articulated Bucket (Fixed-arm) ⁽⁵⁾ | Conventional Cutterhead ⁽⁶⁾ | Swinging Ladder Cutterhead | Horizontal Auger ⁽⁷⁾ | Plain Suction ⁽⁸⁾ | Pneumatic ⁽⁹⁾ | Specialty ⁽¹⁰⁾ | Diver ⁽¹¹⁾ | Mechanical Excavators ⁽¹²⁾ |
| Sediment Resuspension Control ⁽¹⁴⁾ | Low | Medium | Medium | Medium | Medium | Low to Medium | High | High | High | High | High |
| Contaminant Release Control ⁽¹⁵⁾ | Low | Low to Medium | Medium | Low to Medium | Low to Medium | Low | Medium to High | Medium to High | Medium to High | High | High |
| Residual Sediment/ Cleanup Levels ⁽¹⁶⁾ | Low | Low to Medium | Medium | Low | Low | Low | Medium to High | Medium to High | High | High | High |
| Transport by Pipeline ⁽¹⁷⁾ | Medium | Medium | Medium | High | High | High | High | High | High | High | Medium |
| Transport by Barge ⁽¹⁸⁾ | High | High | High | Low to Medium | Low to Medium | Low to Medium | Medium | Medium | Medium | Medium | High |

| Equipment Selection Factors ⁽¹³⁾ | Equipment Type ⁽²⁾ | | | | | | | | | | |
|--|--|---------------------------------------|---|--|----------------------------|---------------------------------|------------------------------|--------------------------|---------------------------|-----------------------|---------------------------------------|
| | Mechanical Dredges (2 to 8 m ³ buckets) | | | Hydraulic / Pneumatic Dredges (15 to 30 cm pump sizes) | | | | | | | Dry Excavation |
| | Conventional Clamshell (Wire) ⁽³⁾ | Enclosed Bucket (Wire) ⁽⁴⁾ | Articulated Bucket (Fixed-arm) ⁽⁵⁾ | Conventional Cutterhead ⁽⁶⁾ | Swinging Ladder Cutterhead | Horizontal Auger ⁽⁷⁾ | Plain Suction ⁽⁸⁾ | Pneumatic ⁽⁹⁾ | Specialty ⁽¹⁰⁾ | Diver ⁽¹¹⁾ | Mechanical Excavators ⁽¹²⁾ |
| Positioning Control in Currents/Wind/Tides ⁽¹⁹⁾ | Medium | Medium | High | High | High | Medium | High | High | High | Medium | High |
| Maneuverability ⁽²⁰⁾ | High | High | High | Low | High | Low | Low | High | Low | High | High |
| Portability/ Access ⁽²¹⁾ | High | High | High | High | High | High | High | High | Medium to High | High | High |
| Availability ⁽²²⁾ | High | High | High | High | High | High | High | Medium | Medium | High | High |
| Debris/Loose Rock/Vegetation ⁽²³⁾ | High | High | High | Low to Medium | Low to Medium | Low to Medium | Low to Medium | Low to Medium | Low | Low | High |
| Hardpan/ Rock Bottom ⁽²⁴⁾ | Low | Low | Low | Low | Low | Low | Medium | Medium | Medium to High | High | High |
| Sloping Bottom | Low | Low | Medium | Low | Medium to High | Low | Low to Medium | Low to Medium | Medium to High | High | High |
| Flexibility for Varying Conditions ⁽²⁵⁾ | High | High | Medium | High | High | Low | Low | Low | Low | Low | High |
| Thin Lift / Residuals Removal ⁽²⁶⁾ | Low | Medium | Medium | Medium | Medium | Medium | High | High | High | High | High |

This table summarizes SELECTION FACTORS shown as qualitative entries, reflecting the potential performance of a given dredge type, and are a function of both the capability of the equipment type and the site and/or sediment conditions. The information in this table should be applied only after consideration of the details on the definitions of the various dredge types, selection factors, and the technical basis for the entries in this table as described in: Palermo, M. R., P. R. Schroeder, T. J. Estes, and N. R. Francingues. 2008. "Technical Guidelines for Environmental Dredging of Contaminated Sediments," Technical Report ERDC/EL TR-08-29, U.S. Army Engineer Research and Development Center, Vicksburg, MS. This general information is intended to help project managers initially assess dredge capabilities, and screen and select equipment types for evaluation at the feasibility study stage or for pilot field testing. This table is NOT intended as a guide for final equipment selection for remedy implementation. There are many site-specific, sediment-specific, and project-specific circumstances that will dictate which equipment is most appropriate for any given situation, and each equipment type can be applied in different ways to adapt to site and sediment conditions. In addition, because new equipment is being continuously developed, project managers will need to consult with experts who are familiar with the latest technologies.

The *qualitative* entries of High, Medium or Low, are defined as follows:

High - indicating the given dredge type is generally suitable or favorable for a given issue or concern,

Medium - indicating the given dredge type addresses the issue or concern, but it may not be preferred, and

Low - indicating the given dredge type may not be a suitable selection for addressing the issue or concern.

A review of the open literature (primarily projects in the United States) determined that some specifics were documented related to the *quantitative* operational characteristics of the various dredge types in Table 1, but there was very little information supporting the *qualitative* evaluation of dredge selection factors in Table 3. Consequently, the technical basis for the *qualitative* entries in Table 3 presented here was developed using best professional judgment and interpretation of the readily available data. Each factor in Table 3 is given a *qualitative* entry of High, Medium and/or Low, defined as follows:

- **High** — indicating the given dredge type is generally suitable or favorable for a given issue or concern.
- **Medium** — indicating the given dredge type addresses the issue or concern, but it may not be preferred.
- **Low** — indicating the given dredge type may not be a suitable selection for addressing the issue or concern.

Earlier efforts to summarize dredge operational capability and selection factors lacked a consistent definition of the factors involved and lacked adequate explanation of the technical basis for the ratings given. The information in Tables 1 and 3 serves to develop and document such a technical basis, building on the earlier efforts, and reflecting the most recent information available from the open literature and from recent field experience.

The following subsections provide definitions of each of the operational characteristics and selection factors and the technical basis for each of the associated entries in Tables 1, 2, and 3. The information presented in the subsections below and summarized in Tables 1, 2, and 3 is intended to help project managers initially assess dredge capabilities, and screen and select equipment types for evaluation at the feasibility study stage or for pilot field testing. Tables 1 and 3 are NOT intended as a guide for final equipment selection for remedy implementation. Many site-specific, sediment-specific, and project-specific circumstances will dictate which equipment is most appropriate for any given situation, and each equipment type can be applied in different ways to adapt to site and sediment conditions. In addition, because new equipment is being continuously developed, project managers will need to consult with experts who are familiar with the latest technologies.

5.3.1. Production rates

Planning level estimates for maximum operating production rates for both mechanical and hydraulic dredges are shown in Table 1. The values shown in Table 1 are for production cuts and are for periods of continuous operation under average conditions as opposed to “cleanup passes” which have a different objective and operating constraints (meeting CULs, high precision and frequently thin cuts). The numbers reflect what the dredge type and size is capable of removing while actually operating for a full production cut and therefore are maximum operating production rates that have not been adjusted for effective working time (typically 55 to

70 percent for environmental dredging projects). The numbers also assume conditions for soft, fine-grained sediments, representative of most environmental dredging projects.

For hydraulic dredging, a planning-level estimate of maximum operating production rate can be determined as the product of pump size, pump discharge velocity, and the ratio of slurry solids concentration to in situ sediment solids concentration (See Section 6.3.3). The rates for hydraulic dredges shown in Table 1 were calculated for 15-, 20-, 25-, and 30-cm pump sizes, using 35-percent solids by weight in situ, 10-percent solids by weight for slurry, and a pump discharge velocity of 15 ft/sec. The rate shown for diver-assisted assumes a maximum pump size of 10 cm and roughly 50-percent efficiency of diver effort (5-percent solids by weight for slurry).

For mechanical dredging, a planning-level estimate of the maximum operating production rate can be determined as the product of bucket volume, cycle time, and percent bucket fill (See Section 6.3.2). The rates for mechanical dredges shown in Table 1 were calculated for 2-, 4-, 6-, and 8-m³ buckets, using 80-percent bucket fill and a bucket cycle time of 2 minutes. While an 80-percent fill factor may be achieved for situations that provide sufficient bank height to normally fill the bucket (navigation dredging), lesser bucket fill factors are associated with environmental dredging projects where thin layers of contaminated sediment is removed. An average fill factor of 50 percent to 70 percent may be representative for such projects.

Production data for dry excavation is highly site- and project-specific. The time required to isolate and dewater the areas targeted for excavation generally is a big factor in effective production rate.

It is important to note that the operating production rates in Table 1 are based on simplifying assumptions and should be used for planning level estimates only. A more rigorous estimation of production is needed for project design and implementation phases. Furthermore, it is important to note that the operating production rates in Table 1 do not reflect impacts of effective dredging time (daily operating period minus downtime) or constraints related to throughput capacity of coupled treatment systems or disposal operations on sustained or overall production rates. More

detailed discussions of production and methods of estimating production rates are presented in Chapter 6.

5.3.2. Percent solids by weight (solids concentration)

Percent solids by weight is defined as the ratio of weight of dry solids in a sample to total wet weight of the sample, expressed as a percentage. This is a convenient way to describe the density of removed material, especially for hydraulic dredging. Percent solids by weight should not be confused with the term percent sediment by weight (a term commonly used in the dredging industry), defined as the ratio of the weight of in situ sediment (composed of solids and water) in a sample to the total wet weight of the sample, expressed as a percentage. Percent solids by weight is used in this report, because these values are not a function of the site-specific in situ sediment density and therefore have the same physical meaning for all sites.

The percent solids in the material as it is removed and transported by the dredge will have a major impact on the production rate and the compatibility of the dredging operation with subsequent handling, treatment, and disposal of the material. Normally, a higher solids content delivered by the dredge translates to lower costs for handling, treatment, and disposal of water and sediment. Most environmental dredging projects involve predominantly fine-grained sediments, and the in situ sediments often have low solids content. Thus, there is a substantial volume of water in the removed sediments, even with a dredging process capable of removal at near the in situ solids content.

Physical characteristics of the sediment (density, particle size distribution, cohesiveness, etc.) influence the slurry solids content achievable by a hydraulic dredge. Conventional hydraulic dredges add a volume of water equivalent to about four times the volume of in situ sediment removed. For navigation dredging, average solids contents of 10 to 15 percent solids by weight are routinely achieved varying as much as 0 percent to 30 percent solids during a single dredge cycle. The available data for environmental dredging indicate lower solids content for many projects with a wide range of percent solids for hydraulic dredges reported, but approximately 8- to 12-percent solids can be expected for production cuts for most environmental dredging projects (See Section 6.3.3 for further discussions). In recent years, newer dredgehead and pump designs have been developed for hydraulic systems that are capable of removing

material at higher percent solids as compared to conventional pipeline dredges (Herbich 1995). In some cases, removal at near in situ concentrations has been reported for sediments with relatively low in situ solids contents.

Percent solids for mechanical dredging is a function of the in situ percent solids and the effective bucket fill (expressed as a percentage of the bucket capacity filled by in situ sediment as opposed to free water). Mechanical dredges can remove sediment with less entrainment of water if a full cut is possible. A common rule of thumb for navigation mechanical dredging is addition of 10 percent water by volume, reflecting a condition equivalent to the bucket filled to 90 percent of its volume with in situ sediment and 10 percent with overlying water. For environmental dredging, partial or overlapping cuts may be required and the depth of cut must be carefully controlled, so a higher percentage of the bucket may be filled with water. Data from the Head of Hylebos project showed 15 percent water entrainment into the dredged material that was shipped for landfill disposal. The volume of excess water pumped from the barges during dredging was roughly equal to the in situ volume of dredged material, indicating an average bucket fill factor of 50 percent (Fuglevand and Webb 2006). Estimates for production for dredging in the East Waterway in Commencement Bay assumed a bucket filled with sediment to 70 percent of capacity (Wang et al. 2000). A 39-percent bulking for clamshell dredging, equivalent to an effective bucket fill of 72 percent, was reported at a site in Baltimore's inner harbor (Snyder et al. 1995).

5.3.3. Vertical operating accuracy

In the context of this document, vertical operating accuracy refers to the ability of the equipment to position the dredgehead at a desired depth or elevation for the cut and maintain or consistently repeat that vertical position during the dredging operation. The cut line in the sediment is established from the site characterization data to delineate the targeted sediment to be removed by precisely locating the base of the dredgehead on the cut line.

Accuracy in positioning is dependent on several factors including the positioning system, dredge type and specific configuration, site conditions such as water depth, bottom slope, wave climate, wind and current, skill and alertness of the operator, etc. This characteristic is focused on inherent accuracy attainable by the equipment (dredge and positioning

system), and does not account for factors that may degrade accuracy such as site conditions or operator-related factors. Non-equipment-related positioning factors are rated for the various dredge types in Table 3 under the selection factor for Positioning Control (Section 5.3).

Strictly speaking, the term accuracy refers to how close a series of measurements is to the actual value being measured, while precision refers to the variability in a series of measurements (i.e., the ability to repeat a measurement exactly). Both accuracy and precision are important in the context of environmental dredging because the key to a successful environmental dredging project is the removal of the “target layer” without excessively removing clean material. Since removal of excessive clean material will normally lead to higher costs for treatment and disposal, the ability to accurately and precisely position the dredgehead, both horizontally and vertically, is critical. Vertical control may be particularly important when contamination occurs in a relatively thin or uneven layer.

The development of electronic positioning technologies such as Differential Global Positioning Systems (DGPS) and Real-Time Kinematic Global Positioning Systems (RTK-GPS) has greatly enabled dredging operators to remove precisely targeted material. The accuracies of the dredge positioning can vary greatly based on how the dredge is set up, based on site conditions, and based on the skill of the dredge operators. The design of the dredge and the linkages between the dredgehead and the positioning system will affect the operating accuracy attainable in positioning the dredgehead and vertically maintaining the desired cutline as dredging progresses. Transponders may be mounted at critical points on the dredge (such as at the top of a crane boom) or directly on the dredgehead to improve accuracy of the dredging operation. Sensors to provide real-time feedback on the actual cut achieved are also possible (DeRuggeris and Pena 2004; Dalton et al. 2008).

Accurately establishing the position of the dredgehead involves locating the dredge pontoon in a three-dimensional coordinate system, and then tracking the position of the dredgehead with respect to the dredge pontoon. For dredges not using spuds, the orientation of the dredge pontoon may be constantly changing due to the wave environment (pitch and roll) as well as due to the dynamic forces from operating the dredge head. Monitoring the dynamic location of the dredge pontoon can be achieved by multiple fixed RTK-GPS antennas on the pontoon, or a

combination of GPS antennas, pitch and roll sensors, and a gyro compass on the pontoon. DGPS systems by themselves do not have the vertical accuracy to locate the dynamic position of the dredge pontoon.

Positioning for required dredge elevations

Environmental dredge cut elevations can be specified in half-foot increments, or sometimes even less. Assuring that the targeted elevation has been achieved requires that the accuracy of the navigation system has been accounted for in placing the bucket (Figure 19). For example, if the vertical accuracy of a wire-rope mechanical dredge is ± 1 ft, then the target dredge elevation would have to be 1 ft lower than the required dredging elevation to assure that the bucket at least reached the required depth. In the case of an RTK-GPS instrumented articulated fixed-arm dredge with vertical accuracy of 4 in., the targeted/mapped depth of dredging would have to be at least 4-in. deeper than the required depth in order to assure the targeted depth was achieved.

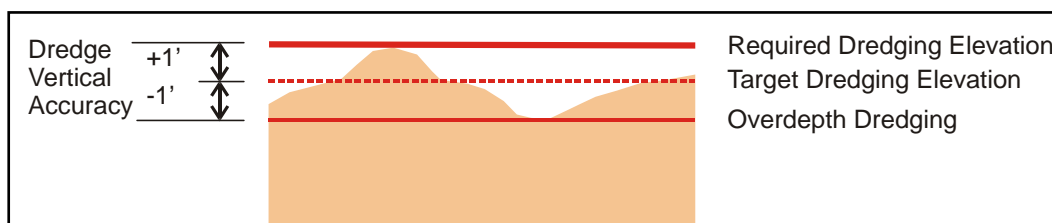

Figure 19. Cross section showing required dredging elevation vs. target dredging elevation as a function of vertical accuracy of dredge.

Equipment innovations such as the newer level-cut environmental buckets (either wire or fixed-arm supported) can result in increased precision of cut as compared to older conventional bucket designs, which can leave a cratered bottom. Greater precision can generally be achieved in softer sediments as compared to sediments containing debris, logs, loose rock, or in sediment overlying bedrock or hardpan layers.

Technological developments in surveying (vessel) and positioning (dredgehead) instruments have improved the dredging process. Video cameras and multibeam forward-looking sonars are sometimes useful in monitoring dredging operations, although turbidity and lack of spatial references may present limitations to their usefulness. Surveying software can be used to generate pre- and post-dredging bathymetric charts, determine the volume of dredged sediment, locate obstacles, and calculate

linear dimensions of surface areas (Jacques Berube, Inc. 1993). Digital positioning systems are also available that enable dredge operators to follow a complex sediment contour (Van Oostrum 1992). However, the bottom might be difficult to delineate during active dredging operation due to the generation of fluffy residuals.

Where the accuracy of site characterization data or the high cost of disposal warrant very precise control, it is possible to use optical (laser) surveying instruments at one or more locations on shore. These techniques, in conjunction with on-vessel instruments, spuds (if water depths are less than about 50 ft) and anchoring systems, might enable the dredge operator to more accurately target specific sediment deposits. The effectiveness of anchoring systems diminishes as water depth increases (USEPA 2005).

The positioning technologies described above enhance the accuracy of dredging. However, while accurately dredging to pre-established cut-lines is an important component of meeting remedial action objectives, both accuracy and precision of the positioning systems are not generally sufficient for meeting them. Contaminated sediment cannot be removed with surgical accuracy even with the most sophisticated equipment. Equipment may not be the only factor affecting the accuracy of the dredging operation. Site conditions (e.g., weather, currents), sediment characteristics (e.g., physical and chemical data), and the skill of the dredge operator are all important factors.

Dredge operator accuracy

In addition to providing a positioning system capable of recording bucket locations within a specified tolerance, achieving that accuracy in the field is still dependent on the skills of the dredge operator. It is not uncommon for a dredge operator to sit at the controls of the dredge for 8 to 12 hr per day, taking breaks when the dredge is being relocated or serviced. Considerable concentration and skill are required to maintain accuracy throughout a day of repetitive actions typically associated with dredging. It is not uncommon for the accuracy of the bucket placement by the operator to decrease throughout both the work day and the work week. While a fresh operator may achieve bucket placement within 0.1-0.2 ft as shown by electronics of the target elevation, the variability may increase to several tenths or more when the operator is fatigued.

A second operational factor regarding dredge positioning accuracy is the effect of sediment conditions on dredgehead placement. For example, an operator may accurately position a level-cut mechanical bucket at the target location (horizontal and vertical), but as soon as the bucket starts to close it may be lifted up, drawn down, or pushed to one side or the other by sediment or the debris in the sediment. In this case, the initial bucket location will be different than the position of the bucket as it closes by a few to several inches. The accuracy of the positioning system will be dependent on which bucket location the system records.

Accuracy of dredging vs. accuracy of sediment characterization

It is important to note that in some cases, the attainable accuracy in locating the cut is greater than the accuracy of the sediment characterization data (Palermo and Averett 2003). A site investigation with accurate vertical delineation of contaminated sediments to be removed based on adequate control on data locations is essential. Referencing data locations to a known elevation datum is also an important consideration. It should be noted that even with a well-designed and well-executed site characterization program, site-specific conditions could greatly impact the ability to fully understand the nature of a given site. This can be due to a high degree of variability in contaminant distribution, difficult/variable site bottom conditions, and sediment characteristics that are not conducive to subsurface profiling technologies. Considering the above issues, project managers should not develop unrealistic expectations of dredging accuracy.

Wire-rope-connected mechanical bucket

The typical horizontal positioning configuration for a wire-rope-connected bucket is to place a GPS antenna at the tip of the boom at the point where cable hangs to the bucket. While the GPS antenna is capable of locating the boom tip to a known accuracy (feet for DGPS, inches for RTK-GPS), it can not account for the swing of the bucket on the cable as the dredge rotates back and forth from the cut and the sediment barge, or currents that deflect the bucket out of plumb with the boom tip. The swing position of the bucket can be several feet out of plumb from the boom tip when suspended 50 to 100 ft below the boom tip. The swinging offset has been observed both for buckets swinging through the air as well as through the water column. Evolving technology is examining the use of a

forward-looking multibeam sonar to track the position of the bucket under water (including the swing) as it approaches the mudline.

Determining the vertical position of a wire-rope-connected bucket has proven to be as complicated as establishing the horizontal position of the bucket. Systems that have tracked the length of wire rope deployed to track the vertical position of the bucket have been hampered by the stretch of the wire rope when the bucket is loaded. Some of those challenges have been overcome by placing a pore-pressure transducer on the bucket to measure depth below water line, which can be converted to elevation when combined with a tide gage that tracks the elevation of the water surface.

Articulated fixed-arm mechanical dredge

Locating the dredgehead for an articulated fixed-arm dredge is simplified by the fact that the dredgehead is connected structurally to the pontoon by the relatively rigid system of booms and sticks. Inclinoimeters or rotation sensors can be placed on each boom/stick member to measure its orientation, which in combination with the known length of each member allows for the calculation of the vertical and horizontal position of the dredgehead. Because the bucket is structurally connected to the articulated fixed arm, positioning of the bucket for these dredges is generally more accurate than can currently be achieved for wire-rope-supported buckets.

Hydraulic dredge

Locating the dredgehead for a hydraulic dredge is similar to locating an articulated fixed-arm dredge, since both use a structural member to connect the dredgehead to the pontoon. Inclinoimeters or rotation sensors placed on the ladder measure its orientation, which in combination with the known length of each member allows for the calculation of the vertical and horizontal position of the dredgehead. Because the dredgehead is structurally connected to the ladder, positioning of the dredgehead is generally more accurate than can currently be achieved for wire-rope-supported buckets or dredgeheads.

5.3.4. Horizontal operating accuracy

Horizontal operating accuracy refers to the ability to position and operate the dredgehead at a desired location or within a desired surface area. The considerations for expected horizontal operating accuracies are similar to

those for the vertical accuracy, although horizontal accuracy would not normally be affected by varying sediment properties. Positioning systems and displays now allow the operator to “see” and record specific locations of each bucket cut or each arc cut with a hydraulic dredge. The goal is to excavate all the area targeted for removal; therefore, some overlap of the horizontal extent of sediment removal is often practiced. However, excessive overlapping of cuts can increase the excess water removed by the dredge and may result in reduced production and higher water treatment costs. Another factor related to horizontal accuracy is the ability of the dredge to maintain its position in wind or currents. This is described below as a separate selection factor. Depending on site conditions, size and type of dredge, and positioning instrumentation, the horizontal position of the dredgehead can vary within an accuracy of about 3 to 20 cm (DeRuggeris and Nilson 2000).

DGPS systems can typically establish the horizontal position of the antenna to within ± 1 m. Sub-meter horizontal accuracy is possible using on-site differential reference stations. DGPS systems are generally not capable of providing reliable vertical positions to the degree needed for environmental dredging. With RTK-GPS, the horizontal accuracy of the antenna location is 1-2 cm, while vertical accuracy of the antenna location is about 1.5 times horizontal or about 2-3 cm (Lillycrop et al. 2003). These accuracies are related to the capability of the positioning of the GPS antenna themselves, but accuracies of the dredge positioning can vary greatly based on how the dredge is set up, site conditions, and the skill of the dredge operators.

Assuming a state-of-the-art positioning system, horizontal operating accuracies of ± 10 cm should be consistently attainable. Considering operating accuracies of ± 10 to ± 15 cm in the vertical and ± 10 cm in the horizontal, an environmental dredging operation supported by state-of-the-art positioning systems could accurately remove the mass of contaminated sediment from a water body under most project conditions. However, as previously stated, accuracy is also limited by operational factors and the accuracy of the sediment characterization data.

Positioning for horizontal overlap of dredge cuts

The goal of sediment remediation is often to excavate all the area targeted for removal; therefore, some horizontal overlap of the mechanical bucket is often practiced. It is not uncommon to call for 6 in. and in some cases

1 ft of overlap of bucket placements. In order to achieve actual overlap, the bucket placement needs to account for both the desired overlap and the accuracy of the navigation system in placing the bucket.

Because of the accuracy limitations of positioning systems, the actual location of the dredgehead will not be specifically known even though the system records an exact location of the bucket. While the positioning systems display a computer-generated image of the position of the locations of each bucket cut or each arc cut with a hydraulic dredge along with targeted sediment, it cannot display the actual location of the dredgehead because of the accuracy of the positioning system. For example, the actual location of the dredgehead will be ± 1 ft from the mapped/displayed location of the bucket when using a navigation system that provides horizontal positioning accuracy of ± 1 ft.

In order to assure at least a 6-in. actual overlap between bucket placements using a positioning system with an accuracy of ± 1 ft will require a targeted/mapped overlap of bucket placements of 2.5 ft (add the ± 1 ft accuracy plus the 6-in. desired overlap). If the accuracy of the positioning system was ± 3 ft (not uncommon for typical DGPS systems), then the targeted/mapped overlap would have to be 6.5 ft in order to assure that at least a 6-in. actual overlap is achieved. On the other hand, a targeted/mapped overlap of only about 1 ft would assure a 6-in. minimum overlap using an RTK-GPS-based positioning system with an accuracy of 4 in.

As shown by this exercise, use of RTK-GPS for dredgehead positioning is far more effective in assuring dredge cut overlap as compared to a DGPS positioning system. Excessive overlapping of cuts can increase the water removed by the dredge and may result in reduced production and higher dredging and water treatment costs.

Another factor related to horizontal accuracy is the ability of the dredge to maintain its position in wind or currents. This is described below as a separate selection factor.

Overall system accuracy

Considering all of the above factors, it would be reasonable to plan on overall dredging accuracy of no better than ± 6 in. vertical and horizontal, and only if:

- RTK-GPS based positioning systems are employed.
- A fixed arm or ladder dredge is used.
- Experienced and skilled operators are employed.
- There is limited debris and obstructions to dredging.
- A proper quality control system is employed to verify the positioning system at least once per day throughout the full range of motion.

Without these factors in place, the overall accuracy of dredges can quickly degrade to \pm several feet. If the positioning system has errors, these can be very hard to detect and can continue for multiple days without being noticed.

5.3.5. Maximum dredging depth

The operating characteristic for maximum dredging depth refers to the physical limitations of equipment to reach below a given depth. Some dredges have a physical limitation on their ability to reach below a given depth, based on the length of the dredging arm or ladder. For example, the limiting reach of conventional backhoe equipment is about 50 ft (about 15 m) while the more recently developed high-capacity fixed-arm dredges can reach as deep as 75 to 100 ft. Hydraulic dredges have a limiting depth of removal of about 50 ft due to the limitation of suction pressure (cavitation), but this limitation can be overcome by addition of a submerged pump on the ladder. Reach of fixed-arm supported buckets or hydraulic dredges is limited by the length of the arm or ladder. Since wire-supported buckets or pumps can be deployed at substantial depths, the maximum dredging depth is usually limited by stability of the excavation. Summary data on dredging depth limitations (Herbich 1995; 2000) show a wide variation across dredge types. The entries for this operational characteristic in Table 1 are for equipment types and smaller equipment sizes commonly considered for environmental dredging. None of the entries should be interpreted as hard and fast limits, since larger dredge sizes and designs are available for deeper depths.

5.3.6. Minimum dredging depth

Conversely, the draft limitations of some floating dredges limit their ability to work in very shallow water (less than 1 m). This limitation can be managed if the dredge “digs its way into the area” or the flotation of the dredge platform or barge is increased relative to the weight of the dredge plant. In addition, for hydraulic equipment, excessively shallow water can

cause the pump to lose prime or require use of a small dredgehead. Minimum draft may also be an important factor for the auxiliary vessels that service or reposition the dredge, since the propeller wash will resuspend the bottom sediment in shallow areas. Shallow water was documented as a challenge with New Bedford (< 6 ft) and in the mud flat and marsh areas at Marathon Battery (Cushing 1998).

5.3.7. Sediment resuspension control

Sediment resuspension is defined as the process by which the dredging operation results in the dislodgement of bedded sediment particles that disperse into the water column (see Chapter 1). The resuspended sediment particles may settle in or adjacent to the dredging area or be transported downstream (Bridges et al. 2008). Additional descriptions of sediment resuspension processes and considerations for evaluating sediment resuspension are found in Chapter 7.

The equipment selection factor for sediment resuspension control refers to the inherent potential of a given dredge type to limit sediment resuspension when expressed as the fraction of the fine-grained material lost to the water column from the sediment. The available data on the magnitude of the resuspension “source strength” (the mass of sediment resuspended per unit time) for various dredges are based on field measurements of suspended solids at points near an operating dredge (although there is no rigorous protocol for such measurements). For example, some monitoring programs have not measured the very near bottom resuspension. Comparison of the source strengths in mass of sediment resuspended per unit of time for various dredges as opposed to resuspension potential can be misleading because source strength is also a function of the size of the dredge and the production rate. Comparisons between dredges should be performed at the same production rate. A smaller dredge or a slower operating dredge of a given type would produce a smaller source strength (concentration of resuspended sediment) but might produce a greater mass of resuspended sediment when summed over the entire course of dredging.

Other sources of resuspension related to use of a particular dredge type, such as propeller wash from workboats or grounding of barges, should also be considered. For example, at the New Bedford site, data indicate higher sediment resuspension due to workboats than due to the dredging operation (Battelle 2007).

There are data for sediment resuspension at a number of sites and for a number of different dredge types. The most informative data regarding performance of different dredge types have been developed in field studies that compared the resuspension behavior of multiple dredge types operating at the same site and dredging the same sediment (Hayes 1986a; 1986b). However, these older data sets do not capture the advances in technology and methods after 1986, which have shown improvement in resuspension control. The specialized equipment put into practice in the past five years is significantly different from that used on many previous projects and has overcome many of the limitations of classic navigation dredges, showing the ability to produce improved results (Otten and Webb 2008).

The available resuspension data have been summarized and interpreted over the years by several investigators (Herbich and Brahme 1991; Herbich 2000; Hayes and Wu 2001). The available data show that dredge type and method of operation both influence the magnitude of resuspension “source strength” for given sediment and site conditions. For mechanical dredges, the use of enclosed buckets has shown some advantages over conventional open clamshells. For hydraulic dredges, conventional cutterheads have shown some advantage over horizontal augers.

The ratings and associated technical basis for each dredge type for sediment resuspension control are as follows:

- **Conventional Clamshell (Low)** – Resuspension due to bank sloughing, leakage, and spillage from open buckets has potential to generate high levels of suspended sediment. Conventional clamshell buckets use a circular-shaped cutting action, leaving a cratered bottom subject to bank sloughing. The open bucket design is subject to washout and spillage during the raising and swinging portions of the dredging cycle. The operation and movement of scows and workboats would also resuspend material when working in shallow areas.
- **Enclosed Bucket (Medium)** – Enclosed clamshell buckets are designed with a seal around the cutting edges and jaws of the bucket and an enclosed top when in the closed position. The enclosed bucket design reduces washout and spillage during the dredging cycle. Newer designs also result in a shallow level cut, which reduces sloughing.
- **Articulated Bucket (Medium)** – Grab buckets for articulated mechanical dredges are designed with seals around the cutting edges of

the bucket, and an enclosed top when the bucket is in the closed position. Some are designed with a level cutting action. The articulated design may also provide better control and consistency for vertical and horizontal positioning as compared to wire-supported buckets, which may reduce resuspension.

- **Conventional Cutterhead/ Swinging Ladder Cutterhead (Medium)** – Available data show conventional cutterhead dredges generate less sediment resuspension than conventional clamshell dredges. Data are not available to compare the current environmental cutterhead dredges to the current environmental mechanical dredges, both of which have improved control of sediment resuspension.
- **Horizontal Auger (Low to Medium)** – Available data show auger dredges when using shrouds to control losses generate less resuspension than conventional clamshell dredges, but higher resuspension as compared to cutters due to the higher rotation speed of the augers. However, data are not available to compare augers with current environmental cutterhead and mechanical dredges.
- **Plain Suction (High)** – Plain suction dredges have no mechanical action at the dredgehead to dislodge sediment; therefore, resuspension potential is solely due to the advance of the dredgehead through the sediment.
- **Pneumatic (High)** – Pneumatic dredges have no mechanical action to dislodge the material, acting essentially in the same manner as a plain suction dredge with respect to resuspension.
- **Specialty Dredgeheads (High)** – Although designs vary, many of the specialty dredges and dredgeheads have features specifically intended to reduce resuspension.
- **Diver-Assisted (High)** – The precision of diver-assisted hydraulic dredging, the smaller size of the dredgeheads used, and the inherent speed of the operation all contribute to low potential for sediment resuspension.
- **Dry Excavation (High)** – This approach completely isolates the excavation process from the water column.

5.3.8. Contaminant release control

Contaminant release is defined as the process by which the dredging operation results in the movement of contaminants from the pore water of the sediment or from the surface of resuspended sediment into the water column. Some portion of the contaminants that are released to the water column (e.g., dissolved phase) are typically transported farther

downstream than contaminants sorbed to resuspended sediment. Volatile releases to the air are also a potential concern (see Chapter 1). Additional descriptions of contaminant release processes and considerations for evaluating contaminant release are found in Chapter 7.

The selection factor for contaminant release control refers to the inherent ability to control sediment disturbance and resuspension and dissolved and volatile releases for the given equipment type and associated operation. Disturbance and resuspension of sediment during dredging (such as remolding the sediment with water under the shearing action of a bucket or auger or cutterhead; suspending sediment into the water column by high-velocity rotation of an auger or cutterhead; erosion of sediment out of a bucket into the water column as the bucket is transported through the water column) will result in release of contaminants to the dissolved phase in the water column by release of pore water and by desorption from resuspended sediment particles. The resuspension due to operation and movement of scows and workboats in shallow water areas is another consideration, but is generally not amenable to control.

Depending on the contaminant, subsequent releases to the air through volatilization may also be a concern (Cushing 1998). Volatile releases from the material in the barge may also be an issue for some sites. Volatile releases may also be an issue at the disposal or rehandling/treatment site, but these releases can be controlled to some degree using covers, vapor control barriers/coatings, and adsorbents such as activated carbon.

Potential for contaminant releases at the dredging site is directly related to the degree of sediment resuspension and its location in the water column. Sediment resuspension at the bottom of the water has a lower potential for contaminant release than resuspension at the surface of the water column because the concentration of the contaminant at the surface will be lower. This causes the volatile flux and resulting contaminant concentrations in the air to be lower. In addition, solids resuspended at the bottom are likely to settle out of the water column more quickly, providing less time for contaminant release to the resuspended solids. Therefore, contaminant release control is considered as a separate equipment selection factor focused on the ability to control releases, rather than the inherent potential of a given dredge type to minimize sediment resuspension. Of course, limiting resuspension is favorable for controlling contaminant releases.

A distinction should be made between engineered controls and operational controls for environmental dredging. Operational controls may be defined as changes in operation of the equipment or operational approach for the project that result in reduced resuspension and release. Examples of operational controls might include reducing the rate of removal (essentially slowing the operation), limiting operations to specific hydrodynamic conditions (such as flow rate or tidal cycle), optimizing specific operations (such as ladder swing speed, cutter rotation speed, depth of cut, or speed of advance of the dredge), and optimizing the sequence of dredging (upstream to downstream units or with respect to number of vertical cuts). Engineered controls for environmental dredging may be defined as designed controls or containments deployed around or in conjunction with the dredge plant. Examples of engineered controls might include installation of dredgehead shrouds, silt curtains, sheet-pile enclosures, surface membranes or coatings to minimize volatilization, adsorbents, or other containment types.

Application of operational and engineered controls is potentially expensive and can significantly reduce overall production rates and efficiency. Therefore, controls should be applied only when conditions clearly indicate a need and should not be set as a requirement for a project solely because they can be applied. An engineered control such as a silt curtain does not reduce turbidity or sediment resuspension, rather it merely confines the resuspended sediment to a smaller area. The containment devices might allow concentrations of both suspended solids and dissolved contaminants to increase to high values within the enclosure, only to be released when the curtain is moved. Additionally, the greater concentrations lead to increased strength of the volatile releases at the dredging site. However, containment controls can reduce the total mass of suspended solids and contaminants released from the dredging site. There are few data to support reductions in resuspension and release (total mass as opposed to concentration) resulting from application of operational controls related to rates of operation. With appropriate feedback, experienced dredge operators can find a rate and method of operation that balances production and contaminant release for a given set of conditions.

The ratings and associated technical basis for contaminant release control are as follows:

- **Conventional Clamshell (Low)** – Conventional clamshells can be operated such that the excavation and water column exposure of the bucket is within a silt curtain containment or enclosure; however, high suspended solids within the silt curtain may be released when the curtain is moved. In addition, much of the solids losses are near the surface, increasing the potential for contaminant releases. The presence of debris can keep the jaws from closing and cause the loss of much of the bucket contents. The barge also provides a source of contaminant release to the air and possibly to the surface water. Additionally, clamshells leave a significant residuals layer that is also a major source of contaminant release.
- **Enclosed Bucket (Low to Medium)** – Enclosed buckets can be operated such that the excavation and water column exposure of the bucket is within a silt curtain enclosure; however, the bucket continuously moves through the water column drawing and releasing solids throughout the depth of the water column. Contaminants are released by washing the surfaces of the dirty bucket as well as some drainage and release of water from the vents after the bucket breaks the surface; these losses are typically much smaller than the losses from a conventional clamshell. The enclosed buckets act as a control to reduce greatly erosion of the sediment from the bucket as it is raised through the water column. In addition, the seals of the bucket reduce the loss of the bucket contents as the forces increase when the bucket breaks the water surface. The presence of debris can keep the jaws from closing and cause the loss of much of the bucket contents. Additionally, enclosed buckets leave a significant residuals layer that is also a major source of contaminant release.
- **Articulated Bucket (Medium)** – Enclosed buckets can be operated such that the excavation and water column exposure of the bucket are within a silt curtain enclosure; however, the bucket continuously moves through the water column drawing and releasing solids throughout the depth of the water column. Contaminants are released by washing the surfaces of the dirty bucket as well as some drainage and release of water from the bucket after the bucket breaks the surface; these losses are typically much smaller than the losses from a conventional clamshell. The enclosed buckets act as a control to greatly reduce erosion of the sediment from the bucket as it is raised through the water column. In addition, the seals of the bucket reduce the loss of the bucket contents as the forces increase when the bucket breaks the water surface. The presence of debris can keep the jaws from closing

- and cause the loss of much of the bucket contents. Enclosed and articulated buckets can often provide controls to reduce the potential for and magnitude of such losses. When necessary for erodible, sticky sediments, rinse tanks can be used to wash the bucket at the end of each cycle to reduce potential releases. The barge also provides a source of contaminant release to the air and possibly to the surface water. Articulated buckets manage the residuals layer better and lessen the potential contaminant release from residuals.
- **Horizontal Auger (Low)** -- Auger dredges have been fitted with hoods or shrouds in an attempt to partially control the spread of resuspended sediments, but there are no definitive data to support their effectiveness. Auger dredges require multiple passes for all but a very thin contaminated sediment layer; the contaminant releases become greater with each pass as a fluid residuals layer is formed that is readily resuspended by the auger dredge on subsequent passes. Horizontal auger dredges can be operated within silt curtain or sheet pile enclosures, but the cable and wire arrangements would make operations difficult and the footprint of such enclosures would necessarily be larger than that for mechanical dredges or swinging ladder cutterheads.
 - **Conventional Cutterhead/ Swinging Ladder Cutterhead (Low to Medium)** – Cutterheads have been fitted with hoods or shrouds in an attempt to partially control the spread of resuspended sediments, but there are no definitive data to support their effectiveness. Cutterhead dredges can also be fitted with a variety of cutter baskets or dredgeheads, some specially designed to reduce resuspension. All hydraulic and pneumatic dredges are capable of transporting the material directly by pipeline to subsequent disposal or treatment, minimizing exposure to the entire water column and exposure of excavated material to volatilization at the dredging site. Conventional cutterhead dredges can be operated within silt curtain or sheet-pile enclosures, but the cable and wire arrangements would make operations difficult and the footprint of such enclosures would necessarily be larger than that for mechanical dredges or swinging ladder cutterheads. Additionally, cutterhead dredges leave a thick residuals layer that is also a major source of contaminant release. However, the residuals and contaminant release can be reduced by using an articulated ladder. Cutterhead dredges tend to require fewer passes for thick contaminated sediment layers than many other dredges, which would reduce the potential contaminant releases but

- may increase contaminant concentration due to its higher production rate.
- **Plain Suction/ Pneumatic/Specialty (Medium to High)** – All hydraulic and pneumatic dredges are capable of transporting the material directly by pipeline to subsequent disposal or treatment, minimizing exposure to the entire water column and exposure of excavated material to volatilization at the dredging site. Plain suction and pneumatic dredges do not mechanically disturb the sediment bed and therefore control resuspension and residuals. In addition, these dredges may have specialty dredgeheads designed specifically to control resuspension and contaminant release during production passes, but production dredgeheads are not usually as efficient at controlling/capturing residuals as cleanup dredgeheads, permitting contaminant release from residuals. Consequently, these dredges limit the potential contaminant release.
 - **Diver-Assisted (High)** – The scale of diver-assisted dredging would seldom require contaminant release controls.
 - **Dry Excavation (High)** – Dewatering of the dredging area effectively eliminates dissolved releases.

5.3.9. Residual sediment control and cleanup levels

Residuals generation is the process by which the dredging operation leaves some mass and concentration of contaminated sediment remaining in the area dredged after completion of dredging. The level of concern surrounding the residuals depends on both the concentration of the contamination in the sediment and the density and thickness of the contaminated surface layer (see Chapter 1). Additional descriptions of residuals processes and considerations for evaluating residuals are found in Chapter 7.

Residual sediment may be in the form of dredge-generated residuals or undisturbed residuals (Bridges et al. 2008). This selection factor refers to how efficient the dredge is in removing material without leaving a dredge-generated residual or sediment above the cut line, and therefore how efficient the dredge type may be in meeting a cleanup level.

All dredges leave some residual sediment, and it has become clear with field experience that residual sediment can be a major factor driving cost and effectiveness of an environmental dredging project. Generated residuals thicknesses for environmental dredging projects have ranged

from an inch up to a foot, while measured residual contaminant concentrations have varied widely, ranging from less than 1 percent to near 100 percent of the pre-dredge concentrations (surficial concentrations were actually higher after dredging for a few projects) (Herrenkohl et al. 2003). Residuals contaminant concentrations have been predicted for some projects based on an average contaminant concentration of the pre-dredging sediment profile or on an average concentration of the last dredge cut/pass (Herrenkohl et al. 2003, Service Environmental 2002, Palermo and Patmont 2007), and such predictions compared favorably with post-dredging sampling at the New Bedford Harbor site (Herrenkohl et al. 2003). A cleanup pass with overdredging into a clean sediment layer may yield cleaner residuals. The dredge plan can be designed with explicit consideration of potential residuals (LaRosa and Patmont 2007).

The ratings and associated technical basis for residual sediment control/cleanup levels are as follows:

- **Conventional Clamshell (Low)** – Conventional clamshell dredges have a high potential to leave residual sediment because of the circular-shaped cutting action and the tendency to leave a cratered irregular bottom subject to sloughing; the spillage of sediment from the open bucket as it is raised through the water column; and the positioning difficulties associated with a wire-rope-suspended bucket. One favorable aspect of a conventional bucket is that it tends to close on an arc around a mass of sediment with limited remolding that can cause near-liquid-like residual material.
- **Enclosed Bucket (Low to Medium)** – Enclosed buckets generally result in lower residuals than conventional clamshell buckets. Both clamshells and enclosed buckets that are wire supported are difficult to hold on station on slopes, which may contribute to the formation of residual layers.
- **Articulated Bucket (Medium)** – While many of the bucket issues associated with enclosed buckets apply to articulated buckets, the control accuracy offered by the articulated bucket provides a significant advantage for removal compared to a wire-rope-supported bucket. Articulated buckets are also effective in removing material from slopes. These factors combined can result in more effective removal and less residual formation as compared to other mechanical dredges. The

- control offered by the articulated arm also provides an advantage for removal of thin residual layers.
- **Conventional Cutterhead/ Swinging Ladder Cutterhead/ Horizontal Auger (Low)** – All dredges with active dredgeheads and/or movement in contact with the bottom sediment will leave residual sediment. Conventional cutterhead dredges can generate significant spillage layers of contaminated sediment, even when dredging is advanced into underlying clean material. Horizontal auger dredges can generate significant spillage layers if the sediment has low strength or if debris is present in the sediment, and have difficulty holding track lines in the presence of debris, rock, or sloping bottom resulting in incomplete removal of contaminated sediment. Articulated ladders allow the cutterhead dredges to operate with less potential for generated residuals related to fallback.
 - **Plain Suction/ Pneumatic (Medium to High)** – Hydraulic dredgeheads that don't shear and disturb the sediment, but primarily draw the sediment into the suction pipe, can be effective in capturing the impacted sediment without significant residuals, provided that the material to be dredged is of low strength that can be captured without application of disturbing forces from cutterheads or augers.
 - **Specialty Dredgeheads (High)** – Some specialty dredges and dredgeheads are specifically designed for control of generated residuals or removal of generated residual layers, and application has proven effective in meeting CULs.
 - **Diver-Assisted (High)** – The hand-held action of diver-assisted work has a low potential for generating residual sediment.
 - **Dry Excavation (High)** – Any fallback of sediment excavated under dry conditions can be readily observed and managed.

5.3.10. Transport by pipeline

Distance to the treatment/disposal location and the optimal condition for the material arriving at that location will greatly influence the selected method of transport. The selection factor for transport by pipeline refers to the compatibility of the dredge with subsequent transport by pipeline. This selection factor and the companion selection factor for transport by barge are closely related to the operational characteristic of percent solids as described above.

Hydraulic pipeline dredges are designed to pump material directly to a disposal or treatment site for distances up to several miles and even over

longer distances if booster pumps are used. However, the pumping distances associated with the smaller hydraulic dredges commonly used for sediment remediation are typically much less than associated with larger navigation hydraulic dredges. Debris present in the sediment can plug the pipeline, especially the smaller-diameter pipelines typically associated with sediment remediation.

The addition of water by the hydraulic dredging process (as described above) allows for easy hydraulic transport, but the additional water released from a disposal facility may require treatment. Also, if the dredged material must be in a dewatered condition prior to disposal (e.g., in a landfill) or treatment, active dewatering would usually be needed as pre-treatment, and the excess water would likely require treatment prior to discharge. Some specialty dredges and pneumatic dredges are able to transport slurry at comparatively high solids contents, but long-distance pumping of high solids slurries can present challenges.

Pipeline transport can be used in conjunction with mechanical dredging through the use of specialized additional equipment. Mechanical dredging removes the sediment at close to the in situ conditions as described above, but material at this solids content is generally too stiff to pump via pipeline without the addition of water. High solids content pumps can be used or water can be added to slurry the material. Some of the newer concepts and designs involve use of dual pipelines for hydraulic re-slurry of mechanically dredged material from barges (one for transport to the treatment/disposal site with another for return of excess water for subsequent re-use).

The ratings and associated technical basis for transport by pipeline are as follows:

- **Conventional Clamshell/ Enclosed Bucket/ Articulated Bucket (Medium)** – All mechanical dredges remove material at near in situ density, and are typically paired with barges for transport of dredged material. Additional reslurry and rehandling equipment must be employed to allow for pipeline transport.
- **Conventional Cutterhead/ Swinging Ladder Cutterhead/ Plain Suction/ Horizontal Auger/ Pneumatic/ Specialty Dredgeheads/ Diver-Assisted (High)** – All hydraulic and pneumatic dredges are designed for pipeline transport.

- **Dry Excavation (Medium)** – Dry excavation normally involves placing excavated material into trucks for transport. Additional reslurry and rehandling equipment must be employed to allow for pipeline transport.

5.3.11. Transport by barge

This selection factor refers to the compatibility of the dredge with subsequent transport by barge and is practically the mirror image of that for transport by pipeline. A barge transport operation ideally involves use of several barges, one being filled while others are being transported and emptied, so that the dredge may operate on a close-to-continuous basis with minimal downtime. Since many environmental dredging projects involve removal of material in relatively shallow water, smaller shallow-draft barges (approximately 500 to 1500 m³) would normally be used as compared to the larger barge sizes commonly used for navigation dredging (up to 4500 m³).

Efficient use of barges requires the material to be loaded in as dense a condition as possible. For this reason, mechanical dredging is ideally matched with barge transport. Barge transport requires an offloading process. If mechanically dredged, the offloading can be accomplished either mechanically or hydraulically, but if hydraulically dredged, the offloading would also most likely need to be performed hydraulically as well. Hydraulic pipeline dredges can be used with barge transport, but such an operation is an inefficient use of equipment capability. The flowrate generated by hydraulic dredging would quickly fill a small barge with low-density slurry, and once the slurry is transported for offloading, the requirements for dewatering and water treatment would be similar to that for direct pipeline transport.

The ratings and associated technical basis for transport by barge are as follows:

- **Conventional Clamshell/ Enclosed Bucket/ Articulated Bucket (High)** – Material excavated with mechanical dredges is close to in situ density and may be directly placed in barges for transport.
- **Conventional Cutterhead/ Swinging Ladder Cutterhead/ Plain Suction/ Horizontal Auger/ Pneumatic/ Specialty Dredgeheads/ Diver-Assisted (Low to Medium)** – Barge transport of hydraulically dredged material is inefficient. Although

pneumatic and some specialty dredges are capable of removing soft sediments at high solids content, intermittent operation for change-out of barges will reduce efficiency.

- **Dry Excavation (High)** – Material excavated in the dry may be placed directly in barges using conveyers or front-end loaders.

5.3.12. Positioning control

This selection factor refers to the ability of the dredge to hold a desired position of the dredgehead horizontally with current, wind, or vertically with fluctuating tides. All the dredge types listed in Table 3 operate with a spud arrangement with the exception of the horizontal auger dredge that is free-floating and uses a cable-and-anchor system. Spuds are essentially vertical piles that can be set in the bottom material to provide reaction force for the excavating action of mechanical dredges or a pivot for the swinging action of hydraulic pipeline dredges. Some of the dredge types may also use jack-up piles, an even more stable arrangement. Of course, divers are free-standing and subject to currents. Clamshell and enclosed buckets that are wire-supported are subject to movement by currents and are therefore more difficult to maintain in position, especially for deeper water depths. In addition, the wire-supported arrangement allows buckets to skew as they impact a sloping bottom, and this may reduce the accuracy of position and overlap. Positioning control is easily maintained for dry excavation.

The ratings and associated technical basis for positioning control are as follows:

- **Conventional Clamshell/ Enclosed Bucket (Medium)** – Mechanical dredges operate with spuds or jack-up piles and are inherently stable against movement by normal winds and currents. However, positioning control (horizontal and vertical) of buckets suspended on wire rope is difficult to maintain.
- **Articulated Bucket (High)** – Mechanical dredges operate with spuds or jack-up piles and are inherently stable against movement by normal winds and currents. The fixed-arm support allows for steady positioning of the bucket in currents. Positioning control (horizontal and vertical) of articulated fixed-arm dredges can be quite accurate when based on RTK-GPS and electronic instrumentation.
- **Conventional Cutterhead/ Swinging Ladder Cutterhead/ Plain Suction/ Specialty Dredgeheads (High)** – Hydraulic

dredges equipped with spuds and using a “walking spud” or kicker spud method of operation are inherently stable against movement by normal winds and current.

- **Horizontal Auger (Medium)** – Horizontal auger dredges are free-floating and operate using an anchor-and-cable system. The auger dredge is subject to movement in winds and currents with longer anchor sets. The dredge can also be pulled off line if the auger engages stiff sediment, debris, or rock.
- **Pneumatic (High)** – Pneumatic dredges operate from spudded barges or platforms and are inherently stable against movement by normal winds and currents.
- **Diver-Assisted (Medium)** – The ability of divers to maintain a desired position is hampered by currents.
- **Dry Excavation (High)** – Dry excavation is not affected by wind and currents. The containment must be designed for normal tidal or river stage fluctuation.

5.3.13. Maneuverability

Maneuverability refers to the ability of the dredge to operate effectively within the physical limitations of a dredging site that may limit the type and size of equipment that can be used. These limitations include proximity to utilities and other infrastructure, narrow channel widths, surface and submerged obstructions, and overhead and other site access restrictions, such as bridges. Contaminated sediments may be located next to piers, stabilized shorelines, under bridges, etc. The presence of buried utilities, pipelines, and other infrastructure may also require buffer zones for clearance that may limit the ability of the dredge to gain access to all the areas requiring excavation. The mechanical dredges generally have the ability to operate closer to infrastructure and within tighter areas than the hydraulic dredge types.

The ratings and associated technical basis for maneuverability are as follows:

- **Conventional Clamshell/ Enclosed Bucket/ Articulated Bucket/ Pneumatic (High)** – Because the buckets are wire-supported or fixed-arm articulated, mechanical dredges may be operated close to infrastructure, such as bridges or piers, and within tightly restricted areas, such as narrow slips or channels. Pneumatic pumps supported by wire would have similar advantages.

- **Conventional Cutterhead/ Plain Suction/ Horizontal Auger/ Specialty Dredges (Low)** – The swinging action of the walking spud method of operation for hydraulic pipeline dredges and the need for long anchor and cable setup for horizontal auger dredges limit their ability to operate near infrastructure or within tightly restricted areas.
- **Swinging Ladder Cutterhead (High)** - Dredges with walking spuds or any system for self propulsion can maneuver into more restricted areas than those same dredges with anchor or cable systems. The swinging-ladder cutterhead dredge operates from a position fixed by spuds with only the ladder swinging. Its relatively small size and ability to move on a walking spud make this dredge quite maneuverable.
- **Diver-Assisted (High)** – Diver-assisted work can be conducted close to infrastructure and within tightly restricted areas.
- **Dry Excavation (High)** – Containments for dry excavation can be designed for areas near infrastructure and tightly restricted areas may be completely contained.

5.3.14. Portability/Access

This selection factor refers to the ability of the dredge to pass under bridges, through narrow channels, or to be transported by truck and easily launched to the site. Since this document focuses only on small dredges, the ability to pass under bridges or through narrow channels would not normally be of concern. Nevertheless, the ability for truck transport and easy launching is a consideration for some small dredges.

The ratings and associated technical basis for portability/access are as follows:

- **Conventional Clamshell/ Enclosed Bucket/ Articulated Bucket/ Conventional Cutterhead/ Swinging Ladder Cutterhead/ Plain Suction/ Horizontal Auger/ Pneumatic/ Diver-Assisted/ Dry Excavation (High)** – The dredge types considered here are smaller in size and are generally truck transportable.
- **Specialty Dredgeheads (Medium to High)** – Some specialty dredge designs are too large for truck transport.

5.3.15. Availability

This factor refers to the potential availability of dredge types to contractors and the potential physical presence of the equipment in the United States. All the basic dredge types described in this section are available to contractors to perform environmental dredging work. The one exception is the full range of the specialty dredges. Since these dredges were designed and are widely available only in countries outside the United States, there may be constraints on availability for U.S. projects. The Jones Act restricts use of dredges mounted on foreign-made hulls, but the use of a foreign-made dredgehead on a U.S. vessel is not restricted. Several U.S. companies have formed partnerships allowing for use of specialty equipment from a variety of countries, but the availability of a specific specialty dredge through only one contractor presents a significant constraint on competitive bidding.

The ratings and associated technical basis for availability are as follows:

- **Conventional Clamshell/ Enclosed Bucket/ Articulated Bucket/ Conventional Cutterhead/ Swinging Ladder Cutterhead/ Plain Suction/ Horizontal Auger/ Diver-Assisted/ Dry Excavation (High)** – Most dredge types are readily available.
- **Pneumatic/ Specialty Dredgeheads (Medium)** – Some specialty dredges are only available through one contractor or may be subject to restrictions under the Jones Act.

5.3.16. Debris/Loose Rock/Vegetation

Debris is commonly present in rivers in industrialized areas and in nearshore sediments, especially in areas adjacent to piers, etc. The debris may be composed of almost anything, but pieces of piling, logs, vegetation, cable, welding rods, shopping carts, etc., are common. Some projects also involve presence of loose rock (cobble size to boulder size). Such debris tends to clog hydraulic dredgeheads, causing downtime and loss of production (in fact large debris is essentially left behind by small hydraulic dredges). Debris can prevent mechanical buckets from fully closing, causing increased sediment resuspension and contaminant release. This factor refers to the ability of the dredge type to effectively remove sediment containing debris or loose rock without excessive resuspension or excessive downtime to remove clogs, etc. In general, mechanical

dredges are well-suited to remove debris (as in a debris removal pass) or to remove sediment with small debris present, even though presence of debris may result in some bucket leakage. The smaller hydraulic dredges can cut through some small debris, and small rocks and debris can pass through the pumps, but these dredges cannot remove larger loose rock or large debris such as logs or pilings. The effectiveness of the smaller hydraulic dredges normally associated with sediment remediation is diminished by the presence of debris. The smaller hydraulic dredges can pass small debris (3" to 6", depending upon clearance within the pump, up to approximately 0.5 x discharge pipe diameter if pump clearance allows) but cannot remove larger loose rock or larger debris such as logs or pilings. Specific debris, such as rope or small pieces of carpet, typical in many marinas, can be especially problematic for small dredges.

The ratings and associated technical basis for debris, loose rock, and vegetation are as follows:

- **Conventional Clamshell/ Enclosed Bucket/ Articulated Bucket (High)** – Mechanical dredges can effectively remove sediments containing debris, although leakage may result. Mechanical equipment is the only approach for debris removal passes.
- **Conventional Cutterhead/ Swinging Ladder Cutterhead/ Plain Suction/ Horizontal Auger/ Pneumatic/ Specialty Dredgeheads (Low to Medium)** – The hydraulic or pneumatic dredges are subject to clogging by debris and are incapable of removing larger pieces of loose rock and larger debris. Loose rock and large debris can also cause inefficient sediment removal. Some specialty dredges have systems to screen or clear debris.
- **Diver-Assisted (Low)** – Presence of logs and large debris may present dangerous conditions for diver-assisted dredging. Although divers can remove sediment from around large debris or rocks, this type of operation would be inefficient.
- **Dry Excavation (High)** – Dewatering of areas for dry excavation allows use of conventional excavation equipment. Leakage from buckets caused by debris is not a consideration for dry excavation.

5.3.17. Hardpan/Rock Bottom

The presence of a rock bottom or hardpan with overlying softer contaminated sediments presents a most difficult condition for environmental dredging. No dredge type is ideally suited for efficient

operation in such conditions. This factor refers to the ability of a dredge type to remove efficiently a sediment layer overlying hardpan or rock bottom without leaving excessive residual sediment. Rock bottom or hardpan interfaces would normally be uneven and may contain loose rock from natural processes or from blasting if the project is in proximity to navigation channels, etc. The uneven hard surface prevents any dredgehead from maintaining a level cutting action. Dredgeheads with moving cutting components (e.g., cutterheads or augers) would tend to “bounce” off the hard surface during operation, leaving behind excessive residual sediments. The rotating auger of an auger dredge will catch on and then walk along a portion of protruding rock or hard sediment, resulting in the dredge being pulled off line. Mechanical buckets would be prevented from level cutting action and would tend to leave behind excessive residuals at the hard surface. Plain suction, including some of the specialty dredges that operate with essentially a plain suction removal action, may provide some advantage. However, even the advance action of these dredge types over an uneven hard surface may be impeded and leave excessive residuals. Use of one equipment type for removal of most of the sediment mass, followed by another equipment type for residuals atop the hard surface, may be the best approach for these conditions. An exception is a specialty dredge (Slope Cleaner) that has been designed specifically for removal of soft sediments accumulating between riprap linings along channels in The Netherlands.

The ratings and associated technical basis for hardpan/rock bottom are as follows:

- **Conventional Clamshell/ Enclosed Bucket/ Articulated Bucket/Cutterhead/ Horizontal Auger (Low)** – The closing action of mechanical buckets, the cutting action of hydraulic pipeline dredgeheads, and the walking of an auger that catches a hard edge would result in problems maintaining a desired vertical cutting position and would tend to leave behind excessive residual sediment. Power associated with articulated mechanical dredges has an advantage in removing hard materials.
- **Plain Suction/ Pneumatic/ Specialty Dredgeheads (Medium to High)** – Plain suction dredges and some pneumatic and specialty dredges lack an active closing or cutting action and can operate over an uneven hard surface, although removal efficiency may be low. Specialty

dredgeheads (VicVac) have proven effective in removing residual layers overlying hardpan.

- **Diver-Assisted (High)** – Diver-assisted dredging may be the most effective approach for precise cleanup of a hard face, since the divers can feel the surface and adjust the excavation accordingly.
- **Dry Excavation (High)** – Dry excavation allows the visual location of pockets of residuals remaining on an uneven hard surface.

5.3.18. Sloping bottom

Environmental dredging is often required in areas extending from deeper water to the nearshore, and the bottom bathymetry as well as the target layer of contaminated sediment is therefore often sloping. A sloping bottom presents difficulties for conventional dredge equipment types that were developed to produce level cuts, as for navigation dredging. Although dredge prisms can be designed with level box or step cuts (See Chapter 9), application of conventional dredging techniques to the removal of a sloping layer of sediment has yielded mixed results. Dredging on slopes can be operationally inefficient and can result in increased sediment resuspension, increased residuals (especially undisturbed residuals), and increased removal of underlying clean sediments. This selection factor refers to the ability of equipment types to effectively remove sediments from sites with a sloping bottom bathymetry.

- **Conventional Clamshell/ Enclosed Bucket (Low)** – Wire-rope-supported buckets have limited effectiveness removing contaminated sediment from sloping sites. As wire-supported buckets are lowered towards a sloping bed, the uphill side of the bucket contacts the slope first, causing the bucket to tip and then slide down the slope, moving off the intended location and disturbing the sediment on the slope. The penetration of wire-supported buckets is also dependent on the stiffness of the sediments, and this may make it more difficult to control the construction of box or step cuts.
- **Articulated Bucket (Medium)** - The control and excavating force of the fixed arm allow articulated buckets to more effectively remove material from slopes at the desired cut elevation and better control the desired position and overlap. The articulated fixed-arm dredge can place, hold, and close its bucket on slopes with more control than wire-supported buckets.

- **Conventional Cutterhead (Low)** – Conventional cutterheads are designed for making level cuts, with the ladder swinging at a set depth across the width of the cut.
- **Swinging Ladder Cutterhead (Medium to High)** – Swing Ladder Cutterheads constructed for environmental dredging are usually equipped with an articulated ladder and recent advancements in digital positioning that provide the capability to swing the ladder along a sloping bottom and simultaneously control the cutterhead orientation to remain parallel to the bottom, resulting in effective removal along the slope.
- **Horizontal Auger (Low)** – Augers are designed to make horizontal cuts and are not configured for removing a sloping layer of material. The width of the auger, combined with the straight-ahead mode of advancing the dredge, presents challenges for creation of step cuts on sloping bottoms.
- **Plain Suction/ Pneumatic (Low to Medium)** – Plain suction dredges and pneumatic dredges have similar limitations for slope dredging as mechanical or conventional cutterheads.
- **Specialty Dredgeheads (High)** - Some specialty dredges have been designed specifically for slope dredging.
- **Diver-Assisted (High)** – The hand-held action of diver-assisted work allows for working on a sloping bottom. Divers can guide the dredge along a sloping surface and remove a sloping layer of material, provided that the material is of low strength that can be captured by the diver-assisted dredge. However, positioning in real time of the diver and suction pipe can be difficult. If soft sediment overlying stiffer material exists on a slope, the diver can typically follow the interface, removing the soft sediment.
- **Dry Excavation (High)** – Sloping bottoms may require more substantial containment structures, but once contained, dry excavation allows use of a full range of conventional excavation equipment to remove contaminated sediment from a sloping surface.

5.3.19. Flexibility for varying conditions

For some projects, the thickness of sediment to be removed or the sediment and site conditions may vary considerably. This selection factor refers to the flexibility of a given dredge type in adapting to differing conditions, such as sediment stiffness, variable cut thicknesses, and the overall ability to take thick cuts.

The ratings and associated technical basis for flexibility for varying conditions are as follows:

- **Conventional Clamshell/ Enclosed Bucket (High)** – Conventional clamshells and enclosed buckets are capable of taking thin cuts or thicker cuts in proportion to the bucket size. In addition, different bucket sizes can be easily switched with these dredge types to adapt to varying conditions between areas to be dredged.
- **Articulated Bucket (Medium)** – Grab buckets for articulated mechanical dredges are capable of taking thin cuts or thicker cuts in proportion to the bucket size. The ability to change bucket sizes for articulated mechanical is more limited than for wire-supported buckets, but different buckets are available and can be easily switched to adapt to varying conditions.
- **Conventional Cutterhead/ Swinging Ladder Cutterhead (Medium)** – Cutterhead dredges are capable of taking variable cut thicknesses by varying the burial depth of the cutter. In addition, different cutterhead sizes or designs can be used to adapt to changing cut thicknesses or sediment stiffness. In addition, cutters can be removed, and the dredge may be used as a plain suction dredge or specialty dredgeheads for cleanup may be used. However, the effectiveness of the dredges is readily impacted by debris and hard substrate.
- **Horizontal Auger (Low)** – Auger dredges are designed for a set optimized cut thickness and cannot be easily changed.
- **Plain Suction (Low)** – Plain suction dredges remove material without any cutting action and are limited in their ability to take thicker cuts or remove stiffer materials.
- **Pneumatic (Low)** – Pneumatic dredges remove material without any cutting action and are limited in their ability to take thicker cuts or remove stiffer materials.
- **Specialty Dredgeheads (Low)** – Most specialty dredges are designed for a specific application and have limited flexibility.
- **Diver-Assisted (Low)** – Diver-assisted removal is limited to thin cuts.
- **Dry Excavation (High)** – Dry excavation allows use of a full range of conventional excavation equipment.

5.3.20. Thin lift/residuals removal

Contaminated sediments are often present in thin lifts or thicknesses, which requires the dredge to remove thin cuts. In addition, environmental dredging projects, regardless of the initial thickness of material, may require removal of thin layers of residual sediment once the full cuts have been completed. This selection factor refers to the ability of a given dredge type to remove thin layers of contaminated material without excessive overdredging.

The ratings and associated technical basis for thin lift/residuals removal are as follows:

- **Conventional Clamshell (Low)** – The circular-shaped cut of a conventional clamshell is not suited to efficient removal of thin layers.
- **Enclosed Bucket/ Articulated Bucket (Medium)** – Enclosed buckets with level cutting action are capable of removing thin layers, particularly if they can dig a bit deeper than the thin layer. Taking thin cuts will result in buckets mostly filled with water, resulting in higher handling and treatment costs.
- **Conventional Cutterhead/ Swinging Ladder Cutterhead (Medium)** – Cutterheads are capable of removing thin layers, provided the cutterhead can dig deeper than the thin layer. However, the cutterhead will still leave a spillage layer impacted by the contamination in the thin layer. The percent solids in the pipeline is reduced under these conditions.
- **Horizontal Auger (Medium)** – Augers are capable of removing thin layers provided the auger can dig deeper than the thin layer, but only for horizontal cuts. The auger dredge will still leave a spillage layer impacted by the contamination in the thin layer. The percent solids in the pipeline is reduced under these conditions.
- **Plain Suction (High)** – The action of a plain suction dredge is well suited for removal of thin lifts, especially loose material such as residual sediment. Recent development of special suction dredgeheads has resulted in projects meeting the remediation goals (Otten and Webb 2008).
- **Pneumatic (High)** – Pneumatic dredges use plain suction and are well suited for removal of thin lifts, especially loose material such as residual sediment.
- **Specialty Dredgeheads (High)** – Some specialty dredges are designed specifically for removal of thin lifts.

- **Diver-Assisted (High)** – The precision of diver-assisted dredging is well suited for removal of thin layers, especially residuals.
- **Dry Excavation (High)** – Dry excavation allows for a precise control of cut thickness and is amenable to removal of thin layers.

5.4. Summary of considerations in selection of equipment

The information in this chapter is intended to help project managers make initial screening assessments of general dredge capabilities and identify equipment types for further evaluation at the feasibility study stage or for pilot field testing. Note that whenever an equipment type receives a rating of “high,” it means that a particular dredge type should perform better for that selection factor. It is not intended as a guide for final equipment selection for remedy implementation. Many site-specific circumstances dictate which equipment type is most appropriate for any given situation, and each type can be applied in different ways to adapt to site conditions. In applying the equipment selection factors in Table 3, consideration should be given to weighting factors most critical at the specific site.

If the past is any indication of the future, technological advances will continue to enhance the effectiveness of dredges. That may change the rating of the effectiveness of the dredges as presented on Table 3. Project managers should use their own experience and judgment in applying this information and they might find it useful to consider other sources of information for purposes of comparison. In addition, because new equipment is being continuously developed and tested, project managers may need to consult with experts who are familiar with the latest in equipment technologies.

In addition to selection of the proper equipment, a sound dredging plan, experienced operators, monitoring, and management of operations are important factors for a successful environmental dredging operation. Experience has shown that an effective environmental dredging operation depends on the use of experienced contractors and highly skilled dredge operators familiar with the goals of environmental remediation. An operationally efficient dredge plan that accounts for site conditions, dredging requirements, and equipment capabilities, paired with good monitoring and management, will also help to ensure an effective dredging operation.

5.5. Case studies

Equipment used, site conditions, performance specifications, and other useful information can be found in the project summaries on the MCSS website. Excerpts from these and other projects are included here.

From a review of the MCSS database, it is apparent that for many environmental dredging projects, excavation is not limited to sediments, but includes excavation of banks and upland or wetland soils as part of a comprehensive site remedy. In these cases, multiple excavation methods are used. Of 62 projects reviewed from the MCSS, over 30 percent used multiple dredging methods. Of those projects using a single excavation method, dry excavation was most common (24 percent), followed by hydraulic (18 percent), mechanical (16 percent), and wet excavation (5 percent). (For purposes of this document, wet and dry excavation represents excavation with conventional earthmoving equipment, either through the water column or in the dry.) A small percentage of projects (3 percent) used capping in addition to excavation.

At Newburgh Lake, sediment removal was by cutterhead in the flooded (river) sector of the lake (the remainder of the lake was drained), by dragline bucket in the 500 ft upstream into the Middle Branch (of the Rouge River), and by earth-moving equipment in the dry lake bottom. At the Marathon Battery site, dry excavation was used in marsh areas, and hydraulic and mechanical dredging for cove and pond areas. Water depth and obstructions were determinants for which sediments were dredged hydraulically and which were dredged mechanically.

The impact of site conditions on equipment selection and production is a common theme throughout the project histories. Obstructions such as debris, structures, silt curtains or other in-water containment structures common to environmental dredging projects, contribute to increased dredge downtime and reduced production. Deep water, high winds, and bedrock also present challenges to the dredging operation, in some cases necessitating changes in equipment. In one case, an area where bedrock was encountered was ultimately dewatered and conventional earthmoving equipment was used to remove layers of residuals that could not be removed with the dredge. In other cases, diver-assisted dredging was employed to remove sediment inaccessible to the dredge.

At Cumberland Bay, for example, dredging of paper sludge, contaminated wood pulp, and wood chips was accomplished with two horizontal auger dredges operating simultaneously along with diver-assisted dredging. Over two years of dredging, the average production rate reported was a very low 25-30 yd³/hr/dredge (at 3.5 percent solids). Post-dredging sampling and diver inspection showed areas where the dredgehead had bridged, leaving sludge in bottom valleys, and where the dredge had failed to penetrate a thin (4-in.) hardpan overlying more contaminated sludge several feet thick. At Manistique River/Harbor, where dredging was done with a hydraulic matchbox dredge, problems were encountered due to high polychlorinated biphenyl (PCB) levels near the bedrock interface, imprecision of the dredge, and heterogeneous layers of sediment, paper pulp, and slab wood. Diver-assisted dredging was required to work around the slab wood. On-land water handling ability reportedly was also a dredging constraint. A total of 187K yd³ was dredged at Manistique over a period of six years, with volumes ranging from 10K yd³ to 37K yd³ annually. However, it is unknown what role budget and other planning issues played in the slow production/completion for this project.

The Dupont Newport site and Ketchikan (Ward Cove) sites are examples of sites where all dredging was done mechanically, but site conditions required the use of multiple equipment types. In both cases, cable arm clamshells were used for unconsolidated materials (specifically an environmental cable arm clamshell at Ketchikan). At the Dupont site, the contractor switched to a barge-mounted backhoe in order to achieve higher production and facilitate work under overhead lines. At Ketchikan, a conventional clamshell was used for dredging native (consolidated) materials in which the cable arm clamshell was ineffective. The Lavaca Bay – Project 1 Treatability Study utilized a 20-in. hydraulic cutterhead to remove 51K yd³ from deep water and a 12-in. hydraulic cutterhead to remove 22K yd³ from shallow areas.

Use of conventional earthmoving equipment might be the least-cost option for excavation, since the equipment is common and readily available everywhere. An example is the Bryant Mill Pond (Allied Paper/Portage Creek/Kalamazoo River - Project 1). Materials were excavated from the dry pond area (22 acres, where the dam was previously breached), from the creek bed running through the pond and approximately 4000 ft below the pond, which was diverted prior to excavation. At Bayou Bonfouca, a custom-designed “backhoe on a barge” was used for excavating

4000 linear ft of bayou in depths up to 17 ft. Debris was removed at the dredge, and no significant delays due to debris were reported.

Production and downtime are quite variable at environmental dredging sites. At Gruber's Grove Bay, targeted areas were dredged within a 25-acre water body using a hydraulic auger dredge. On average, dredge production time was 38.9 hr/wk. About 28 days of downtime over a period of 24 weeks was reported due to debris and geotube tearing. Average rigging downtime was 7.2 hr/wk, average equipment downtime was 6.1 hr/wk, and average weather downtime was 3.8 hr/wk. An average production rate of 79 yd³/hr was reported. At New Bedford Harbor, where dredging is ongoing, two Ellicot Mudcat dredges (MC 2000) were used with pump production capacities of 1500 to 3000 gpm at up to 15-percent solids. The dredges are being used to dredge PCB-contaminated sediments and feed a sand separation and dewatering operation. Average production is over 500 yd³ of in situ sediment per day for a 12-hr workday, roughly 42 yd³/hr. The maximum average production capacity of the New Bedford dredges, as equipped, is estimated to be about 150 in situ yd³/hr, considering normal downtime for repositioning and dredge tending. A production rate of 42 yd³/hr represents about 28-percent efficiency for these dredges, without taking into account the additional impact of one dredge operating only 3 to 4 hr per day (1.5 to 2 hr either side of high tide). In order to perform continuous dredging during the entire 12-hr day, the second dredge is set up in an area that is not affected by the tide. These examples illustrate the typical infeasibility of using large, production-type dredges for environmental dredging projects, and the impact of site conditions on production, equipment selection, and dredging cost. Mechanical dredging is somewhat less sensitive, but production rates are nevertheless impacted. Wang et al. (2002) report cycle times of 1 to 1.2 min/cycle (340 to 408 cy/hr) for conventional production dredging and cycle times of 4 to 8 min/cycle (42 to 84 yd³/hr) for environmental dredging (assuming an 8-yd³ bucket in 50 ft of water).

6 Evaluating Production, Project Duration, and Transport

The next step in the environmental dredging evaluation/design process is evaluating production rate. The evaluation should result in the selection of the number of dredges required, the required dredge size(s), and the associated transport requirements needed to implement the project. Dredge types, production rates, and sizes are needed to evaluate resuspension, release, and residuals processes. This chapter describes the considerations in evaluating production and the relationship of production and other factors to selection of dredge sizes, number of dredges, transport requirements, and estimated duration of the project.

6.1. General considerations for evaluation of production

6.1.1. Approach

Dredging production refers to the rate of sediment volume removed per unit time from the site, usually expressed in cubic yards per hour or cubic yards per day. The standard measure of volume used in calculating dredge production is the in-place, or in situ, quantity of cubic yards removed by dredging. Two standard measures of time are used in calculating dredge production, the “effective working time” and the “dredging time.” The specific definitions of these time measures are described below [Engineer Regulation 1110-2-1302, Appendix G Preparation of Dredge Cost Estimates USACE 1994)]:

- **Effective Working Time.** Effective working time is the time during the dredging operations when actual production is taking place, such as material moving through the pipeline or being placed into a sediment barge. This is also referred to as “operating time.”
- **Non-effective Working Time.** Non-effective working time is the time during the dredging operations when the dredge is operational but no production is taking place, such as time spent making changes to pipelines, cleaning debris from the suction head, changing sediment barges, moving the dredge, standing by for navigation traffic, making minor operating repairs, and refueling. This is also referred to as “allowable downtime.” The time required for cleanup passes would

- typically be included as non-effective working time because much of the sediment removed is not typically in the dredging prism.
- **Dredging Time.** Dredging time is the sum of effective working time and non-effective working time.
 - **Lost Time.** Lost time is the time when the dredge is not operational due to factors such as lack of required crew, major repairs and alterations, dry-docking, and cessation of the work due to quality of life or water quality concerns.
 - **Effective Working Time Efficiency (EWTE)** (also Time Efficiency). The ratio of the effective working time to the dredging time is the effective working time efficiency.
 - **Seasonal Efficiency (SE).** The ratio of the dredging time to the dredging duration (sum of dredging time and lost time) is the overall time or seasonal efficiency.

The EWTE for navigation dredging tends to be in the range of 70 percent to 85 percent. The EWTE for sediment remediation projects is typically less than for navigation dredging and can run in the range of 55 percent to 70 percent. The lower EWTE for sediment remediation is associated with increased non-effective time for non-production activities such as maintenance of precision navigation systems, agency inspections, water quality management, turbidity curtains, waiting for test results and/or direction from the owner/engineer, standby for the offloading and/or treatment activities, and health and safety meetings and related activities.

Production rates calculated based on effective working time efficiency and seasonal efficiency are described below as operating production rate and sustained production rate. These rates can be considered and defined in several ways, and it is important to distinguish between operating production rate and overall or sustained production rate:

- **Maximum Operating Production Rate** – The maximum operating production rate is the average production during the effective working time.
- **Average Operating Production Rate** - The average operating production rate is based on the volume of sediment removed during the dredging time, usually expressed in cubic yards per hour. The actual average operating production rate for a given project is calculated by taking the volume of in situ sediment dredged in a shift, a day, a week or over the course of a project, and dividing that by the

dredging time for the shift, day, or week. For example, if there are six 12-hr dredging shifts in a week (72 hr per week) during which the dredge removes 6,200 yd³ of the targeted in situ sediment from full production passes, then the average operating production rate would be 86 yd³/hr (6,200 yd³/72 hr). If the dredge is effective (producing) 44 hr per week, the effective working time efficiency would be 61 percent (44 hr/72 hr = 61 percent EWTE) and the maximum operating production rate would be 140 yd³/hr (6,200 yd³/44 hr or 86 yd³/hr/0.61). The average operating production rate is equal to the product of the maximum production rate and the effective working time efficiency.

- **Sustained Production Rate** - The sustained production rate is based on the volume of targeted in situ sediment removed during the entire dredging season, expressed in cubic yards per day, or as cubic yards per week. This represents an overall or sustained production rate defined as the production rate across a full operating season. Sustained production rates are driven by the need for both production and partial or “cleanup” passes, constraints on allowable times for dredging due to operational and quality of life issues, and possible transport or disposal-related constraints. For example, if a dredge removed 87,000 yd³ over a 14-week time frame, working six 12-hr days per week (a seasonal efficiency of 72 hr/168 hr = 43 percent), the sustained production rate would be about 6200 yd³/week (87,000 yd³/14 weeks) or 890 yd³/day or 37 yd³/hr. The sustained production rate is equal to the product of the average operating production rate and the seasonal efficiency.

The operating production rate represents the pace at which the dredge can remove sediment when it is actually producing material, and the sustained production rate represents the rate at which the overall sediment remediation program can achieve the cleanup goal, accounting for all components of the work. In the above example, the dredge had a maximum operating production rate of 140 yd³/hr, an average operating production rate of 86 yd³/hr and a sustained production rate of 37 yd³/hr, or 890 yd³ per day or 6200 yd³ per week. If the dredge had worked six 24-hr days for 7 weeks, then the sustained production rate could have been 74 yd³/hr or 1780 yd³ per day or 12400 yd³ per week.

A general approach for evaluation of production is as follows:

1. Select dredge type(s) based on the site factors (Table 3).
2. For the dredge equipment type(s) being evaluated, determine whether constraints other than production will dictate the dredge size for the project, and select a dredge size or sizes for evaluation. Estimate maximum operating production rate(s) and effective working time efficiency, and compute the average operating production rate(s). Cleanup dredging should be factored into the estimate of effective working time efficiency.
3. Estimate seasonal efficiency based on allowable working hours due to seasonal restrictions (or dredging windows) estimated times for winter icing, etc., and compute sustained production rate(s).
4. Compare calculated seasonal production rates to daily capacity of transportation/treatment/disposal and adjust as appropriate.
5. Estimate project duration based on the dredging prism volume and sustained production rates.
6. Compare project duration with schedule constraints (environmental windows, dredging season) and related performance standards and select the required number and size of dredges.
7. Determine transport requirements such as numbers of barges, pipeline size, trucks, rail cars.

The number of dredges and dredge sizes should be selected such that:

1. The dredging project is completed in the desired timeframe, considering the potential need for additional dredging to meet cleanup objectives. (Cleanup dredging should be factored into the estimate of effective working time efficiency.).
2. Operations meet performance standards for resuspension, release, and residuals, and post-dredging surface sediment quality.
3. Dredging operations are compatible with the transport, treatment, and disposal components of the remedy.

Each of these factors may yield a different estimate of sustained production. The production evaluation is therefore necessarily an iterative process. For example, a range of production rates for a range of dredge sizes may be calculated, and the numbers and sizes of dredges finally selected to meet the performance standards or desired project duration.

As discussed in Chapter 3, the sediment volume corresponding to a dredging prism should serve as the basis for evaluation of production requirements. The initial neat line prism volume, calculated directly from

the site and sediment characterization data and the CUL, can be adjusted for operational requirements to obtain a dredge prism volume, or a detailed dredge plan can serve as the basis for a dredging prism volume.

As discussed in Chapter 4, there may be specific performance standards for production or for the maximum allowable duration of the project. If there are no specific production-related standards, the project duration can be evaluated in terms of a reasonable timeframe for completion, with completion of the work in a single dredging season when possible.

6.1.2. Factors affecting production for environmental dredging

As compared to navigation dredging, environmental dredging projects are normally characterized by thinner cuts, dredging side slopes as opposed to flat navigation channels, upland delivery of dredged material for processing and/or treatment, and off-site disposal as opposed merely to disposal, smaller equipment sizes with lower operating production rates, increased down time, and environmental constraints on operations resulting in lower sustained production rates.

Cost-effective removal of sediments is a common goal for both navigation and environmental dredging, but the objectives are different and therefore the approaches to dredging and resulting production rates are also different. Efficient production for navigation projects is often expressed as the lowest cost (which often equates to the highest dredging production rate) to remove sediment from a waterway to achieve a required navigation depth (bottom elevation). Unit price navigation dredging contracts motivate the dredging contractor to complete the removal in as little dredging time as possible. In that case the quality of the sediment surface at the end of dredging is of little interest as long as the channel bottom is at or below the required depth.

Efficient production for sediment remediation projects is based on achieving the remediation goal in a cost-effective manner. Using cost-effective navigation dredging concepts (contracts that motivate the contractor to remove the sediment as quickly as possible) has been shown to be ineffective in achieving the cleanup goal, because of the environmental quality issues related to sediment remediation. Considerations such as high bucket speeds through the water column and high fill factors, which are required for cost-effective navigation dredging, are contrary to good practices for sediment remediation. The cost-

effectiveness of sediment remediation is better stated as the lowest unit cost to achieve the remediation goal per square yard of cleanup area. Environmental dredging needs to consider other non-production requirements such as resuspension control and minimization of residuals in order to be effective.

Techniques used to calculate production rates for environmental dredging have been adapted from those used in estimating navigation dredging projects. However, these estimation techniques must consider constraints related to the rate of transport, treatment, or disposal as well as resuspension and release of contaminants, final sediment quality, and the need for cleanup passes. If a high sustained production rate is a critical dredge selection factor in order to complete a block of work in a specified time frame, then multiple dredges may be needed to meet a production standard.

Dredges can be operated in a way to limit resuspension, release, and residuals. For example, reducing swing speed for hydraulic dredging or lengthening cycle time for bucket dredges may reduce the rate of resuspension but will prolong the time required for removal. In some cases the cumulative release from a higher production rate over a shorter time frame may be less than the cumulative release from a slower production rate over a longer time frame. In some situations, slower operations might not achieve efficient production with lower overall resuspension and release. Multiple dredge passes increase the likelihood of removal accuracy as well as decreasing contaminated sediment residuals. Use of skilled operators can have a greater influence on controlling resuspension than dredge rate (Francingues 2001).

A major factor in overall production for environmental dredging is the noneffective dredging time required to meet environmental or other constraints on the operation. Environmental dredging projects are more likely to have such constraints than navigation dredging projects.

Constraints of this nature might include:

- Limitations on water quality impacts, sediment resuspension, contaminant release, or residuals.
- Requirements for moving in and out of enclosures and/or moving such enclosures (silt curtains or release controls).

- Monitoring requirements to verify residual sediment concentrations or water column concentrations prior to movement of enclosures.
- Limitations on dredging during certain times of the day or night, days of the week, or seasons of the year due to adjacent homeowners, other waterway uses, etc.
- Increased maintenance for items such as level cut buckets and precision navigation systems.

Reduction in sustained production rates to meet these constraints can result in the need for multiple dredges, improved control measures, and changes in operation.

Another key consideration regarding production is the throughput rate for any necessary rehandling, pre-treatment, treatment, dewatering, and disposal. Experience with many projects indicates that the overall dredging production rate can be severely limited by these processes, and not by the dredging process itself (Maher and Nichols 1995). Increased stockpile or feed storage volume for sediment removal as a pre-treatment/disposal step and multiple and redundant units for various processes can offset this constraint, albeit at greater cost.

6.2. Selection of dredge size(s) for evaluation

The size and number of dredges will determine the overall production rates for the project. However, production is not the only consideration in selecting dredge size(s). There may be constraints on the maximum dredge size that would require use of multiple dredges to meet a production-related performance standard.

Selection of dredge size(s) for evaluation to satisfy production performance standards for the volume to be dredged should be based on an assessment of the following:

- Constraints on the rate or throughput of sediments as related to transport, rehandling, treatment, or disposal of sediments.
- Thickness(es) of target sediments to be removed.
- Site characteristics and nature of the dredge prism, including debris.
- Dredgeability of the target sediments.
- Production requirements.
- Potential for control of sediment resuspension and associated contaminant release.

- Post-dredging remediation goals and standards.

6.2.1. Dredge size related to transport, rehandling, and disposal constraints

Constraints not directly related to the dredging process itself are especially important and require an evaluation of the integration of the various components of the remedy approach being evaluated. If there are constraints on throughput of sediments not related to the dredging and transport components of the remedy, such constraints will effectively set a ceiling on the production rate and, consequently, the dredge size(s) that can be used for the project.

Some possible constraints on dredge size related to transport, rehandling, etc. are:

- **Accessibility** - If the site is land-locked, only truck-transportable dredges may be used for the work. The largest truck-transportable hydraulic dredges are the 16-in. (0.4-m) diameter discharge pipe size, so mobilization of larger dredges at some sites may be difficult. An exception to this would be an amphibious dredge able to cross land to reach the site. These dredges can be operated with mechanical buckets or hydraulic cutterheads.
- **Disposal site throughput capacity** – The available size of a confined disposal facility (CDF) or a limitation on the daily capacity of a landfill may present a limitation on the daily volume of material that can be dredged.
- **Rehandling, transport, dewatering or treatment capacity** – There may be limitations on the volume of sediments that can be effectively rehandled, transported, dewatered, or treated. Redundancy and additional capacity can reduce some bottlenecks, but there may be limitations due to available space or other factors.
- **Navigation and lockage limitations** – If dredged sediments transported by barge must pass through locks, the size of the locks may limit the barge sizes. Limits may also be set on the number of lockages possible per day. There may be limitations related to interference with navigation.

6.2.2. Dredge size as related to cut thickness

The required cut thicknesses for a project will vary, but there will be large areas within a range of cut thicknesses that may strongly influence the selection of dredge size.

For mechanical dredges, there are advantages in matching the bucket size to the depth of the cut to maintain a higher fill factor and limit the amount of water captured in the bucket. However, this requires ability to control bucket vertical elevation and monitoring of mudline elevation to prevent overfilled buckets, which can have significant negative impacts on water quality and residuals. When thick banks of sediment need to be removed, multiple dredging lifts of only a few feet each will aid in limiting bank instability and sloughing that can contribute to residuals. While a larger bucket has a larger footprint and might result in a thinner cut in filling the bucket, it draws the sediment a greater distance, potentially entraining more water in the sediment and making the sediment slurry more difficult to capture and retain in the bucket. Bucket penetration is also a consideration in selecting bucket size – greater penetration is achieved by increasing bucket weight or force per unit area, which is usually associated with larger buckets. Overall, the bucket design will dictate the depth of the dredge cut. Environmental buckets are often lighter than comparably sized navigation buckets and may not be able to dig the desired lift thickness, depending upon sediment type. Because environmental buckets are typically lighter, they are also more easily damaged by debris, requiring increased maintenance that can reduce production rates.

For hydraulic dredges, the dredge size may be limited by available draft in shallow areas, difficulties in mobilizing larger dredges to the site or dewatering/treatment rates. For cutterhead hydraulic dredges, dredge cuts that maximize sediment production rates are sediment removal thicknesses between 80 percent and 110 percent of the cutter basket diameter. Typical cutter basket diameters for small hydraulic dredges range between three and four times the dredge size (discharge pipe diameter), with most being about three and one-half times the pipe diameter. For example, a typical 12-in. (0.3-m) hydraulic cutter suction dredge would use a 36- to 42-in.-diam (0.9- to 1.1 m-diam) cutter. Shallower cuts entrain more water and can substantially reduce the slurry solids concentration, but with a potentially more limited residual layer. Deeper cuts can leave behind a deeper-than-normal residual sediment layer, since they increase the volume of sediment disturbed, but not

captured. Deeper cuts also tend to increase the amount of resuspended sediment in the water column. While the rotating cutter basket on most dredges can be interchanged, the cutter should be sized to deliver the appropriate amount of sediment to the suction intake during normal operation (Hayes et al. 2004).

The range of normal cut thicknesses for cutterhead dredges based on the above description for optimal production is given in Table 4. For horizontal auger dredges, the normal thickness of cut is approximately the diameter of the auger, which ranges from 14 to 20 in.

Table 4. Typical operating limits for cutterhead dredges.

| Dredge Size ^a , in. | Cutter Basket Size ^b , in. | Optimal Cut Thickness ^c , in. | Minimum Water Depth, ft | Maximum Digging Depth, ft | |
|--------------------------------|---------------------------------------|--|-------------------------|---------------------------|-----------------------|
| | | | | Standard | Modified ^d |
| 6 | 21 | 17 - 23 | 2.5 | 15 | |
| 8 | 28 | 22 - 31 | 2.5 | 18 | 40 |
| 10 | 35 | 28 - 39 | 3 | 20 | 40 |
| 12 | 42 | 34 - 46 | 3 | 26 | 65 |
| 14 | 49 | 39 - 54 | 3.5 | 33 | 65 |

^a Dredge size as the discharge pipeline diameter.
^b Cutter basket size as 3.5 times the dredge size.
^c Optimal cut thickness for production as 80 to 110 percent of cutter basket size.
^d Modified with an extended ladder and ladder pump.

6.2.3. Dredge size related to site characteristics

The site characteristics and the nature of the dredge prism may also constrain the size of dredge which may work efficiently. Site conditions such as water depth, width of target sediment deposits, and need to work in tight areas are possible factors. Table 4 provides limits for cutterhead dredges. Smaller target sediment widths and tight areas tend to restrict operation of larger dredge sizes and may dictate the use of a swinging ladder dredge or the need for mechanical dredging.

6.2.4. Dredge size related to dredgeability

Dredgeability issues may influence the selection of dredge size as well as dredge type. The presence of debris and the nature of the debris may adversely impact the effectiveness of smaller hydraulic dredges, or require larger mechanical bucket sizes. Removal of hardpan or rock-like sediments

is usually not required for environmental dredging, but if required, their removal would require larger dredge sizes. Stiffer sediments may also limit penetration for smaller or lighter buckets or cutterheads.

All of the above factors should be considered in selecting a range of dredge sizes for evaluation of production and ability to produce a clean bottom. High production rates that generate significant residuals or do not produce a clean bottom can result in additional dredge passes being required, increasing the total sediment volume removed and the project costs, and requiring additional time to complete the project.

6.3. Estimate of operating production rates

Many factors affect operating production rates for hydraulic dredges. These include dredge size, dredge design, pump horsepower, dredging depth, length of pipeline, elevation of the discharge point, possible addition of a submerged ladder pump, grain-size distribution, in situ sediment density, stiffness of the material, thickness of the cut, operator experience, and other minor factors. Therefore, hydraulic production is tied to the inherent capability of the equipment, site, and operating conditions, and the properties of the material being dredged. Further, the operating production rate will change with changing sediment or operating conditions. Overall or sustained production is tied to the production rate, the effective working time efficiency, and the seasonal efficiency. Reported overall production rates vary greatly across projects and hydraulic dredge types. For example, sustained production rates for three 10- and 12-in. cutterheads for environmental dredging ranged from 28 to 56 m³/hr (Hayes and Wu 2001) and 19 to 38 m³/hr (Cushing and Hammaker 2001). This is in comparison to a maximum operating production rate of 140 m³/hr for a 10-in. dredge completing navigation maintenance dredging (USACE 1983).

Production for mechanical dredges is a function of the bucket size (expressed as a volume), the effective bucket fill (expressed as a percentage of the bucket capacity filled by in situ sediment as opposed to free water), the effective cycle time per bucket load, barge size, cut thickness, and the effective working time efficiency. Bucket sizes for environmental projects have typically ranged from 3 to 10 yd³ (approximately 2 to 8 m³), which is at the lower range of available bucket sizes. Buckets up to 50 yd³ are not uncommon in navigational work on

large machines, but such large bucket sizes would rarely be appropriate for environmental dredging.

Cycle time is usually defined as the total time required to complete the process of closing the bucket to excavate a bucket load of sediment, raise the bucket through the water column, slough the material to the barge, place the material into the transport barge or other conveyance, and swing back and lower the bucket to the bottom and reposition for the next bucket load. For navigation projects, the cycle times are approximately 1 minute. However, cycle times may be longer (2-8 minutes) for remediation projects, because greater care is needed to precisely position the bucket for each bucket load, and there may be requirements related to limiting resuspension by restricting bucket speeds and rinsing out/off the bucket between cuts. The effective working time for mechanical dredges also depends on the logistics of changing out barges and the number of transport barges used for the project as well as the crews' ability to maintain the equipment, including navigation system.

Published sustained dredging rates for mechanical dredges vary greatly depending on the size of the bucket, cycle time, bucket fill, and amount of debris encountered. A sustained production rate of 31 m³/hr from daily logs at Saginaw River over 209 dredging days was achieved using two Cable Arm buckets (6- and 16-yd³ buckets) and four conventional clamshell buckets (4-, 5-, 8-, and 10-yd³ buckets) (Cushing and Hammaker 2001). Cycle times of 4 to 8 minutes with production of 32 to 64 m³/hr were reported for a 9-yd³ environmental bucket operating on the East Waterway project (Wang et al. 2000). The production for the newer enclosed bucket designs should be similar to conventional buckets of the same size.

The Head of Hylebos project (2004-2005) achieved operating and sustained productions of 120 and 55 yd³/hr respectively, with two enclosed buckets (6.5 yd³ and 4 yd³) on two articulated fixed arm dredges. Bucket cycle times typically ranged from 1-2 minutes in water depths up to 50 ft. This resulted in a project that met sediment cleanup goals based on post-dredge confirmation samples.

Diver-assisted dredging may be required for some remediation situations, such as removal under piers and around piling, from hard rock bottoms, etc. Data are available from several projects to support estimates of

possible production. For example, hard-hat divers were used to remove sediments from around intakes at a water supply reservoir in Westchester County, New York in water depths of 80 ft. In this case, a modified portable dredge was outfitted with an 18-in.-diam steel manifold with 4-in. nipples and a 100-ft suction hose attached to each nipple with a 12-in. by 4-in. funnel-shaped attachment at the end of each hose. Reported production with this arrangement was about 48 m³/hr or about 12 m³/hr per suction line (Pound 2000). Production rates for diver-operated equipment depend upon sediment type, water depth, thickness of cut, debris, diver experience, and amount of fixed obstructions such as piles that impact diver mobility.

6.3.1. Methods for estimating operating production rate

Operating production rate can be evaluated using any of several approaches and tools, from conceptual level algorithms based on operating characteristics to sophisticated computer programs. These methods are routinely used at navigational dredging projects. In principle, these techniques could also be used at environmental dredging projects after accounting for the effect of treatment/dewatering systems, compliance monitoring, resuspension and release control measures, and cleanup passes.

Operating production rate (the production rate during periods of active operation while making production cuts) is a function of the following factors:

- Material characteristics.
- In situ density and grain size distribution of the sediments.
- Cut thickness.
- Water depths.
- Currents and waves.
- For hydraulic dredging:
 - Pipeline lengths including potential need for booster pumps.
 - Static head between water surface and disposal site discharge point.
 - Pump designs and use of booster pumps.
 - Variability of sediment grain size and in situ density.
 - Potential for clay ball formation.
- For mechanical dredging:
 - Water depth.
 - Limits on descent speed, etc.

- Barge availability (includes haul distance and tug availability).
- Use of traveling spud or tug to move dredge.

Several methods are available for estimating an operating production rate. These vary from available published production rate information and simple analytical computations based on operating parameters to more sophisticated computations or models that consider all parameters such as pipeline lengths, need for booster pumps, etc.

Production based on operating parameters

This method of estimating operating production rates is based on typical capability of dredges and typical operating parameters such as percent bucket fill and cycle time for mechanical dredges or percent solids in the pipeline and flowrates for hydraulic dredges. This approach is appropriate for periods of continuous operation under average conditions during production cuts as opposed to “cleanup passes.” The numbers therefore reflect what the dredge type and size is capable of removing while actually operating for a full production cut. This approach also assumes conditions for soft, fine-grained sediments, representative of most environmental dredging projects. See the sections below for specific relationships for mechanical and hydraulic dredges.

Hydraulic production based on systems analysis

More rigorous tools or models are available for evaluation of production for hydraulic dredges based on an analysis of the hydraulic dredging “system.” These tools range from computer models to electronic spreadsheets. USACE has developed a production computer program called the Corps of Engineers Dredge Estimating Program (CEDEP) that is available to Federal government personnel and is tied to a cost-estimating program (http://www.nww.usace.army.mil/cost/Obtain_dredge.asp). There are also commercial programs available for hydraulic dredge production estimating. A number of dredging equipment manufacturers, dredging contractors, and consulting firms have also developed these tools. Such programs utilize input data for specific dredge pump characteristics, details on pipeline length, static head, material type, etc. Details on these comprehensive models are largely proprietary and beyond the scope of this technical resource document.

6.3.2. Mechanical production rates based on operating parameters

The maximum and average operating production rates for mechanical dredges can be estimated using operating parameters of bucket size, cycle time, and percent bucket fill as follows:

$$P_m = V_b \times \left(\frac{60}{t_c} \right) \times \left(\frac{f}{100} \right) \quad (1)$$

where:

- P_m = maximum operating production rate (mechanical) (yd³/hr)
- V_b = bucket size (yd³)
- f = bucket fill (percent)
- t_c = cycle time (min)
- 60 = conversion factor (min/hr)

and

$$P_o = P_m \times \text{EWTE} \quad (2)$$

where:

- P_o = average operating production rate (mechanical) (yd³/hr)
- EWTE = effective working time efficiency

The bucket size or volume is specific to manufacturers, but bucket sizes for environmental dredging usually range from about 3 to 10 yd³ (2 to 8 m³).

The percent bucket fill is largely a function of the overlap of the bucket cuts. Most environmental (sealed) buckets are designed for a 100 percent fill for a set cut depth. However, because of the variable nature of contaminated sediment deposits, as well as the removal of relatively thin layers of contaminated sediment, not every bucket grab will be at the optimum fill thickness. There is also danger of over-penetration when attempting to achieve a 100-percent fill factor that can result in increased residuals and water quality impacts. In addition, the necessary overlap of cuts will result in less efficient bucket fill. In general, assuming precise positioning, the larger the bucket size, the smaller the overlap percentage. For the smaller buckets normally considered for environmental dredging,

a 10-percent overlap in both directions (side-to-side and top-to-bottom) may be attainable, provided a RTK-GPS based positioning system is employed.

Published average bucket fill factors for full-bank navigation dredging of clean sediment, where overlap is not required, range from 0.7 to 0.75 for loose sand to mud. Considering the effect of overlap and thin/irregular cut depths, bucket fill factors for environmental dredging would be expected to average more on the order of 0.5 to 0.65. For example, the Head of Hylebos project had an average bucket fill factor of 0.5 over the course of removing 400,000 yd³ of sediment, using a two-stage dredging approach with re-dredging of approximately 25 percent of the area.

Cycle times can vary significantly as discussed above. A cycle time of 2 to 4 minutes can be used for production estimates for water depths of 20 ft or less and no required bucket rinse steps during the cycle. Longer cycle times may be appropriate for deeper water depths and other requirements such as bucket rinse during the cycle, etc.

Larger projects may require separate calculations for areas with differing cut thicknesses, material properties, or operating conditions.

6.3.3. Hydraulic production rates based on operating parameters

For hydraulic dredging, the maximum operating production rate can be estimated using the operating parameters of pump size, pump discharge velocity, and the ratio of slurry solids concentration in the pipeline to in situ sediment solids concentration (both by weight) as follows:

$$P_m = 0.926 \left[3.14 \left(\frac{d^2}{4} \right) \right] (v) \left(\frac{S_{sl}}{S_{sed}} \right) \quad (3)$$

where:

- P_m = maximum operating production rate (hydraulic) (yd³/hr)
- d = pipe I.D. (inches)
- v = pipeline discharge velocity (feet/sec)
- S_{sl} = slurry solids concentration or dry bulk density or percent solids by volume

S_{sed} = sediment solids concentration or dry bulk density or percent solids by volume
 0.926 = conversion factor for (sec/hr)/[(cu ft/cu yard) (in.²/ft²)]

and

$$P_o = P_m \times \text{EWTE} \quad (4)$$

where:

P_o = average operating production rate (hydraulic) (yd³/hr)
 EWTE = effective working time efficiency

The dredge size is usually defined in terms of the diameter of the discharge pipe.

Discharge velocity of the pipeline varies with a number of factors such as pump horsepower, pipeline length, static head difference between the water surface at the dredging site and the discharge point, the friction losses in the pipeline, addition of booster pumps, etc. In general, hydraulic dredging systems operate with a pipeline discharge velocity of about 15 ft/sec plus or minus 35 percent.

The percent solids of the sediments to be dredged will be defined by the sediment characterization data. The percent solids in the pipeline discharge average about 10 percent solids by weight for full production cuts in fine-grained sediments at typical dredgehead swing speeds. However, for many environmental projects, the swing speed is usually slower than optimal in an attempt to reduce residuals and the concentration of resuspended solids in the water column, often decreasing the average solids concentration to 7 percent or much less. Solids concentrations for partial cuts would be proportionally reduced. For cleanup or "sweep" passes with minimal overdredge thickness, the solids concentration may be as low as 1 percent solids by weight.

While the average percent solids generated in the discharge pipeline may be 10 percent over the course of a project, the minute-to-minute percent solids, as shown in Figure 20, can easily range from 0 percent to 30 percent as the cutterhead swings from a full bank in the middle of the cut to virtually no bank as it starts a return swing.

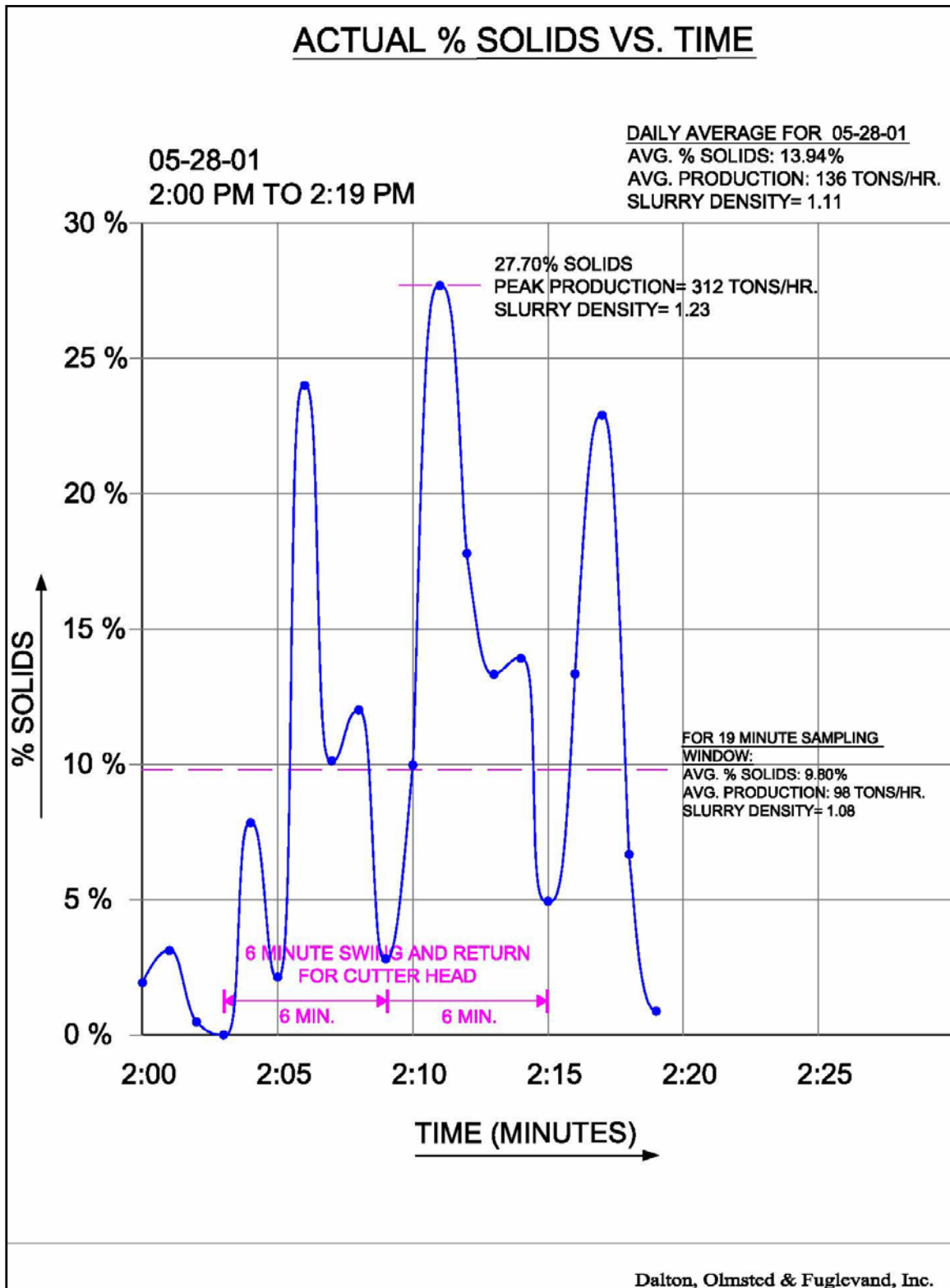

Figure 20. Variation of percent solids from cutterhead hydraulic dredge during dredging cycles.

Larger projects may require separate calculations for areas with differing cut thicknesses, material properties, or operating conditions.

6.4. Estimate of sustained production rate

The total volume to be dredged by each dredge, the operating production rate(s) of dredges, the production time of each dredge, and the sustained production rate(s) will determine the total duration time for the project for a given dredge or the numbers and sizes of dredges required to complete a project within a given timeframe.

As mentioned in Chapter 4, a production rate and/or a limit on the total duration of the project may be set as a performance standard for an environmental dredging project. Even in the absence of a performance standard related to production, it is advantageous to plan and design the project so that implementation is completed in a reasonable timeframe. When possible, completion of a project in a single dredging season is desirable.

The most straightforward method of computing the required duration of a project is to first determine the sustained production rate and calculate directly the required number of dredging seasons to complete the project. The sustained production rate should consider the production hours of operation per day, allowable days of operation per week, and allowable weeks of operation per year.

The sustained production rate can be calculated as follows:

$$P_s = P_m \times \text{EWTE} \times \text{SE} \quad (5)$$

where:

P_s = sustained production rate (cubic yards/hour for a dredging season or project duration)

P_m = maximum operating production rate (cubic yards/hour)

EWTE = effective working time efficiency

SE = seasonal efficiency expressed as a ratio

The above relationship for sustained production rate can also be evaluated in terms of cubic yards per month, week, or day, as appropriate.

Considerations in determining the effective working time efficiency (EWTE) include the time anticipated for the following:

- Routine daily maintenance (for dredge, dewatering systems, etc.).
- Movement of equipment (barges, movements of pipeline, or movements of the dredge between dredging lanes and in and out of enclosures).
- Surveys and monitoring.
- Dredge refueling.
- Calibration and maintenance of precision navigation systems.
- Standby time for agency inspections, water quality management, waiting for test results and/or direction from the owner/engineer.
- Standby waiting for the offloading and/or treatment activities.
- Health and safety meetings and related activities.
- Weather.
- Other vessel traffic within waterway, etc.

Considerations for allowable dredging hours per day, dredging days per week, or dredging weeks per year are included in the seasonal efficiency term, which is computed using the following considerations:

- Hours per day considerations:
 - Length of work shifts and number of shifts, considering overlap periods.
 - Quality of life issues resulting in restrictions on daily hours of operation due to noise, light, truck traffic, etc.
- Days per week considerations:
 - Quality of life issues or work shift issues preventing work on weekends.
 - Anticipated down days per week for major maintenance, etc. (maintenance for dredge, dewatering systems, etc.).
 - Crew fatigue.
 - Schedule slack to make up for lost production (i.e., working six days per week with option for seventh if needed).
- Weeks per year considerations:
 - Seasonal restrictions on operations due to environmental windows to protect biological resources. Such restrictions should be comparable to those for navigation dredging and are set by state regulatory agencies. USACE has developed guidance on evaluation of seasonal restrictions (LaSalle et al. 1991; Sanders and Killgore

1989 and the Dredging Operations and Technical Support (DOTS) website <http://el.erd.usace.army.mil/programs/dots>).

- Periods related to ice cover during winter or peak storm or flood flow seasons that may restrict operations.

6.5. Project duration and needed dredge sizes and number of dredges

Once sustained production rates are estimated for a range of dredge sizes, the estimated time required to complete the project (project duration) can be estimated and the required number of dredges and dredge sizes can be determined.

The estimated total duration for the project may be calculated as follows:

$$T_{project} = \frac{V_{dp}}{P_s} \quad (6)$$

where:

$T_{project}$ = project duration (dredging seasons)

V_{dp} = volume of the dredging prism (cubic yards)

P_s = sustained production rate (cubic yards/ dredging season)

Project duration in dredging seasons can be calculated for a given number and size of dredges using a composite sustained production rate for a given dredging “fleet.” The estimated project duration in dredging seasons may then be compared to specific performance standards for the maximum allowable duration of the project. If there are no specific production or duration standards, the project duration can be evaluated in terms of a reasonable time for completion. For moderate-sized projects, a dredge size or sizes could be selected to allow for completion of the entire dredging project in a single dredging season. This comparison can be made by trial until the best combination of numbers of dredges and dredge sizes is determined.

6.6. Considerations for sediment transportation

A major consideration in selecting equipment and an operational approach for environmental dredging is the method for transporting the sediment and the compatibility of that method with subsequent treatment and/or disposal requirements. This section describes the interface

between the environmental dredging operation and the subsequent transport of the dredged sediments from the dredging area to rehandling or disposal sites. A detailed treatment of sediment rehandling and transport is beyond the scope of this document; therefore, the level of detail here is limited to a general description of the processes and considerations for the various transport modes. Detailed information on transport systems for dredged materials is available (Souder et al. 1978).

Treatment and disposal of the dredged material account for a major proportion of the total cost of remediation projects, and the ability to process the sediment may be the rate-limiting step when planning the overall schedule. Typically, there is a “process train” for dredging, transport, rehandling, pre-treatment, treatment, and ultimate disposal, though not all projects require all steps. The environmental dredging process must be compatible with the initial transport, rehandling, and pre-treatment steps.

Depending on the equipment selected for dredging and the approach to rehandling and transporting sediment, the dredging process will result in a given throughput rate and solids content of the dredged sediment. For some equipment types, transportation could be viewed essentially as a separate process (e.g., transportation by barges filled by mechanical dredges), provided there is sufficient transport capacity to not hinder dredge production and operating time. In other cases, the transportation process is inherent to the removal process, as it is in the case of hydraulic dredging with pipeline transport directly to the next process step. Many other combinations are also possible (Palermo et al. 2003).

Transportation methods must be considered in light of the distance to the treatment/disposal location, the method of disposal, and the desired condition for the material arriving at that location. In general, mechanical dredging methods remove the sediment with resulting water contents close to the in situ conditions. Hydraulic dredging for navigation typically adds about four to five volumes of excess water on average for every volume of in situ sediment removed. Even more water may be entrained during environmental dredging due to constraints on cutting depth, contaminant releases, multiple dredging passes, or other operational parameters. Each of these options holds advantages and disadvantages for subsequent sediment transport, treatment, and disposal. Dewatering of the sediment prior to disposal is a requirement in many cases, and

mechanical dredging has advantages in this regard by limiting the volume of water needing treatment. However, for treatment or disposal sites located inland, mechanical dredging would require double or triple handling of the material, but can accommodate transport farther inland more readily than hydraulic dredging. Hydraulically dredged material can be pumped directly to the site, but the dewatering process will produce a large volume of water requiring treatment.

Several recent equipment innovations can reduce the needs for rehandling and/or excess water production and subsequent treatment requirements. These include newer pump designs for increased solids concentrations, use of dual pipelines for hydraulic slurring of mechanically dredged material from barges, (one for transport to the treatment/disposal site and another for return of excess water for subsequent re-use), and the use of hybrid dredging and transport combinations (e.g., mechanical dredging with dual pipelines for reslurry directly from the dredging site).

The dredging method that may result in the least resuspension, release or residuals may not result in a production or density of dredged material most suitable for efficient or economic treatment or disposal. Usually, a balancing of considerations is needed between the potential for increased resuspension, release, and residuals and the overall benefits of a given method as related to treatment or disposal.

After removal, sediment often is transported to a staging or rehandling area for dewatering (if necessary), separation (if desired), and further processing, treatment, or final disposal. Transport links all dredging or excavation components and may involve several different technologies or modes of transport. The first element in the transport process is to move sediment from the removal site to the disposal, staging, or rehandling site. Sediment may then be transported for pretreatment, treatment, and/or ultimate disposal (USEPA 1994).

As noted previously, where possible, project managers should design for as few rehandling operations as possible, in order to decrease risks and cost. Project plans should be developed to ensure that the offloading areas are not contaminated during operations. Appropriate technologies and best practices, such as aprons and catch basins, should be used if losses are expected. Project managers should also consider community concerns regarding these operations (e.g., odor, noise, lighting, and other issues).

Health and safety plans should address both workers and community members.

Modes of transportation may include one or more of the following waterborne or overland technologies (USEPA 2005):

- **Pipeline** -- Direct placement of material into disposal sites by pipeline is economical only when the disposal and/or treatment site is located near the dredging areas (typically a few kilometers or less unless booster pumps are used). Mechanically dredged material may also be hydraulically offloaded from barges and pumped into disposal sites by pipeline. Pipeline transport distances usually range up to about 2 miles. For longer pumping distances, with pipeline lengths reaching as far as 15 miles, the use of multiple booster pumps is necessary (USACE 1983, in publication). Pipeline systems can be designed to reduce risk of pipeline ruptures and leaks by use of high strength pipe with properly sized pumps. In some circumstances it may be appropriate to consider containment features or double-walled pipes. Floating discharge pipeline, made up of sections of pipe mounted on pontoons and held in place by anchors, is commonly used, in combination with submerged pipelines where needed to allow for ship traffic. Pipelines are constructed of both steel pipe and continuous heat-sealed or ultrasonically welded HDPE pipelines.
- **Barge** -- A rehandling facility located on shore is a common option for sediment remediation. With a rehandling facility, dredging can be accomplished with mechanical (bucket) dredges where the sediment is excavated at near in situ density (solids content) and placed in a scow or barge for transport to a shoreline rehandling facility. Sealed (leak-free) barges should be selected when offloading for upland disposal and have sufficient size to maintain efficiency. Bottom dump barges, used to dump dredged material in open water, are not recommended for sediment remediation projects, as material can leak from the bottom doors during filling, transport, and offloading.
- **Conveyor** -- Conveyors may be used to move material from barges to adjacent rehandling facilities or to move material relatively short distances. Conveyors can also be used to transfer material directly from a clamshell dredging operation for short distances. Materials should generally be in a dewatered condition for transport by conveyor. Conveyors may not be effective where significant debris is located in the sediment due to the potential of the debris to damage the conveyor

- system or create worker hazards. Linear debris such as ropes, chains, and cables can be especially problematic for conveyor systems.
- **Railcar** -- Rail spurs may be constructed to link rehandling/treatment facilities to the rail network. Many licensed landfills have rail links, so long-distance transport by rail is generally an option and can reduce impacts to local roads and populations compared to truck transport.
 - **Truck/Trailer** -- Dredged material can be rehandled directly from the barges to roll-off containers or dump trucks for transport to a CDF or a landfill by direct dumping or unloading into a chute or conveyor. Truck transport of treated material to landfills may also be considered. The material should be dewatered as needed for truck transport over surface streets. In some smaller sites where construction of dewatering beds or filters may be difficult or the cost of disposal is not great, addition of non-toxic absorbent materials such as ash, lime, or cement may be feasible, but this will increase the volume that must be transported and disposed.

While truck and rail transport are for longer transport distances (such as between rehandling/treatment facilities to distant disposal sites), barge and pipeline transport methods are the most common direct links between the operating dredge and the shoreline or for placement in confined aquatic disposal (CAD) cells.

In general, transportation and rehandling requirements should be integrated with dredge production so as not to constrain production by the rehandling and transport components of the remedy. For example, the number of barges employed for transport should ideally be sufficient such that the dredge operation is not delayed by waiting for the arrival of barges. Barges can also provide buffering capacity between the dredge and offload/processing facilities, allowing the dredge to continue operating when the offload/processing facility is down. The same principle applies for transport of sediments from rehandling/ dewatering/treatment facilities to final disposal sites. The remedy components for these steps should ideally be sized for throughput rates that complement, not delay, the operation of the dredge. If such delays cannot be avoided, the additional non-effective time should be accounted for in the sustained production calculations.

7 Methods for Estimating Resuspension, Residuals, and Release

All dredging operations resuspend sediment, release contaminants, and generate residuals (see Figure 1). Resuspension is the dislodgement and dispersal of sediment into the water column where the finer sediment particles and flocs are subject to transport and dispersion by currents. Resuspension of sediment will also result in some short-term release of contaminants to the dissolved phase in the water column by release of pore water and by desorption from suspended sediment particles. Since contaminants normally associated with sediments tend to remain tightly bound to fine-grained sediment particles, control of sediment resuspension will also help in control of contaminant release. The vast majority of resuspended sediments settle close to the dredge within one hour, and only a small fraction takes longer to resettle (Wright 1978; Van Oostrum and Vroege 1994; Grimwood 1983). However, fine particles and flocs with critical settling velocities below the ambient localized turbulence-induced velocities are subject to transport for hours and perhaps days before settling; therefore, these resuspended particles pose a potentially significant release of contaminants over a large area during their transport and dispersion. Contaminants are also released and subjected to transport with dissolved organic constituents, colloidal organics, and oil. Once the contaminants are in the dissolved phase, or in the air, the released contaminants are subject to far-field transport.

Generated residuals are defined as sediment dislodged, but not removed, by dredging which falls back, spills, sloughs, or settles in or near the dredging footprint and forms a new sediment layer (Figure 21). Undisturbed residuals can result from poor site characterization or sample spacing during characterization, issues related to long tube sediment sampling as discussed in previous sections, dredging that did not achieve the required elevation or poor bucket positioning due to operator error or insufficient positioning system accuracy. Residuals contribute to the short-term release of contaminants by release of pore water during settling and consolidation and to the long-term release by molecular diffusion, bioturbation, and erosion of the exposed residual sediment layer.

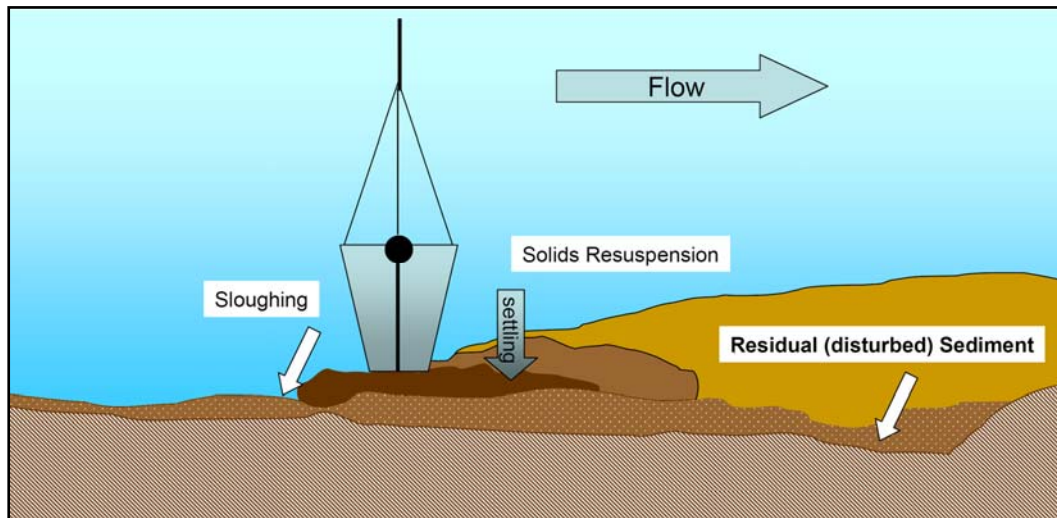

Figure 21. Schematic of dredging residuals.

This chapter presents methods for the prediction and evaluation of the resuspension of sediment due to dredging, contaminant release by dredging, and generated residuals of dredging (Note: the effect of controls, such as silt curtains, are discussed in Chapter 8). Considerable field measurements of resuspension and residuals have been made, but these empirical observations have limited predictive value. The actual operation of the dredge by the operator can have significant impacts on residuals and resuspension. Issues such as bucket overfilling, overpenetration, bucket speed when contacting bottom, and bucket speed when lifting bucket off bottom can all significantly impact resuspension and residuals for mechanical dredging. Cutterhead speed, swing speed, and bank height all impact resuspension and residuals by hydraulic dredges. Support equipment such as tug boats can also be a significant source of resuspension. Nevertheless, these field observations provide the basis for predicting resuspension and residuals. A variety of sediment resuspension and contaminant release models based on field observations and laboratory tests are available for dredging operations, but, until recently, the process of sediment resuspension has received much more attention than the associated contaminant releases. Field measurements of contaminant release are very limited; therefore, predictive methods for contaminant release to the water column and air are more theoretically based than empirical. However, contaminant release is strongly dependent on both resuspension and generated residuals predictions, and risk is dependent on contaminant release and residuals.

Resuspension and generated residuals prediction methodologies serve as source strength inputs for fate and transport models to predict solids behavior, contaminant release, and contaminant concentrations/exposure for risk calculations. This chapter focuses on resuspension and residuals models because they are unique to dredging operations and are in their infancy, while both simple screening level and comprehensive fate and transport models for water quality prediction and toxicity are well developed.

7.1. Sediment resuspension

Resuspension will occur in every dredging project, but the degree of resuspension is a function of a number of factors that includes (Hayes et al., in preparation):

- Sediment properties such as in situ dry bulk density (solids concentration, solids content or water content), organic content, particle-size distribution, and mineralogy.
- Site conditions such as water depth, currents, waves, and presence of hardpan or bedrock.
- Nature and extent of impediments, such as debris, loose cobbles, boulders, and obstructions.
- Operational considerations such as the thickness of dredge cuts, dredging equipment type, method of operation, and skill of the operator.

The sensitivity of these factors is unknown, but is expected to account for the large differences in field observations.

Suspended sediment data for specific dredging operations have been published, and a few methods for estimating release have been developed. However, the available data do not cover a sufficient range of sediment, environmental, and operational conditions to serve as a predictive base for distinctly different dredging operations. Predictive techniques developed by Nakai (1978), Collins (1995), and Hayes et al. (2000) either suffer from limited empirical data sets, apply to only a relatively narrow set of conditions, or require information seldom known early in the project when these estimates are needed most. Therefore, the best predictive approach currently available is to rely on past field measurements as a baseline to develop an equipment-specific characteristic resuspension factor that can be adjusted for site-specific sediment properties, site conditions,

impediments, and operations. The resuspension factor is defined as the fraction of the fine-grained material in the sediment that is dispersed in the water column.

7.1.1. Characteristic resuspension factors

Resuspension data from environmental dredging projects is minimal. However, navigational dredging has been studied much more extensively and, because resuspension is driven by the same processes, it is relevant to the environmental dredging experience. Sediment resuspension data have been collected from a variety of navigation dredging operations and provide useful insight into resuspension rates relating to the dredgehead (Nakai 1978, Pennekamp et al. 1996, Hayes et al. 2000). Nakai (1978) monitored 10 cutterhead navigation maintenance dredging operations. The estimated resuspension factors ranged from 0.02 percent to 3.93 percent. The mean resuspension factor for these operations was about 1.2 percent, while the median was about 0.5 percent. Hayes and Wu (2001) and Hayes and et al. (2000) showed resuspension factors for five cutterhead navigation maintenance dredging operations. The average resuspension factors ranged from 0.003 percent to 0.13 percent for the five sites, and the maximum observed resuspension factor of the nearly 400 observations was 0.51 percent.

Nakai (1978) monitored seven mechanical clamshell and bucket navigation maintenance dredging operations, but only three or four of the seven operations were likely without overflow from the barge. The mean resuspension factor without overflow was about 0.2 percent to 0.6 percent, while with overflow the mean was about 8.6 percent to 10.9 percent. Hayes and Wu (2001) computed resuspension factors for five mechanical clamshell navigation maintenance dredging operations. The resuspension factors ranged from 0.2 percent to 0.9 percent and had a mean of 0.45 percent. Pennekamp et al. (1996) monitored 12 mechanical navigation maintenance dredging operations that varied greatly in equipment type, which included open clamshells with and without silt curtains, watertight clamshells with and without silt curtains, excavators with and without silt curtains, and bucket dredges. The resuspension factors ranged from 0.3 percent to 1 percent for open clamshells, from 0.3 percent to 2 percent for watertight clamshells, from 0.6 percent to 5 percent for excavators, and from 0.3 percent to 2 percent for bucket dredges. The mean resuspension factor was about 1.5 percent, and the median was 1.1 percent. The mean value for the seven clamshell dredges

was 1 percent, and the median was 1.1 percent. The backhoe excavators had resuspension factors that were equal to two to three times those of the clamshell dredges.

The range in resuspension factors shows that there is no such thing as a typical resuspension factor. However, based on these data sets, Hayes et al. (in preparation) estimate that the conservative characteristic resuspension factor for cutterhead dredges is about 0.5 percent of the fine silt and clay fraction of the sediment, and the conservative characteristic resuspension factor for mechanical dredges with open or watertight buckets without overflow is about 1 percent. (The coarse-grained fraction (sands and gravels) is assumed to settle back quickly near the dredge and is not able to be transported from the site as a suspended load.) More modern environmental clamshell dredges would be expected to perform better than the watertight clamshell dredges reported in the literature by Pennekamp et al. (1996); the use of precision dredging navigation systems can reduce overpenetration and bucket overfilling and therefore reduce resuspension. Therefore, the conservative characteristic resuspension factor for mechanical dredges with environmental buckets without overflow is about 0.5 percent. These characteristic resuspension factors reflect the central tendency (average and median) of the empirical data and represent resuspension for characteristic site, sediment, and operating parameters. Actual resuspension would deviate from the characteristic resuspension as actual site, sediment, and operating parameters deviate from characteristic conditions. Adjustments to the characteristic resuspension factors for actual conditions are given below.

Since these data were collected primarily from navigation maintenance dredging where limited quantities of debris were present, the characteristic resuspension factors should be increased by a factor of two or three for environmental dredging sites when significant quantities of debris are encountered. Additional resuspension will occur from supporting activities such as debris removal, barge/pipe/silt curtain tending, barge/dredge transport (tug operations), and crew operations, which should be included in the overall estimate of resuspension. However, these activities are limited and infrequent when compared with the dredging.

7.1.2. Adjustments to characteristic resuspension factors

Prediction of a representative resuspension factor for a specific project requires adjustment of the characteristic resuspension factors given above in Section 7.1.1 for project-specific conditions. The magnitudes of these required adjustments are unknown, but the range in the results for the reported field data provides a basis for bounding the adjustments.

Maximum resuspension factors tend to be equal to three to five times the average or median resuspension factor for a given type of equipment.

Minimum resuspension factors tend to be equal to only 5 to 10 percent of the average or median resuspension factor for cutterhead dredges and 30 to 40 percent of the average or median resuspension factor for mechanical dredges.

The resuspension factor should increase with the liquidity of the sediment. Liquidity is a geotechnical property of the sediment and is related to the water content and Atterberg limits (plasticity and nature of a fine-grained soil) of the sediment as follows:

$$LI = \frac{W - PL}{LL - PL} \quad \text{or} \quad LI = \frac{W - PL}{PI} \quad (7)$$

where:

- LI = liquidity index
- W = water content, percent
- PL = plastic limit, percent
- LL = liquid limit, percent
- PI = plastic index, percent

Very soupy sediments resuspend more easily. Liquidity may have the single largest effect on resuspension. Liquidity incorporates numerous sediment properties. Liquidity increases with a decrease in the density of the sediment or an increase in the water content, porosity, or void ratio of the sediment. Liquidity also increases with the grain size for fine-grained sediments or a decrease in clay content. Silts are more liquid than clays at the same water content. Sands are neither liquid nor plastic because liquidity and plasticity are only measures of fine-grained materials. Liquidity increases with a decrease in the plasticity or plasticity index of the sediment.

Increases in currents and wave energy should increase the resuspension factors. Stronger currents are able to disperse dislodged sediments in the water column. The impacts should be greater for mechanical dredging, particularly with open buckets, which expose the sediments during vertical transport of the dredged material through the water column. Similarly, increases in water depth would increase resuspension for mechanical dredges. The effects are greater for sediments with higher liquidity.

An increase in impediments to dredging such as debris, cobbles, boulders, hardpan, bedrock, and rock outcroppings results in an increase in resuspension. Of these impediments, debris poses the greatest problem to resuspension because it can prevent closure or seal of the clamshell, causing significant leakage or loss of dredged material to the water column. Debris can also disrupt the capture of sediment by cutterhead dredges and increase dispersion of the dislodged sediments. Additionally, debris is often removed in a separate removal operation that can resuspend nearly as much sediment as the dredging operation as well as increasing the liquidity of the material for subsequent dredging.

Operations can also affect resuspension. Low production rates and shallow cuts for hydraulic dredges can increase resuspension (increase the fraction of fines lost, but not necessarily the concentration of suspended sediment). Similarly, high production rates can increase resuspension when currents are high because more sediment can be dislodged than is captured by the dredge head. Operations also affect resuspension for mechanical dredges. High bucket drop speeds can erode the sediment bed and increase resuspension. Overfilling the bucket or excessive cut depth can cause spillage from the bucket or release of sediment from bucket vents during penetration, leading to an increase in resuspension. Barge transport over the site can contribute to resuspension that can be controlled by equipment selection and site management.

7.1.3. Nakai TGU method

The oldest and most commonly referenced method to predict dredging-induced resuspension loss rates was published by Nakai in 1978. Referred to as the TGU method (Turbidity Generation Unit), it is a readily implemented predictive tool for open clamshell dredges, cutterhead dredges, and hopper dredges. Nakai (1978) measured TSS downstream of a dredging operation; his measurements are summarized above in Section 7.1.1. After measuring the TSS downstream, Nakai used a simple

relationship to infer what the resuspension losses were at the dredge. This inference required knowledge of the settling velocities, particle distribution, turbulent velocities in the water column, shear stress distributions in the water column, and critical shear stress for settling. These items were not measured at the sites and are largely unknown at dredging sites. Nakai assumed that all particles above 5 microns settled to develop his table of TGU values. Recent measurements of particle/floc sizes in turbidity plumes from dredging operations showed large quantities of material above 5 microns, typically up to 20 to 30 microns. As such, the TGU values in his table are greatly overestimated because the multiplier (the ratio of materials released to material settled assumed to be the ratio of mass smaller than 74 microns to the mass smaller than 5 microns) used to obtain the TGU values is considerably larger than the ratio of mass smaller than 74 microns to the mass smaller than 20 microns, particularly for sediments with low clay fractions. In addition to the overestimated TGU values, the number of sediments, pieces of equipment, and lack of key site, sediment, and operations descriptors limit the utility of the method and its application.

7.1.4. Collins (1995) resuspension correlations for open clamshells

Collins (1995) developed a model to estimate dredging-induced sediment resuspension rates at the point of dredging. These rates were a function of the dredge, operational characteristics, and sediment properties based on empirical observations. TSS concentrations at the point of dredging were not directly available; therefore, TSS concentrations at the source of the resuspension were calculated for clamshell buckets by plotting measured TSS concentrations at various depths and distances from the dredge and then extrapolating to the concentration at the dredging location. A mathematical model for the source concentration was developed based on the parameters of settling velocity, bucket size, channel depth, and cycle time. The source volume having the initial TSS concentration was defined as the apparent bucket footprint multiplied by the channel depth.

The model assumes that sediment is resuspended in the source volume of the water column during the fraction of the dredging cycle when the bucket is ascending from the channel bottom towards the water surface. When the bucket surfaces, the concentration throughout the cylinder is assumed uniform. This concentration of sediments is then progressively expelled, at an assumed linear rate, from the source volume as the bucket descends back through the water column toward the channel bottom.

When the bucket reaches the channel bottom, it is assumed that the entire mass of suspended sediments in the column has been emptied. The contribution of sediments to the near-field volume from this source volume is averaged over the duration of the entire dredging cycle, although in reality sediment is contributed only in certain phases of dredging for clamshell bucket dredges.

A sediment resuspension loss rate was ascertained for open clamshell buckets. Data were insufficient for such analysis of enclosed buckets. The sediment generation rate obtained was directly linked to the source concentrations that were extrapolated from the available data. Collins' open clamshell source strength correlation is

$$R = \frac{2(\rho \cdot 10^{-6})hb^5(1+k_{cb})^2}{v_s^3 T^4 (f_u + 2f_o + f_d)} \quad (8)$$

where:

- R = rate of sediment resuspension due to bucket dredging operations (g/m³)
- ρ = dry bulk density (g/cm³)
- h = depth of dredging (m)
- b = representative size of bucket (m)
- k_{cb} = empirical bucket constant (assumed 1)
- v_s = Stokes' Law settling velocity for median grain size (m/s)
- T = dredging cycle time (sec)
- f_u = fraction of dredging cycle that the bucket is rising through the water
- f_o = fraction of dredging cycle that the bucket is out of the water
- f_d = fraction of dredging cycle that the bucket is descending through the water

Collins concluded that a reasonable correlation between the field-observed source concentrations and the modeled concentrations was reached. Nevertheless, it was also concluded that the sediment resuspension loss rate model for a clamshell bucket should be considered unverified and rudimentary. It was suggested that further studies and more complex modeling of the mixing around the bucket should be undertaken to verify this model.

7.1.5. Hayes et al. (2000) cutterhead correlation method

Hayes et al. (2000) developed a dimensional and non-dimensional model for estimating the resuspension factor of sediment due to cutterhead dredging operations. The fundamental basis for both models followed Hayes' (1986b) hypothesis that the majority of sediment resuspended during cutterhead dredging operations was due to the stripping of fine-grained sediment that adhered to the cutter blades following sediment cutting. Field data from the cutterhead dredging operations on the James River, VA, Savannah River, GA, Calumet River, IL, and Acushnet River, MA (New Bedford Harbor) were used to develop the empirical source strength models.

The field data from these sites yielded 106 observations of the parameters used to develop the source models, namely

- rate of sediment suspended by the cutter that will be transported away from the dredge (\dot{m}_R)
- rate of in situ sediment cut by the dredge (\dot{m}_S)
- rate of sediment removal by the dredge (\dot{m}_P)
- swing speed of cutter tip (V_S)
- tangential speed of cutter blades (V_T)
- intake suction velocity at cutter blades (V_I)
- total surface area of cutter blades exposed to washing (A_E)
- total surface area of the cutter (A_C)

Dimensional model

An empirical relationship was drawn between \dot{m}_R and \dot{m}_S , \dot{m}_P , V_S , V_T , V_I , and $(A_E)/ (A_C)$. A stepwise regression was performed to evaluate the significance of each variable, leading to the dimensional model equation

$$\dot{m}_R = 10^{5.666} V_t^{1.864} \left(\frac{A_E}{A_C} \right)^{14.143} \quad (9)$$

Non-dimensional model

The parameters \dot{m}_S , \dot{m}_P , V_S , V_T , V_I , and $(A_E)/ (A_C)$ were combined into nondimensional variable groups to reduce the number of variables involved in the empirical solution, which takes the form

$$\dot{m}_R = \frac{C_s t_c d_c^{1.966} L_c^{2.966} V_s^{2.804} A_E^{1.804} |V_s \pm d_c \pi \alpha|^{1.966}}{30.5 Q^{3.770}} \quad (10)$$

where:

- C_s = in situ sediment concentration (g/L)
- t_c = depth of cut for each dredging pass (m)
- d_c = cutter diameter (m)
- L_c = cutter length (m)
- α = cutter rotational speed (rps)
- Q = dredge flow rate (m³/s)

Percent loss

The sediment resuspended as a percentage of the total sediment dredged in terms of operational parameters is

Dimensional Model

$$\hat{g} = \frac{|V_s \pm d_c \pi \alpha|^{1.864}}{27.4 C_s V_s t_c L_c^{15.143}} \left(\frac{A_E}{d_c} \right)^{14.143} \quad (11)$$

Non – Dimensional Model

$$\hat{g} = \frac{(L_c d_c)^{1.966} |V_s \pm d_c \pi \alpha|^{1.966} (V_s A_E)^{1.804}}{1,099 Q^{3.770}} \quad (12)$$

where \hat{g} is the predicted rate of sediment suspended and able to be transported from the dredging site as a percentage of the sediment mass dredged (percent).

Model discussion and application issues

Hayes et al. (2000) stated that the following factors should be considered when employing the dimensional and non-dimensional models:

- The models are most applicable to scenarios similar to those used in their development.
- The models should only be applied to dredges within the range of operating characteristics found at the four field sites.

- If applied outside the range of operating characteristics for which the models were derived, very high (conservative) estimates can result.
- The models have not been validated against independently collected field data.

7.1.6. USACE DREDGE model

The DREDGE model (Hayes and Je 2000) is a steady-state screening level model for modeling resuspension and contaminant release (Figure 22). DREDGE couples resuspension source models with a Gaussian dispersion model (Kuo and Lukens 1985; Kuo and Hayes 1991) and Stokian settling model in a uniform flow field. DREDGE estimates the mass rate at which bottom sediments become suspended into the water column as the result of hydraulic and mechanical dredging operations and computes the resulting suspended sediment and contaminant concentrations. DREDGE allows the user to select from and apply either the predictive methods for resuspension described or their own estimate from empirical observations. The Nakai (1978) TGU method, Collins (1995) and Hayes et al. (2000) correlation methods, and Hayes et al. (in prep) resuspension factor method are incorporated as source strength models and each can be examined to aid users when selecting their own estimate of the resuspension. These are combined with information about site conditions to simulate the size and extent of the resulting suspended sediment plume under steady-state conditions. DREDGE also estimates total and dissolved contaminant concentrations in the water column based upon sediment contaminant concentrations and equilibrium partitioning theory.

Hayes and Je (2000) developed the DREDGE model for USACE to assist users in making a priori assessments of environmental impacts from proposed navigational dredging operations. DREDGE is a module of the Automated Dredging and Disposal Alternatives Modeling System (ADDAMS) distributed by the Environmental Laboratory of the U.S. Army Engineer Research and Development Center. ADDAMS (Schroeder et al. 2004) consists of approximately 20 modules to assist in design and evaluation of various aspects of dredging and dredged material disposal operations.

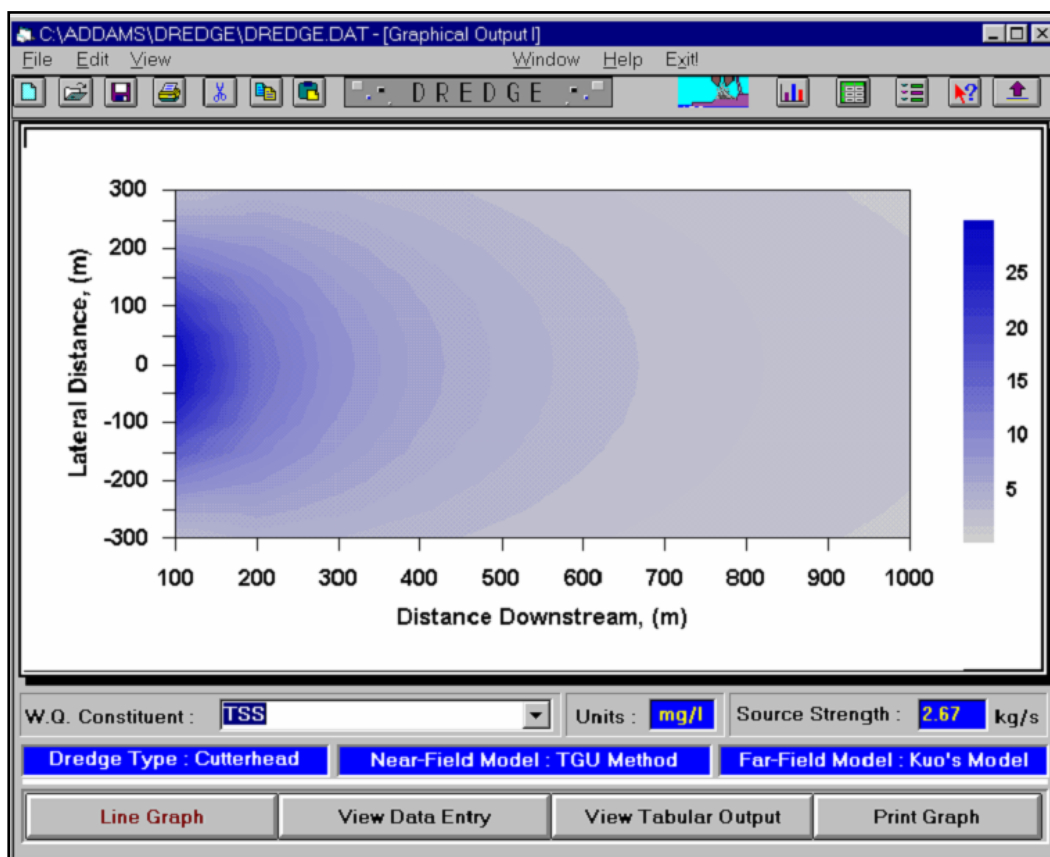

Figure 22. Example of DREDGE model graphical output.

7.1.7. EPA ARCS guidance

The EPA Great Lakes National Program Office (GLNPO) Assessment and Remediation of Contaminated Sediments (ARCS) Program published guidance on “Estimating Contaminant Losses from Components of Remediation Alternatives for Contaminated Sediments” (USEPA 1996). The guidance provides observations of resuspension losses and TSS concentrations for a large variety of dredges. These observations and descriptions of dredging equipment can assist in developing estimates of resuspension factors for other dredging equipment. In addition, the guidance provides information for estimating losses by other components of dredging operations such as transport by pipelines and barges. In addition, the observations of TSS concentrations provide a basis to check the predictions of resuspension and its fate and transport for consistency.

7.1.8. Fate and transport models

A thorough discussion on the use and selection of models to evaluate remedial alternatives is given in the *Contaminated Sediment Remediation*

Guidance for Hazardous Waste Sites (USEPA 2005). A wide range of simpler empirical models and more robust computer models can be applied to model the fate of resuspended sediment and associated sediments. Simple models that aggregate processes or consider only some portion of a problem can provide significant insights and should be applied routinely at sediment sites, even complex sites. These models are particularly useful in modeling the source, the dredging zone, and the near field. The models can help identify appropriate monitoring locations, impact areas for residuals formation by settling of resuspended sediment, and potential accumulation of residuals. The DREDGE model described above in Section 7.1.6 is such a model.

Often a complex fate and transport model is developed for a site to understand more fully the potential future risks of a site and to verify a site conceptual model. Comprehensive technical reviews of available models have been conducted for the EPA's ORD National Exposure Research Laboratory (Imhoff et al. 2003). When available, these models can be quite useful in predicting the fate of resuspended sediment particles in the far field. Complex processes such as flocculation, settling, and erosion in unsteady flow regimes are best modeled using more advanced fate and transport models. However, if a complex fate and transport model is not developed, simple modeling can be used to develop a better understanding of the resuspension and release processes by incorporating unsteady features and variable parameter descriptions. The USACE PTM (Particle Tracking Model) is an example of a model that can address unsteady flow regimes, handle a number of particle sizes and settling rates, and allow erosion of settled particles (MacDonald et al. 2006). Whether and when to use a model and what models to use are site-specific decisions, and modeling experts should be consulted (USEPA 2005).

7.1.9. Resuspension controls

Resuspension controls such as silt curtains do not affect the resuspension source strength in terms of the resuspension factor. However, controls may affect production rates, and the resuspension rate in terms of kilograms per second may change. Controls are likely to alter the transport of resuspended solids and perhaps settling rates. Confining the resuspended sediments in a small area may increase flocculation and settling rates. Additionally, silt curtains can slow currents in the dredging zone and cause release and transport of solids to occur only near the bottom of the water column. When controls are employed, the input to the

source and transport models should incorporate the effects of the controls. Silt curtains can also cause an increase in resuspension and residuals by providing a false sense of security to dredge operators who may increase dredge speed or pay less attention to other best management practices (BMPs) because they are operating within a contained area.

7.2. Residuals

One of the more significant limitations currently associated with assessing the effectiveness of environmental dredging is the uncertainty associated with estimating the nature and extent of residual contamination following removal. No removal technology can remove every particle of contaminated sediment, and field results to date for completed environmental dredging pilots and full-scale projects suggest that post-dredging residual contamination levels have often not met desired cleanup levels; however, it should be noted that many projects were completed using standard navigation equipment and did not benefit from positioning systems such as RTK GPS. This is to be expected due to the inherent limitations of even the most modern dredging equipment, and the distribution of contamination found in many sites – where typically higher concentrations exist at deeper unexposed sediments. It is logical that the nature and extent of post-dredging sediment residuals are related to dredging equipment, dredging methods, sediment geotechnical and geophysical characteristics, the variability in contaminant distributions, and physical site conditions (including hydrodynamics). In many situations, these complicating factors can make the sediment removal process and achievement of risk-based remediation goals particularly difficult as well as costly.

The descriptions of residuals processes, factors affecting residuals, and considerations for prediction of residuals described in this section were primarily adapted from Palermo and Patmont (2007), Patmont and Palermo (2007), and Bridges et al. (2008). As defined in Chapter 1, residuals are contaminated sediment found at the post-dredge surface of the sediment profile, either within or adjacent to the dredging footprint. Because there are numerous potential sources of residual sediment contaminants, residuals can be broadly grouped into two categories: 1) undisturbed residuals, and 2) generated residuals.

Undisturbed residuals are contaminated sediments found at the post-dredge sediment surface that have been uncovered by dredging but not

fully removed. Generated residuals are contaminated post-dredge surface sediments that are dislodged or suspended by the dredging operation and are subsequently redeposited on the bottom of the water body.

It can be important to distinguish the differences between undisturbed residuals and generated residuals, as they may pose different risks, may require different methods for prediction, and may require different monitoring and management responses. Depending on their origin, undisturbed residuals may or may not be amenable to removal by an additional cleanup dredging pass. Because of their physical characteristics (discussed below), generated residuals may be even more difficult to remove with an additional cleanup dredging pass. Depending on the risk posed by the residuals and the regulatory approach to cleanup at a particular site, residuals that may accumulate outside of the dredging footprint may or may not trigger a need to manage such materials actively. Furthermore, assessment of risks posed by residuals remaining within the dredging footprint may influence decisions regarding subsequent removal or management efforts.

Understanding residuals is important at a number of different stages of the cleanup process and somewhat different approaches may be needed at each stage. For example, during the Feasibility Study, it is important to be able to predict the nature and extent of residual contamination in order to predict the likely effectiveness of a dredging alternative and supply information to help select the most appropriate remedy for the site (USEPA 2005). During Remedial Design, an understanding of the sources and characteristics of likely residuals can be important for development of appropriate construction contingency plans (e.g., determining the likely need for and costs of additional cleanup pass dredging or cover/backfill placement). During and following Remedial Action, assessment and management of residuals may be important to comply with project-specific action level requirements.

The level of concern surrounding residuals is dependent on many factors, including:

- Concentrations of contaminants of concern (COCs) (e.g., are the concentrations high enough to cause significant risk?)

- Residence time of the residual sediment layer (e.g., does it exist as an identifiable layer for periods of time likely to result in significant exposure and risk?)
- Residual sediment layer thickness (e.g., is bioturbation likely to cause the layer to be mixed with underlying sediment?)
- Dry density, as a measure of stability (e.g., is the layer likely to remain in place?)
- COC variability (esp. vertical profiles) (e.g., if the layer is thick, what are biota exposed to?)
- Geochemical availability (e.g., are contaminants bioavailable in their present form?)
- Mobility and fate (e.g., what is likely to happen in the future?)

Projects with performance standards related to residual contaminant concentrations normally have provisions for multiple passes of the dredge to achieve the objectives. A common approach for multiple passes is to focus on mass removal of contaminated sediment with the initial passes of the dredge, followed by passes used for “cleanup.” Removing the bulk of the material in several passes that do not exceed 3 to 5 ft in any one pass tend to limit sloughage from adjacent undredged areas. See Figure 23.

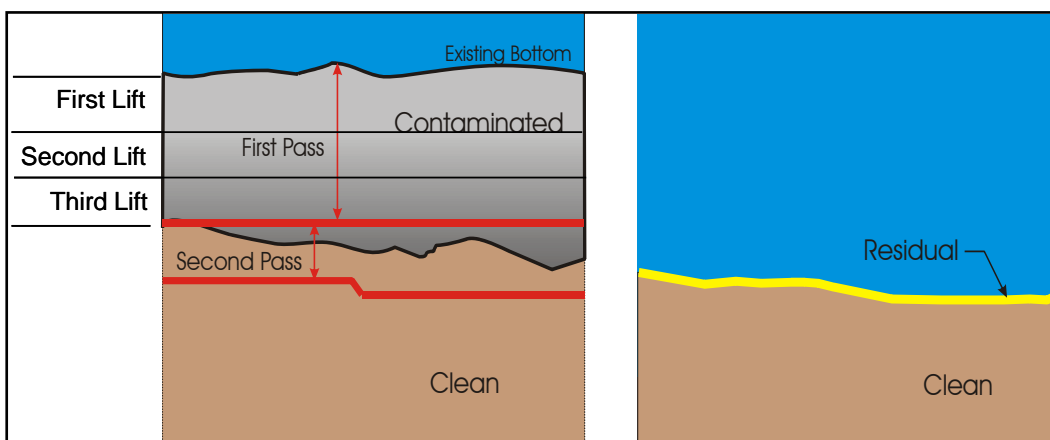

Figure 23. Multiple dredge passes, each lift not to exceed 3 to 5 ft. (Source: Dalton, Olmsted & Fuglevand).

7.2.1. Residuals characteristics

Undisturbed and generated residuals may have similar or very different characteristics depending on the process by which they were created. For example, dislodged sediment not picked up by the dredge generally falls back to the bottom relatively close to the point of dredging and may have

characteristics similar to undisturbed residuals. Resuspended sediment, which has settled to the bottom after it has been transported as a plume, may have very different characteristics from the undisturbed sediment. Generally, undisturbed residuals remain below the dredge cut elevation at a higher dry bulk density than generated residuals; their dry bulk density would be similar to those of the in situ/native sediments. In some cases, undisturbed residuals may exist as relatively thick layers amenable to further cleanup pass dredging. In contrast, generated residuals are the result of the dredging process itself, and such dislodged materials accumulate at the sediment/water interface in thin layers and at relatively low dry bulk density if deposited from suspension or from fluid mud layers. Generated residuals may also exhibit a less fluid-like, but still soft, unconsolidated layer resulting from resettlement and fluidized mud flows, along with sloughing (i.e., shallow slope failures) of dredge cut slopes. Finally, generated layers of residuals may be underlain by more consolidated undisturbed residuals [see Figure 24 (Patmont 2006)].

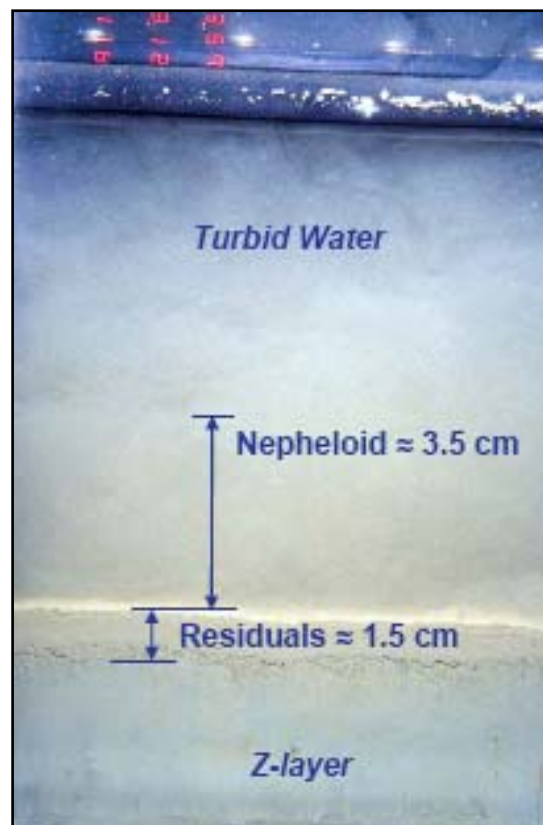

Figure 24. Photo of resuspension, generated residuals and undisturbed residuals/sediment (Z-layer) (Patmont 2006).

Field results to date for completed environmental dredging pilot projects and full-scale projects (Patmont and Palermo 2007) suggest there are common geotechnical and geochemical characteristics of residuals, as follows:

- Physical and geotechnical characteristics
 - Generated residuals (excluding sloughed materials) are more prone to resuspension immediately after dredging.
 - At some sites, there is a potential for downslope migration of fluid mud portions of the generated residuals.
 - After the initial consolidation period (i.e., within a period of several days to a few weeks, depending on sediment characteristics and site conditions), generated residuals (excluding sloughed materials) typically occur as a thin veneer (1 to 10 cm thick) of fine-grained material, with relatively low dry bulk density (ranging from approximately 0.2 to 0.5 gm/cm³), the typical dry bulk density for fine-grained sediment is 0.5 to 0.9 gm/cm³.
 - The physical and geotechnical characteristics of generated layers of residuals (excluding sloughed materials) will significantly change immediately following completion of dredging. Column settling tests indicate that fluidized fine sediments will self-consolidate to near surficial in situ densities within a period of a few weeks to several months, depending on sediment characteristics and site conditions. Conversely, the physical and geotechnical characteristics of sloughed materials and undisturbed residuals will likely not change appreciably after dredging.
 - There is often a discernible (i.e., measurable) difference in dry bulk density characteristics between generated residuals and underlying in situ sediments (including undisturbed residuals). However, sloughed material that contributes to generated residuals may have physical and geotechnical characteristics that are similar to in situ conditions, and thus may not be easily discernible from undisturbed residuals.
 - Mixing due to bioturbation of surficial residuals into the biological mixing zone (typically 2 to 5 cm in freshwater environments and 10 cm in saltwater environments) generally occurs within a period of several months to several years. Recolonization data and bioturbation depths and rates are available from multiple sources (e.g., Boudreau 1997 and Clarke et al. 2001).

- During this mixing period, sedimentation, biodegradation, and other natural recovery processes may also contribute to overall reductions in contaminant concentrations in the top 10 cm of the sediment profile.
- Geochemical characteristics
 - Existing data suggest that the average concentration of COCs in generated residuals can be reasonably approximated based on the weighted average sediment concentration in the final production cut profile (the concentration of the final production cut would in turn be influenced by the previous dredge passes necessary to remove the entire sediment column dredged) (Patmont and Palermo 2007). If clean-up passes are used, the remaining generated residuals can be reasonably approximated based on the mass-weighted average sediment concentration in the final clean-up cut profile.
 - Immediately after the consolidation period (i.e., within a period of several days to a few weeks, depending on sediment characteristics and site conditions), and before bioturbation/mixing, generated residuals are present at the sediment/water interface.
 - Little research has been performed to date on the bioavailability of generated residuals (e.g., geochemical processes and biological uptake/food web transfer).

7.2.2. Factors affecting dredging residuals

Similar to resuspension releases discussed above in Section 7.1, the extent of residual contamination is dependent on a number of factors including:

- Type and size of dredging equipment.
- Operation of the dredging equipment.
- Amount of contaminated sediment resuspended by the dredging operation.
- Extent of controls on dispersion of resuspended sediment (e.g., silt curtains, sheet piling).
- Relationship of surface and sub-surface contaminant concentrations in the area to be dredged.
- Contaminant concentrations in surrounding undredged areas.
- Characteristics of sediment being dredged, including grain size, water content, and organic content.
- Characteristics of underlying sediment or bedrock (e.g., whether over-dredging is feasible).

- Site conditions including depth and currents.
- Extent of debris, obstructions or confined operating area (e.g., which may limit effectiveness of dredge operation).
- Skill of operators.

The primary causes of undisturbed residuals include:

- Attempting to dredge sediment which
 - Directly overlies bedrock or hardpan,
 - Covers highly uneven surfaces, or debris or boulders which are left in place,
 - Is located near piers, pilings, utility crossing which are left in place.
- Incomplete characterization of the horizontal and vertical extent of contaminants and/or over-reliance on the ability of geostatistical models to adequately represent the distribution of contaminants.
- Inappropriate selection of a target dredge cut design elevation.
- Inaccuracies in meeting targeted dredging elevations, or horizontal bucket placement resulting in missed material.
- Development of dredge plans that intentionally do not target complete removal of contaminated sediments (e.g., due to engineering limitations).

The primary causes of generated residuals include:

- Sediments dislodged but left behind by the dredgehead that fall to the bottom without being widely dispersed.
- Sediment dislodged but left behind by debris-removal operations.
- Attempting to dredge sediment in settings that limit the operation of the dredge (e.g., in debris fields), including preventing complete closure of the bucket.
- Sediment that sloughs into the dredge cut from adjacent undredged areas.
- Sediment moved by slope failures caused by the process of dredging or innate slope instability.
- Sediments resuspended by the dredgehead that quickly resettle.
- Sediments resuspended by dredging or other dredging-related activities that resettle within or adjacent to the dredging footprint.
- Bucket overpenetration and overfilling.

7.2.3. Predicting dredging residuals

It is logical that the quantity and quality of post-dredging residuals are related to dredging equipment, dredging methods, sediment characteristics, and physical site conditions. However, there is currently no commonly accepted method to accurately predict post-dredging contaminant concentrations in generated residuals immediately following completion of the dredging (Palermo and Averett 2003).

Patmont (2006) compiled data on residuals from 12 environmental dredging projects completed between 1999 and 2005, using a variety of equipment. He found that the residuals contained 5 to 9 percent of contaminant mass removed for the eight projects containing PCBs. The other four sites having more mobile contaminants had residuals ranging from 2 to 4 percent of the contaminant mass removed. These masses of residuals are much larger than the observed masses of resuspension, indicating that fallback, slumping, sloughing, and spillage are major sources of residuals.

Given the field observations, Hayes and Patmont (2004) and Desrosiers et al. (2005) recommend estimating the residual contaminant concentration to be equal to the depth-averaged contaminant concentration of the sediment removed in the last pass, which would include residuals from the previous pass. Patmont (2006) showed this approach with data from the Segment 4 of the Hybelos Waterway dredging project in Figure 25, which was performed using a conventional open clamshell bucket and DGPS equipment. The sediment concentration of the last pass would be influenced by the residuals volume and concentration from prior dredge passes. The residuals volume would be 5 to 20 percent of the volume of the previous pass, depending on equipment type, sediment properties, water depth, and other site conditions. The volume would be expected to be greater with softer sediments or more steeply sloped sediments where slumping, sloughing, and spillage would be greater, or when conventional navigation equipment and less precise positioning systems are used. The percentage is also likely to be greater with thin cuts when using non-level bottom cutting equipment. Hayes and Patmont (2004) caution that these values and procedures have a high degree of uncertainty, but no other predictive techniques are available.

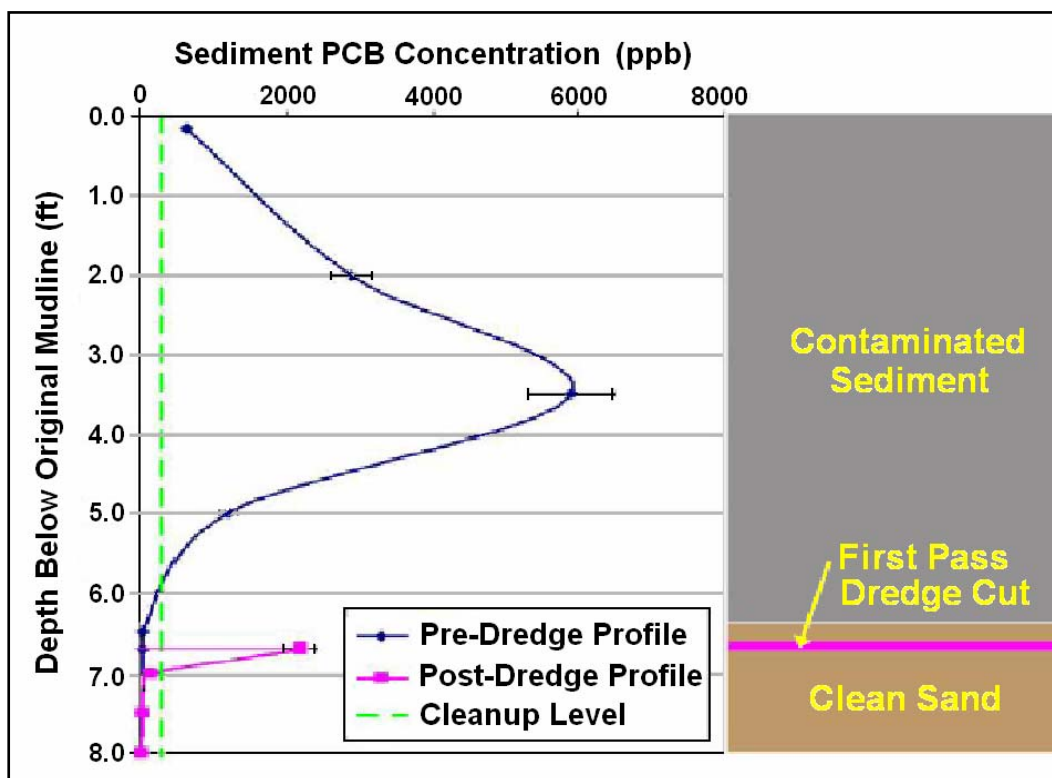

Figure 25. Sampling data for Hylebos Segment 4 (Patmont 2006).

7.2.4. Example calculation of generated residuals

This example is based on multiple dredging passes as illustrated in Figure 23, where three full production passes are performed followed by a partial production pass with overdredging. The first pass is 3.5 ft thick and has a bulk dry density of 550 kg/m³ and a contaminant concentration of 30 mg/kg (ppm). The second pass will consist of residuals from the first pass plus 3 ft of sediment with a dry bulk density of 600 kg/m³ and a contaminant concentration of 80 mg/kg (ppm). The third pass will consist of residuals from the second pass plus 3 ft of sediment with a dry bulk density of 650 kg/m³ and a contaminant concentration of 50 mg/kg (ppm). The fourth pass will consist of residuals from the third pass plus 0.5 ft of contaminated sediment with a dry bulk density of 650 kg/m³ and a contaminant concentration of 40 mg/kg (ppm) and 1.0 ft of overdredging with a dry bulk density of 700 kg/m³ and a contaminant concentration of 0.5 mg/kg (ppm). Sediment removal is performed with a 12-in. cutterhead dredge with an articulated ladder where 10 percent of the dry mass of the sediment in each pass is left as residuals in a spillage layer. The example calculations follow:

- First Production Pass Residuals Layer:
 - Mass: $10\% \times 3.5 \text{ ft} \times 550 \text{ kg/m}^3 = 192.5 \text{ kg-ft/m}^3$
 - Contaminant Mass: $30 \text{ mg/kg} \times 192.5 \text{ kg-ft/m}^3 = 5775 \text{ mg-ft/m}^3$
 - Contaminant Concentration: $5775 \text{ mg-ft/m}^3 / 192.5 \text{ kg-ft/m}^3 = 30 \text{ mg/kg}$
- Second Production Pass Sediment:
 - Mass: $3 \text{ ft} \times 600 \text{ kg/m}^3 = 1800 \text{ kg-ft/m}^3$
 - Contaminant Mass: $80 \text{ mg/kg} \times 1800 \text{ kg-ft/m}^3 = 144,000 \text{ mg-ft/m}^3$
- Second Production Pass Composite:
 - Mass: $192.5 \text{ kg-ft/m}^3 + 1800 \text{ kg-ft/m}^3 = 1992.5 \text{ kg-ft/m}^3$
 - Contaminant Mass: $5775 \text{ mg-ft/m}^3 + 144,000 \text{ mg-ft/m}^3 = 149,775 \text{ mg-ft/m}^3$
- Second Production Pass Residuals Layer:
 - Mass: $10\% \times 1992.5 \text{ kg-ft/m}^3 = 199.25 \text{ kg-ft/m}^3$
 - Contaminant Mass: $10\% \times 149,775 \text{ mg-ft/m}^3 = 14,977.5 \text{ mg-ft/m}^3$
 - Contaminant Concentration: $14,977.5 \text{ mg-ft/m}^3 / 199.25 \text{ kg-ft/m}^3 = 75.17 \text{ mg/kg}$
- Third Production Pass Sediment:
 - Mass: $3 \text{ ft} \times 650 \text{ kg/m}^3 = 1950 \text{ kg-ft/m}^3$
 - Contaminant Mass: $50 \text{ mg/kg} \times 1950 \text{ kg-ft/m}^3 = 97,500 \text{ mg-ft/m}^3$
- Third Production Pass Composite:
 - Mass: $199.25 \text{ kg-ft/m}^3 + 1950 \text{ kg-ft/m}^3 = 2149.25 \text{ kg-ft/m}^3$
 - Contaminant Mass: $14,977.5 \text{ mg-ft/m}^3 + 97,500 \text{ mg-ft/m}^3 = 112,477.5 \text{ mg-ft/m}^3$
- Third Production Pass Residuals Layer:
 - Mass: $10\% \times 2149.25 \text{ kg-ft/m}^3 = 214.925 \text{ kg-ft/m}^3$
 - Contaminant Mass: $10\% \times 112,477.5 \text{ mg-ft/m}^3 = 11,247.75 \text{ mg-ft/m}^3$
 - Contaminant Concentration: $11,247.75 \text{ mg-ft/m}^3 / 214.925 \text{ kg-ft/m}^3 = 52.33 \text{ mg/kg}$
- Final Pass Contaminated Sediment:
 - Mass: $0.5 \text{ ft} \times 650 \text{ kg/m}^3 = 325 \text{ kg-ft/m}^3$
 - Contaminant Mass: $40 \text{ mg/kg} \times 325 \text{ kg-ft/m}^3 = 13,000 \text{ mg-ft/m}^3$
- Final Pass Overdredging:
 - Mass: $1.0 \text{ ft} \times 700 \text{ kg/m}^3 = 700 \text{ kg-ft/m}^3$
 - Contaminant Mass: $0.5 \text{ mg/kg} \times 700 \text{ kg-ft/m}^3 = 350 \text{ mg-ft/m}^3$
- Final Pass Composite:
 - Mass: $214.925 \text{ kg-ft/m}^3 + 325 \text{ kg-ft/m}^3 + 700 \text{ kg-ft/m}^3 = 1239.925 \text{ kg-ft/m}^3$

- Contaminant Mass: $11,247.75 \text{ mg-ft/m}^3 + 13,000 \text{ mg-ft/m}^3 + 350 \text{ mg-ft/m}^3 = 24,597.75 \text{ mg-ft/m}^3$
- Final Pass Residuals Layer:
 - Mass: $10\% \times 1239.925 \text{ kg-ft/m}^3 = 123.9925 \text{ kg-ft/m}^3$
 - Contaminant Mass: $10\% \times 24,597.75 \text{ mg-ft/m}^3 = 2,459.775 \text{ mg-ft/m}^3$
 - Contaminant Concentration:
 $2,459.775 \text{ mg-ft/m}^3 / 123.9925 \text{ kg-ft/m}^3 = 19.84 \text{ mg/kg}$
 - Residual Thickness (assuming a dry bulk density of 450 kg/m^3):
 $123.9925 \text{ kg-ft/m}^3 / 450 \text{ kg/m}^3 = 0.28 \text{ ft}$ or 8.4 cm

7.3. Contaminant release

Contaminant releases associated with dredging can occur in particulate, dissolved, or volatile fractions, with each characterized by a different transport and/or exposure pathway. Particulate-associated contaminants are released as resuspension of fine-grained and organic particulates as discussed above in the introduction to this chapter. Some resuspended fine particles have low settling velocities and can remain suspended in the water column for hours or days, and the suspended sediment particles and associated contaminants will be transported with currents from the dredging area into the surrounding environment.

Resuspension of sediment will also result in release of contaminants to the dissolved phase in the water column by release of contaminants in the sediment pore water and by desorption of contaminants from suspended sediment particles. Once in the dissolved phase, released contaminants are subject to far-field transport and can increase the contaminant exposure and resulting risk. This release pathway can be a particularly significant pathway to consider given the bioavailability of dissolved contaminants. While the exposures and risks associated with dissolved contaminant release would be expected to be shorter than those associated with bedded sediments, the magnitude and temporal extent of these risks will depend on a number of factors. These factors include the length of the dredging operation and a range of other physical and chemical factors. These dissolved contaminants will interact with background solids and materials outside the dredging zone, undergo abiotic and biotic reactions, be dispersed and incorporated in the local ecosystem, and/or be transported away.

Releases to the air through volatilization may also be a concern. Releases to air are a function of the dissolved contaminant concentration at the surface of the water column. In addition, floating oils are sometimes released to the water column during the dredging process, providing another avenue for facilitating contaminant transport. Fortunately, contaminants normally associated with sediments tend to remain tightly bound to fine-grained and organic sediment particles; therefore, control of sediment resuspension will also help in control of contaminant release.

Releases can be quite difficult to quantify because particulate and dissolved releases of contaminants vary widely temporally and spatially due to the nature of dredging operations. To measure the variability of contaminant concentrations temporally and spatially is both difficult and expensive. Therefore, there is very little data on contaminant releases and contaminant release processes/sources. Consequently, predictions of contaminant releases are largely theoretical or based on laboratory measurements such as the dredging elutriate test (DRET) (DiGiano et al. 1995). DRET procedures are illustrated in Figure 26 and given in detail in Appendix A. However, even DRET is largely unverified and protocols for application of the test results are unsettled.

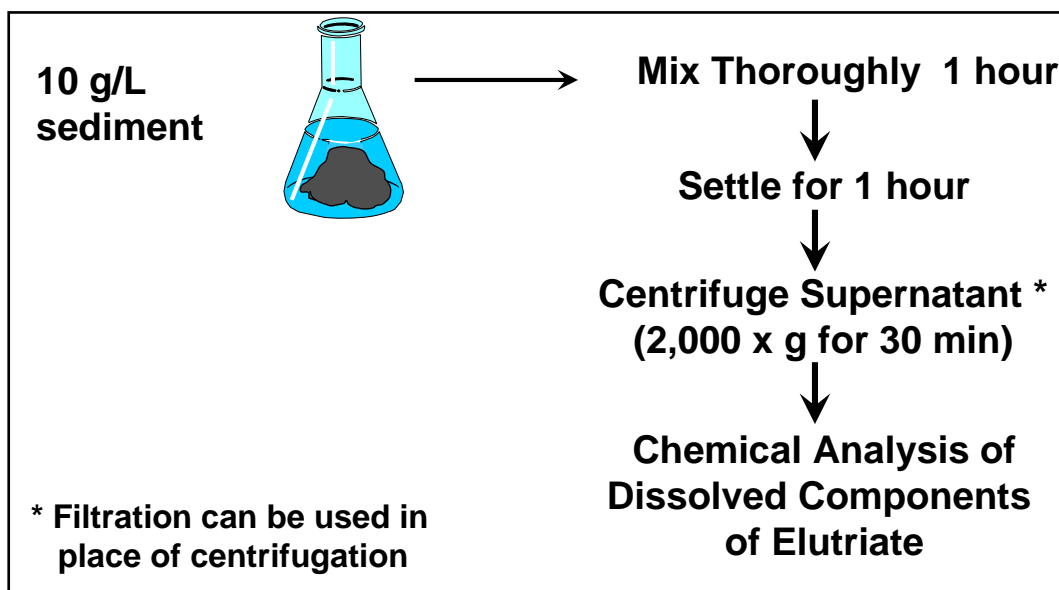

Figure 26. Schematic of DRET test procedure.

In practice, contaminant releases have been estimated from measurements of dissolved and total contaminant concentration from samples collected from a sparse spatial grid with limited frequency.

Typically, samples are taken at distances of 300 to 1,000 ft from the dredge head, which correspond to travel times of 10 to 30 minutes. The sampling location often corresponds with mixing zone and water quality compliance boundaries where monitoring can be performed safely. Thus, available measurements of dredging-related releases have been operationally defined to date by such practical and regulatory-driven spatial and temporal scales. The sampling has not been designed to quantify release processes, which would require more frequent sampling across a grid in proximity to the sources.

Consideration of the dredge program and schedule is important in predicting (modeling) the release effects of the dredging operations. The time frame over which the entire project will be implemented and the spatial dredge plan should be factored into the evaluation of short-term exposure.

Contaminant losses also occur from residuals both during and following dredging operations. Contaminant losses from residuals result from densification/ consolidation of the residuals layer, expelling pore water with dissolved contaminants from the forming and consolidating residuals layer. Residuals may have very low solids concentrations when initially formed and, potentially, may continuously release large quantities of contaminated water during the dredging operation, perhaps corresponding to 1 m of water across the dredging footprint. These releases of water from the residuals layer formation may be largely indistinguishable from the resuspension losses. The residuals may also be eroded during the dredging operations and release contaminated particulates and pore water. Contaminant losses from residuals may exceed the losses from resuspension. Following the dredging operations, dissolved contaminants will continue to be released from the residuals by molecular diffusion and bioturbation, and particulate-associated contaminants will be released by erosion. Residuals provide the same sources of risk as the original sediment bed, but the magnitude of the risk will depend on the bioavailable contaminant concentration and thickness of the residuals.

7.3.1. Particulate contaminant releases from resuspension

This section was adapted from “Estimating Contaminant Losses from Components of Remediation Alternatives for Contaminated Sediments,” prepared for the Assessment and Remediation of Contaminated Sediments

(ARCS) Program, Great Lakes National Program Office (GLNPO) (USEPA 1996).

Resuspension of particulates is a function of dredge type and operation and sediment properties. Sediment properties are a site-specific concern that cannot be definitively quantified without reference to a specific dredging project. In general, finer, less cohesive sediments have the greatest potential for resuspension.

Contaminants associated with resuspended particulates are primarily metals and other elemental species and organic contaminants. Elemental species of concern may be in geochemical phases with slow release properties or in geochemical phases that readily accept and release elemental species. Organic contaminants are usually bound in the organic fraction of the sediment through reversible sorption reactions. Contaminant species may also be dissolved in the pore water adjacent to the sediment particles; but for most contaminants, the dissolved fraction is much smaller than the particulate fraction.

The mass release of a contaminant during dredging is defined by

$$m = f_r \rho_s A D C_s \quad (13)$$

where:

- m = contaminant mass released (g)
- f_r = fraction of sediment resuspended during dredging
(dimensionless)
- ρ_s = in situ bulk density of the sediment (g/cm³)
- A = dredging area available for mass transfer (cm²)
- D = dredging depth (cm)
- C_s = contaminant concentration in sediment (dry wt) (g/g)

Equation 13 is useful as a definition, but not as a predictive equation because the fraction of sediment resuspended is difficult to estimate and mass release is more conveniently expressed on a rate basis. To obtain the rate of mass release, the dredging area A is replaced with A_d , the area of dredging per unit time (square centimeters per second) and m becomes R_D , the mass of contaminant released per unit time (grams per second). Alternatively, if an average water column resuspended solid concentration

is known over some volume, the rate of contaminant resuspension R_D is given by

$$R_D = C_p Q_d C_s \quad (14)$$

where:

R_D = rate of particulate-associated contaminant release (g/sec)

C_p = suspended solids concentration averaged over a characteristic volume at point of dredging (g/cm³)

Q_d = volumetric flow of water through averaging volume (cm³/sec)

It should be noted that the bulk sediment contaminant concentration is generally reported as mass of contaminant per mass of dry sediment and implicitly assumes that all the contaminant mass resides on the solid phase. The contaminant release rate defined in Equation 14 is based on the total contaminant concentration initially in the in situ sediment and, therefore, includes both particulate and dissolved contaminant fractions.

Estimation of the total contaminant release or the release rate per unit time by resuspension of the sediment is thus reduced to estimation of the fraction of particles that are resuspended. The rate of sediment resuspension or the resuspension factor is discussed in Section 7.1.

7.3.2. Dissolved contaminant releases from resuspension

This section was adapted from “Estimating Contaminant Losses from Components of Remediation Alternatives for Contaminated Sediments,” prepared for the Assessment and Remediation of Contaminated Sediments (ARCS) Program, Great Lakes National Program Office (GLNPO) (USEPA 1996).

Resuspension of sediment solids during dredging can also affect water quality through the release of contaminants in dissolved form. Before resuspension, contaminant distribution between sediment solids and sediment pore water is probably at equilibrium. Dredging exposes sediments to major shifts in the liquids/solids ratio and oxidation-reduction potential (redox). Because the sediment solids are removed from the previously existing equilibrium conditions, there is a potential for change in the distribution of contaminant between solid and aqueous

phases. Initially upon resuspension, the bulk of the contaminants are sorbed to particulate matter. As the resuspended particulate concentration is diluted by mixing with dredging site water, release of sorbed contaminants to adjacent waters results in a continuous increase in the fraction of contaminants that are dissolved.

It should be noted that the total release of contaminants at the point of dredging is estimated by the equations of the previous section. The dissolved release calculated by the methods of this section largely occurs after the mixing and dilution of the resuspended sediments with the ambient waters. The fraction of the contaminant associated with the particulate phase continues to change as dilution reduces the particle concentration. The majority of the dilution occurs in less than an hour in many systems. However, it may take days for the particles contaminated with hydrophobic organics to achieve a new pseudo-equilibrium with the water column, which is often longer than the settling time for the particles.

In this section, equilibrium partitioning is discussed as a predictive technique for dissolved organic contaminants. Equilibrium partitioning is a conservative approach that may over-predict dissolved contaminant releases by a factor of 2 or 3 and perhaps up to an order of magnitude for some contaminants. Equilibrium partitioning approaches are more appropriate in the far field than in the dredging zone and near field where dilution is occurring rapidly and rapid, pronounced changes in redox of the sediment particles make equilibrium approaches unreliable and uncertain.

The most accurate predictive indicator of dissolved contaminant release during dredging would be a fully developed and verified laboratory test that reproduces the mixing and dilution processes that are observed in the water column after resuspension of contaminated sediments. Such a test would indicate sediment-specific effects on desorption rate and contaminant tendency to desorb. The test would be especially important for elemental species, such as heavy metals, that undergo complex reactions that are not easily predicted by mathematical models. The test would also be important for strongly sorbed hydrophobic organic species that may desorb slowly due to mass transfer resistances. The dredging elutriate test (DRET), discussed below in Section 7.3.4, was developed to serve this goal (DiGiano et al. 1995).

In the absence of specific information to the contrary, it seems appropriate to use equilibrium partitioning to establish an upper bound on dissolved organic concentrations at the point of dredging. However, equilibrium partitioning is usually a very conservative assumption. DiGiano et al. (1993) found that an equilibrium partitioning model did a *good* job of predicting the soluble PCB concentrations. Estimates of the partitioning (distribution) coefficient derived from DRET results for the sediment may provide better predictions. At low contaminant concentrations, equilibrium partitioning between sediment and water can usually be represented by a linear isotherm, that is, $C_{sorb} = K_d C_w$, where K_d is a distribution coefficient assumed independent of concentration. Here, C_w is the water phase concentration and C_{sorb} is the concentration of the contaminant sorbed to the solid phase. The sorbed concentration in the solid phase is usually assumed to be approximately equal to the bulk sediment contaminant concentration C_s , so that $C_{sorb} \approx C_s$.

Using local equilibrium partitioning, the dissolved concentration is given by

$$C_w = \frac{C_s C_p}{K_d C_p + 1} \quad (15)$$

where

- C_w = dissolved phase contaminant concentration (mg/L)
- C_s = bulk contaminant concentration in sediment (mg/kg)
- C_p = suspended solids concentration averaged over a characteristic volume at point of dredging (kg/L)
- K_d = contaminant-specific equilibrium distribution coefficient (L/kg)

The distribution coefficient in Equation 15 can be determined in batch equilibrium tests, estimated using empirical relationships from the literature, or computed from DRET results.

The release rate for dissolved contaminants is the product of the dissolved contaminant concentration averaged over the volume dislodged by the dredge and the volumetric flow through the averaging volume. The dissolved contaminant release rate for a cutterhead dredge is thus given by

$$R_{d,ch} = C_w V_t \alpha H_{ch} \beta L_{ch} \quad (16)$$

where

$\alpha H_{ch} \beta L_{ch}$ = effective cross-sectional of the advancing cutterhead

H_{ch} = height of the cutterhead

L_{ch} = length of the cutterhead

α and β account for the fact that the sweep area is typically larger than the cutterhead and are estimated as $\alpha = 1.75$ and $\beta = 1.25$.

Similarly, the dissolved contaminant release rate for a clamshell bucket dredge is given by

$$R_{d,b} = \gamma \rho_w (L_{bc})^2 \frac{h_b}{\tau_{cb}} C_w \quad (17)$$

where

γ = Bohlen sweep area correction factor (ranges from 2 to 4)

ρ_w = density of water (g/cm³)

h_b = water depth (cm)

τ_{cb} = bucket cycle time (sec)

Several limitations apply to Equations 16 and 17. First, field data to verify these equations are very limited. Second, Equations 16 and 17 are not applicable to estimation of dissolved metals releases unless developed from DRET results. In addition, the linear partitioning used in Equations 16 and 17 assumes dissolved phase concentrations much lower than the water solubility limit. Deviations from linear partitioning might be expected when dissolved phase concentrations approach 50 percent of the solubility limit.

The total contaminant release for cutterhead hydraulic and bucket dredges is provided by Equations 13 and 14. Although dissolved losses at the point of dredging represent a small fraction of the total loss for strongly sorbing chemicals, some estimation of dissolved losses, such as provided in Equations 16 and 17, may be needed for transport models used to assess impacts and risks and to compare the no-action alternative to dredging and treatment/disposal alternatives. Finally, Equations 16 and 17 predict

dissolved concentrations at the point of dredging (the source), not downstream dissolved concentrations. Fate and transport models should be used to predict downstream dissolved concentrations.

Although hydrophobic organic species often partition in the simple manner discussed previously, the release of metals is much more complex. During the development of the standard elutriate test (SET), little correlation was observed between sediment bulk metal concentration and the dissolved metal concentration at disposal sites or in the standard elutriate. In most cases, dissolved metal concentrations in site water prior to and during disposal operations were about the same (Jones and Lee 1978). In some cases, dissolved metal concentrations were higher in site water prior to disposal operation than after disposal operations (Jones and Lee 1978). These results can often be explained in terms of the aqueous environmental chemistry of iron. Many sediments contain a large reservoir of reactive ferrous iron that readily reacts with oxygen in site water to form amorphous iron oxyhydroxides. Iron oxyhydroxides tend to floc and scavenge metals. Thus, an adaptation of the SET such as DRET is probably required to get reliable estimates of soluble metal releases during dredging.

7.3.3. Dissolved contaminant releases from residuals

In addition to resuspension as the primary source of contaminants, there are a number of contaminant release sources that may be worthy of consideration for some site conditions, sediment properties, equipment types, and contaminant classes. These additional release sources include:

- Release of dissolved contaminants and dispersed solids from densification of a high solids concentration layer on the bottom, including fluff layers, fluid mud, and residuals.
- Molecular diffusion from the dredging cut face and residuals.
- Groundwater advection.
- Non-aqueous phase liquids (NAPL) exposure.

With the exception of NAPL exposure, these additional release sources have potential to be significant where the contaminants have low partitioning characteristics or where the areal extent of the residuals is large in comparison to the dredging zone. Releases from densification are more important when thick, extensive layers of fluff, fluid mud, and residuals are created. Their creation would be both equipment and

sediment dependent. Release by molecular diffusion from the residuals increases with porosity of the sediment and the areal extent of the cut face and residuals.

Release predictions computed by the methods given above in Section 7.3.2 using DRET data from a test run on a 5 g/L or a 10 g/L suspension of sediment likely incorporates these additional releases. DRET results from tests run on 0.5 g/L or 1 g/L suspensions likely only provide information on releases from resuspension. Care should be taken in selecting the suspension concentration for a DRET to account for the predicted resuspension factor and residual mass. Additional information on the DRET is provided below.

In the absence of DRET results, prediction of these additional releases is difficult and very uncertain due to a lack of information on the formation of layers of residuals, the initial solids concentrations of components (spillage, sloughing, settling, etc.) forming the residuals layer and their relative contribution in mass of the layer. If little densification of the layer components occurs, then the release could be estimated by molecular diffusion and pore water advection.

7.3.4. DRET test

DiGiano et al. (1995) proposed an adaptation of the standard elutriate test, a dredging elutriate test (DRET), for the purpose of predicting dissolved contaminant releases (Figure 26). The DRET requires further verification before the test should be unconditionally applied and accepted (verified with only one sediment); however, the DRET is the only test available to develop sediment- and operation-specific contaminant release characteristics. The standard elutriate test (SET) was developed during the DMRP to predict contaminant release during open-water disposal operations (Jones and Lee 1978). In the SET, water and sediment are mixed for 30 min in a proportion of 4:1 and allowed to settle for 1 hr. The modifications suggested by DiGiano et al. (1995) were designed to achieve a more realistic solids/water ratio (0.5 to 10 g/L) consistent with conditions for resuspended sediment due to dredging. DiGiano et al. (1993) employed an aerated mixing time of 1 to 6 hr and a settling time of 1 hr (0.5 to 24 hr were also investigated). The solids concentration and mixing time should be selected to be representative of the predicted resuspension and dredging operation, respectively.

Procedures for running a DRET are given in Appendix A. Fine-grained sediment concentrations dispersed by dredge-induced resuspension in the water column are typically about 0.3 to 2 g TSS/L at a distance of 1 to 3 m from the dredgehead or bucket. TSS concentrations of 5 to 10 g/L tend to limit dispersion due to density differences with the water column. Typical concentrations, adjusted for the fine-grained fraction of the sediment, should be selected when estimating releases by resuspension alone. The test sediment concentration should be

$$C_{test} = \frac{TSS}{f_{74}} \quad (18)$$

where

C_{test} = dry sediment concentration for conduct of DRET (g/L)

TSS = target resuspension suspended solids concentration (g/L)

f_{74} = fraction of sediment mass having a grain size less than 74 microns

When estimating releases by resuspension and residuals, a higher concentration of sediment should be used in the test to account for release of water during densification of the residuals that entrained a large volume of water. The fraction of the residuals mass formed by spillage, density flows, and settling should be included in the DRET. The test sediment concentration could then be computed as follows

$$C_{test} = \frac{TSS}{f_{74}} \times \left(1 + \frac{\% Residuals}{\% Resuspension} \right) \quad (19)$$

where:

$\% Residuals$ = percent of sediment mass in fluid residuals (perhaps 1 to 4 percent)

$\% Resuspension$ = percent resuspended or resuspension factor (see Section 7.1.2)

The DRET results provide an estimate of contaminant concentrations near the dredgehead or bucket. In addition, the DRET results can provide an estimate of the non-equilibrium partitioning (distribution) coefficient for

estimating short-term dissolved releases. The partitioning coefficient can be computed from the DRET results as follows

$$K_d = \frac{(C_s C_{test}) - C_w}{C_w C_{test}} \quad (20)$$

where:

- K_d = contaminant-specific, non-equilibrium distribution coefficient (L/kg)
- C_s = bulk (total) contaminant concentration in sediment (mg/kg)
- C_{test} = solids concentration in the test (kg/L)
- C_w = aqueous phase (dissolved) contaminant concentration (mg/L)

DRET was evaluated by comparison to field dredging studies conducted in New Bedford Harbor, Massachusetts. DRET was found to be a reasonable indicator of the soluble and total (soluble plus unsettled particulate) polychlorinated biphenyl (PCB) concentrations released during cutterhead or matchbox suction dredging, but the DRET underpredicted PCB concentrations when a horizontal auger dredge head was used. The New Bedford Harbor studies involved highly contaminated sediment at an estuarine location. Extrapolation of the New Bedford Harbor results to freshwater sites with contamination levels one to two orders of magnitude lower is not technically defensible at this time. Where feasible, additional testing/verification of DRET should be performed and the DRET results should not be used as the sole basis of evaluation and design.

7.3.5. Contaminant volatilization to air

Another potential route of contaminant release during dredging or excavation is volatilization of contaminants, either near the dredge or excavation site or in a holding facility like a confined disposal facility (CDF) (Chiarenzeli et al. 1998). At sites with high concentrations of volatile contaminants, dredging or excavation might present special challenges for monitoring and operational controls if volatile contaminants pose a potential risk to workers and the nearby community.

The EPA Great Lakes National Program Office (GLNPO) Assessment and Remediation of Contaminated Sediments (ARCS) Program published guidance on “Estimating Contaminant Losses from Components of

Remediation Alternatives for Contaminated Sediments” (USEPA 1996). The guidance provides methods to compute volatilization from water bodies, barges, tanks, and disposal facilities, both ponded and dewatered based on theoretical chemodynamic models developed by Thibodeaux (1989). These computational approaches have been incorporated into volatilization screening methodology of the Evaluation of Dredged Material Proposed for Disposal at Island, Nearshore, or Upland Confined Disposal Facilities — Testing Manual (better known as the Upland Testing Manual) (USACE 2003).

After computing contaminant flux by volatilization, the dispersion of contaminants in the air can be modeled using commonly available air dispersion models to calculate exposure concentrations required to estimate airborne risks. Numerous air dispersion models are available ranging from steady-state, area source, Gaussian models for simple terrains such as EPA’s SCREEN3 (USEPA 1995c) to more complex 3D models such as EPA’s ISC3 (USEPA 1995d) and AERMOD (USEPA 2004b).

7.3.6. Volatilization flux test

Predictions of volatilization flux can be improved using a laboratory test to measure volatilization from dilute suspensions of contaminated sediment and from exposed sediment samples. The test yields volatilization constants specific to the sediment (partitioning constants including Henry’s constant). Guidance on conducting volatilization flux tests is found in the Upland Testing Manual (USACE 2003).

7.3.7. Fate and transport models

A wide range of simpler empirical models and more robust computer models can be applied to model the fate of contaminants and associated particulates. Fate and transport models for contaminants are particularly useful to illustrate how contaminant concentrations will vary spatially at a site; to predict contaminant fate and transport over long periods of time (e.g., decades) or during episodic, high-energy events (e.g., tropical storm or low-frequency flood event); and to predict future contaminant concentrations in sediment, water, and biota for evaluating relative differences among the proposed remedial alternatives, including capping of residuals (USEPA 2005). Simple models that aggregate processes or consider only some portion of a problem can provide significant insights

and should be applied routinely at sediment sites, even complex sites. These models are particularly useful in modeling resuspension and release at the source, and dispersion and settling in the dredging zone and the near field. The USACE DREDGE (Hayes and Je 2000) and RECOVERY (Ruiz et al. 2001) models are good examples of screening level models that aggregate and integrate processes. Simple mass balance and equilibrium partitioning models of the residuals and sediment can help define the contaminant mass release from pore water, and areal extent and volume of the source. While useful, these screening level approaches need to be further developed to greater predictive accuracy. Research in this area is currently being conducted (Hayes et al. 2007).

Often a complex fate and transport model is developed for a site in order to more fully understand the potential future risks of a site and to verify a site conceptual model. Examples of more complex fate and contaminant transport models include EFDC (Tetra Tech, Inc. 2002), ICM (Cercio and Cole 1995), and WASP (Di Toro et al. 1983; Connolly and Winfield 1984; Ambrose et al. 1988). These models can be quite useful in predicting the fate of contaminants in the far field. Comprehensive technical reviews of available models have been conducted for the EPA's ORD National Exposure Research Laboratory (Imhoff et al. 2003). Complex processes such as non-equilibrium partitioning, particle interactions with the sediment bed, and biogeochemical transformations in unsteady flow regimes are best modeled using more complex fate and transport models. However, if a project-specific complex fate and transport model is never developed, simple modeling can be used to develop a better understanding of the resuspension and release processes by incorporating unsteady features and variable parameter descriptions. As described by EPA, whether and when to use a model and what models to use are site-specific decisions and modeling experts should be consulted (USEPA 2005).

7.3.8. Release controls

Silt curtains to control resuspension may have little effect on dissolved releases of contaminants, since silt curtains do not affect the resuspension source strength, in terms of the resuspension factor. However, silt curtains can reduce flow through the dredging zone, which can reduce the flux of contaminants that are in equilibrium with the TSS in the dredging zone. This is more likely for readily mobile contaminants. During the RD phase of the Milltown Reservoir Superfund Project in Missoula, Montana, Schroeder (2002) documented a strategy to deploy silt curtains to reduce

flow and metals flux during dredging of a reservoir impacted by mine tailings. However, other project considerations caused this project to select dry excavation. New developments in silt curtain technology include filtering curtains that incorporate layers of adsorbents to remove both particulate and dissolved contaminants. Additionally, dispersal of adsorbents in the water column within the silt curtain enclosure has potential to control releases, but this approach is untested.

7.4. Summary of predictive methods for resuspension, residuals, and release

All environmental dredging operations resuspend sediment, generate residuals, and release contaminants, although newer equipment and methods can provide improvements over results achieved with conventional navigation equipment. This chapter presented methods for prediction and evaluation of the resuspension of sediment due to dredging, contaminant release from dredging, and residuals of dredging. The predictive methods presented in this chapter are empirically based on limited data sets of actual field measurements. Considerable field measurements of resuspension and residuals have been made, but these empirical observations have limited predictive value. Nevertheless, these field observations provide the basis for prediction of resuspension and residuals. Field measurements of contaminant release are very limited; therefore, predictive methods for contaminant release to the water column and air are based on laboratory tests and theoretical models. Full-scale pilot studies using the anticipated results can be particularly useful for predicting site-specific information and for verifying predictions of the magnitude and characteristics of these processes. Resuspension, residuals, and release prediction methodologies serve as source strength inputs for fate and transport models to predict solids behavior, contaminant release, and contaminant concentrations/exposure for risk calculations.

8 Control Measures

As discussed in Chapter 7, the evaluation of sediment resuspension, contaminant release, and dredging residuals will help determine the need for any control measures. The potential need for controls will be determined in the FS and RD phases based on predictions of these processes and any regulatory control requirements.

A distinction should be made between operational controls and engineered controls. Operational controls include actions that can be undertaken by the dredge operator to reduce the impacts of the dredging operations. Engineered controls require a physical construction technology or modification of the physical dredge plant to cause the desired change in conditions. Implementation of operational and/or engineered controls should be based on a clear understanding of how the dredge is actually being operated, not just knowledge of what is in the project plans. Examples of engineered controls might include installation of dredgehead shrouds, silt curtains, sheet-pile enclosures, and surface foams to minimize volatilization, etc. Usually, an attempt will be made to implement an operational fix prior to using the engineered method because of the costs of engineered controls (Francingues and Thompson 2006).

Application of operational and engineered controls is potentially expensive and can significantly reduce overall production rates and efficiency. Further, the improper use of controls can have direct negative impacts on a project and the environment (e.g., through increased sediment resuspension or increasing the time needed to complete the project). The degree of controls needed is a site-specific or area-specific decision. Therefore, controls should be applied only when conditions clearly indicate their need and should not be set as a requirement solely because they can be applied (USEPA 2005).

8.1. Control measures for sediment resuspension

One factor in selecting a dredge type for an environmental dredging project is reducing sediment resuspension. All dredges resuspend some sediment, and depending on the specific performance standards for a project, resuspension control measures might or might not be needed.

Based on experience to date, a tiered approach to implementing resuspension controls is appropriate in many cases. The tiers may include:

- More intensive monitoring.
- Implementation of operational and/or engineered controls.
- Cessation of dredging operations (in the most extreme cases).

The various tiers for control measures would be triggered based on exceedance of any sediment resuspension and/or contaminant release thresholds that were established for the site.

8.1.1. Operational control measures for sediment resuspension

Operational controls for resuspension may include changes in dredging methods and/or in operation of the equipment. Examples of operational controls that have been tested on a limited basis include:

- Reducing the dredging rate to slow down the dredging operation (this is especially important with respect to bucket speed approaching the sediment surface and bucket removal from the surface after closing).
- Reducing bucket over-penetration, which can cause sediment to be expelled from the vents in the bucket or cause sediment to become piled on top of the bucket, then eroded during bucket retrieval.
- Eliminating overflow from barges during dredging or transport.
- Changing the method of operating the dredge, based on changing site conditions such as tides, waves, currents, and wind.
- Modifying the depth of the cutterhead, rate of swing of the ladder and of the rotating cutterhead, and reducing the speed of advance of the dredge.
- Modifying the descent or hoist speed of a wire-supported bucket, employing aprons to catch spillage, and using a rinse tank to clean the bucket each cycle.
- Sequencing the dredging by moving upstream to downstream.
- Varying the number of dredging passes (vertical cuts) to increase sediment capture.
- Using properly sized tugs and support equipment.

Unfortunately, few data are available to support the effectiveness of most of the above operational modifications in reducing resuspension (Bridges et al. 2006). Experienced dredge operators are often challenged to find an optimal rate and method of operation for a given set of conditions. For

hydraulic dredging, resuspension is generally minimized at the same point that production is optimized. If the rate of operation is slowed or accelerated, the resuspension and release may be increased (Francingues and Thompson 2006).

In addition to controls placed on operation of the basic dredging equipment, other operational control measures may be considered for mechanical dredging. These include use of submerged trays or plates to catch or contain spillage from buckets as they are raised and slewed to the barge, and use of wash tanks to remove adhering sediments from a bucket prior to start of the next cycle (Lane et al. 2005). Such measures would slow the overall dredging process, and the advantages with respect to reduction of resuspension should be considered in light of the disadvantages with respect to production.

8.1.2. Engineered control measures for resuspension

Engineered resuspension controls for environmental dredging can be defined as designed controls or containments deployed around or in conjunction with the dredge plant (USEPA 2005). Transport of resuspended contaminated sediment released during dredging can be reduced by using physical barriers around the dredging operation. Under favorable site conditions, these barriers help limit the areal extent of particle-bound contaminant migration resulting from dredging resuspension and enhance the long-term benefits gained by the removal process. Conversely, because the barriers contain resuspended sediment, they may increase, at least temporarily, residual contaminant concentrations inside the barrier compared to what it would have been without the barriers (USEPA 2005).

Types of physical barriers may include:

- Cofferdams.
- Removable dams (e.g., Geotubes).
- Sheet-pile enclosures.
- Silt curtains.
- Silt screens.
- Pneumatic (Bubble) curtains.

Selecting physical barriers as engineered controls for a remediation should include a) considerations of compliance (e.g., predicted water quality

criteria exceedances), and b) considerations of the risks posed by the anticipated releases of contaminants from the dredging operation. In the latter, the balance between the predicted extent and duration of such releases, and the long-term benefits gained by the overall remediation project should be evaluated (USEPA 1994).

Different types of physical barriers for control of sediment resuspension are shown in Figure 27. Cofferdams and removable dams are generally associated with “dry excavation” remedies as compared to the other types of containments for resuspended sediments around a dredging operation.



Figure 27. Control measures.

8.1.3. Silt curtains/screens

Perhaps the most recognized engineered control for resuspended sediment at dredging projects is the “silt curtain.” Silt curtains and silt screens are flexible barriers that hang down from the water surface. Both systems use a series of floats on the surface and a ballast chain or anchors along the bottom. Although the terms “silt curtain,” “turbidity curtain,” and “silt screen” may frequently be used interchangeably, there are fundamental differences. Curtains are made of impervious materials, such as coated nylon, and primarily redirect all water flow around the enclosed area. In contrast, screens are made from synthetic geotextile fabrics, which allow water to flow through, but retain a large fraction of the suspended solids inside the screened area (Averett et al. 1990). Throughout this section, the term “curtains” is used for both curtains and screens. Silt curtains may be appropriate when site conditions warrant minimal transport of suspended sediment, for example when dredging hot spots of high contaminant concentration (USEPA 2005).

An engineered control such as a silt curtain does not treat turbidity resulting from sediment resuspension; depending on the deployment configuration of the curtain, it merely contains or directs the movement of resuspended sediment. Partial depth deployments, normally extending from the surface to a set depth, will act to contain the resuspended sediment and reduce spreading in the upper water column; however, the resuspended material is free to move beneath the partial curtain. A full depth deployment will act to further contain and prevent spreading, and further limit resuspended sediment movement. However, there are potential releases from full-depth deployments due to ineffective seals along the bottom, tidal fluctuations, movement of vessels through gaps in the curtains, etc. Even with an effective containment, the result may be an increase in concentrations of both suspended solids and dissolved contaminants within the curtain containment area that have the potential for being released when the curtain is relocated or removed during demobilization (Francingues and Thompson 2006).

Much of the experience with silt curtains stems from their use on navigation dredging projects, but this experience is directly applicable to environmental dredging. Francingues and Palermo (2005) provide guidance on use of silt curtains as a dredging management practice for navigation dredging projects, and include a good description of the components of silt curtains and how silt curtains may be deployed. Project

managers should review the information provided by Francingues and Palermo (2005) when considering use of silt curtains for a given sediment remediation project.

Some key “lessons learned” regarding selection, design, and deployments of silt curtains are (from Francingues and Palermo 2005):

- Very few silt curtain applications are alike; each deployment has unique features that require a site-specific application and adaptation.
- For all practical purposes, silt curtains are not very effective at current velocities $> 1 \frac{1}{2}$ knots (2.5 ft/sec).
- Effectiveness is influenced by
 - quantity and type of suspended solids.
 - mooring method.
 - characteristics of the curtain.
- Deployment should
 - remain in place until the dredging is completed.
 - allow for traffic in and out.
 - allow relocation as the dredge moves to a new site.
- Best Management Practices (BMPs, practices employed to minimize consequences of dredging and disposal on water quality) should not be mandatory for every project.
- Topics that should be covered when using silt curtains include:
 - planning considerations (site-specific project conditions).
 - design or performance criteria.
 - construction specifications (curtains and other materials).
 - installation or deployment, removal, decontamination, and maintenance.
 - monitoring of silt curtain performance.
- Silt curtains are
 - not a *one solution fits all* type of best management practice.
 - highly specialized, *temporary-use* devices.
 - selected only after *careful evaluation* of the intended function.
 - designed based on a *detailed knowledge of the site* where it will be used.

The effectiveness of a silt curtain installation is primarily determined by the hydrodynamic conditions at the site. Conditions that will reduce the effectiveness of the silt curtain include:

- Strong currents.
- High winds.
- Changing water levels.
- Excessive wave height (including ship wakes).
- Drifting ice and debris.
- Movement of equipment into or out of the curtained area.

As a generalization, silt curtains are most effective in relatively shallow, quiescent water, without significant tidal fluctuations. As water depth increases and turbulence caused by currents and waves increases, it becomes increasingly difficult to isolate the dredging operation from the ambient water effectively. The effectiveness of silt curtains is also influenced by the quantity and type of suspended solids, the mooring method, and the characteristics of the barrier (JBF Scientific Corp. 1978). Typical configurations for silt curtains can be found in Francingues and Palermo (2005). Care must be taken that the curtains do not impede navigation traffic. Silt curtains may also be used to protect specific areas (e.g., valuable habitat, water intakes, or recreational areas) from suspended sediment contamination (USEPA 1994). Protecting sensitive areas with curtains as opposed to enclosing the dredging area may provide the required protection with less impact to the dredging operation.

The integrity of silt curtains should be inspected periodically by divers and verified by water column analysis, since their deployment is not visible from the surface, and a tear would not be noticeable in a full-length curtain absent water quality sample data and/or a diver inspection. How and when the curtain is removed also affect the actual effectiveness of the curtain. Curtains can collect fine-grained sediment on their surface or within folds that develop near the bottom in tidal areas. These materials can then be released when the curtain is removed, often after monitoring has ceased.

General considerations regarding the limits for silt curtains include (Francingues and Palermo 2005):

- Currents greater than 1 to 1-1/2 knots are problematic and lead to difficult and often expensive silt curtain designs. For all practical purposes, the 1 to 1-1/2 knot value appears to be an industry standard for limits on conventional silt curtain application.

- Application of silt curtains in higher current velocities (> 3 knots) would require special designs and engineered features and would be considered in only the most unusual circumstances.
- Curtain deployments for high, fast water and winds require highly customized designs.
- At depths greater than 10-15 ft, loads or pressures on curtains and mooring systems become excessive and could result in failure of standard construction materials.

To decide whether to select silt curtains, several key questions should be answered by the project manager of the environmental dredging project. These questions include (Francingues and Thompson 2006):

- What type of silt curtain is needed?
- What components will be needed for the silt curtain?
- What are the functions of the silt curtain?
- What project site-specific processes will affect the silt curtain selection, deployment, and operation?
- How will the silt curtain be deployed?
- What types of products are commercially available for use at this project?
- What is known about the effectiveness of silt curtains on similar projects?
- What information is available on selection, design, specification, and deployment of silt curtains on similar projects?
- What should be done to properly select and use a silt curtain at this site?

Silt curtains have been used at many locations with varying degrees of success. For example, silt curtains were found to be effective in limiting suspended solids transport during in-water dike construction of the CDF for the New Bedford Harbor pilot project. However, the same silt curtains were ineffective in limiting contaminant migration during dredging operations at the same site primarily because of tidal fluctuation and wind (Averett et al. 1990). Problems were experienced during installation of silt curtains at the General Motors site in Massena, New York due to high current velocities and back eddying (turbulence and countercurrents at the downstream end of the enclosure). Dye tests conducted after installation revealed significant leakage, and the silt curtains were removed. Sheet piling was then installed around the area to be dredged with silt curtains

used as supplemental containment for hot spot areas. A silt curtain containment system was effectively applied during dredging of the Sheboygan River in 1990 and 1991, where water depths were 2 m or less. A silt curtain was found to reduce suspended solids from approximately 400 mg/L (inside) to 5 mg/L (outside) during rock fill and dredging activities in Halifax Harbor, Canada (USEPA 1994). At some sites, changes in dredge operating procedures may offer more effective control of resuspension than containment barriers.

In a more recent application, a silt curtain was installed around the Black Lagoon Removal Action Legacy site on the Detroit River in Trenton, Michigan to contain resuspended sediment (Figures 28a and 28b). Prior to the start of dredging in 2004, significant problems were encountered with the silt curtain. The current in the Detroit River at the site ranges from 2.5 to 5.5 knots. The silt curtain manufacturer only warranted the product to a maximum current of 1.5 knots. As a result, the curtain was unable to be maintained vertically even though it was heavily weighted. Many steel pipes were driven into the river bottom at spacing from 5- to 10-ft centers in an attempt to hold the curtain vertically (Figure 28c). The current caused numerous rips in the curtain, particularly at the seams. Multiple layers of curtain were eventually installed between the steel pipes. Later during the project, a semi-permeable curtain (Figure 28d) was placed inside and back from the impermeable curtain to aid in reducing the migration of suspended solids. Floating booms were also placed inside the curtains to capture any floating oil or grease.

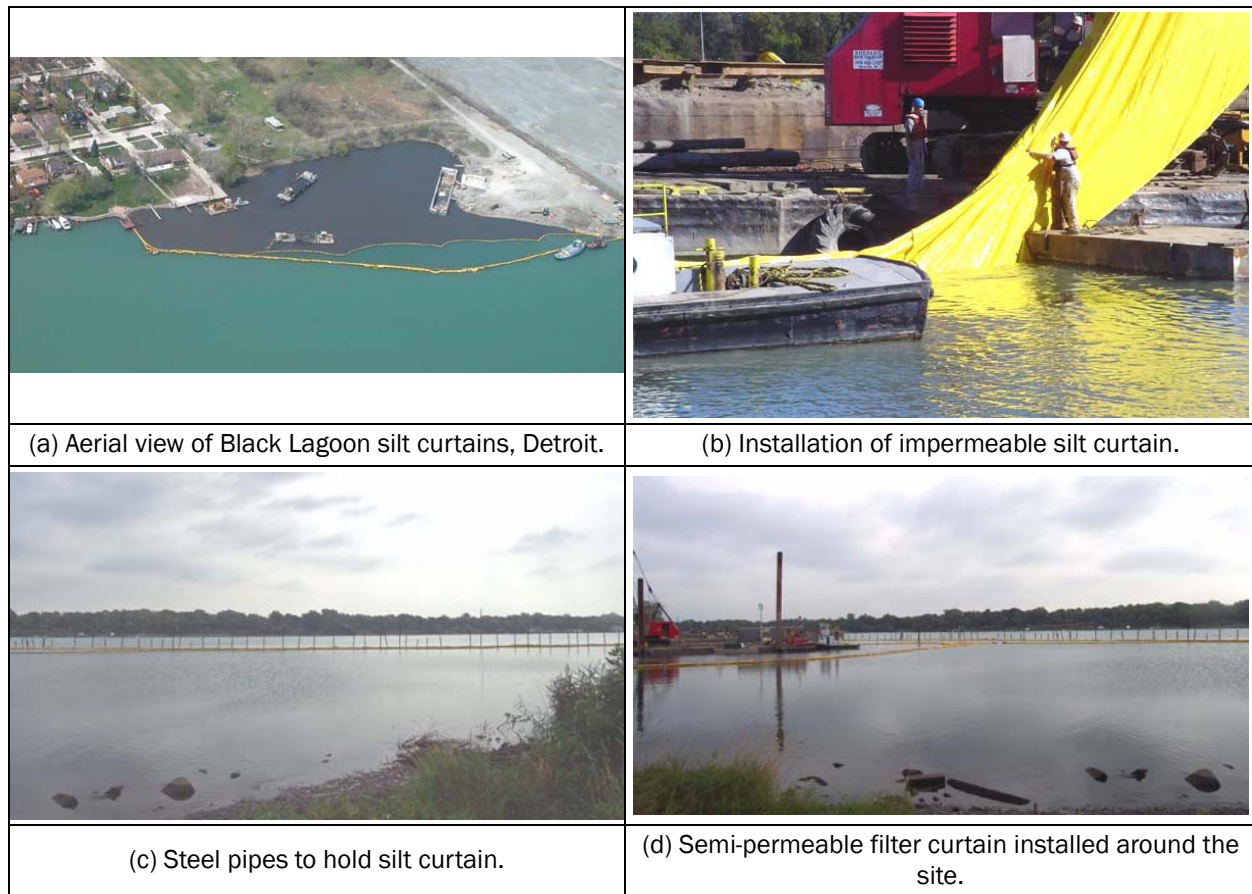

Figure 28. Silt curtain installation at Black Lagoon, Detroit River, Trenton, Michigan.

Other examples of silt curtain usage at sediment remediation projects are available but not well documented in the open literature. One silt curtain supplier (Elastec/American Marine) lists a few case study examples on their website, <http://www.elastec.com/curtainsCaseStudies.html> including projects on the Grasse River, New York; River Raisin, Monroe, Michigan; and Saint Lawrence Seaway, New York. Unfortunately, there are no good examples of sediment remediation projects with all the information needed to make a good assessment of silt curtain performance (Francingues and Palermo 2005). To date, no widely available analytical or numerical modeling tools exist for evaluation of silt curtain design or performance, with the exception of one study of flow conditions around a deployed silt curtain (Hayes et al. 2008).

8.1.4. Sheet-pile enclosures and other structural barriers

Structural barriers, such as sheet-pile walls, have been used for sediment excavation and in some cases (e.g., high current velocities) for dredging projects. Structural barriers should be considered when there is a need to

contain resuspended sediments that contain highly mobile, highly toxic, or bioaccumulative contaminants, and when there is uncertainty that a silt curtain will be effective. Structural walls (e.g., sheet pile deflection walls) can also be used to partially shield silt curtain enclosures from high current velocities (Erickson et al. 2007). Determining whether these types of barriers are necessary should be based on a thorough evaluation of the site. This can be accomplished by evaluating the relative risks posed by the anticipated release of contaminants from the dredging operation absent use of such structural barriers, considering the predicted extent and duration of such releases, the potential for trapping and accumulating residual contaminated sediment within the barrier, and the impacts to the project schedule given the operational interference caused by the structures. The project manager should consult the Risk Assessment and Modeling Overview Document (USEPA 1993) and Estimating Contaminant Losses from Components of Remediation Alternatives for Contaminated Sediment (USEPA 1996) for further information about evaluating the need for structural barriers (USEPA 2005).

Sheet-pile containment structures are more likely to provide reliable containment of resuspended sediment than silt curtains, although at significantly higher cost and with different technological limitations. Project managers should also be aware of the increased potential for scour to occur around the outside of the containment area and the resuspension and contaminant release that will occur during placement and removal of these structures. In order to limit costs and obstruction to navigation, these containment structures are seldom placed far enough from the dredging prism to be located in completely clean areas. Where water levels are lowered on one side of the wall, project managers should be aware of the hydraulic loading effects of water level variations inside and outside of these walls and resulting safety concerns. In addition, use of sheet piling may significantly change the carrying capacity of a stream or river and make it temporarily more susceptible to flooding (USEPA 2005).

Evaluation of rigid containments such as sheet-pile enclosures requires an engineering design. Considerations in such a design include the geotechnical characteristics of the sediment profile along the proposed alignment of the enclosure, the proximity of bedrock, the potential hydraulic head acting on the enclosure (to include heads resulting from tidal fluctuation or high flow events), ice forces (if the enclosures are to be left in place during the winter months), etc. The detailed engineering

design procedures related to these considerations are beyond the scope of this technical resource document.

8.2. Control measures for contaminant release

Control of contaminant release to the water column is directly linked to control of sediment resuspension. However, control of contaminant releases from the dredging site is also a function of transport and removal of contaminants from the water column. Increasing sedimentation rates will also decrease the release of dissolved contaminant, the spread of contaminants, bioavailability, and short-term risks. Nevertheless, the first consideration for control of dissolved and volatile releases is control of resuspension. However, in some extreme cases, the control of sediment resuspension may not be adequate in controlling contaminant release and the resulting risks.

8.2.1. Control of NAPL releases and floatable materials

Oil booms may be used for sediment that is expected to release oils or floatable materials (such as light non-aqueous-phase liquids, or LNAPL) when disturbed. Such booms typically consist of a series of synthetic foam floats encased in fabric and connected with a cable or chains. Oil booms may be supplemented with oil-absorbent materials, such as polypropylene mats (USEPA 1994). However, booms do not aid in retaining the soluble portion of floatable materials [e.g., polycyclic aromatic hydrocarbons (PAHs) from oils] that can volatilize (USEPA 2005). A visibly and fully soaked sorbent pad is one indication of the need for change-out. But, in addition to visible sheen indications, a proactive feedback loop of chemical monitoring can also help to determine the need for change-out.

8.2.2. Control of particulate contaminant releases

Experience with controls for particulate contaminant releases due to environmental dredging operations is limited to the controls for resuspension. However, increasing sedimentation rates will also decrease the spread of contaminants, bioavailability and short-term risks. Improved sedimentation can be achieved by providing a zone for quiescent settling or by adding flocculants. Particulate contaminants can also be removed by designing the containment enclosures to be filters. Filtering geotextiles have been developed for application with silt curtains to provide permeable sections that act as layers of filters and adsorbents integrated in

the permeable curtain sections to treat water passing through the dredging site. Bypass of water around or under the curtain due to its resistance to flow may reduce the effectiveness of the geotextile system. These innovations might be viable controls when the dredging operation poses unacceptable risks, but the application of some of these technologies may need to be proven in pilot studies before applying them to large-scale environmental dredging projects.

8.2.3. Control of dissolved contaminant releases

Experience with controls for dissolved contaminant releases due to environmental dredging and associated operations is limited to the controls for resuspension. However, any control for particulate contaminant releases should also provide some beneficial control of dissolved releases. Dissolved contaminants may also be removed by dispersing adsorbents in the containment enclosures, which will strip contaminants from the water column. After the adsorbents settle into the residuals layer, the adsorbents might aid in control of contaminant releases from the sediment bed and residuals and limit bioavailability of contaminants from the residuals. However, the long-term impacts of adsorbents on the local environment should be considered and weighed against the need for contaminant release control before employing such approaches. Dissolved contaminants may also be removed by designing the containment enclosures to be adsorbents. Filtering geotextiles with adsorbents have been developed for application with silt curtains to provide permeable sections that act as layers of filters and adsorbents in permeable curtain sections to treat water passing through the dredging site. These innovations might be viable controls when the dredging operation poses unacceptable risks, but the application of some of these technologies may need to be proven in pilot studies before applying them to large-scale environmental dredging projects.

8.2.4. Control of volatile emissions

Experience with controls for volatile releases due to environmental dredging operations is limited. However, any control for resuspension and particulate and dissolved contaminant releases given above should also provide some beneficial control of volatile emissions. In addition to the operational and physical controls mentioned above, the following controls for volatiles when concerns are limited to small hotspots may include:

- Modifying the dredging schedule or sequence such that most of the contaminated sediments are dredged in winter, when cooler temperatures reduce volatilization.
- Modifying the dredging schedule so that hot spots are dredged during nighttime hours.
- Using hydraulic dredging to reduce contaminant concentrations at the surface of the water column, contaminant concentrations in the air, and contaminant flux to the air.
- Applying surface volatilization barriers at the dredging site.
- Reducing the area of the dredge enclosure to reduce the area emitting volatiles and, therefore, the mass of volatiles emitted.

Physical measures to control volatiles during transport and offloading may include:

- Covering the dredged material with physical barriers such as (foam), mulch, plastic liner, or absorbent mats or materials.
- Degassing the pipeline before discharging into an onshore facility.

At the New Bedford Harbor site, a cutterhead dredge was modified by placing a cover over the dredgehead that retained PCB-laden oils, thus reducing the air concentrations of PCBs during dredging to background levels (USEPA 1997). In addition, the CDF used for placement of the project was fitted with a plastic cover that effectively reduced air emissions.

During excavation and barge transport and offloading, volatilization could be of greater concern, as contaminated materials may be exposed to air. Care should be taken in dewatering activities to ensure that temperatures are not elevated (e.g., cautious application of lime or cement for dewatering), and other control measures should be taken as needed (e.g., foam). As with operational controls for resuspension, operational controls for volatiles have not been adequately evaluated in the field to measure their effectiveness.

8.3. Control of residuals

One of the more significant limitations currently associated with predicting the effectiveness of environmental dredging is the uncertainty associated with estimating the nature and extent of residual contamination following removal. As defined and described in Chapter 1, residuals may

be comprised of dredging-generated residuals and/or undisturbed residuals, which can differ significantly in both thickness and density and in the concentrations of COCs. No removal technology can remove every particle of contaminated sediment, and field results to date for completed environmental dredging pilots and full-scale projects suggest that post-dredging residual contamination levels have often not met desired cleanup levels (Bridges et al. 2008).

As defined and described in Chapter 1, residuals may be comprised of dredging-generated residuals and/or undisturbed residuals, which can differ significantly in both thickness and density and in the concentrations of COCs. This section focuses on generated residuals, which are unavoidable. Undisturbed residuals can be reduced by accurate and precise site characterization, proper establishment of the cut line, accurate and precise positioning of the dredge passes, accurate and precise post-dredging bathymetric surveys, and an accurate cleanup pass to remove all sediment above the cut line as defined by initial characterization or confirmation sampling.

During the FS and RD phases of evaluation, the likelihood of the need to manage relatively high residual concentrations should be considered in selecting alternatives, developing cost estimates, scheduling, and preparing operations plans for implementation. As mentioned in Chapter 7, no commonly accepted method exists for predicting the nature and extent of residuals, but it is commonly accepted that a residuals layer will be present following production dredging, and that some management of these production dredging residuals might be needed if the project objectives include meeting a low cleanup level for contaminant concentrations.

8.3.1. Operational controls for residuals

Operational controls and considerations can help in reducing residuals, and should be considered in the RD phase and during development of the operations plan for the project, and should be implemented during the production dredging phase of the project.

Operational controls for residuals may include:

- Considering the need for separate debris-removal operations prior to sediment dredging, during the production dredging if multiple passes

- are performed, and possibly prior to a cleanup pass if debris is a major cause for residuals generation.
- Sequencing the dredging from upslope to downslope and upcurrent to downcurrent.
 - Setting and sequencing production cuts to reduce concentrations in residuals.
 - Providing for an appropriate overdredging allowance for production cuts.
 - Overdredging with a cleanup pass to reduce the thickness of the contaminated residuals layer and to mix residuals from clean underlying sediment with the contaminated residuals, decreasing the contaminant concentration in the residuals.
 - Placing bucket accurately so as not to allow missed sediments between bucket placements.
 - Eliminating bucket overpenetration and overfilling.
 - Rapid sampling after dredging to provide feedback to the dredge operator showing effects of operations.

The effectiveness of such operational controls has not been documented across a range of site conditions. In addition, implementing operational controls may result in increased dredging costs and increased time to complete dredging operations. These potential impacts should be compared with the potential benefits of reduced residuals prior to implementing operational controls.

8.3.2. Post-dredging control measures for residuals

Depending on the results of monitoring following production dredging, one of several options for managing the residuals may be required. There is a linkage between environmental dredging performance standards for residuals, approaches and tools for monitoring residuals, and selection of options for residuals management. As discussed below, there are several possible post-dredging management actions for residuals based on the residuals' characteristics and site conditions. An engineering/operational evaluation should be conducted to determine which control measures are most amenable to conditions. If needed, the selection of a residuals management approach would depend on the nature and extent of the residuals (presence of generated residuals vs. undisturbed residuals, residuals thickness, residuals density, and COC concentrations) as well as an engineering/operational assessment of site conditions as related to potential management actions (Palermo and Patmont 2007). Depending

on the specific management option selected, additional sediment verification sampling may need to be performed to verify the effectiveness of the action. The need for post-dredging residuals management and controls may also extend outside of the original dredged prism.

Monitored natural recovery (MNR)

MNR refers to a remedial approach in which natural processes such as sedimentation, sediment mixing, and degradation reduce contaminant concentrations over time. MNR is a potential management approach for post-dredging residuals if the layer thickness and concentrations of the residuals would allow for MNR within acceptable time frames. Essentially, the same considerations that apply to selection of MNR as a primary remedial approach (e.g., as opposed to dredging) would apply in selection of MNR as a post-dredging management approach for residuals.

Cleanup dredging pass

At some sites, a cleanup dredge pass has been performed to remove layers of residuals. Such actions have been referred to as a cleanup or sweep pass, and are usually conducted in such a way as to attempt to remove only a thin surficial layer of material, with the intent of removing the residuals layer and a minimal thickness of underlying clean material. A cleanup pass may be appropriate as a residuals management approach at some sites. However, performance requirements for multiple passes of the dredge to achieve a very low residual contaminant concentration can be inefficient (from a volume per time standpoint) and costly. However, a cleanup pass can be effective in removing the required material to meet cleanup objectives. As discussed in USEPA guidance, project managers should consider limiting the number of required passes (to one or two) and providing an option for placement of a residuals cap or cover of clean material to achieve a residuals standard. This also brings more certainty into the process of cost estimating and bidding.

Additional production passes

Additional production dredging may be required for thicker layers of residuals, especially undisturbed residuals. This action would be needed for cases where a considerable thickness of contaminated sediment was left (e.g., when initial site characterization was incomplete, setting of the initial production dredge cutline elevation left a considerable thickness of

contaminated sediment, site conditions such as hard and uneven rock bottoms limited the ability of the dredge to reach some contaminated sediments, or dredge positioning or control was poor).

Residuals cover

Residuals caps or sand covers are terms used to describe a thin layer of clean material (usually a few inches) placed over residuals to provide short-term isolation and long-term reduction in surficial contamination. The clean material used to cover the residuals does not need to be sand; in fact, other materials with the potential to reduce the bioavailability of the contaminants (such as clay and organics) may be preferable. Covers would be a potential management action for layers of residuals that are sufficiently thin and at sufficiently low contaminant concentrations such that possible mixing of the cover materials into underlying residuals would still ensure attainment of the action level. Some mixing of cover materials and layers of residuals would occur upon placement of the cover. As bioturbation and sediment transport processes work the surface, additional mixing may occur. The placement of a cover would thus result in a lower contaminant concentration in the biologically active zone. At some sites, covers may also provide physical and chemical isolation of the residuals, depending on the thickness of the cover, the thickness of the residuals layer, and the rate of sediment mixing. Any additional deposition of clean sediment in the short or long term may extend and enhance the isolation ability of a cover.

Engineered isolation cap

An engineered isolation cap can be considered as a residuals management action in cases where substantial layers of residuals, especially undisturbed residuals, cannot be effectively removed. The considerations for evaluating engineered caps as a residuals management option are identical to those for design of engineered caps as a primary remedial option, and USEPA guidance for design of engineered caps is generally followed (USEPA 2005).

The basis for selecting one or more of the above residuals management approaches should be defined in the monitoring and management plan for the project. In some cases, a project-specific “decision tree” may be developed with specific rules for selection of the management option

based on the nature of the layers of residuals as defined by post-dredging verification sampling (Fox et al. 2007).

8.4. Summary

Project managers should recognize unique project features that require a site-specific application and adaptation of control measures for environmental dredging projects. They should also:

- Be aware of the increased potential for scour to occur around the outside of structural controls.
- Recognize that resuspension will occur during placement and removal of structural controls, reducing the potential benefit.
- Be aware that sheet piling can change the carrying capacity of a stream or river, making it temporarily more susceptible to flooding.
- Recognize that silt curtains are highly specialized, temporary-use devices that should be selected only after careful evaluation of the intended function and designed based on a detailed knowledge of the site where they will be used.
- Recognize that all dredging will result in some residuals, but that these can be reduced through use of proper equipment and methods.
- Plan for dredging activities having quality of life issues (e.g., odors, noise, and light) resulting in impacts on project production rates and schedules.
- Consider the use of controls for contaminant release and residuals because the total mass of contaminants left in the residuals layer or released and then transported outside the dredging site are much greater than the resuspension loss and may pose greater risk.

8.5. Case studies

Examples of most, if not all, of the control measures mentioned in this chapter can be found in the environmental dredging projects listed in the MCSS database (General Electric et al. 2004). Excerpts from the project summaries in the database are reported here. For these projects, silt curtains were the most commonly reported measure employed for control of resuspended sediments. A number of projects used sheet piles for containment, to permit excavation in the dry, and to stabilize banks during or following dredging, and as settling basins for water management and for control of suspended solids and contaminant releases, including NAPL associated with contaminated groundwater. Although the latter instance

falls more within the purview of source control, dredging was impacted for at least two projects (Housatonic Project 2, Velsicol Project 1 (Pine River)) by the discovery of contaminant seeps that had to be addressed before dredging could continue.

8.5.1. Examples of structural controls

The types of structures that were used to control releases or to isolate excavation areas for these projects were quite varied and were used for both hydraulic and mechanical dredging. The size and the configuration of the installations also varied.

At Bayou Bonfouca, silt curtains with absorbent booms placed along the bayou were recommended in the Explanation of Significant Differences (ESD) issued in 1990, in addition to turbidity curtains around the excavation process.

For the St. Lawrence River project (Reynolds metals site) near Massena, NY, approximately 3800 ft of sheetpile was installed to isolate the work area from the river. In addition, silt and air curtains were utilized to isolate one dredged area (Area C) from the others. The area was dredged mechanically, with the air curtains allowing the movement of equipment into and out of the work area. Also on the St. Lawrence River, a 2500-ft-long nearshore area was enclosed with sheetpile and dredged hydraulically at the GM Central Foundry site. Three cofferdam areas, each 1/2-mile long, were installed in the upper 1-1/2 miles of the Grand Calumet River. In addition, sheetpile was installed within the cofferdams in some areas of the river to provide for bank stabilization following dredging. Dredging within the cofferdams was done with an 8-in. hydraulic dredge. A 12-in. dredge was used for open water dredging. Sheetpile was placed in Tyler Pond (Willow Run Creek project) to permit dewatering and excavation of one third of the pond at a time.

At Fields Brook, the creek was dammed and the flows bypassed to permit excavation in the dry. Similarly, Gill Creek (DuPont) was isolated with a cofferdam and the creek was rerouted. Removal was then accomplished by vacuum dredging, mechanical excavation, and spray washing. On the Housatonic River (Project 3), the river was diverted with sheet piling over approximately 0.8 mile and by pumping bypass over another 0.7 mile, and then excavated in the dry. The Tennessee Products – Project 1 Hot Spot removal was also done in the dry. Port-A-Dams and flume tubes were

initially proposed, but discontinued in favor of rock dams, with removal from the bank using a long-stick excavator.

Earthen berms were used in conjunction with sheet piling at Ottawa River Project 2 (removal from an unnamed tributary) to permit excavation in the dry. Two removal zones, one 11 acres and the other 14 acres (subsequently divided into four cells), were created for the Velsicol Project 1 (Pine River), by placing a sheetpile cofferdam along the centerline of the Middle Basin portion of the impoundment from the downstream Mill Street Bridge to approximately the upstream boundary of the former plant property. Water produced in dewatering the impoundment was pumped to a sheetpile settling basin prior to treatment and discharge back to the river. A sheetpile was also placed around the 3-acre hot spot (Velsicol Chemical Project 2 Pine River Hot Spot) located within the 11-acre removal zone. Stabilized sediments were then removed by dry excavation.

A bladder structure and stone dam were used at Mallinckrodt Baker (formerly J.T. Baker) to isolate the excavation area. Infiltration to the excavation area was managed by pumping, and sediment was removed with excavators.

A double silt curtain was placed across the width of the creek at Starkweather Creek to reduce transport of sediment and construction debris downstream of the work areas.

8.5.2. Examples of operational controls

In addition to a shield over the cutterhead, operational controls employed at Lavaca Bay included slow advance rate for the dredge, slow cutterhead speed (5 RPM), and slow lateral movement of the cutterhead.

Starkweather Creek is a good example of staging and sequencing the work to reduce sediment transport. Excavation was done with a conventional backhoe through the water column, on 100-yd sections of the creek individually. Banks were stabilized in each section before moving to the next section. The work proceeded from upstream to downstream. Upstream to downstream excavation was noted at a number of other projects as well, including the Velsicol Project 1, for example.

At the St. Lawrence River project, initial sediment removal was conducted with a derrick barge and 5¹/₂-yd³ bucket. Cleanup passes were conducted

with 2½-yd³ buckets, which presumably allowed more precise control of removal thickness.

Operational controls proposed for the Ashtabula River project included limiting bucket cycle time, prohibiting nighttime dredging, and partial filling of watertight barges.

8.5.3. Monitoring effectiveness of controls

Quantitative information was limited, but a few references were found regarding the effectiveness of controls at environmental dredging sites. For the St. Lawrence River project previously mentioned, water column monitoring was performed on both sides of the sheetpile and inside the silt curtain isolating Area C. “Turbidity measurements were obtained outside the sheetpile wall every two hours adjacent to, 100-ft upstream of, and 100-ft and 350-ft downstream of each dredge” (General Electric et al. 2004). Samples were also obtained 6 hr into each shift from outside the sheetpile and analyzed for PCBs, PAHs, and other analytes. Samples were taken for chemical analysis within the sheetpile on a once-weekly basis; however, results of the sampling and analysis were not provided in the database.

Water column, oyster, and sediment monitoring was reportedly done outside the dredge area for the Lavaca Bay Project 1 Treatability Study. “No significant resuspension or transport of contaminants outside the silt curtain area was observed during dredging” (General Electric et al. 2004); however, “some elevated mercury levels were observed during water column readings.”

“Water samples collected from outside the silt curtains during dredging were below the site-specific turbidity action levels and non-detect for toxaphene” for the Terry Creek Project I (Creek Hot Spots/Outfall Ditch). For the Fox River Project I (SMU 56/57), “no increase in river turbidity levels was reported due to the dredging; however, river water was periodically very turbid due to an unusually large algae bloom.”

8.5.4. Reported costs and production rates

Five environmental dredging projects reviewed from the MCSS database provided some level of breakout cost for in-water containment, so a full range of conditions is not well covered by the data. Mean reported cost

was 12 percent of total project cost, ranging from 0.5 percent (Gruber's Grove Bay) to 26 percent (DuPont Newport site). One project (Cumberland Bay) reported unit costs for sheet piles of \$52/ft² (\$34/ft² to install, \$16/ft² to remove), as well as \$44/lineal foot for soldier piles and \$42/lineal foot for silt curtains (adjusted to August 2006 cost basis). Based on total reported containment cost (\$6.1 M) and site area (30 acres), in-water containment for the St. Lawrence River project (Reynolds Metals) near Massena, NY was \$204,000/acre (adjusted to August 2006 cost basis).

An often cited "cost" associated with the use of controls is lower production and increased time for project completion. This may be inherent in the operational controls employed, or incidental to the structural controls. Several projects reported production rates and differences between projected and actual dredging period, which might, in part, have been associated with restricted operations due to in-place controls. In some cases, other factors such as debris or capacity of upland treatment or water handling processes may have had equal or greater impact on production rates.

At the Velsicol Project 1, an area previously thought to be uncontaminated was found to be contaminated. Consequently, dredging was "significantly slowed" to prevent disturbance of the sheet-pile base, which had not been deeply anchored in that area.

Dredging at Gruber's Grove Bay was conducted using a 10-in. hydraulic auger dredge with an average discharge rate between 62 yd³/hr and 83 yd³/hr, depending upon the information source. A maximum production rate of 1500 yd³/day was reported, and a total volume of 88,300 yd³ of sediment was achieved during the 7-month dredging period, with 28 days down time attributed to geotube tearing problems. A silt curtain was used for this project, but was placed across the mouth of the bay, suggesting that impacts on production within the dredging area may have been minimal. Dredging was conducted in a grid pattern with overlap, which may have reduced production somewhat.

In 98 days of active dredging, a total volume of 85,600 yd³ was removed by mechanical dredging at the Reynolds Metals site on the St. Lawrence River, approximately 873 yd³/day. Delays were attributed to the inexperience of the local crane operators, who required "significant time

and effort...to increase the competency of the crane operators with the dredging and positioning equipment, as well as procedures for environmental dredging.” Operations were conducted within a sheetpile impoundment and, in Area C, within silt and air curtains within the impoundment, through which equipment was moved in and out. Impact of the structures on the dredging rate was not reported and the average production is comparable to that achieved with a hydraulic dredge at Gruber’s Grove.

Dredging of 50,000 yd³ of sediment from the Fox River (Project I SMU 56/57) by hydraulic auger dredge (size not specified) required 69 days, 9 days longer than projected. This is an average production rate of 724 yd³/day, or 30 yd³/hr, roughly one half to one third that reported for Gruber’s Grove Bay. Silt curtains were in place around the perimeter of the dredging area, dividing the area into separate cells and may have been partly responsible for lower production, but capacity of the mechanical dewatering facility was also a factor.

9 Operating Methods and Strategies

This chapter presents strategies and methods related to environmental dredging operations. In the context of this document, operations refers to those aspects of design related to how the project is delineated and sequenced and how the dredge will operate with respect to vertical depth increments, production and cleanup passes, overdredging allowances, etc. The considerations described in this chapter impact costs and performance.

9.1. Management units and dredging prisms

Subdividing the site into management units is often desirable for purposes of remedial investigation and design and implementation. Such subdivisions or subareas are particularly useful for management of operations, monitoring, and compliance.

There are no standardized definitions of the various types of horizontal and vertical subdivisions, and management units may include several types or levels. For purposes of this document, the various types are defined as follows:

9.1.1. Sediment management unit

A Sediment Management Unit (SMU) is a horizontally defined subarea within the overall project area. SMUs are a common method of subdividing large and complex sites and are usually defined based on differing site physical conditions or differing sediment physical or chemical characteristics. A key consideration in developing SMUs is the potential for areas within a larger site to have important distinctions such as differing water depths, current or wave regimes, required thicknesses of cuts, differing COCs, hot spot concentrations of COCs, etc. Multiple SMUs can be adjoining or can be separated by areas not slated for active remediation. In the case of a project with large areas separated from one another, each such area would logically be a separate SMU. Other possible considerations for defining SMUs may include the presence of hot spots requiring special consideration for dredging, or areas with debris fields or other characteristics that may require special consideration for equipment selection or operational approach. The concept of SMUs is similar to that

for Operable Units (OUs), but the designation of OUs can be a function of both technical and non-technical considerations. So, for the purposes of this document, the term SMU is used. The Onondaga Lake Project, located near Syracuse, NY, is an example of a large and complex site with a number of distinctly different SMUs. Figure 29 illustrates the boundaries for the SMUs for this site. This project involves the removal of 2.6 million yd^3 of contaminated sediment from six of eight SMUs as shown in Figure 29. In this case, the SMUs within the lake were defined either based on differing physical site conditions such as water depth or depositional environment or differing sediment physical and chemical characteristics.

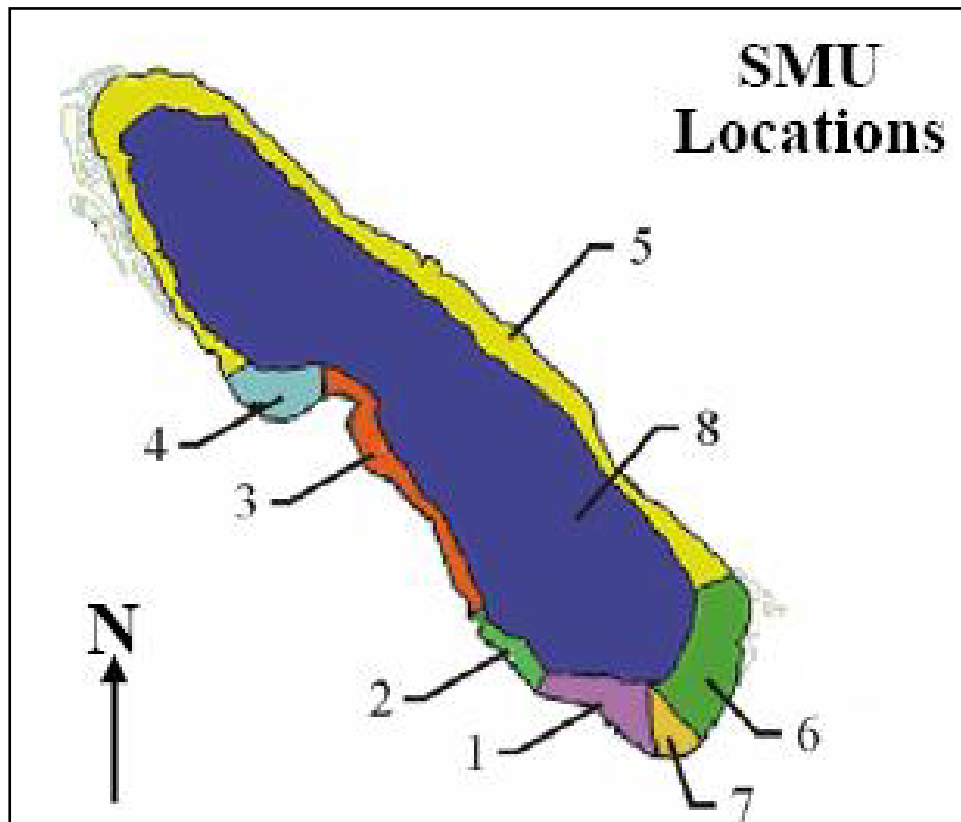

Figure 29. Illustration of sediment management units (SMU) for the Onondaga Lake, NY site.

9.1.2. Neat line prism and neat line volume

The neat line prism may be defined as an exact three-dimensional (3-D) geometric shape corresponding to the volume of sediments exceeding the action level. These prisms are usually defined in the feasibility stage of evaluations. The neat line volume is the corresponding volume of the 3-D neat line prism. Such a prism is based on a neat line cut elevation at each

sampling/boring location established to meet a target concentration for removal (see Figure 30). A neat line volume can be established by interpolating the cut elevation between boring locations using techniques such as kriging and/or Thiessen polygons. Figure 31 illustrates the use of Thiessen polygons to define a neat line prism for the Fox River project. In some cases, the target removal concentration might not be bracketed by available data, and in such cases, no definite “bottom” for the cut will be defined by sediment characterization data, and the neat line volume would be based on statistical analyses. Neat line volumes can be established for specific SMUs and for the total project. It is important to note that a neat line prism would normally be an irregular geometric shape, and additional volume would be required for removal based on the method of dredging. As discussed in Chapter 3, adjusting the neat line volume upward to account for the limitations/precision of the dredge operation results in dredging prism volume that can be used in both the FS and RD phases of evaluation for estimating costs, required times for completion of work, etc.

9.1.3. Dredging prism or dredging prism volume

A dredging prism may be defined as a 3-D geometric volume of sediments to be dredged that accounts for the anticipated dredge operation (see Figure 30). The dredging prism volume is the corresponding volume of the 3-D dredging prism. The term “dredging prism” has long been used in the context of navigational dredging. The dredging prism could be used in reference to the total project, a specific SMU, or for a smaller subdivision. A dredging prism may have areas with differing target cut elevations. Figure 32 is an example of a dredging prism for the Puget Sound Naval Station, near Bremerton, WA, and shows a range of target cut elevations within one contiguous prism.

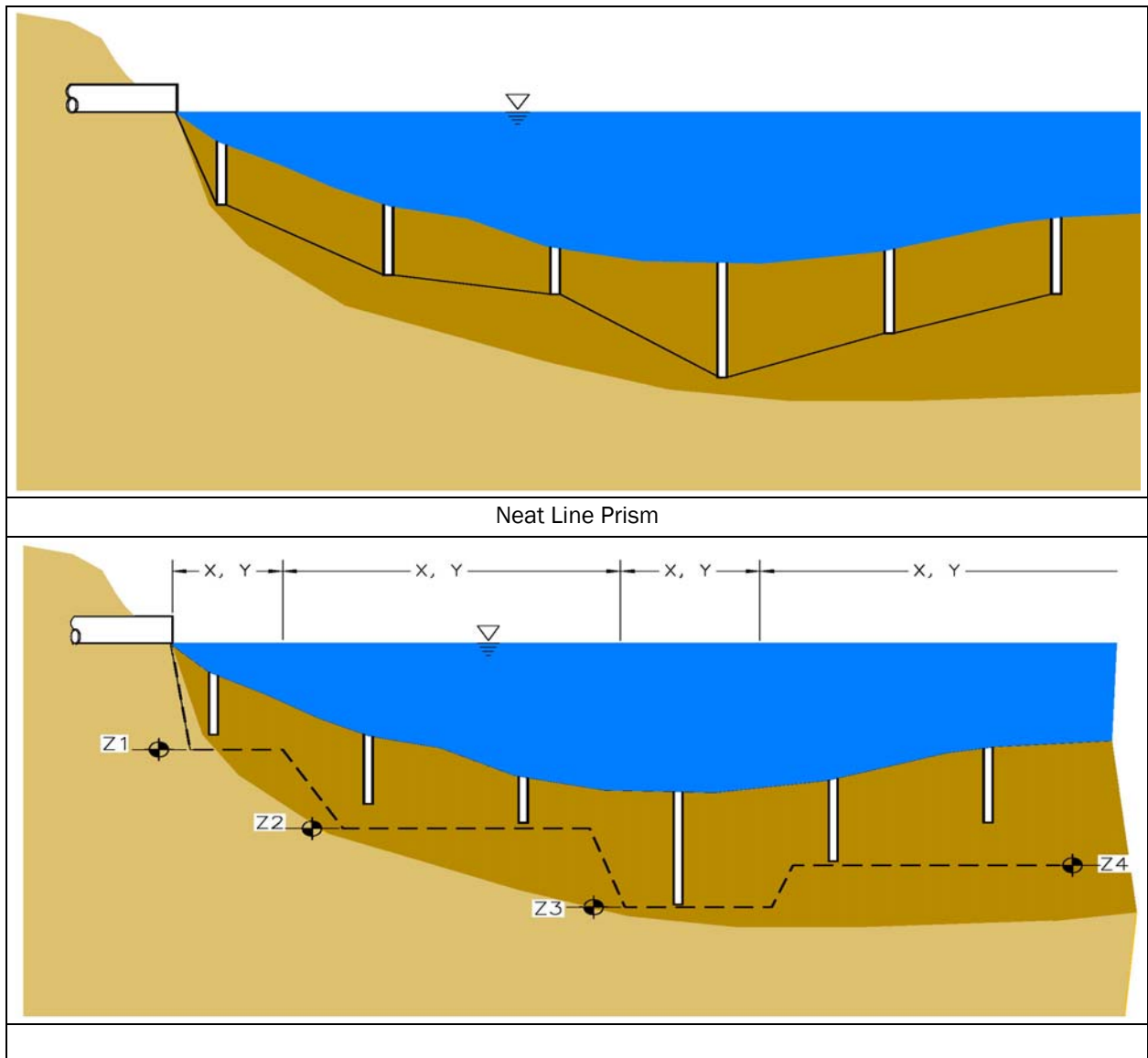

Figure 30. Conceptual illustration comparing neat line prism and dredge cut prism.
Source: Weber et al. (2003).

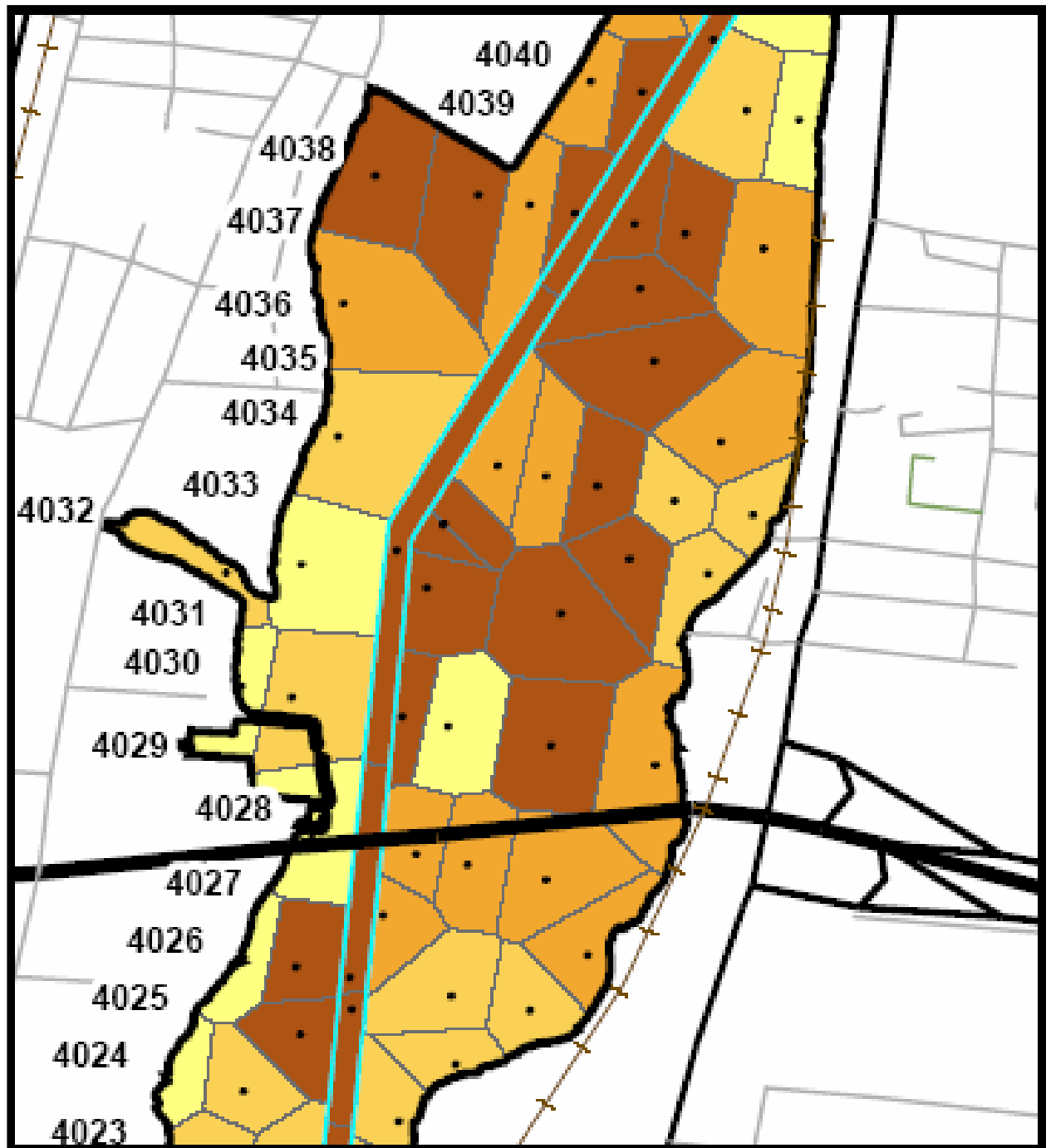

Figure 31. Fox River example illustrating use of Thiessen polygons to define a neat line prism.

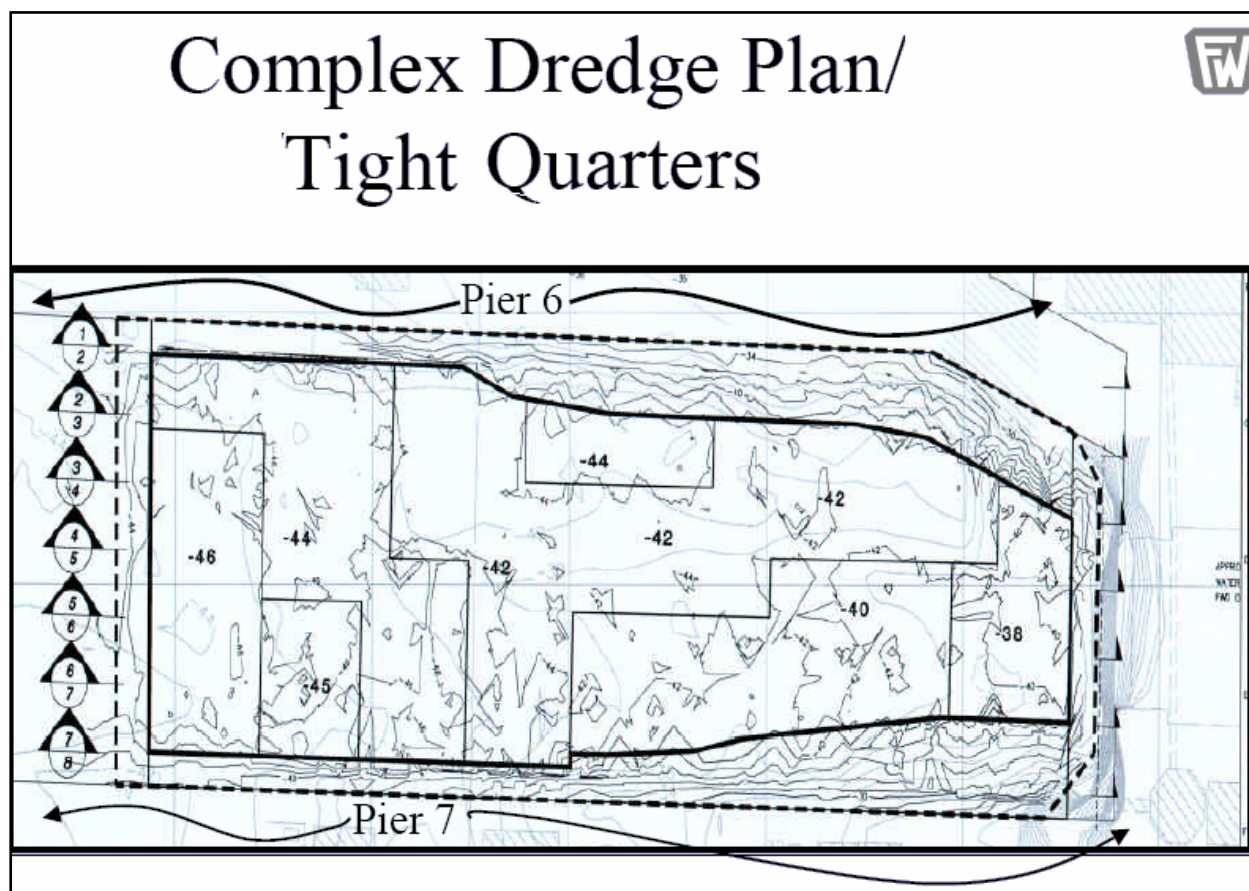

Figure 32. Puget Sound Naval Station example illustrating dredge cut prism. Source: Elmer and Lally (EPA Forum).

9.1.4. Dredging management unit

A dredging management unit (DMU) may be defined as a smaller subdivision within a larger SMU. DMU subdivisions may be defined for differing purposes. For example, DMUs were defined for the New Bedford Harbor project for projecting annual resource requirements; improving accuracy of material balance calculations; specifying sequence of removal; providing data to bidders on sediment types for each unit; and monitoring remedial progress (see Figures 33 and 34). In some cases, DMUs may correspond to defined dredge cut areas, each with a specified unique final target cutline elevation (see Section 9.2). For example, at the Head of Hylebos project, 50-ft by 100-ft DMUs were defined primarily on the basis of the cutline elevation, i.e., a single cutline elevation was set for each DMU.

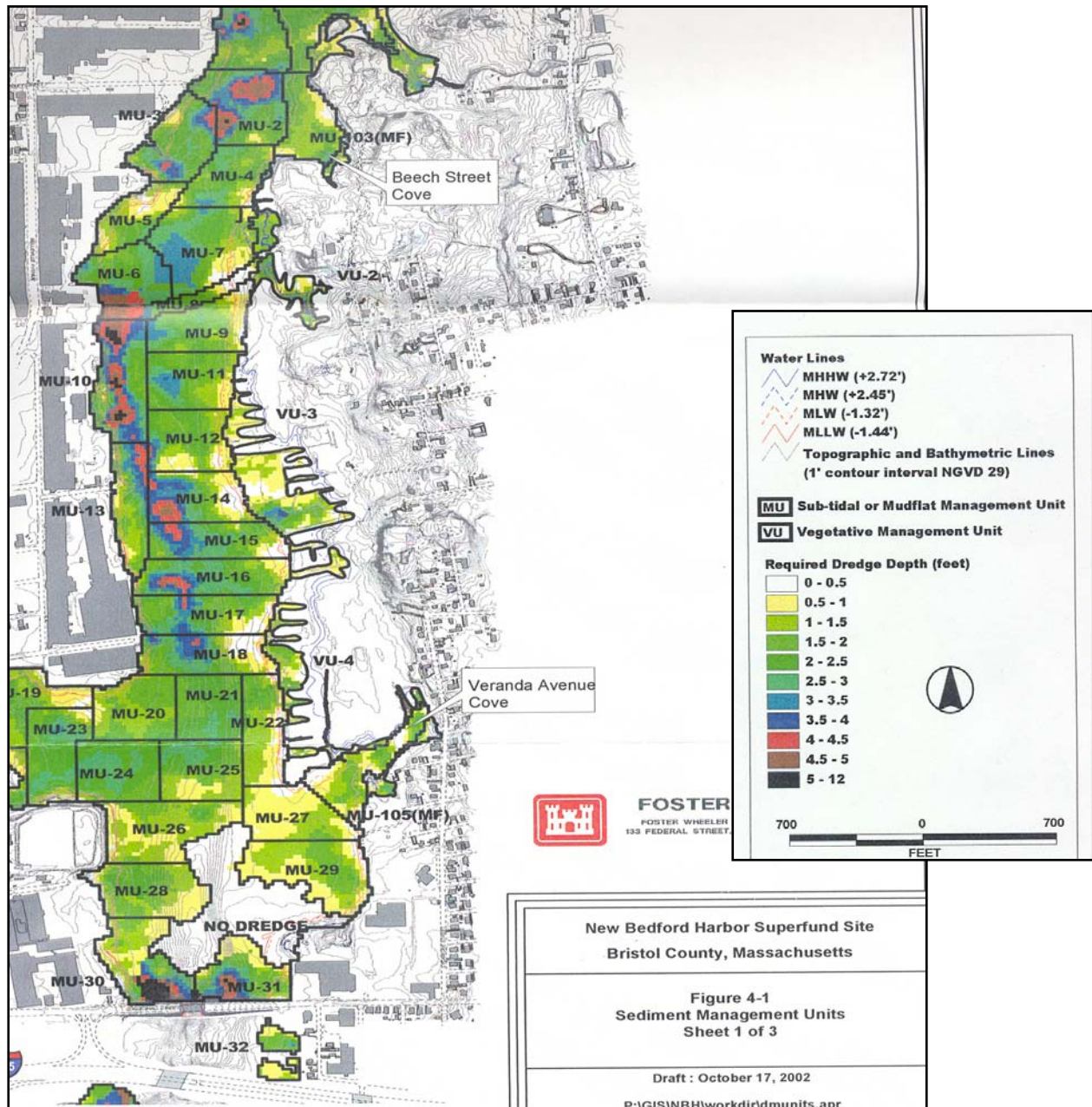
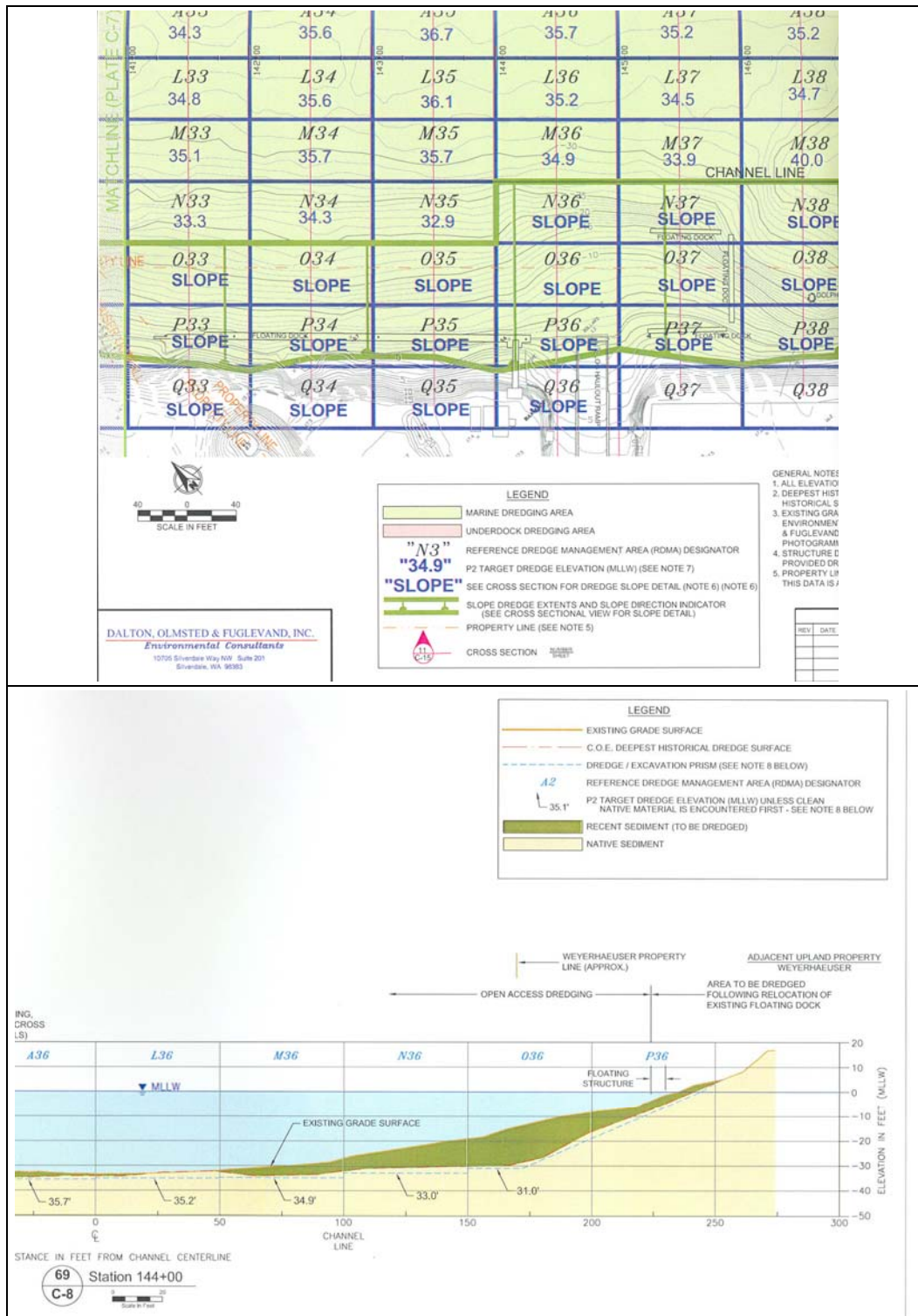

Figure 33. Dredging management units, New Bedford example.



9.1.5. Compliance demonstration areas

Compliance demonstration areas (CDAs) are areas for monitoring and management of the dredging process. CDAs could correspond to the DMUs for a project or might be separately defined. For example, CDAs for the Fox River OU1 project were defined as areas corresponding to the equivalent of 2 weeks of dredging effort. CDAs were sampled to confirm dredging effectiveness, and each CDA was “accepted” by separate evaluation of monitoring data for final cut elevation and concentrations of COCs. The largest size for CDAs is related to an acceptable size for “approval” by the appropriate monitoring methods and means.

9.2. Dredge cuts and cleanup passes

9.2.1. Cuts

Dredging operations within specific areas (either DMUs or CDAs) are planned in terms of the areas to be cut and the types and numbers of dredge cuts. Some useful definitions are as follows:

Dredge cut

A dredge cut is defined as a three-dimensional volume with a specific final target cut elevation. The dredge cut might consist of only a fraction of the width and length of the DMU based on the dredge type and method of operation. Dredges typically operate in lanes cutting across the dredge area. The largest size for a dredge cut area is often tied to operational factors for the selected dredging equipment. For example, the width of production cut or pass might be the limiting swing width for a cutterhead dredge or the limit of reach for a clamshell and length of the dredge cut would be restricted by the anchor placements. The thickness of sediment to be removed for a dredge cut may require several production cuts or passes to reach the final target cut elevation. The use of lifts not exceeding 5 ft is recommended for sediment remediation. Most dredges are designed to target relatively level dredge cut design elevations, although the actual final surface is a function of equipment and operation. In some cases, dredge cut areas will correspond to dredging management units (DMUs) for the project (see Section 9.1.4).

Production cut

A production cut is a volume within a DMU for which intermediate target cut elevations are set. Depending on the optimal cut thickness for the dredge, multiple full cuts or production passes may be necessary to meet the final target cut elevation. The objective of a production pass is bulk removal of the targeted sediment to achieve the dredge cut as efficiently as possible. Figure 35 illustrates use of two production cuts to achieve the target cut elevations for the Lockheed Project in Seattle, Washington. The cutline elevation of the final production cut is usually set at the lowest elevation with concentration of the COC higher than the action level.

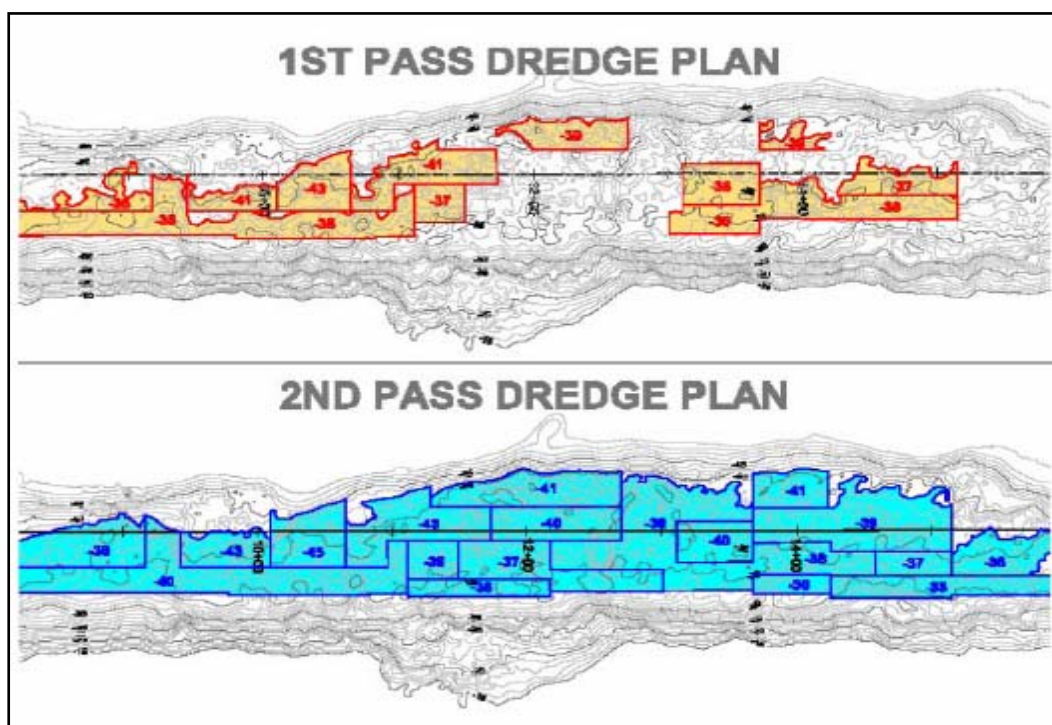

Figure 35. Example of a two-pass dredge cut plan, Lockheed example.

Box cuts and step cuts

A few dredge designs allow for the dredgehead to make an inclined cut along a sloping bottom, but most dredges, both hydraulic and mechanical, make level cuts and cannot easily follow slopes in removing sediments. A box cut is a step-shaped production cut along the sloping portion of a dredging prism. A box cut is made by removing material within a level cut, leaving a vertical face that forms the “box.” Box cuts are common in navigation dredging and are usually formed by removing material to the limit of the authorized navigation channel, and allowing the slope to

conform to its angle of repose. For environmental dredging, a series of box cuts or “step cuts” is sometimes used as the basis of defining a dredge prism for an area with a sloping bottom. In sloping areas, the step cuts are formed by stepping the box cuts downward, with the series of box cuts following the desired overall slope. The vertical face or steps for environmental dredging would usually be smaller than in box cuts for navigation dredging. Since the contaminant removal neat line corresponding to the action level generally follows the slope, use of box cuts requires increased sediment removal as compared to a cut paralleling the slope because the entire box cut must fall below the neat line. Sloughing of the vertical face of the box cut will occur over time, resulting in the desired final slope. Figure 36 illustrates the principle of box cuts.

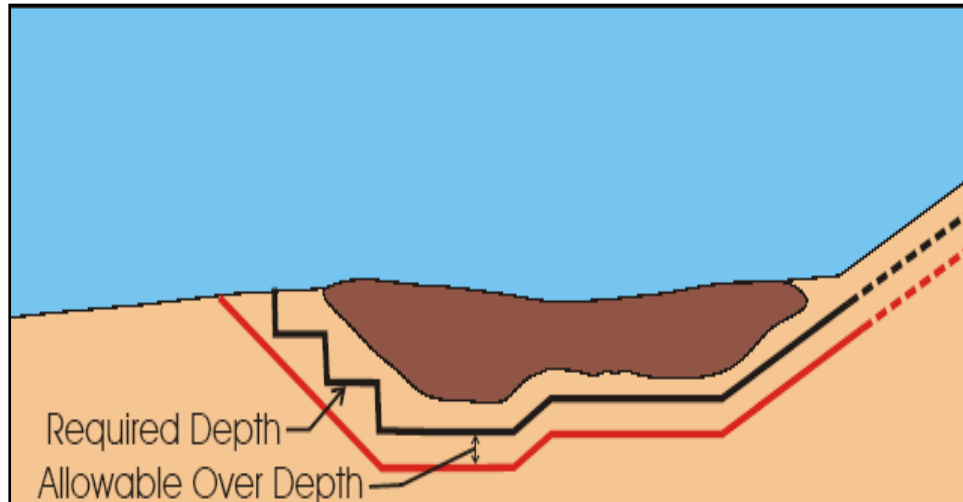

Figure 36. Illustration of dredging box cuts. Source: USACE Dredging Fundamentals (USACE 1983).

There are several considerations in planning for the required number of production cuts or passes for a given dredge cut area:

- First, the final target cutline elevation should be determined based on the sediment chemistry, the action level, and the final CUL. The sediment chemistry as defined by boring samples at locations within the site will determine the profile of concentration of COCs.
- For areas selected for full dredging of all sediments exceeding an action level, the cutline at discrete locations is set at the lowest elevation exceeding the action level.
- For areas selected for partial dredging, the basis for selecting a final target cutline elevation may vary.

- The optimal cut thickness for the given dredge type and size will determine the number of production cuts necessary for completion of a given dredge cut.
- Relatively thin production cuts are often needed, and such cuts are often not compatible with the optimal hydraulic dredgehead embedment depth.
- Areas of deeper excavation may require additional “layback slopes” (a greater top width for the dredge cut than required to remove sediment having a concentration above the action level) to ensure stability of the cut. Layback slopes result in additional sediment volumes to be dredged.
- All additional sediment volumes due to box cuts, limitations of dredge operation, layback slopes, etc. should be considered in determining the volume of sediments to be dredged for the project.

9.2.2. Overdredging

Overdredging is a common practice used in navigation dredging to permit the dredge to increase productivity and efficiency. Overdredging is acceptable for navigation dredging because it facilitates meeting the design depth, provides for advanced maintenance of the channel, and increases the interval required between maintenance projects.

Overdredging also provides benefits for environmental dredging with respect to meeting a CUL, minimizing residuals, and increasing dredging effectiveness. Therefore, some overdredging is recommended for projects in which contaminated sediments overlie clean sediments and in which the sediments at the interface have relatively high contaminant concentrations. However, excessive overdredging is less desirable for production cuts when dredging contaminated sediments because it increases the volume of dredged material to be treated and disposed. Therefore, increased precision, as compared to that needed for navigation dredging, is desired for environmental dredging of contaminated sediments (Riley 2006).

Overdredge allowances should be tighter (smaller) for environmental dredging as compared to navigational dredging and based on the precision of the dredge. Inaccuracies of positioning should be considered in setting the target cutline. The overdredging is only that thickness below the target cutline allowed for payment, not to be considered an accuracy allowance. Some dredging inefficiencies result from the need to locate the dredgehead

as precisely as possible to the design cutline to minimize removal of clean underlying material. Due to the high unit costs of sediment management, incentives and/or disincentives might be considered in developing contract requirements for environmental dredging.

Considering the water depths at most contaminated sediment sites, the size of dredges normally employed, and the precision attainable for positioning the dredgehead, an overdredge allowance for environmental dredging projects of 6 in. is the current “state of the practice.”

9.2.3. Cleanup passes

If performance standards for environmental dredging include meeting a CUL after dredging, the generation of residuals and/or the degree of undredged inventory may require further management actions, even if some overdredging is conducted in the production cuts. Possible management actions may include placement of a residuals cap (see Chapter 8) or additional dredging in the form of cleanup passes. A cleanup pass (sometimes called a sweep pass) is simply a thin cut taken by the dredge in an attempt to remove residuals and at the same time limit removal of clean underlying sediments. Different dredging equipment may be used for the cleanup passes if the residuals are limited to a thin, loose layer of disturbed sediment generated by resuspension, and fallback. A thicker residuals layer resulting from sloughing, interference from debris, and previously unidentified contamination may require an additional production pass rather than a cleanup pass.

If the cleanup pass is taken with a cutterhead, auger, or other hydraulic dredgehead with an active cutting action, the depth of cut is normally controlled to avoid taking excessive clean underlying material. Even so, a cutterhead or auger dredge will still generate a spillage layer that is not captured by the dredge, reducing the effectiveness of the cleanup pass by that equipment. A more effective means to complete a cleanup pass for a hydraulic dredging project is to utilize a straight suction dredge with no active cutting action. In this case, the cleanup pass is conducted as a true sweeping pass, with the dredge essentially “vacuuming” the loose residuals from above the cut surface. In either case, cleanup passes by their nature will result in a low solids concentration in the discharge, and the resulting production rate in volume removed per unit time will be low, but actual effectiveness in producing a clean bottom can be high in terms of area

covered per unit time. The excess water in the discharge for cleanup passes may also require some adjustments to treatment systems, etc.

Cleanup passes with bucket dredges would require very precise vertical positioning of the bucket. Use of smaller bucket sizes may be desirable for cleanup passes to avoid taking excessive water, although most environmental buckets are designed for thin cuts, so volume of water versus area cleaned per bucket should be evaluated.

Two-Stage Dredging Program. Recent projects have applied so-called “two-stage” dredging programs using both mechanical and hydraulic dredging equipment to achieve effective control of residuals (Otten and Webb 2008). The two stages of dredging are summarized below and shown in Figure 21:

- **First Stage Dredge Cut (production cuts)** – The first stage involves removal of the bulk of the contaminated sediment down to, or close to, the interface with the non-contaminated sediment. This “first stage” dredging may be completed in several sequential “lifts” or dredge cuts in order to limit the height of the cut face at any one time.
- **Second Stage Dredge Cut (cleanup pass)** -- The second stage is a cleanup pass that removes the remaining relatively thin layer of impacted material, including any residual material that has been generated by the first stage dredging. The second stage may include the planned overdredge thickness, and is intended to remove remaining contaminated sediment while limiting the removal of the underlying non-contaminated sediment.

The second pass production rates are typically lower than the first pass production rates because only small volumes of material are removed while the dredge still covers the full footprint of the dredge site. This is shown by both lower fill factors for mechanical dredges and lower percent solids for hydraulic dredges. Consequently, more water is generated per cubic yard of material removed.

The Head of Hylebos, a sediment remediation project, completed using articulated fixed arm dredges, applied a cleanup pass to areas that did not meet the performance criteria following a two-stage dredging program. Monitoring showed that 72 percent of the dredging area passed the performance criteria following the two-pass dredging program. The cost of

re-dredging the remaining 28 percent of the site accounted for about 10 percent of the dredging costs, and did result in the area passing the performance criteria. In addition to the benefit of getting a clean bottom, this re-dredging effort also reduced the need for long-term monitoring and reduced the risk of future recontamination from leaving impacted material in an active waterway (Fuglevand and Webb 2007).

9.3. Sequence of work

Correct sequencing of the dredging operation is an important consideration for any environmental dredging project. Both horizontal and vertical sequencing should be considered. Horizontal sequencing refers here to the sequencing of dredging for DMUs defined along the length of a riverine site or within larger areas of lakes or estuaries. Vertical sequencing refers here to the sequencing of production cuts within a specific DMU.

The considerations for horizontal sequencing will differ between riverine sites and estuarine, open coastal or lake sites. Riverine sites have uni-directional flows, and the currents will tend to transport any resuspended sediment only in the downstream direction. It logically follows that the basic sequence of work for a riverine site should be removal from upstream to downstream. In this way, a large portion of the resuspended sediment that is transported downstream and redeposited on the bottom will be removed as the work progresses downstream.

Horizontal sequencing of work for DMUs located within larger areas in lakes or estuaries is more complicated. With no single “downstream” direction due to tidal flows or seiche events, the best sequence to avoid potential recontamination cannot be determined easily. Estuarine sites are subject to bi-directional flow. For lake sites, the current directions are driven by wind, circulation and tributary inflows, and may vary with individual inflow events, seasons, etc. The optimum sequence under such conditions would necessarily depend on the specific site conditions and distribution of contamination. Some possible considerations in horizontal sequencing for such sites include:

- Remove hot spots first. By dredging areas of highest contamination first, the potential for recontamination for the remainder of the project is reduced.

- Work upstream to downstream with respect to the predominant flow regime, depositional conditions, or wind circulation pattern. Flow reversals, which occur in estuaries, means that the down-current direction changes with the tides. However, near the head of the estuary or where tributaries enter the estuary, there is a predominant flow direction if the freshwater flow is significant; this can be exploited in determining the best dredging sequence.
- Partial removals over the entire area can be considered, especially if the deeper layers to be removed have lower contamination as compared to upper or mid-depth layers. In any case, partial removals over the entire area may hold advantages if the final production cuts include some overdredging because it would limit the recontamination by cleaner residuals resulting from overdredging.
- For critical DMUs or hot spots, scheduling active dredging operations around the optimum tidal cycle may be desirable.
- Perform all production cuts in a given area or reach before performing any cleanup passes if there is a high potential for recontamination.

Vertical sequencing is the sequencing of production cuts within a specific DMU. The final target cut elevation is usually set at the lowest elevation with contaminant concentrations exceeding the action level. The maximum thickness of a production cut is limited by the dredge size, so the minimum number of production cuts required can be easily determined considering the target cut elevation and the most recent bathymetry data. For dredging areas with relatively flat bathymetry and thick deposits to be removed, multiple production cuts would simply be sequenced from top to bottom. In some cases, the vertical distribution of contaminants or planned overdredging to help achieve a lower residuals contaminant concentration may drive the number and thickness of production cuts.

Another consideration for vertical sequencing is related to dredging along slopes. As described above, box cuts are needed for dredging along slopes. Since box cuts involve the assumed sloughing of the vertical cut face to form a new slope, box cuts from higher elevation to lower elevation along the slope is the usual sequence. This avoids excessive undermining of the slope and reduces the potential for slope failure. In addition, the successive box cuts moving down the slope would remove the sloughed residuals from the previous box cuts.

9.4. Operations plan

The dredging contractor and the remediation contractor for environmental dredging projects should develop an operation plan as part of the project remedial design (this level of detail would rarely be needed for a feasibility study). The operations plan should be a written document, approved by the project manager, which describes all operational aspects of the dredging operations.

Items that should be included in the operations plan are:

- Mobilization and demobilization needs.
- Descriptions and specifications for all equipment needed for the project, to include the dredge(s) to be used for both production and cleanup passes, any separate equipment required for debris removal; tug and crew boats; barges (if needed); and other equipment needed for the project.
- Method of operation of equipment.
- Logistics for rehandling and transport of dredged material.
- Delineation of SMUs, DMUs, acceptance areas, etc.
- Description of the horizontal and vertical sequence of work for all DMUs.
- Management actions and contingencies for debris, weather, resuspension, contaminant release, residuals, air quality, noise, public welfare, lighting, interference with navigation, safety, unexpected contamination, and failure to achieve the cleanup level.

In some cases, the monitoring plan (see Chapter 10) might be combined with the operations plan because monitoring needs are contingent on operations.

10 Monitoring

A monitoring program for environmental dredging should be designed to measure effectiveness or success of the environmental dredging component of the remedy, and provide feedback to dredging contractors that can be used to adaptively manage their operations to improve project outcome. The dredging would be considered effective if the project-specific objectives are met (See Chapter 1), and the components of monitoring should therefore reflect the design/performance standards for the environmental dredging component of the remedy (see Chapter 4). The technical guidance in this chapter is intended to aid in developing detailed monitoring plans which should be appropriately incorporated into the remedy design and implementation process. Guidance on establishing the necessary scope of the monitoring program is available elsewhere (USEPA 2005).

It should be noted that some of the tools used for field monitoring and sampling during and following project implementation (this Chapter) overlap those for site and sediment characterization (see Chapter 3), but the tools are applied in different ways for the two purposes.

The major categories of monitoring for environmental dredging described in this chapter include monitoring for production and implementation time, sediment resuspension and contaminant releases, volatile releases and dredging effectiveness as it relates to removing intended target sediments, limiting residuals, and achieving the overall cleanup level.

10.1. General monitoring considerations

10.1.1. Monitoring framework and the six-step process

USEPA has recently developed new “Monitoring Guidance,” Office of Solid Waste and Emergency Response (OSWER) Directive 9355.4-28 *Guidance for Monitoring at Hazardous Waste Sites: Framework for Monitoring Plan Development and Implementation* (USEPA 2004a). This guidance describes a six-step process for developing and implementing a monitoring plan. The six-step process ensures that all data are collected for a valid purpose, that procedures for data analysis and interpretation are established, and that appropriate decision rules and management

actions are identified prior to the data collection. Additional guidance on application of general monitoring considerations to sediment sites is provided in the *Contaminated Sediment Remediation Guidance for Hazardous Waste Sites* (USEPA 2005).

10.1.2. Short-term versus long-term monitoring

The monitoring of a remedy should focus on the effectiveness of the dredging operation itself and can include evaluating short-term impacts associated with dredging if such requirements were established in the ROD. The residual contamination is the primary concern of a monitoring program (i.e., is the resulting sediment concentration below the sediment CUL?) but short-term protection of resources outside of the impacted area is also a consideration for monitoring. Monitoring during project implementation should focus on those elements and components needed to measure compliance with the project requirements. Only those components needed for compliance should be included in such a compliance monitoring program. These components may include:

- The bathymetry of the dredge cut prism to ensure that the identified contaminated sediment has been removed.
- Contaminant concentration and thickness of the dredging residuals to ensure compliance with the CUL and to determine the need for residuals management operations such as a cleanup pass or capping.
- The TSS concentration or turbidity in the downstream water column to determine compliance with state or other standards.
- Contaminant concentrations in the air and water column to determine compliance with state and other standards such as ambient water quality criteria.
- Other parameters as needed to facilitate the assessment of potential short- and long-term effects.

The objective of environmental dredging is usually to achieve a specified sediment cleanup level to reduce the environmental risk associated with the sediment. This CUL can vary by site; for example, it can be defined as a SWAC, an upper confidence level of a mean, or an absolute value. To demonstrate compliance, sufficient short-term monitoring needs to be performed.

As with all remedies, a long-term monitoring effort will normally be required to determine the effectiveness of the remedy with respect to risk

reduction, i.e., were the RAOs achieved in the anticipated timeframe? This effort might include monitoring components for sediment toxicity, benthic community recovery, bioaccumulative contaminants, and/or tissue concentrations in fish or shellfish. In cases where all recontamination sources or upcurrent contaminated areas cannot be addressed by the remedy, long-term monitoring may also be required if recontamination is considered an issue. The approaches and tools used to evaluate risk reduction effectiveness and activities associated with the treatment and disposal components of a remedy are generally described in the *Contaminated Sediment Remediation Guidance for Hazardous Waste Sites* (USEPA 2005) and OSWER Directive 9355.4-28 (USEPA 2004a) and are not covered in this document.

10.1.3. Monitoring objectives and elements for environmental dredging

Monitoring objectives for environmental dredging should coincide and support the performance standards developed for the project (see Chapter 4 for details on performance standards). Environmental dredging monitoring objectives normally include:

- Confirm that the volume of contaminated material is removed in accordance with the plans and specifications.
- Determine post-dredging compliance with CULs.

Monitoring elements for environmental dredging may also include:

- Measure contaminated sediment removal efficiency – this may include measuring dredge production rates and measuring dredged volumes by bathymetry. Additionally, the monitoring may focus on the size of the area cleaned per unit time as a more appropriate measurement for remediation because significant volumes of sediment can be removed and yet not achieve remediation goals if not properly performed.
- Measure sediment resuspension and transport – this may include measurements in the water column at the point of dredging, at near-field stations, and at far-field stations; and measurements of re-deposited sediments in areas inside and outside areas slated for active remediation.
- Measure contaminant release and transport – this may include direct measurement of total and dissolved concentrations of COC in the water column at the point of dredging and at near-field and far-field stations.

- Measure residuals – this may include measurements of the thickness, density, and contaminant concentrations of generated residuals and the extent of undredged sediment inventory, and the comparison of post-dredging contaminant concentrations with CULs, SWACs, etc.
- Measure performance of silt curtains and other engineered controls – this may include measuring the relative efficiency of barriers in reducing migration of resuspended sediment, the efficiency of volatile control measures, etc.

10.2. Monitoring for removal accuracy, production, and times of completion

In addition to comparisons of pre- and post-dredging contaminant data, post-dredging surveys should be compared with established cut-line elevations for the dredging prisms to determine if the intended cut-line elevations are achieved.

For larger project areas, the surveys may be staged as work progresses. Pre-dredging surveys of specific subareas of the project (SMUs or DMUs or acceptance areas) should be taken shortly before the dredging operations begin for those subareas to reduce the potential for short-term changes in bathymetry. Data collected during earlier phases of evaluation may not be accurate enough for the pre-dredging survey during project implementation. Production surveys for larger subareas may be warranted to establish production rates and to determine whether the expected overall time of completion can be achieved.

Post-dredging surveys should be taken shortly after completing dredging within specific subareas for comparison with the pre-dredge surveys. The allowable time lag between the completion of work and the post-dredging survey would also depend on the site conditions and potential for short-term changes in bathymetry. The potential for rapid sedimentation and infilling of depressions created by the dredging should be considered in setting allowable lag times for post-dredging surveys. The same equipment is used for both pre- and post-dredging surveys to eliminate compounding factors related to equipment type and setup.

Monitoring for production and times of completion is conducted for most projects, but such monitoring is especially important when performance standards for times of completion are in place. The approaches used for production monitoring of environmental dredging can be straightforward

and similar to those used for navigation dredging. With known times for incremental completion of operations in sub-areas (dredge cuts, DMUs, etc.) of the project, the sustained production rates can be determined.

10.3. Monitoring for sediment resuspension and water column contaminant release

At some sites, regulatory constraints on dredging, monitoring of sediment resuspension, and water column contaminant release may be required to help ensure that resuspended sediments and/or surface water concentrations do not cause unacceptable impacts downcurrent. Additionally, monitoring can be conducted as a component of an adaptive management program for implementation of controls on sediment resuspension and contaminant release.

Possible program components for resuspension and contaminant release monitoring include:

- Stationary or towed instruments for real time feedback and/or suspended sediment plume definition.
- Water column sampling.

In developing monitoring approaches for resuspension and release, it may be important to include provisions for fast turnaround analysis of samples and tools for real-time feedback on resuspension. Such provisions will allow for early identification of problems as operations proceed and will provide the opportunity for implementing management actions in a timely manner.

10.3.1. Points of compliance and sampling locations

Point(s) of compliance may be established by regulatory agencies in consultation with stakeholders as a part of the performance standards prior to development of the monitoring program (see Chapter 4). In some cases, the points of compliance for water quality parameters will be at some set distance downcurrent of the active dredging operation. These can be “floating” points of compliance, in that they move as the active dredging operation moves within the overall project area, or the entire project area may be considered an active work area and compliance points set at some distance from the project limits. In other cases, fixed points of compliance may be at set specific locations, such as at bridges, municipal water

intakes, or other structures or at geographical choke points. Floating or fixed points of compliance may be near-field, far-field, or both. Monitoring points in the near field are usually located to measure effectiveness of dredging equipment and/or control measures such as silt curtain or sheet-pile enclosures to reduce sediment resuspension and limit total contaminant release. These may also serve as intermediate points of compliance for adaptive management programs; the monitoring results at these points are compared with action triggers to provide short-term protection. Compliance points in the far field may be set at distances to measure dissolved releases. For example, the Upper Hudson River Superfund project has established both intermediate points of compliance at set distances downstream and far-field points of compliance at set locations. In another example, the New Bedford Superfund project has a set point of compliance at a geographical constriction at a bridge marking the boundary between the Acushnet River upper estuary and lower estuary. Figure 37 illustrates the concept of intermediate and far field points of compliance. Overall, determinations of the sampling locations will be site-specific and dependent on a host of physical and hydrodynamic conditions.

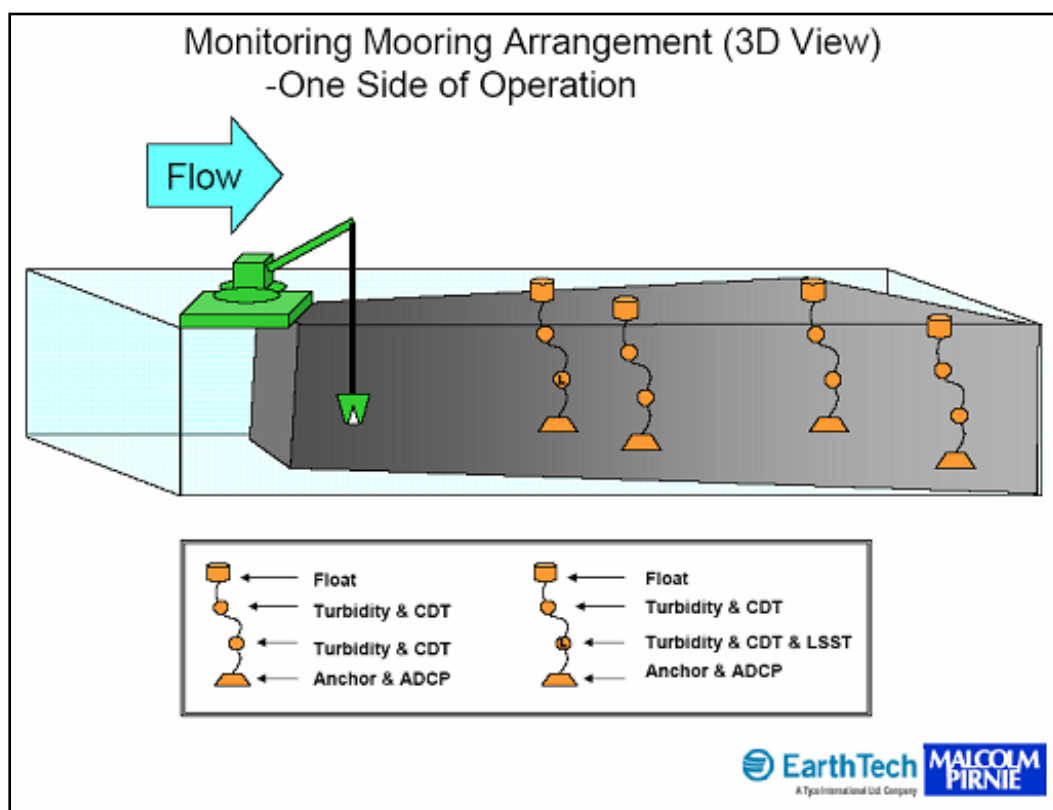

Figure 37. Compliance monitoring.

Regardless of where the points of compliance are set, monitoring station(s) for background conditions should also be set at locations upcurrent from the active dredging operations. Clarke and Wilber (2000) provide information on spatial and temporal scales of dredging resuspension plumes that may aid in establishing appropriate sampling locations and timing.

10.3.2. Total suspended solids versus turbidity

Total suspended solids (TSS) is the recommended parameter for evaluation of sediment resuspension due to dredging operations. TSS is determined by collecting a water sample and performing laboratory tests, and the time required for laboratory analysis does not allow for fast turnaround. However, fast turnaround is needed to determine if levels of resuspension would require implementing control measures or changes in dredging operations. Therefore, measurements of turbidity (a measure of water clarity) are commonly used to obtain real-time feedback on the degree of resuspension and the potential for contaminant release. Both towed and stationary instruments (normally nephelometers) can be used to measure turbidity. Sediment-specific correlations of TSS and turbidity can sometimes be developed to allow direct correlation of turbidity with TSS (Thackston and Palermo 2000).

10.3.3. Plume definition

Definition of the extent of the resuspended sediment plume is not normally a requirement of compliance monitoring. However, these studies can provide useful information in environments with complex flow patterns (e.g., large lakes, harbors, and estuaries). This type of monitoring can be established as a part of a pilot study, or in the initial stages of implementation monitoring to confirm monitoring design assumptions and establish monitoring locations (plume centerline and depths). The plume dimensions can be established in real time by using towed instruments such as nephelometers or Acoustic Doppler Current Profilers (ADCPs) and/or by establishing a series of downcurrent stations for water column samples in a radial pattern.

Puckette (1998) describes the use of various plume tracking tools and their advantages and disadvantages. Unfortunately, instruments such as ADCP do not provide a direct measure of TSS and cannot be used alone with an acceptable level of accuracy. Calibration with real time samples can

increase the utility of data collected with ADCP, and commercially available systems for such calibration are available. Even with these drawbacks, the use of instruments such as ADCP can define the plume in three-dimensions and the relative distribution of TSS. This information provides real-time feedback that can aid in selecting locations for water column samples (Tubman and Corson 2000).

10.3.4. Water column sampling

Water column sampling and subsequent testing for contaminant concentrations is the definitive monitoring component for determining contaminant release and compliance with any water quality requirements. Water column samples are typically collected at one or more upcurrent locations to establish background concentrations and at one or more downcurrent locations from the dredging site to establish resuspension and release rates. The downcurrent location should correspond to the point of compliance for water quality standards or sediment resuspension, but intermediate sampling locations can also be established for adaptive management. Samples may be collected at multiple depths in the water column, but samples collected at mid-depth are normally sufficient for shallow sites. Near-bottom concentrations are likely to be higher than the concentrations at other depths, especially when silt curtains or hydraulic dredging are used.

Parameters to be evaluated for water column samples would normally include TSS, concentrations of COCs, and other parameters such as TOC, DOC, pH, etc. Both dissolved concentrations (normally defined as that passing a 0.45 µm filter) and total concentrations of COCs may be required, depending on the location of sampling stations and the method of defining water quality standards. Methods for sampling, handling, and analysis of water are presented in detail in several EPA and USACE manuals (USEPA 2001a; USEPA/USACE 1991; 1995; 1998) and should be followed.

10.4. Monitoring for volatile contaminant release

Some dissolved contaminants in the water column are subject to volatilization to the air. This process may be of concern for high concentrations of certain volatile organics and for cases when some types of NAPL are present in the sediments. Monitoring for volatile releases is normally conducted using fixed stations for air monitoring. The optimal

locations of the air monitoring stations are selected considering the prevalent wind directions in the project area and the locations of potential human receptors such as nearby residential areas, schools, etc.

10.5. Monitoring for dredging effectiveness

All dredges leave behind some residual sediments following completion of production cuts. If one of the objectives of the project is to remove the sediments such that a CUL is met, residuals monitoring will be necessary to ensure dredging effectiveness and provide feedback to dredge operators regarding the ongoing effectiveness of their operations.

As discussed in Chapter 4, an environmental dredging remedy component is considered effective if it is implemented such that the CULs are met and maintained. This can be determined by monitoring for residual sediments following completion of the dredging operation.

As described in Chapters 1 and 7, residuals may be composed of both dredge-generated residuals and undredged inventory. Generated residuals accumulate above the dredging cutline in thin layers at relatively low density, while undredged inventory remains below the cutline as undisturbed sediment at higher density and may exist as thick layers.

It can be important to address the various characteristics of generated and undisturbed residuals when developing performance standards and monitoring strategies. These differences may also need to be considered in selection of appropriate residuals management responses. In many cases, determining the scope of an appropriate management response(s) to the presence of residuals is necessarily based on location-specific data collected by the monitoring program. Therefore, there is often a strong linkage between residuals monitoring and residuals management. Considerations for residuals monitoring include:

- Compatibility with residuals performance standards.
- Lag time between completion of a dredging management unit(s) and subsequent monitoring.
- Appropriate techniques for measuring the thickness of layers of residuals.
- Appropriate techniques for residuals sampling.
- Core handling and segmentation.

- Sediment residuals physical and chemical testing.
- Post-dredging engineering/operational conditions.

Each of these considerations is discussed in more detail below.

10.5.1. Lag times and points of compliance

Lag times for residuals sampling

Environmental dredging projects are usually managed by establishing dredging management units (DMUs), with work in individual DMUs performed in a pre-determined sequence. Consideration should be given to the appropriate time lag between completion of dredging of a DMU and the collection of residuals data to determine compliance with performance standards. Since generated residuals initially have relatively low density and at some sites may be susceptible to erosion and transport, there may be a potential for downslope and/or downcurrent migration, potentially depositing in downcurrent areas. In these situations, timely monitoring may be needed to initiate management actions, if any, to reduce dredging-related risks. However, consideration for potential recontamination by future dredging and its magnitude should also be included in scheduling residuals monitoring.

In other cases, the concentration, mass, and/or migration potential of layers of residuals may not pose unacceptable site risks. In such cases, an appropriate time of compliance in meeting the action level may be considered in developing the performance standards for the project. At many sites, natural sediment deposition and bioturbation processes are capable of mixing the residuals layer(s) with underlying and recently deposited cleaner sediment within several years; in these cases, the action level can often be met without further management action. These considerations should be factored into the monitoring program and potential management actions.

Points of compliance within the sediment profile

Just as any residuals layer remaining following dredging operations should be the focus of a performance standard for environmental dredging effectiveness, the same layer should also be the focus of monitoring for dredging effectiveness. Since the performance standard for dredging effectiveness should be defined in terms of achieving the CUL in the

biologically active zone (see Chapter 4), the monitoring of residuals should also focus on the sediment depth corresponding to the biologically active zone. (This depth is greater than the sediment bioturbation mixing zone that was described earlier.) This thickness is greater for estuarine and marine sites (up to 15 cm or 0.5 ft) than for freshwater sites (generally, 5 to 10 cm or 2 to 4 in.). Therefore, the residuals samples used for comparison with the CUL should be taken from the post-dredging sediment depth interval corresponding to the biologically active zone for the site.

10.5.2. Thickness of residuals

The thickness of layers of residuals can be determined using several approaches. In many cases, standard residuals sampling methods such as careful grab or core sampling and appropriate inspection and sectioning can be used to characterize the thickness of generated and/or undisturbed residuals. However, at some sites other techniques such as sediment profiling imagery (SPI) or sub-bottom profiling surveys can provide informative supplemental information.

Sediment profile imagery

Thickness of layers of residuals can be determined by sediment profiling imagery (SPI) or by collecting core samples. SPI can be used as a monitoring tool to determine the thickness of dredge-generated residuals if the visual differences due to density differences can be distinguished. SPI has the advantage of rapid deployment at multiple stations, low cost, and no requirements for core sampling, testing, etc. This has been done on several projects and potentially is more applicable to pilot studies than to compliance monitoring. SPI will not provide useful information regarding the presence of undredged inventory, but it can screen areas for the presence of substantial residuals. Cores can provide the same data as SPI, although at higher cost.

In the Duwamish Waterway (Washington), SPI was used successfully to determine the thickness and longer-term mixing of generated residuals, given the presence of a visually discernible density structure at that site (Anchor 2006). However, in other situations the density structure may not be visually discernible using SPI. Furthermore, this method typically does not provide useful information on the presence of undisturbed residuals unless there is a clear difference between the physical properties of the targeted contaminated sediment and the underlying cleaner sediments.

Sub-bottom profiling

Sub-bottom profiling may be useful in estimating the layer thickness of generated residuals if site conditions will allow detection of thin layers. This is possible with shallow water depths and when using multi-beam profilers.

10.5.3. Sampling for residuals

The tools most often used for monitoring residuals are sediment grab and core sampling and subsequent laboratory testing. Shallow grab samples have been used most frequently for residuals monitoring, but in some cases have not been able to consistently sample to a given sediment depth within the sediment profile. Sampling equipment used for residuals monitoring should be capable of obtaining an intact vertical profile to a depth at least equal to the biologically active zone, given the range of site conditions. In Puget Sound (Washington), van Veen samplers utilizing a modified hydraulic hinged jaw assembly (often referred to as a Powergrab) have proven effective in collecting relatively undisturbed, large-volume surficial sediment samples, allowing for detailed vertical characterization and shallow core subsampling (PSEP 1997, Ecology 2003). At many sites, shallow cores have advantages because they provide a more direct method to separate and section surficial residuals from underlying sediments. Depending on the site conditions, gravity cores, vibracores, piston cores, and diver cores have proven effective for residuals sampling.

Depth of sampling

At most sites, the sampled (or “push”) depth of sediments collected for residuals determination should generally be approximately 1 ft below mudline (or to refusal in hardpan areas) to allow for appropriate characterization. This target push depth allows for adequate sample recovery and subsequent core sectioning and sequential analysis of the core segments if needed.

Numbers of samples

Pre-dredging characterization data may often be limited to one core per subarea (compliance area) of a DMU, depending on how the site is subdivided, and this approach may also be appropriate for post-dredge monitoring. At heterogeneous sites, depending on the specific performance standard, residuals monitoring may be improved by

collecting and/or compositing sediments from multiple sampling stations within each DMU or compliance area. More samples would be desirable for sites with large variability in sediment concentrations. If site conditions indicate a potential for resettlement of resuspended sediments outside of the dredged areas (i.e., areas not slated for active remediation), sampling of those areas for accumulation of residuals may be warranted. Appropriate statistical treatment of the data may be required, based on site-specific performance standards.

Core handling and segmentation

In many cases, a post-dredging core (or grab) sample will exhibit a watery “fluff” layer at the top of the core if freshly formed. This layer may be the result of sampling-related disturbances, generated residuals, bed load transport, and/or natural nepheloid layer bottom water transport conditions within the water body. For monitoring purposes, only that portion of the fluff layer that readily settles onto the sediment surface (e.g., within an operationally defined settling period) is normally interpreted as a component of the generated residuals layer and the rest of the suspended material is typically interpreted as a component of surface water, and is often discarded from the sediment sample (Puget Sound Estuary Program (PSEP) 1997, Ecology 2003). The density of the core will increase with depth until undredged sediment is reached. The denser sediments in the core can be considered as undredged sediments, and depending on the sampling program, may be sectioned into two or more vertical segments for possible testing.

The recommended procedure for handling and sectioning of cores taken for residuals monitoring is:

- Cores should be kept in a vertical orientation on the sampling boat and during handling to avoid mixing of vertical layers within the core.
- Cores should also be allowed to stand for several hours prior to segmentation to allow any fluff layer to settle.
- Soft disturbed sediment at the top of the sample is likely generated residual.
- Undisturbed sediment that is firm, cohesive, and stiff is likely undredged sediment.
- Core samples should be divided into watery surficial material (fluff) that can be poured or siphoned from the top of the core (if present),

- Fluff material that can be poured or siphoned from the surface of the core could be considered part of the generated residuals; material that is cohesive and stiff and remains intact could be considered undredged sediment. (Figure 22 shows a picture of these layers.)
- The volume of poured fluff material (if present) should be measured and the water content determined (to aid in estimating the ultimate thickness and density of residuals upon consolidation).
- If present, the generated residuals layer (a visibly observable layer of disturbed solids that potentially has a lighter color) should be analyzed separately.
- The upper core segment should be analyzed initially; the lower core segment should only be analyzed if the upper core segment exceeds the CUL.

Testing for residuals samples

Testing on core (or grab) segments typically includes COC concentrations, total solids, total organic carbon (TOC), and bulk density. Focused grain size distribution determinations may also provide useful data to determine residuals characteristics and evaluate potential management actions. As discussed below, appropriate management actions may vary depending on the physical and chemical characteristics of the surficial and underlying sediment layers.

Core (or grab) segments collected for residuals monitoring are typically tested sequentially. The uppermost core segment (which should correspond to the surficial biologically active zone) is often submitted for initial analysis. This core segment would consist of the generated residuals and perhaps the surficial portion of the undisturbed sediment. If COC concentrations in this uppermost segment are below the action level, there is typically no residual contaminated sediment and no further action is required. Conversely, if COC concentrations in the uppermost segment exceed the action level, the next lower core segment is often analyzed, and so on, until the full depth of the residual contamination is defined.

10.5.4. Engineering/operational evaluation of post-dredging conditions

In addition to collecting data on the characteristics of layers of residuals, post-dredge monitoring can also inform engineering/operational

evaluations as needed to assist in selection of an appropriate management action for residuals. This evaluation typically includes:

- Accuracy and precision of target dredge cutlines.
- Depth to bedrock or hardpan layer.
- Proximity of the residuals to infrastructure.
- Proximity and stability of shoreline structures and bulkheads.
- Post-dredging water depths.
- Slopes.

Such an evaluation often determines the potential effectiveness, implementability, and cost of possible management actions.

10.6. Monitoring plans

The monitoring plan for environmental dredging operations should be completed in detail to include all aspects of monitoring for dredging effectiveness, resuspension, contaminant release, and production. It is essential that monitoring objectives, tools and techniques, and the monitoring sampling and testing program be documented in a written monitoring plan. The monitoring plan should essentially document the who, what, when, where, and how of the monitoring program. Some key elements of the monitoring plan are similar to those for a sampling plan (see Chapter 3) and include:

- Project background.
- Roles and responsibilities of the parties.
- Existing data summary and evaluation.
- Delineation of sediment management units and compliance areas for monitoring.
- Locations of fixed points of compliance and fixed sampling/instrumentations.
- Sample locations and contingency locations.
- Number of samples.
- Sampling method (e.g., cores or grab samples or continuous or discrete water samples).
- Sampling handling procedures.
- Monitoring and sampling equipment.
- Sample containers and preservation.
- Depth and/or length of samples.
- Decontamination procedures.

- Compositing intervals and method.
- Packaging, labeling, and chain of custody procedures.
- Packaging, labeling, shipping and handling procedures, and chain of custody.
- Chemical analytes.
- Physical and engineering properties to be tested.
- Analytical procedures, sample clean-up, extraction methods, holding times, and required detection limits.
- Applicable environmental criteria (for determining detection limit requirements and comparing resulting data).
- Data analysis and reporting.
- Management and disposal of sampled materials.

10.7. Management actions

If monitoring determines that performance standards for production, resuspension/ contaminant release, or residuals are not met, management actions may be necessary to bring the operation into compliance. An investigation into the cause of the performance failure could be conducted to select the appropriate management action, considering the impact of that action on the overall system performance. Management actions should be pre-determined (prior to implementation) and should be documented in the monitoring plan. Some of the possible management actions include implementing operational control measures or engineered control measures (see Chapter 8 for details on these control measures).

10.7.1. Management actions for production

If there are production standards and the rate of progress indicates the standards will not be met for overall production, the possible management actions include:

- **Increase Operating Hours** – If operating hours are limited to one shift, the length of the shift may be increased or additional shifts can be added. Additional work days can be added if the work week is limited.
- **Larger Dredge Size** – One management response to a production shortfall is the use of a larger dredge size. This may be as simple as changing bucket sizes for mechanical operations, although the crane capacity may be a limiting factor, or mobilizing a larger crane or larger hydraulic dredge (greater horsepower and pipeline diameter). (However, this may conflict with other objectives.)

- **Change in Dredge Type** – In some cases, the selected dredge type may not result in the anticipated production rate, and a change of dredge type may be required. For example, a cutterhead could be substituted for a horizontal auger, or vice-versa. In some cases, a change from a hydraulic or mechanical dredging approach or vice-versa may be appropriate.
- **Multiple Dredges** – If the project area, staging area, and supporting systems are large enough, multiple dredges can be used.
- **Greater Sediment Processing and Transport Capacity** – If the project area, staging area, and supporting systems are limiting dredge production, then larger, more, or more efficient sediment processing facilities can be used.

10.7.2. Management actions for resuspension and contaminant release

If resuspension/release requirements are not being met, the following management actions may be considered:

- Increase monitoring to assess impacts.
- Implement operational controls.
 - Temporary work stoppage.
 - Slow down the operation.
 - Use rinse tanks.
 - Alter debris management.
 - Change equipment (add shrouds, etc.).
- Implement engineered controls.
 - Containment (curtains, etc.).
 - Volatile controls (foams, etc.).
 - Adsorbents.
 - Skimmers.

These actions can be set up in a tiered response mode.

10.7.3. Management actions for residuals

Management actions if layers of residuals exceed CULs may include the following:

- No action – consider thickness and concentrations and anticipated mixing with underlying layers, which may bring the residuals to within the CUL.

- Placement of a thin-layer residuals cap.
- Placement of an engineered isolation cap.
- Additional cleanup pass.
- Additional production dredging pass.

Additional details on all management actions and control measures are provided in Chapter 8.

10.8. Monitoring for adaptive management

Major sediment remediation projects can take place over a large area, over an extended period of time, and involve a wide range of variable site conditions. Successful completion of such complex projects can be enhanced by a flexible management framework that encourages ongoing adaptation of the remediation methods through continuous gathering and review of performance data, followed by real-time method adjustments to improve the effectiveness of the remedial action. The application of adaptive management to sediment remedial actions provides a mechanism to improve the effectiveness of the planned action by learning from the outcomes of ongoing actions and modifying the actions to achieve the desired outcome, as well as a means to respond quickly to unanticipated conditions.

The Head of Hylebos Waterway sediment remediation project applied adaptive management through full-time observation of the dredging and subsequent sampling with concurrent adjustment of the dredging plan to improve the capture of impacted sediment and achieve a clean bottom throughout the dredging area. This approach resulted in 99 percent of the dredging area meeting the project cleanup criteria, with 1 percent of the area requiring capping to control groundwater-related impacts that could not be resolved by sediment removal.

For the Head of Hylebos project, full-time observation of dredging from the cab of the dredge (Type 1 Monitoring) facilitated real-time adjustment to the dredging plan. It provided a means to adapt to the unknown site conditions that existed between pre-dredging data points and achieved full removal of the target material (no undredged residual). The information from the Power Grab samples collected each day immediately behind the dredge (Type 2 Monitoring) provided visual classification of the nature and thickness of the residual layer and provided the dredge operator immediate feedback on effectiveness of the dredging in limiting residual

layer formation. This resulted in ongoing adjustments to the dredging program to further reduce the residual layer. The chemical concentrations were measured in the top 10 cm of sediment each day following the planned two-pass dredging program (Type 3 Monitoring). The monitoring results showed that even a residual layer of 5 cm could result in failure of the compliance samples. This finding led to further modifications of the dredging methods to reduce the post-dredging residual layer to less than 4 cm on average, and to less than 1 cm for two-thirds of the dredge area. (Fuglevand and Webb 2007).

11 Summary, Integration, and Conclusions

11.1 Summary and integration

Chapters 1 through 10 of this document provide guidelines for evaluating the various technical aspects of environmental dredging as a potential remedy component. Once these evaluations are conducted, the results may be summarized and the overall acceptability of the environmental dredging component design can be determined.

Overall acceptability of the environmental dredging design should be evaluated in terms of providing environmental protection, meeting performance standards, and balancing criteria related to implementability, effectiveness, and cost. If the evaluations indicate that the dredging design is not feasible, aspects of the design should be reevaluated. This reevaluation may begin with collecting additional site and sediment data, considering differing removal volumes or areas (perhaps including consideration of partial dredging with capping or other non-dredging components for the remedy), revising the performance standards, or selecting a different dredging equipment type for evaluation.

If the overall dredging design is feasible, it can be carried forward for integration with other components of the removal remedy. The dredging design should be combined with other dredging remedy components (such as long distance transport, rehandling and treatment, and disposal) to form a complete removal remedy alternative(s). The completed alternative is either compared with other remedial alternatives in the FS phase of evaluation or is fully developed in the RD phase for preparation of plans and specifications and eventual implementation of the remedy.

11.2. Conclusions

The main conclusions in this document are summarized as follows:

- Environmental dredging is the removal of contaminated sediments from a water body for purposes of remediation.
- Environmental dredging removes contaminated sediments from the aquatic environment. Recent advances in equipment operation and design have reduced residuals and allowed projects to meet cleanup

- objectives. However, the potential for sediment resuspension and associated contaminant release and the magnitude and quality of residual sediments may limit the effectiveness of environmental dredging as a remedial approach at some sites.
- Residuals management should be an integral part of any remedy using environmental dredging to ensure that cleanup levels are achieved.
 - Environmental dredging is normally considered as an operational component of a remedy. However, sediment removal is just one of the components of an environmental dredging remedial operation that is designed to fit within a system. The design of the system evaluates the interrelationships of the components in a sequence with major decision points in determining acceptability of an environmental dredging design (see Figure 2).
 - Knowledge of site conditions and sediment characteristics is critical to the evaluation of environmental dredging as a potential remedy component. Inadequate site and sediment characterization is one of the major causes for problems associated with implementation of environmental dredging, and can potentially cause delays, higher costs, unacceptable environmental impacts, and failure to meet cleanup levels and remediation goals.
 - Selection of equipment for environmental dredging must be considered in the context of the entire project. The dredging operation must be compatible with and fully integrated with the materials handling, transport, treatment, and ultimate disposal of the dredged material. A number of factors must be considered in evaluating and selecting equipment for environmental dredging (see Table 1). The *quantitative* capabilities and limitations of equipment commonly available in the United States for environmental dredging related to removal precision, production rates, dredging depths, etc., vary among equipment types and designs. Data related to the equipment selection factors that are a function of site and sediment conditions is *qualitative*.
 - Many equipment types are suitable for environmental dredging. No single equipment type or design is best suited for all projects. Selection of equipment should be site-specific and sediment-specific. Each dredge type has both advantages and disadvantages with respect to operational characteristics and selection factors. For many projects, multiple dredge types may be used to optimize operations, e.g., one dredge for production cuts and another dredge for thin cuts and/or residuals passes.

- Although conventional dredges normally used for navigation dredging (e.g., conventional clamshells or cutterheads) can be effective for environmental dredging, evolving technologies for dredge and dredgehead designs (e.g., enclosed buckets, articulated fixed-arm mechanical, swinging ladder cutterheads, and articulated ladder cutterheads) may offer better performance for environmental dredging.
- Accurate removal of contaminated sediment without excessively removing clean material is critical for cost-effective environmental dredging. Positioning technology now allows a dredging cut line to be set within an accuracy of several inches, generally better than sediments can be characterized. Detailed site and sediment data are essential for realizing benefits of dredging accuracy. Data locations for both physical and chemical sediment parameters should be precisely located both horizontally and vertically.
- Overdredging, combined with other appropriate environmental dredging BMP's, particularly in a cleanup pass, can greatly improve dredging effectiveness for achieving CULs.
- Estimates of production rate for environmental dredging can be developed using the approaches used for navigation dredging. The size and numbers of dredges required for the project and the time required for project completion are dependent on both the operating production rate and the sustained production rate over a dredging season.
- All dredges resuspend some sediment, but removal can generally be achieved at an efficient rate with acceptable resuspension rates. Operational and engineering control measures can be applied to reduce the impacts of sediment resuspension.
- Sediment resuspension results in release of dissolved contaminants to the water column and release to the air through volatilization. Operational and engineering control measures can be applied to reduce the impacts of dissolved contaminants and volatilization.
- All dredges will leave behind some residuals, but the magnitude of residuals is difficult to predict. Residual sediment can be a major issue, directly affecting cost and effectiveness of environmental dredging.
- Management options for residuals include monitored natural recovery, placement of a thin residuals cap, placement of an engineered isolation cap, cleanup dredging passes, and additional production dredging passes. Selection of residuals management options should be based on thickness and contaminant concentrations in layers of residuals and engineering/operational constraints.

- An operations plan or work plan should be developed for environmental dredging projects. It should include how the project is delineated and sequenced horizontally and vertically; how the dredge will operate with respect to vertical depth increments, production and cleanup passes, overdredging allowances, etc.
- A monitoring and management plan should be developed for environmental dredging projects to ensure compliance with performance standards. It should include descriptions of the monitoring approaches and tools to determine production and completion times, sediment resuspension and contaminant releases, volatile releases and dredging effectiveness as it relates to removing the targeted sediments and limiting residuals. Management actions, to include use of control measures, should be pre-determined prior to project implementation and should be documented in the monitoring and management plan.
- Environmental dredging design should be project-specific, site-specific and sediment-specific.
- Environmental dredging operations are highly complex and their performance effectiveness is highly project-, site-, and sediment-specific. The available data from these operations are limited, which constrains the general conclusions and understanding that can be drawn from past projects. Therefore, additional data collection is crucial to further enhancing understanding of dredging as a remedial alternative for contaminated sediments.

References

- Ambrose, R. B., T. A. Wool, J. P. Connolly, and R. W. Schanz. 1988. *WASP4, a hydrodynamic and water quality model--model theory, user's manual, and programmer's guide*. EPA/600/3-87-039. Athens, GA: EPA.
- Anchor. 2006. Duwamish/Diagonal Sediment Remediation Project: 4-Acre Residuals Interim Action Closure Report and 2005 Monitoring Report. Report prepared for Elliot Bay/Duwamish Restoration Program Panel.
- Averett, D. E., B. D. Perry, E. J. Torre, and J. A. Miller. 1990. *Review of removal, containment, and treatment technologies for remediation of contaminated sediments in the Great Lakes*. Miscellaneous Paper EL-90-25. Prepared for U.S. Environmental Protection Agency - Great Lakes National Program Office, Chicago, IL. Vicksburg, MS: U.S. Army Engineer Waterways Experiment Station. <http://www.epa.gov/glnpo/arcs/EL-90-25/EL-90-25.html>.
- Battelle. 2007. Final Water Quality Summary Report, 2006 Remedial Dredging, Environmental Monitoring, Sampling and Analysis, New Bedford Harbor Superfund Site, New Bedford Harbor, Mass. Contract No. DACW-33-03-D-0004. Boston, MA: U.S. Army Corps of Engineers, New England District.
- Boudreau, B. P. 1997. *Diagenetic models and their implementation*. Berlin: Springer-Verlag.
- Bridges, T. S., S. Ells, D. Hayes, D. Mount, S. Nadeau, M. Palermo, C. Patmont, and P. Schroeder. 2006. Relating the 4 Rs of environmental dredging: Resuspension, Release, Residual, and Risk. Paper 598 presented at *Global Environment and Sustainability: Sound Science in a World of Diversity*, SETAC North America 27th Annual Meeting, November 5-9, Quebec, Canada.
- Bridges, T. S., S. Ells, D. Hayes, D. Mount, S. Nadeau, M. Palermo, C. Patmont, and P. Schroeder. 2008. *The four Rs of environmental dredging: Resuspension, Release, Residual, and Risk*. Technical Report ERDC/EL TR-08-4. Vicksburg, MS: U.S. Army Engineer Research and Development Center. <http://el.erd.usace.army.mil/publications>.
- Cerco, C. F., and T. Cole. 1995. User's guide to the CE-QUAL4CM three-dimensional eutrophication model, release version 1.0. Technical Report EL-95-15. Vicksburg, MS: U.S. Army Engineer Waterways Experiment Station. <http://el.erd.usace.army.mil/elpubs/pdf/trel95-15.pdf>.
- Chiarenzeli, J., R. Scudata, B. Bush, D. Carpenter, and S. Bushart. 1998. Do large scale remedial dredging events have the potential to release significant amounts of semivolatile components to the atmosphere? *Environmental Health Perspectives* 106(2).
- Clarke, D. G., and D. H. Wilber. 2000. *Assessment of potential impacts of dredging operations due to sediment resuspension*. DOER Technical Notes Collection, ERDC TN-DOER-E9. Vicksburg, MS: U.S. Army Engineer Research and Development Center. <http://el.erd.usace.army.mil/dots/doer/>.

- Clarke, D. G., M. R. Palermo, and T. C. Sturgis. 2001. *Subaqueous Cap Design: Selection of Bioturbation Profiles, Depths, and Process Rates*. DOER Technical Notes Collection, ERDC TN-DOER-C21. Vicksburg, MS: U.S. Army Engineer Research and Development Center. <http://el.erd.usace.army.mil/dots/doer/>.
- Collins, M. A. 1995. *Dredging-induced near-field resuspended sediment concentrations and source strengths*. Miscellaneous Paper D-95-2. Vicksburg, MS: U.S. Army Engineer Waterways Experiment Station. <http://el.erd.usace.army.mil/publications>.
- Connolly, J. P., and R. Winfield. 1984. A User's Guide for WASTOX, a Framework for Modeling the Fate of Toxic Chemicals in Aquatic Environments. Part 1: Exposure Concentration. Gulf Breeze, FL: EPA.
- Cushing, B. S. 1998. Remediation of sediments by dredging: Methods and case histories. *Proceedings, Fifteenth World Dredging Congress*, June 28-July 2, Las Vegas, NV.
- Cushing, B., and M. Hammaker. 2001. Environmental dredging: Methods, trends, and case histories. *Proceedings, 21st Annual Meeting of the Western Dredging Association (WEDA XXI) and 33rd Annual Texas A&M Dredging Seminar*, Houston, TX.
- Dalton, Olmsted, and Fuglevand. 2008. Dredging Fundamentals Prospect Course #333 Notes. Prepared for U.S. Army Corps of Engineers, Training Management Division, Huntsville, AL.
- DeRuggeris, J., and S. Nilson. 2000. Dredge guidance technologies – environmental dredging project: Two case studies. *Proceedings, Western Dredging Association 20th Technical Conference and 32nd Annual Texas A&M Dredging Seminar*, June 25-28, Warwick, RI.
- DeRuggeris, J., and C. Pena. 2004. How accurate is accurate? The history, present state & future of dredging accuracies & how it relates to contaminated dredging environments. *Proceedings of the 24th Annual Meeting of the Western Dredging Association (WEDAXXIV) and 36th Annual Texas A&M Dredging Seminar*, July 6-9, 2004, Orlando, FL.
- Desrosiers, R., C. Patmont, E. Appy, and P. LaRosa. 2005. Effectively managing dredging residuals: Balancing remedial goals and construction costs. *Proceedings of the Third International Conference on Remediation of Contaminated Sediments*, January 24-27, 2005. New Orleans, LA.
- DiGiano, F. A., C. T. Miller, and J. Yoon. 1993. Predicting release of PCBs at the point of dredging. *Journal of Environmental Engineering* 119(1):72-89, American Society of Civil Engineers.
- DiGiano, F. A., C. T. Miller, and J. Yoon. 1995. *Dredging Elutriate Test (DRET) development*. Contract Report D-95-1. Vicksburg, MS: U.S. Army Engineer Waterways Experiment Station. <http://el.erd.usace.army.mil/publications>.

- DiToro, D. M., J. J. Fitzpatrick, and R. V. Thomann. 1983. *Water Quality Analysis Simulation Program (WASP) and Model Verification Program (MVP) - Documentation*. Hydrosience, Inc., Westwood, NY, Contract No. 68-01-3872. Duluth, MN: EPA.
- Ecology. 2003. *Sediment Sampling and Analysis Appendix: Guidance on Development of Sediment Sampling and Analysis Plans Meeting the Requirements of the Sediment Management Standards*. Prepared by PTI Environmental Services, Bellevue, WA. Washington Department of Ecology, Olympia, WA.
- Elmer, W., and J. Lally. 2001. *Thin layer dredging and capping: Recent case histories. Panel #4a Remedy Effectiveness: Comparison of Remediation Technologies, EPA Forum on Managing Contaminated Sediments at Hazardous Waste Sites, Alexandria, Virginia*.
<http://epa.gov/oerrpage/superfund/health/conmedia/sediment/sedforum/sedpresent.htm>.
- Erickson, M., R. Mohan, W. Dinicola, and M. Henderson. 2007. *Targeted dredging of near-shore debris and sediment, Upper Trenton Channel, Detroit River: A case study. Proceedings of World Dredging Congress WODCON XVIII*, May 27-June 1, Orlando, FL.
- Fox, R., M. Palermo, R. Johnson, G. Berken, J. Kern, J. Killian, S. Jaeger, G. Kincaid, G. Hill, and J. Hahnenberg. 2007. *Lower Fox River mega-site decision tree for managing dredge residuals. Proceedings, 4th International Conference on Remediation of Contaminated Sediments*, January 22-25, Savannah, GA.
- Francingues, N. 2001. *Special PIANC session on environmental dredging*. DOER Technical Notes Collection, ERDC TN-DOER-T4. Vicksburg, MS: U.S. Army Engineer Research and Development Center.
<http://el.erd.usace.army.mil/dots/doer/>.
- Francingues, N. R., and M. R. Palermo. 2005. *Silt curtains as a dredging project management practice*. DOER Technical Notes Collection, ERDC TN-DOER-E21. Vicksburg, MS: U.S. Army Engineer Research and Development Center.
<http://el.erd.usace.army.mil/dots/doer/>.
- Francingues, N. R. and D. Thompson. 2006. *Control of Resuspended sediments in dredging projects. Proceedings of WEDA XXVI Annual Meeting and 38th TAMU Dredging Seminar*, June 25-28, San Diego, CA.
- Fuglevand, P. F., and R. S. Webb. 2006. *Water management during mechanical dredging of contaminated sediment. Proceedings of WEDA XXVI Annual Meeting and 38th TAMU Dredging Seminar*, June 25-28: 461-467. San Diego, CA.
- Fuglevand, P. F., and R. S. Webb. 2007. *Head of Hylebos – Adaptive management during sediment remediation. Proceedings of World Dredging Congress WODCON XVIII*, May 27-June 1, Orlando, FL.
- General Electric Company, Applied Environmental Management, Inc., and Blasland, Bouck & Lee, Inc. 2004. *Major contaminated sediment sites database release 5.0*. <http://www.hudsoninformation.com/mcss/>.

- Greene, G., V. Buhr, and M. Binsfeld. 2007. Controlling dredge cut accuracy, sediment resuspension, and sediment dewatering: Fox River OU1 Contaminated Sediment Project. *4th International Conference on Remediation of Contaminated Sediments*, January 22-25, 2007, Savannah, GA.
- Grimwood, C. 1983. Effects of dredging on adjacent water. *Journal of Environmental Engineering* 109(1):47-65, American Society of Civil Engineers.
- Hales, L. Z. 1995. *Material properties related to navigation and dredging: Summary report for technical area 2*. Technical Report DRP-95-7, NTIS No. AD-A301 847. Vicksburg, MS: U.S. Army Engineer Waterways Experiment Station.
<http://el.erd.usace.army.mil/publications/drp>.
- Hand, T. D., A. W. Ford, P. G. Malone, D. W. Thompson, and R. B. Mercer. 1978. *A feasibility study of response techniques for discharges of hazardous chemicals that sink*. Technical Report CG-D-56-78. Prepared for the U.S. Coast Guard. Vicksburg, MS: U.S. Army Engineer Waterways Experiment Station.
- Hayes, D. F. 1986a. *Guide to selecting a dredge for minimizing resuspension of sediment*. Environmental Effects of Dredging Technical Note EEDP-09-1. Vicksburg, MS: U.S. Army Engineer Waterways Experiment Station.
<http://el.erd.usace.army.mil/eedp>.
- Hayes, D. F. 1986b. Development of a near field source strength model to predict sediment resuspension from cutter suction dredges. M.S. thesis, Department of Civil Engineering, Mississippi State University.
- Hayes, D., L. Hvasta, and W. Montgomery. 2008. Turbidity barriers in simple flow regimes. *Proceedings of the 28th Annual Meeting of the Western Dredging Association (WEDA XXVI) and 39th Annual Texas A&M Dredging Seminar*, June 8-11, 2008, St. Louis, MO.
- Hayes, D. F., T. R. Crockett, T. J. Ward, and D. Averett. 2000. Sediment resuspension during cutterhead dredging operations. *Journal of Waterway, Port, Coastal, and Ocean Engineering* 126(3):153-161. American Society of Civil Engineers.
- Hayes, D. F., and C. H. Je. 2000. *DREDGE module user's guide*. Draft. Vicksburg, MS: U.S. Army Engineer Research and Development Center.
<http://el.erd.usace.army.mil/models>.
- Hayes, D. F., M. R. Palermo, D. Reible, and J. R. Verduin. 2004. Evaluation of dredging options for the Onondaga Lake feasibility study. Appendix L in Parson et al., *Onondaga Lake Feasibility Study Report, Draft Final*, November.
- Hayes, D. F. and C. Patmont. 2004. Estimating & evaluating post-dredging residuals: approaches, tools, and methods, addressing uncertainty and managing risk at contaminated sediment sites. *USACE/USEPA/SMWG Joint Sediment Conference*, October 26-28, 2004.
<http://el.erd.usace.army.mil/workshops/04oct-ccs/M-Hayes-Patmont.pdf>.
- Hayes, D. F., P. R. Schroeder, and T. D. Borrowman. 2007. Process-based estimation of sediment resuspension losses during bucket dredging. *Proceedings of World Dredging Congress WODCON XVIII, May 27-June 1*. Orlando, FL.

- Hayes, D. F., P. R. Schroeder, and T. D. Borrowman. In preparation. *Resuspension factor approach for estimating dredging-related sediment resuspension*. DOER Technical Notes Collection ERDC TN DOER-NXX. Vicksburg, MS: U.S. Army Engineer Research and Development Center.
<http://el.erd.usace.army.mil/dots/doer/>.
- Hayes, D., and P. Wu. 2001. Simple approach to TSS source strength estimates. *Proceedings, 21st Annual Meeting of the Western Dredging Association (WEDA XXI) and 33rd Annual Texas A&M Dredging Seminar*, Houston, TX.
- Herbich, J. B. 1995. Removal of contaminated sediments: Equipment and recent field studies, in dredging, remediation, and containment of contaminated sediments. Edited by K. R. Demars, G. N. Richardson, R. N. Yong, and R. C. Chaney. *Special Technical Publication 1293, ASTM*. Philadelphia, PA: American Society of Testing and Materials (ASTM).
- Herbich, J. B. 2000. *Handbook of coastal engineering*. 2nd ed. New York: McGraw Hill.
- Herbich, J. B. and S. B. Brahme. 1991. *Literature review and technical evaluation of sediment resuspension during dredging*. Contract Report HL-91-1. Vicksburg, MS: US Army Engineer Waterways Experiment Station.
<http://el.erd.usace.army.mil/e2d2/pdfs/crhl91-1.pdf>.
- Herrenkohl, M., D. Hayes, R. Marnicio, and J. Lally. 2003. Predicting residual contamination in surface sediments after dredging. *Proceedings, 2nd International Conference on Remediation of Contaminated Sediments*, 30 September – 3 October, Venice, Italy.
- Imhoff, J. C., A. Stoddard, and E. M. Buchak. 2003. *Evaluation of contaminated sediment fate and transport models: final report*. pp. 141. Prepared by Aqua Terra for U.S. Environmental Protection Agency. Athens, GA: National Exposure Research Laboratory. <http://hspf.com/pdf/FinalReport110.pdf>
- Jacques Berube, Inc. 1993. *Selecting and operating dredging equipment – A guide to sound environmental practices*. Cat. No. En 40-438/1993E. Prepared in collaboration with Public Works Canada and the ministere de l'Environnement du Quebec. 75. St. Lawrence Centre.
- JBF Scientific Corporation. 1978. *An analysis of the functional capabilities and performance of silt curtains*. Technical Report D-78-39. Vicksburg, MS: U.S. Army Engineer Waterways Experiment Station.
<http://el.erd.usace.army.mil/trd78-39.pdf>.
- Jones, R. A., and G. F. Lee. 1978. *Evaluation of the elutriate test as a method of predicting contaminant release during open-water disposal of dredged sediments and environmental impact of open-water dredged material disposal Vol. I: Discussion*. Technical Report D-78-45. Vicksburg, MS: U.S. Army Engineer Waterways Experiment Station.
<http://el.erd.usace.army.mil/e2d2/pdfs/trd78-45I/cover.pdf>.
- Kuo, A. Y., and D. F. Hayes. 1991. A model for turbidity plume induced by bucket dredge. *Journal of Waterways, Port, Coastal, and Ocean Engineering* 117(6):610-623. American Society of Civil Engineers.

- Kuo, W., and Lukens. 1985. Dredge induced turbidity plume model. *Journal of Waterways, Port, Coastal, and Ocean Engineering* 111(3):476-495. American Society of Civil Engineers.
- Lane, D., R. Ogburn, and R. Bergeron. 2005. Environmental dredging system for turbidity control, Jacksonville Harbor, Florida. *Proceedings, 3rd International Conference on Remediation of Contaminated Sediments*, January 24-27, 2005, New Orleans, LA.
- LaRosa, P., and C. Patmont. 2007. Designing a dredge plan to accommodate anticipated residuals. *Proceedings, 4th International Conference on Remediation of Contaminated Sediments*, January 22-25, Savannah, GA.
- LaSalle, M. W., D. G. Clarke, J. Homziak, J. D. Lunz, and T. J. Fredette. 1991. *A framework for assessing the need for seasonal restrictions on dredging and disposal operations*. Technical Report D-91-1. Vicksburg, MS: U.S. Army Engineer Waterways Experiment Station.
<http://el.erd.c.usace.army.mil/e2d2/pdfs/trd91-1.pdf>.
- Lee, L. T. 2001a. *In situ expedient test methods to determine geotechnical properties of dredged materials*. DOER Technical Notes Collection, ERDC TN-DOER-N12. Vicksburg, MS: U.S. Army Engineer Research and Development Center.
<http://el.erd.c.usace.army.mil/dots/doer/>.
- Lee, L. T. 2001b. *Geotechnical properties and sediment characterization for dredged material models*. DOER Technical Notes Collection, ERDC TN-DOER-N13. Vicksburg, MS: U.S. Army Engineer Research and Development Center.
<http://el.erd.c.usace.army.mil/dots/doer/>.
- Lee, L. T. 2004. *Variability in dredged material geotechnical properties*. DOER Technical Notes Collection, ERDC TN-DOER-D2. Vicksburg, MS: U.S. Army Engineer Research and Development Center.
<http://el.erd.c.usace.army.mil/dots/doer/>.
- Lillycrop, J., J. Clausner, and J. Rosati. 2003. *Personal communications*.
- MacDonald, N. J., M. H. Davies, A. K. Zundel, J. D. Howlett, Z. Demirbilek, J. Z. Gailani, T. C. Lackey, and J. Smith. 2006. PTM: Particle Tracking Model, Report 1: Model theory, implementation, and example applications. Technical Report ERDC/CHL TR-06-20. Vicksburg, MS: U.S. Army Engineer Research and Development Center. <http://cirp.wes.army.mil/cirp/pubs/pdf/TR-06-20.pdf>
- Maher, E. M., and J. A. Nichols. 1995. Dredging of contaminated sediments-Port of San Diego. *Proceedings of the Western Dredging Association Sixteenth Technical Conference, Twenty-Eighth Annual Texas A&M Dredging Seminar and University of Wisconsin Sea Grant Dredging Workshop*, May 23-26, Minneapolis, MN. CDS Report No. 343. Center for Dredging Studies: Texas A&M University. College Station, TX.
- Mohan, R. 1998. Remedial dredging of contaminated rivers and harbors – challenges & prospects. *Proceedings, Fifteenth World Dredging Congress*, June 28-July 2, Las Vegas, NV.

- Mohan, R. K., and R. F. Thomas. 1997. Practical guidelines for environmental dredging projects. *Proceedings, SUPERFUND XXV Conference*. Washington, DC.
- Nakai, O. 1978. Turbidity generated by dredging projects, management of bottom sediments containing toxic substances. *Proceedings of the Third U.S.-Japan Experts Meetings*. EPA-600/3-78-084, 1-47.
- National Research Council (NRC). 1989. *Contaminated marine sediments – assessment and remediation*. Marine Board, National Research Council. Washington, DC: National Academy Press.
- National Research Council (NRC). 1997. *Contaminated sediments in ports and waterways*. Washington, DC: National Academy Press.
<http://www.nap.edu/bookstore>.
- National Research Council (NRC). 2001. *A risk management strategy for PCB-contaminated sediments*. DC: National Academy Press.
<http://www.nap.edu/bookstore>.
- National Research Council (NRC). 2007. *Sediment dredging at Superfund megasites: assessing the effectiveness*. Washington DC: National Academy Press.
<http://www.nap.edu/bookstore>.
- Otten, M. T. 2006. Environmental dredging versus shoreline stability. *Proceedings Western Dredging Association XXVI Technical Conference*, June 25-27, San Diego, CA.
- Otten, M. T., and R. S. Webb. 2008. Dredging systems used to meet remediation goals: evaluation of three successful projects. *Proceedings of Western Dredge Association XXVIII Conference*, June 9-11, St. Louis, MO.
- Palermo, M. R. 1991. Equipment choices for dredging contaminated sediments. *Remediation-The journal of environmental cleanup costs, technologies, and techniques*, 1(Autumn).
- Palermo, M. R. 2003. Environmental dredging – A state of the art review. *Proceedings of the Second International Symposium on Contaminated Sediments: Characterization, Evaluation, Mitigation/Restoration, Monitoring, and Performance*, May 26-28. Quebec, Canada.
- Palermo, M. R. 2006. Design sequence for environmental dredging. *Proceedings of the 26th Annual Meeting of the Western Dredging Association (WEDA XXIII) and 38th Annual Texas A&M Dredging Seminar*. San Diego, CA.
- Palermo, M. R., and V. R. Pankow. 1988. New Bedford Harbor superfund project, Acushnet River estuary engineering feasibility study of dredging and dredged material disposal alternatives. In: Report 10. *Evaluation of dredging and dredging control technologies*. Technical Report EL-88-15. Vicksburg, MS: U.S. Army Engineer Waterways Experiment Station.
<http://el.erd.c.usace.army.mil/e2d2/pdfs/trel88-15-10.pdf>.

- Palermo, M. R., and D. E. Averett. 2003. Environmental dredging – A state of the art review. *Proceedings of the Second International Symposium on Contaminated Sediments: Characterization, Evaluation, Mitigation/Restoration, Monitoring, and Performance*, May 26-28. Quebec, Canada.
- Palermo, M. R., and S. J. Ells. 2005. Evaluating remediation success at contaminated sediment sites. *Proceedings, Third International Conference on Remediation of Contaminated Sediments*, January 24-27, New Orleans, LA.
- Palermo, M., N. Francingues, and D. Averett. 2004. Operational characteristics and equipment selection factors for environmental dredging. *Journal of Dredging Engineering* 6(3). Western Dredging Association.
- Palermo, M., and C. Patmont. 2007. Considerations for monitoring and management of environmental dredging residuals. *Proceedings, Fourth International Conference on Remediation of Contaminated Sediments*, January 22-25, Savannah, GA.
- Palermo, M. R., and J. R. Wilson. 2000. Corps of Engineers role in contaminated sediment management and remediation. *Proceedings, American Bar Association, Section of Environment, Energy, and Resources, Panel on Contaminated Sediments: Science, Law, and Politics, 8th Section Fall Meeting*, 22 September. New Orleans, LA.
- Patmont, C. 2006. *Contaminated sediment dredging residuals: recent monitoring data and management implications*. Presentation to National Research Council Committee on sediment dredging at superfund megasites. http://www.smwg.org/Patmont_NAS%20Residual%20Presentation%20-%206-7-06%20ext.pdf.
- Patmont, C., and M. Palermo. 2007. Case studies of environmental dredging residuals and management implications. *Proceedings, Fourth International Conference on Remediation of Contaminated Sediments*, January 22-25, Savannah, GA.
- Pennekamp, J. G. S., R. J. C. Eskamp, W. F. Rosenbrand, A. Mullie, G. L. Wessel, T. Arts, and I. K. Decibel. 1996. *Turbidity caused by dredging; viewed in perspective*. *Terra et Aqua*, 64:10-17.
- Philips, K., and J. Malek. 1984. Dredging as a remedial method for a Superfund site. In: *Proc. of the Dredging Conference '84. Dredging and Dredged Material Disposal*, Vol. 2, American Society of Civil Engineers. New York, NY.
- PIANC. 1996. Handling and treatment of contaminated dredged material from ports and inland waterways – CDM. *Report of Working Group No. 17 of the Permanent Technical Committee I. Supplement to Bulletin No. 89*. Brussels, Belgium: Permanent International Association of Navigation Congresses. <http://www.pianc-aipcn.org/>.
- Pound, C. E. 2000. Innovative Dredging Technology. *Proceedings, Western Dredging Association 20th Technical Conference and 32d Annual Texas A&M Dredging Seminar*, June 25-28. Warwick, RI.

- Puckette, T. P. 1998. *Evaluation of dredged material plumes – Physical monitoring techniques*. DOER Technical Notes Collection, ERDC TN-DOER-E5. Vicksburg, MS: U.S. Army Engineer Research and Development Center.
<http://el.erd.usace.army.mil/dots/doer/>.
- Puget Sound Estuary Program (PSEP). 1997. Recommended guidelines for sampling marine sediment, water column, and tissue in Puget Sound. U.S. Environmental Protection Agency, Region 10, Seattle WA and Puget Sound Water Quality Authority, Olympia, WA.
- Reine, K. J., D. D. Dickerson, and D. G. Clarke. 1998. *Environmental windows associated with dredging operations*. DOER Technical Notes Collection, ERDC TN-DOER-E2. Vicksburg, MS: U.S. Army Engineer Research and Development Center.
<http://el.erd.usace.army.mil/dots/doer/>.
- ReTec. 2001. *Sediment technologies memorandum, lower Fox River and Green Bay Wisconsin*.
<http://www.dnr.state.wi.us/org/water/wm/lowerfox/rifs/fs/appendixb.pdf>.
- Riley, D. T. 2006. *Subject: Assuring the Adequacy of Environmental Documentation for Construction and Maintenance Dredging of Federal Navigation Projects*. Memorandum CECW-P/CECW-O. 17 January.
- Ruiz, C. E., N. M. Aziz, and P. R. Schroeder. 2001. RECOVERY: A contaminated sediment-water interaction model. *Environmental Modeling & Assessment* 6(3): 151-158. Baltzer Science Publishers.
- Sanders, L., and J. Killgore. 1989. *Seasonal restrictions on dredging operations in freshwater systems*. Environmental Effects of Dredging Technical Note EEDP-09-1. Vicksburg, MS: US Army Engineer Waterways Experiment Station.
<http://el.erd.usace.army.mil/eedp>.
- Schroeder, P. R. 2002. *Estimation of contaminant release from the dredging of Clark Fork and Blackfoot River sediments in area 1 of Milltown Reservoir*. Technical Memorandum. Vicksburg, MS: U.S. Army Engineer Research and Development Center. <http://www.epa.gov/region8/superfund/sites/mt/resuspensrpt.usace.0205.pdf>.
- Schroeder, P. R., M. R. Palermo, T. E. Myers, and C. M. Lloyd. 2004. *The automated dredging and disposal alternatives modeling system (ADDAMS)*. Environmental Effects of Dredging Technical Notes Collection, ERDC TN EEDP-06-12. Vicksburg, MS: U.S. Army Engineer Research and Development Center.
<http://el.erd.usace.army.mil/eedp>.
- Service Environmental. 2003. *Data Gap Report – St. Louis River/ Interlake/ Duluth Tar Site*. Duluth, MN. <ftp://ftp.visi.com/users/servenv/DataGapReport/html%20files/datagap/report/dgr.htm>.
- Snyder, G. W., J. R. Ponton, and P. W. Deming. 1995. Dredging with environmental controls Baltimore, Maryland, inner harbor. *Proceedings of the Western Dredging Association Sixteenth Technical Conference, Twenty-Eighth Annual Texas A&M Dredging Seminar and University of Wisconsin Sea Grant Dredging Workshop*, May 23-26, Minneapolis, MN. CDS Report No. 343. College Station, TX: Center for Dredging Studies, Texas A&M University.

- Souder, P. S., L. Tobias, J. F. Imperial, and F. C. Mushal. 1978. *Dredged material transport systems for inland disposal and/or productive use concepts*. Contract Report D-78-28. Vicksburg, MS: U.S. Army Engineer Waterways Experiment Station. <http://el.erd.usace.army.mil/e2d2/pdfs/trd78-28/cover.pdf>.
- Spigolon, S. J. 1993a. Geotechnical factors in the dredgability of sediments. *Report 1: Geotechnical Descriptors for Sediments to be Dredged*. Contract Report DRP-93-3, NTIS No. AD-A274 782. Vicksburg, MS: U.S. Army Engineer Waterways Experiment Station. <http://el.erd.usace.army.mil/e2d2/pdfs/drp93-3-R1.pdf>.
- Spigolon, S. J. 1993b. Geotechnical factors in the dredgability of sediments. *Report 2: Geotechnical Site Investigation Strategy for Dredging Projects; Literature Review*. Contract Report DRP-93-3, NTIS No. AD-A273 221. Vicksburg, MS: U.S. Army Engineer Waterways Experiment Station. <http://el.erd.usace.army.mil/e2d2/pdfs/drp93-3-R2.pdf>.
- Spigolon, S. J. 1993c. Geotechnical factors in the dredgability of sediments. *Report 3: Guidance in the Geotechnical Evaluation of the Dredgability of Sediments Using GEODREDG*. Contract Report DRP-93-3, NTIS No. AD-A273 222. Vicksburg, MS: U.S. Army Engineer Waterways Experiment Station. <http://el.erd.usace.army.mil/e2d2/pdfs/drp93-3-R3.pdf>.
- Spigolon, S. J. 1993d. Geotechnical factors in the dredgability of sediments. *Report 4: Reducing the Impact of Contract Claims*. Contract Report DRP-93-3. Vicksburg, MS: U.S. Army Engineer Waterways Experiment Station. <http://el.erd.usace.army.mil/e2d2/pdfs/drp93-3-R4.pdf>.
- Spigolon, S. J. 1995a. *GEOSITE, Geotechnical site investigation methods*. Contract Report DRP-95-1, NTIS No. AD-A286 859. Vicksburg, MS: U.S. Army Engineer Waterways Experiment Station. <http://el.erd.usace.army.mil/e2d2/pdfs/drp95-1.pdf>.
- Spigolon, S. J. 1995b. *Geotechnical descriptors for dredgeability*. Technical Note DRP-2-13. Vicksburg, MS: U.S. Army Engineer Waterways Experiment Station. <http://el.erd.usace.army.mil/drp>.
- Spigolon, S. J. 1995c. *Geotechnical site investigations for dredging projects*. Technical Note DRP-2-12. Vicksburg, MS: U.S. Army Engineer Waterways Experiment Station. <http://el.erd.usace.army.mil/drp>.
- Spigolon, S. J. and R. M. Bakeer. 1994a. *Geotechnical site investigation methods (GEOSITE)*. Technical Note DRP-2-10. Vicksburg, MS: U.S. Army Engineer Waterways Experiment Station. <http://el.erd.usace.army.mil/drp>.
- Spigolon, S. J. and R. M. Bakeer. 1994b. *Geotechnical factors in dredgeability (DREDGABL)*. Technical Note DRP-2-11. Vicksburg, MS: U.S. Army Engineer Waterways Experiment Station. <http://el.erd.usace.army.mil/drp>.
- Tetra Tech, Inc. 2002. *User's manual for environmental fluid dynamics code*. Draft. Atlanta, GA: EPA Region 4. <http://www.epa.gov/athens/wwqtsc/html/efdc.html>.

- Thackston, E. L., and M. R. Palermo. 2000. *Improved Methods for Correlating Turbidity and Suspended Solids for Monitoring*. DOER Technical Notes Collection, ERDC TN-DOER-E8. Vicksburg, MS: U.S. Army Engineer Research and Development Center. <http://el.erd.usace.army.mil/dots/doer/>.
- Thibodeaux, L. J. 1989. *Theoretical models for evaluation of volatile emissions to air during dredged material disposal with applications to New Bedford Harbor, MA*. Miscellaneous Paper EL-89-3. Vicksburg, MS: U.S. Army Engineer Waterways Experiment Station. <http://el.erd.usace.army.mil/e2d2/pdfs/mpel89-3.pdf>.
- Tubman, M. W., and W. D. Corson. 2000. *Acoustic monitoring of dredging-related suspended-sediment plumes*. DOER Technical Notes Collection, ERDC TN-DOER-E7. Vicksburg, MS: U.S. Army Engineer Research and Development Center. <http://el.erd.usace.army.mil/dots/doer/>.
- U.S. Army Corps of Engineers (USACE). 1970. *Engineering and design – laboratory soils testing*. EM-1110-2-1906. Washington, DC: USACE Office, Chief of Engineers. <http://www.usace.army.mil/inet/usace-docs/eng-manuals/em1110-2-1906/toc.htm>
- U.S. Army Corps of Engineers (USACE). 1983. *Dredging and dredged material disposal*. EM 1110-2-5025, (currently being revised). Washington, DC: USACE Office, Chief of Engineers. <http://www.usace.army.mil/inet/usace-docs/eng-manuals/em1110-2-5025/toc.htm>
- _____. 2002. *Engineering and design - hydrographic surveying*. EM-1110-2-1003. Washington, DC: USACE Office, Chief of Engineers. <http://www.usace.army.mil/inet/usace-docs/eng-manuals/em1110-2-1003/toc.htm>
- _____. 2003. *Evaluation of dredged material proposed for disposal at island, nearshore, or upland confined disposal facilities - testing manual*. Technical Report ERDC/EL TR-03-1. Vicksburg, MS: U.S. Army Engineer Research and Development Center. <http://el.erd.usace.army.mil/dots/pdfs/trel03-1.pdf>.
- _____. *In Publication. Dredging and dredged material management*. Engineer Manual EM 1110-2-5025. Washington, DC: USACE Office, Chief of Engineers.
- U.S. Environmental Protection Agency (USEPA). 1993. *Risk assessment and modeling overview document*. EPA 905-R93-007. Assessment and Remediation of Contaminated Sediments Program. Chicago, IL: EPA Great Lakes National Program Office.
- _____. 1994. *Remediation guidance document*. EPA 905-B94-003. Assessment and Remediation of Contaminated Sediments Program. Chicago, IL: EPA Great Lakes National Program Office. <http://www.epa.gov/glnpo/arcs/EPA-905-B94-003/EPA-905-B94-003.html>.
- _____. 1995c. *SCREEN3 model user's guide*. EPA-454/B-95-004. Research Triangle Park, NC: EPA Office of Air Quality Planning and Standards. http://www.epa.gov/scram001/dispersion_screening.htm#screen3.

-
- _____. 1995d. *User's guide for the industrial source complex (ISC3) dispersion models*. EPA-454/B-95-003. Research Triangle Park, NC: EPA Office of Air Quality Planning and Standards.
http://www.epa.gov/scram001/dispersion_alt.htm#isc3.
-
- _____. 1996. *Estimating contaminant losses from components of remediation alternatives for contaminated sediments*. EPA 905-R96-001. Assessment and Remediation of Contaminated Sediments Program. Chicago, IL: EPA Great Lakes National Program Office. <http://www.epa.gov/glnpo/arcs/EPA-905-R96-001/EPA%20905-R96-001.pdf>.
-
- _____. 1997. *Report on the effects of the hot spot dredging operations: New Bedford Harbor Superfund Site*. New Bedford, MA.
<http://www.epa.gov/region01/superfund/sites/newbedford/47203.pdf>.
-
- _____. 1998a. *EPA's contaminated sediment management strategy*. EPA 823-R-98-001. Washington, DC: EPA Office of Water.
<http://www.epa.gov/waterscience/cs/strategy.pdf>.
-
- _____. 2000. *Data quality objectives process for hazardous waste site investigations (EPA QA/G-4HW)*. EPA/600/R-00/007. Washington, DC: EPA Office of Environmental Information.
http://www.epa.gov/quality/qa_docs.html.
-
- _____. 2006a. *Data Quality Assessment: A Reviewer's Guide (EPA QA/G-9R)*. EPA/600/R-96/084. Washington, DC: EPA Office of Environmental Information. http://www.epa.gov/quality/qa_docs.html.
-
- _____. 2001a. *Methods for collection, storage and manipulation of sediments for chemical and toxicological analyses: Technical manual*. EPA-823-B-01-002. Washington, DC: EPA Office of Water.
<http://www.epa.gov/waterscience/cs/collectionmanual.pdf>.
-
- _____. 2001b. *Data quality objectives: Decision error feasibility trials software (DEFT) – User's guide (EPA QA/G-4D)*. EPA/240/B-01/007. Washington, DC: EPA Office of Environmental Information.
http://www.epa.gov/quality/qa_docs.html
-
- _____. 2002a. *Principles for managing contaminated sediment risks at hazardous waste sites*. OSWER Directive 9285.6-08. Washington, DC: EPA Office of Solid Waste and Emergency Response.
<http://www.epa.gov/superfund/resources/principles/9285.6-08.pdf>.
-
- _____. 2002b. *Guidance on choosing a sampling design for environmental data collection for use in developing a quality assurance project plan*. EPA/240/R-02/005. Washington, DC: EPA Office of Environmental Information.
<http://www.epa.gov/QUALITY/qs-docs/g5s-final.pdf>.
-
- _____. 2002c. *Guidance for Quality Assurance Project Plans*. EPA QA/G-5. EPA/240/R-02/009. Washington, DC: EPA Office of Environmental Information. <http://www.epa.gov/quality/qs-docs/g5-final.pdf>.

- _____. 2004a. *Guidance for monitoring at hazardous waste sites: Framework for monitoring plan development and implementation*. OSWER Directive 9355.4-28. Washington, DC: EPA Office of Solid Waste and Emergency Response. <http://www.epa.gov/superfund/policy/pdfs/dir9355.pdf>.
- _____. 2004b. *User's Guide for the AMS/EPA Regulatory Model – AERMOD*. EPA-454/B-03-001. Research Triangle Park, NC: Office of Air Quality Planning and Standards. http://www.epa.gov/scram001/dispersion_prefrec.htm#aermod
- _____. 2005. *Contaminated sediment remediation guidance for hazardous waste sites*. EPA-540-R-05-012, OSWER 9355.0-85. Washington, DC: EPA Office of Solid Waste and Emergency Response. <http://www.epa.gov/superfund/resources/sediment/guidance.htm>.
- _____. 2006b. *Guidance on systematic planning using the data quality objectives process (EPA QA/G-4)*. EPA/240/B-06/001. Washington, DC: EPA Office of Environmental Information. <http://www.epa.gov/quality/qs-docs/g4-final.pdf>.
- _____. 2007. *Guidance for preparing standard operating procedures (SOPs) (EPA QA/G-6)*. EPA/600/B-07/001. Washington, DC: EPA Office of Environmental Information. <http://www.epa.gov/QUALITY/qs-docs/g6-final.pdf>.
- U.S. Environmental Protection Agency/United States Army Corps of Engineers (USEPA/USACE). 1991. *Evaluation of dredged material proposed for ocean disposal (Testing manual)*. EPA-503/8-91/001. Washington, DC: EPA Office of Water. <http://www.epa.gov/OWOW/oceans/gbook/index.html>.
- _____. 1995. *QA/QC guidance for sampling and analysis of sediments, water, and tissues for dredged material evaluations - chemical evaluations*. EPA-823-B-95-001. Washington, DC: EPA Office of Water. <http://www.epa.gov/ostwater/library/sediment/evaluationguide.pdf>.
- _____. 1998. *Evaluation of dredged material proposed for discharge in waters of the U.S. – Testing manual*. EPA-823-B-98-004. Washington, DC: EPA Office of Water and U.S. Army Corps of Engineers. <http://www.epa.gov/waterscience/itm/ITM/inland.pdf>.
- Van Oostrum, R. W. 1992. Dredging of contaminated sediment between pre-dredging survey and treatment. In: *Proc. of the International Symposium on Environmental Dredging*. Buffalo, New York.
- Van Oostrum, R. W. and P. Vroege. 1994. Turbidity and contaminant release during dredging of contaminated sediments. *Proceedings of the Second International Conference on Dredging and Dredge Material Placement*, American Society of Civil Engineers, Lake Buena Vista, FL.
- Wang, T., K. Larm, D. Hotchkiss, and J. Scudder. 2000. Evaluation of closed buckets for East Waterway deepening. *Proceedings, Western Dredging Association 20th Technical Conference and 32d Annual Texas A&M Dredging Seminar*, June 25-28. Warwick, RI.

- Wang, T., K. Larm, and D. Hotchkiss. 2002. Evaluation of closed buckets for remedial dredging and case histories. *Proceedings, 3d Specialty Conference on Dredging and Dredged Material Management*, American Society of Civil Engineers, Orlando, FL.
- Weber, R. H., T. J. Harrington, and R. G. Fox. 2003. Important factors in specifying and contracting environmental dredging projects and case histories. *Proceedings, WEDA XXV, June 19-22*. New Orleans, LA.
- Weber, R. H., M. A. Binsfeld, D. J. Plomb, and S. E. Cieniawski. 2008. Dredging aspects of the Ashtabula River Great Lakes Legacy Act Project. *Proceedings of Western Dredge Association XXVIII Conference*, June 9-11, St. Louis, MO.
- Weber, R., M. Binsfeld, D. Plomb, and S. Cieniawski. 2008. Dredging aspects of the Ashtabula River Great Lakes Legacy Act Project. *Proceedings of the 39th Texas A&M Dredging Seminar and Western Dredging Association XXVIII Technical Conference*, June 8-11, 2008, St. Louis MO.
- Wright, T. D. 1978. *Aquatic dredged material disposal impacts*. Synthesis of Research Results. Dredged Material Research Program. Technical Report DS-78-1. Vicksburg, MS: U.S. Army Engineer Waterways Experiment Station.
<http://el.erd.c.usace.army.mil/e2d2/pdfs/ds78-1.pdf>.
- Zappi, P. A. and D. F. Hayes. 1991. *Innovative technologies for dredging contaminated sediments*. Miscellaneous Paper EL-91-20. Vicksburg, MS: U.S. Army Engineer Waterways Experiment Station.
<http://el.erd.c.usace.army.mil/e2d2/pdfs/mpel91-20.pdf>.

Bibliography

- Appel, P., and M. Jeroense. 2001. Silt removal from a reservoir in heel, the Netherlands. In *Proceedings of the International Conference on Remediation of Contaminated Sediments*, 10-12 October, Venice, Italy.
- Babcock, D., T. Drachenberg, and M. Palermo. 2007. Applying DRET to Assess Impacts of Sediment Resuspended during Dredging. *Proceedings, 4th International Conference on Remediation of Contaminated Sediments*, January 22-25, 2007, Savannah, GA.
- Baron, L., M. Bilimoria, S. Thompson, and P. Wepler. 2007. Environmental Dredging Pilot on the Lower Passaic River, New Jersey. *Proceedings, 4th International Conference on Remediation of Contaminated Sediments*, January 22-25, 2007, Savannah, GA.
- Barth, R., E. Appy, D. Templeton, B. McDonald, and E. Bershinski. 2004. Middle Waterway Sediment Remediation: An Environmental Case Study. *Proceedings of the 24th Annual Meeting of the Western Dredging Association (WEDAXXIV) and 36th Annual Texas A&M Dredging Seminar*, July 6-9, 2004, Orlando, FL.
- Bennett, B. G., and I. K. Hill. 1994. Underwater cleanup of a pool of liquid creosote. *Proceedings of Dredging 94, the Second International Conference and Exhibition on Dredging and Dredged Material Placement*, American Society of Civil Engineers, Lake Buena Vista, FL.
- Blanchard, S., and W. J. Priore. 2002. Verification of environmental clamshell dredging-St. Lawrence River remediation project. *Proceedings, 3rd Specialty Conference on Dredging and Dredged Material Management*, American Society of Civil Engineers, Orlando, FL.
- Case-O'Bourke, N., and G. Hartman. 2007. Excess Dredging: Implications for Negotiating Environmental Documents. *Proceedings of World Dredging Congress WODCON XVIII*, May 27-June 1, Orlando, FL.
- Cushing, B., and M. Hammaker. 2002. Site characterization: Its importance for environmental dredging. *Proceedings, 3rd Specialty Conference on Dredging and Dredged Material Management*, American Society of Civil Engineers, Orlando, FL.
- Dalton, M. 2007. Recontamination of Waterway Cap – Thea Foss Waterway, Tacoma Washington. *Proceedings of World Dredging Congress WODCON XVIII*, May 27-June 1, Orlando, FL.
- Drachenberg, T., M. Costello, and K. Fountain. 2007. Estimating volatile air emissions and odors from a large-scale environmental dredging project. *Proceedings, 4th International Conference on Remediation of Contaminated Sediments*, January 22-25, 2007, Savannah, GA.

- Dunn, S., P. Krause, K. Fabian, and T. Shaw. 2005. Water Quality Monitoring During Capping at the Pacific Sound Resources Superfund Site, Marine Sediments Operable Unit, Seattle, Washington. *Proceedings of the 25th Annual Meeting of the Western Dredging Association (WEDA XXV) and 37th Annual Texas A&M Dredging Seminar*, June 19-22, 2005, New Orleans, LA.
- Esterline, R. C., J. B. Cange, and R. K. Lambert. 2002. Dredging PCB-contaminated sediment from the St. Lawrence River: Project overview. *Proceedings, 3rd Specialty Conference on Dredging and Dredged Material Management*, American Society of Civil Engineers, Orlando, FL.
- Hartman, G., G. Gunderson, J. Frederick, and P. Rude. 2005. Sediment Removal and Capping of the Lockheed Shipyard Site, West Duwamish Waterway Using Conventional Dredge Equipment. *Proceedings of the 25th Annual Meeting of the Western Dredging Association (WEDA XXV) and 37th Annual Texas A&M Dredging Seminar*, June 19-22, 2005, New Orleans, LA.
- Hayes, D. F., and P. R. Schroeder. 1992. *Documentation of the SETTLE module for ADDAMS: Design of confined disposal facilities for solids retention and initial storage*. Environmental Effects of Dredging Technical Notes Collection, ERDC TN EEDP-06-18. Vicksburg, MS: U.S. Army Engineer Research and Development Center. <http://el.ercd.usace.army.mil/eedp>.
- Hicks, G., and R. Traver. 2003. Remediation of contaminated sediment sites: Engineering for implementation with pilot projects. *Proceedings of the 23rd Annual Meeting of the Western Dredging Association (WEDAXXIII) and 35th Annual Texas A&M Dredging Seminar*, June 10-12, 2003, Chicago, IL.
- Hornsby, R. G., R. Martinek, and S. Marwitz. 1995. Harbor spill cleanup using specialized dredging. *Proceedings of the Western Dredging Association Sixteenth Technical Conference, Twenty-Eighth Annual Texas A&M Dredging Seminar and University of Wisconsin Sea Grant Dredging Workshop*, May 23-26, 1995, Minneapolis, MN. CDS Report No. 343. College Station, TX: Center for Dredging Studies, Texas A&M University.
- Jingui, L., L. Jinjun, Y. Jianhua, and D. Shuyou. 2007. Technical research on the precise dredging of contaminated sediment. *Proceedings of World Dredging Congress WODCON XVIII*, May 27-June 1, Orlando, FL.
- Johnson, K. 2005. Geotechnical investigations for dredging projects. *Proceedings of the 25th Annual Meeting of the Western Dredging Association (WEDA XXV) and 37th Annual Texas A&M Dredging Seminar*, June 19-22, 2005, New Orleans, LA.
- Lehrke, S., S. Laszewski, J. Eykholt, T. Konkle, and B. Hartman. 2007. Fox River sediment dredging performance and model evaluation by statistical variance components. *Proceedings, 4th International Conference on Remediation of Contaminated Sediments*, January 22-25, 2007, Savannah, GA.
- Mahmutoglu, S., L. Baron, R. Chant, T. Wilson, E. Garvey, A. Burton, and S. Ahsan. 2007. Environmental dredging pilot study in the Lower Passaic River: Updated results. *Proceedings of World Dredging Congress WODCON XVIII*, May 27-June 1, Orlando, FL.

- Malcolm Pirnie, Inc. and TAMS Consultants, Inc. 2004. *Hudson River superfund site – engineering performance standards*. Prepared for U.S. Army Corps of Engineers, Kansas City District on behalf of Region 2: U.S. Environmental Protection Agency. http://www.epa.gov/hudson/eng_perf/FP1001.pdf.
- Mallee, G. T. 2002. State of the art on Dredge Track Presentation System (DTPS) in conjunction with dredge related instruments/automation and sensors. *Proceedings, American Society of Civil Engineers, Third Specialty Conference on Dredging and Dredged Material Management*. Orlando, FL.
- Menozi, R., T. Binsfield, V. Buhr, S. McGee, C. Moses, S. LaViolette, and T. Balckmar. 2003. Grand Calumet River sediment remediation project: Largest impacted sediment, hydraulically dredged project in North America. *Proceedings of the 23rd Annual Meeting of the Western Dredging Association (WEDAXXIII) and 35th Annual Texas A&M Dredging Seminar*, June 10-12, 2003, Chicago, IL.
- Palermo, M. R. 2005a. Remedial design standards for environmental dredging and subaqueous capping effectiveness. *Proceedings, Third International Conference on Remediation of Contaminated Sediments*, January 24-27. New Orleans, LA.
- Palermo, M. R. 2005b. *USEPA sediment remediation course: Technical considerations for evaluating and implementing dredging and capping remedies*. Office of Solid Waste and Emergency Response. Washington, DC: USEPA.
- Palermo, M. R., N. R. Francingues, and D. E. Averett. 2003. Equipment selection factors for environmental dredging. *Proceedings of the 23rd Annual Meeting of the Western Dredging Association (WEDA XXIII) and 35th Annual Texas A&M Dredging Seminar*, Chicago, IL.
- Patmont, C., and T. Wang. 2007. Commencement Bay Case Studies of Environmental Dredging Residuals. *Proceedings of World Dredging Congress WODCON XVIII*, May 27-June 1, Orlando, FL.
- Pelletier, J. P. 1995. Demonstrations and commercial applications of innovative sediment removal technologies, in dredging, remediation, and containment of contaminated sediments. Edited by K. R. Demars, G. N. Richardson, R. N. Yong, and R. C. Chaney. *American Society of Testing and Materials (ASTM)*. Special Technical Publication 1293, ASTM. Philadelphia, PA.
- Scott, J., R. Carscadden, J. Lally, and R. Webb. 2002. Specifying an overdredge allowance for environmental clamshell dredging in Puget Sound. *Proceedings, American Society of Civil Engineers, Third Specialty Conference on Dredging and Dredged Material Management*. Orlando, FL.
- Seagren, E. H. 2002. Latest developments in small hydraulic dredges for contaminated sediment removal in the USA. *Proceedings, American Society of Civil Engineers, Third Specialty Conference on Dredging and Dredged Material Management*. Orlando, FL.
- Spigolon, S. J. 1994. *DREDGABL: Geotechnical factors in dredgeability*. Instruction Report DRP-94-1, NTIS No. AD-A286 724. Vicksburg, MS: U.S. Army Engineer Waterways Experiment Station.

- Thompson, T., C. Houck, L. Bransch, S. Muttige, R. Paulson, and S. Hinton. 2003. Application of a combined dredging and venner-capping remedy to soft unconsolidated sediments. *Proceedings of the 23rd Annual Meeting of the Western Dredging Association (WEDAXXIII) and 35th Annual Texas A&M Dredging Seminar*, June 10-12, 2003, Chicago, IL.
- U.S. Environmental Protection Agency (USEPA). 1988. *Guidance for conducting remedial investigations and feasibility studies under CERCLA*. EPA/540/G-89/004. Washington, DC: EPA Office of Emergency and Remedial Response. <http://www.epa.gov/superfund/policy/remedy/pdfs/540g-89004-s.pdf>.
- _____. 1990. *Guidance on expediting remedial design and remedial actions*. EPA/540/G-90/006, OSWER 9355.5-02. Washington, DC: EPA Office of Emergency and Remedial Response. <http://www.epa.gov/superfund/cleanup/pdfs/rdra/expeditingrdra.pdf>.
- _____. 1991. *Handbook - remediation of contaminated sediments*. EPA/625/6-91/028. Washington, DC: EPA Office of Research and Development.
- _____. 1995a. *Guidance for scoping the remedial design*. EPA/540/R-95/025. Washington, DC: EPA Office of Solid Waste and Emergency Response. <http://www.epa.gov/superfund/resources/remedy/pdf/540r-95025-s.pdf>.
- _____. 1995b. *Remedial design/remedial action handbook*. EPA 540/R-95/059. Washington, DC: EPA Office of Emergency and Remedial Response. <http://www.epa.gov/superfund/cleanup/rdrabook.htm>.
- _____. 1998b. *Guide to documenting and managing cost and performance information for remediation projects*. EPA 542-B-98-007. Federal Remediation Technologies Roundtable. <http://www.frtr.gov/publib.htm>.
- U.S. Environmental Protection Agency/United States Army Corps of Engineers (USEPA/USACE). 2004. *Evaluating environmental effects of dredged material management alternatives - A technical framework*. EPA 842-B-92-008. Washington, DC: EPA Office of Water and U.S. Army Corps of Engineers. <http://www.epa.gov/owow/oceans/regulatory/dumpedredged/framework/techframework.pdf>.
- Van Raalte, G. H. 1986. The disc-bottom cutterhead: a report on laboratory and field tests. *Proceedings of the WODCON XI, World Dredging Congress*. Brighton, UK.
- Webb, R., P. Fuglevand, A. van den Adel, and J. Lally. 2004. Head of Hylelbos Waterway Sediment Remediation Innovative Design, Dredging, and Monitoring Methods. *Proceedings of the 24th Annual Meeting of the Western Dredging Association (WEDAXXIV) and 36th Annual Texas A&M Dredging Seminar*, July 6-9, 2004, Orlando, FL.
- Weber, R., T. Harrington, and R. Fox. 2005. Important factors in specifying and contracting environmental dredging projects and project examples. *Proceedings of the 25th Annual Meeting of the Western Dredging Association (WEDA XXV) and 37th Annual Texas A&M Dredging Seminar*, June 19-22, 2005, New Orleans, LA.

- Wilson, D., H. Millican, and J. Niermeyer. 2007. Sediment Removal Action Northwest Oil Drain Canal, Salt Lake City, Utah. *Proceedings, 4th International Conference on Remediation of Contaminated Sediments*, January 22-25, 2007, Savannah, GA.
- Wu, P. 2000. Verification and modification of TSS source strength models for hydraulic cutter dredging operations. *Proceedings, Western Dredging Association 20th Technical Conference and 32d Annual Texas A&M Dredging Seminar*. June 25-28. Warwick, RI.

Appendix A: Dredging Elutriate Test Procedure

Introduction

This appendix provides detailed step-by-step procedures for conducting tests for evaluation of contaminant release at the point of dredging. The background, rationale, and tiered framework for application of these procedures are discussed in Chapter 7 of the main text. Two test procedures are included in this appendix:

1. Dredging Elutriate Test (DRET) for water quality evaluations.
2. DRET for water column toxicity evaluations.

The detailed test procedures described here are patterned after those for the effluent elutriate test (U.S. Army Corps of Engineers (USACE) 2003).

Dredging elutriate tests for water quality evaluation

DRET test procedures were developed by USACE as a predictive tool for estimating the degree of contaminant release from sediments due to resuspension at the point of dredging (DiGiano et al. 1993, 1995). The DRET test consists of mixing sediment and site water at a total suspended solids concentration of typically 1 to 10 g/l (considered representative of resuspended sediment as generated at the dredgehead source; see Section 7.3.4), aerating the slurry for 1 hr, allowing the slurry to settle for a period of 1 hr, and analyzing the elutriate for TSS and both dissolved and total concentrations of contaminants. DRET results only apply to releases due to dredging-induced resuspension, and would not be necessarily representative of releases resulting from debris removal activities, propeller wash, spudding/anchoring activities, and other potential resuspended and dissolved contaminant loss sources. However, the DRET results provide information on the potential for contaminant release from dispersal of sediment in the water column.

DRET is designed to simulate the quality of water resulting from sediment resuspension at the point of dredging. The aeration step in the test accounts for geochemical changes occurring in the water column during

resuspension. Test procedures allow for estimates of dissolved contaminant concentrations in milligrams per liter and particulate-associated contaminant concentrations in milligrams per kilogram suspended solids (SS). The test consists of mixing a sediment sample with dredging site water to form a slurry, allowing the slurry to settle, then extracting a dredging elutriate sample for chemical analysis. Field verification studies have shown that the DRET is a conservative predictor of contaminant release at the point of dredging (DiGiano et al. 1993, 1995).

The DRET should be conducted, and appropriate chemical analyses should be performed, as soon as possible after sample collection. If DRETs for both water quality and toxicity evaluations are to be conducted, sufficient elutriate should be prepared for both purposes. The volume of elutriate needed for water quality evaluations will vary depending upon the number and types of chemical analyses to be conducted. Both dissolved and total concentrations of contaminants may be determined. The volume required for each analysis, the number of variables measured, and the desired analytical replication will influence the total elutriate sample volume required. A 4-L cylinder is normally used to prepare the elutriate, and the supernatant volume available for sample extraction will vary from approximately 1,500 to 2,000 mL, depending on the sediment properties, settling times, and initial concentration of the slurry. It may be necessary to composite several extracted sample volumes or to use large diameter cylinders to obtain the total required volume.

Apparatus

The following items are required:

- Laboratory mixer, preferably with Teflon shaft and blades.
- Several 4-L graduated cylinders. Larger cylinders may be used if large sample volumes are required for analytical purposes. Nalgene cylinders are acceptable for testing involving analysis of inorganic compounds such as metals and nutrients. Glass cylinders are required for testing involving analysis of organic compounds.
- Assorted glassware for sample extraction and handling.
- Compressed air source with deionized water trap and tubing for bubble aeration of slurry.
- Vacuum or pressure filtration equipment, including vacuum pump or compressed air source and an appropriate filter holder capable of accommodating 47-, 105-, or 155-mm-diameter filters.

- Presoaked filters with a 0.45-um pore-size diameter.
- Plastic sample bottles, 500-mL capacity for storage of water and liquid phase samples for metal and nutrient analyses.
- Wide-mouth, 1-gal-capacity glass jars with Teflon-lined screw-type lids for sample mixing. These jars should also be used for sample containers when samples are to be analyzed for organic COC.

Prior to use, all glassware, filtration equipment, and filters should be thoroughly cleaned. Wash all glassware with detergent, rinse five times with tap water, place in a clean 10-percent (or stronger) HCl acid bath for a minimum of 4 hr, rinse five times with tap water, and then rinse five times with distilled or deionized water. Soak filters for a minimum of 2 hr in 5 molar HCl bath, and then rinse 10 times with distilled water. It is also a good practice to discard the first 50 mL of filtrate.

Dredging elutriate test procedure

The step-by-step procedure for conducting the DRET is outlined below and is illustrated in Figure A1.

Step 1 – Slurry preparation. The sediment and water from the proposed dredging site should be mixed to the target concentration (1 to 10 g/L, typically 5 to 10 g/L dry weight basis, see Section 7.3.4). Predetermine the concentration of the well-mixed sediment in grams per liter (dry weight basis) by oven drying a small subsample of known volume. Each 4-L cylinder to be filled will require a mixed slurry volume of 3-3/4 L. The volumes of sediment and water to be mixed for a 3-3/4-L slurry volume may be calculated using the following expressions:

$$V_{\text{sediment}} = 3.75 \frac{C_{\text{slurry}}}{C_{\text{sediment}}} \quad (\text{A1})$$

and

$$V_{\text{water}} = 3.75 - V_{\text{sediment}} \quad (\text{A2})$$

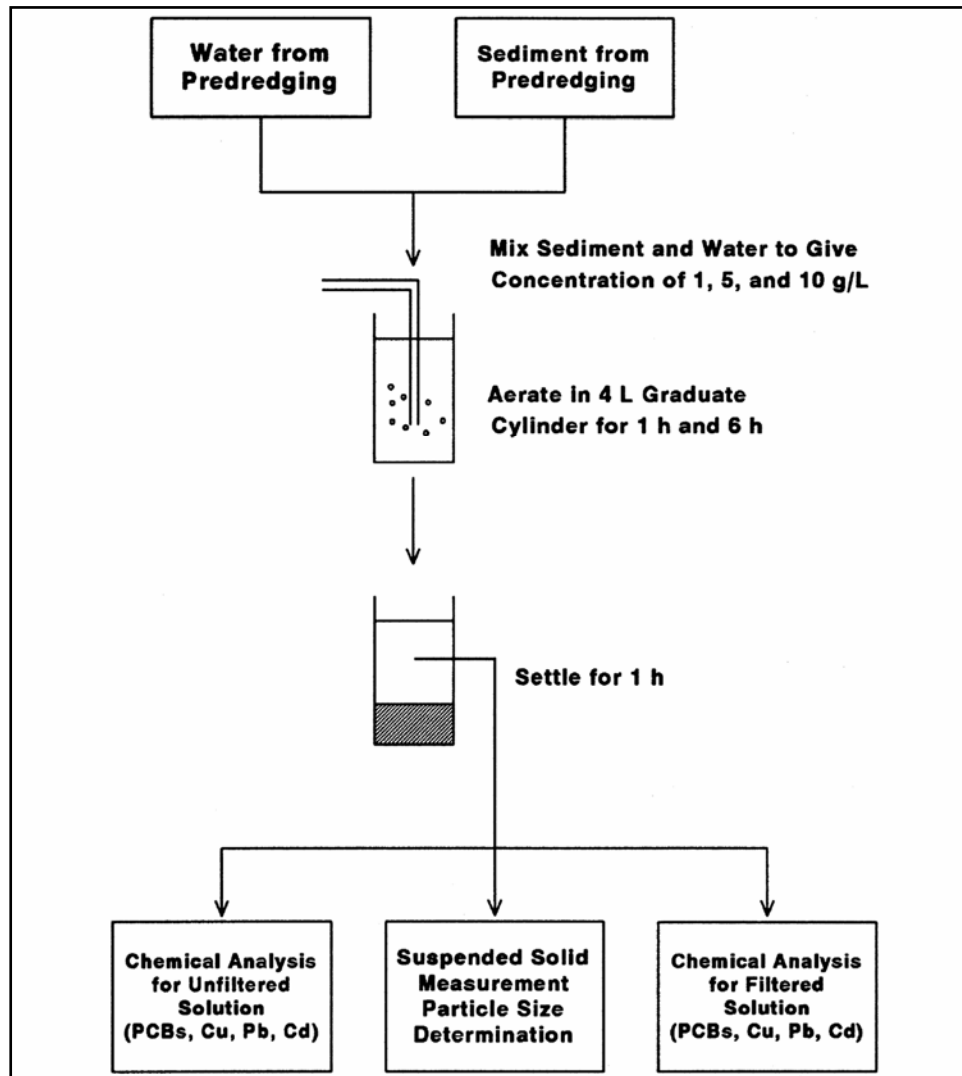

Figure A1. Schematic of the Dredging Elutriate Test (DRET).

where:

$V_{sediment}$ = volume of sediment (liters)

3.75 = volume of slurry for 4-L cylinder (liters)

C_{slurry} = desired concentration of slurry (typically 5 to 10 g/L dry weight basis, see Section 7.3.4)

$C_{sediment}$ = predetermined concentration of sediment (g/L dry weight basis)

V_{water} = volume of disposal site water (liters)

Step 2 – Mixing. Mix the 3-3/4 L of slurry by placing appropriate volumes of sediment and water from the proposed dredging site in a 1-gal

glass jar and mixing for 5 min with the laboratory mixer. The slurry should be mixed to a uniform consistency, with no unmixed clumps of sediment.

Step 3 – Aeration. The prepared slurry must be aerated to ensure that oxidizing conditions will be present in the supernatant water during the subsequent settling phase. Bubble aeration is therefore used as a method of sample agitation. Pour the mixed slurry into a 4-L graduated cylinder. Attach glass tubing to the aeration source and insert the tubing to the bottom of the cylinder. The tubing can be held in place by insertion through a predrilled No. 4 stopper placed in the top of the cylinder. Compressed air should be passed through a deionized water trap, through the tubing, and bubbled through the slurry. The flow rate should be adjusted to agitate the mixture vigorously for 1 hr.

Step 4 – Settling. Remove the tubing, and allow the aerated slurry to undergo quiescent settling for 1 hr.

Step 5 – Sample Extraction. After the period of quiescent settling, an interface will usually be evident between the supernatant water with a low concentration of suspended solids and the more concentrated settled material below the interface. Samples of the supernatant water should be extracted from the cylinder at a point about 2 in. above the interface using a syringe and tubing. Care should be taken not to resuspend the settled material.

Step 6 – Sample Preservation and Analyses. The sample should be analyzed as soon as possible after extraction. The elutriate samples should be split and analyzed for both dissolved and total concentrations of COC and TOC and for total suspended solids in milligrams per liter. This will allow the calculation of the fraction of analytes in the total suspended solids in milligrams per kilogram SS. Filtration using 0.45- μ m filters should be used to obtain subsamples for analysis of dissolved concentrations. Samples to be analyzed for dissolved pesticides or polychlorinated biphenyls (PCBs) must be free of particles but should not be filtered because of the tendency for these materials to adsorb on the filter. However, particulate matter can be removed before analysis by high-speed centrifugation at 10,000 times gravity using Teflon, glass, or aluminum centrifuge tubes (Fulk et al. 1975). The total suspended solids concentration can also be determined by filtration (0.45 μ m).

Chemical analyses

Chemical analyses of the elutriate samples should be performed according to the guidance in Chapter 9 of the ITM (USEPA/USACE 1998).

Released contaminant concentrations

Dissolved Concentrations. The measured dissolved contaminant concentrations are indicative of the dissolved contaminant concentrations that would be expected to build up in the vicinity of the dredge if no transport and dispersion were to occur. It is comparable to an equilibrium dissolved concentration that would result from dredge-induced resuspension where the TSS concentrations remaining in suspension would be less than 1 g/L. In circumstances where transport and dispersion occur, the dissolved contaminant concentrations and the TSS concentration will be diluted and contaminant repartitioning between the TSS and the water column will occur. The dissolved concentrations downstream of the dredge would have to be predicted using short-, mid- and possibly long-term (near-, mid- and possibly far-field) fate and transport models that, at a minimum, consider advection, dispersion, settling, partitioning, and potentially erosion.

Calculation of Particulate-Associated Concentrations. Measured total and dissolved contaminant concentrations and measured TSS and TOC concentrations are used to characterize the partitioning of the contaminants between the particulate and dissolved phases. The particulate –associated concentration of a COC may be calculated in terms of milligrams of contaminant per kilogram SS as follows:

$$F_{SS} = (1 \times 10^6) \frac{C_{total} - C_{diss}}{SS} \quad (A3)$$

where

F_{SS} = particulate-associated concentration (mg analyte/kg of suspended solids)

C_{total} = total concentration (mg analyte/L of sample)

C_{diss} = dissolved concentration (mg analyte/L of sample)

SS = total suspended solids concentration (mg solids/L of samples)

Calculating Total Concentrations. Calculating total concentration of COCs at the dredging-induced resuspension source is based on the DRET results and an estimate of the TSS at the source under the anticipated operating conditions at the site (in the dredge zone). The total COC concentration in milligrams per liter in the water column may be estimated as:

$$C_o = C_{diss} + \frac{F_{SS} SS_o}{(1 \times 10^6)} \quad (A4)$$

where

C_o = estimated initial total concentration in water column at the source (mg analyte/L of water)

C_{diss} = dissolved concentration determined by DRET tests (mg analyte/L of sample)

F_{SS} = fraction of analyte in the total suspended solids calculated from DRET results (mg analyte/kg of suspended solids)

SS_o = suspended solids concentration in the water column at the resuspension source (dredge zone), estimated from evaluation of sediment resuspension and/or modeling (mg/L)

(1×10^6) = conversion factor, mg/mg to mg/kg

Calculating total concentration of COCs in the water column at the point of compliance is based on initial total contaminant concentration, plume dispersion, and settling. The total concentrations downstream of the dredge would have to be predicted using short-, mid- and possibly long-term (near-, mid- and possibly far-field) fate and transport models that, at a minimum, consider advection, dispersion, settling, partitioning, and potentially erosion. The total concentration in the plume is updated continuously as suspended solids and associated contaminant concentration settle out of the plume and as the plume is diluted by dispersion (turbulent diffusion).

Calculating Partitioning Coefficient. A short-term partitioning coefficient can be computed from the measured dissolved contaminant concentrations and the computed particulate-associated contaminant concentration. The partitioning coefficient K_d , in L/kg, is computed as follows:

$$K_d = \frac{F_{SS}}{C_{diss}} \quad (A5)$$

The partitioning coefficient is used in a fate and transport model along with an estimate of the resuspension source strength to predict the contaminant concentration downstream of the dredging. Procedures to estimate the resuspension source strength are given in Chapter 7.

Calculating Dissolved Concentrations at Point of Compliance.

Predicting dissolved concentration at the point of compliance is primarily a function of the initial total contaminant concentration, dilution, and settling. The total concentration is approximated as:

$$C_t = \frac{\left[C_o - \frac{R_{SS} F_{SS} SS_o}{(1 \times 10^6)} \right]}{D} \quad (A6)$$

where

C_t = estimated total concentration in water column at the point of compliance (mg analyte/L of water)

R_{SS} = fraction of resuspended solids that settled before reaching the point of compliance

D = dilution ratio between source and point of compliance (volume of water column mixed with one volume of source)

The dissolved concentration at the point of compliance can be estimated by equilibrium partitioning. The dissolved concentration is computed by multiplying the total concentration by the fraction dissolved in the water column. The fraction of the total contaminant that is dissolved is a function of the TSS concentration and the partitioning coefficient as follows:

$$F_d = \frac{10^6}{10^6 + K_d SS} \quad (A7)$$

where

F_d = fraction dissolved in water column at the point of compliance
 SS = suspended solids concentration at the point of compliance

$$SS = \frac{(1 - R_{SS}) SS_o}{D} \quad (A8)$$

The dissolved contaminant concentration at the point of compliance can be estimated as:

$$C_d = F_d C_t \quad (A9)$$

where

C_d = dissolved concentration at the point of compliance
(mg analyte/L of water)

Dredging elutriate for water column toxicity

For water column toxicity evaluations, a dredging elutriate for the suspended phase is prepared and used as a test medium for water column toxicity tests. This procedure is essentially the same as that for water quality evaluations, except that the elutriate sample is handled differently following extraction. The volume of effluent elutriate required for toxicity testing will be influenced by the number of species to be tested, their size, and requirements for water change during the test. A 4-L cylinder is normally used to prepare the effluent elutriate, and the resulting supernatant volume will vary from approximately 1,500 to 2,000 mL, depending on the sediment properties, settling times, and initial concentration of the slurry. It may be necessary to composite several extracted sample volumes or to use large-diameter cylinders to obtain the total required volume.

Elutriate apparatus

The apparatus necessary for preparation of dredging elutriate is described earlier in the "Apparatus" section on page 279. However, for biological testing the elutriate is not filtered, so only items a through d are required to prepare dredging elutriate for toxicity testing.

Prior to use, all glassware should be thoroughly cleaned. Wash all glassware with detergent, rinse five times with tap water, place in a clean bath for a minimum of 4 hr, rinse five times with tap water, and then rinse five times with distilled or deionized water.

Dredging elutriate procedure

The step-by-step procedure for preparing the dredging elutriate for use in toxicity tests is outlined below.

- **Step 1 - Slurry preparation.** Given earlier for the DRET procedure.
- **Step 2 - Mixing.** Given earlier for the DRET procedure.
- **Step 3 - Aeration.** Given earlier for the DRET procedure.
- **Step 4 - Settling.** Given earlier for the DRET procedure.
- **Step 5 - Sample extraction.** After the appropriate period of quiescent settling, an interface will usually be evident between the supernatant water, with a low concentration of suspended solids above, and the more concentrated settled material below the interface. The liquid plus the material remaining in suspension after the settling period represents the 100 percent dredging elutriate for toxicity testing. Carefully siphon the supernatant, without disturbing the settled material, and immediately use it for toxicity testing. The suspension should be clear enough at the first observation time for the organisms to be visible. With some very fine-grained dredged materials, it may be necessary to centrifuge the supernatant for a short time to achieve this.

Toxicity tests should be performed according to the guidance in Chapter 11 of the ITM (USEPA/USACE 1998), using the elutriate prepared as described in this section as the test medium. Results should be evaluated in light of mixing considerations.

Dredging elutriate toxicity evaluation

The end result of this evaluation is the 96-hr LC₅₀ or 96-hr EC₅₀ expressed as a percentage of the suspended dredged material concentration (or 100 percent elutriate). The LC₅₀ is the dilution of the elutriate that would be expected to produce 50 percent mortality, and the EC₅₀ is the dilution of the elutriate that would be expected to produce an effect of concern other than mortality (such as infertility) in 50 percent of the organisms. To provide protection from chronic toxicity, a toxicity

criteria of 1 percent of the LC₅₀ is often used. The toxicity test can also be used to determine other endpoints that might be needed for the evaluation; these are the NOEL (no observable effects level) and the LOEL (lowest observable effects levels). These values are important when less than 50 percent mortality is observed in the toxicity test. The toxicity test endpoints determine the magnitude of the dilution required to render the contaminant releases from dredge-induced resuspension acceptable. The dilution available between the release source and the point of compliance can be estimated using fate and transport models. This result is then compared with the dilution required at the point of compliance.

References

- DiGiano, F. A., C. T. Miller, and J. Yoon. 1993. Predicting release of PCBs at the point of dredging. *Journal of Environmental Engineering* 119(1):72-89, American Society of Civil Engineers.
- _____. 1995. *Dredging Elutriate Test (DRET) development*. Contract Report D-95-1. Vicksburg, MS: U.S. Army Engineer Waterways Experiment Station. <http://el.erd.usace.army.mil/publications>.
- Fulk, R., D. Gruber, and R. Wullschleger. 1975. *Laboratory study of the release of pesticide and PCB materials to the water column during dredging and disposal operations*. Contract Report D-75-6. Prepared by Envirex, Inc. Vicksburg, MS: U.S. Army Engineer Waterways Experiment Station. <http://el.erd.usace.army.mil/publications>.
- U.S. Army Corps of Engineers (USACE). 2003. *Evaluation of dredged material proposed for disposal at island, nearshore, or upland confined disposal facilities - testing manual*. Technical Report ERDC/EL TR-03-1. Vicksburg, MS: U.S. Army Engineer Research and Development Center. <http://el.erd.usace.army.mil/dots/pdfs/tre03-1.pdf>.
- U.S. Environmental Protection Agency/United States Army Corps of Engineers (USEPA/USACE). 1998. *Evaluation of dredged material proposed for discharge in waters of the U.S. - Testing manual*. EPA-823-B-98-004. Washington, DC: EPA Office of Water and U.S. Army Corps of Engineers. <http://www.epa.gov/waterscience/itm/ITM/inland.pdf>.

REPORT DOCUMENTATION PAGE

Form Approved
OMB No. 0704-0188

Public reporting burden for this collection of information is estimated to average 1 hour per response, including the time for reviewing instructions, searching existing data sources, gathering and maintaining the data needed, and completing and reviewing this collection of information. Send comments regarding this burden estimate or any other aspect of this collection of information, including suggestions for reducing this burden to Department of Defense, Washington Headquarters Services, Directorate for Information Operations and Reports (0704-0188), 1215 Jefferson Davis Highway, Suite 1204, Arlington, VA 22202-4302. Respondents should be aware that notwithstanding any other provision of law, no person shall be subject to any penalty for failing to comply with a collection of information if it does not display a currently valid OMB control number. **PLEASE DO NOT RETURN YOUR FORM TO THE ABOVE ADDRESS.**

| | | | | | | | | | |
|--|------------------------------------|---------------------------------------|-----------------------------------|---|--|--|------------------------|--------------------|----------------------|
| 1. REPORT DATE (DD-MM-YYYY) September 2008 | | 2. REPORT TYPE Final report | | 3. DATES COVERED (From - To) | | | | | |
| 4. TITLE AND SUBTITLE Technical Guidelines for Environmental Dredging of Contaminated Sediments | | | | 5a. CONTRACT NUMBER | | | | | |
| | | | | 5b. GRANT NUMBER | | | | | |
| | | | | 5c. PROGRAM ELEMENT NUMBER | | | | | |
| 6. AUTHOR(S) Michael R. Palermo, Paul R. Schroeder, Trudy J. Estes, and Norman R. Francingues | | | | 5d. PROJECT NUMBER | | | | | |
| | | | | 5e. TASK NUMBER | | | | | |
| | | | | 5f. WORK UNIT NUMBER | | | | | |
| 7. PERFORMING ORGANIZATION NAME(S) AND ADDRESS(ES) Environmental Laboratory U.S. Army Engineer Research and Development Center 3909 Halls Ferry Road Vicksburg, MS 39180-6199 | | | | 8. PERFORMING ORGANIZATION REPORT NUMBER ERDC/EL TR-08-29 | | | | | |
| 9. SPONSORING / MONITORING AGENCY NAME(S) AND ADDRESS(ES) U.S. Environmental Protection Agency Office of Solid Waste and Emergency Response Washington, DC 20314-1000 | | | | 10. SPONSOR/MONITOR'S ACRONYM(S) | | | | | |
| | | | | 11. SPONSOR/MONITOR'S REPORT NUMBER(S) | | | | | |
| 12. DISTRIBUTION / AVAILABILITY STATEMENT Approved for public release; distribution is unlimited. | | | | | | | | | |
| 13. SUPPLEMENTARY NOTES | | | | | | | | | |
| 14. ABSTRACT <p>This report provides technical guidelines for evaluating environmental dredging as a sediment remedy component. This document supports the <i>Contaminated Sediment Remediation Guidance for Hazardous Waste Sites</i>, released by the U.S. Environmental Protection Agency (USEPA) in 2005, by providing detailed information regarding evaluation of environmental dredging as a remedy component. This document is intended to be applicable to contaminated sediment sites evaluated under various environmental laws and regulatory programs. The intended audience for this report includes all stakeholders potentially involved in evaluating environmental dredging for purposes of a feasibility study, remedial design, and implementation.</p> <p>The scope of this document is limited to the technical aspects of the environmental dredging process itself, but it is important that environmental dredging be integrated with other components such as transport, dewatering, treatment, and rehandling and disposal options. This report covers initial evaluation, pertinent site conditions and sediment characteristics, environmental dredging performance standards, equipment capabilities and selection, evaluation of production, duration, and transport, methods for estimating resuspension, residuals and release, control measures, operating methods and strategies, and monitoring.</p> | | | | | | | | | |
| 15. SUBJECT TERMS <table style="width: 100%; border: none;"> <tr> <td style="width: 50%;">Contaminated sediment</td> <td style="width: 50%;">Environmental dredging</td> </tr> <tr> <td>Dredging equipment</td> <td>Sediment remediation</td> </tr> </table> | | | | | | Contaminated sediment | Environmental dredging | Dredging equipment | Sediment remediation |
| Contaminated sediment | Environmental dredging | | | | | | | | |
| Dredging equipment | Sediment remediation | | | | | | | | |
| 16. SECURITY CLASSIFICATION OF: | | | 17. LIMITATION OF ABSTRACT | 18. NUMBER OF PAGES | 19a. NAME OF RESPONSIBLE PERSON | | | | |
| a. REPORT UNCLASSIFIED | b. ABSTRACT UNCLASSIFIED | c. THIS PAGE UNCLASSIFIED | | | 304 | 19b. TELEPHONE NUMBER (include area code) | | | |