

This Health Hazard Evaluation (HHE) report and any recommendations made herein are for the specific facility evaluated and may not be universally applicable. Any recommendations made are not to be considered as final statements of NIOSH policy or of any agency or individual involved. Additional HHE reports are available at <http://www.cdc.gov/niosh/hhe/reports>

**HETA 93-0667-2585
Bundy Corporation
Cynthiana, Kentucky**

**C. Eugene Moss
Don Booher**

PREFACE

The Hazard Evaluations and Technical Assistance Branch of NIOSH conducts field investigations of possible health hazards in the workplace. These investigations are conducted under the authority of Section 20(a)(6) of the Occupational Safety and Health Act of 1970, 29 U.S.C. 669(a)(6) which authorizes the Secretary of Health and Human Services, following a written request from any employer or authorized representative of employees, to determine whether any substance normally found in the place of employment has potentially toxic effects in such concentrations as used or found.

The Hazard Evaluations and Technical Assistance Branch also provides, upon request, technical and consultative assistance to Federal, State, and local agencies; labor; industry; and other groups or individuals to control occupational health hazards and to prevent related trauma and disease. Mention of company names or products does not constitute endorsement by the National Institute for Occupational Safety and Health.

ACKNOWLEDGMENTS AND AVAILABILITY OF REPORT

This report was prepared by C. Eugene Moss of the Hazard Evaluations and Technical Assistance Branch, Division of Surveillance, Hazard Evaluations and Field Studies (DSHEFS). Field assistance provided by Don Booher. Desktop publishing by Ellen E. Blythe.

Copies of this report have been sent to employee and management representatives at BUNDY and the OSHA Regional Office. This report is not copyrighted and may be freely reproduced. Single copies of this report will be available for a period of three years from the date of this report. To expedite your request, include a self-addressed mailing label along with your written request to:

NIOSH Publications Office
4676 Columbia Parkway
Cincinnati, Ohio 45226
800-356-4674

After this time, copies may be purchased from the National Technical Information Service (NTIS) at 5825 Port Royal Road, Springfield, Virginia 22161. Information regarding the NTIS stock number may be obtained from the NIOSH Publications Office at the Cincinnati address.

For the purpose of informing affected employees, copies of this report shall be posted by the employer in a prominent place accessible to the employees for a period of 30 calendar days.

**Health Hazard Evaluation Report 93-0667-2585
Bundy Corporation
Cynthiana, Kentucky
July 1996**

**C. Eugene Moss
Don Booher**

SUMMARY

On June 30-July 1, and November 8, 1993, and September 8-9, 1994, the National Institute for Occupational Safety and Health (NIOSH) conducted an investigation at the Bundy Corporation (BUNDY) facility located in Cynthiana, Kentucky. This investigation was performed in response to a joint management and union request, which NIOSH received on February 18, 1993, to evaluate occupational exposure to electromagnetic fields (EMF) generated by high frequency induction welders and other sources located at the facility.

EMF measurements suggest that BUNDY workers who operate butt welder units, the 400 hertz (Hz) AC welder, or the 10 kilohertz (kHz) induction units may be exposed to magnetic field levels in excess of occupational guidelines promulgated by the American Conference of Governmental Industrial Hygienists (ACGIH™). EMF exposure from other sources, as measured on the days of evaluation, appear to be below the ACGIH guidelines. Excessive exposures are influenced by location of the worker relative to the EMF source, and exposure of extremities (often 10 times higher than the body exposure). Significant exposure reduction can be accomplished by locating workers further from EMF sources, and by determining whether tasks that require insertion of hands in close proximity to various sources, are appropriate and necessary.

Based on a comparison of the data collected in this evaluation with current ACGIH occupational exposure criteria, the NIOSH investigators determined that workers who operate the butt welder units, 400 Hz AC welder, or the induction heaters are exposed to magnetic fields in excess of applicable occupational limits. Suggestions for lowering this exposure are offered in the recommendation section of this report.

Keywords: SIC 3499 (Fabricated Metal Products, Not Elsewhere Classified) Electromagnetic fields, EMF, extremely low frequency, ELF, very low frequency, VLF

TABLE OF CONTENTS

Preface	ii
Acknowledgments and Availability of Report	ii
Summary	iii
Introduction	2
Process Description	2
Methods	2
Evaluation Criteria	4
Static Magnetic Fields	4
Microwave and Radiofrequency Radiation	5
Results	5
Weldline Area	6
DC Weld Process Measurements	6
High Frequency Welder Measurements	6
Resistance Furnaces	7
400 Hz AC Welder Measurements	7
AC Resistance Annealer Measurements	7
10 kHz Annealer Measurements	7
Other Sub–Radiofrequency Electric and Magnetic Field Measurements	8
Alignment Magnets	8
Break Room	8
Personal Measurements	8
Galfan Area	8
Exterior Plant Areas	9
Discussion	9
Weldline Area	9
Butt Welder Unit	9
DC Weld Process	9
High Frequency Welder	10
Resistance Furnaces	10
400 Hz AC Welder	10
AC Resistance Annealer Unit	10
10 kHz Annealer	10
Conclusions	10
Other Comments	11
Recommendations	11
References	12

INTRODUCTION

On February 18, 1993, the National Institute for Occupational Safety and Health (NIOSH) received a joint management and union request for a health hazard evaluation (HHE) to evaluate occupational exposure to magnetic fields generated by high frequency (induction) welders and other sources at the Bundy Corporation (BUNDY) facility located in Cynthiana, Kentucky. On June 30–July 1, November 8, 1993, and September 8–9, 1994, NIOSH investigators conducted evaluations at the BUNDY facility.

BUNDY is a major manufacturer of specialized small diameter metal tubes for the automotive and refrigeration industries and is headquartered in the United Kingdom. The Cynthiana plant produces about 1600 tons per month of various types of steel tubing having diameters normally less than 1 inch. The Cynthiana plant was opened in 1965 and over time has expanded to an area of 188,000 square feet where 11 mill lines operate over three shifts. At the time of evaluation, the facility employed about 200 workers, of which 35 worked in administration. Workers are represented by the United Automobile Workers, Local 1937. No reports of medical symptoms were cited in the request to NIOSH.

Process Description

At BUNDY, the manufacturing of the small (3/16 to 3/4 inch in diameter) tubing is performed on 11 mill lines that use machines which generate various electromagnetic fields (EMFs). The EMF sources found on all lines are a butt welder, welding source, and an annealing source. The butt welder joins rolls of strip metal together using high resistance heating produced by power line (60 hertz [Hz]) frequencies. The strip metal is slowly bent by special machinery to form metal tubing that will be welded together using either a direct current (DC), alternating current (AC), or a high frequency (450 kilohertz [kHz]) welding process. The tubing can then be annealed or have special coatings applied to the metal. It is then cut to appropriate length and shipped to various

customers. The tubing can be annealed by using either a resistance annealer or a 10 kHz annealer. Table 1 shows the types of welding and annealing equipment (EMF sources) found on the various mill lines on the days of evaluations. At BUNDY, most of the EMF-producing sources are found on the mill lines (denoted weldlines), but there are some 10 kHz annealers located in what is denoted the galfan area.

METHODS

Measurement of occupational levels of static magnetic and sub-radiofrequency electric fields (SREF) and sub-radiofrequency magnetic fields (SRMF) found in and around the BUNDY facility was designed to survey actual worker exposures. While measurements were taken at many locations both inside and outside the facility, the majority of measurements were made at two locations: weldline and the galfan areas.

The various sources at BUNDY produce many different types of EMF, such as static magnetic fields (SMF) and time-varying fields related to rectified currents (i.e., “AC ripple”) from the incoming alternating current. The three resistance heaters, 400 Hz AC welding units, butt welders, 10 kHz induction heaters, and the 450 kHz welders generate both power line and other frequencies. All of the AC fields, except the 450 kHz sources, are designated in this report as SREF and SRMF fields; the 450 kHz fields are designated as radiofrequency fields.

The following equipment was used by the NIOSH investigators to assess the various types of EMF levels in this evaluation:

- A Holaday Industries, Inc. model HI-3602 ELF sensor, connected to a HI-3600 survey meter, was used to measure both the magnitude of ELF electric and magnetic fields and the electrical frequency (as well as the waveforms) produced by such fields. The electric field strength was measured in units of volts per meter (V/m) and the magnetic field strength was measured in units of gauss (G) or milligauss (mG) over the frequency range from 30 to 800 Hz.

- A Holaday Industries, Inc. model HI-3627 3-axis ELF magnetic field meter was used to make isotropic measurements of the magnetic field in and around different workstations. The magnetic field is measured over the frequency region from 30 to 2000 Hz and the dynamic range of the instrument is from 0.2 mG to 20 G.

- Selected measurements were made with the EMDEX II exposure system, developed by Enertech Consultants, under project sponsorship of the Electric Power Research Institute, Inc. The EMDEX II is a programmable data-acquisition meter which measures the orthogonal vector components of the magnetic field through its internal sensors. Measurements can be made at various time intervals in the instantaneous read or storage mode. The system was designed to measure, record, and analyze power frequency magnetic fields up to about 5.6 G (low-read) in the frequency region from 30 to 800 Hz. In addition, the system has been modified to read up to 140 G (high-read) over the frequency range from 40 to 3000 Hz. Measurements were made with the low-read meter in both the walk-around and personal dosimetry modes while the high-read meter was used only in the walk-around mode. All of the meters have the capability of displaying magnetic field levels in the following three frequency bandwidths: (1) broadband (BB), which measures magnetic fields from 30 to 800 Hz; (2) harmonic (H), which measures fields from 100 to 800 Hz; and (3) fundamental (F), a bandwidth which measures fields at 60 Hz.

- A Holaday Industries, Inc. model 3637 3-axis very low frequency (VLF) magnetic field meter was used to make isotropic measurements of the magnetic field in and around different workstations. The magnetic field is measured over the frequency region from 2 kHz to 400 kHz and the dynamic range of the instrument is 6 mG to 400 G when using special probe adapters.

- A Holaday Industries, Inc. model HI-3603 VLF radiation survey meter was used to measure the VLF

electric fields around annealers. The electric field is measured over the frequency region from 2 to 300 kHz and the dynamic range of the meter covers 1 to 2000 V/m.

- Measurements of radiofrequency radiation were made with a Holaday Model 3002 survey meter using two probes: a model STE for the electric (E) field and a model STH for the magnetic (H) field. The E-field probe is designed to cover the frequency range from 0.5 to 6000 megahertz (MHZ) and measures the electric field strength in units of volts squared per meter squared (V/m)². The lowest meter indicating level (LMIL) for this probe-meter combination system is 500 (V/m)². The H-field probe is designed to cover the frequency range from 5 to 300 MHZ and measures the magnetic field strength in units of amperes squared per meter squared (A/m)². The LMIL for this probe-meter combination system is 0.005 (A/m)².

- Measurement of microwave radiation was performed with a Narda electromagnetic radiation monitor model 8616 connected to either a Narda magnetic field isotropic probe model 8633 (10 to 300 MHZ) or an electric field isotropic probe model 8621B (0.3 to 40 gigahertz [GHz]). Both field probes, when connected to the monitor, measure field intensities in milliwatts per square centimeter (mW/cm²) over their respective frequency region. The LMIL is 0.05 mW/cm² for the 8616/8633 system and 0.01 mW/cm² for the 8616/8621B system.

- A Holaday model HI-3550 magnetic field monitor measured static magnetic fields. This monitor is a lightweight, battery operated personal magnetic field monitor that could measure fields in three axes. The monitor can measure both instantaneous and time-integrated field strengths. The measurement range is from 0.1 millitesla (mT) to 0.3 tesla (T) on a three second measurement update period. One mT is equivalent to 10,000 mG.

- The source frequencies were measured either using an Optoelectronics Handi-Counter Model 3000 battery powered frequency counter or a

Hewlett-Packard Model 3561A Digital Signal Analyzer capable of reading from 1 MHz to 100 kHz which was connected to a wide band Antenna Research Associates, Inc. model PLA-205/B passive loop antenna calibrated from 20 Hz to 5 MHz.

In addition, a limited number of area measurements were made with the Holaday monitors at selected work locations inside the facility. All measurements were made during daylight hours at waist height. Where possible, at least two readings were taken at each measurement site with the Holaday monitors and the average reading recorded.

All equipment used to document exposure to electric and magnetic fields had been calibrated within six months use either by NIOSH or their respective manufacturer. Most measurements were taken at positions considered to be typical of occupational exposure (one meter away and one meter from the floor). In making measurements for this evaluation, the NIOSH investigators could not obtain simultaneous results for the various sources, or for a given source, due to the need to use different meters, often at different locations, over wide frequency ranges.

EVALUATION CRITERIA

Static Magnetic Fields^[1-3]

Magnetic field exposures can occur either from a steady or time-varying field. In a steady magnetic field, the flux does not change with time and will not cause current to flow in a fixed object. In a time-varying field, the magnetic flux passing through a surface changes with time and can induce an electrical current flow in conductive objects. Both types of fields create biological effects.

Exposure to SMF has been linked to slight increases in blood pressures, alternation in operation of artificial cardiac pacemakers, movement of implanted metal objects, rotation of sickle cells, influencing length of circadian cycle, and attractiveness of metal objects. Many scientists

believe that the effect of SMF is very subtle and may not represent a particularly hazardous exposure. There are no Occupational Safety and Health Administration (OSHA) or NIOSH exposure criteria for static magnetic fields. The Stanford Linear Accelerator Center proposed, in 1971, values of 2000 to 20,000 G, depending on time and exposure area of body, for an upper limit, based on lack of complaints. In 1979, the Department of Energy, based on known biological effects that had been reported, established a level of 20,000 G. The American Conference of Governmental Industrial Hygienists (ACGIH) in 1987 proposed a Threshold Limit Value (TLV) for SMF, stating "Routine occupational exposures should not exceed 600 G whole body or 6000 G to the extremities on a daily, time-weighted average basis. A flux density of 20,000 G is recommended as a ceiling value."

Sub-Radiofrequency Electric and Magnetic Fields^[4]

At the present time, there are no OSHA or NIOSH exposure criteria for sub-radiofrequency (RF) fields. ACGIH has published TLVs for sub-radiofrequency electric and magnetic fields (30 kHz and below). The TLV for sub-radiofrequency magnetic fields (B_{TLV}) states occupational exposure from 1 to 300 Hz should not exceed the ceiling value given by the equation:

$$B_{TLV} \text{ (in mT)} = 60/f$$

where f is the frequency in hertz. One mT equals 10 Gauss. For frequencies in the range of 300 to 30,000 Hz, occupational exposures should not exceed the ceiling value of 0.2 mT (2 G). These ceiling values for frequencies of 300 to 30,000 Hz are intended for both partial- and whole-body exposures. For frequencies below 300 Hz, the TLV for exposure of the extremities can be increased by a factor of 5. This extremity factor means that workers can receive exposure of 50 G to the arms and legs for the 60 Hz power line frequency.

Conversely, the sub-radiofrequency electric field TLV (E_{TLV}) states occupational exposures should not

exceed a field strength of 25 kV/m from 0 to 100 Hz. For frequencies in the range of 100 Hz to 4 kHz, the ceiling value is given by:

$$E_{\text{TLV}} \text{ (in V/m)} = 2.5 \times 10^6 / f$$

where f is the frequency in hertz. A value of 625 V/m is the ceiling value for frequencies from 4 kHz to 30 kHz. These ceiling values for frequencies of 0 to 30 kHz are intended for both partial- and whole-body exposures. This means, for example, at the power line frequency of 60 Hz, which is classified as extremely low frequency (ELF), the E-field intensity TLV is 25,000 V/m and the magnetic flux density TLV is 1 mT or 10,000 mG.

The basis of the ELF E-field TLV is to minimize occupational hazards arising from spark discharge and contact current situations. The B-field TLV addresses induction of magnetophosphenes in the visual system and production of induced currents in the body. Prevention of cancer is not a basis for either of these TLVs because exposure to ELF fields has not been conclusively linked to cancer.

Microwave and Radiofrequency Radiation

Many of the observed biological effects of exposure to microwave (MW) and RF radiation can be attributed to a rise in body temperature. The heating effect of MW within the body depends on the amount of energy absorbed by the skin. The rate of absorption, denoted as the specific absorption rate (SAR), is measured in watts per kilogram (W/kg) for the whole body or parts of the body. The SAR depends on many factors such as the frequency and intensity of the radiation, size and shape of the exposed worker, and the worker's orientation in the radiation field.

The most influential standard for occupational exposure to MW radiation is the Institute of Electrical and Electronics Engineers (IEEE) standard published by the American National Standards Institute (ANSI) and known as ANSI

C95-1991. The IEEE committee concluded that a SAR of 4 W/kg represents the threshold absorption level above which adverse health effects may arise as body temperature increases. A safety factor of 10 was then added to give a SAR of 0.4 W/kg as the maximum permissible exposure limit, averaged over the entire body. The standard uses dosimetry measurements of MW radiation to calculate the power density limit necessary to achieve a SAR of 0.4 W/kg when averaged over a 0.1 hour period. Table 2 shows the radiation levels presently considered safe by the IEEE^[5] as a function of frequency.

OSHA has a radiation protection guide (defined as the radiation level which should not be exceeded without careful considerations of the reasons for doing so) of 10 mW/cm² averaged over any possible 0.1 hour period (29 CFR 1910.97 [1991]). This standard is applicable for far field measurements and is not useful in evaluating near field exposure scenarios, which are of concern in this evaluation.

RESULTS

Measurements were made at various locations on the 11 weldlines, two galfan lines, near the three resistance heaters, and outside the facility near transformer bays. Walk-around measurements using the EMDEX meters were made at many locations where workers were performing their job tasks. The results for the two major areas (galfan and weldlines) are presented in Table 3, while EMDEX data is shown in Table 4.

Weldline Area

Butt Welder Unit Measurements

The magnetic field levels were determined using a high reading EMDEX unit held at worker locations of 12 to 18 inches from the butt welder, 48 inches above the floor, for the approximately 5 seconds of

heating time every 20 minutes. Generally, the hands were exposed more than the body core due to the workers' position relative to the welding unit. SRMF levels ranged from 2 to 36 G; however, not all welder units were measured since some were not operating during the evaluation.

Since occupational exposure measurements at various butt welders indicated that the SRMF levels were greater than 10 G, measurements were made at one location to verify reproducibility of the SRMF. Four measurements were made at the same operator to welder distance. In addition, all measurements were made when joining the same thickness of metal. The average of four trials was 24 G, but the maximum variance of any of the four readings from the average was only 7 G. The magnetic field levels associated with the welder decreased rapidly as a function of distance from the operating line unit.

A typical frequency domain distribution, to 1250 Hz, is shown in the top part of both Figures 1a and 1b. These Figures illustrate the relative magnetic field frequency distribution produced by the Line 9 butt welder unit when operating (Figure 1a) and not operating (Figure 1b). Notice in Figure 1b (when the butt welder unit on Line 9 was not operating) it was still possible to pick up signals produced from various AC sources from adjacent lines. The bottom part of Figures 1a and 1b shows the time domain structure associated with the butt welder's output waveform. Figure 1b shows no waveform distribution since the butt welder was not operating. Figure 2 shows the frequency and time domain distribution associated with the butt welder located on Line 1. It is apparent that such a source produces frequencies at regular intervals over the entire frequency bandwidth setting of the detector.

DC Weld Process Measurements

On the days of evaluation only two of the six DC weld mills were operating. At a distance of less than 2 inches from the two operating DC weld mills SMF measurements ranged from 130 to 180 G. These levels dropped to 65 to 80 G at 6 inches away and were about 3 G at 36 inches. At one DC weld unit

location, SMF measurements at the worker's waist and outstretched hands were about 12 G and 160 G, respectively. This approximate order of magnitude difference in SMF readings between the waist and hand locations has been observed previously by NIOSH investigators in other evaluations.

The DC weld process operates at 480 volts and 18,000 Amperes (A). Since water was used for cooling the tubing it was difficult to accurately measure the SMFs without damaging the meter. The NIOSH investigators observed that line workers would stand about 25 inches away from the source, for short periods of time, and bend over to check the tube integrity and possibly make adjustments only a few times per day. When this occurred the estimated SMF near the head region would be about 40 G.

High Frequency Welder Measurements

There were two 450 kHz welders in the plant located on Lines 2 and 5. Measurements were made on the Line 5 unit at worker positions as well as close to the source of radiation. At the worker location, electric field levels were not detected and magnetic field levels were 1 (A/m)^2 . At the worker's hand and wrist location, about 8 inches from the source, the electric field was $5 \times 10^5 \text{ (V/m)}^2$ and the magnetic field was $1 \times 10^3 \text{ (A/m)}^2$. There is a tendency for workers to position their hands close to the source during those times when the source is on. Therefore, all measurements must be corrected for the work cycle duration (DCF) before comparison with occupational exposure criteria. The DCF is defined as the ratio of the magnetic field on-time to the sum of the time on and time off during any six minutes of operation, and it is normally expressed as a fraction. The NIOSH investigators estimated a 0.1 DCF value for this operation.

Resistance Furnaces

The highest magnetic field level associated with either of the two GE resistance furnaces was 2.5 G at 6 inches from unshielded furnace cables. Levels as

high as 23 mG were measured at a work desk near the 400 kW furnace. All other locations near the two furnaces produced levels that ranged from 3 to 6 mG.

400 Hz AC Welder Measurements

There were three 400 Hz AC welder units in the facility located on Lines 9–11. Figure 3 shows a frequency distribution up to 1000 Hz on the Line 9 welder. While these AC welders were designated as operating at 400 Hz, in actuality they operated near 417 to 420 Hz. Magnetic field levels of 200 to 700 mG were measured at 24 inches from the AC source. These levels increased to between 1 to 8 G at a distance of 2 inches from the source. Most of these weld processes were covered to minimize water splatter. Normally, the line does not require extensive adjustments so workers often stand at least 3 to 5 feet away. At this distance the levels are typically less than 20 mG, depending on whether the worker was standing near other EMF producing devices. It was estimated by several workers that their work tasks brings them to within 12 inches of the AC source only 5% of the time. The electric field was measured around 3 to 5 V/m at the workstations.

AC Resistance Annealer Measurements

The resistance annealer units were located on Lines 3, 4, 6, 7, and 8. Typically, at close distances, i.e., 6 to 12 inches, magnetic field levels were on the order of 3 to 7 G. At distances of 36 inches, the magnetic field levels dropped to less than 400 mG. While these annealers can produce high magnetic field levels, the NIOSH investigators did not see workers remain in the immediate vicinity (i.e., at distances less than 36 inches) of these devices for time periods greater than 30 seconds during any of the visits made to the facility.

10 kHz Annealer Measurements

There were two induction annealers that were designed to operate near 10 kHz (NIOSH

measurements indicated the frequency to be closer to 8.5 kHz) located on Lines 1 and 5 in the weldline area. A typical frequency and time domain distribution up to 12.5 kHz for one of the annealers is shown in Figure 4. Measurements on the Line 1 annealer were made at several locations and distances during operation as shown in Table 5. Confirming measurements were made on the Line 5 unit under the same parameters. Table 5 shows that the highest level recorded was at one end of the unit, at a worker to source distance of 12 inches. Measurements made at locations 3 and 4 would represent realistic occupational exposures to workers performing job tasks during the unit operation. Most of the time, workers would not go any closer than 24 inches to the source, and were never seen by the NIOSH investigators, on the days of evaluation, to stand or sit immediately adjacent or next to these units. The measured occupational magnetic field levels for the 8.5 kHz annealers were approximately 20 G. All magnetic field measurements of induction heaters were corrected for the work cycle duration before comparison with occupational exposure criteria. Since these units were on continuously for large parts of the work day, it was assumed the DCF for these sources was the maximum of 1. The DCF is defined as the ratio of the magnetic field on–time in seconds to the sum of the time on and time off during any six minutes of operation, and it is normally expressed as a fraction. The highest DCF corrected magnetic field level measured on Line 5 was 300 G at a distance of 12 inches in front of the heater compared to a maximum DCF corrected value of 60 G as measured 12 inches in front of the heater on Line 1. If workers were to spend time at this location, then values would exceed the ACGIH TLV ceiling level of 0.2 mT (2 G) by 30 to 150 times. It was observed that the magnetic field levels at the location where the workers, using the 10 kHz annealer systems, spent most of their time during line operations (i.e., near their station’s work desk) gave values near 100 mG. However, these levels can be quite variable depending on the length of time spent by workers at locations closer to the annealers.

Other Sub–Radiofrequency Electric and Magnetic Field Measurements

Alignment Magnets

Occupational measurements were made at the locations where workers might come into contact with static magnetic field produced by the alignment magnets. Levels of SMF were found to range between 80–90 G at contact with the magnets. At a distance of 12 inches from the magnets, the levels dropped to 1 G. During this evaluation, no worker was seen within 10 feet of these small alignment magnets and therefore they would not appear to present a large occupational exposure scenario.

Break Room

SRE/H Fields measurements made in the center of the break room, which also serves as the cafeteria, ranged from 1 to 5 V/m and 1.4 to 3.0 mG, respectively, over various times of the work day.

Personal Measurements

Table 4 shows the results of all the EMDEX II measurements made at the facility during the evaluation. A total of nine measurements were made with five of these being personal measurements. These five measurements were made at the waist level of selected workers while they performed assigned work tasks in the weld line area. Since these meters do not give complete frequency-dependent magnetic field levels over their frequency region, it is not possible to determine if the occupational magnetic field levels adhere to the ACGIH TLVs. While some of the maximum magnetic field levels recorded were high, as shown in Table 4, both the mean and median levels for the fundamental 60 Hz frequency were all below 8.3 mG. No worker received exposures anywhere near the recommended ceiling level of 10 G. Moreover, these levels suggest that the personal measurements made on magnetic fields in the frequency range from 30 to 800 Hz are relatively low and are approximately the same magnitude as measured by NIOSH investigators in previous evaluations.

The mean for the four walk-around measurements

ranged from 2 to 42 mG. The highest level documented on the walk-around measurements was 4.1 G. This level was documented near one of the butt welder units.

Galfan Area

In this area there were two induction heaters, operating with 80 kW at 8.4 and 8.7 kHz. The two heaters were positioned parallel to each other about 10 feet apart. All measurements were made with both heaters operating. Magnetic field levels as high as 180 G were measured at one foot; at three feet away (considered a typical occupational position) the levels decreased to 12 G. The control panels for both heaters were located near the midway point between the two furnaces. Measurements made at this location were found to be 2 G. Figure 5 depicts the frequency spectrum emitted by one heater. During the days of evaluation, few workers were seen in the immediate areas of either heater (unless maintenance problems existed). However, just as in the weldline area, the presence of other metal surfaces near the heaters served as an antenna which allowed the signals to be detected inside and outside the facility. For example, at locations outside the plant near the galfan area, levels near 4 mG were recorded. Workers, who are located within 3 feet of these induction heaters, are exposed to magnetic field levels in excess of the ACGIH TLV limit of 2 G.

In addition to the approximate 8.5 kHz fields generated by the heaters, other non-ionizing frequencies were produced in the galfan area by the use of spot welding equipment, located near the heaters, to seal small sections of pipe. In the VLF frequency region, levels as high as 60 mG were measured at 6 inches from these units.

Exterior Plant Areas

SRE/M fields were documented in front of the three outside transformer bays located on the east, south, and west side of the facility. The maximum magnetic fields documented at these bays, when standing 5 feet away, were 60 mG, 8 mG, and

130 mG, respectively while the maximum electric fields measured at the same locations were 4 V/m, 24 V/m, and 4 V/m, respectively. SRMF measured at the various corners of the facility at outside locations one meter from the building and at 4 feet from the ground ranged from 0.4 to 2.4 mG. Electric fields were all below 5 V/m at the same locations.

DISCUSSION

Weldline Area

Butt Welder Unit

Figure 2 shows the frequency distribution up to 2500 Hz of a typical butt welder unit. The high-read EMDEX monitor, that responds up to 3 kHz, measured magnetic field levels in excess of 20 G where workers were located. The frequency distribution shows many peaks with dominant structures at 360, 720, 1080, 1440, 1800, and 2160 Hz. There is limited commercially available instrumentation to accurately and easily measure the root mean square magnetic field contributions over the 1 to 300 Hz frequency region. Therefore, it is not possible for the NIOSH investigators to determine if the occupational exposures from 1 to 300 Hz are below the 600/f G ceiling level as specified by the ACGIH TLV. The only thing that can be said is that workers who are located close to the welder are exposed to magnetic fields in excess of 20 G and that some of the exposures are in the 1 to 300 Hz region while most of the exposures are probably at frequencies above 300 Hz where the magnetic field should not exceed a ceiling value of 2 G. While these butt welder units did produce high ELF fields at a closer distance, it is important to emphasize that these units were on for only 5 seconds approximately every half-hour (a total of 80 seconds per day). Hence, the total exposure time per worker is less than 2 minutes per day. Furthermore, the levels did decrease rapidly with distance from the units. In addition, some of the workers remained near the butt welders during the weld cycle. In that situation, the hands and fingers (extremities) received a higher exposure to magnetic fields than

the whole body. The latest revision of the ACGIH TLV does permit a five fold excursion factor for exposure to extremities for frequencies less than 300 Hz. However, as mentioned earlier, equipment was not available to determine adherence to the TLV and therefore it is not known if workers would exceed the extremity limit when working near the butt welders. Finally, it was observed that the occupational magnetic field levels appeared to vary directly as a function of the metal thickness being joined, with higher magnetic field levels generated with increasing metal thickness. During the days of evaluation, the metal thickness varied from 0.02 to 0.06 inches. The electric field levels at the butt welders were below the TLV in all situations.

Since the butt welder units produce very high magnetic fields, the exposure potential for workers having to work close to these units must be addressed. While it is not clearly known if these magnetic fields are linked to any type of biological effects, one simple way to minimize the exposures is to relocate the off-on power switch for these welders to a location further removed from the source. While such actions will reduce exposure to the worker on a particular line, it may not entirely minimize exposure to workers on other lines.

DC Weld Process

Occupational magnetic field levels were approximately one-third the TLV of 600 G for whole body exposure and almost 30 times less than the TLV for extremity exposure. Since operators of this process are not normally located near to these sources for any extended period of time, the NIOSH investigators do not consider such exposures hazardous.

High Frequency Welder

The occupational electric and magnetic field levels, at the operator's chest location, for the 450 kHz welding unit are non-detectable and 0.1 (A/m)^2 , respectively. The electric and magnetic field levels at the operator's hand was $5 \times 10^4 \text{ (V/m)}^2$ and $1 \times 10^2 \text{ (A/m)}^2$, respectively. All of these exposure levels are

below the ANSI C95–1991 occupational exposure guideline limits and therefore they do not represent a hazardous situation. However, if the DCF should ever change due to use of different metals or change in manufacturing process, the exposure scenario should be re-evaluated.

Resistance Furnaces

The levels of sub-radiofrequency electric and magnetic fields were all below occupational limits at all locations around the furnaces. It was noted by the NIOSH investigators that no workers were seen in the immediate vicinity of either furnace on the days of evaluation.

400 Hz AC Welder

Within a distance of 2 to 5 inches from these units, magnetic field levels at 410–417 Hz are typically above 0.2 mT (2 G) and, therefore, would exceed the ACGIH ceiling TLV limit. However, operators of these units estimated that they locate within 12 inches of the wheel only 5% of the time. At the typical operator distance of 36 to 60 inches, the magnetic field levels are well below 2 G. The ACGIH TLV does not allow for an extremity factor for frequencies greater than 300 Hz.

It is suggested that the BUNDY safety office make workers aware of the need to maintain working distances of at least 36 inches away whenever possible. Furthermore, if it is essential for the workers to work at distances shorter than this, consideration be given for halting the pipe lines and working with the system under a power down mode.

AC Resistance Annealer Unit

As long as these operators remain at distances greater than 24 inches from the annealer unit, magnetic field levels do not exceed occupational guideline levels. In practice, it appears that workers move along the lines containing these sources always at distances greater than 24 inches except for maintenance situations.

10 kHz Annealer

Very few measurements on induction heaters have been reported in the literature but those results that do exist suggest that the operators are exposed to magnetic field levels which are high relative to recommended exposure limits.^[6-7] The literature suggests that the hands are the most exposed parts of the body and, in most cases, the total body exposure was low. During the three visits to this facility, workers, when asked, did not report any effects of exposure to such fields. It is noted that while metal objects can be heated to high temperatures in short periods of time, exposure to the hands did not produce the same effect. Power absorption is directly proportional to the conductivity of the object. Near 10 kHz, there is a factor of 10⁸ difference between conductivity of the hands and metals. This factor could be a very important health concern if workers performing annealing tasks were to have any type of implanted metal in their wrists or hands.

CONCLUSIONS

Measurement results suggest that BUNDY workers who are involved with operating the butt welder units, the 400 Hz AC welder, and the 10 kHz induction units may be exposed to magnetic field levels that are in excess of occupational guideline values. Occupational exposure to all other sources, as measured on the days of evaluation, appear to be below guideline levels. In those situations where exposures are above guideline levels, it appears the levels are greatly influenced by two factors: location of worker relative to source and extremity exposure scenarios. The closer the worker is to the sources, the higher the exposure. This suggests a possible control measure of locating a worker further from the sources in order to decrease occupational exposure. In addition, worker exposure to their extremities is often 10 times higher than their body exposure. The NIOSH investigators believe that significant reduction in potential exposure levels can be accomplished by locating workers at further distances from sources and by considering if work

tasks that require insertion of hands at close distances to various sources are appropriate and necessary.

Other Comments

During the evaluation, NIOSH investigators would often see the contributions of the annealers appear on the Digital Signal Analyzer display. Whether or not this type of electromagnetic interference (EMI) problem is associated with other electronic or production issues at the BUNDY facility was not investigated, but it would appear that some sort of shielding or grounding solution may help to negate this type of electronic noise. The 8.5 kHz signal was also seen outside the front door of the facility — far away from any production. Whether or not this signal can cause interference with other local communication signals may need to be investigated.

In 1993, NIOSH conducted a HHE at the BUNDY facility in Hillsdale, Michigan (HETA 93-0843). One of the employee's concern in that evaluation was possible health problems caused by excess rust inhibitor found on tubing manufactured in the Cynthiana facility delivered to the Hillsdale facility. While NIOSH investigators were not able to establish definite linkage between the inhibitor and medical symptoms, several recommendations were made to minimize exposures at Hillsdale. Two of those recommendations may be of importance to the Cynthiana facility and are reproduced here:

1. BUNDY should develop methods of minimizing excess application of the rust inhibitor at both facilities in order to reduce problems at Hillsdale, and
2. Encourage employees to thoroughly wash hands prior to work and lunch breaks to reduce potential for hand-to-mouth ingestion of all contaminants.

RECOMMENDATIONS

The following recommendations are offered to reduce potentially significant occupational exposures and safety risks at the BUNDY facility:

- Illumination levels throughout the weldline area were low and at many locations made it difficult to view workplace activities. Since the manufacturing of small tubing pipe requires certain work activities to be performed which utilizes observing details of small objects, it is recommended that consideration be given to increasing overall illumination levels throughout the mill shop portion of the facility.
- While the facility requires all of its workers to wear safety eyewear, not all workers wore them. This issue needs to be better controlled by the safety office to insure appropriate ocular protection.
- BUNDY needs to make workers aware to maintain working distances of at least 36 inches from the 400 Hz AC welders in order to maintain levels below the occupational exposure guideline values.
- During the three visits, the NIOSH investigators observed that smoking occurred by personnel working in the weldline area. NIOSH recommends that BUNDY institute a smoking policy that provides a smoke free environment for all employees. Reports from the Surgeon General and the National Research Council have concluded that exposure to environmental tobacco smoke (ETS) may be associated with a wide range of health and comfort effects.^[8-9] NIOSH has concluded that ETS may be related to an increased risk of lung cancer and possibly heart disease in occupationally exposed workers who do not themselves smoke.^[10] Worker exposure to ETS is most efficiently and completely controlled by simply eliminating tobacco use from the workplace. To facilitate elimination of tobacco use, employers should implement smoking cessation programs. Another way to provide for a smoke free environment is to prohibit smoking at the workplace. Until this goal is achieved, smoking should be restricted to designated smoking areas. These areas should be provided with a dedicated exhaust system and the area should be under negative pressure relative to surrounding occupied areas.
- The safety office should post various areas within the facilities as high magnetic field areas. Based on the measurements made in this evaluation,

the particular areas that need posting are the butt welder and the induction heater/annealer areas. The posting of these areas should indicate levels of fields, need to remove various metal objects and perhaps credit cards, and warnings about presence of metallic implants, such as pacemakers and stents. The possibility of electromagnetic interference (EMI) with various electronic devices, such as pacemakers and stents, raises some basic environmental and occupational safety issues in those workers who may have such devices placed in them for medical reasons. It is suggested that BUNDY develop a corporate policy to address the EMI concerns as well as health problems that could be encountered when workers receive such devices into their body for medical reasons.

- During the evaluation, three different visits were made to the BUNDY facility and on all three occasions NIOSH investigators observed that the floors in and around the weldline area were very slippery, possibly resulting from the anti-rusting lubricant on the pipes. It is suggested that BUNDY improve housekeeping by cleaning up spills as they occur or by placing non-slip mats, wooden platforms, or raised workstations as means to minimize potential slips and falls. Improvements in the housekeeping may also aid in minimizing spread of contaminants on tubing that can affect other BUNDY facilities, as mentioned earlier.
- The starter controls on all butt-welder units should be relocated away from the units to reduce hand and arm exposure to sub-radiofrequency fields.
- Each weldline has an area that is used by the worker as a desk. The worker typically will spend a majority of their time in close proximity to that desk. It was determined by NIOSH investigators that in many situations these desk spaces are close to exposure sources. It is recommended that BUNDY, using appropriate instrumentation, consider relocating those work tables that give high exposure levels.

REFERENCES

1. [1988]. Static magnetic fields. *Applied Industrial Hygiene* V3(1):R/4-R/5.
2. [1985]. Biological effects and dosimetry of static and ELF electromagnetic fields. Edited by Grandolfo M, Michaelson SM, and Rindl A. Published by Plenum Publishing Corporation.
3. [1986]. CRC Handbook of biological effects of electromagnetic fields. Edited by Polk C and Postow E. CRC Press, Inc. Boca Raton, Florida.
4. ACGIH [1995]. 1995-1996 threshold limit values for chemical substances and physical agents and biological exposure indices. Cincinnati, OH: American Conference of Governmental Industrial Hygienists.
5. IEEE [1991]. Safety levels with respect to human exposure to radio frequency electromagnetic fields, 3 kHz to 300 GHz. Institute of electrical and electronics engineers standard C95.1-1991.
6. Lovsund P, Oberg PA, Nilsson, SEG [1982]. ELF magnetic fields in electrosteel and welding industries. *Radio Science* 17(5): 355-385.
7. Stuchly MA and Lecuyer DW [1985]. Induction heating and operator exposure to electromagnetic fields. *Health Physics* 49(5): 693-700.
8. U.S. DHHS [1986]. The health consequences of involuntary smoking. A report of the surgeon general. U. S. Department of Health and Human Services, Public Health Service, Office of Smoking and Health. DHHS Publication No. (PHS) 87-8398.
9. NRC [1987]. National Research Council Committee on Indoor Air Quality. Policies and procedures for control of indoor air quality. National Academy Press, Washington, D.C.
10. NIOSH [1991]. Current Intelligence Bulletin

54: Environmental tobacco smoke in the workplace: lung cancer and other health effects. Cincinnati, OH: U. S. DHHS, Public Health Service, Centers for

Disease Control, National Institute for Occupational Safety and Health, DHHS (NIOSH) Publication No. 91-108.

**Table 1. Types of EMF Sources Found on Various Lines in Facility
BUNDY, Cynthiana, Kentucky (HETA 93-0667)**

Line Number or Production Area	Butt Welder	AC Weld Process	DC Weld Process	High Frequency 450 kHz Weld Process	Resistance Annealer	10 kHz Annealer Unit	Total
Line 1	✓		✓			✓	3
Line 2	✓			✓			2
Line 3	✓		✓		✓		3
Line 4	✓		✓		✓		3
Line 5	✓			✓		✓	3
Line 6	✓		✓		✓		3
Line 7	✓		✓		✓		3
Line 8	✓		✓		✓		3
Line 9	✓	✓					2
Line 10	✓	✓					2
Line 11	✓	✓					2
GE #1	500 kW Resistance Furnace						1
GE #2	400 kW Resistance Furnace						1
Batch Tinner	400 kW Resistance Heater						1
Galfan 1						✓	1
Galfan 2						✓	1
Totals	11	3	6	2	5	4	34

**Table 2. RF and Microwave IEEE Occupational Exposure Guidelines
BUNDY, Cynthiana, Kentucky (HETA 93-0667)**

Frequency Range (MHz)	Electric Field Strength (V/m)²	Magnetic Field Strength (A/m)²	Power Density E-field/H-field (mW/cm²)
0.003 – 0.1	377,000	26,600	
0.1 – 3	377,000	(16.3/f) ²	
3 – 30	(1842/f) ²	(16.3/f) ²	
30 – 100	3770	(16.3/f) ²	
100 – 300	3770	0.027	1.0
300 – 3,000			f/300
3,000 – 15,000			10
15,000 – 300,000			10

f = frequency in MHz
 MHz = megahertz
 V/m = Volts per meter
 A/m = Amps per meter
 mW/cm² = Milliwatts per square centimeter

**Table 3. Range of Exposures from EMF Sources
BUNDY, Cynthia, Kentucky (HETA 93-0667)**

Source	Dominant Frequencies Produced	Major Body Part Exposed	# Units Measured	Range of Exposure	Criteria
Weld Line Area					
Butt Welder	Power line frequency	Head, arms, hands	6	2 – 36 G	10 G Body 50 G Hands
AC Welder	417 – 420 Hz	Head, arms, hands	3	0.2 – 8 G	2 G
DC Welder	0 Hz	Head, hands	2	12 – 160 G	600 G Head 6000 G Hand
High-Frequency Welder	450 kHz	Hands, chest	1	Electric field 5×10^4 (V/m) ² (DCF) Magnetic Field 10^2 (A/m) ² (DCF)	3.8×10^5 (V/m) ² 1.3×10^3 (A/m) ²
Resistance Annealer	Power line frequency	Head, hands	2	0.4 – 7 G	10 G Body 50 G Hands
10 kHz Annealer	8.5 kHz	Head, hands	1	60 – 300 G (DCF)	2 G
Alignment Magnets	0 Hz	Hands	Many	80 – 90 G	600 G Head 6000 G Hand
Galfan Area					
10 kHz Annealer	8.5 kHz	Head, hands	2	12 G	same as above

Abbreviations:

- Hz = Hertz
- kHz = kilohertz
- G = gauss
- (V/m)² = volt²/meter²
- (A/m)² = amperes²/meter²
- DCF = Duty cycle factor

**Table 4. Personal EMDEX Results (Waist Level) at Various Plant Locations
BUNDY, Cynthia, Kentucky (HETA 93-0667)**

Subject	Mode	(milliGauss)					N	mG-Hr	t (sec)
		Max	Min	Median	Mean	Std Dev			
Walk-around	BB	4133	0.1	2.4	42	220	5475	96	1.5
Walk-around	BB	1144	0.1	2.8	20	56	6152	51	1.5
Walk-around	BB	616	0.1	3.3	17	50	6217	43	1.5
1 Line #9	BB	1127	0.4	3.0	27	69	4778 @4 hrs	106	3.0
	F	865	0.1	1.5	7	28			
	H	1162	0.2	1.0	25	70			
2 Line #2	BB	314	0.3	1.9	5.1	13.2	4775	20	3.0
	F	235	0.1	1.4	3.2	9.8			
	H	285	0.2	0.6	3.2	9.7			
3 Line #1	BB	1111	0.3	1.6	13.3	33.5	4674	52	3.0
	F	1111	0.1	1.5	8.3	25.8			
	H	206	0.2	0.4	9.4	22.5			
4 Line #10	BB	385	0.3	2.3	8.7	22.4	5091	37	3.0
	F	204	0.1	1.9	4.8	13.0			
	H	333	0.2	0.9	6.6	21.7			
5 Line #1	BB	6.1	0.3	0.9	0.9	0.4	4825	4	3.0
	F	5.9	0.1	0.8	0.8	0.4			
	H	1.0	0.2	0.3	0.3	0.1			
Walk-around	BB	176	0.1	0.2	2.0	14.7	4825	4	1.5

BB = Broadband measurements
 F = Fundamental measurements
 H = Harmonic measurements
 N = Number of measurements made

Table 5
Magnetic Field Levels Associated with Induction Annealer (Line 1)
Note: Levels are shown as a function of their location
Bundy Corporation – HETA 93-0667

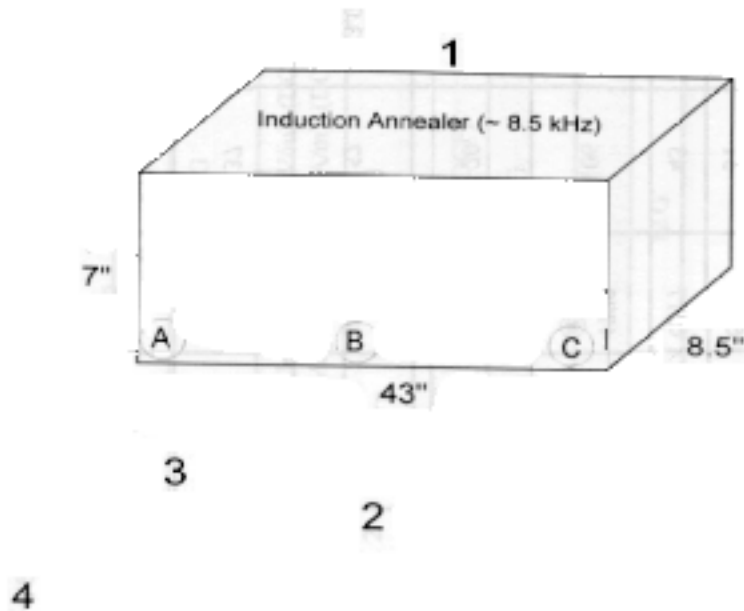

Location 1: 12" above unit
 Location 2: 12" below unit
 Location 3: 12" in front of unit
 Location 4: 36" in front of unit

Location	Site A	Site B	Site C
#1	220	180	50
#2	40	60	60
#3	60	60	60
#4	18	18	18

Magnetic field levels expressed in Gauss

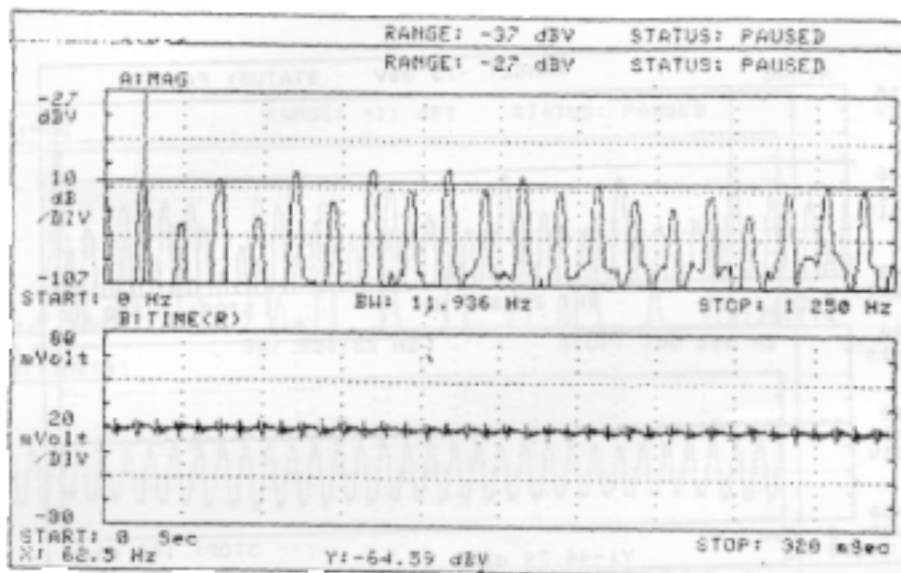

(a)

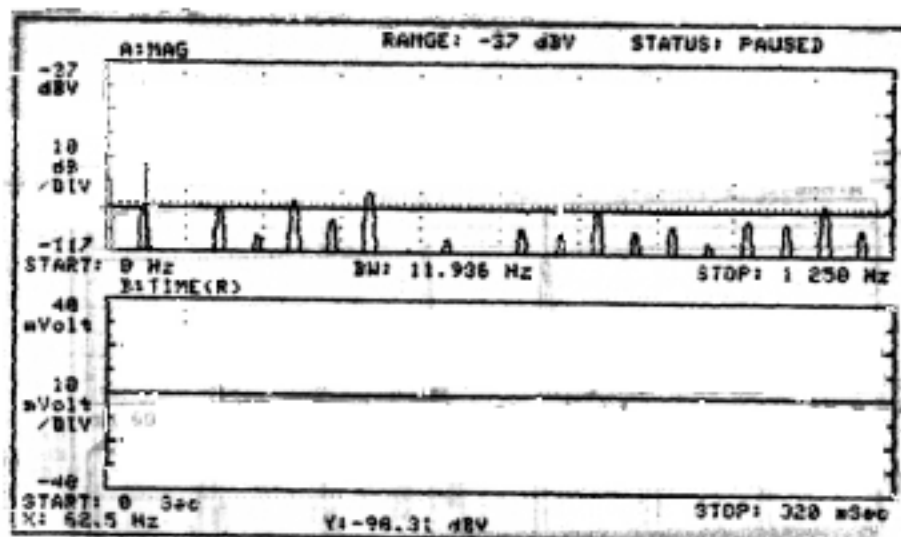

(b)

Figure 1. Frequency distribution up to 1250 Hz from the Butt Welder unit on Line 9. Distance from the source was 60" and marker was set on 62.5 Hz. (a) Unit operating. (b) Unit not operating.

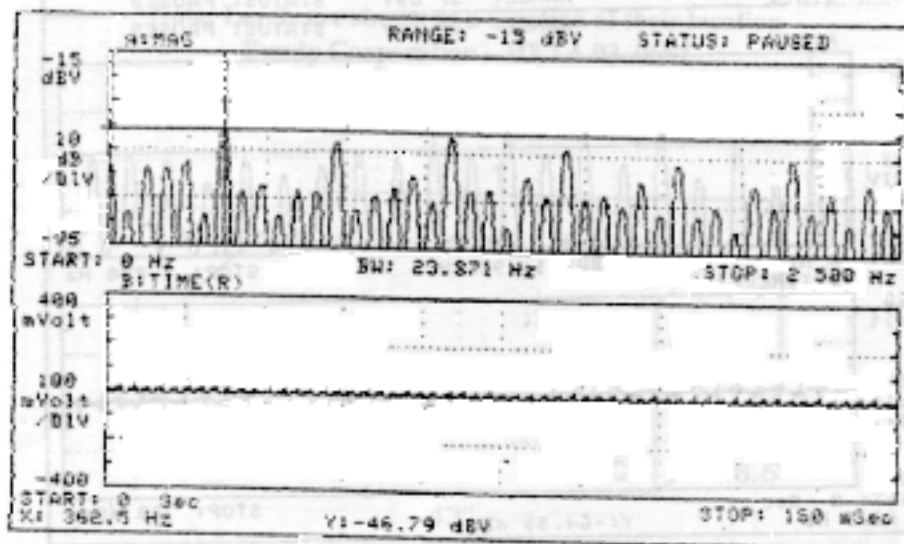

Figure 2. Frequency and time domain distribution for the butt welder on Line 1 at a distance of 60" from the source. The frequency distribution goes to 2500 Hz and the marker was set on 362.5 Hz.

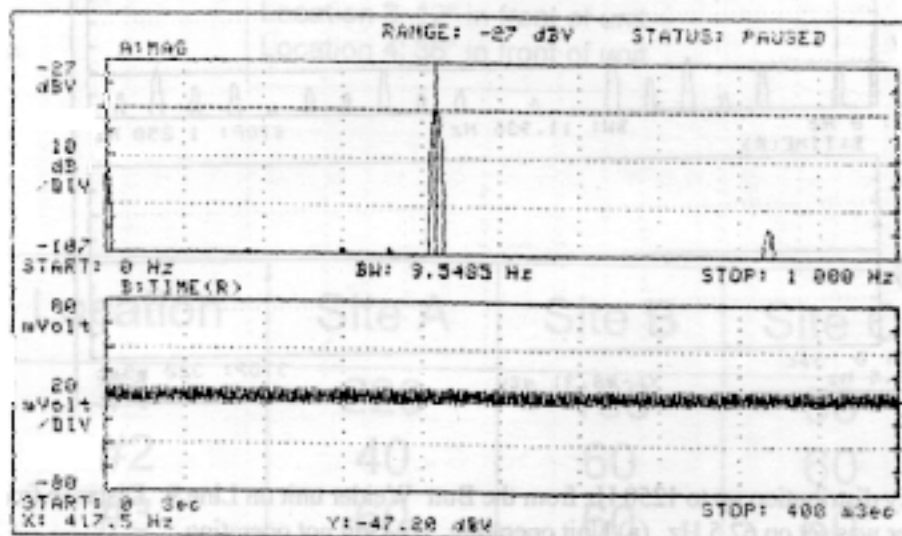

Figure 3. Frequency distribution up to 1000 Hz on Line 9. AC welder unit operating at 417.5 Hz. Measurements were taken at 54" from the source.

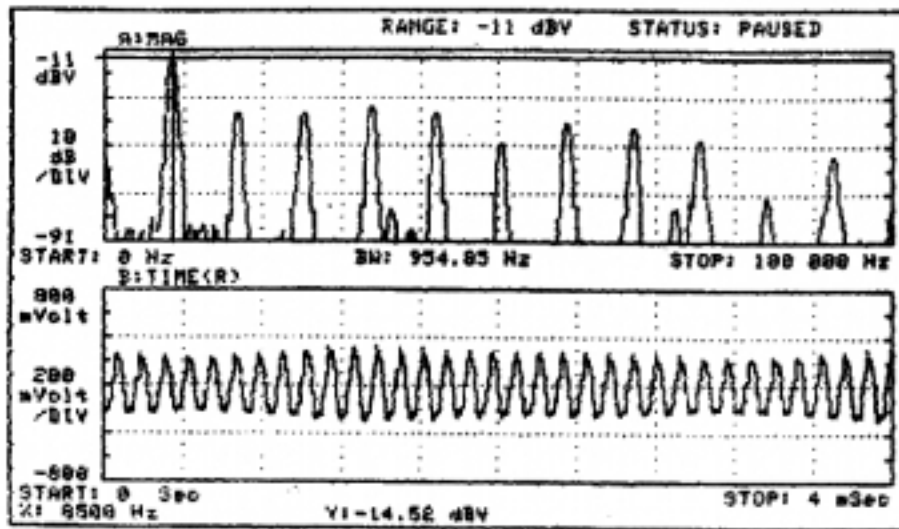

Figure 4. Typical frequency and time domain distribution for an induction annealer.

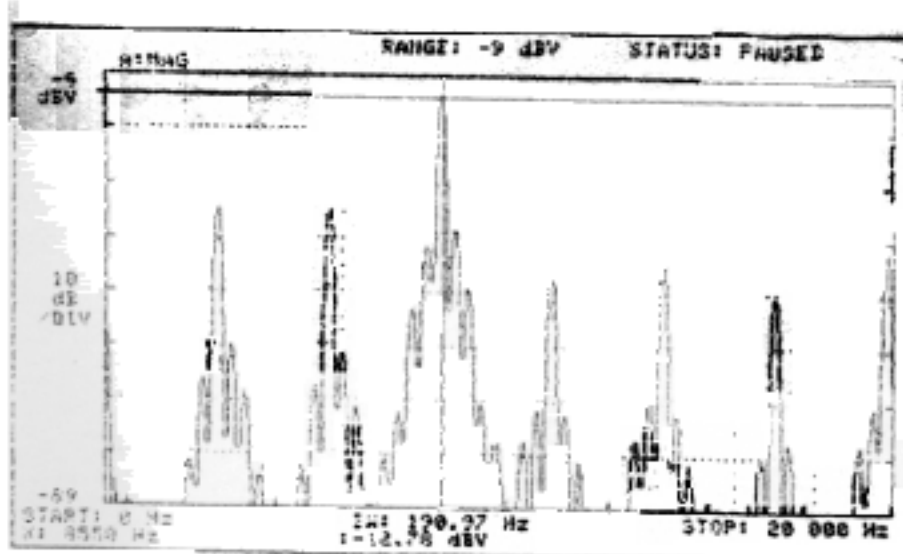
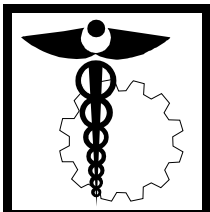

Figure 5. Frequency and time domain distribution associated with an 8.55 kHz induction heater located in the Galfan.



NIOSH

Delivering on the Nation's promise:
Safety and health at work for all people
Through research and prevention