

Aquatic Species Program (ASP): Lessons Learned

**AFOSR Workshop
Washington, D.C.
February 19-21, 2008**

**Eric E. Jarvis, Ph.D.
National Renewable Energy Laboratory
National Bioenergy Center
eric_jarvis@nrel.gov**



The ASP Didn't Invent the Concept of Fuels from Algae...

- Algae for methane (via anaerobic digestion)
 - Meier (1955); UC Berkeley 1957-59 (Oswald and Golueke)
 - Wastewater use, recycling of CO₂ and nutrients
- Revival during Energy Crisis of 1970's
 - Uziel *et al.* (1975); Benemann *et al.* (1976-80)
 - Still focused on methane and hydrogen
 - Energy Research and Development Administration (ERDA)
 - Later DOE (SERI founded in 1977)

...But the ASP Took the Concept to the Next Level

- Supported work at SERI/NREL and through dozens of subcontracts to universities and private companies
- Focus turned to lipid oils, diesel replacements, microalgae rather than other “aquatic species”
 - Algal hydrogen research moved to different program
- Explored all aspects of the technology

The ASP Funding Rollercoaster

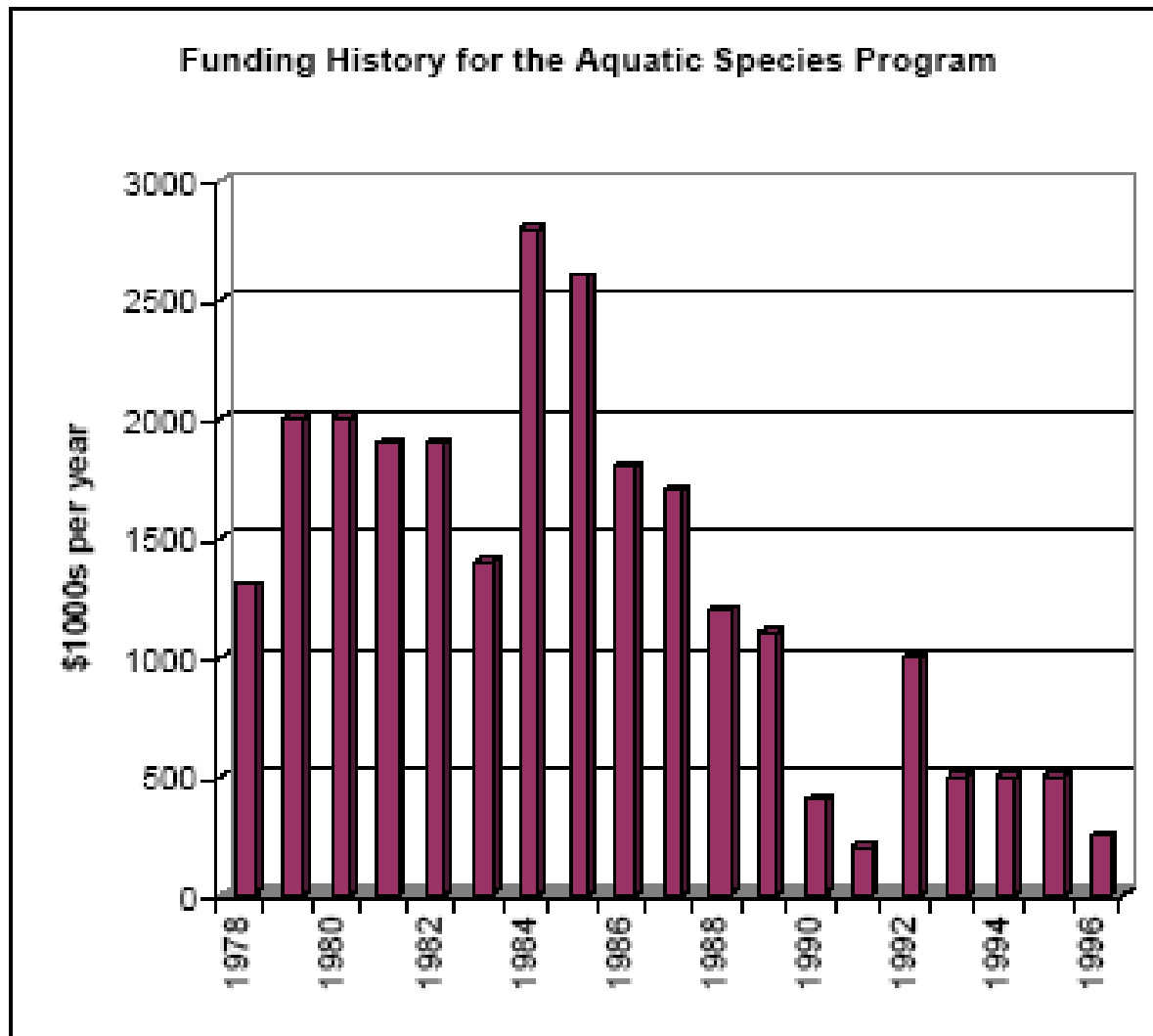

- ASP began in 1978
- Ended in 1996 to focus lean budgets on bioethanol
- Overall investment ~\$25M

The ASP Chronology

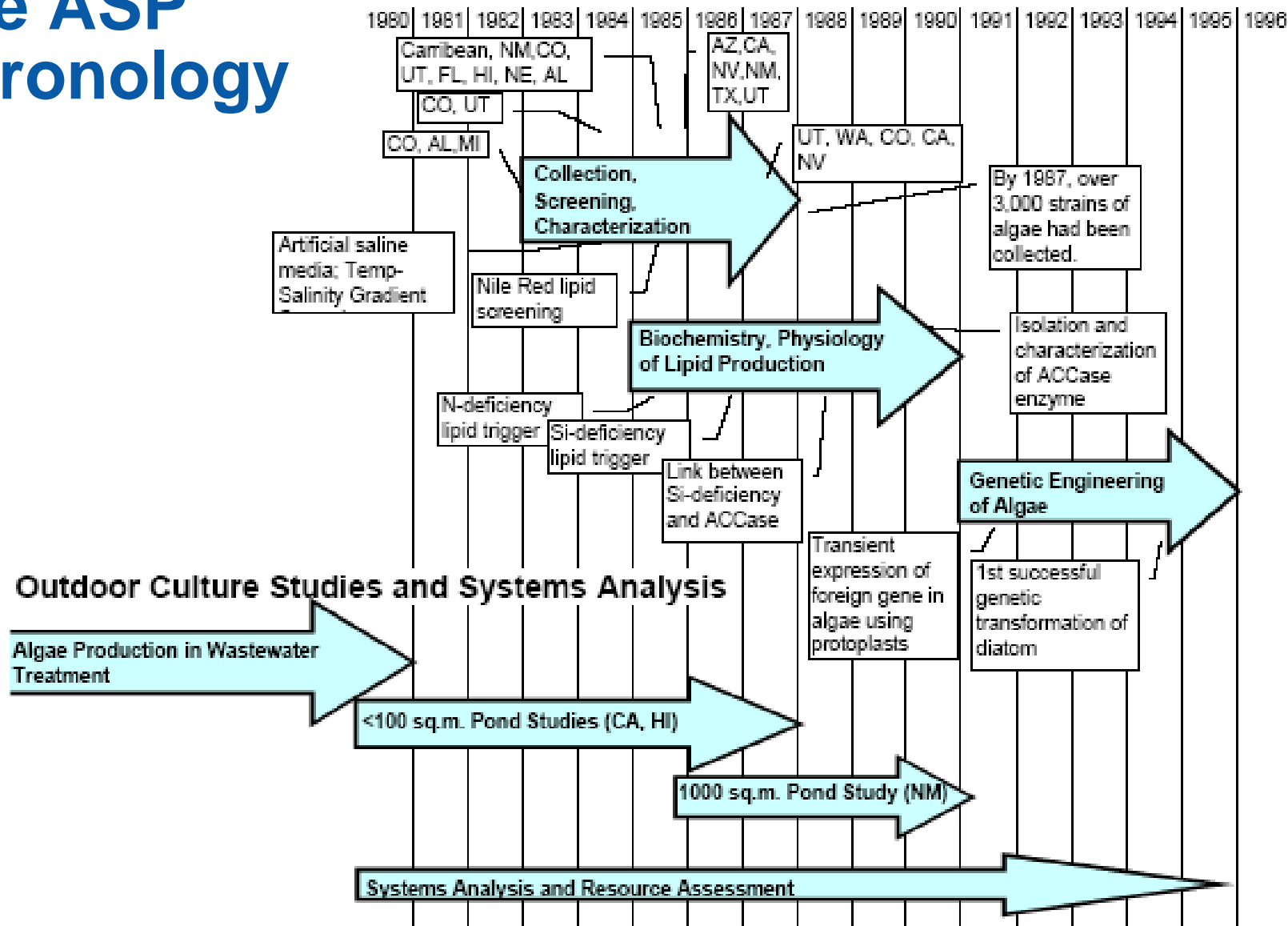

Program Justification

- Lignocellulosic ethanol can't for substitute for energy-dense diesel (and aviation) fuels
- FAME (biodiesel) was evolving as an option
 - Renewable oil sources insufficient to meet diesel fuel demand
 - Algae offers alternative
- Energy security concerns dominated at first, later global climate change became important factor (flue gas CO₂ capture)

ASP Topic Areas

1. Microalgae collection and screening
2. Physiology, biochemistry, and genetic engineering
3. Process engineering
4. Outdoor mass culture
5. Analysis

Microalgae Collection and Screening

- >3000 strains of microalgae collected over 7 years
- Western, northwestern, southeastern US and Hawaii
- Most from shallow, inland saline habitats

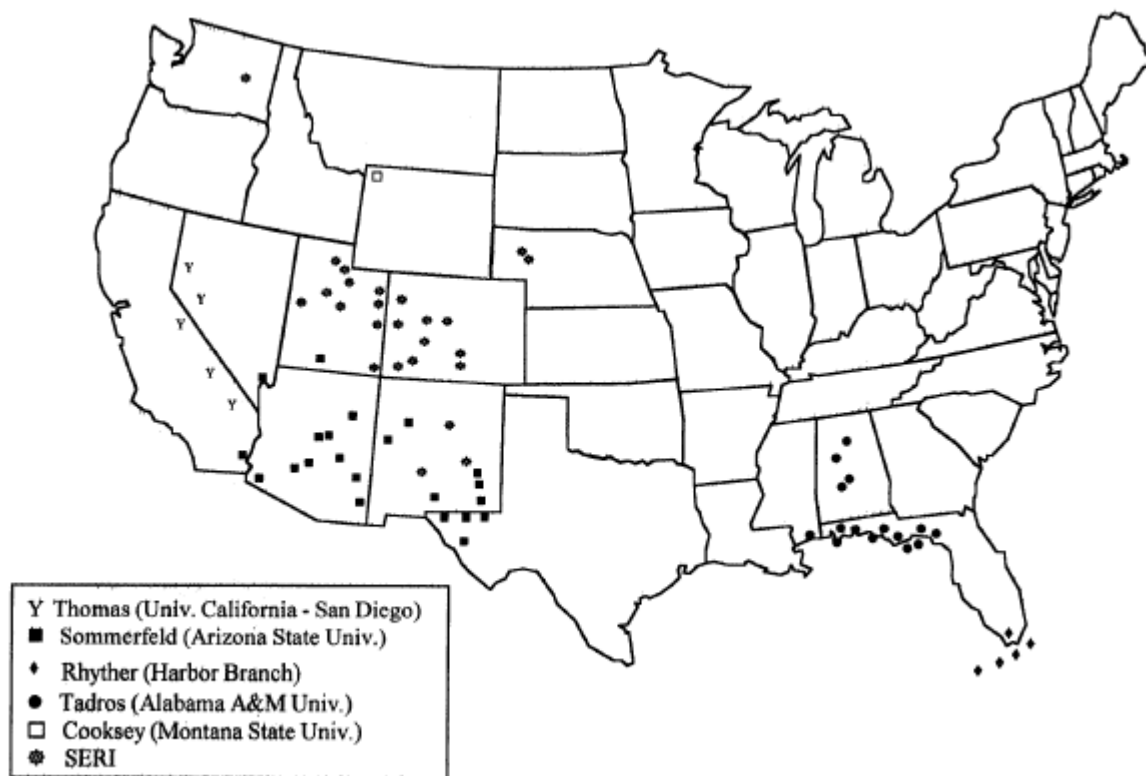

Microalgae Collection and Screening...

- Screened for tolerance to salinity, pH, temperature
- Screened for neutral lipid production (Nile Red)
- Media optimization
 - SERI Type I and II, etc.
 - Laboratory surrogates

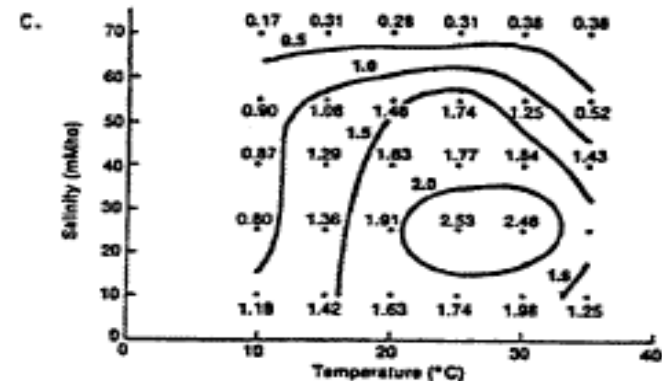
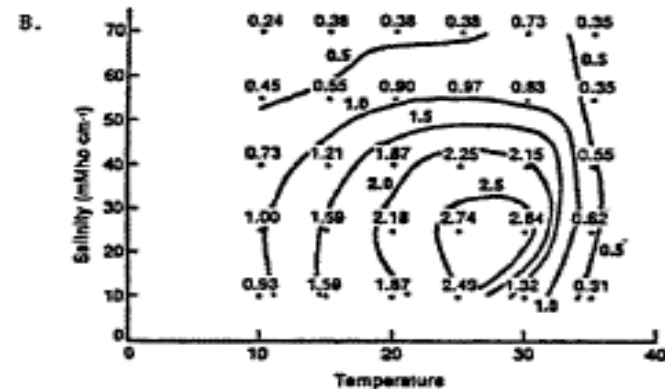
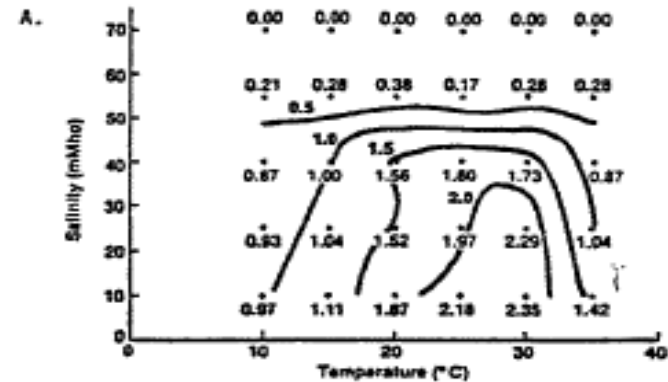

Microalgae Collection and Screening...

- Collection narrowed to 300 most promising strains (partly by attrition)
- Primarily greens (Chlorophyceae) and diatoms (Bacillariophyceae)

Amphora, Chaetoceros, Chlorella, Cyclotella, Monoraphidium, Nannochloris, Nannochloropsis, Navicula, Nitzschia, Phaeodactylum, Tetraselmis, Thalassiosira

- Some made axenic
- In 1996, remaining cultures transferred to the Center for Marine Microbial Ecology and Diversity (CMMED) at U. Hawaii
- About half the strains still available

Microalgae Collection and Screening: **Lessons Learned**

- Many microalgae can accumulate neutral lipids
- Diatoms and greens most promising
- No perfect strain for all climates, water types
- Serial transfer less than ideal



Physiology, Biochemistry, and Genetic Engineering

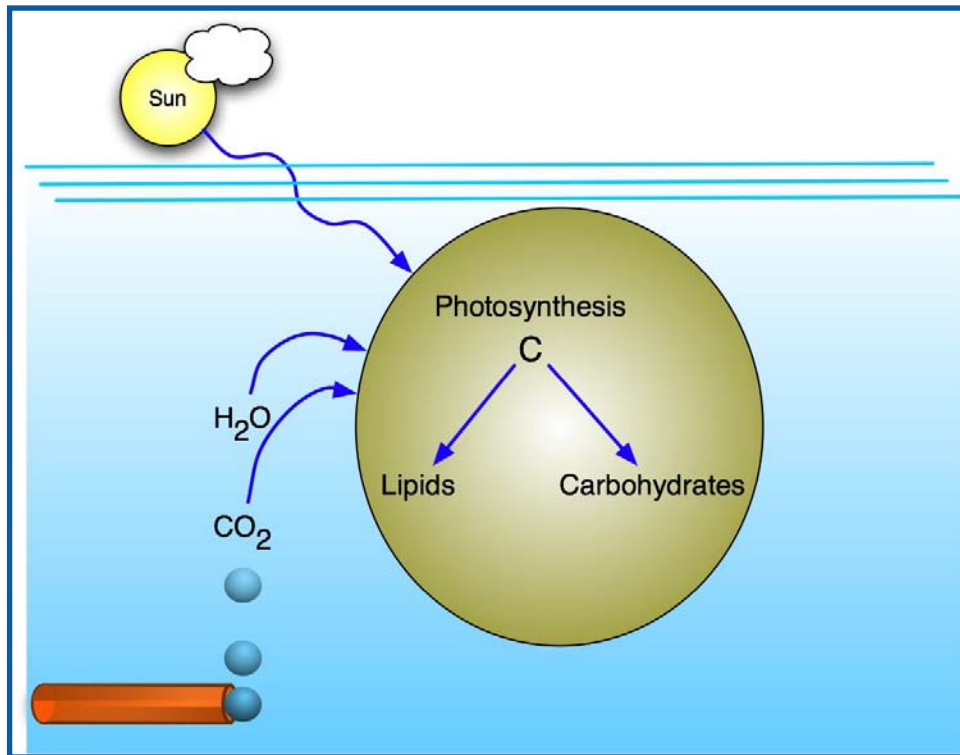

- Studies on induction of lipid accumulation response
 - N or Si depletion
- What are the biochemical and genetic underpinnings of photosynthate partitioning?
 - The “lipid trigger”

Physiology, Biochemistry, and Genetic Engineering...

- *Cyclotella cryptica* primary model organism for biochemistry
- Identification of key enzymes in fatty acid and carbohydrate (chrysolaminarin) pathways

– **Acetyl CoA carboxylase** (ACCase) activity increases upon Si depletion (Roessler 1988), enzyme characterized

– **UDP glucose pyrophosphorylase** (UGPase) and **chrysolaminarin synthase** activities also characterized (Roessler 1987, 1988)

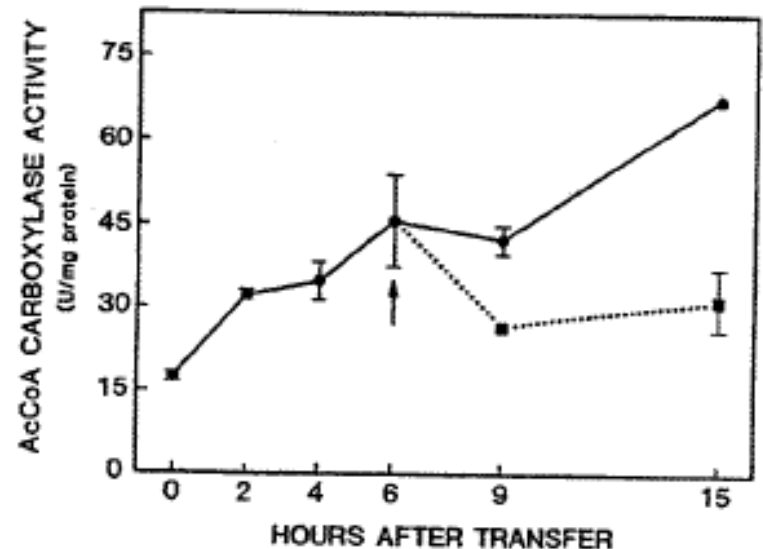

Physiology, Biochemistry, and Genetic Engineering...

Genetic “toolbox” developed

- Transient and stable marker systems
- Effective methods of DNA introduction
- Achieved genetic transformation of diatoms *C. cryptica* and *Navicula saprophila* (Dunahay *et al.*, 1995)
 - Antibiotic resistance marker under control of ACCase gene promoter & terminator
 - Cell wall penetration *via* “biolistics”
 - Random chromosomal integration

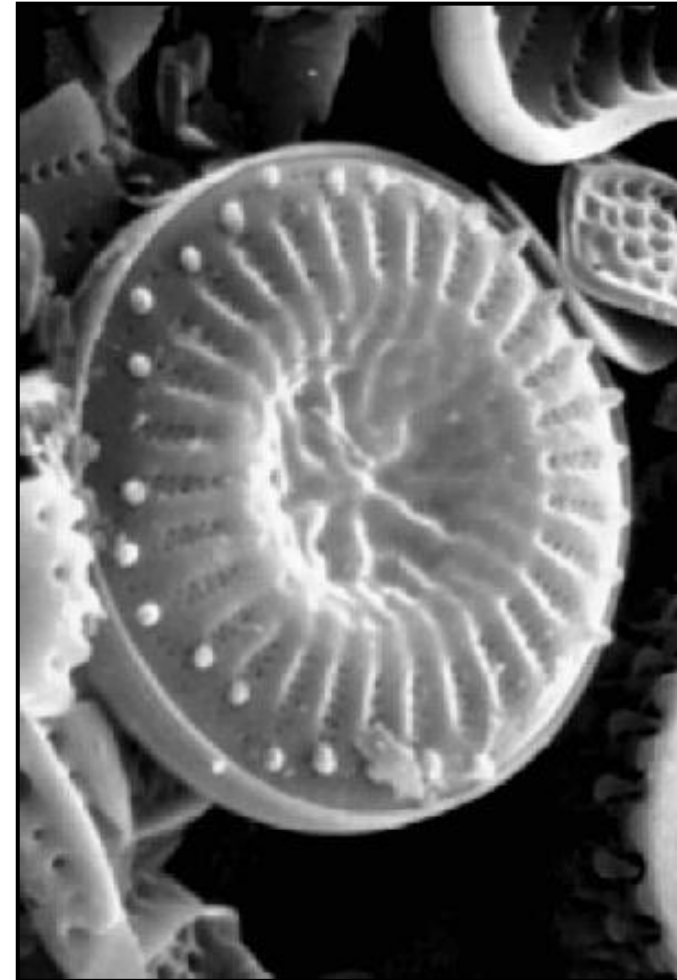

Physiology, Biochemistry, and Genetic Engineering...



Key genes isolated from *C. cryptica*

- ACCase gene cloned (Roessler and Ohlrogge, 1993)
 - First from photosynthetic organism
- UGPase gene cloned (Jarvis and Roessler, 1999)
 - Chimera with phosphoglucomutase (previous step in pathway)

Attempts at gene modulation

- Successful ACCase overexpression (2-3x)
- Successful UGPase overexpression, but not turn-down
- No effects seen on lipid accumulation in these early experiments

Physiology, Biochemistry, and Genetic Engineering: **Lessons Learned**

- Choosing right starting species is critical
- Lipid induction upon nutrient stress doesn't help productivity
- Key enzymes change activity upon induction, but no obvious “lipid trigger”
- We have only begun to scratch the surface
 - Need to understand pathways, regulation, devise genetic strategies

Process Engineering

- Explored methodologies for dewatering algal suspensions and solvent extraction of oil
- Tested transesterification of lipids to fuel (no other methods, scale-up, fuel characterization, or engine testing of algal fuels)
- Laboratory-scale experimentation, but not major focus of project

Process Engineering: **Lessons Learned**

- The scale, energy input, and cost challenges make dewatering and extraction significant hurdles
- Flocculation/bioflocculation may be most promising route for dewatering
- Solvent extraction of oil through the cell wall is feasible
- Transesterification is straightforward, but many challenges in making a quality fuel
- There's much more work to be done!

Outdoor Mass Culture

Hawaii experiments (1980-87)

- Patented “Algae Raceway Production System” (ARPS)
- 60 cm deep, 48 m² raceway with cover

California experiments (1981-86)

- “High Rate Pond” (HRP) system (developed at UC Berkeley)
- Four 200 m², three 100 m² open raceways, paddlewheel mixed
- 15-30 cm deep
- Many species tested, *Amphora* and *Cyclotella* did well

Israeli experiments (1984-86)

- Multiple investigators, configurations, species, harvesting methods

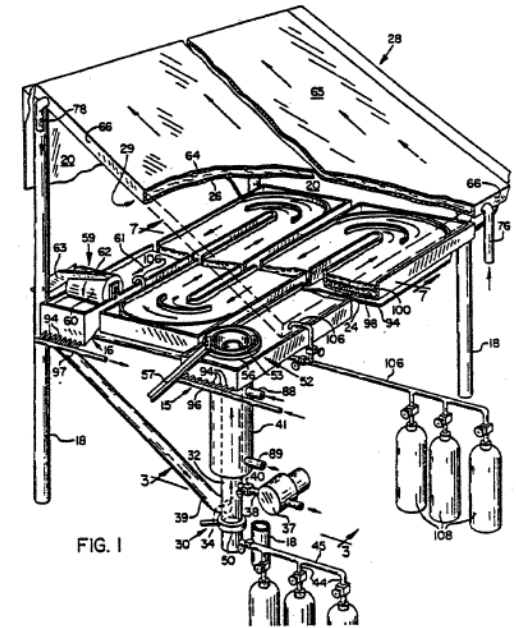

Outdoor Mass Culture...

Roswell, NM facility (late 1980's)

- Subcontract to Microbial Products, Inc. (Weissman *et al.*, 1989)
- Based on the HRP design
- Two 1,000 m² raceway ponds, 15-25 cm deep
- *Cyclotella*, *Monoraphidium*, *Amphora*, *Tetraselmis*, etc.

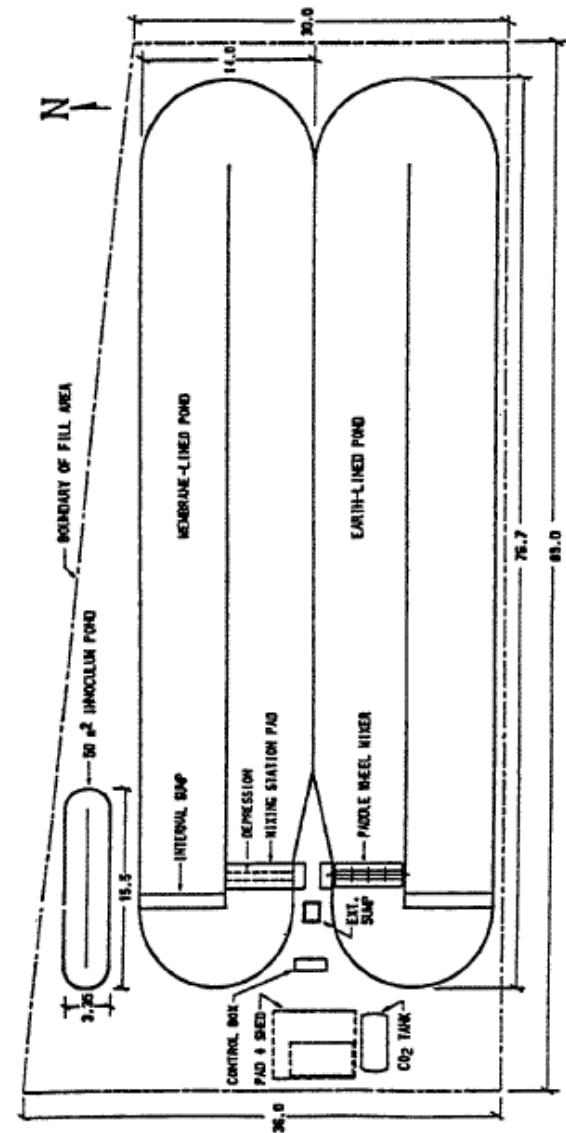

Outdoor Mass Culture: **Lessons Learned**

- Important successes
 - Typical productivities 15-25 g/m²/day biomass over productive months
 - Roswell gave occasional productivities approaching 50 g/m²/day (but closer to 10 g/m²/day overall)
 - **NOTE: But not 50% lipid!**
 - Long-term, stable cultivation achieved
 - CO₂ utilization >90% with proper sump and pH control
 - Mixing energy low in paddlewheel systems

Outdoor Mass Culture: **Lessons Learned...**

- Issues identified
 - Temperature affects productivity, culture collapse, invasion, grazers, nighttime respiration, O₂ inhibition
 - Invasion by native microalgae species
 - Lab conditions ≠ outdoor culture conditions
 - Productivity ≠ persistence
 - O₂ levels problematic
 - Hydraulics critical
 - Water loss (evaporation and percolation)
 - Low lipid contents

Analysis

Resource assessments

- Land suitability
 - Insolation
 - Slope
 - Land use
 - etc.
- Water (saline aquifers)
- CO₂ sources
- Focus on US desert southwest

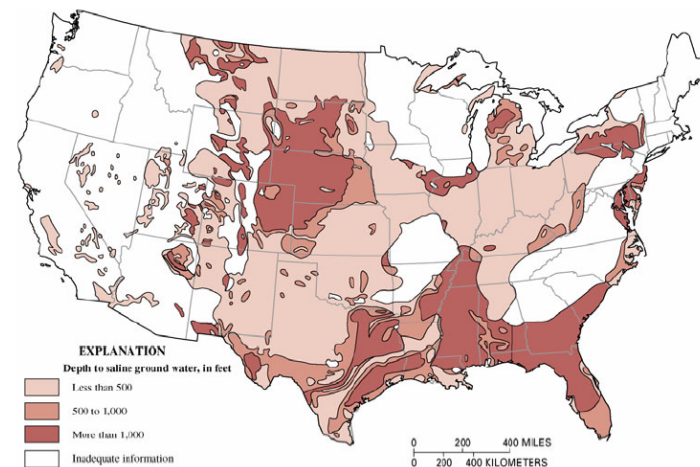
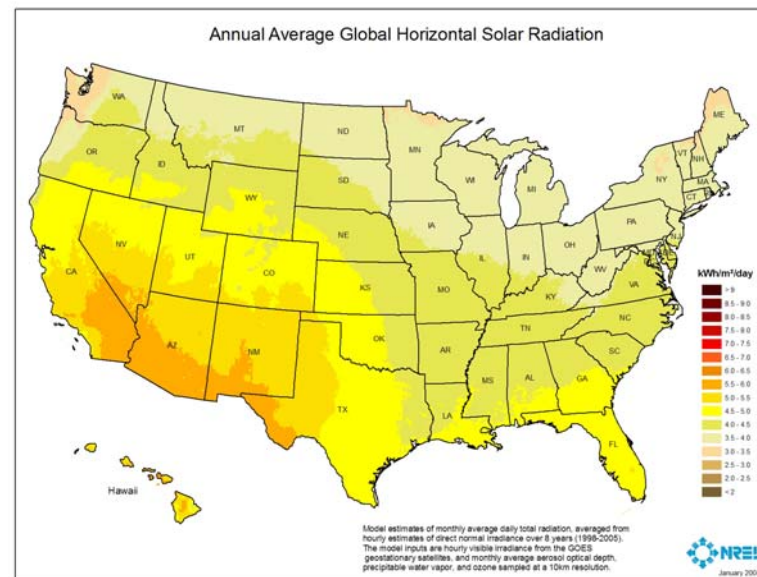

Analysis...

Life Cycle Analysis (LCA)

- Small amount of LCA done
- Focus on co-combustion of algae
- Needs to be revisited

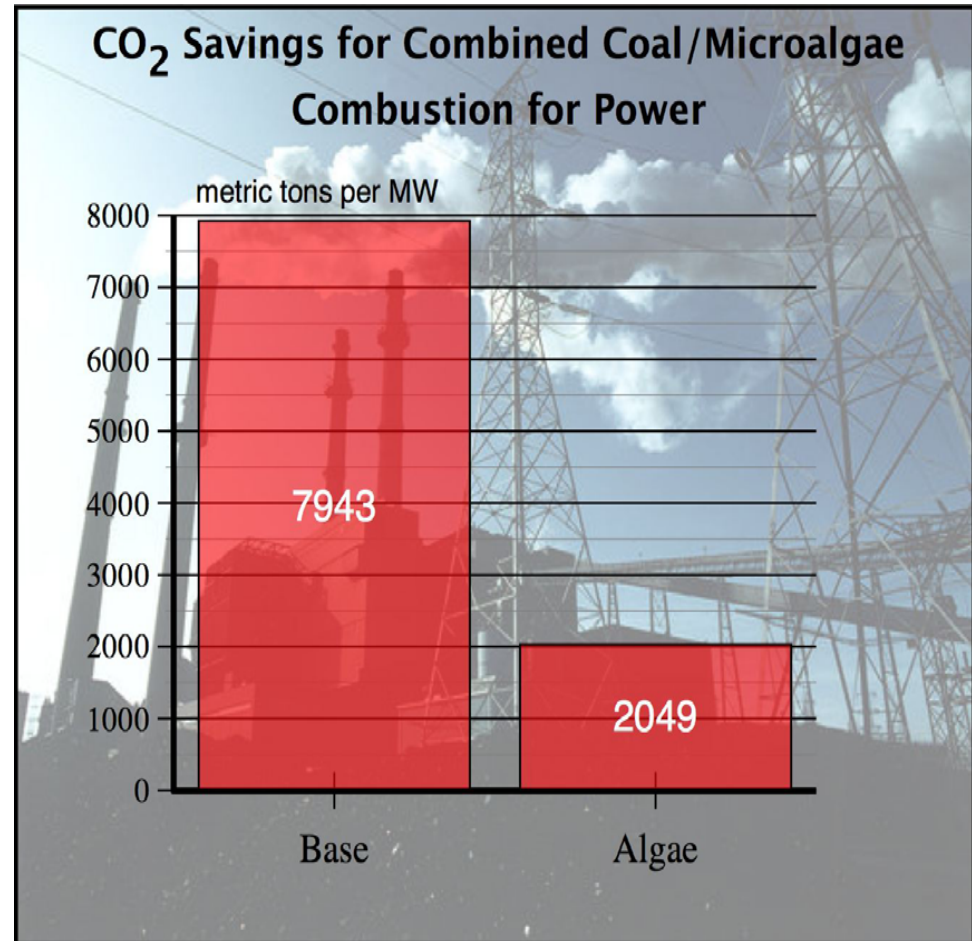

Analysis...

Technoeconomics

- Several different analyses over the course of the program (Benemann and others)
- Many assumptions and unknowns, differing conclusions
- Most optimistic of analyses not competitive with 1996 petroleum costs
 - Most recent analysis (Kadam 1995) estimated cost of unextracted lipid from \$186/bbl (“current” case) to \$59/bbl (optimistic “improved” case) with no CO₂ credit
 - Petroleum at <\$20/bbl in 1996 and “DOE expects petroleum costs to remain relatively flat over the next 20 years.”

Analysis: **Lessons Learned**

- Ample land, water, CO₂ resources available in Southwest for “several Quads” (30+ billion gallons?) of fuel per year
- Economics are challenging
 - Biological productivity largest influence on fuel cost
 - Capital costs huge factor
 - Unlined, open ponds only option
 - Land costs minor
 - CO₂ cost and transport distance significant
 - Need to get value from residual biomass
 - Water, nutrient recycle
- Significant R&D still required to reduce costs!

What's Changed Since 1996?

- Oil prices didn't stay flat
- Increasing concern about CO₂
- New photobioreactor designs, advances in material science
- Explosion in biotechnology
 - Advances in metabolic engineering
 - Genomics, proteomics, metabolomics, bioinformatics, etc.

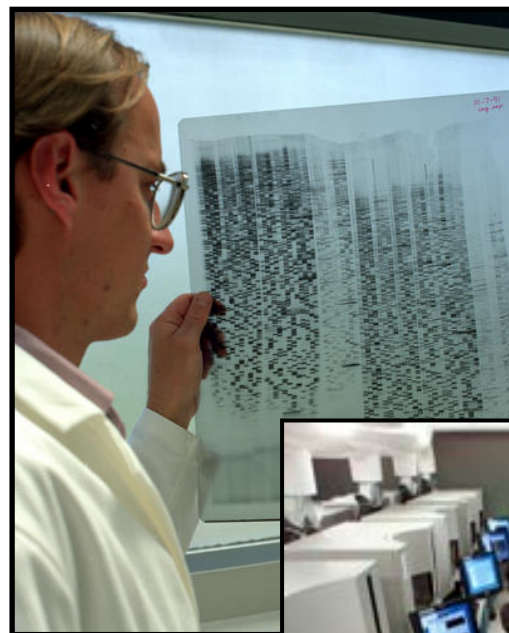

DOE Joint Genome Institute

Accessing the Legacy of the ASP

- Close-out report (Sheehan, *et al.* 1998)
 - <http://govdocs.aquake.org/cgi/reprint/2004/915/9150010.pdf>
- Electronic documents
 - Ongoing effort at NREL to scan old ASP reports and make publicly available
 - >100 electronic documents now posted on the NREL Publications website
 - <http://www.nrel.gov/publications/>
 - Search “microalgae”

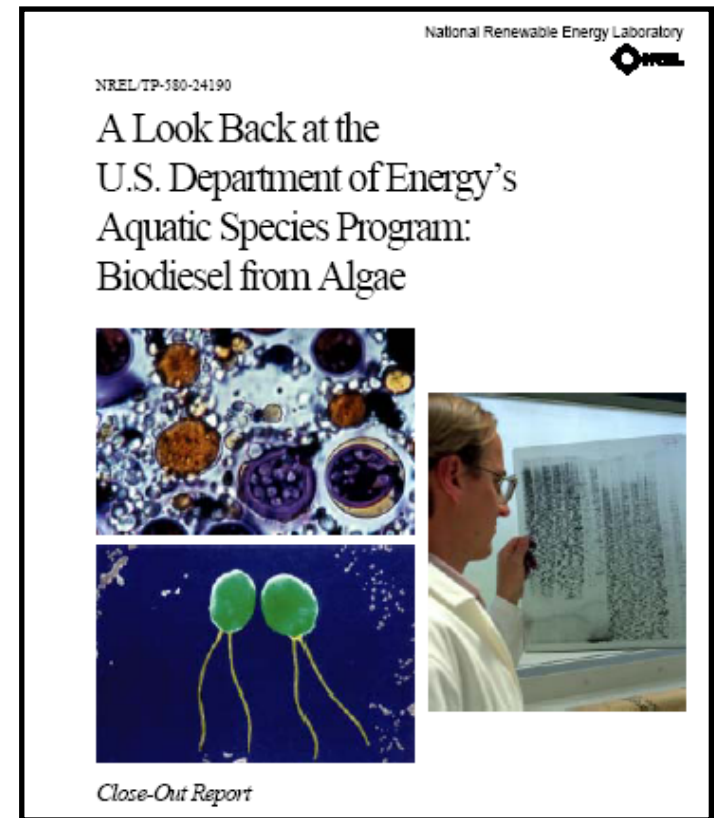

Conclusions

- The ASP has provided a solid foundation for fuels-from-algae research
- Sheehan *et al.* presaged the current revival in this field:

... this report should be seen not as an ending, but as a beginning. When the time is right, we fully expect to see renewed interest in algae as a source of fuels and other chemicals. The highlights presented here should serve as a foundation for these future efforts.