



Oregon 4-H

Shooting Sports

Member Guide Answer Supplement

Archery

Name the types of bows. Label the parts of the archery equipment using the letters listed at the bottom of the page. Then find the words in the puzzle below.

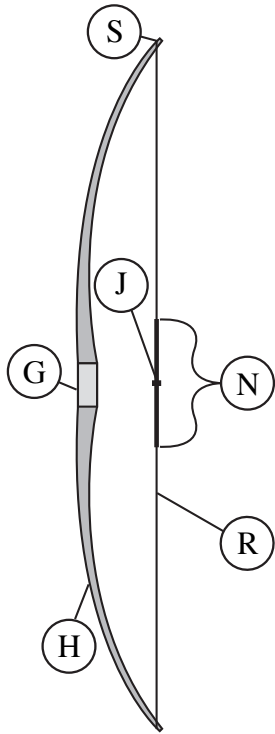

LONG BOW

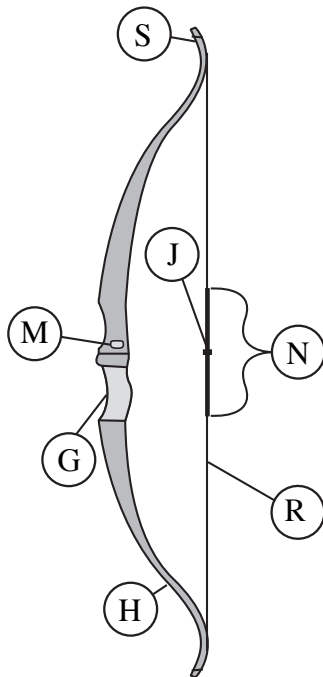

RECURVE BOW

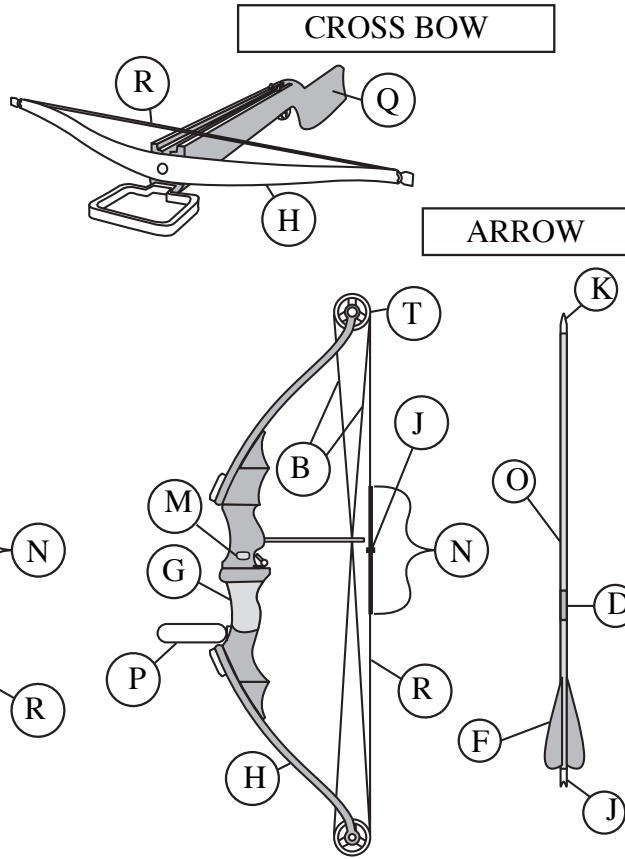

COMPOUND BOW

- A - ARROW
- B - CABLES
- C - COMPOUND BOW
- D - CREST
- E - CROSSBOW
- F - FLETCH
- G - GRIP
- H - LIMB
- I - LONG BOW
- J - NOCK
- K - POINT
- L - RECURVE BOW
- M - REST
- N - SERVING
- O - SHAFT
- P - STABILIZER
- Q - STOCK
- R - STRING
- S - STRING NOTCH
- T - WHEEL

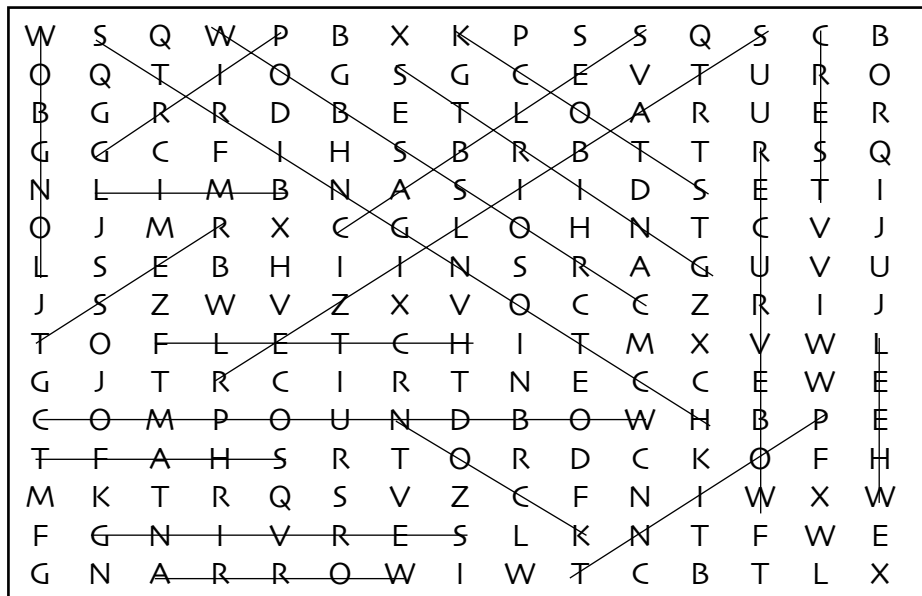

NOTE: Two-word terms are shown as one word.



Hunting



Woodland

Draw a line from the animals at the top of the page to the habitat you would expect to find them in. Then use their names listed below to complete the word search.

- A - COYOTE
- B - DEER
- C - FISH
- D - FOX
- E - FROG
- F - HAWK
- G - RABBIT
- H - RACCOON
- I - SNAKE
- J - TURKEY
- K-TURTLE

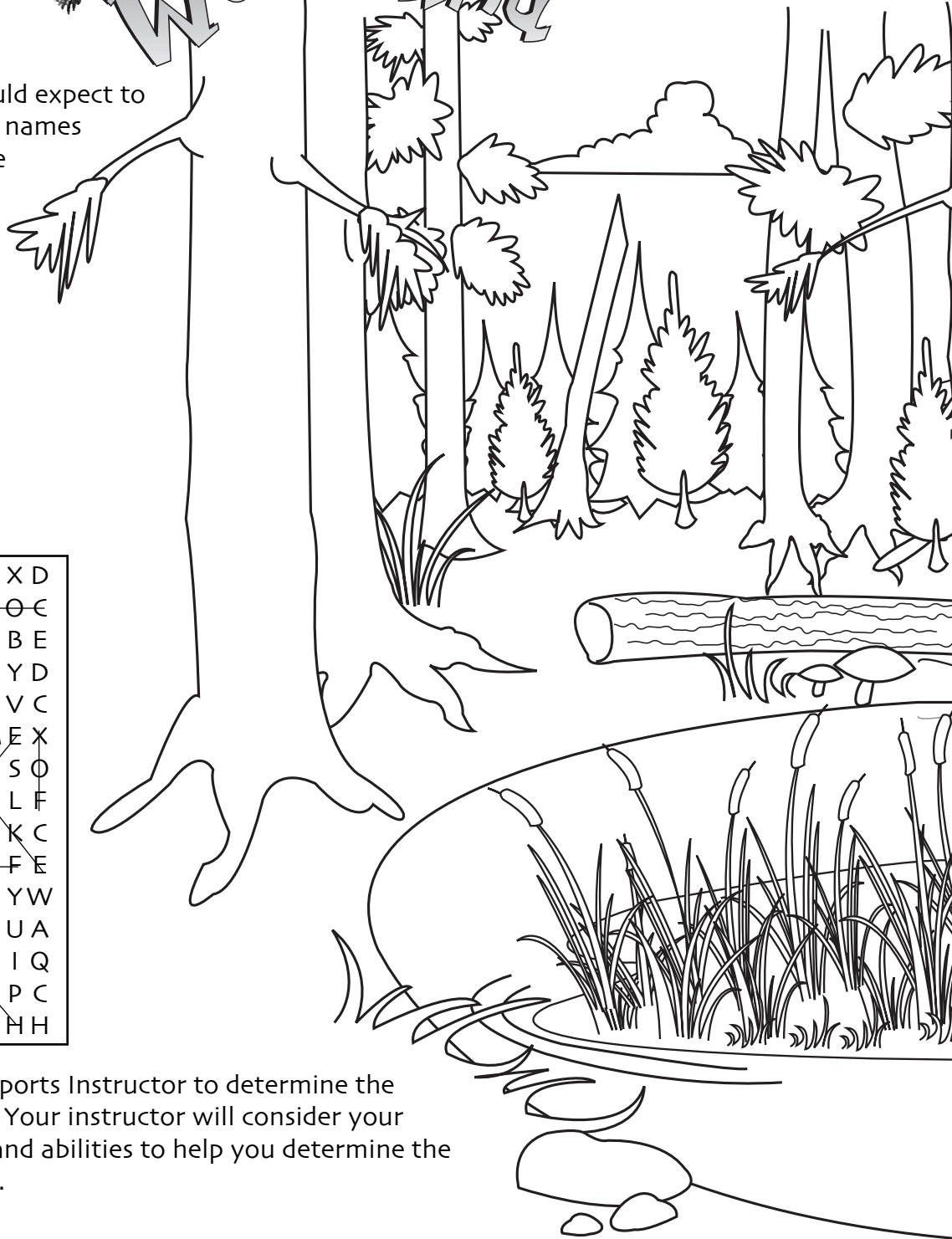

Work with your Shooting Sports Instructor to determine the project that is best for you. Your instructor will consider your interests, age, experience, and abilities to help you determine the project that is right for you.

Project Ideas

- Make plaster casts of tracks.
- Carve a decoy.
- Tan a hide.
- Make a duckwing board.
- Make a deer jawbone board.
- Build bird feeders.
- Build bird houses.
- Build bat houses.
- Make deer antler jewelry (buttons, tie slides, etc.).
- Fur crafts (hat, gloves, etc.).
- Taxidermy.
- Take wildlife photographs.
- Make a duck, goose, or turkey call.
- Identify scat.

Rifle

Name the types of actions. Label the parts of the rifle using the words listed at the bottom of the page. Then find them in the word search.

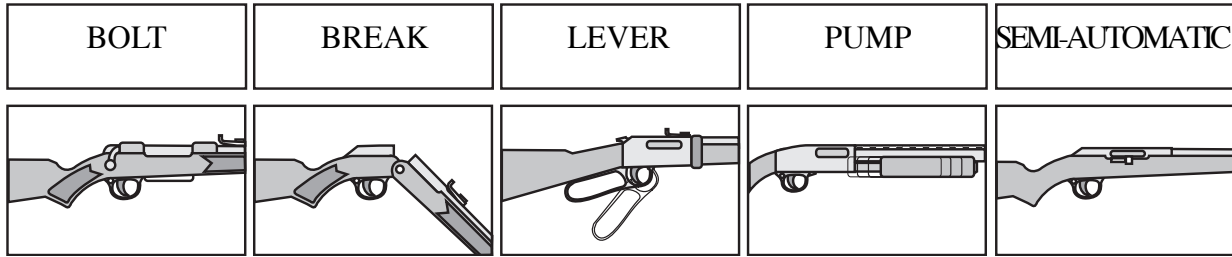
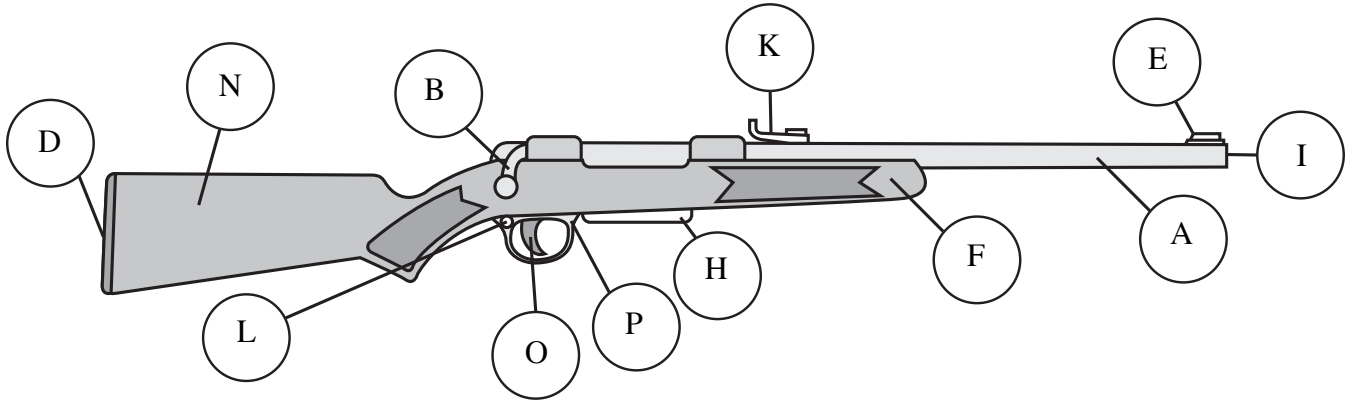

- A - BARREL
- B - BOLT
- C - BREAK
- D - BUTT PLATE
- E - FRONT SIGHT
- F - FOREARM
- G - LEVER
- H - MAGAZINE
- I - MUZZLE
- J - PUMP
- K - REAR SIGHT
- L - SAFETY
- M - SEMI-AUTOMATIC
- N - STOCK
- O - TRIGGER
- P - TRIGGER GUARD

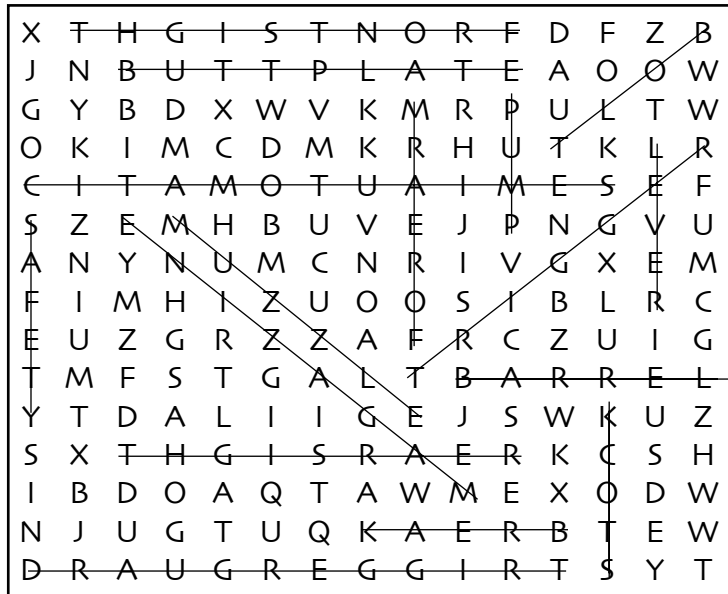

Pistol

Name the types of pistols. Label their parts using the words listed at the bottom of the page. Then find them in the word search.

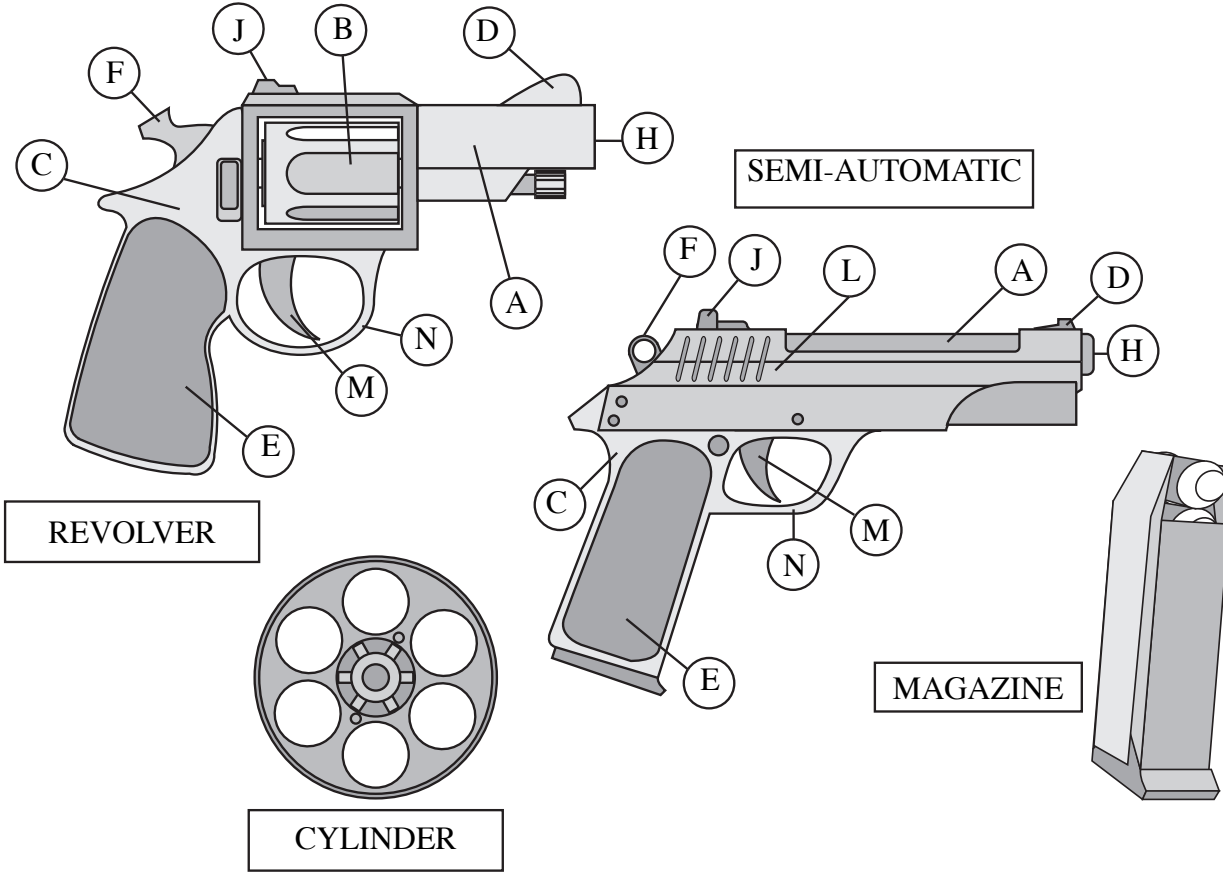

- A - BARREL
- B - CYLINDER
- C - FRAME
- D - FRONT SIGHT
- E - GRIP
- F - HAMMER
- G - MAGAZINE
- H - MUZZLE
- I - REVOLVER
- J - REAR SIGHT
- K - SEMI-AUTOMATIC
- L - SLIDE
- M - TRIGGER
- N - TRIGGER GUARD

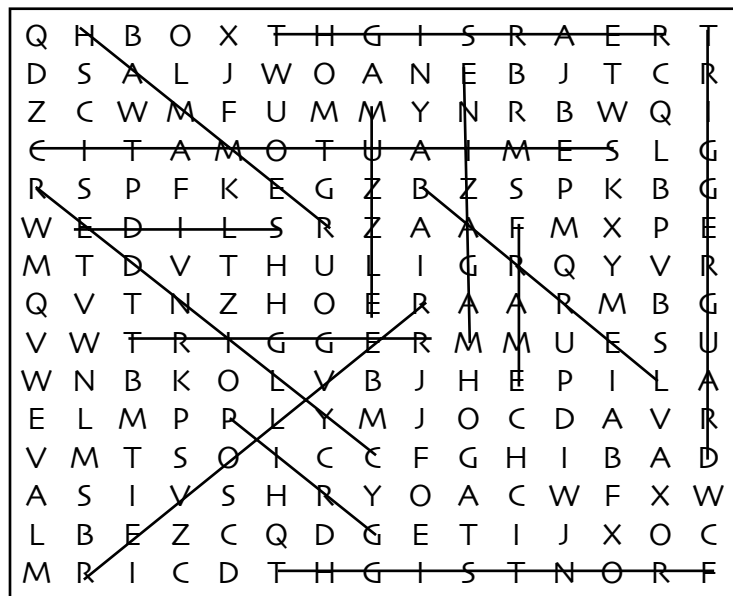

Shotgun

Name the actions. Label the parts of the shotgun using the letters that correspond to the parts listed at the bottom of the page. Then find the words in the word search.

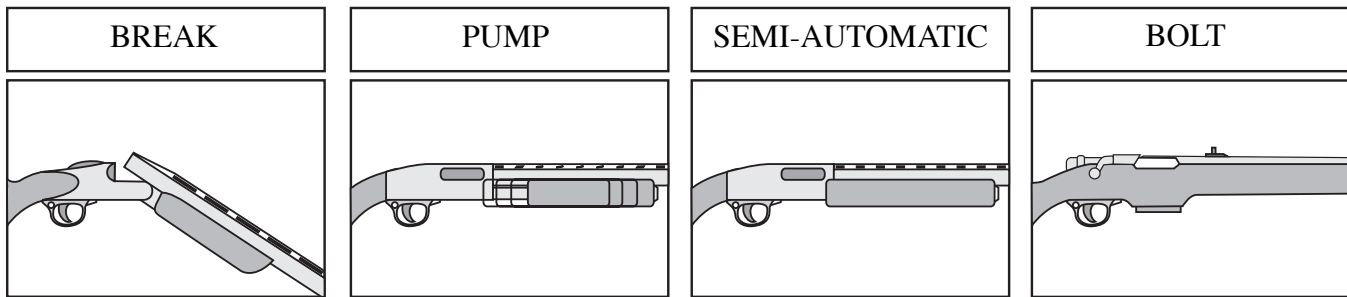
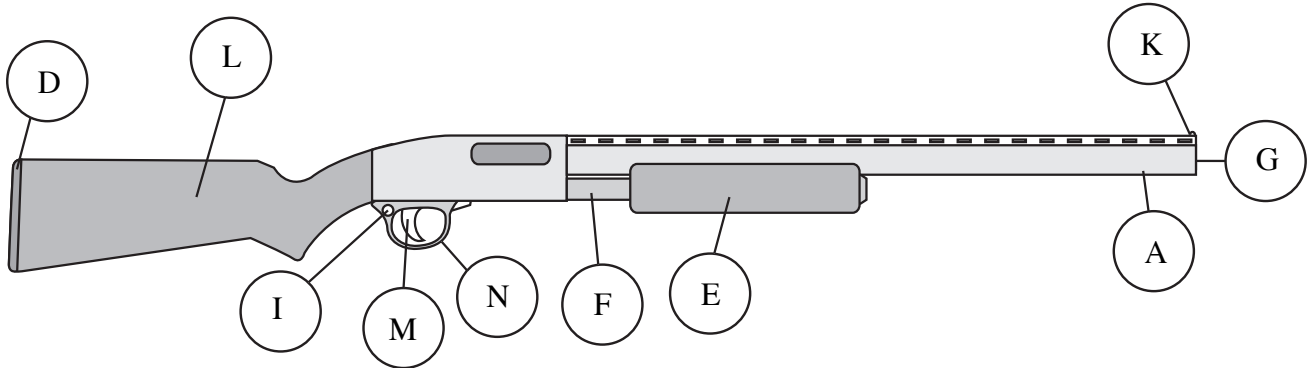

- A - BARREL
- B - BOLT ACTION
- C - BREAK
- D - BUTT
- E - FOREARM
- F - MAGAZINE TUBE
- G - MUZZLE
- H - PUMP
- I - SAFETY
- J - SEMI-AUTOMATIC
- K - SIGHT BEAD
- L - STOCK
- M - TRIGGER
- N - TRIGGER GUARD

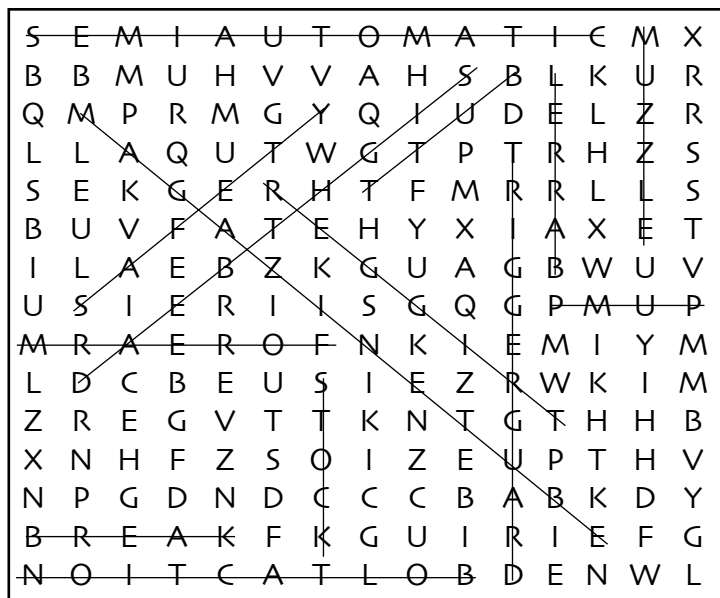

Ammunition

Name the ammunition. Label the parts of the ammunition using the letters listed at the bottom of the page. Then find them in the word search.

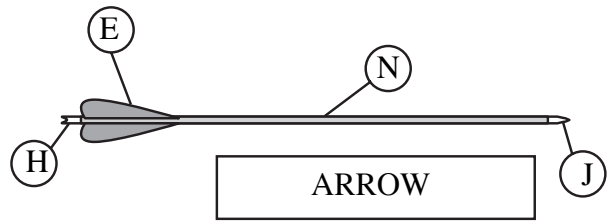

ARROW

RIM FIRE

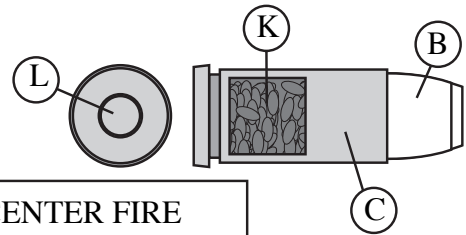
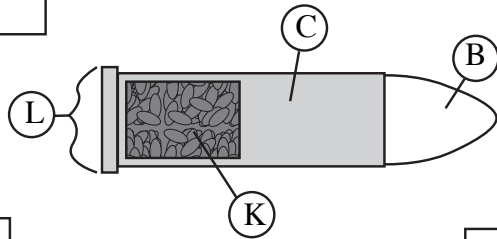

CENTER FIRE

SHOTGUN SHELL

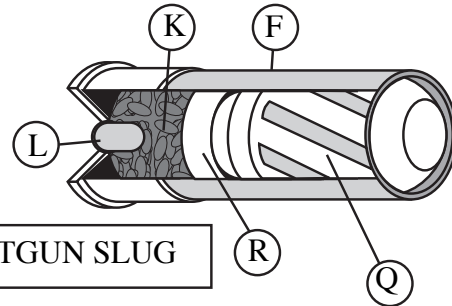
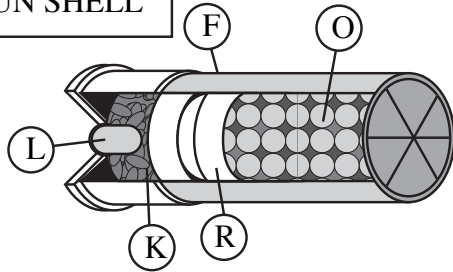

SHOTGUN SLUG



PELLET

LEAD BALLS

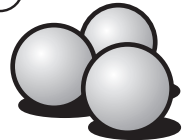

- A - ARROW
- B - BULLET
- C - CASE
- D - CENTERFIRE
- E - FLETCHING
- F - HULL
- G - LEAD BALLS
- H - NOCK
- I - PELLET
- J - POINT
- K - POWDER
- L - PRIMER
- M - RIM FIRE
- N - SHAFT
- O - SHOT
- P - SHOTGUN SHELL
- Q - SHOTGUN SLUG
- R - WAD

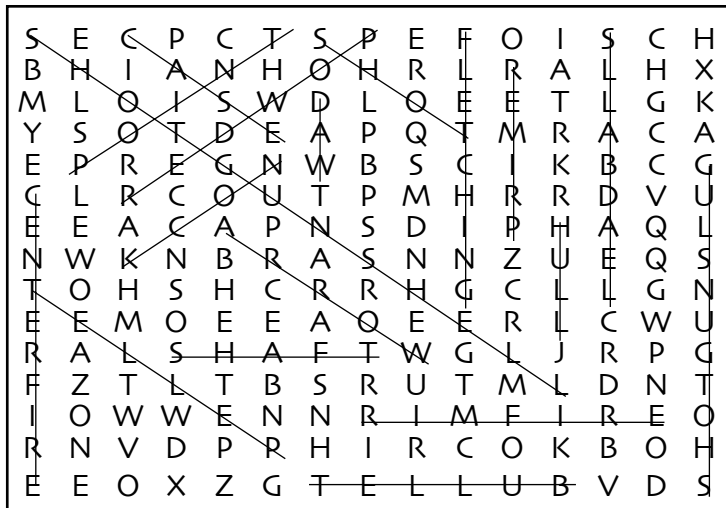

Use words from glossary to answer the questions and write them in the crossword puzzle.

ACROSS

1. moveable locking device that seals a cartridge in the chamber of a firearm
2. lever used to release a sear and fire a firearm
4. specialized arrow designed for limited flight distance
8. cartridge with priming compound sandwiched between the layers of a folded rim
10. body of an arrow
14. front portion of a stock on firearms with a two-piece stock; forend or fore stock
- 16 a firearm using a primer or battery cup located in the center of the cartridge head
- 17 hand-held mechanical device to fire the bow
19. self-loading firearm
20. mechanical parts of a muzzleloader or other firearm
21. protective device surrounding the trigger
23. terminal end of the bore, opening from which the projectile or projectiles emerge
24. device to assist in aligning the eye with the bore or bow and pointing the aligned system at a target
27. bow designed to give the shooter a mechanical advantage during the draw
29. straight or slightly reflexed bow based upon the old English design
30. firing mechanism where a match is inserted into a touch hole to ignite the powder charge
32. firearm lock using a spring-loaded, serrated wheel whirling against a pyrite flint to produce a shower of sparks and ignite a priming powder charge
33. conventional bow with the tips of the limb curved toward the back of the bow
34. shooting position where the shooter stands upright and supports the firearm with the arms and shoulder alone
35. continuing the appropriate action of the shooting sequence through the shot until the target is struck

DOWN

1. shoulder end of a rifle or shotgun stock
3. flange at the base of a cartridge case
4. lock used on muzzleloading firearms, featuring a cock, flint, frizzen and flash pan
5. trigger used to activate a hair-trigger sensitivity on a firing trigger in a double-set trigger arrangement
6. pressing the trigger straight back through a firing sequence without disturbing the sight alignment and sight picture
7. the tube that contains and directs the projectile
9. part of a firearm where ammunition is stored prior to being inserted into the chamber for firing
- 11 holding the string at full draw
- 12 hollow cup of copper or gilding metal containing a small amount of pressure sensitive explosive, used to ignite the powder charge in percussion or caplock firearms and cap-and-ball revolvers
- 13 location at which a projectile strikes another object
15. wooden or composite materials acting as a handle for the firearm
- 18 feathers or vanes used to steer and stabilize the flight of an arrow
22. rod used for loading or cleaning firearms
25. process of pulling the string back to the anchor point
26. slotted device at the end of an arrow to receive the string or the slots in the ends of conventional bow limbs to anchor the string
28. projectiles developed for use in air rifles and pistols, consisting of a hollow-based lead cup. Also a shooter's synonym for shot in shotshells.
- 31 extremely hard stone used in flintlock firearms and arrowheads

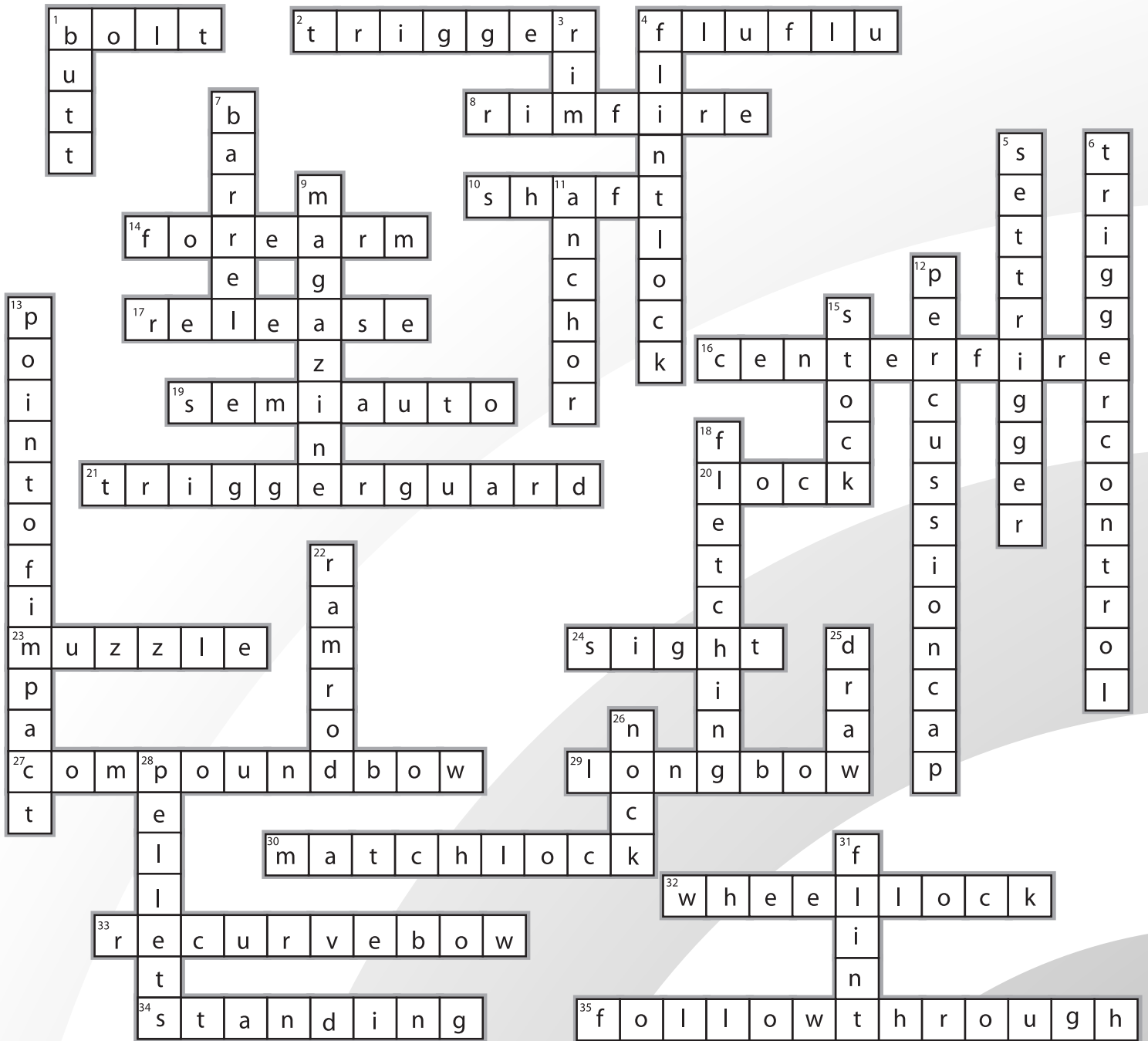

Reprinted for use in Oregon from materials produced by Purdue Extension.

This publication was produced and distributed in furtherance of the Acts of Congress of May 8 and June 30, 1914. Extension work is a cooperative program of Oregon State University, the U.S. Department of Agriculture, and Oregon counties.

Oregon State University Extension Service offers educational programs, activities, and materials—*without discrimination based on race, color, religion, sex, sexual orientation, national origin, age, marital status, disability, or disabled veteran or Vietnam-era veteran status*. Oregon State University Extension Service is an Equal Opportunity Employer.

Published May 2005.