

EARTH SYSTEM MONITOR

Coastal and Estuarine Forecast Systems

A multi-purpose infrastructure for the Columbia River

A guide to
NOAA's data and
information
services

INSIDE

3

News briefs

6

Real-time ERS
altimetry at NOAA

10

Ferret and the Live
Access Server

14

NOAA marine
environmental buoy
data

15

Data products
and services

Antonio M. Baptista, Michael Wilkin, Phillip Pearson, Paul Turner, Cole McCandlish, and Philip Barrett
Center for Coastal and Land-Margin Research,
Dept. of Environmental Science and Engineering
Oregon Graduate Institute of Science and Technology

On February 4, 1999, the *M/V New Carissa* ran aground near Coos Bay, OR during a strong winter storm. On March 3, 1999, amidst an even stronger storm, the bow section of the vessel broke free from a tugboat towing it to deep sea, drifting with the wind in a north-northeast course until it ran aground again at the mouth of Alsea Bay, near Waldport, OR. The fuel tanks of the vessel still contained some 130,000 gallons of fuel oil, about a third of the original load. Of the balance, some 70,000 gallons leaked from the ship while grounded in Coos Bay and much of the rest was burned *in situ* or pumped away in a salvage effort rendered extremely difficult by inclement weather. After spending weeks trying to protect the marine life near Coos Bay and to remove the fuel-holding bow section of the *New Carissa*, salvage officials faced essentially the same challenges in a region of the coast that supports more diverse and abundant populations of birds and marine mammals.

The saga of the *New Carissa* raises a multiplicity of navigational safety, environmental, political and economic questions. Many are important and unresolved, but few are fundamentally new. Natural and man-made hazards have long been a testament to the complex challenges inherent to sustainable coastal development. Managing these hazards requires anticipatory and predictive capabilities that must be in place where and when they become necessary, regardless of the specific hazard and the associated time and space scales.

We believe that such capabilities are within the reach of

coastal and estuarine forecasting systems (Figure 1). We define CEFS as a multidimensional integration of environmental data, simulation models, information and control technology, and human interactions, within and across a network of physical sites.

While a national CEFS does not exist, local CEFS implementations (including NOAA/PORTS, http://www.opsd.nos.noaa.gov/d_ports.html) provide in specific pilot regions an essential but underutilized infrastructure of anticipatory and predictive capabilities towards hazard mitigation, resource management and scientific discovery. Our experience in the development and maintenance of CORIE, a pilot CEFS for the Columbia

— continued on page 2

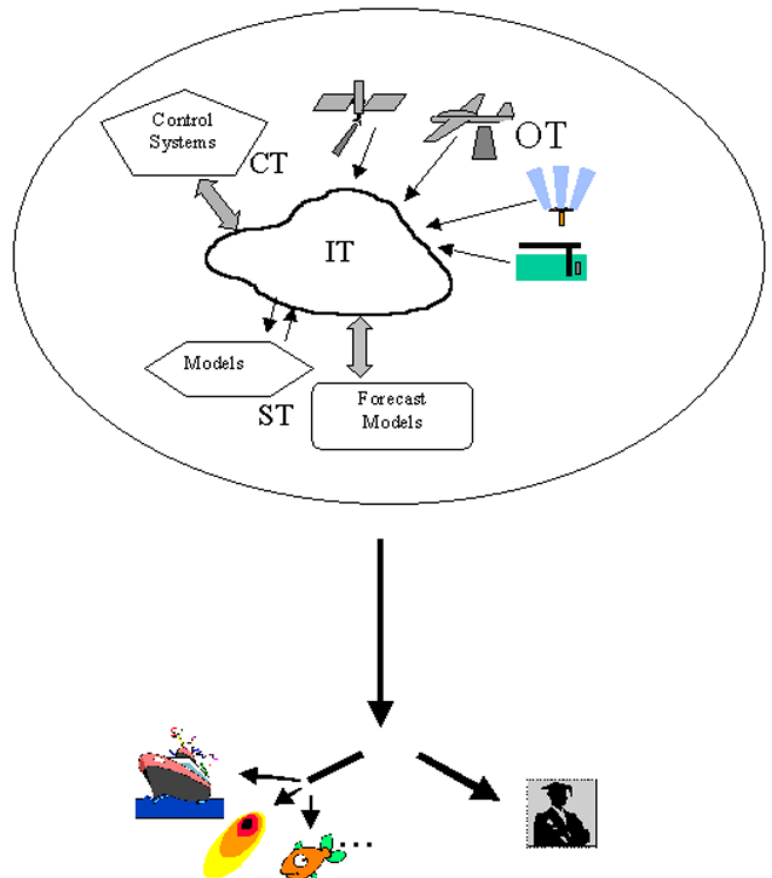

▲ Figure 1. CEFS (Coastal and Estuarine Forecast Systems) use integration technology (IT) to coordinate observation (OT), simulation (ST), and control technologies (CT) and their products. CEFS products include detailed descriptions of circulation and transport processes over multiple space and time scales, including but not limited to real time. We view these products as multi-purpose infrastructure for scientific discovery and for resource management.



U.S. DEPARTMENT
OF COMMERCE
National Oceanic
and Atmospheric
Administration

Forecast systems, from page 1

River, is used in this article to illustrate capabilities, discuss challenges and encourage national cooperation towards a national CEFS.

The pilot system, Columbia River Estuary or CORIE (<http://www.ccalmr.ogi.edu/>), was designed as a multi-purpose infrastructure for scientific discovery and for resource management towards sustainable coastal development. We view CORIE both as a Columbia River-specific scientific and management tool and as a testbed for evolving site-independent technologies for observation and predictive understanding of coasts and estuaries.

The Columbia River system

The Columbia River is the second largest river in the United States in river discharge (annual average of 211 kcf), and provides 60% (winter) to 90% (summer) of the freshwater input to the Northeast Pacific Ocean between San Francisco Bay and the Strait of Juan de Fuca. While intense hydropower regulation has reduced natural variations, monthly-average discharge, Q_m , still ranges from 100 to 500 kcf. Climate variability at interannual to interdecadal scales creates additional system complexity.

The estuary is a classic river estuary. Tidal currents are strong and ebb-dominated, salinity intrusion is compressed, and vertical stratification is highly variable, ranging from homogeneous to salt wedge conditions. The plume is a major oceanographic feature in the Northeast Pacific Ocean. In response to prevailing coastal winds and currents, the plume generally extends south and offshore to northern California in summer and north and alongshore to southern British Columbia in winter.

The Columbia River basin is the focus of natural resource and environmental management issues that profoundly affect the economic viability of communities in the region. Users and regulators grapple with issues related to navigational safety, dredging and dredged materials management, water

quality management, environmental monitoring, oil spill response, search and rescue and natural hazards planning. However, the major natural resource controversy facing the region is the recovery of threatened and endangered salmon and steelhead stocks. Anadromous fish use all segments of the Columbia River system—tributaries, mainstem channel, estuary and plume—at different stages of their life histories, but a century of intensive human development throughout the basin has impacted the ecosystem function of each segment. Hydropower operations and structural modifications for navigation and reclamation are among the most visible causes of impact.

CORIE real-time observation network

The CORIE observation network includes an array of 14 permanent stations (Figure 2), a variable number of temporary stations, and one mobile station. Thirteen stations are located in the estuary, and one offshore. We currently monitor in various combinations at each station: temperature, salinity (via conductivity), water level, water velocity, acoustic and optical backscatter, wind speed and direction, and air temperature.

All instruments report data in real-time through a telemetry network based on spread-spectrum radio technology. "Real-time" is defined by latencies of typically a few seconds. The sampling interval ranges from 1 to 15 minutes, with choices determined mostly by the type of power available. Most stations in the network have shore power, and are equipped with a computer for local data stream handling and backup storage. A few stations are powered by batteries or by battery/solar panel combinations.

Several stations are Internet nodes, enabling two-way communication with the instruments. We routinely use two-way communication for the operation of the fixed network (e.g., monitoring of instrumentation status, initiating or modifying sampling protocols, etc.). We also have demonstrated, as a proof of concept, the feasibility of providing Internet-based navigation information products, both real-time and predicted, to a vessel operating in the lower Columbia River. In particular, we config-

EARTH SYSTEM MONITOR

The *Earth System Monitor* (ISSN 1068-2678) is published quarterly by the NOAA Environmental Information Services office. Questions, comments, or suggestions for articles, as well as requests for subscriptions and changes of address, should be directed to the Editor, Sheri A. Phillips.

The mailing address for the *Earth System Monitor* is:

National Oceanographic Data Center
NOAA/NESDIS E/OC1
SSMC3, 4th Floor
1315 East-West Highway
Silver Spring, MD 20910-3282

MANAGING EDITOR

Dr. Anthony R. Picciolo
Telephone: 301-713-3281 ext.140
Fax: 301-713-3302
E-mail: apicciolo@nodc.noaa.gov

EDITOR

Sheri Phillips
Telephone: 301-713-3280 ext.127
Fax: 301-713-3302
E-mail: sphillips@nodc.noaa.gov

ASSOCIATE EDITOR

Roger Torstenson
Telephone: 301-713-3281 ext.107
Fax: 301-713-3302
E-mail: rtorstenson@nodc.noaa.gov

DISCLAIMER

Mention in the *Earth System Monitor* of commercial companies or commercial products does not constitute an endorsement or recommendation by the National Oceanic and Atmospheric Administration or the U.S. Department of Commerce. Use for publicity or advertising purposes of information published in the *Earth System Monitor* concerning proprietary products or the tests of such products is not authorized.

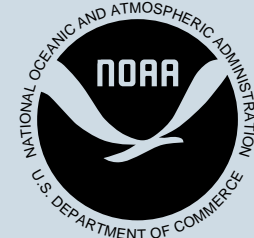

U.S. DEPARTMENT OF COMMERCE
William M. Daley, Secretary

National Oceanic and
Atmospheric Administration
D. James Baker,
Under Secretary and Administrator

Oregon Graduate Institute

P.O. Box 91000

Portland, OR 97291

E-mail: baptista@ccalmr.ogi.edu

— continued on page 4

CU-Boulder researchers to map polar ice on Mars

NASA's Office of Space Science has selected a group of University of Colorado at Boulder researchers to spend three years mapping the polar ice on Mars using satellite data. The research team from the National Snow and Ice Data Center will create a "virtual sensor" by combining data from two instruments currently orbiting the Red Planet on NASA's Mars Global Surveyor satellite, said principal investigator and glaciologist Anne Nolin. The scientists will apply remote-sensing techniques to study the Mars data and help them to both identify the surface composition of Mars' polar ice and plot its perimeters.

In addition to increasing the human understanding of Mars' climate and geophysical properties, the scientists believe the \$225,000 project may help explain some of Earth's evolutionary processes, she said. "Mars is the planet most similar to Earth," Nolin said. "There used to be a lot of liquid water on Mars, but not any longer. We want to know what has caused a planet relatively similar to ours to change so much, and how and why it evolved. Ice provides a long-term archive of climate change."

Although Nolin said distinctions between Mars ice and Earth ice will influence the study, both planets have large polar ice caps that play a role in their hydrological cycles, temperature gradients and atmospheric circulation. The northern ice cap on Mars is mainly fresh water, but the southern ice cap is thought to be almost entirely composed of frozen carbon dioxide. "Ice on Earth is comparatively close to the melting point, and is therefore the most dynamic type of surface cover due to seasonal changes in ice and snow extent," she says. "The lower temperatures on Mars mean that the poles experience fewer seasonal changes, but still experience changes in frost-covered areas."

Ice on Mars extends to lower latitudes than ice on Earth and there is probably more frozen ground on Mars than on Earth, Nolin said. In addition to the presence of carbon dioxide ice on Mars, the substantial amount of dust in the Martian atmosphere and within the ice caps indicates that Martian ice differs greatly from Earth's polar ice and presents the greatest challenge in studying Martian ice.

To address such difficulties, the researchers plan to combine images from the Mars Orbital Camera with reflectance

News briefs

information from the Mars Orbiter Laser Altimeter to create a multi-spectral "virtual" sensor. The camera on the Mars Global Surveyor satellite is sensitive to the visible characteristics of ice and dust, while the altimeter measures both the near infrared reflectance of ice and its surface height characteristics.

By analyzing the combined data through a series of "refining steps," the researchers will be able to measure the relative abundance of dust to ice or snow and possibly identify other surface components, Nolin said.

The National Snow and Ice Data Center is part of the CU-Boulder-headquartered Cooperative Institute for Research in Environmental Sciences (CIRES). CIRES is a joint institute of CU and the National Oceanic and Atmospheric Administration.

Scientists find El Niño-like climate fluctuations from 5000 years ago

For the first time, a team of government and university scientists has found a high-resolution, 15,000-year record of rain-induced erosion in sediment layers of an Ecuadorian lake that indicates El Niño-like climate fluctuations became more common about 5,000 years ago.

Writing in a current issue of *Science*, the researchers found that a core sample of layers of sediment deposited during severe storms in Lake Pallacocha in southwestern Ecuador closely correlates with El Niños that are known to have occurred over the past 200 years. "The full sediment record indicates that 15,000 years ago severe El Niño-like storms occurred at least about every 15 years, and that they have since occurred with progressively increasing frequency. Over the past 5,000 years, storms from El Niño-like climate fluctuations have occurred about every two to eight and one-half years, possibly due to enhanced trade winds," said the study's lead author, Donald T. Rodbell of Union College, Schenectady, N.Y.

The authors point out that there are proxy records of prehistoric El Niños in a variety of natural archives, including corals, ice cores, tree rings, flood deposits, beach ridges, archeological middens and soils. But high-resolution records in corals and ice cores are limited to the past 2,000 years, while longer records are not continuous.

Sea surface temperatures near this part of Ecuador are among the first to warm in the region during the onset of an El Niño, when rainfall greatly increases. Since extreme El Niño-driven storms are known to deposit organic and inorganic debris in coastal basins, the scientists analyzed a 9.2-meter-long core of sedimentary rock obtained in June 1993 from Lake Pallacocha, which is about 75 kilometers from the Pacific Ocean. These layers of sediment, known as clastic laminae, are made up of fragments of vegetation that were washed into the lake from the surrounding landscape during torrential rain storms.

The sediment record from 1800 to 1976 A.D. reveals a close match between the layers of clastic laminae and moderate to severe El Niños. Of the seventeen El Niños that occurred in this time period, eleven correlate within two years of major layers of clastic laminae, and one is within three years. The other five severe El Niños during this period occurred within two years of relatively minor layers of clastic sediment. The eight severe El Niños of the past 100 years correlate precisely with clastic laminae in the core.

Remote sensing of sea urchins

The National Geophysical Data Center's (NGDC) Chris Elvidge and Professor Robert Steneck, University of Maine, have been discussing the potential use of high resolution remote sensing to observe the propagation of sea urchins in overharvested rocky shoreline areas in the State of Maine. Sea urchin is the second most highly valued fishery in Maine, following lobster. Sea urchins eat kelp and seaweed. Where their numbers are high, the rocks are covered with coralline encrustations while kelp and seaweed densities are kept low. In areas where the sea urchins have been overharvested, kelp and seaweed form dense mats which harbor sea urchin predators. High resolution remote sensing data is seen as an effective way to document the effectiveness of the experimental procedures being contemplated. An NGDC review of recent color aerial photographs has revealed that rocky areas, typical of high sea urchin numbers, can be readily distinguished from zones with dense kelp and seaweed.

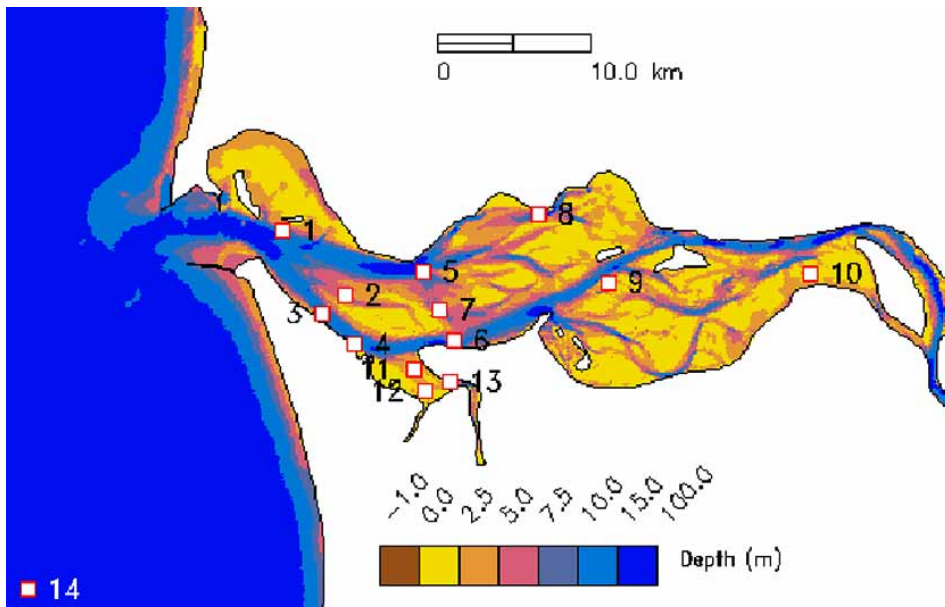

▲ **Figure 2.** CORIE stations are predominantly located in the estuary. Stations are strategically distributed along the deep channels, in shallow areas in the mainstem and in one lateral bay. We have recently deployed an offshore station (at ~100 m depth), reflecting an increased interest in plume dynamics.

Forecast system, from page 2

ured the education and research vessel *M/V Forerunner* to maintain a continuous Internet connection, by pointing to different CORIE receiving stations depending on the vessel location.

Numerical models

The CORIE modeling system includes a suite of circulation and transport codes, applied to multiple domains:

- 1) the Columbia River estuary, upstream river forcings and near-shore coastal zone;
- 2) the Columbia River zone of influence, focused on the plume; and
- 3) the Northeast Pacific Ocean, north of latitude 30° N and east of longitude 165° W, a domain used primarily to define ocean boundary conditions for the smaller domains.

Codes differ in dimensionality (2D or 3D) and on whether they include wetting and drying and baroclinic effects.

Early modeling focused on tidal propagation and circulation over the complex topography of the estuary. This modeling has resulted in regular daily forecasts of barotropic circulation (Figure 3) and in an evolving long-term database of uninterrupted barotropic simulations and related analyses. Modeling emphasis is now on the vertical structure of circulation and density in

the estuary and the plume, and on residual transport. Overall, results suggest that we are able to describe the depth-averaged circulation (levels and 2D velocities) quite effectively, but that we still systematically under-estimate salt-water intrusion in 3D baroclinic runs. This appears to result from combined

limitations in the description of vertical mixing in the estuary and of (S,T) boundary conditions in the ocean.

Information management

Data acquired from the CORIE instruments are pulled across the Internet in real-time, using a data acquisition system that, while conceptually inspired by the Real-time Environmental Information Network and Analysis System or REINAS (<http://csl.cse.ucsc.edu/projects/reinas/>), relies on different software and archival choices. Typically, data backups are generated at various intermediate steps between the instrument and OGI. The data are parsed and then archived in a NetCDF-based flat file system. In parallel, automatic scripts access the data in a pre-defined schedule, process the data at a basic level, and display them in near real-time on the Web (Figure 4). More detailed processing has been performed *a posteriori*, mostly on an as-needed basis. We are now exploring procedures for systematic non-real time processing. Recognizing that "one person's noise is another person's signal," these procedures will enable users to choose among various pre-defined levels of quality control (including none).

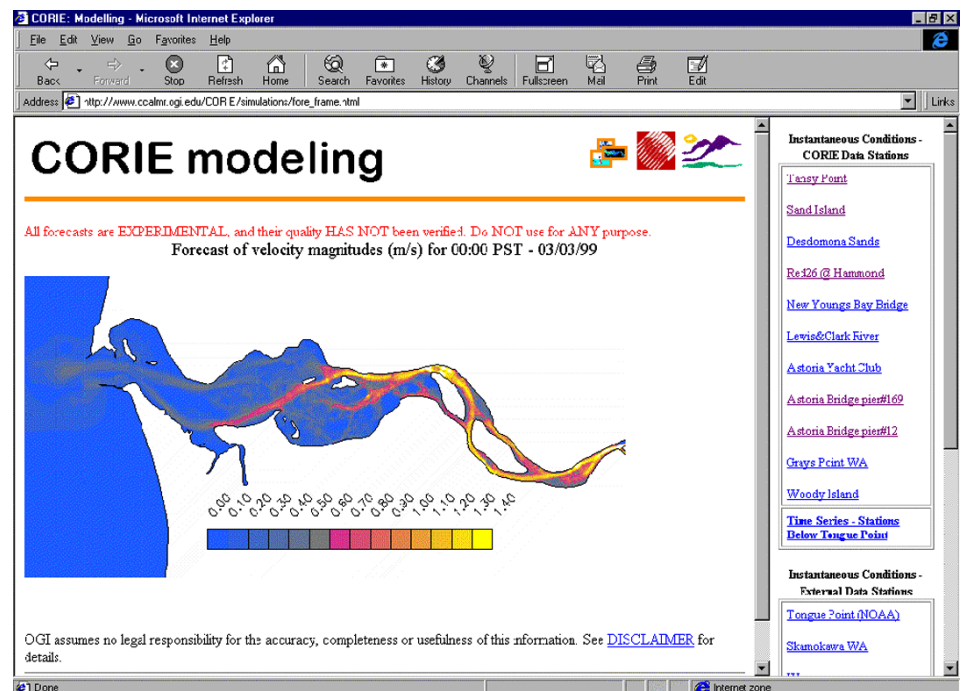

▲ **Figure 3.** Forecasts of depth-averaged barotropic circulation have been produced routinely since March 1998, with hourly results posted daily on the Web (http://www.ccalmr.ogi.edu/CORIE/simulations/fore_frame.html).

Operational logistics and applications

The authors have provided the vision and ensured the continued daily operation of CORIE. A much broader group of researchers has provided additional hands-on or conceptual expertise on an as-needed basis, or has served as beta users for observational and simulation data.

Field operations are conducted out of the Marine Environmental Research and Training Station (MERTS), in Astoria, OR. Vessels (the 50-ft *M/V Fore-runner* and the 21-ft *R/V Tansy Point*) and operators have been provided by the Maritime Science Program of the Clatsop Community College, a MERTS partner with OGI.

CORIE is currently used primarily in support of theoretical and applied research on multiple topics, including:

- residence times (Sommerfield 1998);
- estuarine turbidity maxima (<http://weber.u.washington.edu/~cretmweb/CRETM.html>);
- ocean survival of salmonids (<http://www.ccalmr.ogi.edu/nmfs/>);
- physical and ecosystem impacts of hydropower management and climate change (Jay *et al.* 1999);
- biogeochemistry of sediment-water interfaces (<http://www.ccalmr.ogi.edu/baptista/ralf.html>); and
- software-enabled vessel control (<http://www.cse.ogi.edu/PacSoft/projects/sec>).

In addition, impromptu uses of CORIE have included instrumentation testing and informal support to navigation and to search and rescue operations.

Critical limitations and next steps

While the functionality of CORIE often meets or exceeds our initial expectations, critical limitations remain at the following levels:

1) Adaptability of the integration software to new technologies and additional data sources is still too labor-intensive. We anticipate a progressive evolution, likely in collaboration with other groups, towards more open architectures that further streamline expansions within and across sites.

2) The *in situ* observation network is labor-intensive and expensive to maintain. We anticipate a substantial research effort towards sampling optimization strategies (via data assimilation by-products) and a progressive incorporation of satellite, airborne and

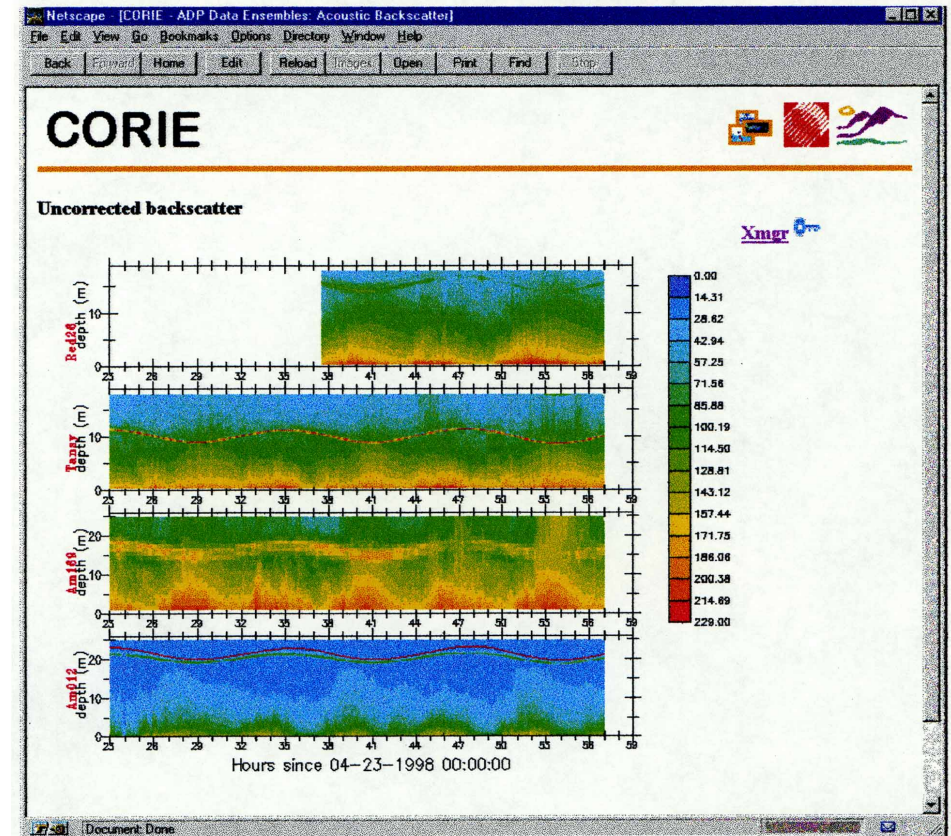

▲ **Figure 4.** The contrast among 36 h time-series of profiles of acoustic backscatter at four stations is one of various displays automatically posted in the web at pre-defined intervals. CORIE scripts are able to recognize and report temporary data gaps. However, they have only limited capability to automatically assess the intrinsic quality of the data.

land-based remote sensing observations.

3) Quality assessment is still labor-intensive, and satisfactory cross-application protocols are difficult to establish. Advances in integration technologies may progressively reduce labor requirements, but cross-site collaboration of multiple CEFS stakeholders is necessary to establish satisfactory standards and protocols.

4) Reliable 3D simulations and forecasts require both further advances in computational performance (likely through hardware advances) and integration with ocean and atmospheric models at multiple-scales, a capability that is only progressively being developed.

5) The user base of the system remains heavily biased towards researchers. Education and training programs with focus on managers, regulators and operators need to be designed and implemented.

Towards a national coastal and estuarine forecasting system

Coastal areas are the most intensely developed in the nation, sustaining large-scale economic activity in sectors such as transportation and international trade, manufacturing, resource exploitation, recreation and defense. This narrow fringe comprising 17% of the contiguous U.S. land area is home to more than 53% of the nation's population.

Further, this coastal population is increasing by 3,600 people per day, giving a projected total increase of 27 million people between now and 2015. Mitigation of natural and man-made hazards, coupled with emergency response and mitigation programs, costs the US more than \$2 billion annually.

Within this context, a national CEFS is easy to justify conceptually. We believe that no engineering system will more significantly impact sustainable coastal development in the next decades. CEFS can fuse observations and

— continued on page 16

Real-time ERS altimetry at NOAA

Generating products for oceanographic analyses and model assimilation

*John Lillibridge
Laboratory for Satellite Altimetry
NOAA/NESDIS/NODC*

The Laboratory for Satellite Altimetry (LSA) is a division within NODC which processes and analyzes data from all current altimetry missions (Topex/Poseidon, ERS-2, Geosat Follow-On) as well as historical ones (GEOS-3, Seasat, Geosat, ERS-1). The data obtained from the European Space Agency's satellites, ERS-1 and ERS-2 (Figure 1), are unique in that ESA's ground system makes the data available to NOAA and other agencies within 6 hours of acquisition. This makes it possible for NOAA to generate near real-time altimetry products which can be used in oceanographic analyses and model assimilation.

ERS-1 (the first European Remote Sensing satellite) was launched in August 1991, and LSA began routine processing of the altimeter data six months later. The fast-delivery altimeter data received from ESA contain the range measurements between the satellite and sea surface, but in order to compute changes in sea surface topography, it is necessary to also have accurate satellite orbit information. The altimetry group at the Delft University of Technology has been providing "quick-look" orbits for both ERS satellites, through a cooperative effort with NOAA. LSA combines the altimeter range data with these orbits, adds corrections for travel time delays of the radar pulse through the troposphere and ionosphere, and removes the tidal components of sea level since these are not related to large scale ocean circulation. The flow chart in Figure 2 describes the LSA processing system. (The most important media correction, which accounts for path delays due to water vapor, can be measured by ERS's onboard microwave radiometer. However, those corrections did not become available in ESA's fast-delivery data until late 1998.)

*Laboratory for Satellite Altimetry
NOAA/NESDIS/NODC
1315 East West Highway
Silver Spring, MD 20910
E-mail: jllilibrige@nodc.noaa.gov*

During the first years of the ERS-1 mission, the Delft orbits had radial orbit errors on the order of 1-2 meters. To accommodate delays in receiving all the laser tracking data for generation of the final orbit, there was a latency of nearly two weeks between reception of the altimetry data from ESA and production of the NOAA sea surface height data. Over the course of the ERS-1 mission enhancements were made, most notably the utilization of orbits based on better gravity models, which reduced the radial orbit error to the 10-20 cm level.

In November 1995 LSA began a new method of data production which allowed generation of daily data with a latency of only 13-14 hours. Since the orbits were still the time-limiting factor, it was necessary to use "predicted" orbits in order to operate in near real-

time. The Delft group modified their orbit production scheme to extend the orbit beyond that part of the solution which is based on actual laser tracking data. The gain in timeliness, however, exacted a price in terms of orbit error: data based on predictions of a few days typically had uncertainties of 30-50 cm, despite further improvements in the gravity model.

ERS-2 (which differs only slightly from ERS-1) was launched on April 20, 1995, and after a year of calibration/validation activities, replaced ERS-1 as the operational satellite. For the next two years the ERS processing at LSA was very stable, and data sets were automatically generated with little manual intervention. In the last half of 1998, however, several significant improvements were made:

- 1) The Delft orbits incorporated a

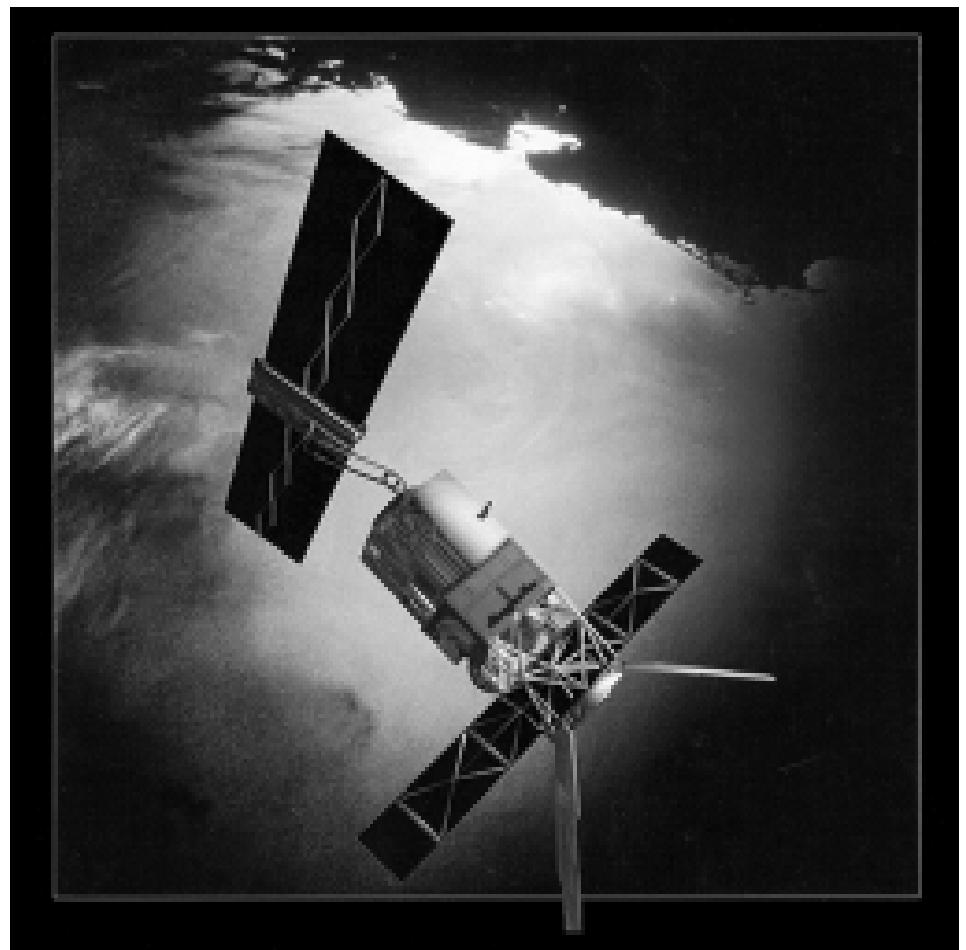

▲ Figure 1. Artist's rendering of the European Space Agency's ERS-2 satellite.

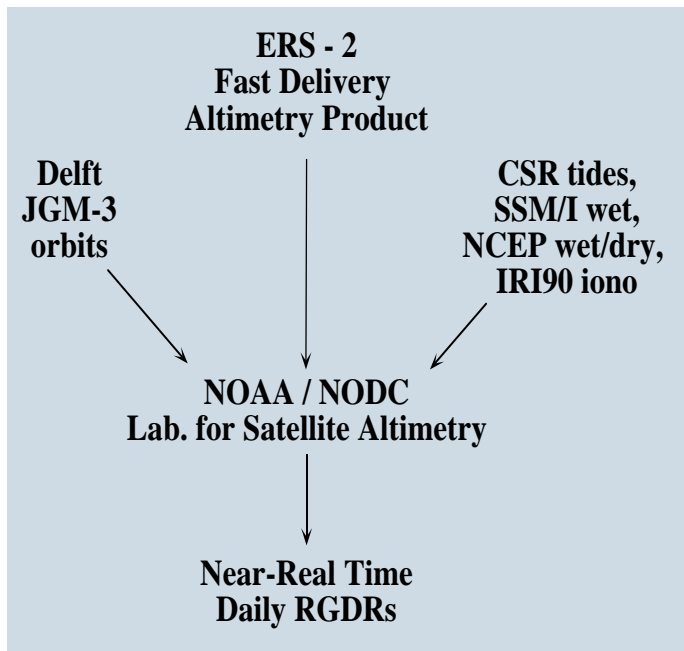

▲ **Figure 2.** Flow chart of the real-time altimetry system at NOAA. The fast-delivery altimeter data from ESA lack an orbit and (until 1998) a measured wet troposphere correction. Orbits are provided by the Delft University of Technology, and media and tidal corrections are supplied at NOAA. The final "Real-time Geophysical Data Records" (RGDRs) are distributed via the Internet.

new gravity model optimized for ERS-2. These state-of-the-art orbits reduced the orbit error in the NOAA products.

2) In order to further reduce orbit error, a "feedback" scheme was developed which minimizes the lack of laser-tracking data in the orbit prediction. A first-cut RGDR is generated using the previous day's orbit; the resulting height data are then utilized by Delft to compute a better constrained orbit for the current day; and NOAA then incorporates this improved orbit into the final data set.

3) ESA began providing the measured wet troposphere correction from the radiometer onboard ERS-2.

The net effect of these improvements in late 1998 can be readily seen in Figure 3. This plot is based on a collinear analysis of the real-time data for ERS-2. Every 35 days ERS-2 repeats its ground track, and each "pole-to-pole" pass (between 81.5° N and 81.5° S) can be compared to the other passes along the same ground track. The rms variability of each pass, relative to its reference pass, is plotted at the equator crossing time of the pass.

To highlight the changes over time a 70-day (two repeat-cycle) median

filter was applied to the original time series. The large drop in variability, indicative of a large decrease in orbit and media errors, can be seen in the fall of 1998. After these improvements were made, the rms variability of each pass is stable at about 25 cm. This variability includes the true oceanic variability as well as orbit and media correction errors. Similar pass statistics for Topex/Poseidon are at the 15-20 cm level, indicating that the errors in the real-time ERS-2 data are only 5-10 cm higher.

The NOAA real-time products are utilized by altimetric specialists at a number of institutions. LSA currently

supplies ERS-2 data to the University of Delft, the University of Colorado, the Naval Research Laboratory, the Naval Oceanographic Office, and the Southampton Oceanography Center in the United Kingdom. Each of these institutions regularly retrieves ERS-2 data via ftp, resulting in network traffic of several hundred megabytes per month (Figure 4).

Examples of the ways in which the NOAA RGDRs are being utilized can be found on the web sites of LSA's primary customers. The altimetry group at the Naval Research Laboratory assimilates ERS-2 data (along with Topex/Poseidon and Geosat Follow-On altimetry) into a global ocean model and produces daily maps of sea surface dynamic topography. By assimilating the data into a dynamical ocean model, it is possible to generate synoptic pictures of the sea surface in spite of the variable space/time sampling of the original data. Figure 5 shows an example of their real-time global model output. Refer to the NRL web site for further information: <http://www7300.nrlssc.navy.mil/altimetry>.

Another example of the use of RGDR data in real-time altimetry can be — *continued on page 8*

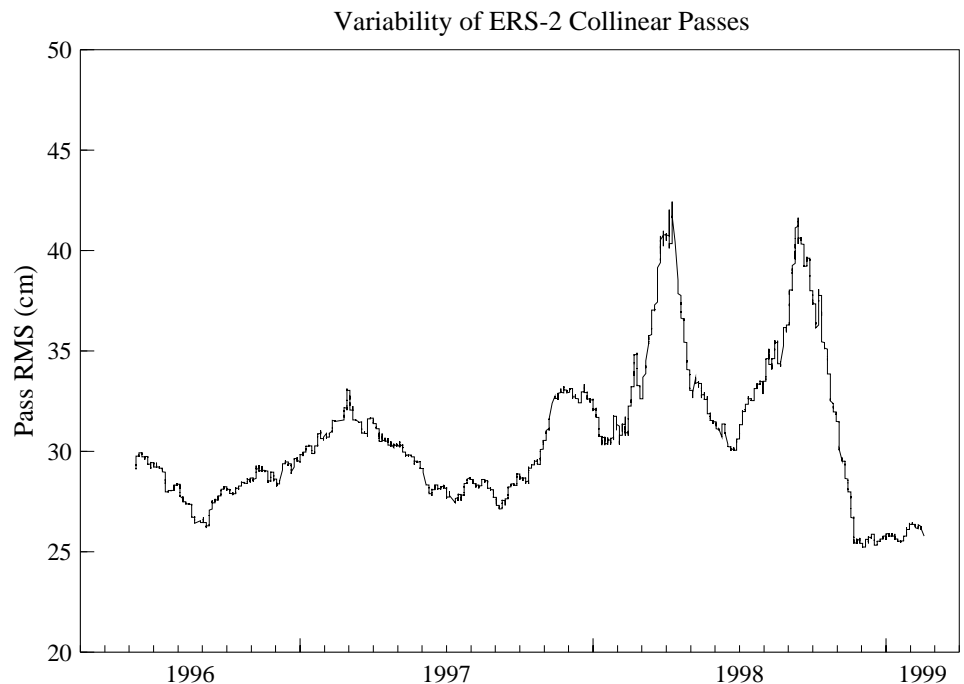

▲ **Figure 3.** Global sea surface height variability from ERS-2 altimeter collinear differences. This plot provides an estimate of the change in uncertainty in the real-time data. "Perfect" observations of sea level would yield rms values of 15-20 cm, due to actual variations in currents and the effects of seasonal and interannual signals. Since late 1998, improvements in ERS-2 processing have reduced the global value to 25 cm rms, or only 5-10 cm higher than the true variability.

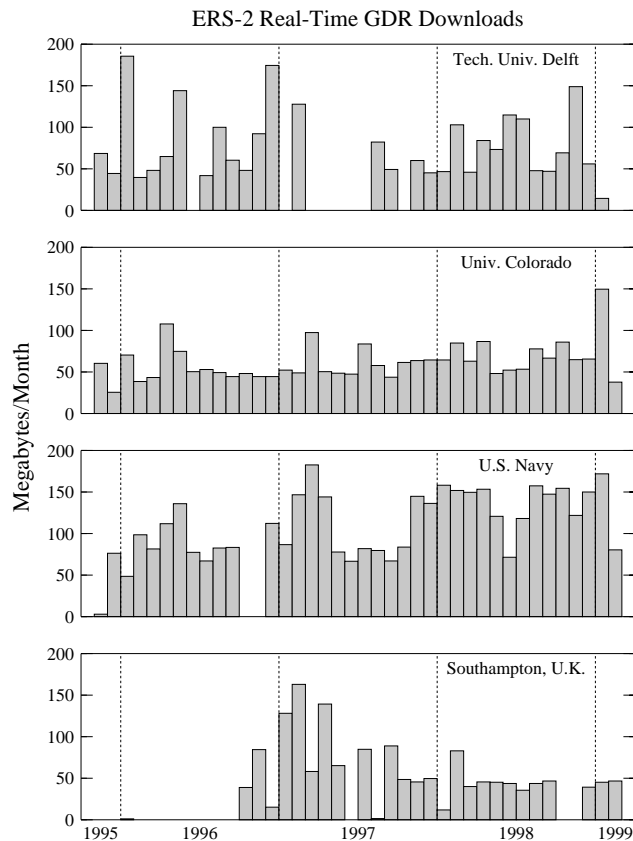

▲ **Figure 4.** Network traffic between the NOAA Laboratory for Satellite Altimetry and its primary customers. Each group routinely downloads at a rate of 50 Mb/month, with peak traffic of nearly 200 Mb/month.

ERS, from page 7 found at the University of Colorado's Gulf of Mexico web site: http://www-ccar.colorado.edu/~realtime/gom/gom_nrt.html. This group has been using real-time ERS-2 data in conjunction with the higher precision (but more widely spaced) Topex/Poseidon data to generate sea surface topography maps in the Gulf of Mexico. The Loop Current in the Gulf, which feeds into the Gulf Stream south of Florida, can be monitored in this way along with eddy features that have broken off the main current. Figure 6 shows an example from the summer of 1996, when surface drifters were deployed in the Loop Current during a research cruise. The flow of the drifters along the contours of sea surface topography illustrates how well the altimetry system performs.

In addition to supplying ERS-2 data to the altimetric community, LSA is providing weekly Topex/Poseidon analyses to the National Weather Service for El Niño forecasting and monitoring (see the article by Bob Cheney in the September, 1997, Vol. 8/1, issue of the *Earth System Monitor*). In the future, other applications of the real-time data from ERS-2 as well as the Navy's Geosat Follow-On mission will be explored. There is potential for near-coastal applications (such as Gulf Stream monitoring) as well as open-ocean analyses to benefit from the timely production and delivery of altimetry data. NOAA will continue to play an important role in this operational activity. ■

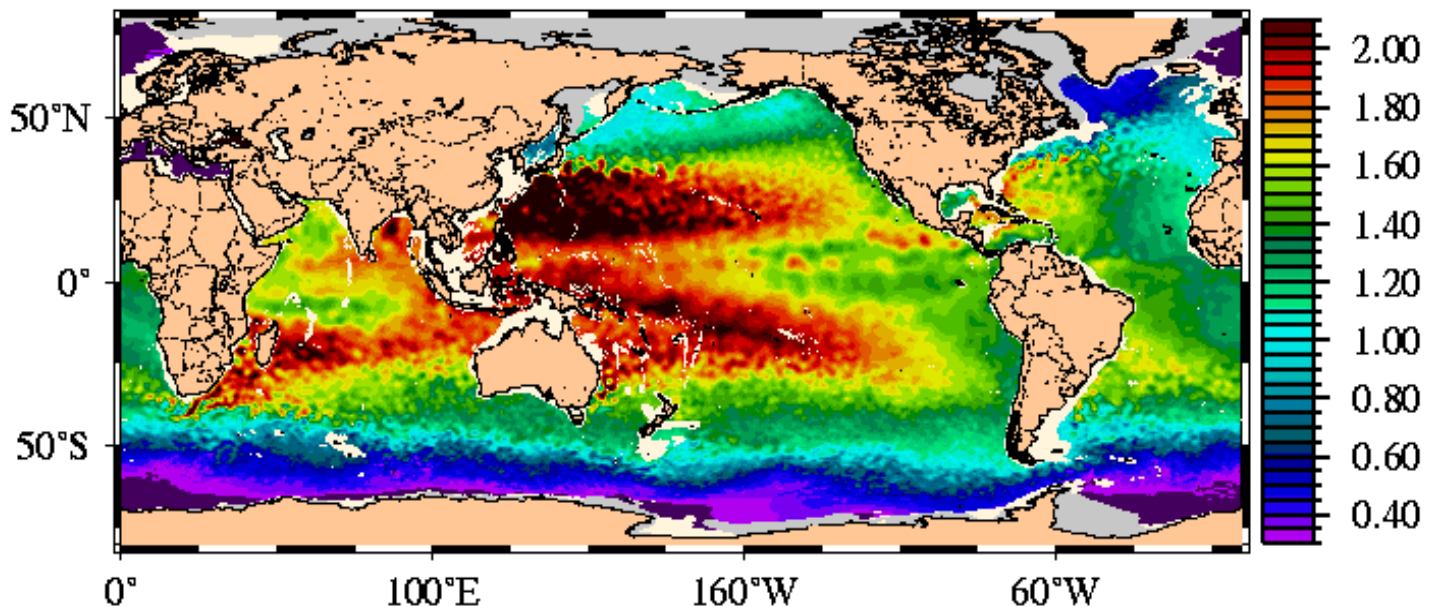

▲ **Figure 5.** Global sea surface dynamic topography from the Modular Ocean Data Assimilation System model (courtesy of the Naval Research Laboratory). Altimetric data from ERS-2, Topex/Poseidon, and GFO are assimilated into the ocean model and daily global grids are generated. The dynamic heights, scaled by the color bar on the right, are in dynamic meters—roughly equivalent to meters of sea surface elevation.

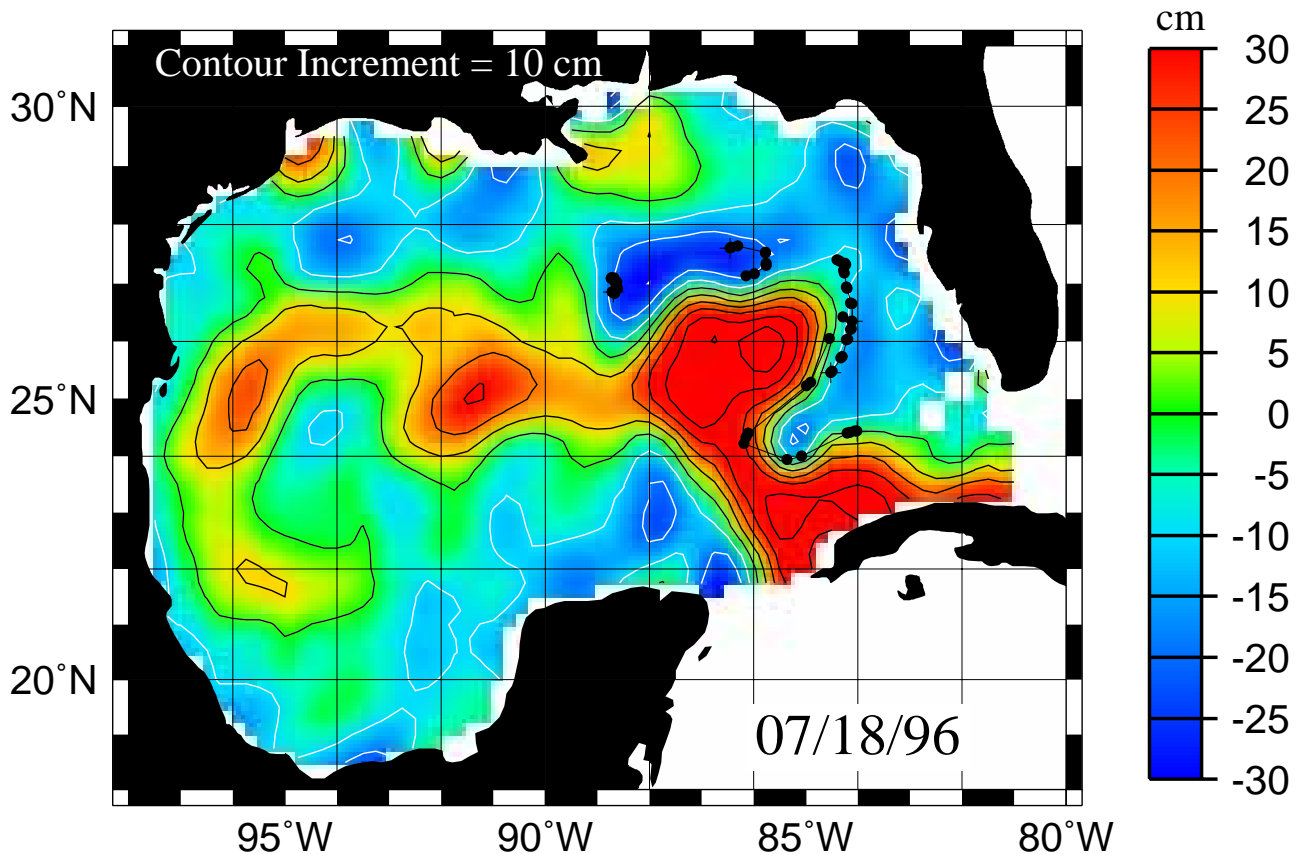

▲ **Figure 6.** Sea surface topography in the Gulf of Mexico, based on ERS-2 and Topex/Poseidon altimetry (courtesy of the Colorado Center for Astrodynamics Research). The relative high in the sea surface delineates the Loop Current as it enters the Gulf between Cuba and the Yucatan and exits into the Gulf Stream between Florida and Cuba. The black dots show the tracks of surface drifters in the Loop Current, which follow the contours of sea surface topography.

Silver Anniversary for NODC Division Chief



Bob Cheney, Chief of NODC's Laboratory for Satellite Altimetry, celebrated 25 years of government service in February. Most of this time has been spent with NOAA. After receiving an engineering degree from Duke University in 1971, Cheney studied oceanography under John Knauss at the University of Rhode Island (Knauss would later serve as NOAA Administrator).

Cheney began his professional career in 1974 with the Naval Oceanographic Office in Washington, DC. Following 4 years during which he observed the ocean at close range from ships and aircraft, Cheney turned his attention to satellite remote sensing and accepted a position at the NASA Goddard Space Flight Center in 1978. There he joined a select group of scientists working with

data collected by Seasat, the first satellite dedicated to oceanography. Cheney is credited with developing a number of pioneering oceanographic applications based on satellite altimetry and has authored 40 journal articles on the subject.

Since 1982, Cheney has led NOAA's satellite altimeter program and has been rewarded with about every honor the Commerce Department can bestow, including the Bronze, Silver, and Gold Medals, and the Administrator's Award. Silver has been a recurrent theme for Cheney during the past year; he received a silver pin from the American Geophysical Union for 25 years of membership and also celebrated a silver wedding anniversary with his wife, Lois.

—John Lillibridge
 Laboratory for Satellite Altimetry
 NOAA/NESDIS/NODC
 1315 East West Highway
 Silver Spring, MD 20910
 E-mail: jlillibridge@nodc.noaa.gov ■

Ferret and the Live Access Server

Analysis and visualization on the desktop and on the Web

*S. Hankin, D.E. Harrison, J. Sirott, and
A. Manke
Pacific Marine Environmental Laboratory
NOAA/OAR*

*J. Callahan, J. Davison, and K. O'Brien
Joint Institute for the Study of Atmosphere
and Ocean
University of Washington, Seattle*

Ferret is a computer application designed to meet the visualization and analysis needs of oceanographers and atmospheric scientists. It was developed at NOAA's Pacific Marine Environmental Laboratory (PMEL) in Seattle, as an adjunct to the data analysis and numerical modeling studies of the Thermal Modeling and Analysis Project (TMAP). Ferret was created in the belief that integrating data management, analysis, and visualization and placing the control of the data directly in the hands of scientists would lead to new levels of productivity.

The success of the approach is evident in the growing use of Ferret. It was made publicly available in 1991 and is now installed at hundreds of laboratories and universities in over 20 countries with the community of users growing steadily. It has been written about in hundreds of journal articles.

Ferret also forms the foundation of a Web data server, the Live Access

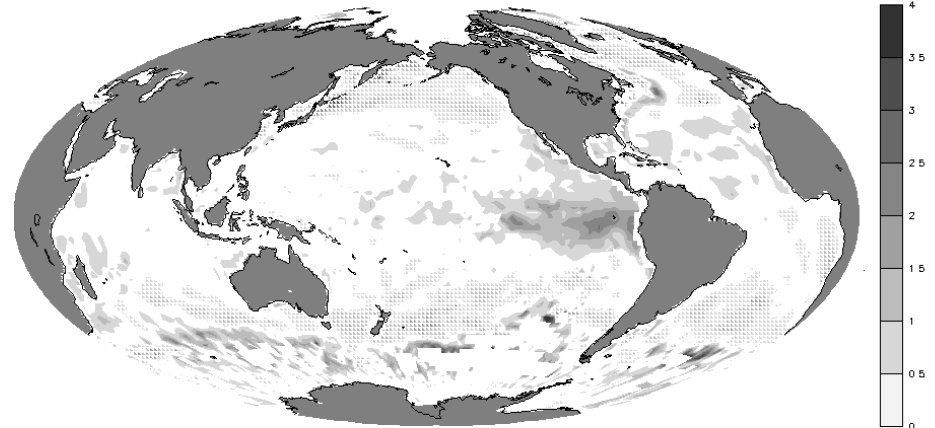

1982–1983 SST Anomalies

▲ **Figure 1.** Two years of Sea Surface Temperature values from COADS were averaged. The climatological signal from the World Ocean Atlas, regrided to 2 x 2 degree cells, was subtracted from the COADS average to produce this SST anomaly plot for the 1982-1983 El Niño.

Server (LAS). LAS is used throughout NOAA, within NESDIS at NCDC, NGDC, NODC, and SAA, at NMFS and ERL facilities, and at many non-NOAA sites (Table 1). Ferret and LAS have been funded over a 15-year history by PMEL, the NOAA EPOCS program, the NOAA ESDIM program, the NOAA HPCC program, and recently by NASA.

Ferret strives to free the scientist from data access and management concerns and permits him to focus on the data to “ferret out” the story told. This

goal requires a high level of automation. Ferret provides automation at many levels—management of files, memory, and graphics resources—and produces fully labeled output graphics by default.

Yet flexibility is also a requirement for scientific research. No one can envision beforehand all the explorations that may be needed for a particular study. Ferret achieves flexibility in analysis by providing a toolkit of basic mathematical operations from which variables may be defined. The user builds up a set of operations as needed by defining symbolic hierarchies of these variables. Once defined, it is simple to store the “scripts” for future use. If additional flexibility in graphics is desired beyond the default plots, Ferret allows the user to modify every aspect of the automatically generated output.

Another level of flexibility comes from the user's ability to extend the application itself. The user can write

▲ **Table 1.** Locations using the Live Access Server (LAS)

NOAA/PMEL/TMAP	http://ferret.wrc.noaa.gov/fbin/climate_server
NOAA/PMEL/VENTS	http://ferret.wrc.noaa.gov/fbin/VENTS/model_server
NOAA Pacific Fisheries Environ. Laboratory	http://salmonid.pfeg.noaa.gov/cgi-bin/climate_server
NOAA/NCDC	http://www.ncdc.noaa.gov/cgi-bin/otter/NNDC/LAS
NOAA/SAA	http://las.saa.noaa.gov/las-bin/climate_server
Princeton Univ/CMC	http://www.cmc.Princeton.EDU/ferret/cgi-bin/climate_server
UW/JISAO	http://tao.atmos.washington.edu/cgi-bin/ferret/climate_server

India's CSIR Centre for Mathematical Modeling and Computer Simulation
http://www.cmmacs.ernet.in/cgi-bin/climate_server

Laboratoire de Meteorologie Dynamique du Centre National de la Recherche Scientifique
http://www.lmd.jussieu.fr/sechiba/live_access.html

*Pacific Environmental Marine Laboratory
NOAA/OAR
Bin C 15700
7600 Sand Point Way NE
Seattle, WA 98115-0070
E-mail: hankin@pmel.noaa.gov*

new functions in programming languages such as FORTRAN or C, or can access higher level functions from, for example, MATLAB or IDL, which Ferret will dynamically incorporate into its toolkit.

Ferret as a tool for numerical model output

Ferret was created to aid in the analysis of the gridded output produced by numerical modelers. We regard model output as ideally sampled collections of observations—multi-dimensional and multivariate—and analyze model output in comparison with theory, with other model results, and with observations. Typically, the size of model output far exceeds the memory capacity of the computers on which Ferret is run.

Ferret addresses this challenge through the use of “delayed evalua-

tion”. As the user defines new variables (e.g., heat advection as the derivative of temperature times velocity) Ferret handles the definitions symbolically. It is only when a product is requested—a visualization, a table of values, or a file—that Ferret handles data.

Ferret as a tool for environmental data

Arguably the most talked about aspect of environmental data among scientists is the data’s limitations. The difficulties of long-term monitoring and the challenges of *in situ* data collection lead to data sets that are frequently gap-filled, of inconsistent quality, and of insufficient duration. In order to address the shortcomings, NOAA scientists and others engage in the creation of high quality data products—quality-checking, interpolating, and filtering data to produce more complete and usable fields.

Ferret is designed to perform “data fusion”, bringing together data from a range of disparate sources, and allowing the scientist quickly to bin, average, gap-fill, and filter the data, reconciling their differences. It provides a flexible collection of regridding tools, tightly integrated into the analysis environment.

Ferret’s style of analysis typically avoids intermediate files, preferring to work directly from raw data files. Ferret journal files, which record the user’s variable definitions, provide an audit trail. Recreating an analysis from raw data or modifying an analysis is a simple matter of editing and running a journal file. A Ferret user can work entirely from “raw” data and record their mathematical musings in the form of journal files.

— continued on page 12

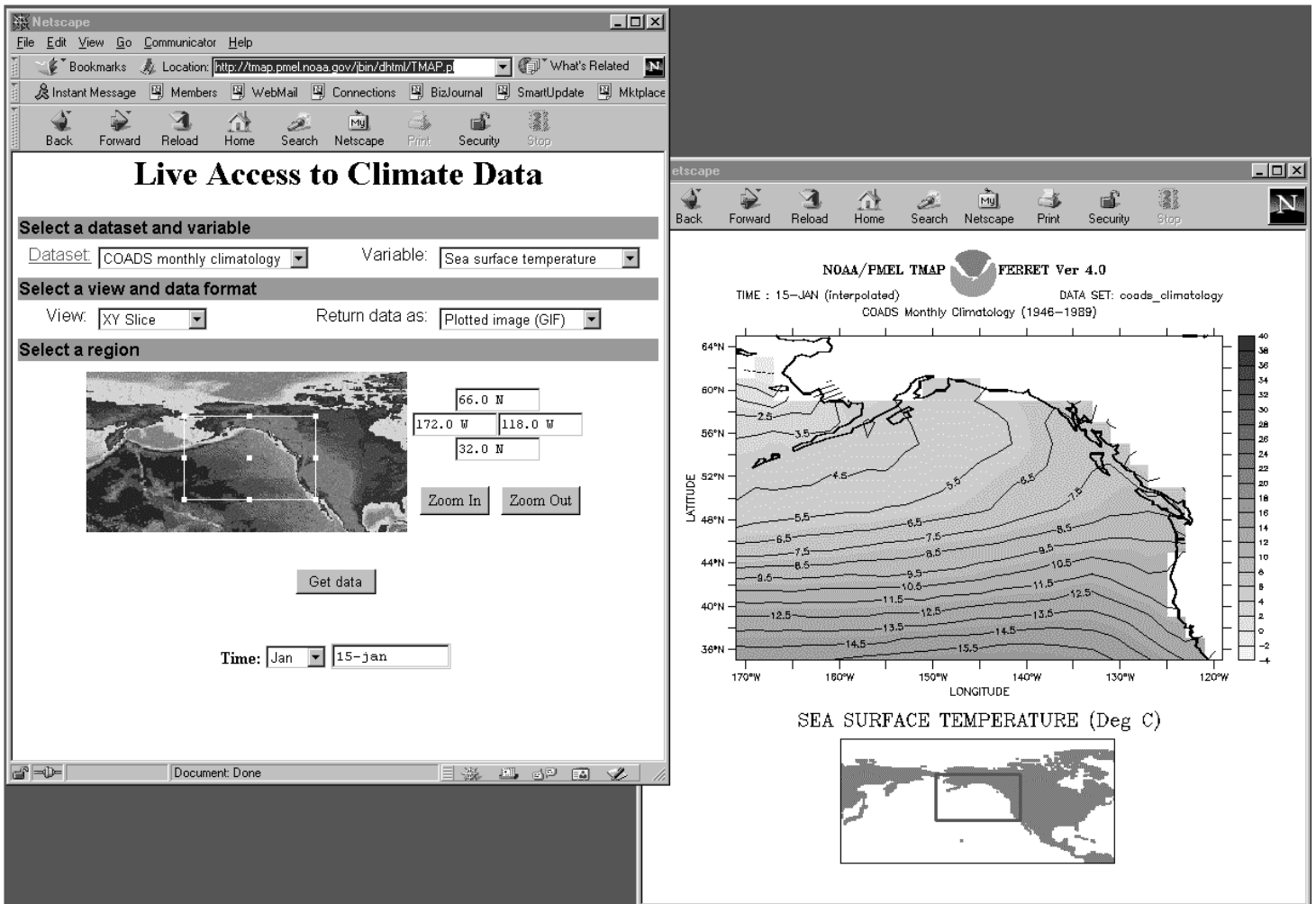

▲ **Figure 2.** The Live Access Server presents a remote user a web interface to Ferret through which the user can select datasets and variables, set a region in space and time, and choose an output type. Requested data is returned as a gif image or in one of several supported data formats.

Ferret, from page 11**A short example**

A simple example will illustrate how one works with Ferret. We will compare two widely used NOAA data products: COADS and the World Ocean Atlas gridded products. The COADS data set is made up of global observations of surface marine variables binned month by month to a 2 X 2 degree lat/lon grid. The World Ocean Atlas contains gridded climatological fields annual, seasonal and monthly on a global 1x1 degree grid.

Suppose we wish to compare the global sea surface temperature average from COADS over the two-year period comprising the 1982-83 El Niño with the climatological annual mean SST from the World Ocean Atlas. The five steps of this SST anomaly plot calculation are:

- 1) Open COADS and World Ocean Atlas data sets
- 2) Define A as COADS SST averaged from Jan. 1982 to Dec. 1983
- 3) Define B as World Ocean Atlas temperature regridded to a 2x2 degree grid
- 4) Define C = A-B
- 5) Plot C

Ferret defers data access until the last step. Figure 1 shows the results. The full details of the sample calculation are available as an online Web page at http://ferret.wrc.noaa.gov/papers/ESM_3-99.

V5 Internet Features

Ferret version 5, to be released in Spring '99, will contain enhancements that turn Ferret into an Internet tool. Version 5 will incorporate networking from the Distributed Ocean Data System (DODS). DODS networking builds upon the application programmer interfaces (APIs) of standardized file formats as its foundation. To an application DODS presents remote data files as if they are (for example) local netCDF files. With DODS, Ferret has become an Internet gateway to hundreds of gigabytes of distributed research-quality data served from NOAA/PMEL, NOAA/CDC, and elsewhere.

The Live Access Server: Ferret on the Web

The Live Access Server or LAS (Figure 2) provides web access to data using

Ferret as its data management and graphics "engine". LAS allows a remote user to interactively browse and explore data sets, as well as to select, subset, display and retrieve custom data subsets in a variety of formats. Although LAS restricts users to a fraction of Ferret's functionality, the simple Web interface allows users to quickly perform the most common tasks: choosing a data set, a variable and a view; defining a region and time of interest; selecting an output type (graphical or data); and requesting that output.

We have found that this functionality, when combined with the configurable features available to the data provider who installs LAS, provides quite a complete data exploration and data delivery capability. LAS is also 100% compatible with the NOAA Server data search and browse interface. Data sets served by LAS can be added to the

NOAA Server framework by following the NOAA Server's simple registration process.

LAS architectural overview

The Live Access Server is built from three modular pieces of code, controlling the user interface, the invocation of Ferret, and the translation of data requests into Ferret commands, respectively. Because of its modular design, LAS can be used with scientific applications other than Ferret. Data providers who wish to provide discipline-specific, specialized graphics for particular data sets can specify another graphics engine for those data sets.

The preferred data format for data providers installing LAS is netCDF, although a range of binary and ASCII data formats may also be used. With netCDF files, Ferret's data access time is significantly faster. Additionally, con-

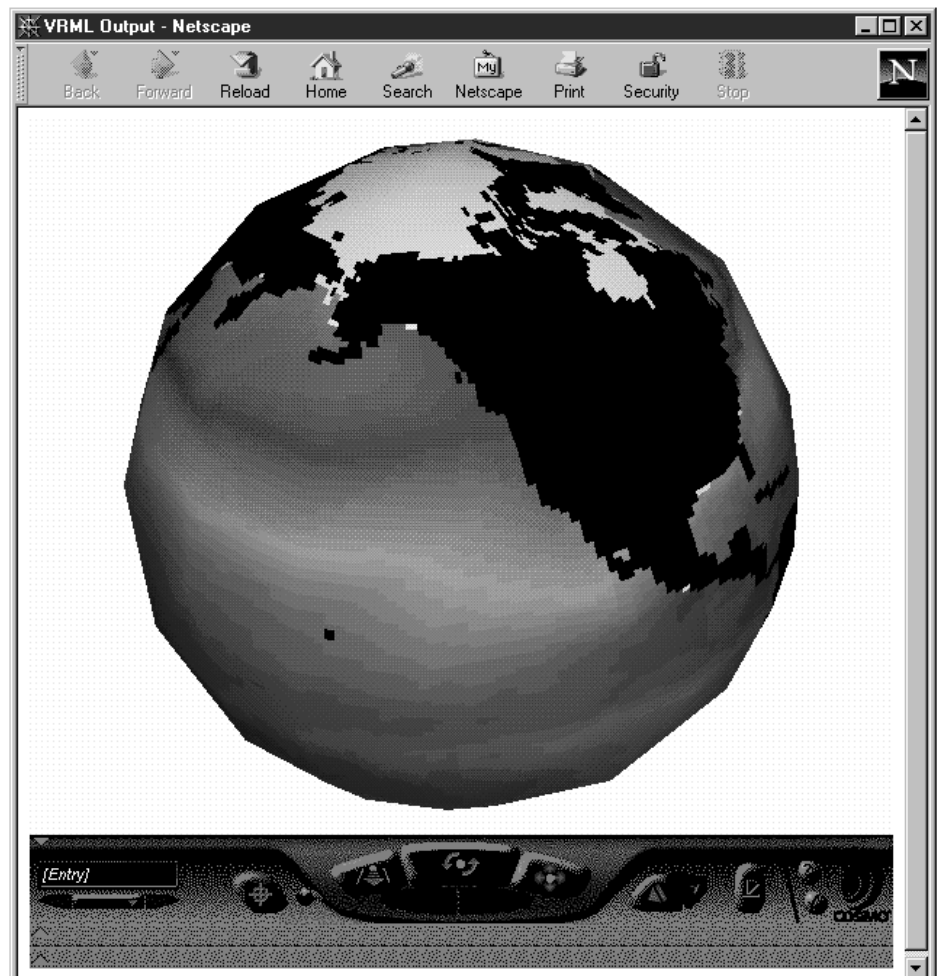

▲ **Figure 3.** Using the Virtual Reality Modelling Language (VRML), LAS can provide global data as a 3D earth that the web user can manipulate (rotate, zoom, pan) with free VRML playback software.

figuration files describing a data set can be automatically generated from netCDF header files by a script provided with the LAS. Users of LAS may choose graphical output in .gif or PostScript format. Output data subsets are available as netCDF, tab or comma delimited files and generic ASCII tables. Global data sets may also be requested in VRML. With a free VRML viewer the user will experience the global field as an interactive 3D globe that can be rotated and zoomed at will. When a VRML file is downloaded, the user's browser launches a VRML player (standard in most browser installations). With the player, the user can zoom in and rotate the globe in real time. This "view from space" provides a very natural way to look at global data, and presents these data with a minimum of spatial distortion at the earth's poles (Figure 3).

LAS is highly configurable through ASCII scripts, templates, and configuration files. The data provider has the power to customize the look and feel of the interface, the layout and style of the output graphics, and the presentation of the data. LAS can also use Ferret to provide variables which are derived on-the-fly, a capability often used to create anomaly fields from monthly data and climatological averages.

Virtual databases from distributed servers

The Live Access Server, as described thus far, allows providers of scientific data sets to communicate with users of data. Recognizing today's trend toward collaborative research, we realize that data providers are also frequently users of their colleagues' data and vice versa. LAS has features that allow collections of LAS "sister servers" to join together to form collaborative networks. The goal of the collaborative network is two-fold: to create a single virtual data base from distributed sources, and to provide data fusion services for the distributed data by producing side-by-

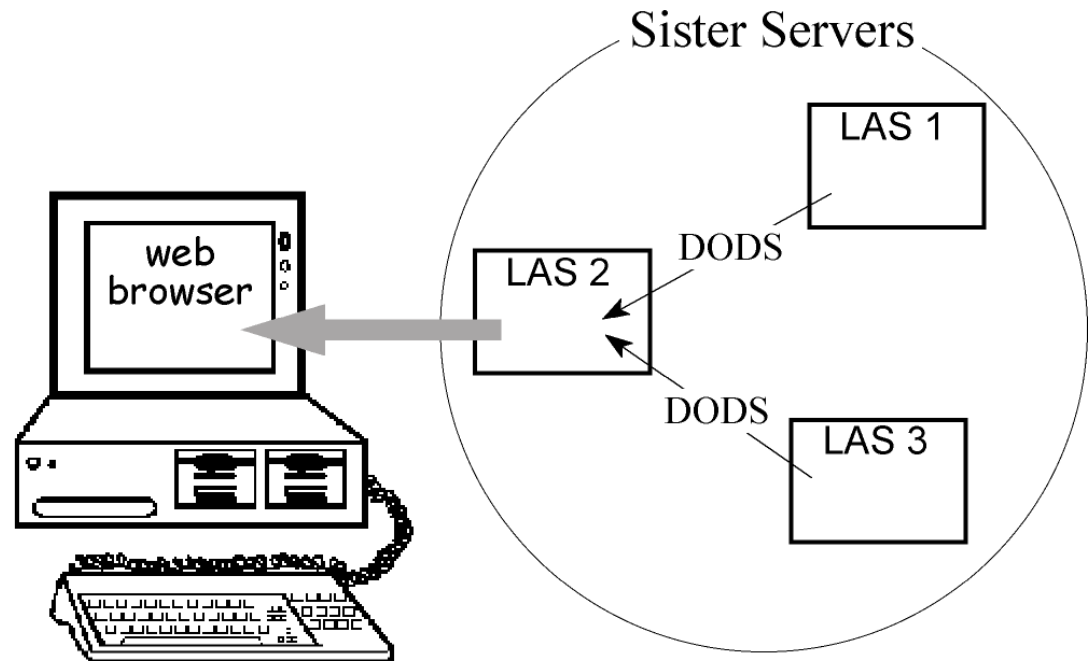

▲ Figure 4. The web user connecting to an LAS site (LAS 2) sees a single virtual database. Requests for plots and subsets from a single data set are directed to the site at which the data resides. Requests for data fusion (multiple data sets) use DODS to access remote data.

side plots, graphical overlays, and difference fields generated with the help of Ferret's on-the-fly regridding.

The collaborative aspects of LAS are under development, funded by HPCC and NASA, and scheduled for deployment in the next 12 months. LAS's modular separation of user interface from data delivery allows any LAS server in the collaboration to serve as the interface to data sets that reside on its sisters (Figure 4). This shared awareness is achieved through exchanging information from the configuration files via the Internet. Data fusion in the form of on-the-fly differencing and custom graphical overlays of distributed data sets relies on the DODS connection between Ferret and the data sets located on sister servers.

Availability

Both Ferret and the Live Access Server are available with full documentation at no cost from <http://ferret.pmel.noaa.gov>. Both run on most Unix systems. Ferret on Windows NT/9x will be released with Version 5 in the Spring of 1999. Distributed with version 5 will also be a web server ("WebFerret") that provides full access to Ferret within a Web browser.

Websites

NOAAServer URL: <http://www.esdim.noaa.gov>

DODS URL: <http://www.unidata.ucar.edu/packages/dods/netcdf/index.html>

COSMO URL: <http://www.cosmosoftware.com/products/player/brief.html>

ESDIM URL: <http://www.esdim.noaa.gov>

HPCC URL: <http://www.hpcc.noaa.gov/>



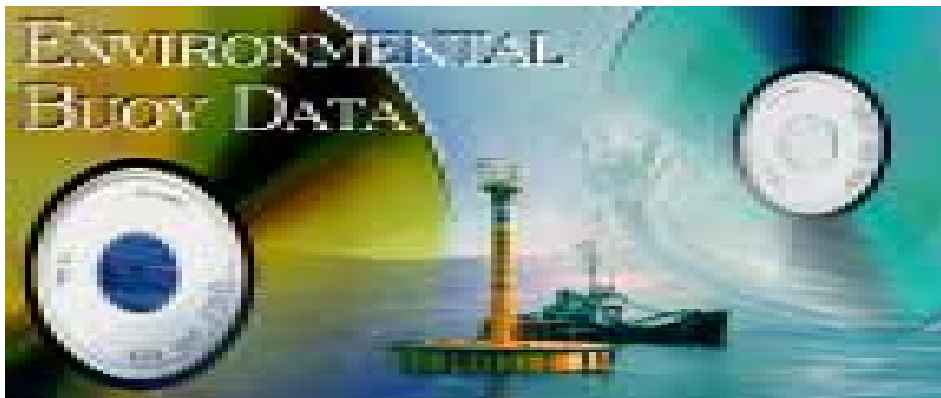

NOAA marine environmental buoy data

The National Oceanographic Data Center has announced the release of a seven disc CD-ROM set containing 16.5 gigabytes of coastal buoy data. This set contains historical data through December 1997 with online Internet links to updated data and information, real-time data, and time series plots available on the NODC website.

The CD-ROMs contain meteorological and oceanographic data collected by moored buoys and C-MAN (Coastal-Marine Automated Network) stations operated by the NOAA National Data Buoy Center (NDBC). C-MAN stations are located on piers, offshore towers, lighthouses, and beaches with excellent exposure to the marine environment. The observations are transmitted, typically once each hour, through GOES (Geostationary Operational Environmental Satellite) to the National Weather Service Telecommunications Gateway, where the data

are placed in meteorological codes for real-time transmission. After post-processing and quality control of the GOES messages, NDBC submits these data each month to the NOAA National Oceanographic Data Center for permanent storage in NODC's F291 format.

These CD-ROM data are more complete and have undergone more quality control than the data transmitted in real-time. The real-time data for these stations can be obtained online from the National Data Buoy Center at www.ndbc.noaa.gov.

The earliest buoy data archived at NODC is from the early 1970s, and the NODC archive of C-MAN data begins in 1985. The geographic areas included on the CD-ROMs are the U.S. East Coast, West Coast, Gulf Coast, Great Lakes, Gulf of Alaska, Bering Sea, Western Pacific, and offshore Hawaii.

Station identifier, position, date, time, sampling duration, and sampling

rate are reported for each series of measurements. Principal parameters reported by both moored buoys and C-MAN stations include air temperature and pressure, wind speed and direction, wind gust, and sea surface temperature. Some buoys (and a few C-MAN stations located on offshore platforms) also report wave data which usually includes wave height, wave period, and wave spectra.

This is an Internet/CD-ROM hybrid set that can be viewed using your Internet browser. The data was compressed using the UNIX compress command, and your Internet browser (with the proper plug-in) can decompress the data files right to your screen. Decompression software is also included on the discs. There are Internet links to updated data and contact information, as well as buoy payloads and sensor information on the CD-ROMs. Each CD-ROM contains an inventory for all buoys, however the actual historical data is divided geographically between seven separate discs. To order one CD-ROM or the whole set please see the NODC User Services contact information below. The NODC online buoy website can be reached at www.nodc.noaa.gov/BUOY/buoy.html.

—Andrew Allegra
National Oceanographic Data Center
NOAA/NESDIS
1315 East-West Highway
Silver Spring, MD 20910
E-mail: aallegra@nodc.noaa.gov ■

New navigation system to protect Keys coral reefs

The federal government has installed state-of-the-art navigational aids in the Florida Keys National Marine Sanctuary to help ships avoid grounding on fragile, threatened coral reefs, the Commerce Department's National Oceanic and Atmospheric Administration has announced. The new beacons were purchased by the owners of a ship that grounded on a coral reef in 1997, as part of a damage assessment and restoration agreement.

Officials with the U.S. Coast Guard and NOAA installed the northernmost of eight Racon radar transponder beacons at Fowey Rocks, approximately 20 miles southeast of Miami.

The beacons are mounted on navigational structures along the Florida reef tract, stretching from Miami to Loggerhead Key in the Dry Tortugas, 70 nautical miles west of Key West. The devices emit unique signals that appear on ship radar, allowing mariners to precisely identify the location of navigational aids and warn ships that they are nearing a reef. Each signal has a range of 15-20 nautical miles.

The owners of the *Contship Houston*, a 613-foot container ship that went aground on a coral reef near Maryland Shoal off the lower Florida Keys, purchased the beacons. The installation of this navigation system represents a

creative solution to compensating the public for the injury that was done to the reef by reducing the likelihood of future navigational errors. The U.S. Coast Guard installed the system and has agreed to maintain the beacons.

The hull of the *Contship Houston* cut a swath through the reef, crushing and breaking corals for approximately 400 meters. Under federal and state statutes, the parties that injure resources in national marine sanctuaries are responsible for restoring the injured resources and the services they provide.

The restoration subsequent to the *Houston* grounding is the result of un-

—continued on page 16

Coastal Relief Model advertised

The National Geophysical Data Center's (NGDC) Coastal Relief Model (CRM), a gridded, GIS-friendly, integrated representation of coastal elevations and bathymetry has debuted with volumes 1 and 2. Volume 1 covers the Northeast Atlantic Coast, from 40 to 48 degrees North Latitude, while Volume 2 covers the Southeast Atlantic Coast, from 31 to 40 degrees North Latitude. Ultimately the data set will include all of the U.S. coastal regions.

The release of these first volumes was announced in the January 26 issue of *EOS, Transactions of the American Geophysical Union*, in an article, "Exposing the U.S. Coastal Zone." The article detailed the generation, quality assurance, and system software of the CRM as well as the ancillary data provided with the CRM. The product was also announced with an experimental, monitored e-mailing from NGDC to over 2000 individuals. In addition, the CRM is among the seven Digital Hydrographic Data Bases listed in the January/February 1999 issue of *Hydro International* with the theme of IT in Hydrography.

Contact: NGDC

NNDC Online Store update

The National Climatic Data (NCDC) finished programming that will allow the Customer Order Management Processing System (COMPS) to ingest online orders into the COMPS order system for processing. A few test orders, which appear to be correct, have been ingested and further testing of the process will continue including ingesting of online/offline orders. The next step in the Online Store programming will be to complete the existing online/offline module along with programming online/offline module for ingesting into COMPS.

Annual Climatological summaries were added as a product and subscription item to the store during December. NCDC has also completed the work necessary for placing select National Centers for Environmental Prediction (NCEP) charts on the Online Store for access via the Worldwide Web. A total of 22,000 customers contacted the NCDC via the Online Data Store and accessed 31 gigabytes of climate data; revenue for December 1998 represented a 14% increase from the previous month.

Contact: NCDC

Data products and services

National Ocean Sciences Bowl

The second annual National Ocean Sciences Bowl sponsored by the Consortium for Oceanographic Research and Education (CORE), along with its 51 member institutions and in partnership with the National Marine Educators Association (NMEA) was held in Ann Arbor, Michigan at the end of February. The national competition for high schools on topics related to the study of the oceans included 70 competing students from twelve area high schools. Awards and recognition included scholarships, research cruises aboard oceanographic vessels and visits to oceanographic research laboratories. Each participating high school received a Bathymetry of Lake Erie and a Nighttime Lights of the USA poster from NGDC. For more information, refer to <http://www.glerl.noaa.gov/news/1998/nosb99/nosb99.html>.

Contact: NGDC

CONTACT POINTS

National Climatic Data Center (NCDC)
704-271-4800
Fax: 704-271-4876
E-mail: *Climate Services - orders@ncdc.noaa.gov*
Satellite Services - satorder@ncdc.noaa.gov
WWW: <http://www.ncdc.noaa.gov/>

National Geophysical Data Center (NGDC)
303-497-6419
Fax: 303-497-6513
E-mail: *info@ngdc.noaa.gov*
WWW: <http://www.ngdc.noaa.gov/>

National Oceanographic Data Center (NODC)
301-713-3277
Fax: 301-713-3302
E-mail: *services@nodc.noaa.gov*
WWW: <http://www.nodc.noaa.gov/>

NOAA Environmental Services Data Directory
301-713-0572
(Gerry Barton)
Fax: 301-713-1249
E-mail: *barton@esdim.noaa.gov*
WWW: <http://www.esdim.noaa.gov/#data-products>

NOAA Central Library
Reference Services:
301-713-2600
Fax: 301-713-4599
E-mail: *reference@nodc.noaa.gov*
WWW: <http://www.lib.noaa.gov/>

Global warming WWW pages

A new "handbook" on global warming that focuses on the perspective from the past hundreds to millions of years has just been published on the World Wide Web. The web site, called "A Paleo Perspective on Global Warming" provides a wealth of information of global warming and the greenhouse effect. What makes this site stand out from other global warming web sites is how it places current warming in the context of past temperature variations through the use of paleoclimatic data archived at NGDC. The site can be found at <http://www.ngdc.noaa.gov/paleo/globalwarming/home.html>.
Contact: NGDC

GOES Space Environment Monitor

Dr. Wayne McRae with the Physics Department of the University of Otago, New Zealand, is using the online GOES Space Environment Monitor (SEM) data to model the effects of solar flares on VLF radio wave propagation. Dr. McRae is excited with his initial results and thinks he can vastly improve on current techniques for classifying flares for their potential to disrupt radio wave propagation related to both amplitude and phase. Dr. McRae described the GOES SEM data as an "incredible goldmine of information."
Contact: NGDC

ESRI releases GIS Spatial Data Transfer Standard translator

The Environmental Systems Research Institute (ESRI), developers of the Arc/Info Geographic Information Systems (GIS) software, has released a beta version of the SDTSIMPORT command for Arc/Info (Version 7.2.1), which supports the Point Profile of the Spatial Data Transfer Standard (SDTS). The Point Profile was developed by the National Geophysical Data Center (NGDC) and the National Geodetic Survey (NGS) in collaboration with the Federal Geographic Data Committee (FGDC) to provide SDTS-formatted geodetic control data on the World Wide Web. NGDC has coordinated the effort to gain support for the Point Profile in GIS SDTS translators. The new translator, available for free download from <http://www.esri.com/software/arcinfo/sdts.html>, enables users to easily import NOAA's SDTS-compliant point data into Arc/Info's coverage data model.

Contact: NGDC

Forecast system, from page 5

model simulations into unique descriptions and predictions of natural dynamics and man-made impacts. This information is critically needed, often in a blend of real-time data and long historical records, by a wide range of stakeholders in marine safety and transportation, coastal hazards and ecosystem management. CEFS can communicate this information effectively across heterogeneous user communities, using well-defined data interfaces.

Many first-generation CEFS have 2-5 years of experience. Various other CEFS are planned. Barriers relating to cost, user base, enabling technologies, product reliability and system functionality are often similar across sites. There is a critical need for inter-agency initiatives that coalesce resources, develop shared technologies and common protocols, and enable transition to a second-generation of CEFS that is more modular and adaptable to evolving technologies and applications. Education and outreach activities are also critically needed to ensure that there is a receptive, knowledgeable audience to use, cost-share, improve upon and market CEFS products and derivative technology and applications.

Navigation System, from page 14

precedented cooperation between the vessel owner, insurer, NOAA, and the state of Florida. From the start, the owner and insurer assisted with assessment and emergency restoration of the injured coral reef habitat. As a result, restoration activities were completed within 10 months of the vessel grounding.

Shortly after the grounding, more than 3,000 injured pieces of coral were reattached to the reef substrate, and pieces of reef debris were removed or stabilized with epoxy to prevent ongoing injury to the reef and marine life. The vessel owners paid for and deployed flexible concrete mats to stabilize more than 7,650 square feet of reef substrate and also placed large boulders to provide three dimensional habitat for resident organisms.

Acknowledgements

Early development of CORIE (Jun 96-Sep 98) was partially funded by the Office of Naval Research (Grant N00014-96-1-0893). Applications of CORIE have been partially funded by the National Science Foundation (LMER, EGB and SGER programs), Bonneville Power Administration, National Marine Fisheries Service, Defense Advanced Research Projects Agency (Software Enabled Control Program) and Office of Naval Research (Modeling and Prediction Program).

The development and maintenance of a system like CORIE requires strong community support. Thanks are due the Clatsop Community College, U.S. Coast Guard, Northwest River Forecast Center, U.S. Geological Survey, Oregon Department of Transportation, Coastal Studies and Technology Center, U.S. Army Corps of Engineers, Port of Portland, City of Astoria, Columbia Pacific Community Information Center, and Capt. R. Johnson (Columbia River Bar Pilots).

References

- Baptista A.M., *et al.* 1998. Towards a multi-purpose forecast system for the Columbia River estuary. In: Ocean Community Conference '98. Baltimore, Maryland. 6 pp.
- Sommerfield W., 1998. Variability of residual properties in the Columbia River estuary: pilot application of emerging technologies. Oregon Graduate Institute. MSc Thesis. 43 pp.
- Jay D., *et al.* 1999. Streamflow and sediment discharge response to climate events impacting the North American West Coast. Estuarine Research Federation conference, New Orleans (abstract, submitted). ■

“This effort brought together a great team of federal, state and private partners that was able to do more with less, and provide a new era of protection for our coral reefs,” said NOAA Sanctuary Superintendent Billy Causey.

—Cheva Heck
 Phone: 305-292-0311
 and Justin Kenney
 Phone: 301-713-3145
 Sanctuaries and Reserves Division
 NOAA/NOS
 1305 East-West Highway, SSMC4
 Silver Spring, MD 20910 ■

Address Correction Requested
 OFFICIAL BUSINESS
 Penalty for Private Use \$300

U.S. DEPARTMENT OF COMMERCE
 National Oceanic and Atmospheric Administration
 Publication Distribution Facility
 1315 East-West Highway
 Silver Spring, MD 20910-3282
 ATTN: Earth System Monitor